

United States of America

United States Patent and Trademark Office

MasterFile

Reg. No. 4,152,036

Registered June 5, 2012

Int. Cl.: 9

TRADEMARK

PRINCIPAL REGISTER

EBRAHIM, MOHIB S. (CANADA INDIVIDUAL)
73 TOWNSEND DRIVE
OTTAWA, ONTARIO, CANADA K2J 2V3

FOR: COMPUTER SOFTWARE AND PROGRAMS FOR USE IN LEGAL, LITIGATION, INVESTIGATION, JOURNALISM, RESEARCH, BUSINESS, ACADEMIA AND EDUCATION; COMPUTER SOFTWARE AND PROGRAMS FOR DOCUMENT CONTROL, TRANSFORMATION, CONVERSION, PROCESSING, MANIPULATION AND MANAGEMENT; COMPUTER SOFTWARE AND PROGRAMS FOR ENABLING DOCUMENT RETRIEVAL; COMPUTER SOFTWARE AND PROGRAMS FOR ENABLING ACCESS TO, ORGANIZING AND ANALYZING FACTS AND DATA INCLUDING THOSE RELATING TO TIME AND DATE EVENTS; COMPUTER SOFTWARE AND PROGRAMS FOR NAMING AND MANAGING DATA FILES, IN CLASS 9 (U.S. CLS. 21, 23, 26, 36 AND 38).

FIRST USE 1-30-2004; IN COMMERCE 4-24-2004.

PRIORITY CLAIMED UNDER SEC. 44(D) ON CANADA APPLICATION NO. 1299558, FILED 4-27-2006, REG. NO. TMA815130, DATED 1-9-2012, EXPIRES 1-9-2027.

THE COLOR(S) BLACK, WHITE AND GRAY IS/ARE CLAIMED AS A FEATURE OF THE MARK.

THE MARK CONSISTS OF THE WORDING "MASTERFILE" LOCATED NEXT TO A DOUBLE OUTLINED DIAMOND SHAPE WHICH ENCLOSES A FIGURE HOLDING UP A SHEET OF PAPER. THE COLOR BLACK APPEARS IN THE WORDING "MASTERFILE" AND OUTLINING THE DOUBLE OUTLINED DIAMOND SHAPE, THE FIGURE AND THE SHEET OF PAPER. THE COLOR WHITE APPEARS OUTSIDE THE FIGURE BUT WITHIN THE DOUBLE OUTLINED DIAMOND SHAPE, IN THE FIGURE'S HEAD, AND IN THE SHEET OF PAPER. THE COLOR GRAY APPEARS BORDERING THE COLOR WHITE, WITHIN THE DOUBLE OUTLINED DIAMOND SHAPE, AND WITHIN THE BODY OF THE FIGURE.



SER. NO. 76-664,790, FILED 8-17-2006.

PAUL MORENO, EXAMINING ATTORNEY

David J. Kyjars

Director of the United States Patent and Trademark Office

United States of America

United States Patent and Trademark Office

The logo for "POWER GLUE" features the words in a bold, sans-serif font. "POWER" is in white with a black outline, and "GLUE" is in a grey, slightly shadowed font. The text is set against a dark, rectangular background that has a slight 3D effect with a lighter top edge.

Reg. No. 4,152,037

Registered June 5, 2012

Int. Cl.: 16

TRADEMARK

PRINCIPAL REGISTER

CANACHEME INC. (CANADA CORPORATION)
56 POST ROAD
TORONTO, ONTARIO, CANADA M3B 1H8

FOR: GLUES FOR OFFICE USE; GLUES AND ADHESIVES FOR STATIONERY OR HOUSEHOLD USE, IN CLASS 16 (U.S. CLS. 2, 5, 22, 23, 29, 37, 38 AND 50).

PRIORITY CLAIMED UNDER SEC. 44(D) ON CANADA APPLICATION NO. 1421484, FILED 12-5-2008, REG. NO. TMA812819, DATED 11-28-2011, EXPIRES 11-28-2026.

NO CLAIM IS MADE TO THE EXCLUSIVE RIGHT TO USE "GLUE", APART FROM THE MARK AS SHOWN.

THE MARK CONSISTS OF THE WORDING "POWER GLUE" IN STYLIZED FORM BACKED BY TWO OFFSET RECTANGULAR DESIGNS.

SER. NO. 76-694,854, FILED 12-16-2008.

TIMOTHY FINNEGAN, EXAMINING ATTORNEY



David J. Kybas

Director of the United States Patent and Trademark Office

United States of America

United States Patent and Trademark Office



WWW.BETHEWALL.ORG

Reg. No. 4,152,038

Registered June 5, 2012

Int. Cls.: 16, 20 and 25

TRADEMARK

PRINCIPAL REGISTER

CHARLOTTE ALLIANCE FOR A SAFE & DRUG FREE COMMUNITY (FLORIDA NOT FOR PROFIT CORPORATION), DBA DRUG FREE CHARLOTTE COUNTY
1445 EDUCATION WAY
PORT CHARLOTTE, FL 33948

FOR: POSTERS; BALL POINT PENS; BUMPER STICKERS; COASTERS OF PAPER; STATIC CLING STICKERS; MOTIVATIONAL CARDS; PENCILS; STICKERS; NOTE PADS; PRINTED PAPER SIGNS; POST CARDS; STENCILS, IN CLASS 16 (U.S. CLS. 2, 5, 22, 23, 29, 37, 38 AND 50).

FIRST USE 10-1-2008; IN COMMERCE 10-1-2008.

FOR: VINYL BANNERS; MAGNETIZED PHOTO FRAMES; PLASTIC KEY TAGS; VINYL HANGER USED BY THE REAL ESTATE INDUSTRY TO HAND PROMOTIONAL MATERIAL ON DOORS, IN CLASS 20 (U.S. CLS. 2, 13, 22, 25, 32 AND 50).

FIRST USE 10-1-2008; IN COMMERCE 10-1-2008.

FOR: T-SHIRTS; POLO SHIRTS; BASEBALL CAPS, IN CLASS 25 (U.S. CLS. 22 AND 39).

FIRST USE 10-1-2008; IN COMMERCE 10-1-2008.

THE MARK CONSISTS OF A DESIGN OF A BRICK WALL WITH THE WORDING "BE THE WALL" SUPERIMPOSED OVER THE WALL AND THE WORDING "WWW.BETHEWALL.ORG" UNDERNEATH THE DESIGN OF THE WALL.

SER. NO. 76-702,331, FILED 4-1-2010.

JANET LEE, EXAMINING ATTORNEY



David J. Kyros

Director of the United States Patent and Trademark Office

United States of America

United States Patent and Trademark Office

ZARTIN

Reg. No. 4,152,039

Registered June 5, 2012

Int. Cl.: 1

TRADEMARK

PRINCIPAL REGISTER

VAN HEES GMBH (FED REP GERMANY LIMITED LIABILITY COMPANY)
KURT-VAN-HEES-STRASSE 1
65396 WALLUF, FED REP GERMANY

FOR: PRODUCTS FOR TENDERIZING AND SOFTENING MEAT, NAMELY, MEAT TENDERIZING AND SOFTENING COMPOSITIONS; CHEMICAL COMPOSITIONS FOR PRESERVING, EMULSIFYING, CURING, MATURING AND PRESERVING MEAT PRODUCTS; COMPOSITIONS FOR THE MANUFACTURE OF FOODS, NAMELY, COMPOSITIONS FOR INFLUENCING THE CONSISTENCY AND COLOR OF MEAT AND MEAT PRODUCTS; COMPOSITIONS FOR PRESERVING FOODSTUFFS; COMPOSITIONS FOR TENDERIZING MEAT; CHEMICAL COMPOSITIONS FOR SOFTENING MEAT; LACTOSE PRODUCTS, NAMELY, LACTOSE PRODUCTS FOR USE IN THE MANUFACTURE OF FOODSTUFFS, IN CLASS 1 (U.S. CLS. 1, 5, 6, 10, 26 AND 46).

FIRST USE 0-0-2002; IN COMMERCE 0-0-2002.

THE MARK CONSISTS OF STANDARD CHARACTERS WITHOUT CLAIM TO ANY PARTICULAR FONT, STYLE, SIZE, OR COLOR.

SER. NO. 76-704,866, FILED 10-13-2010.

BRIAN NEVILLE, EXAMINING ATTORNEY



David J. Kyffers

Director of the United States Patent and Trademark Office

United States of America

United States Patent and Trademark Office

DATAGEAR

Reg. No. 4,152,040

Registered June 5, 2012

Int. Cls.: 35, 37 and 42

SERVICE MARK

PRINCIPAL REGISTER

DATAGEAR, INC. (CALIFORNIA CORPORATION)
500 W. DYER ROAD
SANTA ANA, CA 92707

FOR: RETAIL STORE SERVICES FEATURING DATA COLLECTION SYSTEMS, NAMELY, FIXED, MANUAL AND PORTABLE BAR CODE READERS, SCANNERS AND DECODERS, AND PARTS THEREOF, WIRED AND WIRELESS TELECOMMUNICATIONS AND COMPUTER NETWORK NETWORKS SYSTEMS, PROVIDING BOTH HARDWARE AND SOFTWARE, AND PARTS THEREOF, PRINTERS USED IN PRODUCING AND PRINTING BAR CODES AND BAR CODE LABELS, AND PARTS THEREOF, VIDEO SURVEILLANCE SYSTEMS, AND PARTS THEREOF; LEASING AND RENTAL OF OFFICE EQUIPMENT, NAMELY, DATA COLLECTION SYSTEMS FOR OFFICE USE, NAMELY, FIXED, MANUAL AND PORTABLE BAR CODE READERS, SCANNERS AND DECODERS; RENTAL OF PRINTERS FOR OFFICE USE FOR PRODUCING AND PRINTING BAR CODES AND BAR CODE LABELS, IN CLASS 35 (U.S. CLS. 100, 101 AND 102).

FIRST USE 1-28-1998; IN COMMERCE 1-28-1998.

FOR: INSTALLATION, MAINTENANCE AND REPAIR OF DATA COLLECTION SYSTEMS, NAMELY, FIXED, MANUAL AND PORTABLE BAR CODE READERS, SCANNERS AND DECODERS, WIRED AND WIRELESS TELECOMMUNICATIONS AND COMPUTER NETWORK NETWORKS SYSTEMS, INCLUDING COMPUTER HARDWARE, PRINTERS USED IN PRODUCING AND PRINTING BAR CODES AND BAR CODE LABELS, AND VIDEO SURVEILLANCE SYSTEMS, IN CLASS 37 (U.S. CLS. 100, 103 AND 106).

FIRST USE 1-28-1998; IN COMMERCE 1-28-1998.

FOR: INSTALLATION, MAINTENANCE AND REPAIR OF COMPUTER NETWORKS SYSTEM SOFTWARE, IN CLASS 42 (U.S. CLS. 100 AND 101).

FIRST USE 1-28-1998; IN COMMERCE 1-28-1998.

THE MARK CONSISTS OF STANDARD CHARACTERS WITHOUT CLAIM TO ANY PARTICULAR FONT, STYLE, SIZE, OR COLOR.

SER. NO. 76-705,393, FILED 11-18-2010.



David J. Kyffers

Director of the United States Patent and Trademark Office

Reg. No. 4,152,040 ANTHONY RINKER, EXAMINING ATTORNEY

United States of America

United States Patent and Trademark Office



Reg. No. 4,152,041

Registered June 5, 2012

Int. Cls.: 1, 4 and 35

TRADEMARK

SERVICE MARK

PRINCIPAL REGISTER

WESTERN INTERNATIONAL GAS & CYLINDERS, INC. (TEXAS CORPORATION)
7173 HIGHWAY 159 EAST
BELLVILLE, TX 77418

FOR: COMPRESSED GASES AND GAS MIXTURES FOR INDUSTRIAL USE OTHER THAN AS FUEL, NAMELY, STABILIZED METHYACETYLENE AND PROPADIENE MIXTURES, PROPYLENE AND ACETYLENE GAS, OXYGEN, BREATHING AIR, NITROGEN, ARGON, HELIUM, HYDROGEN, CARBON DIOXIDE, AND TRI-MIX AND SPECIALTY GAS MIXTURES COMBINING THE FOREGOING; PROPYLENE AND ACETYLENE GAS USED IN WELDING AND CUTTING, IN CLASS 1 (U.S. CLS. 1, 5, 6, 10, 26 AND 46).

FIRST USE 6-0-2008; IN COMMERCE 6-0-2008.

FOR: FUEL GASES, NAMELY, ACETYLENE, PROPYLENE, HYDROGEN, AND A MIXTURE OF STABILIZED METHYACETYLENE AND PROPADIENE, IN CLASS 4 (U.S. CLS. 1, 6 AND 15).

FIRST USE 6-0-2008; IN COMMERCE 6-0-2008.

FOR: DISTRIBUTORSHIPS IN THE FIELDS OF PROPYLENE AND ACETYLENE GAS USED IN WELDING AND CUTTING, AND CYLINDER VALVES, IN CLASS 35 (U.S. CLS. 100, 101 AND 102).

FIRST USE 6-0-2008; IN COMMERCE 6-0-2008.

OWNER OF U.S. REG. NOS. 2,860,300, 3,585,320 AND OTHERS.

NO CLAIM IS MADE TO THE EXCLUSIVE RIGHT TO USE "HIGH PURITY GAS", APART FROM THE MARK AS SHOWN.

THE MARK CONSISTS OF THE WORDS "HIGH PURITY GAS" IN STYLIZED FONT IN THE MIDDLE OF A PARTIAL OVAL DESIGN WHICH IS CENTERED BELOW A STYLIZED FLAME COMPRISED OF THE STYLIZED LETTERS "HPG".

SER. NO. 76-706,438, FILED 2-17-2011.

STEVEN PEREZ, EXAMINING ATTORNEY



David J. Kyros

Director of the United States Patent and Trademark Office

United States of America

United States Patent and Trademark Office

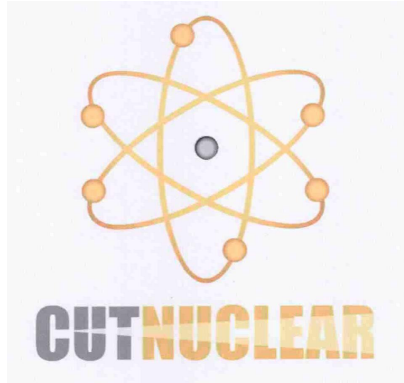

Reg. No. 4,152,042

Registered June 5, 2012

Int. Cl.: 7

TRADEMARK

PRINCIPAL REGISTER

CUT NUCLEAR, INC. (LOUISIANA CORPORATION)
169 THOMPSON ROAD
HOUMA, LA 70363

FOR: CUTTING MACHINES FOR USE UNDERWATER TO ASSIST IN NUCLEAR POWER PLANT IMPROVEMENTS AND MODIFICATIONS, IN CLASS 7 (U.S. CLS. 13, 19, 21, 23, 31, 34 AND 35).

FIRST USE 11-1-2008; IN COMMERCE 5-1-2009.

THE MARK CONSISTS OF THE WORDING "CUTNUCLEAR" IN STYLIZED LETTERING. THE LETTERS "CUT" APPEAR IN GREY. THE LETTERS "NUCLEAR" APPEAR IN GOLDISH YELLOW. THE WORDING "CUTNUCLEAR" APPEARS TOGETHER UNDERNEATH YELLOW AND GOLD ELECTRONS AND ELECTRON ORBITAL CIRCLES. THE ELECTRON ORBITAL CIRCLES REVOLVE AROUND A GREY NUCLEUS WHICH SYMBOLIZES NUCLEAR POWER. A LIGHT GREY HIGHLIGHT APPEARS IN THE NUCLEUS. A BEAM OF LIGHT DESIGN APPEARS IN THE WORDING "UT NUCLEAR" GROWING LARGER TOWARDS THE RIGHT FADING THE COLORS.

THE COLOR(S) GREY, LIGHT GREY, GOLD, YELLOW AND GOLDISH YELLOW IS/ARE CLAIMED AS A FEATURE OF THE MARK.

SER. NO. 76-706,490, FILED 2-22-2011.

ROBERT C. CLARK JR., EXAMINING ATTORNEY



David J. Kybas

Director of the United States Patent and Trademark Office

United States of America

United States Patent and Trademark Office



Reg. No. 4,152,043

Registered June 5, 2012

Int. Cl.: 25

TRADEMARK

PRINCIPAL REGISTER

MEHDI LAISSAOUI (MOROCCO INDIVIDUAL), AKA MOROCCO YANKEE
1230 E. COUNTY LINE RD. STE A
RIDGELAND, MS 39158

FOR: CLOTHING, NAMELY, SHIRTS, JACKETS, CAPS, DRESSES, AND SWIMWEAR, IN
CLASS 25 (U.S. CLS. 22 AND 39).

FIRST USE 3-12-2007; IN COMMERCE 3-12-2007.

NO CLAIM IS MADE TO THE EXCLUSIVE RIGHT TO USE "CLOTHING", APART FROM
THE MARK AS SHOWN.

THE MARK CONSISTS OF THE WORDING "KEEZ CLOTHING" IN SCRIPT LETTERS IN
FRONT OF DESIGNS OF KEYS WITH A SILHOUETTE OF A CITY SKYLINE SHOWN IN
THE HEADS OF THE KEYS.

SER. NO. 76-706,631, FILED 3-2-2011.

CORY BOONE, EXAMINING ATTORNEY



David J. Kybas

Director of the United States Patent and Trademark Office

United States of America

United States Patent and Trademark Office

FUNGURAN

Reg. No. 4,152,044

Registered June 5, 2012

Int. Cls.: 1 and 5

TRADEMARK

PRINCIPAL REGISTER

SPIESS-URANIA CHEMICALS GMBH (FED REP GERMANY GMBH)
HEIDENKAMPSWEG 77
D-20097 HAMBURG, FED REP GERMANY

FOR: CHEMICALS FOR USE IN AGRICULTURE, FORESTRY AND GARDENING, NAMELY, FERTILIZERS; PLANT TREATMENT CHEMICALS, NAMELY, CHEMICALS FOR PROTECTING AND DENATURING SEEDS FOR AGRICULTURE, FORESTRY AND GARDENING USE; CHEMICALS WITH BASIC BIOLOGICAL MATERIALS FOR THE TREATMENT OF DEFICIENCY DISEASES IN PLANTS FOR AGRICULTURE, FORESTRY AND GARDENING USE; CHEMICALS FOR USE IN PROTECTING AGRICULTURAL AND FORESTRY PRODUCTS HELD IN STORAGE; SOIL TREATMENT ADDITIVES FOR AGRICULTURE, FORESTRY AND GARDENING USE; AND PLANT GROWTH REGULATORS FOR AGRICULTURAL, FORESTRY AND GARDENING USE, IN CLASS 1 (U.S. CLS. 1, 5, 6, 10, 26 AND 46).

FOR: FUNGAL, ANIMAL, INSECT, AND MICROBIAL PESTICIDES, HERBICIDES AND INSECTICIDES, ALL FOR AGRICULTURAL, GARDENING AND FORESTRY USE, IN CLASS 5 (U.S. CLS. 6, 18, 44, 46, 51 AND 52).

THE MARK CONSISTS OF STANDARD CHARACTERS WITHOUT CLAIM TO ANY PARTICULAR FONT, STYLE, SIZE, OR COLOR.

OWNER OF FED REP GERMANY REG. NO. 1136281, DATED 3-16-1989, EXPIRES 10-1-2018.

THE WORDING "FUNGURAN" HAS NO MEANING IN A FOREIGN LANGUAGE.

SER. NO. 76-706,961, FILED 3-25-2011.

MARTHA FROMM, EXAMINING ATTORNEY



David J. Kypos

Director of the United States Patent and Trademark Office

United States of America

United States Patent and Trademark Office

CARNEVALE “THE FESTIVAL OF THE PEOPLE”

Reg. No. 4,152,045

Registered June 5, 2012

Int. Cl.: 41

SERVICE MARK

PRINCIPAL REGISTER

MIND'S EYE ENTERPRISES INCORPORATED (FLORIDA CORPORATION)
4044 W. LAKE MARY BLVD, UNIT #104-127
LAKE MARY, FL 32746

FOR: ORGANIZING AND ARRANGING THEMED SHOWROOMS, EXHIBITIONS AND INTERACTIVE ATTRACTIONS FOR ENTERTAINMENT, EDUCATION AND CULTURAL PURPOSES, IN CLASS 41 (U.S. CLS. 100, 101 AND 107).

FIRST USE 10-6-2004; IN COMMERCE 12-12-2006.

THE MARK CONSISTS OF STANDARD CHARACTERS WITHOUT CLAIM TO ANY PARTICULAR FONT, STYLE, SIZE, OR COLOR.

NO CLAIM IS MADE TO THE EXCLUSIVE RIGHT TO USE "CARNEVALE" AND "FESTIVAL", APART FROM THE MARK AS SHOWN.

THE ENGLISH TRANSLATION OF "CARNEVALE" IN THE MARK IS "CARNIVAL".

SER. NO. 76-707,074, FILED 4-1-2011.

SHARON MEIER, EXAMINING ATTORNEY



David J. Kybas

Director of the United States Patent and Trademark Office

United States of America

United States Patent and Trademark Office

THE ULTIMATE TREAT FOR DOGS!

Reg. No. 4,152,046

Registered June 5, 2012

Int. Cl.: 31

TRADEMARK

PRINCIPAL REGISTER

EURO-CAN MANUFACTURING INC. (CANADA CORPORATION)
367 VICTORIA STREET
NEW HAMBURG, ONTARIO N3A2K5, CANADA

FOR: PET TREATS, IN CLASS 31 (U.S. CLS. 1 AND 46).

FIRST USE 12-31-1995; IN COMMERCE 12-31-1995.

THE MARK CONSISTS OF STANDARD CHARACTERS WITHOUT CLAIM TO ANY PARTICULAR FONT, STYLE, SIZE, OR COLOR.

NO CLAIM IS MADE TO THE EXCLUSIVE RIGHT TO USE "TREAT FOR DOGS", APART FROM THE MARK AS SHOWN.

SEC. 2(F).

SER. NO. 76-707,180, FILED 4-8-2011.

JAMES MACFARLANE, EXAMINING ATTORNEY



David J. Kybas

Director of the United States Patent and Trademark Office

United States of America

United States Patent and Trademark Office



Reg. No. 4,152,047

ZEISEL, LAURA (UNITED STATES INDIVIDUAL)
858 EAST HILL RD.
PLAINFIELD, VT 05667

Registered June 5, 2012

Int. Cl.: 18

FOR: KNITTING-RELATED ACCESSORIES, NAMELY, CANVAS SHOPPING BAGS, IN CLASS 18 (U.S. CLS. 1, 2, 3, 22 AND 41).

TRADEMARK

FIRST USE 9-9-2008; IN COMMERCE 11-7-2008.

PRINCIPAL REGISTER

NO CLAIM IS MADE TO THE EXCLUSIVE RIGHT TO USE "KNIT", APART FROM THE MARK AS SHOWN.

SER. NO. 76-707,201, FILED 4-11-2011.

THOMAS MANOR, EXAMINING ATTORNEY



David J. Kyffers

Director of the United States Patent and Trademark Office

United States of America

United States Patent and Trademark Office

MAGENIC

Reg. No. 4,152,048

Registered June 5, 2012

Int. Cl.: 42

SERVICE MARK

PRINCIPAL REGISTER

MAGENIC TECHNOLOGIES, INC. (MINNESOTA CORPORATION)
4150 OLSON MEMORIAL HIGHWAY
SUITE 400
GOLDEN VALLEY, MN 55422

FOR: MAINTENANCE OF COMPUTER APPLICATION SOFTWARE; MAINTENANCE OF COMPUTER APPLICATION SOFTWARE FOR MOBILE DEVICES; HOSTING OF WEB SITES; PROVIDING QUALITY ASSURANCE SERVICES IN THE FIELD OF COMPUTER APPLICATION SOFTWARE FOR MOBILE DEVICES; PROVIDING QUALITY ASSURANCE SERVICES IN THE FIELD OF COMPUTER APPLICATION SOFTWARE; DESIGN AND MAINTENANCE OF COMPUTER APPLICATION SOFTWARE FOR MOBILE DEVICES; DESIGN AND MAINTENANCE OF COMPUTER APPLICATION SOFTWARE, IN CLASS 42 (U.S. CLS. 100 AND 101).

FIRST USE 2-1-2008; IN COMMERCE 2-1-2008.

THE MARK CONSISTS OF STANDARD CHARACTERS WITHOUT CLAIM TO ANY PARTICULAR FONT, STYLE, SIZE, OR COLOR.

OWNER OF U.S. REG. NOS. 2,469,963 AND 2,509,833.

SER. NO. 76-707,324, FILED 4-18-2011.

GIANCARLO CASTRO, EXAMINING ATTORNEY



David J. Kyffers

Director of the United States Patent and Trademark Office

United States of America

United States Patent and Trademark Office

dynewTech

Reg. No. 4,152,049

PROELL, BRUNO (UNITED STATES INDIVIDUAL)
P.O. BOX 3417
YOUNTVILLE, CA 94599

Registered June 5, 2012

Int. Cl.: 11

FOR: LED (LIGHT EMITTING DIODE) LIGHTING FIXTURES, IN CLASS 11 (U.S. CLS. 13, 21, 23, 31 AND 34).

TRADEMARK

FIRST USE 2-0-2011; IN COMMERCE 2-0-2011.

PRINCIPAL REGISTER

THE MARK CONSISTS OF THE WORD "DYNEWTECH" IN BLACK AND "T" APPEARING IN RED. THE RED LETTER "T" IS OUTLINED IN BLACK.

THE COLOR(S) RED AND BLACK IS/ARE CLAIMED AS A FEATURE OF THE MARK.

SER. NO. 76-707,443, FILED 4-29-2011.

MIDGE BUTLER, EXAMINING ATTORNEY



David J. Kyffers

Director of the United States Patent and Trademark Office

United States of America
United States Patent and Trademark Office

ORION

Reg. No. 4,152,050

Registered June 5, 2012

Int. Cl.: 9

TRADEMARK

PRINCIPAL REGISTER

SIGNATURE CONTROL SYSTEMS, INC. (CALIFORNIA CORPORATION)
18 GOODYEAR, SUITE 110
IRVINE, CA 92618

FOR: IRRIGATION PUMP STATIONS COMPRISED OF ELECTRICAL CONTROL PANELS,
CONTROL SOFTWARE, AND ELECTRICAL CONTROLS, FOR USE IN IRRIGATION SYS-
TEMS , IN CLASS 9 (U.S. CLS. 21, 23, 26, 36 AND 38).

FIRST USE 1-31-2002; IN COMMERCE 1-31-2002.

THE MARK CONSISTS OF STANDARD CHARACTERS WITHOUT CLAIM TO ANY PAR-
TICULAR FONT, STYLE, SIZE, OR COLOR.

SER. NO. 76-707,458, FILED 5-2-2011.

CHRISIE B. KING, EXAMINING ATTORNEY



David J. Kyffers

Director of the United States Patent and Trademark Office

United States of America

United States Patent and Trademark Office



Reg. No. 4,152,051

Registered June 5, 2012

Int. Cls.: 9 and 11

TRADEMARK

PRINCIPAL REGISTER

SIGNATURE CONTROL SYSTEMS, INC. (CALIFORNIA CORPORATION)
18 GOODYEAR, SUITE 110
IRVINE, CA 92618

FOR: COMPUTER SOFTWARE FOR OPERATION AND CONTROL OF IRRIGATION SYSTEMS; ELECTRICAL CONTROLS FOR IRRIGATION SPRINKLER SYSTEMS; WIRELESS RECEIVERS AND TRANSMITTERS FOR USE WITH A NETWORKED IRRIGATION SYSTEM; COMPUTERIZED SPRINKLER VALVE WIRING HUBS AND NON-COMPUTERIZED SPRINKLER VALVE WIRING UNITS; ELECTRONIC RECEIVERS AND TRANSMITTERS FOR A NETWORKED VEHICLE TRACKING AND MAINTENANCE SYSTEM; COMPUTER SOFTWARE FOR VEHICLE TRACKING AND PREVENTIVE MAINTENANCE; ELECTRONIC AUTOMATIC IRRIGATION AND WATERING TIMERS AND CONTROLS; HAND HELD ELECTRONIC UNITS FOR PROGRAMMING AUTOMATIC IRRIGATION AND WATERING CONTROLS; IRRIGATION PUMP STATIONS COMPRISED OF ELECTRICAL CONTROL PANELS, CONTROL SOFTWARE, AND ELECTRICAL CONTROLS, FOR USE IN IRRIGATION SYSTEMS, IN CLASS 9 (U.S. CLS. 21, 23, 26, 36 AND 38).

FIRST USE 9-30-2009; IN COMMERCE 9-30-2009.

FOR: IRRIGATION SPRINKLERS; IRRIGATION SPRINKLER HEADS, IN CLASS 11 (U.S. CLS. 13, 21, 23, 31 AND 34).

FIRST USE 9-30-2009; IN COMMERCE 9-30-2009.

THE MARK CONSISTS OF THE LETTERS "SCS" UNDER A HORIZONTAL LINE; OVER THE LEFT OF THE LINE IS A LARGE CIRCLES WITH SMALLER CIRCLES OF INCREASING DIAMETER EXTENDING THEREFROM; THE LETTERS, CIRCLES AND LINE ARE WITHIN A RECTANGLE.

SER. NO. 76-707,459, FILED 5-2-2011.

CHRISIE B. KING, EXAMINING ATTORNEY



David J. Kybas

Director of the United States Patent and Trademark Office

United States of America

United States Patent and Trademark Office



Reg. No. 4,152,052

Registered June 5, 2012

Int. Cl.: 9

TRADEMARK

PRINCIPAL REGISTER

TALENT MUSIC GROUP, INC. (CALIFORNIA CORPORATION)
7228 CERRITOS AVE
STANTON, CA 90680

FOR: AUDIO AND VIDEO RECORDINGS FEATURING MUSIC AND LIVE ARTISTIC PERFORMANCES, IN CLASS 9 (U.S. CLS. 21, 23, 26, 36 AND 38).

FIRST USE 5-1-2005; IN COMMERCE 5-1-2005.

THE NAME "SAUL EL JAGUAR" IDENTIFIES THE PSEUDONYM/NICKNAME OF SAUL ALARCON WHOSE CONSENT IS OF RECORD.

THE COLOR(S) RED, BLACK, BLUE, AND WHITE IS/ARE CLAIMED AS A FEATURE OF THE MARK.

THE MARK CONSISTS OF THE WORDING "SAUL EL JAGUAR" REPRESENTED IN STYLIZED FONT WITH WORDING "EL JAGUAR" IN THE COLOR RED OUTLINED IN BLACK, THE WORD "SAUL" IN THE COLOR BLUE AND OUTLINE BLACK, A DESIGN FEATURING A STYLIZED JAGUAR ANIMAL IN THE COLORS BLACK AND WHITE, AND ALL WITHIN A RECTANGLE DESIGN FEATURING WHITE CLOUD AND BLUE SKY.

SER. NO. 76-707,572, FILED 5-11-2011.

WARREN L. OLANDRIA, EXAMINING ATTORNEY



David J. Kybas

Director of the United States Patent and Trademark Office

United States of America

United States Patent and Trademark Office



Reg. No. 4,152,053

Registered June 5, 2012

Int. Cl.: 25

TRADEMARK

PRINCIPAL REGISTER

AKERS, MENERVIA M (UNITED STATES INDIVIDUAL)
PO BOX 288
MARBLEHEAD, MA 01945

FOR: HAND MADE APPAREL, NAMELY, NECKWEAR, WRISTBANDS, BELTS AND MIL-
LINERY, NAMELY, FASCINATORS AND HATS, IN CLASS 25 (U.S. CLS. 22 AND 39).

FIRST USE 9-0-2009; IN COMMERCE 9-0-2010.

THE MARK CONSISTS OF A RECTANGLE WITH AN ABSTRACT REPEATING GEOMETRIC
STYLIZED FLOWER DESIGN IN GREY ON A BLACK BACKGROUND THAT CARRIES
THE LARGE TERM "MENERVIA" AT THE TOP CENTER, APPEARING IN HOT PINK WITH
A WHITE STAR ON THE UPPER LEFT EDGE OF THE "M" AND "A" AND WHITE HIGH-
LIGHTS ON THE EDGES OF THE OTHER LETTERS; BELOW THIS IS A DESIGN OF A
SHIELD IN BLACK WITH A HOT PINK OUTLINE AND GREY HIGHLIGHTS ON THE UPPER
EDGES WITH A LARGE STYLIZED PINK CAPITAL LETTER "M" IN THE CENTER THAT
HAS A WHITE STAR ON THE LOWER LEFT CORNER AND WHITE HIGHLIGHTS ON THE
EDGES; LEOPARD SKIN PATTERNED SCROLL DESIGNS APPEAR ON EACH SIDE OF
THE BOTTOM OF THE SHIELD IN THE COLORS YELLOW, TAN, DARK BROWN AND
BLACK WITH HOT PINK HIGHLIGHTS; BELOW THE SHIELD ARE THE STYLIZED SCRIPT
TERMS "DARE U TO BE U" IN HOT PINK WITH WHITE HIGHLIGHTS.

THE COLOR(S) HOT PINK, BLACK, TAN, YELLOW, DARK BROWN, WHITE AND GREY
IS/ARE CLAIMED AS A FEATURE OF THE MARK.

SER. NO. 76-707,725, FILED 5-20-2011.

ANTHONY RINKER, EXAMINING ATTORNEY



David J. Kybas

Director of the United States Patent and Trademark Office

United States of America

United States Patent and Trademark Office

DIRECTSYNC

Reg. No. 4,152,054

BOXWAVE CORPORATION (NEVADA CORPORATION)
227 BELLEVUE WAY NE #558
BELLEVUE, WA 98004

Registered June 5, 2012

Int. Cl.: 9

FOR: CABLES FOR ELECTRONIC DEVICES, NAMELY, CELLULAR PHONES, MOBILE PHONES, SMART PHONES, PERSONAL DIGITAL ASSISTANTS (PDA), CAMERAS, GLOBAL POSITIONING SYSTEMS, TABLET COMPUTERS, AND OTHER DEVICES, IN CLASS 9 (U.S. CLS. 21, 23, 26, 36 AND 38).

TRADEMARK

PRINCIPAL REGISTER

FIRST USE 7-4-2004; IN COMMERCE 7-4-2004.

THE MARK CONSISTS OF STANDARD CHARACTERS WITHOUT CLAIM TO ANY PARTICULAR FONT, STYLE, SIZE, OR COLOR.

SEC. 2(F).

SER. NO. 76-708,102, FILED 6-23-2011.

ALICIA COLLINS, EXAMINING ATTORNEY



David J. Kyros

Director of the United States Patent and Trademark Office

United States of America

United States Patent and Trademark Office



Reg. No. 4,152,055

Registered June 5, 2012

Int. Cl.: 7

TRADEMARK

PRINCIPAL REGISTER

FMF OF OREGON, LLC (OREGON LIMITED LIABILITY COMPANY)
P.O. BOX 1302
SALOME, AZ 85348

FOR: MINING MACHINERY, NAMELY, EQUIPMENT FOR SEPARATING MATERIALS BY SPECIFIC GRAVITY, ELECTRIC GENERATORS, ELECTRIC WATER PUMPS, ELECTRIC GRAVEL PUMPS, DREDGING MACHINES, CONVEYORS AND ROCK CRUSHERS, IN CLASS 7 (U.S. CLS. 13, 19, 21, 23, 31, 34 AND 35).

FIRST USE 5-0-2011; IN COMMERCE 5-0-2011.

THE MARK CONSISTS OF THE STYLIZED LETTER "G" OVER THE DESIGN OF A GLOBE.

SER. NO. 76-708,617, FILED 8-5-2011.

KIM SAITO, EXAMINING ATTORNEY



David J. Kyffers

Director of the United States Patent and Trademark Office

United States of America

United States Patent and Trademark Office

Successful Classroom Management Initiative

Reg. No. 4,152,056

MCCOLLUM, DELORES L. (UNITED STATES INDIVIDUAL)
4266 EAST 170TH PLACE
CLEVELAND, OH 441283306

Registered June 5, 2012

Int. Cl.: 41

FOR: EDUCATIONAL SERVICES, NAMELY, PROVIDING INSTRUCTION IN THE FIELD OF CLASSROOM MANAGEMENT, IN CLASS 41 (U.S. CLS. 100, 101 AND 107).

SERVICE MARK

FIRST USE 4-2-2011; IN COMMERCE 4-16-2011.

PRINCIPAL REGISTER

NO CLAIM IS MADE TO THE EXCLUSIVE RIGHT TO USE "SUCCESSFUL CLASSROOM MANAGEMENT INITIATIVE", APART FROM THE MARK AS SHOWN.

THE COLOR(S) BROWN, RED, GREEN, AND BLACK IS/ARE CLAIMED AS A FEATURE OF THE MARK.

THE MARK CONSISTS OF THE BLACK STYLIZED WORDS "SUCCESSFUL CLASSROOM MANAGEMENT INITIATIVE" WITH THE "A" IN "CLASSROOM" SUBSTITUTED WITH A DESIGN OF AN APPLE WITH GREEN LEAVES, BROWN STEM, AND RED SKIN.

SER. NO. 76-708,742, FILED 8-15-2011.

MICHAEL LITZAU, EXAMINING ATTORNEY



David J. Kyros

Director of the United States Patent and Trademark Office

United States of America

United States Patent and Trademark Office

POLYQUEST

Reg. No. 4,152,057

POLYQUEST, INCORPORATED (NORTH CAROLINA CORPORATION)
1985 EASTWOOD ROAD, SUITE 206
WILMINGTON, NC 28403

Registered June 5, 2012

Int. Cl.: 1

FOR: POLYETHYLENE TEREPHTHALATE (PET) RESINS, IN CLASS 1 (U.S. CLS. 1, 5, 6, 10, 26 AND 46).

TRADEMARK

FIRST USE 5-25-2000; IN COMMERCE 5-25-2000.

PRINCIPAL REGISTER

THE MARK CONSISTS OF STANDARD CHARACTERS WITHOUT CLAIM TO ANY PARTICULAR FONT, STYLE, SIZE, OR COLOR.

SER. NO. 76-708,773, FILED 8-17-2011.

PAUL E. FAHRENKOPF, EXAMINING ATTORNEY



David J. Kyffers

Director of the United States Patent and Trademark Office

United States of America

United States Patent and Trademark Office

THE ACT FORMULA

Reg. No. 4,152,058

Registered June 5, 2012

Int. Cl.: 41

SERVICE MARK

PRINCIPAL REGISTER

FOCUSED, LLC (PENNSYLVANIA LIMITED LIABILITY COMPANY)
1045 ROBIN ROAD
WYOMISSING, PA 19610

FOR: PROVIDING EMPLOYEE TRAINING FOR DIVERSE PERSONNEL FEATURING UTILIZATION OF ACCOUNTABILITY, COMMUNICATION AND TRUST CONCEPTS FOR SUCCESS, IN CLASS 41 (U.S. CLS. 100, 101 AND 107).

FIRST USE 3-26-2011; IN COMMERCE 5-18-2011.

THE MARK CONSISTS OF THE WORDING "THE ACT FORMULA" IN ALL CAPS.

SER. NO. 76-708,818, FILED 8-22-2011.

ODESSA BIBBINS, EXAMINING ATTORNEY



David J. Kybas

Director of the United States Patent and Trademark Office

United States of America

United States Patent and Trademark Office

i²Contact

Reg. No. 4,152,059

Registered June 5, 2012

Int. Cl.: 42

SERVICE MARK

PRINCIPAL REGISTER

INTEGRATED BANK TECHNOLOGIES, INC. (TEXAS CORPORATION)
1101 ARROW POINT DRIVE, SUITE 305
CEDAR PARK, TX 78613

FOR: DEVELOPMENT AND MAINTENANCE OF COMPUTER SOURCE CODE FOR MAN-
AGING CUSTOMER DATA AND COMMUNICATIONS IN THE FINANCIAL INDUSTRY ,
IN CLASS 42 (U.S. CLS. 100 AND 101).

FIRST USE 9-15-2009; IN COMMERCE 9-15-2009.

THE MARK CONSISTS OF THE LETTERS "I" AND "CONTACT" WITH THE MATHEMATICAL SYMBOL "SQUARED" REPRESENTED BY THE NUMBER "2" SUPERSCRIPED FOLLOWING "I" AND BEFORE "CONTACT". THE ENTIRE MARK IS SET ON A TRANSPARENT BACKGROUND.

SER. NO. 76-708,827, FILED 8-22-2011.

JENNIFER VASQUEZ, EXAMINING ATTORNEY



David J. Kyjars

Director of the United States Patent and Trademark Office

United States of America

United States Patent and Trademark Office

ACRALYTE

Reg. No. 4,152,060

HARBOR FURNITURE MANUFACTURING, INC. (ALABAMA CORPORATION)
P.O. BOX 340
ELBERTA, AL 36530

Registered June 5, 2012

Int. Cl.: 2

FOR: PROTECTIVE COATINGS USED FOR FURNITURE FINISH, IN CLASS 2 (U.S. CLS. 6, 11 AND 16).

TRADEMARK

FIRST USE 12-1-1996; IN COMMERCE 12-1-1996.

PRINCIPAL REGISTER

THE MARK CONSISTS OF STANDARD CHARACTERS WITHOUT CLAIM TO ANY PARTICULAR FONT, STYLE, SIZE, OR COLOR.

SER. NO. 76-708,995, FILED 9-6-2011.

DARRYL SPRUILL, EXAMINING ATTORNEY



David J. Kyffers

Director of the United States Patent and Trademark Office

United States of America

United States Patent and Trademark Office

TABLETOPICS

Reg. No. 4,152,061

Registered June 5, 2012

Int. Cl.: 20

TRADEMARK

PRINCIPAL REGISTER

HARBOR FURNITURE MANUFACTURING, INC. (ALABAMA CORPORATION)
P.O. BOX 340
ELBERTA, AL 36530

FOR: FURNITURE, IN CLASS 20 (U.S. CLS. 2, 13, 22, 25, 32 AND 50).

FIRST USE 3-1-1985; IN COMMERCE 3-1-1985.

THE MARK CONSISTS OF STANDARD CHARACTERS WITHOUT CLAIM TO ANY PARTICULAR FONT, STYLE, SIZE, OR COLOR.

SER. NO. 76-708,996, FILED 9-6-2011.

DARRYL SPRUILL, EXAMINING ATTORNEY



David J. Kybas

Director of the United States Patent and Trademark Office

United States of America

United States Patent and Trademark Office



Chowpatty

Reg. No. 4,152,062

Registered June 5, 2012

Int. Cl.: 43

SERVICE MARK

PRINCIPAL REGISTER

PATEL, SANDIP (UNITED STATES INDIVIDUAL), DBA CHOWPATTY
1349 OAKTREE ROAD
ISELIN, NJ 08830

FOR: CATERING; PREPARATION OF FOOD AND BEVERAGES; RESTAURANT SERVICES;
SERVING OF FOOD AND DRINK/BEVERAGES; AND TAKE-OUT RESTAURANT SERVICES,
IN CLASS 43 (U.S. CLS. 100 AND 101).

FIRST USE 6-0-2006; IN COMMERCE 6-0-2006.

OWNER OF U.S. REG. NO. 3,814,219.

THE MARK CONSISTS OF THE WORD "CHOWPATTY" IN STYLIZED FONT WITH THE
LEAFY TOPS OF TWO COCONUT TREES, EACH BEARING COCONUTS, APPEARING
ABOVE THE "TTY" IN THE WORD.

SER. NO. 76-709,023, FILED 9-9-2011.

AISHA CLARKE, EXAMINING ATTORNEY



David J. Kybas

Director of the United States Patent and Trademark Office

United States of America

United States Patent and Trademark Office



Reg. No. 4,152,063

Registered June 5, 2012

Int. Cl.: 8

TRADEMARK

PRINCIPAL REGISTER

PANTHER TRADING, INC. (MARYLAND CORPORATION)
2652 WEST PATAPSCO AVENUE
BALTIMORE, MD 21230

FOR: FIXED BLADE KNIVES, POCKET KNIVES, HUNTING KNIVES, IN CLASS 8 (U.S. CLS. 23, 28 AND 44).

FIRST USE 8-1-2011; IN COMMERCE 8-1-2011.

THE MARK CONSISTS OF THE WORDS CROWING ROOSTER IN A STYLIZED FONT WITH THE WORD CROWING ABOVE AND THE WORD ROOSTER BELOW A CIRCLE CONTAINING THE IMAGE OF A ROOSTER IN A FIELD.

SER. NO. 76-709,082, FILED 9-16-2011.

KATHRYN COWARD, EXAMINING ATTORNEY



David J. Kybas

Director of the United States Patent and Trademark Office

United States of America

United States Patent and Trademark Office



Reg. No. 4,152,064

QFIT4LIFE, LLC (OHIO LIMITED LIABILITY COMPANY)
2872 TIMBER RANGE COURT
COLUMBUS, OH 43231

Registered June 5, 2012

Int. Cl.: 41

FOR: PHYSICAL FITNESS TRAINING AND INSTRUCTION FEATURING AN ABDOMINAL AND CORE EXERCISE WORKOUT PROGRAM, IN CLASS 41 (U.S. CLS. 100, 101 AND 107).

SERVICE MARK

FIRST USE 0-0-2006; IN COMMERCE 0-0-2006.

PRINCIPAL REGISTER

THE MARK CONSISTS OF THE PHRASE "QFIT4LIFE", WHEREIN THE WORD "Q" AND THE NUMBER "4" ARE IN SHADES OF WHITE AND GRAY, THE WORDS "FIT" AND "LIFE" ARE IN BLACK AND THE NUMBER "4" AND THE WORD "LIFE" ARE POSITIONED ABOVE AN ARC THAT IS IN RED.

THE COLOR(S) RED, GRAY, WHITE AND BLACK IS/ARE CLAIMED AS A FEATURE OF THE MARK.

SER. NO. 76-709,163, FILED 9-21-2011.

PATRICIA EVANKO, EXAMINING ATTORNEY



David J. Kybas

Director of the United States Patent and Trademark Office

United States of America

United States Patent and Trademark Office

DOCUTAINMENT

Reg. No. 4,152,065

Registered June 5, 2012

Int. Cl.: 41

SERVICE MARK

PRINCIPAL REGISTER

GENESIS COMMUNICATIONS II, INC. (FLORIDA CORPORATION)
800 8TH AVENUE, SE
LARGO, FL 33771

FOR: PRODUCTION OF BROADCAST DOCUMENTARY FILMS AND VIDEOS, IN CLASS
41 (U.S. CLS. 100, 101 AND 107).

FIRST USE 9-7-2011; IN COMMERCE 9-7-2011.

THE MARK CONSISTS OF STANDARD CHARACTERS WITHOUT CLAIM TO ANY PAR-
TICULAR FONT, STYLE, SIZE, OR COLOR.

SER. NO. 76-709,264, FILED 9-30-2011.

JENNIFER WILLISTON, EXAMINING ATTORNEY



David J. Kybas

Director of the United States Patent and Trademark Office

United States of America

United States Patent and Trademark Office

CULINARY CONCEPTS

Reg. No. 4,152,066

DORINA/SO-GOOD, INC. (ILLINOIS CORPORATION)
17400 EAST JEFFERSON STREET
UNION, IL 60180

Registered June 5, 2012

Int. Cl.: 30

FOR: SAUCES, COMBINATIONS OF SAUCES AND MARINADES, AND SALAD DRESSINGS,
IN CLASS 30 (U.S. CL. 46).

TRADEMARK

FIRST USE 6-26-2000; IN COMMERCE 6-26-2000.

PRINCIPAL REGISTER

THE MARK CONSISTS OF STANDARD CHARACTERS WITHOUT CLAIM TO ANY PARTICULAR FONT, STYLE, SIZE, OR COLOR.

NO CLAIM IS MADE TO THE EXCLUSIVE RIGHT TO USE "CULINARY", APART FROM THE MARK AS SHOWN.

SER. NO. 76-709,310, FILED 10-4-2011.

ELLEN BURNS, EXAMINING ATTORNEY



David J. Kyffers

Director of the United States Patent and Trademark Office

United States of America

United States Patent and Trademark Office

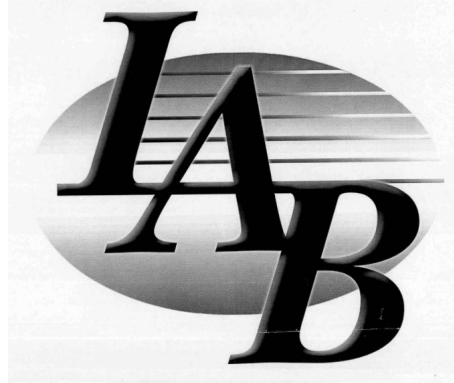

Reg. No. 4,152,067

Registered June 5, 2012

Int. Cl.: 35

SERVICE MARK

PRINCIPAL REGISTER

INDEPENDENT ASSOCIATION OF BUSINESSES (D.C. NONPROFIT CORPORATION)
701 HIGHLAND BOULEVARD SUITE 400
ARLINGTON, TX 76015

FOR: ASSOCIATION SERVICES, NAMELY, PROMOTING THE INTERESTS OF INDEPENDENT BUSINESSES AND SELF-EMPLOYED INDIVIDUALS AND THE VARIOUS ISSUES AND NEEDS CONFRONTING THE INDEPENDENT BUSINESS COMMUNITY, IN CLASS 35 (U.S. CLS. 100, 101 AND 102).

FIRST USE 1-1-1995; IN COMMERCE 1-1-1995.

THE MARK CONSISTS OF THE SHADED LETTERS "IAB" SUPERIMPOSED DIAGONALLY OVER AN OVAL WITH HORIZONTAL LINES RUNNING FROM THE LETTER "I".

SER. NO. 76-709,363, FILED 10-11-2011.

BERNICE MIDDLETON, EXAMINING ATTORNEY



David J. Kyffers

Director of the United States Patent and Trademark Office

United States of America

United States Patent and Trademark Office

FOR LOCALS
ONLY ... AND
THOSE WHO
WISH THEY
WERE

Reg. No. 4,152,068

Registered June 5, 2012

Int. Cl.: 43

SERVICE MARK

PRINCIPAL REGISTER

O.C. SEACRETS, INC. (MARYLAND CORPORATION)
117 WEST 49TH STREET
OCEAN CITY, MD 21842

FOR: HOTEL, MOTEL, RESTAURANT, BAR AND CATERING SERVICES, IN CLASS 43
(U.S. CLS. 100 AND 101).

FIRST USE 6-0-1988; IN COMMERCE 6-0-1988.

THE MARK CONSISTS OF STANDARD CHARACTERS WITHOUT CLAIM TO ANY PARTICULAR FONT, STYLE, SIZE, OR COLOR.

SER. NO. 76-709,412, FILED 10-17-2011.

RAUL CORDOVA, EXAMINING ATTORNEY



David J. Kyffers

Director of the United States Patent and Trademark Office

United States of America

United States Patent and Trademark Office

DARKSIDE

Reg. No. 4,152,069

O.C. SEACRETS, INC. (MARYLAND CORPORATION)
117 WEST 49TH STREET
OCEAN CITY, MD 21842

Registered June 5, 2012

Int. Cls.: 41 and 43

FOR: ENTERTAINMENT SERVICES, NAMELY, SPONSORING MONTHLY PARTIES AND EVENTS, IN CLASS 41 (U.S. CLS. 100, 101 AND 107).

SERVICE MARK

FIRST USE 11-0-1992; IN COMMERCE 11-0-1992.

PRINCIPAL REGISTER

FOR: RESTAURANT, BAR AND HOTEL SERVICES, IN CLASS 43 (U.S. CLS. 100 AND 101).

FIRST USE 11-0-1992; IN COMMERCE 11-0-1992.

THE MARK CONSISTS OF STANDARD CHARACTERS WITHOUT CLAIM TO ANY PARTICULAR FONT, STYLE, SIZE, OR COLOR.

SER. NO. 76-709,413, FILED 10-17-2011.

RAUL CORDOVA, EXAMINING ATTORNEY



David J. Kybas

Director of the United States Patent and Trademark Office

United States of America

United States Patent and Trademark Office

QUIVER

Reg. No. 4,152,070

Registered June 5, 2012

Int. Cl.: 35

SERVICE MARK

PRINCIPAL REGISTER

QUIVER, LLC (CALIFORNIA LIMITED LIABILITY COMPANY)
14292 EAST MALL STREET
IRVINE, CA 92606

FOR: ADVERTISING AND MARKETING CONSULTANCY; ADVERTISING AND MARKETING SERVICES, NAMELY, PROMOTING THE GOODS AND SERVICES OF OTHERS, IN CLASS 35 (U.S. CLS. 100, 101 AND 102).

FIRST USE 8-0-2011; IN COMMERCE 8-0-2011.

THE MARK CONSISTS OF STANDARD CHARACTERS WITHOUT CLAIM TO ANY PARTICULAR FONT, STYLE, SIZE, OR COLOR.

SER. NO. 76-709,473, FILED 10-21-2011.

TARAH HARDY, EXAMINING ATTORNEY



David J. Kyffers

Director of the United States Patent and Trademark Office

United States of America

United States Patent and Trademark Office

NICKEL BAG

Reg. No. 4,152,071

Registered June 5, 2012

Int. Cl.: 3

TRADEMARK

PRINCIPAL REGISTER

OLDE GRANDDAD INDUSTRIES, INC. (NEW JERSEY CORPORATION)
160 PASSAIC AVENUE, BLDG. 31 B
KEARNY, NJ 07032

FOR: FRAGRANCE AND DEODORIZING PRODUCTS FOR LAND VEHICLES, AIRCRAFT, WATERCRAFT, PERSONAL, COMMERCIAL, INDUSTRIAL, INDUSTRIAL AND HOME USE, NAMELY, AIR FRESHENERS, IN CLASS 3 (U.S. CLS. 1, 4, 6, 50, 51 AND 52).

FIRST USE 12-17-2011; IN COMMERCE 12-17-2011.

THE MARK CONSISTS OF STANDARD CHARACTERS WITHOUT CLAIM TO ANY PARTICULAR FONT, STYLE, SIZE, OR COLOR.

NO CLAIM IS MADE TO THE EXCLUSIVE RIGHT TO USE "BAG", APART FROM THE MARK AS SHOWN.

SER. NO. 76-710,092, FILED 12-23-2011.

CURTIS FRENCH, EXAMINING ATTORNEY



David J. Kyros

Director of the United States Patent and Trademark Office

United States of America

United States Patent and Trademark Office

FRESH CONTROL

Reg. No. 4,152,072

BLUE SKIN S.A. (FRANCE CORPORATION)

Registered June 5, 2012

34 CAMILLE-PELLETAN 92300

LEVALLOIS-PERRET, FRANCE

Int. Cls.: 3, 5, 10 and 25

FOR: BATH FOAMS, BATH GELS, BATH OILS, BATH OILS FOR COSMETIC PURPOSES, BATH SOAPS IN LIQUID, SOLID OR GEL FORM, BODY LOTIONS, MOUSSE FOR SKIN CARE, PERFUME, PERFUMED SOAP, SHOWER AND BATH GEL, SKIN SOAP, IN CLASS 3 (U.S. CLS. 1, 4, 6, 50, 51 AND 52).

TRADEMARK

PRINCIPAL REGISTER

FOR: ANTIBACTERIAL CLEANERS, ANTIBACTERIAL HANDWASH, FEMININE HYGIENE CLEANSING TOWELETTES, FUNGICIDES, FUNGICIDES FOR MEDICAL USE, IN CLASS 5 (U.S. CLS. 6, 18, 44, 46, 51 AND 52).

FOR: CLOTHING FOR MEDICAL PURPOSES, NAMELY, UNDERGARMENTS, SURGICAL SCRUB SUITS, IN CLASS 10 (U.S. CLS. 26, 39 AND 44).

FOR: UNDERWEAR, IN CLASS 25 (U.S. CLS. 22 AND 39).

THE MARK CONSISTS OF STANDARD CHARACTERS WITHOUT CLAIM TO ANY PARTICULAR FONT, STYLE, SIZE, OR COLOR.

PRIORITY CLAIMED UNDER SEC. 44(D) ON CANADA APPLICATION NO. 1321289, FILED 10-23-2006, REG. NO. 810708, DATED 10-31-2011, EXPIRES 10-31-2026.

SER. NO. 77-031,284, FILED 10-27-2006.

LINDA POWELL, EXAMINING ATTORNEY



David J. Kyros

Director of the United States Patent and Trademark Office

United States of America

United States Patent and Trademark Office

DOES YOUR DOG *BARKSTRONG*

Reg. No. 4,152,073

OHMAN, CHRIS (UNITED STATES INDIVIDUAL)
2751 S. 96TH E. AVENUE
TULSA, OK 74129

Registered June 5, 2012

Int. Cl.: 18

FOR: COLLARS FOR PETS; LEADS, LEASHES AND HARNESSSES FOR ANIMALS, IN CLASS 18 (U.S. CLS. 1, 2, 3, 22 AND 41).

TRADEMARK

FIRST USE 2-1-2005; IN COMMERCE 6-11-2005.

PRINCIPAL REGISTER

THE MARK CONSISTS OF THE WORDING "DOES YOUR DOG BARKSTRONG" IN A STYLIZED FONT.

SER. NO. 77-060,432, FILED 12-8-2006.

ALYSSA STEEL, EXAMINING ATTORNEY



David J. Kybas

Director of the United States Patent and Trademark Office

United States of America

United States Patent and Trademark Office

PIN STRIKES

Reg. No. 4,152,074

Registered June 5, 2012

Int. Cl.: 41

SERVICE MARK

PRINCIPAL REGISTER

ASHEEV LLC (GEORGIA LIMITED LIABILITY COMPANY)
911 HANNOVER COURT
STOCKBRIDGE, GA 30253

FOR: ENTERTAINMENT SERVICES, NAMELY, PROVIDING A FAMILY ENTERTAINMENT AND AMUSEMENT CENTER FEATURING INDOOR BUMPER CARS, LASER TAG, ARCADES, BOWLING AND POKER GAMES, IN CLASS 41 (U.S. CLS. 100, 101 AND 107).

FIRST USE 9-0-2006; IN COMMERCE 1-0-2007.

THE MARK CONSISTS OF STANDARD CHARACTERS WITHOUT CLAIM TO ANY PARTICULAR FONT, STYLE, SIZE, OR COLOR.

SER. NO. 77-135,957, FILED 3-20-2007.

ARETHA SOMERVILLE, EXAMINING ATTORNEY



David J. Kybas

Director of the United States Patent and Trademark Office

United States of America

United States Patent and Trademark Office

FINE TOUCH

Reg. No. 4,152,075

Registered June 5, 2012

Int. Cls.: 35 and 36

SERVICE MARK

PRINCIPAL REGISTER

FINE TOUCH DENTAL MANAGEMENT CORPORATION (CANADA CORPORATION)
UNIT 3
1257 ALGOMA ROAD
OTTAWA, CANADA K1B3W7

FOR: BUSINESS MANAGEMENT CONSULTING FOR PROFESSIONAL PRACTITIONERS, NAMELY, BOOKKEEPING, TAX PREPARATION, AND PROCUREMENT, NAMELY, PURCHASING OF DENTAL SUPPLIES, DENTAL EQUIPMENT, OFFICE SUPPLIES AND OFFICE FURNITURE FOR OTHERS; BUSINESS CONSULTING SERVICES FOR PROFESSIONAL PRACTICES AND TAX RETURN PREPARATION, IN CLASS 35 (U.S. CLS. 100, 101 AND 102).

FOR: MANAGEMENT, CONSULTING AND ADMINISTRATIVE SERVICES FOR PROFESSIONAL PRACTICES, NAMELY, FINANCIAL ANALYSIS AND PROCESSING, ADMINISTERING AND MANAGING EMPLOYEE BENEFIT PLANS, IN CLASS 36 (U.S. CLS. 100, 101 AND 102).

THE MARK CONSISTS OF STANDARD CHARACTERS WITHOUT CLAIM TO ANY PARTICULAR FONT, STYLE, SIZE, OR COLOR.

OWNER OF CANADA REG. NO. TMA749352, DATED 10-2-2009, EXPIRES 10-2-2024.

OWNER OF U.S. REG. NO. 3,339,828.

SER. NO. 77-136,853, FILED 3-21-2007.

JULIE GUTTADAURO, EXAMINING ATTORNEY



David J. Kypos

Director of the United States Patent and Trademark Office

United States of America

United States Patent and Trademark Office

WEBAXIS

Reg. No. 4,152,076

Registered June 5, 2012

Int. Cl.: 9

TRADEMARK

PRINCIPAL REGISTER

CADWORKS (ILLINOIS CORPORATION)
SUITE 102
641 WEST LAKE STREET
CHICAGO, IL 60661

FOR: COLLABORATION AND PROJECT MANAGEMENT SOFTWARE FOR THE ARCHITECTURAL AND ENGINEERING COMMUNITY, IN CLASS 9 (U.S. CLS. 21, 23, 26, 36 AND 38).

FIRST USE 12-15-2006; IN COMMERCE 12-15-2006.

THE MARK CONSISTS OF STANDARD CHARACTERS WITHOUT CLAIM TO ANY PARTICULAR FONT, STYLE, SIZE, OR COLOR.

SER. NO. 77-143,506, FILED 3-29-2007.

LINDSEY RUBIN, EXAMINING ATTORNEY



David J. Kyffers

Director of the United States Patent and Trademark Office

United States of America

United States Patent and Trademark Office

USfalcon

Reg. No. 4,152,077

Registered June 5, 2012

Int. Cls.: 35, 37 and 42

SERVICE MARK

PRINCIPAL REGISTER

USFALCON, INC. (MASSACHUSETTS CORPORATION)
SUITE 200, BOX 23
ONE COPLEY PARKWAY
MORRISVILLE, NC 27560

FOR: TRANSPORTATION LOGISTICS SERVICES, NAMELY, ARRANGING THE TRANSPORTATION OF GOODS FOR OTHERS; BUSINESS ANALYTICAL SERVICES, NAMELY, BUSINESS APPRAISALS AND CONSULTATION, IN CLASS 35 (U.S. CLS. 100, 101 AND 102).

FIRST USE 12-5-2004; IN COMMERCE 12-5-2004.

FOR: SECURITY EQUIPMENT INSTALLATION, IN CLASS 37 (U.S. CLS. 100, 103 AND 106).

FIRST USE 12-5-2004; IN COMMERCE 12-5-2004.

FOR: INFORMATION TECHNOLOGY CONSULTATION; ENGINEERING, IN CLASS 42 (U.S. CLS. 100 AND 101).

FIRST USE 12-5-2004; IN COMMERCE 12-5-2004.

THE MARK CONSISTS OF STANDARD CHARACTERS WITHOUT CLAIM TO ANY PARTICULAR FONT, STYLE, SIZE, OR COLOR.

SER. NO. 77-157,793, FILED 4-16-2007.

TEJBIR SINGH, EXAMINING ATTORNEY



David J. Kybas

Director of the United States Patent and Trademark Office

United States of America

United States Patent and Trademark Office



Reg. No. 4,152,078

Registered June 5, 2012

**Int. Cls.: 35, 36, 39, 41
and 43**

SERVICE MARK

PRINCIPAL REGISTER

VB VENTURES PTY LTD (AUSTRALIA CORPORATION)
LEVEL 7, CENTENARY SQUARE
100 WICKHAM STREET
FORTITUDE VALLEY, AUSTRALIA 4006

FOR: BUSINESS MANAGEMENT AND SUPERVISION IN RELATION TO LOYALTY PROGRAMS OR INCENTIVE SCHEMES; BUSINESS MANAGEMENT AND CONSULTATION IN THE FIELD OF THE SUPPLY OF REDEEMABLE VOUCHERS, CASH VOUCHERS, TRAVEL VOUCHERS, DISCOUNT VOUCHERS, REDEEMABLE COUPONS, LOYALTY CARDS, STORED VALUE CARDS, DISCOUNT CARDS, LOYALTY AWARD POINTS OR MILEAGE POINTS IN CONNECTION WITH LOYALTY PROGRAMS OR INCENTIVE SCHEMES THAT RELATE TO PRODUCTS OR SERVICES SUPPLIED BY OTHERS, IN CLASS 35 (U.S. CLS. 100, 101 AND 102).

FOR: FINANCIAL SERVICES ASSOCIATED WITH LOYALTY PROGRAMS OR INCENTIVE SCHEMES, NAMELY, ISSUANCE OF TOKENS OF VALUE, VOUCHERS OR POINTS ACCUMULATED THROUGH THE USE OF CREDIT CARDS AND DEBIT CARDS FOR TRANSPORTATION SERVICES, ENTERTAINMENT, SPORTING OR CULTURAL ACTIVITIES, AND FOOD, BEVERAGE OR ACCOMMODATION SERVICES, IN CLASS 36 (U.S. CLS. 100, 101 AND 102).

FOR: TRANSPORTATION AND TRAVEL SERVICES IN RELATION TO AIR, ROAD, RAIL AND SEA TRANSPORT, NAMELY, PRIORITY BOARDING FOR PASSENGERS, PRIORITY CHECK-IN SERVICES FOR PASSENGERS, PRIORITY CHECK-IN SERVICES FOR BAGGAGE, SEATING RESERVATION SERVICES AND BAGGAGE RESERVATION SERVICES; CHAUFFEUR SERVICES; PROVIDING DRIVER AND PARKING VALET SERVICES; PROVIDING VEHICLE PARKING FACILITIES; PROVISION OF TRANSPORTATION SERVICES AND TRAVEL ARRANGEMENT SERVICES IN RELATION TO AIR, ROAD, RAIL AND SEA TRANSPORT VIA REDEMPTION OF REWARDS FROM LOYALTY PROGRAMS OR INCENTIVE SCHEMES; TRANSPORT SERVICES AND TRAVEL ARRANGEMENT SERVICES IN RELATION TO AIR, ROAD, RAIL AND SEA TRANSPORT, WITH A LOYALTY PROGRAM OR INCENTIVE PROGRAM INVOLVING REWARDS, IN THE NATURE OF LOYALTY AWARD POINTS OR MILEAGE POINTS, IN CLASS 39 (U.S. CLS. 100 AND 105).



David J. Kyjars

Director of the United States Patent and Trademark Office

FOR: PROVISION OF ENTERTAINMENT, SPORTING AND CULTURAL ACTIVITIES IN THE NATURE OF MUSIC CONCERTS, EDUCATIONAL CONVENTIONS AND ATHLETIC COMPETITIONS VIA REDEMPTION OF REWARDS FROM LOYALTY PROGRAMS OR

Reg. No. 4,152,078 INCENTIVE SCHEMES; ENTERTAINMENT, SPORTING AND CULTURAL ACTIVITIES IN THE NATURE OF LIVE MUSIC CONCERTS, EDUCATIONAL CONVENTIONS AND ATHLETIC COMPETITIONS WITH A LOYALTY PROGRAM OR INCENTIVE PROGRAM INVOLVING REWARDS IN THE NATURE OF LOYALTY AWARD POINTS; TICKET RESERVATION AND BOOKING SERVICES FOR ENTERTAINMENT EVENTS AND PACKAGES, IN CLASS 41 (U.S. CLS. 100, 101 AND 107).

FOR: PROVISION OF FOOD, BEVERAGE OR TEMPORARY ACCOMMODATION SERVICES VIA REDEMPTION OF REWARDS FROM LOYALTY PROGRAMS OR INCENTIVE SCHEMES; PROVISION OF FOOD, BEVERAGE OR TEMPORARY ACCOMMODATION SERVICES FOR TRAVELLERS' RELAXATION, NAMELY, PASSENGER LOUNGE FACILITIES, VIA REDEMPTION OF REWARDS FROM LOYALTY PROGRAMS OR INCENTIVE SCHEMES; PROVISION OF FOOD, BEVERAGE AND TEMPORARY ACCOMMODATIONS, WITH A LOYALTY PROGRAM OR INCENTIVE PROGRAM INVOLVING REWARDS, IN THE NATURE OF LOYALTY AWARD POINTS, IN CLASS 43 (U.S. CLS. 100 AND 101).

PRIORITY CLAIMED UNDER SEC. 44(D) ON AUSTRALIA APPLICATION NO. 1174562, FILED 5-4-2007, REG. NO. 1174562, DATED 5-4-2007, EXPIRES 5-4-2017.

SER. NO. 77-240,719, FILED 7-27-2007.

STEVEN R. FINE, EXAMINING ATTORNEY

United States of America

United States Patent and Trademark Office

SOUTHERN IMPERIAL

Reg. No. 4,152,079

Registered June 5, 2012

Int. Cls.: 6, 16 and 20

TRADEMARK

PRINCIPAL REGISTER

SOUTHERN IMPERIAL, INC. (ILLINOIS CORPORATION)
1400 EDDY AVENUE
ROCKFORD, IL 61103

FOR: METAL SCANNING AND NON-SCANNING DISPLAY HOOKS, PEG HOOKS, HAMMER HOOKS, CLOCK HOOKS, SPACE HOOKS, J-HOOKS, BLADE HOOKS, BAR HOOKS, GRID WALL HOOKS, WATERFALL HOOKS, TUBE BAR DISPLAY HOOKS, SELF FACING HOOKS AND SECURITY HOOKS; METAL LABEL HOLDERS FOR SCANNING HOOKS, SHELF EDGE PRICING, AND DISPLAYS; METAL MODULAR AND CHROME SIGN HOLDERS; LARGE AND STANDARD FORMAT METAL SIGN CLIPS; METAL CLIP STRIPS AND CLIP STRIP HANGERS; DISPLAY FASTENERS; METAL WIRE AND CHAIN FOR USE AS HANGING BANNER HOLDERS; METAL CEILING CLIPS AND METAL EXTRUDED BANNER RAILS; METAL FASTENERS, NAMELY, INVENTORY CONTROL CLIPS; METAL DIE CUT, WIRE STRIP, AND EXTRUDED STRIP RETAILERS, NAMELY, METAL CLIPS, HANG TABS OR HOOKS FOR USE IN DISPLAYING MERCHANDISE IN A RETAIL ENVIRONMENT; METAL DIE CUT AND WIRE SHELF AND PRODUCT DIVIDERS; METAL INDICIA HANG TABS, IN CLASS 6 (U.S. CLS. 2, 12, 13, 14, 23, 25 AND 50).

FIRST USE 4-12-1962; IN COMMERCE 4-12-1962.

FOR: ADHESIVE LABELS; NON-ADHESIVE PRICE TAGS AND PRINTED PAPER SIGNS; PUSH PINS, IN CLASS 16 (U.S. CLS. 2, 5, 22, 23, 29, 37, 38 AND 50).

FIRST USE 4-12-1962; IN COMMERCE 4-12-1962.

FOR: NON-METAL DISPLAY HOOKS, SCANNING AND SINGLE STEM DISPLAY HOOKS; PLASTIC BACKS FOR DISPLAY HOOKS; NON-METAL LABEL HOLDERS FOR SCANNING HOOKS, SHELF EDGE PRICING, AND DISPLAYS; NON-METAL SIGN HOLDERS; LARGE AND STANDARD FORMAT NON-METAL SIGN CLIPS; NON-METAL CLIP STRIPS AND CLIP STRIP HANGERS; NON-METAL DISPLAY FASTENERS; NON-METAL FASTENERS, NAMELY, INVENTORY CONTROL CLIPS; PLASTIC DIE CUT, EXTRUDED, AND INJECTION MOLDED STRIP RETAILERS, NAMELY, PLASTIC CLIPS, HANG TABS OR HOOKS FOR USE IN DISPLAYING MERCHANDISE IN A RETAIL ENVIRONMENT; NON-METAL INJECTION MOLDED SHELF AND PRODUCT DIVIDERS; STOCK DISPLAY RACKS AND DISPLAY STANDS, INCLUDING SPINNER RACKS, LITERATURE HOLDERS, AND MAGAZINE DISPLAYS; MERCHANDISE DISPLAY RACKS; PLASTIC HANG TAGS; EXHIBITOR PLASTIC DISPLAY BANNERS, IN CLASS 20 (U.S. CLS. 2, 13, 22, 25, 32 AND 50).



David J. Kyjars

Director of the United States Patent and Trademark Office

Reg. No. 4,152,079 FIRST USE 4-12-1962; IN COMMERCE 4-12-1962.

THE MARK CONSISTS OF STANDARD CHARACTERS WITHOUT CLAIM TO ANY PARTICULAR FONT, STYLE, SIZE, OR COLOR.

SER. NO. 77-320,099, FILED 11-2-2007.

JOHN GARTNER, EXAMINING ATTORNEY

United States of America

United States Patent and Trademark Office

VEO

Reg. No. 4,152,080

Registered June 5, 2012

Int. Cls.: 1, 3 and 5

TRADEMARK

PRINCIPAL REGISTER

RECKITT & COLMAN (OVERSEAS) LIMITED (ENGLAND PRIVATE LIMITED COMPANY)
DANSOM LANE
HULL HU87DS, ENGLAND

FOR: WATER SOFTENERS, NAMELY, WATER SOFTENING CHEMICALS; DESCALING AGENTS, NOT FOR DOMESTIC USE; PROTECTIVE CHEMICAL PREPARATIONS FOR GLASSWARE, PORCELAIN AND EARTHENWARE, CROCKERY AND OTHER KITCHENWARE; CHEMICAL PREPARATIONS FOR THE PREVENTION OF TARNISHING OF NON-METAL KITCHENWARE AND GLASSWARE, IN CLASS 1 (U.S. CLS. 1, 5, 6, 10, 26 AND 46).

FOR: GENERAL PURPOSE CLEANING, POLISHING, BLEACHING, SCOURING AND ABRASIVE PREPARATIONS; DETERGENTS FOR LAUNDRY USE AND DISHWASHING; POLISHING PREPARATIONS FOR KITCHEN AND GLASSWARE; OVEN CLEANING PREPARATIONS; STOVE-TOP CLEANING PREPARATIONS; CLEANING PREPARATIONS FOR VITROCERAMIC AND KITCHEN SURFACES; GLASS AND METAL CLEANING PREPARATIONS; WINDOW CLEANING PREPARATIONS; SOAPS AND DETERGENTS; DECALCIFYING AND DESCALING PREPARATIONS FOR HOUSEHOLD PURPOSES; LAUNDRY ADDITIVES, NAMELY, LAUNDRY STARCH, LAUNDRY BLEACH, LAUNDRY PRE-SOAK AND FABRIC SOFTENERS; STAIN REMOVING PREPARATIONS; PERFUMING PREPARATIONS FOR THE ATMOSPHERE, NAMELY, ROOM FRAGRANCES; ESSENTIAL OILS; DISPOSABLE WIPES AND TISSUES IMPREGNATED WITH CLEANING PREPARATIONS FOR HOUSEHOLD USE; NON-MEDICATED TOILETRIES; ALL AFOREMENTIONED GOODS WITH OR WITHOUT A DISINFECTIVE COMPONENT, IN CLASS 3 (U.S. CLS. 1, 4, 6, 50, 51 AND 52).

FOR: AIR FRESHENING PREPARATIONS; AIR PURIFYING PREPARATIONS, NAMELY, AIR DEODORANT; PREPARATIONS FOR NEUTRALIZING ODORS IN TEXTILES, CARPETING AND IN THE AIR; ALL-PURPOSE DISINFECTANTS; DISINFECTANTS FOR HOUSEHOLD USE OR FOR HYGIENE OR SANITARY PURPOSES; ALL PURPOSE DISINFECTING PREPARATIONS, IN CLASS 5 (U.S. CLS. 6, 18, 44, 46, 51 AND 52).

THE MARK CONSISTS OF STANDARD CHARACTERS WITHOUT CLAIM TO ANY PARTICULAR FONT, STYLE, SIZE, OR COLOR.

PRIORITY CLAIMED UNDER SEC. 44(D) ON MALTA APPLICATION NO. 46727, FILED 7-18-2007.



David J. Kappas

Director of the United States Patent and Trademark Office

Reg. No. 4,152,080 PRIORITY CLAIMED UNDER SEC. 44(D) ON MALTA APPLICATION NO. 46726, FILED 7-18-2007.

PRIORITY CLAIMED UNDER SEC. 44(D) ON MALTA APPLICATION NO. 46725, FILED 7-18-2007.

OWNER OF EUROPEAN UNION REG. NO. 006247043, DATED 11-30-2009, EXPIRES 9-7-2017.

THE WORDING "VEO" HAS NO MEANING IN A FOREIGN LANGUAGE.

SER. NO. 77-354,337, FILED 12-18-2007.

YAT SYE, LEE, EXAMINING ATTORNEY

United States of America
United States Patent and Trademark Office

EPI

Reg. No. 4,152,081

Registered June 5, 2012

Int. Cls.: 17, 35, 40 and 42

TRADEMARK

SERVICE MARK

PRINCIPAL REGISTER

OSTERMAN & COMPANY, INC. (DELAWARE CORPORATION)
726 SOUTH MAIN STREET
CHESHIRE, CT 06410

FOR: POLYMER PELLETS, NAMELY, ENGINEERED COMPOUNDED POLYMER PELLETS, NAMELY, POLYCARBONATE, ABS (ACRYLONITROLE BUTADIENE STYRENE), PC/ABS (POLYCARBONATE ACRYLONITRILE BUTADIENE STYRENE), NYLON, POLYSTYRENE, PC/PET (POLYCARBONATE POLYETHYLENE TEREPHTHALATE), TPU (THERMOPLASTIC URETHANE), TPE (THERMOPLASTIC ELASTOMER) FOR USE IN THE MANUFACTURE OF A WIDE VARIETY OF GOODS, IN CLASS 17 (U.S. CLS. 1, 5, 12, 13, 35 AND 50).

FIRST USE 0-0-1987; IN COMMERCE 0-0-1988.

FOR: DISTRIBUTORSHIP SERVICES IN THE FIELD OF COMPOUNDED POLYMER PELLETS, IN CLASS 35 (U.S. CLS. 100, 101 AND 102).

FIRST USE 0-0-1987; IN COMMERCE 0-0-1988.

FOR: CUSTOM MANUFACTURE OF COMPOUNDED POLYMER PRODUCTS IN THE NATURE OF ENGINEERED COMPOUNDED POLYMER PELLETS, IN CLASS 40 (U.S. CLS. 100, 103 AND 106).

FIRST USE 0-0-1987; IN COMMERCE 0-0-1988.

FOR: ENGINEERING OF COMPOUNDED POLYMER PELLETS FOR OTHERS, IN CLASS 42 (U.S. CLS. 100 AND 101).

FIRST USE 0-0-1987; IN COMMERCE 0-0-1988.

THE MARK CONSISTS OF STANDARD CHARACTERS WITHOUT CLAIM TO ANY PARTICULAR FONT, STYLE, SIZE, OR COLOR.

SEC. 2(F).

SER. NO. 77-360,406, FILED 12-27-2007.

DAVID ELTON, EXAMINING ATTORNEY



David J. Kyros

Director of the United States Patent and Trademark Office

United States of America

United States Patent and Trademark Office

MEZZANOVE  CAPITAL

Reg. No. 4,152,082

Registered June 5, 2012

Int. Cls.: 35 and 36

SERVICE MARK

PRINCIPAL REGISTER

BI-INVEST HOLDINGS S.A. (LUXEMBOURG CORPORATION)
51 AVENUE J.F. KENNEDY
LUXEMBOURG, LUXEMBOURG L1855

FOR: BUSINESS ADVISORY SERVICES; BUSINESS MANAGEMENT; BUSINESS MANAGEMENT CONSULTING, INCLUDING MANAGEMENT BUYOUT ADVICE; BUSINESS ORGANIZATION CONSULTING; BUSINESS RESEARCH; BUSINESS APPRAISALS; BUSINESS PLANNING; BUSINESS INFORMATION SERVICES; ACQUISITION AND MERGER CONSULTATION; PERSONNEL RECRUITMENT AND MANAGEMENT, IN CLASS 35 (U.S. CLS. 100, 101 AND 102).

FOR: FINANCIAL ADVISORY AND CONSULTANCY SERVICES; FINANCIAL MANAGEMENT; MANAGEMENT OF A CAPITAL INVESTMENT FUND; PROVIDING FINANCIAL INFORMATION; FINANCIAL SERVICES IN THE FIELD OF MONEY LENDING; INVESTMENT CONSULTATION; INVESTMENT MANAGEMENT; FINANCIAL GUARANTEE AND SURETY; FUND RAISING FOR OTHERS FOR THE PURPOSE OF PURCHASING COMPANIES; INVESTMENT ADVISORY SERVICES RELATING TO VENTURE AND CORPORATE CAPITAL, IN CLASS 36 (U.S. CLS. 100, 101 AND 102).

OWNER OF LUXEMBOURG REG. NO. 004660783, DATED 11-10-2006, EXPIRES 10-19-2015.

OWNER OF U.S. REG. NOS. 3,242,501, 4,661,013 AND OTHERS.

NO CLAIM IS MADE TO THE EXCLUSIVE RIGHT TO USE "CAPITAL", APART FROM THE MARK AS SHOWN.

THE MARK CONSISTS OF THE LETTERS "MEZZANOVE" FOLLOWED BY THE TOP HALF OF A "9" OVER THE BOTTOM HALF OF A "9" FOLLOWED BY THE LETTERS "CAPITAL".

SER. NO. 77-368,264, FILED 1-10-2008.

IRA J. GOODSAY, EXAMINING ATTORNEY



David J. Kyros

Director of the United States Patent and Trademark Office

United States of America

United States Patent and Trademark Office

MEZZANOVE  MEZZANINE

Reg. No. 4,152,083

Registered June 5, 2012

Int. Cls.: 35 and 36

SERVICE MARK

PRINCIPAL REGISTER

BI-INVEST HOLDINGS S.A. (LUXEMBOURG CORPORATION)
51 AVENUE J.F. KENNEDY
LUXEMBOURG, LUXEMBOURG L1855

FOR: BUSINESS ADVISORY SERVICES; BUSINESS MANAGEMENT; BUSINESS MANAGEMENT CONSULTING, INCLUDING MANAGEMENT BUYOUT ADVICE; BUSINESS ORGANIZATION CONSULTING; BUSINESS RESEARCH; BUSINESS APPRAISALS; BUSINESS PLANNING; BUSINESS INFORMATION SERVICES; ACQUISITION AND MERGER CONSULTATION; PERSONNEL RECRUITMENT AND MANAGEMENT, IN CLASS 35 (U.S. CLS. 100, 101 AND 102).

FOR: FINANCIAL ADVISORY AND CONSULTANCY SERVICES; FINANCIAL MANAGEMENT; MANAGEMENT OF A CAPITAL INVESTMENT FUND; PROVIDING FINANCIAL INFORMATION; FINANCIAL SERVICES IN THE FIELD OF MONEY LENDING; INVESTMENT CONSULTATION; INVESTMENT MANAGEMENT; FINANCIAL GUARANTEE AND SURETY; FUND RAISING FOR OTHERS FOR THE PURPOSE OF PURCHASING COMPANIES; INVESTMENT ADVISORY SERVICES RELATING TO VENTURE AND CORPORATE CAPITAL, IN CLASS 36 (U.S. CLS. 100, 101 AND 102).

OWNER OF LUXEMBOURG REG. NO. 004661013, DATED 11-10-2006, EXPIRES 10-19-2015.

OWNER OF U.S. REG. NOS. 3,242,501, 4,661,013 AND OTHERS.

NO CLAIM IS MADE TO THE EXCLUSIVE RIGHT TO USE "MEZZANINE", APART FROM THE MARK AS SHOWN.

THE MARK CONSISTS OF THE LETTERS "MEZZANOVE" FOLLOWED BY THE TOP HALF OF A "9" OVER THE BOTTOM HALF OF A "9" FOLLOWED BY THE LETTERS "MEZZANINE".

SER. NO. 77-368,267, FILED 1-10-2008.

IRA J. GOODSAY, EXAMINING ATTORNEY



David J. Kyros

Director of the United States Patent and Trademark Office

United States of America

United States Patent and Trademark Office

FLY KINGFISHER

Reg. No. 4,152,084

Registered June 5, 2012

Int. Cl.: 39

SERVICE MARK

PRINCIPAL REGISTER

KINGFISHER AIRLINES LIMITED (INDIA CORPORATION)
UB CITY, 24 VITTAL MALLYA ROAD
UB TOWER, LEVEL 12
BANGALORE 560 001, INDIA

FOR: AIR TRANSPORT SERVICES; AIRLINE TRANSPORTATION SERVICES, IN CLASS 39 (U.S. CLS. 100 AND 105).

THE MARK CONSISTS OF STANDARD CHARACTERS WITHOUT CLAIM TO ANY PARTICULAR FONT, STYLE, SIZE, OR COLOR.

OWNER OF INDIA REG. NO. 1519889, DATED 1-10-2007, EXPIRES 1-10-2017.

NO CLAIM IS MADE TO THE EXCLUSIVE RIGHT TO USE "FLY", APART FROM THE MARK AS SHOWN.

SER. NO. 77-385,713, FILED 1-31-2008.

BARBARA GAYNOR, EXAMINING ATTORNEY



David J. Kyffers

Director of the United States Patent and Trademark Office

United States of America

United States Patent and Trademark Office

WATERPRESS

Reg. No. 4,152,085

Registered June 5, 2012

Int. Cls.: 11 and 21

TRADEMARK

PRINCIPAL REGISTER

PATRICIA KIM STURGESS (CANADA INDIVIDUAL)
36 PINETREE DRIVE SW
CALGARY, CANADA T3Z3KA

FOR: WATER PURIFICATION FILTER SYSTEMS, NAMELY, PORTABLE WATER PURIFIERS, WATER BOTTLES WITH PORTABLE WATER PURIFIERS, IN CLASS 11 (U.S. CLS. 13, 21, 23, 31 AND 34).

FOR: PORTABLE WATER CARRIERS AND PLASTIC, ALUMINUM AND STAINLESS STEEL WATER BOTTLES SOLD EMPTY, IN CLASS 21 (U.S. CLS. 2, 13, 23, 29, 30, 33, 40 AND 50).

THE MARK CONSISTS OF STANDARD CHARACTERS WITHOUT CLAIM TO ANY PARTICULAR FONT, STYLE, SIZE, OR COLOR.

PRIORITY CLAIMED UNDER SEC. 44(D) ON CANADA APPLICATION NO. 1358766, FILED 8-7-2007, REG. NO. TMA800063, DATED 6-16-2011, EXPIRES 6-16-2026.

SER. NO. 77-390,367, FILED 2-6-2008.

INGA ERVIN, EXAMINING ATTORNEY



David J. Kyros

Director of the United States Patent and Trademark Office

United States of America

United States Patent and Trademark Office



Reg. No. 4,152,086

Registered June 5, 2012

Int. Cl.: 35

SIGNET ARMORLITE EUROPE LIMITED (UNITED KINGDOM PUBLIC LIMITED COMPANY (PLC))
OLYMPUS PARK
NO. 1, APOLLO
GLOUCESTER, UNITED KINGDOM GL24NF

SERVICE MARK

PRINCIPAL REGISTER

FOR: RETAIL STORE AND ON-LINE RETAIL STORE SERVICES FEATURING OPTICAL APPARATUS AND INSTRUMENTS, SPECTACLES, SUNGLASSES, CONTACT LENSES, RELATED ACCESSORIES AND PREPARATIONS, HEARING AIDS, HEARING APPARATUS, HEARING INSTRUMENTS, RELATED ACCESSORIES AND PREPARATIONS; MAIL ORDER SERVICES FEATURING OPTICAL APPARATUS AND INSTRUMENTS, SPECTACLES, SUNGLASSES, CONTACT LENSES, RELATED ACCESSORIES AND PREPARATIONS, HEARING AIDS, HEARING APPARATUS, HEARING INSTRUMENTS, RELATED ACCESSORIES AND PREPARATIONS; ONLINE ORDERING SERVICES FEATURING OPTICAL APPARATUS AND INSTRUMENTS, SPECTACLES, SUNGLASSES, CONTACT LENSES, RELATED ACCESSORIES AND PREPARATIONS, HEARING AIDS, HEARING APPARATUS, HEARING INSTRUMENTS, RELATED ACCESSORIES AND PREPARATIONS; OFFICE FUNCTIONS IN THE FIELD OF OPTICAL APPARATUS AND INSTRUMENT, SPECTACLES, SUNGLASSES, CONTACT LENSES, RELATED ACCESSORIES AND PREPARATIONS, HEARING AIDS, HEARING APPARATUS, HEARING INSTRUMENTS, RELATED ACCESSORIES AND PREPARATIONS; BUSINESS MANAGEMENT IN THE FIELD OF OPTICAL APPARATUS AND INSTRUMENT, SPECTACLES, SUNGLASSES, CONTACT LENSES, RELATED ACCESSORIES AND PREPARATIONS, HEARING AIDS, HEARING APPARATUS, HEARING INSTRUMENTS, RELATED ACCESSORIES AND PREPARATIONS; BUSINESS DEVELOPMENT, NAMELY, PROVIDING START-UP SUPPORT FOR BUSINESSES OF OTHERS IN THE FIELD OF OPTICAL APPARATUS AND INSTRUMENT, SPECTACLES, SUNGLASSES, CONTACT LENSES, RELATED ACCESSORIES AND PREPARATIONS, HEARING AIDS, HEARING APPARATUS, HEARING INSTRUMENTS, RELATED ACCESSORIES AND PREPARATIONS; BUSINESS ADVICE AND ADMINISTRATION SERVICES IN THE FIELD OF OPTICAL APPARATUS AND INSTRUMENT, SPECTACLES, SUNGLASSES, CONTACT LENSES, RELATED ACCESSORIES AND PREPARATIONS, HEARING AIDS, HEARING APPARATUS, HEARING INSTRUMENTS, RELATED ACCESSORIES AND PREPARATIONS; BUSINESS PLANNING IN THE FIELD OF OPTICAL APPARATUS AND INSTRUMENT, SPECTACLES, SUNGLASSES, CONTACT LENSES, RELATED ACCESSORIES AND PREPARATIONS, HEARING AIDS, HEARING APPARATUS, HEARING INSTRUMENTS, RELATED ACCESSORIES AND PREPARATIONS; OPERATIONAL BUSINESS SERVICES IN THE FIELD OF OPTICAL APPARATUS AND INSTRUMENT, SPECTACLES,

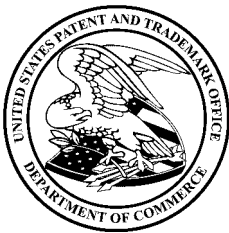

David J. Kybas

Director of the United States Patent and Trademark Office

Reg. No. 4,152,086 SUNGLASSES, CONTACT LENSES, RELATED ACCESSORIES AND PREPARATIONS, HEARING AIDS, HEARING APPARATUS, HEARING INSTRUMENTS, RELATED ACCESSORIES AND PREPARATIONS; ADVERTISING, PROMOTIONAL AND MARKETING SERVICES IN THE FIELD OF OPTICAL APPARATUS AND INSTRUMENT, SPECTACLES, SUNGLASSES, CONTACT LENSES, RELATED ACCESSORIES AND PREPARATIONS, HEARING AIDS, HEARING APPARATUS, HEARING INSTRUMENTS, RELATED ACCESSORIES AND PREPARATIONS; PROCUREMENT OF GOODS, NAMELY, OPTICAL APPARATUS AND INSTRUMENTS, SPECTACLES, SUNGLASSES, CONTACT LENSES, RELATED ACCESSORIES AND PREPARATIONS, HEARING AIDS, HEARING APPARATUS, HEARING INSTRUMENTS, RELATED ACCESSORIES AND PREPARATIONS; PROFESSIONAL MANAGEMENT AND PERSONNEL RECRUITMENT SERVICES; ACCOUNT AUDITING SERVICES, ALL OF THE AFORESAID SERVICES FOR OPTICIANS, PROFESSIONALS FOR THE TESTING OF HEARING AND OTHER HEALTHCARE PROFESSIONALS; THE PROVISION OF INFORMATION AND ADVISORY SERVICES, ALL RELATING TO THE AFORESAID SERVICES, IN CLASS 35 (U.S. CLS. 100, 101 AND 102).

OWNER OF ERPN CMNTY TM OFC REG. NO. 006054035, DATED 2-4-2008, EXPIRES 6-29-2017.

THE COLOR(S) ORANGE IS/ARE CLAIMED AS A FEATURE OF THE MARK.

THE MARK CONSISTS OF AN ORANGE DESIGN.

SER. NO. 77-396,647, FILED 2-14-2008.

ANN E. SAPPENFIELD, EXAMINING ATTORNEY

United States of America

United States Patent and Trademark Office

MEDICYTE

Reg. No. 4,152,087

Registered June 5, 2012

**Int. Cls.: 1, 5, 10, 35, 42
and 44**

TRADEMARK

SERVICE MARK

PRINCIPAL REGISTER

MEDICYTE GMBH (FED REP GERMANY GESELLSCHAFT MIT BESCHRÄNKTER
HAFTUNG (GMBH))
IM NEUENHEIMER FELD 581
69120 HEIDELBERG, FED REP GERMANY

FOR: PROTEINS, NUCLEIC ACIDS, GENES, AND CELLS FOR MEDICAL RESEARCH
PURPOSES, IN CLASS 1 (U.S. CLS. 1, 5, 6, 10, 26 AND 46).

FOR: PHARMACEUTICAL AND VETERINARY PRODUCTS FOR THE TREATMENT OF
CARDIOVASCULAR DISEASE, STROKE, CANCER, TUMOR, NAMELY, BY THE WAY OF
CELL AND GENE THERAPY; DRUGS FOR THE TREATMENT OF CARDIOVASCULAR
DISEASE, STROKE, CANCER, TUMOR, NAMELY, BY THE WAY OF CELL AND GENE
THERAPY IN HUMANS; PROTEIN SUPPLEMENTS; PROTEINS, NUCLEIC ACIDS, GENES,
AND CELLS FOR MEDICAL DIAGNOSTICS AND TREATMENT; MEDICAL, BIOLOGICAL,
CHEMICAL, BIOTECHNOLOGICAL, AND GENE-TECHNOLOGICAL PRODUCTS AND
PREPARATIONS FOR MEDICAL USE FOR THE TREATMENT OF CARDIOVASCULAR
DISEASE, STROKE, CANCER, TUMOR, NAMELY, BY THE WAY OF CELL AND GENE
THERAPY; DIAGNOSTIC PREPARATIONS FOR MEDICAL AND VETERINARY USE, IN
CLASS 5 (U.S. CLS. 6, 18, 44, 46, 51 AND 52).

FOR: DIAGNOSTIC DEVICES FOR MEDICAL AND VETERINARY USE, NAMELY, FOR
DIAGNOSING CARDIOVASCULAR DISEASE, STROKE, CANCER, TUMORS, DISEASES
OF THE PANCREAS, KIDNEY AND LIVER AND NEURODEGENERATIVE DISEASES, IN
CLASS 10 (U.S. CLS. 26, 39 AND 44).

FOR: ADMINISTRATIVE PROCESSING OF PURCHASE ORDERS IN THE FIELD OF
CHEMISTRY, BIOTECHNOLOGY, DIAGNOSTICS, AND GENE-THERAPY; ADMINISTRATIVE
PROCESSING OF PURCHASE ORDERS IN THE FIELD OF PHARMACEUTICALS AND
MEDICINES, MEDICINES FOR HUMANS, VETERINARY MEDICINES, AND GENE-THER-
APY; BUSINESS CONSULTATION SERVICES IN THE FIELD OF MEDICINE, ALL SUCH
SERVICES LIMITED TO PRIMARY CELL PRODUCTION TECHNOLOGY, IN CLASS 35
(U.S. CLS. 100, 101 AND 102).

FOR: SCIENTIFIC SERVICES FOR PHARMACEUTICAL BIOTECHNOLOGICAL, DIAGNOSTIC,
ANALYTICAL, MEDICAL, OR GENE-TECHNOLOGICAL LABORATORIES, INDUSTRIAL
FACILITIES, RESEARCH AND DEVELOPMENT FACILITIES IN THE FIELD OF CARDI-
OVASCULAR DISEASE, STROKE, CANCER, TUMOR, NAMELY, BY THE WAY OF CELL



David J. Kyjars

Director of the United States Patent and Trademark Office

Reg. No. 4,152,087 AND GENE THERAPY; SCIENTIFIC CONSULTING SERVICES IN THE FIELD OF CHEMISTRY, BIOTECHNOLOGY, DIAGNOSTICS, AND GENE-TECHNOLOGY, NAMELY, CONSULTING SERVICES PROVIDED VIA THE INTERNET; MISSION-ORIENTED RESEARCH IN THE FIELD OF CHEMISTRY, PHARMACY, BIOTECHNOLOGY, DIAGNOSTICS, GENE-TECHNOLOGY, AND MEDICINE; SERVICES OF A CHEMICAL LABORATORY; CONDUCTING OF CHEMICAL EXAMINATIONS; SERVICES OF A MEDICAL LABORATORY; MEDICAL LABORATORY SERVICES IN THE NATURE OF CONDUCTING MEDICAL AND CLINICAL TRIALS, IN CLASS 42 (U.S. CLS. 100 AND 101).

FOR: MEDICAL CONSULTATION; CONSULTING SERVICES IN THE FIELD OF MEDICINE, NAMELY, HUMAN MEDICINE, VETERINARY MEDICINE, PHARMACY, AND GENE-THERAPY IN THE NATURE OF CELL THERAPY; MEDICAL CONSULTATION SERVICES PROVIDED VIA THE INTERNET; MEDICAL CARE; MEDICAL INFORMATION SERVICES, NAMELY, LABORATORY SERVICES THAT REPORT RESULTS DIRECTLY TO THE PATIENT, IN CLASS 44 (U.S. CLS. 100 AND 101).

THE MARK CONSISTS OF STANDARD CHARACTERS WITHOUT CLAIM TO ANY PARTICULAR FONT, STYLE, SIZE, OR COLOR.

PRIORITY CLAIMED UNDER SEC. 44(D) ON FED REP GERMANY APPLICATION NO. 30760952.9, FILED 9-17-2007, REG. NO. 30760952, DATED 3-4-2008, EXPIRES 9-30-2017.

SER. NO. 77-423,742, FILED 3-17-2008.

ANDREA HACK, EXAMINING ATTORNEY

United States of America

United States Patent and Trademark Office



Reg. No. 4,152,088

Registered June 5, 2012

Int. Cls.: 36, 37 and 39

SERVICE MARK

PRINCIPAL REGISTER

TRAFIGURA BEHEER BV (NETHERLANDS CORPORATION)
GUSTAV MAHLERPLEIN 102, ITO TOWER
AMSTERDAM, NETHERLANDS 1082MA

FOR: FINANCIAL SERVICES, NAMELY, INVESTMENT OF FUNDS FOR OTHERS IN COMMODITIES AND TRADING IN COMMODITIES FOR OTHERS, ALL RELATING TO THE GENERATION, SUPPLY, TRADING, DISTRIBUTION AND TRANSMISSION OF ELECTRICITY, GAS, OIL, CHEMICALS AND METALS; COMMODITY TRADING FOR OTHERS; FINANCING OF PROJECTS RELATING TO THE GENERATION, SUPPLY, TRADING, DISTRIBUTION AND TRANSMISSION OF ELECTRICITY, GAS, OIL, CHEMICALS AND METALS; PROVIDING LOAN FINANCING; PROVIDING CREDIT AND LOAN SERVICES TO THIRD PARTIES, IN CLASS 36 (U.S. CLS. 100, 101 AND 102).

FOR: MACHINERY INSTALLATION FOR USE IN THE STORAGE, DISTRIBUTION AND TRANSPORTATION OF ELECTRICITY, GAS, OIL, CHEMICALS, AND METALS FOR OTHERS; INSTALLATION OF METAL CONDUITS, METAL PIPEWORK AND MACHINERY TO PERMIT THE FLOW OF ELECTRICITY, GAS, OIL, CHEMICALS AND METALS INTO A SHIPYARD, FACTORY, OR SIMILAR FACILITIES, IN CLASS 37 (U.S. CLS. 100, 103 AND 106).

FOR: STORAGE OF ELECTRICITY, GAS, OIL, CHEMICALS AND METALS; DISTRIBUTION SERVICES, NAMELY, DELIVERY OF ELECTRICITY, GAS, OIL, CHEMICALS AND METALS VIA AIR, RAIL, ROAD, BOAT AND PIPELINE; TRANSPORTATION AND DELIVERY SERVICES BY AIR, ROAD, RAIL AND SEA FEATURING ELECTRICITY, GAS, OIL, CHEMICALS AND METALS; PROVIDING ADVICE AND INFORMATION IN THE FIELDS OF STORAGE, TRANSPORTATION AND DELIVERY OF ELECTRICITY, GAS, OIL, CHEMICALS AND METALS; CONSULTING SERVICES IN THE FIELDS OF STORAGE, TRANSPORTATION AND DELIVERY OF ELECTRICITY, GAS, OIL, CHEMICALS AND METALS, IN CLASS 39 (U.S. CLS. 100 AND 105).



PRIORITY CLAIMED UNDER SEC. 44(D) ON ERPN CMNTY TM OFC APPLICATION NO. 006772181, FILED 3-21-2008, REG. NO. 006772181, DATED 10-20-2009, EXPIRES 3-21-2018.

SER. NO. 77-453,449, FILED 4-21-2008.

DAWN HAN, EXAMINING ATTORNEY

David J. Kappas

Director of the United States Patent and Trademark Office

United States of America

United States Patent and Trademark Office

MICRON
CUTTERS

Reg. No. 4,152,089

Registered June 5, 2012

Int. Cl.: 7

TRADEMARK

PRINCIPAL REGISTER

AKIYAMA INTERNATIONAL CORPORATION (USA) (DELAWARE CORPORATION)
UNIT B
13311 E. 166TH STREET
CERRITOS, CA 90703

FOR: PAPER CUTTING MACHINES, IN CLASS 7 (U.S. CLS. 13, 19, 21, 23, 31, 34 AND 35).

FIRST USE 9-1-2007; IN COMMERCE 9-1-2007.

NO CLAIM IS MADE TO THE EXCLUSIVE RIGHT TO USE "CUTTERS", APART FROM THE MARK AS SHOWN.

THE COLOR(S) RED, BLACK AND WHITE IS/ARE CLAIMED AS A FEATURE OF THE MARK.

THE MARK CONSISTS OF BLACK STYLIZED WORDING "MICRON" CONTAINING A RED TRIANGULAR "DOT" OVER THE LETTER "I" WITH THE WORD "CUTTERS" APPEARING BELOW IN WHITE LETTERING WITHIN A GRADIENT BAR OF RED.

SER. NO. 77-456,540, FILED 4-24-2008.

ERIN FALK, EXAMINING ATTORNEY



David J. Kyffers

Director of the United States Patent and Trademark Office

United States of America

United States Patent and Trademark Office



pal fashions

naari

naari

embroidery pyaari. sundar naari

Reg. No. 4,152,090

Registered June 5, 2012

Int. Cl.: 25

TRADEMARK

PRINCIPAL REGISTER

ACE IMPEX (INDIA PARTNERSHIP)
SAKI NAKA
104 NEW TEJPAL PREMISES ANDHERI KURLA RD
ANDHERI (EAST), MUMBAI, INDIA 400072

FOR: EMBROIDERED AND NON-EMBROIDERED CLOTHING FOR MEN, WOMEN AND CHILDREN, NAMELY, DRESSES, SHIRTS, T-SHIRTS, INDIAN ETHNIC WEAR NAMELY KURTAS, PAJAMAS, SARIS, TOPS, SKIRTS, GHAGRA, CHOLIS, ODHANIS, SHERWANIS, JODHPURIS, SUITS, WEDDING DRESSES, CEREMONIAL DRESSES; SALWAR KAMEEZ AND CHURIDAR, NAMELY, A WOMEN'S DRESS-LIKE GARMENT, BLOUSES; LINGERIE, BRACES FOR CLOTHING, NAMELY, SUSPENDERS, BRASSIERES, COATS, DRESSING GOWNS, FROCKS, FUR CLOTHINGS, NAMELY, FUR COATS, FUR JACKETS, FUR CAPS, FUR STOLES; SLIPS, SMOCKS, SOCKS, STOCKINGS, TROUSERS, TIGHTS, TROUSER STRAPS, CHINO PANTS, SHORTS, JUMPERS IN THE NATURE OF SHIRT FRONTS, KNITWEAR, NAMELY, KNIT SHIRTS AND CAPS, OVERCOATS, PANTS, PETTICOATS, BATH ROBES, BATHING CAPS, BATHING SUITS, BELTS, PULLOVERS, SCARVES, SHAWLS, SWEATERS, SWIMSUITS, BATHING TRUNKS, TURBANS, UNDERCLOTHING, NAMELY, UNDERPANTS, UNDERWEAR, LADIES PANTIES, UNIFORMS, VEILS, VESTS, WAISTCOATS, WATERPROOF CLOTHING, NAMELY, WATERPROOF JACKETS AND PANTS, FOOTWEAR INCLUDING BOOTS; SHOES, SANDALS AND SLIPPERS, HOSIERY, TIES, APRONS, GLOVES, IN CLASS 25 (U.S. CLS. 22 AND 39).

OWNER OF INDIA REG. NO. 1547142, DATED 4-5-2007, EXPIRES 4-5-2017.

NO CLAIM IS MADE TO THE EXCLUSIVE RIGHT TO USE "FASHIONS" "NAARI" AND "EMBROIDERY", APART FROM THE MARK AS SHOWN.

THE ENGLISH TRANSLATION OF "NAARI"; "PYAARI" AND "SUNDAR" IN THE MARK IS WOMAN; LOVABLE AND BEAUTIFUL.

SER. NO. 77-513,739, FILED 7-2-2008.

KATHRYN COWARD, EXAMINING ATTORNEY



David J. Kyffers

Director of the United States Patent and Trademark Office

United States of America

United States Patent and Trademark Office



Reg. No. 4,152,091

Registered June 5, 2012

**Int. Cls.: 4, 6, 9, 11, 20,
21 and 28**

TRADEMARK

PRINCIPAL REGISTER

GIFTCRAFT LTD. (CANADA CORPORATION)
8550 AIRPORT ROAD
BRAMPTON, CANADA L6T5A3

FOR: CANDLES, IN CLASS 4 (U.S. CLS. 1, 6 AND 15).

FOR: METAL PLAQUES; METAL TRINKET BOXES; METAL KEEPSAKE BOXES; NON-LUMINOUS AND NON-MECHANICAL METAL DECORATIVE SIGNS; METAL KEY CHAINS, IN CLASS 6 (U.S. CLS. 2, 12, 13, 14, 23, 25 AND 50).

FOR: DECORATIVE MAGNETS; MECHANICAL DECORATIVE SIGNS, LUMINOUS DECORATIVE SIGNS, IN CLASS 9 (U.S. CLS. 21, 23, 26, 36 AND 38).

FOR: DIFFUSERS FOR SCENTED OILS, IN CLASS 11 (U.S. CLS. 13, 21, 23, 31 AND 34).

FOR: PLAQUES MADE OF BONE, IVORY, PLASTIC, WAX, OR WOOD; NON-METAL AND NON-LEATHER KEY CHAINS; RESIN ORNAMENTS, IN CLASS 20 (U.S. CLS. 2, 13, 22, 25, 32 AND 50).

FOR: PLAQUES OF CHINA, CRYSTAL, EARTHENWARE, GLASS, PORCELAIN, OR TERRACOTTA; COASTERS NOT OF PAPER AND NOT BEING TABLE LINEN; VASES; DECORATIVE PLATES; GLASS ORNAMENTS; GLASS DECORATIVE PLAQUES, GLASS WALL PLAQUES, AND GLASS COMMEMORATIVE PLAQUES, ALL FOR DECORATIVE PURPOSES ON A WALL FOR OR ON A STAND; CANDLE HOLDERS NOT OF PRECIOUS METAL, IN CLASS 21 (U.S. CLS. 2, 13, 23, 29, 30, 33, 40 AND 50).

FOR: CHRISTMAS TREE ORNAMENTS, IN CLASS 28 (U.S. CLS. 22, 23, 38 AND 50).

PRIORITY CLAIMED UNDER SEC. 44(D) ON CANADA APPLICATION NO. 1,388,633, FILED 3-25-2008, REG. NO. TMA809,492, DATED 10-19-2011, EXPIRES 10-19-2026.

NO CLAIM IS MADE TO THE EXCLUSIVE RIGHT TO USE "BOUTIQUE", APART FROM THE MARK AS SHOWN.

THE MARK CONSISTS OF THE STYLIZED WORDS "BELLA" AND "BOUTIQUE" WITH A STYLIZED FLOURISH ABOVE THE WORD "BELLA".



David J. Kappas

Director of the United States Patent and Trademark Office

Reg. No. 4,152,091 THE ENGLISH TRANSLATION OF THE WORD "BELLA" IN THE MARK IS "BEAUTIFUL".

SER. NO. 77-515,603, FILED 7-7-2008.

JASON BLAIR, EXAMINING ATTORNEY

United States of America

United States Patent and Trademark Office



Reg. No. 4,152,092

Registered June 5, 2012

Int. Cls.: 37 and 40

SERVICE MARK

PRINCIPAL REGISTER

SAMSUNG ELECTRONICS CO., LTD. (REPUBLIC OF KOREA CORPORATION)
416, MAETAN-DONG, YEONGTONG-GU
SUWON-SI, GYEONGGI-DO, REPUBLIC OF KOREA

FOR: COLLECTION AND DISPOSAL OF WASTE TONER CARTRIDGES; COLLECTION AND DISPOSAL OF WASTE INK CARTRIDGES FOR PRINTERS; REFILLING OF TONER CARTRIDGES; REFILLING OF INK CARTRIDGES FOR PRINTERS, IN CLASS 37 (U.S. CLS. 100, 103 AND 106).

FOR: RECYCLING OF TONER CARTRIDGE; RECYCLING OF INK CARTRIDGES FOR PRINTERS, IN CLASS 40 (U.S. CLS. 100, 103 AND 106).

PRIORITY CLAIMED UNDER SEC. 44(D) ON REPUBLIC OF KOREA APPLICATION NO. 2008-0020054, FILED 7-22-2008, REG. NO. 0190054, DATED 9-22-2009, EXPIRES 9-22-2019.

THE COLOR(S) GREEN, WHITE, AND GREY IS/ARE CLAIMED AS A FEATURE OF THE MARK.

NO CLAIM IS MADE TO THE EXCLUSIVE RIGHT TO USE "PROGRAMME", APART FROM THE MARK AS SHOWN.

THE MARK CONSISTS OF A WHITE AND GREY RING SHAPED LIKE AN ARROW WITH THE WORDS "S.T.A.R. PROGRAMME" IN GREEN AROUND A GREEN CIRCLE WITH A WHITE LEAF.

SER. NO. 77-529,819, FILED 7-23-2008.

GIANCARLO CASTRO, EXAMINING ATTORNEY



David J. Kyjars

Director of the United States Patent and Trademark Office

United States of America

United States Patent and Trademark Office

WACHOVIA TRADEWORKS

Reg. No. 4,152,093

WELLS FARGO & COMPANY (DELAWARE CORPORATION)
420 MONTGOMERY STREET
SAN FRANCISCO, CA 94163

Registered June 5, 2012

Int. Cl.: 36

FOR: FINANCIAL TRANSACTION SERVICES, NAMELY, PROCESSING INTERNATIONAL TRADE TRANSACTIONS VIA AN ON-LINE COMPUTER WEBSITE, IN CLASS 36 (U.S. CLS. 100, 101 AND 102).

SERVICE MARK

FIRST USE 2-13-2008; IN COMMERCE 2-13-2008.

PRINCIPAL REGISTER

THE MARK CONSISTS OF STANDARD CHARACTERS WITHOUT CLAIM TO ANY PARTICULAR FONT, STYLE, SIZE, OR COLOR.

SER. NO. 77-567,901, FILED 9-11-2008.

JACQUELINE A. LAVINE, EXAMINING ATTORNEY



David J. Kyjars

Director of the United States Patent and Trademark Office

United States of America

United States Patent and Trademark Office

MINK

Reg. No. 4,152,094

Registered June 5, 2012

Int. Cls.: 30 and 43

TRADEMARK

SERVICE MARK

PRINCIPAL REGISTER

MINK CHOCOLATES INC. (CANADA CORPORATION)
357 EAST 44TH AVENUE
VANCOUVER, B.C., CANADA V5W1W1

FOR: (BASED ON USE IN COMMERCE)(BASED ON 44(E)) CHOCOLATE, CANDY, CHOCOLATE TRUFFLES, AND CHOCOLATE COVERED FRUIT, IN CLASS 30 (U.S. CL. 46).

FIRST USE 3-19-2007; IN COMMERCE 3-19-2007.

FOR: (BASED ON 44(E)) COFFEE BAR SERVICES, NAMELY, COFFEE SHOPS SERVING NON-ALCOHOLIC BEVERAGES WHICH ARE PRIMARILY COFFEE OR CHOCOLATE BASED, IN CLASS 43 (U.S. CLS. 100 AND 101).

THE MARK CONSISTS OF STANDARD CHARACTERS WITHOUT CLAIM TO ANY PARTICULAR FONT, STYLE, SIZE, OR COLOR.

PRIORITY CLAIMED UNDER SEC. 44(D) ON CANADA APPLICATION NO. 1387062, FILED 3-12-2008, REG. NO. TMA745449, DATED 8-14-2009, EXPIRES 8-14-2024.

SER. NO. 77-568,713, FILED 9-12-2008.

MICHAEL GAAFAR, EXAMINING ATTORNEY



David J. Kybas

Director of the United States Patent and Trademark Office

United States of America

United States Patent and Trademark Office

LIVE LARGE FOR LESS

Reg. No. 4,152,095

Registered June 5, 2012

Int. Cl.: 41

SERVICE MARK

PRINCIPAL REGISTER

RADIO SHOPPING SHOW, INC. (DELAWARE CORPORATION)
14 DOUGLAS AVENUE
ELGIN, IL 60120

FOR: ENTERTAINMENT SERVICES, NAMELY, AN ONGOING RADIO PROGRAM IN THE FIELD OF SHOPPING AND PRODUCT SALES FEATURING AT-HOME DISCOUNT SHOPPING FOR A WIDE VARIETY OF GOODS, IN CLASS 41 (U.S. CLS. 100, 101 AND 107).

FIRST USE 8-19-2008; IN COMMERCE 8-19-2008.

THE MARK CONSISTS OF STANDARD CHARACTERS WITHOUT CLAIM TO ANY PARTICULAR FONT, STYLE, SIZE, OR COLOR.

SER. NO. 77-568,778, FILED 9-12-2008.

TASNEEM HUSSAIN, EXAMINING ATTORNEY



David J. Kyffers

Director of the United States Patent and Trademark Office

United States of America

United States Patent and Trademark Office



Reg. No. 4,152,096

Registered June 5, 2012

Int. Cl.: 42

SERVICE MARK

PRINCIPAL REGISTER

ZING TECHNOLOGIES, LLC (INDIANA LIMITED LIABILITY COMPANY)
14055 SPRINGMILL PONDS CIRCLE
CARMEL, IN 46032

FOR: INFORMATION TECHNOLOGY CONSULTATION SERVICES, IN CLASS 42 (U.S. CLS. 100 AND 101).

FIRST USE 1-1-2008; IN COMMERCE 1-1-2008.

NO CLAIM IS MADE TO THE EXCLUSIVE RIGHT TO USE "TECHNOLOGIES", APART FROM THE MARK AS SHOWN.

THE STIPPLING IS FOR SHADING PURPOSES ONLY.

THE MARK CONSISTS OF THE CUSTOMIZED TEXT "ZING TECHNOLOGIES" WITH A STYLIZED SWOOSH.

SER. NO. 77-570,481, FILED 9-15-2008.

CAROL SPILS, EXAMINING ATTORNEY



David J. Kyffers

Director of the United States Patent and Trademark Office

United States of America

United States Patent and Trademark Office

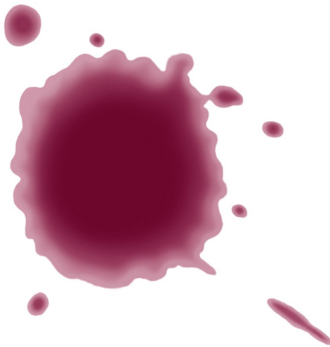

Reg. No. 4,152,097

Registered June 5, 2012

Int. Cl.: 33

TRADEMARK

PRINCIPAL REGISTER

PEARL FAMILY VINEYARDS INC. (CANADA CORPORATION), DBA PEARLMORISSETTE
SUITE 200
145 DAVENPORT ROAD
CONCORD, ONTARIO, CANADA M5R1J1

FOR: WINES, IN CLASS 33 (U.S. CLS. 47 AND 49).

OWNER OF CANADA REG. NO. 767093, DATED 5-18-2010, EXPIRES 5-17-2025.

THE COLOR(S) BURGUNDY IS/ARE CLAIMED AS A FEATURE OF THE MARK.

THE MARK CONSISTS OF A BURGUNDY WINE BLOT DESIGN.

SER. NO. 77-571,972, FILED 9-17-2008.

SUSAN RICHARDS, EXAMINING ATTORNEY



David J. Kybas

Director of the United States Patent and Trademark Office

United States of America

United States Patent and Trademark Office



Reg. No. 4,152,098

Registered June 5, 2012

Int. Cls.: 35 and 43

SERVICE MARK

PRINCIPAL REGISTER

SARAVANA BHAVAN HOLDINGS LIMITED (UNITED ARAB EMIR. CORPORATION)
P. O. BOX 52515
KARAMA, UNITED ARAB EMIR.

FOR: RESTAURANT FRANCHISING; SERVICES RENDERED BY A FRANCHISOR, NAMELY, ASSISTANCE IN THE RUNNING OR MANAGEMENT OF INDUSTRIAL OR COMMERCIAL ENTERPRISES, IN CLASS 35 (U.S. CLS. 100, 101 AND 102).

FIRST USE 7-1-1992; IN COMMERCE 7-1-1992.

FOR: BAR AND RESTAURANT SERVICES, IN CLASS 43 (U.S. CLS. 100 AND 101).

FIRST USE 7-1-1992; IN COMMERCE 7-1-1992.

THE MARK CONSISTS OF "SARAVANA BHAVAN" IN RED AND THE LETTERS "HSB" IN THE SHAPE OF A LEAF IN GREEN. THE COLOR WHITE IS NOT CLAIMED AS A FEATURE OF THE MARK AND MERELY REPRESENTS THE BACKGROUND.

THE COLOR(S) GREEN AND RED IS/ARE CLAIMED AS A FEATURE OF THE MARK.

THE FOREIGN WORDING IN THE MARK TRANSLATES TO "GOD" AND "HOUSE".

SER. NO. 77-572,335, FILED 9-17-2008.

KELLY BOULTON, EXAMINING ATTORNEY



David J. Kyjars

Director of the United States Patent and Trademark Office

United States of America

United States Patent and Trademark Office

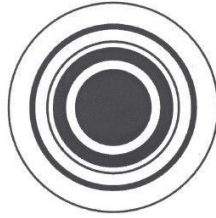

VICTORIA PARK

Reg. No. 4,152,099

Registered June 5, 2012

Int. Cls.: 25, 41 and 44

TRADEMARK

SERVICE MARK

PRINCIPAL REGISTER

6751342 CANADA, INC. (CANADA CORPORATION)
SUITE 240
376 VICTORIA AVENUE
WESTMOUNT QUEBEC, CANADA H3Z1C3

FOR: CLOTHING FOR ATHLETIC, EXERCISE, GYM, AND SPORTSWEAR, NAMELY, T-SHIRTS AND SWEATSHIRTS, SHORTS, ATHLETIC PANTS, ROBES, HATS, APRONS, VISORS; SLIPPERS, IN CLASS 25 (U.S. CLS. 22 AND 39).

FOR: PERSONAL COACHING SERVICES IN THE FIELD OF PERSONAL WELLNESS, SELF-IMPROVEMENT AND PHYSICAL EXERCISE; HEALTH CLUB SERVICES, NAMELY, PROVIDING INSTRUCTION AND EQUIPMENT IN THE FIELD OF PHYSICAL EXERCISE, EXCEPT AS OFFERED WITHIN PRIVATE RESIDENTIAL COMMUNITIES, IN CLASS 41 (U.S. CLS. 100, 101 AND 107).

FOR: MEDICAL CLINICS; HEALTH SPA SERVICES, NAMELY, COSMETIC FACE AND BODY CARE SERVICES; HEALTH SPA SERVICES PROVIDING NON-TRADITIONAL HEALTH CARE TREATMENTS, NAMELY, ACUPUNCTURE, HOMEOPATHY, HYDROTHERAPY, NATUROPATHY, OSTEOPATHY, RELAXATION THERAPY AND THERAPEUTIC MASSAGE; MANICURE AND PEDICURE SERVICES; NUTRITION AND HEALTH CONSULTING SERVICES, IN CLASS 44 (U.S. CLS. 100 AND 101).

PRIORITY CLAIMED UNDER SEC. 44(D) ON CANADA APPLICATION NO. 1,410,070, FILED 9-9-2008, REG. NO. TMA803,285, DATED 8-1-2011, EXPIRES 8-1-2026.

"VICTORIA PARK" DOES NOT IDENTIFY A LIVING INDIVIDUAL.

THE MARK CONSISTS OF FOUR CONCENTRIC CIRCLES OF VARYING WIDTH AROUND A SOLID CIRCLE IN THE CENTER, ALL APPEARING OVER THE WORDS "VICTORIA PARK" APPEARING IN ALL CAPS.

SER. NO. 77-583,300, FILED 10-1-2008.

WON TEAK OH, EXAMINING ATTORNEY



David J. Kyros

Director of the United States Patent and Trademark Office

United States of America

United States Patent and Trademark Office

Authority Lighting

Reg. No. 4,152,100

Registered June 5, 2012

Int. Cl.: 9

TRADEMARK

PRINCIPAL REGISTER

AUTHORITY LIGHTING INC. (CANADA CORPORATION), DBA AUTHORITY LIGHTING
11811 10 AVE NW
EDMONTON, CANADA T6J7A6

FOR: EMERGENCY WARNING LIGHTS, IN CLASS 9 (U.S. CLS. 21, 23, 26, 36 AND 38).

FIRST USE 4-29-2008; IN COMMERCE 4-30-2008.

THE MARK CONSISTS OF STANDARD CHARACTERS WITHOUT CLAIM TO ANY PARTICULAR FONT, STYLE, SIZE, OR COLOR.

PRIORITY CLAIMED UNDER SEC. 44(D) ON CANADA APPLICATION NO. 1413025, FILED 9-2-2008, REG. NO. TMA769757, DATED 6-15-2010, EXPIRES 6-15-2025.

NO CLAIM IS MADE TO THE EXCLUSIVE RIGHT TO USE "LIGHTING", APART FROM THE MARK AS SHOWN.

SER. NO. 77-584,692, FILED 10-2-2008.

CIMMERIAN COLEMAN, EXAMINING ATTORNEY



David J. Kyfos

Director of the United States Patent and Trademark Office

United States of America

United States Patent and Trademark Office

WESTERN SAGE

Reg. No. 4,152,101

WESTERN SAGE DESIGNS LTD. (CANADA CORPORATION)

Registered June 5, 2012

1431 - 232ND STREET
LANGLEY, BC, CANADA V2Z2W9

Int. Cls.: 1, 5, 29 and 30

FOR: FERTILIZERS, IN CLASS 1 (U.S. CLS. 1, 5, 6, 10, 26 AND 46).

TRADEMARK

FOR: BEE POLLEN FOR USE AS A DIETARY FOOD SUPPLEMENT; PROPOLIS FOR MEDICINAL OR THERAPEUTIC PURPOSES, IN CLASS 5 (U.S. CLS. 6, 18, 44, 46, 51 AND 52).

PRINCIPAL REGISTER

FOR: FOOD PRODUCTS, NAMELY, MEAT, EGGS, IN CLASS 29 (U.S. CL. 46).

FOR: FOOD PRODUCTS, NAMELY, HONEY, SPICES, GRANOLA BASED SNACKS, GRANOLA BASED SNACK BARS; PROPOLIS FOR FOOD PURPOSES, IN CLASS 30 (U.S. CL. 46).

THE MARK CONSISTS OF STANDARD CHARACTERS WITHOUT CLAIM TO ANY PARTICULAR FONT, STYLE, SIZE, OR COLOR.

PRIORITY CLAIMED UNDER SEC. 44(D) ON CANADA APPLICATION NO. 1,395,792, FILED 5-15-2008, REG. NO. TMA797,532, DATED 5-13-2011, EXPIRES 5-13-2026.

NO CLAIM IS MADE TO THE EXCLUSIVE RIGHT TO USE "SAGE", APART FROM THE MARK AS SHOWN.

SER. NO. 77-590,788, FILED 10-10-2008.

WON TEAK OH, EXAMINING ATTORNEY



David J. Kyros

Director of the United States Patent and Trademark Office

United States of America

United States Patent and Trademark Office

PRISTINE

Reg. No. 4,152,102

Registered June 5, 2012

Int. Cl.: 4

TRADEMARK

PRINCIPAL REGISTER

TYLER CANDLE COMPANY, L.L.C. (TEXAS LIMITED LIABILITY COMPANY)
11733 HIGHWAY 155 NORTH
TYLER, TX 75708

FOR: LAMP FUEL, IN CLASS 4 (U.S. CLS. 1, 6 AND 15).

FIRST USE 6-1-2006; IN COMMERCE 6-1-2006.

THE MARK CONSISTS OF STANDARD CHARACTERS WITHOUT CLAIM TO ANY PARTICULAR FONT, STYLE, SIZE, OR COLOR.

OWNER OF U.S. REG. NO. 2,995,243.

SER. NO. 77-596,909, FILED 10-21-2008.

ROBERT C. CLARK JR., EXAMINING ATTORNEY



David J. Kyffers

Director of the United States Patent and Trademark Office

United States of America

United States Patent and Trademark Office

dPals

Reg. No. 4,152,103

Registered June 5, 2012

Int. Cl.: 41

SERVICE MARK

PRINCIPAL REGISTER

DPALS LIMITED (UNITED KINGDOM LIMITED COMPANY (LTD.))
HELLABY INDUSTRIAL ESTATE
2 DENBY WAY
ROTHERHAM, UNITED KINGDOM S668HR

FOR: ENTERTAINMENT SERVICES IN THE NATURE OF COMPUTER AND VIDEO GAME AMUSEMENT SERVICES, NAMELY, PROVIDING AN ON-LINE COMPUTER GAME FOR OTHERS OVER GLOBAL AND LOCAL AREA COMPUTER NETWORKS, INTERACTIVE TELECOMMUNICATIONS AND COMPUTER NETWORKS FOR EXPLORING, COLLABORATING AND INTERACTING WITH OTHER USERS, OBJECTS AND THE VIRTUAL WORLD VIA GLOBAL TELECOMMUNICATIONS NETWORKS; ENTERTAINMENT SERVICES, NAMELY, PROVIDING A WEBSITE FEATURING NON-DOWNLOADABLE MUSICAL PERFORMANCES, MUSICAL VIDEOS, RELATED FILM CLIPS, PHOTOGRAPHS, CARTOONS, COMPUTER IMAGES, AND OTHER MULTIMEDIA MATERIALS IN THE FIELDS OF SPORTS, ENTERTAINMENT, CLOTHES, ANIMALS, POP MUSIC AND CULTURAL ACTIVITIES; PROVIDING INFORMATION ABOUT VIDEO GAMES AND COMPUTER GAMES VIA GLOBAL TELECOMMUNICATION AND COMPUTER NETWORKS; PROVISION OF NON-DOWNLOADABLE COMPUTER AND VIDEO GAMES AND NON-DOWNLOADABLE COMPUTER AND VIDEO GAME PROGRAMMES FROM A COMPUTER DATABASE OR VIA THE INTERNET; VIDEO ENTERTAINMENT SERVICES, NAMELY, PROVIDING A WEB SITE FEATURING NON-DOWNLOADABLE MUSICAL PERFORMANCES, MUSICAL VIDEOS, RELATED FILM CLIPS, PHOTOGRAPHS, SPORTING CLIPS, COMEDY SHOWS, CHILDREN'S PROGRAMMES, VARIETY, NEWS, CARTOONS AND CULTURAL ACTIVITIES; MULTIMEDIA ENTERTAINMENT AND EDUCATIONAL SERVICES, NAMELY, PROVIDING A WEBSITE THAT DISPLAYS VARIOUS REQUESTS, REVIEWS, RECOMMENDATIONS, RANKINGS, TRACKINGS, VOTES, AND INFORMATION RELATING TO UNCREATED, UNRELEASED, NEW, SPECIAL AND POPULAR, EVENTS IN THE FIELDS OF POP CULTURE, ENTERTAINMENT, EDUCATION, CLOTHES AND SPORTS, ALL EXCLUSIVELY FOR NON-BUSINESS AND NON-COMMERCIAL TRANSACTIONS AND PURPOSES; MULTIMEDIA ENTERTAINMENT SERVICES IN THE NATURE OF ON-LINE COMPETITIONS IN THE FIELD OF ENTERTAINMENT, EDUCATION, CULTURE, SPORTS, FILMS AND OTHER NON-BUSINESS AND NON-COMMERCIAL FIELDS; PROVIDING NON-DOWNLOADABLE ELECTRONIC PUBLICATIONS, NAMELY, BOOKS, MAGAZINES AND ARTICLES IN THE FIELDS OF SPORTS, MUSIC, COMEDY, CHILDREN'S PROGRAMMES, VARIETY, NEWS, FILMS, CARTOONS AND CULTURAL ACTIVITIES, IN CLASS 41 (U.S. CLS. 100, 101 AND 107).



David J. Kyros

Director of the United States Patent and Trademark Office

Reg. No. 4,152,103 THE MARK CONSISTS OF STANDARD CHARACTERS WITHOUT CLAIM TO ANY PARTICULAR FONT, STYLE, SIZE, OR COLOR.

OWNER OF ERPN CMNTY TM OFC REG. NO. 006345128, DATED 6-10-2009, EXPIRES 10-9-2017.

SER. NO. 77-604,287, FILED 10-30-2008.

REGINA DRUMMOND, EXAMINING ATTORNEY

United States of America

United States Patent and Trademark Office

ZZ

Reg. No. 4,152,104

Registered June 5, 2012

Int. Cl.: 33

TRADEMARK

PRINCIPAL REGISTER

ZORZAL INCORPORATED (CANADA CORPORATION)
8246 EDGEBROOK DRIVE NW
CALGARY, CANADA T3A4K6

FOR: WINES, IN CLASS 33 (U.S. CLS. 47 AND 49).

THE MARK CONSISTS OF STANDARD CHARACTERS WITHOUT CLAIM TO ANY PARTICULAR FONT, STYLE, SIZE, OR COLOR.

PRIORITY CLAIMED UNDER SEC. 44(D) ON CANADA APPLICATION NO. 1416535, FILED 10-30-2008, REG. NO. TMA810365, DATED 10-26-2011, EXPIRES 10-26-2026.

SER. NO. 77-624,524, FILED 12-2-2008.

STEVEN R. FINE, EXAMINING ATTORNEY



David J. Kybas

Director of the United States Patent and Trademark Office

United States of America

United States Patent and Trademark Office

SKY SHARK PRO

Reg. No. 4,152,105

Registered June 5, 2012

Int. Cl.: 28

TRADEMARK

PRINCIPAL REGISTER

SPIN MASTER LTD. (CANADA CORPORATION)
450 FRONT STREET WEST
TORONTO ONTARIO, CANADA M5V1B6

FOR: TOY HELICOPTERS, IN CLASS 28 (U.S. CLS. 22, 23, 38 AND 50).

THE MARK CONSISTS OF STANDARD CHARACTERS WITHOUT CLAIM TO ANY PARTICULAR FONT, STYLE, SIZE, OR COLOR.

PRIORITY CLAIMED UNDER SEC. 44(D) ON CANADA APPLICATION NO. 1417394, FILED 11-6-2008, REG. NO. TMA812056, DATED 11-18-2011, EXPIRES 11-18-2026.

OWNER OF U.S. REG. NO. 2,689,624.

SER. NO. 77-626,475, FILED 12-4-2008.

DEBRA LEE, EXAMINING ATTORNEY



David J. Kyffers

Director of the United States Patent and Trademark Office

United States of America

United States Patent and Trademark Office

SANDPLAY

Reg. No. 4,152,106

Registered June 5, 2012

Int. Cl.: 41

SERVICE MARK

PRINCIPAL REGISTER

SANDPLAY THERAPISTS OF AMERICA (DELAWARE CORPORATION)
PO BOX 4847
WALNUT CREEK, CA 94596

FOR: TRAINING SERVICES IN THE FIELD OF PSYCHOLOGICAL ASSESSMENT AND DISTRIBUTION OF TRAINING MATERIAL IN CONNECTION THEREWITH; PUBLICATION OF SCHOLARLY JOURNALS RELATED TO SUCH SERVICES, IN CLASS 41 (U.S. CLS. 100, 101 AND 107).

FIRST USE 1-1-1992; IN COMMERCE 1-1-1992.

THE MARK CONSISTS OF STANDARD CHARACTERS WITHOUT CLAIM TO ANY PARTICULAR FONT, STYLE, SIZE, OR COLOR.

SEC. 2(F).

SER. NO. 77-638,828, FILED 12-23-2008.

TAMARA FRAZIER, EXAMINING ATTORNEY



David J. Kyffers

Director of the United States Patent and Trademark Office

United States of America

United States Patent and Trademark Office



Reg. No. 4,152,107

Registered June 5, 2012

Int. Cls.: 35, 36 and 41

SERVICE MARK

PRINCIPAL REGISTER

INFINITY HEALTHCARE, INC. (ILLINOIS CORPORATION)
SUITE 2100
111 EAST WISCONSIN AVENUE
MILWAUKEE, WI 53202

FOR: STAFFING OF PHYSICIANS AND OTHER MEDICAL PERSONNEL IN HOSPITAL SPECIALTY-BASED MEDICAL DEPARTMENTS PURSUANT TO CONTRACTS WITH SUCH HOSPITALS FOR THE MANAGEMENT SUCH DEPARTMENTS; BUSINESS MANAGEMENT, NAMELY, MANAGING HOSPITAL MEDICAL DEPARTMENTS PROVIDING MEDICAL CARE IN HOSPITAL-BASED MEDICAL SPECIALITIES, IN CLASS 35 (U.S. CLS. 100, 101 AND 102).

FIRST USE 9-1-1996; IN COMMERCE 9-1-1996.

FOR: DEBT COLLECTION, IN CLASS 36 (U.S. CLS. 100, 101 AND 102).

FIRST USE 9-1-1996; IN COMMERCE 9-1-1996.

FOR: EDUCATIONAL SERVICES, NAMELY, CONDUCTING CLASSES IN THE FIELD OF REGULATORY HEALTH COMPLIANCE, INCLUDING AMERICANS WITH DISABILITIES ACT AND OCCUPATIONAL SAFETY AND HEALTH ACT COMPLIANCE; AND PARAMEDIC TRAINING COURSES, IN CLASS 41 (U.S. CLS. 100, 101 AND 107).

FIRST USE 9-1-1996; IN COMMERCE 9-1-1996.

NO CLAIM IS MADE TO THE EXCLUSIVE RIGHT TO USE "HEALTHCARE", APART FROM THE MARK AS SHOWN.

THE MARK CONSISTS OF THE WORD "INFINITY" IN LARGE BLOCK LETTERS THAT IS SET FORTH ABOVE THE WORD "HEALTHCARE" IN SMALLER BLOCK LETTERS; A THIN LINE RUNS DIRECTLY ABOVE AND BELOW THE WORD "HEALTHCARE" ACROSS THE ENTIRE LENGTH OF SAID WORD; A CADUCEUS IS SET FORTH TO DIRECTLY TO THE RIGHT OF SAID WORDS AND AN INFINITY SYMBOL IS FORMED ABOVE THE CADUCEUS BY THE SERPENT WRAPPED AROUND THE STAFF OF THE CADUCEUS.

SER. NO. 77-640,272, FILED 12-28-2008.



David J. Kyros

Director of the United States Patent and Trademark Office

Reg. No. 4,152,107 ANTHONY RINKER, EXAMINING ATTORNEY

United States of America

United States Patent and Trademark Office

BUFFALO WILD WINGS

Reg. No. 4,152,108

Registered June 5, 2012

Int. Cl.: 35

SERVICE MARK

PRINCIPAL REGISTER

BUFFALO WILD WINGS, INC. (MINNESOTA CORPORATION)
SUITE 1600
5500 WAYZATA BLVD.
MINNEAPOLIS, MN 55416

FOR: FRANCHISE SERVICES, NAMELY, OFFERING BUSINESS MANAGEMENT ASSISTANCE IN THE ESTABLISHMENT AND OPERATION OF RESTAURANTS, IN CLASS 35 (U.S. CLS. 100, 101 AND 102).

FIRST USE 6-6-1997; IN COMMERCE 6-6-1997.

THE MARK CONSISTS OF STANDARD CHARACTERS WITHOUT CLAIM TO ANY PARTICULAR FONT, STYLE, SIZE, OR COLOR.

OWNER OF U.S. REG. NOS. 1,496,316, 2,187,765 AND OTHERS.

NO CLAIM IS MADE TO THE EXCLUSIVE RIGHT TO USE "BUFFALO" AND "WINGS", APART FROM THE MARK AS SHOWN.

SER. NO. 77-654,679, FILED 1-22-2009.

MICHELLE DUBOIS, EXAMINING ATTORNEY

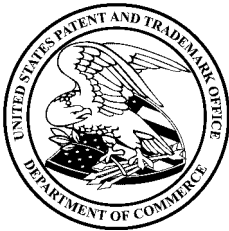

David J. Kybas

Director of the United States Patent and Trademark Office

United States of America

United States Patent and Trademark Office

APPZERO

Reg. No. 4,152,109

Registered June 5, 2012

Int. Cls.: 9 and 42

TRADEMARK

SERVICE MARK

PRINCIPAL REGISTER

APPZERO SOFTWARE CORP. (CANADA CORPORATION)
750 PALLADIUM DRIVE
SUITE 210
OTTAWA, ONTARIO, CANADA K2V 1C7

FOR: COMPUTER SOFTWARE FOR MANAGING THE INSTALLATION, DEPLOYMENT, TRANSFER AND OPERATION OF SOFTWARE APPLICATIONS STORED AND USED ON COMPUTING DEVICES, IN CLASS 9 (U.S. CLS. 21, 23, 26, 36 AND 38).

FIRST USE 4-3-2009; IN COMMERCE 4-3-2009.

FOR: INFORMATION TECHNOLOGY CONSULTATION; COMPUTER TECHNOLOGY SUPPORT SERVICES, NAMELY, HELP DESK SERVICES, IN CLASS 42 (U.S. CLS. 100 AND 101).

FIRST USE 3-2-2009; IN COMMERCE 3-2-2009.

THE MARK CONSISTS OF STANDARD CHARACTERS WITHOUT CLAIM TO ANY PARTICULAR FONT, STYLE, SIZE, OR COLOR.

PRIORITY CLAIMED UNDER SEC. 44(D) ON CANADA APPLICATION NO. 1425460, FILED 1-23-2009, REG. NO. TMA815968, DATED 1-24-2012, EXPIRES 1-24-2027.

SER. NO. 77-679,599, FILED 2-27-2009.

RONALD MCMORROW, EXAMINING ATTORNEY



David J. Kybas

Director of the United States Patent and Trademark Office

United States of America

United States Patent and Trademark Office

H2U

Reg. No. 4,152,110

A&B BUSINESS, INC (SOUTH DAKOTA CORPORATION)
1600 NORTH A AVENUE
SIOUX FALLS, SD 57104

Registered June 5, 2012

Int. Cl.: 35

FOR: RETAIL STORE SERVICES FEATURING WATER COOLERS AND PURIFIERS, IN CLASS 35 (U.S. CLS. 100, 101 AND 102).

SERVICE MARK

FIRST USE 1-2-2008; IN COMMERCE 1-2-2008.

PRINCIPAL REGISTER

THE MARK CONSISTS OF STANDARD CHARACTERS WITHOUT CLAIM TO ANY PARTICULAR FONT, STYLE, SIZE, OR COLOR.

SER. NO. 77-683,467, FILED 3-4-2009.

GIANCARLO CASTRO, EXAMINING ATTORNEY



David J. Kybas

Director of the United States Patent and Trademark Office

United States of America

United States Patent and Trademark Office

1aveos

Reg. No. 4,152,111

Registered June 5, 2012

**Int. Cls.: 16, 35, 37, 39,
41 and 42**

TRADEMARK

SERVICE MARK

PRINCIPAL REGISTER

AVEOS FLEET PERFORMANCE INC. (CANADA CORPORATION)
2311 ALFRED NOBEL BLVD., BAN 3
SAINT-LAURENT, QUEBEC, CANADA H4S2B6

FOR: PRINTED TRAINING MATERIALS RELATING TO AIRCRAFT MAINTENANCE, REPAIR AND OVERHAUL, IN CLASS 16 (U.S. CLS. 2, 5, 22, 23, 29, 37, 38 AND 50).

FOR: BUSINESS MANAGEMENT SERVICES, NAMELY, ENGINE FLEET MANAGEMENT; SUPPLY CHAIN MANAGEMENT SERVICES, IN CLASS 35 (U.S. CLS. 100, 101 AND 102).

FOR: AIRCRAFT AND AIRFRAME MAINTENANCE, REPAIR AND OVERHAUL SERVICES; AIRCRAFT CABIN CONVERSIONS AND MODIFICATIONS; AIRCRAFT ENGINE AND ENGINE PARTS AND COMPONENTS MAINTENANCE, REPAIR AND OVERHAUL SERVICES, IN CLASS 37 (U.S. CLS. 100, 103 AND 106).

FOR: LEASING OF AIRCRAFT ENGINES AND PARTS, IN CLASS 39 (U.S. CLS. 100 AND 105).

FOR: AIRCRAFT SAFETY AND MAINTENANCE TRAINING; TRAINING FOR MAINTENANCE, REPAIR AND OVERHAUL OF AIRCRAFT, AIRFRAMES, ENGINES AND ENGINE PARTS AND COMPONENTS, IN CLASS 41 (U.S. CLS. 100, 101 AND 107).

FOR: TECHNICAL WRITING FOR OTHERS, NAMELY, CREATING CUSTOMIZED TRAINING MATERIALS RELATING TO AIRCRAFT MAINTENANCE, REPAIR AND OVERHAUL; AIRCRAFT WEIGHING SERVICES, IN CLASS 42 (U.S. CLS. 100 AND 101).

PRIORITY CLAIMED UNDER SEC. 44(D) ON CANADA APPLICATION NO. 1413810, FILED 10-8-2008, REG. NO. TMA810402, DATED 10-27-2011, EXPIRES 10-27-2026.

THE MARK CONSISTS OF THE DESIGN OF A TAIL WING AND THE WORD "AVEOS" IN STYLIZED SCRIPT.

SER. NO. 77-709,883, FILED 4-8-2009.

DANNEAN HETZEL, EXAMINING ATTORNEY



David J. Kypos

Director of the United States Patent and Trademark Office

United States of America

United States Patent and Trademark Office



Reg. No. 4,152,112

Registered June 5, 2012

**Int. Cls.: 16, 35, 37, 39,
41 and 42**

TRADEMARK

SERVICE MARK

PRINCIPAL REGISTER

AVEOS FLEET PERFORMANCE INC. (CANADA CORPORATION)
2311 ALFRED NOBEL BLVD., BAN 3
SAINT-LAURENT, QUEBEC, CANADA H4S2B6

FOR: PRINTED TRAINING MATERIALS RELATING TO AIRCRAFT MAINTENANCE, REPAIR AND OVERHAUL, IN CLASS 16 (U.S. CLS. 2, 5, 22, 23, 29, 37, 38 AND 50).

FOR: BUSINESS MANAGEMENT SERVICES, NAMELY, ENGINE FLEET MANAGEMENT; SUPPLY CHAIN MANAGEMENT SERVICES, IN CLASS 35 (U.S. CLS. 100, 101 AND 102).

FOR: AIRCRAFT AND AIRFRAME MAINTENANCE, REPAIR AND OVERHAUL SERVICES; AIRCRAFT CABIN CONVERSIONS AND MODIFICATIONS; AIRCRAFT ENGINE AND ENGINE PARTS AND COMPONENTS MAINTENANCE, REPAIR AND OVERHAUL SERVICES, IN CLASS 37 (U.S. CLS. 100, 103 AND 106).

FOR: LEASING OF AIRCRAFT ENGINES AND PARTS, IN CLASS 39 (U.S. CLS. 100 AND 105).

FOR: AIRCRAFT SAFETY AND MAINTENANCE TRAINING; TRAINING FOR MAINTENANCE, REPAIR AND OVERHAUL OF AIRCRAFT, AIRFRAMES, ENGINES AND ENGINE PARTS AND COMPONENTS, IN CLASS 41 (U.S. CLS. 100, 101 AND 107).

FOR: TECHNICAL WRITING FOR OTHERS, NAMELY, CREATING CUSTOMIZED TRAINING MATERIALS RELATING TO AIRCRAFT MAINTENANCE, REPAIR AND OVERHAUL; AIRCRAFT WEIGHING SERVICES, IN CLASS 42 (U.S. CLS. 100 AND 101).

PRIORITY CLAIMED UNDER SEC. 44(D) ON CANADA APPLICATION NO. 1413811, FILED 10-8-2008, REG. NO. TMA810401, DATED 10-27-2011, EXPIRES 10-27-2026.

THE MARK CONSISTS OF THE DESIGN OF A TAIL WING ABOVE THE WORD "AVEOS" IN STYLIZED SCRIPT.

SER. NO. 77-709,908, FILED 4-8-2009.

DANNEAN HETZEL, EXAMINING ATTORNEY



David J. Kyros

Director of the United States Patent and Trademark Office

United States of America

United States Patent and Trademark Office

MUNICIPAY

Reg. No. 4,152,113

NATIONWIDE PAYMENT SOLUTIONS, LLC (DELAWARE LIMITED LIABILITY COMPANY)
400 TECHNOLOGY WAY
SCARBOROUGH, ME 04074

Registered June 5, 2012

Int. Cl.: 36

FOR: PROVIDING ELECTRONIC PROCESSING OF ELECTRONIC FUNDS TRANSFER, ACH, CREDIT CARD, DEBIT CARD, ELECTRONIC CHECK AND ELECTRONIC PAYMENTS, IN CLASS 36 (U.S. CLS. 100, 101 AND 102).

SERVICE MARK

FIRST USE 9-1-2008; IN COMMERCE 9-1-2008.

PRINCIPAL REGISTER

THE MARK CONSISTS OF STANDARD CHARACTERS WITHOUT CLAIM TO ANY PARTICULAR FONT, STYLE, SIZE, OR COLOR.

SER. NO. 77-717,136, FILED 4-20-2009.

BRENDAN REGAN, EXAMINING ATTORNEY



David J. Kyros

Director of the United States Patent and Trademark Office

United States of America

United States Patent and Trademark Office

Core-Tech

Reg. No. 4,152,114

Registered June 5, 2012

Int. Cl.: 7

TRADEMARK

PRINCIPAL REGISTER

BRIDGESTONE CORPORATION (JAPAN CORPORATION)
10-1, KYOBASHI 1-CHOME CHUO-KU
TOKYO, JAPAN

FOR: RUBBER TRACKS FOR USE WITH CRAWLERS ON CONSTRUCTION, CARGO HANDLING, AGRICULTURAL, MINING MACHINERY, IN CLASS 7 (U.S. CLS. 13, 19, 21, 23, 31, 34 AND 35).

OWNER OF JAPAN REG. NO. 5539742, DATED 7-23-2010, EXPIRES 7-23-2020.

THE MARK CONSISTS OF THE WORDING "CORE-TECH" IN STYLIZED FONT.

SER. NO. 77-722,774, FILED 4-27-2009.

SUZANNE BLANE, EXAMINING ATTORNEY



David J. Kyffers

Director of the United States Patent and Trademark Office

United States of America

United States Patent and Trademark Office

PerfecTemp

Reg. No. 4,152,115

Registered June 5, 2012

Int. Cl.: 21

TRADEMARK

PRINCIPAL REGISTER

CONAIR CORPORATION (DELAWARE CORPORATION)
ONE CUMMINGS POINT ROAD
STAMFORD, CT 06902

FOR: KETTLES, IN CLASS 21 (U.S. CLS. 2, 13, 23, 29, 30, 33, 40 AND 50).

FIRST USE 7-1-2008; IN COMMERCE 7-1-2008.

THE MARK CONSISTS OF STANDARD CHARACTERS WITHOUT CLAIM TO ANY PARTICULAR FONT, STYLE, SIZE, OR COLOR.

OWNER OF U.S. REG. NO. 3,521,911.

SER. NO. 77-786,687, FILED 7-22-2009.

SALLY SHIH, EXAMINING ATTORNEY



David J. Kybas

Director of the United States Patent and Trademark Office

United States of America

United States Patent and Trademark Office



Reg. No. 4,152,116

Registered June 5, 2012

Int. Cl.: 42

SERVICE MARK

PRINCIPAL REGISTER

THE SIROKY GROUP INC. (CANADA CORPORATION)
300 JOHN STREET, SUITE 506
MARKHAM, ONTARIO, CANADA L3T5W4

FOR: COMPUTER SOFTWARE, NAMELY, WEB BASED NON-DOWNLOADABLE SOFTWARE PROGRAMS WHICH TRACKS CONTRACT DELIVERY ACTIVITY AND PROVIDES MAPPING, WORKFORCE AUTOMATION, CONTRACT DATABASE MANAGEMENT AND PROOF OF PERFORMANCE VIA WEB AND MOBILE DEVICES, IN CLASS 42 (U.S. CLS. 100 AND 101).

FIRST USE 3-31-2007; IN COMMERCE 3-31-2007.

PRIORITY CLAIMED UNDER SEC. 44(D) ON CANADA APPLICATION NO. 1441149, FILED 6-11-2009.

THE MARK CONSISTS OF TWO OVERLAPPING SQUARES WITH THE WORDING "EYEWITNESS" TO THE RIGHT.

SER. NO. 77-786,867, FILED 7-22-2009.

SARA BENJAMIN, EXAMINING ATTORNEY



David J. Kyros

Director of the United States Patent and Trademark Office

United States of America

United States Patent and Trademark Office

I AM ROGUE

Reg. No. 4,152,117

Registered June 5, 2012

Int. Cl.: 41

SERVICE MARK

PRINCIPAL REGISTER

RML JACKSON, LLC (CALIFORNIA LIMITED LIABILITY COMPANY)
8899 BEVERLY BLVD., SUITE 510
LOS ANGELES, CA 90048

FOR: ENTERTAINMENT SERVICES, NAMELY, PROVIDING A WEBSITE SITE FEATURING ENTERTAINMENT INFORMATION, NEWS AND COMMENTARY REGARDING THE ARTS, ENTERTAINMENT, SPORTS, AND THE MEDIA; PROVIDING A WEBSITE WHERE USERS CAN POST RATINGS, REVIEWS, OR RECOMMENDATIONS ON ENTERTAINMENT EVENTS AND ACTIVITIES IN THE FIELDS OF THE ARTS, ENTERTAINMENT, SPORTS, AND THE MEDIA; PROVIDING A WEBSITE FEATURING MUSICAL OR SPOKEN PERFORMANCES, MUSICAL OR NON-MUSICAL VIDEOS, RELATED FILM CLIPS, PHOTOGRAPHS, AND OTHER MULTIMEDIA MATERIALS FEATURING SPORTS, POP CULTURE, TELEVISION, NEWS, FASHION, CULTURE, ENTERTAINMENT, MEDIA, THE ARTS, COMEDY, HISTORY, MUSIC AND LIFESTYLES; ENTERTAINMENT SERVICES, NAMELY, PROVIDING A WEB SITE FEATURING USER-GENERATED VIDEOS ON A WIDE VARIETY OF TOPICS AND SUBJECTS; PROVIDING AN INTERNET NEWS PORTAL FEATURING LINKS TO NEWS STORIES AND ARTICLES IN THE FIELD OF CURRENT EVENTS, IN CLASS 41 (U.S. CLS. 100, 101 AND 107).

FIRST USE 4-20-2009; IN COMMERCE 4-20-2009.

THE MARK CONSISTS OF STANDARD CHARACTERS WITHOUT CLAIM TO ANY PARTICULAR FONT, STYLE, SIZE, OR COLOR.

SER. NO. 77-803,712, FILED 8-13-2009.

KEVIN DINALLO, EXAMINING ATTORNEY



David J. Kypos

Director of the United States Patent and Trademark Office

United States of America

United States Patent and Trademark Office

ARE YOU ROGUE?

Reg. No. 4,152,118

Registered June 5, 2012

Int. Cl.: 41

SERVICE MARK

PRINCIPAL REGISTER

RML JACKSON, LLC (CALIFORNIA LIMITED LIABILITY COMPANY)
8899 BEVERLY BLVD., SUITE 510
LOS ANGELES, CA 90048

FOR: PROVIDING AN ON-LINE GLOBAL COMPUTER WEBSITE FEATURING ENTERTAINMENT INFORMATION PERTAINING TO MOTION PICTURES, MUSIC, VIDEO, PHOTOGRAPHY, AND INTERVIEWS FEATURING ENTERTAINERS AND ARTISTS, IN CLASS 41 (U.S. CLS. 100, 101 AND 107).

FIRST USE 3-16-2009; IN COMMERCE 3-16-2009.

THE MARK CONSISTS OF STANDARD CHARACTERS WITHOUT CLAIM TO ANY PARTICULAR FONT, STYLE, SIZE, OR COLOR.

SER. NO. 77-808,146, FILED 8-19-2009.

KEVIN DINALLO, EXAMINING ATTORNEY



David J. Kybas

Director of the United States Patent and Trademark Office

United States of America

United States Patent and Trademark Office

IAMROGUE

Reg. No. 4,152,119

Registered June 5, 2012

Int. Cl.: 41

SERVICE MARK

PRINCIPAL REGISTER

RML JACKSON, LLC (CALIFORNIA LIMITED LIABILITY COMPANY)
8899 BEVERLY BLVD., SUITE 510
LOS ANGELES, CA 90048

FOR: ENTERTAINMENT SERVICES, NAMELY, PROVIDING A WEBSITE SITE FEATURING ENTERTAINMENT INFORMATION, NEWS AND COMMENTARY REGARDING THE ARTS, ENTERTAINMENT, SPORTS, AND THE MEDIA; PROVIDING A WEBSITE WHERE USERS CAN POST RATINGS, REVIEWS, OR RECOMMENDATIONS ON ENTERTAINMENT EVENTS AND ACTIVITIES IN THE FIELDS OF THE ARTS, ENTERTAINMENT, SPORTS, AND THE MEDIA; PROVIDING A WEBSITE FEATURING MUSICAL OR SPOKEN PERFORMANCES, MUSICAL OR NON-MUSICAL VIDEOS, RELATED FILM CLIPS, PHOTOGRAPHS, AND OTHER MULTIMEDIA MATERIALS FEATURING SPORTS, POP CULTURE, TELEVISION, NEWS, FASHION, CULTURE, ENTERTAINMENT, MEDIA, THE ARTS, COMEDY, HISTORY, MUSIC AND LIFESTYLES; ENTERTAINMENT SERVICES, NAMELY, PROVIDING A WEB SITE FEATURING USER-GENERATED VIDEOS ON A WIDE VARIETY OF TOPICS AND SUBJECTS; PROVIDING AN INTERNET NEWS PORTAL FEATURING LINKS TO NEWS STORIES AND ARTICLES IN THE FIELD OF CURRENT EVENTS, IN CLASS 41 (U.S. CLS. 100, 101 AND 107).

FIRST USE 4-20-2009; IN COMMERCE 4-20-2009.

THE MARK CONSISTS OF STANDARD CHARACTERS WITHOUT CLAIM TO ANY PARTICULAR FONT, STYLE, SIZE, OR COLOR.

SER. NO. 77-810,025, FILED 8-21-2009.

KEVIN DINALLO, EXAMINING ATTORNEY



David J. Kyros

Director of the United States Patent and Trademark Office

United States of America

United States Patent and Trademark Office



Reg. No. 4,152,120

LG ELECTRONICS INC. (REPUBLIC OF KOREA CORPORATION)
20, YOIDO-DONG, YONGDUNGPO-GU
SEOUL, REPUBLIC OF KOREA

Registered June 5, 2012

Int. Cls.: 7, 9, 10, 11 and 35

FOR: ELECTRIC CLOTHES WASHING MACHINES; AUTOMATIC DISHWASHERS; ELECTRIC VACUUM CLEANERS, IN CLASS 7 (U.S. CLS. 13, 19, 21, 23, 31, 34 AND 35).

TRADEMARK

SERVICE MARK

PRINCIPAL REGISTER

FOR: TELEPHONE SETS; WIRELESS TELEPHONE SETS; PORTABLE COMMUNICATIONS APPARATUS, NAMELY, HANDSETS, WALKIE-TALKIES, SATELLITE TELEPHONES AND PERSONAL DIGITAL ASSISTANTS; MOBILE PHONES; MPEG AUDIO LAYER-3 PLAYERS; TELEVISION RECEIVERS; TELEVISION REMOTE CONTROLLERS; UNIVERSAL SERIAL BUS DRIVES; DIGITAL MEDIA BROADCASTING PLAYERS; HEADSETS FOR MOBILE PHONES; PORTABLE CHARGERS FOR BATTERIES; ELECTRONIC PICTURE FRAMES; ELECTRONIC ALBUMS; DIGITAL PICTURE FRAMES; MONITORS FOR COMPUTER; LAPTOP COMPUTERS; COMPUTERS; DIGITAL VERSATILE DISC PLAYERS; PORTABLE HARD DISK DRIVES; APPARATUS FOR RECORDING, TRANSMISSION OR REPRODUCTION OF SOUND OR IMAGES FOR USE IN TELECOMMUNICATION; APPARATUS FOR RECORDING, TRANSMISSION OR REPRODUCTION OF SOUND OR IMAGES; COMPUTER SOFTWARE FOR MOBILE PHONES; DIGITAL VERSATILE DISC PLAYERS FOR HOME THEATERS; SPEAKERS FOR HOME THEATERS; AUDIO-VIDEO RECEIVERS FOR HOME THEATERS; PROJECTORS FOR HOME THEATERS; INTEGRATED CIRCUITS; AUDIO RECEIVERS; ON BOARD UNITS AND ELECTRONIC TOLL SMART CARDS FOR EXPEDITED PASS THROUGH HIGHWAY TOLL FACILITIES; TRANSPONDERS, NAMELY, SECURE ELECTRONIC TERMINALS EQUIPPED IN VEHICLE FOR TOLL PAYMENT TRANSACTIONS; CLOSED-CIRCUIT TELEVISION CAMERAS; NETWORK MONITORING CAMERAS, IN CLASS 9 (U.S. CLS. 21, 23, 26, 36 AND 38).



FOR: MESSAGE APPARATUS, IN CLASS 10 (U.S. CLS. 26, 39 AND 44).

FOR: ELECTRIC REFRIGERATORS; REFRIGERATORS FOR KIMCHI; LIGHTWAVE COOKING OVENS; TEMPERATURE CONTROLLED ELECTRIC WINE CELLARS; ELECTRIC OVENS; ELECTRIC FREEZERS; ELECTRIC LAUNDRY DRYERS; GAS RANGES; MICROWAVE RANGES; GAS COOKTOP; ELECTRIC RANGES FOR HOUSEHOLD USE; AIR PURIFIERS; AIR CONDITIONERS; WATER PURIFIERS FOR HOUSEHOLD PURPOSES; HOT AIR SPACE HEATING APPARATUS; HUMIDIFIERS; ELECTRIC DEHUMIDIFIER FOR HOUSEHOLD USE, IN CLASS 11 (U.S. CLS. 13, 21, 23, 31 AND 34).

David J. Kyros

Director of the United States Patent and Trademark Office

Reg. No. 4,152,120 FOR: ADVERTISEMENT PLANNING; ADVERTISING AGENCIES; DEMONSTRATION OF PRODUCTS; PUBLIC OPINION POLLING; DISTRIBUTION OF PUBLICITY MATERIALS; EMPLOYMENT AGENCIES; AUCTIONEERING; COMMERCIAL INFORMATION AGENCY; SALES ARRANGING SERVICES FOR PORTABLE COMMUNICATIONS APPARATUS; ON-LINE AUCTIONEERING SERVICES VIA COMPUTER NETWORKS; ON-LINE EMPLOYMENT AGENCIES VIA GLOBAL COMPUTER NETWORKS; PROVIDING WEBSITE LINKS FOR THE SALE OF PRODUCTS VIA COMPUTER NETWORKS; PROVISION OF CONSUMER INFORMATION VIA GLOBAL COMPUTER NETWORK; PROVISION OF COMMERCIAL INFORMATION VIA GLOBAL INTERNET; ARRANGEMENT AND OPERATION OF ADVERTISING MATERIAL ON COMPUTER NETWORK AND GLOBAL COMMUNICATION NETWORK; CONSUMER PURCHASE ASSISTANCE FOR GOODS AND SERVICES VIA GLOBAL COMPUTER NETWORK; BUSINESS MANAGEMENT; ADVERTISING SERVICES BY MEANS OF MOBILE TELEPHONES FOR BUSINESS MANAGEMENT; ADVERTISING VIA ELECTRONIC MEDIA AND THE INTERNET FOR BUSINESS MANAGEMENT; SALES PROMOTION FOR OTHERS VIA COMPUTER NETWORK; PROVISION OF COMMERCIAL INFORMATION VIA COMPUTER NETWORK; PROVISION OF ADVERTISING INFORMATION VIA GLOBAL COMPUTER NETWORK; OFFICE MACHINES AND EQUIPMENT RENTAL; COMMERCIAL BUSINESS INTERMEDIARY SERVICES FOR THE SALE OF PRODUCTS, NAMELY, INFORMATION COMMUNICATION MACHINES AND APPARATUS, COMPUTERS, OFFICE MACHINES AND EQUIPMENT, APPARATUS FOR FOOD AND DRINK PROCESSING, TELECOMMUNICATION MACHINES AND IMPLEMENTS, ELECTRIC HEAT APPARATUS AND EQUIPMENT FOR HOUSEHOLD PURPOSES, HEATING APPARATUS, REFRIGERATING MACHINES AND APPARATUS, HEATERS, DISH DISINFECTANT APPARATUS, ELECTRONIC MACHINES, APPARATUS AND THEIR PARTS, NAMELY, ELECTRIC CLOTHES WASHING MACHINES, AUTOMATIC DISHWASHERS, ELECTRIC VACUUM CLEANERS, TELEPHONE SETS, WIRELESS TELEPHONE SETS, PORTABLE COMMUNICATIONS APPARATUS, NAMELY, HANDSETS, WALKIE-TALKIES, SATELLITE TELEPHONES AND PERSONAL DIGITAL ASSISTANTS, MOBILE PHONES, MPEG AUDIO LAYER-3 PLAYERS, TELEVISION RECEIVERS, TELEVISION REMOTE CONTROLLERS, UNIVERSAL SERIAL BUS DRIVES, DIGITAL MEDIA BROADCASTING PLAYERS, HEADSETS FOR MOBILE PHONES, PORTABLE CHARGERS FOR BATTERIES, ELECTRONIC PICTURE FRAMES, ELECTRONIC ALBUMS, DIGITAL PICTURE FRAMES, MONITORS FOR COMPUTER, LAPTOP COMPUTERS, COMPUTERS, DIGITAL VERSATILE DISC PLAYERS, PORTABLE HARD DISK DRIVES, APPARATUS FOR RECORDING, TRANSMISSION OR REPRODUCTION OF SOUND OR IMAGES FOR USE IN TELECOMMUNICATION, APPARATUS FOR RECORDING, TRANSMISSION OR REPRODUCTION OF SOUND OR IMAGES, COMPUTER SOFTWARE FOR MOBILE PHONES, DIGITAL VERSATILE DISC PLAYERS FOR HOME THEATERS, SPEAKERS FOR HOME THEATERS, AUDIO-VIDEO RECEIVERS FOR HOME THEATERS, PROJECTORS FOR HOME THEATERS, INTEGRATED CIRCUITS, AUDIO RECEIVERS, ON BOARD UNITS AND ELECTRONIC TOLL SMART CARDS FOR EXPEDITED PASS THROUGH HIGHWAY TOLL FACILITIES, TRANSPONDERS, NAMELY, SECURE ELECTRONIC TERMINALS EQUIPPED IN VEHICLE FOR TOLL PAYMENT TRANSACTIONS, CLOSED-CIRCUIT TELEVISION CAMERAS, NETWORK MONITORING CAMERAS, MASSAGE APPARATUS, ELECTRIC REFRIGERATORS, REFRIGERATORS FOR KIMCHI, LIGHTWAVE COOKING OVENS, TEMPERATURE CONTROLLED ELECTRIC WINE CELLARS, ELECTRIC OVENS, ELECTRIC FREEZERS, ELECTRIC LAUNDRY DRYERS, GAS RANGES, MICROWAVE RANGES, GAS COOKTOP, ELECTRIC RANGES FOR HOUSEHOLD USE, AIR PURIFIERS, AIR CONDITIONERS, WATER PURIFIERS FOR HOUSEHOLD PURPOSES, HOT AIR SPACE HEATING APPARATUS, HUMIDIFIERS, ELECTRIC DEHUMIDIFIER FOR HOUSEHOLD USE; SALES ARRANGING SERVICES FOR PRODUCTS, NAMELY, INFORMATION COMMUNICATION MACHINES AND APPARATUS, COMPUTERS, OFFICE MACHINES AND EQUIPMENT, APPARATUS FOR FOOD AND DRINK PROCESSING, TELECOMMUNICATION MACHINES AND IMPLEMENTS, ELECTRIC HEAT APPARATUS AND EQUIPMENT FOR HOUSEHOLD PURPOSES, HEATING APPARATUS, REFRIGERATING MACHINES AND APPARATUS, HEATERS, DISH DISINFECTANT APPARATUS, ELECTRONIC MACHINES, APPARATUS AND THEIR PARTS, NAMELY, ELECTRIC CLOTHES WASHING MACHINES, AUTOMATIC DISHWASHERS, ELECTRIC VACUUM CLEANERS, TELEPHONE SETS, WIRELESS TELEPHONE SETS,

Reg. No. 4,152,120 PORTABLE COMMUNICATIONS APPARATUS, NAMELY, HANDSETS, WALKIE-TALKIES, SATELLITE TELEPHONES AND PERSONAL DIGITAL ASSISTANTS, MOBILE PHONES, MPEG AUDIO LAYER-3 PLAYERS, TELEVISION RECEIVERS, TELEVISION REMOTE CONTROLLERS, UNIVERSAL SERIAL BUS DRIVES, DIGITAL MEDIA BROADCASTING PLAYERS, HEADSETS FOR MOBILE PHONES, PORTABLE CHARGERS FOR BATTERIES, ELECTRONIC PICTURE FRAMES, ELECTRONIC ALBUMS, DIGITAL PICTURE FRAMES, MONITORS FOR COMPUTER, LAPTOP COMPUTERS, COMPUTERS, DIGITAL VERSATILE DISC PLAYERS, PORTABLE HARD DISK DRIVES, APPARATUS FOR RECORDING, TRANSMISSION OR REPRODUCTION OF SOUND OR IMAGES FOR USE IN TELECOMMUNICATION, APPARATUS FOR RECORDING, TRANSMISSION OR REPRODUCTION OF SOUND OR IMAGES, COMPUTER SOFTWARE FOR MOBILE PHONES, DIGITAL VERSATILE DISC PLAYERS FOR HOME THEATERS, SPEAKERS FOR HOME THEATERS, AUDIO-VIDEO RECEIVERS FOR HOME THEATERS, PROJECTORS FOR HOME THEATERS, INTEGRATED CIRCUITS, AUDIO RECEIVERS, ON BOARD UNITS AND ELECTRONIC TOLL SMART CARDS FOR EXPEDITED PASS THROUGH HIGHWAY TOLL FACILITIES, TRANSPONDERS, NAMELY, SECURE ELECTRONIC TERMINALS EQUIPPED IN VEHICLE FOR TOLL PAYMENT TRANSACTIONS, CLOSED-CIRCUIT TELEVISION CAMERAS, NETWORK MONITORING CAMERAS, MASSAGE APPARATUS, ELECTRIC REFRIGERATORS, REFRIGERATORS FOR KIMCHI, LIGHTWAVE COOKING OVENS, TEMPERATURE CONTROLLED ELECTRIC WINE CELLARS, ELECTRIC OVENS, ELECTRIC FREEZERS, ELECTRIC LAUNDRY DRYERS, GAS RANGES, MICROWAVE RANGES, GAS COOKTOP, ELECTRIC RANGES FOR HOUSEHOLD USE, AIR PURIFIERS, AIR CONDITIONERS, WATER PURIFIERS FOR HOUSEHOLD PURPOSES, HOT AIR SPACE HEATING APPARATUS, HUMIDIFIERS, ELECTRIC DEHUMIDIFIER FOR HOUSEHOLD USE, IN CLASS 35 (U.S. CLS. 100, 101 AND 102).

OWNER OF REPUBLIC OF KOREA REG. NO. 008541542, DATED 4-26-2010, EXPIRES 9-10-2019.

THE COLOR(S) ORANGE, WHITE, BLACK IS/ARE CLAIMED AS A FEATURE OF THE MARK.

NO CLAIM IS MADE TO THE EXCLUSIVE RIGHT TO USE "ENERGY EFFICIENCY" AND THE LETTER "E", APART FROM THE MARK AS SHOWN.

THE MARK CONSISTS OF AN ELECTRICAL OUTLET PLUG IN WHITE WITH A LETTER "E" APPEARING WITHIN THE PLUG IN THE COLOR ORANGE, APPEARING UPON AN ORANGE SQUARE WITH CURVED EDGES AND THE WORDING "ENERGY EFFICIENCY" IN BLACK.

SER. NO. 77-814,446, FILED 8-27-2009.

EDWARD NELSON, EXAMINING ATTORNEY

United States of America

United States Patent and Trademark Office

BIG WHEEL

Reg. No. 4,152,121

2008474 ONTARIO INC. (CANADA CORPORATION)
21 BATHURST STREET

Registered June 5, 2012

TORONTO, ONTARIO, CANADA M5V2N6

Int. Cl.: 32

FOR: BEER, IN CLASS 32 (U.S. CLS. 45, 46 AND 48).

TRADEMARK

THE MARK CONSISTS OF STANDARD CHARACTERS WITHOUT CLAIM TO ANY PARTICULAR FONT, STYLE, SIZE, OR COLOR.

PRINCIPAL REGISTER

PRIORITY CLAIMED UNDER SEC. 44(D) ON CANADA APPLICATION NO. 1429698, FILED 3-4-2009, REG. NO. TMA785,732, DATED 12-22-2010, EXPIRES 12-22-2025.

SER. NO. 77-818,998, FILED 9-2-2009.

JANET LEE, EXAMINING ATTORNEY



David J. Kybas

Director of the United States Patent and Trademark Office

United States of America

United States Patent and Trademark Office

STRENGTH

Reg. No. 4,152,122

DS WATERS OF AMERICA, INC. (DELAWARE CORPORATION)
5660 NEW NORTHSIDE DRIVE, SUITE 500
ATLANTA, GA 30328

Registered June 5, 2012

Int. Cl.: 32

FOR: POWDERS USED IN THE PREPARATION OF NON-ALCOHOLIC FRUIT FLAVORED BEVERAGES, IN CLASS 32 (U.S. CLS. 45, 46 AND 48).

TRADEMARK

FIRST USE 3-1-2011; IN COMMERCE 3-1-2011.

PRINCIPAL REGISTER

THE MARK CONSISTS OF STANDARD CHARACTERS WITHOUT CLAIM TO ANY PARTICULAR FONT, STYLE, SIZE, OR COLOR.

SER. NO. 77-829,805, FILED 9-18-2009.

KAREN BRACEY, EXAMINING ATTORNEY



David J. Kybas

Director of the United States Patent and Trademark Office

United States of America

United States Patent and Trademark Office

BUZZMAMA

Reg. No. 4,152,123

Registered June 5, 2012

Int. Cl.: 35

SERVICE MARK

PRINCIPAL REGISTER

MABEL'S LABELS INC. (CANADA CORPORATION)
P.O. BOX 33561
RPO DUNDURN
HAMILTON, ONTARIO, CANADA L8P4X4

FOR: ARRANGING AND CONDUCTING INCENTIVE REWARD PROGRAMS TO PROMOTE THE SALE OF STICKERS, LABELS AND TAGS VIA A WORD OF MOUTH MARKETING PROGRAM WHERE PEOPLE SIGN ON AND ARE REWARDED WITH PRODUCTS FOR REFERRING FRIENDS, IN CLASS 35 (U.S. CLS. 100, 101 AND 102).

THE MARK CONSISTS OF STANDARD CHARACTERS WITHOUT CLAIM TO ANY PARTICULAR FONT, STYLE, SIZE, OR COLOR.

PRIORITY CLAIMED UNDER SEC. 44(D) ON CANADA APPLICATION NO. 1450820, FILED 9-1-2009, REG. NO. TMA803718, DATED 8-5-2011, EXPIRES 8-5-2026.

SER. NO. 77-841,153, FILED 10-5-2009.

ANTHONY RINKER, EXAMINING ATTORNEY



David J. Kyffers

Director of the United States Patent and Trademark Office

United States of America

United States Patent and Trademark Office

SEOvB

Reg. No. 4,152,124

KA, TAT-YIK JARVIS (UNITED STATES INDIVIDUAL)
9665 HALSEY DR
INDIANAPOLIS, IN 46256

Registered June 5, 2012

Int. Cl.: 42

FOR: COMPUTER SERVICES, NAMELY, SEARCH ENGINE OPTIMIZATION; CONSULTING SERVICES IN THE FIELD OF COMPUTER-BASED INFORMATION SYSTEMS FOR BUSINESSES, IN CLASS 42 (U.S. CLS. 100 AND 101).

SERVICE MARK

FIRST USE 3-24-2008; IN COMMERCE 3-24-2008.

PRINCIPAL REGISTER

THE MARK CONSISTS OF STANDARD CHARACTERS WITHOUT CLAIM TO ANY PARTICULAR FONT, STYLE, SIZE, OR COLOR.

SER. NO. 77-846,148, FILED 10-11-2009.

CHRISTINE MARTIN, EXAMINING ATTORNEY



David J. Kybas

Director of the United States Patent and Trademark Office

United States of America

United States Patent and Trademark Office

EUROTEC

Reg. No. 4,152,125

Registered June 5, 2012

Int. Cls.: 7, 9, 12, 37 and 39

TRADEMARK

SERVICE MARK

PRINCIPAL REGISTER

EUROTEC VERTICAL FLIGHT SOLUTIONS, LLC (KANSAS LIMITED LIABILITY COMPANY)
1040 OCL PARKWAY
EUDORA, KS 66025

FOR: HELICOPTER ENGINES AND ENGINE COMPONENTS, NAMELY, ADJUSTED DRAIN VALVE, BLEED VALVE, CONTROL HARNESS, DIGITAL ENGINE CONTROL UNIT, DRAIN AND OVERSPEED VALVE, ELECTRONIC CONTROL UNIT, ENGINE ASSEMBLY, EXHAUST PIPE, FREE WHEEL SHAFT, FUEL CONTROL UNIT, HEAT SHIELD, HIGH ENERGY GENERATOR, HYDROMECHANICAL UNIT, IGNITION SOLENOID VALVE, OIL PUMP, PRESSURIZATION VALVE, STARTING DRAIN VALVE, TACHOMETER BOX, TACHOMETER TRANSMITTER, THERMOCOUPLE HARNESS, TORQUEMETER TRANSMITTER, ACCESSORY GEARBOX, AXIAL COMPRESSOR, GAS GENERATOR, FREE TURBINE, REDUCTION GEARBOX, BLEED VALVE AND DC STARTER GENERATOR, IN CLASS 7 (U.S. CLS. 13, 19, 21, 23, 31, 34 AND 35).

FIRST USE 2-1-2006; IN COMMERCE 2-1-2006.

FOR: HELICOPTER ELECTRICAL COMPONENTS, NAMELY, AIRSPEED INDICATOR, ALTIMETER, AMMETER, ARTIFICIAL HORIZON, STAND-BY INDICATOR, ATTITUDE GYRO, AUTO-RELIGHT BOX, BLEED AIR ACTUATOR, A/C BLOWER MOTOR, OIL COOLER BLOWER MOTOR, CIRCUIT BOARD, TIME CLOCK, CLUSTER INDICATOR, COCKPIT DISPLAY UNIT, COMPUTER, CONTROL HARNESS, CYCLIC TRIM ACTUATOR, DC AMPS INDICATOR, DC GENERATOR CONTROL UNIT, DC VOLTAGE INDICATOR, DIGITAL ENGINE CONTROL UNIT, DIRECTIONAL GYRO, DISPLACEMENT GYROSCOPE, DUAL DIMMER PASSENGER CONTROL UNIT, DUAL ENGINE INDICATOR, DUAL TURBINE OUTLET TEMPERATURE INDICATOR, ELECTRONIC CONTROL UNIT, ENCODING ALTIMETER, ENGINE OIL TEMPERATURE/PRESSURE INDICATOR, ENGINE SPEED INDICATOR, FREE TURBINE SPEED INDICATOR, FUEL GAUGE INDICATOR, FUEL LEVEL TRANSMITTER, FUEL PRESSURE INDICATOR, FUEL PUMP FAIL DETECTOR, FUEL QUANTITY - AUXILIARY TRANSMITTER, FUEL QUANTITY - MAIN TRANSMITTER, FUEL QUANTITY INDICATOR, FUEL QUANTITY TRANSMITTER, FUEL SENSOR MAIN TANK, FUEL SENSOR SUPPLY TANK, GAS GENERATOR SPEED INDICATOR, GAS PRODUCER TACH INDICATOR, GENERATOR CIRCUIT BOARD, HORIZON GYRO, IGNITION SOLENOID VALVE, LIGHT DIMMER SUPPLY, LIGHT GRADUATOR, LIGHT INTENSITY CONTROL UNIT, LIGHT SIGN EMERGENCY EXIT, LOWER LEVEL TRANSMITTER, MAIN GEARBOX OIL TEMP INDICATOR, MASTER BATTERY BOX, MASTER ELECTRICAL



David J. Kyros

Director of the United States Patent and Trademark Office

Reg. No. 4,152,125 BOX, MULTIPLE INDICATOR, NAVIGATION RECEIVER, OIL PRESSURE INDICATOR, OIL PRESSURE TRANSMITTER/SWITCH, PANEL ANNUNCIATOR, POWER MODULE, POWER SUPPLY, EMERGENCY EXIT LIGHTS, PRESSURE SWITCH, PRINTED CIRCUIT BOARD, PULSELIGHT CONTROL UNIT, RADIO MAGNETIC INDICATOR, RETRACTABLE LANDING LIGHT, ROTOR RPM INDICATOR, ROTOR SPEED INDICATOR, RPM CONTROL UNIT, SENSOR ASSEMBLY, ENGINE RE-LIGHT KIT, SIGNAL CONDITIONER, STARTER GENERATOR, T4 INDICATOR, TACHOMETER BOX, TACHOMETER TRANSMITTER, THERMOCOUPLE HARNESS, TORQUEMETER TRANSMITTER, TRANSMISSION OIL PRESSURE INDICATOR, TRANSPONDER, TRIPLE TACHOMETER INDICATOR, TURBINE OUTLET TEMPERATURE INDICATOR, VEHICLE ENGINE MAINTENANCE DISPLAY, VERTICAL SPEED INDICATOR, VHF COMMUNICATION TRANSCEIVER, VOLTMETER, WARNING CONTROL UNIT, WIPER CONVERTER AND YAW ACTUATOR, IN CLASS 9 (U.S. CLS. 21, 23, 26, 36 AND 38).

FIRST USE 2-1-2006; IN COMMERCE 2-1-2006.

FOR: HELICOPTERS AND STRUCTURAL COMPONENTS THEREFOR, IN CLASS 12 (U.S. CLS. 19, 21, 23, 31, 35 AND 44).

FIRST USE 2-1-2006; IN COMMERCE 2-1-2006.

FOR: REPAIR OF HELICOPTERS AND THEIR COMPONENT PARTS AND ENGINES AND ENGINE PARTS RELATED THERETO, IN CLASS 37 (U.S. CLS. 100, 103 AND 106).

FIRST USE 2-1-2006; IN COMMERCE 2-1-2006.

FOR: LEASING OF HELICOPTERS AND THEIR COMPONENT PARTS AND ENGINES AND ENGINE PARTS RELATED THERETO, IN CLASS 39 (U.S. CLS. 100 AND 105).

FIRST USE 2-1-2006; IN COMMERCE 2-1-2006.

THE MARK CONSISTS OF STANDARD CHARACTERS WITHOUT CLAIM TO ANY PARTICULAR FONT, STYLE, SIZE, OR COLOR.

SER. NO. 77-848,833, FILED 10-14-2009.

CHRISTINE COOPER, EXAMINING ATTORNEY

United States of America

United States Patent and Trademark Office

BroadMan 

Reg. No. 4,152,126

Registered June 5, 2012

Int. Cl.: 1

TRADEMARK

PRINCIPAL REGISTER

AGRIUM INC. (CANADA CORPORATION)
13131 LAKE FRASER DRIVE SE
CALGARY, ALBERTA, CANADA T2J7E8

FOR: FERTILIZER, IN CLASS 1 (U.S. CLS. 1, 5, 6, 10, 26 AND 46).

FIRST USE 9-0-2009; IN COMMERCE 9-0-2009.

PRIORITY CLAIMED UNDER SEC. 44(D) ON CANADA APPLICATION NO. 1454237, FILED 10-5-2009.

THE MARK CONSISTS OF THE WORD "BROADMAN" IN LOWER CASE WITH A CAPITAL "M" AND AT THE END OF THE WORD IS A CIRCLE DESIGN WITH THE NUMBER "20" AND A LEAF.

SER. NO. 77-852,272, FILED 10-19-2009.

JOHN GARTNER, EXAMINING ATTORNEY



David J. Kybas

Director of the United States Patent and Trademark Office

United States of America

United States Patent and Trademark Office

MEDICHARGER

Reg. No. 4,152,127

Registered June 5, 2012

Int. Cls.: 9, 10 and 44

TRADEMARK

SERVICE MARK

PRINCIPAL REGISTER

MILUX HOLDING S.A. (LUXEMBOURG CORPORATION)
12, RUE GUILLAUME SCHNEIDER
LUXEMBOURG, LUXEMBOURG L-2522

FOR: APPARATUS, DEVICES AND INSTRUMENTS, ALL NOT USED IN DIRECT ASSOCIATION WITH ACTIVE IMPLANTS, FOR MEASURING, RECEIVING, SENDING, CHECKING, CONTROLLING, DRIVING, TRANSFERRING, TRANSMITTING, PROCESSING, ANALYZING, CONDUCTING, SWITCHING, TRANSFORMING, ACCUMULATING, AND REGULATING ELECTRICITY, ENERGY AND/OR DATA, INCLUDING PHYSICAL PARAMETERS, NAMELY, ELECTRONIC STORAGE DEVICES IN THE NATURE OF BLANK MEMORY DISCS, MEMORY CARDS AND DATA STORAGE MEDIA, NAMELY, PACKAGED SEMICONDUCTORS, ELECTRONIC CONTROL UNIT AND PROGRAMMER WHICH CONTROLS THE WORKING PARAMETERS OF WIRELESS COMMUNICATION SYSTEMS AND WIRELESS POWERING SYSTEMS, CHARGERS IN THE NATURE OF BATTERY CHARGERS, DIGITAL CHARGERS AND ELECTRONIC CHARGERS, ELECTRONIC TRANSMITTERS AND ELECTRONIC RECEIVERS OF ELECTRONIC SIGNALS, AND ELECTRONIC CIRCUITS; REMOTE CONTROLS FOR WIRELESS CONTROLLING, AND PROGRAMMING WIRELESS CHARGER APPARATUS FOR WIRELESS ENERGIZING AND CONTROL STATIONS FOR WIRELESS CONTROLLING, PROGRAMMING AND ENERGIZING OF ACTIVE IMPLANTS; SOFTWARE, IN PARTICULAR FOR ACTIVE MEDICAL IMPLANTS, FOR MEASURING, RECEIVING, SENDING, CHECKING, TRANSFERRING, CALCULATING, PROCESSING, CONTROLLING, PRESENTING AND ANALYZING OF DATA, NAMELY, DATA ABOUT ELECTRICITY, ENERGY, PHYSICAL PARAMETERS, AND COMMUNICATION AND PROGRAMMING DATA IN MEDICAL IMPLANTS; SOFTWARE, IN PARTICULAR FOR MEASURING, RECEIVING, SENDING, CHECKING, TRANSFERRING, CALCULATING, PROCESSING, CONTROLLING, PRESENTING AND ANALYZING OF DATA, NAMELY, DATA ABOUT ELECTRICITY, ENERGY, PHYSICAL PARAMETERS, COMMUNICATION AND PROGRAMMING DATA IN APPARATUS, DEVICES AND INSTRUMENTS FOR COMMUNICATING WITH, ENERGIZING AND PROGRAMMING OF MEDICAL IMPLANTS; AND DATA PROCESSING EQUIPMENT AND COMPUTERS, IN CLASS 9 (U.S. CLS. 21, 23, 26, 36 AND 38).



David J. Kyffers

Director of the United States Patent and Trademark Office

FOR: MEDICAL AND SURGICAL APPARATUS, INSTRUMENTS AND DEVICES, INCLUDING ACTIVE AND NON-ACTIVE MEDICAL IMPLANTS, NAMELY, MEDICAL IMPLANTS COMPRISED OF ARTIFICIAL MATERIAL; MEDICAL AND SURGICAL APPARATUS, INSTRUMENTS AND DEVICES INTENDED FOR USE INSIDE THE MAMMAL OR HUMAN BODY, IN PARTICULAR MANUAL, ELECTRICAL OR A COMBINATION OF MANUAL

Reg. No. 4,152,127 AND ELECTRICAL APPARATUS, DEVICES AND INSTRUMENTS, IN ALL GOODS INCLUDING MEDICAL HYDRAULIC, MECHANICAL, AND PNEUMATIC APPARATUS, DEVICES AND INSTRUMENTS, NAMELY, MEDICAL IMPLANTS COMPRISED OF ARTIFICIAL MATERIAL; MEDICAL AND SURGICAL APPARATUS, INSTRUMENTS AND DEVICES FOR REPLACING AND ADDING ONE OR MORE BODILY FUNCTIONS AND PARTS INSIDE THE BODY, NAMELY, MEDICAL IMPLANTS COMPRISED OF ARTIFICIAL MATERIAL; MEDICAL AND SURGICAL APPARATUS, INSTRUMENTS AND DEVICES DESIGNED FOR WIRELESS PROGRAMMING, WIRELESS CONTROLLING, WIRELESS COMMUNICATING AND WIRELESS ENERGIZING, NAMELY, ACTIVE IMPLANTS IN THE NATURE OF IMPLANTS CONSISTING OF ARTIFICIAL MATERIALS, AND A WIRELESS TRANSMITTER AND A RECEIVER AS AN INTEGRAL COMPONENT OF A SURGICAL IMPLANT; WIRELESS COMMUNICATION SYSTEMS, APPARATUS, DEVICES, AND INSTRUMENTS AND WIRELESS ENERGIZING SYSTEMS, APPARATUS, DEVICES, AND INSTRUMENTS FOR MEASURING, RECEIVING, SENDING, SWITCHING, TRANSFORMING, ACCUMULATING, REGULATING, STORING, CHECKING, CONTROLLING, DRIVING, TRANSFERRING, TRANSMITTING, PROCESSING AND ANALYZING, IN ALL THE APPLICABLE AFOREMENTIONED GOODS, OF DATA INCLUDING PHYSICAL PARAMETERS, ELECTRICITY, ENERGY AND DATA, NAMELY, ELECTRONIC TRANSMITTERS FOR COMMUNICATING WITH, AND ENERGIZING OF, AND USED IN DIRECT ASSOCIATION WITH, ACTIVE MEDICAL IMPLANTS CONSISTING OF ARTIFICIAL MATERIALS; SURGICAL INSTRUMENTS IN PARTICULAR TO BE USED DURING OPERATIONS OF ACTIVE OR NON-ACTIVE MEDICAL IMPLANTS; VETERINARY MEDICAL AND SURGICAL APPARATUS, INSTRUMENTS AND DEVICES, FOR USE IN IMPLANT SURGERIES; MEDICAL AND SURGICAL APPARATUS, INSTRUMENTS AND DEVICES FOR ORTHOPAEDIC JOINT IMPLANTS; AND MEDICAL IMPLANTS FOR COLLECTING, RECEIVING, SENDING, STORING, PREPARING, CONTROLLING, ANALYZING AND PROCESSING OF DATA AND ENERGY TO AND FROM SAID MEDICAL IMPLANTS, IN CLASS 10 (U.S. CLS. 26, 39 AND 44).

FOR: MEDICAL SERVICES IN RELATION TO MEDICAL IMPLANTS FOR COLLECTING, SENDING, RECEIVING, STORING, PREPARING, CONTROLLING, PRESENTING, CALCULATING, ANALYZING AND PROCESSING OF DATA TO AND FROM PATIENTS AND TO AND FROM MEDICAL IMPLANTS AND TO AND FROM REMOTE CONTROLS, WIRELESS CHARGER APPARATUS AND CONTROL STATIONS FOR ACTIVE IMPLANTS; SURGICAL AND HEALTH SERVICES, NAMELY, IMPLANTATION OF ARTIFICIAL IMPLANTS TO ALLOW THE IMPLANTS TO COLLECT, SEND, RECEIVE, STORE, PREPARE, CONTROL, PRESENT, CALCULATE, ANALYZE, AND PROCESS OF DATA TO AND FROM PATIENTS AND TO AND FROM MEDICAL IMPLANTS AND TO AND FROM MEDICAL IMPLANTS AND TO AND FROM REMOTE CONTROLS, WIRELESS CHARGER APPARATUS AND CONTROL STATIONS FOR ACTIVE IMPLANTS; PROVIDING A MEDICAL, SURGICAL AND HEALTH DATABASE FEATURING MEDICAL, SURGICAL AND HEALTH INFORMATION RELATING TO MEDICAL IMPLANTS THAT HAS BEEN INPUT, COLLECTED, RECEIVED, PREPARED, CONTROLLED, PROGRAMMED, CALCULATED, AND ANALYZED, FROM MEDICAL IMPLANTS, REMOTE CONTROLS OR CONTROL STATIONS FOR USE BY MEDICAL, SURGICAL AND HEALTH PROFESSIONALS FOR THE PURPOSES OF MONITORING AND DIAGNOSING MEDICAL CONDITIONS; MEDICAL AND SURGICAL SERVICES, NAMELY, IMPLANTATION OF ARTIFICIAL IMPLANTS IN RELATION TO MEDICAL IMPLANTS FOR PROGRAMMING, CONTROLLING, COMMUNICATING WITH, AND ENERGIZING OF, ACTIVE IMPLANTS; AND MEDICAL AND SURGICAL SERVICES, NAMELY, ARTIFICIAL IMPLANTATION SERVICES FOR PERSONS HAVING A MEDICAL RELATED CONDITION AND BEING CANDIDATES FOR OR BEING OPERATED ON WITH AN ACTIVE OR A NON-ACTIVE IMPLANT, IN CLASS 44 (U.S. CLS. 100 AND 101).

THE MARK CONSISTS OF STANDARD CHARACTERS WITHOUT CLAIM TO ANY PARTICULAR FONT, STYLE, SIZE, OR COLOR.

PRIORITY CLAIMED UNDER SEC. 44(D) ON ERPN CMNTY TM OFC APPLICATION NO. 008246233, FILED 4-27-2009, REG. NO. 008246233, DATED 9-10-2011, EXPIRES 4-27-2019.

Reg. No. 4,152,127 SER. NO. 77-858,115, FILED 10-27-2009.

ALEX KEAM, EXAMINING ATTORNEY

United States of America

United States Patent and Trademark Office

PRESTON MARTIN

Reg. No. 4,152,128

Registered June 5, 2012

Int. Cl.: 3

TRADEMARK

PRINCIPAL REGISTER

AZZURO HOLDINGS LTD. (CANADA CORPORATION)
123 - 2631 VIKING WAY
RICHMOND, BC, CANADA V6V1N3

FOR: SKIN, BODY, FACE AND COSMETIC PREPARATIONS, NAMELY, SKIN CLARIFIERS, SKIN CLEANSERS, SKIN CLEANSING CREAM, SKIN CLEANSING LOTION, SKIN CONDITIONERS, SKIN CREAM, SKIN MOISTURIZER MASKS, SKIN SOAP, SKIN TONERS, SKIN CARE SERUMS AND TREATMENT OILS, CONTOURING CREAMS AND GELS, FACE CREAMS, FACE MASKS, FACE TREATMENT CREAMS, FACIAL CLEANSERS, FACIAL CREAMS, FACIAL EMULSIONS, FACIAL MASKS, FACIAL SCRUBS, FACIAL PEELS, FACIAL MAKEUP, EYE CREAM, EYE GELS, EYE MAKEUP, EYE MAKEUP REMOVER, AND TRAVEL KITS CONTAINING TWO OR MORE OF SKIN CLARIFIERS, SKIN CLEANSERS, SKIN CLEANSING CREAM, SKIN CLEANSING LOTION, SKIN CONDITIONERS, SKIN CREAM, SKIN MOISTURIZER MASKS, SKIN SOAP, SKIN TONERS, SKIN CARE SERUMS AND TREATMENT OILS, CONTOURING CREAMS AND GELS, FACE CREAMS, FACE MASKS, FACE TREATMENT CREAMS, FACIAL CLEANSERS, FACIAL CREAMS, FACIAL EMULSIONS, FACIAL MASKS, FACIAL SCRUBS, FACIAL PEELS, FACIAL MAKEUP, EYE CREAM, EYE GELS, EYE MAKEUP AND/OR EYE MAKEUP REMOVER; HAND AND FOOT CARE, NAMELY, NON-MEDICATED CREAMS, SCRUBS, LOTIONS, SOAKS, SOAP AND CLEANSERS; COSMETIC BODY CARE IN THE NATURE OF BODY WRAPS; COSMETICS, IN CLASS 3 (U.S. CLS. 1, 4, 6, 50, 51 AND 52).

FIRST USE 12-31-2009; IN COMMERCE 12-31-2009.

THE MARK CONSISTS OF STANDARD CHARACTERS WITHOUT CLAIM TO ANY PARTICULAR FONT, STYLE, SIZE, OR COLOR.

PRIORITY CLAIMED UNDER SEC. 44(D) ON CANADA APPLICATION NO. 1457437, FILED 10-30-2009, REG. NO. TMA798,417, DATED 5-25-2011, EXPIRES 5-25-2026.

THE NAME(S), PORTRAIT(S), AND/OR SIGNATURE(S) SHOWN IN THE MARK DOES NOT IDENTIFY A PARTICULAR LIVING INDIVIDUAL.

SER. NO. 77-861,996, FILED 10-30-2009.

FLORENTINA BLANDU, EXAMINING ATTORNEY



David J. Kyros

Director of the United States Patent and Trademark Office

United States of America

United States Patent and Trademark Office

CPRX

Reg. No. 4,152,129

Registered June 5, 2012

Int. Cl.: 44

SERVICE MARK

PRINCIPAL REGISTER

ADVANCED MEDICAL/MENTAL HEALTH OUTREACH SERVICES TEAM, INC. (FLORIDA CORPORATION)
SUITE 101
2012 VERNON PLACE SOUTH
MELBOURNE, FL 32901

FOR: HEALTH CARE SERVICES, NAMELY, PROVIDING DETOXIFICATION, MENTAL HEALTH, GERIATRIC HEALTH CARE MANAGEMENT AND PAIN RELIEF TREATMENTS AND PROGRAMS, IN CLASS 44 (U.S. CLS. 100 AND 101).

FIRST USE 7-0-1999; IN COMMERCE 7-0-1999.

THE MARK CONSISTS OF STANDARD CHARACTERS WITHOUT CLAIM TO ANY PARTICULAR FONT, STYLE, SIZE, OR COLOR.

SER. NO. 77-866,879, FILED 11-6-2009.

ROBERT STRUCK, EXAMINING ATTORNEY



David J. Kyffers

Director of the United States Patent and Trademark Office

United States of America

United States Patent and Trademark Office

Hunting With A Hero

Reg. No. 4,152,130

Registered June 5, 2012

Int. Cl.: 41

SERVICE MARK

PRINCIPAL REGISTER

GOODING III, WILLIAM RONEL (UNITED STATES INDIVIDUAL), DBA HUNTING WITH
A HERO
1207 SAYLORS AVE
MONCKS CORNER, SC 24961

FOR: HUNTING GUIDE SERVICES; PROVIDING INFORMATION IN THE FIELD OF
HUNTING AND FISHING VIA THE INTERNET; RECREATIONAL SERVICES, NAMELY,
PROVIDING HUNTING PRESERVES, IN CLASS 41 (U.S. CLS. 100, 101 AND 107).

FIRST USE 3-15-2009; IN COMMERCE 3-15-2009.

THE MARK CONSISTS OF STANDARD CHARACTERS WITHOUT CLAIM TO ANY PAR-
TICULAR FONT, STYLE, SIZE, OR COLOR.

NO CLAIM IS MADE TO THE EXCLUSIVE RIGHT TO USE "HUNTING", APART FROM
THE MARK AS SHOWN.

SER. NO. 77-869,712, FILED 11-10-2009.

KAREN BRACEY, EXAMINING ATTORNEY



David J. Kybas

Director of the United States Patent and Trademark Office

United States of America

United States Patent and Trademark Office

IN CUISIN

Reg. No. 4,152,131

Registered June 5, 2012

Int. Cls.: 29 and 30

TRADEMARK

PRINCIPAL REGISTER

ALIMENTS IN FOODS INC. (CANADA CORPORATION)
1010 SHERBROOKE STREET WEST
SUITE 2202
MONTREAL, QUEBEC H3A 2R7

FOR: FROZEN MEALS CONSISTING PRIMARILY OF MEAT, FISH, POULTRY OR VEGETABLES; CANDIED FRUIT SNACKS; DEHYDRATED FRUIT SNACKS; FRUIT-BASED SNACK FOOD; MEAT-BASED SNACK FOODS; NUT AND SEED-BASED SNACK BARS; POTATO-BASED SNACK FOODS; SNACK DIPS EXCLUDING SALSA AND OTHER SAUCES USED AS DIPS; SNACK MIX CONSISTING OF DEHYDRATED FRUIT AND PROCESSED NUTS; TOFU-BASED SNACKS; VEGETABLE-BASED SNACK FOODS; DIPS EXCLUDING SALSA AND OTHER SAUCES USED AS DIPS; PRE-PACKAGED DINNERS CONSISTING OF PRIMARILY OF MEAT, SEAFOOD OR POULTRY SERVED WITH PASTA; RICE WITH VEGETABLES; CHEESE SPREADS; DAIRY-BASED SPREADS; FRUIT-BASED SPREADS; MEAT-BASED SPREADS; VEGETABLE-BASED SPREADS; FROZEN, PREPARED OR PACKAGED SIDE DISH CONSISTING PRIMARILY OF MASHED POTATOES OR PUREED VEGETABLES; FROZEN, PREPARED OR PACKAGED SIDE DISH CONSISTING PRIMARILY OF POTATOES MIXED WITH VEGETABLES; SHELLED NUTS; ROASTED NUTS; PROCESSED NUTS; NUT-BASED SNACK FOODS, IN CLASS 29 (U.S. CL. 46).

FOR: FOOD STUFFING MIXES CONTAINING BREAD; FROZEN MEALS CONSISTING PRIMARILY OF PASTA OR RICE; SALSA; SAUCES; CEREAL-BASED SNACK FOODS; MULTIGRAIN-BASED SNACK FOODS; RICE-BASED SNACK FOODS; FROZEN CONFECTIONERY; RICE; FROZEN, PREPARED OR PACKAGED MEALS CONSISTING PRIMARILY OF RICE; PITA BREAD AND PITA CHIPS; FRUIT PIES; PIES, IN CLASS 30 (U.S. CL. 46).

THE MARK CONSISTS OF STANDARD CHARACTERS WITHOUT CLAIM TO ANY PARTICULAR FONT, STYLE, SIZE, OR COLOR.

PRIORITY CLAIMED UNDER SEC. 44(D) ON CANADA APPLICATION NO. 1,442,119, FILED 6-18-2009, REG. NO. TMA810,726, DATED 11-1-2011, EXPIRES 11-1-2026.

NO CLAIM IS MADE TO THE EXCLUSIVE RIGHT TO USE "CUISINE", APART FROM THE MARK AS SHOWN.

SER. NO. 77-870,207, FILED 11-11-2009.



David J. Kyros

Director of the United States Patent and Trademark Office

Reg. No. 4,152,131 LESLEY LAMOTHE, EXAMINING ATTORNEY

United States of America

United States Patent and Trademark Office

SMART TV SOLUTIONS

Reg. No. 4,152,132

Registered June 5, 2012

Int. Cl.: 8

TRADEMARK

PRINCIPAL REGISTER

SOMERSET WAREHOUSING PLUS INC. (NEW JERSEY CORPORATION), DBA SMART
WORKS CONSUMER PRODUCTS
800-B, APGAR DRIVE
SOMERSET, NJ 08873

FOR: HAND-OPERATED FOOD PROCESSOR, IN CLASS 8 (U.S. CLS. 23, 28 AND 44).

FIRST USE 6-30-2009; IN COMMERCE 8-15-2009.

THE MARK CONSISTS OF STANDARD CHARACTERS WITHOUT CLAIM TO ANY PARTICULAR FONT, STYLE, SIZE, OR COLOR.

SER. NO. 77-875,840, FILED 11-18-2009.

GEOFFREY FOSDICK, EXAMINING ATTORNEY



David J. Kyffers

Director of the United States Patent and Trademark Office

United States of America

United States Patent and Trademark Office

My Harleysville
LifeLink

Reg. No. 4,152,133

Registered June 5, 2012

Int. Cl.: 36

SERVICE MARK

PRINCIPAL REGISTER

HARLEYSVILLE MUTUAL INSURANCE COMPANY (PENNSYLVANIA CORPORATION)
355 MAPLE AVENUE
HARLEYSVILLE, PA 19438

FOR: PROVIDING AN INTERNET WEBSITE PORTAL OFFERING INFORMATION TO AGENTS AND GROUP ADMINISTRATORS REGARDING INSURANCE BENEFITS AND INSURANCE INFORMATION FOR LIFE, LONG TERM DISABILITY AND/OR SHORT TERM DISABILITY INSURANCE COVERAGE, IN CLASS 36 (U.S. CLS. 100, 101 AND 102).

FIRST USE 3-30-2009; IN COMMERCE 3-30-2009.

OWNER OF U.S. REG. NOS. 2,708,595, 2,723,300 AND OTHERS.

THE MARK CONSISTS OF THE WORDING "MY HARLEYSVILLE LIFELINK" WITH THE WORDING "MY HARLEYSVILLE" IN SMALLER LETTERS ABOVE THE WORDING "LIFELINK" IN LARGER LETTERS.

SEC. 2(F) AS TO "HARLEYSVILLE".

SER. NO. 77-884,016, FILED 12-2-2009.

JANET LEE, EXAMINING ATTORNEY



David J. Kyffers

Director of the United States Patent and Trademark Office

United States of America

United States Patent and Trademark Office

BLARNEY STONE

Reg. No. 4,152,134

Registered June 5, 2012

Int. Cl.: 29

TRADEMARK

PRINCIPAL REGISTER

SQUARE-H BRANDS, INC. (DELAWARE CORPORATION)
2731 SOUTH SOTO STREET
LOS ANGELES, CA 90058

FOR: MEAT, IN CLASS 29 (U.S. CL. 46).

FIRST USE 0-0-1985; IN COMMERCE 0-0-1985.

THE MARK CONSISTS OF STANDARD CHARACTERS WITHOUT CLAIM TO ANY PARTICULAR FONT, STYLE, SIZE, OR COLOR.

THE NAME(S), PORTRAIT(S), AND/OR SIGNATURE(S) SHOWN IN THE MARK DOES NOT IDENTIFY A PARTICULAR LIVING INDIVIDUAL.

SER. NO. 77-886,843, FILED 12-4-2009.

NAAKWAMA ANKRAH, EXAMINING ATTORNEY



David J. Kyffers

Director of the United States Patent and Trademark Office

United States of America

United States Patent and Trademark Office

PAXON

Reg. No. 4,152,135

Registered June 5, 2012

Int. Cl.: 5

TRADEMARK

PRINCIPAL REGISTER

VETOQUINOL N.-A. INC. (CANADA CORPORATION)
2000, CHEMIN GEORGES
LAVALTRIE, CANADA

FOR: VETERINARY PRODUCTS AND DIETETIC SUPPLEMENTS, NAMELY, A NUTRITIONAL PRODUCT TO PROMOTE NORMAL URINARY TRACT HEALTH IN DOGS AND CATS HAVING PROANTHOCYANIADIN AS ACTIVE ELEMENT, IN CLASS 5 (U.S. CLS. 6, 18, 44, 46, 51 AND 52).

THE MARK CONSISTS OF STANDARD CHARACTERS WITHOUT CLAIM TO ANY PARTICULAR FONT, STYLE, SIZE, OR COLOR.

PRIORITY CLAIMED UNDER SEC. 44(D) ON CANADA APPLICATION NO. 1462456, FILED 12-11-2009, REG. NO. TMA813573, DATED 12-7-2011, EXPIRES 12-7-2026.

SER. NO. 77-891,489, FILED 12-11-2009.

ESTHER BELENKER, EXAMINING ATTORNEY



David J. Kybas

Director of the United States Patent and Trademark Office

United States of America

United States Patent and Trademark Office

FROSTT

Reg. No. 4,152,136

Registered June 5, 2012

Int. Cls.: 9 and 42

TRADEMARK

SERVICE MARK

PRINCIPAL REGISTER

MARINER PARTNERS INC. (CANADA CORPORATION OF THE PROVINCE OF NEW BRUNSWICK)
SUITE 300, 12 SMYTHE STREET, SAINT JOHN
NEW BRUNSWICK, CANADA E2L5G5

FOR: COMPUTER SOFTWARE TO ALLOW USERS OF INTERNET PROTOCOL TELEVISION (IPTV) TECHNOLOGIES TO PERSONALIZE, VIEW, AND MANAGE IPTV DIGITAL CONTENT; COMPUTER SOFTWARE TO MANAGE PASSWORDS, SET-TOP BOX REGISTRATIONS, AND SCHEDULING OF IPTV SERVICES; COMPUTER SOFTWARE TO INTERFACE WITH, ACCESS, AND USE INTERNET E-MAIL THROUGH IPTV TECHNOLOGIES, TO CAPTURE INCOMING CALLING LINE IDENTIFICATION INFORMATION AND REDIRECT AND REFORMAT SUCH INFORMATION TO THE TELEVISION SCREEN, AND TO INTERFACE WITH, ACCESS, AND USE INTERNET SERVICES FOR THE TELEVISION, IN CLASS 9 (U.S. CLS. 21, 23, 26, 36 AND 38).

FOR: INSTALLATION, MAINTENANCE AND UPDATING OF COMPUTER SOFTWARE FOR USE WITH IPTV TECHNOLOGIES; COMPUTER SOFTWARE DESIGN, DEVELOPMENT, CUSTOMIZATION, CONFIGURATION, IMPLEMENTATION, AND CONSULTING SERVICES IN THE FIELD OF IPTV, IN CLASS 42 (U.S. CLS. 100 AND 101).

THE MARK CONSISTS OF STANDARD CHARACTERS WITHOUT CLAIM TO ANY PARTICULAR FONT, STYLE, SIZE, OR COLOR.

PRIORITY CLAIMED UNDER SEC. 44(D) ON CANADA APPLICATION NO. 1464779, FILED 12-24-2009, REG. NO. TMA803335, DATED 8-2-2011, EXPIRES 8-2-2026.

SER. NO. 77-911,979, FILED 1-14-2010.

KATHLEEN M. VANSTON, EXAMINING ATTORNEY



David J. Kyros

Director of the United States Patent and Trademark Office

United States of America

United States Patent and Trademark Office



Reg. No. 4,152,137

Registered June 5, 2012

Int. Cls.: 9 and 42

TRADEMARK

SERVICE MARK

PRINCIPAL REGISTER

MARINER PARTNERS INC. (CANADA CORPORATION OF THE PROVINCE OF NEW BRUNSWICK)
SUITE 300, 12 SMYTHE STREET, SAINT JOHN
NEW BRUNSWICK, CANADA E2L5G5

FOR: COMPUTER SOFTWARE TO ALLOW USERS OF INTERNET PROTOCOL TELEVISION (IPTV) TECHNOLOGIES TO PERSONALIZE, VIEW, AND MANAGE IPTV DIGITAL CONTENT; COMPUTER SOFTWARE TO MANAGE PASSWORDS, SET-TOP BOX REGISTRATIONS, AND SCHEDULING OF IPTV SERVICES; COMPUTER SOFTWARE TO INTERFACE WITH, ACCESS, AND USE INTERNET E-MAIL THROUGH IPTV TECHNOLOGIES, TO CAPTURE INCOMING CALLING LINE IDENTIFICATION INFORMATION AND REDIRECT AND REFORMAT SUCH INFORMATION TO THE TELEVISION SCREEN, AND TO INTERFACE WITH, ACCESS, AND USE INTERNET SERVICES FOR THE TELEVISION, IN CLASS 9 (U.S. CLS. 21, 23, 26, 36 AND 38).

FOR: INSTALLATION, MAINTENANCE AND UPDATING OF COMPUTER SOFTWARE FOR USE WITH IPTV TECHNOLOGIES; COMPUTER SOFTWARE DESIGN, DEVELOPMENT, CUSTOMIZATION, CONFIGURATION, IMPLEMENTATION, AND CONSULTING SERVICES IN THE FIELD OF IPTV, IN CLASS 42 (U.S. CLS. 100 AND 101).

PRIORITY CLAIMED UNDER SEC. 44(D) ON CANADA APPLICATION NO. 1464814, FILED 12-24-2009, REG. NO. TMA803336, DATED 8-2-2011, EXPIRES 8-2-2026.

THE MARK CONSISTS OF A SNOWFLAKE DESIGN FOLLOWED BY THE WORD "FROSTT" IN STYLIZED LETTERING.

SER. NO. 77-911,984, FILED 1-14-2010.

KATHLEEN M. VANSTON, EXAMINING ATTORNEY



David J. Kyros

Director of the United States Patent and Trademark Office

United States of America

United States Patent and Trademark Office

HBIMED

Reg. No. 4,152,138

Registered June 5, 2012

Int. Cls.: 9, 10 and 42

TRADEMARK

SERVICE MARK

PRINCIPAL REGISTER

HBIMED AG (SWITZERLAND AKTIENGESELLSCHAFT)
UNTERE GASSE 17
CHUR, SWITZERLAND 7000

FOR: SCIENTIFIC AND TEACHING APPARATUS AND INSTRUMENTS, NAMELY, APPARATUS FOR RECORDING AUDIO, AUDIO-VISUAL, VISUAL AND TACTILE DATA, IN PARTICULAR PHYSICAL DATA, INCLUDING TEMPERATURE, RESISTANCE, PRESSURE, HUMIDITY, ELECTRICAL CURRENT BY HUMAN AND ANIMAL BODIES; APPARATUS FOR THE RECORDING, TRANSMITTING AND REPRODUCING OF SOUND, IMAGES OR DATA; COMPUTER SOFTWARE FOR USE IN ANALYZING, CONTROLLING AND MANAGING PATIENT MEDICAL INFORMATION IN THE FIELD OF MENTAL DISORDERS AND NEUROFEEDBACK; COMPUTER SOFTWARE FOR INTERPRETATION OF NEURO AND BRAIN SCANS PROVIDED BY DIAGNOSTIC IMAGING EQUIPMENT; HARDWARE, NAMELY, COMPUTER HARDWARE OR ELECTRONIC HARDWARE OR ELECTRONIC CIRCUITS WHICH ALLOWS TO RECORD AUDIO, AUDIO-VISUAL, VISUAL AND TACTILE DATA, IN PARTICULAR PHYSICAL DATA, INCLUDING TEMPERATURE, RESISTANCE, PRESSURE, HUMIDITY, ELECTRICAL CURRENT, ALL AFORESAID GOODS FOR MAKING A DIAGNOSE AND ADMINISTERING A THERAPY IN THE FIELD OF MENTAL DISORDERS, IN CLASS 9 (U.S. CLS. 21, 23, 26, 36 AND 38).

FOR: MEDICAL APPARATUS FOR MAKING A DIAGNOSE IN THE FIELD OF MENTAL DISORDERS; THERAPY APPARATUS FOR THE TREATMENT OF MENTAL DISORDERS, NAMELY, ELECTROENCEPHALOGRAPHY, IN CLASS 10 (U.S. CLS. 26, 39 AND 44).

FOR: PRODUCT DEVELOPMENT, NAMELY, DEVELOPMENT OF DEVICES, APPARATUS AND PROCESSES FOR DIAGNOSTICS AND THERAPY OF MENTAL DISORDERS; DATABASES DESIGN; COMPUTER PROGRAMMING; ENCRYPTION AND DECRYPTION OF INFORMATION AND DATAS, IN CLASS 42 (U.S. CLS. 100 AND 101).

THE MARK CONSISTS OF STANDARD CHARACTERS WITHOUT CLAIM TO ANY PARTICULAR FONT, STYLE, SIZE, OR COLOR.

OWNER OF ERPN CMNTY TM OFC REG. NO. 008800047, DATED 6-22-2010, EXPIRES 6-22-2020.

SER. NO. 77-916,014, FILED 1-20-2010.



David J. Kyjars

Director of the United States Patent and Trademark Office

Reg. No. 4,152,138 FLORENTINA BLANDU, EXAMINING ATTORNEY

United States of America

United States Patent and Trademark Office

INFOJOBS

Reg. No. 4,152,139

Registered June 5, 2012

Int. Cl.: 38

SERVICE MARK

PRINCIPAL REGISTER

INFOJOBS, S.A. (SPAIN CORPORATION)
CALLE NUMANCIA 46
BARCELONA, SPAIN 08029

FOR: COMPUTER-AIDED TRANSMISSION AND ELECTRONIC PROCESSING OF MESSAGES AND IMAGES; SENDING AND RECEIVING OF MESSAGES VIA ELECTRONIC MAIL AND INTERNET, IN CLASS 38 (U.S. CLS. 100, 101 AND 104).

THE MARK CONSISTS OF STANDARD CHARACTERS WITHOUT CLAIM TO ANY PARTICULAR FONT, STYLE, SIZE, OR COLOR.

OWNER OF ERPN CMNTY TM OFC REG. NO. 001751148, DATED 3-21-2002, RENEWED AS REG. NO. 001751148, DATED 7-7-2010, EXPIRES 7-7-2020.

SER. NO. 77-916,077, FILED 1-20-2010.

SUE LAWRENCE, EXAMINING ATTORNEY



David J. Kybas

Director of the United States Patent and Trademark Office

United States of America

United States Patent and Trademark Office

NOEMIE LENOIR

Reg. No. 4,152,140

Registered June 5, 2012

Int. Cls.: 3, 14 and 25

TRADEMARK

PRINCIPAL REGISTER

NOEMIE LENOIR (FRANCE INDIVIDUAL)
32 RUE DES ARCHIVES
PARIS, FRANCE 75003

FOR: SOAP FOR BODY CARE; FRAGRANCES AND PERFUMERY; TOILET WATERS; EAU DE COLOGNES; DEODORANT FOR PERSONAL USE; ETHEREAL OILS; INCENSE; POT-POURRI; BODY AND BEAUTY CARE COSMETICS; NAIL CARE PREPARATIONS; COSMETIC PREPARATIONS FOR SLIMMING PURPOSES; TONING LOTION FOR THE FACE, BODY AND HANDS; BEAUTY MASKS; COSMETIC CREAMS; SKIN WHITENING CREAMS; NON-MEDICATED LIP CARE PREPARATIONS; HAIR SHAMPOOS AND CONDITIONERS; SUN-TANNING PREPARATIONS; SELF-TANNING LOTIONS; OILS FOR TOILETRY PURPOSES; SHOWER AND BATH GEL; BATH AND SHOWER GELS AND SALTS, NOT FOR MEDICAL PURPOSES; BUBBLE BATH; BATH BEADS; TALCUM POWDER, FOR TOILET USE; CLEANSING MILK FOR TOILET PURPOSES; MAKE-UP REMOVING PREPARATIONS; LIP GLOSS; LIP LINER; BLUSH; MASCARA; EYE LINER; EYE SHADOW; FINGER NAIL POLISH, IN CLASS 3 (U.S. CLS. 1, 4, 6, 50, 51 AND 52).

FOR: PRECIOUS METALS AND THEIR ALLOYS; JEWELRY; CLOCKS AND WATCHES; PRECIOUS STONES, IN CLASS 14 (U.S. CLS. 2, 27, 28 AND 50).

FOR: CLOTHING AND KNITWEAR, NAMELY, TROUSERS, DRESSES, BATH ROBES, BATHING SUITS, PAJAMAS, SHIRTS, TEE-SHIRTS, CLOTHING BELTS, LINGERIE BODICES, BRAS, CORSETS, KNICKERS, BODYSUITS, BASQUES, BABYDOLLS, SLIPS, BRASSIERES, UNDERWEAR, COMBINATION CLOTHING, LINGERIE, BREECHES, SWIMMING SUITS, COATS, JACKETS FOR CITY, JACKETS FOR SPORT, DRESSING GOWNS; GLOVES, CAPS, HATS, FOOTWEAR, SHOES BOOTS, BEACH SHOES, MULES, BATH SANDALS, HEADWEAR, IN CLASS 25 (U.S. CLS. 22 AND 39).

THE MARK CONSISTS OF STANDARD CHARACTERS WITHOUT CLAIM TO ANY PARTICULAR FONT, STYLE, SIZE, OR COLOR.

OWNER OF ERPN CMNTY TM OFC REG. NO. 008749988, DATED 6-11-2010, EXPIRES 12-11-2019.

THE NAME(S), PORTRAIT(S), AND/OR SIGNATURE(S) SHOWN IN THE MARK IDENTIFIES THE OWNER, WHOSE CONSENT(S) TO REGISTER IS MADE OF RECORD.



David J. Kyros

Director of the United States Patent and Trademark Office

Reg. No. 4,152,140 SER. NO. 77-922,135, FILED 1-28-2010.

MARGERY A. TIERNEY, EXAMINING ATTORNEY

United States of America

United States Patent and Trademark Office

SANMARCO

Reg. No. 4,152,141

Registered June 5, 2012

Int. Cl.: 25

TRADEMARK

PRINCIPAL REGISTER

VIANA CANADA INC. (CANADA CORPORATION)
81 ZENWAY BOULEVARD, UNIT 11
WOODBIDGE, ONTARIO, CANADA L4H0S5

FOR: MEN AND LADIES APPAREL, NAMELY, SCARVES, TIES, POCKET SQUARES, SWEATERS, BELTS, PONCHOS, FOULARD, DRESS SHIRTS, TROUSERS, SUITS, IN CLASS 25 (U.S. CLS. 22 AND 39).

THE MARK CONSISTS OF STANDARD CHARACTERS WITHOUT CLAIM TO ANY PARTICULAR FONT, STYLE, SIZE, OR COLOR.

PRIORITY CLAIMED UNDER SEC. 44(D) ON CANADA APPLICATION NO. 1465629, FILED 1-13-2010, REG. NO. TMA786,161, DATED 12-30-2010, EXPIRES 12-30-2025.

SER. NO. 77-922,445, FILED 1-28-2010.

BARBARA BROWN, EXAMINING ATTORNEY



David J. Kybas

Director of the United States Patent and Trademark Office

United States of America

United States Patent and Trademark Office

SQUIRE AUSTRALIA

Reg. No. 4,152,142

Registered June 5, 2012

Int. Cl.: 25

TRADEMARK

PRINCIPAL REGISTER

CLICKERS PTY LTD (AUSTRALIA LIMITED LIABILITY COMPANY)
147 NORTHUMBERLAND STREET
LIVERPOOL, NSW, AUSTRALIA 1675

FOR: CLOTHING, NAMELY, SHIRTS, PANTS, UNDERWEAR, DRESSES, COATS, JACKETS, PULLOVERS; FOOTWEAR, NAMELY, SHOES AND SOCKS; HEADGEAR, NAMELY, HATS, CAPS AND HEADWEAR, IN CLASS 25 (U.S. CLS. 22 AND 39).

THE MARK CONSISTS OF STANDARD CHARACTERS WITHOUT CLAIM TO ANY PARTICULAR FONT, STYLE, SIZE, OR COLOR.

OWNER OF AUSTRALIA REG. NO. 1314888, DATED 8-13-2009, EXPIRES 8-13-2019.

NO CLAIM IS MADE TO THE EXCLUSIVE RIGHT TO USE "AUSTRALIA", APART FROM THE MARK AS SHOWN.

SER. NO. 77-933,388, FILED 2-11-2010.

RUDY R. SINGLETON, EXAMINING ATTORNEY



David J. Kybas

Director of the United States Patent and Trademark Office

United States of America

United States Patent and Trademark Office

MAILSTREAM MANAGER

Reg. No. 4,152,143

Registered June 5, 2012

Int. Cl.: 9

TRADEMARK

PRINCIPAL REGISTER

SYNTEL, LLC (ARKANSAS LIMITED LIABILITY COMPANY)
3401 ONE PLACE
JONESBORO, AR 72404

FOR: COMPUTER SOFTWARE THAT MEETS POSTAL SERVICE AUTOMATION STANDARDS, PARTICULARLY IN HIGH-VOLUME MAIL FINISHING OPERATIONS, BY PROVIDING CODING FOR ADDRESS ACCURACY USING A CODING ACCURACY SUPPORT SYSTEM AND BAR CODING, PRESORT ACCURACY VALIDATION AND EVALUATION CERTIFIED SORTING FOR POSTAL DISCOUNTS, MAIL MANIFESTING FOR ELIMINATION OF METERING, DOCUMENT DESIGN CAPABILITY TO ENHANCE THE PRESENTATION OF FINISHED DOCUMENTS, AND/OR ROBUST OPTICAL MARK RECOGNITION OR BAR CODING FOR PROPER, SECURE FUNCTION OF AUTOMATED, SMART FOLDING OR INSERTING EQUIPMENT AND MARKETING DOCUMENTS FOR OTHERS, IN CLASS 9 (U.S. CLS. 21, 23, 26, 36 AND 38).

FIRST USE 7-0-2005; IN COMMERCE 11-0-2005.

THE MARK CONSISTS OF STANDARD CHARACTERS WITHOUT CLAIM TO ANY PARTICULAR FONT, STYLE, SIZE, OR COLOR.

OWNER OF U.S. REG. NO. 3,188,379.

SEC. 2(F).

SER. NO. 77-936,977, FILED 2-16-2010.

JEFF DEFORD, EXAMINING ATTORNEY



David J. Kyros

Director of the United States Patent and Trademark Office

United States of America

United States Patent and Trademark Office



Reg. No. 4,152,144

Registered June 5, 2012

Int. Cl.: 9

TRADEMARK

PRINCIPAL REGISTER

MICHELLE HAUNOLD (UNITED STATES INDIVIDUAL), AKA GEARHEAD PRODUCTIONS, INC
PO BOX 2234
DAVIS, CA 956172234

FOR: SOUND RECORDINGS FEATURING MUSIC, NAMELY, PHONOGRAPH/VINYL RECORDS, COMPACT DISCS, DVDS, AUDIO TAPES, ENHANCED CDS, VIDEO TAPES, PRE-RECORDED RECORDS, AUDIO CASSETTES, VIDEOCASSETTES, PRE-RECORDED DVDS, AND DIGITAL MUSIC DOWNLOADABLE FROM THE INTERNET, IN CLASS 9 (U.S. CLS. 21, 23, 26, 36 AND 38).

FIRST USE 1-1-2000; IN COMMERCE 4-1-2000.

NO CLAIM IS MADE TO THE EXCLUSIVE RIGHT TO USE "RECORDS", APART FROM THE MARK AS SHOWN.

THE MARK CONSISTS OF TWO CROSSED CHECKERED FLAGS SET IN AN OVAL WITH THE WORDS "GEARHEAD RECORDS" SET WITH IN THE OVAL UNDER THE FLAGS.

SER. NO. 77-944,202, FILED 2-24-2010.

MARTHA SANTOMARTINO, EXAMINING ATTORNEY



David J. Kyffers

Director of the United States Patent and Trademark Office

United States of America

United States Patent and Trademark Office

Home of Purdue Half Marathon

Reg. No. 4,152,145

Registered June 5, 2012

Int. Cl.: 41

SERVICE MARK

PRINCIPAL REGISTER

THE TRUSTEES OF PURDUE UNIVERSITY (INDIANA LIMITED LIABILITY COMPANY)
1063 HOVDE HALL
WEST LAFAYETTE, IN 47907

FOR: ORGANIZING SPORTING EVENTS, NAMELY, ARRANGING, ORGANIZING, OPERATING AND CONDUCTING MARATHON RACES, IN CLASS 41 (U.S. CLS. 100, 101 AND 107).

FIRST USE 11-4-2009; IN COMMERCE 11-4-2009.

THE MARK CONSISTS OF STANDARD CHARACTERS WITHOUT CLAIM TO ANY PARTICULAR FONT, STYLE, SIZE, OR COLOR.

NO CLAIM IS MADE TO THE EXCLUSIVE RIGHT TO USE "HALF MARATHON", APART FROM THE MARK AS SHOWN.

SER. NO. 77-946,677, FILED 2-27-2010.

MIDGE BUTLER, EXAMINING ATTORNEY



David J. Kyffers

Director of the United States Patent and Trademark Office

United States of America

United States Patent and Trademark Office

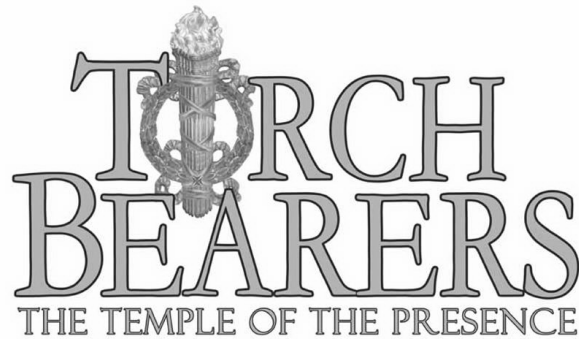

Reg. No. 4,152,146

Registered June 5, 2012

**COLLECTIVE
MEMBERSHIP**

PRINCIPAL REGISTER

THE TEMPLE OF THE PRESENCE, INC. (VERMONT CORPORATION)
11902 E. IRVINGTON ROAD
TUCSON, AZ 857478947

FOR: INDICATING MEMBERSHIP IN A RELIGIOUS ORGANIZATION, IN CLASS 200 (U.S. CL. 200).

FIRST USE 10-1-1999; IN COMMERCE 10-1-1999.

OWNER OF U.S. REG. NOS. 3,532,922, 3,728,312 AND OTHERS.

THE MARK CONSISTS OF THE WORDS "TORCH BEARERS" IN LARGER SIZE LETTERS, AND THE WORDS "THE TEMPLE OF THE PRESENCE" UNDERNEATH IN SMALLER LETTERS, WITH A FLAMING TORCH THAT IS MADE UP OF MANY SMALLER TORCHES BOUND TOGETHER, WITH A WREATH BEHIND IT, AND A SMALL MALTESE CROSS ON THE LOWER PART OF THE TORCH.

SER. NO. 77-946,850, FILED 2-28-2010.

GRETCHEN ULRICH, EXAMINING ATTORNEY



David J. Kybas

Director of the United States Patent and Trademark Office

United States of America

United States Patent and Trademark Office

HOME OF PURDUE HALF MARATHON



Reg. No. 4,152,147

Registered June 5, 2012

Int. Cl.: 41

SERVICE MARK

PRINCIPAL REGISTER

THE TRUSTEES OF PURDUE UNIVERSITY (INDIANA LIMITED LIABILITY COMPANY)
1063 HOVDE HALL
WEST LAFAYETTE, IN 47907

FOR: ORGANIZING SPORTING EVENTS, NAMELY, ARRANGING, ORGANIZING, OPERATING AND CONDUCTING RUNNING EVENTS, IN CLASS 41 (U.S. CLS. 100, 101 AND 107).

FIRST USE 11-4-2009; IN COMMERCE 11-4-2009.

NO CLAIM IS MADE TO THE EXCLUSIVE RIGHT TO USE "HALF MARATHON", APART FROM THE MARK AS SHOWN.

THE MARK CONSISTS OF A RUNNER IN THE CENTER OF THE MARK FLANKED BY TWO HORIZONTAL RIBBONS AGAINST A SKYLINE OF TWO CITIES CONNECTED BY A BRIDGE AT THE BOTTOM OF THE MARK WITH THE WORDS "HOME OF PURDUE" AT THE TOP AND THE WORDS "HALF MARATHON" BELOW "HOME OF PURDUE".

SER. NO. 77-948,002, FILED 3-2-2010.

MIDGE BUTLER, EXAMINING ATTORNEY



David J. Kyffers

Director of the United States Patent and Trademark Office

United States of America
United States Patent and Trademark Office

IOWNIT.

Reg. No. 4,152,148

Registered June 5, 2012

Int. Cl.: 36

SERVICE MARK

PRINCIPAL REGISTER

METRO CREDIT UNION (MISSOURI CORPORATION)
447 S. CAMPBELL AVENUE
SPRINGFIELD, MO 65806

FOR: CREDIT UNION SERVICES, IN CLASS 36 (U.S. CLS. 100, 101 AND 102).

FIRST USE 1-1-2009; IN COMMERCE 1-1-2009.

THE MARK CONSISTS OF STANDARD CHARACTERS WITHOUT CLAIM TO ANY PARTICULAR FONT, STYLE, SIZE, OR COLOR.

SER. NO. 77-950,481, FILED 3-4-2010.

JUDITH HELFMAN, EXAMINING ATTORNEY



David J. Kybas

Director of the United States Patent and Trademark Office

United States of America

United States Patent and Trademark Office

THE UNIVERSE

Reg. No. 4,152,149

Registered June 5, 2012

Int. Cls.: 9 and 41

TRADEMARK

SERVICE MARK

PRINCIPAL REGISTER

A&E TELEVISION NETWORKS, LLC (DELAWARE LIMITED LIABILITY COMPANY)
235 EAST 45TH STREET
NEW YORK, NY 10020

FOR: MULTIMEDIA GOODS, NAMELY, PRE-RECORDED DIGITAL VIDEO DISCS AND DVDS IN THE FIELDS OF SCIENCE, EXPLORATION AND NATURAL HISTORY; DIGITAL MEDIA, NAMELY, DOWNLOADABLE AUDIO AND VIDEO FILES IN THE FIELDS OF SCIENCE, EXPLORATION AND NATURAL HISTORY; DOWNLOADABLE WEBCASTS IN THE FIELDS OF SCIENCE, EXPLORATION AND NATURAL HISTORY; DOWNLOADABLE ON-LINE DISCUSSION BOARDS, AND WEBCASTS IN THE FIELDS OF SCIENCE, EXPLORATION AND NATURAL HISTORY, IN CLASS 9 (U.S. CLS. 21, 23, 26, 36 AND 38).

FIRST USE 5-29-2007; IN COMMERCE 5-29-2007.

FOR: EDUCATIONAL AND ENTERTAINMENT SERVICES, NAMELY, A SERIES IN THE FIELDS OF SCIENCE, EXPLORATION AND NATURAL HISTORY; PROVIDING INFORMATION IN THE FIELDS OF SCIENCE, EXPLORATION AND NATURAL HISTORY VIA THE INTERNET, IN CLASS 41 (U.S. CLS. 100, 101 AND 107).

FIRST USE 5-29-2007; IN COMMERCE 5-29-2007.

THE MARK CONSISTS OF STANDARD CHARACTERS WITHOUT CLAIM TO ANY PARTICULAR FONT, STYLE, SIZE, OR COLOR.

SEC. 2(F).

SER. NO. 77-952,764, FILED 3-8-2010.

CHERYL CLAYTON, EXAMINING ATTORNEY



David J. Kyros

Director of the United States Patent and Trademark Office

United States of America

United States Patent and Trademark Office

Eagle

Reg. No. 4,152,150

Registered June 5, 2012

Int. Cl.: 11

TRADEMARK

PRINCIPAL REGISTER

QUEST TECHNOLOGIES, INC (GEORGIA CORPORATION), DBA CRYSTAL QUEST MFG
355 BRIARWOOD CT
MARIETTA, GA 30068

FOR: WATER FILTERING UNITS FOR DOMESTIC USE, IN CLASS 11 (U.S. CLS. 13, 21, 23,
31 AND 34).

FIRST USE 6-1-2009; IN COMMERCE 6-1-2009.

THE MARK CONSISTS OF STANDARD CHARACTERS WITHOUT CLAIM TO ANY PAR-
TICULAR FONT, STYLE, SIZE, OR COLOR.

SER. NO. 77-955,806, FILED 3-10-2010.

DAVID MURRAY, EXAMINING ATTORNEY



David J. Kybas

Director of the United States Patent and Trademark Office

United States of America

United States Patent and Trademark Office



Reg. No. 4,152,151

Registered June 5, 2012

Int. Cl.: 12

TRADEMARK

PRINCIPAL REGISTER

PETELKA INVESTMENTS LTD. (CANADA CORPORATION)
1088 STURBRIDGE STREET
BURLINGTON, ONTARIO, CANADA L7P 5B5

FOR: SLIDING FITTED TARPAULIN COVERS FOR FLATBEDS AND SEMI TRAILERS, IN CLASS 12 (U.S. CLS. 19, 21, 23, 31, 35 AND 44).

PRIORITY CLAIMED UNDER SEC. 44(D) ON CANADA APPLICATION NO. 1472413, FILED 3-9-2010, REG. NO. TMA784000, DATED 12-2-2010, EXPIRES 12-2-2025.

NO CLAIM IS MADE TO THE EXCLUSIVE RIGHT TO USE "SLIDE KIT STEEL HAULERS SLIDING SYSTEM", APART FROM THE MARK AS SHOWN.

THE STIPPLING IS A FEATURE OF THE MARK AND DOES NOT INDICATE COLOR.

THE MARK CONSISTS OF THE WORDING "THE LOOK" WITHIN A CONCENTRIC CIRCLE. THE CIRCLE HAS A SHADOW EXTENDING BEHIND IT AND TO THE RIGHT. ON THE SHADOW THAT EXTENDS TO THE RIGHT SIDE THE WORDING "SLIDE KIT" APPEARS. BELOW THE WORD "SLIDE" THE WORDING "STEEL HAULERS SLIDING SYSTEM" APPEARS.

SER. NO. 77-957,837, FILED 3-12-2010.

ANDREA HACK, EXAMINING ATTORNEY



David J. Kyjars

Director of the United States Patent and Trademark Office

United States of America

United States Patent and Trademark Office



Reg. No. 4,152,152

Registered June 5, 2012

Int. Cls.: 29 and 30

TRADEMARK

PRINCIPAL REGISTER

V&V SUPREMO FOODS, INC. (ILLINOIS CORPORATION)
2141 S. THROOP ST.
CHICAGO, IL 60608

FOR: SOUR CREAM, IN CLASS 29 (U.S. CL. 46).

FIRST USE 1-31-1984; IN COMMERCE 1-31-1984.

FOR: SOPES, FLAN, FLAVORED AND SWEETENED GELATINS, IN CLASS 30 (U.S. CL. 46).

FIRST USE 11-10-2009; IN COMMERCE 11-10-2009.

OWNER OF U.S. REG. NOS. 1,928,829, 2,072,917, AND 2,547,216.

THE MARK CONSISTS OF A STYLIZED "V V" AND A STYLIZED "SUPREMO" ABOVE TWO CURVED LINES WITH THE TOP LINE EXTENDING INTO AN ARCH ABOVE THE WORDING.

THE ENGLISH TRANSLATION OF "SUPREMO" IN THE MARK IS "SUPREME".

SEC. 2(F) AS TO "SUPREMO".

SER. NO. 77-961,312, FILED 3-17-2010.

MARGARET POWER, EXAMINING ATTORNEY



David J. Kybas

Director of the United States Patent and Trademark Office

United States of America

United States Patent and Trademark Office

ANTOINE DE CLAIRVOY

Reg. No. 4,152,153

Registered June 5, 2012

Int. Cl.: 33

TRADEMARK

PRINCIPAL REGISTER

CPC CELLARS LLC (WASHINGTON LIMITED LIABILITY COMPANY)
5400 CARILLON POINT
KIRKLAND, WA 98033

FOR: WINE, IN CLASS 33 (U.S. CLS. 47 AND 49).

FIRST USE 6-6-2010; IN COMMERCE 6-6-2010.

THE MARK CONSISTS OF STANDARD CHARACTERS WITHOUT CLAIM TO ANY PARTICULAR FONT, STYLE, SIZE, OR COLOR.

PRIORITY CLAIMED UNDER SEC. 44(D) ON FRANCE APPLICATION NO. 103710999, FILED 2-5-2010.

THE NAME(S), PORTRAIT(S), AND/OR SIGNATURE(S) SHOWN IN THE MARK DOES NOT IDENTIFY A PARTICULAR LIVING INDIVIDUAL.

THE ENGLISH TRANSLATION OF "DE" IN THE MARK IS "OF". THE WORD "CLAIRVOY" HAS NO MEANING IN A FOREIGN LANGUAGE.

SER. NO. 77-962,614, FILED 3-18-2010.

KATHY DE JONGE, EXAMINING ATTORNEY



David J. Kybas

Director of the United States Patent and Trademark Office

United States of America

United States Patent and Trademark Office

CHATEAU DE CLAIRVOY

Reg. No. 4,152,154

Registered June 5, 2012

Int. Cl.: 33

TRADEMARK

PRINCIPAL REGISTER

CPC CELLARS LLC (WASHINGTON LIMITED LIABILITY COMPANY)
5400 CARILLON POINT
KIRKLAND, WA 98033

FOR: WINE, IN CLASS 33 (U.S. CLS. 47 AND 49).

FIRST USE 6-2-2010; IN COMMERCE 6-2-2010.

THE MARK CONSISTS OF STANDARD CHARACTERS WITHOUT CLAIM TO ANY PARTICULAR FONT, STYLE, SIZE, OR COLOR.

PRIORITY CLAIMED UNDER SEC. 44(D) ON FRANCE APPLICATION NO. 103711000, FILED 2-5-2010.

NO CLAIM IS MADE TO THE EXCLUSIVE RIGHT TO USE "CHATEAU", APART FROM THE MARK AS SHOWN.

THE ENGLISH TRANSLATION OF "CHATEAU DE" IN THE MARK IS "CASTLE OF". THE WORD "CLAIRVOY" HAS NO MEANING IN A FOREIGN LANGUAGE.

SER. NO. 77-962,624, FILED 3-18-2010.

KATHY DE JONGE, EXAMINING ATTORNEY



David J. Kybas

Director of the United States Patent and Trademark Office

United States of America

United States Patent and Trademark Office

MORPHOSYS

Reg. No. 4,152,155

Registered June 5, 2012

Int. Cl.: 11

TRADEMARK

PRINCIPAL REGISTER

BAINS ULTRA INC. (CANADA CORPORATION)
956, CHEMIN OLIVIER
SAINT-NICOLAS QUEBEC, CANADA G7A2N1

FOR: BATH ACCESSORIES, NAMELY, INTERCHANGEABLE LATERAL AND MODULAR PANELS PERMITTING BATHTUBS TO BECOME FREESTANDING, IN CLASS 11 (U.S. CLS. 13, 21, 23, 31 AND 34).

THE MARK CONSISTS OF STANDARD CHARACTERS WITHOUT CLAIM TO ANY PARTICULAR FONT, STYLE, SIZE, OR COLOR.

PRIORITY CLAIMED UNDER SEC. 44(D) ON CANADA APPLICATION NO. 1473741, FILED 3-18-2010, REG. NO. TMA795191, DATED 4-11-2011, EXPIRES 4-11-2026.

SER. NO. 77-965,915, FILED 3-23-2010.

MARTHA SANTOMARTINO, EXAMINING ATTORNEY



David J. Kyffers

Director of the United States Patent and Trademark Office

United States of America

United States Patent and Trademark Office

The World Flag

Reg. No. 4,152,156

Registered June 5, 2012

Int. Cls.: 24 and 25

TRADEMARK

PRINCIPAL REGISTER

PAUL CARROLL (UNITED STATES INDIVIDUAL)
2323 NW HOYT ST.
PORTLAND, OR 97210

FOR: (BASED ON USE IN COMMERCE) CLOTH FLAGS; FABRIC FLAGS; FABRICS THAT MAY OR MAY NOT HAVE PRINTED PATTERNS AND DESIGNS THEREON FOR USE IN TEXTILE APPLICATIONS, NAMELY, THE MANUFACTURE OF APPAREL, UPHOLSTERY, SIGNAGE, FLAGS, BANNERS AND WALLPAPER; NYLON FLAGS, IN CLASS 24 (U.S. CLS. 42 AND 50).

FIRST USE 10-15-1988; IN COMMERCE 3-15-1999.

FOR: (BASED ON USE IN COMMERCE) HOODED SWEAT SHIRTS; SHIRTS; SWEAT SHIRTS; T-SHIRTS, IN CLASS 25 (U.S. CLS. 22 AND 39).

FIRST USE 10-15-1988; IN COMMERCE 3-15-1999.

THE MARK CONSISTS OF STANDARD CHARACTERS WITHOUT CLAIM TO ANY PARTICULAR FONT, STYLE, SIZE, OR COLOR.

NO CLAIM IS MADE TO THE EXCLUSIVE RIGHT TO USE "FLAG", APART FROM THE MARK AS SHOWN.

SEC. 2(F).

SER. NO. 77-983,160, FILED 3-1-2010.

KELLY BOULTON, EXAMINING ATTORNEY



David J. Kyjars

Director of the United States Patent and Trademark Office

United States of America

United States Patent and Trademark Office

RL

Reg. No. 4,152,157

Registered June 5, 2012

Int. Cl.: 12

TRADEMARK

PRINCIPAL REGISTER

HONDA MOTOR CO., LTD. (JAPAN CORPORATION)
NO. 1-1, 2-CHOME, MINAMIAOYAMA
MINATO-KU
TOKYO, JAPAN 107-8556

FOR: AUTOMOBILES AND STRUCTURAL PARTS THEREOF, IN CLASS 12 (U.S. CLS. 19, 21, 23, 31, 35 AND 44).

FIRST USE 10-0-2004; IN COMMERCE 10-0-2004.

THE MARK CONSISTS OF STANDARD CHARACTERS WITHOUT CLAIM TO ANY PARTICULAR FONT, STYLE, SIZE, OR COLOR.

OWNER OF U.S. REG. NO. 2,281,336.

SER. NO. 78-514,746, FILED 11-10-2004.

SHAUNIA CARLYLE, EXAMINING ATTORNEY



David J. Kyffers

Director of the United States Patent and Trademark Office

United States of America

United States Patent and Trademark Office

VORTEX

Reg. No. 4,152,158

Registered June 5, 2012

Int. Cls.: 38 and 41

SERVICE MARK

PRINCIPAL REGISTER

YTV CANADA, INC. (CANADA CORPORATION)
64 JEFFERSON AVENUE, UNIT 18
TORONTO, CANADA M6K 3H3

FOR: TELEVISION BROADCASTING; INTERACTIVE ELECTRONIC TELEVISION TRANSMISSION BROADCASTING SERVICES PROVIDED VIA THE MEDIUM OF TELEVISION, ELECTRONIC MAIL, THE INTERNET AND OTHER ELECTRONIC MEDIA; VIDEO ON DEMAND TRANSMISSION SERVICES; PAY PER VIEW TELEVISION TRANSMISSION SERVICES; VIDEO ON DEMAND TRANSMISSION SERVICES; ON-LINE TRANSMISSION OF SOUND, VIDEO AND INFORMATION VIA TELECOMMUNICATIONS NETWORKS, IN CLASS 38 (U.S. CLS. 100, 101 AND 104).

FOR: ENTERTAINMENT SERVICES, NAMELY, THE PRODUCTION AND DISTRIBUTION OF TELEVISION PROGRAMS; ENTERTAINMENT IN THE NATURE OF ON-GOING TELEVISION PROGRAMS IN THE FIELD OF CHILDREN'S TELEVISION PROGRAMMING; TELEVISION PROGRAMMING; AUDIO AND VIDEO RECORDING; PROVIDING ON-LINE ENTERTAINMENT INFORMATION IN THE FIELD OF CHILDREN'S TELEVISION PROGRAMMING; ON-LINE ENTERTAINMENT SERVICES OFFERED OVER A WORLDWIDE COMMUNICATION NETWORK, NAMELY, ON-LINE COMPUTER GAMES, CONTESTS, AND INFORMATION RELATING TO A BLOCK OF TELEVISION PROGRAMMING; AUDIO RECORDING AND PRODUCTION OF AUDIO CASSETTES, VIDEO CASSETTES, COMPACT DISCS, DIGITAL AUDIO DISCS, VIDEO DISCS AND CD ROMS; ENTERTAINMENT SERVICES, NAMELY, LIVE PERFORMANCES AND PERSONAL APPEARANCES BY INDIVIDUALS AND CHARACTERS ASSOCIATED WITH TELEVISION PROGRAMS; PROVIDING ENTERTAINMENT SERVICES VIA THE MEDIA OF COMPUTER AND VIA THE INTERNET, NAMELY, ON-LINE CHILDREN'S COMPUTER GAMES, CONTESTS, AND INFORMATION RELATING TO A BLOCK OF TELEVISION PROGRAMMING IN THE FIELD OF CHILDREN'S ENTERTAINMENT; DEVELOPMENT, PRODUCTION AND DISTRIBUTION, TRANSMISSION, AND BROADCAST OF TELEVISION PROGRAMMING; DEVELOPMENT, PRODUCTION AND DISTRIBUTION OF A CHILDREN'S TELEVISION SHOW; PROVISION OF NON-DOWNLOADABLE FILMS AND TELEVISION PROGRAMS VIA A VIDEO-ON-DEMAND SERVICE, IN CLASS 41 (U.S. CLS. 100, 101 AND 107).



David J. Kyjars

Director of the United States Patent and Trademark Office

THE MARK CONSISTS OF STANDARD CHARACTERS WITHOUT CLAIM TO ANY PARTICULAR FONT, STYLE, SIZE, OR COLOR.

Reg. No. 4,152,158 PRIORITY CLAIMED UNDER SEC. 44(D) ON CANADA APPLICATION NO. 1241852, FILED 12-23-2004, REG. NO. TMA751,018, DATED 10-23-2009, EXPIRES 10-23-2024.

SER. NO. 78-549,933, FILED 1-19-2005.

JOHN GARTNER, EXAMINING ATTORNEY

United States of America

United States Patent and Trademark Office



太平洋

Reg. No. 4,152,159

Registered June 5, 2012

Int. Cl.: 11

TRADEMARK

PRINCIPAL REGISTER

LEYANT INDUSTRY CO. (TAIWAN CORPORATION)
1F, NO. 20, LANE 929, SAN FENG RD.
TAICHUNG HSIEN, TAIWAN

FOR: ELECTRIC HOT WATER BOTTLES; HOT AIR BLOWERS; HUMIDIFIERS FOR HOUSEHOLD PURPOSES; ELECTRIC AIR DEODORIZERS; AIR FILTERS FOR AIR CONDITIONING UNITS; AIR CONDITIONING UNITS; EXTRACTOR HOODS FOR HOUSEHOLD PURPOSES, IN CLASS 11 (U.S. CLS. 13, 21, 23, 31 AND 34).

FIRST USE 1-1-1981; IN COMMERCE 1-1-1981.

THE MARK CONSISTS OF THE WORD "PACIFIC" ABOVE CHINESE CHARACTERS AND BELOW A MISCELLANEOUS DESIGN ENCLOSED WITHIN A RECTANGULAR BORDER.

THE NON-LATIN CHARACTER(S) IN THE MARK TRANSLITERATES INTO TAI PING YANG, AND THIS MEANS "PACIFIC" IN ENGLISH.

SER. NO. 78-867,455, FILED 4-22-2006.

SHAUNIA CARLYLE, EXAMINING ATTORNEY



David J. Kyffers

Director of the United States Patent and Trademark Office

United States of America

United States Patent and Trademark Office



Reg. No. 4,152,160

Registered June 5, 2012

Int. Cls.: 9, 16 and 28

TRADEMARK

PRINCIPAL REGISTER

FERRARI S.P.A. (ITALY JOINT STOCK COMPANY)
VIA EMILIA EST 1163
MODENA, ITALY 41100

FOR: EYE WEAR, NAMELY, PROTECTIVE, SAFETY AND SPORTS EYEWEAR, EYEGLASSES, SUNGLASSES, ANTI-GLARE EYEGLASSES, PROTECTIVE EYEGLASSES, SAFETY EYEGLASSES, PRESCRIPTION ACCESSORIES FOR EYEGLASSES AND SUNGLASSES, NAMELY, REPLACEMENT EYEGLASSES, CASES FOR EYEGLASSES AND SUNGLASSES, STRUCTURAL PARTS FOR EYEGLASSES AND EYEGLASS LENSES, NAMELY, FRAMES, EAR-STEMS AND NOSE PIECES; SAFETY HELMETS FOR MOTORCYCLISTS, FIREPROOF AUTOMOBILE RACING SUITS FOR SAFETY PURPOSE; PRE-RECORDED VIDEO CASSETTES AND CD-ROMS FEATURING HIGH PERFORMANCE CARS AND AUTOMOBILES, CAR RACES AND THE HISTORY OF AUTOMOBILE MANUFACTURERS; COMPUTER SCREEN SAVERS SOFTWARE, MOUSE PADS, COMPUTER MICE, DESKTOP COMPUTERS, NOTEBOOK COMPUTERS, LAPTOP COMPUTERS, PORTABLE COMPUTERS, LAN MAGNETIC AND ENCODED CARDS FOR CONNECTING PORTABLE COMPUTERS TO COMPUTER NETWORKS, PERSONAL COMPUTERS, KEYBOARDS, TABLET PCS, COMPUTER MONITORS, LCD COMPUTER MONITORS, PRINTERS, BAGS AND CASES ADAPTED FOR COMPUTER BATTERIES FOR NOTEBOOK COMPUTERS, PERSONAL DIGITAL ASSISTANTS, ELECTRONIC PERSONAL ORGANIZERS, DIGITAL VOICE RECORDERS, CAMERAS, DIGITAL CAMERAS, DIGITAL VIDEO CAMERAS, MOVIE PROJECTORS, DIGITAL MOVIE PROJECTORS, VIDEO PROJECTORS, DIGITAL VIDEO PROJECTORS, SLIDE DIGITAL PROJECTORS, DIGITAL PHOTO PROJECTORS, STRUCTURAL PARTS FOR CAMERAS, NAMELY, ZOOM LENSES, SCANNERS, PHOTO PRINTERS; HIGH FIDELITY SYSTEMS COMPRISED OF STEREOS, CD-PLAYERS AND CD RECORDERS, AUDIO SPEAKERS, AND LIQUID CRYSTAL DISPLAYS; TELEVISION SETS, LCD TELEVISIONS, LCD SCREENS, CD PLAYERS, DIGITAL VIDEO DISCS PLAYERS, BAROMETERS, BAROMETERS WITH PROJECTION DEVICES INCORPORATED THEREIN, ELECTRONIC LANGUAGE TRANSLATORS, ELECTRONIC TIME AND DATE DEVICES IN THE NATURE OF TIME AND DATE STAMPING MACHINES, GLOBAL POSITIONING SYSTEMS, WIRELESS WEATHER INFORMATION APPARATUS AND SYSTEMS, NAMELY, STAND ALONE WIRELESS WEATHER STATIONS WITH WEATHER FORECASTING, BAROMETRIC, INDOOR AND OUTDOOR TEMPERATURE AND HUMIDITY FUNCTIONS FOR DOMESTIC USE, WIRELESS REMOTE THERMO HYGROMETER SENSORS, REMOTE TEMPERATURE SENSORS; CORDLESS TELEPHONES, TELEPHONES, CELLULAR PHONES, CELLULAR MASKS IN THE NATURE OF COVERS FOR CELLULAR PHONES, DEVICES FOR HANDS-FREE USAGE OF CELLULAR PHONES, HEAD SETS FOR HANDS



David J. Kappas

Director of the United States Patent and Trademark Office

Reg. No. 4,152,160 FREE USAGE OF CELLULAR PHONES, CALCULATORS, BINOCULARS, OPERA GLASSES, TELEVISION CAMERAS, TELESCOPES, MICROSCOPES, ELECTRONIC HANDHELD UNITS AND ACCESSORIES THEREFORE, NAMELY, BATTERIES, CHARGERS, HEADSETS, STANDS, CASES, COVERS, HOLSTERS AND DOCKING STATIONS FOR THE WIRELESS RECEIPT AND TRANSMISSION OF DATA, VOICE COMMUNICATIONS, E-MAIL MESSAGES AND STORAGE OF DATA; MP3 PLAYERS, HOME THEATRE SYSTEMS COMPRISED OF SPEAKERS, CUBE SUB WOOFERS, DVD CHARGERS AND A/V HOME THEATRE RECEIVERS, WALKIE-TALKIES, IN CLASS 9 (U.S. CLS. 21, 23, 26, 36 AND 38).

FOR: PAPER, CARDBOARD AND GOODS MADE FROM THESE MATERIALS, NOT INCLUDED IN OTHER CLASSES, NAMELY, ART PAPERS, BOXES AND PACKAGING; DECALS, PHOTOGRAPHS, PICTURES, STICKERS AND IRON-ON TRANSFERS BEING DECALCOMANIAS, PLASTIC TRANSFERS BEING DECALCOMANIAS; PLASTIC MATERIALS FOR PACKAGING, NAMELY, PLASTIC BAGS; SMALL BLACKBOARDS; RUBBER ERASERS, CARDBOARD BOXES, RUBBER STAMPS, ENVELOPES, IN CLASS 16 (U.S. CLS. 2, 5, 22, 23, 29, 37, 38 AND 50).

FOR: GAMES AND PLAYTHINGS, NAMELY, BOARD GAMES, BEECHWOOD ROCKING HORSES; MODULAR STRUCTURES CONSTRUCTION TOYS AND CONNECTING LINKS THEREFOR, TOY CONSTRUCTION BLOCK KITS COMPRISED OF BLOCKS, DOLLS, DOLLS CLOTHING, ACCESSORIES FOR DOLLS, SOFT FELT TOYS, GAME PUZZLES, BAGS SPECIALLY ADAPTED FOR SPORTS EQUIPMENT, NAMELY, TENNIS BAGS, GOLF BAGS, GOLF POUCHES; GOLF CLUBS, PLAYING CARDS, IN CLASS 28 (U.S. CLS. 22, 23, 38 AND 50).

PRIORITY CLAIMED UNDER SEC. 44(D) ON ITALY APPLICATION NO. 5107883, FILED 5-11-2006, REG. NO. 0001235788, DATED 11-1-2010, EXPIRES 3-8-2016.

OWNER OF U.S. REG. NOS. 2,049,710, 2,629,713 AND OTHERS.

NO CLAIM IS MADE TO THE EXCLUSIVE RIGHT TO USE "CHALLENGE", APART FROM THE MARK AS SHOWN.

SER. NO. 78-930,573, FILED 7-17-2006.

ANDREA HACK, EXAMINING ATTORNEY

United States of America

United States Patent and Trademark Office

TESLA

Reg. No. 4,152,161

Registered June 5, 2012

Int. Cls.: 7 and 9

TRADEMARK

PRINCIPAL REGISTER

TESLA S.R.L. (ITALY LIMITED LIABILITY COMPANY)
VIA DEL LAVORO, 3
I-36040 SAN GERMANO DEI BERICI (VICENZA)
ITALY

FOR: ELECTRIC MOTORS FOR SUBMERSIBLE PUMPS, ELECTRIC MOTORS FOR MACHINES USED IN BOREHOLE APPLICATIONS, ELECTRIC SUBMERSIBLE MOTORS FOR USE WITH MACHINES OTHER THAN LAND VEHICLES, ELECTRIC MOTORS FOR PUMPS, ELECTRIC MOTORS FOR MACHINES, SUMP PUMPS, AQUARIUM PUMPS, ELECTRIC PUMPS FOR SWIMMING POOLS, ROTARY PUMPS, NAMELY, WET ROTOR PUMPS, ELECTRIC PUMPS IN THE NATURE OF ELECTRO PUMP MACHINES, SHAFTS FOR PUMPS, BEARINGS BEING PARTS OF MACHINES, STATORS AND ROTORS BEING PARTS OF PUMPS, ELECTRIC CIRCULATING PUMPS FOR HEATING PLANTS, ELECTRIC PUMPS FOR MACHINES, ELECTRIC PUMPS FOR HEATING INSTALLATIONS, WATER PUMPS FOR IRRIGATION, WATER PUMPS FOR WATER SUPPLY, IN CLASS 7 (U.S. CLS. 13, 19, 21, 23, 31, 34 AND 35).

FOR: ELECTRIC SWITCH PLATES, PUMP CONTROL VALVES, ELECTRONIC CONTROLS FOR PUMPS, MECHANICAL REMOTE CONTROLS FOR PUMPS, WATER FILTER CONTROLLERS, IN CLASS 9 (U.S. CLS. 21, 23, 26, 36 AND 38).

PRIORITY DATE OF 9-23-2005 IS CLAIMED.

OWNER OF INTERNATIONAL REGISTRATION 0888438 DATED 12-13-2005, EXPIRES 12-13-2015.

SER. NO. 79-025,196, FILED 12-13-2005.

DEBRA LEE, EXAMINING ATTORNEY



David J. Kyros

Director of the United States Patent and Trademark Office

United States of America

United States Patent and Trademark Office

EQUAVIE

Reg. No. 4,152,162

Registered June 5, 2012

Int. Cls.: 5, 29 and 30

TRADEMARK

PRINCIPAL REGISTER

EQUAVIE (FRANCE SAS)
70 RUE DU COMMANDANT L'HERMINIER
F-35400 SAINT-MALO
FRANCE

FOR: NUTRITIONAL SUPPLEMENTS FOR MEDICAL USE, FOOD SUPPLEMENTS FOR MEDICAL USE, DIETETIC FOODS ADAPTED FOR MEDICAL USE, EDIBLE PLANT FIBRES, NAMELY, PLANT EXTRACTS FOR MEDICAL PURPOSES, MEDICINAL HERBS IN DRIED OR PRESERVED FORMS, MINERAL SUPPLEMENTS, VITAMINS, PLANT-BASED FOOD SUPPLEMENTS FOR NUTRITIONAL PURPOSES, NAMELY, HERBAL SUPPLEMENTS, PREPARATIONS OF TRACE MINERAL ELEMENTS FOR HUMAN CONSUMPTION, NAMELY, MINERAL SUPPLEMENTS; SANITARY CHEMICAL PREPARATIONS FOR MEDICAL OR PHARMACEUTICAL USE; PROCESSED FOOD ADAPTED FOR MEDICAL PURPOSES, IN CLASS 5 (U.S. CLS. 6, 18, 44, 46, 51 AND 52).

FOR: FOOD AND NUTRITIONAL SUPPLEMENTS FOR NON-MEDICAL USE, NAMELY, EXTRACTS OF FRUITS, VEGETABLES, SEAWEED, AND EDIBLE FLOWERS IN PILL FORM; DIETETIC FOODSTUFFS FOR NON-MEDICAL USE, NAMELY, EXTRACTS OF FRUITS, VEGETABLES, SEAWEED, AND EDIBLE FLOWERS IN THE FORM OF FOOD SUPPLEMENTS AND FISH-BASED FOOD SUPPLEMENTS IN PILL FORM; PROCESSED SEAWEED, CRUSTACEANS NOT LIVE FOR HUMAN CONSUMPTION, SHELLFISH, MEAT, POULTRY, MEAT EXTRACTS, PROCESSED FRUITS AND VEGETABLES, PRESERVED, DRIED AND COOKED VEGETABLES, EGGS AND MILK, EDIBLE OILS AND FATS; AND PROTEIN FOR HUMAN CONSUMPTION, IN CLASS 29 (U.S. CL. 46).

FOR: NON-MEDICAL FOOD AND NUTRITIONAL SUPPLEMENTS, NAMELY, EXTRACTS OF CEREALS AND GRAINS IN PILL FORM; YEAST EXTRACTS IN PILL FORM NOT FOR MEDICAL USE, ROYAL JELLY FOR HUMAN CONSUMPTION NOT FOR MEDICAL USE, IN CLASS 30 (U.S. CL. 46).



OWNER OF INTERNATIONAL REGISTRATION 0917172 DATED 12-20-2006, EXPIRES 12-20-2016.

SER. NO. 79-035,844, FILED 12-20-2006.

DAVID HOFFMAN, EXAMINING ATTORNEY

David J. Kypas

Director of the United States Patent and Trademark Office

United States of America

United States Patent and Trademark Office

COSWORTH

Reg. No. 4,152,163

Registered June 5, 2012

Int. Cls.: 7, 12, 25 and 42

TRADEMARK

SERVICE MARK

PRINCIPAL REGISTER

COSWORTH LIMITED (UNITED KINGDOM LIMITED LIABILITY COMPANY)
4 MORE LONDON RIVERSIDE
LONDON SE1 2AU
UNITED KINGDOM

FOR: CASTING MACHINES FOR USE IN CASTING METALS AND FOR USE IN MAKING CORES FOR FOUNDRY USE AND MOULDS FOR FOUNDRY USE; CONVEYORS; PARTS AND FITTINGS FOR INTERNAL COMBUSTION ENGINES, NAMELY, CARBURETORS, VALVES, SPARK PLUGS, ENGINE BLOCKS, CAMSHAFTS, CRANKSHAFTS, GEARS AND GEAR BOXES OTHER THAN THOSE FOR LAND VEHICLES; FILTERS FOR INTERNAL COMBUSTION ENGINES, IN CLASS 7 (U.S. CLS. 13, 19, 21, 23, 31, 34 AND 35).

FOR: LAND VEHICLES, AND STRUCTURAL PARTS THEREFOR; AUTOMOBILES; AUTOMOBILE ENGINES, IN CLASS 12 (U.S. CLS. 19, 21, 23, 31, 35 AND 44).

FOR: CLOTHING, NAMELY, HATS, CAPS, COATS, JACKETS, SHIRTS, PANTS, T-SHIRTS, FOOTWEAR, SOCKS, IN CLASS 25 (U.S. CLS. 22 AND 39).

FOR: ADVISORY SERVICES RELATING TO DESIGN ENGINEERING; COMPUTER AIDED DESIGN ENGINEERING SERVICES FOR OTHERS; DESIGN FOR OTHERS IN THE FIELD OF ENGINEERING; ENGINEERING AND ENGINEERING CONSULTANCY SERVICES; ENGINEERING DESIGN SERVICES; RESEARCH RELATING TO MECHANICAL AND AUTOMOBILE ENGINEERING; ENGINEERING SERVICES FOR THE TECHNICAL ANALYSIS OF MACHINERY, STRUCTURES, INTERNAL COMBUSTION ENGINES AND VEHICLES; ENGINEERING SERVICES RELATING TO MACHINE TOOL DESIGN, METAL FORMING SYSTEMS DESIGN, METAL HANDLING SYSTEMS DESIGN, AND TO ROBOTICS DESIGN; ENGINEERING SERVICES RELATING TO THE DESIGN OF ELECTRONIC COMMUNICATION SYSTEMS AND ELECTRONIC SYSTEMS; MECHANICAL AND AUTOMOBILE ENGINEERING TESTING AND ANALYSIS SERVICES FOR OTHERS; SCIENTIFIC AND TECHNICAL RESEARCH SERVICES IN THE FIELDS OF MECHANICAL AND AUTOMOBILE ENGINEERING DESIGN; MANAGEMENT OF SCIENTIFIC AND TECHNICAL RESEARCH PROJECTS; ADVISORY SERVICES RELATING TO MECHANICAL ENGINEERING; TECHNOLOGICAL ADVISORY SERVICES RELATING TO ENGINEERING, INTERNAL COMBUSTION ENGINES AND VEHICLES; SCIENTIFIC ADVISORY SERVICES IN THE FIELDS OF MECHANICAL AND AUTOMOBILE ENGINEERING AND INTERNAL COMBUSTION ENGINES; SCIENTIFIC TESTING AND ANALYSIS SERVICES IN THE



David J. Kyjars

Director of the United States Patent and Trademark Office

Reg. No. 4,152,163 FIELDS OF MECHANICAL AND AUTOMOBILE ENGINEERING AND INTERNAL COMBUSTION ENGINES, IN CLASS 42 (U.S. CLS. 100 AND 101).

THE MARK CONSISTS OF STANDARD CHARACTERS WITHOUT CLAIM TO ANY PARTICULAR FONT, STYLE, SIZE, OR COLOR.

PRIORITY DATE OF 6-27-2006 IS CLAIMED.

OWNER OF INTERNATIONAL REGISTRATION 0919915 DATED 12-22-2006, EXPIRES 12-22-2016.

OWNER OF U.S. REG. NO. 1,801,314.

SER. NO. 79-036,861, FILED 12-22-2006.

MARIAM MAHMOUDI, EXAMINING ATTORNEY

United States of America

United States Patent and Trademark Office



Reg. No. 4,152,164

Registered June 5, 2012

Int. Cl.: 3

HUGO BOSS; TRADE MARK MANAGEMENT GMBH & CO. KG (FED REP GERMANY LIMITED PARTNERSHIP)
DIESELSTR. 12
72555 METZINGEN
FED REP GERMANY

TRADEMARK

PRINCIPAL REGISTER

FOR: PERFUMERY AND COSMETIC PREPARATIONS, NAMELY, PERFUMES, EAU DE PARFUM, EAU DE TOILETTE, AFTERSHAVE, BODY, HAND AND SKIN CLEANSERS, NAMELY, TOILET SOAPS, SOAPS FOR BODY CARE, SHOWER GELS, BATH GELS AND SKIN CLEANSERS; BODY, HAND AND SKIN LOTIONS AND CREAMS; ESSENTIAL OILS FOR PERSONAL USE; AND DEODORANTS FOR PERSONAL USE, IN CLASS 3 (U.S. CLS. 1, 4, 6, 50, 51 AND 52).

OWNER OF U.S. REG. NOS. 2,399,198, 3,125,287 AND OTHERS.

OWNER OF INTERNATIONAL REGISTRATION 0945297 DATED 10-26-2007, EXPIRES 10-26-2017.

THE COLOR(S) GREY, RED AND BLACK IS/ARE CLAIMED AS A FEATURE OF THE MARK.

NO CLAIM IS MADE TO THE EXCLUSIVE RIGHT TO USE "XY", APART FROM THE MARK AS SHOWN.

THE MARK CONSISTS OF "HUGO" APPEARING IN THE COLOR RED; THE COLOR BLACK APPEARS IN THE LETTERS "X" AND "Y"; THE COLOR GRAY APPEARS ON THE DEPICTION OF RECTANGLE SURROUNDING THE WORDING "HUGO" AND THE LETTERS "X" AND "Y".

SER. NO. 79-046,919, FILED 10-26-2007.

BRIDGETT SMITH, EXAMINING ATTORNEY



David J. Kyffers

Director of the United States Patent and Trademark Office

United States of America

United States Patent and Trademark Office



Reg. No. 4,152,165

Registered June 5, 2012

Int. Cl.: 28

TRADEMARK

PRINCIPAL REGISTER

FINLEASE S.R.L. (ITALY LIMITED LIABILITY COMPANY)
VIA GUIDO D'AREZZO, 15
I-20145 MILANO
ITALY

FOR: GAMES AND PLAYTHINGS, NAMELY, ARCADE-TYPE ELECTRONIC VIDEO GAMES SIMULATING SPORTS ACTIVITIES, ARCADE-TYPE ELECTRONIC VIDEO GAMES SIMULATING ROAD RUNNER RACES, ACTION SKILL GAMES, DICE GAMES, ARCADE GAMES, MUSICAL TOYS, TOY BOXING GLOVES, TOY PUNCHING BALLS, TOY TENNIS RACKETS, AND TOY TABLE TENNIS RACKETS; EXERCISE AND FITNESS EQUIPMENT AND APPARATUS, NAMELY, TREADMILLS, STATIONARY EXERCISE BIKES, AND WEIGHTLIFTING APPARATUS; GYMNAS TIC AND SPORTING ARTICLES, NAMELY, GYMNAS TIC INCLINED BENCHES, PERSONAL FLOOR EXERCISE MATS, GYMNAS TIC POMMEL HORSES, STILL RINGS, HIGH BARS, WALL BARS, PARALLEL BARS, BALANCE BEAMS, WEIGHTS AND BALANCES, GYMNAS TIC ROPES AND STRINGS, NAMELY, JUMP ROPES; SWEDISH GYMS, NAMELY, GYM LADDERS FOR CLIMBING EXERCISES, IN CLASS 28 (U.S. CLS. 22, 23, 38 AND 50).

NO CLAIM IS MADE TO THE EXCLUSIVE RIGHT TO USE STRIDING, APART FROM THE MARK AS SHOWN.

OWNER OF INTERNATIONAL REGISTRATION 0945643 DATED 11-1-2007, EXPIRES 11-1-2017.

SER. NO. 79-054,979, FILED 5-6-2008.

TASNEEM HUSSAIN, EXAMINING ATTORNEY



David J. Kyros

Director of the United States Patent and Trademark Office

United States of America

United States Patent and Trademark Office

VALENTINO

Reg. No. 4,152,166

Registered June 5, 2012

Int. Cls.: 11, 36 and 43

TRADEMARK

SERVICE MARK

PRINCIPAL REGISTER

VALENTINO S.P.A. (ITALY CORPORATION)
VIA TURATI, 16/18
I-20121 MILANO
ITALY

FOR: ELECTRIC LAMPS, ELECTRIC CHANDELIERS AND ELECTRIC LIGHTING FIXTURES; LAMPS OF ALL KINDS, NAMELY, TABLE LAMPS, HANGING LAMPS, CHANDELIERS, WALL LAMPS, STANDARD LAMPS, CEILING LAMPS, HALOGEN LAMPS AND MODULAR LAMPS, IN CLASS 11 (U.S. CLS. 13, 21, 23, 31 AND 34).

FOR: REAL ESTATE AGENCIES; REAL ESTATE INVESTMENT; REAL ESTATE MANAGEMENT; REAL ESTATE RENTAL SERVICES, NAMELY, RENTAL OF RESIDENTIAL HOUSING AND RENTAL OF VACATION HOMES; REAL ESTATE SERVICES, NAMELY, LEASING AND MANAGEMENT FOR OTHERS OF RESIDENTIAL CONDOMINIUMS LOCATED WITHIN HOTEL DEVELOPMENTS, IN CLASS 36 (U.S. CLS. 100, 101 AND 102).

FOR: PROVIDING TEMPORARY HOUSING ACCOMMODATIONS; RENTAL OF ROOMS AS TEMPORARY LIVING ACCOMMODATIONS, IN CLASS 43 (U.S. CLS. 100 AND 101).

THE MARK CONSISTS OF STANDARD CHARACTERS WITHOUT CLAIM TO ANY PARTICULAR FONT, STYLE, SIZE, OR COLOR.

PRIORITY DATE OF 5-26-2008 IS CLAIMED.

OWNER OF INTERNATIONAL REGISTRATION 0978396 DATED 7-22-2008, EXPIRES 7-22-2018.

OWNER OF U.S. REG. NOS. 956,665, 3,298,206 AND OTHERS.

SEC. 2(F).

SER. NO. 79-059,290, FILED 7-22-2008.

MICHAEL TANNER, EXAMINING ATTORNEY



David J. Kypos

Director of the United States Patent and Trademark Office

United States of America

United States Patent and Trademark Office



Reg. No. 4,152,167

Registered June 5, 2012

**Int. Cls.: 16, 35, 38, 41
and 42**

TRADEMARK

SERVICE MARK

PRINCIPAL REGISTER

THE BRITISH COMPUTER SOCIETY (UNITED KINGDOM A BODY INCORPORATED BY ROYAL CHARTER)
NORTH STAR HOUSE
NORTH STAR AVENUE
SWINDON SN2 1FA, UNITED KINGDOM

FOR: PRINTED MATTER, NAMELY, PRINTED INSTRUCTIONAL AND TEACHING MATERIAL IN THE FIELD OF INFORMATION TECHNOLOGY, PUBLICATIONS, NAMELY, MAGAZINES, BOOKS, WORKBOOKS IN THE FIELD OF INFORMATION TECHNOLOGY, IN CLASS 16 (U.S. CLS. 2, 5, 22, 23, 29, 37, 38 AND 50).

FOR: BUSINESS MANAGEMENT AND BUSINESS ADMINISTRATION SERVICES; RECRUITMENT SERVICES, NAMELY, PERSONNEL PLACEMENT AND RECRUITMENT; EMPLOYMENT AGENCY SERVICES; EMPLOYMENT CONSULTANCY, NAMELY, CONSULTANCY OF PERSONNEL RECRUITMENT; EMPLOYMENT COUNSELING AND RECRUITMENT; JOB AGENCY SERVICES; PERSONNEL PLACEMENT; PERSONNEL RECRUITMENT; INCLUDING SUCH SERVICES PROVIDED VIA A LOCAL OR INTERNATIONAL COMPUTER NETWORK, IN CLASS 35 (U.S. CLS. 100, 101 AND 102).

FOR: TELECOMMUNICATIONS SERVICES, NAMELY, PROVIDING TELECOMMUNICATIONS CONNECTIONS TO A GLOBAL COMPUTER NETWORK, IN CLASS 38 (U.S. CLS. 100, 101 AND 104).

FOR: EDUCATION AND TRAINING SERVICES, NAMELY, CLASSES, COURSES, SEMINARS IN THE FIELD OF INFORMATION TECHNOLOGY; EDUCATIONAL EXAMINATIONS SERVICES; CONDUCTING EDUCATIONAL EXHIBITIONS AND SEMINARS IN THE FIELD OF INFORMATION TECHNOLOGY; ENTERTAINMENT, NAMELY, PROVIDING MOTIVATIONAL AND EDUCATIONAL SPEAKERS IN THE FIELD OF INFORMATION TECHNOLOGY, IN CLASS 41 (U.S. CLS. 100, 101 AND 107).

FOR: SCIENTIFIC RESEARCH; TECHNOLOGICAL SERVICES, NAMELY, TECHNOLOGICAL CONSULTATION IN THE TECHNOLOGY FIELD OF INFORMATION TECHNOLOGY; INDUSTRIAL ANALYSIS AND RESEARCH SERVICES, NAMELY, IN THE FIELD OF INFORMATION TECHNOLOGY; DESIGN AND DEVELOPMENT OF COMPUTER HARDWARE AND SOFTWARE, IN CLASS 42 (U.S. CLS. 100 AND 101).



David J. Kyjars

Director of the United States Patent and Trademark Office

PRIORITY DATE OF 1-19-2009 IS CLAIMED.

Reg. No. 4,152,167 OWNER OF INTERNATIONAL REGISTRATION 1013235 DATED 7-17-2009, EXPIRES 7-17-2019.

SER. NO. 79-072,894, FILED 7-17-2009.

LOURDES AYALA, EXAMINING ATTORNEY

United States of America

United States Patent and Trademark Office



Reg. No. 4,152,168

Registered June 5, 2012

Int. Cls.: 9, 16 and 42

FUTURE TECHNOLOGY DEVICES; INTERNATIONAL LIMITED (UNITED KINGDOM CORPORATION)
UNIT 1
2 SEAWARD PLACE,; CENTURION BUSINESS PARK; GLASGOW G41 1HH
UNITED KINGDOM

TRADEMARK

SERVICE MARK

PRINCIPAL REGISTER

FOR: UNIVERSAL SERIAL BUS HARDWARE, NAMELY, INTEGRATED CIRCUITS, SEMICONDUCTORS; PHOTOLITHOGRAPHIC MASKS FOR USE IN SEMICONDUCTOR MANUFACTURE; SEMICONDUCTOR CHIPS; COMPUTER INTERFACE BOARDS; MOTHERBOARDS; SILICON WAFERS; COMPUTER HARDWARE; COMPUTER SOFTWARE FOR DATA PROCESSING IN THE FIELD OF UNIVERSAL SERIAL BUS HARDWARE; MEMORY MODULES; COMPUTER DATA STORAGE APPARATUS; BLANK MAGNETIC DATA CARRIERS; BLANK OPTICAL DATA CARRIERS; FLASH MEMORY CARDS; COMPUTER FIRMWARE FOR INTERFACING UNIVERSAL SERIAL BUS HARDWARE WITH SOFTWARE, ALL OF THE FOREGOING EXCLUDES FLORISTS, IN CLASS 9 (U.S. CLS. 21, 23, 26, 36 AND 38).

FOR: PAPER, CARDBOARD AND GOODS MADE FROM THESE MATERIALS, NAMELY, CARDBOARD BOXES AND PROMOTIONAL MATERIAL, NAMELY, PRINTED INFORMATIONAL FLYERS IN THE FIELD OF COMPUTERS, COMPUTER SOFTWARE, COMPUTER FIRMWARE AND COMPUTER PERIPHERALS; POSTERS; PRINTED SHEETS, PRODUCT CATALOGS, PRINTED MATERIALS, NAMELY, PRESS RELEASES, BOOKS AND MAGAZINES, TRAINING MANUALS, INSTRUCTION MANUALS, INSTRUCTION LEAFLETS, PERIODICALS, HANDOUTS, HANDBOOKS, PRINTED PUBLICATIONS, NAMELY, PRESS RELEASES AND NEWSLETTERS, BROCHURES AND BOOKLETS, ALL IN THE FIELD OF COMPUTERS, COMPUTER SOFTWARE AND COMPUTER PERIPHERALS; PRINTED OPERATION MANUALS, DATA BOOKS, MEMORANDUM BOOKS, NOTE PADS, BLANK FORMS, PAPER FOR RECORDING COMPUTER PROGRAMS, STICKERS, STATIONERY, PACKAGING MATERIALS OF PAPER AND CARDBOARD, ALL IN THE FIELD OF COMPUTER HARDWARE AND PERIPHERALS, COMPUTER SOFTWARE, INTEGRATED CIRCUITS AND ELECTRONIC PRODUCTS, IN CLASS 16 (U.S. CLS. 2, 5, 22, 23, 29, 37, 38 AND 50).



David J. Kyros

Director of the United States Patent and Trademark Office

FOR: DESIGN OF COMPUTER PROGRAMS; DESIGNING OF DATA PROCESSING SYSTEMS; DESIGN OF INTEGRATED CIRCUITS, DESIGN OF COMPUTER HARDWARE EQUIPMENT; DESIGN OF UNIVERSAL SERIAL BUS HARDWARE AND SOFTWARE; PROVIDING TECHNICAL RESEARCH FOR OTHERS IN THE FIELD OF UNIVERSAL SERIAL BUS, AND

Reg. No. 4,152,168 CONSULTANCY THEREOF, ALL OF THE FOREGOING EXCLUDES FLORISTS, IN CLASS 42 (U.S. CLS. 100 AND 101).

NO CLAIM IS MADE TO THE EXCLUSIVE RIGHT TO USE "CHIP", APART FROM THE MARK AS SHOWN.

PRIORITY DATE OF 4-15-2009 IS CLAIMED.

OWNER OF INTERNATIONAL REGISTRATION 1019711 DATED 10-13-2009, EXPIRES 10-13-2019.

THE MARK CONSISTS OF THE LETTERS "FTDI" OVER THE WORD "CHIP" WHICH ARE TO THE RIGHT OF A CYLINDER.

SER. NO. 79-075,445, FILED 10-13-2009.

DEZMONA MIZELLE, EXAMINING ATTORNEY

United States of America

United States Patent and Trademark Office

LB3

Reg. No. 4,152,169

Registered June 5, 2012

Int. Cls.: 11, 20 and 21

TRADEMARK

PRINCIPAL REGISTER

KERAMIK HOLDING AG LAUFEN (SWITZERLAND SOCIÉTÉ ANONYME (SA))
WAHLENSTRASSE 46
CH-4242 LAUFEN, SWITZERLAND

FOR: APPARATUS FOR LIGHTING, NAMELY, LIGHTING APPARATUS FOR BATHROOMS AND LAVATORIES, ELECTRIC LAMPS, ELECTRIC LIGHTING FIXTURES IN THE NATURE OF SCONCES, POWER FAILURE BACKUP SAFETY LIGHTING, AND LIGHTING FIXTURES, LAMPS, LIGHTING APPARATUS IN THE NATURE OF LIGHTING INSTALLATIONS; APPARATUS FOR REFRIGERATING, NAMELY, REFRIGERATORS; APPARATUS FOR DRYING, NAMELY, CLOTHES DRYERS; APPARATUS FOR VENTILATING, NAMELY, VENTILATORS FOR BATHROOMS; APPARATUS FOR WATER SUPPLY AND SANITARY PURPOSES, NAMELY, TOILETS, LAVATORY BOWLS, BIDETS, BATHTUBS, SHOWERS, URINALS, CERAMIC TOILET BOWLS, CERAMIC BIDETS, CERAMIC BATHTUBS, CERAMIC SHOWERS, CERAMIC URINALS, SINK PEDESTALS; PLUMBING FITTINGS, NAMELY, COCKS, TRAPS, VALVES; TOILET TANK BALLS, TOILET STOOL UNITS WITH WASHING WATER SQUIRTER; SINKS; SHOWERS; TAPS (FAUCETS) FOR WATER PIPES; FLEXIBLE PIPES BEING PART OF BATH, SHOWER, TOILET AND SINK INSTALLATIONS; MIXER TAPS (FAUCETS) FOR WATER PIPES; TOILET BOWLS; TOILET SEATS; WATER FLUSHING INSTALLATIONS, NAMELY, FLUSH LEVERS, TOILET TANK BALLS, FLUSH METERS; FLUSHING TANKS; FAUCETS, HAND SHOWERS; HAND HELD SHOWER HEADS; PLUMBER FITTINGS, NAMELY, SPOUTS; FLUSH LEVERS; SINGLE LEVER FIXTURES FOR LAVATORIES AND SINKS; WALL SPOUTS FOR BATHS, BASINS AND BIDETS, IN CLASS 11 (U.S. CLS. 13, 21, 23, 31 AND 34).



David J. Kappas

Director of the United States Patent and Trademark Office

FOR: MIRRORS, PICTURE FRAMES OF WOOD, CORK, REED, WICKER, HORN, BONE, IVORY, WHALEBONE, TORTOISE-SHELL, AMBER, MOTHER-OF-PEARL, MEERSCHAUM, AND SUBSTITUTES FOR ALL THESE MATERIALS, OR OF PLASTICS; FURNITURE, ESPECIALLY FOR BATHROOMS, OF WOOD AND PLASTICS; HOLDERS FOR BATHROOMS IN THE NATURE OF SHELVES AND SHELVES FOR STORAGE, FOOTSTOOLS, BED HEADBOARDS, BOLSTERS, CUPBOARDS, BATHROOM VANITY UNITS, MIRRORED CABINETS, CABINETS, SIDE CABINETS, OPEN WALL CABINETS, TALL CABINETS, WALL CABINETS, SERVING TROLLEYS, FURNITURE FRAMES, EASY ENTRY STEPS IN THE NATURE OF NON-METAL STEP STOOLS AND LADDERS, TOWEL CLOSETS, SEATS, ALL THE FOREGOING BEING OF WOOD, CORK, REED, WICKER, HORN, BONE, IVORY, WHALEBONE, TORTOISE-SHELL, AMBER, MOTHER-OF-PEARL, MEERSCHAUM, AND SUBSTITUTES FOR ALL THESE MATERIALS, OR OF PLASTICS, IN CLASS 20 (U.S. CLS. 2, 13, 22, 25, 32 AND 50).

Reg. No. 4,152,169 FOR: TOILET BRUSHES; CLEANING BRUSHES; DUSTING BRUSHES; CLEANING CLOTHS; CLEANING PADS; CLEANING SPONGES; UNWORKED OR SEMIWORKED GLASS, (EXCEPT BUILDING GLASS); GLASS, NAMELY, GLASS CONTAINERS SOLD EMPTY FOR TOOTHBRUSH TUMBLERS AND STORING COSMETICS; CRYSTAL GLASS, NAMELY, GLASS CONTAINERS SOLD EMPTY FOR TOOTHBRUSH TUMBLERS AND STORING COSMETICS; HOLDERS FOR TOILET PAPER; NAPKIN HOLDERS; SOAP HOLDERS; SOAP DISPENSERS; BEVERAGE GLASSWARE; PORCELAIN WARE AND EARTHENWARE NOT INCLUDED IN OTHER CLASSES, NAMELY, SOAP DISHES, DECORATIVE CERAMIC TILES AND CERAMIC FIGURINES INCLUDED IN THIS CLASS; HAND WASH BASINS; HANGERS AND HOLDERS FOR BATHROOMS, NAMELY, TOWEL RINGS AND TOWEL WALL HANGERS; KNOBS AND HANDLES OF CERAMICS, DECORATIVE DISCS AND PLAQUE FOR BATHROOM FITTINGS MADE FROM CERAMICS, GLASS AND PLASTER; TOWEL RAILS, TOWEL HOOKS NOT OF METAL, TOILET PAPER DISPENSER WITH SHELVES, FREESTANDING TOILET BRUSH HOLDER, TOILET BRUSH HOLDER, BATHROOM GLASS HOLDER NOT OF PRECIOUS METAL, IN CLASS 21 (U.S. CLS. 2, 13, 23, 29, 30, 33, 40 AND 50).

THE MARK CONSISTS OF STANDARD CHARACTERS WITHOUT CLAIM TO ANY PARTICULAR FONT, STYLE, SIZE, OR COLOR.

PRIORITY DATE OF 3-5-2009 IS CLAIMED.

OWNER OF INTERNATIONAL REGISTRATION 1024945 DATED 9-4-2009, EXPIRES 9-4-2019.

SER. NO. 79-077,326, FILED 9-4-2009.

WILLIAM P. SHANAHAN, EXAMINING ATTORNEY

United States of America

United States Patent and Trademark Office

FINGER-PATCH

Reg. No. 4,152,170

Registered June 5, 2012

Int. Cls.: 7, 9 and 42

TRADEMARK

SERVICE MARK

PRINCIPAL REGISTER

CONOPTICA AS (NORWAY LIMITED CORPORATION)
HALLSETVEIEN 3
N-7540 KLÆBU, NORWAY

FOR: MACHINES AND MACHINE TOOLS, NAMELY, MACHINES FOR MILLING GRINDING, TURNING, CUTTING, DRILLING, SAWING; MOTORS AND ENGINES EXCEPT FOR LAND VEHICLES; MACHINE COUPLING AND TRANSMISSION COMPONENTS EXCEPT FOR LAND VEHICLES; AGRICULTURAL IMPLEMENTS OTHER THAN HAND-OPERATED, NAMELY, SEED DRILLS; INCUBATORS FOR EGGS, IN CLASS 7 (U.S. CLS. 13, 19, 21, 23, 31, 34 AND 35).

FOR: SCIENTIFIC, NAUTICAL, SURVEYING, PHOTOGRAPHIC, CINEMATOGRAPHIC, OPTICAL, WEIGHING, MEASURING, SIGNALLING, LIFE-SAVING AND TEACHING APPARATUS AND INSTRUMENTS, NAMELY, COORDINATE MEASURING MACHINES, OPTICAL MEASUREMENT SYSTEMS EQUIPPED WITH VISION SOFTWARE, NAMELY, DIMENSION, GEOMETRY, AND POSITION MEASURING SOFTWARE, AND CAMERAS, OPTICAL MICROSCOPES, MICROSCOPES, AND TELESCOPES; APPARATUS AND INSTRUMENTS FOR CONDUCTING, SWITCHING, TRANSFORMING, ACCUMULATING, REGULATING OR CONTROLLING ELECTRICITY, NAMELY, ELECTRICAL TRANSFORMERS; APPARATUS FOR RECORDING, TRANSMISSION OR REPRODUCTION OF SOUND OR IMAGES; PRE-RECORDED MAGNETIC DATA CARRIERS AND RECORDING DIGITAL VIDEO DISCS FEATURING ANALYSIS RESULTS IN THE FIELD OF POSITION AND DIMENSION CONTROL OF MACHINES TOOLS; AUTOMATIC VENDING MACHINES AND MECHANISMS FOR COIN-OPERATED APPARATUS; CASH REGISTERS, CALCULATING MACHINES, DATA PROCESSING EQUIPMENT AND COMPUTERS; FIRE-EXTINGUISHING APPARATUS, IN CLASS 9 (U.S. CLS. 21, 23, 26, 36 AND 38).

FOR: SCIENTIFIC AND TECHNOLOGICAL SERVICES AND RESEARCH AND DESIGN RELATING THERETO, NAMELY, SERVICES AND RESEARCH REGARDING COMPUTER CONTROL OF MACHINES, ACCURATE POSITION CONTROL, AND PART HANDLING TECHNOLOGY; DESIGN AND DEVELOPMENT OF COMPUTER HARDWARE AND SOFTWARE, IN CLASS 42 (U.S. CLS. 100 AND 101).

THE MARK CONSISTS OF STANDARD CHARACTERS WITHOUT CLAIM TO ANY PARTICULAR FONT, STYLE, SIZE, OR COLOR.

PRIORITY DATE OF 5-25-2009 IS CLAIMED.



David J. Kyros

Director of the United States Patent and Trademark Office

Reg. No. 4,152,170 OWNER OF INTERNATIONAL REGISTRATION 1026439 DATED 11-18-2009, EXPIRES 11-18-2019.

SER. NO. 79-077,911, FILED 11-18-2009.

ALYSSA STEEL, EXAMINING ATTORNEY

United States of America

United States Patent and Trademark Office

ONEKIND

Reg. No. 4,152,171

Registered June 5, 2012

Int. Cls.: 16, 35, 36 and 41

TRADEMARK

SERVICE MARK

PRINCIPAL REGISTER

ONEKIND CHARITY (UNITED KINGDOM LIMITED COMPANY)
10 QUEENSFERRY STREET
EDINBURGH EH2 4PG, UNITED KINGDOM

FOR: PRINTED MATTER AND PUBLICATIONS, NAMELY, BOOKS, MAGAZINES, PERIODICALS, JOURNALS, LEAFLETS, NEWSLETTERS, NEWSPAPERS, BROCHURES, BOOKLETS, CATALOGUES, ALL IN THE FIELD OF ANIMAL WELFARE; GREETING CARDS; INSTRUCTIONAL AND TEACHING MATERIALS IN THE FIELD OF ANIMAL WELFARE; STATIONERY WRITING AND DRAWING MATERIALS, NAMELY, WRITING AND DRAWING PAPER, PADS AND WRITING BOOKS, PENCILS, PENS, PENCIL SHARPENERS, PEN AND PENCIL CASES; STICKERS; OFFICE REQUISITES, NAMELY, OFFICE FILES, LETTER FILES, FOLDERS; RUBBER ERASERS; RULERS; BOOKENDS; ALBUMS, NAMELY, PHOTOGRAPH ALBUMS, EVENT ALBUMS; CALENDARS; CARDS; POSTCARDS; CHEQUE BOOKS; CHEQUE BOOK COVERS AND HOLDERS; POSTERS; PAINTINGS; PHOTO-ENGRAVINGS; PHOTOGRAPHS; SCRAPBOOKS; TABLE CLOTHS, MATS AND NAPKINS OF PAPER ARTICLES OF CARDBOARD, NAMELY, BOXES; WRAPPING PAPER, IN CLASS 16 (U.S. CLS. 2, 5, 22, 23, 29, 37, 38 AND 50).

FOR: DEVELOPING PROMOTIONAL AND PUBLIC AWARENESS CAMPAIGNS IN THE FIELD OF ANIMAL WELFARE; MANAGEMENT OF FUNDRAISING CAMPAIGNS IN THE FIELD OF ANIMAL WELFARE; ONLINE RETAIL STORE SERVICES FOR T-SHIRTS, CLOTHING, HEADGEAR AND FOOTWEAR, MUGS, STATIONERY, STATIONERY WRITING AND DRAWING MATERIALS, WRITING AND DRAWING PAPER, PADS AND BOOKS, PENCILS, PENS, PENCIL SHARPENERS, PEN AND PENCIL CASES, STICKERS, OFFICE REQUISITES, RUBBER ERASERS, RULERS, BOOKENDS, ALBUMS, PHOTOGRAPH ALBUMS, CALENDARS, CARDS, POSTCARDS, CHEQUE BOOKS, CHEQUE BOOK COVERS AND HOLDERS, FILES, FOLDERS, POSTERS, PAINTINGS, PHOTO-ENGRAVINGS, PHOTOGRAPHS, SCRAPBOOKS, TABLE CLOTHS, MATS AND NAPKINS OF PAPER ARTICLES OF CARDBOARD, WRAPPING AND PACKAGING MATERIAL, BADGES, KEY RINGS, JEWELLERY, TOYS, GAMES AND PLAYTHINGS, TEXTILE ARTICLES, TEA TOWELS, CHRISTMAS DECORATIONS, BALLOONS, KITCHEN UTENSILS, ARTICLES MADE OF LEATHER OR IMITATION LEATHER, BAGS, PURSES, WALLETS, UMBRELLAS, PARASOLS, ANIMAL COLLARS AND LEADS; DISTRIBUTION SERVICES RELATING TO ADVERTISING AND PROMOTIONAL ANNOUNCEMENTS, BROCHURES, LEAFLETS, MATERIAL AND SAMPLES; BUSINESS ADMINISTRATION AND ADVICE; BUSINESS CONSULTANCY SERVICES; ADVERTISING AND PROMOTIONAL SERVICES; PROMOTIONAL



David J. Kyros

Director of the United States Patent and Trademark Office

Reg. No. 4,152,171 SERVICES TO RAISE PUBLIC AWARENESS OF ANIMAL RIGHTS AND WELFARE, IN CLASS 35 (U.S. CLS. 100, 101 AND 102).

FOR: CHARITABLE FUNDRAISING SERVICES, NAMELY, ORGANIZING AND CONDUCTING CHARITABLE FUNDRAISING CAMPAIGNS IN THE FIELD OF ANIMAL WELFARE; CHARITABLE FUNDRAISING SERVICES; FINANCIAL SERVICES TO FACILITATE CHARITABLE GIVING, NAMELY, FACILITATING CHARITABLE DONATIONS BY DIRECT DEBIT OR ONLINE, CREDIT CARD SERVICES MANDATES, DIRECT DEBITS AND FINANCIAL ADVICE ON WILLS AND TRUSTS; CHARITABLE FUNDRAISING SERVICES, NAMELY, ELEEMOSYNARY SERVICES IN THE FIELD OF COLLECTION, MANAGEMENT AND DISBURSEMENT OF MONEY IN CONNECTION WITH PROGRAMMES AND FACILITIES IN THE FIELD OF ANIMAL WELFARE; FINANCIAL SPONSORSHIP SERVICES, NAMELY, PROVISION OF FINANCIAL SPONSORSHIP FOR ANIMAL WELFARE PROJECTS AND OBTAINING SPONSORSHIP FOR ANIMAL WELFARE PROJECTS FROM THIRD PARTIES; PROVIDING OF FINANCIAL GRANTS TO IMPROVE ANIMAL WELFARE; CHARITABLE FOUNDATION SERVICES, NAMELY, PROVIDING FUNDRAISING ACTIVITIES AND INVESTMENT MANAGEMENT SERVICES TO SUPPORT ANIMAL WELFARE; CHARITABLE-FUNDING CHARITABLE FOUNDATION SERVICES, NAMELY, PROVIDING CHARITABLE FUNDING FOR PROGRAMS AND SERVICES OF OTHERS IN THE FIELD OF ANIMAL WELFARE; RESEARCH AND INFORMATION SERVICES RELATING TO FUND RAISING SERVICES; FINANCIAL AND INSURANCE SERVICES, NAMELY, FINANCIAL ADVICE RELATING TO DONATIONS; INFORMATION AND ADVISORY SERVICES RELATING TO ALL THE AFORESAID SERVICES, IN CLASS 36 (U.S. CLS. 100, 101 AND 102).

FOR: EDUCATION AND TRAINING SERVICES, NAMELY, ARRANGING AND CONDUCTING COLLOQUIUMS, CONFERENCES, SEMINARS, SYMPOSIUMS, LECTURES AND WORKSHOPS IN THE FIELD OF ANIMAL WELFARE; ORGANISATION OF EXHIBITIONS FOR EDUCATIONAL PURPOSES IN THE FIELD OF ANIMAL WELFARE; LIBRARY SERVICES, NAMELY, ONLINE LIBRARY SERVICES IN THE FIELD OF ANIMAL WELFARE; PUBLISHING SERVICES, NAMELY, ON-LINE PUBLICATION OF TEST, GRAPHIC AND FILM WORK OF OTHERS IN THE FIELD OF ANIMAL WELFARE; VIDEO AND FILM PRODUCTION IN CONNECTION WITH THE PROMOTION OF PUBLIC AWARENESS OF ANIMAL RIGHTS AND WELFARE; PRODUCTION AND PUBLISHING OF BOOKS AND TEXTS, NAMELY, BOOKS, NEWSLETTERS, SHORT PAPERS, ESSAYS, ALL IN THE FIELD OF ANIMAL WELFARE; ORGANISATION OF COMPETITIONS, RAFFLES AND DRAWS; ENTERTAINMENT SERVICES, NAMELY, CONDUCTING OF CONTESTS, IN CLASS 41 (U.S. CLS. 100, 101 AND 107).

THE MARK CONSISTS OF STANDARD CHARACTERS WITHOUT CLAIM TO ANY PARTICULAR FONT, STYLE, SIZE, OR COLOR.

PRIORITY DATE OF 9-9-2009 IS CLAIMED.

OWNER OF INTERNATIONAL REGISTRATION 1033830 DATED 2-26-2010, EXPIRES 2-26-2020.

SER. NO. 79-080,782, FILED 2-26-2010.

PAULA MAHONEY, EXAMINING ATTORNEY

United States of America

United States Patent and Trademark Office

D **DUPLOMATIC**
OLEODINAMICA

Reg. No. 4,152,172

Registered June 5, 2012

Int. Cl.: 7

TRADEMARK

PRINCIPAL REGISTER

DUPLOMATIC OLEODINAMICA S.P.A. (ITALY JOINT STOCK COMPANY)
VIA MARIO RE DEPAOLINI, 24
I-20015 PARABIAGO (MILANO), ITALY

FOR: MACHINES AND MACHINE TOOLS, NAMELY, MILLING MACHINES, GRINDING MACHINES, TRANSFER MACHINES, NIBBLING AND SAWING MACHINES; MOTORS AND ENGINES EXCEPT FOR LAND VEHICLES; MACHINE COUPLING AND TRANSMISSION COMPONENTS EXCEPT FOR LAND VEHICLES; AGRICULTURAL IMPLEMENTS, NAMELY, SEED DRILLS, INCORPORATORS, HAY BALERS, COMBINE HARVESTER, HEDGE TRIMMER; INCUBATORS FOR EGGS, IN CLASS 7 (U.S. CLS. 13, 19, 21, 23, 31, 34 AND 35).

THE MARK CONSISTS OF THE WORDING "DUPLOMATIC OLEODINAMICA" INSIDE A LONG DESIGN WITH A STYLIZED LETTER "D" TO THE LEFT OF THE DESIGN.

OWNER OF INTERNATIONAL REGISTRATION 1039648 DATED 4-29-2010, EXPIRES 4-29-2020.

THE WORDING "DUPLOMATIC" HAS NO MEANING IN A FOREIGN LANGUAGE.

THE ENGLISH TRANSLATION OF "OLEODINAMICA" IS "OIL-PRESSURE".

SER. NO. 79-082,886, FILED 4-29-2010.

ALICE BENMAMAN, EXAMINING ATTORNEY



David J. Kybas

Director of the United States Patent and Trademark Office

United States of America

United States Patent and Trademark Office



Reg. No. 4,152,173

Registered June 5, 2012

Int. Cls.: 18, 25 and 28

TRADEMARK

PRINCIPAL REGISTER

MICHAEL PRAIG (AUSTRIA INDIVIDUAL)
WIENER STRASSE 135
A-3100 ST. PÖLTEN
AUSTRIA

FOR: ANIMAL SKINS, ANIMAL HIDES; TRUNKS AND TRAVELING BAGS; RUCKSACKS; BAGS NOT INCLUDED IN OTHER CLASSES, NAMELY, BOOK BAGS, TREATMENT BAGS FOR DOGS, SIDE BAGS FOR DOG-HARNESS, BACKPACK FOR DOGS; UMBRELLAS, PARASOLS AND WALKING STICKS; WHIPS; HARNESS FOR ANIMALS; SADDLERY, ANIMAL LEASHES; CLOTHING FOR ANIMALS, IN CLASS 18 (U.S. CLS. 1, 2, 3, 22 AND 41).

FOR: CLOTHING FOR ATHLETIC USE FOR SPORTS WITH DOGS, NAMELY, PADDED TROUSERS, PADDED JACKETS, PADDED PANTS, PADDED SHIRTS FOR OUTDOOR WEAR; FOOTWEAR; HEADGEAR, NAMELY, CAPS, HOODS; LEISURE, GYMNASTICS AND SPORTS CLOTHING, NAMELY, TROUSERS, JACKETS, PANTS, SHIRTS FOR OUTDOOR USE, IN CLASS 25 (U.S. CLS. 22 AND 39).

FOR: GAMES AND PLAYTHINGS, NAMELY, TOYS FOR DOGS AND CATS LIKE BALLS, THINGS TO SCRATCH, RASP, BITE, PULL, JUMP CRAWL INTO OR UNDER AND CHASE; GYMNASTIC AND SPORTING ARTICLES NOT INCLUDED IN OTHER CLASSES, NAMELY, AGILITY OBSTACLES LIKE DOGWALKS, TEETER-TOTTER, TUNNELS, HORIZONTAL BARS, HURDLES, WEAVE POLES, IN CLASS 28 (U.S. CLS. 22, 23, 38 AND 50).

NO CLAIM IS MADE TO THE EXCLUSIVE RIGHT TO USE "TECHNICAL K9 EQUIPMENT", APART FROM THE MARK AS SHOWN.

OWNER OF INTERNATIONAL REGISTRATION 1042747 DATED 4-9-2010, EXPIRES 4-9-2020.

THE MARK CONSISTS OF THE WORDING "DOXLOCK TECHNICAL K9 EQUIPMENT" IN AN OVAL LIKE SHAPE ON A BLACK BACKGROUND. THE COLOR BLACK REPRESENTS THE BACKGROUND AND IS NOT PART OF THE MARK.

SER. NO. 79-083,995, FILED 4-9-2010.

ROSELLE HERRERA, EXAMINING ATTORNEY



David J. Kyffers

Director of the United States Patent and Trademark Office

United States of America
United States Patent and Trademark Office

ASSOS

Reg. No. 4,152,174

Registered June 5, 2012

Int. Cls.: 3, 12 and 25

TRADEMARK

PRINCIPAL REGISTER

ROGER MAIER (SWITZERLAND INDIVIDUAL)
VIA BRESCE, 1
CH-6854 SAN PIETRO DI STABIO
SWITZERLAND

FOR: AFTER-SHAVE, MAKE-UP, PERFUMERY, COSMETICS, COSMETIC CREAMS FOR SKIN CARE, BODY CREAMS, SOAPS, ESSENTIAL OILS, HAIR LOTIONS; DENTIFRICES, IN CLASS 3 (U.S. CLS. 1, 4, 6, 50, 51 AND 52).

FOR: BICYCLES AND THEIR COMPONENT PARTS, NAMELY, DIALS, HANDLEBARS, POSTS, SEAT POSTS, SADDLES, SEATS, WHEELS, TIRES, BRAKES, BRAKE LEVERS, BICYCLE CHAINS, HUBS, AXLES, GEAR-SHIFT LEVERS, KICKSTANDS FOR BICYCLES, MUDFLAPS, PEDALS AND WATER BOTTLE HOLDERS, HANDLEBAR ACCESSORIES FOR BICYCLES, NAMELY, BICYCLE GRIP TAPE, BICYCLE HORNS, BICYCLE BELLS AND BASKETS, IN CLASS 12 (U.S. CLS. 19, 21, 23, 31, 35 AND 44).

FOR: DRESSES, CAPS, HATS, BELTS, SKIRTS, JACKETS, COATS, SWEATERS, SINGLETs, OVERALLS, DRESSING GOWNS, HOUSECOATS, BATHING SUITS, UNDERWEAR, STOCKINGS, SOCKS, NECKTIES, SCARVES, GLOVES, CAPES, TROUSERS, SLIPPERS, PARKAS, PAJAMAS, FUR COATS, FUR JACKETS, PULLOVERS, GARTERS, BRASSIERES, SANDALS, FOOTWEAR, SHAWLS, SASHES FOR WEAR, OVERCOATS, FUR STOLEs, DUNGAREES, BOOTS, TEE-SHIRTS, SHIRTS, PANTIES, SHORTS, BRIEFS, JEANS, PAREOS, SUN VISORS, HOSIERY, SLEEVELESS JACKETS, ARM WARMERS, CLOTHING FOR SPORTS, NAMELY, CLOTHING FOR CYCLISTS, NAMELY, BICYCLIST JERSEYS, BICYCLIST SHORTS, BICYCLIST PANTS AND BICYCLIST GLOVES, IN CLASS 25 (U.S. CLS. 22 AND 39).

THE MARK CONSISTS OF STANDARD CHARACTERS WITHOUT CLAIM TO ANY PARTICULAR FONT, STYLE, SIZE, OR COLOR.

OWNER OF INTERNATIONAL REGISTRATION 0872524 DATED 11-14-2005, EXPIRES 11-14-2015.

SER. NO. 79-084,650, FILED 2-17-2010.

JEFFREY LOOK, EXAMINING ATTORNEY



David J. Kyros

Director of the United States Patent and Trademark Office

United States of America

United States Patent and Trademark Office

DESIGO

Reg. No. 4,152,175

Registered June 5, 2012

Int. Cls.: 9 and 11

TRADEMARK

PRINCIPAL REGISTER

SIEMENS SCHWEIZ AG (SWITZERLAND JOINT STOCK COMPANY)
FREILAGERSTRASSE 40
CH-8047 ZÜRICH
SWITZERLAND

FOR: APPARATUS FOR REGULATING, CONTROLLING, SIGNALING AND MONITORING FOR HEATING, VENTILATION AND AIR CONDITIONING TECHNOLOGY, NAMELY, COMPUTER HARDWARE FOR USE IN BUILDING AUTOMATION AND CONTROL SYSTEMS, ELECTRONIC CONTROLLERS FOR CONTROLLING BUILDING HEATING, VENTILATION, AND AIR CONDITIONING, TEMPERATURE CONTROLLERS, HEATING CONTROLLERS, VENTILATION AND AIR FLOW CONTROLLERS, AIR CONDITIONING SYSTEM CONTROLLERS, REFRIGERATION CONTROLLERS, ELECTRICITY, GAS, WATER AND HEAT METERS, TEMPERATURE, HEATING, VENTILATION, REFRIGERATION AND AIR-CONDITIONING REGULATORS, COMPUTER HARDWARE AND SOFTWARE FOR THE REMOTE CONTROL OF TEMPERATURE, HEATING, VENTILATION, REFRIGERATION, AND AIR CONDITIONING REGULATORS, THERMOSTATS, AUTOMATIC TIMERS, AUTOMATIC TEMPERATURE MONITORS, AIR FLOW MONITORS, AIR QUALITY MONITORS, DATA TRANSMITTERS AND RECEIVERS FOR TRANSMITTING DATA RELATING TO STATUS OF HEATING, VENTILATING AND AIR CONDITIONING SYSTEMS AND FOR COMMUNICATION BETWEEN SYSTEMS, COMPUTER SOFTWARE FOR CONTROLLING BUILDING AUTOMATION AND CONTROL SYSTEMS AND FOR REVIEWING AND ANALYZING DATA AND PREPARING REPORTS ON ENERGY CONSUMPTION AND ENERGY COSTS, COMPUTER SOFTWARE FOR USE IN OPTIMIZING ENERGY USAGE, NAMELY, SOFTWARE FOR USE IN MEASURING, MONITORING, AND RECORDING ENERGY USAGE DATA AND ANALYZING THE DATA TO OPTIMIZE ENERGY USAGE; APPARATUS FOR MONITORING POWER SUPPLIES, NAMELY, VOLTAGE AND CURRENT METERS, VOLTAGE STABILIZING POWER SUPPLIES, APPARATUS FOR REGULATING AND CONTROLLING ELECTRIC CURRENT, IN CLASS 9 (U.S. CLS. 21, 23, 26, 36 AND 38).

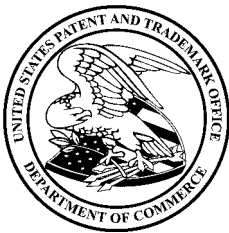

David J. Kappas

Director of the United States Patent and Trademark Office

FOR: APPARATUS AND INSTALLATIONS FOR LIGHTING, HEATING, STEAM GENERATION, REFRIGERATION, AIR-CONDITIONING, VENTILATING AND THEIR PARTS, NAMELY, LIGHTS FOR ILLUMINATING STAIRS, DOORS AND OTHER PORTIONS OF BUILDINGS, HEATING APPARATUS AND INSTALLATIONS, NAMELY, HVAC UNITS AND HEATING INSTALLATIONS, SOLAR COLLECTORS FOR HEATING, STEAM GENERATORS, REFRIGERATING APPLIANCES AND INSTALLATIONS, AIR CONDITIONING APPARATUS AND INSTALLATIONS, AIR COOLING AND VENTILATION APPARATUS

Reg. No. 4,152,175 AND INSTRUMENTS, STRUCTURAL REPLACEMENT PARTS FOR THE FOREGOING, IN CLASS 11 (U.S. CLS. 13, 21, 23, 31 AND 34).

THE MARK CONSISTS OF STANDARD CHARACTERS WITHOUT CLAIM TO ANY PARTICULAR FONT, STYLE, SIZE, OR COLOR.

PRIORITY DATE OF 6-10-2010 IS CLAIMED.

OWNER OF INTERNATIONAL REGISTRATION 1045875 DATED 6-15-2010, EXPIRES 6-15-2020.

SER. NO. 79-085,374, FILED 6-15-2010.

CIMMERIAN COLEMAN, EXAMINING ATTORNEY

United States of America

United States Patent and Trademark Office



Reg. No. 4,152,176

Registered June 5, 2012

Int. Cls.: 9, 11 and 42

TRADEMARK

SERVICE MARK

PRINCIPAL REGISTER

EVCO S.P.A. (ITALY SOCIÉTÉ PAR ACTIONS)
VIA MEZZATERRA, 6
I-32036 SEDICO (BL)
ITALY

FOR: ELECTRIC AND ELECTRONIC MEASURING, CONTROL AND REGULATION APPARATUS AND INSTRUMENTS, NAMELY, VOLTAGE REGULATORS, OXYGEN REGULATORS, TEMPERATURE CONTROLLERS FOR THE MANAGEMENT OF REFRIGERATED CABINETS, FREEZERS, AND DISPLAYS IN INDUSTRIAL REFRIGERATION APPLICATIONS; TEMPERATURE CONTROLLERS FOR THE MANAGEMENT OF PASTRY, BAKING, PIZZA AND MIXED OVENS, FRYERS, PROVERS AND RETARDER-PROVERS IN CATERING EQUIPMENT APPLICATIONS; WATER AND AIR TEMPERATURE CONTROLLERS FOR THE MANAGEMENT OF CHILLERS; ELECTRICAL HUMIDITY CONTROLLERS, ELECTRONIC REGULATING AND CONTROL DEVICES FOR THE OPERATION OF LIGHT EMITTING DIODE, CONTROL VALVES FOR REGULATING THE FLOW OF GASES AND LIQUIDS, CONTROL UNITS FOR REGULATING START-UP ELECTRICAL MOTORS, GAS SENSOR FOR MEASURING GAS CONCENTRATION, MEASURING DEVICES IN THE NATURE OF FLUOROMETERS, IN CLASS 9 (U.S. CLS. 21, 23, 26, 36 AND 38).

FOR: MODULAR COUNTERS FOR REFRIGERATING, HEATING AND CHILLING FOODS; HEAT PUMPS; AIR HANDLING UNITS; ROOFTOPS AIR-CONDITIONING INSTALLATIONS FOR INDUSTRIAL AND RESIDENTIAL; APPARATUS AND INSTALLATIONS FOR COOKING, REFRIGERATION, DRYING, EVAPORATING, HEATING AND AIR-CONDITIONING OR FOR VENTILATION, NAMELY, BLAST CHILLERS FOR COMMERCIAL FOOD PREPARATION AND STORAGE USED IN INDUSTRIAL KITCHENS LIKE RESTAURANTS AND CANTEENS, FOR COOKED AND PRE-COOKED FOOD STORING AND LONG TERM FREEZING, DOUGH PROOFING AND RETARDING UNITS, NAMELY, HEATING, COOLING AND HUMIDITY CONTROLLING UNITS FOR PROCESSING DOUGH USED IN BAKERY SHOPS AND BAKERY LABORATORIES FOR THE AUTOMATIC MANAGEMENT OF BREAD DOUGH RETARDING-PROOFING CYCLE WITH CONTROLLED TEMPERATURE AND HUMIDITY IN PRESET TIMINGS; PIZZA, PASTRY, BREAD AND GASTRONOMY COOKING OVENS USED IN INDUSTRIAL KITCHENS FOR RESTAURANTS AND CANTEENS, BAKERY AND PASTRY LABORATORIES, FOR THE FOOD COOKING WITH VARIOUS METHODOLOGIES, NAMELY, TOP AND FLOOR FOR PASTRY, CONVECTION FOR GASTRONOMY, STEAM BASED FOR VEGETABLES, MIXED WITH CONVECTION AND STEAM FOR MEAT AND FISH; REFRIGERATING APPLIANCES AND INSTALLATIONS, NAMELY, REFRIGERATED CABINETS FOR MEAT, FISH AND VEGETABLES



David J. Kyros

Director of the United States Patent and Trademark Office

Reg. No. 4,152,176 CONSERVATION; REFRIGERATORS, NAMELY, BOTTLE COOLERS; ELECTRIC DISH DRYERS USED INTO INDUSTRIAL KITCHENS LIKE RESTAURANTS AND CANTEENS FOR DISHES WASHING; EVAPORATORS FOR AIR CONDITIONERS, EVAPORATIVE AIR COOLERS, COOLING EVAPORATORS, HEATING INSTALLATIONS, CENTRAL HEATING RADIATORS, ELECTRIC HEATING FANS, AIR CONDITIONING APPARATUS, AIR CONDITIONING UNITS, VENTILATION HOODS, AIR-CONDITIONING, AIR COOLING AND VENTILATION APPARATUS AND INSTRUMENTS, IN CLASS 11 (U.S. CLS. 13, 21, 23, 31 AND 34).

FOR: DESIGN FOR OTHERS IN THE FIELD OF APPARATUS, INSTRUMENTS AND INSTALLATIONS FOR COOKING, REFRIGERATION, DRYING, EVAPORATION, HEATING AND AIR-CONDITIONING AND VENTILATION, IN CLASS 42 (U.S. CLS. 100 AND 101).

NO CLAIM IS MADE TO THE EXCLUSIVE RIGHT TO USE "CONTROL" AS TO CLASS 9, APART FROM THE MARK AS SHOWN.

OWNER OF INTERNATIONAL REGISTRATION 0736140 DATED 3-6-2000, EXPIRES 3-6-2020.

THE COLOR(S) GREY AND YELLOW IS/ARE CLAIMED AS A FEATURE OF THE MARK.

THE MARK CONSISTS OF THE WORDING "EVERY CONTROL" IN UPPERCASE YELLOW LETTERS ON A GRAY OVAL SHAPED BACKGROUND. TO THE LEFT IS A GRAY AND YELLOW ELLIPSOID REPRESENTING A STYLIZED YELLOW LETTER "E" ON A GRAY BACKGROUND.

SER. NO. 79-085,665, FILED 5-19-2010.

KATHERINE CONNOLLY, EXAMINING ATTORNEY

United States of America

United States Patent and Trademark Office



Reg. No. 4,152,177

Registered June 5, 2012

Int. Cl.: 9

AGENCE SPATIALE EUROPÉENNE (ESA) (FRANCE INTERGOVERNMENTAL SPACE AGENCY)
8/10 RUE MARIO NIKIS
F-75015 PARIS
FRANCE

TRADEMARK

PRINCIPAL REGISTER

FOR: APPARATUS AND INSTRUMENTS FOR SCIENTIFIC USE, OTHER THAN FOR MEDICAL PURPOSES, NAMELY, INTEGRATED CIRCUIT CARDS AND PROCESSING UNITS FOR PROCESSING DATA AND SOUND IN THE NATURE OF INTEGRATED CIRCUIT CARDS FOR CODING AND DECODING OF DATA AND SOUND; ELECTRONIC DATABASES IN THE FIELD OF SPACE ACTIVITY RECORDED ON COMPUTER MEDIA; RECORDED COMPUTER SOFTWARE FEATURING DATA FOR COMMAND AND CONTROL OF SPACECRAFT AND SPACE NAVIGATION; SATELLITES FOR SCIENTIFIC PURPOSES; SATELLITE NAVIGATIONAL APPARATUS, NAMELY, A GLOBAL POSITIONING SYSTEM FOR SATELLITE POSITION INDICATION AND CONTROL; COMPUTER SOFTWARE FOR COMMAND AND CONTROL OF SPACE VEHICLES AND SATELLITES, DATABASE MANAGEMENT, ARCHIVING AND TELEMETRY, ALL IN THE FIELD OF SPACE EXPLORATION AND ACTIVITY; SOFTWARE FOR NAVIGATING AND COMMUNICATING IN OUTER SPACE; BLANK MAGNETIC AND OPTICAL DATA CARRIERS FOR OUTER SPACE ACTIVITY; BLANK ELECTRONIC DATA CARRIERS FOR OUTER SPACE ACTIVITY, NAMELY, COMPUTER DISKS, USB FLASH DRIVES, AND MEMORY CARDS; DATABASE MANAGEMENT SOFTWARE FOR SPACE ACTIVITY; COMPUTER SOFTWARE FOR CONTROLLING AND MANAGING DATABASE SERVERS, ALL OF THE AFORESAID PRODUCTS BEING USED FOR SPACE EXPLORATION AND ACTIVITIES, IN CLASS 9 (U.S. CLS. 21, 23, 26, 36 AND 38).



THE MARK CONSISTS OF THE STYLIZED WORD "EGOS" WHICH APPEARS TO THE RIGHT OF AN OVAL WITH A CURVED LINE APPEARING THERE WITHIN.

PRIORITY DATE OF 12-18-2009 IS CLAIMED.

OWNER OF INTERNATIONAL REGISTRATION 1046616 DATED 6-16-2010, EXPIRES 6-16-2020.

SER. NO. 79-085,703, FILED 6-16-2010.

JENNIFER WILLISTON, EXAMINING ATTORNEY

David J. Kyros

Director of the United States Patent and Trademark Office

United States of America

United States Patent and Trademark Office

TRAYFORMER

Reg. No. 4,152,178

Registered June 5, 2012

Int. Cls.: 9 and 20

TRADEMARK

PRINCIPAL REGISTER

ATLANTA INTERNATIONAL B.V. (NETHERLANDS LIMITED LIABILITY COMPANY)
TECHNIEKWEG 1
NL-9601 MD HOOGEZAND, NETHERLANDS

FOR: COMPUTER HARDWARE; SOFTWARE FOR DOCUMENT MANAGEMENT, NAMELY, DOCUMENT IMAGING, RETRIEVAL AND BARCODE TRACKING, AND PRINTERS AND SCANNERS THEREFOR; COMPUTER SOFTWARE USED FOR ELECTRONIC MAIL; ON-DEMAND COLOR CODE LABEL PRINTING SOFTWARE AND PRINTERS FOR DOCUMENT TRACKING; DATABASE MANAGEMENT SOFTWARE FOR DATA AND IMAGE MANAGEMENT; FACSIMILE MANAGEMENT SOFTWARE; COMPUTER LASER DISK SOFTWARE AND HARDWARE FOR DOCUMENT MANAGEMENT; SOFTWARE FOR ROUTING OF FAX AND DOCUMENT INFORMATION; DOCUMENT ARCHIVING SOFTWARE, AND MANUALS FOR ALL OF THE ABOVE, RECORDED ON OPTICAL, MAGNETIC AND ELECTRONIC DATA CARRIERS, IN CLASS 9 (U.S. CLS. 21, 23, 26, 36 AND 38).

FOR: OFFICE FURNITURE, FILING CABINETS, MAGAZINE RACKS; PLASTIC BINS, IN CLASS 20 (U.S. CLS. 2, 13, 22, 25, 32 AND 50).

PRIORITY DATE OF 2-8-2010 IS CLAIMED.

OWNER OF INTERNATIONAL REGISTRATION 1048605 DATED 7-1-2010, EXPIRES 7-1-2020.

SER. NO. 79-086,434, FILED 7-1-2010.

JESSICA FATHY, EXAMINING ATTORNEY



David J. Kybas

Director of the United States Patent and Trademark Office

United States of America

United States Patent and Trademark Office

H. DEFENCE

Reg. No. 4,152,179

Registered June 5, 2012

Int. Cl.: 3

TRADEMARK

PRINCIPAL REGISTER

NORDBEAUTY S.R.L. (ITALY SOCIETE A RESPONSABILITE LIMITEE)
VIA BACCHELLI, 6/C
LOC. MARENGO
I-46045 MARMIROLO (MN), ITALY

FOR: DETERGENTS FOR COSMETIC USE; LOTIONS FOR THE FACE, NECK AND BODY; COSMETIC CREAMS; CREAMS FOR MASSAGE FOR COSMETIC TREATMENT OF THE INDIVIDUAL; COSMETIC MASKS; COSMETICS IN THE FORM OF SERUMS FOR THE FACE, NECK AND BODY; COSMETIC CREAMS FOR SKIN CARE; COSMETIC PREPARATIONS IN THE FORM OF MUDS FOR BODY CARE; ALGAE FOR COSMETIC USE, IN CLASS 3 (U.S. CLS. 1, 4, 6, 50, 51 AND 52).

PRIORITY DATE OF 6-17-2010 IS CLAIMED.

OWNER OF INTERNATIONAL REGISTRATION 1050547 DATED 8-4-2010, EXPIRES 8-4-2020.

SER. NO. 79-087,139, FILED 8-4-2010.

LEIGH LOWRY, EXAMINING ATTORNEY



David J. Kyffers

Director of the United States Patent and Trademark Office

United States of America

United States Patent and Trademark Office

MENO⁻CELL

Reg. No. 4,152,180

Registered June 5, 2012

Int. Cls.: 3, 10 and 44

TRADEMARK

SERVICE MARK

PRINCIPAL REGISTER

NORDBEAUTY S.R.L. (ITALY SOCIÉTÉ À RESPONSABILITÉ LIMITÉE)
VIA BACCHELLI, 6/C
LOC. MARENGO; I-46045 MARMIROLO (MN)
ITALY

FOR: DETERGENTS FOR COSMETIC USE; LOTIONS FOR FACE, NECK AND BODY; COSMETIC CREAMS; CREAMS FOR MASSAGE FOR COSMETIC TREATMENT OF CELLULITIS; COSMETIC MASKS; COSMETICS IN THE FORM OF SERUMS FOR THE BODY; COSMETIC PREPARATIONS IN THE FORM OF MUDS FOR TREATING CELLULITIS; COSMETIC PREPARATIONS HELD IN VIALS FOR TREATING CELLULITIS, NAMELY, BEAUTY SERUMS FOR CELLULITE REDUCTION, IN CLASS 3 (U.S. CLS. 1, 4, 6, 50, 51 AND 52).

FOR: ELECTROMEDICAL APPARATUS FOR MICROMASSAGE BY POSITIVE AND NEGATIVE IONS, IN CLASS 10 (U.S. CLS. 26, 39 AND 44).

FOR: BEAUTY FARMS, NAMELY, BEAUTY SPA AND HEALTH SPA SERVICES FOR HEALTH AND WELLNESS OF THE BODY AND SPIRIT; BEAUTY SALONS; HYGIENE AND BEAUTY CARE FOR HUMAN BEINGS, INCLUDING COSMETIC TREATMENTS AND TREATMENT OF CELLULITIS ALSO PROVIDED BY BEAUTY SALONS, BEAUTY SALON SERVICES, BEAUTY SALONS SERVICES, BEAUTY SPAS AND WELLNESS CENTERS; SERVICES OF BEAUTY AND MASSAGE SALONS; PERFORMING OF MASSAGES; ADVICE AND INFORMATION FOR THE ABOVE-MENTIONED SERVICES, IN CLASS 44 (U.S. CLS. 100 AND 101).



NO CLAIM IS MADE TO THE EXCLUSIVE RIGHT TO USE "CELL", APART FROM THE MARK AS SHOWN.

PRIORITY DATE OF 5-17-2010 IS CLAIMED.

OWNER OF INTERNATIONAL REGISTRATION 1050719 DATED 8-17-2010, EXPIRES 8-17-2020.

THE ENGLISH TRANSLATION OF THE WORDS "MENO CELL" IN THE MARK IS "LESS CELL".

SER. NO. 79-087,210, FILED 8-17-2010.

David J. Kybas

Director of the United States Patent and Trademark Office

Reg. No. 4,152,180 LEIGH LOWRY, EXAMINING ATTORNEY

United States of America
United States Patent and Trademark Office

XCEON

Reg. No. 4,152,181

Registered June 5, 2012

Int. Cls.: 9 and 11

APOLLO (ZHUHAI) ELECTRONICS LIMITED COMPANY (CHINA LIMITED LIABILITY COMPANY)

LANPU INDUSTRIAL AREA FACTORY BLDG.#3
ZHUHAI

519000 GUANGDONG, CHINA

TRADEMARK

PRINCIPAL REGISTER

FOR: SUPPLY MATERIALS, NAMELY, ELECTRIC WIRES, ELECTRICAL CABLES; ELECTRICAL WIRE CONNECTORS; CALENDAR SOFTWARE FOR MOBILE PHONES; COUNTERFEIT COIN DETECTOR; BATTERY CHARGER; ELECTRIC THEFT PREVENTION INSTALLATIONS, NAMELY, BURGLAR ALARMS; PROTECTION DEVICES FOR PERSONAL USE AGAINST ACCIDENTS, NAMELY, FACE PROTECTION SHIELDS; SURVEYING MACHINES AND INSTRUMENTS; CABINETS FOR LOUDSPEAKERS; COMPUTER PERIPHERALS; PROJECTORS PARTICULARLY PROJECTORS FOR THE ENTERTAINMENT INDUSTRY, IN CLASS 9 (U.S. CLS. 21, 23, 26, 36 AND 38).

FOR: LIGHTING APPARATUS AND INSTALLATIONS, NAMELY, LAMPS; ELECTRIC TORCHES FOR LIGHTING; LIGHTING APPARATUS FOR VEHICLES; COOKING UTENSILS, NAMELY, BUTANE TORCH FOR COOKING; REFRIGERATION EQUIPMENT AND DEVICES, NAMELY, REFRIGERATORS; AIR CONDITIONING EQUIPMENT, NAMELY, AIR CONDITIONING APPARATUS, FILTERS FOR AIR CONDITIONING; TAP WATER FAUCETS; SANITARY APPARATUS AND INSTALLATIONS, NAMELY, TOILETS; STERILIZERS; STERILIZING EQUIPMENT, NAMELY, AIR STERILIZERS AND WATER STERILIZERS, IN CLASS 11 (U.S. CLS. 13, 21, 23, 31 AND 34).



THE WORDING "XCEON" HAS NO MEANING IN A FOREIGN LANGUAGE.

OWNER OF INTERNATIONAL REGISTRATION 1052055 DATED 7-1-2010, EXPIRES 7-1-2020.

SER. NO. 79-087,681, FILED 7-1-2010.

ELI HELLMAN, EXAMINING ATTORNEY

David J. Kyros

Director of the United States Patent and Trademark Office

United States of America

United States Patent and Trademark Office

ionbond

THE SURFACE ENGINEERS

Reg. No. 4,152,182

IONBOND AG OLTEN (SWITZERLAND SOCIÉTÉ ANONYME)
INDUSTRIESTRASSE 211
CH-4600 OLTEN, SWITZERLAND

Registered June 5, 2012

Int. Cls.: 6, 7, 14 and 40

FOR: COMMON METALS AND THEIR ALLOYS, IN CLASS 6 (U.S. CLS. 2, 12, 13, 14, 23, 25 AND 50).

TRADEMARK

FOR: MACHINE INSTALLATIONS USING VAPOUR PHASE METHODS SUCH AS PHYSICAL VAPOUR DEPOSITION, CHEMICAL VAPOUR DEPOSITION, PLASMA ASSISTED CHEMICAL VAPOUR DEPOSITION, FOR COATING THE SURFACES OF METALS, METAL ALLOYS, METAL GRAPHITE, GRAPHITE, CERAMICS, CERAMIC-METAL MIXTURES, OXIDES, CARBIDES, SILICIDES, NITRIDES, PLASTICS, AND COMPOSITE MATERIALS, THE MACHINES BEING PRIMARILY COMPOSED OF ENERGY SOURCES, REACTORS, MECHANICAL MANIPULATION EQUIPMENT AND CONTROL EQUIPMENT; MACHINE PARTS MADE OF COMMON OR PRECIOUS METALS, OF CERAMICS, OF PLASTIC, AND COMPOSITE MATERIALS HAVING SURFACE PROTECTION APPLIED BY VAPOUR PHASE METHODS AGAINST CORROSION, ABRASION, EROSION/CAVITATION, COLD WELDING, AND FRICTIONAL OXIDATION, NAMELY, MACHINE TOOLS FOR CUTTING AND NON-CUTTING SHAPING; GUIDING ELEMENTS AND CLAMPING BODIES AS COATING MACHINE PARTS, NAMELY, NOZZLES AND WORK PIECES IN THE NATURE OF METAL AND/OR PLASTIC PIPES, PRESSURE CYLINDERS, SLEEVES AND BEARINGS, IN CLASS 7 (U.S. CLS. 13, 19, 21, 23, 31, 34 AND 35).

SERVICE MARK

PRINCIPAL REGISTER

FOR: JEWELRY, PRECIOUS STONES; HOROLOGICAL AND CHRONOMETRIC INSTRUMENTS, IN CLASS 14 (U.S. CLS. 2, 27, 28 AND 50).



FOR: SURFACE TREATMENT BY MEANS OF ELECTRICITY OR HEAT, NAMELY, COATING FOR WEAR, CORROSION, TEMPERATURE PROTECTION, LOW FRICTION, CATALYTIC AND DECORATIVE PURPOSES, PARTICULARLY PREPARATIONS FOR IMPROVING, PLATING AND HARDENING METALS, ALLOYS, CERAMICS, PLASTICS AND COMPOSITE MATERIALS, IN CLASS 40 (U.S. CLS. 100, 103 AND 106).

NO CLAIM IS MADE TO THE EXCLUSIVE RIGHT TO USE "THE SURFACE ENGINEERS", APART FROM THE MARK AS SHOWN.

PRIORITY DATE OF 2-19-2010 IS CLAIMED.

David J. Kybas

Director of the United States Patent and Trademark Office

Reg. No. 4,152,182 OWNER OF INTERNATIONAL REGISTRATION 1052705 DATED 7-29-2010, EXPIRES 7-29-2020.

THE COLOR(S) BLACK AND RED IS/ARE CLAIMED AS A FEATURE OF THE MARK.

THE MARK CONSISTS OF THE LITERAL ELEMENTS "IONBOND THE SURFACE ENGINEERS" IN BLACK AND THE "I" IN "IONBOND" IS DOTTED WITH A FIVE SIDED RED DESIGN.

SER. NO. 79-087,937, FILED 7-29-2010.

CHRISIE B. KING, EXAMINING ATTORNEY

United States of America

United States Patent and Trademark Office



Reg. No. 4,152,183

Registered June 5, 2012

Int. Cls.: 7, 8 and 9

TRADEMARK

PRINCIPAL REGISTER

MIRCONA AB (SWEDEN AKTIEBOLAG (AB))
BOX 955
SE-801 33 GÄVLE
SWEDEN

FOR: MACHINES, NAMELY, PRECISION TURNING AND GROOVING MACHINES, BORING MACHINES, MILLING MACHINES, CLAMPING SYSTEMS COMPRISED OF VICE, CLAMPS AND JAWS FOR USE IN THE PRECISION CLAMPING OF WORK PIECES, AND MACHINE TOOLS, NAMELY, GROOVING TOOLS, TURNING TOOLS, PARTING-OFF AND GROOVING TOOLS, SLOT TOOLS, MILLING TOOLS, BORING TOOLS, IN CLASS 7 (U.S. CLS. 13, 19, 21, 23, 31, 34 AND 35).

FOR: HAND TOOLS AND HAND-OPERATED IMPLEMENTS, NAMELY, GROOVING TOOLS, MILLING CUTTERS, CLAMPING BUSHINGS; CUTLERY; SIDE ARMS, NOT INCLUDING FIRE ARMS, NAMELY, RAZORS, IN CLASS 8 (U.S. CLS. 23, 28 AND 44).

FOR: APPARATUS FOR RECORDING, TRANSMISSION OR REPRODUCTION OF SOUND OR IMAGES; BLANK MAGNETIC DATA CARRIERS, BLANK RECORDING DISCS; AUTOMATIC VENDING MACHINES AND MECHANISMS FOR COIN-OPERATED APPARATUS; CASH REGISTERS, CALCULATING MACHINES, DATA PROCESSING EQUIPMENT AND COMPUTERS; FIRE-EXTINGUISHING APPARATUS, IN CLASS 9 (U.S. CLS. 21, 23, 26, 36 AND 38).



THE MARK CONSISTS OF THE LETTERS "ZVT" WITH THE "Z" IN BLUE AND WHITE, THE LETTERS "VT" IN BLUE AND THE LETTERS "ERO" IN WHITE WITHIN THE TOP OF THE LETTER "Z".

OWNER OF INTERNATIONAL REGISTRATION 1053410 DATED 9-21-2010, EXPIRES 9-21-2020.

THE COLOR(S) BLUE AND WHITE IS/ARE CLAIMED AS A FEATURE OF THE MARK.

SER. NO. 79-088,171, FILED 9-21-2010.

SARA BENJAMIN, EXAMINING ATTORNEY

David J. Kyros

Director of the United States Patent and Trademark Office

United States of America

United States Patent and Trademark Office

SL30

Reg. No. 4,152,184

Registered June 5, 2012

Int. Cls.: 6 and 19

TRADEMARK

PRINCIPAL REGISTER

REMKO MARK B.V. (NETHERLANDS LIMITED LIABILITY COMPANY)
ONDERSTALSTRAAT 3
NL-6674 ME HERVELD
NETHERLANDS

FOR: COMMON METALS AND THEIR ALLOYS; METAL BUILDING MATERIALS, NAMELY, WINDOW PROFILES AND DOOR PROFILES; NON-ELECTRIC CABLES AND WIRES OF COMMON METAL; IRONMONGERY AND SMALL ITEMS OF METAL HARDWARE, NAMELY, METAL PULLS, METAL PINS, METAL GATE LATCHES; PIPES AND TUBES OF METAL; METAL SAFES; STEEL AND STAINLESS STEEL PROFILES, WINDOWS, DOORS, FACADES; STEEL AND STAINLESS STEEL FRAMED GLAZED DOORS AND STEEL AND STAINLESS STEEL FRAMED GLAZED WINDOWS AND STEEL AND STAINLESS STEEL FRAMED GLAZED WALL PROFILES, IN CLASS 6 (U.S. CLS. 2, 12, 13, 14, 23, 25 AND 50).

FOR: NON-METALLIC RIGID PIPES FOR BUILDING; NON-METALLIC TRANSPORTABLE BUILDINGS; MONUMENTS, NOT OF METAL; NON-METAL WINDOW PROFILES, NAMELY, CASINGS AND FRAMES; DOOR PROFILES, NAMELY, PANELS, FRAMES AND CASINGS; WALL PANELS AND FAÇADE PROFILES, NAMELY, FAÇADE PANELS FOR CONSTRUCTION PURPOSES; NON-METAL WINDOWS, DOORS, WALL PANELS, GLASS WINDOWS, GLASS PANES FOR DOORS AND GLASS PANES FOR WALL FACADE PANELS FOR CONSTRUCTION PURPOSES, IN CLASS 19 (U.S. CLS. 1, 12, 33 AND 50).

THE MARK CONSISTS OF STANDARD CHARACTERS WITHOUT CLAIM TO ANY PARTICULAR FONT, STYLE, SIZE, OR COLOR.

PRIORITY DATE OF 3-23-2010 IS CLAIMED.

OWNER OF INTERNATIONAL REGISTRATION 1053797 DATED 9-23-2010, EXPIRES 9-23-2020.

SER. NO. 79-088,312, FILED 9-23-2010.

SAIMA MAKHDOOM, EXAMINING ATTORNEY



David J. Kyros

Director of the United States Patent and Trademark Office

United States of America

United States Patent and Trademark Office

MIGHTY EAGLE

Reg. No. 4,152,185

Registered June 5, 2012

Int. Cls.: 9 and 28

TRADEMARK

PRINCIPAL REGISTER

ROVIO ENTERTAINMENT LTD (FINLAND CORPORATION)
KEILARANTA 17 C
FI-02150 ESPOO
FINLAND

FOR: VIDEO GAME SOFTWARE FOR MOBILE DEVICES, PERSONAL COMPUTERS, CONSOLES, TABLETS; ELECTRONIC GAME PROGRAMS; DOWNLOADABLE ELECTRONIC GAME PROGRAMS; ELECTRONIC GAME SOFTWARE; COMPUTER GAME PROGRAMS; DOWNLOADABLE COMPUTER GAME PROGRAMS; INTERACTIVE GAME PROGRAMS; INTERACTIVE GAME SOFTWARE; APPARATUS FOR GAMES ADAPTED FOR USE WITH TELEVISION RECEIVERS; CINEMATOGRAPHIC APPARATUS; PROTECTIVE CARRYING CASES SPECIALLY ADAPTED FOR PHONES AND HANDHELD COMPUTERS; COMPACT DISCS FEATURING GAMES, MUSIC AND VIDEOS, OPTICAL APPARATUS, NAMELY, SUNGLASSES, AND MOBILE PHONE ACCESSORIES, NAMELY, CHARGERS, IN CLASS 9 (U.S. CLS. 21, 23, 26, 36 AND 38).

FOR: BOARD GAMES; ELECTRONIC GAME EQUIPMENT FOR PLAYING VIDEO GAMES, NAMELY, HAND HELD UNITS FOR PLAYING VIDEO GAMES OTHER THAN THOSE ADAPTED FOR USE WITH AN EXTERNAL DISPLAY SCREEN OR MONITOR; GAME CARDS; NON ELECTRIC HAND-HELD SKILL GAMES, SOFT DOLLS; PUZZLES; TOY ACTION FIGURES; BALLOONS AND YO-YOS; PLUSH TOYS; CHRISTMAS TREE DECORATIONS; TOY FIGURES ATTACHABLE TO PENCILS; PLUSH TOYS THAT CONNECT TO BELTS BY A HOOK; NON-ARTICULATED PVC FIGURES; RUBBER BALLS; AND PET TOYS, IN CLASS 28 (U.S. CLS. 22, 23, 38 AND 50).

THE MARK CONSISTS OF STANDARD CHARACTERS WITHOUT CLAIM TO ANY PARTICULAR FONT, STYLE, SIZE, OR COLOR.

OWNER OF INTERNATIONAL REGISTRATION 1053918 DATED 9-14-2010, EXPIRES 9-14-2020.

SER. NO. 79-088,353, FILED 9-14-2010.

TASNEEM HUSSAIN, EXAMINING ATTORNEY



David J. Kyjars

Director of the United States Patent and Trademark Office

United States of America

United States Patent and Trademark Office

CELLINSIGHT

Reg. No. 4,152,186

Registered June 5, 2012

Int. Cls.: 5 and 44

TRADEMARK

SERVICE MARK

PRINCIPAL REGISTER

CELLMADE SAS (FRANCE SOCIÉTÉ PAR ACTIONS SIMPLIFIÉE)
BÂTIMENT ACTIPRO,
TECHNOPÔLE D'ARCHAMPS; F-74160 ARCHAMPS
FRANCE

FOR: PHARMACEUTICAL PREPARATION FOR THE TREATMENT OF INFLAMMATORY DISEASE IN HUMAN TISSUE, CELLS AND CELL COMPONENTS; SANITARY PREPARATIONS FOR MEDICAL USE; DIETETIC FOODS ADAPTED FOR MEDICAL USE; MEDICAL PLASTERS; ALL PURPOSE DISINFECTANTS; DIETETIC SUGAR FOR MEDICAL USE; ALLOYS OF PRECIOUS METALS FOR DENTAL USE, IN CLASS 5 (U.S. CLS. 6, 18, 44, 46, 51 AND 52).

FOR: MEDICAL SERVICES; VETERINARY SERVICES; HYGIENIC AND BEAUTY CARE FOR HUMAN BEINGS OR ANIMALS; MEDICAL ASSISTANCE SERVICES; PLASTIC SURGERY; HOSPITAL SERVICES; OPTICIAN SERVICES, IN CLASS 44 (U.S. CLS. 100 AND 101).

THE MARK CONSISTS OF STANDARD CHARACTERS WITHOUT CLAIM TO ANY PARTICULAR FONT, STYLE, SIZE, OR COLOR.

PRIORITY DATE OF 11-20-2009 IS CLAIMED.

OWNER OF INTERNATIONAL REGISTRATION 1054621 DATED 5-19-2010, EXPIRES 5-19-2020.

SER. NO. 79-088,610, FILED 5-19-2010.

KAREN SEVERSON, EXAMINING ATTORNEY



David J. Kypos

Director of the United States Patent and Trademark Office

United States of America

United States Patent and Trademark Office

ISTOXX

Reg. No. 4,152,187

Registered June 5, 2012

Int. Cls.: 9, 35, 36 and 41

TRADEMARK

SERVICE MARK

PRINCIPAL REGISTER

STOXX AG (SWITZERLAND SOCIÉTÉ ANONYME (SA))
SELNAUSTRASSE 30
CH-8001 ZÜRICH
SWITZERLAND

FOR: DOWNLOADABLE ELECTRONIC PUBLICATIONS IN THE NATURE OF DOWNLOADABLE TEXT FILES IN THE FIELD OF BUSINESS AND THE ECONOMY, FINANCE, STOCK EXCHANGE, SECURITIES SOLD ON THE STOCK EXCHANGE AND OVER-THE-COUNTER AND ECONOMIC FACTORS, IN CLASS 9 (U.S. CLS. 21, 23, 26, 36 AND 38).

FOR: CALCULATIONS, RECORDING, COLLECTION AND SYSTEMATIZATION OF FINANCIAL INDICES RELATING TO SECURITIES SOLD ON THE STOCK EXCHANGE AND OTHER TRADING PLATFORMS, FINANCIAL AND OTHER ECONOMIC INDICES FOR ENABLING MARKET PARTICIPANTS TO EVALUATE INVESTMENTS AND MARKET TRENDS IN THE FINANCIAL MARKETS AND FOR ENABLING FINANCIAL INSTITUTIONS CREATING, DEVELOPING AND ISSUING FINANCIAL INSTRUMENTS, NAMELY, SECURITIES, OPTIONS, BONDS, FUTURES, FORWARD CONTRACTS, INDEX TRACKING FUNDS IN THE NATURE OF EXCHANGE TRADED FUNDS; SERVICES OF COMPUTER DATA PROCESSING IN CONNECTION WITH STOCK EXCHANGE AND COMMERCIAL INFORMATION; CONSULTING AND INFORMATION IN THE FIELD OF CALCULATING, RECORDING, COLLECTING AND SYSTEMATIZING OF FINANCIAL INDICES; COMPILATION AND SYSTEMATIZATION OF INFORMATION, NAMELY, STOCK EXCHANGE AND BUSINESS DATA, IN CLASS 35 (U.S. CLS. 100, 101 AND 102).

FOR: STOCK EXCHANGE QUOTATIONS; FINANCIAL SERVICES, NAMELY, CREATING, DEVELOPING AND ISSUING FINANCIAL INSTRUMENTS, NAMELY, SECURITIES, OPTIONS, BONDS, FUTURES, FORWARD CONTRACTS, INDEX TRACKING FUNDS IN THE NATURE OF MUTUAL FUNDS AND EXCHANGE TRADED FUNDS; FINANCIAL EVALUATION, TRACKING, ANALYSIS, CONSULTANCY, ADVISORY AND RESEARCH SERVICES RELATING TO SECURITIES AND OTHER FINANCIAL INSTRUMENTS, NAMELY, DETERMINATION AND CALCULATION OF FINANCIAL INDICES IN CONNECTION WITH STOCK EXCHANGE SECURITIES, OTHER SECURITIES, COMMODITIES, FIXED INCOME AND OTHER ASSET CLASSES; PROVIDING FINANCIAL INFORMATION ON STOCK MARKETS AND OTHER ECONOMIC MARKETS; FINANCIAL SERVICES IN THE FIELD OF RESEARCH, DEVELOPMENT, CONSULTING AND MONITORING IN CONNECTION WITH INDICES LINKED TO SECURITIES SOLD ON THE STOCK EXCHANGE AND OTHER TRADING PLATFORMS; DEFINING, MAINTAINING AND CALCULATING INDICES OF



David J. Kyros

Director of the United States Patent and Trademark Office

Reg. No. 4,152,187 SECURITIES; PROVIDING INFORMATION AND DATA IN CONNECTION WITH STOCK EXCHANGES; PROVIDING OF INFORMATION AND FINANCIAL DATA IN CONNECTION WITH BUSINESS ENTERPRISES AND THE ECONOMY, IN CLASS 36 (U.S. CLS. 100, 101 AND 102).

FOR: PUBLISHING ELECTRONIC PUBLICATIONS IN THE FIELDS OF BUSINESS AND ECONOMIC INFORMATION, FINANCIAL AND STOCK EXCHANGE INFORMATION, INFORMATION ON SECURITIES SOLD ON THE STOCK EXCHANGE AND ECONOMIC FACTORS; PUBLISHING ELECTRONIC PUBLICATIONS FEATURING FINANCIAL INDICES, FIGURES AND INFORMATION ON SUCH INDICES IN THE FORM OF TEXTS, OTHER THAN ADVERTISING TEXTS, AND DATA, NAMELY, INDICES IN THE FIELDS OF SECURITIES TRADED ON STOCK EXCHANGES, COMMODITIES, FIXED INCOME AND OTHER ASSET CLASSES; ONLINE PUBLISHING OF REAL ESTATE INDEX FIGURES, ASSETS AND INFORMATION CONCERNING FINANCIAL INDICES, TEXTS, OTHER THAN ADVERTISING TEXTS, AND DATA, NAMELY, INDICES RELATED TO SECURITIES TRADED ON STOCK EXCHANGES, COMMODITIES, FIXED INCOME AND OTHER ASSET CLASSES; PUBLISHING OF FINANCIAL INDICES CONCERNING SECURITIES SOLD ON THE STOCK EXCHANGE AND OTHER TRADING PLATFORMS, COMMODITIES, FIXED INCOME AND OTHER ASSET CLASSES, IN CLASS 41 (U.S. CLS. 100, 101 AND 107).

THE MARK CONSISTS OF STANDARD CHARACTERS WITHOUT CLAIM TO ANY PARTICULAR FONT, STYLE, SIZE, OR COLOR.

PRIORITY DATE OF 8-23-2010 IS CLAIMED.

OWNER OF INTERNATIONAL REGISTRATION 1055243 DATED 9-22-2010, EXPIRES 9-22-2020.

OWNER OF U.S. REG. NOS. 3,076,939, 3,673,139 AND OTHERS.

SER. NO. 79-088,838, FILED 9-22-2010.

JENNIFER DIXON, EXAMINING ATTORNEY

United States of America

United States Patent and Trademark Office

SHIATZY CHEN

Reg. No. 4,152,188

Registered June 5, 2012

**Int. Cls.: 3, 9, 14, 18, 20,
24, 25, 26 and 42**

TRADEMARK

SERVICE MARK

PRINCIPAL REGISTER

SHIATZY INTERNATIONAL COMPANY LIMITED (CHINA CORPORATION)
NO. 49-2, SEC. 2, ZHONGSHAN N. RD.
ZHONGSHAN DIST.
TAIPEI CITY, TAIWAN, CHINA

FOR: COSMETICS; PERFUMES; HAIR LOTIONS; ESSENTIAL OILS; LIPSTICKS; ROUGE;
COSMETIC KITS COMPRISED OF LIPSTICK, LIP GLOSS, ROUGE; SOAP; DENTIFRICES;
AROMATIC POTPOURRIS, IN CLASS 3 (U.S. CLS. 1, 4, 6, 50, 51 AND 52).

FOR: PINCE-NEZ CHAINS; EYEGLOSS CASES; SPECTACLES; SPECTACLE FRAMES;
PINCE-NEZ MOUNTINGS; EYEGASSES; PINCE-NEZ; SPECTACLE CASES; SUNGLASSES,
IN CLASS 9 (U.S. CLS. 21, 23, 26, 36 AND 38).

FOR: WRISTWATCHES; CLOCKS; PEARLS; WORKS OF ART OF PRECIOUS METAL;
PERSONAL ORNAMENTS IN THE NATURE OF JEWELRY; JEWELRY, NAMELY, CHARMS;
EARRINGS; PINS BEING JEWELRY, IN CLASS 14 (U.S. CLS. 2, 27, 28 AND 50).

FOR: IMITATION LEATHER; PURSES; LEATHER BAGS; POCKET WALLETS; VANITY
CASES SOLD EMPTY; TRAVELLING BAGS; LEATHER SHOPPING BAGS; MESH SHOPPING
BAGS; REUSABLE SHOPPING BAGS; LEATHER STRAPS; UMBRELLAS, IN CLASS 18
(U.S. CLS. 1, 2, 3, 22 AND 41).

FOR: FURNITURE; COAT HANGERS; DRESSING TABLES; MIRRORED CABINETS; DIS-
PLAY STANDS; PICTURE FRAMES; MATTRESSES MANUFACTURED BY STRAW
PLAITING; CUSHIONS MANUFACTURED BY STRAW PLAITING; BOLSTERS MANUFAC-
TURED BY STRAW PLAITING; PLACARDS OF WOOD OR PLASTICS; WOOD BEDSTEADS;
CUSHIONS, IN CLASS 20 (U.S. CLS. 2, 13, 22, 25, 32 AND 50).

FOR: COTTON CLOTH; WOOLEN CLOTH; LINEN CLOTH; SILK CLOTH; CURTAINS;
TEXTILE ARTWORK IN THE NATURE OF WALL HANGINGS, QUILTS, TAPESTRIES;
FELTS; FELT CLOTH; TOWELS OF TEXTILE; BED CLOTHES IN THE NATURE OF BED-
SPREADS, SHEET SETS; BED COVERS; TABLE CLOTHS OF TEXTILE; WASHING MITTS,
IN CLASS 24 (U.S. CLS. 42 AND 50).

FOR: CLOTHING, NAMELY, SHIRTS, PANTS, SKIRTS; CHEONG-SAM (BODY HANGING
ONE PIECE CHINESE DRESS FOR WOMEN WITH DISTINCTIVE CHINESE FEATURES);
BATHING SUITS; CLOTHING FOR BABIES, NAMELY, SHIRTS, PANTS, PAJAMAS; SHOES;



David J. Kappas

Director of the United States Patent and Trademark Office

Reg. No. 4,152,188 HEADGEAR FOR WEAR, NAMELY, HATS AND CAPS; HOSIERY; GLOVES; SCARFS; BELTS, IN CLASS 25 (U.S. CLS. 22 AND 39).

FOR: TRIMMINGS FOR CLOTHING, NAMELY, LACE; HAT ORNAMENTS NOT OF PRECIOUS METAL; HAIR ORNAMENTS; BUTTONS; ZIP FASTENERS FOR BAGS; FALSE HAIR; NEEDLES; SHOULDER PADS FOR CLOTHING, BUCKLES OF PRECIOUS METAL FOR CLOTHING, IN CLASS 26 (U.S. CLS. 37, 39, 40, 42 AND 50).

FOR: DRESS DESIGNING, IN CLASS 42 (U.S. CLS. 100 AND 101).

THE MARK CONSISTS OF THE WORDING "SHIATZY CHEN". A DESIGN ELEMENT CONSISTING OF THE STYLIZED LETTERS "SC" IN A SQUARE APPEARS BETWEEN THE TERMS "SHIATZY" AND "CHEN".

PRIORITY DATE OF 12-11-2009 IS CLAIMED.

OWNER OF INTERNATIONAL REGISTRATION 1056365 DATED 3-24-2010, EXPIRES 3-24-2020.

THE ENGLISH TRANSLATION OF "SHIATZY CHEN" IN THE MARK IS "THE NEW LOOK OF CHINA".

SER. NO. 79-089,235, FILED 3-24-2010.

KAREN SEVERSON, EXAMINING ATTORNEY

United States of America

United States Patent and Trademark Office



Triennale di Milano

Reg. No. 4,152,189

Registered June 5, 2012

Int. Cls.: 35, 41, 42 and 43

SERVICE MARK

PRINCIPAL REGISTER

LA TRIENNALE DI MILANO (ITALY FOUNDATION)
VIALE EMILIO ALEMAGNA, 6
I-20121 MILANO
ITALY

FOR: RETAIL STORE SERVICES ON BEHALF OF THIRD PARTIES THAT ARE CARRIED OUT IN STORES, ONLINE AND IN CATALOGUES FEATURING WORKS OF ARTS; BUSINESS MANAGEMENT FOR SHOPS, INCLUDING WITHIN MUSEUMS AND EXHIBITIONS; SALES PROMOTIONAL SERVICES; ADVERTISING SERVICES, NAMELY, BUSINESS EXPOSURES OF GOODS FOR MARKETING AND PROMOTIONAL ACTIVITIES, IN CLASS 35 (U.S. CLS. 100, 101 AND 102).

FOR: ORGANIZATION OF EXHIBITIONS, SHOWS, FOR CULTURAL OR EDUCATIONAL PURPOSES; ORGANIZATION OF CONFERENCES, SEMINARS, CONVENTIONS, CULTURAL AND EDUCATIONAL EVENTS, NAMELY, EXHIBITS AND WORKSHOPS IN THE FIELD OF ART, INDUSTRIAL DESIGN, ARCHITECTURE, URBANISM, CRAFTS, FASHION AND AUDIO-VISUAL COMMUNICATION; ORGANIZATION OF TRAINING COURSES IN THE FIELD OF ART, INDUSTRIAL DESIGN, ARCHITECTURE, URBANISM, CRAFTS, FASHION AND AUDIO-VISUAL COMMUNICATION; PUBLISHING SERVICES PROVIDED ALSO ONLINE, NAMELY, BOOKS MAGAZINES, BROCHURES, BOOKLETS, INSTRUCTION HANDBOOK, REFERENCE GUIDES AND CATALOGUES, ALL COVERING A WIDE VARIETY OF TOPICS; ORGANIZATION OF COMPETITIONS, NAMELY, COMPETITIONS IN THE FIELD ART, INDUSTRIAL DESIGN, ARCHITECTURE, URBANISM, CRAFTS, FASHION AND AUDIO-VISUAL COMMUNICATION; ORGANIZING EDUCATIONAL COMPETITIONS IN THE FIELDS OF ARCHITECTURE, GRAPHICS, DECORATIVE ARTS, INTERIOR DESIGN AND FASHION DESIGN AIMED AT OFFERING STUDENTS EDUCATIONAL REWARDS AND SCHOLARSHIPS; CULTURAL AND EDUCATIONAL ACTIVITIES, NAMELY, COURSES IN THE FIELD ART, INDUSTRIAL DESIGN, ARCHITECTURE, URBANISM, CRAFTS, FASHION AND AUDIO-VISUAL COMMUNICATION, IN CLASS 41 (U.S. CLS. 100, 101 AND 107).

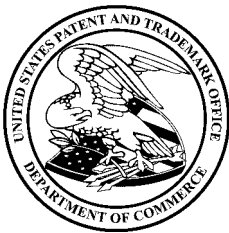

David J. Kyros

Director of the United States Patent and Trademark Office

FOR: SCIENTIFIC AND TECHNOLOGICAL SERVICES AND RESEARCH AND DESIGN RELATING THERETO, NAMELY, RESEARCH AND DESIGN IN THE FIELD OF ART AND INDUSTRIAL DESIGN, ARCHITECTURE, URBANISM, CRAFTS, FASHION AND AUDIO-VISUAL COMMUNICATION; INDUSTRIAL ANALYSIS AND RESEARCH SERVICES RELATED TO ART, INDUSTRIAL DESIGN, ARCHITECTURE, URBANISM, CRAFTS, FASHION AND AUDIO-VISUAL COMMUNICATION; DESIGN AND DEVELOPMENT OF COMPUTER

Reg. No. 4,152,189 HARDWARE AND SOFTWARE; SCIENTIFIC RESEARCH AND RESEARCH IN THE FIELDS OF GRAPHIC ART DESIGNS, ARCHITECTURE, GRAPHICS, DECORATIVE ARTS, INTERIOR DESIGN AND FASHION DESIGN, IN CLASS 42 (U.S. CLS. 100 AND 101).

FOR: SERVICES FOR PROVIDING FOOD AND DRINK; TEMPORARY ACCOMMODATION; CAFES, RESTAURANTS AND PUBS SERVICES FOR GIVING FOODS AND BEVERAGES, IN CLASS 43 (U.S. CLS. 100 AND 101).

NO CLAIM IS MADE TO THE EXCLUSIVE RIGHT TO USE "TRIENNALE DI MILANO", APART FROM THE MARK AS SHOWN.

PRIORITY DATE OF 7-6-2010 IS CLAIMED.

OWNER OF INTERNATIONAL REGISTRATION 1056468 DATED 7-15-2010, EXPIRES 7-15-2020.

THE MARK CONSISTS OF THE WORDING "TRIENNALE DI MILANO" COMBINED TO A LETTER "T", ALL IN SPECIAL SCRIPT.

THE ENGLISH TRANSLATION OF "TRIENNALE DI MILANO" IN THE MARK IS "TRIENNIAL EXHIBIT OF MILAN".

SER. NO. 79-089,274, FILED 7-15-2010.

MARILYN IZZI, EXAMINING ATTORNEY

United States of America

United States Patent and Trademark Office

ROTALUX

Reg. No. 4,152,190

Registered June 5, 2012

Int. Cls.: 9 and 11

TRADEMARK

PRINCIPAL REGISTER

ELINCHROM S.A. (ELINCHROM LTD) (SWITZERLAND SOCIÉTÉ ANONYME (SA))
AVENUE DE LONGEMALLE 11
CH-1020 RENENS
SWITZERLAND

FOR: LAMPS FOR FLASHES, FLASH TUBES FOR CAMERAS, FLASH BULBS, CAMERA FLASHES AND ELECTRONIC CAMERA FLASHES, IN CLASS 9 (U.S. CLS. 21, 23, 26, 36 AND 38).

FOR: LIGHT SOURCES AND DEVICES, NAMELY, LANTERNS FOR LIGHTING, ELECTRIC LIGHTING FIXTURES, ELECTRIC DISCHARGE TUBES FOR LIGHTING, LED LIGHTING FIXTURES, LIGHTING TRACKS, LIGHTING FIXTURES, ELECTRIC LAMPS, ARC LAMPS, INFRARED LAMPS, LAMP CASINGS, LAMP FINIALS, LAMPS; FIBER OPTIC LIGHTING APPARATUS AND INSTALLATIONS, NAMELY, FIBER OPTIC LIGHTING FIXTURES USED IN CONJUNCTION WITH ELECTRICAL ILLUMINATORS; LIGHTING INSTALLATIONS FOR PHOTOGRAPHY; HIGH INTENSITY SEARCHLIGHTS; POCKET SEARCH LIGHTS; SPOTLIGHTS, FLASHLIGHTS, PROTECTIVE COOLING DOMES, LIGHT REFLECTORS, LAMP REFLECTORS, GRID REFLECTORS, CONE REFLECTORS, LIGHT DIFFUSERS, ELECTRIC FANS, HALOGEN LIGHT BULBS, LIGHT DIFFUSER UMBRELLAS, IN CLASS 11 (U.S. CLS. 13, 21, 23, 31 AND 34).

THE MARK CONSISTS OF STANDARD CHARACTERS WITHOUT CLAIM TO ANY PARTICULAR FONT, STYLE, SIZE, OR COLOR.

OWNER OF INTERNATIONAL REGISTRATION 1056562 DATED 9-17-2010, EXPIRES 9-17-2020.

THE WORD "ROTALUX" HAS NO MEANING IN A FOREIGN LANGUAGE.

SER. NO. 79-089,305, FILED 9-17-2010.

CHARLES L. JENKINS, EXAMINING ATTORNEY



David J. Kyros

Director of the United States Patent and Trademark Office

United States of America

United States Patent and Trademark Office

SL30-ISO

Reg. No. 4,152,191

Registered June 5, 2012

Int. Cls.: 6 and 19

TRADEMARK

PRINCIPAL REGISTER

REMKO MARK B.V. (NETHERLANDS LIMITED LIABILITY COMPANY)
ONDERSTALSTRAAT 3
NL-6674 ME HERVELD
NETHERLANDS

FOR: COMMON METALS AND THEIR ALLOYS; METAL BUILDING MATERIALS, NAMELY, WINDOW PROFILES AND DOOR PROFILES; NON-ELECTRIC CABLES AND WIRES OF COMMON METAL; IRONMONGERY AND SMALL ITEMS OF METAL HARDWARE, NAMELY, METAL PULLS, METAL PINS, METAL GATE LATCHES; PIPES AND TUBES OF METAL; METAL SAFES; STEEL AND STAINLESS STEEL PROFILES, WINDOWS, DOORS, FACADES; STEEL AND STAINLESS STEEL FRAMED GLAZED DOORS AND STEEL AND STAINLESS STEEL FRAMED GLAZED WINDOWS AND STEEL AND STAINLESS STEEL FRAMED GLAZED WALL PROFILES, IN CLASS 6 (U.S. CLS. 2, 12, 13, 14, 23, 25 AND 50).

FOR: NON-METALLIC RIGID PIPES FOR BUILDING; NON-METALLIC TRANSPORTABLE BUILDINGS; MONUMENTS, NOT OF METAL; NON-METAL WINDOW PROFILES, NAMELY, CASINGS AND FRAMES; DOOR PROFILES, NAMELY, PANELS, FRAMES AND CASINGS; WALL PANELS AND FAÇADE PROFILES, NAMELY, FAÇADE PANELS FOR CONSTRUCTION PURPOSES; NON-METAL WINDOWS, DOORS, WALL PANELS, GLASS WINDOWS, GLASS PANES FOR DOORS AND GLASS PANES FOR WALL FACADE PANELS FOR CONSTRUCTION PURPOSES, IN CLASS 19 (U.S. CLS. 1, 12, 33 AND 50).

THE MARK CONSISTS OF STANDARD CHARACTERS WITHOUT CLAIM TO ANY PARTICULAR FONT, STYLE, SIZE, OR COLOR.

PRIORITY DATE OF 3-23-2010 IS CLAIMED.

OWNER OF INTERNATIONAL REGISTRATION 1056637 DATED 9-23-2010, EXPIRES 9-23-2020.

SER. NO. 79-089,331, FILED 9-23-2010.

SAIMA MAKHDOOM, EXAMINING ATTORNEY



David J. Kyros

Director of the United States Patent and Trademark Office

United States of America

United States Patent and Trademark Office

CLIMATE FRIENDLY

Reg. No. 4,152,192

Registered June 5, 2012

**Int. Cls.: 35, 36, 42 and
45**

SERVICE MARK

PRINCIPAL REGISTER

CLIMATE FRIENDLY PTY LTD (AUSTRALIA AUSTRALIAN PROPRIETARY COMPANY,
LIMITED BY SHARES)
SUITE B LEVEL 2
140 WILLIAM STREET
SYDNEY NSW 2011, AUSTRALIA

FOR: BUSINESS MANAGEMENT; BUSINESS MANAGEMENT AND CONSULTATION FOR COMPANIES IN THE FIELDS OF GREENHOUSE GAS EMISSIONS, CARBON EMISSIONS, AND CARBON OFFSETS; BUSINESS ADMINISTRATION AND CONSULTANCY IN RELATION TO EMISSION REDUCTION, EMISSION BENCHMARKS, RENEWABLE ENERGY AND ENERGY EFFICIENT MEASURES; AUDITING SERVICES; PREPARATION OF BUSINESS REPORTS RELATED TO EMISSION REDUCTION, EMISSION BENCHMARKS, RENEWABLE ENERGY AND ENERGY EFFICIENT MEASURES; BUSINESS RESEARCH SERVICES; COLLECTION AND COMPILATION OF INFORMATION INTO BUSINESS DATABASES IN THE FIELDS OF GREENHOUSE GAS EMISSIONS, CARBON EMISSIONS, CARBON OFFSETS, EMISSION REDUCTIONS, EMISSION BENCHMARKS, RENEWABLE ENERGY AND ENERGY EFFICIENT MEASURES; BUSINESS MANAGEMENT CONSULTING SERVICES; BUSINESS MANAGEMENT ADVISORY SERVICES RELATING TO FRANCHISING; OPERATION OF INCENTIVE AWARD PROGRAMS TO PROMOTE ENERGY EFFICIENCY AND THE USE OF RENEWABLE ENERGY USED IN BUSINESSES; MARKET RESEARCH SERVICES IN THE AREAS OF GREENHOUSE GAS EMISSIONS; SUSTAINABLE ENERGY TECHNOLOGIES, RENEWABLE ENERGY AND CARBON EMISSIONS, IN CLASS 35 (U.S. CLS. 100, 101 AND 102).



FOR: TRADING OF CARBON DIOXIDE AND GREENHOUSE GAS EMISSION CREDITS, ALLOWANCES OR OFFSETS OF OTHERS; BROKERAGE OF CARBON DIOXIDE AND OTHER GREENHOUSE GAS EMISSION CREDITS, ALLOWANCES OR OFFSETS ON BEHALF OF OFFSET PRODUCERS; FINANCIAL SERVICES, NAMELY, THE TRADING OF FINANCIAL INSTRUMENTS, OPTIONS, FUTURES, COMMODITIES AND OTHER DERIVATIVE PRODUCTS; ENVIRONMENTAL BROKERAGE SERVICES IN THE FIELD OF ENVIRONMENTAL CREDITS AND ALLOWANCES; COMMODITIES EXCHANGE SERVICES; FINANCIAL SERVICES, NAMELY, RAISING DEBT AND EQUITY CAPITAL FOR OTHERS, IN CLASS 36 (U.S. CLS. 100, 101 AND 102).

David J. Kappas

Director of the United States Patent and Trademark Office

FOR: DESIGN AND DEVELOPMENT OF COMPUTER SOFTWARE FOR THE AUTOMATED COLLECTION OF DATA FOR THE PURPOSE OF CARBON EMISSION MANAGEMENT AND FOR THE CALCULATION OF CARBON USAGE; TECHNOLOGY CONSULTANCY IN

Reg. No. 4,152,192 THE FIELD OF ENERGY-SAVING TECHNIQUES AND INNOVATIONS; RESEARCH IN THE FIELD OF ENVIRONMENTAL PROTECTION; MAINTENANCE OF COMPUTER SOFTWARE; DESIGN AND DEVELOPMENT OF COMPUTER SOFTWARE; PREPARATION OF TECHNICAL PROJECTS, NAMELY, TECHNOLOGY RESEARCH REGARDING RENEWABLE ENERGY, ENERGY RENEWABLE PRODUCTS, PREVENTION OF GREENHOUSE GAS EMISSIONS, REDUCTION OF GREENHOUSE GAS EMISSIONS; TECHNICAL RESEARCH AND CONSULTANCY SERVICES IN THE FIELD OF CARBON OFFSETTING; RESEARCH IN THE FIELD OF ENVIRONMENTAL SUSTAINABILITY, ENERGY USE AND ENERGY CONSERVATION; POLLUTION EMISSIONS TESTING SERVICES, IN CLASS 42 (U.S. CLS. 100 AND 101).

FOR: INTELLECTUAL PROPERTY LICENSING SERVICES, IN CLASS 45 (U.S. CLS. 100 AND 101).

THE MARK CONSISTS OF STANDARD CHARACTERS WITHOUT CLAIM TO ANY PARTICULAR FONT, STYLE, SIZE, OR COLOR.

PRIORITY DATE OF 3-1-2010 IS CLAIMED.

OWNER OF INTERNATIONAL REGISTRATION 1057387 DATED 9-1-2010, EXPIRES 9-1-2020.

OWNER OF U.S. REG. NO. 3,725,672.

SEC. 2(F).

SER. NO. 79-089,656, FILED 9-1-2010.

DAWN FELDMAN, EXAMINING ATTORNEY

United States of America

United States Patent and Trademark Office



Reg. No. 4,152,193

Registered June 5, 2012

**Int. Cls.: 3, 9, 14, 16, 18,
28 and 41**

TRADEMARK

SERVICE MARK

PRINCIPAL REGISTER

EXTREME SAILING SERIES S.A. (SWITZERLAND JOINT STOCK COMPANY)
C/O FIDUCIAIRE MAILLARD S.A.
PONT CHARLES-BESSIERES 3CH-1005 LAUSANNE
SWITZERLAND

FOR: PREPARATIONS AND SUBSTANCES FOR USE IN THE CARE AND APPEARANCE OF THE HAIR, SCALP, LIPS, FACE, SKIN, TEETH, NAILS AND EYES, NAMELY, COSMETICS; NON-MEDICATED TOILETRIES; PERFUMES, FRAGRANCES, COLOGNES AND OILS FOR SCENTS; SOAPS AND CLEANING PREPARATIONS, NAMELY, SHAMPOOS, CONDITIONERS, MOISTURIZERS AND RINSES FOR HAIR; TOOTH CLEANING PREPARATIONS; DEPILATORY PREPARATIONS; SUN-SCREEN PREPARATIONS AND SUN TANNING PREPARATIONS; ANTI-PERSPIRANTS, PERSONAL DEODORANTS, COTTON WOOL FOR COSMETIC PURPOSES; ESSENTIAL OILS; PREPARATIONS AND SUBSTANCES FOR USE IN MASSAGE AND AROMATHERAPY, NAMELY, NON-MEDICATED OILS, WAXES, LOTIONS, AND SCENTED ROOM AND BODY SPRAYS, IN CLASS 3 (U.S. CLS. 1, 4, 6, 50, 51 AND 52).

FOR: PERSONAL STEREO AND COMPUTER GAMES EQUIPMENT, NAMELY, DISCS, CASSETTES, CARTRIDGES, JOYSTICKS, SOFTWARE, PROGRAMS, AND CONSOLES; CONSUMER DOMESTIC ELECTRIC AND ELECTRONIC APPARATUS AND INSTRUMENTS, NAMELY, BATTERY CHARGERS, CAMCORDERS, CAMERAS, CASSETTE PLAYERS, COMPACT DISC PLAYERS, COMPUTERS, COMPUTER PRINTERS, DISC DRIVES FOR COMPUTERS, BLANK COMPUTER FLOPPY DISCS, HEADPHONES, LOUDSPEAKERS, MODEMS, COMPUTER MONITORS, COMPUTER MOUSE, PERSONAL STEREO, POCKET CALCULATORS, MOBILE PHONES, RADIOS, RECORD PLAYERS, STEREO RECEIVERS, STEREO TUNERS, STEREO AMPLIFIERS, SCANNERS, TAPE RECORDERS, TVS, VIDEO DISC PLAYERS, VISUAL DISPLAY UNITS AND DVD PLAYERS; COMMUNICATIONS, PHOTOGRAPHIC, NAUTICAL, LIFE-SAVING APPARATUS AND INSTRUMENTS, NAMELY, CAMERAS, LIFE SAVING RAFTS, BUOYANCY AIDS IN THE NATURE OF LIFE JACKETS, DIVERS' LIFE JACKETS, FLOATATION CLOTHING FOR LIFESAVING PURPOSES, INFLATABLE VESTS FOR USE IN LIFE SAVING, INFLATABLE LIFEBOATS, INFLATABLE JACKETS FOR USE IN LIFE SAVING, LIFE JACKETS, LIFEBELTS, LIFE BUOYS, AND NAUTICAL INSTRUMENTS FOR USE IN NAVIGATION OF A SAILING CRAFT; COMPUTER SOFTWARE FOR DATABASE MANAGEMENT FOR MANAGING SPORTING EVENTS; COMPUTER HARDWARE; COMPUTER FIRMWARE FOR OPERATING SYSTEM PROGRAMS; COMPUTER GAMES SOFTWARE; APPARATUS, INSTRUMENTS AND MEDIA FOR RECORDING, REPRODUCING, CARRYING, STORING, PROCESSING, MANIPULATING,



David J. Kappas

Director of the United States Patent and Trademark Office

Reg. No. 4,152,193 TRANSMITTING, BROADCASTING AND RETRIEVING PUBLICATIONS, TEXT, SIGNALS, SOFTWARE, INFORMATION, DATA, CODE, SOUNDS AND IMAGES, NAMELY, DIGITAL MEDIA STREAMING DEVICES, DIGITAL MEDIA HUBS, AND MEDIA PLAYERS; AUDIO AND VIDEO RECORDINGS FEATURING SPORTING EVENTS; DOWNLOADABLE AUDIO RECORDINGS FEATURING SPORTING EVENTS; DOWNLOADABLE VIDEO RECORDINGS FEATURING SPORTING EVENTS; MUSIC DOWNLOADABLE FROM THE INTERNET; DOWNLOADABLE MUSIC SOUND RECORDINGS; DOWNLOADABLE IMAGE FILES CONTAINING IMAGES OF SPORTING EVENTS; DOWNLOADABLE PUBLICATIONS, NAMELY, MAGAZINES, PAMPHLETS, NEWSLETTERS, NEWSPAPERS, PERIODICALS, MANUALS IN THE FIELD OF SPORTS; DOWNLOADABLE SOFTWARE FOR PROCESSING IMAGES, GRAPHICS AND TEXT IN THE FIELD OF SPORTS; SOUND AND VIDEO RECORDING AND PLAYBACK MACHINES; COIN OPERATED VENDING MACHINES; ELECTRONIC ARCADE GAMES ADAPTED FOR USE WITH TV RECEIVERS; TELEVISIONS AND TELEVISION GAMES APPARATUS AND INSTRUMENTS, NAMELY, VIDEO GAME MACHINES FOR USE WITH TELEVISIONS; PHOTOGRAPHIC AND CINEMATOGRAPHIC FILMS PREPARED FOR EXHIBITION IN THE FIELD OF SPORTS, SAILING AND BOATING; PHOTOGRAPHIC TRANSPARENCIES; EDUCATIONAL AND TEACHING APPARATUS AND INSTRUMENTS, NAMELY, EDUCATIONAL COMPUTER SOFTWARE FEATURING INSTRUCTION IN SPORTS, SAILING AND ORGANIZATION OF SPORTING EVENTS; ELECTRONIC, MAGNETIC AND OPTICAL IDENTITY AND MEMBERSHIP CARDS FOR USE IN CONNECTION WITH PAYMENT FOR SERVICES; SUNGLASSES; MOUSE PADS; PROTECTIVE CLOTHING AND HEADGEAR FOR USE IN SPORTS, NAMELY, LIFE VESTS, PROTECTIVE EYEWEAR AND PROTECTIVE HELMETS, IN CLASS 9 (U.S. CLS. 21, 23, 26, 36 AND 38).

FOR: JEWELRY; ARTICLES OF PRECIOUS METALS AND THEIR ALLOYS AND GOODS IN PRECIOUS METALS OR COATED THEREWITH, NAMELY, GOLD, SILVER, PLATINUM, TROPHIES, STATUES, STATUETTES, KEY RINGS, CHARMS, SCULPTURES, AND ORNAMENTS; SEMI-PRECIOUS AND PRECIOUS STONES; HOROLOGICAL AND CHRONOMETRIC INSTRUMENTS; WATCHES, CLOCKS; IMITATION JEWELRY; STATUES OF PRECIOUS METAL; CUFFLINKS; TIE PINS AND SHIRT STUDS, IN CLASS 14 (U.S. CLS. 2, 27, 28 AND 50).

FOR: PRINTED MATTER AND PUBLICATIONS, NAMELY, BOOKS, MANUALS, PAMPHLETS, NEWSLETTERS, ALBUMS, NEWSPAPERS, MAGAZINES AND PERIODICALS IN THE FIELD OF SPORTS; PRINTED TICKETS, PRINTED VOUCHERS, COUPONS AND TRAVEL DOCUMENTS, NAMELY, BUSINESS CARDS, NON-MAGNETICALLY ENCODED IDENTITY CARDS, BLANK FOREIGN RESIDENT CARDS, BLANK DRIVERS LICENSES, BLANK VOTER REGISTRATION CARDS, BLANK PASSPORTS AND PASSPORT COVERS, BLANK VISAS, AND BLANK IMMIGRATION CONTROL DOCUMENTS; PAPER LABELS AND TAGS; POSTERS, POSTCARDS, CALENDARS, DIARIES, PHOTOGRAPHS, GIFT CARDS AND GREETING CARDS; PRINTED TEACHING AND INSTRUCTIONAL MATERIALS IN THE FIELD OF SPORTS; STATIONERY, ARTISTS' MATERIALS, NAMELY, BRUSHES, PENS, PENCILS, AND PASTELS, WRITING INSTRUMENTS; WRITING PAPER AND ENVELOPES SOLD IN SETS; WRITING PAPER HOLDERS; ENGAGEMENT CARDS, VISITING CARDS, INVITATION CARDS; NOTE BOOKS; BOOK COVERS; BOOK MARKS; PRINTS; PICTURES; PHOTOGRAPHS; PHOTOGRAPH ALBUMS; PEN HOLDERS; PENCIL HOLDERS; PENS; PENCILS; PEN STANDS; INK STANDS; UNGRADUATED RULERS, DRAWING RULERS; PENCIL SHARPENERS; LETTER OPENERS; PAPER KNIVES; LETTER TRAYS; DIARIES; ORGANIZERS FOR STATIONERY USE; WRAPPING AND PACKAGING MATERIALS OF PAPER AND CARDBOARD; PAPER GIFT TAGS; WRITING INSTRUMENT CASES FOR PENS AND PENCILS; DESK SETS, ALL BEING ITEMS OF STATIONERY; CHECK BOOK COVERS, IN CLASS 16 (U.S. CLS. 2, 5, 22, 23, 29, 37, 38 AND 50).

FOR: LEATHER AND IMITATION LEATHER; GOODS MADE OF LEATHER OR IMITATIONS OF LEATHER, NAMELY, SPORTS PACKS, ALL PURPOSE SPORTS BAGS, GENERAL PURPOSE SPORT TROLLEY BAGS, CASES, BRIEFCASES, BANDS OF LEATHER, KEY CHAINS, KEY CASES, HANDBAGS, LEADS, LEASHES, POUCHES, STRAPS, THONGS,

Reg. No. 4,152,193 THREAD, BELTS, AND SADDLERY; SKINS AND HIDES; TRUNKS, DUFFEL BAGS, BAGS FOR SPORT, ATHLETIC BAGS, BACKPACKS, BUM BAGS, DRY BAGS, KIT BAGS AND TRAVELLING BAGS; PURSES, WALLETS AND HANDBAGS; LUGGAGE; SPORTS BAGS; SADDLE HORN BAGS; BACKPACKS; UMBRELLAS AND PARASOLS; HARNESSSES AND SADDLERY, IN CLASS 18 (U.S. CLS. 1, 2, 3, 22 AND 41).

FOR: GAMES AND PLAYTHINGS, NAMELY, TOY BOATS, MODEL TOY VEHICLES, CONSTRUCTION TOYS, DRAWING TOYS, COLLECTABLE TOY FIGURES, SCALE MODEL KITS, STACKING TOYS, TOY ANIMALS, TOY BALLOONS, TOY BOXES, TOY BUILDING BLOCKS, WATER TOYS, GAME CARDS, AND TOY FIGURINES; GYMNASIAC AND SPORTING ARTICLES, NAMELY, SAIL BOARD MASTS, SAIL BOARD LEASHES, SAIL BOARD FOOT STRAPS, SAIL BOARD FOOT RESTRAINTS, SAILBOARDS, BOARDS FOR USE IN THE PRACTICE OF WATER SPORTS; DECORATIONS FOR CHRISTMAS TREES, SCALE MODEL AIRPLANES, TOY SCOOTERS, TEDDY BEARS, BALLS FOR GAMES, GOLF BALLS; ELECTRONIC ARCADE GAMES NOT ADAPTED FOR USE WITH TV RECEIVERS, IN CLASS 28 (U.S. CLS. 22, 23, 38 AND 50).

FOR: INFORMATION RELATING TO ENTERTAINMENT AND EDUCATION, PROVIDED ON-LINE FROM A COMPUTER DATABASE OR THE INTERNET; ENTERTAINMENT SERVICES PROVIDED ON-LINE FROM A COMPUTER DATABASE OR THE INTERNET, NAMELY, PROVIDING A WEBSITE FEATURING ENTERTAINMENT INFORMATION, PROVIDING INFORMATION, NEWS AND COMMENTARY IN THE FIELD OF ENTERTAINMENT, PROVISION OF INFORMATION RELATING TO LIVE ENTERTAINMENT; EDUCATIONAL INFORMATION PROVIDED ON-LINE FROM A COMPUTER DATABASE OR THE INTERNET, NAMELY, EDUCATIONAL INFORMATION RELATING TO SPORTING EVENTS; ENTERTAINMENT SERVICES, NAMELY, ENTERTAINMENT IN THE NATURE OF SAILING TOURNAMENTS AND RACES, ORGANIZATION OF COMPETITIONS IN THE FIELD OF SAILING, MULTIMEDIA PRODUCTION SERVICES, ORGANIZING EXHIBITIONS FOR SPORTING PURPOSES, ARRANGING FOR TICKET RESERVATIONS FOR SHOWS AND OTHER ENTERTAINMENT EVENTS, ARRANGING, ORGANIZING, CONDUCTING, AND HOSTING SOCIAL ENTERTAINMENT EVENTS, ORGANIZATION OF ON-LINE COMPETITIONS IN THE FIELD OF ENTERTAINMENT, EDUCATION, CULTURE, SPORTS, AND OTHER NON-BUSINESS AND NON-COMMERCIAL FIELDS, NAMELY, SAILING AND BOATING, AND ENTERTAINMENT EVENT BOOKING AGENCIES; EDUCATION SERVICES, NAMELY, PROVIDING CLASSES, SEMINARS, WORKSHOPS, LECTURES AND TUTORIALS IN THE FIELD OF SPORTS, SAILING, AND BOATING; PUBLISHING OF BOOKS, MANUALS, PAMPHLETS, NEWSLETTERS, ALBUMS, NEWSPAPERS, MAGAZINES, PERIODICALS, AND PUBLISHING OF SPORTS RESULTS IN THE FORM OF BOOKS, MAGAZINES OR MANUALS; PRODUCTION OF SOUND AND VIDEO RECORDINGS, ORGANIZING GAMES IN THE FIELD OF SAILING AND BOATING AND ORGANIZING SPORTS COMPETITIONS; RENTAL OF ELECTRIC AND ELECTRONIC GOODS, NAMELY, RENTAL OF AUDIO AND VISUAL APPARATUS AND EQUIPMENT, CAMCORDERS, COMPACT DISC PLAYERS, COMPACT DISCS, FRUIT MACHINES, CASSETTE PLAYERS, CASSETTE RECORDERS, CASSETTE TAPES, AUDIO TAPES, VIDEO CAMERAS, ELECTRONIC GAMES, VIDEO CASSETTES, VIDEO DISCS, VIDEO TAPES, CD-ROMS, VIDEO CASSETTES AND TV SETS, TOYS, GAMES AND PLAYTHINGS; EDUCATION, NAMELY, EDUCATIONAL COURSES RELATING TO THE SPORTS, SAILING, AND BOATING INDUSTRIES AND PHYSICAL EDUCATION; TRAINING, NAMELY, SPORTS TRAINING SERVICES; ORGANIZING COMMUNITY SPORTING AND CULTURAL ACTIVITIES; PROVIDING SPORTS FACILITIES, LENDING LIBRARIES, DESKTOP PUBLISHING FOR OTHERS; SAILING INSTRUCTION; HOLIDAY CAMP SERVICES, PROVIDING BOAT SCHOOL FACILITIES FOR SAILING AND MOTOR BOAT INSTRUCTION, PHOTOGRAPHY, PROVIDING RECREATION FACILITIES AND WATER SPORTS FACILITIES, SPORTS CAMP SERVICES, TICKET AGENCY SERVICES FOR ENTERTAINMENT EVENTS, RENTAL OF SPORTS EQUIPMENT, RENTAL OF SPORTS DIVING EQUIPMENT, ARRANGING OF SAILING AND BOATING REGATTAS; ORGANIZATION OF SPORT COMPETITIONS AND SPORTS EVENTS; ORGANIZATION OF TRAINING LECTURES AND SEMINARS IN THE FIELD OF SAILING AND BOATING AND DISTRIBUTION OF TRAINING AND EDUCATIONAL MATERIALS IN CONNECTION THEREWITH;

Reg. No. 4,152,193 PROVIDING INFORMATION RELATING TO SPORTING EVENTS, COMPETITIONS AND TOURNAMENTS; ORGANIZATION OF SEMINARS, CONFERENCES, AND WORKSHOPS, IN THE FIELD OF SAILING AND BOATING, IN CLASS 41 (U.S. CLS. 100, 101 AND 107).

NO CLAIM IS MADE TO THE EXCLUSIVE RIGHT TO USE "SAILING SERIES" , APART FROM THE MARK AS SHOWN.

OWNER OF INTERNATIONAL REGISTRATION 1057735 DATED 8-25-2010, EXPIRES 8-25-2020.

THE MARK CONSISTS OF THE STYLIZED WORDING "EXTREME SAILING SERIES" IN A RECTANGULAR DESIGN.

SER. NO. 79-089,779, FILED 8-25-2010.

WILLIAM BRECKENFELD, EXAMINING ATTORNEY

United States of America

United States Patent and Trademark Office

TENNECT

Reg. No. 4,152,194

Registered June 5, 2012

**Int. Cls.: 6, 7, 8, 20, 22
and 37**

TRADEMARK

SERVICE MARK

PRINCIPAL REGISTER

CARL STAHL GMBH (FED REP GERMANY GESELLSCHAFT MIT BESCHRÄNKTER
HAFTUNG)
POSTWEG 41
73079 SÜSSEN
FED REP GERMANY

FOR: METAL BUILDING MATERIALS, NAMELY, METAL BUILDING WALLS; TRANSPORTABLE BUILDINGS OF METAL; SUPPORTING FRAMEWORKS, WIRE MESHWORK AND WIRE NETTING; METAL FENCING, METAL DOORWAY BARRIERS AND METAL CRASH BARRIERS COMPRISING WIRE MESH AND NETTING; NETS OF WIRE MESH AND NETTING FOR CATCHING BALLS; SUPPORTING FRAMEWORKS FOR SUPPORTING OUTSIDE PLANTS AND FOR CANOPIES PROVIDING PROTECTION FROM THE WEATHER, IN PARTICULAR SUN-SCREENS; METAL BRACING SYSTEMS IN THE NATURE OF HARDWARE MOUNTING SYSTEMS FOR LIGHTING UNITS, COMPRISING METAL ROPE AND METAL CABLE WIRES; METAL RAILINGS FOR BUILDINGS AND ARCHITECTURAL STRUCTURES AND METAL BUILDING MATERIALS IN THE NATURE OF RAILING FILLINGS; CABLES, ROPES AND WIRES OF METAL, NOT FOR ELECTRIC PURPOSES; IRONMONGERY AND SMALL ITEMS OF METAL HARDWARE, NAMELY, NUTS, BOLTS, CONNECTORS AND FASTENERS FOR METAL CABLES, ROPES AND WIRES; HAND-OPERATED ROPE WINDERS, ROPE HOLDERS, ROPE DEFLECTION PULLEYS, ROPE CLAMPS, METAL STRAPPING TIES, METAL STRAPPING TIE DOWNS USED IN CONNECTION NODES WITH MULTIPLE CONNECTOR TERMINALS FOR ROPES; METAL ANGLE HOLDERS, ELBOW HOLDERS AND SPACERS, FOR HOLDING IN PLACE METAL CABLES, ROPES AND WIRES; METAL HARDWARE, NAMELY, RAILS, ADAPTERS, PLATES, HOOKS, EYES, THIMBLES AND RINGS; METAL SHELF AND ELBOW HOLDERS FOR FIXING OBJECTS TO WALLS, CEILINGS AND FLOORS; METAL DECORATIVE ARTICLES, NAMELY, COVERING SCREENS FOR WINDOWS AND DOORS, AND COVERING SPHERES IN THE NATURE OF DECORATIONS FOR BUILDING STRUCTURES; FIXING ELEMENTS FOR FIXING AND FASTENING THE AFORESAID GOODS, IN PARTICULAR HEADLESS PINS, SCREWS AND BOLTS, NUTS, CAPS, PLUGS AND ANCHORS; SMALL ITEMS OF METAL HARDWARE, NAMELY, SPRINGS, TENSION SPRINGS AND COMPRESSION SPRINGS, SPIRAL SPRINGS, FLAT AND ROUND-WIRE SPRINGS; ALL THE AFORESAID GOODS ARE MADE PRIMARILY OF METAL, IN CLASS 6 (U.S. CLS. 2, 12, 13, 14, 23, 25 AND 50).



David J. Kyjars

Director of the United States Patent and Trademark Office

FOR: ROPES AND CORDS, NAMELY, SHEATHED ROPES, DRIVE CABLES AND ACTIVATING CABLES, BOWDEN CABLES, CONTROL CABLES, PULL ROPES, RELEASE CABLES,

Reg. No. 4,152,194 POSITIONING ROPES, POSITIONING LANYARDS, TENSIONING ROPES, CAPTIVE SCREW LOCKINGS, CABLE END CONNECTORS, NAMELY, PRESS-ON AND/OR MOLDED CONNECTORS, GROMMET THIMBLES, DEVICES, SPRING CUP PINS, SLEEVES; CHAINS AND QUICK CLOSURES FOR CHAINS, NAMELY, SNAP HOOKS; BEARINGS, NEEDLE ROLLER BEARINGS, SLIDING BEARINGS, ROLLER BEARINGS, PULLEYS; MACHINE COUPLING AND TRANSMISSION COMPONENTS, NAMELY, GEARS, BELTS AND PULLEYS; SPRINGS, TENSION SPRINGS AND COMPRESSION SPRINGS, FLAT AND ROUND-WIRE SPRINGS, ALL BEING MACHINE PARTS; ALL THE AFORESAID GOODS FOR, OR BEING STRUCTURAL COMPONENTS FOR MACHINES AND MACHINE TOOLS, IN CLASS 7 (U.S. CLS. 13, 19, 21, 23, 31, 34 AND 35).

FOR: ACTIVATION TOOLS FOR HANDLING AND ATTACHING ROPES AND CORDS, NAMELY, HAND OPERATED GRIPPING AND CLAMPING TOOLS; HAND-OPERATED CRIMPING PLIERS, WIRE ROPE SHEARS, IN CLASS 8 (U.S. CLS. 23, 28 AND 44).

FOR: NON-METAL HARDWARE FOR USE IN DESCENDING AND BELAYING ROPES, NAMELY, ROPE WINDERS, ROPE HOLDERS, ROPE DEFLECTION PULLEYS, ROPE CLAMPS, TIES, ANGLE HOLDERS, ELBOW HOLDERS AND SPACERS, RAILS, ADAPTERS, PLATES, AWNINGS, HOOKS, EYES AND THIMBLES, RING, SHELF AND ELBOW HOLDERS FOR FIXING OBJECTS TO WALLS, CEILINGS AND FLOORS; NON-METAL FASTENERS FOR FIXING AND FASTENING THE AFORESAID GOODS, NAMELY, HEADLESS PINS, SCREWS AND BOLTS, NUTS, CAPS, PLUGS AND ANCHORS; ALL THE AFOREMENTIONED GOODS MAINLY OF PLASTIC, IN CLASS 20 (U.S. CLS. 2, 13, 22, 25, 32 AND 50).

FOR: CABLES, ROPES; ROPES FOR SUPPORTING LIGHTING UNITS, IN CLASS 22 (U.S. CLS. 1, 2, 7, 19, 22, 42 AND 50).

FOR: BUILDING CONSTRUCTION CONSULTANCY AND PLANNING IN THE FIELDS OF CONSTRUCTING SUPPORTING FRAMEWORKS, INCLUDING ROPE AND MESH FRAMEWORKS; BUILDING CONSTRUCTION CONSULTANCY AND PLANNING IN THE FIELDS OF ERECTION, MAINTENANCE AND RENTAL OF SUPPORTING FRAMEWORKS, INCLUDING ROPE AND MESH FRAMEWORKS, IN CLASS 37 (U.S. CLS. 100, 103 AND 106).

THE MARK CONSISTS OF STANDARD CHARACTERS WITHOUT CLAIM TO ANY PARTICULAR FONT, STYLE, SIZE, OR COLOR.

PRIORITY DATE OF 4-8-2010 IS CLAIMED.

OWNER OF INTERNATIONAL REGISTRATION 1058375 DATED 9-28-2010, EXPIRES 9-28-2020.

THE WORDING "TENNECT" HAS NO MEANING IN A FOREIGN LANGUAGE.

SER. NO. 79-090,017, FILED 9-28-2010.

ADA HAN, EXAMINING ATTORNEY

United States of America

United States Patent and Trademark Office

maxlogic

Reg. No. 4,152,195

Registered June 5, 2012

Int. Cl.: 9

TRADEMARK

PRINCIPAL REGISTER

MAVILI ELEKTRONIK TIC. VE SAN. A.S. (TURKEY INCORPORATED COMPANY)
KUTUP SK. NO:29-31 YUKARI DUDULLU
UMRANIYE ISTANBUL
TURKEY

FOR: SECURITY AND FIRE ALARMS; SOFTWARE FOR MONITORING AND CONTROLLING COMMUNICATION BETWEEN COMPUTERS AND AUTOMATED SECURITY FIRE ALARM MACHINE SYSTEMS; ALARM MONITORING SYSTEMS; ACCESS CONTROL AND ALARM MONITORING SYSTEMS; PERSONAL SECURITY ALARMS; SECURITY ALARM CONTROLLERS; FIRE ALARM AND EMERGENCY EVACUATION DEVICES, NAMELY, FIRE ALARM CONTROL PANELS, SMOKE DETECTORS, HEAT DETECTORS, ALARM PULL STATIONS, AUDIBLE AND VISIBLE NOTIFICATION APPLIANCES, STROBES, SIRENS, BELLS, HORNS, AND SPEAKERS; ALARM CENTRAL UNITS, NAMELY, ANALOGUE ADDRESSABLE FIRE ALARM CONTROL PANELS, MICROPROCESSOR-BASED FIRE ALARM CONTROL PANELS, REMOTE LOCATION REPEATER PANELS DISPLAYING MESSAGES OF MAIN CONTROL PANEL AT REMOTE DISTANCE, REMOTE LOCATION MIMIC PANELS DISPLAYING MESSAGES OF MAIN CONTROL PANEL AT REMOTE DISTANCE, ADDRESSABLE RELAY CONTROL MODULES, GAS ALARM CONTROL PANELS, COMBINATION FIRE AND GAS ALARM CONTROL PANELS; ELECTRONIC PUBLIC ADDRESS SYSTEM DEVICES, NAMELY, ELECTRONIC GLASS BREAK DETECTORS, SMOKE ALARMS, FIRE DETECTORS, GAS DETECTORS FOR DETECTING THE PRESENCE OF GAS, HEAT DETECTORS, TEMPERATURE SENSORS, ELECTRO-OPTIC AND ULTRAVIOLET FLAME DETECTORS, ELECTRONIC WARNING HORNS, ELECTRONIC WARNING LAMPS AND FLASHERS; INTELLIGENT ANALOG ADDRESSABLE OPTICAL SMOKE DETECTORS; INTELLIGENT ANALOG ADDRESSABLE IONIZATION SMOKE DETECTORS; INTELLIGENT ANALOG ADDRESSABLE HEAT DETECTORS; INTERACTIVE OPTICAL SMOKE DETECTORS; SAFETY EQUIPMENT, NAMELY, BEACON LIGHTS; INTERFACES FOR DETECTORS; SECURITY CONTROL PANELS AND MOTION DETECTORS; PANEL METERS, NAMELY, AN ELECTRONIC INSTRUMENT THAT DISPLAYS AN INPUT SIGNAL IN EITHER A DIGITAL OR ANALOG FORM; ELECTRIC CONTROL PANELS, IN CLASS 9 (U.S. CLS. 21, 23, 26, 36 AND 38).

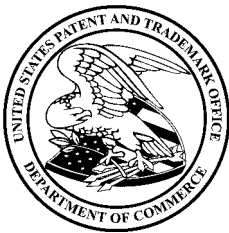

David J. Kyros

Director of the United States Patent and Trademark Office

THE MARK CONSISTS OF THE WORD "MAXLOGIC" SHOWN IN DARK BLUE. THE COLOR WHITE REPRESENTS TRANSPARENT BACKGROUND AND IS NOT CLAIMED AS A FEATURE OF THE MARK.

Reg. No. 4,152,195 OWNER OF INTERNATIONAL REGISTRATION 1058490 DATED 8-22-2009, EXPIRES 8-22-2019.

THE COLOR(S) DARK BLUE IS/ARE CLAIMED AS A FEATURE OF THE MARK.

SER. NO. 79-090,052, FILED 8-22-2009.

JENNIFER DIXON, EXAMINING ATTORNEY

United States of America

United States Patent and Trademark Office



Reg. No. 4,152,196

Registered June 5, 2012

Int. Cl.: 11

TRADEMARK

PRINCIPAL REGISTER

SIFIM S.R.L. (ITALY LIMITED COMPANY)
VIA IGNAZIO SILONE, 3
I-60035 JESI (AN)
ITALY

FOR: APPARATUS FOR LIGHTING, HEATING, STEAM GENERATION, COOKING, REFRIGERATION, DRYING AND VENTILATION, NAMELY, LAMPS, CEILING LIGHTS, LAMP STANDS, LAMP HANGING SUPPORTS, AIR FILTERS FOR DOMESTIC USE, AIR FILTERS FOR INDUSTRIAL INSTALLATIONS, RANGE HOODS, EXTRACTOR HOODS FOR KITCHENS, VENTILATION HOODS, VENTILATION HOODS FOR LABORATORIES, RANGE COOKER HOODS, DEEP FRYING MACHINES, ELECTRIC DEEP FRYERS, MICROWAVE OVENS, INDUCTION OVENS, GAS COOKING OVENS, ELECTRIC COOKING OVENS, BRACKETS FOR GAS BURNERS, PIERCED IRON PLATES FOR OVENS, CEILING PANELS AND FIXTURES INCORPORATING MESH OR FILTERS FOR PURIFYING AIR IN AIR CONDITIONING UNITS AND AIR FILTRATION SYSTEMS, FALSE CEILINGS WITH FILTERS FOR PURIFYING AIR IN AIR CONDITIONING UNITS AND AIR FILTRATION SYSTEMS, AQUARIUM FILTRATION MACHINES; WATER DISTRIBUTION INSTALLATIONS, NAMELY, PIPES, VALVES IN THE NATURE OF PLUMBING FITTINGS, PUMPS AND CONTAINERS FOR SANITARY FACILITIES AND PLUMBING INSTALLATIONS, DISTRIBUTION LINES, DISTRIBUTION MANIFOLDS, DROP TUBES AND BLOWERS, WATER PURIFICATION INSTALLATIONS, WATER SOFTENING APPARATUS AND INSTALLATIONS, WATER FILTERING APPARATUS, WATER DISTILLING UNITS, WATER PURIFYING APPARATUS; AIR FILTERS FOR DOMESTIC USE, FOR INDUSTRIAL INSTALLATIONS, FOR AIR CONDITIONERS IN VEHICLE PASSENGER COMPARTMENTS AND FOR KITCHENS FOR USE IN RANGE HOODS; DUST FILTERS FOR INDUSTRIAL USE; ANTI-GREASE FILTERS, NAMELY, METALLIC ANTI-GREASE FILTERS FOR DOMESTIC RANGE HOODS AND INDUSTRIAL KITCHENS, ANTI-GREASE FILTERS FOR RANGE HOODS WITH SUCTION MOTOR, ANTI-GREASE FILTERS IN PLASTIC AND SYNTHETIC MATERIALS FOR RANGE HOODS, ANTI-GREASE FILTERS FOR SUCTION OVEN CONDUCTS, NET METALLIC ANTI-GREASE FILTERS NOT FOR OVENS, FRYERS OR GRILLS BUT FOR RANGE HOODS; CARBON FILTERS FOR PURIFYING AIR IN AIR DUCTS AND IN AIR CONDITIONING SYSTEMS, AND FOR ELIMINATING ODORS; WATER FILTERS; POCKET FILTERS, NAMELY, COFFEE FILTERS NOT OF PAPER BEING PART OF ELECTRIC COFFEE MAKERS; ELECTROSTATIC FILTERS FOR REMOVING SMELL OF DOMESTIC AND INDUSTRIAL COOKING AND THE SURROUNDINGS; ANTI-FLAME FILTERS FOR DOMESTIC RANGE HOODS AND INDUSTRIAL KITCHENS, AIR TREATMENT BOXES IN THE NATURE OF AIR PURIFIERS; SELF-CLEANING AIR FILTERS FOR DOMESTIC,



David J. Kappas

Director of the United States Patent and Trademark Office

Reg. No. 4,152,196 COMMERCIAL AND INDUSTRIAL USE; EQUIPMENT FOR PERSONAL CARE AND WELLBEING, NAMELY, DRINKING WATER FILTERS, BATHTUBS, SITZ BATHS, BIDETS, SHOWER STALLS COMPLETE WITH FAUCETS, DOORS AND SHOWER HEADS, WASH BASINS AS PARTS OF SANITARY EQUIPMENT, URINALS AS SANITATION FIXTURE, TOILETS FOR WATER CLOSETS, TOILET BOWLS FOR WATER CLOSETS, TOILET SEATS FOR WATER CLOSETS, ELECTRIC BLANKETS NOT FOR MEDICINAL PURPOSES, ELECTRIC HEATING PADS, NOT FOR MEDICINAL PURPOSES, ELECTRIC FOOT WARMERS, ELECTRIC HOT-WATER BOTTLES, HAIR DRYERS, FACIAL SAUNAS, PERSONAL CARE FOOT SPAS IN THE NATURE OF PORTABLE FOOT BATHS FOR PERSONAL USE, AIR AND ROOM HUMIDIFIERS NOT FOR MEDICAL USE, ELECTRIC FRAGRANCE DISPENSERS, HYDROTHERAPY TUBS, NAMELY, WHIRLPOOL BATHS, WHIRLPOOLS, PERSONAL SAUNA AND STEAMING EQUIPMENT, NAMELY, PERSONAL PORTABLE SAUNAS; EQUIPMENT FOR COOKING, FRYING AND GRILLING, NAMELY, LIGHTERS, ELECTRIC COOKING UTENSILS, NAMELY, TOASTER OVENS, WAFFLE IRONS, HOT WATER KETTLES; ELECTRIC STOVES, ELECTRIC COOKING OVENS; INDUCTION RANGES, NAMELY, COOKING RANGES AND ELECTRIC RANGES, GAS GRILLS, AND ELECTRIC GRILLS; WHITE GOODS, NAMELY, RANGE HOODS, AIR CONDITIONING SYSTEMS COMPRISING MOTOR AND COMPRESSOR UNITS, CHILLER, EVAPORATORS, HEAT-EXCHANGERS AND HEAT PUMPS, AND DEHUMIDIFIERS; LIGHTING APPARATUS, NAMELY, LIGHTING INSTALLATIONS AND OVERHEAD LIGHTING FIXTURES FOR INDUSTRIAL AND DOMESTIC ENVIRONMENT, COOKING FACILITIES, BUILDINGS, FACTORIES, HOMES, APARTMENTS, SCHOOLS, AND INSTITUTIONS, LED LAMPS FOR LIGHTING FOR INDUSTRIAL AND DOMESTIC ENVIRONMENT, COOKING FACILITIES, BUILDINGS, FACTORIES, HOMES, APARTMENTS, SCHOOLS, AND INSTITUTIONS; FILTRATION EQUIPMENT, NAMELY, PIERCED IRON PLATES IN THE NATURE OF FILTERS, IRONED NETS IN THE NATURE OF FILTERS; FILTRATION MACHINES FOR INDUSTRIAL AIR PURIFICATION, RESIDENTIAL AIR CONDITIONERS, AQUARIUMS; HEATING AND AIR CONDITIONING APPLIANCES, NAMELY, ELECTRIC FANS, BRACKETS FOR GAS BURNERS; VENTILATION EQUIPMENT, NAMELY, FILTERS FOR VENTILATION HOODS, ELECTRIC FANS, CEILING FANS, IN CLASS 11 (U.S. CLS. 13, 21, 23, 31 AND 34).

THE TRADEMARK CONSISTS OF THE WORD "SIFIM" IN CAPITAL FANCY CHARACTERS WHERE, ON THE LEFT, IT IS LOCATED A PARALLELOGRAM IN WHICH IS SITUATED A FANCY FIGURE REPRESENTING A FILTER STYLIZED, OBLIQUELY DISPOSED.

PRIORITY DATE OF 2-26-2010 IS CLAIMED.

OWNER OF INTERNATIONAL REGISTRATION 1058619 DATED 3-30-2010, EXPIRES 3-30-2020.

THE WORDING "SIFIM" HAS NO MEANING IN A FOREIGN LANGUAGE.

SER. NO. 79-090,089, FILED 3-30-2010.

MICHAEL WIENER, EXAMINING ATTORNEY

United States of America

United States Patent and Trademark Office

InnoWa

Reg. No. 4,152,197

Registered June 5, 2012

**Int. Cls.: 1, 7, 9, 11, 17,
24, 40 and 42**

TRADEMARK

SERVICE MARK

PRINCIPAL REGISTER

INNOWA MEMBRANE GMBH (FED REP GERMANY GMBH)
ALFRED-SCHEFENACKER-STR. 1
71409 SCHWAIKHEIM, FED REP GERMANY

FOR: CHEMICAL PREPARATIONS FOR GENERAL INDUSTRIAL FILTRATION, SCIENTIFIC, AND PHOTOGRAPHIC USES; CHEMICAL PREPARATIONS FOR AGRICULTURAL, HORTICULTURAL AND SILVICULTURAL USES, NAMELY, CHEMICAL PREPARATIONS FOR WATER, FOOD AND PRODUCT FILTRATION, AND CHEMICAL PREPARATIONS FOR GROUNDWATER PROTECTION; UNPROCESSED SYNTHETIC RESINS; GLUES FOR INDUSTRIAL USES IN THE AREA OF THE FILTRATION OF FLUIDS BY MEMBRANES AND OTHER FILTRATION MEDIA, IN CLASS 1 (U.S. CLS. 1, 5, 6, 10, 26 AND 46).

FOR: MACHINES IN THE AREA OF THE FILTRATION OF FLUIDS BY MEMBRANES AND OTHER FILTRATION MEDIA, NAMELY, FOOD FILTRATION, PRODUCT FILTRATION, WATER FILTRATION, PUMPS FOR WATER, FOOD AND PRODUCT FILTERING UNITS; MACHINES FOR THE FABRICATION OF FIBRES, MEMBRANES AND WATER PURIFICATION PLANTS, NAMELY, INDUSTRIAL MIXING MACHINES, INDUSTRIAL SPINNING MACHINES, INDUSTRIAL MOLDING MACHINES, INDUSTRIAL METAL PROCESSING MACHINES, IN CLASS 7 (U.S. CLS. 13, 19, 21, 23, 31, 34 AND 35).

FOR: SCIENTIFIC APPARATUS AND INSTRUMENTS, NAUTICAL, SURVEYING, PHOTOGRAPHIC, FILMING, OPTICAL, WEIGHING, MEASURING, SIGNALING, CONTROLLING, LIFE-SAVING AND TEACHING APPARATUS AND INSTRUMENTS IN THE AREA OF THE FILTRATION OF FLUIDS BY MEMBRANES AND OTHER FILTRATION MEDIA, NAMELY, WATER FILTER CONTROLLERS, ELECTRONIC FILTER CONTROLLERS FOR ALCOHOLIC AND NON ALCOHOLIC BEVERAGE FILTERS, ELECTRONIC FILTER CONTROLLERS FOR GAS FILTERS, ELECTRONIC FILTER CONTROLLERS FOR OIL FILTERS; MEMBRANES AS PARTS OF SCIENTIFIC APPARATUS AND INSTRUMENTS, IN THE AREA OF WATER TREATMENT, WATER PURIFICATION AND THE FILTRATION OF FLUIDS, NAMELY, POLYMER AND CERAMIC MEMBRANES MADE OF HOMOGENOUS FILMS AND HETEROGENEOUS SOLIDS, IN CLASS 9 (U.S. CLS. 21, 23, 26, 36 AND 38).

FOR: DEVICES FOR ILLUMINATION, HEATING, STEAM PRODUCTION, COOKING, COOLING, VENTILATION AND WATER TRANSPORT AS WELL AS SANITARY FACILITIES IN THE AREA OF THE FILTRATION OF FLUIDS BY MEMBRANES AND OTHER FILTRATION MEDIA, NAMELY, STEAM HEATING APPARATUS, APPARATUS FOR THE EXCHANGE OF SUBSTANCES AND HEAT FOR USE IN THE PRODUCTION OF STEAM, FOR



David J. Kyros

Director of the United States Patent and Trademark Office

Reg. No. 4,152,197 USE IN COOKING, FOR USE IN REFRIGERATION AND FOR USE IN THE FIELD OF SEWAGE PURIFICATION AND TREATMENT, WATER FILTRATION UNITS, FLUID FILTRATION UNITS; WATER PURIFICATION TANKS AND WATER PURIFICATION MACHINES AND WATER PURIFICATION INSTALLATIONS COMPOSED OF THESE DEVICES OR MACHINES; SEWAGE PURIFICATION APPARATUS, SUSTAINABLE ONSITE WATER RECYCLING APPARATUS, STRUCTURAL PARTS OF THE PRODUCTS MENTIONED ABOVE, IN CLASS 11 (U.S. CLS. 13, 21, 23, 31 AND 34).

FOR: SEMI-FINISHED PRODUCTS MADE OF SYNTHETICS IN THE AREA OF THE FILTRATION OF FLUIDS BY MEMBRANES AND OTHER FILTRATION MEDIA, NAMELY, SYNTHETIC POLYMER AND CERAMIC FIBERS AND SYNTHETIC POLYMER AND CERAMIC TUBES; FILTRATION MATERIALS MADE OF SYNTHETICS AND SEMI FINISHED FOAM PRODUCTS, NAMELY, SEMI-WORKED SYNTHETIC PLASTIC AND SYNTHETIC RESINS AS SEMI-FINISHED PRODUCTS IN FORM OF FOAMS USED IN THE AREA OF WATER TREATMENT, WATER PURIFICATION AND THE FILTRATION OF FLUIDS, IN CLASS 17 (U.S. CLS. 1, 5, 12, 13, 35 AND 50).

FOR: TEXTILE FABRICS USED IN THE AREA OF THE FILTRATION OF FLUIDS BY MEMBRANES AND OTHER FILTRATION MEDIA, IN CLASS 24 (U.S. CLS. 42 AND 50).

FOR: PROCESSING OF MATERIALS IN THE AREA OF THE FILTRATION OF FLUIDS BY MEMBRANES AND OTHER FILTRATION MEDIA, NAMELY, PREPARATION AND TREATMENT OF SEMI-FINISHED PRODUCTS MADE OF SYNTHETICS IN THE AREA OF THE FILTRATION OF FLUIDS BY MEMBRANES AND OTHER FILTRATION MEDIA, NAMELY, SYNTHETIC RUBBER, FIBERS AND TUBING; PROCESSING OF MATERIALS IN THE AREA OF THE FILTRATION OF FLUIDS BY MEMBRANES AND OTHER FILTRATION MEDIA, NAMELY, PREPARATION AND TREATMENT OF FILTRATION MATERIALS MADE OF SYNTHETICS AND SEMI FINISHED FOAM PRODUCTS, NAMELY, SEMI-WORKED SYNTHETIC PLASTIC AND SYNTHETIC RESINS AS SEMI-FINISHED PRODUCTS IN FORM OF FOAMS USED IN THE AREA OF WATER TREATMENT, WATER PURIFICATION AND THE FILTRATION OF FLUIDS, TEXTILE FABRICS USED IN THE AREA OF THE FILTRATION OF FLUIDS BY MEMBRANES AND OTHER FILTRATION MEDIA; SEWAGE PURIFICATION AND SEWAGE TREATMENT, NAMELY, INDUSTRIAL TYPE UTILITY SERVICES IN THE NATURE OF SEWAGE PURIFICATION AND TREATMENT; PROVIDING INFORMATION IN THE FIELD OF SEWAGE PURIFICATION AND SEWAGE TREATMENT, IN CLASS 40 (U.S. CLS. 100, 103 AND 106).

FOR: SCIENTIFIC AND TECHNOLOGICAL SERVICES AND RESEARCH WORK AND CORRESPONDING DESIGNERS' SERVICES IN THE AREA OF THE FILTRATION OF FLUIDS BY MEMBRANES AND OTHER FILTRATION MEDIA, NAMELY, DESIGN OF APPARATUS AND MACHINES FOR WATER FILTRATION, GAS FILTRATION, OIL FILTRATION AND ALCOHOLIC AND NON ALCOHOLIC BEVERAGE FILTRATION; CONSULTATION IN THE FIELD OF AUXILIARY DESIGN FOR INDUSTRIAL MACHINES AND SCIENTIFIC RESEARCH SERVICES IN THE AREA OF THE FILTRATION OF FLUIDS BY MEMBRANES AND OTHER FILTRATION MEDIA; DESIGN AND DEVELOPMENT OF COMPUTER HARDWARE AND SOFTWARE IN THE AREA OF THE FILTRATION OF FLUIDS BY MEMBRANES AND OTHER FILTRATION MEDIA; TECHNICAL ADVICE FOR THE PLANNING AND DEVELOPMENT OF FACILITIES FOR SEWAGE PURIFICATION AND SEWAGE TREATMENT, IN CLASS 42 (U.S. CLS. 100 AND 101).

THE MARK CONSISTS OF STANDARD CHARACTERS WITHOUT CLAIM TO ANY PARTICULAR FONT, STYLE, SIZE, OR COLOR.

PRIORITY DATE OF 8-18-2010 IS CLAIMED.

OWNER OF INTERNATIONAL REGISTRATION 1058664 DATED 9-28-2010, EXPIRES 9-28-2020.

Reg. No. 4,152,197 THE WORD(S) "INNOWA" HAS NO MEANING IN A FOREIGN LANGUAGE.

SER. NO. 79-090,101, FILED 9-28-2010.

CHERYL CLAYTON, EXAMINING ATTORNEY

United States of America

United States Patent and Trademark Office



Reg. No. 4,152,198

Registered June 5, 2012

**Int. Cls.: 3, 5, 9, 12, 18,
25 and 41**

TRADEMARK

SERVICE MARK

PRINCIPAL REGISTER

ROGER MAIER (SWITZERLAND INDIVIDUAL)
VIA BRESCE, 1
CH-6854 SAN PIETRO DI STABIO
SWITZERLAND

FOR: AFTER-SHAVES, MAKE-UP, PERFUMERY, COSMETICS, COSMETIC CREAMS FOR SKIN CARE, BODY CREAMS, SOAPS, ESSENTIAL OILS, HAIR LOTIONS; DENTIFRICES, IN CLASS 3 (U.S. CLS. 1, 4, 6, 50, 51 AND 52).

FOR: SANITARY PREPARATIONS FOR MEDICAL PURPOSES; DIETETIC FOODS ADAPTED FOR MEDICAL USE; MEDICAL PLASTERS; FOOD SUPPLEMENTS FOR MEDICAL PURPOSES, NAMELY, MINERAL AND VITAMIN SUPPLEMENTS, IN CLASS 5 (U.S. CLS. 6, 18, 44, 46, 51 AND 52).

FOR: PROTECTIVE HELMETS FOR SPORTS, IN CLASS 9 (U.S. CLS. 21, 23, 26, 36 AND 38).

FOR: BICYCLES AND COMPONENT PARTS THEREOF, NAMELY, FRAMES, HANDLEBARS, POSTS, SEAT POSTS, SADDLES, SEATS, WHEELS, PNEUMATIC TIRES, BRAKES, BRAKE LEVERS, BICYCLE CHAINS, HUBS, AXLES, LEVERS, KICKSTANDS FOR BICYCLES, MUDGUARDS, HANDLEBAR ACCESSORIES FOR BICYCLES, NAMELY, BICYCLE GRIP TAPE, BICYCLE HORNS, BICYCLE BELLS AND BASKETS, PEDALS AND WATER BOTTLE CLIPS SPECIFICALLY ADAPTED FOR USE ON BICYCLES, IN CLASS 12 (U.S. CLS. 19, 21, 23, 31, 35 AND 44).

FOR: LEATHER AND IMITATIONS OF LEATHER AND GOODS MADE OF THESE MATERIALS AND NOT INCLUDED IN OTHER CLASSES, NAMELY, BELTS, WALLETS, PURSES, KEY-RINGS, PEN HOLDERS AND DUFFEL BAGS; TRUNKS AND TRAVELING BAGS, UMBRELLAS, PARASOLS, BACKPACKS, ALL-PURPOSE CARRYING BAGS; LEATHER CASES; PURSES, CREDIT CARD HOLDERS, SPORTS BAGS, HANDBAGS; KEY CASES; SPORTS AND ALL-PURPOSE LEISURE BAGS; TRAVEL BAGGAGE; VALISES; PLASTIC BAGGAGE LABELS; WALLETS; POUCHES OF LEATHER; PURSES; SADDLEBAGS; SCHOOL BAGS, IN CLASS 18 (U.S. CLS. 1, 2, 3, 22 AND 41).

FOR: DRESSES, CAPS, HATS, BELTS, SKIRTS, JACKETS, COATS, SWEATERS, SINGLETs, SMOCKS, DRESSING GOWNS, HOUSECOATS, BATHING SUITS, UNDERWEAR, STOCKINGS, SOCKS, NECKTIES, SCARVES, GLOVES, CAPES, TROUSERS, SLIPPERS, PARKAS, PAJAMAS, FUR COATS, FUR JACKETS, PULLOVERS, GARTERS, BRASSIERES, SANDALS,



David J. Kybas

Director of the United States Patent and Trademark Office

Reg. No. 4,152,198 FOOTWEAR, SHAWLS, SASHES FOR WEAR, OVERCOATS, STOLES, DUNGAREES, BOOTS, TEE-SHIRTS, SHIRTS, BREECHES, SHORTS, BRIEFS, JEANS, WRAPAROUNDS, EYE-SHADES, HOSIERY, SLEEVELESS JACKETS, ATTACHABLE SLEEVES, SPORTSWEAR, NAMELY, CYCLISTS' CLOTHING, NAMELY, BICYCLIST JERSEYS, BICYCLIST PANTS AND BICYCLIST GLOVES; GLOVES OF LEATHER, JACKETS OF LEATHER AND SUEDE, IN CLASS 25 (U.S. CLS. 22 AND 39).

FOR: TRAINING IN THE FIELD OF SPORTS; ENTERTAINMENT SERVICES, NAMELY, ORGANIZING OF EXHIBITIONS FOR SPORTS PURPOSES IN THE FIELD OF SPORTS; ORGANIZATION OF SPORTS ACTIVITIES, NAMELY, ORGANIZATION OF CYCLING COMPETITIONS, IN CLASS 41 (U.S. CLS. 100, 101 AND 107).

OWNER OF U.S. REG. NO. 3,265,345.

PRIORITY DATE OF 1-21-2010 IS CLAIMED.

OWNER OF INTERNATIONAL REGISTRATION 1059286 DATED 7-21-2010, EXPIRES 7-21-2020.

THE MARK CONSISTS OF THE WORDING "A ASSOS" IN STYLIZED FORM. THE "A" INCORPORATES A PLUS SIGN DESIGN.

SER. NO. 79-090,301, FILED 7-21-2010.

CURTIS FRENCH, EXAMINING ATTORNEY

United States of America
United States Patent and Trademark Office

CHARGEON

Reg. No. 4,152,199

Registered June 5, 2012

Int. Cl.: 9

TRADEMARK

PRINCIPAL REGISTER

KONINKLIJKE PHILIPS ELECTRONICS N.V. (NETHERLANDS A PUBLIC LIMITED LIABILITY COMPANY)
GROENEWOUDSEWEG 1
BA EINDHOVEN, NETHERLANDS NL5621

FOR: BATTERY PACKS, POWER SUPPLIES, BATTERY CHARGERS, ATTACHABLE BATTERY PACKS, IN CLASS 9 (U.S. CLS. 21, 23, 26, 36 AND 38).

THE MARK CONSISTS OF STANDARD CHARACTERS WITHOUT CLAIM TO ANY PARTICULAR FONT, STYLE, SIZE, OR COLOR.

PRIORITY DATE OF 6-22-2010 IS CLAIMED.

OWNER OF INTERNATIONAL REGISTRATION 1059530 DATED 11-2-2010, EXPIRES 11-2-2020.

SER. NO. 79-090,364, FILED 11-2-2010.

CHRISTOPHER BUONGIORNO, EXAMINING ATTORNEY



David J. Kybas

Director of the United States Patent and Trademark Office

United States of America

United States Patent and Trademark Office

the
swedish solution

dolph lundgren

Reg. No. 4,152,200

Registered June 5, 2012

Int. Cls.: 9, 16 and 41

TRADEMARK

SERVICE MARK

PRINCIPAL REGISTER

LUNDGREN DOLPH (SWEDEN INDIVIDUAL)
BIRGER JARLSGATAN 73-75
SE-113 56 STOCKHOLM
SWEDEN

FOR: PRE-RECORDED CDS, VIDEO TAPES, LASER DISCS AND DVDS FEATURING EXERCISE; RECORDED FILMS, NAMELY, CINEMATOGRAPHIC FILMS FEATURING EXERCISE; INSTRUCTION MANUALS IN ELECTRONIC FORMAT, NAMELY, DOWNLOADABLE INSTRUCTION MANUALS RECORDED ON COMPUTER MEDIA IN THE FIELD OF EXERCISE, IN CLASS 9 (U.S. CLS. 21, 23, 26, 36 AND 38).

FOR: BOOKS, NAMELY, INSTRUCTION BOOKS, MANUALS AND MAGAZINES IN THE FIELD OF EXERCISE; POSTERS, IN CLASS 16 (U.S. CLS. 2, 5, 22, 23, 29, 37, 38 AND 50).

FOR: PROVISION OF COURSES OF INSTRUCTION IN THE FIELD OF EXERCISE; EXERCISE INSTRUCTION; ENTERTAINMENT SERVICES, NAMELY, ENTERTAINMENT IN THE NATURE OF FITNESS PERFORMANCES, IN CLASS 41 (U.S. CLS. 100, 101 AND 107).

NO CLAIM IS MADE TO THE EXCLUSIVE RIGHT TO USE "SWEDISH", APART FROM THE MARK AS SHOWN.

PRIORITY DATE OF 9-13-2010 IS CLAIMED.

OWNER OF INTERNATIONAL REGISTRATION 1059852 DATED 10-29-2010, EXPIRES 10-29-2020.

THE NAME(S), PORTRAIT(S), AND/OR SIGNATURE(S) SHOWN IN THE MARK IDENTIFIES "DOLPH LUNDGREN", WHOSE CONSENT(S) TO REGISTER IS MADE OF RECORD.

SER. NO. 79-090,505, FILED 10-29-2010.

MATTHEW EINSTEIN, EXAMINING ATTORNEY



David J. Kyffers

Director of the United States Patent and Trademark Office

United States of America

United States Patent and Trademark Office

SONIA RYKIEL

Reg. No. 4,152,201

Registered June 5, 2012

Int. Cls.: 20, 24 and 26

SONIA RYKIEL CREATION ET DIFFUSION DE MODELES (FRANCE SOCIÉTÉ PAR
ACTIONS SIMPLIFIÉE)
175, BOULEVARD SAINT GERMAIN
F-75006 PARIS
FRANCE

TRADEMARK

PRINCIPAL REGISTER

FOR: FURNITURE, MIRRORS, PICTURE FRAMES; GOODS MADE OF WOOD, CORK, REED, CANE, WICKER, HORN, BONE, IVORY, WHALEBONE, SHELL, AMBER, MOTHER-OF-PEARL, MEERSCHAUM AND SUBSTITUTES FOR ALL THESE MATERIALS OR OF PLASTICS, NAMELY, FIGURINES, WORKS OF ART, WALL PLAQUES, WALL MOTIFS, NAMELY, THREE-DIMENSIONAL WALL DECORATIONS, LETTERS AND SHAPES USED TO SPELL WORDS AND NAMES, NON-METAL WINDOW FITTINGS, NON-METAL DOOR FITTINGS, CURTAIN HOOKS, CURTAIN RODS AND FINIALS, CURTAIN RINGS, CUSHIONS, PILLOWS, BEAN BAG CHAIRS, PILLOWS, BEDS AND POUFS, IN CLASS 20 (U.S. CLS. 2, 13, 22, 25, 32 AND 50).

FOR: TEXTILES AND TEXTILE GOODS, NAMELY, KITCHEN LINEN, BATH LINEN, BED LINEN, TABLE LINEN, CURTAINS, TOWELS, HANDKERCHIEFS, TEXTILE NAPKINS, TEXTILE PLACE MATS, POT HOLDERS; BED AND TEXTILE TABLE COVERS, NAMELY BED BLANKETS, BEDSPREADS, QUILTS, THROWS, CUSHION AND PILLOW COVERS, TABLE CLOTHS AND FABRIC TABLE RUNNERS, IN CLASS 24 (U.S. CLS. 42 AND 50).

FOR: LACE AND EMBROIDERY, RIBBONS AND BRAID; BUTTONS, HOOKS AND EYES, SEWING PINS AND NEEDLES; ARTIFICIAL FLOWERS; WIGS AND HAIR ORNAMENTS, IN CLASS 26 (U.S. CLS. 37, 39, 40, 42 AND 50).

THE MARK CONSISTS OF STANDARD CHARACTERS WITHOUT CLAIM TO ANY PARTICULAR FONT, STYLE, SIZE, OR COLOR.

OWNER OF INTERNATIONAL REGISTRATION 1060325 DATED 10-26-2010, EXPIRES 10-26-2020.

OWNER OF U.S. REG. NOS. 913,787, 3,616,336 AND OTHERS.

THE NAME(S), PORTRAIT(S), AND/OR SIGNATURE(S) SHOWN IN THE MARK IDENTIFIES "SONIA RYKIEL", WHOSE CONSENT(S) TO REGISTER IS MADE OF RECORD.



David J. Kyros

Director of the United States Patent and Trademark Office

Reg. No. 4,152,201 SER. NO. 79-090,699, FILED 10-26-2010.

ELISSA GARBER KON, EXAMINING ATTORNEY

United States of America

United States Patent and Trademark Office



Reg. No. 4,152,202

Registered June 5, 2012

Int. Cl.: 29

KAANLAR GIDA SANAYI VE TICARET ANONIM SIRKETI (TURKEY JOINT STOCK COMPANY)
KOCATEPE MAHALLESİ
MEGA CENTER C12.; BLOK NO:97-98-99-100-101-102; BAYRAMPASA - ISTANBUL
TURKEY

TRADEMARK

PRINCIPAL REGISTER

FOR: MEAT, FISH, POULTRY AND GAME; MEAT EXTRACTS; PRESERVED, DRIED AND COOKED FRUITS AND VEGETABLES, INCLUDING CANNED PROCESSED OLIVES, OLIVE PASTES, PROCESSED OLIVE PUREE, PROCESSED OLIVES, PROCESSED STUFFED OLIVES, STUFFED OLIVES WITH RED PEPPER AND ALMOND, STUFFED OLIVES WITH FETA CHEESE IN SUNFLOWER OIL, STUFFED OLIVES WITH PESTO IN SUNFLOWER OIL; JELLIES; JAMS; FRUIT SAUCES, NAMELY, CRANBERRY SAUCE AND APPLESAUCE; MILK; MILK AND DAIRY PRODUCTS EXCLUDING ICE CREAM, ICE MILK AND FROZEN YOGURT, NAMELY, BUTTER, BUTTERMILK, CHEESE, CHEESE FONDUE, CHEESE FOOD, CHEESE POWDER, CHEESE SPREADS, COTTAGE CHEESE, COWS' MILK, CREAM, CREAM CHEESE, CREAM FRAICHE, CREAM POWDER, CURD, DAIRY-BASED CHOCOLATE FOOD BEVERAGES, DAIRY-BASED DIPS, DAIRY-BASED SPREADS, DRIED MILK FOR FOOD, DRIED MILK POWDER, DRINKING YOGURTS, DRINKS BASED ON YOGURT, DRY WHEY, FERMENTED MILK, FRESH UNRIPENED CHEESES, GHEE, GOAT MILK, HEADCHEESE, MILK BEVERAGES WITH HIGH MILK CONTENT, MILK DRINKS CONTAINING FRUITS, MILK POWDER FOR FOOD PURPOSES, MILK POWDER FOR NUTRITIONAL PURPOSES, MILK PROTEINS, MILK SOLIDS, MOLD-RIPENED CHEESE, MOZZARELLA STICKS, POWDERED MILK FOR FOOD PURPOSES, PROCESSED CHEESE, RIPENED CHEESES, SHEEP CHEESE, SHEEP MILK, SOFT CHEESE, SOFT WHITE CHEESE, SOFT-RIPENED CHEESE, SOUR CREAM, STRAINED CHEESE, STRAINED SOFT WHITE CHEESES, YOGURTS, CHEESE, NAMELY, GOUDA, EDAM, CHEDDAR; EDIBLE OILS AND FATS, INCLUDING ANIMAL OILS AND FATS AND OLIVE OIL, IN CLASS 29 (U.S. CL. 46).



THE MARK CONSISTS OF THE WORDING "KAANLAR" IN STYLIZED LETTERING BE- NEATH TWO INCOMPLETE CRESCENT SHAPE DESIGNS, ALL WITHIN AN OVAL BOR- DER.

David J. Kyros

OWNER OF INTERNATIONAL REGISTRATION 0772591 DATED 1-16-2002, EXPIRES 1-16- 2022.

Director of the United States Patent and Trademark Office

SER. NO. 79-091,073, FILED 6-16-2010.

Reg. No. 4,152,202 JOHN GARTNER, EXAMINING ATTORNEY

United States of America

United States Patent and Trademark Office

SMAXTEC

Reg. No. 4,152,203

Registered June 5, 2012

Int. Cls.: 9, 10 and 42

SMAXTEC ANIMAL CARE SALES GMBH (AUSTRIA GESELLSCHAFT MIT
BESCHRÄNKTER HAFTUNG)
WASTIANGASSE 4
A-8010 GRAZ
AUSTRIA

TRADEMARK

SERVICE MARK

PRINCIPAL REGISTER

FOR: SCIENTIFIC, MEASURING, SIGNALING AND CHECKING AND SUPERVISION APPARATUS AND INSTRUMENTS, NAMELY, PH METERS, ACIDITY ANALYZERS, THERMOMETERS, TEMPERATURE SENSORS, AND CLINICAL LABORATORY ANALYZERS FOR MEASURING, TESTING AND ANALYZING BLOOD AND OTHER BODILY FLUIDS IN THE FIELD OF HUMAN AND VETERINARY MEDICINE; COMPUTER PROGRAMS AND SOFTWARE FOR USE IN DATA ACQUISITION, DATA STORAGE AND DATA VISUALISATION IN THE FIELD OF HUMAN AND VETERINARY MEDICINE AND ANIMAL HUSBANDRY; ELECTRONIC, MECHANICAL AND ELECTROMECHANICAL CONTROLS AND REGULATORS FOR CONTROLLING AND REGULATING APPARATUS AND INSTRUMENTS IN THE FIELD OF HUMAN AND VETERINARY MEDICINE AND ANIMAL HUSBANDRY; APPARATUS FOR RECORDING TEST SIGNALS IN THE FIELD OF HUMAN AND VETERINARY MEDICINE AND ANIMAL HUSBANDRY; APPARATUS FOR FURTHER PROCESSING SIGNALS, IN PARTICULAR APPARATUS WITH PROCESSORS, IN THE FIELD OF HUMAN AND VETERINARY MEDICINE AND ANIMAL HUSBANDRY; MEASURING APPARATUS, EQUIPMENT AND INSTRUMENTS FOR DATA RECORDING, FOR CLIMATE MONITORING IN STABLES OR SIMILAR BUILDINGS USED IN ANIMAL HUSBANDRY; APPARATUS, EQUIPMENT AND INSTRUMENTS FOR RECORDING MEASUREMENT DATA IN AND ON BUILDINGS AND FACILITIES USED IN ANIMAL HUSBANDRY, IN CLASS 9 (U.S. CLS. 21, 23, 26, 36 AND 38).

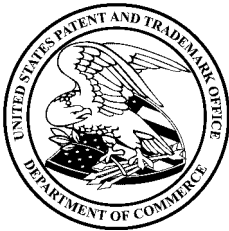

David J. Kyros

Director of the United States Patent and Trademark Office

FOR: MEDICAL AND VETERINARY APPARATUS, EQUIPMENT AND INSTRUMENTS, NAMELY, PATIENT MONITORING SENSORS FOR MEASURING, SIGNALING, CHECKING AND SUPERVISING VITAL SIGNS, BLOOD PROPERTIES, RESPIRATORY EVENTS, GASTROINTESTINAL EVENTS, PH AND TEMPERATURE; VETERINARY APPARATUS, EQUIPMENT AND INSTRUMENTS FOR RECORDING INTRARUMINAL MEASUREMENT DATA FOR DIAGNOSIS AND TREATMENT OF ANIMALS, NAMELY, AN INTRARUMINAL BOLUS COMPRISING A WIRELESS DATA TRANSMITTER AND A PH METER; VETERINARY APPARATUS, EQUIPMENT AND INSTRUMENTS FOR RECORDING MEASUREMENT DATA, IN AND ON ANIMALS, NAMELY, PATIENT MONITORING SENSORS FOR MEASURING INTRARUMINAL PH, VITAL SIGNS, BLOOD PROPERTIES, RESPIRATORY EVENTS, GASTROINTESTINAL EVENTS, PH AND TEMPERATURE USED FOR DIAGNOSIS AND

Reg. No. 4,152,203 TREATMENT PURPOSES; MEDICAL AND VETERINARY APPARATUS AND INSTRUMENTS FOR MONITORING VITAL SIGNS, BLOOD PROPERTIES AND RESPIRATORY EVENTS; MEDICAL AND VETERINARY APPARATUS AND INSTRUMENTS FOR MONITORING GASTROINTESTINAL EVENTS; MEDICAL DEVICE FOR USE IN DIAGNOSIS OF THE GASTRO-INTESTINAL TRACT; VETERINARY APPARATUS FOR DIAGNOSTIC AND TREATMENT PURPOSES, NAMELY, PH METERS AND THERMOMETERS, IN CLASS 10 (U.S. CLS. 26, 39 AND 44).

FOR: SCIENTIFIC AND TECHNOLOGICAL SERVICES, NAMELY, SCIENTIFIC RESEARCH AND DESIGN SERVICES RELATING TO THE FIELD OF HUMAN AND VETERINARY MEDICINE AND ANIMAL HUSBANDRY; ANALYSIS AND SCIENTIFIC RESEARCH SERVICES IN THE FIELDS OF HUMAN AND VETERINARY MEDICINE AND ANIMAL HUSBANDRY; DESIGN AND DEVELOPMENT OF COMPUTER HARDWARE AND SOFTWARE IN THE FIELD OF HUMAN AND VETERINARY MEDICINE AND ANIMAL HUSBANDRY; SCIENTIFIC RESEARCH AND DESIGN RELATING THERETO, NAMELY, DESIGN OF APPARATUS AND INSTRUMENTS IN THE FIELD OF HUMAN AND VETERINARY MEDICINE AND ANIMAL HUSBANDRY, IN CLASS 42 (U.S. CLS. 100 AND 101).

THE MARK CONSISTS OF STANDARD CHARACTERS WITHOUT CLAIM TO ANY PARTICULAR FONT, STYLE, SIZE, OR COLOR.

PRIORITY DATE OF 5-7-2010 IS CLAIMED.

OWNER OF INTERNATIONAL REGISTRATION 1061359 DATED 10-27-2010, EXPIRES 10-27-2020.

SER. NO. 79-091,146, FILED 10-27-2010.

GINA FINK, EXAMINING ATTORNEY

United States of America
United States Patent and Trademark Office

RUYI

Reg. No. 4,152,204

Registered June 5, 2012

Int. Cl.: 28

TRADEMARK

PRINCIPAL REGISTER

ZHEJIANG RUYI GIFTS & CRAFT CO.,LTD. (CHINA CORPORATION)
D2 CHENG Dong INDUSTRIAL AREA
LONGGANG TOWN.; CANGNAN PREFECTURE; ZEJIANG PROVINCE
CHINA

FOR: ROCKING HORSES; TOYS; MACHINES FOR PHYSICAL EXERCISES; BOARD GAMES;
BODY REHABILITATION APPARATUS; BATTING GLOVES BEING ACCESSORIES FOR
GAMES; ORNAMENTS FOR CHRISTMAS TREES, EXCEPT ILLUMINATION ARTICLES
AND CONFECTIONERY; CHRISTMAS TREE STAND; FISHING TACKLE; BALLS FOR
GAMES, IN CLASS 28 (U.S. CLS. 22, 23, 38 AND 50).

THE MARK CONSISTS OF STANDARD CHARACTERS WITHOUT CLAIM TO ANY PAR-
TICULAR FONT, STYLE, SIZE, OR COLOR.

PRIORITY DATE OF 12-14-2009 IS CLAIMED.

OWNER OF INTERNATIONAL REGISTRATION 1061888 DATED 4-5-2010, EXPIRES 4-5-
2020.

THE NAME "RUYI" IN THE MARK DOES NOT IDENTIFY A LIVING INDIVIDUAL.

THE WORDING "RUYI" HAS NO MEANING IN A FOREIGN LANGUAGE.

SER. NO. 79-091,331, FILED 4-5-2010.

RONALD DELGIZZI, EXAMINING ATTORNEY



David J. Kybas

Director of the United States Patent and Trademark Office

United States of America

United States Patent and Trademark Office

CliniMACS Prodigy

Reg. No. 4,152,205

Registered June 5, 2012

Int. Cls.: 1, 2, 5, 9 and 10

TRADEMARK

PRINCIPAL REGISTER

MILTENYI BIOTEC GMBH (FED REP GERMANY GMBH)
FRIEDRICH-EBERT-STR. 68
51429 BERGISCH GLADBACH
FED REP GERMANY

FOR: CHEMICAL PREPARATIONS FOR SCIENTIFIC PURPOSES, IN CLASS 1 (U.S. CLS. 1, 5, 6, 10, 26 AND 46).

FOR: DYESTUFFS AND COLORANTS FOR PHARMACEUTICAL, MEDICAL AND SCIENTIFIC PURPOSES, IN CLASS 2 (U.S. CLS. 6, 11 AND 16).

FOR: BIOCHEMICAL, BIOLOGICAL AND CHEMICAL PREPARATIONS FOR MEDICAL PURPOSES FOR USE IN CELLULAR THERAPY; CELLS FOR MEDICAL OR CLINICAL USE, IN CLASS 5 (U.S. CLS. 6, 18, 44, 46, 51 AND 52).

FOR: LABORATORY APPARATUS, NAMELY, AN AUTOMATED SYSTEM FOR INTEGRATED CELL PROCESSING FROM VARIABLE CELL SOURCE TO FINAL PRODUCT AND PARTS AND FITTINGS THEREFOR; REAGENTS AND OTHER ACCESSORY ITEMS FOR USE IN LABORATORIES, NAMELY, CYTOKINES AND MONOCLONAL ANTIBODIES CONJUGATED TO SUPERPARAMAGNETIC IRON-DEXTRAN PARTICLES; MAGNETIC CELL SEPARATION SYSTEM COMPRISED OF INSTRUMENTS FOR LABORATORY USE, NAMELY, A PERMANENT MAGNET, VALVE AND PUMP; DISPOSABLES FOR LABORATORY USE, NAMELY, SELECTION COLUMN, TUBING AND BAGS FOR CELL SELECTION, PREPARATION, SEPARATION AND COLLECTION; REAGENTS AND OTHER ACCESSORY ITEMS, NAMELY, SUPERPARAMAGNETIC IRON-DEXTRAN PARTICLES AND SOLUTIONS FOR LABORATORY USE, IN CLASS 9 (U.S. CLS. 21, 23, 26, 36 AND 38).

FOR: MEDICAL APPARATUS AND INSTRUMENTS, NAMELY, AN AUTOMATED SYSTEM FOR INTEGRATED CELL PROCESSING FROM VARIABLE CELL SOURCE TO FINAL PRODUCT AND PARTS AND FITTINGS THEREFOR; MAGNETIC CELL SEPARATION SYSTEM COMPRISED OF INSTRUMENTS FOR MEDICAL USE, NAMELY, A PERMANENT MAGNET, VALVE AND PUMP; DISPOSABLES FOR MEDICAL USE, NAMELY, SELECTION COLUMN, TUBING AND BAGS FOR CELL SELECTION, PREPARATION, SEPARATION AND COLLECTION; REAGENTS AND OTHER ACCESSORY ITEMS, NAMELY, SUPERPARAMAGNETIC IRON-DEXTRAN PARTICLES AND SOLUTIONS FOR MEDICAL USE, IN CLASS 10 (U.S. CLS. 26, 39 AND 44).



David J. Kyjars

Director of the United States Patent and Trademark Office

Reg. No. 4,152,205 THE MARK CONSISTS OF STANDARD CHARACTERS WITHOUT CLAIM TO ANY PARTICULAR FONT, STYLE, SIZE, OR COLOR.

PRIORITY DATE OF 6-23-2010 IS CLAIMED.

OWNER OF INTERNATIONAL REGISTRATION 1062014 DATED 12-8-2010, EXPIRES 12-8-2020.

OWNER OF U.S. REG. NOS. 2,494,628 AND 2,494,629.

SER. NO. 79-091,389, FILED 12-8-2010.

KIM SAITO, EXAMINING ATTORNEY

United States of America
United States Patent and Trademark Office

splash

Reg. No. 4,152,206

Registered June 5, 2012

Int. Cls.: 11 and 44

TRADEMARK

SERVICE MARK

PRINCIPAL REGISTER

EPS HOLDING GMBH (FED REP GERMANY CORPORATION)
TALANGERSTRASSE 5
82152 KRAILING
FED REP GERMANY

FOR: PORTABLE TOILETS, PORTABLE SHOWERS OTHER THAN TECHNICAL APPARATUS FOR THE CHILLING AND/OR CARBONIZATION OF WATER, IN CLASS 11 (U.S. CLS. 13, 21, 23, 31 AND 34).

FOR: RENTAL OF SANITARY INSTALLATIONS, NAMELY, OF PORTABLE TOILETS, OF MOBILE SHOWER INSTALLATIONS, OF MOBILE SANITATION FACILITIES FOR WASHING PURPOSES, EXCEPT TECHNICAL APPARATUS FOR THE CHILLING AND/OR CARBONIZATION OF WATER, IN CLASS 44 (U.S. CLS. 100 AND 101).

THE MARK CONSISTS OF STANDARD CHARACTERS WITHOUT CLAIM TO ANY PARTICULAR FONT, STYLE, SIZE, OR COLOR.

OWNER OF INTERNATIONAL REGISTRATION 1062367 DATED 7-26-2010, EXPIRES 7-26-2020.

SER. NO. 79-091,571, FILED 7-26-2010.

NAPOLEON SHARMA, EXAMINING ATTORNEY



David J. Kyffers

Director of the United States Patent and Trademark Office

United States of America

United States Patent and Trademark Office

TRA.Q

Reg. No. 4,152,207

Registered June 5, 2012

Int. Cls.: 9, 38 and 42

TRADEMARK

SERVICE MARK

PRINCIPAL REGISTER

Q-CELLS SE (FED REP GERMANY SOCIETAS EUROPEA)
SONNENALLEE 17-21
06766 BITTERFELD-WOLFEN
FED REP GERMANY

FOR: SOLAR INSTALLATIONS AND SYSTEMS, SOLAR THERMAL INSTALLATIONS AND SYSTEMS AND PHOTOVOLTAIC INSTALLATIONS AND SYSTEMS AND PARTS THEREFOR, NAMELY, SOLAR CELLS, SOLAR MODULES FOR THE PRODUCTION OF ELECTRICITY, SOLAR INVERTERS, AND SILICON WAFERS; SOLAR CELLS AND SILICON WAFERS MARKED AND CODED WITH MACHINE-READABLE INFORMATION IN THE FORM OF LASER MARKINGS RELATING TO QUALITY ASSURANCE, FORGERY PROTECTION, AUTHENTICITY TESTING, OPTIMIZING REDRESS PROCEDURES, AND SERVICING; OPTICAL READERS AND SCANNERS FOR THE AFORESAID MARKINGS AND CODINGS, IN CLASS 9 (U.S. CLS. 21, 23, 26, 36 AND 38).

FOR: PROVIDING ACCESS TO DATABASES AND THE INTERNET, NAMELY, PROVIDING ACCESS TO ONLINE INFORMATION AND TELECOMMUNICATIONS CONNECTIONS TO A COMPUTER DATABASE, IN CLASS 38 (U.S. CLS. 100, 101 AND 104).

FOR: DATABASE DEVELOPMENT SERVICES, NAMELY, PLANNING AND DESIGN OF DATABASES OF LASER MARKINGS; ENGINEERING SERVICES FOR SOLAR CELLS AND SILICON WAFERS; PROVIDING QUALITY ASSURANCE SERVICES IN THE FIELD OF SOLAR CELLS AND SILICON WAFERS, IN CLASS 42 (U.S. CLS. 100 AND 101).

THE MARK CONSISTS OF STANDARD CHARACTERS WITHOUT CLAIM TO ANY PARTICULAR FONT, STYLE, SIZE, OR COLOR.

PRIORITY DATE OF 5-11-2010 IS CLAIMED.

OWNER OF INTERNATIONAL REGISTRATION 1062556 DATED 11-11-2010, EXPIRES 11-11-2020.

SER. NO. 79-091,645, FILED 11-11-2010.

KRISTIN DAHLING, EXAMINING ATTORNEY



David J. Kyros

Director of the United States Patent and Trademark Office

United States of America

United States Patent and Trademark Office

STAR BY JULIEN MACDONALD

Reg. No. 4,152,208

Registered June 5, 2012

Int. Cls.: 18, 24 and 25

TRADEMARK

PRINCIPAL REGISTER

JULIEN MACDONALD LIMITED (UNITED KINGDOM LIMITED COMPANY)
31 OLD BURLINGTON STREET
LONDON W1S 3AS
UNITED KINGDOM

FOR: LEATHER AND IMITATIONS OF LEATHER; GOODS MADE FROM LEATHER AND IMITATIONS OF LEATHER, NAMELY, KEY FOBS, KEY RINGS AND HANDBAG CHARMS; ANIMAL SKINS; ANIMAL HIDES; TRUNKS AND TRAVELLING BAGS; UMBRELLAS, PARASOLS AND WALKING STICKS; BAGS, NAMELY, RUCKSACKS, HOLDALLS, ATHLETIC BAGS; HANDBAGS; LEATHER SHOULDER BELTS; CASES, NAMELY, LEATHER CASES, COSMETIC MAKE UP CASES SOLD EMPTY, OVERNIGHT CASES, TRAVELLING CASES, BEAUTY CASES SOLD EMPTY, ATTACHÉ CASES AND PORTFOLIO CASES; GARMENT BAGS FOR TRAVEL; HANDBAG FRAMES; LEATHER HANDLES FOR BAGS; HAT BOXES FOR TRAVEL AND STORAGE PURPOSES NOT OF PAPER OR CARDBOARD AND HAT BOXES OF LEATHER; KEY CASES; SHOULDER BELTS, STRAPS AND THONGS MADE FROM LEATHER AND FROM IMITATIONS OF LEATHER; LEATHER LEADS AND LEASHES; WALLETTS AND PURSES; SUITCASES; LUGGAGE; VALISES; VANITY CASES SOLD EMPTY; WHIPS, IN CLASS 18 (U.S. CLS. 1, 2, 3, 22 AND 41).

FOR: HOUSEHOLD LINEN; TOWELS, FACE CLOTHS, SHOWER CURTAINS; EIDERDOWNS; DUVETS; COVERS FOR EIDERDOWN AND DUVETS PILLOW CASES, PILLOW SHAMS, BED SHEETS AND BATH SHEETS, BED SPREADS; BLANKETS, NAMELY, BABY BLANKETS, BED BLANKETS, SOFA BLANKETS AND LAP BLANKETS, QUILTS, COMFORTERS AND COMFORTER CASES; THROWS; TABLE CLOTHS NOT OF PAPER, TEXTILE NAPKINS, PLACE MATS AND COASTERS NOT OF PAPER; CURTAINS, DRAPES IN THE NATURE OF WINDOW CURTAINS AND BLACKOUT BLINDS, SLATTED BLINDS, VENETIAN BLINDS, OUTDOOR BLINDS, PLEATED BLINDS AND ROLLER BLINDS ALL MADE OF FABRIC; WINDOW SHADES; LAPRUGS; UNFITTED FURNITURE COVERINGS NOT OF PAPER; TAPESTRIES AND QUILTS IN THE NATURE OF ORNAMENTAL WALL-HANGINGS OF TEXTILE; COTTON, SILK, CHENILLE, CREPE, LINEN, LACE AND WOOLLEN FABRIC AND COTTON, SILK, CHENILLE, CREPE, LINEN, LACE AND WOOLLEN FABRIC FOR MAKING CURTAINS AND DRAPES, AND FOR USE IN UPHOLSTERY AND OTHER HOME FURNISHINGS; CLOTH LABELS; CUSHION COVERS, IN CLASS 24 (U.S. CLS. 42 AND 50).



David J. Kappas

Director of the United States Patent and Trademark Office

FOR: CLOTHING, NAMELY, GILETS, SHORTS, JEANS, BLOUSES, TOPS, NIGHTDRESSES, FUR COATS, FUR JACKETS, FUR GILETS, FUR WAISTCOATS; HEADGEAR, NAMELY,

Reg. No. 4,152,208 HATS, CAPS, HOODS, WOOLLEN HATS AND VEILS AND FOOTWEAR; BELTS; UNDERWEAR; LINGERIE; COATS; CLOTHING OF LEATHER AND OF IMITATIONS OF LEATHER, NAMELY, COATS, JACKETS, SHIRTS, TROUSERS, WAISTCOATS, SKIRTS AND CORSETS; JACKETS; TROUSERS; SKIRTS; SHIRTS; SMOCKS; DRESSES; SUITS; ARTICLES OF KNITWEAR, NAMELY, SWEATERS, CARDIGANS, SHRUGS, T-SHIRTS, TOPS, DRESSES, SKIRTS, TROUSERS, JACKETS, COATS, WAISTCOATS AND GILETS; T-SHIRTS; SWEATERS; SWEATSHIRTS; SPORTS CLOTHING, NAMELY, T-SHIRTS, VESTS, SWEATERS, HOODED TOPS, TRACKSUIT TOPS, JOGGING PANTS, SHORTS AND LEGGINGS; SPORTS HATS; SPORTS FOOTWEAR; SPORTS SHOES; GYMNASTIC CLOTHING, NAMELY, LEOTARDS, LEGGINGS, SHORTS AND TRACKSUITS; BEACH CLOTHES, NAMELY, KAFTANS AND SARONGS; BEACH SHOES; BELTS; BATHING SUITS AND BATHING TRUNKS; DRESSING GOWNS AND BATH ROBES; CLOTHES FOR BABIES, NAMELY, VESTS, INFANT BODY SUITS, TOPS, SHIRTS, TROUSERS, SHORTS, SKIRTS, DRESSES, SOCKS, TIGHTS, SWEATERS, CARDIGANS, LEGGINGS, JEANS, SWIMWEAR, PYJAMAS, NIGHTDRESSES, DRESSING GOWNS, COATS, JACKETS, JUMPSUITS, SHOES, SLIPPERS, GLOVES, SCARVES, HATS AND EARMUFFS; COSTUMES, NAMELY, DANCE COSTUMES; EAR MUFFS; BOOTS, SHOES AND SLIPPERS; STOLE; GLOVES; HEADBANDS; HOSIERY; LEGGINGS; TIES; PYJAMAS; SARIS; SCARVES AND SHAWLS; SHIRTS; STOCKINGS; SUN VISORS; SWIMSUITS; TIGHTS; TOGAS; UNIFORMS; WAISTCOATS; WATERPROOF CLOTHING, NAMELY, JACKETS, COATS, GILETS, TROUSERS, DUNGAREES AND OVERALLS; WRISTBANDS, IN CLASS 25 (U.S. CLS. 22 AND 39).

THE MARK CONSISTS OF STANDARD CHARACTERS WITHOUT CLAIM TO ANY PARTICULAR FONT, STYLE, SIZE, OR COLOR.

OWNER OF INTERNATIONAL REGISTRATION 1055641 DATED 7-3-2010, EXPIRES 7-3-2020.

THE NAME(S), PORTRAIT(S), AND/OR SIGNATURE(S) SHOWN IN THE MARK IDENTIFIES "JULIEN MACDONALD", A LIVING INDIVIDUAL, WHOSE CONSENT(S) TO REGISTER IS MADE OF RECORD.

SER. NO. 79-092,178, FILED 11-16-2010.

RAMONA ORTIGA, EXAMINING ATTORNEY

United States of America

United States Patent and Trademark Office



Reg. No. 4,152,209

Registered June 5, 2012

Int. Cl.: 11

TRADEMARK

PRINCIPAL REGISTER

JAMES BOWERS (AUSTRALIA INDIVIDUAL)
LOCKED BAG 5000
AUSTRALIA FAIR; SOUTHPORT QLD 4215
AUSTRALIA

FOR: BIDET TAPS; BIDETS; FITTINGS FOR BIDETS, NAMELY, PLUMING CLAMPS, COUPLERS, BIBBS, COCKS, TRAPS, VALVES, DRAINS, BAFFLES, AERATORS FOR FAUCETS AND FAUCET FILTERS; RECEPTACLES FOR USE AS BIDETS WHICH ARE CONNECTED TO WATER SUPPLY SYSTEMS, ALL GOODS IN THIS CLASS BEING ENVIRONMENTALLY FRIENDLY PRODUCTS, IN CLASS 11 (U.S. CLS. 13, 21, 23, 31 AND 34).

NO CLAIM IS MADE TO THE EXCLUSIVE RIGHT TO USE "ECO" AND "BIDET", APART FROM THE MARK AS SHOWN.

OWNER OF INTERNATIONAL REGISTRATION 1064273 DATED 11-12-2010, EXPIRES 11-12-2020.

THE COLOR(S) GREEN AND WHITE IS/ARE CLAIMED AS A FEATURE OF THE MARK.

THE MARK CONSISTS OF THE FOLLOWING: THE WORD "ECO" WITH THE LETTERS "EC" IN GREEN AND THE LETTER "O" APPEARING IN THE COLOR GREEN WHERE IT IS OUTSIDE THE LEAF DESIGN AND WHITE WHERE IT OVERLAPS THE LEAF DESIGN. THE LEAF IS GREEN WITH A WHITE LINE DOWN THE CENTER. THE WORD "ECO" AND LEAF ARE ABOVE THE WHITE WORDING "BIDET" WHICH IS CONTAINED WITHIN A GREEN RECTANGLE.

SER. NO. 79-092,279, FILED 11-12-2010.

REGINA DRUMMOND, EXAMINING ATTORNEY



David J. Kybas

Director of the United States Patent and Trademark Office

United States of America

United States Patent and Trademark Office



Sevilla Fútbol Club

Reg. No. 4,152,210

Registered June 5, 2012

Int. Cls.: 25, 35 and 41

SEVILLA FUTBOL CLUB SOCIEDAD DEPORTIVA, S.A.D. (SPAIN SOCIEDAD ANONIMA DEPORTIVA)

ESTADIO RAMÓN SÁNCHEZ PIZJUÁN
C/SEVILLA FÚTBOL CLUB, S/N; E-41005 SEVILLA
SPAIN

TRADEMARK

SERVICE MARK

PRINCIPAL REGISTER

FOR: CLOTHING, NAMELY, TOPS, BOTTOMS, UNDERWEAR, JACKETS, COATS, DRESSES, SUITS, JERSEYS, SOCCER JERSEYS AND SHORTS, GOAL KEEPERS' SWEATERS, SHORTS AND PANTS, TRACK SUITS, T-SHIRTS, SWEAT TOPS, POLO SHIRTS, SOCKS, GLOVES, FLEECE TOPS, TRACK SINGLETS AND TRACK SHORTS, JACKETS, SHOWER JACKETS, CLOTH TRAINING BIBS IN THE NATURE OF A GARMENT WORN OVER A TRAINING JERSEY, BELTS; FOOTWEAR, NAMELY, SHOES, TRAINING SHOES AND FOOTBALL BOOTS; HEADGEAR, NAMELY, HATS AND CAPS, IN CLASS 25 (U.S. CLS. 22 AND 39).

FOR: RETAIL STORE SERVICES PROVIDED IN SHOPS AND VIA GLOBAL COMPUTER NETWORKS FEATURING ALL TYPES OF GOODS AND, IN PARTICULAR, SPORTING GEAR, TEXTILE GOODS, READY-MADE CLOTHING, ACCESSORIES, TIMEPIECES, TROPHIES, INSIGNIA, POSTCARDS, PHOTOGRAPHS, COLOGNE AND TOILETRIES, AND SPORTING AND GYMNASTIC GOODS, IN CLASS 35 (U.S. CLS. 100, 101 AND 102).

FOR: EDUCATIONAL SERVICES, NAMELY, PROVIDING CLASSES IN THE FIELD OF SOCCER; EDUCATIONAL SERVICES, NAMELY, PROVIDING INFORMATION ABOUT ORGANIZING CULTURAL AND SPORTING ACTIVITIES THROUGH GLOBAL COMPUTER NETWORKS; TRAINING IN THE FIELD OF PLAYING SOCCER; PROVIDING SPORTS FACILITIES, NAMELY, PROVIDING FIELDS AND FACILITIES FOR SPORTS ACTIVITIES AND TRAINING; ORGANIZING AND CONDUCTING COMMUNITY SPORTING AND CULTURAL ACTIVITIES, NAMELY, SOCCER GAMES; ENTERTAINMENT SERVICES, NAMELY, ORGANIZING OF LIVE SPORTS COMPETITION AND PRESENTATION OF LIVE SPORTING EVENT SHOW PERFORMANCES; PRODUCTION OF RADIO AND TELEVISION PROGRAMS RELATED TO SPORT, NAMELY, SOCCER; PROVIDING MUSEUM FACILITIES, NAMELY, MUSEUM SERVICES; SPORTS TRAINING SERVICES; ORGANIZATION OF SPORTING EXHIBITIONS AND COMPETITIONS IN THE FIELD OF SOCCER FOR ENTERTAINMENT PURPOSES; PUBLISHING SERVICES, NAMELY, PUBLISHING OF BOOKS, REVIEWS, MAGAZINES, JOURNALS, AND ELECTRONIC PUBLICATIONS, IN CLASS 41 (U.S. CLS. 100, 101 AND 107).



David J. Kyjars

Director of the United States Patent and Trademark Office

Reg. No. 4,152,210 NO CLAIM IS MADE TO THE EXCLUSIVE RIGHT TO USE "SEVILLA FUTBOL CLUB", APART FROM THE MARK AS SHOWN.

OWNER OF INTERNATIONAL REGISTRATION 0996839 DATED 12-4-2008, EXPIRES 12-4-2018.

THE COLOR(S) WHITE, RED, BLACK, GOLD, AND ORANGE IS/ARE CLAIMED AS A FEATURE OF THE MARK.

THE MARK CONSISTS OF THE WORDS "SEVILLA FUTBOL CLUB" IN THE COLOR RED AND THE REPRESENTATION OF A COAT OF ARMS OUTLINED IN THE COLOR ORANGE, THE UPPER PART OF WHICH IS IN THE COLOR RED AND THE LOWER PART OF WHICH HAS VERTICAL STRIPES IN THE COLORS RED AND WHITE; THE LETTERS "SFC" CORRESPONDING TO THE APPLICANT'S INITIALS IN THE COLOR BLACK IN THE UPPER RIGHT PORTION OF THE COAT OF ARMS; IN THE CENTER IS A REPRESENTATION OF A SOCCER BALL IN THE COLORS RED, ORANGE AND BLACK; AND, IN THE UPPER LEFT-HAND PART IS A REPRESENTATION OF KING SAN FERNANDO AND THE ARCHBISHOPS SAN ISIDORO AND SAN LEANDRO IN THE COLORS GOLD, BLACK, RED, ORANGE AND WHITE; THE KING IS IN REGAL DRESS AND THE ARCHBISHOPS ARE IN ECCLESIASTICAL DRESS; EACH FIGURE IS HOLDING AN ORACLE. ALL ELEMENTS OF THE MARK ARE SURROUNDED BY THE OUTLINE OF A RECTANGLE IN THE COLOR BLACK.

SER. NO. 79-092,764, FILED 1-24-2011.

JAY BESCH, EXAMINING ATTORNEY

United States of America

United States Patent and Trademark Office

LOMBARD

Reg. No. 4,152,211

Registered June 5, 2012

Int. Cls.: 33 and 35

LOMBARD & MEDOT (SOCIÉTÉ ANONYME À DIRECTOIRE ET CONSEIL DE SURVEILLANCE) (FRANCE SOCIÉTÉ ANONYME À DIRECTOIRE ET CONSEIL DE SURVEILLANCE)
1 RUE DES COTELLES
F-51200 EPERNAY
FRANCE

TRADEMARK

FOR: WINES PROTECTED BY THE APPELLATION OF ORIGIN "CHAMPAGNE"; RATAFIA, IN CLASS 33 (U.S. CLS. 47 AND 49).

SERVICE MARK

FOR: WHOLESALE AND RETAIL STORE SERVICES FEATURING WINES PROTECTED BY THE APPELLATION OF ORIGIN "CHAMPAGNE" AND RATAFIA, IN CLASS 35 (U.S. CLS. 100, 101 AND 102).

PRINCIPAL REGISTER

THE MARK CONSISTS OF STANDARD CHARACTERS WITHOUT CLAIM TO ANY PARTICULAR FONT, STYLE, SIZE, OR COLOR.

PRIORITY DATE OF 12-16-2010 IS CLAIMED.

OWNER OF INTERNATIONAL REGISTRATION 1065768 DATED 1-13-2011, EXPIRES 1-13-2021.

SER. NO. 79-092,802, FILED 1-13-2011.

KAREN SEVERSON, EXAMINING ATTORNEY



David J. Kyros

Director of the United States Patent and Trademark Office

United States of America

United States Patent and Trademark Office

ERISMA

Reg. No. 4,152,212

Registered June 5, 2012

Int. Cl.: 10

TRADEMARK

PRINCIPAL REGISTER

CLARIANCE S.A.S (FRANCE SOCIÉTÉ PAR ACTIONS SIMPLIFIÉE (SAS))
RUE JAMES WATT, Z.A
F-62000 DAINVILLE, FRANCE

FOR: SURGICAL AND MEDICAL APPARATUS AND INSTRUMENTS FOR USE IN GENERAL SURGERY; ORTHOPEDIC ARTICLES, NAMELY, IMPLANTS MADE OF ARTIFICIAL MATERIALS; ARTIFICIAL IMPLANTS, PROSTHESES, FIXING DEVICES FOR SPINAL COLUMNS, NAMELY, SPINAL IMPLANTS MADE FROM ARTIFICIAL SUBSTANCES; INTERVERTEBRAL FRAMES; CERVICAL FRAMES; FACET PROSTHESES FOR VERTEBRAE; INTERVERTEBRAL DISK PROSTHESES; PROSTHESES FOR THE VERTEBRAL COLUMN; POSTERIOR FIXING DEVICES FOR THE VERTEBRAL COLUMN, NAMELY, MONOAXIAL SCREWS, POLYAXIAL SCREWS, REDUCTION MONOAXIAL SCREWS, REDUCTION POLYAXIAL SCREWS, MONOAXIAL CANULATED SCREWS, POLYAXIAL CANULATED SCREWS, SACRAL SCREWS, SACRAL CONNECTORS, OFFSET CONNECTORS, RODS, STRAIGHT RODS, PRE-BENT RODS, CROSSLINKS, ARTICULATED CROSSLINKS, SET SCREWS; DYNAMIC FIXING DEVICES FOR THE VERTEBRAL COLUMN, NAMELY, MONOAXIAL SCREWS, POLYAXIAL SCREWS, MONOAXIAL CANULATED SCREWS, POLYAXIAL CANULATED SCREWS, RODS, DYNAMIC RODS; DEVICES FOR FIXING AND EXTENDING FOR CORRECTING SCOLIOSIS, NAMELY, MONOAXIAL SCREWS, POLYAXIAL SCREWS, REDUCTION MONOAXIAL SCREWS, REDUCTION POLYAXIAL SCREWS, MONOAXIAL CANULATED SCREWS, POLYAXIAL CANULATED SCREWS, SACRAL SCREWS, SACRAL CONNECTORS, ILIO-SACRAL CONNECTORS, HOOKS, LAMINAR HOOKS, PEDICULAR HOOKS, TRANSVERSE HOOKS, OFFSET HOOKS, RODS, STRAIGHT RODS, PRE-BENT RODS, CROSSLINKS, ARTICULATED CROSSLINKS, SET SCREWS, IN CLASS 10 (U.S. CLS. 26, 39 AND 44).



THE MARK CONSISTS OF STANDARD CHARACTERS WITHOUT CLAIM TO ANY PARTICULAR FONT, STYLE, SIZE, OR COLOR.

PRIORITY DATE OF 7-9-2010 IS CLAIMED.

OWNER OF INTERNATIONAL REGISTRATION 1066441 DATED 1-4-2011, EXPIRES 1-4-2021.

SER. NO. 79-093,033, FILED 1-4-2011.

STEPHANIE ALI, EXAMINING ATTORNEY

David J. Kyros

Director of the United States Patent and Trademark Office

United States of America

United States Patent and Trademark Office

BERTHOUD

Reg. No. 4,152,213

Registered June 5, 2012

Int. Cl.: 8

TRADEMARK

PRINCIPAL REGISTER

EXEL INDUSTRIES (FRANCE SOCIÉTÉ ANONYME)
54 RUE MARCEL PAUL
F-51200 EPERNAY
FRANCE

FOR: HAND-OPERATED TOOLS AND INSTRUMENTS, NAMELY, HAND OPERATED ATOMIZERS, VAPORIZERS, AND SPRAYERS FOR USE WITH INDUSTRIAL LIQUIDS; HAND-HELD AND HAND-OPERATED AGRICULTURAL INSTRUMENTS, NAMELY, BROAD-FORKS; HAND-HELD AND HAND-OPERATED GARDENING TOOLS, NAMELY, CULTIVATORS; HAND-OPERATED INSECTICIDE SPRAYERS; HAND-PUMPED SPRAYERS FOR USE WITH INDUSTRIAL LIQUIDS; SPRAY GUNS FOR PAINT; HAND-OPERATED HAND TOOLS AND INSTRUMENTS, NAMELY, PAINT SCRAPERS FOR TREATING SURFACES BEFORE PAINTING; MANUALLY-OPERATED GRINDING WHEELS AND SANDERS; HAND-HELD SPRAY GUNS IN THE NATURE OF HAND-PUMPED SPRAYERS FOR USE WITH INDUSTRIAL LIQUIDS FOR ELECTROSTATIC PAINTING; HAND-HELD SPRAY GUNS IN THE NATURE OF HAND-PUMPED SPRAYERS FOR USE WITH INDUSTRIAL LIQUIDS FOR ELECTROSTATIC ENAMELING; HAND-HELD SPRAY GUNS IN THE NATURE OF HAND-PUMPED SPRAYERS FOR USE WITH INDUSTRIAL LIQUIDS FOR ELECTROSTATIC DUSTING, IN CLASS 8 (U.S. CLS. 23, 28 AND 44).

THE MARK CONSISTS OF STANDARD CHARACTERS WITHOUT CLAIM TO ANY PARTICULAR FONT, STYLE, SIZE, OR COLOR.

OWNER OF INTERNATIONAL REGISTRATION 0964068 DATED 10-11-2007, EXPIRES 10-11-2017.

OWNER OF U.S. REG. NO. 1,432,714.

SER. NO. 79-093,115, FILED 12-3-2010.

TASNEEM HUSSAIN, EXAMINING ATTORNEY



David J. Kyros

Director of the United States Patent and Trademark Office

United States of America

United States Patent and Trademark Office



Reg. No. 4,152,214

Registered June 5, 2012

**Int. Cls.: 9, 18, 28, 29, 30,
31, 35 and 43**

TRADEMARK

SERVICE MARK

PRINCIPAL REGISTER

YAGI AKIRA (JAPAN INDIVIDUAL)
4-14-14-2206, AKASAKA,
MINATOKUTOKYO
JAPAN

FOR: STRAP FOR PORTABLE TELEPHONES; TELECOMMUNICATION DEVICES AND APPARATUS, NAMELY, TELEPHONE APPARATUS, NAMELY, INTERCOMS, MOBILE PHONES, AUTOMATIC SWITCHING APPARATUS FOR TELECOMMUNICATION, TELEPHONE SETS; TELECOMMUNICATION DEVICES AND APPARATUS, NAMELY, WIRE COMMUNICATION MACHINES AND APPARATUS, NAMELY, TELETYPEWRITERS, AUTOMATIC TELEGRAPH APPARATUS, PHOTOTELEGRAPHY APPARATUS, MANUAL TELEGRAPH APPARATUS; FACSIMILE MACHINES; TELECOMMUNICATION DEVICES AND APPARATUS, NAMELY, TRANSMISSION MACHINES AND APPARATUS FOR TELECOMMUNICATION, NAMELY, AUDIO FREQUENCY TRANSMISSION MACHINES AND APPARATUS, CABLE TRANSMISSION MACHINES AND APPARATUS, POWER-LINE TRANSMISSION MACHINES AND APPARATUS, OPEN-WIRE TRANSMISSION MACHINES AND APPARATUS; TELECOMMUNICATION DEVICES AND APPARATUS, NAMELY, BROADCASTING MACHINES AND APPARATUS, NAMELY, TELEVISION RECEIVERS BEING TV SETS, TELEVISION TRANSMITTERS, RADIO RECEIVERS, RADIO TRANSMITTERS; TELECOMMUNICATION DEVICES AND APPARATUS, NAMELY, RADIO COMMUNICATION MACHINES AND APPARATUS, NAMELY, PORTABLE RADIO COMMUNICATION MACHINES AND APPARATUS, AERONAUTICAL RADIO COMMUNICATION MACHINES AND APPARATUS, MULTICHANNEL RADIO COMMUNICATION MACHINES AND APPARATUS FOR FIXED STATIONS, SINGLE-CHANNEL RADIO COMMUNICATION MACHINES AND APPARATUS FOR FIXED STATIONS, VEHICULAR RADIO COMMUNICATION MACHINES AND APPARATUS, MARINE RADIO COMMUNICATION MACHINES AND APPARATUS; TELECOMMUNICATION DEVICES AND APPARATUS, NAMELY, RADIO APPLICATION MACHINES AND APPARATUS, NAMELY, NAVIGATION APPARATUS FOR VEHICLES BEING ON-BOARD COMPUTERS, RADIO BEACON MACHINES AND APPARATUS, RADIO DIRECTION FINDERS, RADAR MACHINES AND APPARATUS, LORAN NAVIGATION MACHINES AND APPARATUS; TELECOMMUNICATION DEVICES AND APPARATUS, NAMELY, REMOTE CONTROL TELEMETERING MACHINES AND INSTRUMENTS; TELECOMMUNICATION DEVICES AND APPARATUS, NAMELY, AUDIO FREQUENCY MACHINES AND APPARATUS, NAMELY, PUBLIC-ADDRESS SYSTEMS AND INSTRUMENTS, COMPACT DISC PLAYERS, JUKE BOXES, TAPE RECORDERS, ELECTRIC PHONOGRAPHS, RECORD PLAYERS, SOUND RECORDING MACHINES AND APPARATUS BEING AUDIO-



David J. Kypas

Director of the United States Patent and Trademark Office

Reg. No. 4,152,214 FREQUENCY APPARATUS; TELECOMMUNICATION DEVICES AND APPARATUS, NAMELY, VIDEO FREQUENCY MACHINES AND APPARATUS, NAMELY, DIGITAL CAMERAS, VIDEO CAMERAS BEING CAMCORDERS, VIDEODISC PLAYERS, VIDEOTAPE RECORDERS, DVD PLAYERS, DVD RECORDERS; TELECOMMUNICATION DEVICES AND APPARATUS, NAMELY, PARTS AND ACCESSORIES FOR TELECOMMUNICATION MACHINES AND APPARATUS, NAMELY, ANTENNAS BEING AERIALS, CABINETS, COILS, MAGNETIC TAPE ERASERS, MAGNETIC TAPE CLEANERS, MAGNETIC HEAD ERASERS, MAGNETIC HEAD CLEANERS BEING APPARATUS, LOUDSPEAKERS, CONNECTORS, STANDS AND RACKS, DIALS, ELECTRIC CAPACITORS, FUSES, ELECTRIC RESISTORS, BLANK MAGNETIC TAPES FOR TAPE RECORDERS, CHANGE-OVER SWITCHES, PLUGBOARDS, PICKUPS, BLANK VIDEO TAPES, INDICATOR LIGHTS, ELECTRICAL PHONOMOTORS, HEADPHONES, ELECTRICAL TRANSFORMERS, PROTECTORS, MICROPHONES, CLEANING APPARATUS FOR PHONOGRAPH RECORDS, BLANK RECORD DISKS, SPRAYS FOR PHONOGRAPH RECORDS; ELECTRONIC MACHINES, APPARATUS AND THEIR STRUCTURAL PARTS, NAMELY, ELECTRONIC MACHINES AND APPARATUS, NAMELY, GEIGER COUNTERS, HIGH FREQUENCY WELDERS, CYCLOTRONS NOT FOR MEDICAL PURPOSES, INDUSTRIAL X-RAY MACHINES AND APPARATUS NOT FOR MEDICAL USE, INDUSTRIAL BETATRONS NOT FOR MEDICAL USE, MAGNETIC OBJECT DETECTORS, SHIELD CASES FOR MAGNETIC DISKS, SEISMIC EXPLORATION MACHINES AND APPARATUS, HYDROPHONE MACHINES AND APPARATUS, ECHO SOUNDERS, ULTRASONIC FLAW DETECTORS, ULTRASONIC SENSORS, ELECTROSTATIC COPYING MACHINES, ELECTRONIC DOOR CLOSING SYSTEMS, COMPUTERS, COMPUTER HARDWARE, COMPUTER PERIPHERALS, ELECTRON MICROSCOPES, ELECTRONIC DESK CALCULATORS, HARD DISK DRIVES, WORD PROCESSORS; ELECTRONIC MACHINES, APPARATUS AND THEIR STRUCTURAL PARTS, NAMELY, ELECTRON TUBES, NAMELY, X-RAYS TUBES NOT FOR MEDICAL USE, VACUUM TUBES, RECTIFIER TUBES, CATHODE RAY TUBES; ELECTRONIC MACHINES, APPARATUS AND THEIR STRUCTURAL PARTS, NAMELY, SEMI-CONDUCTOR ELEMENTS, NAMELY, THERMISTORS, DIODES, TRANSISTORS; ELECTRONIC MACHINES, APPARATUS AND THEIR STRUCTURAL PARTS, NAMELY, ELECTRONIC CIRCUITS NOT INCLUDING THOSE RECORDED WITH COMPUTER PROGRAMS, NAMELY, INTEGRATED CIRCUITS, LARGE SCALE INTEGRATED CIRCUITS; COMPUTER PROGRAMS, NAMELY, COMPUTER OPERATING PROGRAMS, COMPUTER WORD PROCESSING PROGRAMS, COMPUTER PROGRAMS FOR USE AS A SPREADSHEET, COMPUTER PROGRAMS FOR EDITING IMAGES, SOUND AND VIDEO, COMPUTER PROGRAMS FOR USING THE INTERNET AND THE WORLD WIDE WEB, COMPUTER PROGRAMS FOR SEARCHING REMOTELY FOR CONTENT ON COMPUTERS AND COMPUTER NETWORKS; COMPUTER GAME PROGRAMS; PORTABLE TELEPHONES GAME PROGRAMS; EYEGLASSES; AMUSEMENT APPARATUS ADAPTED FOR USE WITH AN EXTERNAL DISPLAY SCREEN OR MONITOR; ELECTRONIC CIRCUITS AND CD-ROMS RECORDED WITH PROGRAMS FOR HAND-HELD GAMES WITH LIQUID CRYSTAL DISPLAYS; PHONOGRAPH RECORDS FEATURING MUSIC; METRONOMES; ELECTRONIC CIRCUITS AND CD-ROMS RECORDED WITH AUTOMATIC PERFORMANCE PROGRAMS FOR ELECTRONIC MUSICAL INSTRUMENTS; DOWNLOADABLE MUSIC FILES VIA THE INTERNET AND WIRELESS DEVICES; EXPOSED CINEMATOGRAPHIC FILMS; EXPOSED SLIDE FILMS; SLIDE FILM MOUNTS; DOWNLOADABLE IMAGE FILES, NAMELY, IMAGE FILES FEATURING IMAGES OF ANIMALS, IMAGE FILES FEATURING PHOTOGRAPHS OF SPORTING EVENTS, IMAGE FILES FEATURING CLOTHING AND FASHION; RECORDED VIDEO DISCS AND VIDEO TAPES, NAMELY, VIDEO DISCS AND VIDEO TAPES FEATURING MUSIC, VIDEO DISCS AND VIDEO TAPES FEATURING COMEDY AND DRAMATIC TELEVISION SHOWS, VIDEO DISCS AND VIDEO TAPES FEATURING LECTURES ON APPLIED PHYSICS, VIDEO DISCS AND VIDEO TAPES FEATURING CLOTHING AND FASHION; ELECTRONIC PUBLICATIONS, NAMELY, NEWSLETTERS, MAGAZINES, BOOKS DOWNLOADED FROM THE INTERNET OR RECORDED ON COMPUTER MEDIA ON THE SUBJECT OF MUSIC AND ENTERTAINMENT, MEDICAL AND HEALTH TOPICS, TAX ACCOUNTING, CLOTHING AND FASHION, IN CLASS 9 (U.S. CLS. 21, 23, 26, 36 AND 38).

Reg. No. 4,152,214 FOR: INDUSTRIAL PACKAGING CONTAINERS OF LEATHER; CLOTHING FOR DOMESTIC PETS; BAGS AND THE LIKE, NAMELY, FOLDING BRIEFCASES, SHOULDER BAGS, GLADSTONE BAGS, JAPANESE WICKER TRUNKS (KORI), BRIEFCASES, SUITCASES, CARRY-ON BAGS, TRUNKS, BOSTON BAGS, SCHOOLCHILDREN'S BACKPACKS, BACKPACKS; POUCHES AND THE LIKE, NAMELY, CHARM BAGS (OMAMORI-IRE), SHOPPING BAGS, NAMELY, LEATHER SHOPPING BAGS, MESH SHOPPING BAGS, TEXTILE SHOPPING BAGS, AND WHEELED SHOPPING BAGS; KEY CASES, WALLETS, JAPANESE UTILITY POUCHES (SHINGEN-BUKURO), BUSINESS CARD CASES; VANITY CASES SOLD EMPTY; UMBRELLAS AND THEIR PARTS; WALKING STICKS; CANES; METAL PARTS OF CANES AND WALKING-STICKS; WALKING STICK HANDLES; UN-WORKED OR SEMI-WORKED LEATHER AND FUR PELTS; HANDBAGS; TRAVELLING BAGS; CARD CASES IN THE NATURE OF NOTECASES; PURSES, IN CLASS 18 (U.S. CLS. 1, 2, 3, 22 AND 41).

FOR: AMUSEMENT MACHINES AND APPARATUS FOR USE IN AMUSEMENT PARKS OTHER THAN ARCADE VIDEO GAME MACHINES, NAMELY, AMUSEMENT PARK RIDES, ARCADE CRANE GAME MACHINES, ARCADE GAME MACHINES, ARCADE GAME MACHINES ACTIVATED BY MEDALS OR TOKENS, ARCADE RACING GAME MACHINES, ARCADE REDEMPTION GAME MACHINES WHICH DISPENSE TICKETS OR THE LIKE TO SUCCESSFUL PLAYERS, ARCADE VIRTUAL SHOOTING GAME MACHINES, AUTOMATIC AND COIN-OPERATED AMUSEMENT MACHINES, BOWLING APPARATUS AND MACHINERY, ROLLER COASTERS, FERRIS WHEELS; TOYS FOR DOMESTIC PETS; TOYS, NAMELY, METAL TOYS, NAMELY, TOY CLOCKS AND WATCHES, CLOCKWORK TOYS OF METAL, TOY BROOCHES, TOY WHISTLES, LEVER ACTION TOYS; TOYS, NAMELY, PAPER TOYS, NAMELY, PAPER BALLOONS BEING PLAY ARTICLES, KARUTA PLAYING CARDS (JAPANESE CARD GAME), SETS OF SHEET-PAPER DOLLS AND CHANGING CLOTHES THEREFOR; TOYS, NAMELY, RUBBER TOYS, NAMELY, HOLLOW RUBBER TOYS FORMED BY MOLDING PROCESS, NAMELY, RUBBER BALLS, INFLATABLE THIN RUBBER TOYS; TOYS, NAMELY, MUSICAL TOYS, NAMELY, MUSICAL BOXES BEING PLAY ARTICLES, TOY GLOCKENSPIELS, TOY HARMONICAS, TOY PIANOS, TOY XYLOPHONES; TOYS, NAMELY, TOY SETS, NAMELY, TOY CONSTRUCTION SETS, TOY SETS OF CARPENTERS' TOOLS, HOUSEKEEPING-PLAY SETS; TOY TOOLS, NAMELY, GOOD-LUCK CHARM BAMBOO RAKES FOR DECORATION (ENGI-KUMADE); TOYS, NAMELY, TOY BEANBAGS (OTEDAMA), MARBLES, TOY PISTOLS, TOY MASKS, TOY FIREWORKS, CORN STEM TOYS (KIBIGARA), TOY CHRISTMAS TREES, HAND-HELD GAMES WITH LIQUID CRYSTAL DISPLAYS, TOY KOI-NOBORI STREAMERS, TOY SCOOTERS, JIGSAW PUZZLES, FOUR-WHEELED GO-CARTS, BUBBLE MAKING WANDS AND SOAP SOLUTION SETS BEING TOYS, KITES, CLAY BEING PLAY ARTICLES, HAGOITA BATTLEDORES, SHUTTLECOCKS FOR HAGOITA GAME, GLASS BEADS BEING PLAY ARTICLES, BODHIDHARMA DOLLS WITH PUPILS UNDRAWN (MENASHI-DARUMA), ROCKING HORSES, TRICYCLES FOR INFANTS, INFLATABLE SWIMMING POOLS BEING PLAY ARTICLES, RING GAMES; STUFFED TOYS; DOLLS; GO GAMES; JAPANESE PLAYING CARDS (UTAGARUTA); JAPANESE CHESS (SHOGI GAMES); DICE; JAPANESE DICE GAMES (SUGOROKU); DICE CUPS; DIAMOND GO GAMES; CHESS GAMES; CHECKERS IN THE NATURE OF CHECKER SETS; CONJURING APPARATUS, NAMELY, MAGIC TRICKS; DOMINOES; PLAYING CARDS; JAPANESE PLAYING CARDS (HANAFUDA); MAH-JONG; AMUSEMENT GAME MACHINES; BILLIARD EQUIPMENT; SPORTS EQUIPMENT, NAMELY, BASEBALL AND SOFTBALL IMPLEMENTS, NAMELY, BASEBALL GLOVES, BASEBALLS, SOFTBALLS, RUBBER BASEBALLS, BATTING GLOVES, BACKSTOPS BEING BASEBALL NETS, BASEBALL BATS, BASEBALL BAT CASES, BASEBALL BASES, CATCHERS' MASKS, BASEBALL MITTS, CHEST PROTECTORS FOR BASEBALL; SPORTS EQUIPMENT, NAMELY, BALL GAME IMPLEMENTS, NAMELY, SHOULDER PADS FOR BALL GAMES, SHIN PADS AND GUARDS FOR BALL GAMES, TUBES FOR BALL GAMES, NETS FOR BALL GAMES, KNEE PADS GUARDS BEING SPORTS ARTICLES, BALLS FOR BALL GAMES; SPORTS EQUIPMENT, NAMELY, TRACK AND FIELD EVENTS IMPLEMENTS, NAMELY, DISCUSSES FOR FIELD SPORTS, THROWING CIRCLES, STARTING BLOCKS FOR TRACK SPORTS, CROSSBARS FOR FIELD SPORTS, HURDLES FOR TRACK SPORTS, RELAY BATONS, HAMMERS FOR FIELD

Reg. No. 4,152,214 SPORTS, TARGETS FOR FIELD SPORTS, VAULTING POLES, JAVELINS FOR FIELD SPORTS; SPORTS EQUIPMENT, NAMELY, TENNIS AND BADMINTON IMPLEMENTS, NAMELY, TENNIS BALLS, BADMINTON SHUTTLECOCKS, SOFT TENNIS BALLS, NETS FOR TENNIS OR BADMINTON, RACKETS FOR TENNIS OR BADMINTON, GUTS FOR RACKETS FOR TENNIS OR BADMINTON, RACKET CASES FOR TENNIS OR BADMINTON; SPORTS EQUIPMENT, NAMELY, TABLE TENNIS IMPLEMENTS, NAMELY, TABLE TENNIS TABLES, NETS FOR TABLE TENNIS, TABLE TENNIS BALLS, TABLE TENNIS PADDLES, TABLE TENNIS PADDLE CASES; SPORTS EQUIPMENT, NAMELY, HOCKEY IMPLEMENTS, NAMELY, HOCKEY STICKS, SHIN PADS FOR HOCKEY, GLOVES FOR HOCKEY, HOCKEY PUCKS, HOCKEY BALLS, CHEST PROTECTORS FOR HOCKEY; SPORTS EQUIPMENT, NAMELY, GOLF IMPLEMENTS, NAMELY, GOLF BAGS, GOLF CLUBS, GOLF BALL MARKERS, GOLF TEES, GLOVES FOR GOLF, GOLF BALLS, PUTTING PRACTICE MATS; SPORTS EQUIPMENT, NAMELY, BOWLING IMPLEMENTS, NAMELY, BOWLING GLOVES, BOWLING BAGS, BOWLING BALLS; SPORTS EQUIPMENT, NAMELY, SKIING IMPLEMENTS, NAMELY, SEAL SKINS FOR COVERING SKIS, SKIS, SKI EDGES, SKI CASES, SKI BINDINGS, SCRAPER FOR SKIS, SKI POLES; SPORTS EQUIPMENT, NAMELY, SKATING IMPLEMENTS, NAMELY, ICE SKATE BLADES, ICE SKATES, ROLLER SKATES; SPORTS EQUIPMENT, NAMELY, BOXING IMPLEMENTS, NAMELY, BOXING GLOVES, SAND BAGS FOR BOXING PRACTICE, PUNCHING BALLS FOR BOXING PRACTICE, FIST BANDAGES FOR BOXING, MOUTHPIECES FOR BOXING; SPORTS EQUIPMENT, NAMELY, ARCHERY IMPLEMENTS OF JAPANESE AND WESTERN STYLES, NAMELY, BOWSTRINGS, GAUNTLETS BEING GLOVES FOR ARCHERY, ARCHERY TARGETS, ARROWS FOR ARCHERY, ARCHERY QUIVERS, BOWS FOR JAPANESE ARCHERY (YUMI BOWS), ARCHERY BOWS; SPORTS EQUIPMENT, NAMELY, FENCING IMPLEMENTS, NAMELY, SABRES BEING FENCING WEAPONS, EPEE BEING FENCING WEAPONS, GAUNTLETS FOR FENCING, FOILS BEING FENCING WEAPONS, FENCING MASKS; SPORTS EQUIPMENT, NAMELY, KENDO IMPLEMENTS, NAMELY, KOTE GAUNTLETS, KENDO BAMBOO SWORDS, KENDO PLASTRONS, KENDO WOODEN SWORDS, KENDO MASKS; SPORTS EQUIPMENT, NAMELY, APPLIANCES FOR GYMNASSTICS, NAMELY, POMMEL HORSES FOR GYMNASSTIC, SPRINGBOARDS FOR GYMNASSTIC, RINGS FOR GYMNASSTIC, HORIZONTAL BARS FOR GYMNASSTIC, BOXES FOR GYMNASSTIC, SPRING BOARDS BEING SPORTING ARTICLES, BALANCE BEAMS FOR GYMNASSTIC, PARALLEL BARS FOR GYMNASSTIC; SPORTS EQUIPMENT, NAMELY, APPLIANCES FOR RHYTHMIC SPORTIVE GYMNASSTICS WITH APPARATUS, NAMELY, RIBBONS SPECIALLY ADAPTED FOR RHYTHMIC SPORTIVE GYMNASSTICS, CLUBS FOR RHYTHMIC SPORTIVE GYMNASSTICS, ROPES FOR RHYTHMIC SPORTIVE GYMNASSTICS, BALLS FOR RHYTHMIC SPORTIVE GYMNASSTICS, HOOPS FOR RHYTHMIC SPORTIVE GYMNASSTICS; SPORTS EQUIPMENT, NAMELY, WEIGHT LIFTING IMPLEMENTS, NAMELY, DUMB-BELLS FOR WEIGHT LIFTING, WEIGHT LIFTING BELTS BEING SPORTS ARTICLES, DUMB-BELL SHAFTS FOR WEIGHT LIFTING, BAR-BELLS FOR WEIGHT LIFTING; SPORTS EQUIPMENT, NAMELY, SWIM FINS, SNORKELS, SPEAR GUNS; SPORTS EQUIPMENT, NAMELY, SAILBOARDS FOR BOARDSAILING, STATIONARY EXERCISE BICYCLES AND ROLLERS THEREFOR, CHEST EXPANDERS, CURLING IMPLEMENTS, PREFABRICATED SWIMMING POOLS BEING PLAY ARTICLES, GATEBALL IMPLEMENTS, NAMELY, RACKETS, PADDLES, BALLS, AND GLOVES; SURF BOARDS, BAGS ESPECIALLY DESIGNED FOR SURFBOARDS, ATHLETIC WRIST AND JOINT SUPPORTS, ELBOW GUARDS FOR ATHLETIC USE, KNEE PADS FOR ATHLETIC USE, SEE-SAWS, WATER SKIS, SQUASH IMPLEMENTS, NAMELY, RACKETS AND BALLS; SKATEBOARDS, STARTING PISTOLS, SNOWBOARDS, SLIDES, SKIPPING ROPES, TWIRLING BATONS, PARAGLIDERS, HANG GLIDERS, SWINGS, SPORTS WHISTLES, BOB-SLEIGHS, ROCKING HORSES BEING SPORTS EQUIPMENT, LINE MARKERS FOR SPORTS FIELDS, LACROSSE IMPLEMENTS, NAMELY, STICKS, BALLS, PADS, AND NETS; ROSIN USED BY ATHLETES; FISHING TACKLE, IN CLASS 28 (U.S. CLS. 22, 23, 38 AND 50).

FOR: MILK PRODUCTS EXCLUDING ICE CREAM, ICE MILK AND FROZEN YOGURT; MEAT; EGGS; FRESH, CHILLED OR FROZEN EDIBLE AQUATIC ANIMALS, NOT LIVE; PROCESSED VEGETABLES AND FRUITS; FRIED TOFU PIECES (ABURA-AGE); FREEZE-

Reg. No. 4,152,214 DRIED TOFU PIECES (KOHRI-DOFU); JELLY MADE FROM DEVILS' TONGUE ROOT (KONNYAKU); SOYA MILK; TOFU; FERMENTED SOYBEANS (NATTO); RAW PULSES, IN CLASS 29 (U.S. CL. 46).

FOR: TEA; CONFECTIONERY, NAMELY, JAPANESE TRADITIONAL CONFECTIONERY, NAMELY, CHESTNUTS ROASTED WITH SYRUP (AMA-GURI), SUGARED BEANS (AMANNATTO), STARCH-BASED CANDIES (AME), PELLET-SHAPED RICE CRACKERS (ARARE), RICE DUMPLINGS DRESSED WITH SWEET BEAN JAM (ANKORO), ROASTED CHESTNUTS (IRI-GURI), ROASTED BEANS (IRI-MAME), CAKES OF SUGAR-BOUNDED MILLET OR POPPED RICE (OKOSHI), FRIED DOUGH COOKIES (KARINTOH), SOFT PIN-ROLLED CAKES OF POUNDED RICE (GYUHI), CRYSTAL SUGAR PIECES BEING CONFECTIONERY, CANDIED FRUITS OR VEGETABLES (SATOH-ZUKE), SWEET SOUP OF ADZUKI-BEAN FLOUR (SHIRUKO), INSTANT SHIRUKO, SWEET SOUP OF ADZUKI-BEANS WITH RICE CAKE (ZENZAI), INSTANT ZENZAI, RICE CRACKERS (SENBEI), SWEET DUMPLINGS (DANGO), SWEET BEAN JAM COATED WITH SUGARED-BEAN BASED SOFT SHELL (NERIKIRI), GLUTINOUS STARCH SYRUP (MIZU-AME), BOILED BEANS AND AGAR GEL CUBES IN SUGAR SYRUP (MITSUMAME), JAPANESE STYLE STEAMED CAKES (MUSHI-GASHI), SWEET POUNDED RICE CAKES (MOCHI-GASHI), BEAN-JAM FILLED WAFERS (MONAKA), PASTRY SHELLS FOR MONAKA, SWEETENED BOILED ADZUKI-BEANS (YUDE-ADZUKI), BARS OF SWEET JELLIED BEAN PASTE (YOHKAN), DRIED SUGARED CAKES OF RICE FLOUR (RAKUGAN); CONFECTIONERY, NAMELY, WESTERN-STYLE CONFECTIONERY, NAMELY, ICE CANDIES, ICE CREAM, WAFERS, CASTILIA SPONGE CAKES, HARDTACKS, CARAMELS, CANDY, COOKIES, CRACKERS, CONES FOR ICE CREAM, SHERBETS (SORBETS), CREAM PUFFS, SPONGE CAKES, TOFFEES, CHEWING GUMS, CHOCOLATES, DOUGHNUTS, GUM DROPS, CANDY DROPS, NOUGAT, PIES, BISCUITS, FRUIT JELLIES BEING CONFECTIONERY, FROZEN YOGURT, BALLS OF SWEETS, PANCAKES, POPCORN, MARSHMALLOWS, BAKED APPLES, RUSKS, WAFFLES; BREAD AND BUNS; SEASONINGS OTHER THAN SPICES; SPICES; CHINESE STUFFED DUMPLINGS (GYOZA, COOKED); SANDWICHES; CHINESE STEAMED DUMPLINGS (SHUMAI, COOKED); SUSHI; FRIED BALLS OF BATTER MIX WITH SMALL PIECES OF OCTOPUS (TAKOYAKI); STEAMED BUNS STUFFED WITH MINCED MEAT (NIKU-MANJU); HAMBURGERS; PIZZAS; BOXED LUNCHESES CONSISTING OF RICE, WITH ADDED MEAT, FISH AND VEGETABLES; HOT DOGS; MEAT PIES; RAVIOLI; HUSKED RICE; HUSKED OATS; HUSKED BARLEY; FLOUR FOR FOOD, IN CLASS 30 (U.S. CL. 46).

FOR: LIVE EDIBLE AQUATIC ANIMALS; FRESH OR UNPROCESSED EDIBLE SEaweEDS; FRESH VEGETABLES; SUGAR CROPS, NAMELY, SUGAR CANE, SUGAR BEET; FRESH FRUITS; UNPROCESSED GRAINS, NAMELY, FOXTAIL MILLET, PROSO MILLET, SESAME, BUCKWHEAT, CORN, JAPANESE BARNYARD MILLET, WHEAT, BARLEY, OATS, RICE, AND SORGHUM; LIVE TREES; LIVE GRASSES; NATURAL TURF; DRIED FLOWERS; SEEDLINGS; SAPLINGS; NATURAL FLOWERS; LIVE PASTURE GRASS; POTTED DWARFED TREES (BONSAI), IN CLASS 31 (U.S. CLS. 1 AND 46).

FOR: RETAIL AND WHOLESALE STORE SERVICES FEATURING CLOTHING, FOOTWEAR, PERSONAL ARTICLES, NAMELY, BAGS, LUGGAGE, WALLETS AND POUCHES AND JEWELRY, FOODS AND BEVERAGES, PRINTED MATERIALS, PAPER, STATIONERY, CLOCKS, WATCHES AND EYEGLASSES AND UNWROUGHT AND SEMI-WROUGHT PRECIOUS STONES AND THEIR IMITATIONS; ONLINE RETAIL AND WHOLESALE STORE SERVICES FEATURING CLOTHING, FOOTWEAR, PERSONAL ARTICLES, NAMELY, BAGS, LUGGAGE, WALLETS AND POUCHES AND JEWELRY, FOODS AND BEVERAGES, PRINTED MATERIALS, PAPER, STATIONERY, CLOCKS, WATCHES AND EYEGLASSES AND UNWROUGHT AND SEMI-WROUGHT PRECIOUS STONES AND THEIR IMITATIONS; MAIL ORDER CATALOG SERVICES, FEATURING CLOTHING, FOOTWEAR, PERSONAL ARTICLES, NAMELY, BAGS, LUGGAGE, WALLETS AND POUCHES AND JEWELRY, FOODS AND BEVERAGES, PRINTED MATERIALS, PAPER, STATIONERY, CLOCKS, WATCHES AND EYEGLASSES AND UNWROUGHT AND SEMI-WROUGHT PRECIOUS STONES AND THEIR IMITATIONS, IN CLASS 35 (U.S. CLS. 100, 101 AND 102).

Reg. No. 4,152,214 FOR: PROVIDING TEMPORARY ACCOMMODATION; ACCOMMODATION BUREAUX SERVICES, NAMELY, MAKING RESERVATIONS FOR HOTELS, BOARDING HOUSES AND PLACES PROVIDING TEMPORARY ACCOMMODATIONS; PROVIDING FOODS AND BEVERAGES IN A RESTAURANT OR BAR; BOARDING FOR ANIMALS; PRESCHOOLER AND INFANT CARE AT DAYCARE CENTERS; RETIREMENT HOME; PROVIDING CONFERENCE ROOMS; PROVIDING FACILITIES FOR EXHIBITIONS, IN CLASS 43 (U.S. CLS. 100 AND 101).

THE MARK CONSISTS OF THE WORD "PINZA" IN STYLIZED FORM INSIDE A RECTANGULAR SHAPED BLOCK WITH A CLEAT OR BRACKET LOOKING DEVICE SITUATED ABOVE THE LETTER "I." THERE ARE TWO DOTS LOCATED ON EITHER SIDE OF THE TOP OF THE LETTER "I."

PRIORITY DATE OF 3-12-2010 IS CLAIMED.

OWNER OF INTERNATIONAL REGISTRATION 1066692 DATED 9-9-2010, EXPIRES 9-9-2020.

THE WORDING "PINZA" HAS NO MEANING IN A FOREIGN LANGUAGE.

SER. NO. 79-093,157, FILED 9-9-2010.

JEFFREY LOOK, EXAMINING ATTORNEY

United States of America

United States Patent and Trademark Office

avedia

Reg. No. 4,152,215

Registered June 5, 2012

Int. Cls.: 9 and 42

TRADEMARK

SERVICE MARK

PRINCIPAL REGISTER

AVEDIA SYSTEM INC. (CHINA CORPORATION)

2706-2708 NEW WORLD CENTRE

YITIAN ROAD WEST, FUZHONG ROAD NORTH, FUTIAN DISTRICT

SHENZHEN, GUANGDONG, CHINA

FOR: COMPUTER PERIPHERALS; COMPUTER SOFTWARE, NAMELY, COMPUTER OPERATING SOFTWARE, WORD PROCESSING SOFTWARE, SOFTWARE FOR USE IN CONNECTION WITH INFORMATION DISPLAY, MULTIMEDIA DISPLAY; NOTEBOOK COMPUTERS; COMPUTER HARDWARE; LIGHT EMITTING DIODE; LED DISPLAYS FOR USE WITH COMPUTERS; ELECTRONIC NOTICE BOARDS; ELECTRONIC POSTER BOARDS, NAMELY, ELECTRONIC POSTER DISPLAY BOARDS, ELECTRONIC POSTER SIGN BOARDS, ELECTRONIC ADVERTISING POSTER SIGN BOARDS FEATURING A NEON LAMP; LCD MONITORS FOR USE WITH COMPUTERS; PROJECTION SCREENS FOR USE WITH COMPUTERS; DATA PROCESSING EQUIPMENT; COMPUTERS; COMPUTER MEMORIES; TRANSMITTERS OF ELECTRONIC SIGNALS; NETWORK COMMUNICATION EQUIPMENT, NAMELY, COMMUNICATIONS HEADSETS FOR USE WITH COMMUNICATION RADIOS, INTERCOM SYSTEMS, OR OTHER COMMUNICATIONS NETWORK TRANSCEIVERS, TELECOMMUNICATIONS AND DATA NETWORKING HARDWARE, NAMELY, DEVICES FOR TRANSPORTING AND AGGREGATING VOICE, DATA, AND VIDEO COMMUNICATIONS ACROSS MULTIPLE NETWORK INFRASTRUCTURES AND COMMUNICATIONS PROTOCOLS, NETWORK ROUTERS, MODEMS; VISUAL RECORDINGS AND AUDIOVISUAL RECORDINGS FEATURING MUSIC AND ANIMATION, IN CLASS 9 (U.S. CLS. 21, 23, 26, 36 AND 38).

FOR: ENGINEERING DRAWING; CAD DRAFTING SERVICES; COMPUTER SOFTWARE DESIGN; CREATING AND MAINTAINING WEB SITES FOR OTHERS; CONVERSION OF DATA OR DOCUMENTS FROM PHYSICAL TO ELECTRONIC MEDIA; CONSULTANCY IN THE FIELD OF COMPUTER HARDWARE; PROVIDING SEARCH ENGINES, NAMELY, PROVIDING CUSTOMIZED ON-LINE WEB PAGES FEATURING USER-DEFINED INFORMATION, WHICH INCLUDES SEARCH ENGINES AND ON-LINE WEB LINKS TO OTHER WEB SITES, PROVISION OF INTERNET SEARCH ENGINES, PROVIDING SEARCH ENGINES FOR OBTAINING DATA ON A GLOBAL COMPUTER NETWORK; INDUSTRIAL DESIGN; COMPUTER SYSTEM ANALYSIS; COMPUTER RENTAL; MAINTENANCE OF COMPUTER SOFTWARE; PACKAGING DESIGN; GRAPHIC ART DESIGN, IN CLASS 42 (U.S. CLS. 100 AND 101).



David J. Kyjars

Director of the United States Patent and Trademark Office

Reg. No. 4,152,215 THE MARK CONSISTS OF STANDARD CHARACTERS WITHOUT CLAIM TO ANY PARTICULAR FONT, STYLE, SIZE, OR COLOR.

OWNER OF INTERNATIONAL REGISTRATION 1066708 DATED 11-9-2010, EXPIRES 11-9-2020.

THE WORDING "AVEDIA" HAS NO MEANING IN A FOREIGN LANGUAGE.

SER. NO. 79-093,162, FILED 11-9-2010.

JEFFREY LOOK, EXAMINING ATTORNEY

United States of America

United States Patent and Trademark Office

EXPLOROTEL.COM

Reg. No. 4,152,216

Registered June 5, 2012

Int. Cls.: 35, 38, 42 and 43

SERVICE MARK

PRINCIPAL REGISTER

WIHP (FRANCE SOCIÉTÉ PAR ACTIONS SIMPLIFIÉE (SAS))
77 RUE DU FAUBOURG SAINT ANTOINE
F-75011 PARIS, FRANCE

FOR: ADVERTISING, ON-LINE ADVERTISING ON A COMPUTER NETWORK, RADIO ADVERTISING, ADVERTISING BY MAIL ORDER, TELEVISION ADVERTISING, DISSEMINATION OF ADVERTISING MATTER, DIFFUSION, DISTRIBUTION AND RENTAL OF ADVERTISING MATERIAL NAMELY LEAFLETS, PROSPECTUSES, PRINTED MATTER, SAMPLES, RENTAL OF ADVERTISING TIME AND ADVERTISING SPACES ON THE INTERNET, ADVERTISING AGENCIES, COMMERCIAL INFORMATION AGENCIES, MARKETING STUDIES, OPINION POLLING, COST-PRICE ANALYSIS, SALES PROMOTION FOR OTHERS, PROMOTION OF HOTEL SERVICES OR HOTEL AND RESTAURANT SERVICES, PROMOTION OF HOTEL SERVICES OR HOTEL AND RESTAURANT SERVICES THROUGH THE INTERNET NETWORK, ORGANIZATION OF EXHIBITIONS FOR COMMERCIAL OR ADVERTISING PURPOSES, COMPILATION OF INFORMATION INTO A CENTRAL FILE, SYSTEMIZATION OF INFORMATION INTO A CENTRAL FILE, COMPUTERIZED FILE MANAGEMENT, BUSINESS MANAGEMENT OF HOTELS, STATISTICAL INFORMATION, COMMERCIAL OR INDUSTRIAL MANAGEMENT ASSISTANCE, AUCTIONEERING, SERVICES CONSISTING IN PROMOTING HOTELS TO TOURISTS OR TRAVELERS AND IN SUGGESTING AND DRIVING/LEADING TOURISTS OR TRAVELERS SO THAT THEY ACCESS TO THE WEBSITES OF HOTELS; GROUPING SERVICES FOR OTHERS, EXCLUDING THE TRANSPORT THEREOF, ALLOWING CONSUMERS TO SEE AND BUY CONVENIENTLY HOTEL STAYS, ONLINE RETAIL STORE SERVICE FOR MAKING RESERVATIONS AND BOOKINGS FOR TEMPORARY ACCOMMODATIONS OVER COMPUTER NETWORKS, GLOBAL COMPUTER COMMUNICATION NETWORKS AND MOBILE NETWORKS, IN CLASS 35 (U.S. CLS. 100, 101 AND 102).



David J. Kyffers

Director of the United States Patent and Trademark Office

FOR: TRANSMITTING INFORMATION, MESSAGES, PROGRAMS, DATA, SOUND, IMAGES, BY RADIO RELAY CHANNELS, CABLE, SATELLITE, OR VIA ANY OTHER METHOD, TRANSMISSION AND EXCHANGE OF DATA HELD IN DATABASES, SERVICES INVOLVING AUCTION TRANSMISSION BY MEANS OF A GLOBAL COMPUTER NETWORK, TRANSMISSION OF ELECTRONIC MAIL INTENDED TO INFORM THEIR RECIPIENTS OF THE EXISTENCE OF PROMOTIONAL OFFERS, PROVIDING ACCESS TO A WEBSITE AND TO WEBPAGES INTENDED TO INFORM INTERNET USERS OF PROMOTIONAL OFFERS, PROVISION OF INTERNET ACCESS, PROVIDING ACCESS TO A GLOBAL COMPUTER NETWORK CONNECTING MANY TERMINALS TO EACH OTHER, PROVIDING ACCESS TO SEARCH ENGINES, SOFTWARE AND TO ELECTRONIC TELEPHONE DIRECTORIES

Reg. No. 4,152,216 OVER THE INTERNET, ELECTRONIC MESSAGING, RENTAL OF ACCESS TIME TO A DATABASE SERVER CENTER, IN CLASS 38 (U.S. CLS. 100, 101 AND 104).

FOR: COMPUTER SERVICES, NAMELY, HOSTING AND MAINTAINING AN ON-LINE WEB SITE FOR OTHERS TO OFFER HOTEL SERVICES, RESERVATIONS FOR HOTELS, AND TO RENT HOTEL ROOMS, IN CLASS 42 (U.S. CLS. 100 AND 101).

FOR: HOTEL SERVICES, RESERVATIONS FOR HOTELS, TOURIST HOMES, BOARDING HOUSES, MOTELS, TEMPORARY ACCOMMODATION, MEETING ROOMS, RENTAL OF HOTEL ROOMS, BOARDING HOUSES, MOTELS, RENTAL OF TOURIST HOMES, ACCOMMODATION BUREAUS, NAMELY, MAKING RESERVATIONS AND BOOKINGS FOR TEMPORARY ACCOMMODATIONS AND PROVIDING ACCOMMODATION INFORMATION OVER COMPUTER NETWORKS, GLOBAL COMPUTER COMMUNICATION NETWORKS AND MOBILE NETWORKS, SERVICES FOR PROVIDING FOOD AND DRINK, CAFÉS, BARS, IN CLASS 43 (U.S. CLS. 100 AND 101).

PRIORITY DATE OF 5-26-2010 IS CLAIMED.

OWNER OF INTERNATIONAL REGISTRATION 1066893 DATED 11-16-2010, EXPIRES 11-16-2020.

SER. NO. 79-093,236, FILED 11-16-2010.

JACQUELINE A. LAVINE, EXAMINING ATTORNEY

United States of America

United States Patent and Trademark Office

DISHMATIC

Reg. No. 4,152,217

Registered June 5, 2012

Int. Cl.: 21

TRADEMARK

PRINCIPAL REGISTER

EASY-DO PRODUCTS LIMITED (UNITED KINGDOM COMPANY)
NEPTUNE HOUSE
2A ALEXANDRA GROVE; NORTH FINCHLEY, LONDON N12 8NU
UNITED KINGDOM

FOR: HOUSEHOLD KITCHEN UTENSILS AND CONTAINERS, NAMELY, CLEANING, SCOURING, AND SCRUBBING SPONGES, PADS AND BRUSHES ALL FEATURING HANDLES; HAND-HELD DISPENSERS FOR DISHWASHING LIQUID WITH REMOVABLE SPONGE OR BRUSH HEADS; DISHWASHING UTENSILS, NAMELY, WASH BOWLS; NON-ELECTRIC DOMESTIC UTENSILS FOR CLEANING AND POLISHING PURPOSES, NAMELY, CLEANING, SCOURING, AND SCRUBBING SPONGES, PADS AND BRUSHES ALL FEATURING HANDLES; DISHWASHING UTENSILS, NAMELY, CLEANING AND POLISHING CLOTHS; ARTICLES FOR CLEANING PURPOSES, NAMELY, CLEANING, SCOURING, AND SCRUBBING SPONGES, PADS AND BRUSHES; CLEANING, SCOURING, AND SCRUBBING SPONGES, PADS AND BRUSHES ALL FEATURING HANDLES; CLEANING AND POLISHING CLOTHS, CLEANING PADS, CLEANING RAGS; SPONGES FOR HOUSEHOLD USE; SAUCEPAN SCOURERS; BRUSHES, NAMELY, DISHWASHING BRUSHES; CLEANING SPONGES, CLEANING BRUSHES AND CLEANING AND POLISHING MATERIALS IN THE NATURE OF CLOTHS, SPONGES, BRUSHES OR PADS, ALL FOR HOUSEHOLD USE WITH THE AFORESAID UTENSILS, IN CLASS 21 (U.S. CLS. 2, 13, 23, 29, 30, 33, 40 AND 50).

THE MARK CONSISTS OF STANDARD CHARACTERS WITHOUT CLAIM TO ANY PARTICULAR FONT, STYLE, SIZE, OR COLOR.

PRIORITY DATE OF 7-21-2010 IS CLAIMED.

OWNER OF INTERNATIONAL REGISTRATION 1067575 DATED 1-14-2011, EXPIRES 1-14-2021.

SER. NO. 79-093,742, FILED 1-14-2011.

TARA PATE, EXAMINING ATTORNEY



David J. Kyffers

Director of the United States Patent and Trademark Office

United States of America

United States Patent and Trademark Office

LUCETTA

Reg. No. 4,152,218

Registered June 5, 2012

Int. Cls.: 9 and 42

TRADEMARK

SERVICE MARK

PRINCIPAL REGISTER

LONZA COLOGNE AG (FED REP GERMANY AKTIENGESELLSCHAFT)
NATTERMANNALLEE 1
50829 KÖLN, FED REP GERMANY

FOR: APPARATUS AND INSTRUMENTS FOR MEASURING LUMINESCENCE, PHOSPHORESCENCE AND/OR FLUORESCENCE, NAMELY, LUMINOMETERS; LUMINOMETERS; PHOTOMETERS; MICROSCOPES; COMPUTERS, IN CLASS 9 (U.S. CLS. 21, 23, 26, 36 AND 38).

FOR: SCIENTIFIC AND TECHNOLOGICAL SERVICES, NAMELY, BIOLOGICAL RESEARCH AND ANALYSIS; RESEARCH AND RESEARCH SERVICES IN THE FIELD OF THE TRANSFER OF BIOLOGICAL MOLECULES INTO LIVING CELLS, INTEGRATION OF FOREIGN NUCLEIC ACIDS INTO THE GENOME OF LIVING CELLS AND TRANSIENT EXPRESSION OF PROTEINS; SCIENTIFIC RESEARCH SERVICES FOR OTHERS IN THE FIELD OF BIOCHEMISTRY; DESIGN AND DEVELOPMENT OF COMPUTER HARDWARE AND SOFTWARE, IN CLASS 42 (U.S. CLS. 100 AND 101).

THE MARK CONSISTS OF STANDARD CHARACTERS WITHOUT CLAIM TO ANY PARTICULAR FONT, STYLE, SIZE, OR COLOR.

PRIORITY DATE OF 9-25-2009 IS CLAIMED.

OWNER OF INTERNATIONAL REGISTRATION 1068000 DATED 3-24-2010, EXPIRES 3-24-2020.

SER. NO. 79-093,885, FILED 3-24-2010.

EDWARD FENNESSY, EXAMINING ATTORNEY



David J. Kypos

Director of the United States Patent and Trademark Office

United States of America

United States Patent and Trademark Office

Donner des Ailes au talent

Reg. No. 4,152,219

Registered June 5, 2012

**Int. Cls.: 35, 36, 41, 42
and 45**

SERVICE MARK

PRINCIPAL REGISTER

FONDATION BETTENCOURT SCHUELLER (FRANCE A TRUST ORGANIZATION OF FRANCE)
16 PLACE VENDÔME
F-75001 PARIS 1
FRANCE

FOR: SPONSORSHIP AND ADVERTISING, NAMELY, ASSISTANCE WITH BUSINESS MANAGEMENT AND PLANNING IN THE FIELD OF COMMUNICATION; PUBLIC RELATIONS SERVICES FOR FOUNDATIONS, RESEARCH INSTITUTES, HOSPITALS, ORGANIZATIONS AND OTHER ESTABLISHMENTS INVOLVED IN OR DEDICATED TO RESEARCH AND BIOMEDICAL, MEDICAL AND SCIENTIFIC TRAINING, CULTURAL LIFE AND HUMANITARIAN AND SOCIAL ACTION, IN CLASS 35 (U.S. CLS. 100, 101 AND 102).

FOR: FINANCIAL SPONSORING OF BIOMEDICAL AND MEDICAL RESEARCH; FINANCIAL SPONSORSHIP, NAMELY, CAPITAL INVESTMENT, MUTUAL FUND INVESTMENT, CHARITABLE FOUNDATION SERVICES IN THE NATURE OF PROVIDING FINANCIAL ASSISTANCE IN NATURE OF AWARDING SUBSIDIES FOR PROGRAMS AND SERVICES OF OTHERS, FINANCING AND PHILANTHROPIC SERVICES CONCERNING MONETARY DONATIONS OR SHAREHOLDING IN THE NATURE OF BROKERAGE OF SHARES IN FINANCING FOR FOUNDATIONS, RESEARCH INSTITUTES, HOSPITALS, ORGANIZATIONS AND OTHER ESTABLISHMENTS INVOLVED IN OR DEDICATED TO RESEARCH AND BIOMEDICAL, MEDICAL AND SCIENTIFIC TRAINING, CULTURAL LIFE AND HUMANITARIAN AND SOCIAL ACTION; CHARITABLE FUND-RAISING SERVICES FOR CHARITY WORK, PROVIDING GRANTS, FUNDING RESEARCH AWARDS IN THE FIELD OF BIOMEDICAL AND MEDICAL RESEARCH AND ISSUANCE OF ANNUITIES ALL FOR ORGANIZATIONS AND OTHER ESTABLISHMENTS INVOLVED IN OR DEDICATED TO RESEARCH AND BIOMEDICAL, MEDICAL AND SCIENTIFIC TRAINING, CULTURAL LIFE AND HUMANITARIAN AND SOCIAL ACTION; CHARITABLE FOUNDATION SERVICES, NAMELY, PROVIDING FUNDING FOR CREATING OF WORKS OF ART FOR MUSEUMS; CHARITABLE FOUNDATION SERVICES, NAMELY, PROVIDING FUNDING FOR FUNDAMENTAL, BIOMEDICAL, MEDICAL AND SCIENTIFIC RESEARCH IN THE WORLD, IN CLASS 36 (U.S. CLS. 100, 101 AND 102).



David J. Kappas

Director of the United States Patent and Trademark Office

FOR: AWARDS PROGRAM FOR MAJOR CORPORATIONS AND INDIVIDUALS WHO HAVE MADE SIGNIFICANT CHARITABLE CONTRIBUTIONS; ARRANGING SOCIAL ENTERTAINMENT, CULTURAL AND ARTS EVENTS; ARRANGING AND CONDUCTING TRAINING WORKSHOPS, COLLOQUIUMS, CONFERENCES, FORA, CONGRESSES, SEM-

Reg. No. 4,152,219 INARS OR SYMPOSIA, TRADE SHOWS AND EXHIBITIONS OR PROVIDING CONTINUING PROFESSIONAL EDUCATION COURSES ALL FOR CULTURAL OR EDUCATIONAL PURPOSES IN THE FIELD OF SCIENTIFIC RESEARCH AND BIOMEDICAL, MEDICAL AND SCIENTIFIC TRAINING, CULTURAL LIFE AND HUMANITARIAN AND SOCIAL ACTION; CULTURAL ACTIVITIES, NAMELY, ORGANIZATION OF EXHIBITIONS FOR CULTURAL PURPOSES; MUSIC PRODUCTION SERVICES, CONSULTATION AND ADVICE REGARDING MUSICAL ARRANGEMENT FOR SOUND RECORDINGS AND LIVE PERFORMANCES; ORCHESTRA SERVICES IN THE NATURE OF CONDUCTING MUSICAL WORKS, PERFORMING MUSIC WORKS, NAMELY, LIVE PERFORMANCES BY A MUSICAL GROUP; PRODUCTION OF MOVIES, PLANNING ARRANGEMENT OF SHOWING MOVIES IN THE FIELD OF RESEARCH AND BIOMEDICAL, MEDICAL AND SCIENTIFIC TRAINING, CULTURAL LIFE AND HUMANITARIAN AND SOCIAL ACTION; EDITING AND PUBLICATION OF PRINTED MATTER, NAMELY, TEXTS OTHER THAN ADVERTISING, ILLUSTRATIONS, BOOKS, REVIEWS, NEWSPAPERS, PERIODICALS, INFORMATION BULLETINS AND PUBLICATIONS IN THE FIELD OF RESEARCH AND BIOMEDICAL, MEDICAL AND SCIENTIFIC TRAINING, CULTURAL LIFE AND HUMANITARIAN AND SOCIAL ACTION; THE PROVISION OF INFORMATION AND ADVICE CONCERNING EDUCATION; ORGANIZING SEMINARS, COLLOQUIUMS, EXHIBITIONS FOR CULTURAL OR EDUCATIONAL PURPOSES, AND EDUCATIONAL CONFERENCES IN THE FIELD OF SCIENTIFIC RESEARCH AND BIOMEDICAL, MEDICAL AND SCIENTIFIC TRAINING, CULTURAL LIFE AND HUMANITARIAN AND SOCIAL ACTION; ART EXHIBITIONS FEATURING WORKS OF ART INTENDED FOR THE PUBLIC; ORGANIZATION OF INFORMATION CAMPAIGNS IN THE FIELD OF CULTURAL LIFE, NAMELY, PROVISION OF INFORMATION RELATING TO THE ORGANIZING OF EDUCATIONAL, CULTURAL, SPORTING OR ENTERTAINMENT EXHIBITIONS , IN CLASS 41 (U.S. CLS. 100, 101 AND 107).

FOR: PROVISION OF SCIENTIFIC RESEARCH ADVICE AND SCIENTIFIC RESEARCH TO SCIENTISTS INVOLVED IN BIOMEDICAL, MEDICAL AND SCIENTIFIC RESEARCH VIA BIOMEDICAL, MEDICAL, AND SCIENTIFIC COLLABORATIONS FOR FOUNDATIONS, RESEARCH INSTITUTES, HOSPITALS, ORGANIZATIONS AND OTHER ESTABLISHMENTS INVOLVED IN OR DEDICATED TO RESEARCH AND BIOMEDICAL, MEDICAL AND SCIENTIFIC TRAINING, IN THE FIGHT AGAINST CONTEMPORARY WIDESPREAD DISEASES AND IN CULTURAL LIFE AND HUMANITARIAN AND SOCIAL ACTION, NAMELY, CONSULTATION IN THE FIELD OF SCIENTIFIC RESEARCH AND MEDICAL RESEARCH; SCIENTIFIC, BIOMEDICAL AND MEDICAL RESEARCH; SCIENTIFIC RESEARCH AND DEVELOPMENT; MEDICAL RESEARCH; DEVELOPMENT OF MEDICINES; PHARMACEUTICAL RESEARCH AND DEVELOPMENT; BIOLOGICAL RESEARCH; PROVIDING SCIENTIFIC RESEARCH INFORMATION TO OTHERS IN THE BIOMEDICAL, MEDICAL AND PHARMACEUTICAL FIELDS; ORGANIZATION OF INFORMATION CAMPAIGNS IN THE FIELD OF BIOMEDICAL, MEDICAL AND SCIENTIFIC RESEARCH, NAMELY, PROVIDING INFORMATION IN THE FIELD OF MEDICAL RESEARCH, IN CLASS 42 (U.S. CLS. 100 AND 101).

FOR: HUMANITARIAN AND SOCIAL ACTION, NAMELY, PROVIDING INFORMATION CONCERNING HUMANITARIAN EFFORTS IN THE FIELD OF SOCIAL JUSTICE; HUMANITARIAN, SOCIAL AND PERSONAL SERVICES PROVIDED TO OR BY THIRD PARTIES TO MEET THE NEEDS OF INDIVIDUALS, NAMELY, SERVICES INVOLVING RECEPTION, ORIENTATION AND ACCOMPANYING OF PEOPLE IN DISTRESS, THE SICK, THE DISADVANTAGED OR THOSE IN A PRECARIOUS SITUATION, FIGHTING FOR HUMAN RIGHTS AND FREEDOMS IN ADMINISTRATIVE AND SOCIAL PROCESSES, SEEKING PARTNERS, ASSOCIATIONS AND ORGANIZATIONS MEETING THEIR NEEDS, NAMELY, PROVIDING INFORMATION RELATING TO DIVERSE HUMAN CULTURES, BELIEFS, AND LIFESTYLES; ORGANIZATION OF INFORMATION CAMPAIGNS IN THE FIELD OF HUMANITARIAN AND SOCIAL ACTION, NAMELY, PROVIDING INFORMATION CONCERNING CHARITABLE CAUSES AND HUMANITARIAN EFFORTS IN THE FIELD OF SOCIAL JUSTICE, IN CLASS 45 (U.S. CLS. 100 AND 101).

Reg. No. 4,152,219 THE MARK CONSISTS OF THE STYLIZED WORDING "DONNER DES AILES AU TALENT" IN BLACK ON A WHITE BACKGROUND.

PRIORITY DATE OF 9-16-2010 IS CLAIMED.

OWNER OF INTERNATIONAL REGISTRATION 1068236 DATED 11-30-2010, EXPIRES 11-30-2020.

THE COLOR(S) BLACK AND WHITE IS/ARE CLAIMED AS A FEATURE OF THE MARK.

THE ENGLISH TRANSLATION OF THE FOREIGN WORD(S) IN THE MARK IS "GIVING WINGS TO TALENT".

SER. NO. 79-094,003, FILED 11-30-2010.

ROBERT STRUCK, EXAMINING ATTORNEY

United States of America

United States Patent and Trademark Office

GP JOULE

Reg. No. 4,152,220

Registered June 5, 2012

Int. Cls.: 6, 9, 19 and 25

TRADEMARK

PRINCIPAL REGISTER

OVE PETERSEN (FED REP GERMANY INDIVIDUAL)
CECILIENKOOG 16
25821 REUBENKÖGE
FED REP GERMANY

FOR: METAL BUILDINGS MATERIALS, NAMELY, SOFFITS, FASCIA, BORDERS AND RAILS; TRANSPORTABLE BUILDINGS OF METAL; BUILDINGS, INSTALLATIONS AND SUBSTRUCTURES OF METAL FOR BEARING DEVICES FOR THE PRODUCTION OF SOLAR POWER, NAMELY, FLASHING, METAL ROOFING PANELS, METAL GROUND PANELS, MOBILE METAL PANELS, METAL RACKS, METAL ROOF-MOUNTING HARDWARE KITS COMPRISING FRAMES, TRACKS, NUTS, BOLTS AND SCREWS AND METAL GROUND-MOUNTING HARDWARE KITS COMPRISING FRAMES, TRACKS, NUTS, BOLTS AND SCREWS; BUILDINGS, INSTALLATIONS AND SUBSTRUCTURES OF METAL FOR BEARING SOLAR PANELS, NAMELY, FLASHING, METAL ROOFING PANELS, METAL GROUND PANELS, MOBILE METAL PANELS, METAL RACKS AND METAL ROOF-MOUNTING HARDWARE KITS COMPRISING FRAMES, TRACKS, NUTS, BOLTS AND SCREWS AND METAL GROUND-MOUNTING HARDWARE KITS COMPRISING FRAMES, TRACKS, NUTS, BOLTS AND SCREWS, IN CLASS 6 (U.S. CLS. 2, 12, 13, 14, 23, 25 AND 50).

FOR: DEVICES FOR THE PRODUCTIONS OF SOLAR POWER, NAMELY, PHOTOVOLTAIC SOLAR MODULES AND SOLAR PANELS, IN CLASS 9 (U.S. CLS. 21, 23, 26, 36 AND 38).



FOR: BUILDINGS, INSTALLATIONS AND SUBSTRUCTURES NOT OF METAL FOR BEARING DEVICES FOR THE PRODUCTION OF SOLAR POWER, NAMELY, NON-METAL ROOFING PANELS, NON-METAL GROUND PANELS, NON-METAL MOBILE PANELS, NON-METAL RACKS, NON-METAL ROOF-MOUNTING HARDWARE KITS COMPRISING FRAMES, TRACKS, NUTS, BOLTS AND SCREWS AND NON-METAL GROUND-MOUNTING HARDWARE KITS COMPRISING FRAMES, TRACKS, NUTS, BOLTS AND SCREWS; BUILDINGS, INSTALLATIONS AND SUBSTRUCTURES NOT OF METAL FOR BEARING SOLAR PANELS, NAMELY, NON-METAL ROOFING PANELS, NON-METAL GROUND PANELS, NON-METAL MOBILE PANELS, NON-METAL RACKS, NON-METAL ROOF-MOUNTING HARDWARE KITS COMPRISING FRAMES, TRACKS, NUTS, BOLTS AND SCREWS AND NON-METAL GROUND-MOUNTING HARDWARE KITS COMPRISING FRAMES, TRACKS, NUTS, BOLTS AND SCREWS, IN CLASS 19 (U.S. CLS. 1, 12, 33 AND 50).

David J. Kyjars

Director of the United States Patent and Trademark Office

Reg. No. 4,152,220 FOR: CLOTHING, NAMELY, HEADWEAR, BELTS, FLIP-FLOPS, HATS, CAPS, JACKETS, JERSEYS, DRESSES, SHIRTS, TIES, SOCKS, STOCKINGS, SWEATERS AND T-SHIRTS; AND FOOTWEAR, IN CLASS 25 (U.S. CLS. 22 AND 39).

THE MARK CONSISTS OF STANDARD CHARACTERS WITHOUT CLAIM TO ANY PARTICULAR FONT, STYLE, SIZE, OR COLOR.

OWNER OF INTERNATIONAL REGISTRATION 1068443 DATED 12-27-2010, EXPIRES 12-27-2020.

NO CLAIM IS MADE TO THE EXCLUSIVE RIGHT TO USE "Joule" IN INTERNATIONAL CLASSES 6, 9 AND 19, APART FROM THE MARK AS SHOWN.

SER. NO. 79-094,080, FILED 12-27-2010.

BARBARA BROWN, EXAMINING ATTORNEY

United States of America

United States Patent and Trademark Office

RIG-TIG

Reg. No. 4,152,221

Registered June 5, 2012

Int. Cls.: 8 and 21

STELTON A/S (DENMARK CORPORATION)
CHRISTIANSHAVNS KANAL 4
DK-1406 KØBENHAVN K
DENMARK

FOR: ICE TONGS, IN CLASS 8 (U.S. CLS. 23, 28 AND 44).

TRADEMARK

PRINCIPAL REGISTER

FOR: HOUSEHOLD AND KITCHEN UTENSILS, NOT OF PRECIOUS METALS OR COATED THEREWITH, NAMELY, PLATES, SERVING TRAYS, TRAYS FOR DOMESTIC USE, POTS, PANS, SAUCEPANS, DISHES, HAND-OPERATED SALT AND PEPPER MILLS, COASTERS NOT OF PAPER AND NOT BEING TABLE LINEN, TABLE PLACE CARD HOLDERS NOT OF PRECIOUS METALS, NAPKIN RINGS AND HOLDERS, NOT OF PRECIOUS METALS, DRIP MATS FOR TEA, WINE DRIP COLLARS SPECIALLY ADAPTED FOR USE AROUND THE TOP OF WINE BOTTLES TO STOP DRIPS, WINE FUNNELS, BOTTLE POURERS, ICE BUCKETS, COUNTERTOP HOLDERS FOR PAPER TOWELS, DISPENSERS FOR PAPER TOWELS, COFFEEPOTS AND COFFEE SERVICES, NOT OF PRECIOUS METALS, TEAPOTS, COFFEE GLASSES AND COFFEE MUGS, ESPRESSO CUPS, COFFEE MEASURERS, VACUUM JUGS, BOTTLE OPENERS, CORKSCREWS, COOLERS FOR WINE, COMBS, BATH SPONGES, CLEANING SPONGES, CLEANING BRUSHES FOR HOUSEHOLD USE, BRUSH-MAKING MATERIALS, CHAIN-TYPE CLEANING UTENSIL FOR CALCIUM DEPOSITS IN CARAFES, STEEL WOOL, UNWORKED OR SEMI-WORKED GLASS EXCEPT GLASS USED IN BUILDING, GLASSWARE, NAMELY, BEVERAGE GLASSWARE, FLASKS, BOTTLES, SOLD EMPTY, GLASS BASINS, GLASS BOWLS AND VASES, GOODS MADE OF PORCELAIN AND EARTHENWARE, NAMELY, BASINS, BOWLS, DISHES, PLATES, SAUCERS, JARS, CROCKS, POTS, TUREENS, GOBLETS, BEER MUGS, FLOWER POTS, CANDY BOXES, BREAD BINS, BUTTER DISHES, SOAP BOXES, TEA CADDIES, SUGAR BOWLS, EGG CUPS, BUCKETS, VINEGAR CRUETS, KITCHEN CONTAINERS AND VASES, CANDLESTICKS, TEA LIGHT HOLDERS, IN CLASS 21 (U.S. CLS. 2, 13, 23, 29, 30, 33, 40 AND 50).



THE MARK CONSISTS OF STANDARD CHARACTERS WITHOUT CLAIM TO ANY PARTICULAR FONT, STYLE, SIZE, OR COLOR.

PRIORITY DATE OF 10-1-2010 IS CLAIMED.

OWNER OF INTERNATIONAL REGISTRATION 1068829 DATED 1-6-2011, EXPIRES 1-6-2021.

David J. Kyros

Director of the United States Patent and Trademark Office

Reg. No. 4,152,221 THE ENGLISH TRANSLATION OF "RIGTIG" IS "CORRECT", "REAL" OR "RIGHT".

SER. NO. 79-094,224, FILED 1-6-2011.

KIM SAITO, EXAMINING ATTORNEY

United States of America

United States Patent and Trademark Office



Reg. No. 4,152,222

Registered June 5, 2012

Int. Cls.: 9, 14, 18 and 25

TRADEMARK

PRINCIPAL REGISTER

TESSILFORM SPA (ITALY JOINT STOCK COMPANY)
VIA GOBETTI, 7/9
I-50013 CAMPI BISENZIO (FI), ITALY

FOR: OPTICAL APPARATUS AND INSTRUMENTS, NAMELY, EYEGLASSES, SUNGLASSES, CHAINS AND CASES FOR EYEWEAR, IN CLASS 9 (U.S. CLS. 21, 23, 26, 36 AND 38).

FOR: JEWELRY, PRECIOUS STONES, WATCHES, TIMEPIECES AND CHRONOMETRIC INSTRUMENTS, IN CLASS 14 (U.S. CLS. 2, 27, 28 AND 50).

FOR: GOODS MADE OF LEATHER AND IMITATION LEATHER, NAMELY, HANDBAGS, SHOULDER BAGS, SATCHELS, BACKPACKS, RUCKSACKS, BRIEF CASES AND DOCUMENT HOLDERS, TRUNKS, SUITCASES, WALLETS, AND PURSES; PARASOLS AND WALKING STICKS, IN CLASS 18 (U.S. CLS. 1, 2, 3, 22 AND 41).

FOR: CLOTHING, NAMELY, SHIRTS, T-SHIRTS, BLOUSES, SKIRTS, SHORTS, TROUSERS, DRESSES, MEN SUITS, WOMEN'S SUITS, PANTS, COATS, OVERCOATS, RAINCOATS, OVERALLS, UNDERWEAR, TIES, JACKETS, SWEATERS, PULLOVERS, CARDIGANS, JUMPERS, SWEATSHIRTS, VESTS, PARKAS, RAINWEAR, SWIMWEAR, SHAWLS, SCARVES, GLOVES, BELTS; FOOTWEAR; HEADGEAR, NAMELY, HATS, IN CLASS 25 (U.S. CLS. 22 AND 39).

OWNER OF U.S. REG. NO. 3,853,808.

PRIORITY DATE OF 10-19-2010 IS CLAIMED.

OWNER OF INTERNATIONAL REGISTRATION 1069590 DATED 1-14-2011, EXPIRES 1-14-2021.

THE MARK CONSISTS OF THE STYLIZED LETTERS "PP" APPEARING AT THE TOP AND BOTTOM OF THE MARK.

SER. NO. 79-094,527, FILED 1-14-2011.

BRIAN PINO, EXAMINING ATTORNEY



David J. Kyros

Director of the United States Patent and Trademark Office

United States of America

United States Patent and Trademark Office

DURAMEM

Reg. No. 4,152,223

Registered June 5, 2012

Int. Cls.: 9 and 17

TRADEMARK

PRINCIPAL REGISTER

EVONIK MEMBRANE EXTRACTION TECHNOLOGY LTD. (UNITED KINGDOM LTD.)
UNIT 25 TALINA CENTRE,
BAGLEY'S LANE; LONDON SW6 2BW
UNITED KINGDOM

FOR: POLYMERIC MEMBRANES FOR THE FILTRATION OF ORGANIC SOLVENTS FOR LABORATORY, SCIENTIFIC AND RESEARCH USES; POLYMERIC MEMBRANES FOR THE FILTRATION OF ORGANIC SOLVENTS FOR LABORATORY, SCIENTIFIC AND RESEARCH USES FOR MOLECULAR SEPARATION, IN CLASS 9 (U.S. CLS. 21, 23, 26, 36 AND 38).

FOR: FILTER MATERIALS, NAMELY, PLASTIC OR FOAM IN EXTRUDED FORM FOR USE IN MANUFACTURE OF FILTER, FILTER MODULES, MICRO FILTER AND MEMBRANES, IN PARTICULAR FOR NANOFILTRATION, IN CLASS 17 (U.S. CLS. 1, 5, 12, 13, 35 AND 50).

THE MARK CONSISTS OF STANDARD CHARACTERS WITHOUT CLAIM TO ANY PARTICULAR FONT, STYLE, SIZE, OR COLOR.

PRIORITY DATE OF 7-20-2010 IS CLAIMED.

OWNER OF INTERNATIONAL REGISTRATION 1069755 DATED 9-3-2010, EXPIRES 9-3-2020.

THE WORDING "DURAMEM" HAS NO MEANING IN A FOREIGN LANGUAGE.

SER. NO. 79-094,594, FILED 9-3-2010.

BRENDAN REGAN, EXAMINING ATTORNEY



David J. Kybas

Director of the United States Patent and Trademark Office

United States of America

United States Patent and Trademark Office



Reg. No. 4,152,224

Registered June 5, 2012

Int. Cl.: 36

SERVICE MARK

PRINCIPAL REGISTER

TÜRKİYE VAKIFLAR BANKASI T.A.O. (TURKEY CORPORATION)
ATATÜRK BULVARI NO:207
KAVAKLIDERE; ANKARA
TURKEY

FOR: FINANCIAL AND MONETARY SERVICES, NAMELY, SAVINGS BANK SERVICES, ISSUANCE OF BANK CHECK; FINANCIAL ANALYSIS AND CONSULTATION; FINANCIAL SPONSORSHIP OF SPORTING TEAMS, SPORTS EVENTS AND COMPETITIONS, MUSICAL PERFORMANCES OF OTHERS; FACTORING AGENCIES, AGENCIES FOR LEASING OF LAND; FINANCIAL LOAN CONSULTATION FOR SHOPPING CARDS; MONETARY EXCHANGE, IN CLASS 36 (U.S. CLS. 100, 101 AND 102).

NO CLAIM IS MADE TO THE EXCLUSIVE RIGHT TO USE "VAKIF BANK", APART FROM THE MARK AS SHOWN.

OWNER OF INTERNATIONAL REGISTRATION 1070837 DATED 1-10-2011, EXPIRES 1-10-2021.

THE COLOR(S) DARK GREEN, YELLOW AND WHITE IS/ARE CLAIMED AS A FEATURE OF THE MARK.

THE MARK CONSISTS OF THE WORDINGS "VAKIFBANK" IN DARK GREEN AND UNDER THE WORDING "BANK" THERE ARE WORDS "BURASI SIZIN YERINIZ" ALSO IN DARK GREEN AND THE LETTERS "VB" APPEARS IN YELLOW AND WHITE ABOVE THE WORDING "BANK".

THE ENGLISH TRANSLATION OF "VAKIFBANK BURASI SIZIN YERINIZ" IN THE MARK IS "WAQF BANK HERE IS YOUR PLACE".

SER. NO. 79-095,011, FILED 1-10-2011.

DANIEL CAPSHAW, EXAMINING ATTORNEY



David J. Kypos

Director of the United States Patent and Trademark Office

United States of America

United States Patent and Trademark Office

JULIA KEMPER

Reg. No. 4,152,225

Registered June 5, 2012

Int. Cl.: 33

TRADEMARK

PRINCIPAL REGISTER

CESCE - SOCIEDADE AGRÍCOLA, EXPLORAÇÃO, TRANSFORMAÇÃO E
COMERCIALIZAÇÃO AGRÍCOLAS, S.A. (PORTUGAL CORPORATION)
AVENIDA DA LIBERDADE, N° 245, 9° D
P-1250-143 LISBOA, PORTUGAL

FOR: WINES, IN CLASS 33 (U.S. CLS. 47 AND 49).

THE MARK CONSISTS OF STANDARD CHARACTERS WITHOUT CLAIM TO ANY PARTICULAR FONT, STYLE, SIZE, OR COLOR.

PRIORITY DATE OF 10-11-2010 IS CLAIMED.

OWNER OF INTERNATIONAL REGISTRATION 1071269 DATED 2-18-2011, EXPIRES 2-18-2021.

THE NAME(S), PORTRAIT(S), AND/OR SIGNATURE(S) SHOWN IN THE MARK IDENTIFIES A PARTICULAR LIVING INDIVIDUAL, WHOSE CONSENT(S) TO REGISTER IS MADE OF RECORD.

SER. NO. 79-095,146, FILED 2-18-2011.

EVELYN BRADLEY, EXAMINING ATTORNEY



David J. Kybas

Director of the United States Patent and Trademark Office

United States of America

United States Patent and Trademark Office



Reg. No. 4,152,226

Registered June 5, 2012

Int. Cls.: 3, 8, 12, 20 and 21

TRADEMARK

PRINCIPAL REGISTER

SINITUOTE OY (FINLAND CORPORATION)
ERKYLÄN KARTANO 50
FI-05820 HYVINKÄÄ
FINLAND

FOR: CLEANING, POLISHING, SCOURING AND ABRASIVE PREPARATIONS; SOAPS; PERFUMERY, ESSENTIAL OILS, COSMETICS, HAIR LOTIONS; DENTIFRICES, IN CLASS 3 (U.S. CLS. 1, 4, 6, 50, 51 AND 52).

FOR: HAND-OPERATED HAND TOOLS AND IMPLEMENTS, NAMELY, ICE SCRAPERS, SNOW SHOVELS; CUTLERY; RAZORS, IN CLASS 8 (U.S. CLS. 23, 28 AND 44).

FOR: APPARATUS FOR LOCOMOTION BY LAND, AIR OR WATER, NAMELY, BICYCLE COVERS, TOW BAR BALL COVERS, TYRE BAGS, IN CLASS 12 (U.S. CLS. 19, 21, 23, 31, 35 AND 44).

FOR: FURNITURE, MIRRORS, PICTURE FRAMES; GOODS OF WOOD, CORK, REED, CANE, WICKER, HORN, BONE, IVORY, WHALEBONE, SHELL, AMBER, MOTHER-OF-PEARL, MEERSCHAUM AND SUBSTITUTES FOR ALL THESE MATERIALS, OR OF PLASTICS, NAMELY, CONTAINERS FOR STORAGE, IN CLASS 20 (U.S. CLS. 2, 13, 22, 25, 32 AND 50).

FOR: CONTAINERS FOR HOUSEHOLD USE; COMBS AND CLEANING SPONGES; BRUSHES, NAMELY, BRUSHES FOR WASHING, CLEANING, SCOURING AND POLISHING OF CARS AND VEHICLES; BRUSH-MAKING MATERIALS; ARTICLES FOR CLEANING PURPOSES, NAMELY, BRUSHES, SPONGES, SQUEEGEES AND MITTS, SNOW BRUSHES, LINT ROLLERS; STEELWOOL; UNWORKED OR SEMI-WORKED GLASS, IN CLASS 21 (U.S. CLS. 2, 13, 23, 29, 30, 33, 40 AND 50).

THE MARK CONSISTS OF THE WORDING "KUNGS" SUPERIMPOSED OVER THE DESIGN OF A CAR SILHOUETTE, ALL WITHIN A FRAMED RECTANGULAR CARRIER.

OWNER OF INTERNATIONAL REGISTRATION 1072170 DATED 3-23-2011, EXPIRES 3-23-2021.

THE WORDING "KUNGS" HAS NO MEANING IN A FOREIGN LANGUAGE.

SER. NO. 79-095,452, FILED 3-23-2011.



David J. Kyros

Director of the United States Patent and Trademark Office

Reg. No. 4,152,226 DAVID HOFFMAN, EXAMINING ATTORNEY

United States of America

United States Patent and Trademark Office



Reg. No. 4,152,227

Registered June 5, 2012

Int. Cl.: 7

TRADEMARK

PRINCIPAL REGISTER

GA.VO MECCANICA S.N.C. DI TANCREDI & C. (ITALY CO-PARTNERSHIP)
VIA A. GRAMSCI, 2074
I-51036 LARCIANO
ITALY

FOR: MACHINES AND MACHINE TOOLS FOR THE CUTTING AND FORMING OF MATERIALS; CUTTING MACHINES FOR CARDBOARD OR PLASTIC TUBES; MACHINES FOR CONNECTING CUT TUBES, IN CLASS 7 (U.S. CLS. 13, 19, 21, 23, 31, 34 AND 35).

NO CLAIM IS MADE TO THE EXCLUSIVE RIGHT TO USE "MECCANICA", APART FROM THE MARK AS SHOWN.

PRIORITY DATE OF 9-21-2010 IS CLAIMED.

OWNER OF INTERNATIONAL REGISTRATION 1072261 DATED 3-21-2011, EXPIRES 3-21-2021.

THE COLOR(S) BLACK, WHITE AND BLUE IS/ARE CLAIMED AS A FEATURE OF THE MARK.

THE MARK CONSISTS OF THE LETTERS "GA.VO MECCANICA" IN FANCY CHARACTERS IN BLACK, WHERE THE WORD "GA.VO" IS BIGGER AND SURROUNDED BY A ROTATED "S" SHAPE IN BLUE. THE COLOR WHITE APPEARS AS THE BACKGROUND OF THE MARK.

SER. NO. 79-095,484, FILED 3-21-2011.

SKYE YOUNG, EXAMINING ATTORNEY



David J. Kyros

Director of the United States Patent and Trademark Office

United States of America

United States Patent and Trademark Office

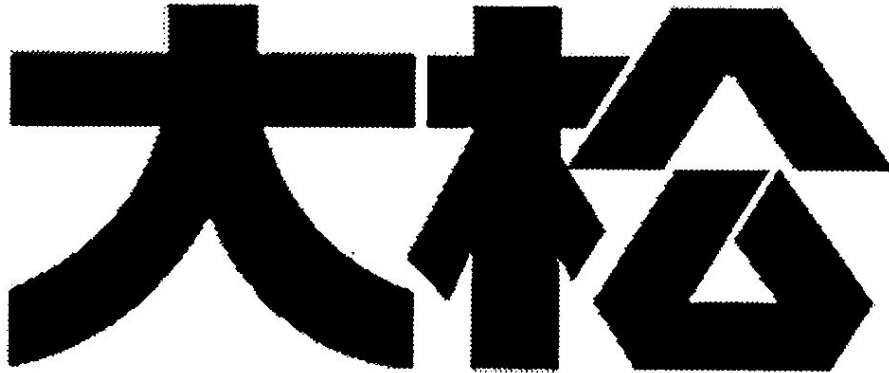

Reg. No. 4,152,228

Registered June 5, 2012

**Int. Cls.: 7, 9, 11, 16, 35
and 37**

TRADEMARK

SERVICE MARK

PRINCIPAL REGISTER

GREE ELECTRIC APPLIANCES, INC. OF ZHUHAI (CHINA CORPORATION)
JINJI WEST ROAD
QIANSHAN ZHUHAI; GUANGDONG
CHINA

FOR: COMPRESSORS, NAMELY, AIR COMPRESSORS, COMPRESSORS FOR AIR CONDITIONERS; COMPRESSORS FOR REFRIGERATORS; AIR CONDENSERS; PRESSES, NAMELY, METAL EXTRUSION PRESSES, PRINTING PRESSES; COMPRESSION MOLDING MACHINES, NAMELY, PLASTIC JET AND INJECTION MOLDING MACHINES; MACHINES TOOLS, NAMELY, BROACHERS CHASERS, GEAR CUTTERS; ELECTRIC MOTORS FOR MACHINES; BRUSH WIRE BUNDLES BEING PARTS OF ELECTRIC MOTORS; VALVES BEING PARTS OF MACHINES; FILTERS BEING PARTS OF MACHINES OR ENGINES, NAMELY, FILTERS AND PURIFIERS FOR REMOVING CONTAMINANTS FROM GASES USED IN THE SEMICONDUCTOR INDUSTRY; FILTERS FOR CLEANING AND COOLING AIR FOR ENGINES; MACHINES FOR PLASTIC WORKING, NAMELY, PLASTIC POURING MACHINES; MACHINES, NAMELY, CONVEYORS; BELTS FOR MACHINES; WRAPPING MACHINES; PACKAGING MACHINES; ELECTRIC BLENDERS FOR HOUSEHOLD PURPOSES; WASHING MACHINES, NAMELY, CLOTHES WASHING MACHINES; WRINGING MACHINES FOR LAUNDRY; DRYING MACHINES, NAMELY, CLOTHES DRYING MACHINES; SPRAY PAINT MACHINES; SPRAY GUNS FOR PAINT; PRINTING MACHINES, NAMELY, INDUSTRIAL PRINTING MACHINES; ELECTRIC MACHINES AND APPARATUS FOR CLEANING, NAMELY, COMPRESSOR CLEANING MACHINES, DRY-CLEANING MACHINES; ELECTRICALLY OPERATED MOTORS FOR DRAWING CURTAINS; IRONING MACHINES, NAMELY, ELECTRIC CLOTHING PRESSING MACHINES FOR COMMERCIAL DRY CLEANING AND LAUNDRY PURPOSES; SEWING MACHINES; BICYCLE ASSEMBLING MACHINES, NAMELY, A SERIES OF MACHINES FOR ASSEMBLING BICYCLES IN SUCCESSIVE STAGES; CRUSHING MACHINES FOR INDUSTRIAL PURPOSES; DIP-DYEING MACHINES; ELECTRIC CLOTHING SIZING MACHINES; VACUUM CLEANERS; ELECTRIC HOUSEHOLD BEAN JUICE MAKER; ELECTROMECHANICAL BEVERAGE PREPARATION MACHINES, NAMELY, ELECTRIC JUICERS; ELECTRIC PORTABLE DRILLS, EXCLUDING ELECTRIC COAL BORER; ELECTROMAGNETIC CLUTCHES FOR MACHINES OTHER THAN FOR LAND VEHICLES; MACHINE COUPLINGS EXCEPT FOR LAND VEHICLES; ELECTRIC MOTORS, OTHER THAN FOR LAND VEHICLES; METAL-WORKING MACHINES, NAMELY, LATHES; SPRAYING MACHINES; ELECTRIC FOOD GRINDERS AND CRUSHERS FOR HOUSEHOLD PURPOSES; DISHWASHERS, IN CLASS 7 (U.S. CLS. 13, 19, 21, 23, 31, 34 AND 35).



David J. Kyros

Director of the United States Patent and Trademark Office

Reg. No. 4,152,228 FOR: CAPACITORS; BLANK MAGNETIC DISKS AND DISKETTES; MAGNETIC HEADS TO BE USED WITH DISKETTES; RADIOS; TAPE RECORDERS; ACOUSTIC APPARATUS, NAMELY, APPARATUS FOR WIRELESS TRANSMISSION OF ACOUSTIC INFORMATION; LOUDSPEAKERS; KARAOKE MACHINES; AMUSEMENT APPARATUS ADAPTED FOR USE WITH TELEVISIONS; WIDE SCREEN COLOR DISPLAYS, NAMELY, LCD MONITORS; ELECTROLYSERS; ELECTRIC RESISTANCES; ELECTRIC COMPONENTS IN THE NATURE OF PLUGS, CONTACTORS AND CONNECTORS; COMPUTERS; DATA PROCESSING APPARATUS, NAMELY, APPARATUS FOR RECORDING, TRANSMISSION, PROCESSING AND REPRODUCTION OF SOUND, IMAGES OR DATA; RECORDED COMPUTER PROGRAMS AND SOFTWARE, NAMELY, COMPUTER OPERATING SOFTWARE; WIRED OR WIRELESS COMMUNICATION EQUIPMENT, NAMELY, TELEPHONE APPARATUS AND RECEIVERS; TRANSMITTERS OF ELECTRONIC SIGNALS; ELECTRO-DYNAMIC APPARATUS FOR THE REMOTE CONTROL OF SIGNALS, NAMELY, REMOTE CONTROLS FOR RADIOS, TELEVISIONS AND STEREOS; ANTENNAS; PHOTOGRAPHY CAMERAS; RECORD PLAYERS; COUNTERFEIT COIN DETECTORS; ELECTRIC ALARM BELLS; ELECTRIC FLAT IRONS; INSULATED COPPER WIRES; ENAMELED WIRES, NAMELY, WIRES FOR CONDUCTING ELECTRICITY; MATERIAL FOR ELECTRICITY MAINS, NAMELY, WIRES AND CABLES; ELECTRIC WIRES; ELECTRIC CABLES; APPARATUS FOR GAMES ADAPTED FOR USE WITH AN EXTERNAL DISPLAY SCREEN OR MONITOR; VIDEO GAME CARTRIDGES; MEASURING INSTRUMENTS, NAMELY, GRADUATED RULERS; ELECTROSTATIC PHOTOCOPIERS; THERMIC PHOTOCOPIERS; AMPLIFIERS; VISUAL DISPLAY UNITS, NAMELY, ELECTRONIC PENS; PHONOGRAPH RECORDS FEATURING MUSIC; BATTERIES FOR LIGHTING; MAGNETIC WIRES; ELECTRIC TEMPERATURE SENSORS; ELECTRIC TEMPERATURE INDICATORS; ELECTRIC WIRE CLUSTERS, IN CLASS 9 (U.S. CLS. 21, 23, 26, 36 AND 38).

FOR: AIR CONDITIONERS; VENTILATORS FOR AIR-CONDITIONING INSTALLATIONS AND APPARATUS; ELECTRIC AIR REHEATERS; ELECTRIC RADIATORS; HEAT ACCUMULATORS; ELECTRIC LAUNDRY DRYERS; AIR-CONDITIONING FANS; AIR DEHUMIDIFIERS; AIR PURIFYING APPARATUS AND MACHINES; ELECTRIC RICE COOKERS; EXTRACTOR HOODS FOR KITCHEN USE; COAL GAS WATER HEATERS; ELECTRIC WATER HEATERS; ELECTROMAGNETIC OVENS, NAMELY, COOKING OVENS; ELECTRIC COOKING UTENSILS, NAMELY, ELECTRIC SKILLETTS; ELECTRIC DRINKING WATER DISPENSERS; ELECTRIC KETTLES; AIR HUMIDIFIERS; ELECTRIC PRESSURE COOKERS, NAMELY, AUTOCLAVES; AIR CONDITIONERS FOR VEHICLES; FANS BEING PARTS OF AIR CONDITIONING INSTALLATIONS; FILTERS FOR AIR CONDITIONING; AIR HEATER FOR VEHICLES; AIR STERILIZERS NOT FOR MEDICAL PURPOSES; ELECTRIC HAIR DRYERS; EVAPORATORS FOR COOLING OR AIR CONDITIONING; STERILIZERS FOR BABY BOTTLES, MILK AND WATER; ELECTRIC STERILIZING CUPBOARD NOT FOR MEDICAL PURPOSES; HEAT EXCHANGERS, NOT BEING PARTS OF MACHINES; EXHAUST FANS; SOLAR ENERGY WATER HEATERS; ELECTRIC WAFFLE IRON PANS; HEATERS FOR BATHS, NAMELY, HOT WATER HEATERS; GAS BURNERS; AIR REFRESHERS, NAMELY, AIR PURIFIERS; REFRIGERATORS; COOKING APPARATUS, NAMELY, MICROWAVE OVENS; WATER PURIFICATION INSTALLATIONS; ELECTRIC EGG BOILERS; ELECTRIC APPLIANCES FOR MAKING YOGURT; STEAM FACIAL APPARATUS, NAMELY, SAUNAS; BREAD TOASTERS; ELECTRIC COFFEE MACHINES; BAKERS' OVENS; ELECTRIC SLOW COOKERS; AUTOMATIC BREAD-MAKING OVEN MACHINES FOR DOMESTIC USE, IN CLASS 11 (U.S. CLS. 13, 21, 23, 31 AND 34).

FOR: PAPER; STATIONERY, NAMELY, COPYING PAPER; HYGIENIC PAPER; TOWELS OF PAPER; PRINTED ADVERTISEMENT BOARDS OF PAPER OR CARDBOARD; NOTE BOOKS; NEWSPAPER, NAMELY, NEWSPRINT PAPER; PICTURES; PACKING PAPER; OFFICE EQUIPMENT, NAMELY, BOOK BINDERS; OFFICE REQUISITES, EXCEPT FURNITURE, NAMELY, ADHESIVE TAPE DISPENSERS, CORRECTING FLUID FOR TYPE, ELECTRIC PAPER HOLE PUNCHES, FRANKING MACHINES, ENVELOPE SEALING MACHINES, PAPER EMBOSSERS, PAPER FOLDING MACHINES, PAPER TRIMMERS, PUNCHES, RUBBER BANDS, STAPLERS, STAPLES, PAPER CLIPS, PAPER CLIP HOLDERS, ENVELOPES; PREPARED CHINESE INK FOR WRITING AND STAMPING; STAMPS AND

Reg. No. 4,152,228 SEALS, NAMELY, SEALS FOR THE OFFICE; WRITING INSTRUMENTS; GUMS AND ADHESIVES FOR STATIONERY OR HOUSEHOLD PURPOSES; DRAWING INSTRUMENTS; DRAWING MATERIALS FOR BLACKBOARDS, CRAYONS, DRAWING PAPER, PENCILS, DRAWING RULERS, DRAWING TEMPLATES, DRAWING TRAYS; ELECTRIC OR NON-ELECTRIC TYPEWRITERS; TEACHING MATERIALS, NAMELY, PRINTED TEACHING MATERIALS IN THE FIELD OF SCIENCE, MATH, LANGUAGE ARTS, HISTORY, MUSIC; ARCHITECTS' MODELS; CHAPLETS, IN CLASS 16 (U.S. CLS. 2, 5, 22, 23, 29, 37, 38 AND 50).

FOR: ADVERTISING SERVICES FOR OTHERS; IMPORT-EXPORT AGENCIES IN THE FIELD OF GOODS; PROMOTING THE SALE OF GOODS AND SERVICES OF OTHERS BY THE DISTRIBUTION OF PRINTED MATERIAL AND PROMOTIONAL CONTEST, BY DISTRIBUTING COUPONS, BY AWARDING PURCHASING POINTS FOR CREDIT CARD USE; SYSTEMIZATION OF INFORMATION INTO COMPUTER DATABASES; TENDER OFFERS, NAMELY, PROMOTING THE GOODS OF OTHERS, NAMELY, PROVIDING INFORMATION REGARDING DISCOUNTS, COUPONS, REBATES, VOUCHERS AND SPECIAL OFFERS FOR THE GOODS OF OTHERS, PROMOTING AND MARKETING THE GOODS AND SERVICES OF OFFERS BY DISTRIBUTING ADVERTISING MATERIAL, COUPONS AND DISCOUNT OFFERS VIA TEXT MESSAGES; PROFESSIONAL BUSINESS CONSULTANCY; ADVISORY SERVICES FOR BUSINESS MANAGEMENT; MARKETING ANALYSIS FOR OTHERS; PERSONNEL MANAGEMENT CONSULTANCY; ACCOUNTING; COMMERCIAL AND INDUSTRIAL MANAGEMENT ASSISTANCE; AUDITING, NAMELY, ACCOUNT AUDITING, BUSINESS AUDITING AND AUDITING OF INSURANCE CLAIMS, IN CLASS 35 (U.S. CLS. 100, 101 AND 102).

FOR: AIR CONDITIONING APPARATUS INSTALLATION AND REPAIR; UPHOLSTERING SERVICES; HEATING EQUIPMENT INSTALLATION AND REPAIR; MACHINERY INSTALLATION, MAINTENANCE AND REPAIR; ELECTRIC APPLIANCES INSTALLATION AND REPAIR; FREEZING EQUIPMENT INSTALLATION AND REPAIR; COMPUTER HARDWARE INSTALLATION, MAINTENANCE AND REPAIR; OFFICE MACHINES AND EQUIPMENT INSTALLATION, MAINTENANCE AND REPAIR; INTERFERENCE SUPPRESSION SERVICES IN ELECTRICAL APPARATUS; DRY CLEANING, IN CLASS 37 (U.S. CLS. 100, 103 AND 106).

THE MARK CONSISTS OF TWO CHINESE CHARACTERS HORIZONTALLY STATED IN A STYLIZED FORM.

PRIORITY DATE OF 4-9-2010 IS CLAIMED.

OWNER OF INTERNATIONAL REGISTRATION 1072283 DATED 8-19-2010, EXPIRES 8-19-2020.

THE NON-LATIN CHARACTERS IN THE MARK TRANSLITERATE TO "DA SONG" AND THIS MEANS "BIG PINE" IN ENGLISH.

THE ENGLISH TRANSLATION OF THE FOREIGN WORDS IN THE MARK IS "BIG PINE".

SER. NO. 79-095,494, FILED 8-19-2010.

JEFFREY LOOK, EXAMINING ATTORNEY

United States of America

United States Patent and Trademark Office

VIBROGRAF

Reg. No. 4,152,229

Registered June 5, 2012

**Int. Cls.: 1, 7, 8, 9, 11, 14,
35 and 42**

TRADEMARK

SERVICE MARK

PRINCIPAL REGISTER

GREINER VIBROGRAF AG (SWITZERLAND SOCIÉTÉ ANONYME (CORPORATION))
MITTELSTRASSE 2
CH-4900 LANGENTHAL
SWITZERLAND

FOR: CHEMICAL PREPARATIONS FOR INDUSTRIAL AND SCIENTIFIC PURPOSES FOR THE CLOCK AND WATCH MAKING SECTOR, IN CLASS 1 (U.S. CLS. 1, 5, 6, 10, 26 AND 46).

FOR: PRECISION MACHINES AND MACHINE TOOLS, NAMELY, FOR ADJUSTING, CUTTING AND ADAPTING SPIRAL SPRINGS, SPIRAL COILS, BALANCES AND OTHER CLOCK PARTS AND PARTS THEREFOR; ELECTRICAL AND ELECTRONIC MACHINES FOR CLEANING SPIRAL SPRINGS, SPIRAL COILS, BALANCES, MOVEMENTS, WATCHES AND JEWELLERY AND PARTS THEREFOR; ELECTRIC ULTRASONIC CLEANING DEVICES FOR WATCH PARTS, WATCHES AND PARTS THEREFOR; POLISHING MACHINES FOR POLISHING METAL WATCHES, WATCH PARTS AND JEWELLERY PARTS AND PARTS THEREFOR; ACCESSORIES FOR THE AFORESAID GOODS, NAMELY, BASKETS FOR PARTS OF WATCHES AND JEWELLERY THAT ARE SPECIALLY ADAPTED TO BE USED WITH THE FOREGOING MACHINES; INSTRUMENTS AND MACHINES FOR REFINING OBJECTS, PARTICULARLY MACHINES FOR THE DEGREASING, STRIPPING, PLATING, NICKEL PLATING, RHODIUM PLATING, GILDING AND SILVERING OF METAL PARTS, PARTICULARLY USED IN WATCHES AND JEWELLERY, IN CLASS 7 (U.S. CLS. 13, 19, 21, 23, 31, 34 AND 35).

FOR: HAND-OPERATED HAND TOOLS AND IMPLEMENTS FOR PROCESSING METALS, SPIRAL SPRINGS, SPIRAL COILS, BALANCES AND OTHER WATCH PARTS, NAMELY, NIPPERS, TAPS, TONGS, RASPS, PINNERS AND PARTS THEREFOR AND HAND-OPERATED TOOL ACCESSORIES FOR THE AFORESAID GOODS, NAMELY, PLIERS SETS, IN CLASS 8 (U.S. CLS. 23, 28 AND 44).

FOR: PRECISION MEASURING APPARATUS AND INSTRUMENTS FOR ANALYZING THE OPERATIONAL CAPABILITIES OF CHRONOMETERS AND WATCHES OF ALL KINDS AND PARTS THEREFOR AND ELECTRONIC AND MECHANICAL MEASURING INSTRUMENTS FOR WATCHES, NAMELY, CHRONOGRAPHS AND CHRONOMETERS AS INTEGRATED PARTS OF INSTRUMENTS FOR TESTING WATCHES; APPARATUS FOR DEMAGNETIZING SPIRAL SPRINGS, SPIRAL COILS, BALANCES, MOVEMENTS AND WATCHES AND PARTS THEREFOR; CALCULATING APPARATUS AND INSTRUMENTS, NAMELY,



David J. Kyros

Director of the United States Patent and Trademark Office

Reg. No. 4,152,229 CALCULATING MACHINES AND PARTS THEREFOR; SCIENTIFIC, OPTICAL, WEIGHING, MEASURING, SIGNALING AND CHECKING AND SUPERVISION APPARATUS AND INSTRUMENTS, PARTICULARLY INSTRUMENTS FOR MEASURING, COMPARING AND ANALYZING WATCH PARTS IN THE NATURE OF SPIRAL SPRINGS, SPIRAL COILS, BALANCES, MOVEMENTS AND OTHER RELATED WATCH PARTS AND PARTS THEREFOR; SEAL TESTING APPARATUS AND PARTS THEREFOR; AND ACCESSORIES FOR THE AFORESAID GOODS, NAMELY, INSTRUMENTS FOR MEASURING LENGTH; COMPUTER HARDWARE AND SOFTWARE FOR ANALYZING THE OPERATIONAL CAPABILITIES OF WATCHES AND WATCH PARTS, IN CLASS 9 (U.S. CLS. 21, 23, 26, 36 AND 38).

FOR: APPARATUS FOR DRYING MECHANICAL PARTS, NAMELY, WATCHES, WATCH PARTS, JEWELLERY, PARTS OF JEWELLERY AND PARTS THEREFORE, IN CLASS 11 (U.S. CLS. 13, 21, 23, 31 AND 34).

FOR: WATCH SPRINGS; WATCH GLASSES; MOVEMENTS FOR CLOCKS AND WATCHES, CLOCK HANDS; CLOCKWORKS; WATCH PARTS, NAMELY, BARRELS; SPIRAL COILS OF BRASS FOR WATCHES; AND PARTS THEREFOR, IN CLASS 14 (U.S. CLS. 2, 27, 28 AND 50).

FOR: RETAIL STORE SERVICES FEATURING MEASURING APPARATUS AND INSTRUMENTS FOR WATCHES AND CLOCKS, IN CLASS 35 (U.S. CLS. 100, 101 AND 102).

FOR: SCIENTIFIC AND TECHNOLOGICAL SERVICES, NAMELY, SCIENTIFIC RESEARCH, ANALYSIS, TESTING AND RESEARCH SERVICES RELATING TO MEASURING APPARATUS AND INSTRUMENTS USED IN THE MANUFACTURE OF CLOCKS AND WATCHES; DESIGN OF MEASURING APPARATUS AND INSTRUMENTS USED IN THE MANUFACTURE OF CLOCKS AND WATCHES; INDUSTRIAL ANALYSIS AND RESEARCH SERVICES RELATING TO MEASURING APPARATUS AND INSTRUMENTS USED IN THE MANUFACTURE OF CLOCKS AND WATCHES; DESIGN AND DEVELOPMENT OF COMPUTER HARDWARE AND SOFTWARE, IN CLASS 42 (U.S. CLS. 100 AND 101).

THE MARK CONSISTS OF STANDARD CHARACTERS WITHOUT CLAIM TO ANY PARTICULAR FONT, STYLE, SIZE, OR COLOR.

PRIORITY DATE OF 7-23-2010 IS CLAIMED.

OWNER OF INTERNATIONAL REGISTRATION 1072306 DATED 1-17-2011, EXPIRES 1-17-2021.

OWNER OF U.S. REG. NO. 592,720.

SER. NO. 79-095,503, FILED 1-17-2011.

KRISTINA MORRIS, EXAMINING ATTORNEY

United States of America

United States Patent and Trademark Office



Reg. No. 4,152,230

Registered June 5, 2012

Int. Cls.: 7, 11, 40 and 42

TRADEMARK

SERVICE MARK

PRINCIPAL REGISTER

PROCESS GROUP PTY LTD (AUSTRALIA AN AUSTRALIAN PROPRIETARY COMPANY LIMITED BY SHARES)
5 HOBBS COURT
ROWVILLE VIC 3178, AUSTRALIA

FOR: MACHINES FOR THE PROCESSING AND REFINEMENT OF NATURAL RESOURCES IN THE NATURE OF PETROLEUM IN THE NATURE OF OIL AND GAS, PETROCHEMICALS, CHEMICALS USED IN THE CARBON CAPTURE INDUSTRIES; SEPARATING MACHINES; PARTS AND FITTINGS FOR SEPARATING MACHINES; PUMPS, NAMELY, POSITIVE DISPLACEMENT PUMPS AND CENTRIFUGAL PUMPS; CONVEYORS, CYCLONES AND SPIRAL SEPARATORS, HYDROCYCLONES, SPIRAL CONCENTRATORS, MAGNETIC SEPARATORS, CENTRIFUGES, HEAT EXCHANGERS BEING PARTS OF MACHINES, FLOTATION MACHINES, NAMELY, FLOTATION SEPARATORS USED FOR SEPARATING DIFFERENT TYPES OF ORES, MINERALS AND CHEMICALS FROM EACH OTHER; OIL AND GAS PRODUCTION PROCESS SYSTEMS MACHINES AND EQUIPMENT, NAMELY, PROCESS SEPARATION MACHINES FOR SEPARATION OF COMPONENTS FROM A GAS OR VAPOR OR LIQUID STREAM IN THE PETROLEUM, PETROCHEMICAL, CHEMICAL AND CARBON CAPTURE INDUSTRIES; ABSORBER TOWERS AND REGENERATOR TOWERS; PARTS FOR ALL THE AFORESAID GOODS, IN CLASS 7 (U.S. CLS. 13, 19, 21, 23, 31, 34 AND 35).

FOR: WATER TREATMENT SYSTEMS; GAS SCRUBBING TOWERS; PARTS OF ALL THE AFORESAID GOODS, IN CLASS 11 (U.S. CLS. 13, 21, 23, 31 AND 34).

FOR: CUSTOM CONSTRUCTION AND FABRICATION OF OIL AND GAS PRODUCTION PROCESS SYSTEMS MACHINES AND EQUIPMENT, IN CLASS 40 (U.S. CLS. 100, 103 AND 106).

FOR: TECHNOLOGICAL CONSULTING SERVICES IN THE FIELDS OF NATURAL RESOURCES, PETROLEUM, PETROCHEMICAL, CHEMICAL AND CARBON CAPTURE; ENGINEERING SERVICES IN THE FIELDS OF NATURAL RESOURCES, PETROLEUM, PETROCHEMICAL, CHEMICAL AND CARBON CAPTURE; ENGINEERING DRAWING IN THE FIELDS OF NATURAL RESOURCES, PETROLEUM, PETROCHEMICAL, CHEMICAL AND CARBON CAPTURE; PROFESSIONAL ENGINEERING CONSULTANCY SERVICES IN THE FIELDS OF NATURAL RESOURCES, PETROLEUM, PETROCHEMICAL, CHEMICAL AND CARBON CAPTURE; DESIGN OF PROCESS MACHINES AND EQUIPMENT IN THE FIELDS OF NATURAL RESOURCES, PETROLEUM, PETROCHEMICAL, CHEMICAL AND CARBON CAPTURE; DESIGN OF PROCESS MACHINES AND EQUIPMENT IN THE FIELDS OF NATURAL RESOURCES, PETROLEUM, PETROCHEMICAL, CHEMICAL AND CARBON CAPTURE.



David J. Kyros

Director of the United States Patent and Trademark Office

Reg. No. 4,152,230 CAPTURE; DETAILED ENGINEERING SERVICES IN THE FIELDS OF NATURAL RESOURCES, PETROLEUM, PETROCHEMICAL, CHEMICAL AND CARBON CAPTURE; COMMISSIONING IN THE NATURE OF INSTALLATION AND/OR STARTING CONSULTING SERVICES, AND INSPECTION OF PROCESS SYSTEMS AND EQUIPMENT IN THE FIELDS OF NATURAL RESOURCES, PETROLEUM, PETROCHEMICAL, CHEMICAL AND CARBON CAPTURE; TECHNICAL CONSTRUCTION DRAFTING IN THE FIELDS OF NATURAL RESOURCES, PETROLEUM, PETROCHEMICAL, CHEMICAL AND CARBON CAPTURE; TECHNICAL PROJECT PLANNING IN THE FIELDS OF NATURAL RESOURCES, PETROLEUM, PETROCHEMICAL, CHEMICAL AND CARBON CAPTURE; PLANNING OF INSTALLATIONS IN THE NATURE OF PROCESS MACHINES AND EQUIPMENT IN THE FIELDS OF NATURAL RESOURCES, PETROLEUM, PETROCHEMICAL, CHEMICAL AND CARBON CAPTURE, IN CLASS 42 (U.S. CLS. 100 AND 101).

NO CLAIM IS MADE TO THE EXCLUSIVE RIGHT TO USE "PROCESS GROUP", APART FROM THE MARK AS SHOWN.

PRIORITY DATE OF 4-20-2010 IS CLAIMED.

OWNER OF INTERNATIONAL REGISTRATION 1072523 DATED 10-4-2010, EXPIRES 10-4-2020.

THE MARK CONSISTS OF THE WORDING "PROCESS GROUP" TO THE RIGHT OF A DESIGN ELEMENT CONSISTING OF A WIDE-BORDERED SQUARE SURROUNDING AN INNER SQUARE.

SER. NO. 79-095,558, FILED 10-4-2010.

KAREN SEVERSON, EXAMINING ATTORNEY

United States of America

United States Patent and Trademark Office

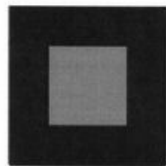

process group
INTERNATIONAL

Reg. No. 4,152,231

Registered June 5, 2012

Int. Cls.: 7, 11, 40 and 42

TRADEMARK

SERVICE MARK

PRINCIPAL REGISTER

PROCESS GROUP PTY LTD (AUSTRALIA AN AUSTRALIAN PROPRIETARY COMPANY LIMITED BY SHARES)
5 HOBBS COURT
ROWVILLE VIC 3178, AUSTRALIA

FOR: MACHINES FOR THE PROCESSING AND REFINEMENT OF NATURAL RESOURCES IN THE NATURE OF PETROLEUM IN THE NATURE OF OIL AND GAS, PETROCHEMICALS, CHEMICALS USED IN THE CARBON CAPTURE INDUSTRIES; SEPARATING MACHINES; PARTS AND FITTINGS FOR SEPARATING MACHINES; PUMPS, NAMELY, POSITIVE DISPLACEMENT PUMPS AND CENTRIFUGAL PUMPS; CONVEYORS, CYCLONES AND SPIRAL SEPARATORS, HYDROCYCLONES, SPIRAL CONCENTRATORS, MAGNETIC SEPARATORS, CENTRIFUGES, HEAT EXCHANGERS BEING PARTS OF MACHINES, FLOTATION MACHINES, NAMELY, FLOTATION SEPARATORS USED FOR SEPARATING DIFFERENT TYPES OF ORES, MINERALS AND CHEMICALS FROM EACH OTHER; OIL AND GAS PRODUCTION PROCESS SYSTEMS MACHINES AND EQUIPMENT, NAMELY, PROCESS SEPARATION MACHINES FOR SEPARATION OF COMPONENTS FROM A GAS OR VAPOR OR LIQUID STREAM IN THE PETROLEUM, PETROCHEMICAL, CHEMICAL AND CARBON CAPTURE INDUSTRIES; ABSORBER TOWERS AND REGENERATOR TOWERS; PARTS FOR ALL THE AFORESAID GOODS, IN CLASS 7 (U.S. CLS. 13, 19, 21, 23, 31, 34 AND 35).

FOR: WATER TREATMENT SYSTEMS; GAS SCRUBBING TOWERS; PARTS OF ALL THE AFORESAID GOODS, IN CLASS 11 (U.S. CLS. 13, 21, 23, 31 AND 34).

FOR: CUSTOM CONSTRUCTION AND FABRICATION OF OIL AND GAS PRODUCTION PROCESS SYSTEMS MACHINES AND EQUIPMENT, IN CLASS 40 (U.S. CLS. 100, 103 AND 106).

FOR: TECHNOLOGICAL CONSULTING SERVICES IN THE FIELDS OF NATURAL RESOURCES, PETROLEUM, PETROCHEMICAL, CHEMICAL AND CARBON CAPTURE; ENGINEERING SERVICES IN THE FIELDS OF NATURAL RESOURCES, PETROLEUM, PETROCHEMICAL, CHEMICAL AND CARBON CAPTURE; ENGINEERING DRAWING IN THE FIELDS OF NATURAL RESOURCES, PETROLEUM, PETROCHEMICAL, CHEMICAL AND CARBON CAPTURE; PROFESSIONAL ENGINEERING CONSULTANCY SERVICES IN THE FIELDS OF NATURAL RESOURCES, PETROLEUM, PETROCHEMICAL, CHEMICAL AND CARBON CAPTURE; DESIGN OF PROCESS MACHINES AND EQUIPMENT IN THE FIELDS OF NATURAL RESOURCES, PETROLEUM, PETROCHEMICAL, CHEMICAL AND CARBON CAPTURE; DESIGN OF PROCESS MACHINES AND EQUIPMENT IN THE FIELDS OF NATURAL RESOURCES, PETROLEUM, PETROCHEMICAL, CHEMICAL AND CARBON CAPTURE.



David J. Kyros

Director of the United States Patent and Trademark Office

Reg. No. 4,152,231 CAPTURE; DETAILED ENGINEERING SERVICES IN THE FIELDS OF NATURAL RESOURCES, PETROLEUM, PETROCHEMICAL, CHEMICAL AND CARBON CAPTURE; COMMISSIONING IN THE NATURE OF INSTALLATION AND/OR STARTING CONSULTING SERVICES, AND INSPECTION OF PROCESS SYSTEMS AND EQUIPMENT IN THE FIELDS OF NATURAL RESOURCES, PETROLEUM, PETROCHEMICAL, CHEMICAL AND CARBON CAPTURE; TECHNICAL CONSTRUCTION DRAFTING IN THE FIELDS OF NATURAL RESOURCES, PETROLEUM, PETROCHEMICAL, CHEMICAL AND CARBON CAPTURE; TECHNICAL PROJECT PLANNING IN THE FIELDS OF NATURAL RESOURCES, PETROLEUM, PETROCHEMICAL, CHEMICAL AND CARBON CAPTURE; PLANNING OF INSTALLATIONS IN THE NATURE OF PROCESS MACHINES AND EQUIPMENT IN THE FIELDS OF NATURAL RESOURCES, PETROLEUM, PETROCHEMICAL, CHEMICAL AND CARBON CAPTURE, IN CLASS 42 (U.S. CLS. 100 AND 101).

NO CLAIM IS MADE TO THE EXCLUSIVE RIGHT TO USE "PROCESS GROUP INTERNATIONAL", APART FROM THE MARK AS SHOWN.

PRIORITY DATE OF 4-20-2010 IS CLAIMED.

OWNER OF INTERNATIONAL REGISTRATION 1072649 DATED 10-4-2010, EXPIRES 10-4-2020.

THE MARK CONSISTS OF THE WORDING "PROCESS GROUP" ABOVE THE WORDING "INTERNATIONAL", ALL TO THE RIGHT OF A DESIGN ELEMENT CONSISTING OF A WIDE-BORDERED SQUARE SURROUNDING AN INNER SQUARE.

SER. NO. 79-095,598, FILED 10-4-2010.

KAREN SEVERSON, EXAMINING ATTORNEY

United States of America

United States Patent and Trademark Office

DLX

Reg. No. 4,152,232

Registered June 5, 2012

Int. Cl.: 25

TRADEMARK

PRINCIPAL REGISTER

JACOBS & TURNER LIMITED (UNITED KINGDOM LIMITED COMPANY)
VERMONT HOUSE
149 VERMONT STREET,; KINNING PARK; GLASGOW G41 1LU
UNITED KINGDOM

FOR: ARTICLES OF CLOTHING, NAMELY, SHIRTS, BLOUSES, JACKETS, COATS, TROUSERS, SKI-SUITS, FOOTWEAR AND HEADWEAR, IN CLASS 25 (U.S. CLS. 22 AND 39).

THE MARK CONSISTS OF STANDARD CHARACTERS WITHOUT CLAIM TO ANY PARTICULAR FONT, STYLE, SIZE, OR COLOR.

OWNER OF INTERNATIONAL REGISTRATION 1072887 DATED 3-29-2011, EXPIRES 3-29-2021.

SER. NO. 79-095,717, FILED 3-29-2011.

GILBERT SWIFT, EXAMINING ATTORNEY



David J. Kyffers

Director of the United States Patent and Trademark Office

United States of America

United States Patent and Trademark Office



Reg. No. 4,152,233

Registered June 5, 2012

Int. Cl.: 12

TRADEMARK

PRINCIPAL REGISTER

GRABZOOM PTY LTD
UNIT 72/85 ALEXANDRA AVENUE
SOUTH YARRA VIC 3141
AUSTRALIA

FOR: AUTOMOTIVE VEHICLE PARTS, NAMELY, AUTOMOBILE TIRES, AUTOMOBILE WHEELS, AND AUTOMOBILE TIRE INNER TUBES, IN CLASS 12 (U.S. CLS. 19, 21, 23, 31, 35 AND 44).

NO CLAIM IS MADE TO THE EXCLUSIVE RIGHT TO USE "TIRES", APART FROM THE MARK AS SHOWN.

OWNER OF INTERNATIONAL REGISTRATION 1072910 DATED 11-11-2010, EXPIRES 11-11-2020.

THE MARK CONSISTS OF THE WORDS "VENDETTA TYRES" WITH A SEMI-CIRCLE CONTAINING A "V" AND FIVE LINES BEFORE THE WORD "TYRES".

SER. NO. 79-095,731, FILED 11-11-2010.

CHARLES L. JENKINS, EXAMINING ATTORNEY



David J. Kyros

Director of the United States Patent and Trademark Office

United States of America

United States Patent and Trademark Office

ARIJE

Reg. No. 4,152,234

Registered June 5, 2012

Int. Cls.: 14 and 35

TRADEMARK

SERVICE MARK

PRINCIPAL REGISTER

BRO & SIS HOLDING (FRANCE SOCIETE PAR ACTIONS SIMPLIFIEE)
5, RUE LINCOLN
F-75008 PARIS
FRANCE

FOR: JEWELRY, PRECIOUS STONES; HOROLOGICAL AND CHRONOMETRIC INSTRUMENTS; PRECIOUS METALS AND THEIR ALLOYS; COINS, NAMELY, NON-MONETARY COINS; WORKS OF ART OF PRECIOUS METAL; JEWELRY CASES; BOXES OF PRECIOUS METAL; WATCH CASES, BANDS, CHAINS, SPRINGS AND GLASSES; KEY RINGS IN THE NATURE OF TRINKETS OR FOBS OF PRECIOUS METAL; STATUES AND STATUETTES OF PRECIOUS METAL; CASES OR PRESENTATION CASES, NAMELY, CASES FOR WATCHES AND CLOCKS, JEWELRY CASES, FOR TIMEPIECES; MEDALS, IN CLASS 14 (U.S. CLS. 2, 27, 28 AND 50).

FOR: RETAIL STORE AND WHOLESALE STORE SERVICES, AVAILABLE VIA TELECOMMUNICATIONS NETWORKS AND BY ANY OTHER MEANS, FEATURING WATCHES, CHRONOMETRIC INSTRUMENTS, JEWELS, WATCH AND TIMEPIECE ACCESSORIES, COINS, MEDALS, PERFUMES AND COSMETICS, CUTLERY ITEMS, FORKS AND SPOONS, SPECTACLES AND OPTICAL GOODS, HANDBAGS, LEATHER GOODS, TRUNKS AND TRAVELLING BAGS, UMBRELLAS, WALKING STICKS, WALLETS, PURSES, RUCKSACKS, WHEELED SHOPPING BAGS, PICTURE FRAMES, WORKS OF ART, TABLEWARE, STATUES, STATUETTES, FABRICS, HOUSEHOLD LINEN, BATH LINEN, CLOTHING, FOOTWEAR, HEADGEAR, ARTICLES FOR SMOKERS, LIGHTERS FOR SMOKERS, IN CLASS 35 (U.S. CLS. 100, 101 AND 102).

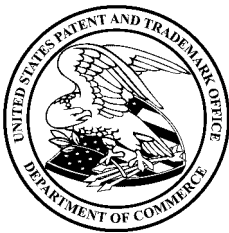

THE MARK CONSISTS OF STANDARD CHARACTERS WITHOUT CLAIM TO ANY PARTICULAR FONT, STYLE, SIZE, OR COLOR.

PRIORITY DATE OF 3-9-2011 IS CLAIMED.

OWNER OF INTERNATIONAL REGISTRATION 1072938 DATED 3-18-2011, EXPIRES 3-18-2021.

THE WORDING "ARIJE" HAS NO MEANING IN A FOREIGN LANGUAGE.

SER. NO. 79-095,743, FILED 3-18-2011.

David J. Kyros

Director of the United States Patent and Trademark Office

Reg. No. 4,152,234 CHARISMA HAMPTON, EXAMINING ATTORNEY

United States of America

United States Patent and Trademark Office

ZONKEY BOOT

Reg. No. 4,152,235

Registered June 5, 2012

Int. Cls.: 18 and 25

TRADEMARK

PRINCIPAL REGISTER

MICHAEL ROLLIG (AUSTRIA INDIVIDUAL)
HAINBURGERSTR. 29/10/18
A-1030 WIEN
AUSTRIA AND

ALEXANDRA-ROXANA DIACONU (ROMANIA INDIVIDUAL)
HAINBURGER STR. 29/10/18
A-1030 WIEN
AUSTRIA

FOR: LEATHER AND IMITATIONS OF LEATHER; GOODS MADE OF LEATHER AND IMITATIONS OF LEATHER, NAMELY, PURSES, WALLETS, BAGS, TRAVEL BAGGAGE, RUCKSACKS, CASES, IN CLASS 18 (U.S. CLS. 1, 2, 3, 22 AND 41).

FOR: SHOES, IN CLASS 25 (U.S. CLS. 22 AND 39).

THE MARK CONSISTS OF STANDARD CHARACTERS WITHOUT CLAIM TO ANY PARTICULAR FONT, STYLE, SIZE, OR COLOR.

OWNER OF INTERNATIONAL REGISTRATION 1073056 DATED 3-29-2011, EXPIRES 3-29-2021.

NO CLAIM IS MADE TO THE EXCLUSIVE RIGHT TO USE "BOOT", APART FROM THE MARK AS SHOWN.

SER. NO. 79-095,787, FILED 3-29-2011.

GILBERT SWIFT, EXAMINING ATTORNEY



David J. Kybas

Director of the United States Patent and Trademark Office

United States of America

United States Patent and Trademark Office



Reg. No. 4,152,236

Registered June 5, 2012

Int. Cls.: 6 and 7

VASTAS VALF ARMATÜR SANAYI TICARET ANONIM SİRKETİ (TURKEY JOINT STOCK COMPANY)
PERPA TICARET MERKEZİ B
BLOK KAT: 13 NO: 2365
OKMEYDANI SISLI ISTANBUL, TURKEY

TRADEMARK

PRINCIPAL REGISTER

FOR: COMMON METALS AND THEIR ALLOYS; METAL BUILDING MATERIALS, NAMELY, SOFFITS, FASCIA, CEILING BOARDS AND FLOOR BOARDS, TRANSPORTABLE BUILDINGS OF METAL; MATERIALS OF METAL FOR RAILWAY TRACKS; NON-ELECTRIC CABLES AND WIRES OF COMMON METAL; IRONMONGERY, NAMELY, IRON GATES, STEEL SCRAPS, PYRITES, JUNCTIONS OF METAL FOR PIPES INCLUDING THOSE FROM ALLOY STEEL AND TITANIUM, SMALL ITEMS OF METAL HARDWARE, NAMELY, NUTS, BOLTS, PIPES AND TUBES OF METAL; METAL SAFES; METAL VALVES, FITTINGS, CONNECTORS, COUPLINGS AND JOINTS FOR PIPES, DUCTS; PINS FOR USE IN MOUNTING INSECTS, COMMON METALS FOR FURTHER MANUFACTURE OF STEEL GRATINGS, PORTABLE METAL BUILDINGS, METAL FLOORS, METAL STAIRS, IRON RAILINGS FOR FENCES AND FOR BALCONIES, IRON FENCES, METAL ROOFS, METAL FENCES, PREFABRICATED METAL PLATFORMS, METAL TELEPHONE BOOTHS, MOBILE METAL GREENHOUSES, METAL SWIMMING POOLS, METAL SILOS, METAL BARRIERS FOR ROADS, METAL SCREENS, METAL FILTERS, INCLUDING THOSE MADE OF METAL MESH, FOR USE IN METAL WINDOW SCREENS, METAL FURNACE SCREENS, AND METAL FIREPLACE SCREENS, METAL DOORS AND WINDOWS, METAL DOOR AND WINDOW FRAMES; MOLDS MADE OF METAL, METAL SCAFFOLDING AND METAL PIPES, METAL SUPPORTS, METAL TELESCOPIC POLES FOR CONSTRUCTION, WELDING AND SOLDERING WIRES, METAL ROPES, USED FOR LIFTING AND TRANSPORTING METAL HANGERS, METAL TIES, STRAPS, BELTS AND RIBBONS FOR HANDLING LOADS; AIR-CONDITIONING, HEATING AND AIR CONDITIONING INSTALLATIONS FOR THE METAL HVAC DUCTS, VENTS AND VENT COVERS, METAL PIPES, METAL CHIMNEY CAPS, METAL ROAD SIGNS, METAL LICENSE PLATES, NON-ILLUMINATED AND NON MECHANICAL METAL SIGNS, METAL ADVERTISEMENTS COLUMNS OF METAL AND BILLBOARDS, LIFTING, LOADING AND TRANSPORTING METAL PALLETS FOR CONTAINERS, DRUMS, BARRELS, TANKS AND TANKS FOR STORAGE AND TRANSPORTATION, INDUSTRIAL PACKAGING MATERIALS MADE OF METAL, METAL PACKING BOXES, METAL FOILS, EMPTY METAL PRESSURE VESSELS, EMPTY METAL TUBES, METAL CYLINDERS FOR COMPRESSED GAS OR LIQUIDS, SOLD EMPTY; METAL PIPES FOR LIQUID AND GAS TRANSPORTATION; METAL DRILLING PIPES, METAL PIPE FITTINGS, METAL FLANGES, METAL PIPES SHAPED AS THE LETTER T, METAL NIPPLES,



David J. Kappas

Director of the United States Patent and Trademark Office

Reg. No. 4,152,236 METAL COUPLINGS FOR PIPES, METAL ELBOWS FOR PIPES, METAL HARDWARE NAMELY, NUTS, WASHERS, METAL VALVES, NOT BEING PARTS OF MACHINES OR ENGINES, METAL KEG TAPS, METAL COIN BOXES, METAL MONEY BOXES, METAL TOOL BOXES, METAL EQUIPMENT BOXES, METAL MAIL BOXES, METAL BICYCLE STORAGE RACKS, METAL RAILROAD TIES, CASTING MOLDS MADE OF METAL, WORKS OF ART MADE OF COMMON METALS AND THEIR ALLOYS NAMELY, MADE OF METAL CAPS, BOTTLE CAPS, NAME TAGS, METAL CAPS, PORTABLE LADDERS MADE OF METAL, IN CLASS 6 (U.S. CLS. 2, 12, 13, 14, 23, 25 AND 50).

FOR: MILKING MACHINES, CHURNING MACHINES, MILK PROCESSING MACHINES, EGG INCUBATORS, AND HOME MACHINES NAMELY, KITCHEN MIXERS, POWER DRILLS, AGRICULTURAL TOOLS AND MACHINES NAMELY, TILLERS, HARVESTERS, MECHANICAL SEALS; PISTON RINGS, GEARS FOR MACHINES, OTHER THAN FOR LAND VEHICLES, BEARINGS AS PART OF MACHINES, SUMP SHAFTS FOR MACHINES, FOR PUMPS, MACHINERY AND ENGINES AS PART OF THE PRESSURE REDUCERS, REGULATORS, PRESSURE VALVES, HYDRAULIC AND PNEUMATIC CONTROLS, PULLEYS BEING PART OF MACHINES, INTERNAL COMBUSTION ENGINE LAND VEHICLE PARTS NAMELY, COILS, PISTONS AND LINERS FOR INTERNAL COMBUSTION ENGINES, DRIVES FOR MOTORS OR VARIABLE SPEED DRIVES FOR MACHINES, TORQUE CONVERTERS NOT FOR LAND VEHICLES, CLUTCHES FOR MACHINES, CARDAN UNIVERSAL JOINTS FOR MACHINES, TURBINES NOT FOR LAND VEHICLES, BRAKE REPAIR KITS NOT FOR LAND VEHICLES, NAMELY, COMPRISED OF BRAKES FOR MACHINES, BRAKE LININGS FOR MACHINES, AND PARTS, BRAKES FOR MACHINES, BRAKE PADS AND SHOES FOR MACHINES, STARTERS FOR MOTORS AND/OR ENGINES, DYNAMO, DYNAMO BRUSHES, BICYCLE DYNAMOS, SPARK PLUGS, IGNITION DEVICES FOR MOTORS OF LAND VEHICLES, FUEL OR ENGINE INJECTORS, BEARINGS AS PART OF MACHINES, BALL OR ROLLER BEARINGS AS PART OF MACHINES, CARBURETORS, CARBURETORS FOR FEEDERS, FUEL SAVING DEVICES FOR ENGINES, NAMELY, FILTERS, CATALYSTS, FUEL CONVERSION EQUIPMENT FOR INTERNAL COMBUSTION ENGINES, LPG CONVERSION EQUIPMENT, RADIATORS FOR VEHICLES, ENGINE COOLERS, FANS FOR MOTORS AND ENGINES, FUEL AND AIR FILTERS FOR MECHANICAL PURPOSES, ENGINE PARTS, NAMELY, CYLINDER HEADS, CAMSHAFTS, ELECTRIC MOTORS EXCEPT FOR LAND TRANSPORTATION VEHICLES, TIRE REMOVAL AND REPLACEMENT MACHINES, ALTERNATORS, GENERATORS OF ELECTRICITY, ELECTRICITY GENERATORS, SOLAR-POWERED ELECTRICITY GENERATORS, PAINTING MACHINES, ELECTRIC HAND DRILLS, HAND-HELD POWER SAWS, JIGSAW MACHINES, SPIRAL BINDING MACHINES FOR INDUSTRIAL USE, INDUSTRIAL ROBOTS, COMPRESSED AIR GENERATORS, COMPRESSORS FOR MACHINES, FOR AIR CONDITIONERS, ELECTRIC, GAS OR LASER WELDING MACHINES; ELECTRIC WELDING MACHINES, ELECTRIC, GAS OR LASER SPOT WELDING MACHINES, PRINTING MACHINES AND PARTS, MINERAL GRINDING MACHINES, CRUSHING MACHINES FOR INDUSTRIAL PURPOSES, PACKAGING MACHINES, FILLING, PLUGGING AND SEALING MACHINES, LABELING MACHINES FOR INDUSTRIAL PURPOSES, SORTING MACHINES, LEATHER TANNING MACHINES, CHOPPING, GRINDING, CRUSHING, MIXING AND POWER TOOLS USED FOR CRUSHING IN THE KITCHEN, NAMELY, KITCHEN MIXERS, ELECTRIC FOOD BLENDERS, ELECTRIC KNIVES, ELECTRIC MINCING MACHINES, ELECTRIC FOOD GRINDING MACHINES, GARBAGE DISPOSALS, DISH-WASHING MACHINES, LAUNDRY FOR WASHING AND DRYING, AND PRESSING MACHINES, ELECTRIC OR MOTORIZED FLOOR POLISHING MACHINES, ELECTRIC VACUUM CLEANERS AND CARPET CLEANING MACHINES AND THEIR PIPES, FITTINGS AND ACCESSORIES, CASTING MACHINES AND PARTS THEREOF FOR CASTING CRUCIBLES IN THE NATURE OF CONVERTERS AND TREATMENT LADLES, CAR WASHING MACHINERY, AUTOMATIC DOUGH KNEADING MACHINES, DOUGH FORMING MACHINES, INTERMEDIATE DOUGH PROOFING MACHINES, CUTTING MACHINES, DOUGH CUTTING MACHINES, FOREIGN MATERIAL SEPARATOR MACHINES, SCREEN MACHINE FOR GRAVEL AND DIRT, ELECTRO-MAGNETIZING MACHINES FOR SEPARATING RECYCLABLE MATERIALS, FANS FOR MOTORS AND ENGINES, MILLING MACHINES, GRAIN PROCESSING MACHINES, GRAIN CRUSHER

Reg. No. 4,152,236 MACHINES, DANDRUFF BRUSH MACHINES, PEELING AND SEPARATING MACHINES,
IN CLASS 7 (U.S. CLS. 13, 19, 21, 23, 31, 34 AND 35).

THE MARK CONSISTS OF THREE GREEN CURVED LINES AND THE GREEN WORDING
"VASTAS".

OWNER OF INTERNATIONAL REGISTRATION 1059445 DATED 10-22-2010, EXPIRES 10-
22-2020.

THE COLOR(S) GREEN IS/ARE CLAIMED AS A FEATURE OF THE MARK.

SER. NO. 79-095,952, FILED 12-14-2010.

TOBY BULLOFF, EXAMINING ATTORNEY

United States of America

United States Patent and Trademark Office

MasterTag

Reg. No. 4,152,237

Registered June 5, 2012

Int. Cls.: 35, 38 and 42

SERVICE MARK

PRINCIPAL REGISTER

ZANOX.DE AG (FED REP GERMANY PUBLIC LIMITED COMPANY)
STRALAUER ALLEE 2
10245 BERLIN, FED REP GERMANY

FOR: ADVERTISING, IN PARTICULAR MARKETING; OFFICE FUNCTIONS; ARRANGING AND CONCLUDING OF COMMERCIAL TRANSACTIONS ON THE INTERNET; ARRANGING SERVICES AND SALES AND THE BILLING THEREFORE, NAMELY, ON-LINE TRADING SERVICES TO FACILITATE TRADING OF GOODS AND SERVICES FOR OTHERS; OPERATING VIRTUAL MARKETPLACES ON ELECTRONIC MEDIA, IN PARTICULAR THE INTERNET, NAMELY, ARRANGING CONTRACTS FOR THE BUYING OF GOODS AND THE PROVIDING OF SERVICES FOR THIRD PARTIES; ON-LINE SERVICES, NAMELY, ELECTRONIC PROCESSING OF ORDERS FOR OTHERS; E-COMMERCE PROVIDER SERVICES, NAMELY, THE PRESENTATION OF GOODS ON COMMUNICATION MEDIA FOR RETAIL PURPOSES; BUSINESS SERVICES, NAMELY, PREPARING INVOICES OVER ELECTRONIC ORDERING SYSTEMS; ON-LINE INFORMATION PROVIDER SERVICES, NAMELY, PROVIDING A WEB SITE AT WHICH USERS CAN OFFER GOODS FOR SALE AND BUY GOODS OFFERED BY OTHERS; PROVIDING A WEB SITE FEATURING INFORMATION REGARDING MARKETING AND ADVERTISEMENT; COLLECTION OF DATA IN ONLINE DATABASES FOR BUSINESS PURPOSES; PROVIDING AN ON-LINE COMPUTER DATABASE IN THE FIELD OF MARKETING, INTEGRATED TRACKING AND MANAGEMENT OF COMMERCIAL TRANSACTIONS IN THE BUSINESS TO BUSINESS AND BUSINESS TO CONSUMER AREAS, IN CLASS 35 (U.S. CLS. 100, 101 AND 102).



FOR: TELECOMMUNICATIONS SERVICES, NAMELY, TELECOMMUNICATIONS ACCESS SERVICES AND TELECOMMUNICATIONS GATEWAY SERVICES; PROVIDING ACCESS TO THE INTERNET; LEASING OF TELECOMMUNICATIONS LINES TO AFFORD ACCESS TO INTERNET PAGES, DATA NETWORKS AND DATABASES; TRANSMISSION OF INFORMATION IN THE FORM OF DATA, TEXTS AND SOUND RELATING TO OFFERS FOR GOODS; TRANSMISSION OF INFORMATION BY ELECTRONIC COMMUNICATIONS NETWORKS; PROVISION OF ACCESS TO A GLOBAL COMPUTER NETWORK; INTERNET SERVICES PROVIDER SERVICES, NAMELY, TRANSMITTING INFORMATION VIA THE INTERNET CONCERNING GLOBAL COMPUTER NETWORK DATA IN THE FIELD OF OFFERS FOR GOODS, IN CLASS 38 (U.S. CLS. 100, 101 AND 104).

David J. Kyffers

Director of the United States Patent and Trademark Office

FOR: CREATING AND MAINTAINING WEB SITES FOR OTHERS; DESIGN OF DATABASES; DESIGN OF TECHNICAL COMMUNICATION SYSTEMS; COMPUTER SERVICES, NAMELY, CREATING AND MAINTAINING WEB SITES FOR OTHERS; CONSULTANCY WITH RE-

Reg. No. 4,152,237 GARD TO THE DESIGN OF WEB SITES; DESIGN OF HOME PAGES AND WEB SITES; COMPUTER PROJECT MANAGEMENT SERVICES IN THE NATURE OF TECHNICAL PROJECT MANAGEMENT IN THE FIELD OF ELECTRONIC DATA PROCESSING; SUPPORT SERVICES IN THE NATURE OF MAINTAINING OF WEB SITES, IN CLASS 42 (U.S. CLS. 100 AND 101).

THE MARK CONSISTS OF STANDARD CHARACTERS WITHOUT CLAIM TO ANY PARTICULAR FONT, STYLE, SIZE, OR COLOR.

PRIORITY DATE OF 11-4-2010 IS CLAIMED.

OWNER OF INTERNATIONAL REGISTRATION 1073477 DATED 3-3-2011, EXPIRES 3-3-2021.

SER. NO. 79-095,963, FILED 3-3-2011.

ALLISON HOLTZ, EXAMINING ATTORNEY

United States of America

United States Patent and Trademark Office

Camelight

Reg. No. 4,152,238

Registered June 5, 2012

Int. Cls.: 9 and 11

TRADEMARK

PRINCIPAL REGISTER

CAMELION BATTERY CO., LTD. (CHINA LIMITED COMPANY)
UNIT 705, CYBER TIMES TOWER A
TIANAN CYBER PARK SHENZHEN
518041 GUANGDONG, CHINA

FOR: GALVANIC CELLS, NAMELY, ELECTRIC BATTERIES; BATTERY CHARGERS; ELECTRIC THEFT PREVENTION INSTALLATIONS, NAMELY, BURGLAR ALARMS; ELECTRIC REGULATED POWER SUPPLY, NAMELY, HIGH-FREQUENCY SWITCHING POWER SUPPLIES; MODEMS; CABINETS FOR LOUDSPEAKERS; COMPUTERS; WIRES, ELECTRIC; BATTERIES FOR POCKET LAMPS; SOLAR BATTERIES, IN CLASS 9 (U.S. CLS. 21, 23, 26, 36 AND 38).

FOR: ELECTRIC TORCHES FOR LIGHTING; LIGHTING APPARATUS FOR VEHICLES AND LIGHTING APPARATUS, NAMELY, LIGHTING INSTALLATIONS; LAMPS; COOKING APPARATUS AND INSTALLATIONS, NAMELY, COMMERCIAL COOKING OVENS; REFRIGERATORS; AIR PURIFYING APPARATUS AND MACHINES; SHOWERS; FILTERS FOR DRINKING WATER; RADIATORS, ELECTRIC; FANS FOR AIR CONDITIONING APPARATUS, IN CLASS 11 (U.S. CLS. 13, 21, 23, 31 AND 34).

THE MARK CONSISTS OF THE STYLIZED WORDING "CAMELIGHT" FEATURED ABOVE THE DESIGN OF A ROW OF HORIZONTAL CIRCLES.

OWNER OF INTERNATIONAL REGISTRATION 1073688 DATED 3-28-2011, EXPIRES 3-28-2021.

SER. NO. 79-096,062, FILED 3-28-2011.

CHARISMA HAMPTON, EXAMINING ATTORNEY



David J. Kyros

Director of the United States Patent and Trademark Office

United States of America

United States Patent and Trademark Office



Reg. No. 4,152,239

Registered June 5, 2012

Int. Cls.: 35 and 41

SERVICE MARK

PRINCIPAL REGISTER

FRANÇOIS BOGACZ (FRANCE INDIVIDUAL)
RUA SÃO JOÃO DA MATA, Nº 112 B, VV2
P-1200-851 LISBOA
PORTUGAL

FOR: SELECTION OF PERSONNEL THROUGH PSYCHOLOGICAL TESTING, IN CLASS 35 (U.S. CLS. 100, 101 AND 102).

FOR: ARRANGING AND CONDUCTING OF EDUCATIONAL CONFERENCES; EDUCATION IN THE FIELD OF NEGOTIATION, CONFLICT PREVENTION, MANAGEMENT AND RESOLUTION, LEADERSHIP DEVELOPMENT, LAW, ADVOCACY, HUMAN RESOURCES, PSYCHOLOGY, MEDIATION, COACHING, PERSONAL AND PROFESSIONAL DEVELOPMENT, TEAM-BUILDING, PEDAGOGY, AND THE NEUROSCIENCES RENDERED THROUGH CORRESPONDENCE COURSES; TEACHING OF CORRESPONDENCE COURSES IN THE FIELD OF NEGOTIATION, CONFLICT PREVENTION, MANAGEMENT AND RESOLUTION, LEADERSHIP DEVELOPMENT, LAW, ADVOCACY, HUMAN RESOURCES, PSYCHOLOGY, MEDIATION, COACHING, PERSONAL AND PROFESSIONAL DEVELOPMENT, TEAM-BUILDING, PEDAGOGY, AND THE NEUROSCIENCES; FILM PRODUCTION; PUBLICATION OF BOOKS; ARRANGING AND CONDUCTING OF WORKSHOPS AND TRAINING IN THE FIELD OF NEGOTIATION, CONFLICT PREVENTION, MANAGEMENT AND RESOLUTION, LEADERSHIP DEVELOPMENT, LAW, ADVOCACY, HUMAN RESOURCES, PSYCHOLOGY, MEDIATION, COACHING, PERSONAL AND PROFESSIONAL DEVELOPMENT, TEAM-BUILDING, PEDAGOGY, AND THE NEUROSCIENCES; PUBLICATION OF ELECTRONIC BOOKS AND JOURNALS ON-LINE; ARRANGING AND CONDUCTING OF SYMPOSIUMS IN THE FIELD OF NEGOTIATION, CONFLICT PREVENTION, MANAGEMENT AND RESOLUTION, LEADERSHIP DEVELOPMENT, LAW, ADVOCACY, HUMAN RESOURCES, PSYCHOLOGY, MEDIATION, COACHING, PERSONAL AND PROFESSIONAL DEVELOPMENT, TEAM-BUILDING, PEDAGOGY, AND THE NEUROSCIENCES; ARRANGING AND CONDUCTING OF SEMINARS IN THE FIELD OF NEGOTIATION, CONFLICT PREVENTION, MANAGEMENT AND RESOLUTION, LEADERSHIP DEVELOPMENT, LAW, ADVOCACY, HUMAN RESOURCES, PSYCHOLOGY, MEDIATION, COACHING, PERSONAL AND PROFESSIONAL DEVELOPMENT, TEAM-BUILDING, PEDAGOGY, AND THE NEUROSCIENCES, IN CLASS 41 (U.S. CLS. 100, 101 AND 107).

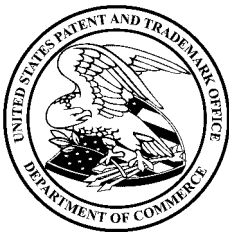

David J. Kyjars

THE MARK CONSISTS OF THE WORDING "NEUROAWARENESS" WITH "NEURO" IN BLACK AND "AWARENESS" IN GRAY, TO THE RIGHT OF TWELVE CIRCLES ARRANGED

Reg. No. 4,152,239 IN A GEOMETRIC FORMATION. THE CENTER CONNECTED CIRCLES ARE BLUE AND THE OTHER CIRCLES ARE BLACK.

PRIORITY DATE OF 1-25-2011 IS CLAIMED.

OWNER OF INTERNATIONAL REGISTRATION 1073865 DATED 2-11-2011, EXPIRES 2-11-2021.

THE COLOR(S) BLACK, GRAY, AND BLUE IS/ARE CLAIMED AS A FEATURE OF THE MARK.

SER. NO. 79-096,142, FILED 2-11-2011.

KIMBERLY FRYE, EXAMINING ATTORNEY

United States of America

United States Patent and Trademark Office



Reg. No. 4,152,240

Registered June 5, 2012

Int. Cl.: 41

SERVICE MARK

PRINCIPAL REGISTER

OY KWC ORGANIZATION LTD (FINLAND PUBLIC LIMITED COMPANY)
KÄKIKATU 29
FI-18130 HEINOLA SUOMI
FINLAND

FOR: ARRANGING ENTERTAINMENT EVENTS AND COMPETITIONS IN THE FIELD OF KARAOKE; EVENT MANAGEMENT SERVICES IN THE NATURE OF ORGANIZATION OF ENTERTAINMENT EVENTS AND COMPETITIONS IN THE FIELD OF KARAOKE; ORGANIZING KARAOKE EVENTS AND COMPETITIONS; PRODUCTION OF KARAOKE EVENTS; PROVIDING KARAOKE EVENT MANAGEMENT SERVICES; ENTERTAINMENT SERVICES, NAMELY, CONDUCTING SHOWS FEATURING KARAOKE PERFORMANCES BY INDIVIDUALS AND GROUPS; ORGANIZATION OF KARAOKE EVENTS AND COMPETITIONS, IN CLASS 41 (U.S. CLS. 100, 101 AND 107).

OWNER OF U.S. REG. NO. 3,307,573.

OWNER OF INTERNATIONAL REGISTRATION 0902079 DATED 9-29-2006, EXPIRES 9-29-2016.

NO CLAIM IS MADE TO THE EXCLUSIVE RIGHT TO USE "KARAOKE WORLD CHAMPIONSHIPS", APART FROM THE MARK AS SHOWN.

SER. NO. 79-096,208, FILED 7-15-2010.

ALICE BENMAMAN, EXAMINING ATTORNEY



David J. Kyffers

Director of the United States Patent and Trademark Office

United States of America

United States Patent and Trademark Office

WHITEBOOK TAILORED NOTEBOOKS

Reg. No. 4,152,241

Registered June 5, 2012

**Int. Cls.: 9, 16, 18, 35
and 39**

TRADEMARK

SERVICE MARK

PRINCIPAL REGISTER

PETER ZELLER (SWITZERLAND INDIVIDUAL)
FLIGUETSTRASSE 14
CH-8872 WEESEN
SWITZERLAND

FOR: DATA PROCESSING EQUIPMENT, NAMELY, COMPUTERS, DATA PROCESSORS, COMPUTER SOFTWARE FOR PROCESSING DIGITAL INFORMATION AND IMAGES, MICROPROCESSORS; DIGITAL DATA RECORDING MEDIA, NAMELY, PORTABLE AND HANDHELD DIGITAL ELECTRONIC DEVICES FOR RECORDING, ORGANIZING, TRANSMITTING, MANIPULATING AND REVIEWING TEXT, DATA IMAGE, AUDIO AND VIDEO FILES AND ALL TYPES OF STORAGE SUPPORT, NAMELY, BLANK DIGITAL STORAGE MEDIA, BLANK ELECTRONIC STORAGE MEDIA, FLASH MEMORY CARDS, IN CLASS 9 (U.S. CLS. 21, 23, 26, 36 AND 38).

FOR: BOOKBINDING ARTICLES, NAMELY, NOTEBOOKS, BINDINGS FOR REFILLABLE NOTEBOOKS, NOTEBOOKS FOR JOTTING, SKETCHES AND DRAWINGS, IN CLASS 16 (U.S. CLS. 2, 5, 22, 23, 29, 37, 38 AND 50).

FOR: LEATHER OR IMITATIONS OF LEATHER, NAMELY, LEATHER COVERS FOR NOTEBOOKS; LEATHER CASES FOR NOTEBOOKS AND DIGITAL DATA RECORDING EQUIPMENT ALSO FOR DATA PROCESSING EQUIPMENT, IN CLASS 18 (U.S. CLS. 1, 2, 3, 22 AND 41).

FOR: ADVERTISING, BUSINESS DEALINGS MANAGEMENT, BUSINESS MANAGEMENT, PARTICULARLY HELP IN PLANNING FOR BUSINESS MANAGEMENT, IN CLASS 35 (U.S. CLS. 100, 101 AND 102).

FOR: STORAGE OF ELECTRONICALLY STORED DOCUMENTS, NAMELY, PHYSICAL STORAGE OF ELECTRONICALLY STORED DOCUMENTS, STORAGE SERVICES FOR ARCHIVING ELECTRONICALLY STORED DOCUMENTS, TEMPORARY ELECTRONIC STORAGE FOR ELECTRONICALLY STORED DOCUMENTS; ELECTRONIC STORAGE OF PAPER DOCUMENTS, IN CLASS 39 (U.S. CLS. 100 AND 105).

THE MARK CONSISTS OF STANDARD CHARACTERS WITHOUT CLAIM TO ANY PARTICULAR FONT, STYLE, SIZE, OR COLOR.

PRIORITY DATE OF 12-6-2010 IS CLAIMED.



David J. Kyros

Director of the United States Patent and Trademark Office

Reg. No. 4,152,241 OWNER OF INTERNATIONAL REGISTRATION 1074328 DATED 3-9-2011, EXPIRES 3-9-2021.

NO CLAIM IS MADE TO THE EXCLUSIVE RIGHT TO USE "TAILORED NOTEBOOKS",
APART FROM THE MARK AS SHOWN.

SER. NO. 79-096,343, FILED 3-9-2011.

CHARISMA HAMPTON, EXAMINING ATTORNEY

United States of America

United States Patent and Trademark Office



SAS LE PRINCE *Albert II de Monaco* *AB* MADMOISELLE *Charlene Wittstock*

MONACO, LE 2 JUILLET 2011

Reg. No. 4,152,242

Registered June 5, 2012

**Int. Cls.: 8, 14, 16, 18, 20,
21, 24, 26 and 35**

TRADEMARK

SERVICE MARK

PRINCIPAL REGISTER

CABINET GRANGER (FRANCE SELARL)
13 RUE PAUL VALÉRY
F-75016 PARIS
FRANCE

FOR: HAND TOOLS AND HAND-OPERATED IMPLEMENTS, NAMELY, CLAMPS; SILVERWARE, NAMELY, CUTLERY, FORKS AND SPOONS; SCISSORS; TABLE CUTLERY, NAMELY, CUTLERY, FORKS AND SPOONS; SUGAR TONGS; ICE CUBE TONGS; CUTLERY, NAMELY, FORKS WITH CHOPSTICK HANDLES; SIDE ARMS, OTHER THAN FIREARMS, NAMELY, SWORDS; RAZORS, IN CLASS 8 (U.S. CLS. 23, 28 AND 44).

FOR: PRECIOUS METALS AND THEIR ALLOYS; JEWELRY, PRECIOUS STONES; HOROLOGICAL AND CHRONOMETRIC INSTRUMENTS, NAMELY, WATCHES; WATCHES AND WATCH BANDS; CUFF LINKS; KEY RINGS, NAMELY, TRINKETS AND FOBS OF PRECIOUS METALS; JEWELRY CASES; TIE PINS AND ORNAMENTAL PINS, WALL CLOCKS, ALARM CLOCKS; GOODS OF PRECIOUS METALS AND THEIR ALLOYS OR COATED THEREWITH, NAMELY, BOXES AND PRESENTATION CASES, BUSTS, FIGURINES, STATUES AND STATUETTES, BADGES, INGOTS, MEDALS AND MEDALLIONS, IN CLASS 14 (U.S. CLS. 2, 27, 28 AND 50).

FOR: PAPER AND CARDBOARD, NAMELY, UNPROCESSED AND SEMI-PROCESSED PAPER AND CARDBOARD FOR STATIONERY OR FOR PRINTING PURPOSES; PRINTED MATTER, NAMELY, MAGAZINES IN THE FIELD OF HOUSEHOLD DECOR; BOOKS IN THE FIELD OF HOUSEHOLD DÉCOR; POSTCARDS; PHOTOGRAPH ALBUMS; STATIONERY; BOOKBINDING MATERIAL; PHOTOGRAPHS; ADHESIVE GLUES FOR STATIONERY OR HOUSEHOLD PURPOSES; ARTISTS' MATERIALS, NAMELY, PAINT BOXES; PAINTBRUSHES; AND OFFICE REQUISITES EXCEPT FURNITURE, NAMELY, STAPLERS, PENS, BALLPOINT PENS, FOUNTAIN PENS, PENCIL LEAD HOLDERS, PENCILS, PENCIL HOLDERS, PENHOLDERS, BOXES FOR PENS, WRITING INK STANDS, LETTER OPENERS, DESKTOP CALLING CARD HOLDERS, LETTER TRAYS, PAPERWEIGHTS, BOOKENDS, WRITING PADS, BLOTTERS, DESKTOP CABINETS FOR STATIONERY, TEAR-OFF CALENDARS, LETTER PAPER, PAPER-CLIPS, BOOKMARKERS, PENCIL CASES; PRINTED INSTRUCTIONAL AND TEACHING MATERIAL EXCEPT APPARATUS IN THE FIELD OF HOUSEHOLD DECOR; PRINTING TYPE, IN CLASS 16 (U.S. CLS. 2, 5, 22, 23, 29, 37, 38 AND 50).



David J. Kappas

Director of the United States Patent and Trademark Office

Reg. No. 4,152,242 FOR: LEATHER AND IMITATIONS OF LEATHER; TANNED HIDES; LEATHERWARE, NAMELY, BAGS, TRUNKS AND SUITCASES; HANDBAGS, TRAVELING BAGS, SCHOOL BAGS, PURSES, WALLETS, KEY CASES, LUGGAGE CHESTS, PRESENTATION CASES, NAMELY, ATTACHÉ CASES, CUTLERY HOLDERS OF LEATHER OR IMITATION LEATHER, UMBRELLAS, PARASOLS AND WALKING STICKS, IN CLASS 18 (U.S. CLS. 1, 2, 3, 22 AND 41).

FOR: FURNITURE, MIRRORS, PICTURE FRAMES; PHOTOGRAPH FRAMES; TEA AND DESSERT SERVING TROLLEYS; BOTTLE RACKS; CHESTS, NOT OF METAL; COMPUTER KEYBOARD TRAYS, NOT OF METAL; DRINKING STRAWS; FIGURINES AND STATUES OF WOOD, WAX, PLASTER OR PLASTIC; FLOWER-POT PEDESTALS; NEWSPAPER DISPLAY STANDS; BOOK RESTS, MAGAZINE RACKS; DECORATIVE MOBILES , IN CLASS 20 (U.S. CLS. 2, 13, 22, 25, 32 AND 50).

FOR: HOUSEHOLD OR KITCHEN SPATULAS AND CONTAINERS; COMBS AND BATH SPONGES; FLOOR BRUSHES; GOODS OF GLASS, PORCELAIN, CRYSTAL AND EARTH-ENWARE, NAMELY, PLATES, CUPS, SAUCERS, DISHES, TRAYS FOR DOMESTIC PURPOSES, SOUP TUREENS, VEGETABLE DISHES, BOWLS, BUTTER-DISH AND CHEESE-DISH COVERS, BUTTER DISHES, DRINKING VESSELS, BOXES FOR SWEETMEATS, EGG CUPS, FRUIT CUPS, FLOWER POTS AND VASES; FINGER BOWLS; PEPPER POTS, SALT CELLARS, SUGAR BOWLS; DRINKING GLASSES; TOWEL RAILS AND RINGS; COOKING POT SETS; GLASS JARS, TEA BOXES, TEA INFUSERS, CANDLE HOLDERS, PERFUME BURNERS, CANDELABRA, NAMELY, CANDLE STICKS, CORKSCREWS, BOTTLE OPENERS, BOTTLES SOLD EMPTY, DECANTERS, FLASKS, OPALINE GLASS; BUSTS, STATUETTES AND STATUES, OF PORCELAIN, TERRA-COTTA OR GLASS; CLAY POTS; TEA SERVICES, COFFEE SERVICES; LIQUEUR GLASS SETS; SKEWERS, NAMELY, METAL NEEDLES FOR COOKING; KNIFE RESTS FOR THE TABLE; TOOTHPICKS AND TOOTHPICK HOLDERS; TABLE MATS, NAMELY, SPOON RESTS; ICE BUCKETS; CAKE MOLDS; ICE CUBE MOLDS; CRUET STANDS FOR OIL AND VINEGAR; BASTING SPOONS, FOR KITCHEN USE; BREAD BASKETS FOR DOMESTIC USE AND BREAD BOARDS; PIE SERVERS, PIPETTES, NAMELY, WINE-TASTING CUPS, POWDER COMPACTS SOLD EMPTY, NAPKIN RINGS, KITCHEN UTENSILS, NAMELY, SPATULAS AND MIXING SPOONS, CROCKERY SETS, NAMELY, DISHES AND POTS, CENTERPIECES, NAMELY, VASES AND BOWL, IN CLASS 21 (U.S. CLS. 2, 13, 23, 29, 30, 33, 40 AND 50).

FOR: FABRICS FOR TEXTILE USE, UPHOLSTERY FABRICS, FABRICS OF COTTON, WOOL, SILK, LINEN AND DAMASK CLOTH; WALL HANGINGS OF TEXTILE, COTTON FABRICS, TABLECLOTHS NOT OF PAPER, TABLECLOTHS OF FABRIC, PLACE MATS NOT OF PAPER, TABLE NAPKINS OF TEXTILE, TABLE THROWS NOT OF PAPER, FABRIC TABLE RUNNERS, FABRIC TABLE COVERS, CLOTH COASTERS FOR CARAFES, FOR GLASSES AND FOR BEER MUGS, GLASS CLOTH COASTERS, TABLE LINEN NOT OF PAPER, TABLE LINEN OF FABRIC, TABLE MATS NOT OF PAPER, BED LINEN, BED SHEETS, PILLOWCASES, PILLOW SHAMS, COVERS FOR CUSHIONS, BED BLANKETS, LAP RUGS, TRAVEL RUGS, COVERLETS, SLEEPING BAGS IN THE NATURE OF SHEETING, HOUSEHOLD LINEN, BATH LINEN EXCEPT CLOTHING, HAND TOWELS OF TEXTILE, WASHING MITTS, FACE TOWELS OF TEXTILE, HANDKERCHIEFS OF TEXTILE, CURTAINS OF TEXTILE OR PLASTIC, MOSQUITO NETS, ADHESIVE FABRICS FOR APPLICATION BY HEAT, BANNERS OF TEXTILE, FLAGS OF TEXTILE, PENNANTS OF TEXTILE, BILLIARD CLOTH, TEXTILE USED AS LININGS FOR HATS; FABRIC FOR BOOTS AND SHOES, IN CLASS 24 (U.S. CLS. 42 AND 50).

FOR: ORNAMENTS FOR SHOES AND CLOTHING NOT OF PRECIOUS METAL, BROOCHES IN THE NATURE OF CLOTHING ACCESSORIES, FASTENINGS FOR CLOTHING AND TIES FOR CLOTHING, NAMELY, SNAP BUTTONS AND HOOKS, BELT BUCKLES, ORNAMENTAL NOVELTY BADGES FOR WEAR, NOT OF PRECIOUS METAL, CLASPS FOR CLOTHING, BELT CLASPS, FASTENINGS FOR SUSPENDERS, DECORATIVE ARTICLES FOR THE HAIR, HAIR ORNAMENTS, HAIR PINS, HAIR ELASTICS, LONG HAIR PINS, HAIR BANDS, BARRETTES, HAT ORNAMENTS NOT OF PRECIOUS METAL, ARTIFICIAL FLOWERS,

Reg. No. 4,152,242 OSTRICH FEATHERS, BIRDS' ORNAMENTATION FEATHERS USED AS CLOTHING ACCESSORIES, SHOE FASTENERS, SHOE BUCKLES, LACE TRIMMINGS AND EMBROIDERY, FRILLS, NAMELY, LACE TRIMMINGS, DRESS, SKIRT OR JACKET FLOUNCES, SILVER EMBROIDERY, GOLD EMBROIDERY, RIBBONS AND BRAIDS, BUTTONS, SNAP FASTENERS, EYELETS, DETACHABLE COLLAR SUPPORTS, COLLAR SUPPORTS, ORNAMENTAL BADGES, ROSETTES IN THE NATURE OF PASSEMENTERIE, EDGINGS FOR CLOTHING, EDGE TRIMS, NAMELY, EDGINGS FOR CLOTHING, DRESS FASTENINGS, NAMELY, HOOKS, FANCY GOODS IN THE NATURE OF EMBROIDERY, SEWING PINS AND NEEDLES, SEWING BOXES, SEWING THIMBLES, NEEDLE CASES NOT OF PRECIOUS METAL, HEAT ADHESIVE PATCHES FOR DECORATION OF TEXTILE ARTICLES IN THE NATURE OF HABERDASHERY, NUMERALS OR LETTERS IN THE NATURE OF MARKING PINS FOR LINEN OR CLOTHING, SPANGLES FOR CLOTHING, SPANGLES OF MICA, ORSEDEW IN THE NATURE OF TRIMMINGS FOR CLOTHING, PASSEMENTERIE, TASSELS, WREATHS OF ARTIFICIAL FLOWERS, ARTIFICIAL GARLANDS, IN CLASS 26 (U.S. CLS. 37, 39, 40, 42 AND 50).

FOR: ADVERTISING ON ALL MEDIA; BUSINESS MANAGEMENT, BUSINESS ADMINISTRATION, OFFICE FUNCTIONS; BUSINESS ADVICE, INFORMATION AND INQUIRIES; BUSINESS MANAGEMENT CONSULTANCY, DISSEMINATION OF ADVERTISING MATTER, DISTRIBUTION OF ADVERTISING MAILINGS, SHOP-WINDOW DRESSING, DEMONSTRATION OF GOODS, DIRECT MAIL ADVERTISING, NAMELY, THE MAILING OF ADVERTISING LEAFLETS, PROSPECTUSES, PRINTED MATTER, SAMPLES, AUCTIONEERING, MARKETING STUDIES AND RESEARCH; ORGANIZATION OF TRADE FAIRS, EXHIBITIONS, EVENTS AND FAIRS FOR COMMERCIAL OR ADVERTISING PURPOSES, SALES PROMOTION, PUBLIC OPINION POLLING; PERSONNEL RECRUITMENT; ON-LINE ADVERTISING ON A COMPUTER NETWORK; PUBLIC RELATIONS; NEWS CLIPPING SERVICES; RETAIL STORE SERVICES FEATURING GOLD AND SILVER PLATE PRODUCTS, JEWELS, DECORATIVE ARTICLES IN THE NATURE OF VASES, PICTURE FRAMES, FRUIT CUPS, CANDLE HOLDERS, ASHTRAYS AND CARRIAGE CLOCKS AND TABLE ART; PROCUREMENT SERVICES, NAMELY, PURCHASING GOODS FOR OTHERS OF A VARIETY OF GOODS IN THE FIELD OF GOLD AND SILVER PLATE PRODUCTS, JEWELRY, DECORATION VASES, PICTURE FRAMES, FRUITS CUPS, CANDLE HOLDERS, ASHTRAYS AND CARRIAGE CLOCKS AND TABLE ART EXCLUDING THE TRANSPORT THEREOF AND ENABLING CUSTOMERS TO VIEW AND PURCHASE THOSE GOODS IN RETAIL STORES OR IN DEPARTMENT STORES, IN A GENERAL CATALOG OF GOODS OR FROM A WEB SITE OR OTHER FORM OF ELECTRONIC TELECOMMUNICATION MEDIA; TECHNICAL CONSULTING BY DEMONSTRATING GOODS; BRINGING TOGETHER, FOR THE BENEFIT OF OTHERS, OF GOLD AND SILVER PLATE PRODUCTS, JEWELS, DECORATIVE ARTICLES IN THE NATURE OF VASES, PICTURE FRAMES, FRUITS CUPS, CANDLE HOLDERS, ASHTRAYS AND CARRIAGE CLOCKS AND TABLE ART EXCLUDING THE TRANSPORT THEREOF AND ENABLING CONSUMERS TO VIEW, SELECT AND PURCHASE THEM CONVENIENTLY EQUIPPED WITH INFORMATION AND ADVICE IN SHOWROOMS; DOCUMENT REPRODUCTION, COMPUTERIZED FILE MANAGEMENT, IN CLASS 35 (U.S. CLS. 100, 101 AND 102).

NO CLAIM IS MADE TO THE EXCLUSIVE RIGHT TO USE "MONACO, LE 2 JUILLET 2011", APART FROM THE MARK AS SHOWN.

PRIORITY DATE OF 3-1-2011 IS CLAIMED.

OWNER OF INTERNATIONAL REGISTRATION 1074345 DATED 3-2-2011, EXPIRES 3-2-2021.

THE NAME(S), PORTRAIT(S), AND/OR SIGNATURE(S) SHOWN IN THE MARK IDENTIFIES "SAS LE PRINCE ALBERT II DE MONACO" AND "MADEMOISELLE CHARLENE WITSTOCK", WHOSE CONSENT(S) TO REGISTER IS MADE OF RECORD.

Reg. No. 4,152,242 THE MARK CONSISTS OF THE WORDING "SAS LE PRINCE ALBERT II DE MONACO AC MADemoiselle CHARLENE WITTSTOCK" IN A RECTANGLE WITH A CROWN DESIGN ABOVE THE RECTANGLE AND THE WORDING "MONACO, LE 2 JUILLET 2011" BELOW THE RECTANGLE.

THE ENGLISH TRANSLATION OF "JUILLET" IN THE MARK IS "JULY".

SER. NO. 79-096,353, FILED 3-2-2011.

JENNIFER VASQUEZ, EXAMINING ATTORNEY

United States of America

United States Patent and Trademark Office



Reg. No. 4,152,243

Registered June 5, 2012

Int. Cl.: 25

TRADEMARK

PRINCIPAL REGISTER

FRANCISCO JAVIER PUJOLAR PLA (SPAIN INDIVIDUAL)
VEINAT MILLARS, 28
E-17462 MADREMANYA (GIRONA)
SPAIN

FOR: CLOTHING, NAMELY, T-SHIRT, SHIRTS, SWEATERS, TROUSERS, LINGERIE, SOCKS, JACKETS, ANORAKS, WIND RESISTANT JACKETS, PARKAS; FOOTWEAR, HEADWEAR, IN CLASS 25 (U.S. CLS. 22 AND 39).

NO CLAIM IS MADE TO THE EXCLUSIVE RIGHT TO USE "CLOTHING", APART FROM THE MARK AS SHOWN.

OWNER OF INTERNATIONAL REGISTRATION 1074694 DATED 4-6-2011, EXPIRES 4-6-2021.

THE COLOR(S) BLACK, RED AND GREY IS/ARE CLAIMED AS A FEATURE OF THE MARK.

THE MARK CONSISTS OF A STYLIZED LETTER "Y" WITH BLACK DASHES AND GREY BACKGROUND INSIDE THE LETTER AND BLACK JAGGED LINES OUTLINING THE LETTER AND BLACK LIGHTNING BOLTS EMANATING FROM THE LETTER; UNDERNEATH APPEARS THE TERM "YHEHS" IN RED WITH THE BLACK TERM "CLOTHING" BELOW.

SER. NO. 79-096,483, FILED 4-6-2011.

CHRISTOPHER BUONGIORNO, EXAMINING ATTORNEY



David J. Kybas

Director of the United States Patent and Trademark Office

United States of America

United States Patent and Trademark Office



Reg. No. 4,152,244

Registered June 5, 2012

Int. Cls.: 18 and 25

TRADEMARK

PRINCIPAL REGISTER

DAFF SRL (ITALY LIMITED LIABILITY COMPANY)
VIA F. FILZI, 42
I-50059 SOVIGLIANA VINCI (FI), ITALY AND

ROBERTO DALLARMI (ITALY INDIVIDUAL)
VIA DEL PIANO, 62
I-50056 MONTELUPO F.NO (FI), ITALY AND

SIMONE MELANI (ITALY INDIVIDUAL)
VIA MANZONI, 31
I-50053 EMPOLI (FI), ITALY AND

RAAL S.R.L. (ITALY LIMITED LIABILITY COMPANY)
VIALE MANZONI, 10 A
I-47122 FORLÌ (FO), ITALY

FOR: UNWORKED LEATHER AND IMITATION LEATHER SOLD IN BULK; ANIMAL SKINS, HIDES; TRUNKS AND TRAVELING BAGS; BACKPACKS, BELT BAGS, BRIEFCASES, CHANGE PURSES, CREDIT CARD CASES MADE OF LEATHER; ALL PURPOSE SPORT BAGS, OVERNIGHT BAGS, SCHOOL BAGS, SHOE BAGS FOR TRAVEL, PURSES; UMBRELLAS, PARASOLS AND WALKING STICKS; WHIPS, HARNESS AND SADDLERY, IN CLASS 18 (U.S. CLS. 1, 2, 3, 22 AND 41).

FOR: CLOTHING FOR MEN, WOMEN AND CHILDREN, NAMELY, COATS, RAINCOATS, JACKETS, TROUSERS, SKIRTS, DRESSES, SUITS, SHIRTS AND CHEMISES, T-SHIRTS, SWEATERS, UNDERWEAR, SWIMWEAR, BEACHWEAR, SOCKS AND STOCKINGS, GLOVES, TIES, SCARVES, FOULARDS, HATS AND CAPS; BOOTS, SHOES AND SLIPPERS, BELTS FOR CLOTHING, IN CLASS 25 (U.S. CLS. 22 AND 39).

THE MARK CONSISTS OF THE WORD "MONOCROM" IN A WHITE STYLIZED FONT, ON A GREY RECTANGLE, WITH THE DESIGN OF A RED ANCHOR BETWEEN THE WORDING "MONO" AND "CROM".

OWNER OF INTERNATIONAL REGISTRATION 1074842 DATED 4-8-2011, EXPIRES 4-8-2021.

THE COLOR(S) RED, GREY, WHITE IS/ARE CLAIMED AS A FEATURE OF THE MARK.



David J. Kappas

Director of the United States Patent and Trademark Office

Reg. No. 4,152,244 THE ENGLISH TRANSLATION OF "MONOCROM" IN THE MARK IS "MONOCHROME".

SER. NO. 79-096,544, FILED 4-8-2011.

JAMES MACFARLANE, EXAMINING ATTORNEY

United States of America

United States Patent and Trademark Office

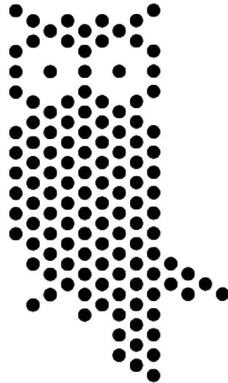

Reg. No. 4,152,245

Registered June 5, 2012

Int. Cls.: 9, 41 and 42

SPECS SURFACE NANO ANALYSIS GMBH (FED REP GERMANY LIMITED LIABILITY COMPANY)
VOLTA STR. 5
13355 BERLIN
FED REP GERMANY

TRADEMARK

SERVICE MARK

PRINCIPAL REGISTER

FOR: SCIENTIFIC APPARATUS AND INSTRUMENTS, NAMELY, MICROSCOPES, IN PARTICULAR SCANNING PROBE MICROSCOPES; MEASURING APPARATUS AND INSTRUMENTS, NAMELY, MICROSCOPES, IN PARTICULAR SCANNING PROBE MICROSCOPES, ACCESSORY PARTS FOR SCIENTIFIC APPARATUS AND INSTRUMENTS AND FOR MEASURING APPARATUS AND INSTRUMENTS, NAMELY, MICROSCOPES, IN PARTICULAR SCANNING PROBE MICROSCOPES; PROBES AND SENSORS, IN PARTICULAR FOR SCIENTIFIC PURPOSES, IN PARTICULAR PROBES AND SENSORS FOR SCANNING PROBE MICROSCOPES AND FOR MEASURING APPARATUS AND INSTRUMENTS; COMPUTER HARDWARE AND SOFTWARE, FOR USE IN TRANSMITTING, PROCESSING, EDITING, AND ANALYZING OF DATA IN THE FIELD OF SCIENTIFIC APPARATUS AND INSTRUMENTS, NAMELY, MICROSCOPES, IN PARTICULAR SCANNING PROBE MICROSCOPES; COMPUTER PROGRAMS, NAMELY, COMPUTER PROGRAMS FOR TRANSMITTING, PROCESSING, EDITING, AND ANALYZING OF DATA, AND COMPUTER PROGRAMS FOR CONTROLLING SCIENTIFIC APPARATUS AND INSTRUMENTS, IN THE FIELD OF SCIENTIFIC APPARATUS AND INSTRUMENTS; ELECTRIC AND ELECTRONIC CONTROL DEVICES AND INSTRUMENTS, IN PARTICULAR FOR CONTROLLING SCIENTIFIC APPARATUS AND INSTRUMENTS, NAMELY, MICROSCOPES, IN PARTICULAR SCANNING PROBE MICROSCOPES, IN CLASS 9 (U.S. CLS. 21, 23, 26, 36 AND 38).



FOR: EDUCATIONAL SERVICES IN THE NATURE OF ARRANGING AND CONDUCTING SEMINARS AND WORKSHOPS IN THE FIELD OF HANDLING AND OPERATING SCIENTIFIC APPARATUS AND INSTRUMENTS, NAMELY, MICROSCOPES, IN PARTICULAR SCANNING PROBE MICROSCOPES; TRAINING ADVICE IN THE FIELD OF HANDLING AND OPERATING SCIENTIFIC APPARATUS AND INSTRUMENTS, NAMELY, MICROSCOPES, IN PARTICULAR SCANNING PROBE MICROSCOPES, IN CLASS 41 (U.S. CLS. 100, 101 AND 107).

David J. Kyjars

Director of the United States Patent and Trademark Office

FOR: SCIENTIFIC AND TECHNOLOGICAL SERVICES AND RESEARCH AND DESIGN RELATING THERETO IN THE FIELD OF SCIENTIFIC APPARATUS AND INSTRUMENTS, NAMELY, MICROSCOPES, IN PARTICULAR SCANNING PROBE MICROSCOPES, AND

Reg. No. 4,152,245 IN THE FIELD OF COMPUTER HARDWARE AND SOFTWARE FOR SCIENTIFIC APPARATUS AND INSTRUMENTS, NAMELY, MICROSCOPES, IN PARTICULAR SCANNING PROBE MICROSCOPES; INDUSTRIAL ANALYSIS AND RESEARCH SERVICES IN THE FIELD OF SCIENTIFIC APPARATUS AND INSTRUMENTS, NAMELY, MICROSCOPES, IN PARTICULAR SCANNING PROBE MICROSCOPES, AND IN THE FIELD OF COMPUTER HARDWARE AND SOFTWARE FOR SCIENTIFIC APPARATUS AND INSTRUMENTS, NAMELY, MICROSCOPES, IN PARTICULAR SCANNING PROBE MICROSCOPES; RESEARCH IN THE FIELD OF TECHNOLOGY, NAMELY, THE FIELD OF MICROSCOPY, IN PARTICULAR IN THE FIELD OF SCANNING PROBE MICROSCOPY; DESIGN AND DEVELOPMENT OF COMPUTER HARDWARE AND SOFTWARE, IN PARTICULAR DESIGN AND DEVELOPMENT OF COMPUTER HARDWARE AND SOFTWARE FOR TRANSMITTING, PROCESSING, EDITING, AND ANALYZING OF DATA, AND DESIGN AND DEVELOPMENT OF COMPUTER PROGRAMS FOR CONTROLLING SCIENTIFIC APPARATUS AND INSTRUMENTS; UPDATING OF COMPUTER SOFTWARE, IN PARTICULAR UPDATING OF COMPUTER SOFTWARE FOR TRANSMITTING, PROCESSING, EDITING, AND ANALYZING OF DATA AND UPDATING OF COMPUTER SOFTWARE FOR CONTROLLING SCIENTIFIC APPARATUS AND INSTRUMENTS; ENGINEERING AND SERVICES IN THE FIELD OF PHYSICS, NAMELY, SOFTWARE CONFIGURATION AND DESIGN OF SCIENTIFIC APPARATUS AND INSTRUMENTS; TECHNICAL PROJECT PLANNING IN THE FIELD OF SOFTWARE CONFIGURATION AND DESIGN OF SCIENTIFIC APPARATUS AND INSTRUMENTS, NAMELY, SCANNING PROBE MICROSCOPES, AND IN THE FIELD OF CONFIGURATION AND IMPLEMENTATION OF HARDWARE AND SOFTWARE FOR SCIENTIFIC APPARATUS AND INSTRUMENTS, NAMELY, SCANNING PROBE MICROSCOPES, IN CLASS 42 (U.S. CLS. 100 AND 101).

THE MARK CONSISTS OF DOTS FORMING A STYLIZED OWL DESIGN.

PRIORITY DATE OF 1-19-2011 IS CLAIMED.

OWNER OF INTERNATIONAL REGISTRATION 1075285 DATED 2-28-2011, EXPIRES 2-28-2021.

SER. NO. 79-096,748, FILED 2-28-2011.

KAREN SEVERSON, EXAMINING ATTORNEY

United States of America

United States Patent and Trademark Office

PRINTERA

Reg. No. 4,152,246

Registered June 5, 2012

Int. Cl.: 37

SERVICE MARK

PRINCIPAL REGISTER

UAB SERVEA (LITHUANIA CLOSED STOCK COMPANY)
BIR, ELIO 23-IOSIOS G. 23G
LT-50220 KAUNAS, LITHUANIA

FOR: OFFICE MACHINES AND EQUIPMENT INSTALLATION, MAINTENANCE AND REPAIR; INSTALLATION, MAINTENANCE AND REPAIR OF COMPUTER HARDWARE; RE-FILLING OF TONER CARTRIDGES, IN CLASS 37 (U.S. CLS. 100, 103 AND 106).

THE MARK CONSISTS OF THE WORDING "PRINTERA" IN LIME GREEN.

OWNER OF INTERNATIONAL REGISTRATION 1075299 DATED 4-7-2011, EXPIRES 4-7-2021.

THE COLOR(S) LIME GREEN IS/ARE CLAIMED AS A FEATURE OF THE MARK.

SER. NO. 79-096,751, FILED 4-7-2011.

JULIE VEPPUMTHARA, EXAMINING ATTORNEY



David J. Kyros

Director of the United States Patent and Trademark Office

United States of America

United States Patent and Trademark Office

Tyto

Reg. No. 4,152,247

Registered June 5, 2012

Int. Cls.: 9, 41 and 42

SPECS SURFACE NANO ANALYSIS GMBH (FED REP GERMANY LIMITED LIABILITY COMPANY)
VOLTA STR. 5
13355 BERLIN
FED REP GERMANY

TRADEMARK

SERVICE MARK

PRINCIPAL REGISTER

FOR: SCIENTIFIC APPARATUS AND INSTRUMENTS, NAMELY, MICROSCOPES, IN PARTICULAR SCANNING PROBE MICROSCOPES; MEASURING APPARATUS AND INSTRUMENTS, NAMELY, MICROSCOPES, IN PARTICULAR SCANNING PROBE MICROSCOPES, ACCESSORY PARTS FOR SCIENTIFIC APPARATUS AND INSTRUMENTS AND FOR MEASURING APPARATUS AND INSTRUMENTS, NAMELY, MICROSCOPES, IN PARTICULAR SCANNING PROBE MICROSCOPES; PROBES AND SENSORS, IN PARTICULAR FOR SCIENTIFIC PURPOSES, IN PARTICULAR PROBES AND SENSORS FOR SCANNING PROBE MICROSCOPES AND FOR MEASURING APPARATUS AND INSTRUMENTS; COMPUTER HARDWARE AND SOFTWARE, FOR USE IN TRANSMITTING, PROCESSING, EDITING, AND ANALYZING OF DATA IN THE FIELD OF SCIENTIFIC APPARATUS AND INSTRUMENTS, NAMELY, MICROSCOPES, IN PARTICULAR SCANNING PROBE MICROSCOPES; COMPUTER PROGRAMS, NAMELY, COMPUTER PROGRAMS FOR TRANSMITTING, PROCESSING, EDITING, AND ANALYZING OF DATA, AND COMPUTER PROGRAMS FOR CONTROLLING SCIENTIFIC APPARATUS AND INSTRUMENTS, IN THE FIELD OF SCIENTIFIC APPARATUS AND INSTRUMENTS; ELECTRIC AND ELECTRONIC CONTROL DEVICES AND INSTRUMENTS, IN PARTICULAR FOR CONTROLLING SCIENTIFIC APPARATUS AND INSTRUMENTS, NAMELY, MICROSCOPES, IN PARTICULAR SCANNING PROBE MICROSCOPES, IN CLASS 9 (U.S. CLS. 21, 23, 26, 36 AND 38).



FOR: EDUCATIONAL SERVICES IN THE NATURE OF ARRANGING AND CONDUCTING SEMINARS AND WORKSHOPS IN THE FIELD OF HANDLING AND OPERATING SCIENTIFIC APPARATUS AND INSTRUMENTS, NAMELY, MICROSCOPES, IN PARTICULAR SCANNING PROBE MICROSCOPES; TRAINING ADVICE IN THE FIELD OF HANDLING AND OPERATING SCIENTIFIC APPARATUS AND INSTRUMENTS, NAMELY, MICROSCOPES, IN PARTICULAR SCANNING PROBE MICROSCOPES, IN CLASS 41 (U.S. CLS. 100, 101 AND 107).

David J. Kyjars

Director of the United States Patent and Trademark Office

FOR: SCIENTIFIC AND TECHNOLOGICAL SERVICES AND RESEARCH AND DESIGN RELATING THERETO IN THE FIELD OF SCIENTIFIC APPARATUS AND INSTRUMENTS, NAMELY, MICROSCOPES, IN PARTICULAR SCANNING PROBE MICROSCOPES, AND

Reg. No. 4,152,247 IN THE FIELD OF COMPUTER HARDWARE AND SOFTWARE FOR SCIENTIFIC APPARATUS AND INSTRUMENTS, NAMELY, MICROSCOPES, IN PARTICULAR SCANNING PROBE MICROSCOPES; INDUSTRIAL ANALYSIS AND RESEARCH SERVICES IN THE FIELD OF SCIENTIFIC APPARATUS AND INSTRUMENTS, NAMELY, MICROSCOPES, IN PARTICULAR SCANNING PROBE MICROSCOPES, AND IN THE FIELD OF COMPUTER HARDWARE AND SOFTWARE FOR SCIENTIFIC APPARATUS AND INSTRUMENTS, NAMELY, MICROSCOPES, IN PARTICULAR SCANNING PROBE MICROSCOPES; RESEARCH IN THE FIELD OF TECHNOLOGY, NAMELY, THE FIELD OF MICROSCOPY, IN PARTICULAR IN THE FIELD OF SCANNING PROBE MICROSCOPY; DESIGN AND DEVELOPMENT OF COMPUTER HARDWARE AND SOFTWARE, IN PARTICULAR DESIGN AND DEVELOPMENT OF COMPUTER HARDWARE AND SOFTWARE FOR TRANSMITTING, PROCESSING, EDITING, AND ANALYZING OF DATA, AND DESIGN AND DEVELOPMENT OF COMPUTER PROGRAMS FOR CONTROLLING SCIENTIFIC APPARATUS AND INSTRUMENTS; UPDATING OF COMPUTER SOFTWARE, IN PARTICULAR UPDATING OF COMPUTER SOFTWARE FOR TRANSMITTING, PROCESSING, EDITING, AND ANALYZING OF DATA AND UPDATING OF COMPUTER SOFTWARE FOR CONTROLLING SCIENTIFIC APPARATUS AND INSTRUMENTS; ENGINEERING AND SERVICES IN THE FIELD OF PHYSICS, NAMELY, SOFTWARE CONFIGURATION AND DESIGN OF SCIENTIFIC APPARATUS AND INSTRUMENTS; TECHNICAL PROJECT PLANNING IN THE FIELD OF SOFTWARE CONFIGURATION AND DESIGN OF SCIENTIFIC APPARATUS AND INSTRUMENTS, NAMELY, SCANNING PROBE MICROSCOPES, AND IN THE FIELD OF CONFIGURATION AND IMPLEMENTATION OF HARDWARE AND SOFTWARE FOR SCIENTIFIC APPARATUS AND INSTRUMENTS, NAMELY, SCANNING PROBE MICROSCOPES, IN CLASS 42 (U.S. CLS. 100 AND 101).

THE MARK CONSISTS OF STANDARD CHARACTERS WITHOUT CLAIM TO ANY PARTICULAR FONT, STYLE, SIZE, OR COLOR.

PRIORITY DATE OF 8-4-2010 IS CLAIMED.

OWNER OF INTERNATIONAL REGISTRATION 1075306 DATED 1-19-2011, EXPIRES 1-19-2021.

SER. NO. 79-096,752, FILED 1-19-2011.

KAREN SEVERSON, EXAMINING ATTORNEY

United States of America

United States Patent and Trademark Office



Reg. No. 4,152,248

Registered June 5, 2012

Int. Cls.: 16 and 18

TRADEMARK

PRINCIPAL REGISTER

STRAWBERRY DESIGN LTD (UNITED KINGDOM LIMITED COMPANY)
THIRD FLOOR EAST,
12 BRIDEWELL PLACE; LONDON EC4V 6AP
UNITED KINGDOM

FOR: PAPER, CARDBOARD AND GOODS MADE FROM THESE MATERIALS NOT INCLUDED IN OTHER CLASSES, NAMELY, WRITING PADS, WRITING PAPER AND TABLETS; PENS AND PENCILS, IN CLASS 16 (U.S. CLS. 2, 5, 22, 23, 29, 37, 38 AND 50).

FOR: LEATHER AND IMITATIONS OF LEATHER, AND GOODS MADE OF THESE MATERIALS NOT INCLUDED IN OTHER CLASSES, NAMELY, LEATHER HANDBAGS, LEATHER KEY CASES, LEATHER WALLETS, LEATHER SOLD IN BULK, LEATHER AND IMITATION LEATHER BAGS, LEATHER CREDIT CARD HOLDERS; LEATHER DOCUMENT HOLDERS, NAMELY, LEATHER DOCUMENT CASES, LEATHER BRIEFCASES FOR DOCUMENTS; LEATHER TAPE MEASURE HOLDERS, NAMELY, LEATHER TOOL POUCHES FOR HOLDING TAPE MEASURERS SOLD EMPTY; LEATHER STORAGE BOXES, NAMELY, LEATHER BOXES FOR STORING GREETING CARDS, LEATHER OR LEATHER-BOARD BOXES; LEATHER LUGGAGE TRUNKS, LEATHER TRAVELING BAGS, IN CLASS 18 (U.S. CLS. 1, 2, 3, 22 AND 41).

NO CLAIM IS MADE TO THE EXCLUSIVE RIGHT TO USE "I CARTAI" IN INTERNATIONAL CLASS 16 FOR "PAPER WRITING PADS, WRITING PAPER AND TABLETS", APART FROM THE MARK AS SHOWN.

PRIORITY DATE OF 4-28-2011 IS CLAIMED.

OWNER OF INTERNATIONAL REGISTRATION 1075428 DATED 4-29-2011, EXPIRES 4-29-2021.

THE MARK CONSISTS OF THE STYLIZED WORDING "I CARTAI" APPEARING BELOW THE DEPICTION OF A CROWN WITH AN OPEN TOP.

THE ENGLISH TRANSLATION OF "I CARTAI" IN THE MARK IS "THE PAPERMAKERS".

SER. NO. 79-096,790, FILED 4-29-2011.

MICHAEL TANNER, EXAMINING ATTORNEY



David J. Kyros

Director of the United States Patent and Trademark Office

United States of America
United States Patent and Trademark Office

RCOM

Reg. No. 4,152,249

Registered June 5, 2012

Int. Cl.: 7

TRADEMARK

PRINCIPAL REGISTER

AUTO ELEX CO., LTD. (REPUBLIC OF KOREA CORPORATION)
612 DUCKARM-RI
JUCHON-MYOEN
KIMHAE-CITY, KYOUNGNAM 621-843, REPUBLIC OF KOREA

FOR: INCUBATORS FOR EGGS; CHICK BROODERS; COCOON DRYING MACHINES, IN
CLASS 7 (U.S. CLS. 13, 19, 21, 23, 31, 34 AND 35).

OWNER OF INTERNATIONAL REGISTRATION 1075433 DATED 2-1-2011, EXPIRES 2-1-
2021.

SER. NO. 79-096,791, FILED 2-1-2011.

SANI KHOURI, EXAMINING ATTORNEY

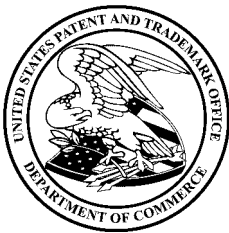

David J. Kyffers

Director of the United States Patent and Trademark Office

United States of America

United States Patent and Trademark Office

BIMladder

Reg. No. 4,152,250

Registered June 5, 2012

Int. Cls.: 9, 35 and 42

TRADEMARK

SERVICE MARK

PRINCIPAL REGISTER

NEDERLANDSE ORGANISATIE VOOR TOEGEPAST-NATUURWETENSCHAPPELIJK
ONDERZOEK TNO (NETHERLANDS CORPORATION)
SCHOEMAKERSTRAAT 97
NL-2628 VK DELFT, NETHERLANDS

FOR: SOFTWARE FOR EVALUATION OF COMPETENCY OF A COMPANY OR PROJECT
ON THE USE OF BUILDING MODEL INFORMATION, IN CLASS 9 (U.S. CLS. 21, 23, 26, 36
AND 38).

FOR: BUSINESS MANAGEMENT; COMPILATION OF INFORMATION INTO COMPUTER
DATABASES; COMPILATION OF STATISTICS; PROFESSIONAL BUSINESS CON-
SULTANCY, IN CLASS 35 (U.S. CLS. 100, 101 AND 102).

FOR: SCIENTIFIC AND TECHNOLOGICAL SERVICES AND RESEARCH AND DESIGN
RELATING THERETO, NAMELY, RESEARCH SERVICES IN THE FIELD OF BUILDING
INFORMATION MODELING; DESIGN AND DEVELOPMENT OF COMPUTER HARDWARE
AND SOFTWARE , IN CLASS 42 (U.S. CLS. 100 AND 101).

THE MARK CONSISTS OF STANDARD CHARACTERS WITHOUT CLAIM TO ANY PAR-
TICULAR FONT, STYLE, SIZE, OR COLOR.

PRIORITY DATE OF 12-15-2010 IS CLAIMED.

OWNER OF INTERNATIONAL REGISTRATION 1075685 DATED 4-7-2011, EXPIRES 4-7-
2021.

SER. NO. 79-096,866, FILED 4-7-2011.

JULIE VEPPUMTHARA, EXAMINING ATTORNEY



David J. Kypos

Director of the United States Patent and Trademark Office

United States of America

United States Patent and Trademark Office

Follow Your Instinct

Reg. No. 4,152,251

Registered June 5, 2012

Int. Cls.: 9, 25 and 41

TRADEMARK

SERVICE MARK

PRINCIPAL REGISTER

MUSSA ADDIS (FED REP GERMANY INDIVIDUAL)
SCHMALKALDENERSTR. 2
80807 MÜNCHEN
FED REP GERMANY

FOR: MUSICAL SOUND RECORDINGS; AUDIO-VISUAL RECORDINGS, NAMELY, COMPACT DISCS, TAPE CASSETTES, AUDIO CASSETTES, AUDIO TAPES, AUDIO DISCS, RECORDS, CD-ROMS, VIDEO TAPES, VIDEO CASSETTES, VIDEO DISCS, PHONOGRAPHIC RECORDS, DVDS, DATS, DOWNLOADABLE MP3S VIA THE INTERNET, AND LASER DISCS, ALL FEATURING MUSICS; DOWNLOADABLE MUSICAL SOUND RECORDINGS; DOWNLOADABLE VIDEO RECORDINGS FEATURING MUSIC; DOWNLOADABLE TELEPHONE RING TONES FEATURING MUSIC VIA THE INTERNET AND WIRELESS DEVICES, IN CLASS 9 (U.S. CLS. 21, 23, 26, 36 AND 38).

FOR: CLOTHING, NAMELY, HATS, T-SHIRTS, JACKETS, SHIRTS, SWEATSHIRTS, SWEAT PANTS, JERSEYS, JEANS, PANTS AND SHORTS, IN CLASS 25 (U.S. CLS. 22 AND 39).

FOR: ENTERTAINMENT SERVICES, NAMELY, LIVE MUSICAL PERFORMANCES, PRODUCTION OF MUSIC RECORDINGS, SHOWS AND VIDEOS FEATURING MUSICAL PERFORMANCES, MUSIC SHOWS, DANCE EVENTS AND FASHION SHOWS BEFORE A LIVE AUDIENCE, WHICH MAY BE BROADCAST LIVE OR RECORDED FOR LATER BROADCAST, IN CLASS 41 (U.S. CLS. 100, 101 AND 107).

THE MARK CONSISTS OF STANDARD CHARACTERS WITHOUT CLAIM TO ANY PARTICULAR FONT, STYLE, SIZE, OR COLOR.

PRIORITY DATE OF 3-6-2011 IS CLAIMED.

OWNER OF INTERNATIONAL REGISTRATION 1076057 DATED 4-4-2011, EXPIRES 4-4-2021.

SER. NO. 79-097,006, FILED 4-4-2011.

ANNE FARRELL, EXAMINING ATTORNEY



David J. Kyffers

Director of the United States Patent and Trademark Office

United States of America

United States Patent and Trademark Office

Jetts

Reg. No. 4,152,252

Registered June 5, 2012

Int. Cls.: 35 and 41

SERVICE MARK

PRINCIPAL REGISTER

24/7 BRANDS PTY LTD (AUSTRALIA PROPRIETARY COMPANY)
PO BOX 519
BUDDINA QLD 4575
AUSTRALIA

FOR: ADMINISTRATION OF THE BUSINESS AFFAIRS OF FRANCHISES; BUSINESS ADVISORY SERVICES RELATING TO THE ESTABLISHMENT OF FRANCHISES; BUSINESS ADVISORY SERVICES RELATING TO THE OPERATION OF FRANCHISES; BUSINESS MANAGEMENT ASSISTANCE RELATING TO THE ESTABLISHMENT OF FRANCHISES; PROVISION OF BUSINESS PLANNING ASSISTANCE IN THE ESTABLISHMENT OF FRANCHISES; PROVISION OF MANAGEMENT ASSISTANCE IN THE OPERATION OF FRANCHISES; BUSINESS ADMINISTRATION RELATING TO MARKETING; ADVICE RELATING TO MARKETING MANAGEMENT; BUSINESS ADVICE RELATING TO MARKETING; BUSINESS CONSULTANCY SERVICES RELATING TO MARKETING; BUSINESS CONSULTANCY SERVICES RELATING TO THE MARKETING OF FUND RAISING CAMPAIGNS; CONDUCTING OF MARKETING STUDIES; CONSULTANCY RELATING TO MARKETING; DIRECT MARKETING; DIRECT MARKETING AND RETAIL STORE SERVICES FEATURING HOME PARTY PLAN; MARKETING; MARKETING ADVISORY SERVICES; MARKETING AGENCY SERVICES; MARKETING ANALYSIS; MARKETING AND BUSINESS DEVELOPMENT OF INVENTIONS; MARKETING ASSISTANCE RELATING TO THE ESTABLISHMENT AND OPERATION OF FRANCHISES; MARKETING CONSULTANCY; MARKETING FORECASTING; MARKETING INFORMATION; MARKETING MANAGEMENT ADVICE; MARKETING RESEARCH; CONDUCTING MARKETING STUDIES; PLANNING OF MARKETING STRATEGIES; BUSINESS STRATEGIC PLANNING SERVICES FOR MARKETING STUDIES; PREPARATION OF MARKETING PLANS; PREPARATION OF MARKETING REPORTS; PRODUCT MARKETING; PROMOTIONAL MARKETING; PROVISION OF ADVICE RELATING TO MARKETING; PROVISION OF INFORMATION RELATING TO MARKETING; RESEARCH SERVICES RELATING TO MARKETING; TELEPHONE MARKETING SERVICES; ADVERTISING; ADVERTISING SERVICES PROVIDED BY TELEVISION; ADVERTISING SERVICES PROVIDED OVER THE INTERNET, IN CLASS 35 (U.S. CLS. 100, 101 AND 102).



David J. Kappas

Director of the United States Patent and Trademark Office

FOR: CONDUCTING FITNESS CLASSES; CONDUCTING FITNESS CLASSES IN THE NATURE OF AEROBICS; PROVIDING FITNESS AND EXERCISE FACILITIES NAMELY, CLINICS, CLUBS AND SALONS; HEALTH CLUB AS FITNESS SERVICES; INSTRUCTION, IN PHYSICAL FITNESS; PROCESSES AND OPERATING OF PHYSICAL FITNESS CENTERS, NAMELY, PROVIDING FITNESS AND EXERCISE FACILITIES THAT ARE FOCUSED IN

Reg. No. 4,152,252 THE FIELDS OF GENERAL FITNESS, EXERCISE AND AEROBICS; PERSONAL TRAINER SERVICES AS FITNESS TRAINING; PHYSICAL FITNESS INSTRUCTION; PHYSICAL FITNESS TRAINING SERVICES PHYSICAL FITNESS INSTRUCTION AND TRAINING; PRODUCTION OF SOUND RECORDINGS FOR MARKETING PURPOSES; PRODUCTION OF VIDEO RECORDINGS FOR MARKETING PURPOSES, IN CLASS 41 (U.S. CLS. 100, 101 AND 107).

THE MARK CONSISTS OF STANDARD CHARACTERS WITHOUT CLAIM TO ANY PARTICULAR FONT, STYLE, SIZE, OR COLOR.

OWNER OF INTERNATIONAL REGISTRATION 1076277 DATED 2-7-2011, EXPIRES 2-7-2021.

SER. NO. 79-097,066, FILED 2-7-2011.

WILLIAM ROSSMAN, EXAMINING ATTORNEY

United States of America

United States Patent and Trademark Office

Etapara

Reg. No. 4,152,253

Registered June 5, 2012

Int. Cls.: 35, 38 and 42

SERVICE MARK

PRINCIPAL REGISTER

ETAPARA AG (FED REP GERMANY AKTIENGESELLSCHAFT)
HOHENZOLLERNNDAMM 88
14199 BERLIN
FED REP GERMANY

FOR: ADVERTISING; MARKET RESEARCH; PROFESSIONAL BUSINESS CONSULTATIONS; ONLINE ADVERTISING IN COMPUTER NETWORKS; PRESENTATION OF THE SERVICES OF COMPANIES AND GOODS ON THE INTERNET AND IN OTHER MEDIA, NAMELY, DISPLAYING ADVERTISEMENTS FEATURING THE SERVICES OF COMPANIES AND GOODS OF OTHERS; ADVERTISING, IN PARTICULAR ADVERTISING ON THE INTERNET, FOR OTHERS; CONSUMER CONSULTANCY, NAMELY, PROVIDING INFORMATION AND CONSULTANCY FOR CONSUMERS IN TRADE AND BUSINESS AFFAIRS; CONSUMER CONSULTANCY, NAMELY, BUSINESS CONSULTING IN THE CONSUMER PRODUCTS INDUSTRY, COMMERCIAL INFORMATION AND ADVICE FOR CONSUMERS; ADVISORY SERVICES FOR BUSINESS MANAGEMENT; ORGANIZATIONAL AND PROFESSIONAL BUSINESS CONSULTANCY IN CONNECTION WITH PERSONNEL MANAGEMENT AND BUSINESS QUALITY MANAGEMENT; BUSINESS MANAGEMENT; UPDATING AND MAINTENANCE OF DATA IN COMPUTER DATABASES, IN CLASS 35 (U.S. CLS. 100, 101 AND 102).

FOR: PROVIDING ACCESS TO INFORMATION ON THE INTERNET, NAMELY, PROVIDING MULTIPLE USE ACCESS TO GLOBAL COMPUTER INFORMATION NETWORKS FOR THE TRANSFER AND DISSEMINATION OF A WIDE RANGE OF INFORMATION; PROVIDING CHATROOMS ON THE INTERNET; ELECTRONIC EXCHANGE OF MESSAGES USING CHATROOMS, CHATLINES AND INTERNET FORUMS; WEB MESSAGING; PROVIDING OF ACCESS TO DATABASES ON THE INTERNET; PROVIDING INTERNET ACCESS, IN CLASS 38 (U.S. CLS. 100, 101 AND 104).

FOR: CONDUCTING ENGINEERING SURVEYS, CONDUCTING GEOLOGICAL SURVEYS USING DATABASES AND THE INTERNET; RESEARCH, NAMELY, PRODUCTS RESEARCH, CHEMICAL RESEARCH, MECHANICAL RESEARCH USING DATABASES AND THE INTERNET; RESEARCH RELATING TO SCIENCE, NAMELY, SCIENTIFIC RESEARCH; SERVER ADMINISTRATION, NAMELY, TECHNICAL SUPPORT SERVICES IN THE NATURE OF TECHNICAL ADMINISTRATION OF SERVERS FOR OTHERS; PROVIDING SEARCH ENGINES FOR THE INTERNET; INDUSTRIAL ANALYSIS AND RESEARCH SERVICES, NAMELY, ANALYSIS AND RESEARCH OF COMPUTER SYSTEMS AND TECHNICAL SYSTEMS OF PRODUCT MANUFACTURING EQUIPMENT, ANALYSIS EQUIPMENT AND



David J. Kyjars

Director of the United States Patent and Trademark Office

Reg. No. 4,152,253 RESEARCH EQUIPMENT; CERTIFICATION SERVICES, NAMELY, TESTING, ANALYSIS, AND EVALUATION OF THE KNOWLEDGE, SKILLS AND ABILITIES OF OTHERS, NAMELY, GOVERNMENTS, AUTHORITIES, NON-GOVERNMENTAL ORGANIZATION, COMPANIES, BUSINESSES AND PERSONS FOR THE PURPOSE OF CERTIFICATION IN THE FIELD OF ETHICAL CONDUCT IN PROVIDING CONSUMER INFORMATION AND TESTING, ANALYSIS AND EVALUATION OF THE PRODUCTS AND SERVICES PROVIDED BY THOSE ENTITIES FOR THE PURPOSES OF CERTIFICATION; INSTALLING WEBPAGES ON THE INTERNET, FOR OTHERS, NAMELY, WEB SITE HOSTING, IN CLASS 42 (U.S. CLS. 100 AND 101).

THE MARK CONSISTS OF STANDARD CHARACTERS WITHOUT CLAIM TO ANY PARTICULAR FONT, STYLE, SIZE, OR COLOR.

PRIORITY DATE OF 5-28-2010 IS CLAIMED.

OWNER OF INTERNATIONAL REGISTRATION 1076307 DATED 11-9-2010, EXPIRES 11-9-2020.

THE WORDING "ETAPARA" HAS NO MEANING IN A FOREIGN LANGUAGE.

SER. NO. 79-097,079, FILED 11-9-2010.

JEAN IM, EXAMINING ATTORNEY

United States of America

United States Patent and Trademark Office

CRITYCWORLD

Reg. No. 4,152,254

Registered June 5, 2012

Int. Cls.: 35, 38, 41 and 42

SERVICE MARK

PRINCIPAL REGISTER

BENAYOUN STÉPHANE PAUL (FRANCE INDIVIDUAL)
16 ALLÉE DU PRIEURÉ
F-77111 SOIGNOLLES-EN-BRIE, FRANCE

FOR: DIRECT MAIL ADVERTISING; ARRANGING NEWSPAPER SUBSCRIPTIONS FOR OTHERS; DOCUMENT REPRODUCTION; COMPUTERIZED FILE MANAGEMENT; ORGANIZATION OF EXHIBITIONS FOR COMMERCIAL OR ADVERTISING PURPOSES; ON-LINE ADVERTISING ON A COMPUTER NETWORK; PUBLICATION OF PUBLICITY TEXTS; RENTAL OF ADVERTISING SPACE; DISSEMINATION OF ADVERTISING MATTER; PUBLIC RELATIONS; SERVICES INVOLVING PROMOTION AND ADVERTISING FOR OTHERS, IN CLASS 35 (U.S. CLS. 100, 101 AND 102).

FOR: INFORMATION ABOUT TELECOMMUNICATION; COMMUNICATIONS VIA COMPUTER TERMINALS OR VIA FIBER-OPTIC NETWORKS; MOBILE RADIO TELEPHONE SERVICES; PROVIDING USER ACCESS TO A GLOBAL COMPUTER NETWORK; PROVIDING TELECOMMUNICATIONS CONNECTIONS TO A GLOBAL COMPUTER NETWORK; TELECONFERENCING SERVICES; ELECTRONIC MESSAGING; RENTAL OF ACCESS TIME TO GLOBAL COMPUTER NETWORKS; WEBCASTING SERVICES, IN CLASS 38 (U.S. CLS. 100, 101 AND 104).

FOR: PROVIDING RECREATION FACILITIES; PUBLICATION OF BOOKS; VIDEOTAPE FILM PRODUCTION; VIDEOTAPE EDITING; PHOTOGRAPHY; ORGANIZATION OF EXHIBITIONS FOR CULTURAL OR EDUCATIONAL PURPOSES; BOOKING OF SEATS FOR SHOWS; PUBLICATION OF ELECTRONIC BOOKS AND JOURNALS ON-LINE; ELECTRONIC DESKTOP PUBLISHING; SERVICES INVOLVING PUBLISHING MULTIMEDIA ENTERTAINMENT, DIGITAL VIDEO AND AUDIO, IN CLASS 41 (U.S. CLS. 100, 101 AND 107).

FOR: COMPUTER PROGRAMMING; CONSULTANCY IN THE FIELD OF COMPUTER HARDWARE; DATA CONVERSION OF COMPUTER PROGRAMS AND DATA NOT PHYSICAL CONVERSION; CONVERSION OF DATA OR DOCUMENTS FROM PHYSICAL TO ELECTRONIC MEDIA; GRAPHIC ARTS DESIGNING, IN CLASS 42 (U.S. CLS. 100 AND 101).

THE MARK CONSISTS OF STANDARD CHARACTERS WITHOUT CLAIM TO ANY PARTICULAR FONT, STYLE, SIZE, OR COLOR.

PRIORITY DATE OF 4-30-2010 IS CLAIMED.



David J. Kyros

Director of the United States Patent and Trademark Office

Reg. No. 4,152,254 OWNER OF INTERNATIONAL REGISTRATION 1076563 DATED 10-25-2010, EXPIRES 10-25-2020.

SER. NO. 79-097,163, FILED 10-25-2010.

JENNIFER DIXON, EXAMINING ATTORNEY

United States of America

United States Patent and Trademark Office

PRINT **NON STOP**

Reg. No. 4,152,255

Registered June 5, 2012

Int. Cls.: 2 and 37

TRADEMARK

SERVICE MARK

PRINCIPAL REGISTER

UAB "SERVEA" (LITHUANIA CLOSED STOCK COMPANY)
BIRZELIO 23-IOSIOS G. 23G
LT-50220 KAUNAS, LITHUANIA

FOR: PAINTS, VARNISHES, LACQUERS; PRESERVATIVE COATINGS AGAINST RUST AND AGAINST DETERIORATION OF WOOD; COLORANTS; COLOURING MATERIALS, NAMELY, PAINTS AND DYES FOR GENERAL INDUSTRIAL USE, COLORINGS FOR USE IN THE MANUFACTURE OF PAINT, PAPER, AND PRINTING INK; STAINS FOR USE IN THE MANUFACTURE OF PAINT, PAPER, AND PRINTING INK; RAW NATURAL RESINS; METALS IN FOIL AND POWDER FORM FOR PAINTERS, DECORATORS, PRINTERS AND ARTISTS, IN CLASS 2 (U.S. CLS. 6, 11 AND 16).

FOR: INSTALLATION, REPAIR AND MAINTENANCE OF OFFICE EQUIPMENT; INSTALLATION, REPAIR AND MAINTENANCE OF COMPUTER HARDWARE; FILLING OF PRINTER CARTRIDGES, IN CLASS 37 (U.S. CLS. 100, 103 AND 106).

THE MARK CONSISTS OF THE WORDING "PRINT NON STOP" IN STYLIZED LETTERING, WITH THE WORDING "NON STOP" ON A STYLIZED LEAF DESIGN.

OWNER OF INTERNATIONAL REGISTRATION 1076567 DATED 4-7-2011, EXPIRES 4-7-2021.

SER. NO. 79-097,164, FILED 4-7-2011.

JULIE VEPPUMTHARA, EXAMINING ATTORNEY



David J. Kyros

Director of the United States Patent and Trademark Office

United States of America

United States Patent and Trademark Office

SPIRO

Reg. No. 4,152,256

Registered June 5, 2012

Int. Cls.: 6, 7 and 11

TRADEMARK

PRINCIPAL REGISTER

SPIRO INTERNATIONAL S.A. (SWITZERLAND JOINT STOCK COMPANY)
INDUSTRIESTRASSE 173
CH-3178 BÖSINGEN
SWITZERLAND

FOR: TUBES, PIPING, DUCTS, CONDUITS, MANUALLY-OPERATED MIXING AND OUTFLOW CONTROL VALVES MADE OF BASE METAL, ALL FOR USE IN VENTILATION, AIR-CONDITIONING, WARM-AIR HEATING AND EXHAUST SYSTEMS AND STRUCTURAL PARTS AND FITTINGS THEREFOR, NONE OF THESE GOODS BEING EQUIPMENT FOR TREATING STEAM OR USED WITH SUCH EQUIPMENT, AND BEING EQUIPMENT FOR CONTROLLING FLUIDS OR USED WITH SUCH EQUIPMENT, IN CLASS 6 (U.S. CLS. 2, 12, 13, 14, 23, 25 AND 50).

FOR: MACHINES FOR USE IN THE SHEET METAL INDUSTRY, NAMELY, METAL WORKING MACHINES FOR MANUFACTURING SPIRAL TUBES AND DUCTS, SHAPING MACHINES FOR METALWORKING IN THE NATURE OF FLANGING AND LOCKING MACHINES, CUTTING MACHINES FOR METAL WORKING, ROLLING MILLS FOR METALWORKING, ROLLING MACHINES FOR ROLLING METALS, HYDRAULIC PRESSES FOR METALWORKING, ELECTRICAL WELDING MACHINES FOR METALWORKING, MECHANICAL PRESSES FOR METALWORKING, SHAPING MACHINES FOR METALWORKING AND STRUCTURAL PARTS AND FITTINGS THEREFOR; MIXING AND CONTROL VALVES BEING OF MACHINES, AND STRUCTURAL PARTS AND FITTINGS THEREFOR; NONE OF THESE GOODS BEING EQUIPMENT FOR TREATING STEAM OR USED WITH SUCH EQUIPMENT AND BEING EQUIPMENT FOR CONTROLLING FLUIDS OR USED WITH SUCH EQUIPMENT, IN CLASS 7 (U.S. CLS. 13, 19, 21, 23, 31, 34 AND 35).

FOR: TUBES, PIPING, DUCTS, CONDUITS, MIXING AND OUTFLOW CONTROL VALVES, ALL AS PART OF VENTILATION, AIR-CONDITIONING, HOT-AIR HEATING AND EVACUATION INSTALLATIONS, NAMELY, VENTILATION, AIR-CONDITIONING, WARM-AIR HEATING, AND EXHAUST SYSTEMS COMPOSED PRIMARILY OF TUBES, PIPING, DUCTS, MIXING AND OUTFLOW CONTROL VALVES; COMPONENT PARTS OF VENTILATION, AIR-CONDITIONING, HOT-AIR HEATING AND EVACUATION INSTALLATIONS, NAMELY, TUBES, PIPING, DUCTS, CONDUITS AND MIXING AND OUTFLOW CONTROL VALVES ALL SPECIFICALLY DESIGNED FOR USE AS INTEGRATED PARTS OF AIR-CONDITIONING, AIR-COOLING, HOT-AIR SPACE HEATING AND VENTILATION APPARATUS AND INSTRUMENTS; NONE OF THESE GOODS BEING EQUIPMENT FOR TREATING STEAM OR USED WITH SUCH EQUIPMENT, AND BEING EQUIPMENT, AND BEING



David J. Kappas

Director of the United States Patent and Trademark Office

Reg. No. 4,152,256 EQUIPMENT FOR CONTROLLING FLUIDS OR USED WITH SUCH EQUIPMENT, IN CLASS 11 (U.S. CLS. 13, 21, 23, 31 AND 34).

THE MARK CONSISTS OF STANDARD CHARACTERS WITHOUT CLAIM TO ANY PARTICULAR FONT, STYLE, SIZE, OR COLOR.

OWNER OF INTERNATIONAL REGISTRATION 0662522 DATED 10-3-1996, EXPIRES 10-3-2016.

OWNER OF U.S. REG. NOS. 1,560,461 AND 2,142,121.

SER. NO. 79-097,235, FILED 4-29-2011.

MICHAEL TANNER, EXAMINING ATTORNEY

United States of America

United States Patent and Trademark Office



Reg. No. 4,152,257

Registered June 5, 2012

Int. Cls.: 9, 12, 39 and 42

TRADEMARK

SERVICE MARK

PRINCIPAL REGISTER

COMPAGNIE NATIONALE DU RHÔNE (FRANCE SOCIÉTÉ ANONYME)
2 RUE ANDRÉ BONIN
F-69004 LYON
FRANCE

FOR: ELECTRONIC APPARATUS COMPRISING USER INTERFACE SOFTWARE AND GLOBAL POSITIONING SYSTEM FOR MEASURING, MANAGING, CONTROLLING AND REGULATING FROM REMOTE LOCATIONS THE RECHARGING OF BATTERIES OF AN ELECTRIC MOTOR VEHICLE; BATTERY CHARGERS FOR ELECTRIC MOTOR VEHICLES; CHARGE STATION FOR CHARGING ELECTRIC MOTOR VEHICLES, IN CLASS 9 (U.S. CLS. 21, 23, 26, 36 AND 38).

FOR: ELECTRIC MOTOR VEHICLES OR PLUG-IN HYBRID VEHICLES IN THE NATURE OF BOATS OR TERRESTRIAL VEHICLES IN THE NATURE OF AUTOMOBILES, TRUCKS, BUSES, VANS, MOTORCYCLES, MOTORSCOOTERS, MOPEDS AND MOTORIZED BICYCLES, IN CLASS 12 (U.S. CLS. 19, 21, 23, 31, 35 AND 44).

FOR: TRANSPORT AND DISTRIBUTION OF ELECTRICAL ENERGY, IN CLASS 39 (U.S. CLS. 100 AND 105).

FOR: ENGINEERING SERVICES, NAMELY, ELECTRICAL ENGINEERING; SCIENTIFIC CONSULTATION RELATING TO ENERGY; SCIENTIFIC AND INDUSTRIAL RESEARCH IN THE FIELD OF ENERGY; COMPUTER PROGRAMMING IN THE FIELD OF ENERGY; SCIENTIFIC ANALYSIS OF TECHNICAL DATA RELATING TO ENERGY; SCIENTIFIC RESEARCH, NAMELY, TECHNICAL STUDIES FOR LARGE SCALE ENERGY OPTIMISATION VIA MANAGEMENT OF RECHARGING ELECTRIC VEHICLES, IN CLASS 42 (U.S. CLS. 100 AND 101).

THE MARK CONSISTS OF THE WORDING "MOVE IN PURE" SURROUNDED BY A PARTIAL CIRCLE WHEREIN PART OF THE CIRCLE FEATURES THE WORDING "POWERED BY CNR".

PRIORITY DATE OF 10-7-2010 IS CLAIMED.

OWNER OF INTERNATIONAL REGISTRATION 1076762 DATED 3-31-2011, EXPIRES 3-31-2021.



David J. Kybas

Director of the United States Patent and Trademark Office

Reg. No. 4,152,257 SER. NO. 79-097,254, FILED 3-31-2011.

MELISSA VALLILLO, EXAMINING ATTORNEY

United States of America

United States Patent and Trademark Office



Reg. No. 4,152,258

Registered June 5, 2012

Int. Cl.: 33

TRADEMARK

PRINCIPAL REGISTER

AFFENTALER WINZERGENOSSENSCHAFT BÜHL EG (FED REP GERMANY GMBH
(LIMITED LIABILITY COMPANY))
BETSCHGRÄBLERPLATZ
77815 BÜHL, FED REP GERMANY

FOR: ALCOHOLIC BEVERAGES (EXCEPT BEERS), IN CLASS 33 (U.S. CLS. 47 AND 49).

NO CLAIM IS MADE TO THE EXCLUSIVE RIGHT TO USE "AFFENTALER WINZERGEN-
OSSENSCHAFT", APART FROM THE MARK AS SHOWN.

OWNER OF INTERNATIONAL REGISTRATION 1076809 DATED 4-23-2011, EXPIRES 4-23-
2021.

THE MARK CONSISTS OF A DESIGN OF A WINE CARAFE WITH GRAPES ON THE SIDE
OF IT AND A SINGLE LEAF ON TOP OF THE BOTTLE. THE WORDING "AFFENTALER
WINZERGENOSSENSCHAFT" APPEARS BELOW THE DESIGN.

THE ENGLISH TRANSLATION OF "WINZERGENOSSENSCHAFT" IN THE MARK IS "CO-
OPERATIVE WINE GROWER'S ASSOCIATION".

SER. NO. 79-097,275, FILED 4-23-2011.

REBECCA SMITH, EXAMINING ATTORNEY



David J. Kybas

Director of the United States Patent and Trademark Office

United States of America
United States Patent and Trademark Office

ETERNAL

Reg. No. 4,152,259

Registered June 5, 2012

Int. Cl.: 27

TRADEMARK

PRINCIPAL REGISTER

FORBO FINANCIAL SERVICES AG (SWITZERLAND CORPORATION)
LINDENSTRASSE 8
CH-6340 BAAR
SWITZERLAND

FOR: COVERINGS FOR FLOORS, NAMELY, VINYL FLOOR COVERINGS, MATS, CARPETS AND RUGS, LINOLEUM, IN CLASS 27 (U.S. CLS. 19, 20, 37, 42 AND 50).

THE MARK CONSISTS OF STANDARD CHARACTERS WITHOUT CLAIM TO ANY PARTICULAR FONT, STYLE, SIZE, OR COLOR.

PRIORITY DATE OF 11-3-2010 IS CLAIMED.

OWNER OF INTERNATIONAL REGISTRATION 1077244 DATED 4-8-2011, EXPIRES 4-8-2021.

SER. NO. 79-097,419, FILED 4-8-2011.

MARILYN IZZI, EXAMINING ATTORNEY



David J. Kyffers

Director of the United States Patent and Trademark Office

United States of America

United States Patent and Trademark Office



Reg. No. 4,152,260

Registered June 5, 2012

Int. Cls.: 24 and 25

TRADEMARK

PRINCIPAL REGISTER

RICHARD LÖFFLER (FED REP GERMANY INDIVIDUAL)
GROßE THEATERSTRABE 7
20354 HAMBURG
FED REP GERMANY

FOR: BED LINEN, BED SHEETS, QUILTS, DUVETS, EIDERDOWNS, COVERLETS, BED BLANKETS, BED COVERS, COVERS FOR CUSHIONS, HOUSEHOLD LINEN, BATH LINEN, BANNERS AND FLAGS OF TEXTILE, TOWELS OF TEXTILE, TABLE LINEN AND TABLECLOTHS NOT OF PAPER, IN CLASS 24 (U.S. CLS. 42 AND 50).

FOR: BOOTS, PANTS, SHORTS, GYM SUITS, COATS, SHIRTS, STOCKINGS, SPORTS BRAS, JACKETS, JERSEYS, ATHLETIC UNIFORMS, SWEATPANTS, VESTS, JUMPERS, PULLOVERS, T-SHIRTS, SWEATSHIRTS, SWEATERS, HOODS, HOODED SWEATSHIRTS, CARDIGANS, TROUSERS, JEANS, SKIRTS, PARKAS, BLAZERS, BATHING SUITS, PYJAMAS, SOCKS, BOTTOMS, DRESSES, TOPS, GLOVES, WAISTCOATS; HEADGEAR, NAMELY, HATS, CAPS, BASEBALL CAPS, MESH BASEBALL CAPS, CAP PEAKS, HEADBANDS AND BERETS; BELTS, SCARVES, TRAINING SUITS, SNEAKERS, SHOES, BOOTS, SLIPPERS, SANDALS, BEACH SHOES, IN CLASS 25 (U.S. CLS. 22 AND 39).

THE MARK CONSISTS OF THE WORDING "TRAP EXPERIENCE" DISPLAYED ONE STACKED ON TOP OF THE OTHER WITH A STYLIZED DEPICTION OF THE FRONT VIEW OF A SKATEBOARD DECK, AXIS AND WHEELS SEPARATING THE TERMS, ALL INSIDE A RECTANGULAR DESIGN.

OWNER OF INTERNATIONAL REGISTRATION 1077392 DATED 4-5-2011, EXPIRES 4-5-2021.

SER. NO. 79-097,471, FILED 4-5-2011.

GENE MACIOL, EXAMINING ATTORNEY



David J. Kybas

Director of the United States Patent and Trademark Office

United States of America

United States Patent and Trademark Office

UV CITY

Reg. No. 4,152,261

Registered June 5, 2012

Int. Cl.: 3

TRADEMARK

PRINCIPAL REGISTER

CASTER (FRANCE SOCIÉTÉ PAR ACTIONS SIMPLIFIÉE (SAS))
99 RUE DU FAUBOURG SAINT HONORÉ
F-75008 PARIS
FRANCE

FOR: COSMETICS; NON-MEDICATED SKIN CARE PREPARATIONS AND COSMETIC PREPARATIONS FOR SKIN EMBELLISHMENT; SUN CARE AND AFTER-SUN PREPARATIONS, NAMELY, COSMETIC PREPARATIONS FOR SKIN TANNING; HAIR CARE PREPARATIONS; HAIR MAINTENANCE AND BEAUTIFICATION PREPARATIONS, NAMELY, HAIR CARE CREAMS AND HAIR CONDITIONERS; SHAMPOOS, HAIR LOTIONS; ALL THE AFOREMENTIONED GOODS PROVIDING UV PROTECTION, IN CLASS 3 (U.S. CLS. 1, 4, 6, 50, 51 AND 52).

THE MARK CONSISTS OF STANDARD CHARACTERS WITHOUT CLAIM TO ANY PARTICULAR FONT, STYLE, SIZE, OR COLOR.

PRIORITY DATE OF 11-17-2010 IS CLAIMED.

OWNER OF INTERNATIONAL REGISTRATION 1077394 DATED 4-8-2011, EXPIRES 4-8-2021.

NO CLAIM IS MADE TO THE EXCLUSIVE RIGHT TO USE "UV", APART FROM THE MARK AS SHOWN.

SER. NO. 79-097,473, FILED 4-8-2011.

KAREN SEVERSON, EXAMINING ATTORNEY



David J. Kyffers

Director of the United States Patent and Trademark Office

United States of America
United States Patent and Trademark Office

MICRO VASCULAR INTERVENTIONS
αcandis

Reg. No. 4,152,262

Registered June 5, 2012

Int. Cl.: 10

TRADEMARK

PRINCIPAL REGISTER

ACANDIS GMBH & CO. KG (FED REP GERMANY GMBH & CO. KG)
KOLPINGSTRASSE 5
76327 PFINZTAL
FED REP GERMANY

FOR: SURGICAL, MEDICAL, VETERINARY, DENTAL APPARATUSES, INSTRUMENTS AND SYSTEMS, IN PARTICULAR SURGICAL AND MEDICAL APPARATUSES AND INSTRUMENTS AND MEDICAL SYSTEMS COMPRISED OF MEDICAL APPARATUSES AND INSTRUMENTS FOR STROKE TREATMENT AND PROPHYLAXIS, FOR THE TREATMENT OF CEREBRAL VESSELS AND FOR NEUROMODULATION; SURGICAL IMPLANTS MADE OF ARTIFICIAL MATERIAL, NAMELY MEDICAL STENTS AND ARTERIAL AND VASCULAR GRAFTS, MEDICAL IMPLANTS COMPRISED OF ARTIFICIAL MATERIAL AND INSTRUMENTS FOR THE MINIMAL INVASIVE SURGERY, IN PARTICULAR IMPLANTS MADE OF DEGRADABLE AND NON-DEGRADABLE MATERIALS; MEDICAL APPLICATION SYSTEMS FOR SURGICAL AND MEDICAL APPARATUSES AND INSTRUMENTS, NAMELY, CATHETERS, IN CLASS 10 (U.S. CLS. 26, 39 AND 44).

OWNER OF U.S. REG. NO. 3,352,214.

PRIORITY DATE OF 10-12-2010 IS CLAIMED.

OWNER OF INTERNATIONAL REGISTRATION 1077429 DATED 4-12-2011, EXPIRES 4-12-2021.

NO CLAIM IS MADE TO THE EXCLUSIVE RIGHT TO USE "MICRO VASCULAR INTERVENTIONS", APART FROM THE MARK AS SHOWN.

THE MARK CONSISTS OF THE WORDING "MICRO VASCULAR INTERVENTIONS" ABOVE THE WORDING "ACANDIS" IN STYLIZED FONT WHERE THE FIRST "A" IS THE WORDING "ACANDIS" APPEARS AS THE GREEK LETTER ALPHA AND THE WORDING IS UNDERLINED BY ONE STROKE.

SER. NO. 79-097,488, FILED 4-12-2011.

MARIA-VICTORIA SUAREZ, EXAMINING ATTORNEY



David J. Kyffers

Director of the United States Patent and Trademark Office

United States of America

United States Patent and Trademark Office

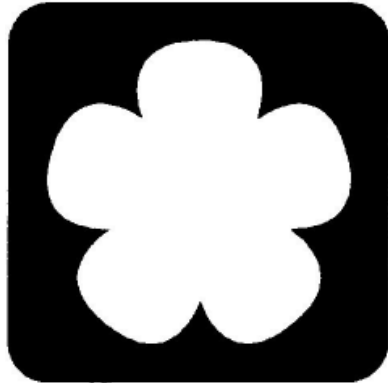

mia
electric

Reg. No. 4,152,263

Registered June 5, 2012

Int. Cls.: 12, 35 and 37

TRADEMARK

SERVICE MARK

PRINCIPAL REGISTER

MIA ELECTRIC GMBH (FED REP GERMANY LIMITED LIABILITY COMPANY)
NORBERTSTRASSE 5
45131 ESSEN
FED REP GERMANY

FOR: MOTOR VEHICLES, NAMELY, LAND VEHICLES; ELECTRIC DRIVES FOR MOTOR VEHICLES; ELECTRIC VEHICLES, NAMELY, ELECTRIC LAND VEHICLES; ELECTRIC MOTORS AND ENGINES FOR LAND VEHICLES; CHASSIS FOR MOTOR VEHICLES; STRUCTURAL PARTS FOR THE AFORESAID GOODS INCLUDED IN THIS CLASS, IN CLASS 12 (U.S. CLS. 19, 21, 23, 31, 35 AND 44).

FOR: WHOLESALE STORE AND RETAIL STORE SERVICES FEATURING MOTOR VEHICLES, DRIVES FOR MOTOR VEHICLES, ELECTRIC VEHICLES, AND ELECTRIC MOTORS AND ENGINES FOR LAND VEHICLES, IN CLASS 35 (U.S. CLS. 100, 101 AND 102).

FOR: MAINTENANCE, REPAIR AND SERVICING OF ELECTRIC LAND VEHICLES, IN CLASS 37 (U.S. CLS. 100, 103 AND 106).

OWNER OF U.S. REG. NO. 4,043,838.

PRIORITY DATE OF 10-6-2010 IS CLAIMED.

OWNER OF INTERNATIONAL REGISTRATION 1077534 DATED 4-5-2011, EXPIRES 4-5-2021.

NO CLAIM IS MADE TO THE EXCLUSIVE RIGHT TO USE "ELECTRIC", APART FROM THE MARK AS SHOWN.

THE MARK CONSISTS OF THE STYLIZED WORDING "MIA ELECTRIC" STACKED ONE ON TOP OF THE OTHER WITH A STYLIZED FLOWER DESIGN APPEARING INSIDE A RECTANGLE DESIGN AND TO THE LEFT OF THE WORDING.

THE ENGLISH TRANSLATION OF "MIA" IN THE MARK IS "MY".

SER. NO. 79-097,520, FILED 4-5-2011.



David J. Kyros

Director of the United States Patent and Trademark Office

Reg. No. 4,152,263 GENE MACIOL, EXAMINING ATTORNEY

United States of America

United States Patent and Trademark Office

WVTB

Reg. No. 4,152,264

Registered June 5, 2012

Int. Cl.: 1

TRADEMARK

PRINCIPAL REGISTER

CASTER (FRANCE SOCIÉTÉ PAR ACTIONS SIMPLIFIÉE)
99 RUE DU FAUBOURG SAINT HONORÉ
F-75008 PARIS
FRANCE

FOR: ACTIVE CHEMICAL INGREDIENTS USED IN THE COSMETICS INDUSTRY, NAMELY, ACTIVE SUBSTANCES OBTAINED FROM NATURAL, PLANT-BASED OR SYNTHETIC EXTRACTS FOR THE MANUFACTURE OF COSMETICS, IN CLASS 1 (U.S. CLS. 1, 5, 6, 10, 26 AND 46).

THE MARK CONSISTS OF STANDARD CHARACTERS WITHOUT CLAIM TO ANY PARTICULAR FONT, STYLE, SIZE, OR COLOR.

PRIORITY DATE OF 10-18-2010 IS CLAIMED.

OWNER OF INTERNATIONAL REGISTRATION 1077539 DATED 4-8-2011, EXPIRES 4-8-2021.

SER. NO. 79-097,523, FILED 4-8-2011.

KAREN SEVERSON, EXAMINING ATTORNEY



David J. Kyffers

Director of the United States Patent and Trademark Office

United States of America
United States Patent and Trademark Office

Le Gioventù

凡 朵

Reg. No. 4,152,265

Registered June 5, 2012

Int. Cl.: 24

TRADEMARK

PRINCIPAL REGISTER

NINGBO YOUNGOR WORSTED SPINNING WEAVING & DYEING CO., LTD. (CHINA CORPORATION)
CHANGFENG ONE VILLAGE
ZHONGGONGMIAO STREET;; YINZHOU QU.; NINGBO; ZHEJIANG
CHINA

FOR: TEXTILE MATERIAL FOR MANUFACTURE OF CLOTHING; WOOLEN CLOTH; VELVET; COTTON FABRICS; WOOLEN FABRIC; LINEN CLOTH; RAMIE FABRIC; CANVAS FOR TAPESTRY OR EMBROIDERY; NON-WOVEN FABRICS, IN CLASS 24 (U.S. CLS. 42 AND 50).

THE MARK CONSISTS OF THE WORDING "LE GIOVENTU" AND CHINESE CHARACTERS IN STYLIZED FONT.

OWNER OF INTERNATIONAL REGISTRATION 1077703 DATED 1-4-2011, EXPIRES 1-4-2021.

THE TRANSLITERATION OF THE FIRST CHINESE CHARACTER IS "FAN", THE SECOND IS "DUO".

THE ENGLISH TRANSLATION OF THE FIRST CHINESE CHARACTER IN THE MARK IS "ORDINARY" AND THE ENGLISH TRANSLATION OF THE SECOND CHINESE CHARACTER IS "FLOWER". THE ENGLISH TRANSLATION OF "LE GIOVENTU" IN THE MARK IS "THE YOUTH".



SER. NO. 79-097,577, FILED 1-4-2011.

JERI J. FICKES, EXAMINING ATTORNEY

David J. Kybas

Director of the United States Patent and Trademark Office

United States of America

United States Patent and Trademark Office

GUARDIAN OF TIME

Reg. No. 4,152,266

FONDATION DE LA HAUTE HORLOGERIE (SWITZERLAND PRIVATE FOUNDATION)
22, AVENUE DU MAIL
CH-1205 GENÈVE, SWITZERLAND

Registered June 5, 2012

Int. Cls.: 9, 16, 38 and 41

FOR: DOWNLOADABLE ELECTRONIC PUBLICATIONS, NAMELY, BOOKLETS, BROCHURES, NEWSLETTERS, AND MAGAZINES IN THE FIELD OF LUXURY GOODS, IN CLASS 9 (U.S. CLS. 21, 23, 26, 36 AND 38).

TRADEMARK

FOR: PRINTED MATTER, NAMELY, BOOKLETS, PAMPHLETS, BROCHURES, BOOKS AND MAGAZINES IN THE FIELD OF LUXURY GOODS; PHOTOGRAPHS; POSTERS; GRAPHIC PRINTS; STATIONERY INDEX CARDS; PRINTING BLOCKS; PENCILS; STATIONERY; WRITING INSTRUMENTS; FOUNTAIN PENS AND PENS, IN CLASS 16 (U.S. CLS. 2, 5, 22, 23, 29, 37, 38 AND 50).

SERVICE MARK

PRINCIPAL REGISTER

FOR: TRANSMISSION OF INFORMATION VIA ELECTRONIC AND COMPUTER MEANS; DATA DOWNLOADING SERVICES, NAMELY, ELECTRONIC DATA INTERCHANGE OF INFORMATION, IMAGES, AND SOUNDS VIA A GLOBAL COMPUTER NETWORK, VIA COMPUTERS LINKED IN A NETWORK BY MEANS OF A COMPUTER SITE ON COMMUNICATION NETWORKS; PROVIDING ACCESS TO THE INTERNET, NAMELY, PROVIDING ACCESS TO ONLINE INFORMATION, DISCUSSION SITES, ELECTRONIC FORUMS AND CHAT ROOMS IN THE FIELD OF LUXURY GOODS OVER THE INTERNET AND OTHER DATA NETWORKS; PROVIDING ACCESS TO COMPUTER DATABASES, NAMELY, DATA IN COMPUTER DATABASES, PARTICULARLY AUDIO, VIDEO AND IMAGE FILES, AS WELL AS LINKS, IN CLASS 38 (U.S. CLS. 100, 101 AND 104).

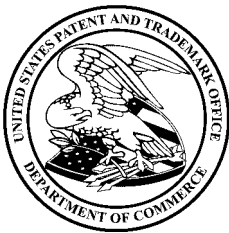

FOR: ARRANGING AND HOLDING OF EXHIBITIONS, TRADE FAIRS, COLLOQUIUMS, CONFERENCES, CONVENTIONS, SEMINARS, SYMPOSIUMS, AND TRADE SHOWS FOR CULTURAL AND EDUCATIONAL PURPOSES; INFORMATION ON EDUCATION; PUBLISHING SERVICES, NAMELY, PUBLISHING OF BOOKS, MAGAZINES, TEXTS; PUBLISHING OF TEXTS OTHER THAN ADVERTISING TEXTS ON ANY MEDIA, NAMELY, ELECTRONIC PUBLICATIONS; PARTY PLANNING, IN CLASS 41 (U.S. CLS. 100, 101 AND 107).

THE MARK CONSISTS OF STANDARD CHARACTERS WITHOUT CLAIM TO ANY PARTICULAR FONT, STYLE, SIZE, OR COLOR.

PRIORITY DATE OF 10-14-2010 IS CLAIMED.

David J. Kyros

Director of the United States Patent and Trademark Office

Reg. No. 4,152,266 OWNER OF INTERNATIONAL REGISTRATION 1077936 DATED 3-31-2011, EXPIRES 3-31-2021.

SER. NO. 79-097,646, FILED 3-31-2011.

SHANNON TWOHIG, EXAMINING ATTORNEY

United States of America

United States Patent and Trademark Office

FLYRINGE

Reg. No. 4,152,267

Registered June 5, 2012

Int. Cls.: 9 and 10

TRADEMARK

PRINCIPAL REGISTER

WEIBEL CDS AG (SWITZERLAND STOCK CORPORATION)
SÄNTISSTRASSE 11
CH-9104 WALDSTATT
SWITZERLAND

FOR: DOSAGE DISPENSERS, IN CLASS 9 (U.S. CLS. 21, 23, 26, 36 AND 38).

FOR: SYRINGES FOR MEDICAL USE; DISPOSABLE SYRINGES; REUSABLE SYRINGES FOR MEDICAL USE, IN CLASS 10 (U.S. CLS. 26, 39 AND 44).

THE MARK CONSISTS OF STANDARD CHARACTERS WITHOUT CLAIM TO ANY PARTICULAR FONT, STYLE, SIZE, OR COLOR.

PRIORITY DATE OF 10-26-2010 IS CLAIMED.

OWNER OF INTERNATIONAL REGISTRATION 1077956 DATED 4-21-2011, EXPIRES 4-21-2021.

SER. NO. 79-097,654, FILED 4-21-2011.

SHANNON TWOHIG, EXAMINING ATTORNEY



David J. Kybas

Director of the United States Patent and Trademark Office

United States of America

United States Patent and Trademark Office

YUZU MAN

Reg. No. 4,152,268

Registered June 5, 2012

Int. Cl.: 3

TRADEMARK

PRINCIPAL REGISTER

PARFUMS CARON (FRANCE SOCIETE PAR ACTIONS SIMPLIFIEE)
99, RUE DU FAUBOURG SAINT HONORÉ
F-75008 PARIS
FRANCE

FOR: SOAP, NAMELY, SKIN SOAP, HAND SOAP; PERFUMERY PRODUCTS, NAMELY, PERFUMED BATH SALTS, PERFUMED SOAPS, PERFUMED SACHETS; TOILET WATER; EAU-DE-COLOGNE; PERFUMES; PERFUMERY; ESSENTIAL OILS; COSMETICS; SHOWER GELS; DEODORANTS FOR PERSONAL USE; SHAVING PRODUCTS, NAMELY, SHAVING CREAMS, AFTER-SHAVE LOTIONS; SHAMPOOS, HAIR LOTIONS, IN CLASS 3 (U.S. CLS. 1, 4, 6, 50, 51 AND 52).

THE MARK CONSISTS OF STANDARD CHARACTERS WITHOUT CLAIM TO ANY PARTICULAR FONT, STYLE, SIZE, OR COLOR.

PRIORITY DATE OF 10-18-2010 IS CLAIMED.

OWNER OF INTERNATIONAL REGISTRATION 1077966 DATED 4-15-2011, EXPIRES 4-15-2021.

NO CLAIM IS MADE TO THE EXCLUSIVE RIGHT TO USE "YUZU", APART FROM THE MARK AS SHOWN.

SER. NO. 79-097,658, FILED 4-15-2011.

HAI-LY LAM, EXAMINING ATTORNEY



David J. Kyffers

Director of the United States Patent and Trademark Office

United States of America

United States Patent and Trademark Office



Reg. No. 4,152,269

Registered June 5, 2012

**Int. Cls.: 1, 3, 5, 7, 10
and 41**

TRADEMARK

SERVICE MARK

PRINCIPAL REGISTER

ERNST MÜHLBAUER GMBH & CO. KG (FED REP GERMANY LIMITED PARTNERSHIP)
KOOGSTRAAT 4
25870 NORDERFRIEDRICHSKOOG
FED REP GERMANY

FOR: SYNTHETIC AND ARTIFICIAL RESINS, UNPROCESSED FOR RAPID PROTOTYPING; PLASTIC MOULDING COMPOUNDS, NAMELY, MODELLING UNPROCESSED PLASTIC FOR THE MAKING OF EARPLUGS, IN CLASS 1 (U.S. CLS. 1, 5, 6, 10, 26 AND 46).

FOR: NON-MEDICATED PREPARATIONS FOR ORAL HYGIENE PURPOSES, NAMELY, MOUTHWASHES, MOUTH RINSE, TOOTHPASTE, IN CLASS 3 (U.S. CLS. 1, 4, 6, 50, 51 AND 52).

FOR: DENTAL MATERIAL FOR STOPPING TEETH; FASTENING AND MOULDING MATERIAL FOR DENTAL PURPOSES, NAMELY, FIXING MATERIALS FOR DENTAL PURPOSES AND MATERIALS FOR MAKING DENTAL IMPRESSIONS; PHARMACEUTICAL PRODUCTS AND PREPARATIONS FOR DENTAL PURPOSES; BONDING PRODUCTS, ADHESIVE CEMENTS AND SELF AND LIGHT-CURED CEMENTS FOR DENTAL USE, IN CLASS 5 (U.S. CLS. 6, 18, 44, 46, 51 AND 52).

FOR: AUTOMATIC MIXERS FOR DENTAL IMPRESSION MATERIALS USED IN THE DIAGNOSIS AND TREATMENT OF DENTAL CONDITIONS; FILLING MACHINES, IN CLASS 7 (U.S. CLS. 13, 19, 21, 23, 31, 34 AND 35).

FOR: DENTAL APPARATUS AND INSTRUMENTS, NAMELY, MILLING APPARATUS FOR DENTAL PURPOSES, PROGRAMMABLE MILLING APPARATUS FOR DENTAL PURPOSES, MECHANICAL DISPENSERS FOR ADMINISTERING DENTAL FILLING MATERIAL, DRILLS FOR DENTAL APPLICATIONS, SYRINGES FOR THE APPLICATION OF DENTAL FILLING MATERIAL, IN CLASS 10 (U.S. CLS. 26, 39 AND 44).

FOR: PROVIDING OF TRAINING IN THE DENTAL FIELD, IN CLASS 41 (U.S. CLS. 100, 101 AND 107).

OWNER OF U.S. REG. NOS. 1,943,389, 2,822,233 AND OTHERS.

PRIORITY DATE OF 8-7-2010 IS CLAIMED.



David J. Kyjars

Director of the United States Patent and Trademark Office

Reg. No. 4,152,269 OWNER OF INTERNATIONAL REGISTRATION 1078065 DATED 2-4-2011, EXPIRES 2-4-2021.

THE COLOR(S) WHITE, BLUE, BLACK, AND GRAY IS/ARE CLAIMED AS A FEATURE OF THE MARK.

THE MARK CONSISTS OF A BLUE RECTANGLE WITH A WHITE RECTANGLE OVERLAPPING THE BLUE RECTANGLE WHICH APPEARS TO BE PEELING BACK FROM THE BLUE RECTANGLE UPWARD FROM THE LOWER RIGHT CORNER. THERE IS GRAY SHADING ON THE PEELED BACK PORTION OF THE WHITE RECTANGLE AND BLACK SHADING ALONG THE DIAGONAL ON THE BLUE RECTANGLE WHERE THE BLUE AND WHITE RECTANGLES MEET. THE LETTERS "DMG" APPEAR IN WHITE IN THE LOWER RIGHT CORNER OF THE BLUE RECTANGLE. A WHITE SQUARE WITH CURVED CUTOUTS IN THE TOP LEFT PORTION AND RIGHT SIDE PORTION AND WITH A BLUE ARROW DIAGONALLY ACROSS IT GOING FROM THE LOWER LEFT CORNER TOWARD THE TOP RIGHT CORNER APPEARS TO THE LEFT OF THE LETTERS "DMG".

SER. NO. 79-097,685, FILED 2-4-2011.

TINA BROWN, EXAMINING ATTORNEY

United States of America

United States Patent and Trademark Office

PRONE

Reg. No. 4,152,270

Registered June 5, 2012

Int. Cls.: 18, 25 and 28

TRADEMARK

PRINCIPAL REGISTER

PROVASI ROBERTO (ITALY INDIVIDUAL)
VIA MONTELLO, 79/B
I-22060 CABIATE (CO)
ITALY

FOR: LEATHER AND IMITATIONS OF LEATHER, AND GOODS MADE OF THESE MATERIALS AND NOT INCLUDED IN OTHER CLASSES, NAMELY, HANDBAGS, BRIEFCASES; ANIMAL SKINS, ANIMAL HIDES; TRUNKS AND TRAVELLING BAGS; UMBRELLAS, PARASOLS AND WALKING STICKS; WHIPS, HARNESS AND SADDLERY, IN CLASS 18 (U.S. CLS. 1, 2, 3, 22 AND 41).

FOR: CLOTHING, NAMELY, SHIRTS, PANTS, T-SHIRTS, JUMPERS, SWEATERS, JACKETS, COATS, TROUSERS, BERMUDA SHORTS, BOXER SHORTS, GYM SHORTS, SWEAT SHORTS, SOCCER SHORTS, TRACKSUITS, SOCKS; FOOTWEAR, HEADGEAR, NAMELY, HATS, CAPS, IN CLASS 25 (U.S. CLS. 22 AND 39).

FOR: GAMES AND PLAYTHINGS, NAMELY, DOLLS, PLAYING CARDS, ACTION SKILL GAMES, BOARD GAMES; GYMNASTIC AND SPORTING ARTICLES NOT INCLUDED IN OTHER CLASSES, NAMELY, BALLS, FOOTBALLS, ROLLER SKATES, ICE HOCKEY STICKS, HOCKEY GLOVES, HOCKEY PUCKS, BAGS SPECIALLY ADAPTED FOR SPORTS EQUIPMENT, CASES SPECIALLY ADAPTED FOR SPORTS EQUIPMENT, MEN'S ATHLETIC SUPPORTERS, SKIS, WATERSKIS, SURF SKIS, BAGS ESPECIALLY DESIGNED FOR SKIS AND SURFBOARDS, GAMES AND TOY; DECORATION FOR CHRISTMAS TREES, IN CLASS 28 (U.S. CLS. 22, 23, 38 AND 50).

THE MARK CONSISTS OF CONSISTS OF THE WORD "PRONE" WITH THE LETTER "O" SPLIT VERTICALLY. THE NUMBER "1" IS SUPERIMPOSED OVER THE "O".

PRIORITY DATE OF 4-12-2011 IS CLAIMED.

OWNER OF INTERNATIONAL REGISTRATION 1078554 DATED 4-19-2011, EXPIRES 4-19-2021.

SER. NO. 79-097,844, FILED 4-19-2011.

SHANNON TWOHIG, EXAMINING ATTORNEY



David J. Kyffers

Director of the United States Patent and Trademark Office

United States of America
United States Patent and Trademark Office

PROOONE

Reg. No. 4,152,271

Registered June 5, 2012

Int. Cls.: 18, 25 and 28

TRADEMARK

PRINCIPAL REGISTER

PROVASI ROBERTO (ITALY INDIVIDUAL)
VIA MONTELLO, 79/B
I-22060 CABIATE (CO)
ITALY

FOR: LEATHER AND IMITATIONS OF LEATHER, AND GOODS MADE OF THESE MATERIALS AND NOT INCLUDED IN OTHER CLASSES, NAMELY, HANDBAGS, BRIEFCASES; ANIMAL SKINS, ANIMAL HIDES; TRUNKS AND TRAVELLING BAGS; UMBRELLAS, PARASOLS AND WALKING STICKS; WHIPS, HARNESS AND SADDLERY, IN CLASS 18 (U.S. CLS. 1, 2, 3, 22 AND 41).

FOR: CLOTHING, NAMELY, SHIRTS, PANTS, T-SHIRTS, JUMPERS, SWEATERS, JACKETS, COATS, TROUSERS, BERMUDA SHORTS, BOXER SHORTS, GYM SHORTS, SWEAT SHORTS, SOCCER SHORTS, TRACKSUITS, SOCKS; FOOTWEAR, HEADGEAR, NAMELY, HATS, CAPS, IN CLASS 25 (U.S. CLS. 22 AND 39).

FOR: GAMES AND PLAYTHINGS, NAMELY, DOLLS, PLAYING CARDS, ACTION SKILL GAMES, BOARD GAMES; GYMNASTIC AND SPORTING ARTICLES NOT INCLUDED IN OTHER CLASSES, NAMELY, BALLS, FOOTBALLS, ROLLER SKATES, ICE HOCKEY STICKS, HOCKEY GLOVES, HOCKEY PUCKS, BAGS SPECIALLY ADAPTED FOR SPORTS EQUIPMENT, CASES SPECIALLY ADAPTED FOR SPORTS EQUIPMENT, MEN'S ATHLETIC SUPPORTERS, SKIS, WATERSKIS, SURF SKIS, BAGS ESPECIALLY DESIGNED FOR SKIS AND SURFBOARDS, GAMES AND TOY; DECORATION FOR CHRISTMAS TREES, IN CLASS 28 (U.S. CLS. 22, 23, 38 AND 50).

THE MARK CONSISTS OF STANDARD CHARACTERS WITHOUT CLAIM TO ANY PARTICULAR FONT, STYLE, SIZE, OR COLOR.

PRIORITY DATE OF 4-12-2011 IS CLAIMED.

OWNER OF INTERNATIONAL REGISTRATION 1078555 DATED 4-19-2011, EXPIRES 4-19-2021.

SER. NO. 79-097,845, FILED 4-19-2011.

SHANNON TWOHIG, EXAMINING ATTORNEY



David J. Kyros

Director of the United States Patent and Trademark Office

United States of America

United States Patent and Trademark Office

MISSLYN

Reg. No. 4,152,272

Registered June 5, 2012

**Int. Cls.: 3, 8, 14, 18 and
21**

TRADEMARK

PRINCIPAL REGISTER

ARTDECO COSMETIC GMBH (FED REP GERMANY GMBH (LIMITED LIABILITY COMPANY))
GAUSSSTR. 13
85757 KARLSFELD, FED REP GERMANY

FOR: SOAPS; PERFUMERY; ESSENTIAL OILS; COSMETICS; LADIES' COSMETICS; EYEBROW COSMETICS; EYEBROW PENCILS; COSMETIC BATHING PREPARATIONS; COSMETIC CREAMS FOR THE SKIN; ARTIFICIAL EYELASHES; EYELASH ADHESIVES FOR FALSE EYELASHES; NON-MEDICAL PREPARATIONS FOR THE APPLICATION OF FALSE NAILS, NON-MEDICAL PREPARATIONS FOR THE CONDITIONING AND CARE OF NAILS; FALSE NAILS; NAIL TIPS; NAIL LACQUERS; NAIL LACQUER REMOVERS; NAIL HARDENERS FOR NON-MEDICAL PURPOSES; NON-MEDICAL PREPARATIONS FOR STRENGTHENING OF NAILS; LIPSTICKS; BEAUTY MASKS; COSMETIC SLIMMING PREPARATIONS; COSMETIC POWDER, NAMELY, COSMETIC WHITE FACE POWDER, FACE POWDER, MAKE-UP POWDER, NON-MEDICATED FOOT POWDER, HAIR-WASHING POWDER; MEN'S COSMETICS, IN PARTICULAR AFTER SHAVES, SHAVING CREAMS, SKIN CREAMS FOR NON-MEDICAL PURPOSES; HAIR LOTIONS; SHAMPOOS; HAIR-DYEING PREPARATIONS; COTTON BUDS FOR COSMETIC PURPOSES; COTTON SWABS FOR COSMETIC PURPOSES; COSMETIC BAGS SOLD FILLED WITH SOAPS, PERFUMERY, ESSENTIAL OILS, COSMETICS, BEAUTY MASKS, IN CLASS 3 (U.S. CLS. 1, 4, 6, 50, 51 AND 52).

FOR: MANUALLY OPERATED DEVICES AND INSTRUMENTS FOR BODY AND BEAUTY CARE, INCLUDED IN THIS CLASS, NAMELY, ELECTRIC AND NON-ELECTRIC SHAVERS AND RAZORS, ELECTRIC AND NON-ELECTRIC DEPILATORY APPLIANCES, ELECTRIC AND NON-ELECTRIC FINGERNAIL POLISHERS, NAIL SCISSORS, HAND-OPERATED HAIR CLIPPERS, MANICURE SETS, PEDICURE SETS; NAIL FILES; ELECTRIC OR NON-ELECTRIC NAIL POLISHERS; CUTICLE PLIERS; NAIL PLIERS; NAIL CUTTING DEVICES, NAMELY, NAIL CLIPPERS, NAIL SCISSORS; EYELASH PLIERS; EYELASH CURLERS; EYEBROW CURLERS; TWEEZERS, IN CLASS 8 (U.S. CLS. 23, 28 AND 44).

FOR: JEWELLERY AND COSTUME JEWELLERY, IN PARTICULAR AMULETS, BRACELETS FOR JEWELLERY PURPOSES, NECKLACES, EARRINGS, RINGS, BROOCHES, RHINESTONES, AND JEWELLERY CASES; ALL OF THE AFORESAID GOODS INCLUDED IN THIS CLASS ONLY, IN CLASS 14 (U.S. CLS. 2, 27, 28 AND 50).



David J. Kyjars

Director of the United States Patent and Trademark Office

Reg. No. 4,152,272 FOR: LEATHER AND IMITATIONS OF LEATHER; GOODS MADE OF LEATHER AND IMITATIONS OF LEATHER, AND NOT INCLUDED IN OTHER CLASSES, NAMELY, ALL-PURPOSE CARRYING BAGS, LEATHER HANDBAGS, LEATHER KEY CASES, LEATHER WALLETS, LEATHER CASES, LEATHER BAGS, POCKET WALLETS, PURSES, HANDBAGS, SUITCASES, TRAVELLING BAGS, BAGS FOR SPORTS, LUGGAGE, PURSES, SCHOOL BAGS, BABY CARRYING BAGS, COSMETIC BAGS SOLD EMPTY, KEY BAGS, LEATHER AND IMITATION LEATHER BAGS, SUITCASES, BRIEFCASES, CREDIT CARD CASES AND WALLETS; TRUNKS AND TRAVELLING BAGS; HANDBAGS; PURSES; CASES, NAMELY, COSMETIC CASES SOLD EMPTY, VANITY CASES SOLD EMPTY, TOILETRY CASES SOLD EMPTY; RUCKSACKS; UMBRELLAS, PARASOLS , IN CLASS 18 (U.S. CLS. 1, 2, 3, 22 AND 41).

FOR: MANUALLY OPERATED DEVICES AND INSTRUMENTS FOR BODY AND BEAUTY CARE, INCLUDED IN THIS CLASS ONLY, NAMELY, ELECTRIC TOOTH BRUSHES, ELECTRIC HAIR COMBS, COSMETIC SPATULAS FOR USE WITH DEPILATORY PREPARATIONS; BRUSHES EXCEPT FOR PAINTBRUSHES, NAMELY, HAIR BRUSHES, TOOTH BRUSHES, NAIL BRUSHES, BATH BRUSHES, CLEANING BRUSHES FOR HOUSEHOLD USE, CLOTHES BRUSHES, COSMETIC BRUSHES, EYEBROW BRUSHES, LIP BRUSHES, MAKE-UP BRUSHES, SCRUBBING BRUSHES, SHAVING BRUSHES, SHOE BRUSHES, TOILET BRUSHES, WASHING BRUSHES; COMBS; SPONGES, NAMELY, SPONGES FOR HOUSEHOLD PURPOSES, BODY SPONGES, BATH SPONGES, CLEANING SPONGES, SCRUB SPONGES, SPONGES USED FOR APPLYING MAKE-UP, TOILET SPONGES; COSMETIC BRUSHES; POWDER PUFFS; BRUSHES FOR BODY AND BEAUTY CARE, NAMELY, HAIR BRUSHES, NAIL BRUSHES, COSMETIC BRUSHES, EYEBROW BRUSHES, LIP BRUSHES, MAKE-UP BRUSHES; COMBS AND BRUSHES FOR EYEBROWS; COMBS AND BRUSHES FOR EYELASHES; NAIL BRUSHES; APPLICATOR STICKS FOR APPLYING COSMETICS AND MAKE-UP; PERFUME ATOMIZERS SOLD EMPTY; NON-METAL POWDER COMPACTS, IN CLASS 21 (U.S. CLS. 2, 13, 23, 29, 30, 33, 40 AND 50).

THE MARK CONSISTS OF STANDARD CHARACTERS WITHOUT CLAIM TO ANY PARTICULAR FONT, STYLE, SIZE, OR COLOR.

PRIORITY DATE OF 12-6-2010 IS CLAIMED.

OWNER OF INTERNATIONAL REGISTRATION 1078702 DATED 3-4-2011, EXPIRES 3-4-2021.

THE NAME(S), PORTRAIT(S), AND/OR SIGNATURE(S) SHOWN IN THE MARK DOES NOT IDENTIFY A PARTICULAR LIVING INDIVIDUAL.

SER. NO. 79-097,893, FILED 3-4-2011.

MICHAEL WIENER, EXAMINING ATTORNEY

United States of America

United States Patent and Trademark Office

SUNIFIC

Reg. No. 4,152,273

Registered June 5, 2012

Int. Cl.: 3

TRADEMARK

PRINCIPAL REGISTER

CASTER (FRANCE SOCIÉTÉ PAR ACTIONS SIMPLIFIÉE)
99 RUE DU FAUBOURG SAINT HONORÉ
F-75008 PARIS, FRANCE

FOR: SOAP, PERFUMERY, ESSENTIALS OILS, COSMETICS, NON-MEDICATED SKIN CARE PREPARATIONS AND COSMETIC PREPARATIONS FOR SKIN EMBELLISHMENTS; MAKE-UP AND MAKE-UP REMOVING PREPARATIONS; BEAUTY MASKS; FACE AND BODY POWDER; SUN AND AFTER SUN PREPARATIONS, NAMELY, SUN SCREENS AND AFTER SUN LOTIONS; COSMETIC HAIR CARE PREPARATIONS; SHAMPOOS; PRE-SHAVE AND AFTER SHAVE PREPARATIONS, IN CLASS 3 (U.S. CLS. 1, 4, 6, 50, 51 AND 52).

THE MARK CONSISTS OF STANDARD CHARACTERS WITHOUT CLAIM TO ANY PARTICULAR FONT, STYLE, SIZE, OR COLOR.

PRIORITY DATE OF 10-18-2010 IS CLAIMED.

OWNER OF INTERNATIONAL REGISTRATION 1079027 DATED 4-8-2011, EXPIRES 4-8-2021.

SER. NO. 79-097,995, FILED 4-8-2011.

KAREN SEVERSON, EXAMINING ATTORNEY



David J. Kyffers

Director of the United States Patent and Trademark Office

United States of America

United States Patent and Trademark Office

BIM Quicksan

Reg. No. 4,152,274

Registered June 5, 2012

Int. Cls.: 9, 16 and 42

NEDERLANDSE ORGANISATIE VOOR TOEGEPAST-NATUURWETENSCHAPPELIJK
ONDERZOEK TNO (NETHERLANDS CORPORATION)
SCHOEMAKERSTRAAT 97
NL-2628 VK DELFT
NETHERLANDS

TRADEMARK

FOR: SOFTWARE FOR EVALUATION OF COMPETENCY OF A COMPANY OR PROJECT ON THE USE OF BUILDING MODEL INFORMATION; DOWNLOADABLE ELECTRONIC QUESTIONNAIRES AND DOWNLOADABLE REPORTS ON BUILDING INFORMATION MODELING, IN CLASS 9 (U.S. CLS. 21, 23, 26, 36 AND 38).

SERVICE MARK

PRINCIPAL REGISTER

FOR: PRINTED MATTER, NAMELY, QUESTIONNAIRES AND REPORTS IN THE FIELD OF SOFTWARE GENERATED MODELS OF BUILDING DESIGN AND BUILDING CONSTRUCTION DATA, IN CLASS 16 (U.S. CLS. 2, 5, 22, 23, 29, 37, 38 AND 50).

FOR: SCIENTIFIC AND TECHNOLOGICAL SERVICES AND RESEARCH AND DESIGN RELATING THERETO, NAMELY, RESEARCH SERVICES IN THE FIELD OF BUILDING INFORMATION MODELING; DESIGN AND DEVELOPMENT OF COMPUTER HARDWARE AND SOFTWARE, IN CLASS 42 (U.S. CLS. 100 AND 101).

THE MARK CONSISTS OF STANDARD CHARACTERS WITHOUT CLAIM TO ANY PARTICULAR FONT, STYLE, SIZE, OR COLOR.

PRIORITY DATE OF 12-20-2010 IS CLAIMED.

OWNER OF INTERNATIONAL REGISTRATION 1079036 DATED 4-7-2011, EXPIRES 4-7-2021.

NO CLAIM IS MADE TO THE EXCLUSIVE RIGHT TO USE "BIM", APART FROM THE MARK AS SHOWN.

SER. NO. 79-098,000, FILED 4-7-2011.

JULIE VEPPUMTHARA, EXAMINING ATTORNEY



David J. Kyros

Director of the United States Patent and Trademark Office

United States of America

United States Patent and Trademark Office

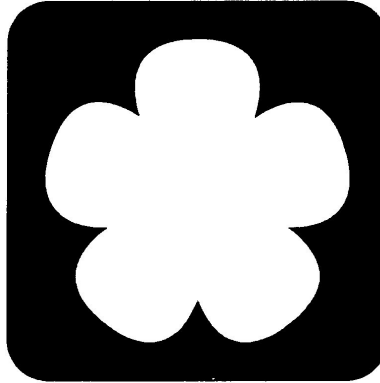

Reg. No. 4,152,275

Registered June 5, 2012

Int. Cls.: 12, 35 and 37

TRADEMARK

SERVICE MARK

PRINCIPAL REGISTER

MIA ELECTRIC GMBH (FED REP GERMANY LIMITED LIABILITY COMPANY)
NORBERTSTRASSE 5
45131 ESSEN
FED REP GERMANY

FOR: MOTOR VEHICLES, NAMELY, LAND VEHICLES; ELECTRIC DRIVES FOR MOTOR VEHICLES; ELECTRIC VEHICLES, NAMELY, ELECTRIC LAND VEHICLES; ELECTRIC MOTORS AND ENGINES FOR LAND VEHICLES; CHASSIS FOR MOTOR VEHICLES; STRUCTURAL PARTS FOR THE AFORESAID GOODS INCLUDED IN THIS CLASS, IN CLASS 12 (U.S. CLS. 19, 21, 23, 31, 35 AND 44).

FOR: WHOLESALE STORE AND RETAIL STORE SERVICES FEATURING MOTOR VEHICLES, DRIVES FOR MOTOR VEHICLES, ELECTRIC VEHICLES, AND ELECTRIC MOTORS AND ENGINES FOR LAND VEHICLES, IN CLASS 35 (U.S. CLS. 100, 101 AND 102).

FOR: MAINTENANCE, REPAIR AND SERVICING OF ELECTRIC LAND VEHICLES, IN CLASS 37 (U.S. CLS. 100, 103 AND 106).

THE MARK CONSISTS OF THE STYLIZED FLOWER DESIGN APPEARING IN A RECTANGLE DESIGN.

PRIORITY DATE OF 10-6-2010 IS CLAIMED.

OWNER OF INTERNATIONAL REGISTRATION 1079098 DATED 4-5-2011, EXPIRES 4-5-2021.

SER. NO. 79-098,016, FILED 4-5-2011.

GENE MACIOL, EXAMINING ATTORNEY



David J. Kybas

Director of the United States Patent and Trademark Office

United States of America

United States Patent and Trademark Office

Paddock's

Reg. No. 4,152,276

Registered June 5, 2012

Int. Cl.: 25

TRADEMARK

PRINCIPAL REGISTER

OSPIG GMBH & CO. KG (FED REP GERMANY GMBH & CO KG)
CARSTEN-DRESSLER-STR. 11
28279 BREMEN
FED REP GERMANY

FOR: CLOTHING, FOOTWEAR, AND HEADGEAR, NAMELY, TROUSERS, BERMUDA SHORTS, SHORTS, SKIRTS, DRESSES, T-SHIRTS, POLO SHIRTS, SWEATSHIRTS, SWEATERS, PULLOVERS, SHIRTS, BLOUSES, JACKETS, BLAZERS, WAISTCOATS, SHOES, BOOTS, STOCKINGS, SCARVES AND CAPS, IN CLASS 25 (U.S. CLS. 22 AND 39).

THE MARK CONSISTS OF STANDARD CHARACTERS WITHOUT CLAIM TO ANY PARTICULAR FONT, STYLE, SIZE, OR COLOR.

OWNER OF INTERNATIONAL REGISTRATION 1079163 DATED 5-23-2011, EXPIRES 5-23-2021.

SER. NO. 79-098,041, FILED 5-23-2011.

CARYN GLASSER, EXAMINING ATTORNEY



David J. Kyffers

Director of the United States Patent and Trademark Office

United States of America

United States Patent and Trademark Office



Reg. No. 4,152,277

Registered June 5, 2012

Int. Cls.: 16, 39, 41 and 43

TRADEMARK

SERVICE MARK

PRINCIPAL REGISTER

INSTITUTO DE TURISMO DE ESPAÑA (TURESPAÑA) (SPAIN ENTIDAD DE DERECHO PÚBLICO)
JOSÉ LÁZARO GALDIANO, 6-4
E-28036 MADRID, SPAIN

FOR: PAPER, CARDBOARD, PRINTED MATTER, NAMELY, NEWSPAPERS, MAGAZINES AND BOOKS IN THE FIELD OF TOURISM, TRAVEL, TRADE PROMOTION BUSINESS PROMOTION, AND PROMOTION OF INVESTMENT; BOOKBINDINGS; PHOTOGRAPHS, STATIONERY; ADHESIVES FOR STATIONERY OR HOUSEHOLD PURPOSES; ARTISTS' MATERIALS, NAMELY, ARTISTS' BRUSHES, ARTISTS' PENS; PAINTBRUSHES; TYPEWRITERS; OFFICE REQUISITES, NAMELY, OFFICE LABELING MACHINES, STAPLERS, RUBBER BANDS AND PAPER HOLE PUNCHES; PRINTED INSTRUCTIONAL AND TEACHING MATERIALS ON THE SUBJECT OF TOURISM, TRADE PROMOTION, BUSINESS PROMOTION AND PROMOTION OF INVESTMENTS; PLASTIC PACKAGING MATERIALS IN THE NATURE OF PLASTIC BAGS, PRINTING TYPE; PRINTING BLOCKS, IN CLASS 16 (U.S. CLS. 2, 5, 22, 23, 29, 37, 38 AND 50).

FOR: TRANSPORTATION OF PASSENGERS AND/OR GOODS BY AIR, BOAT, RAIL, BUS; STORAGE OF PAPER, CARDBOARD, PRINTED MATTER, NAMELY, NEWSPAPERS, MAGAZINES AND BOOKS IN THE FIELD OF TOURISM, TRAVEL, TRADE PROMOTION BUSINESS PROMOTION, AND PROMOTION OF INVESTMENT, BOOKBINDINGS, PHOTOGRAPHS, STATIONERY, ADHESIVES FOR STATIONERY OR HOUSEHOLD PURPOSES, ARTISTS' MATERIALS, NAMELY, ARTISTS' BRUSHES, ARTISTS' PENS, PAINTBRUSHES, TYPEWRITERS, OFFICE REQUISITES, NAMELY, OFFICE LABELING MACHINES, STAPLERS, RUBBER BANDS AND PAPER WHOLE PUNCHES, PRINTED INSTRUCTIONAL AND TEACHING MATERIALS ON THE SUBJECT OF TOURISM, TRADE PROMOTION, BUSINESS PROMOTION AND PROMOTION OF INVESTMENTS, PLASTIC PACKAGING MATERIALS IN THE NATURE OF PLASTIC BAGS, PRINTING TYPE, PRINTING BLOCKS, IN CLASS 39 (U.S. CLS. 100 AND 105).

FOR: EDUCATION SERVICES, NAMELY, PROVIDING CLASSES, SEMINARS, WORKSHOPS IN THE FIELD OF TOURISM, TRAVEL, TRADE PROMOTION, BUSINESS PROMOTION, AND PROMOTION OF INVESTMENTS; TRAINING SERVICES IN THE FIELD OF TRAVEL, TOURISM, TRADE PROMOTION, BUSINESS PROMOTION, AND PROMOTION OF INVESTMENTS; ENTERTAINMENT SERVICES IN THE NATURE OF LIVE MUSICAL GROUPS, TELEVISION COMEDY SERIES, ETHNIC FESTIVALS, LIVE DANCE AND MUSICAL PERFORMANCES, WINE AND FOOD TASTING, PLANNING AND CONDUCTING A SERIES



David J. Kyros

Director of the United States Patent and Trademark Office

Reg. No. 4,152,277 OF FILM FESTIVALS, CONDUCTING CARNIVALS, ORGANIZATION OF EXHIBITIONS FOR CULTURAL AND EDUCATIONAL PURPOSES, IN CLASS 41 (U.S. CLS. 100, 101 AND 107).

FOR: SERVICES RENDERED TO FACILITATE ACCOMMODATION, NAMELY, ARRANGING TEMPORARY HOUSING ACCOMMODATIONS, HOTEL ACCOMMODATION SERVICES; MAKING RESERVATIONS AND BOOKINGS FOR OTHERS FOR ACCOMMODATIONS AND MEALS AT HOTELS, MOTELS, AND HEALTH SPAS, PROVIDING INFORMATION IN THE FIELD OF TEMPORARY ACCOMMODATIONS FOR TRAVELERS, PROVIDING PERSONALIZED INFORMATION ABOUT HOTELS AND TEMPORARY ACCOMMODATIONS FOR TRAVEL VIA THE INTERNET, PROVIDING TEMPORARY HOUSING ACCOMMODATIONS, AND PROVIDING OF FOOD AND DRINK, IN CLASS 43 (U.S. CLS. 100 AND 101).

OWNER OF U.S. REG. NO. 1,665,196.

OWNER OF INTERNATIONAL REGISTRATION 1079280 DATED 4-7-2011, EXPIRES 4-7-2021.

THE COLOR(S) BLACK, YELLOW, RED, GREEN AND WHITE IS/ARE CLAIMED AS A FEATURE OF THE MARK.

NO CLAIM IS MADE TO THE EXCLUSIVE RIGHT TO USE "ESPANA", APART FROM THE MARK AS SHOWN.

THE MARK CONSISTS OF THE WORD "ESPAÑA" IN BLACK WITH RED ON THE BOTTOM, INSIDE OF THE LETTER "E" AND WITHIN THE LETTERS "P" AND THE FINAL "A", AND WITH YELLOW ON THE BOTTOM, INSIDE OF THE LETTERS "S" AND "N" AND WITHIN THE FIRST LETTER "A", AND WITH GREEN ABOVE THE FINAL FLIPPED PART OF THE FINAL LETTER "A". ABOVE THE WORD IS A DESIGN OF A RED CIRCLE, ENCIRCLED BY A BLACK CIRCLE BUT FOR A WHITE EDGE ON THE BOTTOM RIGHT OF THE RED CIRCLE AND A BIT ON THE TOP, ALL TO THE RIGHT OF A YELLOW HALF-CIRCLE, AND WITH A BLACK EIGHT-POINT STAR IN THE UPPER LEFT OF THE DESIGN.

SER. NO. 79-098,109, FILED 4-7-2011.

LAURA KOVALSKY, EXAMINING ATTORNEY

United States of America

United States Patent and Trademark Office



Reg. No. 4,152,278

Registered June 5, 2012

Int. Cls.: 18 and 25

TRADEMARK

PRINCIPAL REGISTER

J.C. RAGS B.V. (NETHERLANDS B.V.)
MANGAAN 11
NL-5234 GD DEN BOSCH
NETHERLANDS

FOR: LEATHER AND IMITATIONS LEATHER; GOODS MADE OF LEATHER AND IMITATION LEATHER, NAMELY BELT BAGS AND HIP BAGS, AND LEATHER SHOULDER BAGS; ANIMAL SKINS, HIDES; TRUNKS AND TRAVELING BAGS; BAGS AND SMALL CASES, NAMELY WALLETS, BILLFOLDS, BOXES AND CASES OF LEATHER OR STOUT LEATHER; TOOL BAGS SOLD EMPTY, BRIEFCASES, CANVAS, LEATHER, MESH, TEXTILE, REUSABLE AND STRING SHOPPING BAGS, AND SCHOOL BAGS; RUCKSACKS, UMBRELLAS, MAKE-UP CASES SOLD EMPTY AND TOILETRY BAGS SOLD EMPTY, IN CLASS 18 (U.S. CLS. 1, 2, 3, 22 AND 41).

FOR: CLOTHING, NAMELY, SHIRTS, T-SHIRTS, BLOUSES, PANTS, SWEATERS, JACKETS, COATS, VESTS, VESTS, ALL EXCLUDING CHILDREN'S CLOTHING; FOOTWEAR, HEADGEAR, NAMELY, HATS, IN CLASS 25 (U.S. CLS. 22 AND 39).

OWNER OF U.S. REG. NOS. 3,312,730, 3,818,611 AND OTHERS.

PRIORITY DATE OF 4-4-2011 IS CLAIMED.

OWNER OF INTERNATIONAL REGISTRATION 1079289 DATED 4-20-2011, EXPIRES 4-20-2021.

THE NAME J.C. RAGS DOES NOT IDENTIFY A LIVING INDIVIDUAL.

THE MARK CONSISTS OF THE WORDS J.C. RAGS IN STYLIZED FONT ON AN INCOMPLETE RECTANGULAR SHAPE WITH FOUR CIRCLES UNDERNEATH THE SHAPE.

SER. NO. 79-098,113, FILED 4-20-2011.

ERNEST SHOSHO, EXAMINING ATTORNEY

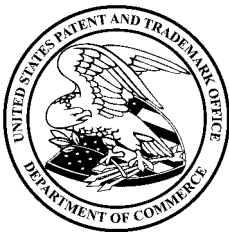

David J. Kypos

Director of the United States Patent and Trademark Office

United States of America

United States Patent and Trademark Office

POINT

Reg. No. 4,152,279

Registered June 5, 2012

Int. Cls.: 9, 37 and 42

TRADEMARK

SERVICE MARK

PRINCIPAL REGISTER

SEAWELL LIMITED (UNITED KINGDOM LIMITED COMPANY (LTD.))
PAVILLION 5
HOWEMOSS DRIVE.; KIRKHILL BUSINESS PARK;DYCE, ABERDEEN AB21 0GL
UNITED KINGDOM

FOR: APPARATUS AND INSTRUMENTS FOR INSPECTING AND EVALUATING THE INTEGRITY AND PERFORMANCE OF OIL, GAS AND WATER WELLS USING ULTRASOUND MEASUREMENT, RECORDING AND DISPLAY TECHNOLOGY DEVICES AND OTHER MEASUREMENT TECHNOLOGY DEVICES, CONSISTING OF HIGH-DEFINITION ULTRASOUND INSPECTION, MEASUREMENT AND IMAGING APPARATUS, INSTRUMENTS AND DEVICES FOR NON-MEDICAL, NON-DESTRUCTIVE TESTING, HIGH-DEFINITION 3D IMAGING APPARATUS, INSTRUMENTS AND DEVICES, AND RELATED PARTS AND COMPONENTS; SURVEY AND MEASUREMENT SENSOR EQUIPMENT FOR OIL, GAS AND WATER WELLS AND RELATED PROCESS AND PRODUCTION SYSTEMS FOR MEASUREMENT OF OIL, GAS AND WATER WELL ENVIRONMENTAL TEMPERATURE, PRESSURE, DIRECTIONALITY AND COMPOSITION OF ASSOCIATED MATERIALS AND STRUCTURES, IN CLASS 9 (U.S. CLS. 21, 23, 26, 36 AND 38).

FOR: BUILDING CONSTRUCTION; REPAIR SERVICES FOR OIL, GAS AND WATER WELLS; INSTALLATION SERVICES FOR OIL, GAS AND WATER WELLS; DRILLING OF WELLS FOR EXPLOITATION OF OIL AND GAS; ASSESSMENT OF WELLS FOR EXPLOITATION OF OIL AND GAS THROUGH DRILLING; WIRELINE SERVICES FOR OIL, GAS AND WATER WELLS; SERVICES FOR NON-DESTRUCTIVE TESTING, INSPECTION AND EVALUATION OF THE STRUCTURAL INTEGRITY OF OIL, GAS AND WATER WELLS AND THEIR SUPPORTING STRUCTURES, DURING CONSTRUCTION AND REPAIR ACTIVITIES, USING HIGH-DEFINITION ULTRASOUND IMAGING TECHNOLOGIES, IN CLASS 37 (U.S. CLS. 100, 103 AND 106).

FOR: SCIENTIFIC RESEARCH AND TECHNOLOGICAL MATERIALS TESTING AND EVALUATION SERVICES RELATING TO OIL AND GAS EXPLORATION AND PRODUCTION; HIGH-DEFINITION ULTRASOUND SURVEYING OF OIL, GAS AND WATER WELLS TO EVALUATE INTEGRITY AND PERFORMANCE; NON-MEDICAL ULTRASOUND MEASUREMENT, INSPECTION AND IMAGING SERVICES IN THE FIELD OF OIL AND GAS DRILLING IN THE NATURE OF PROVIDING MEASUREMENTS AND DOWN HOLE IMAGING TELEMETRY WHILE DRILLING; WELL LOGGING TECHNOLOGY AND WIRELINE SERVICES RELATING TO THE TESTING AND EVALUATION OF OIL, GAS



David J. Kyros

Director of the United States Patent and Trademark Office

Reg. No. 4,152,279 AND WATER WELLS; GEOLOGICAL SURVEYING SERVICES OF OIL, GAS AND WATER WELLS, IN CLASS 42 (U.S. CLS. 100 AND 101).

THE MARK CONSISTS OF STANDARD CHARACTERS WITHOUT CLAIM TO ANY PARTICULAR FONT, STYLE, SIZE, OR COLOR.

PRIORITY DATE OF 6-16-2010 IS CLAIMED.

OWNER OF INTERNATIONAL REGISTRATION 1079304 DATED 12-16-2010, EXPIRES 12-16-2020.

SER. NO. 79-098,121, FILED 12-16-2010.

PAUL MORENO, EXAMINING ATTORNEY

United States of America

United States Patent and Trademark Office

BASMAT

Reg. No. 4,152,280

Registered June 5, 2012

Int. Cl.: 27

TRADEMARK

PRINCIPAL REGISTER

BAGLINOX, S.L. (SPAIN SOCIEDAD LIMITADA)
POL. COMARCA I, CALLE L, N° 27
E-31160 ORCOYEN (NAVARRA)
SPAIN

FOR: CARPETS; RUGS; DOOR MATS AND DOOR MATTING; FLOOR MATS AND FLOOR MATTING; LINOLEUM AND OTHER MATERIALS FOR COVERING EXISTING FLOORS, NAMELY, CORK MATS, BRUSH MATS, MATS MADE OF TEXTILE AND RUBBER AND SYNTHETIC RUBBER, IN CLASS 27 (U.S. CLS. 19, 20, 37, 42 AND 50).

THE MARK CONSISTS OF STANDARD CHARACTERS WITHOUT CLAIM TO ANY PARTICULAR FONT, STYLE, SIZE, OR COLOR.

OWNER OF INTERNATIONAL REGISTRATION 1079423 DATED 4-19-2011, EXPIRES 4-19-2021.

THE WORDING "BASMAT" HAS NO MEANING IN A FOREIGN LANGUAGE.

SER. NO. 79-098,172, FILED 4-19-2011.

TINA BROWN, EXAMINING ATTORNEY



David J. Kyffers

Director of the United States Patent and Trademark Office

United States of America

United States Patent and Trademark Office

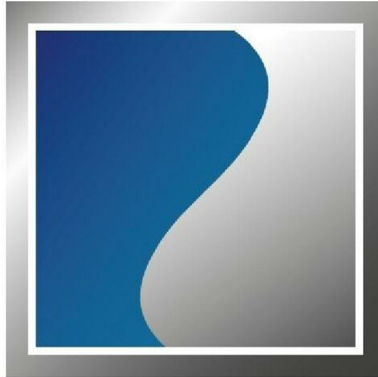

Reg. No. 4,152,281

Registered June 5, 2012

Int. Cl.: 36

SERVICE MARK

PRINCIPAL REGISTER

BLUEBAY ASSET MANAGEMENT LTD (GREAT BRITAIN LIMITED LIABILITY COMPANY)
77 GROSVENOR STREET
LONDON W1K 3JR
UNITED KINGDOM

FOR: FINANCIAL SERVICES, NAMELY, ASSET MANAGEMENT SERVICES, DEALING IN INVESTMENTS, NAMELY, INVESTMENT OF FUNDS FOR OTHERS, FINANCIAL ADVICE, RESEARCH AND CONSULTANCY SERVICES, PROVIDING INFORMATION IN THE FORM OF REPORTS, NEWSLETTERS, AND ARTICLES ON FINANCIAL MARKETS, FINANCIAL INVESTMENTS AND FINANCIAL ASSET MANAGEMENT, IN CLASS 36 (U.S. CLS. 100, 101 AND 102).

OWNER OF U.S. REG. NO. 3,524,369.

PRIORITY DATE OF 11-5-2010 IS CLAIMED.

OWNER OF INTERNATIONAL REGISTRATION 1079455 DATED 5-5-2011, EXPIRES 5-5-2021.

THE COLOR(S) BLUE, SILVER AND WHITE IS/ARE CLAIMED AS A FEATURE OF THE MARK.

THE MARK CONSISTS OF A SQUARE DESIGN WITH TWO OVERALL RECTANGULAR SHAPED SECTIONS INSIDE. THE OUTER BORDER OF THE SQUARE IS SILVER, WITH WHITE SHADING, THE INNER BORDER IS WHITE, THE RECTANGULAR SECTION ON THE RIGHT IS SILVER AND THE SECTION ON THE LEFT IS BLUE.

SER. NO. 79-098,184, FILED 5-5-2011.

SCOTT BIBB, EXAMINING ATTORNEY



David J. Kybas

Director of the United States Patent and Trademark Office

United States of America

United States Patent and Trademark Office



Reg. No. 4,152,282

Registered June 5, 2012

Int. Cl.: 9

TRADEMARK

PRINCIPAL REGISTER

KONINKLIJKE PHILIPS ELECTRONICS N.V. (NETHERLANDS LIMITED LIABILITY COMPANY)
GROENEWOUDSEWEG 1
EINDHOVEN, NETHERLANDS

FOR: APPARATUS FOR RECORDING, PROCESSING, TRANSMITTING AND REPRODUCING OF SOUND AND/OR IMAGES, IN CLASS 9 (U.S. CLS. 21, 23, 26, 36 AND 38).

NO CLAIM IS MADE TO THE EXCLUSIVE RIGHT TO USE "CRYSTAL CLEAR SOUND", APART FROM THE MARK AS SHOWN.

PRIORITY DATE OF 12-1-2010 IS CLAIMED.

OWNER OF INTERNATIONAL REGISTRATION 1079611 DATED 5-24-2011, EXPIRES 5-24-2021.

THE MARK CONSISTS OF TWO STARS OVER THREE CURVED LINES TO THE LEFT OF THE TERMS "CRYSTAL CLEAR SOUND".

SER. NO. 79-098,235, FILED 5-24-2011.

JANICE L. MCMORROW, EXAMINING ATTORNEY



David J. Kyjars

Director of the United States Patent and Trademark Office

United States of America
United States Patent and Trademark Office

ADJANI

Reg. No. 4,152,283

Registered June 5, 2012

Int. Cl.: 18

TRADEMARK

PRINCIPAL REGISTER

ISABELLE ADJANI C/O ISIA FILMS (FRANCE INDIVIDUAL)
134 AVENUE DE VILLIERS
F-75017 PARIS
FRANCE

FOR: BAGS AND HANDBAGS; POUCHES, NAMELY, POUCHES OF LEATHER; CARRY-ALL BAGS; CLUTCH BAGS; SHOE BAGS; SHOULDER BAGS; SCHOOL BAGS; BEACH BAGS; TRAVELING BAGS; SHOPPING BAGS; SPORTS BAGS; BAGS FOR CLOTHES; TRAVELING TRUNKS; BRIEFCASES; POCKET WALLETS; CARD CASES; WALLETS; BILLFOLDS, HANDBAGS NOT OF PRECIOUS METAL, SATCHELS, PURSES; DRIVING LICENSE CASES OF LEATHER, CASES OF LEATHER, LEATHER POUCHES, SLEEVES AND DISPLAY CASES OF LEATHER FOR BUSINESS CARDS, LEATHER KEY CASES, LEATHER CASES FOR CHECKBOOKS, PEN CASES; POUCHES FOR MAKE-UP, VANITY CASES, TRUNKS AND SUITCASES, ATTACHÉ CASES, IN CLASS 18 (U.S. CLS. 1, 2, 3, 22 AND 41).

THE MARK CONSISTS OF STANDARD CHARACTERS WITHOUT CLAIM TO ANY PARTICULAR FONT, STYLE, SIZE, OR COLOR.

PRIORITY DATE OF 12-8-2010 IS CLAIMED.

OWNER OF INTERNATIONAL REGISTRATION 1079654 DATED 3-16-2011, EXPIRES 3-16-2021.

THE WORDING "ADJANI" HAS NO MEANING IN A FOREIGN LANGUAGE.

SER. NO. 79-098,257, FILED 3-16-2011.

GIANCARLO CASTRO, EXAMINING ATTORNEY



David J. Kyros

Director of the United States Patent and Trademark Office

United States of America

United States Patent and Trademark Office

MORISEI

Reg. No. 4,152,284

Registered June 5, 2012

Int. Cl.: 17

TRADEMARK

PRINCIPAL REGISTER

MORISEI KAKO CO., LTD. (JAPAN CORPORATION)
1-30-9 YAHIRO
SUMIDA-KU, TOKYO 131-0041, JAPAN

FOR: O-RINGS OF RUBBER FOR USE AS CONNECTION SEALS IN INDUSTRIAL APPLICATIONS; O-RINGS OF RUBBER FOR USE AS CONNECTION SEALS FOR VACUUM EQUIPMENT; SEALS OF RUBBER FOR USE AS CONNECTION SEALS FOR VACUUM EQUIPMENT; O-RINGS OF RUBBER FOR USE AS CONNECTION SEALS FOR PRESSURIZED EQUIPMENT; SEALS OF RUBBER FOR USE AS CONNECTION SEALS FOR PRESSURIZED EQUIPMENT; O-RINGS OF RUBBER FOR USE AS CONNECTION SEALS FOR ETCHING EQUIPMENT; SEALS OF RUBBER FOR USE AS CONNECTION SEALS FOR ETCHING EQUIPMENT; O-RINGS OF RUBBER FOR USE WITH PIPES; SEALS OF RUBBER FOR USE IN CONNECTING PIPES; FLEXIBLE RUBBER PIPES; VALVES OF RUBBER FOR PIPES; VALVES OF RUBBER FOR USE AS A CONNECTION FOR ETCHING EQUIPMENT; RUBBER SEALS AND GASKETS; O-RINGS FOR INDUSTRIAL USE; INDUSTRIAL RUBBER COMPONENTS, NAMELY, MOLDED RUBBER PARTS; O-RINGS OF RUBBER FOR USE IN A GLASS PLATE TRANSPORT DEVICE FOR LCD (LIQUID CRYSTAL DISPLAY), IN CLASS 17 (U.S. CLS. 1, 5, 12, 13, 35 AND 50).

PRIORITY DATE OF 4-8-2011 IS CLAIMED.

OWNER OF INTERNATIONAL REGISTRATION 1079855 DATED 4-21-2011, EXPIRES 4-21-2021.

SER. NO. 79-098,341, FILED 4-21-2011.

KAREN K. BUSH, EXAMINING ATTORNEY



David J. Kyros

Director of the United States Patent and Trademark Office

United States of America

United States Patent and Trademark Office



Reg. No. 4,152,285

Registered June 5, 2012

Int. Cls.: 7 and 42

TRADEMARK

SERVICE MARK

PRINCIPAL REGISTER

GECOFIN S.P.A. (ITALY JOINT STOCK COMPANY)
58, VIA CORNAGGIA
I-20092 CINISELLO BALSAMO (MI)
ITALY

FOR: PAINTING MACHINES, IN CLASS 7 (U.S. CLS. 13, 19, 21, 23, 31, 34 AND 35).

FOR: RESEARCH AND DEVELOPMENT SERVICES IN THE FIELD OF PAINTING PLANTS AND PAINTING MACHINES WITH RELATED EQUIPMENT AND ACCESSORIES; PRODUCT RESEARCH AND DEVELOPMENT; DESIGN OF PAINTING MACHINES, IN CLASS 42 (U.S. CLS. 100 AND 101).

THE MARK CONSISTS OF THE TERM "PARDIS" IN STYLIZED FONT AND WITH A TREE DESIGN INCORPORATED INTO THE LETTER "P".

PRIORITY DATE OF 4-26-2011 IS CLAIMED.

OWNER OF INTERNATIONAL REGISTRATION 1079935 DATED 4-27-2011, EXPIRES 4-27-2021.

THE WORDING "PARDIS" HAS NO MEANING IN A FOREIGN LANGUAGE.

SER. NO. 79-098,374, FILED 4-27-2011.

KAREN SEVERSON, EXAMINING ATTORNEY



David J. Kybas

Director of the United States Patent and Trademark Office

United States of America

United States Patent and Trademark Office



Reg. No. 4,152,286

Registered June 5, 2012

Int. Cls.: 9, 38 and 42

TRADEMARK

SERVICE MARK

PRINCIPAL REGISTER

GMC SOFTWARE AG (SWITZERLAND CORPORATION)
HIRSCHENGASSE 12
CH-9050 APPENZELL
SWITZERLAND

FOR: SOFTWARE FOR CUSTOMIZING ELECTRONIC COMMUNICATION SYSTEMS AND DIGITAL PRINTING SYSTEMS, IN CLASS 9 (U.S. CLS. 21, 23, 26, 36 AND 38).

FOR: PROVIDING THIRD PARTY USERS WITH ACCESS TO TELECOMMUNICATION INFRASTRUCTURE, IN ORDER FOR THEM TO COMMUNICATE WITH THEIR CUSTOMERS, VIA AUDIO, VIDEO AND OTHER DATA CARRIERS, OVER THE INTERNET AND OTHER INFORMATION SERVICES NETWORKS, IN CLASS 38 (U.S. CLS. 100, 101 AND 104).

FOR: DEVELOPMENT, DESIGN AND MAINTENANCE OF SOFTWARE FOR CUSTOMIZED COMMUNICATION SYSTEMS AND DIGITAL PRINTING SYSTEMS, AS WELL AS CONSULTANCY ON SOFTWARE MIGRATION, INTEGRATION AND INSTALLATION , IN CLASS 42 (U.S. CLS. 100 AND 101).

THE MARK CONSISTS OF THE WORDING "INSPIRE" BELOW A CURVED BAR DESIGN.

PRIORITY DATE OF 12-27-2010 IS CLAIMED.

OWNER OF INTERNATIONAL REGISTRATION 1079997 DATED 5-13-2011, EXPIRES 5-13-2021.

SER. NO. 79-098,407, FILED 5-13-2011.

DAVID HOFFMAN, EXAMINING ATTORNEY



David J. Kybas

Director of the United States Patent and Trademark Office

United States of America

United States Patent and Trademark Office

Pi

Reg. No. 4,152,287

Registered June 5, 2012

Int. Cl.: 33

TRADEMARK

PRINCIPAL REGISTER

LODESTAR ANSTALT (A LIECHTENSTEIN COMPANY) (LIECHTENSTEIN ANSTALT)
LOVA-CENTER, PO BOX 1150
VADUZ, LIECHTENSTEIN FL9490

FOR: ALCOHOLIC BEVERAGES EXCEPT BEERS, IN CLASS 33 (U.S. CLS. 47 AND 49).

THE MARK CONSISTS OF STANDARD CHARACTERS WITHOUT CLAIM TO ANY PARTICULAR FONT, STYLE, SIZE, OR COLOR.

PRIORITY DATE OF 7-27-2010 IS CLAIMED.

OWNER OF INTERNATIONAL REGISTRATION 1080024 DATED 1-27-2011, EXPIRES 1-27-2021.

SER. NO. 79-098,415, FILED 1-27-2011.

WON TEAK OH, EXAMINING ATTORNEY



David J. Kyffers

Director of the United States Patent and Trademark Office

United States of America

United States Patent and Trademark Office

22 over 7

Reg. No. 4,152,288

Registered June 5, 2012

Int. Cl.: 33

TRADEMARK

PRINCIPAL REGISTER

LODESTAR ANSTALT (A LIECHTENSTEIN COMPANY) (LIECHTENSTEIN ANSTALT)
LOVA-CENTER, P.O. BOX 1150
VADUZ, LIECHTENSTEIN FL9490

FOR: ALCOHOLIC BEVERAGES EXCEPT BEERS, IN CLASS 33 (U.S. CLS. 47 AND 49).

THE MARK CONSISTS OF STANDARD CHARACTERS WITHOUT CLAIM TO ANY PARTICULAR FONT, STYLE, SIZE, OR COLOR.

PRIORITY DATE OF 7-27-2010 IS CLAIMED.

OWNER OF INTERNATIONAL REGISTRATION 1080026 DATED 1-27-2011, EXPIRES 1-27-2021.

SER. NO. 79-098,417, FILED 1-27-2011.

WON TEAK OH, EXAMINING ATTORNEY



David J. Kyffers

Director of the United States Patent and Trademark Office

United States of America

United States Patent and Trademark Office

458 ITALIA

Reg. No. 4,152,289

Registered June 5, 2012

**Int. Cls.: 9, 12, 16, 18, 25,
28 and 35**

TRADEMARK

SERVICE MARK

PRINCIPAL REGISTER

FERRARI S.P.A. (ITALY JOINT STOCK COMPANY)
VIA EMILIA EST, 1163
I-41100 MODENA
ITALY

FOR: VIDEO GAME MACHINES FOR USE WITH TELEVISION AND WITH AN EXTERNAL DISPLAY SCREEN OR MONITOR; AMUSEMENT APPARATUS AND GAMES ADAPTED FOR USE WITH TELEVISION RECEIVERS AND WITH AN EXTERNAL DISPLAY SCREEN OR MONITOR; COMPUTER GAME EQUIPMENT IN THE NATURE OF STEERING WHEELS FOR PCS WITH DOUBLE GEAR-SHIFTING SYSTEMS; VIDEO GAMES FOR USE WITH AUTOMATIC OR TOKEN-OPERATED MACHINES; CONTROLLERS, JOYSTICKS, CONSOLES, MEMORY CARDS, VOLUME CONTROLLERS AND MICE FOR CONSUMER VIDEO GAME MACHINES ADAPTED FOR USE WITH TELEVISION RECEIVERS AND WITH AN EXTERNAL DISPLAY SCREEN OR MONITOR; MEDIA-RECORDED PROGRAMS FOR HAND-HELD ELECTRONIC GAMES; VIDEO GAME CASSETTES, CARTRIDGES AND DISCS; COMPUTER GAME EQUIPMENT CONTAINING MEMORY DISCS FOR USE WITH COMPUTER MONITORS; COMPUTER GAME PROGRAMS; RECORDED PROGRAMS FOR ELECTRONIC GAMES; RECORDED COMPUTER SOFTWARE FOR VIDEO GAMES TO BE USED IN CONNECTION WITH AUTOMATIC AND COIN OPERATED MACHINES; EXCLUSIVE EARPHONES, CONNECTED AND USED FOR HAND-HELD GAMES WITH LIQUID CRYSTAL DISPLAYS; VIDEO GAME INTERACTIVE REMOTE CONTROL UNITS, IN CLASS 9 (U.S. CLS. 21, 23, 26, 36 AND 38).

FOR: CARS; LAND VEHICLES AND STRUCTURAL PARTS THEREOF, IN CLASS 12 (U.S. CLS. 19, 21, 23, 31, 35 AND 44).

FOR: PAPER; PLACARDS OF PAPER OR CARDBOARD; PLASTIC OR PAPER BAGS FOR MERCHANDISE PACKAGING, BEING ENVELOPES AND POUCHES; BIBS OF PAPER; BOXES OF CARDBOARD OR PAPER; CARDBOARD TUBES; COASTERS OF PAPER; PAPER BANNERS; FLAGS OF PAPER; PENNANTS AND PENNONS MADE OF PAPER; MATS FOR BEER GLASSES; TABLE LINEN OF PAPER; TABLE NAPKINS OF PAPER; TABLECLOTHS OF PAPER; TABLE MATS OF PAPER; TOWELS OF PAPER; BROCHURES, CATALOGUES, PRINTED PERIODICALS, PRINTED REPORTS, GUIDES, PICTURE CARDS, NEWSPAPERS, JOURNALS, MAGAZINES, GENERAL FEATURE MAGAZINES, YEARBOOKS, BOOKS, BOOKLETS, PAMPHLETS, LEAFLETS, DIRECTORIES, NEWSLETTERS AND MANUALS ON THE SUBJECTS OF AUTOMOBILES, AUTOMOBILE MAINTENANCE AND REPAIR, AUTOMOBILE RACING AND AUTOMOBILE COMPETITIONS, THE HISTORY OF THE



David J. Kyros

Director of the United States Patent and Trademark Office

Reg. No. 4,152,289 APPLICANT AND ITS PARTICIPATION IN AUTOMOBILE RACING AND COMPETITIONS AND ON THE SUBJECT OF LIFESTYLE, CULTURE, FASHION, DESIGN, MOTOR AND AUTOMOTIVE NEWS, SPORTS, ENTERTAINMENT AND SAFE DRIVING SCHOOLS; CAR MANUALS; BROCHURES, LEAFLETS, BOOKLETS, CATALOGUES, GUIDES FEATURING INFORMATION ABOUT AUTOMOBILES AND AUTOMOTIVE PRODUCTS AND SHOWING THE APPLICANT'S OFFICIAL MERCHANDISE; PRINTED PUBLICATIONS, NAMELY, EVENT PROGRAMS, MANUALS TO ACCOMPANY COMPUTER SOFTWARE IN THE FIELD OF VIDEO GAMES; CATALOGUES RELEVANT TO AUCTIONS OF CARS AND RACING CARS; ENCYCLOPEDIAS; CALENDARS; WRITING OR DRAWING BOOKS; LITHOGRAPHS; PRINTED REPRODUCTIONS OF ART, RACING CARS, PILOTS; POSTERS; ALBUMS FOR STICKERS; EVENT ALBUMS; ALBUMS FOR DRAWING; ALBUMS FOR COINS, PHOTOGRAPHS AND STAMPS; ROARING PHOTOGRAPH ALBUMS; PHOTO HOLDERS MADE OF PAPER; PHOTOGRAPHS; PICTURES; PHOTOGRAPHIC PRINTS; STATIONERY; GREETING CARDS; ROARING SOUVENIR CARDS; COLOURING CARDS FOR CHILDREN; POSTCARDS; EXERCISE BOOKS; NOTEBOOKS; CUBE-SHAPED NOTEBOOKS; DIARIES; AGENDAS, WEEKLY PLANNERS, ADDRESS BOOKLETS, BEING STATIONERY ARTICLES; COVERS OF PAPER FOR AGENDAS, WEEKLY PLANNERS, ADDRESS BOOKLETS, ALBUMS AND BOOKS; FOLDERS FOR PAPERS, CARDS AND DOCUMENTS; NOTE PADS; NOTE PAPERS; LABELS, NOT OF TEXTILE, NAMELY, PAPER LABELS, SHIPPING LABELS, BAR CODE LABELS; ADHESIVE LABELS; PAPERWEIGHTS; STAMPS FOR COLLECTORS MADE PRIMARILY OF PAPER; COMMEMORATIVE STAMP SHEETS; DRAWING SQUARES; DRAWING RULERS; PENS; PASTELS; PENCILS; BOXES FOR PENCILS AND PENS; PENCIL AND PEN HOLDERS; PENCIL AND PEN CASES; PENCIL AND PEN TOPPERS; TUBE-SHAPED HOLDERS FOR PENCILS, PENS AND PASTELS; TRAYS FOR HOLDING AND CARRYING PENS, PENCILS AND PASTELS; ELECTRIC OR NON-ELECTRIC PENCIL SHARPENERS; DESK PADS AND DESK TOP ORGANIZERS; BOOKMARKERS; ERASERS; STICKERS, BEING STATIONERY ARTICLES; BLACKBOARDS; PAPER CUTTERS, BEING OFFICE REQUISITES; STAPLERS FOR OFFICES; TRAYS FOR SORTING AND COUNTING MONEY; ENTRY AND PRINTED TICKETS; PAPER TICKET HOLDERS; PASSES MADE OF PAPER; NON-MAGNETICALLY ENCODED PASSES OR IDENTIFICATION CARDS MADE OF PAPER FOR ACCESS TO A RESTRICTED AREA; IRON-ON, PLASTIC TRANSFERS, BEING DECALCOMANIAS; REMOVABLE TATTOOS, BEING WATER-COLOUR PICTURES TRANSFERABLE TO THE SKIN; MONEY CLIPS, IN CLASS 16 (U.S. CLS. 2, 5, 22, 23, 29, 37, 38 AND 50).

FOR: BOXES AND CASES OF LEATHER OR LEATHER BOARD; KEY CASES OF LEATHER OR IMITATION LEATHER; LEATHER KEY HOLDERS; CASES AND COVERS OF LEATHER FOR AGENDAS, WEEKLY PLANNERS AND ADDRESS BOOKS; LEATHER LUGGAGE TAGS; LEATHER CLIPBOARDS; LEATHER BUSINESS CARD BOOKLETS; LEATHER BUSINESS CARD HOLDERS; LEATHER ADDRESS BOOKLETS; LEATHER PEN CASES AND HOLDERS; LEATHER PHOTO ALBUMS; LEATHER PHOTO HOLDERS; LEATHER HOLDERS FOR MP3, CD AND DVD; LEATHER MP3, CD AND DVD PLAYER HOLDERS; LEATHER HOLDERS FOR COMPUTERS AND MOBILE PHONES; CARD HOLDERS AND DOCUMENT HOLDERS OF SKIN OR LEATHER; ATTACH CASES; BACKPACKS; HAVERSACKS; SACKS OF LEATHER AND OF TEXTILE NOT FOR PACKAGING, NAMELY, KNAP SACKS, RUCK SACKS; BAGS, BEING ENVELOPES AND POUCHES, OF LEATHER, FOR PACKAGING; ALL PURPOSE SPORTS BAGS; BEACH BAGS; BRIEFCASES; LEATHER CARD CASES, BEING NOTECASES; GARMENT BAGS FOR TRAVEL; LEATHER SUIT HOLDERS; TOOL BAGS OF LEATHER, EMPTY; HANDBAGS; SHOULDER BAGS; CLUTCH BAGS; TOTE BAGS; NET BAGS FOR SHOPPING; POCKET WALLETS; PURSES; KID'S SCHOOL LUNCH BAGS; SCHOOL BAGS; SCHOOL SATCHELS; SCHOOL BACKPACKS; SHOPPING BAGS, NAMELY, LEATHER SHOPPING BAGS, MESH SHOPPING BAGS, RE-USABLE SHOPPING BAGS, SHOPPING BAGS MADE OF SKIN, TEXTILE SHOPPING BAGS; WHEELED SHOPPING BAGS; SLING BAGS FOR CARRYING INFANTS; SUITCASES; TRAVELING BAGS; TRAVELING TRUNKS; TRUNKS, BEING LUGGAGE; VALISES; LUGGAGE; VANITY CASES, NOT FITTED; LEATHER ROLL-UP BEAUTY CASES, NOT FITTED; CABIN BAGS; BABIES' TEDDY BEAR BACKPACKS; PILOT CASES IN THE NATURE OF ALL PURPOSE CARRYING BAG FOR TRAVEL; DUFFEL BAGS; TROLLEY

Reg. No. 4,152,289 DUFFLE BAGS; TROLLEY-TYPE SUITCASES; BELT BAGS; WAIST BAGS; UMBRELLAS; UMBRELLAS WITH SEATS; PARASOLS; WALKING STICKS; WALKING STICK SEATS; CLOTHING FOR PETS; COLLARS AND LEADS FOR PETS; FUR-SKINS; SADDLERY, IN CLASS 18 (U.S. CLS. 1, 2, 3, 22 AND 41).

FOR: AUTOMOBILE RACING SUITS NOT IN THE NATURE OF PROTECTIVE CLOTHING; COVERALLS FOR CAR RACING; POLO SHIRTS, SHIRTS, RUGBY SHIRTS, BLOUSES, T-SHIRTS, VESTS, SINGLET, SWEATSHIRTS, HOODED SWEATSHIRTS, SWEATERS, V-NECK SWEATERS, PULLOVERS, FLEECE PULLOVERS, JUMPERS, CARDIGANS, TWIN SET, JERKINS, BOMBER JACKETS, JACKETS, RAIN JACKETS, LEATHER JACKETS, PADDED JACKETS, FLEECE JACKETS, WIND-RESISTANT JACKETS, WINDCHEATERS, WATERPROOF JACKETS, STUFF JACKETS, BLAZERS, COATS, RAINCOATS, ANORAKS, PARKAS, PADDED VESTS, WAISTCOATS, WATERPROOF WAISTCOATS; TROUSERS, JOGGING SUIT TROUSERS, PANTS, SWEAT PANTS, JEANS, SHORTS, BERMUDA SHORTS; JOGGING SUITS, GYM SUITS, TRAINING SUITS, TRACK SUITS; OVERALLS; BABIES' OVERALLS, INFANTS' TRAINING OUTFITS, RACING ROMPER SUITS FOR BABIES, ROMPERS; CHILDREN'S AND INFANTS' CLOTH BIBS; BABY BODYSUITS; RAIN-CAPES; BATH ROBES; SWIMWEAR; UNDERWEAR; SLEEPWEAR; NECKTIES, SCARVES; FOU-LARDS, BEING CLOTHING ARTICLES; NECKWEAR; BANDANAS, BEING NECKERCHIEFS; BELTS, BEING CLOTHING; GLOVES, BEING CLOTHING; DRIVING GLOVES, FINGERLESS GLOVES, FINGERLESS DRIVING GLOVES; EAR MUFFS, BEING CLOTHING; JERSEYS, BEING CLOTHING, SPORTS JERSEYS; LAYETTES, BEING CLOTHING; MONEY BELTS, BEING CLOTHING; POCKET SQUARES, SKIRTS; SOCKS; SUITS, DRESSES; SKI SUITS; WRISTBANDS, BEING CLOTHING; SHOES, SNEAKERS, SLIPPERS, SKI BOOTS, SKI BOOT BAGS, FOOTWEAR; CAPS, BASEBALL CAPS; CAP VISORS; HEADWEAR, IN CLASS 25 (U.S. CLS. 22 AND 39).

FOR: MODEL CARS, TOY MODEL CARS, RIDE-ON TOY CARS, SCALE MODEL RACING VEHICLES; RACING CAR MODEL SILHOUETTES; FULL-SIZE CAR REPLICAS FOR SPORTING EXHIBITIONS AND ENTERTAINMENT PURPOSES; HAND HELD VIDEO GAMES FEATURING CARS FOR PLAYING ELECTRONIC GAMES OTHER THAN THOSE ADAPTED FOR USE WITH AN EXTERNAL DISPLAY SCREEN OR MONITOR; POCKET OR HAND-HELD VIDEO GAMES FOR PLAYING ELECTRONIC GAMES OTHER THAN THOSE ADAPTED FOR USE WITH AN EXTERNAL DISPLAY SCREEN OR MONITOR; APPARATUS FOR GAMES OTHER THAN THOSE ADAPTED FOR USE WITH AN EXTERNAL DISPLAY SCREEN OR MONITOR; ELECTRONIC GAMES AND AMUSEMENT MACHINES OTHER THAN THOSE ADAPTED FOR USE WITH TELEVISION SETS AND WITH AN EXTERNAL DISPLAY SCREEN OR MONITOR; STAND ALONE MACHINES FOR VIDEO GAMES; POCKET-SIZED ELECTRONIC GAMES FOR PLAYING ELECTRONIC GAMES OTHER THAN THOSE ADAPTED FOR USE WITH AN EXTERNAL DISPLAY SCREEN OR MONITOR; PORTABLE ELECTRONIC GAMES FOR PLAYING ELECTRONIC GAMES OTHER THAN THOSE ADAPTED FOR USE WITH AN EXTERNAL DISPLAY SCREEN OR MONITOR; HAND-HELD UNITS FOR PLAYING VIDEO GAMES OTHER THAN THOSE ADAPTED FOR USE WITH TELEVISION SETS AND WITH AN EXTERNAL DISPLAY SCREEN OR MONITOR; STAND ALONE VIDEO GAME MACHINES; ARCADE-TYPE ELECTRONIC VIDEO GAMES NOT FOR USE WITH TELEVISION RECEIVERS; COIN OR TOKEN-OPERATED VIDEO GAME MACHINES USED IN STORES AND NOT FOR USE WITH TELEVISION SETS AND WITH AN EXTERNAL DISPLAY SCREEN OR MONITOR; SLOT MACHINES, IN CLASS 28 (U.S. CLS. 22, 23, 38 AND 50).

FOR: ON-LINE AND NON-ON-LINE RETAIL AND WHOLESALE STORE SERVICES OF VIDEO GAMES, VIDEO GAME MACHINES, AMUSEMENT APPARATUS AND GAMES, ADAPTED AND NOT ADAPTED FOR USE WITH TELEVISION RECEIVERS AND WITH AN EXTERNAL DISPLAY SCREEN OR MONITOR, AND THEIR ACCESSORIES, COMPUTER GAME EQUIPMENT, VIDEO GAME CASSETTES, CARTRIDGES AND DISCS, RECORDED PROGRAMS FOR VIDEO GAMES, COMPUTER GAME PROGRAMS, CARS, LAND VEHICLES AND STRUCTURAL PARTS THEREOF, PAPER, GOODS OF PAPER AND CARDBOARD, PRINTED PUBLICATIONS, STATIONERY ARTICLES, OFFICE REQUISITES, KEY CASES,

Reg. No. 4,152,289 KEY HOLDERS, GOODS MADE OF LEATHER OR LEATHER BOARD, CASES, HOLDERS AND COVERS OF LEATHER OR LEATHER BOARD, BAGS OF ALL KIND, HANDBAGS, BACKPACKS, SUITCASES, TRAVELING BAGS, LUGGAGE, UMBRELLAS, UMBRELLAS WITH SEATS, PARASOLS, WALKING STICKS, WALKING STICK SEATS, CLOTHING FOR PETS, COLLARS AND LEADS FOR PETS, FUR-SKINS, SADDLERY, CLOTHING ARTICLES, FOOTWEAR, HEADGEAR, MODEL CARS, SCALE MODEL RACING VEHICLES, RACING CAR MODEL SILHOUETTES, FULL-SIZE CAR REPLICAS FOR SPORTING EXHIBITIONS AND ENTERTAINMENT PURPOSES, TOYS, PLAYTHINGS, GYMNASTIC AND SPORTING ARTICLES; FRANCHISING, NAMELY, SERVICES RENDERED BY A FRANCHISOR, THAT IS TRANSFER OF BUSINESS AND ORGANIZATIONAL KNOW-HOW IN THE RUNNING OF ESTABLISHMENTS AS FRANCHISES; ASSISTANCE IN THE DEVELOPMENT AND MANAGEMENT OF A COMMERCIAL ENTERPRISE, OF A CHAIN OF RETAIL SHOPS, RESTAURANTS, BARS, CAFES AND OTHER ESTABLISHMENTS FOR FACILITIES ENGAGED IN PROVIDING FOOD AND DRINKS PREPARED FOR CONSUMPTION; RETAIL OUTLET MANAGEMENT ASSISTANCE; BUSINESS ASSISTANCE, BUSINESS CONSULTANCY AND ORGANIZATION IN CONNECTION WITH THE ESTABLISHMENT OF ON-LINE RETAIL SALE SERVICES AND THE LAUNCHING OF ON-LINE RETAIL TRADING ACTIVITIES; AUCTIONEERING; ORGANIZATION OF EXHIBITIONS FOR COMMERCIAL OR ADVERTISING PURPOSES, ORGANIZATION OF TRADE FAIRS FOR COMMERCIAL OR ADVERTISING PURPOSES, PUBLIC RELATIONS, SHOP WINDOW DRESSING, MARKETING RESEARCH, MARKETING STUDIES, BUSINESS INVESTIGATIONS, MARKET SURVEYS; MAIL-ORDER SERVICES FEATURING MAGAZINES, CLOTHING, TOYS, VIDEO GAMES; COMMERCIAL ASSISTANCE IN THE PURCHASE OF SECOND-HAND CARS; ADVERTISING, ADVERTISING OF GOODS AND SERVICES ON THE INTERNET AND BY MEANS OF MOBILE TELEPHONY SERVICES AND BY ELECTRONIC MAIL, LAYOUT SERVICES FOR ADVERTISING PURPOSES, MODELLING FOR ADVERTISING OR SALES PROMOTION, ON-LINE ADVERTISING ON A COMPUTER NETWORK, PRESENTATION OF GOODS ON COMMUNICATION MEDIA FOR RETAIL PURPOSES, PUBLICATION OF PUBLICITY TEXTS, SPONSORSHIP SEARCH, PROMOTION OF GOODS AND SERVICES OF OTHERS BY PREPARING AND ORGANIZING PROMOTIONAL CONTESTS AND COMPETITIONS WITH PRIZES TO BE WON, ON A GLOBAL COMPUTER NETWORK AND/OR BY MEANS OF MOBILE TELEPHONY SERVICES; PROMOTION OF GOODS AND SERVICES OF OTHERS BY PLACING ADVERTISEMENTS AND ADVERTISING DISPLAYS ON AN ON-LINE ELECTRONIC SITE ACCESSIBLE VIA A GLOBAL COMPUTER NETWORK AND/OR BY MEANS OF MOBILE TELEPHONY SERVICES; BUSINESS INFORMATION SERVICES PROVIDED ONLINE FROM A GLOBAL COMPUTER NETWORK OR THE INTERNET; BUSINESS MANAGEMENT AND ORGANIZATION CONSULTANCY, BUSINESS MANAGEMENT OF HOTELS; COMMERCIAL ADMINISTRATION OF THE LICENSING OF THE GOODS AND SERVICES OF OTHERS, IN CLASS 35 (U.S. CLS. 100, 101 AND 102).

NO CLAIM IS MADE TO THE EXCLUSIVE RIGHT TO USE "ITALIA", APART FROM THE MARK AS SHOWN.

PRIORITY DATE OF 7-17-2009 IS CLAIMED.

OWNER OF INTERNATIONAL REGISTRATION 1080042 DATED 12-22-2009, EXPIRES 12-22-2019.

THE MARK CONSISTS OF A SIGN DEPICTING THE WORDING "458 ITALIA" IN FANCY OUTLINED CHARACTERS AND PLACED ON TWO LINES, THE NUMERIC COMPONENT BEING OF A LARGER SIZE AND WITH EACH NUMBER SLIGHTLY INCLINED TOWARDS THE RIGHT, THE WORD "ITALIA" BEING PLACED UNDER THE AFORESAID COMPONENT IN A POSITION OFFSET TOWARDS THE RIGHT, WITH THE LETTERS "I", "T", "A" PLACED UNDER THE NUMBER EIGHT, EACH LETTER BEING SLIGHTLY INCLINED TOWARDS THE RIGHT AND BOTH THE LETTERS "A" HAVING THE HORIZONTAL STROKE JOINED ON THE LEFT TO THE BASE END OF THE RESPECTIVE OBLIQUE STROKE AND INTERRUPTED NEAR TO THE RIGHT-HAND END.

Reg. No. 4,152,289 THE ENGLISH TRANSLATION OF THE WORD "ITALIA" IN THE MARK IS ITALY.

SER. NO. 79-098,423, FILED 12-22-2009.

JENNY PARK, EXAMINING ATTORNEY

United States of America

United States Patent and Trademark Office

SWITCHALIVE

Reg. No. 4,152,290

Registered June 5, 2012

Int. Cls.: 9, 37 and 42

TRADEMARK

SERVICE MARK

PRINCIPAL REGISTER

TRÖNDERENERGI NETT AS (NORWAY CORPORATION)
INGVALD YSTGAARDS VEG 1
N-7047 TRONDHEIM
NORWAY

FOR: APPARATUS AND INSTRUMENTS FOR CONDUCTING, SWITCHING, TRANSFORMING, ACCUMULATING, REGULATING OR CONTROLLING ELECTRICITY, NAMELY, HIGH VOLTAGE ELECTRICAL SWITCHES, SWITCHGEAR, FUSES, DIVERTER SWITCHES, DISCONNECTING SWITCHES, HIGH-VOLTAGE NETWORK STATIONS COMPRISING ELECTRICAL SWITCHES, SWITCHGEAR, FUSES, DIVERTER SWITCHES AND/OR DISCONNECTING SWITCHES, HIGH-VOLTAGE DISTRIBUTING STATIONS COMPRISING, ELECTRICAL SWITCHES, SWITCHGEAR, FUSES, DIVERTER SWITCHES AND/OR DISCONNECTING SWITCHES AND HIGH-VOLTAGE SUBSTATIONS COMPRISING, ELECTRICAL SWITCHES, SWITCHGEAR, FUSES, DIVERTER SWITCHES AND/OR DISCONNECTING SWITCHES, IN CLASS 9 (U.S. CLS. 21, 23, 26, 36 AND 38).

FOR: INSTALLATION, REPAIR AND MAINTENANCE OF APPARATUS AND INSTRUMENTS FOR CONDUCTING, SWITCHING, TRANSFORMING, ACCUMULATING, REGULATING OR CONTROLLING ELECTRICITY, IN CLASS 37 (U.S. CLS. 100, 103 AND 106).

FOR: ENGINEERING SERVICES CONCERNING DEVELOPMENT AND PLANNING OF APPARATUS AND INSTRUMENTS FOR CONDUCTING, SWITCHING, TRANSFORMING, ACCUMULATING, REGULATING OR CONTROLLING ELECTRICITY, IN CLASS 42 (U.S. CLS. 100 AND 101).

THE MARK CONSISTS OF STANDARD CHARACTERS WITHOUT CLAIM TO ANY PARTICULAR FONT, STYLE, SIZE, OR COLOR.

PRIORITY DATE OF 8-10-2010 IS CLAIMED.

OWNER OF INTERNATIONAL REGISTRATION 1080105 DATED 2-8-2011, EXPIRES 2-8-2021.

SER. NO. 79-098,446, FILED 2-8-2011.

MARK SPARACINO, EXAMINING ATTORNEY



David J. Kyfos

Director of the United States Patent and Trademark Office

United States of America

United States Patent and Trademark Office

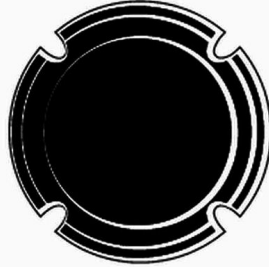

Champagnothèque

Reg. No. 4,152,291

Registered June 5, 2012

Int. Cls.: 33 and 41

TRADEMARK

SERVICE MARK

PRINCIPAL REGISTER

VAUTHIER, ERIC (BELGIUM INDIVIDUAL)
AVENUE JEAN VOLDERS 61 BTE 10
B-1060 BRUXELLES
BELGIUM

FOR: ALCOHOLIC BEVERAGES EXCEPT BEERS, IN CLASS 33 (U.S. CLS. 47 AND 49).

FOR: EDUCATION, NAMELY, PROVIDING CLASSES, WORKSHOP AND CONFERENCES IN THE FIELD OF CHAMPAGNE; PROVIDING TRAINING WITH RESPECT TO HOW TO STOCK, SERVE, TASTE, RECOGNIZE AND DIFFERENTIATE CHAMPAGNES; ENTERTAINMENT IN THE NATURE OF CONDUCTING A CHAMPAGNE FESTIVAL; ORGANIZATION AND HOLDING OF EXHIBITIONS FOR CULTURAL OR EDUCATIONAL PURPOSES; ARRANGING AND CONDUCTING OF TRAINING WORKSHOPS, CONFERENCES AND SEMINARS IN THE FIELD OF CHAMPAGNE, IN CLASS 41 (U.S. CLS. 100, 101 AND 107).

THE MARK CONSISTS OF THE WORD "CHAMPAGNOTHEQUE" APPEARING UNDER A SHADED CIRCULAR DESIGN REPRESENTING THE TOP VIEW OF A CHAMPAGNE BOTTLE CONTAINING THREE CONCENTRIC RINGS AND FOUR CUTOUT SECTIONS ON EACH CORNER.

PRIORITY DATE OF 9-28-2010 IS CLAIMED.

OWNER OF INTERNATIONAL REGISTRATION 1080131 DATED 3-28-2011, EXPIRES 3-28-2021.

THE WORDING "CHAMPAGNOTHEQUE" HAS NO MEANING IN A FOREIGN LANGUAGE.

SER. NO. 79-098,458, FILED 3-28-2011.

KELLY TRUSILO, EXAMINING ATTORNEY



David J. Kybas

Director of the United States Patent and Trademark Office

United States of America

United States Patent and Trademark Office

La Cornue W.

Reg. No. 4,152,292

Registered June 5, 2012

Int. Cls.: 11 and 20

TRADEMARK

PRINCIPAL REGISTER

LA CORNUE (FRANCE SOCIÉTÉ PAR ACTIONS SIMPLIFIÉE)
ZI LES BÉTHUNES
14 RUE DU BOIS DU PONT
F-95310 SAINT-OUEN L'AUMONE, FRANCE

FOR: COOKING APPARATUS AND INSTALLATIONS, NAMELY COOKING RANGES, OVENS AND FURNACES, IN CLASS 11 (U.S. CLS. 13, 21, 23, 31 AND 34).

FOR: KITCHEN FURNITURE, IN CLASS 20 (U.S. CLS. 2, 13, 22, 25, 32 AND 50).

THE MARK CONSISTS OF STANDARD CHARACTERS WITHOUT CLAIM TO ANY PARTICULAR FONT, STYLE, SIZE, OR COLOR.

PRIORITY DATE OF 11-22-2010 IS CLAIMED.

OWNER OF INTERNATIONAL REGISTRATION 1080181 DATED 5-18-2011, EXPIRES 5-18-2021.

OWNER OF U.S. REG. NOS. 1,552,759, 2,396,947, AND 2,720,841.

THE ENGLISH TRANSLATION OF "LA CORNUE" IN THE MARK IS "THE RETORT".

SER. NO. 79-098,472, FILED 5-18-2011.

MELISSA VALLILLO, EXAMINING ATTORNEY



David J. Kyros

Director of the United States Patent and Trademark Office

United States of America

United States Patent and Trademark Office

DESIGNING SILENCE

Reg. No. 4,152,293

Registered June 5, 2012

Int. Cls.: 17, 20 and 24

TRADEMARK

PRINCIPAL REGISTER

TEXAA (FRANCE SOCIÉTÉ PAR ACTIONS SIMPLIFIÉE)
43, ALLÉE MÉGEVIE
F-33170 GRADIGNAN
FRANCE

FOR: ACOUSTIC ABSORBING MATERIALS WITH TEXTILE SURFACES, NAMELY, IN THE FORM OF WALL AND CEILING COVERINGS, WALL PANELS AND WALL HANGINGS, IN CLASS 17 (U.S. CLS. 1, 5, 12, 13, 35 AND 50).

FOR: FURNITURE, FRAMES, NAMELY, FURNITURE FRAMES; CUSHIONS NOT FOR MEDICAL USE; FURNITURE, NAMELY, INDOOR BLINDS, IN CLASS 20 (U.S. CLS. 2, 13, 22, 25, 32 AND 50).

FOR: WALL PANELS IN THE NATURE OF WALL HANGINGS OF TEXTILE; COVERS FOR CUSHIONS OF TEXTILE; CURTAINS AND BLINDS OF TEXTILES AND PLASTICS, NAMELY, DOOR AND WINDOW TREATMENTS IN THE NATURE OF DOOR AND WINDOW PANELS OF TEXTILES AND PLASTICS, IN CLASS 24 (U.S. CLS. 42 AND 50).

THE MARK CONSISTS OF STANDARD CHARACTERS WITHOUT CLAIM TO ANY PARTICULAR FONT, STYLE, SIZE, OR COLOR.

PRIORITY DATE OF 11-17-2010 IS CLAIMED.

OWNER OF INTERNATIONAL REGISTRATION 1080272 DATED 5-10-2011, EXPIRES 5-10-2021.

SER. NO. 79-098,525, FILED 5-10-2011.

TINA BROWN, EXAMINING ATTORNEY



David J. Kyros

Director of the United States Patent and Trademark Office

United States of America

United States Patent and Trademark Office

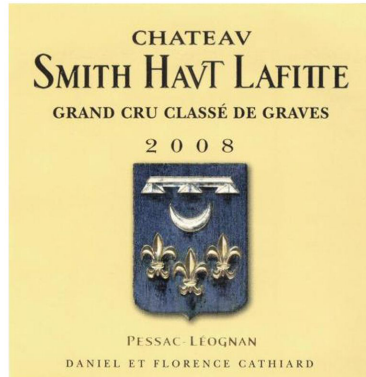

Reg. No. 4,152,294

Registered June 5, 2012

Int. Cl.: 33

TRADEMARK

PRINCIPAL REGISTER

SAS D. CATHIARD (FRANCE SOCIÉTÉ PAR ACTIONS SIMPLIFIÉE)
CHÂTEAU SMITH HAUT LAFITTE
F-33650 MARTILLAC
FRANCE

FOR: PESSAC LÉOGNAN AOC WINES FROM THE WINE-MAKING ESTATE CALLED CHÂTEAU SMITH HAUT LAFITTE, IN CLASS 33 (U.S. CLS. 47 AND 49).

NO CLAIM IS MADE TO THE EXCLUSIVE RIGHT TO USE CHATEAU, "GRAND CRU CLASSE DE GRAVES", "2008" AND "PESSAC-LEOGNAN", APART FROM THE MARK AS SHOWN.

PRIORITY DATE OF 10-5-2010 IS CLAIMED.

OWNER OF INTERNATIONAL REGISTRATION 1080311 DATED 2-22-2011, EXPIRES 2-22-2021.

THE COLOR(S) BLACK, YELLOW, GOLD, GREY-WHITE AND BLUE IS/ARE CLAIMED AS A FEATURE OF THE MARK.

THE NAME(S), PORTRAIT(S), AND/OR SIGNATURE(S) SHOWN IN THE MARK IDENTIFIES "DANIEL" AND "FLORENCE CATHIARD", WHOSE CONSENT(S) TO REGISTER IS MADE OF RECORD.



David J. Kybas

Director of the United States Patent and Trademark Office

THE MARK CONSISTS OF THE WORDING "CHATEAU" ABOVE THE WORDING "SMITH HAUT LAFITTE", ABOVE THE WORDING "GRAND CRU CLASSE DE GRAVES", ABOVE THE NUMBER "2008". THE DESIGN OF A SHIELD IS IN THE CENTER. WITHIN THE SHIELD IS A FLEUR-DE-LIS DESIGN. JUST ABOVE THE FLEUR-DE-LIS, THERE IS A CRESCENT MOON, AND ABOVE THAT IS A BAR TO WHICH THREE PYRAMIDAL STRUCTURES ARE ATTACHED. THE WORDING "PESSAC-LEOGNAN" IS BELOW THE DESIGN AND THE WORDING "DANIEL ET FLORENCE CATHIARD" IS AT THE BOTTOM. ALL WORDING IS IN THE COLOR BLACK. THE SHIELD DESIGN HAS A BLUE BACKGROUND. THE FLEUR-DE-LIS DESIGNS WITHIN THE SHIELD ARE GOLD IN COLOR. THE CRESCENT MOON DESIGN AND THE DESIGN OF THE BAR WITH THE THREE PYRAMIDAL STRUCTURES WITHIN THE SHIELD ARE GREY-WHITE. ALL WORDING AND DESIGNS ARE ON A YELLOW BACKGROUND.

Reg. No. 4,152,294 THE ENGLISH TRANSLATION OF "HAUT" IS "HIGH". THE ENGLISH TRANSLATION OF "GRAND CRU CLASSE" IS "CLASSIFIED GROWTH".

SER. NO. 79-098,538, FILED 2-22-2011.

DAVID HOFFMAN, EXAMINING ATTORNEY

United States of America
United States Patent and Trademark Office

BACON

Reg. No. 4,152,295

Registered June 5, 2012

Int. Cl.: 25

TRADEMARK

PRINCIPAL REGISTER

BARRAS S.R.L. (ITALY SOCIÉTÉ À RESPONSABILITÉ LIMITÉE)
VIA GIUSEPPE VERDI, 74
I-20063 CERNUSCO SUL NAVIGLIO (MI), ITALY

FOR: CLOTHING FOR MEN, WOMEN AND CHILDREN IN GENERAL, NAMELY, DRESSES MADE FROM SKINS; SHIRTS; BLOUSES; SKIRTS; SUITS; SUIT JACKETS; TROUSERS; SHORTS; UNDERSHIRTS; KNITWEAR, NAMELY, KNIT SHIRTS, KNIT PANTS; PAJAMAS; SOCKS; KNITTED UNDERWEAR; BODICES; STOCKING SUSPENDERS; PANTIES; UNDERPANTS; BRASSIERES; COMBINATIONS; HATS; SCARVES; NECKTIES; WATERPROOF CLOTHING; OVERCOATS; COATS; BATHING SUITS; SPORTS SUITS; ANORAKS; SKI PANTS; BELTS; FURS; SASHES FOR WEAR; GLOVES; DRESSING GOWNS, FOOTWEAR IN GENERAL, NAMELY, SLIPPERS; SHOES; FOOTWEAR FOR SPORTS; BOOTS AND SANDALS, IN CLASS 25 (U.S. CLS. 22 AND 39).

THE MARK CONSISTS OF STANDARD CHARACTERS WITHOUT CLAIM TO ANY PARTICULAR FONT, STYLE, SIZE, OR COLOR.

OWNER OF INTERNATIONAL REGISTRATION 1080402 DATED 4-11-2011, EXPIRES 4-11-2021.

SER. NO. 79-098,570, FILED 4-11-2011.

KATINA MISTER, EXAMINING ATTORNEY



David J. Kyffers

Director of the United States Patent and Trademark Office

United States of America

United States Patent and Trademark Office

SEATS2MEET.COM

Reg. No. 4,152,296

Registered June 5, 2012

Int. Cls.: 35, 41, 42 and 45

SERVICE MARK

PRINCIPAL REGISTER

C.D.E.F. HOLDING B.V. (NETHERLANDS BESLOTEN VENNOOTSCHAP)
MOREELSEPARK 65
NL-3511 EP UTRECHT, NETHERLANDS

FOR: BUSINESS NETWORKING SERVICES; SYSTEMATIZATION OF DATA INTO A CENTRAL DATABASE IN ORDER TO ENABLE THIRD PARTIES TO MAKE BUSINESS ARRANGEMENTS FOR MEETING SPACE, WHETHER OR NOT IN HOUSE; SYSTEMATIZATION OF DATA INTO A CENTRAL DATABASE IN ORDER TO ENABLE THIRD PARTIES TO SEARCH THE DATA FOR BUSINESS RELATIONS AND POTENTIAL CUSTOMERS; ADVERTISING AND DISSEMINATION OF ADVERTISING MATERIAL; PROVISION OF ADVERTISING SPACE BY ELECTRONIC MEANS AND GLOBAL INFORMATION NETWORKS; ADVERTISING AND PROMOTION OF PRODUCTS AND SERVICES THROUGH THE INTERNET; COMPILATION OF DATA IN COMPUTER DATABASES FOR THE ADVERTISING AND PROMOTION OF A WIDE RANGE OF TELECOMMUNICATION AND MULTIMEDIA PRODUCTS, COMPILATION OF DATA IN COMPUTER DATABASES, IN CLASS 35 (U.S. CLS. 100, 101 AND 102).

FOR: ORGANIZATION OF CONFERENCES, MEETINGS, WORKSHOPS, SEMINARS IN THE FIELDS OF EDUCATION AND ENTERTAINMENT FOR NON-BUSINESS AND NON-COMMERCIAL PURPOSES; TRAININGS AND COACHING INSTRUCTION IN THE FIELD OF COMPUTERS; ORGANIZATION OF SOCIAL ENTERTAINMENT EVENTS WITH THE AIM TO ENABLE PARTICIPANTS TO EXPAND THEIR BUSINESS NETWORK, ALL AFOREMENTIONED SERVICES ALSO PROVIDED ON-LINE FROM A COMPUTER NETWORK, IN CLASS 41 (U.S. CLS. 100, 101 AND 107).

FOR: HOSTING OF WEBSITES WITH REGISTERED USERS PARTICIPATING IN A VIRTUAL COMMUNITY FOR ORGANIZING GROUPS AND EVENTS TO PARTICIPATE IN DISCUSSIONS, TO GATHER INFORMATION AND RESOURCES IN ORDER TO BUILD A SOCIAL AND BUSINESS NETWORK; HOSTING OF WEBSITES THAT PROVIDE ACCESS TO SOFTWARE .IN ORDER TO ENABLE THIRD PARTIES TO MAKE ON-LINE BOOKINGS FOR MEETING SPACE, WHETHER OR NOT IN HOUSE; THE HOSTING OF AN INTERACTIVE WEBSITE AND NON-DOWNLOADABLE ONLINE SOFTWARE TO UPLOAD, DOWNLOAD, POST, DISPLAY, VIEW, SHARE AND SEND MESSAGES, COMMENTS, MULTIMEDIA MATERIALS, VIDEOS, MOVIES, PHOTOS, AUDIO, ANIMATION, PICTURES, GRAPHICS, TEXT, INFORMATION AND OTHER CONTENT GENERATED BY IT'S USERS; HOSTING AN ONLINE WEBSITE IN THE FIELD OF BUSINESS AND SOCIAL NETWORKING, ADVERTISING, MARKETING AND PROMOTION; THE CREATION AND MAINTAINING OF



David J. Kybas

Director of the United States Patent and Trademark Office

Reg. No. 4,152,296 WEBSITES THAT PROVIDE AN ONLINE COMMUNITY FOR BUSINESS AND SOCIAL NETWORKS , IN CLASS 42 (U.S. CLS. 100 AND 101).

FOR: PERSONAL AND SOCIAL SERVICES RENDERED TO SATISFY INDIVIDUAL NEEDS, NAMELY, PERSONAL LIFESTYLE CONSULTING; PERSONAL AND SOCIAL SERVICES TO ENABLE PEOPLE TO EXPAND THEIR SOCIAL NETWORK, NAMELY, SOCIAL NETWORK DATING SERVICES; LICENSING WITH RESPECT TO SOFTWARE AND OTHER TECHNOLOGY, NAMELY, INTELLECTUAL PROPERTY, IN CLASS 45 (U.S. CLS. 100 AND 101).

THE MARK CONSISTS OF STANDARD CHARACTERS WITHOUT CLAIM TO ANY PARTICULAR FONT, STYLE, SIZE, OR COLOR.

OWNER OF INTERNATIONAL REGISTRATION 1080670 DATED 2-11-2011, EXPIRES 2-11-2021.

SER. NO. 79-098,649, FILED 2-11-2011.

WILLIAM VERHOSEK, EXAMINING ATTORNEY

United States of America

United States Patent and Trademark Office



Reg. No. 4,152,297

Registered June 5, 2012

Int. Cls.: 7 and 12

PAN OTO RADYATÖR MAKINA SANAYI VE TICARET ANONİM SİRKETİ (TURKEY JOINT STOCK COMPANY)
BAKSAV SITESİ MUSTAFA KURTOĞLU,
CAD. NO. 18 BEYLİKDÜZÜ; BÜYÜKÇEKMECE - İSTANBUL
TURKEY

TRADEMARK

PRINCIPAL REGISTER

FOR: SPARE PARTS FOR AUTOMOBILES, NAMELY, RADIATORS, OIL RADIATORS AND THEIR COOLER CORES, BODIES, BOILERS, COVERS, DUCTS, CONNECTION PIPES AND PARTS AND ACCESSORIES ALL BEING FOR LAND VEHICLES AND MOTORS; COOLER AND OIL RADIATORS AND THEIR PARTS AND ACCESSORIES FOR WORKING MACHINES, AGRICULTURAL MACHINES, GENERATORS, IN CLASS 7 (U.S. CLS. 13, 19, 21, 23, 31, 34 AND 35).

FOR: MOTOR LAND VEHICLES AND MOTORS, SPARE PARTS AND ACCESSORIES THEREOF, BICYCLES AND THEIR BODIES, HANDLE BARS, FENDERS; VEHICLE BODY, VEHICLE BODY FOR LOAD CARRYING, TIPPING BODIES FOR LORRIES, TRACTOR TRAILERS, REFRIGERATED VEHICLES; TRAILER CONNECTIONS, DAMPERS FOR VEHICLES, LIFTING CARS; VEHICLE SEATS, HEAD SUPPORTS FOR SEATS, SAFETY SEATS FOR CHILDREN, FOR VEHICLES, SEATS COVERING, CAR COVERS (WITH DESIGNS), SUN VISORS; SIGNALS AND DIRECTIONS ARMS FOR SIGNALING; WINDSHIELD WIPERS, ARMS FOR WINDSHIELD WIPERS; TIRE TUBES AND TIRE COVERS, TUBELESS TIRES FOR VEHICLES, TIRE REPAIR SETS, VEHICLE TIRE PATCHES, PATCHES ASSEMBLED BY WELDING, VALVES FOR VEHICLE TIRES; GLASSES FOR VEHICLES, SAFETY WINDOWS FOR VEHICLES, REAR VIEW MIRRORS AND SIDE-MIRRORS FOR VEHICLES; ANTI-SKID CHAINS; SKIDS; LUGGAGE CARRIERS FOR VEHICLES, BICYCLE AND SKI CARRIERS, SADDLES; TIRE INFLATING PUMPS; BURGLAR ALARMS, HORNS FOR VEHICLES; SAFETY BELTS, AIRBAGS FOR PASSENGERS, IN CLASS 12 (U.S. CLS. 19, 21, 23, 31, 35 AND 44).



THE MARK CONSISTS OF A SWIRL DESIGN NEXT TO "PANOTO".

PRIORITY DATE OF 5-21-2010 IS CLAIMED.

OWNER OF INTERNATIONAL REGISTRATION 1080849 DATED 8-4-2010, EXPIRES 8-4-2020.

SER. NO. 79-098,697, FILED 8-4-2010.

David J. Kyros

Director of the United States Patent and Trademark Office

Reg. No. 4,152,297 JOHN HWANG, EXAMINING ATTORNEY

United States of America
United States Patent and Trademark Office

CRACOTTI

Reg. No. 4,152,298

Registered June 5, 2012

Int. Cl.: 30

IAN ADRIAN DAVID RUSSELL, AND RACHEL VICTORIA RUSSELL (UNITED KINGDOM INDIVIDUAL)
122 SELLY PARK ROAD,
SELLY PARK; BIRMINGHAM B29 7LH
UNITED KINGDOM

TRADEMARK

PRINCIPAL REGISTER

FOR: BISCUITS; CRACKERS; CRACKERS FLAVOURED WITH CHEESE; CRACKERS FLAVOURED WITH FRUIT; CRACKERS FLAVOURED WITH HERBS; CRACKERS FLAVOURED WITH SPICES; CRACKERS FLAVOURED WITH VEGETABLES; EDIBLE CRACKERS; CRACKERS MADE OF PREPARED CEREALS; CREAM CRACKERS; CANAPÉS; BREAD BISCUITS; OAT BISCUITS FOR HUMAN CONSUMPTION; SALTED BISCUITS; SALTY BISCUITS; SAVOURY BISCUITS (OTHER THAN BISCUITS FOR ANIMALS); SWEET BISCUITS FOR HUMAN CONSUMPTION; TOASTS (BISCUITS); WAFER BISCUITS; WAFERS (BISCUITS); APERITIF BISCUITS; BISCUIT MIXES; BISCUIT PRODUCTS; BISCUITS CONTAINING FRUIT; BISCUITS FLAVOURED WITH FRUIT; BISCUITS FOR HUMAN CONSUMPTION MADE FROM CEREALS; BISCUITS FOR HUMAN CONSUMPTION MADE FROM MALT; CARAWAY SEEDS; CEREAL SEEDS, PROCESSED; SESAME SEEDS; LIN-SEED OILS (EDIBLE); FLOUR; CEREAL AND GRAIN BASED SNACK FOODS, IN CLASS 30 (U.S. CL. 46).

THE MARK CONSISTS OF STANDARD CHARACTERS WITHOUT CLAIM TO ANY PARTICULAR FONT, STYLE, SIZE, OR COLOR.

PRIORITY DATE OF 3-10-2010 IS CLAIMED.

OWNER OF INTERNATIONAL REGISTRATION 1080867 DATED 9-8-2010, EXPIRES 9-8-2020.

THE WORDING "CRACOTTI" HAS NO MEANING IN A FOREIGN LANGUAGE.

SER. NO. 79-098,703, FILED 9-8-2010.

JOHN HWANG, EXAMINING ATTORNEY



David J. Kyffers

Director of the United States Patent and Trademark Office

United States of America

United States Patent and Trademark Office

Helio

Reg. No. 4,152,299

Registered June 5, 2012

Int. Cls.: 1 and 3

KASPAR WALTER GMBH & CO. KG MASCHINENFABRIK (FED REP GERMANY GMBH & CO. KG)
KONRAD-ZUSE-BOGEN 18
82152 KRAILLING/MÜNCHEN
FED REP GERMANY

TRADEMARK

PRINCIPAL REGISTER

FOR: INDUSTRIAL CHEMICALS; CHEMICAL PRODUCTS FOR DE-CHROMING, NAMELY, INDUSTRIAL CHEMICALS FOR DE-CHROMING; METAL PLATING COMPOSITIONS IN THE NATURE OF ALKALINE PRE-COPPER PLATING CHEMICAL PRODUCTS, COPPER PLATING AND CHROMIUM PLATING CHEMICAL PRODUCTS; ALL THE AFOREMENTIONED FOR GALVANIC EQUIPMENT FOR ROTOGRAVURE CYLINDER PROCESSING EQUIPMENT; INDUSTRIAL CHEMICALS IN THE NATURE OF DEGREASING PREPARATIONS FOR USE ON INDUSTRIAL MACHINES AND GALVANIC EQUIPMENT FOR ROTOGRAVURE CYLINDER PROCESSING EQUIPMENT, IN CLASS 1 (U.S. CLS. 1, 5, 6, 10, 26 AND 46).

FOR: DEGREASING PREPARATIONS NOT USED IN MANUFACTURING PROCESSES FOR GALVANIC EQUIPMENT FOR ROTOGRAVURE CYLINDER PROCESSING EQUIPMENT; PREPARATIONS FOR DEGREASING NOT USED IN MANUFACTURING PROCESSES FOR GALVANIC EQUIPMENT FOR ROTOGRAVURE CYLINDER PROCESSING EQUIPMENT; DEGREASING PREPARATIONS FOR USE ON INDUSTRIAL MACHINES AND GALVANIC EQUIPMENT FOR ROTOGRAVURE CYLINDER PROCESSING EQUIPMENT, IN CLASS 3 (U.S. CLS. 1, 4, 6, 50, 51 AND 52).

THE MARK CONSISTS OF STANDARD CHARACTERS WITHOUT CLAIM TO ANY PARTICULAR FONT, STYLE, SIZE, OR COLOR.

PRIORITY DATE OF 9-1-2010 IS CLAIMED.

OWNER OF INTERNATIONAL REGISTRATION 1080884 DATED 1-20-2011, EXPIRES 1-20-2021.

THE ENGLISH TRANSLATION OF "HELIO" IN THE MARK IS "SUN".

SER. NO. 79-098,712, FILED 1-20-2011.

MICHAEL ENGEL, EXAMINING ATTORNEY



David J. Kyros

Director of the United States Patent and Trademark Office

United States of America

United States Patent and Trademark Office

EATING WELL STARTS WITH PICCOLINI

Reg. No. 4,152,300

Registered June 5, 2012

Int. Cls.: 29 and 30

TRADEMARK

PRINCIPAL REGISTER

BARILLA G.E.R. FRATELLI - SOCIETÀ PER AZIONI (ITALY JOINT STOCK COMPANY)
VIA MANTOVA, 166
I-43100 PARMA, ITALY

FOR: MEAT, FISH, POULTRY AND GAME; MEAT EXTRACTS; PRESERVED, FROZEN, DRIED AND COOKED FRUITS AND VEGETABLES; JELLIES, JAMS, COMPOTES; EGGS, MILK AND MILK PRODUCTS EXCLUDING ICE CREAM, ICE MILK AND FROZEN YOGURT; EDIBLE OILS AND FATS, IN CLASS 29 (U.S. CL. 46).

FOR: RICE, FLOUR AND PREPARATIONS MADE FROM CEREALS, NAMELY, CEREAL BASED SNACK FOODS, BREAKFAST CEREALS; BREAD, PASTA, BISCUITS, YEAST, BAKING POWDER, SALT, MUSTARD, VINEGAR, CONDIMENTS, NAMELY, SAUCES, SPICES, FROZEN READY MEALS CONSISTING PRIMARILY OF PIZZAS, PASTA DISHES COOKED AND UNCOOKED, AND RICE, IN CLASS 30 (U.S. CL. 46).

THE MARK CONSISTS OF STANDARD CHARACTERS WITHOUT CLAIM TO ANY PARTICULAR FONT, STYLE, SIZE, OR COLOR.

PRIORITY DATE OF 3-10-2011 IS CLAIMED.

OWNER OF INTERNATIONAL REGISTRATION 1080894 DATED 3-18-2011, EXPIRES 3-18-2021.

OWNER OF U.S. REG. NOS. 3,107,090, 3,850,230 AND OTHERS.

SER. NO. 79-098,716, FILED 3-18-2011.

AISHA CLARKE, EXAMINING ATTORNEY



David J. Kyros

Director of the United States Patent and Trademark Office

United States of America

United States Patent and Trademark Office

BEKO AIRAUDIT

Reg. No. 4,152,301

BEKO TECHNOLOGIES GMBH (FED REP GERMANY GMBH)
IM TAUBENTAL 7

Registered June 5, 2012

41468 NEUSS, FED REP GERMANY

Int. Cls.: 9, 37 and 42

FOR: APPARATUS FOR MEASURING ELECTRIC CURRENT CONSUMPTION; APPARATUS FOR MEASURING THE PRESSURE DEW POINT; APPARATUS FOR MEASURING THE FLOW RATE OF FLUIDS; APPARATUS FOR MEASURING TEMPERATURES; APPARATUS FOR MEASURING THE OIL VAPOR CONTENT IN COMPRESSED AIR AND COMPRESSED GAS; APPARATUS FOR MEASURING DROPS IN WATER, HYDRAULIC AND/OR BAROMETRIC PRESSURE, IN CLASS 9 (U.S. CLS. 21, 23, 26, 36 AND 38).

TRADEMARK

SERVICE MARK

PRINCIPAL REGISTER

FOR: REPAIR OF LEAKING COMPRESSED AIR AND COMPRESSED GAS SYSTEMS AND INSTALLATIONS; REPAIR OF LEAKING WATER PIPES, IN CLASS 37 (U.S. CLS. 100, 103 AND 106).

FOR: TECHNICAL MEASUREMENTS, NAMELY, MEASURING OF ELECTRIC CURRENT CONSUMPTION, MEASURING THE PRESSURE DEW POINT, MEASURING THE FLOW RATE OF FLUIDS, MEASURING TEMPERATURES, MEASURING THE OIL VAPOR CONTENT IN COMPRESSED AIR AND COMPRESSED GAS AND MEASURING DROPS IN WATER, HYDRAULIC AND/OR BAROMETRIC PRESSURE, IN CLASS 42 (U.S. CLS. 100 AND 101).



THE MARK CONSISTS OF STANDARD CHARACTERS WITHOUT CLAIM TO ANY PARTICULAR FONT, STYLE, SIZE, OR COLOR.

PRIORITY DATE OF 10-13-2010 IS CLAIMED.

OWNER OF INTERNATIONAL REGISTRATION 1080896 DATED 4-4-2011, EXPIRES 4-4-2021.

OWNER OF U.S. REG. NO. 3,882,662.

NO CLAIM IS MADE TO THE EXCLUSIVE RIGHT TO USE "AIR AUDIT", APART FROM THE MARK AS SHOWN.

SER. NO. 79-098,717, FILED 4-4-2011.

David J. Kyjars

Director of the United States Patent and Trademark Office

Reg. No. 4,152,301 AISHA CLARKE, EXAMINING ATTORNEY

United States of America

United States Patent and Trademark Office

JOLICLOUD

Reg. No. 4,152,302

Registered June 5, 2012

Int. Cls.: 9, 35, 38 and 42

TRADEMARK

SERVICE MARK

PRINCIPAL REGISTER

JOLICLOUD (FRANCE SOCIÉTÉ PAR ACTIONS SIMPLIFIÉE)
9 RUE AMBROISE THOMAS
F-75009 PARIS
FRANCE

FOR: DATA PROCESSING EQUIPMENT, NAMELY, DATA PROCESSORS; PORTABLE AND HANDHELD DIGITAL ELECTRONIC DEVICES FOR RECORDING, ORGANIZING, TRANSMITTING, HANDLING AND REVIEWING OF AUDIO AND VIDEO FILES, TEXT AND DATA; COMPUTER SOFTWARE FOR USE IN RECORDING, ORGANIZING, TRANSMITTING, HANDLING AND REVIEWING AUDIO AND VIDEO FILES, DATA AND TEXTS ON PORTABLE AND HANDHELD DIGITAL ELECTRONIC DEVICES; MP3 PLAYERS; LAPTOP COMPUTERS, PERSONAL DIGITAL ASSISTANTS, ELECTRONIC PERSONAL ORGANIZERS, ELECTRONIC WRITING TABLETS, NAMELY, NOTEPADS, SMARTPHONES, TELEPHONES; MICROPROCESSORS, MEMORY CARDS, COMPUTER MONITORS, COMPUTER SCREENS, KEYBOARDS, COMPUTER CABLES, MODEMS, PRINTERS, VIDEOPHONES, COMPUTER DISK DRIVES, CAMERAS; COMPUTER SOFTWARE FOR DATABASE MANAGEMENT; OPTICAL CHARACTER RECOGNITION SOFTWARE; COMPUTER SOFTWARE USED FOR ELECTRONIC MESSAGES AND MAIL; COMPUTER PROGRAMS FOR ACCESSING, NAVIGATING AND SEARCHING ON-LINE DATABASES; COMPUTER SOFTWARE AND FIRMWARE FOR DEVELOPING COMPUTER APPLICATIONS FOR PERSONAL COMPUTERS AND LAPTOPS, DIGITAL PERSONAL ASSISTANTS, ELECTRONIC PERSONAL ORGANIZERS, ELECTRONIC WRITING TABLETS, NAMELY, ELECTRONIC NOTEPADS, SMARTPHONES, AND TELEPHONES; COMPUTER SOFTWARE DEVELOPMENT TOOLS, NAMELY, OPERATING SYSTEM PROGRAMS AND PROGRAMS COMPRISING TOOLS FOR DEVELOPING APPLICATIONS FOR PERSONAL COMPUTERS AND LAPTOPS, DIGITAL PERSONAL ASSISTANTS, ELECTRONIC ORGANIZERS, ELECTRONIC NOTEPADS, NOTEBOOK COMPUTERS, SMARTPHONES AND TELEPHONES; PORTABLE ELECTRONIC DEVICES FOR THE WIRELESS TRANSMISSION AND/OR RECEPTION OF DATA; COMPUTER PROGRAMS FOR ENABLING USERS TO STORE OR MANAGE PERSONAL DATA; COMPUTER SOFTWARE TO REDIRECT ELECTRONIC MAIL AND MESSAGES ON THE INTERNET AND/OR OTHER DATA TO ONE OR SEVERAL MOBILE DEVICES FROM A DATABASE RECORDED ON OR ASSOCIATED WITH A PERSONAL COMPUTER OR A SERVER; COMPUTER SOFTWARE FOR THE SYNCHRONIZATION OF DATA BETWEEN A REMOTE UNIT OR DEVICE AND A FIXED REMOTE UNIT OR DEVICE; COMPUTER SOFTWARE, NOT DOWNLOADABLE, ACCESSIBLE ON A GLOBAL COMPUTER NETWORK, FOR THE MANAGEMENT OF COMPUTER APPLICATIONS, OPERATING SYSTEMS AND DATABASES, IN CLASS 9 (U.S. CLS. 21, 23, 26, 36 AND 38).



David J. Kyros

Director of the United States Patent and Trademark Office

Reg. No. 4,152,302 FOR: DISTRIBUTION OF ADVERTISING MATERIAL, INCLUDING, LEAFLETS, PROSPECTUSES, PRINTED MATTER, AND SAMPLES; DOCUMENT REPRODUCTION; ON-LINE ADVERTISING ON A COMPUTER NETWORK; RENTAL OF ADVERTISING SPACE, NAMELY, RENTAL OF ADVERTISING TIME ON COMMUNICATION MEDIA; RETAIL STORE SERVICES, TO THIRD PARTIES, FEATURING COMPUTER APPLICATIONS AND OPERATING SYSTEMS; DISTRIBUTION OF SAMPLES FOR PUBLICITY PURPOSES, NAMELY, PROVIDING AND PRESENTING COMPUTER APPLICATIONS AND OPERATING SYSTEMS TO CONSUMERS FOR COMMERCIAL OR ADVERTISING PURPOSES; COMMERCIAL INFORMATION AND ADVICE IN THE FIELD OF COMPUTER APPLICATIONS AND OPERATING SYSTEMS, IN CLASS 35 (U.S. CLS. 100, 101 AND 102).

FOR: COMMUNICATION SERVICES, NAMELY, TRANSMITTING AUDIO AND VIDEO FILES, DATA AND TEXTS VIA THE INTERNET; PROVIDING USER ACCESS TO COMPUTER APPLICATIONS AND OPERATING SYSTEMS HOSTED REMOTELY, VIA THE INTERNET; PROVIDING TELECOMMUNICATIONS CONNECTION TO THE INTERNET OR DATABASES, NAMELY, CREATING SECURE CONNECTIONS VIA VIRTUAL COMPUTER ENVIRONMENTS, IN CLASS 38 (U.S. CLS. 100, 101 AND 104).

FOR: DESIGN AND DEVELOPMENT OF COMPUTER SOFTWARE AND HARDWARE; RESEARCH AND DEVELOPMENT OF NEW PRODUCTS FOR OTHERS; DESIGN, INSTALLATION, MAINTENANCE, UPDATING OR RENTAL OF COMPUTER SOFTWARE; COMPUTER PROGRAMMING; CONSULTING IN THE FIELD OF COMPUTER HARDWARE; COMPUTER SERVICES, NAMELY, ACTING AS AN APPLICATION SERVICES PROVIDER FOR OTHERS, IN THE FIELD OF INFORMATION MANAGEMENT TO HOST COMPUTER APPLICATION SOFTWARE FOR THE PURPOSE OF ACCESSING, MANAGING, SEARCHING AND SHARING DATA; REMOTE HOSTING OF COMPUTER APPLICATIONS AND OPERATING SYSTEMS, NAMELY, APPLICATION SERVICE PROVIDER, NAMELY, HOSTING APPLICATIONS AND SOFTWARE IN THE FIELD OF REMOTE DATA MANAGEMENT FOR WIRELESS DELIVERY OF CONTENT TO HANDHELD COMPUTERS, LAPTOPS AND MOBILE ELECTRONIC DEVICES; COMPUTER SERVICES, NAMELY, PROVIDING A SECURE VIRTUAL COMPUTER ENVIRONMENT THAT CAN BE ACCESSED VIA THE INTERNET BY AUTHENTICATED USERS, NAMELY, CREATING AN ON-LINE VIRTUAL ENVIRONMENT FOR ACCESSING, MANAGING, SEARCHING AND SHARING DATA; RENTAL, TO OTHERS, OF COMPUTER AND DATA STORAGE INFRASTRUCTURE OF VARIABLE CAPACITY; DESIGN, PROVISION AND DEVELOPMENT OF COMPUTER SYSTEMS ENABLING REMOTE INTEROPERABILITY BETWEEN A WORK STATION AND AN OPERATING SYSTEM OR COMPUTER APPLICATIONS, IN CLASS 42 (U.S. CLS. 100 AND 101).

THE MARK CONSISTS OF STANDARD CHARACTERS WITHOUT CLAIM TO ANY PARTICULAR FONT, STYLE, SIZE, OR COLOR.

PRIORITY DATE OF 8-24-2010 IS CLAIMED.

OWNER OF INTERNATIONAL REGISTRATION 1080991 DATED 2-22-2011, EXPIRES 2-22-2021.

SER. NO. 79-098,763, FILED 2-22-2011.

BENJAMIN OKEKE, EXAMINING ATTORNEY

United States of America

United States Patent and Trademark Office



Reg. No. 4,152,303

Registered June 5, 2012

Int. Cls.: 21 and 35

TRADEMARK

SERVICE MARK

PRINCIPAL REGISTER

CRYSTALEX CZ, S.R.O. (CZECH REPUBLIC CORPORATION)
MASARYKOVO NÁBŘEŽÍ 236/30
CZ-110 00 PRAHA 1
CZECH REPUBLIC

FOR: UNWORKED OR SEMI-WORKED GLASS, EXCEPT GLASS USED IN BUILDING; GLASS AND CRYSTAL GOODS DESIGNATED SOLELY TO THE MARKET OF GASTRONOMY, NAMELY GLASS BEVERAGEWARE, DRINKING GLASSES, CARAFES, DECANTERS, AND VASES, IN CLASS 21 (U.S. CLS. 2, 13, 23, 29, 30, 33, 40 AND 50).

FOR: PROMOTIONAL, MARKETING AND PUBLICITY SERVICES; BUSINESS CONSULTANCY AND BUSINESS MANAGEMENT; BUSINESS MANAGEMENT ASSISTANCE; BUSINESS ORGANIZATION CONSULTANCY; BUSINESS INVESTIGATIONS IN CONNECTION SOLELY WITH A GLASS INDUSTRY, IN CLASS 35 (U.S. CLS. 100, 101 AND 102).

THE MARK CONSISTS OF TWO CHEVRONS THAT FACE EACH OTHER, BUT DO NOT INTERSECT OR TOUCH; WITH THE STYLIZED WORDING "SPARKLE" TO THE RIGHT OF THIS DESIGN.

OWNER OF INTERNATIONAL REGISTRATION 1081023 DATED 2-8-2011, EXPIRES 2-8-2021.

SER. NO. 79-098,773, FILED 2-8-2011.

BENJAMIN OKEKE, EXAMINING ATTORNEY



David J. Kyros

Director of the United States Patent and Trademark Office

United States of America

United States Patent and Trademark Office

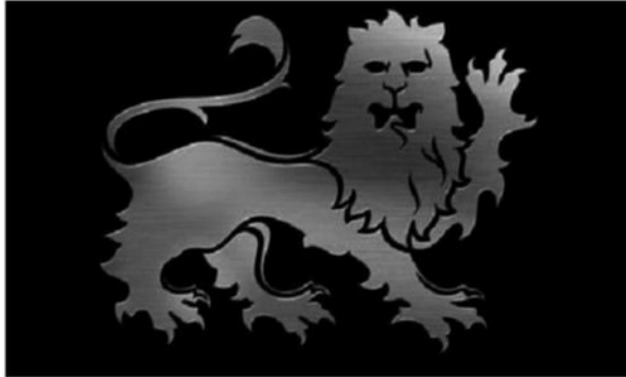

Reg. No. 4,152,304

Registered June 5, 2012

Int. Cl.: 33

TRADEMARK

PRINCIPAL REGISTER

CHIVAS HOLDINGS (IP) LIMITED (UNITED KINGDOM LIMITED COMPANY (LTD.))
111-113 RENFREW ROAD
PAISLEY, RENFREWSHIRE PA3 4DY
UNITED KINGDOM

FOR: ALCOHOLIC BEVERAGES EXCEPT BEERS, IN CLASS 33 (U.S. CLS. 47 AND 49).

THE MARK CONSISTS OF THE STYLIZED DESIGN OF A LION IN A RECTANGULAR SHAPED DESIGN.

PRIORITY DATE OF 1-25-2011 IS CLAIMED.

OWNER OF INTERNATIONAL REGISTRATION 1081305 DATED 4-20-2011, EXPIRES 4-20-2021.

SER. NO. 79-098,869, FILED 4-20-2011.

WILLIAM ROSSMAN, EXAMINING ATTORNEY



David J. Kyffers

Director of the United States Patent and Trademark Office

United States of America

United States Patent and Trademark Office

Hill's Collection

Reg. No. 4,152,305

Registered June 5, 2012

Int. Cl.: 29

TRADEMARK

PRINCIPAL REGISTER

OAK LAWN MARKETING, INC. (JAPAN CORPORATION)
1-13-3 HIGASHI SAKURA
HIGASHI-KU.; NAGOYA-SHI; AICHI 461-0005
JAPAN

FOR: PROCESSED FOOD STUFFS MAINLY CONSISTING OF SESAME EXTRACTS, AND HARP SEAL OIL IN THE FORM OF PILLS, GRANULARS, GRANULES, POWDER, CAPSULES, JELLY, LIQUID, TABLETS; PROCESSED FOOD STUFFS MAINLY CONSISTING OF EVENING PRIMROSE OIL AND SOY ISOFLAVONES AS THE MAIN INGREDIENT, IN THE FORM OF PILLS, GRANULARS, GRANULES, POWDER, CAPSULES, JELLY, LIQUID, TABLETS; EDIBLE OILS AND FATS; MILK PRODUCTS EXCLUDING ICE CREAM, ICE MILK AND FROZEN YOGURT; FRESH, CHILLED OR FROZEN EDIBLE AQUATIC ANIMALS NOT LIVE; CHARCUTERIE; PROCESSED MEAT; PROCESSED SEAFOOD, NAMELY FISH, EDIBLE SEAWEED, DRIED PIECES OF AGAR JELLY KANTEN; PROCESSED VEGETABLES AND FRUITS; PROCESSED FOODS CONSISTING PRIMARILY OF PROCESSED VEGETABLES AND PROCESSED FRUITS CONTAINING COLLAGEN WITH ADDED VITAMINS AND MINERALS IN THE FORM OF PILLS, GRANULARS, GRANULES, POWDER, CAPSULES, JELLY, LIQUID, TABLETS, IN CLASS 29 (U.S. CL. 46).

NO CLAIM IS MADE TO THE EXCLUSIVE RIGHT TO USE "COLLECTION", APART FROM THE MARK AS SHOWN.

OWNER OF INTERNATIONAL REGISTRATION 1081320 DATED 11-29-2010, EXPIRES 11-29-2020.

SER. NO. 79-098,873, FILED 11-29-2010.

NAAKWAMA ANKRAH, EXAMINING ATTORNEY



David J. Kyffers

Director of the United States Patent and Trademark Office

United States of America

United States Patent and Trademark Office

BARÇA

Reg. No. 4,152,306

Registered June 5, 2012

Int. Cls.: 9 and 38

TRADEMARK

SERVICE MARK

PRINCIPAL REGISTER

FUTBOL CLUB BARCELONA (SPAIN CORPORATION)
AVENIDA ARISTIDES MAILLOL, S/N
E-08028 BARCELONA
SPAIN

FOR: BLANK SMART CARDS; PRE-PAID TELEPHONE CALLING CARDS, MAGNETICALLY ENCODED; ENCRYPTED PRE-PAID TELEPHONE CALLING CARDS, MAGNETICALLY ENCODED; ENCODED TELEPHONE CARDS IN THE NATURE OF SUBSCRIBED IDENTITY MODULE (SIM) CARDS FOR CELLULAR TELEPHONES; ENCODED CARDS, NAMELY, MAGNETICALLY ENCODED DEBIT, CREDIT AND KEY CARDS; MAGNETICALLY ENCODED IDENTITY CARDS; CAMERAS AND PARTS AND COMPONENT PIECES FOR THEM; EXPOSED CAMERA FILM; SPECTACLES; COMPASSES AND BAROMETERS; SIGNAL BELLS; BINOCULARS; CALCULATING MACHINES; VIDEO DISKS AND VIDEO TAPES WITH RECORDED ANIMATED CARTOONS; VISION CORRECTIVE AND NON-CORRECTIVE SPECTACLES AND SPECTACLES FOR ADULTS AND CHILDREN; VISION CORRECTIVE AND NON-CORRECTIVE SUNGLASSES; CASES FOR SPECTACLES AND FOR SUNGLASSES; CHAINS FOR SPECTACLES AND FOR SUNGLASSES; CORDS AND FRAMES FOR SPECTACLES AND FOR SUNGLASSES; CASES FOR PHOTOGRAPHIC APPARATUS AND INSTRUMENTS; CONTAINERS FOR CONTACT LENSES; HOLOGRAPHIC OPTICAL GOODS, NAMELY, ELECTRONIC MACHINES USED TO APPLY HOLOGRAPHIC OVERLAY AND TO SET UP AND CONTROL HOLOGRAMS AND VERIFICATION THEREOF; ELECTRICAL AND ELECTRONIC EQUIPMENT, NAMELY, DATA PROCESSING EQUIPMENT AND COMPUTERS; TELEVISION APPARATUS, NAMELY, TELEVISION APPARATUS FOR PROJECTION PURPOSES AND TELEVISIONS; VIDEO RECORDERS; APPARATUS AND INSTRUMENTS FOR RECORDING AND REPRODUCTION OF SOUND; APPARATUS AND INSTRUMENTS FOR REPRODUCTION OF SOUND AND/OR IMAGES; COMPONENT PARTS AND PIECES FOR ALL THE AFORESAID GOODS; GRAMOPHONE AND PHONOGRAPHIC RECORDS FEATURING MUSIC; TAPE RECORDERS; BLANK MAGNETIC COMPUTER TAPES FOR RECORDING OR REPRODUCTION OF SOUND OR IMAGES; BLANK VIDEO TAPE; JUKE BOXES; RADIOS; EQUIPMENT FOR REPRODUCING RECORDS AND CDS, NAMELY, AUDIO CASSETTE, VIDEO DISC, CD AND DVD PLAYERS; REMOTE CONTROL APPARATUS FOR RADIOS, TELEVISIONS, STEREOS, COMPUTERS; PHOTOGRAPHIC SLIDES AND EXPOSED PHOTOGRAPHIC FILMS PREPARED FOR EXHIBITION; COMPUTERS AND COMPONENT AND PARTS AND PIECES FOR THEM; COMPUTER SOFTWARE, PROGRAMS, TAPES AND DISKS FOR USE IN DATABASE MANAGEMENT, USE AS A SPREADSHEET, WORD PROCESSING; COMPUTER PERIPHERAL DEVICES; MOUSE PADS; PALM RESTS FOR USE WITH COMPUTERS; COMPUTER



David J. Kyros

Director of the United States Patent and Trademark Office

Reg. No. 4,152,306 MICE; COVERS FOR KEYBOARDS AND COMPUTER SCREENS; PERSONALIZED FLOPPY DISKS, NAMELY, BLANK FLOPPY COMPUTER DISCS FEATURING WORDING ETCHED ONTO THE EXTERIOR OF THE DISC AND CD-ROM DRIVES FEATURING WORDING ETCHED ONTO THE EXTERIOR OF THE DRIVE; PERSONALIZED STORAGE BOXES FOR DATA AND FOR GOODS INCLUDED IN THIS CLASS, NAMELY, DISC STORAGE CONTAINERS FEATURING WORDING ETCHED ONTO THE EXTERIOR OF THE BOXES; TELEPHONES; ANSWERING MACHINES, TELEPHONE CALL CONVERSATION AND MESSAGE RECORDERS AND TELEPHONES INCORPORATING A FACSIMILE MACHINE; COMPUTER GAME PROGRAMS ON CD, COMPUTER GAME SOFTWARE, VIDEO GAME CARTRIDGES AND DISCS AND COMPUTER GAME PROGRAMS CONTAINED ON MEDIA; TIME RECORDING APPARATUS; MAGNETS; MAGNIFYING GLASSES; MEASURING INSTRUMENTS AND DEVICES, NAMELY, LASER MEASURING SYSTEMS, LENGTHY MEASURING GAUGES, MEASURING GLASSWARE, MEASURING CUPS, CLAMP METERS FOR MEASURING ELECTRICITY, BEVELS, RAIN GAUGES AND MEASURING RULES; MECHANICAL SIGNS; NEON SIGNS FOR ADVERTISING; ELECTRIC SOCKETS; ELECTRIC PLUGS AND SWITCHES; AUTOMATIC TICKET DISPENSERS; SIGNALING APPARATUS FOR BROKEN-DOWN VEHICLES, NAMELY, HIGHWAY, EMERGENCY AND RESCUE FLARES; COMPONENT PARTS AND PIECES FOR ALL THE AFORESAID GOODS, IN CLASS 9 (U.S. CLS. 21, 23, 26, 36 AND 38).

FOR: TELECOMMUNICATIONS SERVICES, NAMELY, LOCAL AND LONG DISTANCE TRANSMISSION OF VOICE, DATA, GRAPHICS BY MEANS OF TELEPHONE, TELEGRAPHIC, AND CABLE TRANSMISSIONS; TELEMATIC SERVICES IN THE NATURE OF INFORMATION TRANSMISSION BY TELEMATIC CODES, TELEMATIC SENDING OF INFORMATION AND TRANSMISSION OF INFORMATION VIA COMPUTERS CONNECTED TO THE SAME TELEMATIC NETWORK; SATELLITE TRANSMISSION SERVICES; BROADCASTING OF RADIO AND TELEVISION PROGRAMS; VIDEO BROADCASTING AND TRANSMISSION SERVICES, VIA THE INTERNET, FEATURING FILMS, TELEVISION AND RADIO REPORTS AND DOCUMENTARIES; COMMUNICATIONS VIA COMPUTER TERMINALS; MESSAGE TRANSMISSION AND RECEPTION VIA GLOBAL COMPUTER NETWORKS, NAMELY, ELECTRONIC TRANSMISSION OF MESSAGES ON GLOBAL COMPUTER NETWORKS; INFORMATION ABOUT TELECOMMUNICATIONS; NEWS AGENCIES, NAMELY, THE TRANSMISSION OF NEWS ITEMS TO NEWS REPORTING ORGANIZATIONS; RENTAL OF TELECOMMUNICATIONS APPARATUS; COMMUNICATIONS SERVICES, NAMELY, CELLULAR TELEPHONE COMMUNICATION, TELEPHONY COMMUNICATION, FACSIMILE COMMUNICATION, COMMUNICATION BY TELEGRAPH, COLLECTION AND TRANSMISSION OF MESSAGES, AND RADIO-PAGING AND ELECTRONIC MAIL; TRANSMISSION AND RECEPTION OF DATA AND INFORMATION VIA A TELECOMMUNICATION NETWORK; ELECTRONIC MESSAGE DELIVERY SERVICES; ON-LINE INFORMATION SERVICES RELATING TO TELECOMMUNICATIONS; ELECTRONIC DATA INTERCHANGE SERVICES; TRANSFER OF DATA BY MEANS OF TELECOMMUNICATIONS; VIDEOTEXT AND TELETEXT SERVICES; DATA VIEWING SERVICES, NAMELY, PROVIDING ACCESS TO DATABASES; VIDEO WEB MESSAGING SERVICES; VIDEO CONFERENCING SERVICES ; VIDEO TELEPHONE SERVICES; PROVIDING ELECTRONIC TELECOMMUNICATIONS CONNECTIONS TO THE INTERNET AND TO DATABASES; PROVIDING ACCESS TO DIGITAL MUSIC WEBSITES ON THE INTERNET; DELIVERY OF DIGITAL MUSIC BY MEANS OF TELECOMMUNICATIONS, NAMELY, DELIVERY OF DIGITAL MUSIC BY ELECTRONIC TRANSMISSION; TELECOMMUNICATIONS ACCESS SERVICES; COMPUTER AIDED TRANSMISSION OF MESSAGES AND IMAGES; COMMUNICATION BY COMPUTER TERMINALS; NEWS AGENCY SERVICES FOR ELECTRONIC TRANSMISSION; TRANSMISSION OF NEWS AND CURRENT AFFAIRS INFORMATION, IN CLASS 38 (U.S. CLS. 100, 101 AND 104).

THE MARK CONSISTS OF STANDARD CHARACTERS WITHOUT CLAIM TO ANY PARTICULAR FONT, STYLE, SIZE, OR COLOR.

OWNER OF INTERNATIONAL REGISTRATION 1081332 DATED 1-11-2011, EXPIRES 1-11-2021.

Reg. No. 4,152,306 OWNER OF U.S. REG. NO. 3,440,573.

THE WORDING "BARCA" HAS NO MEANING IN A FOREIGN LANGUAGE.

SER. NO. 79-098,878, FILED 1-11-2011.

ANDREA K. NADELMAN, EXAMINING ATTORNEY

United States of America

United States Patent and Trademark Office

sanju

Reg. No. 4,152,307

Registered June 5, 2012

Int. Cl.: 1

BEIJING SANJU ENVIRONMENTAL PROTECTION AND NEW MATERIAL CO., LTD.
(CHINA CORPORATION)
9/F, DAHANG JIYE BUILDING
NO. 33 NORTH RENDA ROAD
HAIDIAN DISTRICT, 100080 BEIJING, CHINA

TRADEMARK

PRINCIPAL REGISTER

FOR: ACTIVATED CARBONS FOR INDUSTRIAL PURPOSES; BIOCHEMICAL CATALYSTS;
GAS PURIFYING PREPARATIONS; DECOLORANTS FOR INDUSTRIAL PURPOSES; DE-
TERGENTS FOR INDUSTRIAL PURPOSES; ANTIBUBBLING INDUSTRIAL AGENTS;
PETROLEUM DISPERSANTS; DYE ABSTERGENTS FOR INDUSTRIAL PURPOSES; OIL
PURIFYING CHEMICALS, IN CLASS 1 (U.S. CLS. 1, 5, 6, 10, 26 AND 46).

OWNER OF INTERNATIONAL REGISTRATION 1081341 DATED 3-1-2011, EXPIRES 3-1-
2021.

SER. NO. 79-098,883, FILED 3-1-2011.

STEVEN JACKSON, EXAMINING ATTORNEY

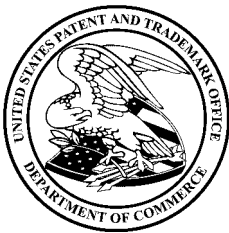

David J. Kyffers

Director of the United States Patent and Trademark Office

United States of America

United States Patent and Trademark Office

BIOLOG-ID

Reg. No. 4,152,308

Registered June 5, 2012

Int. Cls.: 9 and 42

TRADEMARK

SERVICE MARK

PRINCIPAL REGISTER

BIOLOG-ID
27-29 RUE RAFFET
F-75016 PARIS
FRANCE

FOR: ELECTRONIC IDENTIFICATION AND TRACEABILITY SYSTEMS COMPRISED OF PORTABLE AND FIXED RFID DATA READERS AND BAR CODES DATA READERS, COMPUTER INPUTTING TERMINALS, OPERATING SOFTWARE, COMPUTERS, INTERNET SERVERS; ELECTRONIC IDENTIFICATION APPARATUS, NAMELY, PORTABLE AND FIXED RFID DATA READERS AND BAR CODES DATA READERS, COMPUTER INPUTTING TERMINALS, OPERATING SOFTWARE, COMPUTERS, INTERNET SERVERS; ELECTRONIC IDENTIFICATION SOFTWARE FOR OPERATING RADIO FREQUENCY AND BAR CODES ENABLED IDENTIFICATION AND TRACEABILITY SYSTEMS DESIGNED TO PROVIDE ELECTRONIC IDENTIFICATION, MONITORING AND MANAGEMENT OF INDIVIDUALS, NAMELY, FOR PATIENTS IN HOSPITALS; ELECTRONIC IDENTIFICATION SOFTWARE FOR OPERATING RADIO FREQUENCY AND BAR CODES ENABLED IDENTIFICATION AND TRACEABILITY SYSTEMS DESIGNED TO PROVIDE ELECTRONIC IDENTIFICATION, MONITORING AND MANAGEMENT OF ANIMALS, BLOOD BAGS, BIOLOGICAL ANALYSES, MEDICINES, NAMELY, FOR HOSPITAL PHARMACIES, FOODSTUFFS, AGRI-FOOD PRODUCTS, GOODS, SIDE ARMS AND FIREARMS, AND INDUSTRIAL PRODUCTS; ELECTRONIC IDENTIFICATION SYSTEMS COMPRISED OF PORTABLE AND FIXED RFID DATA READERS AND BAR CODES DATA READERS, COMPUTER INPUTTING TERMINALS, OPERATING SOFTWARE, COMPUTERS, INTERNET SERVERS INTENDED FOR ELECTRONIC IDENTIFICATION, TRACKING, GEOPOSITIONING AND MANAGING INDIVIDUALS, NAMELY, PATIENTS IN HOSPITALS, ANIMALS, BLOOD BAGS, BIOLOGICAL ANALYSES, MEDICINES, NAMELY, FOR HOSPITAL PHARMACIES, FOODSTUFFS, AGRI-FOOD PRODUCTS, GOODS, SIDE ARMS AND FIREARMS, AND INDUSTRIAL PRODUCTS; ELECTRONIC IDENTIFICATION SYSTEMS COMPRISED OF PORTABLE AND FIXED RFID DATA READERS AND BAR CODES DATA READERS, COMPUTER INPUTTING TERMINALS, OPERATING SOFTWARE, COMPUTERS, INTERNET SERVERS FOR ELECTRONIC IDENTIFICATION, MONITORING OF THE TEMPERATURE OF COMMERCIAL REFRIGERATOR CONTENT; SOFTWARE FOR CONTROLLING AUTOMATED INDUSTRIAL MACHINES; BAR CODE READERS; ELECTRONIC DEVICES FOR REMOTE DATA ACQUISITION, NAMELY, BARCODE SCANNERS, MOBILE DATA RECEIVERS; DATA ACQUISITION COMPUTER TERMINALS AND READER DEVICES, HANDHELD AND FIXED; POINT-OF-SALE TERMINALS; DATA TRANSMITTER-RECEIVER DEVICES VIA RADIO FREQUENCY; RADIO FREQUENCY TRANSMITTER-RECEIVER DEVICES, ESPECIALLY FOR CONTACT-



David J. Kyjars

Director of the United States Patent and Trademark Office

Reg. No. 4,152,308 LESS CARD READERS; ELECTRONIC CHIPS IN THE NATURE OF INTEGRATED CIRCUITS, ESPECIALLY ELECTRONIC IDENTIFICATION CHIPS; ELECTRONIC TAGS FOR GOODS; RADIO FREQUENCY LABELS FOR GOODS; MAGNETIC IDENTIFICATION BRACELETS FOR HOSPITALS; COMMUNICATORS, NAMELY, INTERFACES FOR INDUSTRIAL NETWORKS; DEVICES FOR MONITORING, AUTOMATING AND SUPERVISING INDUSTRIAL INSTALLATIONS, NAMELY, COMPUTERS, VIDEO CAMERAS; DEVICES FOR MONITORING, AUTOMATING AND SUPERVISING COLD CHAIN, NAMELY, COMPUTERS, VIDEO CAMERAS; DATA PROCESSING EQUIPMENT AND COMPUTERS; SERVER CENTERS, NAMELY, COMPUTER SERVERS, COMMUNICATION SERVERS; TELECOMMUNICATIONS EQUIPMENT, NAMELY, AUTOMATIC SWITCHING APPARATUS, TELECOMMUNICATION CABLES, TELECOMMUNICATION TRANSMITTERS, IN CLASS 9 (U.S. CLS. 21, 23, 26, 36 AND 38).

FOR: DESIGN, DEVELOPMENT, INSTALLATION, MAINTENANCE AND UPDATING OF SOFTWARE, ESPECIALLY SOFTWARE FOR OPERATING ELECTRONIC IDENTIFICATION SYSTEMS AND TRACEABILITY SYSTEMS; DESIGN, DEVELOPMENT, INSTALLATION, MAINTENANCE AND UPDATING OF SOFTWARE, ESPECIALLY DATABASE MANAGEMENT SOFTWARE; ENGINEERING IN CONNECTION WITH INDUSTRIAL DATA PROCESSING, AUTOMATION AND ROBOTIZATION OF INDUSTRIAL PROCESSES, IN CLASS 42 (U.S. CLS. 100 AND 101).

THE MARK CONSISTS OF STANDARD CHARACTERS WITHOUT CLAIM TO ANY PARTICULAR FONT, STYLE, SIZE, OR COLOR.

PRIORITY DATE OF 11-2-2010 IS CLAIMED.

OWNER OF INTERNATIONAL REGISTRATION 1081445 DATED 4-26-2011, EXPIRES 4-26-2021.

SER. NO. 79-098,941, FILED 4-26-2011.

REBECCA POVARCHUK, EXAMINING ATTORNEY

United States of America
United States Patent and Trademark Office

NGM

Reg. No. 4,152,309

Registered June 5, 2012

Int. Cl.: 9

TRADEMARK

PRINCIPAL REGISTER

NGM ITALIA S.R.L. (ITALY LIMITED LIABILITY COMPANY)
VIA L. DA VINCI N., 7
LOC. PONTICELLI; I-56020 SANTA MARIA A MONTE (PI)
ITALY

FOR: APPARATUS FOR RECORDING, TRANSMISSION OR REPRODUCTION OF SOUND OR IMAGES, NAMELY, MOBILE PHONES, IN CLASS 9 (U.S. CLS. 21, 23, 26, 36 AND 38).

THE MARK CONSISTS OF STANDARD CHARACTERS WITHOUT CLAIM TO ANY PARTICULAR FONT, STYLE, SIZE, OR COLOR.

OWNER OF INTERNATIONAL REGISTRATION 1081488 DATED 5-18-2011, EXPIRES 5-18-2021.

SER. NO. 79-098,956, FILED 5-18-2011.

MELISSA VALLILLO, EXAMINING ATTORNEY



David J. Kyffers

Director of the United States Patent and Trademark Office

United States of America

United States Patent and Trademark Office

BIPLEX

Reg. No. 4,152,310

Registered June 5, 2012

Int. Cl.: 10

TRADEMARK

PRINCIPAL REGISTER

VASCUTEK LIMITED (UNITED KINGDOM COMPANY)
NEWMAINS AVENUE
INCHINNAN, RENFREWSHIRE PA4 9RR, UNITED KINGDOM

FOR: SURGICAL AND MEDICAL APPARATUS AND INSTRUMENTS, NAMELY, IMPLANTABLE MEDICAL DEVICES, NAMELY, SYNTHETIC VASCULAR PROSTHESES, ARTIFICIAL VASCULAR GRAFTS, AND SYNTHETIC HEART VALVE CONDUITS; SURGICAL COMPONENTS, NAMELY, ARTIFICIAL GRAFTS AND VASCULAR PROSTHESES FOR SURGICAL IMPLANTATION; MEDICAL COMPONENTS, NAMELY, IMPLANTABLE VASCULAR PROSTHESES, ARTIFICIAL GRAFTS AND SYNTHETIC HEART VALVE CONDUITS; SURGICAL GRAFT MATERIALS, NAMELY, ARTIFICIAL VASCULAR GRAFTS, IMPLANTABLE TISSUE BARRIER MATERIAL, NAMELY, IMPLANTABLE SCAFFOLDS COMPRISING ARTIFICIAL MATERIALS FOR MAINTAINING TISSUE CONTOUR, IN CLASS 10 (U.S. CLS. 26, 39 AND 44).

THE MARK CONSISTS OF STANDARD CHARACTERS WITHOUT CLAIM TO ANY PARTICULAR FONT, STYLE, SIZE, OR COLOR.

PRIORITY DATE OF 9-7-2010 IS CLAIMED.

OWNER OF INTERNATIONAL REGISTRATION 1081514 DATED 1-12-2011, EXPIRES 1-12-2021.

SER. NO. 79-098,961, FILED 1-12-2011.

MEGHAN REINHART, EXAMINING ATTORNEY



David J. Kyjars

Director of the United States Patent and Trademark Office

United States of America

United States Patent and Trademark Office



PIERRE GEORGES

Reg. No. 4,152,311

Registered June 5, 2012

Int. Cls.: 25 and 35

TRADEMARK

SERVICE MARK

PRINCIPAL REGISTER

POTH PIERRE (UNITED STATES INDIVIDUAL)
14 RUE EUGÈNE SUE
F-75018 PARIS
FRANCE

FOR: CLOTHING, NAMELY, SHIRTS, PANTS, JEANS, SHORTS, JACKETS, VESTS, COATS, RAINCOATS, SUITS, HANDKERCHIEFS, NECKTIES, BOWTIES, SCARVES, UNDERWEAR, SOCKS, HATS, DRESSES, BLOUSES, SKIRTS, SHORTS, JEANS, CAPES, SHAWLS, SWEATERS, TEE SHIRTS, BRAS, PANTIES, NIGHT GOWNS, PYJAMAS, TUXEDOS, FOOTWEAR, HEADWEAR; CLOTHING BELTS; FUR JACKETS AND STOLE; GLOVES; HOSIERY, IN CLASS 25 (U.S. CLS. 22 AND 39).

FOR: PRESENTATION OF GOODS FOR RETAIL PURPOSES, NAMELY, ONLINE RETAIL STORE SERVICES FEATURING CLOTHING, HEADWEAR, FOOTWEAR, AND CLOTHING ACCESSORIES, RETAIL STORE SERVICES FEATURING CLOTHING, HEADWEAR, FOOTWEAR, AND CLOTHING ACCESSORIES, IN CLASS 35 (U.S. CLS. 100, 101 AND 102).

THE NAME(S), PORTRAIT(S), AND/OR SIGNATURE(S) SHOWN IN THE MARK IDENTIFIES "PIERRE GEORGE" POTH, WHOSE CONSENT(S) TO REGISTER IS MADE OF RECORD.

PRIORITY DATE OF 12-30-2010 IS CLAIMED.

OWNER OF INTERNATIONAL REGISTRATION 1081719 DATED 5-25-2011, EXPIRES 5-25-2021.

THE MARK CONSISTS OF A DESIGN OF A SEA HORSE ABOVE THE TERMS "PIERRE GEORGES".

SER. NO. 79-099,028, FILED 5-25-2011.

ANTHONY RINKER, EXAMINING ATTORNEY



David J. Kybas

Director of the United States Patent and Trademark Office

United States of America

United States Patent and Trademark Office

vetrotech

SAINT-GOBAIN

Reg. No. 4,152,312

Registered June 5, 2012

Int. Cls.: 12, 19, 21 and 42

VETROTECH SAINT-GOBAIN (INTERNATIONAL) AG (SWITZERLAND SOCIÉTÉ ANONYME)
BERNSTRASSE 41-43
CH-3175 FLAMATT
SWITZERLAND

FOR: WINDOWS FOR LAND, AIR AND WATER VEHICLES, IN CLASS 12 (U.S. CLS. 19, 21, 23, 31, 35 AND 44).

TRADEMARK

FOR: GLASS PANES FOR CONSTRUCTION PURPOSES; FIRE-RESISTANT GLAZING UNITS FOR CONSTRUCTION PURPOSES; INSULATING GLASS AND SECURITY GLASS FOR CONSTRUCTION PURPOSES; LAMINATED GLASS PANES, IN CLASS 19 (U.S. CLS. 1, 12, 33 AND 50).

SERVICE MARK

PRINCIPAL REGISTER

FOR: WINDOW GLASS IN SEMI-FINISHED FORM FOR LAND, SEA AND AIR VEHICLES; FIRE-RESISTANT, INSULATING AND SAFETY GLASS IN SEMI-FINISHED FORM FOR WINDOWS FOR LAND, AIR AND WATER VEHICLES, IN CLASS 21 (U.S. CLS. 2, 13, 23, 29, 30, 33, 40 AND 50).

FOR: ARCHITECTURAL CONSULTATION; MATERIAL TESTING, IN CLASS 42 (U.S. CLS. 100 AND 101).



THE MARK CONSISTS OF THE STYLIZED WORDING "VETROTECH", WITH "SAINT-GOBAIN" AND UNDERLINING BENEATH.

PRIORITY DATE OF 12-23-2010 IS CLAIMED.

OWNER OF INTERNATIONAL REGISTRATION 1081887 DATED 6-8-2011, EXPIRES 6-8-2021.

THE ENGLISH TRANSLATION OF THE WORD "VETRO" IN THE MARK IS "GLASS".

SER. NO. 79-099,081, FILED 6-8-2011.

TOBY BULLOFF, EXAMINING ATTORNEY

David J. Kyros

Director of the United States Patent and Trademark Office

United States of America
United States Patent and Trademark Office

SIR MAX

Reg. No. 4,152,313

Registered June 5, 2012

Int. Cls.: 18, 25 and 35

TRADEMARK

SERVICE MARK

PRINCIPAL REGISTER

SIR MAX B.V. (NETHERLANDS B.V.)
HARTENSTRAAT 2 2HG
NL-1016 CB AMSTERDAM, NETHERLANDS

FOR: LEATHER AND IMITATIONS OF LEATHER, AND GOODS MADE FROM THESE MATERIALS AND NOT INCLUDED IN OTHER CLASSES, NAMELY, TRUNKS, TRAVELING BAGS; BAGS, NAMELY, MESSENGER BAGS, BOOK BAGS, SCHOOL BAGS AND ATHLETIC BAGS; AND UMBRELLAS, IN CLASS 18 (U.S. CLS. 1, 2, 3, 22 AND 41).

FOR: CLOTHING, NAMELY, T-SHIRTS, SHIRTS, PANTS, SWEATERS, SCARFS, JACKETS, COATS, SOCKS; FOOTWEAR AND HEADGEAR, NAMELY, HATS AND CAPS, IN CLASS 25 (U.S. CLS. 22 AND 39).

FOR: RETAIL STORE SERVICES FEATURING LEATHER AND IMITATIONS OF LEATHER, BAGS, CLOTHING, FOOTWEAR AND HEADGEAR; IMPORT AND EXPORT AGENCIES FEATURING LEATHER AND IMITATIONS OF LEATHER, BAGS, CLOTHING, FOOTWEAR AND HEADGEAR; THE BRINGING TOGETHER FOR THE BENEFIT OF OTHERS, OF A VARIETY OF GOODS, EXCLUDING THE TRANSPORT THEREOF, ENABLING CUSTOMERS TO CONVENIENTLY VIEW AND PURCHASE THOSE GOODS IN THE FIELD OF LEATHER AND IMITATIONS OF LEATHER, BAGS, CLOTHING, FOOTWEAR AND HEADGEAR; PROVIDING AN ON-LINE COMPUTER DATABASE IN THE FIELD OF BUSINESS INFORMATION AND BUSINESS CONTACTS; FRANCHISING, NAMELY, CONSULTATION AND ASSISTANCE IN BUSINESS MANAGEMENT ORGANIZATION AND PROMOTION; PROFESSIONAL BUSINESS CONSULTANCY, IN CLASS 35 (U.S. CLS. 100, 101 AND 102).

THE MARK CONSISTS OF STANDARD CHARACTERS WITHOUT CLAIM TO ANY PARTICULAR FONT, STYLE, SIZE, OR COLOR.

OWNER OF INTERNATIONAL REGISTRATION 1082172 DATED 12-31-2010, EXPIRES 12-31-2020.

SER. NO. 79-099,188, FILED 12-31-2010.

RENEE MCCRAY, EXAMINING ATTORNEY



David J. Kyjars

Director of the United States Patent and Trademark Office

United States of America

United States Patent and Trademark Office

Reg. No. 4,152,314

Registered June 5, 2012

Int. Cls.: 7 and 9

TRADEMARK

PRINCIPAL REGISTER

HYUNDAI HEAVY INDUSTRIES CO., LTD. (REPUBLIC OF KOREA CORPORATION)
1, JEONHA-DONG, DONG-KU
ULSAN 682-792
REPUBLIC OF KOREA

FOR: ELECTRIC WELDING MACHINES; ELECTRON BEAM WELDING MACHINES; ULTRASONIC WELDING MACHINES; ROBOTS MACHINES; INDUSTRIAL ROBOTS; INDUSTRIAL ROBOTS, NAMELY, ROBOTS FOR THE CONSTRUCTION OF RAILWAY CARRIAGES; INDUSTRIAL ROBOTS, NAMELY, ROBOTS FOR WELDING; INDUSTRIAL ROBOTS, NAMELY, ROBOTS FOR METALWORKING; INDUSTRIAL ROBOTS, NAMELY, ROBOTS FOR PAINTING; INDUSTRIAL ROBOTS, NAMELY, ROBOTS FOR ASSEMBLING AUTOMOBILES, IN CLASS 7 (U.S. CLS. 13, 19, 21, 23, 31, 34 AND 35).

FOR: ARC WELDING APPARATUS, NAMELY, WELDING TORCHES; ELECTRIC INSTALLATIONS FOR THE REMOTE CONTROL OF INDUSTRIAL OPERATIONS; REMOTE CONTROL APPARATUS, NAMELY, REMOTE CONTROL TRANSMITTER FOR RADIO-CONTROLLED DEVICES; REMOTE CONTROL TELEMETERING MACHINES AND APPARATUS ; REMOTE CONTROL APPARATUS USED IN INDUSTRIAL ROBOTS, NAMELY, ELECTRONIC APPARATUS FOR THE REMOTE CONTROL OF THE OPERATION OF INDUSTRIAL ROBOTS AND REMOTE CONTROL TRANSMITTERS FOR RADIO-CONTROLLED DEVICES ; REMOTE CONTROLS USED IN ROBOTS FOR ASSEMBLING EQUIPMENT OF RAILWAY CARRIAGE; COMPUTER SOFTWARE FOR USE IN OPERATING AND CONTROLLING ROBOTS FOR ASSEMBLING EQUIPMENT OF RAILWAY CARRIAGE; RECORDED COMPUTER SOFTWARE FOR USE IN OPERATING AND CONTROLLING ROBOTS FOR ASSEMBLING EQUIPMENT OF RAILWAY CARRIAGE; COMPUTER OPERATING PROGRAMS, RECORDED; RECORDED COMPUTER PROGRAMS FOR USE IN OPERATING AND CONTROLLING ROBOTS FOR ASSEMBLING EQUIPMENT OF RAILWAY CARRIAGE; COMPUTER OPERATING SYSTEM PROGRAMS; ROBOT OPERATING PROGRAMS, NAMELY, COMPUTER PROGRAMS DESIGNED FOR ENABLING THE USE AND CONTROL OF ROBOTS; ROBOT OPERATING SOFTWARE, NAMELY, COMPUTER SOFTWARE DESIGNED FOR ENABLING THE USE AND CONTROL OF ROBOTS; ROBOT CONTROL PROGRAM, NAMELY, COMPUTER PROGRAMS DESIGNED FOR ENABLING THE CONTROL AND MONITOR OF ROBOTS; ROBOT CONTROL SOFTWARE, NAMELY, COMPUTER SOFTWARE DESIGNED FOR ENABLING THE CONTROL AND MONITOR OF ROBOTS; ROBOT CONTROL SYSTEMS COMPRISING COMPUTER HARDWARE AND SOFTWARE DESIGNED FOR ENABLING THE CONTROL AND MONITOR OF ROBOTS; ROBOT OPERATING SYSTEM COMPRISING COMPUTER HARDWARE AND SOFTWARE FOR ASSEMBLING



David J. Kybas

Director of the United States Patent and Trademark Office

Reg. No. 4,152,314 EQUIPMENT OF RAILWAY CARRIAGE; ROBOT CONTROL SYSTEM FOR ASSEMBLING
EQUIPMENT OF RAILWAY CARRIAGE, IN CLASS 9 (U.S. CLS. 21, 23, 26, 36 AND 38).

PRIORITY DATE OF 1-19-2011 IS CLAIMED.

OWNER OF INTERNATIONAL REGISTRATION 1082271 DATED 3-23-2011, EXPIRES 3-23-
2021.

SER. NO. 79-099,249, FILED 3-23-2011.

MATTHEW KLINE, EXAMINING ATTORNEY

United States of America

United States Patent and Trademark Office

AURA LOEWE

Reg. No. 4,152,315

Registered June 5, 2012

Int. Cl.: 3

TRADEMARK

PRINCIPAL REGISTER

LOEWE, S.A. (SPAIN SOCIEDAD ANÓNIMA)
C/ GOYA, 4
E-28001 MADRID
SPAIN

FOR: SOAP; PERFUMERY; COSMETICS; HAIR CARE LOTIONS, IN CLASS 3 (U.S. CLS. 1, 4, 6, 50, 51 AND 52).

THE MARK CONSISTS OF STANDARD CHARACTERS WITHOUT CLAIM TO ANY PARTICULAR FONT, STYLE, SIZE, OR COLOR.

OWNER OF INTERNATIONAL REGISTRATION 1082327 DATED 4-25-2011, EXPIRES 4-25-2021.

OWNER OF U.S. REG. NOS. 636,670, 2,572,866 AND OTHERS.

SER. NO. 79-099,272, FILED 4-25-2011.

ANDREA K. NADELMAN, EXAMINING ATTORNEY



David J. Kybas

Director of the United States Patent and Trademark Office

United States of America

United States Patent and Trademark Office

Studio Hamburg Doclights

Reg. No. 4,152,316

Registered June 5, 2012

**Int. Cls.: 9, 35, 38, 40, 41
and 45**

STUDIO HAMBURG DOCLIGHTS GMBH (FED REP GERMANY LIMITED LIABILITY COMPANY)

JENFELDER ALLEE 80
22045 HAMBURG

FED REP GERMANY

TRADEMARK

SERVICE MARK

PRINCIPAL REGISTER

FOR: PRERECORDED DVDS FEATURING MOTION PICTURES AND TELEVISION PROGRAMS FEATURING ACTION, ADVENTURE, COMEDY, DRAMA, ANIMATION, DOCUMENTARIES ABOUT HISTORY, NATURE, WILDLIFE, TECHNOLOGY, BUSINESS, FINANCE, ENVIRONMENTAL ISSUES, GEOGRAPHY, MUSIC, ART, CULTURE, EDUCATION, POLITICS AND ONGOING REALITY-BASED STORIES ABOUT THE EXPERIENCES OF PEOPLE; PRERECORDED CDS FEATURING MUSIC; CAMERAS, LENSES FOR CAMERAS, PHOTOGRAPHIC CAMERA STANDS, AND MICROPHONES, APPARATUS FOR RECORDING, TRANSMISSION AND REPRODUCTION OF SOUND AND/OR IMAGES, IN CLASS 9 (U.S. CLS. 21, 23, 26, 36 AND 38).

FOR: BUSINESS MANAGEMENT; BUSINESS ORGANIZATIONAL CONSULTANCY IN THE FIELD OF TELEVISION AND RADIO PROGRAMS; BUSINESS ORGANIZATIONAL CONSULTANCY IN THE FIELD OF DEVELOPMENT, DESIGN, PRODUCTION AND BROADCASTING OF FILMS, IN CLASS 35 (U.S. CLS. 100, 101 AND 102).

FOR: BROADCASTING OF TELEVISION PROGRAMS AND TELEVISION AND AUDIO BROADCASTS ON THE INTERNET AND OTHER AUDIO-VISUAL MEDIA; SIMULCASTING BROADCAST TELEVISION OVER GLOBAL COMMUNICATION NETWORKS, THE INTERNET AND WIRELESS NETWORKS, IN CLASS 38 (U.S. CLS. 100, 101 AND 104).

FOR: PROCESSING OF CINEMATOGRAPHIC FILMS, IN CLASS 40 (U.S. CLS. 100, 103 AND 106).

FOR: FILM PRODUCTION; ELECTRONIC EDITING OF FILMS BY COMPUTER; MOTION PICTURE STUDIOS, IN PARTICULAR STUDIOS FOR TELEVISION AND VIDEO PRODUCTION; RECORDING STUDIO SERVICES; DUBBING; PUBLICATION OF TEXT, GRAPHICS, IMAGES AND SOUND DATA WHICH CAN BE TRANSMITTED ELECTRONICALLY AND IS ACCESSIBLE VIA DATA NETWORKS OTHER THAN FOR ADVERTISING PURPOSES; PUBLICATION OF PRINTED MATTER IN THE NATURE OF ADVENTURE, COMEDY, DRAMA, HISTORY, NATURE, TECHNOLOGY, BUSINESS, GEOGRAPHY, MUSIC, ART,



David J. Kybas

Director of the United States Patent and Trademark Office

Reg. No. 4,152,316 EDUCATION, POLITICS OTHER THAN FOR ADVERTISING PURPOSES; DIGITAL IMAGING SERVICES, IN CLASS 41 (U.S. CLS. 100, 101 AND 107).

FOR: FILM, TELEVISION AND VIDEO LICENSING; LICENSING OF BOOKS CONTAINING SCREENPLAYS; LICENSING OF INTELLECTUAL PROPERTY, IN CLASS 45 (U.S. CLS. 100 AND 101).

THE MARK CONSISTS OF STANDARD CHARACTERS WITHOUT CLAIM TO ANY PARTICULAR FONT, STYLE, SIZE, OR COLOR.

PRIORITY DATE OF 9-6-2010 IS CLAIMED.

OWNER OF INTERNATIONAL REGISTRATION 1082488 DATED 3-3-2011, EXPIRES 3-3-2021.

NO CLAIM IS MADE TO THE EXCLUSIVE RIGHT TO USE "STUDIO HAMBURG", APART FROM THE MARK AS SHOWN.

SER. NO. 79-099,338, FILED 3-3-2011.

ELLEN B. AWRICH, EXAMINING ATTORNEY

United States of America

United States Patent and Trademark Office

TheBestDay

Reg. No. 4,152,317

Registered June 5, 2012

Int. Cl.: 45

SERVICE MARK

PRINCIPAL REGISTER

THEBESTDAY PTY LTD (AUSTRALIA PROPRIETARY LIMITED COMPANY (PTY LTD))
15 NOONBINNA CRESCENT
NORTHBRIDGE NSW 2063
AUSTRALIA

FOR: ONLINE OR INTERNET BASED SOCIAL NETWORKING SERVICES TO ASSIST OTHERS TO ORGANIZE SOCIAL MEETINGS, IN CLASS 45 (U.S. CLS. 100 AND 101).

THE MARK CONSISTS OF STANDARD CHARACTERS WITHOUT CLAIM TO ANY PARTICULAR FONT, STYLE, SIZE, OR COLOR.

PRIORITY DATE OF 12-17-2010 IS CLAIMED.

OWNER OF INTERNATIONAL REGISTRATION 1082506 DATED 6-10-2011, EXPIRES 6-10-2021.

SER. NO. 79-099,346, FILED 6-10-2011.

RON FAIRBANKS, EXAMINING ATTORNEY



David J. Kyffers

Director of the United States Patent and Trademark Office

United States of America

United States Patent and Trademark Office

SPEEDELIA

Reg. No. 4,152,318

Registered June 5, 2012

Int. Cls.: 9, 12, 37 and 39

TRADEMARK

SERVICE MARK

PRINCIPAL REGISTER

ALSTOM (FRANCE SOCIÉTÉ ANONYME)
3 AVENUE ANDRÉ MALRAUX
F-92300 LEVALLOIS-PERRET
FRANCE

FOR: ELECTRONIC SIGNALING MECHANISM FOR RAILWAYS, NAMELY, ELECTRICAL APPARATUS FOR SIGNALLING, CONTROLLING AND MONITORING FIXED OR STREET INSTALLATIONS ON SINGLE OR DOUBLE-DECK ROLLING STOCK DESIGNED FOR RAILWAYS, SUBWAYS, MONORAILS AND SIMILAR TRANSPORT SYSTEMS, IN PARTICULAR, HIGH SPEED AND VERY HIGH SPEED SINGLE AND DOUBLE-DECK RAILWAY VEHICLES THE ARE USED WITH DISTRIBUTED OR CONCENTRATED TRACTION SINGLE OR DOUBLE-DECK RAILWAY SETS, SINGLE OR DOUBLE-DECK RAILWAY SETS COMPRISING A DRIVING MOTOR CAR OR NOT, OR SINGLE OR DOUBLE-DECK RAILWAY SETS, ARTICULATED OR NOT , IN CLASS 9 (U.S. CLS. 21, 23, 26, 36 AND 38).

FOR: RAILCARS, NAMELY, SINGLE OR DOUBLE-DECK ROLLING STOCK, DESIGNED FOR RAILWAYS, SUBWAYS, MONORAILS AND SIMILAR TRANSPORT SYSTEMS, NAMELY, LOCOMOTIVES, CARRIAGES, DRIVING MOTOR CARS, HIGH SPEED AND VERY HIGH SPEED SINGLE AND DOUBLE-DECK RAILWAY VEHICLES, DISTRIBUTED OR CONCENTRATED TRACTION SINGLE OR DOUBLE-DECK RAILWAY SETS, SINGLE OR DOUBLE-DECK RAILWAY SETS COMPRISING A DRIVING MOTOR CAR OR NOT, SINGLE OR DOUBLE-DECK RAILWAY SETS, ARTICULATED OR NOT, IN CLASS 12 (U.S. CLS. 19, 21, 23, 31, 35 AND 44).

FOR: CONSTRUCTION, REPAIR, RENOVATION, MAINTENANCE AND INSTALLATION OF RAILCARS, NAMELY, SINGLE OR DOUBLE-DECK ROLLING STOCK DESIGNED FOR RAILWAYS, SUBWAYS, MONORAILS AND SIMILAR TRANSPORT SYSTEMS, IN PARTICULAR, LOCOMOTIVES, CARRIAGES, DRIVING MOTOR CARS, HIGH SPEED AND VERY HIGH SPEED SINGLE AND DOUBLE-DECK ROLLING STOCK RAILWAY VEHICLES, FOR USE WITH DISTRIBUTED OR CONCENTRATED TRACTION SINGLE OR DOUBLE-DECK RAILWAY SETS, SINGLE OR DOUBLE-DECK RAILWAY SETS COMPRISING A DRIVING MOTOR CAR OR NOT, SINGLE OR DOUBLE-DECK RAILWAY SETS, ARTICULATED OR NOT, IN CLASS 37 (U.S. CLS. 100, 103 AND 106).

FOR: TRANSPORTATION OF PASSENGERS BY RAILWAYS, SUBWAYS, MONORAILS, LOCOMOTIVES, CARRIAGES, DRIVING MOTOR CARS, HIGH SPEED AND VERY HIGH SPEED SINGLE AND DOUBLE-DECK ROLLING STOCK RAILWAY VEHICLES VIA DIS-



David J. Kyros

Director of the United States Patent and Trademark Office

Reg. No. 4,152,318 TRIBUTED OR CONCENTRATED TRACTION SINGLE OR DOUBLE-DECK RAILWAY SETS, SINGLE OR DOUBLE-DECK RAILWAY SETS COMPRISING A DRIVING MOTOR CAR OR NOT, SINGLE OR DOUBLE-DECK RAILWAY SETS, ARTICULATED OR NOT, IN CLASS 39 (U.S. CLS. 100 AND 105).

THE MARK CONSISTS OF THE WORDING "SPEEDELIA" IN STYLIZED FONT.

PRIORITY DATE OF 9-21-2010 IS CLAIMED.

OWNER OF INTERNATIONAL REGISTRATION 1082707 DATED 2-4-2011, EXPIRES 2-4-2021.

SER. NO. 79-099,423, FILED 2-4-2011.

ALYSSA STEEL, EXAMINING ATTORNEY

United States of America

United States Patent and Trademark Office

CL COMPANION

Reg. No. 4,152,319

Registered June 5, 2012

Int. Cl.: 9

TRADEMARK

PRINCIPAL REGISTER

SWAROVSKI-OPTIK KG (AUSTRIA PUBLIC LIMITED COMPANY)
DANIEL-SWAROVSKI-STRASSE 70
A-6067 ABSAM
AUSTRIA

FOR: BINOCULARS, IN CLASS 9 (U.S. CLS. 21, 23, 26, 36 AND 38).

THE MARK CONSISTS OF STANDARD CHARACTERS WITHOUT CLAIM TO ANY PARTICULAR FONT, STYLE, SIZE, OR COLOR.

PRIORITY DATE OF 11-16-2010 IS CLAIMED.

OWNER OF INTERNATIONAL REGISTRATION 1082944 DATED 4-28-2011, EXPIRES 4-28-2021.

SER. NO. 79-099,508, FILED 4-28-2011.

MARC LEIPZIG, EXAMINING ATTORNEY



David J. Kyffers

Director of the United States Patent and Trademark Office

United States of America

United States Patent and Trademark Office



interwell

Reg. No. 4,152,320

Registered June 5, 2012

Int. Cls.: 37 and 42

SERVICE MARK

PRINCIPAL REGISTER

INTERWELL NORWAY AS (NORWAY STOCK COMPANY)
POSTBOKS 916
N-4089 HAFRSFJORD
NORWAY

FOR: REPAIR, INSTALLATION AND MAINTENANCE SERVICES WITHIN THE OIL, AND GAS INDUSTRY, NAMELY, REPAIR OF DEEP OIL AND GAS WELLS, INSTALLATION IN THE NATURE OF CEMENTING SERVICES FOR OIL AND GAS WELLS, MAINTENANCE OF OIL AND GAS WELLS; WELL DRILLING SERVICES FOR EXPLOITATION OF OIL AND GAS; WELL INTERVENTION SERVICES, NAMELY CONSTRUCTION AND REPAIR OF WELLS, AND PERFORMING PROCEDURES ON OIL AND GAS WELLS THAT ALTER THE PRODUCTIVE STATE OF THE WELLS OR ALTER WELL GEOMETRY, IN CLASS 37 (U.S. CLS. 100, 103 AND 106).

FOR: SCIENTIFIC AND TECHNOLOGICAL SERVICES AND RESEARCH AND DESIGN RELATING THERETO, NAMELY, SCIENTIFIC RESEARCH, ANALYSIS AND TESTING IN THE FIELD OF OIL AND GAS PRODUCTION, DESIGN IN THE NATURE OF ENGINEERING, ALL WITHIN THE OIL AND GAS SECTOR; INDUSTRIAL ANALYSIS AND RESEARCH SERVICES WITHIN THE OIL, AND GAS SECTOR, NAMELY ANALYSIS OF INDUSTRIAL FLUIDS AND INDUSTRIAL RESEARCH IN THE FIELD OF OIL AND GAS PRODUCTION; ANALYSIS SERVICES FOR THE EXPLOITATION OF OIL, AND GAS RESOURCES; OIL AND GAS WELL SURVEYS; GEOLOGICAL SURVEYS; ENGINEERING SERVICES; OIL-FIELD SURVEYS; OIL PROSPECTING SERVICES, IN CLASS 42 (U.S. CLS. 100 AND 101).

THE MARK CONSISTS OF A COIL DESIGN COMPOSED OF THREE CURVED WEDGES IN BLUE FADING TO LIGHT BLUE AND THE TERM "INTERWELL" IN GRAY.

PRIORITY DATE OF 3-17-2011 IS CLAIMED.

OWNER OF INTERNATIONAL REGISTRATION 1082956 DATED 4-19-2011, EXPIRES 4-19-2021.

THE COLOR(S) BLUE, LIGHT BLUE AND GRAY IS/ARE CLAIMED AS A FEATURE OF THE MARK.

THE DEVICE CONSISTS OF DIFFERENT SHADES OF BLUE, THE WORD "INTERWELL" IS IN GREY.



David J. Kyjars

Director of the United States Patent and Trademark Office

Reg. No. 4,152,320 SER. NO. 79-099,512, FILED 4-19-2011.

ANDREA K. NADELMAN, EXAMINING ATTORNEY

United States of America

United States Patent and Trademark Office

INTERWELL

Reg. No. 4,152,321

Registered June 5, 2012

Int. Cls.: 37 and 42

SERVICE MARK

PRINCIPAL REGISTER

INTERWELL NORWAY AS (NORWAY STOCK COMPANY)
POSTBOKS 916
N-4089 HAFRSFJORD
NORWAY

FOR: REPAIR, INSTALLATION AND MAINTENANCE SERVICES WITHIN THE OIL, AND GAS INDUSTRY, NAMELY, REPAIR OF DEEP OIL AND GAS WELLS, INSTALLATION IN THE NATURE OF CEMENTING SERVICES FOR OIL AND GAS WELLS, MAINTENANCE OF OIL AND GAS WELLS; WELL DRILLING SERVICES FOR EXPLOITATION OF OIL AND GAS; WELL INTERVENTION SERVICES, NAMELY CONSTRUCTION AND REPAIR OF WELLS, AND PERFORMING PROCEDURES ON OIL AND GAS WELLS THAT ALTER THE PRODUCTIVE STATE OF THE WELLS OR ALTER WELL GEOMETRY, IN CLASS 37 (U.S. CLS. 100, 103 AND 106).

FOR: SCIENTIFIC AND TECHNOLOGICAL SERVICES AND RESEARCH AND DESIGN RELATING THERETO, NAMELY, SCIENTIFIC RESEARCH, ANALYSIS AND TESTING IN THE FIELD OF OIL AND GAS PRODUCTION, DESIGN IN THE NATURE OF ENGINEERING, ALL WITHIN THE OIL AND GAS SECTOR; INDUSTRIAL ANALYSIS AND RESEARCH SERVICES WITHIN THE OIL, AND GAS SECTOR, NAMELY ANALYSIS OF INDUSTRIAL FLUIDS AND INDUSTRIAL RESEARCH IN THE FIELD OF OIL AND GAS PRODUCTION; ANALYSIS SERVICES FOR THE EXPLOITATION OF OIL, AND GAS RESOURCES; OIL AND GAS WELL SURVEYS; GEOLOGICAL SURVEYS; ENGINEERING SERVICES; OIL-FIELD SURVEYS; OIL PROSPECTING SERVICES, IN CLASS 42 (U.S. CLS. 100 AND 101).

THE MARK CONSISTS OF STANDARD CHARACTERS WITHOUT CLAIM TO ANY PARTICULAR FONT, STYLE, SIZE, OR COLOR.

PRIORITY DATE OF 2-2-2011 IS CLAIMED.

OWNER OF INTERNATIONAL REGISTRATION 1082958 DATED 4-19-2011, EXPIRES 4-19-2021.

SER. NO. 79-099,513, FILED 4-19-2011.

ANDREA K. NADELMAN, EXAMINING ATTORNEY



David J. Kyffers

Director of the United States Patent and Trademark Office

United States of America

United States Patent and Trademark Office

Mini Ants

Reg. No. 4,152,322

Registered June 5, 2012

Int. Cl.: 10

BERNHARD FÖRSTER GMBH (FED REP GERMANY GESELLSCHAFT MIT
BESCHRÄNKTER HAFTUNG)
WESTLICHE KARL-FRIEDRICH-STRABE 151
75172 PFORZHEIM
FED REP GERMANY

TRADEMARK

PRINCIPAL REGISTER

FOR: SURGICAL IMPLANTS OF ARTIFICIAL MATERIALS; PRODUCTS FOR USE IN JAW-ORTHOPEDICS AND ORTHODONTIA BEING METALLIC COMPONENTS, CERAMIC COMPONENTS AND COMPONENTS OF PLASTIC, IN PARTICULAR WIRES, PREFORMED WIRES, ARCH WIRES, BRACKETS, BUCCAL TUBES, BANDS AND MOLAR BANDS WITH AND WITHOUT PARTS WELDED THERETO, SPRINGS, SCREWS HAVING A SPRING-LOADED PISTON, EXPANSION SCREWS AND DENTAL SCREWS; ARTIFICIAL TEETH; DENTAL PROSTHESIS; ORTHODONTIC APPLIANCES; PINS FOR ARTIFICIAL TEETH; ROOT CANAL PINS; JAW SURGICAL IMPLANTS OF ARTIFICIAL MATERIALS, IN PARTICULAR SCREW IMPLANTS AND IMPLANT ABUTMENTS FOR IMPLANTS; FOILS AND PLATES MADE OF PLASTIC FOR DENTAL PURPOSES; PARTS FOR THE AFORESAID GOODS, IN CLASS 10 (U.S. CLS. 26, 39 AND 44).

THE MARK CONSISTS OF STANDARD CHARACTERS WITHOUT CLAIM TO ANY PARTICULAR FONT, STYLE, SIZE, OR COLOR.

PRIORITY DATE OF 10-7-2010 IS CLAIMED.

OWNER OF INTERNATIONAL REGISTRATION 1083025 DATED 3-7-2011, EXPIRES 3-7-2021.

SER. NO. 79-099,539, FILED 3-7-2011.

RICHARD WHITE, EXAMINING ATTORNEY



David J. Kyjars

Director of the United States Patent and Trademark Office

United States of America

United States Patent and Trademark Office

EVOLIS Premium Suite

Reg. No. 4,152,323

Registered June 5, 2012

Int. Cls.: 9 and 37

TRADEMARK

SERVICE MARK

PRINCIPAL REGISTER

EVOLIS (FRANCE SA)
ZI ANGERS BEAUCOUZE -
14 AVENUE DE LA FONTAINE; F-49070 BEAUCOUZE
FRANCE

FOR: PRINTERS FOR USE WITH PLASTIC CARDS, MAGNETIC CARDS, MEMORY CARDS AND CARDS OF PAPER; COMPUTER PERIPHERALS, NAMELY, PRINT DRIVERS AND ENCODERS FOR USE WITH PLASTIC CARDS; COMPUTER SOFTWARE FOR PROCESSING, MANAGING AND CREATING CARDS; COMPUTER SOFTWARE FOR MANAGING PRINTERS; COMPUTER SOFTWARE FOR ENCODING CARDS BEARING MAGNETIC STRIPS AND FOR ENCODING INTEGRATED CIRCUIT CARDS WITH AND WITHOUT CONTACT; COMPUTER PROGRAMS FOR CONFIGURING PRINTING AND ENCODING APPARATUS, IN CLASS 9 (U.S. CLS. 21, 23, 26, 36 AND 38).

FOR: INSTALLATION OF PRINTING AND ENCODING MACHINES FEATURING INCLUDING ACTIVATING, CONNECTING AND CONFIGURING OF PRINTING AND ENCODING MACHINES; MAINTAINING, SERVICING AND REPAIRING OF PRINTING AND ENCODING MACHINES, IN CLASS 37 (U.S. CLS. 100, 103 AND 106).

NO CLAIM IS MADE TO THE EXCLUSIVE RIGHT TO USE "PREMIUM SUITE", APART FROM THE MARK AS SHOWN.

PRIORITY DATE OF 2-24-2011 IS CLAIMED.

OWNER OF INTERNATIONAL REGISTRATION 1083174 DATED 6-6-2011, EXPIRES 6-6-2021.

SER. NO. 79-099,602, FILED 6-6-2011.

TRACY FLETCHER, EXAMINING ATTORNEY



David J. Kypos

Director of the United States Patent and Trademark Office

United States of America
United States Patent and Trademark Office

Agilit

Reg. No. 4,152,324

Registered June 5, 2012

Int. Cls.: 14, 40 and 42

TRADEMARK

SERVICE MARK

PRINCIPAL REGISTER

UMICORE AG & CO. KG (FED REP GERMANY PARTNERSHIP)
RODENBACHER CHAUSSEE 4
HANAU-WOLFGANG, FED REP GERMANY 63457

FOR: PRECIOUS METALS AND THEIR ALLOYS, UNWROUGHT OR SEMI-WROUGHT; OXIDE DISPERSION STRENGTHENED PLATINUM OR ALLOYS OF PLATINUM FOR USE IN ASSEMBLY PARTS, COMPONENTS AND SYSTEMS FOR HIGH TEMPERATURE APPLICATIONS, IN CLASS 14 (U.S. CLS. 2, 27, 28 AND 50).

FOR: TREATMENT OF MATERIALS, NAMELY, PRECIOUS METALS AND THEIR ALLOYS INCLUDING DISPERSION STRENGTHENED PLATINUM OR ALLOYS OF PLATINUM, RELATED TO CUSTOM PRODUCTION OF BUILDING ELEMENTS, COMPONENTS AND SYSTEMS FOR HIGH TEMPERATURE APPLICATIONS FOR OTHERS, IN CLASS 40 (U.S. CLS. 100, 103 AND 106).

FOR: CONSULTANCY IN THE FIELD OF MANUFACTURING TECHNOLOGY, IN CLASS 42 (U.S. CLS. 100 AND 101).

THE MARK CONSISTS OF STANDARD CHARACTERS WITHOUT CLAIM TO ANY PARTICULAR FONT, STYLE, SIZE, OR COLOR.

PRIORITY DATE OF 9-15-2010 IS CLAIMED.

OWNER OF INTERNATIONAL REGISTRATION 1083229 DATED 3-9-2011, EXPIRES 3-9-2021.

SER. NO. 79-099,617, FILED 3-9-2011.

TOBY BULLOFF, EXAMINING ATTORNEY



David J. Kypos

Director of the United States Patent and Trademark Office

Reg. No. 4,152,325 IN EXHIBITION CENTERS, NAMELY, PROVIDING SEMINARS, WORKSHOPS, LECTURES AND TUTORIALS IN THE FIELD OF GRANITES, STONES, MARBLE, MACHINERY AND ARCHITECTURAL DESIGN, ON SHOW GROUNDS AND IN UNIVERSITY CENTERS FOR CULTURAL, EDUCATIONAL, SPORTING AND ENTERTAINMENT PURPOSES; PROFESSIONAL TRAINING SERVICES FOR ARCHITECTS AND DESIGNERS; ALL THE AFORESAID SERVICES ON BEHALF OF THIRD PARTIES, IN CLASS 41 (U.S. CLS. 100, 101 AND 107).

FOR: PROVIDING FACILITIES FOR EXHIBITIONS; PROVIDING CONFERENCE ROOMS; ALL THE AFORESAID SERVICES ON BEHALF OF THIRD PARTIES, IN CLASS 43 (U.S. CLS. 100 AND 101).

NO CLAIM IS MADE TO THE EXCLUSIVE RIGHT TO USE "STONE ACADEMY", APART FROM THE MARK AS SHOWN.

PRIORITY DATE OF 9-16-2010 IS CLAIMED.

OWNER OF INTERNATIONAL REGISTRATION 1083254 DATED 1-26-2011, EXPIRES 1-26-2021.

THE MARK CONSISTS OF A SIGN DEPICTING THE WORDING "MARMOMACC" IN FANCY CHARACTERS, UNDER WHICH THERE IS A SERIES OF STYLIZED BOXES PLACED HORIZONTALLY ONE NEXT TO THE OTHER, UNDER WHICH THERE ARE THE WORDINGS "STONE ACADEMY" IN FANCY CHARACTERS.

SER. NO. 79-099,628, FILED 1-26-2011.

FRANK LATTUCA, EXAMINING ATTORNEY

United States of America
United States Patent and Trademark Office

STERICUP

Reg. No. 4,152,326

Registered June 5, 2012

Int. Cl.: 10

TRADEMARK

PRINCIPAL REGISTER

IMBERT ELLIOT (FRANCE INDIVIDUAL)
9 RUE DES INNOCENTS
F-75001 PARIS
FRANCE

FOR: METAL CONTAINERS FOR MEDICAL USE SPECIFICALLY DESIGNATED TO BE USED IN DILUTING AND HEATING INJECTABLE PREPARATIONS, IN CLASS 10 (U.S. CLS. 26, 39 AND 44).

THE MARK CONSISTS OF STANDARD CHARACTERS WITHOUT CLAIM TO ANY PARTICULAR FONT, STYLE, SIZE, OR COLOR.

OWNER OF INTERNATIONAL REGISTRATION 0687090 DATED 12-29-1997, EXPIRES 12-29-2017.

SER. NO. 79-099,674, FILED 3-7-2011.

MICHAEL TANNER, EXAMINING ATTORNEY



David J. Kyffers

Director of the United States Patent and Trademark Office

United States of America
United States Patent and Trademark Office

RENCHTÄLER



Reg. No. 4,152,327

Registered June 5, 2012

Int. Cl.: 33

TRADEMARK

PRINCIPAL REGISTER

LIDL STIFTUNG & CO. KG (FED REP GERMANY STIFLUNG & CO. KG)
STIFTSBERGSTRASSE 1
74167 NECKARSULM
FED REP GERMANY

FOR: SPIRITS, NAMELY, DISTILLED SPIRITS, CALVADOS, KIRSCH, SCHNAPPS, RUM,
SCOTCH, WHISKY, VODKA, TEQUILA, BRANDY, COGNAC, GIN, IN CLASS 33 (U.S. CLS.
47 AND 49).

OWNER OF U.S. REG. NO. 2,934,799.

OWNER OF INTERNATIONAL REGISTRATION 0711733 DATED 3-29-1999, EXPIRES 3-29-
2019.

THE MARK CONSISTS OF THE TERM "RENCHTÄLER" CONTAINED BETWEEN TWO
HORIZONTAL LINES, APPEARING ABOVE A TRIANGULAR SHAPED DESIGN EMBEDDED
WITHIN TWO CURVED LINES.

SER. NO. 79-099,676, FILED 1-26-2011.

PAM WILLIS, EXAMINING ATTORNEY



David J. Kyffers

Director of the United States Patent and Trademark Office

United States of America

United States Patent and Trademark Office



Reg. No. 4,152,328

Registered June 5, 2012

Int. Cl.: 1

TRADEMARK

PRINCIPAL REGISTER

TAIZHOU BAILLY CHEMICAL CO., LTD. (CHINA CORPORATION)
TAIXING ECONOMIC DEVELOPMENT ZONE
JIANGSU PROVINCE, CHINA

FOR: FLAME RETARDANT; FIRE EXTINGUISHING COMPOSITIONS; FIREPROOFING PREPARATIONS; CHEMICAL ADDITIVES FOR USE IN THE MANUFACTURE OF FUNGICIDES; SOIL CONDITIONING PREPARATIONS; CHEMICAL FERTILIZERS, IN CLASS 1 (U.S. CLS. 1, 5, 6, 10, 26 AND 46).

THE MARK CONSISTS OF AN ABSTRACT REPRESENTATION OF A LEAF LOCATED IN A RECTANGULAR CARRIER THAT INCLUDES A BAND CARRYING THE WORD "BAILLY" LOCATED THEREBELOW.

OWNER OF INTERNATIONAL REGISTRATION 1083322 DATED 3-10-2011, EXPIRES 3-10-2021.

SER. NO. 79-099,715, FILED 3-10-2011.

MARK RADEMACHER, EXAMINING ATTORNEY



David J. Kybas

Director of the United States Patent and Trademark Office

United States of America

United States Patent and Trademark Office

SIETESIETE

Reg. No. 4,152,329

Registered June 5, 2012

Int. Cl.: 33

TRADEMARK

PRINCIPAL REGISTER

BODEGA LA SOTERRAÑA, S.L. (SPAIN LIMITED LIABILITY COMPANY)
POL. IND. JOSÉ ANTONIO GONZÁLEZ CAVIEDES
E-47410 OLMEDO (VALLADOLID)
SPAIN

FOR: ALCOHOLIC BEVERAGES EXCEPT BEERS, IN CLASS 33 (U.S. CLS. 47 AND 49).

THE MARK CONSISTS OF STANDARD CHARACTERS WITHOUT CLAIM TO ANY PARTICULAR FONT, STYLE, SIZE, OR COLOR.

OWNER OF INTERNATIONAL REGISTRATION 1083453 DATED 3-23-2011, EXPIRES 3-23-2021.

THE ENGLISH TRANSLATION OF "SIETESIETE" IN THE MARK IS "SEVENSEVEN".

SER. NO. 79-099,751, FILED 3-23-2011.

C. DIONNE CLYBURN, EXAMINING ATTORNEY



David J. Kyros

Director of the United States Patent and Trademark Office

United States of America
United States Patent and Trademark Office

EXXELENS

Reg. No. 4,152,330

Registered June 5, 2012

Int. Cl.: 40

SERVICE MARK

PRINCIPAL REGISTER

LUXEXCEL HOLDING B.V. (NETHERLANDS BESLOTEN VENNOOTSCHAP)
VEERWEG 34
NL-4471 NC WOLPHAARTSDIJK
NETHERLANDS

FOR: OPTICAL LENS GRINDING, NAMELY, PROCESSING OF OPTICAL GLASSES, OPTICAL INSTRUMENTS, OPTICAL LENSES AS WELL AS TRANSPARENT SHEETS MADE OF PLASTIC WITH THE AIM OF GIVING THEM DIFFERENT STRUCTURES, IN CLASS 40 (U.S. CLS. 100, 103 AND 106).

THE MARK CONSISTS OF STANDARD CHARACTERS WITHOUT CLAIM TO ANY PARTICULAR FONT, STYLE, SIZE, OR COLOR.

PRIORITY DATE OF 2-8-2011 IS CLAIMED.

OWNER OF INTERNATIONAL REGISTRATION 1083498 DATED 5-27-2011, EXPIRES 5-27-2021.

THE WORDING "EXXELENS " HAS NO MEANING IN A FOREIGN LANGUAGE.

SER. NO. 79-099,768, FILED 5-27-2011.

MARLENE BELL, EXAMINING ATTORNEY



David J. Kyffers

Director of the United States Patent and Trademark Office

United States of America

United States Patent and Trademark Office

ALKOS

Reg. No. 4,152,331

Registered June 5, 2012

Int. Cl.: 3

ALKOS COSMETIQUES SAS (FRANCE SOCIÉTÉ PAR ACTIONS SIMPLIFIÉE
UNIPERSONNELLE)
PARC D'ACTIVITÉS ZAC DE LANDACRES
F-62360 HESDIN-L'ABBE
FRANCE

TRADEMARK

PRINCIPAL REGISTER

FOR: COSMETICS; COSMETIC SETS, NAMELY, COSMETIC SETS COMPRISED OF EYE-LINERS AND BLUSH, COSMETIC SETS COMPRISING LIPSTICK AND LIP GLOSS, COSMETIC SETS COMPRISING MAKE-UP FOUNDATION AND MAKE-UP POWDER; COSMETIC PREPARATIONS FOR SKIN CARE; EYEBROW COSMETICS; COSMETIC PENCILS, COSMETIC CREAMS; LOTIONS FOR COSMETIC PURPOSES; MAKE-UP PRODUCTS, NAMELY, MAKE-UP FOUNDATIONS, MAKE-UP REMOVING PREPARATIONS, MAKE-UP FOR THE BODY AND FACE, MAKE-UP PENCILS; MAKE-UP PREPARATIONS; MAKE-UP POWDER; LIPSTICKS; DEODORANTS FOR PERSONAL USE; SOAP; ESSENTIAL OILS; PERFUMES; HAIR LOTIONS; SHAMPOOS; DENTIFRICES, IN CLASS 3 (U.S. CLS. 1, 4, 6, 50, 51 AND 52).

THE MARK CONSISTS OF STANDARD CHARACTERS WITHOUT CLAIM TO ANY PARTICULAR FONT, STYLE, SIZE, OR COLOR.

PRIORITY DATE OF 5-2-2011 IS CLAIMED.

OWNER OF INTERNATIONAL REGISTRATION 1083612 DATED 5-13-2011, EXPIRES 5-13-2021.

SER. NO. 79-099,807, FILED 5-13-2011.

BRENDAN MCCAULEY, EXAMINING ATTORNEY



David J. Kyros

Director of the United States Patent and Trademark Office

United States of America

United States Patent and Trademark Office

P
PIERRE PETIT

Reg. No. 4,152,332

Registered June 5, 2012

Int. Cls.: 9, 14 and 16

TRADEMARK

PRINCIPAL REGISTER

JACQUES LEMANS GESMBH (AUSTRIA LIMITED LIABILITY COMPANY)
JACQUES-LEMANS-STRASSE 1
A-9300 ST. VEIT AN DER GLAN
AUSTRIA

FOR: SUNGLASSES, SPECTACLE CASES, SPECTACLE FRAMES, IN CLASS 9 (U.S. CLS. 21, 23, 26, 36 AND 38).

FOR: JEWELLERY, CLOCKS, HOROLOGICAL INSTRUMENTS, IN CLASS 14 (U.S. CLS. 2, 27, 28 AND 50).

FOR: WRITING INSTRUMENTS, IN CLASS 16 (U.S. CLS. 2, 5, 22, 23, 29, 37, 38 AND 50).

THE NAME "PIERRE PETIT" DOES NOT IDENTIFY A LIVING INDIVIDUAL.

PRIORITY DATE OF 12-6-2010 IS CLAIMED.

OWNER OF INTERNATIONAL REGISTRATION 1083648 DATED 5-25-2011, EXPIRES 5-25-2021.

THE MARK CONSISTS OF AN UPSIDE DOWN LETTER "P" BACK TO BACK TO A LETTER "P" ABOVE THE WORDS "PIERRE PETIT".

SER. NO. 79-099,821, FILED 5-25-2011.

PAULA MAHONEY, EXAMINING ATTORNEY



David J. Kybas

Director of the United States Patent and Trademark Office

United States of America

United States Patent and Trademark Office



Reg. No. 4,152,333

Registered June 5, 2012

Int. Cls.: 35, 41, 42 and 45

SERVICE MARK

PRINCIPAL REGISTER

C.D.E.F. HOLDING B.V. (NETHERLANDS BESLOTEN VENNOOTSCHAP)
MOREELSEPARK 65
NL-3511 EP UTRECHT, NETHERLANDS

FOR: BUSINESS NETWORKING SERVICES; SYSTEMATIZATION OF DATA INTO A CENTRAL DATABASE IN ORDER TO ENABLE THIRD PARTIES TO MAKE ON-LINE BOOKINGS FOR MEETING SPACE, WHETHER OR NOT IN HOUSE; SYSTEMATIZATION OF DATA INTO A CENTRAL DATABASE IN ORDER TO ENABLE THIRD PARTIES TO SEARCH THE DATA FOR BUSINESS RELATIONS AND POTENTIAL CUSTOMERS; ADVERTISING AND DISSEMINATION OF ADVERTISING MATERIAL; PROVISION OF ADVERTISING SPACE BY ELECTRONIC MEANS AND GLOBAL INFORMATION NETWORKS; PROMOTING THE GOODS AND SERVICES OF OTHERS BY PROVIDING A WEBSITE FEATURING PRODUCT REVIEWS, DISCOUNT INFORMATION; THE BRINGING TOGETHER, FOR THE BENEFIT OF OTHERS, OF A VARIETY OF GOODS, EXCLUDING THE TRANSPORT THEREOF, ENABLING CUSTOMERS TO CONVENIENTLY VIEW AND PURCHASE THOSE GOODS IN THE FIELD OF TELECOMMUNICATION GOODS AND MULTIMEDIA PRODUCTS; COMPILATION OF DATA IN COMPUTER DATABASES, IN CLASS 35 (U.S. CLS. 100, 101 AND 102).

FOR: ORGANIZATION OF EDUCATIONAL CONFERENCES, MEETINGS, WORKSHOPS, SEMINARS IN THE FIELD OF SOCIAL NETWORKING; TRAINING, NAMELY, BUSINESS TRAINING; ORGANIZATION OF LEISURE EVENTS IN THE NATURE OF SOCIAL ENTERTAINMENT EVENTS, GAME AND SPORTS ACTIVITIES WITH THE AIM TO ENABLE PARTICIPANTS TO EXPAND THEIR BUSINESS NETWORK, IN CLASS 41 (U.S. CLS. 100, 101 AND 107).

FOR: HOSTING AN ON-LINE COMMUNITY WEB SITE FEATURING REGISTERED USERS PARTICIPATING IN A VIRTUAL COMMUNITY FOR ORGANIZING GROUPS AND EVENTS TO PARTICIPATE IN DISCUSSIONS, TO GATHER INFORMATION AND RESOURCES IN ORDER TO BUILD A SOCIAL AND BUSINESS NETWORK; HOSTING OF WEBSITES THAT PROVIDE ACCESS TO SOFTWARE IN ORDER TO ENABLE THIRD PARTIES TO MAKE ON-LINE BOOKINGS FOR MEETING SPACE, WHETHER OR NOT IN HOUSE; THE HOSTING OF AN INTERACTIVE WEBSITE AND NON-DOWNLOADABLE ONLINE SOFTWARE TO GIVE USERS THE ABILITY TO REVIEW VARIOUS PRINT, PHOTOGRAPHIC, GRAPHIC IMAGE, AND AUDIO AND VIDEO CONTENT, AND ENGAGE IN SOCIAL, BUSINESS AND COMMUNITY NETWORKING; THE CREATION AND MAINTAINING OF

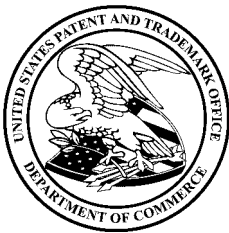

David J. Kyjars

Director of the United States Patent and Trademark Office

Reg. No. 4,152,333 WEBSITES FOR OTHERS THAT PROVIDE AN ONLINE COMMUNITY FOR BUSINESS AND SOCIAL NETWORKS, IN CLASS 42 (U.S. CLS. 100 AND 101).

FOR: PERSONAL AND SOCIAL SERVICES RENDERED TO SATISFY INDIVIDUAL NEEDS, NAMELY, PERSONAL GROWTH AND MOTIVATION CONSULTING SERVICES; PERSONAL AND SOCIAL SERVICES TO ENABLE PEOPLE TO EXPAND THEIR SOCIAL NETWORK, NAMELY, AN ONLINE SOCIAL NETWORK DATING SERVICE; LICENSING OF SOFTWARE AND OTHER INTELLECTUAL PROPERTY TECHNOLOGY, IN CLASS 45 (U.S. CLS. 100 AND 101).

THE MARK CONSISTS OF THE TEXT "S2M" WITHIN TWO IRREGULARLY SHAPED CIRCLES.

OWNER OF INTERNATIONAL REGISTRATION 1084149 DATED 2-7-2011, EXPIRES 2-7-2021.

SER. NO. 79-099,998, FILED 2-7-2011.

CARYN GLASSER, EXAMINING ATTORNEY

United States of America

United States Patent and Trademark Office

MONTECARLO
 **OFFSHORE**

Reg. No. 4,152,334

Registered June 5, 2012

Int. Cl.: 25

TRADEMARK

PRINCIPAL REGISTER

MONDO S.P.A. (ITALY CORPORATION)
PIAZZALE EDMONDO STROPPIANA, 1
I-12051 ALBA FRAZIONE GALLO (CN)
ITALY

FOR: ARTICLES OF CLOTHING, NAMELY, ACTIVE WEAR, NAMELY, PANTS, SHORTS, SHIRTS, T-SHIRTS, POLO SHIRTS, JACKETS, SWEATSHIRTS, BONNETS, HEADWEAR; SPORTSWEAR, NAMELY, SHIRTS, T-SHIRTS, SHORTS; SWIMWEAR, UNDERWEAR, NIGHTWEAR, AND LOUNGEWEAR; SPORTS UNIFORMS AND JERSEYS, PANTS, TROUSERS, JEANS, SHORTS, JACKETS, WIND JACKETS, COATS, OVERCOATS, RAINCOATS, HOSIERY, SWEATERS, CARDIGANS, FLEECE PULLOVERS AND PANTS, TRAINING AND TRACK SUITS, SHIRTS, WOVEN SHIRTS, SWEAT SHIRTS, PLUSH SHIRTS, POLO SHIRTS, T-SHIRTS, TANK TOPS, TOPS, CUT AND SEW TOPS, PAJAMAS, OVERALLS, DRESSES, EVENING DRESSES, TIGHTS, SKIRTS, GOWNS; SOCKS; ROBES; WAIST BANDS AS PARTS OF CLOTHING; SCARVES; NECK WARMERS, NAMELY, SCARVES, NECK TUBES, NECK GAITERS; GLOVES; BATH ROBES, SWIMSUITS, BEACH WEAR, PAREOS; HEADWEAR, NAMELY, HATS, CAPS AND HEAD BANDS, BANDANAS; WRISTBANDS; BELTS AND TIES; FOOTWEAR, NAMELY, SHOES, BOOTS, CHAPS, SANDALS, SLIPPERS, SPORT AND ATHLETIC SHOES, SOCCER AND FOOTBALL SHOES, TENNIS SHOES; CLIMBING SHOES, IN CLASS 25 (U.S. CLS. 22 AND 39).

NO CLAIM IS MADE TO THE EXCLUSIVE RIGHT TO USE "MONTECARLO", APART FROM THE MARK AS SHOWN.

PRIORITY DATE OF 2-24-2011 IS CLAIMED.

OWNER OF INTERNATIONAL REGISTRATION 1084161 DATED 2-25-2011, EXPIRES 2-25-2021.

THE MARK CONSISTS OF THE FANCIFUL WORDING "MONTECARLO OFFSHORE", ORIGINALLY WRITTEN, ON TWO LINES, AND REPRESENTATION OF A CROWN.

SER. NO. 79-100,004, FILED 2-25-2011.

CARYN GLASSER, EXAMINING ATTORNEY



David J. Kyros

Director of the United States Patent and Trademark Office

United States of America

United States Patent and Trademark Office

SCHOTT Nanotec

Reg. No. 4,152,335

Registered June 5, 2012

Int. Cls.: 11, 20 and 21

TRADEMARK

PRINCIPAL REGISTER

SCHOTT AKTIENGESELLSCHAFT (FED REP GERMANY AKTIENGESELLSCHAFT (JOINT STOCK COMPANY))
HATTENBERGSTRASSE 10
55122 MAINZ, FED REP GERMANY

FOR: CUSTOMIZED REFRIGERATOR SHELVES MADE OF GLASS; CUSTOMIZED FRONT PANELS MADE OF GLASS FOR REFRIGERATORS, BAKING OVENS AND MICROWAVE OVENS; COOKTOPS MADE OF GLASS FOR GAS COOKING APPLIANCES; CUSTOMIZED COVER PANELS MADE OF GLASS FOR COOKTOPS AND COOKING STOVES, IN CLASS 11 (U.S. CLS. 13, 21, 23, 31 AND 34).

FOR: FRONT PANELS MADE OF GLASS FOR KITCHEN FURNITURE, NAMELY, KITCHEN CABINETS; BUILT-IN SHELVES MADE OF GLASS FOR KITCHEN FURNITURE, NAMELY, KITCHEN CABINETS, IN CLASS 20 (U.S. CLS. 2, 13, 22, 25, 32 AND 50).

FOR: UNWORKED OR SEMI-WORKED GLASS FOR USE IN MANUFACTURE OF NON-BUILDING GOODS BEING MANUFACTURED; BAKE WARE, NAMELY, GLASS TRAYS FOR USE IN BAKING OVENS AND MICROWAVE OVENS, IN CLASS 21 (U.S. CLS. 2, 13, 23, 29, 30, 33, 40 AND 50).

THE MARK CONSISTS OF STANDARD CHARACTERS WITHOUT CLAIM TO ANY PARTICULAR FONT, STYLE, SIZE, OR COLOR.

PRIORITY DATE OF 10-12-2010 IS CLAIMED.

OWNER OF INTERNATIONAL REGISTRATION 1084169 DATED 3-24-2011, EXPIRES 3-24-2021.

OWNER OF U.S. REG. NOS. 370,164, 3,832,190 AND OTHERS.

NO CLAIM IS MADE TO THE EXCLUSIVE RIGHT TO USE "NANOTECH", APART FROM THE MARK AS SHOWN.

SEC. 2(F) AS TO "SCHOTT".

SER. NO. 79-100,007, FILED 3-24-2011.



David J. Kyffers

Director of the United States Patent and Trademark Office

Reg. No. 4,152,335 CORY BOONE, EXAMINING ATTORNEY

United States of America
United States Patent and Trademark Office

SKUDO

Reg. No. 4,152,336

Registered June 5, 2012

Int. Cls.: 6 and 7

TRADEMARK

PRINCIPAL REGISTER

SPECIAL SPRINGS S.R.L. (ITALY LIMITED LIABILITY COMPANY)
VIA BREGA, 216
I-36027 ROSA' (VICENZA)
ITALY

FOR: SPRINGS OF METAL, OTHER THAN FOR MACHINES, IN CLASS 6 (U.S. CLS. 2, 12, 13, 14, 23, 25 AND 50).

FOR: ELEMENTS FOR COVERING AND PROTECTING GAS CYLINDERS AS PARTS OF MACHINES, NAMELY, PROTECTIVE METAL CONTAINERS BEING PARTS OF GAS CYLINDER MACHINE PARTS; GAS CYLINDERS AS PARTS OF MACHINES; PUNCHING MACHINES, NAMELY, PUNCHING PRESSES; PUNCHES FOR PUNCHING MACHINES; SPRINGS AS PARTS OF MACHINES; RODS FOR CYLINDERS BEING PARTS OF MACHINES, IN CLASS 7 (U.S. CLS. 13, 19, 21, 23, 31, 34 AND 35).

THE MARK CONSISTS OF THE WORD "SKUDO" IN STYLIZED FONT.

PRIORITY DATE OF 12-14-2010 IS CLAIMED.

OWNER OF INTERNATIONAL REGISTRATION 1084213 DATED 4-27-2011, EXPIRES 4-27-2021.

THE WORDING "SKUDO" HAS NO MEANING IN A FOREIGN LANGUAGE.

SER. NO. 79-100,033, FILED 4-27-2011.

TINA BROWN, EXAMINING ATTORNEY



David J. Kyros

Director of the United States Patent and Trademark Office

United States of America
United States Patent and Trademark Office

UBS NEO

Reg. No. 4,152,337

Registered June 5, 2012

Int. Cl.: 36

SERVICE MARK

PRINCIPAL REGISTER

UBS AG (SWITZERLAND SOCIÉTÉ ANONYME)
BAHNHOFSTRASSE 45
CH-8001 ZÜRICH, SWITZERLAND

FOR: PROVIDING ONLINE SERVICES OF AN INVESTMENT BANK, NAMELY, PROVIDING INVESTMENT BANKING SERVICES VIA THE INTERNET, SIMILAR COMPUTER-BASED NETWORKS OR WIRELESS NETWORKS , IN CLASS 36 (U.S. CLS. 100, 101 AND 102).

THE MARK CONSISTS OF STANDARD CHARACTERS WITHOUT CLAIM TO ANY PARTICULAR FONT, STYLE, SIZE, OR COLOR.

PRIORITY DATE OF 5-20-2011 IS CLAIMED.

OWNER OF INTERNATIONAL REGISTRATION 1084352 DATED 6-24-2011, EXPIRES 6-24-2021.

OWNER OF U.S. REG. NOS. 3,398,810, 3,790,957 AND OTHERS.

NO CLAIM IS MADE TO THE EXCLUSIVE RIGHT TO USE "NEO", APART FROM THE MARK AS SHOWN.

SER. NO. 79-100,082, FILED 6-24-2011.

MAUREEN DALL, EXAMINING ATTORNEY



David J. Kybas

Director of the United States Patent and Trademark Office

United States of America

United States Patent and Trademark Office

THE BISCUIT READINGS

Reg. No. 4,152,338

Registered June 5, 2012

Int. Cl.: 41

SERVICE MARK

PRINCIPAL REGISTER

BARKING SPIDER VISUAL THEATRE INC (AUSTRALIA INCORPORATED ASSOCIATION)
PO BOX 357
CLIFTON HILL VIC 3068
AUSTRALIA

FOR: ENTERTAINMENT SERVICES IN THE NATURE OF THEATRICAL AND COMEDIC PERFORMANCES; LIVE ENTERTAINMENT SERVICES IN THE NATURE OF PERFORMANCES BY ACTORS AND COMEDIANS; ENTERTAINMENT SERVICES DELIVERED VIA ONLINE SOCIAL MEDIA NETWORKS IN THE NATURE OF PROVISION OF ONLINE THEATRICAL AND COMEDIC PERFORMANCES; IMPROVISED LIVE COMEDY PERFORMANCES; LIVE SATIRICAL THEATRICAL PERFORMANCES; INTERACTIVE, PARTICIPATORY THEATRICAL PERFORMANCES; SATIRICAL THEATRICAL PERFORMANCES DELIVERED VIA ONLINE SOCIAL MEDIA NETWORKS, IN CLASS 41 (U.S. CLS. 100, 101 AND 107).

THE MARK CONSISTS OF STANDARD CHARACTERS WITHOUT CLAIM TO ANY PARTICULAR FONT, STYLE, SIZE, OR COLOR.

PRIORITY DATE OF 3-9-2011 IS CLAIMED.

OWNER OF INTERNATIONAL REGISTRATION 1084481 DATED 6-27-2011, EXPIRES 6-27-2021.

NO CLAIM IS MADE TO THE EXCLUSIVE RIGHT TO USE "READINGS", APART FROM THE MARK AS SHOWN.

SER. NO. 79-100,142, FILED 6-27-2011.

KELLY TRUSILO, EXAMINING ATTORNEY



David J. Kybas

Director of the United States Patent and Trademark Office

United States of America

United States Patent and Trademark Office



Reg. No. 4,152,339

Registered June 5, 2012

Int. Cl.: 29

TRADEMARK

PRINCIPAL REGISTER

LACTALIS FORLASA, S.L.U. (SPAIN SOCIEDAD LIMITADA UNIPERSONAL)
AVDA. REYES CATÓLICOS, 135
E-02600 VILLARROBLEDO (ALBACETE)
SPAIN

FOR: MEAT, FISH, POULTRY AND GAME; MEAT EXTRACTS; PRESERVED, FROZEN, DRIED AND COOKED FRUITS AND VEGETABLES; JELLIES, JAMS, COMPOTES; EGGS, MILK AND MILK PRODUCTS, NAMELY, BUTTER; EDIBLE OILS AND FATS, CHEESE, IN CLASS 29 (U.S. CL. 46).

OWNER OF U.S. REG. NO. 2,745,702.

PRIORITY DATE OF 4-8-2011 IS CLAIMED.

OWNER OF INTERNATIONAL REGISTRATION 1084525 DATED 5-5-2011, EXPIRES 5-5-2021.

THE COLOR(S) RED, WHITE, BEIGE AND BROWN IS/ARE CLAIMED AS A FEATURE OF THE MARK.

THE MARK CONSISTS OF A RED BANNER WITH WHITE ACCENTS WITH THE WHITE WORDING "EL VENTERO" ACROSS IT. ABOVE THE WORDING IS A MAN THAT IS IN BEIGE AND BROWN WEARING A WHITE SHIRT AND A RED APRON, WHICH CONTAINS THE WHITE WORDING "EL VENTERO" ON IT. IN FRONT OF THE MAN ARE PIECES OF CHEESE IN BEIGE AND WHITE WITH BROWN SHADING UNDERNEATH. AROUND THE MAN IS A RED AND WHITE SCENE WITH A WINDMILL, HILLS AND TREES.

THE ENGLISH TRANSLATION OF "EL VENTERO" IN THE MARK IS THE INNKEEPER.

SER. NO. 79-100,162, FILED 5-5-2011.

JENNIFER VASQUEZ, EXAMINING ATTORNEY



David J. Kyros

Director of the United States Patent and Trademark Office

United States of America

United States Patent and Trademark Office



innosearch

Reg. No. 4,152,340

Registered June 5, 2012

Int. Cl.: 3

TRADEMARK

PRINCIPAL REGISTER

INNOSEARCH, S.L. (SPAIN SOCIEDAD LIMITADA)
RONDA CANIGÓ, AGRUPACIÓN 5, CASA 7
ESPLUGUES DE LLOBREGAT, SPAIN E08950

FOR: SOAPS FOR PERSONAL USE, PERFUMERY, ESSENTIAL OILS FOR USE ON THE BODY, COSMETICS, HAIR LOTIONS, DENTIFRICES, IN CLASS 3 (U.S. CLS. 1, 4, 6, 50, 51 AND 52).

OWNER OF U.S. REG. NOS. 3,373,326 AND 3,696,141.

OWNER OF INTERNATIONAL REGISTRATION 1084619 DATED 6-2-2011, EXPIRES 6-2-2021.

THE MARK CONSISTS OF THE STYLIZED WORDING "INNO" WITH THE LETTERS FORMED FROM CONNECTED CURVED LINES AND THE DOT IN THE LETTER -I- FORMED BY A INCOMPLETE CIRCLE. BENEATH THE DESIGN, THE WORDING " INNOSEARCH" APPEARS IN A STYLIZED FORM.

THE TERM "INNO" CAN BE TRANSLATED FROM LATIN AS "SWIM," "FLOAT," OR "SAIL " AND CAN ALSO BE TRANSLATED FROM ITALIAN AS "HYMN" OR "ANTHEM."

SER. NO. 79-100,199, FILED 6-2-2011.

MARILYN IZZI, EXAMINING ATTORNEY



David J. Kyros

Director of the United States Patent and Trademark Office

United States of America

United States Patent and Trademark Office

PTAH SOCAR

Reg. No. 4,152,341

Registered June 5, 2012

**Int. Cls.: 6, 7, 9, 11, 12,
13, 16, 17, 19, 37, 40, 41
and 42**

TRADEMARK

SERVICE MARK

PRINCIPAL REGISTER

MBDA FRANCE (FRANCE SOCIÉTÉ PAR ACTIONS SIMPLIFIÉE)
37 BOULEVARD MONTMORENCY
F-75116 PARIS
FRANCE

FOR: STRUCTURED COMPOSITE MATERIALS COMPOSED OF A METAL MATRIX FOR USE IN SATELLITES, ROCKETS AND APPARATUS FOR LOCOMOTION BY AIR, NAMELY, METAL ROCKET LAUNCHING PLATFORMS; CARBONACEOUS COMPOSITE MATERIALS COMPOSED OF A METAL MATRIX FOR USE IN PARTS TESTED UNDER FRICTION, NAMELY, CARBON STEELS, IN CLASS 6 (U.S. CLS. 2, 12, 13, 14, 23, 25 AND 50).

FOR: MACHINES AND LINE COMPOSED THEREOF FOR PRODUCTION OF TURBOJET PARTS, RAMJET ENGINE PARTS, PULSE JET PARTS AND ROCK-PROPELLED PARTS, PARTS FOR AFOREMENTIONED MACHINES, PARTICULARLY FOAMING LINES, DIE-CUTTING MACHINES, MOLDING PRESSES, SCORING MACHINES, LAMINATING MACHINES, WATER JET CUTTING MACHINES, MILLING MACHINES, LONG FIBER INJECTION MACHINES, PARTS FOR THE AFOREMENTIONED MACHINES, PARTICULARLY FOAMING TOOLS, DIE-CASTING TOOLS, DIE-CUTTING TOOLS AND LAMINATING TOOLS; ELECTRIC MOTORS FOR MACHINES AND ELECTRIC MOTORS AND THEIR PARTS, NOT FOR LAND VEHICLES, AND ENGINES NOT FOR LAND VEHICLES; GAS TURBINE ENGINES, NOT FOR LAND VEHICLES AND REPLACEMENT PARTS; ELECTROTHERMAL ENGINES, NOT FOR LAND VEHICLES; THERMAL ENGINES, NOT FOR LAND VEHICLES; JET ENGINES; ION, ELECTRIC AND PLASMA THRUSTERS FOR MACHINERY; PLASMA ETCHING MACHINES; THRUST REVERSERS FOR AIRCRAFT ENGINES; COMBUSTION ENGINE FUEL NOZZLES, IN CLASS 7 (U.S. CLS. 13, 19, 21, 23, 31, 34 AND 35).

FOR: SATELLITES; SPACE STATIONS, NAMELY, SATELLITES FOR SCIENTIFIC PURPOSES, IN CLASS 9 (U.S. CLS. 21, 23, 26, 36 AND 38).

FOR: INSTALLATIONS FOR HEATING AND COOKING, NAMELY, BOILERS FOR HEATING INSTALLATIONS; INSTALLATIONS FOR STEAM GENERATING; HEAT-TREATMENT FURNACES AND FURNACE HEARTHS; INCINERATORS, SPECIFICALLY GARBAGE INCINERATORS AND STRUCTURAL PARTS THEREOF; INTERMEDIATE TRAYS AND END BLOCKS FOR USE IN FURNACES, IN CLASS 11 (U.S. CLS. 13, 21, 23, 31 AND 34).

FOR: AIRCRAFT AND SPACECRAFT OF ALL KINDS, SPECIFICALLY SPACECRAFT MANNED AND UNMANNED; SPACE ROCKETS; SPACE SHUTTLES FOR USE IN SPACE,



David J. Kappas

Director of the United States Patent and Trademark Office

Reg. No. 4,152,341 SPECIFICALLY THOSE EQUIPPED WITH A HYPERSONIC MOTOR; BRAKES FOR AUTOMOBILES; ROLLING STOCK FOR RAILWAYS AND AIRCRAFT, SPECIFICALLY BRAKE DRUMS, BRAKE LININGS, BRAKE DISKS AND BRAKE BLOCKS; APPARATUS FOR LOCOMOTION BY AIR WITH A ROCKET MOTOR, NAMELY, AIRBORNE PLATFORMS FOR SERVING SPACECRAFT AND CONDUCTING SPACE APPLICATIONS AND STRUCTURAL FITTINGS FOR ALL OF THE AFOREMENTIONED GOODS, IN CLASS 12 (U.S. CLS. 19, 21, 23, 31, 35 AND 44).

FOR: MISSILES, NAMELY, BALLISTIC MISSILES, GUIDED MISSILES, IN CLASS 13 (U.S. CLS. 2 AND 9).

FOR: PRINTED MATTER NAMELY, PAPER SIGNS, BOOKS, MANUALS, CURRICULUM, NEWSLETTERS, INFORMATIONAL CARDS AND BROCHURES IN THE FIELD OF AIRCRAFT, SPACECRAFT, SPACE STATIONS, ROCKETS, RAMJETS AND SPACE LAUNCHERS, IN CLASS 16 (U.S. CLS. 2, 5, 22, 23, 29, 37, 38 AND 50).

FOR: STRUCTURED COMPOSITE MATERIALS COMPOSED OF A PLASTIC MATRIX FOR USE IN SATELLITES, ROCKETS AND APPARATUS FOR LOCOMOTION BY AIR, NAMELY, ADHESIVE PLASTIC FILM FOR INDUSTRIAL AND COMMERCIAL USE; CARBONACEOUS COMPOSITE MATERIALS COMPOSED OF A PLASTIC MATRIX FOR USED IN PARTS TESTED UNDER FRICTION, NAMELY, FIRE-RESISTANT COMPOSITE PANELS MADE OF ARAMID, GLASS, CARBON OR CERAMIC FIBERS; THERMAL PROTECTION SYSTEMS FOR PROTECTION AGAINST HEAT IN THE FORM OF SUPER STRUCTURES AND COVERING, NAMELY, THERMAL INSULATORS, IN CLASS 17 (U.S. CLS. 1, 5, 12, 13, 35 AND 50).

FOR: COMPOSITE MATERIALS WITH A CERAMIC MATRIX, NAMELY, BUILDING MATERIALS, NAMELY COMPOSITE PANELS PRIMARILY OF NON-METAL MATERIALS; REFRACTORY MATERIALS, NAMELY, REFRACTORY CONCRETE, REFRACTORY MORTARS AND REFRACTORY CONSTRUCTION MATERIALS, NOT MADE OF METAL, IN CLASS 19 (U.S. CLS. 1, 12, 33 AND 50).

FOR: CONSTRUCTION, REPAIR AND MAINTENANCE OF AIRCRAFT, SPACECRAFT, SPACE STATIONS, ROCKETS, RAMJETS, AND SPACE LAUNCHERS; CONSTRUCTION OF INDUSTRIAL BUILDINGS AND TEST STANDS FOR PROPULSION UNITS FOR ROCKET AND RAMJET ENGINES; REPAIR AND RECONDITIONING OF AERONAUTICAL ENGINES AND SPACE PROPULSION UNITS; REPAIR AND RECONDITIONING OF HOT SECTIONS OF FURNACES, HEATING ELEMENTS, COMBUSTION CHAMBERS, ROCKET CHAMBERS, THRUST NOZZLES AND AIR INLETS; REPAIR AND MAINTENANCE OF COMPONENTS TESTED UNDER FRICTION, NAMELY, BRAKE DRUMS, BRAKE LININGS, BRAKE DISKS AND BRAKE BLOCKS; PROVIDING INFORMATION CONCERNING CONSTRUCTION, REPAIR AND MAINTENANCE OF AIRCRAFT, SPACECRAFT, SPACE STATIONS, ROCKETS, RAMJETS AND SPACE LAUNCHERS, CONSTRUCTION OF INDUSTRIAL BUILDINGS AND TEST STANDS FOR PROPULSION UNITS FOR ROCKET ENGINES, IN CLASS 37 (U.S. CLS. 100, 103 AND 106).

FOR: TREATMENT OF MATERIALS BY LASER BEAM AND THERMAL PROCESSING; INCINERATION OF WASTE AND TRASH, NAMELY, WASTE PROCESSING; PHYSICO-CHEMICAL TREATMENT OR OPERATIONS FOR PROTECTIVE PURPOSES AGAINST OXIDIZATION OR CORROSION OF COMPOSITE MATERIALS MADE OF METAL, NAMELY TREATMENT OF METAL; PROVIDING INFORMATION CONCERNING TREATMENT OF MATERIAL BY LASER BEAM, INCINERATION OF WASTE AND TRASH, NAMELY WASTE PROCESSING AND PHYSICO-CHEMICAL TREATMENT OR OPERATIONS FOR PROTECTIVE PURPOSES AGAINST OXIDIZATION OR CORROSION OF COMPOSITE MATERIALS MADE OF METAL, NAMELY, TREATMENT OF METAL, IN CLASS 40 (U.S. CLS. 100, 103 AND 106).

Reg. No. 4,152,341 FOR: PROVIDING OF EDUCATION TRAINING IN THE FIELD OF AIRCRAFT, SPACECRAFT, SPACE STATIONS, ROCKETS, RAMJETS AND SPACE LAUNCHERS; PROVIDING SEMINARS IN THE FIELD OF COMPUTER EDUCATION TRAINING, AIRCRAFT, SPACECRAFT, SPACE STATIONS, ROCKET, RAMJETS AND SPACE LAUNCHERS, IN CLASS 41 (U.S. CLS. 100, 101 AND 107).

FOR: DRAFTING OF PLANS AND ENGINEERING DRAWINGS FOR OTHERS; DESIGN AND MAINTENANCE OF COMPUTER SOFTWARE AND COMPUTER PROGRAMS; ENGINEERING; CONSULTING SERVICES IN THE FIELD OF INDUSTRIAL ENGINEERING; MATERIAL TESTING; SCIENTIFIC LABORATORY SERVICES AND INDUSTRIAL RESEARCH IN THE FIELD OF AIRCRAFT, SPACECRAFT, SPACE STATIONS, ROCKETS, RAMJETS AND SPACE LAUNCHERS, IN CLASS 42 (U.S. CLS. 100 AND 101).

THE MARK CONSISTS OF STANDARD CHARACTERS WITHOUT CLAIM TO ANY PARTICULAR FONT, STYLE, SIZE, OR COLOR.

PRIORITY DATE OF 12-7-2010 IS CLAIMED.

OWNER OF INTERNATIONAL REGISTRATION 1084708 DATED 3-24-2011, EXPIRES 3-24-2021.

SER. NO. 79-100,223, FILED 3-24-2011.

SAMUEL E. SHARPER JR., EXAMINING ATTORNEY

United States of America
United States Patent and Trademark Office

EdelWasser

Reg. No. 4,152,342

Registered June 5, 2012

Int. Cl.: 11

TRADEMARK

PRINCIPAL REGISTER

FIELDPOINT B.V.
PAASHEUVELWEG 16
NL-1105 BH AMSTERDAM
NETHERLANDS

FOR: WATER FILTERS, IN CLASS 11 (U.S. CLS. 13, 21, 23, 31 AND 34).

THE MARK CONSISTS OF STANDARD CHARACTERS WITHOUT CLAIM TO ANY PARTICULAR FONT, STYLE, SIZE, OR COLOR.

PRIORITY DATE OF 4-27-2011 IS CLAIMED.

OWNER OF INTERNATIONAL REGISTRATION 1084754 DATED 5-20-2011, EXPIRES 5-20-2021.

THE NAME(S), PORTRAIT(S), AND/OR SIGNATURE(S) SHOWN IN THE MARK DOES NOT IDENTIFY A PARTICULAR LIVING INDIVIDUAL.

THE ENGLISH TRANSLATION OF THE WORD "EDELWASSER" IN THE MARK IS "NOBLE WATER".

SER. NO. 79-100,243, FILED 5-20-2011.

WARREN L. OLANDRIA, EXAMINING ATTORNEY



David J. Kyffers

Director of the United States Patent and Trademark Office

United States of America

United States Patent and Trademark Office

HIUT

Reg. No. 4,152,343

Registered June 5, 2012

Int. Cls.: 16, 18 and 25

TRADEMARK

PRINCIPAL REGISTER

HIUT LIMITED (UNITED KINGDOM LIMITED COMPANY)
THE CHICKEN SHED PARC Y PRATT FARM
CARDIGAN BAY
CARDIGAN, CEREDIGION SA43 3DR, UNITED KINGDOM

FOR: PRINTED MATTER, NAMELY, PRINTED AWARDS, PRINTED CALENDARS AND PRINTED CHARTS; PAPER, CARDBOARD AND GOODS MADE FROM THESE MATERIALS, NOT INCLUDED IN OTHER CLASSES, NAMELY, PAPER BOARD, PAPER AND CARDBOARD BOXES, CARDBOARD TUBES; SWING TAGS, NAMELY, PAPER AND PRICE TAGS; LABELS, NAMELY, PAPER LABELS AND ADHESIVE LABELS FOR AFFIXING TO CLOTHING; MAGAZINES IN THE FIELD OF FASHION, JEANS AND DENIM; PRINTED PERIODICALS IN THE FIELD OF FASHION, JEANS AND DENIM; NEWSPAPERS; POSTERS; ORGANIZERS; PHOTOGRAPHS; STATIONERY; GREETING CARDS; CALENDARS; PLASTIC BAGS AND PAPER BAGS, NAMELY, GENERAL PURPOSE PLASTIC AND PAPER BAGS FOR PACKING AND PACKAGING, IN CLASS 16 (U.S. CLS. 2, 5, 22, 23, 29, 37, 38 AND 50).

FOR: TRAVELLING BAGS; HANDBAGS; SPORTS BAGS; PURSES; WALLETS; ATTACHÉ, BUSINESS AND CARRYING CASES; ALL PURPOSE SPORT AND ALL PURPOSE CARRYING BAGS; HOLDALLS; RUCKSACKS; BELT BAGS; BRIEFCASES; SUITCASES; BRIEFCASE-TYPE PORTFOLIOS; CARDHOLDERS, NAMELY, CARD WALLETS, CREDIT CARD CASES AND BUSINESSES CARD CASES; DRAWSTRING, JEWELLERY AND LEATHER POUCHES; GOODS MADE OF LEATHER AND IMITATIONS OF LEATHER NOT INCLUDED IN OTHER CLASSES, NAMELY, BRIEFCASES, KEYCHAINS, AND LEASHES, LEATHER STRAPS, BACKPACK STRAPS, BANDS OF LEATHER; TRUNKS AND UMBRELLAS; WALKING STICKS; WHIPS; HARNESES AND SADDLERY; BAGS MADE FROM DENIM, NAMELY, HANDBAGS, PURSES AND SHOPPING BAGS; WALLETS; FABRIC BAGS, NAMELY, HANDBAGS, CANVAS SHOPPING BAGS, SCHOOL BAGS, IN CLASS 18 (U.S. CLS. 1, 2, 3, 22 AND 41).

FOR: ARTICLES OF CLOTHING, NAMELY, PANTS, JEANS, SHORTS, OVERALLS, SHIRTS, T-SHIRTS, BLOUSES, VESTS, SKIRTS, JACKETS, COATS, SPORTCOATS, SWEATERS, SWEATSHIRTS, SWEATPANTS, HATS, TIES, BELTS, SOCKS, UNDERWEAR AND CARDIGANS; ARTICLES OF CLOTHING MADE OF DENIM, NAMELY, JEANS, SKIRTS, DRESSES AND JACKETS; CAPS; RAINWEAR; TRACK SUITS; COATS; NECKWEAR; SCARVES; GLOVES; BRACES; BOOTS; SHOES; FOOTWEAR FOR SPORTS, IN CLASS 25 (U.S. CLS. 22 AND 39).



David J. Kappas

Director of the United States Patent and Trademark Office

Reg. No. 4,152,343 THE MARK CONSISTS OF STANDARD CHARACTERS WITHOUT CLAIM TO ANY PARTICULAR FONT, STYLE, SIZE, OR COLOR.

OWNER OF INTERNATIONAL REGISTRATION 1084843 DATED 5-10-2011, EXPIRES 5-10-2021.

THE WORDING "HIUT" HAS NO MEANING IN A FOREIGN LANGUAGE.

SER. NO. 79-100,276, FILED 5-10-2011.

TINA BROWN, EXAMINING ATTORNEY

United States of America
United States Patent and Trademark Office

CoreIT

Reg. No. 4,152,344

Registered June 5, 2012

Int. Cl.: 10

TRADEMARK

PRINCIPAL REGISTER

SSB TECHNOLOGY PTY LTD (AUSTRALIA PROPRIETARY COMPANY)
CARIBBEAN BUSINESS PARK
1 DALMORE DRIVE
SCORESBY VIC 3179, AUSTRALIA

FOR: DISPOSABLE SYRINGES; HYPODERMIC SYRINGES; MEDICAL SYRINGES; INJECTION SYRINGES FOR MEDICAL PURPOSES; DISPOSABLE HYPODERMIC SYRINGES FOR MEDICAL USE, DISPOSABLE NEEDLES FOR HYPODERMIC SYRINGES; MEDICAL SYRINGE NEEDLES; MEDICINAL INJECTION SYRINGES; PUSH SYRINGES FOR MEDICAL USE; SYRINGES FOR INJECTIONS, IN CLASS 10 (U.S. CLS. 26, 39 AND 44).

THE MARK CONSISTS OF STANDARD CHARACTERS WITHOUT CLAIM TO ANY PARTICULAR FONT, STYLE, SIZE, OR COLOR.

PRIORITY DATE OF 11-4-2010 IS CLAIMED.

OWNER OF INTERNATIONAL REGISTRATION 1085086 DATED 5-4-2011, EXPIRES 5-4-2021.

THE WORD(S) "COREIT" HAS NO MEANING IN A FOREIGN LANGUAGE.

SER. NO. 79-100,413, FILED 5-4-2011.

TEJBIR SINGH, EXAMINING ATTORNEY



David J. Kybas

Director of the United States Patent and Trademark Office

United States of America

United States Patent and Trademark Office

John Laing

Reg. No. 4,152,345

Registered June 5, 2012

Int. Cl.: 25

DAWSON INTERNATIONAL HOLDINGS (UK) LIMITED (UNITED KINGDOM LIMITED COMPANY)
BURNFOOT INDUSTRIAL ESTATE
HAWICK SCOTLAND TD9 8RJ
UNITED KINGDOM

TRADEMARK

FOR: KNITTED ARTICLES OF CLOTHING, NAMELY SWEATERS, CARDIGANS, PULLOVERS, JUMPERS, WAISTCOATS, VESTS, SOCKS, GLOVES, HATS AND SCARVES, ALL FOR MEN, WOMEN AND CHILDREN, IN CLASS 25 (U.S. CLS. 22 AND 39).

PRINCIPAL REGISTER

THE NAME(S), PORTRAIT(S), AND/OR SIGNATURE(S) SHOWN IN THE MARK DOES NOT IDENTIFY A PARTICULAR LIVING INDIVIDUAL.

OWNER OF INTERNATIONAL REGISTRATION 1085275 DATED 5-25-2011, EXPIRES 5-25-2021.

THE MARK CONSISTS OF THE NAME "JOHN LAING" IN A STYLIZED CURSIVE FONT.

SER. NO. 79-100,478, FILED 5-25-2011.

PAULA MAHONEY, EXAMINING ATTORNEY



David J. Kyffers

Director of the United States Patent and Trademark Office

United States of America
United States Patent and Trademark Office

STAID

Reg. No. 4,152,346

Registered June 5, 2012

Int. Cls.: 7 and 10

TRADEMARK

PRINCIPAL REGISTER

VENTRADE B.V. (NETHERLANDS BESLOTEN VENNOOTSCHAP)
KOPERSTEDEN 24-1
NL-7547 TK ENSCHEDE
NETHERLANDS

FOR: ELEVATORS FOR MOVING AND LIFTING ELDERLY PEOPLE, IN CLASS 7 (U.S. CLS. 13, 19, 21, 23, 31, 34 AND 35).

FOR: MEDICAL APPARATUS, NAMELY, INVALID LIFT FOR LIFTING AND MOVING PATIENTS AND DISABLED PEOPLE, IN CLASS 10 (U.S. CLS. 26, 39 AND 44).

THE MARK CONSISTS OF STANDARD CHARACTERS WITHOUT CLAIM TO ANY PARTICULAR FONT, STYLE, SIZE, OR COLOR.

OWNER OF INTERNATIONAL REGISTRATION 1085304 DATED 6-16-2011, EXPIRES 6-16-2021.

SER. NO. 79-100,486, FILED 6-16-2011.

SHARON MEIER, EXAMINING ATTORNEY



David J. Kybas

Director of the United States Patent and Trademark Office

United States of America

United States Patent and Trademark Office

AURI

Reg. No. 4,152,347

SJØTROLL HAVBRUK AS C/O SJØTROLL AS (NORWAY LIMITED STOCK COMPANY)
N-5397 BEKKJARVIK
NORWAY

Registered June 5, 2012

Int. Cls.: 29, 31 and 42

FOR: FISH AND FISH PRODUCTS, NAMELY, FRESH FISH, FROZEN FISH, SMOKED FISH AND FISH PRESERVES, IN CLASS 29 (U.S. CL. 46).

TRADEMARK

FOR: LIVE FISH, IN CLASS 31 (U.S. CLS. 1 AND 46).

SERVICE MARK

FOR: RESEARCH AND DEVELOPMENT OF PROCESSING METHODS FOR FISH AND FISH PRODUCTS, IN CLASS 42 (U.S. CLS. 100 AND 101).

PRINCIPAL REGISTER

THE MARK CONSISTS OF STANDARD CHARACTERS WITHOUT CLAIM TO ANY PARTICULAR FONT, STYLE, SIZE, OR COLOR.

OWNER OF INTERNATIONAL REGISTRATION 1085350 DATED 5-25-2011, EXPIRES 5-25-2021.

THE WORDING "AURI" HAS NO MEANING IN A FOREIGN LANGUAGE.

SER. NO. 79-100,500, FILED 5-25-2011.

TINA MAI, EXAMINING ATTORNEY



David J. Kybas

Director of the United States Patent and Trademark Office

United States of America

United States Patent and Trademark Office

ADAKVEO

Reg. No. 4,152,348

Registered June 5, 2012

Int. Cl.: 5

TRADEMARK

PRINCIPAL REGISTER

NOVARTIS AG (SWITZERLAND SOCIÉTÉ ANONYME (SA))
CH-4002 BASEL
SWITZERLAND

FOR: ANTI-INFLAMMATORIES; ANTIBACTERIAL PHARMACEUTICALS; ANTIBIOTICS; ANTIFUNGAL PREPARATIONS; ANTIVIRALS; CARDIOVASCULAR PHARMACEUTICALS; PHARMACEUTICAL PREPARATIONS ACTING ON THE CENTRAL NERVOUS SYSTEM; PHARMACEUTICAL PREPARATIONS AND SUBSTANCES FOR THE TREATMENT OF GASTRO-INTESTINAL DISEASES; PHARMACEUTICAL PREPARATIONS FOR THE TREATMENT AND PREVENTION OF DISEASES AND DISORDERS OF THE AUTOIMMUNE SYSTEM, THE METABOLIC SYSTEM, THE MUSCULO-SKELETAL SYSTEM AND THE GENITOURINARY SYSTEM; PHARMACEUTICAL PREPARATIONS FOR USE IN HEMATOLOGY AND IN TISSUE AND ORGAN TRANSPLANTATION; PHARMACEUTICAL PREPARATIONS FOR THE TREATMENT OF EYE DISEASES AND CONDITIONS; PHARMACEUTICAL PREPARATIONS FOR THE TREATMENT OF HEART RHYTHM DISORDERS; PHARMACEUTICAL PREPARATIONS FOR THE TREATMENT OF IMMUNE SYSTEM RELATED DISEASES AND DISORDERS; PHARMACEUTICAL PREPARATIONS FOR THE TREATMENT OF KIDNEY DISEASES; PHARMACEUTICAL PREPARATIONS FOR TREATING DIABETES; PHARMACEUTICAL PREPARATIONS FOR USE IN DERMATOLOGY; PHARMACEUTICAL PRODUCTS FOR OPHTHALMOLOGICAL USE; PHARMACEUTICAL PRODUCTS FOR THE PREVENTION AND TREATMENT OF CANCER; PHARMACEUTICAL PRODUCTS FOR THE TREATMENT OF BONE DISEASES; PHARMACEUTICAL PRODUCTS FOR TREATING RESPIRATORY DISEASES; PHARMACEUTICAL PRODUCTS FOR TREATING RESPIRATORY DISEASES AND ASTHMA; PHARMACEUTICALS, NAMELY, ANTI-INFECTIVES; VACCINES; DIAGNOSTIC PREPARATIONS FOR MEDICAL USE, IN CLASS 5 (U.S. CLS. 6, 18, 44, 46, 51 AND 52).



THE MARK CONSISTS OF STANDARD CHARACTERS WITHOUT CLAIM TO ANY PARTICULAR FONT, STYLE, SIZE, OR COLOR.

PRIORITY DATE OF 7-1-2011 IS CLAIMED.

OWNER OF INTERNATIONAL REGISTRATION 1085446 DATED 7-8-2011, EXPIRES 7-8-2021.

THE WORDING "ADAKVEO" HAS NO MEANING IN A FOREIGN LANGUAGE.

David J. Kybas

Director of the United States Patent and Trademark Office

Reg. No. 4,152,348 SER. NO. 79-100,532, FILED 7-8-2011.

ESTHER A. BORSUK, EXAMINING ATTORNEY

United States of America

United States Patent and Trademark Office

GESAT

Reg. No. 4,152,349

Registered June 5, 2012

Int. Cl.: 38

GESAT GESELLSCHAFT FÜR SOFTWARE, AUTOMATISIERUNG + TECHNIK MBH (FED REP GERMANY LIMITED LIABILITY COMPANY)
HANAUER LANDSTRABE 121A
60314 FRANKFURT/MAIN
FED REP GERMANY

SERVICE MARK

PRINCIPAL REGISTER

FOR: TELECOMMUNICATION ACCESS SERVICES; TELECOMMUNICATIONS CONSULTATION; TELECOMMUNICATION SERVICES, NAMELY, LOCAL AND LONG DISTANCE TRANSMISSION OF VOICE, AUDIO, DATA, GRAPHICS, VIDEO BY MEANS OF TELEPHONE, TELEGRAPHIC, CABLE, AND SATELLITE TRANSMISSIONS; TELECOMMUNICATIONS, NAMELY, SATELLITE TRANSMISSION SERVICES, SATELLITE COMMUNICATION SERVICES, PROVIDING USER ACCESS TO A GLOBAL COMPUTER NETWORK, PROVIDING TELECOMMUNICATIONS CONNECTIONS TO A GLOBAL COMPUTER NETWORK, PROVIDING USER ACCESS TO COMPUTER PROGRAMS ON DATA NETWORKS, PROVIDING USER ACCESS TO INFORMATION ON THE INTERNET, ELECTRONIC MAIL, COMMUNICATION BY FIBER OPTIC NETWORKS, TELECOMMUNICATIONS ROUTING AND JUNCTION SERVICES, PROVIDING ACCESS TO DATABASES, IN CLASS 38 (U.S. CLS. 100, 101 AND 104).

THE MARK CONSISTS OF STANDARD CHARACTERS WITHOUT CLAIM TO ANY PARTICULAR FONT, STYLE, SIZE, OR COLOR.

PRIORITY DATE OF 12-17-2010 IS CLAIMED.

OWNER OF INTERNATIONAL REGISTRATION 1085508 DATED 6-15-2011, EXPIRES 6-15-2021.

THE WORDING "GESAT" HAS NO MEANING IN A FOREIGN LANGUAGE.

SER. NO. 79-100,555, FILED 6-15-2011.

KIM SAITO, EXAMINING ATTORNEY



David J. Kyffers

Director of the United States Patent and Trademark Office

United States of America

United States Patent and Trademark Office



Reg. No. 4,152,350

Registered June 5, 2012

Int. Cls.: 9, 12 and 38

TRADEMARK

SERVICE MARK

PRINCIPAL REGISTER

FIAT GROUP AUTOMOBILES S.P.A. (ITALY CORPORATION)
CORSO GIOVANNI AGNELLI, 200
I-10135 TORINO
ITALY

FOR: ELECTRONIC DEVICES, NAMELY, RADIOS AND RADIO TRANSMITTERS, AMPLIFIER FOR WIRELESS COMMUNICATION; APPARATUS FOR RECORDING, TRANSMISSION AND REPRODUCTION OF SOUND; APPARATUS FOR WIRELESS TRANSMISSION OF DATA, NAMELY, COMPUTER ROUTERS; AUDIO EQUIPMENT FOR VEHICLES, NAMELY, SUBWOOFERS, LOUD SPEAKERS AND CD PLAYERS; TELEPHONE TRANSMITTERS, ELECTRONIC TELEPHONY APPARATUS, NAMELY, RESISTORS; NAVIGATION DEVICE FOR MOTOR LAND VEHICLES, HANDS-FREE DEVICES FOR MOBILE-PHONE, ELECTRONIC APPARATUS FOR HANDLING AUDIO, VIDEO AND DATA, NAMELY, AUDIO MIXERS AND COMPUTERS; SURROUND SOUND SYSTEMS, IN CLASS 9 (U.S. CLS. 21, 23, 26, 36 AND 38).

FOR: MOTORIZED LAND VEHICLES, IN CLASS 12 (U.S. CLS. 19, 21, 23, 31, 35 AND 44).

FOR: CELLULAR TELEPHONE COMMUNICATION; COMMUNICATIONS BY COMPUTER TERMINALS; COMMUNICATIONS BY TELEPHONE AND ELECTRONIC COMPUTER TERMINALS; COMPUTER AIDED TRANSMISSION OF MESSAGES AND IMAGES; ELECTRONIC MAIL; ELECTRONIC MESSAGE SENDING, PROVIDING ACCESS TO DATABASES, PAGING SERVICES BY RADIO, TELEPHONE OR OTHER MEANS OF ELECTRONIC COMMUNICATION; PROVIDING TELECOMMUNICATIONS CONNECTIONS TO A GLOBAL COMPUTER NETWORK; SATELLITE TRANSMISSION, IN CLASS 38 (U.S. CLS. 100, 101 AND 104).

THE MARK CONSISTS OF A DESIGN OF A SILHOUETTE OF A MAN WITH CONCENTRIC OVALS RADIATING FROM HIS HEAD.

OWNER OF INTERNATIONAL REGISTRATION 0886868 DATED 3-29-2006, EXPIRES 3-29-2016.

SER. NO. 79-100,571, FILED 6-17-2010.

FRED CARL, EXAMINING ATTORNEY



David J. Kybas

Director of the United States Patent and Trademark Office

United States of America

United States Patent and Trademark Office

BLUE&ME

Reg. No. 4,152,351

Registered June 5, 2012

Int. Cls.: 9, 12 and 38

TRADEMARK

SERVICE MARK

PRINCIPAL REGISTER

FIAT GROUP AUTOMOBILES S.P.A. (ITALY CORPORATION)
CORSO GIOVANNI AGNELLI, 200
I-10135 TORINO, ITALY

FOR: ELECTRONIC DEVICES, NAMELY, RADIOS AND RADIO TRANSMITTERS, AMPLIFIER FOR WIRELESS COMMUNICATION; APPARATUS FOR RECORDING, TRANSMISSION AND REPRODUCTION OF SOUND; APPARATUS FOR WIRELESS TRANSMISSION OF DATA, NAMELY, COMPUTER ROUTERS; AUDIO EQUIPMENT FOR VEHICLES, NAMELY, SUBWOOFERS, LOUD SPEAKERS AND CD PLAYERS; TELEPHONE TRANSMITTERS, ELECTRONIC TELEPHONY APPARATUS, NAMELY, RESISTORS; NAVIGATION DEVICE FOR MOTOR LAND VEHICLES, HANDS-FREE DEVICES FOR MOBILE-PHONE, ELECTRONIC APPARATUS FOR HANDLING AUDIO, VIDEO AND DATA, NAMELY, AUDIO MIXERS AND COMPUTERS; SURROUND SOUND SYSTEMS, IN CLASS 9 (U.S. CLS. 21, 23, 26, 36 AND 38).

FOR: MOTORIZED LAND VEHICLES, IN CLASS 12 (U.S. CLS. 19, 21, 23, 31, 35 AND 44).

FOR: CELLULAR TELEPHONE COMMUNICATION; COMMUNICATIONS BY COMPUTER TERMINALS; COMMUNICATIONS BY TELEPHONE AND ELECTRONIC COMPUTER TERMINALS; COMPUTER AIDED TRANSMISSION OF MESSAGES AND IMAGES; ELECTRONIC MAIL; ELECTRONIC MESSAGE SENDING, PROVIDING ACCESS TO DATABASES; PAGING SERVICES BY RADIO, TELEPHONE OR OTHER MEANS OF ELECTRONIC COMMUNICATION; PROVIDING TELECOMMUNICATIONS CONNECTIONS TO A GLOBAL COMPUTER NETWORK, SATELLITE TRANSMISSION, IN CLASS 38 (U.S. CLS. 100, 101 AND 104).

THE MARK CONSISTS OF STANDARD CHARACTERS WITHOUT CLAIM TO ANY PARTICULAR FONT, STYLE, SIZE, OR COLOR.

OWNER OF INTERNATIONAL REGISTRATION 0901040 DATED 8-21-2006, EXPIRES 8-21-2016.

SER. NO. 79-100,572, FILED 6-17-2010.

FRED CARL, EXAMINING ATTORNEY



David J. Kyros

Director of the United States Patent and Trademark Office

United States of America
United States Patent and Trademark Office

Yaler

Reg. No. 4,152,352

Registered June 5, 2012

Int. Cl.: 9

TRADEMARK

PRINCIPAL REGISTER

YALER GMBH (SWITZERLAND LIMITED LIABILITY COMPANY)
TECHNOPARKSTRASSE 1
CH-8005 ZÜRICH
SWITZERLAND

FOR: COMPUTER OPERATING PROGRAMS, NAMELY, COMPUTER SOFTWARE WHICH ENABLES THE USER TO REMOTELY ACCESS, MONITOR, CONTROL AND MANAGE THROUGH THE INTERNET OTHER COMPUTER APPLICATIONS EMBEDDED IN COMPUTERIZED DEVICES, IN CLASS 9 (U.S. CLS. 21, 23, 26, 36 AND 38).

THE MARK CONSISTS OF STANDARD CHARACTERS WITHOUT CLAIM TO ANY PARTICULAR FONT, STYLE, SIZE, OR COLOR.

OWNER OF INTERNATIONAL REGISTRATION 1085720 DATED 7-6-2011, EXPIRES 7-6-2021.

THE WORDING "YALER" HAS NO MEANING IN A FOREIGN LANGUAGE.

SER. NO. 79-100,669, FILED 7-6-2011.

STEVEN PEREZ, EXAMINING ATTORNEY



David J. Kyffers

Director of the United States Patent and Trademark Office

United States of America

United States Patent and Trademark Office



Reg. No. 4,152,353

Registered June 5, 2012

Int. Cl.: 28

TRADEMARK

PRINCIPAL REGISTER

GUANGDONG JIADA ELECTRONIC TECHNOLOGY HOLDING CO., LTD. (CHINA CORPORATION)
NO. 2, ROAD 2
SOUTH OF WAIPU INDUSTRIAL ZONE FENGXIANG, CHENGHAI DISTRICT
SHANTOU CITY, CHINA

FOR: TOYS, NAMELY, TOY AIRPLANES, TOY ANIMALS, TOY BAKEWARE AND COOKWARE, TOY BOXES, TOY BUILDING BLOCKS, TOY MODEL CARS AND TOY PISTOLS; SCALE MODEL VEHICLES; TOY VEHICLES; INTELLIGENT TOYS, NAMELY, TOY ROBOTS, TRANSFORMING ROBOTIC TOY VEHICLES AND TRANSFORMING ROBOTIC TOYS; TOY AIR PISTOLS; TOY CAMERAS; BUILDING GAMES; TOYS FOR HOUSEHOLD PETS; TOY SLIDING APPARATUS, NAMELY, MODULAR PLAY CENTERS CONSISTING OF PANELS, DECKS, PLATFORMS, HANDRAILS, SLIDES, AND STEPS ALL SOLD SEPARATELY OR IN SELECTED COMBINATIONS AND WATER SLIDES, IN CLASS 28 (U.S. CLS. 22, 23, 38 AND 50).

THE MARK CONSISTS OF THE STYLIZED WORDING "JIADA" AND A DESIGN ELEMENT ABOVE THE WORDING OF TWO SIDE-BY-SIDE GLOBES WITH MERIDIANS AND PARALLELS ONLY ON SQUARE BACKGROUNDS.

OWNER OF INTERNATIONAL REGISTRATION 1086001 DATED 6-1-2011, EXPIRES 6-1-2021.

THE WORDING "JIADA" HAS NO MEANING IN A FOREIGN LANGUAGE.

SER. NO. 79-100,763, FILED 6-1-2011.

GINA FINK, EXAMINING ATTORNEY



David J. Kybas

Director of the United States Patent and Trademark Office

United States of America

United States Patent and Trademark Office

F-PAC

Reg. No. 4,152,354

Registered June 5, 2012

Int. Cl.: 18

TRADEMARK

PRINCIPAL REGISTER

ALAN WAYNE STRANG (AUSTRALIA INDIVIDUAL)
271 CLIVEDEN AVENUE
OXLEY QLD 4075, AUSTRALIA

FOR: SPORTS PACKS FOR SPORTING ARTICLES, NOT FITTED OR SHAPED ; ATTACHE CASES; CASES OF LEATHER OR LEATHERBOARD; TRAVELLING CASES, IN CLASS 18 (U.S. CLS. 1, 2, 3, 22 AND 41).

THE MARK CONSISTS OF STANDARD CHARACTERS WITHOUT CLAIM TO ANY PARTICULAR FONT, STYLE, SIZE, OR COLOR.

OWNER OF INTERNATIONAL REGISTRATION 1086034 DATED 6-20-2011, EXPIRES 6-20-2021.

SER. NO. 79-100,775, FILED 6-20-2011.

ANTHONY RINKER, EXAMINING ATTORNEY



David J. Kybas

Director of the United States Patent and Trademark Office

United States of America

United States Patent and Trademark Office

LATIOHM

Reg. No. 4,152,355

Registered June 5, 2012

Int. Cls.: 1 and 17

TRADEMARK

PRINCIPAL REGISTER

LATI INDUSTRIA TERMOPLASTICI S.P.A. (ITALY JOINT STOCK COMPANY)
VIA F. BARACCA 7
I-21040 VEDANO OLONA (VA)
ITALY

FOR: UNPROCESSED POLYMERS FOR USE IN INDUSTRIAL MANUFACTURING, IN CLASS 1 (U.S. CLS. 1, 5, 6, 10, 26 AND 46).

FOR: PLASTIC IN EXTRUDED FORM FOR USE IN MANUFACTURE; SEMI-PROCESSED PLASTIC SUBSTANCES IN THE FORM OF PELLETS FOR USE IN INJECTION MOULDING APPLICATIONS, IN CLASS 17 (U.S. CLS. 1, 5, 12, 13, 35 AND 50).

THE MARK CONSISTS OF STANDARD CHARACTERS WITHOUT CLAIM TO ANY PARTICULAR FONT, STYLE, SIZE, OR COLOR.

OWNER OF INTERNATIONAL REGISTRATION 0850422 DATED 9-23-2004, EXPIRES 9-23-2014.

SER. NO. 79-100,846, FILED 5-31-2011.

CHRISIE B. KING, EXAMINING ATTORNEY



David J. Kybas

Director of the United States Patent and Trademark Office

United States of America

United States Patent and Trademark Office

LATILUB

Reg. No. 4,152,356

Registered June 5, 2012

Int. Cls.: 1 and 17

TRADEMARK

PRINCIPAL REGISTER

LATI INDUSTRIA TERMOPLASTICI S.P.A. (ITALY JOINT STOCK COMPANY)
VIA F. BARACCA 7
I-21040 VEDANO OLONA (VA)
ITALY

FOR: UNPROCESSED POLYMERS FOR USE IN INDUSTRIAL MANUFACTURING, IN CLASS 1 (U.S. CLS. 1, 5, 6, 10, 26 AND 46).

FOR: PLASTIC IN EXTRUDED FORM FOR USE IN MANUFACTURE; SEMI-PROCESSED PLASTIC SUBSTANCES IN THE FORM OF PELLETS FOR USE IN INJECTION MOULDING APPLICATIONS, IN CLASS 17 (U.S. CLS. 1, 5, 12, 13, 35 AND 50).

THE MARK CONSISTS OF STANDARD CHARACTERS WITHOUT CLAIM TO ANY PARTICULAR FONT, STYLE, SIZE, OR COLOR.

OWNER OF INTERNATIONAL REGISTRATION 0850424 DATED 9-23-2004, EXPIRES 9-23-2014.

SER. NO. 79-100,847, FILED 5-31-2011.

CHRISIE B. KING, EXAMINING ATTORNEY



David J. Kybas

Director of the United States Patent and Trademark Office

United States of America

United States Patent and Trademark Office

QuickStep

Reg. No. 4,152,357

Registered June 5, 2012

Int. Cl.: 9

TRADEMARK

PRINCIPAL REGISTER

DOMINO PRINTING SCIENCES PLC (UNITED KINGDOM PUBLIC LIMITED COMPANY)
TRAFALGAR WAY, BAR HILL
CAMBRIDGE,; CAMBRIDGESHIRE CB23 8TU
UNITED KINGDOM

FOR: INK-JET PRINTERS; INK-JET PRINTING APPARATUS; ELECTRONIC CONTROLLERS AND SOFTWARE FOR USE WITH INK-JET PRINTERS; PRINTERS; PRINT HEADS FOR INK-JET PRINTERS; ELECTRICAL AND ELECTRONIC CONTROL APPARATUS FOR PRINTERS; INK-JET MARKING APPARATUS; LASER MARKING APPARATUS; ELECTRONIC CONTROL APPARATUS FOR PRINTERS; COMPUTER SOFTWARE FOR USE IN CONFIGURING AND CONTROLLING THE OPERATION OF PRINTERS, LABELLING APPARATUS, CODING APPARATUS AND MARKING APPARATUS; BAR CODE PRINTERS; COMPUTER PROGRAMS FOR PRINTERS; CONTROLLING SOFTWARE FOR PRINTERS; LASER PRINTERS; LINE PRINTERS; OPTICAL PRINTERS; PAPER FEED APPARATUS FOR USE WITH PRINTERS; SOFTWARE FOR PROGRAMMING FORMS FOR LASER PRINTERS; EMPTY INK CARTRIDGES FOR INK-JET PRINTERS; THERMAL PRINTERS; EMPTY TONER CARTRIDGES FOR PRINTERS; ELECTRONIC CODING UNITS; ELECTRIC APPARATUS FOR INK-JET CODING; MECHANIZED CODING APPARATUS; TIME CODING APPARATUS; THERMAL IMAGE TRANSFER DEVICES; APPARATUS FOR CHECKING THE TENSIONS OF INK-LEVEL STRIPS; METERS FOR CHECKING INK CONSUMPTION; PLOTTERS EMPLOYING INK-JET TECHNOLOGY; APPARATUS FOR DATA COMMUNICATION BETWEEN LASER COPYING MACHINES; LASER BEAM PRINTERS; LASER PRINTER CONTROLLERS; PHOTO-TYPE SETTING APPARATUS UTILIZING LASER BEAMS; PARTS AND FITTINGS FOR THE AFORESAID GOODS, IN CLASS 9 (U.S. CLS. 21, 23, 26, 36 AND 38).



THE MARK CONSISTS OF STANDARD CHARACTERS WITHOUT CLAIM TO ANY PARTICULAR FONT, STYLE, SIZE, OR COLOR.

PRIORITY DATE OF 2-28-2011 IS CLAIMED.

OWNER OF INTERNATIONAL REGISTRATION 1086711 DATED 6-27-2011, EXPIRES 6-27-2021.

SER. NO. 79-101,030, FILED 6-27-2011.

KELLY TRUSILO, EXAMINING ATTORNEY

David J. Kyros

Director of the United States Patent and Trademark Office

United States of America

United States Patent and Trademark Office

Blue Pirogue

Reg. No. 4,152,358

Registered June 5, 2012

Int. Cl.: 29

TRADEMARK

PRINCIPAL REGISTER

RACINES SA (FRANCE SOCIETE ANONYME)
PARC SCIENTIFIQUE AGROPOLIS II
BAT. 5, BLD DE LA LIRONDE, MONTFERRIER SUR LEZ
F-34980 ST GELY DU FESC, FRANCE

FOR: FISH, NAMELY, PRESERVED, DRIED, COOKED AND SALTED FISH, IN CLASS 29
(U.S. CL. 46).

THE MARK CONSISTS OF STANDARD CHARACTERS WITHOUT CLAIM TO ANY PARTICULAR FONT, STYLE, SIZE, OR COLOR.

PRIORITY DATE OF 3-11-2011 IS CLAIMED.

OWNER OF INTERNATIONAL REGISTRATION 1086758 DATED 7-8-2011, EXPIRES 7-8-2021.

THE ENGLISH TRANSLATION OF "PIROGUE" IN THE MARK IS "CANOE" OR "DUGOUT".

SER. NO. 79-101,045, FILED 7-8-2011.

JACLYN KIDWELL WALKER, EXAMINING ATTORNEY



David J. Kybas

Director of the United States Patent and Trademark Office

United States of America

United States Patent and Trademark Office

CoffeeWell

Reg. No. 4,152,359

Registered June 5, 2012

Int. Cls.: 5 and 30

TRADEMARK

PRINCIPAL REGISTER

UNGERSTEDT, JOHAN (SWEDEN INDIVIDUAL)
KOTTGATAN 213
SE-122 64 ENSKEDE, SWEDEN AND

PALMQVIST, LARS (SWEDEN INDIVIDUAL)
TUSSMÖTEVÄGEN 222
SE-122 64 ENSKEDE, SWEDEN

FOR: DIETETIC FOODS, DIETETIC FOOD SUPPLEMENTS, AND NUTRITIONAL ADDITIVES FOR USE IN FOODS AND DIETARY SUPPLEMENTS FOR HUMAN CONSUMPTION, ALL FOR MEDICAL PURPOSES AND ALL CONTAINING COFFEE OR COFFEE EXTRACTS, IN CLASS 5 (U.S. CLS. 6, 18, 44, 46, 51 AND 52).

FOR: COFFEE, ARTIFICIAL COFFEE; COFFEE EXTRACTS AND ESSENCES; COFFEE-BASED BEVERAGES; COFFEE BEVERAGES WITH MILK; COFFEE FLAVORINGS; CHOCOLATE-BASED DRINKS, IN CLASS 30 (U.S. CL. 46).

THE MARK CONSISTS OF STANDARD CHARACTERS WITHOUT CLAIM TO ANY PARTICULAR FONT, STYLE, SIZE, OR COLOR.

PRIORITY DATE OF 12-21-2010 IS CLAIMED.

OWNER OF INTERNATIONAL REGISTRATION 1086794 DATED 5-16-2011, EXPIRES 5-16-2021.

SER. NO. 79-101,060, FILED 5-16-2011.

CHRISTINE MARTIN, EXAMINING ATTORNEY



David J. Kyros

Director of the United States Patent and Trademark Office

United States of America

United States Patent and Trademark Office

PE-Design

Reg. No. 4,152,360

Registered June 5, 2012

Int. Cl.: 7

EMITEC GESELLSCHAFT FÜR EMISSIONSTECHNOLOGIE MBH (FED REP GERMANY
PRIVATE LIMITED LIABILITY COMPANY)
HAUPTSTRASSE 128
53797 LOHMAR
FED REP GERMANY

TRADEMARK

PRINCIPAL REGISTER

FOR: CATALYTIC CONVERTERS AND ENHANCEMENT PARTS IN THE NATURE OF CATALYST SUBSTRATES FOR INTERNAL COMBUSTION ENGINES; CATALYTIC CONVERTERS AND ENHANCEMENT PARTS IN THE NATURE OF CATALYST SUBSTRATES FOR THE TRACTION OR PROPULSION SYSTEMS OF LAND VEHICLES, AIRCRAFT AND WATERCRAFT, IN CLASS 7 (U.S. CLS. 13, 19, 21, 23, 31, 34 AND 35).

THE MARK CONSISTS OF STANDARD CHARACTERS WITHOUT CLAIM TO ANY PARTICULAR FONT, STYLE, SIZE, OR COLOR.

OWNER OF INTERNATIONAL REGISTRATION 1086955 DATED 2-18-2011, EXPIRES 2-18-2021.

SER. NO. 79-101,121, FILED 2-18-2011.

SHANNON TWOHIG, EXAMINING ATTORNEY



David J. Kyffers

Director of the United States Patent and Trademark Office

United States of America

United States Patent and Trademark Office

BRANA VITA

Reg. No. 4,152,361

Registered June 5, 2012

Int. Cl.: 1

TRADEMARK

PRINCIPAL REGISTER

FUGEIA NV (BELGIUM CORPORATION)
GASTON GEENSLAAN 1
B-3001 HEVERLEE
BELGIUM

FOR: OLIGOSACCHARIDES AND POLYSACCHARIDES FOR INDUSTRIAL AND CHEMICAL USE IN FERMENTATION; OLIGOSACCHARIDES AND POLYSACCHARIDES FOR INDUSTRIAL USE IN THE MANUFACTURE OF FLAVORINGS, FOODSTUFFS AND OF PHARMACEUTICAL PRODUCTS; SACCHARIDE PREPARATIONS FOR USE IN THE MANUFACTURE OF FLAVORINGS AND FOODSTUFFS OTHER THAN FOR MEDICAL USE; PLANT EXTRACTS, NAMELY, NATURAL FIBRES FOR INDUSTRIAL USE IN THE MANUFACTURE OF FOODSTUFFS; PRODUCTS TO IMPROVE THE QUALITY OF FOOD, INTENDED FOR INDUSTRIAL AND CRAFT USE, NOT INCLUDED IN OTHER CLASSES, NAMELY, FOOD TEXTURE IMPROVEMENT COMPOSITIONS; FLOUR IMPROVERS, NAMELY, SOURDOUGH FOR USE AS A PRESERVATIVE OF BREAD; BREAD IMPROVERS, NAMELY, SOURDOUGH FOR INDUSTRIAL USE IN THE MANUFACTURE OF BREAD; CHEMICAL ADDITIVES FOR USE IN THE MANUFACTURE OF FOOD; DOUGH CONDITIONERS AND DOUGH STABILIZERS FOR INDUSTRIAL USE; FERMENTATION EXTRACTS FOR INDUSTRIAL USE; ENZYMES FOR INDUSTRIAL USE IN THE FOODS AND DRINKS INDUSTRY, NAMELY, FOR THE PROCESSING OF FOOD BY-PRODUCTS; ENZYMES FOR INDUSTRIAL USE IN THE MANUFACTURE OF NUTRACEUTICALS AND OF PHARMACEUTICAL PRODUCTS; ENZYMES FOR INDUSTRIAL AND CHEMICAL USE IN FERMENTATION; PREBIOTICS AND ANTI-OXIDANTS FOR INDUSTRIAL USE IN THE MANUFACTURE OF FOODSTUFFS, IN CLASS 1 (U.S. CLS. 1, 5, 6, 10, 26 AND 46).

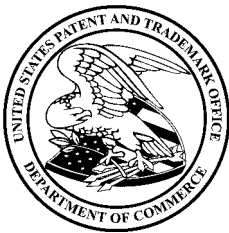

THE MARK CONSISTS OF STANDARD CHARACTERS WITHOUT CLAIM TO ANY PARTICULAR FONT, STYLE, SIZE, OR COLOR.

PRIORITY DATE OF 4-13-2010 IS CLAIMED.

OWNER OF INTERNATIONAL REGISTRATION 1086964 DATED 10-4-2010, EXPIRES 10-4-2020.

David J. Kyjars

THE ENGLISH TRANSLATION OF THE POLISH WORD "BRANA" IN THE MARK IS "TAKEN" AND THE ENGLISH TRANSLATION OF THE ITALIAN WORD "VITA" IN THE MARK IS "LIFE".

Reg. No. 4,152,361 SER. NO. 79-101,124, FILED 10-4-2010.

SHANNON TWOHIG, EXAMINING ATTORNEY

United States of America

United States Patent and Trademark Office



Reg. No. 4,152,362

Registered June 5, 2012

Int. Cls.: 9, 12 and 25

TRADEMARK

PRINCIPAL REGISTER

HELD GMBH (FED REP GERMANY GMBH)
AN DER OSTRACH 7
87545 BURGBERG-ERZFLÖBE
FED REP GERMANY

FOR: MOTORCYCLE HELMETS, CLOTHING OF LEATHER AND FABRIC FOR WORK PROTECTION AGAINST ACCIDENT OR INJURY; PROTECTION WORK GLOVES OF LEATHER, ANIMAL SKINS AND FABRIC, IN CLASS 9 (U.S. CLS. 21, 23, 26, 36 AND 38).

FOR: MOTORCYCLE BAGS, NAMELY, TANK BAGS IN THE NATURE OF TANKS RUCK-SACKS; MOTORCYCLE SADDLEBAGS; LUGGAGE, ESPECIALLY ADAPTED FOR USE ON MOTORCYCLES, NAMELY, MOTORCYCLE LUGGAGE ROLLS, IN CLASS 12 (U.S. CLS. 19, 21, 23, 31, 35 AND 44).

FOR: FASHION GLOVES OF LEATHER, ANIMAL SKINS OR FABRIC; MOTOR-CYCLE GLOVES; CLOTHING OF LEATHER OR FABRIC FOR MOTORCYCLING, NAMELY, PANTS, JERSEYS, SHIRTS, MOTORCYCLE GLOVES, LEATHER JACKETS, RAINPROOF JACKETS, AND JACKETS; WEATHER-PROOF CLOTHING, NAMELY, RAINCOATS, WIND RESISTANT JACKETS, AND LEATHER JACKETS; MOTORCYCLE SHOES AND BOOTS, HIP BAGS FOR MOTORCYCLISTS, IN CLASS 25 (U.S. CLS. 22 AND 39).

THE MARK CONSISTS OF THE FOLLOWING: A GREY NUMBER "4" IN STYLIZED FONT AGAINST A RED CIRCLE BACKGROUND, WHICH IS SHADED DARK RED EXCEPT FOR LIGHT CRESCENT SHAPE, AND A BLACK AND WHITE CIRCLE OUTLINE.

PRIORITY DATE OF 12-3-2010 IS CLAIMED.

OWNER OF INTERNATIONAL REGISTRATION 1087136 DATED 5-20-2011, EXPIRES 5-20-2021.

THE COLOR(S) RED, WHITE, BLACK AND GREY IS/ARE CLAIMED AS A FEATURE OF THE MARK.

SER. NO. 79-101,207, FILED 5-20-2011.

JOHN KELLY, EXAMINING ATTORNEY



David J. Kyros

Director of the United States Patent and Trademark Office

United States of America

United States Patent and Trademark Office



Reg. No. 4,152,363

Registered June 5, 2012

Int. Cl.: 14

TRADEMARK

PRINCIPAL REGISTER

TIME STYLE S.R.L. (ITALY LIMITED LIABILITY COMPANY)
VIA PEDERZANA, 16
I-40055 CASTENASO (BO)
ITALY

FOR: WRISTWATCHES, IN CLASS 14 (U.S. CLS. 2, 27, 28 AND 50).

NO CLAIM IS MADE TO THE EXCLUSIVE RIGHT TO USE "MILANO", APART FROM THE MARK AS SHOWN.

PRIORITY DATE OF 7-5-2011 IS CLAIMED.

OWNER OF INTERNATIONAL REGISTRATION 1087361 DATED 7-12-2011, EXPIRES 7-12-2021.

THE MARK CONSISTS OF THE WORDING "AVIO MILANO" IN STYLIZED FONT WITH AN AIRPLANE PROP ABOVE THE WORDING.

THE ENGLISH TRANSLATION OF "AVIO" IN THE MARK IS "AVIATION".

SER. NO. 79-101,296, FILED 7-12-2011.

WILLIAM BRECKENFELD, EXAMINING ATTORNEY



David J. Kyffers

Director of the United States Patent and Trademark Office

United States of America
United States Patent and Trademark Office

BOXER
MILANO

Reg. No. 4,152,364

Registered June 5, 2012

Int. Cl.: 14

TRADEMARK

PRINCIPAL REGISTER

TIME STYLE S.R.L. (ITALY LIMITED LIABILITY COMPANY)
VIA PEDERZANA, 16
I-40055 CASTENASO (BO)
ITALY

FOR: WRISTWATCHES, IN CLASS 14 (U.S. CLS. 2, 27, 28 AND 50).

NO CLAIM IS MADE TO THE EXCLUSIVE RIGHT TO USE "MILANO", APART FROM THE MARK AS SHOWN.

PRIORITY DATE OF 7-5-2011 IS CLAIMED.

OWNER OF INTERNATIONAL REGISTRATION 1087362 DATED 7-12-2011, EXPIRES 7-12-2021.

THE MARK CONSISTS OF THE WORDING "BOXER MILANO" IN STYLIZED FONT.

SER. NO. 79-101,297, FILED 7-12-2011.

WILLIAM BRECKENFELD, EXAMINING ATTORNEY



David J. Kyffers

Director of the United States Patent and Trademark Office

United States of America

United States Patent and Trademark Office



Reg. No. 4,152,365

Registered June 5, 2012

Int. Cls.: 16, 20 and 28

TRADEMARK

PRINCIPAL REGISTER

GONZAGARREDI SOCIETA' COOPERATIVA (ITALY COOPERATIVE SOCIETY)
STRADA PROVINCIALE PASCOLETTO, 5
GONZAGA (MANTOVA), ITALY

FOR: TEACHING MATERIALS, NAMELY, PRINTED INSTRUCTIONAL AND EDUCATIONAL MATHEMATICS FORMS AND PUBLICATIONS, NAMELY, NOTEPADS, WORKSHEET COLLECTIONS, FLASH CARD SETS, FLASH CARDS, AND WORKSHEETS FEATURING EXERCISE SETS FOR MATHEMATICS, GRAMMAR, GEOGRAPHY, LITERATURE, HISTORY, SCIENCE, ART AND MUSIC FOR CHILDREN AND YOUNG ADULTS; PRINTED TEACHING MATERIALS AIMED TO DEVELOP MATHEMATICS ABILITIES; MAPS, IN CLASS 16 (U.S. CLS. 2, 5, 22, 23, 29, 37, 38 AND 50).

FOR: BENCHES, BEING FURNITURE; WORK BENCHES; SIGN BOARDS MADE OF WOOD AND PLASTIC; BOOKCASES; CABINETS BEING FURNITURE; CHAIRS; DECK CHAIRS; CHESTS OF DRAWERS; NON-METAL CHESTS, BEING FURNITURE; HANGERS FOR CLOTHES; COAT HANGERS; CUPBOARDS; CUSHIONS; SEAT CUSHIONS; DESKS; DISPLAY RACKS; DIVANS; DIVIDERS FOR DRAWERS; WOOD DOORKNOBS; DOORS FOR FURNITURE; DRAWERS, BEING FURNITURE PARTS; FURNITURE FRAMES; FURNITURE; FURNITURE PARTITIONS; FURNITURE PARTS; FURNITURE PARTS, NAMELY, CHAIR LEGS, TABLE LEAVES, ARM RESTS; PLASTIC HANDLES FOR DOORS AND DRAWERS; WOOD HANDLES FOR DOORS AND DRAWERS; HIGH CHAIRS; NON-METAL CLOTHES HOOKS; NON-METAL HOOKS; INFANT CRADLES; NON-METAL LADDERS; MAGAZINE RACKS; MATTRESSES; MIRRORS, BEING FURNITURE; SEATS, BEING FURNITURE; SHELVES; SHELVING; SIDEBOARDS; SOFAS; TABLES, BEING FURNITURE; TOY BOXES, BEING FURNITURE; TOY CHESTS; WARDROBES, IN CLASS 20 (U.S. CLS. 2, 13, 22, 25, 32 AND 50).



David J. Kybas

Director of the United States Patent and Trademark Office

FOR: BABY MULTIPLE ACTIVITY TOYS; TOY BUILDING BLOCKS; TOY CONSTRUCTION BLOCKS; MANIPULATIVE GAMES; MANIPULATIVE PUZZLES; MUSICAL TOYS; CRIB MOBILES; TOY MOBILES; MOBILES FOR CHILDREN; THREE-DIMENSIONAL PUZZLES, BEING CUBE-TYPE PUZZLES; TOY FIGURES; CHILDREN'S MULTIPLE ACTIVITY TOYS; TEACHING GAMES AIMED TO DEVELOP MATHEMATICS ABILITIES, NAMELY, STAMP GAMES, BANK GAMES, CARD GAMES, COUNTING GAMES, NUMBER GAMES, GEOMETRIC GAMES, FRACTION GAMES, THREE-DIMENSIONAL GAMES, IN CLASS 28 (U.S. CLS. 22, 23, 38 AND 50).

Reg. No. 4,152,365 NO CLAIM IS MADE TO THE EXCLUSIVE RIGHT TO USE "1925" , APART FROM THE MARK AS SHOWN.

PRIORITY DATE OF 12-23-2010 IS CLAIMED.

OWNER OF INTERNATIONAL REGISTRATION 1087638 DATED 4-8-2011, EXPIRES 4-8-2021.

THE MARK CONSISTS OF A SIGN DEPICTING THE WORDING "GAM 1925" IN FANCY PROFILED CHARACTERS, THE LETTERS "G" AND "A" BEING PLACED ABOVE THE LETTER "M", HAVING THE NUMERAL "1925" OF A SMALLER SIZE, INSERTED IN THE SPACE CONTAINED BETWEEN THE TWO EXTERNAL VERTICAL STROKES, ALL BEING INSERTED WITHIN A QUADRILATERAL FIGURE.

SER. NO. 79-101,401, FILED 4-8-2011.

LAURIE KAUFMAN, EXAMINING ATTORNEY

United States of America

United States Patent and Trademark Office



Reg. No. 4,152,366

Registered June 5, 2012

Int. Cl.: 7

UGUR MAKINA SANAYI GIDA INSAAT TAAHHÜT ENDÜSTRIYEL YAPILAR TURIZM
TARIM DIS TICARET LIMITED SIRKETI (TURKEY LIMITED COMPANY)
ANKARA ASFALTI 7. KM
ÇORUM
TURKEY

TRADEMARK

PRINCIPAL REGISTER

FOR: MILLING MACHINES FOR GRAIN PROCESSING, SEPARATORS FOR GRAIN PROCESSING, NAMELY, CENTRIFUGAL SEPARATORS FOR SEMOLINA, SQUARE SHAPED VIBRATORY SCREEN SEPARATORS, IN CLASS 7 (U.S. CLS. 13, 19, 21, 23, 31, 34 AND 35).

THE MARK CONSISTS OF A WIND MILL FIGURE IN COLORS ORANGE AND WHITE; THE WIND MILL FIGURE IS IN WHITE AND THE SAILS ARE IN ORANGE COLOR; THE CENTER OF THE WINDMILL HAS AN ORANGE SQUARE WINDOW; THE BACKGROUND OF THE WIND MILL FIGURE IS AN ELLIPTICAL SHAPE IN ORANGE COLOR; THE WINDMILL IS ON TOP OF A CURVED ORANGE LINE; THE ORANGE LETTERS "MB" APPEAR IN CIRCULAR SHAPE MADE UP OF AN ORANGE LINE WITH WHITE IN THE CENTER AND THE SAID SHAPE IS ON THE TOP RIGHT OF THE ELLIPTICAL SHAPE.

PRIORITY DATE OF 3-18-2011 IS CLAIMED.

OWNER OF INTERNATIONAL REGISTRATION 1088174 DATED 4-8-2011, EXPIRES 4-8-2021.

THE COLOR(S) ORANGE AND WHITE IS/ARE CLAIMED AS A FEATURE OF THE MARK.

SER. NO. 79-101,622, FILED 4-8-2011.

MAYUR VAGHANI, EXAMINING ATTORNEY



David J. Kyros

Director of the United States Patent and Trademark Office

United States of America

United States Patent and Trademark Office



iOpener Institute
for people & performance

Reg. No. 4,152,367

Registered June 5, 2012

**Int. Cls.: 9, 16, 35, 41, 42
and 45**

TRADEMARK

SERVICE MARK

PRINCIPAL REGISTER

IOPENER HOLDINGS LIMITED (UNITED KINGDOM PRIVATE LIMITED COMPANY)
2A SOUTH PARADE, THE OLD BAKEHOUSE
OXFORD OX2 7JL
UNITED KINGDOM

FOR: DOWNLOADABLE ELECTRONIC PUBLICATIONS IN THE NATURE OF QUESTIONNAIRES, PSYCHOMETRIC TESTS AND PRINTED REPORTS IN THE FIELD OF PERSONNEL DEVELOPMENT, ORGANIZATIONAL CHANGE, MANAGEMENT AND DEVELOPMENT, MANAGEMENT AND LEADERSHIP, PERFORMANCE AND PRODUCTIVITY PROVIDED ON-LINE FROM DATABASES OR THE INTERNET; COMPUTER SOFTWARE FOR ORGANIZING AND VIEWING BUSINESS DATA; COMPUTER SOFTWARE FOR THE ASSESSMENT OF PERSONAL DATA; ELECTRONIC DATABASES RECORDED ON COMPUTER MEDIA CONTAINING INFORMATION REGARDING PERSONAL ATTITUDES, APTITUDES AND CHARACTER TRAITS; DOWNLOADABLE ELECTRONIC PUBLICATIONS IN THE NATURE OF REPORTS, GUIDES, QUESTIONNAIRES IN THE FIELD OF PERSONAL ATTITUDES, ATTITUDES AND CHARACTER TRAITS; PRE-RECORDED AUDIO-VISUAL MEDIA, NAMELY, DVDS AND VIDEO FILES FEATURING INSTRUCTIONAL, COACHING AND TRAINING INFORMATION; DOWNLOADABLE ELECTRONIC PUBLICATIONS IN THE NATURE OF MANUALS AND INSTRUCTION MATERIALS PROVIDED BY ELECTRONIC MEANS AND OTHER ON-LINE COMMUNICATIONS FEATURING BUSINESS AND ORGANIZATIONAL DEVELOPMENT INFORMATION, IN CLASS 9 (U.S. CLS. 21, 23, 26, 36 AND 38).



FOR: PRINTED MATTER, NAMELY, BOOKS, LEAFLETS, MANUALS, QUESTIONNAIRES, TESTS AND REPORTS IN THE FIELD OF PERSONAL ASSESSMENT RELATING TO JOBS AND CAREERS, LEADERSHIP AND TEAM DEVELOPMENT, ORGANIZATIONAL CHANGE MANAGEMENT, PERFORMANCE AND PRODUCTIVITY IMPROVEMENT; PRINTED PUBLICATIONS, NAMELY, BOOKS AND MAGAZINES IN THE FIELD OF BUSINESS; PRINTED QUESTIONNAIRES, NAMELY, PRINTED QUESTIONNAIRES FOR PERSONAL ASSESSMENT; PRINTED EDUCATIONAL GUIDES FOR CAREER COUNSELING, PRINTED SELF-HELP AND SELF-IMPROVEMENT GUIDES, PRINTED PSYCHOMETRIC TESTS; PRINTED REPORTS IN THE FIELD OF PSYCHOMETRIC TESTING; TRAINING GUIDES IN THE FIELD OF PERSONNEL AND EXECUTIVE COACHING, LEADERSHIP AND TEAM DEVELOPMENT, ORGANIZATIONAL CHANGE MANAGEMENT AND DEVELOPMENT AND PSYCHOMETRIC TESTING; PRINTED MANUALS IN THE FIELD OF BUSINESS PERSONNEL DEVELOPMENT; INSTRUCTION MATERIALS IN THE FIELD OF ORGANIZ-

David J. Kappas

Director of the United States Patent and Trademark Office

Reg. No. 4,152,367 ATIONAL CHANGE MANAGEMENT AND CAREER COUNSELING , IN CLASS 16 (U.S. CLS. 2, 5, 22, 23, 29, 37, 38 AND 50).

FOR: BUSINESS MANAGEMENT CONSULTANCY AND APPRAISAL SERVICES; BUSINESS CONSULTANCY AND APPRAISAL SERVICES; MANAGEMENT, APPRAISAL AND CONSULTANCY SERVICES IN RELATION TO ORGANIZATIONAL CHANGE MANAGEMENT AND DEVELOPMENT, PERSONNEL MANAGEMENT AND PERFORMANCE MANAGEMENT; BUSINESS CULTURE CHANGE CONSULTING; BUSINESS PROCESS MANAGEMENT; HUMAN RESOURCES MANAGEMENT; ARRANGING, ORGANIZING AND CONDUCTING PSYCHOMETRIC TESTS, SURVEYS, QUESTIONNAIRES AND POLLS; COMPILATION, ANALYSIS AND PROVISION OF BUSINESS DATA AND STATISTICAL INFORMATION; COMPILATION, ANALYSIS AND PROVISION OF PSYCHOMETRIC BUSINESS DATA AND STATISTICAL INFORMATION; PREPARATION OF BUSINESS AND MANAGEMENT REPORTS; BUSINESS INFORMATION, ADVISORY AND CONSULTANCY SERVICES RELATING TO ALL THE AFORESAID; ALL THE AFORESAID INCLUDING THAT PROVIDED ON-LINE FROM A COMPUTER DATABASE OR BY MEANS OF THE INTERNET; ASSESSMENT ANALYSIS RELATING TO BUSINESS MANAGEMENT; BUSINESS ASSISTANCE RELATING TO FRANCHISING; BUSINESS MANAGEMENT; BUSINESS ADVISORY SERVICES RELATING TO FRANCHISING; PROVISION OF BUSINESS ADVICE RELATING TO FRANCHISING; PROVISION OF BUSINESS INFORMATION RELATING TO FRANCHISING; ADVISORY SERVICES RELATING TO PUBLICITY FOR FRANCHISEES; PROVISION OF BUSINESS ASSISTANCE IN THE ESTABLISHMENT AND OPERATION OF FRANCHISES, IN CLASS 35 (U.S. CLS. 100, 101 AND 102).

FOR: EDUCATIONAL, INSTRUCTIONAL, COACHING, TRAINING AND TEACHING SERVICES, NAMELY, COURSES, WORKSHOPS AND SEMINARS IN THE FIELD OF EXECUTIVE COACHING AND LEADERSHIP DEVELOPMENT; TRAINING SERVICES, NAMELY, PERSONNEL AND EXECUTIVE COACHING, BUSINESS TRAINING IN THE FIELD OF LEADERSHIP AND TEAM DEVELOPMENT SERVICES, INCLUDING THE AFORESAID IN RELATION TO ORGANIZATIONAL CHANGE MANAGEMENT AND DEVELOPMENT, BUSINESS MANAGEMENT, PRESENTATION SKILLS, INTERCULTURAL MANAGEMENT, LEADERSHIP, NEGOTIATING, STRESS MANAGEMENT, TEAM DEVELOPMENT AND WRITING SKILLS; BUSINESS TRAINING IN RELATION TO THE DESIGN AND USE OF PSYCHOMETRIC TESTS, SURVEYS, QUESTIONNAIRES AND POLLS; ORGANIZING AND CONDUCTING CLASSES, WORKSHOPS, TRAINING COURSES, SEMINARS, SYMPOSIUMS, CONFERENCES AND EXHIBITIONS IN THE FIELD OF BUSINESS TRAINING; PUBLISHING OF QUESTIONNAIRES, MAGAZINES, REPORTS, GUIDES, INCLUDING ELECTRONIC PUBLISHING SERVICES; PROVISION OF ONLINE NON-DOWNLOADABLE QUESTIONNAIRES, PSYCHOMETRIC TESTS AND REPORTS; PROVIDING ONLINE NON-DOWNLOADABLE ELECTRONIC PUBLICATIONS IN THE NATURE OF QUESTIONNAIRES, MAGAZINES, REPORTS, GUIDES RELATING TO LEADERSHIP AND TEAM DEVELOPMENT, ORGANIZATIONAL CHANGE MANAGEMENT, PERFORMANCE AND PRODUCTIVITY IMPROVEMENT; PRODUCTION, PRESENTATION, DISTRIBUTION, SYNDICATION, NETWORKING AND RENTAL OF TELEVISION PROGRAMMES, RADIO PROGRAMMES, MOTION PICTURE FILMS, PRODUCTION AND RENTAL OF VIDEOS, SOUND/VIDEO RECORDINGS AND OF ELECTRONIC PUBLICATIONS; PROVIDING ON-LINE NON-DOWNLOADABLE ELECTRONIC PUBLICATIONS IN THE NATURE OF NEWSLETTERS IN THE FIELD OF BUSINESS LEADERSHIP; NON-DOWNLOADABLE MANUALS AND INSTRUCTION MATERIALS PROVIDED BY ELECTRONIC MEANS AND OTHER ON-LINE COMMUNICATIONS FEATURING BUSINESS DEVELOPMENT AND EXECUTIVE LEADERSHIP; BUSINESS TRAINING INFORMATION, ADVISORY AND CONSULTANCY SERVICES RELATING TO ALL THE AFORESAID; ALL THE AFORESAID INCLUDING THAT PROVIDED ON-LINE FROM A COMPUTER DATABASE OR BY MEANS OF THE INTERNET, IN CLASS 41 (U.S. CLS. 100, 101 AND 107).

FOR: DESIGN OF ONLINE SURVEYS, FORMS, QUESTIONNAIRES AND POLLS; INFORMATION, ADVISORY AND CONSULTANCY SERVICES RELATING TO ALL THE AFORESAID; RESEARCH AND DEVELOPMENT IN THE FIELD OF BUSINESS AND PERSONNEL

Reg. No. 4,152,367 MANAGEMENT; UNDERTAKING RESEARCH PROJECTS RELATING TO WORKPLACE PERFORMANCE, NAMELY, ASSESSING WHAT ENABLES PEOPLE TO CONSISTENTLY DELIVER MEASURABLE AND SUSTAINABLE RESULTS, MAXIMIZE PERFORMANCE AND ACHIEVE THEIR POTENTIAL, IN CLASS 42 (U.S. CLS. 100 AND 101).

FOR: LICENSING OF ACCREDITATION SCHEMES FEATURING BUSINESS AND PERSONNEL CONSULTANTS, AS WELL AS EXECUTIVE COACHES; PREPARATION OF PERSONAL REPORTS, NAMELY, REPORTS FEATURING PERSONAL IMAGE DEVELOPMENT CONSULTATION, IN CLASS 45 (U.S. CLS. 100 AND 101).

NO CLAIM IS MADE TO THE EXCLUSIVE RIGHT TO USE "INSTITUTE", APART FROM THE MARK AS SHOWN.

OWNER OF INTERNATIONAL REGISTRATION 1088914 DATED 4-26-2011, EXPIRES 4-26-2021.

THE COLOR(S) BLACK AND WHITE AND GRAY IS/ARE CLAIMED AS A FEATURE OF THE MARK.

THE MARK CONSISTS OF THE FOLLOWING: THE WORDS "IOPENER INSTITUTE" IN WHITE LETTERS AROUND A BLACK CIRCLE WITH AN INTERIOR WHITE CIRCLE CONTAINING THE STYLISED LETTERS "IPP" IN BLACK, ALL TO THE LEFT OF THE WORDING "IOPENER INSTITUTE" IN BLACK ABOVE A GREY HORIZONTAL LINE BAND THE WORDING "FOR PEOPLE & PERFORMANCE" IN GREY LETTERS, ALL ON A WHITE BACKGROUND.

SER. NO. 79-101,889, FILED 4-26-2011.

PATRICIA EVANKO, EXAMINING ATTORNEY

United States of America
United States Patent and Trademark Office

KROON

Reg. No. 4,152,368

Registered June 5, 2012

Int. Cl.: 29

TRADEMARK

PRINCIPAL REGISTER

FRIESLAND BRANDS B.V. (NETHERLANDS BESLOTEN VENNOOTSCHAP (B.V.))
STATIONSPLEIN 4
NL-3818 LE AMERSFOORT
NETHERLANDS

FOR: CHEESE AND CHEESE PRODUCTS, NOT INCLUDED IN OTHER CLASSES, IN CLASS
29 (U.S. CL. 46).

THE MARK CONSISTS OF STANDARD CHARACTERS WITHOUT CLAIM TO ANY PAR-
TICULAR FONT, STYLE, SIZE, OR COLOR.

OWNER OF INTERNATIONAL REGISTRATION 0841968 DATED 10-19-2004, EXPIRES 10-
19-2014.

OWNER OF U.S. REG. NO. 2,297,741.

THE ENGLISH TRANSLATION OF "KROON" IN THE MARK IS CROWN.

SER. NO. 79-101,988, FILED 7-11-2011.

AMY KELLY, EXAMINING ATTORNEY



David J. Kyffers

Director of the United States Patent and Trademark Office

United States of America

United States Patent and Trademark Office



Reg. No. 4,152,369

Registered June 5, 2012

Int. Cls.: 30, 35 and 43

SATO & TAO (SOCIÉTÉ PAR ACTIONS SIMPLIFIÉE) (FRANCE SOCIÉTÉ PAR ACTIONS SIMPLIFIÉE)
40 BOULEVARD RASPAIL
F-75007 PARIS
FRANCE

TRADEMARK

SERVICE MARK

PRINCIPAL REGISTER

FOR: COFFEE, TEA, COCOA, SUGAR, RICE, TAPIOCA, SAGO, ARTIFICIAL COFFEE; FLOURS AND CEREAL PREPARATIONS, NAMELY, BREAKFAST CEREALS, CEREAL-BASED SNACK FOODS, PROCESSED CEREALS; BREAD, PASTRY AND CONFECTIONERY, NAMELY, SWEETS, FONDANTS, PASTILLES; EDIBLE ICES; HONEY, TREACLE; ICE FOR REFRESHMENT; SANDWICHES, PIZZAS; FOOD, NAMELY, PANCAKES; COOKIES AND BISCUITS; CAKES; TARTS; SUGAR CONFECTIONERY; CHOCOLATE; COCOA, COFFEE, CHOCOLATE AND TEA-BASED BEVERAGES, IN CLASS 30 (U.S. CL. 46).

FOR: RETAIL STORE SERVICES, MAIL-ORDER SERVICES, AND ON-LINE RETAIL STORE SERVICES ALL FEATURING MEAT, FISH, POULTRY AND GAME, MEAT EXTRACTS, PRESERVED, FROZEN, DRIED AND COOKED FRUITS AND VEGETABLES, JELLIES, JAMS, COMPOTES, EGGS, MILK AND DAIRY PRODUCTS, EDIBLE OILS AND FATS, COFFEE, TEA, COCOA, SUGAR, RICE, TAPIOCA, FLOURS AND CEREAL PREPARATIONS, BREAD, PASTRY AND CONFECTIONERY, CAKES, TARTS, CHOCOLATES, MACAROONS, CANDY, CANDIED FRUITS, CONFECTIONERY IN THE NATURE OF FRUIT JELLIES, EDIBLE ICES, HONEY, TREACLE, YEAST, BAKING POWDER, SALT, MUSTARD, VINEGAR, CONDIMENTS IN THE NATURE OF SAUCES, SPICES, ICE FOR REFRESHMENT, BEERS, MINERAL AND AERATED WATERS AND OTHER NON-ALCOHOLIC BEVERAGES, FRUIT DRINKS AND FRUIT JUICES, SYRUPS AND OTHER PREPARATIONS FOR MAKING BEVERAGES, AND ALCOHOLIC BEVERAGES OTHER THAN BEERS, IN CLASS 35 (U.S. CLS. 100, 101 AND 102).

FOR: SERVICES FOR PROVIDING FOOD AND DRINK; BAR SERVICES; CATERING SERVICES; HOTEL SERVICES, IN CLASS 43 (U.S. CLS. 100 AND 101).

THE MARK CONSISTS OF THE INTERCONNECTED LETTERS "H" AND "V" IN THE CENTER OF A DOUBLE CIRCLE.

PRIORITY DATE OF 7-19-2011 IS CLAIMED.



David J. Kyjars

Director of the United States Patent and Trademark Office

Reg. No. 4,152,369 OWNER OF INTERNATIONAL REGISTRATION 1089527 DATED 7-22-2011, EXPIRES 7-22-2021.

SER. NO. 79-102,091, FILED 7-22-2011.

KRISTIN CARLSON, EXAMINING ATTORNEY

United States of America

United States Patent and Trademark Office

HUGO & VICTOR

Reg. No. 4,152,370

Registered June 5, 2012

Int. Cls.: 30, 35 and 43

SATO ET TAO (SOCIÉTÉ PAR ACTIONS SIMPLIFIÉE) (FRANCE SOCIÉTÉ PAR ACTIONS SIMPLIFIÉE)
40 BOULEVARD RASPAIL
F-75007 PARIS
FRANCE

TRADEMARK

SERVICE MARK

PRINCIPAL REGISTER

FOR: COFFEE, TEA, COCOA, SUGAR, RICE, TAPIOCA, SAGO, ARTIFICIAL COFFEE; FLOURS AND CEREAL PREPARATIONS, NAMELY, BREAKFAST CEREALS, CEREAL-BASED SNACK FOODS, PROCESSED CEREALS; BREAD, PASTRY AND CONFECTIONERY, NAMELY, SWEETS, FONDANTS, PASTILLES; EDIBLE ICES; HONEY, TREACLE; ICE FOR REFRESHMENT; SANDWICHES, PIZZAS; FOOD, NAMELY, PANCAKES; COOKIES AND BISCUITS; CAKES; TARTS; SUGAR CONFECTIONERY; CHOCOLATE; COCOA, COFFEE, CHOCOLATE AND TEA-BASED BEVERAGES, IN CLASS 30 (U.S. CL. 46).

FOR: RETAIL STORE SERVICES, MAIL-ORDER SERVICES, AND ON-LINE RETAIL STORE SERVICES ALL FEATURING MEAT, FISH, POULTRY AND GAME, MEAT EXTRACTS, PRESERVED, FROZEN, DRIED AND COOKED FRUITS AND VEGETABLES, JELLIES, JAMS, STEWED FRUIT, EGGS, MILK AND DAIRY PRODUCTS, EDIBLE OILS AND FATS, COFFEE, TEA, COCOA, SUGAR, RICE, TAPIOCA, FLOURS AND CEREAL PREPARATIONS, BREAD, PASTRY AND CONFECTIONERY, CAKES, TARTS, CHOCOLATES, MACAROONS, CANDY, FROSTED FRUITS, CONFECTIONERY IN THE NATURE OF FRUIT JELLIES, EDIBLE ICES, HONEY, TREACLE, YEAST, BAKING POWDER, SALT, MUSTARD, VINEGAR, CONDIMENTS IN THE NATURE OF SAUCES, SPICES, ICE FOR REFRESHMENT, BEERS, MINERAL AND AERATED WATERS AND OTHER NON-ALCOHOLIC BEVERAGES, FRUIT DRINKS AND FRUIT JUICES, SYRUPS AND OTHER PREPARATIONS FOR MAKING BEVERAGES, AND ALCOHOLIC BEVERAGES OTHER THAN BEERS, IN CLASS 35 (U.S. CLS. 100, 101 AND 102).

FOR: SERVICES FOR PROVIDING FOOD AND DRINK; BAR SERVICES; FOOD AND DRINK CATERING; HOTELS, IN CLASS 43 (U.S. CLS. 100 AND 101).

PRIORITY DATE OF 7-19-2011 IS CLAIMED.

OWNER OF INTERNATIONAL REGISTRATION 1089658 DATED 7-22-2011, EXPIRES 7-22-2021.

SER. NO. 79-102,133, FILED 7-22-2011.



David J. Kyros

Director of the United States Patent and Trademark Office

Reg. No. 4,152,370 KRISTIN CARLSON, EXAMINING ATTORNEY

United States of America
United States Patent and Trademark Office

C-TRACK

Reg. No. 4,152,371

Registered June 5, 2012

Int. Cl.: 6

TRADEMARK

PRINCIPAL REGISTER

XLNT ADVANCED TECHNOLOGIES B.V.
PROOSTWETERING 50
NL-3543 AH UTRECHT
NETHERLANDS

FOR: METAL RAILS, IN CLASS 6 (U.S. CLS. 2, 12, 13, 14, 23, 25 AND 50).

THE MARK CONSISTS OF STANDARD CHARACTERS WITHOUT CLAIM TO ANY PARTICULAR FONT, STYLE, SIZE, OR COLOR.

PRIORITY DATE OF 2-11-2011 IS CLAIMED.

OWNER OF INTERNATIONAL REGISTRATION 1090011 DATED 8-4-2011, EXPIRES 8-4-2021.

SER. NO. 79-102,293, FILED 8-4-2011.

JOHN HWANG, EXAMINING ATTORNEY



David J. Kybas

Director of the United States Patent and Trademark Office

United States of America

United States Patent and Trademark Office

Land of Beowulf

Reg. No. 4,152,372

Registered June 5, 2012

Int. Cl.: 39

SERVICE MARK

PRINCIPAL REGISTER

PETER JARTOFT (SWEDEN INDIVIDUAL)
BJÖRCKSGATAN 42A
SE-416 52 GÖTEBORG
SWEDEN

FOR: CAR TRANSPORT; TRANSPORTATION OF PASSENGERS AND GOODS BY BUS AND RAIL; TRANSPORT OF TRAVELLERS; TRANSPORT BROKERAGE; BOOKING OF TRAVEL TICKETS; TRANSPORT OF GOODS AND PASSENGERS BY AIR, IN CLASS 39 (U.S. CLS. 100 AND 105).

THE MARK CONSISTS OF STANDARD CHARACTERS WITHOUT CLAIM TO ANY PARTICULAR FONT, STYLE, SIZE, OR COLOR.

OWNER OF INTERNATIONAL REGISTRATION 1090198 DATED 8-4-2011, EXPIRES 8-4-2021.

SER. NO. 79-102,367, FILED 8-4-2011.

LINDA MICKLEBURGH, EXAMINING ATTORNEY



David J. Kyffers

Director of the United States Patent and Trademark Office

United States of America

United States Patent and Trademark Office

VIGNA DOGARINA

Reg. No. 4,152,373

Registered June 5, 2012

Int. Cls.: 33, 35 and 43

AZIENDA AGRICOLA VIGNA DOGARINA SAS DI TONUS GUIDO & C. (ITALY LIMITED PARTNERSHIP SOCIETY)
VIA ARZERI, 35 -
FRAZ. CAMPODIPIETRA
I-31040 SALGAREDA (TV), ITALY

TRADEMARK

FOR: WINES, SPARKLING WINES, ALCOHOLIC BEVERAGES EXCEPT BEERS, IN CLASS 33 (U.S. CLS. 47 AND 49).

SERVICE MARK

FOR: ADVERTISING SERVICES; BUSINESS MANAGEMENT; BUSINESS ADMINISTRATION AND MANAGEMENT; PROVIDING OFFICE FUNCTIONS; BUSINESS ORGANIZATION CONSULTING AND BUSINESS ADMINISTRATION SERVICES OF SALES PROMOTION FOR OTHERS BY E-MAIL, TELEPHONE AND BY TELEMARKETING OF WINES, SPARKLING WINES, ALCOHOLIC BEVERAGES EXCEPT BEERS; RETAIL STORE AND ONLINE RETAIL STORE SERVICES FEATURING WINES, SPARKLING WINES, ALCOHOLIC BEVERAGES EXCEPT BEERS, IN CLASS 35 (U.S. CLS. 100, 101 AND 102).

PRINCIPAL REGISTER

FOR: SERVICES FOR PROVIDING FOOD AND DRINK; TEMPORARY ACCOMMODATION, NAMELY, PROVIDING TEMPORARY HOUSING ACCOMMODATIONS, RENTAL OF ROOMS AS TEMPORARY LIVING ACCOMMODATIONS, IN CLASS 43 (U.S. CLS. 100 AND 101).



THE MARK CONSISTS OF STANDARD CHARACTERS WITHOUT CLAIM TO ANY PARTICULAR FONT, STYLE, SIZE, OR COLOR.

PRIORITY DATE OF 6-14-2011 IS CLAIMED.

OWNER OF INTERNATIONAL REGISTRATION 1090340 DATED 6-24-2011, EXPIRES 6-24-2021.

NO CLAIM IS MADE TO THE EXCLUSIVE RIGHT TO USE "VIGNA", APART FROM THE MARK AS SHOWN.

THE ENGLISH TRANSLATION OF "VIGNA" IN THE MARK IS "VINEYARD".

THE WORD(S) "DOGARINA" HAS NO MEANING IN A FOREIGN LANGUAGE.

David J. Kyffers

Director of the United States Patent and Trademark Office

Reg. No. 4,152,373 SER. NO. 79-102,415, FILED 6-24-2011.

RONALD AIKENS, EXAMINING ATTORNEY

United States of America

United States Patent and Trademark Office

DISHMATIC

Reg. No. 4,152,374

Registered June 5, 2012

Int. Cl.: 3

EASY-DO PRODUCTS LIMITED (UNITED KINGDOM A COMPANY ORGANISED UNDER THE LAWS OF ENGLAND AND WALES)
NEPTUNE HOUSE,
2A ALEXANDRA GROVE; NORTH FINCHLEY, LONDON N12 8NU
UNITED KINGDOM

TRADEMARK

PRINCIPAL REGISTER

FOR: CLEANING, POLISHING, SCOURING AND ABRASIVE PREPARATIONS, WASHING PREPARATIONS, WASHING-UP LIQUIDS, PREPARATIONS FOR THE WASHING, CLEANING, POLISHING AND SHINING OF DISHES AND CUTLERY, DISHWASHING PREPARATIONS; PREPARATIONS FOR USE IN DISHWASHING MACHINES, NAMELY, DISHWASHING LIQUID, DISHWASHING POWDER, DISHWASHING TABLETS, DISHWASHING RINSE AID AGENT, BLEACHING PREPARATIONS FOR HOUSEHOLD USE, DETERGENTS FOR DISHWASHING, DISHWASHER CLEANER; PREPARATIONS FOR USE IN DISHWASHING MACHINES, NAMELY, DISHWASHING LIQUID, DISHWASHING POWDER, DISHWASHING TABLETS, DISHWASHING RINSE AID AGENT, BLEACHING PREPARATIONS FOR HOUSEHOLD USE, DETERGENTS FOR DISHWASHING, DISHWASHER CLEANER, ALL OF WHICH CONTAIN DEODORIZING AND FRESHENING SCENTS AS AN INGREDIENT; DECALCIFYING AGENTS FOR CLEANING HOUSEHOLD PRODUCTS, INCLUDING DISHWASHERS; RINSE AGENTS FOR DISHWASHING MACHINES, POLISHING PREPARATIONS FOR KITCHEN AND GLASSWARE, IN CLASS 3 (U.S. CLS. 1, 4, 6, 50, 51 AND 52).

THE MARK CONSISTS OF STANDARD CHARACTERS WITHOUT CLAIM TO ANY PARTICULAR FONT, STYLE, SIZE, OR COLOR.

PRIORITY DATE OF 6-21-2011 IS CLAIMED.

OWNER OF INTERNATIONAL REGISTRATION 1090365 DATED 7-28-2011, EXPIRES 7-28-2021.

SER. NO. 79-102,420, FILED 7-28-2011.

SANDRA BUJA, EXAMINING ATTORNEY



David J. Kyffers

Director of the United States Patent and Trademark Office

United States of America

United States Patent and Trademark Office

Wellmaxx

Reg. No. 4,152,375

Registered June 5, 2012

**Int. Cls.: 3, 11, 35, 41
and 42**

TRADEMARK

SERVICE MARK

PRINCIPAL REGISTER

SP-GMBH & CO. KG (FED REP GERMANY GMBH & CO. KG)
CARL-FRIEDRICH-GAUSS-STR. 11
50259 PULHEIM, FED REP GERMANY

FOR: COSMETICS, IN CLASS 3 (U.S. CLS. 1, 4, 6, 50, 51 AND 52).

FOR: TANNING APPARATUS AS WELL AS THEIR PARTS, NAMELY, TANNING BEDS
AND TANNING LAMPS, IN CLASS 11 (U.S. CLS. 13, 21, 23, 31 AND 34).

FOR: FRANCHISING, NAMELY, OFFERING BUSINESS MANAGEMENT ASSISTANCE
AND KNOW-HOW IN THE ESTABLISHMENT AND/OR OPERATION OF TANNING SALONS
AND FITNESS STUDIOS, IN CLASS 35 (U.S. CLS. 100, 101 AND 102).

FOR: PROVIDING SPORTS FACILITIES; PROVIDING FITNESS AND EXERCISE FACILITIES,
IN CLASS 41 (U.S. CLS. 100, 101 AND 107).

FOR: SERVICES OF A TANNING STUDIO, IN CLASS 42 (U.S. CLS. 100 AND 101).

THE MARK CONSISTS OF STANDARD CHARACTERS WITHOUT CLAIM TO ANY PAR-
TICULAR FONT, STYLE, SIZE, OR COLOR.

OWNER OF INTERNATIONAL REGISTRATION 0722178 DATED 9-21-1999, EXPIRES 9-21-
2019.

SER. NO. 79-102,546, FILED 7-19-2011.

DAVID HOFFMAN, EXAMINING ATTORNEY



David J. Kyfos

Director of the United States Patent and Trademark Office

United States of America

United States Patent and Trademark Office

INSIDE.

Reg. No. 4,152,376

Registered June 5, 2012

Int. Cl.: 35

SERVICE MARK

PRINCIPAL REGISTER

LIWE ESPAÑOLA, S.A. (SPAIN SOCIEDAD ANÓNIMA)
APARTADO 741
E-30080 MURCIA
SPAIN

FOR: ADVERTISING SERVICES; IMPORT-EXPORT AGENCIES IN THE FIELD OF PRECIOUS METALS AND THEIR ALLOYS, PASTE JEWELRY, JEWELRY, PRECIOUS STONES, HOROLOGICAL AND CHRONOMETRIC INSTRUMENTS, NECKLACES, EARRINGS, BRACELETS, RINGS (JEWELRY), CLOTHING, FOOTWEAR, HEADGEAR, BELTS, KERCHIEFS, BANDANAS, BATHING SUITS, UNDERWEAR, GLOVES (CLOTHING), EAR MUFFS (CLOTHING), FURS (CLOTHING); WHOLESALING DISTRIBUTORSHIPS FEATURING PRECIOUS METALS AND THEIR ALLOYS, PASTE JEWELRY, JEWELRY, PRECIOUS STONES, HOROLOGICAL AND CHRONOMETRIC INSTRUMENTS, NECKLACES, EARRINGS, BRACELETS, RINGS (JEWELRY), CLOTHING, FOOTWEAR, HEADGEAR, BELTS, KERCHIEFS, BANDANAS, BATHING SUITS, UNDERWEAR, GLOVES CLOTHING, EAR MUFFS (CLOTHING), FURS (CLOTHING); RETAIL STORE SERVICES FEATURING PRECIOUS METALS AND THEIR ALLOYS, PASTE JEWELRY, JEWELRY, PRECIOUS STONES, HOROLOGICAL AND CHRONOMETRIC INSTRUMENTS, NECKLACES, EARRINGS, BRACELETS, RINGS (JEWELRY), CLOTHING, FOOTWEAR, HEADGEAR, BELTS, KERCHIEFS, BANDANAS, BATHING SUITS, UNDERWEAR, GLOVES CLOTHING, EAR MUFFS (CLOTHING), FURS (CLOTHING); ON-LINE RETAIL STORE SERVICES FEATURING PRECIOUS METALS AND THEIR ALLOYS, PASTE JEWELRY, JEWELRY, PRECIOUS STONES, HOROLOGICAL AND CHRONOMETRIC INSTRUMENTS, NECKLACES, EARRINGS, BRACELETS, RINGS (JEWELRY), CLOTHING, FOOTWEAR, HEADGEAR, BELTS, KERCHIEFS, BANDANAS, BATHING SUITS, UNDERWEAR, GLOVES CLOTHING, EAR MUFFS (CLOTHING), FURS (CLOTHING); BUSINESS MANAGEMENT ADVISORY SERVICE RELATING TO FRANCHISING, IN CLASS 35 (U.S. CLS. 100, 101 AND 102).



THE MARK CONSISTS OF STANDARD CHARACTERS WITHOUT CLAIM TO ANY PARTICULAR FONT, STYLE, SIZE, OR COLOR.

OWNER OF INTERNATIONAL REGISTRATION 1090873 DATED 7-4-2011, EXPIRES 7-4-2021.

SER. NO. 79-102,623, FILED 7-4-2011.

DAVID I, EXAMINING ATTORNEY

David J. Kyros

Director of the United States Patent and Trademark Office

United States of America

United States Patent and Trademark Office

FUO

Reg. No. 4,152,377

Registered June 5, 2012

Int. Cls.: 6, 7 and 40

TRADEMARK

SERVICE MARK

PRINCIPAL REGISTER

FRÖHLICH & DÖRKEN GMBH (FED REP GERMANY GESELLSCHAFT MIT
BESCHRÄNKTER HAFTUNG (GMBH))
STEFANSBECKE 44
SPROCKHÖVEL, FED REP GERMANY 45549

FOR: FITTINGS OF METAL FOR FURNITURE, IN CLASS 6 (U.S. CLS. 2, 12, 13, 14, 23, 25 AND 50).

FOR: SLIDING BEARING, ROLLER BEARINGS AND STRUCTURAL PARTS AND FITTINGS THEREFOR, NAMELY, BEARING RINGS, BEARING SLEEVES, BEARING DISCS, ROLL BARREL CAGES, BALL HOLDERS, BALLS, ROLLERS, PINS; BEARINGS; BALL BEARINGS; ROLLER COTS, BARREL-SHAPED BEARINGS, NEEDLE BEARINGS, SELF OILING BEARINGS; PNEUMATIC AND HYDRAULIC APPARATUS AND EQUIPMENT AND ESSENTIAL UNITS AND PARTS THEREFOR, NAMELY, PNEUMATIC AND HYDRAULIC VALVE ACTUATORS, PRESSURE CONTROL CYLINDERS FOR LIMITING AND RELEASING FLUID PRESSURE IN PNEUMATIC AND HYDRAULIC LINES; LINEAR GUIDES, PROFILE RAIL GUIDES, SCREW DRIVES; DRILLING, MILLING AND CUTTING TOOLS, ALL OF THE AFOREMENTIONED GOODS BEING PARTS OF MACHINES, IN CLASS 7 (U.S. CLS. 13, 19, 21, 23, 31, 34 AND 35).

FOR: CUSTOM ASSEMBLING OF MECHANICAL PARTS AND COMPONENTS, IN PARTICULAR FOR DOORS, WINDOWS, MOVABLE PARTITIONS AND BOARDS, FOR OTHERS, IN CLASS 40 (U.S. CLS. 100, 103 AND 106).

THE MARK CONSISTS OF STANDARD CHARACTERS WITHOUT CLAIM TO ANY PARTICULAR FONT, STYLE, SIZE, OR COLOR.

PRIORITY DATE OF 3-24-2011 IS CLAIMED.

OWNER OF INTERNATIONAL REGISTRATION 1090894 DATED 7-22-2011, EXPIRES 7-22-2021.

SER. NO. 79-102,634, FILED 7-22-2011.

DORITT L. CARROLL, EXAMINING ATTORNEY

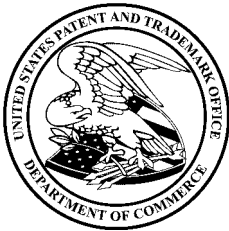

David J. Kyros

Director of the United States Patent and Trademark Office

United States of America

United States Patent and Trademark Office



Reg. No. 4,152,378

Registered June 5, 2012

Int. Cl.: 3

KABUSHIKI KAISHA NOEVIR (DOING BUSINESS AS NOEVIR CO., LTD.) (JAPAN CORPORATION)
13-1 MINATOJIMA-NAKAMACHI 6-CHOME
CHUO-KU, KOBE-SHI; HYOGO 650-0046
JAPAN

TRADEMARK

PRINCIPAL REGISTER

FOR: SOAPS; DENTIFRICES; MOUTHWASHES; COSMETIC PREPARATIONS FOR SKIN-CARE, NAMELY, CREAMS, SKIN LOTIONS, MILK LOTIONS; CLEANSING OILS, CLEANSING CREAMS, CLEANSING FOAM, CLEANSING GELS; COSMETIC PREPARATIONS FOR MAKE UP, NAMELY, FOUNDATIONS, FACE POWDER, CHEEK COLORS, EYE LINERS, EYE SHADOWS, MASCARAS, EYEBROWS, LIPSTICKS; COSMETIC SUN-PROTECTING PREPARATIONS, NAMELY, SUN-PROTECTING CREAMS, SUN-PROTECTING LOTIONS; COSMETIC PREPARATIONS FOR BODY CARE, NAMELY, BODY LOTIONS, BODY CREAMS, BODY SHAMPOOS, BODY SOAPS, HAND CREAMS, NAIL VARNISH, NAIL VARNISH REMOVERS; COSMETIC PREPARATIONS FOR BATH, NAMELY, BATH SALTS, BATH OILS, BATH CREAMS, BATH GELS; COSMETIC PREPARATIONS FOR HAIR CARE, NAMELY, SHAMPOOS, HAIR RINSES, HAIR CONDITIONERS, HAIR SPRAYS, HAIR FOAM, HAIR CREAMS, HAIR WAXES, HAIR TONICS; PERFUMES; EAU DE TOILETTE; DEODORANTS FOR BODY CARE; AFTER-SHAVE LOTIONS; SHAVING PREPARATIONS, IN CLASS 3 (U.S. CLS. 1, 4, 6, 50, 51 AND 52).

THE MARK CONSISTS OF PALE GREEN RIBBON SEGMENT THAT FOLLOWS A TWISTING PATH FROM LEFT TO RIGHT.

PRIORITY DATE OF 3-25-2011 IS CLAIMED.

OWNER OF INTERNATIONAL REGISTRATION 1091014 DATED 8-12-2011, EXPIRES 8-12-2021.

THE COLOR(S) PALE GREEN IS/ARE CLAIMED AS A FEATURE OF THE MARK.

SER. NO. 79-102,679, FILED 8-12-2011.

RON FAIRBANKS, EXAMINING ATTORNEY



David J. Kyros

Director of the United States Patent and Trademark Office

United States of America

United States Patent and Trademark Office

Grammer Office

Reg. No. 4,152,379

Registered June 5, 2012

Int. Cl.: 20

SATO OFFICE GMBH (FED REP GERMANY GELLSCHAFT MIT BESCHRÄNKTER
HAFTUNG (GMBH))
JUBATUS-ALLEE 1
92263 EBERMANNSDORF
FED REP GERMANY

TRADEMARK

FOR: SEATING FURNITURE, IN PARTICULAR OFFICE CHAIRS, IN CLASS 20 (U.S. CLS.
2, 13, 22, 25, 32 AND 50).

PRINCIPAL REGISTER

THE MARK CONSISTS OF STANDARD CHARACTERS WITHOUT CLAIM TO ANY PAR-
TICULAR FONT, STYLE, SIZE, OR COLOR.

PRIORITY DATE OF 12-15-2010 IS CLAIMED.

OWNER OF INTERNATIONAL REGISTRATION 1091083 DATED 6-14-2011, EXPIRES 6-14-
2021.

NO CLAIM IS MADE TO THE EXCLUSIVE RIGHT TO USE "OFFICE", APART FROM THE
MARK AS SHOWN.

SER. NO. 79-102,701, FILED 6-14-2011.

MICHAEL WIENER, EXAMINING ATTORNEY



David J. Kybas

Director of the United States Patent and Trademark Office

United States of America

United States Patent and Trademark Office

PURETOPIA

Reg. No. 4,152,380

Registered June 5, 2012

Int. Cls.: 3, 4 and 5

TRADEMARK

PRINCIPAL REGISTER

FROSTBLAND PTY LTD (AUSTRALIA CORPORATION)
UNIT 1
47-53 MOXON ROAD; PUNCHBOWL NSW 2196
AUSTRALIA

FOR: COSMETICS; MAKE-UP; COSMETIC KITS; SKIN CARE PREPARATIONS, NAMELY, CREAMS AND MOISTURISERS FOR FACE AND BODY, BODY LOTIONS, FACE CLEANSING GELS AND CREAMS, TONERS, EXFOLIATING SCRUBS, MAKE-UP REMOVING LOTIONS, EYE CREAMS AND EYE GELS, LIP BALMS, FACE SERUMS, FACIAL MASKS, BODY WASHES, HAND WASHES, ARTIFICIAL TANNING LOTIONS AND ARTIFICIAL TANNING SPRAYS, HAND AND NAIL CREAMS; MOISTURIZERS AND SKIN CREAMS; LOTIONS FOR COSMETIC PURPOSES; BEAUTY MASKS; SOAPS; NON-MEDICATED TOILETRIES; NON-MEDICATED PREPARATIONS FOR DENTAL PURPOSES AND NON-MEDICATED PREPARATIONS FOR ORAL HYGIENE; BREATH FRESHENING SPRAYS; PERSONAL DEODORANTS; TALCUM POWDER; PERFUMERY, NAMELY, PERFUMES, PARFUM, EAU DE COLOGNE, EAU DE TOILETTE, EAU DE PARFUM, SPRAY COLOGNE, PERFUMED BODY SPRAYS, FRAGRANCED OILS; ESSENTIAL OILS; HAIR CARE PREPARATIONS, NAMELY, SHAMPOOS AND CONDITIONERS, HAIR COLORANTS, LOTIONS AND SPRAYS, OIL TREATMENTS FOR HAIR, HAIR MOISTURISING TREATMENTS; NAIL CARE PREPARATIONS; DEPILATORY PREPARATIONS; SHAVING PREPARATIONS; AFTER-SHAVE LOTIONS; NON-MEDICATED BATH SALTS; NON-MEDICATED SUNSCREENS AND SUN-TANNING PREPARATIONS, IN CLASS 3 (U.S. CLS. 1, 4, 6, 50, 51 AND 52).

FOR: CANDLES AND WICKS FOR LIGHTING, CANDLE WAX, CANDLE MOULDS, SOY CANDLES, PALM CANDLES, NATURAL CANDLES, PERFUMED CANDLES, IN CLASS 4 (U.S. CLS. 1, 6 AND 15).

FOR: DIETETIC SUBSTANCES ADAPTED FOR MEDICAL USE; DIETARY AND NUTRITIONAL SUPPLEMENTS, IN CLASS 5 (U.S. CLS. 6, 18, 44, 46, 51 AND 52).

THE MARK CONSISTS OF STANDARD CHARACTERS WITHOUT CLAIM TO ANY PARTICULAR FONT, STYLE, SIZE, OR COLOR.

PRIORITY DATE OF 12-24-2010 IS CLAIMED.



David J. Kyros

Director of the United States Patent and Trademark Office

Reg. No. 4,152,380 OWNER OF INTERNATIONAL REGISTRATION 1091274 DATED 6-24-2011, EXPIRES 6-24-2021.

SER. NO. 79-102,761, FILED 6-24-2011.

RONALD AIKENS, EXAMINING ATTORNEY

United States of America

United States Patent and Trademark Office



Reg. No. 4,152,381

Registered June 5, 2012

Int. Cls.: 6 and 20

TRADEMARK

PRINCIPAL REGISTER

OS ID AS (NORWAY STOCK COMPANY)
VERJAFARET 1
N-2550 ØSTERDALEN
NORWAY

FOR: EAR TAGS AND NUMBER PLATES FOR LIVESTOCK IN THE NATURE OF FARM ANIMALS; NAMEPLATES; COLLARS OF METAL FOR FASTENING BELLS OR ROPES FOR ANIMALS; BELLS FOR ANIMALS; ALL THE AFOREMENTIONED GOODS OF METAL, IN CLASS 6 (U.S. CLS. 2, 12, 13, 14, 23, 25 AND 50).

FOR: NON-METAL EAR TAGS AND NUMBER PLATES FOR LIVESTOCK IN THE NATURE OF FARM ANIMALS; NON-METAL NAME PLATES, IN CLASS 20 (U.S. CLS. 2, 13, 22, 25, 32 AND 50).

NO CLAIM IS MADE TO THE EXCLUSIVE RIGHT TO USE "ID", APART FROM THE MARK AS SHOWN.

PRIORITY DATE OF 10-22-2010 IS CLAIMED.

OWNER OF INTERNATIONAL REGISTRATION 1091288 DATED 4-12-2011, EXPIRES 4-12-2021.

THE COLOR(S) GREEN AND WHITE IS/ARE CLAIMED AS A FEATURE OF THE MARK.

THE MARK CONSISTS OF THE STYLIZED LETTERS "OS" AND "ID" IN WHITE LETTERING, WHERE "OS" IS HOUSED IN A LARGE GREEN SQUARE, AND "ID" IS HOUSED IN A SMALLER GREEN SQUARE TO THE UPPER RIGHT.

SER. NO. 79-102,763, FILED 4-12-2011.

ADA HAN, EXAMINING ATTORNEY



David J. Kyjars

Director of the United States Patent and Trademark Office

United States of America

United States Patent and Trademark Office

XTREME

Reg. No. 4,152,382

Registered June 5, 2012

Int. Cls.: 7, 9 and 40

TRADEMARK

SERVICE MARK

PRINCIPAL REGISTER

BYSTRONIC LASER AG (SWITZERLAND JOINT STOCK COMPANY)
INDUSTRIESTRASSE 21
CH-3362 NIEDERÖNZ
SWITZERLAND

FOR: MECHANICAL AND HYDRAULIC PRESSES FOR METAL PROCESSING; MACHINE TOOLS FOR METAL TREATMENT, NAMELY, BENDING TOOLS, FORMING PUNCHES AND SHEET FOLDING MATRICES; LASER CUTTING AND FOLDING MACHINES FOR METAL TREATMENT; MACHINES FOR ROUNDING OFF AND FOLDING SHEETS OF METAL, IN CLASS 7 (U.S. CLS. 13, 19, 21, 23, 31, 34 AND 35).

FOR: COMPUTER PROGRAM FOR MONITORING MACHINES FOR ROUNDING OFF AND FOLDING SHEETS OF METAL; LASERS FOR NON-MEDICAL PURPOSES, NAMELY, LASERS FOR CUTTING, SOLDERING AND ENGRAVING MATERIALS IN SHEET FORM, IN CLASS 9 (U.S. CLS. 21, 23, 26, 36 AND 38).

FOR: TREATMENT OF MATERIALS, NAMELY, METAL TREATMENT. WE HOPE THAT ALL REQUIREMENTS IN THE OFFICE ACTION HAVE BEEN FULFILLED THIS WAY AND OUR TRADEMARK "XTREME" WILL BE ALLOWED FOR REGISTRATION IN THE USA SOON, IN CLASS 40 (U.S. CLS. 100, 103 AND 106).

THE MARK CONSISTS OF STANDARD CHARACTERS WITHOUT CLAIM TO ANY PARTICULAR FONT, STYLE, SIZE, OR COLOR.

PRIORITY DATE OF 1-28-2011 IS CLAIMED.

OWNER OF INTERNATIONAL REGISTRATION 1091487 DATED 7-25-2011, EXPIRES 7-25-2021.

SER. NO. 79-102,829, FILED 7-25-2011.

PATRICIA EVANKO, EXAMINING ATTORNEY



David J. Kybas

Director of the United States Patent and Trademark Office

United States of America

United States Patent and Trademark Office

NO ONE CAN SEE HOW WELL YOU HEAR

Reg. No. 4,152,383

Registered June 5, 2012

Int. Cl.: 10

TRADEMARK

PRINCIPAL REGISTER

SONOVA HOLDING AG (SWITZERLAND AKTIENGESELLSCHAFT)
LAUBISRÜTISTRASSE 28
CH-8712 STÄFA
SWITZERLAND

FOR: TECHNICAL AND MEDICAL DEVICES, NAMELY, HEARING AIDS FOR THE DEAF,
IN CLASS 10 (U.S. CLS. 26, 39 AND 44).

THE MARK CONSISTS OF STANDARD CHARACTERS WITHOUT CLAIM TO ANY PAR-
TICULAR FONT, STYLE, SIZE, OR COLOR.

OWNER OF INTERNATIONAL REGISTRATION 1053376 DATED 8-26-2010, EXPIRES 8-26-
2020.

OWNER OF U.S. REG. NO. 3,991,907.

SER. NO. 79-102,861, FILED 1-19-2011.

JAY BESCH, EXAMINING ATTORNEY



David J. Kybas

Director of the United States Patent and Trademark Office

United States of America
United States Patent and Trademark Office

ALUSTAR

Reg. No. 4,152,384

Registered June 5, 2012

Int. Cl.: 11

TRADEMARK

PRINCIPAL REGISTER

NV BEKAERT SA (BELGIUM NAAMLOZE VENNOOTSCHAP)
BEKAERTSTRAAT 2
B-8550 ZWEVEGEM
BELGIUM

FOR: HEATING INSTALLATIONS AND PARTS THEREOF, NAMELY, HEAT EXCHANGERS,
IN CLASS 11 (U.S. CLS. 13, 21, 23, 31 AND 34).

THE MARK CONSISTS OF STANDARD CHARACTERS WITHOUT CLAIM TO ANY PAR-
TICULAR FONT, STYLE, SIZE, OR COLOR.

OWNER OF INTERNATIONAL REGISTRATION 1092028 DATED 8-20-2011, EXPIRES 8-20-
2021.

SER. NO. 79-103,048, FILED 8-20-2011.

SUE LAWRENCE, EXAMINING ATTORNEY



David J. Kyros

Director of the United States Patent and Trademark Office

United States of America

United States Patent and Trademark Office

SES[▲]

your satellite company

Reg. No. 4,152,385

Registered June 5, 2012

Int. Cl.: 38

SERVICE MARK

PRINCIPAL REGISTER

SES S.A. (LUXEMBOURG S.A.)
CHÂTEAU DE BETZDORF
L-6815 BETZDORF
LUXEMBOURG

FOR: TELECOMMUNICATION SERVICES, NAMELY, COLLECTION, TRANSMISSION AND DELIVERY OF VOICE, VIDEO AND AUDIO SIGNALS, TRANSMISSION AND DELIVERY OF DATA BY SATELLITES, IN CLASS 38 (U.S. CLS. 100, 101 AND 104).

OWNER OF U.S. REG. NOS. 3,794,742 AND 4,040,391.

OWNER OF INTERNATIONAL REGISTRATION 1092094 DATED 7-14-2011, EXPIRES 7-14-2021.

NO CLAIM IS MADE TO THE EXCLUSIVE RIGHT TO USE "SATELLITE COMPANY", APART FROM THE MARK AS SHOWN.

THE MARK CONSISTS OF THE LETTERS "SES" IN ALL CAPS, FOLLOWED BY A SHADED TRIANGLE WITH THE ONE CURVED SIDE PLACED NEXT TO THE UPPER PORTION OF THE LETTER "S", WITH THE WORDING, "YOUR SATELLITE COMPANY" PRINTED BELOW IN LOWER CASE LETTERS.

SER. NO. 79-103,068, FILED 7-14-2011.

ODESSA BIBBINS, EXAMINING ATTORNEY



David J. Kyros

Director of the United States Patent and Trademark Office

United States of America
United States Patent and Trademark Office

yachtonus

Reg. No. 4,152,386

Registered June 5, 2012

Int. Cl.: 37

SERVICE MARK

PRINCIPAL REGISTER

AXVECO B.V. (NETHERLANDS B.V.)
REGENTESSELAAN 19
NL-3818 HH AMERSFOORT
NETHERLANDS

FOR: MAINTENANCE AND REPAIR OF PARTS AND FITTINGS FOR BOATS; SURFACE
CONDITIONING OF BOATS, NAMELY, CLEANING AND RESTORATION OF BOAT SUR-
FACES, IN CLASS 37 (U.S. CLS. 100, 103 AND 106).

THE MARK CONSISTS OF STANDARD CHARACTERS WITHOUT CLAIM TO ANY PAR-
TICULAR FONT, STYLE, SIZE, OR COLOR.

OWNER OF INTERNATIONAL REGISTRATION 1092280 DATED 9-5-2011, EXPIRES 9-5-
2021.

SER. NO. 79-103,129, FILED 9-5-2011.

KEVIN CORWIN, EXAMINING ATTORNEY



David J. Kyfos

Director of the United States Patent and Trademark Office

United States of America

United States Patent and Trademark Office

OCTAGAM

Reg. No. 4,152,387

Registered June 5, 2012

Int. Cl.: 5

TRADEMARK

PRINCIPAL REGISTER

OCTAPHARMA AG (SWITZERLAND AKTIENGESELLSCHAFT)
SEIDENSTRASSE 2
CH-8853 LACHEN SZ
SWITZERLAND

FOR: MEDICINES IN THE NATURE OF BLOOD PLASMA DERIVED PRODUCTS, NAMELY, IMMUNOGLOBULINS TO BE INJECTED, IN CLASS 5 (U.S. CLS. 6, 18, 44, 46, 51 AND 52).

THE MARK CONSISTS OF STANDARD CHARACTERS WITHOUT CLAIM TO ANY PARTICULAR FONT, STYLE, SIZE, OR COLOR.

OWNER OF INTERNATIONAL REGISTRATION 0575095 DATED 7-25-1991, EXPIRES 7-25-2021.

OWNER OF U.S. REG. NO. 2,921,100.

SER. NO. 79-103,174, FILED 9-8-2011.

LANA PHAM, EXAMINING ATTORNEY



David J. Kybas

Director of the United States Patent and Trademark Office

United States of America

United States Patent and Trademark Office

KID'SLEEP

Reg. No. 4,152,388

Registered June 5, 2012

Int. Cls.: 14 and 28

TRADEMARK

PRINCIPAL REGISTER

CLAESSENS' KIDS SÀRL (SWITZERLAND SOCIÉTÉ À RESPONSABILITÉ LIMITÉE (SARL))
RUE DU COLLÈGE 3
CH-1168 VILLARS-SUR-YENS
SWITZERLAND

FOR: TIMEPIECES AND CHRONOMETRIC INSTRUMENTS, IN CLASS 14 (U.S. CLS. 2, 27, 28 AND 50).

FOR: ELECTRONIC LEARNING TOYS, IN CLASS 28 (U.S. CLS. 22, 23, 38 AND 50).

THE MARK CONSISTS OF STANDARD CHARACTERS WITHOUT CLAIM TO ANY PARTICULAR FONT, STYLE, SIZE, OR COLOR.

OWNER OF INTERNATIONAL REGISTRATION 0819934 DATED 1-22-2004, EXPIRES 1-22-2014.

SER. NO. 79-103,177, FILED 7-27-2011.

RON FAIRBANKS, EXAMINING ATTORNEY



David J. Kybas

Director of the United States Patent and Trademark Office

United States of America

United States Patent and Trademark Office

JACKLOC

Reg. No. 4,152,389

Registered June 5, 2012

Int. Cl.: 6

TRADEMARK

PRINCIPAL REGISTER

THE JACKLOC COMPANY LIMITED (UNITED KINGDOM LIMITED COMPANY)
ULVERSCROFT LODGE,
PRIORY LANE; ULVERSCROFT, LEICESTERSHIRELE67 9PB
UNITED KINGDOM

FOR: DOOR AND WINDOW FITTINGS OF METAL, NAMELY, RESTRICTORS FOR LIMITING THE DISTANCE BY WHICH WINDOWS AND DOORS CAN OPEN, IN CLASS 6 (U.S. CLS. 2, 12, 13, 14, 23, 25 AND 50).

THE MARK CONSISTS OF STANDARD CHARACTERS WITHOUT CLAIM TO ANY PARTICULAR FONT, STYLE, SIZE, OR COLOR.

OWNER OF INTERNATIONAL REGISTRATION 1021452 DATED 10-27-2009, EXPIRES 10-27-2019.

SER. NO. 79-103,185, FILED 8-10-2011.

ANTHONY RINKER, EXAMINING ATTORNEY



David J. Kyffers

Director of the United States Patent and Trademark Office

United States of America

United States Patent and Trademark Office

ALTRO AQUARIUS

Reg. No. 4,152,390

Registered June 5, 2012

Int. Cl.: 27

TRADEMARK

PRINCIPAL REGISTER

ALTRO LIMITED (UNITED KINGDOM LIMITED COMPANY)
WORKS ROAD
LETCHWORTH GARDEN CITY; HERTFORDSHIRE SG6 1NW
UNITED KINGDOM

FOR: MATERIALS FOR COVERING FLOORS, WALLS AND STAIRS, NAMELY, FLOOR COVERINGS, ANTI-SLIP FLOOR COVERINGS FOR USE ON FLOORS OR STAIRCASES, VINYL, RUBBER AND RESILIENT HARD SURFACE COVERINGS FOR COVERING FLOORS, WALLS AND STAIRS; DECORATIVE SLIP RESISTANT FLOOR COVERINGS IN SHEET FORM, IN CLASS 27 (U.S. CLS. 19, 20, 37, 42 AND 50).

THE MARK CONSISTS OF STANDARD CHARACTERS WITHOUT CLAIM TO ANY PARTICULAR FONT, STYLE, SIZE, OR COLOR.

PRIORITY DATE OF 2-24-2011 IS CLAIMED.

OWNER OF INTERNATIONAL REGISTRATION 1092549 DATED 8-5-2011, EXPIRES 8-5-2021.

OWNER OF U.S. REG. NOS. 867,088, 3,899,473 AND OTHERS.

SER. NO. 79-103,251, FILED 8-5-2011.

TOBY BULLOFF, EXAMINING ATTORNEY



David J. Kybas

Director of the United States Patent and Trademark Office

United States of America

United States Patent and Trademark Office



Reg. No. 4,152,391

Registered June 5, 2012

Int. Cl.: 28

TRADEMARK

PRINCIPAL REGISTER

SAKURAI HIROKATSU (JAPAN INDIVIDUAL)
7 FLOOR, KANDA SAKURA BUILDING
8-1, KAJI-CHO 1-CHOME, CHIYODA-KU
TOKYO 101-0044, JAPAN

FOR: ARTIFICIAL FISHING BAIT, RODS FOR FISHING, FISHING ROD STANDS, POLES FOR SUPPORTING FISHING RODS, LANDING NETS FOR ANGLERS, POLES FOR LANDING NETS, FLOATS FOR FISHING, FISH HOOKS, LURES FOR FISHING, FISHING TACKLE, LINES FOR FISHING, REELS FOR FISHING, CREELS FOR FISHING EQUIPMENT, GUT FOR FISHING, BITE INDICATORS AS FISHING EQUIPMENT, BITE SENSORS AS FISHING EQUIPMENT, IN CLASS 28 (U.S. CLS. 22, 23, 38 AND 50).

THE MARK CONSISTS OF THE WORD "SAKURA" WITHIN A RECTANGULAR BACKGROUND WITHIN A DESIGN REPRESENTING A CHERRY BLOSSOM.

OWNER OF INTERNATIONAL REGISTRATION 0995870 DATED 12-24-2008, EXPIRES 12-24-2018.

THE ENGLISH TRANSLATION OF "SAKURA" IN THE MARK IS "CHERRY BLOSSOM".

SER. NO. 79-103,476, FILED 8-9-2011.

CARYN GLASSER, EXAMINING ATTORNEY



David J. Kyjars

Director of the United States Patent and Trademark Office

United States of America

United States Patent and Trademark Office

SCANFLAVOUR

Reg. No. 4,152,392

Registered June 5, 2012

Int. Cls.: 5, 29 and 30

TRADEMARK

PRINCIPAL REGISTER

SCANFLAVOUR A/S (DENMARK LIMITED LIABILITY COMPANY)
HOBROVEJ, 1
DK-9632 MOLDRUP
DENMARK

FOR: RAW MATERIALS BEING DIETETIC FOODS ADAPTED FOR MEDICAL USE; NON-NUTRITIVE EDIBLE PLANT FIBRES IN THE NATURE OF PLANT EXTRACTS FOR MEDICAL PURPOSES; DIETETIC FOODS BEING FRUIT PECTINS ADAPTED FOR MEDICAL USE, IN CLASS 5 (U.S. CLS. 6, 18, 44, 46, 51 AND 52).

FOR: PROTEINS BEING FOODSTUFFS FOR HUMAN CONSUMPTION; MILK PRODUCTS, EXCLUDING ICE CREAM, ICE MILK AND FROZEN YOGHURT; CASEIN, UNFLAVOURED GELATIN, PROCESSED AND EDIBLE SEAWEED AND FRUIT PECTIN EXTRACTS FOR FOOD, IN CLASS 29 (U.S. CL. 46).

FOR: COFFEE, TEA, COCOA, SUGAR, SAGO, COFFEE SUBSTITUTES; EDIBLE ICES; HONEY, SALT, MUSTARD; VINEGAR, CONDIMENTS BEING SAUCES; SPICES; ICE; FLAVOURINGS OTHER THAN ESSENTIAL OILS; ESSENCES FOR FOODSTUFFS EXCEPT ETHERIC ESSENCES AND ESSENTIAL OILS, NAMELY, EXTRACTS USED AS FOOD FLAVOURING, IN CLASS 30 (U.S. CL. 46).

THE MARK CONSISTS OF STANDARD CHARACTERS WITHOUT CLAIM TO ANY PARTICULAR FONT, STYLE, SIZE, OR COLOR.

PRIORITY DATE OF 7-11-2011 IS CLAIMED.

OWNER OF INTERNATIONAL REGISTRATION 1093172 DATED 9-7-2011, EXPIRES 9-7-2021.

SER. NO. 79-103,510, FILED 9-7-2011.

NAPOLEON SHARMA, EXAMINING ATTORNEY



David J. Kybas

Director of the United States Patent and Trademark Office

United States of America

United States Patent and Trademark Office

BIOCEL

Reg. No. 4,152,393

Registered June 5, 2012

Int. Cls.: 1, 22 and 23

TRADEMARK

PRINCIPAL REGISTER

LENZING AKTIENGESELLSCHAFT (AUSTRIA CORPORATION)
WERKSTR. 2
A-4860 LENZING
AUSTRIA

FOR: DISSOLVING WOOD PULP FOR MANUFACTURING PURPOSES SPECIFICALLY FOR USE IN THE MANUFACTURE OF PAPER; DISSOLVING WOOD PULP FOR MANUFACTURING PURPOSES SPECIFICALLY FOR USE IN THE MANUFACTURE OF CHEMICAL FIBERS THAT ARE USED FOR TEXTILE PURPOSES, IN CLASS 1 (U.S. CLS. 1, 5, 6, 10, 26 AND 46).

FOR: RAW TEXTILE FIBERS FOR USE IN MAKING CLOTHING FABRICS, IN CLASS 22 (U.S. CLS. 1, 2, 7, 19, 22, 42 AND 50).

FOR: YARNS AND TWISTED YARNS FOR TEXTILE USE MADE OF MAN MADE OR RECLAIMED CELLULOSE SPECIFICALLY FOR USE IN THE MANUFACTURE OF CLOTHING, IN CLASS 23 (U.S. CL. 43).

THE MARK CONSISTS OF STANDARD CHARACTERS WITHOUT CLAIM TO ANY PARTICULAR FONT, STYLE, SIZE, OR COLOR.

OWNER OF INTERNATIONAL REGISTRATION 1093176 DATED 6-27-2011, EXPIRES 6-27-2021.

SER. NO. 79-103,514, FILED 6-27-2011.

MICHAEL TANNER, EXAMINING ATTORNEY



David J. Kyros

Director of the United States Patent and Trademark Office

United States of America

United States Patent and Trademark Office

SPENCER HART PALM SPRINGS

Reg. No. 4,152,394

Registered June 5, 2012

Int. Cls.: 3, 18 and 25

TRADEMARK

PRINCIPAL REGISTER

NICHOLAS RUSSELL HART (UNITED KINGDOM INDIVIDUAL)
C/O SHERRARDS SOLICITORS LLP
45 GROSVENOR ROAD; ST ALBANS, HERTFORDSHIRE AL1 3AW
UNITED KINGDOM

FOR: NON-MEDICATED PREPARATIONS FOR CARE OF THE SKIN, HAIR AND NAILS; PERFUMES; COLOGNES; COSMETICS; SOAPS AND LIQUID SOAPS FOR USE ON THE HUMAN BODY, COSMETIC BODY MILKS, COSMETIC BODY POWDERS, COSMETIC BODY OILS, BUBBLE BATH, COSMETIC BATH AND SHOWER PREPARATIONS, NAMELY, BATH SALTS, BATH GEL AND BATH OILS; ESSENTIAL OILS FOR PERSONAL USE; HAIR LOTIONS; DENTIFRICES; PREPARATIONS FOR USE IN AND AFTER SHAVING; AFTER-SHAVE LOTIONS; NON-MEDICATED TOILET PREPARATIONS, NAMELY, TOILET SOAP, TOILET WATER; TALCUM POWDER FOR TOILET USE; ANTIPERSPIRANTS; DEODORANTS FOR PERSONAL USE; SHOE CLEANING PREPARATIONS, NAMELY, SHOE CREAM, SHOE POLISH, SHOE WAX, IN CLASS 3 (U.S. CLS. 1, 4, 6, 50, 51 AND 52).

FOR: LEATHER AND IMITATION LEATHER GOODS, NAMELY, BOXES OF LEATHER OR IMITATION LEATHER FOR PACKAGING AND CARRYING GOODS, TRUNKS, SUIT-CASES, LEATHER TRAVELING SETS CONSISTING OF LUGGAGE, TRAVELING BAGS, LUGGAGE, GARMENT BAGS FOR TRAVEL, HAT BOXES, VANITY CASES AND COSMETIC CASES SOLD EMPTY, TOILETRY BAGS SOLD EMPTY, BACKPACKS, SATCHELS, HANDBAGS, BEACH BAGS, LEATHER SHOPPING BAGS, TEXTILE SHOPPING BAGS, SHOULDER BAGS, WAIST BAGS, RUCKSACKS, DUFFLE BAGS, VALISES; PURSES, ATTACH CASES, BRIEFCASES, SCHOOL BAGS, DOCUMENT CASES, CLUTCH BAGS, WALLETS, CHANGE PURSES, KEY CASES, BUSINESS AND CREDIT CARD CASES; UMBRELLAS AND WALKING STICKS, IN CLASS 18 (U.S. CLS. 1, 2, 3, 22 AND 41).

FOR: CLOTHING, NAMELY, SUITS, JACKETS, VESTS, TROUSERS, PANTS, SHIRTS, BLOUSES, SKIRTS, DRESSES, PULLOVERS, SWEATERS, SOCKS, COATS, BATHROBES, DRESSING GOWNS, PAJAMAS, NIGHTSHIRTS, GLOVES, SCARVES, BELTS, BRACES AND TIES; FOOTWEAR, NAMELY, BOOTS, SHOES, SLIPPERS; HEADGEAR, NAMELY, HATS, CAPS, IN CLASS 25 (U.S. CLS. 22 AND 39).

THE MARK CONSISTS OF STANDARD CHARACTERS WITHOUT CLAIM TO ANY PARTICULAR FONT, STYLE, SIZE, OR COLOR.



David J. Kyros

Director of the United States Patent and Trademark Office

Reg. No. 4,152,394 OWNER OF INTERNATIONAL REGISTRATION 1093400 DATED 7-9-2011, EXPIRES 7-9-2021.

THE NAME(S), PORTRAIT(S), AND/OR SIGNATURE(S) SHOWN IN THE MARK IDENTIFIES "SPENCER HART", WHOSE CONSENT(S) TO REGISTER IS MADE OF RECORD.

SER. NO. 79-103,601, FILED 7-9-2011.

KEVIN DINALLO, EXAMINING ATTORNEY

United States of America

United States Patent and Trademark Office

TurboTight

Reg. No. 4,152,395

Registered June 5, 2012

Int. Cls.: 7 and 9

TRADEMARK

PRINCIPAL REGISTER

ATLAS COPCO TOOLS AB (SWEDEN JOINT STOCK COMPANY)
SICKLA INDUSTRIVÄG 11
SE-105 23 STOCKHOLM
SWEDEN

FOR: INDUSTRIAL FASTENING MACHINES AND TOOLS, NAMELY, ELECTRIC NUT RUNNERS AND ELECTRIC CONTROLS FOR NUT RUNNERS, ALL SOLD AS A UNIT, IN CLASS 7 (U.S. CLS. 13, 19, 21, 23, 31, 34 AND 35).

FOR: SOFTWARE FOR USE WITH CONTROLLERS FOR INDUSTRIAL FASTENING SYSTEMS, IN CLASS 9 (U.S. CLS. 21, 23, 26, 36 AND 38).

THE MARK CONSISTS OF STANDARD CHARACTERS WITHOUT CLAIM TO ANY PARTICULAR FONT, STYLE, SIZE, OR COLOR.

PRIORITY DATE OF 6-23-2011 IS CLAIMED.

OWNER OF INTERNATIONAL REGISTRATION 1093766 DATED 9-22-2011, EXPIRES 9-22-2021.

SER. NO. 79-103,734, FILED 9-22-2011.

APRIL ROACH, EXAMINING ATTORNEY



David J. Kyffers

Director of the United States Patent and Trademark Office

United States of America

United States Patent and Trademark Office

Adventeer

Reg. No. 4,152,396

Registered June 5, 2012

Int. Cls.: 38, 39 and 43

SERVICE MARK

PRINCIPAL REGISTER

ALLAN TORP JENSEN (DENMARK INDIVIDUAL)
MINERVAVEJ 11
DK-9310 VODSKOV
DENMARK

FOR: PROVIDING ACCESS TO INTERNET PAGES, PROVIDING AN ON-LINE FORUM WHERE READERS CAN COMMUNICATE NEWS, TIPS AND OPINIONS REGARDING TRAVEL, RESTAURANTS, LODGING, SPORTS, CULTURAL EVENTS, IN CLASS 38 (U.S. CLS. 100, 101 AND 104).

FOR: TRAVEL BOOKING, INFORMATION ON THE INTERNET REGARDING TRAVEL TRANSPORTATION AND TRAVEL RESERVATIONS, IN CLASS 39 (U.S. CLS. 100 AND 105).

FOR: RESTAURANT, CAFE AND HOTEL SERVICES, ONLINE INFORMATION TO TOURISTS ABOUT RESTAURANTS, CAFES, CATERING AND HOTELS, IN CLASS 43 (U.S. CLS. 100 AND 101).

THE MARK CONSISTS OF STANDARD CHARACTERS WITHOUT CLAIM TO ANY PARTICULAR FONT, STYLE, SIZE, OR COLOR.

PRIORITY DATE OF 12-4-2010 IS CLAIMED.

OWNER OF INTERNATIONAL REGISTRATION 1093932 DATED 4-19-2011, EXPIRES 4-19-2021.

SER. NO. 79-103,822, FILED 4-19-2011.

TOBY BULLOFF, EXAMINING ATTORNEY



David J. Kyffers

Director of the United States Patent and Trademark Office

United States of America

United States Patent and Trademark Office

CARKOON

Reg. No. 4,152,397

Registered June 5, 2012

Int. Cl.: 12

TRADEMARK

PRINCIPAL REGISTER

JULLIAN JOSHUA PRESTON-POWERS, C/O THERMAHELM LIMITED (UNITED KINGDOM
INDIVIDUAL)
SUSSEX INNOVATION CENTRE
SCIENCE PARK SQUARE; FALMER, BRIGHTON, EAST SUSSEX BN1 9SB
UNITED KINGDOM

FOR: SAFETY SEATS FOR VEHICLES; CHILDREN'S SEATS FOR USE IN CARS; STRUC-
TURAL PARTS AND FITTINGS FOR ALL THE AFORESAID GOODS, IN CLASS 12 (U.S.
CLS. 19, 21, 23, 31, 35 AND 44).

THE MARK CONSISTS OF STANDARD CHARACTERS WITHOUT CLAIM TO ANY PAR-
TICULAR FONT, STYLE, SIZE, OR COLOR.

PRIORITY DATE OF 12-29-2010 IS CLAIMED.

OWNER OF INTERNATIONAL REGISTRATION 1093995 DATED 6-27-2011, EXPIRES 6-27-
2021.

SER. NO. 79-103,841, FILED 6-27-2011.

KATHERINE E. HALMEN, EXAMINING ATTORNEY



David J. Kyffers

Director of the United States Patent and Trademark Office

United States of America

United States Patent and Trademark Office



C4S
(compression for sport)

Reg. No. 4,152,398

Registered June 5, 2012

Int. Cls.: 10 and 25

TRADEMARK

PRINCIPAL REGISTER

GLORIA MED S.P.A. (ITALY JOINT STOCK COMPANY)
VIA DIAZ, 7
I-22017 MENAGGIO (COMO)
ITALY

FOR: ORTHOPEDIC ARTICLES, NAMELY, ORTHOPEDIC BELTS AND ORTHOPEDIC BRACES; ORTHOPEDIC KNEE BANDAGES; ORTHOPEDIC SUPPORT BANDAGES; ELASTIC STOCKINGS; ORTHOPEDIC SUPPORT BANDS FOR ANKLES AND KNEES; ORTHOPEDIC SUSPENDERS IN THE NATURE OF SUPPORT BANDS FOR ANKLES AND KNEES; ELASTIC BRIEFS FOR ORTHOPEDIC PURPOSES; CORSETS FOR THERAPEUTIC USE; CORSETS FOR MEN AND WOMEN FOR ORTHOPEDIC PURPOSES; ELASTIC SUPPORT BANDS FOR ANKLES AND KNEES, IN CLASS 10 (U.S. CLS. 26, 39 AND 44).

FOR: STOCKINGS, SOCKS, PANTY HOSE, TIGHTS AND GIRDLES, WAIST AND LEG BANDS, IN CLASS 25 (U.S. CLS. 22 AND 39).

NO CLAIM IS MADE TO THE EXCLUSIVE RIGHT TO USE "COMPRESSION FOR SPORT", APART FROM THE MARK AS SHOWN.

PRIORITY DATE OF 3-1-2011 IS CLAIMED.

OWNER OF INTERNATIONAL REGISTRATION 1094032 DATED 8-11-2011, EXPIRES 8-11-2021.

THE TRADEMARK CONSISTS OF THE ITEM "C4S (COMPRESSION FOR SPORT)" IN SPECIAL SCRIPT PLACED ON TWO LINES.

SER. NO. 79-103,855, FILED 8-11-2011.

KELLY TRUSILO, EXAMINING ATTORNEY



David J. Kybas

Director of the United States Patent and Trademark Office

United States of America

United States Patent and Trademark Office



Reg. No. 4,152,399

Registered June 5, 2012

Int. Cl.: 25

TRADEMARK

PRINCIPAL REGISTER

FIVE SEASONS S.R.L. (ITALY LIMITED LIABILITY COMPANY)
SS 11 PADANA SUPERIORE
I-20063 CERNUSCO SUL NAVIGLIO (MI)
ITALY

FOR: CLOTHING, NAMELY, T-SHIRTS, SHIRTS, JUMPERS, TROUSERS, SKIRTS, BATHING SUITS, JEANS, JACKETS, ARTICLES OF UNDERCLOTHING, HATS AND CAPS, FOOTWEAR, IN CLASS 25 (U.S. CLS. 22 AND 39).

OWNER OF U.S. REG. NOS. 3,740,264 AND 3,793,270.

PRIORITY DATE OF 4-22-2011 IS CLAIMED.

OWNER OF INTERNATIONAL REGISTRATION 1094180 DATED 7-28-2011, EXPIRES 7-28-2021.

THE COLOR(S) WHITE AND PINK IS/ARE CLAIMED AS A FEATURE OF THE MARK.

THE MARK CONSISTS OF THE WORDING "MAISON ESPIN MADE WITH LOVE" IN WHITE LETTERS ARRANGED IN THE SHAPE OF AN ARCH ON A PINK RECTANGULAR BACKGROUND WITH TWO WHITE TWO PARTIALLY SUPERIMPOSED HEARTS WITH A WHITE BOW WITH THE WORDING "MAISON ESPIN" APPEARING ABOVE THE HEARTS AND "MADE WITH LOVE" APPEARING BELOW.

THE ENGLISH TRANSLATION OF "MAISON" IN THE MARK IS HOUSE.

SER. NO. 79-103,908, FILED 7-28-2011.

JACLYN KIDWELL WALKER, EXAMINING ATTORNEY



David J. Kybas

Director of the United States Patent and Trademark Office

United States of America

United States Patent and Trademark Office



Reg. No. 4,152,400

Registered June 5, 2012

Int. Cls.: 29, 30, 31 and 32

TRADEMARK

PRINCIPAL REGISTER

FERMERSKE GOSPODARSTVO "VLADAM" (UKRAINE FERMERSKE GOSPODARSTVO)
VUL. KOTOVSKOGO, 25
SMT. VOSKRESENSKE; ZHOVTNEVIY R-N; MIKOLAYIVSKA OBL. 57210
UKRAINE

FOR: BACON; BOUILLON CONCENTRATES; JAMS; CREAM; PEAS, PRESERVED; MUSHROOMS, PRESERVED; JELLIES FOR FOOD; EDIBLE FATS, NAMELY, SUET FOR FOOD; SPREAD COMPRISING EDIBLE FATS FOR USE ON BREAD SLICES; FROZEN FRUITS; SALTED FISH; CRYSTALLIZED FRUITS; RAISINS; CAVIAR; GINGER JAM; YOGHURT; COCOA BUTTER FOR FOOD PURPOSES; SAUERKRAUT; POTATO FLAKES; POTATO CHIPS; KEFIR; CHARCUTERIE; BLACK PUDDING; CHICKEN CROQUETTES; MEAT FISH CROQUETTES; CORN OIL; MEAT EXTRACTS; MEAT, TINNED; MEAT, PRESERVED; SALTED MEATS; MARGARINE; MARMALADE; BUTTER; CHOCOLATE BUTTER; BUTTERCREAM; MILK; MILK PRODUCTS EXCLUDING ICE CREAM, ICE MILK AND FROZEN YOGURT; VEGETABLES, TINNED; VEGETABLE SALADS; VEGETABLES, PRESERVED; VEGETABLES, DRIED; GHERKINS; OLIVES, PRESERVED; LIVER PASTES; LIVER; PICCALILLI; FISH FILLETS; FISH, TINNED; FOODS PREPARED FROM FISH, NAMELY, PREPARED ENTREES CONSISTING PRIMARILY OF FISH; FRUIT SALADS; PORK; CHEESE; WHEY; RENNET; TOFU; SOYA BEANS, PRESERVED, FOR FOOD; SUN-FLOWER OIL FOR FOOD; SAUSAGES; SAUSAGES IN BATTER; SOUPS; PREPARATIONS FOR MAKING SOUPS; VEGETABLE SOUP PREPARATIONS; TOMATO PUREE; TOMATO JUICE FOR COOKING; TUNA FISH; FRUIT, PRESERVED; FROSTED FRUITS; FRUIT PEEL; FRUIT PULP; FRUIT JELLIES; FRUIT, STEWED; FRUITS, TINNED; EDIBLE FATS; EDIBLE OILS; APPLE PUREE; POWDERED EGGS; EGGS, IN CLASS 29 (U.S. CL. 46).



David J. Kyros

Director of the United States Patent and Trademark Office

FOR: FLOUR FOR FOOD; FARINACEOUS FOODS, NAMELY, PASTA; PASTRIES; BREAD ROLLS; BUNS; SANDWICHES; WAFFLES; VERMICELLI, OATMEAL; OAT FLAKES; OAT-BASED FOOD, NAMELY, ROLLED OATS; BISCUITS; MUSTARD; MUSTARD MEAL; CUSTARD; FOOD LEAVENING AGENTS, NAMELY, YEAST; ARTIFICIAL COFFEE; AROMATIC PREPARATIONS FOR FOOD, NAMELY, FOOD FLAVORINGS; CEREAL PREPARATIONS, NAMELY, PROCESSED CEREALS, BREAKFAST CEREALS; COFFEE-BASED BEVERAGES; COFFEE BEVERAGES WITH MILK; COCOA; COCOA BEVERAGES WITH MILK; COCOA-BASED BEVERAGES; CARAMELS; POTATO FLOUR FOR FOOD; KETCHUP; TORTILLAS; STARCH FOR FOOD; PROCESSED CEREALS, NAMELY, GROATS FOR HUMAN FOOD; CORN, ROASTED; CORN FLOUR; POPCORN; TURMERIC FOR FOOD; COOKING SALT; LIQUORICE; MEAT PIES; PEPPERMINT SWEETS; MAYONNAISE; MACARONI; FARINACEOUS FOOD PASTES FOR HUMAN CONSUMPTION; PROCESSED

Reg. No. 4,152,400 SEMOLINA; CHOW-CHOW; MARZIPAN; ROYAL JELLY FOR HUMAN CONSUMPTION, NOT FOR MEDICAL PURPOSES; HONEY; MOLASSES FOR FOOD; ALMOND CONFECTIONERY, NAMELY, SUGAR-COATED ALMONDS; FLOUR-MILLING PRODUCTS, NAMELY, FLOUR; PANCAKES; SPRING ROLLS; GRUEL, NAMELY, PROCESSED GRAINS WITH A MILK BASE, FOR FOOD; TEA-BASED BEVERAGES; INFUSIONS, NOT MEDICINAL, NAMELY, HERBAL INFUSIONS; RAVIOLI; PEPPER; PEPPER SEASONINGS; ALLSPICE; COOKIES; QUICHES; PIZZAS; CHIPS, NAMELY, GRAIN BASED CHIPS, CORN CHIPS, FLOUR-BASED CHIPS; CORN FLAKES; PIES; FONDANTS; CONDIMENTS, NAMELY, PREPARED HORSERADISH, CHUTNEYS, MUSTARD; GINGERBREAD; SPICES; PUDDINGS; RICE; VEGETABLE PREPARATIONS FOR USE AS COFFEE SUBSTITUTES; SOYA SAUCE; MALT FOR HUMAN CONSUMPTION, NAMELY, MALT FOR FOOD PURPOSES; TOMATO SAUCE; SAUCES; GARDEN HERBS, PRESERVED; SPAGHETTI; RUSKS; BREADCRUMBS; PETIT-BEURRE BISCUITS; CAKES; CAKE PASTE; FRUIT JELLY CANDY; BREAD; CHICORY-BASED COFFEE SUBSTITUTE; SWEETMEATS; SUGAR, SUGAR CONFECTIONERY, NAMELY, CONFECTIONERY MADE OF SUGAR, CRYSTAL SUGAR PIECES; TEA; SAFFRON, IN CLASS 30 (U.S. CL. 46).

FOR: FRESH ORANGES; FRESH PEANUTS; BEANS, FRESH; FRESH BEETS; GRAPES, FRESH; MARROWS, NAMELY, DIGESTIBLE CHEWING BONES FOR DOGS; UNPROCESSED NUTS; PEAS, FRESH; MUSHROOMS, FRESH; MUSHROOM SPAWN FOR PROPAGATION; LIVE ANIMALS; UNPROCESSED RYE; CEREAL SEEDS, UNPROCESSED; GRAINS FOR ANIMAL CONSUMPTION; FISH SPAWN; POTATOES, FRESH; CHESTNUTS, FRESH; FLOWERS, NATURAL; FLOWER BULBS; ROOTS FOR FOOD, NAMELY, RAW HORSERADISH ROOT; NETTLES, NAMELY, LIVE PLANTS; GROATS FOR POULTRY FEED; UNPROCESSED MAIZE; UNPROCESSED EDIBLE SEEDS, NAMELY, SESAME SEEDS; FRESH LEMONS; UNPROCESSED GRAINS; UNPROCESSED OATS; VEGETABLES, FRESH; FRESH CUCUMBERS; LIVE PEPPER PLANTS; FORAGE, NAMELY, ANIMAL FEED; LIVE BRED STOCK; FRUIT, FRESH; UNPROCESSED WHEAT; FISH, LIVE; FISHMEAL FOR ANIMAL CONSUMPTION; SEEDLINGS; LIVE PLANTS; UNPROCESSED LETTUCE; HAY; TRUFFLES, FRESH; CATTLE FOOD; HOP CONES, NAMELY, RAW HOPS; UNPROCESSED HOPS; FRESH LEEKS; RAW ONIONS, FRESH VEGETABLES; FRESH CITRUS FRUIT; LIVE ROSE BUSHES; BERRIES, FRESH FRUITS; UNPROCESSED BARLEY, IN CLASS 31 (U.S. CLS. 1 AND 46).

FOR: APERITIFS, NON-ALCOHOLIC; NON-ALCOHOLIC BEVERAGES, NAMELY, NON-ALCOHOLIC CARBONATED BEVERAGES; NON-ALCOHOLIC FRUIT JUICE BEVERAGES; GRAPE MUST, UNFERMENTED; SELTZER WATER; WATER BEVERAGES; TABLE WATERS; AERATED WATER; COCKTAILS, NON-ALCOHOLIC; LEMONADES; MINERAL WATER; PREPARATIONS FOR MAKING MINERAL WATER, NAMELY, SYRUPS FOR MAKING FLAVORED MINERAL WATERS; WHEY BEVERAGES; PREPARATIONS FOR MAKING BEVERAGES, NAMELY, FRUIT DRINKS; FRUIT NECTARS, NON-ALCOHOLIC; VEGETABLE JUICE BEVERAGES; BEER; SARSAPARILLA; SYRUPS FOR BEVERAGES; SYRUPS FOR LEMONADE; SODA WATER; FRUIT JUICES; MALT BEER; MUST; TOMATO JUICE BEVERAGES; NON-ALCOHOLIC FRUIT EXTRACTS, IN CLASS 32 (U.S. CLS. 45, 46 AND 48).

THE MARK CONSISTS OF A DESIGN OF A PIGEON CARRYING A FLAG IN ITS MOUTH, TO THE LEFT OF NON-LATIN CHARACTERS WHOSE TRANSLITERATION IS "VLADAM AVEN-EZER".

OWNER OF INTERNATIONAL REGISTRATION 1094545 DATED 6-14-2011, EXPIRES 6-14-2021.

THE NON-LATIN CHARACTERS IN THE MARK TRANSLITERATE TO "VLADAM AVEN-EZER "AND THIS HAS NO MEANING IN A FOREIGN LANGUAGE.

THE WORDING "VLADAM AVEN-EZER" HAS NO MEANING IN A FOREIGN LANGUAGE.

Reg. No. 4,152,400 SER. NO. 79-104,046, FILED 6-14-2011.

PATRICIA EVANKO, EXAMINING ATTORNEY

United States of America

United States Patent and Trademark Office

CRISVON

Reg. No. 4,152,401

Registered June 5, 2012

Int. Cl.: 1

TRADEMARK

PRINCIPAL REGISTER

DIC CORPORATION (JAPAN CORPORATION)
35-58, SAKASHITA 3-CHOME
ITABASHI-KU, TOKYO 174-8520
JAPAN

FOR: UNPROCESSED SYNTHETIC RESINS; UNPROCESSED PLASTICS (PLASTICS IN PRIMARY FORM); INDUSTRIAL CHEMICALS; ADHESIVES FOR INDUSTRIAL PURPOSES , IN CLASS 1 (U.S. CLS. 1, 5, 6, 10, 26 AND 46).

THE MARK CONSISTS OF STANDARD CHARACTERS WITHOUT CLAIM TO ANY PARTICULAR FONT, STYLE, SIZE, OR COLOR.

OWNER OF INTERNATIONAL REGISTRATION 1094629 DATED 9-20-2011, EXPIRES 9-20-2021.

OWNER OF U.S. REG. NO. 3,580,917.

SER. NO. 79-104,079, FILED 9-20-2011.

KIM MONINGHOFF, EXAMINING ATTORNEY



David J. Kyffers

Director of the United States Patent and Trademark Office

United States of America
United States Patent and Trademark Office

LG Global

Reg. No. 4,152,402

Registered June 5, 2012

Int. Cl.: 36

SERVICE MARK

PRINCIPAL REGISTER

LION GLOBAL INVESTORS LIMITED (SINGAPORE COMPANY)
65 CHULIA STREET
#18-01 OCBC CENTRE; SINGAPORE 049513
SINGAPORE

FOR: FINANCIAL SERVICES, NAMELY, FINANCIAL PORTFOLIO ANALYSIS SERVICES, FINANCIAL CONSULTATION, TRADING OF AND INVESTMENTS IN SECURITIES, FINANCIAL INSTRUMENTS AND FINANCIAL PRODUCTS FOR OTHERS, TRANSACTIONS INVOLVING FUNDS IN THE FIELDS OF STOCKS, BONDS, OPTIONS, COMMODITIES, FUTURES AND OTHER SECURITIES; FUND MANAGEMENT, NAMELY, VENTURE CAPITAL FUND MANAGEMENT, PRIVATE EQUITY FUND MANAGEMENT, MUTUAL FUND MANAGEMENT; INVESTMENT MANAGEMENT; FINANCIAL ASSET MANAGEMENT; UNIT TRUST SECURITIES MANAGEMENT; FINANCIAL AND INVESTMENT PORTFOLIO MANAGEMENT; FINANCIAL ADVISORY SERVICES; FINANCIAL INVESTMENT ADVISORY SERVICES; INVESTMENT ADVISORY SERVICES; ADVISORY SERVICES RELATING TO UNIT TRUSTS SECURITIES; FINANCIAL INVESTMENT ANALYSIS; FUND INVESTMENT; CAPITAL INVESTMENT; UNIT TRUST SECURITIES INVESTMENTS; MUTUAL FUND DISTRIBUTION; MUTUAL FUND ADMINISTRATION; UNIT TRUST SERVICES, NAMELY, FINANCIAL ASSET MANAGEMENT AND DISTRIBUTION OF PROFITS AND/OR ASSETS; CAPITAL FUND INVESTMENT; CAPITAL FUND MANAGEMENT; INVESTMENT FUND FINANCIAL SPONSORSHIP; INVESTMENT FUND DISTRIBUTION, INCLUDING SUCH SERVICES PROVIDED ON-LINE OR VIA THE INTERNET, IN CLASS 36 (U.S. CLS. 100, 101 AND 102).



THE MARK CONSISTS OF STANDARD CHARACTERS WITHOUT CLAIM TO ANY PARTICULAR FONT, STYLE, SIZE, OR COLOR.

PRIORITY DATE OF 1-18-2011 IS CLAIMED.

OWNER OF INTERNATIONAL REGISTRATION 1094737 DATED 7-18-2011, EXPIRES 7-18-2021.

SER. NO. 79-104,141, FILED 7-18-2011.

MARILYN IZZI, EXAMINING ATTORNEY

David J. Kyppas

Director of the United States Patent and Trademark Office

United States of America

United States Patent and Trademark Office



Reg. No. 4,152,403

MARTA FERNANDEZ GUADAÑO (SPAIN INDIVIDUAL)
C/ FUENCARRAL, NÚM. 112-3º-C
E-28010 MADRID, SPAIN

Registered June 5, 2012

Int. Cl.: 35

FOR: ADVERTISING AND PROMOTIONAL MARKETING ON A WEBPAGE, NAMELY, PROMOTING THE SERVICES OF OTHERS BY PROVIDING A WEBPAGE FEATURING LINKS TO THE WEBSITES OF OTHERS, IN CLASS 35 (U.S. CLS. 100, 101 AND 102).

SERVICE MARK

THE MARK CONSISTS OF THE STYLIZED TERM "GASTROECONOMY" WITHIN A BLACK RECTANGLE. THE LETTERS "GASTRO" ARE IN WHITE AND THE LETTERS "ECONOMY" ARE IN GRAY. THE LETTER "G" IN THE TERM IS WITHIN A GRAY SQUARE. A STYLIZED FORK IN GRAY EXTENDS DOWNWARD FROM THE LETTER "Y".

PRINCIPAL REGISTER

OWNER OF INTERNATIONAL REGISTRATION 1094825 DATED 7-29-2011, EXPIRES 7-29-2021.

THE COLOR(S) WHITE, BLACK, AND GRAY IS/ARE CLAIMED AS A FEATURE OF THE MARK.

SER. NO. 79-104,170, FILED 7-29-2011.

JAMES STEIN, EXAMINING ATTORNEY



David J. Kyros

Director of the United States Patent and Trademark Office

United States of America

United States Patent and Trademark Office



Reg. No. 4,152,404

Registered June 5, 2012

Int. Cls.: 10, 25 and 35

TRADEMARK

SERVICE MARK

PRINCIPAL REGISTER

GLORIA MED S.P.A. (ITALY JOINT STOCK COMPANY)
VIA DIAZ, 7
I-22017 MENAGGIO (COMO)
ITALY

FOR: ORTHOPEDIC ARTICLES, NAMELY, ORTHOPEDIC BELTS AND ORTHOPEDIC BRACES; ORTHOPEDIC KNEE BANDAGES; ORTHOPEDIC SUPPORT BANDAGES; ELASTIC STOCKINGS; ORTHOPEDIC SUPPORT BANDS FOR ANKLES AND KNEES; ORTHOPEDIC SUSPENDERS IN THE NATURE OF SUPPORT BANDS FOR ANKLES AND KNEES; ELASTIC BRIEFS FOR ORTHOPEDIC PURPOSES; CORSETS FOR THERAPEUTIC USE; CORSETS FOR MEN AND WOMEN FOR ORTHOPEDIC PURPOSES; ELASTIC SUPPORT BANDS FOR ANKLES AND KNEES, IN CLASS 10 (U.S. CLS. 26, 39 AND 44).

FOR: STOCKINGS, SOCKS, PANTY HOSE, TIGHTS AND GIRDLES, WAIST AND LEG BANDS, IN CLASS 25 (U.S. CLS. 22 AND 39).

FOR: RETAIL STORE SERVICES AND ONLINE RETAIL STORE SERVICES ON BEHALF OF THIRD PARTIES, FEATURING SOAPS, PERFUMERY, ESSENTIAL OILS, COSMETICS, HAIR LOTIONS, DENTIFRICES, CREAMS, COSMETIC LOTIONS AND OILS FOR THE TREATMENT AND CARE OF THE LEGS, SUN CREAMS, ANTI-CELLULITE CREAMS, PHARMACEUTICAL AND VETERINARY PREPARATIONS, SANITARY PREPARATIONS FOR MEDICAL PURPOSES, NUTRITIONAL ADDITIVES FOR MEDICAL PURPOSES, DIETETIC PREPARATIONS AND SUBSTANCES FOR MEDICAL USE, FOOD FOR BABIES, PLASTERS, MATERIAL FOR DRESSINGS, MATERIAL FOR STOPPING TEETH, DENTAL WAX, DISINFECTANTS, POST-SCLEROTHERAPY CREAMS, MEDICATED CREAMS, LOTIONS AND OILS FOR THE TREATMENT AND CARE OF THE LEGS, COMPLEMENTARY TO THE TREATMENT OF VENOUS DISORDERS, ORTHOPEDIC ARTICLES, MEDICAL APPARATUS AND INSTRUMENTS, ORTHOPEDIC BANDAGES, ELASTIC STOCKINGS, BANDS FOR ANKLES AND KNEES, SUSPENDERS (BANDS), ELASTIC BRIEFS FOR ORTHOPEDIC PURPOSES, CORSETS FOR MEDICAL PURPOSES, CORSETS FOR MEN AND WOMEN, ELASTIC BANDS AND CORSETS FOR ORTHOPEDIC PURPOSES, CLOTHING, STOCKINGS, SOCKS, LEOTARDS, TIGHTS AND GIRDLES, IN CLASS 35 (U.S. CLS. 100, 101 AND 102).



David J. Kyros

Director of the United States Patent and Trademark Office

THE MARK CONSISTS OF THE WORDING "I" FOLLOWED BY A SHADED HEART "MY LEGS" WITH THE WORD "BY" APPEARING UNDER THE WORD "LEGS" AND THE WORD "GLORIA" APPEARING IN SCRIPT BELOW THE WORD "BY".

Reg. No. 4,152,404 PRIORITY DATE OF 3-1-2011 IS CLAIMED.

OWNER OF INTERNATIONAL REGISTRATION 1094846 DATED 8-11-2011, EXPIRES 8-11-2021.

SER. NO. 79-104,179, FILED 8-11-2011.

KELLY TRUSILO, EXAMINING ATTORNEY

United States of America

United States Patent and Trademark Office

POSTCAP

Reg. No. 4,152,405

Registered June 5, 2012

Int. Cls.: 1, 40 and 42

TRADEMARK

SERVICE MARK

PRINCIPAL REGISTER

SIEMENS AKTIENGESELLSCHAFT (FED REP GERMANY JOINT STOCK COMPANY)
WITTELSBACHERPLATZ 2
80333 MÜNCHEN
FED REP GERMANY

FOR: CHEMICALS FOR INDUSTRIAL PURPOSES, NAMELY, FOR THE DEPOSITION AND STORAGE OF COMBUSTION GASES, IN CLASS 1 (U.S. CLS. 1, 5, 6, 10, 26 AND 46).

FOR: PHYSICAL AND CHEMICAL TREATMENT OF GASES, IN CLASS 40 (U.S. CLS. 100, 103 AND 106).

FOR: SCIENTIFIC RESEARCH; INDUSTRIAL RESEARCH IN THE FIELD OF GAS DEPOSITION AND STORAGE; RESEARCH AND DEVELOPMENT IN THE FIELD OF GAS DEPOSITION AND STORAGE; TECHNICAL SUPPORT SERVICES, NAMELY, DEVELOPMENT OF PROCESS CONTROL AND MONITORING PROCESSES; TECHNICAL CONSULTANCY SERVICES REGARDING THE APPLICATION OF THE DEVELOPED PROCESSES FOR DEPOSITION AND STORAGE OF GASES, IN PARTICULAR COMBUSTION GASES, IN CLASS 42 (U.S. CLS. 100 AND 101).

THE MARK CONSISTS OF STANDARD CHARACTERS WITHOUT CLAIM TO ANY PARTICULAR FONT, STYLE, SIZE, OR COLOR.

PRIORITY DATE OF 7-4-2011 IS CLAIMED.

OWNER OF INTERNATIONAL REGISTRATION 1094869 DATED 9-9-2011, EXPIRES 9-9-2021.

SER. NO. 79-104,191, FILED 9-9-2011.

LAURA KOVALSKY, EXAMINING ATTORNEY



David J. Kypos

Director of the United States Patent and Trademark Office

United States of America
United States Patent and Trademark Office

DURIS

Reg. No. 4,152,406

Registered June 5, 2012

Int. Cls.: 9 and 11

TRADEMARK

PRINCIPAL REGISTER

OSRAM AG (FED REP GERMANY CORPORATION)
HELLABRUNNER STR. 1
81543 MÜNCHEN, FED REP GERMANY

FOR: LIGHT EMITTING DIODES; LIGHT EMITTING DIODE MODULES AND COMPONENT PARTS THEREOF, IN CLASS 9 (U.S. CLS. 21, 23, 26, 36 AND 38).

FOR: APPARATUS FOR LIGHTING, NAMELY, ELECTRIC LAMPS AND LUMINAIRES; LED LAMPS AND LED LUMINAIRES AND THEIR PARTS; LED LIGHTING FIXTURES BASED ON LED MODULES, IN CLASS 11 (U.S. CLS. 13, 21, 23, 31 AND 34).

THE MARK CONSISTS OF STANDARD CHARACTERS WITHOUT CLAIM TO ANY PARTICULAR FONT, STYLE, SIZE, OR COLOR.

PRIORITY DATE OF 3-24-2011 IS CLAIMED.

OWNER OF INTERNATIONAL REGISTRATION 1094918 DATED 9-14-2011, EXPIRES 9-14-2021.

SER. NO. 79-104,206, FILED 9-14-2011.

JEFF DEFORD, EXAMINING ATTORNEY



David J. Kybas

Director of the United States Patent and Trademark Office

United States of America

United States Patent and Trademark Office



Reg. No. 4,152,407

Registered June 5, 2012

Int. Cl.: 33

CONSEJO REGULADOR DE LA DENOMINACION DE ORIGEN TORO (SPAIN CONSEJO REGULADOR)
CONCEPCIÓN, 3
PALACIO CONDE DE REQUENA
E-49800 TORO (ZAMORA), SPAIN

TRADEMARK

FOR: WINES WITH THE APPELLATION OF ORIGIN TORO, IN CLASS 33 (U.S. CLS. 47 AND 49).

PRINCIPAL REGISTER

NO CLAIM IS MADE TO THE EXCLUSIVE RIGHT TO USE "D. ORIGEN TORO", APART FROM THE MARK AS SHOWN.

OWNER OF INTERNATIONAL REGISTRATION 1095017 DATED 8-18-2011, EXPIRES 8-18-2021.

THE TRANSLITERATION OF THE NON-LATIN CHARACTERS IN THE MARK IS "D. ORIGEN TORO".

THE MARK CONSISTS OF AN ARCH WITH THE WORDS "D. ORIGEN" WRITTEN ON IT AND A SHIELD AT THE TOP OF THE ARCH AND IN THE RIGHT FOREFRONT IS A DESIGN OF GRAPES AND WITH THE WORD "TORO" INSIDE OF A RECTANGLE BELOW A STATUE OF A BULL.

THE ENGLISH TRANSLATION OF THE FOREIGN WORD(S) IN THE MARK IS FROM ORIGIN TORO.

SER. NO. 79-104,250, FILED 8-18-2011.

ROBERT C. CLARK JR., EXAMINING ATTORNEY



David J. Kybas

Director of the United States Patent and Trademark Office

United States of America

United States Patent and Trademark Office

ERNI WoR&D

Reg. No. 4,152,408

Registered June 5, 2012

**Int. Cls.: 9, 17, 35, 37, 40
and 42**

TRADEMARK

SERVICE MARK

PRINCIPAL REGISTER

ERNI ELECTRONICS GMBH (FED REP GERMANY GESELLSCHAFT MIT BESCHRÄNKTER
HAFTUNG (GMBH))
SEESTRASSE 9
73099 ADELBERG
FED REP GERMANY

FOR: ELECTRICAL AND ELECTRONIC DEVICE, NAMELY, PLUG CONNECTORS; ELECTRICAL CONTACT PINS, ELECTRICAL CONTACT SPRINGS, SCREENING PLATES FOR PLUG CONNECTORS, PLUG CONNECTORS AND ELECTRICAL FITTINGS AND FASTENERS FOR BACKPLANES; ELECTRICAL WIRES, ELECTRIC CABLES; PRINTED CIRCUIT BOARDS ASSEMBLIES; ELECTRICAL APPARATUS AND INSTRUMENTS, NAMELY, PLUG CONNECTORS AND REPLACEMENT PARTS THEREOF, IN CLASS 9 (U.S. CLS. 21, 23, 26, 36 AND 38).

FOR: INSULATING PARTS MADE OF PLASTIC FOR ELECTRICAL WIRES, ELECTRICAL SWITCHES AND PLUG CONNECTORS, IN CLASS 17 (U.S. CLS. 1, 5, 12, 13, 35 AND 50).

FOR: SALES PROMOTION, FOR OTHERS, ARRANGING OF CONTRACTS FOR PURCHASE AND SALE OF GOODS, FOR OTHERS, NAMELY, ARRANGING OF THE BUYING AND SELLING OF CONTRACTS FEATURING THE PURCHASE AND SALE OF GOODS FOR OTHERS; ORGANIZING OF GOODS FOR PRESENTATION AND RETAIL PURPOSES, FOR OTHERS, NAMELY, ORGANIZATION AND CONDUCTING OF PRODUCT PRESENTATIONS FOR OTHERS; PRESENTATION OF GOODS ON COMMUNICATION MEDIA, FOR OTHERS, NAMELY, PROVIDING TELEVISION HOME SHOPPING SERVICES IN THE FIELD OF GENERAL CONSUMER MERCHANDISE; PROMOTING THE GOODS AND SERVICES OF OTHERS THROUGH THE DISTRIBUTION OF TOOLS, METAL TOOLS, MACHINES AND ELECTRICAL GOODS AND ELECTRONIC GOODS, IN CLASS 35 (U.S. CLS. 100, 101 AND 102).

FOR: INSTALLATION AND REPAIR OF ELECTRICAL APPARATUS AND INSTRUMENTS, IN CLASS 37 (U.S. CLS. 100, 103 AND 106).

FOR: CUSTOM MANUFACTURING OF ELECTRICAL APPARATUS AND INSTRUMENTS, CUSTOM ASSEMBLING OF ELECTRICAL APPARATUS AND INSTRUMENTS, AND PRINTED CIRCUIT BOARDS, IN CLASS 40 (U.S. CLS. 100, 103 AND 106).



David J. Kyjars

Director of the United States Patent and Trademark Office

Reg. No. 4,152,408 FOR: DESIGN AND DEVELOPMENT OF COMPUTER HARDWARE, ESPECIALLY PLUG CONNECTORS AND EQUIPPED PRINTED BOARDS, IN CLASS 42 (U.S. CLS. 100 AND 101).

THE MARK CONSISTS OF STANDARD CHARACTERS WITHOUT CLAIM TO ANY PARTICULAR FONT, STYLE, SIZE, OR COLOR.

PRIORITY DATE OF 4-21-2011 IS CLAIMED.

OWNER OF INTERNATIONAL REGISTRATION 1095147 DATED 7-21-2011, EXPIRES 7-21-2021.

OWNER OF U.S. REG. NOS. 1,356,310 AND 3,318,453.

THE WORDING "ERNI" HAS NO MEANING IN A FOREIGN LANGUAGE.

SER. NO. 79-104,283, FILED 7-21-2011.

SEAN CROWLEY, EXAMINING ATTORNEY

United States of America

United States Patent and Trademark Office

OFFICE VIP

Reg. No. 4,152,409

Registered June 5, 2012

Int. Cls.: 16, 35 and 41

TRADEMARK

SERVICE MARK

PRINCIPAL REGISTER

STATESIDE MEDIA LIMITED (UNITED KINGDOM COMPANY)
SUITE 1A, DIAMOND HOUSE
36-38 HATTON GARDEN; LONDON EC1N 8EB
UNITED KINGDOM

FOR: PRINTED PUBLICATIONS, NAMELY, MAGAZINES, JOURNALS, PERIODICALS, NEWSPAPERS, BOOKS, NEWSLETTERS, GUIDES AND CATALOGS ALL IN THE FIELD OF OFFICE MANAGEMENT, FACILITIES MANAGEMENT, OFFICE PRODUCTS AND OFFICE EQUIPMENT; PRINTED TICKETS; PRINTS; PHOTOGRAPHS, IN CLASS 16 (U.S. CLS. 2, 5, 22, 23, 29, 37, 38 AND 50).

FOR: ARRANGING AND CONDUCTING TRADE SHOW EXHIBITIONS IN THE FIELD OF OFFICE MANAGEMENT, FACILITIES MANAGEMENT, OFFICE PRODUCTS AND OFFICE EQUIPMENT; CONDUCTING, ARRANGING AND ORGANISING TRADE SHOWS FOR COMMERCIAL AND ADVERTISING PURPOSES; ORGANISATION OF EVENTS AND EXHIBITIONS FOR COMMERCIAL OR ADVERTISING PURPOSES, IN CLASS 35 (U.S. CLS. 100, 101 AND 102).

FOR: ORGANISING AND ARRANGING EXHIBITIONS FOR CULTURAL AND EDUCATIONAL PURPOSES; ORGANISING SHOWS AND EVENTS FOR CULTURAL AND EDUCATIONAL PURPOSES; PUBLICATION OF PRINTED MATTER, IN CLASS 41 (U.S. CLS. 100, 101 AND 107).

THE MARK CONSISTS OF STANDARD CHARACTERS WITHOUT CLAIM TO ANY PARTICULAR FONT, STYLE, SIZE, OR COLOR.

PRIORITY DATE OF 3-25-2011 IS CLAIMED.

OWNER OF INTERNATIONAL REGISTRATION 1095256 DATED 9-22-2011, EXPIRES 9-22-2021.

NO CLAIM IS MADE TO THE EXCLUSIVE RIGHT TO USE "OFFICE", APART FROM THE MARK AS SHOWN.

SER. NO. 79-104,335, FILED 9-22-2011.

TARAH HARDY, EXAMINING ATTORNEY



David J. Kyffers

Director of the United States Patent and Trademark Office

United States of America

United States Patent and Trademark Office



Reg. No. 4,152,410

Registered June 5, 2012

Int. Cls.: 1, 6 and 40

TRADEMARK

SERVICE MARK

PRINCIPAL REGISTER

GOTEC GORSCHLUETER GMBH (FED REP GERMANY LIMITED LIABILITY COMPANY)
DIESELSTRASSE 70
42489 WÜLFRAETH
FED REP GERMANY

FOR: CHEMICAL PRODUCTS, NAMELY, ADHESIVE POWER ENHANCERS FOR INDUSTRIAL PURPOSES FOR THE CONNECTION BETWEEN RUBBER, METAL AND PLASTIC, IN CLASS 1 (U.S. CLS. 1, 5, 6, 10, 26 AND 46).

FOR: METAL GOODS FOR THE AUTOMOTIVE SUPPLY INDUSTRY NOT BEING MACHINE PARTS IN THE FORM OF SLEEVES, BUSHINGS, OUTER AND INNER SHELLS OF METAL, IN PARTICULAR FOR VIBRATION AND DAMPING BEARINGS, IN CLASS 6 (U.S. CLS. 2, 12, 13, 14, 23, 25 AND 50).

FOR: MATERIAL TREATMENT, NAMELY, PREPARATION FOR THE APPLICATION OF ADHESIVE POWER ENHANCERS TO METAL PARTS, PLASTIC AND RUBBER; TREATMENT OF METAL, NAMELY, DEGREASING, IRRADIATION AND COATING OF VULCANIZATION SUPPORTS; ZINC PLATING, NICKEL PLATING AND PHOSPHATING OF METAL PARTS, IN CLASS 40 (U.S. CLS. 100, 103 AND 106).

THE MARK CONSISTS OF A BLUE RECTANGLE ABOVE A STYLIZED WORDING "GOTEC". THE LETTERS "GO" AND "EC" ARE IN BLACK THE LETTER "T" IS IN BLUE.

OWNER OF INTERNATIONAL REGISTRATION 1095417 DATED 7-23-2011, EXPIRES 7-23-2021.

THE COLOR(S) BLUE AND BLACK IS/ARE CLAIMED AS A FEATURE OF THE MARK.

SER. NO. 79-104,408, FILED 7-23-2011.

KRISTINA MORRIS, EXAMINING ATTORNEY



David J. Kyros

Director of the United States Patent and Trademark Office

United States of America

United States Patent and Trademark Office

HolidayCheck



Reg. No. 4,152,411

Registered June 5, 2012

**Int. Cls.: 35, 38, 39, 41,
42 and 43**

SERVICE MARK

PRINCIPAL REGISTER

HOLIDAYCHECK AG (SWITZERLAND SOCIÉTÉ ANONYME (SA))
MÜHLIGÄSSLI 1
CH-8598 BOTTIGHOFEN
SWITZERLAND

FOR: ADVERTISING, BUSINESS MANAGEMENT, OFFICE ADMINISTRATION SERVICES FOR COMPANIES, OFFICE FUNCTIONS, AUCTIONEERING AND HOLDING AUCTIONS FOR PHOTOGRAPHS, RETAIL STORE SERVICES FEATURING PHOTOGRAPHS, IN CLASS 35 (U.S. CLS. 100, 101 AND 102).

FOR: PROVIDING INTERNET CHAT ROOMS; TRANSMISSION AND DISTRIBUTION OF DATA OR AUDIO VISUAL IMAGES VIA A GLOBAL COMPUTER NETWORK OR THE INTERNET; TRANSMISSION OF SOUND, VIDEO AND INFORMATION BY MEANS OF ELECTRONIC COMMUNICATIONS NETWORKS; ELECTRONIC TRANSMISSION OF IMAGES AND PHOTOGRAPHS ON A GLOBAL COMPUTER NETWORK; TRANSMISSION OF NEWS OF ALL KINDS IN SOUND AND IMAGE FORM; PROVIDING ACCESS TO AN INTERNET PORTAL TO ONLINE PHOTOGRAPHS; RENTAL OF ACCESS TIME TO GLOBAL COMPUTER NETWORKS; PROVIDING ACCESS TO AN INTERNET PORTAL, NAMELY, TO ONLINE PHOTO GALLERIES, IN CLASS 38 (U.S. CLS. 100, 101 AND 104).

FOR: ORGANIZING TRAVEL ARRANGEMENTS FOR INDIVIDUALS AND GROUPS AND PROVIDING TRAVEL INFORMATION; INFORMATION RELATING TO TRAFFIC, NAMELY, PROVIDING ROAD AND TRAFFIC INFORMATION; CHAUFFEUR SERVICES FOR MOTOR VEHICLES, AIRPLANE PILOT SERVICES; AIR TRAFFIC CONTROL SERVICES IN THE NATURE OF PROVIDING AIR NAVIGATION; BUS TRANSPORT; TOURIST AGENCY SERVICES, NAMELY, MAKING RESERVATIONS AND BOOKINGS FOR TOURISTS; TRAVEL BOOKING AGENCY SERVICES; ORGANIZATION OF TRIPS AND EXCURSIONS; BOOKING OF SEATS FOR TRAVEL, TRAVEL RESERVATION SERVICE; AGENCY SERVICES FOR THE ORGANIZATION OF HOLIDAYS, NAMELY, MAKING RESERVATIONS AND BOOKINGS FOR TRANSPORTATION FOR TOURISTS; INFORMATION RELATING TO TRANSPORT, NAMELY, TRANSPORTATION INFORMATION; TRANSPORT SERVICES FOR THE SICK, NAMELY, MEDICAL TRANSPORT SERVICES; AIR TRANSPORT; TRANSPORT OF GOODS, NAMELY, FURNITURE; MAKING BOOKINGS FOR TRANSPORTATION; EMERGENCY RESCUE TRANSPORT SERVICES, NAMELY, MEDICAL TRANSPORT SERVICES; MARINE TRANSPORT; SERVICES OF A FREIGHT BROKERAGE; TRANSPORT BY RIVER BOAT; RAILWAY TRANSPORT; TRANSPORT BY FERRY-BOAT; TRANSPORT BY MOTOR VEHICLE, NAMELY, BUS TRANSPORT, CAR TRANSPORT; AIR TRANSPORT;



David J. Kappas

Director of the United States Patent and Trademark Office

Reg. No. 4,152,411 TRANSPORT BY BARGE; TRANSPORT BY TRUCK; TRANSPORT BY BOAT; TRANSPORT OF VALUABLES; TRANSPORTATION LOGISTICS SERVICES, NAMELY, ARRANGING THE TRANSPORTATION OF GOODS FOR OTHERS; SERVICES OF A TOUR OPERATOR, NAMELY, PASSENGER TRANSPORT, TRAVEL TRANSPORTATION RESERVATIONS, BOOKINGS FOR TRANSPORTATION, ORGANIZATION OF TRIPS AND TOURS; PROVISION OF TRAVEL INFORMATION; PROVIDING TRAVEL INFORMATION TO TRAVELERS REGARDING TIMETABLES; PROVIDING TOURIST INFORMATION, NAMELY, PROVIDING TOURISM-RELATED TRAVEL INFORMATION ON TRANSPORT PROVIDED BY TOURIST AGENCIES, NAMELY, PROVIDING INFORMATION ON RESERVATIONS FOR TRANSPORTATION TO GUIDED TOURS OF TOWNS, TOURS OF THE COUNTRYSIDE AND NATURAL ATTRACTIONS; PROVIDING TOURISM-RELATED INFORMATION ON TRANSPORT TO TOWNS, TOURIST REGIONS, AND TRAVEL DESTINATIONS, LANDMARKS; INFORMATION AND ADVICE ON TRAVEL TRANSPORTATION PROVIDED OVER THE INTERNET AS WELL AS VIA ON LINE SERVICES OR A CALL CENTER; AIR-LINE TRANSPORTATION SERVICES; INFORMATION AND ADVICE CONCERNING RESERVATIONS AND BOOKINGS FOR TRAVEL TRANSPORTATION; ARRANGING OF TOURS; TRAVEL BOOKING AGENCIES , IN CLASS 39 (U.S. CLS. 100 AND 105).

FOR: PUBLISHING ILLUSTRATED REPORTS; DIGITAL IMAGING SERVICES; PUBLICATION OF AN ELECTRONIC MAGAZINE; ENTERTAINMENT, NAMELY, ORGANIZING COMMUNITY SPORTING AND CULTURAL ACTIVITIES; DIGITAL ARRANGEMENT OF IMAGES AND TEXTS, NAMELY, DIGITAL IMAGING SERVICES; EDITING OF PRINTED MATTER RELATING TO INTERNET FEEDBACK; PROVIDING TOURIST INFORMATION DURING GUIDED TRIPS, NAMELY, CULTURAL INFORMATION ABOUT THE TOWNS, COUNTRYSIDE AND NATURAL ATTRACTIONS; PROVIDING CULTURAL INFORMATION IN THE FIELD OF TOURISM REGARDING TOWNS, TOURIST REGIONS, ROUTES, TOURIST DESTINATIONS, LANDMARKS, IN CLASS 41 (U.S. CLS. 100, 101 AND 107).

FOR: TECHNICAL EDITING SERVICES FOR OTHERS, NAMELY, COMPUTER GRAPHICS DESIGN SERVICES; TECHNICAL WRITING FOR OTHERS IN THE FIELD OF SERVICE INSTRUCTIONS, INSTALLATION INSTRUCTIONS, ASSEMBLY INSTRUCTIONS AND INSTRUCTIONAL MATERIAL, PROJECT SPECIFICATIONS, SPECIFICATIONS IN THE TECHNICAL FIELD; DESIGN AND DEVELOPMENT OF COMPUTER SOFTWARE PROGRAMS FOR PROCESSING DATA; MAINTAINING AND UPDATING COMPUTER PROGRAMS FOR PROCESSING DATA, AS WELL AS ON-LINE UPDATING SERVICES FOR COMPUTER PROGRAMS; RESEARCH AND DEVELOPMENT IN CONNECTION WITH DATA PROCESSING COMPUTER PROGRAMS; DEVELOPMENT AND CONSULTING SERVICES IN THE FIELD OF COMPUTER SYSTEMS; ONLINE CONSULTANCY SERVICES IN THE FIELD OF COMPUTER SOFTWARE; COMPUTER NETWORK CONFIGURATION SERVICES; CREATION, DESIGN AND LAUNCHING OF SITES FOR OTHERS; DESIGN, MAINTENANCE AND UPDATING OF INTERNET SITE CONTENT FOR OTHERS; DEVELOPING AND SETTING-UP OF DIGITAL SOUND AND IMAGE CARRIERS, IN CLASS 42 (U.S. CLS. 100 AND 101).

FOR: INTERMEDIARY SERVICES, NAMELY, ARRANGING TEMPORARY HOUSING ACCOMMODATIONS RELATING TO THE RENTAL OF HOLIDAY ACCOMMODATION; INTERMEDIARY SERVICES, NAMELY, TRAVEL AGENCY SERVICES FOR MAKING RESERVATIONS RELATING TO TEMPORARY LODGING IN TOURIST DESTINATIONS; INTERMEDIARY SERVICES, NAMELY, MAKING HOTEL AND BOARDING HOUSE RESERVATIONS FOR OTHERS; TRAVEL AGENCY SERVICES, NAMELY, BOOKING OF ACCOMMODATIONS AT HOTELS; TRAVEL AGENCY SERVICES IN CONNECTION WITH BOOKING ACCOMMODATION AT HOTELS, MOTELS, CAMPGROUNDS; BED AND BREAKFAST INN SERVICES; BOOKING HOTEL ROOMS, BED AND BREAKFASTS AND GUEST HOUSES; RENTAL OF ROOMS IN A BED AND BREAKFAST AS TEMPORARY LIVING ACCOMMODATIONS; RENTAL OF GUEST HOUSE FOR TEMPORARY OCCUPANCY; PROVIDING INFORMATION IN THE FIELD OF HOTELS AND ALTERNATIVE OPTIONS FOR ACCOMMODATION TO TOURISTS AND BUSINESS TRAVELERS , IN CLASS 43 (U.S. CLS. 100 AND 101).

Reg. No. 4,152,411 THE MARK CONSISTS OF THE WORD "HOLIDAYCHECK" IN BLUE WITH FIVE STARS BELOW IN YELLOW TO THE LEFT OF A BLUE BAR

PRIORITY DATE OF 3-8-2011 IS CLAIMED.

OWNER OF INTERNATIONAL REGISTRATION 1095565 DATED 5-6-2011, EXPIRES 5-6-2021.

THE COLOR(S) BLUE AND YELLOW IS/ARE CLAIMED AS A FEATURE OF THE MARK.

SER. NO. 79-104,479, FILED 5-6-2011.

CARYN GLASSER, EXAMINING ATTORNEY

United States of America

United States Patent and Trademark Office

NOBERASCO

Reg. No. 4,152,412

Registered June 5, 2012

Int. Cl.: 29

TRADEMARK

PRINCIPAL REGISTER

NOBERASCO S.P.A. (ITALY CORPORATION)
REGIONE BAGNOLI 5
I-17031 ALBENGA (SV)
ITALY

FOR: PRESERVED, FROZEN, DRIED AND COOKED FRUITS; JELLIES, JAMS, COMPOTES; FROSTED FRUITS AND FRUIT JELLIES; FRUIT CHIPS; FRUIT PULP; DRIED FRUITS; PRESERVED FRUIT; FRUIT SALADS; FRUIT COMPOTES; STEWED FRUITS; CANNED FRUITS; FRUIT PEEL; FRUIT PRESERVED IN ALCOHOL; FROZEN FRUITS; CRYSTALLIZED FRUITS; FRUIT PUREE; PRESERVES, NAMELY, FRUIT PRESERVES; FRUIT IN SYRUP; FRUIT DESSERTS, NAMELY, CANDIED FRUIT AND FRUIT SALAD; FRUIT-BASED FOOD BARS; MIXED PROCESSED FRUITS; FRUIT PRESERVES; FRUIT YOGHURT; FRUIT PUREES; MUESLI WITH FRUIT; DEHYDRATED FRUITS; FRUIT OILS; FRUIT PRODUCTS, NAMELY, FRUIT BUTTERS AND FRUIT LEATHERS; FRUIT RINDS; FRUIT JAMS; FRUIT CREAMS COMPRISED OF FRUIT AND CREAM; DRIED FRUITS AND DRIED FRUIT PRODUCTS, NAMELY, DRIED FRUIT MIXES; FRUIT ROLLS, NAMELY, FRUIT BASED SNACK FOODS; FRUIT PECTIN; FRUIT SLICES MADE OF DRIED FRUITS; SANDWICH FILLINGS WITH A FRUIT BASE; FRUIT PREPARATIONS, NAMELY, FRUIT SPREADS AND FRUIT TOPPING; ROOTS FOR FOOD, NAMELY, PROCESSED ROOTS; FRUIT-BASED SNACK FOODS WITH A DRIED FRUIT OR CONCENTRATED FRUIT COMPONENT; MIXED DRIED FRUITS; PACKAGED PREPARED NUTS; CUT FRUITS THAT ARE BOTTLED; CUT FRUITS THAT ARE CANNED; CUT FRESH FRUITS THAT ARE BAGGED; DRIED DATES; PROCESSED DATES; PRESERVED, DRIED AND COOKED DATES; PREPARED FIGS AND RAISINS; PREPARED NUTS AND ALMONDS; GROUND DATES AND ALMONDS; PROCESSED PEANUTS; RAISINS; FRUIT PASTE, IN CLASS 29 (U.S. CL. 46).



THE MARK CONSISTS OF STANDARD CHARACTERS WITHOUT CLAIM TO ANY PARTICULAR FONT, STYLE, SIZE, OR COLOR.

OWNER OF INTERNATIONAL REGISTRATION 1095599 DATED 9-23-2011, EXPIRES 9-23-2021.

SER. NO. 79-104,494, FILED 9-23-2011.

LINDA LAVACHE, EXAMINING ATTORNEY

David J. Kyros

Director of the United States Patent and Trademark Office

United States of America
United States Patent and Trademark Office

RAYSTAR

Reg. No. 4,152,413

Registered June 5, 2012

Int. Cl.: 11

TRADEMARK

PRINCIPAL REGISTER

OSRAM AG (FED REP GERMANY CORPORATION), DBA/AKA/TA/FORMERLY OSRAM
G.M.B.H.
HELLABRUNNER STR. 1
DEPT. OSR R&D IP TM; 2011W05172WOUS
MUENCHEN, FED REP GERMANY D81543

FOR: LIGHTING APPARATUS, NAMELY, ELECTRIC LAMPS AND LUMINAIRES; PARTS
OF AFOREMENTIONED GOODS; ELECTRIC FLASHLIGHTS, IN CLASS 11 (U.S. CLS. 13,
21, 23, 31 AND 34).

THE MARK CONSISTS OF STANDARD CHARACTERS WITHOUT CLAIM TO ANY PAR-
TICULAR FONT, STYLE, SIZE, OR COLOR.

PRIORITY DATE OF 3-10-2011 IS CLAIMED.

OWNER OF INTERNATIONAL REGISTRATION 1095873 DATED 9-9-2011, EXPIRES 9-9-
2021.

SER. NO. 79-104,593, FILED 9-9-2011.

JEFF DEFORD, EXAMINING ATTORNEY



David J. Kyffers

Director of the United States Patent and Trademark Office

United States of America

United States Patent and Trademark Office

ULTRON

Reg. No. 4,152,414

Registered June 5, 2012

Int. Cl.: 6

TRADEMARK

PRINCIPAL REGISTER

DOCKWEILER AG (FED REP GERMANY CORPORATION)
AN DER AUTOBAHN 10/20
19306 NEUSTADT-GLEWE
FED REP GERMANY

FOR: TUBE MADE OF SEAMLESS STAINLESS STEEL, OF AISI 316L MATERIAL, POLISHED BY ELECTROCHEMICAL POLIGRAT 2668 VN PROCESSING, IN CLASS 6 (U.S. CLS. 2, 12, 13, 14, 23, 25 AND 50).

THE MARK CONSISTS OF THE WORD "ULTRON" IN STYLIZED LETTERING WITH THE LETTER "O" RESEMBLING A DIAMOND IN THE INSIDE OF A TUBE.

OWNER OF INTERNATIONAL REGISTRATION 0555463 DATED 5-10-1990, EXPIRES 5-10-2020.

SER. NO. 79-104,687, FILED 8-9-2011.

CARYN GLASSER, EXAMINING ATTORNEY



David J. Kyffers

Director of the United States Patent and Trademark Office

United States of America

United States Patent and Trademark Office

3RB

Reg. No. 4,152,415

Registered June 5, 2012

Int. Cl.: 9

TRADEMARK

PRINCIPAL REGISTER

SIEMENS AKTIENGESELLSCHAFT (FED REP GERMANY JOINT STOCK COMPANY)
WITTELSBACHERPLATZ 2
80333 MÜNCHEN
FED REP GERMANY

FOR: ELECTROTECHNICAL AND ELECTRONIC APPARATUS AND EQUIPMENT, NAMELY,
ELECTRIC RELAYS, IN CLASS 9 (U.S. CLS. 21, 23, 26, 36 AND 38).

THE MARK CONSISTS OF STANDARD CHARACTERS WITHOUT CLAIM TO ANY PAR-
TICULAR FONT, STYLE, SIZE, OR COLOR.

OWNER OF INTERNATIONAL REGISTRATION 0873414 DATED 11-25-2005, EXPIRES 11-
25-2015.

SER. NO. 79-104,747, FILED 8-9-2010.

LAURA KOVALSKY, EXAMINING ATTORNEY



David J. Kyffers

Director of the United States Patent and Trademark Office

United States of America

United States Patent and Trademark Office

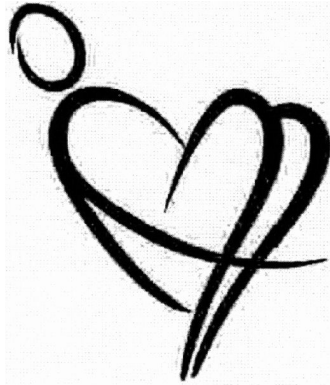

Reg. No. 4,152,416

Registered June 5, 2012

Int. Cls.: 3, 5, 10 and 25

TRADEMARK

PRINCIPAL REGISTER

GLORIA MED S.P.A. (ITALY JOINT STOCK COMPANY)
VIA DIAZ, 7
I-22017 MENAGGIO (COMO)
ITALY

FOR: PERFUMES, TOILET SOAPS; COSMETICS, NAMELY, DEODORANTS FOR PERSONAL USE; CREAMS, LOTIONS AND OILS FOR THE FACE AND THE BODY; CLEANSING MILKS, CREAMS AND OILS; MAKE-UP CREAMS; BEAUTY MASKS; MAKE-UP REMOVERS; EYE SHADOWS; LIPSTICKS; MASCARA; ROUGE; CRAYONS FOR THE EYES AND THE LIPS; POWDERS, CREAMS, OILS AND LOTIONS FOR SUNTANNING AND AFTER SUN EXPOSURE; PRE- AND AFTER SHAVE CREAMS AND LOTIONS; TALCUM POWDERS; BATH SALTS, BATH FOAMS AND OILS; AFTER-BATH CREAMS AND LOTIONS; HAIR SHAMPOOS; DEPILATORY PREPARATIONS; NAIL POLISHES; HAIR LOTIONS; DENTIFRICES; CREAMS, COSMETIC LOTIONS AND OILS FOR THE TREATMENT AND CARE OF THE LEGS, SUN CREAMS, CREAMS FOR CELLULITE REDUCTION, IN CLASS 3 (U.S. CLS. 1, 4, 6, 50, 51 AND 52).

FOR: PHARMACEUTICAL AND VETERINARY PREPARATIONS, NAMELY, SANITARY PREPARATIONS FOR MEDICAL PURPOSES; FOOD SUPPLEMENTS FOR MEDICAL PURPOSES, DIETARY SUBSTANCES FOR MEDICAL PURPOSES, BABY FOOD; MEDICAL PLASTERS; MEDICAL DRESSINGS; MATERIAL FOR STOPPING TEETH, DENTAL WAX; ALL PURPOSE DISINFECTANTS; MEDICINAL CREAMS FOR SKIN CARE, NAMELY, POST-SCLEROTHERAPY CREAMS; MEDICATED CREAMS, LOTIONS AND OILS FOR THE TREATMENT AND CARE OF THE LEGS COMPLEMENTARY TO THE TREATMENT OF VENOUS DISORDERS, IN CLASS 5 (U.S. CLS. 6, 18, 44, 46, 51 AND 52).

FOR: ORTHOPEDIC ARTICLES, NAMELY, ORTHOPEDIC BELTS AND ORTHOPEDIC BRACES; ORTHOPEDIC KNEE BANDAGES; ORTHOPEDIC SUPPORT BANDAGES; ELASTIC STOCKINGS; ORTHOPEDIC SUPPORT BANDS FOR ANKLES AND KNEES; ORTHOPEDIC SUSPENDERS IN THE NATURE OF SUPPORT BANDS FOR ANKLES AND KNEES; ELASTIC BRIEFS FOR ORTHOPEDIC PURPOSES; CORSETS FOR THERAPEUTIC USE; CORSETS FOR MEN AND WOMEN FOR ORTHOPEDIC PURPOSES; ELASTIC SUPPORT BANDS FOR ANKLES AND KNEES, IN CLASS 10 (U.S. CLS. 26, 39 AND 44).

FOR: STOCKINGS, SOCKS, PANTY HOSE, TIGHTS AND GIRDLES, WAIST AND LEG BANDS, IN CLASS 25 (U.S. CLS. 22 AND 39).



David J. Kyjars

Director of the United States Patent and Trademark Office

Reg. No. 4,152,416 THE MARK CONSISTS OF A DESIGN OF A STYLIZED HEART WITH A SINGLE LINE CIRCLE APPEARING IN THE UPPER LEFT CORNER.

PRIORITY DATE OF 3-1-2011 IS CLAIMED.

OWNER OF INTERNATIONAL REGISTRATION 1096400 DATED 8-11-2011, EXPIRES 8-11-2021.

SER. NO. 79-104,896, FILED 8-11-2011.

KELLY TRUSILO, EXAMINING ATTORNEY

United States of America
United States Patent and Trademark Office

Nabto

Reg. No. 4,152,417

Registered June 5, 2012

Int. Cl.: 9

TRADEMARK

PRINCIPAL REGISTER

NABTO APS (DENMARK PRIVATE COMPANY)
AABOGADE 15
DK-8200 AARHUS N
DENMARK

FOR: COMPUTER SOFTWARE FOR THE REMOTE CONTROL OF ELECTRONIC DEVICES
VIA ONLINE NETWORKS, IN CLASS 9 (U.S. CLS. 21, 23, 26, 36 AND 38).

THE MARK CONSISTS OF STANDARD CHARACTERS WITHOUT CLAIM TO ANY PAR-
TICULAR FONT, STYLE, SIZE, OR COLOR.

OWNER OF INTERNATIONAL REGISTRATION 1096682 DATED 10-18-2011, EXPIRES 10-
18-2021.

SER. NO. 79-104,997, FILED 10-18-2011.

FRED CARL, EXAMINING ATTORNEY



David J. Kyffers

Director of the United States Patent and Trademark Office

United States of America
United States Patent and Trademark Office

SNAP-X

Reg. No. 4,152,418

Registered June 5, 2012

Int. Cl.: 28

TRADEMARK

PRINCIPAL REGISTER

LYKKE.IT S.R.L. (ITALY LIMITED LIABILITY COMPANY)
VIA DELLE PRIMULE, 5
I-20020 COGLIATE (MB), ITALY

FOR: GAMES AND PLAYTHINGS, NAMELY, BUILDING GAMES, JIGSAW AND MANIPULATIVE PUZZLES; COLLECTABLE TOY FIGURES; ACCESSORIES FOR COLLECTABLE TOY FIGURES, NAMELY, CLOTHES, VEHICLES, HOUSES, FURNISHINGS AND PLAY SETS; ACTION FIGURES AND ACCESSORIES THEREFOR, PLAY SETS AND CASES FOR ACTION FIGURES; BALLS FOR GAMES; SPORTING ARTICLES FOR CHILDREN, NAMELY, BALLS FOR SPORTS, TOY SCOOTERS, SKATEBOARDS, ROLLER AND ICE SKATES, IN CLASS 28 (U.S. CLS. 22, 23, 38 AND 50).

THE MARK CONSISTS OF STANDARD CHARACTERS WITHOUT CLAIM TO ANY PARTICULAR FONT, STYLE, SIZE, OR COLOR.

PRIORITY DATE OF 2-17-2011 IS CLAIMED.

OWNER OF INTERNATIONAL REGISTRATION 1096711 DATED 8-8-2011, EXPIRES 8-8-2021.

SER. NO. 79-105,007, FILED 8-8-2011.

DEIRDRE ROBERTSON, EXAMINING ATTORNEY



David J. Kyffers

Director of the United States Patent and Trademark Office

United States of America

United States Patent and Trademark Office

eBREEZHALER

Reg. No. 4,152,419

NOVARTIS AG (SWITZERLAND CORPORATION)
CH-4002 BASEL
SWITZERLAND

Registered June 5, 2012

Int. Cls.: 5 and 10

FOR: PHARMACEUTICAL PREPARATIONS FOR THE TREATMENT OF DISORDERS OF THE RESPIRATORY SYSTEM, IN CLASS 5 (U.S. CLS. 6, 18, 44, 46, 51 AND 52).

TRADEMARK

FOR: INHALERS FOR MEDICAL PURPOSES, IN CLASS 10 (U.S. CLS. 26, 39 AND 44).

PRINCIPAL REGISTER

THE MARK CONSISTS OF STANDARD CHARACTERS WITHOUT CLAIM TO ANY PARTICULAR FONT, STYLE, SIZE, OR COLOR.

PRIORITY DATE OF 5-19-2011 IS CLAIMED.

OWNER OF INTERNATIONAL REGISTRATION 1096712 DATED 9-12-2011, EXPIRES 9-12-2021.

SER. NO. 79-105,008, FILED 9-12-2011.

WILLIAM BRECKENFELD, EXAMINING ATTORNEY



David J. Kybas

Director of the United States Patent and Trademark Office

United States of America

United States Patent and Trademark Office



Reg. No. 4,152,420

Registered June 5, 2012

Int. Cl.: 11

A.C.V. INTERNATIONAL,; NAAMLOZE VENNOOTSCHAP (BELGIUM LIMITED LIABILITY COMPANY)
39, KERKPLEIN
SINT-PIETERS-LEEUEW, VOORHEEN RUISBROEK
BELGIUM

TRADEMARK

PRINCIPAL REGISTER

FOR: BOILERS FOR HEATING INSTALLATIONS; CENTRAL HEATING RADIATORS; ELECTRIC HEATERS FOR COMMERCIAL USE; ELECTRICAL BOILERS, ELECTRICALLY HEATED DIFFUSION FURNACES FOR INDUSTRIAL USE; GAS BURNERS; GAS WATER HEATERS; HEAT ACCUMULATORS; HEATING BOILERS; HEATING INSTALLATIONS; HEATING SYSTEMS FOR RESIDENTIAL AND COMMERCIAL BUILDINGS COMPRISED OF BIOMASS BURNERS, BOILERS, VALVES, PIPES, MANIFOLDS, SOLAR PANELS, CONTROL PANELS, SWITCHES AND ELECTRICAL WIRE, ALL SOLD AS A UNIT; HOT WATER HEATERS; HOT WATER TANKS, OIL AND GAS BURNERS FOR INDUSTRIAL, COMMERCIAL AND DOMESTIC USE; SOLAR COLLECTORS FOR HEATING; SOLAR HEAT COLLECTION PANELS; SOLAR THERMAL AIR SYSTEMS FOR HEATING PURPOSES; SOLAR WATER HEATERS; WATER HEATERS FOR DOMESTIC, COMMERCIAL AND INDUSTRIAL USE, IN CLASS 11 (U.S. CLS. 13, 21, 23, 31 AND 34).

THE MARK CONSISTS OF A POLYGON SHAPE WITH A FLAME DESIGN AT THE TOP AND THE LETTERS "ACV" INSIDE THE POLYGON.

OWNER OF INTERNATIONAL REGISTRATION 0376443 DATED 3-24-1971, EXPIRES 3-24-2021.

SER. NO. 79-105,043, FILED 9-1-2011.

JENNIFER MARTIN, EXAMINING ATTORNEY



David J. Kyffers

Director of the United States Patent and Trademark Office

United States of America

United States Patent and Trademark Office

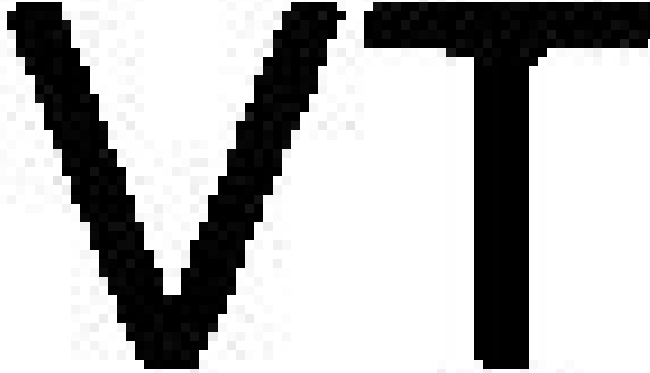

Reg. No. 4,152,421

Registered June 5, 2012

Int. Cl.: 9

MASCHINENFABRIK REINHAUSEN GMBH (FED REP GERMANY LIMITED LIABILITY COMPANY)
FALKENSTEINSTRASSE 8
93059 REGENSBURG
FED REP GERMANY

TRADEMARK

PRINCIPAL REGISTER

FOR: ELECTRIC TAP CHANGERS FOR TRANSFORMERS FOR THE REGULATION OF THE OUTPUT VOLTAGE TO REQUIRED LEVELS FOR USE IN REGULATING TRANSFORMERS IN THE TECHNICAL FIELD OF HIGH-VOLTAGE ENGINEERING, IN CLASS 9 (U.S. CLS. 21, 23, 26, 36 AND 38).

THE MARK CONSISTS OF STANDARD CHARACTERS WITHOUT CLAIM TO ANY PARTICULAR FONT, STYLE, SIZE, OR COLOR.

PRIORITY DATE OF 2-3-2011 IS CLAIMED.

OWNER OF INTERNATIONAL REGISTRATION 1096858 DATED 7-20-2011, EXPIRES 7-20-2021.

OWNER OF U.S. REG. NO. 3,663,843.

SER. NO. 79-105,095, FILED 7-20-2011.

JESSICA FATHY, EXAMINING ATTORNEY



David J. Kybas

Director of the United States Patent and Trademark Office

United States of America
United States Patent and Trademark Office

WindGuard

Reg. No. 4,152,422

Registered June 5, 2012

Int. Cl.: 9

TRADEMARK

PRINCIPAL REGISTER

GN RESOUND A/S (DENMARK LIMITED LIABILITY COMPANY)
LAUTRUPBJERG 7
DK-2750 BALLERUP
DENMARK

FOR: COMPUTER SOFTWARE CONTAINING ALGORITHMS TO EFFECTIVELY REDUCE THE LEVEL OF WIND NOISE AMPLIFIED BY HEARING AIDS, IN CLASS 9 (U.S. CLS. 21, 23, 26, 36 AND 38).

THE MARK CONSISTS OF STANDARD CHARACTERS WITHOUT CLAIM TO ANY PARTICULAR FONT, STYLE, SIZE, OR COLOR.

PRIORITY DATE OF 5-2-2011 IS CLAIMED.

OWNER OF INTERNATIONAL REGISTRATION 1097169 DATED 8-20-2011, EXPIRES 8-20-2021.

SER. NO. 79-105,205, FILED 8-20-2011.

ALEXANDER L. POWERS, EXAMINING ATTORNEY



David J. Kyffers

Director of the United States Patent and Trademark Office

United States of America

United States Patent and Trademark Office

LEDular

Reg. No. 4,152,423

Registered June 5, 2012

Int. Cls.: 9 and 11

TRADEMARK

PRINCIPAL REGISTER

OSRAM AG (FED REP GERMANY CORPORATION)
HELLABRUNNER STRAÙE 1
81543 MÜNCHEN, FED REP GERMANY

FOR: LIGHT EMITTING DIODES; LIGHT EMITTING DIODE MODULES AND COMPONENT PARTS THEREOF, IN CLASS 9 (U.S. CLS. 21, 23, 26, 36 AND 38).

FOR: APPARATUS FOR LIGHTING, NAMELY, ELECTRIC LAMPS AND LUMINAIRES; LED LAMPS AND LED LUMINAIRES AND THEIR PARTS; LED LIGHTING FIXTURES BASED ON LED MODULES, IN CLASS 11 (U.S. CLS. 13, 21, 23, 31 AND 34).

THE MARK CONSISTS OF STANDARD CHARACTERS WITHOUT CLAIM TO ANY PARTICULAR FONT, STYLE, SIZE, OR COLOR.

PRIORITY DATE OF 2-18-2011 IS CLAIMED.

OWNER OF INTERNATIONAL REGISTRATION 1097448 DATED 8-17-2011, EXPIRES 8-17-2021.

SER. NO. 79-105,312, FILED 8-17-2011.

JEFF DEFORD, EXAMINING ATTORNEY



David J. Kybas

Director of the United States Patent and Trademark Office

United States of America
United States Patent and Trademark Office

Mamba

Reg. No. 4,152,424

AUGUST STORCK KG (FED REP GERMANY LIMITED PARTNERSHIP)
WALDSTRASSE 27

Registered June 5, 2012

13403 BERLIN, FED REP GERMANY

Int. Cls.: 29 and 30

FOR: FRUIT JELLIES NOT BEING CONFECTIONERY, IN CLASS 29 (U.S. CL. 46).

TRADEMARK

FOR: JELLY FRUITS; CHOCOLATE, CHOCOLATE PRODUCTS, NAMELY, CHOCOLATES AND CHOCOLATE CANDIES, CHOCOLATE PRALINES, CHOCOLATE BARS, CHOCOLATE FIGURES; PASTRY AND CONFECTIONERY, NAMELY, CANDY, CHEWY CANDY, CHEWING GUM, FRUIT GUM SWEETS, PASTILLES, LOLLIPOPS; ICE CREAM AND FRUIT FLAVORED ICE CREAM, IN CLASS 30 (U.S. CL. 46).

PRINCIPAL REGISTER

OWNER OF U.S. REG. NOS. 2,064,487 AND 4,036,909.

OWNER OF INTERNATIONAL REGISTRATION 0175989 DATED 3-31-1954, EXPIRES 3-31-2014.

SER. NO. 79-105,325, FILED 8-6-2010.

HOWARD SMIGA, EXAMINING ATTORNEY



David J. Kyffers

Director of the United States Patent and Trademark Office

United States of America

United States Patent and Trademark Office

NAVI⚡ANI

Reg. No. 4,152,425

Registered June 5, 2012

Int. Cl.: 11

TRADEMARK

PRINCIPAL REGISTER

XIAMEN WING TECHNOLOGY CO., LTD (CHINA CORPORATION)
2/F, 3/F, NO. 298 SHANGZHONGSHE
HULI DISTRICT.; XIAMEN; FUJIAN
CHINA

FOR: LAMPS; WATER HEATERS; AIR CONDITIONING INSTALLATIONS; HOT WATER HEATING INSTALLATIONS; HYDRANTS; SANITARY INSTALLATIONS IN THE NATURE OF STEAM ROOMS; TOILET BOWLS; TOILET SEATS; DISINFECTANT DISPENSERS FOR TOILETS, IN CLASS 11 (U.S. CLS. 13, 21, 23, 31 AND 34).

THE MARK CONSISTS OF LATIN CHARACTERS "NAVISANI" WITH THE LETTER "S" DESIGNED AS A LIGHTNING.

OWNER OF INTERNATIONAL REGISTRATION 1097750 DATED 8-10-2011, EXPIRES 8-10-2021.

SER. NO. 79-105,560, FILED 8-10-2011.

APRIL ROACH, EXAMINING ATTORNEY



David J. Kyffers

Director of the United States Patent and Trademark Office

United States of America

United States Patent and Trademark Office

trustedSafe

Reg. No. 4,152,426

Registered June 5, 2012

Int. Cls.: 9, 38 and 42

EGOV CONSULTING AND DEVELOPMENT GMBH (FED REP GERMANY GMBH (LIMITED LIABILITY COMPANY))
PASCALSTRASSE 10 B
10587 BERLIN
FED REP GERMANY

TRADEMARK

FOR: COMPUTER SOFTWARE FOR USE IN SECURELY STORING AND TRANSFERRING DOCUMENTS TO A CLOUD SERVER; PRE-RECORDED MAGNETIC DATA CARRIERS FEATURING COMPUTER OPERATING PROGRAMS, IN CLASS 9 (U.S. CLS. 21, 23, 26, 36 AND 38).

SERVICE MARK

PRINCIPAL REGISTER

FOR: TRANSMISSION OF DIGITAL FILES, IN CLASS 38 (U.S. CLS. 100, 101 AND 104).

FOR: DEVELOPMENT AND CREATION OF COMPUTER PROGRAMS FOR DATA PROCESSING; DESIGN AND DEVELOPMENT OF COMPUTER SOFTWARE SYSTEMS FOR USE IN THE STORAGE OF ELECTRONIC DATA AND DOCUMENTS, IN CLASS 42 (U.S. CLS. 100 AND 101).

THE MARK CONSISTS OF STANDARD CHARACTERS WITHOUT CLAIM TO ANY PARTICULAR FONT, STYLE, SIZE, OR COLOR.

OWNER OF INTERNATIONAL REGISTRATION 1097756 DATED 11-15-2010, EXPIRES 11-15-2020.

SER. NO. 79-105,564, FILED 11-15-2010.

DAVID ELTON, EXAMINING ATTORNEY



David J. Kyfos

Director of the United States Patent and Trademark Office

United States of America

United States Patent and Trademark Office

X - G a t e

Reg. No. 4,152,427

Registered June 5, 2012

Int. Cl.: 10

TRADEMARK

PRINCIPAL REGISTER

SUMITOMO BAKELITE CO., LTD. (JAPAN CORPORATION)
5-8, HIGASHI-SHINAGAWA 2-CHOME
SHINAGAWA-KU; TOKYO 140-0002
JAPAN

FOR: MEDICAL AND SURGICAL APPARATUS AND INSTRUMENTS, NAMELY, DEVICES FOR USE IN LAPAROSCOPIC SURGERY OR IN REDUCED PORT SURGERY AND PARTS AND FITTINGS THEREFOR, IN CLASS 10 (U.S. CLS. 26, 39 AND 44).

THE MARK CONSISTS OF STANDARD CHARACTERS WITHOUT CLAIM TO ANY PARTICULAR FONT, STYLE, SIZE, OR COLOR.

PRIORITY DATE OF 8-24-2011 IS CLAIMED.

OWNER OF INTERNATIONAL REGISTRATION 1098558 DATED 10-19-2011, EXPIRES 10-19-2021.

SER. NO. 79-105,939, FILED 10-19-2011.

ANDREA K. NADELMAN, EXAMINING ATTORNEY



David J. Kybas

Director of the United States Patent and Trademark Office

United States of America

United States Patent and Trademark Office

Linked4

Reg. No. 4,152,428

Registered June 5, 2012

Int. Cls.: 9 and 42

UNIT4; BUSINESS SOFTWARE HOLDING B.V. (NETHERLANDS LIMITED LIABILITY COMPANY)
STATIONSPARK 1000
NL-3364 DA SLIEDRECHT
NETHERLANDS

TRADEMARK

FOR: RECORDED COMPUTER PROGRAMS FOR USE WITH THE ONLINE PUBLICATION OF DATA IN A SEARCHABLE FORMAT, IN CLASS 9 (U.S. CLS. 21, 23, 26, 36 AND 38).

SERVICE MARK

FOR: COMPUTERIZATION SERVICES, NAMELY COMPUTER PROGRAMMING; DESIGNING AND WRITING OF COMPUTER SOFTWARE; CONSULTANCY IN THE FIELD OF COMPUTERIZATION IN THE NATURE OF COMPUTER PROGRAMMING; INSTALLATION, IMPLEMENTATION AND MAINTENANCE OF COMPUTER SOFTWARE, IN CLASS 42 (U.S. CLS. 100 AND 101).

PRINCIPAL REGISTER

PRIORITY DATE OF 2-8-2011 IS CLAIMED.

OWNER OF INTERNATIONAL REGISTRATION 1098778 DATED 8-3-2011, EXPIRES 8-3-2021.

THE COLOR(S) VARIOUS SHADES OF PURPLE, BLUE AND GREEN IS/ARE CLAIMED AS A FEATURE OF THE MARK.

THE MARK CONSISTS OF THE STYLIZED WORDING "LINKED4", WITH THE COLOR PURPLE APPEARING IN THE CHARACTERS "L" AND "I", AND THE COLOR BLUE APPEARING IN THE CHARACTERS "N", "K" AND "E", AND THE COLOR GREEN APPEARING IN THE CHARACTERS "E", "D" AND "4".

SER. NO. 79-106,006, FILED 8-3-2011.

JACQUELINE A. LAVINE, EXAMINING ATTORNEY



David J. Kyros

Director of the United States Patent and Trademark Office

United States of America
United States Patent and Trademark Office

AZIMUT

Reg. No. 4,152,429

AZIMUT-BENETTI S.P.A. (ITALY SOCIETÀ PER AZIONI)
VIA MICHELE COPPINO, 104
I-55049 VIAREGGIO (LU), ITALY

Registered June 5, 2012

Int. Cl.: 12

FOR: WATER VEHICLES, NAMELY, BOATS AND YACHTS, IN CLASS 12 (U.S. CLS. 19, 21, 23, 31, 35 AND 44).

TRADEMARK

THE MARK CONSISTS OF STANDARD CHARACTERS WITHOUT CLAIM TO ANY PARTICULAR FONT, STYLE, SIZE, OR COLOR.

PRINCIPAL REGISTER

OWNER OF INTERNATIONAL REGISTRATION 0837133 DATED 6-14-2004, EXPIRES 6-14-2014.

OWNER OF U.S. REG. NOS. 1,662,395 AND 3,651,387.

THE ENGLISH TRANSLATION OF "AZIMUT" IN THE MARK IS "AZIMUTH".

SER. NO. 79-106,317, FILED 10-14-2011.

CARRIE GENOVESE, EXAMINING ATTORNEY



David J. Kybas

Director of the United States Patent and Trademark Office

United States of America

United States Patent and Trademark Office

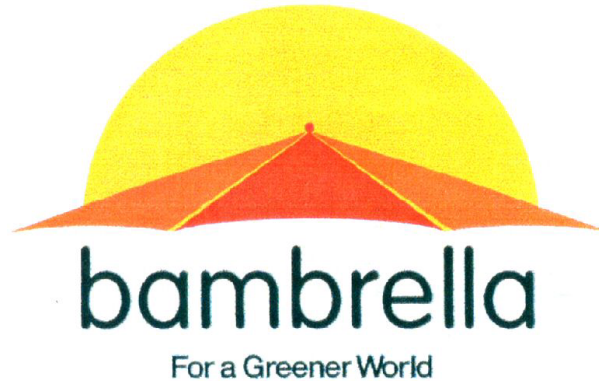

Reg. No. 4,152,430

Registered June 5, 2012

Int. Cls.: 18 and 20

TRADEMARK

PRINCIPAL REGISTER

WOODSTOCKS INTERNATIONAL LTD.;; JAN AUKSTOLIS (UNITED KINGDOM CORPORATION)
THE CONSERVATORY
56 STATION ROAD; GOMSHALL
SURREY GU5 9LB, UNITED KINGDOM

FOR: BAMBOO GARDEN PARASOLS, IN CLASS 18 (U.S. CLS. 1, 2, 3, 22 AND 41).

FOR: BAMBOO GARDEN FURNITURE, IN CLASS 20 (U.S. CLS. 2, 13, 22, 25, 32 AND 50).

THE MARK CONSISTS OF A YELLOW SUN RISING BEHIND A YELLOW, ORANGE AND RED UMBRELLA, WITH WORDING "BAMBRELLA FOR A GREENER WORLD" UNDERNEATH IN THE COLOR DARK GREEN.

OWNER OF INTERNATIONAL REGISTRATION 1099659 DATED 6-3-2011, EXPIRES 6-3-2021.

THE COLOR(S) YELLOW, DARK GREEN, ORANGE AND RED IS/ARE CLAIMED AS A FEATURE OF THE MARK.

SER. NO. 79-106,381, FILED 6-3-2011.

JAY FLOWERS, EXAMINING ATTORNEY



David J. Kyffers

Director of the United States Patent and Trademark Office

United States of America

United States Patent and Trademark Office

PIVOT

Reg. No. 4,152,431

Registered June 5, 2012

Int. Cl.: 7

APPLIED MATERIALS GMBH & CO. KG (FED REP GERMANY LIMITED LIABILITY COMPANY)
SIEMENSSTRASSE 100
63755 ALZENAU
FED REP GERMANY

TRADEMARK

PRINCIPAL REGISTER

FOR: COATING MACHINES AND APPARATUSES CONSISTING THEREOF, PARTICULARLY SPUTTER MACHINES AND APPARATUSES CONSISTING THEREOF; ALL OF THE BEFORE-MENTIONED MACHINES AND APPARATUSES ADAPTED TO COAT ALL KINDS OF SUBSTRATES OF SYNTHETIC AND/OR MINERAL MATERIALS, PARTICULARLY, MINERAL GLASSES, WITH TRANSPARENT AND/OR WEAR RESISTANT, AND/OR OPTICAL COATINGS, AND/OR CONDUCTIVE COATINGS, AND/OR COATINGS HAVING AN ELECTRICAL OR ELECTRONIC FUNCTIONALITY, AND/OR TRANSPARENT CONDUCTIVE COATINGS, SUCH AS INDIUM TIN OXIDE COATINGS, IN CLASS 7 (U.S. CLS. 13, 19, 21, 23, 31, 34 AND 35).

THE MARK CONSISTS OF STANDARD CHARACTERS WITHOUT CLAIM TO ANY PARTICULAR FONT, STYLE, SIZE, OR COLOR.

PRIORITY DATE OF 7-20-2011 IS CLAIMED.

OWNER OF INTERNATIONAL REGISTRATION 1100315 DATED 10-24-2011, EXPIRES 10-24-2021.

SER. NO. 79-106,614, FILED 10-24-2011.

TOBY BULLOFF, EXAMINING ATTORNEY



David J. Kyffers

Director of the United States Patent and Trademark Office

United States of America

United States Patent and Trademark Office

VONDIC

Reg. No. 4,152,432

Registered June 5, 2012

Int. Cl.: 1

TRADEMARK

PRINCIPAL REGISTER

DIC CORPORATION (JAPAN CORPORATION)
35-58, SAKASHITA 3-CHOME
ITABASHI-KU TOKYO 174-8520
JAPAN

FOR: UNPROCESSED SYNTHETIC RESINS; UNPROCESSED PLASTICS (PLASTICS IN PRIMARY FORM), IN CLASS 1 (U.S. CLS. 1, 5, 6, 10, 26 AND 46).

THE MARK CONSISTS OF STANDARD CHARACTERS WITHOUT CLAIM TO ANY PARTICULAR FONT, STYLE, SIZE, OR COLOR.

PRIORITY DATE OF 11-2-2011 IS CLAIMED.

OWNER OF INTERNATIONAL REGISTRATION 1100455 DATED 11-17-2011, EXPIRES 11-17-2021.

OWNER OF U.S. REG. NOS. 1,860,593, 3,534,370 AND OTHERS.

SER. NO. 79-106,676, FILED 11-17-2011.

KIM MONINGHOFF, EXAMINING ATTORNEY



David J. Kyffers

Director of the United States Patent and Trademark Office

United States of America
United States Patent and Trademark Office

Track IQ

Reg. No. 4,152,433

Registered June 5, 2012

Int. Cls.: 9 and 37

TRADEMARK

SERVICE MARK

PRINCIPAL REGISTER

TRACKSIDE INTELLIGENCE PTY LTD (AUSTRALIA CORPORATION)
279 NORMANBY ROAD
PORT MELBOURNE VIC 3207
AUSTRALIA

FOR: MONITORING DEVICES FOR DETECTING BEARING FAULTS, MEASURING NOISE AND MONITORING WAYSIDE VEHICLE CONDITION; MEASURING DEVICES AND APPARATUS FOR MEASURING NOISE AND ACOUSTIC FREQUENCIES; ELECTRONIC SENSING APPARATUS FOR ANALYSIS OF RAILWAY VEHICLE PERFORMANCE; SOFTWARE FOR THE MONITORING, DETECTING, MEASURING AND SENSING OF NOISE AND ACOUSTIC FREQUENCIES, IN CLASS 9 (U.S. CLS. 21, 23, 26, 36 AND 38).

FOR: REPAIR, MAINTENANCE AND INSTALLATION SERVICES, NAMELY, REPAIR, MAINTENANCE AND INSTALLATION OF RAIL TRANSPORT MONITORS, DETECTORS AND SENSING EQUIPMENT; PROVIDING INFORMATION, ADVISORY AND CONSULTANCY SERVICES IN RELATION TO REPAIR, MAINTENANCE AND INSTALLATION OF RAIL TRANSPORT MONITORS, DETECTORS AND SENSING EQUIPMENT, IN CLASS 37 (U.S. CLS. 100, 103 AND 106).

THE MARK CONSISTS OF STANDARD CHARACTERS WITHOUT CLAIM TO ANY PARTICULAR FONT, STYLE, SIZE, OR COLOR.

PRIORITY DATE OF 7-27-2011 IS CLAIMED.

OWNER OF INTERNATIONAL REGISTRATION 1100532 DATED 8-17-2011, EXPIRES 8-17-2021.

NO CLAIM IS MADE TO THE EXCLUSIVE RIGHT TO USE "TRACK", APART FROM THE MARK AS SHOWN.

SER. NO. 79-106,705, FILED 8-17-2011.

MAYUR VAGHANI, EXAMINING ATTORNEY



David J. Kyffers

Director of the United States Patent and Trademark Office

United States of America

United States Patent and Trademark Office

CONTROLMEC

Reg. No. 4,152,434

Registered June 5, 2012

Int. Cls.: 9, 37 and 42

TRADEMARK

SERVICE MARK

PRINCIPAL REGISTER

MEC A/S (DENMARK PUBLIC LIMITED COMPANY)
INDUSTRI PARKEN 23
DK-2750 BALLERUP
DENMARK

FOR: ELECTRICAL CONTACTS AND SWITCHES, ASSEMBLIES OF ELECTRICAL CONTACTS AND SWITCHES, ELECTRICAL PUSH-BUTTON CONTACTS AND SWITCHES, ASSEMBLIES OF ELECTRICAL PUSH-BUTTON CONTACTS AND SWITCHES; KEY BUTTONS, KEY BUTTON ASSEMBLIES AND KEYBOARDS, KEY BUTTON SWITCH PLATES, ASSEMBLIES OF KEY BUTTON SWITCH PLATES, HOUSING AND HOUSING ASSEMBLIES, ALL THE AFORESAID GOODS IN THE FORM OF PARTS FOR ELECTRICAL CONTACTS AND SWITCHES AND ASSEMBLIES OF ELECTRICAL CONTACTS AND SWITCHES, IN CLASS 9 (U.S. CLS. 21, 23, 26, 36 AND 38).

FOR: CONSULTANCY REGARDING INSTALLATION OF ELECTRICAL CONTACTS, ASSEMBLIES OF ELECTRICAL PUSH-BUTTON CONTACTS AND SWITCHES AND KEY BUTTON ASSEMBLIES AND KEYBOARDS, IN CLASS 37 (U.S. CLS. 100, 103 AND 106).

FOR: INDUSTRIAL DESIGN OF AND TECHNOLOGICAL CONSULTANCY REGARDING USE OF ELECTRICAL CONTACTS, ASSEMBLIES OF ELECTRICAL PUSH-BUTTON CONTACTS AND SWITCHES AND KEY BUTTON ASSEMBLIES AND KEYBOARDS, IN CLASS 42 (U.S. CLS. 100 AND 101).

THE MARK CONSISTS OF STANDARD CHARACTERS WITHOUT CLAIM TO ANY PARTICULAR FONT, STYLE, SIZE, OR COLOR.

OWNER OF INTERNATIONAL REGISTRATION 1101539 DATED 10-18-2011, EXPIRES 10-18-2021.

SER. NO. 79-107,121, FILED 10-18-2011.

SHAILA SETTLES, EXAMINING ATTORNEY



David J. Kyros

Director of the United States Patent and Trademark Office

United States of America

United States Patent and Trademark Office



HOMICHEF

Reg. No. 4,152,435

Registered June 5, 2012

Int. Cls.: 6 and 20

TRADEMARK

PRINCIPAL REGISTER

XINHUI RIXING STAINLESS; STEEL PRODUCTS CO., LTD. (CHINA COMPANY LIMITED)
SIQIAN INDUSTRY DEVELOPMENT ZONE
XINHUI DISTRICT;; JIANGMEN CITY; GUANGDONG PROVINCE
CHINA

FOR: COMMON METALS, UNWROUGHT AND SEMI-WROUGHT, FOR FURTHER MANUFACTURE; PIPES OF METAL; BUILDING MATERIALS OF METAL, NAMELY, BUILDING WALL FRAMING MADE PRIMARILY OF METAL, BUILDING CURTAIN WALLS MADE PRIMARILY OF METAL, COMPOSITE PANELS COMPOSED PRIMARILY OF METAL, CLADDING OF METAL FOR CONSTRUCTION AND BUILDING, DRYWALL CORNER BEAD OF METAL, METAL BUILDING FLASHING, METAL FASCIA, METAL SOFFITS, METAL CEILING BOARDS AND FLOOR BOARDS, METAL TRIM FOR BUILDINGS, PREFABRICATED METAL BUILDING ASSEMBLY KITS, AND REINFORCING MATERIALS OF METAL FOR BUILDING PURPOSES; WIRE GAUZE; FITTINGS OF METAL FOR FURNITURE, NAMELY, METAL JOINERY FITTINGS, RING-SHAPED FITTINGS OF METAL, AND METAL HANDLES; SMALL HARDWARE OF METAL, NAMELY, BUCKLES OF COMMON METAL, METAL GATE LATCHES, PULLEYS, SPRINGS, NUTS, WASHERS, CARABINERS OF METAL, RIVETS, SCREWS, BOLTS, NAILS, FASTENING ANCHORS; CHESTS OF METAL FOR FOOD; PALLETS OF METAL; STORAGE TANKS OF METAL; SIGNBOARDS OF METAL, NAMELY, UPRIGHT SIGNBOARDS OF COMMON METAL, AND NON-LUMINOUS AND NON-MECHANICAL SIGNS, IN CLASS 6 (U.S. CLS. 2, 12, 13, 14, 23, 25 AND 50).

FOR: FURNITURE; NONMETAL AND NON-PAPER CONTAINERS FOR STORAGE OR TRANSPORT; TABLES OF METAL; CRAFTWORK PRIMARILY OF GLASS ALSO CONTAINING STEEL, NAMELY, GLASS KNOBS, GLASS PULLS, DRAWER PULLS, AND MIRRORS; DISPLAY BOARDS, DECORATIONS OF PLASTIC FOR FOODSTUFFS, NESTING BOXES FOR HOUSEHOLD PETS; FURNITURE FITTINGS, NOT OF METAL; SLEEPING BAGS FOR CAMPING; NON-METAL, NON-ELECTRIC LOCKS, IN CLASS 20 (U.S. CLS. 2, 13, 22, 25, 32 AND 50).



OWNER OF U.S. REG. NO. 3,395,758.

PRIORITY DATE OF 5-6-2011 IS CLAIMED.

OWNER OF INTERNATIONAL REGISTRATION 1101726 DATED 9-16-2011, EXPIRES 9-16-2021.

David J. Kyros

Director of the United States Patent and Trademark Office

Reg. No. 4,152,435 THE COLOR(S) BLUE, RED AND GREEN IS/ARE CLAIMED AS A FEATURE OF THE MARK.

THE MARK CONSISTS OF THE STYLIZED WORDING "HOMICHEF" IN THE COLOR RED, WITH THE DESIGN OF A BLUE OVERLINE ABOVE THE WORDING, AND ABOVE ALL OTHER ELEMENTS OF THE MARK IS THE DESIGN OF THREE ARROW SHAPED BANDS IN THE COLORS RED, BLUE AND GREEN. THE COLOR WHITE REPRESENTS BACKGROUND AND IS NOT A FEATURE OF THE MARK.

SER. NO. 79-107,179, FILED 9-16-2011.

JAY BESCH, EXAMINING ATTORNEY

United States of America

United States Patent and Trademark Office

Mamarella

Reg. No. 4,152,436

Registered June 5, 2012

**Int. Cls.: 3, 14, 18, 24
and 25**

TRADEMARK

PRINCIPAL REGISTER

FRAU PETRA BEDFORD (FED REP GERMANY INDIVIDUAL)
JOSEF-FISCHHABER-STRASSE 62
82319 STARNBERG
FED REP GERMANY

FOR: LAUNDRY BLEACH, BLUING, DETERGENT, PRE-SOAK, SIZING AND STARCH; GENERAL PURPOSE CLEANING, POLISHING AND ABRASIVE LIQUIDS AND POWDERS; PERFUMERY; ESSENTIAL OILS; COSMETICS; HAIR LOTIONS; DENTIFRICES; BABY, BODY, BATH AND MASSAGE OILS FOR USE BY PREGNANT OR LACTATING WOMEN; BABY LOTION, OIL, POWDER, SHAMPOO AND WIPES, IN CLASS 3 (U.S. CLS. 1, 4, 6, 50, 51 AND 52).

FOR: JEWELLERY; PRECIOUS STONES; KEY CHAINS, NAMELY, KEY CHAINS OF PRECIOUS METAL, KEY CHAINS AS JEWELLERY, IN CLASS 14 (U.S. CLS. 2, 27, 28 AND 50).

FOR: IMITATION LEATHER; LEATHER SOLD IN BULK; LEATHER AND IMITATION LEATHER BAGS, LEATHER CASES, HANDBAGS, LUGGAGE, PURSES AND LEATHER STRAPS; SLING BAGS FOR CARRYING INFANTS; DIAPER BAGS; HANDBAGS; SHOULDER BAGS, IN CLASS 18 (U.S. CLS. 1, 2, 3, 22 AND 41).

FOR: TEXTILE FABRICS FOR THE MANUFACTURE OF CLOTHING, FOR LINGERIE AND FOR HOME AND COMMERCIAL INTERIORS; TEXTILE LABELS, SIGNAGE PANELS AND WALL HANGINGS; BED LINEN, IN CLASS 24 (U.S. CLS. 42 AND 50).

FOR: FOOTWEAR; HEADWEAR; MATERNITY LINGERIE AND SLEEPWEAR; BABY BIBS NOT OF PAPER; BABY BUNTING; ONE PIECE GARMENT FOR INFANTS AND TODDLERS; INFANT CLOTH DIAPERS, SLEEPERS AND TROUSERS; NURSING BRAS; CLOTHING, NAMELY, BOTTOMS, TOPS, PANTS, SHORTS, SHIRTS, DRESSES, COATS, JACKETS, JUMPERS, SWEATERS, UNDERWEAR AND VESTS; SHOES, IN CLASS 25 (U.S. CLS. 22 AND 39).

THE MARK CONSISTS OF STANDARD CHARACTERS WITHOUT CLAIM TO ANY PARTICULAR FONT, STYLE, SIZE, OR COLOR.

PRIORITY DATE OF 4-12-2011 IS CLAIMED.



David J. Kyros

Director of the United States Patent and Trademark Office

Reg. No. 4,152,436 OWNER OF INTERNATIONAL REGISTRATION 1102412 DATED 9-7-2011, EXPIRES 9-7-2021.

OWNER OF U.S. REG. NOS. 3,520,742 AND 3,639,875.

SER. NO. 79-107,483, FILED 9-7-2011.

SANI KHOURI, EXAMINING ATTORNEY

United States of America

United States Patent and Trademark Office

CLOPV

Reg. No. 4,152,437

Registered June 5, 2012

Int. Cl.: 9

TRADEMARK

PRINCIPAL REGISTER

SHANXI CHUANGLING PHOTOVOLTAIC; ELECTRIC CO. LTD. (CHINA CORPORATION)
NO. 188, GAOXIN ROAD
WIBIN DISTRICT; BAOJI; SHANXI
CHINA

FOR: CIRCUIT BREAKERS; SURGE PROTECTION DEVICE, NAMELY VOLTAGE SURGE
PROTECTORS; LIGHTNING ARRESTER, IN CLASS 9 (U.S. CLS. 21, 23, 26, 36 AND 38).

THE MARK CONSISTS OF THE STYLIZED LETTERS CLOPV WITH A SHADED CIRCLE
DESIGN FORMING THE LETTER O.

OWNER OF INTERNATIONAL REGISTRATION 1102906 DATED 8-26-2011, EXPIRES 8-26-
2021.

THE WORDING "CLOPV" HAS NO MEANING IN A FOREIGN LANGUAGE.

SER. NO. 79-107,658, FILED 8-26-2011.

NATALIE POLZER, EXAMINING ATTORNEY



David J. Kyffers

Director of the United States Patent and Trademark Office

United States of America

United States Patent and Trademark Office

VIASOL

Reg. No. 4,152,438

Registered June 5, 2012

Int. Cls.: 1, 37, 40 and 42

VIACOR POLYMER GMBH (FED REP GERMANY GMBH (GESELLSCHAFT MIT
BESCHRÄNKTER HAFTUNG))
HOHENNEUFFENSTRASSE 14
72622 NÜRTINGEN
FED REP GERMANY

TRADEMARK

FOR: REACTIVE RESINS AND/OR POLYMERIC MATERIALS FOR COATING SYSTEMS AND MOULDING COMPOUNDS INCLUDED IN THIS CLASS; ALL OF THE AFOREMENTIONED GOODS TO BE EXCLUSIVELY USED FOR FLOOR COATING AND FLOOR COVERINGS, RESPECTIVELY, IN CLASS 1 (U.S. CLS. 1, 5, 6, 10, 26 AND 46).

SERVICE MARK

PRINCIPAL REGISTER

FOR: SEALING, IMPREGNATING, COATING OF FLOORS, WALLS AND CEILINGS; INSTALLATION AND REPAIR OF FLOORS; INSTALLATION, MAINTENANCE AND REPAIR OF RESIN-BOUND ELASTIC MATS, IN CLASS 37 (U.S. CLS. 100, 103 AND 106).

FOR: POURING/MOULDING AND PRODUCTION OF REACTION RESIN-BONDED POLYMER CONCRETE FOR STRUCTURES, FOUNDATIONS, RACKS, SUPPORTS, MOULDING MODELS, MOULDING MATERIALS IN MECHANICAL ENGINEERING AND/OR MACHINE TOOL MANUFACTURE AND/OR MODEL MAKING, IN CLASS 40 (U.S. CLS. 100, 103 AND 106).

FOR: DEVELOPMENT, SCIENTIFIC AND INDUSTRIAL RESEARCH IN THE FIELD OF REACTIVE RESINS AND/OR POLYMERIC MATERIALS AND/OR UNPROCESSED SYNTHETIC RESINS FOR USE IN THE MANUFACTURE OF RESIN-BOUND ELASTIC MATS, IN CLASS 42 (U.S. CLS. 100 AND 101).

THE MARK CONSISTS OF STANDARD CHARACTERS WITHOUT CLAIM TO ANY PARTICULAR FONT, STYLE, SIZE, OR COLOR.

OWNER OF INTERNATIONAL REGISTRATION 1104005 DATED 9-7-2011, EXPIRES 9-7-2021.

SER. NO. 79-108,066, FILED 9-7-2011.

BRIAN NEVILLE, EXAMINING ATTORNEY



David J. Kypos

Director of the United States Patent and Trademark Office

United States of America

United States Patent and Trademark Office



Reg. No. 4,152,439

Registered June 5, 2012

Int. Cl.: 40

SERVICE MARK

PRINCIPAL REGISTER

SAVERGLASS (FRANCE SOCIÉTÉ PAR ACTIONS SIMPLIFIÉE)
3 RUE DE LA GARE
F-60960 FEUQUIERES
FRANCE

FOR: TREATMENT OF MATERIALS, NAMELY, SILK SCREEN PRINTING OF PACKAGING OF GLASS, TINTING GLASS BY SURFACE TREATMENT, IN CLASS 40 (U.S. CLS. 100, 103 AND 106).

OWNER OF U.S. REG. NOS. 2,840,162 AND 3,440,974.

PRIORITY DATE OF 11-5-2010 IS CLAIMED.

OWNER OF INTERNATIONAL REGISTRATION 1079815 DATED 3-22-2011, EXPIRES 3-22-2021.

THE COLOR(S) GREEN, PINK, YELLOW, BLUE, RED, ORANGE, VIOLET, LIGHT GREEN, PALE BLUE AND GRAY IS/ARE CLAIMED AS A FEATURE OF THE MARK.

THE LETTERS IN THE WORD "ORGANIC" ARE GREEN; FOR THE LETTERS IN THE WORD "COLOR"; THE "C" IS PINK, THE FIRST "O" IS YELLOW, THE "L" IS BLUE, THE SECOND "O" IS RED AND THE "R" IS ORANGE; FOR THE LETTERS IN THE WORD "PLAY", THE "P" IS GREEN, THE "L" IS VIOLET, THE "A" IS LIGHT GREEN AND THE "Y" IS PALE BLUE; THE LETTERS IN "BY SAVERGLASS" ARE GRAY; ALL OF THIS IS SURROUNDED BY A GREEN SQUARE FRAME; THE COLOR WHITE MERELY REPRESENTS A TRANSPARENT AREA OF THE MARK AND IS NOT CLAIMED AS A FEATURE OF THE MARK.

SER. NO. 79-975,203, FILED 3-22-2011.

KELLY BOULTON, EXAMINING ATTORNEY



David J. Kybas

Director of the United States Patent and Trademark Office

United States of America

United States Patent and Trademark Office

PANTA

Reg. No. 4,152,440

Registered June 5, 2012

Int. Cl.: 9

TRADEMARK

PRINCIPAL REGISTER

SUMIDA FLEXIBLE CONNECTIONS GMBH (FED REP GERMANY GESELLSCHAFT MIT BESCHRÄNKTER HAFTUNG (GMBH))
AGATHE-ZEIS-STR. 5
01454 RADEBERG, FED REP GERMANY

FOR: APPARATUS AND INSTRUMENTS FOR CONDUCTING, SWITCHING, TRANSFORMING, ACCUMULATING, REGULATING OR CONTROLLING ELECTRICITY, NAMELY, ELECTRICAL AND OPTICAL CABLES, ELECTRICAL AND OPTICAL WIRES, ELECTRICAL CABLES, JUMPER CABLES, CABLE CONNECTORS, ELECTRICAL AND ELECTRONIC CONNECTORS, CONNECTORS FOR ELECTRONIC CIRCUITS, ELECTRICAL SWITCHES, CONNECTORS AND INTERCONNECTION SYSTEMS, CABLE ASSEMBLIES, CABLE TERMINALS AND SPLICES, ELECTRIC PIN AND SOCKET CONNECTORS, PRINTED CIRCUIT BOARD CONNECTORS, RF COAXIAL CABLE CONNECTORS, RIBBON AND FLAT PANEL CONNECTORS, ELECTRICAL MPI INTERCONNECT CABLES, ELECTRICAL WIRE TO BOARD CONNECTORS, ELECTRICAL BOARD-TO-BOARD CONNECTORS, ELECTRICAL CABLE-TO-BOARD CONNECTORS, ELECTRICAL CABLE-TO-CABLE CONNECTION AND SERIES CONNECTORS, ELECTRICAL PLUGS AND SOCKETS, PLUG ADAPTERS, PLUG CONNECTORS, IN CLASS 9 (U.S. CLS. 21, 23, 26, 36 AND 38).

THE MARK CONSISTS OF STANDARD CHARACTERS WITHOUT CLAIM TO ANY PARTICULAR FONT, STYLE, SIZE, OR COLOR.

PRIORITY CLAIMED UNDER SEC. 44(D) ON ERPN CMNTY TM OFC APPLICATION NO. 008647315, FILED 10-28-2009, REG. NO. 008647315, DATED 3-22-2010, EXPIRES 10-28-2019.

SER. NO. 85-006,649, FILED 4-5-2010.

ALYSSA STEEL, EXAMINING ATTORNEY



David J. Kyffers

Director of the United States Patent and Trademark Office

United States of America

United States Patent and Trademark Office

Xupernova

Reg. No. 4,152,441

Registered June 5, 2012

Int. Cl.: 11

TRADEMARK

PRINCIPAL REGISTER

LG ELECTRONICS INC. (REPUBLIC OF KOREA CORPORATION)
20, YEOUIDO-DONG, YEONGDEUNGPO-GU
SEOUL, REPUBLIC OF KOREA 150-721

FOR: LIGHT EMITTING DIODE LIGHTING FIXTURES, NOT FOR USE IN VEHICLES, IN CLASS 11 (U.S. CLS. 13, 21, 23, 31 AND 34).

THE MARK CONSISTS OF STANDARD CHARACTERS WITHOUT CLAIM TO ANY PARTICULAR FONT, STYLE, SIZE, OR COLOR.

PRIORITY CLAIMED UNDER SEC. 44(D) ON REPUBLIC OF KOREA APPLICATION NO. 40-2010-0018, FILED 4-7-2010, REG. NO. 0883765, DATED 10-6-2011, EXPIRES 10-6-2021.

SER. NO. 85-012,516, FILED 4-13-2010.

GISELLE AGOSTO, EXAMINING ATTORNEY



David J. Kybas

Director of the United States Patent and Trademark Office

United States of America

United States Patent and Trademark Office



Reg. No. 4,152,442

Registered June 5, 2012

Int. Cl.: 25

TRADEMARK

PRINCIPAL REGISTER

RICHARD COHEN (UNITED STATES INDIVIDUAL)
155 CATALPA DR
BIRMINGHAM, MI 48009

FOR: GOLF PANTS, SHIRTS AND SKIRTS; PANTS; SHIRTS; SHIRTS AND SHORT-SLEEVED SHIRTS; SHORT-SLEEVED OR LONG-SLEEVED T-SHIRTS; SWEAT PANTS; SWEAT SHIRTS; SWEAT SHORTS; T-SHIRTS; WATERPROOF JACKETS AND PANTS; WIND PANTS; WIND SHIRTS, IN CLASS 25 (U.S. CLS. 22 AND 39).

FIRST USE 4-15-2009; IN COMMERCE 3-1-2010.

THE MARK CONSISTS OF A SUNGLASS WEARING PARROT SITTING ON A HAMMOCK TIED TO TWO PALM TREES ON A DESERTED ISLAND SURROUNDED BY WATER AND UNDER A BRIGHT FULL SUN. ABOVE THE ISLAND AND PALM TREES AND PARTIALLY OVERLAPPING THE SUN, CHARACTERS SPELL OUT THE WORDS "LAZY DAZE" IN BOLD.

SER. NO. 85-020,347, FILED 4-22-2010.

WILLIAM VERHOSEK, EXAMINING ATTORNEY



David J. Kyffers

Director of the United States Patent and Trademark Office

United States of America

United States Patent and Trademark Office

SHH! HOTELS

Reg. No. 4,152,443

Registered June 5, 2012

Int. Cl.: 43

SERVICE MARK

PRINCIPAL REGISTER

THE RICHDALE GROUP (NEBRASKA CORPORATION)
10040 REGENCY CIRCLE, SUITE 200
OMAHA, NE 68114

FOR: HOTELS, IN CLASS 43 (U.S. CLS. 100 AND 101).

FIRST USE 2-22-2010; IN COMMERCE 2-22-2010.

THE MARK CONSISTS OF STANDARD CHARACTERS WITHOUT CLAIM TO ANY PARTICULAR FONT, STYLE, SIZE, OR COLOR.

NO CLAIM IS MADE TO THE EXCLUSIVE RIGHT TO USE "HOTELS", APART FROM THE MARK AS SHOWN.

SER. NO. 85-023,895, FILED 4-27-2010.

DAVID TOOLEY, EXAMINING ATTORNEY



David J. Kyffers

Director of the United States Patent and Trademark Office

United States of America

United States Patent and Trademark Office

ClearChoice is the Perfect Choice

Reg. No. 4,152,444

CLEARCHOICE HOLDINGS, LLC (COLORADO LIMITED LIABILITY COMPANY)
8350 E. CRESCENT PKWY, STE 100
GREENWOOD VILLAGE, CO 80111

Registered June 5, 2012

Int. Cl.: 44

FOR: DENTIST SERVICES, NAMELY, DENTAL IMPLANT SERVICES, IN CLASS 44 (U.S. CLS. 100 AND 101).

SERVICE MARK

FIRST USE 4-29-2010; IN COMMERCE 4-29-2010.

PRINCIPAL REGISTER

THE MARK CONSISTS OF STANDARD CHARACTERS WITHOUT CLAIM TO ANY PARTICULAR FONT, STYLE, SIZE, OR COLOR.

SER. NO. 85-027,270, FILED 4-30-2010.

KATHRYN COWARD, EXAMINING ATTORNEY



David J. Kybas

Director of the United States Patent and Trademark Office

United States of America

United States Patent and Trademark Office

IT'S NOT THE WORKOUT BUT THE INTENSITY

Reg. No. 4,152,445

Registered June 5, 2012

Int. Cls.: 28 and 41

TRADEMARK

SERVICE MARK

PRINCIPAL REGISTER

UPFRONT MEGATAINMENT, INC. (GEORGIA CORPORATION)
SUITE 3310
101 MARIETTA STREET
ATLANTA, GA 30303

FOR: APPARATUS AND DEVICES DESIGNED FOR BODY SCULPTING AND THE ENHANCEMENT OF PHYSICAL FITNESS ATTRIBUTES AND ABILITIES, NAMELY, MANUALLY-OPERATED EXERCISE EQUIPMENT FOR PHYSICAL FITNESS PURPOSES; SYSTEMS DESIGNED FOR BODY SCULPTING AND THE ENHANCEMENT OF PHYSICAL FITNESS ATTRIBUTES AND ABILITIES, COMPRISED OF BOXES, BOARDS, PLANKS AND STRAPS FOR INCREASING RESISTANCE AND STRETCHING CAPABILITIES, IN CLASS 28 (U.S. CLS. 22, 23, 38 AND 50).

FIRST USE 1-1-2005; IN COMMERCE 1-1-2005.

FOR: PHYSICAL FITNESS SERVICES, NAMELY, BODY SCULPTING CLASSES, AND GROUP AND INDIVIDUAL FITNESS PROGRAMS DESIGNED TO INCREASE STAMINA AND MUSCLE TONE, IN CLASS 41 (U.S. CLS. 100, 101 AND 107).

FIRST USE 1-1-2005; IN COMMERCE 1-1-2005.

THE MARK CONSISTS OF STANDARD CHARACTERS WITHOUT CLAIM TO ANY PARTICULAR FONT, STYLE, SIZE, OR COLOR.

SER. NO. 85-027,873, FILED 4-30-2010.

KAELIE KUNG, EXAMINING ATTORNEY

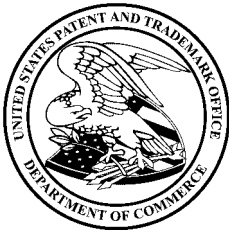

David J. Kypos

Director of the United States Patent and Trademark Office

United States of America

United States Patent and Trademark Office



Reg. No. 4,152,446

Registered June 5, 2012

Int. Cl.: 8

TRADEMARK

PRINCIPAL REGISTER

FERGUSON ENTERPRISES, INC. (VIRGINIA CORPORATION)
12500 JEFFERSON AVE.
NEWPORT NEWS, VA 23602

FOR: HAND TOOLS USED FOR PLUMBING, NAMELY, BRUSHES FOR CLEANING PLUMBING FITTINGS AND PIPES AND FOR THE APPLICATION OF PLUMBING SEALANTS, SOCKET SETS, WATER HEATER ELEMENT SOCKETS, PIPE CUTTERS, HANDLE PULLERS, NAMELY, HAND TOOLS USED TO PULL FAUCET HANDLES OFF THEIR FITTINGS, NIPPLE EXTRACTORS, SEAT WRENCHES, SPUD WRENCHES, STREET KEYS, NAMELY, METAL HAND TOOLS USED TO TURN A WATER MAIN OFF AND ON AT STREET LOCATIONS, BASIN WRENCHES AND TUBING CUTTERS; BITS FOR HAND DRILLS, CAULKING GUNS, CUTTING PLIERS, NAMELY, LINEMAN'S PLIERS, HAND SAWS, NAMELY, HACK SAWS; HAND SAWS, NAMELY, WOOD SAWS; HAND TOOLS, NAMELY, AUGERS AND DRILLS; HAND-OPERATED CUTTING TOOLS, HAND-OPERATED CUTTING TOOLS, NAMELY, BOX CUTTERS; HAND OPERATED TIN SNIPS; MANUALLY OPERATED HAND TOOLS, NAMELY, SCREWDRIVERS, SHOVELS, WRENCHES, HAMMERS, METAL-CUTTING SCISSORS, NAMELY, TIN SHEARS; PLIERS; SCREWDRIVERS; TORQUE WRENCHES; UTILITY KNIVES; HAND-OPERATED WRENCHES, IN CLASS 8 (U.S. CLS. 23, 28 AND 44).

FIRST USE 4-20-2010; IN COMMERCE 4-20-2010.

THE MARK CONSISTS OF A STYLIZED DINOSAUR IN AN OVAL WITH THE WORD "RAPTOR".

SER. NO. 85-029,471, FILED 5-4-2010.

JORDAN BAKER, EXAMINING ATTORNEY



David J. Kybas

Director of the United States Patent and Trademark Office

United States of America

United States Patent and Trademark Office

WarmWise

Reg. No. 4,152,447

Registered June 5, 2012

Int. Cl.: 35

SERVICE MARK

PRINCIPAL REGISTER

NISOURCE CORPORATE SERVICES COMPANY (DELAWARE CORPORATION)
801 E. 86TH AVENUE
MERRILLVILLE, IN 46410

FOR: ENERGY USAGE CONSERVATION AND ENERGY EFFICIENCY SERVICES IN THE FIELD OF NATURAL GAS, NAMELY PROVIDING COST-SAVINGS PROGRAMS AND INFORMATION ON WAYS TO SAVE MONEY ON NATURAL GAS BILLS AND THE IMPORTANCE OF ENERGY EFFICIENCY AND CONSERVATION; HOME ENERGY ASSESSMENT SERVICES FOR THE PURPOSE OF DETERMINING ENERGY EFFICIENCY OR USAGE MANAGEMENT, IN CLASS 35 (U.S. CLS. 100, 101 AND 102).

FIRST USE 4-1-2010; IN COMMERCE 4-1-2010.

THE MARK CONSISTS OF THE WORDS "WARMWISE" TO THE LEFT OF TWO WAVY LINES.

SER. NO. 85-029,996, FILED 5-4-2010.

NAAKWAMA ANKRAH, EXAMINING ATTORNEY



David J. Kyffers

Director of the United States Patent and Trademark Office

United States of America

United States Patent and Trademark Office

Silkscreen

Reg. No. 4,152,448

LG ELECTRONICS INC. (REPUBLIC OF KOREA CORPORATION)
20, YEOUIDO-DONG, YEONGDEUNGPO-GU
SEOUL, REPUBLIC OF KOREA 150-721

Registered June 5, 2012

Int. Cl.: 9

FOR: TELEVISION RECEIVERS, IN CLASS 9 (U.S. CLS. 21, 23, 26, 36 AND 38).

TRADEMARK

THE MARK CONSISTS OF STANDARD CHARACTERS WITHOUT CLAIM TO ANY PARTICULAR FONT, STYLE, SIZE, OR COLOR.

PRINCIPAL REGISTER

PRIORITY CLAIMED UNDER SEC. 44(D) ON REPUBLIC OF KOREA APPLICATION NO. 40-2010-0021, FILED 4-22-2010, REG. NO. 0873805, DATED 7-22-2011, EXPIRES 7-22-2021.

SER. NO. 85-035,323, FILED 5-11-2010.

JAMES MACFARLANE, EXAMINING ATTORNEY



David J. Kyffers

Director of the United States Patent and Trademark Office

United States of America

United States Patent and Trademark Office

Nano Silkscreen

Reg. No. 4,152,449

LG ELECTRONICS INC. (REPUBLIC OF KOREA CORPORATION)
20, YEOUIDO-DONG, YEONGDEUNGPO-GU
SEOUL, REPUBLIC OF KOREA 150-721

Registered June 5, 2012

Int. Cl.: 9

FOR: TELEVISION RECEIVERS, IN CLASS 9 (U.S. CLS. 21, 23, 26, 36 AND 38).

TRADEMARK

THE MARK CONSISTS OF STANDARD CHARACTERS WITHOUT CLAIM TO ANY PARTICULAR FONT, STYLE, SIZE, OR COLOR.

PRINCIPAL REGISTER

PRIORITY CLAIMED UNDER SEC. 44(D) ON REPUBLIC OF KOREA APPLICATION NO. 40-2010-0021, FILED 4-22-2010, REG. NO. 0873846, DATED 7-22-2011, EXPIRES 7-22-2021.

SER. NO. 85-035,348, FILED 5-11-2010.

JAMES MACFARLANE, EXAMINING ATTORNEY



David J. Kyffers

Director of the United States Patent and Trademark Office

United States of America

United States Patent and Trademark Office

WINGITS

Reg. No. 4,152,450

Registered June 5, 2012

Int. Cls.: 6 and 20

TRADEMARK

PRINCIPAL REGISTER

WINGITS INNOVATIONS, LLC (NEW JERSEY LIMITED LIABILITY COMPANY)
714 5TH AVE.
BRADLEY BEACH, NJ 07720

FOR: METAL FASTENING ANCHORS, EXCLUDING THOSE USED FOR EMBEDDING IN CONCRETE FOR SEISMIC BRACING, IN CLASS 6 (U.S. CLS. 2, 12, 13, 14, 23, 25 AND 50).

FIRST USE 5-0-1997; IN COMMERCE 5-0-1997.

FOR: NON-METAL FASTENING ANCHORS, EXCLUDING THOSE USED FOR EMBEDDING IN CONCRETE FOR SEISMIC BRACING, IN CLASS 20 (U.S. CLS. 2, 13, 22, 25, 32 AND 50).

FIRST USE 5-0-1997; IN COMMERCE 5-0-1997.

THE MARK CONSISTS OF STANDARD CHARACTERS WITHOUT CLAIM TO ANY PARTICULAR FONT, STYLE, SIZE, OR COLOR.

SER. NO. 85-037,258, FILED 5-13-2010.

BRENDAN MCCAULEY, EXAMINING ATTORNEY



David J. Kyros

Director of the United States Patent and Trademark Office

United States of America

United States Patent and Trademark Office

EPIPHANY

Reg. No. 4,152,451

AUSTRALIAN GOLD, LLC (INDIANA LIMITED LIABILITY COMPANY)
6270 CORPORATE DR.
INDIANAPOLIS, IN 46278

Registered June 5, 2012

Int. Cl.: 3

FOR: NON-MEDICATED INDOOR SKIN TANNING PREPARATIONS DISTRIBUTED AND MARKETED FOR SALE IN INDOOR TANNING SALONS, IN CLASS 3 (U.S. CLS. 1, 4, 6, 50, 51 AND 52).

TRADEMARK

FIRST USE 11-1-2010; IN COMMERCE 11-1-2010.

PRINCIPAL REGISTER

THE MARK CONSISTS OF STANDARD CHARACTERS WITHOUT CLAIM TO ANY PARTICULAR FONT, STYLE, SIZE, OR COLOR.

SER. NO. 85-037,555, FILED 5-13-2010.

MICHELLE DUBOIS, EXAMINING ATTORNEY



David J. Kyros

Director of the United States Patent and Trademark Office

United States of America

United States Patent and Trademark Office

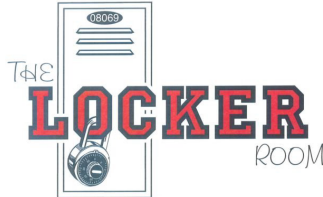

Reg. No. 4,152,452

Registered June 5, 2012

Int. Cl.: 35

SERVICE MARK

PRINCIPAL REGISTER

DILLARD PROPERTIES LLC (NEW JERSEY LIMITED LIABILITY COMPANY)
12 S. BROAD STREET, UNIT B
PENNS GROVE, NJ 08069

FOR: RETAIL STORE AND ON-LINE RETAIL STORE SERVICES FEATURING CLOTHING, NAMELY, SHIRTS, T-SHIRTS, POLO SHIRTS, GOLF SHIRTS, TANK TOPS, COATS, BLOUSES, FLEECE PULLOVERS, VESTS, SWEATERS, SWEATSHIRTS, SWEATPANTS, SHORTS, HATS, CAPS, SUNVISORS, BANDANAS, WRIST BANDS, FOOTWEAR, AND FOOTWEAR ACCESSORIES, IN CLASS 35 (U.S. CLS. 100, 101 AND 102).

FIRST USE 3-1-2010; IN COMMERCE 3-1-2010.

THE MARK CONSISTS OF THE WORD "THE" IN BLACK AND BELOW THIS THE WORD "LOCKER" IN RED OUTLINED IN BLACK, WITH A PICTURE OF A COMBINATION LOCK EXTENDING THROUGH THE LETTER "O" IN THE WORD "LOCKER". THE BACKGROUND IS A BLACK OUTLINE OF A WHITE LOCKER DOOR, THE DOOR HAVING THE WHITE NUMBERS "08069" ON A BLACK CIRCULAR BACKGROUND.

THE COLOR(S) BLACK, RED AND WHITE IS/ARE CLAIMED AS A FEATURE OF THE MARK.

SER. NO. 85-038,026, FILED 5-13-2010.

JASON TURNER, EXAMINING ATTORNEY



David J. Kyffers

Director of the United States Patent and Trademark Office

United States of America

United States Patent and Trademark Office



Reg. No. 4,152,453

BLUSKY RESTORATION CONTRACTORS, INC. (COLORADO CORPORATION)
9767 EAST EASTER AVE.
CENTENNIAL, CO 800123747

Registered June 5, 2012

Int. Cl.: 35

FOR: EMERGENCY PREPAREDNESS PLANNING, NAMELY, BUSINESS PLANNING AND BUSINESS CONTINUITY CONSULTING, IN CLASS 35 (U.S. CLS. 100, 101 AND 102).

SERVICE MARK

FIRST USE 2-0-2008; IN COMMERCE 2-0-2008.

PRINCIPAL REGISTER

NO CLAIM IS MADE TO THE EXCLUSIVE RIGHT TO USE "FIRST AID DISASTER RESPONSE PLAN", APART FROM THE MARK AS SHOWN.

THE MARK CONSISTS OF THE WORDS "FIRST AID DISASTER RESPONSE PLAN" POSITIONED ADJACENT TO A CROSS CENTERED IN A PARTIAL CIRCLE WITH THE NUMBER 1 IN THE CENTER OF THE CROSS.

SER. NO. 85-038,879, FILED 5-14-2010.

MARIA-VICTORIA SUAREZ, EXAMINING ATTORNEY



David J. Kyffers

Director of the United States Patent and Trademark Office

United States of America

United States Patent and Trademark Office



Reg. No. 4,152,454

Registered June 5, 2012

Int. Cl.: 36

SERVICE MARK

PRINCIPAL REGISTER

ISMIE MUTUAL INSURANCE COMPANY (ILLINOIS MUTUAL INSURANCE COMPANY)
7TH FLOOR
20 NORTH MICHIGAN
CHICAGO, IL 60606

FOR: INSURANCE SERVICES, NAMELY, UNDERWRITING MEDICAL, LIFE AND PROFESSIONAL LIABILITY INSURANCE, IN CLASS 36 (U.S. CLS. 100, 101 AND 102).

FIRST USE 0-0-1998; IN COMMERCE 0-0-1998.

NO CLAIM IS MADE TO THE EXCLUSIVE RIGHT TO USE "PHYSICIANS' BENEFITS" AND "LIFE INSURANCE COMPANY", APART FROM THE MARK AS SHOWN.

THE MARK CONSISTS OF A CIRCLE WITHIN A LARGER CIRCLE, THE SMALLER CENTER CIRCLE IS SHADED WITH THE LETTERS "PBT", THE OUTSIDE CIRCLE CONSISTS OF THE WORDS "PHYSICIANS' BENEFITS TRUST" ON THE TOP HALF OF THE CIRCLE AND THE WORDS "LIFE INSURANCE COMPANY" ON THE BOTTOM HALF OF THE CIRCLE. THE COLORS BLACK, WHITE, AND/OR GRAY REPRESENT BACKGROUND, OUTLINING, SHADING, AND/OR TRANSPARENT AREAS AND ARE NOT PART OF THE MARK.

SER. NO. 85-042,403, FILED 5-19-2010.

NAAKWAMA ANKRAH, EXAMINING ATTORNEY



David J. Kybas

Director of the United States Patent and Trademark Office

United States of America

United States Patent and Trademark Office

EXTREMES

Reg. No. 4,152,455

CARHARTT, INC. (MICHIGAN CORPORATION)
5750 MERCURY DRIVE
DEARBORN, MI 48121

Registered June 5, 2012

Int. Cl.: 25

FOR: BIB OVERALLS; COATS; COVERALLS; HOODS; JACKETS; SOCKS, IN CLASS 25
(U.S. CLS. 22 AND 39).

TRADEMARK

FIRST USE 5-1-1997; IN COMMERCE 5-1-1997.

PRINCIPAL REGISTER

THE MARK CONSISTS OF STANDARD CHARACTERS WITHOUT CLAIM TO ANY PARTICULAR FONT, STYLE, SIZE, OR COLOR.

OWNER OF U.S. REG. NO. 2,845,058.

SER. NO. 85-045,744, FILED 5-22-2010.

MARTHA SANTOMARTINO, EXAMINING ATTORNEY



David J. Kybas

Director of the United States Patent and Trademark Office

United States of America

United States Patent and Trademark Office

LIVE LOCAL . SEARCH LOCAL . ELOCAL

Reg. No. 4,152,456

Registered June 5, 2012

Int. Cl.: 35

SERVICE MARK

PRINCIPAL REGISTER

ELOCAL USA LLC (DELAWARE LIMITED LIABILITY COMPANY)
PO BOX 495, 1405 DRESHERTOWN ROAD
DRESHER, PA 19025

FOR: PROVIDING A SEARCHABLE ON-LINE ADVERTISING WEBSITE AND GUIDE, FEATURING THE GOODS AND SERVICES OF OTHER VENDORS VIA THE INTERNET, FOR THE PURPOSE OF MATCHING CONSUMERS WITH THE GOODS AND SERVICES OF OTHERS, IN CLASS 35 (U.S. CLS. 100, 101 AND 102).

FIRST USE 10-6-2006; IN COMMERCE 10-6-2006.

THE MARK CONSISTS OF STANDARD CHARACTERS WITHOUT CLAIM TO ANY PARTICULAR FONT, STYLE, SIZE, OR COLOR.

SER. NO. 85-046,022, FILED 5-24-2010.

PAUL MORENO, EXAMINING ATTORNEY



David J. Kyffers

Director of the United States Patent and Trademark Office

United States of America

United States Patent and Trademark Office

ELOCAL

Reg. No. 4,152,457

Registered June 5, 2012

Int. Cl.: 35

SERVICE MARK

PRINCIPAL REGISTER

ELOCAL USA LLC (DELAWARE LIMITED LIABILITY COMPANY)
PO BOX 495, 1405 DRESHERTOWN ROAD
DRESHER, PA 19025

FOR: PROVIDING A SEARCHABLE ON-LINE ADVERTISING WEBSITE AND GUIDE, FEATURING THE GOODS AND SERVICES OF OTHER VENDORS VIA THE INTERNET, FOR THE PURPOSE OF MATCHING CONSUMERS WITH THE GOODS AND SERVICES OF OTHERS, IN CLASS 35 (U.S. CLS. 100, 101 AND 102).

FIRST USE 10-6-2006; IN COMMERCE 10-6-2006.

THE MARK CONSISTS OF STANDARD CHARACTERS WITHOUT CLAIM TO ANY PARTICULAR FONT, STYLE, SIZE, OR COLOR.

SER. NO. 85-046,046, FILED 5-24-2010.

PAUL MORENO, EXAMINING ATTORNEY



David J. Kyffers

Director of the United States Patent and Trademark Office

United States of America

United States Patent and Trademark Office

ROADRUNNER FOOD BANK

Reg. No. 4,152,458

ROADRUNNER FOOD BANK, INC. (NEW MEXICO CORPORATION)
5840 OFFICE BOULEVARD, N.E.
ALBUQUERQUE, NM 87109

Registered June 5, 2012

Int. Cl.: 39

FOR: PROVIDING COLD-STORAGE SERVICES ON-SITE AT A FOOD BANK, NAMELY, OF GOODS IN REFRIGERATED CONDITIONS, IN CLASS 39 (U.S. CLS. 100 AND 105).

SERVICE MARK

FIRST USE 11-19-2009; IN COMMERCE 11-19-2009.

PRINCIPAL REGISTER

THE MARK CONSISTS OF STANDARD CHARACTERS WITHOUT CLAIM TO ANY PARTICULAR FONT, STYLE, SIZE, OR COLOR.

NO CLAIM IS MADE TO THE EXCLUSIVE RIGHT TO USE "FOOD BANK", APART FROM THE MARK AS SHOWN.

SER. NO. 85-048,637, FILED 5-26-2010.

BRIAN CALLAGHAN, EXAMINING ATTORNEY



David J. Kybas

Director of the United States Patent and Trademark Office

United States of America

United States Patent and Trademark Office

MICROCLAR

Reg. No. 4,152,459

Registered June 5, 2012

Int. Cl.: 9

TRADEMARK

PRINCIPAL REGISTER

MEYER, MATIAS (ARGENTINA INDIVIDUAL)
GENERAL PACHECO
BARRIO SANTA BÁRBARA CASA 343
BUENOS AIRES, ARGENTINA 1617 AND

MEYER, ALEJANDRO (ARGENTINA INDIVIDUAL)
GENERAL PACHECO
BARRIO SANTA BÁRBARA CASA 343
BUENOS AIRES, ARGENTINA 1617

FOR: FILTERING UNITS FOR USE IN LABORATORY EQUIPMENT FOR MAKING MICRO-BIOLOGICAL AND PHYSICAL-CHEMICAL ANALYSIS, IN CLASS 9 (U.S. CLS. 21, 23, 26, 36 AND 38).

FIRST USE 5-18-2010; IN COMMERCE 5-18-2010.

THE MARK CONSISTS OF STANDARD CHARACTERS WITHOUT CLAIM TO ANY PARTICULAR FONT, STYLE, SIZE, OR COLOR.

THE WORDING "MICROCLAR" HAS NO MEANING IN A FOREIGN LANGUAGE.

SER. NO. 85-049,087, FILED 5-27-2010.

ERIN FALK, EXAMINING ATTORNEY



David J. Kybas

Director of the United States Patent and Trademark Office

United States of America

United States Patent and Trademark Office



Reg. No. 4,152,460

NIPPON STEEL TOPY BRIDGE CO., LTD. (JAPAN CORPORATION)
1, AKEMI-CHO, TOYOHASHI
AICHI, JAPAN

Registered June 5, 2012

Int. Cls.: 6 and 37

FOR: IRONS AND STEELS; METAL MATERIALS FOR BUILDING OR CONSTRUCTION;
PREFABRICATED BUILDING ASSEMBLY KITS COMPRISED OF AWNINGS OF METAL,
BEAMS OF METAL, IN CLASS 6 (U.S. CLS. 2, 12, 13, 14, 23, 25 AND 50).

TRADEMARK

FOR: CONSTRUCTION; CONSTRUCTION CONSULTANCY; CONSTRUCTION SUPERVI-
SION, IN CLASS 37 (U.S. CLS. 100, 103 AND 106).

SERVICE MARK

PRINCIPAL REGISTER

PRIORITY CLAIMED UNDER SEC. 44(D) ON JAPAN APPLICATION NO. 2010-002526,
FILED 1-18-2010, REG. NO. 5347378, DATED 8-20-2010, EXPIRES 8-20-2020.

THE COLOR(S) BLUE AND YELLOW IS/ARE CLAIMED AS A FEATURE OF THE MARK.

THE MARK CONSISTS OF THE LETTERING "NTB" WITH THE TOP PORTION IN BLUE
AND THE BOTTOM PORTION IN YELLOW.

SER. NO. 85-053,739, FILED 6-3-2010.

CHARLES L. JENKINS, EXAMINING ATTORNEY



David J. Kyros

Director of the United States Patent and Trademark Office

United States of America

United States Patent and Trademark Office

WatchLock

Reg. No. 4,152,461

Registered June 5, 2012

Int. Cls.: 6 and 9

TRADEMARK

PRINCIPAL REGISTER

MUL-T-LOCK TECHNOLOGIES LTD. (ISRAEL CORPORATION)
MUL-T-LOCK PARK
YAVNE, ISRAEL 81104 AND

STARCOM G.P.S SYSTEMS LTD. (ISRAEL CORPORATION)
2 HABONIM STREET
RAMAT GAN, ISRAEL

FOR: METAL LOCKS, METAL SECURITY LOCKS, METAL LOCK CYLINDERS, METAL MORTISE LOCKS, METAL PADLOCKS, METAL MULTIPOINT LOCKS; METAL KEYS FOR LOCKS AND METAL KEY BLANKS; METAL BOLTS, METAL PADLOCK HASPS, METAL LOCK CASES, METAL SAFETY CHAINS, METAL STRIKING PLATES, METAL KEY METAL RINGS, METAL BOXES, METAL IDENTITY PLATES, METAL KING-PIN LOCKS, METAL SHIPMENT CONTAINER LOCKS; METAL SAFES, HINGES AND HANDLES; METAL PARTS AND ACCESSORIES FOR ALL THE AFORESAID GOODS; SMALL ITEMS OF METAL HARDWARE, NAMELY, HINGES, HANDLES, STUDS, AND SCREWS; METAL HARDWARE FOR BUILDINGS, NAMELY, FRAMES, STRIKE PLATE, RAILINGS, IN CLASS 6 (U.S. CLS. 2, 12, 13, 14, 23, 25 AND 50).

FOR: BIOMETRIC, ELECTRIC, ELECTRONIC AND ELECTROMECHANICAL LOCKS; BIOMETRIC AND ELECTRONICALLY OPERATED LOCK CYLINDERS; ELECTRIC STRIKING PLATES, DOOR MAGNETS, ELECTRONIC KEYS, ELECTRONIC OR MAGNETIC KEY CARDS, ELECTRONIC OR MAGNETIC ACCESS CONTROL CARDS AND SMART CARDS, AND KEY CARD READERS; BIOMETRIC ACCESS CONTROL READERS; ELECTRONIC UNITS FOR PROGRAMMING LOCKS, LOCK CYLINDERS, KEYS, BIOMETRIC SENSORS READERS, KEY CARDS AND KEY CARD READERS; APPARATUS FOR MEASURING BIOMAGNETIC SIGNALS; BIOMETRIC, ELECTRONIC AND MAGNETIC SENSORS; APPARATUS AND INSTRUMENTS FOR SIGNALING AND CHECKING, NAMELY, SENSORS FOR CHECKING AND/OR CONTROLLING PEOPLE'S MOVEMENT WITHIN, ENTRANCE TO AND EXIT FROM BUILDINGS AND THROUGH DOORS AND GATES AND/OR FOR USE WITH LOCKS; MAGNETIC AND ELECTRONIC IDENTITY CARDS; BLANK AND CODED TO LOCK/KEY INFORMATION MAGNETIC DATA CARRIERS AND COMPUTER SOFTWARE, NAMELY, SOFTWARE FOR MANAGEMENT OF KEYING SYSTEMS; SATELLITE NAVIGATIONAL SYSTEM, NAMELY, A GLOBAL POSITIONING SYSTEM (GPS); GLOBAL POSITIONING SYSTEM (GPS) CONSISTING OF COMPUTERS, COMPUTER SOFTWARE, TRANSMITTERS, RECEIVERS, AND NETWORK INTERFACE DEVICES; COMPUTER PROGRAMS AND SOFTWARE FOR THE COLLECTION, COMPIL-



David J. Kybas

Director of the United States Patent and Trademark Office

Reg. No. 4,152,461 ATION, AND TRANSMISSION OF GPS DATA; AUTOMATIC VEHICLE LOCATION (AVL) SYSTEMS; NAVIGATION APPARATUS FOR VEHICLES; SOFTWARE, INSTRUMENTS AND APPARATUS FOR THE LOCATION AND NAVIGATION OF VEHICLES AND PERSONNEL; EMERGENCY AND PANIC DEVICES FOR DOORS AND WINDOWS WHICH RELEASE UPON APPLICATION OF FORCE, IN CLASS 9 (U.S. CLS. 21, 23, 26, 36 AND 38).

PRIORITY CLAIMED UNDER SEC. 44(D) ON ISRAEL APPLICATION NO. 229998, FILED 5-13-2010, REG. NO. 229998, DATED 6-16-2011, EXPIRES 5-13-2020.

PRIORITY CLAIMED UNDER SEC. 44(D) ON ISRAEL APPLICATION NO. 229997, FILED 5-13-2010, REG. NO. 229997, DATED 9-7-2011, EXPIRES 5-13-2020.

THE MARK CONSISTS OF THE CAPITAL LETTER "W", FOLLOWED BY THE SMALL LETTERS "ATCH", FOLLOWED BY A CAPITAL LETTER "L", FOLLOWED BY THE SMALL LETTERS "OCK".

SER. NO. 85-059,856, FILED 6-10-2010.

ANN E. SAPPENFIELD, EXAMINING ATTORNEY

United States of America

United States Patent and Trademark Office

UNIVERSITY OF NORTH TEXAS DISCOVER THE POWER OF IDEAS

Reg. No. 4,152,462

Registered June 5, 2012

Int. Cls.: 21 and 41

TRADEMARK

SERVICE MARK

PRINCIPAL REGISTER

UNIVERSITY OF NORTH TEXAS (TEXAS STATE UNIVERSITY)
1501 CHESTNUT STREET
DENTON, TX 76203

FOR: HOUSEWARES AND GLASS, NAMELY, CUPS, MUGS, STEINS, BEVERAGE GLASSWARE; BARWARE, NAMELY, FLASKS, TRIVETS, ALCOHOL AND WINE DECANTERS; WINE BOTTLE CHILLERS, NAMELY, ICE BUCKETS; CHINA, NAMELY, PLATES, CUPS, BOWLS AND SERVING DISHES; CRYSTAL, NAMELY, HIGH BALL GLASSES, SHOT GLASSES, BEVERAGE AND WINE GLASSES; COASTERS, NAMELY, COASTERS NOT OF PAPER AND OTHER THAN TABLE LINEN; COOLERS, NAMELY, PORTABLE BEVERAGE COOLERS, COOLERS FOR WINE, ICE COOLERS; TRAYS, NAMELY, BUTLER'S TRAYS, SERVING PLATTERS, CRUMB TRAYS AND SERVING TRAYS; BARWARE ACCESSORIES, NAMELY, WINE BOTTLE OPENERS, DRINK SHAKERS AND STIRRERS; AND CONCESSION CUPS MADE OF PAPER AND PLASTIC, AND SPORT BOTTLES SOLD EMPTY, IN CLASS 21 (U.S. CLS. 2, 13, 23, 29, 30, 33, 40 AND 50).

FIRST USE 4-0-2005; IN COMMERCE 4-0-2005.

FOR: EDUCATIONAL SERVICES, NAMELY, PROVIDING COLLEGE AND GRADUATE LEVEL COURSES OF INSTRUCTION AND SEMINARS, AND EDUCATIONAL OPPORTUNITIES TO PARTICIPATE IN RESEARCH PROGRAMS; AND ENTERTAINMENT SERVICES, NAMELY, PROVIDING COLLEGE SPORT GAMES AND EVENTS, MUSICAL CONCERTS AND ENTERTAINMENT AND PERFORMANCES OF DRAMATIC WORKS, IN CLASS 41 (U.S. CLS. 100, 101 AND 107).

FIRST USE 4-0-2005; IN COMMERCE 4-0-2005.

THE MARK CONSISTS OF STANDARD CHARACTERS WITHOUT CLAIM TO ANY PARTICULAR FONT, STYLE, SIZE, OR COLOR.

OWNER OF U.S. REG. NO. 3,780,422.

NO CLAIM IS MADE TO THE EXCLUSIVE RIGHT TO USE "UNIVERSITY" AS TO THE CLASS 41 SERVICES, APART FROM THE MARK AS SHOWN.

SEC. 2(F) AS TO "UNIVERSITY OF NORTH TEXAS".



David J. Kyjars

Director of the United States Patent and Trademark Office

Reg. No. 4,152,462 SER. NO. 85-061,582, FILED 6-13-2010.

THOMAS MANOR, EXAMINING ATTORNEY

United States of America

United States Patent and Trademark Office

AMPLEFORTH

Reg. No. 4,152,463

Registered June 5, 2012

**Int. Cls.: 16, 30, 32, 33,
41, 43 and 45**

TRADEMARK

SERVICE MARK

PRINCIPAL REGISTER

AMPLEFORTH ABBEY TRUST (UNITED KINGDOM TRUST)
AMPLEFORTH ABBEY
NORTH YORKSHIRE, UNITED KINGDOM Y062-4EN

FOR: PRINTED MATTER, NAMELY, MAGAZINES, BROCHURES, BOOKS, INFORMATION LEAFLETS, PERIODICALS, CATALOGUES IN THE FIELDS OF RELIGIOUS STUDIES, SCIENCE AND HUMANITIES; PRINTED INSTRUCTIONAL AND TEACHING MATERIALS IN THE FIELDS OF RELIGIOUS STUDIES, SCIENCE, HUMANITIES, WORK; PRINTED BOOKS AND HANDBOOKS IN THE FIELDS OF RELIGIOUS STUDIES, SCIENCE AND HUMANITIES; SCHOOL STATIONERY SUPPLIES, NAMELY, DRAWING RULERS, PENCILS, PAPER FOLDERS, DOCUMENT FOLDERS IN THE FORM OF WALLETS; STATIONERY; EDUCATIONAL COURSE MATERIALS, NAMELY, WORK BOOKS, HAND BOOKS, MUSIC BOOKS AND MANUSCRIPTS; RELIGIOUS BOOKS AND INSTRUCTIONAL MATERIALS, NAMELY, BOOKS, CATALOGUES, BROCHURES, LITURGICAL BOOKS, IN CLASS 16 (U.S. CLS. 2, 5, 22, 23, 29, 37, 38 AND 50).

FOR: COFFEE, TEA, COCOA, SUGAR, RICE; FLOUR AND PREPARATIONS MADE FROM CEREALS, NAMELY, CAKES, BISCUITS; BREAD, PASTRY AND CONFECTIONERY, NAMELY, WHOLE MEAL BREAD, LOAVES, ROLLS, CHOCOLATE, CANDIES; FRUIT ICES; HONEY, TREACLE, YEAST; CONDIMENTS, NAMELY, MUSTARD, VINEGAR AND SAUCES; SPICES, PREPARED MEALS AND SNACKS CONSISTING OF BEEF, PORK, FISH, LAMB, VEGETABLES, RICE, IN CLASS 30 (U.S. CL. 46).

FOR: NON-ALCOHOLIC BEVERAGES, NAMELY, NON-ALCOHOLIC AERATED BEVERAGES, CARBONATED BEVERAGES, SPRING WATER, MINERAL WATER AND DRINKING WATER; BEER, IN CLASS 32 (U.S. CLS. 45, 46 AND 48).

FOR: ALCOHOLIC BEVERAGES, NAMELY, CIDER, BRANDY, CIDER BRANDY, LIQUEURS, WHISKY, GIN, GIN, RUM; WINES; DISTILLED SPIRITS AND DISTILLED LIQUEURS, IN CLASS 33 (U.S. CLS. 47 AND 49).

FOR: EDUCATIONAL SERVICES, NAMELY, PROVIDING TRAINING IN THE FIELDS OF RELIGION, THEOLOGY, ORDINATION TRAINING, MONASTIC TRAINING, MUSIC, SPORTS, GENERAL EDUCATION QUALIFICATIONS AND INTERMEDIATE EDUCATION LEVEL FOR CHILDREN, LANGUAGES, MANAGEMENT TRAINING, CONDUCTING SPORTING AND CULTURAL ACTIVITIES; EDUCATIONAL SERVICES, NAMELY; OFFERING SECONDARY SCHOOL CLASSES AND PREPARATORY CLASSES; RELIGIOUS



David J. Kyros

Director of the United States Patent and Trademark Office

Reg. No. 4,152,463 EDUCATION IN THE NATURE OF COURSES, SEMINARS AND CONFERENCES; RELIGIOUS EDUCATION CLASSES IN THE FIELD OF RELIGIOUS DEVELOPMENT; NURSERY SCHOOL EDUCATION; ARRANGING AND CONDUCTING CONFERENCES, CONVENTIONS, SEMINARS; ARRANGING AND CONDUCTING RECREATIONAL ACTIVITIES AND COURSE FOR STUDENTS; ORGANIZING RECREATIONAL AND EDUCATIONAL ACTIVITIES, NAMELY, COACHING COURSES, SPORT TRIPS, MUSICAL AND RELIGIOUS VISITS, EDUCATIONAL VISITS; ENTERTAINMENT IN THE NATURE OF COMPETITIONS IN THE FIELD OF MUSIC, SPORT, GENERAL KNOWLEDGE, ARRANGING TOURNAMENTS AND SPORTING EVENTS; PROVISION OF FACILITIES FOR OUTDOOR RECREATIONAL ACTIVITIES, NAMELY, HUNTING, FISHING, HORSE RIDING, SHOOTING, SWIMMING, BASKETBALL, NETBALL, CRICKET, RUGBY, HOCKEY, SOCCER, BADMINTON, TENNIS, GYMNASIUMS PROVIDING RECREATIONAL ACTIVITIES, NAMELY, HOCKEY, RUGBY, SWIMMING, HORSE RIDING CRICKET, BASKETBALL, NETBALL, SOCCER, LACROSSE, HOCKEY, ROUNDERS; BOARDING SCHOOL; EDUCATIONAL SERVICES, NAMELY, RESIDENTIAL COURSES AND RELIGIOUS RESIDENTIAL COURSES, IN CLASS 41 (U.S. CLS. 100, 101 AND 107).

FOR: PROVIDING TEMPORARY HOUSING ACCOMMODATIONS; PROVIDING FACILITIES FOR CONDUCTING CONFERENCES, RETREATS AND CONVENTIONS; PROVIDING TEMPORARY RESIDENTIAL ACCOMMODATIONS; PROVIDING TEMPORARY ACCOMMODATION FOR VACATION, IN CLASS 43 (U.S. CLS. 100 AND 101).

FOR: RELIGIOUS MINISTERIAL SERVICES, NAMELY, ADMINISTERING BAPTISMS, FUNERALS, SACRAMENTS, WEDDINGS AND SPIRITUAL DIRECTION COUNSELING; ORGANIZING RELIGIOUS MEETINGS; CONDUCTING RELIGIOUS SERVICES, NAMELY, BAPTISMS, FUNERALS, SACRAMENTS, PRAYER MEETINGS, SACRAMENTAL CELEBRATIONS AND THE EUCHARIST , IN CLASS 45 (U.S. CLS. 100 AND 101).

THE MARK CONSISTS OF STANDARD CHARACTERS WITHOUT CLAIM TO ANY PARTICULAR FONT, STYLE, SIZE, OR COLOR.

PRIORITY CLAIMED UNDER SEC. 44(D) ON ERPN CMNTY TM OFC APPLICATION NO. 9127424, FILED 5-24-2010, REG. NO. 9127424, DATED 5-24-2010, EXPIRES 5-24-2020.

SER. NO. 85-064,348, FILED 6-16-2010.

REGINA DRUMMOND, EXAMINING ATTORNEY

United States of America
United States Patent and Trademark Office

LIQUIDLENS

Reg. No. 4,152,464

ENTEGRIS, INC. (DELAWARE CORPORATION)
129 CONCORD ROAD
BILLERICA, MA 018214600

Registered June 5, 2012

Int. Cl.: 11

FOR: ULTRAPURE WATER PURIFICATION UNITS FOR USE IN THE MICROELECTRONICS INDUSTRY, IN CLASS 11 (U.S. CLS. 13, 21, 23, 31 AND 34).

TRADEMARK

FIRST USE 11-30-2004; IN COMMERCE 11-30-2004.

PRINCIPAL REGISTER

THE MARK CONSISTS OF STANDARD CHARACTERS WITHOUT CLAIM TO ANY PARTICULAR FONT, STYLE, SIZE, OR COLOR.

SER. NO. 85-065,502, FILED 6-17-2010.

TARA PATE, EXAMINING ATTORNEY



David J. Kybas

Director of the United States Patent and Trademark Office

United States of America

United States Patent and Trademark Office

THE HARTFORD | MOBILE

Reg. No. 4,152,465

Registered June 5, 2012

Int. Cl.: 9

TRADEMARK

PRINCIPAL REGISTER

HARTFORD FIRE INSURANCE COMPANY (CONNECTICUT CORPORATION)
LAW DEPT. IP TRADEMARK UNIT HO109
ONE HARTFORD PLAZA
HARTFORD, CT 06155

FOR: MOBILE SOFTWARE APPLICATION PROVIDING POLICYHOLDERS AND CONSUMERS WITH THE ABILITY TO COLLECT, MANAGE, STORE AND TRANSMIT AUTOMOBILE ACCIDENT AND POLICY INFORMATION, AND PROVIDING CLAIMANT SERVICES PERTAINING TO AUTOMOBILE ACCIDENT AND POLICY INFORMATION, IN CLASS 9 (U.S. CLS. 21, 23, 26, 36 AND 38).

FIRST USE 4-27-2010; IN COMMERCE 4-27-2010.

THE MARK CONSISTS OF STANDARD CHARACTERS WITHOUT CLAIM TO ANY PARTICULAR FONT, STYLE, SIZE, OR COLOR.

OWNER OF U.S. REG. NOS. 1,155,051, 3,831,879 AND OTHERS.

NO CLAIM IS MADE TO THE EXCLUSIVE RIGHT TO USE "MOBILE", APART FROM THE MARK AS SHOWN.

SEC. 2(F) AS TO "THE HARTFORD".

SER. NO. 85-070,410, FILED 6-24-2010.

EDWARD NELSON, EXAMINING ATTORNEY



David J. Kyffers

Director of the United States Patent and Trademark Office

United States of America

United States Patent and Trademark Office

THE HARTFORD MOBILE

Reg. No. 4,152,466

Registered June 5, 2012

Int. Cl.: 9

TRADEMARK

PRINCIPAL REGISTER

HARTFORD FIRE INSURANCE COMPANY (CONNECTICUT CORPORATION)
LAW DEPT. IP TRADEMARK UNIT HO109
ONE HARTFORD PLAZA
HARTFORD, CT 06155

FOR: MOBILE SOFTWARE APPLICATION PROVIDING POLICYHOLDERS AND CONSUMERS WITH THE ABILITY TO COLLECT, MANAGE, STORE AND TRANSMIT AUTOMOBILE ACCIDENT AND POLICY INFORMATION, AND PROVIDING CLAIMANT SERVICES PERTAINING TO AUTOMOBILE ACCIDENT AND POLICY INFORMATION, IN CLASS 9 (U.S. CLS. 21, 23, 26, 36 AND 38).

FIRST USE 4-27-2010; IN COMMERCE 4-27-2010.

THE MARK CONSISTS OF STANDARD CHARACTERS WITHOUT CLAIM TO ANY PARTICULAR FONT, STYLE, SIZE, OR COLOR.

OWNER OF U.S. REG. NOS. 1,155,051, 3,831,879 AND OTHERS.

NO CLAIM IS MADE TO THE EXCLUSIVE RIGHT TO USE "MOBILE", APART FROM THE MARK AS SHOWN.

SEC. 2(F) AS TO "THE HARTFORD".

SER. NO. 85-070,412, FILED 6-24-2010.

EDWARD NELSON, EXAMINING ATTORNEY



David J. Kyffers

Director of the United States Patent and Trademark Office

United States of America

United States Patent and Trademark Office

SAVINGSMANIA

Reg. No. 4,152,467

Registered June 5, 2012

Int. Cl.: 35

SERVICE MARK

PRINCIPAL REGISTER

SCHMIDT, DIANE (UNITED STATES INDIVIDUAL)
5580 OPAL STREET
NORTH RIDGEVILLE, OH 44039

FOR: PROMOTING THE GOODS AND SERVICES OF OTHERS BY PROVIDING A WEB SITE FEATURING COUPONS, REBATES, PRICE-COMPARISON INFORMATION, PRODUCT REVIEWS, LINKS TO THE RETAIL WEB SITES OF OTHERS, AND DISCOUNT INFORMATION, IN CLASS 35 (U.S. CLS. 100, 101 AND 102).

FIRST USE 10-2-2003; IN COMMERCE 10-2-2003.

THE MARK CONSISTS OF STANDARD CHARACTERS WITHOUT CLAIM TO ANY PARTICULAR FONT, STYLE, SIZE, OR COLOR.

SER. NO. 85-075,933, FILED 7-1-2010.

LESLIE RICHARDS, EXAMINING ATTORNEY



David J. Kybas

Director of the United States Patent and Trademark Office

United States of America

United States Patent and Trademark Office

SH'BAM

Reg. No. 4,152,468

Registered June 5, 2012

Int. Cl.: 41

SERVICE MARK

PRINCIPAL REGISTER

LES MILLS INTERNATIONAL LIMITED (NEW ZEALAND LIMITED LIABILITY COMPANY)
22 CENTRE STREET
AUCKLAND, NEW ZEALAND

FOR: PROVIDING RECREATIONAL FACILITIES FOR ADULTS AND TEENAGERS, NOT INCLUDING CHILDREN; SPORTING ACTIVITIES IN THE NATURE OF PHYSICAL FITNESS TRAINING SERVICES FOR ADULTS AND TEENAGERS, NOT INCLUDING CHILDREN; EDUCATIONAL SERVICES IN THE NATURE OF DEVELOPING AND CONDUCTING WORKOUTS, WORKSHOPS, PRESENTATIONS IN THE FIELD OF PERSONAL AND GROUP FITNESS TRAINING; EXERCISE CLASSES SET TO MUSIC; GYMNASIUM SERVICES; HEALTH CLUB SERVICES, NAMELY, PROVIDING INSTRUCTION AND EQUIPMENT IN THE FIELD OF PHYSICAL EXERCISE; PHYSICAL EXERCISE INSTRUCTION; ADVISORY SERVICES IN THE FIELD OF PHYSICAL EXERCISE; TRAINING IN THE FIELD OF PHYSICAL EXERCISE; PROVIDING TUTORING, CLASSES AND COACHING IN THE FIELD OF SPORTS; INFORMATION, ADVISORY AND CONSULTANCY SERVICES RELATING TO ANY OR ALL OF THE AFORESAID; PUBLICATION OF PRINTED MATTER FEATURING FITNESS AND HEALTH CLUB RELATED PROGRAMS AND TRAINING MATERIALS; PROVIDING ONLINE NON-DOWNLOADABLE ELECTRONIC PUBLICATIONS, NAMELY, ARTICLES IN THE FIELD FITNESS TRAINING AND SPORTING ACTIVITIES FOR ADULTS AND TEENAGERS, NOT INCLUDING CHILDREN; PROVIDING NON-DOWNLOADABLE PRERECORDED MUSIC VIA THE INTERNET, ALL OF THE FOREGOING SERVICES BEING INTENDED FOR ADULTS AND TEENAGERS AND EXCLUDING SERVICES FOR CHILDREN, IN CLASS 41 (U.S. CLS. 100, 101 AND 107).



THE MARK CONSISTS OF STANDARD CHARACTERS WITHOUT CLAIM TO ANY PARTICULAR FONT, STYLE, SIZE, OR COLOR.

PRIORITY CLAIMED UNDER SEC. 44(D) ON NEW ZEALAND APPLICATION NO. 823343, FILED 4-28-2010, REG. NO. 823343, DATED 10-28-2010, EXPIRES 4-28-2020.

SER. NO. 85-077,837, FILED 7-5-2010.

RENEE SERVANCE, EXAMINING ATTORNEY

David J. Kyjars

Director of the United States Patent and Trademark Office

United States of America

United States Patent and Trademark Office



Reg. No. 4,152,469

Registered June 5, 2012

Int. Cl.: 42

SERVICE MARK

PRINCIPAL REGISTER

TURTLE CONSERVANCY (CALIFORNIA CORPORATION)
49 BLEECKER ST., SUITE 601
NEW YORK, NY 10012

FOR: SCIENTIFIC RESEARCH IN THE FIELD OF TURTLES AND TORTOISES AND THEIR FRESHWATER AND TERRESTRIAL HABITATS; HABITAT PRESERVATION SERVICES, NAMELY, MONITORING, TESTING AND ANALYZING ECOLOGICAL SUCCESS IN THE FIELD OF ENVIRONMENTALLY SENSITIVE HABITAT CONSERVATION AND PRESERVATION OF ENDANGERED TURTLES AND TORTOISES THROUGH MAINTENANCE OF A CAPTURE COLLECTION, IN CLASS 42 (U.S. CLS. 100 AND 101).

FIRST USE 3-1-2009; IN COMMERCE 4-1-2009.

NO CLAIM IS MADE TO THE EXCLUSIVE RIGHT TO USE "TURTLE CONSERVANCY", APART FROM THE MARK AS SHOWN.

THE MARK CONSISTS OF THE WORDING "TURTLE CONSERVANCY T.C." IN A CIRCULAR SEAL WITH TWO DOTS, AND A DESIGN OF A TORTOISE IN THE CENTER.

SER. NO. 85-079,266, FILED 7-7-2010.

MICHAEL SOUDERS, EXAMINING ATTORNEY



David J. Kyros

Director of the United States Patent and Trademark Office

United States of America

United States Patent and Trademark Office

MODA **BRASIL**
magazine

Reg. No. 4,152,470

MATOS, WANDERLEY A. (BRAZIL INDIVIDUAL)
401, REID STREET
FAIRFIELD, CT 06824

Registered June 5, 2012

Int. Cl.: 16

FOR: PUBLICATIONS, NAMELY, PRINTED MATTER AND ONLINE MAGAZINE IN THE FIELDS OF FASHION, ENTERTAINMENT, NEWS, HEALTH, TRAVEL AND TOURISM, BUSINESS AND CURRENT EVENTS, IN CLASS 16 (U.S. CLS. 2, 5, 22, 23, 29, 37, 38 AND 50).

TRADEMARK

PRINCIPAL REGISTER

FIRST USE 11-18-2008; IN COMMERCE 10-10-2009.

NO CLAIM IS MADE TO THE EXCLUSIVE RIGHT TO USE "MAGAZINE", APART FROM THE MARK AS SHOWN.

THE MARK CONSISTS OF THE WORDING "MODA BRASIL MAGAZINE" IN STYLIZED TYPEFACE WHEREIN THE "S" IN "BRASIL" FACES BACKWARDS.

THE ENGLISH TRANSLATION OF "MODA BRASIL" IN THE MARK IS "BRAZIL FASHION".

SEC. 2(F).

SER. NO. 85-082,118, FILED 7-11-2010.

HEATHER THOMPSON, EXAMINING ATTORNEY



David J. Kyros

Director of the United States Patent and Trademark Office

United States of America

United States Patent and Trademark Office

sunsep

Reg. No. 4,152,471

Registered June 5, 2012

Int. Cls.: 9, 10 and 11

TRADEMARK

PRINCIPAL REGISTER

AGC ENGINEERING CO., LTD. (JAPAN CORPORATION)
MIHAMA-KU, CHIBA-SHI
WBG MARIVE WEST 19F, 2-6 NAKASE,
CHIBA, JAPAN 261-7119

FOR: ELECTROLYSERS; GAS ALARMS; LABORATORY APPARATUS AND INSTRUMENTS, NAMELY, AIR-GAS PRODUCERS AND CONSTANT HUMIDITY INCUBATORS; LABORATORY EXPERIMENTAL MACHINES AND APPARATUS, NAMELY, AIR-GAS PRODUCERS AND CONSTANT HUMIDITY INCUBATORS; MEASURING OR TESTING MACHINES AND INSTRUMENTS, NAMELY, GASOMETERS, HYGROMETERS, AUTOMATIC PRESSURE CONTROL MACHINES AND INSTRUMENTS, AND AUTOMATIC VACUUM CONTROL MACHINES AND INSTRUMENTS; EXPIRED GAS ANALYZERS USED FOR SCIENTIFIC PURPOSES WHEN EUTHANIZING SMALL ANIMALS, IN CLASS 9 (U.S. CLS. 21, 23, 26, 36 AND 38).

FOR: MEDICAL MACHINES AND APPARATUS, NAMELY, SPHYGMOMANOMETERS, BLOOD TESTING APPARATUS, ANESTHETIC INHALERS, THERAPEUTIC INHALERS, OXYGEN INHALATORS FOR MEDICAL PURPOSES SOLD EMPTY; PNEUMOTHORAX APPARATUS FOR REINFLATING A COLLAPSED LUNG, INFUSION APPARATUS FOR ADMINISTERING DRUGS, MASSAGE APPARATUS; INCUBATORS FOR BABIES, FILLING INSTRUMENTS FOR DENTAL PURPOSES; DENTAL DRILLS, DENTAL UNITS FOR SERVICING DENTAL AND ORTHODONTAL PATIENTS, COMPRISED OF PATIENT'S CHAIRS, WATER/AIR SUCTION HOSES, OPERATING LAMPS, CUSPIDOR AND ASSISTANT BARS, DENTAL STOOLS, ROTATABLE HANDPIECE HOLDERS AND COMPRESSORS FOR DENTAL INSTRUMENTS; SUPPORTERS FOR MEDICAL PURPOSES; DIAGNOSTIC APPARATUS AND INSTRUMENTS, NAMELY, SPHYGMOMANOMETERS AND BLOOD TESTING APPARATUS; ANESTHETIC INHALERS SOLD EMPTY; SPRAYERS FOR MEDICAL PURPOSES; OXYGEN INHALATORS FOR MEDICAL PURPOSES SOLD EMPTY; DENTAL MACHINES AND APPARATUS, NAMELY, FILLING INSTRUMENTS, DENTAL DRILLS, AND DENTAL UNITS FOR SERVICING DENTAL AND ORTHODONTAL PATIENTS, COMPRISED OF PATIENT'S CHAIRS, WATER/AIR SUCTION HOSES, OPERATING LAMPS, CUSPIDOR AND ASSISTANT BARS, DENTAL STOOLS, ROTATABLE HANDPIECE HOLDERS AND COMPRESSORS FOR DENTAL INSTRUMENTS; AUXILIARY MEDICAL DEVICES AND ORTHODONTIC APPARATUS, NAMELY, SUPPORTERS FOR MEDICAL PURPOSES, IN CLASS 10 (U.S. CLS. 26, 39 AND 44).



David J. Kyjars

Director of the United States Patent and Trademark Office

Reg. No. 4,152,471 FOR: DRYING APPARATUS FOR CHEMICAL PROCESSING; RECUPERATORS FOR CHEMICAL PROCESSING FOR HEAT RECOVERY; STEAMERS FOR CHEMICAL PROCESSING; EVAPORATORS FOR CHEMICAL PROCESSING; DISTILLERS FOR CHEMICAL PROCESSING; HEAT EXCHANGERS FOR CHEMICAL PROCESSING; AIR-CONDITIONING APPARATUS; ELECTRIC LAUNDRY DRYERS FOR INDUSTRIAL PURPOSES; INDUSTRIAL ELECTRIC DISH DRYERS; HOUSEHOLD ELECTROTHERMIC APPLIANCES, NAMELY, HUMIDIFIERS FOR HOUSEHOLD PURPOSES, AIR PURIFIERS FOR HOUSEHOLD PURPOSES, DEHUMIDIFIERS FOR HOUSEHOLD PURPOSES; FUTON DRIERS FOR HOUSEHOLD PURPOSES, HAIR DRYERS FOR HOUSEHOLD PURPOSES, AND ELECTRIC SPACE COOLING APPARATUS FOR HOUSEHOLD PURPOSES; INDUSTRIAL DRYERS FOR THE REMOVAL OF WATER VAPOR FROM COMPRESSED AIR AND GASES; INDUSTRIAL HUMIDIFIERS; INDUSTRIAL DEHUMIDIFIERS, IN CLASS 11 (U.S. CLS. 13, 21, 23, 31 AND 34).

THE MARK CONSISTS OF STANDARD CHARACTERS WITHOUT CLAIM TO ANY PARTICULAR FONT, STYLE, SIZE, OR COLOR.

OWNER OF JAPAN REG. NO. 5301740, DATED 2-12-2010, EXPIRES 2-12-2020.

SER. NO. 85-082,484, FILED 7-12-2010.

WON TEAK OH, EXAMINING ATTORNEY

United States of America

United States Patent and Trademark Office

Deal Line-Up

Reg. No. 4,152,472

Registered June 5, 2012

Int. Cl.: 36

SERVICE MARK

PRINCIPAL REGISTER

MAVERICK ANGELS, LLC (CALIFORNIA LIMITED LIABILITY COMPANY)
5737 KANAN ROAD, NO. 177
AGOURA HILLS, CA 91301

FOR: VENTURE CAPITAL SERVICES, NAMELY, PROVIDING FINANCING TO EMERGING AND START-UP COMPANIES; INVESTMENT MANAGEMENT, IN CLASS 36 (U.S. CLS. 100, 101 AND 102).

FIRST USE 3-1-2006; IN COMMERCE 3-1-2006.

THE MARK CONSISTS OF STANDARD CHARACTERS WITHOUT CLAIM TO ANY PARTICULAR FONT, STYLE, SIZE, OR COLOR.

SER. NO. 85-083,886, FILED 7-13-2010.

DEBRA LEE, EXAMINING ATTORNEY



David J. Kyffers

Director of the United States Patent and Trademark Office

United States of America

United States Patent and Trademark Office

BUST A MOVE FOR BREAST HEALTH

Reg. No. 4,152,473

Registered June 5, 2012

**Int. Cls.: 9, 14, 16, 18, 20,
21, 25, 28, 36 and 41**

TRADEMARK

SERVICE MARK

PRINCIPAL REGISTER

THE TRUSTEES OF THE QUEEN ELIZABETH II HEALTH SCIENCES CENTRE
FOUNDATION (CANADA TRUST)
1276 SOUTH PARK STREET
HALIFAX, NOVA SCOTIA, CANADA B3H2Y9

FOR: PRE-RECORDED VIDEOS AND DVDS FEATURING INFORMATION RELATED TO FUNDRAISING, BREAST HEALTH, DIET AND EXERCISE, IN CLASS 9 (U.S. CLS. 21, 23, 26, 36 AND 38).

FOR: JEWELRY, NAMELY, RINGS, PENDANTS AND PINS, IN CLASS 14 (U.S. CLS. 2, 27, 28 AND 50).

FOR: DECALS AND TEMPORARY TATTOOS; SOUVENIR PROGRAMS CONCERNING INFORMATION RELATED TO FUNDRAISING, BREAST HEALTH, DIET AND EXERCISE; PAMPHLETS AND BROCHURES IN THE FIELDS OF FUNDRAISING, BREAST HEALTH, DIET AND EXERCISE; MAPS; LITHOGRAPHIC PRINTS, POSTERS, PENS, CALENDARS, NOTEBOOKS, NOTEPADS, PRINTED MATTER, NAMELY, BOOKLETS IN THE FIELDS OF FUNDRAISING, BREAST HEALTH, DIET AND EXERCISE, IN CLASS 16 (U.S. CLS. 2, 5, 22, 23, 29, 37, 38 AND 50).

FOR: FANNY PACKS, TOTE BAGS, BACK PACKS, SPORTS BAGS AND CANVAS BAGS, IN CLASS 18 (U.S. CLS. 1, 2, 3, 22 AND 41).

FOR: NON-METAL AND NON-LEATHER KEY CHAINS, IN CLASS 20 (U.S. CLS. 2, 13, 22, 25, 32 AND 50).

FOR: PLASTIC WATER BOTTLES SOLD EMPTY; AND MUGS, IN CLASS 21 (U.S. CLS. 2, 13, 23, 29, 30, 33, 40 AND 50).

FOR: CAPS, HATS, SNEAKERS, RUNNING SHOES, SHIRTS, SWEATSHIRTS, T-SHIRTS, JACKETS, GLOVES AND SHORTS, IN CLASS 25 (U.S. CLS. 22 AND 39).

FOR: PERSONAL EXERCISE AND YOGA MATS, IN CLASS 28 (U.S. CLS. 22, 23, 38 AND 50).

FOR: CHARITABLE FUNDRAISING SERVICES; CHARITABLE FUNDRAISING, NAMELY, ARRANGING AND CONDUCTING FITNESS AND RECREATION EVENTS, NAMELY, EX-



David J. Kybas

Director of the United States Patent and Trademark Office

Reg. No. 4,152,473 EXERCISE CHALLENGES COMPRISED OF CHOREOGRAPHED EXERCISE LED BY CERTIFIED INSTRUCTORS, BOTH AEROBIC AND NON-AEROBIC, IN CLASS 36 (U.S. CLS. 100, 101 AND 102).

FOR: ARRANGING AND CONDUCTING FITNESS AND RECREATION EVENTS, NAMELY, EXERCISE CHALLENGES COMPRISED OF CHOREOGRAPHED EXERCISE LED BY CERTIFIED INSTRUCTORS, BOTH AEROBIC AND NON-AEROBIC FOR FUNDRAISING AND RECREATIONAL PURPOSES; EDUCATIONAL SERVICES, NAMELY, SEMINARS TO RAISE AWARENESS OF THE PREVALENCE OF BREAST CANCER, THE BENEFIT OF VARIOUS PIECES OF EQUIPMENT, HEALTHY LIVING, INCLUDING DIET AND EXERCISE, AND IMPROVEMENTS IN THE AREA OF HEALTH CARE FOR BREAST CANCER PATIENTS, AND THE NEED FOR ENHANCEMENTS TO BREAST HEALTH CARE SERVICES, IN CLASS 41 (U.S. CLS. 100, 101 AND 107).

THE MARK CONSISTS OF STANDARD CHARACTERS WITHOUT CLAIM TO ANY PARTICULAR FONT, STYLE, SIZE, OR COLOR.

OWNER OF CANADA REG. NO. TMA796,652, DATED 5-4-2011, EXPIRES 5-4-2026.

OWNER OF CANADA REG. NO. TMA812,118, DATED 11-18-2011, EXPIRES 11-18-2026.

NO CLAIM IS MADE TO THE EXCLUSIVE RIGHT TO USE "BREAST HEALTH" , APART FROM THE MARK AS SHOWN.

SER. NO. 85-085,652, FILED 7-15-2010.

SHAUNIA CARLYLE, EXAMINING ATTORNEY

United States of America

United States Patent and Trademark Office

VISTA

Reg. No. 4,152,474

Registered June 5, 2012

Int. Cl.: 21

TRADEMARK

PRINCIPAL REGISTER

PROTECT PLUS, LLC (NORTH CAROLINA LIMITED LIABILITY COMPANY)
420 3RD AVENUE NW
HICKORY, NC 28601

FOR: PITCHERS, IN CLASS 21 (U.S. CLS. 2, 13, 23, 29, 30, 33, 40 AND 50).

FIRST USE 11-13-2009; IN COMMERCE 11-13-2009.

THE MARK CONSISTS OF STANDARD CHARACTERS WITHOUT CLAIM TO ANY PARTICULAR FONT, STYLE, SIZE, OR COLOR.

SER. NO. 85-089,606, FILED 7-21-2010.

MARLENE BELL, EXAMINING ATTORNEY



David J. Kyffers

Director of the United States Patent and Trademark Office

United States of America

United States Patent and Trademark Office

THINKING OUTSIDE THE BIG BOX

Reg. No. 4,152,475

Registered June 5, 2012

Int. Cl.: 35

SERVICE MARK

PRINCIPAL REGISTER

MITCHELL ARMATA (CANADA INDIVIDUAL)
555 RICHMOND ST W, STE 600, PO BOX 1102
TORONTO, ONTARIO, CANADA M5V3B1

FOR: ADVERTISING SERVICES, NAMELY, PROMOTING THE BRANDS, GOODS AND SERVICES OF OTHERS, IN CLASS 35 (U.S. CLS. 100, 101 AND 102).

THE MARK CONSISTS OF STANDARD CHARACTERS WITHOUT CLAIM TO ANY PARTICULAR FONT, STYLE, SIZE, OR COLOR.

PRIORITY CLAIMED UNDER SEC. 44(D) ON CANADA APPLICATION NO. 1488541, FILED 7-13-2010, REG. NO. TMA804465, DATED 8-16-2011, EXPIRES 8-16-2026.

SER. NO. 85-090,381, FILED 7-22-2010.

REGINA DRUMMOND, EXAMINING ATTORNEY



David J. Kybas

Director of the United States Patent and Trademark Office

United States of America

United States Patent and Trademark Office

Home House

Reg. No. 4,152,476

Registered June 5, 2012

Int. Cls.: 16, 41, 43 and 45

TRADEMARK

SERVICE MARK

PRINCIPAL REGISTER

HOME HOUSE LIMITED (UNITED KINGDOM CORPORATION)
20 PORTMAN SQUARE
LONDON, UNITED KINGDOM W1H6LW

FOR: PRINTED MATTER, NAMELY, MAGAZINES, NEWSLETTERS AND BROCHURES IN THE FIELDS OF NEWS, CURRENT AFFAIRS, FASHION, FILM, CULTURE, FOOD, WINE, HISTORY, MUSIC AND PERFORMING ARTS, TRAVEL, HOTELS, RESTAURANTS, SPORTS AND FITNESS, HEALTH AND BEAUTY, AND PARTY PLANNING; PAPER, NAMELY, PAPER LABELS, PRE-PRINTED FORMS AND PAPER CARRIER BAGS; CARDS, NAMELY, ANNOUNCEMENT CARDS, BUSINESS CARDS, CHRISTMAS CARDS, GIFT CARDS, GREETING CARDS, MEMBERSHIP CARDS AND POSTCARDS; POSTERS; PAPER COASTERS; MENUS; MAPS; FOLDERS; AND NOTEPADS, IN CLASS 16 (U.S. CLS. 2, 5, 22, 23, 29, 37, 38 AND 50).

FOR: HEALTH AND FITNESS CLUBS; PROVIDING FACILITIES FOR RECREATIONAL ACTIVITIES; DRINKING AND DINING CLUBS IN THE NATURE OF NIGHT CLUBS; SOCIAL CLUB SERVICES, NAMELY, ARRANGING, ORGANIZING AND HOSTING SOCIAL EVENTS, GET-TOGETHERS AND PARTIES FOR CLUB MEMBERS FEATURING DRINKING AND DINING, IN CLASS 41 (U.S. CLS. 100, 101 AND 107).

FOR: HOTEL SERVICES, RESTAURANT SERVICES, CATERING SERVICES FOR THE PROVISION OF FOOD AND DRINK; PROVIDING PRIVATE PARTY FACILITIES; DRINKING AND DINING CLUBS IN THE NATURE OF RESTAURANTS AND BARS, IN CLASS 43 (U.S. CLS. 100 AND 101).

FOR: SOCIAL CLUBS; DRINKING AND DINING CLUBS IN THE NATURE OF SOCIAL CLUBS, IN CLASS 45 (U.S. CLS. 100 AND 101).

OWNER OF UNITED KINGDOM REG. NO. 2184574, DATED 9-24-1999, EXPIRES 12-16-2018.

THE MARK CONSISTS OF THE WORDS "HOME HOUSE" IN SCRIPT FORM WITH A LOOPED CURVED LINE UNDERNEATH THE WORDS.

SER. NO. 85-090,418, FILED 7-22-2010.

KATINA MISTER, EXAMINING ATTORNEY



David J. Kyros

Director of the United States Patent and Trademark Office

United States of America

United States Patent and Trademark Office

Cleaning the planet... one drop at a time!

Reg. No. 4,152,477

Registered June 5, 2012

Int. Cl.: 1

TRADEMARK

PRINCIPAL REGISTER

AMADOR, LUZ M (UNITED STATES INDIVIDUAL), DBA SYSTEMS AND ENGINEERING CONSULTING
1044 E EDGEMONT DR
FRESNO, CA 93720

FOR: CATALYSTS FOR CHEMICAL AND BIOCHEMICAL PROCESSES, IN CLASS 1 (U.S. CLS. 1, 5, 6, 10, 26 AND 46).

FIRST USE 6-1-2010; IN COMMERCE 6-1-2010.

THE MARK CONSISTS OF STANDARD CHARACTERS WITHOUT CLAIM TO ANY PARTICULAR FONT, STYLE, SIZE, OR COLOR.

SER. NO. 85-091,144, FILED 7-22-2010.

STEVEN R. FINE, EXAMINING ATTORNEY



David J. Kyffers

Director of the United States Patent and Trademark Office

United States of America

United States Patent and Trademark Office

AIRZONE XTREME

Reg. No. 4,152,478

Registered June 5, 2012

Int. Cl.: 16

TRADEMARK

PRINCIPAL REGISTER

TRACH, ANN, ROSE (UNITED STATES INDIVIDUAL)
1601 OCEAN DRIVE SOUTH, UNIT 505
JACKSONVILLE BEACH, FL 32250

FOR: PAPER GOODS, NAMELY, APPLIQUES IN THE FORM OF DECALS, PAPER BANNERS, POSTERS, CALENDARS, GIFT CARDS, GREETING CARDS, NOTE CARDS, TRADING CARDS, DAILY PLANNERS, DESK PADS, PAPER EMBLEMS, PAPER FLAGS, PAPER SIGNS, PAPERWEIGHTS, POSTCARDS, PRICE AND PRINTED TICKETS, BLANK OR PARTIALLY PRINTED PAPER LABELS, BLANK OR PARTIALLY PRINTED FORMS, CROSSWORD PUZZLES, MAPS, STICKERS, AND PENS AND PENCILS, IN CLASS 16 (U.S. CLS. 2, 5, 22, 23, 29, 37, 38 AND 50).

FIRST USE 10-20-2000; IN COMMERCE 8-7-2001.

THE MARK CONSISTS OF STANDARD CHARACTERS WITHOUT CLAIM TO ANY PARTICULAR FONT, STYLE, SIZE, OR COLOR.

SER. NO. 85-091,152, FILED 7-22-2010.

DEBRA LEE, EXAMINING ATTORNEY



David J. Kyffers

Director of the United States Patent and Trademark Office

United States of America

United States Patent and Trademark Office

STYLUS

Reg. No. 4,152,479

Registered June 5, 2012

Int. Cl.: 35

SERVICE MARK

PRINCIPAL REGISTER

STYLUS MEDIA GROUP LIMITED (UNITED KINGDOM COMPANY)
239 REGENTS PARK ROAD
LONDON, UNITED KINGDOM N33LF

FOR: ADVERTISING; ADVERTISING ANALYSIS, NAMELY, ANALYSIS OF ADVERTISING RESPONSE; ADVERTISING AND PROMOTIONAL SERVICES PROVIDED VIA THE INTERNET; BUSINESS INFORMATION; BUSINESS MANAGEMENT; BUSINESS ADMINISTRATION; BUSINESS ORGANISATION CONSULTING; BUSINESS PLANNING; DATABASE MANAGEMENT SERVICES; MARKETING SERVICES; MARKET RESEARCH AND ANALYSIS; MARKET RESEARCH SERVICES, NAMELY, MARKET FORECASTING; ECONOMIC FORECASTING; ONLINE BUSINESS RESEARCH AND INFORMATION; BUSINESS SURVEY SERVICES; MARKET OPINION POLLING; ONLINE ADVERTISING ON A COMPUTER NETWORK; ONLINE PROVISION OF BUSINESS AND TRADE INFORMATION; BUSINESS SUPERVISION, IN CLASS 35 (U.S. CLS. 100, 101 AND 102).

THE MARK CONSISTS OF STANDARD CHARACTERS WITHOUT CLAIM TO ANY PARTICULAR FONT, STYLE, SIZE, OR COLOR.

PRIORITY CLAIMED UNDER SEC. 44(D) ON UNITED KINGDOM APPLICATION NO. 2537146, FILED 1-25-2010, REG. NO. 2537146, DATED 5-21-2010, EXPIRES 1-25-2020.

SER. NO. 85-091,687, FILED 7-23-2010.

DAVID TAYLOR, EXAMINING ATTORNEY



David J. Kypos

Director of the United States Patent and Trademark Office

United States of America

United States Patent and Trademark Office

BATTLE CLAW

Reg. No. 4,152,480

Registered June 5, 2012

Int. Cl.: 28

TRADEMARK

PRINCIPAL REGISTER

MATTEL, INC. (DELAWARE CORPORATION)
M1-1518
333 CONTINENTAL BOULEVARD
EL SEGUNDO, CA 90245

FOR: TOY ACTION FIGURES AND ACCESSORIES THEREFOR, IN CLASS 28 (U.S. CLS. 22, 23, 38 AND 50).

FIRST USE 4-18-2011; IN COMMERCE 4-18-2011.

THE MARK CONSISTS OF STANDARD CHARACTERS WITHOUT CLAIM TO ANY PARTICULAR FONT, STYLE, SIZE, OR COLOR.

NO CLAIM IS MADE TO THE EXCLUSIVE RIGHT TO USE "CLAW", APART FROM THE MARK AS SHOWN.

SER. NO. 85-094,529, FILED 7-28-2010.

EDWARD FENNESSY, EXAMINING ATTORNEY



David J. Kyffers

Director of the United States Patent and Trademark Office

United States of America

United States Patent and Trademark Office

ECOLAB

Reg. No. 4,152,481

Registered June 5, 2012

Int. Cl.: 42

SERVICE MARK

PRINCIPAL REGISTER

ECOLAB USA INC. (DELAWARE CORPORATION)
ESC-F7610
370 WABASHA STREET NORTH
SAINT PAUL, MN 55102

FOR: BACTERIOLOGICAL RESEARCH AND TESTING; ENVIRONMENTAL TESTING AND INSPECTION SERVICES; FOOD SAFETY TESTING AND CONSULTATION RELATED THEREOF; INSPECTION OF CLEANING AND SANITATION SYSTEMS; CALIBRATION IN THE FIELD OF COMMERCIAL KITCHEN EQUIPMENT; CUSTOM DESIGN AND ENGINEERING OF CLEAN-IN-PLACE SYSTEMS AND EQUIPMENT, AUTOMATED CLEANING SYSTEMS, AND CONTROL SYSTEMS FOR CLEANING SYSTEMS; INSPECTIONS OF COMMERCIAL KITCHEN EQUIPMENT; PERFORMING ASSESSMENTS FOR OTHERS, NAMELY, ANALYZING COMPLIANCE WITH STANDARDS IN THE FIELD OF WATER CARE, WATER USAGE, ENERGY USAGE, AND WASTE REDUCTION; TESTING, ANALYSIS, AND EVALUATION OF WATER QUALITY; PROVIDING TEMPORARY USE OF ON-LINE, NON-DOWNLOADABLE SOFTWARE FOR MONITORING AND ANALYZING WATER USAGE AND CONDITIONS DATA REMOTE MONITORING SERVICES OF POOL AND SPA WATER QUALITY APPARATUS; PROVIDING QUALITY ASSURANCE SERVICES IN THE FIELD OF CLEANING, DISINFECTING, SANITIZING, PERSONAL HYGIENE AND PEST ELIMINATION FOR THE BEVERAGE, DAIRY AND FOOD PROCESSING INDUSTRY; FOOD SAFETY TESTING AND CONSULTATION RELATED THERETO; PROVIDING INFORMATION IN THE FIELD OF FOOD SAFETY TESTING AND CONSULTATION, IN CLASS 42 (U.S. CLS. 100 AND 101).

FIRST USE 5-31-1987; IN COMMERCE 5-31-1987.

THE MARK CONSISTS OF STANDARD CHARACTERS WITHOUT CLAIM TO ANY PARTICULAR FONT, STYLE, SIZE, OR COLOR.

OWNER OF U.S. REG. NOS. 1,497,423, 1,538,458 AND OTHERS.

SER. NO. 85-094,770, FILED 7-28-2010.

PAUL E. FAHRENKOPF, EXAMINING ATTORNEY



David J. Kypos

Director of the United States Patent and Trademark Office

United States of America

United States Patent and Trademark Office

Fluff Ice

Reg. No. 4,152,482

Registered June 5, 2012

Int. Cl.: 30

TRADEMARK

PRINCIPAL REGISTER

FLUFF ICE, LLC (CALIFORNIA LIMITED LIABILITY COMPANY), DBA FLUFF ICE
500 N. ATLANTIC BLVD. SUITE III-B
MONTEREY PARK, CA 91754

FOR: ICE CREAM DESSERTS; ICE CREAMS; ICE-CREAM; ICES AND ICE CREAMS;
ITALIAN ICE; SHAVED ICE CONFECTIONS; TAPIOCA, IN CLASS 30 (U.S. CL. 46).

FIRST USE 6-30-2010; IN COMMERCE 6-30-2010.

THE MARK CONSISTS OF STANDARD CHARACTERS WITHOUT CLAIM TO ANY PAR-
TICULAR FONT, STYLE, SIZE, OR COLOR.

NO CLAIM IS MADE TO THE EXCLUSIVE RIGHT TO USE "ICE", APART FROM THE
MARK AS SHOWN.

SER. NO. 85-097,651, FILED 8-1-2010.

JENNIFER VASQUEZ, EXAMINING ATTORNEY



David J. Kyffers

Director of the United States Patent and Trademark Office

United States of America

United States Patent and Trademark Office

HottandHandy

Reg. No. 4,152,483

Registered June 5, 2012

Int. Cl.: 37

SERVICE MARK

PRINCIPAL REGISTER

DUFFY GALLEGOS LLC (NEW YORK LIMITED LIABILITY COMPANY)
P.O. BOX 779
NEW YORK, NY 10108

FOR: GENERAL HANDYMAN SERVICES AROUND THE HOME; TECHNICAL SUPPORT SERVICES, NAMELY, TROUBLESHOOTING IN THE NATURE OF THE REPAIR OF COMPUTER AND WIRELESS HARDWARE; TECHNICAL SUPPORT SERVICES, NAMELY, TROUBLESHOOTING IN THE NATURE OF THE REPAIR OF VIDEO AND AUDIO EQUIPMENT; PICTURE HANGING; SWIMMING POOL CLEANING; WASHING AND DETAILING AUTOMOBILES; PAINTING; PLUMBING, NAMELY, TIGHTENING FAUCETS AND CAULKING TUBS; ELECTRICAL CONTRACTOR SERVICES, NAMELY, CHANGING LIGHT BULBS AND INSTALLING DIMMERS; INSTALLATION, MAINTENANCE AND REMOVAL OF SEASONAL DECORATIONS FOR OTHERS, IN CLASS 37 (U.S. CLS. 100, 103 AND 106).

FIRST USE 1-31-2010; IN COMMERCE 1-31-2010.

THE MARK CONSISTS OF STANDARD CHARACTERS WITHOUT CLAIM TO ANY PARTICULAR FONT, STYLE, SIZE, OR COLOR.

SER. NO. 85-097,739, FILED 8-2-2010.

JAMES A. RAUEN, EXAMINING ATTORNEY



David J. Kyros

Director of the United States Patent and Trademark Office

United States of America

United States Patent and Trademark Office

SP-1288

Reg. No. 4,152,484

Registered June 5, 2012

Int. Cl.: 2

TRADEMARK

PRINCIPAL REGISTER

SPECIALTY POLYMER COATINGS, INC. (CANADA CORPORATION)
101 - 20529 62ND AVENUE
LANGLEY, B.C., CANADA V3A8R4

FOR: A TWO COMPONENT AMBIENT CURED EPOXY COATING USED IN APPLICATIONS ON METAL SUBSTRATES WHERE ABRASIVE BLASTING IS NOT POSSIBLE OR FEASIBLE , IN CLASS 2 (U.S. CLS. 6, 11 AND 16).

THE MARK CONSISTS OF STANDARD CHARACTERS WITHOUT CLAIM TO ANY PARTICULAR FONT, STYLE, SIZE, OR COLOR.

PRIORITY CLAIMED UNDER SEC. 44(D) ON CANADA APPLICATION NO. 1475999, FILED 4-7-2010, REG. NO. TMA803174, DATED 7-28-2011, EXPIRES 7-28-2026.

SER. NO. 85-098,457, FILED 8-2-2010.

ERNEST SHOSHO, EXAMINING ATTORNEY



David J. Kyffers

Director of the United States Patent and Trademark Office

United States of America

United States Patent and Trademark Office

SP-98130

Reg. No. 4,152,485

Registered June 5, 2012

Int. Cl.: 2

TRADEMARK

PRINCIPAL REGISTER

SPECIALTY POLYMER COATINGS, INC. (CANADA CORPORATION)
101 - 20529 62ND AVENUE
LANGLEY, B.C., CANADA V3A8R4

FOR: EPOXY COATINGS, NAMELY, AN EPOXY COATING FOR USE AS A TWO COMPONENT HIGH PERFORMANCE LINING BASED ON PHENOLIC EPOXY NOVALAC POLYMER FOR USE AS A CORROSION RESISTANT FOR LINING FOR TANKS AND VESSELS CONTAINING CRUDE OIL, FRESH OR SALT WATER, HYDROGEN SULPHIDE CARBON DIOXIDE AND ASSOCIATED HYDROCARBON GASES AT WET TEMPERATURES TO 130 DEGREES CELSIUS AND PRESSURES TO 1000 PSI, IN CLASS 2 (U.S. CLS. 6, 11 AND 16).

THE MARK CONSISTS OF STANDARD CHARACTERS WITHOUT CLAIM TO ANY PARTICULAR FONT, STYLE, SIZE, OR COLOR.

PRIORITY CLAIMED UNDER SEC. 44(D) ON CANADA APPLICATION NO. 1475990, FILED 4-7-2010, REG. NO. TMA803172, DATED 7-28-2011, EXPIRES 7-28-2026.

SER. NO. 85-098,484, FILED 8-2-2010.

ERNEST SHOSHO, EXAMINING ATTORNEY



David J. Kybas

Director of the United States Patent and Trademark Office

United States of America

United States Patent and Trademark Office

AC MANAGER

Reg. No. 4,152,486

Registered June 5, 2012

Int. Cl.: 11

TRADEMARK

PRINCIPAL REGISTER

LG ELECTRONICS INC. (REPUBLIC OF KOREA CORPORATION)
20 YEOUIDO-DONG YEONGDEUNGPO-GU
SEOUL, REPUBLIC OF KOREA 150-721

FOR: ELECTRIC REFRIGERATORS FOR HOUSEHOLD PURPOSES; LIGHT-WAVE COOKING OVENS; WINE COOLERS, NAMELY, REFRIGERATED CABINETS CONTAINING RACKS FOR WINE BOTTLES AND STORAGE SHELVES; ELECTRIC COOKING OVENS; ELECTRIC FREEZERS; ELECTRIC CLOTHES DRYERS; GAS RANGES; MICROWAVE OVENS; GAS COOKTOPS; ELECTRIC RANGES FOR HOUSEHOLD PURPOSES; AIR PURIFYING APPARATUS; AIR CONDITIONERS; HOT AIR BLOWERS; HUMIDIFIERS; ELECTRIC DEHUMIDIFIERS FOR HOUSEHOLD PURPOSES; GAS GRILLS; DISH DISINFECTANT APPARATUS FOR HOUSEHOLD PURPOSES; WATER PURIFIERS FOR HOUSEHOLD PURPOSES; ELECTRIC WATER PURIFIERS FOR HOUSEHOLD PURPOSES; WATER IONIZERS; NON-ELECTRIC WATER PURIFIERS FOR HOUSEHOLD PURPOSES; WATER PURIFYING APPARATUS; ELECTRIC FOOTWARMERS; WATER PURIFICATION INSTALLATIONS; WATER FILTERS, IN CLASS 11 (U.S. CLS. 13, 21, 23, 31 AND 34).

THE MARK CONSISTS OF STANDARD CHARACTERS WITHOUT CLAIM TO ANY PARTICULAR FONT, STYLE, SIZE, OR COLOR.

OWNER OF REPUBLIC OF KOREA REG. NO. 0766723, DATED 10-28-2008, EXPIRES 10-28-2018.

NO CLAIM IS MADE TO THE EXCLUSIVE RIGHT TO USE "AC", APART FROM THE MARK AS SHOWN.

SER. NO. 85-100,151, FILED 8-4-2010.

IRA J. GOODSaid, EXAMINING ATTORNEY



David J. Kyros

Director of the United States Patent and Trademark Office

United States of America

United States Patent and Trademark Office

AZOTE

Reg. No. 4,152,487

Registered June 5, 2012

Int. Cl.: 17

TRADEMARK

PRINCIPAL REGISTER

ZOTEFOAMS PLC (UNITED KINGDOM PUBLIC LIMITED COMPANY (PLC))
675 MITCHAM ROAD
CROYDON SURREY, UNITED KINGDOM C493AL

FOR: PLASTICS IN THE FORM OF SHEETS, BLOCKS, FILMS, RODS, TUBES, PIPES, AND SHAPED SECTIONS, ALL FOR USE IN MANUFACTURE, NON-METALLIC EXPANSION JOINT SEALS FOR USE IN THE CONSTRUCTION OF BUILDINGS, ROADS AND CIVIL ENGINEERING STRUCTURES; AND NON-METALLIC MATERIALS, NAMELY, EXPANDED FOAM FOR INSULATION AND GAP FILLING PURPOSES FOR USE IN THE CONSTRUCTION OF BUILDINGS, ROADS AND CIVIL ENGINEERING STRUCTURES, IN CLASS 17 (U.S. CLS. 1, 5, 12, 13, 35 AND 50).

THE MARK CONSISTS OF STANDARD CHARACTERS WITHOUT CLAIM TO ANY PARTICULAR FONT, STYLE, SIZE, OR COLOR.

OWNER OF ERPN CMNTY TM OFC REG. NO. 004571551, DATED 1-26-2007, EXPIRES 8-2-2015.

SER. NO. 85-100,395, FILED 8-4-2010.

MICHAEL WEBSTER, EXAMINING ATTORNEY



David J. Kyros

Director of the United States Patent and Trademark Office

United States of America

United States Patent and Trademark Office



Reg. No. 4,152,488

Registered June 5, 2012

Int. Cls.: 9 and 42

TRADEMARK

SERVICE MARK

PRINCIPAL REGISTER

SACA TECHNOLOGIES, INC. (CALIFORNIA CORPORATION)
SUITE 102
ANAHEIM HILLS, CA 92807

FOR: COMPUTERS, NAMELY, DESKTOP PERSONAL COMPUTERS, LAPTOP PERSONAL COMPUTERS, SERVER COMPUTERS, FIREWALL COMPUTERS; DIGITAL VIDEO RECORDERS, SURVEILLANCE CAMERAS AND SURVEILLANCE VIDEO RECORDERS, IN CLASS 9 (U.S. CLS. 21, 23, 26, 36 AND 38).

FIRST USE 3-11-2010; IN COMMERCE 3-11-2010.

FOR: DESKTOP VIRTUALIZATION, NAMELY, PROVIDING TEMPORARY USE OF NON-DOWNLOADABLE OPERATING SYSTEM SOFTWARE ONLINE FOR OPERATING A VIRTUAL COMPUTER; HOSTED VIRTUAL DESKTOP SERVICES, NAMELY, TECHNICAL SUPPORT IN THE NATURE OF TROUBLE SHOOTING OF COMPUTER SOFTWARE PROBLEMS AND TECHNICAL SUPPORT IN THE NATURE OF MONITORING OF NETWORK SYSTEMS FOR USERS OF VIRTUAL DESKTOPS; APPLICATION SERVICE PROVIDER (ASP), NAMELY, HOSTING COMPUTER SOFTWARE APPLICATIONS OF OTHERS; APPLICATION AS A SERVICE, NAMELY, ONLINE RENTAL OF COMPUTER SOFTWARE; HARDWARE AS SERVICE, NAMELY, RENTAL OF COMPUTER HARDWARE, IN CLASS 42 (U.S. CLS. 100 AND 101).

FIRST USE 3-11-2010; IN COMMERCE 3-11-2010.

OWNER OF U.S. REG. NOS. 3,601,590 AND 3,615,073.

THE COLOR(S) ORANGE IS/ARE CLAIMED AS A FEATURE OF THE MARK.

NO CLAIM IS MADE TO THE EXCLUSIVE RIGHT TO USE "TECHNOLOGIES", APART FROM THE MARK AS SHOWN.

THE MARK CONSISTS OF THE STYLIZED WORDING "SACA TECHNOLOGIES", WHERE EACH LETTER "A" IN THE TERM "SACA" IS FORMED BY A STYLIZED TRIANGLE. THE WHITE SHOWN IN THE MARK IS FOR BACKGROUND PURPOSES ONLY AND IS NOT INTENDED AS A FEATURE OF THE MARK.

SER. NO. 85-103,652, FILED S.R. 8-9-2010 AM. P.R. 8-9-2010.



David J. Kyros

Director of the United States Patent and Trademark Office

Reg. No. 4,152,488 WILLIAM ROSSMAN, EXAMINING ATTORNEY

United States of America

United States Patent and Trademark Office

IPEX

Reg. No. 4,152,489

INSTITUTE OF FOOD TECHNOLOGISTS (ILLINOIS NON-PROFIT CORPORATION)
525 W. VAN BUREN ST., SUITE 1000
CHICAGO, IL 60607

Registered June 5, 2012

Int. Cl.: 35

FOR: BUSINESS NETWORKING IN THE FIELD OF FOOD SCIENCE, TECHNOLOGY, AND INTELLECTUAL PROPERTY, IN CLASS 35 (U.S. CLS. 100, 101 AND 102).

SERVICE MARK

FIRST USE 6-7-2009; IN COMMERCE 6-7-2009.

PRINCIPAL REGISTER

THE MARK CONSISTS OF STANDARD CHARACTERS WITHOUT CLAIM TO ANY PARTICULAR FONT, STYLE, SIZE, OR COLOR.

SER. NO. 85-104,844, FILED 8-11-2010.

JESSICA FATHY, EXAMINING ATTORNEY



David J. Kybas

Director of the United States Patent and Trademark Office

United States of America

United States Patent and Trademark Office

VITCO

Reg. No. 4,152,490

Registered June 5, 2012

Int. Cl.: 6

TRADEMARK

PRINCIPAL REGISTER

UNITED STATES PIPE AND FOUNDRY COMPANY, LLC (ALABAMA LIMITED LIABILITY COMPANY)
3300 FIRST AVENUE NORTH
BIRMINGHAM, AL 35222

FOR: GLASS LININGS SOLD AS AN INTEGRAL COMPONENT OF METAL PIPES AND METAL PIPE FITTINGS, IN CLASS 6 (U.S. CLS. 2, 12, 13, 14, 23, 25 AND 50).

FIRST USE 0-0-1988; IN COMMERCE 0-0-1988.

THE MARK CONSISTS OF STANDARD CHARACTERS WITHOUT CLAIM TO ANY PARTICULAR FONT, STYLE, SIZE, OR COLOR.

SER. NO. 85-106,072, FILED 8-12-2010.

JIM RINGLE, EXAMINING ATTORNEY



David J. Kyffers

Director of the United States Patent and Trademark Office

United States of America

United States Patent and Trademark Office

ROCKET MATH

Reg. No. 4,152,491

Registered June 5, 2012

Int. Cls.: 9 and 16

TRADEMARK

PRINCIPAL REGISTER

R & D INSTRUCTIONAL SOLUTIONS LLC (MARYLAND LIMITED LIABILITY COMPANY)
5614 MATTFELDT AVENUE
BALTIMORE, MD 21209

FOR: ELECTRONIC DOWNLOADABLE EDUCATIONAL MATERIALS AND INSTRUCTIONAL TEXT IN THE FORM OF WORKSHEETS IN THE FIELD OF MATH AND CURRICULUM ASSESSMENTS FOR USE BY TEACHERS, IN CLASS 9 (U.S. CLS. 21, 23, 26, 36 AND 38).

FIRST USE 1-0-2007; IN COMMERCE 1-0-2007.

FOR: PRINTED EDUCATIONAL MATERIALS, NAMELY, WORKSHEETS, FLASHCARDS AND PRINTED WALL CHARTS IN THE FIELD OF MATH AND CURRICULUM ASSESSMENTS, IN CLASS 16 (U.S. CLS. 2, 5, 22, 23, 29, 37, 38 AND 50).

FIRST USE 1-0-2007; IN COMMERCE 1-0-2007.

THE MARK CONSISTS OF STANDARD CHARACTERS WITHOUT CLAIM TO ANY PARTICULAR FONT, STYLE, SIZE, OR COLOR.

NO CLAIM IS MADE TO THE EXCLUSIVE RIGHT TO USE "MATH", APART FROM THE MARK AS SHOWN.

SER. NO. 85-108,361, FILED 8-16-2010.

B. PARADEWELAI, EXAMINING ATTORNEY



David J. Kybas

Director of the United States Patent and Trademark Office

United States of America

United States Patent and Trademark Office

DOELEGAL

Reg. No. 4,152,492

Registered June 5, 2012

Int. Cl.: 42

SERVICE MARK

PRINCIPAL REGISTER

DOELEGAL, LLC (DELAWARE LIMITED LIABILITY COMPANY)
1200 PHILADELPHIA PIKE
WILMINGTON, DE 19809

FOR: COMPUTER SERVICES, NAMELY, PROVIDING A WEB-BASED SYSTEM AND ON-LINE PORTAL FOR CUSTOMERS TO REMOTELY MANAGE, ADMINISTER, MODIFY, AND CONTROL THEIR END USER COMPUTER DEVICES, DATA AND SOFTWARE APPLICATIONS, IN CLASS 42 (U.S. CLS. 100 AND 101).

FIRST USE 10-11-2000; IN COMMERCE 10-11-2000.

THE MARK CONSISTS OF STANDARD CHARACTERS WITHOUT CLAIM TO ANY PARTICULAR FONT, STYLE, SIZE, OR COLOR.

THE WORDING "DOELEGAL" HAS NO MEANING IN A FOREIGN LANGUAGE.

SER. NO. 85-110,712, FILED 8-18-2010.

MYRIAH HABEEB, EXAMINING ATTORNEY



David J. Kyros

Director of the United States Patent and Trademark Office

United States of America

United States Patent and Trademark Office

DOT NET WORKFLOW

Reg. No. 4,152,493

Registered June 5, 2012

Int. Cl.: 9

TRADEMARK

PRINCIPAL REGISTER

PARKER, PATRICK (UNITED STATES INDIVIDUAL)
4393 TULLER ROAD
DUBLIN, OH 43017

FOR: COMPUTER AND SOFTWARE PRODUCTS AND ELECTRICAL AND SCIENTIFIC PRODUCTS, NAMELY, SOFTWARE FOR IDENTITY MANAGEMENT, ROLE BASED ACCESS CONTROL, WORKFLOW MANAGEMENT, BUSINESS PROCESS AUTOMATION, BUSINESS PROCESS MANAGEMENT, WORKFLOW DESIGN, APPLICATION DEVELOPMENT ENVIRONMENT; WORKFLOW SERVERS OPERATING SYSTEM SOFTWARE, SOFTWARE FOR PERMISSIONS AUDIT AND ENFORCEMENT; SOFTWARE FOR IDENTITY MANAGEMENT FOR DEVELOPERS, PROGRAMMERS, BUSINESS PROCESS ENGINEERS, AND NETWORK ADMINISTRATORS OF ALL AGES, IN CLASS 9 (U.S. CLS. 21, 23, 26, 36 AND 38).

FIRST USE 5-23-2010; IN COMMERCE 5-23-2010.

THE MARK CONSISTS OF STANDARD CHARACTERS WITHOUT CLAIM TO ANY PARTICULAR FONT, STYLE, SIZE, OR COLOR.

NO CLAIM IS MADE TO THE EXCLUSIVE RIGHT TO USE "NET WORKFLOW", APART FROM THE MARK AS SHOWN.

SER. NO. 85-110,889, FILED 8-19-2010.

RUDY R. SINGLETON, EXAMINING ATTORNEY



David J. Kyffers

Director of the United States Patent and Trademark Office

United States of America

United States Patent and Trademark Office



whichwaytopay

Reg. No. 4,152,494

Registered June 5, 2012

Int. Cls.: 35 and 36

SERVICE MARK

PRINCIPAL REGISTER

WHICH WAY TO PAY LTD (UNITED KINGDOM LIMITED COMPANY (LTD.))
5 PAMIR COURT
36 WORCESTER ROAD, SUTTON
SURREY, SM2 6PY, UNITED KINGDOM

FOR: ADVERTISING, MARKETING, AND PROMOTION SERVICES; COMMERCIAL INFORMATION AGENCY SERVICES; PROVISION OF BUSINESS ADVICE AND INFORMATION RELATING TO BUSINESSES AND COMPANIES; OPERATIONAL BUSINESS ASSISTANCE TO ENTERPRISES, BUSINESS ADVISORY AND BUSINESS MANAGEMENT INFORMATION SERVICES, BUSINESS MANAGEMENT; BUSINESS INFORMATION OR INQUIRIES; COMPILATION AND SYSTEMIZATION OF INFORMATION INTO COMPUTER DATABASES; COST PRICE ANALYSIS SERVICES; PRICE COMPARISON OF THE GOODS OR SERVICES OF OTHER TRADERS; PROVIDING PRICE COMPARISON AND COST PRICE ANALYSIS OF GOODS, NAMELY, COMPUTER HARDWARE AND FIRMWARE, COMPUTER SOFTWARE, COMPACT DISCS, TELECOMMUNICATIONS APPARATUS, COMPUTER GAMES EQUIPMENT, MOBILE PHONE ACCESSORIES, ELECTRIC KETTLES, GAS AND ELECTRIC COOKERS, REFRIGERATION EQUIPMENT, MOTOR VEHICLES, CLOCKS, WATCHES, JEWELLERY, MUSICAL INSTRUMENTS, DISPOSABLE NAPPIES, PRINTED PUBLICATIONS, METALLIC AND NON-METALLIC FURNITURE INCLUDING GARDEN FURNITURE, PILLOWS, CUSHIONS, SELF CONTAINED HAND-HELD COMPUTER GAMES; RETAIL STORE SERVICES IN THE FIELD OF COMPUTER HARDWARE AND FIRMWARE, COMPUTER SOFTWARE, COMPACT DISCS, TELECOMMUNICATIONS APPARATUS, COMPUTER GAMES EQUIPMENT, MOBILE PHONE ACCESSORIES, ELECTRIC KETTLES, GAS AND ELECTRIC COOKERS, REFRIGERATION EQUIPMENT, MOTOR VEHICLES, CLOCKS, WATCHES, JEWELLERY, MUSICAL INSTRUMENTS, DISPOSABLE NAPPIES, PRINTED PUBLICATIONS, METALLIC AND NON-METALLIC FURNITURE INCLUDING GARDEN FURNITURE, PILLOWS, CUSHIONS, SELF CONTAINED HAND-HELD COMPUTER GAMES; PROVIDING BUSINESS MANAGEMENT AND MARKETING INFORMATION, ADVISORY AND CONSULTANCY SERVICES RELATING TO ALL THE FOREGOING, IN CLASS 35 (U.S. CLS. 100, 101 AND 102).



David J. Kyros

Director of the United States Patent and Trademark Office

FOR: INSURANCE CONSULTING, INSURANCE INFORMATION, INSURANCE AGENCY AND BROKERAGE, AND INSURANCE, NAMELY, INSURANCE UNDERWRITING SERVICES FOR ALL TYPES OF INSURANCE; FINANCING SERVICES; FINANCIAL TRANSACTION SERVICES, NAMELY, PROVIDING SECURE COMMERCIAL TRANSACTIONS AND PAYMENT OPTIONS; ELECTRONIC FUNDS TRANSFER; FINANCIAL AFFAIRS AND MONETARY AFFAIRS, NAMELY, FINANCIAL CONSULTANCY, FINANCIAL INFORMATION,

Reg. No. 4,152,494 MANAGEMENT AND ANALYSIS SERVICES; REAL ESTATE AFFAIRS, NAMELY, APPRAISAL AND EVALUATION OF REAL ESTATE, REAL ESTATE BROKERAGE, REAL ESTATE AGENCIES, REAL ESTATE CONSULTANCY, REAL ESTATE EVALUATIONS, REAL ESTATE APPRAISALS; BANKING; CAPITAL INVESTMENT SERVICES; CREDIT CARD SERVICES; DEBIT CARDS SERVICES; FINANCIAL EVALUATIONS; HOME BANKING; INSURANCE BROKERAGE; EQUITY CAPITAL INVESTMENT SERVICES; MORTGAGE BROKERAGE SERVICES; FINANCIAL MANAGEMENT INFORMATION, FINANCIAL ADVISORY AND FINANCIAL CONSULTANCY SERVICES RELATING TO ALL THE FOREGOING, IN CLASS 36 (U.S. CLS. 100, 101 AND 102).

PRIORITY CLAIMED UNDER SEC. 44(D) ON UNITED KINGDOM APPLICATION NO. 2551932, FILED 7-1-2010, REG. NO. 2551932, DATED 7-1-2010, EXPIRES 7-1-2020.

THE MARK CONSISTS OF THE WORDS "WHICH WAY TO PAY" WITH NO SPACES BETWEEN THE WORDS AND WITH THE WORDS "WAY" AND "PAY" APPEARING IN BOLD, AND A DESIGN OF A CALCULATOR WITHIN A CIRCLE APPEARING TO THE LEFT OF THE WORDING.

SER. NO. 85-110,935, FILED 8-19-2010.

JAMES MACFARLANE, EXAMINING ATTORNEY

United States of America

United States Patent and Trademark Office

VRC

Reg. No. 4,152,495

VITAL HOLDINGS, LLC (TENNESSEE LIMITED LIABILITY COMPANY)
5400 MELTECH, SUITE 101
MEMPHIS, TN 38118

Registered June 5, 2012

Int. Cls.: 35, 39, 40 and 41

FOR: INFORMATION MANAGEMENT, NAMELY, BUSINESS RECORD MANAGEMENT, RECORDS MANAGEMENT FOR OTHERS, NAMELY, DOCUMENT INDEXING, DOCUMENT COPYING, DOCUMENT INVENTORYING, DOCUMENT STORING, IN CLASS 35 (U.S. CLS. 100, 101 AND 102).

SERVICE MARK

FIRST USE 3-14-1988; IN COMMERCE 3-14-1988.

PRINCIPAL REGISTER

FOR: ELECTRONIC STORAGE OF FILES AND DOCUMENTS; STORAGE SERVICES FOR ELECTRONIC DATA; INFORMATION STORAGE, NAMELY, TEMPORARY AND LONG-TERM ELECTRONIC STORAGE OF INFORMATION AND DATA, STORAGE SERVICES FOR ARCHIVING ELECTRONIC DATA, ELECTRONIC STORAGE OF FINANCIAL, PAYROLL, MEDICAL, PRODUCTION, ACCOUNTS RECEIVABLE, ACCOUNTS PAYABLE, LOGISTICS, SALES, MARKETING, TAX, LEGAL, HUMAN RESOURCE, AND INSURANCE RECORDS, ELECTRONIC STORAGE OF ELECTRONIC MESSAGES AND E-MAILS; OFF-SITE RECORDS STORAGE, NAMELY, PHYSICAL RECORDS SUCH AS PAYROLL, HUMAN RESOURCE, INSURANCE, MEDICAL, FINANCIAL, PRODUCTION, ACCOUNTS RECEIVABLE, ACCOUNTS PAYABLE, ARCHITECTURAL, MAINTENANCE, LOGISTICS, HISTORICAL, MARKETING, SALES, TAX, AND LEGAL RECORDS; HARD-COPY RECORDS STORAGE, NAMELY, PHYSICAL RECORDS SUCH AS PAYROLL, HUMAN RESOURCE, INSURANCE, MEDICAL, FINANCIAL, PRODUCTION, ACCOUNTS RECEIVABLE, ACCOUNTS PAYABLE, ARCHITECTURAL, MAINTENANCE, LOGISTICS, HISTORICAL, MARKETING, SALES, TAX, AND LEGAL RECORDS; STORAGE SERVICES, NAMELY, LONG-TERM ARCHIVAL STORAGE OF PAPER AND ELECTRONIC DATA IN SECURE STORAGE ENVIRONMENTS; STORAGE OF ELECTRONIC MEDIA, NAMELY, IMAGES, TEXT AND AUDIO DATA, IN CLASS 39 (U.S. CLS. 100 AND 105).



FIRST USE 3-14-1988; IN COMMERCE 3-14-1988.

David J. Kyros

FOR: RECORDS DESTRUCTION, NAMELY, DOCUMENT DESTRUCTION SERVICES; MOBILE SHREDDING OF DOCUMENTS, MICROFICHE, MICROFILM, AND PHYSICAL RECORDS, IN CLASS 40 (U.S. CLS. 100, 103 AND 106).

FIRST USE 3-14-1988; IN COMMERCE 3-14-1988.

Reg. No. 4,152,495 FOR: DIGITAL IMAGING SERVICES; PHOTOGRAPHIC COMPUTER IMAGING, IN CLASS 41 (U.S. CLS. 100, 101 AND 107).

FIRST USE 11-1-1999; IN COMMERCE 11-1-1999.

THE MARK CONSISTS OF STANDARD CHARACTERS WITHOUT CLAIM TO ANY PARTICULAR FONT, STYLE, SIZE, OR COLOR.

SER. NO. 85-112,018, FILED 8-20-2010.

DAVID I, EXAMINING ATTORNEY

United States of America

United States Patent and Trademark Office

VITALWEB

Reg. No. 4,152,496

Registered June 5, 2012

Int. Cls.: 35 and 39

SERVICE MARK

PRINCIPAL REGISTER

VITAL HOLDINGS, LLC (TENNESSEE LIMITED LIABILITY COMPANY)
5400 MELTECH, SUITE 101
MEMPHIS, TN 38118

FOR: INFORMATION MANAGEMENT, NAMELY, BUSINESS RECORD MANAGEMENT, RECORDS MANAGEMENT FOR OTHERS, NAMELY, DOCUMENT INDEXING, DOCUMENT COPYING, DOCUMENT INVENTORYING, DOCUMENT STORING, IN CLASS 35 (U.S. CLS. 100, 101 AND 102).

FIRST USE 9-0-1999; IN COMMERCE 9-0-1999.

FOR: ELECTRONIC STORAGE OF FILES AND DOCUMENTS; STORAGE SERVICES FOR ELECTRONIC DATA; INFORMATION STORAGE, NAMELY, TEMPORARY AND LONG-TERM ELECTRONIC STORAGE OF INFORMATION AND DATA, STORAGE SERVICES FOR ARCHIVING ELECTRONIC DATA, ELECTRONIC STORAGE OF FINANCIAL, PAYROLL, MEDICAL, PRODUCTION, ACCOUNTS RECEIVABLE, ACCOUNTS PAYABLE, LOGISTICS, SALES, MARKETING, TAX, LEGAL, HUMAN RESOURCE, AND INSURANCE RECORDS, ELECTRONIC STORAGE OF ELECTRONIC MESSAGES AND E-MAILS; OFF-SITE RECORDS STORAGE, NAMELY, PHYSICAL RECORDS SUCH AS PAYROLL, HUMAN RESOURCE, INSURANCE, MEDICAL, FINANCIAL, PRODUCTION, ACCOUNTS RECEIVABLE, ACCOUNTS PAYABLE, ARCHITECTURAL, MAINTENANCE, LOGISTICS, HISTORICAL, MARKETING, SALES, TAX, AND LEGAL RECORDS; HARD-COPY RECORDS STORAGE, NAMELY, PHYSICAL RECORDS SUCH AS PAYROLL, HUMAN RESOURCE, INSURANCE, MEDICAL, FINANCIAL, PRODUCTION, ACCOUNTS RECEIVABLE, ACCOUNTS PAYABLE, ARCHITECTURAL, MAINTENANCE, LOGISTICS, HISTORICAL, MARKETING, SALES, TAX, AND LEGAL RECORDS; STORAGE SERVICES, NAMELY, LONG-TERM ARCHIVAL STORAGE OF PAPER AND ELECTRONIC DATA IN SECURE STORAGE ENVIRONMENTS; STORAGE OF ELECTRONIC MEDIA, NAMELY, IMAGES, TEXT AND AUDIO DATA, IN CLASS 39 (U.S. CLS. 100 AND 105).

FIRST USE 9-0-1999; IN COMMERCE 9-0-1999.

THE MARK CONSISTS OF STANDARD CHARACTERS WITHOUT CLAIM TO ANY PARTICULAR FONT, STYLE, SIZE, OR COLOR.

SER. NO. 85-112,032, FILED 8-20-2010.



David J. Kyros

Director of the United States Patent and Trademark Office

Reg. No. 4,152,496 DAVID I, EXAMINING ATTORNEY

United States of America

United States Patent and Trademark Office

MASTER WALL

Reg. No. 4,152,497

Registered June 5, 2012

Int. Cls.: 2 and 19

TRADEMARK

PRINCIPAL REGISTER

MASTER WALL, INC. (GEORGIA CORPORATION)
6975 FLAT ROCK ROAD
MIDLAND, GA 31820

FOR: COATINGS COMPRISED OF STUCCO; COATINGS IN THE NATURE OF ACRYLIC AND SILICONE FINISHES TO BE APPLIED OVER CEMENT, STUCCO OR EIFS (EXTERIOR INSULATION FINISHING SYSTEM), IN CLASS 2 (U.S. CLS. 6, 11 AND 16).

FIRST USE 3-1-1992; IN COMMERCE 3-1-1992.

FOR: COMMERCIAL AND RESIDENTIAL INTERIOR AND EXTERIOR INSULATION AND FINISH SYSTEMS CONSISTING OF WATERPROOFING MEMBRANES FOR ROOFING, FLOORS AND WALLS, NON-METALLIC WATER RESISTANT DRAINAGE BOARDS AND SPACERS, WEATHER INSULATION BOARDS, BASE COATS, STUCCO AND FINISH, IN CLASS 19 (U.S. CLS. 1, 12, 33 AND 50).

FIRST USE 3-1-1992; IN COMMERCE 3-1-1992.

THE MARK CONSISTS OF STANDARD CHARACTERS WITHOUT CLAIM TO ANY PARTICULAR FONT, STYLE, SIZE, OR COLOR.

NO CLAIM IS MADE TO THE EXCLUSIVE RIGHT TO USE "WALL", APART FROM THE MARK AS SHOWN.

SER. NO. 85-113,010, FILED 8-22-2010.

MEGHAN REINHART, EXAMINING ATTORNEY



David J. Kypos

Director of the United States Patent and Trademark Office

United States of America

United States Patent and Trademark Office

VITALSCAN

Reg. No. 4,152,498

VITAL HOLDINGS, LLC (TENNESSEE LIMITED LIABILITY COMPANY)
5400 MELTECH, SUITE 101
MEMPHIS, TN 38118

Registered June 5, 2012

Int. Cls.: 35, 39 and 41

FOR: INFORMATION MANAGEMENT, NAMELY, BUSINESS RECORD MANAGEMENT, RECORDS MANAGEMENT FOR OTHERS, NAMELY, DOCUMENT INDEXING, DOCUMENT COPYING, DOCUMENT INVENTORYING, DOCUMENT STORING, IN CLASS 35 (U.S. CLS. 100, 101 AND 102).

SERVICE MARK

PRINCIPAL REGISTER

FIRST USE 11-1-1999; IN COMMERCE 11-1-1999.

FOR: ELECTRONIC STORAGE OF FILES AND DOCUMENTS; STORAGE SERVICES FOR ELECTRONIC DATA; INFORMATION STORAGE, NAMELY, TEMPORARY AND LONG-TERM ELECTRONIC STORAGE OF INFORMATION AND DATA, STORAGE SERVICES FOR ARCHIVING ELECTRONIC DATA, ELECTRONIC STORAGE OF FINANCIAL, PAYROLL, MEDICAL, PRODUCTION, ACCOUNTS RECEIVABLE, ACCOUNTS PAYABLE, LOGISTICS, SALES, MARKETING, TAX, LEGAL, HUMAN RESOURCE, AND INSURANCE RECORDS, ELECTRONIC STORAGE OF ELECTRONIC MESSAGES AND E-MAILS; OFF-SITE RECORDS STORAGE, NAMELY, PHYSICAL RECORDS SUCH AS PAYROLL, HUMAN RESOURCE, INSURANCE, MEDICAL, FINANCIAL, PRODUCTION, ACCOUNTS RECEIVABLE, ACCOUNTS PAYABLE, ARCHITECTURAL, MAINTENANCE, LOGISTICS, HISTORICAL, MARKETING, SALES, TAX, AND LEGAL RECORDS; HARD-COPY RECORDS STORAGE, NAMELY, PHYSICAL RECORDS SUCH AS PAYROLL, HUMAN RESOURCE, INSURANCE, MEDICAL, FINANCIAL, PRODUCTION, ACCOUNTS RECEIVABLE, ACCOUNTS PAYABLE, ARCHITECTURAL, MAINTENANCE, LOGISTICS, HISTORICAL, MARKETING, SALES, TAX, AND LEGAL RECORDS; STORAGE SERVICES, NAMELY, LONG-TERM ARCHIVAL STORAGE OF PAPER AND ELECTRONIC DATA IN SECURE STORAGE ENVIRONMENTS; STORAGE OF ELECTRONIC MEDIA, NAMELY, IMAGES, TEXT AND AUDIO DATA, IN CLASS 39 (U.S. CLS. 100 AND 105).



FIRST USE 11-1-1999; IN COMMERCE 11-1-1999.

FOR: DIGITAL IMAGING SERVICES; PHOTOGRAPHIC COMPUTER IMAGING, IN CLASS 41 (U.S. CLS. 100, 101 AND 107).

FIRST USE 11-1-1999; IN COMMERCE 11-1-1999.

David J. Kyjars

Director of the United States Patent and Trademark Office

Reg. No. 4,152,498 THE MARK CONSISTS OF STANDARD CHARACTERS WITHOUT CLAIM TO ANY PARTICULAR FONT, STYLE, SIZE, OR COLOR.

SER. NO. 85-113,121, FILED 8-23-2010.

DAVID I, EXAMINING ATTORNEY

United States of America

United States Patent and Trademark Office

VITALRF

Reg. No. 4,152,499

Registered June 5, 2012

Int. Cls.: 35 and 39

SERVICE MARK

PRINCIPAL REGISTER

VITAL HOLDINGS, LLC (TENNESSEE LIMITED LIABILITY COMPANY)
5400 MELTECH, SUITE 101
MEMPHIS, TN 38118

FOR: INFORMATION MANAGEMENT, NAMELY, BUSINESS RECORD MANAGEMENT, RECORDS MANAGEMENT FOR OTHERS, NAMELY, DOCUMENT INDEXING, DOCUMENT COPYING, DOCUMENT INVENTORYING, DOCUMENT STORING, IN CLASS 35 (U.S. CLS. 100, 101 AND 102).

FIRST USE 1-0-2005; IN COMMERCE 1-0-2005.

FOR: ELECTRONIC STORAGE OF FILES AND DOCUMENTS; STORAGE SERVICES FOR ELECTRONIC DATA; INFORMATION STORAGE, NAMELY, TEMPORARY AND LONG-TERM ELECTRONIC STORAGE OF INFORMATION AND DATA, STORAGE SERVICES FOR ARCHIVING ELECTRONIC DATA, ELECTRONIC STORAGE OF FINANCIAL, PAYROLL, MEDICAL, PRODUCTION, ACCOUNTS RECEIVABLE, ACCOUNTS PAYABLE, LOGISTICS, SALES, MARKETING, TAX, LEGAL, HUMAN RESOURCE, AND INSURANCE RECORDS, ELECTRONIC STORAGE OF ELECTRONIC MESSAGES AND E-MAILS; OFF-SITE RECORDS STORAGE, NAMELY, PHYSICAL RECORDS SUCH AS PAYROLL, HUMAN RESOURCE, INSURANCE, MEDICAL, FINANCIAL, PRODUCTION, ACCOUNTS RECEIVABLE, ACCOUNTS PAYABLE, ARCHITECTURAL, MAINTENANCE, LOGISTICS, HISTORICAL, MARKETING, SALES, TAX, AND LEGAL RECORDS; HARD-COPY RECORDS STORAGE, NAMELY, PHYSICAL RECORDS SUCH AS PAYROLL, HUMAN RESOURCE, INSURANCE, MEDICAL, FINANCIAL, PRODUCTION, ACCOUNTS RECEIVABLE, ACCOUNTS PAYABLE, ARCHITECTURAL, MAINTENANCE, LOGISTICS, HISTORICAL, MARKETING, SALES, TAX, AND LEGAL RECORDS; STORAGE SERVICES, NAMELY, LONG-TERM ARCHIVAL STORAGE OF PAPER AND ELECTRONIC DATA IN SECURE STORAGE ENVIRONMENTS; STORAGE OF ELECTRONIC MEDIA, NAMELY, IMAGES, TEXT AND AUDIO DATA, IN CLASS 39 (U.S. CLS. 100 AND 105).

FIRST USE 1-0-2005; IN COMMERCE 1-0-2005.

THE MARK CONSISTS OF STANDARD CHARACTERS WITHOUT CLAIM TO ANY PARTICULAR FONT, STYLE, SIZE, OR COLOR.

SER. NO. 85-113,181, FILED 8-23-2010.



David J. Kyjars

Director of the United States Patent and Trademark Office

Reg. No. 4,152,499 DAVID I, EXAMINING ATTORNEY

United States of America

United States Patent and Trademark Office

VITALTRAC

Reg. No. 4,152,500

VITAL HOLDINGS, LLC (TENNESSEE LIMITED LIABILITY COMPANY)
5400 MELTECH, SUITE 101
MEMPHIS, TN 38118

Registered June 5, 2012

Int. Cls.: 35 and 39

FOR: INFORMATION MANAGEMENT, NAMELY, BUSINESS RECORD MANAGEMENT, RECORDS MANAGEMENT FOR OTHERS, NAMELY, DOCUMENT INDEXING, DOCUMENT COPYING, DOCUMENT INVENTORYING, DOCUMENT STORING, IN CLASS 35 (U.S. CLS. 100, 101 AND 102).

SERVICE MARK

PRINCIPAL REGISTER

FIRST USE 3-14-1988; IN COMMERCE 3-14-1988.

FOR: ELECTRONIC STORAGE OF FILES AND DOCUMENTS; STORAGE SERVICES FOR ELECTRONIC DATA; INFORMATION STORAGE, NAMELY, TEMPORARY AND LONG-TERM ELECTRONIC STORAGE OF INFORMATION AND DATA, STORAGE SERVICES FOR ARCHIVING ELECTRONIC DATA, ELECTRONIC STORAGE OF FINANCIAL, PAYROLL, MEDICAL, PRODUCTION, ACCOUNTS RECEIVABLE, ACCOUNTS PAYABLE, LOGISTICS, SALES, MARKETING, TAX, LEGAL, HUMAN RESOURCE, AND INSURANCE RECORDS, ELECTRONIC STORAGE OF ELECTRONIC MESSAGES AND E-MAILS; OFF-SITE RECORDS STORAGE, NAMELY, PHYSICAL RECORDS SUCH AS PAYROLL, HUMAN RESOURCE, INSURANCE, MEDICAL, FINANCIAL, PRODUCTION, ACCOUNTS RECEIVABLE, ACCOUNTS PAYABLE, ARCHITECTURAL, MAINTENANCE, LOGISTICS, HISTORICAL, MARKETING, SALES, TAX, AND LEGAL RECORDS; HARD-COPY RECORDS STORAGE, NAMELY, PHYSICAL RECORDS SUCH AS PAYROLL, HUMAN RESOURCE, INSURANCE, MEDICAL, FINANCIAL, PRODUCTION, ACCOUNTS RECEIVABLE, ACCOUNTS PAYABLE, ARCHITECTURAL, MAINTENANCE, LOGISTICS, HISTORICAL, MARKETING, SALES, TAX, AND LEGAL RECORDS; STORAGE SERVICES, NAMELY, LONG-TERM ARCHIVAL STORAGE OF PAPER AND ELECTRONIC DATA IN SECURE STORAGE ENVIRONMENTS; STORAGE OF ELECTRONIC MEDIA, NAMELY, IMAGES, TEXT AND AUDIO DATA, IN CLASS 39 (U.S. CLS. 100 AND 105).



FIRST USE 3-14-1988; IN COMMERCE 3-14-1988.

THE MARK CONSISTS OF STANDARD CHARACTERS WITHOUT CLAIM TO ANY PARTICULAR FONT, STYLE, SIZE, OR COLOR.

David J. Kyjars

SER. NO. 85-113,201, FILED 8-23-2010.

Reg. No. 4,152,500 DAVID I, EXAMINING ATTORNEY

United States of America

United States Patent and Trademark Office

MYCOLOGIX

Reg. No. 4,152,501

Registered June 5, 2012

**Int. Cls.: 1, 4, 7, 35, 40
and 42**

TRADEMARK

SERVICE MARK

PRINCIPAL REGISTER

MYCOLOGIX LIMITED (UNITED KINGDOM LIMITED LIABILITY COMPANY)
IMPERIAL COLLEGE, 12TH FLOOR
ELECTRICAL AND ELECTRONIC ENG. BLDG.
LONDON, UNITED KINGDOM SW72AZ

FOR: CHEMICALS USED IN INDUSTRY AND SCIENCE; PHOTOGRAPHIC CHEMICALS; CHEMICALS FOR USE IN AGRICULTURE, HORTICULTURE AND FORESTRY, EXCEPT FUNGICIDES, HERBICIDES, INSECTICIDES AND PARASITICIDES; UNPROCESSED ARTIFICIAL RESINS, UNPROCESSED PLASTICS; MANURES; WOOD PULP FOR MANUFACTURING PURPOSES; CHEMICAL ADDITIVES FOR USE IN THE MANUFACTURE OF FUEL; CHEMICAL FUEL ADDITIVES, DETERGENT ADDITIVES FOR FUEL, ADDITIVES FOR FUEL, CHEMICAL GASOLINE ADDITIVES; MICRO-BIOLOGICAL PREPARATIONS AND CULTURES OF MICRO-ORGANISMS OTHER THAN FOR MEDICAL AND VETERINARY USE, NAMELY, FUNGAL PREPARATIONS, BROWN ROT FUNGI, FUNGAL INOCULANTS ALL FOR THE TREATMENT OF BIOMASS IN ORDER TO PRODUCE BIOFUELS AND BIOCHEMICALS, IN CLASS 1 (U.S. CLS. 1, 5, 6, 10, 26 AND 46).

FOR: BIOFUELS, NAMELY, BIOETHANOL, BUTANOL, BIODIESEL, VEGETABLE OIL, BIOETHERS, BIOGAS, CELLULOSIC BIOFUELS, BIOHYDROGEN, BIOMETHANOL, WOOD DIESEL, LIGNOCELLULOSES, MYCO-DIESEL, BIOMASS ALL DERIVED FROM PLANT MATERIALS, INDUSTRIAL OILS AND GREASES; AUTOMOBILE LUBRICANTS; FUELS, NAMELY, MOTOR SPIRITS, FUEL ALCOHOL, FUEL GAS, MIXED ALCOHOL FUEL, MOTOR FUEL, WOOD ALCOHOL, IN CLASS 4 (U.S. CLS. 1, 6 AND 15).

FOR: MOTORS AND ENGINES EXCEPT FOR LAND VEHICLES; INDUSTRIAL AGRICULTURAL IMPLEMENTS OTHER THAN HAND OPERATED, NAMELY, EQUIPMENT FOR THE MANUFACTURE OF BIOREACTORS, NAMELY, VESSELS, REACTORS, AND CLOSED VESSEL-TYPE BIOREACTORS, FOR TREATMENT OF LIGNOCELLULOSIC MATERIALS REGARDING BIOMASS SUGARS, MODIFIED BIOMASS, AND BIOFUELS; INDUSTRIAL CHEMICAL REACTORS FOR THE TREATMENT OF LIGNOCELLULOSIC MATERIALS; INDUSTRIAL MECHANICAL PROCESSING EQUIPMENT, NAMELY, EQUIPMENT FOR HANDLING, COMMINATION, AND PROCESSING OF LIGNOCELLULOSIC MATERIALS, NAMELY, BIOREACTORS, NAMELY, CLOSED VESSEL-TYPE BIOREACTORS FOR THE TREATMENT OF BIOMASS IN ORDER TO PRODUCE BIOFUELS AND BIOCHEMICALS; PARTS AND FITTINGS FOR ALL THE AFORESAID GOODS, IN CLASS 7 (U.S. CLS. 13, 19, 21, 23, 31, 34 AND 35).



David J. Kyjars

Director of the United States Patent and Trademark Office

Reg. No. 4,152,501 FOR: ADVERTISING IN THE FIELD OF FUNGI; BUSINESS MANAGEMENT; BUSINESS ADMINISTRATION; OFFICE FUNCTIONS; LOGISTICS MANAGEMENT IN THE FIELD OF BIOMASS, BIOFUELS, FUNGI, FUNGI INOCULANT, IN CLASS 35 (U.S. CLS. 100, 101 AND 102).

FOR: TREATMENT OF WOOD AND OTHER MATERIALS, NAMELY, WASTE COTTON, CARDBOARD, AND BIOMASS, NAMELY, GRASSES, IN CLASS 40 (U.S. CLS. 100, 103 AND 106).

FOR: RESEARCH AND DEVELOPMENT IN THE FIELD OF MICROBIOLOGY, NAMELY, MYCOLOGY; RESEARCH AND DEVELOPMENT IN THE FIELD OF BIOFUEL PRODUCTION, MICROBIOLOGICAL TREATMENT OF MATERIALS AND COMPOSTING, SCIENTIFIC AND TECHNOLOGICAL SERVICES AND RESEARCH DESIGN RELATING TO BIOMASS, BIOFUELS, FUNGI, AND FUNGAL INOCULANT; INDUSTRIAL ANALYSIS AND RESEARCH SERVICES IN THE FIELD OF BIOMASS, BIOFUELS, FUNGI, FUNGI INOCULANT, IN CLASS 42 (U.S. CLS. 100 AND 101).

THE MARK CONSISTS OF STANDARD CHARACTERS WITHOUT CLAIM TO ANY PARTICULAR FONT, STYLE, SIZE, OR COLOR.

PRIORITY CLAIMED UNDER SEC. 44(D) ON ERPN CMNTY TM OFC APPLICATION NO. 009326711, FILED 8-20-2010, REG. NO. 009326711, DATED 2-3-2011, EXPIRES 8-20-2020.

SER. NO. 85-113,338, FILED 8-23-2010.

DEZMONA MIZELLE, EXAMINING ATTORNEY

United States of America

United States Patent and Trademark Office



Reg. No. 4,152,502

Registered June 5, 2012

Int. Cl.: 36

SERVICE MARK

PRINCIPAL REGISTER

THE CHANGE GROUP INTERNATIONAL PLC (UNITED KINGDOM PUBLIC LIMITED COMPANY (PLC))
42 UPPER BERKELEY STREET
LONDON W1H 5EP, UNITED KINGDOM

FOR: CURRENCY EXCHANGE SERVICES, IN CLASS 36 (U.S. CLS. 100, 101 AND 102).

FIRST USE 8-12-1996; IN COMMERCE 8-12-1996.

NO CLAIM IS MADE TO THE EXCLUSIVE RIGHT TO USE "GROUP", APART FROM THE MARK AS SHOWN.

THE MARK CONSISTS OF THE WORDS "THE CHANGE GROUP" DISPLAYED BETWEEN TWO HORIZONTAL LINES, OF DIFFERENT SIZES, BOTH ABOVE AND BELOW THE WORDING, ALL DISPLAYED AGAINST A STYLIZED GLOBE DESIGN.

SER. NO. 85-113,458, FILED 8-23-2010.

GEORGE LORENZO, EXAMINING ATTORNEY



David J. Kybas

Director of the United States Patent and Trademark Office

United States of America

United States Patent and Trademark Office

JAC-RACK

Reg. No. 4,152,503

Registered June 5, 2012

Int. Cls.: 6 and 9

TRADEMARK

PRINCIPAL REGISTER

JAC-RACK, INC. (DELAWARE CORPORATION)
3937 CAMPUS DRIVE
PONTIAC, MI 48341

FOR: METAL FRAME SYSTEMS COMPRISED PRIMARILY OF RAILS, BRACKETS, TUBING, AND BASES FOR MOUNTING PHOTOVOLTAIC SYSTEMS ON A SUPPORT SURFACE , IN CLASS 6 (U.S. CLS. 2, 12, 13, 14, 23, 25 AND 50).

FIRST USE 10-27-2009; IN COMMERCE 10-27-2009.

FOR: ELECTRICAL GROUNDING COMPONENTS FOR GROUNDING PHOTOVOLTAIC PANELS BEING SUPPORTED ON A METAL FRAME SYSTEM, NAMELY, GROUNDING RODS, CLAMPS, SPIKES AND CABLES, IN CLASS 9 (U.S. CLS. 21, 23, 26, 36 AND 38).

FIRST USE 10-27-2009; IN COMMERCE 10-27-2009.

THE MARK CONSISTS OF STANDARD CHARACTERS WITHOUT CLAIM TO ANY PARTICULAR FONT, STYLE, SIZE, OR COLOR.

SER. NO. 85-114,462, FILED 8-24-2010.

TINA L. SNAPP, EXAMINING ATTORNEY



David J. Kybas

Director of the United States Patent and Trademark Office

United States of America

United States Patent and Trademark Office



Reg. No. 4,152,504

Registered June 5, 2012

Int. Cl.: 35

SERVICE MARK

PRINCIPAL REGISTER

CITI TRENDS, INC. (GEORGIA CORPORATION)
104 COLEMAN BOULEVARD
POOLER, GA 31408

FOR: RETAIL DEPARTMENT STORES, IN CLASS 35 (U.S. CLS. 100, 101 AND 102).

FIRST USE 7-22-2010; IN COMMERCE 7-22-2010.

THE MARK CONSISTS OF THE LETTERS "CITI" IN ORANGE FOLLOWED BY THE LETTER "T" FORMED FROM WHITE DOTS FOLLOWED BY THE LETTERS "RENDS" IN WHITE TO FORM THE WORD "CITITRENDS" JUSTIFIED IN THE LOWER RIGHT CORNER OF A RECTANGULAR BLACK BACKGROUND.

THE COLOR(S) ORANGE, BLACK AND WHITE IS/ARE CLAIMED AS A FEATURE OF THE MARK.

SER. NO. 85-117,316, FILED 8-27-2010.

PAUL MORENO, EXAMINING ATTORNEY



David J. Kyffers

Director of the United States Patent and Trademark Office

United States of America

United States Patent and Trademark Office



Reg. No. 4,152,505

Registered June 5, 2012

Int. Cl.: 42

SERVICE MARK

PRINCIPAL REGISTER

COLORADO ENERGY MANAGEMENT, LLC (COLORADO LIMITED LIABILITY COMPANY)
2575 PARK LANE, SUITE 200
LAFAYETTE, CO 800263200

FOR: TECHNICAL CONSULTATION IN THE FIELD OF POWER PLANT TECHNOLOGY;
TECHNICAL PLANNING OF POWER PLANTS; DEVELOPMENT OF NEW POWER PLANT
TECHNOLOGIES , IN CLASS 42 (U.S. CLS. 100 AND 101).

FIRST USE 10-16-2009; IN COMMERCE 10-16-2009.

OWNER OF U.S. REG. NOS. 3,895,682 AND 3,895,683.

NO CLAIM IS MADE TO THE EXCLUSIVE RIGHT TO USE "COLORADO ENERGY", APART
FROM THE MARK AS SHOWN.

THE MARK CONSISTS OF THE STYLIZED LETTERS "C" AND "E" TO THE LEFT OF THE
STYLIZED WORDS "COLORADO ENERGY".

SER. NO. 85-117,587, FILED 8-27-2010.

MICHAEL LITZAU, EXAMINING ATTORNEY



David J. Kyffers

Director of the United States Patent and Trademark Office

United States of America

United States Patent and Trademark Office



HAIR PROSTHESIS
I N S T I T U T E

Reg. No. 4,152,506

Registered June 5, 2012

Int. Cl.: 44

SERVICE MARK

PRINCIPAL REGISTER

HAIR PROSTHESIS INSTITUTE (TENNESSEE SOLE PROPRIETORSHIP)
125 BELLE FOREST CIRCLE, SUITE 100
NASHVILLE, TN 37221

FOR: HAIR REPLACEMENT; MEDICAL SERVICES, NAMELY, CONSULTATION REGARDING HAIR LOSS AND HAIR REPLACEMENT, AND CUSTOMIZATION AND FITTING OF HAIR ADDITIONS AND HAIR PIECES, IN CLASS 44 (U.S. CLS. 100 AND 101).

FIRST USE 3-0-1995; IN COMMERCE 3-0-1995.

NO CLAIM IS MADE TO THE EXCLUSIVE RIGHT TO USE "HAIR PROSTHESIS INSTITUTE", APART FROM THE MARK AS SHOWN.

THE MARK CONSISTS OF THE LOWER-CASE LETTERS "hpi", WITH THE "p" REPRESENTED BY A LOCK OF HAIR, UNDER WHICH APPEAR THE CAPITALIZED WORDS "HAIR PROSTHESIS INSTITUTE" IN TWO LINES.

SER. NO. 85-119,104, FILED 8-30-2010.

RUSS HERMAN, EXAMINING ATTORNEY



David J. Kyffers

Director of the United States Patent and Trademark Office

United States of America

United States Patent and Trademark Office

G S T A A D

COME UP - SLOW DOWN

Reg. No. 4,152,507

GSTAAD SAANENLAND TOURISMUS (SWITZERLAND CORPORATION)
CHALET GSTAAD
GSTAAD, SWITZERLAND 3780

Registered June 5, 2012

**Int. Cls.: 3, 7, 9, 11, 12,
14, 16, 18, 20, 21, 22, 28,
29, 30, 33, 34, 35, 39, 41,
43 and 44**

FOR: HAIR BLEACHING PREPARATIONS; LAUNDRY BLEACH; BOOT POLISH; CHROME POLISH; SKIN CARE EXFOLIANTS; CLEANING, POLISHING, SCOURING, AND ABRASIVE PREPARATIONS; SOAPS, NAMELY, ANTI-BACTERIAL SOAP, DEODORANT SOAP, SKIN SOAP, MEDICATED SOAP, DETERGENT SOAP; PERFUME OILS; PERFUME; ESSENTIAL OILS FOR AROMATHERAPY USE; ESSENTIAL OILS FOR PERSONAL USE; COSMETICS, NAMELY, LIPSTICK, BLUSH, ROUGE, AND RELATED PRODUCTS, NAMELY, FACIAL POWDER, MASCARA, EYELINER, EYE SHADOW AND FACE FOUNDATION; COSMETIC PADS; HAIR LOTIONS AND DENTIFRICES, ALL OF THE ABOVE GOODS OF SWISS ORIGIN, IN CLASS 3 (U.S. CLS. 1, 4, 6, 50, 51 AND 52).

TRADEMARK

SERVICE MARK

PRINCIPAL REGISTER

FOR: ELECTRIC PARQUET FLOOR WAX-POLISHERS; VACUUM CLEANERS, AND ACCESSORIES, NAMELY, BRUSHES FOR VACUUM CLEANERS, HOSES FOR VACUUM CLEANERS AND SUCTION NOZZLES FOR VACUUM CLEANERS, AND REPLACEMENT PARTS THEREFOR; VACUUM CLEANER BAGS, ALL OF THE ABOVE GOODS OF SWISS ORIGIN, IN CLASS 7 (U.S. CLS. 13, 19, 21, 23, 31, 34 AND 35).

FOR: OPTICAL MIRRORS; ELECTRONIC, ELECTRIC AND ELECTRO TECHNIC APPARATUS, NAMELY, ELECTRIC FLAT IRONS, CASH REGISTERS, CALCULATORS AND COMPUTERS; SPECTACLES AND ACCESSORIES, NAMELY, EYEGGLASS CASES, EYEGGLASS CHAINS, EYEGGLASS FRAMES AND EYEGGLASS LENSES, AND REPLACEMENT PARTS THEREFOR; CALCULATING MACHINES; FIRE EXTINGUISHERS; LIFE SAVING AND TEACHING APPARATUS AND INSTRUMENTS, NAMELY, AVALANCHE DETECTORS, SAFETY ROPE SYSTEMS COMPRISED OF LANYARDS, HARNESSSES AND CONNECTORS, DETECTORS FOR SEARCHING FOR AVALANCHE VICTIMS AND DISTRESS CALL TRANSMITTERS, ALL OF THE ABOVE GOODS OF SWISS ORIGIN, IN CLASS 9 (U.S. CLS. 21, 23, 26, 36 AND 38).



FOR: ELECTRONIC APPARATUS, NAMELY, CLOTHES DRYERS; ELECTRIC KETTLES AND HOT WATER BOTTLES, ALL OF THE ABOVE GOODS OF SWISS ORIGIN, IN CLASS 11 (U.S. CLS. 13, 21, 23, 31 AND 34).

David J. Kappas

Director of the United States Patent and Trademark Office

Reg. No. 4,152,507 FOR: LAND VEHICLES, BOATS, SHIPS, RECREATIONAL MARINE VEHICLES, NAMELY, PERSONAL JET BOATS, AND GLIDER PLANES, ALL OF THE ABOVE GOODS OF SWISS ORIGIN, IN CLASS 12 (U.S. CLS. 19, 21, 23, 31, 35 AND 44).

FOR: JEWELRY, PRECIOUS GEMSTONES, WATCHES, CLOCKS, PRECIOUS METALS AND THEIR ALLOYS SOLD IN BULK; GOODS MADE OR COATED WITH PRECIOUS METALS, NAMELY, JEWELRY BOXES, WATCH BANDS, ALL OF THE ABOVE GOODS OF SWISS ORIGIN, IN CLASS 14 (U.S. CLS. 2, 27, 28 AND 50).

FOR: ADDING MACHINE PAPER, ART PAPER AND BUNTING PAPER; PRINTED PUBLICATIONS AND MATERIALS, NAMELY, TOURISM RELATED BOOKS AND NEWSLETTERS, AND SPORTS RELATED BOOKS; BOOKBINDING MATERIALS, NAMELY, TAPE, WIRE AND CLOTH; PHOTOGRAPHS, NAMELY, MOUNTED AND UNMOUNTED PHOTOGRAPHS; MAGAZINES IN THE FIELD OF TOURISM, SPORTS MAGAZINES, AND MUSIC MAGAZINES, NEWSPAPERS, POSTERS, STATIONERY; ADHESIVES FOR STATIONERY OR HOUSEHOLD PURPOSES; PRINTED INSTRUCTIONAL, TEACHING AND EDUCATIONAL MATERIALS, NAMELY, BOOKS ABOUT MUSIC, SPORTS AND TOURISM, PAMPHLETS AND NEWSLETTERS IN THE FIELDS OF TOURISM, MUSIC AND LITERATURE; PRINTING BLOCKS, ALL OF THE ABOVE GOODS OF SWISS ORIGIN, IN CLASS 16 (U.S. CLS. 2, 5, 22, 23, 29, 37, 38 AND 50).

FOR: LUGGAGE, TRUNKS, TRAVELING BAGS, UMBRELLAS, PARASOLS, WALKING STICKS, WHIPS, HARNESS STRAPS AND SADDLERY; PURSES MADE OR COATED WITH PRECIOUS METALS, ALL OF THE ABOVE GOODS OF SWISS ORIGIN, IN CLASS 18 (U.S. CLS. 1, 2, 3, 22 AND 41).

FOR: FURNITURE; HAND-HELD AND FURNITURE MIRRORS; PICTURE FRAMES; GOODS OF WOOD, CORK, REED, CANE, WICKER, HORN, BONE, IVORY, SHELL, AMBER, MOTHER-OF-PEARL, MEERSCHAUM, AND SUBSTITUTES FOR ALL OF THESE MATERIALS, NAMELY, BARRELS, BINS, BOXES, MAGAZINE RACKS AND TEA TROLLEYS; PLASTIC PICTURE FRAMES; BRACKETS AND MOLDINGS FOR PICTURE FRAMES, CURTAIN RODS, COAT HANGERS, COAT HOOKS AND CURTAIN HOOKS; NON-METAL GARDEN STAKES FOR PLANTS AND TREES, ALL OF THE ABOVE GOODS OF SWISS ORIGIN, IN CLASS 20 (U.S. CLS. 2, 13, 22, 25, 32 AND 50).

FOR: NON-ELECTRIC CANDELABRAS AND COFFEE SERVICES CONSISTING OF COFFEE POT, CUPS AND SAUCERS, AND TRAYS MADE OF OR COATED WITH PRECIOUS METALS, ALL OF THE ABOVE GOODS OF SWISS ORIGIN, IN CLASS 21 (U.S. CLS. 2, 13, 23, 29, 30, 33, 40 AND 50).

FOR: STORAGE BAGS MADE OF NYLON OR CANVAS FOR VACUUM CLEANER ACCESSORIES, ALL OF THE ABOVE GOODS OF SWISS ORIGIN, IN CLASS 22 (U.S. CLS. 1, 2, 7, 19, 22, 42 AND 50).

FOR: GAMES, NAMELY, PLAYING CARDS, JIGSAW PUZZLES AND INDOOR FOOTBALL GAMES; PLAYTHINGS, NAMELY, RATTLES, DOLLS, TOY VEHICLES, PUPPETS AND PLUSH TOYS; GYMNAS TIC AND SPORTING ARTICLES, NAMELY, KNEE GUARDS, TABLES FOR TABLE TENNIS, SHIN GUARDS FOR ATHLETIC USE, SCRAPERS FOR SKIS, RODS FOR FISHING AND ICE SKATES; BALLS, NAMELY, SOCCER BALLS, TENNIS BALLS, GOLF BALLS, SQUASH BALLS AND PLAYING BALLS; TENNIS AND SQUASH RACKETS, TENNIS NETS, ICE SKATES AND OTHER TYPES OF SKATES, NAMELY, IN-LINE SKATES, ROLLER SKATES, SKIS, SKI BINDINGS, SKI STICKS, SNOW BOARDS AND GOLF TEES; CRAZY GOLF BALLS AND CRAZY GOLF CLUBS, ALL OF THE ABOVE GOODS OF SWISS ORIGIN, IN CLASS 28 (U.S. CLS. 22, 23, 38 AND 50).

FOR: MEAT, DRY MEAT, FISH, POULTRY AND GAME; MEAT EXTRACTS; SAUSAGES; PRESERVED, DRIED AND COOKED FRUITS AND VEGETABLES; JELLIES; JAMS; EGGS; MILK; DAIRY PRODUCTS, EXCLUDING ICE CREAM, ICE MILK AND FROZEN YOGURT;

Reg. No. 4,152,507 EDIBLE OILS AND FATS, ALL OF THE ABOVE GOODS OF SWISS ORIGIN, IN CLASS 29 (U.S. CL. 46).

FOR: SALAD DRESSING; PREPARED MILK PRODUCTS, NAMELY, ICE MILK, MILK SHAKES AND BASES FOR MAKING MILK SHAKES; COFFEE; TEA; COCOA; SUGAR; RICE; TAPIOCA; SAGO; FLOUR; HONEY; MAPLE AND PANCAKE SYRUP; YEAST; BAKING POWDER; SALT; MUSTARD; VINEGAR; SAUCES; SPICES AND ICE CREAM, ALL OF THE ABOVE GOODS OF SWISS ORIGIN, IN CLASS 30 (U.S. CL. 46).

FOR: ALCOHOLIC BEVERAGES, NAMELY, SPARKLING WINES, LIQUEURS, BITTERS AND BRANDIES, ALL OF THE ABOVE GOODS OF SWISS ORIGIN, IN CLASS 33 (U.S. CLS. 47 AND 49).

FOR: TOBACCO; SMOKERS' ARTICLES, NAMELY, CIGARS, CIGARETTES, AND ACCESSORIES, NAMELY, NON-ELECTRIC LIGHTERS AND CIGARETTE CASES NOT OF PRECIOUS METAL; MATCHES; ELECTRIC CIGAR AND CIGARETTE LIGHTERS; CIGAR BOXES, AND MATCH BOXES MADE OF OR COATED WITH PRECIOUS METALS, ALL OF THE ABOVE GOODS OF SWISS ORIGIN, IN CLASS 34 (U.S. CLS. 2, 8, 9 AND 17).

FOR: ADVERTISING AGENCY SERVICES; BUSINESS MANAGEMENT; BUSINESS ADMINISTRATION SERVICES; PROVIDING OFFICE FUNCTIONS, NAMELY, PROVIDING OFFICE PERSONNEL; ORGANIZING MEETINGS, CONVENTIONS, JOB FAIRS AND CONGRESSES; PROVIDING FOREIGN TRADE INFORMATION; OPERATING CONCESSIONS STANDS FEATURING FOOD AND BEVERAGES, IN CLASS 35 (U.S. CLS. 100, 101 AND 102).

FOR: TRAVEL INFORMATION SERVICES; ORGANIZING CULTURAL BACKGROUND RELATED DAY TRIPS, IN CLASS 39 (U.S. CLS. 100 AND 105).

FOR: TRAINING REGARDING MUSIC AND SPORTS PROVIDED ONSITE AND REMOTE; EDUCATIONAL SERVICES, NAMELY, PROVIDING CLASSES, WORKSHOPS, LECTURES AND SEMINARS IN THE FIELD OF MUSIC, SPORTS AND LITERATURE; ENTERTAINMENT SERVICES, NAMELY, PROVIDING MUSICAL CONCERTS, PIANO COMPETITIONS, CONDUCTING ART EXHIBITS AND SPORTS TOURNAMENTS; ORGANIZING FESTIVALS AND SPORTING, MUSICAL AND CULTURAL EVENTS, ART EXHIBITIONS; PARTY PLANNING CONSULTATION, IN CLASS 41 (U.S. CLS. 100, 101 AND 107).

FOR: TRAVEL AGENCY SERVICES, NAMELY, MAKING RESERVATIONS AND BOOKING FOR TEMPORARY LODGING; PROVIDING TEMPORARY HOUSING ACCOMMODATIONS; RESTAURANT SERVICES; TRAVEL AGENCY SERVICES, NAMELY, FOR THE RESERVATION OF TEMPORARY ACCOMMODATION; PROVIDING TEMPORARY HOUSING ACCOMMODATIONS, IN CLASS 43 (U.S. CLS. 100 AND 101).

FOR: MEDICAL CLINICS; BEAUTY SALONS, IN CLASS 44 (U.S. CLS. 100 AND 101).

OWNER OF SWITZERLAND REG. NO. 469475, DATED 2-11-2000, EXPIRES 11-12-2019.

OWNER OF U.S. REG. NO. 3,578,306.

THE MARK CONSISTS OF THE TERM "GSTAAD" ABOVE A LINE SEPARATED IN THE MIDDLE BY A FANCIFUL DEPICTION OF A STAR WITH A CROSS IN THE MIDDLE, ABOVE THE WORDS "COME UP-SLOW DOWN".

SEC. 2(F) AS TO "GSTAAD".

SER. NO. 85-121,656, FILED 9-2-2010.

THEODORE MCBRIDE, EXAMINING ATTORNEY

United States of America

United States Patent and Trademark Office

Global Animal

Reg. No. 4,152,508

Registered June 5, 2012

Int. Cl.: 38

SERVICE MARK

PRINCIPAL REGISTER

JEON, ARTHUR (UNITED STATES INDIVIDUAL)
1431 7TH STREET, SUITE 301
SANTA MONICA, CA 90401

FOR: PROVIDING MULTIPLE-USER ACCESS TO DATA ON THE INTERNET IN THE FIELD OF ANIMALS; ELECTRONIC TRANSMISSION OF DATA, IMAGES, DOCUMENTS, MESSAGES, AND SOUND CONCERNING TOPICS RELATING TO WILDLIFE, PETS, PET CARE, ECOLOGY, TRAVEL, ANIMAL AND NATURE PHOTOGRAPHY AND VIDEOS, CHARITABLE DONATIONS FOR THE BENEFIT OF WILDLIFE AND CONSERVATION, OCEANOGRAPHY, GLOBAL WARMING, VEGETARIANISM, FARMING, RANCHING, ZOOLOGY, BIOLOGY, HUNTING, AND CONVERSATION ACTIVISM VIA COMPUTER NETWORKS; PROVIDING ONLINE ELECTRONIC BULLETIN BOARDS AND CHAT ROOMS FOR TRANSMISSION OF MESSAGES AMONG COMPUTER USERS CONCERNING TOPICS OF GENERAL INTEREST; ELECTRONIC MAIL SERVICES; PROVIDING ONLINE COMPUTER NETWORK FACILITIES FOR REAL TIME INTERACTION AND COMMUNICATION WITH OTHER COMPUTER USERS CONCERNING TOPICS OF GENERAL INTEREST, IN CLASS 38 (U.S. CLS. 100, 101 AND 104).

FIRST USE 6-1-2010; IN COMMERCE 6-1-2010.

THE MARK CONSISTS OF STANDARD CHARACTERS WITHOUT CLAIM TO ANY PARTICULAR FONT, STYLE, SIZE, OR COLOR.

SER. NO. 85-122,301, FILED 9-2-2010.

ANNE E. GUSTASON, EXAMINING ATTORNEY



David J. Kyros

Director of the United States Patent and Trademark Office

United States of America

United States Patent and Trademark Office

AngelSounds

Reg. No. 4,152,509

Registered June 5, 2012

Int. Cl.: 10

TRADEMARK

PRINCIPAL REGISTER

SHENZHEN JUMPER MEDICAL EQUIPMENT CO., LTD. (CHINA LIMITED LIABILITY COMPANY)
6/F, NO. 6 BLDG., NANSHUI IND. VILLAGE
SHENZHEN, CHINA

FOR: STETHOSCOPES; HEARING AIDS FOR THE DEAF; EAR TRUMPETS, NAMELY, CONICAL ACOUSTIC HEARING AIDS; OBSTETRIC APPARATUS, NAMELY, OBSTETRIC APPARATUS FOR CATTLE; PROBES FOR MEDICAL PURPOSES; DIAGNOSTIC APPARATUS FOR MEDICAL PURPOSES, NAMELY, FLOW CYTOMETERS FOR MEDICAL DIAGNOSTIC USES, MEDICAL DIAGNOSTIC INSTRUMENTS FOR THE ANALYSIS OF BODY FLUIDS, ULTRASONIC MEDICAL DIAGNOSTIC APPARATUS; MEDICAL TREATMENT ULTRASONIC INSTRUMENT AND PARTS, NAMELY, MEDICAL ULTRASOUND APPARATUS, ULTRASONIC DIAGNOSTIC APPARATUS, ULTRASOUND PROBE FOR MEDICAL USE; MEDICAL APPARATUS AND INSTRUMENTS, NAMELY, MEDICAL ULTRASOUND APPARATUS, BLOOD PRESSURE MONITORS, CARDIAC PROBES; ULTRASONIC FETAL PULSE DETECTOR, IN CLASS 10 (U.S. CLS. 26, 39 AND 44).

FIRST USE 8-31-2000; IN COMMERCE 11-30-2000.

THE MARK CONSISTS OF STANDARD CHARACTERS WITHOUT CLAIM TO ANY PARTICULAR FONT, STYLE, SIZE, OR COLOR.

SER. NO. 85-122,411, FILED 9-3-2010.

TINA BROWN, EXAMINING ATTORNEY



David J. Kyros

Director of the United States Patent and Trademark Office

United States of America

United States Patent and Trademark Office



Reg. No. 4,152,510

Registered June 5, 2012

Int. Cl.: 9

TRADEMARK

PRINCIPAL REGISTER

DESIGN POOL LIMITED (HONG KONG LIMITED LIABILITY COMPANY)
ROOM 1105, 11/F, YU YUET LAI BUILDING
43-55 WYNDHAM STREET
CENTRAL, HONG KONG

FOR: MEMORY CARDS; BLANK SMART CARDS; MAGNETICALLY ENCODED PRE-PAID TELEPHONE CARDS; MAGNETICALLY ENCODED TELEPHONE CREDIT CARDS; DIGITAL MUSIC DOWNLOADABLE FROM A COMPUTER DATABASE OR THE INTERNET; DIGITAL MUSIC DOWNLOADABLE FROM AN MP3 INTERNET WEBSITES; DEVICES FOR PLAYING MUSIC RECEIVED FROM THE INTERNET, NAMELY, DIGITAL AUDIO PLAYERS; MP3 PLAYERS; EQUIPMENT FOR FIXED, TRANSPORTABLE, MOBILE, HANDS-FREE OR VOICE-ACTIVATED TELEPHONES, NAMELY, TELEPHONE SETS, MAGNETIC TELEPHONE WIRES, TELEPHONE TRANSMITTERS, MODEMS, INTERCOMS, TELEPHONE ANSWERING MACHINES, DOOR VIDEO-INTERPHONES, COMMUTATORS, MOBILE PHONE SHELLS, MOBILE PHONE HEADSETS, MOBILE HANDSETS, MOBILE PHONE CHARGERS, MOBILE PHONE BATTERIES, MOBILE PHONE MEMORY CARDS, AND MOBILE PHONE COVERS; MULTIMEDIA TERMINALS; RADIO-TELEPHONES; TELEPHONES, MOBILE TELEPHONES AND TELEPHONE HANDSETS; MOBILE PHONE HANDSETS; ACCESSORIES FOR TELEPHONES AND TELEPHONE HANDSETS, NAMELY, HANDS-FREE KITS, CLIP-ON FASCIAS, EARPIECES, BELT CLIPS, LAPEL MICROPHONES, MICROPHONES, MICROPHONE MOUNTING BRACKETS, HEADSETS, HEADPHONES, ADAPTERS, SPEAKERS, LOUD-SPEAKERS, SPEAKER PHONES, HOLDERS, DATA CABLES, PORTABLE FLASH DRIVES AND COMPUTER MEMORY DRIVES, HOUSINGS AND COVERS, CASES AND BAGS SPECIALLY ADAPTED FOR HOLDING AND CARRYING TELEPHONES AND MOBILE TELEPHONES, TELEPHONE ACCESSORIES, PORTABLE HANDHELD COMPUTERS, COMPUTERS, VIDEO APPARATUS, CABLE TIDIES, CHARGING CABLES, CHARGERS, CHARGING UNITS, BATTERY CHARGING DEVICES; ADAPTERS FOR USE WITH TELEPHONES; BATTERY CHARGERS FOR USE WITH TELEPHONES; DESK OR CAR MOUNTED UNITS INCORPORATING A LOUDSPEAKER TO ALLOW A TELEPHONE HANDSET TO BE USED HANDS-FREE; IN-CAR TELEPHONE HANDSET CRADLES; BAGS AND CASES SPECIALLY ADAPTED FOR HOLDING OR CARRYING PORTABLE TELEPHONES AND TELEPHONE EQUIPMENT AND ACCESSORIES; BATTERIES FOR MOBILE PHONES; USB ADAPTORS; ELECTRONIC DOCKING STATIONS FOR DIGITAL MUSIC PLAYERS; ELECTRONIC DOCKING STATIONS FOR MOBILE PHONES; ELECTRONIC DOCKING STATIONS FOR MULTIMEDIA EQUIPMENT; MODEMS; LIQUID CRYSTAL DISPLAY SCREENS FOR TELEPHONES; APPARATUS FOR RECORDING, TRANSMISSION, AMPLIFYING OR REPRODUCTION OF SOUND, IMAGES, INFORMATION AND ENCODED DATA;



David J. Kyros

Director of the United States Patent and Trademark Office

Reg. No. 4,152,510 COMPUTERS; PERIPHERAL EQUIPMENT FOR COMPUTERS; DATA CARDS FOR STORING INFORMATION ON MOBILE TELEPHONES, PORTABLE HANDHELD COMPUTER, COMPUTERS, VIDEO APPARATUS AND ELECTRONIC DEVICES; ELECTRIC WIRES AND CABLES; TERMINALS FOR TELEPHONE NETWORKS, NAMELY, TELEPHONE TERMINALS; TELEPHONE SWITCHBOARDS; TELEPHONE EQUIPMENT, NAMELY, TELEPHONE SETS, MAGNETIC TELEPHONE WIRES, TELEPHONE TRANSMITTERS, MODEMS, INTERCOMS, TELEPHONE ANSWERING MACHINES, DOOR VIDEO-INTERPHONES, COMMUTATORS, MOBILE PHONE SHELLS, MOBILE PHONE HEADSETS, MOBILE HANDSETS, MOBILE PHONE CHARGERS, MOBILE PHONE BATTERIES, MOBILE PHONE MEMORY CARDS, AND MOBILE PHONE COVERS; FACSIMILE MACHINES; COMPUTERIZED PERSONAL ORGANIZERS; AERIALS; BATTERIES; MICRO PROCESSORS; KEY BOARDS; CALCULATORS; AND FLAT PANEL DISPLAY SCREENS, IN CLASS 9 (U.S. CLS. 21, 23, 26, 36 AND 38).

PRIORITY CLAIMED UNDER SEC. 44(D) ON UNITED KINGDOM APPLICATION NO. 2546910, FILED 5-6-2010.

OWNER OF HONG KONG REG. NO. 301690326, DATED 8-16-2010, EXPIRES 8-16-2020.

THE MARK CONSISTS OF A SQUARE DISPOSED AT AN ANGLE WITHIN ANOTHER SQUARE AND CONTAINING THE TERMS "NATIVE UNION" AND TWO STICK FIGURE DESIGNS.

SER. NO. 85-122,578, FILED 9-3-2010.

JEFFERY COWARD, EXAMINING ATTORNEY

United States of America

United States Patent and Trademark Office



CENTER FOR A
SECURE RETIREMENT

Reg. No. 4,152,511

Registered June 5, 2012

Int. Cl.: 36

SERVICE MARK

PRINCIPAL REGISTER

BANKERS LIFE AND CASUALTY COMPANY (ILLINOIS CORPORATION)
600 WEST CHICAGO AVENUE
CHICAGO, IL 60654

FOR: PROVIDING INFORMATION AND RESEARCH ON INSURANCE; PROVIDING INFORMATION AND FINANCIAL RESEARCH ON THE FINANCIAL ASPECTS OF RETIREMENT; FINANCIAL RESEARCH AND INFORMATION SERVICES; PROVIDING FINANCIAL INFORMATION AND FINANCIAL RESEARCH ABOUT EMPLOYER PROVIDED BENEFITS AND GOVERNMENTAL BENEFITS, IN CLASS 36 (U.S. CLS. 100, 101 AND 102).

FIRST USE 12-22-2010; IN COMMERCE 12-22-2010.

NO CLAIM IS MADE TO THE EXCLUSIVE RIGHT TO USE "CENTER FOR A SECURE RETIREMENT", APART FROM THE MARK AS SHOWN.

THE MARK CONSISTS OF A STYLIZED LETTER "C" INSIDE OF A SQUARE FOLLOWED BY THE WORDS "CENTER FOR A SECURE RETIREMENT" IN STACKED FORMAT.

SER. NO. 85-122,847, FILED 9-3-2010.

APRIL HESIK, EXAMINING ATTORNEY



David J. Kybas

Director of the United States Patent and Trademark Office

United States of America

United States Patent and Trademark Office

ATOMIC

Reg. No. 4,152,512

Registered June 5, 2012

Int. Cl.: 30

TRADEMARK

PRINCIPAL REGISTER

FERRARA PAN CANDY CO., INC. (ILLINOIS CORPORATION)
7301 WEST HARRISON STREET
FOREST PARK, IL 60130

FOR: CANDY, IN CLASS 30 (U.S. CL. 46).

FIRST USE 4-30-1968; IN COMMERCE 4-30-1968.

THE MARK CONSISTS OF STANDARD CHARACTERS WITHOUT CLAIM TO ANY PARTICULAR FONT, STYLE, SIZE, OR COLOR.

OWNER OF U.S. REG. NOS. 1,316,009, 3,631,230 AND OTHERS.

SER. NO. 85-125,636, FILED 9-9-2010.

JERI J. FICKES, EXAMINING ATTORNEY



David J. Kybas

Director of the United States Patent and Trademark Office

United States of America

United States Patent and Trademark Office



Reg. No. 4,152,513

Registered June 5, 2012

Int. Cl.: 25

TRADEMARK

PRINCIPAL REGISTER

FLASH & PARTNERS S.P.A. (ITALY CORPORATION)
VIA TIEPOLO, 6
TOMBOLO (PADOVA), ITALY 35019

FOR: CLOTHING, NAMELY, SKIRTS, DRESSES, TROUSERS, JEANS, JACKETS, SHIRTS, HOSIERY, OVERCOATS, RAINCOATS, COATS, VESTS, BANDANAS, SWEATERS, T-SHIRTS, GLOVES, BELTS, NECKTIES, SCARVES, NECKERCHIEFS, AND FOULARDS; CLOTHING OF LEATHER, NAMELY, JACKETS, TROUSERS, OVERCOATS, WAISTCOATS, SKIRTS, SHIRTS, BELTS, AND GLOVES; FOOTWEAR; AND HEADWEAR, IN CLASS 25 (U.S. CLS. 22 AND 39).

OWNER OF ERPN CMNTY TM OFC REG. NO. 1844240, DATED 4-12-2002, EXPIRES 8-18-2020.

THE COLOR(S) BLACK AND RED IS/ARE CLAIMED AS A FEATURE OF THE MARK.

OWNER OF U.S. REG. NOS. 2,951,878, 2,981,226, AND 3,256,680.

NO CLAIM IS MADE TO THE EXCLUSIVE RIGHT TO USE "RECYCLE", APART FROM THE MARK AS SHOWN.

THE MARK CONSISTS OF THE WORDS "RAG RECYCLE" ABOVE THE WORD "RA---RE" AND, BENEATH THAT, THE INVERTED WORDS "RAG RESTYLE" AND "RA---RE", ALL IN BLACK LETTERING, WITH A VERTICALLY ORIENTED RED STRIPE BEGINNING ABOVE AND EXTENDING BELOW THE WORDING.

SER. NO. 85-125,974, FILED 9-9-2010.

CYNTHIA TRIPI, EXAMINING ATTORNEY



David J. Kybas

Director of the United States Patent and Trademark Office

United States of America

United States Patent and Trademark Office



Reg. No. 4,152,514

Registered June 5, 2012

Int. Cl.: 42

SERVICE MARK

PRINCIPAL REGISTER

ARACELI SOLIS RABAGO (MEXICO INDIVIDUAL)
MASCARONES ST. 1971 JARDINES DEL COUNTRY
GUADALAJARA, MEXICO 44210

FOR: TECHNICAL CONSULTANCY IN RELATION TO THE TECHNICAL RESEARCH IN THE FIELD OF FOOD AND BEVERAGES, IN CLASS 42 (U.S. CLS. 100 AND 101).

FIRST USE 1-22-1991; IN COMMERCE 8-30-2006.

OWNER OF MEXICO REG. NO. 953024, DATED 9-19-2006, EXPIRES 6-29-2016.

OWNER OF MEXICO REG. NO. 951022, DATED 8-30-2006, EXPIRES 6-29-2016.

THE MARK CONSISTS OF THE DEPICTION OF A FILTER USED IN THE ALCOHOLIC BEVERAGES INDUSTRY. BELOW IT, THE "PEFIL" WORD, TWO ARROWS BETWEEN THE FILTER DEPICTION AND THE WORDING, THE LEFT ARROW POINTING DOWN AND THE RIGHT ARROW POINTING UP.

THE WORDING "PEFIL" HAS NO MEANING IN A FOREIGN LANGUAGE.

SER. NO. 85-126,799, FILED 9-10-2010.

ADA HAN, EXAMINING ATTORNEY



David J. Kybas

Director of the United States Patent and Trademark Office

United States of America

United States Patent and Trademark Office



Reg. No. 4,152,515

Registered June 5, 2012

Int. Cl.: 25

TRADEMARK

PRINCIPAL REGISTER

SHALOND ESSIX (UNITED STATES INDIVIDUAL), DBA CAPSTONE CLOTHING COMPANY
7575 JEFFERSON HIGHWAY, SUITE 194
BATON ROUGE, LA 70806

FOR: SPORTSWEAR, NAMELY, POLO SHIRTS, T-SHIRTS, TANK TOPS, SWEATERS, DRESSES, JACKETS, BLAZERS, SKIRTS, BLOUSES, SHORTS AND SOCKS; ATHLETIC APPAREL, NAMELY, SHIRTS, PANTS, JACKETS, SWEATSHIRTS, SWEAT PANTS, SHORTS, LEGGINGS, TANK TOPS, HATS AND CAPS; T-SHIRTS, HOODED SWEATSHIRTS, BATHING SUITS, SWIM SUITS, SARONGS, SLIPPERS, LINGERIE, UNDERGARMENTS, BELTS, FOOTWEAR, HEADBANDS, MITTENS, GLOVES, SLEEPWEAR, SCARVES, HATS AND CAPS; CLOTHING AND CLOTHING ACCESSORIES FOR WOMEN, IN CLASS 25 (U.S. CLS. 22 AND 39).

FIRST USE 4-24-2010; IN COMMERCE 7-10-2010.

THE MARK CONSISTS OF THE PROFILE OF AN ELEPHANT IN A PINK AND WHITE HOUNDSTOOTH PATTERN WITH ITS TRUNK, TUSKS AND TAIL LIFTED UP. THE MARK IS OUTLINED IN BLACK TO SHOW THE OUTLINE OF THE MARK, BUT THE LINE IS NOT PART OF THE MARK.

THE COLOR(S) PINK AND WHITE IS/ARE CLAIMED AS A FEATURE OF THE MARK.

SER. NO. 85-127,620, FILED 9-12-2010.

LINDA POWELL, EXAMINING ATTORNEY



David J. Kyjars

Director of the United States Patent and Trademark Office

United States of America

United States Patent and Trademark Office

Boxcar Candle Company, LLC

Reg. No. 4,152,516

Registered June 5, 2012

Int. Cl.: 4

TRADEMARK

PRINCIPAL REGISTER

BOXCAR CANDLE COMPANY, LLC (WISCONSIN LIMITED LIABILITY COMPANY)
STE 251
5760 S 108TH ST
HALES CORNERS, WI 53130

FOR: CANDLES; CANDLES BEING OF WAX OR LIQUID, FOR THE ILLUMINATION OF CARVED PUMPKINS, MINI-PUMPKINS, GOURDS, AND OTHER FRUITS AND VEGETABLES; CANDLES FOR LIGHTING; PERFUMED CANDLES; SCENTED CANDLES; TEA LIGHT CANDLES; WICKS FOR CANDLES FOR LIGHTING, IN CLASS 4 (U.S. CLS. 1, 6 AND 15).

FIRST USE 5-18-2010; IN COMMERCE 5-18-2010.

THE MARK CONSISTS OF STANDARD CHARACTERS WITHOUT CLAIM TO ANY PARTICULAR FONT, STYLE, SIZE, OR COLOR.

NO CLAIM IS MADE TO THE EXCLUSIVE RIGHT TO USE "CANDLE COMPANY, LLC", APART FROM THE MARK AS SHOWN.

SER. NO. 85-128,381, FILED 9-13-2010.

ANGELA DUONG, EXAMINING ATTORNEY



David J. Kyffers

Director of the United States Patent and Trademark Office

United States of America

United States Patent and Trademark Office

IGREASE

Reg. No. 4,152,517

Registered June 5, 2012

Int. Cls.: 1, 4 and 40

TRADEMARK

SERVICE MARK

PRINCIPAL REGISTER

RHEIN CHEMIE RHEINAU GMBH (FED REP GERMANY GESELLSCHAFT MIT
BESCHRÄNKTER HAFTUNG (GMBH))
68219
MANNHEIM, FED REP GERMANY

FOR: CHEMICAL ADDITIVES FOR USE IN THE PRODUCTION OF LUBRICANTS AND
GREASES, IN CLASS 1 (U.S. CLS. 1, 5, 6, 10, 26 AND 46).

FOR: TECHNICAL OILS AND GREASES, LUBRICANTS, NAMELY, LUBRICATING OILS
AND GREASES, IN CLASS 4 (U.S. CLS. 1, 6 AND 15).

FOR: TECHNICAL ADVICE IN CONNECTION WITH THE PRODUCTION AND MANUFAC-
TURING OF GREASES AND LUBRICANTS, IN CLASS 40 (U.S. CLS. 100, 103 AND 106).

THE MARK CONSISTS OF STANDARD CHARACTERS WITHOUT CLAIM TO ANY PAR-
TICULAR FONT, STYLE, SIZE, OR COLOR.

PRIORITY CLAIMED UNDER SEC. 44(D) ON FED REP GERMANY APPLICATION NO.
302010041549, FILED 7-13-2010, REG. NO. 302010041549, DATED 8-6-2010, EXPIRES 7-31-
2020.

SER. NO. 85-129,561, FILED 9-14-2010.

JACQUELINE A. LAVINE, EXAMINING ATTORNEY

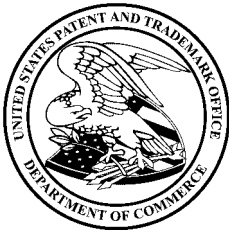

David J. Kyros

Director of the United States Patent and Trademark Office

United States of America

United States Patent and Trademark Office

iGREASE

Reg. No. 4,152,518

Registered June 5, 2012

Int. Cls.: 1, 4 and 40

TRADEMARK

SERVICE MARK

PRINCIPAL REGISTER

RHEIN CHEMIE RHEINAU GMBH (FED REP GERMANY GESELLSCHAFT MIT
BESCHRÄNKTER HAFTUNG (GMBH))
68219
MANNHEIM, FED REP GERMANY

FOR: CHEMICAL ADDITIVES FOR USE IN THE PRODUCTION OF LUBRICANTS AND
GREASES, IN CLASS 1 (U.S. CLS. 1, 5, 6, 10, 26 AND 46).

FOR: TECHNICAL OILS AND GREASES, LUBRICANTS, NAMELY, LUBRICATING OILS
AND GREASES, IN CLASS 4 (U.S. CLS. 1, 6 AND 15).

FOR: TECHNICAL ADVICE IN CONNECTION WITH THE PRODUCTION AND MANUFAC-
TURING OF GREASES AND LUBRICANTS, IN CLASS 40 (U.S. CLS. 100, 103 AND 106).

PRIORITY CLAIMED UNDER SEC. 44(D) ON FED REP GERMANY APPLICATION NO.
302010041550, FILED 7-13-2010, REG. NO. 302010041550, DATED 8-6-2010, EXPIRES 7-31-
2020.

THE MARK CONSISTS OF A STYLIZED VERSION OF THE TERM "IGREASE".

SER. NO. 85-129,597, FILED 9-14-2010.

JACQUELINE A. LAVINE, EXAMINING ATTORNEY



David J. Kybas

Director of the United States Patent and Trademark Office

United States of America

United States Patent and Trademark Office

TRAVELER OVERSEAS

Reg. No. 4,152,519

Registered June 5, 2012

Int. Cl.: 39

SERVICE MARK

PRINCIPAL REGISTER

TRAVELER OVERSEAS MAGAZINE, L.L.C. (TEXAS LIMITED LIABILITY COMPANY)
SUITE 130
3100 MONTICELLO
DALLAS, TX 75205

FOR: PROVIDING A WEBSITE FEATURING INFORMATION ON TRAVEL, IN CLASS 39
(U.S. CLS. 100 AND 105).

FIRST USE 12-0-2003; IN COMMERCE 12-0-2003.

THE MARK CONSISTS OF STANDARD CHARACTERS WITHOUT CLAIM TO ANY PARTICULAR FONT, STYLE, SIZE, OR COLOR.

OWNER OF U.S. REG. NO. 2,885,384.

SEC. 2(F).

SER. NO. 85-130,342, FILED 9-15-2010.

MICHAEL WEBSTER, EXAMINING ATTORNEY



David J. Kybas

Director of the United States Patent and Trademark Office

United States of America

United States Patent and Trademark Office

HIGH RIVER ANGUS

Reg. No. 4,152,520

Registered June 5, 2012

Int. Cl.: 29

TRADEMARK

PRINCIPAL REGISTER

COLORADO BOXED BEEF CO. (FLORIDA CORPORATION)
302 PROGRESS RD.
AUBURNDALE, FL 33823

FOR: ANGUS BEEF, IN CLASS 29 (U.S. CL. 46).

FIRST USE 7-17-2010; IN COMMERCE 7-17-2010.

THE MARK CONSISTS OF STANDARD CHARACTERS WITHOUT CLAIM TO ANY PARTICULAR FONT, STYLE, SIZE, OR COLOR.

NO CLAIM IS MADE TO THE EXCLUSIVE RIGHT TO USE "ANGUS", APART FROM THE MARK AS SHOWN.

SER. NO. 85-131,439, FILED 9-16-2010.

GEORGE LORENZO, EXAMINING ATTORNEY



David J. Kyros

Director of the United States Patent and Trademark Office

United States of America

United States Patent and Trademark Office

SKY

Reg. No. 4,152,521

Registered June 5, 2012

Int. Cls.: 41 and 42

SERVICE MARK

PRINCIPAL REGISTER

THE LEARNING INTERNET, INC. (OREGON CORPORATION)
1620 SW TAYLOR STREET, SUITE 100
PORTLAND, OR 97205

FOR: PROVIDING ONLINE PROFESSIONAL DEVELOPMENT, NAMELY, TRAINING FOR TEACHERS IN THE FIELD OF K-12 EDUCATION, TEACHER TRAINING TOOLS IN THE NATURE OF INFORMATION TO ENABLE TEACHERS TO ORGANIZE AND DEVELOP K-12 CURRICULUM, TEACHER AND STUDENT EDUCATION PERFORMANCE ASSESSMENTS, INFORMATION FOR ENCOURAGING TEACHER COLLABORATION AND SHARING OF STUDENT CURRICULUM DEVELOPMENT AND ASSESSMENT TECHNIQUES, AND IDENTIFYING AND LOCATING INFORMATION AND RESOURCES FOR TEACHER TRAINING, TEACHING SKILL IMPROVEMENT AND EDUCATIONAL ASSESSMENT MATERIALS FOR TEACHERS; EDUCATION SERVICES, NAMELY, PROVIDING FORMATIVE AND SUMMATIVE EDUCATIONAL ASSESSMENTS AND DEVELOPING SUGGESTED CURRICULUM TIED TO STUDENT RESULTS, IN CLASS 41 (U.S. CLS. 100, 101 AND 107).

FIRST USE 4-16-2010; IN COMMERCE 4-16-2010.

FOR: PROVIDING TEMPORARY USE OF ONLINE NON-DOWNLOADABLE SOFTWARE FOR DIGITAL CONTENT MANAGEMENT, CURRICULUM MANAGEMENT, ASSESSMENT SERVICES, AND AN ONLINE COLLABORATION AND COMMUNICATION PLATFORM THAT CONNECTS TEACHERS, ADMINISTRATION, STUDENTS AND PARENTS, IN THE FIELD OF EDUCATION; PROVIDING TEMPORARY USE OF ONLINE NON-DOWNLOADABLE SOFTWARE FOR THE CREATION OF FORMATIVE AND SUMMATIVE ASSESSMENT AND SUGGESTED CURRICULUM TIED TO STUDENT RESULTS, WITH DATA IMPORT AND ANALYSIS FEATURES; PROVIDING A WEB SITE INTENDED FOR USE BY TEACHER TRAINERS FEATURING TECHNOLOGY THAT ENABLES USERS TO ASSIGN CURRICULUM TO TEACHERS, THAT ENABLES TEACHERS TO GET THE PROFESSIONAL DEVELOPMENT RESOURCES TO ACCESS ONLINE IN A PARTICULAR ORDER, THAT PROVIDES TEACHERS WITH A MEANS TO RESPOND TO ASSIGNMENTS ONLINE IN THE FORM OF TEXT, IMAGES, VIDEO, EMBEDDED WEB CONTENT AND ATTACHED FILES, AND THAT PROVIDES A MEANS FOR TEACHER TRAINERS TO TRACK PROGRESS THROUGH THE CONTENT AND ACCESS THE WORK SUBMITTED BY THE TEACHER; PROVIDING A WEB SITE INTENDED FOR USE BY TEACHER TRAINERS FEATURING TECHNOLOGY THAT ENABLES USERS TO ADMINISTER BOTH FORMATIVE AND SUMMATIVE ONLINE ASSESSMENTS TO TEACHERS ONLINE, BOTH AUTO-SCORED AND MANUALLY-SCORED, AND RECEIVE REPORTS IN BOTH AGGREGATE AND INDI-

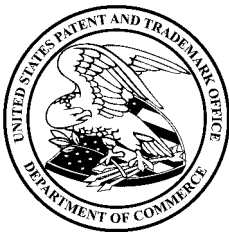

David J. Kappas

Director of the United States Patent and Trademark Office

Reg. No. 4,152,521 VIDUAL FORM ON TEACHER PERFORMANCE; PROVIDING A WEB SITE INTENDED FOR USE BY TEACHERS FEATURING TECHNOLOGY THAT ENABLES USERS TO CREATE AND SHARE LESSON PLANS USING CONTENT THEY CREATED AS WELL AS LINKS TO CONTENT AVAILABLE ONLINE AND GIVE AND RECEIVE FEEDBACK TO AND FROM OTHER EDUCATORS ON THE EFFECTIVENESS OF THEIR LESSON PLANS, IN CLASS 42 (U.S. CLS. 100 AND 101).

FIRST USE 4-16-2010; IN COMMERCE 4-16-2010.

THE MARK CONSISTS OF STANDARD CHARACTERS WITHOUT CLAIM TO ANY PARTICULAR FONT, STYLE, SIZE, OR COLOR.

SER. NO. 85-132,170, FILED 9-17-2010.

KRISTINA MORRIS, EXAMINING ATTORNEY

United States of America

United States Patent and Trademark Office



Reg. No. 4,152,522

Registered June 5, 2012

Int. Cl.: 39

SERVICE MARK

PRINCIPAL REGISTER

RAPID ENTERPRISES, INC. (NEVADA CORPORATION)
7910 SOUTH 3500 EAST
SALT LAKE CITY, UT 84121

FOR: EXPRESS DELIVERY OF DOCUMENTS AND GENERALLY SMALL GOODS, NOT INCLUDING GOODS THAT REQUIRE SPECIALIZED PACKAGING AND/OR ARE DIFFICULT TO PACKAGE, OR HIGHLY FRAGILE, BY MEANS OF AIR AND TRUCK; PACKAGING SUCH ARTICLES FOR OTHERS FOR TRANSPORTATION, IN CLASS 39 (U.S. CLS. 100 AND 105).

FIRST USE 10-7-2008; IN COMMERCE 10-7-2008.

THE MARK CONSISTS OF "E1SHIP" WITH A DRAWING OF THE GLOBE BEHIND.

SER. NO. 85-132,605, FILED 9-17-2010.

YAT SYE, LEE, EXAMINING ATTORNEY



David J. Kyros

Director of the United States Patent and Trademark Office

United States of America

United States Patent and Trademark Office

AMI CLUBWEAR

Reg. No. 4,152,523

Registered June 5, 2012

Int. Cl.: 35

SERVICE MARK

PRINCIPAL REGISTER

DESE ENTERPRISE, INC. (CALIFORNIA CORPORATION)
14426 BONELLI STREET
CITY OF INDUSTRY, CA 91746

FOR: ONLINE RETAIL STORE SERVICES FEATURING CLOTHING, OUTERWEAR, COSTUMES, SWIMSUITS, BELTS, HANDBAGS, SCARVES, FOOTWEAR, HOSIERY, COSMETICS, HEADWEAR, WIGS, HAIR ACCESSORIES, PERSONAL CARE PRODUCTS, EYEWEAR AND FASHION ACCESSORIES EXCLUDING JEWELRY AND WATCHES, IN CLASS 35 (U.S. CLS. 100, 101 AND 102).

FIRST USE 6-30-2007; IN COMMERCE 6-30-2007.

THE MARK CONSISTS OF STANDARD CHARACTERS WITHOUT CLAIM TO ANY PARTICULAR FONT, STYLE, SIZE, OR COLOR.

NO CLAIM IS MADE TO THE EXCLUSIVE RIGHT TO USE "CLUBWEAR", APART FROM THE MARK AS SHOWN.

SER. NO. 85-133,492, FILED 9-20-2010.

BRIAN CALLAGHAN, EXAMINING ATTORNEY



David J. Kyros

Director of the United States Patent and Trademark Office

United States of America

United States Patent and Trademark Office

Bambu Snacks & Coffee Shoppe

Reg. No. 4,152,524

Registered June 5, 2012

**Int. Cls.: 29, 30, 32 and
43**

NGUYEN, KIMHONG THI (UNITED STATES INDIVIDUAL), DBA BAMBU SNACKS AND
COFFEE CORPORATION
1688 HOSTETTER ROAD, SUITE D
SAN JOSE, CA 95131

FOR: DAIRY-BASED SNACK FOODS EXCLUDING ICE CREAM, ICE MILK AND FROZEN
YOGURT, IN CLASS 29 (U.S. CL. 46).

TRADEMARK

FIRST USE 6-1-2010; IN COMMERCE 6-1-2010.

SERVICE MARK

FOR: BAKERY GOODS AND DESSERT ITEMS, NAMELY, CHEESECAKES FOR RETAIL
AND WHOLESALE DISTRIBUTION AND CONSUMPTION ON OR OFF THE PREMISES;
COFFEE AND TEA; DESSERT MOUSSE; FLAVORED, SWEETENED GELATIN DESSERTS;
FROZEN DESSERT CONSISTING OF FRUIT AND CREAM OR CREAM SUBSTITUTES;
FROZEN DESSERTS CONSISTING OF FLAVORED ICE BLOCKS WITH TOPPINGS; ICE
CREAM DESSERTS, IN CLASS 30 (U.S. CL. 46).

PRINCIPAL REGISTER

FIRST USE 6-1-2010; IN COMMERCE 6-1-2010.

FOR: PREPARED ENTREES CONSISTING OF FRUIT DRINKS AND FRUIT JUICES, FRUIT-
BASED BEVERAGES, NON-ALCOHOLIC BEVERAGES CONTAINING FRUIT JUICES, NON-
ALCOHOLIC FRUIT EXTRACTS USED IN THE PREPARATION OF BEVERAGES, NON-
ALCOHOLIC FRUIT JUICE BEVERAGES, VEGETABLE JUICES, VEGETABLE-FRUIT
JUICES AND SMOOTHIES, IN CLASS 32 (U.S. CLS. 45, 46 AND 48).

FIRST USE 6-1-2010; IN COMMERCE 6-1-2010.

FOR: COFFEE SHOPS; COFFEE-HOUSE AND SNACK-BAR SERVICES, IN CLASS 43 (U.S.
CLS. 100 AND 101).

FIRST USE 6-1-2010; IN COMMERCE 6-1-2010.

THE MARK CONSISTS OF STANDARD CHARACTERS WITHOUT CLAIM TO ANY PAR-
TICULAR FONT, STYLE, SIZE, OR COLOR.

NO CLAIM IS MADE TO THE EXCLUSIVE RIGHT TO USE "SNACKS & COFFEE SHOPPE",
APART FROM THE MARK AS SHOWN.



David J. Kyros

Director of the United States Patent and Trademark Office

Reg. No. 4,152,524 THE ENGLISH TRANSLATION OF THE WORD "BAMBU" IN THE MARK IS "BAMBOO".

SER. NO. 85-133,833, FILED 9-20-2010.

ALAIN LAPTER, EXAMINING ATTORNEY

United States of America

United States Patent and Trademark Office

FUSION UV

Reg. No. 4,152,525

Registered June 5, 2012

Int. Cls.: 37 and 42

SERVICE MARK

PRINCIPAL REGISTER

FUSION UV SYSTEMS, INC. (DELAWARE CORPORATION)
910 CLOPPER ROAD
GAITHERSBURG, MD 208781357

FOR: MAINTENANCE AND REPAIR SERVICES IN THE FIELD OF ULTRAVIOLET LAMPS, ULTRAVIOLET LAMP SYSTEMS AND COMPONENTS THEREOF; PRODUCT SUPPORT SERVICES, NAMELY, TECHNICAL SUPPORT SERVICES, NAMELY, TROUBLESHOOTING IN THE NATURE OF THE REPAIR OF ULTRAVIOLET LAMPS, ULTRAVIOLET LAMP SYSTEMS AND COMPONENTS THEREOF, AND TECHNICAL ADVICE RELATED TO THE INSTALLATION OF ULTRAVIOLET LAMPS, ULTRAVIOLET LAMP SYSTEMS AND COMPONENTS THEREOF, IN CLASS 37 (U.S. CLS. 100, 103 AND 106).

FIRST USE 9-20-2010; IN COMMERCE 9-20-2010.

FOR: TECHNOLOGY CONSULTATION AND RESEARCH IN THE FIELD OF ULTRAVIOLET PROCESSING TECHNOLOGY; AND DESIGN OF ULTRAVIOLET CURING PRODUCTION SYSTEMS AND LINES INTENDED TO BE USED FOR POLYMERIZING COATINGS, INKS, POWDERS, COMPOSITE STRUCTURES AND GELS USING ULTRAVIOLET LIGHT AND PRODUCT DEVELOPMENT IN THE FIELD OF ULTRAVIOLET CURING PRODUCTION SYSTEMS AND LINES INTENDED TO BE USED FOR POLYMERIZING COATINGS, INKS, POWDERS, COMPOSITE STRUCTURES AND GELS USING ULTRAVIOLET LIGHT, IN CLASS 42 (U.S. CLS. 100 AND 101).

FIRST USE 9-20-2010; IN COMMERCE 9-20-2010.

THE MARK CONSISTS OF STANDARD CHARACTERS WITHOUT CLAIM TO ANY PARTICULAR FONT, STYLE, SIZE, OR COLOR.

OWNER OF U.S. REG. NO. 2,215,060.

NO CLAIM IS MADE TO THE EXCLUSIVE RIGHT TO USE "UV", APART FROM THE MARK AS SHOWN.

SER. NO. 85-134,050, FILED 9-20-2010.

SETH A. RAPPAPORT, EXAMINING ATTORNEY

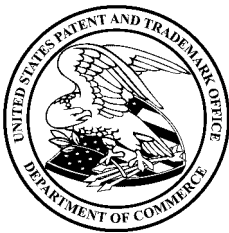

David J. Kyffers

Director of the United States Patent and Trademark Office

United States of America

United States Patent and Trademark Office

3 EYED FISH

Reg. No. 4,152,526

Registered June 5, 2012

Int. Cl.: 43

SERVICE MARK

PRINCIPAL REGISTER

CINDY GOULET (WASHINGTON LIMITED LIABILITY COMPANY), DBA FLORENTYNAS
3601 N 20TH AVE
PASCO, WA 99301

FOR: BAR AND RESTAURANT SERVICES, IN CLASS 43 (U.S. CLS. 100 AND 101).

FIRST USE 2-2-2011; IN COMMERCE 2-2-2011.

THE MARK CONSISTS OF STANDARD CHARACTERS WITHOUT CLAIM TO ANY PARTICULAR FONT, STYLE, SIZE, OR COLOR.

NO CLAIM IS MADE TO THE EXCLUSIVE RIGHT TO USE "FISH", APART FROM THE MARK AS SHOWN.

SER. NO. 85-134,863, FILED 9-21-2010.

NAPOLEON SHARMA, EXAMINING ATTORNEY



David J. Kyffers

Director of the United States Patent and Trademark Office

United States of America

United States Patent and Trademark Office



Reg. No. 4,152,527

Registered June 5, 2012

Int. Cl.: 19

TRADEMARK

PRINCIPAL REGISTER

STARECASING INC. (OHIO CORPORATION)
2908 CRESENT DRIVE
COLUMBUS, OH 43204

FOR: STAIR REMODELING SYSTEM COMPRISED OF WOOD PARTS FOR STAIRS, NAMELY, STAIR TREADS, OVERLAYS FOR STAIR TREADS, STAIR RISERS, OVERLAYS FOR STAIR RISERS, STAIR RETURNS, OVERLAYS FOR STAIR RETURNS, STAIR NOSINGS AND FLOORING FOR STAIR LANDINGS; NON-METAL STAIRS; STAIR TREADS AND RISERS NOT OF METAL, IN CLASS 19 (U.S. CLS. 1, 12, 33 AND 50).

FIRST USE 8-1-2010; IN COMMERCE 8-1-2010.

NO CLAIM IS MADE TO THE EXCLUSIVE RIGHT TO USE "STAIR CASING", APART FROM THE MARK AS SHOWN.

THE MARK CONSISTS OF A LOGO WHICH INCLUDES A GRAPHIC OF A SET OF STAIRS WITH SEVERAL STAIR OVERLAYS OVER SOME OF THE STAIRS AND THE WORD "STARECASING".

SER. NO. 85-135,766, FILED 9-22-2010.

BRIAN CALLAGHAN, EXAMINING ATTORNEY



David J. Kyros

Director of the United States Patent and Trademark Office

United States of America

United States Patent and Trademark Office

BAI I-MODIFY

Reg. No. 4,152,528

Registered June 5, 2012

Int. Cl.: 42

SERVICE MARK

PRINCIPAL REGISTER

BANK ADMINISTRATION INSTITUTE (ILLINOIS CORPORATION)
115 S. LASALLE STREET, SUITE 3300
CHICAGO, IL 60603

FOR: PROVIDING TEMPORARY USE OF ONLINE NON-DOWNLOADABLE SOFTWARE DEVELOPMENT TOOLS FOR DESIGNING COURSES OF INSTRUCTION IN THE FIELD OF BANKING AND FINANCE , IN CLASS 42 (U.S. CLS. 100 AND 101).

FIRST USE 8-6-2009; IN COMMERCE 8-6-2009.

THE MARK CONSISTS OF STANDARD CHARACTERS WITHOUT CLAIM TO ANY PARTICULAR FONT, STYLE, SIZE, OR COLOR.

OWNER OF U.S. REG. NOS. 1,905,615, 1,905,888, AND 1,911,871.

SER. NO. 85-136,877, FILED 9-23-2010.

COLLEEN KEARNEY, EXAMINING ATTORNEY



David J. Kyffers

Director of the United States Patent and Trademark Office

United States of America

United States Patent and Trademark Office

ENBALA POWER NETWORKS

Reg. No. 4,152,529

Registered June 5, 2012

Int. Cls.: 9 and 42

TRADEMARK

SERVICE MARK

PRINCIPAL REGISTER

ENBALA POWER NETWORKS INC. (CANADA CORPORATION)
360 BAY STREET, SUITE 401
TORONTO, ON, CANADA M5H2V6

FOR: A SYSTEM CONSISTING OF SOFTWARE AND HARDWARE USED TO TRACK, MANAGE AND CONTROL HOW AND WHEN ENERGY IS CONSUMED BY ELECTRICAL EQUIPMENT, SOLD TOGETHER AS AN INTEGRATED UNIT, IN CLASS 9 (U.S. CLS. 21, 23, 26, 36 AND 38).

FOR: DESIGNING ENERGY CONTROL SYSTEMS TO ENABLE OWNERS OF ELECTRICAL EQUIPMENT TO SUPPORT THE ELECTRICITY SYSTEM OPERATOR, IN CLASS 42 (U.S. CLS. 100 AND 101).

THE MARK CONSISTS OF STANDARD CHARACTERS WITHOUT CLAIM TO ANY PARTICULAR FONT, STYLE, SIZE, OR COLOR.

PRIORITY CLAIMED UNDER SEC. 44(D) ON CANADA APPLICATION NO. 1496194, FILED 9-16-2010, REG. NO. TMA815416, DATED 1-11-2012, EXPIRES 1-11-2027.

NO CLAIM IS MADE TO THE EXCLUSIVE RIGHT TO USE "POWER NETWORKS", APART FROM THE MARK AS SHOWN.

SER. NO. 85-136,979, FILED 9-23-2010.

JORDAN BAKER, EXAMINING ATTORNEY



David J. Kybas

Director of the United States Patent and Trademark Office

United States of America

United States Patent and Trademark Office

Folligenix

Reg. No. 4,152,530

MARIO DIAB LLC (NEW YORK LIMITED LIABILITY COMPANY)
62 CROSBY STREET
NEW YORK, NY 10012

Registered June 5, 2012

Int. Cl.: 5

FOR: DIETARY AND NUTRITIONAL SUPPLEMENTS, IN CLASS 5 (U.S. CLS. 6, 18, 44, 46, 51 AND 52).

TRADEMARK

FIRST USE 9-7-2010; IN COMMERCE 9-13-2010.

PRINCIPAL REGISTER

THE MARK CONSISTS OF STANDARD CHARACTERS WITHOUT CLAIM TO ANY PARTICULAR FONT, STYLE, SIZE, OR COLOR.

SER. NO. 85-137,779, FILED 9-24-2010.

WILLIAM VERHOSEK, EXAMINING ATTORNEY



David J. Kybas

Director of the United States Patent and Trademark Office

United States of America

United States Patent and Trademark Office

IDEX

Reg. No. 4,152,531

Registered June 5, 2012

Int. Cl.: 1

TRADEMARK

PRINCIPAL REGISTER

FIELD FORENSICS, INC. (FLORIDA CORPORATION)
SUITE 510
7887 BRYAN DAIRY ROAD
LARGO, FL 33777

FOR: CHEMICAL TEST KITS CONTAINING REAGENTS FOR FIELD DETECTION OF CHEMICALS USED IN EXPLOSIVES OR THE MANUFACTURE OF EXPLOSIVES, IN CLASS 1 (U.S. CLS. 1, 5, 6, 10, 26 AND 46).

FIRST USE 4-30-2010; IN COMMERCE 4-30-2010.

THE MARK CONSISTS OF STANDARD CHARACTERS WITHOUT CLAIM TO ANY PARTICULAR FONT, STYLE, SIZE, OR COLOR.

SER. NO. 85-137,823, FILED 9-24-2010.

MARK RADEMACHER, EXAMINING ATTORNEY



David J. Kybas

Director of the United States Patent and Trademark Office

United States of America

United States Patent and Trademark Office

HAVE YOU SEEN ME?

Reg. No. 4,152,532

VALASSIS COMMUNICATIONS, INC. (DELAWARE CORPORATION)
19975 VICTOR PARKWAY
LIVONIA, MI 48152

Registered June 5, 2012

Int. Cl.: 35

FOR: PROMOTING PUBLIC AWARENESS OF THE NEED FOR FINDING LOST CHILDREN,
IN CLASS 35 (U.S. CLS. 100, 101 AND 102).

SERVICE MARK

FIRST USE 5-24-1985; IN COMMERCE 5-24-1985.

PRINCIPAL REGISTER

THE MARK CONSISTS OF STANDARD CHARACTERS WITHOUT CLAIM TO ANY PARTICULAR FONT, STYLE, SIZE, OR COLOR.

SER. NO. 85-139,112, FILED 9-27-2010.

JESSICA A. POWERS, EXAMINING ATTORNEY



David J. Kybas

Director of the United States Patent and Trademark Office

United States of America

United States Patent and Trademark Office

MIDWEST DAIRY ASSOCIATION

Reg. No. 4,152,533

Registered June 5, 2012

Int. Cls.: 41 and 44

SERVICE MARK

PRINCIPAL REGISTER

MIDWEST DAIRY ASSOCIATION (MINNESOTA NON-PROFIT CORPORATION)
2015 N. RICE STREET
ST. PAUL, MN 55113

FOR: ARRANGING AND CONDUCTING CONTESTS, SWEEPSTAKES, AND FAIRS FOR NON-COMMERCIAL PURPOSES IN THE FIELDS OF DAIRY PRODUCTS AND NUTRITION; PROVIDING ONLINE INFORMATION AND NEWS IN THE NATURE OF A WEBSITE FEATURING NON-DOWNLOADABLE EDUCATIONAL VIDEOS, VIGNETTES, AND FARMER PROFILES ABOUT HOW DAIRY PRODUCTS ARE PRODUCED AND THE CARE OF FARM ANIMALS AND THE ENVIRONMENT, IN CLASS 41 (U.S. CLS. 100, 101 AND 107).

FIRST USE 1-1-2000; IN COMMERCE 1-1-2000.

FOR: PROVIDING ONLINE INFORMATION AND NEWS IN THE FIELD OF NUTRITION, IN CLASS 44 (U.S. CLS. 100 AND 101).

FIRST USE 1-1-2000; IN COMMERCE 1-1-2000.

THE MARK CONSISTS OF STANDARD CHARACTERS WITHOUT CLAIM TO ANY PARTICULAR FONT, STYLE, SIZE, OR COLOR.

NO CLAIM IS MADE TO THE EXCLUSIVE RIGHT TO USE "ASSOCIATION", APART FROM THE MARK AS SHOWN.

SEC. 2(F).

SER. NO. 85-140,818, FILED 9-29-2010.

MICHAEL TANNER, EXAMINING ATTORNEY



David J. Kybas

Director of the United States Patent and Trademark Office

United States of America

United States Patent and Trademark Office

FLATRON SUPER IMAGE

Reg. No. 4,152,534

LG ELECTRONICS INC. (REPUBLIC OF KOREA CORPORATION)
20 YEUIDO-DONG YEONGDEUNGPO-GU
SEOUL 150-721, REPUBLIC OF KOREA

Registered June 5, 2012

Int. Cl.: 9

FOR: COMPUTER MONITORS, IN CLASS 9 (U.S. CLS. 21, 23, 26, 36 AND 38).

TRADEMARK

THE MARK CONSISTS OF STANDARD CHARACTERS WITHOUT CLAIM TO ANY PARTICULAR FONT, STYLE, SIZE, OR COLOR.

PRINCIPAL REGISTER

PRIORITY CLAIMED UNDER SEC. 44(D) ON REPUBLIC OF KOREA APPLICATION NO. 2010-0041527, FILED 8-11-2010, REG. NO. 0897379, DATED 1-2-2012, EXPIRES 1-2-2022.

OWNER OF U.S. REG. NOS. 2,309,738, 3,515,118 AND OTHERS.

NO CLAIM IS MADE TO THE EXCLUSIVE RIGHT TO USE "SUPER IMAGE", APART FROM THE MARK AS SHOWN.

SER. NO. 85-143,275, FILED 10-1-2010.

MICHAEL GAAFAR, EXAMINING ATTORNEY



David J. Kyffers

Director of the United States Patent and Trademark Office

United States of America

United States Patent and Trademark Office

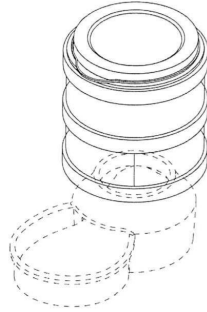

Reg. No. 4,152,535

Registered June 5, 2012

Int. Cl.: 21

TRADEMARK

PRINCIPAL REGISTER

DOSKOCIL MANUFACTURING COMPANY, INC. (TEXAS CORPORATION)
4209 BARNETT BOULEVARD
ARLINGTON, TX 76017

FOR: NON-MECHANIZED PET FEEDERS AND WATERERS IN THE NATURE OF PORTABLE FOOD AND WATER DISPENSERS FOR PETS, IN CLASS 21 (U.S. CLS. 2, 13, 23, 29, 30, 33, 40 AND 50).

FIRST USE 3-16-1999; IN COMMERCE 3-16-1999.

NO CLAIM IS MADE TO THE EXCLUSIVE RIGHT TO USE "THE CONFIGURATION OF A ROUND CONTAINER LID", APART FROM THE MARK AS SHOWN.

THE MARK CONSISTS OF THE THREE-DIMENSIONAL CONFIGURATION OF A FOOD OR WATER DISPENSER FOR A PET, COMPRISING A CYLINDRICAL CONTAINER WITH THREE CIRCUMFERENTIAL BANDS. THE BROKEN LINES ARE NOT PART OF THE MARK AND MERELY SERVE TO SHOW THE POSITION OF THE MARK.

SEC. 2(F).

SER. NO. 85-143,336, FILED 10-1-2010.

DAVID H. STINE, EXAMINING ATTORNEY



David J. Kybas

Director of the United States Patent and Trademark Office

United States of America

United States Patent and Trademark Office

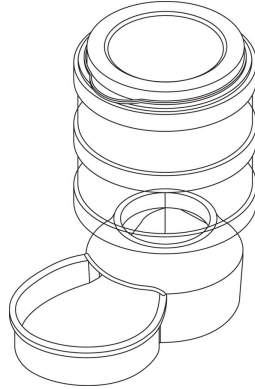

Reg. No. 4,152,536

Registered June 5, 2012

Int. Cl.: 21

TRADEMARK

PRINCIPAL REGISTER

DOSKOCIL MANUFACTURING COMPANY, INC. (TEXAS CORPORATION)
4209 BARNETT BOULEVARD
ARLINGTON, TX 76017

FOR: NON-MECHANIZED PET FEEDERS AND WATERERS IN THE NATURE OF PORTABLE FOOD AND WATER DISPENSERS FOR PETS, IN CLASS 21 (U.S. CLS. 2, 13, 23, 29, 30, 33, 40 AND 50).

FIRST USE 3-16-1999; IN COMMERCE 3-16-1999.

NO CLAIM IS MADE TO THE EXCLUSIVE RIGHT TO USE "THE CONFIGURATION OF A ROUND CONTAINER LID OR A ROUND SERVING BOWL", APART FROM THE MARK AS SHOWN.

THE MARK CONSISTS OF THE THREE-DIMENSIONAL CONFIGURATION OF A FOOD OR WATER DISPENSER FOR A PET, COMPRISING A CYLINDRICAL CONTAINER WITH THREE CIRCUMFERENTIAL BANDS POSITIONED ON TOP OF A BASE WHICH IS CONNECTED TO A BOWL TO FORM INTERLOCKING CIRCLES.

SEC. 2(F).

SER. NO. 85-143,350, FILED 10-1-2010.

DAVID H. STINE, EXAMINING ATTORNEY



David J. Kybas

Director of the United States Patent and Trademark Office

United States of America

United States Patent and Trademark Office

dispatchNow

Reg. No. 4,152,537

Registered June 5, 2012

Int. Cl.: 42

SERVICE MARK

PRINCIPAL REGISTER

TIBURON, INC. (VIRGINIA CORPORATION)
SUITE 400
6200 STONERIDGE MALL ROAD
PLEASANTON, CA 94588

FOR: APPLICATIONS SERVICE PROVIDER (ASP), NAMELY, HOSTING COMPUTER SOFTWARE APPLICATIONS FOR AUTOMATING THE DISPATCH FUNCTIONS OF GOVERNMENT AGENCIES, NAMELY, CITY/COUNTY/STATE/FEDERAL POLICE, FIRE AND EMERGENCY MEDICAL SERVICES, IN CLASS 42 (U.S. CLS. 100 AND 101).

FIRST USE 2-22-2011; IN COMMERCE 2-22-2011.

THE MARK CONSISTS OF STANDARD CHARACTERS WITHOUT CLAIM TO ANY PARTICULAR FONT, STYLE, SIZE, OR COLOR.

OWNER OF U.S. REG. NO. 1,753,660.

SER. NO. 85-144,275, FILED 10-4-2010.

DARRYL SPRUILL, EXAMINING ATTORNEY



David J. Kyffers

Director of the United States Patent and Trademark Office

United States of America

United States Patent and Trademark Office

Wellaby's

Reg. No. 4,152,538

Registered June 5, 2012

Int. Cl.: 30

TRADEMARK

PRINCIPAL REGISTER

UNISMACK ANONYMI VIOMICHANIKI KE EMPORIKI ETERIA TROFIMON (GREECE CORPORATION), TA U&S UNISMACK AVEE INDUSTRIAL ZONE KILKIS, GR 61100 STAVROCHORI, GREECE

FOR: CHEESE-FLAVORED SNACKS, NAMELY, GLUTEN-FREE CHEESE CHIPS MADE PRIMARILY OF POTATO STARCH AND ALSO CHEESE, IN CLASS 30 (U.S. CL. 46).

FIRST USE 8-5-2010; IN COMMERCE 8-5-2010.

THE NAME(S), PORTRAIT(S), AND/OR SIGNATURE(S) SHOWN IN THE MARK DOES NOT IDENTIFY A PARTICULAR LIVING INDIVIDUAL.

THE MARK CONSISTS OF THE TERM "WELLABY'S" WITH THE BOTTOM OF THE "Y" EXTENDING LEFTWARD IN AN ARC TO FORM A FANCIFUL REPRESENTATION OF A SMILE AND UNDERNEATH THE ELONGATED "Y" APPEARS A LITTLE UPTURNED CURVED LINE CREATING THE IMPRESSION OF A CHIN.

SER. NO. 85-145,257, FILED 10-5-2010.

KATHERINE E. HALMEN, EXAMINING ATTORNEY



David J. Kyros

Director of the United States Patent and Trademark Office

United States of America

United States Patent and Trademark Office

BLAZE

Reg. No. 4,152,539

Registered June 5, 2012

Int. Cl.: 3

TRADEMARK

PRINCIPAL REGISTER

HATTERAS ENTERPRISES, INC. (CALIFORNIA CORPORATION)
18740 OXNARD STREET, SUITE 315
TARZANA, CA 91356

FOR: NAIL ENAMEL, IN CLASS 3 (U.S. CLS. 1, 4, 6, 50, 51 AND 52).

FIRST USE 1-1-1992; IN COMMERCE 1-1-1992.

THE MARK CONSISTS OF STANDARD CHARACTERS WITHOUT CLAIM TO ANY PARTICULAR FONT, STYLE, SIZE, OR COLOR.

SER. NO. 85-147,791, FILED 10-7-2010.

DEIRDRE ROBERTSON, EXAMINING ATTORNEY



David J. Kybas

Director of the United States Patent and Trademark Office

United States of America

United States Patent and Trademark Office

PROGRAM PULSE

Reg. No. 4,152,540

Registered June 5, 2012

Int. Cl.: 35

SERVICE MARK

PRINCIPAL REGISTER

BRIDGE ENTERTAINMENT, INC. (CALIFORNIA CORPORATION)
SUITE 905
16133 VENTURA BOULEVARD
ENCINO, CA 914362413

FOR: PROVISION OF MARKET RESEARCH, ANALYSIS AND INTELLIGENCE CONCERNING THE AWARENESS, BUSINESS VALUE, USAGE BEHAVIOR, FAMILIARITY, APPEAL, AND ATTRIBUTES OF TELEVISION PROGRAMS, IN CLASS 35 (U.S. CLS. 100, 101 AND 102).

FIRST USE 7-17-2009; IN COMMERCE 7-17-2009.

THE MARK CONSISTS OF STANDARD CHARACTERS WITHOUT CLAIM TO ANY PARTICULAR FONT, STYLE, SIZE, OR COLOR.

NO CLAIM IS MADE TO THE EXCLUSIVE RIGHT TO USE "PROGRAM", APART FROM THE MARK AS SHOWN.

SER. NO. 85-148,031, FILED 10-8-2010.

VERNA BETH RIRIE, EXAMINING ATTORNEY



David J. Kybas

Director of the United States Patent and Trademark Office

United States of America

United States Patent and Trademark Office

SleepXcel Sleep well. Play
well.

Reg. No. 4,152,541

Registered June 5, 2012

Int. Cl.: 41

SERVICE MARK

PRINCIPAL REGISTER

BARKER SLEEP MEDICINE PROFESSIONALS, PLLC (TENNESSEE PROFESSIONAL
LIMITED LIABILITY COMPANY)
1388 PAPERMILL POINTE WAY
KNOXVILLE, TN 37909

FOR: MEDICAL EDUCATIONAL SERVICES, NAMELY, PROVIDING MEDICAL EDUCATION
PROGRAMS AND TRAINING IN THE FIELD OF SLEEP DISORDERS FOR PATIENTS,
HEALTHCARE PROVIDERS, AND PROFESSIONAL GROUPS, IN CLASS 41 (U.S. CLS. 100,
101 AND 107).

FIRST USE 7-1-2010; IN COMMERCE 7-1-2010.

THE MARK CONSISTS OF STANDARD CHARACTERS WITHOUT CLAIM TO ANY PAR-
TICULAR FONT, STYLE, SIZE, OR COLOR.

SER. NO. 85-149,896, FILED 10-11-2010.

JAMES LOVELACE, EXAMINING ATTORNEY



David J. Kyffers

Director of the United States Patent and Trademark Office

United States of America

United States Patent and Trademark Office

Natural News Network

Reg. No. 4,152,542

ADAMS, MICHAEL A. (UNITED STATES INDIVIDUAL)
2055 NORTH KOLB ROAD, #131
TUSCON, AZ 85715

Registered June 5, 2012

Int. Cl.: 35

FOR: PROVIDING CONSUMER INFORMATION AND RELATED NEWS IN THE FIELD OF NATURAL HEALTH, NATURAL LIVING, IN CLASS 35 (U.S. CLS. 100, 101 AND 102).

SERVICE MARK

FIRST USE 4-19-2006; IN COMMERCE 4-19-2006.

PRINCIPAL REGISTER

THE MARK CONSISTS OF STANDARD CHARACTERS WITHOUT CLAIM TO ANY PARTICULAR FONT, STYLE, SIZE, OR COLOR.

OWNER OF U.S. REG. NO. 3,801,329.

NO CLAIM IS MADE TO THE EXCLUSIVE RIGHT TO USE "NEWS NETWORK", APART FROM THE MARK AS SHOWN.

SEC. 2(F).

SER. NO. 85-150,143, FILED 10-11-2010.

DOMINIC J. FERRAIUOLO, EXAMINING ATTORNEY



David J. Kyffers

Director of the United States Patent and Trademark Office

United States of America

United States Patent and Trademark Office

REUTERS INSIDER

Reg. No. 4,152,543

Registered June 5, 2012

Int. Cls.: 35, 36 and 41

SERVICE MARK

PRINCIPAL REGISTER

THOMSON REUTERS CANADA LIMITED (CANADA CORPORATION)
SUITE 2706 PO BOX 24
TD BANK TOWER, TORONTO DOMINION CENTER
TORONTO, CANADA M5K1A1

FOR: PROVIDING PROFESSIONALS WITH PROPRIETARY AND THIRD PARTY MULTI-MEDIA BUSINESS NEWS AND PROVIDING COMMENTARY THEREON; PROVIDING A WEBSITE FEATURING NON-DOWNLOADABLE VIDEO ON BUSINESS NEWS AND PROVIDING A WEBSITE FEATURING NON-DOWNLOADABLE TRANSCRIPTS OF BUSINESS NEWS PROGRAMS; PROVIDING PROPRIETARY AND THIRD PARTY BUSINESS NEWS AND COMMENTARY VIA ONLINE DATABASES; PROVISION OF BUSINESS NEWS, BUSINESS INFORMATION AND BUSINESS COMMENTARY, IN CLASS 35 (U.S. CLS. 100, 101 AND 102).

FIRST USE 5-11-2010; IN COMMERCE 5-11-2010.

FOR: PROVIDING PROFESSIONALS WITH PROPRIETARY AND THIRD PARTY MULTI-MEDIA FINANCIAL NEWS AND PROVIDING COMMENTARY THEREON; PROVIDING A WEBSITE FEATURING NON-DOWNLOADABLE VIDEO ON FINANCIAL NEWS, AND PROVIDING A WEBSITE FEATURING NON-DOWNLOADABLE TRANSCRIPTS OF FINANCIAL NEWS PROGRAMS; PROVIDING PROPRIETARY AND THIRD PARTY FINANCIAL NEWS AND COMMENTARY AND FINANCIAL INFORMATION VIA ONLINE DATABASES, IN CLASS 36 (U.S. CLS. 100, 101 AND 102).

FIRST USE 5-11-2010; IN COMMERCE 5-11-2010.

FOR: PROVIDING NEWS AND COMMENTARY IN THE FIELD OF CURRENT EVENTS VIA ONLINE DATABASES, IN CLASS 41 (U.S. CLS. 100, 101 AND 107).

FIRST USE 5-11-2010; IN COMMERCE 5-11-2010.

THE MARK CONSISTS OF STANDARD CHARACTERS WITHOUT CLAIM TO ANY PARTICULAR FONT, STYLE, SIZE, OR COLOR.

OWNER OF U.S. REG. NOS. 2,489,044, 2,936,035, AND 3,140,820.



David J. Kyjars

Director of the United States Patent and Trademark Office

Reg. No. 4,152,543 NO CLAIM IS MADE TO THE EXCLUSIVE RIGHT TO USE "INSIDER", APART FROM THE MARK AS SHOWN.

SER. NO. 85-150,590, FILED 10-12-2010.

CHRISTOPHER BUONGIORNO, EXAMINING ATTORNEY

United States of America

United States Patent and Trademark Office



Reg. No. 4,152,544

Registered June 5, 2012

Int. Cls.: 36 and 41

SERVICE MARK

PRINCIPAL REGISTER

RESTORING SIGHT INTERNATIONAL, INC. (MASSACHUSETTS NON-PROFIT CORPORATION)
20 PINE LODGE ROAD
WEST ROXBURY, MA 021323415

FOR: CHARITABLE FUND RAISING SERVICES FOR OPHTHALMIC OUTREACH PROGRAMS; CHARITABLE FUND RAISING TO ASSIST AGENCIES IN DEVELOPING COUNTRIES DEDICATED TO THE DELIVERY OF EYE CARE AND EYE CARE EQUIPMENT AND THE ADVANCEMENT OF OPHTHALMOLOGY; CHARITABLE SERVICES, NAMELY, ORGANIZING FUNDRAISING SERVICES AND EVENTS TO RAISE FUNDS IN THE FIELD OF THE DELIVERY OF EYE CARE AND EYE CARE EQUIPMENT AND THE ADVANCEMENT OF OPHTHALMOLOGY; FINANCIAL SPONSORSHIP OF FELLOWSHIPS IN THE FIELD OF OPHTHALMOLOGY, IN CLASS 36 (U.S. CLS. 100, 101 AND 102).

FIRST USE 3-16-2009; IN COMMERCE 3-16-2009.

FOR: EDUCATIONAL SERVICES, NAMELY, CONDUCTING PROGRAMS AND LECTURES AND PROVIDING TRAINING SERVICES IN THE FIELD OF OPHTHALMOLOGY; ORGANIZING AND CONDUCTING FELLOWSHIPS IN THE FIELD OF OPHTHALMOLOGY; ORGANIZING COMMUNITY SPORTING EVENTS, IN CLASS 41 (U.S. CLS. 100, 101 AND 107).

FIRST USE 3-16-2009; IN COMMERCE 3-16-2009.

NO CLAIM IS MADE TO THE EXCLUSIVE RIGHT TO USE "SIGHT INTERNATIONAL", APART FROM THE MARK AS SHOWN.

THE MARK CONSISTS OF THE LETTERS "RSI" STACKED VERTICALLY ON THE LEFT, FOLLOWED TO THE RIGHT BY A STYLIZED EYE DESIGN, FOLLOWED TO THE RIGHT BY THE WORDS "RESTORING SIGHT INTERNATIONAL," STACKED VERTICALLY.

SER. NO. 85-150,880, FILED 10-12-2010.

SUSAN STIGLITZ, EXAMINING ATTORNEY



David J. Kyjars

Director of the United States Patent and Trademark Office

United States of America

United States Patent and Trademark Office

CCS Presentation Systems

Reg. No. 4,152,545

COMMERCIAL COMPUTER SERVICES, INC. (ARIZONA CORPORATION)
17350 N. HARTFORD DRIVE
SCOTTSDALE, AZ 85255

Registered June 5, 2012

Int. Cls.: 35, 37 and 41

FOR: RESELLER SERVICES, NAMELY, DISTRIBUTORSHIP SERVICES IN THE FIELD OF AUDIO AND VIDEO PRODUCTS, COMPONENTS AND ACCESSORIES; RETAIL STORE SERVICES FEATURING AUDIO AND VIDEO PRODUCTS, COMPONENTS AND ACCESSORIES, IN CLASS 35 (U.S. CLS. 100, 101 AND 102).

SERVICE MARK

PRINCIPAL REGISTER

FIRST USE 11-1-1997; IN COMMERCE 11-1-1997.

FOR: INSTALLATION OF AUDIO AND VIDEO PRODUCTS, COMPONENTS AND ACCESSORIES; REPAIR OF AUDIO AND VIDEO PRODUCTS, COMPONENTS AND ACCESSORIES, IN CLASS 37 (U.S. CLS. 100, 103 AND 106).

FIRST USE 11-1-1997; IN COMMERCE 11-1-1997.

FOR: TRAINING SERVICES IN THE FIELD OF AUDIO VISUAL SYSTEM DESIGN AND INTEGRATION, AND IN THE SELECTION, INSTALLATION, REPAIR AND USE OF AUDIO AND VIDEO PRODUCTS, COMPONENTS AND ACCESSORIES, IN CLASS 41 (U.S. CLS. 100, 101 AND 107).

FIRST USE 5-16-2005; IN COMMERCE 5-16-2005.

THE MARK CONSISTS OF STANDARD CHARACTERS WITHOUT CLAIM TO ANY PARTICULAR FONT, STYLE, SIZE, OR COLOR.

NO CLAIM IS MADE TO THE EXCLUSIVE RIGHT TO USE "PRESENTATION SYSTEMS", APART FROM THE MARK AS SHOWN.

SER. NO. 85-150,918, FILED 10-12-2010.

IRA J. GOODSaid, EXAMINING ATTORNEY



David J. Kyffers

Director of the United States Patent and Trademark Office

United States of America

United States Patent and Trademark Office



Reg. No. 4,152,546

Registered June 5, 2012

Int. Cl.: 36

SERVICE MARK

PRINCIPAL REGISTER

SM INVESTMENTS CORPORATION (PHILIPPINES CORPORATION)
10TH FLOOR, ONEE-COM CENTER
HARBOR DRIVE, MALL OF ASIA COMPLEX
CBP-1A, PASAY CITY, PHILIPPINES 1300

FOR: SHOPPING MALL SERVICES, NAMELY, LEASING OF SHOPPING MALL SPACE;
BUILDING MANAGEMENT OF MALL STORES AND SHOPPING MALL SPACES, IN CLASS
36 (U.S. CLS. 100, 101 AND 102).

PRIORITY CLAIMED UNDER SEC. 44(D) ON PHILIPPINES APPLICATION NO. 04-2010-
0392, FILED 4-14-2010, REG. NO. 42010003925, DATED 11-18-2010, EXPIRES 11-18-2020.

THE COLOR(S) "BLUE" IS/ARE CLAIMED AS A FEATURE OF THE MARK.

THE MARK CONSISTS OF THE LETTERS "S" AND "M" IN STYLIZED FONT SURROUNDED
BY A CIRCLE, ALL IN THE COLOR BLUE.

SER. NO. 85-152,580, FILED 10-14-2010.

MATTHEW KLINE, EXAMINING ATTORNEY



David J. Kappas

Director of the United States Patent and Trademark Office

United States of America

United States Patent and Trademark Office

CAMBRIDGE

Reg. No. 4,152,547

GARAGA INC. (CANADA CORPORATION)

Registered June 5, 2012

8500, 25TH AVENUE

ST-GEORGES DE BEAUCE, CANADA QUEBECG6A

Int. Cl.: 6

FOR: METAL GARAGE DOORS, IN CLASS 6 (U.S. CLS. 2, 12, 13, 14, 23, 25 AND 50).

TRADEMARK

PRIORITY CLAIMED UNDER SEC. 44(D) ON CANADA APPLICATION NO. 1498520, FILED 10-5-2010, REG. NO. TMA807051, DATED 9-20-2011, EXPIRES 9-20-2026.

PRINCIPAL REGISTER

THE MARK CONSISTS OF A STYLIZATION OF "CAMBRIDGE".

SER. NO. 85-153,451, FILED 10-15-2010.

HOWARD SMIGA, EXAMINING ATTORNEY



David J. Kyros

Director of the United States Patent and Trademark Office

United States of America

United States Patent and Trademark Office



Reg. No. 4,152,548

Registered June 5, 2012

Int. Cls.: 16, 39 and 43

TRADEMARK

SERVICE MARK

PRINCIPAL REGISTER

ORIZONIA DESTINATION MANAGEMENT, S.L. (SPAIN LIMITED LIABILITY COMPANY)
C/ RITA LEVI, S/N - EDIFICIO ORIZONIA
PARCBIT - CTRA. VALDEMOSSA, KM. 7,4
PALMA DE MALLORCA, SPAIN 07121

FOR: PRINTED PUBLICATIONS, NAMELY, TOURIST LEAFLETS AND BROCHURES, IN CLASS 16 (U.S. CLS. 2, 5, 22, 23, 29, 37, 38 AND 50).

FOR: PROVIDING TRAVEL ARRANGEMENTS, GROUND TRANSPORT OF PASSENGERS, TICKET RESERVATION FOR THE AFORESAID MEANS OF TRANSPORT, IN CLASS 39 (U.S. CLS. 100 AND 105).

FOR: PROVIDING RESERVATION OF TEMPORARY ACCOMMODATIONS, SERVICES FOR PROVIDING FOOD, DRINK AND HOTEL TRADE SERVICES, IN CLASS 43 (U.S. CLS. 100 AND 101).

OWNER OF SPAIN REG. NO. 2.841.104, DATED 2-6-2009, EXPIRES 8-14-2018.

THE COLOR(S) DARK BLUE, ORANGE, GRAY, WHITE, RED, PINK, GREEN, LIGHT BLUE, AND YELLOW IS/ARE CLAIMED AS A FEATURE OF THE MARK.

OWNER OF SPAIN REG. NO. 2.841.103, DATED 2-6-2009, EXPIRES 8-14-2018.

OWNER OF SPAIN REG. NO. 2.841.102, DATED 2-6-2009, EXPIRES 8-14-2018.

NO CLAIM IS MADE TO THE EXCLUSIVE RIGHT TO USE "DESTINATION MANAGEMENT", APART FROM THE MARK AS SHOWN.

THE MARK CONSISTS OF THE WORD "SMILO" IN DARK BLUE WITH AN ORANGE DOT OVER THE LETTER "I". THE LETTER "O" CONTAINS A FACE IN WHITE WITH GRAY EYES AND A GRAY MOUTH THAT EXTENDS TO THE RIGHT INTO A PINWHEEL WITH FIVE PRONGS, IN THE COLORS RED, PINK, GREEN, LIGHT BLUE, AND YELLOW. THE WORDS "DESTINATION MANAGEMENT" APPEAR IN GRAY COLOR BELOW "SMILO".

SER. NO. 85-153,777, FILED 10-15-2010.

TEJBIR SINGH, EXAMINING ATTORNEY



David J. Kyros

Director of the United States Patent and Trademark Office

United States of America
United States Patent and Trademark Office

MiScale

Reg. No. 4,152,549

Registered June 5, 2012

Int. Cl.: 9

TRADEMARK

PRINCIPAL REGISTER

MISCALE, LLC (DELAWARE LIMITED LIABILITY COMPANY)
#200
1340 CENTRE ST.
NEWTON, MA 02459

FOR: SCALES, IN CLASS 9 (U.S. CLS. 21, 23, 26, 36 AND 38).

FIRST USE 4-1-2010; IN COMMERCE 4-1-2010.

THE MARK CONSISTS OF THE WORD MARK "MISCALE" IN STYLIZED TEXT. THE "M" AND "S" ARE CAPITALIZED, AND THE "I" IS IN ITALICS.

SER. NO. 85-155,642, FILED 10-19-2010.

JOHN WILKE, EXAMINING ATTORNEY



David J. Kybas

Director of the United States Patent and Trademark Office

United States of America

United States Patent and Trademark Office

COUNCIL OF SUPPLY CHAIN MANAGEMENT PROFESSIONALS

Reg. No. 4,152,550

Registered June 5, 2012

Int. Cl.: 35

SERVICE MARK

PRINCIPAL REGISTER

COUNCIL OF SUPPLY CHAIN MANAGEMENT PROFESSIONALS (ILLINOIS CORPORATION)
333 EAST BUTTERFIELD ROAD, SUITE 140
LOMBARD, IL 60148

FOR: PROMOTING THE INTERESTS AND EDUCATION OF SUPPLY CHAIN MANAGEMENT PROFESSIONALS, IN CLASS 35 (U.S. CLS. 100, 101 AND 102).

FIRST USE 1-1-2005; IN COMMERCE 1-1-2005.

THE MARK CONSISTS OF STANDARD CHARACTERS WITHOUT CLAIM TO ANY PARTICULAR FONT, STYLE, SIZE, OR COLOR.

OWNER OF U.S. REG. NO. 2,982,452.

NO CLAIM IS MADE TO THE EXCLUSIVE RIGHT TO USE "SUPPLY CHAIN MANAGEMENT PROFESSIONALS", APART FROM THE MARK AS SHOWN.

SEC. 2(F).

SER. NO. 85-157,257, FILED 10-20-2010.

TEJBIR SINGH, EXAMINING ATTORNEY



David J. Kyros

Director of the United States Patent and Trademark Office

United States of America

United States Patent and Trademark Office

RALLY

Reg. No. 4,152,551

Registered June 5, 2012

Int. Cl.: 12

TRADEMARK

PRINCIPAL REGISTER

SCAT ENTERPRISES, INC. (CALIFORNIA CORPORATION)
1400 KINGSDALE AVENUE
REDONDO BEACH, CA 90278

FOR: VEHICLE SEATS; CUSTOM VEHICLE SEATS; VEHICLE BUCKET SEATS; VEHICLE RACING SEATS; VEHICLE SPORT SEATS; AUTOMOTIVE AFTER MARKET SEATS; VEHICLE SEAT ACCESSORIES AND STRUCTURAL PARTS THEREFOR, NAMELY, SEAT COVERS, SEAT HARNESSSES, SEAT PADDING, AND SEAT ARMRESTS; AND AUTOMOTIVE SEAT KITS, NAMELY, FRONT SEAT CONSOLES, REAR SEAT CONSOLES, SEAT COVERS, MAP POCKETS AND CASSETTE COMPARTMENTS, IN CLASS 12 (U.S. CLS. 19, 21, 23, 31, 35 AND 44).

FIRST USE 1-31-1982; IN COMMERCE 1-31-1982.

THE MARK CONSISTS OF STANDARD CHARACTERS WITHOUT CLAIM TO ANY PARTICULAR FONT, STYLE, SIZE, OR COLOR.

SER. NO. 85-157,296, FILED 10-20-2010.

KEVIN DINALLO, EXAMINING ATTORNEY



David J. Kybas

Director of the United States Patent and Trademark Office

United States of America

United States Patent and Trademark Office

Fearless Kid

Reg. No. 4,152,552

Registered June 5, 2012

Int. Cl.: 41

SERVICE MARK

PRINCIPAL REGISTER

LATIBEAUDIERE DELMAR O (JAMAICA INDIVIDUAL), AKA FEARLESS KID
2751 ARBOR AVE APT.#4
CINCINNATI, OH 45209

FOR: ENTERTAINMENT SERVICES BY A MUSICAL ARTIST, NAMELY, LIVE MUSICAL PERFORMANCES AND PRODUCTION OF MUSICAL SOUND RECORDINGS, IN CLASS 41 (U.S. CLS. 100, 101 AND 107).

FIRST USE 1-12-2002; IN COMMERCE 1-12-2002.

THE MARK CONSISTS OF STANDARD CHARACTERS WITHOUT CLAIM TO ANY PARTICULAR FONT, STYLE, SIZE, OR COLOR.

THE NAME "FEARLESS KID" IDENTIFIES A LIVING INDIVIDUAL WHOSE CONSENT IS OF RECORD.

SER. NO. 85-157,348, FILED 10-20-2010.

BRIDGETT SMITH, EXAMINING ATTORNEY



David J. Kyros

Director of the United States Patent and Trademark Office

United States of America

United States Patent and Trademark Office

BEST DRESSED OF LOUISVILLE

Reg. No. 4,152,553

BLUE EQUITY PUBLISHING LOUISVILLE LLC (FLORIDA LIMITED LIABILITY COMPANY)
333 E MAIN STREET, SUITE 200
LOUISVILLE, KY 40202

Registered June 5, 2012

Int. Cl.: 41

FOR: ORGANIZING AND CONDUCTING AN ANNUAL EVENT TO SELECT THE BEST DRESSED PEOPLE IN LOUISVILLE, IN CLASS 41 (U.S. CLS. 100, 101 AND 107).

SERVICE MARK

FIRST USE 6-8-2006; IN COMMERCE 6-8-2006.

PRINCIPAL REGISTER

THE MARK CONSISTS OF STANDARD CHARACTERS WITHOUT CLAIM TO ANY PARTICULAR FONT, STYLE, SIZE, OR COLOR.

NO CLAIM IS MADE TO THE EXCLUSIVE RIGHT TO USE "BEST DRESSED", APART FROM THE MARK AS SHOWN.

SEC. 2(F).

SER. NO. 85-158,146, FILED 10-21-2010.

KEVIN DINALLO, EXAMINING ATTORNEY



David J. Kybas

Director of the United States Patent and Trademark Office

United States of America

United States Patent and Trademark Office



Reg. No. 4,152,554

Registered June 5, 2012

Int. Cl.: 32

TRADEMARK

PRINCIPAL REGISTER

GASEOSAS COLOMBIANAS S.A. (COLOMBIA CORPORATION)
CALLE 52 NO. 47-42
MEDELLIN, COLOMBIA

FOR: ARTIFICIALLY FLAVORED SOFT DRINKS, EXCLUDING FRUIT DRINKS AND HORCHATA, IN CLASS 32 (U.S. CLS. 45, 46 AND 48).

FIRST USE 6-0-2008; IN COMMERCE 6-0-2008.

OWNER OF U.S. REG. NO. 1,420,354.

THE COLOR(S) BLUE, YELLOW AND RED IS/ARE CLAIMED AS A FEATURE OF THE MARK.

THE MARK CONSISTS OF CONDENSATION DROPLETS ON A BLUE BACKGROUND WHICH MAKES THE TOP PORTION OF THE MARK. A BLUE EAGLE DESIGN IS PERCHED ON THE LETTER "M" OF THE WORD "COLOMBIANA" WHICH IS MADE UP OF RED LETTERS. THE RED LETTERS ARE OUTLINED IN THE COLOR YELLOW AND BLUE SHADOW AROUND THE LETTERS TO GIVE THE LETTERS A 3-DIMENSIONAL APPEARANCE. BELOW THE WORD "COLOMBIANA" ARE THE WORDS "LA NUESTRA" MADE UP OF YELLOW LETTERS. THESE WORDS ARE INSIDE A BLUE OVAL DESIGN WHICH IS OUTLINED IN THE COLOR YELLOW. ALL THIS IS FOUND WITHIN THE MIDDLE OF A CURVED YELLOW DESIGN. THE BOTTOM PORTION OF THE MARK IS MADE UP OF CONDENSATION DROPLETS ON A RED BACKGROUND.

THE ENGLISH TRANSLATION OF "COLOMBIANA" AND "LA NUESTRA" IN THE MARK IS "COLUMBIAN" AND "OURS".

SEC. 2(F) AS TO "COLOMBIANA".

SER. NO. 85-159,292, FILED 10-22-2010.

BRIAN CALLAGHAN, EXAMINING ATTORNEY



David J. Kybas

Director of the United States Patent and Trademark Office

United States of America

United States Patent and Trademark Office

NEIGHBORHOOD UNITY FOUNDATION

Reg. No. 4,152,555

Registered June 5, 2012

Int. Cls.: 35 and 36

SERVICE MARK

PRINCIPAL REGISTER

NEIGHBORHOOD UNITY FOUNDATION (CALIFORNIA CORPORATION)
JOE & VI JACOBS CENTER
404 EUCLID AVENUE
SAN DIEGO, CA 92114

FOR: CHARITABLE SERVICES, NAMELY, ORGANIZING AND CONDUCTING VOLUNTEER PROGRAMS, COMMUNITY SERVICE PROJECTS AND NEIGHBORHOOD IMPROVEMENT PROJECTS, IN CLASS 35 (U.S. CLS. 100, 101 AND 102).

FIRST USE 5-0-2004; IN COMMERCE 5-0-2004.

FOR: CHARITABLE SERVICES, NAMELY, THE PROVISION OF GRANTS AND FUNDING FOR NEIGHBORHOOD IMPROVEMENT PROJECTS RELATED TO PROMOTION OF SOCIAL, ECONOMIC AND CULTURAL DEVELOPMENT IN THE COMMUNITY, URBAN DEVELOPMENT AND IMPROVING DISADVANTAGED COMMUNITIES; PROVIDING GRANTS FOR COMMUNITY ORGANIZATIONS SERVICE PROJECTS, VOLUNTEER PROGRAMS, AND NEIGHBORHOOD IMPROVEMENT PROJECTS TO UNITE NEIGHBORHOOD RESIDENTS, IN CLASS 36 (U.S. CLS. 100, 101 AND 102).

FIRST USE 5-0-2004; IN COMMERCE 5-0-2004.

THE MARK CONSISTS OF STANDARD CHARACTERS WITHOUT CLAIM TO ANY PARTICULAR FONT, STYLE, SIZE, OR COLOR.

NO CLAIM IS MADE TO THE EXCLUSIVE RIGHT TO USE "FOUNDATION", APART FROM THE MARK AS SHOWN.

SEC. 2(F).

SER. NO. 85-159,509, FILED 10-22-2010.

LESLEY LAMOTHE, EXAMINING ATTORNEY



David J. Kyros

Director of the United States Patent and Trademark Office

United States of America

United States Patent and Trademark Office

TRADENOMIX

Reg. No. 4,152,556

Registered June 5, 2012

Int. Cl.: 36

SERVICE MARK

PRINCIPAL REGISTER

TRADENOMIX INC. (CANADA CORPORATION)
P.O. BOX 93029
CAULFIELD VILLAGE RPO
WEST VANCOUVER, B.C., CANADA V7W 3G4

FOR: REAL ESTATE SERVICES, NAMELY, PROVIDING REAL ESTATE LISTINGS AND REAL ESTATE INFORMATION VIA THE INTERNET, IN CLASS 36 (U.S. CLS. 100, 101 AND 102).

THE MARK CONSISTS OF STANDARD CHARACTERS WITHOUT CLAIM TO ANY PARTICULAR FONT, STYLE, SIZE, OR COLOR.

PRIORITY CLAIMED UNDER SEC. 44(D) ON CANADA APPLICATION NO. 1500570, FILED 10-21-2010, REG. NO. TMA816073, DATED 1-25-2012, EXPIRES 1-25-2027.

SER. NO. 85-160,398, FILED 10-25-2010.

KAREN BRACEY, EXAMINING ATTORNEY



David J. Kybas

Director of the United States Patent and Trademark Office

United States of America

United States Patent and Trademark Office

STEAM ROLLER

Reg. No. 4,152,557

Registered June 5, 2012

Int. Cl.: 28

TRADEMARK

PRINCIPAL REGISTER

MATTEL, INC. (DELAWARE CORPORATION)
M1-1518
333 CONTINENTAL BOULEVARD
EL SEGUNDO, CA 90245

FOR: TOY VEHICLES, EXCLUDING ROAD PAVING EQUIPMENT VEHICLES, AND ACCESSORIES THEREFOR, IN CLASS 28 (U.S. CLS. 22, 23, 38 AND 50).

FIRST USE 11-22-2011; IN COMMERCE 11-22-2011.

THE MARK CONSISTS OF STANDARD CHARACTERS WITHOUT CLAIM TO ANY PARTICULAR FONT, STYLE, SIZE, OR COLOR.

SER. NO. 85-161,836, FILED 10-26-2010.

JIM RINGLE, EXAMINING ATTORNEY



David J. Kybas

Director of the United States Patent and Trademark Office

United States of America

United States Patent and Trademark Office

WATTS POWER WHITE

Reg. No. 4,152,558

Registered June 5, 2012

Int. Cl.: 3

TRADEMARK

PRINCIPAL REGISTER

DIRECT 2U WHOLESALE LLC (FLORIDA LIMITED LIABILITY COMPANY)
17604 ARCHLAND PASS ROAD
LUTZ, FL 33558

FOR: TEETH WHITENING KIT; TOOTH WHITENING GELS; TOOTHPASTE, IN CLASS 3
(U.S. CLS. 1, 4, 6, 50, 51 AND 52).

FIRST USE 12-15-2009; IN COMMERCE 12-15-2009.

THE MARK CONSISTS OF STANDARD CHARACTERS WITHOUT CLAIM TO ANY PARTICULAR FONT, STYLE, SIZE, OR COLOR.

NO CLAIM IS MADE TO THE EXCLUSIVE RIGHT TO USE "WHITE", APART FROM THE MARK AS SHOWN.

SER. NO. 85-162,412, FILED 10-27-2010.

DEIRDRE ROBERTSON, EXAMINING ATTORNEY



David J. Kybas

Director of the United States Patent and Trademark Office

United States of America

United States Patent and Trademark Office



Reg. No. 4,152,559

Registered June 5, 2012

Int. Cls.: 39 and 45

SERVICE MARK

PRINCIPAL REGISTER

BRICKELL FINANCIAL SERVICES-MOTOR CLUB, INC. (FLORIDA CORPORATION)
7300 CORPORATE CENTER DRIVE, SUITE 601
CHICAGO, IL 33126

FOR: EMERGENCY ROADSIDE ASSISTANCE SERVICES, NAMELY, TOWING, WINCH-OUT AND KEY DELIVERY SERVICES, IN CLASS 39 (U.S. CLS. 100 AND 105).

FIRST USE 4-1-2006; IN COMMERCE 4-1-2006.

FOR: EMERGENCY ROADSIDE ASSISTANCE SERVICES, NAMELY, OPENING OF LOCKS, IN CLASS 45 (U.S. CLS. 100 AND 101).

FIRST USE 4-1-2006; IN COMMERCE 4-1-2006.

OWNER OF U.S. REG. NOS. 2,784,355, 3,229,466 AND OTHERS.

THE COLOR(S) RED, BLACK, GRAY, WHITE IS/ARE CLAIMED AS A FEATURE OF THE MARK.

NO CLAIM IS MADE TO THE EXCLUSIVE RIGHT TO USE "AMERICA" AND "COMPANY", APART FROM THE MARK AS SHOWN.

THE MARK CONSIST OF THE COLOR RED APPEARS IN THE WORD "ROAD", THE LETTERING "MAPFRE" AND THE BOTTOM THIRD OF THE CIRCLE. THE COLOR GRAY APPEARS IN THE UPPER TWO THIRDS OF THE CIRCLE DESIGN, THE WORDS, "AMERICA", "A", AND "COMPANY", AND THE VERTICAL LINE BETWEEN THE WORDS "ROAD" AND "AMERICA". THE COLOR WHITE APPEARS IN THE TRIANGULAR DESIGN INSIDE THE CIRCLE.

SER. NO. 85-164,048, FILED 10-28-2010.

MARILYN IZZI, EXAMINING ATTORNEY



David J. Kyjars

Director of the United States Patent and Trademark Office

United States of America

United States Patent and Trademark Office



Reg. No. 4,152,560

Registered June 5, 2012

Int. Cls.: 9 and 25

TRADEMARK

PRINCIPAL REGISTER

KIMPEX INC. (CANADA CORPORATION)
5355 ST-ROCH
DRUMMONDVILLE, QUEBEC, CANADA J2B6V4

FOR: HELMETS, GOGGLES AND PROTECTION MASKS, IN CLASS 9 (U.S. CLS. 21, 23, 26, 36 AND 38).

FIRST USE 3-31-2009; IN COMMERCE 3-31-2009.

FOR: CLOTHING AND ACCESSORIES FOR SNOWMOBILE, MOTORCYCLE AND ATV, NAMELY, HATS, VISORS, BOOTS, JACKETS, COATS, PANTS, LEATHER OR NYLON JACKETS, GLOVES, GLOVE LINERS, MITTENS, HOODS, MASKS, HEADBANDS, UNDER STOCKINGS, UNDERWEAR, THERMAL UNDERWEAR, BASE LAYERS, SLEEVES, BELTS, SWEAT SUITS, IN CLASS 25 (U.S. CLS. 22 AND 39).

FIRST USE 3-31-2009; IN COMMERCE 3-31-2009.

THE MARK CONSISTS OF FOUR TRIANGLES WITH ROUNDED CORNERS IN DIFFERENT SIZES CONTAINED INSIDE RECTANGULAR BACKGROUND.

SER. NO. 85-164,711, FILED 10-29-2010.

TRACY WHITTAKER-BROWN, EXAMINING ATTORNEY



David J. Kybas

Director of the United States Patent and Trademark Office

United States of America

United States Patent and Trademark Office

OMEGACRANS

Reg. No. 4,152,561

Registered June 5, 2012

Int. Cl.: 29

TRADEMARK

PRINCIPAL REGISTER

DECAS CRANBERRY PRODUCTS INC (MASSACHUSETTS CORPORATION)
4 OLD FORGE DRIVE
CARVER, MA 02330

FOR: DRIED FRUITS, IN CLASS 29 (U.S. CL. 46).

FIRST USE 10-29-2008; IN COMMERCE 10-29-2008.

THE MARK CONSISTS OF STANDARD CHARACTERS WITHOUT CLAIM TO ANY PARTICULAR FONT, STYLE, SIZE, OR COLOR.

SER. NO. 85-165,009, FILED 10-29-2010.

DAWN FELDMAN, EXAMINING ATTORNEY



David J. Kybas

Director of the United States Patent and Trademark Office

United States of America

United States Patent and Trademark Office

Kid Glove Diva

Reg. No. 4,152,562

WIEDEMANN, HARTY (UNITED STATES INDIVIDUAL)
448 BRADFORD LANE
QUINCY, FL 32351

Registered June 5, 2012

Int. Cl.: 35

FOR: ONLINE RETAIL STORE SERVICES FEATURING CLOTHING AND ACCESSORIES,
IN CLASS 35 (U.S. CLS. 100, 101 AND 102).

SERVICE MARK

FIRST USE 2-6-2008; IN COMMERCE 12-21-2009.

PRINCIPAL REGISTER

THE MARK CONSISTS OF STANDARD CHARACTERS WITHOUT CLAIM TO ANY PARTICULAR FONT, STYLE, SIZE, OR COLOR.

NO CLAIM IS MADE TO THE EXCLUSIVE RIGHT TO USE "KID GLOVE", APART FROM THE MARK AS SHOWN.

SER. NO. 85-166,063, FILED 11-1-2010.

JANICE KIM, EXAMINING ATTORNEY



David J. Kyros

Director of the United States Patent and Trademark Office

United States of America
United States Patent and Trademark Office

KEIKO

MECHERI

Reg. No. 4,152,563

Registered June 5, 2012

Int. Cl.: 3

TRADEMARK

PRINCIPAL REGISTER

LES PARFUMS KEIKO MECHEI (CALIFORNIA CORPORATION)
311 N. ROBERTSON BLVD. #716
BEVERLY HILLS, CA 90211

FOR: COLOGNES, PERFUMES AND COSMETICS; COSMETICS IN GENERAL, INCLUDING PERFUMES; DISINFECTING PERFUMED SOAPS; EAU DE COLOGNE; EAU DE COLOGNES; EAU DE PARFUM; EAU DE PERFUME; EAU DE TOILETTE; EAU DE TOILETTE AND EAU DE COLOGNE; EAU-DE-COLOGNE; EAU-DE-TOILETTE; EAUX DE COLOGNE; EAUX DE TOILETTE; ESSENTIAL OILS AS PERFUME FOR LAUNDRY PURPOSES; LIQUID PERFUMES; OILS FOR PERFUMES AND SCENTS; PERFUME; PERFUME OILS; PERFUME OILS FOR THE MANUFACTURE OF COSMETIC PREPARATIONS; PERFUMED CREAMS; PERFUMED EXTRACTS FOR TISSUES AND PERFUMES; PERFUMED PASTE; PERFUMED POWDER; PERFUMED POWDERS; PERFUMED SOAP; PERFUMED SOAPS; PERFUMED TALCUM POWDER; PERFUMES; PERFUMES AND COLOGNES; PERFUMES AND TOILET WATERS; PERFUMES IN SOLID FORM; PERFUMES, AFTERSHAVES AND COLOGNES; PERFUMES, EAU DE COLOGNES AND AFTERSHAVES; PERFUMES, EAUX DE COLOGNE AND AFTERSHAVES; PERFUMING SACHETS; SACHETS FOR PERFUMING LINEN, IN CLASS 3 (U.S. CLS. 1, 4, 6, 50, 51 AND 52).

FIRST USE 1-1-2002; IN COMMERCE 1-1-2002.

THE MARK CONSISTS OF STANDARD CHARACTERS WITHOUT CLAIM TO ANY PARTICULAR FONT, STYLE, SIZE, OR COLOR.

THE NAME(S), PORTRAIT(S), AND/OR SIGNATURE(S) SHOWN IN THE MARK IDENTIFIES "KEIKO MECHEI", WHOSE CONSENT(S) TO REGISTER IS MADE OF RECORD.

SER. NO. 85-166,239, FILED 11-1-2010.

JAMES LOVELACE, EXAMINING ATTORNEY



David J. Kyffers

Director of the United States Patent and Trademark Office

United States of America

United States Patent and Trademark Office



Reg. No. 4,152,564

Registered June 5, 2012

Int. Cls.: 35 and 37

SERVICE MARK

PRINCIPAL REGISTER

REPROCAD ASSOCIATES, INC. (MISSOURI CORPORATION), DBA REPRMAX
SUITE 101
16141 SWINGLEY RIDGE ROAD
CHESTERFIELD, MO 63017

FOR: BUSINESS ASSISTANCE, RECORDS MANAGEMENT, AND INFORMATION SERVICES FOR CONSTRUCTION AND ARCHITECTURE, ENGINEERING AND CONSTRUCTION INDUSTRIES REQUIRING THE STORAGE OF PROPRIETARY DATA VIA A SECURE ONLINE REPOSITORY; BUSINESS RECORDS MANAGEMENT SERVICES IN THE NATURE OF DOCUMENT COLLABORATION, IN CLASS 35 (U.S. CLS. 100, 101 AND 102).

FIRST USE 11-1-2010; IN COMMERCE 11-1-2010.

FOR: PROVIDING ON-LINE COMPUTER DATABASES IN THE FIELD OF CONSTRUCTION, NAMELY, DATABASES CONTAINING CONSTRUCTION BLUEPRINTS AND OTHER DOCUMENTS IN THE FIELD OF CONSTRUCTION, WITH THE AFOREMENTIONED DATABASES PROVIDING STORAGE OF PROPRIETARY DATA VIA A SECURE ONLINE REPOSITORY, IN CLASS 37 (U.S. CLS. 100, 103 AND 106).

FIRST USE 11-1-2010; IN COMMERCE 11-1-2010.

THE MARK CONSISTS OF AN L-SHAPED LINE. A BOX APPEARS AT THE INTERSECTION OF THE TWO LINES. THE WORD "CMAX" APPEARS DIRECTLY TO THE RIGHT AND BELOW THE L-SHAPED LINE. THE LETTER "C" APPEARS IN LOWER CASE LETTERS AND IS CENTERED PARTIALLY OVER TOP OF THE LETTER "M". THE LETTERS "MAX" APPEAR IN CAPITAL LETTERS AND ARE UNDERLINED. A BOX APPEARS UNDER THE LETTER "M" WHICH EXTENDS BELOW THE UNDERLINING. THE LINE EXTENDS PAST THE BOX ON THE LEFT SIDE OF THE LETTER "M".

SER. NO. 85-166,587, FILED 11-1-2010.

KEVIN CORWIN, EXAMINING ATTORNEY



David J. Kyppas

Director of the United States Patent and Trademark Office

United States of America

United States Patent and Trademark Office

OMNIPLUS

Reg. No. 4,152,565

Registered June 5, 2012

Int. Cl.: 12

TRADEMARK

PRINCIPAL REGISTER

DAIMLER AG (FED REP GERMANY CORPORATION)
MERCEDSSTRASSE 137
STUTTGART, FED REP GERMANY 70327

FOR: STRUCTURAL PARTS FOR BUSES, IN CLASS 12 (U.S. CLS. 19, 21, 23, 31, 35 AND 44).

THE MARK CONSISTS OF STANDARD CHARACTERS WITHOUT CLAIM TO ANY PARTICULAR FONT, STYLE, SIZE, OR COLOR.

OWNER OF ERPN CMNTY TM OFC REG. NO. 009099474, DATED 10-26-2010, EXPIRES 5-12-2020.

SER. NO. 85-167,391, FILED 11-2-2010.

SANJEEV VOHRA, EXAMINING ATTORNEY



David J. Kybas

Director of the United States Patent and Trademark Office

United States of America

United States Patent and Trademark Office



Reg. No. 4,152,566

Registered June 5, 2012

Int. Cl.: 30

HERSHEY CHOCOLATE & CONFECTIONERY CORPORATION (DELAWARE CORPORATION)
SUITE 204
4860 ROBB STREET
WHEAT RIDGE, CO 80033

FOR: CANDY, IN CLASS 30 (U.S. CL. 46).

FIRST USE 2-15-2010; IN COMMERCE 2-15-2010.

OWNER OF U.S. REG. NOS. 1,074,163, 3,601,728 AND OTHERS.

THE COLOR(S) ORANGE, YELLOW, BROWN, WHITE, TAN, GREEN, RED AND GOLD IS/ARE CLAIMED AS A FEATURE OF THE MARK.

NO CLAIM IS MADE TO THE EXCLUSIVE RIGHT TO USE "MILK CHOCOLATE" AND "PEANUT BUTTER CUPS" AND THE PICTORIAL REPRESENTATION OF THE GOODS BEING CANDY, APART FROM THE MARK AS SHOWN.

THE MARK CONSISTS OF AN ORANGE BACKGROUND. IN THE UPPER RIGHT HAND CORNER ARE THE STYLIZED WORDS "MILK CHOCOLATE" IN BROWN. BELOW THIS IS LOCATED THE STYLIZED WORDING "REESE'S" IN THE COLOR YELLOW AND OUTLINED IN BROWN. BELOW THIS IS LOCATED A DESIGN OF A PEANUT BUTTER CUP IN THE COLOR BROWN ACROSS WHICH IS LOCATED THE STYLIZED WORDING "PEANUT BUTTER CUPS" IN THE COLOR YELLOW. BELOW THIS IS LOCATED THE STYLIZED WORDING "MINIATURES" IN WHITE AND OUTLINED IN BROWN. BELOW THIS AND ACROSS THE ENTIRE ORANGE BACKGROUND IS A STYLIZED DESIGN OF A STRING OF HOLIDAY LIGHTS WHERE THE STRING IS GREEN WITH THE LIGHTS BEING REPRESENTED BY STYLIZED DESIGN ELEMENTS OF FOUR PEANUT BUTTER CUPS IN THE COLORS RED, GOLD, GREEN AND GREEN FROM LEFT TO RIGHT. BELOW THE DESIGN OF THE STRING OF LIGHTS IS LOCATED THE STYLIZED WORDING "PERFECT" IN BROWN TO THE RIGHT OF WHICH IS LOCATED THE DESIGN OF A HOLLY BERRY WITH THE BERRY IN RED AND THE LEAVES IN GREEN. BELOW THE WORDING "PERFECT" AND DESIGN OF THE HOLLY BERRY IS LOCATED THE STYLIZED WORDING "REESE'S" IN THE COLOR YELLOW AND OUTLINED IN BROWN. TO THE RIGHT OF STYLIZED WORDING "REESE'S" IS LOCATED THE STYLIZED WORDING "MINIATURES" IN WHITE AND OUTLINED IN BROWN. ABOVE THE STYLIZED WORDING "MINIATURES"

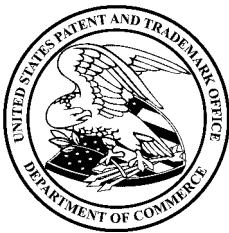

David J. Kyjars

Director of the United States Patent and Trademark Office

Reg. No. 4,152,566 IS LOCATED THE DESIGN ELEMENTS OF ONE WHOLE PEANUT BUTTER CUP IN BROWN AND THE OTHER THAT IS HALF OPEN WITH THE OUTSIDE IN THE COLOR BROWN INSIDE FILLING IN THE COLOR TAN. THE DOTTED LINING SHOWN IN THE MARK IS NOT A FEATURE OF THE MARK BUT IS INTENDED TO SHOW PLACEMENT OF THE MARK ON THE PACKAGE.

SEC. 2(F) AS TO "MINIATURES".

SER. NO. 85-171,361, FILED 11-8-2010.

NAPOLEON SHARMA, EXAMINING ATTORNEY

United States of America

United States Patent and Trademark Office



Reg. No. 4,152,567

Registered June 5, 2012

Int. Cl.: 35

SERVICE MARK

PRINCIPAL REGISTER

LEVY, JEFFREY (CANADA INDIVIDUAL)
315 EGLINTON AVENUE, WEST, SUITE 201
TORONTO, ONTARIO, CANADA M5N1A1

FOR: ON-LINE PROFESSIONAL NETWORKING SERVICES; ON-LINE BUSINESS NETWORKING SERVICES; PROVIDING AN ON-LINE COMMERCIAL INFORMATION DIRECTORY ON THE INTERNET; ADVERTISING AND MARKETING SERVICES, NAMELY, PROMOTING GOODS AND SERVICES FOR BUSINESSES; PROVIDING AN ONLINE SEARCHABLE DATABASE FEATURING EMPLOYMENT AND CAREER OPPORTUNITIES AND BUSINESS, EMPLOYMENT AND PROFESSIONAL QUERIES AND ANSWERS; JOB PLACEMENT SERVICES, HUMAN RESOURCES CONSULTING SERVICES; PROMOTING THE GOODS AND SERVICES OF OTHERS VIA A GLOBAL COMPUTER NETWORK; ADVERTISING, MARKETING AND PROMOTIONAL SERVICES RELATED TO ALL INDUSTRIES FOR THE PURPOSE OF FACILITATING NETWORKING AND SOCIALIZING OPPORTUNITIES FOR BUSINESS PURPOSES; PROVIDING ONLINE CAREER NETWORKING SERVICES AND INFORMATION IN THE FIELDS OF EMPLOYMENT, RECRUITMENT, JOB RESOURCES, AND JOB LISTINGS; PERSONNEL RECRUITMENT AND PLACEMENT SERVICES; PROVIDING NETWORKING OPPORTUNITIES FOR INDIVIDUALS SEEKING EMPLOYMENT; ON-LINE PROFESSIONAL NETWORKING OPPORTUNITIES; PROVIDING ONLINE COMPUTER DATABASES AND ONLINE SEARCHABLE DATABASES IN THE FIELDS OF BUSINESS AND PROFESSIONAL NETWORKING, IN CLASS 35 (U.S. CLS. 100, 101 AND 102).

FIRST USE 8-8-2007; IN COMMERCE 8-8-2007.

THE MARK CONSISTS OF A STYLIZED LETTER "I" IN THE SHAPE OF A FLYING BIRD OR STICK FIGURE OF THE HUMAN FORM.

SER. NO. 85-172,388, FILED 11-9-2010.

SCOTT BIBB, EXAMINING ATTORNEY



David J. Kyffers

Director of the United States Patent and Trademark Office

United States of America

United States Patent and Trademark Office

VIVASMILES

Reg. No. 4,152,568

Registered June 5, 2012

Int. Cl.: 44

SERVICE MARK

PRINCIPAL REGISTER

RUTH GOMES, D.M.D., INC. (MISSOURI CORPORATION)
SUITE 217
141 N. MERAMEC AVE.
ST. LOUIS, MO 63105

FOR: DENTIST SERVICES, IN CLASS 44 (U.S. CLS. 100 AND 101).

FIRST USE 6-0-2008; IN COMMERCE 6-0-2008.

THE MARK CONSISTS OF STANDARD CHARACTERS WITHOUT CLAIM TO ANY PARTICULAR FONT, STYLE, SIZE, OR COLOR.

SER. NO. 85-173,378, FILED 11-10-2010.

DAVID COLLIER, EXAMINING ATTORNEY



David J. Kybas

Director of the United States Patent and Trademark Office

United States of America

United States Patent and Trademark Office

IFEELGOOD 24/7

Reg. No. 4,152,569

Registered June 5, 2012

Int. Cl.: 41

SERVICE MARK

PRINCIPAL REGISTER

IFEELGOOD 24/7 PTY LTD (AUSTRALIA CORPORATION)
78 HAMMERSMITH STREET
COOPERS PLAINS, QLD, AUSTRALIA 4108

FOR: CONDUCTING EXERCISE CLASSES; PROVIDING FITNESS AND EXERCISE CLINICS, CLUBS AND SALONS, NAMELY, PROVIDING FITNESS FACILITIES FOR OTHERS; HEALTH CLUB SERVICES, NAMELY, PROVIDING INSTRUCTION AND EQUIPMENT IN THE FIELD OF PHYSICAL EXERCISE; PROVIDING CLASSES IN THE FIELD OF PRENATAL EXERCISES; PROVISION OF APPARATUS FOR EXERCISE, NAMELY, PROVIDING GYMNASIUMS; PROVISION OF EXERCISE FACILITIES; RENTAL OF EXERCISE EQUIPMENT; HEALTH CLUB SERVICES, NAMELY, PROVIDING FITNESS TRAINING CLASSES; CONDUCTING FITNESS CLASSES, NAMELY, AEROBIC CLASSES; INSTRUCTION IN PHYSICAL FITNESS; OPERATION OF PHYSICAL FITNESS FACILITIES; PERSONAL TRAINER SERVICES, NAMELY, FITNESS TRAINING; PHYSICAL FITNESS INSTRUCTION; PHYSICAL FITNESS TRAINING SERVICES; PHYSICAL FITNESS SERVICES, NAMELY, PROVIDING FITNESS TRAINING CLASSES; PHYSICAL EDUCATION; PHYSICAL EDUCATION INSTRUCTION; PHYSICAL HEALTH EDUCATION; PHYSICAL TRAINING SERVICES; INSTRUCTION IN PHYSICAL FITNESS; INSTRUCTION SERVICES IN THE FIELD OF FITNESS; PROVIDING COURSES OF INSTRUCTION IN THE FIELD OF FITNESS; PROVISION OF INSTRUCTION FOR THE DISABLED IN THE FIELD OF FITNESS; SPORTS INSTRUCTION SERVICES; YOGA INSTRUCTION; GYMNASIUM SERVICES; GYMNASTIC INSTRUCTION; INSTRUCTION IN GYMNASTICS; GYMNASIUM CLUB SERVICES; PROVISION OF GYMNASIUM FACILITIES; CONDUCTING CLASSES IN WEIGHT CONTROL, IN CLASS 41 (U.S. CLS. 100, 101 AND 107).



THE MARK CONSISTS OF STANDARD CHARACTERS WITHOUT CLAIM TO ANY PARTICULAR FONT, STYLE, SIZE, OR COLOR.

PRIORITY CLAIMED UNDER SEC. 44(D) ON AUSTRALIA APPLICATION NO. 1360775, FILED 5-11-2010, REG. NO. 1360775, DATED 5-11-2010, EXPIRES 5-11-2020.

SER. NO. 85-173,791, FILED 11-10-2010.

Laurie Kaufman, Examining Attorney

David J. Kyros

Director of the United States Patent and Trademark Office

United States of America

United States Patent and Trademark Office

AICA

Reg. No. 4,152,570

Registered June 5, 2012

Int. Cl.: 44

SERVICE MARK

PRINCIPAL REGISTER

ACCIDENT INJURY CENTERS OF ATLANTA, INC. (GEORGIA CORPORATION)
1132 HIGHTOWER TRAIL, SUITE C
SANDY SPRINGS, GA 30350

FOR: HEALTH CARE SERVICES, NAMELY, MEDICAL, CHIROPRACTIC, PHYSICAL THERAPY, DIAGNOSTIC TESTING AND IMAGING SERVICES, IN CLASS 44 (U.S. CLS. 100 AND 101).

FIRST USE 9-0-2007; IN COMMERCE 9-0-2007.

THE MARK CONSISTS OF STANDARD CHARACTERS WITHOUT CLAIM TO ANY PARTICULAR FONT, STYLE, SIZE, OR COLOR.

SER. NO. 85-174,740, FILED 11-11-2010.

SARA BENJAMIN, EXAMINING ATTORNEY



David J. Kyffers

Director of the United States Patent and Trademark Office

United States of America

United States Patent and Trademark Office



Reg. No. 4,152,571

Registered June 5, 2012

Int. Cls.: 9 and 25

TRADEMARK

PRINCIPAL REGISTER

WHITES MANUFACTURING, LTD. (CANADA LIMITED COMPANY (LTD.))
6820 KIRKPATRICK CRESCENT
SAANICHTON, BC V8M 1ZP, CANADA

FOR: SURVIVAL SUITS, NAMELY, INSULATED OVERALL WET SUITS AND DRY SUITS;
DIVING GLOVES, DIVING HOODS, DIVING BOOTIES, DIVING SOCKS, IN CLASS 9 (U.S.
CLS. 21, 23, 26, 36 AND 38).

FIRST USE 10-27-1995; IN COMMERCE 10-27-1995.

FOR: CLOTHING, NAMELY, DRY SUITS, WET SUITS, HATS, SHIRTS, JACKETS, BEANIES,
CAPS, BAGS SPECIFICALLY ADAPTED FOR CARRYING AND HOLDING DRY SUITS
AND WET SUITS, UNDERGARMENTS FOR WET AND DRY SUITS, IN CLASS 25 (U.S.
CLS. 22 AND 39).

FIRST USE 10-27-1995; IN COMMERCE 10-27-1995.

NO CLAIM IS MADE TO THE EXCLUSIVE RIGHT TO USE "THE COLD WATER SPECIAL-
ISTS SINCE 1956", APART FROM THE MARK AS SHOWN.

THE MARK CONSISTS OF THE IMAGE OF A BEAR CONTAINED WITHIN AN INNER
CIRCLE SURROUNDED BY AN OUTER CIRCLE CONTAINING THE WORDS "THE COLD
WATER SPECIALISTS" IN THE UPPER PORTION OF THE OUTER CIRCLE AND CONTAIN-
ING THE WORDS "SINCE 1956" IN THE LOWER PORTION OF THE OUTER CIRCLE. THE
WORD "WHITES" IS DISPLAYED ACROSS AND IN FRONT OF THE LOWER PORTION OF
THE TWO CIRCLES IN AN ARCUATE-SHAPED RIBBON. ANOTHER PARTIAL ARCUATE-
SHAPED RIBBON IS DISPLAYED ACROSS AND BEHIND THE TWO CIRCLES JUST BELOW
THE FIRST ARCUATE-SHAPED RIBBON.

SER. NO. 85-174,770, FILED 11-11-2010.

FLORENTINA BLANDU, EXAMINING ATTORNEY



David J. Kyjars

Director of the United States Patent and Trademark Office

United States of America

United States Patent and Trademark Office

One Handed World

Reg. No. 4,152,572

Registered June 5, 2012

Int. Cl.: 35

SERVICE MARK

PRINCIPAL REGISTER

KELLEY STYRING (UNITED STATES INDIVIDUAL)
19960 NE RIBBON RIDGE ROAD
NEWBERG, OR 97132

FOR: ANALYSIS OF MARKET RESEARCH DATA AND STATISTICS; COLLECTION OF MARKET RESEARCH INFORMATION; COMPUTERIZED MARKET RESEARCH SERVICES; CONDUCTING BUSINESS AND MARKET RESEARCH SURVEYS; CONSUMER MARKETING RESEARCH AND CONSULTING RELATED THERETO; INTERNATIONAL BUSINESS CONSULTING SERVICES RELATING TO MERCHANDISE TRADING, HUMAN RESOURCE INTERCHANGE, MANAGEMENT SUPPORT, MARKETING, ADVERTISING, PROMOTION, AND DOMESTIC AND INTERNATIONAL MARKET RESEARCH AND DEVELOPMENT; MARKET RESEARCH; MARKET RESEARCH AND BUSINESS ANALYSES; MARKET RESEARCH AND MARKET INTELLIGENCE SERVICES; MARKET RESEARCH BY MEANS OF A COMPUTER DATABASE; MARKET RESEARCH CONSULTATION; MARKET RESEARCH SERVICES; MARKET RESEARCH STUDIES; MARKETING RESEARCH IN THE FIELDS OF COSMETICS, PERFUMERY AND BEAUTY PRODUCTS; MARKETING RESEARCH SERVICES; MARKETING SERVICES, NAMELY, CONSUMER MARKETING RESEARCH; ONLINE BUSINESS RESEARCH SERVICES THAT ALLOW USERS TO SHARE OPINIONS WITH A MARKETING RESEARCH COMPANY RELATED TO EVERYDAY CONSUMER PRODUCTS AND SERVICES; PROVIDING A WEB SITE FEATURING A DIRECTORY OF MARKET RESEARCH PANELS FOR CONSUMERS; PROVISION OF MARKET RESEARCH INFORMATION, IN CLASS 35 (U.S. CLS. 100, 101 AND 102).

FIRST USE 8-17-2009; IN COMMERCE 8-17-2009.

THE MARK CONSISTS OF STANDARD CHARACTERS WITHOUT CLAIM TO ANY PARTICULAR FONT, STYLE, SIZE, OR COLOR.

SER. NO. 85-175,631, FILED 11-12-2010.

GISELLE AGOSTO, EXAMINING ATTORNEY



David J. Kyros

Director of the United States Patent and Trademark Office

United States of America
United States Patent and Trademark Office

REBOOT

Reg. No. 4,152,573

MARZ, KEITH (UNITED STATES INDIVIDUAL)
6077 VAN NUYS BLVD.
VAN NUYS, CA 91401

Registered June 5, 2012

Int. Cl.: 5

FOR: ORAL SPRAY FOR BOOSTING ENERGY, IN CLASS 5 (U.S. CLS. 6, 18, 44, 46, 51 AND 52).

TRADEMARK

FIRST USE 4-1-2010; IN COMMERCE 4-1-2010.

PRINCIPAL REGISTER

THE MARK CONSISTS OF STANDARD CHARACTERS WITHOUT CLAIM TO ANY PARTICULAR FONT, STYLE, SIZE, OR COLOR.

SER. NO. 85-176,010, FILED 11-12-2010.

KAREN SEVERSON, EXAMINING ATTORNEY



David J. Kybas

Director of the United States Patent and Trademark Office

United States of America

United States Patent and Trademark Office

GREENCORE

Reg. No. 4,152,574

Registered June 5, 2012

Int. Cls.: 16 and 18

TRADEMARK

PRINCIPAL REGISTER

PETOSKEY PLASTICS, INC. (MICHIGAN CORPORATION)
ONE PETOSKEY STREET
PETOSKEY, MI 49770

FOR: PLASTIC BAGS FOR PACKAGING, DELIVERY, AND RECYCLING; PLASTIC TRASH BAGS, TRASH CAN LINERS, AND PLASTIC TRASH COMPACTOR BAGS MADE AT LEAST IN PART FROM RECYCLED MATERIALS, IN CLASS 16 (U.S. CLS. 2, 5, 22, 23, 29, 37, 38 AND 50).

FIRST USE 3-31-2009; IN COMMERCE 3-31-2009.

FOR: REUSABLE ALL PURPOSE CARRYING BAGS MADE OF PLASTIC MADE AT LEAST IN PART FROM RECYCLED MATERIALS, IN CLASS 18 (U.S. CLS. 1, 2, 3, 22 AND 41).

FIRST USE 3-31-2009; IN COMMERCE 3-31-2009.

THE MARK CONSISTS OF STANDARD CHARACTERS WITHOUT CLAIM TO ANY PARTICULAR FONT, STYLE, SIZE, OR COLOR.

OWNER OF U.S. REG. NOS. 3,788,456 AND 3,797,164.

SER. NO. 85-178,123, FILED 11-16-2010.

DANNEAN HETZEL, EXAMINING ATTORNEY



David J. Kyros

Director of the United States Patent and Trademark Office

United States of America

United States Patent and Trademark Office

BE BOLD BE SEXY BE GLAM
BE CHIC

Reg. No. 4,152,575

Registered June 5, 2012

Int. Cls.: 25 and 35

TRADEMARK

SERVICE MARK

PRINCIPAL REGISTER

SPECIALTY FASHION GROUP LTD (AUSTRALIA CORPORATION)
151-163 WYNDHAM STREET
ALEXANDRIA NSW, AUSTRALIA 2015

FOR: CLOTHING, NAMELY, LADIES FASHION APPAREL, NAMELY, DRESSES, TOPS, TANK TOPS, T-SHIRTS, SWEAT SHIRTS, SHIRTS, SKIRTS, JEANS, PANTS, SHORTS, SWEAT PANTS, SLACKS, CARDIGANS, SWEATERS, BLAZERS, JACKETS, COATS, VESTS, JERSEYS, TIGHTS, LEOTARDS, SWIMMING COSTUMES, SWIMWEAR, CLOTHING BELTS, BRAS, UNDERWEAR, NIGHT SHIRTS, SLEEPWEAR, LINGERIE NIGHT GOWNS, OVERALLS, PAJAMAS, PONCHOS, RAINWEAR, ROBES, KERCHIEFS, MITTENS, GLOVES, NECKTIES, BOW TIES, SCARVES, HATS, CAPS, AND DENIM WEAR IN THE NATURE OF DENIM DRESSES, DENIM TOPS, DENIM SKIRTS, DENIM JEANS, DENIM SHORTS, DENIM JACKETS, DENIM COATS AND DENIM VESTS; FOOTWEAR AND HEADWEAR, IN CLASS 25 (U.S. CLS. 22 AND 39).

FOR: WHOLESALE AND RETAIL STORE SERVICES FEATURING CLOTHING, LADIES FASHION APPAREL, FOOTWEAR, HEADWEAR, FASHION ACCESSORIES; DIRECT MARKETING SERVICES; MAIL ORDER AND DIRECT MAIL ADVERTISING SERVICES FEATURING CLOTHING, FOOTWEAR, HEADWEAR AND FASHION ACCESSORIES; ARRANGING AND CONDUCTING INCENTIVE REWARD PROGRAMS TO PROMOTE THE SALE OF CLOTHING, LADIES FASHION APPAREL, FOOTWEAR, HEADGEAR, FASHION ACCESSORIES; ADMINISTRATION OF A PROGRAM FOR ENABLING PARTICIPANTS TO OBTAIN DISCOUNTS ON GOODS AND RECEIVE IMPROVED SERVICES; CUSTOMER LOYALTY SERVICES FOR COMMERCIAL, PROMOTIONAL AND/OR ADVERTISING PURPOSES, IN CLASS 35 (U.S. CLS. 100, 101 AND 102).



THE MARK CONSISTS OF STANDARD CHARACTERS WITHOUT CLAIM TO ANY PARTICULAR FONT, STYLE, SIZE, OR COLOR.

PRIORITY CLAIMED UNDER SEC. 44(D) ON AUSTRALIA APPLICATION NO. 1389965, FILED 10-21-2010, REG. NO. 1389965, DATED 10-21-2010, EXPIRES 10-21-2020.

SER. NO. 85-180,718, FILED 11-19-2010.

David J. Kyros

ARETHA SOMERVILLE, EXAMINING ATTORNEY

United States of America

United States Patent and Trademark Office



Reg. No. 4,152,576

Registered June 5, 2012

Int. Cl.: 35

SERVICE MARK

PRINCIPAL REGISTER

PIPPENBURG, AUTUMN DOLORES (UNITED STATES INDIVIDUAL), DBA SHOWGIRLZ ENTERTAINMENT, INC.
1048 B. HERITAGE HILL DR.
NAPERVILLE, IL 60563

FOR: TEMPORARY EMPLOYMENT AGENCY SERVICES, NAMELY, PROVIDING MODELS AND ACTRESSES TO BUSINESSES FOR EVENT STAFFING, IN CLASS 35 (U.S. CLS. 100, 101 AND 102).

FIRST USE 11-18-2010; IN COMMERCE 11-18-2010.

NO CLAIM IS MADE TO THE EXCLUSIVE RIGHT TO USE "ENT", APART FROM THE MARK AS SHOWN.

THE COLOR(S) BLACK, PURPLE, WHITE AND GRAY IS/ARE CLAIMED AS A FEATURE OF THE MARK.

THE MARK CONSISTS OF THE LETTERS "SG" WHICH ARE BLACK AND COVERED WITH WHITE AND GRAY SPECKS. THE ABBREVIATION "ENT", IN PURPLE LETTERING, APPEARS VERTICALLY INSIDE THE RIGHT PORTION OF THE LETTER "G".

SER. NO. 85-181,742, FILED 11-19-2010.

WENDY GOODMAN, EXAMINING ATTORNEY



David J. Kybas

Director of the United States Patent and Trademark Office

United States of America

United States Patent and Trademark Office

MONDOLUX

Reg. No. 4,152,577

HEINZ-JOSEF, KAPPE (FED REP GERMANY INDIVIDUAL)

Registered June 5, 2012

AM WILDPFAD 24

LOHMAR, FED REP GERMANY 53797

Int. Cls.: 9 and 11

FOR: ELECTRIC AND ELECTRONIC COMPONENTS FOR OPERATING, CONTROLLING AND REGULATING ELECTRONIC LAMPS IN THE NATURE OF ELECTRONIC LIGHT EMITTING DIODES (LED) LIGHTING FIXTURES, LIGHT EMITTING ELECTRONIC GAS LAMPS, LIGHT EMITTING ELECTRONIC FILAMENT LAMPS, NAMELY, SWITCHES, INDUCTORS, RESISTORS, CAPACITORS, TRANSISTORS, DIODES, CURRENT INTERRUPTERS, CIRCUIT-BREAKERS, VOLTAGE DIVIDERS, POTENTIOMETERS, INTEGRATED CIRCUITS, CONTROL CIRCUITS, REGULATING CIRCUITS, CIRCUIT-BOARDS, CONTROL KNOBS, COMPUTER KEYPADS AND LIQUID CRYSTAL DISPLAYS, IN CLASS 9 (U.S. CLS. 21, 23, 26, 36 AND 38).

TRADEMARK

PRINCIPAL REGISTER

FOR: ELECTRIC LAMPS, AND LIGHTING FIXTURES, IN CLASS 11 (U.S. CLS. 13, 21, 23, 31 AND 34).

THE MARK CONSISTS OF STANDARD CHARACTERS WITHOUT CLAIM TO ANY PARTICULAR FONT, STYLE, SIZE, OR COLOR.

PRIORITY CLAIMED UNDER SEC. 44(D) ON ERPN CMNTY TM OFC APPLICATION NO. 009253139, FILED 7-16-2010, REG. NO. 009253139, DATED 1-27-2011, EXPIRES 7-16-2020.

SER. NO. 85-184,959, FILED 11-24-2010.

GRETCHEN ULRICH, EXAMINING ATTORNEY



David J. Kybas

Director of the United States Patent and Trademark Office

United States of America

United States Patent and Trademark Office



Reg. No. 4,152,578

Registered June 5, 2012

Int. Cl.: 25

TRADEMARK

PRINCIPAL REGISTER

TINSLEY TRANSFERS, INC. (CALIFORNIA CORPORATION)
11684 PENDLETON STREET
SUN VALLEY, CA 91352

FOR: SHIRTS; SLEEVES, NAMELY, SUN SLEEVES, AND SLEEVES WORN SEPARATE AND APART FROM BLOUSES, SHIRTS AND OTHER TOPS; CAMISOLES, TANK TOPS AND UNDERWEAR, IN CLASS 25 (U.S. CLS. 22 AND 39).

FIRST USE 8-1-2000; IN COMMERCE 8-1-2000.

OWNER OF U.S. REG. NO. 2,901,068.

NO CLAIM IS MADE TO THE EXCLUSIVE RIGHT TO USE "TRANSFERS", APART FROM THE MARK AS SHOWN.

THE MARK CONSISTS OF THE STYLIZED WORDING "TINSLEY" ABOVE THE STYLIZED WORDING "TRANSFERS", AND BEHIND THE WORDING IS THE DESIGN OF AN OUTLINE OF A CIRCLE AND A CURVED BAND THAT STARTS BENEATH THE WORDING AND BENDS UPWARD IN A SEMI-CIRCLE ON THE LEFT SIDE OF THE WORDING.

SER. NO. 85-185,456, FILED 11-26-2010.

JAY BESCH, EXAMINING ATTORNEY



David J. Kyffers

Director of the United States Patent and Trademark Office

United States of America

United States Patent and Trademark Office

INTENTIONAL TALK

Reg. No. 4,152,579

MAJOR LEAGUE BASEBALL PROPERTIES, INC. (NEW YORK CORPORATION)
245 PARK AVENUE
NEW YORK, NY 10167

Registered June 5, 2012

Int. Cl.: 41

FOR: ENTERTAINMENT SERVICES, NAMELY, ONGOING TELEVISION SERIES IN THE FIELD OF SPORTS, NEWS, POPULAR CULTURE, CURRENT EVENTS AND ENTERTAINMENT DISTRIBUTED VIA BROADCAST MEDIA, IN CLASS 41 (U.S. CLS. 100, 101 AND 107).

SERVICE MARK

PRINCIPAL REGISTER

FIRST USE 4-4-2011; IN COMMERCE 4-4-2011.

THE MARK CONSISTS OF STANDARD CHARACTERS WITHOUT CLAIM TO ANY PARTICULAR FONT, STYLE, SIZE, OR COLOR.

NO CLAIM IS MADE TO THE EXCLUSIVE RIGHT TO USE "TALK", APART FROM THE MARK AS SHOWN.

SER. NO. 85-185,887, FILED 11-29-2010.

TRACY CROSS, EXAMINING ATTORNEY



David J. Kyffers

Director of the United States Patent and Trademark Office

United States of America

United States Patent and Trademark Office

THE SCHWARTZ CENTER FOR COMPASSIONATE HEALTHCARE

Reg. No. 4,152,580

Registered June 5, 2012

Int. Cls.: 36 and 41

SERVICE MARK

PRINCIPAL REGISTER

COHEN, ELLEN (UNITED STATES INDIVIDUAL)
34 MONADNOCK ROAD
CHESTNUT HILL, MA 02467

FOR: CHARITABLE FUNDRAISING SERVICES FOR THE PURPOSE OF PROMOTING THE COMPASSIONATE DELIVERY OF HEALTHCARE SERVICES, EDUCATING AND TRAINING HEALTHCARE DELIVERY PROFESSIONALS TO DELIVER COMPASSIONATE HEALTHCARE AND TO SUPPORT THE NEEDS OF PATIENTS AND CAREGIVERS THROUGHOUT THE HEALTH CARE DELIVERY PROCESS, AND PROVIDING FELLOWSHIPS IN THE FIELD OF HEALTHCARE; PROVIDING GRANTS TO SUPPORT PROJECTS IN THE AREAS OF CULTURAL COMPETENCY, SPIRITUALITY, END OF LIFE CARE AND COMMUNICATION SKILLS, IN CLASS 36 (U.S. CLS. 100, 101 AND 102).

FIRST USE 11-16-2010; IN COMMERCE 11-16-2010.

FOR: EDUCATIONAL SERVICES, NAMELY, CONDUCTING WORKSHOPS, TRAINING PROGRAMS, EDUCATIONAL SPEAKER SERIES, AND CONTINUING MEDICAL EDUCATIONAL COURSES AND SEMINARS IN THE AREAS OF CULTURAL COMPETENCY, SPIRITUALITY, END OF LIFE CARE AND COMMUNICATION SKILLS; HOSTING SOCIAL ENTERTAINMENT AND EDUCATIONAL EVENTS IN THE FIELDS OF HEALTHCARE, CULTURAL COMPETENCY, SPIRITUALITY, END OF LIFE CARE AND COMMUNICATION SKILLS; ON-LINE JOURNALS, NAMELY, BLOGS FEATURING INFORMATION IN THE AREAS OF CULTURAL COMPETENCY, SPIRITUALITY, END OF LIFE CARE AND COMMUNICATION SKILLS; PROVIDING A VOLUNTEER EDUCATIONAL PROGRAMS IN THE AREAS OF CULTURAL COMPETENCY, SPIRITUALITY, END OF LIFE CARE AND COMMUNICATION SKILLS; EDUCATIONAL SERVICES, NAMELY, A PROGRAM IN THE FIELD OF ENHANCING COMPASSION, COMMUNICATION, AND COLLABORATION AMONG HEALTH CARE PROVIDERS AND BETWEEN PROVIDERS AND PATIENTS; ENTERTAINMENT SERVICES, NAMELY, ORGANIZING AND CONDUCTING EVENTS IN THE NATURE OF AWARDS CEREMONIES TO DEMONSTRATE EXCELLENCE IN THE FIELDS OF CULTURAL COMPETENCY, SPIRITUALITY, END OF LIFE CARE AND COMMUNICATION SKILLS IN THE HEALTHCARE FIELD; ON-LINE ELECTRONIC NEWSLETTERS DELIVERED BY E-MAIL IN THE AREAS OF CULTURAL COMPETENCY, SPIRITUALITY, END OF LIFE CARE AND COMMUNICATION SKILLS, IN CLASS 41 (U.S. CLS. 100, 101 AND 107).

FIRST USE 11-16-2010; IN COMMERCE 11-16-2010.



David J. Kappas

Director of the United States Patent and Trademark Office

Reg. No. 4,152,580 THE MARK CONSISTS OF STANDARD CHARACTERS WITHOUT CLAIM TO ANY PARTICULAR FONT, STYLE, SIZE, OR COLOR.

OWNER OF U.S. REG. NOS. 2,661,415, 2,697,003, AND 3,588,139.

NO CLAIM IS MADE TO THE EXCLUSIVE RIGHT TO USE "CENTER FOR COMPASSIONATE HEALTHCARE", APART FROM THE MARK AS SHOWN.

SER. NO. 85-186,174, FILED 11-29-2010.

ANDREW LEASER, EXAMINING ATTORNEY

United States of America

United States Patent and Trademark Office



Reg. No. 4,152,581

Registered June 5, 2012

Int. Cls.: 36 and 41

SERVICE MARK

PRINCIPAL REGISTER

COHEN, ELLEN (UNITED STATES INDIVIDUAL)
34 MONADNOCK ROAD
CHESTNUT HILL, MA 02467

FOR: CHARITABLE FUNDRAISING SERVICES FOR THE PURPOSE OF PROMOTING THE COMPASSIONATE DELIVERY OF HEALTHCARE SERVICES, EDUCATING AND TRAINING HEALTHCARE DELIVERY PROFESSIONALS TO DELIVER COMPASSIONATE HEALTHCARE AND TO SUPPORT THE NEEDS OF PATIENTS AND CAREGIVERS THROUGHOUT THE HEALTH CARE DELIVERY PROCESS, AND PROVIDING FELLOWSHIPS IN THE FIELD OF HEALTHCARE; PROVIDING GRANTS TO SUPPORT PROJECTS IN THE AREAS OF CULTURAL COMPETENCY, SPIRITUALITY, END OF LIFE CARE AND COMMUNICATION SKILLS, IN CLASS 36 (U.S. CLS. 100, 101 AND 102).

FIRST USE 11-16-2010; IN COMMERCE 11-16-2010.

FOR: EDUCATIONAL SERVICES, NAMELY, CONDUCTING WORKSHOPS, TRAINING PROGRAMS, EDUCATIONAL SPEAKER SERIES, AND CONTINUING MEDICAL EDUCATIONAL COURSES AND SEMINARS IN THE AREAS OF CULTURAL COMPETENCY, SPIRITUALITY, END OF LIFE CARE AND COMMUNICATION SKILLS; HOSTING SOCIAL ENTERTAINMENT AND EDUCATIONAL EVENTS IN THE FIELDS OF HEALTHCARE, CULTURAL COMPETENCY, SPIRITUALITY, END OF LIFE CARE AND COMMUNICATION SKILLS; ON-LINE JOURNALS, NAMELY, BLOGS FEATURING INFORMATION IN THE AREAS OF CULTURAL COMPETENCY, SPIRITUALITY, END OF LIFE CARE AND COMMUNICATION SKILLS; PROVIDING A VOLUNTEER EDUCATIONAL PROGRAMS IN THE AREAS OF CULTURAL COMPETENCY, SPIRITUALITY, END OF LIFE CARE AND COMMUNICATION SKILLS; EDUCATIONAL SERVICES, NAMELY, A PROGRAM IN THE FIELD OF ENHANCING COMPASSION, COMMUNICATION, AND COLLABORATION AMONG HEALTH CARE PROVIDERS AND BETWEEN PROVIDERS AND PATIENTS; ENTERTAINMENT SERVICES, NAMELY, ORGANIZING AND CONDUCTING EVENTS IN THE NATURE OF AWARDS CEREMONIES TO DEMONSTRATE EXCELLENCE IN THE FIELDS OF CULTURAL COMPETENCY, SPIRITUALITY, END OF LIFE CARE AND COMMUNICATION SKILLS IN THE HEALTHCARE FIELD; ON-LINE ELECTRONIC NEWSLETTERS DELIVERED BY E-MAIL IN THE AREAS OF CULTURAL COMPETENCY, SPIRITUALITY, END OF LIFE CARE AND COMMUNICATION SKILLS, IN CLASS 41 (U.S. CLS. 100, 101 AND 107).

FIRST USE 11-16-2010; IN COMMERCE 11-16-2010.



David J. Kappas

Director of the United States Patent and Trademark Office

Reg. No. 4,152,581 OWNER OF U.S. REG. NOS. 2,661,415, 3,588,139 AND OTHERS.

NO CLAIM IS MADE TO THE EXCLUSIVE RIGHT TO USE "CENTER FOR COMPASSIONATE HEALTHCARE", APART FROM THE MARK AS SHOWN.

THE MARK CONSISTS OF FOUR HANDS AND A FLOWER DESIGN WITH THE WORDS "THE SCHWARTZ CENTER FOR COMPASSIONATE HEALTHCARE" ON THE RIGHT HAND SIDE.

SER. NO. 85-186,209, FILED 11-29-2010.

ANDREW LEASER, EXAMINING ATTORNEY

United States of America

United States Patent and Trademark Office



muramatz

Reg. No. 4,152,582

Registered June 5, 2012

Int. Cls.: 29, 30 and 31

TRADEMARK

PRINCIPAL REGISTER

MARUHACHI MURAMATSU, INC. (JAPAN CORPORATION)
65-1, JONOKOSHI, YAIZU
SHIZUOKA, JAPAN 425-0025

FOR: EDIBLE VEGETABLE OILS AND FATS, NAMELY, OLIVE OIL, PALM OIL, RAPE OIL, SESAME OIL, SALAD OIL, SOYBEAN OIL, WELSH ONION OIL; EDIBLE ANIMAL OILS AND FATS, NAMELY, CHICKEN OIL, PORK OIL, BEEF OIL, WHALE OIL; EDIBLE FISH OILS, NAMELY, SARDINE OIL, BONITO OIL; MILK PRODUCTS, NAMELY, YOGURT, POWDERED CHEESE; MEAT FOR HUMAN CONSUMPTION, NAMELY, CHICKEN, BEEF, PORK, MUTTON, BEEF WITH BONE, PORK WITH BONE, MUTTON WITH BONE; FRESH, CHILLED OR FROZEN EDIBLE AQUATIC ANIMALS, NOT LIVING, NAMELY, JAPANESE LITTLENECK MANILA CLAM AND SHORT-NECKED CLAMS, CORBICULAS, SCALLOPS, CLAMS, OYSTERS, BLUE MUSSELS, TUNAS, BONITOS, SARDINES, POMPANOS, SAURY, EEL, PIKE EEL, SEA BREAMS, FLAT FISHES, SALMONS, CODS, WHALES, CRUSTACEANS, PRAWNS, CRABS, LOBSTER, HERMIT CRAB; PROCESSED MEAT PRODUCTS, NAMELY, BEEF JERKY, DRIED CHICKEN, DRIED PORK; MEAT EXTRACT, NAMELY, BEEF EXTRACT, CHICKEN EXTRACT, PORK EXTRACT; MEAT POWDER, NAMELY, BEEF POWDER, CHICKEN POWDER, PORK POWDER; SAUSAGE; CANNED COOKED MEAT, HEATED MEAT, NAMELY, HEATED CHICKEN, HEATED BEEF, HEATED PORK, HEATED MUTTON, HEATED BEEF WITH BONE, HEATED PORK WITH BONE, HEATED MUTTON WITH BONE, RETORT POUCHED CHICKEN; BOILED AND SEASONED MEAT; MEAT BOILED DOWN IN SOY SAUCE (TSUKUDANI MEAT); PROCESSED SEAFOOD, NAMELY, SEAFOODS BOILED DOWN IN SOY SAUCE (TSUKUDANI); CANNED OR BOTTLED FISH; FISH MEAT SAUSAGE; FISH EXTRACT, NAMELY, BONITO EXTRACT, KATSUO-BUSHI (BLOCKS OF BOILED, SMOKED AND THEN DRIED BONITOS) EXTRACT; BOILED-DRIED FISH EXTRACT, WHITE MEAT FISH EXTRACT, SALMON EXTRACT, TUNA EXTRACT, FISH SAUCE EXTRACT, CRUSTACEAN EXTRACT, NAMELY, PRAWN EXTRACT, CRAB EXTRACT; SEAWEED EXTRACT, NAMELY, KELP EXTRACT, SARGASSUM HORNEI EXTRACT; SHELLFISH EXTRACT, NAMELY, JAPANESE LITTLENECK MANILA CLAM EXTRACT, CORBICULA EXTRACT, SCALLOP EXTRACT, OYSTER EXTRACT, CLAM EXTRACT, BLUE MUSSEL EXTRACT; BONITO FLAKES; SALMON FLAKES; COD FLAKES; TUNA FLAKES; STEAMED OR TOASTED CAKES OF FISH PASTE (KAMABOKO); DRIED KAMABOKO (STEAMED OR TOASTED CAKES OF FISH PASTE); IMITATION CRAB; LIGHTLY ROASTED BONITO; MINCED FRESH TUNA; BOILED SHELLFISH REMOVED FROM THE SHELL, NAMELY, BOILED JAPANESE LITTLENECK MANILA CLAM AND SHORT-NECKED CLAMS REMOVED FROM THE SHELL, BOILED CORBICULA REMOVED FROM THE SHELL, BOILED CLAM REMOVED FROM THE SHELL, BOILED SCALLOP



David J. Kyros

Director of the United States Patent and Trademark Office

Reg. No. 4,152,582 REMOVED FROM THE SHELL, BOILED PAPHIA UNDULATA REMOVED FROM THE SHELL; RETORT POUCHED JAPANESE LITTLE MANILA; RETORT POUCHED CRAB; RETORT POUCHED TUNA; RETORT POUCHED SALMON; RETORT POUCHED WHITE MEAT FISH; RETORT POUCHED SCALLOP; BOILED AND SEASONED FISH; CANNED FISH; ANCHOVY WITH SALT; FRIED PRAWNS; FRIED WHITE MEAT; SEAWEED POWDER, NAMELY, KELP POWDER, WAKAME SEAWEED POWDER, LAYER POWDER, HIJIKI SEAWEED POWDER; SHELLFISH POWDER, NAMELY, JAPANESE LITTLENECK MANILA CLAM POWDER, CORBICULA POWDER, SCALLOP POWDER, CLAM POWDER; FISH EXTRACT POWDER, NAMELY, BONITO EXTRACT POWDER, KATSUO-BUSHI EXTRACT POWDER (BLOCKS OF BOILED, SMOKED AND THEN DRIED BONITOS), EXTRACT POWDER OF BOILED AND DRIED FISH MEAT, EXTRACT POWDER OF BOILED AND DRIED WHITE FISH MEAT, EXTRACT POWDER OF BOILED AND DRIED FISH AND SHELLFISH; CRUSTACEAN EXTRACT POWDER, NAMELY, PRAWN EXTRACT POWDER, CRAB EXTRACT POWDER; SEAWEED EXTRACT POWDER, NAMELY, KELP EXTRACT POWDER, SARGASSUM HORNEI EXTRACT; SHELLFISH EXTRACT POWDER, NAMELY, JAPANESE LITTLENECK MANILA CLAM EXTRACT POWDER, CORBICULA EXTRACT POWDER, SCALLOP EXTRACT POWDER, OYSTER EXTRACT POWDER, CLAM EXTRACT POWDER; BOILED AND DRIED FISH AND SHELLFISH; BLOCKS OF BOILED, SMOKED AND THEN DRIED BONITOS (KATSUO-BUSHI), BLOCKS OF BOILED, SMOKED AND THEN DRIED AUXIS THAZARD OR AUXIS ROCHEI, NAMELY, DRIED AUXIS THAZARD, DRIED AUXIS ROCHEI (SOUDA-BUSHI), BLOCKS OF BOILED, SMOKED AND THEN DRIED MACKEREL (SABA-BUSHI), BLOCKS OF BOILED, SMOKED AND THEN DRIED BROWNSTRIPED MACKEREL (MURO-BUSHI), BLOCKS OF BOILED, SMOKED AND THEN DRIED TUNA (MAGURO-BUSHI); BOILED BONITO; YAKIAGO (BAKED AND DRIED FLYING FISH); FISHMEAT FOR HUMAN CONSUMPTION, NAMELY, FISH BONE POWDER, KATSUO-BUSHI (BLOCKS OF BOILED, SMOKED AND THEN DRIED BONITOS) POWDER, SOUDA-BUSHI (BLOCKS OF BOILED, SMOKED AND THEN DRIED AUXIS THAZARD OR AUXIS ROCHEI) POWDER, SABA-BUSHI (BLOCKS OF BOILED, SMOKED AND THEN DRIED MACKEREL) POWDER, MURO-BUSHI (BLOCKS OF BOILED, SMOKED AND THEN DRIED BROWNSTRIPED MACKEREL) POWDER, MAGURO-BUSHI (BLOCKS OF BOILED, SMOKED AND THEN DRIED TUNA) POWDER, DRIED SARDINES POWDER, YAKIAGO (BAKED AND DRIED FLYING FISH) POWDER; CRUSTACEAN POWDER, NAMELY, PRAWN POWDER, CRAB POWDER; BOILED AND DRIED FISH AND SHELLFISH, NAMELY, BOILED AND DRIED SARDINE, BOILED AND DRIED LOBSTER, BOILED AND DRIED ADDUCTOR MUSCLE OF SCALLOPS, BOILED AND DRIED ORMER; SEASONED LAYER; FLAKES OF DRIED FISH MEAT (KEZURI-BUSHI); EDIBLE GELATIN OF FISH; EDIBLE COLLAGEN OF FISH; DRIED BROWN ALGA (HOSHI-HIZIKI); DRIED EDIBLE SEAWEED (HOSHI-WAKAME); DRIED KELP; PROCESSED VEGETABLES AND FRUITS, NAMELY, DRIED MUSHROOM (SHIITAKE), DRIED MATSUTAKE MUSHROOM, DRIED PRINCESS MATSUTAKE MUSHROOM, DRIED SHIMEJI MUSHROOM, DRIED OYSTER MUSHROOM); MUSHROOM EXTRACT, NAMELY, MUSHROOM (SHIITAKE) EXTRACT, MATSUTAKE MUSHROOM EXTRACT, PRINCESS MATSUTAKE MUSHROOM EXTRACT; MUSHROOM POWDER, NAMELY, MUSHROOM (SHIITAKE) POWDER, MATSUTAKE MUSHROOM POWDER, PRINCESS MATSUTAKE MUSHROOM POWDER; DRIED VEGETABLE, NAMELY, DRIED CHINESE CABBAGE, DRIED JAPANESE RADISH, DRIED WELSH ONION, DRIED CARROT, DRIED CORN, DRIED ONION, DRIED CABBAGE, DRIED BAMBOO SHOOT, DRIED POTATO, DRIED EGGPLANT; VEGETABLE EXTRACT, NAMELY, DU ZHONG EXTRACT, CHINESE CABBAGE EXTRACT, JAPANESE RADISH EXTRACT, ONION EXTRACT, GARLIC EXTRACT, GINGER EXTRACT; VEGETABLE POWDER, NAMELY, WELSH ONION POWDER, ONION POWDER, CARROT POWDER, CORN POWDER, GARLIC POWDER, GINGER POWDER; CANNED VEGETABLES; CANNED MUSHROOM; HEATED VEGETABLES, NAMELY, HEATED CARROT, HEATED ASPARAGUS, HEATED ONION, HEATED TARO, HEATED SOYBEAN, HEATED LOTUS ROOT; VEGETABLES PICKLED IN SOY SAUCE; BOILED AND SEASONED VEGETABLE; FERMENTED SOYBEANS (NATTO); SOUP MIXES, NAMELY, INSTANT OR PRE-COOKED SOUP; POTAGE, WAKAME (SEAWEED) SOUP; MUSHROOM SOUP, CLAM CHOWDER SOUP; BOUILLON, NAMELY, CONSOMME, BEEF BOUILLON, CHICKEN BOUILLON, CHINESE SOUP STOCK; PROCESSED EGGS, NAMELY, ROLLED EGG (TAMAGOYAKI,

Reg. No. 4,152,582 JAPANESE OMELETTE); INSTANT OR PRE-COOKED WHITE STEW; INSTANT OR PRE-COOKED MISO SOUP; SEASONED POWDER FOR SPRINKLING ON RICE (FURI-KAKE), NAMELY, DRIED BONITO FLAKES OF LAYER FOR SPRINKLING ON RICE (KATSUOFURI-KAKE), DRIED SALMON FLAKES OF LAYER FOR SPRINKLING ON RICE (SAKEFURI-KAKE); PROCESSED SOYBEANS; DRIED SOYBEANS; FROZEN VEGETABLES; FROZEN FRUIT; NON-MEDICATED INGREDIENTS OR ADDITIVES FOR USE AS INGREDIENTS IN NUTRITIONAL SUPPLEMENTS, NAMELY, DIETARY SUPPLEMENT MATERIAL COMPOSED OF FREE AMINO ACIDS AND LOW MOLECULAR-WEIGHT PEPTIDES OBTAINED BY CONCENTRATING THE EXTRACT FROM FRESH BONITO, ANTI-STRESS MATERIAL ENRICHED WITH AFFLUENT DHA-BOUND PHOSPHOLIPIDS EXTRACTED FROM THE OVARY OF FRESH BONITO, MATERIAL WHICH INHIBITS BONE RESORPTION AND ENHANCES BONE FORMATION TO PREVENT OSTEOPOROSIS; SOUP MIXES FOR INSTANT NOODLE (RAMEN); SOUP MIXES FOR NOODLE SOUP; SOUP MIXES FOR UDON NOODLES; SOUP MIXES FOR JAPANESE STEAM BOAT DISHES (NABEMONO), DRIED SEASONING POWDER FOR SOUP; SOUP MIXES FOR LIQUID SOUP FOR SEASONING; WHITE STEWS, IN CLASS 29 (U.S. CL. 46).

FOR: FLAVORINGS, OTHER THAN ESSENTIAL OILS, FOR FOODS; TEA, NAMELY, JAPANESE GREEN TEA, OOLONG TEA (CHINESE TEA), PUER TEA, TEA OF PARCHED POWDER OF BARLEY WITH HUSK (MUGI-CHA); CONFECTIONERY MADE OF SUGAR; BREAD AND BUNS; RICE CRACKERS (SENBEI); SNACK CAKES; RICE-BASED SNACK FOODS; MULTIGRAIN-BASED SNACK FOODS; PIES; SEASONINGS, NAMELY, SOYA BEAN PASTE (CONDIMENT); SOY SAUCE, NAMELY, SOUP STOCK SOY SAUCE, KELP SOY SAUCE, OYSTER SOY SAUCE, AMINO ACID SOY SAUCE, MADE OF RAW MATERIAL OF DEFATTED SOYMEAL CHEMICAL BASED MAINLY ON THE AMINO ACID TAKEN APART), WORCESTER SAUCE, WHITE SAUCE; VINEGAR, NAMELY, RICE VINEGAR, GRAIN VINEGAR, FRUIT VINEGAR, BLACK VINEGAR, PONZU/CITRUS SAUCE, KOMBU (KELP) BLEND VINEGAR, DRIED BONITO BLEND VINEGAR; PASTA-SAUCE; OKONOMIYAKI (JAPANESE-STYLE PIZZA) SAUCE; YAKISOBA (JAPANESE STYLE NOODLES) SAUCE; BROAD BEAN CHILI PASTE (DOUBANJIANG) FOR USE AS A SEASONING; SWEETENED SOYBEAN PASTE (TIANMENJIANG, SEASONING FOR CHINESE FOOD); HOT PEPPER PASTE (GOUCHUJANG); KOREAN MISO (DOINJIANG); XO SAUCE; HOISIN SAUCE; FISH SAUCE; DIPPING SAUCE FOR SOBA, NAMELY, SOBA-TSUYU; DIPPING SAUCE FOR SOMEN, NAMELY, SOMEN-TSUYU; FLAKES OF DRIED FISH MEAT (KEZURIBUSHI) FOR SEASONING; SAUCES FOR BARBECUED MEAT; SALAD DRESSINGS; SEASONING VINEGAR; COOKING SALT, NAMELY, REFINED SALT, MINERAL SALT, SEASONING SALT, NAMELY, HERB SALT, PRAWN SALT; SPICES, NAMELY, HOT PEPPER POWDER, PEPPER POWDER, JAPANESE PEPPER POWDER SPICE (SANSHO POWDER), HABANERO; CEREAL PREPARATIONS, NAMELY, INSTANT NOODLES, INSTANT RAMEN NOODLES, INSTANT UDON NOODLES, INSTANT SOBA NOODLES, DRIED RAMEN NOODLES, DRIED UDON NOODLES, DRIED SOBA NOODLES, BEAN-STARCH NOODLES (HARUSAME, UNCOOKED ASIAN DRIED NOODLE MADE WITH GREEN PEA), DRIED SOMEN (VERY THIN WHEAT NOODLES) NOODLES, RAMEN NOODLES, UNCOOKED; UDON NOODLES, UNCOOKED, SOBA NOODLES (JAPANESE NOODLES OF BUCKWHEAT, UNCOOKED), PASTA, MACARONI, UNCOOKED; FRIED BALLS OF BATTER MIX WITH SMALL PIECES OF OCTOPUS (TAKOYAKI); FROZEN TAKOYAKI (FRIED BALLS OF BATTER MIX WITH SMALL PIECES OF OCTOPUS); FRENCH DISHES HAVING BREAD CRUMBS OR CHEESE ON TOP, NAMELY, GRATIN; YEAST EXTRACT; YEAST; HUSKED RICE; FLOUR FOR FOOD; STARCH FOR FOOD; CURRY ROUX, IN CLASS 30 (U.S. CL. 46).

FOR: LIVE EDIBLE AQUATIC ANIMALS, NAMELY, JAPANESE LITTLENECK MANILA CLAMS OR SHORT-NECKED CLAMS, CORBICULAS, SCALLOPS, CLAMS, OYSTERS, BLUE MUSSELS, TUNAS, BONITOS, SARDINES, POMPANO, SAURYS, EELS, PIKE EELS, SEA BREAMS, RED SNAPPERS, FLAT FISHES, SALMONS, CODS; LIVE CRUSTACEANS, NAMELY, PRAWNS, CRABS, LOBSTER, HERMIT CRAB; EDIBLE SEAWEEDS, NAMELY, KELP (KOMBU SEAWEED), SEAWEED (WAKAME), BROWN ALGAE (HIJIKI SEAWEED), LAYER (NORI SEAWEED), SARGASSUM HORNERI, MOZUKU, G-KELP; FRESH VEGET-

Reg. No. 4,152,582 ABLES, NAMELY, GREEN CABBAGES, LETTUCES, ONIONS, CARROTS, CELERIES, CUCUMBERS, BROCCOLIS, POTATOES, WELSH ONION OILS; FRESH MUSHROOMS, NAMELY, SHIITAKE MUSHROOMS, MATSUTAKE MUSHROOMS, SHIMEJI MUSHROOMS, KING OYSTER MUSHROOMS, ENOKI MUSHROOMS, TRUFFES, MAITAKE MUSHROOMS, PRINCESS MATSUTAKE MUSHROOMS; FRESH FRUITS, NAMELY, MANDARIN ORANGES (TANGERINES), WATERMELONS, MELONS, APPLES, PEACHES, PEARS, STRAWBERRIES, BANANAS, GRAPES, SUGAR CANE; UNPROCESSED GRAIN, NAMELY, CORN, WHEAT, BARLEY, BUCKWHEAT; FRESH SOYBEANS IN THE POD (EDA-MAME), IN CLASS 31 (U.S. CLS. 1 AND 46).

PRIORITY CLAIMED UNDER SEC. 44(D) ON JAPAN APPLICATION NO. 2010-84988, FILED 11-1-2010, REG. NO. 5415958, DATED 6-3-2011, EXPIRES 6-3-2021.

THE MARK CONSISTS OF "MURAMATZ" AND THREE TRIANGULAR DESIGNS WITH CURVED SIDES.

SER. NO. 85-186,423, FILED 11-29-2010.

PAUL E. FAHRENKOPF, EXAMINING ATTORNEY

United States of America

United States Patent and Trademark Office

SOLUTIONS AT HOME

Reg. No. 4,152,583

Registered June 5, 2012

**Int. Cls.: 36, 37, 43, 44
and 45**

SERVICE MARK

PRINCIPAL REGISTER

JEWISH HOME LIFECARE (NEW YORK NOT FOR PROFIT CORPORATION)
120 WEST 106TH STREET
NEW YORK, NY 10025

FOR: FINANCIAL ADVICE IN THE NATURE OF ASSESSMENT OF PERSONAL FINANCIAL SITUATIONS; PROVIDING COUNSELING AND CONSULTING IN THE FIELD OF HEALTHCARE BENEFITS, IN CLASS 36 (U.S. CLS. 100, 101 AND 102).

FIRST USE 6-0-2008; IN COMMERCE 12-0-2008.

FOR: PERSONAL HOME CARE SERVICES, NAMELY, LAUNDERING, IN CLASS 37 (U.S. CLS. 100, 103 AND 106).

FIRST USE 6-0-2008; IN COMMERCE 12-0-2008.

FOR: PROVIDING CUSTOMIZED REPORTS WITH OPTIONS FOR DAYCARE OF THE ELDERLY; PERSONAL HOME CARE SERVICES, NAMELY, FOOD PREPARATION, IN CLASS 43 (U.S. CLS. 100 AND 101).

FIRST USE 6-0-2008; IN COMMERCE 12-0-2008.

FOR: GERIATRIC HEALTH CARE MANAGEMENT SERVICES, NAMELY, PERSONAL HEALTH ASSESSMENTS IN THE NATURE OF MONITORING AND EVALUATING THE HEALTH OF ELDERLY PERSONS; PSYCHIATRIC EVALUATION AND COUNSELING; PROVIDING CUSTOMIZED REPORTS WITH OPTIONS FOR HEALTH CARE OF THE ELDERLY; PERSONAL SAFETY CONSULTING SERVICES IN THE NATURE OF FALLS RISK ASSESSMENT; SOCIAL WORK SERVICES, NAMELY, COORDINATION OF PERSONAL CARE COUNSELING RELATED TO PERSONAL CARE; SUPERVISED HOME HEALTH CARE SERVICES; EVALUATIONS OF HEALTH NEEDS; PROVIDING NURSING CARE; REMOTE HEALTH MONITORING OF NON-INSTITUTIONALIZED PERSONS, NAMELY, MONITORING OF WEIGHT, BLOOD PRESSURE, BLOOD SUGAR, TAKING OF MEDICATIONS, PERSONAL HEALTH INDICATORS, IN CLASS 44 (U.S. CLS. 100 AND 101).

FIRST USE 6-0-2008; IN COMMERCE 12-0-2008.

FOR: GERIATRIC CARE MANAGEMENT SERVICES, NAMELY, THE COORDINATION OF NECESSARY SERVICES AND PERSONAL CARE FOR OLDER INDIVIDUALS; SAFETY



David J. Kyjars

Director of the United States Patent and Trademark Office

Reg. No. 4,152,583 CONSULTATION SERVICES, NAMELY, PROVIDING A REVIEW OF HOME AND NEIGHBORHOOD SAFETY ISSUES; PROVIDING CUSTOMIZED REPORTS WITH OPTIONS FOR PERSONAL CARE OF THE ELDERLY; CASE MANAGEMENT SERVICES, NAMELY, CONSULTATION AND COORDINATION WITH PHYSICIANS FOR THERAPIES FOR PATIENTS; SUPERVISED IN-HOME SUPPORT SERVICES TO PROVIDE PERSONAL HOME CARE, NAMELY, ASSISTANCE WITH ACTIVITIES OF DAILY LIVING, NAMELY, BATHING, AMBULATION, BATHROOM NEEDS, SHOPPING, HOUSEKEEPING, ERRANDS, ESCORTING, COMPANIONSHIP, HOUSE CHORES, ASSISTANCE WITH VISITS TO MEDICAL PERSONNEL; PROVIDING AT HOME ASSISTANCE WITH BASIC ACTIVITIES, NAMELY, BATHING, DRESSING, EATING, AND GROOMING, IN CLASS 45 (U.S. CLS. 100 AND 101).

FIRST USE 6-0-2008; IN COMMERCE 12-0-2008.

THE MARK CONSISTS OF STANDARD CHARACTERS WITHOUT CLAIM TO ANY PARTICULAR FONT, STYLE, SIZE, OR COLOR.

NO CLAIM IS MADE TO THE EXCLUSIVE RIGHT TO USE "AT HOME", APART FROM THE MARK AS SHOWN.

SER. NO. 85-190,054, FILED 12-3-2010.

KATHERINE CHANG, EXAMINING ATTORNEY

United States of America

United States Patent and Trademark Office

NEWORLD

Reg. No. 4,152,584

Registered June 5, 2012

Int. Cl.: 9

TRADEMARK

PRINCIPAL REGISTER

KIERIG, JEREMY (UNITED STATES INDIVIDUAL)
228 BROADWAY STREET
CHICO, CA 95928

FOR: COMPUTER SOFTWARE FOR COMPUTER SYSTEM AND APPLICATION DEVELOPMENT, DEPLOYMENT AND MANAGEMENT, IN CLASS 9 (U.S. CLS. 21, 23, 26, 36 AND 38).

FIRST USE 10-15-2010; IN COMMERCE 10-15-2010.

THE MARK CONSISTS OF STYLIZED TEXT OF "NEW I WORLD" WHERE THE TWO "W'S" AND THE "I" ARE COMBINED INTO A SINGLE SQUARE ICON ELEMENT. THE ICON HAS ROUNDED CORNERS.

SER. NO. 85-190,624, FILED 12-3-2010.

SHAUNIA CARLYLE, EXAMINING ATTORNEY



David J. Kyffers

Director of the United States Patent and Trademark Office

United States of America

United States Patent and Trademark Office



Reg. No. 4,152,585

Registered June 5, 2012

Int. Cl.: 35

SERVICE MARK

PRINCIPAL REGISTER

FLOW CONSULTING, INC. (FLORIDA CORPORATION)
10340 SE 138TH PLACE ROAD
SUMMERFIELD, FL 34491

FOR: ADVISORY SERVICES RELATING TO BUSINESS MANAGEMENT AND BUSINESS OPERATIONS; ARRANGING AND CONDUCTING BUSINESS CONFERENCES; BUSINESS ADVISORY SERVICES, CONSULTANCY AND INFORMATION; BUSINESS ADVISORY SERVICES, NAMELY, SEARCH FOR AND SELECTION OF THE BEST POTENTIAL SUPPLIERS FOR OTHERS; BUSINESS ANALYSIS AND BUSINESS STRATEGIC PLANNING SERVICES IN THE TECHNOLOGY INDUSTRY; BUSINESS ASSISTANCE, MANAGEMENT AND INFORMATION SERVICES; BUSINESS CONSULTATION; BUSINESS CONSULTATION IN THE FIELD OF BUSINESS LEADERSHIP DEVELOPMENT; BUSINESS CONSULTATION SERVICES; BUSINESS CONSULTATION SERVICES IN THE FIELDS OF SUPPLY CHAIN ANALYSIS, REGULATION COMPLIANCE AND COUNTERFEIT DETECTION; BUSINESS CONSULTATION SERVICES, NAMELY, BUSINESS PROCESS IMPROVEMENT AND ENTERPRISE ARCHITECTURE DESIGN; BUSINESS CONSULTING AND INFORMATION SERVICES; BUSINESS CONSULTING SERVICES IN THE FIELD OF LEAN MANUFACTURING CONCEPTS, NAMELY, BUSINESS ASSESSMENTS OF OPERATIONS AND ASSESSMENTS OF FACILITIES MANAGEMENT OF TECHNICAL OPERATIONS; BUSINESS CONSULTING SERVICES RELATING TO THE INTEGRATION OF THE AREAS OF BUSINESS PROCESS TECHNOLOGY, ORGANIZATIONAL LEARNING, CHANGE MANAGEMENT, AND OPERATIONAL SUSTAINABILITY; BUSINESS INFORMATION IN THE FIELD OF LEAN SIGMA CONCEPTS, NAMELY, PROVIDING BUSINESS ADVICE AND INFORMATION; MANAGEMENT CONSULTING AND ADVISORY SERVICES IN THE AREAS OF CORPORATE GROWTH STRATEGY, INNOVATION AND GROWTH PROCESSES, ORGANIZATIONAL TRANSFORMATION, AND TALENT MANAGEMENT AND DEVELOPMENT STRATEGIES, IN CLASS 35 (U.S. CLS. 100, 101 AND 102).



FIRST USE 8-21-2010; IN COMMERCE 8-21-2010.

NO CLAIM IS MADE TO THE EXCLUSIVE RIGHT TO USE "CONSULTING", APART FROM THE MARK AS SHOWN.

THE COLOR(S) BLUE AND RED IS/ARE CLAIMED AS A FEATURE OF THE MARK.

THE MARK CONSISTS OF THE WORDING, "FLOW CONSULTING" IN ALL CAPS, WITH THE LETTERS "F", "L", "W" IN BLUE, AND THE PARTIAL LETTER "O" IN "FLOW" IN

David J. Kyros

Director of the United States Patent and Trademark Office

Reg. No. 4,152,585 BLUE, WITH A BLUE AND RED WAVY LINE CENTERED IN THE PARTIAL LETTER "O" ENDING IN A BLUE WAVY LINE, WITH THE BLUE WORDING, "CONSULTING", BELOW THE LETTER, "W" IN "FLOW".

SER. NO. 85-194,008, FILED 12-9-2010.

ODESSA BIBBINS, EXAMINING ATTORNEY

United States of America

United States Patent and Trademark Office

Call 4 Eat

Reg. No. 4,152,586

Registered June 5, 2012

Int. Cl.: 35

SERVICE MARK

PRINCIPAL REGISTER

JUSTGOB LLC (TEXAS LIMITED LIABILITY COMPANY)
P.O. BOX 352 334
ALBERTRUSS@GMAIL.COM
LOS ANGELES, CA 90335

FOR: ADMINISTRATION OF A CONSUMER LOYALTY PROGRAM TO PROMOTE RESTAURANT SERVICES AND RETAIL SERVICES OF OTHERS; ADVERTISING AGENCIES PROVIDING THE STRATEGY, DESIGN AND EXECUTION OF PROGRAMS TO PROMOTE BUSINESSES IN THE FOOD AND FOOD SERVICE INDUSTRIES; ADVERTISING SERVICES, NAMELY, PROMOTING AND MARKETING THE GOODS AND SERVICES OF OTHERS IN THE FIELD OF UPSCALE CHOICES SUCH AS CULTURAL EVENTS, RESTAURANTS, SHOPPING, AND TRAVEL VIA PRINT AND ELECTRONIC MEDIA; ADVERTISING SERVICES, NAMELY, PROMOTING THE FOOD AND WINE OF OTHERS; ASSOCIATION SERVICES, NAMELY, PROMOTING DIVERSITY IN THE RESTAURANT AND HOTEL INDUSTRIES ON BEHALF OF EMPLOYEES; ON-LINE BUSINESS DIRECTORIES FEATURING FAST-FOOD RESTAURANTS; PROMOTIONAL SERVICES, NAMELY, PROMOTING THE GOODS OF OTHERS BY MEANS OF PROVIDING ONLINE RESTAURANT MENUS; PROVIDING A WEBSITE FEATURING INFORMATION FOR CONSUMERS IN THE FIELD OF PET FOOD; PROVIDING A WEBSITE WHERE USERS CAN POST RATINGS, REVIEWS AND RECOMMENDATIONS ON RESTAURANTS; OFFERING BUSINESS MANAGEMENT ASSISTANCE IN THE ESTABLISHMENT AND/OR OPERATION OF RESTAURANTS; RESTAURANT MANAGEMENT FOR OTHERS, IN CLASS 35 (U.S. CLS. 100, 101 AND 102).

FIRST USE 12-12-2010; IN COMMERCE 12-12-2010.

THE MARK CONSISTS OF STANDARD CHARACTERS WITHOUT CLAIM TO ANY PARTICULAR FONT, STYLE, SIZE, OR COLOR.

SER. NO. 85-196,959, FILED 12-13-2010.

APRIL HESIK, EXAMINING ATTORNEY



David J. Kyffers

Director of the United States Patent and Trademark Office

United States of America

United States Patent and Trademark Office



Reg. No. 4,152,587

Registered June 5, 2012

**Int. Cls.: 9, 16, 35, 36, 38,
39, 41 and 42**

TRADEMARK

SERVICE MARK

PRINCIPAL REGISTER

ALIBABA GROUP HOLDING LIMITED (CAYMAN ISLANDS CORPORATION)
FOURTH FLOOR, ONE CAPITAL PLACE
P.O. BOX 847, GEORGE TOWN
GRAND CAYMAN, CAYMAN ISLANDS

FOR: SCIENTIFIC, NAUTICAL, PHOTOGRAPHIC, OPTICAL, SIGNALING, MEASURING, CHECKING, LIFE-SAVING APPARATUS AND INSTRUMENTS, NAMELY, TELEPHONES, PUNCH CLOCKS, TIME RECORDING DEVICES, NAMELY, TIME CLOCKS, SCALES AND BALANCES, GRADUATED RULERS, ELECTRONIC POCKET TRANSLATORS, NEON SIGNS, ELECTRONIC NOTICE BOARDS, TRANSPARENCY PROJECTION APPARATUS, KILOMETER RECORDERS IN THE NATURE OF ODOMETERS FOR VEHICLES, TELESCOPES, MECHANISMS FOR COUNTER OPERATED APPARATUS, NAMELY, POINT-OF-SALE TERMINALS, FIRE EXTINGUISHERS, ACOUSTIC ALARMS, NAMELY, SMOKE AND FIRE ALARMS, EYEGLASSES, BATTERIES, EXPOSED FILMS, NAMELY, EXPOSED CAMERA FILM; APPARATUS AND INSTRUMENTS FOR CONDUCTING, SWITCHING, TRANSFORMING, ACCUMULATING, REGULATING OR CONTROLLING ELECTRICITY, NAMELY, ELECTRIC WIRES, ELECTRIC SWITCHES, ELECTROPLATING APPARATUS, NAMELY, ELECTROPLATING MACHINES, ELECTRIC WELDING APPARATUS, NAMELY, TORCHES, AND ELECTRIFIED FENCES, NAMELY, ELECTRIC FENCES; APPARATUS FOR RECORDING, TRANSMISSION OR REPRODUCTION OF SOUND OR IMAGES; BLANK MAGNETIC DATA CARRIERS AND RECORDING DISCS; AUTOMATIC VENDING MACHINES AND MECHANISMS FOR COIN-OPERATED APPARATUS; CASH REGISTERS, CALCULATING MACHINES, DATA PROCESSING EQUIPMENT AND COMPUTERS; COMPUTER PROGRAMS IN THE FIELD OF BUSINESS FOR USE IN FINANCIAL MANAGEMENT, FINANCIAL PLANNING, BUSINESS MANAGEMENT, CUSTOMER RELATIONSHIP MANAGEMENT (CRM), INVENTORY MANAGEMENT, SALES FORCE MANAGEMENT, PLANNING AND MANAGEMENT OF PERSONAL AND BUSINESS FINANCES, AND MARKETING INFORMATION MANAGEMENT, ALL IN THE FIELD OF E-COMMERCE; SOFTWARE FOR PROCESSING ELECTRONIC PAYMENTS TO AND FROM OTHERS; AUTHENTICATION SOFTWARE FOR CREDIT CARD AND CHECK VERIFICATION IN RELATION TO ONLINE PAYMENT OR TRANSFER OF FUNDS; COMPUTER SOFTWARE THAT MAY BE DOWNLOADED FROM A GLOBAL COMPUTER NETWORK FOR USE IN CONNECTION WITH THE PROVISION OF AN INTERACTIVE WEBSITE, NAMELY, FOR USE BY THIRD PARTIES TO POST INFORMATION, CREATE ELECTRONIC PRODUCT CATALOGS, RESPOND TO REQUESTS AND PLACE AND FULFILL ORDERS FOR PRODUCTS, SERVICES AND BUSINESS OPPORTUNITIES VIA LOCAL AND GLOBAL COMPUTER NETWORKS, FOR USE IN DOCUMENT MANAGEMENT, FOR SEARCHING, BROWSING



David J. Kyjars

Director of the United States Patent and Trademark Office

Reg. No. 4,152,587 AND RECEIVING TRANSMISSIONS OF TEXT, ELECTRONIC DOCUMENTS, GRAPHICS AND AUDIOVISUAL INFORMATION ON LOCAL REMOTE AREA, GLOBAL COMPUTER NETWORKS, ON INTRANETS OR DIRECTORIES OF INFORMATION AVAILABLE ON COMPUTER NETWORKS, FOR USE IN SOFTWARE DEVELOPMENT AND WEB AUTHORIZING, FOR USE IN EXCHANGING INFORMATION VIA GLOBAL COMPUTER NETWORKS AND ONLINE FROM A COMPUTER DATABASE AND THE INTERNET, FOR BUSINESS USE FOR FINANCIAL MANAGEMENT, FINANCIAL PLANNING, BUSINESS MANAGEMENT, CUSTOMER RELATIONSHIP MANAGEMENT (CRM), INVENTORY MANAGEMENT, SALES FORCE MANAGEMENT, PLANNING AND MANAGEMENT OF PERSONAL AND BUSINESS FINANCES, AND MARKETING INFORMATION MANAGEMENT, DATA MINING, HIGH-SPEED MASSIVE E-COMMERCE DATA PROCESSING, AND DATA CUSTOMIZATION ALL IN THE FIELD OF E-COMMERCE; COMPUTER PERIPHERALS; NOTEBOOK COMPUTERS; LAPTOP COMPUTERS; PORTABLE COMPUTERS; HANDHELD COMPUTERS; PERSONAL DIGITAL ASSISTANTS; PERSONAL PORTABLE MEDIA PLAYERS; MOBILE TELEPHONES; SMART PHONES; DIGITAL CAMERAS; COMPUTER WORKSTATIONS COMPRISING COMPUTERS AND COMPUTER MONITORS; SERVERS, NAMELY, COMPUTER SERVERS; COMPUTER AND TELECOMMUNICATIONS NETWORKING COMPUTER HARDWARE; COMPUTER NETWORK ADAPTORS, SWITCHES, ROUTERS AND HUBS; WIRELESS AND WIRED MODEMS AND COMPUTER EQUIPMENT, NAMELY, WIRELESS CARDS; LAPTOP HOLDERS IN THE NATURE OF PROTECTIVE SLEEVES AND CARRYING CASES, COMPUTER BAGS; FIRE-EXTINGUISHING APPARATUS; COMPUTER HARDWARE; COMPACT DISCS FEATURING MUSIC, COMPUTER PROGRAMS AND COMPUTER SOFTWARE IN THE FIELD OF BUSINESS FOR USE IN FINANCIAL MANAGEMENT, FINANCIAL PLANNING, BUSINESS MANAGEMENT, CUSTOMER RELATIONSHIP MANAGEMENT (CRM), INVENTORY MANAGEMENT, SALES FORCE MANAGEMENT, PLANNING AND MANAGEMENT OF PERSONAL AND BUSINESS FINANCES, AND MARKETING INFORMATION MANAGEMENT, ALL IN THE FIELD OF E-COMMERCE; DIGITAL MUSIC DOWNLOADABLE FROM THE INTERNET; TELECOMMUNICATIONS APPARATUS, NAMELY, VOIP PHONES, ELECTRONIC FACSIMILE APPARATUS, PORTABLE DIGITAL ELECTRONIC DEVICE FOR SENDING AND RECEIVING ELECTRONIC MAILS, AND INSTANT MESSAGING COMMUNICATION TOOL IN THE NATURE OF PORTABLE TELECOMMUNICATION INSTANT MESSAGING DEVICES; MOUSE PADS; MOBILE PHONE HANDSETS; MOBILE PHONE ACCESSORIES, NAMELY, BATTERY CHARGERS, CASES, COVERS, EAR PHONES AND DEVICES FOR HANDS-FREE USE OF MOBILE PHONES; DOWNLOADABLE COMPUTER GAMES AND MUSIC VIA THE INTERNET AND WIRELESS DEVICES; ALARM MONITORING SYSTEMS; SECURITY CAMERAS; MOBILE TRANSMITTING AND RECEIVING APPARATUS FOR RADIO AND TELEVISION BROADCASTING AND FOR LONG-DISTANCE TRANSMISSION; TELEVISION BROADCASTING EQUIPMENT, NAMELY, VIDEO CAMERAS, VIDEO MONITORS, VIDEO PLAYBACK AND EDITING CONSOLES, AUDIO MIXING BOARDS, VIDEO RECORDERS, VIDEO AND VIDEO CABLES; CAMERAS; VIDEO CAMERAS; HEADPHONES; EAR PIECES, NAMELY, EAR BUDS; SPEAKERS, NAMELY, LOUD SPEAKERS; GLOBAL POSITIONING SYSTEM (GPS) APPARATUS AND EQUIPMENT, NAMELY, GPS SYSTEMS; DOWNLOADABLE COMPUTER, ELECTRONIC AND VIDEO GAMES PROGRAMS AND SOFTWARE VIA THE INTERNET; LIQUID CRYSTAL DISPLAYS FOR TELECOMMUNICATIONS AND ELECTRONIC EQUIPMENT; SET TOP BOXES; REMOTE CONTROL FOR RADIOS, TELEVISIONS, STEREOS, COMPUTERS, VIDEO RECORDERS AND PLAYBACK MACHINES; DATA STORAGE PROGRAMS, NAMELY, SOFTWARE USED FOR THE STORAGE OF DATA ON HARD DISCS, COMPACT DISCS, TAPES, OPTICAL DISCS; SPECTACLES AND SUNGLASSES; MAGNETICALLY ENCODED BANK CREDIT, DEBIT, CASH AND IDENTIFICATION CARDS; AUTOMATIC TELLER MACHINES, CASH DISPENSERS, IN CLASS 9 (U.S. CLS. 21, 23, 26, 36 AND 38).

FOR: NEWSPAPERS; MAGAZINES IN THE FIELD OF BUSINESS AND E-COMMERCE; PRINTED PERIODICALS IN THE FIELD OF BUSINESS AND E-COMMERCE; JOURNALS CONCERNING BUSINESS AND E-COMMERCE; PAPER, CARDBOARD AND GOODS MADE FROM THESE MATERIALS, NOT INCLUDED IN OTHER CLASSES, NAMELY, COMPUTER PAPER, CARDBOARD BOXES AND OFFICE STATIONERY, AND BOOKBINDING MATER-

Reg. No. 4,152,587 IALS; PRINTED MATTER, NAMELY, PHOTOGRAPHS, STATIONERY, ADHESIVES FOR STATIONERY OR HOUSEHOLD PURPOSES; BOOKBINDING MATERIAL; ARTISTS' MATERIALS, NAMELY, PAINT BRUSHES; TYPEWRITERS; PRINTED INSTRUCTIONAL AND TEACHING MATERIAL, NAMELY, BOOKS AND WORKBOOKS IN THE FIELD OF BUSINESS AND E-COMMERCE; PLASTIC MATERIALS FOR PACKAGING, NAMELY, PLASTIC BAGS FOR PACKAGING; PRINTERS' TYPE; PRINTING BLOCKS; POSTERS; CIRCULARS AND CATALOGS IN THE FIELD OF BUSINESS AND E-COMMERCE; CALENDARS, PRICE TAGS, PAPER PRICE LABELS; CARRY BAGS OF PAPER, NAMELY, GENERAL PURPOSE BAGS OF PAPER AND CARDBOARD; CARDBOARD AND PLASTIC WRAP; PRINTED TELEPHONE, FACSIMILE, NAMELY, FACSIMILE TRANSMISSION PAPER, ELECTRONIC MAIL AND WEB SITE DIRECTORIES; CARDS IN THE FORM OF DEBIT CARDS, CREDIT CARDS, CHARGE CARDS AND TELEPHONE CARDS NOT MAGNETICALLY ENCODED; PRINTED VISUALS IN THE NATURE OF MARKETING AND PROMOTIONAL MATERIALS; PRINTED ADVERTISEMENTS, NAMELY, FLYERS; PACKAGING MATERIALS MADE OF RECYCLED PAPER; TISSUES, NAMELY, FACIAL AND TOILET TISSUE; HANDKERCHIEFS MADE OF PAPER; PAPER PARTY BAGS, IN CLASS 16 (U.S. CLS. 2, 5, 22, 23, 29, 37, 38 AND 50).

FOR: ADVERTISING; BUSINESS MANAGEMENT; BUSINESS ADMINISTRATION; PROVIDING OFFICE FUNCTIONS; ADVERTISING AGENCY SERVICES; ADVERTISING SERVICES PROVIDED FOR OTHERS; DATABASE MANAGEMENT; COMPILATION OF INFORMATION INTO COMPUTER DATABASES IN THE FIELD OF BUSINESS AND E-COMMERCE; MARKET RESEARCH AND BUSINESS CONSULTING SERVICES IN THE FIELD OF E-COMMERCE; BUSINESS CONSULTANCY SERVICES RELATING TO FACILITATING THE TRANSACTION OF BUSINESS VIA LOCAL AND GLOBAL COMPUTER NETWORKS BY LOCATING AND PROVIDING REFERRALS FOR THE DELIVERY OF A WIDE VARIETY OF BUSINESS AND CONSUMER PRODUCTS AND SERVICES; DISSEMINATION OF BUSINESS INFORMATION OF GOODS AND SERVICES OF OTHERS VIA LOCAL AND GLOBAL COMPUTER NETWORKS; BUSINESS CONSULTANCY SERVICES IN THE FIELD OF GLOBAL COMPUTER WEB SITES WHERE THIRD PARTIES CAN OFFER AND SOURCE GOODS AND SERVICES, PLACE, DETERMINE THE STATUS OF AND FULFILL TRADE LEADS AND ORDERS, ENTER INTO CONTRACTS AND TRANSACT BUSINESS; PROVIDING COMPUTERIZED ONLINE ORDERING SERVICES FEATURING A WIDE VARIETY OF CONSUMER, BUSINESS AND INDUSTRIAL PRODUCTS; ADVERTISING OF GOODS AND SERVICES OF OTHERS VIA LOCAL AND GLOBAL COMPUTER NETWORKS; INTERNATIONAL IMPORT AND EXPORT AGENCY SERVICES; RENTAL OF ADVERTISING SPACE ON COMMUNICATION MEDIA; ONLINE TRADING SERVICES RELATING TO ELECTRONIC AUCTIONEERING AND PROVIDING ONLINE BUSINESS EVALUATION RELATING THERETO; ONLINE RETAIL STORE SERVICES FEATURING A WIDE VARIETY OF CONSUMER GOODS OF OTHERS; PROVIDING AN ONLINE BUSINESS DIRECTORY OF THIRD PARTY WEB SITES TO FACILITATE BUSINESS TRANSACTIONS; BUSINESS CONSULTANCY SERVICES IN THE FIELD OF OPERATING AN ELECTRONIC MARKETPLACE FOR THE BUYERS AND SELLERS OF GOODS AND/OR SERVICES ON A GLOBAL COMPUTER NETWORK; BUSINESS ASSISTANCE FOR OTHERS IN THE FIELD OF FACILITATING BUSINESS TRANSACTION VIA LOCAL AND GLOBAL COMPUTER NETWORKS; CORPORATE BUSINESS MANAGEMENT CONSULTANCY SERVICES; MARKETING AND PROMOTION SERVICES; PUBLICATION OF PUBLICITY MATERIALS; REAL ESTATE MARKETING SERVICES, NAMELY, MARKETING OF VACANT PROPERTY IN THE NATURE OF CONDOMINIUMS, APARTMENTS, HOMES, COMMERCIAL STOREFRONTS, OFFICE BUILDINGS, WAREHOUSES, AND FACTORIES; DISSEMINATION OF ADVERTISING MATERIALS, UPDATING OF ADVERTISING MATERIALS, COMPILATION OF ADVERTISEMENTS FOR USE AS WEB PAGES ON THE INTERNET; RENTAL OF ADVERTISING SPACE; COMPUTER DATA PROCESSING; PROVIDING INFORMATION CONCERNING COMMERCIAL SALES, PROVIDING BUSINESS INFORMATION, PROMOTIONAL INFORMATION SERVICES, NAMELY, PROMOTING THE GOODS OF OTHERS BY PROVIDING INFORMATION REGARDING DISCOUNTS, COUPONS, REBATES, VOUCHERS AND SPECIAL OFFERS FOR THE GOODS OF OTHERS; TELEPHONE ANSWERING SERVICE; AUCTIONEERING PROVIDED ON THE INTERNET; PERSONNEL

Reg. No. 4,152,587 MANAGEMENT; PROVISION OF SALES, BUSINESS, ADVERTISING AND PROMOTIONAL INFORMATION THROUGH A GLOBAL COMPUTER NETWORK AND VIA THE INTERNET; PRESENTATION OF GOODS ON COMMUNICATION MEDIA FOR RETAIL PURPOSES; THE BRINGING TOGETHER, FOR THE BENEFIT OF OTHERS, OF A VARIETY OF GOODS, ENABLING CUSTOMERS TO CONVENIENTLY VIEW AND PURCHASE THOSE GOODS FROM A GENERAL MERCHANDISE INTERNET WEB SITE PARTICULARLY SPECIALIZING IN THE MARKETING OF THE SALE OF GOODS AND SERVICES OF OTHERS; RETAIL AND WHOLESALE STORES FEATURING TELEPHONES, MOBILE PHONE HANDSETS, MOBILE PHONE ACCESSORIES, ELECTRONIC AND TELECOMMUNICATIONS GOODS, COMPUTER HARDWARE AND COMPUTER SOFTWARE, BATTERIES, BATTERY CHARGERS, APPARATUS AND INSTRUMENTS FOR RECORDING, RECEIVING, TRANSMITTING AND/OR REPRODUCING DATA, INFORMATION, PICTURES, IMAGES AND/OR SOUND, PRECIOUS METALS, JEWELRY, PRECIOUS STONES, PRINTED MATTER, STATIONERY AND MAGNETIC AND NON MAGNETICALLY ENCODED CARDS, FURNITURE, PICTURE FRAMES, HOUSEHOLD AND KITCHEN UTENSILS, GLASSWARE, PORCELAIN AND EARTHENWARE, TEXTILES, CLOTHING, FOOTWEAR, HEADGEAR, LACES AND EMBROIDERY, BUTTONS, RIBBONS, PINS AND NEEDLES, ARTIFICIAL FLOWERS, CARPETS, RUGS, GAMES AND ELECTRONIC TOYS, CHEMICALS USED IN INDUSTRY, SCIENCE, PHOTOGRAPHY AND AGRICULTURE, PAINTS, VARNISHES AND LACQUERS, PERSONAL HYGIENE PRODUCTS, SOAPS, PERFUMERY, COSMETICS, HAIR AND BODY LOTIONS, ESSENTIAL OILS, CLEANING AND BLEACHING PREPARATIONS, LUBRICANTS, FUELS, CANDLES, PHARMACEUTICAL, VETERINARY AND SANITARY PREPARATIONS, IRONMONGERY AND SMALL ITEMS OF METAL HARDWARE, MACHINES AND MACHINE TOOLS, CUTLERY, RAZORS AND HAND TOOLS, COMPUTERS, CALCULATING MACHINES, ELECTRICAL, PHOTOGRAPHIC, CINEMATOGRAPHIC AND OPTICAL APPARATUS AND INSTRUMENTS, SPECTACLES AND SUN GLASSES, SURGICAL AND MEDICAL APPARATUS AND INSTRUMENTS, APPARATUS FOR LIGHTING, HEATING, STEAM GENERATING, COOKING, REFRIGERATING, DRYING, VENTILATING, WATER SUPPLY AND SANITARY PURPOSES, VEHICLES, FIREARMS, FIREWORKS, SILVERWARE, HOROLOGICAL AND CHRONOMETRIC INSTRUMENTS, MUSICAL INSTRUMENTS, MAGAZINE, CARDS, PAPER AND CARDBOARD PRODUCTS, PICTURE, TYPEWRITERS AND OFFICE REQUISITES, PACKAGING MATERIALS, RUBBER AND PLASTICS FOR MANUFACTURE USE, PACKING AND INSULATING MATERIALS, LEATHER AND IMITATIONS OF LEATHER AND GOODS MADE FROM THESE MATERIALS, HANDBAGS, PURSES, WALLETS, LEATHER HOLDERS, BAGS, LUGGAGE, UMBRELLAS, MIRRORS, ROPES, STRING, NETS, TENTS, YARNS AND THREADS FOR TEXTILE USE, COAT HANGERS, PLACE MATS, DRESSMAKER'S ARTICLES, BED AND TABLE COVERS, PLAYTHINGS AND SPORTING ARTICLES, FOODSTUFFS AND BEVERAGES, MEAT, FISH, POULTRY, PRESERVED, DRIED AND COOKED FRUITS AND VEGETABLES, JAMS AND FRUIT SAUCES, EGGS, MILK AND MILK PRODUCTS, EDIBLE OILS AND FATS, COFFEE, TEA, COCOA, SUGAR, RICE, FLOUR, BREAD AND CAKES, CONDIMENTS, FRESH FRUIT AND VEGETABLES, BEER, MINERAL WATER, FRUIT JUICES AND OTHER NON-ALCOHOLIC DRINKS, ALCOHOLIC BEVERAGES, FLORAL PRODUCTS, TOBACCO, SMOKERS' ARTICLES AND MATCHES; DIRECT MAIL ADVERTISING SERVICES; BUYING AND SELLING AGENCY SERVICES, NAMELY, PURCHASING A WIDE VARIETY OF CONSUMER, BUSINESS AND INDUSTRIAL PRODUCTS AND SERVICES FOR OTHERS; SELECTION OF GOODS AND PROCUREMENT OF GOODS FOR INDIVIDUALS AND BUSINESSES, NAMELY, PURCHASING OF A WIDE VARIETY OF CONSUMER, BUSINESS AND INDUSTRIAL PRODUCTS AND SERVICES FOR INDIVIDUALS AND BUSINESSES FOR INDIVIDUALS AND BUSINESSES; ONLINE ORDERING SERVICES FEATURING THE GENERAL CONSUMER GOODS OF OTHERS; DEPARTMENT STORE RETAILING SERVICES; SUPERMARKET RETAILING SERVICES; SECRETARIAL SERVICES; PROVISION OF BUSINESS STATISTICAL INFORMATION; ORGANIZATION OF EXHIBITIONS FOR COMMERCIAL OR ADVERTISING PURPOSES; BUSINESS ASSISTANCE SERVICES, NAMELY, COMPILATION AND RENTAL OF MARKETING MAILING LISTS; BUSINESS INVESTIGATION; BUSINESS ADMINISTRATION CONSULTATION SERVICES IN THE FIELD OF PROCESSING OF SALES MADE ON THE INTERNET; BUSINESS NETWORKING REFERRAL SERVICES AND PERSONNEL PLACEMENT; IMPORT-EXPORT AGENCY SERVICES; ARRANGING

Reg. No. 4,152,587 NEWSPAPER SUBSCRIPTIONS FOR OTHERS; DOCUMENT REPRODUCTION; TRANSCRIPTION, NAMELY, CONFERENCE CALL, MESSAGE AND STENOGRAPHIC TRANSCRIPTION; RENTAL OF OFFICE EQUIPMENT; CUSTOMER RELATIONSHIP MANAGEMENT; BUSINESS MANAGEMENT SERVICES RELATING TO ELECTRONIC COMMERCE; BUSINESS MANAGEMENT AND ADMINISTRATION SERVICES RELATING TO SPONSORSHIP PROGRAMS; ACCOUNTING SERVICES; CHARITABLE SERVICES, NAMELY, ORGANIZING AND CONDUCTING VOLUNTEER PROGRAMS AND COMMUNITY SERVICE PROJECTS; TAX INFORMATION AND CONSULTANCY SERVICES; ON-LINE AUTHENTICATION OF ELECTRONIC SIGNATURES, NAMELY, ELECTRONIC SIGNATURE VERIFICATION SERVICES PROVIDED IN CONNECTION WITH BANKING AND FINANCIAL SERVICES, IN CLASS 35 (U.S. CLS. 100, 101 AND 102).

FOR: INSURANCE SERVICES, NAMELY, INSURANCE AGENCIES; FINANCIAL AFFAIRS AND MONETARY AFFAIRS, NAMELY, FINANCIAL ANALYSIS AND ONLINE ESCROW SERVICE FOR EXCHANGE OF GOODS AND SERVICES; REAL ESTATE AFFAIRS, NAMELY, ASSESSMENT AND MANAGEMENT OF REAL ESTATE, PROVIDING INFORMATION IN THE FIELD OF REAL ESTATE VIA THE INTERNET; CLEARING AND RECONCILING FINANCIAL TRANSACTIONS VIA A GLOBAL COMPUTER NETWORK, NAMELY, PROVIDING SECURE COMMERCIAL TRANSACTIONS AND PAYMENT OPTIONS; ONLINE BANKING SERVICES AND FINANCIAL PLANNING SERVICES; CREDIT CARD SERVICES; ELECTRONIC PAYMENT, NAMELY, ELECTRONIC PROCESSING AND TRANSMISSION OF BILL PAYMENTS DATA; UNDERWRITING FINANCIAL TRANSACTIONS, NAMELY, PROVIDING INSURANCE FOR FINANCIAL TRANSACTIONS; ELECTRONIC FUNDS TRANSFER SERVICES; TRANSMISSION OF FUNDS BY ELECTRONIC MEANS FOR OTHERS; TRANSFER OF ELECTRONIC PAYMENTS FOR OTHERS VIA THE INTERNET; FINANCIAL SERVICES IN THE NATURE OF CREDIT CARD AND DEBIT CARD PAYMENT PROCESSING SERVICES; REAL ESTATE SERVICES, NAMELY, ARRANGEMENT AND MANAGEMENT OF LEASES AND TENANCY; RENTING AND LEASING OF REAL ESTATE; REAL ESTATE APPRAISAL; REAL ESTATE VALUATION, REAL ESTATE FINANCING, REAL ESTATE INVESTMENT SERVICES; REAL ESTATE BROKERAGE SERVICES; REAL ESTATE AGENCY SERVICES; HOUSING AGENCY SERVICES; ACTUARIAL SERVICES; REAL ESTATE MANAGEMENT AND CONSULTANCY SERVICES; RENT COLLECTION; RENTAL OF OFFICES; RENTAL OF APARTMENTS AND FLATS; PROVISION OF FINANCIAL INFORMATION VIA THE INTERNET; SAFETY DEPOSIT SERVICES AND ISSUING OF TRAVEL VOUCHERS SERVICES, NAMELY, PROVIDING VOUCHERS FOR PAYMENT OF TRANSPORTATION EXPENSES; CAPITAL INVESTMENTS SERVICES; FINANCIAL EVALUATION; FINANCIAL AND FINANCIAL ASSET MANAGEMENT SERVICES; INSURANCE AND FINANCIAL SERVICES, NAMELY, PROVIDING FINANCIAL INFORMATION; FINANCIAL SERVICES, NAMELY, FINANCIAL ANALYSIS SERVICES PROVIDED BY TELECOMMUNICATION MEANS; FINANCIAL CONSULTANCY AND ADVISORY SERVICES; HOME BANKING; BANKING SERVICES PROVIDED ON-LINE FROM A COMPUTER DATABASES OR THE INTERNET; SECURITIES BROKERAGE SERVICES, STOCK EXCHANGE QUOTATION SERVICES; STOCKS AND BONDS BROKERAGE, FINANCIAL ANALYSIS; DEBIT CARD SERVICES, CHARGE CARD SERVICES AND CHECK VERIFICATION SERVICES; BANKING, SAVINGS ACCOUNT AND INVESTMENT BANKING SERVICES; FINANCIAL CLEARING HOUSE SERVICES; CREDIT CARD VERIFICATION VIA GLOBAL COMPUTER INFORMATION NETWORK; ELECTRONIC CREDIT RISK MANAGEMENT SERVICES; ELECTRONIC PURCHASE PAYMENT AND ELECTRONIC BILL PAYMENT SERVICES; ELECTRONIC BANKING SERVICES VIA A GLOBAL NETWORK; ISSUANCE OF STORED VALUE CARDS, AND CHARGE CARDS AND DEBIT CARDS SERVICES; TELEPHONE CREDIT CARDS SERVICES, NAMELY, TELEPHONE CALLING CARDS SERVICES; PROVIDING FINANCE AND INSURANCE INFORMATION ONLINE FROM A COMPUTER DATABASE OR INTERNET; COLLECTION AGENCY FOR COLLECTION OF GAS AND ELECTRICITY FEES; ANTIQUE APPRAISAL; ART APPRAISAL; JEWELRY APPRAISAL; USED CAR APPRAISAL; CHARITABLE FUND RAISING; RENTAL OF PAPER MONEY AND COIN COUNTING MACHINES; RENTAL OF CASH DISPENSERS OR AUTOMATED-TELLER MACHINES; ONLINE PAYMENT SERVICES, NAMELY, ELECTRONIC PROCESSING OF CREDIT CARD TRANSACTIONS AND ELECTRONIC PAYMENTS

Reg. No. 4,152,587 VIA A GLOBAL COMPUTER NETWORK; AUTHENTICATION AND VERIFICATION, NAMELY, CREDIT CARD AND CHECK VERIFICATION IN RELATION TO ONLINE PAYMENT OR TRANSFER OF FUNDS; CONSULTANCY, INFORMATION AND ADVISORY SERVICES RELATING TO THE AFORESAID SERVICES, IN CLASS 36 (U.S. CLS. 100, 101 AND 102).

FOR: TELECOMMUNICATIONS ACCESS SERVICES; PROVISION OF TELECOMMUNICATION ACCESS AND LINKS TO COMPUTER DATABASE AND TO THE INTERNET; ELECTRONIC COMMUNICATION SERVICES; INTERACTIVE TELECOMMUNICATIONS SERVICES, NAMELY, INTERACTIVE DELIVERY OF AUDIO AND VIDEO OVER DIGITAL NETWORKS; TELECOMMUNICATIONS SERVICES, NAMELY, THE ELECTRONIC TRANSMISSION OF DATA AND DOCUMENTS; PROVIDING TELECOMMUNICATIONS CONNECTIONS TO THE INTERNET OR DATA BASES; PROVISION OF TELECOMMUNICATION ACCESS TO WORLD-WIDE WEB FACILITIES AND STRUCTURES; COMMUNICATION BY COMPUTER TERMINALS; COMMUNICATION BY FIBER OPTIC NETWORKS; ELECTRONIC TRANSMISSION OF MESSAGES AND IMAGES BY COMPUTER; FACSIMILE TRANSMISSION; MESSAGE SENDING; PAGING SERVICES; RENTAL OF MODEMS; TRANSMISSION OF DATA BY ELECTRONIC MEANS; RENTAL OF TELECOMMUNICATION EQUIPMENT; ELECTRONIC MESSAGE SENDING, RECEIVING AND FORWARDING SERVICES; TRANSMISSION AND DELIVERY OF DATA BY ELECTRONIC MEANS; ELECTRONIC TRANSMISSION AND DELIVERY OF MAIL MESSAGES, STILL PICTURE AND/OR MOVING PICTURE INFORMATION SUCH AS CHARACTERS, MESSAGES, MUSIC AND IMAGES, TELEGRAMS, INFORMATION AND DATA BY MECHANICAL, ELECTRONIC, TELEPHONE, TELEGRAPH, CABLE, COMPUTER AND SATELLITE MEANS; TRANSMISSION, BROADCAST AND RECEPTION OF AUDIO, VIDEO, STILL AND MOVING IMAGES AND DATA WHETHER IN COMPRESSED OR UNCOMPRESSED FORM AND WHETHER IN REAL OR DELAYED TIME; ELECTRONIC MESSAGING SERVICES, TELEPHONE, VIDEO AND WEB CONFERENCING SERVICES AND ORDER-TRANSMISSION SERVICES; VIDEO CONFERENCING SERVICES; PROVIDING AN ELECTRONIC BULLETIN BOARD THAT ENABLES USERS TO PERFORM A REAL-TIME INTERACTIVE TALK BETWEEN A COMPUTER TERMINAL AND AN ELECTRONIC BULLETIN BOARD CONTAINING STILL PICTURE AND MOVING PICTURE INFORMATION AND VOICE INFORMATION SUCH AS CHARACTERS, MESSAGES, MUSIC AND IMAGES, TELEGRAMS, INFORMATION AND DATA BY ELECTRONIC, TELEPHONE, TELEGRAPH, CABLE, COMPUTER AND SATELLITE MEANS; PROVIDING ELECTRONIC BULLETIN BOARDS AND MESSAGE BOARDS FOR TRANSMISSION OF MESSAGES AMONG USERS CONCERNING BUSINESS AND E-COMMERCE; PROVISION OF ONLINE DISCUSSION FORUMS FOR TRANSMISSION OF MESSAGES AMONG COMPUTER USERS CONCERNING BUSINESS AND E-COMMERCE; TELEVISION BROADCASTING SERVICES; BROADCASTING AND TRANSMISSION OF RADIO AND TELEVISION PROGRAMS; MUSIC BROADCASTING; TRANSMISSION OF MUSIC, FILMS, INTERACTIVE PROGRAMS, VIDEOS, ELECTRONIC COMPUTER GAMES VIA A GLOBAL COMPUTER NETWORK OR THE INTERNET; ELECTRONIC TRANSMISSION OF INFORMATION IN THE FIELD OF ON-LINE SHOPPING AND GENERAL RETAIL SERVICES; VIDEO-ON-DEMAND TRANSMISSION SERVICES; NEWS AGENCY SERVICES FOR ELECTRONIC TRANSMISSION; PROVIDING ACCESS TO COMPUTER DATABASE ON THE GLOBAL COMPUTER NETWORK; PROVIDING CHAT ROOM SERVICES OR TRANSMISSION OF MESSAGES AMONG COMPUTER USERS CONCERNING BUSINESS AND E-COMMERCE; PROVIDING MULTIPLE-USER ACCESS TO A GLOBAL COMPUTER INFORMATION NETWORK; COMMUNICATION SERVICES, NAMELY, TEXT AND NUMERIC WIRELESS DIGITAL MESSAGING SERVICES; TRANSMISSION OF INFORMATION AND DATA COMMUNICATIONS FOR ASSISTING DECISION MAKING; TRANSMISSION OF INFORMATION THROUGH VIDEO COMMUNICATION SYSTEMS; WEB CONFERENCING SERVICES; ELECTRONIC COMMUNICATION SERVICES FOR ESTABLISHING VIRTUAL CHAT ROOMS VIA TEXT MESSAGING, NAMELY, CHAT ROOMS CONCERNING BUSINESS AND E-COMMERCE; PROVIDING ELECTRONIC BULLETIN BOARDS FOR THE POSTING AND TRANSMISSION OF MESSAGES AMONG AND BETWEEN COMPUTER USERS CONCERNING CONSUMER PRODUCTS, SERVICES AND BUSINESS LEADS AND OPPORTUNITIES; PROVIDING AN ONLINE INTERACTIVE BULLETIN BOARD FOR THE

Reg. No. 4,152,587 POSTING, PROMOTION, SALE AND RESALE OF ITEMS VIA A GLOBAL COMPUTER NETWORK; PROVIDING ELECTRONIC MAIL AND ELECTRONIC MAIL FORWARDING SERVICES; AUDIO AND VIDEO COMMUNICATION VIA COMPUTERS AND COMPUTER NETWORKS, AND VIA A GLOBAL COMMUNICATIONS NETWORK; PROVIDING COMPUTER ACCESS TO ONLINE INTERACTIVE BULLETIN BOARDS AND DATABASES; CONSULTANCY, INFORMATION AND ADVISORY SERVICES RELATING TO THE AFORESAID SERVICES, IN CLASS 38 (U.S. CLS. 100, 101 AND 104).

FOR: TRANSPORT, NAMELY, TRANSPORTATION OF PASSENGERS AND GOODS BY RAIL; PACKAGING OF ARTICLE FOR TRANSPORTATION AND STORAGE OF GOODS; ARRANGING TRAVEL TOURS; ELECTRONIC STORAGE OF DATA OR DOCUMENTS; TRANSPORTATION INFORMATION; SHIP BROKERAGE; CAR TRANSPORT; AIR TRANSPORT; VEHICLE RENTAL; WATER SUPPLYING; MESSAGE DELIVERY; TRAVEL RESERVATION SERVICES, NAMELY, MAKING RESERVATIONS AND BOOKING FOR TRANSPORTATION; TRANSPORT BY PIPELINE; DELIVERY OF GOODS BY MAIL ORDER; COURIER SERVICES; LOGISTIC MANAGEMENT RELATING TO TRANSPORT, NAMELY, STORAGE, TRANSPORTATION AND DELIVERY OF GOODS FOR OTHERS BY AIR, RAIL, SHIP OR TRUCK; CAR RENTAL SERVICES; CAR PARKING SERVICES; YACHT AND BOAT CHARTERING; TRAVEL AGENCY SERVICES, NAMELY, MAKING RESERVATIONS AND BOOKINGS FOR TRANSPORTATION; ONLINE TRAVEL RESERVATION SERVICES AND PROVIDING TRAVEL INFORMATION; TRAVEL TICKET RESERVATION SERVICES; ARRANGING TRAVEL TOURS AND PROVIDING TRAVEL INFORMATION ON-LINE FROM A COMPUTER DATABASE OR THE INTERNET; PROVISION OF INFORMATION RELATING TO TRAVEL AND TOURS THROUGH THE INTERNET OR THROUGH TELECOMMUNICATION NETWORKS; TRANSPORT OF GOODS AND PASSENGERS; MERCHANDISE PACKAGING FOR OTHERS; PROVIDING ROAD AND TRAFFIC INFORMATION, CHAUFFEUR SERVICES; LOADING AND UNLOADING OF CARGO; FREIGHT BROKERAGE; REMOVAL SERVICES, NAMELY, JUNK REMOVAL SERVICES; RENTAL, LEASING, AND/OR CHARTERING OF SHIPS AND BOATS; SALVAGE AND REFLOATING OF SHIPS AND BOATS; PILOTING; GAS DISTRIBUTION AND SUPPLY; ELECTRICITY DISTRIBUTION; HEAT DISTRIBUTION AND SUPPLY; WATER DISTRIBUTION AND SUPPLY; PROVIDING MOORING FACILITY SERVICES; RENTAL OF WAREHOUSES; RENTAL AND/OR LEASING OF WHEEL CHAIRS; PROVIDING CAR PARKING FACILITIES; RENTAL AND/OR LEASING OF AIRPLANES; RENTAL AND/OR LEASING OF DELIVERY OR STORAGE CONTAINERS; RENTAL AND/OR LEASING OF BICYCLES; RENTAL AND/OR LEASING OF CARS; RENTAL AND/OR LEASING OF SHIPS AND/OR BOATS; RENTAL AND/OR LEASING OF MAN-POWERED VEHICLES; RENTAL AND/OR LEASING OF MECHANICAL PARKING SYSTEMS; RENTAL AND/OR LEASING OF PALLETS; RENTAL AND/OR LEASING OF PACKAGING OR WRAPPING MACHINES; RENTAL AND/OR LEASING OF REFRIGERATOR; COLLECTION OF DOMESTIC WASTE AND TRASH; COLLECTION OF INDUSTRIAL WASTE AND TRASH; CONSULTANCY, INFORMATION AND ADVISORY SERVICES RELATING TO THE AFORESAID SERVICES, IN CLASS 39 (U.S. CLS. 100 AND 105).

FOR: EDUCATION, NAMELY, PROVIDING SEMINARS AND CONFERENCES IN THE FIELD OF BUSINESS AND E-COMMERCE; PROVIDING TRAINING IN THE FIELD OF BUSINESS AND E-COMMERCE; ENTERTAINMENT, NAMELY, PROVIDING ON-LINE VIDEO GAMES, COMPUTER GAMES AND ARRANGING COMPUTER GAME CONTESTS; ORGANIZING COMMUNITY SPORTING AND CULTURAL ACTIVITIES; PUBLICATION OF TEXTS, BOOKS AND JOURNALS; PUBLICATION OF NEWSPAPERS, MAGAZINES AND PERIODICALS CONTAINING DIAGRAMS, IMAGES AND PHOTOGRAPHS; EDUCATION, NAMELY, TRAINING COURSES AND INSTRUCTIONAL CLASSES IN THE FIELD OF TELECOMMUNICATIONS HARDWARE AND SOFTWARE, OPERATION OF COMPUTERS, COMPUTER PROGRAMMING, WEB SITE DESIGN, E-COMMERCE, BUSINESS MANAGEMENT AND ADVERTISING; PROVIDING INFORMATION ABOUT EDUCATION, RECREATION ACTIVITIES, INSTRUCTION AND TRAINING IN THE FIELD OF BUSINESS AND ECOMMERCE; DESIGN OF EDUCATIONAL COURSES AND EXAMINATIONS, NAMELY, DEVELOPMENT OF EDUCATIONAL COURSES AND EXAMINATIONS FOR

Reg. No. 4,152,587 OTHERS; ENTERTAINMENT PROVIDED VIA ELECTRONIC AND DIGITAL INTERACTIVE MEDIA, NAMELY, PROVIDING ON-LINE COMPUTER GAMES; PROVISION OF INFORMATION ABOUT EDUCATION, ENTERTAINMENT INFORMATION, INFORMATION IN THE FIELD OF SPORTS AND SPORTING EVENTS, AND INFORMATION IN THE FIELD OF RECREATION AND LEISURE ACTIVITIES AND CULTURAL ACTIVITIES AND EXHIBITIONS; PROVIDING ON-LINE NON-DOWNLOADABLE ELECTRONIC PUBLICATIONS IN THE NATURE OF BOOKS, JOURNALS, NEWSLETTERS AND ARTICLES IN THE FIELD OF BUSINESS AND E-COMMERCE; ARRANGING, ORGANIZING, HOSTING AND CONDUCTING SINGING COMPETITIONS; ARRANGING, ORGANIZING, HOSTING AND CONDUCTING MUSICAL CONCERTS; ENTERTAINMENT SERVICES, NAMELY, PRODUCTION AND DISTRIBUTION OF A GAME SHOW; ENTERTAINMENT TICKET AGENCY SERVICES; ENTERTAINMENT INFORMATION AND INFORMATION ABOUT EDUCATION, PROVIDED ONLINE FROM A COMPUTER DATABASE OR THE INTERNET; PROVIDING NON-DOWNLOADABLE PRERECORDED DIGITAL MUSIC FROM THE INTERNET; PROVIDING NON-DOWNLOADABLE PRERECORDED DIGITAL MUSIC FROM MP3 INTERNET WEB SITES; ENTERTAINMENT AND EDUCATION SERVICES, NAMELY, PROVIDING COURSES OF INSTRUCTION ABOUT PLANNING, PRODUCTION AND DISTRIBUTION OF SOUND, IMAGES, DIGITAL MUSIC, MOVIES AND LIVE OR RECORDED AUDIO, VISUAL OR AUDIOVISUAL MATERIAL FOR BROADCASTING ON TERRESTRIAL CABLE, SATELLITE CHANNELS, THE INTERNET, WIRELESS OR WIRE-LINK SYSTEMS AND OTHER MEANS OF COMMUNICATIONS; MUSIC ENTERTAINMENT SERVICES, NAMELY, LIVE MUSIC CONCERTS; RENTAL OF SOUND RECORDINGS; PREPARATION OF ENTERTAINMENT, EDUCATIONAL, DOCUMENTARY AND NEWS PROGRAMS FOR BROADCASTING, NAMELY, PROVIDING ON-GOING TELEVISION PROGRAMS IN THE FIELDS OF BUSINESS AND E-COMMERCE, ENTERTAINMENT TELEVISION PROGRAMS IN THE NATURE OF GAME SHOWS, EDUCATIONAL PROGRAMS IN THE FIELD OF BUSINESS AND ECOMMERCE; NEWS REPORTERS' SERVICES; PROVIDING NEWS IN THE FIELD OF SPORTING OR CULTURAL EVENTS, CURRENT EVENTS REPORTING PROVIDED BY SATELLITE TELEVISION TRANSMISSION, THE INTERNET OR RADIO; PRODUCTION OF TELEVISION AND RADIO PROGRAMS AND FILM PRODUCTION; PREPARATION AND PRODUCTION OF TELEVISION PROGRAMS; GAME SERVICES, NAMELY, ARRANGING COMPUTER GAME CONTESTS; PROVISION OF RECREATION, SPORTING AND GYMNASIUM FACILITIES; LIVE PERFORMANCES BY A MUSICAL BAND; NIGHT CLUB SERVICES, DISCOTHEQUE, AND FASHION SHOWS; ORGANIZING AND CONDUCTING EXHIBITIONS FOR CULTURAL OR EDUCATIONAL PURPOSES; ART EXHIBITION AND GALLERY SERVICES; ART GALLERY SERVICES, NAMELY, RENTAL OF ARTWORK; TRAINING SERVICES IN THE FIELD OF OCCUPATION HEALTH AND SAFETY, ENVIRONMENTAL CONSERVATION; PROVISION OF CIGAR CLASSES, WINE TASTING CLASSES; PROVIDING EDUCATION INFORMATION ABOUT RESEARCH MATERIALS AND AGENCY THEREOF, NAMELY, PROVIDING EDUCATIONAL RESEARCH AND INFORMATION ABOUT EDUCATIONAL RESEARCH; ARRANGING, ORGANIZING, PLANNING AND RUNNING OF SEMINARS IN THE FIELD OF BUSINESS AND E-COMMERCE; ANIMAL TRAINING; DIRECTION IN PRODUCING PROGRAMS, NAMELY, OPERATION OF AUDIOVISUAL MACHINES AND EQUIPMENT FOR THE PRODUCTION OF RADIO AND TELEVISION PROGRAMS; INSTRUCTIONAL SERVICES, NAMELY, TRAINING IN THE OPERATION OF AUDIOVISUAL MACHINES AND EQUIPMENT USED FOR THE PRODUCTION OF BROADCASTING PROGRAMS; PROVIDING AUDIO AND VISUAL STUDIOS; PROVIDING SPORTS FACILITIES; PROVIDING FACILITIES FOR MOVIES, SHOWS, PLAYS, MUSIC OR EDUCATIONAL TRAINING; ENTERTAINMENT BOOKING AGENCIES, NAMELY, BOOKING OF SEATS FOR SHOWS AND SPORTS EVENTS; RENTAL OF MOTION PICTURES; RENTAL AND LEASING OF MUSICAL INSTRUMENTS; RENTAL AND LEASING OF TELEVISION SETS; LENDING LIBRARIES; ARCHIVE LIBRARY SERVICES; SUBTITLING SERVICES, NAMELY, PREPARING SUBTITLES FOR MOVIES; SIGN LANGUAGE INTERPRETATION SERVICES; RENTAL OF ENTERTAINMENT SOFTWARE, NAMELY, RENTAL OF COMPUTER GAME SOFTWARE; PROVIDING ONLINE VIDEO GAMES AND COMPUTER GAMES; PROVIDING ONLINE NON-DOWNLOADABLE MUSIC AND MOVIES THROUGH THE INTERNET; PROVIDING ONLINE COMPUTER GAMES AND CONDUCTING CONTESTS; RENTAL OF PRE-RECORDED VIDEO TAPES; RENTAL

Reg. No. 4,152,587 AND LEASING OF GAME MACHINES; RENTAL OF ARCADE GAME EQUIPMENT; RENTAL OF MOTION PICTURES; PHOTOGRAPHY; TRANSLATION; LANGUAGE INTERPRETATION; EDUCATIONAL AND TRAINING PROGRAMS IN THE FIELD OF RISK MANAGEMENT; PROVISION OF NEWS IN THE NATURE OF CURRENT EVENT REPORTING; LOTTERY SERVICES, IN CLASS 41 (U.S. CLS. 100, 101 AND 107).

FOR: SCIENTIFIC AND TECHNOLOGICAL SERVICES AND RESEARCH AND DESIGN RELATING THERETO, NAMELY, PROVIDING TEMPORARY USE OF ONLINE NON-DOWNLOADABLE SOFTWARE AND TEMPORARY USE OF ONLINE NON-DOWNLOADABLE CLOUD COMPUTING SOFTWARE FEATURING SOFTWARE FOR PLANNING AND MANAGEMENT OF PERSONAL AND BUSINESS FINANCES, E-COMMERCE DATA MINING, HIGH-SPEED MASSIVE E-COMMERCE DATA PROCESSING, AND DATA CUSTOMIZATION, CUSTOMER RELATIONSHIP MANAGEMENT, INVENTORY MANAGEMENT, SALES FORCE MANAGEMENT, AND MARKETING INFORMATION MANAGEMENT; INDUSTRIAL RESEARCH SERVICES IN THE FIELD OF BUSINESS AND E-COMMERCE; DESIGN AND DEVELOPMENT OF COMPUTER HARDWARE AND SOFTWARE; COMPUTER SERVICES, NAMELY, CREATING INDEXES OF INFORMATION, SITES AND RESOURCES ON COMPUTER NETWORKS; PROVIDING SEARCH ENGINES FOR THE INTERNET; DESIGN OF COMPUTERS, NOTEBOOK COMPUTERS, LAPTOP COMPUTERS, PORTABLE COMPUTERS AND HANDHELD COMPUTERS; DESIGN OF PERSONAL DIGITAL ASSISTANTS AND PERSONAL MEDIA PLAYERS FOR OTHERS; DESIGN OF MOBILE TELEPHONES AND SMART PHONE FOR OTHERS; DESIGN OF DIGITAL CAMERAS FOR OTHERS; COMPUTER SERVICES, NAMELY, COMPUTER SYSTEM ADMINISTRATION FOR OTHERS; COMPUTER PROGRAMMING; COMPUTER SYSTEMS INTEGRATION SERVICES; COMPUTER SYSTEMS ANALYSIS SERVICES; COMPUTER PROGRAMMING IN RELATION TO THE DEFENSE AGAINST VIRUS, NAMELY, COMPUTER VIRUS PROTECTION SERVICES; COMPUTER SYSTEM SOFTWARE SERVICES, NAMELY, DESIGN AND DEVELOPMENT OF ON-LINE COMPUTER SOFTWARE SYSTEMS; PROVIDING DIRECT CONNECTION SERVICES BETWEEN COMPUTER USERS FOR EXCHANGING DATA, NAMELY, PROVIDING TEMPORARY USE OF ONLINE NON-DOWNLOADABLE SOFTWARE FOR THE EXCHANGE OF DATA; COMPUTER SOFTWARE DESIGN; COMPUTER SYSTEM DESIGN; DESIGN AND DEVELOPMENT OF WEB PAGES; HOSTING WEB PAGES FOR OTHERS; HOSTING COMPUTER APPLICATION SOFTWARE FOR OTHERS FOR USE IN SEARCHING AND RETRIEVING INFORMATION FROM DATABASES AND COMPUTER NETWORKS; PROVIDING TECHNICAL INFORMATION AT THE SPECIFIC REQUEST OF END-USERS BY MEANS OF TELEPHONE OR GLOBAL COMPUTER NETWORK; COMPUTER SOFTWARE CONSULTANCY; COMPUTER SERVICES RELATING TO CUSTOMIZED SEARCHING OF COMPUTER DATABASES AND WEBSITES, NAMELY, PROVIDING CUSTOMIZED ONLINE WEB PAGES FEATURING USER DEFINED INFORMATION WHICH INCLUDES ONLINE LINKS TO THIRD PARTY WEB SITES; PROVIDING CUSTOMIZED ONLINE WEB PAGES FEATURING USER-DEFINED INFORMATION WHICH INCLUDES ONLINE LINKS TO THIRD PARTY WEB SITES; COMPUTER CODE CONVERSION FOR OTHERS; CONVERSION OF PHYSICAL DATA AND DOCUMENTS INTO ELECTRONIC MEDIA FORMAT; TESTING AND EVALUATION SERVICES IN THE FIELD OF ECOMMERCE; ARCHITECTURAL DESIGN SERVICES; INTERIOR DESIGNS SERVICES OF BUILDINGS, OFFICES AND APARTMENTS; COMPUTER SECURITY SERVICES, NAMELY, THE PROVISION OF USER CERTIFICATION AUTHORITY SERVICES FOR OTHERS TO ENSURE THE SECURITY OF TRANSMITTED INFORMATION, NAMELY, PROVIDING A WEBSITE THAT FEATURES TECHNOLOGY THAT ENABLES THE SECURE EXCHANGE OF INFORMATION BY USERS; COMPUTER AND NETWORK INFORMATION SERVICES, NAMELY, PROVIDING INFORMATION RELATING TO COMPUTERS AND NETWORKS IN THE FIELD OF BUSINESS AND E-COMMERCE; COMPUTER SECURITY RISK MANAGEMENT PROGRAMS, NAMELY, UPDATING OF COMPUTER SOFTWARE RELATING TO COMPUTER SECURITY AND PREVENTION OF COMPUTER RISKS; COMPUTER SECURITY INFORMATION, KNOWLEDGE, AND TESTING SERVICES, NAMELY, COMPUTER SECURITY CONSULTANCY IN THE FIELD OF SCANNING AND PENETRATION TESTING OF COMPUTERS AND NETWORKS TO ASSESS INFORMATION SECURITY VULNERABILITY; PROVIDING QUALITY ASSURANCE SERVICES IN THE FIELD OF E-COMMERCE; AUTHENTICATION

Reg. No. 4,152,587 SERVICES FOR COMPUTER SECURITY, NAMELY, ELECTRONIC DOCUMENT AND E-MAIL AUTHENTICATION SERVICES; COMPUTER SECURITY SERVICE, NAMELY, RESTRICTING ACCESS TO AND BY COMPUTER NETWORKS TO AND OF UNDESIREED WEB SITES, MEDIA AND INDIVIDUALS AND FACILITIES; SECURITY OF DATA TRANSMISSION AND OF TRANSACTIONS VIA COMPUTER NETWORKS, NAMELY, COMPUTER SECURITY SERVICE, NAMELY, RESTRICTING ACCESS TO AND BY COMPUTER NETWORKS TO AND OF UNDESIREED WEB SITES, MEDIA AND INDIVIDUALS AND FACILITIES; CONSULTANCY IN THE FIELD OF DATA SECURITY; CONSULTANCY CONCERNING SECURING TELECOMMUNICATIONS TECHNOLOGY, IN CLASS 42 (U.S. CLS. 100 AND 101).

PRIORITY CLAIMED UNDER SEC. 44(D) ON HONG KONG APPLICATION NO. 301776493, FILED 11-30-2010, REG. NO. 301776493, DATED 11-30-2010, EXPIRES 11-30-2020.

THE MARK CONSISTS OF A SQUARE WITH EARDROP SHAPED IMAGES AND LINES INSIDE THE SQUARE, SOME OF WHICH INTERSECT OR CONNECT WITH EACH OTHER IN A FLUID MANNER.

SER. NO. 85-197,737, FILED 12-14-2010.

LAKEISHA LEWIS, EXAMINING ATTORNEY

United States of America

United States Patent and Trademark Office

MOJO
SPORTSWEAR COMPANY

Reg. No. 4,152,588

MOJO SPORTSWEAR COMPANY INC. (FLORIDA CORPORATION)
644C ANCHORS ST
FORT WALTON BEACH, FL 32548

Registered June 5, 2012

Int. Cl.: 25

FOR: HATS; HEADWEAR; JACKETS; SHIRTS; SHORTS; TOPS, IN CLASS 25 (U.S. CLS. 22 AND 39).

TRADEMARK

FIRST USE 0-0-2009; IN COMMERCE 0-0-2009.

PRINCIPAL REGISTER

NO CLAIM IS MADE TO THE EXCLUSIVE RIGHT TO USE "SPORTSWEAR COMPANY", APART FROM THE MARK AS SHOWN.

THE MARK CONSISTS OF THE STYLIZED WORDING "MOJO SPORTSWEAR COMPANY" WITH THE END OF THE LETTER "M" AND THE TOP OF THE LETTER "J" IN "MOJO" RESEMBLING FISHING HOOKS.

SER. NO. 85-197,988, FILED 12-15-2010.

ELLEN B. AWRICH, EXAMINING ATTORNEY



David J. Kyros

Director of the United States Patent and Trademark Office

United States of America

United States Patent and Trademark Office

AQUAS

C L E A N M A R I N A S E R I E S

Reg. No. 4,152,589

Registered June 5, 2012

Int. Cls.: 7, 11 and 42

TRADEMARK

SERVICE MARK

PRINCIPAL REGISTER

ENVIRONMENTAL CONTROL SYSTEMS, INC. (RHODE ISLAND CORPORATION), DBA
AQUASGROUP
830 WATERMAN AVENUE
EAST PROVIDENCE, RI 02914

FOR: PRESSURE WASHING MACHINES; REVERSE OSMOSIS PUMPS; ELECTRICAL WATER PUMPS FOR INDUSTRIAL USE; ELECTRICAL WATER PUMPS FOR MARINA USE; ELECTRICAL WATER PUMPS FOR VESSEL USE; SUCTION PUMPS; MACHINES FOR CLEANING SURFACES USING HIGH PRESSURE WATER; MACHINES FOR CLEANING MARINAS USING HIGH PRESSURE WATER; BILGE PUMPS FOR INDUSTRIAL AND MUNICIPAL MARINA USE; MACHINES FOR CLEANING VESSELS USING HIGH PRESSURE WATER, IN CLASS 7 (U.S. CLS. 13, 19, 21, 23, 31, 34 AND 35).

FIRST USE 1-1-2007; IN COMMERCE 1-28-2007.

FOR: ENVIRONMENTAL CONTROL APPARATUS, NAMELY, PARTICLE ACTIVATORS FOR USE IN SOIL REMEDIATION, DRINKING WATER TREATMENT, MUNICIPAL AND INDUSTRIAL WASTEWATER TREATMENT; WASTE WATER PURIFICATION APPARATUS, INSTALLATIONS AND TANKS; WASTE WATER PURIFICATION UNITS; WATER FILTERING APPARATUS; WATER PURIFICATION, SEDIMENTATION AND FILTRATION APPARATUS FOR CLARIFICATION, THICKENING AND FILTRATION OF WATER, WASTE WATER AND INDUSTRIAL WATER; SUSTAINABLE ONSITE WATER RECYCLING AND WASTEWATER TREATMENT SYSTEMS; WATER TREATMENT APPARATUS, NAMELY, CLARIFICATION AND THICKENING MACHINES FOR USE IN TREATMENT OF LIQUIDS IN THE NATURE OF WATER, WASTE WATER AND INDUSTRIAL WATER; INDUSTRIAL-WATER PURIFYING APPARATUS; WATER PURIFYING APPARATUS; WATER PURIFYING UNITS, FOR POTABLE WATER FOR, NAMELY, MARINAS AND VESSELS FOR COMMERCIAL AND INDUSTRIAL USE; WATER TREATMENT EQUIPMENT, NAMELY, REVERSE OSMOSIS FILTRATION UNITS; WASTE WATER PURIFICATION UNITS; WASTE WATER RECYCLING UNITS; INDUSTRIAL POWERWASH OR WASTE WATER RECYCLING SYSTEMS COMPRISED OF MIXERS, TANKS, PUMPS, AND CONTROLS; INDUSTRIAL POWERWASH OR WATER TREATMENT AND DISCHARGE SYSTEM COMPRISED OF MIXERS, TANKS, PUMPS, AND CONTROLS; INDUSTRIAL POWERWASH OR WASTE WATER COLLECT AND HAUL SYSTEM COMPRISED OF MIXERS, TANKS, PUMPS, AND CONTROLS; INDUSTRIAL POWERWASH OR WASTE WATER RECYCLING SYSTEM COMPRISED OF MIXERS, TANKS, PUMPS, AND CONTROLS FEATURING SPOT FREE



David J. Kyros

Director of the United States Patent and Trademark Office

Reg. No. 4,152,589 RINSE; FILTER SUPPLIES, NAMELY, WATER FILTERS, IN CLASS 11 (U.S. CLS. 13, 21, 23, 31 AND 34).

FIRST USE 9-1-2006; IN COMMERCE 1-28-2007.

FOR: DESIGN OF HIGH PRESSURE WASHING SYSTEMS; DESIGN OF WATER PURIFICATION SYSTEMS FOR MARINAS; DESIGN OF INDUSTRIAL WASTE WATER REMOVAL SYSTEMS FOR MARINAS; DESIGN OF WASTE WATER RECYCLING SYSTEMS FOR MARINAS, IN CLASS 42 (U.S. CLS. 100 AND 101).

FIRST USE 9-1-2006; IN COMMERCE 1-28-2007.

THE MARK CONSISTS OF THE WORDING "AQUAS" POSITIONED ABOVE THE WORDS "CLEAN MARINA SERIES".

SEC. 2(F) AS TO "CLEAN MARINA SERIES".

SER. NO. 85-198,014, FILED 12-15-2010.

ALICE BENMAMAN, EXAMINING ATTORNEY

United States of America

United States Patent and Trademark Office

SPARKHOUND

Reg. No. 4,152,590

Registered June 5, 2012

Int. Cl.: 42

SERVICE MARK

PRINCIPAL REGISTER

SPARKHOUND, INC. (LOUISIANA CORPORATION)
11207 PROVERBS AVENUE
BATON ROUGE, LA 70816

FOR: COMPUTER SERVICES, NAMELY, INFORMATION TECHNOLOGY CONSULTING FOR BUSINESSES PROVIDING WEB AND SOFTWARE DEVELOPMENT AND DATA AND VOICE NETWORK INFRASTRUCTURE INSTALLATION AND MAINTENANCE; COMPUTER TECHNOLOGY SUPPORT SERVICES, NAMELY, HELP DESK SERVICES, IN CLASS 42 (U.S. CLS. 100 AND 101).

FIRST USE 1-1-1998; IN COMMERCE 1-1-1998.

THE MARK CONSISTS OF STANDARD CHARACTERS WITHOUT CLAIM TO ANY PARTICULAR FONT, STYLE, SIZE, OR COLOR.

SER. NO. 85-199,770, FILED 12-16-2010.

NAAKWAMA ANKRAH, EXAMINING ATTORNEY



David J. Kyffers

Director of the United States Patent and Trademark Office

United States of America

United States Patent and Trademark Office

FEROCIOUS TALENT, BRED FOR SERVICE.

Reg. No. 4,152,591

Registered June 5, 2012

Int. Cl.: 42

SERVICE MARK

PRINCIPAL REGISTER

SPARKHOUND, INC. (LOUISIANA CORPORATION)
11207 PROVERBS AVENUE
BATON ROUGE, LA 70816

FOR: COMPUTER SERVICES, NAMELY, INFORMATION TECHNOLOGY CONSULTING FOR BUSINESSES PROVIDING WEB AND SOFTWARE DEVELOPMENT AND DATA AND VOICE NETWORK INFRASTRUCTURE INSTALLATION AND MAINTENANCE; COMPUTER TECHNOLOGY SUPPORT SERVICES, NAMELY, HELP DESK SERVICES, IN CLASS 42 (U.S. CLS. 100 AND 101).

FIRST USE 10-1-2010; IN COMMERCE 10-1-2010.

THE MARK CONSISTS OF STANDARD CHARACTERS WITHOUT CLAIM TO ANY PARTICULAR FONT, STYLE, SIZE, OR COLOR.

NO CLAIM IS MADE TO THE EXCLUSIVE RIGHT TO USE "SERVICE", APART FROM THE MARK AS SHOWN.

SER. NO. 85-199,794, FILED 12-16-2010.

NAAKWAMA ANKRAH, EXAMINING ATTORNEY



David J. Kyffers

Director of the United States Patent and Trademark Office

United States of America

United States Patent and Trademark Office



Reg. No. 4,152,592

Registered June 5, 2012

Int. Cl.: 35

BATRUS HOLLWEG INTERNATIONAL SELECTION SERVICES, LTD. (TEXAS LIMITED PARTNERSHIP)
SUITE 2900
1820 PRESTON PARK BLVD.
PLANO, TX 75093

SERVICE MARK

PRINCIPAL REGISTER

FOR: PROMOTING PUBLIC INTEREST IN LEADERSHIP FOR MANAGERS THAT DEVELOP AND EXECUTE TALENT MANAGEMENT STRATEGIES IN CORPORATIONS AND PROFESSIONAL SERVICE FIRMS; BUSINESS SERVICES, NAMELY, FORMULATION OF BEST PRACTICES FOR ORGANIZATIONAL TALENT MANAGEMENT STRATEGIES, IN CLASS 35 (U.S. CLS. 100, 101 AND 102).

FIRST USE 1-1-2010; IN COMMERCE 1-1-2010.

NO CLAIM IS MADE TO THE EXCLUSIVE RIGHT TO USE "RESEARCH INSTITUTE", APART FROM THE MARK AS SHOWN.

THE MARK CONSISTS OF THE LETTERS "RI" WITH A CURVED BAR THAT CONNECTS THE DOT OVER THE "I" TO THE BOTTOM OF "R", TO THE RIGHT OF THIS DESIGN ARE THE THREE TERMS "RESEARCH" APPEARING ABOVE "INSTITUTE" APPEARING ABOVE "BATRUSHOLLWEG" VERTICALLY IN A SMALLER FONT THAN "RI" SO THEY ARE THE SAME HEIGHT.

SER. NO. 85-200,156, FILED 12-16-2010.

ANTHONY RINKER, EXAMINING ATTORNEY



David J. Kybas

Director of the United States Patent and Trademark Office

United States of America

United States Patent and Trademark Office

Social Decision Support

Reg. No. 4,152,593

Registered June 5, 2012

Int. Cls.: 35 and 42

SERVICE MARK

PRINCIPAL REGISTER

ANALYX SP. Z O.O. SP.K. (POLAND CORPORATION)
CWX PRODUCT TLM
UL. FREDRY 1/21
POZNAN, POLAND 61-701

FOR: UPDATING OF DATA IN COMPUTER DATABASES, NAMELY, DATABASE MANAGEMENT SERVICES; SPECIFICATION OF COSTS IN THE NATURE OF COST-BENEFIT PRICE ANALYSIS FOR MANAGEMENT DECISION SUPPORT; PROVISION OF COMMERCIAL AND BUSINESS INFORMATION VIA A COMPUTER NETWORK; BUSINESS ORGANIZATION AND MANAGEMENT ADVISORY SERVICES; BUSINESS MANAGEMENT ADVISORY SERVICES; ECONOMIC ADVISORY IN THE NATURE OF ECONOMIC FORECASTING AND ANALYSIS; BUSINESS CONSULTING SERVICES IN THE FIELD OF BUSINESS FORECASTING METHODS, SUPPLY CHAIN SERVICES DESIGN AND EVALUATION; CONDUCTING AUCTIONS AND BIDDINGS IN THE NATURE OF PRIVATE ON-LINE AUCTION BIDDING FOR OTHERS; CONDUCTING AUCTIONS AND BIDDINGS IN THE NATURE OF PRIVATE ON-LINE AUCTION BIDDING FOR OTHERS ON THE INTERNET; PREPARING STATISTICS IN THE NATURE OF COMPILATION OF STATISTICS ON COMMERCIAL SALES FORECASTS, SUPPLY CHAIN PLANS, MARKET RESEARCH DATA, THE BUDGETARY AND TIME STATUS OF PROJECTS, AND OTHER BUSINESS MANAGEMENT-RELATED DATA; PREPARING ECONOMIC FORECASTS AND PROVIDING INFORMATION ON COMPANY-RELATED ISSUES IN THE NATURE OF PROVIDING BUSINESS INFORMATION; PROVIDING BUSINESS INFORMATION RELATING TO COMPANIES; COMMERCIAL ADMINISTRATION OF THE LICENSING OF THE GOODS AND SERVICES OF THIRD PARTIES; CUSTOMER CANVASSING IN THE NATURE OF MARKET OPINION POLLING STUDIES AND ADVERTISING BY MEANS OF MAILING; MARKETING SALES TESTING IN THE NATURE OF MARKET RESEARCH STUDIES, NEW SERVICE IDEAS EVALUATION IN THE NATURE OF BUSINESS EVALUATIONS, MARKET RESEARCH, PUBLIC OPINION POLLING; BUSINESS ORGANIZATIONAL ADVISORY IN COMPANY ISSUES; COMPANY ASSISTANCE IN THE NATURE OF OUTSOURCING SERVICES ADVERTISING PROJECT PLANNING IN THE NATURE OF FORECASTING IMPACT OF ADVERTISING CAMPAIGNS AND OTHER PUBLIC AND PRIVATE ADVERTISING ACTIVITIES; ASSISTANCE WITH BUSINESS MANAGEMENT AND PLANNING; SYSTEMATIZATION OF DATA IN COMPUTER DATABASES; BUSINESS ADVISORY SERVICES; ADVERTISING SERVICES, NAMELY, ADVERTISING BY AND THROUGH ADVERTISING LETTERS IN THE NATURE OF DISTRIBUTION OF ADVERTISING MAIL, ADVERTISING ON THE INTERNET FOR THIRD PARTIES, IN CLASS 35 (U.S. CLS. 100, 101 AND 102).



David J. Kyjars

Director of the United States Patent and Trademark Office

Reg. No. 4,152,593 FIRST USE 1-6-2010; IN COMMERCE 1-6-2010.

FOR: COMPUTER SOFTWARE UPDATING; COMPUTER PROGRAMS UPDATING; WEBSITES UPDATING FOR OTHERS; ADMINISTRATION OF USERS AND USER'S RIGHTS IN COMPUTER NETWORKS IN THE NATURE OF PROVIDING TEMPORARY USE OF NON-DOWNLOADABLE INTRANET PORTAL SOFTWARE FOR CREATING REPORTS AND DATABASES CONTAINING EMPLOYEE GENERATED INFORMATION FOR USE IN BUSINESS MANAGEMENT, BUSINESS FORECASTING, SUPPLY CHAIN MANAGEMENT, KNOWLEDGE MANAGEMENT, PROJECT MANAGEMENT, AND NEW PRODUCT AND SERVICES DESIGN AND EVALUATION; ADVISORY IN CREATING HOME PAGES AND WEBSITES; ADVISORY IN TELECOMMUNICATIONS TECHNOLOGY ISSUES; COMPUTER HARDWARE AND SOFTWARE CONSULTANCY SERVICES; COMPUTER SOFTWARE CONSULTING; ANALYSIS OF COMPUTER SYSTEMS; DESIGN AND CREATION OF HOME PAGES AND WEBSITES; DESIGN OF COMPUTER SYSTEMS; COMPUTER PROGRAMMING SERVICES IN THE IT AREA; IT CONSULTING SERVICES; CREATION OF COMPUTER PROGRAMS FOR DATA PROCESSING; ; CREATION AND MAINTENANCE OF WEBSITES FOR THIRD PARTIES; INSTALLATION AND MAINTENANCE OF COMPUTER SOFTWARE; INSTALLATION OF COMPUTER PROGRAMS; SERVER ADMINISTRATION IN THE NATURE OF TECHNICAL ADMINISTRATION OF SERVICES FOR OTHERS; ENGINEERING SERVICES IN THE NATURE OF TECHNICAL PROJECT PLANNING FOR THE PROCESSING OF WEB PRODUCTS; TECHNICAL PROJECT MANAGEMENT IN THE IT AREA IN THE NATURE OF COMPUTER PROJECT MANAGEMENT SERVICES; HOSTING AND MAINTENANCE OF WEBSITES FOR THIRD PARTIES; RENTAL OF COMPUTER SOFTWARE; RENTAL OF WEB SERVERS; MAINTENANCE OF COMPUTER SOFTWARE; HOSTING OF WEBSITES ON THE INTERNET; ADVISORY SERVICES FOR CORPORATIONS IN THE FIELD OF PRODUCT DEVELOPMENT AND QUALITY IMPROVEMENT OF SOFTWARE. SUPERVISION OF DATA IN COMPUTER DATABASES, NAMELY, SOFTWARE AS A SERVICE (SAAS) IN THE NATURE OF HOSTING DATABASE SOFTWARE FOR USE BY OTHERS IN AUTOMATED AND MANUAL DATA REVIEW AND CORRECTION OF DATA FOR CONSISTENCY AND ERRORS; NEW PRODUCT EVALUATION IN THE NATURE OF PRODUCT TESTING AND PRODUCT CONCEPT TESTS IN THE NATURE OF TESTING FOR NEW PRODUCT DEVELOPMENT; SPECIFICATION OF DATA IN COMPUTER DATABASES IN THE NATURE OF DATABASE DESIGN, DATABASE IMPLEMENTATION IN THE NATURE OF INSTALLATION OF COMPUTER DATABASE SOFTWARE, AND DATABASE OPTIMIZATION IN THE NATURE OF SOFTWARE CUSTOMIZATION SERVICES FOR DATABASE MANAGEMENT SOFTWARE, IN CLASS 42 (U.S. CLS. 100 AND 101).

FIRST USE 1-6-2010; IN COMMERCE 1-6-2010.

THE MARK CONSISTS OF STANDARD CHARACTERS WITHOUT CLAIM TO ANY PARTICULAR FONT, STYLE, SIZE, OR COLOR.

NO CLAIM IS MADE TO THE EXCLUSIVE RIGHT TO USE "DECISION SUPPORT", APART FROM THE MARK AS SHOWN.

SER. NO. 85-201,278, FILED S.R. 12-18-2010 AM. P.R. 12-5-2011.

TIMOTHY FINNEGAN, EXAMINING ATTORNEY

United States of America

United States Patent and Trademark Office

WORK IN PROGRESS

Reg. No. 4,152,594

CARHARTT, INC. (MICHIGAN CORPORATION)
5750 MERCURY DRIVE
DEARBORN, MI 48121

Registered June 5, 2012

Int. Cls.: 18 and 25

FOR: WALLETS; DUFFLE BAGS; KIT BAGS; TOTE BAGS, IN CLASS 18 (U.S. CLS. 1, 2, 3, 22 AND 41).

TRADEMARK

FIRST USE 10-1-2009; IN COMMERCE 10-1-2009.

PRINCIPAL REGISTER

FOR: CLOTHING, NAMELY, PANTS, JEANS, BOTTOMS, JACKETS, SHIRTS, TOPS, SWEATSHIRTS, T-SHIRTS, KNIT TOPS, LONG-SLEEVE POLO SHIRTS; HATS; BEANIES; BELTS, IN CLASS 25 (U.S. CLS. 22 AND 39).

FIRST USE 10-1-2009; IN COMMERCE 10-1-2009.

THE MARK CONSISTS OF STANDARD CHARACTERS WITHOUT CLAIM TO ANY PARTICULAR FONT, STYLE, SIZE, OR COLOR.

SER. NO. 85-201,534, FILED 12-20-2010.

COLLEEN DOMBROW, EXAMINING ATTORNEY



David J. Kybas

Director of the United States Patent and Trademark Office

United States of America

United States Patent and Trademark Office



www.LEDnyc.com

Reg. No. 4,152,595

Registered June 5, 2012

Int. Cl.: 42

SERVICE MARK

PRINCIPAL REGISTER

GREEN LIGHT INITIATIVE CORP. (NEW YORK CORPORATION)
13-15 37TH AVENUE
LONG ISLAND CITY, NY 11101

FOR: LIGHTING DESIGN, DEVELOPMENT AND TECHNOLOGY SPECIFICATION SERVICES PERTAINING TO REPLACING MAJOR LIGHTING APPLICATIONS WITH ENVIRONMENTALLY-FRIENDLY LED LIGHTING , IN CLASS 42 (U.S. CLS. 100 AND 101).

FIRST USE 1-1-2007; IN COMMERCE 1-1-2007.

THE MARK CONSISTS OF A STYLIZED CAPITAL "G" IN LIGHT AND DARK GREEN AND IN LIGHT AND DARK GRAY. THE WORDS "GREENLIGHT INITIATIVE" WITH THE WORDING "GREEN" IN THE COLOR GREEN AND THE WORDING "LIGHT INITIATIVE" IN GRAY APPEARS ABOVE THE WEBSITE ADDRESS "WWW.LEDNYC.COM" WRITTEN IN LIGHT GREEN.

THE COLOR(S) GREEN AND GRAY IS/ARE CLAIMED AS A FEATURE OF THE MARK.

SER. NO. 85-206,467, FILED 12-28-2010.

ALAIN LAPTEK, EXAMINING ATTORNEY



David J. Kyffers

Director of the United States Patent and Trademark Office

United States of America

United States Patent and Trademark Office



Reg. No. 4,152,596

VENDMORE SYSTEMS, LLC (DELAWARE LIMITED LIABILITY COMPANY)
5 HIGH RIDGE PARK
STAMFORD, CT 06905

Registered June 5, 2012

Int. Cls.: 9, 35 and 38

FOR: COMPUTER SOFTWARE FOR CONTROLLING AND MANAGING ACCESS TO VENDING MACHINES, IN CLASS 9 (U.S. CLS. 21, 23, 26, 36 AND 38).

TRADEMARK

FIRST USE 4-26-2005; IN COMMERCE 4-26-2005.

SERVICE MARK

FOR: PROVIDING AN ON-LINE PORTAL THAT PROVIDES CUSTOMERS ACCESS TO THEIR VENDING ACCOUNT INFORMATION, IN CLASS 35 (U.S. CLS. 100, 101 AND 102).

PRINCIPAL REGISTER

FIRST USE 4-26-2005; IN COMMERCE 4-26-2005.

FOR: PROVIDING USER ACCESS TO A GLOBAL COMPUTER NETWORK TO ACCESS VENDING MACHINE ACCOUNTS, IN CLASS 38 (U.S. CLS. 100, 101 AND 104).

FIRST USE 4-26-2005; IN COMMERCE 4-26-2005.

THE MARK CONSISTS OF A CIRCLE OUTLINED IN GREEN WITH THE WORD "THUMB-PASS" OUTLINED IN GREEN, THE CIRCLE INCLUDING A DESIGN, SURROUNDED BY GREEN, OF A BROWN HUMAN THUMB PRESSING A BLUE BUTTON. "THUMB" CONSISTING OF WHITE-FILLED LETTERS, "PASS" CONSISTING OF GREEN-FILLED CHARACTERS AND A GREEN ARROW WITHIN THE LETTER "P".

THE COLOR(S) WHITE, GREEN, BROWN AND BLUE IS/ARE CLAIMED AS A FEATURE OF THE MARK.

SER. NO. 85-208,415, FILED 12-31-2010.

ARETHA SOMERVILLE, EXAMINING ATTORNEY



David J. Kybas

Director of the United States Patent and Trademark Office

United States of America

United States Patent and Trademark Office

TRADEFLOW OPTIMIZATION

Reg. No. 4,152,597

Registered June 5, 2012

Int. Cls.: 35 and 42

SERVICE MARK

PRINCIPAL REGISTER

SOFTWARE PARADIGMS INTERNATIONAL GROUP LLC (GEORGIA LIMITED LIABILITY COMPANY)
FIVE CONCOURSE PARKWAY STE 900
ATLANTA, GA 303287101

FOR: BUSINESS CONSULTING SERVICES IN THE FIELD OF WORKFLOW OF RETAILERS AND VENDORS ASSOCIATED WITH THE PURCHASE OF GOODS AND SERVICES, EXCLUDING THE FINANCIAL SERVICES INDUSTRY, IN CLASS 35 (U.S. CLS. 100, 101 AND 102).

FIRST USE 12-10-2010; IN COMMERCE 12-10-2010.

FOR: APPLICATION SERVICE PROVIDER (ASP) FEATURING SOFTWARE FOR USE IN THE FIELD OF WORKFLOW ASSOCIATED WITH THE PURCHASE OF GOODS AND SERVICES, EXCLUDING THE FINANCIAL SERVICES INDUSTRY, IN CLASS 42 (U.S. CLS. 100 AND 101).

FIRST USE 12-10-2010; IN COMMERCE 12-10-2010.

THE MARK CONSISTS OF STANDARD CHARACTERS WITHOUT CLAIM TO ANY PARTICULAR FONT, STYLE, SIZE, OR COLOR.

NO CLAIM IS MADE TO THE EXCLUSIVE RIGHT TO USE "OPTIMIZATION", APART FROM THE MARK AS SHOWN.

SER. NO. 85-208,466, FILED 12-31-2010.

FLORENTINA BLANDU, EXAMINING ATTORNEY



David J. Kybas

Director of the United States Patent and Trademark Office

United States of America

United States Patent and Trademark Office

Flaunt

Reg. No. 4,152,598

Registered June 5, 2012

Int. Cl.: 25

TRADEMARK

PRINCIPAL REGISTER

THE GIFT SHOPPE, INC. (OKLAHOMA CORPORATION), DBA FLAUNT
P.O. BOX 722410
NORMAN, OK 73070

FOR: ADHESIVE BRAS; ANKLE BOOTS; ANKLE SOCKS; APRONS; ATHLETIC FOOTWEAR; ATHLETIC SHOES; ATHLETIC TIGHTS; BABY BIBS NOT OF PAPER; BABY BODYSUITS; BABY BOTTOMS; BABY TOPS; BALL GOWNS; BALLET SLIPPERS; BANDANAS; BATH SLIPPERS; BATHING SUITS; BATHING SUITS FOR MEN; BATHING TRUNKS; BATH-ROBES; BEACH COVER-UPS; BEACH COVERUPS; BEACH FOOTWEAR; BEACH SHOES; BEANIES; BELTS; BELTS FOR CLOTHING; BELTS MADE FROM IMITATION LEATHER; BELTS MADE OF LEATHER; BELTS MADE OUT OF CLOTH; BELTS OF TEXTILE; BIKINIS; BLAZERS; BLOUSES; BOAS; BOOTIES; BOOTS; BOTTOMS; BOXER BRIEFS; BOXER SHORTS; BRACES; BRAS; BRIDESMAID DRESSES; BRIEFS; BRIEFS; BUSTIERS; BUTTON DOWN SHIRTS; CANVAS SHOES; CAPRI PANTS; CAPRIS; CAPS; CAPS WITH VISORS; CARDIGANS; CARGO PANTS; CHILDREN'S AND INFANT'S APPAREL, NAMELY, JUMPERS, OVERALL SLEEPWEAR, PAJAMAS, ROMPERS AND ONE-PIECE GARMENTS; CHILDREN'S AND INFANTS' APPAREL TREATED WITH FIRE AND HEAT RETARDANTS, NAMELY, JUMPERS, OVERALL SLEEPWEAR, PAJAMAS, ROMPERS AND ONE-PIECE GARMENTS; CHILDREN'S AND INFANTS' CLOTH BIBS; CHILDREN'S CLOTH EATING BIBS; CHILDREN'S HEADWEAR; CLOTHING SHIELDS, NAMELY, PADS APPLIED TO THE UNDERARMS OF SHIRTS, BLOUSES AND SWEATERS; CLOTHING, NAMELY, ARM WARMERS; CLOTHING, NAMELY, ATHLETIC SLEEVES; CLOTHING, NAMELY, KHAKIS; COATS; COATS FOR MEN AND WOMEN; COATS MADE OF COTTON; COATS OF DENIM; COLLARED SHIRTS; COLLARS; CORSETS; COSTUMES FOR USE IN CHILDREN'S DRESS UP PLAY; COSTUMES FOR USE IN ROLE-PLAYING GAMES; COVERUPS; DENIM JACKETS; DISPOSABLE SLIPPERS; DISPOSABLE UNDERWEAR; DRESS PANTS; DRESS SHIRTS; DRESSES; DRESSES THAT MAY ALSO BE USED AS TOWELS; DRESSING GOWNS; DRESSING GOWNS AND BATH ROBES; EAR MUFFS; EAR WARMERS; EARBANDS; EVENING DRESSES; EVENING GOWNS; FABRIC BELTS; FITTED SWIMMING COSTUMES WITH BRA CUPS; FLEECE BOTTOMS; FLEECE PULLOVERS; FLEECE SHORTS; FLEECE TOPS; FLEECE VESTS; FLIP FLOPS; FOAM PEDICURE SLIPPERS; FOOTWEAR; FOOTWEAR FOR MEN; FOOTWEAR FOR MEN AND WOMEN; FOOTWEAR FOR WOMEN; FOOTWEAR, NAMELY, PUMPS; FROCKS; FUR COATS; FUR COATS AND JACKETS; FUR HATS; FUR JACKETS; G-STRINGS; GARTER BELTS; GLOVES; GLOVES AS CLOTHING; GLOVES FOR APPAREL; GOWNS; GYM PANTS; GYM SHORTS; HEAD SCARVES; HEAD SWEATBANDS; HEAD WEAR; HEADBANDS; HEADBANDS AGAINST SWEATING; HEADBANDS FOR CLOTHING; HEADWEAR; HEAVY COATS; HEAVY JACKETS; HEELS; HOODED



David J. Kyros

Director of the United States Patent and Trademark Office

Reg. No. 4,152,598 PULLOVERS; HOODED SWEAT SHIRTS; HOODED SWEATSHIRTS; INFANT WEARABLE BLANKETS; INFANTS' SHOES AND BOOTS; JACKETS AND SOCKS; JEANS; JERSEYS; JOGGING OUTFITS; JOGGING PANTS; JOGGING SUITS; KNEE HIGHS; KNEE-HIGH STOCKINGS; KNITTED CAPS; KNITTED GLOVES; LADIES' BOOTS; LADIES' SUITS; LADIES' UNDERWEAR; LEATHER BELTS; LEATHER COATS; LEATHER HATS; LEATHER HEADWEAR; LEATHER JACKETS; LEATHER PANTS; LEATHER SHIRTS; LEATHER SHOES; LEATHER SKIRTS; LEATHER SLIPPERS; LEATHER VESTS; LEG WARMERS; LEG-WARMERS; LEGGINGS; LEGGINS; LEISURE SHOES; LEISURE SUITS; LINGERIE; LINGERIE ACCESSORIES, NAMELY, REMOVABLE SILICONE BREAST ENHANCER PADS USED IN A BRA; LOAFERS; LONG JACKETS; LONG SLEEVE PULLOVERS; LONG SLEEVED VESTS; MEN'S DRESS SOCKS; MEN'S SOCKS; MEN'S SUITS; MEN'S SUITS, WOMEN'S SUITS; MEN'S UNDERWEAR; MINISKIRTS; MITTENS; MUSCLE TOPS; NECKTIES; NIGHT GOWNS; NIGHT SHIRTS; NIGHTCAPS; NIGHTDRESSES; NIGHT-GOWNS; NIGHTIES; NIGHTSHIRTS; NIGHTWEAR; NIPPLE COVERS, NAMELY, PASTIES; OUTDOOR GLOVES; OUTDOOR MITTENS; OUTER JACKETS; OVER COATS; OVER SHIRTS; PAJAMA BOTTOMS; PAJAMAS; PANTIES; PANTIES, SHORTS AND BRIEFS; PANTS; PANTSUITS; PANTYHOSE; PEACOATS; PEDICURE SANDALS; PEDICURE SLIPPERS; PETTICOATS; POLO SHIRTS; PULLOVERS; PUMPS; RAIN BOOTS; RAIN COATS; RAIN HATS; RAIN JACKETS; RAIN SLICKERS; RAIN WEAR; RAINCOATS; RAINPROOF JACKETS; RAINWEAR; REVERSIBLE JACKETS; RIDING BOOTS; RIDING COATS; RIDING GLOVES; RIDING SHOES; ROBES; ROMPERS; RUNNING SHOES; RUNNING SUITS; SCARFS; SCARVES; SHAMPOO CAPES; SHAWLS; SHAWLS AND HEADSCARVES; SHIRT FRONTS; SHIRTS; SHIRTS AND SHORT-SLEEVED SHIRTS; SHIRTS FOR INFANTS, BABIES, TODDLERS AND CHILDREN; SHOE STRAPS; SHOES; SHORT SETS; SHORT-SLEEVED OR LONG-SLEEVED T-SHIRTS; SHORT-SLEEVED SHIRTS; SHORTS; SHOULDER SCARVES; SHOULDER WRAPS; SHOULDER WRAPS FOR CLOTHING; SHOWER CAPS; SILK SCARVES; SKIRTS; SKIRTS AND DRESSES; SLEEP MASKS; SLEEP PANTS; SLEEP SHIRTS; SLEEPING GARMENTS; SLEEPWEAR; SLEEVED OR SLEEVELESS JACKETS; SLEEVELESS JERSEYS; SLIPOVERS; SMOCKS; SNEAKERS; SOCKS; SOCKS AND STOCKINGS; SPORT COATS; SPORTS BRA; SPORTS BRAS; SPORTS CAPS AND HATS; SPORTS JACKETS; SPORTS JERSEYS; SPORTS PANTS; SPORTS SHIRTS; SPORTS SHIRTS WITH SHORT SLEEVES; STILETTO HEELS; STRAPLESS BRAS; STRAPS FOR BRAS; STRETCH PANTS; SUNDRESSES; SWEAT BANDS; SWEAT JACKETS; SWEAT PANTS; SWEAT SHIRTS; SWEAT SHORTS; SWEAT SUITS; SWEATBANDS; SWEATERS; SWEATPANTS; SWEATSHIRTS; SWEATSOCKS; SWEATSUITS; SWIM CAPS; SWIM SUITS; SWIM TRUNKS; SWIM WEAR; SWIM WEAR FOR GENTLEMEN AND LADIES; SWIMMING CAPS; SWIMMING CAPS; SWIMMING COSTUMES; SWIMMING TRUNKS; SWIMSUITS; SWIMWEAR; T-SHIRTS; TANK TOPS; TANK-TOPS; TEE SHIRTS; TENNIS DRESSES; TENNIS SHOES; TENNIS WEAR; THONGS; THONGS; TIES; TIGHTS; TOP COATS; TRACK JACKETS; TRACK PANTS; TRACK SUITS; TRACKSUITS; TRAINING SHOES; TRAINING SUITS; TRENCH COATS; TUBE TOPS; TURTLE NECK SHIRTS; TURTLENECK PULLOVERS; TURTLENECK SWEATERS; TUXEDOS; UNDERPANTS; UNDERSHIRTS; UNDERWEAR; UNDERWEAR, NAMELY, BOY SHORTS; V-NECK SWEATERS; WEDDING DRESSES; WEDDING GOWNS; WIND PANTS; WIND-JACKETS; WINTER BOOTS; WOMEN'S ATHLETIC TOPS WITH BUILT-IN BRAS; WOMEN'S FOLDABLE SLIPPERS; WOMEN'S HATS AND HOODS; WOMEN'S SHOES; WOMEN'S SHOES, NAMELY, FOLDABLE FLATS; WOMEN'S TOPS, NAMELY, CAMIS; WOMEN'S UNDERWEAR; WORK SHOES AND BOOTS; YOGA PANTS; YOGA SHIRTS, IN CLASS 25 (U.S. CLS. 22 AND 39).

FIRST USE 12-1-2010; IN COMMERCE 12-1-2010.

THE MARK CONSISTS OF STANDARD CHARACTERS WITHOUT CLAIM TO ANY PARTICULAR FONT, STYLE, SIZE, OR COLOR.

OWNER OF U.S. REG. NO. 3,676,380.

SER. NO. 85-210,155, FILED 1-4-2011.

Reg. No. 4,152,598 JOHN DWYER, EXAMINING ATTORNEY

United States of America

United States Patent and Trademark Office



Reg. No. 4,152,599

Registered June 5, 2012

Int. Cl.: 36

SERVICE MARK

PRINCIPAL REGISTER

HILL, ANDREW W (UNITED STATES INDIVIDUAL)
SUITE 318
17319 SAN PEDRO
SAN ANTONIO, TX 78232 AND

NELSON, CHADE V (UNITED STATES INDIVIDUAL)
STE. 318
17319 SAN PEDRO
SAN ANTONIO, TX 78232

FOR: REAL ESTATE SERVICES, NAMELY, CONDOMINIUM MANAGEMENT SERVICES; REAL ESTATE SERVICES, NAMELY, PROPERTY MANAGEMENT SERVICES FOR CONDOMINIUM ASSOCIATIONS, HOMEOWNER ASSOCIATIONS AND APARTMENT BUILDINGS, IN CLASS 36 (U.S. CLS. 100, 101 AND 102).

FIRST USE 1-1-2010; IN COMMERCE 1-1-2011.

NO CLAIM IS MADE TO THE EXCLUSIVE RIGHT TO USE "ASSOCIATION MANAGEMENT, LP", APART FROM THE MARK AS SHOWN.

THE COLOR(S) GREEN, LIGHT GREEN, DARK BROWN, BROWN, BLUE, AND BLACK IS/ARE CLAIMED AS A FEATURE OF THE MARK.

THE MARK CONSISTS OF A GROWING PLANT WITH 5 GREEN LEAVES WITH AREAS OF LIGHT GREEN ON THE LEAVES AND A BROWN STEM ATOP A SEMI CIRCLE OF DARK BROWN GRANULATED DIRT. THE DIRT FORMS A CIRCLE INTERRUPTED BY THE WORDS "MAKING A" IN BROWN, "DIFFERENCE" IN BLUE, AND "SPECTRUM ASSOCIATION MANAGEMENT, LP" IN BLACK. UNDERNEATH THE WORDS THE BROWN DIRT CIRCLE CONTINUES.

SER. NO. 85-210,420, FILED 1-4-2011.

BRENDAN MCCAULEY, EXAMINING ATTORNEY



David J. Kybas

Director of the United States Patent and Trademark Office

United States of America

United States Patent and Trademark Office



Reg. No. 4,152,600

Registered June 5, 2012

Int. Cl.: 28

TRADEMARK

PRINCIPAL REGISTER

PINHIPARTNERS, LLC (MISSOURI LIMITED LIABILITY COMPANY)
5319 SOUTHVIEW HILLS CT.
SAINT LOUIS, MO 63129

FOR: GOLF GAME CONSISTING OF PLASTIC HOOPS OF VARYING SIZES AND COLOR WHICH ARE DISTRIBUTED IN A GRASSY AREA AND PLAYERS COMPETE AND BY TAKING TURNS USING GOLF CLUBS TO HIT EITHER PLASTIC BALLS, FOAM BALLS OR REAL GOLF BALLS INSIDE THE DIFFERENT HOOPS EARNING POINTS BASED ON THE VALUES ASSIGNED TO THE HOOPS WHICH VARIES BY DIFFICULTY, IN CLASS 28 (U.S. CLS. 22, 23, 38 AND 50).

FIRST USE 5-1-2011; IN COMMERCE 5-1-2011.

THE MARK CONSISTS OF AN OVAL GOLF GREEN CONTAINING SMALLER OVAL, 3 GOLF BALLS, A FLAG PIN WITH A FLAG AND THE NAME "CHIPN" WITH A GOLF BALL IN THE CENTER OF THE "P".

SER. NO. 85-210,472, FILED 1-4-2011.

TIMOTHY FINNEGAN, EXAMINING ATTORNEY



David J. Kyffers

Director of the United States Patent and Trademark Office

United States of America

United States Patent and Trademark Office



L'ETOILE ROYALE

Reg. No. 4,152,601

Registered June 5, 2012

Int. Cl.: 35

SERVICE MARK

PRINCIPAL REGISTER

L'ETOILE ROYALE (NEW YORK CORPORATION)
784 MADISON AVENUE
NEW YORK CITY, NY 10065

FOR: RETAIL STORE SERVICES FEATURING JEWELRY, IN CLASS 35 (U.S. CLS. 100, 101 AND 102).

FIRST USE 11-0-1987; IN COMMERCE 11-0-1987.

NO CLAIM IS MADE TO THE EXCLUSIVE RIGHT TO USE "1865", APART FROM THE MARK AS SHOWN.

THE MARK CONSISTS OF A SHIELD EMBLEM WITH THE TERMS "G.D." IN THE CENTER, SURROUNDED BY TWO STYLIZED LIONS. A TOP THE SHIELD IS A 3 POINT CROWN, BELOW THE SHIELD ARE THE TERMS "1865". BELOW THE TERMS "1865" ARE THE TERMS "L'ETOILE ROYALE".

THE ENGLISH TRANSLATION OF "L'ETOILE ROYALE" IN THE MARK IS "STAR ROYAL".

SER. NO. 85-210,752, FILED 1-5-2011.

LEIGH LOWRY, EXAMINING ATTORNEY



David J. Kybas

Director of the United States Patent and Trademark Office

United States of America

United States Patent and Trademark Office

FT AVERAGE DAILY GLOBAL AUDIENCE

Reg. No. 4,152,602

Registered June 5, 2012

Int. Cls.: 35, 38 and 41

SERVICE MARK

PRINCIPAL REGISTER

FINANCIAL TIMES LIMITED, THE (UNITED KINGDOM COMPANY)
NUMBER ONE SOUTHWARK BRIDGE
LONDON, UNITED KINGDOM SE19HL

FOR: BUSINESS INFORMATION SERVICES; BUSINESS APPRAISAL SERVICES; BUSINESS RESEARCH; PROVISION OF ON-LINE BUSINESS AND COMMERCIAL INFORMATION; PREPARATION OF REPORTS CONTAINING INFORMATION AND/OR STATISTICS ABOUT BUSINESSES; PROVISION OF REPORTS CONTAINING INFORMATION AND/OR STATISTICS ABOUT BUSINESSES, INCLUDING THE PROVISION OF THE REPORTS VIA THE INTERNET, VIA WIRELESS COMMUNICATION NETWORKS AND/OR VIA OTHER ONLINE ELECTRONIC COMMUNICATION NETWORKS; PREPARATION AND PROVISION OF MARKET ANALYSIS REPORTS; ANALYSIS OF BUSINESS STATISTICS AND OF MARKET RESEARCH STATISTICS; COLLECTION, COMPILATION AND PREPARATION OF STATISTICS AND BUSINESS STATISTICS; COMMERCIAL INFORMATION AGENCY SERVICES; PUBLICATION OF PUBLICITY TEXTS; ADVERTISING; MARKET RESEARCH; MARKET RESEARCH FOR COMPILING INFORMATION AND STATISTICS ON READERS OF PUBLICATIONS; PREPARATION AND PROVISION OF REPORTS ON INFORMATION AND STATISTICS ON READERS OF PUBLICATIONS; DOCUMENT REPRODUCTION; INFORMATION, ADVISORY AND CONSULTANCY SERVICES RELATING TO ALL THE AFORESAID SERVICES, IN CLASS 35 (U.S. CLS. 100, 101 AND 102).



FOR: COMMUNICATION OF INFORMATION BY ELECTRONIC MEANS AND ELECTRONIC NEWS AGENCY SERVICES, ALL RELATING TO THE PROVISION OF INFORMATION RELATING TO BUSINESS, BUSINESS SERVICES, STATISTICS ABOUT BUSINESS, MARKET RESEARCH AND MARKET ANALYSIS; TRANSMISSION OF BUSINESS INFORMATION AND STATISTICS; COMMUNICATION OF BUSINESS INFORMATION, STATISTICS, RESEARCH, ANALYSIS, NEWS AND COMMENTARY VIA THE INTERNET, VIA WIRELESS COMMUNICATION NETWORKS AND/OR VIA OTHER ONLINE ELECTRONIC COMMUNICATION NETWORKS; COMMUNICATION OF BUSINESS INFORMATION, STATISTICS, RESEARCH, ANALYSIS, NEWS AND COMMENTARY VIA ONLINE FORUMS, BLOGS AND CHAT ROOMS; INFORMATION, ADVISORY AND CONSULTANCY SERVICES RELATING TO ALL THE AFORESAID SERVICES, IN CLASS 38 (U.S. CLS. 100, 101 AND 104).

David J. Kyjars

FOR: PUBLICATION SERVICES RELATING TO THE PUBLICATION OF REPORTS REGARDING BUSINESS AND FINANCIAL MATTERS, STATISTICS ABOUT BUSINESS, MARKET RESEARCH AND MARKET ANALYSIS; INFORMATION, ADVISORY AND CONSULTANCY

Reg. No. 4,152,602 SERVICES RELATING TO THE AFORESAID SERVICES , IN CLASS 41 (U.S. CLS. 100, 101 AND 107).

THE MARK CONSISTS OF STANDARD CHARACTERS WITHOUT CLAIM TO ANY PARTICULAR FONT, STYLE, SIZE, OR COLOR.

PRIORITY CLAIMED UNDER SEC. 44(D) ON ERPN CMNTY TM OFC APPLICATION NO. 9254061, FILED 7-16-2010, REG. NO. 009254061, DATED 12-27-2010, EXPIRES 7-16-2020.

NO CLAIM IS MADE TO THE EXCLUSIVE RIGHT TO USE "GLOBAL AUDIENCE", APART FROM THE MARK AS SHOWN.

SER. NO. 85-210,987, FILED 1-5-2011.

JACQUELINE A. LAVINE, EXAMINING ATTORNEY

United States of America

United States Patent and Trademark Office



Reg. No. 4,152,603

Registered June 5, 2012

Int. Cls.: 16 and 41

GOURMET PILGRIM PTY LTD (AUSTRALIA PROPRIETARY LIMITED COMPANY (P/L OR PTY. LTD.))
ONEFOCUS HOUSE
100 WHARF ROAD
MELROSE PARK NSW, AUSTRALIA 2115

TRADEMARK

FOR: PRINTED PUBLICATIONS, NAMELY, RECIPE BOOKS , IN CLASS 16 (U.S. CLS. 2, 5, 22, 23, 29, 37, 38 AND 50).

SERVICE MARK

FOR: PUBLISHING SERVICES, NAMELY, PUBLICATION OF RECIPE BOOKS, IN CLASS 41 (U.S. CLS. 100, 101 AND 107).

PRINCIPAL REGISTER

OWNER OF AUSTRALIA REG. NO. 1356430, DATED 11-22-2010, EXPIRES 4-15-2020.

NO CLAIM IS MADE TO THE EXCLUSIVE RIGHT TO USE "GOURMET", APART FROM THE MARK AS SHOWN.

THE MARK CONSISTS OF THE IMPRINT OF A BARE FOOTPRINT WITH A FORK AND SPOON COMING UP FROM THE HEEL. THE WORDS "GOURMET PILGRIM" APPEAR STACKED BENEATH THE FOOTPRINT.

SER. NO. 85-211,696, FILED 1-6-2011.

HELENE LIWINSKI, EXAMINING ATTORNEY



David J. Kybas

Director of the United States Patent and Trademark Office

United States of America

United States Patent and Trademark Office

SAN DIEGO ZOO SAFARI PARK

Reg. No. 4,152,604

ZOOLOGICAL SOCIETY OF SAN DIEGO (CALIFORNIA CORPORATION)
P.O. BOX 120551
SAN DIEGO, CA 921120051

Registered June 5, 2012

Int. Cl.: 41

FOR: EDUCATIONAL AND ENTERTAINMENT SERVICES, NAMELY, CONDUCTING CLASSES, SEMINARS AND LIVE SHOWS WHICH INVOLVE THE USE OF LIVE AND/OR PRERECORDED AUDIO OR VIDEO SCRIPTS AND MUSIC, THE EXHIBITION OF WILD ANIMALS, AND TALKS OR APPEARANCES BY ZOOKEEPERS, ZOO PERSONNEL, AND/OR LIVE COSTUMED CHARACTERS, IN CLASS 41 (U.S. CLS. 100, 101 AND 107).

SERVICE MARK

PRINCIPAL REGISTER

FIRST USE 10-1-2010, THE MARK WAS FIRST USED ANYWHERE IN A DIFFERENT FORM OTHER THAN THAT SOUGHT TO BE REGISTERED AT LEAST AS EARLY AS 00/00/1965.; IN COMMERCE 10-1-2010, THE MARK WAS FIRST USED IN COMMERCE IN A DIFFERENT FORM OTHER THAN THAT SOUGHT TO BE REGISTERED AT LEAST AS EARLY AS 00/00/1965. .

THE MARK CONSISTS OF STANDARD CHARACTERS WITHOUT CLAIM TO ANY PARTICULAR FONT, STYLE, SIZE, OR COLOR.

OWNER OF U.S. REG. NOS. 1,828,336, 2,113,280 AND OTHERS.

NO CLAIM IS MADE TO THE EXCLUSIVE RIGHT TO USE "SAFARI PARK", APART FROM THE MARK AS SHOWN.

SEC. 2(F) AS TO "SAN DIEGO ZOO".

SER. NO. 85-214,390, FILED 1-10-2011.

TAMARA FRAZIER, EXAMINING ATTORNEY



David J. Kybas

Director of the United States Patent and Trademark Office

United States of America

United States Patent and Trademark Office

NOTIFY TECHNOLOGY

Reg. No. 4,152,605

Registered June 5, 2012

Int. Cl.: 9

TRADEMARK

PRINCIPAL REGISTER

NOTIFY TECHNOLOGY CORPORATION (CALIFORNIA CORPORATION)
SUITE 202
1054 S. DEANZA BOULEVARD
SAN JOSE, CA 95129

FOR: SOFTWARE FOR SYNCHRONIZING EMAIL ACCOUNTS, CALENDAR, CONTACTS,
AND TASKS WITH MOBILE DEVICES, IN CLASS 9 (U.S. CLS. 21, 23, 26, 36 AND 38).

FIRST USE 10-30-1994; IN COMMERCE 10-30-1994.

THE MARK CONSISTS OF STANDARD CHARACTERS WITHOUT CLAIM TO ANY PAR-
TICULAR FONT, STYLE, SIZE, OR COLOR.

OWNER OF U.S. REG. NOS. 2,602,399 AND 3,780,200.

NO CLAIM IS MADE TO THE EXCLUSIVE RIGHT TO USE "TECHNOLOGY", APART FROM
THE MARK AS SHOWN.

SER. NO. 85-214,948, FILED 1-11-2011.

KHANH LE, EXAMINING ATTORNEY



David J. Kyffers

Director of the United States Patent and Trademark Office

United States of America

United States Patent and Trademark Office



Reg. No. 4,152,606

Registered June 5, 2012

Int. Cls.: 41 and 44

SERVICE MARK

PRINCIPAL REGISTER

MOXIE ATHLETICS (NEW YORK LIMITED LIABILITY COMPANY)
APT. 2F
3115 36TH STREET
ASTORIA, NY 11106

FOR: ON-LINE JOURNALS, NAMELY, BLOGS FEATURING HEALTH AND FITNESS RELATED TOPICS, NAMELY, PERSONAL TRAINING INFORMATION AND WORKOUT PROGRAMS; PROVIDING AN ON-LINE COMPUTER DATABASE FEATURING INFORMATION REGARDING EXERCISE AND FITNESS, IN CLASS 41 (U.S. CLS. 100, 101 AND 107).

FIRST USE 7-1-2009; IN COMMERCE 1-1-2010.

FOR: PROVIDING AN ON-LINE COMPUTER DATABASE FEATURING INFORMATION REGARDING HEALTH AND NUTRITION, IN CLASS 44 (U.S. CLS. 100 AND 101).

FIRST USE 7-1-2009; IN COMMERCE 1-1-2010.

NO CLAIM IS MADE TO THE EXCLUSIVE RIGHT TO USE "ATHLETICS", APART FROM THE MARK AS SHOWN.

THE MARK CONSISTS OF AN "M" SURROUNDED BY A CIRCLE. UNDER THAT IS THE WORD "MOXIE". AROUND THIS CIRCLE IS A HALF CIRCLE LINE. ON THE OUTSIDE OF ALL THIS IS THE WORD "ATHLETICS".

SER. NO. 85-216,101, FILED 1-12-2011.

BARBARA BROWN, EXAMINING ATTORNEY



David J. Kyros

Director of the United States Patent and Trademark Office

United States of America

United States Patent and Trademark Office

BONNIE BABY

Reg. No. 4,152,607

GERSON & GERSON, INC. (NEW YORK CORPORATION)
112 WEST 34TH STREET
NEW YORK, NY 10120

Registered June 5, 2012

Int. Cl.: 25

FOR: GIRLS' JACKETS, DRESSES, JUMPERS, LEGGINGS, SWEATERS, BLOUSES, SHIRTS
AND INFANT BODYSUITS, IN CLASS 25 (U.S. CLS. 22 AND 39).

TRADEMARK

FIRST USE 0-0-2000; IN COMMERCE 0-0-2000.

PRINCIPAL REGISTER

THE MARK CONSISTS OF STANDARD CHARACTERS WITHOUT CLAIM TO ANY PARTICULAR FONT, STYLE, SIZE, OR COLOR.

OWNER OF U.S. REG. NO. 831,505.

NO CLAIM IS MADE TO THE EXCLUSIVE RIGHT TO USE "BABY", APART FROM THE MARK AS SHOWN.

SER. NO. 85-217,285, FILED 1-13-2011.

BRIDGETT SMITH, EXAMINING ATTORNEY



David J. Kyffers

Director of the United States Patent and Trademark Office

United States of America

United States Patent and Trademark Office

PACIFIC STANDARD TIME

Reg. No. 4,152,608

Registered June 5, 2012

Int. Cl.: 35

SERVICE MARK

PRINCIPAL REGISTER

THE J. PAUL GETTY TRUST (CALIFORNIA TRUST)
1200 GETTY CENTER DRIVE
LOS ANGELES, CA 90049

FOR: ORGANIZATION OF EXHIBITIONS FOR CULTURAL OR EDUCATIONAL PURPOSES,
IN CLASS 35 (U.S. CLS. 100, 101 AND 102).

FIRST USE 10-1-2011; IN COMMERCE 10-1-2011.

THE MARK CONSISTS OF STANDARD CHARACTERS WITHOUT CLAIM TO ANY PAR-
TICULAR FONT, STYLE, SIZE, OR COLOR.

SER. NO. 85-218,568, FILED 1-14-2011.

MICHAEL KEATING, EXAMINING ATTORNEY



David J. Kybas

Director of the United States Patent and Trademark Office

United States of America

United States Patent and Trademark Office

TRAVEL NETWORK

Reg. No. 4,152,609

Registered June 5, 2012

Int. Cl.: 35

SERVICE MARK

PRINCIPAL REGISTER

REZCONNECT TECHNOLOGIES, INC (DELAWARE CORPORATION), DBA TRAVEL NETWORK
SUITE 3230
560 SYLVAN AVENUE
ENGLEWOOD CLIFFS, NJ 07632

FOR: ADVERTISING SERVICES, NAMELY, PROMOTING AND MARKETING THE GOODS AND SERVICES OF OTHERS IN THE FIELD OF UPSCALE CHOICES SUCH AS CULTURAL EVENTS, RESTAURANTS, SHOPPING, AND TRAVEL VIA PRINT AND ELECTRONIC MEDIA, IN CLASS 35 (U.S. CLS. 100, 101 AND 102).

FIRST USE 8-1-1979; IN COMMERCE 8-1-1979.

THE MARK CONSISTS OF STANDARD CHARACTERS WITHOUT CLAIM TO ANY PARTICULAR FONT, STYLE, SIZE, OR COLOR.

NO CLAIM IS MADE TO THE EXCLUSIVE RIGHT TO USE "TRAVEL", APART FROM THE MARK AS SHOWN.

SEC. 2(F).

SER. NO. 85-219,747, FILED 1-18-2011.

ELISSA GARBER KON, EXAMINING ATTORNEY



David J. Kybas

Director of the United States Patent and Trademark Office

United States of America

United States Patent and Trademark Office



Reg. No. 4,152,610

Registered June 5, 2012

Int. Cl.: 30

TRADEMARK

PRINCIPAL REGISTER

HERSHEY CHOCOLATE & CONFECTIONERY CORPORATION (DELAWARE CORPORATION)
SUITE 204
4860 ROBB STREET
WHEAT RIDGE, CO 80033

FOR: CANDY, IN CLASS 30 (U.S. CL. 46).

FIRST USE 8-1-2010; IN COMMERCE 8-1-2010.

OWNER OF U.S. REG. NOS. 680,105, 3,023,580 AND OTHERS.

THE COLOR(S) WHITE, BLUE, RED, YELLOW AND BROWN IS/ARE CLAIMED AS A FEATURE OF THE MARK.

NO CLAIM IS MADE TO THE EXCLUSIVE RIGHT TO USE "LOW FAT SNACK", "TWISTS", "MADE WITH REAL", "CHOCOLATE", "NATURALLY AND ARTIFICIALLY FLAVORED", OR THE REPRESENTATION OF THE CANDY, APART FROM THE MARK AS SHOWN.

THE MARK CONSISTS OF "TWIZZLERS" IN WHITE STYLIZED LETTERS OUTLINED IN BLUE AND RED AGAINST A RED BACKGROUND IN THE TOP PORTION, A STYLIZED DESIGN OF TWO PIECES OF BROWN CHOCOLATE FLAVORED CANDY, "LOW FAT" AND "TWISTS" IN YELLOW, "SNACK" AND "TOTALLY TWISTED" WITH AN ARROW IN WHITE, WITH A WAVY BROWN BAND ACROSS THE LOWER PORTION CONTAINING THE WORDING "MADE WITH REAL HERSHEY'S CHOCOLATE NATURALLY AND ARTIFICIALLY FLAVORED" IN WHITE. THE WHITE BAND SHOWN IN THE DRAWING REPRESENTS CLEAR, SEE-THROUGH PACKAGING. THE DOTTED LINES AROUND THE MARK ARE INTENDED TO SHOW PLACEMENT OF THE MARK ON THE PACKAGE.

SER. NO. 85-219,749, FILED 1-18-2011.

TINA L. SNAPP, EXAMINING ATTORNEY



David J. Kybas

Director of the United States Patent and Trademark Office

United States of America

United States Patent and Trademark Office

TOLLESON WEALTH MANAGEMENT

Reg. No. 4,152,611

TOLLESON WEALTH MANAGEMENT, INC. (TEXAS CORPORATION)
5500 PRESTON ROAD, SUITE 250
DALLAS, TX 75205

Registered June 5, 2012

Int. Cl.: 36

FOR: FINANCIAL SERVICES, NAMELY, WEALTH MANAGEMENT SERVICES, IN CLASS 36 (U.S. CLS. 100, 101 AND 102).

SERVICE MARK

FIRST USE 2-19-2003; IN COMMERCE 2-19-2003.

PRINCIPAL REGISTER

THE MARK CONSISTS OF STANDARD CHARACTERS WITHOUT CLAIM TO ANY PARTICULAR FONT, STYLE, SIZE, OR COLOR.

NO CLAIM IS MADE TO THE EXCLUSIVE RIGHT TO USE "WEALTH MANAGEMENT", APART FROM THE MARK AS SHOWN.

SEC. 2(F).

SER. NO. 85-221,339, FILED 1-19-2011.

APRIL HESIK, EXAMINING ATTORNEY



David J. Kybas

Director of the United States Patent and Trademark Office

United States of America

United States Patent and Trademark Office

TOLLESON PRIVATE BANK

Reg. No. 4,152,612

Registered June 5, 2012

Int. Cl.: 36

SERVICE MARK

PRINCIPAL REGISTER

TOLLESON WEALTH MANAGEMENT, INC. (TEXAS CORPORATION)
5500 PRESTON ROAD, SUITE 250
DALLAS, TX 75205

FOR: BANKING SERVICES, IN CLASS 36 (U.S. CLS. 100, 101 AND 102).

FIRST USE 3-3-2003; IN COMMERCE 3-3-2003.

THE MARK CONSISTS OF STANDARD CHARACTERS WITHOUT CLAIM TO ANY PARTICULAR FONT, STYLE, SIZE, OR COLOR.

NO CLAIM IS MADE TO THE EXCLUSIVE RIGHT TO USE "PRIVATE BANK", APART FROM THE MARK AS SHOWN.

SEC. 2(F).

SER. NO. 85-221,345, FILED 1-19-2011.

APRIL HESIK, EXAMINING ATTORNEY



David J. Kybas

Director of the United States Patent and Trademark Office

United States of America

United States Patent and Trademark Office

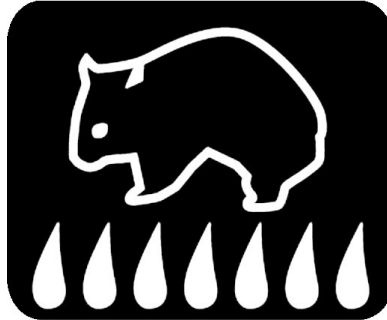

little wombat

Reg. No. 4,152,613

Registered June 5, 2012

Int. Cl.: 11

TRADEMARK

PRINCIPAL REGISTER

LITTLE WOMBAT IP PTY LTD (AUSTRALIA PROPRIETARY LIMITED COMPANY)
113 SOUTH WEST ROAD
BEECHMONT, QUEENSLAND, AUSTRALIA 4211

FOR: BARBECUES AND BARBECUE GRILLS; FIREPLACES AND FIRE BOXES, NAMELY, STANDALONE PORTABLE FIREPLACES; GAS BURNERS; BARBEQUE GRATES FOR USE IN BARBEQUES, IN CLASS 11 (U.S. CLS. 13, 21, 23, 31 AND 34).

OWNER OF AUSTRALIA REG. NO. 1144876, DATED 2-11-2006, EXPIRES 2-11-2016.

THE MARK CONSISTS OF A STYLIZED WOMBAT ATOP FLAMES ON A SHADED SQUARE ABOVE THE WORDING "LITTLE WOMBAT".

SER. NO. 85-221,896, FILED 1-20-2011.

COLLEEN DOMBROW, EXAMINING ATTORNEY



David J. Kybas

Director of the United States Patent and Trademark Office

United States of America

United States Patent and Trademark Office

YELLOW CAFE

Reg. No. 4,152,614

YELLOW HOUSE CAFE, INC. (CALIFORNIA CORPORATION), DBA YELLOW CAFE
3010 WILSHIRE BLVD. #543
LOS ANGELES, CA 90010

Registered June 5, 2012

Int. Cl.: 43

FOR: CAFE AND RESTAURANT SERVICES; CAFE-RESTAURANTS, IN CLASS 43 (U.S. CLS. 100 AND 101).

SERVICE MARK

FIRST USE 5-1-2004; IN COMMERCE 5-1-2004.

PRINCIPAL REGISTER

THE MARK CONSISTS OF STANDARD CHARACTERS WITHOUT CLAIM TO ANY PARTICULAR FONT, STYLE, SIZE, OR COLOR.

NO CLAIM IS MADE TO THE EXCLUSIVE RIGHT TO USE "CAFE", APART FROM THE MARK AS SHOWN.

SER. NO. 85-222,457, FILED 1-20-2011.

TINA L. SNAPP, EXAMINING ATTORNEY



David J. Kybas

Director of the United States Patent and Trademark Office

United States of America

United States Patent and Trademark Office

YOUR HEALTH FIRST

Reg. No. 4,152,615

CIGNA INTELLECTUAL PROPERTY, INC. (DELAWARE CORPORATION)
300 BELLEVUE PARKWAY
WILMINGTON, DE 19809

Registered June 5, 2012

Int. Cls.: 41 and 44

FOR: PERSONAL HEALTH COACHING SERVICES FOR PATIENTS WITH CHRONIC CONDITIONS PROVIDED ONLINE AND TELEPHONICALLY, NAMELY, ADVISING ON LIFESTYLE MANAGEMENT AND LIFESTYLE IMPROVEMENT FOR PATIENTS WITH CHRONIC CONDITIONS, IN CLASS 41 (U.S. CLS. 100, 101 AND 107).

SERVICE MARK

PRINCIPAL REGISTER

FIRST USE 1-10-2011; IN COMMERCE 1-10-2011.

FOR: PERSONAL HEALTH COACHING SERVICES FOR PATIENTS WITH CHRONIC CONDITIONS PROVIDED ONLINE AND TELEPHONICALLY, NAMELY, MEDICAL COUNSELING ON LIFESTYLE WELLNESS MANAGEMENT AND LIFESTYLE WELLNESS IMPROVEMENT FOR PATIENTS WITH CHRONIC CONDITIONS; PROVIDING A RESOURCE WEBSITE FEATURING INFORMATION IN THE FIELD OF MANAGING CHRONIC CONDITIONS, MAKING EDUCATED DECISIONS ABOUT HEALTHCARE TREATMENT OPTIONS, PREPARING FOR HOSPITAL STAYS, PREPARING FOR RECOVERY AND ASSISTANCE WITH MANAGEMENT OF LIFESTYLE WELLNESS HABITS; AND PROVIDING SELF-GUIDED PROGRAMS PROVIDED ONLINE AND TELEPHONICALLY FEATURING ISSUES RELATING TO MANAGING CHRONIC CONDITIONS, MAKING EDUCATED DECISIONS ABOUT HEALTHCARE TREATMENT OPTIONS, PREPARING FOR HOSPITAL STAYS, PREPARING FOR RECOVERY AND ASSISTANCE WITH MANAGEMENT OF LIFESTYLE WELLNESS HABITS, IN CLASS 44 (U.S. CLS. 100 AND 101).

FIRST USE 1-10-2011; IN COMMERCE 1-10-2011.

THE MARK CONSISTS OF STANDARD CHARACTERS WITHOUT CLAIM TO ANY PARTICULAR FONT, STYLE, SIZE, OR COLOR.

SER. NO. 85-223,097, FILED 1-21-2011.

AMEEN IMAM, EXAMINING ATTORNEY



David J. Kybas

Director of the United States Patent and Trademark Office

United States of America

United States Patent and Trademark Office

PERFORMANCE IN EVERY FIBRE

Reg. No. 4,152,616

Registered June 5, 2012

Int. Cls.: 16, 21 and 35

TRADEMARK

SERVICE MARK

PRINCIPAL REGISTER

KRUGER PRODUCTS L.P. (CANADA LIMITED PARTNERSHIP)
1900 MINNESOTA COURT
SUITE 200
MISSISSAUGA, CANADA ONL5N5R5

FOR: PAPER PRODUCTS, NAMELY, PAPER TOWELS, BATHROOM TISSUE, FACIAL TISSUE, IN CLASS 16 (U.S. CLS. 2, 5, 22, 23, 29, 37, 38 AND 50).

FOR: DISPENSERS FOR PAPER PRODUCTS, NAMELY, PAPER TOWELS, TOILET PAPER OR FACIAL TISSUE, IN CLASS 21 (U.S. CLS. 2, 13, 23, 29, 30, 33, 40 AND 50).

FOR: PROVIDING CONSUMER PRODUCT INFORMATION ABOUT HYGIENIC PAPER PRODUCTS AND THEIR DISPENSERS, IN CLASS 35 (U.S. CLS. 100, 101 AND 102).

THE MARK CONSISTS OF STANDARD CHARACTERS WITHOUT CLAIM TO ANY PARTICULAR FONT, STYLE, SIZE, OR COLOR.

PRIORITY CLAIMED UNDER SEC. 44(D) ON CANADA APPLICATION NO. 1510625, FILED 1-10-2011, REG. NO. TMA813435, DATED 12-6-2011, EXPIRES 12-6-2026.

SER. NO. 85-223,488, FILED 1-21-2011.

MICHAEL TANNER, EXAMINING ATTORNEY



David J. Kyros

Director of the United States Patent and Trademark Office

United States of America

United States Patent and Trademark Office



Reg. No. 4,152,617

Registered June 5, 2012

Int. Cl.: 41

SERVICE MARK

PRINCIPAL REGISTER

THE J. PAUL GETTY TRUST (CALIFORNIA TRUST)
1200 GETTY CENTER DRIVE
LOS ANGELES, CA 90049

FOR: ORGANIZATION OF EXHIBITIONS FOR CULTURAL OR EDUCATIONAL PURPOSES,
IN CLASS 41 (U.S. CLS. 100, 101 AND 107).

FIRST USE 10-1-2011; IN COMMERCE 10-1-2011.

THE MARK CONSISTS OF DIFFERENT BUILDINGS IN A CIRCLE.

SER. NO. 85-223,758, FILED 1-21-2011.

MICHAEL KEATING, EXAMINING ATTORNEY



David J. Kyffers

Director of the United States Patent and Trademark Office

United States of America

United States Patent and Trademark Office



Reg. No. 4,152,618

Registered June 5, 2012

Int. Cls.: 41 and 45

SERVICE MARK

PRINCIPAL REGISTER

URBAN GIRL SQUAD LLC (NEW YORK LIMITED LIABILITY COMPANY)
666 WEST END AVENUE, APT 5G
NEW YORK, NY 10025

FOR: ORGANIZING RECREATIONAL ACTIVITIES FOR THE PURPOSE OF INTRODUCING PROFESSIONALS TO EACH OTHER AND TO THE CITY, IN CLASS 41 (U.S. CLS. 100, 101 AND 107).

FIRST USE 2-1-2008; IN COMMERCE 2-1-2008.

FOR: ONLINE SOCIAL NETWORKING SERVICES IN THE FIELD OF ORGANIZING NETWORKING ACTIVITIES FOR PROFESSIONALS, IN CLASS 45 (U.S. CLS. 100 AND 101).

FIRST USE 2-1-2008; IN COMMERCE 2-1-2008.

NO CLAIM IS MADE TO THE EXCLUSIVE RIGHT TO USE "GIRL SQUAD", APART FROM THE MARK AS SHOWN.

THE MARK CONSISTS OF THE WORDS "URBAN GIRL SQUAD" AND A LARGE CITY BUILDING AGAINST WHICH ARE ARRAYED A BIKE, SPOON, WINE GLASS, HIGH-HEEL SHOE, SCISSORS, LOTUS FLOWER, FLIP FLOP AND SILHOUETTE OF A WOMAN.

SER. NO. 85-223,993, FILED 1-23-2011.

INGA ERVIN, EXAMINING ATTORNEY



David J. Kybas

Director of the United States Patent and Trademark Office

United States of America

United States Patent and Trademark Office

GEARBRID

Reg. No. 4,152,619

Registered June 5, 2012

Int. Cls.: 7 and 12

TRADEMARK

PRINCIPAL REGISTER

THE TRUSTEES OF THE STONERIDGE TRUST (NEW ZEALAND TRUST)
11 ROMOLA STREET, GLENDOWIE
AUCKLAND, NEW ZEALAND

FOR: ENGINES AND MOTORS EXCEPT FOR LAND VEHICLES; TRANSMISSIONS FOR MACHINES; MACHINE COUPLING AND TRANSMISSION COMPONENTS EXCEPT FOR LAND VEHICLES, INCLUDING POWER TRANSMISSIONS, GEARBOXES AND TRANSMISSIONS, REVERSE GEARS AND REDUCTION GEARS FOR MACHINES, GEARBOX CONTROLLERS, SHAFT COUPLINGS, MACHINE COUPLINGS AND CLUTCHES FOR MACHINES; GEAR ASSEMBLIES FOR MACHINES; GEARBOXES, GEAR TRAINS AND TRANSMISSIONS FOR MACHINES AND MOTORS; TRANSMISSIONS FOR MACHINES; PARTS, FITTINGS AND COMPONENTS FOR THE AFORESAID, IN CLASS 7 (U.S. CLS. 13, 19, 21, 23, 31, 34 AND 35).

FOR: ENGINES AND TRANSMISSIONS FOR LAND VEHICLES; POWER TRANSMISSIONS AND GEARING FOR LAND VEHICLES, NAMELY, GEARS FOR VEHICLES; TRANSMISSION SHAFTS FOR LAND VEHICLES, GEARS FOR LAND VEHICLES, NAMELY, DIFFERENTIAL GEARS AND DRIVE GEARS, DRIVE SHAFTS FOR LAND VEHICLES; GEARBOXES FOR LAND VEHICLES; DIFFERENTIAL TRANSMISSIONS FOR LAND VEHICLES; TRANSMISSIONS FOR LAND VEHICLES; GEAR BOXES FOR HYDRAULIC TRANSMISSIONS OF LAND VEHICLES; POWER TRANSMISSIONS FOR LAND VEHICLES; TRANSMISSION MECHANISMS FOR LAND VEHICLES; PARTS, FITTINGS AND STRUCTURAL COMPONENT PARTS FOR THE AFORESAID, IN CLASS 12 (U.S. CLS. 19, 21, 23, 31, 35 AND 44).



THE MARK CONSISTS OF STANDARD CHARACTERS WITHOUT CLAIM TO ANY PARTICULAR FONT, STYLE, SIZE, OR COLOR.

PRIORITY CLAIMED UNDER SEC. 44(D) ON NEW ZEALAND APPLICATION NO. 827651, FILED 7-22-2010, REG. NO. 827651, DATED 7-22-2010, EXPIRES 7-22-2020.

SER. NO. 85-224,159, FILED 1-24-2011.

ROBERT C. CLARK JR., EXAMINING ATTORNEY

David J. Kyros

Director of the United States Patent and Trademark Office

United States of America

United States Patent and Trademark Office



Reg. No. 4,152,620

Registered June 5, 2012

Int. Cl.: 9

TRADEMARK

PRINCIPAL REGISTER

SOURCECENTRIX, LLC (ARIZONA LIMITED LIABILITY COMPANY), DBA HOBNOB
ONLINE
324 WEST VALLEY BROOK RD
CALIFON, NJ 07830

FOR: COMPUTER SOFTWARE FOR ALLOWING SALES AND FIELD SERVICE EMPLOYEES TO UPDATE AND RECEIVE DATA STORED IN AN ENTERPRISE COMPUTER DATABASE IN REAL TIME, USING A MOBILE DEVICE, WITH FULL TELEPHONY INTEGRATION WITH THE TELEPHONE AND/OR SOFTWARE FEATURES OF THE MOBILE DEVICE, SPECIFICALLY DESIGNED FOR AND SOLD TO THE COMMERCIAL REAL-ESTATE INDUSTRY AND RELATED COMMERCIAL REAL-ESTATE SERVICE PROVIDERS, IN CLASS 9 (U.S. CLS. 21, 23, 26, 36 AND 38).

FIRST USE 11-5-2010; IN COMMERCE 1-10-2011.

NO CLAIM IS MADE TO THE EXCLUSIVE RIGHT TO USE "ONLINE", APART FROM THE MARK AS SHOWN.

THE COLOR(S) ORANGE AND BLACK IS/ARE CLAIMED AS A FEATURE OF THE MARK.

THE MARK CONSISTS OF THE WORDS HOBNOB ONLINE AND A DESIGN. THE COLOR ORANGE APPEARS IN THE DESIGN OF PEOPLE STANDING ON A CURVED PLATFORM. THE WORDS HOBNOB ONLINE ARE UNDER THE CURVED PLATFORM DESIGN IN BLACK COLOR.

SER. NO. 85-224,481, FILED 1-24-2011.

MARGERY A. TIERNEY, EXAMINING ATTORNEY



David J. Kybas

Director of the United States Patent and Trademark Office

United States of America

United States Patent and Trademark Office

VHO

Reg. No. 4,152,621

ADVANCED NUTRIENTS LTD. (CANADA CORPORATION)
#102 - 32526 GEORGE FERGUSON WAY
ABBOTSFORD, BC, CANADA V2T4Y1

Registered June 5, 2012

Int. Cl.: 1

FOR: PLANT FOOD USED AS A MOTHER PLANT AND VEGETATIVE GROWTH ACCELERATOR, IN CLASS 1 (U.S. CLS. 1, 5, 6, 10, 26 AND 46).

TRADEMARK

FIRST USE 0-0-2001; IN COMMERCE 0-0-2003.

PRINCIPAL REGISTER

THE MARK CONSISTS OF STANDARD CHARACTERS WITHOUT CLAIM TO ANY PARTICULAR FONT, STYLE, SIZE, OR COLOR.

PRIORITY CLAIMED UNDER SEC. 44(D) ON CANADA APPLICATION NO. 1512150, FILED 1-21-2011, REG. NO. TMA815732, DATED 1-18-2012, EXPIRES 1-18-2027.

SER. NO. 85-224,871, FILED 1-24-2011.

ANDREW RHIM, EXAMINING ATTORNEY



David J. Kybas

Director of the United States Patent and Trademark Office

United States of America

United States Patent and Trademark Office

hilary lamon

Reg. No. 4,152,622

Registered June 5, 2012

Int. Cl.: 18

TRADEMARK

PRINCIPAL REGISTER

LAMON, HILARY B. (UNITED STATES INDIVIDUAL)
6530 DOUBLE EAGLE DR. APT. 325
WOODRIDGE, IL 60517

FOR: CLOTHING FOR DOMESTIC PETS; COLLARS FOR PETS; COLLARS FOR PETS BEARING MEDICAL INFORMATION; ELECTRONIC PET COLLARS; GARMENTS FOR PETS; PET ACCESSORIES, NAMELY, CANVAS, VINYL AND LEATHER POUCHES FOR HOLDING DISPOSABLE BAGS TO PLACE PET WASTE IN; PET ACCESSORIES, NAMELY, SPECIALLY DESIGNED CANVAS, VINYL OR LEATHER BAGS ATTACHED TO ANIMAL LEASHES FOR HOLDING SMALL ITEMS SUCH AS KEYS, CREDIT CARDS, MONEY OR DISPOSABLE BAGS FOR DISPOSING OF PET WASTE; PET CLOTHING; PET COLLAR ACCESSORIES, NAMELY, BELLS, SILENCERS, SAFETY LIGHTS AND BLINKERS, PENDANTS AND CHARMS; PET COLLAR ACCESSORIES, NAMELY, BOWS AND CHARMS; PET COLLAR ACCESSORIES, NAMELY, CHARMS; PET HAIR ORNAMENTS; PET PRODUCTS IN THE NATURE OF A RESTRAINING DEVICE, NAMELY, TIE-OUT STAKES AND TIE-OUT CHAINS; PET PRODUCTS, NAMELY, PET RESTRAINING DEVICES CONSISTING OF LEASHES, COLLARS, HARNESSSES, RESTRAINING STRAPS, AND LEASHES WITH LOCKING DEVICES; PET RESTRAINING DEVICES CONSISTING OF HARNESSSES AND/OR RESTRAINING STRAPS, FOR USE IN PET GROOMING OR VETERINARY CARE; PET RESTRAINING DEVICES CONSISTING OF COLLARS, HARNESSSES AND LEASHES FOR USE IN GROOMING OR VETERINARY CARE; PET TAGS SPECIALLY ADAPTED FOR ATTACHING TO PET LEASHES OR COLLARS, IN CLASS 18 (U.S. CLS. 1, 2, 3, 22 AND 41).

FIRST USE 11-22-2010; IN COMMERCE 11-22-2010.

THE MARK CONSISTS OF STANDARD CHARACTERS WITHOUT CLAIM TO ANY PARTICULAR FONT, STYLE, SIZE, OR COLOR.

THE NAME "HILARY LAMON" IDENTIFIES A LIVING INDIVIDUAL WHOSE CONSENT IS OF RECORD.

SER. NO. 85-227,216, FILED 1-26-2011.

JOHN DWYER, EXAMINING ATTORNEY



David J. Kyros

Director of the United States Patent and Trademark Office

United States of America

United States Patent and Trademark Office



Reg. No. 4,152,623

Registered June 5, 2012

Int. Cl.: 35

SERVICE MARK

PRINCIPAL REGISTER

BUYSMART (SOUTH CAROLINA LIMITED LIABILITY COMPANY), AKA
BUYSMARTAUTONOW.COM
BUYSMARTAUTONOW.COM
6941 N. TRENHOLM ROAD, SUITE Q-1
COLUMBIA, SC 29206

FOR: PROFESSIONAL AUTOMOBILE BUYING REPRESENTATION, IN CLASS 35 (U.S. CLS. 100, 101 AND 102).

FIRST USE 3-15-2010; IN COMMERCE 3-15-2010.

THE STIPPLING IS A FEATURE OF THE MARK AND DOES NOT INDICATE COLOR.

THE COLOR(S) BLUE, GREEN AND WHITE IS/ARE CLAIMED AS A FEATURE OF THE MARK.

THE MARK CONSISTS OF A BLUE RECTANGLE WITH A SMALLER GREEN RECTANGLE ON THE RIGHT. THE TWO RECTANGLES ARE DIVIDED BY A WHITE LINE. "BUYSMART" IS WRITTEN IN THE BLUE RECTANGLE IN WHITE WORDS.

SER. NO. 85-227,819, FILED 1-27-2011.

MICHAEL KEATING, EXAMINING ATTORNEY



David J. Kybas

Director of the United States Patent and Trademark Office

United States of America

United States Patent and Trademark Office



Reg. No. 4,152,624

Registered June 5, 2012

Int. Cl.: 18

TRADEMARK

PRINCIPAL REGISTER

FORMULA ONE LICENSING BV (NETHERLANDS CORPORATION)
BEURSPLEIN 37
ROTTERDAM, NETHERLANDS 3011AA

FOR: LEATHER AND IMITATION LEATHER; TRUNKS AND TRAVELLING BAGS; UMBRELLAS, PARASOLS, ATTACHÉ CASES; BACKPACKS; ALL PURPOSE SPORT BAGS; BAGS FOR PACKAGING OF LEATHER; BAGS FOR TRAVEL; BEACH BAGS; BEACH UMBRELLAS; LEATHER AND IMITATION LEATHER; TRUNKS AND TRAVELLING BAGS; UMBRELLAS, PARASOLS ATTACHÉ CASES; BACKPACKS; ALL PURPOSE SPORT BAGS; BAGS FOR PACKAGING OF LEATHER; BAGS FOR TRAVEL; BEACH BAGS; BEACH UMBRELLAS; LEATHER SHOULDER BELTS; BOXES OF LEATHER OR LEATHER BOARD; BRIEFCASES; BUSINESS CARD CASES; CASES, OF LEATHER OR LEATHER BOARD; COIN HOLDERS IN THE NATURE OF WALLETS; CREDIT CARD HOLDERS; DISPATCH BAGS; DOCUMENT WALLETS; GARMENT BAGS FOR TRAVEL; GYM BAG; HANDBAGS; WALKING STICK HANDLES ; HAVERSACKS; KEY CASES; LUGGAGE FOR TRAVELLING; LUGGAGE TAGS; NET BAGS FOR SHOPPING; PARASOLS; POCKET WALLETS; POUCHES OF LEATHER FOR PACKAGING; PURSES; RUCKSACKS; SATCHELS; SCHOOL BAGS; REUSABLE SHOPPING BAGS; TEXTILE SHOPPING BAGS; SLINGS BAGS FOR CARRYING INFANTS; SPORT AND LEISURE BAGS; LEATHER STRAPS; SUIT CARRIER; SUITCASES; TOILETRY BAGS SOLD EMPTY; TOTE BAGS; TRAVEL AND GROOMING CASES SOLD EMPTY; TRAVELLING BAGS; LUGGAGE TAGS MADE OF LEATHER; TRAVELLING SETS COMPRISING LUGGAGE, GARMENT BAGS FOR TRAVEL, VANITY CASES SOLD EMPTY; TRAVELLING TRUNKS; UMBRELLAS; VALISES; VANITY CASES SOLD EMPTY; WALKING-STICKS; WHEELED SHOPPING BAGS, IN CLASS 18 (U.S. CLS. 1, 2, 3, 22 AND 41).

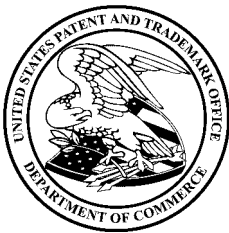

OWNER OF BENELUX REG. NO. 0891899, DATED 6-29-2010, EXPIRES 6-29-2020.

OWNER OF U.S. REG. NOS. 2,586,148, 2,633,750, AND 3,587,198.

THE MARK CONSISTS OF THE WORDING "F1 FORMULA 1" PRESENTED WITH HORIZONTAL LINES EXTENDING FROM THE RIGHT SIDE OF THE "F1".

SER. NO. 85-228,567, FILED 1-28-2011.

CHRISTINA SOBRAL, EXAMINING ATTORNEY

David J. Kybas

Director of the United States Patent and Trademark Office

United States of America

United States Patent and Trademark Office



Reg. No. 4,152,625

Registered June 5, 2012

Int. Cl.: 33

TRADEMARK

PRINCIPAL REGISTER

FORMULA ONE LICENSING BV (NETHERLANDS CORPORATION)
BEURSPLEIN 37
ROTTERDAM, NETHERLANDS 3011AA

FOR: ALCOHOLIC BEVERAGES EXCEPT BEERS; ANISE; ANISETTE; APERITIFS; ARAK; ALCOHOLIC BEVERAGES CONTAINING FRUIT; BRANDY; CHAMPAGNES; HARD CIDER; PREPARED ALCOHOLIC COCKTAILS; ALCOHOLIC BEVERAGES, NAMELY, DIGESTIFS; DISTILLED BEVERAGES, NAMELY, DISTILLED SPIRITS; ALCOHOLIC FRUIT EXTRACTS, ALCOHOLIC; GIN; KIRSCH; LIQUEURS; PORT; RICE ALCOHOL, NAMELY, DISTILLED SPIRITS OF RICE; RUM; SAKE; SPIRITS; VODKA; WHISKY; WINE, IN CLASS 33 (U.S. CLS. 47 AND 49).

OWNER OF BENELUX REG. NO. 0891899, DATED 6-29-2010, EXPIRES 6-29-2020.

OWNER OF U.S. REG. NO. 2,975,281.

THE MARK CONSISTS OF THE WORDING "F1 FORMULA 1" PRESENTED WITH HORIZONTAL LINES EXTENDING FROM THE RIGHT SIDE OF THE "F1".

SER. NO. 85-228,584, FILED 1-28-2011.

CHRISTINA SOBRAL, EXAMINING ATTORNEY



David J. Kybas

Director of the United States Patent and Trademark Office

United States of America

United States Patent and Trademark Office

swype

Reg. No. 4,152,626

Registered June 5, 2012

Int. Cl.: 35

SERVICE MARK

PRINCIPAL REGISTER

CONSUMER BENEFIT SERVICES, INC. (ILLINOIS CORPORATION), DBA CBSI
1620 BOND STREET
NAPERVILLE, IL 60563

FOR: PROMOTING THE GOODS OF OTHERS, NAMELY, PROVIDING INFORMATION REGARDING DISCOUNTS, COUPONS, REBATES, VOUCHERS AND SPECIAL OFFERS FOR THE GOODS OF OTHERS; PROMOTING THE SALE OF GOODS AND SERVICES OF OTHERS THROUGH ELECTRONIC COUPONING, PROMOTIONS AND DISCOUNTS, IN CLASS 35 (U.S. CLS. 100, 101 AND 102).

FIRST USE 12-1-2010; IN COMMERCE 12-1-2010.

THE MARK CONSISTS OF STANDARD CHARACTERS WITHOUT CLAIM TO ANY PARTICULAR FONT, STYLE, SIZE, OR COLOR.

SER. NO. 85-229,626, FILED 1-30-2011.

MATTHEW PAPPAS, EXAMINING ATTORNEY



David J. Kypas

Director of the United States Patent and Trademark Office

United States of America

United States Patent and Trademark Office

HOT PROPERTY

Reg. No. 4,152,627

WALTERS, CHAZ (UNITED STATES INDIVIDUAL)
1240 WEST HENDERSON
CHICAGO, IL 60657

Registered June 5, 2012

Int. Cl.: 36

FOR: REAL ESTATE AGENT SERVICES; REAL ESTATE BROKERAGE, IN CLASS 36 (U.S. CLS. 100, 101 AND 102).

SERVICE MARK

FIRST USE 9-0-1996; IN COMMERCE 10-0-1996.

PRINCIPAL REGISTER

THE MARK CONSISTS OF STANDARD CHARACTERS WITHOUT CLAIM TO ANY PARTICULAR FONT, STYLE, SIZE, OR COLOR.

NO CLAIM IS MADE TO THE EXCLUSIVE RIGHT TO USE "PROPERTY", APART FROM THE MARK AS SHOWN.

SER. NO. 85-231,383, FILED 2-1-2011.

ODESSA BIBBINS, EXAMINING ATTORNEY



David J. Kybas

Director of the United States Patent and Trademark Office

United States of America

United States Patent and Trademark Office

SHROOMZILLA

Reg. No. 4,152,628

Registered June 5, 2012

Int. Cl.: 30

TRADEMARK

PRINCIPAL REGISTER

CHECKERS DRIVE-IN RESTAURANTS, INC. (DELAWARE CORPORATION)
4300 WEST CYPRESS STREET
SUITE 600
TAMPA, FL 33607

FOR: HAMBURGER SANDWICHES, IN CLASS 30 (U.S. CL. 46).

FIRST USE 2-17-2011; IN COMMERCE 2-17-2011.

THE MARK CONSISTS OF STANDARD CHARACTERS WITHOUT CLAIM TO ANY PARTICULAR FONT, STYLE, SIZE, OR COLOR.

SER. NO. 85-231,732, FILED 2-1-2011.

WON TEAK OH, EXAMINING ATTORNEY



David J. Kyros

Director of the United States Patent and Trademark Office

United States of America

United States Patent and Trademark Office

HuBase

Reg. No. 4,152,629

Registered June 5, 2012

Int. Cl.: 42

SERVICE MARK

PRINCIPAL REGISTER

CROWN BIOSCIENCE INC. (CALIFORNIA CORPORATION)
3003 BUNKER HILL LN, STE 104
SANTA CLARA, CA 95054

FOR: MEDICAL AND SCIENTIFIC RESEARCH, NAMELY, CONDUCTING PRECLINICAL DRUG STUDIES, AND PROVIDE PREDICTIVE MODELING PLATFORMS AND EXPERTISE TO TRANSLATE THOSE RESULTS INTO INSIGHTFUL CLINICAL DESIGN STRATEGIES FOR SUCCESSFUL CLINICAL TRIAL OUTCOMES; CONDUCTING RESEARCH AND PRECLINICAL TRIALS RELATING TO PHARMACEUTICALS IN THE FIELD OF TRANS-LATIONAL ONCOLOGY AND DRUG DEVELOPMENT; PROVIDING AN ON-LINE SEARCHABLE DATABASE FEATURING MEDICAL RESEARCH INFORMATION AND PREDICTIVE MODELING PLATFORMS IN THE FIELD OF ONCOLOGY FOR PROVIDING USERS WITH INSIGHTFUL CLINICAL TRIAL DESIGN STRATEGIES FOR SUCCESSFUL CLINICAL TRIAL OUTCOMES, IN CLASS 42 (U.S. CLS. 100 AND 101).

FIRST USE 1-1-2010; IN COMMERCE 2-1-2010.

THE MARK CONSISTS OF STANDARD CHARACTERS WITHOUT CLAIM TO ANY PARTICULAR FONT, STYLE, SIZE, OR COLOR.

OWNER OF U.S. REG. NOS. 3,825,019, 3,825,025, AND 3,825,031.

SER. NO. 85-232,455, FILED 2-2-2011.

AMY KELLY, EXAMINING ATTORNEY



David J. Kyros

Director of the United States Patent and Trademark Office

United States of America

United States Patent and Trademark Office

A.CO

Reg. No. 4,152,630

Registered June 5, 2012

**Int. Cls.: 3, 9, 14, 18, 25
and 26**

TRADEMARK

PRINCIPAL REGISTER

ARDEN HOLDINGS INC. (CANADA CORPORATION)
2575 PITFIELD BOULEVARD
ST. LAURENT, QUEBEC, CANADA H4S1W8

FOR: PERFUMERY, NAMELY, PERFUME, EAU DE PERFUME, EAU DE TOILETTE, EAU DE COLOGNE; ESSENTIAL OILS FOR PERSONAL USE; COSMETICS; MAKE-UP; LIPSTICK, LIP-GLOSS, LIP BALM, EYE SHADOW, FACE POWDER, ROUGE, BLUSH, FOUNDATION, MASCARA, EYELINER, LIP LINER; NAIL POLISH AND NAIL CARE PREPARATIONS, IN CLASS 3 (U.S. CLS. 1, 4, 6, 50, 51 AND 52).

FOR: SUNGLASSES; PARTS AND FITTINGS OF THE AFORESAID, IN CLASS 9 (U.S. CLS. 21, 23, 26, 36 AND 38).

FOR: COSTUME JEWELRY MADE FROM PRECIOUS METALS OR COATED THEREWITH; JEWELRY, BODY JEWELRY; COSTUME JEWELRY; WATCHES, IN CLASS 14 (U.S. CLS. 2, 27, 28 AND 50).

FOR: HANDBAGS; WALLETS; BACKPACKS, IN CLASS 18 (U.S. CLS. 1, 2, 3, 22 AND 41).

FOR: CLOTHING, NAMELY, TOPS, SHIRTS, PANTS, JEANS, SHORTS, SKIRTS, LEGGINGS, T-SHIRTS, DRESSES; FOOTWEAR, NAMELY, SHOES, SLIPPERS, SANDALS, BOOTS, LINGERIE; HOSIERY; HEADWEAR, NAMELY, HATS, TUQUES, CAPS, EARMUFFS; BELTS, IN CLASS 25 (U.S. CLS. 22 AND 39).

FOR: LACE AND EMBROIDERY, HAIR ORNAMENTS; HAIR ORNAMENTS IN THE FORM OF COMBS; HAIR CLIPS, IN CLASS 26 (U.S. CLS. 37, 39, 40, 42 AND 50).

THE MARK CONSISTS OF STANDARD CHARACTERS WITHOUT CLAIM TO ANY PARTICULAR FONT, STYLE, SIZE, OR COLOR.

PRIORITY CLAIMED UNDER SEC. 44(D) ON CANADA APPLICATION NO. 1494682, FILED 9-3-2010, REG. NO. TMA778417, DATED 9-29-2010, EXPIRES 9-29-2025.

OWNER OF CANADA REG. NO. TMA809986, DATED 10-25-2011, EXPIRES 10-25-2026.

SER. NO. 85-234,613, FILED 2-4-2011.



David J. Kyros

Director of the United States Patent and Trademark Office

Reg. No. 4,152,630 MARK SPARACINO, EXAMINING ATTORNEY

United States of America

United States Patent and Trademark Office



Reg. No. 4,152,631

Registered June 5, 2012

Int. Cl.: 25

TRADEMARK

PRINCIPAL REGISTER

DESTROY ATHLETICS, LLC (CONNECTICUT LIMITED LIABILITY COMPANY)
2 RIVERS RIDGE ROAD
OLD SAYBROOK, CT 06475

FOR: ATHLETIC APPAREL, NAMELY, SHIRTS, PANTS, JACKETS, FOOTWEAR, HATS AND CAPS, ATHLETIC UNIFORMS; BASEBALL CAPS AND HATS; BOARD SHORTS; CLOTHING FOR ATHLETIC USE, NAMELY, PADDED SHIRTS; CLOTHING FOR ATHLETIC USE, NAMELY, PADDED SHORTS; HATS; HEADGEAR, NAMELY, HATS, BEANIE STYLE HATS; HOODED SWEAT SHIRTS; HOODED SWEATSHIRTS; HOODED SWEATSHIRTS FOR MEN, WOMEN, CHILDREN; SHIRTS; SWEATSHIRTS; SWEATSHIRTS FOR MEN, WOMEN, CHILDREN; T-SHIRTS; T-SHIRTS FOR MEN, WOMEN, CHILDREN; TEE SHIRTS, IN CLASS 25 (U.S. CLS. 22 AND 39).

FIRST USE 2-1-2011; IN COMMERCE 2-1-2011.

NO CLAIM IS MADE TO THE EXCLUSIVE RIGHT TO USE "ATHLETICS", APART FROM THE MARK AS SHOWN.

THE MARK CONSISTS OF A CAPITAL LETTER "D" AND CAPITAL LETTER "A". THE CURVED PART OF THE LETTER "D" AND THE LEFT SLANTED VERTICAL OF THE LETTER "A" ARE INTERLOCKING. THE VERTICAL PART OF THE LETTER "D" HAS A SLANTED GAP AT THE TOP OF IT. IT DOES NOT COMPLETE CLOSE THE CURVED PART OF THE LETTER "D". THE CURVED PARTS OF THE LETTER "D" EXTEND BEYOND THE VERTICAL PART TO THE LEFT, AND BOTH TOP AND BOTTOM END WITH SLANTS. THE LETTER "A" OPEN TRIANGULAR PART IS A STAR WITH THE SECOND POINT STARTING FROM THE TOP AND GOING CLOCKWISE IS OPEN. THAT PART IS ALSO THE SLANTED VERTICAL RIGHT HAND SIDE OF THE "A". THE TOP OF THE "A" AND THE BOTTOM OF THE RIGHT OF THE "A" EXTEND TO THE RIGHT, BEYOND THE RIGHT SLANTED VERTICAL PART OF THE "A". BOTH THE "D" AND THE "A" ARE BOLD AND ARE OUTLINED BY A STROKE. THE WORDS "DESTROY" IN CAPITAL LETTERS WITH THE "STR" INTERLOCKED AT THE TOP OF THE "S", THE "T", AND THE "R", APPEAR UNDER THE INTERLOCKING "DA". THE WORD "ATHLETICS" IN CAPITAL LETTERS APPEARS UNDER THE WORD "DESTROY". THERE IS A DOUBLE STROKE ABOVE THE WORD "DESTROY" AND BELOW THE WORD "ATHLETICS".



David J. Kappas

SER. NO. 85-234,992, FILED 2-5-2011.

Reg. No. 4,152,631 MICHAEL SOUDERS, EXAMINING ATTORNEY

United States of America
United States Patent and Trademark Office

**IKON GLOBAL
MARKETS, INC.**

Reg. No. 4,152,632

IKON GLOBAL MARKETS, INC. (NEW YORK CORPORATION), DBA IKON GLOBAL
MARKETS, INC.

Registered June 5, 2012

99 WALL STREET, 11TH FLOOR
NEW YORK, NY 10005

Int. Cl.: 36

FOR: COMMODITY BROKERAGE, IN CLASS 36 (U.S. CLS. 100, 101 AND 102).

SERVICE MARK

FIRST USE 5-1-2003; IN COMMERCE 5-1-2003.

PRINCIPAL REGISTER

THE MARK CONSISTS OF STANDARD CHARACTERS WITHOUT CLAIM TO ANY PAR-
TICULAR FONT, STYLE, SIZE, OR COLOR.

NO CLAIM IS MADE TO THE EXCLUSIVE RIGHT TO USE "GLOBAL MARKETS, INC.",
APART FROM THE MARK AS SHOWN.

SER. NO. 85-235,526, FILED 2-7-2011.

JACLYN KIDWELL WALKER, EXAMINING ATTORNEY



David J. Kybas

Director of the United States Patent and Trademark Office

United States of America

United States Patent and Trademark Office



ASPEN

Reg. No. 4,152,633

Registered June 5, 2012

Int. Cl.: 35

SERVICE MARK

PRINCIPAL REGISTER

ASPEN SEARCH ADVISORS, LLC (NEW JERSEY LIMITED LIABILITY COMPANY)
ROCKEFELLER CENTER, 7TH FLOOR
1230 AVENUE OF THE AMERICAS
NEW YORK, NY 10020

FOR: EMPLOYMENT CONSULTATION FEATURING BUSINESS EFFICIENCY ADVICE AND BUSINESS MANAGEMENT CONSULTING ALL IN THE FIELDS OF HUMAN RESOURCES, WORKFORCE PLANNING, STAFFING, RECRUITING, PERSONNEL MANAGEMENT AND RETENTION, WORKFORCE EFFECTIVENESS, COMPLIANCE WITH EMPLOYMENT LAWS AND REGULATIONS, LABOR RELATIONS, CONTINGENT AND TEMPORARY WORKFORCE MANAGEMENT, AND WORKFORCE PRODUCTIVITY, IN CLASS 35 (U.S. CLS. 100, 101 AND 102).

FIRST USE 6-8-2006; IN COMMERCE 6-8-2006.

OWNER OF U.S. REG. NOS. 3,582,897 AND 3,718,174.

THE MARK CONSISTS OF THE STYLIZED WORDING "ASPEN" AND INCLUDES A DESIGN OF A TREE FORMED BY A TRUNK WITH DOTS REPRESENTING LEAVES. THE TREE DESIGN ELEMENT INCLUDES A HORIZONTAL LINE REPRESENTING A SHADOW CAST TO THE LEFT OF THE TRUNK.

SER. NO. 85-237,881, FILED 2-9-2011.

EMILY CHUO, EXAMINING ATTORNEY



David J. Kybas

Director of the United States Patent and Trademark Office

United States of America

United States Patent and Trademark Office

RainLight

Reg. No. 4,152,634

Registered June 5, 2012

Int. Cl.: 11

TRADEMARK

PRINCIPAL REGISTER

GROHE AG (FED REP GERMANY AKTIENGESELLSCHAFT)
HAUPTSTRASSE 137
58675 HEMER, FED REP GERMANY

FOR: WATER SUPPLY EQUIPMENT AND SANITARY INSTALLATIONS; SANITARY FITTINGS, HOT WATER/COLD WATER MIXER FITTINGS; WATER SELF-CLOSING FITTINGS; SHOWERS, HAND AND OVERHEAD SHOWERS, SHOWER FITTINGS, MASSAGE SHOWERS, SHOWER SYSTEMS, SPRAY NOZZLES AND SPRAY HEADS; HOLDERS, TUBES AND TUBE CONNECTIONS FOR THE AFORESAID SHOWERS; SHOWER PANELS, SHOWER COLUMNS, SHOWER CUBICLES, INCLUDING THE AFORESAID WATER SUPPLY AND SANITARY FITTINGS BEING THERMOSTAT AND/OR NON-CONTACT CONTROLLED FITTINGS; PARTS AND FITTINGS OF THE AFORESAID GOODS, IN CLASS 11 (U.S. CLS. 13, 21, 23, 31 AND 34).

THE MARK CONSISTS OF STANDARD CHARACTERS WITHOUT CLAIM TO ANY PARTICULAR FONT, STYLE, SIZE, OR COLOR.

PRIORITY CLAIMED UNDER SEC. 44(D) ON ERPN CMNTY TM OFC APPLICATION NO. 009720079, FILED 2-8-2011, REG. NO. 009720079, DATED 7-12-2011, EXPIRES 7-12-2021.

SER. NO. 85-240,702, FILED 2-11-2011.

LINDA LAVACHE, EXAMINING ATTORNEY



David J. Kybas

Director of the United States Patent and Trademark Office

United States of America

United States Patent and Trademark Office



PASSIVSYSTEMS

Reg. No. 4,152,635

Registered June 5, 2012

Int. Cl.: 9

TRADEMARK

PRINCIPAL REGISTER

PASSIVSYSTEMS LIMITED (UNITED KINGDOM LIMITED LIABILITY COMPANY)
MEDWAY HOUSE, BUSINESS PARK, LONDON RD
NEWBURY, UNITED KINGDOM RG142PZ

FOR: COMPUTERS; COMPUTER HARDWARE AND SOFTWARE FOR PROCESSING SIGNALS FROM SENSORS AND ACTUATORS; FIRMWARE FOR MONITORING, SWITCHING OR CONTROLLING THE FLOW OF ELECTRICITY TO ELECTRICAL DEVICES; COMPUTER HARDWARE AND SOFTWARE SYSTEM FOR REMOTELY MONITORING ENVIRONMENTAL CONDITIONS AND CONTROLLING DEVICES WITHIN A BUILDING, FACILITY, GROUNDS, OR DESIGNATED SPATIAL AREA; SOFTWARE FOR MANAGING ENERGY CONSUMPTION AND FOR PROVIDING ASSISTED LIVING AND SECURITY MONITORING SERVICES WHICH IS DOWNLOADABLE FROM THE INTERNET; TELECOMMUNICATIONS APPARATUS IN THE NATURE OF MOBILE COMPUTERS AND MOBILE DATA RECEIVERS FOR MOBILE DATA COMMUNICATIONS, IN CLASS 9 (U.S. CLS. 21, 23, 26, 36 AND 38).

FIRST USE 2-1-2010; IN COMMERCE 2-1-2010.

OWNER OF U.S. REG. NO. 3,764,400.

THE COLOR(S) WHITE, GREY, FUCHSIA, RED, ORANGE AND YELLOW IS/ARE CLAIMED AS A FEATURE OF THE MARK.

NO CLAIM IS MADE TO THE EXCLUSIVE RIGHT TO USE "SYSTEMS", APART FROM THE MARK AS SHOWN.

THE MARK CONSISTS OF A MARBLE SHAPE PREDOMINATELY WHITE WITH SHADES OF GREY AND A REVERSE "S" SHAPE THROUGH THE MIDDLE COLORED IN FUCHSIA, RED, ORANGE AND YELLOW. BELOW THE DESIGN IS THE WORDING "PASSIVSYSTEMS" IN GREY.

SER. NO. 85-240,976, FILED 2-13-2011.

JAMES STEIN, EXAMINING ATTORNEY



David J. Kappas

Director of the United States Patent and Trademark Office

United States of America

United States Patent and Trademark Office

SPECTROVIAL

Reg. No. 4,152,636

CHEMPLEX INDUSTRIES, INC. (FLORIDA CORPORATION)
2820 S.W. 42ND AVE.
PALM CITY, FL 34990

Registered June 5, 2012

Int. Cl.: 9

FOR: VIALS FOR LABORATORY USE IN PREPARING SAMPLES USED IN SPECTROCHEMICAL ANALYSIS, NAMELY, METAL VIALS, INCLUDING STAINLESS STEEL VIALS, TITANIUM CARBIDE VIALS, TUNGSTEN CARBIDE VIALS, AND AGATE VIALS, IN CLASS 9 (U.S. CLS. 21, 23, 26, 36 AND 38).

TRADEMARK

PRINCIPAL REGISTER

FIRST USE 3-1-1981; IN COMMERCE 3-1-1981.

THE MARK CONSISTS OF STANDARD CHARACTERS WITHOUT CLAIM TO ANY PARTICULAR FONT, STYLE, SIZE, OR COLOR.

OWNER OF U.S. REG. NO. 2,428,604.

SER. NO. 85-241,330, FILED 2-14-2011.

SETH A. RAPPAPORT, EXAMINING ATTORNEY



David J. Kyffers

Director of the United States Patent and Trademark Office

United States of America

United States Patent and Trademark Office

GARDEN OF EVE

Reg. No. 4,152,637

EVE BUCWINSKI (UNITED STATES INDIVIDUAL)
143 MULLIGAN STREET
JUPITER, FL 33458

Registered June 5, 2012

Int. Cl.: 44

FOR: PLANT CARE SERVICES, IN CLASS 44 (U.S. CLS. 100 AND 101).

SERVICE MARK

FIRST USE 8-2-2006; IN COMMERCE 11-1-2006.

PRINCIPAL REGISTER

THE MARK CONSISTS OF STANDARD CHARACTERS WITHOUT CLAIM TO ANY PARTICULAR FONT, STYLE, SIZE, OR COLOR.

SER. NO. 85-241,647, FILED 2-14-2011.

SETH A. RAPPAPORT, EXAMINING ATTORNEY



David J. Kybas

Director of the United States Patent and Trademark Office

United States of America

United States Patent and Trademark Office

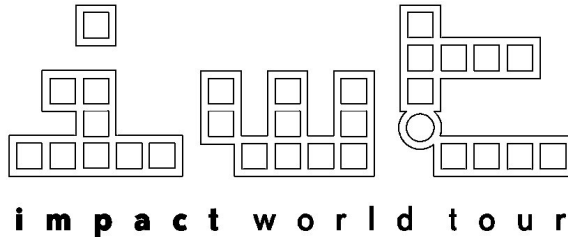

Reg. No. 4,152,638

Registered June 5, 2012

Int. Cl.: 41

SERVICE MARK

PRINCIPAL REGISTER

CHURCH ON THE MOVE INTL. INC (MINNESOTA CORPORATION)
SUITE X
12909 S 71 HWY.
GRANDVIEW, MO 64030

FOR: ENTERTAINMENT SERVICES IN THE NATURE OF SKATEBOARD EXHIBITIONS, DANCING EXHIBITIONS, LIVE MUSIC CONCERTS AND SPORTING EXHIBITIONS , IN CLASS 41 (U.S. CLS. 100, 101 AND 107).

FIRST USE 9-1-1993; IN COMMERCE 9-1-1993.

NO CLAIM IS MADE TO THE EXCLUSIVE RIGHT TO USE "WORLD TOUR", APART FROM THE MARK AS SHOWN.

THE MARK CONSISTS OF THE STYLIZED WORDING "IMPACT WORLD TOUR" UNDER THE LETTERING "IWT" COMPOSED OF SQUARES.

SER. NO. 85-242,085, FILED 2-14-2011.

TIMOTHY FINNEGAN, EXAMINING ATTORNEY



David J. Kyffers

Director of the United States Patent and Trademark Office

United States of America

United States Patent and Trademark Office

RENAISSANCE SCHOOL IMPROVEMENT

Reg. No. 4,152,639

Registered June 5, 2012

Int. Cls.: 16 and 41

TRADEMARK

SERVICE MARK

PRINCIPAL REGISTER

RENAISSANCE LEARNING, INC. (WISCONSIN CORPORATION)
P.O. BOX 8036
WISCONSIN RAPIDS, WI 554958036

FOR: PRINTED PUBLICATIONS, NAMELY, EDUCATIONAL WORKBOOKS, TEXTBOOKS, WORKSHEETS, MANUALS AND BROCHURES IN THE FIELD OF READING, WRITING, MATH AND EARLY LITERACY SKILLS FOR K-12 STUDENTS AND ENTERPRISE LEVEL ACADEMIC IMPROVEMENT INITIATIVES, IN CLASS 16 (U.S. CLS. 2, 5, 22, 23, 29, 37, 38 AND 50).

FIRST USE 1-3-2011; IN COMMERCE 1-3-2011.

FOR: EDUCATIONAL SERVICES, NAMELY, WORKSHOPS IN THE FIELD OF READING, WRITING, MATH AND EARLY LITERACY SKILLS FOR K-12 STUDENTS AND ENTERPRISE LEVEL ACADEMIC IMPROVEMENT INITIATIVES, IN CLASS 41 (U.S. CLS. 100, 101 AND 107).

FIRST USE 1-3-2011; IN COMMERCE 1-3-2011.

THE MARK CONSISTS OF STANDARD CHARACTERS WITHOUT CLAIM TO ANY PARTICULAR FONT, STYLE, SIZE, OR COLOR.

OWNER OF U.S. REG. NOS. 2,657,737, 3,703,394 AND OTHERS.

NO CLAIM IS MADE TO THE EXCLUSIVE RIGHT TO USE "SCHOOL IMPROVEMENT", APART FROM THE MARK AS SHOWN.

SER. NO. 85-242,286, FILED 2-15-2011.

KIMBERLY FRYE, EXAMINING ATTORNEY



David J. Kybas

Director of the United States Patent and Trademark Office

United States of America

United States Patent and Trademark Office



Reg. No. 4,152,640

Registered June 5, 2012

Int. Cl.: 35

SERVICE MARK

PRINCIPAL REGISTER

ARROW ROCK & STONE, LLC (UTAH LIMITED LIABILITY COMPANY)
5602 WEST AXEL PARK ROAD
WEST JORDAN, UT 84081

FOR: RETAIL STORE SERVICES FEATURING LANDSCAPING PRODUCTS AND MATERIALS, AS WELL AS DECORATIVE LANDSCAPING ROCKS, BOULDERS, FLAGSTONE, TOPSOIL, SAND, AND GRAVEL, IN CLASS 35 (U.S. CLS. 100, 101 AND 102).

FIRST USE 3-1-2005; IN COMMERCE 1-1-2008.

NO CLAIM IS MADE TO THE EXCLUSIVE RIGHT TO USE "ROCK & STONE LLC", APART FROM THE MARK AS SHOWN.

THE STIPPLING IS FOR SHADING PURPOSES ONLY.

THE MARK CONSISTS OF AN ARROW WITH FEATHERS, IN MIDDLE OF THE ARROW THERE IS THE STYLIZED TEXT "ARROW" AND ON THE RIGHT END OF THE ARROW THERE IS AN ARROW'S HEAD TIP. IN THE MIDDLE THERE ARE ROCKS AND AT THE BOTTOM THERE IS THE STYLIZED TEXT "ROCK & STONE LLC".

SER. NO. 85-244,345, FILED 2-16-2011.

JORDAN BAKER, EXAMINING ATTORNEY



David J. Kyros

Director of the United States Patent and Trademark Office

United States of America

United States Patent and Trademark Office

meLearning

Reg. No. 4,152,641

Registered June 5, 2012

Int. Cl.: 41

SERVICE MARK

PRINCIPAL REGISTER

FLORIDA VIRTUAL SCHOOL (FLORIDA EDUCATIONAL INSTITUTION)
2145 METRO CENTER BLVD, SUITE 200
ORLANDO, FL 32835

FOR: EDUCATIONAL SERVICES, NAMELY, EDUCATIONAL PROGRAMS FEATURING INSTRUCTION IN LANGUAGES, SCIENCE, MATHEMATICS, HISTORY, SOCIAL STUDIES, READING, WRITING, ART, COMPUTERS, BUSINESS, HEALTH, PHYSICAL FITNESS, MUSIC, DRIVER'S EDUCATION, RESEARCH AND CRITICAL THINKING AT THE PRE-KINDERGARTEN, PRIMARY, SECONDARY, COLLEGE LEVELS, AND AT THE POST-GRADUATE LEVEL FOR EDUCATORS, IN CLASS 41 (U.S. CLS. 100, 101 AND 107).

FIRST USE 12-0-2009; IN COMMERCE 1-1-2010.

THE MARK CONSISTS OF STANDARD CHARACTERS WITHOUT CLAIM TO ANY PARTICULAR FONT, STYLE, SIZE, OR COLOR.

OWNER OF U.S. REG. NO. 3,873,394.

SER. NO. 85-244,854, FILED 2-17-2011.

SUSAN STIGLITZ, EXAMINING ATTORNEY



David J. Kyros

Director of the United States Patent and Trademark Office

United States of America

United States Patent and Trademark Office



Reg. No. 4,152,642

Registered June 5, 2012

Int. Cl.: 41

SERVICE MARK

PRINCIPAL REGISTER

K. HOV IP, II, INC. (CALIFORNIA CORPORATION)
110 WEST FRONT STREET
RED BANK, NJ 07701

FOR: ONLINE JOURNALS, NAMELY, BLOGS FEATURING INFORMATION ON REAL ESTATE, CONSTRUCTION, GREEN BUILDING, SUSTAINABLE LIVING, ENERGY EFFICIENCY, CONSERVATION, AND ENVIRONMENTAL TOPICS; PROVIDING WEBCASTS FEATURING VIDEO CLIPS CONTAINING INFORMATION AND ADVICE REGARDING ENERGY EFFICIENCY, CONSERVATION, AIR QUALITY, AND ENERGY SAVING RESOURCES, IN CLASS 41 (U.S. CLS. 100, 101 AND 107).

FIRST USE 1-26-2011; IN COMMERCE 1-26-2011.

NO CLAIM IS MADE TO THE EXCLUSIVE RIGHT TO USE "NATURE TECHNOLOGY EFFICIENCY", APART FROM THE MARK AS SHOWN.

THE MARK CONSISTS OF THE WORDS "NATURE TECHNOLOGY EFFICIENCY" BELOW A CURVED ARROW POINTING RIGHT AND ABOVE A CURVED ARROW POINTING LEFT.

SER. NO. 85-245,885, FILED 2-18-2011.

KYLE PEETE, EXAMINING ATTORNEY



David J. Kybas

Director of the United States Patent and Trademark Office

United States of America

United States Patent and Trademark Office

ProShip Velocity

Reg. No. 4,152,643

Registered June 5, 2012

Int. Cl.: 9

TRADEMARK

PRINCIPAL REGISTER

BEST WAY TECHNOLOGIES, LLC (WISCONSIN LIMITED LIABILITY COMPANY)
530 NORTH 108TH PLACE
SUITE 100
WAUWATOSA, WI 53226

FOR: COMPUTER SOFTWARE FOR SHIPPING, NAMELY, FOR RATING, ROUTING, MANIFESTING, TRACKING, REPORTING AND LABELING SHIPMENTS, IN CLASS 9 (U.S. CLS. 21, 23, 26, 36 AND 38).

FIRST USE 6-1-2010; IN COMMERCE 6-1-2010.

THE MARK CONSISTS OF STANDARD CHARACTERS WITHOUT CLAIM TO ANY PARTICULAR FONT, STYLE, SIZE, OR COLOR.

OWNER OF U.S. REG. NO. 3,137,910.

SER. NO. 85-246,735, FILED 2-18-2011.

PATRICIA EVANKO, EXAMINING ATTORNEY



David J. Kybas

Director of the United States Patent and Trademark Office

United States of America

United States Patent and Trademark Office



Reg. No. 4,152,644

Registered June 5, 2012

Int. Cls.: 35 and 37

TOP QUALITY FLOORS INC. (US VIRGIN ISLANDS CORPORATION), DBA FULL CIRCLE FLOORING
SUITE A
9720 S VIRGINIA ST
RENO, NV 89511

SERVICE MARK

FOR: RETAIL BUILDING SUPPLY STORE SERVICES FEATURING FLOORING; RETAIL STORE SERVICES FEATURING GREEN AND ECO-FRIENDLY PRODUCTS IN THE NATURE OF FLOORING, IN CLASS 35 (U.S. CLS. 100, 101 AND 102).

PRINCIPAL REGISTER

FIRST USE 12-10-2009; IN COMMERCE 9-3-2010.

FOR: FLOOR POLISHING; FLOOR SANDING; GENERAL CONTRACTING SERVICES IN THE FIELD OF FLOORING; HARDWOOD FLOOR COATING SERVICES; INSTALLING CARPET; INSTALLING FLOOR TILE; INSTALLING WOOD FLOORING; LAYING OF CARPET; TILE INSTALLATION SERVICES, IN CLASS 37 (U.S. CLS. 100, 103 AND 106).

FIRST USE 12-10-2009; IN COMMERCE 9-3-2010.

NO CLAIM IS MADE TO THE EXCLUSIVE RIGHT TO USE "FLOORING" AND "YOUR GREEN FLOORING STORE", APART FROM THE MARK AS SHOWN.

THE COLOR(S) GREEN AND BROWN IS/ARE CLAIMED AS A FEATURE OF THE MARK.

THE MARK CONSISTS OF A GREEN TREE WITH A BROWN HALF CIRCLE TRUNK ABOVE THE WORDS "FULL CIRCLE FLOORING YOUR GREEN FLOORING STORE". THE WORDING "FULL CIRCLE FLOORING" APPEARS IN THE COLOR BROWN, THE WORDING "YOUR GREEN FLOORING STORE" APPEARS IN THE COLOR GREEN, AND A BROWN HALF CIRCLE APPEARS BELOW THE WORDS.

SER. NO. 85-247,129, FILED S.R. 2-20-2011 AM. P.R. 10-20-2011.

DARRYL SPRUILL, EXAMINING ATTORNEY



David J. Kyffers

Director of the United States Patent and Trademark Office

United States of America

United States Patent and Trademark Office

FIND GRIND MIND

Reg. No. 4,152,645

PERFORMANCE INSIGHTS INC. (GEORGIA CORPORATION)
4294 CABRETTA DRIVE
SMYRNA, GA 30080

Registered June 5, 2012

Int. Cl.: 35

FOR: BUSINESS MANAGEMENT CONSULTING; BUSINESS TEAM DEVELOPMENT
CONSULTING, IN CLASS 35 (U.S. CLS. 100, 101 AND 102).

SERVICE MARK

FIRST USE 10-1-2003; IN COMMERCE 1-1-2006.

PRINCIPAL REGISTER

THE MARK CONSISTS OF STANDARD CHARACTERS WITHOUT CLAIM TO ANY PAR-
TICULAR FONT, STYLE, SIZE, OR COLOR.

SER. NO. 85-247,188, FILED 2-21-2011.

DOMINIC J. FERRAIUOLO, EXAMINING ATTORNEY



David J. Kybas

Director of the United States Patent and Trademark Office

United States of America

United States Patent and Trademark Office



Reg. No. 4,152,646

Registered June 5, 2012

Int. Cl.: 9

TRADEMARK

PRINCIPAL REGISTER

WEALTH PLANNING TECHNOLOGY, LLC (DELAWARE LIMITED LIABILITY COMPANY)
20 BRIANS WAY
PRINCETON JUNCTION, NJ 08550

FOR: COMPUTER SOFTWARE FOR PROVIDING AN ON-LINE DATABASE IN THE FIELD OF TRANSACTION PROCESSING TO UPLOAD TRANSACTIONAL DATA, PROVIDE STATISTICAL ANALYSIS, AND PRODUCE NOTIFICATIONS AND REPORTS; COMPUTER SOFTWARE FOR THE COLLECTION, EDITING, ORGANIZING, MODIFYING, BOOK MARKING, TRANSMISSION, STORAGE AND SHARING OF DATA AND INFORMATION; COMPUTER SOFTWARE FOR FINANCIAL PLANNING, PORTFOLIO CONSTRUCTION, INVESTMENT SELECTION, INVESTMENT MONITORING, AND INVESTMENT REPORTING FUNCTIONS; COMPUTER SOFTWARE FOR SELECTING, ANALYZING, AND MONITORING INVESTMENT PRODUCTS THAT MAY BE DOWNLOADED FROM A GLOBAL COMPUTER NETWORK; COMPUTER SOFTWARE PLATFORMS FOR FINANCIAL PLANNERS, INVESTMENT ADVISORS, ACCOUNTANTS, ATTORNEYS, PRIVATE BANKERS, INSURANCE AGENTS, INVESTMENT BROKERS, AND TRUST OFFICERS NECESSARY TO FULFILL FINANCIAL PLANNING, INVESTMENT SELECTION, PORTFOLIO BUILDING, INVESTMENT ANALYSIS, INVESTMENT MONITORING, AND INVESTMENT REPORTING FUNCTIONS, IN CLASS 9 (U.S. CLS. 21, 23, 26, 36 AND 38).

FIRST USE 9-6-2010; IN COMMERCE 9-6-2010.

NO CLAIM IS MADE TO THE EXCLUSIVE RIGHT TO USE "BALANCE SHEET METHODOLOGY", APART FROM THE MARK AS SHOWN.

THE COLOR(S) CHARCOAL, BLACK, WHITE, BLUE, DARK ORANGE, PURPLE AND LIGHT ORANGE IS/ARE CLAIMED AS A FEATURE OF THE MARK.

THE MARK CONSISTS OF "BSM" IN CHARCOAL LETTERING ABOVE THE WORDS "BALANCE SHEET METHODOLOGY" IN BLACK; TO THE LEFT OF "BSM" AND PARTIALLY OBSCURED BY THE LETTERS IS A THREE DIMENSIONAL GLOSSY SPHERICAL PIE CHART DIVIDED INTO FOUR EQUAL SECTIONS. THE UPPER-LEFT QUADRANT IS IN DARK BLUE; THE UPPER-RIGHT QUADRANT IS IN DARK ORANGE; THE LOWER-LEFT QUADRANT IS IN PURPLE AND THE LOWER-RIGHT QUADRANT IS IN LIGHT ORANGE; HORIZONTAL AND VERTICAL WHITE LINES SEPARATES THE QUADRANTS; A WHITE SWOOPING CURVE MOVES FROM THE LOWER LEFT QUADRANT TO THE UPPER RIGHT QUADRANT.



David J. Kybas

Director of the United States Patent and Trademark Office

Reg. No. 4,152,646 SER. NO. 85-247,312, FILED 2-21-2011.

LINDA MICKLEBURGH, EXAMINING ATTORNEY

United States of America

United States Patent and Trademark Office

Parker House

Reg. No. 4,152,647

PARKER HOUSE SAUSAGE COMPANY (ILLINOIS CORPORATION)
4605 S. STATE STREET
CHICAGO, IL 60609

Registered June 5, 2012

Int. Cl.: 29

FOR: SAUSAGE, MEAT AND MEAT JELLIES, PACKAGED AND PREPARED MEATS, PRESERVED MEATS AND SAUSAGES, AND SLICED MEATS, IN CLASS 29 (U.S. CL. 46).

TRADEMARK

FIRST USE 12-31-1958; IN COMMERCE 12-31-1958.

PRINCIPAL REGISTER

THE MARK CONSISTS OF STANDARD CHARACTERS WITHOUT CLAIM TO ANY PARTICULAR FONT, STYLE, SIZE, OR COLOR.

SER. NO. 85-248,133, FILED 2-22-2011.

ALEX KEAM, EXAMINING ATTORNEY



David J. Kybas

Director of the United States Patent and Trademark Office

United States of America

United States Patent and Trademark Office

The logo for 'golfmix' features the word 'golfmix' in a bold, lowercase, sans-serif font. A stylized golf club is positioned above the letter 'l', with its head pointing left and its shaft extending upwards. A large, thick, black arch extends from the top of the letter 'm' to the top of the letter 'x', curving over the top of the word.

Reg. No. 4,152,648

Registered June 5, 2012

Int. Cls.: 41 and 45

SERVICE MARK

PRINCIPAL REGISTER

GOLFMIX, INC. (DELAWARE CORPORATION)
3931 E ROCKINGHAM ROAD
PHOENIX, AZ 85050

FOR: WEBSITE FOR GOLFERS FEATURING GOLF-RELATED CONTENT, IN CLASS 41 (U.S. CLS. 100, 101 AND 107).

FIRST USE 10-12-2010; IN COMMERCE 10-12-2010.

FOR: ONLINE SOCIAL NETWORKING SERVICES VIA A SPORTS COMMUNITY WEBSITE FOR GOLFERS ABOUT GOLF-RELATED CONTENT, IN CLASS 45 (U.S. CLS. 100 AND 101).

FIRST USE 10-12-2010; IN COMMERCE 10-12-2010.

NO CLAIM IS MADE TO THE EXCLUSIVE RIGHT TO USE "GOLF", APART FROM THE MARK AS SHOWN.

THE MARK CONSISTS OF THE WORDING "GOLFMIX" WITH A DESIGN CONSISTING OF A HAT AND GOLF CLUB AT THE TOP OF THE LETTER "L" AND AN ARCH EXTENDING FROM ABOVE THE LETTER "M" AND CONNECTING TO THE LETTER "X".

SER. NO. 85-248,721, FILED 2-22-2011.

DEBRA LEE, EXAMINING ATTORNEY



David J. Kybas

Director of the United States Patent and Trademark Office

United States of America

United States Patent and Trademark Office

B&B LEADERS IN THE NEW TECHNOLOGY

Reg. No. 4,152,649

B & B MANUFACTURING CORPORATION (PUERTO RICO CORPORATION)
P.O. BOX 9574

Registered June 5, 2012

SAN JUAN, PUERTO RICO 009089574

Int. Cl.: 7

FOR: IGNITION DEVICES FOR MOTORS OF LAND VEHICLES, NAMELY, DIRECT IGNITION COIL DEVICES, IN CLASS 7 (U.S. CLS. 13, 19, 21, 23, 31, 34 AND 35).

TRADEMARK

FIRST USE 6-1-2010; IN COMMERCE 6-1-2010.

PRINCIPAL REGISTER

THE MARK CONSISTS OF STANDARD CHARACTERS WITHOUT CLAIM TO ANY PARTICULAR FONT, STYLE, SIZE, OR COLOR.

NO CLAIM IS MADE TO THE EXCLUSIVE RIGHT TO USE "LEADERS IN THE NEW TECHNOLOGY", APART FROM THE MARK AS SHOWN.

SER. NO. 85-249,421, FILED 2-23-2011.

DEIRDRE ROBERTSON, EXAMINING ATTORNEY



David J. Kyffers

Director of the United States Patent and Trademark Office

United States of America

United States Patent and Trademark Office

ANNUAL CREDIT REPORT

Reg. No. 4,152,650

CENTRAL SOURCE LLC (DELAWARE LIMITED LIABILITY COMPANY)

Registered June 5, 2012

P.O. BOX 105283
ATLANTA, GA 303485283

Int. Cl.: 35

FOR: BUSINESS REFERRAL AND INFORMATION SERVICES, NAMELY, REFERRAL OF REQUESTS BY CONSUMERS FOR LEGALLY-AUTHORIZED ANNUAL CONSUMER CREDIT REPORT DISCLOSURE TO THE VARIOUS CONSUMER CREDIT REPORTING AGENCIES, IN CLASS 35 (U.S. CLS. 100, 101 AND 102).

SERVICE MARK

PRINCIPAL REGISTER

FIRST USE 11-30-2004; IN COMMERCE 11-30-2004.

THE MARK CONSISTS OF STANDARD CHARACTERS WITHOUT CLAIM TO ANY PARTICULAR FONT, STYLE, SIZE, OR COLOR.

OWNER OF U.S. REG. NOS. 3,128,221 AND 3,128,222.

SEC. 2(F).

SER. NO. 85-249,432, FILED 2-23-2011.

LEIGH CAROLINE CASE, EXAMINING ATTORNEY



David J. Kyffers

Director of the United States Patent and Trademark Office

United States of America

United States Patent and Trademark Office



Reg. No. 4,152,651

Registered June 5, 2012

Int. Cl.: 30

TRADEMARK

PRINCIPAL REGISTER

HIPPOE HOLDINGS, LLC (DELAWARE LIMITED LIABILITY COMPANY), DBA CHEEKY SANDWICHES
59 JOHN STREET, 4F
NEW YORK, NY 10038

FOR: NEW ORLEANS STYLE SANDWICHES, BEIGNETS, AND BISCUITS, IN CLASS 30 (U.S. CL. 46).

FIRST USE 12-15-2009; IN COMMERCE 12-15-2009.

NO CLAIM IS MADE TO THE EXCLUSIVE RIGHT TO USE "SANDWICHES", APART FROM THE MARK AS SHOWN.

THE COLOR(S) BLUE IS/ARE CLAIMED AS A FEATURE OF THE MARK.

THE MARK CONSISTS OF THE WORDS "CHEEKY SANDWICHES" IN STYLIZED LETTERING APPEARING ABOVE A STYLIZED DESIGN OF A SMILING BOY'S FACE, ALL IN BLUE.

SER. NO. 85-250,498, FILED 2-24-2011.

ANNE FARRELL, EXAMINING ATTORNEY



David J. Kybas

Director of the United States Patent and Trademark Office

United States of America

United States Patent and Trademark Office



Reg. No. 4,152,652

DYNAMIC DENTAL PLLC (NEW YORK LIMITED LIABILITY COMPANY)
79 NELSON AVENUE
STATEN ISLAND, NY 10308

Registered June 5, 2012

Int. Cl.: 44

FOR: DENTISTRY; PROVIDING A WEBSITE FEATURING INFORMATION FOR PATIENTS
IN THE FIELD OF DENTAL HEALTH, IN CLASS 44 (U.S. CLS. 100 AND 101).

SERVICE MARK

FIRST USE 8-28-2002; IN COMMERCE 8-28-2002.

PRINCIPAL REGISTER

NO CLAIM IS MADE TO THE EXCLUSIVE RIGHT TO USE "DENTAL" AND "P.L.L.C.",
APART FROM THE MARK AS SHOWN.

THE COLOR(S) BLUE IS/ARE CLAIMED AS A FEATURE OF THE MARK.

THE MARK CONSISTS OF AN INCOMPLETE OVAL DESIGN IN BLUE, BEHIND WHICH
IS A BLUE RECTANGLE. STACKED BELOW IS THE WORDING "DYNAMIC DENTAL
P.L.L.C." IN BLUE.

SER. NO. 85-251,723, FILED 2-25-2011.

GRETTA YAO, EXAMINING ATTORNEY



David J. Kybas

Director of the United States Patent and Trademark Office

United States of America

United States Patent and Trademark Office

TUFF KNUCKS

Reg. No. 4,152,653

KRISTY LEWELLYN (UNITED STATES INDIVIDUAL), AKA LEWELLYN SAFETY
1870 OAK STREET
LINTON, IN 47441

Registered June 5, 2012

Int. Cl.: 9

FOR: PROTECTIVE GLOVES FOR INDUSTRIAL USE, IN CLASS 9 (U.S. CLS. 21, 23, 26, 36 AND 38).

TRADEMARK

FIRST USE 2-1-2011; IN COMMERCE 2-18-2011.

PRINCIPAL REGISTER

THE MARK CONSISTS OF STANDARD CHARACTERS WITHOUT CLAIM TO ANY PARTICULAR FONT, STYLE, SIZE, OR COLOR.

SER. NO. 85-252,062, FILED S.R. 2-25-2011 AM. P.R. 7-26-2011.

SUZANNE BLANE, EXAMINING ATTORNEY



David J. Kybas

Director of the United States Patent and Trademark Office

United States of America

United States Patent and Trademark Office



Reg. No. 4,152,654

Registered June 5, 2012

Int. Cls.: 10 and 21

TRADEMARK

PRINCIPAL REGISTER

SERENE INNOVATION, INC. (CALIFORNIA CORPORATION)
14615 CARMENITA ROAD
NORWALK, CA 90650

FOR: ASSISTIVE LISTENING DEVICE FOR THE HEARING IMPAIRED; BED VIBRATORS;
WIRELESS TRANSMITTERS AND RECEIVERS FOR USE WITH HEARING AIDS, IN CLASS
10 (U.S. CLS. 26, 39 AND 44).

FIRST USE 1-22-2003; IN COMMERCE 2-5-2008.

FOR: BOTTLE STOPPERS SPECIALLY ADAPTED FOR USE WITH VACUUM BOTTLES;
HOUSEHOLD CONTAINERS FOR FOODS, IN CLASS 21 (U.S. CLS. 2, 13, 23, 29, 30, 33, 40
AND 50).

FIRST USE 1-22-2003; IN COMMERCE 2-5-2008.

THE MARK CONSISTS OF THE WORD "SERENE" IN BLACK, WITH THE WORD "INNOVATIONS" IN BLACK INDENTED LEFT UNDERNEATH. A WAVE-LIKE GRAPHIC STARTS BELOW THESE WORDS AND CONTINUES THROUGH OVER THE TOP. THE WAVE IS BLUE BELOW AND GREEN ON TOP.

THE COLOR(S) BLUE, BLACK, AND GREEN IS/ARE CLAIMED AS A FEATURE OF THE MARK.

SER. NO. 85-253,541, FILED 2-28-2011.

ANDREW LEASER, EXAMINING ATTORNEY



David J. Kyros

Director of the United States Patent and Trademark Office

United States of America

United States Patent and Trademark Office



Reg. No. 4,152,655

YOGURT BLISS, LLC (FLORIDA LIMITED LIABILITY COMPANY)
4457 NW 93 DORAL CT.
MIAMI, FL 33178

Registered June 5, 2012

Int. Cl.: 43

FOR: FROZEN YOGURT SHOP SERVICES IN THE NATURE OF A RESTAURANT, IN CLASS 43 (U.S. CLS. 100 AND 101).

SERVICE MARK

FIRST USE 1-15-2010; IN COMMERCE 1-15-2010.

PRINCIPAL REGISTER

OWNER OF U.S. REG. NO. 3,910,567.

NO CLAIM IS MADE TO THE EXCLUSIVE RIGHT TO USE "YOGURT", APART FROM THE MARK AS SHOWN.

THE MARK CONSISTS OF THE WORDING "MY YOGURT BLISS" APPEARING IN A STYLIZED FONT IN A STACKED ARRANGEMENT WHEREIN THE WORD "MY" IS ABOVE THE WORD "YOGURT" AND THE WORD "YOGURT" IS ABOVE THE WORD "BLISS"; THE "O" OF "YOGURT" IS A STYLIZED BUBBLE DESIGN AND THE WORD "BLISS" FURTHER COMPRISES A CLOUD LIKE DESIGN; SEVEN BUBBLE ELEMENTS APPEAR AROUND THE WORD ELEMENTS.

SER. NO. 85-255,287, FILED 3-2-2011.

GILBERT SWIFT, EXAMINING ATTORNEY



David J. Kybas

Director of the United States Patent and Trademark Office

United States of America

United States Patent and Trademark Office

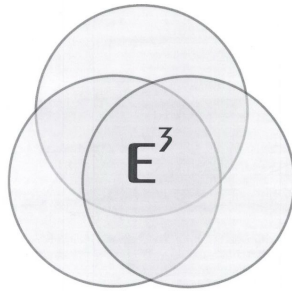

Reg. No. 4,152,656

Registered June 5, 2012

Int. Cls.: 35 and 42

SERVICE MARK

PRINCIPAL REGISTER

EFFICIENCY3 CORP (VIRGINIA CORPORATION)
SUITE 508
2000 15TH STREET NORTH
ARLINGTON, VA 22203

FOR: CONSULTING SERVICES, NAMELY, USE AND COST ANALYSIS IN THE FIELD OF COMMERCIAL, INSTITUTIONAL AND GOVERNMENTAL ENERGY AND WATER OPERATIONS; PROVIDING CONSULTING SERVICES IN THE FIELD OF ENERGY EFFICIENCY FOR LARGE COMMERCIAL, GOVERNMENTAL AND INSTITUTIONAL CLIENTS; PROVIDING CONSULTING SERVICES IN THE FIELD OF WATER USAGE MANAGEMENT FOR LARGE COMMERCIAL, GOVERNMENTAL AND INSTITUTIONAL CLIENTS, IN CLASS 35 (U.S. CLS. 100, 101 AND 102).

FIRST USE 8-20-2010; IN COMMERCE 8-20-2010.

FOR: DEVELOPMENT OF CUSTOM TAILORED COMPUTER SOFTWARE FOR USE IN HELPING LARGE COMMERCIAL, GOVERNMENTAL AND INSTITUTIONAL CLIENTS OPTIMIZE THE OPERATING, FINANCIAL AND PERSONNEL EFFICIENCY OF THEIR ENERGY AND WATER OPERATIONS, IN CLASS 42 (U.S. CLS. 100 AND 101).

FIRST USE 8-20-2010; IN COMMERCE 8-20-2010.

THE MARK CONSISTS OF THE CAPITAL LETTER "E" WITH A SUPERScript "3" PLACED IN THE CENTER OF THREE INTERSECTING CIRCLE DESIGNS.

SER. NO. 85-255,855, FILED 3-2-2011.

HOWARD B. LEVINE, EXAMINING ATTORNEY



David J. Kybas

Director of the United States Patent and Trademark Office

United States of America

United States Patent and Trademark Office

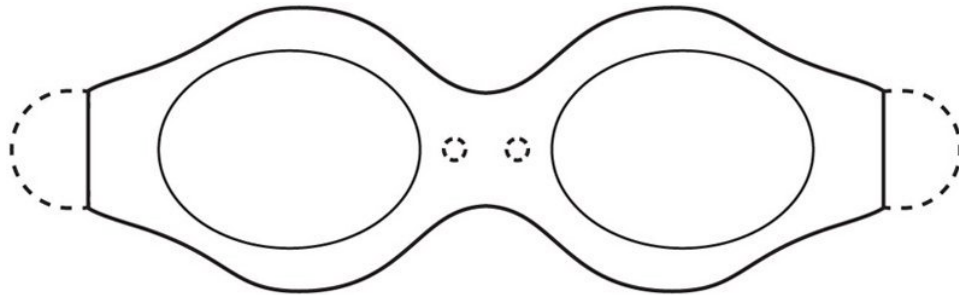

Reg. No. 4,152,657

Registered June 5, 2012

Int. Cl.: 28

TRADEMARK

PRINCIPAL REGISTER

I-STAR ENTERTAINMENT LLC (DELAWARE LIMITED LIABILITY COMPANY)
SUITE 200
11 MIDDLE NECK ROAD
GREAT NECK, NY 11021

FOR: TOYS, NAMELY, SPINNING TOYS IN THE NATURE OF TOYS OF VARIOUS SHAPES THAT ARE CONNECTED TO STRINGS AND SPIN; LIGHT-UP TOYS, NAMELY, TOYS OF VARIOUS SHAPES THAT LIGHT UP AND ARE CONNECTED TO STRING AND SPIN; MOVING TOYS, NAMELY, TOYS OF VARIOUS SHAPES THAT ARE CONNECTED TO STRINGS AND SPIN AND MOVE; PLASTIC SPINNING TOYS, NAMELY, TOYS OF VARIOUS SHAPES MADE OF PLASTIC THAT ARE CONNECTED TO STRINGS AND SPIN; BATTERY-OPERATED TOYS, NAMELY, TOYS OF VARIOUS SHAPES THAT ARE CONNECTED TO STRINGS AND SPIN; MUSICAL TOYS, NAMELY, TOYS OF VARIOUS SHAPES THAT ARE CONNECTED TO STRINGS AND SPIN; HANDHELD TOYS, NAMELY, TOYS OF VARIOUS SHAPES THAT ARE CONNECTED TO STRINGS AND SPIN; NOVELTY TOYS, NAMELY, TOYS OF VARIOUS SHAPES THAT ARE CONNECTED TO STRINGS AND SPIN; LIGHT-SHOW TOYS, NAMELY, TOYS OF VARIOUS SHAPES THAT ARE CONNECTED TO STRINGS AND SPIN AND LIGHT UP; TOYS WITH HANDLES, NAMELY, TOYS OF VARIOUS SHAPES THAT ARE CONNECTED TO STRING AND SPIN AND HAVE HANDLES; TOYS WITH SOUND, NAMELY, TOYS OF VARIOUS SHAPES THAT ARE CONNECTED TO STRINGS AND SPIN AND MAKE SOUNDS; TOYS WITH MICROPHONES, NAMELY, TOYS OF VARIOUS SHAPES THAT ARE CONNECTED TO STRINGS AND SPIN AND HAVE MICROPHONES; TOYS ON A ROPE, NAMELY, TOYS OF VARIOUS SHAPES THAT ARE CONNECTED TO ROPE AND SPIN; TOY WITH BOOK, NAMELY, CHILDREN'S MULTIPLE ACTIVITY TOYS SOLD AS A UNIT WITH PRINTED BOOK, IN CLASS 28 (U.S. CLS. 22, 23, 38 AND 50).



FIRST USE 12-9-2010; IN COMMERCE 12-9-2010.

THE MARK CONSISTS OF A THREE-DIMENSIONAL CONFIGURATION OF THE GOODS IN THE NATURE OF A SPINNING TOY APPEARING IN A GOGGLE DESIGN WITH APPENDAGES REPRESENTING LIGHTS ON EACH END. THE BROKEN LINES DEPICTING THE LIGHTS ON EACH END AND CIRCLES IN THE MIDDLE FOR INSERTION OF THE STRINGS INDICATE PLACEMENT OF THE MARK ON THE GOODS AND ARE NOT PART OF THE MARK.

David J. Kyros

Director of the United States Patent and Trademark Office

SER. NO. 85-256,034, FILED 3-2-2011.

Reg. No. 4,152,657 CHARISMA HAMPTON, EXAMINING ATTORNEY

United States of America

United States Patent and Trademark Office



Reg. No. 4,152,658

Registered June 5, 2012

**Int. Cls.: 1, 2, 3, 4, 5, 6,
7, 9, 10, 11, 12, 14, 16, 17,
18, 19, 25, 28, 29, 30, 32,
35, 36, 37, 38, 39, 40, 41,
42, 43 and 44**

TRADEMARK

SERVICE MARK

PRINCIPAL REGISTER



David J. Kappas

Director of the United States Patent and Trademark Office

COMITÉ INTERNATIONAL OLYMPIQUE (SWITZERLAND COMITÉ INTERNATIONAL OLYMPIQUE IS AN ASSOCIATION DULY ORGANIZED AND IN GOOD STANDING UNDER THE LAWS OF SWITZERLAND)
CHÂTEAU DE VIDY
1007 LAUSANNE, SWITZERLAND

FOR: CHEMICALS FOR USE IN INDUSTRY AND SCIENCE, NAMELY, CHEMICAL ADDITIVES FOR USE IN THE PHARMACEUTICAL INDUSTRY AND THE FOOD INDUSTRY; UNPROCESSED ARTIFICIAL RESINS FOR USE IN MANUFACTURING PLASTICS, UNPROCESSED PLASTICS; MANURES; FIRE EXTINGUISHING COMPOSITIONS; TEMPERING AND SOLDERING PREPARATIONS; CHEMICAL SUBSTANCES FOR PRESERVING FOODSTUFFS; ADHESIVES USED IN INDUSTRY FOR THE BINDING OF BOOKS, FOR THE MANUFACTURE OF SURGICAL BANDAGES, AND ADHESIVES USED IN CONSTRUCTION; SYNTHETIC RESINS; THERMOPLASTIC AND THERMOSETTING SYNTHETIC RESINS ORGANIC MOLDING COMPOSITIONS, FOR GENERAL USE IN THE INDUSTRIAL ARTS; CHEMICAL INTERMEDIATES; ORGANOSILICONE COMPOUNDS, NAMELY, POLYSILOXANES AND SILANES IN THE FORM OF RESINS, PASTES, FLUIDS, ELASTOMERS, VULCANIZING PREPARATIONS AND ACCELERATORS; ANTIFOAMING AGENTS; CHEMICAL CATALYSTS FOR PAINTS; CHEMICALS FOR DEVELOPING AND FIXING X-RAY FILMS AND OTHER CHEMICALS ASSOCIATED WITH THE DEVELOPMENT OF SAID FILMS; PHOSPHORS; CHEMICAL SUBSTANCES FOR USE AS NUCLEAR FISSIONABLE MATERIAL; FUEL FOR NUCLEAR REACTORS; ADHESIVE SUBSTANCES USED IN INDUSTRY; POLYCRYSTALLINE ALUMINA CERAMIC, FOR GENERAL USE IN THE INDUSTRY; SOLDERING FLUXES AND PREPARATIONS; THERMOPLASTIC AND THERMOSETTING ADHESIVES; CHEMICALS, BIOCHEMICALS AND REAGENTS FOR USE IN INDUSTRY, SCIENCE AND RESEARCH FOR NON-MEDICAL PURPOSES; CHEMICAL PREPARATIONS, TEST KITS AND REAGENTS FOR ANALYSIS OR DIAGNOSIS USED FOR SCIENTIFIC PURPOSES, NAMELY, CHEMICAL PREPARATIONS FOR CELL SEPARATION AND CULTURE, NUCLEIC ACID PURIFICATION, NUCLEOTIDES, FLUORESCENT NUCLEOTIDES, OLIGONUCLEOTIDES, PEPTIDES, PROTEINS, AMINO ACIDS, ORGANIC MOLECULES, AND MARKERS FOR DNA/RNA SYNTHESIS; SUBSTANCES FOR SCIENTIFIC OR MEDICAL RESEARCH USE, NAMELY, REAGENTS FOR LUMINESCENCE, REAGENTS FOR GENE EXPRESSION QUANTIFICATION, REAGENTS FOR USE WITH THE POLYMERASE CHAIN REACTION PROCESS, REAGENTS FOR USE WITH THE ROLLING CIRCLE AMPLIFICATION PROCESS, REAGENTS FOR DNA CLONING AND VECTORS, MODIFYING AND RESTRICTION ENZYMES, REAGENTS FOR LABELING, SEQUENCING AND FRAGMENT ANALYSIS OF NUCLEIC ACIDS, PROTEINS AND CUSTOM

Reg. No. 4,152,658 SYNTHESIS, REAGENTS FOR RECOMBINANT PROTEIN EXPRESSION PURIFICATION; CHROMATOGRAPHY CHEMICALS; SUBSTANCES FOR SCIENTIFIC OR MEDICAL RESEARCH USE, NAMELY, REAGENTS FOR ELECTROPHORESIS, BIOINFORMATICS, SPECTROPHOTOMETRY AND FLUOROMETRY; RADIOCHEMICALS FOR SCIENTIFIC RESEARCH USE; SUBSTANCES FOR SCIENTIFIC OR MEDICAL RESEARCH USE, NAMELY, REAGENTS FOR SCINTILLATING PROXIMITY ASSAYS, HIGH THROUGH PUT SCREENING ASSAYS FOR DRUG DEVELOPMENT, REAGENTS FOR HIGH RESOLUTION LASER FLUORESCENCE CONFOCAL MICROSCOPY; SPECIALTY CHEMICALS FOR USE IN INDUSTRY, SCIENCE AND RESEARCH; GASES AND GAS MIXTURES FOR INDUSTRIAL, RESEARCH AND SCIENTIFIC PURPOSES; CHEMICAL PREPARATIONS AND ADDITIVES FOR USE IN THE MANUFACTURE OF PHARMACEUTICAL PRODUCTS, AND DIAGNOSTIC PREPARATIONS AND SUBSTANCES; CHEMICAL TEST REAGENTS, SALINE SOLUTION AND REAGENT-COATED PAPER ALL FOR SCIENTIFIC AND LABORATORY USE; FISSIONABLE CHEMICAL ELEMENTS FOR SCIENTIFIC RESEARCH USE; RADIOACTIVE ELEMENTS AND ISOTOPES FOR INDUSTRIAL, SCIENTIFIC AND RESEARCH PURPOSES; RADIOACTIVE SOURCES AND STANDARDS FOR USE IN RADIOGRAPHIC TECHNIQUES; RADIOACTIVE SOURCES FOR USE IN NON-DESTRUCTIVE TESTING, PURIFICATION AND STERILIZING TECHNIQUES; RADIONUCLIDES FOR SCIENTIFIC RESEARCH USE; CHEMICALS AND CHEMICAL COMPOSITIONS FOR USE IN THE TREATMENT OF WATER SYSTEMS, WASTE WATER TREATMENT SYSTEMS, COOLING WATER SYSTEMS, BOILER WATER AND STEAM GENERATING SYSTEMS, BOILER CONDENSATE SYSTEMS, FLUID SEPARATION SYSTEMS, WATER CLARIFICATION AND DEWATERING IN AQUEOUS SYSTEMS, CONDITIONING SYSTEMS, GAS CLEANING SYSTEMS, INDUSTRIAL PROCESS SYSTEMS, FUELS AND FUEL PROCESSING SYSTEMS, HYDROCARBON AND GAS PROCESSING SYSTEMS, OIL AND GAS PROCESSING AND PETROCHEMICAL SYSTEMS, PULP AND PAPERMAKING SYSTEMS, METAL AND PLASTIC COATING SYSTEMS, METAL PROCESSING SYSTEMS; CHEMICAL PRODUCTS, NAMELY, CHEMICAL GASOLINE ADDITIVES, DISTILLATE CHEMICAL AND DETERGENT FUEL ADDITIVES AND PERFORMANCE ADDITIVES FOR FUELS USED IN TURBINE ENGINES; BAGS OF CHEMICALLY-TREATED WATER-ABSORBING GRANULAR MATERIALS FOR PLACEMENT INTO FUEL TANKS; TEST KIT CONSISTING OF REAGENTS USED FOR DETERMINING THE PRESENCE OF ALGAE AND ACTIVE ORGANIC ORGANISMS IN DIESEL FUEL; BACTERIA CULTURES AND NUTRIENTS FOR WASTE WATER AND SLUDGE TREATMENT; POLYMERIC CHEMICALS USED TO DISPERSE PARTICULATE MATTER IN STEAM GENERATING EQUIPMENT; CHEMICALS AND CHEMICAL COMPOSITIONS AS ANTIFOULANTS AND DEMULSIFIERS IN COKE-MAKING AND BY-PRODUCT OPERATIONS OF IRON AND STEEL INDUSTRIES; CHEMICALS, CATALYSTS, AND UNWORKED PLASTICS FOR USE AS FILTERING MATERIAL, ACID GAS ELIMINATING FILTERS, AND ZINC OXIDE WHISKER CRYSTALS FILTERS; UNPROCESSED PLASTICS, NONE OF THE ABOVE COVERING PHOTOGRAPHIC, CINEMATOGRAPHIC OR OPTICAL GOODS; ETCHING FLUIDS FOR DISSOLVING UNWANTED MATERIALS, NAMELY, METALS, SEMICONDUCTOR MATERIAL AND GLASS, IN CLASS 1 (U.S. CLS. 1, 5, 6, 10, 26 AND 46).

FOR: PAINTS, VARNISHES, LACQUERS; COATINGS IN THE NATURE OF PRESERVATIVES AGAINST RUST AND AGAINST DETERIORATION OF WOOD; COLORANTS; MORDANTS DYES; RAW NATURAL RESINS; METALS IN FOIL AND POWDER FORM FOR PAINTERS, DECORATORS, PRINTERS AND ARTISTS; CORROSION INHIBITANTS IN THE NATURE OF A COATING FOR USE IN THE METAL FINISHING INDUSTRY, NAMELY, A FINAL AQUEOUS ACIDIC RINSE; CORROSION INHIBITANTS IN THE NATURE OF A COATING FOR USE IN COOLING WATER SYSTEMS; CORROSION INHIBITANTS IN THE NATURE OF A COATING, NAMELY, RESINOUS COATINGS FOR METAL AND MASONRY SURFACES; COATING MATERIALS, NAMELY, COATINGS IN THE NATURE OF FLUIDS OR POWDERS FOR PROTECTION AGAINST CHEMICALS, WEATHER DAMAGES, SCRATCHES, PAINT CHIPPING; TONER CARTRIDGES FOR PRINTER USE; INK CARTRIDGES FOR PRINTER USE; TONERS, TONERS FOR COPYING APPARATUS AND MACHINES, TONERS FOR FACSIMILE APPARATUS AND MACHINES, IN CLASS 2 (U.S. CLS. 6, 11 AND 16).

Reg. No. 4,152,658 FOR: BLEACHING PREPARATIONS AND OTHER DETERGENT SUBSTANCES FOR LAUNDRY USE, NAMELY, LAUNDRY BLEACH, LAUNDRY BLUEING, LAUNDRY DETERGENT, LAUNDRY PRE-SOAK, LAUNDRY SIZING, LAUNDRY SOAP, LAUNDRY STARCH FOR LAUNDRY USE; GENERAL PURPOSE CLEANING, POLISHING, SCOURING AND ABRASIVE PREPARATIONS; SOAPS; PERFUMERY, ESSENTIAL OILS, COSMETICS, HAIR LOTIONS; DENTIFRICES; CLEANING PREPARATIONS CONTAINING CHEMICALS AND CHEMICAL COMPOSITIONS FOR USE IN CLEANING STEEL, ALUMINIUM, GALVANIZED AND MIXED METAL SURFACES FOR GENERAL INDUSTRIAL USE IN THE MANUFACTURE OF METAL PRODUCTS; CLEANING AGENTS CONTAINING CHEMICALS AND CHEMICAL COMPOSITIONS FOR USE IN INDUSTRY TO REMOVE CONTAMINANTS FROM INDUSTRIAL PROCESS SYSTEMS; PAINT STRIPPERS CONTAINING CHEMICALS AND CHEMICAL COMPOSITIONS TO REMOVE PAINT FROM EQUIPMENT SURFACES IN PAINT SPRAY BOOTH OPERATIONS, IN CLASS 3 (U.S. CLS. 1, 4, 6, 50, 51 AND 52).

FOR: DIESEL FUEL AND GASOLINE, IN CLASS 4 (U.S. CLS. 1, 6 AND 15).

FOR: PHARMACEUTICAL PREPARATIONS FOR USE IN TREATING RESPIRATORY DISORDERS AND MASCULOSKELETAL SYSTEM DISORDERS; SANITARY PREPARATIONS FOR MEDICAL PURPOSES; DIETETIC FOOD AND BEVERAGES ADAPTED FOR MEDICAL USE, FOOD FOR BABIES; MEDICAL PLASTERS AND DRESSINGS; MATERIAL FOR STOPPING TEETH, DENTAL WAX; ALL PURPOSE DISINFECTANTS; PREPARATIONS FOR DESTROYING VERMIN; FUNGICIDES, HERBICIDES; PHARMACEUTICAL DIAGNOSTIC PREPARATIONS FOR MEDICAL PURPOSES; PHARMACEUTICAL SUBSTANCES FOR MEDICAL PURPOSES, NAMELY, FOR USE IN TREATING RESPIRATORY DISORDERS AND MASCULOSKELETAL SYSTEM DISORDERS; DIAGNOSTIC REAGENTS AND PREPARATIONS FOR MEDICAL PURPOSES; DIAGNOSTIC SUBSTANCES FOR MEDICAL PURPOSES; CONTRAST MEDIA FOR MEDICAL IMAGING; DIAGNOSTIC SCANNING AGENTS FOR IN VIVO USE; DIAGNOSTIC IMAGING AGENTS FOR MAGNETIC RESONANCE IMAGING; DIAGNOSTIC RADIOPHARMACEUTICAL PREPARATIONS FOR CLINICAL, MEDICAL, SCIENTIFIC AND RESEARCH USE; RADIOPHARMACEUTICAL SOURCES AND STANDARDS FOR USE IN NUCLEAR MEDICINE; RADIOACTIVE PHARMACEUTICAL PREPARATIONS AND NON-RADIOACTIVE REAGENTS FOR PRODUCING RADIOPHARMACEUTICALS FOR IN VIVO DIAGNOSTIC OR THERAPEUTIC USE; GASES AND GAS MIXTURES FOR MEDICAL IMAGING; PRE-FILLED VIALS CONTAINING MEDICAL DIAGNOSTIC REAGENTS; PRE-FILLED CARTRIDGES CONTAINING CHEMICAL REAGENTS FOR MEDICAL USE; PRE-FILLED CYLINDERS CONTAINING GASES AND GAS MIXTURES FOR MEDICAL USE, IN CLASS 5 (U.S. CLS. 6, 18, 44, 46, 51 AND 52).

FOR: COMMON METALS AND THEIR ALLOYS; METAL BUILDING MATERIALS, NAMELY, PANELS, BARS, TUBES, COILS, PIPES, SHEETING, FRAMING, SOFFITS; TRANSPORTABLE BUILDINGS OF METAL; MATERIALS OF METAL FOR RAILWAY TRACKS; NON-ELECTRIC CABLES AND WIRES OF COMMON METAL; IRONMONGERY IN THE NATURE OF SMALL ITEMS OF METAL HARDWARE, NAMELY, DOOR HANDLES, DOOR KNOBS, DOOR AND WINDOW HINGES, DOOR AND WINDOW LOCKS, DOOR AND WINDOW FITTINGS, BOLTS, HOOKS, AND BRACKETS; PIPES AND TUBES OF METAL; METAL SAFES; METAL ORES; METAL LOCKS; METAL SECURITY ENCLOSURES, NAMELY, KEY CABINETS, STORAGE TUBES AND STORAGE BOXES FOR SECURING KEYS; METAL LOCK BOXES FOR RESIDENTIAL, VEHICULAR, INDUSTRIAL AND REAL ESTATE SALES USE; METAL KEY CABINETS FOR LOCKING, TRACKING AND STORING KEYS; METAL KEY SAFES; COMMON METALS AND METAL ALLOYS IN RAW, SHEET, WIRE, PELLETS, ROD, FOIL, STRIP, LIQUID, CASTINGS, SINTERED, PRESSED AND FABRICATED FORM; METAL KEY CHAINS AND KEY RINGS; METAL TROLLEY DUCTS FOR WIRING, DOORS OF METAL, GATES OF METAL, WIRELESS OPERATED METAL GARAGE DOORS, ACID-RESISTANT HIGH-POLYMER METAL CLADDING FOR BUILDING AND CONSTRUCTION, STEEL SHEETING, STEEL PANELS FOR OFFICE FLOORING, WELDING WIRE, IN CLASS 6 (U.S. CLS. 2, 12, 13, 14, 23, 25 AND 50).

Reg. No. 4,152,658 FOR: MACHINES AND MACHINE TOOLS FOR CUTTING AND FORMING OF MATERIALS; MOTORS AND ENGINES NOT FOR LAND VEHICLES FOR GENERATING POWER AND ELECTRICITY; MACHINE COUPLINGS AND TRANSMISSION COMPONENTS NOT FOR LAND VEHICLES, NAMELY, SHAFTS AND GEAR BOXES; AGRICULTURAL IMPLEMENTS OTHER THAN HAND OPERATED IMPLEMENTS, NAMELY, INCORPORATORS AND SEED DRILLS; INCUBATORS FOR EGGS; APPARATUS, EQUIPMENT AND INSTRUMENTS FOR THE GENERATION OF POWER, NAMELY, ELECTRIC GENERATORS AND WIND POWERED ELECTRICITY GENERATORS; TURBINES; TURBINES FOR POWER GENERATION; WIND TURBINES FOR POWER GENERATION; WIND TURBINES IN ASSOCIATION WITH WIND FARMS, TURBINE GENERATING INSTALLATIONS, NAMELY, ELECTRIC POWER GENERATING INSTALLATIONS; ENGINES FOR THE GENERATION OF ELECTRICITY; AND PARTS AND FITTINGS FOR ALL THE AFORESAID; SOLAR-POWERED ELECTRICITY GENERATORS; DYNAMO ELECTRIC MACHINES, ELECTRIC MOTORS NOT FOR LAND VEHICLES, STEAM TURBINES, GAS TURBINES AND PARTS THEREOF, ELECTRIC GENERATORS AND THEIR PARTS, AIRCRAFT ENGINES, COMPRESSORS, NAMELY, AIR COMPRESSORS; WASHING MACHINES FOR CLOTHES, DISHWASHERS, GARBAGE DISPOSERS AND COMPACTORS; PUMPS, NAMELY, CENTRIFUGAL PUMPS, DIAPHRAGM PUMPS, BELLOWS PUMPS AND ELECTRIC PROCESS AND TRANSFER PUMPS; MACHINE PARTS, NAMELY, FLUID SEPARATION CARTRIDGES AND PARTS THEREFORE, IN THE NATURE OF SEMI-PERMEABLE MEMBRANES; FILTER CARTRIDGES FOR VARIOUS INDUSTRIAL MACHINES FOR FILTRATION APPLICATIONS INCLUDING THE FILTRATION OF COATING SOLUTIONS FOR THE MANUFACTURE OF MAGNETIC TAPE AND THE FILTRATION OF PETROCHEMICALS, PORTABLE WATER, BEER IN THE BREWING INDUSTRY, AND OTHER SPECIALTY CHEMICALS; MACHINES FOR THE FEEDING AND APPLICATION OF CHEMICALS FOR INDUSTRIAL USE; AXIAL AND CENTRIFUGAL COMPRESSORS; RECIPROCATING COMPRESSORS; SCREW AND VANE COMPRESSORS; ROTARY, VACUUM, ELECTRIC, SUBMERSIBLE AND CENTRIFUGAL PUMPS; TURBOEXPANDERS, NAMELY, AIR AND ELECTRIC COMPRESSORS; CNG (COMPRESSED NATURAL GAS) REFUELING MACHINES FOR LAND VEHICLES AND INDUSTRIAL EQUIPMENT AND ACCESSORIES AND PARTS FOR ALL THE FOREGOING NAMELY, PUMPS, VALVES, FUEL FILTERS, FILTER CASINGS, DISTRIBUTOR ROTORS, BLADES, BEARINGS AND MECHANICAL SEALS; STEAM CONDENSERS; BOAT ENGINES; TURBOCHARGERS FOR ENGINES; FUEL INJECTORS; WELDING MACHINES, INDUSTRIAL ROBOTS, MACHINES FOR INSERTING ELECTRONIC COMPONENTS, DRY ETCHING MACHINERY, MICRO ELECTRIC-DISCHARGE MACHINES, OPTICAL DISC PRODUCTION MACHINES, PRECISION JOINING MACHINES, PROCESSING MACHINES FOR PRINTED WIRED BOARDS AND WELDING WIRE, PARTS MOUNTING MACHINES, SOLDERING MACHINES, SCREW FASTENING MACHINES, ELECTRIC POWER TOOLS, NAMELY, DRILLS, SAWS, STONE CUTTERS, TILE CUTTERS, POLISHERS, SOLDERING CHISELS, SANDERS, BLOWERS, ROTARY HAMMERS, GRINDERS, SCREW DRIVERS, WRENCHES, SHEARS; ELECTRIC MOTORS FOR MACHINES, ELECTRIC GENERATORS; ELEVATORS; LAUNDRY CENTERS, NAMELY, A CLOTHES WASHER COMBINED WITH A CLOTHES DRYER; ELECTRIC CLOTHES WASHING MACHINES, ELECTRIC DISH WASHERS; ELECTRIC COMPRESSORS; PUMPS, NAMELY, ELECTRIC PUMPS; MIXING, CUTTING AND CHOPPING MACHINES, ELECTRIC FOOD BLENDING MACHINES, ELECTRIC JUICE EXTRACTORS, ELECTRIC FOOD PROCESSORS, ELECTRIC MEAT GRINDERS, ELECTRIC CAN OPENERS, ELECTRIC KNIFE SHARPENERS, ELECTRIC COFFEE MILLS, ELECTRIC ICE CRUSHERS, ELECTRIC WASTE PROCESSORS; POWER-OPERATED GARDEN TOOLS, NAMELY, HEDGE TRIMMERS, SHREDDERS, CHIPPERS, CULTIVATORS, LEAF BLOWERS, GRASS SHEARS; ELECTRIC LAWN MOWERS, POWER-OPERATED GARDEN SPRAYERS FOR DISINFECTANTS AND INSECTICIDES; ELECTRIC APPLIANCES FOR CLEANING, NAMELY, ELECTRIC VACUUM CLEANERS, ELECTRIC FLOOR POLISHERS; ELECTRIC WINDOW CLEANERS; ELECTRICITY GENERATORS FOR HOME USE, ARC, GAS AND PLASMA METAL CUTTING MACHINES; ELECTRIC FOOD BLENDERS, ELECTRIC JUICERS, ELECTRIC MIXERS, ELECTRIC FOOD PROCESSOR, ELECTRIC MEAT GRINDERS, ELECTRIC CAN OPENERS, ELECTRIC KNIFE SHARPENERS; FOOD WASTE DISPOSALS FOR KITCHENS, IN CLASS 7 (U.S. CLS. 13, 19, 21, 23, 31, 34 AND 35).

Reg. No. 4,152,658 FOR: BLANK MAGNETIC DATA CARRIERS, BLANK RECORDING DISCS, NAMELY, COMPACT DISCS; CASH REGISTERS, CALCULATING MACHINES, DATA PROCESSING EQUIPMENT AND COMPUTERS; FIRE-EXTINGUISHING APPARATUS; PROTECTIVE HELMETS FOR SPORTS; GLASSES, SUNGLASSES, SPORTS GLASSES, NAMELY, SPORTS GOGGLES FOR USE IN SKIING, RACQUETBALL, SWIMMING; COMPUTER SOFTWARE FOR INDIVIDUAL AND MULTI-PLAYER NETWORK GAMES AND INTERACTIVE EVOLUTIVE SCENARIO GAMES; FUEL PUMPS FOR SERVICE STATIONS FOR FUELING AIRPLANE ENGINES; FUEL DISTRIBUTION EQUIPMENT, NAMELY, METERED FUEL PUMPS, ELECTRICAL FUEL LEVEL GAUGES, CONTROL VALVES FOR REGULATING THE FLOW OF GASES AND FUEL LINES; AUTOMATED FUEL STATION MANAGEMENT SYSTEMS, COMPRISED OF COMPUTER OPERATING SOFTWARE, METERED FUEL PUMPS, RATE CONTROL PANELS, FUEL LINES AND DISPENSING NOZZLES FOR FUELING LAND AND MARINE VEHICLES AND MARINE VEHICLES AND AIRCRAFT; GAS METERS; AUTOMATED RAILWAY TRACK SWITCH MACHINES; GLOBAL POSITION SYSTEM (GPS) BASED TRACKING AND MONITORING SYSTEMS FOR THE RAILROAD AND TRANSIT INDUSTRIES; ELECTRICAL DEVICES AND ELECTRICAL POWER DISTRIBUTION PRODUCTS, NAMELY, CAPACITORS, CIRCUIT BREAKERS, CIRCUIT BREAKER LOAD CENTERS, CIRCUIT CLOSERS, CIRCUIT INTERRUPTERS, COMMUTATORS, CONTACTORS, CURRENT RECTIFIERS, CURRENT LIMITERS, ELECTRIC CONTACTS, ELECTRIC COLLECTORS, ELECTRIC CONDUCTORS, ELECTRIC CONNECTORS, ELECTRIC CONTROLLERS, ELECTRIC INDUCTORS, ELECTRIC POWER SUPPLIES, ELECTRICITY DISTRIBUTION BOARDS AND BOXES, ELECTRICITY DISTRIBUTION CONSOLES, ELECTRICITY SWITCHBOARDS AND SWITCHBOXES; COMPUTER SOFTWARE FOR TROUBLESHOOTING AND MAINTAINING PROGRAMMABLE CONTROLLERS, FOR ANALYZING BLOOD VESSELS INCLUDING CARDIAC VESSELS WHICH ALSO PROVIDES CALCULATION FUNCTIONS WITH RESPECT TO BLOOD VESSELS, FOR USE WITH MEDICAL PATIENT MONITORING EQUIPMENT, FOR RECEIVING, PROCESSING, TRANSMITTING AND DISPLAYING DATA, FOR USE IN DEVELOPING PERSONALIZED ASSET ALLOCATION PROGRAMS, FOR USE ON-LINE TO ENABLE OFFICE EQUIPMENT DEALERS TO SUBMIT APPLICATIONS, MANAGE PORTFOLIOS AND COMMUNICATE WITH THE COMPANY, FOR USE IN ACCESSING MORTGAGE AND INSURANCE INFORMATION, FOR COLLECTING DATA INVOLVING VITAL MEDICAL SIGNS, FOR USE WITH ELECTRICAL POWER SYSTEMS ANALYSES AND INSTRUCTIONAL MANUAL SOLD AS A UNIT THEREWITH, FOR USE BY EMPLOYEES FOR FINANCIAL INSTITUTIONS FOR DETERMINING FINANCIAL INVESTMENTS FOR CLIENTS AND IN PROCESSING THE SALE OF THE IDENTIFIED INVESTMENTS, FOR OBTAINING INFORMATION ON THE FLOOD-HAZARD STATUS OF REAL PROPERTY, FOR THE DEVELOPMENT OF GRAPHICAL USER INTERFACES AND DATA VISUALIZATION, FOR USE TO CALCULATE MORTGAGE PAYMENTS, FOR REGULATING AND MANAGING VEHICLE FLEET MAINTENANCE SERVICES, FOR USE IN CONNECTION WITH ACCESSING AND UTILIZING COMMERCIAL COMPUTER SERVICES, FOR USE BY CUSTOMERS TO OBTAIN LEASE PORTFOLIO INFORMATION, FOR A RADIOLOGY INFORMATION SYSTEM FOR USE BY RADIOLOGISTS AND RADIOLOGY DEPARTMENT IN THE DATABASE MANAGEMENT OF EMPLOYEE AND PATIENT INFORMATION, FOR PATIENT MONITORING AND ARCHIVAL PURPOSES, INSTALLED ON AND USED IN CONNECTION WITH PCS AND MEDICAL MONITORING EQUIPMENT, FOR GRAPHICAL USER INTERFACE, FOR USE IN SENDING ENCRYPTED AND COMPRESSED DATA OVER PAGING CARRIER SYSTEMS, FOR PROVIDING ACCESS TO WEBSITES WHERE BUYERS AND SELLERS CAN CONDUCT BUSINESS ELECTRONICALLY, AND FOR UNDERGROUND NAVIGATION, NAMELY, FOR NAVIGATION OF DOWN HOLE PROBE ASSEMBLY FOR OIL DRILLING AND DRILLING ASSEMBLIES FOR ROUTING UNDERGROUND UTILITIES; ELECTRICAL GOODS, ELECTRICAL POWER GENERATION AND DISTRIBUTION PRODUCTS AND ELECTRICAL VOLTAGE AND OVERVOLTAGE SURGE PRODUCTS, NAMELY, ARRESTERS, BUSWAYS, CAPACITORS, LIGHTING CONTACTORS, CONTROLLERS AND INPUT/OUTPUT DEVICES IN THE NATURE OF KEYBOARDS AND MONITORS, FUSES, LIGHTING CONTROLLERS, SWITCH BOXES, LEDS, NAMELY, LIGHT EMITTING DIODES, VOLTAGE REGULATORS FOR ELECTRIC POWER, VOLTAGE SURGE PROTECTORS, VOLTAGE SURGE SUPPRESSORS, VOLTMETERS, ELECTRICAL CIRCUIT BOARDS, RE-

Reg. No. 4,152,658 LAYS AND TIMERS, SOLENOIDS AND LIMIT SWITCHES, FULL-VOLTAGE MANUAL STARTERS, REDUCED VOLTAGE STARTERS, ELECTRICAL SWITCHES AND DISCONNECTS, CIRCUIT BOARD TERMINAL BLOCKS AND PUMPING PANELS, CIRCUIT BREAKERS AND DISCONNECTS, TRANSFORMERS, ELECTRICAL LIGHTING AND POWER CIRCUIT BOARDS, ELECTRICAL WIRES, CABLES, CORDS, AND CONDUCTORS, ELECTRICAL WIRING, LIGHTNING ARRESTERS, ELECTRICITY METERS, POWER METERS, GROUNDING RESISTORS, HUMIDITY AND TEMPERATURE SENSORS; BUILDING AND WOOD SENSORS, SPECIFICALLY SOUND WAVE AND VIBRATION SENSORS; INDUSTRIAL CALIBRATION SENSORS, SPECIFICALLY, PROXIMITY SENSORS; PUSH BUTTONS, MOTOR CONTROL CENTERS COMPRISED PRIMARILY OF PHYSICAL GROUPINGS OF COMBINATION STARTERS IN ONE ASSEMBLY; ELECTRICAL RESISTANCE HEATING WIRES AND ELECTRICAL CONTROLLERS THEREFOR AND VOLTAGE REGULATORS; SOFTWARE AND SOFTWARE PROGRAMS FOR DATA COLLECTION, DATA MANAGEMENT AND DATA ANALYSIS FOR USE IN INDUSTRIAL, RESEARCH, AND MEDICAL USE; APPARATUS FOR ELECTROPHORESIS NOT FOR MEDICAL USE; CHROMATOGRAPHY COLUMNS AND PUMPS; APPARATUS FOR BIOINFORMATICS SYSTEMS, NAMELY, COMPUTER HARDWARE AND SOFTWARE FOR PROCESSING BIOLOGICAL INFORMATION; APPARATUS FOR SCINTILLATION, NAMELY, SCINTILLATION COUNTER TO MEASURE BETA-EMITTING NUCLIDES; IMAGING APPARATUS FOR RADIOACTIVE AND LUMINESCENT EMISSIONS, NAMELY, CAMERAS AND SCANNERS; SYNTHESIS AND PURIFICATION INTEGRATED SYSTEMS, NAMELY, CHROMATOGRAPHY COLUMNS, CARTRIDGES, FRACTION COLLECTORS, MIXERS, MONITORS, PUMPS, RECORDERS AND ANALYSIS SOFTWARE; APPARATUS FOR MICROARRAYS, NAMELY, PROBES, SLIDES, BUFFERS, BACTERIAL CONTROLS, RACKS AND TRAYS; LASER BASED OPTICAL APPARATUS FOR DIGITAL IMAGING NOT FOR MEDICAL USE; LABORATORY ARTICLES, NAMELY, MICROARRAY SLIDES; LABORATORY GLASSWARE, VIALS AND MICROVIALS AND MICROTITRE PLATES; COMPUTER SOFTWARE FOR HOSPITAL OPERATING ROOM MANAGEMENT; COMPUTER SOFTWARE FOR CRITICAL CARE INFORMATION MANAGEMENT; INDUSTRIAL PROCESS CONTROL SOFTWARE; COMPUTER SOFTWARE PROGRAMS AND PROGRAM MANUALS SOLD AS A UNIT FOR USE IN FACTORY MANAGEMENT; GRAPHICAL USER INTERFACE BASED COMPUTER PROGRAMS FOR CONTROLLING MACHINES IN INDUSTRIAL AUTOMATION APPLICATIONS; SOFTWARE FOR CREATING GRAPHICS DISPLAYS AND EDITING DYNAMIC DATA INTERFACES FOR REAL TIME GRAPHICS APPLICATIONS FOR INDUSTRIAL AND BUSINESS APPLICATIONS; COMMUNICATIONS SOFTWARE FOR CONNECTING COMPUTER NETWORK USERS; INDUSTRIAL PROCESS SOFTWARE FOR PLASTIC INJECTION MOLDING; SOFTWARE FOR CONTROL, MONITORING, SIMULATION, COMMUNICATIONS, DATA LOGGING AND COLLECTION, AND FACTORY AUTOMATION; SOFTWARE TO INTEGRATE MANUFACTURING MACHINE OPERATIONS, CONTROL PROCESSES, PROVIDE DATA FOR VISUALIZATION, TRACK PROBLEMS AND GENERATE PRODUCTION REPORTS; PACKAGED SOFTWARE FOR USE IN THE OPERATION AND PROGRAMMING OF GRINDING MACHINES IN THE MANUFACTURING INDUSTRY; INDUSTRIAL PROCESS CONTROL HARDWARE, NAMELY, COMPUTER MONITORS; LAPTOP COMPUTERS, ETHERNET CARDS AND CABLES; COMPUTER NETWORKING HARDWARE, MEMORY CARDS; MICROCHIPS; MICROPROCESSORS; COMPUTER NETWORK HUBS, SWITCHES AND ROUTERS, COMPUTER PERIPHERALS, DISPLAYS AND TERMINALS; COMPUTER WHITEBOARDS; SYSTEM BOARDS AND PROCESSORS; INDUSTRIAL PROCESS CONTROLLERS FEATURING CALL CONTROL, OPERATOR INTERFACE, GAGE INTERFACES AND DATA COLLECTORS; COMPUTER SOFTWARE FOR CONTROL AND MANUFACTURING APPLICATIONS, NAMELY, STATISTICAL PROCESS CONTROL, DATA COLLECTION, AND DISTRIBUTED NUMERICAL CONTROL; MANUFACTURING EXECUTION SYSTEMS AND DOCUMENT MANAGEMENT SOFTWARE; DIGITAL SIGNAL PROCESSING PRODUCTS AND SYSTEMS, NAMELY, INDUSTRIAL AUTOMATION CONTROLS AND PROGRAMMABLE LOGIC CONTROLLERS; MACHINE TOOLS, NAMELY, AN ADAPTIVE CONTROL PRODUCT IN THE NATURE OF AN EXTERNAL CONTROLLER TO OPTIMIZE MACHINE TOOL CUTTING PERFORMANCE OF ROUGH AND SEMI-ROUGH CUTS; DISTRIBUTED AND REMOTE INPUT/OUTPUT COMPUTER HARDWARE DEVICES, INPUT/OUTPUT MODULES, INTERFACE MODULES, POWER SUPPLIES AND MOUNTING

Reg. No. 4,152,658 HARDWARE THEREFOR; INTRUSION AND BURGLAR ALARM SYSTEMS, SECURITY DEVICES, NAMELY, PROGRAMMING LOGIC COMPUTERS, CONTROL PANELS, ELECTRONIC INTRUSION DETECTORS, ELECTRONIC GLASS-BREAK SENSORS, ELECTRONIC VIBRATION SENSORS, MAGNETIC CONTACTS FOR USE IN SECURITY SYSTEMS, ELECTRONIC SWITCH PLATES, ELECTRONIC MOTION SENSORS FOR ALARM SYSTEMS, ELECTRONIC MOTION SENSITIVE SWITCHES, HARD-WIRE SIRENS, AUDIO SPEAKERS, ELECTRONIC DRIVERS, ACCESS CONTROL AND ALARM MONITORING SYSTEMS; FIRE, HEAT AND SMOKE DETECTING AND ALARM UNITS; COMPUTER CARD OPERATED ACCESS CONTROL SYSTEMS; CARD READERS, CARD ENCODERS, AND ENCODED CARDS FOR USE WITH CARD OPERATED ACCESS CONTROL SYSTEMS; VIDEO CAMERAS; VIDEO OBJECT RECOGNIZERS; VIDEO OBJECT TRACKERS; VIDEO LICENSE PLATE READERS; VIDEO ALARM VERIFIERS; VIDEO FACE RECOGNIZERS; VIDEO VEHICLE RECOGNIZERS; VIDEO TRAFFIC DETECTORS; VIDEO ACCESS DOOR CONTROLLERS; VIDEO INTRUSION DETECTORS; PROCESSING HARDWARE AND SOFTWARE THAT ANALYZES DIGITAL VIDEO IMAGES TO AUTOMATICALLY EXTRACT, RECORD AND REPORT INTELLIGENCE, AND REMOTE VIDEO MONITORING SYSTEMS FOR SECURITY AND SURVEILLANCE APPLICATIONS; CENTRAL VIDEO MONITORS; VIDEO RECORDERS; CAMERAS; CLOSED CIRCUIT VIDEO SYSTEMS; CLOSED CIRCUIT VIDEO SYSTEM COMPRISING ONE OR MORE CAMERAS, AND A CAMERA HOUSING; SHORT RANGE, WIRELESS, RADIO FREQUENCY TRANSCEIVERS; POWER LINE TRANSCEIVERS; COMMUNICATION CONTROL HARDWARE FOR OPERATING CLOSED CIRCUIT CAMERA; COMMUNICATION CONTROL HARDWARE, NAMELY, KEYPAD CONTROLLERS, MATRIX SWITCHERS, MULTIPLEXERS, DIGITAL VIDEO RECORDERS, INTEGRATED PAN-TILT-ZOOM DOMES, REMOTE VIDEO CONTROLLERS, RECEIVERS, ELECTRONIC ALARM, MANAGEMENT CONTROLS AND TRIGGERS, AND VIDEO TRANSMISSION DEVICES SOLD SEPARATELY OR AS PART OF A SYSTEM FOR OPERATING CLOSED CIRCUIT CAMERAS; PERSONAL DIGITAL ASSISTANT DEVICES CONFIGURED FOR USE BY REAL ESTATE PROFESSIONALS; COMMUNICATIONS INTERFACE DEVICES FOR USE WITH PERSONAL DIGITAL ASSISTANT DEVICES, FIBER-OPTIC TRANSMISSION SYSTEMS, NAMELY, FIBER OPTIC TRANSMITTERS, RECEIVERS AND TRANSCEIVERS USED IN THE TRANSMISSION OF VIDEO, AUDIO, AND DATA SIGNALS OVER OPTICAL FIBER; ELECTRICAL SWITCHES; ELECTRO-MECHANICAL LOCKS; MAGNETIC LOCKS; ELECTRIC KEYS; HAND HELD ELECTRONIC HARDWARE FOR RECEIVING, CONTROLLING, STORING, MANIPULATING, DISPLAYING AND TRANSMITTING DATA AND FOR OPERATING ELECTRONIC LOCKS; ELECTRONIC ACCESS CARDS AND READERS AND ENCODERS THEREFORE; MAGNETIC ACCESS CARDS AND READERS AND ENCODERS THEREFORE; SMART ACCESS CARDS AND READERS AND ENCODERS THEREFORE; PROXIMITY CARDS AND READERS AND ENCODERS THEREFORE; ELECTRONIC KEY FOBS AND READERS AND ENCODERS THEREFORE; BAR CODE ACCESS CARDS AND READERS, ENCODERS; ACCESS KEYPADS; RADIO FREQUENCY TRACKING TAGS; TRACKING AND CONTROL SYSTEM COMPRISING ONE OR MORE RADIO FREQUENCY TAGS, TRANSCEIVERS, AND SENSORS USED TO DETERMINE AND MONITOR THE LOCATION AND MOVEMENT OF TANGIBLE ASSETS, INVENTORY AND INDIVIDUALS; INFRARED SENSORS; COMPUTER HARDWARE AND SOFTWARE FOR FACILITIES MANAGEMENT AND CONTROLLING FACILITY ACCESS SYSTEMS AND COMPONENTS THEREFORE, NAMELY, CONTROL PANELS, ACCESS CARD READERS, AND EQUIPMENT AND SYSTEMS FOR VIDEO IMAGING, VIDEO MONITORING, DIGITAL HARD DRIVE RECORDING, NETWORK TRANSMISSION AND REMOTE ACCESS; NETWORKED DIGITAL VIDEO STORAGE SERVERS FOR ACCESS CONTROL AND SURVEILLANCE APPLICATIONS, ALARM MONITORING AND SECURITY; COMPUTER SOFTWARE AND HARDWARE FOR CONTROLLING AND OPERATING SECURITY AND ACCESS SYSTEM COMPRISING LOCKS, DOORS, ACCESS, AND IDENTIFICATION; DEVICES AND SECURITY ENCLOSURES IN THE NATURE OF ELECTRONIC BOXES FOR SECURING KEYS; SURVEILLANCE EQUIPMENT SOLD INDIVIDUALLY AS COMPONENTS OR TOGETHER AS A SYSTEM COMPRISING ONE OR MORE SURVEILLANCE CAMERAS, COVERT CAMERAS, CLOSE CIRCUIT TELEVISION CAMERAS, CAMERA HOUSINGS, CAMERA MOUNTS, CAMERA LENSES, VIDEO MONITORS, VIDEO RECORDERS, DIGITAL RECORDERS, VIDEO STORAGE MEDIA, VIDEO SWITCHES, CONTROL PANELS, KEYPAD CONTROL-

Reg. No. 4,152,658 LERS, JOYSTICK CONTROLLERS, ELECTRONIC DISPLAY INTERFACES FOR ALARMS AND ACCESS CONTROL EQUIPMENT, TRANSCIEVERS, RECEIVERS, TRANSMITTERS, SIGNAL PROCESSORS, MULTIPLEXERS, MATRIX SWITCHES, CONTROLLERS, CONTROL PANEL HOUSING, SWITCH HOUSING, TRANSFORMERS SWITCHES, SPLITTERS, COAXIAL CABLES, CONNECTORS, MOTION DETECTORS, MICROPHONES AND SPEAKERS; COMPUTER USER INTERFACE SOFTWARE AND CONTROL SOFTWARE FOR MANAGING SECURITY, FIRE AND ACCESS SYSTEMS; ELECTRIC LOCKS; HAND-HELD ELECTRONIC COMPUTER AND COMMUNICATION HARDWARE FOR RECEIVING, CONTROLLING, STORING, MANIPULATING, DISPLAYING AND TRANSMITTING DATA FOR OPERATING ELECTRONIC LOCKS, ELECTRONIC KEY FOBS, READERS AND ENCODERS; DATA PROCESSING SOFTWARE AND COMPUTER HARDWARE; POWER SUPPLIES, NAMELY, BATTERIES, VOLTAGE AND CURRENT REGULATORS AND TRANSFORMERS; CONTROL PANELS, NAMELY, ELECTRONIC APPARATUS ADAPTED TO ELECTRICALLY MONITOR A PRE-DETERMINED ACTIVITY AND ACTIVATE A BURGLAR ALARM; SIREN SPEAKERS; AND ELECTRONIC SIREN DRIVERS, NAMELY, TONE GENERATORS AND AMPLIFIERS ADAPTED TO BE USED FOR SIRENS; COMPUTER SOFTWARE TO CONTROL COMMUNICATION HARDWARE FOR OPERATING AND CONTROLLING CLOSED CIRCUIT CAMERAS; SWITCH UNITS INCORPORATING MAGNETICALLY ACTUATED REED SWITCHES FOR USE IN BURGLARY AND FIRE SENSING ALARM SYSTEMS, IN INDUSTRIAL POSITION SENSING APPARATUS, IN REVOLUTION COUNTERS, IN EQUIPMENT CABINET SAFETY INTERLOCK SYSTEMS, IN INDUSTRIAL POSITION CONTROLLING APPARATUS, IN ELECTRICAL CABLES AND IN PUMP AND VALVE CONTROLLING APPARATUS AND HOME SECURITY ALARM SYSTEMS; ELECTRICAL AND ELECTRONIC CHECKING APPARATUS, NAMELY, DETECTORS, SCANNERS AND MONITORS FOR SCREENING INDIVIDUALS, BAGGAGE, AND CARGO FOR THE PRESENCE OF PARTICULAR SUBSTANCES; ELECTRICAL AND ELECTRONIC CHECKING APPARATUS, NAMELY, DETECTORS, SCANNERS AND MONITORS FOR SCREENING INDIVIDUALS, BAGGAGE, AND CARGO FOR THE PRESENCE OF EXPLOSIVES AND/OR NARCOTICS; APPARATUS FOR DETECTING PRESENCE OF EXPLOSIVES AND OTHER CONTRABAND; TIME OR CONDITION SENSING APPARATUS FOR INITIATING AND CONTROLLING REGENERATION OR BACKWASH CYCLES FOR WATER TREATMENT EQUIPMENT; BIOREACTORS FOR CULTURING CELLS; PORTABLE ANALYTICAL INSTRUMENTS NAMELY, A PROBE WITH A MICROPROCESSOR BASED DATA CONVERSION LOGGER FOR MEASUREMENT OF ORGANIC AND INORGANIC CHEMICALS IN WATER; FILTERS AND FILTER HOUSINGS FOR LABORATORY USE; FLUID SEPARATION APPARATUS FOR LABORATORY USE; MEMBRANE FILTERS FOR LABORATORY USE; SILT DENSITY MEASURING DEVICE; DEIONIZATION UNITS FOR LABORATORY USE; FLUID FLOW CONTROL DEVICES, NAMELY, PUMPS, VALVES, FLOW METERS AND REGULATORS FOR LABORATORY USE; OZONE MONITORS; LABORATORY EQUIPMENT, NAMELY, POROUS MICROTITER PLATES FOR USE IN CELL BIOLOGY AND OTHER LIFE SCIENCE APPLICATIONS; ELECTRONIC WATER AND PROCESS TREATMENT CONTROLS, NAMELY, APPARATUS FOR USE IN THE TREATMENT OF COMMERCIAL AND INDUSTRIAL WATER SYSTEMS, BOILER WATER SYSTEMS, COOLING WATER SYSTEMS, AND CLOSED WATER SYSTEMS, PULP AND PAPER PROCESSING SYSTEMS, FUEL PROCESSING SYSTEMS, AND METAL PROCESSING SYSTEMS TO ANALYZE THE CHEMISTRY OF THE SYSTEM, DETERMINE THE PROPER TREATMENT PROGRAM, APPLY THE DESIRED TREATMENT AND MONITOR THE EFFECTIVENESS OF THE TREATMENT; COMPUTER SOFTWARE FOR DATA MANAGEMENT IN THE WATER TREATMENT AND PULP AND PAPER FIELDS; ELECTRONIC CONTROLLERS USED FOR PROCESSING INFORMATION IN THE WATER TREATMENT AND PULP AND PAPER FIELDS; APPARATUS FOR USE IN INDUSTRIAL WATER SYSTEMS TO MEASURE AND CONTROL PH AND CONDUCTIVITY; APPARATUS FOR FEEDING CHEMICAL TO AN INDUSTRIAL, COMMERCIAL OR MUNICIPAL WATER SYSTEM IN MEASURED AMOUNTS; ELECTRONIC TEST APPARATUS FOR USE IN WATER TREATMENT; LABORATORY TESTING EQUIPMENT---NAMELY, DEPOSITION AND CORROSION RATE TESTERS; MOBILE LABORATORY EQUIPPED WITH EQUIPMENT AND INSTRUMENTATION TO MONITOR AND MEASURE PH, CONDUCTIVITY, AND CHROMATE CONCEN-

Reg. No. 4,152,658 TRATION OF INDUSTRIAL AND DOMESTIC WATERS, TO CONDUCT INORGANIC ANALYSIS OF WATER AND TO CONDUCT MICROBIOLOGICAL TESTING OF WATER; ELECTRONIC AND ELECTROCHEMICAL PRODUCTS, NAMELY, FUEL CELLS; PHOTO-VOLTAIC SOLAR CELLS AND CELL MODULES, PHOTOVOLTAIC SOLAR HYBRID MODULES, ELECTRONICAL SENSORS FOR MEASURING SOLAR RADIATION, SOLAR CELLS; APPARATUS FOR CONVERTING ELECTRONIC RADIATION TO ELECTRICAL ENERGY, NAMELY, PHOTOVOLTAIC SOLAR MODULES AND PARTS THEREFOR; PRINTERS, LASER PRINTERS, INK JET PRINTERS, MULTIFUNCTION AND ALL IN ONE PRINTERS; ELECTRONIC HAND-HELD UNITS FOR THE WIRELESS RECEIPT AND TRANSMISSION OF DATA THAT ENABLES THE USER TO KEEP TRACK OF OR MANAGE PERSONAL INFORMATION AND HAS THE CAPACITY TO TRANSMIT AND RECEIVE VOICE, IMAGE AND VIDEO COMMUNICATION; SOFTWARE FOR THE SYNCHRONIZATION OF DATA BETWEEN A REMOTE STATION OR UNIT AND A FIXED OR REMOTE STATION OR UNIT AND SOFTWARE WHICH ENABLES AND PROVIDES ONE-WAY AND TWO-WAY WIRELESS CONNECTIVITY TO DATA; PORTABLE DIGITAL ELECTRONIC DEVICES FOR RECORDING, ORGANIZING, TRANSMITTING, MANIPULATING, AND REVIEWING TEXT, DATA, IMAGE, AND AUDIO FILES AND OPERATING SOFTWARE THEREFOR; HAND-HELD ELECTRONIC DEVICES FOR THE WIRELESS RECEIPT AND TRANSMISSION OF DATA; SOFTWARE FOR THE REDIRECTION OF MESSAGES, E-MAIL, AND OTHER DATA FROM A PERSONAL COMPUTER OR A SERVER TO ONE OR MORE HAND-HELD ELECTRONIC DEVICES; COMPUTER SOFTWARE AND PROGRAMS FOR MANAGEMENT AND OPERATION OF WIRELESS COMMUNICATION DEVICES; PORTABLE TELECOMMUNICATION INSTANT MESSAGING DEVICES; COMPUTER SOFTWARE FOR ACCESSING, SEARCHING, INDEXING AND RETRIEVING INFORMATION AND DATA FROM GLOBAL COMPUTER NETWORKS AND GLOBAL COMMUNICATION NETWORKS, AND FOR BROWSING AND NAVIGATING THROUGH WEB SITES ON SAID NETWORKS; COMPUTER SOFTWARE FOR SENDING AND RECEIVING SHORT MESSAGES AND ELECTRONIC MAIL AND FOR FILTERING NON-TEXT INFORMATION FROM THE DATA; HAND-HELD ELECTRONIC DEVICES FOR DATA, VOICE, IMAGE AND VIDEO COMMUNICATION; COMPUTER GAME SOFTWARE FOR MOBILE HANDSETS; ELECTRONIC GAME SOFTWARE FOR MOBILE HANDSETS; BATTERIES, DRY CELLS, RECHARGEABLE BATTERIES, BATTERY CHARGERS, STORAGE BATTERIES, SOLAR CELLS, FUEL CELLS; CARBON RODS FOR USE AS FUEL CELLS IN DRY BATTERIES, CARBON RODS FOR WELDING USE; WIRING APPARATUS, NAMELY, ELECTRICAL CONNECTORS, ELECTRIC CABLES, ELECTRICAL CONDUITS, FLOOR DUCTING ESPECIALLY FOR HOUSING ELECTRIC CABLES, BALLAST FOR DISCHARGE LAMPS, DIMMER SWITCHES, CIRCUIT BREAKERS, MAGNETIC CONTACTORS AND STARTERS, CIRCUIT PROTECTORS, SWITCH GEARS, ELECTRIC JUNCTION BOXES, APPLIANCE SWITCHES, OUTLET SOCKETS, ELECTRICAL PLUGS, INSULATING MATERIALS IN THE NATURE OF INSULATED ELECTRICAL CONNECTORS, WIRES AND CABLES, ELECTRIC TIME SWITCHES; VIDEO ENTRY PHONES, INTERCOM SYSTEMS, ELECTRIC DOOR CHIMES, ELECTRIC BUZZERS, FIRE ALARMS, GAS LEAKAGE ALARMS, BURGLAR ALARMS, PORTABLE EMERGENCY BUZZERS; ACOUSTIC MACHINES AND APPARATUS, NAMELY, RADIOS, CASSETTE TAPE PLAYERS AND RECORDERS, RADIO CASSETTE RECORDERS, PORTABLE CASSETTE TAPE PLAYERS, COMPACT DISC PLAYERS AND RECORDERS, MINI DISC PLAYERS AND RECORDERS, MINI DISC DECKS, DVD (DIGITAL VERSATILE DISC) AUDIO PLAYERS AND RECORDERS, SECURE DIGITAL PLAYERS AND RECORDERS, SECURE DIGITAL CARD, AUDIO SPEAKERS, STEREO TUNERS, AMPLIFIERS, STEREO COMPONENT SYSTEM COMPRISED OF TUNERS, AMPLIFIERS, AUDIO SPEAKERS, RECORD PLAYERS, GRAPHIC EQUALIZERS, RADIOS INCORPORATING CLOCKS, IC (INTEGRATED CIRCUIT) RECORDERS, DIGITAL SOUND PROCESSORS, HEADPHONES, EARPHONES, MICROPHONES, SING-ALONG CASSETTE PLAYERS AND RECORDERS IN THE NATURE OF KARAOKE PLAYERS, PRE-RECORDED COMPACT DISC FEATURING SPORTS, ELECTRIC MEGAPHONES, AUDIO AND VIDEO RECORDERS AND PLAYERS FOR LANGUAGE LABORATORIES, CAR AUDIO SYSTEMS COMPRISED OF STEREOS, SPEAKERS, AMPLIFIERS, EQUALIZERS, CROSSOVERS AND SPEAKER HOUSINGS, PUBLIC ADDRESS SYSTEMS, AUDIO MIXERS, AUDIO EQUIPMENT CLEANERS, NAMELY, MAGNETIC HEAD CLEANERS, AUDIO CABLES, VIDEO CABLES;

Reg. No. 4,152,658 AUDIO-VISUAL MACHINES AND APPARATUS, NAMELY, TELEVISION RECEIVERS, CATHODE RAY TUBE DISPLAYS, CATHODE RAY TUBES, TELEVISION SIGNAL IMAGE PICK UP TUBES, PLASMA TELEVISION RECEIVERS, PLASMA DISPLAYS, LCD (LIQUID CRYSTAL DISPLAY) TELEVISION RECEIVERS, LIQUID CRYSTAL DISPLAYS, COMBINED TELEVISION RECEIVER WITH VIDEO TAPE RECORDER, COMBINED TELEVISION RECEIVER WITH AUDIO AND VIDEO DISC PLAYER, ANTENNAS, TUNERS FOR SATELLITE BROADCASTING, TUNERS FOR TELEVISION, INTERNET DISPLAY TERMINALS, VIDEO PROJECTORS, VIDEO CASSETTE RECORDERS, CAMCORDERS, VIDEO CAMERAS, VIDEO PRINTERS, LASER DISC PLAYERS, VIDEO CD (COMPACT DISC) PLAYERS, VIDEO CDS (COMPACT DISC) FEATURING SPORTS, DVD (DIGITAL VERSATILE DISC) VIDEO PLAYERS AND RECORDERS, COLOR VIDEO SYSTEMS FOR LARGE-SCALE DISPLAY, COMPRISED OF VIDEO PROJECTOR, AUDIO SPEAKERS, CABLE TELEVISION SYSTEMS, NAMELY, CONVERTERS AND TRANSMITTERS, HARD DISK DRIVERS, VIDEO IMAGERS, ELECTRIC OPTICAL DISPLAY BOARDS, MULTI-PURPOSE ELECTRIC DISPLAY SYSTEMS, COMPRISED OF LED (LIGHT EMITTING DIODES) MONITORS AND SCREENS, CLOSED CIRCUIT VIDEO EQUIPMENT SYSTEMS, COMPRISED OF CAMERAS AND MONITORS FOR VIDEO SURVEILLANCE, DVDS (DIGITAL VERSATILE DISC) FEATURING SPORTS, TELEVISION CAMERAS, VIDEO SWITCHERS, ELECTRONIC EDITING CONTROLLER, LIGHT EMITTING DIODE DISPLAY; OPTICAL-DISC MACHINES AND APPARATUS, NAMELY, OPTICAL DISC DRIVES, OPTICAL DISC RECORDERS, OPTICAL DISC PLAYERS, OPTICAL DISC CHANGERS, BLANK OPTICAL DISCS; COMMUNICATION MACHINES AND APPARATUS, NAMELY, FACSIMILE TRANSCEIVERS, TRANSCEIVERS, TELEPHONES, CELLULAR MOBILE TELEPHONES, CARRY CASE FOR CELLULAR MOBILE TELEPHONE, TELEPHONE ANSWERING MACHINES, PRIVATE AUTOMATIC BRANCH TELEPHONE SWITCHING APPARATUS, GLOBAL POSITIONING SYSTEM RECEIVERS, RADIO TELEPHONES, MARINE RADARS, RADIO PAGING RECEIVERS, MOBILE COMMUNICATION SYSTEMS AND MULTI-CHANNEL ACCESS RADIO SYSTEMS, COMPRISED OF RADIO EMITTERS, RADIO RECEIVERS, RADIO EMITTERS/RECEIVERS, RADIO REPEATERS, RADIO SIGNAL AMPLIFIERS, RADIO ANTENNAS, RADIO-TELEPHONES; ELECTRONIC TRAFFIC INFORMATION BOARDS, VIDEO TELECONFERENCING SYSTEMS, COMPRISED OF CAMERAS, TRANSMITTERS, RECEIVERS AND PLAYERS, PERSONAL HANDY-PHONE SYSTEMS, COMPRISED OF MOBILE TELEPHONES, PAGERS, LOCAL AREA NETWORK (LAN) HARDWARE AND OPERATING SOFTWARE, AV (AUDIO/VISUAL) ENCODERS AND DECODERS, IN-CAR NAVIGATION APPARATUS, ELECTRONIC APPARATUS FOR THE COLLECTION OF ROAD TOLLS, GPS (GLOBAL POSITIONING SYSTEM) ANTENNA; CHECKING AND SUPERVISING APPARATUS AND INSTRUMENTS, NAMELY, ELECTRIC DOOR OPENERS, COMMUNICATION AND MONITORING SYSTEM FOR APARTMENT BUILDINGS COMPRISED OF VIDEO CAMERAS, COMPUTER MONITORS, INTERCOMS, INTRUDER DETECTION SYSTEMS, COMPRISED OF BURGLAR ALARMS, VIDEO MONITORS, AUTOMATED CONTROL SYSTEM COMPRISED OF HARDWARE AND SOFTWARE FOR MONITORING AND CONTROLLING FUNCTIONS WITHIN BUILDINGS AND ELECTRIC MULTI-LAYER SECURITY APPLIANCES; AUTOMATIC CONTROLLING MACHINES AND INSTRUMENTS, NAMELY, ELECTRIC NOTICE BOARDS, TRAFFIC MANAGEMENT EQUIPMENT, NAMELY, DISPLAY MONITORS, COMPUTERS, AUTO COMPASSES, SOFTWARE TO MANAGE TRAFFIC, AUTOMATED TRAFFIC-SIGNAL CONTROL APPARATUS, BUS LOCATION SYSTEM, AND ULTRASONIC VEHICLE DETECTORS, ELECTRIC LIGHT DIMMERS, ELECTRIC DAYLIGHT SWITCHES, INVERTERS, PROGRAMMABLE LOGIC CONTROLLERS, TRANSFORMERS, POWER CAPACITORS; DATA PROCESSING EQUIPMENT, NAMELY, COMPUTERS AND COMPUTER PERIPHERAL DEVICES, COMPUTERS, WORD PROCESSORS, IMAGE SCANNERS FOR PERSONAL COMPUTER, PRINTERS, PC (PERSONAL COMPUTER) CARDS, COMPUTER KEYBOARDS, COMPUTER MOUSE, CD-ROM (COMPACT DISC-READ ONLY MEMORY) DRIVES, FLOPPY DISK DRIVES, ELECTRONIC AND MAGNETIC CARD READER AND WRITERS, BAR CODE READERS, TIME RECORDERS, MOBILE DATA TERMINAL, ELECTRONIC CASH REGISTERS, ELECTRONIC EQUIPMENT FOR POINT-OF-SALES (POS) SYSTEMS, NAMELY, POINT-OF-SALE TERMINALS, BAR CODE READERS, OPTICAL READERS, ADVERTISEMENT DISPLAY MONITORS, KEYBOARDS, PRINTERS, SCANNERS, RADIO TRANSMITTERS, RADIO RECEIVERS, COMPUTER HARDWARE, AND COMPUTER OPERATING

Reg. No. 4,152,658 SOFTWARE, DATA COLLECTION TERMINALS IN THE NATURE OF COMPUTER TERMINALS, PDA (PERSONAL DIGITAL ASSISTANTS), DVD-RAM/ROM (DIGITAL VERSATILE DISC-RANDOM ACCESS MEMORY/READ ONLY MEMORY) DRIVE, CAD/CAM (COMPUTER AIDED DESIGN/COMPUTER AIDED MANUFACTURING) DRIVES, HARD DISC DRIVES, ELECTRONIC CALCULATORS, UNINTERRUPTED POWER SUPPLIES FOR COMPUTERS AND COMMUNICATION AND BROADCASTING EQUIPMENT; EXTERNAL STORAGE MEDIA, NAMELY, BLANK VIDEO CASSETTE TAPES, HEAD CLEANING TAPES FOR AUDIO AND VIDEO RECORDERS, D-VHS (DATA VIDEO HOME SYSTEMS) TAPES FEATURING SPORTS, AND COMPUTER PERIPHERALS; VIDEO CASSETTE TAPES FEATURING SPORTS, AUDIO CASSETTE TAPES FEATURING SPORTS, BLANK FLOPPY COMPUTER DISCS, OPTICAL DISCS FEATURING SPORTS, MINI-DISCS FEATURING SPORTS, DVDS (DIGITAL VERSATILE DISCS) FEATURING SPORTS, IC (INTEGRATED CIRCUIT) MEMORY CARDS; WEIGHING AND MEASURING APPARATUS AND INSTRUMENTS, NAMELY, THERMOLUMINESCENCE DOSIMETERS, ELECTRONIC COUNTERS, AMMETERS, POWER CONSUMPTION METERS, CLAMP METERS, ELECTRIC LEAKAGE METERS, ELECTRIC INSULATION METERS, THERMOMETERS, MEASUREMENT SYSTEM PROCESSORS, MULTI-CIRCUIT TYPE ELECTRIC POWER MONITOR, ELECTRONIC MICRO-PRECISION MEASUREMENTS, STEP COUNTER, NAMELY, Pedometers, AUDIO AND VIDEO SIGNAL ANALYZERS, OSCILLOSCOPES, MODULATORS, VOLTMETERS, AUDIO AND VIDEO SIGNAL DISTORTION METERS; ELECTRONIC SENSORS, NAMELY, PHOTOELECTRIC SENSOR, TEMPERATURE SENSORS, POSITION SENSORS, ANGULAR SPEED SENSORS, ROTATION SENSORS, ANGLE SENSORS, DEW SENSORS; ELECTRIC COMPONENTS, NAMELY, LIGHT EMITTING DIODES, LIQUID CRYSTALS DISPLAYS, LIQUID CRYSTAL DISPLAY MODULES, MAGNETRONS, DIODES, TRANSISTORS, THERMOSTATS, INTEGRATED CIRCUITS, LSI (LARGE SCALE INTEGRATION) CIRCUITS, SEMICONDUCTOR MEMORY DEVICES, ONE-CHIP MICROCOMPUTERS, ELECTRIC CONDENSER MICROPHONE, HALFTONE IMAGE PROCESSORS, THERMAL PRINTING HEADS FOR PRINTERS, MAGNETIC HEADS FOR AUDIO CASSETTE PLAYERS, PERMANENT MAGNETS, ELECTRICAL CONNECTORS, ELECTRIC RELAYS, LASERS FOR USE IN MANUFACTURING SEMICONDUCTORS, IMAGE SENSORS FOR CCDs (CHARGE COUPLED DEVICES), FILM CAPACITOR, ELECTRIC TUNER UNITS, ELECTRIC HIGH FREQUENCY UNITS, ELECTRIC COIN VALIDATING UNITS, ELECTRIC MONETARY BILL VALIDATING UNITS, VOLTAGE CONTROLLED OSCILLATORS, PPL (PHASE-LOCKED LOOP) SYNTHESIZER MODULES, ELECTRONIC WIRELESS COMMUNICATION MODULE UNIT, OPTICAL TRANSMISSION COMPONENTS, NAMELY, CONNECTORS FOR OPTICAL FIBER, PRINTED WIRING BOARDS IN THE NATURE OF CIRCUIT BOARDS, SPEAKER COMPONENTS, NAMELY, SPEAKER ENCLOSURES, SPEAKER DRIVERS, POWER SUPPLIES, AC (ALTERNATING CURRENT) ADAPTERS, CONVERGENCE MAGNETS, AND ELECTRICAL COIL INDUCTORS, CAPACITORS FOR ELECTRICAL APPLIANCES, FILTERS OF ELECTRIC SIGNALS, TRANSFORMERS, DEFLECTION YOKE THERMISTORS, VARISTORS, ACOUSTO-OPTIC DEVICES, NAMELY, RESISTORS, POTENTIOMETERS, ENCODERS, PRINTER UNITS, HYBRID IC (INTEGRATED CIRCUIT) CARDS, ELECTRONIC COMPONENTS, NAMELY, PIEZOELECTRIC SWITCHES, HEAT SINK WIRING BOARDS, TRANSPARENT TOUCH PANELS, ELECTRO LUMINESCENT DISPLAY UNITS, ELECTRO-MAGNETIC RESISTORS, THERMOMAGNETIC CUT-OFFS DEVICES; ELECTRIC UTENSILS FOR THE HOUSEHOLD, NAMELY, ELECTRIC FLAT IRONS, ELECTRIC HAIR CURLERS, ELECTRIC HAIR IRONS, ELECTRIC TIMERS AND ELECTRIC PANTS PRESSES; ELECTRIC ARC WELDERS, WELDING ELECTRODES; DATA PROCESSORS IN PARTICULAR FOR FINANCIAL APPLICATIONS; COMPUTER OPERATING PROGRAMS; COMPUTER HARDWARE AND SOFTWARE FOR THE DEVELOPMENT, MAINTENANCE AND USE OF LOCAL AND WIDE AREA COMPUTER NETWORKS; SYSTEMS FOR READING MEMORY CARDS AND SYSTEMS FOR READING DATA IN MEMORIES IN THE NATURE OF MEMORY READERS FOR READING INTEGRATED CIRCUIT MEMORIES AND BANKING CARD MEMORIES; CASH DISPENSERS; AUTOMATED BILLING MACHINES FOR PROCESSING ACCOUNTING INFORMATION; MAGNETICALLY ENCODED CARDS, NAMELY, MAGNETIC CARDS AND CARDS WITH INTEGRATED CIRCUITS, IN PARTICULAR, FOR FINANCIAL DEBIT AND CREDIT APPLICATIONS; ELECTRONIC CARD READER, PRINTERS FOR USE WITH DATA PROCESSING

Reg. No. 4,152,658 SYSTEMS AND FINANCIAL TRANSACTION SYSTEMS; ENCODERS AND DECODERS; MODEMS; ELECTRONIC DATA CARRIER CARDS, NAMELY, BLANK SMART CARDS, MAGNETIC CODED CARD READERS, ELECTRONIC DATA CARRIER CARD READERS, NAMELY, SMART CARD READERS, ELECTRONIC ENCRYPTION UNITS, COMPUTER HARDWARE, COMPUTER TERMINALS, COMPUTER SOFTWARE FOR DATA COLLECTION, DATABASE MANAGEMENT AND DATA ANALYSIS FOR USE IN CONNECTION WITH PROVIDING FINANCIAL, BANKING AND TELECOMMUNICATIONS SERVICES; ELECTRICAL AND ELECTRONIC GOODS, NAMELY, CALCULATING MACHINES, ELECTRONIC DAY PLANNERS; BANKING CARDS, NAMELY, CREDIT CARDS AND DEBIT CARDS USING MAGNETIC MEMORIES AND INTEGRATED CIRCUIT MEMORIES; BANKING CARDS, NAMELY, CREDIT CARDS AND DEBIT CARDS HAVING INTEGRATED CIRCUITS AND MICROPROCESSORS; MEMORY CARDS; AUTOMATIC CASH DISPENSERS; EQUIPMENT FOR DATA PROCESSORS AND COMPUTERS, NAMELY, CARDS EQUIPPED WITH MICROPROCESSORS AND INTEGRATED CIRCUITS; COMPUTER HARDWARE IN THE NATURE OF INTEGRATED CIRCUIT CARDS AND CARD READERS CONTAINING TRANSPONDERS AND OTHER PROXIMITY PAYMENT DEVICES; MOUSE PADS; FLUID CONTROL DEVICES, NAMELY, EXPANSION VALVES, FLOW METERS, PRESSURE SWITCHES, SEQUENCE TIMERS, REGULATORS, LEVELERS, EJECTORS, AND ELECTRICAL CONTROLS AND SWITCHES; ELECTRICAL INDUCTORS, ELECTRICAL TRANSFORMERS, ELECTRIC REGULATING AND CONTROLLING DEVICES, ELECTRIC MEASURING INSTRUMENTS, SWITCHBOARDS; ELECTRIC DEVICES FOR ATTRACTING AND KILLING INSECTS; ELECTROSTATIC EMISSION CONTROL DEVICES, NAMELY, ELECTROSTATIC PRECIPITATORS FOR REDUCING PARTICULATE EMISSION IN INDUSTRIAL APPLICATIONS; ELECTRONIC NOTICE BOARDS, IN CLASS 9 (U.S. CLS. 21, 23, 26, 36 AND 38).

FOR: SURGICAL APPARATUS AND INSTRUMENTS FOR MEDICAL, DENTAL AND VETERINARY USE, ARTIFICIAL LIMBS, EYES AND TEETH; ORTHOPAEDIC ARTICLES, NAMELY, ORTHOPAEDIC JOINT IMPLANTS, ORTHOPAEDIC SUPPORT BANDAGES, ORTHOPAEDIC BRACES, ORTHOPAEDIC SOLES, ORTHOPAEDIC FOOTWEAR; SUTURE MATERIALS; CLINICAL MEDICAL TEST KITS FOR USE IN ANTI-DOPING TESTS, COMPRISED OF TEST TUBES, TEST PLATES AND INDICATOR CHARTS FOR EVALUATING TEST RESULTS; MEDICAL APPARATUS FOR THE DISPENSING OF MEASURED UNIT DOSES OF PHARMACEUTICAL PREPARATIONS; VIALS FOR MEDICAL USE; CANNULAS FOR MEDICAL USE; SYRINGES FOR MEDICAL USE; FLUID INJECTORS FOR MEDICAL USE; CARTRIDGES FOR MEDICAL USE SOLD EMPTY; MEDICAL DEVICES, NAMELY, INFUSION PUMPS FOR INTRAVENOUS ADMINISTRATION OF FLUIDS; NEEDLES FOR MEDICAL PURPOSES; IMPLANTABLE RADIATION THERAPY DEVICES CONSISTING OF ENCAPSULATED RADIOISOTOPE BRACHYTHERAPY SOURCES; RADIATION THERAPY DELIVERY SYSTEM CONSISTING OF RADIOACTIVE SEEDS AND A BIO-ABSORBABLE CARRIER ASSEMBLY; CARDIAC OUTPUT MONITORS; HEAT AND MOISTURE EXCHANGERS FOR MEDICAL USE; BACTERIA FILTERS FOR MEDICAL USE; GAS ANALYZERS FOR MEDICAL PURPOSES; ANESTHESIA RECORD KEEPING AND DATA MANAGEMENT SYSTEMS AND PATIENT MONITOR SYSTEMS, NAMELY, GAS MONITORS, PULSE OXIMETERS, MULTI-PARAMETER MONITORS, ECG MONITORS, INVASIVE AND NON-INVASIVE BLOOD PRESSURE MONITORS, NEUROMUSCULAR TRANSMISSION MONITORS, METABOLIC MONITORS AND SPIROMETERS FOR ANESTHESIA, INTENSIVE CARE AND DIAGNOSTIC APPLICATIONS; ANESTHESIA MACHINES AND VENTILATORS FOR PATIENT CARE; INTENSIVE CARE AND ANESTHESIA ACCESSORIES FOR SINGLE PATIENT USE, NAMELY, GAS SAMPLING LINES, AIRWAY ADAPTERS, BREATHING CIRCUITS, SPIROMETRY SENSORS AND TUBES, TUBES, WATER TRAPS, PULSE OXIMETRY SENSORS, NON-INVASIVE BLOOD PRESSURE CUFFS, INTRAVENOUS FLUSHING SETS, ANESTHESIA MASKS, CARBON DIOXIDE ABSORBERS, TEMPERATURE PROBES AND NEBULIZERS; CENTRAL NERVOUS SYSTEM MONITORS; GASTROINTESTINAL TONOMETERS; GRADIENT COILS, NAMELY, MAGNETIC GRADIENT COILS USED IN MAGNETIC RESONANCE IMAGING; MEDICAL DIAGNOSTIC DEVICES, NAMELY, BONE DENSITOMETERS; FETAL MONITORING APPARATUS, NAMELY, FETAL PULSE AND VITAL SIGNS MONITORS; PATIENT MONITORING APPARATUS, NAMELY, HEART AND

Reg. No. 4,152,658 VITAL SIGNS MONITORS MEDICAL IMAGING SYSTEMS, NAMELY, ULTRASOUNDS, MEDICAL DIAGNOSTIC IMAGING MACHINES, IMAGING DEVICES FOR SCREENING AND DIAGNOSTIC APPLICATIONS FOR USE IN PLANNING INTERVENTION AND SURGERY, AND PARTS THEREOF AND ATTACHMENTS THERETO; MEDICAL DIAGNOSTIC APPARATUS FOR DISPLAYING DIAGNOSTIC IMAGES, NAMELY, SPOT FILM APPARATUS, X-RAY IMAGE INTENSIFIERS, X-RAY FLUOROSCOPES, MOBILE X-RAY UNITS, RADIOGRAPHIC FILM VIEWERS, COMPUTERIZED TOMOGRAPHY SCANNERS, NUCLEAR RESONANCE SCANNERS, ULTRA SOUND SCANNERS, MAGNETIC RESONANCE SCANNERS, POSITRON EMISSION TOMOGRAPHY (PET) SCANNERS; AND PARTS THEREOF AND ATTACHMENTS THERETO INCLUDING TABLES AND PADS; ELECTRONIC BLOOD PRESSURE METERS, LASER MEDICAL TREATMENT DEVICES, NAMELY, LASERS FOR MEDICAL USE, ULTRASONIC MEDICAL DIAGNOSTIC APPARATUS, HEARING AIDS, LASER SCALPELS, ELECTRIC MASSAGERS, HAND-HELD VIBRATORS FOR MEDICAL USE, LOW FREQUENCY ELECTRONIC MUSCLE STIMULATOR FOR MEDICAL USE, HIGH FREQUENCY ELECTROMAGNETIC THERAPY APPARATUS FOR MEDICAL USE, AIR MATTRESSES FOR MEDICAL USE, NAMELY, ELECTRIC AIR MATS FOR BEDSORES, ELECTRIC INHALERS FOR THERAPEUTIC USE SOLD EMPTY, ELECTRIC HEATING PADS FOR MEDICAL PURPOSES, MEDICAL BONE DENSITOMETERS FOR USE IN THE DIAGNOSIS OF OSTEOPOROSIS; RADIATION DOSIMETERS FOR ASSESSING THERAPEUTIC DOSES OF RADIATION DELIVERED TO PATIENTS; BODY FAT MONITORS, IN CLASS 10 (U.S. CLS. 26, 39 AND 44).

FOR: SOLAR COLLECTORS, SOLAR HEAT COLLECTION PANELS; SOLAR LIGHT FIXTURES, NAMELY, INDOOR AND OUTDOOR SOLAR POWERED LIGHTING UNITS AND FIXTURES; SOLAR THERMAL INSTALLATIONS, NAMELY, SOLAR THERMAL MODULES; SOLAR WATER HEATERS; ROOFING, NOT OF METAL, INCORPORATING SOLAR CELLS; DOMESTIC ELECTRIC AND GAS COOKING APPLIANCES, NAMELY, COOKING RINGS, GAS AND ELECTRIC STOVES; GAS AND ELECTRIC OVENS AND COOK TOPS; HEAT EXCHANGERS FOR USE IN THE DISTRIBUTED RESIDENTIAL AND PORTABLE FUEL CELL POWER APPLICATIONS; CHEMICAL HEAVY WALL REACTORS AND NUCLEAR REACTORS AND ACCESSORIES AND COMPONENT PARTS THEREOF, NAMELY, HEAT PUMPS, STEAM VALVES AND VALVES FOR REGULATING THE FLOW OF GASES AND LIQUIDS; ELECTRIC LAMPS; ELECTRIC LIGHTING FIXTURES AND THEIR PARTS, NAMELY, LAMP SHADES; ELECTRIC REFRIGERATORS, FREEZERS, AIR CONDITIONING APPARATUS; MICROWAVE OVENS FOR COOKING; WALL COOKING OVENS FOR DOMESTIC USE; ELECTRIC AND GAS FOOD WARMING DRAWERS; CONVECTION OVENS, ELECTRIC AND GAS COOK TOPS; ELECTRIC AND GAS COOKING OVENS AND RANGES; VENTILATION HOODS FOR STOVES; AND VENTILATING EXHAUST FANS; WATER FILTERS; WATER SOFTENING UNITS; CLOTHES DRYERS; ELECTRIC FANS, CEILING FANS, FLASHLIGHTS; LAMPS AND LIGHTS FOR VEHICLES; ELECTRIC LIGHTS FOR CHRISTMAS TREES; FLUID SEPARATION UNITS; FLUID CONCENTRATION UNITS; FLUID RECYCLING UNITS; POLYMERIC MEMBRANE MATERIAL FOR USE IN THE SEPARATION OF FLUIDS; FILTER APPARATUS USED FOR FILTERING SOLIDS FROM GASES AND LIQUIDS OR FILTERING LIQUIDS FROM GASES, AND FOR FILTERING ONE IMMISCIBLE LIQUID FROM ANOTHER; SPIRALLY-WOUND ELEMENTS OR CARTRIDGES CONTAINED WITHIN A TUBULAR PLASTIC SLEEVE FOR CONCENTRATING PRODUCTS AND REMOVING IMPURITIES IN FLUID TREATMENT SYSTEMS; WATER CONDITIONING UNITS FOR RESIDENTIAL PURPOSES; WATER TREATMENT EQUIPMENT, NAMELY, REVERSE OSMOSIS MODULES AND MEMBRANES THEREFORE; WATER PURIFICATION UNITS AND SYSTEMS CONSISTING OF CLARIFIERS, ELECTRO-DEIONIZATION SYSTEMS, CONDENSATE POLISHERS, VACUUM DEGASIFICATION UNITS, ULTRA FILTRATION UNITS, ULTRAVIOLET STERILIZERS, ION EXCHANGERS, ACID AND CAUSTIC REGENERATION SYSTEMS, REVERSE OSMOSIS SYSTEMS, FORCED DRAFT DECARBONATOR UNITS, FILTERS, CHEMICAL FEED SYSTEMS AND BULK STORAGE UNITS, SOLD WITH AUTOMATIC CONTROLS AND INSTRUMENTS TO MONITOR OPERATING PARAMETERS OF THE UNITS AND SYSTEMS ELECTROCHEMICAL LIQUID PURIFICATION UNITS FOR USE IN THE INDUSTRIAL, COMMERCIAL AND MUNICIPAL SECTORS; WATER FILTERING UNITS FOR DOMESTIC, COMMERCIAL AND INDUSTRIAL USE;

Reg. No. 4,152,658 WASTE WATER PURIFICATION UNITS; WATER PURIFYING UNITS FOR POTABLE WATER FOR DOMESTIC, COMMERCIAL AND INDUSTRIAL USE; FLUID SEPARATION UNITS, NAMELY, INDUSTRIAL FLUID FILTERS; RECYCLING UNITS, NAMELY, FLUID PURIFICATION UNITS; WATER TREATMENT EQUIPMENT, NAMELY, CARTRIDGE FILTRATION UNITS; WATER TREATMENT EQUIPMENT FOR HOUSEHOLD USE, NAMELY, WATER SOFTENERS AND WATER CONDITIONERS; MEDIA FILTERS AND DEPTH FILTERS FOR REMOVING SEDIMENTS, IRON, SULFUR, TASTES AND ODORS FROM WATER; REVERSE OSMOSIS WATER PURIFICATION UNITS; DEPTH FILTER UNITS AND DEPTH FILTER CARTRIDGES FOR LIQUID AND AIR FILTRATION FOR DOMESTIC, INDUSTRIAL, AND COMMERCIAL USE; DISPOSABLE CARTRIDGE FILTERS FOR INDUSTRIAL WATER FILTRATION; APPARATUS AND INSTALLATIONS FOR LIGHTING, NAMELY, INCANDESCENT LAMPS, GLOW SWITCH STARTERS, SCREW-IN FLUORESCENT LAMPS, FLUORESCENT LAMPS, TUNGSTEN HALOGEN LAMPS, FLASH LIGHTS, FLUORESCENT LANTERNS, LAMPS, FLUORESCENT LIGHTING FIXTURES, DYNAMO LIGHTS FOR BICYCLES, GERMICIDAL LAMPS FOR PURIFYING AIR, AND LIGHTING FIXTURES; APPARATUS AND INSTALLATIONS FOR COOKING, NAMELY, AUTOMATIC BREAD MAKERS FOR DOMESTIC USE, ELECTRIC KETTLE, ELECTRIC RICE COOKER, GAS FUELED RICE COOKERS, ELECTRIC SLOW COOKERS, ELECTRIC ROASTERS, OVENS FOR COOKING, ELECTRIC TOASTERS, ELECTRIC COFFEE MAKERS, ELECTRIC COOKING STOVES, ELECTRIC THERMO POTS, GAS COOKERS, INDUCTION HEATING HOBS, ELECTRIC BARBECUE GRIDDLES, MICROWAVE OVENS, GAS COOKING STOVES WITH OVENS, ELECTRIC FOOD-PANS, SINKS; APPARATUS AND INSTALLATIONS FOR REFRIGERATION AND FREEZING, NAMELY, REFRIGERATORS, FREEZERS, COLD AND HOT WATER DISPENSERS, FREEZING AND REFRIGERATING SHOWCASES, ELECTRIC WATER COOLERS, ELECTRIC ICE MAKERS; VENTILATING APPARATUS AND INSTRUMENTS, NAMELY, ELECTRIC FANS, VENTILATING FANS, ELECTRIC AIR PURIFIERS, EXTRACTION HOODS FOR COOKERS, ELECTRIC DEHUMIDIFIERS, ELECTRIC HUMIDIFIERS, BLOWING MACHINES IN THE NATURE OF ELECTRIC EXHAUST FANS, AIR CONDITIONING APPARATUS IN THE NATURE OF AIR CURTAINS, AIR HANDLING UNITS, CEILING FANS, ROOF VENTILATORS, AND PARTS AND FITTINGS THEREFOR, ALL INCLUDED IN THIS CLASS; APPARATUS AND INSTALLATIONS FOR HEATING, STEAM-GENERATING, DRYING, COOLING AND AIR-CONDITIONING, NAMELY, AIR CONDITIONERS, FAN COIL UNITS FOR AIR-CONDITIONING, EVAPORATIVE AIR REFRESHING APPARATUS, GAS AND ELECTRIC STOVES, ELECTRIC SPACE HEATERS, ELECTRIC BLANKETS, ELECTRICALLY HEATED FLOOR CARPETS, KEROSENE FAN HEATERS, ELECTRIC FOOT WARMERS (KOTATSU), GAS CORDLESS ROOM WARMERS; WATER SUPPLY APPARATUS, NAMELY, HOT WATER TANKS; INSTALLATIONS FOR SANITARY PURPOSES IN THE NATURE OF STEAM ROOMS, ELECTRIC BIDETS, TOILETS, WASHING TOILET SEATS, PORTABLE TOILETS, SEWAGE AERATION TREATMENT SYSTEMS, COMPRISED OF FILTERS AND GAS EXTRACTORS, WATER-PURIFIERS, INCINERATORS IN THE NATURE OF TRASH BURNERS, SAUNA BATHS, BATHTUBS, BATH INSTALLATIONS, ELECTRIC HOME SHOWER; WATER HEATERS, GAS INSTANTANEOUS WATER HEATERS; DRYERS, NAMELY, ELECTRIC DISH DRYERS, ELECTRIC HAIR DRYERS, CLOTHES DRYERS; METALLIC SINKS; ELECTRIC LAMPS; DRYERS FOR CLOTHES, ELECTRIC CLOTHES DRYERS, IN CLASS 11 (U.S. CLS. 13, 21, 23, 31 AND 34).

FOR: VEHICLES; APPARATUS FOR LOCOMOTION BY LAND, AIR OR WATER, NAMELY, CARS, BUSES, COACHES, LIGHT LORRIES AND TRUCKS, VANS, MOTOR HOMES, MOTORBIKES, MOPEDS, SCOOTERS, BOATS, SHIPS, AIRPLANES, HELICOPTERS, LOCOMOTIVES, RAILWAY CARS; TIRES FOR VEHICLES; ELECTRIC MOTORS AND DIESEL ENGINES FOR LAND VEHICLES; BICYCLES, BICYCLE TIRES AND TUBES, AUTOMATIC GUIDED VEHICLES, ELECTRIC POWER ASSISTED BICYCLES, IN CLASS 12 (U.S. CLS. 19, 21, 23, 31, 35 AND 44).

FOR: PRECIOUS METALS AND THEIR ALLOYS AND GOODS IN PRECIOUS METALS OR COATED THEREWITH, NAMELY, COMMEMORATIVE COINS AND MEDALS; JEWELRY, PRECIOUS STONES; HOROLOGICAL AND CHRONOMETRIC INSTRUMENTS, LAPEL PINS, IN CLASS 14 (U.S. CLS. 2, 27, 28 AND 50).

Reg. No. 4,152,658 FOR: PAPER, CARDBOARD AND GOODS MADE FROM THESE MATERIALS, NAMELY, PAPER NAPKINS AND TOWELS, TISSUE AND TOILET PAPER, NEWSPRINT PAPER, PAPER BANNERS, DISPOSABLE PAPER BABY BIBS, PAPER GROCERY BAGS, CARDBOARD AND PAPER CARTONS; PRINTED MATTER, NAMELY, COMMEMORATIVE STAMP SHEETS; NEWSPAPERS, MAGAZINES AND BOOKS IN THE FIELD OF SPORT EVENTS, PHOTOGRAPHS, POSTERS; BOOKBINDING MATERIAL, NAMELY, TAPE, WIRE, CLOTH; STATIONERY; ADHESIVES FOR STATIONERY OR HOUSEHOLD PURPOSES; ARTISTS' MATERIALS, NAMELY, PENS, PENCILS, CALLIGRAPHY SETS, COMPRISED OF WRITING UTENSILS, DRAWING SETS COMPRISED OF ARTISTS' BRUSHES, ARTISTS' PASTELS; PAINT BRUSHES; TYPEWRITERS AND OFFICE REQUISITES, EXCEPT FURNITURE, NAMELY, ENVELOPE SEALING MACHINES, FRANKING MACHINES, ADHESIVE TAPE DISPENSERS, CORRECTING FLUID FOR TYPE, FINGER-STALLS, PAPER EMBOSSERS, PAPER FOLDING MACHINES, PUNCHES, RUBBER BANDS, STAPLERS; PRINTED INSTRUCTIONAL AND TEACHING MATERIAL, EXCEPT APPARATUS, IN THE FIELD OF SPORTS ENTERTAINMENT, SPORTS EVENTS AND SPORTS TRAINING; PLASTIC MATERIALS FOR PACKAGING, NAMELY, BLISTER CARDS, BAGS; PRINTERS' TYPE; PRINTING BLOCKS; CHEQUE BOOKS, CREDIT CARDS WITHOUT MAGNETIC CODING, PUNCHED CARDS WITHOUT MAGNETIC CODING; COMPUTER PAPER FOR USE IN PUBLISHING NEWSPAPERS AND PERIODICALS; PAPER SHREDDERS, ELECTRIC STAPLERS, BATTERY-OPERATED LETTER OPENERS, ELECTRIC PENCIL SHARPENERS, ELECTRIC PAPER HOLE PUNCHES, ELECTRONIC TYPEWRITERS, RIBBON CASSETTES FOR ELECTRONIC TYPEWRITERS, CHEQUE PRINTING MACHINES, THERMAL PAPERS; BABIES' DIAPERS OF PAPER, BABIES' DISPOSABLE TRAINING PANTS OF PAPER AND CELLULOSE; ACCESS CARD LAMINATORS FOR OFFICE USE, IN CLASS 16 (U.S. CLS. 2, 5, 22, 23, 29, 37, 38 AND 50).

FOR: RUBBER, GUTTA-PERCHA, ASBESTOS, MICA AND GOODS MADE FROM THESE MATERIALS AND NOT INCLUDED IN OTHER CLASSES, NAMELY RUBBER BANDS FOR COMMERCIAL AND INDUSTRIAL USES, RUBBER BARS AND RODS, RUBBER BOTTLE STOPPERS, RUBBER CHIPS OR GRANULES FOR USE AS A PLAYGROUND GROUND COVER, RUBBER CORDS AND LACES, RUBBER SEALANT FOR CAULKING AND ADHESIVE PURPOSES, RUBBER SHEETS, RUBBER SLEEVES FOR PROTECTING PARTS OF MACHINERY, RUBBER THREAD AND COVERED RUBBER YARN NOT FOR TEXTILE USE, ELECTRICAL INSULATING RUBBER PRODUCTS, FOAM RUBBER, RINGS OF RUBBER FOR USE AS PIPE CONNECTION SEALS, ASBESTOS FABRICS, ASBESTOS FIRE CURTAINS, ASBESTOS NETS, ASBESTOS PAPER, ASBESTOS POWDER, ASBESTOS YARN, MICA FOR USE IN THE MANUFACTURE OF ELECTRONIC INSTRUMENTS; PLASTICS IN EXTRUDED FORM FOR USE IN MANUFACTURE; PACKING AND INSULATING MATERIALS; FLEXIBLE PIPES, NOT OF METAL; SILICONE SEALANTS FOR A VARIETY OF USES SUCH AS FOR BATH TUB CAULKING, SEALING BOATS AND AUTOMOBILES; SILICONE BASED SEALANTS AND ADHESIVES FOR ROAD AND WEATHER TOPPING, SILICONE RUBBER ROOF COATING; PLASTIC PANELS FOR BUILDING CONSTRUCTION PURPOSES; PLASTIC GLAZING COMPOUNDS; PLASTIC IN THE FORM OF SHEETS, PLATES, FOILS, BLOCKS, ALL FOR USE IN MANUFACTURES; ELECTRICAL INSULATION MATERIAL, ELECTRIC INSULATORS, NAMELY, INSULATING VARNISH, SILICONE RUBBER COMPOUNDS; THERMAL INSULATING MATERIAL, THERMOPLASTIC INSULATION MATERIALS USED AS BUILDING MATERIALS FOR INSULATING, ROOFING AND GLAZING; PLASTIC MATERIAL IN THE FORM OF SHEETS, RODS OR FOILS, MOLDING MATERIALS, PVC (POLYVINYL CHLORIDE) LINED FLEXIBLE WATER PIPES; SOUNDPROOFING MATERIALS FOR BUILDINGS, IN CLASS 17 (U.S. CLS. 1, 5, 12, 13, 35 AND 50).

FOR: KNAPSACKS MADE OF LEATHER; ALL-PURPOSE SPORTS BAGS MADE OF LEATHER; LEATHER BACK PACKS; LEATHER TOTE BAGS; LEATHER HANDBAGS; LEATHER PURSES; LEATHER WALLETS; LEATHER CREDIT CARD CASES; BRIEFCASE-TYPE LEATHER BUSINESS FOLDERS; LEATHER BRIEF CASES; ATTACHÉ CASES OF LEATHER; GARMENT BAGS FOR TRAVEL; LEATHER GYM BAGS; ALL-PURPOSE SPORTS GEAR CARRYING BAGS MADE OF LEATHER; UMBRELLAS; LUGGAGE TRUNKS FOR

Reg. No. 4,152,658 TRAVELING; PARASOLS; WALKING STICKS; WHIPS, HARNESSSES; SADDLERY; LEATHER BARREL BAGS; LEATHER FANNY BACKS; LEATHER DOG LEASHES; TRAVEL BAGS AND SHOE BAGS FOR TRAVEL; LEATHER DUFFEL BAGS; SUIT BAGS FOR TRAVEL; LEATHER SCHOOL BAGS; LEATHER GYM BAGS SHAPED TO FIT INTO FOOTLOCKERS; LEATHER PET COLLARS, IN CLASS 18 (U.S. CLS. 1, 2, 3, 22 AND 41).

FOR: NON METALLIC BUILDING MATERIALS, NAMELY, REINFORCING MATERIALS; NON-METALLIC RIGID PIPES, FOR BUILDING; ASPHALT, PITCH AND BITUMEN; NON-METALLIC TRANSPORTABLE BUILDINGS; MONUMENTS, NOT OF METAL; THERMO-PLASTIC BUILDING AND CONSTRUCTION MATERIALS USED AS WOOD, METAL OR GLASS SUBSTITUTES FOR SUPPORT OR ROOFING, NAMELY, BRICKS, MOUNTING BLOCKS, RIGID PIPES, PLATES, AND TRANSPARENT PLATES; NON-METAL DOORS, NON-METAL RAIN GUTTERS, NON-METAL CEILING PANELS, NON-METAL FOLDING DOORS, WOOD FLOORING, SOUND INSULATING SHEETS, NAMELY, SOUND DEADENING GYPGSUM WALLBOARD, NON-METAL ROOF TILES, PREFABRICATED HOUSES, LAMINATED FLOORING, NON-METAL SIDING, NON-METAL BUILDING MATERIAL, NAMELY, STEPS, IN CLASS 19 (U.S. CLS. 1, 12, 33 AND 50).

FOR: BELTS, NECKTIES; SUSPENDERS; BANDANNAS; BEACH SANDALS; INFANT AND TODDLER SLEEP WEAR; BATHROBES, NIGHTSHIRTS, PAJAMAS AND LOUNGE WEAR; BEACH COVER-UP DRESSES; CLOTH DIAPER SETS COMPRISING OF SHIRTS AND CLOTH DIAPERS; TODDLER SHORT AND TOP SETS; GIRLS KNIT DRESSES WITH PANTS SETS; BOYS SHORTS AND TOP SETS; GIRLS SKIRT/PANTY COMBINATIONS; SOCKS; PLAYS SUITS; COVERALLS; UNION SUITS; COLLARLESS SHIRTS; SHORTS; PANTS AND SLACKS; SHIRTS; JACKETS; JUDGES, TEAM, REFEREE AND UMPIRE UNIFORMS; SWEATERS; PARKAS; TURTLENECKS; MITTENS; GLOVES; UNDERWEAR; ROMPERS; JERSEYS; MATERNITY TOPS; BOW TIES; HEAD WEAR AND SCARVES; EAR MUFFS, EAR BANDS AND HEADBANDS; HOSIERY; RAIN WEAR, NAMELY RAIN PONCHOS AND JACKETS; FOOTWEAR, NAMELY, SHOES, BOOTS AND SLIPPERS; BATH THONGS; HATS; CAPS; VISORS; APRONS; SKI AND CLOTH BIBS; TEAM UNIFORM REPRODUCTIONS, COMPRISING OF JERSEYS FEATURING REPRODUCTIONS OF PROFESSIONAL ATHLETIC TEAM LOGOS; CANVAS FOOTWEAR; KNICKERS; WIND-RESISTANT JACKETS; T-SHIRTS; SWEATSHIRTS; SEAT PANTS; BASEBALL CAPS; COATS; PULLOVERS; ONE-PIECE SKI SUITS; GOLF SHIRTS AND HATS; BLAZERS; LEG WARMERS; SEQUINED EVENING TOPS; JEANS; LEOTARDS; WORKOUT AND SPORTS APPAREL, NAMELY, SHORTS, JACKETS, SLACKS AND SKIRTS; SKI MASKS AND SKI GLOVES; SAILING GLOVES, IN CLASS 25 (U.S. CLS. 22 AND 39).

FOR: GAMES AND PLAYTHINGS, NAMELY, DOLLS AND STUFFED TOY ANIMALS; TOY SCALE MODEL VEHICLES; JIGSAW PUZZLES; ACTION PUPPETS; TOY PLASTIC MINI-HELMETS, BLOW-UP TOYS, NAMELY, BEACH BALLS, NOVELTY FLOTATION DEVICES FOR RECREATIONAL USE, SPECIFICALLY ARM FLOATS, SWIM FLOATS, FOAM FLOATS; COMMEMORATIVE MASCOT DOLLS; BOBBLE-HEAD DOLLS; HAND PUPPETS; TEDDY BEARS; PLASTIC YO-YOS, ACTION FIGURES AND ACCESSORIES TO BE USED WITH ACTION FIGURES; MARBLES; KITES; TOY TRUCKS; PLASTIC TOY HOOPS; TOY MODEL TRAIN SETS; RADIO-OPERATED TOY VEHICLES; TOYS FOR PETS; COIN AND NON-COIN OPERATED PINBALL MACHINES; HAND-HELD UNITS FOR PLAYING VIDEO GAMES; GYMNASTIC AND SPORTING ARTICLES NOT INCLUDED IN OTHER CLASSES, NAMELY, COMMEMORATIVE SPORTS BALLS WITH THE LOGO OF AN INTERNATIONAL ATHLETIC EVENT ON THEM, DART BOARD CABINETS AND DARTS, BASKETBALL BACKBOARDS; GOLF BAG COVERS, SHOULDER STRAP PADS FOR GOLF BAGS; AERODYNAMIC DISCS FOR PLAYING BOARD GAMES; ARCHERY SETS; RUBBER AND WOODEN SPORTS BALLS; JUMP ROPES; ATHLETIC SUPPORTERS; TENNIS, BADMINTON, VOLLEY BALL AND GOALIE NETS; ICE-HOCKEY STICKS; IRON SHOTS SPECIFICALLY FOR USE IN THE SHOT PUT COMPETITION; TENNIS RACQUETBALL AND BADMINTON RACKETS; TABLE TENNIS PADDLES; BASEBALL AND CRICKET BATS; GYMNASTIC EQUIPMENT, NAMELY, BOTTLE-SHAPED CLUBS; BALLOONS; BASEBALL, BOXING, KARATE, SOFTBALL AND HOCKEY GLOVES, BOWLING BALL BAGS; FISHING LURES;

Reg. No. 4,152,658 DISCUSSES; EXERCISE EQUIPMENT, NAMELY, BARBELLS AND WEIGHT-LIFT BENCHES; ATHLETIC EQUIPMENT SHAPED NYLON BAGS FOR CARRYING TENNIS RACKETS, SKIS AND SQUASH RACKETS; ICE SKATES, SKIS, SNOW BOARDS AND CROSS-COUNTRY SKIS; CURLING EQUIPMENT, SPECIFICALLY CURLING STONES; BOB SLEIGHS, PROTECTIVE PADS FOR ALL KINDS OF TEAM SPORTS, SPECIFICALLY, FOOTBALL KNEE PADS, FOOTBALL ELBOW PADS, FOOTBALL CHEST PADS, FOOTBALL SHOULDER PADS, SOCCER LEG PADS, ICE AND FIELD HOCKEY KNEE PADS; PROTECTIVE FACE MASKS FOR BASEBALL, FOOTBALL, ICE HOCKEY AND FIELD HOCKEY; DECORATIONS FOR CHRISTMAS TREES; PLAYING CARDS; ELECTRIC FISHING FLOATS, DEVICES FOR TYING FISHING LINES TO FISHING HOOKS, WAX APPLICATORS FOR SKIS, STATIONARY EXERCISE BICYCLES AND ROLLERS THEREFOR, IN CLASS 28 (U.S. CLS. 22, 23, 38 AND 50).

FOR: MEAT, FISH, POULTRY AND GAME; MEAT EXTRACTS; PRESERVED, DRIED AND COOKED FRUITS AND VEGETABLES; JELLIES, JAMS, COMPOTES; EGGS, MILK AND MILK PRODUCTS, NAMELY CHEESE AND YOGURT; EDIBLE OILS AND FATS, IN CLASS 29 (U.S. CL. 46).

FOR: COFFEE, TEA, COCOA, SUGAR, RICE, TAPIOCA, SAGO, ARTIFICIAL COFFEE; FLOUR AND PREPARATIONS MADE FROM CEREALS, NAMELY, BISCUITS AND COOKIES, BREAD, PASTRY AND CONFECTIONERY, NAMELY, CAKES, FRUIT ICES; HONEY, TREACLE; YEAST, BAKING-POWDER; SALT, MUSTARD; VINEGAR, SAUCES AS CONDIMENTS, NAMELY MAYONNAISE, KETCHUP AND RELISH; SPICES; ICE, IN CLASS 30 (U.S. CL. 46).

FOR: BEERS; MINERAL AND AERATED WATERS AND OTHER NON-ALCOHOLIC DRINKS, NAMELY ALOE VERA DRINKS, COFFEE-FLAVORED SOFT DRINKS, SOFT DRINKS, ENERGY DRINKS, GUARANA DRINKS, ISOTONIC DRINKS, SPORTS DRINKS; FRUIT DRINKS AND FRUIT JUICES; SYRUPS FOR MAKING BEVERAGES AND OTHER PREPARATIONS FOR MAKING SOFT DRINKS, FRUIT DRINKS AND FRUIT JUICES BEVERAGES, IN CLASS 32 (U.S. CLS. 45, 46 AND 48).

FOR: ADVERTISING; DISSEMINATION OF ADVERTISING MATTER VIA ALL MEDIA, NAMELY, IN THE FORM OF THEMATIC MESSAGES CENTERED ON HUMAN VALUES; PROMOTION OF PRODUCTS AND SERVICES OF THIRD PARTIES THROUGH SPONSORING ARRANGEMENTS AND LICENSE AGREEMENTS RELATING TO INTERNATIONAL SPORTS' EVENTS; BUSINESS MANAGEMENT; BUSINESS ADMINISTRATION; PROVIDING OFFICE FUNCTIONS; PROMOTING THE GOODS AND SERVICES OF OTHERS BY MEANS OF CONTRACTUAL AGREEMENTS, NAMELY, ARRANGING FOR SPONSORS TO AFFILIATE THEIR GOODS AND SERVICES WITH AN AWARDS PROGRAM, A SPORTS COMPETITION AND SPORTING ACTIVITIES AND LICENSING AGREEMENTS RELATING TO INTERNATIONAL SPORTS' EVENTS TO ENABLE PARTNERS TO GAIN ADDITIONAL NOTORIETY AND/OR IMAGE DERIVED FROM THOSE OF CULTURAL AND SPORTING EVENTS, IN PARTICULAR INTERNATIONAL SPORTING EVENTS; PROMOTING THE GOODS AND SERVICES OF OTHERS BY MEANS OF IMAGE TRANSFER, NAMELY, MAKING THE PARTNERS' PRODUCTS AND SERVICES BENEFIT FROM THE NOTORIETY AND ATTRACTIVENESS OF SPORTING EVENTS AND COMPETITIONS; RENTAL OF ADVERTISING SPACE OF ALL KINDS AND ON ALL CARRIERS, DIGITAL OR NOT; BUSINESS MANAGEMENT SERVICES, NAMELY, ADMINISTRATION OF COMPETITIONS FOR THE PARTICIPATION OF NATIONAL TEAMS TO AN INTERNATIONAL ATHLETIC COMPETITION, AND PROMOTING THE SUPPORT TO SAID TEAMS WITH THE PUBLIC AND THE CONCERNED CIRCLES BY MEANS OF PROMOTIONAL CAMPAIGNS IN THE MEDIA; INVENTORY CONTROL SERVICES; CONSULTATION IN THE FIELD OF INVENTORY CONTROL SERVICES; BUSINESS ACQUISITION INTEGRATION SERVICES; DIRECT MARKETING ADVERTISING FOR OTHERS FEATURING DATABASE MARKETING; CONSULTATION IN THE FIELD OF DIRECT MARKETING ADVERTISING FOR OTHERS FEATURING DATABASE MARKETING; BUSINESS REORGANIZATION CONSULTING SERVICES; TRUCK AND AUTOMOBILE FLEET MANAGEMENT SERVICES, NAMELY

Reg. No. 4,152,658 VOYAGE REPORTING AND INVOICING VIA A GLOBAL COMPUTER NETWORK; CONSULTATION IN THE FIELD OF TRUCK AND AUTOMOBILE FLEET MANAGEMENT SERVICES; BUSINESS ADMINISTRATION CONSULTING SERVICES; OPERATION AND MANAGEMENT OF POWER PLANTS OF OTHERS; CONSULTATION IN THE FIELD OF OPERATION AND MANAGEMENT OF POWER PLANTS, BUSINESS SERVICES, NAMELY THE ADMINISTRATION OF REPAIR AND SERVICES CONTRACTS, SUPPLY CHAIN MANAGEMENT AND CONSULTING SERVICES IN THE AREAS OF CHEMICAL PRODUCT AND SERVICE SOURCING AND PROCUREMENT, PRODUCT INVENTORY AND SUPPLY MANAGEMENT AND COST; CONSULTING, MARKETING, COST AND PRICING ANALYSIS RELATING TO ELECTROCHEMICAL LIQUID PURIFICATION UNITS FOR USE IN THE INDUSTRIAL SECTOR; ADMINISTRATIVE, COMMERCIAL AND TECHNICAL COMPUTERIZED FILE MANAGEMENT; DATA ENTRY AND DATA PROCESSING SERVICES; CONSULTANCY IN COMPUTERIZED DATABASE AND FILE MANAGEMENT; THE BRINGING TOGETHER, FOR THE BENEFIT OF OTHERS, OF A VARIETY OF GOODS AND SERVICES, ENABLING CUSTOMERS TO CONVENIENTLY VIEW AND PURCHASE THOSE GOODS AND SERVICES FROM AN INTERNET WEB SITE PARTICULARLY SPECIALIZING IN THE MARKETING OF THE SALE OF GOODS AND SERVICES OF OTHERS; BUSINESS INFORMATION, COMMERCIAL INFORMATION AGENCIES, RENTAL OF PHOTOCOPYING MACHINES; PROMOTING THE SALE OF GOODS AND SERVICES OF OTHERS BY MEANS OF ADVERTISEMENTS, PROMOTIONAL CONTESTS, DISCOUNTS AND INCENTIVES IN THE NATURE OF SWEEPSTAKES, REBATES, REWARD POINTS, AND VALUE ADDED OFFERS GENERATED IN CONNECTION WITH THE USE OF PAYMENT CARDS; PROMOTING SPORTS COMPETITIONS AND EVENTS OF OTHERS; PROMOTING CONCERTS AND CULTURAL EVENTS OF OTHERS, ORGANIZATION OF EXPOSITIONS HAVING COMMERCIAL OR ADVERTISING PURPOSES; THE PROVISION OF DOCUMENTATION, NAMELY DIRECT MAIL ADVERTISING, DISSEMINATION OF ADVERTISING MATTER, DISTRIBUTION OF SAMPLES, DOCUMENT REPRODUCTION; ADVERTISING REGARDING COMMERCIAL SALES PROMOTION OF GOODS AND SERVICES AT THE RETAIL LEVEL; PROVIDING CONSUMER PRODUCT INFORMATION REGARDING PURCHASE OF GOODS AND SERVICES ON-LINE VIA THE INTERNET AND OTHER COMPUTER NETWORKS; ADVERTISING SERVICES NAMELY, ADVERTISING FOR TRANSPORT, TRAVEL, HOTELS, LODGING, FOOD AND MEALS, SPORTS, ENTERTAINMENT AND SIGHTSEEING, FOR TOURIST AGENCIES SERVICES; CONSULTATION IN THE FIELD OF DATA PROCESSING, IN PARTICULAR, IN REGARD TO FINANCIAL TRANSACTIONS, IN CLASS 35 (U.S. CLS. 100, 101 AND 102).

FOR: INSURANCE CONSULTATION; FINANCIAL MANAGEMENT; MONETARY EXCHANGE; REAL ESTATE AFFAIRS, NAMELY, REAL ESTATE APPRAISAL, REAL ESTATE INVESTMENT; CREDIT CARD SERVICES; FINANCING OF SPORTING AND CULTURAL ACTIVITIES; RENTAL OF BUILDINGS AND OUTBUILDINGS DESIGNED FOR HOSTING BUSINESS ENTERTAINMENT; ASSET BASED AND PRIVATE LABEL FINANCING SERVICES; FINANCIAL ANALYSIS AND CONSULTATION; CREDIT CARD FINANCIAL SERVICES; CREDIT CARD SERVICES, NAMELY, EXTENSION OF CREDIT TO OTHERS; FINANCIAL ASSET MANAGEMENT FOR OTHERS; INSURANCE AND RE-INSURANCE SERVICES, NAMELY, UNDERWRITING SERVICES FOR ALL TYPES OF INSURANCE; EQUITY INVESTMENT SERVICES; INSURANCE UNDERWRITING SERVICES IN THE FIELD OF BONDS; FINANCIAL GUARANTEE ASSURANCE UNDERWRITING SERVICES; PERSONAL LOAN FINANCING; MORTGAGE BANKING SERVICES; ACQUISITION FINANCING SERVICES; COMMERCIAL FINANCING SERVICES; COMMERCIAL REAL ESTATE AGENCY SERVICES; MUTUAL FUND INVESTMENT; PRIVATE EQUITY AND DEBT INVESTMENT; CONSULTANCY, ADVISORY AND INFORMATION SERVICES RELATING TO ALL THE FOREGOING SERVICES; LEASING AND RENTAL OF MOBILE AND MODULAR BUILDINGS, INSURANCE BROKERAGE SERVICES, CREDIT AGENCY SERVICES IN THE FIELDS OF CONSUMER AND COMMERCIAL CREDIT, REAL ESTATE LOAN FINANCING SERVICES AND BANKING AND FINANCING SERVICES; COMPUTERIZED SERVICES IN CONNECTION WITH FINANCIAL AND MONETARY OPERATIONS RELATING TO ELECTRONIC COMMERCIAL TRANSACTIONS, NAMELY ELECTRONIC FUNDS TRANSFERS, ELECTRONIC DEBIT AND CREDIT CARD TRANSACTIONS; BANKING,

Reg. No. 4,152,658 NAMELY, BANK CARD SERVICES AND STORE ACCOUNT CARD SERVICES; FINANCIAL CLEARING-HOUSE SERVICES; ISSUING OF CHEQUES AND LETTERS OF CREDIT; FINANCIAL TRUST OPERATIONS; BILL PAYMENT SERVICES; DEBIT CARD SERVICES; CHARGE CARD SERVICES; PRE-PAID CARD SERVICES; ELECTRONIC CREDIT AND DEBIT TRANSACTIONS; ELECTRONIC FUNDS TRANSFER; SMART CARD AND ELECTRONIC CASH CARD SERVICES; ELECTRONIC CASH DISBURSEMENTS SERVICES; CASH REPLACEMENT RENDERED BY CREDIT CARD AND DEBIT CARDS; ELECTRONIC CASH TRANSACTIONS; CHEQUE VERIFICATION; CHEQUE CASHING; DEPOSIT ACCESS AND AUTOMATED TELLER MACHINE SERVICES; PAYMENT PROCESSING SERVICES, NAMELY, CREDIT CARD AND DEBIT CARD TRANSACTION PROCESSING SERVICES; PROVIDING FINANCIAL INFORMATION VIA A GLOBAL COMPUTER NETWORK; FINANCIAL SPONSORSHIP OF MUSICAL CONCERTS AND FESTIVALS; INFORMATION SERVICES IN THE TOURIST FIELD, NAMELY, PROVIDING FINANCIAL INFORMATION IN REGARD TO FINANCIAL MATTERS FOR THE ASSISTANCE OF TOURISTS; PROVIDING INFORMATION RELATED TO COMMODITY TRADING, IN CLASS 36 (U.S. CLS. 100, 101 AND 102).

FOR: BUILDING CONSTRUCTION; REPAIR, INSTALLATION AND MAINTENANCE OF COMPUTER SYSTEMS HARDWARE, COMPUTER NETWORK HARDWARE AND COMPUTER HARDWARE; CONSTRUCTION, INSTALLATION, REPAIR, REPLACEMENT, OVERHAUL AND MAINTENANCE OF POWER PLANTS, ENGINES, TURBINES, WIND TURBINES, MOTORS AND APPARATUS, EQUIPMENT AND INSTRUMENT FOR THE GENERATION OF POWER AND ELECTRICITY AND THEIR COMPONENT PARTS, FITTINGS AND ACCESSORIES; INSTALLATION, MAINTENANCE AND REPAIR SERVICES FOR COMPRESSORS AND PUMPS, NAMELY, MACHINE PUMPS AND COMPRESSORS, TURBO EXPANDERS, FUEL PUMPS AND FUEL DISTRIBUTION EQUIPMENT, CNG REFUELING EQUIPMENT, GAS TURBINES, STEAM TURBINES, AIR COOLED HEAT-EXCHANGERS, STEAM CONDENSERS, HEAVY WALL REACTORS AND TUBULAR REACTORS; OIL AND GAS PIPELINE MAINTENANCE AND REPAIR SERVICES; DRILLING AND PUMPING OF OIL AND GAS; DRILLING FOR CRUDE OIL; OIL WELL CASING, TUBING AND DRILL PIPE INSTALLATION; RENTAL OF OIL AND GAS WELL DRILLING TOOLS; DIAGNOSTIC REPAIR AND MAINTENANCE SERVICES RENDERED IN THE REPAIR AND MAINTENANCE OF AIRCRAFT ENGINES, TURBINES, ELECTRICAL EQUIPMENT, MEDICAL EQUIPMENT, LOCOMOTIVES INCLUDING ACCESSORIES AND COMPONENT PARTS OF ALL THE FOREGOING; CONSTRUCTION EQUIPMENT LEASING; CHEMICAL CLEANING SERVICES FOR GLASS-LINED REACTOR VESSELS USED IN THE CHEMICAL AND PHARMACEUTICAL PROCESSING INDUSTRIES; MAINTENANCE SERVICES FOR HEAT TRANSFER SYSTEMS AND CONDENSERS; MAINTENANCE AND REPAIR SERVICES IN THE FIELD OF COMPUTERIZED COOLING SYSTEM EQUIPMENT, REPAIR AND MAINTENANCE OF MACHINERY, INSTRUMENTS, ELECTRICAL EQUIPMENT AND APPLIANCES, NAMELY, OIL AND GAS EQUIPMENT MAINTENANCE AND REPAIR SERVICES; INSTALLATION OF POINT OF SALE TERMINALS IN SHOPS; COMPUTER MAINTENANCE; ELECTRIC APPLIANCE INSTALLATION AND REPAIR, REPAIR OF RADIO RECEIVERS AND TELEVISION RECEIVERS, REPAIR AND MAINTENANCE OF ELECTRICAL COMMUNICATION APPARATUS AND INSTRUMENTS, REPAIR AND MAINTENANCE OF HOUSEHOLD ELECTRIC APPLIANCES, REPAIR AND MAINTENANCE OF ELECTRIC LIGHTING APPARATUS, REPAIR AND MAINTENANCE OF POWER DISTRIBUTION AND CONTROL APPARATUS, REPAIR AND MAINTENANCE OF ELECTRIC MOTORS, REPAIR AND MAINTENANCE OF MEASURING AND TESTING MACHINES AND INSTRUMENTS, REPAIR AND MAINTENANCE OF MEDICAL APPARATUS AND INSTRUMENTS, REPAIR AND MAINTENANCE OF METALWORKING MACHINES AND TOOLS, REPAIR AND MAINTENANCE OF COOKING APPLIANCES, REPAIR AND MAINTENANCE OF AUTOMATIC DISTRIBUTION MACHINES, REPAIR AND MAINTENANCE OF WATER PURIFYING APPARATUS, REPAIR AND MAINTENANCE OF MUSICAL INSTRUMENTS, WATCH AND CLOCK REPAIR AND MAINTENANCE, REPAIR AND MAINTENANCE OF GAS WATER HEATERS FOR HOUSEHOLD PURPOSES, REPAIR AND MAINTENANCE OF BATH EQUIPMENT, REPAIR OF TOILET STOOL UNITS WITH WASHING WATER SQUIRTING FEATURES, INSTALLATION, MAINTENANCE AND REPAIR OF COMPUTER HARDWARE,

Reg. No. 4,152,658 REPAIR AND MAINTENANCE OF AIR CONDITIONING APPARATUS, OFFICE MACHINES AND EQUIPMENT INSTALLATION, MAINTENANCE AND REPAIR, MACHINERY INSTALLATION, MAINTENANCE AND REPAIR, VEHICLE REPAIR, REPAIR AND MAINTENANCE OF ELECTRICAL COMMUNICATION APPARATUS AND INSTRUMENTS, REPAIR AND MAINTENANCE OF COMPUTERS, REPAIR AND MAINTENANCE OF ELECTRONIC PRINTERS, TELEPHONE REPAIR, REPAIR AND MAINTENANCE OF CONSUMER ELECTRONICS AND TELECOMMUNICATIONS EQUIPMENT, IN CLASS 37 (U.S. CLS. 100, 103 AND 106).

FOR: TELECOMMUNICATION SERVICES, NAMELY, LOCAL AND LONG DISTANCE TRANSMISSION OF VOICE, DATA, GRAPHICS BY MEANS OF TELEPHONE, TELEGRAPHIC, CABLE, AND SATELLITE TRANSMISSIONS; TELEVISION BROADCASTING; COMMUNICATIONS BY MOBILE TELEPHONES; COMMUNICATIONS BY ELECTRONIC COMPUTER TERMINALS; PROVIDING ACCESS TO DATABASES AND INTERNET RELATED TELECOMMUNICATIONS NETWORKS; COMMUNICATIONS BY A COMMUNICATIONS SYSTEM CONSISTING OF TELETYPEWRITERS CONNECTED TO A TELEPHONIC NETWORK TO SEND AND RECEIVE SIGNALS; COMMUNICATIONS BY TELEGRAPH; COMMUNICATIONS BY TELEPHONE; COMMUNICATIONS BY FACSIMILE; PAGING BY RADIO; COMMUNICATIONS BY TELECONFERENCING; CABLE TELEVISION BROADCASTING; RADIO BROADCASTING; PRESS AND INFORMATION AGENCY SERVICES, SPECIFICALLY, TRANSMISSION OF NEWS INCLUDING SPORTS RESULTS AND ENTERTAINMENT; OTHER MESSAGE TRANSMISSION SERVICES, SPECIFICALLY, DELIVERY OF MESSAGES BY ELECTRONIC MEANS; BROADCASTING OF A COMMERCIAL SITE ON THE INTERNET; STREAMING OF RADIO AND TELEVISION PROGRAMMING AND BROADCASTING SERVICES PROVIDED VIA THE INTERNET; ELECTRONIC MESSAGING; PROVIDING ACCESS TO COMPUTER BULLETIN BOARDS, AND REAL-TIME CHAT FORUMS FOR TRANSMISSION OF MESSAGES AMONG USERS CONCERNING SPORTS AND ENTERTAINMENT; TRANSMISSION OF MESSAGES AND IMAGES VIA COMPUTER; PROVIDING ACCESS TO TELECOMMUNICATIONS CHANNELS FOR HOME AND OFFICE TELE-SHOPPING SERVICES VIA COMPUTER AND/OR INTERACTIVE COMMUNICATIONS TECHNOLOGIES; TELECOMMUNICATION OF INFORMATION INCLUDING WEB PAGES, COMPUTER PROGRAMS AND ANY OTHER DATA, SPECIFICALLY, DATA TRANSMITTED BY ELECTRONIC COMMUNICATIONS NETWORK; ELECTRONIC MAIL SERVICES; PROVIDING USER ACCESS TO THE INTERNET; PROVIDING TELECOMMUNICATIONS CONNECTIONS TO THE INTERNET OR DATABASES; PROVIDING ACCESS TO DIGITAL MUSIC WEB SITES ON THE INTERNET; PROVIDING ACCESS TO MP3 WEB SITES ON THE INTERNET; DELIVERY OF DIGITAL MUSIC BY TELECOMMUNICATIONS; RENTAL OF ACCESS TIME TO A CENTRAL DATABASE AVAILABLE ON THE INTERNET; PROVIDING ACCESS TO SEARCH ENGINE DATABASES; MANAGEMENT OF CHAT FORUMS ON THE INTERNET FOR TRANSMISSION OF MESSAGES AMONG COMPUTER USERS CONCERNING SPORTS AND ENTERTAINMENT; RENTAL OF TELECOMMUNICATION LINES FOR ACCESS TIME TO A CENTRAL SERVER DATABASE; RENTAL OF TELECOMMUNICATION LINES FOR ACCESS TIME TO A COMPUTER DATABASE; SIMULTANEOUS BROADCASTING OF FILMS AND OF VIDEO AND SOUNDS RECORDINGS VIA ELECTRONIC COMMUNICATIONS NETWORKS; PROVIDING E-MAIL SERVICES; WIRELESS DATA MESSAGING SERVICE, PARTICULARLY SERVICE THAT ENABLE A USER TO SEND AND/OR RECEIVE MESSAGE THROUGH A WIRELESS DATA WORK; ONE-WAY AND TWO-WAY PAGING SERVICES; ELECTRONIC TRANSMISSION OF DATA, IMAGES, AUDIO, VIDEO AND DOCUMENTS, INCLUDING TEXT, CARDS, LETTERS, MESSAGES, MAIL, ANIMATIONS AND ELECTRONIC MAIL, OVER LOCAL OR GLOBAL COMMUNICATIONS NETWORKS, INCLUDING THE INTERNET, INTRANETS, EXTRANETS, TELEVISION, MOBILE COMMUNICATION, CELLULAR AND SATELLITE NETWORKS; ELECTRONIC TRANSMISSION OF COMPUTER SOFTWARE OVER LOCAL OR GLOBAL COMMUNICATIONS NETWORKS, INCLUDING THE INTERNET, INTRANETS, EXTRANETS, TELEVISION, MOBILE COMMUNICATION, CELLULAR, AND SATELLITE NETWORKS; PROVIDING ACCESS TO DATABASES AND LOCAL OR GLOBAL COMMUNICATIONS NETWORKS, NAMELY THE INTERNET, INTRANETS, EXTRANETS, TELEVISION, MOBILE COMMUNICATION, CELLULAR, AND SATELLITE NETWORKS; MESSAGE TRANSMIS-

Reg. No. 4,152,658 SION AND RELAY SERVICES, NAMELY, ELECTRONIC TRANSMISSION OF MESSAGES; TELECOMMUNICATION SERVICES FOR THE DISSEMINATION OF INFORMATION BY MOBILE TELEPHONE, NAMELY, THE TRANSMISSION OF DATA TO MOBILE TELEPHONES; MOBILE TELEPHONE COMMUNICATION SERVICES; ELECTRONIC TRANSMISSION AND RECEPTION OF VOICE COMMUNICATION; COMMUNICATION SERVICES, NAMELY, TRANSMISSION OF DATA BY TELECOMMUNICATIONS NETWORKS, AND MULTIMEDIA COMMUNICATIONS NETWORKS; RENTAL OF ACCESS TIME TO GLOBAL COMPUTER NETWORKS; TRANSMISSION OF DATA, IMAGES, AUDIO, VIDEO AND DOCUMENTS, INCLUDING TEXT, ELECTRONIC CARDS, LETTERS, MESSAGES, E-MAIL, ANIMATIONS AND ELECTRONIC MAIL, OVER LOCAL OR GLOBAL COMMUNICATIONS NETWORKS, INCLUDING THE INTERNET, INTRANETS, EXTRANETS, TELEVISION, MOBILE COMMUNICATION, CELLULAR AND SATELLITE NETWORKS, IN CLASS 38 (U.S. CLS. 100, 101 AND 104).

FOR: COURIER AND AIR TRANSPORTATION SERVICES; TRAVEL ARRANGEMENT; STORAGE SERVICES FOR CARRIERS CONTAINING IMMOBILE AND MOBILE IMAGES, NAMELY, STORAGE OF ELECTRONIC MEDIA, NAMELY, IMAGES, TEXT AND AUDIO DATA; TRANSMISSION OF OIL OR GAS THROUGH PIPELINES; AUTOMOBILE, AIRCRAFT, RAILCAR AND MARINE VESSEL LEASING; CHEMICAL DELIVERY AND STORAGE SERVICES IN THE FIELD OF WATER TREATMENT AND PULP AND PAPER MAKING SYSTEMS; LEASING OF SHIPPING CONTAINERS; BOAT TRANSPORT; VEHICLES RESERVATION SERVICES; TRAVEL SERVICES, NAMELY TRAVEL INFORMATION SERVICES, RESERVATION SERVICES AND ORGANIZATION OF TRAVEL IN THE NATURE OF PRE-TRIP PLANNING ASSISTANCE SERVICES WITH THE EXCEPTION OF ALL SERVICES RELATING TO THE ENDORSEMENT IN A PASSPORT OR SIMILAR DOCUMENT SIGNIFYING THE DOCUMENT IS IN ORDER AND PERMITTING THE BEARER TO TRAVEL INTO OR THROUGH THE COUNTRY OF THE GOVERNMENT ISSUING IT; TRAVEL TICKET RESERVATION SERVICES; INFORMATION SERVICES IN THE TOURIST FIELD, NAMELY TRANSPORTATION INFORMATION SERVICES; INFORMATION SERVICES IN THE TOURIST FIELD, NAMELY TICKET RESERVATION INFORMATION SERVICES FOR TRANSPORTATION, TRAVEL AND SIGHTSEEING; INFORMATION SERVICES IN THE TOURIST FIELD, NAMELY ACTIVITY SCHEDULING INFORMATION SERVICES FOR SIGHTSEEING AND TRANSPORTATION; TRAVEL SERVICES IN THE NATURE OF ARRANGING TRANSPORTATION FOR THE ASSISTANCE OF TOURISTS, WITH THE EXCEPTION OF ALL SERVICES RELATING TO THE ENDORSEMENT IN A PASSPORT OR SIMILAR DOCUMENT SIGNIFYING THE DOCUMENT IS IN ORDER AND PERMITTING THE BEARER TO TRAVEL INTO OR THROUGH THE COUNTRY OF THE GOVERNMENT ISSUING IT; TOURIST RESERVATION SERVICES WITH THE EXCEPTION OF ALL SERVICES RELATING TO THE ENDORSEMENT IN A PASSPORT OR SIMILAR DOCUMENT SIGNIFYING THE DOCUMENT IS IN ORDER AND PERMITTING THE BEARER TO TRAVEL INTO OR THROUGH THE COUNTRY OF THE GOVERNMENT ISSUING IT, NAMELY TRAVEL TICKET RESERVATION AND TRANSPORTATION RESERVATION SERVICES; PROVIDING TRAVEL INFORMATION TO TRAVELERS REGARDING FARES, TIMETABLES AND METHODS OF TRANSPORT; TOURIST ASSISTANCE SERVICES, NAMELY, TICKET RESERVATIONS FOR TRANSPORT, TRAVEL AND SIGHTSEEING, WITH THE EXCEPTION OF ALL SERVICES RELATING TO THE ENDORSEMENT IN A PASSPORT OR SIMILAR DOCUMENT SIGNIFYING THE DOCUMENT IS IN ORDER AND PERMITTING THE BEARER TO TRAVEL INTO OR THROUGH THE COUNTRY OF THE GOVERNMENT ISSUING IT; TOURIST ASSISTANCE SERVICES, NAMELY, ACTIVITY SCHEDULING FOR SIGHTSEEING, WITH THE EXCEPTION OF ALL SERVICES RELATING TO THE ENDORSEMENT IN A PASSPORT OR SIMILAR DOCUMENT SIGNIFYING THE DOCUMENT IS IN ORDER AND PERMITTING THE BEARER TO TRAVEL INTO OR THROUGH THE COUNTRY OF THE GOVERNMENT ISSUING IT; TOURIST RESERVATION SERVICES WITH THE EXCEPTION OF ALL SERVICES RELATING TO THE ENDORSEMENT IN A PASSPORT OR SIMILAR DOCUMENT SIGNIFYING THE DOCUMENT IS IN ORDER AND PERMITTING THE BEARER TO TRAVEL INTO OR THROUGH THE COUNTRY OF THE GOVERNMENT ISSUING IT, NAMELY, TICKET RESERVATION SERVICES FOR TRANSPORT, TRAVEL

Reg. No. 4,152,658 AND SIGHTSEEING; PROVIDING TRAVEL TIMETABLES AND MODES OF TRANSPORT, IN CLASS 39 (U.S. CLS. 100 AND 105).

FOR: TREATMENT OF MATERIALS; DEVELOPING OF FILMS FOR MOVIES; ENLARGING OF PHOTOGRAPHS, PRINTING OF PHOTOGRAPHS, DEVELOPING OF FILMS FOR PHOTOGRAPHS; LEASING OR RENTAL OF MACHINES AND INSTRUMENTS FOR DEVELOPING, PRINTING, ENLARGING OR FINISHING FOR PHOTOGRAPHY; OIL PRODUCTION SERVICES; GAS PRODUCTION SERVICES; OIL AND GAS WELL TREATMENT SERVICES; OIL AND GAS REFINING SERVICES; WASTEWATER TREATMENT SERVICES; WATER TREATMENT SERVICES, NAMELY, DESALINATION, PURIFICATION, CONDITIONING, IDENTIFYING AND CONTROLLING MICROBIOLOGICAL ORGANISMS, CLEANING OF ION EXCHANGE RESINS; MEMBRANE REGENERATION SERVICES; PROVIDING INFORMATION TO OTHERS, OVER A GLOBAL COMPUTER NETWORK, RELATING TO INDUSTRIAL WATER PURIFICATION, IN CLASS 40 (U.S. CLS. 100, 103 AND 106).

FOR: PROVIDING OF TRAINING SERVICES IN THE FIELDS OF AQUATICS, ARCHERY, ATHLETICS, BADMINTON, BASEBALL, BASKETBALL, BOXING, CANOE/KAYAK, CYCLING, EQUESTRIAN, FENCING, FOOTBALL, GOLF, GYMNASTICS, HANDBALL, HOCKEY, JUDO, MODERN PENTATHLON, ROWING, RUGBY, SAILING, SHOOTING, SOFTBALL, TABLE TENNIS, TAE KWON DO, TENNIS, TRIATHLON, VOLLEYBALL, WEIGHTLIFTING, AND WRESTLING; ENTERTAINMENT IN THE NATURE OF INTERNATIONAL SPORTING EVENTS, NAMELY, AQUATICS PERFORMANCES, ARCHERY PERFORMANCES, ATHLETICS PERFORMANCES, BADMINTON PERFORMANCES, BASEBALL PERFORMANCES, BASKETBALL PERFORMANCES, BOXING PERFORMANCES, CANOE/KAYAK PERFORMANCES, CYCLING PERFORMANCES, EQUESTRIAN PERFORMANCES, FENCING PERFORMANCES, FOOTBALL PERFORMANCES, GOLF PERFORMANCES, GYMNASTICS PERFORMANCES, HANDBALL PERFORMANCES, HOCKEY PERFORMANCES, JUDO PERFORMANCES, MODERN PENTATHLON PERFORMANCES, ROWING PERFORMANCES, RUGBY PERFORMANCES, SAILING PERFORMANCES, SHOOTING PERFORMANCES, SOFTBALL PERFORMANCES, TABLE TENNIS PERFORMANCES, TAE KWON DO PERFORMANCES, TENNIS PERFORMANCES, TRIATHLON PERFORMANCES, VOLLEYBALL PERFORMANCES, WEIGHTLIFTING PERFORMANCES, AND WRESTLING PERFORMANCES; ORGANIZING INTERNATIONAL COMMUNITY SPORTING AND CULTURAL EVENTS, TELEVISION SHOW PRODUCTION IN THE FIELD OF SPORTING AND CULTURAL ENTERTAINMENT; ORGANIZATION OF CULTURAL AND EDUCATIONAL EXHIBITIONS IN THE FIELD OF SPORTS; ORGANIZATION OF LOTTERIES; BETTING AND GAMBLING SERVICES RELATING TO OR IN CONJUNCTION WITH SPORT; ENTERTAINMENT SERVICES PROVIDED AT OR RELATING TO SPORTS EVENTS, NAMELY, PRESENTATION OF LIVE SHOW PERFORMANCES IN THE NATURE OF OPENING AND CLOSING CEREMONIES OF INTERNATIONAL SPORTS EVENTS; ORGANIZATION OF INTERNATIONAL COMMUNITY SPORTING AND CULTURAL EVENTS; ORGANIZATION OF SPORTING COMPETITIONS, NAMELY, AQUATICS, ARCHERY, ATHLETICS, BADMINTON, BASEBALL, BASKETBALL, BOXING, CANOE/KAYAK, CYCLING, EQUESTRIAN, FENCING, FOOTBALL, GOLF, GYMNASTICS, HANDBALL, HOCKEY, JUDO, MODERN PENTATHLON, ROWING, RUGBY, SAILING, SHOOTING, SOFTBALL, TABLE TENNIS, TAE KWON DO, TENNIS, TRIATHLON, VOLLEYBALL, WEIGHTLIFTING, AND WRESTLING COMPETITIONS; MANAGEMENT OF SPORTING FACILITIES, NAMELY, PROVIDING SPORTS FACILITIES; RENTAL OF AUDIO AND VIDEO EQUIPMENT; PRODUCTION AND DISTRIBUTION OF MOTION PICTURE FILMS; PRODUCTION OF VIDEO TAPES AND AUDIO SOUNDS RECORDINGS; RENTAL OF FILMS AND VIDEO TAPES AND SOUNDS RECORDINGS; RENTAL OF INTERACTIVE EDUCATION AND ENTERTAINMENT VIDEOTAPES IN THE FIELD OF SPORTS; PRODUCTION OF RADIO AND TELEVISION PROGRAMS FEATURING COVERAGE OF SPORTS AND SPORTING EVENTS; RADIO AND TELEVISION PROGRAM AND VIDEO TAPE PRODUCTION SERVICES; PRODUCTION OF ANIMATED MOTION PICTURE FILMS; PRODUCTION OF ANIMATED TELEVISION PROGRAMS; SEAT BOOKING SERVICES FOR SHOWS AND SPORTING EVENTS; TIMING OF SPORTS EVENTS; ORGANIZATION OF BEAUTY CONTESTS; ON-LINE GAMBLING SERVICES; PROVIDING OF GAMES OVER

Reg. No. 4,152,658 THE INTERNET, NAMELY, ON-LINE COMPUTER GAMES; PROVIDING OF RAFFLE SERVICES IN THE NATURE OF A LOTTERY; PROVIDING INFORMATION RELATING TO SPORTS ENTERTAINMENT AND EDUCATION, PROVIDED ON-LINE FROM A COMPUTER DATABASE OR THE INTERNET; ELECTRONIC GAMES SERVICES PROVIDED BY MEANS OF THE INTERNET, NAMELY, PROVIDING ON-LINE COMPUTER GAMES; PROVIDING ON-LINE ELECTRONIC PUBLICATIONS, NAMELY, PUBLICATION OF ELECTRONIC MAGAZINES AND NEWSPAPERS; PUBLICATION OF ELECTRONIC BOOKS, REVIEWS, JOURNALS, MAGAZINES, TEXTS OTHER THAN PUBLICITY TEXTS; ON-LINE PUBLICATION OF ELECTRONIC BOOKS, REVIEWS, JOURNALS, MAGAZINES, TEXTS OTHER THAN PUBLICITY TEXTS; PROVIDING NON-DOWNLOADABLE DIGITAL MUSIC ON THE INTERNET VIA A GLOBAL COMPUTER NETWORK; PROVIDING NON-DOWNLOADABLE DIGITAL MUSIC BY MEANS OF MP3 INTERNET WEB SITES ON A GLOBAL COMPUTER NETWORK; PROVIDING SPORT RECORDS AND STATISTICAL INFORMATION IN CONNECTION WITH SPORTS AND SPORTING EVENTS; LEASING OF RECORDED SOUND AND IMAGES, NAMELY, AUDIO, VIDEO AND PHOTOGRAPHIC ARCHIVES RELATING TO SPORT COMPETITIONS AND RELATED EVENTS, AUDIO PRODUCTION SERVICES; PROVIDING INFORMATION IN THE FIELD OF SPORTS, NAMELY, PROVIDING SPORTING RESULTS; PROVIDING INFORMATION RELATED TO SPORTING EVENTS PROVIDED ON-LINE FROM A COMPUTER DATABASE OR FROM THE INTERNET; MUSIC PUBLISHING AND PRODUCTION SERVICES; PROVIDING NON-DOWNLOADABLE DIGITAL MUSIC, NAMELY, MUSIC FROM THE OPENING AND CLOSING CEREMONIES OF INTERNATIONAL SPORTING EVENTS, VIA THE INTERNET; PROVIDING STATISTICAL INFORMATION IN RELATION TO SPORTS RESULTS AND AUDIENCE RATINGS FOR SPORTS COMPETITIONS; TRAINING IN THE USE AND OPERATION OF SIGNALING AND CROSS-WARNING SYSTEMS FOR THE RAIL AND TRANSIT INDUSTRIES; EDUCATIONAL SERVICES IN THE FIELD OF MEDICAL IMAGING AND DIAGNOSTICS, NAMELY, HOLDING SEMINARS, CONFERENCES, SYMPOSIUMS OR WORKSHOPS RELATING TO THE PHARMACEUTICAL INDUSTRY, FOR MEDICAL PRACTITIONERS AND EMPLOYEES OF PHARMACEUTICAL COMPANIES; EDUCATIONAL SERVICES, NAMELY, HOLDING SEMINARS, CONFERENCES, SYMPOSIUMS OR WORKSHOPS IN THE FIELD OF LIFE SCIENCE AND BIOTECHNOLOGY FOR SCIENTISTS AND RESEARCHERS; CONDUCTING SEMINARS RELATED TO INDUSTRIAL WATER TREATMENT PROBLEMS; PROVIDING TRAINING SERVICES FOR ALL THE AFORESAID; PROVIDING TRAINING SERVICES IN MANAGEMENT AND THE MEDICAL FIELD THROUGH THE USE OF INSTRUCTIONS AND DEMONSTRATIONS PROVIDED ONLINE, THROUGH THE INTERNET, INTRANET AND EXTRANETS; EDUCATION SERVICES, NAMELY, CONDUCTING PRACTICAL TRAINING WORKSHOPS, CLASSES AND SEMINARS FEATURING DEMONSTRATIONS IN THE FIELD OF MANAGEMENT AND MEDICINE; DESIGN, ORGANIZATION AND CONDUCTING OF EDUCATIONAL COURSES, SEMINARS AND TRAINING IN THE FIELD OF COMPUTERS; ORGANIZING AND CONDUCTING MUSICAL CONCERTS; BOOKING OF SEATS FOR SHOWS AND CINEMA PRESENTATIONS; ENTERTAINMENT INFORMATION; FILM PRODUCTION; PRODUCTION OF TELEVISION AND RADIO SHOWS; ENTERTAINMENT SERVICES IN THE NATURE OF THEATRE PRODUCTIONS; PROVIDING GOLF FACILITIES; HEALTH CLUB SERVICES, NAMELY, PROVIDING INSTRUCTION AND EQUIPMENT IN THE FIELD OF PHYSICAL EXERCISE; SPORT CAMP SERVICES; PRESENTATION OF LIVE SHOW PERFORMANCES; MOVIE THEATRES; ORGANIZATION OF CULTURAL SHOWS; HOLIDAY CAMP SERVICES; MOVIE STUDIOS; NEWS REPORTERS SERVICES; PROVIDING ON-LINE NON-DOWNLOADABLE PUBLICATIONS, IN THE NATURE OF BOOKS, MAGAZINES, REVIEWS IN THE FIELD OF SPORTS; EDUCATION SERVICES, NAMELY, CONDUCTING CLASSES, SEMINARS, PRESENTATIONS, VIDEO PRESENTATIONS IN THE FIELD OF SPORTS, PROVISION OF EDUCATIONAL MATERIAL, NAMELY, DEVELOPMENT AND DISSEMINATION OF EDUCATIONAL MATERIALS IN THE AREA OF FINANCIAL LITERACY; EDUCATIONAL SERVICES IN THE TOURIST FIELD, NAMELY, PROVIDING SEMINARS, CONFERENCES, SYMPOSIUMS AND WORKSHOPS IN THE FIELD OF BOOKING TRAVEL AND ENTERTAINMENT TICKETS; INFORMATION SERVICES IN THE TOURIST FIELD, NAMELY, TICKET RESERVATION INFORMATION IN THE NATURE OF PROVIDING INFORMATION CONCERNING TICKET RESERVATIONS FOR SHOWS AND OTHER ENTERTAINMENT EVENTS ENTERTAINMENT;

Reg. No. 4,152,658 INFORMATION SERVICES IN THE TOURIST FIELD, NAMELY, ENTERTAINMENT INFORMATION SERVICES; INFORMATION SERVICES IN THE TOURIST FIELD, NAMELY, PROVIDING ACTIVITY SCHEDULING INFORMATION SERVICES FOR SPORTS, CULTURE AND OTHER ENTERTAINMENT EVENTS; SERVICES IN REGARD TO ENTERTAINMENT FOR THE ASSISTANCE OF TOURISTS, NAMELY, TOURIST ASSISTANCE SERVICES IN THE NATURE OF ACTIVITY SCHEDULING FOR SPORTING, CULTURAL AND OTHER ENTERTAINMENT EVENTS; TOURIST RESERVATION SERVICES, NAMELY, TICKET RESERVATION SERVICES FOR SPORTING, CULTURAL AND OTHER ENTERTAINMENT EVENTS; TOURIST RESERVATION SERVICES, NAMELY, TICKET RESERVATION SERVICES FOR SPORTING, CULTURAL AND OTHER ENTERTAINMENT EVENTS, IN CLASS 41 (U.S. CLS. 100, 101 AND 107).

FOR: SCIENTIFIC AND TECHNOLOGICAL SERVICES AND RESEARCH AND DESIGN RELATING THERETO IN THE FIELD OF MEDICAL AND PHARMACO-TOXICOLOGICAL SCIENCE AND TESTING; INDUSTRIAL ANALYSIS AND RESEARCH SERVICES IN THE FIELD OF MEDICAL AND PHARMACO-TOXICOLOGICAL SCIENCE AND TESTING; LABORATORY ANALYSIS IN THE FIELD OF MEDICAL AND PHARMACO-TOXICOLOGICAL SCIENCE AND TESTING; DESIGN AND DEVELOPMENT OF COMPUTER HARDWARE AND SOFTWARE; SERVICES RELATING TO WIND AND WIND POWER, NAMELY, PROFESSIONAL ENGINEERING AND DESIGN CONSULTING SERVICES AND ENGINEERING SERVICES; DESIGN OF NEW PRODUCTS FOR OTHERS IN THE FIELD OF WIND POWER; INDUSTRIAL DESIGN SERVICES; DESIGN OF POWER, WIND POWER AND ELECTRIC POWER GENERATING EQUIPMENT AND INSTALLATIONS; ENGINEERING SERVICES, TECHNICAL CONSULTATION AND SCIENTIFIC RESEARCH SERVICES IN THE OIL AND GAS EXPLORATION INDUSTRIES; OIL AND GAS EXPLORATION SERVICES; GEOPHYSICAL EXPLORATION FOR THE OIL AND GAS INDUSTRIES; ANALYSIS OF OIL AND GAS FIELDS; OIL AND GAS PROSPECTING, NAMELY, WELL LOGGING AND TESTING; OIL AND GAS WELL TESTING; OIL AND GAS PIPELINE INSPECTION; REMOTE MONITORING AND DIAGNOSTIC SERVICES FOR COMPRESSORS, PUMPS, TURBOEXPANDERS, FUEL PUMPS AND FUEL DISTRIBUTION EQUIPMENT, CNG REFUELING EQUIPMENT, GAS TURBINES, STEAM TURBINES, AIR COOLED HEAT EXCHANGERS, STEAM CONDENSERS, HEAVY WALL REACTORS AND TUBULAR REACTORS; PLANNING, DESIGN AND MANAGEMENT OF INFORMATION TECHNOLOGY SYSTEMS IN THE FIELD OF GLOBAL RAILROAD AND TRANSIT INDUSTRIES; LEASING OF COMPUTER EQUIPMENT; CONSULTATION, AND ADVISORY SERVICES RELATING TO ENGINEERING, DESIGN AND DEVELOPMENT PROBLEMS ENCOUNTERED BY UTILITY, INDUSTRIAL, AND COMMERCIAL COMPANIES, GOVERNMENTS, AND INDIVIDUALS; COMPUTER PROGRAMMING SERVICES FOR OTHERS; COMPUTER SOFTWARE DESIGN AND ANALYSIS SERVICES FOR OTHERS; COMPUTER CONSULTATION SERVICES; MAINTENANCE AND UPDATING OF COMPUTER SOFTWARE AND COMPUTER PROGRAMS FOR OTHERS; INSTALLATION OF COMPUTER SOFTWARE; COMPUTER SYSTEMS ANALYSIS AND DESIGN SERVICES FOR OTHERS; CONSULTANCY SERVICES RELATING TO CHEMICAL RESEARCH; CONSULTANCY SERVICES RELATING TO THE DISCOVERY AND EVALUATION OF DRUGS AND COMPOUNDS HAVING DIAGNOSTIC, PROPHYLACTIC AND/OR THERAPEUTIC PROPERTIES; MEDICAL AND SCIENTIFIC RESEARCH CONSULTANCY SERVICES RELATING TO METHODS FOR DIAGNOSIS USING LASER BASED OPTICAL SYSTEMS; DEVELOPMENT AND DESIGN OF HIGH THROUGH PUT SCREENING ASSAYS FOR DRUG DEVELOPMENT SERVICES; RESEARCH AND DEVELOPMENT IN THE BIOTECHNOLOGY FIELD; TECHNICAL SUPPORT SERVICES FOR FACTORY AUTOMATION SOFTWARE, NAMELY, PROVIDING MAINTENANCE OF COMPUTER SOFTWARE AND PROVIDING PERIODIC UPGRADES OF SOFTWARE; CUSTOM DESIGN OF SECURITY ACCESS SYSTEMS; DESIGN AND CONSULTING SERVICES IN CONNECTION WITH THE CONFIGURATION OF SYSTEMS USED IN APPLICATIONS SUPPORTING FIBER OPTIC TECHNOLOGY; TECHNICAL SUPPORT, NAMELY, MONITORING OF NETWORK SYSTEMS; TECHNICAL CONSULTATION CONCERNING THE DESIGN AND DEVELOPMENT OF SECURITY AND ACCESS SYSTEMS; LABORATORY AND TESTING SERVICES FOR FLUID SEPARATION AND MEMBRANE TESTING; ENGINEERING AND CONSULTING SERVICES FOR THE DETECTION OF CONTAMINANTS IN

Reg. No. 4,152,658 WATER TREATMENT SYSTEMS, AQUEOUS SYSTEMS, COOLING WATER SYSTEMS, INDUSTRIAL BOILER WATER SYSTEMS, INDUSTRIAL WATER AND PROCESS SYSTEMS, INDUSTRIAL FUEL PROCESSING SYSTEMS, PULP AND PAPER MAKING SYSTEMS, AND METAL AND PLASTIC PROCESSING SYSTEMS; ENGINEERING SERVICES AND TECHNICAL SUPPORT SERVICES, NAMELY, DESIGN AND CONFIGURATION OF COMPUTER SOFTWARE AND HARDWARE SYSTEMS TO BE USED IN THE TREATMENT OF AQUEOUS SYSTEM AND IN THE TREATMENT OF PULP AND PAPER MAKING SYSTEMS, PETROLEUM AND PETROCHEMICAL PROCESSING SYSTEMS, AND METAL AND PLASTIC FINISHING OPERATIONS; PROGRAMMING FOR DATA PROCESSING MACHINES, NAMELY, PROGRAMMING OF ELECTRONIC MONEY MACHINES; PROVIDING ON-LINE NON-DOWNLOADABLE COMPUTER PROGRAMS FOR ASSURING SECURITY OF DATA TRANSFERS; RESEARCH AND INDUSTRIAL DEVELOPMENT IN THE FIELD OF COMPUTERS; TECHNICAL CONSULTATION IN THE FIELD OF COMPUTERS; CREATION AND MAINTENANCE OF COMPUTER DATA BASES AND COMPUTER PROGRAMS; HOSTING THE WEB SITES OF OTHERS ON A COMPUTER SERVER FOR A GLOBAL COMPUTER NETWORK; INSTALLATION OF COMPUTER SOFTWARE; MAINTENANCE OF COMPUTER SOFTWARE; PROVIDING SEARCH ENGINES FOR THE INTERNET; QUALITY CONTROL FOR OTHERS; RECOVERY OF COMPUTER DATA; PRODUCT RESEARCH AND DEVELOPMENT FOR OTHERS; SURVEYING; UPDATING OF COMPUTER SOFTWARE; MAINTENANCE OF COMPUTER SOFTWARE; ENGINEERING, TESTING AND RESEARCH RELATING TO ELECTRIC MACHINES, APPARATUS AND INSTRUMENTS, COMPUTER RENTAL; RENTAL OF COMPUTER SOFTWARE AND PROGRAMS, IN CLASS 42 (U.S. CLS. 100 AND 101).

FOR: SERVING FOOD AND DRINKS; RESTAURANT SERVICES; WELCOMING SERVICES, NAMELY PROVIDING FOOD AND DRINK; CATERING SERVICES; BOOKING OF TEMPORARY ACCOMMODATION AND HOTEL ROOMS; BAR SERVICES; CAFÉS; RENTAL OF MEETING ROOMS, NAMELY, RENTAL OF ROOMS FOR SOCIAL FUNCTIONS; TOURIST HOMES; INFORMATION SERVICES IN THE TOURIST FIELD, NAMELY LODGING INFORMATION SERVICES; INFORMATION SERVICES IN THE TOURIST FIELD, NAMELY INFORMATION ON PROVISION OF FOOD AND DRINKS; SERVICES IN REGARD TO LODGING FOR THE ASSISTANCE OF TOURISTS IN THE NATURE OF TRAVEL AGENCY SERVICES, NAMELY, MAKING RESERVATIONS AND BOOKING FOR TEMPORARY LODGING; SERVICES IN REGARD TO PROVISION OF FOOD AND MEALS FOR THE ASSISTANCE OF TOURISTS, NAMELY, RESTAURANT RESERVATION SERVICES; TOURIST RESERVATION SERVICES, NAMELY HOTEL RESERVATION AND FOOD AND MEAL RESERVATION SERVICES; INFORMATION SERVICES IN THE TOURIST FIELD, NAMELY, RESERVATION INFORMATION CONCERNING HOTEL, LODGING, FOOD AND MEALS; TOURIST ASSISTANCE AND RESERVATION SERVICES, NAMELY, MAKING RESERVATIONS FOR HOTELS, LODGING, FOOD AND MEALS, IN CLASS 43 (U.S. CLS. 100 AND 101).

FOR: MEDICAL SERVICES; MEDICAL AND PHARMACO-TOXICOLOGICAL CONTROLS, NAMELY, DRUG USE TESTING SERVICES IN THE NATURE OF ANTI-DOPING TESTING; VETERINARY SERVICES; HYGIENIC AND BEAUTY CARE FOR HUMAN BEINGS OR ANIMALS; AGRICULTURE, HORTICULTURE AND FORESTRY SERVICES, NAMELY, PEST CONTROL SERVICES FOR AGRICULTURE, HORTICULTURE OR FORESTRY; CONSULTANCY SERVICES RELATING TO MEDICAL AND DIAGNOSTIC IMAGING; CONSULTANCY SERVICES RELATING TO DIAGNOSTIC, PROPHYLACTIC AND THERAPEUTIC PROPERTIES OF PHARMACEUTICALS; MEDICAL INFORMATION SERVICES; MEDICAL IMAGING SERVICES; MEDICAL DIAGNOSTIC TESTING, MONITORING AND REPORTING SERVICES; AND MEDICAL ADVISORY SERVICES RELATED TO ALL THE AFORESAID; LEASING OF MEDICAL EQUIPMENT, IN CLASS 44 (U.S. CLS. 100 AND 101).

PRIORITY CLAIMED UNDER SEC. 44(D) ON LIECHTENSTEIN APPLICATION NO. 2010-864, FILED 11-26-2010.

Reg. No. 4,152,658 OWNER OF SWITZERLAND REG. NO. 614516, DATED 4-27-2011, EXPIRES 1-27-2021.

THE MARK CONSISTS OF THREE STYLIZED FIGURES EMBRACING IN A CIRCULAR MOTION UNDER WHICH APPEARS "RIO 2016" UNDER WHICH APPEARS FIVE INTER-LOCKING RINGS.

SER. NO. 85-256,582, FILED 3-3-2011.

JEFFERY COWARD, EXAMINING ATTORNEY

United States of America

United States Patent and Trademark Office



Reg. No. 4,152,659

Registered June 5, 2012

Int. Cls.: 24 and 25

TRADEMARK

PRINCIPAL REGISTER

JBZ ENTERPRISES LLC (DELAWARE LIMITED LIABILITY COMPANY)
#30C
401 E. 60TH STREET
NEW YORK, NY 10022

FOR: BED SHEETS; CURTAINS; FITTED BED SHEETS; FLAT BED SHEETS; PILLOW CASES; SHOWER CURTAINS, IN CLASS 24 (U.S. CLS. 42 AND 50).

FIRST USE 10-1-2010; IN COMMERCE 10-1-2010.

FOR: SHAPEWEAR, NAMELY, BODY SHAPERS, BODY SUITS, BRAS, SLIPS, PANTIES, UNDERWEAR, LEGGINGS, CORSETS, HOSIERY, TIGHTS AND SOCKS, IN CLASS 25 (U.S. CLS. 22 AND 39).

FIRST USE 9-20-2011; IN COMMERCE 9-20-2011.

THE MARK CONSISTS OF FOUR "Z"'S IN THE FANCIFUL FORMATION OF AN HOUR-GLASS INSIDE A RECTANGULAR OUTLINE.

SER. NO. 85-257,315, FILED 3-3-2011.

JERI J. FICKES, EXAMINING ATTORNEY



David J. Kybas

Director of the United States Patent and Trademark Office

United States of America

United States Patent and Trademark Office

Future of Health Technology Journal

Reg. No. 4,152,660

Registered June 5, 2012

Int. Cl.: 16

TRADEMARK

PRINCIPAL REGISTER

BUSHKO, RENATA G (UNITED STATES INDIVIDUAL), DBA FUTURE OF HEALTH
TECHNOLOGY INSTITUTE
4 LAMPLIGHTER LANE
HOPKINTON, MA 01748

FOR: PUBLICATIONS, NAMELY, JOURNALS IN THE FIELD OF HEALTH TECHNOLOGY,
IN CLASS 16 (U.S. CLS. 2, 5, 22, 23, 29, 37, 38 AND 50).

FIRST USE 1-11-2011; IN COMMERCE 3-1-2011.

THE MARK CONSISTS OF STANDARD CHARACTERS WITHOUT CLAIM TO ANY PAR-
TICULAR FONT, STYLE, SIZE, OR COLOR.

OWNER OF U.S. REG. NO. 2,533,319.

NO CLAIM IS MADE TO THE EXCLUSIVE RIGHT TO USE "HEALTH TECHNOLOGY
JOURNAL", APART FROM THE MARK AS SHOWN.

SER. NO. 85-257,963, FILED 3-4-2011.

CHARLES L. JENKINS, EXAMINING ATTORNEY



David J. Kyffers

Director of the United States Patent and Trademark Office

United States of America

United States Patent and Trademark Office

RANDOM

Reg. No. 4,152,661

EVERYDAY SHORTS INCORPORATED (CANADA CORPORATION)
6019 3RD STREET S.E.

Registered June 5, 2012

CALGARY, ALBERTA, CANADA T2H1K3

Int. Cl.: 3

FOR: SUN TAN PRODUCTS, NAMELY, SUN TAN LOTIONS, OILS, GELS AND CREAMS;
SKIN CARE PRODUCTS, NAMELY, MOISTURIZERS, LOTIONS AND CREAMS, NON-
MEDICATED SKIN SERUMS, SKIN BRONZERS; PERFUMES, FRAGRANCES, AND LIP
BALMS, IN CLASS 3 (U.S. CLS. 1, 4, 6, 50, 51 AND 52).

TRADEMARK

PRINCIPAL REGISTER

FIRST USE 10-1-2011; IN COMMERCE 12-1-2011.

THE MARK CONSISTS OF STANDARD CHARACTERS WITHOUT CLAIM TO ANY PAR-
TICULAR FONT, STYLE, SIZE, OR COLOR.

PRIORITY CLAIMED UNDER SEC. 44(D) ON CANADA APPLICATION NO. 1517705, FILED
3-4-2011.

SER. NO. 85-258,855, FILED 3-5-2011.

DOUGLAS LEE, EXAMINING ATTORNEY



David J. Kybas

Director of the United States Patent and Trademark Office

United States of America

United States Patent and Trademark Office



Centrix Solutions Inc

Reg. No. 4,152,662

Registered June 5, 2012

Int. Cl.: 42

SERVICE MARK

PRINCIPAL REGISTER

CENTRIX SOLUTIONS INC (NEBRASKA CORPORATION)
4910 NORMAL BLVD SUITE D
4910 NORMAL BLVD SUITE D
LINCOLN, NE 68506

FOR: COMPUTER SOFTWARE DEVELOPMENT; COMPUTER SOFTWARE DEVELOPMENT
IN THE FIELD OF FINANCE, IN CLASS 42 (U.S. CLS. 100 AND 101).

FIRST USE 4-1-2000; IN COMMERCE 4-1-2000.

NO CLAIM IS MADE TO THE EXCLUSIVE RIGHT TO USE "SOLUTIONS INC", APART
FROM THE MARK AS SHOWN.

THE COLOR(S) BLACK, RED, GRAY AND WHITE IS/ARE CLAIMED AS A FEATURE OF
THE MARK.

THE MARK CONSISTS OF THE DESIGN OF A THREE-DIMENSIONAL LETTER "C" AP-
PEARING IN THE COLORS GRAY AND BLACK WITH WHITE HIGHLIGHTING AND AN
INNER RED AND BLACK OVAL; THE STYLIZED WORDING "CENTRIX SOLUTIONS INC"
APPEARS BELOW IN THE COLOR RED.

SER. NO. 85-259,659, FILED 3-7-2011.

JEAN IM, EXAMINING ATTORNEY



David J. Kybas

Director of the United States Patent and Trademark Office

United States of America

United States Patent and Trademark Office

Part-Time CFO

Reg. No. 4,152,663

Registered June 5, 2012

Int. Cl.: 35

SERVICE MARK

PRINCIPAL REGISTER

B2B CFO, LLC (ARIZONA LIMITED LIABILITY COMPANY)
316 S. ROCHESTER CT.
GILBERT, AZ 85296

FOR: BUSINESS CONSULTATION SERVICES, IN CLASS 35 (U.S. CLS. 100, 101 AND 102).

FIRST USE 10-1-2002; IN COMMERCE 10-1-2002.

THE MARK CONSISTS OF STANDARD CHARACTERS WITHOUT CLAIM TO ANY PARTICULAR FONT, STYLE, SIZE, OR COLOR.

OWNER OF U.S. REG. NOS. 2,526,102 AND 2,576,655.

SEC. 2(F).

SER. NO. 85-259,769, FILED 3-7-2011.

JULIE GUTTADAURO, EXAMINING ATTORNEY



David J. Kyffers

Director of the United States Patent and Trademark Office

United States of America
United States Patent and Trademark Office

博讯网

Reg. No. 4,152,664

Registered June 5, 2012

Int. Cls.: 35 and 38

SERVICE MARK

PRINCIPAL REGISTER

CHINA DEMOCRACY JOURNAL, INC. (NEW YORK CORPORATION)
41-25 KISSENA BLVD., SUITE 110
FLUSHING, NY 11355

FOR: PROVIDING AN INTERNET WEBSITE FEATURING NEWS AND INFORMATION IN THE FIELD OF NATIONAL AND INTERNATIONAL POLITICS; PROVIDING INFORMATION AND NEWS IN THE FIELD OF BUSINESS, NAMELY, INFORMATION AND NEWS ON CURRENT EVENTS AND ON ECONOMIC, LEGISLATIVE, AND REGULATORY DEVELOPMENTS AS IT RELATES TO AND CAN IMPACT BUSINESSES, IN CLASS 35 (U.S. CLS. 100, 101 AND 102).

FIRST USE 3-3-2011; IN COMMERCE 3-3-2011.

FOR: TRANSMISSION OF NEWS, IN CLASS 38 (U.S. CLS. 100, 101 AND 104).

FIRST USE 3-3-2011; IN COMMERCE 3-3-2011.

NO CLAIM IS MADE TO THE EXCLUSIVE RIGHT TO USE THE NON-LATIN CHARACTERS THAT TRANSLITERATE TO "BOXUN" , APART FROM THE MARK AS SHOWN.

THE NON-LATIN CHARACTERS IN THE MARK TRANSLITERATE TO "BOXUNWANG" AND THIS MEANS "EXTENSIVE NEWS NETWORK" IN ENGLISH.

THE MARK CONSISTS OF THREE SIMPLIFIED CHINESE CHARACTERS AND ITS' ENGLISH MEANING, WHICH IS "EXTENSIVE NEWS NETWORK".

SER. NO. 85-260,092, FILED 3-7-2011.

NAAKWAMA ANKRAH, EXAMINING ATTORNEY



David J. Kyros

Director of the United States Patent and Trademark Office

United States of America

United States Patent and Trademark Office

Start a Feeding Frenzy

Reg. No. 4,152,665

Registered June 5, 2012

Int. Cl.: 28

TRADEMARK

PRINCIPAL REGISTER

EBSCO INDUSTRIES, INC. (DELAWARE CORPORATION)
LEGAL SERVICES
5724 HIGHWAY 280 EAST
BIRMINGHAM, AL 35242

FOR: FISH ATTRACTANTS; FISHING LURES, IN CLASS 28 (U.S. CLS. 22, 23, 38 AND 50).

FIRST USE 7-31-2000; IN COMMERCE 7-31-2000.

THE MARK CONSISTS OF STANDARD CHARACTERS WITHOUT CLAIM TO ANY PARTICULAR FONT, STYLE, SIZE, OR COLOR.

SER. NO. 85-260,392, FILED 3-7-2011.

CARYN GLASSER, EXAMINING ATTORNEY



David J. Kyffers

Director of the United States Patent and Trademark Office

United States of America

United States Patent and Trademark Office

BEAT BY COOL

Reg. No. 4,152,666

BEAT COSMETICS LLC (CALIFORNIA CORPORATION)
631 N MARTEL AVE
LOS ANGELES, CA 90036

Registered June 5, 2012

Int. Cl.: 44

FOR: BEAUTY CONSULTATION SERVICES; CONSULTATION SERVICES IN THE FIELD OF MAKEUP, NAMELY, ON-LINE MAKEUP CONSULTATION SERVICES AND IN-PERSON MAKEUP CONSULTATION AND APPLICATION SERVICES; MAKE-UP APPLICATION SERVICES; PROVIDING INFORMATION ABOUT BEAUTY; PROVIDING NEWS AND INFORMATION IN THE FIELD OF PERSONAL BEAUTY; PROVIDING ON-SITE BEAUTY SERVICES, NAMELY, HAIR STYLING AND MAKE-UP APPLICATION SERVICES; SERVICES OF A MAKE-UP ARTIST, IN CLASS 44 (U.S. CLS. 100 AND 101).

SERVICE MARK

PRINCIPAL REGISTER

FIRST USE 4-15-2009; IN COMMERCE 4-15-2009.

THE MARK CONSISTS OF STANDARD CHARACTERS WITHOUT CLAIM TO ANY PARTICULAR FONT, STYLE, SIZE, OR COLOR.

SER. NO. 85-261,204, FILED 3-8-2011.

DORITT L. CARROLL, EXAMINING ATTORNEY



David J. Kyffers

Director of the United States Patent and Trademark Office

United States of America

United States Patent and Trademark Office

SUBSCRIBE TO A BETTER VOICE

Reg. No. 4,152,667

Registered June 5, 2012

Int. Cl.: 41

SERVICE MARK

PRINCIPAL REGISTER

SINGING SUCCESS INCORPORATED (TENNESSEE CORPORATION)
172 2ND AVENUE NORTH, SUITE 102
NASHVILLE, TN 37201

FOR: ENTERTAINMENT AND EDUCATIONAL SERVICES, NAMELY, PROVIDING SUBSCRIPTION AND NON-SUBSCRIPTION BASED USE OF WEBSITES FEATURING NON-DOWNLOADABLE VIDEOS FEATURING VOCAL INSTRUCTION, VOCAL TRAINING, VOCAL DEMONSTRATIONS AND INTERVIEWS, IN CLASS 41 (U.S. CLS. 100, 101 AND 107).

FIRST USE 7-26-2010; IN COMMERCE 7-26-2010.

THE MARK CONSISTS OF STANDARD CHARACTERS WITHOUT CLAIM TO ANY PARTICULAR FONT, STYLE, SIZE, OR COLOR.

SER. NO. 85-262,323, FILED 3-9-2011.

KAREN SEVERSON, EXAMINING ATTORNEY



David J. Kybas

Director of the United States Patent and Trademark Office

United States of America

United States Patent and Trademark Office

REEL SPINNER

Reg. No. 4,152,668

HOLLIDAY, LARRY R. (UNITED STATES INDIVIDUAL)
24890 ALFALFA MARKET RD.
BEND, OR 97701

Registered June 5, 2012

Int. Cl.: 9

FOR: KNOCK-DOWN WIRE DISPENSER FEET AND JOINTS, IN CLASS 9 (U.S. CLS. 21, 23, 26, 36 AND 38).

TRADEMARK

FIRST USE 0-0-1996; IN COMMERCE 0-0-1996.

PRINCIPAL REGISTER

THE MARK CONSISTS OF STANDARD CHARACTERS WITHOUT CLAIM TO ANY PARTICULAR FONT, STYLE, SIZE, OR COLOR.

SEC. 2(F).

SER. NO. 85-262,404, FILED 3-9-2011.

SUSAN STIGLITZ, EXAMINING ATTORNEY



David J. Kybas

Director of the United States Patent and Trademark Office

United States of America

United States Patent and Trademark Office

ECCE

Reg. No. 4,152,669

Registered June 5, 2012

Int. Cl.: 16

TRADEMARK

PRINCIPAL REGISTER

CAMBRIDGE MICHIGAN LANGUAGE ASSESSMENT LLC (MICHIGAN LIMITED LIABILITY COMPANY)
500 EAST WASHINGTON
ANN ARBOR, MI 48104

FOR: EDUCATIONAL PUBLICATIONS, NAMELY, WORKBOOKS FEATURING STANDARDIZED TESTS FOR ASSESSING A PERSON'S ABILITY TO COMMUNICATE IN ENGLISH FOR EDUCATION, IMMIGRATION AND PROFESSIONAL ACCREDITATION; PUBLICATIONS IN PAPER FORMAT, NAMELY, BOOKS AND WORKBOOKS FEATURING INSTRUCTIONAL, TRAINING, TEACHING, TESTING, EXAMINATION AND ASSESSMENT MATERIALS FOR THE TESTING OF ENGLISH LANGUAGE SKILLS, IN CLASS 16 (U.S. CLS. 2, 5, 22, 23, 29, 37, 38 AND 50).

FIRST USE 0-0-1994; IN COMMERCE 0-0-1994.

THE MARK CONSISTS OF STANDARD CHARACTERS WITHOUT CLAIM TO ANY PARTICULAR FONT, STYLE, SIZE, OR COLOR.

SER. NO. 85-262,734, FILED 3-9-2011.

ROBERT C. CLARK JR., EXAMINING ATTORNEY



David J. Kyros

Director of the United States Patent and Trademark Office

United States of America

United States Patent and Trademark Office

S24

Reg. No. 4,152,670

Registered June 5, 2012

**Int. Cls.: 35, 37, 39, 42
and 45**

SERVICE MARK

PRINCIPAL REGISTER

SECURE-24, INC. (MICHIGAN CORPORATION)
29355 NORTHWESTERN HIGHWAY, 3RD FLOOR
SOUTHFIELD, MI 48034

FOR: BUSINESS RECORD MANAGEMENT SERVICES, IN CLASS 35 (U.S. CLS. 100, 101 AND 102).

FIRST USE 9-3-2010; IN COMMERCE 9-3-2010.

FOR: COMPUTER MONITORING SERVICE, NAMELY, PERFORMING PERIODIC HARDWARE MAINTENANCE, IN CLASS 37 (U.S. CLS. 100, 103 AND 106).

FIRST USE 9-3-2010; IN COMMERCE 9-3-2010.

FOR: STORAGE SERVICES FOR ARCHIVING DATA BASES, IMAGES AND OTHER ELECTRONIC DATA, IN CLASS 39 (U.S. CLS. 100 AND 105).

FIRST USE 9-3-2010; IN COMMERCE 9-3-2010.

FOR: COMPUTER MONITORING SERVICE WHICH TRACKS WIDE AREA NETWORK (WAN) PERFORMANCE, PERFORMS PERIODIC SOFTWARE MAINTENANCE AND PROVIDES REPORTS AND ALERTS CONCERNING SUCH PERFORMANCE; SECURE HOSTING OF WEB SITES AND COMPUTER APPLICATIONS OF OTHERS ON A GLOBAL COMPUTER NETWORK; MONITORING THE COMPUTER SYSTEMS OF OTHERS FOR TECHNICAL PURPOSES AND PROVIDING BACK-UP COMPUTER PROGRAMS AND FACILITIES, IN CLASS 42 (U.S. CLS. 100 AND 101).

FIRST USE 9-3-2010; IN COMMERCE 9-3-2010.

FOR: MONITORING THE COMPUTER SYSTEMS OF OTHERS FOR SECURITY PURPOSES, IN CLASS 45 (U.S. CLS. 100 AND 101).

FIRST USE 9-3-2010; IN COMMERCE 9-3-2010.

THE MARK CONSISTS OF STANDARD CHARACTERS WITHOUT CLAIM TO ANY PARTICULAR FONT, STYLE, SIZE, OR COLOR.



David J. Kyros

Director of the United States Patent and Trademark Office

Reg. No. 4,152,670 OWNER OF U.S. REG. NO. 3,846,221.

SER. NO. 85-263,811, FILED 3-10-2011.

DAVID TOOLEY, EXAMINING ATTORNEY

United States of America

United States Patent and Trademark Office

KALARIS

Reg. No. 4,152,671

Registered June 5, 2012

Int. Cl.: 33

TRADEMARK

PRINCIPAL REGISTER

KALARIS, CONSTANTINE (UNITED STATES INDIVIDUAL)
7113 ALEXANDER DR
HIGHLAND, MD 20777

FOR: WINE, IN CLASS 33 (U.S. CLS. 47 AND 49).

FIRST USE 4-12-2011; IN COMMERCE 4-12-2011.

THE MARK CONSISTS OF STANDARD CHARACTERS WITHOUT CLAIM TO ANY PARTICULAR FONT, STYLE, SIZE, OR COLOR.

SER. NO. 85-265,753, FILED 3-14-2011.

ALLISON SCHRODY, EXAMINING ATTORNEY



David J. Kyros

Director of the United States Patent and Trademark Office

United States of America

United States Patent and Trademark Office

BANGKOK  **BOXING**

Reg. No. 4,152,672

Registered June 5, 2012

Int. Cl.: 41

SERVICE MARK

PRINCIPAL REGISTER

BANGKOK BOXING & ENTERTAINMENT, LLC (GEORGIA LIMITED LIABILITY COMPANY)
1561 BLACK HICKORY PL.
NORCROSS, GA 30093

FOR: MARTIAL ARTS AND FITNESS INSTRUCTION AND FACILITIES, IN CLASS 41 (U.S. CLS. 100, 101 AND 107).

FIRST USE 8-31-2008; IN COMMERCE 8-31-2008.

NO CLAIM IS MADE TO THE EXCLUSIVE RIGHT TO USE "BANGKOK BOXING", APART FROM THE MARK AS SHOWN.

THE MARK CONSISTS OF THE WORDING "BANGKOK BOXING" IN STYLIZED FONT WITH THE SILHOUETTE OF A PERSON PERFORMING A MARTIAL ARTS KICK BETWEEN THE WORDS "BANGKOK" AND "BOXING" WITH A LEG OF THE PERSON EXTENDING ABOUT THE "B" IN THE WORD "BOXING".

SER. NO. 85-266,159, FILED 3-14-2011.

TINA BROWN, EXAMINING ATTORNEY



David J. Kyros

Director of the United States Patent and Trademark Office

United States of America

United States Patent and Trademark Office



Reg. No. 4,152,673

SNAP GREET LLC (WYOMING LIMITED LIABILITY COMPANY)
2510 WARREN AVE
CHEYENNE, WY 82001

Registered June 5, 2012

Int. Cl.: 45

FOR: PROVIDING A SELECTION OF ON-LINE ELECTRONIC GREETING CARDS, IN CLASS 45 (U.S. CLS. 100 AND 101).

SERVICE MARK

FIRST USE 3-3-2011; IN COMMERCE 3-3-2011.

PRINCIPAL REGISTER

THE MARK CONSISTS OF THE TERM "SNAPGREET", WITH THE WORD "SNAP" IN PEA GREEN AND "GREET" IN A LIGHT BLUE FOLLOWED BY A WHITE STYLIZED ARROW FACING TO THE RIGHT SURROUNDED BY A LIGHT BLUE CIRCLE.

THE COLOR(S) PEA GREEN, WHITE AND LIGHT BLUE IS/ARE CLAIMED AS A FEATURE OF THE MARK.

SER. NO. 85-267,047, FILED 3-15-2011.

LINDA MICKLEBURGH, EXAMINING ATTORNEY



David J. Kybas

Director of the United States Patent and Trademark Office

United States of America

United States Patent and Trademark Office

CAN MANUFACTURERS INSTITUTE

Reg. No. 4,152,674

Registered June 5, 2012

Int. Cls.: 35 and 40

SERVICE MARK

PRINCIPAL REGISTER

CAN MANUFACTURERS INSTITUTE, INC. (D.C. NON-PROFIT CORPORATION)
SUITE 1000
1730 RHODE ISLAND AVENUE, N.W.
WASHINGTON, DC 20036

FOR: PROMOTING COMMUNITY RECYCLING SUSTAINABILITY BY SPONSORING RECYCLING EVENTS; PROMOTING PUBLIC AWARENESS OF THE NEED TO RECYCLE AND THE BENEFITS OF RECYCLING; ASSOCIATION SERVICES, NAMELY, PROMOTING THE INTERESTS OF CAN MANUFACTURERS AND THEIR SUPPLIERS; PROVIDING CONSUMER PRODUCT INFORMATION REGARDING THE SUSTAINABILITY OF STEEL AND ALUMINUM AND PRODUCTS MADE OF THESE MATERIALS, IN CLASS 35 (U.S. CLS. 100, 101 AND 102).

FIRST USE 2-11-1939; IN COMMERCE 2-11-1939.

FOR: PROVIDING INFORMATION ABOUT THE IMPORTANCE OF RECYCLING; PROVIDING INFORMATION ABOUT STEEL AND ALUMINUM CAN RECYCLING AND THE SUSTAINABILITY BENEFITS OF RECYCLING; PROVIDING MANUFACTURING INFORMATION REGARDING THE SUSTAINABILITY OF STEEL AND ALUMINUM AND PRODUCTS MADE OF THESE MATERIALS, IN CLASS 40 (U.S. CLS. 100, 103 AND 106).

FIRST USE 0-0-1977; IN COMMERCE 0-0-1977.

THE MARK CONSISTS OF STANDARD CHARACTERS WITHOUT CLAIM TO ANY PARTICULAR FONT, STYLE, SIZE, OR COLOR.

NO CLAIM IS MADE TO THE EXCLUSIVE RIGHT TO USE "INSTITUTE", APART FROM THE MARK AS SHOWN.

SEC. 2(F).

SER. NO. 85-267,462, FILED 3-15-2011.

RUDY R. SINGLETON, EXAMINING ATTORNEY



David J. Kyros

Director of the United States Patent and Trademark Office

United States of America

United States Patent and Trademark Office

Suzi Q Bail Bonds

Reg. No. 4,152,675

Registered June 5, 2012

Int. Cl.: 36

SERVICE MARK

PRINCIPAL REGISTER

SUZI Q BAIL BONDS INC. (MARYLAND CORPORATION)
#209
20 COURTHOUSE SQUARE
ROCKVILLE, MD 20850

FOR: BAIL BONDING, IN CLASS 36 (U.S. CLS. 100, 101 AND 102).

FIRST USE 1-1-2007; IN COMMERCE 1-1-2007.

THE MARK CONSISTS OF STANDARD CHARACTERS WITHOUT CLAIM TO ANY PARTICULAR FONT, STYLE, SIZE, OR COLOR.

NO CLAIM IS MADE TO THE EXCLUSIVE RIGHT TO USE "BAIL BONDS", APART FROM THE MARK AS SHOWN.

SER. NO. 85-267,863, FILED 3-15-2011.

SANI KHOURI, EXAMINING ATTORNEY



David J. Kyffers

Director of the United States Patent and Trademark Office

United States of America

United States Patent and Trademark Office

AZ PainCenters

Reg. No. 4,152,676

Registered June 5, 2012

Int. Cl.: 44

SERVICE MARK

PRINCIPAL REGISTER

PAIN CENTERS IP, LLC (ARIZONA LIMITED LIABILITY COMPANY)
SUITE 400
15262 N 75TH AVE
PEORIA, AZ 85381

FOR: CLINICAL MEDICAL SERVICES, NAMELY TREATMENT OF CHRONIC AND/OR ACUTE PAIN, IN CLASS 44 (U.S. CLS. 100 AND 101).

FIRST USE 8-1-2006; IN COMMERCE 8-28-2006.

THE MARK CONSISTS OF STANDARD CHARACTERS WITHOUT CLAIM TO ANY PARTICULAR FONT, STYLE, SIZE, OR COLOR.

NO CLAIM IS MADE TO THE EXCLUSIVE RIGHT TO USE "PAINCENTERS", APART FROM THE MARK AS SHOWN.

SEC. 2(F).

SER. NO. 85-269,674, FILED 3-17-2011.

PAM WILLIS, EXAMINING ATTORNEY



David J. Kyffers

Director of the United States Patent and Trademark Office

United States of America

United States Patent and Trademark Office

W.A.R. Workout Addiction Recovery

Reg. No. 4,152,677

HAWKINS, DUSTIN LEE (UNITED STATES INDIVIDUAL)
5710 CRESTWOOD DRIVE
SOUTH OGDEN, UT 84405

Registered June 5, 2012

Int. Cl.: 41

FOR: PROVIDING ASSISTANCE, PERSONAL TRAINING AND PHYSICAL FITNESS CONSULTATION TO INDIVIDUALS TO HELP THEM MAKE PHYSICAL FITNESS, STRENGTH, CONDITIONING, AND EXERCISE IMPROVEMENT IN THEIR DAILY LIVING, IN CLASS 41 (U.S. CLS. 100, 101 AND 107).

SERVICE MARK

PRINCIPAL REGISTER

FIRST USE 9-1-2010; IN COMMERCE 9-1-2010.

THE MARK CONSISTS OF STANDARD CHARACTERS WITHOUT CLAIM TO ANY PARTICULAR FONT, STYLE, SIZE, OR COLOR.

NO CLAIM IS MADE TO THE EXCLUSIVE RIGHT TO USE "WORKOUT ADDICTION RECOVERY", APART FROM THE MARK AS SHOWN.

SER. NO. 85-269,809, FILED 3-17-2011.

AMY KERTGATE, EXAMINING ATTORNEY



David J. Kyffers

Director of the United States Patent and Trademark Office

United States of America

United States Patent and Trademark Office

SIERRA 
JULIAN

Reg. No. 4,152,678

Registered June 5, 2012

Int. Cl.: 25

TRADEMARK

PRINCIPAL REGISTER

SOPHIE JAWORSKI (UNITED STATES INDIVIDUAL)
221 EAST 76TH STREET
APT. 5C
NEW YORK, NY 10021

FOR: CHILDREN'S AND INFANT'S APPAREL, NAMELY, JUMPERS, OVERALL SLEEP-WEAR, PAJAMAS, ROMPERS AND ONE-PIECE GARMENTS; SHIRTS FOR INFANTS, BABIES, TODDLERS AND CHILDREN, IN CLASS 25 (U.S. CLS. 22 AND 39).

FIRST USE 9-1-2010; IN COMMERCE 2-1-2011.

THE NAME "SIERRA JULIAN" DOES NOT IDENTIFY A LIVING INDIVIDUAL.

THE MARK CONSISTS OF DESIGN ELEMENT AND THE WORDING "SIERRA JULIAN" PRESENTED IN STYLIZED FONT. THE DESIGN ELEMENT IS COMPRISED OF A STYLIZED DEPICTION OF A SILHOUETTE OF A MALE AND FEMALE RIDING ON A SCOOTER WITH THE LETTERS "SJ" SUPERIMPOSED THEREON. "SIERRA" IS SITUATED TO THE LEFT OF THE DESIGN ELEMENT. "JULIAN" IS SITUATED UNDER THESE ELEMENTS AND IS INDENTED TO THE RIGHT.

SER. NO. 85-269,863, FILED 3-17-2011.

GRETCHEN ULRICH, EXAMINING ATTORNEY



David J. Kyros

Director of the United States Patent and Trademark Office

United States of America

United States Patent and Trademark Office

DUALSMIX

Reg. No. 4,152,679

Registered June 5, 2012

Int. Cl.: 7

TRADEMARK

PRINCIPAL REGISTER

GLV FINANCE HUNGARY KFT., ACTING THROUGH ITS LUXEMBOURG BRANCH
(HUNGARY CORPORATION)
6 PARC D'ACTIVITÉS SYRDALL
MUNSBACH, LUXEMBOURG L-5365

FOR: MACHINE PARTS FOR INDUSTRIAL AND COMMERCIAL MIXERS, NAMELY, MIXER SPARE PARTS AND MIXER COMPONENTS; MIXING MACHINES FOR GASEOUS, LIQUID AND SOLID MATERIALS FOR USE IN THE PULP AND PAPER INDUSTRY; APPARATUS FOR DELIGNIFICATION, BLEACHING AND ADDING CHEMICALS FOR THE USE IN PAPER AND PULP PROCESSING, NAMELY, PULP REFINING MACHINES, INDUSTRIAL AND COMMERCIAL MIXING MACHINES, AND/OR HEATING MACHINES, NAMELY, HEAT TRANSFER MIXERS, IN CLASS 7 (U.S. CLS. 13, 19, 21, 23, 31, 34 AND 35).

THE MARK CONSISTS OF STANDARD CHARACTERS WITHOUT CLAIM TO ANY PARTICULAR FONT, STYLE, SIZE, OR COLOR.

PRIORITY CLAIMED UNDER SEC. 44(D) ON ERPN CMNTY TM OFC APPLICATION NO. 009422254, FILED 10-5-2010, REG. NO. 009422254, DATED 3-14-2011, EXPIRES 10-5-2020.

OWNER OF U.S. REG. NOS. 2,723,112 AND 3,806,376.

SER. NO. 85-271,053, FILED 3-18-2011.

AISHA SALEM, EXAMINING ATTORNEY



David J. Kyros

Director of the United States Patent and Trademark Office

United States of America

United States Patent and Trademark Office

STREETKIND

Reg. No. 4,152,680

Registered June 5, 2012

Int. Cl.: 41

SERVICE MARK

PRINCIPAL REGISTER

SWEETPINE RECORDS, LLC (FLORIDA LIMITED LIABILITY COMPANY)
SUITE 201 C/O ZIGLAW
4500 BISCAYNE BLVD.
MIAMI, FL 33137

FOR: ENTERTAINMENT SERVICES IN THE NATURE OF LIVE MUSICAL PERFORMANCES FEATURING, IN PART, PRERECORDED MUSICAL PERFORMANCES; PROVIDING A WEBSITE FEATURING MUSICAL PERFORMANCES AND VIDEOS OF SAME, RELATED VIDEO CLIPS AND OTHER RELATED MUSICAL MULTI-MEDIA MATERIALS, INFORMATION ON A MUSICAL PERFORMER AND SCHEDULED LIVE MUSICAL PERFORMANCES; ONGOING TELEVISION PROGRAMS FEATURING VARIETY ENTERTAINMENT AND MUSICAL PERFORMANCES THAT ARE BROADCAST AND STREAMED OVER THE INTERNET, AND DISTRIBUTED OVER TELEVISION, CABLE, SATELLITE, WIRELESS NETWORKS, PEER-TO-PEER DISTRIBUTION, AND TERRESTRIAL AND SATELLITE RADIO; PROVIDING NON-DOWNLOADABLE PRERECORDED MUSIC, VIDEOS, MULTI-MEDIA CONTENT AND INFORMATION REGARDING A MUSICAL ARTIST ONLINE VIA THE INTERNET, SATELLITE DISTRIBUTION, WIRELESS NETWORKS AND PEER TO PEER DISTRIBUTION; PROVIDING A WEBSITE FEATURING ENTERTAINMENT INFORMATION ON A RECORDING ARTIST AND HER TOURS, PERFORMANCES, APPEARANCES, NEWS, A BIOGRAPHY, NON-DOWNLOADABLE AUDIO AND AUDIOVISUAL RECORDINGS FEATURING MUSIC AND MUSICAL-BASED ENTERTAINMENT, PHOTOGRAPHS, AND OTHER ENTERTAINMENT INFORMATION; ONLINE JOURNALS, NAMELY, BLOGS FEATURING INFORMATION ON A RECORDING ARTIST; FAN CLUBS; ENTERTAINMENT SERVICES, NAMELY, PROVIDING WEBCASTS FEATURING MUSIC AND MUSICAL-BASED ENTERTAINMENT, IN CLASS 41 (U.S. CLS. 100, 101 AND 107).



FIRST USE 8-1-2004; IN COMMERCE 8-1-2004.

THE MARK CONSISTS OF STANDARD CHARACTERS WITHOUT CLAIM TO ANY PARTICULAR FONT, STYLE, SIZE, OR COLOR.

SER. NO. 85-271,252, FILED 3-18-2011.

EUGENIA MARTIN, EXAMINING ATTORNEY

David J. Kyffers

Director of the United States Patent and Trademark Office

United States of America

United States Patent and Trademark Office

EQUUA VALLE DE GUADALUPE

Reg. No. 4,152,681

MALAGON, RACHEL (UNITED STATES INDIVIDUAL)
2861 CALLE ESTEBAN
SAN CLEMENTE, CA 92673

Registered June 5, 2012

Int. Cl.: 33

FOR: WINE, IN CLASS 33 (U.S. CLS. 47 AND 49).

TRADEMARK

FIRST USE 8-1-2005; IN COMMERCE 7-1-2006.

PRINCIPAL REGISTER

THE MARK CONSISTS OF STANDARD CHARACTERS WITHOUT CLAIM TO ANY PARTICULAR FONT, STYLE, SIZE, OR COLOR.

NO CLAIM IS MADE TO THE EXCLUSIVE RIGHT TO USE "VALLE DE GUADALUPE", APART FROM THE MARK AS SHOWN.

THE ENGLISH TRANSLATION OF "VALLE DE GUADALUPE" IN THE MARK IS "VALLEY OF GUADALUPE". THE WORD "EQUUA" IN THE MARK HAS NO MEANING IN A FOREIGN LANGUAGE.

SER. NO. 85-271,399, FILED 3-18-2011.

LINDA LAVACHE, EXAMINING ATTORNEY



David J. Kyros

Director of the United States Patent and Trademark Office

United States of America

United States Patent and Trademark Office

JACKSONVILLE UPSCALE MOVEMENT

Reg. No. 4,152,682

TASCOTT CAPITAL, LLC (FLORIDA LIMITED LIABILITY COMPANY)
10961 BURNT MILL RD UNIT 1412
JACKSONVILLE, FL 32256

Registered June 5, 2012

Int. Cl.: 41

FOR: PARTY PLANNING SERVICES, IN CLASS 41 (U.S. CLS. 100, 101 AND 107).

SERVICE MARK

FIRST USE 8-1-2009; IN COMMERCE 8-1-2009.

PRINCIPAL REGISTER

THE MARK CONSISTS OF STANDARD CHARACTERS WITHOUT CLAIM TO ANY PARTICULAR FONT, STYLE, SIZE, OR COLOR.

NO CLAIM IS MADE TO THE EXCLUSIVE RIGHT TO USE "JACKSONVILLE", APART FROM THE MARK AS SHOWN.

SER. NO. 85-271,876, FILED 3-21-2011.

CHARISMA HAMPTON, EXAMINING ATTORNEY



David J. Kybas

Director of the United States Patent and Trademark Office

United States of America

United States Patent and Trademark Office

BRING YOUR ART TO LIFE

Reg. No. 4,152,683

Registered June 5, 2012

Int. Cls.: 16 and 20

TRADEMARK

PRINCIPAL REGISTER

GRAPHIK DIMENSIOONS, LTD. (NORTH CAROLINA CORPORATION)
2103 BRENTWOOD STREET
HIGH POINT, NC 27263

FOR: CANVAS FOR PAINTING, IN CLASS 16 (U.S. CLS. 2, 5, 22, 23, 29, 37, 38 AND 50).

FIRST USE 3-17-2011; IN COMMERCE 3-17-2011.

FOR: FRAMES FOR OIL PAINTINGS; FRAMES FOR PAINTINGS, IN CLASS 20 (U.S. CLS. 2, 13, 22, 25, 32 AND 50).

FIRST USE 3-17-2011; IN COMMERCE 3-17-2011.

THE MARK CONSISTS OF STANDARD CHARACTERS WITHOUT CLAIM TO ANY PARTICULAR FONT, STYLE, SIZE, OR COLOR.

SER. NO. 85-272,625, FILED 3-21-2011.

ALYSSA STEEL, EXAMINING ATTORNEY



David J. Kybas

Director of the United States Patent and Trademark Office

United States of America

United States Patent and Trademark Office



Reg. No. 4,152,684

Registered June 5, 2012

Int. Cl.: 30

TRADEMARK

PRINCIPAL REGISTER

TEDKO (CONNECTICUT LIMITED LIABILITY COMPANY), AKA HANGTIME HOT SAUCE
61 TALCOTT AVE.
ROCKVILLE, CT 06066

FOR: HOT CHILI PEPPER SAUCE; HOT SAUCE, IN CLASS 30 (U.S. CL. 46).

FIRST USE 12-1-2010; IN COMMERCE 12-1-2010.

NO CLAIM IS MADE TO THE EXCLUSIVE RIGHT TO USE "ORIGINAL HOT SAUCE",
APART FROM THE MARK AS SHOWN.

THE COLOR(S) RED, GREEN, BLACK WHITE IS/ARE CLAIMED AS A FEATURE OF THE
MARK.

THE MARK CONSISTS OF THE WORDING "HANGTIME ORIGINAL HOT SAUCE" IN THE
COLOR BLACK ABOVE A STYLIZED RED PEPPER WITH A GREEN STEM ABOVE A RED
SHADOW, THE PEPPER DESIGN IS ABOVE THE WORDING "BURNS SO GOOD" IN THE
COLOR BLACK; THE ENTIRE MARK IS WITHIN A RECTANGULAR CARRIER WITH A
WHITE BACKGROUND AND GREEN BORDER .

SER. NO. 85-272,895, FILED 3-21-2011.

BARBARA RUTLAND, EXAMINING ATTORNEY



David J. Kybas

Director of the United States Patent and Trademark Office

United States of America

United States Patent and Trademark Office



Reg. No. 4,152,685

Registered June 5, 2012

Int. Cls.: 6, 12 and 22

TRADEMARK

PRINCIPAL REGISTER

PETELKA INVESTMENTS LTD. (CANADA CORPORATION)
1088 STURBRIDGE STREET
BURLINGTON, ONTARIO, CANADA L7P5B5 AND

PETELKA, JEFFREY ROY WILLIAM (CANADA INDIVIDUAL)
1088 STURBRIDGE STREET
BURLINGTON, ONTARIO, CANADA L7P5B5

FOR: UNFITTED METAL RAMPS FOR USE WITH TRAILERS, IN CLASS 6 (U.S. CLS. 2, 12, 13, 14, 23, 25 AND 50).

FIRST USE 3-1-2011; IN COMMERCE 3-1-2011.

FOR: TRUCK, TRAILER AND SEMI-TRAILER AFTERMARKET PARTS AND ACCESSORIES, NAMELY, FITTED TRUCK TRAILER AND AUTOMOTIVE STORAGE, STEP, SADDLE AND TOOL BOXES, TRAILER BULKHEADS, TRUCK HEADACHE RACKS AND CAB GUARDS, UNDER MOUNT TRUCK AND TRAILER STORAGE RACKS, TRUCK FENDERS, TRUCK FENDER BUSH BARS, LOAD LEVELERS AND FITTED DRIVE ON RAMPS, CARGO EQUIPMENT IN THE NATURE OF FITTED TARPAULIN COVERS FOR TRUCK TRAILERS FOR HAULING SOD, TRUCK BUMPERS, FITTED TRAILER RAMPS, IN CLASS 12 (U.S. CLS. 19, 21, 23, 31, 35 AND 44).

FIRST USE 3-1-2011; IN COMMERCE 3-1-2011.

FOR: TRUCK, TRAILER AND SEMI-TRAILER CARGO EQUIPMENT, NAMELY, UNFITTED LINERS FOR THE CARGO AREA OF VEHICLES IN THE NATURE OF A TARP, TOW ROPES, TOW STRAPS, RATCHET TIE-DOWN STRAPS, QUICK RELEASE TIE DOWN STRAPS, LASHING STRAPS, AND TARP STRAPS, IN CLASS 22 (U.S. CLS. 1, 2, 7, 19, 22, 42 AND 50).

FIRST USE 3-1-2011; IN COMMERCE 3-1-2011.

THE MARK CONSISTS OF "LOAD ARMOUR" INSIDE A RECTANGLE DIVIDED INTO TWO SECTIONS, WITH A HORIZONTAL BAND OR BAR UNDER THE WORD "LOAD".

SER. NO. 85-272,952, FILED 3-22-2011.

KATHY DE JONGE, EXAMINING ATTORNEY



David J. Kyros

Director of the United States Patent and Trademark Office

United States of America

United States Patent and Trademark Office

Reiki In A Bottle

Reg. No. 4,152,686

THORPE, K. L. (UNITED STATES INDIVIDUAL)
BOX 21293
BOULDER, CO 80308

Registered June 5, 2012

Int. Cl.: 44

FOR: REIKI HEALING SERVICES, IN CLASS 44 (U.S. CLS. 100 AND 101).

SERVICE MARK

FIRST USE 3-18-2011; IN COMMERCE 3-18-2011.

PRINCIPAL REGISTER

THE MARK CONSISTS OF STANDARD CHARACTERS WITHOUT CLAIM TO ANY PARTICULAR FONT, STYLE, SIZE, OR COLOR.

NO CLAIM IS MADE TO THE EXCLUSIVE RIGHT TO USE "REIKI", APART FROM THE MARK AS SHOWN.

SER. NO. 85-274,008, FILED 3-22-2011.

ARETHA SOMERVILLE, EXAMINING ATTORNEY



David J. Kybas

Director of the United States Patent and Trademark Office

United States of America

United States Patent and Trademark Office

GreenBev

Reg. No. 4,152,687

GREENBEV LLC (GEORGIA LIMITED LIABILITY COMPANY)
4780 ADAMS RD
ATLANTA, GA 30338

Registered June 5, 2012

Int. Cl.: 42

FOR: CONSULTING IN THE FIELDS OF ENGINEERING AND ARCHITECTURE, IN CLASS 42 (U.S. CLS. 100 AND 101).

SERVICE MARK

FIRST USE 11-21-2007; IN COMMERCE 11-21-2007.

PRINCIPAL REGISTER

THE MARK CONSISTS OF STANDARD CHARACTERS WITHOUT CLAIM TO ANY PARTICULAR FONT, STYLE, SIZE, OR COLOR.

SER. NO. 85-274,621, FILED 3-23-2011.

LINDA LAVACHE, EXAMINING ATTORNEY



David J. Kyffers

Director of the United States Patent and Trademark Office

United States of America

United States Patent and Trademark Office

SKEETOX

Reg. No. 4,152,688

SCOTT KEENEY (UNITED STATES INDIVIDUAL)
6230 WILSHIRE BLVD. #118
LOS ANGELES, CA 90048

Registered June 5, 2012

Int. Cl.: 41

FOR: ENTERTAINMENT, NAMELY, LIVE PERFORMANCES BY A MUSICAL BAND, IN CLASS 41 (U.S. CLS. 100, 101 AND 107).

SERVICE MARK

FIRST USE 4-2-2010; IN COMMERCE 4-2-2010.

PRINCIPAL REGISTER

THE MARK CONSISTS OF STANDARD CHARACTERS WITHOUT CLAIM TO ANY PARTICULAR FONT, STYLE, SIZE, OR COLOR.

OWNER OF U.S. REG. NO. 3,368,118.

SER. NO. 85-275,457, FILED 3-24-2011.

BERYL GARDNER, EXAMINING ATTORNEY



David J. Kyffers

Director of the United States Patent and Trademark Office

United States of America

United States Patent and Trademark Office

GOODBIDDING.ORG

Reg. No. 4,152,689

Registered June 5, 2012

Int. Cl.: 35

SERVICE MARK

PRINCIPAL REGISTER

GOODBIDDING FOUNDATION, INC. (KANSAS CORPORATION)
P.O. BOX 18542
RAYTOWN, MO 64133

FOR: OPERATING ON-LINE MARKETPLACES FEATURING THE SALE OF GOODS AND SERVICES BY NON-PROFIT ORGANIZATIONS, CHARITABLE FOUNDATIONS AND OTHER APPROVED SELLERS, IN CLASS 35 (U.S. CLS. 100, 101 AND 102).

FIRST USE 12-10-2010; IN COMMERCE 12-10-2010.

THE MARK CONSISTS OF STANDARD CHARACTERS WITHOUT CLAIM TO ANY PARTICULAR FONT, STYLE, SIZE, OR COLOR.

SER. NO. 85-275,924, FILED 3-24-2011.

SHARON MEIER, EXAMINING ATTORNEY



David J. Kyros

Director of the United States Patent and Trademark Office

United States of America

United States Patent and Trademark Office



Reg. No. 4,152,690

Registered June 5, 2012

Int. Cl.: 10

TRADEMARK

PRINCIPAL REGISTER

MARKETWIZ LIMITED (ENGLAND LIMITED LIABILITY COMPANY)
NW4 4NJ
129 STATION ROAD
LONDON, UNITED KINGDOM

FOR: CHEMICALLY ACTIVATED HEATING PADS FOR MEDICINAL AND THERAPEUTIC PURPOSES, IN CLASS 10 (U.S. CLS. 26, 39 AND 44).

FIRST USE 10-30-2008; IN COMMERCE 10-30-2008.

NO CLAIM IS MADE TO THE EXCLUSIVE RIGHT TO USE "HEAT", APART FROM THE MARK AS SHOWN.

THE COLOR(S) BLUE AND RED IS/ARE CLAIMED AS A FEATURE OF THE MARK.

THE MARK CONSISTS OF THE WORDS "HEAT IN A CLICK" BENEATH THE IMAGE OF A HAND, WITH THE INDEX FINGER ON THE HAND POINTING DOWN AT THE WORD "IN", THE HAND AND THE WORD "IN" APPEARING IN RED, AND THE WORDS "HEAT", "A" AND "CLICK" APPEARING IN BLUE.

SER. NO. 85-276,043, FILED 3-24-2011.

CHERYL CLAYTON, EXAMINING ATTORNEY



David J. Kyjars

Director of the United States Patent and Trademark Office

United States of America

United States Patent and Trademark Office



Reg. No. 4,152,691

Registered June 5, 2012

Int. Cl.: 36

SERVICE MARK

PRINCIPAL REGISTER

SELFRELIANCE UKRAINIAN AMERICAN FEDERAL CREDIT UNION (UNITED STATES
FEDERALLY CHARTERED CREDIT UNION)
2332 W. CHICAGO AVENUE
CHICAGO, IL 60622

FOR: FINANCIAL SERVICES, NAMELY, CREDIT UNIONS, IN CLASS 36 (U.S. CLS. 100,
101 AND 102).

FIRST USE 6-1-1997; IN COMMERCE 6-1-2001.

NO CLAIM IS MADE TO THE EXCLUSIVE RIGHT TO USE "UKRAINIAN AMERICAN
FEDERAL CREDIT UNION", APART FROM THE MARK AS SHOWN.

THE NON-LATIN CHARACTERS IN THE MARK TRANSLITERATE TO SAMOPOMICH
UKRAINSKO-AMERYKANSKA FEDERALNA KREDYTOVA SPILKA WHICH MEANS
"SELFRELIANCE UKRAINIAN AMERICAN FEDERAL CREDIT UNION" IN ENGLISH.

THE MARK CONSISTS OF AN OPEN BOTTOM OVAL WITH TRIDENT IN CIRCLE IN
MIDDLE AROUND WHICH ARE TWO WAVY LINES. LOCATED NEXT TO THE DESIGN
IS THE WORD "SELFRELIANCE" BELOW WHICH ARE THE WORDS "UKRAINIAN
AMERICAN FEDERAL CREDIT UNION". LOCATED BELOW THE ENGLISH WORDING
IS THE CYRILLIC TRANSLATION OF THE ENGLISH WORDS ABOVE.

THE ENGLISH TRANSLATION OF THE CYRILLIC TEXT IN THE MARK IS "SELFRELIANCE
UKRAINIAN AMERICAN FEDERAL CREDIT UNION".

SER. NO. 85-276,104, FILED 3-24-2011.

Laurie Mayes, Examining Attorney



David J. Kyros

Director of the United States Patent and Trademark Office

United States of America

United States Patent and Trademark Office

Worthwhile Films

Reg. No. 4,152,692

Registered June 5, 2012

Int. Cl.: 41

SERVICE MARK

PRINCIPAL REGISTER

BRAKER, STEVE ABBOT (MINNESOTA SOLE PROPRIETORSHIP), DBA WORTHWHILE FILMS
317 WINONA ST.
NORTHFIELD, MN 55057

FOR: AUDIO AND VIDEO RECORDING SERVICES; DIGITAL VIDEO, AUDIO, AND MULTIMEDIA PUBLISHING SERVICES; FILM AND VIDEO PRODUCTION; MEDIA PRODUCTION SERVICES, NAMELY, VIDEO AND FILM PRODUCTION; OPERATION OF VIDEO EQUIPMENT OR AUDIO EQUIPMENT ETC. FOR PRODUCTION OF RADIO OR TELEVISION PROGRAMS; VIDEO EDITING; VIDEO PRODUCTION SERVICES; VIDEO RECORDING SERVICES, IN CLASS 41 (U.S. CLS. 100, 101 AND 107).

FIRST USE 1-1-1988; IN COMMERCE 1-1-1988.

THE MARK CONSISTS OF STANDARD CHARACTERS WITHOUT CLAIM TO ANY PARTICULAR FONT, STYLE, SIZE, OR COLOR.

NO CLAIM IS MADE TO THE EXCLUSIVE RIGHT TO USE "FILMS", APART FROM THE MARK AS SHOWN.

SER. NO. 85-276,443, FILED S.R. 3-25-2011 AM. P.R. 8-18-2011.

JULIE GUTTADAURO, EXAMINING ATTORNEY



David J. Kyros

Director of the United States Patent and Trademark Office

United States of America

United States Patent and Trademark Office

BOBBILICIOUS BAKING COMPANY

Reg. No. 4,152,693

BOBBILICIOUS BAKING COMPANY LLC (CALIFORNIA LIMITED LIABILITY COMPANY)
369-B THIRD ST.
SAN RAFAEL, CA 94901

Registered June 5, 2012

Int. Cl.: 30

FOR: BAKED GOODS, NAMELY, COOKIES, BROWNIES, CHOCOLATE BASED DESSERT BARS AND OATMEAL BASED DESSERT BARS; BAKED GOODS, NAMELY, FRUIT BASED DESSERT BARS, NUT AND SEED DESSERT BARS, IN CLASS 30 (U.S. CL. 46).

TRADEMARK

FIRST USE 10-1-2010; IN COMMERCE 10-1-2010.

PRINCIPAL REGISTER

THE MARK CONSISTS OF STANDARD CHARACTERS WITHOUT CLAIM TO ANY PARTICULAR FONT, STYLE, SIZE, OR COLOR.

NO CLAIM IS MADE TO THE EXCLUSIVE RIGHT TO USE "BAKING COMPANY", APART FROM THE MARK AS SHOWN.

SER. NO. 85-276,544, FILED 3-25-2011.

ELI HELLMAN, EXAMINING ATTORNEY



David J. Kybas

Director of the United States Patent and Trademark Office

United States of America

United States Patent and Trademark Office

The BarMaster

Reg. No. 4,152,694

CLEAR-VIEW-TECHNOLOGIES INC. (CALIFORNIA CORPORATION)
1722 RINGWOOD AVENUE
SAN JOSE, CA 951311751

Registered June 5, 2012

Int. Cl.: 9

FOR: HARDWARE AND SOFTWARE USED FOR AUTOMATICALLY AND DYNAMICALLY MONITORING INVENTORY, IN CLASS 9 (U.S. CLS. 21, 23, 26, 36 AND 38).

TRADEMARK

FIRST USE 12-14-2009; IN COMMERCE 12-14-2009.

PRINCIPAL REGISTER

THE MARK CONSISTS OF STANDARD CHARACTERS WITHOUT CLAIM TO ANY PARTICULAR FONT, STYLE, SIZE, OR COLOR.

SER. NO. 85-276,996, FILED 3-25-2011.

CARYN GLASSER, EXAMINING ATTORNEY



David J. Kyros

Director of the United States Patent and Trademark Office

United States of America

United States Patent and Trademark Office



Reg. No. 4,152,695

Registered June 5, 2012

Int. Cl.: 9

TRADEMARK

PRINCIPAL REGISTER

TII NETWORK TECHNOLOGIES, INC. (DELAWARE CORPORATION)
141 RODEO DRIVE
EDGEWOOD, NY 11717

FOR: TELEPHONE TERMINALS IN THE NATURE OF WIRE TERMINALS FOR INTERCONNECTION OF COPPER WIRE; WIRE TERMINAL ENCLOSURES, NAMELY, ELECTRIC JUNCTION BOX HOUSINGS; TELEPHONE JACKS; FIBER OPTICS ENCLOSURES, NAMELY, JUNCTION SLEEVES FOR FIBER OPTICS, PROTECTIVE SHEATHS FOR FIBER OPTICAL CABLES; FIBER OPTIC LIGHT AND IMAGE CONDUIT ENCLOSURES, NAMELY, JUNCTION BOXES; TELECOMMUNICATIONS EQUIPMENT, NAMELY, TELECOMMUNICATION LINE INTEGRITY TESTING APPARATUS, OPTICAL LIGHT SOURCE TESTERS AND OPTICAL POWER METERS, FIBER OPTIC FAULT FINDERS, AND FIBER OPTIC TEMPERATURE AND STRAIN SENSORS; TELEPHONE NETWORK INTERFACE DEVICES, NAMELY, AUTOMATIC TELEPHONE EXCHANGES, MAGNETIC TELEPHONE WIRES; TELEPHONE TERMINALS; VOLTAGE SURGE PROTECTORS; DIGITAL SUBSCRIBER LINE (DSL) SIGNAL SPLITTERS AND OPTICAL FILTERS; SIGNAL SPLITTERS FOR ELECTRONIC APPARATUS, IN CLASS 9 (U.S. CLS. 21, 23, 26, 36 AND 38).

FIRST USE 9-0-2007; IN COMMERCE 9-0-2007.

THE MARK CONSISTS OF THE DESIGN OF CURVED INTERSECTING LINES IN A TRAPEZOID BORDER FEATURED TO THE LEFT OF THE WORDING "TII".

SER. NO. 85-277,957, FILED 3-26-2011.

CHARISMA HAMPTON, EXAMINING ATTORNEY



David J. Kyros

Director of the United States Patent and Trademark Office

United States of America

United States Patent and Trademark Office

VAR 10

Reg. No. 4,152,696

DYNAMIC SPORTS NUTRITION, LLC (TEXAS LIMITED LIABILITY COMPANY)
1330 POST OAK BLVD., STE. 2900
HOUSTON, TX 77056

Registered June 5, 2012

Int. Cl.: 5

FOR: DIETARY AND NUTRITIONAL SUPPLEMENTS, IN CLASS 5 (U.S. CLS. 6, 18, 44, 46, 51 AND 52).

TRADEMARK

FIRST USE 10-1-2005; IN COMMERCE 10-1-2005.

PRINCIPAL REGISTER

THE MARK CONSISTS OF STANDARD CHARACTERS WITHOUT CLAIM TO ANY PARTICULAR FONT, STYLE, SIZE, OR COLOR.

NO CLAIM IS MADE TO THE EXCLUSIVE RIGHT TO USE "10", APART FROM THE MARK AS SHOWN.

SER. NO. 85-278,956, FILED 3-28-2011.

JOHN DWYER, EXAMINING ATTORNEY



David J. Kybas

Director of the United States Patent and Trademark Office

United States of America

United States Patent and Trademark Office

Gratitude Seashells

Reg. No. 4,152,697

Registered June 5, 2012

Int. Cl.: 16

TRADEMARK

PRINCIPAL REGISTER

GRATITUDE SEASHELLS, LLC (MICHIGAN LIMITED LIABILITY COMPANY)
6330 NORTH SHORE COURT
WEST BLOOMFIELD, MI 48324

FOR: GIFT SETS CONSISTING PRIMARILY OF PRINTED MESSAGES CONTAINED IN A BAG, GIFT CARDS AND ALSO INCLUDING SEA SHELLS OR SEA GLASS , IN CLASS 16 (U.S. CLS. 2, 5, 22, 23, 29, 37, 38 AND 50).

FIRST USE 3-31-2009; IN COMMERCE 3-31-2009.

THE MARK CONSISTS OF STANDARD CHARACTERS WITHOUT CLAIM TO ANY PARTICULAR FONT, STYLE, SIZE, OR COLOR.

NO CLAIM IS MADE TO THE EXCLUSIVE RIGHT TO USE "SEASHELLS", APART FROM THE MARK AS SHOWN.

SER. NO. 85-279,000, FILED 3-28-2011.

DEBRA LEE, EXAMINING ATTORNEY



David J. Kybas

Director of the United States Patent and Trademark Office

United States of America

United States Patent and Trademark Office

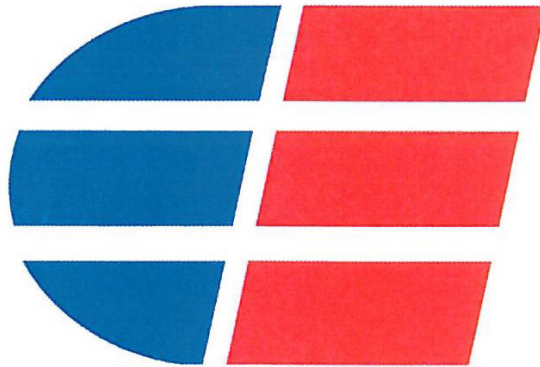

Reg. No. 4,152,698

Registered June 5, 2012

Int. Cls.: 1, 2, 3, 17 and 37

TRADEMARK

SERVICE MARK

PRINCIPAL REGISTER

EFTEC EUROPE HOLDING AG (SWITZERLAND CORPORATION)
GRAFENAUWEG 8
ZUG, SWITZERLAND CH-6304

FOR: CHEMICAL MATERIALS DESIGNED FOR INDUSTRIAL APPLICATION, NAMELY, INDUSTRIAL CHEMICALS AND INDUSTRIAL ADHESIVES IN THE NATURE OF BONDING, INSULATING, SEALING, AND DAMPING SUBSTANCES USED IN THE AUTOMOTIVE AND AIRCRAFT INDUSTRY, IN CLASS 1 (U.S. CLS. 1, 5, 6, 10, 26 AND 46).

FOR: CHEMICAL MATERIALS DESIGNED FOR INDUSTRIAL APPLICATION TO COAT SURFACES, NAMELY, UNDERCOATING FOR VEHICLE CHASSIS, PAINT SEALANT FOR INTERIOR SURFACES OF VEHICLES, AND CLEAR COATING PROTECTANT FOR VEHICLES AS A PRESERVATIVE AGAINST OXIDATION, AND VEHICLE CORROSION INHIBITING AND RUST INHIBITING PREPARATIONS IN THE NATURE OF COATINGS FOR USE ON VEHICLES TO SERVE AS A PROTECTIVE BARRIER FOR SURFACES USED IN THE AUTOMOTIVE AND AIRCRAFT INDUSTRY, IN CLASS 2 (U.S. CLS. 6, 11 AND 16).

FOR: CLEANING AND POLISHING PREPARATIONS, IN CLASS 3 (U.S. CLS. 1, 4, 6, 50, 51 AND 52).

FOR: INSULATING, BONDING, DAMPING AND SEALING SUBSTANCES, NAMELY, INSULATING MATERIALS, ACRYLIC-BASED SEALANTS AND ADHESIVES, ANTI-RUST SEALANTS, POLYURETHANE-BASED BONDING USED AS A SOUND DEADENING MATERIAL FOR USE IN THE AUTOMOTIVE AND AIRCRAFT INDUSTRY; SEMI-PROCESSED PLASTICS AND PLASTIC IN EXTRUDED FORM FOR INDUSTRIAL USE; SEMI-PROCESSED PLASTICS IN FORM OF PLATES, FILMS, BLOCKS, RODS AND TUBES FOR INDUSTRIAL USE; PREFORMED PLASTICS AND AQUEOUS DISPERSIONS FOR NOISE AND VIBRATION DAMPING, NAMELY, INSULATION MATERIALS USED IN THE AUTOMOTIVE AND AIRCRAFT INDUSTRY; ELASTOMERIC CAULKING SEALANTS AND SOLID BUTYL RUBBER SEALANTS; PVC - OR ACRYLIC-BASED PLASTISOLS, NAMELY, SEMI-PROCESSED ACRYLIC RESINS, FOR USE IN THE AUTOMOTIVE AND AIRCRAFT INDUSTRY, IN CLASS 17 (U.S. CLS. 1, 5, 12, 13, 35 AND 50).



David J. Kyjars

Director of the United States Patent and Trademark Office

FOR: CONSTRUCTION, MAINTENANCE AND REPAIR SERVICES, NAMELY, CONSTRUCTION, MAINTENANCE AND REPAIR OF AUTOMOBILES AND AIRCRAFT BODIES IN THE AUTOMOTIVE AND AIRCRAFT INDUSTRY, IN CLASS 37 (U.S. CLS. 100, 103 AND 106).

Reg. No. 4,152,698 OWNER OF SWITZERLAND REG. NO. 601108, DATED 6-2-2010, EXPIRES 12-10-2019.

THE COLOR(S) RED AND BLUE IS/ARE CLAIMED AS A FEATURE OF THE MARK.

THE MARK CONSISTS OF THE DESIGN OF THE LETTER "E" IN STYLIZED FORM, WHERE THE LEFT PORTION CONSISTS OF THREE CURVED PANELS IN BLUE AND THE RIGHT PORTION CONSISTS OF THREE PARALLELOGRAMS IN RED.

SER. NO. 85-279,004, FILED 3-28-2011.

CHARISMA HAMPTON, EXAMINING ATTORNEY

United States of America

United States Patent and Trademark Office

MEMORIAL HEALTH SERVICES

Reg. No. 4,152,699

Registered June 5, 2012

Int. Cls.: 41 and 44

SERVICE MARK

PRINCIPAL REGISTER

MEMORIAL HEALTH SERVICES (CALIFORNIA CORPORATION)
17360 BROOKHURST, FIRST FLOOR
FOUNTAIN VALLEY, CA 92708

FOR: EDUCATION SERVICES, NAMELY, PROVIDING CLASSES, SEMINARS, AND WORKSHOPS IN THE FIELDS OF HEALTHCARE, HEALTHCARE DELIVERY, HOSPITAL SERVICES AND MEDICINE, IN CLASS 41 (U.S. CLS. 100, 101 AND 107).

FIRST USE 4-7-1989; IN COMMERCE 4-7-1989.

FOR: HEALTHCARE; HOSPITALS; PROVIDING A WEB SITE FEATURING INFORMATION ON HEALTH AND NUTRITION; PROVIDING HEALTH INFORMATION; PROVIDING HEALTHCARE INFORMATION, IN CLASS 44 (U.S. CLS. 100 AND 101).

FIRST USE 4-7-1989; IN COMMERCE 4-7-1989.

THE MARK CONSISTS OF STANDARD CHARACTERS WITHOUT CLAIM TO ANY PARTICULAR FONT, STYLE, SIZE, OR COLOR.

OWNER OF U.S. REG. NO. 1,603,159.

NO CLAIM IS MADE TO THE EXCLUSIVE RIGHT TO USE "HEALTH SERVICES", APART FROM THE MARK AS SHOWN.

SER. NO. 85-279,158, FILED 3-28-2011.

PAM WILLIS, EXAMINING ATTORNEY



David J. Kybas

Director of the United States Patent and Trademark Office

United States of America

United States Patent and Trademark Office

MEMORIALCARE HEALTH SYSTEM

Reg. No. 4,152,700

Registered June 5, 2012

Int. Cls.: 41 and 44

SERVICE MARK

PRINCIPAL REGISTER

MEMORIAL HEALTH SERVICES (CALIFORNIA CORPORATION)
17360 BROOKHURST, FIRST FLOOR
FOUNTAIN VALLEY, CA 92708

FOR: EDUCATION SERVICES, NAMELY, PROVIDING CLASSES, SEMINARS, AND WORKSHOPS IN THE FIELDS OF HEALTHCARE, HEALTHCARE DELIVERY, HOSPITAL SERVICES AND MEDICINE, IN CLASS 41 (U.S. CLS. 100, 101 AND 107).

FIRST USE 9-20-2010; IN COMMERCE 9-20-2010.

FOR: HEALTHCARE; HOSPITALS; PROVIDING A WEB SITE FEATURING INFORMATION ON HEALTH AND NUTRITION; PROVIDING HEALTH INFORMATION; PROVIDING HEALTHCARE INFORMATION, IN CLASS 44 (U.S. CLS. 100 AND 101).

FIRST USE 9-20-2010; IN COMMERCE 9-20-2010.

THE MARK CONSISTS OF STANDARD CHARACTERS WITHOUT CLAIM TO ANY PARTICULAR FONT, STYLE, SIZE, OR COLOR.

NO CLAIM IS MADE TO THE EXCLUSIVE RIGHT TO USE "HEALTH SYSTEM", APART FROM THE MARK AS SHOWN.

SER. NO. 85-279,164, FILED 3-28-2011.

PAM WILLIS, EXAMINING ATTORNEY



David J. Kybas

Director of the United States Patent and Trademark Office

United States of America

United States Patent and Trademark Office

BÜLOW

Reg. No. 4,152,701

Registered June 5, 2012

Int. Cl.: 16

TRADEMARK

PRINCIPAL REGISTER

ALDERAAN HOLDINGS CO. LLC (PENNSYLVANIA LIMITED LIABILITY COMPANY)
1232 SARAH STREET, SUITE C
PITTSBURGH, PA 15203

FOR: PENS AND PEN ACCESSORIES, NAMELY, INK PENS, FOUNTAIN PENS, PEN HOLDERS, PEN CASES, AND PEN NIBS, IN CLASS 16 (U.S. CLS. 2, 5, 22, 23, 29, 37, 38 AND 50).

FIRST USE 8-1-2008; IN COMMERCE 8-1-2008.

THE MARK CONSISTS OF STANDARD CHARACTERS WITHOUT CLAIM TO ANY PARTICULAR FONT, STYLE, SIZE, OR COLOR.

SER. NO. 85-279,411, FILED 3-29-2011.

COLLEEN KEARNEY, EXAMINING ATTORNEY



David J. Kyffers

Director of the United States Patent and Trademark Office

United States of America

United States Patent and Trademark Office



Direct Thinking for Direct Response

Reg. No. 4,152,702

SCRIPT TO SCREEN PRODUCTIONS (CALIFORNIA CORPORATION)
200 N. TUSTIN AVENUE #200
SANTA ANA, CA 92705

Registered June 5, 2012

Int. Cl.: 35

FOR: PRODUCING AUDIO OR VIDEO INFOMERCIALS, IN CLASS 35 (U.S. CLS. 100, 101 AND 102).

SERVICE MARK

FIRST USE 5-31-2010; IN COMMERCE 9-23-2010.

PRINCIPAL REGISTER

OWNER OF U.S. REG. NOS. 2,624,420, 2,909,437, AND 2,909,438.

THE COLOR(S) BLACK, WHITE, CHARCOAL AND BLUE IS/ARE CLAIMED AS A FEATURE OF THE MARK.

THE NAME(S), PORTRAIT(S), AND/OR SIGNATURE(S) SHOWN IN THE MARK DOES NOT IDENTIFY A PARTICULAR LIVING INDIVIDUAL.

THE MARK CONSISTS OF THE STYLIZED WORDING "SCRIPT TO SCREEN DIRECT THINKING FOR DIRECT RESPONSE" AND GEOMETRIC DESIGN. THE WORD "SCRIPT" APPEARS IN WHITE FONT IN A HORIZONTAL BLACK RECTANGLE. ATTACHED TO THE RIGHT IS A CHARCOAL SQUARE CONTAINING THE WORD "TO" IN BLACK FONT. THE WORD "SCREEN" APPEARS IN BLACK FONT IN A HORIZONTAL BLUE RECTANGLE, ATTACHED DIRECTLY BENEATH THE BLACK RECTANGLE AND GRAY SQUARE AND OF EQUAL WIDTH. BELOW THIS GEOMETRIC DESIGN APPEAR THE WORDS "DIRECT THINKING FOR DIRECT RESPONSE" IN A SINGLE LINE IN BLACK.



SER. NO. 85-280,085, FILED 3-29-2011.

JERI J. FICKES, EXAMINING ATTORNEY

David J. Kybas

Director of the United States Patent and Trademark Office

United States of America

United States Patent and Trademark Office



PROTECTSTAR

www.protectstar.com

Reg. No. 4,152,703

Registered June 5, 2012

Int. Cl.: 9

TRADEMARK

PRINCIPAL REGISTER

PROTECTSTAR, INC. (FLORIDA CORPORATION)
SUITE 51103
444 BRICKELL AVE.
MIAMI, FL 33131

FOR: COMPUTER SOFTWARE FOR CREATING SEARCHABLE DATABASES OF INFORMATION AND DATA; COMPUTER SOFTWARE FOR APPLICATION AND DATABASE INTEGRATION; COMPUTER SOFTWARE FOR ACCESSING INFORMATION DIRECTORIES THAT MAY BE DOWNLOADED FROM THE GLOBAL COMPUTER NETWORK; COMPUTER SOFTWARE DEVELOPMENT TOOLS; COMPUTER SHAREWARE FOR MANAGING AND PLANNING INFORMATION TECHNOLOGY; COMPUTER NETWORK SECURITY SOFTWARE, NAMELY, COMPUTER SOFTWARE FOR DATA ERASURE OF HARD DISKS; COMPUTER SCREEN SAVER SOFTWARE; COMPUTER SEARCH ENGINE SOFTWARE; COMPUTER OPERATING SYSTEMS; COMPUTER OPERATING PROGRAMS; COMPUTER NETWORKING HARDWARE; DOWNLOADABLE COMPUTER PROGRAMS FOR USE IN DATABASE MANAGEMENT AND MANAGING OF DATA; RECORDED COMPUTER SOFTWARE FOR DATABASE MANAGEMENT AND MANAGING OF DATA, IN CLASS 9 (U.S. CLS. 21, 23, 26, 36 AND 38).

FIRST USE 12-1-2003; IN COMMERCE 12-1-2003.

OWNER OF U.S. REG. NO. 3,229,345.

THE MARK CONSISTS OF THE LITERAL ELEMENTS "PROTECTSTAR WWW PROTECTSTAR COM" WHEREIN THE WORDS "WWW.PROTECTSTAR.COM" ARE PLACED BELOW THE WORD "PROTECTSTAR" AND THERE IS AN IMAGE OF STAR BUILD BY USING FIVE RHOMBUSES PLACED ABOVE THE WORD "PROTECTSTAR" AS SHOWN IN THE MARK.

SER. NO. 85-280,750, FILED 3-30-2011.

JOHN KELLY, EXAMINING ATTORNEY



David J. Kyffers

Director of the United States Patent and Trademark Office

United States of America

United States Patent and Trademark Office

LeadBridge

Reg. No. 4,152,704

Registered June 5, 2012

Int. Cl.: 35

LEADBRIDGE PARTNERS, LLC (MASSACHUSETTS LIMITED LIABILITY COMPANY),
AKA LEADBRIDGE
300 BRICKSTONE SQUARE
SUITE 502
ANDOVER, MA 01810

SERVICE MARK

PRINCIPAL REGISTER

FOR: PREPARING BUSINESS AND CORPORATE REPORTS IN THE FIELD OF INFORMATION AND BUSINESS TECHNOLOGY MATTERS; COMPILING ORGANIZATIONAL AND PROFILE INFORMATION RELATING TO INFORMATION TECHNOLOGY DEPARTMENTS AND TECHNOLOGY LANDSCAPE DECISIONS; AND OUTBOUND CALLING SERVICES TO CLIENT SPECIFIED ENTITIES TO GATHER, COMPILE AND PROVIDE INFORMATION ON TECHNOLOGY MATTERS AND BUSINESS STRATEGIES TO BE IMPLEMENTED BY THE SPECIFIED ENTITY OR THIRD PARTIES, IN CLASS 35 (U.S. CLS. 100, 101 AND 102).

FIRST USE 7-26-2006; IN COMMERCE 7-26-2006.

THE MARK CONSISTS OF STANDARD CHARACTERS WITHOUT CLAIM TO ANY PARTICULAR FONT, STYLE, SIZE, OR COLOR.

SEC. 2(F).

SER. NO. 85-280,933, FILED 3-30-2011.

STEVEN R. FINE, EXAMINING ATTORNEY



David J. Kyffers

Director of the United States Patent and Trademark Office

United States of America

United States Patent and Trademark Office

CONFIDENCE

Reg. No. 4,152,705

Registered June 5, 2012

Int. Cl.: 10

TRADEMARK

PRINCIPAL REGISTER

SALTS HEALTHCARE LIMITED (UNITED KINGDOM LIMITED LIABILITY COMPANY)
RICHARD STREET, ASTON, BIRMINGHAM
WEST MIDLANDS B7 4AA, UNITED KINGDOM

FOR: MEDICAL APPARATUS FOR OSTOMY MAINTENANCE; OSTOMY BAGS AND POUCHES, NAMELY, COLOSTOMY, UROSTOMY AND ILEOSTOMY BAGS AND POUCHES; REPLACEMENT PARTS FOR MEDICAL DEVICES, NAMELY, OSTOMY SEALS, FLANGES AND RINGS, FILTERS AND CLIPS FOR OSTOMY BAGS AND POUCHES; STRUCTURAL PARTS AND STRUCTURAL FITTINGS FOR AFORESAID GOODS, IN CLASS 10 (U.S. CLS. 26, 39 AND 44).

THE MARK CONSISTS OF STANDARD CHARACTERS WITHOUT CLAIM TO ANY PARTICULAR FONT, STYLE, SIZE, OR COLOR.

OWNER OF ERPN CMNTY TM OFC REG. NO. 004014304, DATED 8-7-2006, EXPIRES 9-7-2014.

SER. NO. 85-281,422, FILED 3-30-2011.

ANDREA HACK, EXAMINING ATTORNEY



David J. Kyffers

Director of the United States Patent and Trademark Office

United States of America

United States Patent and Trademark Office

ROBINSON

Reg. No. 4,152,706

Registered June 5, 2012

Int. Cl.: 18

TRADEMARK

PRINCIPAL REGISTER

RIVER LIGHT V, L.P. (DELAWARE LIMITED PARTNERSHIP)
11 WEST 19TH STREET, 7TH FLOOR
NEW YORK, NY 10011

FOR: BUSINESS CARD CASES; CLUTCH BAGS; COIN PURSES; HANDBAGS; ROLL BAGS;
TOTE BAGS; WALLETS; WRISTLET BAGS, IN CLASS 18 (U.S. CLS. 1, 2, 3, 22 AND 41).

FIRST USE 1-18-2011; IN COMMERCE 1-18-2011.

THE MARK CONSISTS OF STANDARD CHARACTERS WITHOUT CLAIM TO ANY PAR-
TICULAR FONT, STYLE, SIZE, OR COLOR.

SEC. 2(F).

SER. NO. 85-281,990, FILED 3-31-2011.

KELLY TRUSILO, EXAMINING ATTORNEY



David J. Kyffers

Director of the United States Patent and Trademark Office

United States of America

United States Patent and Trademark Office

STATICSMART

Reg. No. 4,152,707

JULIE INDUSTRIES, INC. (MASSACHUSETTS CORPORATION)
134 PARK STREET
NORTH READING, MA 01864

Registered June 5, 2012

Int. Cl.: 27

FOR: FLOOR COVERINGS, NAMELY, STATIC CONTROL FLOOR COVERINGS, IN CLASS 27 (U.S. CLS. 19, 20, 37, 42 AND 50).

TRADEMARK

FIRST USE 9-30-2001; IN COMMERCE 9-30-2001.

PRINCIPAL REGISTER

THE MARK CONSISTS OF STANDARD CHARACTERS WITHOUT CLAIM TO ANY PARTICULAR FONT, STYLE, SIZE, OR COLOR.

OWNER OF U.S. REG. NO. 2,423,384.

SER. NO. 85-282,092, FILED 3-31-2011.

MARGARET POWER, EXAMINING ATTORNEY



David J. Kybas

Director of the United States Patent and Trademark Office

United States of America

United States Patent and Trademark Office

Suffolk Pointe Company

Reg. No. 4,152,708

Registered June 5, 2012

Int. Cl.: 25

TRADEMARK

PRINCIPAL REGISTER

DREW LAYNE, L.L.C. (TEXAS LIMITED LIABILITY COMPANY)
2325 SOUTH STEMMONS FREEWAY
SUITE 502B
LEWISVILLE, TX 75067

FOR: BALLET SHOES; DANCE SHOES; DANCE SLIPPERS; LEOTARDS AND TIGHTS FOR WOMEN, MEN AND CHILDREN OF NYLON, COTTON OR OTHER TEXTILE FIBERS; SHOE INSERTS FOR PRIMARILY NON-ORTHOPEDIC PURPOSES, IN CLASS 25 (U.S. CLS. 22 AND 39).

FIRST USE 10-1-2000; IN COMMERCE 11-1-2000.

THE MARK CONSISTS OF STANDARD CHARACTERS WITHOUT CLAIM TO ANY PARTICULAR FONT, STYLE, SIZE, OR COLOR.

NO CLAIM IS MADE TO THE EXCLUSIVE RIGHT TO USE "POINTE COMPANY", APART FROM THE MARK AS SHOWN.

SER. NO. 85-282,307, FILED 3-31-2011.

CHARLOTTE CORWIN, EXAMINING ATTORNEY



David J. Kybas

Director of the United States Patent and Trademark Office

United States of America

United States Patent and Trademark Office

Management Direct

Reg. No. 4,152,709

Registered June 5, 2012

Int. Cl.: 35

SERVICE MARK

PRINCIPAL REGISTER

FRANCHISE DIRECT USA, INC. (DELAWARE CORPORATION)
SUITE 750
3355 LENOX ROAD
ATLANTA, GA 30326

FOR: ADVERTISING AND MARKETING, IN CLASS 35 (U.S. CLS. 100, 101 AND 102).

FIRST USE 1-1-2011; IN COMMERCE 1-1-2011.

THE MARK CONSISTS OF STANDARD CHARACTERS WITHOUT CLAIM TO ANY PARTICULAR FONT, STYLE, SIZE, OR COLOR.

NO CLAIM IS MADE TO THE EXCLUSIVE RIGHT TO USE "DIRECT", APART FROM THE MARK AS SHOWN.

SER. NO. 85-282,621, FILED 3-31-2011.

LESLEY LAMOTHE, EXAMINING ATTORNEY



David J. Kyffers

Director of the United States Patent and Trademark Office

United States of America

United States Patent and Trademark Office

YACHTMASTER

Reg. No. 4,152,710

Registered June 5, 2012

Int. Cl.: 41

SERVICE MARK

PRINCIPAL REGISTER

ROYAL YACHTING ASSOCIATION (UNITED KINGDOM PRIVATE LIMITED COMPANY)
ROYAL YACHTING ASSOCIATION - RYA HOUSE
ENSIGN WAY
HAMBLE, SOUTHAMPTON, UNITED KINGDOM SO314YA

FOR: TEACHING AND TRAINING IN THE FIELD OF SAIL CRUISING AND POWER BOATING OPERATIONS, NAVIGATION, AND SAFETY; ON-LINE TEACHING AND TRAINING IN RELATION TO SAIL CRUISING AND POWER BOATING OPERATIONS, NAVIGATION, AND SAFETY; PROVIDING INSTRUCTIONAL COURSES AND CONDUCTING LECTURES AND SEMINARS IN RELATION TO SAIL CRUISING AND POWER BOATING OPERATIONS, NAVIGATION, AND SAFETY AND DISTRIBUTING TRAINING AND EDUCATIONAL COURSE MATERIALS IN CONNECTION THEREWITH; PROVIDING ON-LINE INSTRUCTIONAL COURSES AND CONDUCTING ON-LINE LECTURES AND SEMINARS IN RELATION TO SAIL CRUISING AND POWER BOATING OPERATIONS, NAVIGATION, AND SAFETY AND DISTRIBUTING ON-LINE TRAINING AND EDUCATIONAL COURSE MATERIALS IN CONNECTION THEREWITH; AND PUBLICATION OF MANUALS, BOOKS, MAPS, CHARTS, PLANS, AND DRAWINGS, IN CLASS 41 (U.S. CLS. 100, 101 AND 107).

FIRST USE 6-15-1998; IN COMMERCE 6-15-1998.

THE MARK CONSISTS OF STANDARD CHARACTERS WITHOUT CLAIM TO ANY PARTICULAR FONT, STYLE, SIZE, OR COLOR.

SEC. 2(F).

SER. NO. 85-282,631, FILED 3-31-2011.

PAULA MAHONEY, EXAMINING ATTORNEY



David J. Kybas

Director of the United States Patent and Trademark Office

United States of America

United States Patent and Trademark Office



DEDICATED TO PROMOTING ACCESS TO HEALTHCARE
FOR THE HISPANIC COMMUNITY

Reg. No. 4,152,711

Registered June 5, 2012

Int. Cl.: 35

SERVICE MARK

PRINCIPAL REGISTER

AHHE EAST COAST CHAPTER, INC. (NEW YORK CORPORATION)
153 WEST 78TH STREET
SUITE #1
NEW YORK, NY 10024

FOR: ASSOCIATION SERVICES, NAMELY, PROMOTING THE INTERESTS OF HISPANICS IN HEALTH ADMINISTRATION PROFESSIONS; PROMOTING PUBLIC AWARENESS OF HEALTHCARE ACCESS FOR THE HISPANIC COMMUNITY, IN CLASS 35 (U.S. CLS. 100, 101 AND 102).

FIRST USE 12-14-2008; IN COMMERCE 6-19-2009.

NO CLAIM IS MADE TO THE EXCLUSIVE RIGHT TO USE "ASSOCIATION OF HISPANIC HEALTHCARE EXECUTIVES" AND "DEDICATED TO PROMOTING ACCESS TO HEALTHCARE FOR THE HISPANIC COMMUNITY", APART FROM THE MARK AS SHOWN.

THE MARK CONSISTS OF THE STYLIZED TEXT "ASSOCIATION OF HISPANIC HEALTHCARE EXECUTIVES" IN A SEMI CIRCLE. IN THE MIDDLE THERE IS THE STYLIZED TEXT "AHHE". AT THE BOTTOM THERE IS THE STYLIZED TEXT "DEDICATED TO PROMOTING ACCESS TO HEALTHCARE FOR THE HISPANIC COMMUNITY".

SER. NO. 85-283,153, FILED 3-31-2011.

MATTHEW KLINE, EXAMINING ATTORNEY



David J. Kappas

Director of the United States Patent and Trademark Office

United States of America

United States Patent and Trademark Office

PrintNinja

Reg. No. 4,152,712

PRINT NINJA, LLC (MISSOURI LIMITED LIABILITY COMPANY)
14525 SW MILLIKAN WAY #28125
BEAVERTON, OR 970052343

Registered June 5, 2012

Int. Cl.: 40

FOR: PRINTING SERVICES, IN CLASS 40 (U.S. CLS. 100, 103 AND 106).

SERVICE MARK

FIRST USE 7-9-2010; IN COMMERCE 3-14-2011.

PRINCIPAL REGISTER

THE MARK CONSISTS OF STANDARD CHARACTERS WITHOUT CLAIM TO ANY PARTICULAR FONT, STYLE, SIZE, OR COLOR.

SER. NO. 85-284,815, FILED 4-3-2011.

KIM SAITO, EXAMINING ATTORNEY



David J. Kyffers

Director of the United States Patent and Trademark Office

United States of America

United States Patent and Trademark Office



Reg. No. 4,152,713

Registered June 5, 2012

Int. Cl.: 45

SERVICE MARK

PRINCIPAL REGISTER

HIPPOCRATES UNIVERSITY (OREGON CORPORATION)
5516 BOULDER HIGHWAY SUITE 2F #113
LAS VEGAS, NV 89122 AND

ANTONIN HRABAL (CZECH REPUBLIC INDIVIDUAL)
5516 BOULDER HIGHWAY SUITE 2F #113
LAS VEGAS, NV 89122

FOR: RELIGIOUS AND SPIRITUAL SERVICES, NAMELY, PROVIDING GATHERINGS AND RETREATS TO DEVELOP AND ENHANCE THE SPIRITUAL LIVES OF INDIVIDUALS, IN CLASS 45 (U.S. CLS. 100 AND 101).

FIRST USE 5-1-1997; IN COMMERCE 5-1-1997.

THE MARK CONSISTS OF LATIN TEXT CONTAINING THREE CROSSES TOPPED WITH HEARTS WHICH SURROUND TWO PILLARS WHICH FORM THE LETTER "H" AND ALSO COVERED BY A CENTRALLY LOCATED SHAPE IN THE FORM OF "A", ALSO INCLUDING A LOGO DEMONSTRATED BY A "T" OVERLAID ON A "S".

THE COLOR(S) BLACK AND WHITE IS/ARE CLAIMED AS A FEATURE OF THE MARK.

THE ENGLISH TRANSLATION OF THE WORDS "AVE HUMANITATEM DEUS ANIMAE NOSTRE" IN THE MARK IS "HAIL HUMANITY AND GOD'S ESSENCE (NATURE) IN OUR SOULS".

SER. NO. 85-285,935, FILED 4-4-2011.

JACQUELINE A. LAVINE, EXAMINING ATTORNEY



David J. Kyjars

Director of the United States Patent and Trademark Office

United States of America

United States Patent and Trademark Office

GREENTURTLE

Reg. No. 4,152,714

Registered June 5, 2012

Int. Cl.: 11

TRADEMARK

PRINCIPAL REGISTER

GREEN TURTLE AMERICAS LTD. (NORTH CAROLINA CORPORATION)
FIVE LAKEPOINTE PLAZA, SUITE 410
2709 WATER RIDGE PARKWAY
CHARLOTTE, NC 28217

FOR: WASTEWATER TREATMENT EQUIPMENT, NAMELY, SEPARATOR UNITS FOR REMOVAL AND STORAGE OF OIL, GREASE, AND SEDIMENT FROM EFFLUENCE AND NEUTRALIZATION OF WASTEWATER DISCHARGED TO THE SANITARY SEWER, AND RAINWATER HARVESTING EQUIPMENT, NAMELY, FILTER UNITS FOR SEDIMENT SEPARATION, AND STORAGE AND DISTRIBUTION OF TREATED WATER, IN CLASS 11 (U.S. CLS. 13, 21, 23, 31 AND 34).

FIRST USE 10-0-2002; IN COMMERCE 10-0-2002.

THE MARK CONSISTS OF STANDARD CHARACTERS WITHOUT CLAIM TO ANY PARTICULAR FONT, STYLE, SIZE, OR COLOR.

SER. NO. 85-286,068, FILED 4-5-2011.

BRIAN PINO, EXAMINING ATTORNEY



David J. Kyffers

Director of the United States Patent and Trademark Office

United States of America

United States Patent and Trademark Office



Reg. No. 4,152,715

Registered June 5, 2012

Int. Cl.: 11

TRADEMARK

PRINCIPAL REGISTER

GREEN TURTLE AMERICAS LTD. (NORTH CAROLINA CORPORATION)
FIVE LAKEPOINTE PLAZA, SUITE 410
2709 WATER RIDGE PARKWAY
CHARLOTTE, NC 28217

FOR: POINT-SOURCE WASTEWATER TREATMENT EQUIPMENT, NAMELY, SEPARATOR UNITS FOR REMOVAL AND STORAGE OF OIL, GREASE, AND SEDIMENT FROM EFFLUENCE AND NEUTRALIZATION OF WASTEWATER DISCHARGED TO THE SANITARY SEWER, AND RAINWATER HARVESTING EQUIPMENT, NAMELY, FILTER UNITS FOR SEDIMENT SEPARATION, AND STORAGE AND DISTRIBUTION OF TREATED WATER, IN CLASS 11 (U.S. CLS. 13, 21, 23, 31 AND 34).

FIRST USE 3-13-2006; IN COMMERCE 3-13-2006.

THE MARK CONSISTS OF THE WORDS "GREEN TURTLE" IN LOWER CASE LETTERS WITH TWO SWOOSHES ABOVE THE MARK.

SER. NO. 85-286,070, FILED 4-5-2011.

BRIAN PINO, EXAMINING ATTORNEY



David J. Kyffers

Director of the United States Patent and Trademark Office

United States of America

United States Patent and Trademark Office

INFOWATCH

Reg. No. 4,152,716

Registered June 5, 2012

Int. Cls.: 9 and 42

TRADEMARK

SERVICE MARK

PRINCIPAL REGISTER

INFODESK, INC. (DELAWARE CORPORATION)
660 WHITE PLAINS ROAD, SUITE 300
TARRYTOWN, NY 10591

FOR: COMPUTER SOFTWARE FOR USE IN THE MANAGEMENT, DISPLAY, AND DELIVERY OF NEWS AND INFORMATION IN THE FIELDS OF BUSINESS, FINANCIAL MARKETS, FINANCE, CURRENT EVENTS AND OTHER GENERAL INTEREST TOPICS, DISPLAYED IN REAL-TIME OR AS THE RESULT OF FEDERATED SEARCHING BASED ON CUSTOMER-PROVIDED CRITERIA, IN CLASS 9 (U.S. CLS. 21, 23, 26, 36 AND 38).

FIRST USE 6-0-2007; IN COMMERCE 6-0-2007.

FOR: PROVIDING TEMPORARY USE OF NON-DOWNLOADABLE SOFTWARE FOR USE IN COLLECTING, MANAGING, AND DELIVERING NEWS AND INFORMATION PROVIDED BY THIRD PARTIES IN THE FIELDS OF BUSINESS, FINANCIAL MARKETS, FINANCE, CURRENT EVENTS AND OTHER GENERAL INTEREST TOPICS, DISPLAYED IN REAL-TIME OR AS THE RESULT OF FEDERATED SEARCHING BASED ON CUSTOMER-PROVIDED CRITERIA, IN CLASS 42 (U.S. CLS. 100 AND 101).

FIRST USE 6-0-2007; IN COMMERCE 6-0-2007.

THE MARK CONSISTS OF STANDARD CHARACTERS WITHOUT CLAIM TO ANY PARTICULAR FONT, STYLE, SIZE, OR COLOR.

SER. NO. 85-286,225, FILED 4-5-2011.

DANIEL CAPSHAW, EXAMINING ATTORNEY



David J. Kyffers

Director of the United States Patent and Trademark Office

United States of America

United States Patent and Trademark Office



MSA
SECURITY

Reg. No. 4,152,717

Registered June 5, 2012

Int. Cl.: 45

SERVICE MARK

PRINCIPAL REGISTER

MICHAEL STAPLETON ASSOCIATES, LTD. (DELAWARE CORPORATION)
9 MURRAY STREET, 2ND FLOOR
NEW YORK, NY 10003

FOR: HOMELAND SECURITY SERVICES, NAMELY, THREAT DETECTION, THREAT ASSESSMENT, EXECUTIVE PROTECTION, CIVIL PROTECTION, AND CRISIS RESPONSE SERVICES, IN CLASS 45 (U.S. CLS. 100 AND 101).

FIRST USE 4-1-2011; IN COMMERCE 4-1-2011.

NO CLAIM IS MADE TO THE EXCLUSIVE RIGHT TO USE "SECURITY", APART FROM THE MARK AS SHOWN.

THE MARK CONSISTS OF THE STYLIZED WORDING "MSA SECURITY" WITH A DESIGN TO THE LEFT CONSISTING OF DOTS FORMING AN IRREGULARLY SHAPED QUADRILATERAL WITH A DIAMOND SHAPE IN THE MIDDLE.

SER. NO. 85-286,836, FILED 4-5-2011.

ADA HAN, EXAMINING ATTORNEY



David J. Kybas

Director of the United States Patent and Trademark Office

United States of America

United States Patent and Trademark Office



Reg. No. 4,152,718

Registered June 5, 2012

Int. Cl.: 9

TRADEMARK

PRINCIPAL REGISTER

QUAXAR.COM, INC. (DELAWARE CORPORATION)
SUITE 305
25 SE 2ND AVENUE
MIAMI, FL 33131

FOR: COMPUTER APPLICATION SOFTWARE FOR DEVICES THAT CAN CONNECT TO THE INTERNET, NAMELY, SOFTWARE FOR BUSINESS MARKETING SERVICES, IN CLASS 9 (U.S. CLS. 21, 23, 26, 36 AND 38).

FIRST USE 7-31-2000; IN COMMERCE 7-31-2000.

THE MARK CONSISTS OF THE WORDING "QUAXAR" IN A STYLIZED FONT WHEREIN THE "Q" IS SURROUNDED BY A SOLID OVAL SHAPE AND TWO OVAL SHAPED RINGS ARE SUPERIMPOSED THEREON.

SER. NO. 85-286,863, FILED 4-5-2011.

CHERYL CLAYTON, EXAMINING ATTORNEY



David J. Kybas

Director of the United States Patent and Trademark Office

United States of America

United States Patent and Trademark Office

POWERED BY THE FAYETTEVILLE SHALE

Reg. No. 4,152,719

Registered June 5, 2012

Int. Cl.: 4

TRADEMARK

PRINCIPAL REGISTER

SOUTHWESTERN ENERGY COMPANY (DELAWARE CORPORATION)
2350 NORTH SAM HOUSTON PARKWAY EAST
SUITE 125
HOUSTON, TX 77032

FOR: COMPRESSED NATURAL GAS, IN CLASS 4 (U.S. CLS. 1, 6 AND 15).

FIRST USE 12-24-2010; IN COMMERCE 1-7-2011.

THE MARK CONSISTS OF STANDARD CHARACTERS WITHOUT CLAIM TO ANY PARTICULAR FONT, STYLE, SIZE, OR COLOR.

NO CLAIM IS MADE TO THE EXCLUSIVE RIGHT TO USE "FAYETTEVILLE SHALE", APART FROM THE MARK AS SHOWN.

SER. NO. 85-287,004, FILED 4-5-2011.

AMY KELLY, EXAMINING ATTORNEY



David J. Kybas

Director of the United States Patent and Trademark Office

United States of America

United States Patent and Trademark Office

shareascare

Reg. No. 4,152,720

Registered June 5, 2012

Int. Cl.: 45

SERVICE MARK

PRINCIPAL REGISTER

BOYUKLIEV, DIMITRE (UNITED STATES INDIVIDUAL)
111 E MOSHOLU PKWY N
APT 2J
BRONX, NY 10467

FOR: PROVIDING A SOCIAL NETWORKING WEBSITE FOR ANONYMOUS MEMBERS WHO HAVE FEARS, PHOBIAS, DETRIMENTAL EXPERIENCES, GRIEF STRICKEN, DEPRESSED, OR ARE EXPERIENCING SOME SORT OF A SOCIAL PROBLEM WHETHER PHYSICAL, SEXUAL, EMOTIONAL, PSYCHOLOGICAL, OR MERELY NEED SUPPORT GETTING THROUGH A HARD TIME IN THEIR LIVES, OR HAVE EXPERIENCED SOMETHING OF THE LIKE LISTED ABOVE OR HAVE KNOWLEDGE AND WOULD LIKE TO AID THE INDIVIDUALS WHO ARE GOING THROUGH IT AND WHICH ALLOWS THESE INDIVIDUALS TO INTERACT IN THE HOPES OF HELPING ONE ANOTHER OUT, IN CLASS 45 (U.S. CLS. 100 AND 101).

FIRST USE 3-31-2011; IN COMMERCE 3-31-2011.

THE MARK CONSISTS OF STANDARD CHARACTERS WITHOUT CLAIM TO ANY PARTICULAR FONT, STYLE, SIZE, OR COLOR.

SER. NO. 85-287,217, FILED 4-5-2011.

RUDY R. SINGLETON, EXAMINING ATTORNEY



David J. Kyros

Director of the United States Patent and Trademark Office

United States of America

United States Patent and Trademark Office



Reg. No. 4,152,721

Registered June 5, 2012

Int. Cl.: 30

TRADEMARK

PRINCIPAL REGISTER

ANDERSON VALLEY ACQUISITION COMPANY, LLC (CALIFORNIA LIMITED LIABILITY COMPANY), DBA ANDERSON VALLEY BREWING COMPANY
17700 HIGHWAY 253
BOONVILLE, CA 95415

FOR: FOOD PRODUCTS, NAMELY, MUSTARDS, IN CLASS 30 (U.S. CL. 46).

FIRST USE 4-1-2007; IN COMMERCE 4-1-2007.

NO CLAIM IS MADE TO THE EXCLUSIVE RIGHT TO USE "BREWING COMPANY", APART FROM THE MARK AS SHOWN.

THE COLOR(S) BROWN, LIGHT BROWN, BLUE, WHITE, BLACK, LIGHT AND DARK GREEN IS/ARE CLAIMED AS A FEATURE OF THE MARK.

THE MARK CONSISTS OF A BROWN BEAR WITH LIGHT BROWN ANTLERS IN A LIGHT BROWN OVAL, DRINKING FROM A BLUE LAKE WHICH CONTAINS A REFLECTION OF THE BEAR. THE COLOR OF THE REFLECTION OF THE BEAR IS BROWN. ABOVE AND BEHIND THE BEAR IS SCENERY OF BROWN AND GREEN MOUNTAINS FEATURING GREEN TREES, GRASS AND BUSHES, AND BLUE SKY AND WHITE CLOUDS. TWO BROWN STICKS SURROUNDING THE OVAL ARE COVERED IN LIGHT AND DARK GREEN VINES THAT ENCIRCLE THE OVAL, WHICH IS OUTLINED IN BROWN. AT EACH END OF THE OVAL THERE ARE TWO GRAIN STALKS IN LIGHT AND DARK BROWN. THE TOP OF THE OVAL HAS THE WORDS "ANDERSON VALLEY" IN BLACK. THE MIDDLE OF THE OVAL HAS THE WORDS "BOONVILLE" AND "CALIFORNIA" IN BLACK. THE BOTTOM OF THE OVAL HAS THE WORDS "BREWING COMPANY" IN BLACK.

SEC. 2(F) AS TO "ANDERSON VALLEY BOONEVILLE CALIFORNIA".

SER. NO. 85-287,261, FILED 4-5-2011.

SUSAN LESLIE DUBOIS, EXAMINING ATTORNEY



David J. Kyjars

Director of the United States Patent and Trademark Office

United States of America

United States Patent and Trademark Office

HANDLE IT

Reg. No. 4,152,722

YO FRESH, LLC (NEW JERSEY LIMITED LIABILITY COMPANY)
153 2ND AVENUE
NEW YORK, NY 10003

Registered June 5, 2012

Int. Cl.: 43

FOR: RESTAURANT SERVICES FEATURING FROZEN YOGURT, IN CLASS 43 (U.S. CLS. 100 AND 101).

SERVICE MARK

FIRST USE 9-1-2010; IN COMMERCE 9-1-2010.

PRINCIPAL REGISTER

THE MARK CONSISTS OF STANDARD CHARACTERS WITHOUT CLAIM TO ANY PARTICULAR FONT, STYLE, SIZE, OR COLOR.

SER. NO. 85-287,485, FILED 4-6-2011.

CHRISTINE MARTIN, EXAMINING ATTORNEY



David J. Kybas

Director of the United States Patent and Trademark Office

United States of America

United States Patent and Trademark Office

VISITING PHYSICIANS ASSOCIATION

Reg. No. 4,152,723

U.S. MEDICAL MANAGEMENT, LLC (DELAWARE LIMITED LIABILITY COMPANY)
500 KIRTS BLVD.
TROY, MI 48084

Registered June 5, 2012

Int. Cl.: 44

FOR: MEDICAL SERVICES, NAMELY, PROVIDING HOUSECALL SERVICES BY PHYSICIANS, IN CLASS 44 (U.S. CLS. 100 AND 101).

SERVICE MARK

FIRST USE 0-0-1993; IN COMMERCE 8-31-1998.

PRINCIPAL REGISTER

THE MARK CONSISTS OF STANDARD CHARACTERS WITHOUT CLAIM TO ANY PARTICULAR FONT, STYLE, SIZE, OR COLOR.

OWNER OF U.S. REG. NO. 3,150,162.

NO CLAIM IS MADE TO THE EXCLUSIVE RIGHT TO USE "PHYSICIANS ASSOCIATION", APART FROM THE MARK AS SHOWN.

SEC. 2(F).

SER. NO. 85-288,049, FILED 4-6-2011.

ELLEN B. AWRICH, EXAMINING ATTORNEY



David J. Kyros

Director of the United States Patent and Trademark Office

United States of America

United States Patent and Trademark Office

CES

Reg. No. 4,152,724

Registered June 5, 2012

Int. Cl.: 42

SERVICE MARK

PRINCIPAL REGISTER

CONTINENTAL ENGINEERING SERVICES GMBH (FED REP GERMANY GESELLSCHAFT
MIT BESCHRÄNKTER HAFTUNG (GMBH))
ESCHBORNER LANDSTR 122
FRANKFURT, FED REP GERMANY 60489

FOR: AUTOMOTIVE ENGINEERING SERVICES; SCIENTIFIC AND TECHNOLOGICAL SERVICES, NAMELY, ENGINEERING CONSULTING SERVICES IN THE FIELD OF AUTOMOTIVE TECHNOLOGIES, ADAPTATION OF AUTOMOTIVE TECHNOLOGIES FOR GENERAL INDUSTRIAL APPLICATIONS, AND RESEARCH AND DESIGN RELATING THERETO; INDUSTRIAL ANALYSIS, NAMELY, FAULT TREE ANALYSIS, PRODUCT RELIABILITY ANALYSIS, FAILURE MODE AND EFFECT ANALYSIS, AND FUNCTIONAL SAFETY ASSESSMENT FOR PRODUCTS; RESEARCH SERVICES, NAMELY, MECHANICAL RESEARCH, SCIENTIFIC RESEARCH, PRODUCT RESEARCH, AND RESEARCH IN THE FIELD OF AUTOMOTIVE TECHNOLOGY; DESIGN AND DEVELOPMENT OF COMPUTER HARDWARE AND SOFTWARE, OTHER THAN IN THE FIELD OF CONVEYOR TECHNOLOGY INSTALLATIONS AND DEVICES, IN PARTICULAR DRIVES, LIFTING GEAR AND CRANE INSTALLATIONS, IN CLASS 42 (U.S. CLS. 100 AND 101).

FIRST USE 0-0-2006; IN COMMERCE 0-0-2006.

THE MARK CONSISTS OF STANDARD CHARACTERS WITHOUT CLAIM TO ANY PARTICULAR FONT, STYLE, SIZE, OR COLOR.

OWNER OF ERPN CMNTY TM OFC REG. NO. 009113127, DATED 11-2-2010, EXPIRES 5-18-2020.

SER. NO. 85-288,082, FILED 4-6-2011.

ALLISON SCHRODY, EXAMINING ATTORNEY



David J. Kyjars

Director of the United States Patent and Trademark Office

United States of America

United States Patent and Trademark Office

HOLE HOPPER

Reg. No. 4,152,725

HERRMANN, JOHN (UNITED STATES INDIVIDUAL)
7447 115TH ST.
CHIPPEWA FALLS, WI 54729

Registered June 5, 2012

Int. Cl.: 28

FOR: TOYS AND SPORTING GOODS, NAMELY, SPORTSMAN'S ICE FISHING SIDE BAG,
IN CLASS 28 (U.S. CLS. 22, 23, 38 AND 50).

TRADEMARK

FIRST USE 1-1-2008; IN COMMERCE 10-20-2008.

PRINCIPAL REGISTER

THE MARK CONSISTS OF STANDARD CHARACTERS WITHOUT CLAIM TO ANY PAR-
TICULAR FONT, STYLE, SIZE, OR COLOR.

SER. NO. 85-288,486, FILED 4-7-2011.

YAT SYE, LEE, EXAMINING ATTORNEY



David J. Kybas

Director of the United States Patent and Trademark Office

United States of America

United States Patent and Trademark Office

FundingShield

Reg. No. 4,152,726

Registered June 5, 2012

Int. Cls.: 42 and 45

SERVICE MARK

PRINCIPAL REGISTER

FUNDINGSHIELD (NEW YORK LIMITED LIABILITY COMPANY)
38TH FLOOR
245 PARK AVENUE
NEW YORK, NY 10167

FOR: PROVIDING QUALITY CONTROL SERVICES FOR THE MORTGAGE INDUSTRY, IN CLASS 42 (U.S. CLS. 100 AND 101).

FIRST USE 8-30-2010; IN COMMERCE 8-30-2010.

FOR: MORTGAGE COMPLIANCE CONSULTING SERVICES CONCERNING MORTGAGE-RELATED LAWS FOR MORTGAGE LENDERS AND SERVICERS AND MORTGAGE BROKERS, IN CLASS 45 (U.S. CLS. 100 AND 101).

FIRST USE 8-30-2010; IN COMMERCE 8-30-2010.

THE MARK CONSISTS OF STANDARD CHARACTERS WITHOUT CLAIM TO ANY PARTICULAR FONT, STYLE, SIZE, OR COLOR.

SER. NO. 85-288,501, FILED 4-7-2011.

WON TEAK OH, EXAMINING ATTORNEY



David J. Kybas

Director of the United States Patent and Trademark Office

United States of America

United States Patent and Trademark Office

b

Reg. No. 4,152,727

Registered June 5, 2012

Int. Cl.: 25

TRADEMARK

PRINCIPAL REGISTER

BURLIN CORPORATION (GEORGIA CORPORATION)
10TH FLOOR
6 EAST 32ND STREET
NEW YORK, NY 10016

FOR: LADIES UNDERWEAR, FOUNDATION GARMENTS, SLEEPWEAR, BATHROBES, SLIPPERS, LOUNGEWEAR, PAJAMAS, GOWNS, SLEEPSHIRTS, DAYWEAR, NAMELY, CAMISOLES, BRAS, SLIPS, CHEMISES , IN CLASS 25 (U.S. CLS. 22 AND 39).

FIRST USE 6-1-2003; IN COMMERCE 6-1-2003.

THE MARK CONSISTS OF A STYLIZED "B".

SER. NO. 85-288,564, FILED 4-7-2011.

KEVIN DINALLO, EXAMINING ATTORNEY



David J. Kyffers

Director of the United States Patent and Trademark Office

United States of America

United States Patent and Trademark Office



Reg. No. 4,152,728

Registered June 5, 2012

Int. Cl.: 25

TRADEMARK

PRINCIPAL REGISTER

SHARON ANN DEWALD (UNITED STATES INDIVIDUAL)
10494 170TH ST. WEST
LAKEVILLE, MN 55044 AND

CRAIG L. DEWALD (UNITED STATES INDIVIDUAL)
10494 170TH ST. WEST
LAKEVILLE, MN 55044

FOR: APPAREL FOR DANCERS, NAMELY, TEE SHIRTS, SWEATSHIRTS, PANTS, LEGGINGS, SHORTS AND JACKETS; ATHLETIC APPAREL, NAMELY, SHIRTS, PANTS, JACKETS, FOOTWEAR, HATS AND CAPS, ATHLETIC UNIFORMS; BASEBALL CAPS AND HATS; CAMOUFLAGE PANTS; CAPRI PANTS; CROP PANTS; DENIMS; GOLF PANTS, SHIRTS AND SKIRTS; GYM PANTS; HATS FOR INFANTS, BABIES, TODDLERS AND CHILDREN; HOODED SWEATSHIRTS; HUNTING PANTS; LEATHER HATS; LOUNGE PANTS; MOISTURE-WICKING SPORTS PANTS; RAIN HATS; SHORT-SLEEVED OR LONG-SLEEVED T-SHIRTS; SKI PANTS; SLEEP PANTS; SNOW PANTS; SNOWBOARD PANTS; SOCKS; SPORTS CAPS AND HATS; SPORTS PANTS; STRETCH PANTS; SWEAT PANTS; SWEATERS; SWEATSHIRTS; T-SHIRTS; TAP PANTS; TRACK PANTS; WATERPROOF JACKETS AND PANTS; WIND PANTS; WOMEN'S HATS AND HOODS; WOOLLY HATS; YOGA PANTS, IN CLASS 25 (U.S. CLS. 22 AND 39).

FIRST USE 8-15-2000; IN COMMERCE 4-4-2011.

THE MARK CONSISTS OF A STYLIZED "W" WITH TWO DOTS IN THE NEGATIVE SPACE REPRESENTING WOMEN'S BREASTS.

SER. NO. 85-289,215, FILED 4-7-2011.

JAMES GRIFFIN, EXAMINING ATTORNEY



David J. Kybas

Director of the United States Patent and Trademark Office

United States of America

United States Patent and Trademark Office

F.A.M.I.L.Y. ~ Forget About Me I Love You

Reg. No. 4,152,729

Registered June 5, 2012

Int. Cl.: 36

SERVICE MARK

PRINCIPAL REGISTER

MICHAEL J MANHARDT (CALIFORNIA SOLE PROPRIETORSHIP), DBA FAMILY
WRISTBANDS

#125
5750 W CENTINELA AVE
LOS ANGELES, CA 90045

FOR: CHARITABLE FUNDRAISING SERVICES BY MEANS OF SELLING BOOKS, CD'S,
WRISTBANDS, BRACELETS, HATS, T-SHIRTS, SWEATBANDS TO RAISE FUNDS FOR
ORGANIZATIONS, IN CLASS 36 (U.S. CLS. 100, 101 AND 102).

FIRST USE 4-20-2001; IN COMMERCE 4-20-2001.

THE MARK CONSISTS OF STANDARD CHARACTERS WITHOUT CLAIM TO ANY PAR-
TICULAR FONT, STYLE, SIZE, OR COLOR.

SER. NO. 85-289,228, FILED 4-7-2011.

MARILYN IZZI, EXAMINING ATTORNEY



David J. Kybas

Director of the United States Patent and Trademark Office

United States of America

United States Patent and Trademark Office

PRSONA

Reg. No. 4,152,730

Registered June 5, 2012

Int. Cl.: 35

SERVICE MARK

PRINCIPAL REGISTER

BOLLINGER, BRANSON (UNITED STATES INDIVIDUAL), DBA PRSONA
602 FOUNTAIN PARKWAY
GRAND PRAIRIE, TX 75050 AND

BOLLINGER, BRENDON (UNITED STATES INDIVIDUAL), DBA PRSONA
602 FOUNTAIN PARKWAY
GRAND PRAIRIE, TX 75050

FOR: EMPLOYMENT AGENCY SERVICES , IN CLASS 35 (U.S. CLS. 100, 101 AND 102).

FIRST USE 12-0-2010; IN COMMERCE 12-0-2010.

THE MARK CONSISTS OF THE WORD "PRSONA" IN STYLIZED FONT WITH A MACRON ABOVE THE LETTER "O".

SER. NO. 85-290,714, FILED 4-8-2011.

BRIAN PINO, EXAMINING ATTORNEY



David J. Kyffers

Director of the United States Patent and Trademark Office

United States of America

United States Patent and Trademark Office

Atomic Records

Reg. No. 4,152,731

Registered June 5, 2012

Int. Cl.: 9

TRADEMARK

PRINCIPAL REGISTER

ATOMIC RECORDS INCORPORATED (CALIFORNIA CORPORATION)
1737 NORTH WHITLEY AVENUE SUITE 300
HOLLYWOOD, CA 90028

FOR: SOUND RECORDINGS FEATURING, NAMELY, PHONOGRAPH RECORDS, PRE-RECORDED AUDIO TAPES, ENHANCED CD'S, COMPACT DISCS, PRE-RECORDED VIDEOTAPES, PRE-RECORDED VIDEOCASSETTES, PRE-RECORDED DIGITAL AUDIO TAPES, DVD'S, AND LASER DISCS FEATURING MUSIC, IN CLASS 9 (U.S. CLS. 21, 23, 26, 36 AND 38).

FIRST USE 4-7-2011; IN COMMERCE 4-7-2011.

THE MARK CONSISTS OF STANDARD CHARACTERS WITHOUT CLAIM TO ANY PARTICULAR FONT, STYLE, SIZE, OR COLOR.

NO CLAIM IS MADE TO THE EXCLUSIVE RIGHT TO USE "RECORDS", APART FROM THE MARK AS SHOWN.

SER. NO. 85-290,783, FILED 4-8-2011.

JANICE L. MCMORROW, EXAMINING ATTORNEY



David J. Kyffers

Director of the United States Patent and Trademark Office

United States of America

United States Patent and Trademark Office

NuDeFood

Reg. No. 4,152,732

Registered June 5, 2012

Int. Cl.: 30

TRADEMARK

PRINCIPAL REGISTER

CRYSTAL RIVER ORGANICS LLC (COLORADO LIMITED LIABILITY COMPANY)
P.O. BOX 2076
CARBONDALE, CO 81623

FOR: CEREAL BASED SNACK BARS; CEREAL BASED HIGH PROTEIN SNACK BARS AND POWDERS; CEREAL BASED HIGH ENERGY BARS NOT FOR USE AS A MEAL REPLACEMENT; CEREALS AND PREPARATIONS MADE FROM CEREALS, NAMELY, BREAKFAST CEREALS, PROCESSED CEREALS AND CEREAL BASED SNACK FOODS; SALAD DRESSINGS, CONDIMENTS, NAMELY, SALSAS, MARINADES; PREPARED AND PACKAGED READY TO EAT MEALS CONSISTING PRIMARILY OF PASTA OR RICE, IN CLASS 30 (U.S. CL. 46).

FIRST USE 1-1-2010; IN COMMERCE 1-1-2010.

THE MARK CONSISTS OF STANDARD CHARACTERS WITHOUT CLAIM TO ANY PARTICULAR FONT, STYLE, SIZE, OR COLOR.

NO CLAIM IS MADE TO THE EXCLUSIVE RIGHT TO USE "FOOD", APART FROM THE MARK AS SHOWN.

SER. NO. 85-290,789, FILED 4-8-2011.

GRETTA YAO, EXAMINING ATTORNEY



David J. Kyros

Director of the United States Patent and Trademark Office

United States of America

United States Patent and Trademark Office

fan page generator

Reg. No. 4,152,733

Registered June 5, 2012

Int. Cls.: 35, 41 and 42

SERVICE MARK

PRINCIPAL REGISTER

FAN PAGE GENERATOR, LLC (CALIFORNIA LIMITED LIABILITY COMPANY)
99 MONTFORD AVE
MILL VALLEY, CA 94941

FOR: ADVICE IN THE FIELD OF BUSINESS MANAGEMENT AND MARKETING; BUSINESS ADVISORY SERVICES, CONSULTANCY AND INFORMATION; SOCIAL MEDIA STRATEGY AND MARKETING CONSULTANCY FOCUSING ON HELPING CLIENTS CREATE AND EXTEND THEIR PRODUCT AND BRAND STRATEGIES BY BUILDING VIRALLY ENGAGING MARKETING SOLUTIONS; CONSULTATION IN THE FIELD OF DEVELOPMENT OF MARKETING STRATEGIES AND CONCEPTS; MARKETING SERVICES, PROVIDING CONSULTATION REGARDING INFORMATIONAL WEB PAGES DESIGNED TO GENERATE SALES TRAFFIC VIA HYPERLINKS TO OTHER WEBSITES, IN CLASS 35 (U.S. CLS. 100, 101 AND 102).

FIRST USE 10-6-2009; IN COMMERCE 11-4-2009.

FOR: CONSULTATION IN THE FIELD OF VIDEOGRAPHY SERVICES, IN CLASS 41 (U.S. CLS. 100, 101 AND 107).

FIRST USE 10-6-2009; IN COMMERCE 11-4-2009.

FOR: COMPUTER SERVICES, NAMELY, CREATING AN ON-LINE COMMUNITY FOR REGISTERED USERS TO PARTICIPATE IN DISCUSSIONS, GET FEEDBACK FROM THEIR PEERS, FORM VIRTUAL COMMUNITIES, AND ENGAGE IN SOCIAL NETWORKING; CREATING AND DESIGNING WEB PAGES FOR OTHERS; COMPUTER SERVICES, NAMELY, CONSULTATION IN THE FIELD OF DESIGNING AND IMPLEMENTING WEB PAGES FOR OTHERS, IN CLASS 42 (U.S. CLS. 100 AND 101).

FIRST USE 10-6-2009; IN COMMERCE 11-4-2009.

THE MARK CONSISTS OF STANDARD CHARACTERS WITHOUT CLAIM TO ANY PARTICULAR FONT, STYLE, SIZE, OR COLOR.

SER. NO. 85-291,149, FILED 4-10-2011.

SAMUEL E. SHARPER JR., EXAMINING ATTORNEY



David J. Kyros

Director of the United States Patent and Trademark Office

United States of America

United States Patent and Trademark Office



Reg. No. 4,152,734

Registered June 5, 2012

Int. Cl.: 9

TRADEMARK

PRINCIPAL REGISTER

BULLET INTERNATIONAL, SA DE CV (MEXICO CORPORATION)
AV. 8 DE MAYO NO. 9-1
NAUCALPAN, EDOMEX, MEXICO 53910

FOR: BULLET-PROOF VESTS AND CLOTHING; CRASH HELMETS; FACE-PROTECTION SHIELDS; GLOVES FOR PROTECTION AGAINST ACCIDENTS, IN CLASS 9 (U.S. CLS. 21, 23, 26, 36 AND 38).

OWNER OF MEXICO REG. NO. 1166590, DATED 6-29-2010, EXPIRES 5-11-2020.

THE MARK CONSISTS OF A SHIELD OUTLINED WITH THE WORDING "DUTY POWER HIT" APPEARING INSIDE THE SHIELD.

SER. NO. 85-291,413, FILED 4-11-2011.

JENNY PARK, EXAMINING ATTORNEY



David J. Kyffers

Director of the United States Patent and Trademark Office

United States of America

United States Patent and Trademark Office

ZiaLast

Reg. No. 4,152,735

Registered June 5, 2012

Int. Cl.: 1

TRADEMARK

PRINCIPAL REGISTER

JJISCO INC. (WISCONSIN CORPORATION)
1815 EXECUTIVE DRICE
OCONOMOWOC, WI 53066

FOR: ENGINEERED CERAMIC AND COMPOSITE MATERIALS FOR HEAT TRANSFER OR THERMAL MANAGEMENT APPLICATIONS, IN CLASS 1 (U.S. CLS. 1, 5, 6, 10, 26 AND 46).

FIRST USE 3-16-2011; IN COMMERCE 3-16-2011.

THE MARK CONSISTS OF STANDARD CHARACTERS WITHOUT CLAIM TO ANY PARTICULAR FONT, STYLE, SIZE, OR COLOR.

OWNER OF U.S. REG. NOS. 3,255,609, 3,258,177 AND OTHERS.

SER. NO. 85-291,480, FILED 4-11-2011.

CURTIS FRENCH, EXAMINING ATTORNEY



David J. Kyffers

Director of the United States Patent and Trademark Office

United States of America

United States Patent and Trademark Office

MIREGO

Reg. No. 4,152,736

Registered June 5, 2012

Int. Cls.: 35 and 42

SERVICE MARK

PRINCIPAL REGISTER

MIREGO INC. (CANADA CORPORATION)
BUREAU 200
2327 BOULEVARD DU VERSANT-NORD
QUÉBEC, CANADA G1N4C2

FOR: MARKETING OF SOFTWARE AND COMPUTER SYSTEMS AND MOBILE SOFTWARE APPLICATIONS OF OTHERS, IN CLASS 35 (U.S. CLS. 100, 101 AND 102).

FOR: DESIGN AND DEVELOPMENT OF SOFTWARE AND COMPUTER SYSTEMS AND MOBILE SOFTWARE APPLICATIONS, IN CLASS 42 (U.S. CLS. 100 AND 101).

THE MARK CONSISTS OF STANDARD CHARACTERS WITHOUT CLAIM TO ANY PARTICULAR FONT, STYLE, SIZE, OR COLOR.

OWNER OF CANADA REG. NO. TMA815217, DATED 1-10-2012, EXPIRES 1-10-2027.

THE WORDING "MIREGO" HAS NO MEANING IN A FOREIGN LANGUAGE.

SER. NO. 85-291,760, FILED 4-11-2011.

TRACY FLETCHER, EXAMINING ATTORNEY



David J. Kyros

Director of the United States Patent and Trademark Office

United States of America

United States Patent and Trademark Office

Moo Moo Musica

Reg. No. 4,152,737

Registered June 5, 2012

Int. Cls.: 9 and 41

MOO MOO MUSICA, LLC (CALIFORNIA LIMITED LIABILITY COMPANY), DBA MOO
MOO MUSICA
13900 PANAY WAY
#R215
MARINA DEL REY, CA 90212

TRADEMARK

FOR: CDS FEATURING ENTERTAINMENT AND EDUCATION FOR CHILDREN IN THE
NATURE OF MUSIC AND SONGS IN MULTIPLE LANGUAGES, IN CLASS 9 (U.S. CLS. 21,
23, 26, 36 AND 38).

SERVICE MARK

FIRST USE 11-20-2010; IN COMMERCE 11-20-2010.

PRINCIPAL REGISTER

FOR: EDUCATION AND ENTERTAINMENT SERVICES, NAMELY, LIVE PROGRAMS,
PERFORMANCES OR THEATRICAL PRODUCTIONS FOR CHILDREN FEATURING MUSIC
AND SONGS IN MULTIPLE LANGUAGES, IN CLASS 41 (U.S. CLS. 100, 101 AND 107).

FIRST USE 4-9-2002; IN COMMERCE 4-9-2002.

THE MARK CONSISTS OF STANDARD CHARACTERS WITHOUT CLAIM TO ANY PAR-
TICULAR FONT, STYLE, SIZE, OR COLOR.

NO CLAIM IS MADE TO THE EXCLUSIVE RIGHT TO USE "MUSICA", APART FROM THE
MARK AS SHOWN.

THE ENGLISH TRANSLATION OF "MUSICA" IN THE MARK IS "MUSIC".

SER. NO. 85-291,899, FILED 4-11-2011.

ELIZABETH HUGHITT, EXAMINING ATTORNEY



David J. Kyros

Director of the United States Patent and Trademark Office

United States of America

United States Patent and Trademark Office

Nature's Palliative

Reg. No. 4,152,738

Registered June 5, 2012

Int. Cl.: 5

TRADEMARK

PRINCIPAL REGISTER

NATURE'S PALLIATIVE (MONTANA PARTNERSHIP)
694 GRANTS DALE ROAD
HAMILTON, MT 59840

FOR: HERBS FOR MEDICINAL PURPOSES, IN CLASS 5 (U.S. CLS. 6, 18, 44, 46, 51 AND 52).

FIRST USE 1-1-2010; IN COMMERCE 1-1-2010.

THE MARK CONSISTS OF STANDARD CHARACTERS WITHOUT CLAIM TO ANY PARTICULAR FONT, STYLE, SIZE, OR COLOR.

NO CLAIM IS MADE TO THE EXCLUSIVE RIGHT TO USE "PALLIATIVE", APART FROM THE MARK AS SHOWN.

SER. NO. 85-292,037, FILED 4-11-2011.

LESLIE RICHARDS, EXAMINING ATTORNEY



David J. Kyffers

Director of the United States Patent and Trademark Office

United States of America

United States Patent and Trademark Office

FILERTEK

Reg. No. 4,152,739

Registered June 5, 2012

Int. Cl.: 16

TRADEMARK

PRINCIPAL REGISTER

FILERTEK INTERNATIONAL PTY LTD (AUSTRALIA LIMITED LIABILITY COMPANY)
78 HOWARD STREET
PADDINGTON
QUEENSLAND 4064, AUSTRALIA

FOR: PAPER, CARDBOARD; STATIONERY; ADHESIVES FOR STATIONERY; FILING SYSTEMS AND RECORD-ORGANISING SYSTEMS IN THIS CLASS COMPRISED OF DOCUMENT FILE RACKS, TRAYS, FOLDERS, FILES AND FILING TABS FOR FOLDERS AND FILES, AND REPLACEMENT PARTS THEREFOR IN THE NATURE OF DOCUMENT FILE FOLDERS AND FILING TABS FOR FOLDERS AND FILES; DESKTOP FILING SYSTEMS COMPRISED OF DESK FILE TRAYS AND DESKTOP DOCUMENT FILE STANDS, FILE STORAGE BOXES FOR STORAGE OF BUSINESS AND PERSONAL RECORDS; AND PORTABLE FILING SYSTEMS COMPRISED OF CORRUGATED RECORD STORAGE BOXES; INDEXING SYSTEMS COMPRISED OF FILING TABS, PAPER LABELS AND TAGS FOR INDEXING FILES AND FOLDERS; INDEXING SYSTEMS FOR HANGING AND SUSPENSION FILES COMPRISED OF PLASTIC FILE TABS THAT ARE MOUNTABLE TO HANGING AND SUSPENSION FILES, REUSABLE FILE INDEXING SYSTEMS COMPRISED OF CLIP-ON PLASTIC MARKING TABS FOR FILES, REUSABLE FILE INDEXING SYSTEMS COMPRISED OF CLIP-ON PLASTIC MARKING TABS FOR FILES WHEREIN THE MARKING TABS EACH HAVE AN ERASABLE WRITING SURFACE, AND REUSABLE FILE INDEXING SYSTEMS COMPRISED OF CLIP-ON PLASTIC MARKING TABS FOR FILES WHEREIN THE MARKING TABS EACH HAVE A POCKET FOR RECEIVING A PAPER INSERT; FILING TABS, INDEXING MARKING TABS, AND CLIP-ON FILE INDEXING MARKING TABS FOR HANGING AND SUSPENSION FILES; FILES AND FOLDERS IN THIS CLASS, NAMELY, DOCUMENT FILES, LETTER FILES, PAPER FILE JACKETS, PAPER EXPANDING FILES, FILE FOLDERS, HANGING FOLDERS, HANGING LETTER FILES, SUSPENDED LETTER FILES AND FOLDERS FOR LETTERS; REPLACEMENT PARTS FOR FILES AND FOLDERS IN THIS CLASS, NAMELY, PAPER FILE JACKETS; DIVIDERS FOR FILES AND FOLDERS IN THE NATURE OF PLASTIC FILE TABS THAT ARE MOUNTABLE TO FILES AND FOLDERS; PAPER FILE LABELS AND COLOUR-CODED PAPER FILE LABELS; WRITING INSTRUMENTS; PENS, MARKERS AND ERASABLE MARKERS; ERASERS FOR USE ON STATIONERY; ERASERS FOR ERASABLE MARKERS, IN CLASS 16 (U.S. CLS. 2, 5, 22, 23, 29, 37, 38 AND 50).



David J. Kyros

Director of the United States Patent and Trademark Office

THE MARK CONSISTS OF STANDARD CHARACTERS WITHOUT CLAIM TO ANY PARTICULAR FONT, STYLE, SIZE, OR COLOR.

Reg. No. 4,152,739 PRIORITY CLAIMED UNDER SEC. 44(D) ON AUSTRALIA APPLICATION NO. 1388474,
FILED 10-13-2010, REG. NO. 1388474, DATED 6-14-2011, EXPIRES 10-13-2020.

SER. NO. 85-292,447, FILED 4-12-2011.

NELSON SNYDER, EXAMINING ATTORNEY

United States of America

United States Patent and Trademark Office

BAKRI

Reg. No. 4,152,740

Registered June 5, 2012

Int. Cl.: 10

TRADEMARK

PRINCIPAL REGISTER

COOK MEDICAL TECHNOLOGIES LLC (INDIANA LIMITED LIABILITY COMPANY)
750 DANIELS WAY, P.O. BOX 2269
BLOOMINGTON, IN 47402

FOR: MEDICAL DEVICE, NAMELY, A POSTPARTUM BALLOON CATHETER, IN CLASS
10 (U.S. CLS. 26, 39 AND 44).

FIRST USE 4-3-2006; IN COMMERCE 4-3-2006.

THE MARK CONSISTS OF STANDARD CHARACTERS WITHOUT CLAIM TO ANY PAR-
TICULAR FONT, STYLE, SIZE, OR COLOR.

THE ENGLISH TRANSLATION OF "BAKRI" IN THE MARK IS "GOAT".

SEC. 2(F).

SER. NO. 85-292,658, FILED 4-12-2011.

BRENDAN REGAN, EXAMINING ATTORNEY



David J. Kybas

Director of the United States Patent and Trademark Office

United States of America

United States Patent and Trademark Office

NUTRITION CARE MANUAL

Reg. No. 4,152,741

Registered June 5, 2012

Int. Cl.: 44

SERVICE MARK

PRINCIPAL REGISTER

ACADEMY OF NUTRITION AND DIETETICS (ILLINOIS CORPORATION)
120 SOUTH RIVERSIDE PLAZA
SUITE 2000
CHICAGO, IL 60606

FOR: PROVIDING AN INTERACTIVE COMPUTER DATABASE AND INFORMATION IN THE FIELD OF FOOD, NUTRITION AND HEALTH TO ASSIST DIETETIC PROFESSIONALS IN PROVIDING CARE TO PATIENTS, IN CLASS 44 (U.S. CLS. 100 AND 101).

FIRST USE 8-27-2004; IN COMMERCE 9-1-2004.

THE MARK CONSISTS OF STANDARD CHARACTERS WITHOUT CLAIM TO ANY PARTICULAR FONT, STYLE, SIZE, OR COLOR.

OWNER OF U.S. REG. NO. 3,064,618.

NO CLAIM IS MADE TO THE EXCLUSIVE RIGHT TO USE "MANUAL", APART FROM THE MARK AS SHOWN.

SEC. 2(F).

SER. NO. 85-292,859, FILED 4-12-2011.

LINDA POWELL, EXAMINING ATTORNEY



David J. Kybas

Director of the United States Patent and Trademark Office

United States of America

United States Patent and Trademark Office

PARTRIDGE HILL

Reg. No. 4,152,742

ADAMS, DANIEL NELSON, JR. (UNITED STATES INDIVIDUAL)
11 SHORELANDS PLACE
OLD GREENWICH, CT 06870

Registered June 5, 2012

Int. Cl.: 35

FOR: RETAIL STORE AND ON-LINE RETAIL STORE SERVICES FEATURING CHEESE AND DAIRY PRODUCTS, HOME-MADE SNACK FOODS EXCLUDING MEAT BASED SNACK FOODS, DECORATIVE HIGH END FLY FISHING GIFTWARE AND TOILETRIES, IN CLASS 35 (U.S. CLS. 100, 101 AND 102).

SERVICE MARK

PRINCIPAL REGISTER

FIRST USE 11-20-2003; IN COMMERCE 11-20-2003.

THE MARK CONSISTS OF STANDARD CHARACTERS WITHOUT CLAIM TO ANY PARTICULAR FONT, STYLE, SIZE, OR COLOR.

OWNER OF U.S. REG. NO. 2,943,762.

SER. NO. 85-293,027, FILED 4-12-2011.

COLLEEN DOMBROW, EXAMINING ATTORNEY



David J. Kyffers

Director of the United States Patent and Trademark Office

United States of America

United States Patent and Trademark Office

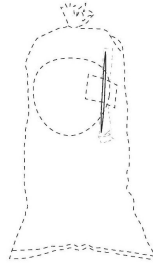

Reg. No. 4,152,743

Registered June 5, 2012

Int. Cl.: 30

TRADEMARK

PRINCIPAL REGISTER

JUST POP IN, INC. (INDIANA CORPORATION)
6302 N. GUILFORD AVE
INDIANAPOLIS, IN 46220

FOR: POPCORN, IN CLASS 30 (U.S. CL. 46).

FIRST USE 11-0-2003; IN COMMERCE 11-0-2003.

THE MARK CONSISTS OF TRADE DRESS PRODUCT PACKAGING CONSISTING OF A TOOTHPICK APPLIED TO A POPCORN CONTAINER. THE DOTTED LINES IN THE DRAWING ARE NOT CLAIMED AS A FEATURE OF THE MARK BUT SHOW ONE METHOD OF ATTACHING THE TOOTHPICK TO THE GOODS; NAMELY, WITH TRANSPARENT TAPE. THE DOTTED LINES FURTHER SHOW ONE TYPE OF CONTAINER; NAMELY, A POPCORN BAG.

SEC. 2(F).

SER. NO. 85-293,028, FILED 4-12-2011.

GRETTA YAO, EXAMINING ATTORNEY



David J. Kyros

Director of the United States Patent and Trademark Office

United States of America

United States Patent and Trademark Office



Reg. No. 4,152,744

Registered June 5, 2012

Int. Cl.: 35

SERVICE MARK

PRINCIPAL REGISTER

ADAMS, DANIEL NELSON, JR. (UNITED STATES INDIVIDUAL)
11 SHORELANDS PLACE
OLD GREENWICH, CT 06870

FOR: RETAIL STORE AND ON-LINE RETAIL STORE SERVICES FEATURING CHEESE AND DAIRY PRODUCTS, HOME-MADE SNACK FOODS EXCLUDING MEAT BASED SNACK FOODS, DECORATIVE HIGH END FLY FISHING GIFTWARE AND TOILETRIES, IN CLASS 35 (U.S. CLS. 100, 101 AND 102).

FIRST USE 4-8-2011; IN COMMERCE 4-8-2011.

OWNER OF U.S. REG. NO. 2,943,762.

THE MARK CONSISTS OF A DRAWING OF A BIRD WITH THE WORDS "PARTRIDGE HILL" APPEARING ABOVE THE BIRD. THE BIRD IS WITHIN A DOUBLE-LINED CIRCLE.

SER. NO. 85-293,067, FILED 4-12-2011.

COLLEEN DOMBROW, EXAMINING ATTORNEY



David J. Kyjars

Director of the United States Patent and Trademark Office

United States of America

United States Patent and Trademark Office



Reg. No. 4,152,745

Registered June 5, 2012

Int. Cl.: 45

SERVICE MARK

PRINCIPAL REGISTER

LOSS PREVENTION GROUP, INC., THE (MARYLAND CORPORATION), DBA METRO
LOSS PREVENTION SERVICES GROUP
900 SOUTH AVENUE SUITE 200, 2ND FLOOR
STATEN ISLAND, NY 10314

FOR: SECURITY SERVICES FOR BUSINESSES, INDIVIDUALS AND BUSINESS PERSONS, NAMELY, PROVIDING ARMED AND UNARMED SECURITY GUARD SERVICES AND SECURITY GUARDING FOR FACILITIES; INVESTIGATION OF ASSETS, CREDIT REPORTS, FISCAL ASSESSMENTS AND COLLECTION REPORTS FOR SECURITY OR AUTHENTICATION PURPOSES, SAID INVESTIGATIONS FOR BUSINESSES AND INDIVIDUALS; PROVIDING EXECUTIVE PROTECTION, IN CLASS 45 (U.S. CLS. 100 AND 101).

FIRST USE 9-1-2001; IN COMMERCE 9-1-2001.

THE MARK CONSISTS OF THE STYLIZED LETTER "M" THAT MERGES THE NUMERAL "1" AS ONE LEG OF THE LETTER, APPEARING UPON A BLACK SQUARE AND TO THE LEFT OF THE WORDING "METRO ONE".

SER. NO. 85-293,114, FILED 4-12-2011.

MARC LEIPZIG, EXAMINING ATTORNEY



David J. Kyffers

Director of the United States Patent and Trademark Office

United States of America

United States Patent and Trademark Office

BIZHUB

Reg. No. 4,152,746

Registered June 5, 2012

Int. Cl.: 35

SERVICE MARK

PRINCIPAL REGISTER

BIZHUB LLC (MICHIGAN LIMITED LIABILITY COMPANY)
SUITE 205
205 N OLD WOODWARD
BIRMINGHAM, MI 48009

FOR: LIFESTYLE BENEFITS SERVICES RELATING TO DISCOUNT CARDS, NAMELY, ADMINISTRATION OF A DISCOUNT PROGRAM FOR ENABLING PARTICIPANTS TO OBTAIN DISCOUNTS ON GOODS AND SERVICES THROUGH USE OF A DISCOUNT MEMBERSHIP CARD, PROMOTING THE GOODS AND SERVICES OF OTHERS THROUGH THE DISTRIBUTION OF DISCOUNT CARDS PROVIDED BY A LICENSED INSURANCE AGENCY, IN CLASS 35 (U.S. CLS. 100, 101 AND 102).

FIRST USE 3-31-2011; IN COMMERCE 3-31-2011.

THE MARK CONSISTS OF STANDARD CHARACTERS WITHOUT CLAIM TO ANY PARTICULAR FONT, STYLE, SIZE, OR COLOR.

SER. NO. 85-293,203, FILED 4-12-2011.

JENNY PARK, EXAMINING ATTORNEY



David J. Kyffers

Director of the United States Patent and Trademark Office

United States of America

United States Patent and Trademark Office

BizHub



Reg. No. 4,152,747

Registered June 5, 2012

Int. Cl.: 35

SERVICE MARK

PRINCIPAL REGISTER

BIZHUB LLC (MICHIGAN LIMITED LIABILITY COMPANY)
SUITE 205
205 N OLD WOODWARD
BIRMINGHAM, MI 48009

FOR: LIFESTYLE BENEFITS SERVICES RELATING TO DISCOUNT CARDS, NAMELY, ADMINISTRATION OF A DISCOUNT PROGRAM FOR ENABLING PARTICIPANTS TO OBTAIN DISCOUNTS ON GOODS AND SERVICES THROUGH USE OF A DISCOUNT MEMBERSHIP CARD, PROMOTING THE GOODS AND SERVICES OF OTHERS THROUGH THE DISTRIBUTION OF DISCOUNT CARDS PROVIDED BY A LICENSED INSURANCE AGENCY, IN CLASS 35 (U.S. CLS. 100, 101 AND 102).

FIRST USE 3-31-2011; IN COMMERCE 3-31-2011.

THE MARK CONSISTS OF THE LITERAL ELEMENTS "BIZHUB" WHEREIN THE IMAGE CONSISTS OF THE LITERAL ELEMENTS WRITTEN IN BLACK COLOR TO THE RIGHT OF WHICH THERE ARE THREE VERTICAL ARC LIKE FIGURES ONE BESIDE THE OTHER IN ORANGE COLOR IN ASCENDING SIZE AS SHOWN IN THE MARK.

THE COLOR(S) BLACK AND ORANGE IS/ARE CLAIMED AS A FEATURE OF THE MARK.

SER. NO. 85-293,222, FILED 4-12-2011.

JENNY PARK, EXAMINING ATTORNEY



David J. Kyffers

Director of the United States Patent and Trademark Office

United States of America

United States Patent and Trademark Office

NUTRITION FOR THE 24-HOUR ATHLETE

Reg. No. 4,152,748

HERBALIFE INTERNATIONAL, INC. (NEVADA CORPORATION)
800 W. OLYMPIC BOULEVARD, SUITE 406
LOS ANGELES, CA 90015

Registered June 5, 2012

Int. Cls.: 5 and 32

FOR: DIETARY AND NUTRITIONAL SUPPLEMENTS FOR SPORTS AND FITNESS, IN CLASS 5 (U.S. CLS. 6, 18, 44, 46, 51 AND 52).

TRADEMARK

FIRST USE 5-23-2011; IN COMMERCE 5-23-2011.

PRINCIPAL REGISTER

FOR: PREPARATIONS FOR MAKING SPORTS AND FITNESS BEVERAGES, IN CLASS 32 (U.S. CLS. 45, 46 AND 48).

FIRST USE 5-23-2011; IN COMMERCE 5-23-2011.

THE MARK CONSISTS OF STANDARD CHARACTERS WITHOUT CLAIM TO ANY PARTICULAR FONT, STYLE, SIZE, OR COLOR.

SER. NO. 85-293,336, FILED 4-12-2011.

KAREN K. BUSH, EXAMINING ATTORNEY



David J. Kyros

Director of the United States Patent and Trademark Office

United States of America

United States Patent and Trademark Office

BABY BARRE

Reg. No. 4,152,749

Registered June 5, 2012

Int. Cl.: 41

SERVICE MARK

PRINCIPAL REGISTER

BARRE N9NE STUDIO (MASSACHUSETTS SOLE PROPRIETORSHIP)
9 PAGE STREET
DANVERS, MA 01923

FOR: EDUCATION AND ENTERTAINMENT, NAMELY, PHYSICAL FITNESS CONDITIONING CLASSES, PHYSICAL FITNESS INSTRUCTION, PERSONAL TRAINING, DANCE CLASSES, AND WORKSHOPS AND SEMINARS IN THE FIELD OF NUTRITION FOR CONSUMERS, IN CLASS 41 (U.S. CLS. 100, 101 AND 107).

FIRST USE 4-7-2010; IN COMMERCE 4-7-2010.

THE MARK CONSISTS OF STANDARD CHARACTERS WITHOUT CLAIM TO ANY PARTICULAR FONT, STYLE, SIZE, OR COLOR.

NO CLAIM IS MADE TO THE EXCLUSIVE RIGHT TO USE "BABY", APART FROM THE MARK AS SHOWN.

SER. NO. 85-293,581, FILED 4-13-2011.

RONALD AIKENS, EXAMINING ATTORNEY



David J. Kyros

Director of the United States Patent and Trademark Office

United States of America

United States Patent and Trademark Office

HIREF

Reg. No. 4,152,750

Registered June 5, 2012

Int. Cls.: 1 and 9

TRADEMARK

PRINCIPAL REGISTER

SILTRONIC AG (FED REP GERMANY JOINT STOCK COMPANY)
HANNS-SEIDEL-PLATZ 4
MUNICH, FED REP GERMANY

FOR: INORGANIC ELEMENTS AND COMPOUNDS IN THE FORM OF HYPERPURE CRYSTALS FOR USE IN THE MANUFACTURE OF SEMICONDUCTORS IN THE ELECTRICAL AND ELECTRONICS INDUSTRY; DOPED AND UNDOPE POLYCRYSTALLINE AND MONOCRYSTALLINE INORGANIC SEMICONDUCTOR MATERIAL IN THE FORM OF CRYSTALS, GRANULES AND POWDERS, IN SAWED, LAPPED, POLISHED, ETCHED AND COATED FORM; DOPED AND UNDOPE POLYCRYSTALLINE AND MONOCRYSTALLINE INORGANIC SEMICONDUCTOR MATERIAL IN THE FORM OF RODS, TUBES, WAFERS AND MOULDED BODIES, IN SAWED, LAPPED, POLISHED, ETCHED AND COATED FORM; SUBSTRATES COATED WITH SEMICONDUCTOR MATERIAL IN THE FORM OF WAFERS, RODS, TUBES, GRANULES AND POWDERS FOR USE IN THE MANUFACTURE OF SEMICONDUCTORS; SUBSTRATES COATED WITH SEMICONDUCTOR MATERIAL IN THE FORM OF MOULDED BODIES FOR USE IN THE MANUFACTURE OF SEMICONDUCTORS; MONOCRYSTALLINE SILICON IN THE FORM OF RODS, BLOCKS, WAFERS AND POWDERS FOR USE IN THE MANUFACTURE OF SEMICONDUCTORS; POLYCRYSTALLINE SILICON IN THE FORM OF POWDERS, GRANULES, BLOCKS, SHEETS AND MOULDED BODIES FOR USE IN THE MANUFACTURE OF SEMICONDUCTORS, IN CLASS 1 (U.S. CLS. 1, 5, 6, 10, 26 AND 46).

FOR: SILICON WAFERS; ORGANIC SEMICONDUCTORS FOR USE IN THE ELECTRICAL AND ELECTRONIC INDUSTRIES; HYPERPURE SILICON SOLD IN THE FORM OF WAFERS FOR USE IN THE ELECTRICAL AND ELECTRONIC INDUSTRIES, IN CLASS 9 (U.S. CLS. 21, 23, 26, 36 AND 38).

THE MARK CONSISTS OF STANDARD CHARACTERS WITHOUT CLAIM TO ANY PARTICULAR FONT, STYLE, SIZE, OR COLOR.

OWNER OF FED REP GERMANY REG. NO. 30255813, DATED 12-16-2002, EXPIRES 11-30-2012.

SER. NO. 85-293,886, FILED 4-13-2011.

BRIAN PINO, EXAMINING ATTORNEY



David J. Kyros

Director of the United States Patent and Trademark Office

United States of America

United States Patent and Trademark Office



Reg. No. 4,152,751

Registered June 5, 2012

Int. Cl.: 35

SERVICE MARK

PRINCIPAL REGISTER

THE GREATER KANSAS CITY SPORTS COMMISSION (MISSOURI NOT FOR PROFIT CORPORATION)
1308 PENNSYLVANIA AVENUE
KANSAS CITY, MO 64105

FOR: PROMOTING THE INTERESTS OF PEOPLE AND ORGANIZATIONS INVOLVED AND CONCERNED WITH SPORTS AND PROMOTING THE SPORTING EVENTS OF OTHERS , IN CLASS 35 (U.S. CLS. 100, 101 AND 102).

FIRST USE 12-0-2010; IN COMMERCE 12-0-2010.

NO CLAIM IS MADE TO THE EXCLUSIVE RIGHT TO USE "SPORTS COMMISSION", APART FROM THE MARK AS SHOWN.

THE MARK CONSISTS OF A FRAMED ARCHED BANNER, WITH THE MIDDLE SECTION FLARED OUT. IN THE TOP THIRD OF THE BANNER, THE WORDS "KANSAS CITY" APPEAR; IN THE MIDDLE THIRD OF THE BANNER, THE WORD "SPORTS" APPEARS; AND IN THE BOTTOM THIRD OF THE BANNER THE WORD "COMMISSION" APPEARS. COLOR IS NOT CLAIMED AS A FEATURE OF THE MARK.

SEC. 2(F) AS TO "KANSAS CITY".

SER. NO. 85-294,181, FILED 4-13-2011.

DOMINICK J. SALEMI, EXAMINING ATTORNEY



David J. Kyros

Director of the United States Patent and Trademark Office

United States of America

United States Patent and Trademark Office

PRODIGIO RTS

Reg. No. 4,152,752

Registered June 5, 2012

Int. Cls.: 41 and 42

SERVICE MARK

PRINCIPAL REGISTER

MPOWER TRADING SYSTEMS, LLC (PENNSYLVANIA LIMITED LIABILITY COMPANY)
521 W. LANCASTER AVENUE
HAVERFORD, PA 19041

FOR: COMPUTER EDUCATION TRAINING, NAMELY, SEMINARS AND WEBINARS FOR INSTRUCTION ON COMPUTER SOFTWARE IN THE NATURE OF AUTOMATED TRADING SYSTEMS, IN CLASS 41 (U.S. CLS. 100, 101 AND 107).

FIRST USE 1-0-2008; IN COMMERCE 1-0-2008.

FOR: PROVIDING TEMPORARY USE OF ONLINE NON DOWNLOADABLE APPLICATIONS IN THE NATURE OF AUTOMATED TRADING SYSTEMS FOR PROFESSIONAL AND INSTITUTIONAL INVESTORS TO ANALYZE THE OVERALL INVESTMENT MARKET, INITIATE ORDERS, MANAGE POSITIONS, QUANTIFY RISK, AND EFFECTIVELY EXECUTE SIMULTANEOUS SOPHISTICATED ORDERS; TECHNICAL SUPPORT SERVICES, NAMELY, TROUBLESHOOTING IN THE NATURE OF DIAGNOSING PROBLEMS WITH AUTOMATED TRADING SYSTEMS, IN CLASS 42 (U.S. CLS. 100 AND 101).

FIRST USE 1-0-2008; IN COMMERCE 1-0-2008.

THE MARK CONSISTS OF STANDARD CHARACTERS WITHOUT CLAIM TO ANY PARTICULAR FONT, STYLE, SIZE, OR COLOR.

NO CLAIM IS MADE TO THE EXCLUSIVE RIGHT TO USE "RTS", APART FROM THE MARK AS SHOWN.

THE WORD(S) "PRODIGIO" HAS NO MEANING IN A FOREIGN LANGUAGE.

SER. NO. 85-294,189, FILED 4-13-2011.

VIVIAN MICZNIK FIRST, EXAMINING ATTORNEY



David J. Kyros

Director of the United States Patent and Trademark Office

United States of America

United States Patent and Trademark Office

Green Clean



Reg. No. 4,152,753

Registered June 5, 2012

Int. Cls.: 37 and 42

SERVICE MARK

PRINCIPAL REGISTER

MAXONS RESTORATIONS, INC. (NEW YORK CORPORATION)
280 MADISON AVENUE
NEW YORK, NY 10016

FOR: ENVIRONMENTALLY FRIENDLY RESTORATION AND RECONSTRUCTION SERVICES WHICH REDUCES OR ELIMINATES CONTAMINATION DURING THE RESTORATION PROCESS FOR ANTIQUES, APPAREL, BOOKS, BUILDING INTERIORS, CARPETS, CHINA, DRAPERY, ORIENTAL RUGS, PAINTING STAINED GLASS, PORCELAIN AND MARBLE AND DOCUMENTS, IN CLASS 37 (U.S. CLS. 100, 103 AND 106).

FIRST USE 1-15-2011; IN COMMERCE 1-15-2011.

FOR: CONSULTING SERVICES IN THE FIELD OF ENVIRONMENTAL CONSERVATION, PRESERVATION, SUSTAINABILITY, IMPACT AND RESTORATION, IN CLASS 42 (U.S. CLS. 100 AND 101).

FIRST USE 1-15-2011; IN COMMERCE 1-15-2011.

NO CLAIM IS MADE TO THE EXCLUSIVE RIGHT TO USE "GREEN CLEAN" , APART FROM THE MARK AS SHOWN.

THE MARK CONSISTS OF BUILDINGS WITH TWO LEAFS APPEARING ON TOP OF CENTER BUILDING AND WORDS "GREEN CLEAN" APPEARING ON TOP OF DESIGN.

SER. NO. 85-294,234, FILED 4-13-2011.

JOHN HWANG, EXAMINING ATTORNEY



David J. Kyros

Director of the United States Patent and Trademark Office

United States of America

United States Patent and Trademark Office

Big Harry Deals

Reg. No. 4,152,754

Registered June 5, 2012

Int. Cl.: 35

SERVICE MARK

PRINCIPAL REGISTER

BIG HARRY DEALS, INC. (FLORIDA CORPORATION)
115 ALLAMANDA DRIVE
LAKELAND, FL 33803

FOR: ADVERTISING AND PROMOTIONAL SERVICES, NAMELY, PROMOTING THE GOODS AND SERVICES OF OTHERS BY PROVIDING INFORMATION REGARDING DISCOUNT VOUCHERS VIA A GLOBAL COMPUTER NETWORK; ADVERTISING SERVICES, NAMELY, PROVIDING SPACE AT A WEB SITE FOR THE ADVERTISEMENT OF THE GOODS AND SERVICES OF OTHERS, IN CLASS 35 (U.S. CLS. 100, 101 AND 102).

FIRST USE 4-1-2011; IN COMMERCE 4-3-2011.

THE MARK CONSISTS OF STANDARD CHARACTERS WITHOUT CLAIM TO ANY PARTICULAR FONT, STYLE, SIZE, OR COLOR.

NO CLAIM IS MADE TO THE EXCLUSIVE RIGHT TO USE "DEALS", APART FROM THE MARK AS SHOWN.

SER. NO. 85-294,382, FILED 4-13-2011.

JULIE GUTTADAURO, EXAMINING ATTORNEY



David J. Kyros

Director of the United States Patent and Trademark Office

United States of America

United States Patent and Trademark Office

TunicLove

Reg. No. 4,152,755

BUTANI CAPITAL PARTNERS LLC (NEW YORK LIMITED LIABILITY COMPANY)
500 EAST 85TH STREET, #12B
NEW YORK, NY 10028

Registered June 5, 2012

Int. Cl.: 25

FOR: BEACH COVER-UPS; SCARVES; SHAWLS; TOPS; TUNICS, IN CLASS 25 (U.S. CLS. 22 AND 39).

TRADEMARK

FIRST USE 5-0-2009; IN COMMERCE 5-0-2009.

PRINCIPAL REGISTER

THE MARK CONSISTS OF STANDARD CHARACTERS WITHOUT CLAIM TO ANY PARTICULAR FONT, STYLE, SIZE, OR COLOR.

SER. NO. 85-294,691, FILED 4-13-2011.

SUNG IN, EXAMINING ATTORNEY



David J. Kybas

Director of the United States Patent and Trademark Office

United States of America

United States Patent and Trademark Office

KINETIC BY KURT

Reg. No. 4,152,756

Registered June 5, 2012

Int. Cls.: 35 and 36

SERVICE MARK

PRINCIPAL REGISTER

KURT MANUFACTURING COMPANY, INC. (MINNESOTA CORPORATION)
5280 MAIN STREET N.E.
FRIDLEY, MN 55421

FOR: PROMOTIONAL SPONSORSHIP OF BICYCLING, NAMELY, PROVIDING EQUIPMENT FOR TEAMS, INDIVIDUALS, ORGANIZATIONS AND RACES, IN CLASS 35 (U.S. CLS. 100, 101 AND 102).

FIRST USE 6-14-2006; IN COMMERCE 6-14-2006.

FOR: FINANCIAL SPONSORSHIPS OF BICYCLING FOR TEAMS AND RACES, IN CLASS 36 (U.S. CLS. 100, 101 AND 102).

FIRST USE 12-30-2007; IN COMMERCE 12-30-2007.

THE MARK CONSISTS OF STANDARD CHARACTERS WITHOUT CLAIM TO ANY PARTICULAR FONT, STYLE, SIZE, OR COLOR.

OWNER OF U.S. REG. NO. 2,587,483.

SER. NO. 85-295,110, FILED 4-14-2011.

BRENDAN MCCAULEY, EXAMINING ATTORNEY



David J. Kyros

Director of the United States Patent and Trademark Office

United States of America

United States Patent and Trademark Office

MK262

Reg. No. 4,152,757

Registered June 5, 2012

Int. Cl.: 13

TRADEMARK

PRINCIPAL REGISTER

BLACK HILLS AMMUNITION, INC. (SOUTH DAKOTA CORPORATION)
1699 SEDIVY LANE
RAPID CITY, SD 57703

FOR: AMMUNITION FOR FIREARMS, IN CLASS 13 (U.S. CLS. 2 AND 9).

FIRST USE 6-0-2002; IN COMMERCE 6-0-2002.

THE MARK CONSISTS OF STANDARD CHARACTERS WITHOUT CLAIM TO ANY PARTICULAR FONT, STYLE, SIZE, OR COLOR.

SER. NO. 85-295,150, FILED 4-14-2011.

MIDGE BUTLER, EXAMINING ATTORNEY



David J. Kyffers

Director of the United States Patent and Trademark Office

United States of America

United States Patent and Trademark Office

MK262 MOD 1

Reg. No. 4,152,758

Registered June 5, 2012

Int. Cl.: 13

TRADEMARK

PRINCIPAL REGISTER

BLACK HILLS AMMUNITION, INC. (SOUTH DAKOTA CORPORATION)
1699 SEDIVY LANE
RAPID CITY, SD 57703

FOR: AMMUNITION FOR FIREARMS, IN CLASS 13 (U.S. CLS. 2 AND 9).

FIRST USE 6-0-2003; IN COMMERCE 6-0-2003.

THE MARK CONSISTS OF STANDARD CHARACTERS WITHOUT CLAIM TO ANY PARTICULAR FONT, STYLE, SIZE, OR COLOR.

SER. NO. 85-295,152, FILED 4-14-2011.

MIDGE BUTLER, EXAMINING ATTORNEY



David J. Kybas

Director of the United States Patent and Trademark Office

United States of America

United States Patent and Trademark Office

MK262 MOD 0

Reg. No. 4,152,759

Registered June 5, 2012

Int. Cl.: 13

TRADEMARK

PRINCIPAL REGISTER

BLACK HILLS AMMUNITION, INC. (SOUTH DAKOTA CORPORATION)
1699 SEDIVY LANE
RAPID CITY, SD 57703

FOR: AMMUNITION FOR FIREARMS, IN CLASS 13 (U.S. CLS. 2 AND 9).

FIRST USE 6-0-2002; IN COMMERCE 6-0-2002.

THE MARK CONSISTS OF STANDARD CHARACTERS WITHOUT CLAIM TO ANY PARTICULAR FONT, STYLE, SIZE, OR COLOR.

SER. NO. 85-295,154, FILED 4-14-2011.

MIDGE BUTLER, EXAMINING ATTORNEY



David J. Kybas

Director of the United States Patent and Trademark Office

United States of America

United States Patent and Trademark Office

ElastiSeal

Reg. No. 4,152,760

Registered June 5, 2012

Int. Cls.: 1, 2 and 17

TRADEMARK

PRINCIPAL REGISTER

ADCO PRODUCTS, INC. (DELAWARE CORPORATION)
4401 PAGE AVENUE
MICHIGAN CITY, MI 49254

FOR: INDUSTRIAL SEALANT USED IN THE MANUFACTURE OR REPAIR OF VEHICLES; SEALANTS FOR VEHICLES OR TRAILERS, NAMELY, SEALANTS USED IN THE MANUFACTURE OR REPAIR OF VEHICLES, IN CLASS 1 (U.S. CLS. 1, 5, 6, 10, 26 AND 46).

FIRST USE 11-1-2010; IN COMMERCE 11-1-2010.

FOR: ELASTOMERIC AND THERMOPLASTIC COATINGS IN THE NATURE OF INDUSTRIAL SEALANTS FOR WATERPROOFING OF VEHICLES, IN CLASS 2 (U.S. CLS. 6, 11 AND 16).

FIRST USE 11-1-2010; IN COMMERCE 11-1-2010.

FOR: WATERPROOF SEALANTS; THERMOPLASTIC RUBBER SEALANTS, NAMELY, SEALANTS USED IN THE MANUFACTURE OR REPAIR OF VEHICLES; RUBBER-BASED ROOFING SEALANTS FOR VEHICLES AND TRAILERS, IN CLASS 17 (U.S. CLS. 1, 5, 12, 13, 35 AND 50).

FIRST USE 11-1-2010; IN COMMERCE 11-1-2010.

THE MARK CONSISTS OF STANDARD CHARACTERS WITHOUT CLAIM TO ANY PARTICULAR FONT, STYLE, SIZE, OR COLOR.

SER. NO. 85-295,350, FILED S.R. 4-14-2011 AM. P.R. 1-27-2012.

LEIGH CAROLINE CASE, EXAMINING ATTORNEY



David J. Kyffers

Director of the United States Patent and Trademark Office

United States of America

United States Patent and Trademark Office

FIVE VILLAGE FIRE SZECHUAN

Reg. No. 4,152,761

Registered June 5, 2012

Int. Cl.: 30

TRADEMARK

PRINCIPAL REGISTER

HUHOT MONGOLIAN GRILLS, LLC (MONTANA LIMITED LIABILITY COMPANY)
223 EAST MAIN STREET
MISSOULA, MT 59802

FOR: SAUCES, IN CLASS 30 (U.S. CL. 46).

FIRST USE 6-17-1999; IN COMMERCE 6-17-1999.

THE MARK CONSISTS OF STANDARD CHARACTERS WITHOUT CLAIM TO ANY PARTICULAR FONT, STYLE, SIZE, OR COLOR.

NO CLAIM IS MADE TO THE EXCLUSIVE RIGHT TO USE "SZECHUAN", APART FROM THE MARK AS SHOWN.

SER. NO. 85-295,554, FILED 4-14-2011.

BRENDAN REGAN, EXAMINING ATTORNEY



David J. Kyffers

Director of the United States Patent and Trademark Office

United States of America

United States Patent and Trademark Office



Reg. No. 4,152,762

Registered June 5, 2012

Int. Cl.: 41

SERVICE MARK

PRINCIPAL REGISTER

TFG, INC. (CALIFORNIA CORPORATION)
SUITE 300
19500 JAMBOREE RD.,
IRVINE, CA 92612

FOR: LIFE COACHING SERVICES IN THE FIELD OF MONEY AND FINANCES; PEER TO PEER COACHING SERVICES IN THE FIELD OF FINANCES; PERSONAL COACHING SERVICES IN THE FIELD OF MONEY MANAGEMENT AND FINANCES; PROFESSIONAL COACHING SERVICES IN THE FIELD OF MONEY MANAGEMENT AND FINANCES, IN CLASS 41 (U.S. CLS. 100, 101 AND 107).

FIRST USE 6-1-2010; IN COMMERCE 6-1-2010.

NO CLAIM IS MADE TO THE EXCLUSIVE RIGHT TO USE "ONE TO ONE COACHING", APART FROM THE MARK AS SHOWN.

THE COLOR(S) BLACK, WHITE, GREY, AND GOLD IS/ARE CLAIMED AS A FEATURE OF THE MARK.

THE MARK CONSISTS OF THE WORDING "ONE 2 ONE", WITH THE WORDING "ONE" IN BLACK AND "2" IN WHITE. THE WORDING IS SUPERIMPOSED OVER A WHITE AND GOLD CIRCLE, WITH THE WORDING "COACHING" AND "DOLLARS TO SENSE" IN GREY IN THE BORDER OF THE CIRCLE. WITHIN THE CENTER OF THE CIRCLE, FOUR GREY ARROWS APPEAR.

SER. NO. 85-295,673, FILED 4-14-2011.

MARILYN IZZI, EXAMINING ATTORNEY



David J. Kybas

Director of the United States Patent and Trademark Office

United States of America

United States Patent and Trademark Office

MEMORIAL HEALTHTECH LABORATORIES

Reg. No. 4,152,763

Registered June 5, 2012

Int. Cl.: 42

SERVICE MARK

PRINCIPAL REGISTER

MEMORIAL HEALTH SERVICES (CALIFORNIA CORPORATION)
17360 BROOKHURST
FIRST FLOOR
FOUNTAIN VALLEY, CA 92708

FOR: MEDICAL LABORATORIES; MEDICAL LABORATORY SERVICES; PROVIDING MEDICAL TESTING SERVICES AND INFORMATION IN THE FIELD OF CANCER RESEARCH AND DISEASE CLASSIFICATION; SCIENTIFIC LABORATORY SERVICES, IN CLASS 42 (U.S. CLS. 100 AND 101).

FIRST USE 6-0-1981; IN COMMERCE 6-0-1981.

THE MARK CONSISTS OF STANDARD CHARACTERS WITHOUT CLAIM TO ANY PARTICULAR FONT, STYLE, SIZE, OR COLOR.

NO CLAIM IS MADE TO THE EXCLUSIVE RIGHT TO USE "LABORATORIES", APART FROM THE MARK AS SHOWN.

SER. NO. 85-295,714, FILED 4-14-2011.

PAM WILLIS, EXAMINING ATTORNEY



David J. Kyros

Director of the United States Patent and Trademark Office

United States of America

United States Patent and Trademark Office



Reg. No. 4,152,764

OPEN DATA CENTER ALLIANCE, INC. (DELAWARE CORPORATION)
3855 SW 153RD DRIVE
BEAVERTON, OR 97006

Registered June 5, 2012

Int. Cls.: 35 and 42

FOR: ASSOCIATION SERVICES, NAMELY, PROMOTING INDUSTRY AWARENESS OF THE NEED FOR TECHNOLOGY STANDARDS AND INTEROPERABILITY IN THE FIELD OF INFORMATION TECHNOLOGY, DATA CENTERS, COMPUTING SYSTEMS AND CLOUD COMPUTING, IN CLASS 35 (U.S. CLS. 100, 101 AND 102).

SERVICE MARK

PRINCIPAL REGISTER

FIRST USE 10-27-2010; IN COMMERCE 10-27-2010.

FOR: CREATING AND DEVELOPING VOLUNTARY STANDARDS, PROCESSES, MEASUREMENTS AND TECHNOLOGIES FOR COMPLIANCE AND INTEROPERABILITY OF INFORMATION TECHNOLOGY, DATA CENTERS, COMPUTING SYSTEMS AND CLOUD COMPUTING, IN CLASS 42 (U.S. CLS. 100 AND 101).

FIRST USE 10-27-2010; IN COMMERCE 10-27-2010.

NO CLAIM IS MADE TO THE EXCLUSIVE RIGHT TO USE "OPEN DATA CENTER ALLIANCE", APART FROM THE MARK AS SHOWN.

THE MARK CONSISTS OF THE WORDS "OPEN DATA CENTER ALLIANCE" DISPLAYED IN A VERTICAL FORMAT; IMMEDIATELY TO THE RIGHT IS A STYLIZED DESIGN OF A HALF CRESCENT FORMED BY MULTIPLE SPHERES THAT VARY IN SIZE.

SER. NO. 85-295,717, FILED 4-14-2011.

KELLEY WELLS, EXAMINING ATTORNEY



David J. Kyjars

Director of the United States Patent and Trademark Office

United States of America

United States Patent and Trademark Office

Chaos The Bear

Reg. No. 4,152,765

Registered June 5, 2012

Int. Cl.: 28

TRADEMARK

PRINCIPAL REGISTER

ALEXANDER DOLL COMPANY, INC. (DELAWARE CORPORATION)
615 WEST 131ST STREET
NEW YORK, NY 10027

FOR: STUFFED TOY ANIMALS, IN CLASS 28 (U.S. CLS. 22, 23, 38 AND 50).

FIRST USE 4-6-2003; IN COMMERCE 4-6-2003.

THE MARK CONSISTS OF STANDARD CHARACTERS WITHOUT CLAIM TO ANY PARTICULAR FONT, STYLE, SIZE, OR COLOR.

NO CLAIM IS MADE TO THE EXCLUSIVE RIGHT TO USE "BEAR", APART FROM THE MARK AS SHOWN.

SER. NO. 85-295,808, FILED 4-14-2011.

ZACHARY BELLO, EXAMINING ATTORNEY



David J. Kyffers

Director of the United States Patent and Trademark Office

United States of America

United States Patent and Trademark Office

Baby Alexander

Reg. No. 4,152,766

ALEXANDER DOLL COMPANY, INC. (DELAWARE CORPORATION)
615 WEST 131ST STREET
NEW YORK, NY 10027

Registered June 5, 2012

Int. Cl.: 28

FOR: DOLLS AND ACCESSORIES THEREFOR, IN CLASS 28 (U.S. CLS. 22, 23, 38 AND 50).

TRADEMARK

FIRST USE 2-28-1998; IN COMMERCE 2-28-1998.

PRINCIPAL REGISTER

THE MARK CONSISTS OF STANDARD CHARACTERS WITHOUT CLAIM TO ANY PARTICULAR FONT, STYLE, SIZE, OR COLOR.

THE NAME(S), PORTRAIT(S), AND/OR SIGNATURE(S) SHOWN IN THE MARK DOES NOT IDENTIFY A PARTICULAR LIVING INDIVIDUAL.

SER. NO. 85-295,816, FILED 4-14-2011.

ZACHARY BELLO, EXAMINING ATTORNEY



David J. Kyffers

Director of the United States Patent and Trademark Office

United States of America

United States Patent and Trademark Office

Huggable Hugums

Reg. No. 4,152,767

ALEXANDER DOLL COMPANY, INC. (DELAWARE CORPORATION)
615 WEST 131ST STREET
NEW YORK, NY 10027

Registered June 5, 2012

Int. Cl.: 28

FOR: DOLLS AND ACCESSORIES THEREFOR, IN CLASS 28 (U.S. CLS. 22, 23, 38 AND 50).

TRADEMARK

FIRST USE 2-1-1998; IN COMMERCE 2-1-1998.

PRINCIPAL REGISTER

THE MARK CONSISTS OF STANDARD CHARACTERS WITHOUT CLAIM TO ANY PARTICULAR FONT, STYLE, SIZE, OR COLOR.

SER. NO. 85-295,822, FILED 4-14-2011.

ZACHARY BELLO, EXAMINING ATTORNEY



David J. Kyffers

Director of the United States Patent and Trademark Office

United States of America

United States Patent and Trademark Office

Huggums

Reg. No. 4,152,768

ALEXANDER DOLL COMPANY, INC. (DELAWARE CORPORATION)
615 WEST 131ST STREET
NEW YORK, NY 10027

Registered June 5, 2012

Int. Cl.: 28

FOR: DOLLS AND ACCESSORIES THEREFOR, IN CLASS 28 (U.S. CLS. 22, 23, 38 AND 50).

TRADEMARK

FIRST USE 2-28-1963; IN COMMERCE 2-28-1963.

PRINCIPAL REGISTER

THE MARK CONSISTS OF STANDARD CHARACTERS WITHOUT CLAIM TO ANY PARTICULAR FONT, STYLE, SIZE, OR COLOR.

SER. NO. 85-295,836, FILED 4-14-2011.

ZACHARY BELLO, EXAMINING ATTORNEY



David J. Kyffers

Director of the United States Patent and Trademark Office

United States of America

United States Patent and Trademark Office

InsureTrack

Reg. No. 4,152,769

Registered June 5, 2012

Int. Cl.: 42

SERVICE MARK

PRINCIPAL REGISTER

SOFTWARE SERVICE AND DEVELOPMENT, INC. (CALIFORNIA CORPORATION)
SUITE 603
110 WEST OCEAN BLVD
LONG BEACH, CA 90802

FOR: SOFTWARE AS A SERVICE (SAAS) SERVICES FEATURING SOFTWARE IN THE FIELD OF MANAGEMENT OF INSURANCE POLICIES, NAMELY, COLLECTING, AGGREGATING, MONITORING AND REPORTING OF INSURANCE POLICIES AND COMPLIANCE ANALYSIS, IN CLASS 42 (U.S. CLS. 100 AND 101).

FIRST USE 12-5-2003; IN COMMERCE 12-5-2003.

THE MARK CONSISTS OF STANDARD CHARACTERS WITHOUT CLAIM TO ANY PARTICULAR FONT, STYLE, SIZE, OR COLOR.

SER. NO. 85-296,016, FILED 4-15-2011.

SHAILA SETTLES, EXAMINING ATTORNEY



David J. Kybas

Director of the United States Patent and Trademark Office

United States of America

United States Patent and Trademark Office

Edith
A. Miller

Reg. No. 4,152,770

Registered June 5, 2012

Int. Cls.: 18 and 25

TRADEMARK

PRINCIPAL REGISTER

EDITH A. MILLER, LLC (NEW YORK LIMITED LIABILITY COMPANY)
7J
51 WEST 81ST STREET
NEW YORK, NY 10024

FOR: HANDBAGS; POUCHES, NAMELY, POUCHES FOR HOLDING MAKE-UP, KEYS AND OTHER PERSONAL ITEMS; SHOULDER BAGS; BRIEFCASES; WALLETS, IN CLASS 18 (U.S. CLS. 1, 2, 3, 22 AND 41).

FIRST USE 3-1-2011; IN COMMERCE 3-1-2011.

FOR: T-SHIRTS; DRESSES; SHIRTS; PANTS; HATS; GOWNS; SWEATERS; CARDIGANS; LEGGINGS; ARM WARMERS; LEG WARMERS; ROMPERS; SKIRTS; TANK TOPS; BODYSUITS; SCARVES; NECKWARMERS, IN CLASS 25 (U.S. CLS. 22 AND 39).

FIRST USE 3-1-2011; IN COMMERCE 3-1-2011.

THE NAME(S), PORTRAIT(S), AND/OR SIGNATURE(S) SHOWN IN THE MARK DOES NOT IDENTIFY A PARTICULAR LIVING INDIVIDUAL.

THE COLOR(S) RED AND BLUE IS/ARE CLAIMED AS A FEATURE OF THE MARK.

THE MARK CONSISTS OF THE WORDS "EDITH A. MILLER" WITH THE WORD "EDITH" APPEARING IN A STYLIZED FONT IN BLUE WITH A RED STAR FOR THE DOT ABOVE THE "I", AND THE WORDS "A. MILLER" APPEARING IN RED BENEATH THE WORD "EDITH".

SER. NO. 85-296,202, FILED 4-15-2011.

JENNY PARK, EXAMINING ATTORNEY



David J. Kybas

Director of the United States Patent and Trademark Office

United States of America

United States Patent and Trademark Office

EDITH A. MILLER

Reg. No. 4,152,771

Registered June 5, 2012

Int. Cls.: 18 and 25

TRADEMARK

PRINCIPAL REGISTER

EDITH A. MILLER, LLC (NEW YORK LIMITED LIABILITY COMPANY)
7J
51 WEST 81ST STREET
NEW YORK, NY 10024

FOR: HANDBAGS; POUCHES, NAMELY, POUCHES FOR HOLDING MAKE-UP, KEYS AND OTHER PERSONAL ITEMS; SHOULDER BAGS; BRIEFCASES; WALLETS, IN CLASS 18 (U.S. CLS. 1, 2, 3, 22 AND 41).

FIRST USE 3-1-2011; IN COMMERCE 3-1-2011.

FOR: T-SHIRTS; DRESSES; SHIRTS; PANTS; HATS; GOWNS; SWEATERS; CARDIGANS; LEGGINGS; ARM WARMERS; LEG WARMERS; ROMPERS; SKIRTS; TANK TOPS; BODYSUITS; SCARVES; NECKWARMERS, IN CLASS 25 (U.S. CLS. 22 AND 39).

FIRST USE 3-1-2011; IN COMMERCE 3-1-2011.

THE MARK CONSISTS OF STANDARD CHARACTERS WITHOUT CLAIM TO ANY PARTICULAR FONT, STYLE, SIZE, OR COLOR.

THE NAME(S), PORTRAIT(S), AND/OR SIGNATURE(S) SHOWN IN THE MARK DOES NOT IDENTIFY A PARTICULAR LIVING INDIVIDUAL.

SER. NO. 85-296,208, FILED 4-15-2011.

JENNY PARK, EXAMINING ATTORNEY



David J. Kyros

Director of the United States Patent and Trademark Office

United States of America

United States Patent and Trademark Office

PLUG-N-TOW

Reg. No. 4,152,772

Registered June 5, 2012

Int. Cls.: 9 and 12

TRADEMARK

PRINCIPAL REGISTER

ETRAILER CORPORATION (MISSOURI CORPORATION)
3707 VETERANS MEMORIAL PARKWAY
ST. CHARLES, MO 63303

FOR: MOTOR VEHICLE TO TRAILER ELECTRICAL CONNECTORS AND ADAPTORS, IN CLASS 9 (U.S. CLS. 21, 23, 26, 36 AND 38).

FIRST USE 8-23-2002; IN COMMERCE 8-23-2002.

FOR: LAND VEHICLE PARTS IN THE NATURE OF WIRE HARNESES, NAMELY, WIRES, TERMINALS, CONNECTORS AND ADAPTORS BUNDLED TOGETHER TO TRANSMIT ELECTRIC POWER AND SIGNALS TO ELECTRIC OR ELECTRONIC EQUIPMENT MOUNTED ON THE BODY PARTS OF TRAILERS, IN CLASS 12 (U.S. CLS. 19, 21, 23, 31, 35 AND 44).

FIRST USE 8-23-2002; IN COMMERCE 8-23-2002.

THE MARK CONSISTS OF STANDARD CHARACTERS WITHOUT CLAIM TO ANY PARTICULAR FONT, STYLE, SIZE, OR COLOR.

OWNER OF U.S. REG. NO. 3,999,564.

SER. NO. 85-296,306, FILED 4-15-2011.

BRIAN CALLAGHAN, EXAMINING ATTORNEY



David J. Kybas

Director of the United States Patent and Trademark Office

United States of America

United States Patent and Trademark Office

CANYON VILLAGE

Reg. No. 4,152,773

Registered June 5, 2012

Int. Cl.: 37

SERVICE MARK

PRINCIPAL REGISTER

LAND TEJAS COMPANIES, LTD. (TEXAS LIMITED PARTNERSHIP)
2450 FONDREN RD., #210
HOUSTON, TX 77063

FOR: REAL ESTATE DEVELOPMENT, IN CLASS 37 (U.S. CLS. 100, 103 AND 106).

FIRST USE 6-1-1998; IN COMMERCE 6-1-1998.

THE MARK CONSISTS OF STANDARD CHARACTERS WITHOUT CLAIM TO ANY PARTICULAR FONT, STYLE, SIZE, OR COLOR.

NO CLAIM IS MADE TO THE EXCLUSIVE RIGHT TO USE "VILLAGE", APART FROM THE MARK AS SHOWN.

SER. NO. 85-296,568, FILED 4-15-2011.

COURTNEY ALVAREZ, EXAMINING ATTORNEY



David J. Kyffers

Director of the United States Patent and Trademark Office

United States of America

United States Patent and Trademark Office

American Tai Chi Association

Reg. No. 4,152,774

Registered June 5, 2012

Int. Cl.: 41

SERVICE MARK

PRINCIPAL REGISTER

AMERICAN TAI CHI ASSOCIATION (PENNSYLVANIA NON-PROFIT NON-STOCK ASSOCIATION)
1928 COTTMAN AVENUE
PHILADELPHIA, PA 19111

FOR: EDUCATION SERVICES, NAMELY, PROVIDING SEMINARS, WORKSHOPS AND CLASSES IN THE FIELD OF TAI CHI, MARTIAL ARTS, HEALTH, FITNESS, NUTRITION, WELLNESS, MEDITATION AND STRESS RELIEF, IN CLASS 41 (U.S. CLS. 100, 101 AND 107).

FIRST USE 8-0-2002; IN COMMERCE 8-0-2002.

THE MARK CONSISTS OF STANDARD CHARACTERS WITHOUT CLAIM TO ANY PARTICULAR FONT, STYLE, SIZE, OR COLOR.

NO CLAIM IS MADE TO THE EXCLUSIVE RIGHT TO USE "TAI CHI ASSOCIATION", APART FROM THE MARK AS SHOWN.

SEC. 2(F).

SER. NO. 85-296,780, FILED 4-15-2011.

CHRIS WELLS, EXAMINING ATTORNEY



David J. Kyffers

Director of the United States Patent and Trademark Office

United States of America

United States Patent and Trademark Office



Reg. No. 4,152,775

Registered June 5, 2012

Int. Cl.: 9

TRADEMARK

PRINCIPAL REGISTER

IPRIZE LLC (NEVADA LIMITED LIABILITY COMPANY)
2816 VIA AVANTI ST.
HENDERSON, NV 89074

FOR: COMPUTER APPLICATION GAME SOFTWARE FOR MOBILE PHONES AND MOBILE DEVICES, NAMELY, GAME SOFTWARE FOR GIVING AWAY PRIZES TO USERS, IN CLASS 9 (U.S. CLS. 21, 23, 26, 36 AND 38).

FIRST USE 3-1-2011; IN COMMERCE 3-9-2011.

NO CLAIM IS MADE TO THE EXCLUSIVE RIGHT TO USE "IPRIZE", APART FROM THE MARK AS SHOWN.

THE MARK CONSISTS OF AN IMAGE OF GIFT BOX WITH THE LITERAL ELEMENTS "IPRIZE" WRITTEN BENEATH THE GIFT BOX ON A DOTTED BACKGROUND AS SHOWN IN THE MARK.

SER. NO. 85-297,009, FILED 4-16-2011.

LAURIE MAYES, EXAMINING ATTORNEY



David J. Kyffers

Director of the United States Patent and Trademark Office

United States of America

United States Patent and Trademark Office



Reg. No. 4,152,776

Registered June 5, 2012

**Int. Cls.: 5, 31, 35, 36, 37,
41, 43 and 44**

TRADEMARK

SERVICE MARK

PRINCIPAL REGISTER

FULLSHARE GROUP LIMITED (HONG KONG CORPORATION)
FLAT/RM 2210 C C WU BUILDING
302 HENNESSY ROAD
WANCHAI, HONG KONG

FOR: CHEMICAL PREPARATIONS FOR SANITARY USE; CHEMICAL PREPARATIONS FOR TREATING MILDEW; DEPURATIVES FOR THE BODY; DIAGNOSTIC PREPARATIONS FOR MEDICAL AND VETERINARY USE; DIETETIC FOODS ADAPTED FOR MEDICAL PURPOSES; FERMENTS FOR PHARMACEUTICAL PURPOSES; FILLINGS FOR TEETH; PESTICIDES; PHARMACEUTICAL PREPARATIONS FOR THE TREATMENT OF EYE DISEASES AND CONDITIONS; PHARMACEUTICAL PREPARATIONS FOR THE TREATMENT OF INFECTIOUS DISEASES; PREPARATIONS FOR TREATING COLDS; SANITARY STERILIZING PREPARATIONS; SURGICAL DRESSINGS, IN CLASS 5 (U.S. CLS. 6, 18, 44, 46, 51 AND 52).

FIRST USE 1-22-2009; IN COMMERCE 1-22-2009.

FOR: ANIMAL LITTER; FODDER; FRESH FRUITS; FRESH VEGETABLES; LIVE ANIMALS; LIVE PLANTS; LIVE TREES; MALT FOR BREWING AND DISTILLING; PLANT SEEDS; UNPROCESSED GRAIN, IN CLASS 31 (U.S. CLS. 1 AND 46).

FIRST USE 3-12-2009; IN COMMERCE 3-12-2009.

FOR: ADVERTISING AND ADVERTISEMENT SERVICES; AUCTIONEERING; BUSINESS ORGANIZATION AND MANAGEMENT CONSULTING; GOODS IMPORT-EXPORT AGENCIES; ORGANIZATION OF FAIRS FOR COMMERCIAL AND ADVERTISING PURPOSES; PERSONNEL MANAGEMENT CONSULTATION; PRESENTATION OF GOODS ON COMMUNICATION MEDIA FOR RETAIL PURPOSES; PROCURING OF CONTRACTS FOR THE PURCHASE AND SALE OF GOODS; SALES PROMOTION FOR THIRD PARTIES; SPONSORSHIP SEARCH, IN CLASS 35 (U.S. CLS. 100, 101 AND 102).

FIRST USE 12-10-2009; IN COMMERCE 12-10-2009.

FOR: ACCIDENT INSURANCE UNDERWRITING; APARTMENT HOUSE MANAGEMENT; ART APPRAISAL; BUSINESS BROKERAGE; CHARITABLE FUNDRAISING SERVICES, NAMELY, RAISING FUNDS FOR COLLEGE EDUCATION COSTS; CORPORATE FINANCE SERVICES, NAMELY, CONSULTATION IN THE FIELD OF ASSET SALES; FINANCIAL



David J. Kappas

Director of the United States Patent and Trademark Office

Reg. No. 4,152,776 GUARANTEE AND SURETY; FINANCING SERVICES; MORTGAGE LENDING; REAL ESTATE MANAGEMENT CONSULTATION; TRUSTEESHIP REPRESENTATIVES, IN CLASS 36 (U.S. CLS. 100, 101 AND 102).

FIRST USE 11-28-2009; IN COMMERCE 11-28-2009.

FOR: BUILDING CONSTRUCTION SUPERVISION; BUILDING OF FAIR STALLS AND SHOPS; CONSTRUCTION OF BUILDINGS; DISINFECTING; DRY CLEANING; ELECTRIC APPLIANCE INSTALLATION AND REPAIR; FURNITURE MAINTENANCE; MOTOR VEHICLE MAINTENANCE AND REPAIR; REPAIR OR MAINTENANCE OF ELEVATORS; UPHOLSTERING, IN CLASS 37 (U.S. CLS. 100, 103 AND 106).

FIRST USE 10-8-2009; IN COMMERCE 10-8-2009.

FOR: AMUSEMENT PARKS; ARRANGING AND CONDUCTING EDUCATIONAL CONFERENCES; BOOKMOBILE SERVICES; EDUCATING AT SENIOR HIGH SCHOOLS; EDUCATING AT UNIVERSITY OR COLLEGES; EDUCATION INFORMATION; EDUCATIONAL SERVICES, NAMELY, CONDUCTING CHESS CLASSES BY MEANS OF A CHESS CLUB; ENTERTAINMENT SERVICES IN THE NATURE OF A WRESTLING CLUB; MODELING FOR ARTISTS; MUSEUM SERVICES; PUBLICATION OF BOOKS; PUBLICATION OF BOOKS, MAGAZINES, ALMANACS AND JOURNALS; ZOOLOGICAL GARDENS, IN CLASS 41 (U.S. CLS. 100, 101 AND 107).

FIRST USE 12-10-2009; IN COMMERCE 12-10-2009.

FOR: BOARDING FOR ANIMALS; CAFETERIAS; CANTEEN SERVICES; DAY-CARE CENTRES; HOTEL AND RESTAURANT SERVICES; RENTAL OF CHAIRS, TABLES, TABLE LINEN, GLASSWARE; RENTAL OF PORTABLE BUILDINGS; RETIREMENT HOMES; SNACK BARS; TEMPORARY ACCOMMODATIONS, NAMELY, PROVIDING RESIDENTIAL RE-ENTRY CENTERS, IN CLASS 43 (U.S. CLS. 100 AND 101).

FIRST USE 8-23-2009; IN COMMERCE 8-23-2009.

FOR: ANIMAL GROOMING; CONVALESCENCE HOMES; GARDENER AND GARDENING SERVICES; HEALTH CARE; HOSPITALS; LANDSCAPE GARDENING; MASSAGES; NURSING CARE; PLANT NURSERIES; VERMIN EXTERMINATING, IN CLASS 44 (U.S. CLS. 100 AND 101).

FIRST USE 3-2-2009; IN COMMERCE 3-2-2009.

THE MARK CONSISTS OF KNOT DESIGN, STYLIZED CHINESE CHARACTERS AND "FULLSHARE".

THE NON-LATIN CHARACTERS IN THE MARK TRANSLITERATE TO "FENG SHENG" AND THIS MEANS "ABUNDANT FLOURISHING" IN ENGLISH.

THE ENGLISH TRANSLATION OF "FENG SHENG" IN THE MARK IS "ABUNDANT FLOURISHING".

SER. NO. 85-297,021, FILED 4-16-2011.

WILLIAM BRECKENFELD, EXAMINING ATTORNEY

United States of America

United States Patent and Trademark Office

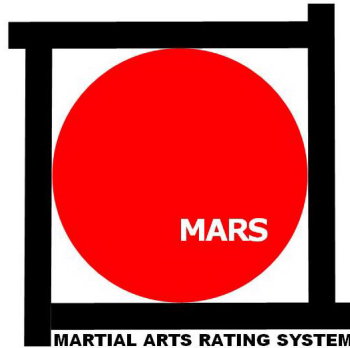

Reg. No. 4,152,777

Registered June 5, 2012

Int. Cls.: 35 and 41

SERVICE MARK

PRINCIPAL REGISTER

KARATE INSTITUTE, INC. (OHIO CORPORATION)
14710 TRISKETT ROAD
CLEVELAND, OH 44111

FOR: ARRANGING AND CONDUCTING MARKETING PROMOTIONAL EVENTS FOR OTHERS; PROMOTING SPORTS COMPETITIONS AND/OR EVENTS OF OTHERS; PROMOTING THE INTERESTS OF PEOPLE INVOLVED AND CONCERNED WITH YOUTH SPORTS; PROVIDING A WEB SITE THAT PROVIDES SPORTS LEAGUE MANAGEMENT; PROVIDING AN ONLINE PORTAL FOR REGISTRATION FOR ATHLETICS AND FUNDRAISING EVENTS, IN CLASS 35 (U.S. CLS. 100, 101 AND 102).

FIRST USE 1-1-1977; IN COMMERCE 1-1-2004.

FOR: ENTERTAINMENT SERVICES, NAMELY, PARTICIPATION IN MARTIAL ARTS; MARTIAL ARTS INSTRUCTION; ORGANIZING EXHIBITIONS FOR MARTIAL ARTS; ORGANIZING LIVE MIXED MARTIAL ARTS EVENTS AND COMPETITIONS; PRESENTATION OF MIXED MARTIAL ARTS (MMA) EVENTS; PROVIDING FACILITIES FOR MARTIAL ARTS TOURNAMENTS; PROVIDING GENERAL FITNESS AND MIXED MARTIAL ARTS FACILITIES THAT REQUIRE MEMBERSHIPS AND ARE FOCUSED IN THE FIELDS OF GENERAL FITNESS, EXERCISE, AND MIXED MARTIAL ARTS; PROVIDING SPORTS FACILITIES FOR MARTIAL ARTS, IN CLASS 41 (U.S. CLS. 100, 101 AND 107).

FIRST USE 1-1-1977; IN COMMERCE 1-1-2004.

NO CLAIM IS MADE TO THE EXCLUSIVE RIGHT TO USE "MARTIAL ARTS RATING SYSTEM", APART FROM THE MARK AS SHOWN.

THE COLOR(S) RED, WHITE AND BLACK IS/ARE CLAIMED AS A FEATURE OF THE MARK.

THE MARK CONSISTS OF A RED CIRCLE CONTAINING THE WHITE LITERAL ELEMENT "MARS"; THE RED CIRCLE IS CONTAINED IN A SQUARE BORDER COMPOSED OF FOUR HEAVY BLACK LINES WHICH, MOVING COUNTER-CLOCKWISE HAS THE END OF EACH BLACK LINE EXTENDING BEYOND THE MEETING POINT OF THE ADJACENT BLACK LINE; THE BLACK LITERAL ELEMENT "MARTIAL ARTS RATING SYSTEM" APPEARS BELOW THE BOTTOM BLACK LINE.



David J. Kyros

Director of the United States Patent and Trademark Office

Reg. No. 4,152,777 SER. NO. 85-297,083, FILED 4-16-2011.

ANDREA K. NADELMAN, EXAMINING ATTORNEY

United States of America

United States Patent and Trademark Office

MICROMATIC

Reg. No. 4,152,778

Registered June 5, 2012

Int. Cl.: 7

TRADEMARK

PRINCIPAL REGISTER

MICROMATIC, LLC (DELAWARE LIMITED LIABILITY COMPANY)
525 BERNE STREET
BERNE, IN 46711

FOR: HYDRAULIC ROTARY ACTUATORS AND STRUCTURAL AND REPLACEMENT PARTS THEREOF; PNEUMATIC ROTARY ACTUATORS AND STRUCTURAL AND REPLACEMENT PARTS THEREOF; ROTATING ACTUATORS, NOT BEING ELECTRICALLY POWERED; COUPLINGS FOR MACHINES; PACKAGING MACHINES; CONVEYORS; ASSEMBLY EQUIPMENT, NAMELY, PISTON ROD ASSEMBLY MACHINES AND PISTON ROD BEARING INSTALLATION MACHINES; ELEVATORS; ROBOTS, NAMELY, INDUSTRIAL ROBOTS AND GANTRY ROBOT MATERIAL HANDLING SYSTEM MACHINES; PART INSERTION MACHINES; AND, ASSEMBLY VERIFICATION MACHINES, IN CLASS 7 (U.S. CLS. 13, 19, 21, 23, 31, 34 AND 35).

FIRST USE 1-31-2006; IN COMMERCE 1-31-2006.

THE MARK CONSISTS OF STANDARD CHARACTERS WITHOUT CLAIM TO ANY PARTICULAR FONT, STYLE, SIZE, OR COLOR.

SER. NO. 85-297,124, FILED 4-16-2011.

PRISCILLA MILTON, EXAMINING ATTORNEY



David J. Kyffers

Director of the United States Patent and Trademark Office

United States of America

United States Patent and Trademark Office



Reg. No. 4,152,779

MICROMATIC LLC (DELAWARE LIMITED LIABILITY COMPANY)
525 BERNE STREET
BERNE, IN 46711

Registered June 5, 2012

Int. Cl.: 42

FOR: ENGINEERING SERVICES, NAMELY, MACHINE DESIGN SERVICES, MECHANICAL DESIGN SERVICES, ELECTRICAL DESIGN SERVICES; DEVELOPMENT OF CONTROL SOFTWARE FOR AUTOMATED MEASUREMENT AND ASSEMBLY PROCESSES, IN CLASS 42 (U.S. CLS. 100 AND 101).

SERVICE MARK

PRINCIPAL REGISTER

FIRST USE 1-31-2006; IN COMMERCE 1-31-2006.

THE MARK CONSISTS OF THE WORDING "MICRO" AND "MATIC" IN WHITE LETTERS ON A BLACK BACKGROUND SEPARATED BY A RED HORIZONTAL LINE. THE CIRCULAR DESIGN IS SURROUNDED BY A SERIES OF CONCENTRIC CIRCLES IN GRAY, WHITE, RED, WHITE AND GRAY. THE TERM "MICROMATIC" IS ADJACENT TO THE CIRCULAR DESIGN IN BLACK LETTERS ON A WHITE BACKGROUND SURROUNDED BY AN INCOMPLETE RED OBLONG DESIGN.

THE COLOR(S) RED, BLACK, GRAY AND WHITE IS/ARE CLAIMED AS A FEATURE OF THE MARK.

SER. NO. 85-297,140, FILED 4-16-2011.

KAREN BRACEY, EXAMINING ATTORNEY



David J. Kyros

Director of the United States Patent and Trademark Office

United States of America

United States Patent and Trademark Office

PEACE ISLANDS INSTITUTE

Reg. No. 4,152,780

Registered June 5, 2012

Int. Cl.: 41

SERVICE MARK

PRINCIPAL REGISTER

SENATES, BEKIR (UNITED STATES INDIVIDUAL)
SUITE 610
2 CENTER PLAZA
BOSTON, MA 02108

FOR: ARRANGING AND CONDUCTING EDUCATIONAL CONFERENCES; EDUCATIONAL AND ENTERTAINMENT SERVICES, NAMELY, CONDUCTING CLASSES, SEMINARS, WORKSHOPS, PANEL DISCUSSIONS, MEETINGS, RETREATS, CAMPS, FIELD TRIPS AND CONFERENCES IN THE FIELD OF FOSTERING INTERFAITH AND INTERCULTURAL DIALOGUE, STIMULATING THINKING AND EXCHANGE OF OPINIONS ON SUPPORTING AND FOSTERING DEMOCRACY AND PEACE ALL OVER THE WORLD AND DISTRIBUTION OF COURSE MATERIALS IN CONNECTION THEREWITH, AND EDUCATION CONSULTING RELATED THERETO; EDUCATIONAL SERVICES, NAMELY, LECTURES, SEMINARS, CONFERENCES AND UNIVERSITY COURSES CONCERNING FOSTERING INTERFAITH AND INTERCULTURAL DIALOGUE, STIMULATING THINKING AND EXCHANGE OF OPINIONS ON SUPPORTING AND FOSTERING DEMOCRACY AND PEACE ALL OVER THE WORLD; ON-LINE PUBLICATION OF ARTICLES FOSTERING INTERFAITH AND INTERCULTURAL DIALOGUE, STIMULATING THINKING AND EXCHANGE OF OPINIONS ON SUPPORTING AND FOSTERING DEMOCRACY AND PEACE ALL OVER THE WORLD, IN CLASS 41 (U.S. CLS. 100, 101 AND 107).

FIRST USE 4-25-2011; IN COMMERCE 4-25-2011.

THE MARK CONSISTS OF STANDARD CHARACTERS WITHOUT CLAIM TO ANY PARTICULAR FONT, STYLE, SIZE, OR COLOR.

NO CLAIM IS MADE TO THE EXCLUSIVE RIGHT TO USE "INSTITUTE", APART FROM THE MARK AS SHOWN.

SER. NO. 85-297,163, FILED 4-17-2011.

DORITT L. CARROLL, EXAMINING ATTORNEY



David J. Kyffers

Director of the United States Patent and Trademark Office

United States of America

United States Patent and Trademark Office

IT Chair

Reg. No. 4,152,781

Registered June 5, 2012

Int. Cl.: 35

SERVICE MARK

PRINCIPAL REGISTER

SOBHE, ASHKAN (UNITED STATES INDIVIDUAL)
6404 WILSHIRE BLVD. SUITE 850
LOS ANGELES, CA 90048

FOR: PROVIDING A SEARCHABLE ON-LINE ADVERTISING WEBSITE AND GUIDE
FEATURING THE GOODS AND SERVICES OF OTHER VENDORS VIA THE INTERNET,
IN CLASS 35 (U.S. CLS. 100, 101 AND 102).

FIRST USE 1-12-2010; IN COMMERCE 1-12-2010.

THE MARK CONSISTS OF STANDARD CHARACTERS WITHOUT CLAIM TO ANY PAR-
TICULAR FONT, STYLE, SIZE, OR COLOR.

NO CLAIM IS MADE TO THE EXCLUSIVE RIGHT TO USE "IT", APART FROM THE MARK
AS SHOWN.

SER. NO. 85-297,176, FILED 4-17-2011.

STEVEN JACKSON, EXAMINING ATTORNEY



David J. Kybas

Director of the United States Patent and Trademark Office

United States of America

United States Patent and Trademark Office

Fighter Foundation

Reg. No. 4,152,782

Registered June 5, 2012

Int. Cl.: 36

SERVICE MARK

PRINCIPAL REGISTER

FIGHTER FOUNDATION (VIRGINIA CORPORATION), DBA FIGHTER FOUNDATION
2600 EAST CARY STREET APT # 3112
RICHMOND, VA 23223

FOR: CHARITABLE FUNDRAISING TO SUPPORT EDUCATIONAL SERVICES RELATING
TO MIXED MARTIAL ARTS AND LIFE SKILL PROGRAMS FOR AT-RISK YOUTH , IN
CLASS 36 (U.S. CLS. 100, 101 AND 102).

FIRST USE 3-11-2011; IN COMMERCE 3-11-2011.

THE MARK CONSISTS OF STANDARD CHARACTERS WITHOUT CLAIM TO ANY PAR-
TICULAR FONT, STYLE, SIZE, OR COLOR.

NO CLAIM IS MADE TO THE EXCLUSIVE RIGHT TO USE "FOUNDATION", APART FROM
THE MARK AS SHOWN.

SER. NO. 85-297,255, FILED 4-17-2011.

ROSELLE HERRERA, EXAMINING ATTORNEY



David J. Kybas

Director of the United States Patent and Trademark Office

United States of America

United States Patent and Trademark Office



APPEAL property**TAX**.com

Reg. No. 4,152,783

Registered June 5, 2012

Int. Cl.: 35

SERVICE MARK

PRINCIPAL REGISTER

APPEALPROPERTYTAX.COM, INC. (TEXAS CORPORATION)
3801 KIRBY #176
HOUSTON, TX 77098

FOR: REAL ESTATE TAX APPEAL SERVICES, NAMELY, RESIDENTIAL AND COMMERCIAL PROPERTY TAX ASSESSMENT REDUCTION SERVICES; BUSINESS SERVICES, NAMELY, PREPARATION AND FILING OF PROPERTY TAX PROTESTS AND APPEAL PETITION FORMS WITH COUNTY AUTHORITIES; BUSINESS SERVICES, NAMELY, THE GATHERING AND ONLINE SUBMISSION OF PROPERTY TAX APPEAL EVIDENCE IN THE NATURE OF COMPARABLE PROPERTY SALES DATA, PROPERTY INCOME DATA, PROPERTY IMPROVEMENTS AND REPAIRS AND PROPERTY APPRAISALS, SAID EVIDENCE PREPARED IN CONSULTATION WITH THE CLIENT; BUSINESS SERVICES, NAMELY, PROPOSAL OF PROPERTY TAX ASSESSMENT REDUCTIONS TO COUNTY AUTHORITIES ON BEHALF OF THE CLIENT AND/OR CLIENT PROPERTY, IN CLASS 35 (U.S. CLS. 100, 101 AND 102).

FIRST USE 4-1-2007; IN COMMERCE 4-1-2007.

NO CLAIM IS MADE TO THE EXCLUSIVE RIGHT TO USE "APPEALPROPERTYTAX.COM", APART FROM THE MARK AS SHOWN.

THE MARK CONSISTS OF THE LITERAL ELEMENT, "APPEALPROPERTYTAX.COM" APPEARING HORIZONTALLY BETWEEN TWO HORIZONTAL LINES; A TRIANGLE IS CENTERED ABOVE THE LITERAL ELEMENT; A RECTANGLE IS CENTERED BELOW THE LITERAL ELEMENT, THE TRIANGLE AND RECTANGLE PROVIDING THE APPEARANCE OF A ROOFED STRUCTURE.

SER. NO. 85-297,279, FILED 4-17-2011.

MARC LEIPZIG, EXAMINING ATTORNEY



David J. Kybas

Director of the United States Patent and Trademark Office

United States of America

United States Patent and Trademark Office

Res Tire

Reg. No. 4,152,784

Registered June 5, 2012

Int. Cl.: 9

TRADEMARK

PRINCIPAL REGISTER

JOSN ELECTRONIC CO., LTD. (TAIWAN CORPORATION)
9F-5, NO.4, LANE 609
SEC.5, CHONGSIN ROAD, SANCHONG CITY
TAIPEI COUNTY 241, TAIWAN

FOR: WIRELESS TIRE PRESSURE MONITORING SYSTEM COMPRISED OF AN AIR PRESSURE SENSOR, SEMICONDUCTOR SENSOR AND TRANSMITTER FOR WIRELESSLY TRANSMITTING A TIRE AIR PRESSURE ELECTRONIC SIGNAL, IN CLASS 9 (U.S. CLS. 21, 23, 26, 36 AND 38).

FIRST USE 2-15-2011; IN COMMERCE 3-1-2011.

THE MARK CONSISTS OF THE STYLIZED LETTERS "RESQTIRE" WITH A CROSS-SECTIONAL CONTOUR OF A TIRE WITHIN THE LETTER "Q".

SER. NO. 85-297,354, FILED 4-18-2011.

CARYN GLASSER, EXAMINING ATTORNEY



David J. Kyffers

Director of the United States Patent and Trademark Office

United States of America

United States Patent and Trademark Office

ADVANCE ARTHRO-SYSTEM

Reg. No. 4,152,785

Registered June 5, 2012

Int. Cls.: 5 and 10

TRADEMARK

PRINCIPAL REGISTER

TEXTILE HI TEC (FRANCE SOCIÉTÉ PAR ACTIONS SIMPLIFIÉE (SAS))
LES VERRERIES DE MOUSSANS
SAINT-PONS, FRANCE 34220

FOR: SURGICAL ORTHOPAEDIC AND ARTHROSCOPIC IMPLANTS COMPRISING LIVING TISSUE, IN CLASS 5 (U.S. CLS. 6, 18, 44, 46, 51 AND 52).

FOR: SURGICAL ORTHOPAEDIC AND ARTHROSCOPIC IMPLANTS MADE OF ARTIFICIAL MATERIAL, IN CLASS 10 (U.S. CLS. 26, 39 AND 44).

THE MARK CONSISTS OF STANDARD CHARACTERS WITHOUT CLAIM TO ANY PARTICULAR FONT, STYLE, SIZE, OR COLOR.

PRIORITY CLAIMED UNDER SEC. 44(D) ON ERPN CMNTY TM OFC APPLICATION NO. 009459868, FILED 10-20-2010, REG. NO. 009459868, DATED 4-1-2011, EXPIRES 10-20-2020.

NO CLAIM IS MADE TO THE EXCLUSIVE RIGHT TO USE "ARTHRO-SYSTEM", APART FROM THE MARK AS SHOWN.

SER. NO. 85-297,375, FILED 4-18-2011.

ANDREA K. NADELMAN, EXAMINING ATTORNEY



David J. Kybas

Director of the United States Patent and Trademark Office

United States of America

United States Patent and Trademark Office



MANAGED
MARKETING

Reg. No. 4,152,786

Registered June 5, 2012

Int. Cls.: 35 and 41

SERVICE MARK

PRINCIPAL REGISTER

MANAGED MARKETING, LLC (DELAWARE LIMITED LIABILITY COMPANY)
PO BOX 1171
PORTSMOUTH, NH 03802

FOR: MANAGEMENT AND BUSINESS CONSULTING SERVICES IN THE FIELD OF BUSINESS ORGANIZATION, BUSINESS MANAGEMENT, BUSINESS PLANNING, STRATEGIC PLANNING, MARKETING BY MEANS OF THE INTERNET AND TRADITIONAL MARKETING, IN CLASS 35 (U.S. CLS. 100, 101 AND 102).

FIRST USE 7-0-2010; IN COMMERCE 7-0-2010.

FOR: EDUCATIONAL SERVICES, NAMELY, CONDUCTING SEMINARS AND PROFESSIONAL COACHING IN THE FIELD OF BUSINESS DEVELOPMENT, BUSINESS MANAGEMENT, STRATEGIC PLANNING, MARKETING BY MEANS OF THE INTERNET AND TRADITIONAL MARKETING; AND ON-LINE TRAINING AND EDUCATIONAL EVALUATIONS IN THE FIELD OF BUSINESS DEVELOPMENT, BUSINESS MANAGEMENT, STRATEGIC PLANNING AND MARKETING BY MEANS OF THE INTERNET, IN CLASS 41 (U.S. CLS. 100, 101 AND 107).

FIRST USE 7-0-2010; IN COMMERCE 7-0-2010.

NO CLAIM IS MADE TO THE EXCLUSIVE RIGHT TO USE "MANAGED MARKETING", APART FROM THE MARK AS SHOWN.

THE MARK CONSISTS OF A STYLIZED "M". THE "M" IS IN A CIRCLE. THERE IS A SHADED LINE UNDERNEATH THE CIRCLE. THE STYLIZED TERMS "MANAGED" AND "MARKETING" ARE NEXT TO THE CIRCLE. THE TERM "MANAGED" IN ALL CAPS. THE TERM "MARKETING" IN ALL CAPS.

SER. NO. 85-297,409, FILED 4-18-2011.

PATRICIA EVANKO, EXAMINING ATTORNEY



David J. Kybas

Director of the United States Patent and Trademark Office

United States of America

United States Patent and Trademark Office

HORIZON HOBBY

Reg. No. 4,152,787

HORIZON HOBBY, INC. (DELAWARE CORPORATION)
4105 FIELDSTONE ROAD
CHAMPAIGN, IL 61822

Registered June 5, 2012

Int. Cls.: 9 and 28

FOR: REMOTE CONTROLS FOR HOBBY PRODUCTS, IN CLASS 9 (U.S. CLS. 21, 23, 26, 36 AND 38).

TRADEMARK

FIRST USE 10-1-1985; IN COMMERCE 10-1-1985.

PRINCIPAL REGISTER

FOR: HOBBY MODEL VEHICLES AND PARTS AND ACCESSORIES THEREFOR, IN CLASS 28 (U.S. CLS. 22, 23, 38 AND 50).

FIRST USE 10-1-1985; IN COMMERCE 10-1-1985.

THE MARK CONSISTS OF STANDARD CHARACTERS WITHOUT CLAIM TO ANY PARTICULAR FONT, STYLE, SIZE, OR COLOR.

NO CLAIM IS MADE TO THE EXCLUSIVE RIGHT TO USE "HOBBY", APART FROM THE MARK AS SHOWN.

SER. NO. 85-297,492, FILED 4-18-2011.

MARIA-VICTORIA SUAREZ, EXAMINING ATTORNEY



David J. Kybas

Director of the United States Patent and Trademark Office

United States of America
United States Patent and Trademark Office

tidy tins

Reg. No. 4,152,788

Registered June 5, 2012

Int. Cl.: 6

TRADEMARK

PRINCIPAL REGISTER

THE HILLMAN GROUP, INC. (DELAWARE CORPORATION)
10590 HAMILTON AVENUE
CINCINNATI, OH 45231

FOR: SMALL MISCELLANEOUS HARDWARE ITEMS AND FASTENERS, NAMELY, METAL PICTURE HANGERS, PADDED METAL PICTURE HANGERS, NAILS FOR METAL PICTURE HANGERS AND METAL GLAZIER POINTS, IN CLASS 6 (U.S. CLS. 2, 12, 13, 14, 23, 25 AND 50).

FIRST USE 5-5-2010; IN COMMERCE 5-5-2010.

NO CLAIM IS MADE TO THE EXCLUSIVE RIGHT TO USE "TINS", APART FROM THE MARK AS SHOWN.

THE MARK CONSISTS OF THE WORDS "TIDY TINS" IN WHICH THE "Y" IN "TIDY" HAS THE SHAPE OF ONE TYPE OF PICTURE HANGER.

SER. NO. 85-297,639, FILED 4-18-2011.

COLLEEN KEARNEY, EXAMINING ATTORNEY



David J. Kyros

Director of the United States Patent and Trademark Office

United States of America

United States Patent and Trademark Office

SHOP: THE INDUSTRY INFORMANT

Reg. No. 4,152,789

Registered June 5, 2012

Int. Cl.: 41

SERVICE MARK

PRINCIPAL REGISTER

MARS ADVERTISING, INC. (MICHIGAN CORPORATION)
5TH FLOOR
25200 TELEGRAPH ROAD
SOUTHFIELD, MI 48033

FOR: EDUCATIONAL SERVICES, NAMELY, SEMINARS IN THE FIELD OF ADVERTISING AND MARKETING, IN CLASS 41 (U.S. CLS. 100, 101 AND 107).

FIRST USE 2-1-2011; IN COMMERCE 2-1-2011.

THE MARK CONSISTS OF STANDARD CHARACTERS WITHOUT CLAIM TO ANY PARTICULAR FONT, STYLE, SIZE, OR COLOR.

SER. NO. 85-297,762, FILED 4-18-2011.

TEJBIR SINGH, EXAMINING ATTORNEY



David J. Kyros

Director of the United States Patent and Trademark Office

United States of America

United States Patent and Trademark Office



yogamonkeykids

teaching to the mind, body and spirit

Reg. No. 4,152,790

Registered June 5, 2012

Int. Cls.: 25 and 41

TRADEMARK

SERVICE MARK

PRINCIPAL REGISTER

YOGA MONKEY KIDS, LLC (VIRGINIA LIMITED LIABILITY COMPANY)
6227 COTTONWOOD STREET
MCLEAN, VA 22101

FOR: ATHLETIC APPAREL, NAMELY, SHIRTS, PANTS, JACKETS, FOOTWEAR, HATS
AND CAPS, ATHLETIC UNIFORMS, IN CLASS 25 (U.S. CLS. 22 AND 39).

FIRST USE 10-23-2010; IN COMMERCE 10-23-2010.

FOR: YOGA INSTRUCTION, IN CLASS 41 (U.S. CLS. 100, 101 AND 107).

FIRST USE 10-23-2010; IN COMMERCE 10-23-2010.

THE MARK CONSISTS OF AN ILLUSTRATION OF A MONKEY IN LOTUS YOGA POSE
WEARING A SHORT SLEEVED SHIRT AND LEGGINGS, BELOW WHICH APPEARS THE
STYLIZED TEXT "YOGAMONKEYKIDS" ABOVE THE STYLIZED WORDING "TEACHING
TO THE MIND, BODY AND SPIRIT".

SER. NO. 85-297,764, FILED 4-18-2011.

DAVID TOOLEY, EXAMINING ATTORNEY

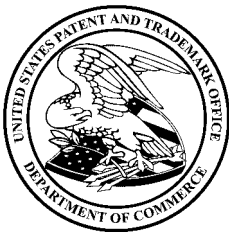

David J. Kybas

Director of the United States Patent and Trademark Office

United States of America
United States Patent and Trademark Office

GENNIUS

Reg. No. 4,152,791

DURASOL AWNINGS, INC. (NEW YORK CORPORATION)
225 TOWER DRIVE
MIDDLETOWN, NY 10941

Registered June 5, 2012

Int. Cl.: 22

FOR: AWNINGS, IN CLASS 22 (U.S. CLS. 1, 2, 7, 19, 22, 42 AND 50).

TRADEMARK

FIRST USE 10-20-2010; IN COMMERCE 10-20-2010.

PRINCIPAL REGISTER

THE MARK CONSISTS OF "GENNIUS" IN STYLIZED LETTERING.

SER. NO. 85-297,811, FILED 4-18-2011.

PAUL E. FAHRENKOPF, EXAMINING ATTORNEY



David J. Kyffers

Director of the United States Patent and Trademark Office

United States of America

United States Patent and Trademark Office



Reg. No. 4,152,792

Registered June 5, 2012

Int. Cl.: 35

SERVICE MARK

PRINCIPAL REGISTER

WILDCAT LIGHTING, LLC (TEXAS LIMITED LIABILITY COMPANY)
2405 LIGHTHOUSE INDUSTRIES
SUITE 106
NEW BRAUNFELS, TX 78130

FOR: RETAIL AND WHOLESALE STORE SERVICES FEATURING LED LIGHTING SYSTEMS, NAMELY, LED LIGHTS, STRIPS AND MODULES FOR MARINE AND OUTDOOR LIGHTING APPLICATIONS, IN CLASS 35 (U.S. CLS. 100, 101 AND 102).

FIRST USE 2-15-2008; IN COMMERCE 2-15-2008.

NO CLAIM IS MADE TO THE EXCLUSIVE RIGHT TO USE "LIGHTING", APART FROM THE MARK AS SHOWN.

THE MARK CONSISTS OF A PROFILE OF A STYLIZED WILDCAT WITH SHADOWING TO THE RIGHT. THE TERMS WILDCAT LIGHTING ARE TO THE RIGHT OF THE DESIGN IN STYLIZED LETTERS.

SER. NO. 85-297,860, FILED 4-18-2011.

MICHAEL KEATING, EXAMINING ATTORNEY



David J. Kyros

Director of the United States Patent and Trademark Office

United States of America

United States Patent and Trademark Office



Reg. No. 4,152,793

Registered June 5, 2012

Int. Cl.: 11

TRADEMARK

PRINCIPAL REGISTER

WILDCAT LIGHTING, LLC (TEXAS LIMITED LIABILITY COMPANY)
2405 LIGHTHOUSE INDUSTRIES
SUITE 106
NEW BRAUNFELS, TX 78130

FOR: LED LIGHTING SYSTEMS, NAMELY, LED LIGHTS, STRIPS AND MODULES FOR MARINE AND OUTDOOR LIGHTING APPLICATIONS, IN CLASS 11 (U.S. CLS. 13, 21, 23, 31 AND 34).

FIRST USE 2-15-2008; IN COMMERCE 2-15-2008.

NO CLAIM IS MADE TO THE EXCLUSIVE RIGHT TO USE "LIGHTING", APART FROM THE MARK AS SHOWN.

THE MARK CONSISTS OF A PROFILE OF A STYLIZED WILDCAT WITH SHADOWING TO THE RIGHT. THE TERMS "WILDCAT LIGHTING" ARE TO THE RIGHT OF THE DESIGN IN STYLIZED LETTERS

SER. NO. 85-297,887, FILED 4-18-2011.

MICHAEL KEATING, EXAMINING ATTORNEY



David J. Kyjars

Director of the United States Patent and Trademark Office

United States of America

United States Patent and Trademark Office

M.E.R.I.T. SYSTEM MULTIPLE EQUIPMENT RECORD INFORMATION TRACKING SYSTEM

Reg. No. 4,152,794

M.E.R.I.T. INVESTIGATIVE SERVICES, INC. (NEW JERSEY CORPORATION)
211 WARREN STREET
NEWARK, NJ 07103

Registered June 5, 2012

Int. Cl.: 42

FOR: CLOUD COMPUTING FEATURING SOFTWARE FOR USE IN MAINTENANCE, PERFORMANCE, TRACKING AND PREDICTIVE ANALYTICS, IN CLASS 42 (U.S. CLS. 100 AND 101).

SERVICE MARK

FIRST USE 3-1-2011; IN COMMERCE 3-1-2011.

PRINCIPAL REGISTER

THE MARK CONSISTS OF STANDARD CHARACTERS WITHOUT CLAIM TO ANY PARTICULAR FONT, STYLE, SIZE, OR COLOR.

NO CLAIM IS MADE TO THE EXCLUSIVE RIGHT TO USE "SYSTEM MULTIPLE EQUIPMENT RECORD INFORMATION TRACKING SYSTEM", APART FROM THE MARK AS SHOWN.

SER. NO. 85-297,908, FILED 4-18-2011.

ALICE BENMAMAN, EXAMINING ATTORNEY



David J. Kyros

Director of the United States Patent and Trademark Office

United States of America

United States Patent and Trademark Office

LIGHT BULBS UNLIMITED

Reg. No. 4,152,795

Registered June 5, 2012

Int. Cl.: 35

SERVICE MARK

PRINCIPAL REGISTER

LBU INTERNATIONAL, INC. (FLORIDA CORPORATION)
SUITE #207
1287 EAST NEWPORT CENTER DRIVE
DEERFIELD BEACH, FL 33442

FOR: RETAIL STORE SERVICES FEATURING LIGHT BULBS, LIGHTING FIXTURES, AND LIGHTING EQUIPMENT, IN CLASS 35 (U.S. CLS. 100, 101 AND 102).

FIRST USE 3-1-1983; IN COMMERCE 3-1-1983.

THE MARK CONSISTS OF STANDARD CHARACTERS WITHOUT CLAIM TO ANY PARTICULAR FONT, STYLE, SIZE, OR COLOR.

NO CLAIM IS MADE TO THE EXCLUSIVE RIGHT TO USE "LIGHT BULBS", APART FROM THE MARK AS SHOWN.

SER. NO. 85-298,098, FILED 4-18-2011.

PRISCILLA MILTON, EXAMINING ATTORNEY



David J. Kyffers

Director of the United States Patent and Trademark Office

United States of America

United States Patent and Trademark Office

Blue
Mystique



Reg. No. 4,152,796

BLUE MYSTIQUE, INC. (FLORIDA CORPORATION)
8010 S.W. 175TH STREET
PALMETTO BAY, FL 33157

Registered June 5, 2012

Int. Cl.: 31

FOR: LIVE PLANTS, NAMELY, ORNAMENTAL PLANTS AND FLOWERS, IN CLASS 31 (U.S. CLS. 1 AND 46).

TRADEMARK

FIRST USE 1-19-2011; IN COMMERCE 1-31-2011.

PRINCIPAL REGISTER

NO CLAIM IS MADE TO THE EXCLUSIVE RIGHT TO USE "BLUE", APART FROM THE MARK AS SHOWN.

THE MARK CONSISTS OF THE STYLIZED LETTERING OF THE WORDING "BLUE MYSTIQUE" WITH DESIGNS OF THREE ORCHIDS TO THE TOP RIGHT PORTION OF THE WORDING "BLUE MYSTIQUE".

SER. NO. 85-298,591, FILED 4-19-2011.

LEIGH CAROLINE CASE, EXAMINING ATTORNEY



David J. Kybas

Director of the United States Patent and Trademark Office

United States of America

United States Patent and Trademark Office

Great Scientists

Reg. No. 4,152,797

GOLD-DWORKIN, HEIDI (UNITED STATES INDIVIDUAL)
201 SENECA PLACE
MILFORD, CT 06460

Registered June 5, 2012

Int. Cl.: 41

FOR: EDUCATION SERVICES, NAMELY, PROVIDING LIVE AND ON-LINE CLASSES AND WORKSHOPS IN THE FIELD OF SCIENCE EDUCATION, IN CLASS 41 (U.S. CLS. 100, 101 AND 107).

SERVICE MARK

FIRST USE 9-1-2010; IN COMMERCE 3-15-2011.

PRINCIPAL REGISTER

NO CLAIM IS MADE TO THE EXCLUSIVE RIGHT TO USE "GREAT SCIENTISTS", APART FROM THE MARK AS SHOWN.

THE MARK CONSISTS OF THE WORDS "GREAT SCIENTISTS" AND THE BACKGROUND DESIGN OF 2 HANDS.

SER. NO. 85-298,779, FILED 4-19-2011.

DORITT L. CARROLL, EXAMINING ATTORNEY



David J. Kybas

Director of the United States Patent and Trademark Office

United States of America

United States Patent and Trademark Office

AUBYN

Reg. No. 4,152,798

Registered June 5, 2012

Int. Cls.: 35, 36 and 45

SERVICE MARK

PRINCIPAL REGISTER

JENKINSON, PHILIP (FRANCE INDIVIDUAL)
C/O TRIPLET & ASSOCIES
75 BOULEVARD VAUBAN
LILLE, FRANCE 59040

FOR: BUSINESS MANAGEMENT AND ORGANISATION CONSULTANCY; BUSINESS MANAGEMENT CONSULTANCY; BUSINESS MANAGEMENT ASSISTANCE; COMMERCIAL AND INDUSTRIAL MANAGEMENT ASSISTANCE; PROFESSIONAL BUSINESS CONSULTANCY; EFFICIENCY EXPERTS; TAX PREPARATION; MARKET STUDIES AND ANALYSIS SERVICES; COMMERCIAL CONSULTANCY; COMMERCIAL FEASIBILITY STUDIES; CONSULTING SERVICES, NAMELY, EXPERT ANALYSIS AND MANAGEMENT CONSULTING IN ECONOMICS; BUSINESS INFORMATION AND INVESTIGATIONS; COMPILATION AND SYSTEMIZATION OF INFORMATION INTO COMPUTER DATABASES; COMPUTERISED FILE MANAGEMENT, SECRETARIAL SERVICES; BOOK-KEEPING, BUSINESS AUDITING; CONSULTING SERVICES IN THE FIELD OF MANAGING INTELLECTUAL PROPERTIES; PROVIDING ELECTRONIC TRACKING OF INTELLECTUAL AND INDUSTRIAL PROPERTY ASSETS TO OTHERS, IN CLASS 35 (U.S. CLS. 100, 101 AND 102).

FOR: ADVICE AND CONSULTANCY IN THE FINANCIAL AND FISCAL FIELD; FISCAL ASSESSMENTS; MUTUAL FUND BROKERAGE, DISTRIBUTION AND INVESTMENT; ESTABLISHMENT OF MUTUAL FUNDS FOR OTHERS; ADVICE AND CONSULTANCY IN RELATION TO REAL ESTATE, INSURANCE AND FINANCIAL TRANSACTIONS; APARTMENT HOUSE MANAGEMENT, IN CLASS 36 (U.S. CLS. 100, 101 AND 102).

FOR: LEGAL SERVICES RENDERED BY LAWYERS; LEGAL ADVICE, NAMELY, PROVIDING LEGAL SERVICES TO ALL NATURAL AND LEGAL PERSONS; ASSISTANCE, ADVICE AND CONSULTANCY IN REGARD TO DRAFTING OF LEGAL DOCUMENTS; LEGAL SERVICES, NAMELY, DRAFTING OF LEGAL DOCUMENTS AND ARTICLES OF INCORPORATION, LITIGATION SERVICES, LEGAL REPRESENTATION, LEGAL ASSISTANCE IN DISPUTES AND IN PARTICULAR IN ADMINISTRATIVE, LEGAL AND ARBITRATION PROCEEDINGS; ARBITRATION AND MEDIATION SERVICES; EXPERT WITNESS SERVICES IN LEGAL MATTERS IN THE FIELD OF FRENCH LAW; LEGAL EXPERTISE, NAMELY, PROVIDING INFORMATION IN THE FIELD OF LEGAL TECHNIQUES; LEGAL RESEARCH; COPYRIGHT MANAGEMENT; INTELLECTUAL PROPERTY RIGHTS PORTFOLIO MANAGEMENT, NAMELY, LICENSING OF INTELLECTUAL PROPERTY AND INTELLECTUAL PROPERTY WATCH SERVICES; PROVIDING AN ON-LINE INTERACTIVE DATABASE FEATURING LEGAL INFORMATION, IN CLASS 45 (U.S. CLS. 100 AND 101).



David J. Kybas

Director of the United States Patent and Trademark Office

Reg. No. 4,152,798 THE MARK CONSISTS OF STANDARD CHARACTERS WITHOUT CLAIM TO ANY PARTICULAR FONT, STYLE, SIZE, OR COLOR.

PRIORITY CLAIMED UNDER SEC. 44(D) ON ERPN CMNTY TM OFC APPLICATION NO. 009463753, FILED 10-21-2010, REG. NO. 009463753, DATED 4-1-2011, EXPIRES 10-21-2020.

SER. NO. 85-298,784, FILED 4-19-2011.

KELLEY WELLS, EXAMINING ATTORNEY

United States of America

United States Patent and Trademark Office

PETER BENCHLEY

Reg. No. 4,152,799

Registered June 5, 2012

Int. Cl.: 16

TRADEMARK

PRINCIPAL REGISTER

WENDY W. BENCHLEY (UNITED STATES INDIVIDUAL)
5024 CATHEDRAL AVE., NW
WASHINGTON, DC 20016

FOR: A SERIES OF FICTION BOOKS; A SERIES OF NON-FICTION HARDCOVER, PAPERBACK, AND TRADE EDITION BOOKS IN THE FIELD OF OCEANOGRAPHY AND OCEAN CONSERVATION; NON-FICTION WRITTEN ARTICLES IN THE FIELD OF OCEANOGRAPHY AND OCEAN CONSERVATION, IN CLASS 16 (U.S. CLS. 2, 5, 22, 23, 29, 37, 38 AND 50).

FIRST USE 0-0-1974; IN COMMERCE 0-0-1974.

THE MARK CONSISTS OF STANDARD CHARACTERS WITHOUT CLAIM TO ANY PARTICULAR FONT, STYLE, SIZE, OR COLOR.

THE NAME(S), PORTRAIT(S), AND/OR SIGNATURE(S) SHOWN IN THE MARK DOES NOT IDENTIFY A PARTICULAR LIVING INDIVIDUAL.

SER. NO. 85-298,816, FILED 4-19-2011.

COURTNEY ALVAREZ, EXAMINING ATTORNEY



David J. Kyffers

Director of the United States Patent and Trademark Office

United States of America

United States Patent and Trademark Office

APPRESPONSE XPERT

Reg. No. 4,152,800

Registered June 5, 2012

Int. Cl.: 9

TRADEMARK

PRINCIPAL REGISTER

OPNET TECHNOLOGIES, INC. (DELAWARE CORPORATION)
7255 WOODMONT AVENUE
BETHESDA, MD 208147900

FOR: SOFTWARE AND PRE-FORMATTED COMPUTERS WHICH ALLOW THIRD PARTIES TO IDENTIFY, MONITOR, AND TRACK END-USER APPLICATION PERFORMANCE, INCLUDING, BUSINESS METRICS, SUCH AS, WEB PAGE TIMING AND FINANCIAL PROTOCOL OPERATIONS, IN CLASS 9 (U.S. CLS. 21, 23, 26, 36 AND 38).

FIRST USE 4-0-2011; IN COMMERCE 4-0-2011.

THE MARK CONSISTS OF STANDARD CHARACTERS WITHOUT CLAIM TO ANY PARTICULAR FONT, STYLE, SIZE, OR COLOR.

NO CLAIM IS MADE TO THE EXCLUSIVE RIGHT TO USE "APP RESPONSE", APART FROM THE MARK AS SHOWN.

SER. NO. 85-298,925, FILED 4-19-2011.

TINA BROWN, EXAMINING ATTORNEY



David J. Kybas

Director of the United States Patent and Trademark Office

United States of America

United States Patent and Trademark Office

OCTOPUS JONES

Reg. No. 4,152,801

CLAY CARLISLE (UNITED STATES INDIVIDUAL)
47 HAMILTON'S FERRY ROAD
LAKE WYLIE, SC 29710

Registered June 5, 2012

Int. Cls.: 9 and 41

FOR: DIGITAL MEDIA, NAMELY, PRE-RECORDED DVDS, DOWNLOADABLE AUDIO AND VIDEO RECORDINGS, AND CDS FEATURING AND PROMOTING MUSICAL PERFORMANCES; DOWNLOADABLE MUSICAL SOUND RECORDINGS; MUSICAL SOUND RECORDINGS, IN CLASS 9 (U.S. CLS. 21, 23, 26, 36 AND 38).

TRADEMARK

SERVICE MARK

FIRST USE 0-0-2008; IN COMMERCE 0-0-2008.

PRINCIPAL REGISTER

FOR: ENTERTAINMENT, NAMELY, LIVE PERFORMANCES BY A MUSICAL BAND; PRODUCTION OF SOUND RECORDINGS, IN CLASS 41 (U.S. CLS. 100, 101 AND 107).

FIRST USE 0-0-2008; IN COMMERCE 0-0-2008.

THE MARK CONSISTS OF STANDARD CHARACTERS WITHOUT CLAIM TO ANY PARTICULAR FONT, STYLE, SIZE, OR COLOR.

SER. NO. 85-299,017, FILED 4-19-2011.

ALEX KEAM, EXAMINING ATTORNEY



David J. Kyros

Director of the United States Patent and Trademark Office

United States of America

United States Patent and Trademark Office

FRATMEN

Reg. No. 4,152,802

ICONNEWMEDIA, INC. (NEVADA CORPORATION)
701 N GREEN VALLEY PKWY, STE 200
HENDERSON, NV 89074

Registered June 5, 2012

Int. Cls.: 9, 16, 38 and 41

FOR: DIGITAL MATERIALS, NAMELY, DOWNLOADABLE VIDEO FILES AND PHOTOGRAPHS FEATURING ADULT ENTERTAINMENT; DIGITAL MEDIA, NAMELY, PRE-RECORDED VIDEO CASSETTES, DIGITAL VIDEO DISCS, DIGITAL VERSATILE DISCS, DOWNLOADABLE AUDIO AND VIDEO RECORDINGS, DVDS, AND HIGH DEFINITION DIGITAL DISCS FEATURING ADULT ENTERTAINMENT; DVDS FEATURING ADULT ENTERTAINMENT, IN CLASS 9 (U.S. CLS. 21, 23, 26, 36 AND 38).

TRADEMARK

SERVICE MARK

PRINCIPAL REGISTER

FIRST USE 5-1-1999; IN COMMERCE 9-27-1999.

FOR: PRINTED MATTER, NAMELY, CALENDARS, GREETING CARDS, BOOKS, MAGAZINES AND PHOTOGRAPHS IN THE FIELD OF EROTIC PHOTOGRAPHY AND ADULT ENTERTAINMENT, IN CLASS 16 (U.S. CLS. 2, 5, 22, 23, 29, 37, 38 AND 50).

FIRST USE 5-1-1999; IN COMMERCE 6-30-2001.

FOR: BROADCASTING SERVICES AND PROVISION OF TELECOMMUNICATION ACCESS TO VIDEO AND AUDIO CONTENT FEATURING ADULT ENTERTAINMENT PROVIDED VIA A VIDEO-ON-DEMAND SERVICE VIA THE INTERNET, IN CLASS 38 (U.S. CLS. 100, 101 AND 104).

FIRST USE 5-1-1999; IN COMMERCE 2-20-2005.

FOR: PRODUCTION OF DVDS, VIDEOTAPES AND TELEVISION PROGRAMS FEATURING ADULT ENTERTAINMENT; PROVIDING AN ONLINE ADULT WEBSITE FEATURING PHOTOGRAPHS AND VIDEOS IN THE FIELD OF ADULT ENTERTAINMENT; DIGITAL MEDIA, NAMELY, A WEBSITE FEATURING ADULT ENTERTAINMENT; ENTERTAINMENT SERVICES IN THE NATURE OF PROVIDING A WEBSITE ON THE GLOBAL COMPUTER NETWORKS FEATURING ENTERTAINMENT INFORMATION IN THE FIELD OF ADULT ENTERTAINMENT; PROVIDING AN ONLINE WEBSITE OF INFORMATION COMPRISING ADULT MATERIAL AND VIEWING THEREOF, AND OTHER ADULT ENTERTAINMENT RELATED MATERIAL, IN CLASS 41 (U.S. CLS. 100, 101 AND 107).

FIRST USE 5-1-1999; IN COMMERCE 5-12-2000.



David J. Kyros

Director of the United States Patent and Trademark Office

Reg. No. 4,152,802 THE MARK CONSISTS OF STANDARD CHARACTERS WITHOUT CLAIM TO ANY PARTICULAR FONT, STYLE, SIZE, OR COLOR.

SEC. 2(F).

SER. NO. 85-299,101, FILED 4-19-2011.

SHANNON TWOHIG, EXAMINING ATTORNEY

United States of America

United States Patent and Trademark Office



Reg. No. 4,152,803

CITY OF MURPHY, TEXAS (TEXAS MUNICIPAL CORPORATION)
206 NORTH MURPHY ROAD
MURPHY, TX 75094

Registered June 5, 2012

Int. Cl.: 35

FOR: BUSINESS OPERATION, BUSINESS ADMINISTRATION AND OFFICE FUNCTIONS,
IN CLASS 35 (U.S. CLS. 100, 101 AND 102).

SERVICE MARK

FIRST USE 3-1-2010; IN COMMERCE 3-1-2010.

PRINCIPAL REGISTER

NO CLAIM IS MADE TO THE EXCLUSIVE RIGHT TO USE "CITY OF MURPHY", APART
FROM THE MARK AS SHOWN.

THE COLOR(S) GREEN AND BLACK IS/ARE CLAIMED AS A FEATURE OF THE MARK.

THE MARK CONSISTS OF THE WORDING " CITY OF MURPHY" IN THE COLOR BLACK
WITH TWO BLACK HORIZONTAL LINES ONE TO THE RIGHT AND ONE UNDERNEATH
THE WORDING, AND THREE ITALIAN TUSCAN CYPRESS TREES IN A HORIZONTAL
LINE, EACH TREE DECREASING IN HEIGHT FROM LEFT TO RIGHT, THE LEFTMOST
BEING THE TALLEST, THE RIGHTMOST BEING SHORTEST. THE FOLIAGE ON THE
TREES IS GREEN AND THE TRUNKS OF THE TREES ARE BLACK.

SER. NO. 85-299,189, FILED 4-19-2011.

WILLIAM ROSSMAN, EXAMINING ATTORNEY



David J. Kyros

Director of the United States Patent and Trademark Office

United States of America

United States Patent and Trademark Office

OUTER LIMITS

Reg. No. 4,152,804

Registered June 5, 2012

Int. Cl.: 33

TRADEMARK

PRINCIPAL REGISTER

MONTES S.A. (CHILE CORPORATION)
AV. DEL VALLE NO. 945, OF. 2611
CIUDAD EMPRESARIAL HUECHURABA
SANTIAGO, CHILE

FOR: WINE, IN CLASS 33 (U.S. CLS. 47 AND 49).

THE MARK CONSISTS OF STANDARD CHARACTERS WITHOUT CLAIM TO ANY PARTICULAR FONT, STYLE, SIZE, OR COLOR.

PRIORITY CLAIMED UNDER SEC. 44(D) ON CHILE APPLICATION NO. 948668, FILED 4-12-2011, REG. NO. 938125, DATED 11-15-2011, EXPIRES 11-15-2021.

SER. NO. 85-299,407, FILED 4-19-2011.

PRISCILLA MILTON, EXAMINING ATTORNEY



David J. Kybas

Director of the United States Patent and Trademark Office

United States of America

United States Patent and Trademark Office

Totally Pumped

Reg. No. 4,152,805

Registered June 5, 2012

Int. Cls.: 38 and 41

SERVICE MARK

PRINCIPAL REGISTER

YOUNG, RICHARD (AUSTRALIA INDIVIDUAL), DBA TOTALLY PUMPED
47 THE BACKWATER
EASTWOOD, AUSTRALIA 3875

FOR: RADIO BROADCASTING; RADIO PROGRAM BROADCASTING; RADIO BROADCASTING INFORMATION; BROADCASTING OF RADIO PROGRAMMES; BROADCASTING OF PROGRAMMES BY RADIO; INTERNET RADIO BROADCASTING SERVICES; RADIO BROADCASTING OF INFORMATION AND OTHER PROGRAMS; MUSIC BROADCASTING VIA RADIO AND THE INTERNET; RADIO NEWS BROADCASTING; RADIO PROGRAMME BROADCASTING; COMMERCIAL RADIO BROADCASTING, IN CLASS 38 (U.S. CLS. 100, 101 AND 104).

FOR: CONDUCTING FITNESS CLASSES; PHYSICAL FITNESS INSTRUCTION; PHYSICAL FITNESS CONSULTATION; INSTRUCTION IN PHYSICAL FITNESS; PHYSICAL FITNESS TRAINING SERVICES; PHYSICAL FITNESS CONDITIONING CLASSES; PERSONAL TRAINER SERVICES; SPORTS TRAINING; GYMNASIUMS; HEALTH CLUB SERVICES, NAMELY, PROVIDING INSTRUCTION AND EQUIPMENT IN THE FIELD OF PHYSICAL EXERCISE, IN CLASS 41 (U.S. CLS. 100, 101 AND 107).

THE MARK CONSISTS OF STANDARD CHARACTERS WITHOUT CLAIM TO ANY PARTICULAR FONT, STYLE, SIZE, OR COLOR.

PRIORITY CLAIMED UNDER SEC. 44(D) ON AUSTRALIA APPLICATION NO. 1420493, FILED 4-15-2011, REG. NO. 1420493, DATED 11-28-2011, EXPIRES 11-28-2021.

PRIORITY CLAIMED UNDER SEC. 44(D) ON AUSTRALIA APPLICATION NO. 1419587, FILED 4-12-2011, REG. NO. 1419587, DATED 11-28-2011, EXPIRES 11-28-2021.

SER. NO. 85-299,448, FILED 4-20-2011.

LAURIE MAYES, EXAMINING ATTORNEY



David J. Kyros

Director of the United States Patent and Trademark Office

United States of America

United States Patent and Trademark Office

ORION

Reg. No. 4,152,806

Registered June 5, 2012

Int. Cls.: 6, 19 and 45

TRADEMARK

SERVICE MARK

PRINCIPAL REGISTER

AXIP LIMITED (NEW ZEALAND LIMITED LIABILITY COMPANY)
8 PAUL MATTHEWS ROAD, NORTH HARBOUR
AUCKLAND, NEW ZEALAND

FOR: METAL CRASH BARRIERS, CRASH BARRIERS OF METAL FOR ROADS, METAL ROAD BARRICADES, METAL BARRICADES FOR ROADS, METAL BOLLARDS, METAL BOLLARDS FOR ROADS, NON-LUMINOUS AND NON-MECHANICAL METAL SIGNS, PORTABLE ROAD HUMPS OF METAL FOR SLOWING TRAFFIC, IN CLASS 6 (U.S. CLS. 2, 12, 13, 14, 23, 25 AND 50).

FOR: CRASH BARRIERS NOT OF METAL, NON-METALLIC CRASH BARRIERS; PLASTIC REFLECTIVE DELINEATOR POSTS; AND NON-METAL FIXED BOLLARDS, AND NON-LUMINOUS, NON-MECHANICAL SIGNS NOT OF METAL; PORTABLE AND PERMANENT NON-METALLIC ROAD HUMPS FOR SLOWING TRAFFIC, IN CLASS 19 (U.S. CLS. 1, 12, 33 AND 50).

FOR: RENTAL OF TRAFFIC APPARATUS, NAMELY, CRASH BARRIERS, CRASH BARRIERS FOR ROADS, ROAD BARRICADES, BOLLARDS, BOLLARDS FOR ROADS, SIGNS, PORTABLE AND PERMANENT ROAD HUMPS FOR SLOWING TRAFFIC, HIGHWAY SAFETY ROAD CONES, PLASTIC REFLECTIVE DELINEATOR POSTS, DISPLAY BOARDS, TRAFFIC DIRECTION DEVICES, NAMELY, DISPLAY BOARDS, AND EQUIPMENT FOR SAFETY PURPOSES, IN CLASS 45 (U.S. CLS. 100 AND 101).

THE MARK CONSISTS OF STANDARD CHARACTERS WITHOUT CLAIM TO ANY PARTICULAR FONT, STYLE, SIZE, OR COLOR.

PRIORITY CLAIMED UNDER SEC. 44(D) ON NEW ZEALAND APPLICATION NO. 832366, FILED 10-26-2010, REG. NO. 832366, DATED 10-26-2010, EXPIRES 10-26-2020.

SER. NO. 85-299,800, FILED 4-20-2011.

ODESSA BIBBINS, EXAMINING ATTORNEY



David J. Kyros

Director of the United States Patent and Trademark Office

United States of America

United States Patent and Trademark Office

WHERE IT ALL BEGINS

Reg. No. 4,152,807

Registered June 5, 2012

Int. Cls.: 35 and 42

SERVICE MARK

PRINCIPAL REGISTER

INFORMATION TECHNOLOGY INDUSTRY COUNCIL, LTD. (DELAWARE NON-PROFIT CORPORATION)
SUITE 610
1101 K STREET, NW
WASHINGTON, DC 20005

FOR: PROMOTING PUBLIC AWARENESS OF THE NEED FOR CONSENSUS STANDARDS IN THE FIELD OF INFORMATION TECHNOLOGY , IN CLASS 35 (U.S. CLS. 100, 101 AND 102).

FIRST USE 1-0-2002; IN COMMERCE 1-0-2002.

FOR: DEVELOPING CONSENSUS STANDARDS IN THE FIELD OF INFORMATION TECHNOLOGY, IN CLASS 42 (U.S. CLS. 100 AND 101).

FIRST USE 1-0-2002; IN COMMERCE 1-0-2002.

THE MARK CONSISTS OF STANDARD CHARACTERS WITHOUT CLAIM TO ANY PARTICULAR FONT, STYLE, SIZE, OR COLOR.

SER. NO. 85-299,864, FILED 4-20-2011.

HANNO RITTNER, EXAMINING ATTORNEY



David J. Kybas

Director of the United States Patent and Trademark Office

United States of America

United States Patent and Trademark Office



Reg. No. 4,152,808

Registered June 5, 2012

Int. Cl.: 35

SERVICE MARK

PRINCIPAL REGISTER

L. RAND INC. (PENNSYLVANIA CORPORATION), DBA SOUP OF THE DAY SEARCH
2300 PINE ST # 7
PHILADELPHIA, PA 19103 AND

WILDERSON, LESLIE RAND (UNITED STATES INDIVIDUAL)
2300 PINE ST #7
PHILADELPHIA, PA 19103

FOR: PROVIDING A SEARCHABLE WEBSITE FEATURING THE GOODS AND SERVICES OF OTHER VENDORS, IN CLASS 35 (U.S. CLS. 100, 101 AND 102).

FIRST USE 3-25-2011; IN COMMERCE 3-25-2011.

NO CLAIM IS MADE TO THE EXCLUSIVE RIGHT TO USE "SOUP OF THE DAY SEARCH", APART FROM THE MARK AS SHOWN.

THE COLOR(S) BLACK, RED AND WHITE IS/ARE CLAIMED AS A FEATURE OF THE MARK.

THE MARK CONSISTS OF THE FOLLOWING: THE WORDS "SOUP OF THE DAY SEARCH" IN BLACK WITHIN A RED OUTLINE OF A SOUP SPOON WITH THE INITIAL "S" IN "SOUP" PLACED OUTSIDE OF THE SPOON HANDLE. THE COLOR WHITE APPEARS ON THE INTERIOR OF THE SPOON.

SER. NO. 85-299,882, FILED 4-20-2011.

KAELIE KUNG, EXAMINING ATTORNEY



David J. Kybas

Director of the United States Patent and Trademark Office

United States of America

United States Patent and Trademark Office

INTERNATIONAL COMMITTEE FOR INFORMATION TECHNOLOGY STANDARDS

Reg. No. 4,152,809

Registered June 5, 2012

Int. Cls.: 35 and 42

SERVICE MARK

PRINCIPAL REGISTER

INFORMATION TECHNOLOGY INDUSTRY COUNCIL, LTD. (DELAWARE NON-PROFIT CORPORATION)
SUITE 610
1101 K STREET, NW
WASHINGTON, DC 20005

FOR: PROMOTING PUBLIC AWARENESS OF THE NEED FOR CONSENSUS STANDARDS IN THE FIELD OF INFORMATION TECHNOLOGY, IN CLASS 35 (U.S. CLS. 100, 101 AND 102).

FIRST USE 1-0-2002; IN COMMERCE 1-0-2002.

FOR: DEVELOPING CONSENSUS STANDARDS IN THE FIELD OF INFORMATION TECHNOLOGY, IN CLASS 42 (U.S. CLS. 100 AND 101).

FIRST USE 1-0-2002; IN COMMERCE 1-0-2002.

THE MARK CONSISTS OF STANDARD CHARACTERS WITHOUT CLAIM TO ANY PARTICULAR FONT, STYLE, SIZE, OR COLOR.

NO CLAIM IS MADE TO THE EXCLUSIVE RIGHT TO USE "COMMITTEE", APART FROM THE MARK AS SHOWN.

SEC. 2(F).

SER. NO. 85-299,885, FILED 4-20-2011.

HANNO RITTNER, EXAMINING ATTORNEY



David J. Kybas

Director of the United States Patent and Trademark Office

United States of America

United States Patent and Trademark Office

TOPCAT MARINE LIGHTING SYSTEM

Reg. No. 4,152,810

Registered June 5, 2012

Int. Cl.: 11

TRADEMARK

PRINCIPAL REGISTER

WILDCAT LIGHTING, LLC (TEXAS LIMITED LIABILITY COMPANY)
2405 LIGHTHOUSE INDUSTRIES
SUITE 106
NEW BRAUNFELS, TX 78130

FOR: LED LIGHTING SYSTEMS, NAMELY, LED LIGHTS, STRIPS AND MODULES FOR MARINE AND OUTDOOR LIGHTING APPLICATIONS, IN CLASS 11 (U.S. CLS. 13, 21, 23, 31 AND 34).

FIRST USE 5-4-2010; IN COMMERCE 5-4-2010.

THE MARK CONSISTS OF STANDARD CHARACTERS WITHOUT CLAIM TO ANY PARTICULAR FONT, STYLE, SIZE, OR COLOR.

NO CLAIM IS MADE TO THE EXCLUSIVE RIGHT TO USE "MARINE LIGHTING SYSTEM", APART FROM THE MARK AS SHOWN.

SER. NO. 85-299,989, FILED 4-20-2011.

MICHAEL KEATING, EXAMINING ATTORNEY



David J. Kyffers

Director of the United States Patent and Trademark Office

United States of America

United States Patent and Trademark Office

VERICOM

Reg. No. 4,152,811

Registered June 5, 2012

Int. Cl.: 9

TRADEMARK

PRINCIPAL REGISTER

DUACARRIER ELECTRONICS TECHNOLOGY, INC. (CALIFORNIA CORPORATION)
10306 YELLOW PINE LANE
KNOXVILLE, TN 37932

FOR: AUDIO CABLES; CABLE CONNECTORS; CABLES AND FIBRES FOR THE TRANSMISSION OF SOUNDS AND IMAGES; CABLES FOR ELECTRICAL AND OPTICAL SIGNAL TRANSMISSION SYSTEMS; CABLES FOR ELECTRICAL OR OPTICAL SIGNAL TRANSMISSION; CABLES FOR OPTICAL SIGNAL TRANSMISSION; CABLES, ELECTRIC; COAXIAL CABLES; COAXIAL CABLES INCORPORATING FILTERS; COMPONENT VIDEO CABLES; COMPUTER CABLES; CONNECTING ELECTRICAL CABLES; CONNECTION CABLES; DUCTING FOR ELECTRIC CABLES; ELECTRIC CABLES AND WIRES; ELECTRIC CABLES, WIRES, CONDUCTORS AND CONNECTION FITTINGS THEREFOR; ELECTRIC WIRE AND CABLE; ELECTRIC WIRES AND CABLES; ELECTRICAL AND OPTICAL CABLES; ELECTRICAL CABLES; ELECTRICAL CABLES AND CORDSETS; ELECTRICAL CABLES FOR MUSICAL INSTRUMENTS; ELECTRICAL CABLES FOR USE IN CONNECTIONS; ELECTRICAL CABLES WITH INTEGRATED FITTINGS, NAMELY, CORDSETS; ELECTRICAL INTERCONNECT CABLES; ELECTRICAL PLUG DEVICE ENABLING CONNECTION AND DISCONNECTION OF POWER AND/OR CONTROL CABLES; ELECTRONIC CABLES; ETHERNET CABLES; EXTENSION CABLES; FIBER OPTIC CABLES; FIBRE-OPTIC CABLES; GUITAR CABLES; HIGH-DEFINITION MULTIMEDIA INTERFACE APPARATUS AND COMPONENT CABLES SOLD AS A UNIT; HIGH-DEFINITION MULTIMEDIA INTERFACE CABLES; JUMPER CABLES; METAL CABINETS SPECIALLY ADAPTED TO PROTECT TELECOMMUNICATIONS EQUIPMENT IN THE NATURE OF FIBER OPTIC CABLES.; MICROPHONE CABLES; MODEM CABLES; OPTICAL CABLES; OPTICAL FIBER CABLES; OPTICAL FIBERS SOLD AS A COMPONENT OF FIBER OPTICAL CABLES; POWER CABLES; PRINTER CABLES; PROTECTIVE SHEATHS FOR FIBER OPTICAL CABLES; PUBLIC ADDRESS (PA) AND SOUND SYSTEM ACCESSORIES, NAMELY, MICROPHONE STANDS, SPEAKER STANDS, MICROPHONE CABLES, SPEAKER CABLES, SPEAKER BOXES AND SOUND MIXERS; SHEATHS FOR ELECTRIC CABLES; STEREO CABLES; TELECOMMUNICATION CABLES; TELECOMMUNICATIONS CABLES; THREADED CABLE CONNECTORS OF METAL; USB CABLES; VIDEO CABLES, IN CLASS 9 (U.S. CLS. 21, 23, 26, 36 AND 38).



David J. Kyros

Director of the United States Patent and Trademark Office

FIRST USE 12-15-2009; IN COMMERCE 1-1-2010.

THE MARK CONSISTS OF STANDARD CHARACTERS WITHOUT CLAIM TO ANY PARTICULAR FONT, STYLE, SIZE, OR COLOR.

Reg. No. 4,152,811 OWNER OF U.S. REG. NO. 3,929,783.

SER. NO. 85-300,106, FILED 4-20-2011.

DAVID H. STINE, EXAMINING ATTORNEY

United States of America

United States Patent and Trademark Office



VANACORE
MUSIC

Reg. No. 4,152,812

Registered June 5, 2012

Int. Cl.: 41

SERVICE MARK

PRINCIPAL REGISTER

VANACORE MUSIC PUBLISHING, LLC (CALIFORNIA LIMITED LIABILITY COMPANY)
SUITE 180
27734 AVENUE SCOTT
SANTA CLARITA, CA 91366

FOR: MUSIC LIBRARY SERVICES; MUSIC PRODUCTION SERVICES; COMPOSITION OF MUSIC FOR OTHERS; DEVELOPMENT, CREATION, PRODUCTION AND RECORDING OF NEW MUSIC PACKAGES, NAMELY, PRODUCTION OF SOUND RECORDINGS FOR USE IN FILM, TELEVISION, OR OTHER MEDIA OUTLETS OR ELECTRONIC COMMUNICATION NETWORKS; PRODUCTION OF SOUND RECORDINGS; RECORDING OF SOUNDS; PROVIDING VOICE OVERS FOR TAPES, RECORDS AND OTHER RECORDED MEDIA FOR ENTERTAINMENT AND EDUCATION PURPOSES; CONSULTATION SERVICES IN THE FIELD OF MUSIC PUBLISHING SERVICES; PROVIDING AN ON-LINE WEBSITE FEATURING LIBRARIES OF MUSICAL COMPOSITION AND MUSIC SOUND RECORDINGS FOR ENTERTAINMENT PURPOSES; PROVIDING INFORMATION ON MUSICAL COMPOSITION AND MUSIC SOUND RECORDINGS VIA ELECTRONIC AND OTHER MEANS; ON-LINE LIBRARY SERVICES, NAMELY, PROVIDING ELECTRONIC LIBRARY SERVICES WHICH FEATURE MUSIC VIA AN ON-LINE COMPUTER NETWORK; MUSIC PUBLISHING SERVICES; ENTERTAINMENT SERVICES, NAMELY, PROVIDING NONDOWNLOADABLE PRERECORDED MUSIC, INFORMATION IN THE FIELD OF MUSIC, AND COMMENTARY AND ARTICLES ABOUT MUSIC, ALL ON-LINE VIA A GLOBAL COMPUTER NETWORK; PRODUCTION OF SOUND RECORDINGS FEATURING MUSIC; MULTIMEDIA ENTERTAINMENT SERVICES IN THE NATURE OF RECORDING, PRODUCTION, AND POSTPRODUCTION SERVICES IN THE FIELDS OF MUSIC, VIDEO AND FILMS, IN CLASS 41 (U.S. CLS. 100, 101 AND 107).



FIRST USE 7-19-2010; IN COMMERCE 7-19-2010.

NO CLAIM IS MADE TO THE EXCLUSIVE RIGHT TO USE "MUSIC", APART FROM THE MARK AS SHOWN.

THE MARK CONSISTS OF THE WORDING "VANACORE MUSIC". A HORIZONTAL SINGLE LINE SEPARATES "VANACORE" FROM "MUSIC". TO THE LEFT OF THE WORDING IS A DESIGN ELEMENT OF SOUND WAVES CONSISTING OF A SERIES OF CONCENTRIC ARCS AND CIRCLES.

David J. Kyros

Director of the United States Patent and Trademark Office

SER. NO. 85-300,415, FILED 4-20-2011.

Reg. No. 4,152,812 WENDY JUN, EXAMINING ATTORNEY

United States of America

United States Patent and Trademark Office



Reg. No. 4,152,813

Registered June 5, 2012

Int. Cl.: 9

TRADEMARK

PRINCIPAL REGISTER

VANACORE MUSIC PUBLISHING, LLC (CALIFORNIA LIMITED LIABILITY COMPANY)
SUITE 180
27734 AVENUE SCOTT
SANTA CLARITA, CA 91366

FOR: COMPUTER SOFTWARE FOR SEARCHING LIBRARIES OF MUSICAL COMPOSITIONS AND MUSIC SOUND RECORDINGS, AND FOR USE IN THE ADMINISTRATION AND MANAGEMENT OF MUSIC SOUND RECORDINGS AND MUSICAL COMPOSITIONS; DOWNLOADABLE MUSICAL COMPOSITIONS IN THE NATURE OF MUSICAL SOUND RECORDINGS; DOWNLOADABLE MUSIC CUES, NAMELY, SOUND RECORDINGS, VIA THE INTERNET, IN CLASS 9 (U.S. CLS. 21, 23, 26, 36 AND 38).

FIRST USE 7-19-2010; IN COMMERCE 7-19-2010.

NO CLAIM IS MADE TO THE EXCLUSIVE RIGHT TO USE "MUSIC LIBRARY", APART FROM THE MARK AS SHOWN.

THE MARK CONSISTS OF THE INTERLOCKING NUMBERS "2", "4" AND "7" ABOVE THE WORDS "MUSIC LIBRARY". TO THE LEFT OF THE NUMBERS ARE A SERIES OF CIRCLES STREAMING FROM THE NUMBERS; TO THE RIGHT OF THE NUMBERS ARE A SERIES OF ARCS. THE BLACK SPACE AROUND THE RECTANGLE IS NOT A PART OF THE MARK AND IS USED ONLY TO DENOTE A RECTANGLE WITH ROUNDED CORNERS.



SER. NO. 85-300,416, FILED 4-20-2011.

WENDY JUN, EXAMINING ATTORNEY

David J. Kybas

Director of the United States Patent and Trademark Office

United States of America

United States Patent and Trademark Office

CHRISTIANO BALDINUCCI

Reg. No. 4,152,814

Registered June 5, 2012

Int. Cl.: 25

TRADEMARK

PRINCIPAL REGISTER

LMSJ LIMITED (UNITED KINGDOM COMPANY)
CIRCLE LINE HOUSE, 8 EAST ROAD, HARLOW
ESSEX, UNITED KINGDOM CM202BJ

FOR: CLOTHING, NAMELY, PANTS, TROUSERS, SHIRTS, CARDIGANS, WAISTCOATS, JACKETS, COATS, BLAZERS, SUITS, SHORTS, SKIRTS; HEADGEAR, NAMELY, HATS AND CAPS; CLOTHING ACCESSORIES, NAMELY, BELTS, SCARVES, HEADSCARVES, NECKTIES, DRESS HANDKERCHIEFS, GLOVES; FOOTWEAR; SOCKS, STOCKINGS AND PANTYHOSE; FOOTWEAR, IN CLASS 25 (U.S. CLS. 22 AND 39).

THE MARK CONSISTS OF STANDARD CHARACTERS WITHOUT CLAIM TO ANY PARTICULAR FONT, STYLE, SIZE, OR COLOR.

PRIORITY CLAIMED UNDER SEC. 44(D) ON ERPN CMNTY TM OFC APPLICATION NO. 9905324, FILED 4-19-2011, REG. NO. 009905324, DATED 11-2-2011, EXPIRES 4-19-2021.

THE NAME "CHRISTIANO BALDINUCCI" DOES NOT IDENTIFY A LIVING INDIVIDUAL.

SER. NO. 85-300,417, FILED 4-20-2011.

WILLIAM ROSSMAN, EXAMINING ATTORNEY



David J. Kyros

Director of the United States Patent and Trademark Office

United States of America

United States Patent and Trademark Office

Texas Home-Land Realty "Let us help put your brand on Texas land"

Reg. No. 4,152,815

Registered June 5, 2012

Int. Cl.: 36

SERVICE MARK

PRINCIPAL REGISTER

TEXAS HOME-LAND REALTY (TEXAS CORPORATION)
855 SAN ANTONIO ST.
MASON, TX 76856

FOR: REAL ESTATE AGENCIES, IN CLASS 36 (U.S. CLS. 100, 101 AND 102).

FIRST USE 1-1-2008; IN COMMERCE 1-1-2010.

THE MARK CONSISTS OF STANDARD CHARACTERS WITHOUT CLAIM TO ANY PARTICULAR FONT, STYLE, SIZE, OR COLOR.

NO CLAIM IS MADE TO THE EXCLUSIVE RIGHT TO USE "TEXAS" AND "REALTY", APART FROM THE MARK AS SHOWN.

SER. NO. 85-300,555, FILED 4-20-2011.

EMILY CARLSEN, EXAMINING ATTORNEY



David J. Kybas

Director of the United States Patent and Trademark Office

United States of America

United States Patent and Trademark Office

Appnostic

Reg. No. 4,152,816

Registered June 5, 2012

Int. Cl.: 42

EPROJECTS GROUP LIMITED LIABILITY COMPANY (NEW JERSEY LIMITED LIABILITY COMPANY)
APARTMENT 306
1025 MAXWELL LANE
HOBOKEN, NJ 07030

SERVICE MARK

PRINCIPAL REGISTER

FOR: PLATFORM AS A SERVICE (PAAS) FEATURING COMPUTER SOFTWARE PLATFORMS FOR USE IN THE CREATION OF ADVERTISING, PROMOTIONAL AND BRAND AWARENESS CONTENT ON SOCIAL MEDIA WEBSITES AND FOR USE IN ENGAGING IN ELECTRONIC COMMERCE TRANSACTIONS AND VIRAL MARKETING CAMPAIGNS ON SOCIAL MEDIA NETWORKS AND ON MOBILE DEVICES, IN CLASS 42 (U.S. CLS. 100 AND 101).

FIRST USE 1-2-2010; IN COMMERCE 1-2-2010.

THE MARK CONSISTS OF STANDARD CHARACTERS WITHOUT CLAIM TO ANY PARTICULAR FONT, STYLE, SIZE, OR COLOR.

SER. NO. 85-300,855, FILED 4-21-2011.

JILL C. ALT, EXAMINING ATTORNEY



David J. Kyffers

Director of the United States Patent and Trademark Office

United States of America

United States Patent and Trademark Office

SACHIN + BABI

Reg. No. 4,152,817

Registered June 5, 2012

Int. Cl.: 25

TRADEMARK

PRINCIPAL REGISTER

ANKASA LTD (NEW YORK CORPORATION)
225 WEST 39TH STREET . 4TH FLOOR
NEW YORK, NY 10018

FOR: COATS; DRESS PANTS; DRESSES; DRESSES MADE FROM SKINS; DRESSING GOWNS; DRESSING GOWNS AND BATH ROBES; FUR COATS AND JACKETS; GLOVES FOR APPAREL; HATS; HOSIERY; JACKETS; JERSEYS; JUMPER DRESSES; KNIT DRESSES; LEATHER BELTS; LEATHER COATS; LINGERIE; MUFFLERS; SKIRTS AND DRESSES; TOPS; WEARABLE GARMENTS AND CLOTHING, NAMELY, SHIRTS; WEDDING DRESSES; WOMEN'S CLOTHING, NAMELY, SHIRTS, DRESSES, SKIRTS, BLOUSES; WOVEN DRESSES, IN CLASS 25 (U.S. CLS. 22 AND 39).

FIRST USE 1-15-2008; IN COMMERCE 3-20-2008.

THE MARK CONSISTS OF STANDARD CHARACTERS WITHOUT CLAIM TO ANY PARTICULAR FONT, STYLE, SIZE, OR COLOR.

SER. NO. 85-300,911, FILED 4-21-2011.

MARC LEIPZIG, EXAMINING ATTORNEY



David J. Kyffers

Director of the United States Patent and Trademark Office

United States of America

United States Patent and Trademark Office

SIMPLE. SMART.

Reg. No. 4,152,818

WOLFE ELECTRIC, INC. (KANSAS CORPORATION)
7761 WEST KELLOGG DR.
WICHITA, KS 67209

Registered June 5, 2012

Int. Cl.: 11

FOR: COMMERCIAL OVENS, NAMELY, FOOD CONVEYOR ADAPTED AND AIR IMPINGEMENT ADAPTED TUNNEL OVENS; AND COMMERCIAL OVEN HOODS, NAMELY, U CONFIGURED TUNNEL OVEN FOOD PORT COVERING OVEN HOODS, IN CLASS 11 (U.S. CLS. 13, 21, 23, 31 AND 34).

TRADEMARK

PRINCIPAL REGISTER

FIRST USE 12-4-2008; IN COMMERCE 12-4-2008.

THE MARK CONSISTS OF STANDARD CHARACTERS WITHOUT CLAIM TO ANY PARTICULAR FONT, STYLE, SIZE, OR COLOR.

NO CLAIM IS MADE TO THE EXCLUSIVE RIGHT TO USE "SMART", APART FROM THE MARK AS SHOWN.

SER. NO. 85-301,185, FILED 4-21-2011.

BRENDAN MCCAULEY, EXAMINING ATTORNEY



David J. Kyffers

Director of the United States Patent and Trademark Office

United States of America

United States Patent and Trademark Office

HYFLEX CM

Reg. No. 4,152,819

Registered June 5, 2012

Int. Cl.: 10

TRADEMARK

PRINCIPAL REGISTER

COLTENE/WHALEDENT, INC. (DELAWARE CORPORATION)
235 ASCOT PARKWAY
CUYAHOGA FALLS, OH 44223

FOR: DENTAL AND ENDODONTIC INSTRUMENTS, NAMELY PLUGGERS, SPREADERS AND FILES, FOR USE IN THE PRACTICE OF DENTISTRY, IN CLASS 10 (U.S. CLS. 26, 39 AND 44).

FIRST USE 11-30-2010; IN COMMERCE 11-30-2010.

THE MARK CONSISTS OF STANDARD CHARACTERS WITHOUT CLAIM TO ANY PARTICULAR FONT, STYLE, SIZE, OR COLOR.

OWNER OF U.S. REG. NO. 1,773,542.

NO CLAIM IS MADE TO THE EXCLUSIVE RIGHT TO USE "CM", APART FROM THE MARK AS SHOWN.

SER. NO. 85-301,457, FILED 4-21-2011.

SAIMA MAKHDOOM, EXAMINING ATTORNEY



David J. Kyffers

Director of the United States Patent and Trademark Office

United States of America

United States Patent and Trademark Office



Reg. No. 4,152,820

Registered June 5, 2012

Int. Cl.: 35

SERVICE MARK

PRINCIPAL REGISTER

LEE'S SANDWICHES INTERNATIONAL, INC. (CALIFORNIA CORPORATION)
660 E. GISH ROAD
SAN JOSE, CA 95112

FOR: WHOLESALE AND RETAIL STORE SERVICES FEATURING RESTAURANT SUPPLIES;
WHOLESALE FOOD DISTRIBUTORSHIP SERVICES, IN CLASS 35 (U.S. CLS. 100, 101 AND
102).

FIRST USE 12-4-2004; IN COMMERCE 12-4-2004.

OWNER OF U.S. REG. NOS. 3,004,157, 5,984,995 AND OTHERS.

THE MARK CONSISTS OF STYLIZED WORD "LEE'S SIGNATURE".

SER. NO. 85-301,603, FILED 4-21-2011.

DAVID H. STINE, EXAMINING ATTORNEY



David J. Kybas

Director of the United States Patent and Trademark Office

United States of America

United States Patent and Trademark Office

LUNDSTROM

Reg. No. 4,152,821

Registered June 5, 2012

Int. Cl.: 36

SERVICE MARK

PRINCIPAL REGISTER

LUNDSTROM INSURANCE AGENCY, INC. (ILLINOIS CORPORATION)
SUITE 200
2205 POINT BLVD
ELGIN, IL 60123

FOR: INSURANCE AGENCY AND INSURANCE BROKERAGE, NAMELY, REPRESENTING INSURANCE CARRIERS IN THE NATURE OF OFFERING PROTECTIONS INCLUDING BUSINESS INSURANCE, LIFE INSURANCE, HEALTH INSURANCE, GROUP HEALTH INSURANCE, GROUP BENEFITS INSURANCE, VEHICLE INSURANCE, HOMEOWNERS INSURANCE, CHURCH INSURANCE, VETERINARY INSURANCE, EQUINE INSURANCE AND OTHER SPECIALTY INSURANCES TO CUSTOMERS INCLUDING CORPORATIONS, BUSINESSES, INDIVIDUALS, FAMILIES AND OTHER ORGANIZED ENTITIES, IN CLASS 36 (U.S. CLS. 100, 101 AND 102).

FIRST USE 1-1-1957; IN COMMERCE 1-1-1957.

THE MARK CONSISTS OF STANDARD CHARACTERS WITHOUT CLAIM TO ANY PARTICULAR FONT, STYLE, SIZE, OR COLOR.

SEC. 2(F).

SER. NO. 85-301,615, FILED 4-21-2011.

KATHLEEN LORENZO, EXAMINING ATTORNEY



David J. Kyjars

Director of the United States Patent and Trademark Office

United States of America

United States Patent and Trademark Office

EARTH FRIENDS CONSERVATION FUND

Reg. No. 4,152,822

EARTH FRIENDS CONSERVATION FUND (D.C. NON-PROFIT CORPORATION)
P.O. BOX 11217
JACKSON, WY 83002

Registered June 5, 2012

Int. Cls.: 35 and 36

FOR: PROMOTING PUBLIC AWARENESS CONCERNING ENVIRONMENTAL CONSERVATION AND WILDLIFE PROTECTION, IN CLASS 35 (U.S. CLS. 100, 101 AND 102).

SERVICE MARK

FIRST USE 3-0-2010; IN COMMERCE 3-0-2010.

PRINCIPAL REGISTER

FOR: CHARITABLE FUNDRAISING AND MAKING GRANTS FOR CONSERVATION AND ENVIRONMENTAL PROTECTION, IN CLASS 36 (U.S. CLS. 100, 101 AND 102).

FIRST USE 3-0-2010; IN COMMERCE 3-0-2010.

THE MARK CONSISTS OF STANDARD CHARACTERS WITHOUT CLAIM TO ANY PARTICULAR FONT, STYLE, SIZE, OR COLOR.

OWNER OF U.S. REG. NO. 3,400,797.

NO CLAIM IS MADE TO THE EXCLUSIVE RIGHT TO USE "CONSERVATION FUND", APART FROM THE MARK AS SHOWN.

SER. NO. 85-301,717, FILED 4-21-2011.

ELIZABETH HUGHITT, EXAMINING ATTORNEY

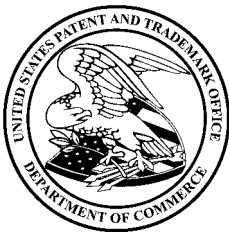

David J. Kyros

Director of the United States Patent and Trademark Office

United States of America

United States Patent and Trademark Office

CONSERVATION DESERVES MORE THAN 2%

Reg. No. 4,152,823

EARTH FRIENDS CONSERVATION FUND (D.C. NON-PROFIT CORPORATION)
P.O. BOX 11217
JACKSON, WY 83002

Registered June 5, 2012

Int. Cls.: 35 and 36

FOR: PROMOTING PUBLIC AWARENESS CONCERNING ENVIRONMENTAL CONSERVATION AND ENVIRONMENTAL PROTECTION, IN CLASS 35 (U.S. CLS. 100, 101 AND 102).

SERVICE MARK

FIRST USE 10-0-2009; IN COMMERCE 1-0-2010.

PRINCIPAL REGISTER

FOR: CHARITABLE FUNDRAISING AND MAKING GRANTS FOR CONSERVATION AND ENVIRONMENTAL PROTECTION, IN CLASS 36 (U.S. CLS. 100, 101 AND 102).

FIRST USE 10-0-2009; IN COMMERCE 1-0-2010.

THE MARK CONSISTS OF STANDARD CHARACTERS WITHOUT CLAIM TO ANY PARTICULAR FONT, STYLE, SIZE, OR COLOR.

SER. NO. 85-301,719, FILED 4-21-2011.

ELIZABETH HUGHITT, EXAMINING ATTORNEY



David J. Kyros

Director of the United States Patent and Trademark Office

United States of America

United States Patent and Trademark Office

ULTRALINE

Reg. No. 4,152,824

Registered June 5, 2012

Int. Cl.: 42

SERVICE MARK

PRINCIPAL REGISTER

ULTRALINE, LLC (TEXAS LIMITED LIABILITY COMPANY)
SUITE 610
40 NE LOOP 410
SAN ANTONIO, TX 78216

FOR: DESIGN, DEVELOPMENT AND IMPLEMENTATION OF SOFTWARE FOR USE IN CREATING AND MANAGING E-LEARNING ENVIRONMENTS AND COURSEWARE, IN CLASS 42 (U.S. CLS. 100 AND 101).

FIRST USE 7-15-2010; IN COMMERCE 7-15-2010.

THE MARK CONSISTS OF STANDARD CHARACTERS WITHOUT CLAIM TO ANY PARTICULAR FONT, STYLE, SIZE, OR COLOR.

SER. NO. 85-301,802, FILED 4-21-2011.

DORITT L. CARROLL, EXAMINING ATTORNEY



David J. Kybas

Director of the United States Patent and Trademark Office

United States of America

United States Patent and Trademark Office



Reg. No. 4,152,825

Registered June 5, 2012

Int. Cl.: 9

TRADEMARK

PRINCIPAL REGISTER

ANT PRECISION INDUSTRY CO., LTD (TAIWAN CORPORATION)
NO.2-9, LANE 195, YUNG FONG ROAD
TU-CHEN DISTRICT
NEW TAIPEI CITY, TAIWAN 236

FOR: ELECTRIC SWITCHES; ELECTRIC PLUGS; ELECTRIC SOCKETS; ELECTRICAL TERMINAL BLOCKS; ELECTRIC CONNECTORS; OPTICAL CONNECTORS; ELECTRICAL CONNECTING TERMINALS, NAMELY, ELECTRIC CONNECTIONS; COMPUTER BUS SLOTS; ELECTRICAL BUSES; COAXIAL CABLE/WIRE PLUGS; BATTERY CHARGERS; CIGARETTE LIGHTER PLUGS; MOBILE PHONE COMPONENTS, NAMELY, BATTERY CHARGER; TELEPHONE WIRE PLUGS; CABLE CONNECTORS; INSULATED ELECTRICAL COPPER WIRES/CABLES; INSULATED ELECTRICAL WIRES/CABLES; MOBILE PHONE COMPONENTS, NAMELY, ANTENNAS; INTERNET HUBS; ELECTRIC WIRES; ELECTRIC CABLES; COMPUTER HARDWARE, NAMELY, A KEYSTROKE LOGGER; MEMORY CARDS; COMPUTER OPERATING PROGRAM; COMPUTER NETWORK INTERFACE DEVICES, IN CLASS 9 (U.S. CLS. 21, 23, 26, 36 AND 38).

PRIORITY CLAIMED UNDER SEC. 44(D) ON TAIWAN APPLICATION NO. 099058933, FILED 11-25-2010, REG. NO. 01481520, DATED 11-1-2011, EXPIRES 10-31-2021.

THE MARK CONSISTS OF THE STYLIZED TERM "ANT" INSIDE A RECTANGLE BOX.

SER. NO. 85-302,063, FILED 4-22-2011.

KIMBERLY PERRY, EXAMINING ATTORNEY



David J. Kyros

Director of the United States Patent and Trademark Office

United States of America

United States Patent and Trademark Office

VTI

Reg. No. 4,152,826

Registered June 5, 2012

Int. Cl.: 9

TRADEMARK

PRINCIPAL REGISTER

VTI GAMES LLC (NEVADA LIMITED LIABILITY COMPANY)
3600 MT. VERNON
HOUSTON, TX 77006

FOR: COMPUTER GAME SOFTWARE, IN CLASS 9 (U.S. CLS. 21, 23, 26, 36 AND 38).

FIRST USE 4-19-2011; IN COMMERCE 4-19-2011.

THE MARK CONSISTS OF STANDARD CHARACTERS WITHOUT CLAIM TO ANY PARTICULAR FONT, STYLE, SIZE, OR COLOR.

SER. NO. 85-302,789, FILED 4-22-2011.

JORDAN BAKER, EXAMINING ATTORNEY



David J. Kybas

Director of the United States Patent and Trademark Office

United States of America

United States Patent and Trademark Office

VMG CREATIVE

Reg. No. 4,152,827

Registered June 5, 2012

Int. Cl.: 35

SERVICE MARK

PRINCIPAL REGISTER

VMG CREATIVE, LLC (NEW YORK LIMITED LIABILITY COMPANY)
APARTMENT 2M
160 WEST 16TH STREET
NEW YORK, NY 10011

FOR: MARKETING AND ADVERTISING SERVICES FOR THE RETAIL AND CONSUMER GOODS INDUSTRY, IN CLASS 35 (U.S. CLS. 100, 101 AND 102).

FIRST USE 1-1-2010; IN COMMERCE 1-1-2010.

THE MARK CONSISTS OF STANDARD CHARACTERS WITHOUT CLAIM TO ANY PARTICULAR FONT, STYLE, SIZE, OR COLOR.

NO CLAIM IS MADE TO THE EXCLUSIVE RIGHT TO USE "CREATIVE", APART FROM THE MARK AS SHOWN.

SER. NO. 85-303,241, FILED 4-25-2011.

ALICIA COLLINS, EXAMINING ATTORNEY



David J. Kybas

Director of the United States Patent and Trademark Office

United States of America

United States Patent and Trademark Office

TOPLINE MD

Reg. No. 4,152,828

FEMWELL GROUP HEALTH, INC. (FLORIDA CORPORATION)
3225 AVIATION AVENUE, #700
COCONUT GROVE, FL 33133

Registered June 5, 2012

Int. Cl.: 35

FOR: BUSINESS MANAGEMENT AND CONSULTING SERVICES DIRECTED TO THE PRIVATE MEDICAL INDUSTRY; BUSINESS MARKETING SERVICES; ACCOUNTING SERVICES; BILLING SERVICES, AND HUMAN RESOURCES CONSULTATION AND MANAGEMENT, IN CLASS 35 (U.S. CLS. 100, 101 AND 102).

SERVICE MARK

PRINCIPAL REGISTER

FIRST USE 3-31-2010; IN COMMERCE 3-31-2010.

THE MARK CONSISTS OF STANDARD CHARACTERS WITHOUT CLAIM TO ANY PARTICULAR FONT, STYLE, SIZE, OR COLOR.

NO CLAIM IS MADE TO THE EXCLUSIVE RIGHT TO USE "MD", APART FROM THE MARK AS SHOWN.

SER. NO. 85-303,442, FILED 4-25-2011.

DAVID C. REIHNER, EXAMINING ATTORNEY



David J. Kyros

Director of the United States Patent and Trademark Office

United States of America

United States Patent and Trademark Office

LAJULE

Designs 

Reg. No. 4,152,829

Registered June 5, 2012

Int. Cl.: 42

SERVICE MARK

PRINCIPAL REGISTER

WILDER, LASHANA (UNITED STATES INDIVIDUAL)
402 GLENMORE DRIVE
MONCKS CORNER, SC 29461

FOR: CUSTOM DESIGN OF WEARABLE WOMEN'S APPAREL BASED ON PERSONAL SELECTIONS MADE BY THE CUSTOMER, IN CLASS 42 (U.S. CLS. 100 AND 101).

FIRST USE 3-1-2010; IN COMMERCE 3-11-2010.

NO CLAIM IS MADE TO THE EXCLUSIVE RIGHT TO USE "DESIGNS", APART FROM THE MARK AS SHOWN.

THE MARK CONSISTS OF THE TEXT "LAJULE" IN ALL CAPITAL LETTERS AND "DESIGNS" IN CURSIVE WRITING. TO THE BOTTOM RIGHT OF THE OF THE LOGO (UNDER THE LAST 3 LETTERS IN "LAJULE" AND TO THE RIGHT OF "DESIGNS") IS A SPIRAL SHAPE ENDING WITH A HORIZONTAL LINE THAT UNDERLINES THE "U" IN "LAJULE". TO THE IMMEDIATE RIGHT OF THE SPIRAL DESIGN ARE FOUR FANNED OUT ELONGATED PETAL SHAPES THAT START UNDER THE "L" IN "LAJULE" AND END UNDER THE "E" IN "LAJULE".

SER. NO. 85-303,612, FILED 4-25-2011.

LAURIE MAYES, EXAMINING ATTORNEY



David J. Kyros

Director of the United States Patent and Trademark Office

United States of America

United States Patent and Trademark Office

BANKITIS

Reg. No. 4,152,830

Registered June 5, 2012

Int. Cl.: 36

SERVICE MARK

PRINCIPAL REGISTER

PUBLIC SERVICE CREDIT UNION (COLORADO CREDIT UNION)
7055 E EVANS AVE
DENVER, CO 80224

FOR: BANKING, IN CLASS 36 (U.S. CLS. 100, 101 AND 102).

FIRST USE 1-1-2011; IN COMMERCE 4-1-2011.

THE MARK CONSISTS OF STANDARD CHARACTERS WITHOUT CLAIM TO ANY PARTICULAR FONT, STYLE, SIZE, OR COLOR.

SER. NO. 85-303,896, FILED 4-25-2011.

KEVIN DINALLO, EXAMINING ATTORNEY



David J. Kyffers

Director of the United States Patent and Trademark Office

United States of America

United States Patent and Trademark Office

Bawdy Storytelling

Reg. No. 4,152,831

URBAN RACONTEUR INC. (CALIFORNIA CORPORATION), DBA BAWDY STORYTELLING
1751 LA SALLE AVENUE
SAN FRANCISCO, CA 94124

Registered June 5, 2012

Int. Cl.: 41

FOR: ENTERTAINMENT SERVICES, NAMELY, STORYTELLING, IN CLASS 41 (U.S. CLS. 100, 101 AND 107).

SERVICE MARK

FIRST USE 12-30-2006; IN COMMERCE 3-13-2011.

PRINCIPAL REGISTER

THE MARK CONSISTS OF STANDARD CHARACTERS WITHOUT CLAIM TO ANY PARTICULAR FONT, STYLE, SIZE, OR COLOR.

NO CLAIM IS MADE TO THE EXCLUSIVE RIGHT TO USE "STORYTELLING", APART FROM THE MARK AS SHOWN.

SER. NO. 85-304,134, FILED 4-25-2011.

SALLY SHIH, EXAMINING ATTORNEY



David J. Kybas

Director of the United States Patent and Trademark Office

United States of America

United States Patent and Trademark Office



Reg. No. 4,152,832

Registered June 5, 2012

Int. Cl.: 9

TRADEMARK

PRINCIPAL REGISTER

CIPEX INTERNATIONAL LIMITED (CALIFORNIA CORPORATION)
12662 CORRAL PLACE
SANTA FE SPRINGS, CA 90670

FOR: CASES FOR MUSIC, AUDIO AND RELATED ELECTRONIC EQUIPMENT, NAMELY, CASES FOR AUDIO TUNERS, AUDIO RECEIVERS, AMPLIFIERS, TAPE PLAYERS, COMPACT DISC PLAYERS, MP3 CONTROLLERS/PLAYERS, AUDIO MIXERS, AUDIO SPEAKERS IN THE NATURE OF MUSIC STUDIO MONITORS, MICROPHONES, AUDIO SPEAKERS, COMPACT DISCS, AUDIO TAPES, PORTABLE COMPUTERS, ANTENNAS, PHONOGRAPHIC RECORD PLAYERS, AUDIO RECORDING EQUIPMENT, AND THE CABLES ASSOCIATED WITH ALL OF THE FOREGOING EQUIPMENT, IN CLASS 9 (U.S. CLS. 21, 23, 26, 36 AND 38).

FIRST USE 3-0-2011; IN COMMERCE 3-0-2011.

OWNER OF U.S. REG. NO. 3,486,921.

THE MARK CONSISTS OF A CIRCULAR CARRIER CONTAINING AN OUTLINED STYLIZED BADGE WITH THE STYLIZED WORDING "ROAD READY VALUE RIGHT WWW.ROAD-READYCASES.COM" INSIDE. SHORT VERTICAL STRIPES APPEAR AT THE TOP OF THE BADGE.

SER. NO. 85-304,319, FILED 4-25-2011.

JAMES STEIN, EXAMINING ATTORNEY



David J. Kybas

Director of the United States Patent and Trademark Office

United States of America

United States Patent and Trademark Office

INSTALERT

Reg. No. 4,152,833

Registered June 5, 2012

Int. Cl.: 9

TRADEMARK

PRINCIPAL REGISTER

FLIR SYSTEMS, INC. (OREGON CORPORATION)
27700 SW PARKWAY AVENUE
WILSONVILLE, OR 97070

FOR: SENSORS SOLD AS AN INTEGRAL COMPONENT OF CAMERAS, SCOPES AND ELECTROMAGNETIC RADIATION DETECTORS, IN CLASS 9 (U.S. CLS. 21, 23, 26, 36 AND 38).

FIRST USE 12-0-2002; IN COMMERCE 12-0-2002.

THE MARK CONSISTS OF STANDARD CHARACTERS WITHOUT CLAIM TO ANY PARTICULAR FONT, STYLE, SIZE, OR COLOR.

SER. NO. 85-304,620, FILED 4-26-2011.

BARBARA BROWN, EXAMINING ATTORNEY



David J. Kyffers

Director of the United States Patent and Trademark Office

United States of America

United States Patent and Trademark Office

PKU COOLER

Reg. No. 4,152,834

Registered June 5, 2012

Int. Cl.: 5

TRADEMARK

PRINCIPAL REGISTER

SOCIÉTÉ DES PRODUITS NESTLÉ S.A. (SWITZERLAND SOCIÉTÉ ANONYME (SA))
CASE POSTALE 353
1800 VEVEY, SWITZERLAND

FOR: FOODS FOR INVALIDS AND INFANTS FOR MEDICAL PURPOSES, NAMELY, MEDICINAL FOOD SUPPLEMENTS FOR NUTRITIONAL PURPOSES; NUTRITIONAL SUPPLEMENTS FOR MEDICAL USE; DIETARY FOOD PREPARATIONS, NAMELY, DIETARY AND NUTRITIONALLY FORTIFIED FOOD PRODUCTS ADAPTED FOR MEDICAL USE; DIETARY FOOD SUPPLEMENTS FOR MEDICAL USE; DIETARY FOODS ADAPTED FOR MEDICAL USE, DIETARY SUBSTANCES, NAMELY, DIETARY DRINKS, DIETARY DRINK MIXES, AND DIETARY DRINK GELS FOR USE AS A MEAL REPLACEMENT FOR INFANTS AND INVALIDS; DIETETIC BEVERAGES ADAPTED FOR MEDICAL PURPOSES; MEDICATED SUPPLEMENTS FOR FORTIFYING FOODSTUFFS ADAPTED FOR MEDICAL PURPOSES FOR PERSONS WITH SPECIAL DIETARY REQUIREMENTS; HEALTH FOOD SUPPLEMENTS FOR PERSONS WITH SPECIAL DIETARY REQUIREMENTS; INVALIDS' FOODS, NAMELY, DIETETIC FOODS ADAPTED FOR MEDICAL PURPOSES FOR PERSONS WITH SPECIAL DIETARY REQUIREMENTS DUE TO A MEDICAL CONDITION; MEDICATED FOODSTUFFS, NAMELY, MEDICATED SUPPLEMENTS FOR FOODSTUFFS FOR PERSONS WITH SPECIAL DIETARY NEEDS DUE TO A MEDICAL CONDITION; MINERAL DIETARY SUPPLEMENTS FOR HUMANS; PROTEIN FOODS FOR DIETETIC PURPOSES, NAMELY, PROTEIN REDUCED FOOD FOR MEDICAL PURPOSES FOR PERSONS WITH A DISORDER OF THE DIGESTIVE SYSTEM; PROTEIN SUBSTITUTES, NAMELY, AMINO ACID BASED NUTRITIONAL SUPPLEMENTS IN POWER, LIQUID AND GEL FORM FOR MEDICAL USE FOR THE MANAGEMENT OF METABOLIC DISORDERS, INCLUDING, PHENYLKETONURIA; FORTIFYING COMPOSITIONS, NAMELY, DIETARY AND NUTRITIONALLY FORTIFIED FOOD PRODUCTS ADAPTED FOR MEDICAL USE FOR THE MANAGEMENT OF MALNUTRITION; ALL OF THE AFORESAID GOODS ARE FOR USE BY PATIENTS WITH METABOLIC DISORDERS, INCLUDING, PHENYLKETONURIA, IN CLASS 5 (U.S. CLS. 6, 18, 44, 46, 51 AND 52).



FIRST USE 8-31-2005; IN COMMERCE 8-31-2005.

THE MARK CONSISTS OF STANDARD CHARACTERS WITHOUT CLAIM TO ANY PARTICULAR FONT, STYLE, SIZE, OR COLOR.

NO CLAIM IS MADE TO THE EXCLUSIVE RIGHT TO USE "PKU", APART FROM THE MARK AS SHOWN.

David J. Kyros

Director of the United States Patent and Trademark Office

Reg. No. 4,152,834 SER. NO. 85-305,154, FILED 4-27-2011.

MARLENE BELL, EXAMINING ATTORNEY

United States of America

United States Patent and Trademark Office

Flock 12

Reg. No. 4,152,835

Registered June 5, 2012

Int. Cl.: 35

SERVICE MARK

PRINCIPAL REGISTER

FLOCK 12, INC (DELAWARE CORPORATION)
TROLLEY SQUARE, SUITE 20C, WILMINGTON
333 W TRADE ST
CHARLOTTE, NC 28202

FOR: RETAIL STORE SERVICES FEATURING CLOTHING AND ACCESSORIES, JEWELRY, COMPACT DISCS, BOOKS, HANDBAGS, AND WALLETS IN THE FIELD OF RELIGION , IN CLASS 35 (U.S. CLS. 100, 101 AND 102).

FIRST USE 4-25-2011; IN COMMERCE 4-25-2011.

THE MARK CONSISTS OF STANDARD CHARACTERS WITHOUT CLAIM TO ANY PARTICULAR FONT, STYLE, SIZE, OR COLOR.

SER. NO. 85-305,189, FILED 4-26-2011.

KARANENDRA S. CHHINA, EXAMINING ATTORNEY



David J. Kybas

Director of the United States Patent and Trademark Office

United States of America

United States Patent and Trademark Office

BEYOND

Reg. No. 4,152,836

Registered June 5, 2012

Int. Cl.: 20

TRADEMARK

PRINCIPAL REGISTER

EBERHARD VON HUENE & ASSOCIATES INC. (CANADA CORPORATION), AKA EVH & ASSOCIATES INC.
370 JOSEPH-CARTIER
VAUDREUIL, QUEBEC, CANADA J7V5V5

FOR: MOVABLE AND DEMOUNTABLE WALL PARTITIONS, IN CLASS 20 (U.S. CLS. 2, 13, 22, 25, 32 AND 50).

THE MARK CONSISTS OF STANDARD CHARACTERS WITHOUT CLAIM TO ANY PARTICULAR FONT, STYLE, SIZE, OR COLOR.

OWNER OF CANADA REG. NO. TMA793441, DATED 3-21-2011, EXPIRES 3-21-2026.

SER. NO. 85-305,311, FILED 4-26-2011.

MARK T. MULLEN, EXAMINING ATTORNEY



David J. Kybas

Director of the United States Patent and Trademark Office

United States of America

United States Patent and Trademark Office

YUMYUM WARRIOR

Reg. No. 4,152,837

YUMYUM WARRIOR, INC. (NORTH CAROLINA CORPORATION)
6804 GLENDOWER RD.
RALEIGH, NC 27613

Registered June 5, 2012

Int. Cl.: 43

FOR: CONSULTING SERVICES IN THE FIELD OF CULINARY ARTS, IN CLASS 43 (U.S. CLS. 100 AND 101).

SERVICE MARK

FIRST USE 3-0-2009; IN COMMERCE 3-0-2009.

PRINCIPAL REGISTER

THE MARK CONSISTS OF STANDARD CHARACTERS WITHOUT CLAIM TO ANY PARTICULAR FONT, STYLE, SIZE, OR COLOR.

OWNER OF U.S. REG. NO. 3,996,571.

SER. NO. 85-305,626, FILED 4-27-2011.

AMY HELLA, EXAMINING ATTORNEY



David J. Kybas

Director of the United States Patent and Trademark Office

United States of America

United States Patent and Trademark Office

SUNSOLUTIONS

Reg. No. 4,152,838

Registered June 5, 2012

Int. Cls.: 35, 36 and 41

SERVICE MARK

PRINCIPAL REGISTER

SUNDANCE REHABILITATION CORPORATION (CONNECTICUT CORPORATION)
101 SUN AVENUE, N.E.
ALBUQUERQUE, NM 87109

FOR: MARKET ANALYSIS, IN CLASS 35 (U.S. CLS. 100, 101 AND 102).

FIRST USE 5-11-2011; IN COMMERCE 6-20-2011.

FOR: PROVIDING COMPLIANCE CONSULTING SERVICES IN THE FIELD OF MEDICARE INSURANCE, IN CLASS 36 (U.S. CLS. 100, 101 AND 102).

FIRST USE 5-11-2011; IN COMMERCE 6-20-2011.

FOR: EDUCATIONAL SERVICES, NAMELY, PROVIDING SEMINARS, TELECONFERENCING CLASSES AND CLASSES TO LONG TERM CARE NURSING, ASSISTED LIVING CENTERS AND SUB ACUTE CARE PROVIDERS IN THE FIELD OF MEDICARE OPERATIONS, REVENUE AND RATE, IN CLASS 41 (U.S. CLS. 100, 101 AND 107).

FIRST USE 5-11-2011; IN COMMERCE 6-20-2011.

THE MARK CONSISTS OF STANDARD CHARACTERS WITHOUT CLAIM TO ANY PARTICULAR FONT, STYLE, SIZE, OR COLOR.

SER. NO. 85-305,989, FILED 4-27-2011.

ESTHER A. BORSUK, EXAMINING ATTORNEY



David J. Kyjars

Director of the United States Patent and Trademark Office

United States of America

United States Patent and Trademark Office

PLAN B ADULT CARE SOLUTIONS

Reg. No. 4,152,839

Registered June 5, 2012

Int. Cls.: 43 and 45

SERVICE MARK

PRINCIPAL REGISTER

PLAN B - ADULT CARE SOLUTIONS, LLC (FLORIDA LIMITED LIABILITY COMPANY),
DBA PLAN B - ADULT CARE SOLUTIONS
SUITE 204
12671 EMERALD COAST PKWY
DESTIN, FL 32550

FOR: ADULT DAY CARE SERVICES, IN CLASS 43 (U.S. CLS. 100 AND 101).

FIRST USE 9-27-2010; IN COMMERCE 9-27-2010.

FOR: COMPANION CARE SERVICES, NAMELY, PROVIDING PERSONAL SUPPORT
SERVICES FOR THE ELDERLY; ADULT SITTING SERVICES, IN CLASS 45 (U.S. CLS. 100
AND 101).

FIRST USE 9-27-2010; IN COMMERCE 9-27-2010.

THE MARK CONSISTS OF STANDARD CHARACTERS WITHOUT CLAIM TO ANY PAR-
TICULAR FONT, STYLE, SIZE, OR COLOR.

NO CLAIM IS MADE TO THE EXCLUSIVE RIGHT TO USE "ADULT CARE SOLUTIONS",
APART FROM THE MARK AS SHOWN.

SER. NO. 85-306,022, FILED 4-27-2011.

MELISSA VALLILLO, EXAMINING ATTORNEY



David J. Kybas

Director of the United States Patent and Trademark Office

United States of America

United States Patent and Trademark Office

my.ability

Reg. No. 4,152,840

Registered June 5, 2012

Int. Cls.: 38, 42 and 45

SERVICE MARK

PRINCIPAL REGISTER

INTRAPACE, INC. (DELAWARE CORPORATION)
967 N. SHORELINE BLVD.
MOUNTAIN VIEW, CA 94043

FOR: PROVIDING ONLINE CHAT ROOMS AND ELECTRONIC BULLETIN BOARDS FOR REGISTERED USERS FOR TRANSMISSION OF MESSAGES IN THE AREA OF WEIGHT LOSS, OBESITY, AND GENERAL INTEREST, VIRTUAL COMMUNITY, SOCIAL NETWORKING, PHOTO SHARING, AND TRANSMISSION OF PHOTOGRAPHIC IMAGES; PROVISION OF ON-LINE FORUMS FOR THE TRANSMISSION OF PHOTOGRAPHIC IMAGES; PROVISION OF ON-LINE FORUMS FOR COMMUNICATIONS ON TOPICS OF OBESITY, WEIGHT LOSS, AND GENERAL INTEREST; AUDIO, BROADCASTING SERVICES OVER COMPUTER OR OTHER COMMUNICATION NETWORKS; TEXT AND MESSAGE TRANSMISSION SERVICES; ELECTRONICALLY TRANSMITTING DATA, INFORMATION, AND PHOTOGRAPHIC IMAGES AMONG INTERNET USERS; TELECOMMUNICATION SERVICES, NAMELY, TRANSMISSION OF PODCASTS AND DIGITAL MUSIC, IN CLASS 38 (U.S. CLS. 100, 101 AND 104).

FIRST USE 8-17-2010; IN COMMERCE 8-17-2010.

FOR: COMPUTER SERVICES, NAMELY, CREATING ON-LINE VIRTUAL COMMUNITIES FOR REGISTERED USERS TO ORGANIZE GROUPS AND EVENTS, PARTICIPATE IN DISCUSSIONS, AND ENGAGE IN SOCIAL, BUSINESS AND COMMUNITY NETWORKING IN THE AREA OF WEIGHT LOSS AND OBESITY; COMPUTER SERVICES, NAMELY, APPLICATION SERVICE PROVIDER (ASP) FEATURING SOFTWARE TO ENABLE OR FACILITATE THE UPLOADING, DOWNLOADING, STREAMING, POSTING, DISPLAYING, BLOGGING, LINKING, SHARING OR OTHERWISE PROVIDING ELECTRONIC MEDIA OR INFORMATION OVER COMMUNICATION NETWORKS; PROVIDING A WEB SITE FEATURING TECHNOLOGY THAT ENABLES ONLINE USERS TO CREATE PERSONAL PROFILES FEATURING SOCIAL NETWORKING INFORMATION AND TO TRANSFER AND SHARE SUCH INFORMATION AMONG MULTIPLE WEBSITES; COMPUTER SERVICES, NAMELY, CREATING INDEXES OF INFORMATION, SITES AND OTHER RESOURCES AVAILABLE ON COMPUTER NETWORKS; PROVIDING TEMPORARY USE OF NON-DOWNLOADABLE SOFTWARE APPLICATIONS FOR CONDUCTING OR PARTICIPATING IN SOCIAL NETWORKING, CREATING A VIRTUAL COMMUNITY, AND TRANSMISSION OF AUDIO, PHOTOGRAPHIC IMAGES, TEXT, GRAPHICS AND DATA; COMPUTER SERVICES IN THE NATURE OF CUSTOMIZED WEB PAGES FEATURING USER-DEFINED OR SPECIFIED INFORMATION; PROVIDING A WEBSITE THAT GIVES USERS THE ABILITY



David J. Kappas

Director of the United States Patent and Trademark Office

Reg. No. 4,152,840 TO CREATE PERSONAL PROFILES, PHOTOGRAPHIC IMAGES, TEXT, GRAPHICS AND DATA; PEER-TO-BROWSER PHOTO SHARING SERVICES, NAMELY, PROVIDING A WEBSITE FEATURING TECHNOLOGY ENABLING USERS TO UPLOAD, VIEW, AND DOWNLOAD DIGITAL PHOTOS; PROVIDING A WEB SITE FEATURING TECHNOLOGY THAT ENABLES USERS TO UPLOAD AND SHARE PHOTOS, TEXT, GRAPHICS AND DATA; CREATING AND MAINTAINING BLOGS FOR OTHERS, IN CLASS 42 (U.S. CLS. 100 AND 101).

FIRST USE 8-17-2010; IN COMMERCE 8-17-2010.

FOR: INTERNET BASED SOCIAL NETWORKING SERVICES IN THE AREA OF WEIGHT LOSS AND OBESITY; PROVIDING ON-LINE SEARCHABLE DATABASES IN THE FIELD OF SOCIAL NETWORKING; PROVIDING SOCIAL SERVICES AND INFORMATION IN THE FIELD OF PERSONAL DEVELOPMENT, NAMELY, SELF-IMPROVEMENT, SELF-FULFILLMENT, PUBLIC AND COMMUNITY SERVICES; IDENTIFICATION VERIFICATION SERVICES, NAMELY, PROVIDING AUTHENTICATION OF PERSONAL IDENTIFICATION INFORMATION, IN CLASS 45 (U.S. CLS. 100 AND 101).

FIRST USE 8-17-2010; IN COMMERCE 8-17-2010.

THE MARK CONSISTS OF STANDARD CHARACTERS WITHOUT CLAIM TO ANY PARTICULAR FONT, STYLE, SIZE, OR COLOR.

SER. NO. 85-306,062, FILED 4-27-2011.

ZACHARY BELLO, EXAMINING ATTORNEY

United States of America

United States Patent and Trademark Office



Reg. No. 4,152,841

Registered June 5, 2012

Int. Cls.: 35 and 42

SERVICE MARK

PRINCIPAL REGISTER

TAKE 5 SOLUTIONS, LLC (DELAWARE LIMITED LIABILITY COMPANY)
6853 SW 18TH STREET
BOCA RATON, FL 33433

FOR: DIRECT MARKETING SERVICES AND MULTI-CHANNEL MARKETING, NAMELY, DIRECT MAIL, TELEMARKETING, PROVIDING A DATABASE OF ELECTRONIC MAIL ADDRESSES FOR MARKETING PURPOSES, MARKETING BY MOBILE TELEPHONE CONNECTIONS, DATABASE COMPILATION AND MARKETING THE ON-LINE DATABASES AND OF OTHERS, SYSTEMIZATION OF INFORMATION INTO COMPUTER DATABASES, CONDUCTING MARKET SURVEYS, IN CLASS 35 (U.S. CLS. 100, 101 AND 102).

FIRST USE 9-13-2003; IN COMMERCE 9-13-2003.

FOR: CONVERSION OF COUPONS, PRINT ADVERTISING AND MARKETING MATERIALS TO DIGITAL FORMAT, IN CLASS 42 (U.S. CLS. 100 AND 101).

FIRST USE 9-13-2003; IN COMMERCE 9-13-2003.

NO CLAIM IS MADE TO THE EXCLUSIVE RIGHT TO USE "SOLUTIONS", APART FROM THE MARK AS SHOWN.

THE MARK CONSISTS OF THE LARGE STYLIZED TERM "TAKE 5" APPEARING ABOVE THE SMALLER TERM "SOLUTIONS" TO THE RIGHT OF A LARGE SHADED CIRCLE WITH FIVE EQUIDISTANT ARROWS EMANATING FROM THE OPEN CENTER OF THE CIRCLE AND ENDING AT THE OUTSIDE EDGE OF THE CIRCLE.

SER. NO. 85-306,127, FILED 4-27-2011.

ANTHONY RINKER, EXAMINING ATTORNEY



David J. Kybas

Director of the United States Patent and Trademark Office

United States of America

United States Patent and Trademark Office

Million Dollar Employee

Reg. No. 4,152,842

Registered June 5, 2012

Int. Cls.: 35 and 36

SERVICE MARK

PRINCIPAL REGISTER

G&A OUTSOURCING, INC. (TEXAS CORPORATION), DBA G&A PARTNERS
4801 WOODWAY, SUITE 210W
HOUSTON, TX 77056

FOR: ADMINISTRATION OF BUSINESS PAYROLL FOR OTHERS; HUMAN RESOURCES CONSULTANCY; OUTSOURCING IN THE FIELD OF HUMAN RESOURCES, BENEFITS ADMINISTRATION, RISK AND SAFETY, PAYROLL, FINANCE AND ACCOUNTING OUTSOURCING, AND BUSINESS PROCESS OUTSOURCING; PAYROLL ADMINISTRATION AND MANAGEMENT SERVICES; PROFESSIONAL BUSINESS CONSULTING; PROFESSIONAL EMPLOYER ORGANIZATION SERVICES IN THE NATURE OF EMPLOYEE LEASING; PROFESSIONAL STAFFING AND RECRUITING SERVICES, IN CLASS 35 (U.S. CLS. 100, 101 AND 102).

FIRST USE 1-1-2008; IN COMMERCE 1-1-2008.

FOR: ADMINISTRATION OF EMPLOYEE BENEFIT PLANS CONCERNING INSURANCE AND FINANCE, IN CLASS 36 (U.S. CLS. 100, 101 AND 102).

FIRST USE 1-1-2008; IN COMMERCE 1-1-2008.

THE MARK CONSISTS OF STANDARD CHARACTERS WITHOUT CLAIM TO ANY PARTICULAR FONT, STYLE, SIZE, OR COLOR.

NO CLAIM IS MADE TO THE EXCLUSIVE RIGHT TO USE "EMPLOYEE", APART FROM THE MARK AS SHOWN.

SER. NO. 85-306,187, FILED 4-27-2011.

RON FAIRBANKS, EXAMINING ATTORNEY



David J. Kybas

Director of the United States Patent and Trademark Office

United States of America

United States Patent and Trademark Office

PKU EXPRESS

Reg. No. 4,152,843

Registered June 5, 2012

Int. Cl.: 5

TRADEMARK

PRINCIPAL REGISTER

SOCIÉTÉ DES PRODUITS NESTLÉ S.A. (SWITZERLAND SOCIÉTÉ ANONYME (SA))
CASE POSTALE 353
1800 VEVEY, SWITZERLAND

FOR: FOODS FOR INVALIDS AND INFANTS FOR MEDICAL PURPOSES, NAMELY, MEDICINAL FOOD SUPPLEMENTS FOR NUTRITIONAL PURPOSES; NUTRITIONAL SUPPLEMENTS FOR MEDICAL USE; DIETARY FOOD PREPARATIONS, NAMELY, DIETARY AND NUTRITIONALLY FORTIFIED FOOD PRODUCTS ADAPTED FOR MEDICAL USE; DIETARY FOOD SUPPLEMENTS FOR MEDICAL USE; DIETARY FOODS ADAPTED FOR MEDICAL USE, DIETARY SUBSTANCES, NAMELY, DIETARY DRINKS, DIETARY DRINK MIXES, AND DIETARY DRINK GELS FOR USE AS A MEAL REPLACEMENT FOR INFANTS AND INVALIDS; DIETETIC BEVERAGES ADAPTED FOR MEDICAL PURPOSES; MEDICATED SUPPLEMENTS FOR FORTIFYING FOODSTUFFS ADAPTED FOR MEDICAL PURPOSES FOR PERSONS WITH SPECIAL DIETARY REQUIREMENTS; HEALTH FOOD SUPPLEMENTS FOR PERSONS WITH SPECIAL DIETARY REQUIREMENTS; INVALIDS' FOODS, NAMELY, DIETETIC FOODS ADAPTED FOR MEDICAL PURPOSES FOR PERSONS WITH SPECIAL DIETARY REQUIREMENTS DUE TO A MEDICAL CONDITION; MEDICATED FOODSTUFFS, NAMELY, MEDICATED SUPPLEMENTS FOR FOODSTUFFS FOR PERSONS WITH SPECIAL DIETARY NEEDS DUE TO A MEDICAL CONDITION; MINERAL DIETARY SUPPLEMENTS FOR HUMANS; PROTEIN FOODS FOR DIETETIC PURPOSES, NAMELY, PROTEIN REDUCED FOOD FOR MEDICAL PURPOSES FOR PERSONS WITH A DISORDER OF THE DIGESTIVE SYSTEM; PROTEIN SUBSTITUTES, NAMELY, AMINO ACID BASED NUTRITIONAL SUPPLEMENTS IN POWER, LIQUID AND GEL FORM FOR MEDICAL USE FOR THE MANAGEMENT OF METABOLIC DISORDERS, INCLUDING, PHENYLKETONURIA; FORTIFYING COMPOSITIONS, NAMELY, DIETARY AND NUTRITIONALLY FORTIFIED FOOD PRODUCTS ADAPTED FOR MEDICAL USE FOR THE MANAGEMENT OF MALNUTRITION; ALL OF THE AFORESAID GOODS ARE FOR USE BY PATIENTS WITH METABOLIC DISORDERS, INCLUDING, PHENYLKETONURIA, IN CLASS 5 (U.S. CLS. 6, 18, 44, 46, 51 AND 52).

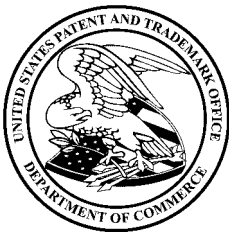

FIRST USE 1-31-2004; IN COMMERCE 1-31-2004.

THE MARK CONSISTS OF STANDARD CHARACTERS WITHOUT CLAIM TO ANY PARTICULAR FONT, STYLE, SIZE, OR COLOR.

NO CLAIM IS MADE TO THE EXCLUSIVE RIGHT TO USE "PKU", APART FROM THE MARK AS SHOWN.

David J. Kybas

Director of the United States Patent and Trademark Office

Reg. No. 4,152,843 SER. NO. 85-306,254, FILED 4-27-2011.

MARLENE BELL, EXAMINING ATTORNEY

United States of America

United States Patent and Trademark Office

MSUD COOLER

Reg. No. 4,152,844

Registered June 5, 2012

Int. Cl.: 5

TRADEMARK

PRINCIPAL REGISTER

SOCIÉTÉ DES PRODUITS NESTLÉ S.A. (SWITZERLAND SOCIÉTÉ ANONYME (SA))
CASE POSTALE 353
1800 VEVEY, SWITZERLAND

FOR: FOODS FOR INVALIDS AND INFANTS FOR MEDICAL PURPOSES, NAMELY, MEDICINAL FOOD SUPPLEMENTS FOR NUTRITIONAL PURPOSES; NUTRITIONAL SUPPLEMENTS FOR MEDICAL USE; DIETARY FOOD PREPARATIONS, NAMELY, DIETARY AND NUTRITIONALLY FORTIFIED FOOD PRODUCTS ADAPTED FOR MEDICAL USE; DIETARY FOOD SUPPLEMENTS FOR MEDICAL USE; DIETARY FOODS ADAPTED FOR MEDICAL USE, DIETARY SUBSTANCES, NAMELY, DIETARY DRINKS, DIETARY DRINK MIXES, AND DIETARY DRINK GELS FOR USE AS A MEAL REPLACEMENT FOR INFANTS AND INVALIDS; DIETETIC BEVERAGES ADAPTED FOR MEDICAL PURPOSES; MEDICATED SUPPLEMENTS FOR FORTIFYING FOODSTUFFS ADAPTED FOR MEDICAL PURPOSES FOR PERSONS WITH SPECIAL DIETARY REQUIREMENTS; HEALTH FOOD SUPPLEMENTS FOR PERSONS WITH SPECIAL DIETARY REQUIREMENTS; INVALIDS' FOODS, NAMELY, DIETETIC FOODS ADAPTED FOR MEDICAL PURPOSES FOR PERSONS WITH SPECIAL DIETARY REQUIREMENTS DUE TO A MEDICAL CONDITION; MEDICATED FOODSTUFFS, NAMELY, MEDICATED SUPPLEMENTS FOR FOODSTUFFS FOR PERSONS WITH SPECIAL DIETARY NEEDS DUE TO A MEDICAL CONDITION; MINERAL DIETARY SUPPLEMENTS FOR HUMANS; PROTEIN FOODS FOR DIETETIC PURPOSES, NAMELY, PROTEIN REDUCED FOOD FOR MEDICAL PURPOSES FOR PERSONS WITH A DISORDER OF THE DIGESTIVE SYSTEM; PROTEIN SUBSTITUTES, NAMELY, AMINO ACID BASED NUTRITIONAL SUPPLEMENTS IN POWER, LIQUID AND GEL FORM FOR MEDICAL USE FOR THE MANAGEMENT OF METABOLIC DISORDERS, INCLUDING, MAPLE SYRUP URINE DISEASE; FORTIFYING COMPOSITIONS, NAMELY, DIETARY AND NUTRITIONALLY FORTIFIED FOOD PRODUCTS ADAPTED FOR MEDICAL USE FOR THE MANAGEMENT OF MALNUTRITION; ALL OF THE AFORESAID GOODS ARE FOR USE BY PATIENTS WITH METABOLIC DISORDERS, INCLUDING, MAPLE SYRUP URINE DISEASE, IN CLASS 5 (U.S. CLS. 6, 18, 44, 46, 51 AND 52).



FIRST USE 6-30-2006; IN COMMERCE 6-30-2006.

THE MARK CONSISTS OF STANDARD CHARACTERS WITHOUT CLAIM TO ANY PARTICULAR FONT, STYLE, SIZE, OR COLOR.

NO CLAIM IS MADE TO THE EXCLUSIVE RIGHT TO USE "MSUD", APART FROM THE MARK AS SHOWN.

David J. Kyros

Director of the United States Patent and Trademark Office

Reg. No. 4,152,844 SER. NO. 85-306,271, FILED 4-27-2011.

MARLENE BELL, EXAMINING ATTORNEY

United States of America

United States Patent and Trademark Office

MSUD EXPRESS

Reg. No. 4,152,845

Registered June 5, 2012

Int. Cl.: 5

TRADEMARK

PRINCIPAL REGISTER

SOCIÉTÉ DES PRODUITS NESTLÉ S.A. (SWITZERLAND SOCIÉTÉ ANONYME (SA))
CASE POSTALE 353
1800 VEVEY, SWITZERLAND

FOR: FOODS FOR INVALIDS AND INFANTS FOR MEDICAL PURPOSES, NAMELY, MEDICINAL FOOD SUPPLEMENTS FOR NUTRITIONAL PURPOSES; NUTRITIONAL SUPPLEMENTS FOR MEDICAL USE; DIETARY FOOD PREPARATIONS, NAMELY, DIETARY AND NUTRITIONALLY FORTIFIED FOOD PRODUCTS ADAPTED FOR MEDICAL USE; DIETARY FOOD SUPPLEMENTS FOR MEDICAL USE; DIETARY FOODS ADAPTED FOR MEDICAL USE, DIETARY SUBSTANCES, NAMELY, DIETARY DRINKS, DIETARY DRINK MIXES, AND DIETARY DRINK GELS FOR USE AS A MEAL REPLACEMENT FOR INFANTS AND INVALIDS; DIETETIC BEVERAGES ADAPTED FOR MEDICAL PURPOSES; MEDICATED SUPPLEMENTS FOR FORTIFYING FOODSTUFFS ADAPTED FOR MEDICAL PURPOSES FOR PERSONS WITH SPECIAL DIETARY REQUIREMENTS; HEALTH FOOD SUPPLEMENTS FOR PERSONS WITH SPECIAL DIETARY REQUIREMENTS; INVALIDS' FOODS, NAMELY, DIETETIC FOODS ADAPTED FOR MEDICAL PURPOSES FOR PERSONS WITH SPECIAL DIETARY REQUIREMENTS DUE TO A MEDICAL CONDITION; MEDICATED FOODSTUFFS, NAMELY, MEDICATED SUPPLEMENTS FOR FOODSTUFFS FOR PERSONS WITH SPECIAL DIETARY NEEDS DUE TO A MEDICAL CONDITION; MINERAL DIETARY SUPPLEMENTS FOR HUMANS; PROTEIN FOODS FOR DIETETIC PURPOSES, NAMELY, PROTEIN REDUCED FOOD FOR MEDICAL PURPOSES FOR PERSONS WITH A DISORDER OF THE DIGESTIVE SYSTEM; PROTEIN SUBSTITUTES, NAMELY, AMINO ACID BASED NUTRITIONAL SUPPLEMENTS IN POWER, LIQUID AND GEL FORM FOR MEDICAL USE FOR THE MANAGEMENT OF METABOLIC DISORDERS, INCLUDING, MAPLE SYRUP URINE DISEASE; FORTIFYING COMPOSITIONS, NAMELY, DIETARY AND NUTRITIONALLY FORTIFIED FOOD PRODUCTS ADAPTED FOR MEDICAL USE FOR THE MANAGEMENT OF MALNUTRITION; ALL OF THE AFORESAID GOODS ARE FOR USE BY PATIENTS WITH METABOLIC DISORDERS, INCLUDING, MAPLE SYRUP URINE DISEASE, IN CLASS 5 (U.S. CLS. 6, 18, 44, 46, 51 AND 52).



FIRST USE 12-31-2003; IN COMMERCE 12-31-2003.

THE MARK CONSISTS OF STANDARD CHARACTERS WITHOUT CLAIM TO ANY PARTICULAR FONT, STYLE, SIZE, OR COLOR.

NO CLAIM IS MADE TO THE EXCLUSIVE RIGHT TO USE "MSUD", APART FROM THE MARK AS SHOWN.

David J. Kyros

Director of the United States Patent and Trademark Office

Reg. No. 4,152,845 SER. NO. 85-306,284, FILED 4-27-2011.

MARLENE BELL, EXAMINING ATTORNEY

United States of America

United States Patent and Trademark Office

Aqua Latch

Reg. No. 4,152,846

Registered June 5, 2012

Int. Cl.: 9

TRADEMARK

PRINCIPAL REGISTER

BOROWSKI, JASON (UNITED STATES INDIVIDUAL)
27801 WASHINGTON ST
BONITA SPRINGS, FL 34135

FOR: ELECTRONICS, NAMELY, WIRELESS WATER DETECTION SENSORS, RECEIVERS, AUTO DIALERS, REPEATERS, AND UNIVERSAL RECEIVERS, IN CLASS 9 (U.S. CLS. 21, 23, 26, 36 AND 38).

FIRST USE 12-7-2000; IN COMMERCE 2-12-2002.

THE MARK CONSISTS OF STANDARD CHARACTERS WITHOUT CLAIM TO ANY PARTICULAR FONT, STYLE, SIZE, OR COLOR.

NO CLAIM IS MADE TO THE EXCLUSIVE RIGHT TO USE "AQUA", APART FROM THE MARK AS SHOWN.

SER. NO. 85-306,477, FILED 4-27-2011.

PAM WILLIS, EXAMINING ATTORNEY



David J. Kyffers

Director of the United States Patent and Trademark Office

United States of America

United States Patent and Trademark Office

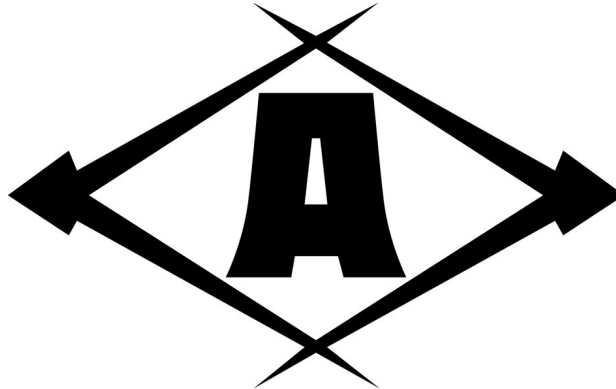

Reg. No. 4,152,847

Registered June 5, 2012

Int. Cls.: 7 and 12

TRADEMARK

PRINCIPAL REGISTER

ATSUMI CAR EQUIPMENT, INC. (VIRGINIA CORPORATION)
3045 PEPPERS FERRY ROAD
WYTHEVILLE, VA 24382

FOR: COMPONENT PARTS FOR LAND VEHICLE ENGINES, NAMELY, STARTER SHAFTS, AND VARIABLE VALVE TIMING PARTS IN THE NATURE OF OIL AND SPRING PRESSURE COMPONENTS WHICH ADVANCE OR RETARD THE CAM SHAFT, IN CLASS 7 (U.S. CLS. 13, 19, 21, 23, 31, 34 AND 35).

FIRST USE 4-15-2011; IN COMMERCE 4-15-2011.

FOR: COMPONENTS FOR LAND VEHICLES, NAMELY, WHEEL HUB OUTER RINGS AND SPINDLES, IN CLASS 12 (U.S. CLS. 19, 21, 23, 31, 35 AND 44).

FIRST USE 5-30-2001; IN COMMERCE 5-30-2001.

THE MARK CONSISTS OF THE LETTER "A" WITHIN A RHOMBUS WHOSE TOP AND BOTTOM CORNERS ARE FORMED BY INTERSECTING LINES THAT TAPER TO A POINT EXTENDED BEYOND THE RHOMBUS AND WHOSE LEFT AND RIGHT CORNERS ARE EACH CAPPED BY TRIANGLES.

SER. NO. 85-306,651, FILED 4-27-2011.

COURTNEY ALVAREZ, EXAMINING ATTORNEY



David J. Kyffers

Director of the United States Patent and Trademark Office

United States of America

United States Patent and Trademark Office

DAVINCI BIOSCIENCES

Reg. No. 4,152,848

Registered June 5, 2012

Int. Cl.: 42

SERVICE MARK

PRINCIPAL REGISTER

DAVINCI BIOSCIENCES LLC (CALIFORNIA LIMITED LIABILITY COMPANY)
1239 VICTORIA STREET
COSTA MESA, CA 92627

FOR: BIOPHARMACEUTICAL DEVELOPMENT, RESEARCH AND EVALUATION SERVICES OF STEM CELL-BASED THERAPEUTICS FOR THE TREATMENT OF DISEASE, INJURIES AND DISORDERS , IN CLASS 42 (U.S. CLS. 100 AND 101).

FIRST USE 12-19-2007; IN COMMERCE 12-19-2007.

THE MARK CONSISTS OF STANDARD CHARACTERS WITHOUT CLAIM TO ANY PARTICULAR FONT, STYLE, SIZE, OR COLOR.

NO CLAIM IS MADE TO THE EXCLUSIVE RIGHT TO USE "BIOSCIENCES", APART FROM THE MARK AS SHOWN.

SER. NO. 85-306,858, FILED 4-28-2011.

DOMINICK J. SALEMI, EXAMINING ATTORNEY



David J. Kybas

Director of the United States Patent and Trademark Office

United States of America

United States Patent and Trademark Office

PARK2GETHER

Reg. No. 4,152,849

Registered June 5, 2012

Int. Cls.: 38 and 39

SERVICE MARK

PRINCIPAL REGISTER

DAIMLER AG (FED REP GERMANY CORPORATION)
MERCEDSTRASSE 137
STUTTGART, FED REP GERMANY 70327

FOR: TELECOMMUNICATION SERVICES, NAMELY, PROVIDING ONLINE FACILITIES FOR INTERACTION WITH OTHER COMPUTER USERS, WHICH ENABLE AN AUTOMOBILE DRIVER WHO NEEDS A PARKING SPACE IN A PARTICULAR AREA TO FIND AN OWNER OF AN APPROPRIATE AVAILABLE PARKING SPACE, AND TO PURCHASE THAT PARKING SPACE FOR A SET AMOUNT OF TIME, IN CLASS 38 (U.S. CLS. 100, 101 AND 104).

FOR: PARKING PLACE SERVICES, NAMELY, RENTAL OF PARKING SPACES, PARKING SPACE RESERVATION SERVICES, AND PROVIDING REAL-TIME INFORMATION CONCERNING VEHICLE PARKING SPACE AVAILABILITY; SERVICES RELATING TO THE CONTROL AND ADMINISTRATION OF PARKING SYSTEMS, NAMELY, TRAFFIC INFORMATION SERVICES, PARTICULARLY THROUGH THE USE OF COMPUTER-SUPPORTED COMMUNICATION SYSTEMS, IN CLASS 39 (U.S. CLS. 100 AND 105).

THE MARK CONSISTS OF STANDARD CHARACTERS WITHOUT CLAIM TO ANY PARTICULAR FONT, STYLE, SIZE, OR COLOR.

PRIORITY CLAIMED UNDER SEC. 44(D) ON FED REP GERMANY APPLICATION NO. 302010064588, FILED 11-8-2010, REG. NO. 302010064588, DATED 2-3-2011, EXPIRES 11-30-2020.

SER. NO. 85-307,155, FILED 4-28-2011.

CARRIE GENOVESE, EXAMINING ATTORNEY



David J. Kybas

Director of the United States Patent and Trademark Office

United States of America

United States Patent and Trademark Office

MARLBORO SKYLINE

Reg. No. 4,152,850

PHILIP MORRIS USA INC. (VIRGINIA CORPORATION)
6601 WEST BROAD STREET
RICHMOND, VA 23230

Registered June 5, 2012

Int. Cl.: 34

FOR: TOBACCO PRODUCTS, NAMELY, CIGARETTES, IN CLASS 34 (U.S. CLS. 2, 8, 9 AND 17).

TRADEMARK

FIRST USE 10-6-2010; IN COMMERCE 10-6-2010.

PRINCIPAL REGISTER

THE MARK CONSISTS OF STANDARD CHARACTERS WITHOUT CLAIM TO ANY PARTICULAR FONT, STYLE, SIZE, OR COLOR.

OWNER OF U.S. REG. NOS. 68,502, 1,709,481, AND 4,002,642.

SER. NO. 85-307,244, FILED 4-28-2011.

EDWARD NELSON, EXAMINING ATTORNEY



David J. Kybas

Director of the United States Patent and Trademark Office

United States of America
United States Patent and Trademark Office

VIASOUND

Reg. No. 4,152,851

PAUL HADJUK (UNITED STATES INDIVIDUAL), DBA VIASOUND
P.O. BOX 30204

Registered June 5, 2012

MIDDLEBURG HEIGHTS, OH 44130

Int. Cl.: 35

FOR: RETAIL STORE FEATURING ELECTRONIC PRODUCTS, NAMELY, RESIDENTIAL AND COMMERCIAL SECURITY SYSTEMS, THEATER, AUDIO/VISUAL ENTERTAINMENT AND AUTOMATION SYSTEMS, IN CLASS 35 (U.S. CLS. 100, 101 AND 102).

SERVICE MARK

FIRST USE 9-18-1997; IN COMMERCE 9-18-1997.

PRINCIPAL REGISTER

THE MARK CONSISTS OF STANDARD CHARACTERS WITHOUT CLAIM TO ANY PARTICULAR FONT, STYLE, SIZE, OR COLOR.

SER. NO. 85-307,307, FILED 4-28-2011.

RON FAIRBANKS, EXAMINING ATTORNEY



David J. Kyros

Director of the United States Patent and Trademark Office

United States of America

United States Patent and Trademark Office

Tru)))Hearing

Reg. No. 4,152,852

Registered June 5, 2012

Int. Cl.: 10

TRADEMARK

PRINCIPAL REGISTER

TRUHEARING, INC. (UTAH CORPORATION)
9071 SOUTH 1300 WEST
WEST JORDAN, UT 84088

FOR: HEARING AIDS, IN CLASS 10 (U.S. CLS. 26, 39 AND 44).

FIRST USE 2-1-2004; IN COMMERCE 2-1-2004.

OWNER OF U.S. REG. NOS. 2,961,127 AND 2,973,590.

NO CLAIM IS MADE TO THE EXCLUSIVE RIGHT TO USE "HEARING", APART FROM THE MARK AS SHOWN.

THE MARK CONSISTS OF THE WORD "TRU" WITH THREE RIGHT PARENTHESIS, EACH LARGER THAN THE PREVIOUS, AND THE WORD "HEARING" AT THE END.

SER. NO. 85-307,752, FILED 4-28-2011.

KATHERINE CONNOLLY, EXAMINING ATTORNEY



David J. Kyffers

Director of the United States Patent and Trademark Office

United States of America

United States Patent and Trademark Office

GREEN SHIELD SERVICES

Reg. No. 4,152,853

THERMO FLUIDS INC. (DELAWARE CORPORATION)
4301 W. JEFFERSON STREET
PHOENIX, AZ 85043

Registered June 5, 2012

Int. Cls.: 39 and 40

FOR: PICK-UP AND TRANSPORT OF USED MINERAL-BASED OILS, HARD AND SOFT HYDROCARBON FILTERS, ABSORBENTS, ANTIFREEZE, OIL/WATER SEPARATORS, SAND-TRAPS, OILY MANUFACTURING WATER AND SOLVENTS FOR RECYCLING, IN CLASS 39 (U.S. CLS. 100 AND 105).

SERVICE MARK

PRINCIPAL REGISTER

FIRST USE 6-0-2008; IN COMMERCE 6-0-2008.

FOR: RECYCLING SERVICES, NAMELY, PROCESSING OF USED MINERAL-BASED OILS, HARD AND SOFT HYDROCARBON FILTERS, ABSORBENTS, ANTIFREEZE, OIL/WATER SEPARATORS, SAND-TRAPS, OILY MANUFACTURING WATER AND SOLVENTS; PROVIDING ENVIRONMENTAL ABATEMENT SERVICES, NAMELY, INDUSTRIAL TOXIC WASTE DISPOSAL, IN CLASS 40 (U.S. CLS. 100, 103 AND 106).

FIRST USE 6-0-2008; IN COMMERCE 6-0-2008.

THE MARK CONSISTS OF STANDARD CHARACTERS WITHOUT CLAIM TO ANY PARTICULAR FONT, STYLE, SIZE, OR COLOR.

OWNER OF U.S. REG. NO. 3,750,421.

NO CLAIM IS MADE TO THE EXCLUSIVE RIGHT TO USE "GREEN" AND "SERVICES", APART FROM THE MARK AS SHOWN.

SER. NO. 85-307,778, FILED 4-28-2011.

LESLIE RICHARDS, EXAMINING ATTORNEY



David J. Kybas

Director of the United States Patent and Trademark Office

United States of America

United States Patent and Trademark Office

BRIGHTLINE

Reg. No. 4,152,854

Registered June 5, 2012

Int. Cl.: 42

SERVICE MARK

PRINCIPAL REGISTER

BRIGHTLINE CPAS AND ASSOCIATES, INC. (FLORIDA CORPORATION)
1300 N. WEST SHORE BOULEVARD, SUITE 240
TAMPA, FL 33607

FOR: TESTING, ANALYSIS, AND EVALUATION OF COMPUTER SECURITY FOR COMPLIANCE WITH THE PAYMENT CARD INDUSTRY DATA SECURITY STANDARDS (PCI DSS); TESTING, ANALYSIS, AND EVALUATION OF THE SERVICES AND MANAGEMENT SYSTEMS OF OTHERS FOR THE PURPOSE OF CERTIFICATION, IN CLASS 42 (U.S. CLS. 100 AND 101).

FIRST USE 1-0-2011; IN COMMERCE 1-0-2011.

THE MARK CONSISTS OF STANDARD CHARACTERS WITHOUT CLAIM TO ANY PARTICULAR FONT, STYLE, SIZE, OR COLOR.

SER. NO. 85-307,986, FILED 4-29-2011.

JAMES STEIN, EXAMINING ATTORNEY



David J. Kyffers

Director of the United States Patent and Trademark Office

United States of America

United States Patent and Trademark Office

PA155

Reg. No. 4,152,855

Registered June 5, 2012

Int. Cl.: 9

TRADEMARK

PRINCIPAL REGISTER

COMMUNICATION DEVICES, INC. (NEW JERSEY CORPORATION)
85 FULTON STREET
BOONTON, NJ 07005

FOR: APPARATUS FOR TRANSMISSION OF COMMUNICATION, IN CLASS 9 (U.S. CLS. 21, 23, 26, 36 AND 38).

FIRST USE 1-1-2011; IN COMMERCE 1-1-2011.

THE MARK CONSISTS OF STANDARD CHARACTERS WITHOUT CLAIM TO ANY PARTICULAR FONT, STYLE, SIZE, OR COLOR.

SER. NO. 85-308,010, FILED 4-29-2011.

FRANK LATTUCA, EXAMINING ATTORNEY



David J. Kybas

Director of the United States Patent and Trademark Office

United States of America

United States Patent and Trademark Office

PA199

Reg. No. 4,152,856

Registered June 5, 2012

Int. Cl.: 9

TRADEMARK

PRINCIPAL REGISTER

COMMUNICATION DEVICES, INC. (NEW JERSEY CORPORATION)
85 FULTON STREET
BOONTON, NJ 07005

FOR: APPARATUS FOR TRANSMISSION OF COMMUNICATION, IN CLASS 9 (U.S. CLS. 21, 23, 26, 36 AND 38).

FIRST USE 1-1-2011; IN COMMERCE 1-1-2011.

THE MARK CONSISTS OF STANDARD CHARACTERS WITHOUT CLAIM TO ANY PARTICULAR FONT, STYLE, SIZE, OR COLOR.

SER. NO. 85-308,017, FILED 4-29-2011.

FRANK LATTUCA, EXAMINING ATTORNEY



David J. Kybas

Director of the United States Patent and Trademark Office

United States of America

United States Patent and Trademark Office

SMARTSTRIPS

Reg. No. 4,152,857

Registered June 5, 2012

Int. Cl.: 5

TRADEMARK

PRINCIPAL REGISTER

VELOX PRODUCTS, LLC (FLORIDA LIMITED LIABILITY COMPANY)
SUITE 1350
2900 GLADES CIRCLE
WESTON, FL 33327

FOR: DIETARY AND NUTRITIONAL SUPPLEMENTS, IN CLASS 5 (U.S. CLS. 6, 18, 44, 46, 51 AND 52).

FIRST USE 11-24-2011; IN COMMERCE 11-24-2011.

THE MARK CONSISTS OF STANDARD CHARACTERS WITHOUT CLAIM TO ANY PARTICULAR FONT, STYLE, SIZE, OR COLOR.

SER. NO. 85-308,166, FILED 4-29-2011.

CAROLINE WOOD, EXAMINING ATTORNEY



David J. Kyros

Director of the United States Patent and Trademark Office

United States of America

United States Patent and Trademark Office



Reg. No. 4,152,858

Registered June 5, 2012

Int. Cl.: 42

SERVICE MARK

PRINCIPAL REGISTER

USABLENET INC. (DELAWARE CORPORATION)
28 WEST 23RD STREET, 6TH FLOOR
NEW YORK, NY 10010

FOR: PROVIDING CONSULTING SERVICES IN THE FIELD OF WEBSITE OPTIMIZATION, DESIGN, FUNCTIONALITY AND OPERABILITY, NAMELY, IMPROVING THE OPERABILITY, USABILITY, EFFICIENCY AND EASE OF USE OF WEBSITES; PROVIDING TECHNOLOGY CONSULTING SERVICES IN THE FIELD OF ADAPTING CONTENT, FEATURES AND FUNCTIONALITY OF WEBSITES, WEB SERVICES AND APPLICATIONS OF OTHERS IN ORDER TO MAKE THEM ACCESSIBLE VIA MOBILE DEVICES AND APPLICATIONS, ASSISTIVE TECHNOLOGY DEVICES AND PLATFORMS, MULTIMEDIA DEVICES, KIOSKS, ELECTRONIC WRITING TABLETS AND SOCIAL MEDIA PLATFORMS AND WEBSITES; TECHNOLOGY PLATFORM PROVIDER, APPLICATION SERVICE PROVIDER (ASP), PROVIDER OF SAAS (SOFTWARE-AS-A-SERVICE) SERVICES, AND CLOUD COMPUTING SERVICES, IN EACH CASE FEATURING SOFTWARE FOR USE IN IMPLEMENTING AND DISPLAYING CONTENT, FEATURES AND FUNCTIONALITY OF WEBSITES, WEB SERVICES AND APPLICATIONS OF OTHERS VIA MOBILE DEVICES AND APPLICATIONS, ASSISTIVE TECHNOLOGY DEVICES AND PLATFORMS, MULTIMEDIA DEVICES, KIOSKS, ELECTRONIC WRITING TABLETS AND SOCIAL MEDIA PLATFORMS AND WEBSITES, AND FEATURING SOFTWARE FOR ADAPTING CONTENT, FEATURES AND FUNCTIONALITY OF WEBSITES, WEB SERVICES AND APPLICATIONS OF OTHERS IN ORDER TO MAKE THEM ACCESSIBLE VIA MOBILE DEVICES AND APPLICATIONS, ASSISTIVE TECHNOLOGY DEVICES AND PLATFORMS, MULTIMEDIA DEVICES, KIOSKS, ELECTRONIC WRITING TABLETS AND SOCIAL MEDIA PLATFORMS AND WEBSITES, AND FEATURING SOFTWARE FOR INTEGRATING WEBSITES, WEB SERVICES AND APPLICATIONS OF OTHERS WITH SOCIAL MEDIA PLATFORMS AND WEBSITES, AND FOR OPTIMIZING WEBSITE ACCESSIBILITY AND NAVIGATION VIA MOBILE DEVICES AND APPLICATIONS, ASSISTIVE TECHNOLOGY DEVICES AND PLATFORMS, MULTIMEDIA DEVICES, KIOSKS, ELECTRONIC WRITING TABLETS AND SOCIAL MEDIA PLATFORMS AND WEBSITES; WEBSITE AND WEB SERVICES DEVELOPMENT FOR OTHERS, NAMELY, DEVELOPMENT OF WEBSITES, AND DEVELOPMENT OF WEB SERVICES IN THE NATURE OF IMPLEMENTING WEB AND DATABASE APPLICATIONS, THAT ARE ACCESSIBLE VIA MOBILE DEVICES AND APPLICATIONS, ASSISTIVE TECHNOLOGY DEVICES AND PLATFORMS, MULTIMEDIA DEVICES, KIOSKS, ELECTRONIC WRITING TABLETS AND SOCIAL MEDIA PLATFORMS AND WEBSITES, IN CLASS 42 (U.S. CLS. 100 AND 101).



David J. Kappas

Director of the United States Patent and Trademark Office

FIRST USE 1-0-2011; IN COMMERCE 1-0-2011.

Reg. No. 4,152,858 THE MARK CONSISTS OF THE LETTER "U" ON TOP OF THREE OVERLAPPING TRI-
ANGLES.

SER. NO. 85-308,243, FILED 4-29-2011.

DEZMONA MIZELLE, EXAMINING ATTORNEY

United States of America

United States Patent and Trademark Office

HIGHLAND PRIVATE WEALTH MANAGEMENT

Reg. No. 4,152,859

Registered June 5, 2012

Int. Cl.: 36

SERVICE MARK

PRINCIPAL REGISTER

HIGHLAND PRIVATE WEALTH MANAGEMENT, LLC (WASHINGTON LIMITED LIABILITY COMPANY)
305 108TH AVE NE STE 102
BELLEVUE, WA 98004

FOR: FINANCIAL ASSET MANAGEMENT; FINANCIAL CONSULTING; FINANCIAL PLANNING; INVESTMENT ADVICE, IN CLASS 36 (U.S. CLS. 100, 101 AND 102).

FIRST USE 4-1-2011; IN COMMERCE 4-1-2011.

THE MARK CONSISTS OF STANDARD CHARACTERS WITHOUT CLAIM TO ANY PARTICULAR FONT, STYLE, SIZE, OR COLOR.

NO CLAIM IS MADE TO THE EXCLUSIVE RIGHT TO USE "PRIVATE WEALTH MANAGEMENT", APART FROM THE MARK AS SHOWN.

SER. NO. 85-308,836, FILED 4-29-2011.

GINA HAYES, EXAMINING ATTORNEY



David J. Kybas

Director of the United States Patent and Trademark Office

United States of America

United States Patent and Trademark Office



THE
Cedalius
GROUP

Reg. No. 4,152,860

Registered June 5, 2012

Int. Cls.: 35 and 45

SERVICE MARK

PRINCIPAL REGISTER

CEDALION ENTERPRISES LLC (GEORGIA LIMITED LIABILITY COMPANY)
759 GARDENSIDE CIRCLE
MARIETTA, GA 30067

FOR: BUSINESS SERVICES, NAMELY, REGISTERING, SCREENING, CREDENTIALING, AND ORGANIZING THIRD-PARTY VENDORS, SUPPLIERS, AND CONTRACTORS, AND DOCUMENTATION AND INFORMATION ON BEHALF OF OTHERS; EMPLOYMENT SERVICES, NAMELY, PROVIDING A WEB SITE WITH ONLINE VIDEO, AUDIO AND TEXTUAL INTERVIEWING APPLICATIONS TO SUPPORT RECRUITING, ADMISSIONS, AND GENERAL CANDIDATE SCREENING PROCESSES; MANAGEMENT OF ADVERTISING THROUGH A COMMAND AND CONTROL CENTER FOR BOTH MOVIE THEATRE ON-SCREEN ADVERTISING AND OVER THE INTERNET, IN CLASS 35 (U.S. CLS. 100, 101 AND 102).

FIRST USE 3-1-2011; IN COMMERCE 3-1-2011.

FOR: BACKGROUND INVESTIGATION AND RESEARCH SERVICES; BACKGROUND INVESTIGATION SERVICES; DRUG, ALCOHOL AND DNA SCREENING FOR SECURITY AND EMPLOYMENT PURPOSES; EMPLOYMENT BACKGROUND SCREENING, NAMELY, BACKGROUND SCREENING OF CURRENT EMPLOYEES OF OTHERS; PERSONAL BACKGROUND INVESTIGATIONS; PRE-EMPLOYMENT BACKGROUND INVESTIGATION SERVICES; PRE-EMPLOYMENT BACKGROUND SCREENING; PROVIDING AN INTERACTIVE WEB SITE THAT FACILITATES THE VERIFICATION OF A PERSON'S BACKGROUND CREDENTIALS, IN CLASS 45 (U.S. CLS. 100 AND 101).

FIRST USE 3-1-2011; IN COMMERCE 3-1-2011.

NO CLAIM IS MADE TO THE EXCLUSIVE RIGHT TO USE "GROUP", APART FROM THE MARK AS SHOWN.

SER. NO. 85-309,309, FILED 5-1-2011.

KIMBERLY FRYE, EXAMINING ATTORNEY

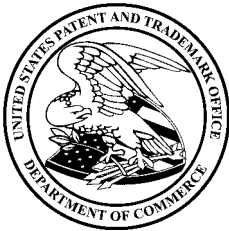

David J. Kyffers

Director of the United States Patent and Trademark Office

United States of America

United States Patent and Trademark Office



Reg. No. 4,152,861

Registered June 5, 2012

Int. Cls.: 16 and 41

TRADEMARK

SERVICE MARK

PRINCIPAL REGISTER

BRADLEY COMMUNICATIONS GROUP, INC. (NEW YORK CORPORATION), DBA BOYER COMMUNICATIONS GROUP
23 EAST 128TH STREET SUITE 4-F
NEW YORK, NY 10035

FOR: PRINTED TRAINING MATERIALS IN THE FIELD OF EDUCATIONAL SEMINARS IN BUSINESS WRITING SKILLS AND PRESENTATION SKILLS, IN CLASS 16 (U.S. CLS. 2, 5, 22, 23, 29, 37, 38 AND 50).

FIRST USE 1-31-2011; IN COMMERCE 1-31-2011.

FOR: EDUCATIONAL SERVICES, NAMELY, CONDUCTING SEMINARS AND WORKSHOPS IN THE FIELDS OF BUSINESS WRITING SKILLS AND PUBLIC PRESENTATION SKILLS AND DISTRIBUTION OF TRAINING MATERIALS IN CONNECTION THEREWITH, IN CLASS 41 (U.S. CLS. 100, 101 AND 107).

FIRST USE 1-31-2011; IN COMMERCE 1-31-2011.

NO CLAIM IS MADE TO THE EXCLUSIVE RIGHT TO USE "COMMUNICATIONS GROUP", APART FROM THE MARK AS SHOWN.

THE COLOR(S) BLUE IS/ARE CLAIMED AS A FEATURE OF THE MARK.

THE MARK CONSISTS OF LEADING BLUE BULLET POINTS IN DECREASING SIZE TO "BOYER" TERM AND UNDERSCORED TOGETHER WITH TERM "COMMUNICATIONS GROUP" AND "MAXIMUM IMPACT/MINIMUM PREP" IN BLUE. THE COLOR BLACK REPRESENT BACKGROUND, OUTLINING, SHADING AND/OR TRANSPARENT AREAS AND ARE NOT PART OF THE MARK.

SER. NO. 85-310,205, FILED 5-2-2011.

PRISCILLA MILTON, EXAMINING ATTORNEY



David J. Kyjars

Director of the United States Patent and Trademark Office

United States of America

United States Patent and Trademark Office

SELECT MEDIA SERVICES

Reg. No. 4,152,862

Registered June 5, 2012

Int. Cls.: 35 and 39

SERVICE MARK

PRINCIPAL REGISTER

SELECT MEDIA SERVICES, LLC (DELAWARE LIMITED LIABILITY COMPANY)
1955 LAKE PARK DRIVE
SMYRNA, GA 30080

FOR: PROMOTIONAL MARKETING SERVICES FOR RETAILERS IN THE FIELD OF PUBLICATIONS IN THE NATURE OF CREATING AND MANAGING CUSTOMIZED PUBLICATION PROGRAMS FOR RETAILERS, NAMELY, ASSISTING RETAILERS IN SELECTING PUBLICATIONS AND DESIGN AND SET UP OF PUBLICATIONS DISPLAYS IN ORDER TO MAXIMIZE SALES OF PUBLICATIONS, IN CLASS 35 (U.S. CLS. 100, 101 AND 102).

FIRST USE 12-31-1998; IN COMMERCE 12-31-1998.

FOR: DISTRIBUTION SERVICES, NAMELY, DELIVERY OF MAGAZINES, PERIODICALS AND BOOKS, IN CLASS 39 (U.S. CLS. 100 AND 105).

FIRST USE 12-31-1998; IN COMMERCE 12-31-1998.

THE MARK CONSISTS OF STANDARD CHARACTERS WITHOUT CLAIM TO ANY PARTICULAR FONT, STYLE, SIZE, OR COLOR.

NO CLAIM IS MADE TO THE EXCLUSIVE RIGHT TO USE "MEDIA SERVICES", APART FROM THE MARK AS SHOWN.

SER. NO. 85-310,280, FILED 5-2-2011.

KRISTINA MORRIS, EXAMINING ATTORNEY



David J. Kybas

Director of the United States Patent and Trademark Office

United States of America

United States Patent and Trademark Office

Peace is my intention

Reg. No. 4,152,863

Registered June 5, 2012

Int. Cl.: 25

TRADEMARK

PRINCIPAL REGISTER

RIDDEL, HOLLY M. (UNITED STATES INDIVIDUAL)
#162
311 N. ROBERTSON
BEVERLY HILLS, CA 90211

FOR: WEARABLE GARMENTS AND CLOTHING, NAMELY, SHIRTS, IN CLASS 25 (U.S. CLS. 22 AND 39).

FIRST USE 3-19-2006; IN COMMERCE 3-19-2006.

THE MARK CONSISTS OF STANDARD CHARACTERS WITHOUT CLAIM TO ANY PARTICULAR FONT, STYLE, SIZE, OR COLOR.

SER. NO. 85-310,380, FILED 5-2-2011.

ANTHONY RINKER, EXAMINING ATTORNEY



David J. Kybas

Director of the United States Patent and Trademark Office

United States of America

United States Patent and Trademark Office

LIFE TREASURE COLLECTOR

Reg. No. 4,152,864

MARIA FOTIADOU (GREECE INDIVIDUAL)

Registered June 5, 2012

P.O. BOX 50013
54013 THESSALONIKI, GREECE

Int. Cl.: 45

FOR: PERSONAL AND SOCIAL EMPOWERMENT INFORMATION PROVIDED BY OTHERS TO MEET INDIVIDUAL NEEDS, IN CLASS 45 (U.S. CLS. 100 AND 101).

SERVICE MARK

FIRST USE 4-1-2011; IN COMMERCE 4-1-2011.

PRINCIPAL REGISTER

THE MARK CONSISTS OF STANDARD CHARACTERS WITHOUT CLAIM TO ANY PARTICULAR FONT, STYLE, SIZE, OR COLOR.

SER. NO. 85-310,436, FILED 5-2-2011.

LAURA HAMMEL, EXAMINING ATTORNEY



David J. Kyros

Director of the United States Patent and Trademark Office

United States of America

United States Patent and Trademark Office

COMPAKSTAR

Reg. No. 4,152,865

SANOFI (FRANCE SOCIETE ANONYME)
54 RUE LA BOÉTIE
PARIS, FRANCE 75008

Registered June 5, 2012

Int. Cl.: 10

FOR: INSULIN INJECTION PENS SOLD EMPTY, IN CLASS 10 (U.S. CLS. 26, 39 AND 44).

TRADEMARK

THE MARK CONSISTS OF STANDARD CHARACTERS WITHOUT CLAIM TO ANY PARTICULAR FONT, STYLE, SIZE, OR COLOR.

PRINCIPAL REGISTER

PRIORITY CLAIMED UNDER SEC. 44(D) ON FRANCE APPLICATION NO. 10/3793557, FILED 12-27-2010, REG. NO. 3793557, DATED 12-27-2010, EXPIRES 12-27-2020.

OWNER OF U.S. REG. NOS. 3,787,454, 3,869,355 AND OTHERS.

SER. NO. 85-310,678, FILED 5-3-2011.

SHAILA SETTLES, EXAMINING ATTORNEY



David J. Kyffers

Director of the United States Patent and Trademark Office

United States of America

United States Patent and Trademark Office

INTROSTAR

Reg. No. 4,152,866

SANOFI (FRANCE SOCIETE ANONYME)
54 RUE LA BOÉTIE
PARIS, FRANCE 75008

Registered June 5, 2012

Int. Cl.: 10

FOR: INSULIN INJECTION PENS SOLD EMPTY, IN CLASS 10 (U.S. CLS. 26, 39 AND 44).

TRADEMARK

THE MARK CONSISTS OF STANDARD CHARACTERS WITHOUT CLAIM TO ANY PARTICULAR FONT, STYLE, SIZE, OR COLOR.

PRINCIPAL REGISTER

PRIORITY CLAIMED UNDER SEC. 44(D) ON FRANCE APPLICATION NO. 10/3793555, FILED 12-27-2010, REG. NO. 3793555, DATED 12-27-2010, EXPIRES 12-27-2020.

OWNER OF U.S. REG. NOS. 3,787,454, 3,869,355 AND OTHERS.

SER. NO. 85-310,702, FILED 5-3-2011.

SHAILA SETTLES, EXAMINING ATTORNEY



David J. Kybas

Director of the United States Patent and Trademark Office

United States of America

United States Patent and Trademark Office

TREASURED FOR GENERATIONS

Reg. No. 4,152,867

Registered June 5, 2012

Int. Cl.: 35

HARDWOOD FEDERATION (D.C. UNINCORPORATED ASSOCIATION), DBA AMERICAN
HARDWOODS
SUITE 800
1111 19TH STREET NW
WASHINGTON, DC 20036

SERVICE MARK

PRINCIPAL REGISTER

FOR: INDUSTRY ASSOCIATION SERVICES, NAMELY, PROMOTING THE INTERESTS OF BUILDERS AND REMODELERS WHO SUPPLY AMERICAN HARDWOOD MATERIALS; PROMOTING THE INTEREST OF RETAILERS AND MANUFACTURERS OF HOME FLOORING, CABINETS, FURNITURE AND MILLWORK MADE FROM AMERICAN HARDWOODS, IN CLASS 35 (U.S. CLS. 100, 101 AND 102).

FIRST USE 3-3-2011; IN COMMERCE 3-3-2011.

THE MARK CONSISTS OF STANDARD CHARACTERS WITHOUT CLAIM TO ANY PARTICULAR FONT, STYLE, SIZE, OR COLOR.

SER. NO. 85-310,847, FILED 5-3-2011.

BRENDAN MCCAULEY, EXAMINING ATTORNEY



David J. Kybas

Director of the United States Patent and Trademark Office

United States of America

United States Patent and Trademark Office

EDIS

Reg. No. 4,152,868

Registered June 5, 2012

Int. Cl.: 37

SERVICE MARK

PRINCIPAL REGISTER

EDIS COMPANY, INC. (DELAWARE CORPORATION)
110 SOUTH POPLAR ST., SUITE 400
WILMINGTON, DE 19801

FOR: CONSTRUCTION MANAGEMENT SERVICES; GENERAL CONSTRUCTION CONTRACTING; FACILITY MANAGEMENT SERVICES, NAMELY, BUILDING CONSTRUCTION, MAINTENANCE, AND REPAIR OF BUILDINGS; PRE-ENGINEERED BUILDING CONSTRUCTION SERVICES; BUILDING CONSTRUCTION CONSULTING IN THE FIELD OF SUSTAINABLE CONSTRUCTION IN CONNECTION WITH BUILDING; HOME INTERIOR CONSTRUCTION SERVICES, IN CLASS 37 (U.S. CLS. 100, 103 AND 106).

FIRST USE 0-0-1979; IN COMMERCE 0-0-1979.

THE MARK CONSISTS OF STANDARD CHARACTERS WITHOUT CLAIM TO ANY PARTICULAR FONT, STYLE, SIZE, OR COLOR.

SER. NO. 85-311,410, FILED 5-3-2011.

NAAKWAMA ANKRAH, EXAMINING ATTORNEY



David J. Kyffers

Director of the United States Patent and Trademark Office

United States of America

United States Patent and Trademark Office



Reg. No. 4,152,869

Registered June 5, 2012

Int. Cl.: 37

SERVICE MARK

PRINCIPAL REGISTER

EDIS COMPANY, INC. (DELAWARE CORPORATION)
110 SOUTH POPLAR ST., SUITE 400
WILMINGTON, DE 19801

FOR: CONSTRUCTION MANAGEMENT SERVICES; GENERAL CONSTRUCTION CONTRACTING; FACILITY MANAGEMENT SERVICES, NAMELY, BUILDING CONSTRUCTION, MAINTENANCE, AND REPAIR OF BUILDINGS; PRE-ENGINEERED BUILDING CONSTRUCTION SERVICES; BUILDING CONSTRUCTION CONSULTING IN THE FIELD OF SUSTAINABLE CONSTRUCTION IN CONNECTION WITH BUILDING; HOME INTERIOR CONSTRUCTION SERVICES, IN CLASS 37 (U.S. CLS. 100, 103 AND 106).

FIRST USE 0-0-2007; IN COMMERCE 0-0-2007.

NO CLAIM IS MADE TO THE EXCLUSIVE RIGHT TO USE "SINCE 1908", APART FROM THE MARK AS SHOWN.

THE MARK CONSISTS OF THE MARK "EDIS SINCE 1908" IN A BOX.

SER. NO. 85-311,417, FILED 5-3-2011.

NAAKWAMA ANKRAH, EXAMINING ATTORNEY



David J. Kyffers

Director of the United States Patent and Trademark Office

United States of America

United States Patent and Trademark Office

S SERIES

Reg. No. 4,152,870

SONOSITE, INC. (WASHINGTON CORPORATION)
21919 30TH DRIVE SE
BOTHELL, WA 98021

Registered June 5, 2012

Int. Cl.: 10

FOR: MEDICAL ULTRASOUND APPARATUS; ULTRASOUND DIAGNOSTIC APPARATUS,
IN CLASS 10 (U.S. CLS. 26, 39 AND 44).

TRADEMARK

FIRST USE 12-14-2007; IN COMMERCE 12-14-2007.

PRINCIPAL REGISTER

THE MARK CONSISTS OF STANDARD CHARACTERS WITHOUT CLAIM TO ANY PAR-
TICULAR FONT, STYLE, SIZE, OR COLOR.

NO CLAIM IS MADE TO THE EXCLUSIVE RIGHT TO USE "SERIES", APART FROM THE
MARK AS SHOWN.

SER. NO. 85-311,541, FILED 5-3-2011.

KEVIN CORWIN, EXAMINING ATTORNEY



David J. Kybas

Director of the United States Patent and Trademark Office

United States of America

United States Patent and Trademark Office

Kam & Kam

Reg. No. 4,152,871

GOLDEN TRIM SPORTS, INC. (CALIFORNIA CORPORATION)
401 E. 11TH STREET, #108
LOS ANGELES, CA 90015

Registered June 5, 2012

Int. Cl.: 25

FOR: WOMEN'S APPAREL, NAMELY, LEGGINGS, BLOUSES, PANTS, SWEATERS, JACKETS, UNDERWEAR, SPORTS BRAS, SOCKS, DRESSES, SKIRTS, IN CLASS 25 (U.S. CLS. 22 AND 39).

TRADEMARK

FIRST USE 7-1-2010; IN COMMERCE 7-1-2010.

PRINCIPAL REGISTER

THE MARK CONSISTS OF STANDARD CHARACTERS WITHOUT CLAIM TO ANY PARTICULAR FONT, STYLE, SIZE, OR COLOR.

SER. NO. 85-311,610, FILED 5-3-2011.

LOURDES AYALA, EXAMINING ATTORNEY



David J. Kybas

Director of the United States Patent and Trademark Office

United States of America

United States Patent and Trademark Office

CAMBIA

Reg. No. 4,152,872

Registered June 5, 2012

Int. Cls.: 36, 44 and 45

SERVICE MARK

PRINCIPAL REGISTER

CAMBIA HEALTH SOLUTIONS, INC. (OREGON CORPORATION)
100 SW MARKET STREET
PORTLAND, OR 97201

FOR: INSURANCE SERVICES, NAMELY, UNDERWRITING, ISSUANCE AND ADMINISTRATION IN THE FIELDS OF LIFE INSURANCE AND HEALTH INSURANCE; PHARMACEUTICAL BENEFIT MANAGEMENT SERVICES, IN CLASS 36 (U.S. CLS. 100, 101 AND 102).

FIRST USE 11-7-2011; IN COMMERCE 11-7-2011.

FOR: HEALTH CARE SERVICES, NAMELY, WELLNESS PROGRAMS, IN CLASS 44 (U.S. CLS. 100 AND 101).

FIRST USE 11-7-2011; IN COMMERCE 11-7-2011.

FOR: ON-LINE SOCIAL NETWORKING SERVICES, IN CLASS 45 (U.S. CLS. 100 AND 101).

FIRST USE 11-7-2011; IN COMMERCE 11-7-2011.

THE MARK CONSISTS OF STANDARD CHARACTERS WITHOUT CLAIM TO ANY PARTICULAR FONT, STYLE, SIZE, OR COLOR.

THE ENGLISH TRANSLATION OF "CAMBIA" IN THE MARK IS "CHANGE".

SER. NO. 85-311,734, FILED 5-4-2011.

CIMMERIAN COLEMAN, EXAMINING ATTORNEY



David J. Kypos

Director of the United States Patent and Trademark Office

United States of America

United States Patent and Trademark Office

EYES OF ASIA

Reg. No. 4,152,873

Registered June 5, 2012

Int. Cl.: 9

TRADEMARK

PRINCIPAL REGISTER

ARISTOCRAT TECHNOLOGIES AUSTRALIA PTY LTD. (AUSTRALIA CORPORATION)
BUILDING A, PINNACLE OFFICE PARK
85 EPPING ROAD
NORTH RYDE, AUSTRALIA 2113

FOR: ELECTRONIC GAMING MACHINES, NAMELY, DEVICES WHICH ACCEPT A WAGER,
IN CLASS 9 (U.S. CLS. 21, 23, 26, 36 AND 38).

THE MARK CONSISTS OF STANDARD CHARACTERS WITHOUT CLAIM TO ANY PAR-
TICULAR FONT, STYLE, SIZE, OR COLOR.

PRIORITY CLAIMED UNDER SEC. 44(D) ON AUSTRALIA APPLICATION NO. 1422067,
FILED 5-3-2011, REG. NO. 1422067, DATED 5-3-2011, EXPIRES 5-3-2021.

SER. NO. 85-312,010, FILED 5-4-2011.

NORA BUCHANAN WILL, EXAMINING ATTORNEY



David J. Kyjars

Director of the United States Patent and Trademark Office

United States of America

United States Patent and Trademark Office

CAMBIA HEALTH SOLUTIONS

Reg. No. 4,152,874

Registered June 5, 2012

Int. Cls.: 36, 44 and 45

SERVICE MARK

PRINCIPAL REGISTER

CAMBIA HEALTH SOLUTIONS, INC. (OREGON CORPORATION)
100 SW MARKET STREET
PORTLAND, OR 97201

FOR: INSURANCE SERVICES, NAMELY, UNDERWRITING, ISSUANCE AND ADMINISTRATION IN THE FIELDS OF LIFE INSURANCE AND HEALTH INSURANCE; PHARMACEUTICAL BENEFIT MANAGEMENT SERVICES, IN CLASS 36 (U.S. CLS. 100, 101 AND 102).

FIRST USE 11-7-2011; IN COMMERCE 11-7-2011.

FOR: HEALTH CARE SERVICES, NAMELY, WELLNESS PROGRAMS, IN CLASS 44 (U.S. CLS. 100 AND 101).

FIRST USE 11-7-2011; IN COMMERCE 11-7-2011.

FOR: ON-LINE SOCIAL NETWORKING SERVICES, IN CLASS 45 (U.S. CLS. 100 AND 101).

FIRST USE 11-7-2011; IN COMMERCE 11-7-2011.

THE MARK CONSISTS OF STANDARD CHARACTERS WITHOUT CLAIM TO ANY PARTICULAR FONT, STYLE, SIZE, OR COLOR.

NO CLAIM IS MADE TO THE EXCLUSIVE RIGHT TO USE "HEALTH SOLUTIONS", APART FROM THE MARK AS SHOWN.

THE ENGLISH TRANSLATION OF "CAMBIA" IN THE MARK IS "CHANGE".

SER. NO. 85-312,030, FILED 5-4-2011.

CIMMERIAN COLEMAN, EXAMINING ATTORNEY



David J. Kyffers

Director of the United States Patent and Trademark Office

United States of America

United States Patent and Trademark Office

TRUSTNODE

Reg. No. 4,152,875

Registered June 5, 2012

Int. Cls.: 36, 41 and 42

SERVICE MARK

PRINCIPAL REGISTER

TRUSTNODE, INC. (CALIFORNIA CORPORATION)
965 MISSION STREET, SUITE 650
SAN FRANCISCO, CA 94103

FOR: BUSINESS SERVICES FOR EMPLOYERS, NAMELY, PROVIDING INFORMATION ON EMPLOYEE BENEFITS PLANS CONCERNING INSURANCE AND FINANCE, EMPLOYEE BENEFITS PLAN ENROLLMENT SUPPORT SERVICES; PROVIDING A WEBSITE FEATURING INFORMATION IN THE FIELD OF INSURANCE AND EMPLOYEE BENEFITS; PROVIDING ONLINE INFORMATION ABOUT EMPLOYEE BENEFIT PLAN PRODUCTS VIA A WEBSITE, IN CLASS 36 (U.S. CLS. 100, 101 AND 102).

FIRST USE 12-31-2009; IN COMMERCE 2-1-2010.

FOR: EDUCATIONAL SERVICES, NAMELY, PROVIDING ONLINE ANIMATION-BASED EDUCATION MODULES FEATURING PRODUCT INFORMATION FOR EMPLOYEES IN THE FIELD OF INSURANCE AND EMPLOYEE BENEFITS VIA A WEBSITE, IN CLASS 41 (U.S. CLS. 100, 101 AND 107).

FIRST USE 12-31-2009; IN COMMERCE 2-1-2010.

FOR: COMPUTER SERVICES, NAMELY, PROVIDING SEARCH PLATFORMS TO ALLOW USERS TO INPUT PERSONAL USER EXPERIENCE AND PRODUCT INFORMATION IN A WAY THAT MORE EFFECTIVELY ENGAGES AND EDUCATES EMPLOYEES ON AVAILABLE EMPLOYEE BENEFITS; SOFTWARE AS A SERVICE (SAAS) SERVICES FEATURING SOFTWARE FOR PRODUCT SPECIFIC INFORMATION, SEGMENTATION BASED PRODUCT EDUCATION, QUOTE AND PRICING, DECISION SUPPORT AND GENERAL ENROLLMENT PROCESS SUPPORT IN THE FIELD OF INSURANCE AND EMPLOYEE BENEFITS, IN CLASS 42 (U.S. CLS. 100 AND 101).

FIRST USE 12-31-2009; IN COMMERCE 2-1-2010.

THE MARK CONSISTS OF STANDARD CHARACTERS WITHOUT CLAIM TO ANY PARTICULAR FONT, STYLE, SIZE, OR COLOR.

SER. NO. 85-312,519, FILED 5-4-2011.

TIMOTHY FINNEGAN, EXAMINING ATTORNEY



David J. Kyros

Director of the United States Patent and Trademark Office

United States of America

United States Patent and Trademark Office

CAFÉ PREPAY

Reg. No. 4,152,876

Registered June 5, 2012

Int. Cl.: 36

SERVICE MARK

PRINCIPAL REGISTER

HEARTLAND PAYMENT SYSTEMS, INC. (DELAWARE CORPORATION)
90 NASSAU STREET
PRINCETON, NJ 08542

FOR: ELECTRONIC COMMERCE PAYMENT SERVICES, NAMELY, ESTABLISHING FUNDED ACCOUNTS WITH SCHOOLS USED TO PREPAY STUDENT'S LUNCHES AND SNACKS; ELECTRONIC COMMERCE PAYMENT SERVICES, NAMELY, ESTABLISHING FUNDED ACCOUNTS WITH SCHOOLS USED TO PREPAY STUDENT'S TRANSPORTATION, SCHOOL BOOKS, SCHOOL PICTURES, FIELD TRIPS, ATHLETIC FEES, AND OTHER SCHOOL-RELATED FEES VIA THE INTERNET, IN CLASS 36 (U.S. CLS. 100, 101 AND 102).

FIRST USE 10-0-1999; IN COMMERCE 10-0-1999.

THE MARK CONSISTS OF STANDARD CHARACTERS WITHOUT CLAIM TO ANY PARTICULAR FONT, STYLE, SIZE, OR COLOR.

NO CLAIM IS MADE TO THE EXCLUSIVE RIGHT TO USE "PREPAY", APART FROM THE MARK AS SHOWN.

SEC. 2(F) AS TO "CAFE" FOR THE SERVICES: ELECTRONIC COMMERCE PAYMENT SERVICES, NAMELY, ESTABLISHING FUNDED ACCOUNTS WITH SCHOOLS USED TO PREPAY STUDENT'S LUNCHES AND SNACKS.

SER. NO. 85-312,641, FILED 5-4-2011.

ZHALEH DELANEY, EXAMINING ATTORNEY



David J. Kybas

Director of the United States Patent and Trademark Office

United States of America

United States Patent and Trademark Office

HONOR A LIFE

Reg. No. 4,152,877

Registered June 5, 2012

Int. Cls.: 44 and 45

SERVICE MARK

PRINCIPAL REGISTER

FOREST LAWN MORTUARY (CALIFORNIA CORPORATION)
1712 SOUTH GLENDALE AVENUE
GLENDALE, CA 91205

FOR: CEMETERY PLOT BEAUTIFICATION, MAINTENANCE AND CONTINUAL UPKEEP
OF CEMETERY GROUNDS, IN CLASS 44 (U.S. CLS. 100 AND 101).

FIRST USE 4-25-2011; IN COMMERCE 4-25-2011.

FOR: ARRANGING AND CONDUCTING FUNERAL AND MEMORIAL SERVICES, IN CLASS
45 (U.S. CLS. 100 AND 101).

FIRST USE 4-25-2011; IN COMMERCE 4-25-2011.

THE MARK CONSISTS OF STANDARD CHARACTERS WITHOUT CLAIM TO ANY PAR-
TICULAR FONT, STYLE, SIZE, OR COLOR.

SER. NO. 85-312,682, FILED 5-4-2011.

MARK SHINER, EXAMINING ATTORNEY



David J. Kybas

Director of the United States Patent and Trademark Office

United States of America

United States Patent and Trademark Office

Sister R.E.I.G.N.

Reg. No. 4,152,878

JENKINS, COZETTA A. (UNITED STATES INDIVIDUAL), AKA SISTER R.E.I.G.N.
5427 JOHNSON DRIVE #116
MISSION, KS 66205

Registered June 5, 2012

Int. Cl.: 41

FOR: LIVE PERFORMANCES BY A MUSICAL GROUP; POEM AND LYRIC WRITING;
PRESENTATION OF LIVE SHOW PERFORMANCES; PRESENTATION OF MUSICAL PER-
FORMANCE; SONG WRITING SERVICES, IN CLASS 41 (U.S. CLS. 100, 101 AND 107).

SERVICE MARK

FIRST USE 1-1-2008; IN COMMERCE 1-1-2008.

PRINCIPAL REGISTER

THE MARK CONSISTS OF STANDARD CHARACTERS WITHOUT CLAIM TO ANY PAR-
TICULAR FONT, STYLE, SIZE, OR COLOR.

SER. NO. 85-312,728, FILED 5-4-2011.

REBECCA SMITH, EXAMINING ATTORNEY



David J. Kyros

Director of the United States Patent and Trademark Office

United States of America

United States Patent and Trademark Office



Reg. No. 4,152,879

HORIZON HOBBY, INC. (DELAWARE CORPORATION)
4105 FIELDSTONE ROAD
CHAMPAIGN, IL 61822

Registered June 5, 2012

Int. Cls.: 9 and 28

FOR: REMOTE CONTROLS FOR HOBBY PRODUCTS, IN CLASS 9 (U.S. CLS. 21, 23, 26, 36 AND 38).

TRADEMARK

FIRST USE 9-1-1999; IN COMMERCE 9-1-1999.

PRINCIPAL REGISTER

FOR: HOBBY MODEL VEHICLES AND PARTS AND ACCESSORIES THEREFOR, IN CLASS 28 (U.S. CLS. 22, 23, 38 AND 50).

FIRST USE 9-1-1999; IN COMMERCE 9-1-1999.

NO CLAIM IS MADE TO THE EXCLUSIVE RIGHT TO USE "HOBBY", APART FROM THE MARK AS SHOWN.

THE MARK CONSISTS OF THE WORD "HORIZON" LOCATED ABOVE THE WORD "HOBBY". THE LETTER "O" ON THE TOP LINE IS PARTIALLY SHADED. THERE IS A CURVED LINE RUNNING FROM THE BOTTOM LINE LETTER "O" THROUGH THE TOP LINE LETTERS OF "R", "I", "Z", "O" AND "N".

SER. NO. 85-313,158, FILED 5-5-2011.

MARIA-VICTORIA SUAREZ, EXAMINING ATTORNEY



David J. Kybas

Director of the United States Patent and Trademark Office

United States of America

United States Patent and Trademark Office

ROTOREADER

Reg. No. 4,152,880

Registered June 5, 2012

Int. Cl.: 16

TRADEMARK

PRINCIPAL REGISTER

ROMANOFF PRODUCTS, INC. (CONNECTICUT CORPORATION)
11 BROOKSIDE AVENUE
CHATHAM, NY 12037

FOR: ROTATING DESKTOP ORGANIZERS, FILE TRAYS, VERTICAL FILES TO HOLD AND ORGANIZE BOOKS, MAGAZINES, PORTFOLIOS, JOURNALS AND WORKBOOKS , IN CLASS 16 (U.S. CLS. 2, 5, 22, 23, 29, 37, 38 AND 50).

FIRST USE 1-1-2011; IN COMMERCE 1-1-2011.

THE MARK CONSISTS OF STANDARD CHARACTERS WITHOUT CLAIM TO ANY PARTICULAR FONT, STYLE, SIZE, OR COLOR.

SER. NO. 85-313,912, FILED 5-6-2011.

JOHN DWYER, EXAMINING ATTORNEY



David J. Kybas

Director of the United States Patent and Trademark Office

United States of America

United States Patent and Trademark Office

Blonde Bombshell

Reg. No. 4,152,881

INDIGO IMP BREWERY, LTD. (OHIO LIMITED LIABILITY COMPANY)
3615 SUPERIOR AVE. SUITE 4201B
CLEVELAND, OH 44114

Registered June 5, 2012

Int. Cl.: 32

FOR: BEER, ALE, LAGER, STOUT AND PORTER, IN CLASS 32 (U.S. CLS. 45, 46 AND 48).

TRADEMARK

FIRST USE 8-6-2006; IN COMMERCE 12-5-2008.

PRINCIPAL REGISTER

THE MARK CONSISTS OF STANDARD CHARACTERS WITHOUT CLAIM TO ANY PARTICULAR FONT, STYLE, SIZE, OR COLOR.

SER. NO. 85-313,975, FILED 5-6-2011.

CARYN GLASSER, EXAMINING ATTORNEY



David J. Kyffers

Director of the United States Patent and Trademark Office

United States of America

United States Patent and Trademark Office



Reg. No. 4,152,882

Registered June 5, 2012

Int. Cl.: 41

SERVICE MARK

PRINCIPAL REGISTER

PWE PRODUCTIONS LLC (NEVADA LIMITED LIABILITY COMPANY)
SUITE 110
10620 SOUTHERN HIGHLANDS PARKWAY
LAS VEGAS, NV 89141

FOR: ENTERTAINMENT SERVICES IN THE NATURE OF LIVE DRAMATIC AND MUSICAL PERFORMANCES, IN CLASS 41 (U.S. CLS. 100, 101 AND 107).

FIRST USE 5-4-2011; IN COMMERCE 5-4-2011.

OWNER OF U.S. REG. NO. 3,048,257.

THE MARK CONSISTS OF THE WORDING "THE SPAZMATICS" AND DESIGN. THE DESIGN CONSISTS OF FOUR STICK-FIGURE MEN DISTINCTIVELY DRESSED AS NERDS. THE FIRST FIGURE IS WEARING A PAIR OF HORN-RIMMED GLASSES, A HELMET, SNEAKERS AND A BACKPACK AND IS HOLDING UP BOTH ARMS WHILE STEPPING ON THE FOOT OF THE SECOND FIGURE. THE SECOND STICK FIGURE IS WEARING A PAIR OF HORN-RIMMED GLASSES, A NECK BRACE, A POCKET PEN CASE WITH THREE PENS AND SNEAKERS AND HAS BOTH HANDS ON HIS HIPS. THE THIRD STICK FIGURE IS WEARING A PAIR OF HORN-RIMMED GLASSES, A HEADBAND, A SWEATER VEST, KNEE PADS AND BOOTS AND HAS RAISED CLASPED HANDS OVER LEFT SHOULDER. THE FOURTH STICK FIGURE IS WEARING A PAIR OF HORN-RIMMED GLASSES, A BOW TIE, PANTS, AND SHOES, AND HAS BOTH HANDS IN HIS POCKETS. THE WORDING "THE SPAZMATICS" APPEARS BELOW THE DESIGN. THE TERM "THE" APPEARS IN A VERY SMALL FONT ABOVE THE LETTER "S" IN "SPAZMATICS". FOUR HORIZONTAL LINES CUT THROUGH ALL OF THE LETTERS IN THE TERM "SPAZMATICS".



SER. NO. 85-314,011, FILED 5-6-2011.

MARLENE BELL, EXAMINING ATTORNEY

David J. Kyjars

Director of the United States Patent and Trademark Office

United States of America

United States Patent and Trademark Office

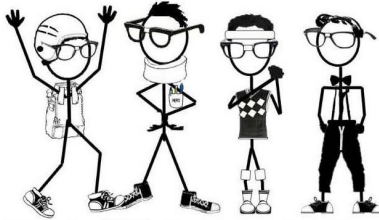

Reg. No. 4,152,883

Registered June 5, 2012

Int. Cl.: 41

SERVICE MARK

PRINCIPAL REGISTER

PWE PRODUCTIONS LLC (NEVADA LIMITED LIABILITY COMPANY)
SUITE 110
10620 SOUTHERN HIGHLANDS PARKWAY
LAS VEGAS, NV 89141

FOR: ENTERTAINMENT SERVICES IN THE NATURE OF LIVE DRAMATIC AND MUSICAL PERFORMANCES, IN CLASS 41 (U.S. CLS. 100, 101 AND 107).

FIRST USE 5-4-2011; IN COMMERCE 5-4-2011.

THE MARK CONSISTS OF FOUR STICK-FIGURE MEN DISTINCTIVELY DRESSED AS NERDS. THE FIRST FIGURE IS WEARING A PAIR OF HORN-RIMMED GLASSES, A HELMET, SNEAKERS AND A BACKPACK AND IS HOLDING UP BOTH ARMS WHILE STEPPING ON THE FOOT OF THE SECOND FIGURE. THE SECOND STICK FIGURE IS WEARING A PAIR OF HORN-RIMMED GLASSES, A NECK BRACE, A POCKET PEN CASE WITH THREE PENS AND SNEAKERS AND HAS BOTH HANDS ON HIS HIPS. THE THIRD STICK FIGURE IS WEARING A PAIR OF HORN-RIMMED GLASSES, A HEADBAND, A SWEATER VEST, KNEE PADS AND BOOTS AND HAS RAISED CLASPED HANDS OVER LEFT SHOULDER. THE FOURTH STICK FIGURE IS WEARING A PAIR OF HORN-RIMMED GLASSES, A BOW TIE, PANTS, AND SHOES, AND HAS BOTH HANDS IN HIS POCKETS.

SER. NO. 85-314,282, FILED 5-6-2011.

MARLENE BELL, EXAMINING ATTORNEY



David J. Kyjars

Director of the United States Patent and Trademark Office

United States of America

United States Patent and Trademark Office

ECONOMIC FAIRY TALES

Reg. No. 4,152,884

Registered June 5, 2012

Int. Cl.: 41

SERVICE MARK

PRINCIPAL REGISTER

PROSPERITY PRANA, LLC (NEW YORK LIMITED LIABILITY COMPANY)
#25D
330 WEST 56TH STREET
NEW YORK, NY 10019

FOR: PROVIDING A WEBSITE FEATURING BLOGS IN THE NATURE OF PUBLICATIONS, ARTICLES, AND BROCHURES IN THE FIELD OF FINANCIAL PLANNING AND EDUCATION; PROVIDING ONLINE PUBLICATIONS IN THE NATURE OF EDUCATIONAL SERIES OF STORIES IN THE FIELD OF FINANCIAL PLANNING AND FINANCIAL EDUCATION; PROVIDING A WEBSITE FEATURING INFORMATION IN THE FIELD OF FINANCIAL EDUCATION, IN CLASS 41 (U.S. CLS. 100, 101 AND 107).

FIRST USE 5-6-2011; IN COMMERCE 5-6-2011.

THE MARK CONSISTS OF STANDARD CHARACTERS WITHOUT CLAIM TO ANY PARTICULAR FONT, STYLE, SIZE, OR COLOR.

NO CLAIM IS MADE TO THE EXCLUSIVE RIGHT TO USE "FAIRY TALES", APART FROM THE MARK AS SHOWN.

SER. NO. 85-314,893, FILED 5-6-2011.

WANDA KAY PRICE, EXAMINING ATTORNEY



David J. Kyffers

Director of the United States Patent and Trademark Office

United States of America

United States Patent and Trademark Office

GUILT-FREE RESULTS

Reg. No. 4,152,885

Registered June 5, 2012

Int. Cl.: 41

SERVICE MARK

PRINCIPAL REGISTER

VICTORIA COOK (ILLINOIS SOLE PROPRIETORSHIP), DBA THE GUILT-FREE COACH
28928 W. KRISTY LANE
CARY, IL 60013

FOR: PROFESSIONAL COACHING SERVICES UTILIZING A SEVEN-STEP PROCESS TO
ACHIEVE PROFESSIONAL GOALS, PERSONAL GOALS, AND PERFORMANCE GOALS ,
IN CLASS 41 (U.S. CLS. 100, 101 AND 107).

FIRST USE 4-19-2009; IN COMMERCE 7-6-2010.

THE MARK CONSISTS OF STANDARD CHARACTERS WITHOUT CLAIM TO ANY PAR-
TICULAR FONT, STYLE, SIZE, OR COLOR.

NO CLAIM IS MADE TO THE EXCLUSIVE RIGHT TO USE "RESULTS", APART FROM
THE MARK AS SHOWN.

SER. NO. 85-315,237, FILED 5-8-2011.

ESTHER BELENKER, EXAMINING ATTORNEY



David J. Kybas

Director of the United States Patent and Trademark Office

United States of America

United States Patent and Trademark Office

One Smile One World One Love

Reg. No. 4,152,886

MISSION SAVE A SMILE (ILLINOIS NON-PROFIT ORGANIZATION)
22 W CRYSTAL LAKE AVE
CRYSTAL LAKE, IL 60014

Registered June 5, 2012

Int. Cl.: 44

FOR: CHARITABLE SERVICES, NAMELY, PROVIDING MEDICAL EQUIPMENT AND SERVICES TO UNDERSERVED COMMUNITIES, IN CLASS 44 (U.S. CLS. 100 AND 101).

SERVICE MARK

FIRST USE 9-13-2007; IN COMMERCE 9-17-2007.

PRINCIPAL REGISTER

THE MARK CONSISTS OF STANDARD CHARACTERS WITHOUT CLAIM TO ANY PARTICULAR FONT, STYLE, SIZE, OR COLOR.

SER. NO. 85-315,264, FILED 5-8-2011.

COLLEEN KEARNEY, EXAMINING ATTORNEY



David J. Kybas

Director of the United States Patent and Trademark Office

United States of America

United States Patent and Trademark Office

NutriCare

Reg. No. 4,152,887

TEO PET L.L.C. (COLORADO LIMITED LIABILITY COMPANY), DBA TEOPET
11908 WEST COOPER DRIVE
LITTLETON, CO 80127

Registered June 5, 2012

Int. Cl.: 31

FOR: DIGESTIBLE CHEWING BONES FOR DOGS, IN CLASS 31 (U.S. CLS. 1 AND 46).

TRADEMARK

FIRST USE 3-2-2011; IN COMMERCE 3-2-2011.

PRINCIPAL REGISTER

THE MARK CONSISTS OF STANDARD CHARACTERS WITHOUT CLAIM TO ANY PARTICULAR FONT, STYLE, SIZE, OR COLOR.

SER. NO. 85-315,283, FILED 5-9-2011.

ANNE MADDEN, EXAMINING ATTORNEY



David J. Kybas

Director of the United States Patent and Trademark Office

United States of America

United States Patent and Trademark Office

I help writers become authors

Reg. No. 4,152,888

SFP MEDIA, INC. (CALIFORNIA CORPORATION)
112 HARVARD AVE 150
CLAREMONT, CA 91711

Registered June 5, 2012

Int. Cl.: 41

FOR: PERSONAL COACHING SERVICES IN THE FIELD OF CREATIVITY, IN CLASS 41
(U.S. CLS. 100, 101 AND 107).

SERVICE MARK

FIRST USE 5-1-2011; IN COMMERCE 5-1-2011.

PRINCIPAL REGISTER

THE MARK CONSISTS OF STANDARD CHARACTERS WITHOUT CLAIM TO ANY PARTICULAR FONT, STYLE, SIZE, OR COLOR.

SER. NO. 85-315,293, FILED 5-9-2011.

CAROLINE WOOD, EXAMINING ATTORNEY



David J. Kybas

Director of the United States Patent and Trademark Office

United States of America

United States Patent and Trademark Office

RADIAN

Reg. No. 4,152,889

Registered June 5, 2012

Int. Cl.: 9

TRADEMARK

PRINCIPAL REGISTER

MANIFOLD SOFTWARE LIMITED (HONG KONG CORPORATION)
22ND FLOOR
3 LOCKHART ROAD
WANCHAI, HONG KONG SAR

FOR: COMPUTER SOFTWARE SPECIFICALLY USED IN CONNECTION WITH ORIGINAL EQUIPMENT MANUFACTURER (OEM) PRODUCTS, NAMELY, FOR OPERATING AND PROGRAMMING GENERAL PURPOSE GEOGRAPHIC INFORMATION SYSTEMS (GIS), FOR PERFORMING GENERAL PURPOSE COMPUTER AIDED DESIGN (CAD), FOR GRAPHICS ART DESIGN, FOR OPERATING A DATABASE MANAGEMENT SYSTEM, FOR MAPPING OF GEOGRAPHIC FEATURES IN PROJECTED OR UNPROJECTED COORDINATE SYSTEMS, FOR MAPPING OF NON-GEOGRAPHIC DATA IN ABSTRACT COORDINATE SYSTEMS AND FOR SOFTWARE DEVELOPMENT, IN CLASS 9 (U.S. CLS. 21, 23, 26, 36 AND 38).

FIRST USE 12-1-2009; IN COMMERCE 12-1-2009.

THE MARK CONSISTS OF STANDARD CHARACTERS WITHOUT CLAIM TO ANY PARTICULAR FONT, STYLE, SIZE, OR COLOR.

SER. NO. 85-315,477, FILED 5-9-2011.

REBECCA GILBERT, EXAMINING ATTORNEY



David J. Kyros

Director of the United States Patent and Trademark Office

United States of America

United States Patent and Trademark Office

PALM BEACH GRILL

Reg. No. 4,152,890

Registered June 5, 2012

Int. Cl.: 43

SERVICE MARK

PRINCIPAL REGISTER

HILLSTONE RESTAURANT GROUP, INC. (DELAWARE CORPORATION)
SUITE 200
2710 E. CAMELBACK ROAD
PHOENIX, AZ 85016

FOR: RESTAURANT AND BAR SERVICES, IN CLASS 43 (U.S. CLS. 100 AND 101).

FIRST USE 12-0-1999; IN COMMERCE 12-0-1999.

THE MARK CONSISTS OF STANDARD CHARACTERS WITHOUT CLAIM TO ANY PARTICULAR FONT, STYLE, SIZE, OR COLOR.

NO CLAIM IS MADE TO THE EXCLUSIVE RIGHT TO USE "GRILL", APART FROM THE MARK AS SHOWN.

SEC. 2(F).

SER. NO. 85-315,507, FILED 5-9-2011.

KIM SAITO, EXAMINING ATTORNEY



David J. Kybas

Director of the United States Patent and Trademark Office

United States of America

United States Patent and Trademark Office

SENSIFLIP

Reg. No. 4,152,891

Registered June 5, 2012

Int. Cl.: 10

TRADEMARK

PRINCIPAL REGISTER

FLIP TECHNOLOGIES LIMITED (IRELAND COMPANY)
GALWAY BUSINESS PARK
DANGAN, COUNTY GALWAY, IRELAND

FOR: MEDICAL APPARATUS, EQUIPMENT, DEVICES AND INSTRUMENTS FOR USE IN SURGERY; MEDICAL AND SURGICAL APPARATUS, EQUIPMENT, DEVICES AND INSTRUMENTS FOR MONITORING AND/OR MEASURING A PHYSICAL CHARACTERISTIC OF A VESSEL, CAVITY, LUMEN, SPHINCTER OR AN ORGAN OF A HUMAN OR ANIMAL SUBJECT; MEDICAL AND SURGICAL APPARATUS, EQUIPMENT, DEVICES AND INSTRUMENTS FOR TREATING, DILATING AND/OR REMOVING AN OCCLUSION IN A VESSEL, CAVITY, LUMEN OR AN ORGAN OF A HUMAN OR ANIMAL SUBJECT; MEDICAL AND SURGICAL APPARATUS, EQUIPMENT, DEVICES AND INSTRUMENTS FOR USE IN THE DIAGNOSIS OF DISEASES, DAMAGE AND/OR FAILURE OF HOLLOW BODY ORGANS AND SPHINCTERS; MEDICAL AND SURGICAL APPARATUS, EQUIPMENT, DEVICES AND INSTRUMENTS FOR SENSITIVITY TESTING AND BIMODAL SENSITIVITY TESTING OF THE OESOPHAGUS AND OTHER LUMENS AND ORGANS OF A HUMAN OR ANIMAL SUBJECT; TEMPERATURE SENSITIVE TESTING APPARATUS AND INSTRUMENTS FOR MEDICAL USE FOR TESTING THE BODY TEMPERATURE OF HUMANS AND ANIMALS; AND PARTS AND FITTINGS FOR ALL THE AFORESAID GOODS, IN CLASS 10 (U.S. CLS. 26, 39 AND 44).

THE MARK CONSISTS OF STANDARD CHARACTERS WITHOUT CLAIM TO ANY PARTICULAR FONT, STYLE, SIZE, OR COLOR.

PRIORITY CLAIMED UNDER SEC. 44(D) ON ERPN CMNTY TM OFC APPLICATION NO. 009723404, FILED 2-9-2011, REG. NO. 009723404, DATED 7-14-2011, EXPIRES 2-9-2021.

SER. NO. 85-315,625, FILED 5-9-2011.

DANIEL CAPSHAW, EXAMINING ATTORNEY



David J. Kyros

Director of the United States Patent and Trademark Office

United States of America

United States Patent and Trademark Office

CUT EM

Reg. No. 4,152,892

Registered June 5, 2012

Int. Cls.: 25 and 28

TRADEMARK

PRINCIPAL REGISTER

CHRIS FASH (UNITED STATES INDIVIDUAL)
16156 WILDWOOD LANE
HOMER GLEN, IL 60491

FOR: CLOTHING, NAMELY, HATS, CAPS, SHIRTS, T-SHIRTS, AND SWEATSHIRTS, IN CLASS 25 (U.S. CLS. 22 AND 39).

FIRST USE 2-1-2007; IN COMMERCE 7-28-2008.

FOR: SPORTING GOODS, NAMELY, HUNTING GAME CALLS, BIRD CALLS, DUCK CALLS, AND GOOSE CALLS, IN CLASS 28 (U.S. CLS. 22, 23, 38 AND 50).

FIRST USE 2-1-2007; IN COMMERCE 7-28-2008.

THE MARK CONSISTS OF STANDARD CHARACTERS WITHOUT CLAIM TO ANY PARTICULAR FONT, STYLE, SIZE, OR COLOR.

SER. NO. 85-315,995, FILED 5-9-2011.

JULIE VEPPUMTHARA, EXAMINING ATTORNEY



David J. Kyros

Director of the United States Patent and Trademark Office

United States of America

United States Patent and Trademark Office

WEBLESSON

Reg. No. 4,152,893

Registered June 5, 2012

Int. Cls.: 38 and 41

SERVICE MARK

PRINCIPAL REGISTER

GOLFTEC INTELLECTUAL PROPERTY LLC (COLORADO LIMITED LIABILITY COMPANY)
12450 E ARAPAHOE ROAD, #B
CENTENNIAL, CO 80111

FOR: ELECTRONIC DELIVERY OF IMAGES AND PHOTOGRAPHS VIA A GLOBAL
COMPUTER NETWORK IN THE FIELD OF GOLF INSTRUCTION, IN CLASS 38 (U.S. CLS.
100, 101 AND 104).

FIRST USE 4-4-2001; IN COMMERCE 4-4-2001.

FOR: EDUCATIONAL SERVICES, NAMELY, PROVIDING ONLINE CONTENT, VIA THE
INTERNET, IN THE FIELD OF ESSENTIAL INSTRUCTION IN GOLF SPORTS TRAINING,
CONSISTING OF VIDEO, PICTURES, AUDIO AND TEXT, IN CLASS 41 (U.S. CLS. 100, 101
AND 107).

FIRST USE 4-4-2001; IN COMMERCE 4-4-2001.

THE MARK CONSISTS OF STANDARD CHARACTERS WITHOUT CLAIM TO ANY PAR-
TICULAR FONT, STYLE, SIZE, OR COLOR.

OWNER OF U.S. REG. NO. 2,974,951.

SEC. 2(F).

SER. NO. 85-316,193, FILED 5-9-2011.

DOMINIC J. FERRAIUOLO, EXAMINING ATTORNEY



David J. Kyros

Director of the United States Patent and Trademark Office

United States of America

United States Patent and Trademark Office

Destiny
chocolates 

Reg. No. 4,152,894

Registered June 5, 2012

Int. Cl.: 30

TRADEMARK

PRINCIPAL REGISTER

DESTINY CHOCOLATES, LLC (WISCONSIN LIMITED LIABILITY COMPANY)
9900 S. GLENMOOR COURT
OAK CREEK, WI 53154

FOR: PACKAGED CONFECTIONS AND DESSERTS, NAMELY, CHOCOLATE CONFECTIONS, IN CLASS 30 (U.S. CL. 46).

FIRST USE 8-1-2010; IN COMMERCE 8-1-2010.

NO CLAIM IS MADE TO THE EXCLUSIVE RIGHT TO USE "CHOCOLATES", APART FROM THE MARK AS SHOWN.

THE COLOR(S) PINK AND BROWN IS/ARE CLAIMED AS A FEATURE OF THE MARK.

THE MARK CONSISTS OF THE WORD "DESTINY" IN PINK CURSIVE LETTERS, WITH A BROWN PIECE OF CHOCOLATE CANDY WITH PINK FROSTING CONTAINED IN THE TAIL OF THE LETTER "Y"; THE LOWER-CASE BROWN WORDING "CHOCOLATES" IS LOCATED BELOW THE WORD "DESTINY".

SER. NO. 85-316,836, FILED 5-10-2011.

KEVIN CORWIN, EXAMINING ATTORNEY



David J. Kybas

Director of the United States Patent and Trademark Office

United States of America
United States Patent and Trademark Office

VASOLABS

Reg. No. 4,152,895

Registered June 5, 2012

Int. Cl.: 44

SERVICE MARK

PRINCIPAL REGISTER

VASOLABS, INC. (UTAH CORPORATION), DBA VASOLABS
1498 BARTON CREEK LANCE
BOUNTIFUL, UT 84010

FOR: MEDICAL IMAGING SERVICES, NAMELY, CONSULTING SERVICES IN THE FIELD OF USING AND OPERATING MEDICAL IMAGING APPARATUS INCLUDING X-RAY, COMPUTED TOMOGRAPHY, MAGNETIC RESONANCE IMAGING, ULTRASOUND, AND POSITRON EMISSION TOMOGRAPHY APPARATUS, IN CLASS 44 (U.S. CLS. 100 AND 101).

FIRST USE 2-1-1996; IN COMMERCE 2-1-1996.

THE MARK CONSISTS OF STANDARD CHARACTERS WITHOUT CLAIM TO ANY PARTICULAR FONT, STYLE, SIZE, OR COLOR.

SER. NO. 85-316,900, FILED 5-10-2011.

TAMARA FRAZIER, EXAMINING ATTORNEY



David J. Kyros

Director of the United States Patent and Trademark Office

United States of America

United States Patent and Trademark Office



Reg. No. 4,152,896

SAN ANTONIO LIVESTOCK EXPOSITION, INC. (TEXAS CORPORATION)
3201 EAST HOUSTON
SAN ANTONIO, TX 78219

Registered June 5, 2012

Int. Cl.: 26

FOR: BELT BUCKLES, IN CLASS 26 (U.S. CLS. 37, 39, 40, 42 AND 50).

TRADEMARK

FIRST USE 2-28-2003; IN COMMERCE 2-28-2003.

PRINCIPAL REGISTER

NO CLAIM IS MADE TO THE EXCLUSIVE RIGHT TO USE "SAN ANTONIO", APART FROM THE MARK AS SHOWN.

THE MARK CONSISTS OF THE LETTER "S" DESIGNED TO FORM A COWBOY HAT IN THE WORD "SAN", WHICH RESTS ABOVE THE WORDS "ANTONIO STOCK SHOW & RODEO".

SER. NO. 85-316,949, FILED 5-10-2011.

THEODORE MCBRIDE, EXAMINING ATTORNEY



David J. Kybas

Director of the United States Patent and Trademark Office

United States of America

United States Patent and Trademark Office



Reg. No. 4,152,897

SAN ANTONIO LIVESTOCK EXPOSITION, INC. (TEXAS CORPORATION)
3201 EAST HOUSTON
SAN ANTONIO, TX 78219

Registered June 5, 2012

Int. Cl.: 18

FOR: LEATHER GOODS, NAMELY, BRIEF CASES, HANDBAGS, SADDLES, HORSE TACK, NAMELY, BRIDLES, REINS, HALTERS, IN CLASS 18 (U.S. CLS. 1, 2, 3, 22 AND 41).

TRADEMARK

FIRST USE 2-28-2003; IN COMMERCE 2-28-2003.

PRINCIPAL REGISTER

NO CLAIM IS MADE TO THE EXCLUSIVE RIGHT TO USE "SAN ANTONIO", APART FROM THE MARK AS SHOWN.

THE MARK CONSISTS OF THE LETTER "S" DESIGNED TO FORM A COWBOY HAT IN THE WORD "SAN", WHICH RESTS ABOVE THE WORDS "ANTONIO STOCK SHOW & RODEO".

SER. NO. 85-316,960, FILED 5-10-2011.

THEODORE MCBRIDE, EXAMINING ATTORNEY



David J. Kybas

Director of the United States Patent and Trademark Office

United States of America

United States Patent and Trademark Office



Reg. No. 4,152,898

SAN ANTONIO LIVESTOCK EXPOSITION, INC. (TEXAS CORPORATION)
3201 EAST HOUSTON
SAN ANTONIO, TX 78219

Registered June 5, 2012

Int. Cl.: 21

FOR: BEVERAGE GLASSWARE, MUGS, BOTTLE OPENERS, AND BARWARE, NAMELY, FLASKS, TRIVETS, ALCOHOL AND SELTZER BOTTLES, AND WINE DECANTERS , IN CLASS 21 (U.S. CLS. 2, 13, 23, 29, 30, 33, 40 AND 50).

TRADEMARK

FIRST USE 2-28-2003; IN COMMERCE 2-28-2003.

PRINCIPAL REGISTER

NO CLAIM IS MADE TO THE EXCLUSIVE RIGHT TO USE "SAN ANTONIO", APART FROM THE MARK AS SHOWN.

THE MARK CONSISTS OF THE LETTER "S" DESIGNED TO FORM A COWBOY HAT IN THE WORD "SAN", WHICH RESTS ABOVE THE WORDS "ANTONIO STOCK SHOW & RODEO".

SER. NO. 85-316,966, FILED 5-10-2011.

THEODORE MCBRIDE, EXAMINING ATTORNEY



David J. Kyros

Director of the United States Patent and Trademark Office

United States of America

United States Patent and Trademark Office



Reg. No. 4,152,899

SAN ANTONIO LIVESTOCK EXPOSITION, INC. (TEXAS CORPORATION)
3201 EAST HOUSTON
SAN ANTONIO, TX 78219

Registered June 5, 2012

Int. Cl.: 33

FOR: SPIRITS, IN CLASS 33 (U.S. CLS. 47 AND 49).

TRADEMARK

FIRST USE 2-28-2003; IN COMMERCE 2-28-2003.

PRINCIPAL REGISTER

NO CLAIM IS MADE TO THE EXCLUSIVE RIGHT TO USE "SAN ANTONIO" , APART FROM THE MARK AS SHOWN.

THE MARK CONSISTS OF THE LETTER "S" DESIGNED TO FORM A COWBOY HAT IN THE WORD "SAN", WHICH RESTS ABOVE THE WORDS "ANTONIO STOCK SHOW & RODEO".

SER. NO. 85-316,970, FILED 5-10-2011.

THEODORE MCBRIDE, EXAMINING ATTORNEY



David J. Kyffers

Director of the United States Patent and Trademark Office

United States of America

United States Patent and Trademark Office

GUILLA BOYZ

Reg. No. 4,152,900

Registered June 5, 2012

Int. Cl.: 41

SERVICE MARK

PRINCIPAL REGISTER

GUILLA BOYZ ENTERTAINMENT (ILLINOIS LIMITED LIABILITY COMPANY)
P.O. BOX 1573
CENTRALIA, IL 62801

FOR: EDUCATION AND ENTERTAINMENT SERVICES, NAMELY, ONGOING TELEVISION PUBLIC SERVICE ANNOUNCEMENTS AND ONGOING TELEVISION PROGRAMS IN THE FIELD OF BUSINESS; EDUCATIONAL AND ENTERTAINMENT SERVICES, NAMELY, A CONTINUING PROGRAM ABOUT MUSIC PRODUCTION, AUDIO PRODUCTION, MUSIC THERAPY, AND CONCEPT AND BRAND DEVELOPMENT FOR THE ENTERTAINMENT INDUSTRY ACCESSIBLE BY RADIO, TELEVISION, SATELLITE, AUDIO, VIDEO AND COMPUTER NETWORKS; EDUCATIONAL AND ENTERTAINMENT SERVICES, NAMELY, CONDUCTING WORKSHOPS, LESSONS, AND SEMINARS IN THE FIELD OF MUSIC AND AUDIO PRODUCTION AND DISTRIBUTION OF COURSE MATERIALS IN CONNECTION THEREWITH, AND EDUCATION CONSULTING RELATED THERETO; EDUCATIONAL AND ENTERTAINMENT SERVICES, NAMELY, PROVIDING A VOLUNTEER PROGRAM FEATURING RECREATIONAL ACTIVITIES, LITERACY TRAINING, ART EVENTS, AND SPORTING EVENTS FOR CHILDREN IN FOSTER CARE; EDUCATIONAL AND ENTERTAINMENT SERVICES, NAMELY, PROVIDING MOTIVATIONAL AND EDUCATIONAL SPEAKERS IN THE FIELD OF SELF- AND PERSONAL IMPROVEMENT; ENTERTAINMENT AND EDUCATIONAL SERVICES, NAMELY, PROVIDING ADVICE AND INFORMATION FOR MUSIC, VIDEO AND FILM CONCEPT AND SCRIPT DEVELOPMENT; ENTERTAINMENT AND EDUCATIONAL SERVICES, NAMELY, THE PRESENTATION OF SEMINARS, LECTURES, WORKSHOPS AND PANEL DISCUSSIONS, AND ONGOING TELEVISION AND RADIO TALK SHOWS ALL IN THE FIELD OF PUBLIC INTEREST CONCERNING THE ENTERTAINMENT INDUSTRY; ENTERTAINMENT AND EDUCATIONAL SERVICES, NAMELY, THE PRESENTATION OF SEMINARS, WORKSHOPS AND PANEL DISCUSSIONS, AND ONGOING TELEVISION AND RADIO SHOWS ALL IN THE FIELD OF MUSIC, FILM AND SPORTS; ENTERTAINMENT IN THE NATURE OF VISUAL AND AUDIO PERFORMANCES BY MUSICIANS, RECORDING ARTISTS, AND MUSICAL BANDS; ENTERTAINMENT IN THE NATURE OF VISUAL AND AUDIO PERFORMANCES, AND MUSICAL, VARIETY, NEWS AND COMEDY SHOWS; ENTERTAINMENT IN THE NATURE OF VISUAL AND AUDIO PERFORMANCES, NAMELY, MUSICAL BAND, ROCK GROUP, GYMNASTIC, DANCE, AND BALLET PERFORMANCES; ENTERTAINMENT MEDIA PRODUCTION SERVICES FOR MOTION PICTURES, TELEVISION AND INTERNET; ENTERTAINMENT SERVICES BY A MUSICAL ARTIST AND PRODUCER, NAMELY, MUSICAL COMPOSITION FOR OTHERS AND PRODUCTION OF MUSICAL SOUND RECORDINGS; ENTERTAINMENT SERVICES IN THE NATURE OF DEVELOPMENT, CREATION, PRO-



David J. Kybas

Director of the United States Patent and Trademark Office

Reg. No. 4,152,900 DUCATION AND POST-PRODUCTION SERVICES OF MULTIMEDIA ENTERTAINMENT CONTENT; ENTERTAINMENT SERVICES IN THE NATURE OF LIVE MUSICAL PERFORMANCES; ENTERTAINMENT SERVICES IN THE NATURE OF PRESENTING LIVE MUSICAL PERFORMANCES; ENTERTAINMENT SERVICES IN THE NATURE OF RECORDING, PRODUCTION AND POST-PRODUCTION SERVICES IN THE FIELD OF MUSIC; ENTERTAINMENT SERVICES, NAMELY, A MULTIMEDIA PROGRAM SERIES FEATURING COMEDY, ACTION AND ADVENTURE DISTRIBUTED VIA VARIOUS PLATFORMS ACROSS MULTIPLE FORMS OF TRANSMISSION MEDIA; ENTERTAINMENT SERVICES, NAMELY, MULTIMEDIA PRODUCTION SERVICES; ENTERTAINMENT SERVICES, NAMELY, NON-DOWNLOADABLE RINGTONES, PRE-RECORDED MUSIC, AND GRAPHICS PRESENTED TO MOBILE COMMUNICATIONS DEVICES VIA A GLOBAL COMPUTER NETWORK AND WIRELESS NETWORKS; ENTERTAINMENT SERVICES, NAMELY, PRODUCTION OF COMPUTER-GENERATED IMAGERY FOR USE IN MOTION PICTURES; ENTERTAINMENT SERVICES, NAMELY, PRODUCTION OF SPECIAL EFFECTS INCLUDING MODEL-MAKING SERVICES AND RELATED PHYSICAL PRODUCTION ELEMENTS FOR USE IN MOTION PICTURES; ENTERTAINMENT SERVICES, NAMELY, PRODUCTION OF SPECIAL EFFECTS INCLUDING MODEL-MAKING SERVICES, COMPUTER-GENERATED IMAGERY AND COMPUTER-GENERATED GRAPHICS FOR THE PRODUCTION OF MOTION PICTURES, VIDEOS, AND MOVIE TRAILERS; ENTERTAINMENT SERVICES, NAMELY, PROVIDING A WEB SITE FEATURING NON-DOWNLOADABLE ADULT-THEMED PHOTOGRAPHS AND VIDEOS; ENTERTAINMENT SERVICES, NAMELY, PROVIDING A WEB SITE FEATURING PHOTOGRAPHIC AND PROSE PRESENTATIONS FEATURING ENTERTAINERS AND EDUCATORS; ENTERTAINMENT SERVICES, NAMELY, PROVIDING A WEB SITE FEATURING PHOTOGRAPHIC, VIDEO AND PROSE PRESENTATIONS FEATURING ENTERTAINERS AND EDUCATORS; ENTERTAINMENT SERVICES, NAMELY, PROVIDING AN ON-GOING RADIO PROGRAM IN THE FIELD OF MUSIC, FILM, AND ENTERTAINMENT; ENTERTAINMENT SERVICES, NAMELY, PROVIDING ON-GOING WEBISODES FEATURING MUSICIANS, CELEBRITIES, RECORDING ARTISTS AND COMMUNITY MEMBERS DISCUSSING CULTURAL ISSUES VIA A GLOBAL COMPUTER NETWORK; ENTERTAINMENT SERVICES, NAMELY, PROVIDING PODCASTS IN THE FIELD OF ENTERTAINMENT; ENTERTAINMENT SERVICES, NAMELY, PROVIDING RADIO PROGRAMS IN THE FIELD OF MUSIC AND FILM VIA A GLOBAL COMPUTER NETWORK; ENTERTAINMENT, NAMELY, LIVE PERFORMANCES BY MUSICAL BANDS; ENTERTAINMENT, NAMELY, PRODUCTION OF CONCERTS, RADIO SHOW BROADCASTS AND AUDIO RECORDING; MULTIMEDIA ENTERTAINMENT SERVICES IN THE NATURE OF DEVELOPMENT, PRODUCTION AND POST-PRODUCTION SERVICES IN THE FIELDS OF VIDEO AND FILMS; MULTIMEDIA ENTERTAINMENT SERVICES IN THE NATURE OF RECORDING, PRODUCTION AND POST-PRODUCTION SERVICES IN THE FIELDS OF MUSIC, VIDEO, AND FILMS; MULTIMEDIA ENTERTAINMENT SOFTWARE PRODUCTION SERVICES; PROVIDING A WEBSITE FEATURING ENTERTAINMENT INFORMATION; PROVIDING A WEBSITE FEATURING INFORMATION IN THE FIELD OF MUSIC AND ENTERTAINMENT; PROVIDING AN EDUCATIONAL WEBSITE IN THE FIELDS OF MUSIC AND ENTERTAINMENT; PROVIDING ON-LINE ENTERTAINMENT INFORMATION, NAMELY, INFORMATION ABOUT TELEVISION PROGRAMMING; RADIO ENTERTAINMENT PRODUCTION; RADIO ENTERTAINMENT SERVICES, NAMELY, RADIO PROGRAMS FEATURING PERFORMANCES BY A MUSICIANS, RECORDING ARTISTS, AND MUSICAL BANDS, IN CLASS 41 (U.S. CLS. 100, 101 AND 107).

FIRST USE 1-1-2005; IN COMMERCE 2-20-2007.

THE MARK CONSISTS OF STANDARD CHARACTERS WITHOUT CLAIM TO ANY PARTICULAR FONT, STYLE, SIZE, OR COLOR.

SER. NO. 85-317,010, FILED 5-10-2011.

BARBARA RUTLAND, EXAMINING ATTORNEY

United States of America

United States Patent and Trademark Office

TRIM TONIQ

Reg. No. 4,152,901

TRUETONIQS, LLC (COLORADO LIMITED LIABILITY COMPANY)
7440 N. 49TH ST.
LONGMONT, CO 80503

Registered June 5, 2012

Int. Cl.: 5

FOR: DIETARY SUPPLEMENTS, NAMELY, HERBAL-ENHANCED BEVERAGES, IN CLASS 5 (U.S. CLS. 6, 18, 44, 46, 51 AND 52).

TRADEMARK

FIRST USE 3-15-2011; IN COMMERCE 3-15-2011.

PRINCIPAL REGISTER

THE MARK CONSISTS OF STANDARD CHARACTERS WITHOUT CLAIM TO ANY PARTICULAR FONT, STYLE, SIZE, OR COLOR.

OWNER OF U.S. REG. NOS. 3,637,800 AND 3,645,231.

NO CLAIM IS MADE TO THE EXCLUSIVE RIGHT TO USE "TONIC", APART FROM THE MARK AS SHOWN.

SER. NO. 85-317,085, FILED 5-10-2011.

KAREN SEVERSON, EXAMINING ATTORNEY



David J. Kybas

Director of the United States Patent and Trademark Office

United States of America

United States Patent and Trademark Office

ENVI

Reg. No. 4,152,902

Registered June 5, 2012

Int. Cl.: 3

TRADEMARK

PRINCIPAL REGISTER

IQ PRODUCTS COMPANY (TEXAS CORPORATION)
16212 STATE HIGHWAY 249
HOUSTON, TX 77086

FOR: HAIR CARE PRODUCTS, NAMELY, HAIR BLEACHES, HAIR COLORANTS, HAIR CONDITIONERS, HAIR GELS, HAIR LIGHTENERS, HAIR MOUSSES, HAIR POMADES, HAIR RELAXERS, HAIR SHAMPOO, HAIR SHAMPOOS AND CONDITIONERS, HAIR SPRAYS, HAIR STRAIGHTENING PREPARATIONS, HAIR WAX, HYDROGEN PEROXIDE FOR USE ON THE HAIR, NON-MEDICATED HAIR SERUMS, AND OILS FOR HAIR CONDITIONING; DEPILATORY PREPARATIONS; NAIL CARE PREPARATIONS, NAMELY NAIL POLISH ENAMEL DRIERS, NAIL GELS, NAIL POLISH REMOVERS, AND NAIL HARDENERS; SHAVING PREPARATIONS, NAMELY SHAVING CREAMS, SHAVING FOAM, SHAVING GELS, AFTER SHAVE BALMS, BABY OILS; NON-MEDICATED DIAPER RASH PREPARATIONS IN THE NATURE OF OINTMENTS, LOTIONS, CREAMS, AND GELS; AND BABY WIPES, IN CLASS 3 (U.S. CLS. 1, 4, 6, 50, 51 AND 52).

FIRST USE 6-1-1994; IN COMMERCE 6-1-1994.

THE MARK CONSISTS OF STANDARD CHARACTERS WITHOUT CLAIM TO ANY PARTICULAR FONT, STYLE, SIZE, OR COLOR.

SER. NO. 85-317,728, FILED 5-11-2011.

CHRISTINA SOBRAL, EXAMINING ATTORNEY



David J. Kybas

Director of the United States Patent and Trademark Office

United States of America

United States Patent and Trademark Office

2KOOOL 2B TRUE

Reg. No. 4,152,903

SMART BRANDS USA INTL, LLC (FLORIDA LIMITED LIABILITY COMPANY)
18445 N.E. 30TH PLACE
AVENTURA, FL 33160

Registered June 5, 2012

Int. Cl.: 25

FOR: APPAREL, NAMELY, T-SHIRTS, PANTS, SHORTS, JACKETS, BATHING SUITS, BOARD SHORTS, TANK TOPS, RAIN COATS, SWEAT PANTS, PULLOVERS, BLOUSES, BEACH-WEAR, COATS, GYM-SHORTS, JERSEYS, FLANNELS, DRESSES, SWEATERS, SOCKS, POLO SHIRTS, BEANIES, SNEAKERS, SANDALS, FLIP FLOPS, AND SKATE SHOES, IN CLASS 25 (U.S. CLS. 22 AND 39).

TRADEMARK

PRINCIPAL REGISTER

FIRST USE 4-0-2011; IN COMMERCE 4-0-2011.

THE MARK CONSISTS OF STANDARD CHARACTERS WITHOUT CLAIM TO ANY PARTICULAR FONT, STYLE, SIZE, OR COLOR.

SER. NO. 85-317,828, FILED 5-11-2011.

JOHN HWANG, EXAMINING ATTORNEY



David J. Kybas

Director of the United States Patent and Trademark Office

United States of America

United States Patent and Trademark Office

VxRGB

Reg. No. 4,152,904

Registered June 5, 2012

Int. Cls.: 9 and 11

TRADEMARK

PRINCIPAL REGISTER

MITSUBISHI CHEMICAL CORPORATION (JAPAN CORPORATION)
14-1, SHIBA 4-CHOME
MINATO-KU, TOKYO, JAPAN

FOR: LIGHT EMITTING DIODES, SEMI-CONDUCTORS, DIGITAL CAMERAS, VIDEO CAMERAS, PHOTOGRAPHIC CAMERAS, CINEMATOGRAPHIC CAMERAS, VIDEO PROJECTORS, SLIDE PROJECTORS, MOVIE PROJECTORS, ACTINOMETERS, ILLUMINOMETERS, HYGROMETERS, PEDOMETERS, ASTRONOMETRIC MEASURING MACHINES AND INSTRUMENTS, VIDEO GAME MACHINES FOR USE WITH EXTERNAL DISPLAY SCREEN OR MONITOR, TELEPHONE APPARATUS, MOBILE TELEPHONES, VIDEO TELEPHONES, FACSIMILE MACHINES, TELEVISION MONITORS, NAVIGATION APPARATUS FOR VEHICLES, NAMELY, ON-BOARD COMPUTERS, SATELLITE NAVIGATIONAL SYSTEM, NAMELY, A GLOBAL POSITIONING SYSTEM, RADAR, VIDEO RECORDERS, VIDEO DISC PLAYERS, JUKE BOXES, COMPUTERS, COMPUTER PERIPHERAL DEVICES, COMPUTER MONITORS, ELECTROSTATIC COPYING MACHINES, SCANNERS, BAR CODE READERS, AND ELECTRONIC NOTICE BOARDS, IN CLASS 9 (U.S. CLS. 21, 23, 26, 36 AND 38).

FOR: LED LIGHT BULBS, LED (LIGHT EMITTING DIODE) LIGHTING FIXTURES, LED (LIGHT EMITTING DIODE) PLANT GROW LIGHT, ELECTRIC LIGHT BULBS, ELECTRIC LAMPS, ELECTRIC LIGHTING FIXTURES AND LIGHTS FOR VEHICLES, IN CLASS 11 (U.S. CLS. 13, 21, 23, 31 AND 34).

THE MARK CONSISTS OF STANDARD CHARACTERS WITHOUT CLAIM TO ANY PARTICULAR FONT, STYLE, SIZE, OR COLOR.

PRIORITY CLAIMED UNDER SEC. 44(D) ON JAPAN APPLICATION NO. 2011-030358, FILED 4-28-2011, REG. NO. 5460874, DATED 1-6-2012, EXPIRES 1-6-2022.

SER. NO. 85-318,502, FILED 5-11-2011.

PAM WILLIS, EXAMINING ATTORNEY



David J. Kyros

Director of the United States Patent and Trademark Office

United States of America

United States Patent and Trademark Office

THE SUSTAINABLE MOVE

Reg. No. 4,152,905

Registered June 5, 2012

Int. Cls.: 39 and 43

SERVICE MARK

PRINCIPAL REGISTER

ADVANCE RELOCATION AND STORAGE INC. (NEW YORK CORPORATION)
195 SWEET HOLLOW ROAD
OLD BETHPAGE, NY 11804

FOR: MOVING AND STORAGE OF FURNITURE, GOODS, UNWANTED OFFICE ASSETS AND HIGH VALUE PRODUCTS, NAMELY, ARTWORK AND COMPUTERS, IN CLASS 39 (U.S. CLS. 100 AND 105).

FIRST USE 4-22-2011; IN COMMERCE 4-22-2011.

FOR: CHARITABLE EXCHANGE PROGRAMS, NAMELY, PROVIDING UNWANTED FURNITURE, HOUSEHOLD AND OFFICE FURNISHINGS TO THOSE IN NEED BY DONATION TO NOT FOR PROFIT ORGANIZATIONS, IN CLASS 43 (U.S. CLS. 100 AND 101).

FIRST USE 4-22-2011; IN COMMERCE 4-22-2011.

THE MARK CONSISTS OF STANDARD CHARACTERS WITHOUT CLAIM TO ANY PARTICULAR FONT, STYLE, SIZE, OR COLOR.

NO CLAIM IS MADE TO THE EXCLUSIVE RIGHT TO USE "MOVE" , APART FROM THE MARK AS SHOWN.

SER. NO. 85-319,325, FILED 5-12-2011.

BARBARA BROWN, EXAMINING ATTORNEY



David J. Kybas

Director of the United States Patent and Trademark Office

United States of America

United States Patent and Trademark Office

ACTIVE HEALTH ROLLER

Reg. No. 4,152,906

NICHOLSON, RANDY (UNITED STATES INDIVIDUAL)
3120 BROOKVIEW DRIVE
MARIETTA, GA 30068

Registered June 5, 2012

Int. Cl.: 10

FOR: MASSAGE APPARATUS, IN CLASS 10 (U.S. CLS. 26, 39 AND 44).

TRADEMARK

FIRST USE 10-14-2010; IN COMMERCE 10-14-2010.

PRINCIPAL REGISTER

THE MARK CONSISTS OF STANDARD CHARACTERS WITHOUT CLAIM TO ANY PARTICULAR FONT, STYLE, SIZE, OR COLOR.

NO CLAIM IS MADE TO THE EXCLUSIVE RIGHT TO USE "HEALTH ROLLER", APART FROM THE MARK AS SHOWN.

SER. NO. 85-319,704, FILED 5-12-2011.

JOHN KELLY, EXAMINING ATTORNEY



David J. Kybas

Director of the United States Patent and Trademark Office

United States of America

United States Patent and Trademark Office

LISTEN TO YOUR MOTHER

Reg. No. 4,152,907

Registered June 5, 2012

Int. Cl.: 41

SERVICE MARK

PRINCIPAL REGISTER

LISTEN TO YOUR MOTHER, LLC (WISCONSIN LIMITED LIABILITY COMPANY)
5406 TOLMAN TERRACE
MADISON, WI 53711

FOR: ENTERTAINMENT IN THE NATURE OF LIVE LITERARY READINGS; PRESENTATION OF LIVE LITERARY READING EVENTS AND SPOKEN WORD PERFORMANCES, IN CLASS 41 (U.S. CLS. 100, 101 AND 107).

FIRST USE 5-9-2010; IN COMMERCE 5-9-2010.

THE MARK CONSISTS OF STANDARD CHARACTERS WITHOUT CLAIM TO ANY PARTICULAR FONT, STYLE, SIZE, OR COLOR.

SER. NO. 85-320,001, FILED 5-13-2011.

MATTHEW PAPPAS, EXAMINING ATTORNEY



David J. Kappas

Director of the United States Patent and Trademark Office

United States of America

United States Patent and Trademark Office

MSAR

Reg. No. 4,152,908

Registered June 5, 2012

Int. Cl.: 41

SERVICE MARK

PRINCIPAL REGISTER

ASSOCIATION OF AMERICAN MEDICAL COLLEGES (ILLINOIS CORPORATION)
2450 N STREET, NW
WASHINGTON, DC 20036

FOR: PROVIDING AN ONLINE PUBLICATION IN THE NATURE OF A COMPENDIUM CONTAINING INFORMATION ABOUT MEDICAL SCHOOLS AND HAVING TOPICS AND ISSUES OF INTEREST TO THOSE INTERESTED IN, ALREADY IN OR CONTEMPLATING THE MEDICAL FIELD; PROVIDING AN ONLINE INTERACTIVE PUBLICATION IN THE NATURE OF A COMPENDIUM IN THE FIELD OF INFORMATION ABOUT MEDICAL SCHOOLS, IN CLASS 41 (U.S. CLS. 100, 101 AND 107).

FIRST USE 4-6-2011; IN COMMERCE 4-6-2011.

THE MARK CONSISTS OF STANDARD CHARACTERS WITHOUT CLAIM TO ANY PARTICULAR FONT, STYLE, SIZE, OR COLOR.

OWNER OF U.S. REG. NO. 3,707,828.

SER. NO. 85-320,365, FILED 5-13-2011.

ROBIN MITTLER, EXAMINING ATTORNEY



David J. Kyffers

Director of the United States Patent and Trademark Office

United States of America

United States Patent and Trademark Office



WORLD CLASS
DEALER SERVICES INC.

Reg. No. 4,152,909

Registered June 5, 2012

Int. Cls.: 16 and 41

TRADEMARK

SERVICE MARK

PRINCIPAL REGISTER

WORLD CLASS DEALER SERVICES INCORPORATED (PENNSYLVANIA CORPORATION)
328 W. BROAD STREET
QUAKERTOWN, PA 18951

FOR: EDUCATIONAL PUBLICATIONS, NAMELY, TRAINING MANUALS IN THE FIELD OF SALES, FINANCE AND INSURANCE OF VEHICLES, IN CLASS 16 (U.S. CLS. 2, 5, 22, 23, 29, 37, 38 AND 50).

FIRST USE 9-11-2003; IN COMMERCE 9-11-2003.

FOR: TRAINING SERVICES IN THE FIELD OF SALES, FINANCE AND INSURANCE OF VEHICLES, IN CLASS 41 (U.S. CLS. 100, 101 AND 107).

FIRST USE 9-11-2003; IN COMMERCE 9-11-2003.

NO CLAIM IS MADE TO THE EXCLUSIVE RIGHT TO USE "DEALER SERVICES INC.", APART FROM THE MARK AS SHOWN.

THE COLOR(S) BLUE AND YELLOW IS/ARE CLAIMED AS A FEATURE OF THE MARK.

THE MARK CONSISTS OF THE DESIGN OF A YELLOW GLOBE, WITH A YELLOW LAUREL WREATH SURROUNDING IT, TO THE LEFT OF THE WORDING "WORLD CLASS DEALER SERVICES INC." IN BLUE. THE WHITE IN THE GLOBE REPRESENTS BACKGROUND AND IS NOT CLAIMED AS A FEATURE OF THE MARK.

SEC. 2(F) AS TO "WORLD CLASS DEALER SERVICES INC.".

SER. NO. 85-320,455, FILED 5-13-2011.

KIMBERLY FRYE, EXAMINING ATTORNEY



David J. Kybas

Director of the United States Patent and Trademark Office

United States of America

United States Patent and Trademark Office



Reg. No. 4,152,910

Registered June 5, 2012

Int. Cl.: 41

SERVICE MARK

PRINCIPAL REGISTER

THE RUSSIAN SCHOOL OF MATHEMATICS, INC. (MASSACHUSETTS CORPORATION)
200 WELLS AVENUE
NEWTON, MA 02459

FOR: EDUCATION SERVICES, NAMELY, PROVIDING MENTORING, TUTORING, CLASSES, SEMINARS AND WORKSHOPS IN THE FIELD OF MATHEMATICS, IN CLASS 41 (U.S. CLS. 100, 101 AND 107).

FIRST USE 9-1-1998; IN COMMERCE 9-1-1998.

NO CLAIM IS MADE TO THE EXCLUSIVE RIGHT TO USE "SCHOOL OF MATHEMATICS" AND "SINCE 1997", APART FROM THE MARK AS SHOWN.

THE COLOR(S) BLACK AND BLUE IS/ARE CLAIMED AS A FEATURE OF THE MARK.

THE MARK CONSISTS OF THE WORDS "SCHOOL OF MATHEMATICS" IN STYLIZED FORM OVER A DIAGONAL X AND Y AXIS WITH THE CAPITAL "S" OF "SCHOOL" IN BLUE AND THE CAPITAL "M" OF "MATHEMATICS" IN BLUE WITH THE REST OF THE WORDS, NUMBERS AND SYMBOLS APPEARING IN BLACK, THE WORDS "SINCE 1997" APPEAR AT THE BOTTOM LEFT.

SER. NO. 85-320,595, FILED 5-13-2011.

JEFF DEFORD, EXAMINING ATTORNEY



David J. Kyros

Director of the United States Patent and Trademark Office

United States of America

United States Patent and Trademark Office



Reg. No. 4,152,911

Registered June 5, 2012

Int. Cl.: 36

SERVICE MARK

PRINCIPAL REGISTER

ENDURING WEALTH ADVISORS (CALIFORNIA CORPORATION), FORMERLY JENICLYN, INC.
30162 CORTE CANTERA
TEMECULA, CA 92591

FOR: ADVICE RELATING TO INVESTMENTS; AGENCIES FOR BROKERAGE OF SECURITIES TRADING IN OVERSEAS SECURITIES MARKETS AND OF TRANSACTIONS ON COMMISSION OF OVERSEAS MARKET SECURITIES FUTURES; AGENCIES IN THE FIELD OF BONDS AND OTHER SECURITIES; AGENCIES OR BROKERAGE FOR TRADING OF SECURITIES, SECURITIES INDEX FUTURES, SECURITIES OPTIONS, AND OVERSEAS MARKET SECURITIES FUTURES; BROKERAGE OF SHARES AND OTHER SECURITIES; BROKERAGE OF SHARES OR STOCKS AND OTHER SECURITIES; BROKERAGE SERVICES IN THE FIELD OF SECURITIES AND COMMODITIES INVESTING; COMMODITY INVESTMENT ADVICE; CREDIT AND FINANCIAL CONSULTATION; FINANCIAL ADVICE; FINANCIAL ADVISORY AND CONSULTANCY SERVICES; FINANCIAL AND INVESTMENT SERVICES, NAMELY, ASSET AND INVESTMENT ACQUISITION, CONSULTATION, ADVISORY AND DEVELOPMENT; FINANCIAL AND INVESTMENT SERVICES, NAMELY, MANAGEMENT AND BROKERAGE IN THE FIELDS OF STOCKS, BONDS, OPTIONS, COMMODITIES, FUTURES AND OTHER SECURITIES, AND THE INVESTMENT OF FUNDS OF OTHERS; FINANCIAL EVALUATION FOR INSURANCE PURPOSES; FINANCIAL INVESTMENT BROKERAGE; FINANCIAL INVESTMENT BROKERAGE SERVICES; FINANCIAL INVESTMENT IN THE FIELD OF SECURITIES; FINANCIAL PLANNING; FINANCIAL PLANNING AND INVESTMENT ADVISORY SERVICES; FINANCIAL PLANNING CONSULTATION; FINANCIAL PLANNING FOR RETIREMENT; FINANCIAL PORTFOLIO ANALYSIS SERVICES; FINANCIAL PORTFOLIO MANAGEMENT; FINANCIAL SERVICES, NAMELY, A TOTAL PORTFOLIO OFFERING FOR HIGH NET WORTH CLIENTS CONSISTING OF BOTH SEPARATE ACCOUNTS AND MUTUAL FUNDS FOR EQUITY AND FIXED INCOME INVESTMENTS; FINANCIAL SERVICES, NAMELY, BROKER/DEALER SERVICES ON SECURITIES EXCHANGES AND OVER-THE-COUNTER MARKETS; FINANCIAL SERVICES, NAMELY, COMMODITY TRADING AND MANAGED FUTURES ADVISORY AND MANAGEMENT SERVICES; FINANCIAL SERVICES, NAMELY, COORDINATION, WITHIN A SINGLE ACCOUNT, OF AN INVESTMENT PORTFOLIO'S MAINTENANCE, TRADING, REBALANCING, AND TAX MANAGEMENT NEEDS; FINANCIAL SERVICES, NAMELY, INVESTMENT ADVICE, INVESTMENT MANAGEMENT, INVESTMENT CONSULTATION AND INVESTMENT OF FUNDS FOR OTHERS, INCLUDING PRIVATE AND PUBLIC EQUITY AND DEBT INVESTMENT SERVICES; FINANCIAL SERVICES, NAMELY, WEALTH MANAGEMENT SERVICES; INVESTMENT ADVICE; INVESTMENT ADVISORY



David J. Kappas

Director of the United States Patent and Trademark Office

Reg. No. 4,152,911 SERVICES; INVESTMENT OF FUNDS FOR OTHERS; MANAGEMENT OF PORTFOLIOS COMPRISING SECURITIES; MANAGEMENT OF PORTFOLIOS OF TRANSFERABLE SECURITIES; MANAGEMENT OF SECURITIES PORTFOLIOS; MUTUAL FUND INVESTMENT; MUTUAL FUNDS AND CAPITAL INVESTMENT; PRIVATE EQUITY FUND INVESTMENT SERVICES; PRIVATE PLACEMENTS OF HEDGE FUNDS, PRIVATE EQUITY FUNDS, SECURITIES AND DERIVATIVES FOR OTHERS; SECURITIES BROKERAGE; SECURITIES BROKERAGE SERVICES; SECURITY BROKERAGE; TRADING IN SECURITIES, IN CLASS 36 (U.S. CLS. 100, 101 AND 102).

FIRST USE 5-11-2011; IN COMMERCE 5-11-2011.

NO CLAIM IS MADE TO THE EXCLUSIVE RIGHT TO USE "WEALTH ADVISORS", APART FROM THE MARK AS SHOWN.

THE COLOR(S) GOLD AND GREEN IS/ARE CLAIMED AS A FEATURE OF THE MARK.

THE MARK CONSISTS OF THE WORDING "ENDURING WEALTH ADVISORS" APPEARS IN GREEN WITH A STYLIZED LETTER "E" CONTAINING A BRANCH OF WHEAT. FOUR ASCENDING GOLD BARS PRECEDE THE STYLIZED "E" AND ARE CROSSED BY THE BRANCH OF WHEAT. THE BRANCH OF WHEAT APPEARS IN GOLD WHILE THE WHEAT BERRIES APPEAR IN GREEN.

SER. NO. 85-321,169, FILED 5-14-2011.

NATALIE POLZER, EXAMINING ATTORNEY

United States of America

United States Patent and Trademark Office

Paper and Pigtails

Reg. No. 4,152,912

KORI M CLARK (FLORIDA SOLE PROPRIETORSHIP), DBA PAPER AND PIGTAILS
5407 CONCH ISLAND DR.
BRADENTON, FL 34203

Registered June 5, 2012

Int. Cl.: 42

FOR: COMPUTER GRAPHICS DESIGN SERVICES, IN CLASS 42 (U.S. CLS. 100 AND 101).

SERVICE MARK

FIRST USE 3-12-2010; IN COMMERCE 3-12-2010.

PRINCIPAL REGISTER

THE MARK CONSISTS OF STANDARD CHARACTERS WITHOUT CLAIM TO ANY PARTICULAR FONT, STYLE, SIZE, OR COLOR.

SER. NO. 85-321,286, FILED 5-15-2011.

BRENDAN REGAN, EXAMINING ATTORNEY



David J. Kybas

Director of the United States Patent and Trademark Office

United States of America

United States Patent and Trademark Office



SUNSOLUTIONS
C O N S U L T I N G

Reg. No. 4,152,913

Registered June 5, 2012

Int. Cls.: 35, 36 and 41

SERVICE MARK

PRINCIPAL REGISTER

SUNDANCE REHABILITATION CORPORATION (CONNECTICUT CORPORATION)
101 SUN AVE. NE
ALBUQUERQUE, NM 87109

FOR: MARKET ANALYSIS, IN CLASS 35 (U.S. CLS. 100, 101 AND 102).

FIRST USE 5-11-2011; IN COMMERCE 6-20-2011.

FOR: PROVIDING COMPLIANCE CONSULTING SERVICES IN THE FIELD OF MEDICARE INSURANCE, IN CLASS 36 (U.S. CLS. 100, 101 AND 102).

FIRST USE 5-11-2011; IN COMMERCE 6-20-2011.

FOR: EDUCATIONAL SERVICES, NAMELY, PROVIDING SEMINARS, TELECONFERENCING CLASSES AND CLASSES TO LONG TERM CARE NURSING, ASSISTED LIVING CENTERS AND SUB ACUTE CARE PROVIDERS IN THE FIELD OF MEDICARE OPERATIONS, REVENUE AND RATE, IN CLASS 41 (U.S. CLS. 100, 101 AND 107).

FIRST USE 5-11-2011; IN COMMERCE 6-20-2011.

OWNER OF U.S. REG. NO. 3,938,341.

NO CLAIM IS MADE TO THE EXCLUSIVE RIGHT TO USE "CONSULTING", APART FROM THE MARK AS SHOWN.

THE MARK CONSISTS OF A DESIGN OF A SUN RISING IN THE CENTER OF A CIRCLE WITH THE WORDING "SUNSOLUTIONS CONSULTING" TO THE RIGHT OF THE DESIGN.

SER. NO. 85-321,639, FILED 5-16-2011.

ESTHER A. BORSUK, EXAMINING ATTORNEY



David J. Kyjars

Director of the United States Patent and Trademark Office

United States of America

United States Patent and Trademark Office



Reg. No. 4,152,914

Registered June 5, 2012

Int. Cl.: 32

TRADEMARK

PRINCIPAL REGISTER

ROY FARMS, INC. (WASHINGTON CORPORATION)
401 WALTERS ROAD
MOXEE, WA 98936

FOR: PROCESSED HOPS, NAMELY, PELLETIZED HOPS FOR MAKING BEER, IN CLASS 32 (U.S. CLS. 45, 46 AND 48).

FIRST USE 8-31-2010; IN COMMERCE 11-15-2010.

NO CLAIM IS MADE TO THE EXCLUSIVE RIGHT TO USE "FRESH", "PELLETS", AND THE REPRESENTATION OF HOPS, APART FROM THE MARK AS SHOWN.

THE COLOR(S) GREEN, BLACK AND GREY IS/ARE CLAIMED AS A FEATURE OF THE MARK.

THE MARK CONSISTS OF THE WORDS "HARVEST FRESH" IN BLACK ARRANGED IN AN ARCH ABOVE A GREY GLASS JAR, AND THE WORD "PELLETS" IN BLACK IS ARRANGED IN AN ARCH BELOW THE GLASS JAR. AN IMAGE OF A GREEN HOP CONE IS LOCATED IN THE CENTER OF THE GLASS JAR.

SER. NO. 85-321,705, FILED 5-16-2011.

BRIAN NEVILLE, EXAMINING ATTORNEY



David J. Kyros

Director of the United States Patent and Trademark Office

United States of America

United States Patent and Trademark Office

FAMOUS FOR OUR FOOD LEGENDARY FOR OUR MARGARITAS

Reg. No. 4,152,915

LOPEZ FOODS, INC. (TEXAS CORPORATION), DBA JORGE'S MEXICAN CAFE
1601 CASTLEFORD RD
MIDLAND, TX 79705

Registered June 5, 2012

Int. Cl.: 43

FOR: RESTAURANT SERVICES FEATURING AUTHENTIC MEXICAN CUISINE, IN CLASS
43 (U.S. CLS. 100 AND 101).

SERVICE MARK

FIRST USE 1-1-2000; IN COMMERCE 1-1-2004.

PRINCIPAL REGISTER

THE MARK CONSISTS OF STANDARD CHARACTERS WITHOUT CLAIM TO ANY PAR-
TICULAR FONT, STYLE, SIZE, OR COLOR.

SER. NO. 85-321,838, FILED 5-16-2011.

TOBY BULLOFF, EXAMINING ATTORNEY



David J. Kybas

Director of the United States Patent and Trademark Office

United States of America

United States Patent and Trademark Office

Chamian Renee

Reg. No. 4,152,916

DZNR CHIC L.L.C. (CALIFORNIA LIMITED LIABILITY COMPANY)
121 BROADWAY SUITE 352
SAN DIEGO, CA 92101

Registered June 5, 2012

Int. Cls.: 18, 25 and 45

FOR: HANDBAGS, PURSES AND WALLETS, IN CLASS 18 (U.S. CLS. 1, 2, 3, 22 AND 41).

TRADEMARK

FIRST USE 11-2-2009; IN COMMERCE 11-2-2009.

SERVICE MARK

FOR: WOMEN'S CLOTHING, NAMELY, SHIRTS, DRESSES, SKIRTS, BLOUSES; WOMEN'S SHOES, IN CLASS 25 (U.S. CLS. 22 AND 39).

PRINCIPAL REGISTER

FIRST USE 11-2-2009; IN COMMERCE 11-2-2009.

FOR: PERSONAL STYLIST SERVICES, NAMELY, EVALUATING THE PHYSICAL ATTRIBUTES, LIFESTYLE, AND FASHION STYLES OF OTHERS AND RECOMMENDING CLOTHING AND ACCESSORIES TO ACHIEVE THE PERSONAL IMAGE DESIRED BY THE CLIENT, IN CLASS 45 (U.S. CLS. 100 AND 101).

FIRST USE 11-2-2009; IN COMMERCE 11-2-2009.

THE NAME(S), PORTRAIT(S), AND/OR SIGNATURE(S) SHOWN IN THE MARK IDENTIFIES "CHAMIAN RENE", WHOSE CONSENT(S) TO REGISTER IS MADE OF RECORD.

THE MARK CONSISTS OF "CHAMIAN RENE".

SER. NO. 85-321,858, FILED 5-16-2011.

SUSAN RICHARDS, EXAMINING ATTORNEY



David J. Kyffers

Director of the United States Patent and Trademark Office

United States of America

United States Patent and Trademark Office

posters.mobi

Reg. No. 4,152,917

METAVVERSE CORPORATION (NEW JERSEY CORPORATION)
49 STOUTS LANE
MONMOUTH JUNCTION, NJ 08852

Registered June 5, 2012

Int. Cl.: 35

FOR: ON-LINE RETAIL STORE SERVICES FEATURING FRAMED AND UNFRAMED ART AND POSTERS, IN CLASS 35 (U.S. CLS. 100, 101 AND 102).

SERVICE MARK

FIRST USE 4-19-2011; IN COMMERCE 4-19-2011.

PRINCIPAL REGISTER

NO CLAIM IS MADE TO THE EXCLUSIVE RIGHT TO USE "POSTERS.MOBI", APART FROM THE MARK AS SHOWN.

THE MARK CONSISTS OF THE STYLIZED TEXT "POSTERS.MOBI" WITH THREE STACKED ARCHES ABOVE THE SECOND "O".

SER. NO. 85-322,176, FILED 5-16-2011.

DOMINIC J. FERRAIUOLO, EXAMINING ATTORNEY



David J. Kyffers

Director of the United States Patent and Trademark Office

United States of America

United States Patent and Trademark Office

BACKTRAX

Reg. No. 4,152,918

Registered June 5, 2012

Int. Cl.: 10

TRADEMARK

PRINCIPAL REGISTER

LOWE & LEE MARKETING LLC (NEW MEXICO LIMITED LIABILITY COMPANY)
5310 KINGS ROW NE
ALBUQUERQUE, NM 87109

FOR: PHYSICAL THERAPY EQUIPMENT, NAMELY, A NON-ELECTRICAL, LIGHTWEIGHT, SOLID, AND PORTABLE PLATFORM FOR STRETCHING, RELAXING, AND SUPPORTING THE BACK AND SURROUNDING MUSCLES, PROVIDING DISC DECOMPRESSION, LUMBAR SUPPORT, AND PASSIVE SPINAL ALIGNMENT, FOR PREVENTION, REDUCTION, AND/OR ELIMINATION OF UPPER AND LOWER BACK PAIN, IN CLASS 10 (U.S. CLS. 26, 39 AND 44).

FIRST USE 3-1-2011; IN COMMERCE 3-1-2011.

THE MARK CONSISTS OF STANDARD CHARACTERS WITHOUT CLAIM TO ANY PARTICULAR FONT, STYLE, SIZE, OR COLOR.

SER. NO. 85-322,921, FILED 5-17-2011.

FRANK LATTUCA, EXAMINING ATTORNEY



David J. Kyffers

Director of the United States Patent and Trademark Office

United States of America

United States Patent and Trademark Office

Karen Dillard's College Prep

Reg. No. 4,152,919

Registered June 5, 2012

Int. Cl.: 41

SERVICE MARK

PRINCIPAL REGISTER

KAREN DILLARD'S COLLEGE PREP, L.P. (TEXAS LIMITED PARTNERSHIP)
2001 COIT ROAD, SUITE 103
PLANO, TX 75075

FOR: EDUCATION SERVICES, NAMELY, PROVIDING LIVE AND ON-LINE CLASSES, SEMINARS, AND WORKSHOPS IN THE FIELD OF PREPARING FOR COLLEGE ENTRANCE EXAMINATIONS, IN CLASS 41 (U.S. CLS. 100, 101 AND 107).

FIRST USE 1-1-2004; IN COMMERCE 2-1-2004.

THE MARK CONSISTS OF STANDARD CHARACTERS WITHOUT CLAIM TO ANY PARTICULAR FONT, STYLE, SIZE, OR COLOR.

NO CLAIM IS MADE TO THE EXCLUSIVE RIGHT TO USE "COLLEGE PREP", APART FROM THE MARK AS SHOWN.

THE NAME(S), PORTRAIT(S), AND/OR SIGNATURE(S) SHOWN IN THE MARK IDENTIFIES "KAREN DILLARD", WHOSE CONSENT(S) TO REGISTER IS MADE OF RECORD.

SER. NO. 85-322,992, FILED 5-17-2011.

SUSAN LESLIE DUBOIS, EXAMINING ATTORNEY



David J. Kyros

Director of the United States Patent and Trademark Office

United States of America

United States Patent and Trademark Office

WILCOXON RESEARCH

Reg. No. 4,152,920

Registered June 5, 2012

Int. Cl.: 9

TRADEMARK

PRINCIPAL REGISTER

MEGGITT (MARYLAND), INC. (MARYLAND CORPORATION), AKA MEGGITT SENSING SYSTEMS
20511 SENECA MEADOWS PARKWAY
GERMANTOWN, MD 20876

FOR: VIBRATION INSTRUMENTATION AND ACCESSORIES, NAMELY, ACCELEROMETERS, SENSORS, ALARMS, TRANSMITTERS, ELECTRICAL CABLES, CABLE CONNECTORS, POWER SUPPLIES AND REPLACEMENT PARTS THEREFOR, POWER/SIGNAL CONDITIONING AND COMMUNICATION MODULES, SWITCH/TERMINATION BOXES, MONITORING SOFTWARE USED IN CONJUNCTION THEREWITH, AND MOUNTING HARDWARE SPECIALLY TAILORED FOR THE AFORESAID GOODS, ALL THE AFORESAID GOODS FOR USE IN MONITORING PLANT/INDUSTRIAL MACHINERY, IN CLASS 9 (U.S. CLS. 21, 23, 26, 36 AND 38).

FIRST USE 0-0-1960; IN COMMERCE 0-0-1960.

THE MARK CONSISTS OF STANDARD CHARACTERS WITHOUT CLAIM TO ANY PARTICULAR FONT, STYLE, SIZE, OR COLOR.

NO CLAIM IS MADE TO THE EXCLUSIVE RIGHT TO USE "RESEARCH", APART FROM THE MARK AS SHOWN.

SER. NO. 85-323,105, FILED 5-17-2011.

ANDREA HACK, EXAMINING ATTORNEY



David J. Kybas

Director of the United States Patent and Trademark Office

United States of America

United States Patent and Trademark Office

EAT, DRINK, & BEAT

Reg. No. 4,152,921

EAT, DRINK, & BEAT LLC (NEW HAMPSHIRE LIMITED LIABILITY COMPANY)
7 DEER MEADOW RD.
DURHAM, NH 03824

Registered June 5, 2012

Int. Cl.: 19

FOR: NON-LUMINOUS, NON-MECHANICAL SIGNS NOT OF METAL, IN CLASS 19 (U.S. CLS. 1, 12, 33 AND 50).

TRADEMARK

FIRST USE 3-4-1998; IN COMMERCE 3-4-1998.

PRINCIPAL REGISTER

THE MARK CONSISTS OF STANDARD CHARACTERS WITHOUT CLAIM TO ANY PARTICULAR FONT, STYLE, SIZE, OR COLOR.

SER. NO. 85-323,352, FILED 5-17-2011.

LAKEISHA LEWIS, EXAMINING ATTORNEY



David J. Kyjars

Director of the United States Patent and Trademark Office

United States of America

United States Patent and Trademark Office

TASTE FOR LIFE

Reg. No. 4,152,922

Registered June 5, 2012

Int. Cl.: 42

SERVICE MARK

PRINCIPAL REGISTER

SYMRISE AG (FED REP GERMANY AKTIENGESELLSCHAFT)
MUHLENFELDSTRASSE 1
HOLZMINDEN, FED REP GERMANY 37603

FOR: INDUSTRIAL PRODUCT DEVELOPMENT ANALYSIS, INDUSTRIAL RESEARCH
AND PRODUCT RESEARCH AND DEVELOPMENT IN THE FIELD OF FLAVORS AND
AROMA CHEMICALS, IN CLASS 42 (U.S. CLS. 100 AND 101).

FIRST USE 1-1-2010; IN COMMERCE 1-1-2010.

THE MARK CONSISTS OF STANDARD CHARACTERS WITHOUT CLAIM TO ANY PAR-
TICULAR FONT, STYLE, SIZE, OR COLOR.

SER. NO. 85-323,742, FILED 5-18-2011.

KATHY DE JONGE, EXAMINING ATTORNEY



David J. Kyjars

Director of the United States Patent and Trademark Office

United States of America

United States Patent and Trademark Office



Reg. No. 4,152,923

Registered June 5, 2012

Int. Cl.: 42

SERVICE MARK

PRINCIPAL REGISTER

MYCO SUITE LIMITED (HONG KONG CORPORATION)
SUITES 1601-1603, KINWICK CENTRE
32 HOLLYWOOD ROAD
CENTRAL, HONG KONG

FOR: RESEARCH AND DEVELOPMENT FOR NEW PRODUCTS FOR OTHERS; QUALITY CONTROL FOR OTHERS; INDUSTRIAL DESIGN; CONSTRUCTION DRAFTING; COMPUTER SOFTWARE DESIGN; RENTAL OF COMPUTER SOFTWARE; COMPUTER SYSTEMS ANALYSIS; COMPUTER SYSTEM DESIGN SERVICES; DATA CONVERSION OF COMPUTER PROGRAMS AND DATA, NOT PHYSICAL CONVERSION; COMPUTER SOFTWARE CONSULTANCY, IN CLASS 42 (U.S. CLS. 100 AND 101).

FIRST USE 1-1-2011; IN COMMERCE 1-1-2011.

NO CLAIM IS MADE TO THE EXCLUSIVE RIGHT TO USE "SUITE", APART FROM THE MARK AS SHOWN.

THE COLOR(S) BLACK, WHITE AND BLUE IS/ARE CLAIMED AS A FEATURE OF THE MARK.

THE MARK CONSISTS OF A BLACK AND WHITE PANDA WEARING A BLUE TIE ABOVE THE WORD "MYCO" IN BLACK, WHICH IS ABOVE THE WORD "SUITE" IN BLUE.

SER. NO. 85-324,123, FILED 5-18-2011.

NAPOLEON SHARMA, EXAMINING ATTORNEY



David J. Kyffers

Director of the United States Patent and Trademark Office

United States of America

United States Patent and Trademark Office

CLOUDPAPERS

Reg. No. 4,152,924

Registered June 5, 2012

Int. Cl.: 42

SERVICE MARK

PRINCIPAL REGISTER

B2LEAD, LLC (DELAWARE LIMITED LIABILITY COMPANY), DBA CLOUDPAPERS
SUITE 105
1870 JEFFERSON STREET
SAN FRANCISCO, CA 94123

FOR: CONSULTING SERVICES IN THE FIELD OF SOFTWARE AS A SERVICE (SAAS);
SOFTWARE AS A SERVICE (SAAS) SERVICES, NAMELY, HOSTING SOFTWARE FOR
USE BY OTHER BUSINESSES FOR USE TO DISTRIBUTE ONLINE CONTENT FOR THE
PURPOSE OF MARKETING, BRANDING, LEAD GENERATION, ONLINE COMMUNITY
BUILDING AND ONLINE SOCIAL MARKETING, IN CLASS 42 (U.S. CLS. 100 AND 101).

FIRST USE 5-3-2011; IN COMMERCE 5-3-2011.

THE MARK CONSISTS OF STANDARD CHARACTERS WITHOUT CLAIM TO ANY PAR-
TICULAR FONT, STYLE, SIZE, OR COLOR.

SER. NO. 85-324,522, FILED 5-19-2011.

NATALIE POLZER, EXAMINING ATTORNEY



David J. Kybas

Director of the United States Patent and Trademark Office

United States of America

United States Patent and Trademark Office

Insurance Without Borders

Reg. No. 4,152,925

Registered June 5, 2012

Int. Cl.: 36

SERVICE MARK

PRINCIPAL REGISTER

GLOBAL BENEFITS GROUP, INC. (CALIFORNIA CORPORATION)
SUITE 100
26000 TOWNE CENTRE DRIVE
FOOTHILL RANCH, CA 92610

FOR: INSURANCE CARRIER SERVICES. PROVIDED HOWEVER, THAT SUCH GOODS AND/OR SERVICES ARE NOT DIRECTLY ASSOCIATED WITH CHARITABLE AND HUMANITARIAN SERVICES OR FUNDRAISING IN CONNECTION WITH MEDICAL OR HEALTH CARE, INTERNATIONAL RELIEF PROJECTS, OR TARGETED TO ASSISTING VICTIMS OF DISASTERS AND CONFLICTS IN UNDERDEVELOPED COUNTRIES, OR CONCERNED WITH PROMOTING PUBLIC AWARENESS OR POPULATIONS AT RISK, IN CLASS 36 (U.S. CLS. 100, 101 AND 102).

FIRST USE 5-8-2003; IN COMMERCE 5-8-2003.

THE MARK CONSISTS OF STANDARD CHARACTERS WITHOUT CLAIM TO ANY PARTICULAR FONT, STYLE, SIZE, OR COLOR.

NO CLAIM IS MADE TO THE EXCLUSIVE RIGHT TO USE "INSURANCE", APART FROM THE MARK AS SHOWN.

SER. NO. 85-325,157, FILED 5-19-2011.

SUE LAWRENCE, EXAMINING ATTORNEY



David J. Kyros

Director of the United States Patent and Trademark Office

United States of America

United States Patent and Trademark Office



ONTOUR

Reg. No. 4,152,926

Registered June 5, 2012

Int. Cls.: 25 and 35

TRADEMARK

SERVICE MARK

PRINCIPAL REGISTER

TRIMARK SPORTSWEAR CANADA INC. (CANADA CORPORATION)
30 STAPLES AVE.
RICHMOND HILL, ONTARIO, CANADA L4B 4W3

FOR: CLOTHING NAMELY GOLF SHIRTS, WIND SHIRTS, JACKETS, PANTS; HATS, CAPS,
IN CLASS 25 (U.S. CLS. 22 AND 39).

FIRST USE 0-0-2005; IN COMMERCE 0-0-2005.

FOR: WHOLESALE DISTRIBUTORSHIPS FEATURING APPAREL FOR USE IN PROMOTING
BUSINESSES AND ORGANIZATIONS AND FOR USE IN CONJUNCTION WITH PROMO-
TIONS AND EVENTS STAGED OR SPONSORED BY THAT BUSINESS OR ORGANIZATION;
SPECIALTY MERCHANDISING SERVICES, NAMELY, PROMOTING THE GOODS AND
SERVICES OF OTHERS THROUGH THE DISTRIBUTION OF CUSTOMIZED ADVERTISING
MATERIALS, NAMELY, APPAREL FOR USE IN CONJUNCTION WITH PROMOTIONS AND
EVENTS STAGED OR SPONSORED BY THAT BUSINESS OR ORGANIZATION, IN CLASS
35 (U.S. CLS. 100, 101 AND 102).

FIRST USE 0-0-2005; IN COMMERCE 0-0-2005.

PRIORITY CLAIMED UNDER SEC. 44(D) ON CANADA APPLICATION NO. 1505101, FILED
11-23-2010, REG. NO. TMA809891, DATED 10-24-2011, EXPIRES 10-24-2026.

THE MARK CONSISTS OF THE WORDING "ONTOUR" CENTERED BELOW A STYLIZED
CIRCLE DESIGN WHICH CONTAINS SEVEN SMALLER DOTS FORMING A CIRCLE
WITHIN THE OUTER CIRCLE.

SER. NO. 85-325,843, FILED 5-20-2011.

PAULA MAHONEY, EXAMINING ATTORNEY



David J. Kybas

Director of the United States Patent and Trademark Office

United States of America

United States Patent and Trademark Office

MEVAC

Reg. No. 4,152,927

Registered June 5, 2012

Int. Cls.: 7, 9 and 11

TRADEMARK

PRINCIPAL REGISTER

SMS MEVAC GMBH (FED REP GERMANY LIMITED LIABILITY COMPANY)
BAMLERSTRASSE 3 A
ESSEN, FED REP GERMANY 45141

FOR: MACHINE FOR SECONDARY METALLURGICAL AND VACUUM-METALLURGICAL PROCESSES; INSTALLATIONS FOR SECONDARY METALLURGICAL AND VACUUM-METALLURGICAL PROCESSES CONSISTING OF MACHINES, PARTS FOR THE AFORESAID MACHINES AND INSTALLATIONS, IN CLASS 7 (U.S. CLS. 13, 19, 21, 23, 31, 34 AND 35).

FOR: CONTROL AND REGULATING APPARATUS FOR MACHINES FOR SECONDARY METALLURGICAL AND VACUUM-METALLURGICAL PROCESSES, AND FOR INSTALLATIONS FOR SECONDARY METALLURGICAL AND VACUUM-METALLURGICAL PROCESSES CONSISTING OF MACHINES, NAMELY, ELECTRIC LUMINESCENT DISPLAY PANELS, LIGHT EMITTING DIODE DISPLAYS, LIQUID CRYSTAL DISPLAYS, STRIP TENSION DYNAMOMETERS, STRIP TENSIONING LABORATORY BLADES, STRIP FLATNESS METERS, THERMOMETERS, SPEEDOMETERS, PRESSURE GAUGES, ANGLE GAUGES, DISTANCE METERS, ROUGHNESS GAUGES, ELECTRIC AND ELECTRONIC CONTROLLERS, NAMELY, FLATNESS CONTROLLERS, ROUGHNESS CONTROLLERS, PRESSURE CONTROLLERS AND TENSIONING CONTROLLERS FOR INFLUENCING THE PROPERTIES OF ROLLED STEEL, CONTROL PANELS FOR ROLLING MILLS, ELECTRICAL AND MAGNETIC DETECTORS FOR MONITORING THE PROPERTIES OF ROLLED STEEL, FREQUENCY METERS; DATA- PROCESSING EQUIPMENT AND COMPUTERS; RECORDED PROGRAMS FOR CONTROLLING AND REGULATING SECONDARY METALLURGICAL AND VACUUM-METALLURGICAL PROCESSES AND CONTROLLING AND REGULATING INSTALLATIONS FOR SECONDARY METALLURGICAL AND VACUUM-METALLURGICAL PROCESSES CONSISTING OF MACHINES, IN CLASS 9 (U.S. CLS. 21, 23, 26, 36 AND 38).

FOR: OVENS, HEATING, REFRIGERATING AND STEAM GENERATING DEVICES FOR SECONDARY METALLURGICAL AND VACUUM-METALLURGICAL PROCESSES, IN CLASS 11 (U.S. CLS. 13, 21, 23, 31 AND 34).

THE MARK CONSISTS OF STANDARD CHARACTERS WITHOUT CLAIM TO ANY PARTICULAR FONT, STYLE, SIZE, OR COLOR.

PRIORITY CLAIMED UNDER SEC. 44(D) ON ERPN CMNTY TM OFC APPLICATION NO. 009656364, FILED 12-22-2010, REG. NO. 009656364, DATED 5-23-2011, EXPIRES 12-22-2020.



David J. Kappas

Director of the United States Patent and Trademark Office

Reg. No. 4,152,927 SER. NO. 85-326,048, FILED 5-20-2011.

TOBY BULLOFF, EXAMINING ATTORNEY

United States of America

United States Patent and Trademark Office

SNUFF SKINS

Reg. No. 4,152,928

WATTENBARGER, JOSEPH (UNITED STATES INDIVIDUAL)
7801 PENNY MARIE AVE.
BAKERSFIELD, CA 93308 AND

Registered June 5, 2012

Int. Cl.: 34

OSBORNE, THOMAS (UNITED STATES INDIVIDUAL)
7801 PENNY MARIE AVE.
BAKERSFIELD, CA 93308

TRADEMARK

PRINCIPAL REGISTER

FOR: COVERS FOR CONTAINERS FOR SMOKELESS TOBACCO , IN CLASS 34 (U.S. CLS. 2, 8, 9 AND 17).

FIRST USE 7-15-2011; IN COMMERCE 7-15-2011.

THE MARK CONSISTS OF STANDARD CHARACTERS WITHOUT CLAIM TO ANY PARTICULAR FONT, STYLE, SIZE, OR COLOR.

NO CLAIM IS MADE TO THE EXCLUSIVE RIGHT TO USE "SNUFF", APART FROM THE MARK AS SHOWN.

SER. NO. 85-326,102, FILED 5-20-2011.

JAMES A. RAUEN, EXAMINING ATTORNEY

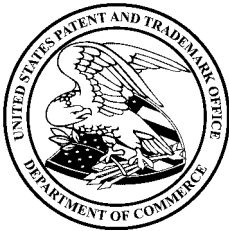

David J. Kyffers

Director of the United States Patent and Trademark Office

United States of America

United States Patent and Trademark Office

SUNBURST

Reg. No. 4,152,929

DAIMLER AG (FED REP GERMANY CORPORATION)
MERCEDSTRASSE 137
STUTTGART, FED REP GERMANY 70327

Registered June 5, 2012

Int. Cl.: 12

FOR: AUTOMOBILES AND THEIR STRUCTURAL PARTS, AUTOMOTIVE INTERIOR PARTS MADE OF WOOD, NAMELY, INTERIOR TRIM, INTERIOR PANELING, ROOF PANELING AND ROOF LINERS, IN CLASS 12 (U.S. CLS. 19, 21, 23, 31, 35 AND 44).

TRADEMARK

THE MARK CONSISTS OF STANDARD CHARACTERS WITHOUT CLAIM TO ANY PARTICULAR FONT, STYLE, SIZE, OR COLOR.

PRINCIPAL REGISTER

PRIORITY CLAIMED UNDER SEC. 44(D) ON FED REP GERMANY APPLICATION NO. 302010075077, FILED 12-23-2010, REG. NO. 302010075077, DATED 3-25-2011, EXPIRES 12-31-2020.

SER. NO. 85-326,995, FILED 5-23-2011.

CARRIE GENOVESE, EXAMINING ATTORNEY



David J. Kybas

Director of the United States Patent and Trademark Office

United States of America

United States Patent and Trademark Office

be the breath
inhale. exhale. live.

Reg. No. 4,152,930

BE THE BREATH, LLC (FLORIDA LIMITED LIABILITY COMPANY)
1216 HOPEDALE DR
FORT MYERS, FL 33919

Registered June 5, 2012

Int. Cls.: 25, 28 and 41

FOR: HOODED SWEAT SHIRTS; PANTS; SHIRTS; SHIRTS FOR INFANTS, BABIES, TODDLERS AND CHILDREN; SHORT-SLEEVED OR LONG-SLEEVED T-SHIRTS; SHORTS; T-SHIRTS; TANK TOPS; YOGA PANTS; YOGA SHIRTS, IN CLASS 25 (U.S. CLS. 22 AND 39).

TRADEMARK

FIRST USE 5-21-2010; IN COMMERCE 6-21-2010.

SERVICE MARK

FOR: BAGS SPECIALLY ADAPTED TO CARRY YOGA EQUIPMENT; YOGA BLOCKS; YOGA MATS, IN CLASS 28 (U.S. CLS. 22, 23, 38 AND 50).

PRINCIPAL REGISTER

FIRST USE 5-21-2010; IN COMMERCE 5-21-2010.

FOR: MEDITATION TRAINING; YOGA INSTRUCTION, IN CLASS 41 (U.S. CLS. 100, 101 AND 107).

FIRST USE 5-21-2010; IN COMMERCE 8-14-2010.

THE MARK CONSISTS OF STANDARD CHARACTERS WITHOUT CLAIM TO ANY PARTICULAR FONT, STYLE, SIZE, OR COLOR.

SER. NO. 85-327,087, FILED 5-23-2011.

TRICIA SONNEBORN, EXAMINING ATTORNEY



David J. Kyros

Director of the United States Patent and Trademark Office

United States of America

United States Patent and Trademark Office



Reg. No. 4,152,931

Registered June 5, 2012

Int. Cls.: 16, 36 and 45

TRADEMARK

SERVICE MARK

PRINCIPAL REGISTER

RIEMANN FUNERAL HOMES, INC. (MISSISSIPPI CORPORATION)
11280 THREE RIVERS ROAD
GULFPORT, MS 39503

FOR: PRINTED LISTS FEATURING MORGUE AND CREMATORY OPERATORS CHECK-LISTS, IN CLASS 16 (U.S. CLS. 2, 5, 22, 23, 29, 37, 38 AND 50).

FIRST USE 1-27-2011; IN COMMERCE 1-27-2011.

FOR: PREPAID FUNERAL EXPENSE SERVICES, IN CLASS 36 (U.S. CLS. 100, 101 AND 102).

FIRST USE 1-20-2011; IN COMMERCE 8-4-2011.

FOR: FUNERAL ARRANGEMENT SERVICES; FUNERAL HOMES; FUNERAL SERVICES ACCOMPANYING CREMATION, IN CLASS 45 (U.S. CLS. 100 AND 101).

FIRST USE 1-20-2011; IN COMMERCE 8-4-2011.

NO CLAIM IS MADE TO THE EXCLUSIVE RIGHT TO USE "CREMATION ASSURANCE", APART FROM THE MARK AS SHOWN.

THE COLOR(S) BLUE, BROWN AND GOLD IS/ARE CLAIMED AS A FEATURE OF THE MARK.

THE MARK CONSISTS OF THE WORD "CREMATION" IN BLUE BLOCK CAPITAL LETTERS ABOVE THE WORD "ASSURANCE" IN BLUE ITALICS SEPARATED BY A GOLD HORIZONTAL LINE, WITH A GOLD PILLAR WITH A BROWN TOP TO THE RIGHT OF THE WORD "CREMATION".

SER. NO. 85-327,541, FILED 5-23-2011.

CAROLYN CATALDO, EXAMINING ATTORNEY



David J. Kybas

Director of the United States Patent and Trademark Office

United States of America

United States Patent and Trademark Office



Reg. No. 4,152,932

Registered June 5, 2012

Int. Cl.: 42

SERVICE MARK

PRINCIPAL REGISTER

STEVEN PRICE (UNITED STATES INDIVIDUAL), DBA TECH ROCKSTARS
850 SOUTH MYRTLE AVENUE
MONROVIA, CA 91016

FOR: ADVICE RELATING TO THE DESIGN OF COMPUTER HARDWARE; APPLICATION SERVICE PROVIDER (ASP), NAMELY, HOSTING COMPUTER SOFTWARE APPLICATIONS OF OTHERS; APPLICATION SERVICE PROVIDER, NAMELY, HOSTING, MANAGING, DEVELOPING, AND MAINTAINING APPLICATIONS, SOFTWARE, AND WEB SITES, IN THE FIELDS OF PERSONAL PRODUCTIVITY, WIRELESS COMMUNICATION, MOBILE INFORMATION ACCESS, AND REMOTE DATA MANAGEMENT FOR WIRELESS DELIVERY OF CONTENT TO HANDHELD COMPUTERS, LAPTOPS AND MOBILE ELECTRONIC DEVICES; AUTOMOTIVE DIAGNOSTIC SERVICES FEATURING COMPUTER SOFTWARE FOR USE BY INDEPENDENT AUTOMOTIVE REPAIR PERSONNEL; BACK-UP SERVICES FOR COMPUTER HARD DRIVE DATA; CHARITABLE SERVICES, NAMELY, PROVIDING COMPUTER EQUIPMENT TO SCHOOLS; COMPUTER AIDED DESIGN FOR OTHERS; COMPUTER AIDED GRAPHIC DESIGN; COMPUTER AND COMPUTER SOFTWARE RENTAL; COMPUTER CO-LOCATION SERVICES, NAMELY, PROVIDING FACILITIES FOR THE LOCATION OF COMPUTER SERVERS WITH THE EQUIPMENT OF OTHERS; COMPUTER CODE CONVERSION FOR OTHERS; COMPUTER COMPATIBILITY SERVICES, NAMELY, DATA MAPPING; COMPUTER CONSULTATION; COMPUTER CONSULTATION IN THE FIELD OF COMPUTER SECURITY; COMPUTER DIAGNOSTIC SERVICES; COMPUTER DISASTER RECOVERY PLANNING; COMPUTER FORENSIC SERVICES; COMPUTER GRAPHICS DESIGN SERVICES; COMPUTER GRAPHICS SERVICES; COMPUTER HARDWARE AND SOFTWARE CONSULTING SERVICES; COMPUTER HARDWARE AND SOFTWARE DESIGN; COMPUTER HARDWARE DEVELOPMENT; COMPUTER MODELING SERVICES, NAMELY, COMPUTER SIMULATION FROM COMPUTER PROGRAMS FOR OTHERS; COMPUTER MONITORING SERVICE WHICH TRACKS APPLICATION SOFTWARE PERFORMANCE, PERFORMS PERIODIC MAINTENANCE AND PROVIDES REPORTS AND ALERTS CONCERNING SUCH PERFORMANCE; COMPUTER MONITORING SERVICE WHICH TRACKS HARDWARE PERFORMANCE AND PROCESSES AND SENDS OUT HISTORICAL REPORTS AND ALERTS; COMPUTER NETWORK CONFIGURATION SERVICES; COMPUTER NETWORK DESIGN FOR OTHERS; COMPUTER PROGRAMMING; COMPUTER PROGRAMMING AND COMPUTER SYSTEM ANALYSIS; COMPUTER PROGRAMMING AND MAINTENANCE OF COMPUTER PROGRAMS; COMPUTER PROGRAMMING AND RENTAL OF COMPUTER PROGRAMS; COMPUTER PROGRAMMING AND SOFTWARE DESIGN; COMPUTER PROGRAMMING CONSULTANCY; COMPUTER PROGRAMMING FOR OTHERS; COMPUTER PROGRAMMING IN THE MEDICAL FIELD;

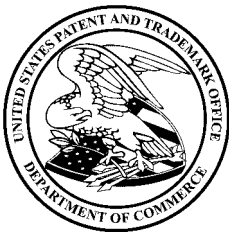

David J. Kappas

Director of the United States Patent and Trademark Office

Reg. No. 4,152,932 COMPUTER PROGRAMMING SERVICES; COMPUTER PROGRAMMING SERVICES FOR COMMERCIAL ANALYSIS AND REPORTING; COMPUTER PROGRAMMING SERVICES FOR CREATING AUGMENTED REALITY VIDEOS AND GAMES; COMPUTER PROGRAMMING SERVICES FOR CUSTOMERS THAT ENABLES THE CUSTOMER'S DIGITAL DEVICES TO PROCESS NATURAL LANGUAGE QUERIES FROM END USERS; COMPUTER PROGRAMMING SERVICES FOR OTHERS IN THE FIELD OF SOFTWARE CONFIGURATION MANAGEMENT; COMPUTER PROGRAMMING SERVICES, NAMELY, CONTENT CREATION FOR VIRTUAL WORLDS AND THREE DIMENSIONAL PLATFORMS; COMPUTER PROJECT MANAGEMENT SERVICES; COMPUTER PROJECT MANAGEMENT SERVICES IN THE FIELD OF TELECOMMUNICATIONS; COMPUTER SECURITY CONSULTANCY; COMPUTER SECURITY CONSULTANCY IN THE FIELD OF SCANNING AND PENETRATION TESTING OF COMPUTERS AND NETWORKS TO ASSESS INFORMATION SECURITY VULNERABILITY; COMPUTER SECURITY SERVICE, NAMELY, HARD DRIVE ERASURE; COMPUTER SECURITY SERVICE, NAMELY, RESTRICTING ACCESS TO AND BY COMPUTER NETWORKS TO AND OF UNDESIREED WEB SITES, MEDIA AND INDIVIDUALS AND FACILITIES; COMPUTER SERVICES IN THE NATURE OF CUSTOMIZED WEB PAGES AND OTHER DATA FEED FORMATS FEATURING USER-DEFINED INFORMATION; COMPUTER SERVICES, NAMELY, CLOUD HOSTING PROVIDER SERVICES; COMPUTER SERVICES, NAMELY, COMPUTER SYSTEM ADMINISTRATION FOR OTHERS; COMPUTER SERVICES, NAMELY, CREATING AN ON-LINE VIRTUAL ENVIRONMENT FOR TRADING VIRTUAL REAL ESTATE; COMPUTER SERVICES, NAMELY, CREATING AND MAINTAINING WEB SITES FOR OTHERS; COMPUTER SERVICES, NAMELY, CREATING COMPUTER NETWORK-BASED INDEXES OF INFORMATION, WEBSITES AND RESOURCES; COMPUTER SERVICES, NAMELY, CREATING, MAINTAINING, DESIGNING AND IMPLEMENTING WEB SITES FOR OTHERS; COMPUTER SERVICES, NAMELY, DATA RECOVERY SERVICES; COMPUTER SERVICES, NAMELY, DESIGNING AND IMPLEMENTING WEB PAGES FOR OTHERS; COMPUTER SERVICES, NAMELY, DESIGNING AND IMPLEMENTING WEB SITES FOR OTHERS; COMPUTER SERVICES, NAMELY, DIGITAL FORMATTING AND COMPRESSION OF MUSIC AND VIDEO IMAGES INTO DOWNLOADABLE MEDIA; COMPUTER SERVICES, NAMELY, DOMAIN FORWARDING SERVICES; COMPUTER SERVICES, NAMELY, ELECTRONIC DETECTION OF PLAGIARIZED CONTENT; COMPUTER SERVICES, NAMELY, ENCRYPTED DATA RECOVERY SERVICES; COMPUTER SERVICES, NAMELY, FILTERING OF UNWANTED E-MAILS; COMPUTER SERVICES, NAMELY, HOSTING ON-LINE INTERACTIVE PUBLIC CALENDARS THAT ALLOW MULTIPLE PARTICIPANTS TO SHARE EVENT SCHEDULES AND FACILITY RESERVATIONS; COMPUTER SERVICES, NAMELY, HOSTING ON-LINE WEB FACILITIES FOR OTHERS FOR ORGANIZING AND CONDUCTING ONLINE MEETINGS, GATHERINGS, AND INTERACTIVE DISCUSSIONS; COMPUTER SERVICES, NAMELY, INTEGRATION OF COMPUTER SOFTWARE INTO MULTIPLE SYSTEMS AND NETWORKS; COMPUTER SERVICES, NAMELY, INTEGRATION OF PRIVATE AND PUBLIC CLOUD COMPUTING ENVIRONMENTS; COMPUTER SERVICES, NAMELY, INTERACTIVE HOSTING SERVICES WHICH ALLOW THE USER TO PUBLISH AND SHARE THEIR OWN CONTENT AND IMAGES ON-LINE; COMPUTER SERVICES, NAMELY, INTERNET PROTOCOL ADDRESS MANAGEMENT; COMPUTER SERVICES, NAMELY, MANAGING WEB SITES FOR OTHERS; COMPUTER SERVICES, NAMELY, MONITORING AND REPORTING ON THE PERFORMANCE, AVAILABILITY, AND ERRORS OF WEB SITES OF OTHERS; COMPUTER SERVICES, NAMELY, MONITORING THE PERFORMANCE OF PARTICIPANTS AT SPORTING EVENTS BY TRACKING A COMPUTER CHIP WORN BY A SPORTING PARTICIPANT; COMPUTER SERVICES, NAMELY, MONITORING THE WEB SITES OF OTHERS TO IMPROVE THEIR SCALABILITY AND PERFORMANCE; COMPUTER SERVICES, NAMELY, MONITORING, TESTING, ANALYZING, AND REPORTING ON THE INTERNET TRAFFIC CONTROL AND CONTENT CONTROL OF THE WEB SITES OF OTHERS; COMPUTER SERVICES, NAMELY, ON-LINE SCANNING, DETECTING, QUARANTINING AND ELIMINATING OF VIRUSES, WORMS, TROJANS, SPYWARE, ADWARE, MALWARE AND UNAUTHORIZED DATA AND PROGRAMS ON COMPUTERS AND ELECTRONIC DEVICES; COMPUTER SERVICES, NAMELY, ON-SITE MANAGEMENT OF THE INFORMATION TECHNOLOGY (IT) SYSTEMS; COMPUTER SERVICES, NAMELY, OPERATING COMPUTER SYSTEMS AND COMPUTER NETWORKS FEATURING BROADBAND TRANSMISSION AND ENERGY TRANSMISSION

Reg. No. 4,152,932 SOFTWARE FOR PUBLIC UTILITIES AND OTHERS; COMPUTER SERVICES, NAMELY, PROVIDING AN INTERACTIVE WEB SITE FEATURING TECHNOLOGY THAT ALLOWS USERS TO COLLECT, STORE, MANAGE, DELIVER AND SHOWCASE ELECTRONIC AND PAPER-BASED CONTENT; COMPUTER SERVICES, NAMELY, PROVIDING AN INTERACTIVE WEB SITE FEATURING TECHNOLOGY THAT ALLOWS USERS TO CONSOLIDATE AND MANAGE SOCIAL NETWORKS, ACCOUNTS, AND CONNECTIONS TO EXISTING AND EMERGING APPLICATION PROGRAMMING INTERFACES (APIS); COMPUTER SERVICES, NAMELY, PROVIDING AN INTERACTIVE WEB SITE FEATURING TECHNOLOGY THAT ALLOWS USERS TO CREATE THEIR OWN BOOKS; COMPUTER SERVICES, NAMELY, PROVIDING CUSTOMIZED WEB PAGES FEATURING USER-DEFINED INFORMATION; COMPUTER SERVICES, NAMELY, PROVIDING SEARCH ENGINES FOR OBTAINING DATA ON A GLOBAL COMPUTER NETWORK; COMPUTER SERVICES, NAMELY, PROVIDING VIRTUAL AND NON VIRTUAL APPLICATION SERVERS, WEB SERVERS, FILE SERVERS, CO-LOCATION SERVERS, LOAD BALANCING SERVERS, REDUNDANCY SERVERS, MEDIA SERVERS AND DATABASE SERVERS OF VARIABLE CAPACITY TO THIRD PARTY COMPUTING AND DATA STORAGE FACILITIES; COMPUTER SERVICES, NAMELY, REDIRECTING ELECTRONIC MAIL TO CHANGED PERSONAL ELECTRONIC ADDRESS; COMPUTER SERVICES, NAMELY, REMOTE MANAGEMENT OF THE INFORMATION TECHNOLOGY (IT) SYSTEMS OF OTHERS; COMPUTER SERVICES, NAMELY, SEARCH ENGINE OPTIMIZATION; COMPUTER SERVICES, NAMELY, UPLOADING MUSIC TO THE INTERNET FOR OTHERS; COMPUTER SITE DESIGN; COMPUTER SOFTWARE CONSULTANCY; COMPUTER SOFTWARE CONSULTING; COMPUTER SOFTWARE DESIGN; COMPUTER SOFTWARE DESIGN AND UPDATING; COMPUTER SOFTWARE DESIGN FOR OTHERS; COMPUTER SOFTWARE DESIGN, COMPUTER PROGRAMMING, OR MAINTENANCE OF COMPUTER SOFTWARE; COMPUTER SOFTWARE DEVELOPMENT; COMPUTER SOFTWARE DEVELOPMENT AND COMPUTER PROGRAMMING DEVELOPMENT FOR OTHERS; COMPUTER SOFTWARE DEVELOPMENT IN THE FIELD OF FREIGHT TRANSPORTATION BY TRUCK, RAIL, AIR AND OCEAN; COMPUTER SOFTWARE DEVELOPMENT IN THE FIELD OF MOBILE APPLICATIONS; COMPUTER SOFTWARE INSTALLATION AND MAINTENANCE; COMPUTER SOFTWARE RENTAL; COMPUTER SYSTEM DESIGN SERVICES; COMPUTER SYSTEMS ANALYSIS; COMPUTER SYSTEMS INTEGRATION SERVICES; COMPUTER TECHNICAL SUPPORT SERVICES, NAMELY, 24/7 SERVICE DESK/HELP DESK SERVICES FOR IT INFRASTRUCTURE, OPERATING SYSTEMS, DATABASE SYSTEMS, AND WEB APPLICATIONS; COMPUTER TECHNOLOGY SUPPORT SERVICES, NAMELY, HELP DESK SERVICES; COMPUTER TIME-SHARING SERVICES; COMPUTER VIRUS PROTECTION SERVICES; COMPUTER-AIDED ENGINEERING SERVICES FOR OTHERS; CONSULTING IN THE FIELD OF CONFIGURATION MANAGEMENT FOR COMPUTER HARDWARE AND SOFTWARE; CONSULTING SERVICES IN THE FIELD OF CLOUD COMPUTING; CONSULTING SERVICES IN THE FIELD OF COMPUTER-BASED INFORMATION SYSTEMS FOR BUSINESSES; CONSULTING SERVICES IN THE FIELD OF DESIGN, SELECTION, IMPLEMENTATION AND USE OF COMPUTER HARDWARE AND SOFTWARE SYSTEMS FOR OTHERS; CONSULTING SERVICES IN THE FIELD OF HOSTING COMPUTER SOFTWARE APPLICATIONS; CONSULTING SERVICES IN THE FIELDS OF SELECTION, IMPLEMENTATION AND USE OF COMPUTER HARDWARE AND SOFTWARE SYSTEMS FOR OTHERS; COPYING OF COMPUTER SOFTWARE; CREATING OF COMPUTER PROGRAMS; CREATING, MAINTAINING, AND MODERNIZING COMPUTER SOFTWARE; CUSTOMIZATION OF COMPUTER HARDWARE AND SOFTWARE; DATA CONVERSION OF COMPUTER PROGRAM DATA OR INFORMATION; DATA CONVERSION OF COMPUTER PROGRAMS AND DATA, NOT PHYSICAL CONVERSION; DEBUGGING COMPUTER SOFTWARE FOR OTHERS; DESIGN AND DEVELOPMENT OF COMPUTER GAME SOFTWARE AND VIRTUAL REALITY SOFTWARE; DESIGN AND DEVELOPMENT OF COMPUTER HARDWARE; DESIGN AND DEVELOPMENT OF COMPUTER HARDWARE AND SOFTWARE; DESIGN AND DEVELOPMENT OF COMPUTER HARDWARE FOR THE MANUFACTURING INDUSTRIES; DESIGN AND DEVELOPMENT OF COMPUTER SOFTWARE; DESIGN AND DEVELOPMENT OF COMPUTER SOFTWARE FOR THE IMPROVEMENTS OF PURCHASING FUNCTIONS OF BUSINESS; DESIGN AND DEVELOPMENT OF COMPUTERS AND PROGRAMS FOR COMPUTERS; DESIGN AND DEVELOPMENT OF ON-LINE COMPUTER

Reg. No. 4,152,932 SOFTWARE SYSTEMS; DESIGN AND DEVELOPMENT OF WIRELESS COMPUTER NETWORKS; DESIGN AND MAINTENANCE OF COMPUTER SITES FOR THIRD PARTIES; DESIGN AND WRITING OF COMPUTER SOFTWARE; DESIGN OF COMPUTER DATABASE; DESIGN OF COMPUTER HARDWARE, INTEGRATED CIRCUITS, COMMUNICATIONS HARDWARE AND SOFTWARE AND COMPUTER NETWORKS FOR OTHERS; DESIGN OF COMPUTER MACHINE AND COMPUTER SOFTWARE FOR COMMERCIAL ANALYSIS AND REPORTING; DESIGN OF COMPUTER PROGRAMS AND SOFTWARE RELATING TO AIRCRAFT; DESIGN OF COMPUTERS; DESIGN OF COMPUTERS FOR OTHERS; DESIGN OF HOME PAGES, COMPUTER SOFTWARE AND WEB SITES; DESIGN, DEVELOPMENT, INSTALLATION AND MAINTENANCE OF COMPUTER SOFTWARE; DESIGN, INSTALLATION, UPDATING AND MAINTENANCE OF COMPUTER SOFTWARE; DESIGN, MAINTENANCE, DEVELOPMENT AND UPDATING OF COMPUTER SOFTWARE; DESIGN, UPDATING AND RENTAL OF COMPUTER SOFTWARE; DESIGN, UPGRADING AND RENTAL OF COMPUTER SOFTWARE; DESIGNING AND DEVELOPING COMPUTER GAME SOFTWARE AND VIDEO GAME SOFTWARE FOR USE WITH COMPUTERS, VIDEO GAME PROGRAM SYSTEMS AND COMPUTER NETWORKS; DESIGNING COMPUTER SOFTWARE FOR CONTROLLING SELF-SERVICE TERMINALS; DEVELOPING AND HOSTING A SERVER ON A GLOBAL COMPUTER NETWORK FOR THE PURPOSE OF FACILITATING E-COMMERCE VIA SUCH A SERVER; DEVELOPING AND IMPLEMENTING CUSTOMIZED PLANS FOR IMPROVING COMPUTER SECURITY AND PREVENTING CRIMINAL ACTIVITY FOR BUSINESSES AND GOVERNMENTAL AGENCIES; DEVELOPING AND UPDATING COMPUTER SOFTWARE; DEVELOPING COMPUTER PROGRAMS FOR ELECTRONIC CASH REGISTER SYSTEMS; DEVELOPING COMPUTER SOFTWARE; DEVELOPMENT AND CREATION OF COMPUTER PROGRAMMES FOR DATA PROCESSING; DEVELOPMENT OF COMPUTER HARDWARE FOR COMPUTER GAMES; DEVELOPMENT OF COMPUTER PROGRAMS RECORDED ON DATA MEDIA (SOFTWARE) DESIGNED FOR USE IN CONSTRUCTION AND AUTOMATED MANUFACTURING (CAD/CAM); DISPLAYING THE WEB SITES AND IMAGES OF OTHERS ON A COMPUTER SERVER; DOCUMENT DATA TRANSFER FROM ONE COMPUTER FORMAT TO ANOTHER; DUPLICATING COMPUTER PROGRAMS; DUPLICATION OF COMPUTER PROGRAMS; ELECTRONIC DIGITIZING OF PHOTOGRAPHS INTO A COMPUTER READABLE MEDIA; HOSTING THE SOFTWARE, WEBSITES AND OTHER COMPUTER APPLICATIONS OF OTHERS ON A VIRTUAL PRIVATE SERVER; HOSTING THE WEB SITES OF OTHERS ON A COMPUTER SERVER FOR A GLOBAL COMPUTER NETWORK; INSTALLATION AND MAINTENANCE OF COMPUTER SOFTWARE; INSTALLATION AND REPAIR OF COMPUTER SOFTWARE, INCLUDING MOBILE PERFORMANCE OF SUCH SERVICES ON CUSTOMER PREMISES; INSTALLATION OF COMPUTER SOFTWARE; INSTALLATION, MAINTENANCE AND REPAIR OF COMPUTER SOFTWARE; INSTALLATION, MAINTENANCE AND REPAIR OF SOFTWARE FOR COMPUTER SYSTEMS; INSTALLATION, REPAIR AND MAINTENANCE OF COMPUTER SOFTWARE; INSTALLING COMPUTER PROGRAMS; INTEGRATION OF COMPUTER SYSTEMS AND NETWORKS; LEASING COMPUTER FACILITIES; LEASING OF COMPUTERS; MAINTENANCE AND UPDATING OF COMPUTER SOFTWARE; MAINTENANCE AND UPGRADING OF COMPUTER SOFTWARE; MAINTENANCE OF COMPUTER SOFTWARE; MAINTENANCE OF COMPUTER SOFTWARE RELATING TO COMPUTER SECURITY AND PREVENTION OF COMPUTER RISKS; MAINTENANCE OF COMPUTER SOFTWARE USED FOR OPERATING FILLING APPARATUS AND MACHINES; MONITORING THE COMPUTER SYSTEMS OF OTHERS FOR TECHNICAL PURPOSES AND PROVIDING BACK-UP COMPUTER PROGRAMS AND FACILITIES; ON-LINE BATCH COMPUTER SERVICES, NAMELY, CONFIGURATION OF MULTIPLE FILES INTO A SINGLE GROUP; ONLINE COMPUTER SERVICES, NAMELY, PROVIDING SPAM FILTERING SERVICES TO PROTECT WEBSITES AND ONLINE APPLICATIONS FROM RECEIVING UNSOLICITED MESSAGES; PERIODIC UPGRADING OF COMPUTER SOFTWARE FOR OTHERS; PLANNING, DESIGN AND IMPLEMENTATION OF COMPUTER TECHNOLOGIES FOR OTHERS; PREPARATION, UPDATE, INSTALLATION AND MAINTENANCE OF COMPUTER SOFTWARE; PROFESSIONAL COMPUTER SERVICES, NAMELY, NETWORK ANALYSIS, LAN/WAN DESIGN, WIRELESS ENGINEERING, VIRTUALIZATION AND COMPUTER PROJECT MANAGEMENT; PROGRAMMING OF COMPUTER SOFTWARE FOR OTHERS; PROVIDING A WEB SITE THAT FEATURES INFORMATION ON COMPUTER

Reg. No. 4,152,932 TECHNOLOGY AND PROGRAMMING; PROVIDING A WEB SITE THAT GIVES COMPUTER USERS THE ABILITY TO UPLOAD AND SHARE USER-GENERATED VIDEOS, ESSAYS AND ARTICLES ON A WIDE VARIETY OF TOPICS AND SUBJECTS; PROVIDING A WEB SITE THAT GIVES COMPUTER USERS THE ABILITY TO UPLOAD AND SHARE VIDEO-BASED SCIENTIFIC PROTOCOLS AND OTHER SCIENTIFIC-BASED VIDEOS; PROVIDING A WEB SITE THAT GIVES COMPUTER USERS THE ABILITY TO UPLOAD AND SHARE VIDEOS DESCRIBING WHAT THEY WOULD DO TO BETTER THE WORLD OR THEIR COMMUNITY IF THEY WERE AWARDED ONE MILLION DOLLARS; PROVIDING A WEB SITE THAT GIVES COMPUTER USERS THE ABILITY TO UPLOAD AND SHARE VIDEOS PROVIDING INSPIRATION AND MOTIVATION FOR WOMEN; PROVIDING A WEB SITE THAT GIVES COMPUTER USERS THE ABILITY TO UPLOAD, EXCHANGE AND SHARE PHOTOS, VIDEOS AND VIDEO LOGS; PROVIDING A WEB SITE THAT GIVES COMPUTER USERS THE ABILITY TO UPLOAD, EXCHANGE AND SHARE PRAYERS; PROVIDING A WEB SITE THAT GIVES MULTIPLE COMPUTER USERS SIMULTANEOUSLY THE ABILITY TO UPLOAD, CREATE AND EDIT DOCUMENTS, PRINTED PUBLICATIONS, ONLINE PUBLICATIONS, PHOTOGRAPHS, PRODUCT PACKAGING AND ADVERTISEMENTS; PROVIDING A WEBSITE THAT GIVES COMPUTER USERS THE ABILITY TO SUBSCRIBE TO ONLINE PUBLICATIONS PERMITTING SEARCHES OF BUILDING CODES AND STANDARDS; PROVIDING AN INTERNET WEBSITE PORTAL OFFERING INFORMATION IN THE FIELD OF COMPUTER AIDED DESIGN; PROVIDING COMPUTER PROGRAMMING SERVICES TO CUSTOMERS THAT ENABLES THE CUSTOMER'S WEBSITE TO PROCESS NATURAL LANGUAGE QUERIES; PROVIDING COMPUTER PROGRAMMING SERVICES TO CUSTOMERS THAT ENABLES THEM TO PROVIDE VIDEO AND AUDIO CONTENT ON THEIR WEB SITES; PROVIDING INFORMATION AT THE SPECIFIC REQUEST OF END-USERS BY MEANS OF TELEPHONE OR GLOBAL COMPUTER NETWORKS; PROVIDING ONLINE RESEARCH AND REFERENCE SERVICES VIA AN ON-LINE COMPUTER NETWORK BY LIBRARIANS AND REFERENCE SERVICE SPECIALISTS; PROVIDING TECHNICAL INFORMATION UPDATES OF INDUSTRIAL PROCESS CONTROL COMPUTER SOFTWARE VIA THE GLOBAL COMPUTER NETWORK; PROVIDING TECHNOLOGY INFORMATION UPDATES FOR HOME SECURITY SYSTEMS VIA THE GLOBAL COMPUTER NETWORK; PROVIDING TEMPORARY USE OF NON-DOWNLOADABLE COGNITIVE STIMULATION COMPUTER PROGRAMS THAT HELP MAINTAIN AN ACTIVE BRAIN AND THUS IMPROVE MEMORY, SPEED OF PROCESSING, AND THAT PROVIDE A VARIETY OF COGNITIVE BENEFITS THAT POSITIVELY IMPACT QUALITY OF LIFE; PROVIDING TEMPORARY USE OF NON-DOWNLOADABLE COMPUTER SOFTWARE FOR PREPARING INVOICES OVER COMPUTER NETWORKS, INTRANETS AND THE INTERNET; PROVIDING TEMPORARY USE OF NON-DOWNLOADABLE COMPUTER SOFTWARE FOR PREPARING SHIPPING DOCUMENTS OVER COMPUTER NETWORKS, INTRANETS AND THE INTERNET; PROVIDING TEMPORARY USE OF NON-DOWNLOADABLE COMPUTER SOFTWARE FOR SHIPMENT PROCESSING OVER COMPUTER NETWORKS, INTRANETS AND THE INTERNET; PROVIDING TEMPORARY USE OF NON-DOWNLOADABLE COMPUTER SOFTWARE FOR TRACKING DOCUMENTS OVER COMPUTER NETWORKS, INTRANETS AND THE INTERNET; PROVIDING TEMPORARY USE OF NON-DOWNLOADABLE COMPUTER SOFTWARE FOR TRACKING FREIGHT OVER COMPUTER NETWORKS, INTRANETS AND THE INTERNET; PROVIDING TEMPORARY USE OF NON-DOWNLOADABLE COMPUTER SOFTWARE FOR TRACKING PACKAGES OVER COMPUTER NETWORKS, INTRANETS AND THE INTERNET; PROVIDING VIRTUAL COMPUTER SYSTEMS AND VIRTUAL COMPUTER ENVIRONMENTS THROUGH CLOUD COMPUTING; RECOVERY OF COMPUTER DATA; REMOTE COMPUTER BACKUP SERVICES; REMOTE COMPUTER NETWORK TECHNICAL MONITORING AND SOFTWARE MAINTENANCE SERVICES; REMOTE ONLINE BACKUP OF COMPUTER DATA; RENTAL AND MAINTENANCE OF COMPUTER SOFTWARE; RENTAL OF COMPUTER HARDWARE; RENTAL OF COMPUTER HARDWARE AND COMPUTER PERIPHERALS; RENTAL OF COMPUTER HARDWARE AND COMPUTER SOFTWARE; RENTAL OF COMPUTER SOFTWARE; RENTAL OF COMPUTER SOFTWARE AND PROGRAMS; RENTAL OF COMPUTER SOFTWARE, DATA PROCESSING EQUIPMENT AND COMPUTER PERIPHERAL DEVICES; RENTAL OF COMPUTERS; RENTAL OF COMPUTERS AND SOFTWARE; RENTAL OF COMPUTERS RELATING TO COMPUTER SECURITY AND

Reg. No. 4,152,932 PREVENTION OF COMPUTER RISKS; RENTAL OF SPACE IN A COMPUTER CO-LOCATION FACILITY FOR CONTAINERIZED DATA CENTERS OF OTHERS; RENTAL SERVICES RELATING TO DATA PROCESSING EQUIPMENT AND COMPUTERS; RENTING COMPUTER SOFTWARE; REPAIR OF COMPUTER SOFTWARE; REPAIR OF DAMAGED COMPUTER PROGRAMS; RESEARCH AND DEVELOPMENT OF COMPUTER SOFTWARE; RESEARCH, DEVELOPMENT, DESIGN AND UPGRADING OF COMPUTER SOFTWARE; ROOM DESIGN CONSISTING OF SELECTION OF ARTWORK, LIGHTING, AND FURNISHINGS FOR AN ENVIRONMENT DESIGNED TO HELP ACHIEVE MENTAL WELLNESS, INCLUDING STRESS MANAGEMENT AND RELAXATION, USING COMPUTER CONTROLLED ADVANCED SOUND WAVE TECHNOLOGY; SEARCHING AND RETRIEVING INFORMATION, SITES, AND OTHER RESOURCES AVAILABLE ON COMPUTER NETWORKS FOR OTHERS; SERVICES FOR DESIGNING COMPUTER SOFTWARE; SERVICES FOR MAINTENANCE OF COMPUTER SOFTWARE; SERVICES FOR RENTING COMPUTERS; SERVICES FOR REPRODUCING COMPUTER PROGRAMS; SERVICES FOR UPDATING COMPUTER SOFTWARE; TECHNICAL ADVICE RELATING TO OPERATION OF COMPUTERS; TECHNICAL CONSULTING SERVICES IN THE FIELDS OF DATACENTER ARCHITECTURE, PUBLIC AND PRIVATE CLOUD COMPUTING SOLUTIONS, AND EVALUATION AND IMPLEMENTATION OF INTERNET TECHNOLOGY AND SERVICES; TECHNICAL SUPPORT SERVICES, NAMELY, REMOTE AND ON-SITE INFRASTRUCTURE MANAGEMENT SERVICES FOR MONITORING, ADMINISTRATION AND MANAGEMENT OF PUBLIC AND PRIVATE CLOUD COMPUTING IT AND APPLICATION SYSTEMS; TECHNICAL SUPPORT SERVICES, NAMELY, TROUBLESHOOTING IN THE NATURE OF DIAGNOSING COMPUTER HARDWARE AND SOFTWARE PROBLEMS; TECHNICAL SUPPORT SERVICES, NAMELY, TROUBLESHOOTING OF COMPUTER SOFTWARE PROBLEMS; TECHNICAL SUPPORT SERVICES, NAMELY, TROUBLESHOOTING OF INDUSTRIAL PROCESS CONTROL COMPUTER SOFTWARE PROBLEMS; TECHNICAL SUPPORT, NAMELY, PROVIDING BACK-UP COMPUTER PROGRAMS AND FACILITIES; UP-DATING OF COMPUTER SOFTWARE; UPDATING AND DESIGN OF COMPUTER SOFTWARE; UPDATING AND MAINTENANCE OF COMPUTER SOFTWARE; UPDATING OF COMPUTER PROGRAMS FOR THIRD PARTIES; UPDATING OF COMPUTER SOFTWARE FOR OTHERS; UPDATING OF COMPUTER SOFTWARE RELATING TO COMPUTER SECURITY AND PREVENTION OF COMPUTER RISKS; WRITING AND UPDATING COMPUTER SOFTWARE, IN CLASS 42 (U.S. CLS. 100 AND 101).

FIRST USE 7-1-2008; IN COMMERCE 7-1-2008.

NO CLAIM IS MADE TO THE EXCLUSIVE RIGHT TO USE "TECH", APART FROM THE MARK AS SHOWN.

THE COLOR(S) BLACK, RED AND WHITE IS/ARE CLAIMED AS A FEATURE OF THE MARK.

THE MARK CONSISTS OF THE WORD "TECH" IN THE COLOR BLACK, THE WORDING "ROCK STARS" IN THE COLOR BLACK WITH WHITE HIGHLIGHTS AND THE TERM ".COM" IN THE COLOR BLACK; SEPARATING THE WORD "TECH" AND THE WORDING "ROCK STARS.COM" IS A RED STAR DESIGN WITH BLACK EDGING.

SER. NO. 85-327,707, FILED 5-23-2011.

BARNEY CHARLON, EXAMINING ATTORNEY

United States of America

United States Patent and Trademark Office

COVEY CLAYS

Reg. No. 4,152,933

WALTEL, JOSEPH (UNITED STATES INDIVIDUAL)
P.O. BOX 758
MANORVILLE, NY 11949

Registered June 5, 2012

Int. Cl.: 41

FOR: ENTERTAINMENT IN THE NATURE OF SHOTGUN TARGET SHOOTING GAMES,
IN CLASS 41 (U.S. CLS. 100, 101 AND 107).

SERVICE MARK

FIRST USE 9-23-2009; IN COMMERCE 9-23-2009.

PRINCIPAL REGISTER

THE MARK CONSISTS OF STANDARD CHARACTERS WITHOUT CLAIM TO ANY PAR-
TICULAR FONT, STYLE, SIZE, OR COLOR.

NO CLAIM IS MADE TO THE EXCLUSIVE RIGHT TO USE "CLAYS", APART FROM THE
MARK AS SHOWN.

SER. NO. 85-328,064, FILED 5-23-2011.

JAY FLOWERS, EXAMINING ATTORNEY



David J. Kybas

Director of the United States Patent and Trademark Office

United States of America

United States Patent and Trademark Office

Experts Academy

Reg. No. 4,152,934

Registered June 5, 2012

Int. Cls.: 9, 16, 35 and 41

TRADEMARK

SERVICE MARK

PRINCIPAL REGISTER

THE BURCHARD GROUP LLC (OREGON LIMITED LIABILITY COMPANY)
PO BOX 5368
PORTLAND, OR 97228

FOR: AUDIO DISCS FEATURING BRAND POSITIONING, MARKETING, BUSINESS, LEADERSHIP, AND TECHNOLOGY INSTRUCTION; DOWNLOADABLE MULTIMEDIA FILE CONTAINING ARTWORK, TEXT, AUDIO, VIDEO, GAMES, AND INTERNET WEB LINKS RELATING TO BRAND POSITIONING, MARKETING, BUSINESS, LEADERSHIP, AND TECHNOLOGY INSTRUCTION; DOWNLOADABLE VIDEO RECORDINGS FEATURING BRAND POSITIONING, MARKETING, BUSINESS, LEADERSHIP, AND TECHNOLOGY INSTRUCTION; ELECTRONIC PUBLICATIONS, NAMELY, ARTICLES AND BOOKS FEATURING BRAND POSITIONING, MARKETING, BUSINESS, LEADERSHIP, AND TECHNOLOGY INSTRUCTION RECORDED ON COMPUTER MEDIA; VIDEO DISCS FEATURING BRAND POSITIONING, MARKETING, BUSINESS, LEADERSHIP, AND TECHNOLOGY INSTRUCTION, IN CLASS 9 (U.S. CLS. 21, 23, 26, 36 AND 38).

FIRST USE 4-30-2010; IN COMMERCE 4-30-2010.

FOR: A SERIES OF BOOKS AND WRITTEN ARTICLES IN THE FIELD OF BUSINESS, NAMELY, BRAND POSITIONING, MARKETING, BUSINESS GROWTH, LEADERSHIP, HOW-TO ADVICE, AND TECHNOLOGY; BOOKS IN THE FIELD OF BUSINESS, NAMELY, BRAND POSITIONING, MARKETING, BUSINESS GROWTH, LEADERSHIP, HOW-TO ADVICE, AND TECHNOLOGY, IN CLASS 16 (U.S. CLS. 2, 5, 22, 23, 29, 37, 38 AND 50).

FIRST USE 7-31-2008; IN COMMERCE 7-31-2008.

FOR: ADVICE IN THE FIELD OF BUSINESS MANAGEMENT AND MARKETING; BUSINESS ADVISORY SERVICES, CONSULTANCY AND INFORMATION; PROVIDING A WEB SITE FEATURING BUSINESS INFORMATION IN THE FORM OF AUDIO AND VIDEO INTERVIEWS, TRANSCRIPTS AND OTHER EDUCATIONAL MATERIALS, IN CLASS 35 (U.S. CLS. 100, 101 AND 102).

FIRST USE 7-31-2008; IN COMMERCE 7-31-2008.

FOR: EDUCATION INFORMATION; EDUCATIONAL SERVICES, NAMELY, CONDUCTING SEMINARS, LECTURES, AND WORKSHOPS IN THE FIELD OF BRAND POSITIONING, MARKETING, BUSINESS, LEADERSHIP, AND TECHNOLOGY AND DISTRIBUTION OF



David J. Kybas

Director of the United States Patent and Trademark Office

Reg. No. 4,152,934 COURSE MATERIAL IN CONNECTION THEREWITH, IN CLASS 41 (U.S. CLS. 100, 101 AND 107).

FIRST USE 7-31-2008; IN COMMERCE 7-31-2008.

THE MARK CONSISTS OF STANDARD CHARACTERS WITHOUT CLAIM TO ANY PARTICULAR FONT, STYLE, SIZE, OR COLOR.

NO CLAIM IS MADE TO THE EXCLUSIVE RIGHT TO USE "ACADEMY", APART FROM THE MARK AS SHOWN.

SER. NO. 85-328,254, FILED 5-24-2011.

LEIGH CAROLINE CASE, EXAMINING ATTORNEY

United States of America

United States Patent and Trademark Office



Reg. No. 4,152,935

Registered June 5, 2012

Int. Cls.: 9, 16, 35 and 41

TRADEMARK

SERVICE MARK

PRINCIPAL REGISTER

THE BURCHARD GROUP LLC (OREGON LIMITED LIABILITY COMPANY)
PO BOX 5368
PORTLAND, OR 97228

FOR: AUDIO DISCS FEATURING BRAND POSITIONING, MARKETING, BUSINESS, LEADERSHIP, AND TECHNOLOGY INSTRUCTION; DOWNLOADABLE MULTIMEDIA FILE CONTAINING ARTWORK, TEXT, AUDIO, VIDEO, GAMES, AND INTERNET WEB LINKS RELATING TO BRAND POSITIONING, MARKETING, BUSINESS, LEADERSHIP, AND TECHNOLOGY INSTRUCTION; DOWNLOADABLE VIDEO RECORDINGS FEATURING BRAND POSITIONING, MARKETING, BUSINESS, LEADERSHIP, AND TECHNOLOGY INSTRUCTION; ELECTRONIC PUBLICATIONS, NAMELY, ARTICLES AND BOOKS FEATURING BRAND POSITIONING, MARKETING, BUSINESS, LEADERSHIP, AND TECHNOLOGY INSTRUCTION RECORDED ON COMPUTER MEDIA; VIDEO DISCS FEATURING BRAND POSITIONING, MARKETING, BUSINESS, LEADERSHIP, AND TECHNOLOGY INSTRUCTION, IN CLASS 9 (U.S. CLS. 21, 23, 26, 36 AND 38).

FIRST USE 4-30-2010; IN COMMERCE 4-30-2010.

FOR: A SERIES OF BOOKS AND WRITTEN ARTICLES IN THE FIELD OF BUSINESS, NAMELY, BRAND POSITIONING, MARKETING, BUSINESS GROWTH, LEADERSHIP, HOW-TO ADVICE, AND TECHNOLOGY; BOOKS IN THE FIELD OF BUSINESS, NAMELY, BRAND POSITIONING, MARKETING, BUSINESS GROWTH, LEADERSHIP, HOW-TO ADVICE, AND TECHNOLOGY, IN CLASS 16 (U.S. CLS. 2, 5, 22, 23, 29, 37, 38 AND 50).

FIRST USE 7-31-2008; IN COMMERCE 7-31-2008.

FOR: ADVICE IN THE FIELD OF BUSINESS MANAGEMENT AND MARKETING; BUSINESS ADVISORY SERVICES, CONSULTANCY AND INFORMATION; PROVIDING A WEB SITE FEATURING BUSINESS INFORMATION IN THE FORM OF AUDIO AND VIDEO INTERVIEWS, TRANSCRIPTS AND OTHER EDUCATIONAL MATERIALS, IN CLASS 35 (U.S. CLS. 100, 101 AND 102).

FIRST USE 7-31-2008; IN COMMERCE 7-31-2008.

FOR: EDUCATION INFORMATION; EDUCATIONAL SERVICES, NAMELY, CONDUCTING SEMINARS, LECTURES, AND WORKSHOPS IN THE FIELD OF BRAND POSITIONING, MARKETING, BUSINESS, LEADERSHIP, AND TECHNOLOGY AND DISTRIBUTION OF



David J. Kyjars

Director of the United States Patent and Trademark Office

Reg. No. 4,152,935 COURSE MATERIAL IN CONNECTION THEREWITH, IN CLASS 41 (U.S. CLS. 100, 101 AND 107).

FIRST USE 7-31-2008; IN COMMERCE 7-31-2008.

NO CLAIM IS MADE TO THE EXCLUSIVE RIGHT TO USE "ACADEMY", APART FROM THE MARK AS SHOWN.

THE MARK CONSISTS OF A SILHOUETTE OF A MAN AND A WOMAN, EACH STANDING ON PLATFORMS, AND SURROUNDING THE WORDS "EXPERTS ACADEMY". THE SILHOUETTE OF THE MAN STANDING ON A PLATFORM WITH ONE HAND RAISED IN THE AIR IS ON THE FAR LEFT. TO THE RIGHT OF THE MAN IS A FIRST VERTICAL LINE THAT IS THE SAME HEIGHT AS THE MAN WITH THE RAISED HAND. TO THE RIGHT OF THE FIRST VERTICAL LINE ARE THE WORDS "EXPERTS ACADEMY", WITH THE WORD "EXPERTS" BEING POSITIONED ON TOP OF THE WORD "ACADEMY". TO THE RIGHT OF THE WORDS "EXPERTS ACADEMY" IS A SECOND VERTICAL LINE THAT IS THE SAME HEIGHT AS THE FIRST VERTICAL LINE. TO THE RIGHT OF THE SECOND VERTICAL LINE IS A SILHOUETTE OF A WOMAN STANDING ON A PLATFORM, WITH ONE HAND RAISED IN THE AIR.

SER. NO. 85-328,292, FILED 5-24-2011.

LEIGH CAROLINE CASE, EXAMINING ATTORNEY

United States of America
United States Patent and Trademark Office

Liquorville

Reg. No. 4,152,936

Registered June 5, 2012

Int. Cl.: 35

SERVICE MARK

PRINCIPAL REGISTER

10 CLAY ENTERPRISES, LLC (MINNESOTA LIMITED LIABILITY COMPANY), DBA
LIQUORVILLE
6540 156TH STREET EAST
HASTINGS, MN 55033

FOR: RETAIL LIQUOR STORES, IN CLASS 35 (U.S. CLS. 100, 101 AND 102).

FIRST USE 7-7-2010; IN COMMERCE 7-7-2010.

THE MARK CONSISTS OF STANDARD CHARACTERS WITHOUT CLAIM TO ANY PARTICULAR FONT, STYLE, SIZE, OR COLOR.

SER. NO. 85-328,320, FILED 5-24-2011.

RUDY R. SINGLETON, EXAMINING ATTORNEY



David J. Kyros

Director of the United States Patent and Trademark Office

United States of America

United States Patent and Trademark Office

Brendon Burchard

Reg. No. 4,152,937

THE BURCHARD GROUP LLC (OREGON LIMITED LIABILITY COMPANY)
PO BOX 5368
PORTLAND, OR 97228

Registered June 5, 2012

Int. Cls.: 9, 16, 35 and 41

FOR: AUDIO DISCS FEATURING BRAND POSITIONING, MARKETING, BUSINESS, LEADERSHIP, AND TECHNOLOGY INSTRUCTION; DOWNLOADABLE MULTIMEDIA FILE CONTAINING ARTWORK, TEXT, AUDIO, VIDEO, GAMES, AND INTERNET WEB LINKS RELATING TO BRAND POSITIONING, MARKETING, BUSINESS, LEADERSHIP, AND TECHNOLOGY INSTRUCTION; DOWNLOADABLE VIDEO RECORDINGS FEATURING BRAND POSITIONING, MARKETING, BUSINESS, LEADERSHIP, AND TECHNOLOGY INSTRUCTION; ELECTRONIC PUBLICATIONS, NAMELY, ARTICLES AND BOOKS FEATURING BRAND POSITIONING, MARKETING, BUSINESS, LEADERSHIP, AND TECHNOLOGY INSTRUCTION RECORDED ON COMPUTER MEDIA; VIDEO DISCS FEATURING BRAND POSITIONING, MARKETING, BUSINESS, LEADERSHIP, AND TECHNOLOGY INSTRUCTION, IN CLASS 9 (U.S. CLS. 21, 23, 26, 36 AND 38).

TRADEMARK

SERVICE MARK

PRINCIPAL REGISTER

FIRST USE 4-30-2010; IN COMMERCE 4-30-2010.

FOR: A SERIES OF BOOKS AND WRITTEN ARTICLES IN THE FIELD OF BUSINESS, NAMELY, BRAND POSITIONING, MARKETING, BUSINESS GROWTH, LEADERSHIP, HOW-TO ADVICE, AND TECHNOLOGY; BOOKS IN THE FIELD OF BUSINESS, NAMELY, BRAND POSITIONING, MARKETING, BUSINESS GROWTH, LEADERSHIP, HOW-TO ADVICE, AND TECHNOLOGY, IN CLASS 16 (U.S. CLS. 2, 5, 22, 23, 29, 37, 38 AND 50).

FIRST USE 5-31-2001; IN COMMERCE 5-31-2001.

FOR: ADVICE IN THE FIELD OF BUSINESS MANAGEMENT AND MARKETING; BUSINESS ADVISORY SERVICES, CONSULTANCY AND INFORMATION; PROVIDING A WEB SITE FEATURING BUSINESS INFORMATION IN THE FORM OF AUDIO AND VIDEO INTERVIEWS, TRANSCRIPTS AND OTHER EDUCATIONAL MATERIALS, IN CLASS 35 (U.S. CLS. 100, 101 AND 102).

FIRST USE 7-31-2008; IN COMMERCE 7-31-2008.

FOR: EDUCATION INFORMATION; EDUCATIONAL SERVICES, NAMELY, CONDUCTING SEMINARS, LECTURES, AND WORKSHOPS IN THE FIELD OF BRAND POSITIONING, MARKETING, BUSINESS, LEADERSHIP, AND TECHNOLOGY AND DISTRIBUTION OF



David J. Kyros

Director of the United States Patent and Trademark Office

Reg. No. 4,152,937 COURSE MATERIAL IN CONNECTION THEREWITH, IN CLASS 41 (U.S. CLS. 100, 101 AND 107).

FIRST USE 7-31-2008; IN COMMERCE 7-31-2008.

THE MARK CONSISTS OF STANDARD CHARACTERS WITHOUT CLAIM TO ANY PARTICULAR FONT, STYLE, SIZE, OR COLOR.

THE NAME "BRENDON BURCHARD" SHOWN IN THE MARK IDENTIFIES A LIVING INDIVIDUAL, WHOSE CONSENT IS OF RECORD.

SER. NO. 85-328,401, FILED 5-24-2011.

LEIGH CAROLINE CASE, EXAMINING ATTORNEY

United States of America

United States Patent and Trademark Office

Doll Avenue

Reg. No. 4,152,938

Registered June 5, 2012

Int. Cl.: 35

SERVICE MARK

PRINCIPAL REGISTER

MILLER, KAREN (UNITED STATES INDIVIDUAL)
94 REDDING RD.
CAMPBELL, CA 95008

FOR: ON-LINE RETAIL STORE SERVICES FEATURING COLLECTIBLE DOLLS, DOLL CLOTHING, AND DOLL ACCESSORIES, IN CLASS 35 (U.S. CLS. 100, 101 AND 102).

FIRST USE 4-30-2006; IN COMMERCE 6-1-2006.

THE MARK CONSISTS OF STANDARD CHARACTERS WITHOUT CLAIM TO ANY PARTICULAR FONT, STYLE, SIZE, OR COLOR.

NO CLAIM IS MADE TO THE EXCLUSIVE RIGHT TO USE "DOLL", APART FROM THE MARK AS SHOWN.

SER. NO. 85-328,487, FILED 5-24-2011.

STEVEN JACKSON, EXAMINING ATTORNEY



David J. Kyfos

Director of the United States Patent and Trademark Office

United States of America

United States Patent and Trademark Office

PREPMUNCH

Reg. No. 4,152,939

Registered June 5, 2012

Int. Cl.: 42

SERVICE MARK

PRINCIPAL REGISTER

PREPMUNCH INC. (TEXAS CORPORATION)
12919, BRAMFORD POINT LANE
HOUSTON, TX 77070

FOR: COMPUTER SERVICES, NAMELY, PROVIDING A WEBSITE FEATURING TEMPORARY USE OF NON-DOWNLOADABLE SOFTWARE FOR MOBILE DEVICES, TABLETS AND PERSONAL COMPUTERS, NAMELY, SOFTWARE FOR THE INTEGRATION OF TEXT, AUDIO, GRAPHICS, STILL IMAGES, MOVING PICTURES AND PHOTOGRAPHS INTO AN INTERACTIVE DELIVERY FOR PREPARING CONTENT AND PRACTICING FOR STANDARDIZED TESTS, IN CLASS 42 (U.S. CLS. 100 AND 101).

FIRST USE 4-10-2010; IN COMMERCE 4-10-2010.

THE MARK CONSISTS OF THE WORD "PREPMUNCH".

SER. NO. 85-328,616, FILED 5-24-2011.

ANGELA DUONG, EXAMINING ATTORNEY



David J. Kyros

Director of the United States Patent and Trademark Office

United States of America

United States Patent and Trademark Office



Reg. No. 4,152,940

SUITER, DONALD (UNITED STATES INDIVIDUAL)
308 E VASA AVE.
FERGUS FALLS, MN 56537

Registered June 5, 2012

Int. Cl.: 21

FOR: STONE AND WOOD CREMATION URNS, IN CLASS 21 (U.S. CLS. 2, 13, 23, 29, 30, 33, 40 AND 50).

TRADEMARK

FIRST USE 3-1-2011; IN COMMERCE 3-1-2011.

PRINCIPAL REGISTER

NO CLAIM IS MADE TO THE EXCLUSIVE RIGHT TO USE "VESSEL", APART FROM THE MARK AS SHOWN.

THE MARK CONSISTS OF STYLIZED SWIRLS SURROUNDING A CROSS. ONE SWIRL EXTENDS AND FLATTENS INTO A LINE THAT UNDERLINES THE STYLIZED TEXT "TREASURE VESSEL".

SER. NO. 85-328,761, FILED 5-24-2011.

NAPOLEON SHARMA, EXAMINING ATTORNEY



David J. Kybas

Director of the United States Patent and Trademark Office

United States of America

United States Patent and Trademark Office

NAKED HAIR SALON & MORE!

Reg. No. 4,152,941

Registered June 5, 2012

Int. Cl.: 44

SERVICE MARK

PRINCIPAL REGISTER

NAKED HAIR SALON (FLORIDA LIMITED LIABILITY COMPANY)
NO. 10 SOUTH EAST 1ST AVENUE
DELRAY BEACH, FL 33445

FOR: BEAUTY SALON SERVICES, IN CLASS 44 (U.S. CLS. 100 AND 101).

FIRST USE 10-21-2009; IN COMMERCE 3-0-2010.

THE MARK CONSISTS OF STANDARD CHARACTERS WITHOUT CLAIM TO ANY PARTICULAR FONT, STYLE, SIZE, OR COLOR.

NO CLAIM IS MADE TO THE EXCLUSIVE RIGHT TO USE "HAIR SALON", APART FROM THE MARK AS SHOWN.

SER. NO. 85-328,785, FILED 5-24-2011.

JOHN WILKE, EXAMINING ATTORNEY



David J. Kyffers

Director of the United States Patent and Trademark Office

United States of America

United States Patent and Trademark Office

E-SUGAR

Reg. No. 4,152,942

BRADLEY RAGUSE (UNITED STATES INDIVIDUAL)
7856 - 650TH AVENUE
WHEATON, MN 56296

Registered June 5, 2012

Int. Cl.: 39

FOR: DELIVERY OF GOODS BY TRUCK, IN CLASS 39 (U.S. CLS. 100 AND 105).

SERVICE MARK

FIRST USE 3-10-2005; IN COMMERCE 3-10-2005.

PRINCIPAL REGISTER

THE MARK CONSISTS OF STANDARD CHARACTERS WITHOUT CLAIM TO ANY PARTICULAR FONT, STYLE, SIZE, OR COLOR.

SER. NO. 85-329,042, FILED 5-24-2011.

AMY C. KEAN, EXAMINING ATTORNEY



David J. Kybas

Director of the United States Patent and Trademark Office

United States of America

United States Patent and Trademark Office

Delivering 21st Century Technology

Reg. No. 4,152,943

Registered June 5, 2012

Int. Cls.: 37 and 42

SERVICE MARK

PRINCIPAL REGISTER

DOCTORDOS CONSULTING, LTD. (ILLINOIS CORPORATION), DBA PROFESSIONAL
NERDS
170 NEWTON AVENUE
GLEN ELLYN, IL 60137

FOR: COMPUTER INSTALLATION AND REPAIR, NAMELY, NEW COMPUTER INSTALLATION, COMPUTER NETWORKING HARDWARE INSTALLATION, AND UPGRADING OF COMPUTER HARDWARE, IN CLASS 37 (U.S. CLS. 100, 103 AND 106).

FIRST USE 11-1-2010; IN COMMERCE 11-1-2010.

FOR: INTERNET SETUP CONFIGURATION AND REPAIR SERVICES, IN CLASS 42 (U.S. CLS. 100 AND 101).

FIRST USE 11-1-2010; IN COMMERCE 11-1-2010.

THE MARK CONSISTS OF STANDARD CHARACTERS WITHOUT CLAIM TO ANY PARTICULAR FONT, STYLE, SIZE, OR COLOR.

SER. NO. 85-329,216, FILED 5-24-2011.

ZACHARY BELLO, EXAMINING ATTORNEY



David J. Kybas

Director of the United States Patent and Trademark Office

United States of America

United States Patent and Trademark Office

NATIONAL JOURNAL DAILY

Reg. No. 4,152,944

ATLANTIC MEDIA COMPANY (DELAWARE CORPORATION)
600 NEW HAMPSHIRE AVE., NW
WASHINGTON, DC 20037

Registered June 5, 2012

Int. Cl.: 16

FOR: JOURNALS IN THE FIELD OF LEGISLATIVE MATTERS AND CONGRESSIONAL ACTIVITIES, IN CLASS 16 (U.S. CLS. 2, 5, 22, 23, 29, 37, 38 AND 50).

TRADEMARK

FIRST USE 10-26-2010; IN COMMERCE 10-26-2010.

PRINCIPAL REGISTER

THE MARK CONSISTS OF STANDARD CHARACTERS WITHOUT CLAIM TO ANY PARTICULAR FONT, STYLE, SIZE, OR COLOR.

OWNER OF U.S. REG. NO. 917,681.

NO CLAIM IS MADE TO THE EXCLUSIVE RIGHT TO USE "JOURNAL DAILY", APART FROM THE MARK AS SHOWN.

SEC. 2(F).

SER. NO. 85-329,951, FILED 5-25-2011.

MICHAEL ENGEL, EXAMINING ATTORNEY



David J. Kybas

Director of the United States Patent and Trademark Office

United States of America
United States Patent and Trademark Office

4Life

Reg. No. 4,152,945

4LIFE TRADEMARKS, LLC (UTAH LIMITED LIABILITY COMPANY)
9850 SOUTH 300 WEST
SANDY, UT 84070

Registered June 5, 2012

Int. Cls.: 5 and 29

FOR: DIETARY AND NUTRITIONAL SUPPLEMENTS IN THE FORM OF CAPSULES, LIQUIDS, POWDERS, AND TABLETS CONTAINING COW COLOSTRUM EXTRACT FOR NUTRITIONAL PURPOSES, IN CLASS 5 (U.S. CLS. 6, 18, 44, 46, 51 AND 52).

TRADEMARK

FIRST USE 4-30-2000; IN COMMERCE 4-30-2000.

PRINCIPAL REGISTER

FOR: DAIRY-BASED PROCESSED FOODS, NAMELY, DAIRY BASED FOOD BEVERAGES CONTAINING COW COLOSTRUMS; AND DAIRY-BASED POWDERS CONTAINING COW COLOSTRUMS FOR MAKING DAIRY-BASED BEVERAGES, IN CLASS 29 (U.S. CL. 46).

FIRST USE 5-1-2006; IN COMMERCE 5-1-2006.

OWNER OF U.S. REG. NOS. 2,475,300, 3,922,645 AND OTHERS.

THE MARK CONSISTS OF "4LIFE" IN STYLIZED LETTERING WITH A SUN-LIKE DESIGN USED FOR THE DOT OF THE "I".

SER. NO. 85-330,075, FILED 5-25-2011.

DOUGLAS LEE, EXAMINING ATTORNEY



David J. Kybas

Director of the United States Patent and Trademark Office

United States of America

United States Patent and Trademark Office

G-WERX

Reg. No. 4,152,946

Registered June 5, 2012

Int. Cls.: 9, 16, 25 and 28

TRADEMARK

PRINCIPAL REGISTER

MILLENNIUM FITNESS LTD (MINNESOTA CORPORATION), DBA G-WERX
501 S. WASHINGTON AVENUE
MINNEAPOLIS, MN 55415

FOR: PRE-RECORDED MEDIA, NAMELY, DVD'S, AND CD ROM DISKS FEATURING PHYSICAL FITNESS, TRAINING AND EXERCISE; DIGITAL MEDIA, NAMELY, PRE-RECORDED DVDS, DOWNLOADABLE AUDIO AND VIDEO RECORDINGS AND CDS FEATURING EXERCISE AND FITNESS, ALL PRE-PROGRAMMED AND LOADED IN VIEWING DEVICES, DOWNLOADABLE DIGITAL MEDIA, NAMELY, PRE-RECORDED DVDS, DOWNLOADABLE AUDIO AND VIDEO RECORDINGS AND CDS, WHICH ARE ACCESSED AND DOWNLOADED THROUGH COMPUTERS, TELEVISIONS, PHONES AND OTHER ELECTRONIC DEVICES FEATURING PHYSICAL FITNESS, TRAINING AND EXERCISE, IN CLASS 9 (U.S. CLS. 21, 23, 26, 36 AND 38).

FIRST USE 2-16-2001; IN COMMERCE 11-27-2002.

FOR: PRINTED MATTER, NAMELY, MAGAZINES, BOOKS, INSTRUCTIONAL MANUALS, TEACHING MANUALS, TRAINING MANUALS, BROCHURES, INFORMATION FLYERS AND CATALOGS, ALL FEATURING PHYSICAL FITNESS, TRAINING AND EXERCISE; POSTERS, COUPONS AND POSTCARDS, IN CLASS 16 (U.S. CLS. 2, 5, 22, 23, 29, 37, 38 AND 50).

FIRST USE 2-16-2001; IN COMMERCE 11-27-2002.

FOR: FITNESS CLOTHING, NAMELY, SHORTS, TOPS, RUNNING SHORTS, JACKETS, SWEATPANTS, SWEATSHIRTS, HATS, VISORS, BANDANAS, SOCKS, SWEATBANDS AND COATS, IN CLASS 25 (U.S. CLS. 22 AND 39).

FIRST USE 2-16-2001; IN COMMERCE 11-27-2002.

FOR: EXERCISE MACHINES, EXERCISE EQUIPMENT, NAMELY, EXERCISE WEIGHTS, DUMBBELLS AND EXERCISE BENCHES; EXERCISE ACCESSORIES, NAMELY, WEIGHT RACKS, AND WEIGHT LIFTING GLOVES FOR ATHLETIC TRAINING AND FOR USE WITH EXERCISE GYMS, FREE WEIGHTS AND EXERCISE MACHINES, IN CLASS 28 (U.S. CLS. 22, 23, 38 AND 50).

FIRST USE 2-16-2001; IN COMMERCE 11-27-2002.

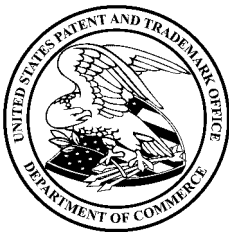

David J. Kyjars

Director of the United States Patent and Trademark Office

Reg. No. 4,152,946 THE MARK CONSISTS OF STANDARD CHARACTERS WITHOUT CLAIM TO ANY PARTICULAR FONT, STYLE, SIZE, OR COLOR.

SER. NO. 85-330,217, FILED 5-25-2011.

SUSAN RICHARDS, EXAMINING ATTORNEY

United States of America
United States Patent and Trademark Office



PROSPECT
MORTGAGE

Reg. No. 4,152,947

Registered June 5, 2012

Int. Cl.: 36

SERVICE MARK

PRINCIPAL REGISTER

PROSPECT MORTGAGE, LLC (DELAWARE LIMITED LIABILITY COMPANY)
15301 VENTURA BOULEVARD
SHERMAN OAKS, CA 91403

FOR: FINANCIAL SERVICES, NAMELY, MORTGAGE LENDING SERVICES, LOAN SERVICING SERVICES, REAL ESTATE OWNED PROPERTY MANAGEMENT SERVICES, LOAN BROKER SERVICES IN THE NATURE OF MORTGAGE BROKERAGE, LOAN CONSULTING SERVICES IN THE FIELD OF LOAN FINANCING, FINANCING AND LOAN SERVICES, IN CLASS 36 (U.S. CLS. 100, 101 AND 102).

FIRST USE 4-1-2009; IN COMMERCE 4-1-2009.

OWNER OF U.S. REG. NOS. 3,744,672 AND 3,744,674.

NO CLAIM IS MADE TO THE EXCLUSIVE RIGHT TO USE "MORTGAGE", APART FROM THE MARK AS SHOWN.

THE MARK CONSISTS OF THE ROOF OF A HOME ABOVE THE WORDING "PROSPECT", WITH A HORIZONTAL LINE UNDER "PROSPECT", AND THE WORDING "MORTGAGE" UNDER THAT LINE.

SER. NO. 85-331,547, FILED 5-26-2011.

LYDIA BELZER, EXAMINING ATTORNEY



David J. Kyffers

Director of the United States Patent and Trademark Office

United States of America

United States Patent and Trademark Office



Reg. No. 4,152,948

Registered June 5, 2012

Int. Cls.: 41, 42 and 44

SERVICE MARK

PRINCIPAL REGISTER

PRACTICEWISE, LLC (FLORIDA LIMITED LIABILITY COMPANY)
285 WILSON AVE.
SATELLITE BEACH, FL 32937

FOR: EDUCATIONAL SERVICES FOR MENTAL HEALTH AND SOCIAL SERVICES PROFESSIONALS AND ADMINISTRATORS, NAMELY, DEVELOPING AND CONDUCTING TRAINING COURSES IN THE FIELD OF THE MENTAL HEALTH AND SOCIAL SERVICES TO BE PROVIDED TO YOUTH AND FAMILIES, AND DISTRIBUTION OF TRAINING MATERIALS IN CONNECTION THEREWITH, SPECIFICALLY EXCLUDING ANYTHING RELATED TO MEDICAL PRACTICE BUSINESS CONSULTING, IN CLASS 41 (U.S. CLS. 100, 101 AND 107).

FIRST USE 9-15-2004; IN COMMERCE 9-15-2004.

FOR: PROVIDING MEDICAL AND SCIENTIFIC RESEARCH INFORMATION IN THE FIELD OF CLINICAL TRIALS FOR YOUTH AND FAMILY DEVELOPMENT; RESEARCH IN THE FIELD OF CHILD AND ADOLESCENT YOUTH DEVELOPMENT, IN CLASS 42 (U.S. CLS. 100 AND 101).

FIRST USE 9-15-2004; IN COMMERCE 9-15-2004.

FOR: MENTAL HEALTH AND WELLNESS CONSULTING SERVICES FOR YOUTH AND FAMILIES, SPECIFICALLY EXCLUDING ANYTHING RELATED TO MEDICAL PRACTICE BUSINESS CONSULTING, IN CLASS 44 (U.S. CLS. 100 AND 101).

FIRST USE 9-15-2004; IN COMMERCE 9-15-2004.

THE MARK CONSISTS OF THE WORD "PRACTICEWISE" IN STYLIZED FORMAT TO THE RIGHT OF THREE DIAMOND SHAPES.

SER. NO. 85-331,560, FILED 5-26-2011.

JASON LOTT, EXAMINING ATTORNEY



David J. Kyffers

Director of the United States Patent and Trademark Office

United States of America

United States Patent and Trademark Office

Lace Up

Reg. No. 4,152,949

EST 19XX, LLC (NEW YORK PARTNERSHIP)
1841 BROADWAY, SUITE 715
NEW YORK, NY 100237672

Registered June 5, 2012

Int. Cl.: 25

FOR: CLOTHING FOR MEN, WOMEN AND CHILDREN, NAMELY, SHORT-SLEEVED OR LONG-SLEEVED T-SHIRTS; T-SHIRTS, SWEATERS, COATS, SPORTS JACKETS, SPORTS JERSEYS, SPORTS SHIRTS, HATS, SWEATSHIRTS, SHORTS AND PANTS, IN CLASS 25 (U.S. CLS. 22 AND 39).

TRADEMARK

PRINCIPAL REGISTER

FIRST USE 4-1-2010; IN COMMERCE 4-1-2010.

THE MARK CONSISTS OF STANDARD CHARACTERS WITHOUT CLAIM TO ANY PARTICULAR FONT, STYLE, SIZE, OR COLOR.

SER. NO. 85-331,735, FILED 5-26-2011.

CAROLYN CATALDO, EXAMINING ATTORNEY



David J. Kybas

Director of the United States Patent and Trademark Office

United States of America

United States Patent and Trademark Office

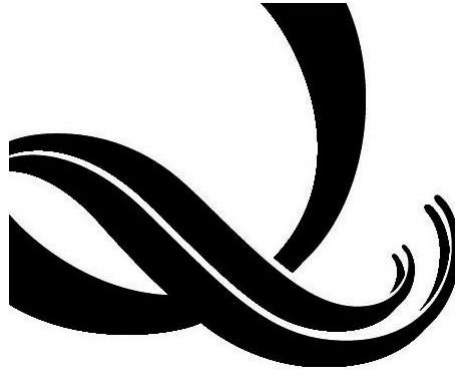

Reg. No. 4,152,950

Registered June 5, 2012

Int. Cl.: 3

TRADEMARK

PRINCIPAL REGISTER

CHOICE HOTELS INTERNATIONAL, INC. (DELAWARE CORPORATION)
10750 COLUMBIA PIKE
SILVER SPRING, MD 20901

FOR: HAIR SHAMPOO, HAIR CONDITIONER, FACIAL SOAP, BODY SOAP, BODY LOTION,
AND MOUTHWASH, IN CLASS 3 (U.S. CLS. 1, 4, 6, 50, 51 AND 52).

FIRST USE 2-0-2002; IN COMMERCE 2-0-2002.

OWNER OF U.S. REG. NOS. 2,729,999, 3,837,912 AND OTHERS.

THE MARK CONSISTS OF A STYLIZED LETTER "Q".

SER. NO. 85-332,009, FILED 5-27-2011.

CURTIS FRENCH, EXAMINING ATTORNEY



David J. Kyffers

Director of the United States Patent and Trademark Office

United States of America

United States Patent and Trademark Office

HORSECLICKS

Reg. No. 4,152,951

FRIDAY MEDIA GROUP LIMITED (UNITED KINGDOM PRIVATE LIMITED COMPANY)
LONDON ROAD
SAYERS COMMON, UNITED KINGDOM BN69HS

Registered June 5, 2012

Int. Cl.: 35

FOR: PROVIDING A WEB SITE WHERE USERS CAN OFFER GOODS AND SERVICES THROUGH ON-LINE CLASSIFIED ADVERTISEMENTS IN THE FIELD OF HORSES, HORSE-RELATED GOODS AND SERVICES, EQUESTRIANISM, REAL ESTATE FOR KEEPING HORSES AND GENERAL REAL ESTATE, IN CLASS 35 (U.S. CLS. 100, 101 AND 102).

SERVICE MARK

PRINCIPAL REGISTER

FIRST USE 3-0-2002; IN COMMERCE 3-0-2002.

THE MARK CONSISTS OF STANDARD CHARACTERS WITHOUT CLAIM TO ANY PARTICULAR FONT, STYLE, SIZE, OR COLOR.

SER. NO. 85-332,021, FILED 5-27-2011.

JENNIFER VASQUEZ, EXAMINING ATTORNEY



David J. Kybas

Director of the United States Patent and Trademark Office

United States of America

United States Patent and Trademark Office



Reg. No. 4,152,952

Registered June 5, 2012

Int. Cl.: 29

COLLECTIVE TRADEMARK

PRINCIPAL REGISTER

CONSORZIO PER LA TUTELA DEL FORMAGGIO MOZZARELLA DI BUFALA CAMPANA
CONSORTIUM ITALY (ITALY CONSORTIUM)
SCALA B (CASERTA)
VIA CARLO III N. 128
SAN NICOLA LA STRADA, ITALY 80120

FOR: CHEESE, IN CLASS 29 (U.S. CL. 46).

FIRST USE 12-0-1993; IN COMMERCE 12-0-1993.

OWNER OF U.S. REG. NO. 2,472,980.

NO CLAIM IS MADE TO THE EXCLUSIVE RIGHT TO USE "MOZZARELLA DI BUFALA" AND "CAMPANA", APART FROM THE MARK AS SHOWN.

THE MARK CONSISTS OF A CIRCLE DESIGN WHICH HAS A BUFFALO HEAD DESIGN IN THE CENTER, THE WORDING "MOZZARELLA DI BUFALA" ALONG THE LOWER PORTION, AND BROKEN VERTICAL LINES ALONG THE TOP PORTION OF THE CIRCLE. DIRECTLY BELOW THE CIRCLE IS THE WORDING "CAMPANA".

THE ENGLISH TRANSLATION OF "MOZZARELLA DI BUFALA" IN THE MARK IS "BUFFALO MOZZARELLA".

SER. NO. 85-332,305, FILED 5-27-2011.

MICHAEL SOUDERS, EXAMINING ATTORNEY



David J. Kybas

Director of the United States Patent and Trademark Office

United States of America

United States Patent and Trademark Office



Reg. No. 4,152,953

Registered June 5, 2012

Int. Cl.: 30

TRADEMARK

PRINCIPAL REGISTER

MEI HUA SIANG CO., LTD. (TAIWAN CORPORATION)
NO.59 SINGONG ROAD, SHENGANG TOWNSHIP
CHANGHUA COUNTY, TAIWAN

FOR: RICE CAKES; RICE BALLS; RICE PUDDING, IN CLASS 30 (U.S. CL. 46).

FIRST USE 11-16-2009; IN COMMERCE 11-16-2009.

THE MARK CONSISTS OF CHINESE CHARACTERS IN RED, ABOVE A FLOWER LIKE LEAF CONTOUR IN BLACK OUTLINE, WITH A CARROT LIKE CONTOUR HAVING THE ROOT IN YELLOW AND LEAVES IN GREEN ON A WHITE BACKGROUND WITHIN THE FLOWER LIKE LEAF CONTOUR.

THE COLOR(S) RED, BLACK, GREEN, YELLOW AND WHITE IS/ARE CLAIMED AS A FEATURE OF THE MARK.

THE NON-LATIN CHARACTERS IN THE MARK TRANSLITERATE TO MEI HUA SIANG AND THIS MEANS A PLUM BLOSSOM COUNTRY IN ENGLISH.

SER. NO. 85-333,104, FILED 5-28-2011.

JACQUELINE A. LAVINE, EXAMINING ATTORNEY



David J. Kybas

Director of the United States Patent and Trademark Office

United States of America

United States Patent and Trademark Office



Reg. No. 4,152,954

Registered June 5, 2012

Int. Cls.: 35, 41 and 42

SERVICE MARK

PRINCIPAL REGISTER

3D RESULTS, LLC (DELAWARE LIMITED LIABILITY COMPANY)
872 S. MILWAUKEE AVE., SUITE 140
LIBERTYVILLE, IL 60048

FOR: BUSINESS ORGANIZATION AND MANAGEMENT CONSULTING SERVICES; BUSINESS CONSULTING SERVICES IN THE FIELDS OF BUSINESS LEADERSHIP DEVELOPMENT, BUSINESS CULTURE, AND THE INTEGRATION OF BUSINESS STRATEGIES AND PROCEDURES, MANAGEMENT STRUCTURES, AND PERSONNEL; CONSULTING IN THE FIELD OF HUMAN RESOURCES, NAMELY, LEADERSHIP DEVELOPMENT, EXECUTIVE SEARCH AND RECRUITMENT, INDIVIDUAL AND TEAM ASSESSMENT, EXECUTIVE COMPENSATION, COMPETENCY DEVELOPMENT, EMPLOYEE BENEFITS, AND DEVELOPING AND IMPLEMENTING EMPLOYEE COMPENSATION PROGRAMS LINKING COMPENSATION OF INDIVIDUAL EMPLOYEES TO COMPANY OR GROUP PERFORMANCE, IN CLASS 35 (U.S. CLS. 100, 101 AND 102).

FIRST USE 1-11-2011; IN COMMERCE 1-11-2011.

FOR: BUSINESS EDUCATION AND TRAINING SERVICES, NAMELY, DEVELOPING AND FACILITATING CUSTOMIZED IN-COMPANY WORKSHOPS, SEMINARS, AND RETREATS IN THE FIELDS OF LEADERSHIP DEVELOPMENT, PROFESSIONAL COMPETENCY, AND TALENT DEVELOPMENT, AND DISTRIBUTION OF EDUCATIONAL MATERIALS IN CONNECTION THEREWITH; PROFESSIONAL IN-COMPANY COACHING SERVICES FOR TEAMS AND INDIVIDUALS IN THE FIELD OF COMPANY AND INDIVIDUAL PERFORMANCE IMPROVEMENT, IN CLASS 41 (U.S. CLS. 100, 101 AND 107).

FIRST USE 1-11-2011; IN COMMERCE 1-11-2011.

FOR: CONSULTING SERVICES IN THE FIELD OF BUSINESS RELATED TO THE SELECTION AND IMPLEMENTATION OF HUMAN RESOURCES SOFTWARE, IN CLASS 42 (U.S. CLS. 100 AND 101).

FIRST USE 1-11-2011; IN COMMERCE 1-11-2011.

NO CLAIM IS MADE TO THE EXCLUSIVE RIGHT TO USE "INTEGRATED SYSTEMS" AND "LEADERSHIP" AND "TALENT" AND "COMMON APPROACH" AND "COLLABORATION" AND "EFFECTIVE STRUCTURE", APART FROM THE MARK AS SHOWN.



David J. Kyjars

Director of the United States Patent and Trademark Office

Reg. No. 4,152,954 THE COLOR(S) ORANGE, DARK GRAY, LIGHT GRAY AND WHITE IS/ARE CLAIMED AS A FEATURE OF THE MARK.

THE MARK CONSISTS OF AN ORANGE ARROW OUTLINED IN DARK GRAY WITH WHITE LETTERS THAT SPELL "STRATEGY" AT THE LEFT END OF THE ARROW AND "RESULTS" AT THE RIGHT END OF THE ARROW. IN THE MIDDLE OF THE ARROW ARE THREE CONCENTRIC CIRCLES WITH THE OUTER TWO CIRCLES MADE OF BROKEN LINES. THE OUTERMOST CIRCLE IS DARK GRAY, THE MIDDLE CIRCLE IS LIGHT GRAY, AND THE INNER CIRCLE IS ORANGE. THERE ARE DARK GRAY LETTERS ON THE MIDDLE CIRCLE THAT SPELL THE WORDS "INTEGRATED SYSTEMS", "LEADERSHIP", "TALENT", "COMMON APPROACH", "COLLABORATION", AND "EFFECTIVE STRUCTURE". THERE ARE WHITE LETTERS ON THE INNER CIRCLE THAT SPELL THE WORD "STRATEGIC CLARITY".

SER. NO. 85-333,471, FILED 5-30-2011.

JULIE GUTTADAURO, EXAMINING ATTORNEY

United States of America

United States Patent and Trademark Office

Excellence Lives Here

Reg. No. 4,152,955

Registered June 5, 2012

Int. Cl.: 35

SERVICE MARK

PRINCIPAL REGISTER

KING SPORTS GROUP, LLC (NEVADA LIMITED LIABILITY COMPANY)
260 S. OSCEOLA AVENUE, SUITE 904
ORLANDO, FL 32801

FOR: CAREER MANAGEMENT SERVICES FOR ATHLETES AND ENTERTAINERS, IN
CLASS 35 (U.S. CLS. 100, 101 AND 102).

FIRST USE 9-1-2009; IN COMMERCE 9-1-2011.

THE MARK CONSISTS OF STANDARD CHARACTERS WITHOUT CLAIM TO ANY PAR-
TICULAR FONT, STYLE, SIZE, OR COLOR.

SER. NO. 85-333,481, FILED 5-30-2011.

FRANK LATTUCA, EXAMINING ATTORNEY



David J. Kybas

Director of the United States Patent and Trademark Office

United States of America

United States Patent and Trademark Office

EAST BEACH BLONDE

Reg. No. 4,152,956

PAPA, NICHOLAS (UNITED STATES INDIVIDUAL)
1084 SLOCUM ROAD
SAUNDERSTOWN, RI 02874 AND

Registered June 5, 2012

Int. Cl.: 31

ARNOUX, JIM (UNITED STATES INDIVIDUAL)
73 WOLF ROCK ROAD
EXETER, RI 02822

TRADEMARK

FOR: OYSTERS, NAMELY, LIVE OYSTERS, IN CLASS 31 (U.S. CLS. 1 AND 46).

PRINCIPAL REGISTER

FIRST USE 8-31-2009; IN COMMERCE 8-31-2009.

THE MARK CONSISTS OF STANDARD CHARACTERS WITHOUT CLAIM TO ANY PARTICULAR FONT, STYLE, SIZE, OR COLOR.

NO CLAIM IS MADE TO THE EXCLUSIVE RIGHT TO USE "EAST BEACH", APART FROM THE MARK AS SHOWN.

SER. NO. 85-333,662, FILED 5-31-2011.

WANDA KAY PRICE, EXAMINING ATTORNEY



David J. Kyros

Director of the United States Patent and Trademark Office

United States of America

United States Patent and Trademark Office

Copperhead Grille

Reg. No. 4,152,957

Registered June 5, 2012

Int. Cl.: 43

SERVICE MARK

PRINCIPAL REGISTER

DKM INC. (PENNSYLVANIA CORPORATION)
5737 ROUTE 378
BETHLEHEM, PA 18015

FOR: RESTAURANT SERVICES, IN CLASS 43 (U.S. CLS. 100 AND 101).

FIRST USE 2-1-2002; IN COMMERCE 3-4-2002.

THE MARK CONSISTS OF STANDARD CHARACTERS WITHOUT CLAIM TO ANY PARTICULAR FONT, STYLE, SIZE, OR COLOR.

NO CLAIM IS MADE TO THE EXCLUSIVE RIGHT TO USE "GRILL", APART FROM THE MARK AS SHOWN.

SER. NO. 85-333,671, FILED 5-31-2011.

WANDA KAY PRICE, EXAMINING ATTORNEY



David J. Kyffers

Director of the United States Patent and Trademark Office

United States of America

United States Patent and Trademark Office

PURCHASING INTELLIGENCE

Reg. No. 4,152,958

Registered June 5, 2012

Int. Cl.: 35

SERVICE MARK

PRINCIPAL REGISTER

ESS TECHNOLOGIES, LLC (DELAWARE LIMITED LIABILITY COMPANY)
SUITE 130
7800 W. INTERSTATE 10
SAN ANTONIO, TX 78230

FOR: BUSINESS MANAGEMENT SERVICES RELATED TO THE PROCUREMENT OF MAINTENANCE, REPAIR AND OPERATIONS SUPPLIES, AND THE ADMINISTRATION, SUPERVISION, AND MANAGEMENT OF SUCH PROCUREMENT, FOR THE PROPERTY MANAGEMENT INDUSTRY, AS PROVIDED VIA A WEB-BASED E-COMMERCE PLATFORM, IN CLASS 35 (U.S. CLS. 100, 101 AND 102).

FIRST USE 5-1-2011; IN COMMERCE 5-1-2011.

THE MARK CONSISTS OF STANDARD CHARACTERS WITHOUT CLAIM TO ANY PARTICULAR FONT, STYLE, SIZE, OR COLOR.

SER. NO. 85-334,367, FILED 5-31-2011.

HEATHER BIDDULPH, EXAMINING ATTORNEY



David J. Kyros

Director of the United States Patent and Trademark Office

United States of America

United States Patent and Trademark Office

INGEGRID

Reg. No. 4,152,959

Registered June 5, 2012

Int. Cl.: 9

TRADEMARK

PRINCIPAL REGISTER

INGETEAM, S.A. (SPAIN SOCIEDAD ANONIMA (SA))
EDIFICIO 106
PARQUE TECNOLÓGICO DE BIZKAIA
ZAMUDIO, SPAIN 48170

FOR: APPARATUS AND INSTRUMENTS FOR SWITCHING, CONDUCTING, TRANSFORMING, ACCUMULATING, REGULATING OR CONTROLLING ELECTRICITY, NAMELY, ELECTRICAL CONDUITS; ELECTRONIC INSTRUMENTS AND EQUIPMENT FOR REGULATING AND CONTROLLING ELECTRIC CURRENT AND ELECTRIC SUPPLY; ELECTRICAL CIRCUIT BOARDS AND ELECTRONIC CIRCUIT BOARDS; COMPUTER SOFTWARE FOR USE IN REGULATING AND CONTROLLING ELECTRICAL CURRENT AND ELECTRIC SUPPLY; COMPUTER HARDWARE FOR USE IN REGULATING AND CONTROLLING ELECTRICAL CURRENT AND ELECTRIC SUPPLY; ALL OF THE FOREGOING USED ON POWER TRANSMISSION AND DISTRIBUTION NETWORKS AND USED TO CONTROL VOLTAGE, QUALITY OF SUPPLY, SUPPRESSION OF LOSSES, POWER FLUX CONTROL AND STORAGE OF ENERGY, IN CLASS 9 (U.S. CLS. 21, 23, 26, 36 AND 38).

THE MARK CONSISTS OF STANDARD CHARACTERS WITHOUT CLAIM TO ANY PARTICULAR FONT, STYLE, SIZE, OR COLOR.

PRIORITY CLAIMED UNDER SEC. 44(D) ON ERPN CMNTY TM OFC APPLICATION NO. 9821042, FILED 3-18-2011, REG. NO. 009821042, DATED 8-29-2011, EXPIRES 3-18-2021.

OWNER OF U.S. REG. NOS. 3,597,351 AND 3,673,281.

SER. NO. 85-335,144, FILED 6-1-2011.

DOMINIC FATHY, EXAMINING ATTORNEY



David J. Kyros

Director of the United States Patent and Trademark Office

United States of America

United States Patent and Trademark Office

RESPONDER INTELLIGENCE

Reg. No. 4,152,960

Registered June 5, 2012

Int. Cl.: 35

SERVICE MARK

PRINCIPAL REGISTER

AGR MARKETING SOLUTIONS, LLC (FLORIDA LIMITED LIABILITY COMPANY)
20071 EAGLE GLEN WAY
ESTERO, FL 33928

FOR: ONLINE BUSINESS RESEARCH SERVICES THAT ALLOW USERS TO SHARE OPINIONS WITH A MARKETING RESEARCH COMPANY RELATED TO EVERYDAY CONSUMER PRODUCTS AND SERVICES , IN CLASS 35 (U.S. CLS. 100, 101 AND 102).

FIRST USE 5-3-2010; IN COMMERCE 5-5-2010.

THE MARK CONSISTS OF STANDARD CHARACTERS WITHOUT CLAIM TO ANY PARTICULAR FONT, STYLE, SIZE, OR COLOR.

NO CLAIM IS MADE TO THE EXCLUSIVE RIGHT TO USE "INTELLIGENCE", APART FROM THE MARK AS SHOWN.

SER. NO. 85-335,228, FILED 6-1-2011.

BERYL GARDNER, EXAMINING ATTORNEY



David J. Kyffers

Director of the United States Patent and Trademark Office

United States of America

United States Patent and Trademark Office



Reg. No. 4,152,961

Registered June 5, 2012

Int. Cl.: 35

SERVICE MARK

PRINCIPAL REGISTER

THE WELLNESS PROVIDER NETWORK LLC (MISSOURI LIMITED LIABILITY COMPANY)
3539A S. LONE PINE
SPRINGFIELD, MO 65804

FOR: ASSOCIATION SERVICES, NAMELY, PROMOTING THE INTERESTS OF MATURE INDIVIDUALS; PROMOTING PUBLIC AWARENESS AND ADVOCACY IN THE FIELDS OF HEALTH AND WELLNESS; REWARD CARD SERVICES, NAMELY, PROMOTING THE SALE OF GOODS AND SERVICES OF OTHERS BY AWARDED DISCOUNTED PRICES OR INCENTIVE OFFERS FROM NETWORK PROVIDERS, PROMOTING THE SALE OF GOODS AND SERVICES OF OTHERS THROUGH THE ADMINISTRATION OF INCENTIVE AWARD PROGRAMS, AND ADMINISTRATION OF A DISCOUNT PROGRAM FOR ENABLING PARTICIPANTS TO OBTAIN DISCOUNTS ON GOODS AND SERVICES THROUGH USE OF A MEMBERSHIP CARD, IN CLASS 35 (U.S. CLS. 100, 101 AND 102).

FIRST USE 1-10-2010; IN COMMERCE 1-10-2010.

NO CLAIM IS MADE TO THE EXCLUSIVE RIGHT TO USE "WELLNESS PROVIDER NETWORK", APART FROM THE MARK AS SHOWN.

THE COLOR(S) BLUE, RED, GREEN AND GRAY IS/ARE CLAIMED AS A FEATURE OF THE MARK.

THE MARK CONSISTS OF THE FOLLOWING: A THREE PEDAL OUTLINES CONNECTED AT THE CENTER IN THE COLORS BLUE, RED AND GREEN WITH ALL THREE OPEN IN THE MIDDLE. TO THE RIGHT THERE IS THE STYLIZED TEXT "THE WELLNESS PROVIDER NETWORK" IN THE COLOR GREY. THE COLOR WHITE SHOWN IN THE MARK IS FOR BACKGROUND PURPOSES ONLY AND IS NOT INTENDED AS A FEATURE OF THE MARK

SER. NO. 85-335,620, FILED 6-1-2011.

WILLIAM ROSSMAN, EXAMINING ATTORNEY



David J. Kyffers

Director of the United States Patent and Trademark Office

United States of America

United States Patent and Trademark Office



Reg. No. 4,152,962

Registered June 5, 2012

Int. Cl.: 25

TRADEMARK

PRINCIPAL REGISTER

COOK, KEVIN (UNITED STATES INDIVIDUAL)
156 SCOTTSDALE DRIVE
CLOVIS, NM 881012739

FOR: HATS, IN CLASS 25 (U.S. CLS. 22 AND 39).

FIRST USE 1-0-2005; IN COMMERCE 1-0-2005.

THE MARK CONSISTS OF A RECTANGLE THAT IS BENT DOWNWARD TO FORM A SEMICIRCLE-LIKE SHAPE. WITHIN IT ARE THE WORDS "AIR COMMANDO" PRESENTED IN STYLIZED FONT. THE RECTANGLE IS OUTLINED WITH A SINGLE LINE BORDER.

SER. NO. 85-336,194, FILED 6-2-2011.

GRETCHEN ULRICH, EXAMINING ATTORNEY



David J. Kybas

Director of the United States Patent and Trademark Office

United States of America

United States Patent and Trademark Office



Reg. No. 4,152,963

Registered June 5, 2012

Int. Cl.: 32

TRADEMARK

PRINCIPAL REGISTER

NITRATE FREE, INC. (CALIFORNIA CORPORATION), DBA SIBERIA WATERS
SUITE C
14807 AETNA STREET
VAN NUYS, CA 91411

FOR: NITRATE FREE AERATED WATER; NITRATE FREE BOTTLED ARTESIAN WATER; NITRATE FREE BOTTLED DRINKING WATER; NITRATE FREE BOTTLED WATER; NITRATE FREE CARBONATED WATERS; NITRATE FREE DRINKING WATER; NITRATE FREE DRINKING WATER WITH VITAMINS; NITRATE FREE FLAVORED BOTTLED WATER; NITRATE FREE FLAVORED WATERS; NITRATE FREE MINERAL WATER; NITRATE FREE SPARKLING WATER; NITRATE FREE SPRING WATER, IN CLASS 32 (U.S. CLS. 45, 46 AND 48).

FIRST USE 1-5-2010; IN COMMERCE 2-1-2010.

OWNER OF U.S. REG. NO. 3,853,407.

NO CLAIM IS MADE TO THE EXCLUSIVE RIGHT TO USE "SIBERIA" AND "NITRATE FREE", APART FROM THE MARK AS SHOWN.

THE MARK CONSISTS OF THE WORD "SIBERIA" IN A STYLIZED FONT; TO THE LOWER RIGHT SIDE OF THE WORD "SIBERIA" CONCENTRIC CIRCLES WITH THE WORDS "NITRATE FREE" IN A STYLIZED FONT BETWEEN THE INNER AND OUTER CIRCLES; THE WORD "NITRATE" IS LOCATED AT THE TOP OF THE CONCENTRIC CIRCLES AND THE WORD "FREE" IS LOCATED AT THE BOTTOM OF THE CONCENTRIC CIRCLES; A LEAF EXTENDING THROUGH THE CENTER OF THE INNER CONCENTRIC CIRCLE BETWEEN THE WORDS "NITRATE" AND "FREE" AND ENDING OUTSIDE THE OUTER CONCENTRIC CIRCLE.

SER. NO. 85-336,269, FILED 6-2-2011.

KAREN K. BUSH, EXAMINING ATTORNEY



David J. Kyros

Director of the United States Patent and Trademark Office

United States of America

United States Patent and Trademark Office

VIEWVANTAGE

Reg. No. 4,152,964

Registered June 5, 2012

Int. Cls.: 42 and 44

SERVICE MARK

PRINCIPAL REGISTER

AEDAS LTD. (HONG KONG CORPORATION)
31/F ONE ISLAND EAST, 18 WESTLANDS ROAD
QUARRY BAY, HONG KONG

FOR: TECHNICAL DESIGN SERVICES FOR OTHERS IN THE FIELD OF ARCHITECTURE; INTERIOR DESIGN SERVICES; LANDSCAPE ARCHITECTURAL DESIGN SERVICES; CONCEPT DESIGN DEVELOPMENT, NAMELY, THE DEVELOPMENT OF CONCEPT DESIGNS IN THE FIELDS OF ARCHITECTURE AND INTERIOR DESIGN; INTERIOR DESIGN SERVICES, NAMELY, SPACE PLANNING; ARCHITECTURAL CONSULTANCY AND ADVISORY SERVICES; ARCHITECTURAL SERVICES; ARCHITECTURAL PLANNING SERVICES; ARCHITECTURAL DESIGN SERVICES; PREPARATION OF ARCHITECTURAL PLANS AND REPORTS IN CONNECTION WITH ARCHITECTURAL CONSULTATION; CIVIL ENGINEERING ADVISORY AND CONSULTANCY SERVICES; STRUCTURAL ENGINEERING ADVISORY AND CONSULTANCY SERVICES; CIVIL ENGINEERING SERVICES; CIVIL ENGINEERING DESIGN SERVICES; CIVIL ENGINEERING DRAWING SERVICES; CIVIL ENGINEERING PLANNING SERVICES; TECHNICAL CONSULTATION IN THE FIELD OF CIVIL ENGINEERING; STRUCTURAL ENGINEERING SERVICES; SURVEYING; CONSULTANCY AND ADVISORY SERVICES RELATING TO BUILDING DESIGN FOR OTHERS; ELECTRICAL ENGINEERING SERVICES; SCIENTIFIC AND TECHNOLOGICAL SERVICES, NAMELY, SCIENTIFIC RESEARCH IN THE FIELDS OF ARCHITECTURE, INTERIOR DESIGN AND ENGINEERING; INDUSTRIAL RESEARCH IN THE FIELDS OF ARCHITECTURE, INTERIOR DESIGN AND ENGINEERING; DESIGN AND DEVELOPMENT OF COMPUTER HARDWARE AND SOFTWARE, IN CLASS 42 (U.S. CLS. 100 AND 101).

FOR: LANDSCAPE DESIGN SERVICES, IN CLASS 44 (U.S. CLS. 100 AND 101).

THE MARK CONSISTS OF STANDARD CHARACTERS WITHOUT CLAIM TO ANY PARTICULAR FONT, STYLE, SIZE, OR COLOR.

OWNER OF HONG KONG REG. NO. 301930356, DATED 5-27-2011, EXPIRES 5-26-2021.

SER. NO. 85-336,309, FILED 6-2-2011.

LINDA M. KING, EXAMINING ATTORNEY



David J. Kyros

Director of the United States Patent and Trademark Office

United States of America

United States Patent and Trademark Office

POWER LEARNING

Reg. No. 4,152,965

Registered June 5, 2012

Int. Cl.: 16

TRADEMARK

PRINCIPAL REGISTER

EDUPOWER, INC. (DELAWARE CORPORATION)
362 MIDDLE STREET
AMHERST, MA 01002

FOR: SERIES OF BOOKS ON STRATEGIES OF LEARNING AND CRITICAL THINKING AS APPLIED TO COLLEGE ACADEMIC PERFORMANCE AND CAREER DEVELOPMENT, IN CLASS 16 (U.S. CLS. 2, 5, 22, 23, 29, 37, 38 AND 50).

FIRST USE 12-31-2003; IN COMMERCE 12-31-2003.

THE MARK CONSISTS OF STANDARD CHARACTERS WITHOUT CLAIM TO ANY PARTICULAR FONT, STYLE, SIZE, OR COLOR.

NO CLAIM IS MADE TO THE EXCLUSIVE RIGHT TO USE "LEARNING", APART FROM THE MARK AS SHOWN.

SER. NO. 85-336,343, FILED 6-2-2011.

KAREN SEVERSON, EXAMINING ATTORNEY



David J. Kyffers

Director of the United States Patent and Trademark Office

United States of America

United States Patent and Trademark Office



Reg. No. 4,152,966

Registered June 5, 2012

Int. Cl.: 43

SERVICE MARK

PRINCIPAL REGISTER

THE TRUSTEE OF THE SAMI LADEKI TRUST (CALIFORNIA TRUST)
SUITE 200
7596 EADS AVENUE
LA JOLLA, CA 92037

FOR: RESTAURANT SERVICES, IN CLASS 43 (U.S. CLS. 100 AND 101).

FIRST USE 11-20-2003; IN COMMERCE 11-20-2003.

OWNER OF U.S. REG. NOS. 1,657,715, 1,821,819, AND 1,901,033.

THE COLOR(S) WHITE, BLACK, RED, AND GREEN IS/ARE CLAIMED AS A FEATURE OF THE MARK.

NO CLAIM IS MADE TO THE EXCLUSIVE RIGHT TO USE "WOODFIRED PIZZA", APART FROM THE MARK AS SHOWN.

THE MARK CONSISTS OF THE WORD "SAMMY'S" APPEARING IN THE COLOR WHITE OUTLINED IN THE COLOR BLACK WITH PALM TREES IN THE COLOR GREEN APPEARING ABOVE IT OVER A RED COLORED BACKGROUND IN THE SHAPE OF THE TOP HALF OF A CIRCLE OUTLINED IN THE COLOR WHITE AND THEN OUTLINED IN THE COLOR BLACK WITH THE WORDS "WOODFIRED PIZZA" APPEARING BELOW IT IN THE COLOR BLACK ALL OVER A WHITE BACKGROUND.

SER. NO. 85-336,885, FILED 6-2-2011.

STEPHANIE ALI, EXAMINING ATTORNEY



David J. Kyros

Director of the United States Patent and Trademark Office

United States of America

United States Patent and Trademark Office

RIVER GREEN BLENDED ASSET FUND

Reg. No. 4,152,967

RIVER GREEN GROUP (DELAWARE LIMITED LIABILITY COMPANY)
9940 HWY 92
WOODSTOCK, GA 30188

Registered June 5, 2012

Int. Cl.: 36

FOR: PRIVATE PLACEMENTS OF HEDGE FUNDS, PRIVATE EQUITY FUNDS, SECURITIES
AND DERIVATIVES FOR OTHERS, IN CLASS 36 (U.S. CLS. 100, 101 AND 102).

SERVICE MARK

FIRST USE 3-1-2011; IN COMMERCE 3-1-2011.

PRINCIPAL REGISTER

THE MARK CONSISTS OF STANDARD CHARACTERS WITHOUT CLAIM TO ANY PAR-
TICULAR FONT, STYLE, SIZE, OR COLOR.

NO CLAIM IS MADE TO THE EXCLUSIVE RIGHT TO USE "BLENDED ASSET FUND",
APART FROM THE MARK AS SHOWN.

SER. NO. 85-337,336, FILED 6-3-2011.

WILLIAM BRECKENFELD, EXAMINING ATTORNEY



David J. Kybas

Director of the United States Patent and Trademark Office

United States of America

United States Patent and Trademark Office



Reg. No. 4,152,968

Registered June 5, 2012

Int. Cls.: 30, 35 and 40

TRADEMARK

SERVICE MARK

PRINCIPAL REGISTER

1147785 ONTARIO LTD. (CANADA CORPORATION), DBA MUSKOKA ROASTERY COFFEE COMPANY
8 CRESCENT ROAD, UNIT 1B
HUNTSVILLE, ONTARIO, CANADA P1H0B3

FOR: ROASTED WHOLE BEAN COFFEE; ROASTED GROUND COFFEE; NON-ALCOHOLIC COFFEE BASED BEVERAGES; NON-ALCOHOLIC BEVERAGES WITH A BASE OF ESPRESSO, IN CLASS 30 (U.S. CL. 46).

FOR: ON-LINE RETAIL STORE SERVICES FEATURING COFFEE BEANS AND GROUND COFFEE, IN CLASS 35 (U.S. CLS. 100, 101 AND 102).

FOR: COFFEE ROASTING; COFFEE PROCESSING, IN CLASS 40 (U.S. CLS. 100, 103 AND 106).

PRIORITY CLAIMED UNDER SEC. 44(D) ON CANADA APPLICATION NO. 1507983, FILED 12-15-2010, REG. NO. TMA812,510, DATED 11-23-2011, EXPIRES 11-23-2026.

NO CLAIM IS MADE TO THE EXCLUSIVE RIGHT TO USE "MUSKOKA ROASTERY COFFEE CO. 100% CERTIFIED HANDCRAFTED", APART FROM THE MARK AS SHOWN.

THE MARK CONSISTS OF THE WORDING "MUSKOKA ROASTERY COFFEE CO. 100% CERTIFIED HANDCRAFTED" IN STYLIZED TYPE; "MUSKOKA ROASTERY COFFEE CO." IS COLORED WHITE AGAINST A BLACK RECTANGULAR BACKGROUND WITH A BORDER AROUND THE RECTANGLE CONSISTING OF TRIANGLES POINTING OUTWARD AND A DOT IN LOCATED AT EACH CORNER OF THE RECTANGLE; AND, A STYLIZED DESIGN OF A MAPLE LEAF IS LOCATED OUTSIDE THE TOP OF THE RECTANGLE.

SER. NO. 85-337,832, FILED 6-3-2011.

BRENDAN MCCAULEY, EXAMINING ATTORNEY



David J. Kyjars

Director of the United States Patent and Trademark Office

United States of America

United States Patent and Trademark Office



Reg. No. 4,152,969

Registered June 5, 2012

Int. Cl.: 7

TRADEMARK

PRINCIPAL REGISTER

TETRA TECHNOLOGIES, INC. (DELAWARE CORPORATION)
24955 I-45 NORTH
THE WOODLANDS, TX 77380

FOR: ELECTRIC COMPRESSORS, IN CLASS 7 (U.S. CLS. 13, 19, 21, 23, 31, 34 AND 35).

FIRST USE 4-1-2010; IN COMMERCE 4-1-2010.

OWNER OF U.S. REG. NOS. 1,688,270 AND 2,775,178.

THE MARK CONSISTS OF A KICKING DONKEY POSITIONED BETWEEN THE LETTER "V" AND THE WORD "JACK".

SER. NO. 85-337,905, FILED 6-3-2011.

MICHAEL ENGEL, EXAMINING ATTORNEY



David J. Kyffers

Director of the United States Patent and Trademark Office

United States of America

United States Patent and Trademark Office

MOYER
MACHINE AND TOOL, LLC.

Reg. No. 4,152,970

Registered June 5, 2012

Int. Cl.: 40

SERVICE MARK

PRINCIPAL REGISTER

MOYER MACHINE AND TOOL, LLC. (COLORADO LIMITED LIABILITY COMPANY)
BUILDING D, UNIT 1
546 SE 8TH STREET
LOVELAND, CO 80537

FOR: MACHINE SHOP SERVICES, NAMELY, MACHINING PARTS FOR OTHERS, IN CLASS 40 (U.S. CLS. 100, 103 AND 106).

FIRST USE 1-1-1997; IN COMMERCE 1-1-1997.

NO CLAIM IS MADE TO THE EXCLUSIVE RIGHT TO USE "MACHINE AND TOOL, LLC.", APART FROM THE MARK AS SHOWN.

THE MARK CONSISTS OF THE STYLIZED TEXT "MOYER" IN ALL CAPITALS. UNDER THIS TEST IS THE STYLIZED TEXT "MACHINE AND TOOL, LLC." CONTAINED IN AN OVAL.

SEC. 2(F).

SER. NO. 85-337,940, FILED 6-3-2011.

JULIE WATSON, EXAMINING ATTORNEY



David J. Kybas

Director of the United States Patent and Trademark Office

United States of America

United States Patent and Trademark Office

*Versa*STUDIO

Reg. No. 4,152,971

Registered June 5, 2012

Int. Cl.: 9

TRADEMARK

PRINCIPAL REGISTER

ROLAND DG CORPORATION (JAPAN CORPORATION)
1-6-4 SHIN MIYAKODA, KITA-KU
HAMAMATSU-SHI
SHIZUOKA-KEN, JAPAN 431-2103

FOR: APPARATUS CONTROLLED BY COMPUTERS, NAMELY, COMPUTER MONITOR DISPLAYS, PRINTERS AND X-Y PLOTTERS; PLOTTER PRINTERS; CUTTING PLOTTERS FOR USE AS SIGN MAKERS; COMBINATION INK JET PRINTER AND CUTTER; COMBINATION THERMAL PRINTER AND CUTTER; COMPUTER PRINTERS; X-Y PLOTTERS; THREE DIMENSIONAL SCANNERS; COMPUTER PROGRAMS FOR CONTROLLING CUTTING, DRILLING, GRINDING AND ENGRAVING MACHINES, POWER OPERATED COMPUTERIZED MACHINE CUTTERS, DRILLERS AND GRINDERS, ENGRAVING MACHINES, LASER ENGRAVING MACHINES, THREE DIMENSIONAL MODELING MACHINES, PLOTTER PRINTERS, CUTTING PLOTTERS FOR USE AS SIGN MAKERS, PRINTING AND CUTTING MACHINES, COMPUTER PRINTERS, X-Y PLOTTERS AND THREE-DIMENSIONAL SCANNERS, IN CLASS 9 (U.S. CLS. 21, 23, 26, 36 AND 38).

FIRST USE 5-24-2011; IN COMMERCE 5-24-2011.

OWNER OF JAPAN REG. NO. 5448307, DATED 11-4-2011, EXPIRES 11-4-2021.

OWNER OF U.S. REG. NOS. 2,987,031, 3,635,701, AND 3,635,702.

THE MARK CONSISTS OF THE WORD "VERSA" IN INITIAL CAPS, FOLLOWED BY THE WORD "STUDIO" IN ALL CAPS, WITH NO SPACING BETWEEN THE TWO WORDS. "VERSASTUDIO" IS IN AN ITALICIZED FONT.

SER. NO. 85-338,077, FILED 6-3-2011.

MEGHAN REINHART, EXAMINING ATTORNEY



David J. Kyros

Director of the United States Patent and Trademark Office

United States of America

United States Patent and Trademark Office

Console Doctor

Reg. No. 4,152,972

Registered June 5, 2012

Int. Cl.: 37

SERVICE MARK

PRINCIPAL REGISTER

GRANT, KYLE D (UNITED STATES INDIVIDUAL)
6653 POWERS AVE.
SUITE 239
JACKSONVILLE, FL 32217

FOR: VIDEO GAME REPAIR SERVICES FOR VIDEO GAMING CONSOLES, IN CLASS 37
(U.S. CLS. 100, 103 AND 106).

FIRST USE 8-1-2008; IN COMMERCE 8-1-2008.

THE MARK CONSISTS OF STANDARD CHARACTERS WITHOUT CLAIM TO ANY PARTICULAR FONT, STYLE, SIZE, OR COLOR.

NO CLAIM IS MADE TO THE EXCLUSIVE RIGHT TO USE "CONSOLE", APART FROM THE MARK AS SHOWN.

SER. NO. 85-338,125, FILED 6-4-2011.

KIM SAITO, EXAMINING ATTORNEY



David J. Kyffers

Director of the United States Patent and Trademark Office

United States of America

United States Patent and Trademark Office

Opportunity, gone mobile.

Reg. No. 4,152,973

Registered June 5, 2012

Int. Cl.: 9

TRADEMARK

PRINCIPAL REGISTER

MOBUBBLE, INC (CALIFORNIA CORPORATION), DBA MOBUBBLE, INC
22910 BANBURY CT
MURRIETA, CA 92562

FOR: COMPUTER APPLICATION SOFTWARE FOR MOBILE PHONES, NAMELY, SOFTWARE FOR MOBILE CLASSIFIEDS AND PROXIMITY SEARCH; COMPUTER SOFTWARE, NAMELY, AN APPLICATION ALLOWING SALES AND FIELD SERVICE EMPLOYEES TO UPDATE AND RECEIVE DATA STORED IN AN ENTERPRISE'S COMPUTER DATABASES IN REAL TIME, USING A MOBILE DEVICE, WITH FULL TELEPHONY INTEGRATION WITH THE TELEPHONE AND/OR SOFTWARE FEATURES OF THE MOBILE DEVICE; COMPUTER SOFTWARE, NAMELY, SOFTWARE DEVELOPMENT TOOLS FOR THE CREATION OF MOBILE INTERNET APPLICATIONS AND CLIENT INTERFACES; MOBILE COMPUTING AND OPERATING PLATFORMS CONSISTING OF DATA TRANSCEIVERS, WIRELESS NETWORKS AND GATEWAYS FOR COLLECTION AND MANAGEMENT OF DATA, IN CLASS 9 (U.S. CLS. 21, 23, 26, 36 AND 38).

FIRST USE 4-20-2011; IN COMMERCE 5-1-2011.

THE MARK CONSISTS OF STANDARD CHARACTERS WITHOUT CLAIM TO ANY PARTICULAR FONT, STYLE, SIZE, OR COLOR.

SER. NO. 85-338,186, FILED 6-4-2011.

DAVID HOFFMAN, EXAMINING ATTORNEY



David J. Kyros

Director of the United States Patent and Trademark Office

United States of America

United States Patent and Trademark Office

RIVER GREEN INVESTMENT MANAGEMENT

Reg. No. 4,152,974

Registered June 5, 2012

Int. Cl.: 36

SERVICE MARK

PRINCIPAL REGISTER

RIVER GREEN INVESTMENT MANAGEMENT (DELAWARE LIMITED LIABILITY
COMPANY)
9940 HWY 92
WOODSTOCK, GA 30188

FOR: FINANCIAL SERVICES, NAMELY, OPERATION AND MANAGEMENT OF HEDGE
FUNDS, COMMODITY POOLS AND OTHER COLLECTIVE INVESTMENT VEHICLES, AND
TRADING FOR OTHERS OF SECURITIES, OPTIONS, FUTURES, DERIVATIVES, DEBT
INSTRUMENTS AND COMMODITIES, IN CLASS 36 (U.S. CLS. 100, 101 AND 102).

FIRST USE 3-1-2011; IN COMMERCE 3-1-2011.

THE MARK CONSISTS OF STANDARD CHARACTERS WITHOUT CLAIM TO ANY PAR-
TICULAR FONT, STYLE, SIZE, OR COLOR.

NO CLAIM IS MADE TO THE EXCLUSIVE RIGHT TO USE "INVESTMENT MANAGEMENT",
APART FROM THE MARK AS SHOWN.

SER. NO. 85-338,657, FILED 6-6-2011.

HELENE LIWINSKI, EXAMINING ATTORNEY



David J. Kyffers

Director of the United States Patent and Trademark Office

United States of America

United States Patent and Trademark Office

Hartford's Personal Retirement Manager

Reg. No. 4,152,975

Registered June 5, 2012

Int. Cl.: 36

SERVICE MARK

PRINCIPAL REGISTER

HARTFORD FIRE INSURANCE COMPANY (CONNECTICUT CORPORATION)
LAW DEPT. IP TRADEMARK UNIT HO109
ONE HARTFORD PLAZA
HARTFORD, CT 06155

FOR: UNDERWRITING, ISSUING AND ADMINISTRATION OF ANNUITIES; FINANCIAL ANALYSIS AND CONSULTATION IN THE FIELDS OF LIFE INSURANCE, LONG TERM CARE INSURANCE, ANNUITIES, INVESTMENTS, AND RETIREMENT PLANNING; FINANCIAL SERVICES, NAMELY, BROKERAGE AND ADMINISTRATION OF ANNUITIES AND PENSIONS, IN CLASS 36 (U.S. CLS. 100, 101 AND 102).

FIRST USE 10-31-2009; IN COMMERCE 10-31-2009.

THE MARK CONSISTS OF STANDARD CHARACTERS WITHOUT CLAIM TO ANY PARTICULAR FONT, STYLE, SIZE, OR COLOR.

NO CLAIM IS MADE TO THE EXCLUSIVE RIGHT TO USE "PERSONAL RETIREMENT MANAGER", APART FROM THE MARK AS SHOWN.

SEC. 2(F) AS TO "HARTFORD'S" .

SER. NO. 85-338,901, FILED 6-6-2011.

SAIMA MAKHDOOM, EXAMINING ATTORNEY



David J. Kyffers

Director of the United States Patent and Trademark Office

United States of America

United States Patent and Trademark Office

EAT ME!

Reg. No. 4,152,976

Registered June 5, 2012

Int. Cl.: 35

SERVICE MARK

PRINCIPAL REGISTER

FUZZY'S TACO HOLDINGS, LLC (TEXAS LIMITED LIABILITY COMPANY)
SUITE 100
200 BAILEY AVENUE
FORT WORTH, TX 76107

FOR: ON-LINE RETAIL STORE SERVICES FEATURING CLOTHING, HEAD WEAR, FOOTWEAR, CONDIMENTS, KEY CHAINS, STICKERS, INSULATED BEVERAGE HOLDERS, CUPS, MUGS AND GLASSES, IN CLASS 35 (U.S. CLS. 100, 101 AND 102).

FIRST USE 12-1-2004; IN COMMERCE 12-1-2004.

THE MARK CONSISTS OF STANDARD CHARACTERS WITHOUT CLAIM TO ANY PARTICULAR FONT, STYLE, SIZE, OR COLOR.

SER. NO. 85-338,987, FILED 6-6-2011.

KATHLEEN LORENZO, EXAMINING ATTORNEY



David J. Kybas

Director of the United States Patent and Trademark Office

United States of America

United States Patent and Trademark Office



Reg. No. 4,152,977

Registered June 5, 2012

Int. Cl.: 39

WORLDWIDE PROJECT CONSORTIUM (HOLDINGS) LIMITED (BR. VIRGIN ISLANDS LIMITED LIABILITY COMPANY)
C/O JUS NORDICUM INC.
LUDVIGINKATU 3-5 A
00130 HELSINKI, FINLAND

SERVICE MARK

FOR: TRANSPORT BY AIR, RAIL, VESSEL, ROAD VEHICLE, AND FREIGHT FORWARDING AND WAREHOUSING SERVICES, IN CLASS 39 (U.S. CLS. 100 AND 105).

PRINCIPAL REGISTER

OWNER OF ERPN CMNTY TM OFC REG. NO. 002239556, DATED 3-5-2003, EXPIRES 5-5-2021.

THE COLOR(S) BLUE, PANTONE 288; YELLOW: PANTONE 116; REDDISH PANTONE 492 THE TEXT AND THE LINE INSIDE THE LOGO ARE WHITE IS/ARE CLAIMED AS A FEATURE OF THE MARK.

OWNER OF U.S. REG. NO. 2,804,053.

NO CLAIM IS MADE TO THE EXCLUSIVE RIGHT TO USE "WORLDWIDE PROJECT CONSORTIUM", APART FROM THE MARK AS SHOWN.

THE MARK CONSISTS OF A BLUE GLOBE WITH YELLOW OUTLINE AND WHITE LINES, WITH THE WHITE LETTERS "W", "W", "P", "C" INSIDE IT AND A CURVED BLUE AND WHITE ARROW UNDER THE TEXT CROSSING THE GLOBE. BELOW THE GLOBE IS THE RED WORDS "WORLDWIDE PROJECT CONSORTIUM".

SER. NO. 85-339,489, FILED 6-7-2011.

LINDA MICKLEBURGH, EXAMINING ATTORNEY



David J. Kyffers

Director of the United States Patent and Trademark Office

United States of America

United States Patent and Trademark Office

Madame Koiteh

Reg. No. 4,152,978

KOITEH, ZAHRAA (UNITED STATES INDIVIDUAL)
2031 CRESTON AVENUE #4E
BRONX, NY 10453

Registered June 5, 2012

Int. Cl.: 3

FOR: BEAUTY SUPPLIES, NAMELY, LOTIONS, CREAMS, SOAPS, AND HAIR AND SKIN PREPARATIONS, IN CLASS 3 (U.S. CLS. 1, 4, 6, 50, 51 AND 52).

TRADEMARK

FIRST USE 5-15-2009; IN COMMERCE 5-15-2009.

PRINCIPAL REGISTER

THE MARK CONSISTS OF STANDARD CHARACTERS WITHOUT CLAIM TO ANY PARTICULAR FONT, STYLE, SIZE, OR COLOR.

THE NAME(S), PORTRAIT(S), AND/OR SIGNATURE(S) SHOWN IN THE MARK IDENTIFIES "MADAME KOITEH", WHOSE CONSENT(S) TO REGISTER IS MADE OF RECORD.

SER. NO. 85-339,538, FILED 6-7-2011.

GRETТА YAO, EXAMINING ATTORNEY



David J. Kybas

Director of the United States Patent and Trademark Office

United States of America

United States Patent and Trademark Office

RIVER GREEN

Reg. No. 4,152,979

Registered June 5, 2012

Int. Cl.: 36

SERVICE MARK

PRINCIPAL REGISTER

RIVER GREEN INVESTMENT MANAGEMENT (DELAWARE LIMITED LIABILITY COMPANY)
9940 HWY 92
WOODSTOCK, GA 30188

FOR: FINANCIAL SERVICES, NAMELY, OPERATION AND MANAGEMENT OF HEDGE FUNDS, COMMODITY POOLS AND OTHER COLLECTIVE INVESTMENT VEHICLES, AND TRADING FOR OTHERS OF SECURITIES, OPTIONS, FUTURES, DERIVATIVES, DEBT INSTRUMENTS AND COMMODITIES, IN CLASS 36 (U.S. CLS. 100, 101 AND 102).

FIRST USE 3-0-2011; IN COMMERCE 3-0-2011.

THE MARK CONSISTS OF THE TERMS "RIVER" AND "GREEN" IN THE COLOR BLUE, SEPARATED BY A WAVY BAND CONSISTING OF TWO CURVES, IN GREEN.

THE COLOR(S) BLUE AND GREEN IS/ARE CLAIMED AS A FEATURE OF THE MARK.

SER. NO. 85-339,635, FILED 6-7-2011.

HELENE LIWINSKI, EXAMINING ATTORNEY



David J. Kyjars

Director of the United States Patent and Trademark Office

United States of America

United States Patent and Trademark Office

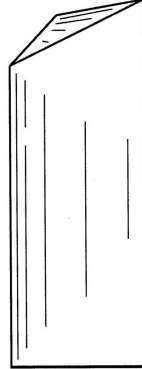

Reg. No. 4,152,980

Registered June 5, 2012

Int. Cls.: 3 and 5

TRADEMARK

PRINCIPAL REGISTER

DIVINE SKIN, INC. (NEW YORK CORPORATION), DBA DS LABORATORIES, INC.
SUITE 301
1680 MERIDIAN AVENUE
MIAMI, FL 33139

FOR: NON-MEDICATED SHAMPOOS AND CONDITIONERS TO STIMULATE HAIR GROWTH, NON-MEDICATED COSMETIC SHAMPOOS AND CONDITIONERS TO IMPROVE THE APPEARANCE OF HAIR, NON-MEDICATED CLARIFYING SHAMPOOS AND CONDITIONERS TO REMOVE BUILD-UP ON HAIR, NON-MEDICATED EYE LASH CONDITIONER TO ENHANCE EYE LASH GROWTH, IN CLASS 3 (U.S. CLS. 1, 4, 6, 50, 51 AND 52).

FIRST USE 3-16-2006; IN COMMERCE 3-16-2006.

FOR: MEDICATED SHAMPOO FOR THE TREATMENT OF DANDRUFF AND FLAKY SCALP, IN CLASS 5 (U.S. CLS. 6, 18, 44, 46, 51 AND 52).

FIRST USE 5-20-2008; IN COMMERCE 5-20-2008.

THE MARK CONSISTS OF A THREE-DIMENSIONAL TRIANGULAR BOX WHERE THE BOTTOM IS PERPENDICULAR TO THE SIDES AND THE TOP IS NOT PERPENDICULAR BUT, RATHER, IS ON AN INCLINE AT AN ANGLE OF LESS THAN 90 DEGREES.

SEC. 2(F).

SER. NO. 85-340,221, FILED 6-7-2011.

MICHAEL W. BAIRD, EXAMINING ATTORNEY



David J. Kyros

Director of the United States Patent and Trademark Office

United States of America

United States Patent and Trademark Office

LIGHTEN UP

Reg. No. 4,152,981

Registered June 5, 2012

Int. Cl.: 42

SERVICE MARK

PRINCIPAL REGISTER

SYMRISE AG (FED REP GERMANY AKTIENGESELLSCHAFT)
MUHLENFELDSTRASSE 1
HOLZMINDEN 37603, FED REP GERMANY

FOR: INDUSTRIAL PRODUCT DEVELOPMENT ANALYSIS, INDUSTRIAL RESEARCH AND PRODUCT RESEARCH AND DEVELOPMENT IN THE FIELD OF FLAVORS AND AROMA CHEMICALS, IN CLASS 42 (U.S. CLS. 100 AND 101).

FIRST USE 2-0-2009; IN COMMERCE 2-0-2009.

THE MARK CONSISTS OF STANDARD CHARACTERS WITHOUT CLAIM TO ANY PARTICULAR FONT, STYLE, SIZE, OR COLOR.

SER. NO. 85-340,393, FILED 6-7-2011.

KATHY DE JONGE, EXAMINING ATTORNEY



David J. Kybas

Director of the United States Patent and Trademark Office

United States of America

United States Patent and Trademark Office

WILBUR'S REVENGE

Reg. No. 4,152,982

FAMOUS DAVE'S OF AMERICA, INC. (MINNESOTA CORPORATION)
12701 WHITEWATER DRIVE, SUITE 200
MINNETONKA, MN 55343

Registered June 5, 2012

Int. Cls.: 29 and 30

FOR: RESTAURANT MENU ITEMS IN THE NATURE OF PREPARED FOODS CONSISTING PRIMARILY OF MEAT AND POULTRY AND FEATURING BARBEQUE SAUCE FOR CONSUMPTION ON OR OFF THE PREMISES, IN CLASS 29 (U.S. CL. 46).

TRADEMARK

FIRST USE 1-11-2010; IN COMMERCE 1-11-2010.

PRINCIPAL REGISTER

FOR: BARBEQUE SAUCE, IN CLASS 30 (U.S. CL. 46).

FIRST USE 1-11-2010; IN COMMERCE 1-11-2010.

THE MARK CONSISTS OF STANDARD CHARACTERS WITHOUT CLAIM TO ANY PARTICULAR FONT, STYLE, SIZE, OR COLOR.

SER. NO. 85-340,908, FILED 6-8-2011.

LINDA ESTRADA, EXAMINING ATTORNEY



David J. Kybas

Director of the United States Patent and Trademark Office

United States of America

United States Patent and Trademark Office

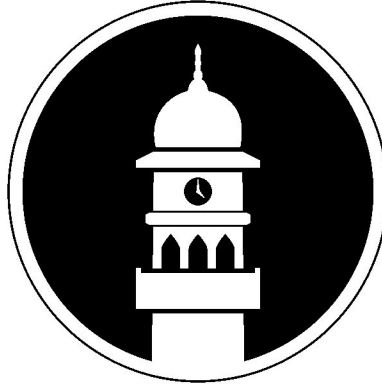

Reg. No. 4,152,983

Registered June 5, 2012

Int. Cl.: 45

SERVICE MARK

PRINCIPAL REGISTER

AHMADIYYA MOVEMENT IN ISLAM, INC. (ILLINOIS CORPORATION)
15000 GOOD HOPE ROAD
SILVER SPRING, MD 20905

FOR: PROVIDING INFORMATION REGARDING RELIGION, NAMELY, INFORMATION REGARDING THE ISLAMIC FAITH, IN CLASS 45 (U.S. CLS. 100 AND 101).

FIRST USE 7-31-2005; IN COMMERCE 7-31-2005.

THE MARK CONSISTS OF A STYLIZED DESIGN OF A MINARET WITHIN A SOLID CIRCLE THAT IS BROKEN AT THE BASE OF THE MINARET; THIS CIRCLE IS WITHIN A LARGER CIRCULAR CARRIER.

SER. NO. 85-340,955, FILED 6-8-2011.

BENJAMIN OKEKE, EXAMINING ATTORNEY



David J. Kyffers

Director of the United States Patent and Trademark Office

United States of America

United States Patent and Trademark Office

Wicked Catch

Reg. No. 4,152,984

Registered June 5, 2012

Int. Cl.: 16

TRADEMARK

PRINCIPAL REGISTER

SILVERS, JOSHUA (UNITED STATES INDIVIDUAL)
300 S AUSTRALIAN AVE.
SUITE 711
WEST PALM BEACH, FL 33401

FOR: BUMPER STICKERS; DECALS; DECORATIVE DECALS FOR VEHICLE WINDOWS,
IN CLASS 16 (U.S. CLS. 2, 5, 22, 23, 29, 37, 38 AND 50).

FIRST USE 12-5-2010; IN COMMERCE 6-9-2011.

THE MARK CONSISTS OF STANDARD CHARACTERS WITHOUT CLAIM TO ANY PAR-
TICULAR FONT, STYLE, SIZE, OR COLOR.

SER. NO. 85-342,561, FILED 6-9-2011.

LINDA POWELL, EXAMINING ATTORNEY



David J. Kybas

Director of the United States Patent and Trademark Office

United States of America

United States Patent and Trademark Office

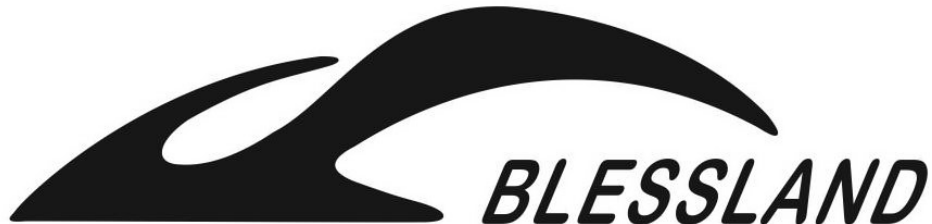

Reg. No. 4,152,985

Registered June 5, 2012

Int. Cl.: 25

TRADEMARK

PRINCIPAL REGISTER

CHANG CHIH-CHEN (TAIWAN INDIVIDUAL)
NO.19, 21ST ROAD, INDUSTRIAL PARK
TAICHUNG, TAIWAN 40850

FOR: ATHLETIC APPAREL, NAMELY, SHIRTS, PANTS, JACKETS, FOOTWEAR, HATS AND CAPS, ATHLETIC UNIFORMS; ANKLE BOOTS, LADIES' BOOTS, WORK SHOES AND BOOTS, INNER SOLES, WINTER BOOTS, HALF-BOOTS, LEISURE SHOES, CANVAS SHOES, WATERPROOF FOOTWEAR, SLIPPERS, RIDING BOOTS, SANDALS AND BEACH SHOES, SNOW BOOTS, CLIMBING SHOES, HIKING BOOTS, MOUNTAINEERING BOOTS, RUNNING SHOES, SNOWBOARD BOOTS, SKIING SHOES, ATHLETIC SHOES, SNEAKERS, BOOTS, MULES; CLOTHING, NAMELY, READY-MADE CLOTHING, NAMELY, SNOW-SUITS, SWIMWEAR, BLOUSES, AND JACKETS; HEADGEAR, NAMELY, HATS, CAPS; ADULT NOVELTY GAG CLOTHING ITEM, NAMELY, SOCKS; CLOTH BIBS, BIBS NOT OF PAPER, BIB TIGHTS; EAR MUFFS; SCARVES, NECKERCHIEFS; GLOVES, OUTDOOR GLOVES, SKI GLOVES; BELTS, GIRDLES, LEATHER BELTS, WAIST BELTS; APRONS, PINAFORES, IN CLASS 25 (U.S. CLS. 22 AND 39).

FIRST USE 4-10-2011; IN COMMERCE 4-10-2011.

THE MARK CONSISTS OF THE STYLIZED WORDING "BLESSLAND" AND A DESIGN COMPRISED OF A HIGHLY STYLIZED ARROW.

SER. NO. 85-342,813, FILED 6-10-2011.

CYNTHIA TRIPI, EXAMINING ATTORNEY



David J. Kybas

Director of the United States Patent and Trademark Office

United States of America

United States Patent and Trademark Office

CHEF NIGEL'S

Reg. No. 4,152,986

CHEF NIGEL, INC. (NEW YORK CORPORATION)
53 TILLMAN STREET
STATEN ISLAND, NY 10314

Registered June 5, 2012

Int. Cl.: 30

FOR: SAUCES, NAMELY, HOT SAUCE, SEASONING RUB, SALSA SAUCE, IN CLASS 30
(U.S. CL. 46).

TRADEMARK

FIRST USE 4-16-2011; IN COMMERCE 4-16-2011.

PRINCIPAL REGISTER

THE MARK CONSISTS OF STANDARD CHARACTERS WITHOUT CLAIM TO ANY PARTICULAR FONT, STYLE, SIZE, OR COLOR.

THE NAME SHOWN IN THE MARK IDENTIFIES CHEF NIGEL, WHOSE CONSENT TO REGISTER IS MADE OF RECORD.

SER. NO. 85-342,954, FILED 6-10-2011.

TINA BROWN, EXAMINING ATTORNEY



David J. Kyffers

Director of the United States Patent and Trademark Office

United States of America

United States Patent and Trademark Office

BOGO

Reg. No. 4,152,987

Registered June 5, 2012

Int. Cl.: 28

TRADEMARK

PRINCIPAL REGISTER

RAZOR USA LLC (DELAWARE LIMITED LIABILITY COMPANY)
16200-A CARMENITA ROAD
CERRITOS, CA 90703

FOR: TOYS, PLAYTHINGS AND SPORTING GOODS, NAMELY, POGO STICKS, IN CLASS 28 (U.S. CLS. 22, 23, 38 AND 50).

FIRST USE 9-15-2009; IN COMMERCE 1-15-2010.

THE MARK CONSISTS OF STANDARD CHARACTERS WITHOUT CLAIM TO ANY PARTICULAR FONT, STYLE, SIZE, OR COLOR.

SER. NO. 85-343,698, FILED 6-10-2011.

MARC LEIPZIG, EXAMINING ATTORNEY



David J. Kybas

Director of the United States Patent and Trademark Office

United States of America

United States Patent and Trademark Office

Petsultant

Reg. No. 4,152,988

INPETNET, LLC (FLORIDA LIMITED LIABILITY COMPANY)
542 SOUTH 29 COURT
HOLLYWOOD, FL 33020

Registered June 5, 2012

Int. Cl.: 44

FOR: PROVIDING INFORMATION AND ADVICE IN THE FIELD OF PET HEALTH, IN CLASS 44 (U.S. CLS. 100 AND 101).

SERVICE MARK

FIRST USE 1-1-2009; IN COMMERCE 1-1-2011.

PRINCIPAL REGISTER

THE MARK CONSISTS OF STANDARD CHARACTERS WITHOUT CLAIM TO ANY PARTICULAR FONT, STYLE, SIZE, OR COLOR.

SER. NO. 85-344,060, FILED 6-12-2011.

SOPHIA S. KIM, EXAMINING ATTORNEY



David J. Kybas

Director of the United States Patent and Trademark Office

United States of America

United States Patent and Trademark Office



Reg. No. 4,152,989

Registered June 5, 2012

CERTIFICATION MARK

PRINCIPAL REGISTER

FOUNDATION FOR PROFESSIONAL PEST MANAGEMENT (VIRGINIA CORPORATION),
DBA QUALITYPRO
10460 NORTH STREET
FAIRFAX, VA 22030

FOR: PEST CONTROL AND VERMIN EXTERMINATION SERVICES, IN CLASS B (U.S. CL. B).

FIRST USE 6-1-2008; IN COMMERCE 6-1-2008.

OWNER OF U.S. REG. NOS. 3,500,808 AND 3,500,811.

NO CLAIM IS MADE TO THE EXCLUSIVE RIGHT TO USE "THE MARK OF EXCELLENCE IN PEST MANAGEMENT", APART FROM THE MARK AS SHOWN.

THE MARK CONSISTS OF THE LETTERS "QP" IN STYLIZED FONT ABOVE THE WORDING "QUALITYPRO", ALL APPEARING ON A SHADED SQUARE. THE WORDING "THE MARK OF EXCELLENCE IN PEST MANAGEMENT" APPEARS BELOW THE SHADED SQUARE.

THE CERTIFICATION MARK, AS USED BY AUTHORIZED PERSONS, CERTIFIES THAT PEST MANAGEMENT COMPANIES HAVE MET SPECIFIC STANDARDS RELATING TO BUSINESS OPERATIONS, ENVIRONMENTAL STEWARDSHIP, COMMUNICATION PRACTICES AND EMPLOYEE TESTING AND TRAINING. THOSE COMPANIES THAT HAVE MET AND AGREED TO ABIDE BY THESE STANDARDS ARE PERMITTED TO USE THIS MARK.

SER. NO. 85-344,273, FILED 6-13-2011.

KAREN SEVERSON, EXAMINING ATTORNEY



David J. Kyjars

Director of the United States Patent and Trademark Office

United States of America

United States Patent and Trademark Office



Reg. No. 4,152,990

Registered June 5, 2012

CERTIFICATION MARK

PRINCIPAL REGISTER

FOUNDATION FOR PROFESSIONAL PEST MANAGEMENT (VIRGINIA CORPORATION),
DBA GREENPRO
10460 NORTH STREET
FAIRFAX, VA 22030

FOR: INTEGRATED PEST CONTROL AND VERMIN EXTERMINATION SERVICES, IN
CLASS B (U.S. CL. B).

FIRST USE 3-1-2009; IN COMMERCE 3-1-2009.

NO CLAIM IS MADE TO THE EXCLUSIVE RIGHT TO USE "GREEN PRO CERTIFIED ECO-EFFECTIVE", APART FROM THE MARK AS SHOWN.

THE COLOR(S) GREEN AND BLACK IS/ARE CLAIMED AS A FEATURE OF THE MARK.

THE MARK CONSISTS OF THE TERM "GREEN" IN GREEN STYLIZED FONT ABOVE THE WORD "PRO" IN BLACK STYLIZED FONT, ALL ABOVE A BLACK HORIZONTAL LINE. THE WORDING "CERTIFIED ECO-EFFECTIVE" IN BLACK STYLIZED FONT APPEARS BELOW THE HORIZONTAL LINE. A BLACK INSECT DESIGN APPEARS IN A BLACK CIRCLE PARTIALLY OBSTRUCTING THE HORIZONTAL BLACK LINE AND THE "O" IN "PRO" AND WITH A VERTICAL BLACK LINE PROTRUDING FROM THE TOP AND BOTTOM OF THE INSECT AND EXTENDING TO THE CIRCLE. ALL OF THE AFOREMENTIONED APPEARS IN A BLACK ROUNDED SQUARE. THE WHITE IN THE MARK MERELY CONSTITUTES BACKGROUND AND IS NOT A FEATURE OF THE MARK.



THE CERTIFICATION MARK, AS USED BY AUTHORIZED PERSONS, CERTIFIES THIS MARK IS INTENDED TO CERTIFY COMPANIES THAT HAVE TAKEN STEPS TO FOLLOW INTEGRATED PEST MANAGEMENT PROTOCOLS. THE CERTIFICATION IS ONLY GIVEN TO MEMBERS WHO ARE FIRST CERTIFIED AS QUALITYPRO COMPANIES. COMPANIES THAT EARN THIS CERTIFICATION MUST BE ABLE TO PROVIDE SERVICES AS REQUESTED BY CUSTOMERS IN ACCORDANCE WITH THE GREENPRO SERVICE STANDARDS. A YEARLY AUDIT IS CONDUCTED ON ALL GREENPRO MEMBER COMPANIES TO ENSURE COMPLIANCE.

David J. Kyros

SER. NO. 85-344,290, FILED 6-13-2011.

KAREN SEVERSON, EXAMINING ATTORNEY

United States of America

United States Patent and Trademark Office

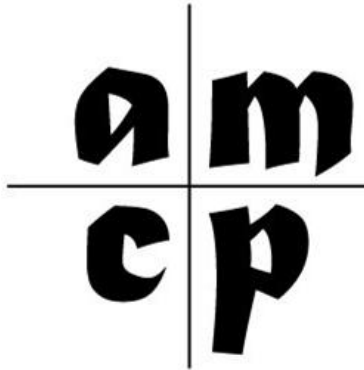

Reg. No. 4,152,991

Registered June 5, 2012

Int. Cl.: 41

SERVICE MARK

PRINCIPAL REGISTER

ERUDISTIC (ILLINOIS LIMITED LIABILITY COMPANY)
433 W HARRISON #803888-48988
CHICAGO, IL 60699

FOR: EDUCATIONAL SERVICES, NAMELY, CONDUCTING CLASSES, SEMINARS, CONFERENCES, WORKSHOPS, RETREATS, CAMPS AND FIELD TRIPS IN THE FIELD OF MENTAL EMERGENCE AND RESPONSE ANTICIPATION AND DISTRIBUTION OF TRAINING MATERIAL IN CONNECTION THEREWITH, IN CLASS 41 (U.S. CLS. 100, 101 AND 107).

FIRST USE 6-2-2011; IN COMMERCE 6-2-2011.

NO CLAIM IS MADE TO THE EXCLUSIVE RIGHT TO USE "CAMP", APART FROM THE MARK AS SHOWN.

THE MARK CONSISTS OF A ARRANGED TEXT GROUP OF STYLIZED LETTERS "C", "A", "M", AND "P" WITH A HORIZONTAL AND VERTICAL LINE.

SER. NO. 85-345,139, FILED 6-13-2011.

FLORENTINA BLANDU, EXAMINING ATTORNEY



David J. Kybas

Director of the United States Patent and Trademark Office

United States of America

United States Patent and Trademark Office

Brook Mays

Reg. No. 4,152,992

Registered June 5, 2012

Int. Cls.: 35, 37 and 41

SERVICE MARK

PRINCIPAL REGISTER

UNIVERSAL MELODY SERVICES, LLC (TEXAS LIMITED LIABILITY COMPANY), DBA
BROOK MAYS MUSIC COMPANY
8605 CARPENTER FREEWAY
DALLAS, TX 75247

FOR: RETAIL STORE AND ON-LINE RETAIL STORE SERVICES FEATURING MUSICAL INSTRUMENTS; DEALERSHIPS IN THE FIELD OF MUSICAL INSTRUMENTS; RETAIL STORE, MAIL ORDER, PHONE ORDER AND CATALOG SERVICES, ALL FEATURING MUSICAL INSTRUMENTS, SUPPLIES AND ACCESSORIES THEREFOR, SOUND EQUIPMENT, SHEET MUSIC, MUSIC RECORDINGS, MUSIC THEORY AND EDUCATIONAL MATERIALS, GIFT ITEMS RELATING TO MUSIC, AND OTHER MUSIC-RELATED MERCHANDISE; DISSEMINATION OF CLASSIFIED ADVERTISING FOR OTHERS VIA A GLOBAL COMPUTER NETWORK; PROVIDING CONSUMER PRODUCT INFORMATION IN THE FIELD OF MUSICAL INSTRUMENTS VIA A GLOBAL COMPUTER NETWORK; PROVIDING CONSUMER PRODUCT INFORMATION VIA A GLOBAL COMPUTER NETWORK FOR THE PURPOSE OF SELECTING MUSICAL INSTRUMENTS TO MEET THE CONSUMER'S SPECIFICATIONS, IN CLASS 35 (U.S. CLS. 100, 101 AND 102).

FIRST USE 9-1-1901; IN COMMERCE 9-1-1901.

FOR: REPAIR OF SOUND EQUIPMENT AND PARTS; REPAIR OR MAINTENANCE OF MUSICAL INSTRUMENTS, IN CLASS 37 (U.S. CLS. 100, 103 AND 106).

FIRST USE 8-1-1954; IN COMMERCE 8-1-1954.

FOR: RENTAL OF MUSICAL INSTRUMENTS; TEACHING IN THE FIELD OF MUSIC EDUCATION, PROVIDING MUSIC EDUCATION LESSONS, CLASSES, SEMINARS, CLINICS AND WORKSHOPS; INFORMATION SERVICES, NAMELY, PROVIDING INFORMATION CONCERNING MUSIC EDUCATION AND ATTRIBUTES OF MUSICAL INSTRUMENTS VIA A GLOBAL COMPUTER NETWORK, IN CLASS 41 (U.S. CLS. 100, 101 AND 107).

FIRST USE 8-1-1954; IN COMMERCE 8-1-1954.

THE MARK CONSISTS OF STANDARD CHARACTERS WITHOUT CLAIM TO ANY PARTICULAR FONT, STYLE, SIZE, OR COLOR.



David J. Kyjars

Director of the United States Patent and Trademark Office

Reg. No. 4,152,992 THE NAME(S), PORTRAIT(S), AND/OR SIGNATURE(S) SHOWN IN THE MARK DOES NOT IDENTIFY A PARTICULAR LIVING INDIVIDUAL.

SER. NO. 85-345,170, FILED 6-14-2011.

LEIGH LOWRY, EXAMINING ATTORNEY

United States of America

United States Patent and Trademark Office

WOODWARD

Reg. No. 4,152,993

Registered June 5, 2012

Int. Cl.: 41

SERVICE MARK

PRINCIPAL REGISTER

POWDR-WOODWARD PA LLC (DELAWARE LIMITED LIABILITY COMPANY)
1790 BONANZA DRIVE
SUITE W-201
PARK CITY, UT 84060

FOR: SPORT CAMPS; SPORTS CAMP SERVICES; SPORTS INSTRUCTION SERVICES; SPORTS TRAINING SERVICES; EDUCATIONAL SERVICES, NAMELY, PROVIDING COURSES OF INSTRUCTION AT THE PRIMARY AND SECONDARY LEVEL AND DISTRIBUTING APPLICABLE COURSE MATERIALS IN CONNECTION THEREWITH; ENTERTAINMENT SERVICES IN THE NATURE OF DEVELOPMENT, CREATION, PRODUCTION AND POST-PRODUCTION SERVICES OF MULTIMEDIA ENTERTAINMENT CONTENT; EDUCATIONAL SERVICES, NAMELY, PROVIDING COURSES OF INSTRUCTION IN DEVELOPMENT, CREATION, PRODUCTION AND POST-PRODUCTION IN MULTI-MEDIA ENTERTAINMENT, IN CLASS 41 (U.S. CLS. 100, 101 AND 107).

FIRST USE 12-31-1970; IN COMMERCE 12-31-1970.

THE MARK CONSISTS OF STANDARD CHARACTERS WITHOUT CLAIM TO ANY PARTICULAR FONT, STYLE, SIZE, OR COLOR.

OWNER OF U.S. REG. NOS. 2,522,557, 3,947,997 AND OTHERS.

SER. NO. 85-345,566, FILED 6-14-2011.

SIMON TENG, EXAMINING ATTORNEY



David J. Kyros

Director of the United States Patent and Trademark Office

United States of America
United States Patent and Trademark Office

HAOWEI
昊威

Reg. No. 4,152,994

Registered June 5, 2012

Int. Cl.: 25

TRADEMARK

PRINCIPAL REGISTER

JIAN, WANG (CHINA INDIVIDUAL)
NO.12 QINGNIAN ROAD
LIANHU DISTRICT
XI'AN, SHAANXI, CHINA

FOR: CLOTHING FOR BABIES, TODDLERS AND CHILDREN, TREATED WITH FIRE AND HEAT RETARDANTS, NAMELY, PAJAMAS, JACKETS, SHIRTS, PANTS, JUMPERS; DOWN JACKETS; FOOTBALL SHOES; GLOVES AS CLOTHING; GYM SUITS; GYMNASTIC SHOES; HATS; HOSIERY; JERSEYS; LEISURE SUITS; NECKTIES; SHOES; SHOULDER WRAPS FOR CLOTHING; SUITS; T-SHIRTS; TIES; TROUSERS; UNDERWEAR; WEDDING DRESSES; WIND COATS, IN CLASS 25 (U.S. CLS. 22 AND 39).

FIRST USE 10-14-2000; IN COMMERCE 6-8-2010.

THE MARK CONSISTS OF THE WORDING "HAOWEI" IN A STYLIZED FRONT WITH TWO CHINESE CHARACTERS BENEATH.

THE NON-LATIN CHARACTERS IN THE MARK TRANSLITERATE TO "HAO WEI" AND THIS HAS NO MEANING IN A FOREIGN LANGUAGE.

THE ENGLISH TRANSLATION OF TWO CHINESE CHARACTERS IN THE MARK IS "SKY" AND "POWER". THE WORDING "HAOWEI" HAS NO MEANING IN A FOREIGN LANGUAGE.

SER. NO. 85-346,384, FILED 6-15-2011.

KATHRYN COWARD, EXAMINING ATTORNEY



David J. Kybas

Director of the United States Patent and Trademark Office

United States of America
United States Patent and Trademark Office

POVADDO

Reg. No. 4,152,995

Registered June 5, 2012

Int. Cl.: 35

SERVICE MARK

PRINCIPAL REGISTER

POVADDO LLC (VIRGINIA LIMITED LIABILITY COMPANY)
SUITE 200
1940 DUKE STREET
ALEXANDRIA, VA 22314

FOR: BUSINESS STRATEGIC COMMUNICATION CONSULTING SERVICES IN THE FIELD OF PUBLIC AFFAIRS AND CORPORATE COMMUNICATIONS, IN CLASS 35 (U.S. CLS. 100, 101 AND 102).

FIRST USE 2-1-2011; IN COMMERCE 2-1-2011.

THE MARK CONSISTS OF STANDARD CHARACTERS WITHOUT CLAIM TO ANY PARTICULAR FONT, STYLE, SIZE, OR COLOR.

SER. NO. 85-346,450, FILED 6-15-2011.

ALICE BENMAMAN, EXAMINING ATTORNEY



David J. Kyros

Director of the United States Patent and Trademark Office

United States of America

United States Patent and Trademark Office

RITZ PARIS

Reg. No. 4,152,996

THE RITZ HOTEL, LIMITED (UNITED KINGDOM CORPORATION)
15, PLACE VENDOME
PARIS, FRANCE 75041

Registered June 5, 2012

Int. Cl.: 11

FOR: LAMPS, IN CLASS 11 (U.S. CLS. 13, 21, 23, 31 AND 34).

TRADEMARK

THE MARK CONSISTS OF STANDARD CHARACTERS WITHOUT CLAIM TO ANY PARTICULAR FONT, STYLE, SIZE, OR COLOR.

PRINCIPAL REGISTER

OWNER OF FRANCE REG. NO. 013138961, DATED 12-26-2001, EXPIRES 12-26-2021.

OWNER OF U.S. REG. NOS. 2,706,448, 3,916,080 AND OTHERS.

NO CLAIM IS MADE TO THE EXCLUSIVE RIGHT TO USE "PARIS", APART FROM THE MARK AS SHOWN.

SER. NO. 85-346,632, FILED 6-15-2011.

JOHN DALIER, EXAMINING ATTORNEY



David J. Kyros

Director of the United States Patent and Trademark Office

United States of America

United States Patent and Trademark Office

THE ART OF DISGUISE

Reg. No. 4,152,997

Registered June 5, 2012

Int. Cl.: 28

TRADEMARK

PRINCIPAL REGISTER

HERSEY, MORGAN (UNITED STATES INDIVIDUAL)
2102 YAKIMA AVE
TACOMA, WA 98405

FOR: THEATRICAL MASKS, IN CLASS 28 (U.S. CLS. 22, 23, 38 AND 50).

FIRST USE 1-1-2005; IN COMMERCE 1-1-2005.

THE MARK CONSISTS OF STANDARD CHARACTERS WITHOUT CLAIM TO ANY PARTICULAR FONT, STYLE, SIZE, OR COLOR.

SER. NO. 85-346,974, FILED 6-15-2011.

ANGELA DUONG, EXAMINING ATTORNEY



David J. Kybas

Director of the United States Patent and Trademark Office

United States of America

United States Patent and Trademark Office

NuVIEW Health

Reg. No. 4,152,998

Registered June 5, 2012

Int. Cl.: 44

NUVIEW HEALTH, LLC (FLORIDA LIMITED LIABILITY COMPANY), DBA NUIVIEW HEALTH, LLC
SUITE 135
5501 S. CONGRESS AVE.
ATLANTIS, FL 33462

SERVICE MARK

FOR: TELEMEDICINE SERVICES FOR USE BY HEALTHCARE SYSTEMS AND HOSPITALS, IN CLASS 44 (U.S. CLS. 100 AND 101).

PRINCIPAL REGISTER

FIRST USE 9-1-2008; IN COMMERCE 9-1-2008.

THE MARK CONSISTS OF STANDARD CHARACTERS WITHOUT CLAIM TO ANY PARTICULAR FONT, STYLE, SIZE, OR COLOR.

NO CLAIM IS MADE TO THE EXCLUSIVE RIGHT TO USE "HEALTH", APART FROM THE MARK AS SHOWN.

SER. NO. 85-347,132, FILED S.R. 6-15-2011 AM. P.R. 2-13-2012.

COLLEEN KEARNEY, EXAMINING ATTORNEY



David J. Kyros

Director of the United States Patent and Trademark Office

United States of America

United States Patent and Trademark Office

computer cabana

Reg. No. 4,152,999

PERLSON, KIP (UNITED STATES INDIVIDUAL)
11742 GOSHEN AVE. #1
LOS ANGELES, CA 90049

Registered June 5, 2012

Int. Cl.: 9

FOR: DISPLAY PROTECTOR TO PROVIDE SHADE AND PRIVACY FOR ELECTRONIC DEVICES HAVING SCREENS, IN CLASS 9 (U.S. CLS. 21, 23, 26, 36 AND 38).

TRADEMARK

FIRST USE 2-2-2011; IN COMMERCE 5-1-2011.

PRINCIPAL REGISTER

THE MARK CONSISTS OF STANDARD CHARACTERS WITHOUT CLAIM TO ANY PARTICULAR FONT, STYLE, SIZE, OR COLOR.

NO CLAIM IS MADE TO THE EXCLUSIVE RIGHT TO USE "COMPUTER", APART FROM THE MARK AS SHOWN.

SER. NO. 85-347,182, FILED 6-15-2011.

LEIGH LOWRY, EXAMINING ATTORNEY



David J. Kybas

Director of the United States Patent and Trademark Office

United States of America

United States Patent and Trademark Office

TYVARIAN

Reg. No. 4,153,000

Registered June 5, 2012

Int. Cl.: 41

SERVICE MARK

PRINCIPAL REGISTER

GIOVANNI HOLDINGS, LLC (UTAH LIMITED LIABILITY COMPANY)
195 SOUTH GENEVA ROAD
LONDON, UT 84042

FOR: PROVIDING MANUFACTURING AND BUSINESS TRAINING FOR DEALERS IN THE FIELD OF PRODUCING IMAGED CULTURE MARBLE PANELS AND UNITS FOR HOME AND COMMERCIAL USE, IN CLASS 41 (U.S. CLS. 100, 101 AND 107).

FIRST USE 4-28-2011; IN COMMERCE 4-28-2011.

THE MARK CONSISTS OF STANDARD CHARACTERS WITHOUT CLAIM TO ANY PARTICULAR FONT, STYLE, SIZE, OR COLOR.

OWNER OF U.S. REG. NO. 3,981,560.

SER. NO. 85-347,279, FILED 6-15-2011.

HANNO RITTNER, EXAMINING ATTORNEY



David J. Kyffers

Director of the United States Patent and Trademark Office

United States of America

United States Patent and Trademark Office

Red Irish

Reg. No. 4,153,001

NYGREN, WESTEN (UNITED STATES INDIVIDUAL)
8738 AUBURN MANE DR
TOMBALL, TX 77375

Registered June 5, 2012

Int. Cl.: 25

FOR: HATS; JACKETS; SHIRTS, IN CLASS 25 (U.S. CLS. 22 AND 39).

TRADEMARK

FIRST USE 8-3-2007; IN COMMERCE 12-1-2010.

PRINCIPAL REGISTER

THE MARK CONSISTS OF STANDARD CHARACTERS WITHOUT CLAIM TO ANY PARTICULAR FONT, STYLE, SIZE, OR COLOR.

SER. NO. 85-347,682, FILED 6-16-2011.

JOHN DWYER, EXAMINING ATTORNEY



David J. Kyffers

Director of the United States Patent and Trademark Office

United States of America

United States Patent and Trademark Office



Reg. No. 4,153,002

COMICX, S.A. DE C.V. (MEXICO CORPORATION)
PASEO RIO SONORA 91-A, PROY. RIO SONORA
HERMOSILLO, SONORA, MEXICO 83270

Registered June 5, 2012

Int. Cl.: 43

FOR: BAR AND RESTAURANT SERVICES; CAFE-RESTAURANTS; SELF SERVICE RESTAURANTS; SNACK BAR SERVICES, IN CLASS 43 (U.S. CLS. 100 AND 101).

SERVICE MARK

OWNER OF MEXICO REG. NO. 1196267, DATED 1-12-2011, EXPIRES 5-26-2020.

PRINCIPAL REGISTER

THE COLOR(S) RED, WHITE AND DARK GRAY IS/ARE CLAIMED AS A FEATURE OF THE MARK.

NO CLAIM IS MADE TO THE EXCLUSIVE RIGHT TO USE "RESTAURANT BAR", APART FROM THE MARK AS SHOWN.

THE MARK CONSISTS OF A RED LETTER "C" IN THE CENTER OF A CIRCLE COMPRISED OF A WHITE CENTER AND AN OUTER DARK GRAY RING DOTTED WITH RED DOTS, AND HAVING A RED STAR IN THE CENTER OF THE TOP AND BOTTOM PARTS OF THE RING, AND THE CENTER OF THE LEFT AND RIGHT PORTIONS OF THE RING. PORTIONS OF THE RING ALSO APPEAR WHITE AS IF SHOWING A REFLECTION OF LIGHT. TO THE RIGHT OF THAT IS THE RED WORDING "COMICX", WITH THE LETTER "X" IN A BIGGER SIZE THAN THE REST OF THE WORD. THE WORDING IS ON A WHITE BACKGROUND WHICH IS OUTLINED IN DARK GRAY. UNDER THE "COMIC" PORTION IS A DARK GRAY BAR WITH THE WHITE WORDING "RESTAURANT BAR". THE BOTTOM PORTION OF THE BAR APPEARS IN WHITE AS IF SHOWING A REFLECTION OF LIGHT.



SER. NO. 85-347,849, FILED 6-16-2011.

LYDIA BELZER, EXAMINING ATTORNEY

David J. Kybas

Director of the United States Patent and Trademark Office

United States of America

United States Patent and Trademark Office

GET SWABBED

Reg. No. 4,153,003

Registered June 5, 2012

Int. Cl.: 35

SERVICE MARK

PRINCIPAL REGISTER

GIFT OF LIFE BONE MARROW FOUNDATION, INC. (NEW JERSEY NON-PROFIT CORPORATION)
SUITE 101
800 YAMATO ROAD
BOCA RATON, FL 33431

FOR: BONE MARROW AND BLOOD STEM CELL DONOR REGISTRY SERVICES; PROMOTING PUBLIC AWARENESS OF THE NEED FOR BONE MARROW AND BLOOD STEM CELL DONATIONS; MAINTAINING A REGISTRY OF BONE MARROW AND BLOOD STEM CELL DONORS TO FACILITATE BONE MARROW AND BLOOD STEM CELL TRANSPLANT SERVICES, IN CLASS 35 (U.S. CLS. 100, 101 AND 102).

FIRST USE 4-13-2010; IN COMMERCE 4-13-2010.

THE MARK CONSISTS OF STANDARD CHARACTERS WITHOUT CLAIM TO ANY PARTICULAR FONT, STYLE, SIZE, OR COLOR.

OWNER OF U.S. REG. NOS. 3,866,426 AND 3,869,212.

NO CLAIM IS MADE TO THE EXCLUSIVE RIGHT TO USE "SWABBED", APART FROM THE MARK AS SHOWN.

SER. NO. 85-347,892, FILED 6-16-2011.

LESLIE RICHARDS, EXAMINING ATTORNEY



David J. Kyffers

Director of the United States Patent and Trademark Office

United States of America

United States Patent and Trademark Office

THE SKIN BREATHES

Reg. No. 4,153,004

PLANT DEVAS, INC. (NEVADA CORPORATION)
3111 VIA DE CABALLO
SAN DIEGO, CA 92024

Registered June 5, 2012

Int. Cl.: 3

FOR: NON-MEDICATED SKIN CARE PREPARATIONS, IN CLASS 3 (U.S. CLS. 1, 4, 6, 50, 51 AND 52).

TRADEMARK

FIRST USE 5-30-2003; IN COMMERCE 5-30-2003.

PRINCIPAL REGISTER

THE MARK CONSISTS OF STANDARD CHARACTERS WITHOUT CLAIM TO ANY PARTICULAR FONT, STYLE, SIZE, OR COLOR.

NO CLAIM IS MADE TO THE EXCLUSIVE RIGHT TO USE "SKIN", APART FROM THE MARK AS SHOWN.

SER. NO. 85-348,510, FILED 6-16-2011.

HENRY S. ZAK, EXAMINING ATTORNEY



David J. Kyffers

Director of the United States Patent and Trademark Office

United States of America

United States Patent and Trademark Office

WADIANA

Reg. No. 4,153,005

Registered June 5, 2012

Int. Cl.: 10

TRADEMARK

PRINCIPAL REGISTER

GRIFOLS, S.A. (SPAIN SOCIEDAD ANONIMA (SA))
CARRER DE JESUS Y MARIA, 6
BARCELONA, SPAIN 08022

FOR: DIAGNOSTIC APPARATUS DESIGNED FOR THE AUTOMATION OF IMMUNOHEMATOLOGIC TECHNIQUES, NAMELY, TESTING AND DETERMINATION OF THE PRESENCE OF BLOOD ANTIGENS AND ANTIBODIES RELATED TO BLOOD GROUPING AND PRE-TRANSFUSION COMPATIBILITY THROUGH THE USE OF GEL MICROMETHODS, IN CLASS 10 (U.S. CLS. 26, 39 AND 44).

THE MARK CONSISTS OF STANDARD CHARACTERS WITHOUT CLAIM TO ANY PARTICULAR FONT, STYLE, SIZE, OR COLOR.

OWNER OF SPAIN REG. NO. 1915786, DATED 12-19-1994, EXPIRES 7-27-2014.

SER. NO. 85-348,892, FILED 6-17-2011.

AISHA CLARKE, EXAMINING ATTORNEY



David J. Kyros

Director of the United States Patent and Trademark Office

United States of America

United States Patent and Trademark Office

GO SWAB YOURSELF

Reg. No. 4,153,006

Registered June 5, 2012

Int. Cl.: 35

SERVICE MARK

PRINCIPAL REGISTER

GIFT OF LIFE BONE MARROW FOUNDATION, INC. (NEW JERSEY NON-PROFIT CORPORATION)
SUITE 101
800 YAMATO ROAD
BOCA RATON, FL 33431

FOR: BONE MARROW AND BLOOD STEM CELL DONOR REGISTRY SERVICES; PROMOTING PUBLIC AWARENESS OF THE NEED FOR BONE MARROW AND BLOOD STEM CELL DONATIONS; MAINTAINING A REGISTRY OF BONE MARROW AND BLOOD STEM CELL DONORS TO FACILITATE BONE MARROW AND BLOOD STEM CELL TRANSPLANT SERVICES, IN CLASS 35 (U.S. CLS. 100, 101 AND 102).

FIRST USE 6-16-2011; IN COMMERCE 6-16-2011.

THE MARK CONSISTS OF STANDARD CHARACTERS WITHOUT CLAIM TO ANY PARTICULAR FONT, STYLE, SIZE, OR COLOR.

OWNER OF U.S. REG. NOS. 3,866,426 AND 3,869,212.

SER. NO. 85-348,931, FILED 6-17-2011.

LESLIE RICHARDS, EXAMINING ATTORNEY



David J. Kybas

Director of the United States Patent and Trademark Office

United States of America

United States Patent and Trademark Office

PREDICTABLE PROFITS

Reg. No. 4,153,007

Registered June 5, 2012

Int. Cls.: 35 and 41

SERVICE MARK

PRINCIPAL REGISTER

MANAGED MARKETING, LLC (DELAWARE LIMITED LIABILITY COMPANY)
PO BOX 1171
PORTSMOUTH, NH 03802

FOR: MANAGEMENT AND BUSINESS CONSULTING SERVICES IN THE FIELD OF BUSINESS ORGANIZATION, BUSINESS MANAGEMENT, BUSINESS PLANNING, STRATEGIC PLANNING, MARKETING BY MEANS OF THE INTERNET AND TRADITIONAL MARKETING, IN CLASS 35 (U.S. CLS. 100, 101 AND 102).

FIRST USE 5-6-2011; IN COMMERCE 5-6-2011.

FOR: EDUCATIONAL SERVICES, NAMELY, CONDUCTING SEMINARS AND PROFESSIONAL COACHING IN THE FIELD OF BUSINESS DEVELOPMENT, BUSINESS MANAGEMENT, STRATEGIC PLANNING, MARKETING BY MEANS OF THE INTERNET AND TRADITIONAL MARKETING; ON-LINE TRAINING AND EDUCATIONAL EVALUATIONS IN THE FIELD OF BUSINESS DEVELOPMENT, BUSINESS MANAGEMENT, STRATEGIC PLANNING AND MARKETING BY MEANS OF THE INTERNET, IN CLASS 41 (U.S. CLS. 100, 101 AND 107).

FIRST USE 5-6-2011; IN COMMERCE 5-6-2011.

THE MARK CONSISTS OF STANDARD CHARACTERS WITHOUT CLAIM TO ANY PARTICULAR FONT, STYLE, SIZE, OR COLOR.

NO CLAIM IS MADE TO THE EXCLUSIVE RIGHT TO USE "PROFITS", APART FROM THE MARK AS SHOWN.

SER. NO. 85-349,199, FILED 6-17-2011.

PATRICIA EVANKO, EXAMINING ATTORNEY



David J. Kybas

Director of the United States Patent and Trademark Office

United States of America

United States Patent and Trademark Office

Go
SWAB
yourself



Reg. No. 4,153,008

Registered June 5, 2012

Int. Cl.: 35

SERVICE MARK

PRINCIPAL REGISTER

GIFT OF LIFE BONE MARROW FOUNDATION, INC. (NEW JERSEY NON-PROFIT CORPORATION)
SUITE 101
800 YAMATO ROAD
BOCA RATON, FL 33431

FOR: BONE MARROW AND BLOOD STEM CELL DONOR REGISTRY SERVICES; PROMOTING PUBLIC AWARENESS OF THE NEED FOR BONE MARROW AND BLOOD STEM CELL DONATIONS; MAINTAINING A REGISTRY OF BONE MARROW AND BLOOD STEM CELL DONORS TO FACILITATE BONE MARROW AND BLOOD STEM CELL TRANSPLANT SERVICES, IN CLASS 35 (U.S. CLS. 100, 101 AND 102).

FIRST USE 6-17-2011; IN COMMERCE 6-17-2011.

OWNER OF U.S. REG. NOS. 3,866,426 AND 3,869,212.

THE MARK CONSISTS OF THE WORD "GO" WITH A CAPITAL "G" AND LOWERCASE "O" ABOVE AND TO THE LEFT OF THE WORD "SWAB" WITH CAPITAL LETTERS "S" AND "W" LOWERCASE "A" AND CAPITAL "B", WITH THE WORD "YOURSELF" TO THE RIGHT AND STARTING HALFWAY UNDERNEATH THE WORD "SWAB", AND A HAND HOLDING A SWAB WITH THE INDEX FINGER POINTING OUTWARD.

SER. NO. 85-349,402, FILED 6-17-2011.

LESLIE RICHARDS, EXAMINING ATTORNEY



David J. Kybas

Director of the United States Patent and Trademark Office

United States of America

United States Patent and Trademark Office



Reg. No. 4,153,009

Registered June 5, 2012

Int. Cl.: 43

SERVICE MARK

PRINCIPAL REGISTER

P.F. CHANG'S CHINA BISTRO, INC. (DELAWARE CORPORATION)
7676 E. PINNACLE PEAK ROAD
SCOTTSDALE, AZ 85255

FOR: BAR AND RESTAURANT SERVICES; RESTAURANT SERVICES, NAMELY, PROVIDING OF FOOD AND BEVERAGES FOR CONSUMPTION ON AND OFF THE PREMISES, IN CLASS 43 (U.S. CLS. 100 AND 101).

FIRST USE 7-18-2011; IN COMMERCE 7-18-2011.

OWNER OF U.S. REG. NO. 4,017,170.

THE COLOR(S) RED, BLACK AND WHITE IS/ARE CLAIMED AS A FEATURE OF THE MARK.

THE NON-LATIN CHARACTERS IN THE MARK TRANSLITERATE TO "SAN XI" AND THIS MEANS "THREE HAPPINESS" IN ENGLISH.

NO CLAIM IS MADE TO THE EXCLUSIVE RIGHT TO USE "DRINKS" "DIM SUM" "STREET FARE", APART FROM THE MARK AS SHOWN.

THE MARK CONSISTS OF A BLACK CIRCLE SHOWING A CHINESE CHARACTER LISTED THREE TIMES WITH THE WORDS "TRIPLE HAPPINESS" IN BLACK ABOVE AND A RED BANNER CONTAINING THE WORDS "DRINKS DIM SUM STREET FARE" IN WHITE ACROSS THE CHINESE CHARACTERS.

SER. NO. 85-349,561, FILED 6-17-2011.

KELLY TRUSILO, EXAMINING ATTORNEY



David J. Kyros

Director of the United States Patent and Trademark Office

United States of America

United States Patent and Trademark Office

SUPERBOOSTER

Reg. No. 4,153,010

Registered June 5, 2012

Int. Cl.: 9

TRADEMARK

PRINCIPAL REGISTER

LASTAR, INC. (OHIO CORPORATION)
3555 KETTERING BOULEVARD
DAYTON, OH 45439

FOR: CABLES, CABLE CONNECTORS AND RELATED GOODS, NAMELY, COMPUTER CABLES, PATCH CORDS, FIBER OPTIC CABLES, POWER CABLES, AUDIO CABLES, VIDEO CABLES, AUDIO/VIDEO CABLES; CABLE COUPLERS; ELECTRICAL CONNECTORS; TELEPHONE CORDS; POWER CORDS; BULK CABLE ELECTRICAL WIRE; SIGNAL SPLITTERS FOR ELECTRONIC APPARATUS, COMPUTER NETWORK ADAPTORS, SWITCHES, AND HUBS; CABLING SYSTEMS FOR USE IN COMPUTER, AUDIO, VIDEO, NETWORKING AND TELECOMMUNICATIONS APPLICATIONS, COMPRISED OF ELECTRICAL AND ELECTRONIC CABLES, CABLE CONNECTORS, WALL PLATES, CABLE LEADS, CABLE COUPLERS AND BULK ELECTRICAL WIRE, AND REPLACEMENT PARTS THEREFOR; CABLE MANAGEMENT PANELS AND RACKS; AND PARTS OF THE FOREGOING, IN CLASS 9 (U.S. CLS. 21, 23, 26, 36 AND 38).

FIRST USE 0-0-2001; IN COMMERCE 0-0-2001.

THE MARK CONSISTS OF STANDARD CHARACTERS WITHOUT CLAIM TO ANY PARTICULAR FONT, STYLE, SIZE, OR COLOR.

SER. NO. 85-349,665, FILED 6-17-2011.

KELLY TRUSILO, EXAMINING ATTORNEY



David J. Kyffers

Director of the United States Patent and Trademark Office

United States of America

United States Patent and Trademark Office

WINESLINGER

Reg. No. 4,153,011

KANE, RUSSELL D. (UNITED STATES INDIVIDUAL)
2318 HULDY ST
HOUSTON, TX 77019

Registered June 5, 2012

Int. Cl.: 43

FOR: PROVIDING INFORMATION ABOUT WINE CHARACTERISTICS, IN CLASS 43 (U.S. CLS. 100 AND 101).

SERVICE MARK

FIRST USE 1-8-2009; IN COMMERCE 1-8-2009.

PRINCIPAL REGISTER

THE MARK CONSISTS OF STANDARD CHARACTERS WITHOUT CLAIM TO ANY PARTICULAR FONT, STYLE, SIZE, OR COLOR.

SER. NO. 85-351,159, FILED 6-20-2011.

ANNE FARRELL, EXAMINING ATTORNEY



David J. Kybas

Director of the United States Patent and Trademark Office

United States of America

United States Patent and Trademark Office

EVERYDAY MEALS

Reg. No. 4,153,012

Registered June 5, 2012

Int. Cl.: 29

TRADEMARK

PRINCIPAL REGISTER

KFC CORPORATION (DELAWARE CORPORATION)
1441 GARDINER LANE
LEGAL - TRADEMARKS
LOUISVILLE, KY 40213

FOR: COMBINATION MEAL CONSISTING PRIMARILY OF COOKED CHICKEN WITH COLE SLAW, COOKED VEGETABLES, VEGETABLE SALADS, MACARONI AND CHEESE, WEDGED OR MASHED POTATOES AND GRAVY, BISCUITS OR BREAD, SOFT DRINK AND/OR DESSERT FOR CONSUMPTION ON OR OFF THE PREMISES, IN CLASS 29 (U.S. CL. 46).

FIRST USE 2-28-2011; IN COMMERCE 2-28-2011.

THE MARK CONSISTS OF STANDARD CHARACTERS WITHOUT CLAIM TO ANY PARTICULAR FONT, STYLE, SIZE, OR COLOR.

NO CLAIM IS MADE TO THE EXCLUSIVE RIGHT TO USE "MEALS", APART FROM THE MARK AS SHOWN.

SER. NO. 85-351,892, FILED 6-21-2011.

ARETHA SOMERVILLE, EXAMINING ATTORNEY



David J. Kyros

Director of the United States Patent and Trademark Office

United States of America

United States Patent and Trademark Office



BRIGHT LIGHT
E D U C A T I O N

Reg. No. 4,153,013

Registered June 5, 2012

Int. Cl.: 41

BRIGHT LIGHT EDUCATION LLC (NEW JERSEY LIMITED LIABILITY COMPANY), AKA
BRIGHT LIGHT EDUCATION
FLOOR 1
43 EASTERN PARKWAY
JERSEY CITY, NJ 07305

SERVICE MARK

PRINCIPAL REGISTER

FOR: CONDUCTING AFTER SCHOOL TUTORING PROGRAMS; CONSULTATION IN THE FIELD OF K-12 EDUCATIONAL SYSTEMS; EDUCATIONAL COUNSELING SERVICES TO ASSIST STUDENTS IN PLANNING AND PREPARING FOR FURTHER EDUCATION; EDUCATIONAL SERVICES, NAMELY, CONDUCTING DISTANCE LEARNING INSTRUCTION AT THE PRIMARY AND SECONDARY LEVELS; EDUCATIONAL SERVICES, NAMELY, CONDUCTING DISTANCE LEARNING INSTRUCTION AT THE SECONDARY, COLLEGE AND GRADUATE LEVELS; EDUCATIONAL SERVICES, NAMELY, DEVELOPING CURRICULUM FOR EDUCATORS; EDUCATIONAL SERVICES, NAMELY, DEVELOPING CURRICULUM FOR TEACHERS; EDUCATIONAL SERVICES, NAMELY, THE OFFERING OF WEB BASED AND CLASSROOM TRAINING FOR CERTIFICATION OF TEACHERS AND CONTINUING EDUCATION FOR TEACHERS AND PRINCIPALS; PROVIDING AFTER SCHOOL EDUCATIONAL PROGRAMS FOR CHILDREN IN GRADES PREK-12; TEACHING, TRAINING, TUTORING AND COURSES OF INSTRUCTION AT THE UNDERGRADUATE, GRADUATE AND POST-GRADUATE LEVEL, IN CLASS 41 (U.S. CLS. 100, 101 AND 107).

FIRST USE 12-1-2010; IN COMMERCE 2-28-2011.



NO CLAIM IS MADE TO THE EXCLUSIVE RIGHT TO USE "EDUCATION", APART FROM THE MARK AS SHOWN.

THE COLOR(S) PINK, BLUE, BROWN, BEIGE, WHITE AND BLACK IS/ARE CLAIMED AS A FEATURE OF THE MARK.

THE MARK CONSISTS OF A LIGHT BULB OUTLINED IN BROWN WITH A PINK HEART OUTLINE IN THE MIDDLE OF IT ALONG SIDE OF A PC TABLET OUTLINED IN BLACK WITH A BLUE SCREEN LEANING ON BROWN AND BEIGE BOOKS IN FRONT OF A PINK SQUARE OUTLINED IN BEIGE AND WHITE WITH WHITE STAR DESIGNS, ALL SET AGAINST A WHITE BACKGROUND WITH THE WORDS "BRIGHT LIGHT EDUCATION" WRITTEN IN BROWN LETTERS UNDER THE IMAGE.

David J. Kyros

Director of the United States Patent and Trademark Office

SER. NO. 85-352,407, FILED 6-22-2011.

Reg. No. 4,153,013 SAMUEL E. SHARPER JR., EXAMINING ATTORNEY

United States of America

United States Patent and Trademark Office

Liberty PL Services

Reg. No. 4,153,014

Registered June 5, 2012

Int. Cl.: 35

SERVICE MARK

PRINCIPAL REGISTER

LIBERTY PL SERVICES, LLC (TEXAS LIMITED LIABILITY COMPANY), AKA LIBERTY PIPELINE SERVICES, LLC
24900 PITKIN ROAD
SUITE 175
SPRING, TX 77386

FOR: BUSINESS CONSULTATION IN THE FIELD OF ENVIRONMENTAL, HEALTH, SAFETY, AND INFORMATION TECHNOLOGY SERVICES , IN CLASS 35 (U.S. CLS. 100, 101 AND 102).

FIRST USE 0-0-2006; IN COMMERCE 0-0-2006.

THE MARK CONSISTS OF STANDARD CHARACTERS WITHOUT CLAIM TO ANY PARTICULAR FONT, STYLE, SIZE, OR COLOR.

NO CLAIM IS MADE TO THE EXCLUSIVE RIGHT TO USE "PL SERVICES", APART FROM THE MARK AS SHOWN.

SER. NO. 85-352,693, FILED 6-22-2011.

WILLIAM ROSSMAN, EXAMINING ATTORNEY



David J. Kyros

Director of the United States Patent and Trademark Office

United States of America

United States Patent and Trademark Office

Liberty Pipeline Services

Reg. No. 4,153,015

Registered June 5, 2012

Int. Cl.: 35

SERVICE MARK

PRINCIPAL REGISTER

LIBERTY PL SERVICES, LLC (TEXAS LIMITED LIABILITY COMPANY), AKA LIBERTY PIPELINE SERVICES, LLC
24900 PITKIN ROAD
SUITE 175
SPRING, TX 77386

FOR: BUSINESS CONSULTATION IN THE FIELD OF ENVIRONMENTAL, HEALTH, SAFETY, AND INFORMATION TECHNOLOGY SERVICES , IN CLASS 35 (U.S. CLS. 100, 101 AND 102).

FIRST USE 0-0-2004; IN COMMERCE 0-0-2004.

THE MARK CONSISTS OF STANDARD CHARACTERS WITHOUT CLAIM TO ANY PARTICULAR FONT, STYLE, SIZE, OR COLOR.

NO CLAIM IS MADE TO THE EXCLUSIVE RIGHT TO USE "PIPELINE SERVICES", APART FROM THE MARK AS SHOWN.

SER. NO. 85-352,772, FILED 6-22-2011.

WILLIAM ROSSMAN, EXAMINING ATTORNEY



David J. Kyros

Director of the United States Patent and Trademark Office

United States of America

United States Patent and Trademark Office



Reg. No. 4,153,016

FORTNER, TRAVIS C (UNITED STATES INDIVIDUAL), DBA PROVEIL
3316 ELM DRIVE
LA CROSSE, WI 54601

Registered June 5, 2012

Int. Cl.: 13

FOR: CASE COVERS FOR FIREARMS; CLEANING RODS FOR FIREARMS; COVERS FOR FIREARMS; FIREARM SIGHTS; FIREARM SLINGS; FIREARMS; MUZZLE-LOADING FIREARMS; SIGHTS, NAMELY, OPEN SIGHTS FOR USE ON FIREARMS; WEAPON CASES FOR FIREARMS, IN CLASS 13 (U.S. CLS. 2 AND 9).

TRADEMARK

PRINCIPAL REGISTER

FIRST USE 3-11-2009; IN COMMERCE 3-11-2009.

THE MARK CONSISTS OF 3 CONCENTRIC DIAMONDS WITH THE INNERMOST DIAMOND CONSISTING OF A STYLIZED DEPICTION OF ANTLERS. TO THE IMMEDIATE RIGHT OF THE DIAMONDS IS THE STYLIZED LITERAL ELEMENT OF THE TERM "PROVEIL".

SER. NO. 85-352,862, FILED 6-22-2011.

ALYSSA STEEL, EXAMINING ATTORNEY



David J. Kyffers

Director of the United States Patent and Trademark Office

United States of America

United States Patent and Trademark Office

APARTSTYLE

Reg. No. 4,153,017

Registered June 5, 2012

Int. Cl.: 35

SERVICE MARK

PRINCIPAL REGISTER

ILYON LIMITED (GUERNSEY CORPORATION)
3 PLACE ISAAC-MERCIER, C.P. 5002
GENEVA 11, SWITZERLAND 1211

FOR: COMPUTERIZED ON-LINE ORDERING SERVICES IN THE FIELD OF APPAREL, WOMEN'S CLOTHING, COCKTAIL DRESSES, SEXY DRESSES, TRENDY CLOTHES, COATS AND TOPS , IN CLASS 35 (U.S. CLS. 100, 101 AND 102).

FIRST USE 3-1-2010; IN COMMERCE 3-1-2010.

THE MARK CONSISTS OF STANDARD CHARACTERS WITHOUT CLAIM TO ANY PARTICULAR FONT, STYLE, SIZE, OR COLOR.

SER. NO. 85-352,901, FILED 6-22-2011.

DAVID COLLIER, EXAMINING ATTORNEY



David J. Kyros

Director of the United States Patent and Trademark Office

United States of America

United States Patent and Trademark Office



Reg. No. 4,153,018

Registered June 5, 2012

Int. Cl.: 35

SERVICE MARK

PRINCIPAL REGISTER

ARAUJO, WILLIAM (UNITED STATES INDIVIDUAL)
801 TEXAS STREET
BAKERSFIELD, CA 93307

FOR: CAR CLUB SERVICES, NAMELY, PROMOTING THE INTERESTS OF THE OWNERS OF CARS FOR THE MODEL YEAR 1969 OR OLDER, IN CLASS 35 (U.S. CLS. 100, 101 AND 102).

FIRST USE 0-0-2006; IN COMMERCE 0-0-2006.

NO CLAIM IS MADE TO THE EXCLUSIVE RIGHT TO USE "C.C." AND "BAKERSFIELD, CA", APART FROM THE MARK AS SHOWN.

THE COLOR(S) GREEN, BROWN, GRAY, RED, BLACK AND WHITE IS/ARE CLAIMED AS A FEATURE OF THE MARK.

THE MARK CONSISTS OF THE WORD "OUTLAWZ" APPEARING IN GREEN CAPITAL LETTERS WITH BLACK OUTLINE SHADING AND WITH BLACK DOTS IN THE CENTER PORTION OF EACH LETTER ABOVE A CARTOON HEAD OF A GRINNING WOLF WEARING A GREEN BANDANNA. THE WOLF'S HEAD IS IN TWO TONES OF GRAY AND BLACK WITH THE PREDOMINANT COLOR GRAY AND WITH BLACK LINING AND SHADING IN THE EARS, NOSE, MUZZLE AND OUTER PORTION OF THE FUR. THE WOLF HAS RED AND WHITE BLOOD SHOT EYES, WHITE TEETH AND A RED TONGUE HANGING OUT OF ITS MOUTH. THE WOLF IS SMOKING A CIGAR BUTT WHICH IS BROWN IN COLOR AND THE TIP HAS GRAY ASH. THE LETTERS "C.C.", IN GREEN CAPITAL LETTERS AND OUTLINED IN BLACK AND WITH BLACK DOTS IN THE CENTER OF THE LETTERS, APPEAR BELOW THE WOLF HEAD. THE WORDS "BAKERSFIELD, CA" APPEAR AT THE BOTTOM OF THE MARK IN BLACK LETTERING.

SER. NO. 85-353,427, FILED 6-22-2011.

JEFFREY LOOK, EXAMINING ATTORNEY



David J. Kybas

Director of the United States Patent and Trademark Office

United States of America

United States Patent and Trademark Office

SCD PROBIOTICS

Reg. No. 4,153,019

Registered June 5, 2012

Int. Cl.: 1

TRADEMARK

PRINCIPAL REGISTER

SUSTAINABLE COMMUNITY DEVELOPMENT, L.L.C. D/B/A SCD PROBIOTICS (MISSOURI LIMITED LIABILITY COMPANY)
1327 E 9TH STREET
KANSAS CITY, MO 64106

FOR: SUBSTANCES FOR GARDENING, REGULATING PLANT GROWTH, CONTROLLING PLANT DISEASE AND IMPROVING PLANT HEALTH, NAMELY, BACTERIA IN THE NATURE OF PROBIOTIC CULTURES; SUBSTANCES FOR WASTE MANAGEMENT, RECYCLING AND COMPOSTING, ODOR CONTROL AND BIO REMEDIATION, NAMELY, BACTERIA IN THE NATURE OF PROBIOTIC CULTURES; SUBSTANCES FOR INDUSTRIAL CLEANING AND SANITATION, NAMELY, BACTERIA IN THE NATURE OF PROBIOTIC CULTURES, IN CLASS 1 (U.S. CLS. 1, 5, 6, 10, 26 AND 46).

FIRST USE 4-21-2009; IN COMMERCE 4-21-2009.

THE MARK CONSISTS OF STANDARD CHARACTERS WITHOUT CLAIM TO ANY PARTICULAR FONT, STYLE, SIZE, OR COLOR.

OWNER OF U.S. REG. NOS. 3,847,082, 3,884,895 AND OTHERS.

NO CLAIM IS MADE TO THE EXCLUSIVE RIGHT TO USE "PROBIOTICS", APART FROM THE MARK AS SHOWN.

SER. NO. 85-353,933, FILED 6-23-2011.

JEFFREY LOOK, EXAMINING ATTORNEY



David J. Kypos

Director of the United States Patent and Trademark Office

United States of America

United States Patent and Trademark Office



Reg. No. 4,153,020

Registered June 5, 2012

Int. Cl.: 44

SERVICE MARK

PRINCIPAL REGISTER

WELLNESS DESIGNED BY AMY, LLC (NEW JERSEY LIMITED LIABILITY COMPANY)
60 LAKEVIEW AVENUE
SHORT HILLS, NJ 07078

FOR: PROVIDING A WEBSITE FEATURING INFORMATION ABOUT HEALTH, WELLNESS
AND NUTRITION, IN CLASS 44 (U.S. CLS. 100 AND 101).

FIRST USE 4-30-2011; IN COMMERCE 5-13-2011.

THE MARK CONSISTS OF A STYLIZED LEFT-LEANING TREE WITH A ROUNDED TOP
PORTION COMPRISED OF POLKA DOTS.

SER. NO. 85-353,988, FILED 6-23-2011.

AMY KERTGATE, EXAMINING ATTORNEY



David J. Kybas

Director of the United States Patent and Trademark Office

United States of America

United States Patent and Trademark Office



Reg. No. 4,153,021

Registered June 5, 2012

Int. Cl.: 2

TRADEMARK

PRINCIPAL REGISTER

SALIM HIOUEL (FRANCE INDIVIDUAL)
1910 ASHLEY HALL RD.
CHARLESTON, SC 29407

FOR: EXTERIOR PAINT; FLOOR PAINTS; HOUSE PAINT; INTERIOR PAINT; PAINT PRIMERS; PAINTS; PAINTS AND LACQUERS; PAINTS, LACQUERS, VARNISHES; WATER-BASED PAINTS, IN CLASS 2 (U.S. CLS. 6, 11 AND 16).

FIRST USE 8-20-2009; IN COMMERCE 8-20-2009.

OWNER OF U.S. REG. NO. 3,750,466.

NO CLAIM IS MADE TO THE EXCLUSIVE RIGHT TO USE "ECO", APART FROM THE MARK AS SHOWN.

THE MARK CONSISTS OF FOUR VERTICALLY OVERLAPPING ROUND FIGURES REPRESENTING PAINT CANS WITH A LEAF AND A DROP OF PAINT IN THE TOP FIGURE. BELOW THE DRAWING ARE THE WORDS "ECO DECO".

SER. NO. 85-354,224, FILED 6-23-2011.

NAAKWAMA ANKRAH, EXAMINING ATTORNEY



David J. Kyros

Director of the United States Patent and Trademark Office

United States of America

United States Patent and Trademark Office

Novus Works

Reg. No. 4,153,022

Registered June 5, 2012

Int. Cls.: 35 and 42

SERVICE MARK

PRINCIPAL REGISTER

NOVUSWORKS LLC (DELAWARE LIMITED LIABILITY COMPANY)
SUITE 500
75 ARLINGTON ST
BOSTON, MA 02116

FOR: ADVISORY SERVICES RELATING TO BUSINESS MANAGEMENT AND BUSINESS OPERATIONS; ASSISTANCE WITH BUSINESS MANAGEMENT AND PLANNING; ASSISTANCE, ADVISORY SERVICES AND CONSULTANCY WITH REGARD TO BUSINESS PLANNING, BUSINESS ANALYSIS, BUSINESS MANAGEMENT, AND BUSINESS ORGANIZATION; BUSINESS MANAGEMENT ADVICE; BUSINESS MANAGEMENT ASSISTANCE TO INDUSTRIAL OR COMMERCIAL COMPANIES; BUSINESS MANAGEMENT CONSULTANCY AND ADVISORY SERVICES; BUSINESS MANAGEMENT CONSULTANCY AS WELL AS DEVELOPMENT OF PROCESSES FOR THE ANALYSIS AND THE IMPLEMENTATION OF STRATEGY PLANS AND MANAGEMENT PROJECTS; BUSINESS MANAGEMENT CONSULTANCY SERVICES; BUSINESS MANAGEMENT CONSULTANCY, ALSO VIA THE INTERNET; BUSINESS MANAGEMENT CONSULTATION; BUSINESS MANAGEMENT CONSULTATION IN THE FIELD OF EXECUTIVE AND LEADERSHIP DEVELOPMENT; BUSINESS MANAGEMENT CONSULTING; BUSINESS MANAGEMENT CONSULTING AND ADVISORY SERVICES; BUSINESS MANAGEMENT CONSULTING IN THE FIELD OF TEAM DEVELOPMENT; CONSULTING SERVICES IN BUSINESS LEADERSHIP DEVELOPMENT AND BUSINESS MANAGEMENT; CONSULTING SERVICES IN THE FIELDS OF BUSINESS MANAGEMENT, HUMAN RESOURCES, AND BUSINESS ORGANIZATIONAL DESIGN; PROVIDING BUSINESS MANAGEMENT INFORMATION IN CONNECTION WITH CONSULTING AND ADVISORY SERVICES IN THE FIELD OF STRATEGIC PLANNING; PROVIDING ORGANIZATIONAL DEVELOPMENT CONSULTING SERVICES, IN CLASS 35 (U.S. CLS. 100, 101 AND 102).

FIRST USE 6-1-2011; IN COMMERCE 6-1-2011.

FOR: CONSULTING IN THE FIELD OF IT PROJECT MANAGEMENT, IN CLASS 42 (U.S. CLS. 100 AND 101).

FIRST USE 6-1-2011; IN COMMERCE 6-1-2011.

THE MARK CONSISTS OF STANDARD CHARACTERS WITHOUT CLAIM TO ANY PARTICULAR FONT, STYLE, SIZE, OR COLOR.



David J. Kyjars

Director of the United States Patent and Trademark Office

Reg. No. 4,153,022 THE ENGLISH TRANSLATION OF "NOVUS" IN THE MARK IS "NEW".

SER. NO. 85-354,992, FILED 6-24-2011.

ESTHER A. BORSUK, EXAMINING ATTORNEY

United States of America

United States Patent and Trademark Office

MINKLA

Reg. No. 4,153,023

Registered June 5, 2012

Int. Cl.: 5

TRADEMARK

PRINCIPAL REGISTER

BAYER AKTIENGESELLSCHAFT (FED REP GERMANY AKTIENGESELLSCHAFT)
KAISER-WILHELM-ALLEE
LEVERKUSEN, FED REP GERMANY 51373

FOR: PHARMACEUTICAL PREPARATIONS, NAMELY, HORMONAL PREPARATIONS, IN CLASS 5 (U.S. CLS. 6, 18, 44, 46, 51 AND 52).

THE MARK CONSISTS OF STANDARD CHARACTERS WITHOUT CLAIM TO ANY PARTICULAR FONT, STYLE, SIZE, OR COLOR.

OWNER OF FED REP GERMANY REG. NO. 302011029783, DATED 6-28-2011, EXPIRES 5-31-2021.

SER. NO. 85-355,258, FILED 6-24-2011.

WILLIAM VERHOSEK, EXAMINING ATTORNEY



David J. Kyros

Director of the United States Patent and Trademark Office

United States of America

United States Patent and Trademark Office

zapunited

Reg. No. 4,153,024

Registered June 5, 2012

Int. Cl.: 35

SERVICE MARK

PRINCIPAL REGISTER

HETTICH, DOMINIK (FED REP GERMANY INDIVIDUAL)
JOSEPH-DOLLINGER-BOGEN 14
MÜNCHEN, FED REP GERMANY

FOR: PLACING ADVERTISEMENTS ON WEBSITES FOR OTHERS USING SPECIALIZED COMPUTER SOFTWARE IN CONNECTION WITH AD SERVING; ADVERTISEMENT FOR OTHERS ON THE INTERNET; ADVERTISING SERVICES, NAMELY, ADVERTISING AND ADVERTISEMENT SERVICES; ADVERTISING AND COMMERCIAL INFORMATION SERVICES, VIA THE INTERNET; ADVERTISING AND DIRECTORY SERVICES, NAMELY, PROMOTING THE SERVICES OF OTHERS BY PROVIDING A WEB PAGE FEATURING LINKS TO THE WEBSITES OF OTHERS; ADVERTISING AND MARKETING; ADVERTISING AND MARKETING SERVICES, NAMELY, PROMOTING THE GOODS AND SERVICES OF OTHERS; ADVERTISING AND PROMOTIONAL SERVICES; ADVERTISING ON THE INTERNET FOR OTHERS; ADVERTISING VIA ELECTRONIC MEDIA AND SPECIFICALLY THE INTERNET; ADVERTISING, INCLUDING ON-LINE ADVERTISING ON A COMPUTER NETWORK; ADVERTISING SERVICES, NAMELY, PROMOTION RELATING TO THE SALE OF ARTICLES AND SERVICES FOR THIRD PARTIES BY THE TRANSMISSION OF ADVERTISING MATERIAL AND THE DISSEMINATION OF ADVERTISING MESSAGES ON COMPUTER NETWORKS; ADVERTISING, MARKETING AND PROMOTION SERVICES; ADVERTISING, PROMOTION, AND MARKETING SERVICES, NAMELY, PROVIDING A SEARCHABLE ON-LINE ADVERTISING WEBSITE FEATURING THE GOODS AND SERVICES OF OTHER VENDORS; BANNER ADVERTISING; DISPLAYING ADVERTISEMENTS FOR OTHERS; DISSEMINATION OF ADVERTISEMENTS; DISSEMINATION OF ADVERTISING FOR OTHERS VIA AN ON-LINE COMMUNICATIONS NETWORK ON THE INTERNET; DISSEMINATION OF ADVERTISING FOR OTHERS VIA THE INTERNET; PROMOTION, ADVERTISING AND MARKETING OF ON-LINE WEBSITES OF OTHERS; PROVIDING A SEARCHABLE ON-LINE ADVERTISING WEBSITE AND GUIDE FEATURING THE GOODS AND SERVICES OF OTHER VENDORS VIA THE INTERNET; PROVIDING A SEARCHABLE ONLINE ADVERTISING GUIDE FEATURING THE GOODS AND SERVICES OF ONLINE VENDORS; PROVIDING A SEARCHABLE ONLINE ADVERTISING GUIDE FEATURING THE GOODS AND SERVICES OF OTHER ON-LINE VENDORS ON THE INTERNET; PROVIDING A SEARCHABLE WEBSITE FEATURING THE GOODS AND SERVICES OF OTHER VENDORS; PROVIDING A WEB SITE WHICH FEATURES ADVERTISEMENTS FOR THE GOODS AND SERVICES OF OTHERS ON A GLOBAL COMPUTER NETWORK; PROVIDING ADVERTISING SERVICES; PROVIDING AN ON-LINE COMMERCIAL INFORMATION DIRECTORY ON THE INTERNET; PROVIDING CONSUMER PRODUCT INFORMATION VIA THE INTERNET; PROVIDING ON-LINE DIRECTORY INFORMATION SERVICES



David J. Kyros

Director of the United States Patent and Trademark Office

Reg. No. 4,153,024 ALSO FEATURING HYPERLINKS TO OTHER WEB SITES; PROVIDING SPACE AT A WEB SITE FOR THE ADVERTISEMENT OF THE GOODS AND SERVICES OF OTHERS; PROVIDING STATISTICAL INFORMATION; PROVISION OF SPACE ON WEBSITES FOR ADVERTISING GOODS AND SERVICES, IN CLASS 35 (U.S. CLS. 100, 101 AND 102).

FIRST USE 6-24-2011; IN COMMERCE 6-24-2011.

THE MARK CONSISTS OF STANDARD CHARACTERS WITHOUT CLAIM TO ANY PARTICULAR FONT, STYLE, SIZE, OR COLOR.

SER. NO. 85-355,576, FILED 6-24-2011.

SETH A. RAPPAPORT, EXAMINING ATTORNEY

United States of America

United States Patent and Trademark Office

EPIC POKER

Reg. No. 4,153,025

FEDERATED SPORTS & GAMING, INC. (DELAWARE CORPORATION)
1740 N STREET NW
WASHINGTON, DC 20036

Registered June 5, 2012

Int. Cls.: 16 and 41

FOR: PRINTED MATERIALS, NAMELY, NEWSLETTERS, PAMPHLETS, ARTICLES AND MAGAZINES FEATURING INFORMATION, NEWS, AND ENTERTAINMENT RELATED TO GAMING AND THE GAME OF POKER, IN CLASS 16 (U.S. CLS. 2, 5, 22, 23, 29, 37, 38 AND 50).

TRADEMARK

SERVICE MARK

FIRST USE 6-27-2011; IN COMMERCE 6-27-2011.

PRINCIPAL REGISTER

FOR: ENTERTAINMENT SERVICES, NAMELY, CASINO GAMING; CONDUCTING AND PROVIDING FACILITIES FOR SPECIAL EVENTS FEATURING CASINO AND GAMING CONTESTS AND TOURNAMENTS; ENTERTAINMENT IN THE NATURE OF POKER TOURNAMENTS; CONDUCTING EDUCATIONAL EXHIBITIONS IN THE NATURE OF POKER TOURNAMENTS; PROVIDING AND ORGANIZING A POKER LEAGUE; ORGANIZING AND CONDUCTING PROFESSIONAL POKER COMPETITIONS; PROVIDING INFORMATION ON THE GAME OF POKER VIA THE INTERNET; PROVIDING ONLINE WEBSITES CONTAINING INFORMATION OF INTEREST RELATING TO POKER; ON-GOING TELEVISION PROGRAMS IN THE FIELD OF POKER TOURNAMENTS; ORGANIZING, CONDUCTING, PRODUCING AND EXHIBITING POKER EVENTS RENDERED LIVE AND THROUGH THE MEDIA OF TELEVISION AND THE INTERNET; TELEVISION SHOW PRODUCTION; ENTERTAINMENT SERVICES IN THE NATURE OF PROVIDING VIRTUAL ENVIRONMENTS, INCLUDING SOCIAL MEDIA, IN WHICH USERS CAN INTERACT THROUGH GAMES, IN CLASS 41 (U.S. CLS. 100, 101 AND 107).



FIRST USE 6-27-2011; IN COMMERCE 6-27-2011.

THE MARK CONSISTS OF STANDARD CHARACTERS WITHOUT CLAIM TO ANY PARTICULAR FONT, STYLE, SIZE, OR COLOR.

NO CLAIM IS MADE TO THE EXCLUSIVE RIGHT TO USE "POKER", APART FROM THE MARK AS SHOWN.

David J. Kyros

SER. NO. 85-355,771, FILED 6-24-2011.

JENNIFER VASQUEZ, EXAMINING ATTORNEY

United States of America

United States Patent and Trademark Office



Reg. No. 4,153,026

Registered June 5, 2012

Int. Cls.: 16 and 41

TRADEMARK

SERVICE MARK

PRINCIPAL REGISTER

FEDERATED SPORTS & GAMING, INC. (DELAWARE CORPORATION)
1740 N STREET NW
WASHINGTON, DC 20036

FOR: PRINTED MATERIALS, NAMELY, NEWSLETTERS, PAMPHLETS, ARTICLES AND MAGAZINES FEATURING INFORMATION, NEWS, AND ENTERTAINMENT RELATED TO GAMING AND THE GAME OF POKER, IN CLASS 16 (U.S. CLS. 2, 5, 22, 23, 29, 37, 38 AND 50).

FIRST USE 6-27-2011; IN COMMERCE 6-27-2011.

FOR: ENTERTAINMENT SERVICES, NAMELY, CASINO GAMING; CONDUCTING AND PROVIDING FACILITIES FOR SPECIAL EVENTS FEATURING CASINO AND GAMING CONTESTS AND TOURNAMENTS; ENTERTAINMENT IN THE NATURE OF POKER TOURNAMENTS; CONDUCTING EDUCATIONAL EXHIBITIONS IN THE NATURE OF POKER TOURNAMENTS; PROVIDING AND ORGANIZING A POKER LEAGUE; ORGANIZING AND CONDUCTING PROFESSIONAL POKER COMPETITIONS; PROVIDING INFORMATION ON THE GAME OF POKER VIA THE INTERNET; PROVIDING ONLINE WEBSITES CONTAINING INFORMATION OF INTEREST RELATING TO POKER; ON-GOING TELEVISION PROGRAMS IN THE FIELD OF POKER TOURNAMENTS; ORGANIZING, CONDUCTING, PRODUCING AND EXHIBITING POKER EVENTS RENDERED LIVE AND THROUGH THE MEDIA OF TELEVISION AND THE INTERNET; TELEVISION SHOW PRODUCTION; ENTERTAINMENT SERVICES IN THE NATURE OF PROVIDING VIRTUAL ENVIRONMENTS, INCLUDING SOCIAL MEDIA, IN WHICH USERS CAN INTERACT THROUGH GAMES, IN CLASS 41 (U.S. CLS. 100, 101 AND 107).

FIRST USE 6-27-2011; IN COMMERCE 6-27-2011.

NO CLAIM IS MADE TO THE EXCLUSIVE RIGHT TO USE "POKER", APART FROM THE MARK AS SHOWN.

THE COLOR(S) RED, WHITE, BLUE AND GRAY IS/ARE CLAIMED AS A FEATURE OF THE MARK.

THE MARK CONSISTS OF THE WORDS "EPIC POKER" IN WHITE WITHIN A RED AND BLUE RECTANGLE WITH ROUNDED CORNERS AND GRAY BORDER. THERE IS WHITE SHADING IN THE TOP INSIDE CORNERS AND THE BOTTOM RIGHT INSIDE CORNER.



David J. Kyros

Director of the United States Patent and Trademark Office

Reg. No. 4,153,026 SER. NO. 85-355,824, FILED 6-24-2011.

JENNIFER VASQUEZ, EXAMINING ATTORNEY

United States of America

United States Patent and Trademark Office

Kid in a Man's World

Reg. No. 4,153,027

Registered June 5, 2012

Int. Cl.: 41

SERVICE MARK

PRINCIPAL REGISTER

PIOLI, SCOTT P. (UNITED STATES INDIVIDUAL)
13 LEIGHTON STREET
ENGLEWOOD CLIFFS, NJ 07632

FOR: PROVIDING ONLINE INFORMATION AND ONLINE ARTICLES FOR MEN IN THE FIELD OF LIFESTYLE AND LEISURE ACTIVITIES FOR MEN, IN CLASS 41 (U.S. CLS. 100, 101 AND 107).

FIRST USE 12-30-2010; IN COMMERCE 6-21-2011.

THE MARK CONSISTS OF STANDARD CHARACTERS WITHOUT CLAIM TO ANY PARTICULAR FONT, STYLE, SIZE, OR COLOR.

SER. NO. 85-355,921, FILED 6-24-2011.

LOURDES AYALA, EXAMINING ATTORNEY



David J. Kyffers

Director of the United States Patent and Trademark Office

United States of America

United States Patent and Trademark Office

SPRINKLE. EAT. LOSE WEIGHT.

Reg. No. 4,153,028

Registered June 5, 2012

Int. Cl.: 5

TRADEMARK

PRINCIPAL REGISTER

SENSA PRODUCTS, LLC (CALIFORNIA LIMITED LIABILITY COMPANY)
SUITE 4100
2301 ROSECRANS AVENUE
EL SEGUNDO, CA 90245

FOR: DIETARY FOOD SUPPLEMENTS; NUTRITIONAL ADDITIVES FOR WEIGHT LOSS AND WEIGHT MANAGEMENT FOR USE IN OR ON FOODS; AND DIETARY SUPPLEMENTS FOR HUMAN CONSUMPTION, IN CLASS 5 (U.S. CLS. 6, 18, 44, 46, 51 AND 52).

FIRST USE 5-0-2011; IN COMMERCE 5-0-2011.

THE MARK CONSISTS OF STANDARD CHARACTERS WITHOUT CLAIM TO ANY PARTICULAR FONT, STYLE, SIZE, OR COLOR.

SER. NO. 85-356,008, FILED 6-24-2011.

JUDITH HELFMAN, EXAMINING ATTORNEY



David J. Kyffers

Director of the United States Patent and Trademark Office

United States of America

United States Patent and Trademark Office

APPROVAL TREE

Reg. No. 4,153,029

Registered June 5, 2012

Int. Cl.: 35

SERVICE MARK

PRINCIPAL REGISTER

NET CYLINDER, INC. (NEW YORK CORPORATION), DBA APPROVALTREE.COM
SUITE 510
888 VETERAN MEMORIAL HIGHWAY
HAUPPAUGE, NY 11788

FOR: MATCHING BORROWERS WITH POTENTIAL LENDERS IN THE FIELD OF CONSUMER LENDING ON-LINE, IN PRINT, AND VIA MOBILE DEVICE APPLICATIONS , IN CLASS 35 (U.S. CLS. 100, 101 AND 102).

FIRST USE 4-22-2008; IN COMMERCE 4-22-2008.

THE MARK CONSISTS OF STANDARD CHARACTERS WITHOUT CLAIM TO ANY PARTICULAR FONT, STYLE, SIZE, OR COLOR.

NO CLAIM IS MADE TO THE EXCLUSIVE RIGHT TO USE "APPROVAL", APART FROM THE MARK AS SHOWN.

SER. NO. 85-356,303, FILED 6-25-2011.

NAKIA HENRY, EXAMINING ATTORNEY



David J. Kyffers

Director of the United States Patent and Trademark Office

United States of America

United States Patent and Trademark Office



Reg. No. 4,153,030

SAINT'S COFFEE IMPORT, INC (NEW YORK CORPORATION)
93 MACON STREET
BROOKLYN, NY 11216

Registered June 5, 2012

Int. Cl.: 30

FOR: COFFEE; COFFEE BEANS; GREEN COFFEE BEANS; ROASTED COFFEE BEANS;
COFFEE BEAN GROUNDS, IN CLASS 30 (U.S. CL. 46).

TRADEMARK

FIRST USE 2-1-2011; IN COMMERCE 2-1-2011.

PRINCIPAL REGISTER

NO CLAIM IS MADE TO THE EXCLUSIVE RIGHT TO USE "WORLD'S BEST COFFEE",
APART FROM THE MARK AS SHOWN.

THE COLOR(S) BROWN, BLUE AND GOLD IS/ARE CLAIMED AS A FEATURE OF THE
MARK.

THE MARK CONSISTS OF THE WORDING "SAINTS' WORLD'S BEST COFFEE" IN BROWN.
BEHIND THE WORDING IS A BLUE MOUNTAIN WITH A GOLD HALO ABOVE THE
MOUNTAIN PEAK.

SER. NO. 85-356,565, FILED 6-27-2011.

TARAH HARDY, EXAMINING ATTORNEY



David J. Kybas

Director of the United States Patent and Trademark Office

United States of America

United States Patent and Trademark Office

UNITEDPLAY

Reg. No. 4,153,031

Registered June 5, 2012

Int. Cl.: 28

TRADEMARK

PRINCIPAL REGISTER

RICHTER SPIELGERAETE GMBH (FED REP GERMANY LIMITED LIABILITY COMPANY)
SIMSSEESTRASSE 29
FRASDORF, FED REP GERMANY 83112

FOR: SENSORY PLAYGROUND UNITS, NAMELY, TACTILE, SOUND-MAKING AND ACOUSTIC PLAYGROUND UNITS COMPRISED OF WIND PIPES, WIND PUMPS, SOUND CUSHIONS, SOUND TUBES, MUSICAL PATH IN THE NATURE OF RUBBER BELT WITH BELLS, SOUND ROLLERS, BELL TOWER, SEA ROARER IN THE NATURE OF A MOVE-ABLE STAINLESS STEEL PLATFORM CONTAINING SOUND-MAKING BALLS, WOODEN AND CONCRETE SOUND WAVE PHONES, PARABOLIC SOUND WAVE REFLECTORS, DANCE CHIMES, STAINLESS STEEL SOUND DISC, ROTATING STAINLESS STEEL BODIES, ROTATING MIRROR ROTUNDA WITH SOUND, IN CLASS 28 (U.S. CLS. 22, 23, 38 AND 50).

FIRST USE 0-0-2008; IN COMMERCE 0-0-2008.

THE MARK CONSISTS OF STANDARD CHARACTERS WITHOUT CLAIM TO ANY PARTICULAR FONT, STYLE, SIZE, OR COLOR.

OWNER OF U.S. REG. NO. 3,968,826.

SER. NO. 85-357,013, FILED 6-27-2011.

REBECCA SMITH, EXAMINING ATTORNEY



David J. Kybas

Director of the United States Patent and Trademark Office

United States of America

United States Patent and Trademark Office

Lion I Clothing

Reg. No. 4,153,032

ROGERS, LYSSA (OREGON SOLE PROPRIETORSHIP)
7432 SE CESAR E CHAVEZ BLVD
PORTLAND, OR 97202

Registered June 5, 2012

Int. Cl.: 25

FOR: ATHLETIC APPAREL, NAMELY, SHIRTS, PANTS, JACKETS, FOOTWEAR, HATS AND CAPS, ATHLETIC UNIFORMS, IN CLASS 25 (U.S. CLS. 22 AND 39).

TRADEMARK

FIRST USE 4-30-2009; IN COMMERCE 6-30-2010.

PRINCIPAL REGISTER

THE MARK CONSISTS OF STANDARD CHARACTERS WITHOUT CLAIM TO ANY PARTICULAR FONT, STYLE, SIZE, OR COLOR.

NO CLAIM IS MADE TO THE EXCLUSIVE RIGHT TO USE "CLOTHING", APART FROM THE MARK AS SHOWN.

SER. NO. 85-357,346, FILED 6-27-2011.

SALLY SHIH, EXAMINING ATTORNEY



David J. Kyros

Director of the United States Patent and Trademark Office

United States of America

United States Patent and Trademark Office



Reg. No. 4,153,033

Registered June 5, 2012

Int. Cl.: 35

SERVICE MARK

PRINCIPAL REGISTER

NET CYLINDER, INC. (NEW YORK CORPORATION), DBA APPROVALTREE.COM
SUITE 510
888 VETERANS MEMORIAL HIGHWAY
HAUPPAUGE, NY 11788

FOR: MATCHING BORROWERS WITH POTENTIAL LENDERS IN THE FIELD OF CONSUMER LENDING ON-LINE, IN PRINT, AND VIA MOBILE DEVICE APPLICATIONS , IN CLASS 35 (U.S. CLS. 100, 101 AND 102).

FIRST USE 4-22-2008; IN COMMERCE 4-22-2008.

NO CLAIM IS MADE TO THE EXCLUSIVE RIGHT TO USE "APPROVAL", APART FROM THE MARK AS SHOWN.

THE COLOR(S) GOLD, GREEN, AND BLUE IS/ARE CLAIMED AS A FEATURE OF THE MARK.

THE MARK CONSISTS OF A TREE WITH LEAVES ON A HILL, WHEREIN THE HILL IS ILLUSTRATED WITH A VARIABLE THICKNESS GOLD LINE, WHEREIN THE LEFT SIDE IS HIGHER THAN THE RIGHT SIDE WITH A CREST THEREBETWEEN; THE TREE IS FORMED BY A PLURALITY OF GOLD TRUNKS RISING SUBSTANTIALLY VERTICALLY FROM THE HILL AND HAVING BRANCHES; ABOUT THE BRANCHES AND TRUNKS ARE GREEN LEAVES WITH VARYING SHAPES; THE MARK FURTHER INCLUDES THE TERMS "APPROVAL TREE" ABOVE THE HILL AND WITH THE TERM "APPROVAL" IN BLUE AND THE TERM "TREE" IN GREEN.

SER. NO. 85-357,792, FILED 6-28-2011.

NAKIA HENRY, EXAMINING ATTORNEY



David J. Kybas

Director of the United States Patent and Trademark Office

United States of America

United States Patent and Trademark Office



MORE



BETTER



EASIER

Reg. No. 4,153,034

MANHEIM, INC. (DELAWARE CORPORATION)
6205 PEACHTREE DUNWOODY ROAD
ATLANTA, GA 30328

Registered June 5, 2012

Int. Cl.: 35

FOR: AUTOMOBILE AUCTION SERVICES; AUTOMOBILE AUCTION SERVICES PROVIDED VIA THE INTERNET, IN CLASS 35 (U.S. CLS. 100, 101 AND 102).

SERVICE MARK

FIRST USE 5-20-2011; IN COMMERCE 5-20-2011.

PRINCIPAL REGISTER

THE MARK CONSISTS OF THREE VERTICALLY ARRANGED, STYLIZED BUTTONS WITH THE FIRST BUTTON FEATURING A PLUS SIGN TO THE RIGHT OF WHICH IS THE WORD "MORE", THE SECOND BUTTON FEATURING A 'GREATER THAN' SIGN TO THE RIGHT OF WHICH IS THE WORD "BETTER", AND THE THIRD BUTTON FEATURING A SMILEY FACE TO THE RIGHT OF WHICH IS THE WORD "EASIER".

SER. NO. 85-358,556, FILED 6-28-2011.

AMY KERTGATE, EXAMINING ATTORNEY



David J. Kyffers

Director of the United States Patent and Trademark Office

United States of America

United States Patent and Trademark Office

MAG-ID

Reg. No. 4,153,035

Registered June 5, 2012

Int. Cls.: 13 and 40

TRADEMARK

SERVICE MARK

PRINCIPAL REGISTER

THE COILED SNAKE, LLC (VIRGINIA LIMITED LIABILITY COMPANY)
4331 MARINER LANE
FAIRFAX, VA 22033

FOR: MAGAZINES FOR WEAPONS; LOADING CLIPS FOR SMALL ARMS; AMMUNITION,
IN CLASS 13 (U.S. CLS. 2 AND 9).

FIRST USE 5-27-2010; IN COMMERCE 3-31-2011.

FOR: CUSTOM MANUFACTURE OF MAGAZINES, LOADING CLIPS, AND AMMUNITION
FOR WEAPONS TO THE ORDER AND SPECIFICATION OF OTHERS, IN CLASS 40 (U.S.
CLS. 100, 103 AND 106).

FIRST USE 5-27-2010; IN COMMERCE 3-31-2011.

THE MARK CONSISTS OF STANDARD CHARACTERS WITHOUT CLAIM TO ANY PAR-
TICULAR FONT, STYLE, SIZE, OR COLOR.

SER. NO. 85-359,136, FILED 6-29-2011.

SALLY SHIH, EXAMINING ATTORNEY



David J. Kyros

Director of the United States Patent and Trademark Office

United States of America

United States Patent and Trademark Office

FRESH & LIGHT

Reg. No. 4,153,036

Registered June 5, 2012

Int. Cl.: 31

TRADEMARK

PRINCIPAL REGISTER

OIL-DRI CORPORATION OF AMERICA (DELAWARE CORPORATION)
SUITE 400
410 NORTH MICHIGAN AVENUE
CHICAGO, IL 60611

FOR: ANIMAL LITTER, IN CLASS 31 (U.S. CLS. 1 AND 46).

FIRST USE 7-21-2011; IN COMMERCE 7-21-2011.

THE MARK CONSISTS OF STANDARD CHARACTERS WITHOUT CLAIM TO ANY PARTICULAR FONT, STYLE, SIZE, OR COLOR.

SER. NO. 85-359,482, FILED 6-29-2011.

KELLEY WELLS, EXAMINING ATTORNEY



David J. Kybas

Director of the United States Patent and Trademark Office

United States of America

United States Patent and Trademark Office

JOULIES

Reg. No. 4,153,037

COFFEE JOULIES, LLC (NEW YORK LIMITED LIABILITY COMPANY)
102 E. SENECA STREET
SHERRILL, NY 13461

Registered June 5, 2012

Int. Cl.: 21

FOR: NON-ELECTRIC HOUSEHOLD UTENSIL IN THE FORM OF A CUBE OR SPHERE THAT IS COMPOSED OF METAL ALLOY WHICH IS PLACED INTO BEVERAGES FOR THE PURPOSE OF MAKING A BEVERAGE THE OPTIMAL TEMPERATURE FOR DRINKING, IN CLASS 21 (U.S. CLS. 2, 13, 23, 29, 30, 33, 40 AND 50).

TRADEMARK

PRINCIPAL REGISTER

FIRST USE 3-27-2011; IN COMMERCE 3-27-2011.

THE MARK CONSISTS OF STANDARD CHARACTERS WITHOUT CLAIM TO ANY PARTICULAR FONT, STYLE, SIZE, OR COLOR.

THE WORDING "JOULIES" HAS NO MEANING OTHER THAN TRADEMARK SIGNIFICANCE.

SER. NO. 85-359,627, FILED 6-29-2011.

KHANH LE, EXAMINING ATTORNEY



David J. Kybas

Director of the United States Patent and Trademark Office

United States of America

United States Patent and Trademark Office

Little Owl Soap

Reg. No. 4,153,038

Registered June 5, 2012

Int. Cl.: 3

TRADEMARK

PRINCIPAL REGISTER

LITTLE OWL SOAP LLC (NEW JERSEY LIMITED LIABILITY COMPANY), AKA LITTLE OWL SOAP
19 HALSEY ST.
METUCHEN, NJ 08840

FOR: AROMATIC BODY CARE PRODUCTS, NAMELY, BODY LOTION, SHOWER GEL, CUTICLE CREAM, SHAMPOO, CONDITIONER, NON-MEDICATED LIP BALM, SOAP, BODY POLISH, BODY AND FOOT SCRUB AND NON-MEDICATED FOOT CREAM; AROMATIC PREPARATIONS, NAMELY, LOTION; BAR SOAP; BATH LOTION; BATH SOAPS; BATH SOAPS IN LIQUID, SOLID OR GEL FORM; BEAUTY LOTIONS; BEAUTY SOAP; BODY SCRUB; CONDITIONERS; COSMETIC SOAPS; CREAM SOAPS; DEODORANT SOAP; FACE AND BODY LOTIONS; FACIAL LOTION; FACIAL SCRUBS; FRAGRANCE BODY CARE PREPARATIONS, NAMELY, MOISTURIZER; FRAGRANCE FACE CARE PREPARATIONS, NAMELY, MOISTURIZER; FRAGRANCE FACIAL MOISTURIZER; FRAGRANCE SKIN CARE PREPARATIONS, NAMELY, MOISTURIZER; HANDMADE SOAP BARS; LIP BALM; LIP BALM; LIQUID BATH SOAPS; LIQUID SOAP; LIQUID SOAPS; LIQUID SOAPS FOR HANDS AND FACE; LIQUID SOAPS FOR HANDS, FACE AND BODY; LOTIONS FOR BODY AND FACE; MOISTURIZING CREAMS; MOISTURIZING PREPARATIONS FOR THE SKIN; MOISTURIZING SOLUTIONS FOR THE SKIN; NATURAL COCOA BUTTER BASED PERSONAL CARE PRODUCTS, NAMELY, BODY LOTION, SHOWER GEL, SOAP, BODY POLISH, BODY AND FOOT SCRUB AND NON-MEDICATED SKIN CREAMS; NATURAL SOAP BARS; NATURALLY HANDMADE SOAP BARS; NON-MEDICATED BALMS FOR USE ON LIPS; NON-MEDICATED HERBAL BODY CARE PRODUCTS, NAMELY, BODY OILS, SALVES, AND LIP BALMS; NON-MEDICATED LIP BALM THAT DOES NOT CONTAIN BEESWAX; NON-MEDICATED SKIN CARE CREAMS AND LOTIONS; NON-MEDICATED SKIN CARE PREPARATIONS, NAMELY, CREAMS, LOTIONS, GELS, TONERS, CLEANERS AND PEELS; NON-MEDICATED SKIN CARE PREPARATIONS, NAMELY, LOTION; ORGANIC SOAP BARS; PERFUMED SOAP; PERFUMED SOAPS; SCENTED BODY LOTIONS AND CREAMS; SKIN AND BODY TOPICAL LOTIONS, CREAMS AND OILS FOR COSMETIC USE; SKIN LOTION; SKIN LOTIONS; SKIN MOISTURIZER; SKIN SOAP; SOAPS; SOAPS AND DETERGENTS; SOAPS FOR BODY CARE; SOAPS FOR PERSONAL USE, IN CLASS 3 (U.S. CLS. 1, 4, 6, 50, 51 AND 52).



David J. Kappas

Director of the United States Patent and Trademark Office

FIRST USE 3-0-2009; IN COMMERCE 4-19-2009.

THE MARK CONSISTS OF STANDARD CHARACTERS WITHOUT CLAIM TO ANY PARTICULAR FONT, STYLE, SIZE, OR COLOR.

Reg. No. 4,153,038 NO CLAIM IS MADE TO THE EXCLUSIVE RIGHT TO USE "SOAP", APART FROM THE MARK AS SHOWN.

SER. NO. 85-360,336, FILED 6-30-2011.

RUDY R. SINGLETON, EXAMINING ATTORNEY

United States of America

United States Patent and Trademark Office

BIOVIGIL

Reg. No. 4,153,039

Registered June 5, 2012

Int. Cl.: 9

TRADEMARK

PRINCIPAL REGISTER

BIOVIGIL HYGIENE TECHNOLOGIES, LLC (DELAWARE LIMITED LIABILITY COMPANY)
912 NORTH MAIN, STE. 111
ANN ARBOR, MI 48104

FOR: HAND HYGIENE MONITORING SYSTEM COMPRISED OF A BASE STATION, BADGES, AND SENSORS, ALL FOR SENSING, RECORDING, AND REPORTING A HEALTH-CARE WORKER'S USE OF AN ALCOHOL-BASED HAND SANITIZING SOLUTION, IN CLASS 9 (U.S. CLS. 21, 23, 26, 36 AND 38).

FIRST USE 6-30-2007; IN COMMERCE 6-30-2007.

THE MARK CONSISTS OF STANDARD CHARACTERS WITHOUT CLAIM TO ANY PARTICULAR FONT, STYLE, SIZE, OR COLOR.

SER. NO. 85-360,377, FILED 6-30-2011.

CHRISTOPHER LAW, EXAMINING ATTORNEY



David J. Kybas

Director of the United States Patent and Trademark Office

United States of America

United States Patent and Trademark Office

THE GLAM SHOPPE

Reg. No. 4,153,040

Registered June 5, 2012

Int. Cl.: 3

TRADEMARK

PRINCIPAL REGISTER

SERRA, DIANIC (UNITED STATES INDIVIDUAL), DBA DIVA LASH BOUTIQUE
P.O. BOX 270741
SAN DIEGO, CA 92116

FOR: BEAUTY PRODUCTS, NAMELY, ARTIFICIAL EYELASHES, ARTIFICIAL EYELASH EXTENSIONS, AND EYELASH COLOR MAKE-UP, IN CLASS 3 (U.S. CLS. 1, 4, 6, 50, 51 AND 52).

FIRST USE 12-1-2009; IN COMMERCE 12-1-2009.

THE MARK CONSISTS OF STANDARD CHARACTERS WITHOUT CLAIM TO ANY PARTICULAR FONT, STYLE, SIZE, OR COLOR.

NO CLAIM IS MADE TO THE EXCLUSIVE RIGHT TO USE "SHOPPE", APART FROM THE MARK AS SHOWN.

SER. NO. 85-360,471, FILED 6-30-2011.

SETH A. RAPPAPORT, EXAMINING ATTORNEY



David J. Kyffers

Director of the United States Patent and Trademark Office

United States of America

United States Patent and Trademark Office



imbrium

Reg. No. 4,153,041

Registered June 5, 2012

Int. Cls.: 11, 19 and 40

TRADEMARK

SERVICE MARK

PRINCIPAL REGISTER

IMBRIUM SYSTEMS CORPORATION (CANADA CORPORATION)
SUITE 2100
TWO ST. CLAIR AVENUE WEST
TORONTO, ONTARIO, CANADA M4V1L5

FOR: STORMWATER TREATMENT DEVICES FOR REMOVAL AND/OR STORAGE OF OIL, SEDIMENT, METALS, PATHOGENS, BACTERIA, NUTRIENTS, TRASH AND OTHER POLLUTANTS FROM STORMWATER, NAMELY, SEPARATOR UNITS, FILTERS AND MEMBRANES, IN CLASS 11 (U.S. CLS. 13, 21, 23, 31 AND 34).

FIRST USE 6-5-2007; IN COMMERCE 6-5-2007.

FOR: STORMWATER TREATMENT DEVICES FOR REMOVAL AND/OR STORAGE OF OIL, SEDIMENT, METALS, PATHOGENS, BACTERIA, NUTRIENTS, TRASH AND OTHER POLLUTANTS FROM STORMWATER, NAMELY, PERVIOUS CONCRETE AND NON-METAL CATCH BASIN INSERTS; STORMWATER MANAGEMENT DEVICES, NAMELY, NON-METAL CATCHMENT BASINS, AND NON-METAL DETENTION BASINS IN THE NATURE OF CISTERNS, IN CLASS 19 (U.S. CLS. 1, 12, 33 AND 50).

FIRST USE 6-5-2007; IN COMMERCE 6-5-2007.

FOR: DISSEMINATION OF INFORMATION RELATING TO STORM WATER MANAGEMENT AND TREATMENT, IN CLASS 40 (U.S. CLS. 100, 103 AND 106).

FIRST USE 6-5-2007; IN COMMERCE 6-5-2007.

OWNER OF U.S. REG. NO. 3,442,440.

THE MARK CONSISTS OF THE WORDS "IMBRIUM" BELOW WATER DROPS DESIGN.

SER. NO. 85-360,561, FILED 6-30-2011.

TINA L. SNAPP, EXAMINING ATTORNEY



David J. Kyffers

Director of the United States Patent and Trademark Office

United States of America

United States Patent and Trademark Office

IMBRIUM

Reg. No. 4,153,042

Registered June 5, 2012

Int. Cls.: 11, 19 and 40

TRADEMARK

SERVICE MARK

PRINCIPAL REGISTER

IMBRIUM SYSTEMS CORPORATION (CANADA CORPORATION)
SUITE 2100
TWO ST. CLAIR AVENUE WEST
TORONTO, ONTARIO, CANADA M4V1L5

FOR: STORMWATER TREATMENT DEVICES FOR REMOVAL AND/OR STORAGE OF OIL, SEDIMENT, METALS, PATHOGENS, BACTERIA, NUTRIENTS, TRASH AND OTHER POLLUTANTS FROM STORMWATER, NAMELY, SEPARATOR UNITS, FILTERS AND MEMBRANES, IN CLASS 11 (U.S. CLS. 13, 21, 23, 31 AND 34).

FIRST USE 6-5-2007; IN COMMERCE 6-5-2007.

FOR: STORMWATER TREATMENT DEVICES FOR REMOVAL AND/OR STORAGE OF OIL, SEDIMENT, METALS, PATHOGENS, BACTERIA, NUTRIENTS, TRASH AND OTHER POLLUTANTS FROM STORMWATER, NAMELY, PERVIOUS CONCRETE AND NON-METAL CATCH BASIN INSERTS; STORMWATER MANAGEMENT DEVICES, NAMELY, NON-METAL CATCHMENT BASINS, AND NON-METAL DETENTION BASINS IN THE NATURE OF CISTERNS, IN CLASS 19 (U.S. CLS. 1, 12, 33 AND 50).

FIRST USE 6-5-2007; IN COMMERCE 6-5-2007.

FOR: DISSEMINATION OF INFORMATION RELATING TO STORM WATER MANAGEMENT AND TREATMENT, IN CLASS 40 (U.S. CLS. 100, 103 AND 106).

FIRST USE 6-5-2007; IN COMMERCE 6-5-2007.

THE MARK CONSISTS OF STANDARD CHARACTERS WITHOUT CLAIM TO ANY PARTICULAR FONT, STYLE, SIZE, OR COLOR.

OWNER OF U.S. REG. NO. 3,442,440.

SER. NO. 85-360,571, FILED 6-30-2011.

TINA L. SNAPP, EXAMINING ATTORNEY



David J. Kyppas

Director of the United States Patent and Trademark Office

United States of America

United States Patent and Trademark Office

SIZE ZERO

Reg. No. 4,153,043

Registered June 5, 2012

Int. Cl.: 3

TRADEMARK

PRINCIPAL REGISTER

RODIAL LIMITED (UNITED KINGDOM LIMITED COMPANY (LTD.))
SUITE 3.25, THE PLAZA, 535 KINGS ROAD
LONDON, UNITED KINGDOM SW100SZ

FOR: PERFUMES; NON-MEDICATED BATH PREPARATIONS, NAMELY, BUBBLE BATHS, BATH OILS, GELS, CREAMS AND LOTIONS; COSMETIC PREPARATIONS; NON-MEDICATED TOILET PREPARATIONS, NAMELY, TOILET WATER AND SOAPS; NON-MEDICATED LOTIONS AND CREAMS FOR USE ON THE SKIN; NON-MEDICATED POWDERS FOR USE ON THE SKIN, NAMELY, BODY POWDERS, DUSTING POWDERS, BABY POWDERS AND FOOT POWDERS; NON-MEDICATED SCRUBBING PREPARATIONS FOR USE ON THE SKIN, NAMELY, BODY SCRUBS, FACIAL SCRUBS; FACE MOISTURIZERS AND TONERS; DEPILATORY PREPARATIONS; DEODORANTS FOR PERSONAL USE; TOILET ARTICLES, NAMELY, TOILET WATER AND SOAPS; LIP BALM; SKIN AND HAIR MASKS; PREPARATIONS FOR CARE OF THE HAIR; SHAMPOOS AND HAIR CONDITIONERS; SOAPS; ESSENTIAL OILS; MASSAGE PREPARATIONS, NAMELY, OILS AND CREAMS; PREPARATIONS FOR CARE OF THE NAILS; COSMETICS FOR SUN SCREENING; COTTON WOOL AND COTTON WOOL BUDS FOR COSMETICS AND TOILET USE, IN CLASS 3 (U.S. CLS. 1, 4, 6, 50, 51 AND 52).

THE MARK CONSISTS OF STANDARD CHARACTERS WITHOUT CLAIM TO ANY PARTICULAR FONT, STYLE, SIZE, OR COLOR.

OWNER OF UNITED KINGDOM REG. NO. 2582897, DATED 5-27-2011, EXPIRES 5-27-2021.

SER. NO. 85-360,898, FILED 6-30-2011.

JAMES LOVELACE, EXAMINING ATTORNEY



David J. Kyffers

Director of the United States Patent and Trademark Office

United States of America

United States Patent and Trademark Office

Diosmin Plus 900

Reg. No. 4,153,044

ARYMAR INC. (FLORIDA CORPORATION)
8004 NW 154 ST NO. 343
MIAMI LAKES, FL 33016

Registered June 5, 2012

Int. Cl.: 5

FOR: DIETARY AND NUTRITIONAL SUPPLEMENTS CONTAINING DIOSMIN; VITAMIN AND MINERAL SUPPLEMENTS CONTAINING DIOSMIN; VITAMIN B PREPARATIONS CONTAINING DIOSMIN; VITAMIN SUPPLEMENTS CONTAINING DIOSMIN; VITAMIN TABLETS CONTAINING DIOSMIN; VITAMINS CONTAINING DIOSMIN, IN CLASS 5 (U.S. CLS. 6, 18, 44, 46, 51 AND 52).

TRADEMARK

PRINCIPAL REGISTER

FIRST USE 4-21-2010; IN COMMERCE 4-21-2010.

THE MARK CONSISTS OF STANDARD CHARACTERS WITHOUT CLAIM TO ANY PARTICULAR FONT, STYLE, SIZE, OR COLOR.

NO CLAIM IS MADE TO THE EXCLUSIVE RIGHT TO USE "DIOSMIN" OR "900", APART FROM THE MARK AS SHOWN.

SER. NO. 85-361,204, FILED 6-30-2011.

KRISTIN CARLSON, EXAMINING ATTORNEY



David J. Kypos

Director of the United States Patent and Trademark Office

United States of America

United States Patent and Trademark Office

Sea Hunt Pearls

Reg. No. 4,153,045

Registered June 5, 2012

Int. Cl.: 14

TRADEMARK

PRINCIPAL REGISTER

LYNCH, JOHN G. (UNITED STATES INDIVIDUAL), DBA SEA HUNT PEARLS
SUITE 1501
703 MARKET ST.
SAN FRANCISCO, CA 94103

FOR: BEADS FOR USE IN THE MANUFACTURE OF JEWELRY, BODY JEWELRY, BRACELETS, BROACHES, BROOCHES, CHARMS, JEWELRY, JEWELRY CHAINS, JEWELRY FINDINGS, JEWELRY FOR ATTACHMENT TO CLOTHING, JEWELRY FOR THE HEAD, JEWELRY IN THE NATURE OF ARMBANDS, JEWELRY PINS FOR USE ON HATS, JEWELRY STICKPINS, JEWELRY TO BE AFFIXED TO BIKINIS, LAPEL PINS, ORNAMENTS OF PRECIOUS METAL IN THE NATURE OF JEWELRY AND RINGS, ALL OF THE FOREGOING CONTAINING OR COMPRISED OF PEARLS; PEARLS, IN CLASS 14 (U.S. CLS. 2, 27, 28 AND 50).

FIRST USE 6-30-1999; IN COMMERCE 6-30-1999.

THE MARK CONSISTS OF STANDARD CHARACTERS WITHOUT CLAIM TO ANY PARTICULAR FONT, STYLE, SIZE, OR COLOR.

NO CLAIM IS MADE TO THE EXCLUSIVE RIGHT TO USE "SEA" AND "PEARLS", APART FROM THE MARK AS SHOWN.

SER. NO. 85-361,464, FILED 7-1-2011.

LAURIE MAYES, EXAMINING ATTORNEY



David J. Kybas

Director of the United States Patent and Trademark Office

United States of America

United States Patent and Trademark Office

CARAFFA

Reg. No. 4,153,046

Registered June 5, 2012

Int. Cl.: 29

TRADEMARK

PRINCIPAL REGISTER

CARAFFA OLIVES, INC. (CANADA CORPORATION)
4130 BRIGHAM ROAD
LONDON, CANADA N6P1P3

FOR: CANNED PROCESSED OLIVES; PRESERVED, DRIED AND COOKED OLIVES; PROCESSED OLIVES; PROCESSED STUFFED OLIVES; TINNED OLIVES, IN CLASS 29 (U.S. CL. 46).

THE MARK CONSISTS OF STANDARD CHARACTERS WITHOUT CLAIM TO ANY PARTICULAR FONT, STYLE, SIZE, OR COLOR.

PRIORITY CLAIMED UNDER SEC. 44(D) ON CANADA APPLICATION NO. 1510205, FILED 1-6-2011, REG. NO. TMA813371, DATED 12-6-2011, EXPIRES 12-6-2026.

THE ENGLISH TRANSLATION OF "CARAFFA" IN THE MARK IS "CARAFE".

SER. NO. 85-362,042, FILED 7-1-2011.

MARK SPARACINO, EXAMINING ATTORNEY



David J. Kybas

Director of the United States Patent and Trademark Office

United States of America

United States Patent and Trademark Office



Reg. No. 4,153,047

Registered June 5, 2012

Int. Cls.: 9 and 42

TRADEMARK

SERVICE MARK

PRINCIPAL REGISTER

FUNDACION PARA LA INVESTIGACION BIOMEDICA DEL HOSPITAL UNIVERSITARIO
LA PAZ (SPAIN FOUNDATION)
PASEO DE LA CASTELLANA, 261
28046 MADRID, SPAIN

FOR: SCIENTIFIC APPARATUS AND INSTRUMENTS, NAMELY, MICROARRAY FOR GENETIC AND GENOMIC DATA; APPARATUS FOR RECORDING, TRANSMITTING, REPRODUCING SOUNDS OR IMAGES, NAMELY, SUPPORT FOR BIOLOGICAL INTENSITY IMAGES IN THE NATURE OF COMPUTER CHIPS WHICH CONTAIN BIOLOGICAL AND GENETIC INFORMATION ON PATIENTS, AND COMPUTERS WHICH PROCESS THE COMPUTER CHIPS IN ORDER TO PROVIDE INFORMATION REGARDING DISEASES AND PREVENTATIVE TREATMENT, IN CLASS 9 (U.S. CLS. 21, 23, 26, 36 AND 38).

FOR: SCIENTIFIC AND TECHNOLOGICAL SERVICES, NAMELY, RESEARCH AND DESIGN SERVICES RELATED TO THE DEVELOPMENT AND USE OF A MICROARRAY AND COMPUTER CHIP TOOL WHICH IS USED TO PROCESS AND PROVIDE INFORMATION ABOUT THE BIOLOGICAL AND GENETIC INFORMATION OF A PATIENT AS WELL AS DISEASES AND PREVENTATIVE TREATMENT, IN CLASS 42 (U.S. CLS. 100 AND 101).

OWNER OF SPAIN REG. NO. 2962910, DATED 5-12-2011, EXPIRES 1-5-2021.

THE COLOR(S) BLACK, BLUE AND WHITE IS/ARE CLAIMED AS A FEATURE OF THE MARK.

THE MARK CONSISTS OF THE WORDING "ONCOARRAY" IN BLACK LETTERS BELOW THE DESIGN ELEMENT. THE DESIGN ELEMENT CONSISTS OF THE LETTERS "OA" IN BLACK. THE COLOR BLUE APPEARS INSIDE THE LETTER "O" AND THE LETTER "A" IS DISPLAYED AT A HORIZONTAL ANGLE. THE BACKGROUND IS WHITE.

SER. NO. 85-363,107, FILED 7-5-2011.

WENDY GOODMAN, EXAMINING ATTORNEY



David J. Kyros

Director of the United States Patent and Trademark Office

United States of America

United States Patent and Trademark Office

THE METLIFE GOOD FOR YOU RATE

Reg. No. 4,153,048

METROPOLITAN LIFE INSURANCE COMPANY (NEW YORK CORPORATION)
1095 AVENUE OF THE AMERICAS
NEW YORK, NY 10036

Registered June 5, 2012

Int. Cl.: 36

FOR: INSURANCE SERVICES, PROVIDING PREMIUM RATE QUOTES VIA ON-LINE,
TELEPHONE AND MAIL MEANS, IN CLASS 36 (U.S. CLS. 100, 101 AND 102).

SERVICE MARK

FIRST USE 10-25-2010; IN COMMERCE 10-25-2010.

PRINCIPAL REGISTER

THE MARK CONSISTS OF STANDARD CHARACTERS WITHOUT CLAIM TO ANY PAR-
TICULAR FONT, STYLE, SIZE, OR COLOR.

OWNER OF U.S. REG. NOS. 1,415,273, 2,789,817 AND OTHERS.

NO CLAIM IS MADE TO THE EXCLUSIVE RIGHT TO USE "RATE", APART FROM THE
MARK AS SHOWN.

SER. NO. 85-363,210, FILED 7-5-2011.

KATHLEEN LORENZO, EXAMINING ATTORNEY



David J. Kybas

Director of the United States Patent and Trademark Office

United States of America

United States Patent and Trademark Office

VAPP

Reg. No. 4,153,049

Registered June 5, 2012

Int. Cl.: 9

TRADEMARK

PRINCIPAL REGISTER

CONDUITV, LLC (WASHINGTON LIMITED LIABILITY COMPANY)
23632 HIGHWAY 99
SUITE F#354
EDMONDS, WA 98026

FOR: COMPUTER SOFTWARE APPLICATION FOR MOBILE PHONE AND COMPUTERS FOR USE IN CONNECTING MILITARY, FIRST RESPONDERS, VETERANS AND THEIR FAMILIES TO COMMAND, RESOURCES AND SERVICES, IN CLASS 9 (U.S. CLS. 21, 23, 26, 36 AND 38).

FIRST USE 5-9-2011; IN COMMERCE 6-1-2011.

THE MARK CONSISTS OF STANDARD CHARACTERS WITHOUT CLAIM TO ANY PARTICULAR FONT, STYLE, SIZE, OR COLOR.

SER. NO. 85-363,773, FILED 7-6-2011.

FRANK LATTUCA, EXAMINING ATTORNEY



David J. Kyffers

Director of the United States Patent and Trademark Office

United States of America

United States Patent and Trademark Office



fivebrothers

Reg. No. 4,153,050

Registered June 5, 2012

Int. Cls.: 36, 37 and 42

SERVICE MARK

PRINCIPAL REGISTER

FIVE BROTHERS MORTGAGE COMPANY SERVICES AND SECURING, INC. (MICHIGAN CORPORATION)
14156 EAST 11 MILE ROAD
WARREN, MI 48089

FOR: FINANCIAL SERVICES, NAMELY, LOSS MITIGATION SERVICES FOR UNDER OR NON-PERFORMING MORTGAGE LOANS IN THE FIELD OF DEFAULT AND DISTRESSED PROPERTIES, IN CLASS 36 (U.S. CLS. 100, 101 AND 102).

FIRST USE 1-0-2010; IN COMMERCE 1-0-2010.

FOR: REAL ESTATE PROPERTY CLEANING, REPAIR AND MAINTENANCE SERVICES FOR DEFAULT AND DISTRESSED PROPERTIES, IN CLASS 37 (U.S. CLS. 100, 103 AND 106).

FIRST USE 1-0-2010; IN COMMERCE 1-0-2010.

FOR: HOUSE INSPECTION OF DEFAULT AND DISTRESSED PROPERTIES; DATA AUTOMATION AND COLLECTION SERVICES USING PROPRIETARY SOFTWARE TO EVALUATE, ANALYZE AND COLLECT SERVICE DATA USED IN THE MANAGEMENT OF DEFAULT AND DISTRESSED PROPERTIES, IN CLASS 42 (U.S. CLS. 100 AND 101).

FIRST USE 1-0-2010; IN COMMERCE 1-0-2010.

THE MARK CONSISTS OF THE WORDING "FIVEBROTHERS" COMBINED WITH A DESIGN SUGGESTIVE OF A SKYLINE COMPOSED OF RECTANGULAR AND GABLE-ROOFED BUILDINGS.

SER. NO. 85-363,911, FILED 7-6-2011.

KIM MONINGHOFF, EXAMINING ATTORNEY



David J. Kybas

Director of the United States Patent and Trademark Office

United States of America

United States Patent and Trademark Office

NIPSCO



Reg. No. 4,153,051

Registered June 5, 2012

**Int. Cls.: 35, 36, 37, 39
and 42**

SERVICE MARK

PRINCIPAL REGISTER

NISOURCE CORPORATE SERVICES COMPANY (DELAWARE CORPORATION)
801 E. 86TH AVENUE
MERRILLVILLE, IN 46410

FOR: ENERGY MANAGEMENT SERVICES, NAMELY, PROVIDING A SERVICE THAT ALLOWS CUSTOMERS TO PURCHASE ENERGY, NAMELY, ELECTRICITY, NATURAL GAS AND RENEWABLE ENERGY AT A FIXED PRICE, IN CLASS 35 (U.S. CLS. 100, 101 AND 102).

FIRST USE 2-15-2010; IN COMMERCE 2-15-2010.

FOR: PROVIDING SERVICE CONTRACTS FOR THE REPAIR, INSTALLATION AND MAINTENANCE OF UTILITY LINES, HEATING, CENTRAL HEATING AND WATER HEATING EQUIPMENT, INSIDE GAS, ELECTRIC, WATER AND DRAIN LINES, KITCHEN AND LAUNDRY APPLIANCES, IN CLASS 36 (U.S. CLS. 100, 101 AND 102).

FIRST USE 2-15-2010; IN COMMERCE 2-15-2010.

FOR: REPAIR, INSTALLATION AND MAINTENANCE SERVICES, NAMELY, REPAIR, INSTALLATION AND MAINTENANCE OF UTILITY LINES, HEATING, CENTRAL HEATING AND WATER HEATING EQUIPMENT, INSIDE GAS, ELECTRIC, WATER AND DRAIN LINES, KITCHEN AND LAUNDRY APPLIANCES; TREE AND POWER LINE MAINTENANCE AND REPAIR, IN CLASS 37 (U.S. CLS. 100, 103 AND 106).

FIRST USE 2-15-2010; IN COMMERCE 2-15-2010.

FOR: PUBLIC UTILITY SERVICES IN THE NATURE OF ELECTRICITY AND NATURAL GAS DISTRIBUTION, IN CLASS 39 (U.S. CLS. 100 AND 105).

FIRST USE 2-15-2010; IN COMMERCE 2-15-2010.

FOR: ELECTRICITY AND NATURAL GAS SERVICES, NAMELY, METER READING, IN CLASS 42 (U.S. CLS. 100 AND 101).

FIRST USE 2-15-2010; IN COMMERCE 2-15-2010.

THE MARK CONSISTS OF THE WORD "NIPSCO" TO THE LEFT OF A STARBURST.



David J. Kybas

Director of the United States Patent and Trademark Office

Reg. No. 4,153,051 SER. NO. 85-364,095, FILED 7-6-2011.

JESSICA FATHY, EXAMINING ATTORNEY

United States of America

United States Patent and Trademark Office

IVIDENCE

Reg. No. 4,153,052

Registered June 5, 2012

Int. Cls.: 9, 35 and 42

TRADEMARK

SERVICE MARK

PRINCIPAL REGISTER

IVIDENCE (FRANCE CORPORATION)
5 RUE DAUNOU
PARIS, FRANCE F-75002

FOR: SOFTWARE PROGRAMS FOR USE IN CONJUNCTION WITH EMAILING CAMPAIGNS, NAMELY, SOFTWARE FOR DATABASE MANAGEMENT, DATA MINING, ADVERTISING CAMPAIGNS ANALYSIS AND PREDICTIVE TARGETING, EMAIL RETARGETING, PERSONALIZING THE CONTENT OF E-MAIL COMMUNICATIONS, IN CLASS 9 (U.S. CLS. 21, 23, 26, 36 AND 38).

FOR: ADVERTISING AND BUSINESS SERVICES, NAMELY, BUSINESS CONSULTATION AND BUSINESS MANAGEMENT IN CONJUNCTION WITH EMAILING CAMPAIGNS; CUSTOMER EVALUATION, NAMELY, BRAND EVALUATION SERVICES, ADVERTISING CAMPAIGN STATISTICAL EVALUATIONS AND PROJECTIONS; MARKET ANALYSIS; BUSINESS CONSULTING SERVICES FOR ONLINE MERCHANTS; DATA MANAGEMENT, NAMELY, DATA COMPILING AND ANALYZING RELATING TO BUSINESS MANAGEMENT AND ADVERTISING CAMPAIGNS EFFICIENCY; MARKETING CONSULTANCY, IN PARTICULAR MARKETING VIA THE INTERNET; MARKETING STUDIES; INFORMATION, CONSULTANCY AND ADVICE RELATING TO ALL THE AFORESAID, IN CLASS 35 (U.S. CLS. 100, 101 AND 102).

FOR: INFORMATION TECHNOLOGY CONSULTANCY SERVICES; DESIGN, SPECIFICATION, INSTALLATION, IMPLEMENTATION, AND MAINTENANCE OF INFORMATION SYSTEMS, NAMELY, INFORMATION TECHNOLOGY SYSTEMS FOR HOSTING AND RUNNING ADVERTISEMENT CAMPAIGNS, IN CLASS 42 (U.S. CLS. 100 AND 101).

THE MARK CONSISTS OF STANDARD CHARACTERS WITHOUT CLAIM TO ANY PARTICULAR FONT, STYLE, SIZE, OR COLOR.

PRIORITY CLAIMED UNDER SEC. 44(D) ON ERPN CMNTY TM OFC APPLICATION NO. 009833815, FILED 3-10-2011, REG. NO. 009833815, DATED 7-29-2011, EXPIRES 3-10-2021.

SER. NO. 85-366,154, FILED 7-8-2011.

APRIL HESIK, EXAMINING ATTORNEY



David J. Kyffers

Director of the United States Patent and Trademark Office

United States of America

United States Patent and Trademark Office

LEONA VALLEY WINERY

Reg. No. 4,153,053

Registered June 5, 2012

Int. Cl.: 33

TRADEMARK

PRINCIPAL REGISTER

DAVID REYNOLDS (UNITED STATES INDIVIDUAL), DBA LEONA VALLEY WINERY
1200 ORANGE STREET
ROSAMOND, CA 93560

FOR: WINE, IN CLASS 33 (U.S. CLS. 47 AND 49).

FIRST USE 10-0-2005; IN COMMERCE 10-0-2005.

THE MARK CONSISTS OF STANDARD CHARACTERS WITHOUT CLAIM TO ANY PARTICULAR FONT, STYLE, SIZE, OR COLOR.

NO CLAIM IS MADE TO THE EXCLUSIVE RIGHT TO USE "WINERY", APART FROM THE MARK AS SHOWN.

SEC. 2(F).

SER. NO. 85-366,491, FILED 7-8-2011.

MARILYN IZZI, EXAMINING ATTORNEY



David J. Kybas

Director of the United States Patent and Trademark Office

United States of America

United States Patent and Trademark Office

Healthy Workplace

Reg. No. 4,153,054

Registered June 5, 2012

Int. Cl.: 36

SERVICE MARK

PRINCIPAL REGISTER

BLUE CROSS & BLUE SHIELD OF MISSISSIPPI, A MUTUAL INSURANCE COMPANY
(MISSISSIPPI CORPORATION)
3545 LAKELAND DRIVE
JACKSON, MS 392151043

FOR: INSURANCE SERVICES, NAMELY, UNDERWRITING, ISSUANCE AND ADMINISTRATION OF HEALTHCARE PLANS, IN CLASS 36 (U.S. CLS. 100, 101 AND 102).

FIRST USE 11-16-2010; IN COMMERCE 11-16-2010.

NO CLAIM IS MADE TO THE EXCLUSIVE RIGHT TO USE "HEALTHY WORKPLACE", APART FROM THE MARK AS SHOWN.

THE COLOR(S) BLUE IS/ARE CLAIMED AS A FEATURE OF THE MARK.

THE MARK CONSISTS OF THE WORDS "HEALTHY WORKPLACE" IN BLUE WITH THE "O" IN "WORKPLACE" REPLACED BY A HEART SHAPED FRUIT WITH A LEAF AND A STEM. THE COLOR WHITE IS NOT CLAIMED AS FEATURE OF THE MARK. WHITE REPRESENTS BACKGROUND, OUTLINING, SHADING AND OR TRANSPARENT AREAS AND IS NOT PART OF THE MARK.

SER. NO. 85-367,283, FILED 7-9-2011.

DOMINICK J. SALEMI, EXAMINING ATTORNEY



David J. Kyros

Director of the United States Patent and Trademark Office

United States of America

United States Patent and Trademark Office

SEE NO EVIL

Reg. No. 4,153,055

ALEX AND ANI, INC. (RHODE ISLAND CORPORATION)
115 PETTACONSETT AVE.
CRANSTON, RI 02920

Registered June 5, 2012

Int. Cl.: 9

FOR: SUNGLASSES AND CASES THEREFOR, IN CLASS 9 (U.S. CLS. 21, 23, 26, 36 AND 38).

TRADEMARK

FIRST USE 1-0-2011; IN COMMERCE 1-0-2011.

PRINCIPAL REGISTER

THE MARK CONSISTS OF STANDARD CHARACTERS WITHOUT CLAIM TO ANY PARTICULAR FONT, STYLE, SIZE, OR COLOR.

OWNER OF U.S. REG. NO. 2,985,469.

SER. NO. 85-367,383, FILED 7-10-2011.

DANIEL CAPSHAW, EXAMINING ATTORNEY



David J. Kyros

Director of the United States Patent and Trademark Office

United States of America

United States Patent and Trademark Office

BANGLE BAR

Reg. No. 4,153,056

Registered June 5, 2012

Int. Cl.: 14

TRADEMARK

PRINCIPAL REGISTER

ALEX AND ANI, INC. (RHODE ISLAND CORPORATION)
115 PETTACONSETT AVE.
CRANSTON, RI 02920

FOR: JEWELRY, IN CLASS 14 (U.S. CLS. 2, 27, 28 AND 50).

FIRST USE 4-0-2009; IN COMMERCE 4-0-2009.

THE MARK CONSISTS OF STANDARD CHARACTERS WITHOUT CLAIM TO ANY PARTICULAR FONT, STYLE, SIZE, OR COLOR.

NO CLAIM IS MADE TO THE EXCLUSIVE RIGHT TO USE "BANGLE", APART FROM THE MARK AS SHOWN.

SER. NO. 85-367,506, FILED 7-10-2011.

DANIEL CAPSHAW, EXAMINING ATTORNEY



David J. Kyffers

Director of the United States Patent and Trademark Office

United States of America

United States Patent and Trademark Office



Reg. No. 4,153,057

Registered June 5, 2012

Int. Cls.: 9 and 35

TRADEMARK

SERVICE MARK

PRINCIPAL REGISTER

ALEX AND ANI, INC. (RHODE ISLAND CORPORATION)
115 PETTACONSETT AVE.
CRANSTON, RI 02920

FOR: SUNGLASSES AND CASES THEREFOR, IN CLASS 9 (U.S. CLS. 21, 23, 26, 36 AND 38).

FIRST USE 1-0-2011; IN COMMERCE 1-0-2001.

FOR: RETAIL STORE SERVICES FEATURING JEWELRY AND FASHION ACCESSORIES, IN CLASS 35 (U.S. CLS. 100, 101 AND 102).

FIRST USE 6-9-2009; IN COMMERCE 6-9-2009.

OWNER OF U.S. REG. NO. 3,084,865.

THE MARK CONSISTS OF A STYLIZED FLOWER DESIGN.

SER. NO. 85-367,518, FILED 7-10-2011.

DANIEL CAPSHAW, EXAMINING ATTORNEY



David J. Kyffers

Director of the United States Patent and Trademark Office

United States of America

United States Patent and Trademark Office

ALEX AND ANI

Reg. No. 4,153,058

ALEX AND ANI, INC. (RHODE ISLAND CORPORATION)
115 PETTACONSETT AVE.
CRANSTON, RI 02920

Registered June 5, 2012

Int. Cls.: 9, 14 and 35

FOR: SUNGLASSES AND CASES THEREFOR, IN CLASS 9 (U.S. CLS. 21, 23, 26, 36 AND 38).

TRADEMARK

FIRST USE 1-0-2011; IN COMMERCE 1-0-2011.

SERVICE MARK

FOR: JEWELRY, IN CLASS 14 (U.S. CLS. 2, 27, 28 AND 50).

PRINCIPAL REGISTER

FIRST USE 4-9-1999; IN COMMERCE 4-9-1999.

FOR: RETAIL STORE SERVICES AND ON-LINE RETAIL STORE SERVICES FEATURING JEWELRY AND FASHION ACCESSORIES, IN CLASS 35 (U.S. CLS. 100, 101 AND 102).

FIRST USE 6-9-2009; IN COMMERCE 6-9-2009.

THE MARK CONSISTS OF STANDARD CHARACTERS WITHOUT CLAIM TO ANY PARTICULAR FONT, STYLE, SIZE, OR COLOR.

OWNER OF U.S. REG. NOS. 2,549,848, 3,108,924, AND 3,276,534.

SER. NO. 85-367,523, FILED 7-10-2011.

DANIEL CAPSHAW, EXAMINING ATTORNEY



David J. Kyros

Director of the United States Patent and Trademark Office

United States of America

United States Patent and Trademark Office

DOC POPCORN

Reg. No. 4,153,059

Registered June 5, 2012

Int. Cls.: 35 and 43

SERVICE MARK

PRINCIPAL REGISTER

DOC POPCORN FRANCHISING, INC. (COLORADO CORPORATION)
5445 DTC PARKWAY
SUITE 1050
GREENWOOD VILLAGE, CO 80111

FOR: FOOD AND DRINK KIOSK SERVICES, IN CLASS 35 (U.S. CLS. 100, 101 AND 102).

FIRST USE 12-10-2003; IN COMMERCE 12-10-2003.

FOR: PROVIDING FOOD AND DRINK; RESTAURANT SERVICES; RESTAURANT SERVICES, NAMELY, RESTAURANTS AND SNACK BARS FEATURING FOOD AND DRINK, IN CLASS 43 (U.S. CLS. 100 AND 101).

FIRST USE 12-10-2003; IN COMMERCE 12-10-2003.

THE MARK CONSISTS OF STANDARD CHARACTERS WITHOUT CLAIM TO ANY PARTICULAR FONT, STYLE, SIZE, OR COLOR.

NO CLAIM IS MADE TO THE EXCLUSIVE RIGHT TO USE "POPCORN", APART FROM THE MARK AS SHOWN.

SER. NO. 85-367,799, FILED 7-11-2011.

AMY KERTGATE, EXAMINING ATTORNEY



David J. Kyros

Director of the United States Patent and Trademark Office

United States of America

United States Patent and Trademark Office

TANGO BUENOS AIRES

Reg. No. 4,153,060

Registered June 5, 2012

Int. Cl.: 41

SERVICE MARK

PRINCIPAL REGISTER

BAUZA, MARIA DEL ROSARIO (ARGENTINA INDIVIDUAL)
C/O 16255 VENTURA BLVD.
SUITE 600
ENCINO, CA 91436

FOR: ENTERTAINMENT SERVICES, NAMELY, DANCE PERFORMANCES, IN CLASS 41
(U.S. CLS. 100, 101 AND 107).

FIRST USE 12-31-1989; IN COMMERCE 12-31-1998.

THE MARK CONSISTS OF STANDARD CHARACTERS WITHOUT CLAIM TO ANY PARTICULAR FONT, STYLE, SIZE, OR COLOR.

NO CLAIM IS MADE TO THE EXCLUSIVE RIGHT TO USE "TANGO", APART FROM THE MARK AS SHOWN.

SEC. 2(F).

SER. NO. 85-369,067, FILED 7-12-2011.

JEFFREY LOOK, EXAMINING ATTORNEY



David J. Kyros

Director of the United States Patent and Trademark Office

United States of America

United States Patent and Trademark Office



Reg. No. 4,153,061

Registered June 5, 2012

Int. Cl.: 42

SERVICE MARK

PRINCIPAL REGISTER

R&D CLOUD, INC. (DELAWARE CORPORATION)
333 WASHINGTON BLVD.
SUITE 376
MARINA DEL REY, CA 90291

FOR: PROVIDING A WEBSITE THAT ALLOWS USERS TO REVIEW, MANAGE, DOWNLOAD AND ORGANIZE PUBLICATIONS IN THE SCIENTIFIC, MEDICAL AND ENGINEERING FIELDS AND COLLABORATE AND DISCUSS SUCH PUBLICATIONS WITH OTHER USERS; PROVIDING A WEBSITE FEATURING TEMPORARY USE OF NON-DOWNLOADABLE SOFTWARE FOR DIGITAL CONTENT AND DATABASE MANAGEMENT FOR USE IN THE SCIENTIFIC, MEDICAL AND ENGINEERING FIELDS, IN CLASS 42 (U.S. CLS. 100 AND 101).

FIRST USE 11-1-2010; IN COMMERCE 11-1-2010.

NO CLAIM IS MADE TO THE EXCLUSIVE RIGHT TO USE "R&D CLOUD", APART FROM THE MARK AS SHOWN.

THE MARK CONSISTS OF THE LETTERS "R&D" IN A RECTANGULAR BOX NEXT TO THE WORD "CLOUD" INSIDE A GRAPHICAL REPRESENTATION OF A CLOUD.

SER. NO. 85-369,068, FILED 7-12-2011.

MARK T. MULLEN, EXAMINING ATTORNEY



David J. Kyffers

Director of the United States Patent and Trademark Office

United States of America

United States Patent and Trademark Office



Reg. No. 4,153,062

Registered June 5, 2012

Int. Cl.: 42

SERVICE MARK

PRINCIPAL REGISTER

R&D CLOUD, INC. (DELAWARE CORPORATION)
333 WASHINGTON BLVD.
SUITE 376
MARINA DEL REY, CA 90291

FOR: PROVIDING A WEBSITE THAT ALLOWS USERS TO REVIEW, MANAGE, DOWNLOAD AND ORGANIZE PUBLICATIONS IN THE SCIENTIFIC, MEDICAL AND ENGINEERING FIELDS AND COLLABORATE AND DISCUSS SUCH PUBLICATIONS WITH OTHER USERS; PROVIDING A WEBSITE FEATURING TEMPORARY USE OF NON-DOWNLOADABLE SOFTWARE FOR DIGITAL CONTENT AND DATABASE MANAGEMENT FOR USE IN THE SCIENTIFIC, MEDICAL AND ENGINEERING FIELDS, IN CLASS 42 (U.S. CLS. 100 AND 101).

FIRST USE 11-1-2010; IN COMMERCE 11-1-2010.

THE MARK CONSISTS OF THE LETTERS "RD" OUTSIDE OF A CLOUD, CONTAINING THE LETTER "C".

SER. NO. 85-369,073, FILED 7-12-2011.

MARK T. MULLEN, EXAMINING ATTORNEY



David J. Kyffers

Director of the United States Patent and Trademark Office

United States of America

United States Patent and Trademark Office

Hyper+Ion

Reg. No. 4,153,063

Registered June 5, 2012

Int. Cl.: 1

TRADEMARK

PRINCIPAL REGISTER

GENERAL CHEMICAL PERFORMANCE PRODUCTS LLC (NEW JERSEY CORPORATION)
LEGAL DEPARTMENT
90 EAST HALSEY ROAD
PARSIPPANY, NJ 07054

FOR: CHEMICAL COAGULANT AND FLOCCULANT FOR WATER TREATMENT IN A
WIDE VARIETY OF INDUSTRIES, IN CLASS 1 (U.S. CLS. 1, 5, 6, 10, 26 AND 46).

FIRST USE 3-4-1986; IN COMMERCE 6-6-1986.

THE MARK CONSISTS OF STANDARD CHARACTERS WITHOUT CLAIM TO ANY PAR-
TICULAR FONT, STYLE, SIZE, OR COLOR.

SER. NO. 85-369,152, FILED 7-12-2011.

DEZMONA MIZELLE, EXAMINING ATTORNEY



David J. Kyros

Director of the United States Patent and Trademark Office

United States of America

United States Patent and Trademark Office

NIVAL

Reg. No. 4,153,064

Registered June 5, 2012

**Int. Cls.: 35, 38, 41, 42
and 45**

SERVICE MARK

PRINCIPAL REGISTER

ZZIMA INTERNATIONAL, SARL (LUXEMBOURG SOCIÉTÉ À RESPONSABILITÉ LIMITÉE (SARL))
75, PARC D'ACTIVITÉS
MAMER / CAPELLEN, LUXEMBOURG L-8308

FOR: ADVERTISING AND MARKETING SERVICES, NAMELY, PROMOTING THE GOODS AND SERVICES OF OTHERS; ONLINE RETAIL STORE SERVICES FEATURING VIRTUAL GOODS, NAMELY, EQUIPMENT, WEAPONS, POWERS, AND OTHER CONSUMER GOODS FOR USE IN ONLINE VIRTUAL WORLDS, IN CLASS 35 (U.S. CLS. 100, 101 AND 102).

FIRST USE 2-29-2000; IN COMMERCE 6-2-2009.

FOR: TRANSMISSION OF INFORMATION BY ELECTRONIC COMMUNICATION NETWORKS; ELECTRONIC TRANSMISSION OF MESSAGES AND IMAGES VIA COMPUTER NETWORKS; PROVIDING ONLINE COMMUNICATION SERVICES IN THE NATURE OF ONLINE CHAT ROOMS AND FORUMS FOR REGISTERED USERS FOR TRANSMISSION OF MESSAGES CONCERNING VIRTUAL COMMUNITY AND SOCIAL NETWORKING; TELECOMMUNICATIONS SERVICES, NAMELY, ELECTRONIC TRANSMISSION OF DATA, MESSAGES AND INFORMATION, IN CLASS 38 (U.S. CLS. 100, 101 AND 104).

FIRST USE 2-29-2000; IN COMMERCE 6-2-2009.

FOR: INTERACTIVE GAME SERVICES PROVIDED ONLINE OVER A COMPUTER NETWORK OR THE INTERNET, NAMELY, PROVIDING A COMPUTER GAME THAT MAY BE ACCESSED NETWORK-WIDE BY USERS; INTERACTIVE GAMES, INTERACTIVE ENTERTAINMENT AND COMPETITION SERVICES, ALL IN THE NATURE OF ONLINE COMPUTER GAMES PROVIDED OVER A COMPUTER NETWORK OR THE INTERNET; PROVIDING ONLINE COMPUTER GAMES SERVICES ON COMPUTER NETWORKS; PROVIDING ONLINE COMPUTER GAMES, ONLINE VIDEO COMPUTER GAMES, ONLINE BROWSER COMPUTER GAMES AND ONLINE COMPUTER GAMES WHICH CAN BE PLAYED THROUGH BROWSERS ON MOBILE DEVICES; ENTERTAINMENT SERVICES, NAMELY, PROVIDING VIRTUAL ENVIRONMENTS IN WHICH USERS CAN INTERACT THROUGH SOCIAL GAMES FOR RECREATIONAL, LEISURE OR ENTERTAINMENT PURPOSES, IN CLASS 41 (U.S. CLS. 100, 101 AND 107).

FIRST USE 2-29-2000; IN COMMERCE 6-2-2009.



David J. Kyjars

Director of the United States Patent and Trademark Office

Reg. No. 4,153,064 FOR: COMPUTER SERVICES, NAMELY, CREATING AN ONLINE COMMUNITY FOR REGISTERED USERS TO PARTICIPATE IN GAME COMPETITION, SHOWCASE THEIR SKILLS, UPLOAD PHOTOS, STATUS, PROFILE AND MESSAGES, GET FEEDBACK FROM THEIR PEERS, FORM VIRTUAL COMMUNITIES, AND ENGAGE IN SOCIAL NETWORKING, IN CLASS 42 (U.S. CLS. 100 AND 101).

FIRST USE 2-29-2000; IN COMMERCE 6-2-2009.

FOR: ONLINE SOCIAL NETWORKING SERVICES; PROVIDING ONLINE COMPUTER DATABASES AND ONLINE SEARCHABLE DATABASES IN THE FIELD OF SOCIAL NETWORKING, IN CLASS 45 (U.S. CLS. 100 AND 101).

FIRST USE 2-29-2000; IN COMMERCE 6-2-2009.

THE MARK CONSISTS OF STANDARD CHARACTERS WITHOUT CLAIM TO ANY PARTICULAR FONT, STYLE, SIZE, OR COLOR.

SER. NO. 85-369,691, FILED 7-12-2011.

WILLIAM BRECKENFELD, EXAMINING ATTORNEY

United States of America

United States Patent and Trademark Office

GMELIN

Reg. No. 4,153,065

Registered June 5, 2012

Int. Cl.: 42

SERVICE MARK

PRINCIPAL REGISTER

ELSEVIER PROPERTIES SA (SWITZERLAND SOCIÉTÉ ANONYME (SA))
ESPACE DE L'EUROPE 3
2000 NEUCHÂTEL, SWITZERLAND

FOR: COMPUTER SERVICES, NAMELY, PROVIDING INFORMATION FROM A COMPUTER DATABASE VIA A GLOBAL COMPUTER NETWORK IN THE FIELD OF INORGANIC AND ORGANOMETALLIC CHEMISTRY, IN CLASS 42 (U.S. CLS. 100 AND 101).

FIRST USE 12-31-1991; IN COMMERCE 12-31-1991.

THE MARK CONSISTS OF STANDARD CHARACTERS WITHOUT CLAIM TO ANY PARTICULAR FONT, STYLE, SIZE, OR COLOR.

THE WORDING "GMELIN" HAS NO MEANING IN A FOREIGN LANGUAGE.

SEC. 2(F).

SER. NO. 85-369,908, FILED 7-13-2011.

WARREN L. OLANDRIA, EXAMINING ATTORNEY



David J. Kybas

Director of the United States Patent and Trademark Office

United States of America

United States Patent and Trademark Office

Medatrax

Reg. No. 4,153,066

Registered June 5, 2012

Int. Cl.: 42

SERVICE MARK

PRINCIPAL REGISTER

FOUR-D SOFTWARE, INC (TENNESSEE CORPORATION)
#1
131 N. FIRST STREET
PULASKI, TN 38478

FOR: SOFTWARE AS A SERVICE (SAAS) SERVICES, NAMELY, HOSTING SOFTWARE FOR USE BY OTHERS FOR USE BY MEDICAL EDUCATION INSTITUTIONS, GRADUATE AND UNDERGRADUATE NURSING, AND SIMILAR MEDICAL PROGRAMS FOR PROVIDING MEDICAL CLINICAL TRACKING AND EDUCATORS OVERSIGHT AND CONTROL, IN CLASS 42 (U.S. CLS. 100 AND 101).

FIRST USE 3-27-1998; IN COMMERCE 3-27-1998.

THE MARK CONSISTS OF STANDARD CHARACTERS WITHOUT CLAIM TO ANY PARTICULAR FONT, STYLE, SIZE, OR COLOR.

SER. NO. 85-370,421, FILED 7-13-2011.

CARRIE GENOVESE, EXAMINING ATTORNEY



David J. Kyffers

Director of the United States Patent and Trademark Office

United States of America

United States Patent and Trademark Office

VELYKA RODYNA

Reg. No. 4,153,067

GLOBAL EYE CLINIC, INC. (ILLINOIS CORPORATION)
887 E. WILMETTE ROAD
PALATINE, IL 60074

Registered June 5, 2012

Int. Cl.: 45

FOR: PROVIDING PATIENT ADVOCATE AND CASE MANAGEMENT SERVICES, NAMELY, COORDINATING THE PROCUREMENT AND ADMINISTRATION OF MEDICAL SERVICES FOR OTHERS AND PLANNING, ORGANIZING, ARRANGING, AND ASSISTING INDIVIDUALS IN OBTAINING MEDICAL CARE, IN CLASS 45 (U.S. CLS. 100 AND 101).

SERVICE MARK

PRINCIPAL REGISTER

FIRST USE 10-1-2010; IN COMMERCE 10-1-2010.

THE MARK CONSISTS OF STANDARD CHARACTERS WITHOUT CLAIM TO ANY PARTICULAR FONT, STYLE, SIZE, OR COLOR.

THE ENGLISH TRANSLATION OF "VELYKA RODYNA" IN THE MARK IS "BIG FAMILY".

SER. NO. 85-371,429, FILED 7-14-2011.

TRICIA SONNEBORN, EXAMINING ATTORNEY



David J. Kybas

Director of the United States Patent and Trademark Office

United States of America

United States Patent and Trademark Office



Reg. No. 4,153,068

Registered June 5, 2012

Int. Cls.: 35 and 36

SERVICE MARK

PRINCIPAL REGISTER

AMERICANS FOR PROSPERITY FOUNDATION (DELAWARE NON-PROFIT CORPORATION)
2111 WILSON BOULEVARD
SUITE 350
ARLINGTON, VA 22201

FOR: ASSOCIATION SERVICES, NAMELY, PROMOTING THE INTERESTS OF U.S. CITIZENS AS THEY RELATE TO ENERGY ISSUES, PROMOTING PUBLIC AWARENESS OF POLICY ISSUES REGARDING ENERGY USAGE AND ENERGY MANAGEMENT, AND PROMOTING THE NEED FOR MORE EFFICIENT GOVERNMENT, IN CLASS 35 (U.S. CLS. 100, 101 AND 102).

FIRST USE 6-1-2011; IN COMMERCE 6-1-2011.

FOR: CHARITABLE FUNDRAISING SERVICES, NAMELY, RAISING FUNDS TO PROMOTE THE INTERESTS OF U.S. CITIZENS AS THEY RELATE TO ENERGY ISSUES, PROMOTE PUBLIC AWARENESS OF ENERGY ISSUES, AND PROMOTE THE NEED FOR MORE EFFICIENT GOVERNMENT, IN CLASS 36 (U.S. CLS. 100, 101 AND 102).

FIRST USE 6-1-2011; IN COMMERCE 6-1-2011.

THE MARK CONSISTS OF THE WORDS "RUNNING ON EMPTY" WITH A PICTURE OF A GAS PUMP NEXT TO THE WORDS AND A DOLLAR SIGN APPEARING ON THE FRONT OF THE GAS PUMP, ALL OF WHICH IS SURROUNDED BY A RECTANGULAR CARRIER.

SER. NO. 85-371,661, FILED 7-14-2011.

SUSAN STIGLITZ, EXAMINING ATTORNEY



David J. Kybas

Director of the United States Patent and Trademark Office

United States of America

United States Patent and Trademark Office

NEYCRAFT

Reg. No. 4,153,069

Registered June 5, 2012

Int. Cl.: 11

TRADEMARK

PRINCIPAL REGISTER

DENTSPLY INTERNATIONAL INC. (DELAWARE CORPORATION)
221 WEST PHILADELPHIA STREET
YORK, PA 174050872

FOR: FURNACES, IN CLASS 11 (U.S. CLS. 13, 21, 23, 31 AND 34).

FIRST USE 1-1-1988; IN COMMERCE 1-1-1988.

THE MARK CONSISTS OF STANDARD CHARACTERS WITHOUT CLAIM TO ANY PARTICULAR FONT, STYLE, SIZE, OR COLOR.

OWNER OF U.S. REG. NOS. 2,026,735 AND 2,857,985.

SER. NO. 85-372,120, FILED 7-15-2011.

MARGARET POWER, EXAMINING ATTORNEY



David J. Kybas

Director of the United States Patent and Trademark Office

United States of America

United States Patent and Trademark Office

If You Spray It They Will Come

Reg. No. 4,153,070

CHARLES HOLMES (UNITED STATES INDIVIDUAL)
17 GONZALES RD.
ROXIE, MS 396619677

Registered June 5, 2012

Int. Cl.: 28

FOR: HUNTER'S SCENT CAMOUFLAGE IN THE NATURE OF A SPRAY, IN CLASS 28 (U.S. CLS. 22, 23, 38 AND 50).

TRADEMARK

FIRST USE 8-25-2009; IN COMMERCE 8-25-2009.

PRINCIPAL REGISTER

THE MARK CONSISTS OF STANDARD CHARACTERS WITHOUT CLAIM TO ANY PARTICULAR FONT, STYLE, SIZE, OR COLOR.

SER. NO. 85-373,108, FILED 7-16-2011.

TIMOTHY FINNEGAN, EXAMINING ATTORNEY



David J. Kybas

Director of the United States Patent and Trademark Office

United States of America

United States Patent and Trademark Office

HARDCORE PAWN

Reg. No. 4,153,071

Registered June 5, 2012

Int. Cl.: 41

SERVICE MARK

PRINCIPAL REGISTER

COURTROOM TELEVISION NETWORK LLC (NEW YORK LIMITED LIABILITY COMPANY)
600 THIRD AVENUE
NEW YORK, NY 10016

FOR: ENTERTAINMENT SERVICES, NAMELY, CONTINUING SCRIPTED AND UNSCRIPTED TELEVISION PROGRAM SERIES IN THE FIELD OF COMEDY, DRAMA, ACTION, ADVENTURE AND/OR REALITY PROVIDED THROUGH CABLE TELEVISION, BROADCAST TELEVISION, INTERNET, VIDEO-ON-DEMAND, AND THROUGH OTHER DISTRIBUTION PLATFORMS; PROVIDING INFORMATION, NAMELY, ENTERTAINMENT INFORMATION OVER THE INTERNET, IN CLASS 41 (U.S. CLS. 100, 101 AND 107).

FIRST USE 8-16-2010; IN COMMERCE 8-16-2010.

THE MARK CONSISTS OF STANDARD CHARACTERS WITHOUT CLAIM TO ANY PARTICULAR FONT, STYLE, SIZE, OR COLOR.

NO CLAIM IS MADE TO THE EXCLUSIVE RIGHT TO USE "PAWN", APART FROM THE MARK AS SHOWN.

SER. NO. 85-373,629, FILED 7-18-2011.

JULIE GUTTADAURO, EXAMINING ATTORNEY



David J. Kybas

Director of the United States Patent and Trademark Office

United States of America

United States Patent and Trademark Office

VANTAGE ALWAYS AWARE

Reg. No. 4,153,072

Registered June 5, 2012

Int. Cl.: 35

SERVICE MARK

PRINCIPAL REGISTER

LOREX TECHNOLOGY INC. (CANADA CORPORATION)
250 ROYAL CREST COURT
MARKHAM, ONTARIO, CANADA L3R3S1

FOR: ON-LINE RETAIL STORE SERVICES FEATURING WIRELESS CONSUMER ELECTRONICS; MAIL ORDER SERVICES FEATURING WIRELESS CONSUMER ELECTRONICS, IN CLASS 35 (U.S. CLS. 100, 101 AND 102).

FIRST USE 4-27-2011; IN COMMERCE 4-27-2011.

THE MARK CONSISTS OF STANDARD CHARACTERS WITHOUT CLAIM TO ANY PARTICULAR FONT, STYLE, SIZE, OR COLOR.

SER. NO. 85-373,734, FILED 7-18-2011.

COLLEEN DOMBROW, EXAMINING ATTORNEY



David J. Kybas

Director of the United States Patent and Trademark Office

United States of America

United States Patent and Trademark Office

LIVE SIMPLY AWARE

Reg. No. 4,153,073

Registered June 5, 2012

Int. Cl.: 35

SERVICE MARK

PRINCIPAL REGISTER

LOREX TECHNOLOGY INC. (CANADA CORPORATION)
250 ROYAL CREST COURT
MARKHAM, ONTARIO, CANADA L3R3S1

FOR: ON-LINE RETAIL STORE SERVICES FEATURING WIRELESS CONSUMER ELECTRONICS; MAIL ORDER SERVICES FEATURING WIRELESS CONSUMER ELECTRONICS, IN CLASS 35 (U.S. CLS. 100, 101 AND 102).

FIRST USE 4-27-2011; IN COMMERCE 4-27-2011.

THE MARK CONSISTS OF STANDARD CHARACTERS WITHOUT CLAIM TO ANY PARTICULAR FONT, STYLE, SIZE, OR COLOR.

SER. NO. 85-373,741, FILED 7-18-2011.

COLLEEN DOMBROW, EXAMINING ATTORNEY



David J. Kybas

Director of the United States Patent and Trademark Office

United States of America

United States Patent and Trademark Office



Reg. No. 4,153,074

MERIDIUM, INC. (VIRGINIA CORPORATION)
207 BULLITT AVENUE, SE
ROANOKE, VA 24013

Registered June 5, 2012

Int. Cl.: 41

FOR: EDUCATIONAL SERVICES, NAMELY, PROVIDING ONLINE INSTRUCTION IN THE FIELD OF ASSET PERFORMANCE MANAGEMENT VIA AN ONLINE WEBSITE, IN CLASS 41 (U.S. CLS. 100, 101 AND 107).

SERVICE MARK

FIRST USE 5-2-2011; IN COMMERCE 5-2-2011.

PRINCIPAL REGISTER

OWNER OF U.S. REG. NOS. 2,762,214, 2,886,484 AND OTHERS.

NO CLAIM IS MADE TO THE EXCLUSIVE RIGHT TO USE "E" AND "COURSE E-LEARNING PRODUCTS", APART FROM THE MARK AS SHOWN.

THE MARK CONSISTS OF THE WORD "MERIDIUM" AND DOTS IN A PYRAMID DESIGN IN A BOX, THE WORDS "QUICK COURSE E-LEARNING PRODUCTS" IN AN ADJACENT BOX WITH A DARKER BACKGROUND SUPERIMPOSED OVER A LOWER CASE STYLIZED LETTER "E".

SER. NO. 85-373,806, FILED 7-18-2011.

BRENDAN MCCAULEY, EXAMINING ATTORNEY



David J. Kyffers

Director of the United States Patent and Trademark Office

United States of America

United States Patent and Trademark Office

HARDCORE PAWN

Reg. No. 4,153,075

Registered June 5, 2012

Int. Cl.: 9

TRADEMARK

PRINCIPAL REGISTER

COURTROOM TELEVISION NETWORK LLC (NEW YORK LIMITED LIABILITY COMPANY)
600 THIRD AVENUE
NEW YORK, NY 10016

FOR: DOWNLOADABLE TELEVISION PROGRAMS IN THE FIELD OF REALITY DISTRIBUTED VIA THE INTERNET AND WIRELESS COMMUNICATIONS NETWORKS, IN CLASS 9 (U.S. CLS. 21, 23, 26, 36 AND 38).

FIRST USE 8-16-2010; IN COMMERCE 8-16-2010.

THE MARK CONSISTS OF STANDARD CHARACTERS WITHOUT CLAIM TO ANY PARTICULAR FONT, STYLE, SIZE, OR COLOR.

NO CLAIM IS MADE TO THE EXCLUSIVE RIGHT TO USE "PAWN", APART FROM THE MARK AS SHOWN.

SER. NO. 85-373,824, FILED 7-18-2011.

JULIE GUTTADAURO, EXAMINING ATTORNEY



David J. Kybas

Director of the United States Patent and Trademark Office

United States of America

United States Patent and Trademark Office

EDUCATION STATION

Reg. No. 4,153,076

Registered June 5, 2012

Int. Cls.: 35 and 41

SERVICE MARK

PRINCIPAL REGISTER

ACCELMED, LLC (INDIANA LIMITED LIABILITY COMPANY)
900 EAST 96TH STREET, SUITE 125
INDIANAPOLIS, IN 46240

FOR: PROMOTING SEMINARS FOR CONTINUING MEDICAL EDUCATION OF MEDICAL PROFESSIONALS IN THE FIELD OF MEDICINE, IN CLASS 35 (U.S. CLS. 100, 101 AND 102).

FIRST USE 6-27-2011; IN COMMERCE 6-27-2011.

FOR: EDUCATIONAL SERVICES, NAMELY, CONDUCTING AND ARRANGING SEMINARS, WORKSHOPS AND CONFERENCES FOR CONTINUING MEDICAL EDUCATION OF MEDICAL PROFESSIONALS IN THE FIELD OF MEDICINE AND DISTRIBUTION OF COURSE MATERIAL IN CONNECTION THEREWITH, IN CLASS 41 (U.S. CLS. 100, 101 AND 107).

FIRST USE 6-27-2011; IN COMMERCE 6-27-2011.

THE MARK CONSISTS OF STANDARD CHARACTERS WITHOUT CLAIM TO ANY PARTICULAR FONT, STYLE, SIZE, OR COLOR.

NO CLAIM IS MADE TO THE EXCLUSIVE RIGHT TO USE "EDUCATION", APART FROM THE MARK AS SHOWN.

SER. NO. 85-374,747, FILED 7-19-2011.

KEVON CHISOLM, EXAMINING ATTORNEY



David J. Kypos

Director of the United States Patent and Trademark Office

United States of America

United States Patent and Trademark Office



Reg. No. 4,153,077

Registered June 5, 2012

Int. Cl.: 37

SERVICE MARK

PRINCIPAL REGISTER

PALMETTO MARINE CONSTRUCTION, INC (SOUTH CAROLINA CORPORATION)
2678 MOUNT ZION ROAD
LITTLE RIVER, SC 295667412

FOR: CONSTRUCTION PLANNING; CONSTRUCTION PROJECT MANAGEMENT SERVICES; CONSTRUCTION, MAINTENANCE AND RENOVATION OF PROPERTY; CRANE RENTAL AND LEASING FOR CONSTRUCTION PURPOSES; CUSTOM CONSTRUCTION AND BUILDING RENOVATION; HARBOR CONSTRUCTION, IN CLASS 37 (U.S. CLS. 100, 103 AND 106).

FIRST USE 5-17-2011; IN COMMERCE 5-18-2011.

NO CLAIM IS MADE TO THE EXCLUSIVE RIGHT TO USE "MARINE CONSTRUCTION, INC.", APART FROM THE MARK AS SHOWN.

THE COLOR(S) LIGHT BLUE, MEDIUM BLUE, DARK BLUE, RED, YELLOW, BLACK, GREEN AND WHITE IS/ARE CLAIMED AS A FEATURE OF THE MARK.

THE MARK CONSISTS OF FOUR CONCENTRIC CIRCLES WITH THE OUTER CIRCLE BEING DARK BLUE, THE SECOND OUTER CIRCLE BEING A WHITE BACKGROUND DISPLAYING THE WORDING "PALMETTO MARINE" IN RED LETTERS ON THE TOP HALF OF ARC AND THE WORDING "MARINE CONSTRUCTION, INC." IN DARK BLUE LETTERS IN THE BOTTOM HALF OF ARC; GREEN PALM TREES APPEAR ON THE LEFT AND RIGHT SIDE BETWEEN THE WORDING "PALMETTO MARINE" AND "CONSTRUCTION, INC."; THE SECOND INNER MOST CIRCLE BEING DARK BLUE; AND THE INNER CIRCLE CONTAINS A DESIGN ELEMENT WHICH CONSISTS OF A BLACK BARGE WITH A YELLOW MECHANICAL ARM WHICH IS SHOWN IN A BODY OF MEDIUM BLUE WATER; THREE BLACK PILINGS ARE ALSO SHOWN IN THE BODY OF WATER; THE HORIZON CONSISTS OF LIGHT BLUE SKY, TWO SMALL WHITE CLOUDS WITH ONE LARGE CLOUD BETWEEN THEM AND THREE BLACK BIRDS ALOFT.



SER. NO. 85-375,276, FILED 7-19-2011.

BILL DAWE, EXAMINING ATTORNEY

David J. Kappas

Director of the United States Patent and Trademark Office

United States of America

United States Patent and Trademark Office



THE BOWLERS TO VETERANS LINK

Reg. No. 4,153,078

Registered June 5, 2012

Int. Cl.: 36

SERVICE MARK

PRINCIPAL REGISTER

BOWLERS TO VETERANS LINK, INC. (D.C. CORPORATION)
11350 RANDOM HILLS ROAD
SUITE # 800
FAIRFAX, VA 22030

FOR: CHARITABLE SERVICES, NAMELY, ORGANIZING AND CONDUCTING FUNDRAISING ACTIVITIES, AIMED AT INCREASING SUPPORT AND MORALE OF VETERANS AND CURRENT MEMBERS OF THE U.S. MILITARY, IN CLASS 36 (U.S. CLS. 100, 101 AND 102).

FIRST USE 6-23-2011; IN COMMERCE 6-23-2011.

NO CLAIM IS MADE TO THE EXCLUSIVE RIGHT TO USE "BOWLERS", "VETERANS", AND THE REPRESENTATION OF A BOWLING PIN, APART FROM THE MARK AS SHOWN.

THE MARK CONSISTS OF THE LETTERS "BVL" ABOVE PHRASE "THE BOWLERS TO VETERANS LINK". FOUR WAVY LINES EXTEND FROM THE VERTICAL PORTION OF THE LETTER "L" AROUND THE BACK OF THE RIGHT SIDE ARM OF THE LETTER "V" AND IN FRONT OF THE LEFT SIDE ARM OF THE LETTER "V". THE WAVY LINES CONTINUE BEHIND THE FRONT OF THE LETTER "B" AND THROUGH THE HOLES IN THE LETTER "B". THE FINAL PORTION OF THE WAVY LINES PASSES IN FRONT OF THE LEFT SIDE OF THE LETTER "B". A BOWLING PIN FORMS PART OF THE VERTICAL PORTION OF THE LETTER "L" FROM WHICH ONE OF THE WAVY LINES STARTS AND FOUR STARS ARE EQUALLY DISTRIBUTED ALONG THE RIGHT SIDE ARM OF THE LETTER "V".

SER. NO. 85-375,819, FILED 7-20-2011.

LINDA MICKLEBURGH, EXAMINING ATTORNEY



David J. Kyjars

Director of the United States Patent and Trademark Office

United States of America

United States Patent and Trademark Office

BVL

Reg. No. 4,153,079

Registered June 5, 2012

Int. Cl.: 36

SERVICE MARK

PRINCIPAL REGISTER

BOWLERS TO VETERANS LINK, INC. (D.C. CORPORATION)
11350 RANDOM HILLS ROAD
SUITE # 800
FAIRFAX, VA 22030

FOR: CHARITABLE SERVICES, NAMELY, ORGANIZING AND CONDUCTING FUNDRAISING ACTIVITIES AIMED AT INCREASING SUPPORT AND MORALE OF VETERANS AND CURRENT MEMBERS OF THE U.S. MILITARY, IN CLASS 36 (U.S. CLS. 100, 101 AND 102).

FIRST USE 0-0-1941; IN COMMERCE 0-0-1941.

THE MARK CONSISTS OF STANDARD CHARACTERS WITHOUT CLAIM TO ANY PARTICULAR FONT, STYLE, SIZE, OR COLOR.

SER. NO. 85-375,830, FILED 7-20-2011.

LINDA MICKLEBURGH, EXAMINING ATTORNEY



David J. Kyffers

Director of the United States Patent and Trademark Office

United States of America

United States Patent and Trademark Office

⊗ BestSellingCar Award

Reg. No. 4,153,080

Registered June 5, 2012

Int. Cl.: 41

SERVICE MARK

PRINCIPAL REGISTER

BESTSELLINGCARAWARD, INC. (CALIFORNIA CORPORATION), DBA BESTSELLINGCAR
AWARD, INC.
1520 PINE DRIVE
LA HABRA, CA 90631

FOR: PROVIDING RECOGNITION BY THE WAY OF AWARDS TO DEMONSTRATE
ACHIEVEMENT IN THE FIELDS OF THE AUTOMOTIVE INDUSTRY, IN CLASS 41 (U.S.
CLS. 100, 101 AND 107).

FIRST USE 8-15-2011; IN COMMERCE 11-19-2011.

NO CLAIM IS MADE TO THE EXCLUSIVE RIGHT TO USE "BEST SELLING CAR AWARD",
APART FROM THE MARK AS SHOWN.

THE MARK CONSISTS OF A PERFECT CIRCLE CROSS-SECTED BY FOUR EQUIDISTANT
LINES, CREATING EIGHT WEDGES OF EQUAL SIZE INSIDE THE CIRCLE. THE FOUR
LINES CROSS THE CIRCLE FROM TOP TO BOTTOM; LEFT TO RIGHT; UPPER LEFT-
HAND CORNER TO BOTTOM RIGHT-HAND CORNER; AND UPPER RIGHT-HAND CORNER
TO BOTTOM LEFT-HAND CORNER. THE WORDS "BESTSELLINGCAR AWARD" APPEAR
TO THE RIGHT OF THE CIRCLE.

SER. NO. 85-375,945, FILED 7-20-2011.

JOHN DWYER, EXAMINING ATTORNEY



David J. Kybas

Director of the United States Patent and Trademark Office

United States of America

United States Patent and Trademark Office

netTrainment

Reg. No. 4,153,081

Registered June 5, 2012

Int. Cls.: 9, 35 and 41

TRADEMARK

SERVICE MARK

PRINCIPAL REGISTER

BSH BOSCH UND SIEMENS HAUSGERATE GMBH (FED REP GERMANY CORPORATION)
CARL-WERY-STRASSE 34
MUNICH, FED REP GERMANY 81739

FOR: APPARATUS FOR RECORDING, TRANSMISSION AND RENDITION OF SOUND AND PICTURE; DATA PROCESSING APPARATUS AND COMPUTERS, COMPUTER OPERATING PROGRAMS, COMPUTER SOFTWARE FOR VIEWING DOMESTIC HOME APPLIANCES, DATA CARRIER OF ALL KINDS, NAMELY, PRERECORDED MAGNETIC DATA CARRIERS FEATURING HOME APPLIANCES; PARTS OF ALL AFORESAID GOODS, IN CLASS 9 (U.S. CLS. 21, 23, 26, 36 AND 38).

FOR: ADVERTISING; BUSINESS MANAGEMENT; BUSINESS ADMINISTRATION; MARKETING, ALSO VIA THE INTERNET OR ONLINE WEBINARS; SALES PROMOTION FOR OTHERS PROVIDED THROUGH THE DISTRIBUTION FOR OTHERS OF ELECTRONIC ADVERTISEMENTS; PRESENTATION OF GOODS AND SERVICES ON COMMUNICATIONS MEDIA FOR RETAIL PURPOSES; MARKET RESEARCH AND ANALYSIS; SUPPLYING BUSINESS CONSULTING TO COMMERCIAL AND BUSINESS COMPANIES RELATED TO HOME APPLIANCES, IN CLASS 35 (U.S. CLS. 100, 101 AND 102).

FOR: PROVIDING INFORMATION REGARDING EDUCATIONAL SERVICES AND TRAINING EVENTS IN THE FIELD OF HOME APPLIANCES, CONDUCTING OF TRAINING AND EDUCATIONAL SERVICES NAMELY, PROVIDING WORKSHOPS RELATED TO HOME APPLIANCES MADE AVAILABLE VIA THE INTERNET OR ONLINE WEBINARS, ARRANGING AND CONDUCTING CULTURAL ACTIVITIES, ORGANIZATION OF COMPETITIONS IN THE FIELD OF HOME APPLIANCES, IN CLASS 41 (U.S. CLS. 100, 101 AND 107).

OWNER OF FED REP GERMANY REG. NO. 30573190, DATED 4-28-2006, EXPIRES 12-31-2015.

THE MARK CONSISTS OF THE WORD "NETTRAINMENT". THE FONT OF THE WORD "NET" DIFFERS FROM THE FONT OF THE WORD "TRAINMENT". ABOVE THE WORD "NET" ARE SIX BLOCKS, EACH BLOCK'S WIDTH GROWING LARGER FROM LEFT TO RIGHT. THE TOP OF THE ORNAMENTAL "T" IN THE WORD "TRAINMENT" EXTENDS TO THE RIGHT OVER THE LETTERS "R" AND "A" TO THE OVERSIZED DOT ABOVE THE LETTER "I".



David J. Kyjars

Director of the United States Patent and Trademark Office

Reg. No. 4,153,081 SER. NO. 85-376,039, FILED 7-20-2011.

FLORENTINA BLANDU, EXAMINING ATTORNEY

United States of America

United States Patent and Trademark Office

Hungry Genius

Reg. No. 4,153,082

HUNGRYGENIUS HOLDING CO., (DELAWARE LIMITED LIABILITY COMPANY)
5173 WARING ROAD #35
SAN DIEGO, CA 92120

Registered June 5, 2012

Int. Cl.: 35

FOR: BRAND CONCEPT AND BRAND DEVELOPMENT SERVICES FOR CORPORATE AND INDIVIDUAL CLIENTS, IN CLASS 35 (U.S. CLS. 100, 101 AND 102).

SERVICE MARK

FIRST USE 5-17-2011; IN COMMERCE 6-4-2011.

PRINCIPAL REGISTER

THE MARK CONSISTS OF STANDARD CHARACTERS WITHOUT CLAIM TO ANY PARTICULAR FONT, STYLE, SIZE, OR COLOR.

SER. NO. 85-376,069, FILED 7-20-2011.

WILLIAM BRECKENFELD, EXAMINING ATTORNEY



David J. Kybas

Director of the United States Patent and Trademark Office

United States of America

United States Patent and Trademark Office

peers

Reg. No. 4,153,083

SEYMOUR, JONATHAN C (UNITED STATES INDIVIDUAL)
8179 E 28TH PLACE
DENVER, CO 80238

Registered June 5, 2012

Int. Cl.: 9

FOR: COMPUTER APPLICATION SOFTWARE FOR MOBILE DEVICES, NAMELY, SOFTWARE FOR SOCIAL NETWORKING, IN CLASS 9 (U.S. CLS. 21, 23, 26, 36 AND 38).

TRADEMARK

FIRST USE 6-1-2011; IN COMMERCE 6-28-2011.

PRINCIPAL REGISTER

THE MARK CONSISTS OF STANDARD CHARACTERS WITHOUT CLAIM TO ANY PARTICULAR FONT, STYLE, SIZE, OR COLOR.

SER. NO. 85-376,669, FILED 7-20-2011.

ZACHARY BELLO, EXAMINING ATTORNEY



David J. Kyros

Director of the United States Patent and Trademark Office

United States of America

United States Patent and Trademark Office

CDHL

Reg. No. 4,153,084

Registered June 5, 2012

Int. Cl.: 41

SERVICE MARK

PRINCIPAL REGISTER

BEN FRANK (UNITED STATES INDIVIDUAL), DBA 212 SPORTS, LLC
600 ANTON BLVD., SUITE 900
COSTA MESA, CA 92626

FOR: AMATEUR YOUTH SPORTS SERVICES, NAMELY, ORGANIZING AND PROVIDING YOUTH SPORTS ACTIVITIES, IN CLASS 41 (U.S. CLS. 100, 101 AND 107).

FIRST USE 7-9-2011; IN COMMERCE 7-9-2011.

THE MARK CONSISTS OF STANDARD CHARACTERS WITHOUT CLAIM TO ANY PARTICULAR FONT, STYLE, SIZE, OR COLOR.

SER. NO. 85-376,760, FILED 7-20-2011.

DAVID H. STINE, EXAMINING ATTORNEY



David J. Kyros

Director of the United States Patent and Trademark Office

United States of America

United States Patent and Trademark Office

2Tone Cleat Covers

Reg. No. 4,153,085

Registered June 5, 2012

Int. Cl.: 25

TRADEMARK

PRINCIPAL REGISTER

CUMMINGS, MICHAEL (UNITED STATES INDIVIDUAL)

4

22001 HAWAIIAN AVE
HAWAIIAN GARDENS, CA 90716

FOR: PANTS; SHIRTS; SHOE COVERS FOR USE WHEN WEARING SHOES; SHORTS, IN CLASS 25 (U.S. CLS. 22 AND 39).

FIRST USE 4-29-2002; IN COMMERCE 4-29-2002.

THE MARK CONSISTS OF STANDARD CHARACTERS WITHOUT CLAIM TO ANY PARTICULAR FONT, STYLE, SIZE, OR COLOR.

NO CLAIM IS MADE TO THE EXCLUSIVE RIGHT TO USE "CLEAT COVERS", APART FROM THE MARK AS SHOWN.

SEC. 2(F).

SER. NO. 85-377,065, FILED 7-21-2011.

JOHN WILKE, EXAMINING ATTORNEY



David J. Kyros

Director of the United States Patent and Trademark Office

United States of America

United States Patent and Trademark Office

GLUTENFREEWORLD

Reg. No. 4,153,086

Registered June 5, 2012

Int. Cl.: 41

SERVICE MARK

PRINCIPAL REGISTER

CREATIVE CONTROL FILMS, INC. (LOUISIANA CORPORATION)
6116 WEATHERBY DRIVE
SHREVEPORT, LA 71129

FOR: EDUCATIONAL SERVICES, NAMELY, PROVIDING ONLINE INSTRUCTION IN THE FIELD OF GLUTEN-FREE DIETING VIA AN ONLINE WEBSITE; PROVIDING A WEBSITE FEATURING INFORMATION ON EXERCISE AND FITNESS; PROVIDING AN INTERACTIVE WEBSITE FEATURING INFORMATION AND LINKS RELATING TO FITNESS, IN CLASS 41 (U.S. CLS. 100, 101 AND 107).

FIRST USE 7-7-2011; IN COMMERCE 7-7-2011.

THE MARK CONSISTS OF STANDARD CHARACTERS WITHOUT CLAIM TO ANY PARTICULAR FONT, STYLE, SIZE, OR COLOR.

SER. NO. 85-377,137, FILED 7-21-2011.

COURTNEY ALVAREZ, EXAMINING ATTORNEY



David J. Kybas

Director of the United States Patent and Trademark Office

United States of America

United States Patent and Trademark Office

the power of insight

Reg. No. 4,153,087

Registered June 5, 2012

Int. Cls.: 35 and 36

SERVICE MARK

PRINCIPAL REGISTER

PINE HILL GROUP, LLC (NEW JERSEY LIMITED LIABILITY COMPANY)
22 MORNING GLORY CIRCLE
MULLICA HILL, NJ 08062

FOR: ACCOUNTANCY SERVICES; ACCOUNTING CONSULTATION; ACQUISITION AND MERGER CONSULTATION; BUSINESS ACQUISITION AND MERGER CONSULTATION; BUSINESS ACQUISITIONS CONSULTATION; BUSINESS ADVISORY SERVICES, CONSULTANCY AND INFORMATION; BUSINESS CONSULTATION; BUSINESS MANAGEMENT CONSULTING AND ADVISORY SERVICES; BUSINESS MERGER CONSULTATION; CONSULTING AND INFORMATION CONCERNING ACCOUNTING; CONSULTING SERVICES, NAMELY, EXPERT ANALYSIS AND MANAGEMENT CONSULTING IN ECONOMICS AND ACCOUNTING, IN CLASS 35 (U.S. CLS. 100, 101 AND 102).

FIRST USE 7-12-2011; IN COMMERCE 7-12-2011.

FOR: FINANCIAL CONSULTING AND ADVISING IN THE FIELD OF MERGERS AND ACQUISITIONS; PRIVATE EQUITY CONSULTANT SERVICES, IN CLASS 36 (U.S. CLS. 100, 101 AND 102).

FIRST USE 7-12-2011; IN COMMERCE 7-12-2011.

THE MARK CONSISTS OF STANDARD CHARACTERS WITHOUT CLAIM TO ANY PARTICULAR FONT, STYLE, SIZE, OR COLOR.

SER. NO. 85-377,383, FILED S.R. 7-21-2011 AM. P.R. 1-31-2012.

LINDSEY RUBIN, EXAMINING ATTORNEY



David J. Kyffers

Director of the United States Patent and Trademark Office

United States of America

United States Patent and Trademark Office

HOMESTRONG USA

Reg. No. 4,153,088

Registered June 5, 2012

Int. Cls.: 36, 37 and 41

SERVICE MARK

PRINCIPAL REGISTER

JBCM, LLC (CALIFORNIA LIMITED LIABILITY COMPANY)
911 SOUTH JOLIET CIRCLE
ANAHEIM, CA 92807

FOR: FINANCIAL COUNSELING SERVICES, NAMELY, SERVICES FOR CONNECTING THE PUBLIC WITH REAL ESTATE PROFESSIONALS, MORTGAGE AND LENDING PROFESSIONALS; FINANCIAL COUNSELING SERVICES RELATING TO CONSUMER CREDIT, BANKRUPTCY, HOME OWNERSHIP, LOAN MODIFICATIONS, FORECLOSURE, DEBT MANAGEMENT, AND FINANCIAL LITERACY, IN CLASS 36 (U.S. CLS. 100, 101 AND 102).

FIRST USE 5-27-2010; IN COMMERCE 5-27-2010.

FOR: HOUSING SERVICES, NAMELY, DEVELOPMENT OF REAL PROPERTY, NAMELY, REPAIR, IMPROVEMENT, AND NEW CONSTRUCTION; REAL ESTATE DEVELOPMENT AND CONSTRUCTION OF RESIDENTIAL HOUSING, IN CLASS 37 (U.S. CLS. 100, 103 AND 106).

FIRST USE 5-27-2010; IN COMMERCE 5-27-2010.

FOR: EDUCATIONAL SERVICES, NAMELY, PROVIDING CLASSES, SEMINARS AND WORKSHOPS IN THE FIELDS OF NON-PROFIT ORGANIZATIONS, CONSUMER CREDIT, BANKRUPTCY, HOME OWNERSHIP, LOAN MODIFICATIONS, FORECLOSURE, DEBT MANAGEMENT, AND FINANCIAL LITERACY, IN CLASS 41 (U.S. CLS. 100, 101 AND 107).

FIRST USE 5-27-2010; IN COMMERCE 5-27-2010.

THE MARK CONSISTS OF STANDARD CHARACTERS WITHOUT CLAIM TO ANY PARTICULAR FONT, STYLE, SIZE, OR COLOR.

NO CLAIM IS MADE TO THE EXCLUSIVE RIGHT TO USE "USA", APART FROM THE MARK AS SHOWN.

SER. NO. 85-378,077, FILED 7-22-2011.

REGINA DRUMMOND, EXAMINING ATTORNEY



David J. Kyros

Director of the United States Patent and Trademark Office

United States of America

United States Patent and Trademark Office



Reg. No. 4,153,089

Registered June 5, 2012

Int. Cl.: 30

TRADEMARK

PRINCIPAL REGISTER

CONROY FOODS, INC. (PENNSYLVANIA CORPORATION)
906 OLD FREEPORT ROAD
PITTSBURGH, PA 15238

FOR: SAUCES AND SALAD DRESSINGS, IN CLASS 30 (U.S. CL. 46).

FIRST USE 3-0-1985; IN COMMERCE 1-0-1990.

OWNER OF U.S. REG. NOS. 1,764,719 AND 2,840,225.

THE MARK CONSISTS OF A FANCIFUL FORM OF THE WORD "BEANO'S" IN AN OVAL BACKGROUND.

SER. NO. 85-378,106, FILED 7-22-2011.

DORITT L. CARROLL, EXAMINING ATTORNEY



David J. Kyffers

Director of the United States Patent and Trademark Office

United States of America

United States Patent and Trademark Office



HomeStrong

USA

Reg. No. 4,153,090

Registered June 5, 2012

Int. Cls.: 36, 37 and 41

SERVICE MARK

PRINCIPAL REGISTER

JBCM, LLC (CALIFORNIA LIMITED LIABILITY COMPANY)
911 SOUTH JOLIET CIRCLE
ANAHEIM, CA 92807

FOR: FINANCIAL COUNSELING SERVICES, NAMELY, SERVICES FOR CONNECTING THE PUBLIC WITH REAL ESTATE PROFESSIONALS, MORTGAGE AND LENDING PROFESSIONALS; FINANCIAL COUNSELING SERVICES RELATING TO CONSUMER CREDIT, BANKRUPTCY, HOME OWNERSHIP, LOAN MODIFICATIONS, FORECLOSURE, DEBT MANAGEMENT, AND FINANCIAL LITERACY, IN CLASS 36 (U.S. CLS. 100, 101 AND 102).

FIRST USE 5-27-2010; IN COMMERCE 5-27-2010.

FOR: HOUSING SERVICES, NAMELY, DEVELOPMENT OF REAL PROPERTY, NAMELY, REPAIR, IMPROVEMENT, AND NEW CONSTRUCTION; REAL ESTATE DEVELOPMENT AND CONSTRUCTION OF RESIDENTIAL HOUSING, IN CLASS 37 (U.S. CLS. 100, 103 AND 106).

FIRST USE 5-27-2010; IN COMMERCE 5-27-2010.

FOR: EDUCATIONAL SERVICES, NAMELY, PROVIDING CLASSES, SEMINARS AND WORKSHOPS IN THE FIELDS OF NON-PROFIT ORGANIZATIONS, CONSUMER CREDIT, BANKRUPTCY, HOME OWNERSHIP, LOAN MODIFICATIONS, FORECLOSURE, DEBT MANAGEMENT, AND FINANCIAL LITERACY, IN CLASS 41 (U.S. CLS. 100, 101 AND 107).

FIRST USE 5-27-2010; IN COMMERCE 5-27-2010.

NO CLAIM IS MADE TO THE EXCLUSIVE RIGHT TO USE "USA", APART FROM THE MARK AS SHOWN.

THE MARK CONSISTS OF A SUN ABOVE A HOUSE AND THE UPPER BODY OF A FIGURE INSIDE THE HOUSE WITH THE WORDING "HOMESTRONG" UNDERNEATH AND THE WORDING "USA" TO THE BOTTOM RIGHT OF "HOMESTRONG".

SER. NO. 85-378,120, FILED 7-22-2011.

REGINA DRUMMOND, EXAMINING ATTORNEY



David J. Kybas

Director of the United States Patent and Trademark Office

United States of America

United States Patent and Trademark Office

**TODAY
TASTES SO
GOOD**



Reg. No. 4,153,091

Registered June 5, 2012

Int. Cl.: 43

SERVICE MARK

PRINCIPAL REGISTER

KFC CORPORATION (DELAWARE CORPORATION)
1441 GARDINER LANE
LEGAL / TRADEMARKS
LOUISVILLE, KY 40213

FOR: RESTAURANT SERVICES, IN CLASS 43 (U.S. CLS. 100 AND 101).

FIRST USE 2-28-2011; IN COMMERCE 2-28-2011.

OWNER OF U.S. REG. NO. 3,243,849.

THE NAME(S), PORTRAIT(S), AND/OR SIGNATURE(S) SHOWN IN THE MARK DOES NOT IDENTIFY A PARTICULAR LIVING INDIVIDUAL.

THE MARK CONSISTS OF THE WORDS "TODAY TASTES SO GOOD" NEXT TO THE IMAGE OF A MAN WEARING A BOW TIE AND A STRIPED APRON INSIDE A TRAPEZOID.

SER. NO. 85-378,142, FILED 7-22-2011.

ARETHA SOMERVILLE, EXAMINING ATTORNEY



David J. Kybas

Director of the United States Patent and Trademark Office

United States of America

United States Patent and Trademark Office

mozilla

Reg. No. 4,153,092

Registered June 5, 2012

Int. Cl.: 35

SERVICE MARK

PRINCIPAL REGISTER

JMC BRANDS, LLC (OHIO LIMITED LIABILITY COMPANY), DBA JMC BRANDS, LLC
68 N. PORTAGE STREET
DOYLESTOWN, OH 44230

FOR: ADVERTISING AGENCY SPECIALIZING IN THE DESIGN AND EXECUTION OF WORD OF MOUTH, VIRAL, BUZZ AND EXPERIENTIAL MARKETING PROGRAMS; ADVERTISING AND MARKETING; ADVERTISING AND MARKETING CONSULTANCY; ADVERTISING AND MARKETING SERVICES PROVIDED BY MEANS OF INDIRECT METHODS OF MARKETING COMMUNICATIONS, NAMELY, SOCIAL MEDIA, SEARCH ENGINE MARKETING, INQUIRY MARKETING, INTERNET MARKETING, MOBILE MARKETING, BLOGGING AND OTHER FORMS OF PASSIVE, SHARABLE OR VIRAL COMMUNICATIONS CHANNELS; ADVERTISING AND MARKETING SERVICES, NAMELY, PROMOTING THE GOODS AND SERVICES OF OTHERS; ADVERTISING SERVICES, NAMELY, PROMOTING AND MARKETING THE GOODS AND SERVICES OF OTHERS IN THE FIELD OF BUSINESS VIA PRINT AND ELECTRONIC MEDIA; ADVERTISING SERVICES, NAMELY, PROMOTING AND MARKETING THE GOODS AND SERVICES OF OTHERS THROUGH ALL PUBLIC COMMUNICATION MEANS; ADVERTISING, MARKETING AND PROMOTION SERVICES; ADVERTISING, MARKETING AND PROMOTION SERVICES IN THE FIELD OF BUSINESS; ADVERTISING, MARKETING AND PROMOTION SERVICES, NAMELY, PROMOTING THE GOODS AND SERVICES OF OTHERS BY PROVIDING CUSTOMIZED EXHIBITS; ADVERTISING, MARKETING AND PROMOTIONAL SERVICES RELATED TO ALL INDUSTRIES FOR THE PURPOSE OF FACILITATING NETWORKING AND SOCIALIZING OPPORTUNITIES FOR BUSINESS PURPOSES; ADVERTISING, PROMOTION AND MARKETING SERVICES IN THE NATURE OF E-MAIL BLAST CAMPAIGNS FOR OTHERS; ADVERTISING, PROMOTION, AND MARKETING SERVICES IN THE NATURE OF WEBSITES FOR BUSINESSES; ADVICE IN THE FIELD OF BUSINESS MANAGEMENT AND MARKETING; ANALYSIS OF MARKET RESEARCH DATA AND STATISTICS; BRANDING SERVICES, NAMELY, CONSULTING, DEVELOPMENT, MANAGEMENT AND MARKETING OF BRANDS FOR BUSINESSES; BUSINESS ADVICE AND ANALYSIS OF MARKETS; BUSINESS CONSULTATION AND MANAGEMENT REGARDING MARKETING ACTIVITIES AND LAUNCHING OF NEW PRODUCTS; BUSINESS MANAGEMENT AND CONSULTING SERVICES FOR THE HEALTH CARE INDUSTRY, NAMELY, CUSTOMER SERVICE, ACCOUNTING SERVICES, AND MARKETING SERVICES; BUSINESS MANAGEMENT AND CONSULTING SERVICES FOR THE HEALTH CARE INDUSTRY, NAMELY, CUSTOMER SERVICE, ACCOUNTING SERVICES, AND WEB-BASED ADVERTISING AND MARKETING SERVICES; BUSINESS MANAGEMENT CONSULTING WITH RELATION TO STRATEGY, FINANCING, MARKETING, PRODUCTION, PERSONNEL



David J. Kyros

Director of the United States Patent and Trademark Office

Reg. No. 4,153,092 AND SALE MATTERS FOR COMPANIES INVOLVED WITH THIN FILM AND NANO TECHNOLOGIES AND PLASMA PROCESSES; BUSINESS MANAGEMENT CONSULTING WITH RELATION TO STRATEGY, MARKETING, PRODUCTION, PERSONNEL AND RETAIL SALE MATTERS; BUSINESS MANAGEMENT CONSULTING WITH RELATION TO STRATEGY, MARKETING, SALES, OPERATION, PRODUCT DESIGN PARTICULARLY SPECIALIZING IN THE USE OF ANALYTIC AND STATISTIC MODELS FOR THE UNDERSTANDING AND PREDICTING OF CONSUMERS, BUSINESSES, AND MARKET TRENDS AND ACTIONS; BUSINESS MARKETING SERVICES; BUSINESS MONITORING AND CONSULTING SERVICES, NAMELY, TRACKING WEB SITES AND APPLICATIONS OF OTHERS TO PROVIDE STRATEGY, INSIGHT, MARKETING, SALES, OPERATION, PRODUCT DESIGN, PARTICULARLY SPECIALIZING IN THE USE OF ANALYTIC AND STATISTIC MODELS FOR THE UNDERSTANDING AND PREDICTING OF CONSUMERS, BUSINESSES, AND MARKET TRENDS AND ACTIONS; BUSINESS TO BUSINESS DIRECT MARKETING SERVICES; COLLECTION OF MARKET RESEARCH INFORMATION; COMPUTERIZED MARKET RESEARCH SERVICES; CONDUCTING BUSINESS AND MARKET RESEARCH SURVEYS; CONDUCTING MARKETING STUDIES; CONSUMER MARKETING RESEARCH AND CONSULTING RELATED THERETO; COOPERATIVE ADVERTISING AND MARKETING SERVICES BY WAY OF SOLICITATION, CUSTOMER SERVICE AND PROVIDING MARKETING INFORMATION VIA WEB SITES ON A GLOBAL COMPUTER NETWORK; CREATIVE MARKETING DESIGN SERVICES, IN CLASS 35 (U.S. CLS. 100, 101 AND 102).

FIRST USE 7-22-2011; IN COMMERCE 7-22-2011.

THE MARK CONSISTS OF STANDARD CHARACTERS WITHOUT CLAIM TO ANY PARTICULAR FONT, STYLE, SIZE, OR COLOR.

SER. NO. 85-379,376, FILED 7-24-2011.

DOMINIC J. FERRAIUOLO, EXAMINING ATTORNEY

United States of America

United States Patent and Trademark Office

IMAGINE THE GOOD

Reg. No. 4,153,093

GOULD, CHERYL (UNITED STATES INDIVIDUAL), DBA IMAGINE THE GOOD
7220 TRADE STREET, SUITE 300
SAN DIEGO, CA 92121

Registered June 5, 2012

Int. Cl.: 41

FOR: PRODUCTION AND DISTRIBUTION OF VIDEOS IN THE FIELD OF WOMEN'S ISSUES,
IN CLASS 41 (U.S. CLS. 100, 101 AND 107).

SERVICE MARK

FIRST USE 3-1-2007; IN COMMERCE 3-1-2007.

PRINCIPAL REGISTER

THE MARK CONSISTS OF STANDARD CHARACTERS WITHOUT CLAIM TO ANY PAR-
TICULAR FONT, STYLE, SIZE, OR COLOR.

SER. NO. 85-379,400, FILED 7-24-2011.

BRENDAN REGAN, EXAMINING ATTORNEY



David J. Kyros

Director of the United States Patent and Trademark Office

United States of America

United States Patent and Trademark Office

THE CONDITIONALS

Reg. No. 4,153,094

THE CONDITIONALS (NEW YORK PARTNERSHIP)
44 FOX RIDGE
NORTH HILLS, NY 11576

Registered June 5, 2012

Int. Cl.: 41

FOR: ENTERTAINMENT SERVICES IN THE NATURE OF LIVE MUSICAL PERFORMANCES,
IN CLASS 41 (U.S. CLS. 100, 101 AND 107).

SERVICE MARK

FIRST USE 6-15-2011; IN COMMERCE 6-15-2011.

PRINCIPAL REGISTER

THE MARK CONSISTS OF STANDARD CHARACTERS WITHOUT CLAIM TO ANY PARTICULAR FONT, STYLE, SIZE, OR COLOR.

SER. NO. 85-379,621, FILED 7-25-2011.

ELISSA GARBER KON, EXAMINING ATTORNEY



David J. Kybas

Director of the United States Patent and Trademark Office

United States of America

United States Patent and Trademark Office

LIVE LIFE INSPIRED

Reg. No. 4,153,095

Registered June 5, 2012

Int. Cls.: 35, 41, 43 and 44

SERVICE MARK

PRINCIPAL REGISTER

BREATHE YOGA & JUICE BAR, INC. (NEW YORK CORPORATION)
19 SOUTH MAIN STREET
PITTSFORD, NY 14534

FOR: FRANCHISING, NAMELY, OFFERING BUSINESS MANAGEMENT ASSISTANCE IN THE ESTABLISHMENT AND/OR OPERATION OF BUSINESSES PROVIDING YOGA INSTRUCTION, JUICE BARS, ACUPUNCTURE, SPA SERVICES, DIET AND NUTRITION COUNSELING AND CLASSES, IN CLASS 35 (U.S. CLS. 100, 101 AND 102).

FIRST USE 9-20-2011; IN COMMERCE 9-20-2011.

FOR: YOGA INSTRUCTION; EDUCATION, NAMELY, DIET AND NUTRITION CLASSES, IN CLASS 41 (U.S. CLS. 100, 101 AND 107).

FIRST USE 4-1-2009; IN COMMERCE 4-1-2009.

FOR: JUICE BAR SERVICES, IN CLASS 43 (U.S. CLS. 100 AND 101).

FIRST USE 4-1-2009; IN COMMERCE 4-1-2009.

FOR: ACUPUNCTURE; HEALTH SPA SERVICES FOR HEALTH AND WELLNESS OF THE BODY AND SPIRIT; NUTRITION COUNSELING; WEIGHT REDUCTION DIET PLANNING AND SUPERVISION, IN CLASS 44 (U.S. CLS. 100 AND 101).

FIRST USE 4-1-2009; IN COMMERCE 4-1-2009.

THE MARK CONSISTS OF STANDARD CHARACTERS WITHOUT CLAIM TO ANY PARTICULAR FONT, STYLE, SIZE, OR COLOR.

SER. NO. 85-379,645, FILED 7-25-2011.

CHRIS WELLS, EXAMINING ATTORNEY



David J. Kybas

Director of the United States Patent and Trademark Office

United States of America

United States Patent and Trademark Office

ICE CUTTER

Reg. No. 4,153,096

Registered June 5, 2012

Int. Cl.: 1

TRADEMARK

PRINCIPAL REGISTER

KISSNER MILLING CO. LTD. (CANADA CORPORATION)
32 CHERRY BLOSSOM ROAD
CAMBRIDGE, ONTARIO, CANADA N3H4R7

FOR: CHEMICAL PREPARATIONS FOR MELTING SNOW AND ICE, IN CLASS 1 (U.S. CLS. 1, 5, 6, 10, 26 AND 46).

FIRST USE 12-19-2001; IN COMMERCE 12-19-2001.

THE MARK CONSISTS OF STANDARD CHARACTERS WITHOUT CLAIM TO ANY PARTICULAR FONT, STYLE, SIZE, OR COLOR.

NO CLAIM IS MADE TO THE EXCLUSIVE RIGHT TO USE "ICE", APART FROM THE MARK AS SHOWN.

SER. NO. 85-379,754, FILED 7-25-2011.

SUSAN LESLIE DUBOIS, EXAMINING ATTORNEY



David J. Kybas

Director of the United States Patent and Trademark Office

United States of America

United States Patent and Trademark Office

THE NEW YORK WORLD

Reg. No. 4,153,097

Registered June 5, 2012

Int. Cl.: 41

SERVICE MARK

PRINCIPAL REGISTER

THE TRUSTEES OF COLUMBIA UNIVERSITY OF THE CITY OF NEW YORK (NEW YORK CORPORATION)
OFFICE OF THE GENERAL COUNSEL
412 LOW MEM. LIBRARY, 535 W. 116TH ST
NEW YORK, NY 10027

FOR: PROVIDING AN ON-LINE NON-DOWNLOADABLE NEWSPAPER FEATURING GENERAL NEWS, INFORMATION AND COMMENTARY ABOUT PEOPLE FROM ALL OVER THE WORLD, IN CLASS 41 (U.S. CLS. 100, 101 AND 107).

FIRST USE 11-5-2010; IN COMMERCE 11-5-2010.

THE MARK CONSISTS OF STANDARD CHARACTERS WITHOUT CLAIM TO ANY PARTICULAR FONT, STYLE, SIZE, OR COLOR.

NO CLAIM IS MADE TO THE EXCLUSIVE RIGHT TO USE "NEW YORK", APART FROM THE MARK AS SHOWN.

SER. NO. 85-380,080, FILED 7-25-2011.

DEBORAH LOBO, EXAMINING ATTORNEY



David J. Kyffers

Director of the United States Patent and Trademark Office

United States of America

United States Patent and Trademark Office

Reflection Creek

Reg. No. 4,153,098

Registered June 5, 2012

Int. Cl.: 16

TRADEMARK

PRINCIPAL REGISTER

CHOLEWA, OLIVIA MARIA (UNITED STATES INDIVIDUAL)
POBOX 2627
EUGENE, OR 97402

FOR: ART PRINTS; ART PRINTS COMPRISED OF DIGITAL ILLUSTRATIONS ORIGINATING FROM PHOTOGRAPHS; COLOR PRINTS; GICLEE PRINTS; GRAPHIC FINE ART PRINTS; LITHOGRAPHIC PRINTS; PHOTOGRAPHIC PRINTS; PRINTED CALENDARS; PRINTS; PRINTS IN THE NATURE OF PHOTOGRAPHS OR LITHOGRAPHS, IN CLASS 16 (U.S. CLS. 2, 5, 22, 23, 29, 37, 38 AND 50).

FIRST USE 7-25-2011; IN COMMERCE 7-25-2011.

THE MARK CONSISTS OF STANDARD CHARACTERS WITHOUT CLAIM TO ANY PARTICULAR FONT, STYLE, SIZE, OR COLOR.

SER. NO. 85-380,334, FILED 7-25-2011.

TARAH HARDY, EXAMINING ATTORNEY



David J. Kybas

Director of the United States Patent and Trademark Office

United States of America

United States Patent and Trademark Office



Reg. No. 4,153,099

Registered June 5, 2012

Int. Cl.: 39

SERVICE MARK

PRINCIPAL REGISTER

THE CUPCAKE DELIVERS (VIRGINIA LIMITED LIABILITY COMPANY)
4839 GREAT HERON TERRACE
FAIRFAX, VA 22033

FOR: CUPCAKE DELIVERY SERVICES, IN CLASS 39 (U.S. CLS. 100 AND 105).

FIRST USE 6-1-2011; IN COMMERCE 6-1-2011.

THE MARK CONSISTS OF THE STYLIZED BLACK WORDS "THE CUPCAKE DELIVERS" OVER A GRAPHIC OF A WHITE CLOUD. ON THE CLOUD ABOVE THE TEXT IS A GRAPHIC OF A YELLOW AND WHITE CUPCAKE WITH PINK, RED AND WHITE FROSTING, A RED CHERRY WITH A GREEN STEM ON TOP, AND BLUE WINGS ON EITHER SIDE. THE CUPCAKE HAS A SMILING FACE WITH RED LIPS, BLUE EYES, AND BLACK EYELASHES. THE MARK IS OUTLINED IN BLACK.

THE COLOR(S) BLUE, PINK, YELLOW, RED, GREEN, WHITE AND BLACK IS/ARE CLAIMED AS A FEATURE OF THE MARK.

SER. NO. 85-380,902, FILED 7-26-2011.

ALYSSA STEEL, EXAMINING ATTORNEY



David J. Kybas

Director of the United States Patent and Trademark Office

United States of America

United States Patent and Trademark Office

The Slanted Lens

Reg. No. 4,153,100

Registered June 5, 2012

Int. Cl.: 41

SERVICE MARK

PRINCIPAL REGISTER

THE SLANTED LENS (UNITED STATES INDIVIDUAL), DBA JAY P. MORGAN
2629 FOOTHILL BLVD. #366
LA CRESCENTA, CA 91214

FOR: PROVIDING EDUCATIONAL COURSES IN THE FIELD OF PHOTOGRAPHY INSTRUCTION OFFERED THROUGH ONLINE NON-DOWNLOADABLE VIDEOS; PHOTOGRAPHY; TELEVISION, VIDEO AND MOVIE FILMING SERVICES, IN CLASS 41 (U.S. CLS. 100, 101 AND 107).

FIRST USE 9-1-1997; IN COMMERCE 9-1-1997.

THE MARK CONSISTS OF STANDARD CHARACTERS WITHOUT CLAIM TO ANY PARTICULAR FONT, STYLE, SIZE, OR COLOR.

SER. NO. 85-381,309, FILED S.R. 7-26-2011 AM. P.R. 2-13-2012.

DAVID MURRAY, EXAMINING ATTORNEY



David J. Kyros

Director of the United States Patent and Trademark Office

United States of America

United States Patent and Trademark Office

QUALITY IS OUR IMAGE

Reg. No. 4,153,101

Registered June 5, 2012

**Int. Cls.: 16, 35, 41, 42
and 44**

TRADEMARK

SERVICE MARK

PRINCIPAL REGISTER

AMERICAN COLLEGE OF RADIOLOGY (CALIFORNIA NON-PROFIT CORPORATION)
1891 PRESTON WHITE DRIVE
RESTON, VA 201914397

FOR: PRINTED JOURNAL IN THE FIELD OF RADIOLOGY; PRINTED EDUCATIONAL MATERIALS IN THE FIELD OF RADIOLOGY; REFERENCE BOOKS IN THE FIELD OF RADIOLOGY, IN CLASS 16 (U.S. CLS. 2, 5, 22, 23, 29, 37, 38 AND 50).

FIRST USE 1-0-2001; IN COMMERCE 1-0-2001.

FOR: ASSOCIATION SERVICES, NAMELY, PROMOTING THE INTERESTS OF MEDICAL PROFESSIONALS AND THEIR PATIENTS IN THE FIELD OF RADIOLOGY; PROMOTING AWARENESS OF THE NEED FOR PATIENT SAFETY BY MINIMIZING RADIATION EXPOSURE IN THE FIELD OF MEDICAL IMAGING STUDIES, SUCH AWARENESS BEING PROMOTED TO PROFESSIONALS IN THE SAME FIELD, OTHER PHYSICIANS AND HEALTH PROFESSIONALS, AND THE PUBLIC; PROMOTING PUBLIC AWARENESS OF THE VALUE OF MAMMOGRAPHY AND ITS PUBLIC HEALTH BENEFITS; LOBBYING AND ADVOCACY SERVICES, NAMELY, PROMOTING THE INTERESTS OF MEDICAL PROFESSIONALS AND THEIR PATIENTS IN THE FIELDS OF POLITICS, LEGISLATION, REGULATION, AND ECONOMICS; PROVIDING ONLINE EMPLOYMENT PLACEMENT SERVICES, NAMELY, MATCHING RESUMES AND POTENTIAL EMPLOYERS VIA THE INTERNET, IN CLASS 35 (U.S. CLS. 100, 101 AND 102).

FIRST USE 4-0-2010; IN COMMERCE 4-0-2010.

FOR: PROVIDING AN ONLINE JOURNAL IN THE FIELD OF RADIOLOGY; PROVIDING CONTINUING MEDICAL EDUCATION COURSES; EDUCATIONAL SERVICES, NAMELY, DEVELOPING, ARRANGING, AND CONDUCTING EDUCATIONAL CONFERENCES AND PROGRAMS AND PROVIDING COURSES OF INSTRUCTION IN THE FIELD OF RADIOLOGY, AND DISTRIBUTING COURSE MATERIAL IN CONNECTION THEREWITH, IN CLASS 41 (U.S. CLS. 100, 101 AND 107).

FIRST USE 1-0-2004; IN COMMERCE 1-0-2004.

FOR: DESIGN FOR OTHERS OF CLINICAL TRIALS IN ADVANCED IMAGING FOR EVALUATING THERAPEUTIC DEVICES AND PHARMACEUTICALS IN THE FIELD OF DIAGNOSTIC AND THERAPEUTIC RADIOLOGY; DESIGNING, CONDUCTING, OVERSEE-



David J. Kyros

Director of the United States Patent and Trademark Office

Reg. No. 4,153,101 ING AND REPORTING ON CLINICAL TRIALS IN THE FIELD OF DIAGNOSTIC AND THERAPEUTIC RADIOLOGY; COMPUTER SERVICES, NAMELY, PROVIDING A WEB-BASED SYSTEM AND ONLINE PORTAL FEATURING ONLINE NON-DOWNLOADABLE SOFTWARE THAT ENABLES USERS TO ACCESS TRAINING AND EDUCATIONAL REFERENCE MATERIALS IN THE FIELD OF MEDICINE; PROVIDING AN INTERACTIVE WEBSITE THAT ENABLES USERS TO ENTER, ACCESS, AND GENERATE MEDICAL CASE REPORTS; MEDICAL RESEARCH; SCIENTIFIC RESEARCH; ACCREDITATION SERVICES, NAMELY, SETTING AND PROVIDING STANDARDS FOR THE RADIOLOGICAL FIELD FOR THE PURPOSE OF ACCREDITATION, AND EVALUATING ORGANIZATIONS TO DETERMINE WHETHER THE ORGANIZATIONS CONFORM TO THE STANDARDS; PROVIDING AN INTERNET WEBSITE FEATURING TECHNOLOGY THAT ENABLES PROFESSIONALS IN THE FIELD OF RADIOLOGY TO SHARE, BOOKMARK, INDEX, STORE, AND COLLECT CONTENT, ARTICLES, IMAGES, AND OTHER INFORMATION RESOURCES IN ELECTRONIC FORM IN THE FIELD OF RADIOLOGY, IN CLASS 42 (U.S. CLS. 100 AND 101).

FIRST USE 4-0-2010; IN COMMERCE 4-0-2010.

FOR: PROVIDING AN ONLINE COMPUTER DATABASE IN THE FIELD OF RADIOLOGY AND THE PRACTICE OF RADIOLOGY; MEDICAL CONSULTING SERVICES IN THE FIELD OF DIAGNOSTIC AND THERAPEUTIC RADIOLOGY FOR PRIVATE COMPANIES THAT WOULD FUND CLINICAL TRIALS RESEARCH; QUANTITATIVE IMAGE ANALYSIS SERVICES IN THE FIELD OF DIAGNOSTIC AND THERAPEUTIC RADIOLOGY; PROVIDING INFORMATION IN THE FIELDS OF RADIOLOGY AND MEDICINE, IN CLASS 44 (U.S. CLS. 100 AND 101).

FIRST USE 4-0-2010; IN COMMERCE 4-0-2010.

THE MARK CONSISTS OF STANDARD CHARACTERS WITHOUT CLAIM TO ANY PARTICULAR FONT, STYLE, SIZE, OR COLOR.

SER. NO. 85-381,373, FILED 7-26-2011.

HEATHER THOMPSON, EXAMINING ATTORNEY

United States of America

United States Patent and Trademark Office



Reg. No. 4,153,102

Registered June 5, 2012

Int. Cl.: 25

TRADEMARK

PRINCIPAL REGISTER

NG, ISABELLE (PHILIPPINES INDIVIDUAL)
865 BALAGTAS ST., BARANGAY ADDITION HILL
METRO MANILA, PHILIPPINES

FOR: SHOES, SLIPPERS, SANDALS, BOOTS, T-SHIRTS, POLO SHIRTS, PANTS, SLACKS, JACKET, SWEATSHIRTS, BLOUSES, BRIEFS, BRAS, PANTIES, SWIM SUITS, SWIMMING TRUNKS, SOCKS, STOCKINGS AND CAPS, IN CLASS 25 (U.S. CLS. 22 AND 39).

OWNER OF PHILIPPINES REG. NO. 4-2009-00150, DATED 4-20-2009, EXPIRES 4-20-2019.

THE MARK CONSISTS OF THE WORD "JUICE" WITH TWO STYLIZED HEART DESIGNS TO THE RIGHT OF THE TERM AND ONE HEART ATOP THE LETTER "I" IN THE TERM "JUICE". SMALL TEARDROP DESIGN ELEMENTS EXTEND OUTWARD FROM THE HEART DESIGNS.

SER. NO. 85-382,194, FILED 7-27-2011.

JAMES STEIN, EXAMINING ATTORNEY



David J. Kybas

Director of the United States Patent and Trademark Office

United States of America

United States Patent and Trademark Office

JS

Reg. No. 4,153,103

Registered June 5, 2012

Int. Cl.: 7

TRADEMARK

PRINCIPAL REGISTER

MAP OIL TOOLS, INC. (TEXAS CORPORATION)
811 WEEKS ISLAND RD.
NEW IBERIA, LA 70560

FOR: OIL AND GAS WELL EQUIPMENT, NAMELY, RETRIEVABLE PACKERS IN THE NATURE OF DRILLING RIG MECHANIZATION MACHINES AND DEVICES, AND STORM PACKERS IN THE NATURE OF OIL-WELL PUMPING MACHINES, IN CLASS 7 (U.S. CLS. 13, 19, 21, 23, 31, 34 AND 35).

FIRST USE 12-1-1999; IN COMMERCE 12-1-1999.

THE MARK CONSISTS OF STANDARD CHARACTERS WITHOUT CLAIM TO ANY PARTICULAR FONT, STYLE, SIZE, OR COLOR.

SER. NO. 85-382,567, FILED 7-27-2011.

ROBERT STRUCK, EXAMINING ATTORNEY



David J. Kyffers

Director of the United States Patent and Trademark Office

United States of America
United States Patent and Trademark Office

Green60

Reg. No. 4,153,104

Registered June 5, 2012

Int. Cl.: 35

SERVICE MARK

PRINCIPAL REGISTER

ROWSHAN, SOHRAB (UNITED STATES INDIVIDUAL)
SUITE 105
3822 CAMPUS DR.
NEWPORT BEACH, CA 92660

FOR: PROVIDING ELECTRONIC PAYROLL SERVICES, NAMELY, PAYROLL PROCESSING, PREPARATION, ADMINISTRATION, AND MANAGEMENT, IN CLASS 35 (U.S. CLS. 100, 101 AND 102).

FIRST USE 9-1-2010; IN COMMERCE 9-1-2010.

THE MARK CONSISTS OF STANDARD CHARACTERS WITHOUT CLAIM TO ANY PARTICULAR FONT, STYLE, SIZE, OR COLOR.

SER. NO. 85-382,926, FILED 7-27-2011.

ROBIN MITTLER, EXAMINING ATTORNEY



David J. Kybas

Director of the United States Patent and Trademark Office

United States of America

United States Patent and Trademark Office

CLEARthru

Reg. No. 4,153,105

Registered June 5, 2012

Int. Cl.: 35

SERVICE MARK

PRINCIPAL REGISTER

JUNCTION SOLUTIONS, INC. (COLORADO CORPORATION)
9785 SOUTH MAROON CIRCLE
SUITE 410
ENGLEWOOD, CO 80112

FOR: PROVIDING COMPUTERIZED TRACKING AND TRACING OF FOODS, BEVERAGES AND OTHER GOODS BY MANUFACTURERS AND RETAILERS VIA APPLYING BAR CODES TO PACKAGING WHICH WHEN SCANNED PROVIDE ORIGIN AND TRACKING INFORMATION, IN CLASS 35 (U.S. CLS. 100, 101 AND 102).

FIRST USE 4-30-2011; IN COMMERCE 5-2-2011.

THE MARK CONSISTS OF STANDARD CHARACTERS WITHOUT CLAIM TO ANY PARTICULAR FONT, STYLE, SIZE, OR COLOR.

SER. NO. 85-383,072, FILED 7-28-2011.

IRA J. GOODSaid, EXAMINING ATTORNEY



David J. Kyffers

Director of the United States Patent and Trademark Office

United States of America

United States Patent and Trademark Office

RUNNYMEDE

Reg. No. 4,153,106

RUNNYMEDE FARM, INC. (KENTUCKY CORPORATION)
600 CYNTHIANA ROAD
PARIS, KY 40361

Registered June 5, 2012

Int. Cls.: 41 and 44

FOR: ENTERTAINMENT IN THE NATURE OF HORSE RACES, IN CLASS 41 (U.S. CLS. 100, 101 AND 107).

SERVICE MARK

FIRST USE 1-1-1890; IN COMMERCE 1-1-1890.

PRINCIPAL REGISTER

FOR: BREEDING AND STUD SERVICES FOR HORSES; HORSE FARMS, IN CLASS 44 (U.S. CLS. 100 AND 101).

FIRST USE 1-1-1890; IN COMMERCE 1-1-1890.

THE MARK CONSISTS OF STANDARD CHARACTERS WITHOUT CLAIM TO ANY PARTICULAR FONT, STYLE, SIZE, OR COLOR.

SER. NO. 85-383,079, FILED 7-28-2011.

SANJEEV VOHRA, EXAMINING ATTORNEY



David J. Kybas

Director of the United States Patent and Trademark Office

United States of America

United States Patent and Trademark Office

XtendaCare

Reg. No. 4,153,107

Registered June 5, 2012

Int. Cl.: 10

TRADEMARK

PRINCIPAL REGISTER

AVATAR ENTERPRISES, INC. (WISCONSIN CORPORATION), DBA COMFORTEX
PO BOX 850
1680 WILKIE DRIVE
WINONA, MN 55987

FOR: MEDICAL PRODUCTS, NAMELY, THERAPEUTIC MATTRESS SUPPORT; MEDICAL PRODUCTS, NAMELY, THERAPEUTIC MATTRESSES, BEDS, SEATS AND CUSHIONS; SUPPORT MATTRESSES FOR MEDICAL USE, IN CLASS 10 (U.S. CLS. 26, 39 AND 44).

FIRST USE 5-1-2010; IN COMMERCE 5-1-2010.

THE MARK CONSISTS OF STANDARD CHARACTERS WITHOUT CLAIM TO ANY PARTICULAR FONT, STYLE, SIZE, OR COLOR.

SER. NO. 85-383,235, FILED 7-28-2011.

WILLIAM ROSSMAN, EXAMINING ATTORNEY



David J. Kybas

Director of the United States Patent and Trademark Office

United States of America

United States Patent and Trademark Office



Reg. No. 4,153,108

Registered June 5, 2012

Int. Cls.: 35 and 36

SERVICE MARK

PRINCIPAL REGISTER

EMPLOYEE STAFF, LLC (TENNESSEE LIMITED LIABILITY COMPANY)
11400 PARKSIDE DR., SUITE 504
KNOXVILLE, TN 37834

FOR: EMPLOYEE ADMINISTRATION SERVICES, NAMELY, PAYROLL ADMINISTRATION AND MANAGEMENT, EMPLOYEE LEASING, BUSINESS RISK MANAGEMENT, AND HUMAN RESOURCES MANAGEMENT SERVICES, IN CLASS 35 (U.S. CLS. 100, 101 AND 102).

FIRST USE 1-1-2010; IN COMMERCE 1-1-2010.

FOR: EMPLOYEE SERVICES, NAMELY, ADMINISTRATION OF EMPLOYEE BENEFIT PLANS CONCERNING INSURANCE AND FINANCE AND WORKERS' COMPENSATION CLAIMS ASSISTANCE, IN CLASS 36 (U.S. CLS. 100, 101 AND 102).

FIRST USE 11-1-2010; IN COMMERCE 11-1-2010.

NO CLAIM IS MADE TO THE EXCLUSIVE RIGHT TO USE "EMPLOYEE", "STAFF" AND "YOUR EMPLOYEE SERVICE PROVIDER", APART FROM THE MARK AS SHOWN.

THE MARK CONSISTS OF THE WORDING, "EMPLOYEE STAFF" WHEREIN THE FIRST LETTERS OF EACH TERM, "E" AND "S", IS SUPERIMPOSED OVER TWO RECTANGLE DESIGNS, AND BELOW APPEARS THE WORDING "YOUR EMPLOYEE SERVICE PROVIDER" IN STYLIZED FONT.

SER. NO. 85-383,421, FILED 7-28-2011.

AMY KELLY, EXAMINING ATTORNEY



David J. Kybas

Director of the United States Patent and Trademark Office

United States of America

United States Patent and Trademark Office

netTrainment

Reg. No. 4,153,109

Registered June 5, 2012

Int. Cl.: 41

SERVICE MARK

PRINCIPAL REGISTER

BSH BOSCH UND SIEMENS HAUSGERATE GMBH (FED REP GERMANY CORPORATION)
CARL-WERY-STRASSE 34
MUNICH, FED REP GERMANY 81739

FOR: PROVIDING INFORMATION REGARDING EDUCATIONAL SERVICES AND TRAINING EVENTS IN THE FIELD OF HOME APPLIANCES, CONDUCTING OF TRAINING AND EDUCATIONAL SERVICES, NAMELY, PROVIDING WORKSHOPS RELATED TO HOME APPLIANCES MADE AVAILABLE VIA THE INTERNET OR ONLINE WEBINARS, ARRANGING AND CONDUCTING CULTURAL ACTIVITIES, ORGANIZATION OF COMPETITIONS IN THE FIELD OF HOME APPLIANCES, IN CLASS 41 (U.S. CLS. 100, 101 AND 107).

FIRST USE 7-1-2011; IN COMMERCE 7-1-2011.

THE MARK CONSISTS OF STANDARD CHARACTERS WITHOUT CLAIM TO ANY PARTICULAR FONT, STYLE, SIZE, OR COLOR.

SER. NO. 85-383,675, FILED 7-28-2011.

FLORENTINA BLANDU, EXAMINING ATTORNEY



David J. Kyros

Director of the United States Patent and Trademark Office

United States of America

United States Patent and Trademark Office

It's About Living

Reg. No. 4,153,110

Registered June 5, 2012

Int. Cl.: 41

SERVICE MARK

PRINCIPAL REGISTER

CREATIVE CONTROL FILMS, INC. (LOUISIANA CORPORATION)
6116 N. WEATHERBY DRIVE
SHREVEPORT, LA 71129

FOR: EDUCATIONAL SERVICES, NAMELY, PROVIDING ONLINE INSTRUCTION IN THE FIELD OF GLUTEN-FREE DIETING VIA AN ONLINE WEBSITE; PROVIDING A WEB SITE FEATURING INFORMATION ON EXERCISE AND FITNESS; PROVIDING AN INTERACTIVE WEBSITE FEATURING INFORMATION AND LINKS RELATING TO FITNESS, IN CLASS 41 (U.S. CLS. 100, 101 AND 107).

FIRST USE 7-7-2011; IN COMMERCE 7-7-2011.

THE MARK CONSISTS OF STANDARD CHARACTERS WITHOUT CLAIM TO ANY PARTICULAR FONT, STYLE, SIZE, OR COLOR.

SER. NO. 85-384,245, FILED 7-29-2011.

COURTNEY ALVAREZ, EXAMINING ATTORNEY



David J. Kyros

Director of the United States Patent and Trademark Office

United States of America

United States Patent and Trademark Office



Reg. No. 4,153,111

DISA (MISSOURI LIMITED LIABILITY COMPANY)
12596 WHIPPOORWILL DR
ROLLA, MO 65401

Registered June 5, 2012

Int. Cl.: 41

FOR: PROVIDING ON-LINE NON-DOWNLOADABLE MAGAZINES FEATURING NEWS, REVIEWS, AND STORIES ABOUT WOMEN IN THE OUTDOORS, IN CLASS 41 (U.S. CLS. 100, 101 AND 107).

SERVICE MARK

FIRST USE 11-4-2008; IN COMMERCE 11-4-2008.

PRINCIPAL REGISTER

NO CLAIM IS MADE TO THE EXCLUSIVE RIGHT TO USE "WOMEN'S OUTDOOR NEWS", APART FROM THE MARK AS SHOWN.

THE COLOR(S) GREEN, DARK GREEN, WHITE, ORANGE, DARK ORANGE AND GRAY IS/ARE CLAIMED AS A FEATURE OF THE MARK.

THE MARK CONSISTS OF THE FOLLOWING: "THE WON WOMEN'S OUTDOOR NEWS" WITH THE WORD "THE" IN DARK GREEN IN SMALL FONT ABOVE THE LETTER "W" IN "WON"; THE WORD "WON" IN OVER-SIZED LETTERS WITH "W" IN DARK ORANGE, "O" IN THE DESIGN OF A TARGET IN GREEN WITH AN ORANGE CENTER, AND "N" IN DARK GREEN; THE WORDS "WOMEN'S OUTDOOR NEWS" IS IN GRAY BELOW THAT IN SMALLER FONT.

SER. NO. 85-385,914, FILED 8-1-2011.

SANDRA BUJA, EXAMINING ATTORNEY



David J. Kybas

Director of the United States Patent and Trademark Office

United States of America

United States Patent and Trademark Office

LIU

Reg. No. 4,153,112

Registered June 5, 2012

Int. Cls.: 25 and 41

TRADEMARK

SERVICE MARK

PRINCIPAL REGISTER

LONG ISLAND UNIVERSITY (NEW YORK NEW YORK STATE NON-FOR-PROFIT
EDUCATION CORPORATION)
700 NORTHERN BOULEVARD
BROOKVILLE, NY 115481327

FOR: BASEBALL CAPS AND HATS; BOXER BRIEFS; HATS; HOODED SWEATSHIRTS;
JACKETS; JERSEYS; POLO SHIRTS; SHORTS; SOCKS; SWEAT PANTS; SWEAT SHIRTS;
T-SHIRTS; TANK TOPS, IN CLASS 25 (U.S. CLS. 22 AND 39).

FIRST USE 0-0-1935; IN COMMERCE 0-0-1935.

FOR: EDUCATION SERVICES IN THE NATURE OF COURSES AT THE UNIVERSITY
LEVEL, IN CLASS 41 (U.S. CLS. 100, 101 AND 107).

FIRST USE 0-0-1935; IN COMMERCE 0-0-1935.

THE MARK CONSISTS OF STANDARD CHARACTERS WITHOUT CLAIM TO ANY PAR-
TICULAR FONT, STYLE, SIZE, OR COLOR.

SEC. 2(F).

SER. NO. 85-386,223, FILED 8-1-2011.

WON TEAK OH, EXAMINING ATTORNEY



David J. Kybas

Director of the United States Patent and Trademark Office

United States of America

United States Patent and Trademark Office



LAPORTE
CPAs & BUSINESS ADVISORS

Reg. No. 4,153,113

Registered June 5, 2012

Int. Cl.: 35

SERVICE MARK

PRINCIPAL REGISTER

LAPORTE, A PROFESSIONAL ACCOUNTING CORPORATION (LOUISIANA CORPORATION), FORMERLY LAPORTE, SEHRT, ROMIG AND HAND, A PROFESSIONAL ACCOUNTING CORPORATION
111 VETERANS BLVD.
SUITE 600
METAIRIE, LA 70005

FOR: ACCOUNTING SERVICES, IN CLASS 35 (U.S. CLS. 100, 101 AND 102).

FIRST USE 8-26-2011; IN COMMERCE 8-26-2011.

NO CLAIM IS MADE TO THE EXCLUSIVE RIGHT TO USE "CPAS & BUSINESS ADVISORS", APART FROM THE MARK AS SHOWN.

THE COLOR(S) YELLOW, ORANGE, RED, BLUE-GREY AND WHITE IS/ARE CLAIMED AS A FEATURE OF THE MARK.

THE MARK CONSISTS OF THE WORD "LAPORTE" IN BLUE-GRAY WITH A CURVILINEAR SHAPE ABOVE THE "L" IN "LAPORTE" IN YELLOW, ORANGE AND RED WITH SUPER-IMPOSED WHITE GRID AND THE WORDS "CPAS & BUSINESS ADVISORS" UNDER THE WORD "LAPORTE".

SER. NO. 85-386,381, FILED 8-1-2011.

WON TEAK OH, EXAMINING ATTORNEY



David J. Kybas

Director of the United States Patent and Trademark Office

United States of America

United States Patent and Trademark Office

SHOCKBOX

Reg. No. 4,153,114

Registered June 5, 2012

Int. Cl.: 9

TRADEMARK

PRINCIPAL REGISTER

IMPAKT PROTECTIVE INC. (CANADA CORPORATION)
275 MICHAEL COWPLAND DRIVE
SUITE 101
KANATA, ONTARIO, CANADA K2M2G2

FOR: ACCELERATION SENSORS FOR USE WITH A PROTECTIVE HELMET TO CHARACTERIZE OR MEASURE IMPACT AT THE PROTECTIVE HELMET, SUCH AS A SPORTS HELMET, HELMET FOR DANGEROUS WORK ACTIVITIES, RECREATIONAL ACTIVITIES OR TRANSPORTATION, IN CLASS 9 (U.S. CLS. 21, 23, 26, 36 AND 38).

FIRST USE 6-8-2011; IN COMMERCE 12-2-2011.

THE MARK CONSISTS OF STANDARD CHARACTERS WITHOUT CLAIM TO ANY PARTICULAR FONT, STYLE, SIZE, OR COLOR.

PRIORITY CLAIMED UNDER SEC. 44(D) ON CANADA APPLICATION NO. 1,537,805, FILED 7-29-2011.

SER. NO. 85-387,241, FILED 8-2-2011.

KARANENDRA S. CHHINA, EXAMINING ATTORNEY



David J. Kybas

Director of the United States Patent and Trademark Office

United States of America

United States Patent and Trademark Office



Reg. No. 4,153,115

Registered June 5, 2012

Int. Cl.: 5

TRADEMARK

PRINCIPAL REGISTER

HUANG, JING (CHINA INDIVIDUAL)
#199
2390C LAS POSAS RD
CAMARILLO, CA 93010

FOR: DIETARY AND NUTRITIONAL SUPPLEMENTS; LIQUID NUTRITIONAL SUPPLEMENT; MINERAL NUTRITIONAL SUPPLEMENTS; POWDERED NUTRITIONAL SUPPLEMENT CONCENTRATE; POWDERED NUTRITIONAL SUPPLEMENT DRINK MIX; POWDERED NUTRITIONAL SUPPLEMENT DRINK MIX AND CONCENTRATE; ALL OF THE FOREGOING CONTAINING HERBS, IN CLASS 5 (U.S. CLS. 6, 18, 44, 46, 51 AND 52).

FIRST USE 7-28-2011; IN COMMERCE 7-28-2011.

THE MARK CONSISTS OF THE WORDING "ESSHERB" WITH "ESS" DEPICTED IN DARK BLUE AND "HERB" DEPICTED IN DARK GREEN WITH THE "H" CONTAINING THE DESIGN OF A LIGHT BLUE LEAF. TO THE LEFT OF THE WORDING IS A STYLIZED LIGHT GREEN LEAF ABOVE AND TO THE LEFT OF A STYLIZED LIGHT BLUE WATER DROP.

THE COLOR(S) LIGHT BLUE, DARK BLUE, LIGHT GREEN AND DARK GREEN IS/ARE CLAIMED AS A FEATURE OF THE MARK.

SER. NO. 85-387,681, FILED S.R. 8-2-2011 AM. P.R. 12-19-2011.

EMILY CARLSEN, EXAMINING ATTORNEY



David J. Kyros

Director of the United States Patent and Trademark Office

United States of America

United States Patent and Trademark Office

GFUELCELL

Reg. No. 4,153,116

Registered June 5, 2012

Int. Cls.: 9 and 42

TRADEMARK

SERVICE MARK

PRINCIPAL REGISTER

PROCESS SYSTEMS ENTERPRISE LIMITED (ENGLAND LIMITED LIABILITY COMPANY)
6TH FLOOR EAST
26-28 HAMMERSMITH GROVE
LONDON, UNITED KINGDOM W69HA

FOR: INDUSTRIAL PROCESS CONTROL SOFTWARE; COMPUTER SOFTWARE FOR MODELLING, SIMULATION AND OPTIMIZATION OF PLANTS AND OPERATIONS IN THE PROCESS INDUSTRIES FOR OPTIMAL DESIGN, PLANNING AND SCHEDULING OF MULTI PURPOSE PLANTS AND FOR PRODUCTION MANAGEMENT AND ON-LINE SCHEDULING OF FLEXIBLE BATCH PLANTS, IN CLASS 9 (U.S. CLS. 21, 23, 26, 36 AND 38).

FOR: COMPUTER CONSULTANCY; COMPUTER PROGRAMMING CONSULTANCY; COMPUTER SOFTWARE CONSULTANCY; CONSULTANCY IN THE FIELD OF SOFTWARE DESIGN; COMPUTER SECURITY CONSULTANCY, IN CLASS 42 (U.S. CLS. 100 AND 101).

THE MARK CONSISTS OF STANDARD CHARACTERS WITHOUT CLAIM TO ANY PARTICULAR FONT, STYLE, SIZE, OR COLOR.

OWNER OF ERPN CMNTY TM OFC REG. NO. 9711755, DATED 7-8-2011, EXPIRES 2-4-2021.

SER. NO. 85-387,794, FILED 8-3-2011.

WILLIAM P. SHANAHAN, EXAMINING ATTORNEY



David J. Kybas

Director of the United States Patent and Trademark Office

United States of America

United States Patent and Trademark Office

GSOLIDS

Reg. No. 4,153,117

Registered June 5, 2012

Int. Cls.: 9 and 42

TRADEMARK

SERVICE MARK

PRINCIPAL REGISTER

PROCESS SYSTEMS ENTERPRISE LIMITED (ENGLAND LIMITED LIABILITY COMPANY)
6TH FLOOR EAST
26-28 HAMMERSMITH GROVE
LONDON, UNITED KINGDOM W69HA

FOR: INDUSTRIAL PROCESS CONTROL SOFTWARE; COMPUTER SOFTWARE FOR MODELLING, SIMULATION AND OPTIMIZATION OF PLANTS AND OPERATIONS IN THE PROCESS INDUSTRIES FOR OPTIMAL DESIGN, PLANNING AND SCHEDULING OF MULTI PURPOSE PLANTS AND FOR PRODUCTION MANAGEMENT AND ON-LINE SCHEDULING OF FLEXIBLE BATCH PLANTS, IN CLASS 9 (U.S. CLS. 21, 23, 26, 36 AND 38).

FOR: COMPUTER CONSULTANCY; COMPUTER PROGRAMMING CONSULTANCY; COMPUTER SOFTWARE CONSULTANCY; CONSULTANCY IN THE FIELD OF SOFTWARE DESIGN; COMPUTER SECURITY CONSULTANCY, IN CLASS 42 (U.S. CLS. 100 AND 101).

THE MARK CONSISTS OF STANDARD CHARACTERS WITHOUT CLAIM TO ANY PARTICULAR FONT, STYLE, SIZE, OR COLOR.

OWNER OF ERPN CMNTY TM OFC REG. NO. 9711698, DATED 7-8-2011, EXPIRES 2-4-2021.

SER. NO. 85-387,802, FILED 8-3-2011.

WILLIAM P. SHANAHAN, EXAMINING ATTORNEY



David J. Kybas

Director of the United States Patent and Trademark Office

United States of America

United States Patent and Trademark Office

GPOWER

Reg. No. 4,153,118

Registered June 5, 2012

Int. Cls.: 9 and 42

TRADEMARK

SERVICE MARK

PRINCIPAL REGISTER

PROCESS SYSTEMS ENTERPRISE LIMITED (ENGLAND LIMITED LIABILITY COMPANY)
6TH FLOOR EAST
26-28 HAMMERSMITH GROVE
LONDON, UNITED KINGDOM W69HA

FOR: INDUSTRIAL PROCESS CONTROL SOFTWARE; COMPUTER SOFTWARE FOR MODELLING, SIMULATION AND OPTIMIZATION OF PLANTS AND OPERATIONS IN THE PROCESS INDUSTRIES FOR OPTIMAL DESIGN, PLANNING AND SCHEDULING OF MULTI PURPOSE PLANTS AND FOR PRODUCTION MANAGEMENT AND ON-LINE SCHEDULING OF FLEXIBLE BATCH PLANTS, IN CLASS 9 (U.S. CLS. 21, 23, 26, 36 AND 38).

FOR: COMPUTER CONSULTANCY; COMPUTER PROGRAMMING CONSULTANCY; COMPUTER SOFTWARE CONSULTANCY; CONSULTANCY IN THE FIELD OF SOFTWARE DESIGN; COMPUTER SECURITY CONSULTANCY, IN CLASS 42 (U.S. CLS. 100 AND 101).

THE MARK CONSISTS OF STANDARD CHARACTERS WITHOUT CLAIM TO ANY PARTICULAR FONT, STYLE, SIZE, OR COLOR.

OWNER OF ERPN CMNTY TM OFC REG. NO. 9711664, DATED 7-8-2011, EXPIRES 2-4-2021.

SER. NO. 85-387,806, FILED 8-3-2011.

WILLIAM P. SHANAHAN, EXAMINING ATTORNEY



David J. Kybas

Director of the United States Patent and Trademark Office

United States of America

United States Patent and Trademark Office

GFLARE

Reg. No. 4,153,119

Registered June 5, 2012

Int. Cls.: 9 and 42

TRADEMARK

SERVICE MARK

PRINCIPAL REGISTER

PROCESS SYSTEMS ENTERPRISE LIMITED (ENGLAND LIMITED LIABILITY COMPANY)
6TH FLOOR EAST
26-28 HAMMERSMITH GROVE
LONDON, UNITED KINGDOM W69HA

FOR: INDUSTRIAL PROCESS CONTROL SOFTWARE; COMPUTER SOFTWARE FOR MODELLING, SIMULATION AND OPTIMIZATION OF PLANTS AND OPERATIONS IN THE PROCESS INDUSTRIES FOR OPTIMAL DESIGN, PLANNING AND SCHEDULING OF MULTI PURPOSE PLANTS AND FOR PRODUCTION MANAGEMENT AND ON-LINE SCHEDULING OF FLEXIBLE BATCH PLANTS, IN CLASS 9 (U.S. CLS. 21, 23, 26, 36 AND 38).

FOR: COMPUTER CONSULTANCY; COMPUTER PROGRAMMING CONSULTANCY; COMPUTER SOFTWARE CONSULTANCY; CONSULTANCY IN THE FIELD OF SOFTWARE DESIGN; COMPUTER SECURITY CONSULTANCY, IN CLASS 42 (U.S. CLS. 100 AND 101).

THE MARK CONSISTS OF STANDARD CHARACTERS WITHOUT CLAIM TO ANY PARTICULAR FONT, STYLE, SIZE, OR COLOR.

OWNER OF ERPN CMNTY TM OFC REG. NO. 9711722, DATED 7-8-2011, EXPIRES 2-4-2021.

SER. NO. 85-387,808, FILED 8-3-2011.

WILLIAM P. SHANAHAN, EXAMINING ATTORNEY



David J. Kybas

Director of the United States Patent and Trademark Office

United States of America

United States Patent and Trademark Office

GCRYSTAL

Reg. No. 4,153,120

Registered June 5, 2012

Int. Cls.: 9 and 42

TRADEMARK

SERVICE MARK

PRINCIPAL REGISTER

PROCESS SYSTEMS ENTERPRISE LIMITED (ENGLAND LIMITED LIABILITY COMPANY)
6TH FLOOR EAST
26-28 HAMMERSMITH GROVE
LONDON, UNITED KINGDOM W69HA

FOR: INDUSTRIAL PROCESS CONTROL SOFTWARE; COMPUTER SOFTWARE FOR MODELLING, SIMULATION AND OPTIMIZATION OF PLANTS AND OPERATIONS IN THE PROCESS INDUSTRIES FOR OPTIMAL DESIGN, PLANNING AND SCHEDULING OF MULTI PURPOSE PLANTS AND FOR PRODUCTION MANAGEMENT AND ON-LINE SCHEDULING OF FLEXIBLE BATCH PLANTS, IN CLASS 9 (U.S. CLS. 21, 23, 26, 36 AND 38).

FOR: COMPUTER CONSULTANCY; COMPUTER PROGRAMMING CONSULTANCY; COMPUTER SOFTWARE CONSULTANCY; CONSULTANCY IN THE FIELD OF SOFTWARE DESIGN; COMPUTER SECURITY CONSULTANCY, IN CLASS 42 (U.S. CLS. 100 AND 101).

THE MARK CONSISTS OF STANDARD CHARACTERS WITHOUT CLAIM TO ANY PARTICULAR FONT, STYLE, SIZE, OR COLOR.

OWNER OF ERPN CMNTY TM OFC REG. NO. 9711714, DATED 7-8-2011, EXPIRES 2-4-2021.

SER. NO. 85-387,812, FILED 8-3-2011.

WILLIAM P. SHANAHAN, EXAMINING ATTORNEY



David J. Kyffers

Director of the United States Patent and Trademark Office

United States of America

United States Patent and Trademark Office

CS Technology

Reg. No. 4,153,121

Registered June 5, 2012

Int. Cl.: 42

SERVICE MARK

PRINCIPAL REGISTER

CS TECHNOLOGY, INC. (DELAWARE CORPORATION)
14TH FLOOR
535 8TH AVE
NEW YORK, NY 10018

FOR: CONSULTING IN THE FIELD OF INFORMATION TECHNOLOGY; CONSULTING IN THE FIELD OF IT PROJECT MANAGEMENT; COMPUTER PROJECT MANAGEMENT SERVICES; CONSULTING SERVICES FOR OTHERS IN THE FIELD OF DESIGN, PLANNING, AND IMPLEMENTATION PROJECT MANAGEMENT OF INFORMATION TECHNOLOGY SYSTEMS; PLANNING, DESIGN, AND MANAGEMENT OF INFORMATION TECHNOLOGY SYSTEMS, IN CLASS 42 (U.S. CLS. 100 AND 101).

FIRST USE 6-24-1992; IN COMMERCE 6-24-1992.

THE MARK CONSISTS OF STANDARD CHARACTERS WITHOUT CLAIM TO ANY PARTICULAR FONT, STYLE, SIZE, OR COLOR.

NO CLAIM IS MADE TO THE EXCLUSIVE RIGHT TO USE "TECHNOLOGY", APART FROM THE MARK AS SHOWN.

SER. NO. 85-387,965, FILED 8-3-2011.

KIMBERLY PERRY, EXAMINING ATTORNEY



David J. Kyros

Director of the United States Patent and Trademark Office

United States of America

United States Patent and Trademark Office



Reg. No. 4,153,122

Registered June 5, 2012

Int. Cls.: 35 and 36

SERVICE MARK

PRINCIPAL REGISTER

NAVITAS WEALTH ADVISORS, INC. (MISSISSIPPI CORPORATION)
574 HIGHLAND COLONY PARKWAY
SUITE 120
RIDGELAND, MS 39157

FOR: BUSINESS DEVELOPMENT AND ORGANIZATIONAL CONSULTATION; TAX CONSULTATION, IN CLASS 35 (U.S. CLS. 100, 101 AND 102).

FIRST USE 2-16-2001; IN COMMERCE 2-16-2001.

FOR: INVESTMENT ADVISORY AND FINANCIAL CONSULTATION SERVICES, USING A HOLISTIC APPROACH TO SERVICE FINANCIAL NEEDS, NAMELY, ESTATE PLANNING AND FINANCIAL ASSET MANAGEMENT CONSULTATION, IN CLASS 36 (U.S. CLS. 100, 101 AND 102).

FIRST USE 2-16-2001; IN COMMERCE 2-16-2001.

THE MARK CONSISTS OF THE WORD "NAVITAS" CENTERED WITHIN A STYLIZED DEPICTION OF A COMPASS, WITH THE NEEDLE OF THE COMPASS FORMING THE LETTER "I".

THE ENGLISH TRANSLATION OF "NAVITAS" IN THE MARK IS "NAVIGATING" THE WHOLE OF LIFE WITH TRUTH, INTEGRITY AND ENERGY".

SER. NO. 85-388,542, FILED 8-3-2011.

REBECCA SMITH, EXAMINING ATTORNEY



David J. Kyros

Director of the United States Patent and Trademark Office

United States of America

United States Patent and Trademark Office

Motion Mechanics

Reg. No. 4,153,123

NOVOSEL, JOHN M. SR. (UNITED STATES INDIVIDUAL)
12708 PEMBROKE LANE
LEAWOOD, KS 66209

Registered June 5, 2012

Int. Cl.: 28

FOR: GOLF CLUB SWING AIDS, NAMELY, GOLF CLUBS WITH HINGES AND ELASTIC BANDS FOR USE IN LEARNING THE GOLF SWING, IN CLASS 28 (U.S. CLS. 22, 23, 38 AND 50).

TRADEMARK

FIRST USE 7-19-2010; IN COMMERCE 7-19-2010.

PRINCIPAL REGISTER

THE MARK CONSISTS OF STANDARD CHARACTERS WITHOUT CLAIM TO ANY PARTICULAR FONT, STYLE, SIZE, OR COLOR.

SER. NO. 85-389,125, FILED 8-4-2011.

SHAILA SETTLES, EXAMINING ATTORNEY



David J. Kyffers

Director of the United States Patent and Trademark Office

United States of America

United States Patent and Trademark Office



Reg. No. 4,153,124

Registered June 5, 2012

Int. Cl.: 36

SERVICE MARK

PRINCIPAL REGISTER

SPRINT COMMUNICATIONS COMPANY L.P. (DELAWARE LIMITED PARTNERSHIP)
6200 SPRINT PARKWAY
OVERLAND PARK, KS 66251

FOR: PROVIDING CASH AND OTHER REBATES FOR CREDIT CARD USE AS PART OF A
CUSTOMER LOYALTY PROGRAM, IN CLASS 36 (U.S. CLS. 100, 101 AND 102).

FIRST USE 7-24-2011; IN COMMERCE 7-24-2011.

OWNER OF U.S. REG. NO. 3,525,717.

THE MARK CONSISTS OF AN ARBITRARY DESIGN WITH A GENERALLY TRIANGULAR
SHAPE FORM BY FIVE BANDS.

SER. NO. 85-389,522, FILED 8-4-2011.

JAY BESCH, EXAMINING ATTORNEY



David J. Kybas

Director of the United States Patent and Trademark Office

United States of America

United States Patent and Trademark Office

CENTRASIGHT

Reg. No. 4,153,125

Registered June 5, 2012

Int. Cls.: 36 and 44

SERVICE MARK

PRINCIPAL REGISTER

VISIONCARE OPHTHALMIC TECHNOLOGIES, INC. (DELAWARE CORPORATION)
14395 SARATOGA AVE., SUITE 150
SARATOGA, CA 95070

FOR: PROVIDING A WEBSITE FEATURING INFORMATION ABOUT ACCESS TO MEDICAL PROCEDURE REIMBURSEMENT PROGRAMS FOR PATIENTS AND PHYSICIANS , IN CLASS 36 (U.S. CLS. 100, 101 AND 102).

FIRST USE 7-1-2010; IN COMMERCE 7-1-2010.

FOR: PROVIDING A WEB SITE FEATURING INFORMATION ABOUT TREATING PATIENTS WITH END-STAGE MACULAR DEGENERATION THROUGH DIAGNOSIS, SCREENING, INTER-OCULAR TELESCOPIC LENS IMPLANTATION, AND REHABILITATION PROCEDURES; PROVIDING MEDICAL INFORMATION IN THE FIELD OF TREATING PATIENTS WITH END-STAGE MACULAR DEGENERATION THROUGH DIAGNOSIS, SCREENING, INTER-OCULAR TELESCOPIC LENS IMPLANTATION, AND REHABILITATION PROCEDURES, IN CLASS 44 (U.S. CLS. 100 AND 101).

FIRST USE 7-1-2010; IN COMMERCE 7-1-2010.

THE MARK CONSISTS OF STANDARD CHARACTERS WITHOUT CLAIM TO ANY PARTICULAR FONT, STYLE, SIZE, OR COLOR.

SER. NO. 85-389,611, FILED 8-4-2011.

YAT SYE, LEE, EXAMINING ATTORNEY



David J. Kypos

Director of the United States Patent and Trademark Office

United States of America

United States Patent and Trademark Office

UMAMI BURGER

Reg. No. 4,153,126

Registered June 5, 2012

Int. Cl.: 43

SERVICE MARK

PRINCIPAL REGISTER

UMAMI BURGER LICENSING USA, LLC (DELAWARE LIMITED LIABILITY COMPANY)
7966 BEVERLY BOULEVARD, SECOND FLOOR
LOS ANGELES, CA 90048

FOR: RESTAURANT SERVICES; TAKEOUT RESTAURANT SERVICES, IN CLASS 43 (U.S. CLS. 100 AND 101).

FIRST USE 2-13-2009; IN COMMERCE 2-13-2009.

THE MARK CONSISTS OF STANDARD CHARACTERS WITHOUT CLAIM TO ANY PARTICULAR FONT, STYLE, SIZE, OR COLOR.

NO CLAIM IS MADE TO THE EXCLUSIVE RIGHT TO USE "BURGER", APART FROM THE MARK AS SHOWN.

SER. NO. 85-389,895, FILED 8-4-2011.

WENDY GOODMAN, EXAMINING ATTORNEY



David J. Kybas

Director of the United States Patent and Trademark Office

United States of America

United States Patent and Trademark Office



Bienvenidos
abordo.com

Reg. No. 4,153,127

Registered June 5, 2012

Int. Cl.: 39

SERVICE MARK

PRINCIPAL REGISTER

TORRES, LUIS EDUARDO DE LA VEGA (MEXICO INDIVIDUAL)
18 DE DICIEMBRE # 304 EL ROBLE
SAN NICOLAS LOS GARZA, MEXICO 66450

FOR: ARRANGING OF TOURS AND CRUISES; ARRANGING TRAVEL TOURS; ESCORTING OF TRAVELLERS; PROVIDING A WEBSITE FEATURING INFORMATION ON TRAVEL; PROVIDING TRAVEL INFORMATION TO TRAVELERS REGARDING FARES, TIMETABLES AND PUBLIC TRANSPORT; PROVISION OF TRAVEL INFORMATION; TRAVEL AGENCY SERVICES, NAMELY, MAKING RESERVATIONS AND BOOKINGS FOR TRANSPORTATION; TRAVEL BOOKING AGENCIES; TRAVEL GUIDE AND TRAVEL INFORMATION SERVICES; TRAVEL ROUTE PLANNING; TRAVEL, EXCURSION AND CRUISE ARRANGEMENT; WEBSITE PROVIDING TRAVEL BOOKING AND RESERVATION SERVICES FOR DIVERS, IN CLASS 39 (U.S. CLS. 100 AND 105).

FIRST USE 6-17-2006; IN COMMERCE 6-17-2006.

THE MARK CONSISTS OF A DESIGN OF SEVEN CURVED ELEMENTS EMANATING FROM A CENTER POINT WITH THE WORDS "BIENVENIDOS ABORDO.COM".

THE ENGLISH TRANSLATION OF "BIENVENIDOS ABORDO" IN THE MARK IS "WELCOME ABOARD".

SER. NO. 85-390,223, FILED 8-4-2011.

NAKIA HENRY, EXAMINING ATTORNEY



David J. Kyros

Director of the United States Patent and Trademark Office

United States of America

United States Patent and Trademark Office



SPRAYABLE

Reg. No. 4,153,128

Registered June 5, 2012

Int. Cl.: 1

TRADEMARK

PRINCIPAL REGISTER

AQUATROLS CORPORATION OF AMERICA (NEW JERSEY CORPORATION)
1273 IMPERIAL WAY
PAULSBORO, NJ 080661808

FOR: SOIL AMENDMENTS; SOIL IMPROVING AGENTS; SOIL SURFACTANT USED TO PROMOTE UNIFORM MOVEMENT OF WATER IN SOIL; SOIL WETTING AGENTS AND SOIL PENETRANTS, IN CLASS 1 (U.S. CLS. 1, 5, 6, 10, 26 AND 46).

FIRST USE 7-1-2011; IN COMMERCE 7-1-2011.

OWNER OF U.S. REG. NOS. 2,671,061, 3,356,968 AND OTHERS.

THE COLOR(S) WHITE, GREEN, BLACK AND DARK GREY IS/ARE CLAIMED AS A FEATURE OF THE MARK.

NO CLAIM IS MADE TO THE EXCLUSIVE RIGHT TO USE "BLAST SPRAYABLE", APART FROM THE MARK AS SHOWN.

THE MARK CONSISTS OF THE WORD "BLAST" IN ALL WHITE UPPER CASE LETTERS, NEXT TO THREE GREEN ROUNDED LINES POINTING DOWN AT DIFFERENT ANGLES, ALL ON A DARK GREY ELONGATED BOX WITH ROUNDED CORNERS WITH THE WORD "SPRAYABLE" IN ALL CAPITAL LETTERS IN THE COLOR BLACK AT THE BOTTOM RIGHT OF THE BOX. THE COLOR WHITE IN THE BACKGROUND REPRESENTS TRANSPARENT AREA AND IS NOT PART OF THE MARK.

SER. NO. 85-390,408, FILED 8-5-2011.

KATHLEEN M. VANSTON, EXAMINING ATTORNEY



David J. Kyjars

Director of the United States Patent and Trademark Office

United States of America

United States Patent and Trademark Office

MOJAVE

Reg. No. 4,153,129

FOUR STAR GREENHOUSE, INC. (MICHIGAN CORPORATION)
1015 INDIAN TRAIL ROAD
CARLETON, MI 48117

Registered June 5, 2012

Int. Cl.: 31

FOR: LIVING PLANTS OTHER THAN IPOMOEA BATATAS, FESTUCA ARUNDINACEA
AND LACTUCA SATIVA, IN CLASS 31 (U.S. CLS. 1 AND 46).

TRADEMARK

FIRST USE 1-24-2011; IN COMMERCE 1-24-2011.

PRINCIPAL REGISTER

THE MARK CONSISTS OF STANDARD CHARACTERS WITHOUT CLAIM TO ANY PAR-
TICULAR FONT, STYLE, SIZE, OR COLOR.

SER. NO. 85-390,694, FILED 8-5-2011.

JOHN GARTNER, EXAMINING ATTORNEY



David J. Kybas

Director of the United States Patent and Trademark Office

United States of America

United States Patent and Trademark Office

NEW CLASSIC
Home Furnishings, Inc.

Reg. No. 4,153,130

Registered June 5, 2012

Int. Cl.: 20

TRADEMARK

PRINCIPAL REGISTER

NEW CLASSIC HOME FURNISHING, INC. (CALIFORNIA CORPORATION)
7351 MCGUIRE AVENUE
FONTANA, CA 92336

FOR: BEDROOM FURNITURE; DINING ROOM TABLES; ENTERTAINMENT CENTERS;
FURNITURE; FURNITURE PARTS; LIVING ROOM FURNITURE; MIRRORS; UPHOLSTERED
FURNITURE, IN CLASS 20 (U.S. CLS. 2, 13, 22, 25, 32 AND 50).

FIRST USE 12-4-2000; IN COMMERCE 8-8-2001.

OWNER OF U.S. REG. NO. 3,037,098.

NO CLAIM IS MADE TO THE EXCLUSIVE RIGHT TO USE "CLASSIC" AND "HOME FUR-
NISHINGS, INC.", APART FROM THE MARK AS SHOWN.

THE MARK CONSISTS OF "NEW CLASSIC HOME FURNISHINGS, INC." IN WHICH "NEW
CLASSIC" IS UNDERLINED.

SER. NO. 85-390,782, FILED 8-5-2011.

B. PARADEWELAI, EXAMINING ATTORNEY



David J. Kybas

Director of the United States Patent and Trademark Office

United States of America

United States Patent and Trademark Office

El Imagenero

Reg. No. 4,153,131

Registered June 5, 2012

Int. Cls.: 16 and 41

TRADEMARK

SERVICE MARK

PRINCIPAL REGISTER

DOUGLAS W. GASTELUM (CALIFORNIA SOLE PROPRIETORSHIP), DBA EL IMAGENERO
1 WORLD TRADE CENTER, 8TH FLOOR
LONG BEACH, CA 90831

FOR: PHOTOGRAPHIC PRINTS, NAMELY, MOUNTED AND UN-MOUNTED FINE ART PRINTS; MOUNTED AND UN-MOUNTED POSTERS; GREETING CARDS; POST CARDS; AND A SERIES OF NON-FICTION BOOKS CONTAINING PHOTOGRAPHS, IN CLASS 16 (U.S. CLS. 2, 5, 22, 23, 29, 37, 38 AND 50).

FIRST USE 6-0-2006; IN COMMERCE 6-0-2006.

FOR: PHOTOGRAPHY SERVICES, NAMELY, PHOTOGRAPHY; PHOTOGRAPHY SERVICES; PORTRAIT PHOTOGRAPHY; DIGITAL IMAGING SERVICES; ART EXHIBITION SERVICES; ART EXHIBITIONS; PHOTOGRAPHY SERVICES PROVIDED IN CONNECTION WITH EVENTS AND PERFORMANCES PHOTOGRAPHY; CONDUCTING ENTERTAINMENT EXHIBITIONS IN THE NATURE OF FINE ART PHOTOGRAPHY; ORGANIZATION OF EXHIBITIONS FOR CULTURAL OR EDUCATIONAL PURPOSES; AND ORGANIZING AND ARRANGING EXHIBITIONS FOR ENTERTAINMENT PURPOSES, IN CLASS 41 (U.S. CLS. 100, 101 AND 107).

FIRST USE 6-0-2006; IN COMMERCE 6-0-2006.

THE MARK CONSISTS OF STANDARD CHARACTERS WITHOUT CLAIM TO ANY PARTICULAR FONT, STYLE, SIZE, OR COLOR.

SER. NO. 85-391,511, FILED 8-6-2011.

SUSAN RICHARDS, EXAMINING ATTORNEY



David J. Kyffers

Director of the United States Patent and Trademark Office

United States of America

United States Patent and Trademark Office

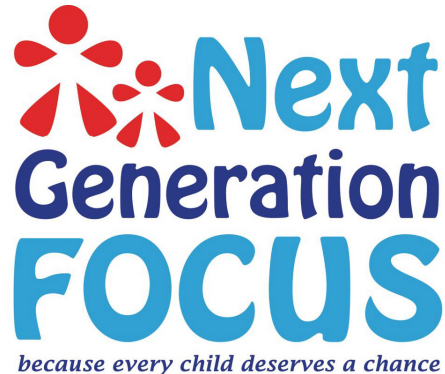

Reg. No. 4,153,132

Registered June 5, 2012

Int. Cl.: 41

SERVICE MARK

PRINCIPAL REGISTER

NEXT GENERATION FOCUS, INC. (GEORGIA CORPORATION)
SUITE 110
133 SAMARITAN DRIVE
CUMMING, GA 30040

FOR: EDUCATION SERVICES, NAMELY, PROVIDING ACADEMIC ENRICHMENT PROGRAMS FOR CHILDREN AND YOUNG ADULTS IN THE FIELDS OF READING, MATH, SCIENCE, TECHNOLOGY, ART, SPORTS, SOCIAL STUDIES, AND MUSIC, IN CLASS 41 (U.S. CLS. 100, 101 AND 107).

FIRST USE 1-1-2009; IN COMMERCE 1-1-2009.

THE MARK CONSISTS OF A STYLIZED DESIGN OF TWO PEOPLE IN WHICH ONE PERSON IS BIGGER THAN THE OTHER AND IN WHICH A RED CIRCLE FORMS THE HEAD, TWO RED TEAR-DROP SHAPES FORM THE ARMS AND TWO RED ROUNDED TRIANGULAR SHAPES FORM THE LEGS OF BOTH INDIVIDUALS. TO THE RIGHT AND UNDERNEATH OF THE DESIGN IS THE WORDING "NEXT GENERATION FOCUS" IN WHICH THE TERMS "NEXT" AND "FOCUS" ARE IN LIGHT BLUE AND "GENERATION" IS IN BLUE. IMMEDIATELY UNDERNEATH THIS WORDING IS THE PHRASE "BECAUSE EVERY CHILD DESERVES A CHANCE" IN BLUE.

THE COLOR(S) RED, LIGHT BLUE AND BLUE IS/ARE CLAIMED AS A FEATURE OF THE MARK.

SER. NO. 85-391,835, FILED 8-8-2011.

HAI-LY LAM, EXAMINING ATTORNEY



David J. Kyjars

Director of the United States Patent and Trademark Office

United States of America

United States Patent and Trademark Office

Simplicity Law

Reg. No. 4,153,133

Registered June 5, 2012

Int. Cl.: 45

SERVICE MARK

PRINCIPAL REGISTER

SIMPLICITY LAW, INC. (COLORADO CORPORATION)
11852 SHAFFER DRIVE, BLDG D, SUITE 200
LITTLETON, CO 80127

FOR: LEGAL SERVICES, IN CLASS 45 (U.S. CLS. 100 AND 101).

FIRST USE 12-15-2008; IN COMMERCE 12-15-2008.

THE MARK CONSISTS OF STANDARD CHARACTERS WITHOUT CLAIM TO ANY PARTICULAR FONT, STYLE, SIZE, OR COLOR.

OWNER OF U.S. REG. NO. 3,588,495.

NO CLAIM IS MADE TO THE EXCLUSIVE RIGHT TO USE "LAW", APART FROM THE MARK AS SHOWN.

SER. NO. 85-392,081, FILED 8-8-2011.

DANNEAN HETZEL, EXAMINING ATTORNEY



David J. Kyffers

Director of the United States Patent and Trademark Office

United States of America

United States Patent and Trademark Office



Reg. No. 4,153,134

Registered June 5, 2012

Int. Cl.: 41

SERVICE MARK

PRINCIPAL REGISTER

DIGITAL AGE LEARNING (CALIFORNIA CORPORATION), DBA DEVELOPENTOR
5777 WEST CENTURY BLVD SUITE 600
LOS ANGELES, CA 90045

FOR: EDUCATIONAL SERVICES, NAMELY CONDUCTING TRAINING COURSES AND WORKSHOPS FOR SOFTWARE DEVELOPERS IN THE FIELD OF COMPUTER PROGRAMMING, SOFTWARE DEVELOPMENT AND GLOBAL COMPUTER INFORMATION NETWORK TECHNOLOGY AND DISTRIBUTING COURSE MATERIAL IN CONNECTION THEREWITH, IN CLASS 41 (U.S. CLS. 100, 101 AND 107).

FIRST USE 12-31-1995; IN COMMERCE 12-31-1995.

THE MARK CONSISTS OF A RECTANGLE WITH FOUR SECTIONS, THE LEFT SECTION WITH THE WORDS "WRITE CODE DAY & NIGHT," THE TOP SECTION WITH THE "DEVELOPENTOR" LOGO, THE RIGHT SECTION WITH A STYLIZED MAN PLAYING A TRUMPET, AND THE BOTTOM SECTION WITH THE WORDS "GUERRILLA EVENTS".

SER. NO. 85-392,160, FILED 8-8-2011.

SANI KHOURI, EXAMINING ATTORNEY



David J. Kyros

Director of the United States Patent and Trademark Office

United States of America

United States Patent and Trademark Office

EXCELERATOR

Reg. No. 4,153,135

Registered June 5, 2012

Int. Cl.: 9

TRADEMARK

PRINCIPAL REGISTER

MARSHALL EXCELSIOR COMPANY (MICHIGAN CORPORATION)
P.O. BOX 228
1506 GEORGE BROWN DRIVE
MARSHALL, MI 49068

FOR: CONTROL VALVES FOR REGULATING THE FLOW OF GASSES AND LIQUIDS, IN CLASS 9 (U.S. CLS. 21, 23, 26, 36 AND 38).

FIRST USE 1-1-2012; IN COMMERCE 1-1-2012.

THE MARK CONSISTS OF STANDARD CHARACTERS WITHOUT CLAIM TO ANY PARTICULAR FONT, STYLE, SIZE, OR COLOR.

SER. NO. 85-392,192, FILED 8-8-2011.

COLLEEN KEARNEY, EXAMINING ATTORNEY



David J. Kybas

Director of the United States Patent and Trademark Office

United States of America

United States Patent and Trademark Office

LAB SMARTER

Reg. No. 4,153,136

Registered June 5, 2012

Int. Cl.: 40

SERVICE MARK

PRINCIPAL REGISTER

DENTSPLY INTERNATIONAL INC. (DELAWARE CORPORATION)
221 WEST PHILADELPHIA STREET
YORK, PA 174050872

FOR: CUSTOM MANUFACTURE OF DENTAL PROSTHETICS, IN CLASS 40 (U.S. CLS. 100, 103 AND 106).

FIRST USE 2-28-2011; IN COMMERCE 2-28-2011.

THE MARK CONSISTS OF STANDARD CHARACTERS WITHOUT CLAIM TO ANY PARTICULAR FONT, STYLE, SIZE, OR COLOR.

NO CLAIM IS MADE TO THE EXCLUSIVE RIGHT TO USE "LAB", APART FROM THE MARK AS SHOWN.

SER. NO. 85-392,416, FILED 8-8-2011.

MARGARET POWER, EXAMINING ATTORNEY



David J. Kyffers

Director of the United States Patent and Trademark Office

United States of America

United States Patent and Trademark Office

CLASSIC WHIMSY

Reg. No. 4,153,137

Registered June 5, 2012

Int. Cl.: 25

TRADEMARK

PRINCIPAL REGISTER

SMOCKED RUNWAY, LLC (TEXAS LIMITED LIABILITY COMPANY)
6440 NORTH CENTRAL EXPRESSWAY, SUITE 810
DALLAS, TX 75206

FOR: CHILDREN'S AND INFANT'S APPAREL, NAMELY, JUMPERS, LONGALLS IN THE NATURE OF ROMPERS, JON JONS, NAMELY, SHORTALLS AND OVERALLS, DRESSES, SHIRTS, BLOUSES, SWEATERS, BLOOMERS, PANTS, LEGGINGS, JACKETS, FLEECES, NAMELY, FLEECE JACKETS, FLEECE PANTS, FLEECE VESTS, FLEECE HATS, AND FLEECE PULLOVER TOPS, SWIMWEAR, SLEEPWEAR, PAJAMAS, ROMPERS AND ONE-PIECE GARMENTS, IN CLASS 25 (U.S. CLS. 22 AND 39).

FIRST USE 12-0-2010; IN COMMERCE 1-0-2011.

THE MARK CONSISTS OF STANDARD CHARACTERS WITHOUT CLAIM TO ANY PARTICULAR FONT, STYLE, SIZE, OR COLOR.

SER. NO. 85-392,507, FILED 8-8-2011.

CHRISTOPHER SIDOTI, EXAMINING ATTORNEY



David J. Kybas

Director of the United States Patent and Trademark Office

United States of America

United States Patent and Trademark Office

Gen+Ion

Reg. No. 4,153,138

Registered June 5, 2012

Int. Cl.: 1

TRADEMARK

PRINCIPAL REGISTER

GENERAL CHEMICAL PERFORMANCE PRODUCTS, LLC (DELAWARE LIMITED LIABILITY COMPANY)

LEGAL DEPARTMENT
90 EAST HALSEY ROAD
PARSIPPANY, NJ 07054

FOR: CHEMICALS USED IN PAPER AND PULP MANUFACTURE, IN CLASS 1 (U.S. CLS. 1, 5, 6, 10, 26 AND 46).

FIRST USE 12-28-1988; IN COMMERCE 4-20-1989.

THE MARK CONSISTS OF STANDARD CHARACTERS WITHOUT CLAIM TO ANY PARTICULAR FONT, STYLE, SIZE, OR COLOR.

SER. NO. 85-392,989, FILED 8-9-2011.

SKYE YOUNG, EXAMINING ATTORNEY



David J. Kybas

Director of the United States Patent and Trademark Office

United States of America

United States Patent and Trademark Office

IC-LOC

Reg. No. 4,153,139

Registered June 5, 2012

Int. Cl.: 1

TRADEMARK

PRINCIPAL REGISTER

BOB SMITH INDUSTRIES (CALIFORNIA CORPORATION)
8060 MORRO ROAD
ATASCADERO, CA 93422

FOR: ADHESIVES FOR INDUSTRIAL AND HOBBY PURPOSES, NAMELY, ADHESIVES FOR APPLICATION TO THE THREADS OF FASTENERS BEFORE ASSEMBLY TO PREVENT LOOSENING OF THE FASTENERS. IN IC 001 , IN CLASS 1 (U.S. CLS. 1, 5, 6, 10, 26 AND 46).

FIRST USE 10-15-2009; IN COMMERCE 10-15-2009.

THE MARK CONSISTS OF STANDARD CHARACTERS WITHOUT CLAIM TO ANY PARTICULAR FONT, STYLE, SIZE, OR COLOR.

SER. NO. 85-393,505, FILED 8-9-2011.

LINDA ORNDORFF, EXAMINING ATTORNEY



David J. Kyjars

Director of the United States Patent and Trademark Office

United States of America

United States Patent and Trademark Office

Tinnie Berlinie

Reg. No. 4,153,140

Registered June 5, 2012

Int. Cl.: 18

TRADEMARK

PRINCIPAL REGISTER

ESCOBAR, DELIA P. (UNITED STATES INDIVIDUAL)
5370 SCHAEFER AVE., SUITE D
CHINO, CA 91710

FOR: ALL-PURPOSE CARRYING BAGS; ALL-PURPOSE REUSABLE CARRYING BAGS;
AMENITY BAGS SOLD EMPTY; BABY CARRYING BAGS; BAGS FOR CARRYING BABIES'
ACCESSORIES; BARREL BAGS; DIAPER BAGS; SHOULDER BAGS, IN CLASS 18 (U.S.
CLS. 1, 2, 3, 22 AND 41).

FIRST USE 3-1-2007; IN COMMERCE 8-9-2011.

THE MARK CONSISTS OF STANDARD CHARACTERS WITHOUT CLAIM TO ANY PAR-
TICULAR FONT, STYLE, SIZE, OR COLOR.

THE NAME "TINNIE BERLINIE" DOES NOT IDENTIFY A LIVING INDIVIDUAL.

SER. NO. 85-393,647, FILED 8-9-2011.

JIM RINGLE, EXAMINING ATTORNEY



David J. Kybas

Director of the United States Patent and Trademark Office

United States of America

United States Patent and Trademark Office

C. MANZINI

Reg. No. 4,153,141

Registered June 5, 2012

Int. Cl.: 25

TRADEMARK

PRINCIPAL REGISTER

SOXLAND INDUSTRIAL, INC. (NEW JERSEY CORPORATION)
485 BLOY STREET
HILLSIDE, NJ 07205

FOR: SOCKS, IN CLASS 25 (U.S. CLS. 22 AND 39).

FIRST USE 6-8-2003; IN COMMERCE 9-20-2003.

THE MARK CONSISTS OF STANDARD CHARACTERS WITHOUT CLAIM TO ANY PARTICULAR FONT, STYLE, SIZE, OR COLOR.

THE NAME(S), PORTRAIT(S), AND/OR SIGNATURE(S) SHOWN IN THE MARK DOES NOT IDENTIFY A PARTICULAR LIVING INDIVIDUAL.

SER. NO. 85-393,833, FILED 8-9-2011.

MICHAEL SOUDERS, EXAMINING ATTORNEY



David J. Kyffers

Director of the United States Patent and Trademark Office

United States of America

United States Patent and Trademark Office

YVES FRANC CLAIRE

Reg. No. 4,153,142

Registered June 5, 2012

Int. Cl.: 25

TRADEMARK

PRINCIPAL REGISTER

SOXLAND INDUSTRIAL, INC. (NEW JERSEY CORPORATION)
485 BLOY STREET
HILLSIDE, NJ 07205

FOR: SOCKS, IN CLASS 25 (U.S. CLS. 22 AND 39).

FIRST USE 6-6-2011; IN COMMERCE 8-1-2011.

THE MARK CONSISTS OF STANDARD CHARACTERS WITHOUT CLAIM TO ANY PARTICULAR FONT, STYLE, SIZE, OR COLOR.

THE NAME(S), PORTRAIT(S), AND/OR SIGNATURE(S) SHOWN IN THE MARK DOES NOT IDENTIFY A PARTICULAR LIVING INDIVIDUAL.

SER. NO. 85-393,928, FILED 8-10-2011.

MICHAEL SOUDERS, EXAMINING ATTORNEY



David J. Kybas

Director of the United States Patent and Trademark Office

United States of America

United States Patent and Trademark Office

PowerFold

Reg. No. 4,153,143

Registered June 5, 2012

Int. Cls.: 7 and 12

TRADEMARK

PRINCIPAL REGISTER

LAFORGE (FRANCE CORPORATION)
POLE D'ACTIVITES, ROUTE DE SOISSONS
02190 GUIGNICOURT, FRANCE

FOR: LIFTS, NAMELY, MECHANICAL FRONT LIFTS AND HYDRAULIC LIFTS FOR TRACTORS, IN CLASS 7 (U.S. CLS. 13, 19, 21, 23, 31, 34 AND 35).

FOR: HITCHES, NAMELY, FRONT 3 POINT HITCHES FOR TRACTORS, IN CLASS 12 (U.S. CLS. 19, 21, 23, 31, 35 AND 44).

THE MARK CONSISTS OF STANDARD CHARACTERS WITHOUT CLAIM TO ANY PARTICULAR FONT, STYLE, SIZE, OR COLOR.

PRIORITY CLAIMED UNDER SEC. 44(D) ON FRANCE APPLICATION NO. 009738667, FILED 2-15-2011, REG. NO. 009738667, DATED 2-15-2011, EXPIRES 2-15-2021.

SER. NO. 85-394,184, FILED 8-10-2011.

AMY ALFIERI, EXAMINING ATTORNEY



David J. Kybas

Director of the United States Patent and Trademark Office

United States of America

United States Patent and Trademark Office

Bye June

Reg. No. 4,153,144

Registered June 5, 2012

Int. Cl.: 41

SERVICE MARK

PRINCIPAL REGISTER

KLINE, GIL (UNITED STATES INDIVIDUAL)
19501 RIDGE HEIGHTS DR
GAITHERSBURG, MD 20879

FOR: ENTERTAINMENT, NAMELY, LIVE PERFORMANCES BY A MUSICAL BAND, IN CLASS 41 (U.S. CLS. 100, 101 AND 107).

FIRST USE 4-4-2011; IN COMMERCE 4-4-2011.

THE MARK CONSISTS OF STANDARD CHARACTERS WITHOUT CLAIM TO ANY PARTICULAR FONT, STYLE, SIZE, OR COLOR.

SER. NO. 85-394,208, FILED 8-10-2011.

HENRY S. ZAK, EXAMINING ATTORNEY



David J. Kybas

Director of the United States Patent and Trademark Office

United States of America

United States Patent and Trademark Office



Reg. No. 4,153,145

Registered June 5, 2012

Int. Cl.: 25

TRADEMARK

PRINCIPAL REGISTER

GYPSY 05, INC. (CALIFORNIA CORPORATION)
3200 UNION PACIFIC AVE
LOS ANGELES, CA 90023

FOR: CLOTHING, NAMELY, T-SHIRTS, SHIRTS, TOPS, SWEATERS, PANTS, SWEATSHIRTS, SWEATPANTS, DRESSES, SHORTS, SKIRTS, SCARVES, IN CLASS 25 (U.S. CLS. 22 AND 39).

FIRST USE 8-1-2011; IN COMMERCE 8-1-2011.

THE MARK CONSISTS OF THE WORD "LOVLI" WRITTEN IN YELLOW WITH A RED HEART ON TOP OF THE LETTER "I" AND INSTEAD OF THE DOT ON THE "I". ALL OUTLINED IN BLACK.

THE COLOR(S) YELLOW, RED, AND BLACK IS/ARE CLAIMED AS A FEATURE OF THE MARK.

SER. NO. 85-394,297, FILED 8-10-2011.

GRETTA YAO, EXAMINING ATTORNEY



David J. Kybas

Director of the United States Patent and Trademark Office

United States of America

United States Patent and Trademark Office

WOOD RIVER CREAMERY

Reg. No. 4,153,146

Registered June 5, 2012

Int. Cl.: 29

TRADEMARK

PRINCIPAL REGISTER

BURNETT DAIRY COOPERATIVE (WISCONSIN MEMBERSHIP COOPERATIVE)
11631 STATE ROAD 70
GRANSTBURG, WI 54840

FOR: CHEESE, IN CLASS 29 (U.S. CL. 46).

FIRST USE 9-1-2007; IN COMMERCE 9-1-2007.

THE MARK CONSISTS OF STANDARD CHARACTERS WITHOUT CLAIM TO ANY PARTICULAR FONT, STYLE, SIZE, OR COLOR.

NO CLAIM IS MADE TO THE EXCLUSIVE RIGHT TO USE "CREAMERY", APART FROM THE MARK AS SHOWN.

SEC. 2(F).

SER. NO. 85-394,366, FILED 8-10-2011.

ELI HELLMAN, EXAMINING ATTORNEY



David J. Kybas

Director of the United States Patent and Trademark Office

United States of America

United States Patent and Trademark Office



Reg. No. 4,153,147

Registered June 5, 2012

Int. Cl.: 36

SERVICE MARK

PRINCIPAL REGISTER

BOSTON PROPERTIES LIMITED PARTNERSHIP (DELAWARE LIMITED PARTNERSHIP)
800 BOYLSTON STREET, SUITE 1900
BOSTON, MA 02199

FOR: LEASING AND MANAGEMENT OF REAL ESTATE, IN CLASS 36 (U.S. CLS. 100, 101 AND 102).

FIRST USE 10-7-2010; IN COMMERCE 10-7-2010.

THE MARK CONSISTS OF A STYLIZED DEPICTION OF A CAPITAL LETTER "A", WHICH SUGGESTS THE SHAPE OF A SAIL.

SER. NO. 85-394,399, FILED 8-10-2011.

ERIN FALK, EXAMINING ATTORNEY



David J. Kyffers

Director of the United States Patent and Trademark Office

United States of America

United States Patent and Trademark Office

ATLANTIC WHARF

Reg. No. 4,153,148

Registered June 5, 2012

Int. Cl.: 36

SERVICE MARK

PRINCIPAL REGISTER

BOSTON PROPERTIES LIMITED PARTNERSHIP (DELAWARE LIMITED PARTNERSHIP)
800 BOYLSTON STREET, SUITE 1900
BOSTON, MA 02199

FOR: LEASING AND MANAGEMENT OF REAL ESTATE, IN CLASS 36 (U.S. CLS. 100, 101 AND 102).

FIRST USE 10-7-2010; IN COMMERCE 10-7-2010.

THE MARK CONSISTS OF STANDARD CHARACTERS WITHOUT CLAIM TO ANY PARTICULAR FONT, STYLE, SIZE, OR COLOR.

SER. NO. 85-394,409, FILED 8-10-2011.

ERIN FALK, EXAMINING ATTORNEY



David J. Kybas

Director of the United States Patent and Trademark Office

United States of America

United States Patent and Trademark Office



Reg. No. 4,153,149

Registered June 5, 2012

Int. Cl.: 35

SERVICE MARK

PRINCIPAL REGISTER

SINGER NY, LLC (DELAWARE LIMITED LIABILITY COMPANY)
150 SOUTH TWIN VALLEY RD
ELVERSON, PA 19520

FOR: DISTRIBUTORSHIP SERVICES FEATURING COMMERCIAL KITCHEN EQUIPMENT,
FURNISHINGS AND SUPPLIES, IN CLASS 35 (U.S. CLS. 100, 101 AND 102).

FIRST USE 12-1-1991; IN COMMERCE 12-1-1991.

THE MARK CONSISTS OF A STYLIZED PLATE WITH STYLIZED UTENSILS.

SER. NO. 85-395,084, FILED 8-11-2011.

NAAKWAMA ANKRAH, EXAMINING ATTORNEY



David J. Kyffers

Director of the United States Patent and Trademark Office

United States of America

United States Patent and Trademark Office



Reg. No. 4,153,150

Registered June 5, 2012

Int. Cl.: 35

SERVICE MARK

PRINCIPAL REGISTER

SINGER EQUIPMENT COMPANY, INC. (DELAWARE CORPORATION)
150 SOUTH TWIN VALLEY RD
ELVERSON, PA 19520

FOR: DISTRIBUTORSHIP SERVICES FEATURING COMMERCIAL KITCHEN EQUIPMENT,
FURNISHINGS AND SUPPLIES, IN CLASS 35 (U.S. CLS. 100, 101 AND 102).

FIRST USE 4-3-2000; IN COMMERCE 4-3-2000.

OWNER OF U.S. REG. NO. 2,708,748.

THE MARK CONSISTS OF THE WORD "SINGER" CENTERED AND IN FRONT OF A
STYLIZED DESIGN CONSISTING OF SIX JAGGED VERTICAL RECTANGLES.

SEC. 2(F).

SER. NO. 85-395,086, FILED 8-11-2011.

NAAKWAMA ANKRAH, EXAMINING ATTORNEY



David J. Kyffers

Director of the United States Patent and Trademark Office

United States of America

United States Patent and Trademark Office

Rainbow Lube

Reg. No. 4,153,151

ASHLEY SCRUPPS (UNITED STATES INDIVIDUAL)
11643 100TH AVE NE #C4
KIRKLAND, WA 98034

Registered June 5, 2012

Int. Cl.: 5

FOR: PERSONAL SEXUAL LUBRICANTS, IN CLASS 5 (U.S. CLS. 6, 18, 44, 46, 51 AND 52).

TRADEMARK

FIRST USE 8-5-2011; IN COMMERCE 8-5-2011.

PRINCIPAL REGISTER

THE MARK CONSISTS OF STANDARD CHARACTERS WITHOUT CLAIM TO ANY PARTICULAR FONT, STYLE, SIZE, OR COLOR.

NO CLAIM IS MADE TO THE EXCLUSIVE RIGHT TO USE "LUBE", APART FROM THE MARK AS SHOWN.

SER. NO. 85-395,313, FILED 8-11-2011.

DOMINICK J. SALEMI, EXAMINING ATTORNEY



David J. Kyppas

Director of the United States Patent and Trademark Office

United States of America

United States Patent and Trademark Office

DENTAL USA

Reg. No. 4,153,152

Registered June 5, 2012

Int. Cl.: 10

TRADEMARK

PRINCIPAL REGISTER

DENTAL USA (ILLINOIS CORPORATION)
5005 MCCOLLUM ROAD
MCHENRY, IL 60050

FOR: DENTAL INSTRUMENTS, NAMELY, EXPLORERS, PROBES, MIRRORS, MIRROR HANDLES, SCALES, CURETTES, HOES, FILES, BONE HOLDERS, CHISELS, CRUSHERS, RONGEURS, FORCEPS, KNIFES, NEEDLE HOLDERS, SCISSORS, RETRACTORS, CARVERS, CARVING KNIFES, BURNISHERS, PLUGGERS, CONDENSERS, ELEVATORS, PICKS, CROWN REMOVERS, IN CLASS 10 (U.S. CLS. 26, 39 AND 44).

FIRST USE 6-30-2000; IN COMMERCE 6-30-2000.

THE MARK CONSISTS OF STANDARD CHARACTERS WITHOUT CLAIM TO ANY PARTICULAR FONT, STYLE, SIZE, OR COLOR.

NO CLAIM IS MADE TO THE EXCLUSIVE RIGHT TO USE "DENTAL", APART FROM THE MARK AS SHOWN.

SEC. 2(F).

SER. NO. 85-395,329, FILED 8-11-2011.

KATHERINE STOIDES, EXAMINING ATTORNEY



David J. Kybas

Director of the United States Patent and Trademark Office

United States of America

United States Patent and Trademark Office

DURA-TAC

Reg. No. 4,153,153

MERCHANT GENERAL CORPORATION (FLORIDA CORPORATION)
170 PINE AVENUE NORTH
OLDSMAR, FL 34677

Registered June 5, 2012

Int. Cl.: 16

FOR: GLUE STICKS FOR HOUSEHOLD USE, IN CLASS 16 (U.S. CLS. 2, 5, 22, 23, 29, 37, 38 AND 50).

TRADEMARK

FIRST USE 4-0-2003; IN COMMERCE 4-0-2003.

PRINCIPAL REGISTER

THE MARK CONSISTS OF STANDARD CHARACTERS WITHOUT CLAIM TO ANY PARTICULAR FONT, STYLE, SIZE, OR COLOR.

SER. NO. 85-395,632, FILED 8-11-2011.

COLLEEN KEARNEY, EXAMINING ATTORNEY



David J. Kybas

Director of the United States Patent and Trademark Office

United States of America

United States Patent and Trademark Office

ACRILUX

Reg. No. 4,153,154

MERCHANT GENERAL CORPORATION (FLORIDA CORPORATION)
170 PINE AVENUE NORTH
OLDSMAR, FL 34677

Registered June 5, 2012

Int. Cl.: 16

FOR: GLUE STICKS FOR HOUSEHOLD USE, IN CLASS 16 (U.S. CLS. 2, 5, 22, 23, 29, 37, 38 AND 50).

TRADEMARK

FIRST USE 4-0-2003; IN COMMERCE 4-0-2003.

PRINCIPAL REGISTER

THE MARK CONSISTS OF STANDARD CHARACTERS WITHOUT CLAIM TO ANY PARTICULAR FONT, STYLE, SIZE, OR COLOR.

SER. NO. 85-395,672, FILED 8-11-2011.

COLLEEN KEARNEY, EXAMINING ATTORNEY



David J. Kybas

Director of the United States Patent and Trademark Office

United States of America

United States Patent and Trademark Office

Lake is great.

Reg. No. 4,153,155

ARMSTRONG, JENNIFER (UNITED STATES INDIVIDUAL)
2991 NEW BRIDGE ROAD
MINERAL, VA 23117

Registered June 5, 2012

Int. Cl.: 25

FOR: BABY LAYETTES FOR CLOTHING; BOTTOMS; HATS; JACKETS; SWEATSHIRTS; T-SHIRTS; TOPS; TRAVEL CLOTHING CONTAINED IN A PACKAGE COMPRISING REVERSIBLE JACKETS, PANTS, SKIRTS, TOPS AND A BELT OR SCARF, IN CLASS 25 (U.S. CLS. 22 AND 39).

TRADEMARK

PRINCIPAL REGISTER

FIRST USE 6-1-2009; IN COMMERCE 1-1-2011.

THE MARK CONSISTS OF THE STYLIZED TEXT "LAKE IS GREAT."

SER. NO. 85-395,893, FILED 8-11-2011.

FLORENTINA BLANDU, EXAMINING ATTORNEY



David J. Kybas

Director of the United States Patent and Trademark Office

United States of America

United States Patent and Trademark Office



Reg. No. 4,153,156

Registered June 5, 2012

Int. Cls.: 7 and 22

TRADEMARK

PRINCIPAL REGISTER

HAMPTON PRODUCTS INTERNATIONAL CORPORATION (DELAWARE CORPORATION)
50 ICON
FOOTHILL RANCH, CA 92610

FOR: ELECTRIC WINCHES, IN CLASS 7 (U.S. CLS. 13, 19, 21, 23, 31, 34 AND 35).

FIRST USE 1-3-2011; IN COMMERCE 1-3-2011.

FOR: STRAPS AND CORDS FOR HANDLING, SECURING, AND STOWING CARGO, NAMELY, BUNGEE CORDS WITH HOOKS, BUNGEE CORDS WITH CARABINER CLIPS, AND NON-METAL TIE DOWN STRAPS WITH RATCHETING MECHANISMS, IN CLASS 22 (U.S. CLS. 1, 2, 7, 19, 22, 42 AND 50).

FIRST USE 1-3-2011; IN COMMERCE 1-3-2011.

OWNER OF U.S. REG. NOS. 2,106,212 AND 3,026,742.

THE MARK CONSISTS OF THE STYLIZED LETTER "K" FORMED BY THREE TRIANGLES AND THE STYLIZED WORD "KEEPER".

SER. NO. 85-395,967, FILED 8-11-2011.

WARREN L. OLANDRIA, EXAMINING ATTORNEY



David J. Kybas

Director of the United States Patent and Trademark Office

United States of America

United States Patent and Trademark Office



Reg. No. 4,153,157

Registered June 5, 2012

Int. Cl.: 1

TRADEMARK

PRINCIPAL REGISTER

NAMIKI SHOJI CO., LTD. (JAPAN CORPORATION)
KENSEISHINJUKU BLDG. 5-5-3 SHINJUKU
SHINJUKU-KU, TOKYO, JAPAN 160-0022

FOR: CHEMICAL REAGENTS FOR NON-MEDICAL PURPOSES; CHEMICAL COMPOUNDS FOR USE IN THE DISCOVERY AND MANUFACTURE OF DRUGS AND PHARMACEUTICALS AND FOR USE IN AGROCHEMISTRY, BIOTECHNOLOGY AND FOR RESEARCH AND DEVELOPMENT IN THESE FIELDS, IN CLASS 1 (U.S. CLS. 1, 5, 6, 10, 26 AND 46).

FIRST USE 11-0-2010; IN COMMERCE 11-0-2010.

THE MARK CONSISTS OF THREE IDENTICAL TRIANGLES COMPRISED OF HORIZONTAL STRIPES NARROWER AT THE TOP AND WIDER AT THE BOTTOM, ABOVE THE WORDING "CHEMICHIBA".

SER. NO. 85-396,377, FILED 8-12-2011.

JEFFERY COWARD, EXAMINING ATTORNEY



David J. Kybas

Director of the United States Patent and Trademark Office

United States of America
United States Patent and Trademark Office

KIDSTOCK

Reg. No. 4,153,158

Registered June 5, 2012

Int. Cl.: 41

SERVICE MARK

PRINCIPAL REGISTER

WOODSTOCK VENTURES LC (WYOMING CORPORATION)
161 WEST 54 ST.
APT. 1302
NEW YORK, NY 10019

FOR: ORGANIZING COMMUNITY FESTIVALS FEATURING A VARIETY OF ACTIVITIES, NAMELY, ART EXHIBITIONS, DANCES, CHILDREN'S FESTIVALS AND CONCERTS AND THE LIKE, IN CLASS 41 (U.S. CLS. 100, 101 AND 107).

FIRST USE 8-3-1990; IN COMMERCE 11-19-1990.

THE MARK CONSISTS OF STANDARD CHARACTERS WITHOUT CLAIM TO ANY PARTICULAR FONT, STYLE, SIZE, OR COLOR.

OWNER OF U.S. REG. NOS. 1,793,003 AND 2,782,085.

SER. NO. 85-396,723, FILED 8-12-2011.

SOPHIA S. KIM, EXAMINING ATTORNEY



David J. Kybas

Director of the United States Patent and Trademark Office

United States of America

United States Patent and Trademark Office

JACK & JINGER

Reg. No. 4,153,159

GARY LEGATOR (UNITED STATES INDIVIDUAL)
250 DURANZO AISLE
IRVINE, CA 92606

Registered June 5, 2012

Int. Cl.: 25

FOR: DRESSES; JACKETS; JEANS; PANTS; SHIRTS; SWEATERS; FOOTWEAR; HEADWEAR,
IN CLASS 25 (U.S. CLS. 22 AND 39).

TRADEMARK

FIRST USE 3-0-2002; IN COMMERCE 3-0-2002.

PRINCIPAL REGISTER

THE MARK CONSISTS OF STANDARD CHARACTERS WITHOUT CLAIM TO ANY PAR-
TICULAR FONT, STYLE, SIZE, OR COLOR.

SER. NO. 85-396,737, FILED 8-12-2011.

DEIRDRE ROBERTSON, EXAMINING ATTORNEY



David J. Kybas

Director of the United States Patent and Trademark Office

United States of America

United States Patent and Trademark Office



Reg. No. 4,153,160

Registered June 5, 2012

Int. Cl.: 5

TRADEMARK

PRINCIPAL REGISTER

THE SKINNY PANTRY (FLORIDA LIMITED LIABILITY COMPANY)
11356 SO CLEVELAND AVE
FORT MYERS, FL 33907

FOR: FOODS AND SNACKS WHICH ARE FREE OF WHEAT, GLUTEN, SOY, SUGAR, NUTS, FATS AND SODIUM TO ACCOMMODATE SPECIAL MEDICAL AND HEALTH CONDITIONS , IN CLASS 5 (U.S. CLS. 6, 18, 44, 46, 51 AND 52).

FIRST USE 10-22-2008; IN COMMERCE 10-22-2008.

THE MARK CONSISTS OF A BROWN WAIST CINCHER WITH A YELLOW AND BLACK TAPE MEASURE AROUND IT. THIS DESIGN SITS ON TOP OF A BLUE OVAL THAT IS OUTLINED IN BROWN, PINK AND WHITE. THE WORDING "THE SKINNY PANTRY" IS PINK WITH WHITE OUTLINING WHICH SITS INSIDE THE OVAL.

THE COLOR(S) BROWN, BLACK, YELLOW, BLUE, PINK, AND WHITE IS/ARE CLAIMED AS A FEATURE OF THE MARK.

SER. NO. 85-396,924, FILED 8-12-2011.

SETH A. RAPPAPORT, EXAMINING ATTORNEY



David J. Kyros

Director of the United States Patent and Trademark Office

United States of America

United States Patent and Trademark Office



IBLD

I'm broke let's deal

Reg. No. 4,153,161

Registered June 5, 2012

Int. Cl.: 35

SERVICE MARK

PRINCIPAL REGISTER

KOSAREFF, MICHAEL JOHN (UNITED STATES INDIVIDUAL), DBA IBLD.COM
1601 PLACENTIA AVE
COSTA MESA, CA 92627

FOR: ADVERTISING AND DIRECTORY SERVICES, NAMELY, PROMOTING THE SERVICES OF OTHERS BY PROVIDING A WEB PAGE FEATURING LINKS TO THE WEBSITES OF OTHERS; PROMOTING THE GOODS AND SERVICES OF OTHERS BY PROVIDING A WEBSITE FEATURING PRODUCT REVIEWS, PRICE COMPARISON INFORMATION VIA CONSUMER AND BUSINESS PROFILES, AND WHERE USERS CAN POST RATINGS ON CONSUMER GOODS AND SERVICES FOR COMMERCIAL PURPOSES; PROMOTING THE GOODS AND SERVICES OF OTHERS BY PROVIDING AN INTERACTIVE WEBSITE WHERE USERS CAN INCREASE THE CURRENT VALUE OF AN ONLINE DISCOUNT BEING OFFERED BY PURCHASING THE GOODS AND SERVICES ASSOCIATED WITH THAT DISCOUNT IN THE FORM OF AN ONLINE COUPON, VOUCHER OR GIFT CARD; PROVIDING A SEARCHABLE ON-LINE ADVERTISING WEBSITE AND GUIDE FEATURING THE GOODS AND SERVICES OF OTHER VENDORS VIA THE INTERNET; PROVIDING A SEARCHABLE WEBSITE FEATURING THE GOODS AND SERVICES OF OTHER VENDORS, IN CLASS 35 (U.S. CLS. 100, 101 AND 102).

FIRST USE 1-1-2009; IN COMMERCE 1-1-2009.

THE MARK CONSISTS OF A DESIGN OF A HOBO WEARING A HAT WITH A STICK OVER HIS SHOULDER AND A BLANKET WRAPPED AROUND THE END OF THE STICK. IN LARGE LETTERS TO THE RIGHT OF THE DESIGN IS THE WORDING "IBLD" WITH THE SMALL WORDING "I'M BROKE LET'S DEAL" UNDERNEATH IT.

SER. NO. 85-397,203, FILED 8-12-2011.

COURTNEY ALVAREZ, EXAMINING ATTORNEY



David J. Kypos

Director of the United States Patent and Trademark Office

United States of America

United States Patent and Trademark Office

ZAFFERANO CAPITAL

Reg. No. 4,153,162

Registered June 5, 2012

Int. Cl.: 36

SERVICE MARK

PRINCIPAL REGISTER

ZAFFERANO CAPITAL LIMITED (CAYMAN ISLANDS CORPORATION)
PO BOX 309, UGLAND HOUSE
GRAND CAYMAN, CAYMAN ISLANDS KY1-1104

FOR: FINANCIAL ASSET AND FUND MANAGEMENT SERVICES, NAMELY, MANAGEMENT OF CAPITAL INVESTMENT FUNDS, VENTURE CAPITAL FUNDS, PROPERTY INVESTMENT FUNDS, STOCK AND PRIVATE EQUITY INVESTMENT FUNDS, EMERGING MARKETS AND GROWTH COMPANY INVESTMENT FUNDS, BONDS INVESTMENT FUNDS, SECURITIES INVESTMENT FUNDS, COMMODITIES INVESTMENT FUNDS, AND LIQUID AND ILLIQUID FINANCIAL INSTRUMENTS; FINANCIAL SERVICES AND INVESTMENT SERVICES, NAMELY, INVESTING FUNDS FOR OTHERS, THE TRADING OF AND ASSISTING OTHERS WITH THE TRADING OF FINANCIAL INSTRUMENTS, STOCKS, EQUITIES, BONDS, COMMODITIES AND SECURITIES, AND IN INVESTMENT FUNDS; FINANCIAL INVESTMENT ADVISORY SERVICES, NAMELY, PROVIDING FINANCIAL INFORMATION RELATING TO INVESTMENT FUNDS, FINANCIAL INSTRUMENTS, STOCKS, EQUITIES, BONDS AND SECURITIES, IN CLASS 36 (U.S. CLS. 100, 101 AND 102).

THE MARK CONSISTS OF STANDARD CHARACTERS WITHOUT CLAIM TO ANY PARTICULAR FONT, STYLE, SIZE, OR COLOR.

PRIORITY CLAIMED UNDER SEC. 44(D) ON ERPN CMNTY TM OFC APPLICATION NO. 010193381, FILED 8-12-2011, REG. NO. 010193381, DATED 12-22-2011, EXPIRES 8-12-2021.

NO CLAIM IS MADE TO THE EXCLUSIVE RIGHT TO USE "CAPITAL", APART FROM THE MARK AS SHOWN.

THE ENGLISH TRANSLATION OF "ZAFFERANO" IN THE MARK IS "SAFFRON".

SER. NO. 85-397,443, FILED 8-14-2011.

NANCY CLARKE, EXAMINING ATTORNEY



David J. Kyjars

Director of the United States Patent and Trademark Office

United States of America

United States Patent and Trademark Office

bare

Reg. No. 4,153,163

Registered June 5, 2012

Int. Cl.: 10

TRADEMARK

PRINCIPAL REGISTER

BITTYLAB, LLC (US VIRGIN ISLANDS LIMITED LIABILITY COMPANY)
11 FLOOR
1515 BROADWAY
NEW YORK, NY 10036

FOR: BABY BOTTLES, IN CLASS 10 (U.S. CLS. 26, 39 AND 44).

FIRST USE 5-1-2011; IN COMMERCE 5-1-2011.

THE MARK CONSISTS OF THE STYLIZED WORD "BARE" IN LOWER CASE LETTERS WITH THE LETTER "B" OVERLAPPING THE LETTER "A".

SER. NO. 85-397,445, FILED 8-14-2011.

DAVID C. REIHNER, EXAMINING ATTORNEY



David J. Kybas

Director of the United States Patent and Trademark Office

United States of America

United States Patent and Trademark Office

John Deere

Reg. No. 4,153,164

Registered June 5, 2012

Int. Cl.: 36

SERVICE MARK

PRINCIPAL REGISTER

DEERE & COMPANY (DELAWARE CORPORATION)
GLOBAL INTELLECTUAL PROPERTY SERVICES
ONE JOHN DEERE PLACE
MOLINE, IL 61265

FOR: FINANCING SERVICES; INSURANCE SERVICES, NAMELY, WRITING PROPERTY AND CASUALTY INSURANCE; INSURANCE ADMINISTRATION; INSURANCE AGENCY SERVICES; INSURANCE CARRIER SERVICES; INSURANCE CLAIMS ADMINISTRATION; INSURANCE CLAIMS PROCESSING; INSURANCE PREMIUM RATE COMPUTING SERVICES; INSURANCE SERVICES IN THE NATURE OF LOSS CONTROL MANAGEMENT FOR OTHERS, IN CLASS 36 (U.S. CLS. 100, 101 AND 102).

FIRST USE 12-31-1958; IN COMMERCE 12-31-1958.

THE MARK CONSISTS OF STANDARD CHARACTERS WITHOUT CLAIM TO ANY PARTICULAR FONT, STYLE, SIZE, OR COLOR.

THE NAME(S), PORTRAIT(S), AND/OR SIGNATURE(S) SHOWN IN THE MARK DOES NOT IDENTIFY A PARTICULAR LIVING INDIVIDUAL.

SER. NO. 85-397,771, FILED 8-15-2011.

SKYE YOUNG, EXAMINING ATTORNEY



David J. Kybas

Director of the United States Patent and Trademark Office

United States of America

United States Patent and Trademark Office

BLOGRAPHY

Reg. No. 4,153,165

Registered June 5, 2012

Int. Cl.: 35

SERVICE MARK

PRINCIPAL REGISTER

PAUL BARNETT, INC. (NEW YORK CORPORATION), DBA NOW WHAT RESEARCH
69 MERCER ST., PH
NEW YORK, NY 10012

FOR: BUSINESS RESEARCH USING FOCUS GROUPS; CONDUCTING BUSINESS AND
MARKET RESEARCH SURVEYS; MARKET ANALYSIS AND RESEARCH SERVICES;
MARKET RESEARCH AND MARKET INTELLIGENCE SERVICES, IN CLASS 35 (U.S. CLS.
100, 101 AND 102).

FIRST USE 2-28-2007; IN COMMERCE 2-28-2007.

THE MARK CONSISTS OF STANDARD CHARACTERS WITHOUT CLAIM TO ANY PAR-
TICULAR FONT, STYLE, SIZE, OR COLOR.

SER. NO. 85-398,037, FILED 8-15-2011.

PATRICIA EVANKO, EXAMINING ATTORNEY



David J. Kyjars

Director of the United States Patent and Trademark Office

United States of America

United States Patent and Trademark Office

TABLE TENTS

Reg. No. 4,153,166

Registered June 5, 2012

Int. Cl.: 35

SERVICE MARK

PRINCIPAL REGISTER

LIQUID COMMON, LLC (NEW MEXICO LIMITED LIABILITY COMPANY)
1112 SAN PEDRO NE, #160
ALBUQUERQUE, NM 87110

FOR: PROVIDING SOCIAL MEDIA SERVICES, NAMELY, SOCIAL MEDIA STRATEGY AND MARKETING CONSULTANCY FOCUSING ON HELPING CLIENTS CREATE AND EXTEND THEIR PRODUCT AND BRAND STRATEGIES BY BUILDING VIRALLY ENGAGING MARKETING SOLUTIONS; PROVIDING AN ONLINE MARKETING COLLABORATION NETWORK FOR SOCIAL MEDIA AND ONLINE MARKETING PROFESSIONALS FOR THE PURPOSE OF SYNDICATING CONTENT THROUGH THE NETWORK TO BE SHARED BY OTHERS, IN CLASS 35 (U.S. CLS. 100, 101 AND 102).

FIRST USE 8-1-2011; IN COMMERCE 8-1-2011.

THE MARK CONSISTS OF STANDARD CHARACTERS WITHOUT CLAIM TO ANY PARTICULAR FONT, STYLE, SIZE, OR COLOR.

SER. NO. 85-398,174, FILED 8-15-2011.

CHRISTINA SOBRAL, EXAMINING ATTORNEY



David J. Kyffers

Director of the United States Patent and Trademark Office

United States of America

United States Patent and Trademark Office

BLAST PAD

Reg. No. 4,153,167

Registered June 5, 2012

Int. Cl.: 28

TRADEMARK

PRINCIPAL REGISTER

MARKY SPARKY, INC. (CALIFORNIA CORPORATION), DBA CALIFORNIA CHARIOT
COMPANY
SUITE 102
2180 CHABLIS COURT
ESCONDIDO, CA 92029

FOR: TOY ROCKET LAUNCHERS, IN CLASS 28 (U.S. CLS. 22, 23, 38 AND 50).

FIRST USE 1-15-2003; IN COMMERCE 2-16-2003.

THE MARK CONSISTS OF STANDARD CHARACTERS WITHOUT CLAIM TO ANY PARTICULAR FONT, STYLE, SIZE, OR COLOR.

NO CLAIM IS MADE TO THE EXCLUSIVE RIGHT TO USE "PAD", APART FROM THE MARK AS SHOWN.

SER. NO. 85-398,214, FILED 8-15-2011.

BERNICE MIDDLETON, EXAMINING ATTORNEY



David J. Kyffers

Director of the United States Patent and Trademark Office

United States of America

United States Patent and Trademark Office

Dare To Care

Reg. No. 4,153,168

Registered June 5, 2012

Int. Cl.: 35

SERVICE MARK

PRINCIPAL REGISTER

COPSIDAS JR, FRANK (UNITED STATES INDIVIDUAL)
24 PREBLE ST, SUITE 300
PORTLAND, ME 04101

FOR: PROMOTING PUBLIC AWARENESS ABOUT THE NEED FOR GETTING INVOLVED WITH A NON-PROFIT ORGANIZATION IN A COMMUNITY THROUGH ANY FORM OF MEDIA INCLUDING THE WORLD WIDE WEB AND RADIO BROADCASTING, IN CLASS 35 (U.S. CLS. 100, 101 AND 102).

FIRST USE 0-0-1994; IN COMMERCE 0-0-1994.

THE MARK CONSISTS OF STANDARD CHARACTERS WITHOUT CLAIM TO ANY PARTICULAR FONT, STYLE, SIZE, OR COLOR.

SER. NO. 85-398,284, FILED 8-15-2011.

JOHN DALIER, EXAMINING ATTORNEY



David J. Kyffers

Director of the United States Patent and Trademark Office

United States of America

United States Patent and Trademark Office

Dare 2 Care

Reg. No. 4,153,169

FRANK COPSIDAS JR (UNITED STATES INDIVIDUAL)
24 PREBLE ST, SUITE 300
PORTLAND, ME 04101

Registered June 5, 2012

Int. Cl.: 35

FOR: PROMOTING PUBLIC AWARENESS ABOUT GETTING INVOLVED WITH A NON-PROFIT ORGANIZATION IN A COMMUNITY THROUGH ANY FORM OF MEDIA INCLUDING THE WORLD WIDE WEB AND RADIO BROADCASTING, IN CLASS 35 (U.S. CLS. 100, 101 AND 102).

SERVICE MARK

PRINCIPAL REGISTER

FIRST USE 8-15-2011; IN COMMERCE 8-15-2011.

THE MARK CONSISTS OF STANDARD CHARACTERS WITHOUT CLAIM TO ANY PARTICULAR FONT, STYLE, SIZE, OR COLOR.

SER. NO. 85-398,290, FILED 8-15-2011.

JOHN DALIER, EXAMINING ATTORNEY



David J. Kyffers

Director of the United States Patent and Trademark Office

United States of America

United States Patent and Trademark Office

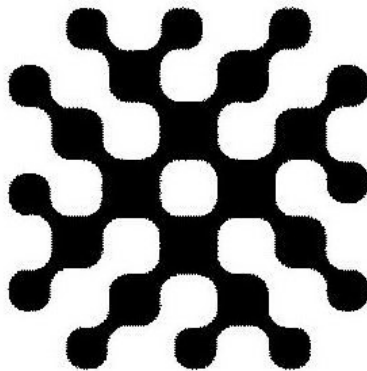

Reg. No. 4,153,170

Registered June 5, 2012

Int. Cls.: 35 and 42

SERVICE MARK

PRINCIPAL REGISTER

KONTAGENT, INC. (DELAWARE CORPORATION)
SUITE 610
55 HAWTHORNE STREET
SAN FRANCISCO, CA 94105

FOR: MARKET RESEARCH SERVICES RELATING TO ADVERTISING AND MARKETING, NAMELY, PROVIDING WEBSITE AND APPLICATION TRAFFIC METRICS, STATISTICS, USER ACTIVITY DATA, AND MARKETING AND ADVERTISING REPORTS OF USERS' ACTIVITIES ON SOCIAL NETWORKS; BUSINESS MONITORING AND CONSULTING SERVICES, NAMELY, TRACKING WEB SITES AND APPLICATIONS OF OTHERS TO PROVIDE STRATEGY AND INSIGHT REGARDING MARKETING, SALES, OPERATION AND PRODUCT DESIGN, PARTICULARLY SPECIALIZING IN THE USE OF ANALYTIC AND STATISTIC MODELS FOR THE UNDERSTANDING AND PREDICTING OF CONSUMERS, BUSINESSES, AND MARKET TRENDS AND ACTIONS, IN CLASS 35 (U.S. CLS. 100, 101 AND 102).

FIRST USE 7-11-2011; IN COMMERCE 7-11-2011.

FOR: PROVIDING A WEBSITE FEATURING NON-DOWNLOADABLE SOFTWARE FOR TRACKING WEB SITES AND APPLICATIONS OF OTHERS; APPLICATION SERVICE PROVIDER, NAMELY, HOSTING, MANAGING, DEVELOPING, ANALYZING, AND MAINTAINING APPLICATIONS, SOFTWARE AND WEB SITES OF OTHERS IN THE FIELDS OF WEBSITE AND APPLICATION TRAFFIC METRICS, STATISTICS, USER ACTIVITY DATA, AND MARKETING AND ADVERTISING REPORTS OF USERS' ACTIVITIES, IN CLASS 42 (U.S. CLS. 100 AND 101).

FIRST USE 7-11-2011; IN COMMERCE 7-11-2011.

THE MARK CONSISTS OF AN ARRAY OF 24 CONNECTED CIRCULAR DOTS FORMING A ROUNDED QUADRANGLE, WITH AN INNER ARRAY OF FOUR LARGER DOTS, CONNECTED TO A MIDDLE ARRAY OF EIGHT SMALLER CIRCULAR DOTS, EACH OF WHICH IS CONNECTED TO EITHER ONE OR TWO SMALLER CIRCULAR DOTS THAT FORM AN OUTER ARRAY.



David J. Kyros

Director of the United States Patent and Trademark Office

SER. NO. 85-398,372, FILED 8-15-2011.

MYRIAH HABEEB, EXAMINING ATTORNEY

United States of America

United States Patent and Trademark Office



Reg. No. 4,153,171

Registered June 5, 2012

Int. Cl.: 16

TRADEMARK

PRINCIPAL REGISTER

PETER J. MIELE (UNITED STATES INDIVIDUAL)
809 EAST AVENUE
RED WING, MN 55066

FOR: COMIC BOOKS; COMIC MAGAZINES, IN CLASS 16 (U.S. CLS. 2, 5, 22, 23, 29, 37, 38 AND 50).

FIRST USE 12-31-1992; IN COMMERCE 12-31-1992.

THE MARK CONSISTS OF THE WORDING "TRAPMAN" IN STYLIZED CAPITAL LETTERS IN RED WITH A YELLOW BACKGROUND OUTLINED IN THE COLOR BLACK

THE COLOR(S) RED, YELLOW AND BLACK IS/ARE CLAIMED AS A FEATURE OF THE MARK.

SEC. 2(F).

SER. NO. 85-399,086, FILED 8-16-2011.

WILLIAM ROSSMAN, EXAMINING ATTORNEY



David J. Kybas

Director of the United States Patent and Trademark Office

United States of America

United States Patent and Trademark Office



Desert Mechanical Incorporated

Reg. No. 4,153,172

Registered June 5, 2012

Int. Cl.: 37

SERVICE MARK

PRINCIPAL REGISTER

DESERT MECHANICAL, INC. (NEVADA CORPORATION)
4475 WEST QUAIL AVENUE
LAS VEGAS, NV 89118

FOR: HVAC CONTRACTOR SERVICES; INSTALLATION, MAINTENANCE AND REPAIR OF PLUMBING, HEATING, VENTILATION, AIR CONDITIONING AND INDUSTRIAL MECHANICAL PROCESS PROJECTS; MECHANICAL CONTRACTOR SERVICES; PLUMBING CONTRACTOR SERVICES, IN CLASS 37 (U.S. CLS. 100, 103 AND 106).

FIRST USE 7-0-2011; IN COMMERCE 7-0-2011.

NO CLAIM IS MADE TO THE EXCLUSIVE RIGHT TO USE "MECHANICAL INCORPORATED", APART FROM THE MARK AS SHOWN.

THE MARK CONSISTS OF THE LETTERS "DMI" IN LARGE LETTERS FOLLOWED BY A PERIOD WITH A CACTUS APPEARING INSIDE THE LETTER "D"; UNDERNEATH OF WHICH APPEARS THE WORDS "DESERT MECHANICAL INCORPORATED" IN SMALLER TYPE.

SER. NO. 85-400,124, FILED 8-17-2011.

NORA BUCHANAN WILL, EXAMINING ATTORNEY



David J. Kyjars

Director of the United States Patent and Trademark Office

United States of America

United States Patent and Trademark Office

Apollo Reef LED

Reg. No. 4,153,173

Registered June 5, 2012

Int. Cl.: 11

TRADEMARK

PRINCIPAL REGISTER

APOLLO REEF LED, LLC (DELAWARE LIMITED LIABILITY COMPANY), AKA APOLLO REEF LED
46 DIAMOND DR
GOULDSBORO, PA 18424

FOR: LIGHT EMITTING DIODE (LED) ASSEMBLY AND FIXTURE FOR LIGHTING AQUARIUMS, IN CLASS 11 (U.S. CLS. 13, 21, 23, 31 AND 34).

FIRST USE 6-7-2011; IN COMMERCE 6-7-2011.

THE MARK CONSISTS OF STANDARD CHARACTERS WITHOUT CLAIM TO ANY PARTICULAR FONT, STYLE, SIZE, OR COLOR.

NO CLAIM IS MADE TO THE EXCLUSIVE RIGHT TO USE "REEF LED", APART FROM THE MARK AS SHOWN.

SER. NO. 85-400,956, FILED 8-18-2011.

KIMBERLY FRYE, EXAMINING ATTORNEY



David J. Kybas

Director of the United States Patent and Trademark Office

United States of America

United States Patent and Trademark Office

Indy Creative Aging

Reg. No. 4,153,174

Registered June 5, 2012

Int. Cl.: 41

SERVICE MARK

PRINCIPAL REGISTER

CICOA AGING & IN-HOME SOLUTIONS (INDIANA CORPORATION)
4755 KINGSWAY DRIVE
SUITE 200
INDIANAPOLIS, IN 462051572

FOR: PROVIDING A WEBSITE FOR SENIOR CITIZENS AND CAREGIVERS FEATURING INFORMATION RELATING TO ORGANIZING COMMUNITY SPORTING AND CULTURAL ACTIVITIES; PROVIDING A WEBSITE FOR SENIOR CITIZENS AND CAREGIVERS FEATURING INFORMATION ON FITNESS SERVICES; PROVIDING A WEBSITE FOR SENIOR CITIZENS AND CAREGIVERS FEATURING INFORMATION REGARDING SPECIAL EVENTS FOR SOCIAL ENTERTAINMENT PURPOSES, IN CLASS 41 (U.S. CLS. 100, 101 AND 107).

FIRST USE 5-1-2007; IN COMMERCE 5-1-2007.

THE MARK CONSISTS OF STANDARD CHARACTERS WITHOUT CLAIM TO ANY PARTICULAR FONT, STYLE, SIZE, OR COLOR.

NO CLAIM IS MADE TO THE EXCLUSIVE RIGHT TO USE "INDY" AND "AGING" , APART FROM THE MARK AS SHOWN.

SER. NO. 85-401,194, FILED 8-18-2011.

LAURA HAMMEL, EXAMINING ATTORNEY



David J. Kybas

Director of the United States Patent and Trademark Office

United States of America

United States Patent and Trademark Office



Reg. No. 4,153,175

SUNERGETICS, LLC (ARIZONA LIMITED LIABILITY COMPANY)
164 COFFEE POT DRIVE, SUITE B
SEDONA, AZ 86336

Registered June 5, 2012

Int. Cl.: 3

FOR: SKIN CARE PRODUCTS, NAMELY, ORGANIC SOAPS, ORGANIC SKIN CREAMS,
AND ORGANIC LOTIONS, IN CLASS 3 (U.S. CLS. 1, 4, 6, 50, 51 AND 52).

TRADEMARK

FIRST USE 6-3-2009; IN COMMERCE 6-3-2009.

PRINCIPAL REGISTER

NO CLAIM IS MADE TO THE EXCLUSIVE RIGHT TO USE "ORGANICS", APART FROM
THE MARK AS SHOWN.

THE MARK CONSISTS OF THE LETTERS "NSIO" SURROUNDED BY TWO CONCENTRIC
CIRCLES, WITH THE TERM "NEW STANDARDS IN ORGANICS" AND TWO LEAF IMAGES
POSITIONED BETWEEN THE TWO CONCENTRIC CIRCLES.

SER. NO. 85-401,320, FILED 8-18-2011.

NAKIA HENRY, EXAMINING ATTORNEY



David J. Kyffers

Director of the United States Patent and Trademark Office

United States of America

United States Patent and Trademark Office

Knowledge Candy Media

Reg. No. 4,153,176

KNOWLEDGE CANDY MEDIA (TEXAS LIMITED LIABILITY COMPANY)
PO BOX 218962
HOUSTON, TX 77218

Registered June 5, 2012

Int. Cl.: 9

FOR: COMPUTER SOFTWARE FOR SELF-PACED, INTERACTIVE LEARNING IN THE FIELD OF SELF-HELP, IN CLASS 9 (U.S. CLS. 21, 23, 26, 36 AND 38).

TRADEMARK

FIRST USE 7-27-2011; IN COMMERCE 7-27-2011.

PRINCIPAL REGISTER

THE MARK CONSISTS OF STANDARD CHARACTERS WITHOUT CLAIM TO ANY PARTICULAR FONT, STYLE, SIZE, OR COLOR.

NO CLAIM IS MADE TO THE EXCLUSIVE RIGHT TO USE "MEDIA", APART FROM THE MARK AS SHOWN.

SER. NO. 85-401,541, FILED 8-18-2011.

MICHAEL KEATING, EXAMINING ATTORNEY



David J. Kybas

Director of the United States Patent and Trademark Office

United States of America

United States Patent and Trademark Office

CHOCOLATE VILLA

Reg. No. 4,153,177

Registered June 5, 2012

Int. Cls.: 35 and 41

SERVICE MARK

PRINCIPAL REGISTER

FIVE DEGREES CONSULTING, LLC (UTAH LIMITED LIABILITY COMPANY)
2536 SOUTH KENWOOD STREET
SALT LAKE CITY, UT 84106

FOR: BUSINESS MANAGEMENT CONSULTATION IN THE FIELD OF EXECUTIVE AND LEADERSHIP DEVELOPMENT; BUSINESS CONSULTING SERVICES IN THE FIELD OF ORGANIZATION, MANAGEMENT, CULTURAL DEVELOPMENT, DIVERSITY AND EMPLOYEE MOTIVATION AND RETENTION, IN CLASS 35 (U.S. CLS. 100, 101 AND 102).

FIRST USE 9-30-2009; IN COMMERCE 9-30-2009.

FOR: BUSINESS EDUCATION AND TRAINING SERVICES, NAMELY, DEVELOPING AND FACILITATING LEADERSHIP AND EXECUTIVE DEVELOPMENT PROGRAMS AND RETREATS, PROVIDING EXECUTIVE COACHING SERVICES, AND PROVIDING BUSINESS EDUCATION PROGRAMS IN THE NATURE OF COMMUNICATION, EMOTIONAL INTELLIGENCE, LEADERSHIP, MENTORING, PRODUCTIVITY, DIVERSITY AND TEAM BUILDING TO EMPLOYEES AND EXECUTIVES, IN CLASS 41 (U.S. CLS. 100, 101 AND 107).

FIRST USE 9-30-2009; IN COMMERCE 9-30-2009.

THE MARK CONSISTS OF STANDARD CHARACTERS WITHOUT CLAIM TO ANY PARTICULAR FONT, STYLE, SIZE, OR COLOR.

SER. NO. 85-401,778, FILED 8-18-2011.

C. DIONNE CLYBURN, EXAMINING ATTORNEY



David J. Kyffers

Director of the United States Patent and Trademark Office

United States of America

United States Patent and Trademark Office

FEDERAL RESERVE BANK OF DALLAS

Reg. No. 4,153,178

Registered June 5, 2012

Int. Cls.: 35 and 36

SERVICE MARK

PRINCIPAL REGISTER

FEDERAL RESERVE BANK OF DALLAS (UNITED STATES FEDERALLY CHARTERED CORPORATION)
2200 N. PEARL STREET
DALLAS, TX 75201

FOR: PROVIDING EDUCATIONAL INFORMATION IN THE FIELD OF ECONOMICS AND MONETARY POLICY, IN CLASS 35 (U.S. CLS. 100, 101 AND 102).

FIRST USE 11-16-1914; IN COMMERCE 11-16-1914.

FOR: FINANCIAL SERVICES IN THE NATURE OF PAYMENT SERVICES, NAMELY, CHECK CLEARING, FUND TRANSFERS, CASH DISTRIBUTION AND AUTOMATED CLEARING HOUSE TRANSACTIONS; BANKING SERVICES, NAMELY, PROVIDING SECONDARY CREDIT ANALYSIS IN SUPPORT OF MONETARY POLICY AND BANKING SUPERVISION; PROVIDING EDUCATIONAL INFORMATION IN THE FIELD OF MONETARY FINANCIAL POLICY, IN CLASS 36 (U.S. CLS. 100, 101 AND 102).

FIRST USE 11-16-1914; IN COMMERCE 11-16-1914.

THE MARK CONSISTS OF STANDARD CHARACTERS WITHOUT CLAIM TO ANY PARTICULAR FONT, STYLE, SIZE, OR COLOR.

NO CLAIM IS MADE TO THE EXCLUSIVE RIGHT TO USE "FEDERAL RESERVE BANK", APART FROM THE MARK AS SHOWN.

SEC. 2(F).

SER. NO. 85-401,805, FILED 8-18-2011.

DEBORAH LOBO, EXAMINING ATTORNEY



David J. Kyjars

Director of the United States Patent and Trademark Office

United States of America
United States Patent and Trademark Office

HORIZON
ASSET
MANAGEMENT

Reg. No. 4,153,179

Registered June 5, 2012

Int. Cl.: 36

SERVICE MARK

PRINCIPAL REGISTER

HORIZON ASSET MANAGEMENT LLC (DELAWARE LIMITED LIABILITY COMPANY)
470 PARK AVENUE SOUTH
4TH FLOOR
NEW YORK, NY 10016

FOR: FINANCIAL PLANNING AND INVESTMENT ADVISORY SERVICES, IN CLASS 36
(U.S. CLS. 100, 101 AND 102).

FIRST USE 6-22-1994; IN COMMERCE 6-22-1994.

THE MARK CONSISTS OF STANDARD CHARACTERS WITHOUT CLAIM TO ANY PARTICULAR FONT, STYLE, SIZE, OR COLOR.

NO CLAIM IS MADE TO THE EXCLUSIVE RIGHT TO USE "ASSET MANAGEMENT", APART FROM THE MARK AS SHOWN.

SER. NO. 85-402,019, FILED 8-19-2011.

CHERYL CLAYTON, EXAMINING ATTORNEY



David J. Kybas

Director of the United States Patent and Trademark Office

United States of America

United States Patent and Trademark Office

GTLS: GAS TO LIQUID SYSTEMS

Reg. No. 4,153,180

Registered June 5, 2012

**Int. Cls.: 35, 37, 40 and
42**

SERVICE MARK

PRINCIPAL REGISTER

CHART INDUSTRIES, INC. (DELAWARE CORPORATION)
ONE INFINITY CORPORATE CENTRE DRIVE
SUITE 300
GARFIELD HEIGHTS, OH 44125

FOR: ONLINE RETAIL STORE SERVICES FEATURING CRYOGENIC, ENERGY, CHEMICAL, BIOMEDICAL, CRYOBIOLOGICAL AND OXYGEN EQUIPMENT AND SYSTEMS; DISTRIBUTORSHIPS IN THE FIELD OF CRYOGENIC, ENERGY, CHEMICAL, BIOMEDICAL, CRYOBIOLOGICAL AND OXYGEN EQUIPMENT AND SYSTEMS, IN CLASS 35 (U.S. CLS. 100, 101 AND 102).

FIRST USE 4-13-2011; IN COMMERCE 4-13-2011.

FOR: INSTALLATION AND REPAIR OF CRYOGENIC, ENERGY, CHEMICAL, BIOMEDICAL, CRYOBIOLOGICAL AND OXYGEN EQUIPMENT AND SYSTEMS, IN CLASS 37 (U.S. CLS. 100, 103 AND 106).

FIRST USE 4-13-2011; IN COMMERCE 4-13-2011.

FOR: CUSTOM MANUFACTURE OF CRYOGENIC, ENERGY, CHEMICAL, BIOMEDICAL, CRYOBIOLOGICAL AND OXYGEN EQUIPMENT AND SYSTEMS, IN CLASS 40 (U.S. CLS. 100, 103 AND 106).

FIRST USE 4-13-2011; IN COMMERCE 4-13-2011.

FOR: DESIGN AND ENGINEERING OF CRYOGENIC, ENERGY, CHEMICAL, BIOMEDICAL, CRYOBIOLOGICAL AND OXYGEN EQUIPMENT AND SYSTEMS, IN CLASS 42 (U.S. CLS. 100 AND 101).

FIRST USE 4-13-2011; IN COMMERCE 4-13-2011.

THE MARK CONSISTS OF STANDARD CHARACTERS WITHOUT CLAIM TO ANY PARTICULAR FONT, STYLE, SIZE, OR COLOR.

NO CLAIM IS MADE TO THE EXCLUSIVE RIGHT TO USE "GAS TO LIQUID SYSTEMS", APART FROM THE MARK AS SHOWN.

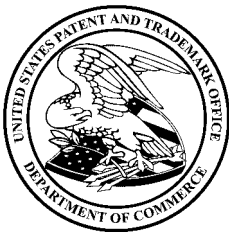

David J. Kybas

Director of the United States Patent and Trademark Office

Reg. No. 4,153,180 SER. NO. 85-402,094, FILED 8-19-2011.

SKYE YOUNG, EXAMINING ATTORNEY

United States of America

United States Patent and Trademark Office



Reg. No. 4,153,181

Registered June 5, 2012

Int. Cls.: 18 and 25

TRADEMARK

PRINCIPAL REGISTER

MINNETONKA MOCCASIN COMPANY, INC. (MINNESOTA CORPORATION)
1113 EAST HENNEPIN AVENUE
MINNEAPOLIS, MN 55414

FOR: HANDBAGS, IN CLASS 18 (U.S. CLS. 1, 2, 3, 22 AND 41).

FIRST USE 9-5-1945; IN COMMERCE 9-5-1945.

FOR: CLOTHING, NAMELY, SHIRTS AND HATS; FOOTWEAR, IN CLASS 25 (U.S. CLS. 22 AND 39).

FIRST USE 9-5-1945; IN COMMERCE 9-5-1945.

OWNER OF U.S. REG. NOS. 3,655,353 AND 3,655,354.

NO CLAIM IS MADE TO THE EXCLUSIVE RIGHT TO USE "MINNETONKA", APART FROM THE MARK AS SHOWN.

THE MARK CONSISTS OF THE WORDING "MINNETONKA" IN STYLIZED FONT WITH THE LETTER "T" REPRESENTED AS AN ARROW, ALL UNDERLINED WITH A DECORATIVE BORDER.

SER. NO. 85-402,120, FILED 8-19-2011.

AMY KELLY, EXAMINING ATTORNEY



David J. Kybas

Director of the United States Patent and Trademark Office

United States of America

United States Patent and Trademark Office



Reg. No. 4,153,182

Registered June 5, 2012

Int. Cl.: 29

TRADEMARK

PRINCIPAL REGISTER

SMOKY SYSTEMS, LLC (NEVADA CORPORATION)
1511 E. 2ND STREET
WEBSTER CITY, IA 50595

FOR: PREPARED MEALS CONSISTING PRIMARILY OF MEAT, FISH, POULTRY OR VEGETABLES, IN CLASS 29 (U.S. CL. 46).

FIRST USE 7-31-2011; IN COMMERCE 7-31-2011.

OWNER OF U.S. REG. NO. 3,914,063.

THE MARK CONSISTS OF THE WORDING "SMOKY MARKET" WITH A STYLIZED LETTER "S" INSIDE A DIAMOND WITH ROUNDED SIDES.

SER. NO. 85-402,599, FILED 8-19-2011.

KIM SAITO, EXAMINING ATTORNEY



David J. Kybas

Director of the United States Patent and Trademark Office

United States of America

United States Patent and Trademark Office

Uptown Kitchen

Reg. No. 4,153,183

Registered June 5, 2012

Int. Cl.: 43

SERVICE MARK

PRINCIPAL REGISTER

THE CLEAN PLATE CLUB, INC. (INDIANA CORPORATION)
7225 HERITAGE SQUARE DRIVE
GRANGER, IN 46530

FOR: RESTAURANT, BAR AND CATERING SERVICES, IN CLASS 43 (U.S. CLS. 100 AND 101).

FIRST USE 8-1-2007; IN COMMERCE 8-1-2007.

THE MARK CONSISTS OF STANDARD CHARACTERS WITHOUT CLAIM TO ANY PARTICULAR FONT, STYLE, SIZE, OR COLOR.

NO CLAIM IS MADE TO THE EXCLUSIVE RIGHT TO USE "KITCHEN", APART FROM THE MARK AS SHOWN.

SER. NO. 85-402,795, FILED 8-19-2011.

BARBARA GAYNOR, EXAMINING ATTORNEY



David J. Kyffers

Director of the United States Patent and Trademark Office

United States of America

United States Patent and Trademark Office

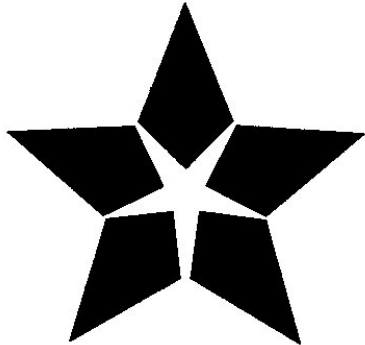

SOUTHSTAR
engineering
& consulting, inc.

Reg. No. 4,153,184

Registered June 5, 2012

Int. Cl.: 42

SERVICE MARK

PRINCIPAL REGISTER

SOUTHSTAR ENGINEERING & CONSULTING, INC. (CALIFORNIA CORPORATION)
SUITE 160
1650 IOWA AVE.
RIVERSIDE, CA 92507

FOR: DESIGN FOR OTHERS IN THE FIELD OF CIVIL INFRASTRUCTURE; ENGINEERING;
INSPECTIONS OF CIVIL INFRASTRUCTURE, IN CLASS 42 (U.S. CLS. 100 AND 101).

FIRST USE 9-14-2006; IN COMMERCE 9-14-2006.

NO CLAIM IS MADE TO THE EXCLUSIVE RIGHT TO USE "ENGINEERING & CONSULTING,
INC.", APART FROM THE MARK AS SHOWN.

THE MARK CONSISTS OF A FIVE POINT STAR WITH ANOTHER FIVE POINT STAR INSIDE
IT. THE POINTS OF THE SMALLER STAR INTERSECT WITH THE ANGLES OF THE
LARGER STAR. TO THE RIGHT IS THE STYLIZED TEXT "SOUTHSTAR". UNDER "SOUTH"
IN "SOUTHSTAR" IS THE STYLIZED TEXT "ENGINEERING" ABOVE THE STYLIZED
TEXT "& CONSULTING, INC.".

SER. NO. 85-402,966, FILED 8-20-2011.

KEVIN CORWIN, EXAMINING ATTORNEY



David J. Kyros

Director of the United States Patent and Trademark Office

United States of America

United States Patent and Trademark Office

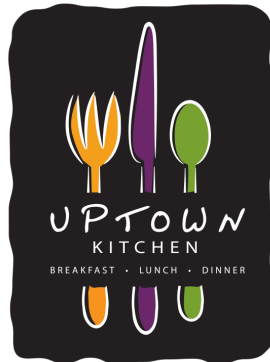

Reg. No. 4,153,185

Registered June 5, 2012

Int. Cl.: 43

SERVICE MARK

PRINCIPAL REGISTER

THE CLEAN PLATE CLUB, INC. (INDIANA CORPORATION)
7225 HERITAGE SQUARE DRIVE
GRANGER, IN 46530

FOR: BAR AND RESTAURANT SERVICES, IN CLASS 43 (U.S. CLS. 100 AND 101).

FIRST USE 8-1-2007; IN COMMERCE 8-1-2007.

NO CLAIM IS MADE TO THE EXCLUSIVE RIGHT TO USE "KITCHEN", "BREAKFAST", "LUNCH" OR "DINNER", APART FROM THE MARK AS SHOWN.

THE COLOR(S) ORANGE, PURPLE, GREEN, BLACK, AND WHITE IS/ARE CLAIMED AS A FEATURE OF THE MARK.

THE MARK CONSISTS OF A BLACK RECTANGULAR SHAPE UPON WHICH ARE AN ORANGE FORK, PURPLE KNIFE, AND GREEN SPOON. THE FORK, KNIFE, AND SPOON ARE OUTLINED IN WHITE. ACROSS THE FORK, KNIFE, AND SPOON IS THE STYLIZED WORDING "UPTOWN KITCHEN BREAKFAST LUNCH DINNER" IN THE COLOR WHITE. THERE IS A WHITE DOT BETWEEN THE WORDS "BREAKFAST" AND "LUNCH" AND BETWEEN THE WORDS "LUNCH" AND "DINNER".

SER. NO. 85-403,089, FILED 8-20-2011.

BARBARA GAYNOR, EXAMINING ATTORNEY



David J. Kybas

Director of the United States Patent and Trademark Office

United States of America

United States Patent and Trademark Office

Dance Daze

Reg. No. 4,153,186

Registered June 5, 2012

Int. Cl.: 41

SERVICE MARK

PRINCIPAL REGISTER

DANCE DAZE (CALIFORNIA SOLE PROPRIETORSHIP)
1151 HARBOR BAY PARKWAY, #100
ALAMEDA, CA 94502

FOR: EDUCATIONAL SERVICES, NAMELY, PROVIDING CLASSES AND INSTRUCTION IN THE FIELD OF DANCE, YOGA, MUSIC, THEATER, PERFORMING ARTS AND HEALTH; EDUCATIONAL AFTER-SCHOOL PROGRAMS IN THE FIELD OF DANCE AND PERFORMING ARTS; PERFORMING ARTS CAMPS, IN CLASS 41 (U.S. CLS. 100, 101 AND 107).

FIRST USE 8-15-2010; IN COMMERCE 8-15-2010.

THE MARK CONSISTS OF STANDARD CHARACTERS WITHOUT CLAIM TO ANY PARTICULAR FONT, STYLE, SIZE, OR COLOR.

NO CLAIM IS MADE TO THE EXCLUSIVE RIGHT TO USE "DANCE", APART FROM THE MARK AS SHOWN.

SER. NO. 85-403,162, FILED 8-21-2011.

PAULA MAHONEY, EXAMINING ATTORNEY



David J. Kyros

Director of the United States Patent and Trademark Office

United States of America

United States Patent and Trademark Office

SPIRIT JUNKIE

Reg. No. 4,153,187

BERNSTEIN, GABRIELLE (UNITED STATES INDIVIDUAL)
143 AVENUE B, APT 3B
NEW YORK, NY 10009

Registered June 5, 2012

Int. Cl.: 41

FOR: EDUCATIONAL AND ENTERTAINMENT SERVICES, NAMELY, PROVIDING COACHING AND EDUCATIONAL SPEAKING SERVICES, NAMELY, A CONTINUING PROGRAM ABOUT SELF AND PERSONAL IMPROVEMENT, MEDITATION, SERENITY, RELAXATION, AND HAPPINESS, IN CLASS 41 (U.S. CLS. 100, 101 AND 107).

SERVICE MARK

PRINCIPAL REGISTER

FIRST USE 6-28-2011; IN COMMERCE 6-28-2011.

THE MARK CONSISTS OF STANDARD CHARACTERS WITHOUT CLAIM TO ANY PARTICULAR FONT, STYLE, SIZE, OR COLOR.

SER. NO. 85-403,501, FILED 8-22-2011.

WILLIAM JACKSON, EXAMINING ATTORNEY



David J. Kybas

Director of the United States Patent and Trademark Office

United States of America

United States Patent and Trademark Office

Design Savvy

Reg. No. 4,153,188

Registered June 5, 2012

Int. Cl.: 42

SERVICE MARK

PRINCIPAL REGISTER

STEVENS, JESSICA (CALIFORNIA SOLE PROPRIETORSHIP), DBA DESIGN SAVVY
31915 RANCHO CALIFORNIA ROAD
STE 200-267
TEMECULA, CA 92591

FOR: COMPUTER AIDED DESIGN FOR OTHERS; COMPUTER SERVICES, NAMELY, DESIGNING AND IMPLEMENTING WEB SITES FOR OTHERS; DESIGNING WEBSITES FOR ADVERTISING PURPOSES, IN CLASS 42 (U.S. CLS. 100 AND 101).

FIRST USE 2-1-2007; IN COMMERCE 6-1-2007.

THE MARK CONSISTS OF STANDARD CHARACTERS WITHOUT CLAIM TO ANY PARTICULAR FONT, STYLE, SIZE, OR COLOR.

NO CLAIM IS MADE TO THE EXCLUSIVE RIGHT TO USE "DESIGN", APART FROM THE MARK AS SHOWN.

SER. NO. 85-403,960, FILED 8-22-2011.

MATTHEW MCDOWELL, EXAMINING ATTORNEY



David J. Kyffers

Director of the United States Patent and Trademark Office

United States of America

United States Patent and Trademark Office



Reg. No. 4,153,189

FD SWEDEN AB (SWEDEN CORPORATION)
DATAVAGEN 10D, 436 32
ASKIM, SWEDEN

Registered June 5, 2012

Int. Cl.: 9

FOR: COMPUTER CHASSIS; INTERNAL COOLING FANS FOR COMPUTERS; ELECTRICAL POWER SUPPLIES, IN CLASS 9 (U.S. CLS. 21, 23, 26, 36 AND 38).

TRADEMARK

FIRST USE 4-1-2009; IN COMMERCE 3-1-2010.

PRINCIPAL REGISTER

NO CLAIM IS MADE TO THE EXCLUSIVE RIGHT TO USE "DESIGN", APART FROM THE MARK AS SHOWN.

THE MARK CONSISTS OF THE WORD "FRACTAL" IN LARGE PRINT WITH THE WORD "DESIGN" IN SMALLER PRINT CENTERED BENEATH, AND A SHAPE RESEMBLING A SNOWFLAKE CENTERED BEHIND THE TWO WORDS.

SER. NO. 85-404,465, FILED 8-23-2011.

JOHN E. MICHOS, EXAMINING ATTORNEY



David J. Kyros

Director of the United States Patent and Trademark Office

United States of America

United States Patent and Trademark Office

SPB

SO PRETTY BABY

Reg. No. 4,153,190

Registered June 5, 2012

Int. Cl.: 26

TRADEMARK

PRINCIPAL REGISTER

TROIKA INTERNATIONAL, INC. (CALIFORNIA CORPORATION)
1560 FLOWER AVE.
DUARTE, CA 91010

FOR: HAIR PIECES AND WIGS; WIG CAPS; WIGS; WIGS, HAIRPIECES, AND ADD-IN AND ADD-ON HAIR ACCESSORIES CONSTRUCTED PRIMARILY OF SYNTHETIC AND/OR HUMAN HAIR, IN CLASS 26 (U.S. CLS. 37, 39, 40, 42 AND 50).

FIRST USE 1-1-2004; IN COMMERCE 1-1-2004.

THE MARK CONSISTS OF STYLIZED LETTERS "S" "P" AND "B" IN ANGULAR DESCENT FROM LEFT TO RIGHT AND "SO PRETTY BABY" WRITTEN IN CAPITALIZED LETTERS UNDERNEATH.

SER. NO. 85-404,628, FILED 8-23-2011.

GIANCARLO CASTRO, EXAMINING ATTORNEY



David J. Kyros

Director of the United States Patent and Trademark Office

United States of America

United States Patent and Trademark Office

Live Life
7 days a week. One day at
a time.

Reg. No. 4,153,191

Registered June 5, 2012

Int. Cl.: 25

TRADEMARK

PRINCIPAL REGISTER

KAM INTER VIVOS TRUST (FLORIDA TRUST)
12918 SOUTH UNION AVE.
CHICAGO, IL 60628

FOR: A-SHIRTS; APPAREL FOR DANCERS, NAMELY, TEE SHIRTS, SWEATSHIRTS, PANTS, LEGGINGS, SHORTS AND JACKETS; ATHLETIC APPAREL, NAMELY, SHIRTS, PANTS, JACKETS, FOOTWEAR, HATS AND CAPS, ATHLETIC UNIFORMS; BODY SHIRTS; BUTTON DOWN SHIRTS; CAMP SHIRTS; CLOTHING FOR ATHLETIC USE, NAMELY, PADDED SHIRTS; CLOTHING FOR BABIES, TODDLERS AND CHILDREN, TREATED WITH FIRE AND HEAT RETARDANTS, NAMELY, PAJAMAS, JACKETS, SHIRTS, PANTS, JUMPERS; COLLARED SHIRTS; DRESS SHIRTS; GOLF PANTS, SHIRTS AND SKIRTS; GOLF SHIRTS; HOODED SWEAT SHIRTS; KNIT SHIRTS; LEATHER SHIRTS; LONG-SLEEVED SHIRTS; NIGHT SHIRTS; OPEN-NECKED SHIRTS; OVER SHIRTS; POLO KNIT TOPS; POLO SHIRTS; RUGBY SHIRTS; SHIRT INSERTS, NAMELY, DICKIES; SHIRTS; SHIRTS AND SHORT-SLEEVED SHIRTS; SHIRTS AND SLIPS; SHIRTS FOR INFANTS, BABIES, TODDLERS AND CHILDREN; SHORT-SLEEVED OR LONG-SLEEVED T-SHIRTS; SHORT-SLEEVED SHIRTS; SLEEP SHIRTS; SLEEVES WORN SEPARATE AND APART FROM BLOUSES, SHIRTS AND OTHER TOPS; SPORT SHIRTS; SPORTS SHIRTS; SPORTS SHIRTS WITH SHORT SLEEVES; SWEAT SHIRTS; T-SHIRTS; T-SHIRTS FOR SPORTS; TEE SHIRTS; TURTLE NECK SHIRTS; WEARABLE GARMENTS AND CLOTHING, NAMELY, SHIRTS; WIND SHIRTS, IN CLASS 25 (U.S. CLS. 22 AND 39).

FIRST USE 6-23-2010; IN COMMERCE 6-23-2010.

THE MARK CONSISTS OF STANDARD CHARACTERS WITHOUT CLAIM TO ANY PARTICULAR FONT, STYLE, SIZE, OR COLOR.

OWNER OF U.S. REG. NO. 3,912,097.

SER. NO. 85-404,719, FILED 8-23-2011.

SANI KHOURI, EXAMINING ATTORNEY



David J. Kyffers

Director of the United States Patent and Trademark Office

United States of America

United States Patent and Trademark Office

Verge

Reg. No. 4,153,192

INDY FOUNDERS, LLC (INDIANA LIMITED LIABILITY COMPANY)
545 EAST WESTFIELD BLVD.
INDIANAPOLIS, IN 46220

Registered June 5, 2012

Int. Cl.: 35

FOR: ASSOCIATION SERVICES, NAMELY, PROMOTING THE INTERESTS OF ENTREPRENEURS AND SOFTWARE DEVELOPERS, IN CLASS 35 (U.S. CLS. 100, 101 AND 102).

SERVICE MARK

FIRST USE 1-31-2011; IN COMMERCE 1-31-2011.

PRINCIPAL REGISTER

THE MARK CONSISTS OF STANDARD CHARACTERS WITHOUT CLAIM TO ANY PARTICULAR FONT, STYLE, SIZE, OR COLOR.

SER. NO. 85-404,792, FILED 8-23-2011.

MATTHEW PAPPAS, EXAMINING ATTORNEY



David J. Kappas

Director of the United States Patent and Trademark Office

United States of America

United States Patent and Trademark Office

CARELIVE

Reg. No. 4,153,193

Registered June 5, 2012

Int. Cl.: 42

SERVICE MARK

PRINCIPAL REGISTER

LIVE SOFTWARE LLC (WISCONSIN LIMITED LIABILITY COMPANY)
20760 HUNTERS RUN
BROOKFIELD, WI 53045

FOR: PROVIDING A WEBSITE FEATURING ONLINE, NON-DOWNLOADABLE SOFTWARE THAT ENABLES USERS TO MANAGE PATIENT INFORMATION, PERFORM BILLING FUNCTIONS, GENERATE REPORTS, AND MANAGE SCHEDULES IN THE HEALTHCARE FIELD, IN CLASS 42 (U.S. CLS. 100 AND 101).

FIRST USE 0-0-2007; IN COMMERCE 0-0-2007.

THE MARK CONSISTS OF STANDARD CHARACTERS WITHOUT CLAIM TO ANY PARTICULAR FONT, STYLE, SIZE, OR COLOR.

SER. NO. 85-404,826, FILED 8-23-2011.

AMY KELLY, EXAMINING ATTORNEY



David J. Kyffers

Director of the United States Patent and Trademark Office

United States of America

United States Patent and Trademark Office



Reg. No. 4,153,194

Registered June 5, 2012

Int. Cl.: 25

TRADEMARK

PRINCIPAL REGISTER

GUANGDONG YINGNAIER APPAREL COMPANY LIMITED (CHINA LIMITED LIABILITY COMPANY)
DONGTANG INDUSTRIAL AREA, XIASHAN
CHAONAN DISTRICT, SHANTOU CITY
GUANG DONG PROVINCE, CHINA

FOR: CLOTHING, NAMELY, SHIRTS; UNDERWEAR; BRASSIERES; HOSIERY; PYJAMAS; BABIES' DIAPERS OF TEXTILE; TEE-SHIRTS; BATHING SUITS; BATH ROBES; LAYETTE; WEDDING GOWN; BELTS; UNDERPANTS; CAPS; NECKTIES; BIBS, NOT OF PAPER; SINGLET; SHOES; BABIES' PANTS, IN CLASS 25 (U.S. CLS. 22 AND 39).

FIRST USE 12-3-2003; IN COMMERCE 12-3-2003.

THE MARK CONSISTS OF THE WORD "ENLAML" WITH CHINESE CHARACTERS TO THE RIGHT OF THE WORD AND A DESIGN OF A LEAF IN A CIRCLE TO THE LEFT OF THE WORD.

THE NON-LATIN CHARACTERS IN THE MARK TRANSLITERATE TO "YING", "NAI" AND "ER" AND THESE WORDS MEAN "CHERRY", "INDEED" AND "YOU" IN ENGLISH. THE COMBINATION AS A WHOLE HAS NO MEANING.

SER. NO. 85-405,433, FILED 8-24-2011.

JENNIFER VASQUEZ, EXAMINING ATTORNEY



David J. Kybas

Director of the United States Patent and Trademark Office

United States of America

United States Patent and Trademark Office



Reg. No. 4,153,195

Registered June 5, 2012

Int. Cl.: 3

TRADEMARK

PRINCIPAL REGISTER

SUNERGETICS, LLC (ARIZONA LIMITED LIABILITY COMPANY)
164 COFFEE POT DRIVE, SUITE B
SEDONA, AZ 86336

FOR: SKIN CARE PRODUCTS, NAMELY, ORGANIC SOAPS, ORGANIC SKIN CREAMS,
AND ORGANIC LOTIONS, IN CLASS 3 (U.S. CLS. 1, 4, 6, 50, 51 AND 52).

FIRST USE 6-3-2009; IN COMMERCE 6-3-2009.

NO CLAIM IS MADE TO THE EXCLUSIVE RIGHT TO USE "SKIN CARE", APART FROM
THE MARK AS SHOWN.

THE MARK CONSISTS OF THE TERM "ORION SKIN CARE" WITH AN ENLARGED LETTER
"O" HAVING AN INNER AND OUTER CIRCUMFERENTIAL BORDER AND THREE STARS
ADJACENT ITS RIGHT SIDE.

SER. NO. 85-405,789, FILED 8-24-2011.

NAKIA HENRY, EXAMINING ATTORNEY



David J. Kybas

Director of the United States Patent and Trademark Office

United States of America

United States Patent and Trademark Office



Reg. No. 4,153,196

Registered June 5, 2012

Int. Cl.: 36

SERVICE MARK

PRINCIPAL REGISTER

PATCHES AND BADGES FOR KIDS, NFP (ILLINOIS NON-PROFIT CORPORATION)
PO BOX 61
BETHALTO, IL 62010

FOR: CHARITABLE SERVICES, NAMELY, CHARITABLE FUNDRAISING FOR NEEDY FAMILIES WITH CHILDREN, IN CLASS 36 (U.S. CLS. 100, 101 AND 102).

FIRST USE 6-7-2010; IN COMMERCE 6-7-2010.

THE MARK CONSISTS OF A CIRCLE WITH AN OUTLINE OF A POLICE BADGE INSIDE. INSIDE THE BADGE IS A CIRCLE WITH A STAR IN THE CENTER AND THE STYLIZED NUMBER "197" INSIDE THE STAR. ON THE TOP OF THE BADGE IS THE STYLIZED WORD "FOR" AND ON THE BOTTOM OF THE BADGE IS THE STYLIZED WORD "KIDS". OUTSIDE THE CIRCLE ON TOP IS A ROCKER WITH THE STYLIZED WORD "PATCHES" INSIDE. OUTSIDE THE CIRCLE ON THE BOTTOM IS A ROCKER WITH THE STYLIZED WORD "BADGES" INSIDE. BOTH ROCKERS FOLLOW THE CONTOUR OF THE CIRCLE.

SER. NO. 85-405,817, FILED 8-24-2011.

MATTHEW MCDOWELL, EXAMINING ATTORNEY



David J. Kybas

Director of the United States Patent and Trademark Office

United States of America

United States Patent and Trademark Office

More Calls, More Sales, More Profits

Reg. No. 4,153,197

Registered June 5, 2012

Int. Cls.: 35 and 38

SERVICE MARK

PRINCIPAL REGISTER

800RESPONSE MARKETING, LLC (VERMONT LIMITED LIABILITY COMPANY)
200 CHURCH STREET
BURLINGTON, VT 05401

FOR: MARKETING CONSULTATION SERVICES; COMMERCIAL ADMINISTRATION OF THE LICENSING OF TOLL FREE VANITY TELEPHONE NUMBERS; PROMOTING THE GOODS AND SERVICES OF OTHERS BY LICENSING A TOLL-FREE TELEPHONE NUMBER; BUSINESS MANAGEMENT AND BUSINESS ADMINISTRATION SERVICES, NAMELY, PROVIDING BUSINESS CONSULTATION, ADVICE AND INFORMATION RELATING TO PERFORMANCE MANAGEMENT AND BUSINESS IMPROVEMENT; BUSINESS SERVICES, NAMELY, TRACKING AND MONITORING OF CALLS FOR OTHERS IN RESPONSE TO ADVERTISING ADS; ANALYSIS OF ADVERTISING RESPONSE, NAMELY, ANALYSIS OF TELEPHONE CALL RESPONSES GENERATED BY ADVERTISEMENTS, IN CLASS 35 (U.S. CLS. 100, 101 AND 102).

FIRST USE 6-6-2004; IN COMMERCE 6-6-2004.

FOR: TELEPHONE CALL RECORDING SERVICES; TELEPHONE CALL ROUTING SERVICES; TELECOMMUNICATIONS SERVICES, NAMELY, PROVIDING TOLL-FREE MNE-MONIC TELEPHONE NUMBERS, IN CLASS 38 (U.S. CLS. 100, 101 AND 104).

FIRST USE 6-6-2004; IN COMMERCE 6-6-2004.

THE MARK CONSISTS OF STANDARD CHARACTERS WITHOUT CLAIM TO ANY PARTICULAR FONT, STYLE, SIZE, OR COLOR.

SER. NO. 85-405,891, FILED 8-24-2011.

CYNTHIA TRIPI, EXAMINING ATTORNEY



David J. Kypos

Director of the United States Patent and Trademark Office

United States of America

United States Patent and Trademark Office



Reg. No. 4,153,198

Registered June 5, 2012

Int. Cls.: 11 and 30

TRADEMARK

PRINCIPAL REGISTER

BREW1 TECHNOLOGIES, INC. (MASSACHUSETTS CORPORATION)
130 CENTRE STREET
DANVERS, MA 01923

FOR: ELECTRIC COFFEE BREWERS: ELECTRIC MACHINES FOR MAKING HOT BEVERAGES, NAMELY, COFFEE, IN CLASS 11 (U.S. CLS. 13, 21, 23, 31 AND 34).

FIRST USE 10-1-2011; IN COMMERCE 10-1-2011.

FOR: COFFEE CONTAINED IN PLASTIC CARTRIDGES HAVING FILTERS FOR USE IN AN ELECTRIC BREWING MACHINE, IN CLASS 30 (U.S. CL. 46).

FIRST USE 10-1-2011; IN COMMERCE 10-1-2011.

NO CLAIM IS MADE TO THE EXCLUSIVE RIGHT TO USE "BREW", APART FROM THE MARK AS SHOWN.

THE MARK CONSISTS OF THE TEXT "BREW1" SUPERIMPOSED ACROSS THE OUTLINE OF A FILLED BEVERAGE CUP.

SER. NO. 85-406,081, FILED 8-24-2011.

H. M. FISHER, EXAMINING ATTORNEY



David J. Kybas

Director of the United States Patent and Trademark Office

United States of America

United States Patent and Trademark Office

NEW HEALTH AGE

Reg. No. 4,153,199

Registered June 5, 2012

Int. Cls.: 35, 41 and 44

SERVICE MARK

PRINCIPAL REGISTER

NEW HEALTH AGE ADVISORS, LLC (FLORIDA LIMITED LIABILITY COMPANY)
802 11TH STREET WEST
BRADENTON, FL 34205

FOR: PROVIDING A WEBSITE FEATURING PUBLIC POLICY INFORMATION ABOUT HEALTH CARE REFORM AND THE FUTURE OF HEALTH CARE; PUBLIC POLICY CONSULTANCY SERVICES FOR THE HEALTH CARE INDUSTRY IN THE FIELDS OF HEALTH CARE DELIVERY SYSTEMS, HEALTH CARE REFORM, MEDICINE, AND THE FUTURE THEREOF; BUSINESS CONSULTATION IN THE HEALTH CARE INDUSTRY IN THE FIELDS OF HEALTH CARE DELIVERY SYSTEMS, HEALTH CARE REFORM, MEDICINE, AND THE FUTURE THEREOF, IN CLASS 35 (U.S. CLS. 100, 101 AND 102).

FIRST USE 6-22-2011; IN COMMERCE 1-6-2012.

FOR: PUBLISHING E-MAIL OR ELECTRONIC NEWSLETTERS AND WHITE PAPERS; EDUCATIONAL SERVICES IN THE HEALTH CARE INDUSTRY, NAMELY, CONDUCTING EDUCATIONAL PROGRAMS IN THE FIELDS OF HEALTH AND WELLNESS, HEALTH CARE DELIVERY SYSTEMS, HEALTH CARE REFORM, MEDICINE, AND THE FUTURE THEREOF; PROVIDING A WEBSITE FEATURING BLOGS IN THE FIELDS OF HEALTH AND WELLNESS, HEALTH CARE DELIVERY SYSTEMS, HEALTH CARE REFORM, MEDICINE, AND THE FUTURE THEREOF; EDUCATIONAL SERVICES FOR THE HEALTH CARE INDUSTRY, NAMELY, CONDUCTING SEMINARS AND WORKSHOPS IN THE FIELDS OF HEALTH CARE DELIVERY SYSTEMS, HEALTH CARE REFORM, AND MEDICINE, AND THE FUTURE THEREOF, IN CLASS 41 (U.S. CLS. 100, 101 AND 107).

FIRST USE 6-22-2011; IN COMMERCE 1-6-2012.

FOR: PROVIDING A WEBSITE FEATURING INFORMATION ABOUT HEALTH AND WELLNESS; PROVIDING A WEBSITE FEATURING HEALTH CARE SERVICES INFORMATION ABOUT HEALTH CARE DELIVERY SYSTEMS AND MEDICINE, IN CLASS 44 (U.S. CLS. 100 AND 101).

FIRST USE 6-22-2011; IN COMMERCE 1-6-2012.

THE MARK CONSISTS OF STANDARD CHARACTERS WITHOUT CLAIM TO ANY PARTICULAR FONT, STYLE, SIZE, OR COLOR.



David J. Kyjars

Director of the United States Patent and Trademark Office

Reg. No. 4,153,199 NO CLAIM IS MADE TO THE EXCLUSIVE RIGHT TO USE "HEALTH AGE", APART FROM THE MARK AS SHOWN.

SER. NO. 85-406,280, FILED 8-24-2011.

DOUGLAS LEE, EXAMINING ATTORNEY

United States of America

United States Patent and Trademark Office

BAY AREA GRAPHICS

Reg. No. 4,153,200

Registered June 5, 2012

Int. Cl.: 40

SERVICE MARK

PRINCIPAL REGISTER

HARRISON, LESLEY (UNITED STATES INDIVIDUAL)
274 KILLDEER COURT
FOSTER CITY, CA 94404

FOR: PRINTING SERVICES, NAMELY, DIGITAL PRINTING AND OFFSET PRINTING; WEB TO PRINT SOLUTIONS, NAMELY, DIGITAL PRINTING; DIGITAL ON-DEMAND PRINTING SERVICES OF BOOKS, DOCUMENTS; CUSTOM IMPRINTING OF APPAREL, SIGNAGE, POSTERS, BANNERS, PACKAGING, MEDIA, DISPLAY PRODUCTS, AND PROMOTIONAL PRODUCTS, IN CLASS 40 (U.S. CLS. 100, 103 AND 106).

FIRST USE 1-8-2004; IN COMMERCE 1-8-2004.

THE MARK CONSISTS OF STANDARD CHARACTERS WITHOUT CLAIM TO ANY PARTICULAR FONT, STYLE, SIZE, OR COLOR.

NO CLAIM IS MADE TO THE EXCLUSIVE RIGHT TO USE "GRAPHICS", APART FROM THE MARK AS SHOWN.

SEC. 2(F).

SER. NO. 85-406,601, FILED 8-24-2011.

DEBORAH LOBO, EXAMINING ATTORNEY



David J. Kybas

Director of the United States Patent and Trademark Office

United States of America

United States Patent and Trademark Office

IDEELI

Reg. No. 4,153,201

Registered June 5, 2012

Int. Cls.: 39 and 41

SERVICE MARK

PRINCIPAL REGISTER

IDEELI INC. (DELAWARE CORPORATION)
148 LAFAYETTE, 10TH FLOOR
NEW YORK, NY 10013

FOR: PROVIDING INFORMATION, NEWS AND COMMENTARY IN THE FIELD OF TRAVEL;
PROVIDING A WEBSITE FEATURING INFORMATION IN THE FIELD OF TRAVEL, IN
CLASS 39 (U.S. CLS. 100 AND 105).

FIRST USE 8-0-2010; IN COMMERCE 8-0-2010.

FOR: PROVIDING INFORMATION, NEWS AND COMMENTARY IN THE FIELDS OF
CLOTHING, SHOES, JEWELRY, HANDBAGS, ENTERTAINMENT, MOVIES, MUSIC, AND
BOOKS; PROVIDING A WEBSITE FEATURING INFORMATION IN THE FIELDS OF
CLOTHING, SHOES, JEWELRY, HANDBAGS, ENTERTAINMENT, MOVIES, MUSIC, AND
BOOKS, IN CLASS 41 (U.S. CLS. 100, 101 AND 107).

FIRST USE 6-1-2007; IN COMMERCE 6-1-2007.

THE MARK CONSISTS OF STANDARD CHARACTERS WITHOUT CLAIM TO ANY PAR-
TICULAR FONT, STYLE, SIZE, OR COLOR.

OWNER OF U.S. REG. NO. 3,915,685.

SER. NO. 85-407,032, FILED 8-25-2011.

SUE LAWRENCE, EXAMINING ATTORNEY



David J. Kybas

Director of the United States Patent and Trademark Office

United States of America

United States Patent and Trademark Office

FLORIDA LOTTERY

Reg. No. 4,153,202

Registered June 5, 2012

Int. Cl.: 41

SERVICE MARK

PRINCIPAL REGISTER

THE STATE OF FLORIDA DEPARTMENT OF THE LOTTERY (FLORIDA STATE AGENCY)
250 MARRIOTT DRIVE
TALLAHASSEE, FL 32301

FOR: LOTTERY SERVICES, IN CLASS 41 (U.S. CLS. 100, 101 AND 107).

FIRST USE 7-31-1987; IN COMMERCE 7-31-1987.

THE MARK CONSISTS OF STANDARD CHARACTERS WITHOUT CLAIM TO ANY PARTICULAR FONT, STYLE, SIZE, OR COLOR.

OWNER OF U.S. REG. NO. 1,542,860.

NO CLAIM IS MADE TO THE EXCLUSIVE RIGHT TO USE "LOTTERY", APART FROM THE MARK AS SHOWN.

SEC. 2(F).

SER. NO. 85-407,460, FILED 8-25-2011.

DANNEAN HETZEL, EXAMINING ATTORNEY



David J. Kyros

Director of the United States Patent and Trademark Office

United States of America

United States Patent and Trademark Office

DEMOCRACY SUITE

Reg. No. 4,153,203

Registered June 5, 2012

Int. Cl.: 9

TRADEMARK

PRINCIPAL REGISTER

DOMINION VOTING SYSTEMS, INC. (DELAWARE CORPORATION)
1201 18TH STREET, SUITE 210
DENVER, CO 80202

FOR: COMPUTER SOFTWARE FOR USE IN THE FIELD OF ELECTIONS, NAMELY, SOFTWARE FOR SETTING UP PRECINCTS AND DISTRICTS, FOR DEFINING THE ELECTION RACE, FOR PROVIDING ELECTRONIC INFORMATION FOR ELECTION MANAGEMENT, FOR VOTING, FOR BALLOT DESIGN, FOR BALLOT DEFINITION AND BALLOT TRANSMISSION, FOR VOTER REGISTRATION AND AUTHENTICATION, FOR ELECTION TABULATION, AND FOR REPORTING THE RESULTS, IN CLASS 9 (U.S. CLS. 21, 23, 26, 36 AND 38).

FIRST USE 4-0-2006; IN COMMERCE 4-0-2006.

THE MARK CONSISTS OF STANDARD CHARACTERS WITHOUT CLAIM TO ANY PARTICULAR FONT, STYLE, SIZE, OR COLOR.

NO CLAIM IS MADE TO THE EXCLUSIVE RIGHT TO USE "SUITE" , APART FROM THE MARK AS SHOWN.

SER. NO. 85-407,749, FILED 8-25-2011.

MARY CRAWFORD, EXAMINING ATTORNEY



David J. Kyros

Director of the United States Patent and Trademark Office

United States of America

United States Patent and Trademark Office



CONTRACTORS HEALTH TRUST

Reg. No. 4,153,204

CONTRACTORS HEALTH TRUST (COLORADO TRUST)
1114 WEST 7TH AVENUE SUITE 240
DENVER, CO 80204

Registered June 5, 2012

Int. Cl.: 36

FOR: INSURANCE SERVICES, NAMELY, UNDERWRITING, ISSUING AND ADMINISTRATION OF INSURED, PRE-PAID AND SELF FUNDED EMPLOYEE BENEFIT PLANS, NAMELY, OF INSURANCE IN THE FIELDS OF HEALTH, LIFE, ACCIDENTAL DEATH AND DISMEMBERMENT, DENTAL, VISION, AND PRESCRIPTION DRUG PROGRAMS FOR PARTICIPATING EMPLOYERS, IN CLASS 36 (U.S. CLS. 100, 101 AND 102).

SERVICE MARK

PRINCIPAL REGISTER

FIRST USE 1-27-2011; IN COMMERCE 1-27-2011.

NO CLAIM IS MADE TO THE EXCLUSIVE RIGHT TO USE "CONTRACTORS HEALTH TRUST", APART FROM THE MARK AS SHOWN.

THE MARK CONSISTS OF A DESIGN OF THREE INTERLOCKING SQUARES AND RECTANGLES TO THE LEFT OF THE WORDS "CONTRACTORS HEALTH TRUST".

SER. NO. 85-408,160, FILED 8-26-2011.

ADA HAN, EXAMINING ATTORNEY



David J. Kyjars

Director of the United States Patent and Trademark Office

United States of America

United States Patent and Trademark Office



Reg. No. 4,153,205

Registered June 5, 2012

Int. Cls.: 35, 36 and 41

THE SUSAN G. KOMEN BREAST CANCER FOUNDATION, INC. (TEXAS NON-PROFIT CORPORATION)
SUITE 250
5005 LBJ FREEWAY
DALLAS, TX 75244

SERVICE MARK

PRINCIPAL REGISTER

FOR: PUBLIC ADVOCACY TO PROMOTE AWARENESS, EDUCATION, RESEARCH, SCREENING, EARLY DETECTION AND TREATMENT OF BREAST CANCER; PROMOTING PUBLIC AWARENESS OF THE IMPORTANCE OF THE EARLY DETECTION OF BREAST CANCER, IN CLASS 35 (U.S. CLS. 100, 101 AND 102).

FIRST USE 1-22-2007; IN COMMERCE 1-22-2007.

FOR: CHARITABLE FUNDRAISING SERVICES, IN CLASS 36 (U.S. CLS. 100, 101 AND 102).

FIRST USE 1-22-2007; IN COMMERCE 1-22-2007.

FOR: EDUCATIONAL SERVICES, NAMELY, PROVIDING SEMINARS IN THE FIELD OF BREAST CANCER, IN CLASS 41 (U.S. CLS. 100, 101 AND 107).

FIRST USE 1-22-2007; IN COMMERCE 1-22-2007.

OWNER OF U.S. REG. NOS. 3,309,532, 3,424,712 AND OTHERS.

THE MARK CONSISTS OF A STYLIZED THREE-DIMENSIONAL REPRESENTATION OF A RIBBON WITH A DOT OVER THE TOP.

SER. NO. 85-408,296, FILED 8-26-2011.

JEFFERY COWARD, EXAMINING ATTORNEY



David J. Kybas

Director of the United States Patent and Trademark Office

United States of America

United States Patent and Trademark Office



Reg. No. 4,153,206

Registered June 5, 2012

Int. Cls.: 35, 36 and 41

THE SUSAN G. KOMEN BREAST CANCER FOUNDATION, INC. (TEXAS NON-PROFIT CORPORATION)
CORPORATION)
SUITE 250
5005 LBJ FREEWAY
DALLAS, TX 75244

SERVICE MARK

PRINCIPAL REGISTER

FOR: PUBLIC ADVOCACY TO PROMOTE AWARENESS, EDUCATION, RESEARCH, SCREENING, EARLY DETECTION AND TREATMENT OF BREAST CANCER; PROMOTING PUBLIC AWARENESS OF THE IMPORTANCE OF THE EARLY DETECTION OF BREAST CANCER, IN CLASS 35 (U.S. CLS. 100, 101 AND 102).

FIRST USE 1-22-2007; IN COMMERCE 1-22-2007.

FOR: CHARITABLE FUNDRAISING SERVICES, IN CLASS 36 (U.S. CLS. 100, 101 AND 102).

FIRST USE 1-22-2007; IN COMMERCE 1-22-2007.

FOR: EDUCATIONAL SERVICES, NAMELY, PROVIDING SEMINARS IN THE FIELD OF BREAST CANCER, IN CLASS 41 (U.S. CLS. 100, 101 AND 107).

FIRST USE 1-22-2007; IN COMMERCE 1-22-2007.

OWNER OF U.S. REG. NOS. 3,309,532, 3,424,712 AND OTHERS.

THE COLOR(S) LIGHT PINK AND DARK PINK IS/ARE CLAIMED AS A FEATURE OF THE MARK.

THE MARK CONSISTS OF A STYLIZED THREE-DIMENSIONAL REPRESENTATION OF A RIBBON WITH A DOT OVER THE TOP. THE OUTER PORTION OF THE RIBBON ON THE RIGHT HAND SIDE IS LIGHT PINK, THE INSIDE PORTION OF THE RIBBON ON THE LEFT HAND SIDE IS DARK PINK, AND THE DOT IS DARK PINK.

SER. NO. 85-408,318, FILED 8-26-2011.

JEFFERY COWARD, EXAMINING ATTORNEY

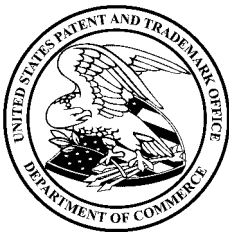

David J. Kyros

Director of the United States Patent and Trademark Office

United States of America

United States Patent and Trademark Office

Catalyst Search Partners

Reg. No. 4,153,207

CATALYST SEARCH PARTNERS LLC (DELAWARE LIMITED LIABILITY COMPANY)
ONE BROADWAY, 14TH FLOOR
CAMBRIDGE, MA 02142

Registered June 5, 2012

Int. Cl.: 35

FOR: EXECUTIVE RECRUITING SERVICES; EXECUTIVE SEARCH AND PLACEMENT SERVICES, IN CLASS 35 (U.S. CLS. 100, 101 AND 102).

SERVICE MARK

FIRST USE 9-22-2010; IN COMMERCE 9-22-2010.

PRINCIPAL REGISTER

THE MARK CONSISTS OF STANDARD CHARACTERS WITHOUT CLAIM TO ANY PARTICULAR FONT, STYLE, SIZE, OR COLOR.

NO CLAIM IS MADE TO THE EXCLUSIVE RIGHT TO USE "SEARCH PARTNERS", APART FROM THE MARK AS SHOWN.

SER. NO. 85-408,322, FILED 8-26-2011.

KAELIE KUNG, EXAMINING ATTORNEY



David J. Kappas

Director of the United States Patent and Trademark Office

United States of America

United States Patent and Trademark Office

DOW JONES

Reg. No. 4,153,208

Registered June 5, 2012

Int. Cl.: 9

TRADEMARK

PRINCIPAL REGISTER

DOW JONES TRADEMARK HOLDINGS LLC (DELAWARE LIMITED LIABILITY COMPANY)
1211 AVENUE OF THE AMERICAS
NEW YORK, NY 10036

FOR: DOWNLOADABLE PUBLICATIONS IN THE NATURE OF NEWSPAPERS, MAGAZINES, NEWSLETTERS, BROCHURES, AND PAMPHLETS IN THE FIELD OF NEWS AS WELL AS CONTENT AND COMMENTARY IN THE FIELDS OF POLITICS, SOCIAL EVENTS, BUSINESS, FINANCE, INVESTING, LIFE STYLES, LEISURE ACTIVITIES, LUXURY TRAVEL, LUXURY REAL ESTATE, AND LUXURY AUTOMOBILES; AND AUDIO RECORDINGS FEATURING CONTENT IN THE FIELD OF NEWS AS WELL AS CONTENT AND COMMENTARY IN THE FIELDS OF POLITICS, SOCIAL EVENTS, BUSINESS, FINANCE, INVESTING, LIFE STYLES, LEISURE ACTIVITIES, LUXURY TRAVEL, LUXURY REAL ESTATE, AND LUXURY AUTOMOBILES, IN CLASS 9 (U.S. CLS. 21, 23, 26, 36 AND 38).

FIRST USE 12-12-1998; IN COMMERCE 12-12-1998.

THE MARK CONSISTS OF STANDARD CHARACTERS WITHOUT CLAIM TO ANY PARTICULAR FONT, STYLE, SIZE, OR COLOR.

OWNER OF U.S. REG. NOS. 616,873, 2,211,181 AND OTHERS.

SER. NO. 85-408,452, FILED 8-26-2011.

DAVID C. REIHNER, EXAMINING ATTORNEY



David J. Kyros

Director of the United States Patent and Trademark Office

United States of America

United States Patent and Trademark Office

DOW JONES

Reg. No. 4,153,209

Registered June 5, 2012

Int. Cl.: 16

TRADEMARK

PRINCIPAL REGISTER

DOW JONES TRADEMARK HOLDINGS LLC (DELAWARE LIMITED LIABILITY COMPANY)
1211 AVENUE OF THE AMERICAS
NEW YORK, NY 10036

FOR: NEWSPAPERS; PRINTED JOURNALS, PRINTED NEWSLETTERS, AND PRINTED MAGAZINES IN THE FIELD OF NEWS AS WELL AS CONTENT AND COMMENTARY IN THE FIELDS OF POLITICS, SOCIAL EVENTS, BUSINESS, FINANCE, INVESTING, LIFE STYLES, LEISURE ACTIVITIES, LUXURY TRAVEL, LUXURY REAL ESTATE, AND LUXURY AUTOMOBILES, IN CLASS 16 (U.S. CLS. 2, 5, 22, 23, 29, 37, 38 AND 50).

FIRST USE 1-2-1997; IN COMMERCE 1-2-1997.

THE MARK CONSISTS OF STANDARD CHARACTERS WITHOUT CLAIM TO ANY PARTICULAR FONT, STYLE, SIZE, OR COLOR.

OWNER OF U.S. REG. NOS. 616,873, 2,213,004 AND OTHERS.

SER. NO. 85-408,462, FILED 8-26-2011.

DAVID C. REIHNER, EXAMINING ATTORNEY



David J. Kyros

Director of the United States Patent and Trademark Office

United States of America

United States Patent and Trademark Office

HALEO

Reg. No. 4,153,210

Registered June 5, 2012

Int. Cls.: 5 and 29

TRADEMARK

PRINCIPAL REGISTER

BODYPLUS INTERNATIONAL K.K. (JAPAN CORPORATION)
2-1 ODAWARA HIROCHO MIYAGINO-KU
SENDAI, JAPAN

FOR: AMINO ACIDS FOR NUTRITIONAL PURPOSES IN POWDER, GRANULE, TABLET, LIQUID, JELLY, BISCUIT AND CAPSULE FORM, IN CLASS 5 (U.S. CLS. 6, 18, 44, 46, 51 AND 52).

FOR: PROCESSED FOODS IN POWDER, GRANULE, TABLET, LIQUID, JELLY, BISCUIT OR CAPSULE FORM, NAMELY, MILK PROTEINS, PROTEIN FOR USE AS A FOOD ADDITIVE, PROTEIN FOR USE AS A FOOD FILLER, AND PROTEINS BEING FOODSTUFFS FOR HUMAN CONSUMPTION, IN CLASS 29 (U.S. CL. 46).

OWNER OF JAPAN REG. NO. 5159089, DATED 8-15-2008, EXPIRES 8-15-2018.

THE MARK CONSISTS OF THE WORD "HALEO" IN BLOCK CAPITAL LETTERS WITH A STYLIZED "A" AND AN ELONGATED "O".

SER. NO. 85-408,844, FILED 8-26-2011.

SOPHIA S. KIM, EXAMINING ATTORNEY



David J. Kyros

Director of the United States Patent and Trademark Office

United States of America

United States Patent and Trademark Office

BULK SPORTS

Reg. No. 4,153,211

Registered June 5, 2012

Int. Cls.: 5 and 29

TRADEMARK

PRINCIPAL REGISTER

BODYPLUS INTERNATIONAL K.K. (JAPAN CORPORATION)
2-1 ODAWARA HIROCHO MIYAGINO-KU
SENDAI, JAPAN

FOR: AMINO ACIDS FOR NUTRITIONAL PURPOSES IN POWDER, GRANULE, TABLET, LIQUID, JELLY, BISCUIT AND CAPSULE FORM, IN CLASS 5 (U.S. CLS. 6, 18, 44, 46, 51 AND 52).

FOR: PROCESSED FOODS IN POWDER, GRANULE, TABLET, LIQUID, JELLY, BISCUIT OR CAPSULE FORM, NAMELY, MILK PROTEINS, PROTEIN FOR USE AS A FOOD ADDITIVE, PROTEIN FOR USE AS A FOOD FILLER, AND PROTEINS BEING FOODSTUFFS FOR HUMAN CONSUMPTION, IN CLASS 29 (U.S. CL. 46).

OWNER OF JAPAN REG. NO. 5159090, DATED 8-15-2008, EXPIRES 8-15-2018.

NO CLAIM IS MADE TO THE EXCLUSIVE RIGHT TO USE "SPORTS", APART FROM THE MARK AS SHOWN.

THE MARK CONSISTS OF THE WORDS "BULK SPORTS" IN CAPITAL, ITALICIZED, BLOCK LETTERS WITH A STYLIZED INITIAL "B".

SER. NO. 85-408,847, FILED 8-26-2011.

SOPHIA S. KIM, EXAMINING ATTORNEY



David J. Kybas

Director of the United States Patent and Trademark Office

United States of America

United States Patent and Trademark Office

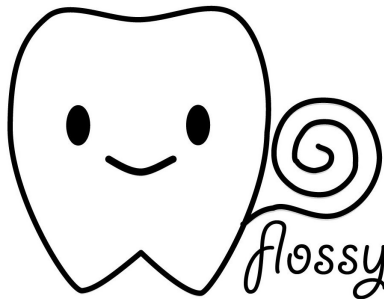

Reg. No. 4,153,212

Registered June 5, 2012

Int. Cl.: 44

SERVICE MARK

PRINCIPAL REGISTER

ONG SHAO DENTAL, INC. (CALIFORNIA CORPORATION), DBA SUNRISE DENTAL
CENTER
SUITE 106
7777 EDINGER AVE.
HUNTINGTON BEACH, CA 92647

FOR: DENTIST SERVICES, IN CLASS 44 (U.S. CLS. 100 AND 101).

FIRST USE 5-20-2010; IN COMMERCE 5-20-2010.

THE MARK CONSISTS OF THE STYLIZED DESIGN OF A TOOTH WITH EYES AND A SMILING MOUTH, WITH A SPIRAL DESIGN APPEARING TO THE RIGHT OF THE TOOTH, AND THE WORDING "FLOSSY" APPEARING BENEATH THE SPIRAL DESIGN.

SER. NO. 85-409,648, FILED 8-29-2011.

GEOFFREY FOSDICK, EXAMINING ATTORNEY



David J. Kybas

Director of the United States Patent and Trademark Office

United States of America

United States Patent and Trademark Office

IAP WORLDWIDE SERVICES

Reg. No. 4,153,213

Registered June 5, 2012

Int. Cls.: 35, 37, 40 and 45

SERVICE MARK

PRINCIPAL REGISTER

IAP WORLDWIDE SERVICES, INC. (DELAWARE CORPORATION)
7315 NORTH ATLANTIC AVENUE
CAPE CANAVERAL, FL 32920

FOR: BUSINESS SERVICES, NAMELY, FACILITIES MANAGEMENT OF TECHNICAL OPERATIONS; COMMERCIAL MANAGEMENT; EMPLOYMENT STAFFING IN THE FIELDS OF HEALTH SERVICES, SCIENCE AND TECHNOLOGY, AND PROFESSIONAL AND MANAGEMENT SERVICES; LOGISTICS MANAGEMENT IN THE FIELD OF FORWARD AND REMOTE BASE OPERATIONS; PROCUREMENT, NAMELY, PURCHASING LIFE SUPPORT EQUIPMENT, EMERGENCY SUPPLIES AND BASIC SUPPLIES FOR REMOTE OPERATIONS FOR OTHERS, IN CLASS 35 (U.S. CLS. 100, 101 AND 102).

FIRST USE 1-31-1997; IN COMMERCE 1-31-1997.

FOR: CONSTRUCTION OF BUILDINGS, ROADS, UTILITIES, AND FORCE PROTECTION FEATURES; CONSTRUCTION PLANNING; CONSTRUCTION PROJECT MANAGEMENT SERVICES; WASTE DISPOSAL FOR OTHERS, IN CLASS 37 (U.S. CLS. 100, 103 AND 106).

FIRST USE 1-31-1997; IN COMMERCE 1-31-1997.

FOR: ENVIRONMENTAL REMEDIATION SERVICES, NAMELY, TREATMENT OF WATER AND WASTE WATER; GENERATION OF POWER THROUGH OPERATION OF POWER GENERATION EQUIPMENT AND FACILITIES, IN CLASS 40 (U.S. CLS. 100, 103 AND 106).

FIRST USE 1-31-1997; IN COMMERCE 1-31-1997.

FOR: SECURITY GUARDING FOR FACILITIES, IN CLASS 45 (U.S. CLS. 100 AND 101).

FIRST USE 1-31-1997; IN COMMERCE 1-31-1997.

THE MARK CONSISTS OF STANDARD CHARACTERS WITHOUT CLAIM TO ANY PARTICULAR FONT, STYLE, SIZE, OR COLOR.

OWNER OF U.S. REG. NOS. 2,991,145 AND 2,991,146.

NO CLAIM IS MADE TO THE EXCLUSIVE RIGHT TO USE "WORLDWIDE SERVICES", APART FROM THE MARK AS SHOWN.



David J. Kyffers

Director of the United States Patent and Trademark Office

Reg. No. 4,153,213 SER. NO. 85-409,862, FILED 8-29-2011.

WANDA KAY PRICE, EXAMINING ATTORNEY

United States of America

United States Patent and Trademark Office



Reg. No. 4,153,214

Registered June 5, 2012

Int. Cl.: 41

SERVICE MARK

PRINCIPAL REGISTER

BIANCHI CORPORATION (CALIFORNIA CORPORATION)
21 E CITRUS AVE.
REDLANDS, CA 92373

FOR: PHYSICAL FITNESS STUDIO SERVICES, NAMELY, PROVIDING GROUP EXERCISE INSTRUCTION, EQUIPMENT, AND FACILITIES, IN CLASS 41 (U.S. CLS. 100, 101 AND 107).

FIRST USE 9-3-2005; IN COMMERCE 9-3-2005.

NO CLAIM IS MADE TO THE EXCLUSIVE RIGHT TO USE "FITNESS STUDIO", APART FROM THE MARK AS SHOWN.

THE MARK CONSISTS OF A CIRCLE WITH A DUMBBELL IN THE MIDDLE. THE WORD "PERFORMANCE" IS SITUATED ABOVE THE DUMBBELL, AND THE WORDS "FITNESS STUDIO" BELOW THE DUMBBELL, WITH TWO MIDDLE DOTS SEPARATING THE UPPER AND LOWER WORDS.

SER. NO. 85-410,018, FILED 8-29-2011.

KEVIN CORWIN, EXAMINING ATTORNEY



David J. Kybas

Director of the United States Patent and Trademark Office

United States of America
United States Patent and Trademark Office

SALSA RIO

Reg. No. 4,153,215

Registered June 5, 2012

Int. Cl.: 30

TRADEMARK

PRINCIPAL REGISTER

FRITO-LAY NORTH AMERICA, INC. (DELAWARE CORPORATION)
7701 LEGACY DRIVE
PLANO, TX 75024

FOR: CORN CHIPS; CORN-BASED SNACK FOODS; TORTILLA CHIPS, IN CLASS 30 (U.S. CL. 46).

FIRST USE 5-0-1986; IN COMMERCE 12-0-2011.

THE MARK CONSISTS OF STANDARD CHARACTERS WITHOUT CLAIM TO ANY PARTICULAR FONT, STYLE, SIZE, OR COLOR.

NO CLAIM IS MADE TO THE EXCLUSIVE RIGHT TO USE "SALSA", APART FROM THE MARK AS SHOWN.

THE ENGLISH TRANSLATION OF "SALSA RIO" IN THE MARK IS "SAUCE RIVER".

SER. NO. 85-410,395, FILED 8-30-2011.

BRIAN CALLAGHAN, EXAMINING ATTORNEY



David J. Kyffers

Director of the United States Patent and Trademark Office

United States of America

United States Patent and Trademark Office

PLANNED PARTYHOOD

Reg. No. 4,153,216

LODER, JORDAN N. (UNITED STATES INDIVIDUAL), DBA PLANNED PARTYHOOD
223 EGREMONT PLAIN RD #14
NORTH EGREMONT, MA 01230

Registered June 5, 2012

Int. Cl.: 41

FOR: ENTERTAINMENT IN THE NATURE OF LIVE PERFORMANCES BY PLANNED PARTYHOOD, IN CLASS 41 (U.S. CLS. 100, 101 AND 107).

SERVICE MARK

FIRST USE 8-10-2011; IN COMMERCE 8-10-2011.

PRINCIPAL REGISTER

THE MARK CONSISTS OF STANDARD CHARACTERS WITHOUT CLAIM TO ANY PARTICULAR FONT, STYLE, SIZE, OR COLOR.

SER. NO. 85-410,547, FILED 8-30-2011.

SCOTT BIBB, EXAMINING ATTORNEY



David J. Kybas

Director of the United States Patent and Trademark Office

United States of America

United States Patent and Trademark Office



Reg. No. 4,153,217

Registered June 5, 2012

Int. Cls.: 35 and 36

SERVICE MARK

PRINCIPAL REGISTER

EMPLOYEE TRANSFER CORPORATION (PENNSYLVANIA CORPORATION)
SUITE 100
1 INTERNATIONAL PLAZA
PHILADELPHIA, PA 19113

FOR: EMPLOYEE RELOCATION AND INFORMATION SERVICES; REAL ESTATE SERVICES IN THE NATURE OF MOVING AND RELOCATION SERVICES, NAMELY, PLANNING AND PROJECT OVERSIGHT OF MOVING FOR OTHERS; REAL ESTATE SERVICES IN THE FIELD OF DISTRESSED RESIDENTIAL REAL ESTATE, NAMELY, MARKETING OF FORECLOSED PROPERTIES IN THE NATURE OF REAL ESTATE ADVERTISING SERVICES AND SHORT SELLING SERVICES FOR DISTRESSED RESIDENTIAL REAL ESTATE IN THE NATURE OF REAL ESTATE SALES MANAGEMENT, IN CLASS 35 (U.S. CLS. 100, 101 AND 102).

FIRST USE 6-3-2011; IN COMMERCE 8-25-2011.

FOR: REAL ESTATE SERVICES IN THE FIELD OF DISTRESSED RESIDENTIAL REAL ESTATE, NAMELY, INSPECTION FOR THE PURPOSE OF DETERMINING OCCUPANCY IN THE NATURE OF REAL ESTATE MANAGEMENT SERVICES AND EVICTION COORDINATION IN THE NATURE OF MORTGAGE FORECLOSURE SERVICES AND REAL ESTATE MANAGEMENT; FINANCIAL SERVICES, NAMELY, DEBT COUNSELING, DEBT SETTLEMENT AND DEBT SETTLEMENT NEGOTIATION SERVICES, ARRANGING OF MODIFIED LOAN TERMS DESIGNED TO PREVENT HOME FORECLOSURE, CREDIT REPAIR AND RESTORATION, BANKRUPTCY COUNSELING IN THE NATURE OF DEBT COUNSELING, MORTGAGE REFINANCING; REAL ESTATE CONSULTATION SERVICES, NAMELY, PLANNING AND PROJECT OVERSIGHT OF HOME BUYING AND SELLING FOR OTHERS, IN CLASS 36 (U.S. CLS. 100, 101 AND 102).

FIRST USE 6-3-2011; IN COMMERCE 8-25-2011.

OWNER OF U.S. REG. NOS. 3,417,356, 3,595,668 AND OTHERS.

THE COLOR(S) GREEN AND BLACK IS/ARE CLAIMED AS A FEATURE OF THE MARK.

THE MARK CONSISTS OF AN IRREGULAR HORIZONTAL BLACK LINE WITH THREE OVERLAPPING GREEN SPHERES NEAR THE END WITH THE LETTERS "ETC" IN BLACK



David J. Kyros

Director of the United States Patent and Trademark Office

Reg. No. 4,153,217 TO THE LEFT OF THE LINE AND A HORIZONTAL BLACK RECTANGLE UNDERNEATH THE DESIGN, ALL ON A TRANSPARENT BACKGROUND.

SER. NO. 85-410,693, FILED 8-30-2011.

ROBERT STRUCK, EXAMINING ATTORNEY

United States of America

United States Patent and Trademark Office



Reg. No. 4,153,218

Registered June 5, 2012

Int. Cl.: 16

TRADEMARK

PRINCIPAL REGISTER

PERFECT CIRCLE PUBLISHING, INC. (OKLAHOMA CORPORATION)
9221 SOUTH 86TH EAST AVENUE
TULSA, OK 74133

FOR: BOOKS IN THE FIELD OF NATIVE AMERICAN CHRISTIANITY, IN CLASS 16 (U.S. CLS. 2, 5, 22, 23, 29, 37, 38 AND 50).

FIRST USE 9-1-2001; IN COMMERCE 6-8-2009.

THE MARK CONSISTS OF A DESIGN OF INCOMPLETE SHADED CONCENTRIC CIRCLES WITH A TRIANGLE CUT OUT OF THEM, OPENING DOWN LIKE A PIE STANDING UP WITH A PIECE CUT OUT ON THE BOTTOM/CENTER. THE CONCENTRIC CIRCLES CONSIST OF ROYAL BLUE ON THE OUTSIDE CIRCLE AND TURQUOISE ON THE INSIDE CIRCLE.

THE COLOR(S) ROYAL BLUE, AND TURQUOISE IS/ARE CLAIMED AS A FEATURE OF THE MARK.

SER. NO. 85-410,696, FILED 8-30-2011.

MICHAEL WEBSTER, EXAMINING ATTORNEY



David J. Kyffers

Director of the United States Patent and Trademark Office

United States of America

United States Patent and Trademark Office

BOMBSHELL

Reg. No. 4,153,219

Registered June 5, 2012

Int. Cl.: 28

TRADEMARK

PRINCIPAL REGISTER

CASTALIA OUTDOORS, INC. (FLORIDA CORPORATION)
117 REEDY CREEK DR.
FROSTPROOF, FL 33843

FOR: ARTIFICIAL FISHING LURES, IN CLASS 28 (U.S. CLS. 22, 23, 38 AND 50).

FIRST USE 4-1-2011; IN COMMERCE 4-1-2011.

THE MARK CONSISTS OF STANDARD CHARACTERS WITHOUT CLAIM TO ANY PARTICULAR FONT, STYLE, SIZE, OR COLOR.

OWNER OF U.S. REG. NO. 4,070,319.

SER. NO. 85-411,155, FILED 8-30-2011.

ALEXANDER L. POWERS, EXAMINING ATTORNEY



David J. Kyffers

Director of the United States Patent and Trademark Office

United States of America

United States Patent and Trademark Office

BLOOD DETECTIVE

Reg. No. 4,153,220

Registered June 5, 2012

Int. Cls.: 5 and 9

TRADEMARK

PRINCIPAL REGISTER

BLOOD LOGIC, INC. (NEW YORK CORPORATION)
55 CROW HILL ROAD
MT. KISCO, NY 10549

FOR: NUTRITIONAL AND DIETARY SUPPLEMENTS, IN CLASS 5 (U.S. CLS. 6, 18, 44, 46, 51 AND 52).

FIRST USE 4-1-2011; IN COMMERCE 4-1-2011.

FOR: COMPUTER SOFTWARE FOR INTERPRETATION OF BLOOD AND LABORATORY TESTS RESULTS AND PRODUCTION OF NUTRITIONAL INTERPRETATION REPORTS FOR USE BY HEALTH CARE PROFESSIONALS AND PATIENTS, IN CLASS 9 (U.S. CLS. 21, 23, 26, 36 AND 38).

FIRST USE 9-1-2006; IN COMMERCE 9-1-2006.

THE MARK CONSISTS OF STANDARD CHARACTERS WITHOUT CLAIM TO ANY PARTICULAR FONT, STYLE, SIZE, OR COLOR.

NO CLAIM IS MADE TO THE EXCLUSIVE RIGHT TO USE "BLOOD", APART FROM THE MARK AS SHOWN.

SER. NO. 85-411,407, FILED 8-31-2011.

BARBARA RUTLAND, EXAMINING ATTORNEY



David J. Kyros

Director of the United States Patent and Trademark Office

United States of America

United States Patent and Trademark Office

Corporate Socialanthropy

Reg. No. 4,153,221

Registered June 5, 2012

Int. Cl.: 35

SERVICE MARK

PRINCIPAL REGISTER

WILCOX, DAWN (UNITED STATES INDIVIDUAL)
SUITE 501
2001 WILSHIRE BLVD
SANTA MONICA, CA 90403

FOR: MARKETING CONSULTING; PUBLIC RELATIONS, IN CLASS 35 (U.S. CLS. 100, 101 AND 102).

FIRST USE 6-2-2009; IN COMMERCE 5-22-2010.

THE MARK CONSISTS OF STANDARD CHARACTERS WITHOUT CLAIM TO ANY PARTICULAR FONT, STYLE, SIZE, OR COLOR.

NO CLAIM IS MADE TO THE EXCLUSIVE RIGHT TO USE "CORPORATE", APART FROM THE MARK AS SHOWN.

SER. NO. 85-411,473, FILED 8-31-2011.

REGINA DRUMMOND, EXAMINING ATTORNEY



David J. Kyros

Director of the United States Patent and Trademark Office

United States of America

United States Patent and Trademark Office

rewardStyle

Reg. No. 4,153,222

Registered June 5, 2012

Int. Cl.: 35

SERVICE MARK

PRINCIPAL REGISTER

NASTYGOAT CORPORATION (TEXAS CORPORATION)
2651 NORTH HARWOOD STREET, SUITE 530
DALLAS, TX 75201

FOR: PROMOTING THE GOODS AND SERVICES OF OTHERS BY PROVIDING WEB-BASED LINKS USED BY STYLE BLOGS TO PROMOTE THE SALE OF STYLE APPAREL AND ACCESSORIES OF OTHERS, IN CLASS 35 (U.S. CLS. 100, 101 AND 102).

FIRST USE 2-28-2011; IN COMMERCE 2-28-2011.

THE MARK CONSISTS OF THE WORDS "REWARD STYLE" IN ALL LOWER CASE, IN STYLIZED FONT.

SER. NO. 85-411,623, FILED 8-31-2011.

DAVID TAYLOR, EXAMINING ATTORNEY



David J. Kybas

Director of the United States Patent and Trademark Office

United States of America

United States Patent and Trademark Office

REWARDSTYLE

Reg. No. 4,153,223

Registered June 5, 2012

Int. Cl.: 35

SERVICE MARK

PRINCIPAL REGISTER

NASTYGOAT CORPORATION (TEXAS CORPORATION)
2651 NORTH HARWOOD STREET
SUITE 530
DALLAS, TX 75201

FOR: PROMOTING THE GOODS AND SERVICES OF OTHERS BY PROVIDING WEB-BASED LINKS USED BY STYLE BLOGS TO PROMOTE THE SALE OF STYLE APPAREL AND ACCESSORIES OF OTHERS , IN CLASS 35 (U.S. CLS. 100, 101 AND 102).

FIRST USE 2-28-2011; IN COMMERCE 2-28-2011.

THE MARK CONSISTS OF STANDARD CHARACTERS WITHOUT CLAIM TO ANY PARTICULAR FONT, STYLE, SIZE, OR COLOR.

SER. NO. 85-411,633, FILED 8-31-2011.

DAVID TAYLOR, EXAMINING ATTORNEY



David J. Kyffers

Director of the United States Patent and Trademark Office

United States of America

United States Patent and Trademark Office



Reg. No. 4,153,224

Registered June 5, 2012

Int. Cl.: 35

SERVICE MARK

PRINCIPAL REGISTER

INTELLIGENT MANAGEMENT SOLUTIONS, INC (FLORIDA CORPORATION)
4400 BAYOU BOULEVARD, NUMBER 6
PENSACOLA, FL 32503

FOR: BUSINESS SERVICES, NAMELY, PROCURING QUALIFIED AND CREDENTIALLED THIRD-PARTY EXPERTS, PROFESSIONALS AND OTHER QUALIFIED PERSONNEL, AND DOCUMENTATION AND INFORMATION ALL ON BEHALF OF OTHERS, IN CLASS 35 (U.S. CLS. 100, 101 AND 102).

FIRST USE 8-1-2011; IN COMMERCE 8-1-2011.

OWNER OF U.S. REG. NO. 3,767,051.

THE MARK CONSISTS OF THE WORDING, "IMS EXPERTSERVICES", TO THE RIGHT OF THE DESIGN OF A SHADED DIAMOND BISECTED BY A VERTICAL ZIG-ZAG LINE.

SEC. 2(F) AS TO "IMS EXPERTSERVICES".

SER. NO. 85-411,786, FILED 8-31-2011.

BARBARA A. GOLD, EXAMINING ATTORNEY



David J. Kyffers

Director of the United States Patent and Trademark Office

United States of America

United States Patent and Trademark Office

BARBOUR VINEYARDS

Reg. No. 4,153,225

BARBOUR VINEYARDS LLC (CALIFORNIA LIMITED LIABILITY COMPANY)
104 CAMINO DORADO
NAPA, CA 94558

Registered June 5, 2012

Int. Cl.: 44

FOR: PROVIDING INFORMATION IN THE FIELD OF VINEYARD HORTICULTURE; VINEYARD AND WINERY SERVICES, NAMELY, THE CULTIVATION OF GRAPES FOR OTHERS; VITICULTURE SERVICES, NAMELY, GRAPE GROWING AND CULTIVATION OF GRAPES FOR OTHERS, IN CLASS 44 (U.S. CLS. 100 AND 101).

SERVICE MARK

PRINCIPAL REGISTER

FIRST USE 6-1-1990; IN COMMERCE 6-1-1990.

THE MARK CONSISTS OF STANDARD CHARACTERS WITHOUT CLAIM TO ANY PARTICULAR FONT, STYLE, SIZE, OR COLOR.

NO CLAIM IS MADE TO THE EXCLUSIVE RIGHT TO USE "VINEYARDS", APART FROM THE MARK AS SHOWN.

SEC. 2(F).

SER. NO. 85-411,936, FILED 8-31-2011.

HEATHER THOMPSON, EXAMINING ATTORNEY



David J. Kybas

Director of the United States Patent and Trademark Office

United States of America

United States Patent and Trademark Office



Reg. No. 4,153,226

Registered June 5, 2012

Int. Cl.: 25

TRADEMARK

PRINCIPAL REGISTER

FILIPINO-AMERICAN LAW ENFORCEMENT OFFICERS ASSOCIATION (CALIFORNIA CORPORATION)
P.O. BOX 77086
SAN FRANCISCO, CA 94107

FOR: JACKETS; SHIRTS; SWEATSHIRTS; T-SHIRTS, IN CLASS 25 (U.S. CLS. 22 AND 39).

FIRST USE 9-25-2008; IN COMMERCE 9-25-2008.

NO CLAIM IS MADE TO THE EXCLUSIVE RIGHT TO USE "EST. 2008", APART FROM THE MARK AS SHOWN.

THE MARK CONSISTS OF A DESIGN ENCOMPASSING A POLICE BADGE WITH A STYLIZED AMERICAN (RIGHT SIDE) AND PHILIPPINE (LEFT SIDE) FLAG ABOVE A STAR WITH BRIDGES IN THE MIDDLE AND THREE STARS POSITIONED ON THE LEFT, RIGHT AND TOP. WRITTEN ON THE TOP IS THE STYLIZED TEXT "FALCO" AND ON BOTTOM THERE IS THE STYLIZED TEXT "EST. 2008".

SER. NO. 85-411,984, FILED 8-31-2011.

DARRYL SPRUILL, EXAMINING ATTORNEY



David J. Kybas

Director of the United States Patent and Trademark Office

United States of America

United States Patent and Trademark Office

MATERIAL EDGE

Reg. No. 4,153,227

Registered June 5, 2012

Int. Cl.: 9

TRADEMARK

PRINCIPAL REGISTER

V-MODA (CALIFORNIA LIMITED LIABILITY COMPANY)
6464 SUNSET BLVD.
HOLLYWOOD, CA 90028

FOR: AUDIO HEADPHONES; EARPHONES AND HEADPHONES; HEADPHONES; MUSIC HEADPHONES; PERSONAL HEADPHONES FOR USE WITH SOUND TRANSMITTING SYSTEMS; STEREO HEADPHONES, IN CLASS 9 (U.S. CLS. 21, 23, 26, 36 AND 38).

FIRST USE 8-1-2011; IN COMMERCE 8-1-2011.

THE MARK CONSISTS OF STANDARD CHARACTERS WITHOUT CLAIM TO ANY PARTICULAR FONT, STYLE, SIZE, OR COLOR.

SER. NO. 85-412,160, FILED 8-31-2011.

LINDA POWELL, EXAMINING ATTORNEY



David J. Kybas

Director of the United States Patent and Trademark Office

United States of America
United States Patent and Trademark Office

RIGBY

Reg. No. 4,153,228

Registered June 5, 2012

Int. Cl.: 13

TRADEMARK

PRINCIPAL REGISTER

RIGBY VENTURES, LLC (TEXAS LIMITED LIABILITY COMPANY)
200 CRESCENT COURT
SUITE 1450
DALLAS, TX 75201

FOR: GUN AND RIFLE CASES; HUNTING RIFLES; RIFLE AMMUNITION; RIFLES;
SHOTGUNS AND PARTS THEREOF, IN CLASS 13 (U.S. CLS. 2 AND 9).

FIRST USE 0-0-1900; IN COMMERCE 0-0-1900.

THE MARK CONSISTS OF STANDARD CHARACTERS WITHOUT CLAIM TO ANY PAR-
TICULAR FONT, STYLE, SIZE, OR COLOR.

OWNER OF U.S. REG. NOS. 1,386,739 AND 1,411,231.

SEC. 2(F).

SER. NO. 85-412,227, FILED 8-31-2011.

JESSICA A. POWERS, EXAMINING ATTORNEY



David J. Kybas

Director of the United States Patent and Trademark Office

United States of America

United States Patent and Trademark Office

RETROTEN

Reg. No. 4,153,229

ADVANCE RESEARCH, LTD (OREGON COMPANY)
P.O. BOX 1705
OREGON CITY, OR 97045

Registered June 5, 2012

Int. Cl.: 19

FOR: HIGH STRENGTH FIBER REINFORCED NON-METAL PANELS USED TO INCREASE STRENGTH OF TENSION FAILED STRUCTURAL WOOD PRODUCTS, IN CLASS 19 (U.S. CLS. 1, 12, 33 AND 50).

TRADEMARK

FIRST USE 12-9-2010; IN COMMERCE 1-28-2011.

PRINCIPAL REGISTER

THE MARK CONSISTS OF STANDARD CHARACTERS WITHOUT CLAIM TO ANY PARTICULAR FONT, STYLE, SIZE, OR COLOR.

SER. NO. 85-412,446, FILED 8-31-2011.

NAPOLEON SHARMA, EXAMINING ATTORNEY



David J. Kyffers

Director of the United States Patent and Trademark Office

United States of America

United States Patent and Trademark Office

VK

Reg. No. 4,153,230

Registered June 5, 2012

Int. Cl.: 34

TRADEMARK

PRINCIPAL REGISTER

FOREFRONT ENTERPRISES, LLC (OKLAHOMA LIMITED LIABILITY COMPANY)
SUITE 300
110 N. GARFIELD
SAND SPRINGS, OK 74063

FOR: ELECTRIC CIGARETTES; ELECTRONIC CIGARETTES; ELECTRONIC CIGARETTES
FOR USE AS AN ALTERNATIVE TO TRADITIONAL CIGARETTES, IN CLASS 34 (U.S.
CLS. 2, 8, 9 AND 17).

FIRST USE 7-10-2010; IN COMMERCE 7-10-2010.

THE MARK CONSISTS OF STANDARD CHARACTERS WITHOUT CLAIM TO ANY PAR-
TICULAR FONT, STYLE, SIZE, OR COLOR.

SER. NO. 85-412,636, FILED 9-1-2011.

MARK T. MULLEN, EXAMINING ATTORNEY



David J. Kybas

Director of the United States Patent and Trademark Office

United States of America

United States Patent and Trademark Office

SAPPHIRE EDGE HD2

Reg. No. 4,153,231

Registered June 5, 2012

Int. Cl.: 9

TRADEMARK

PRINCIPAL REGISTER

SAPPHIRE TECHNOLOGY LTD. (HONG KONG CORPORATION)
1908-1919 19/F TWR2, G.C. PLAZA NO. 138
SHANTIN RURAL COMMITTEE ROAD
SHANTIN, NT, HONG KONG

FOR: NETTOP COMPUTER, ALL IN ONE COMPUTER WITH A MINI FORMAT, NAMELY, A CPU, MAINBOARD, HARD DISK DRIVE, GRAPHICS, MEMORY AND A PERSONAL COMPUTER CASE, IN CLASS 9 (U.S. CLS. 21, 23, 26, 36 AND 38).

FIRST USE 6-30-2011; IN COMMERCE 6-30-2011.

THE MARK CONSISTS OF STANDARD CHARACTERS WITHOUT CLAIM TO ANY PARTICULAR FONT, STYLE, SIZE, OR COLOR.

SER. NO. 85-412,848, FILED 9-1-2011.

CHARLOTTE CORWIN, EXAMINING ATTORNEY



David J. Kyffers

Director of the United States Patent and Trademark Office

United States of America

United States Patent and Trademark Office

KRITTER KOUNTRY

Reg. No. 4,153,232

HERZON, RANDALL GARRETT (UNITED STATES INDIVIDUAL)
1819 H STREET
EUREKA, CA 95501

Registered June 5, 2012

Int. Cl.: 45

FOR: PET SITTING, IN CLASS 45 (U.S. CLS. 100 AND 101).

SERVICE MARK

FIRST USE 0-0-1999; IN COMMERCE 0-0-1999.

PRINCIPAL REGISTER

THE MARK CONSISTS OF STANDARD CHARACTERS WITHOUT CLAIM TO ANY PARTICULAR FONT, STYLE, SIZE, OR COLOR.

NO CLAIM IS MADE TO THE EXCLUSIVE RIGHT TO USE "KRITTER", APART FROM THE MARK AS SHOWN.

SER. NO. 85-412,870, FILED 9-1-2011.

KEVIN DINALLO, EXAMINING ATTORNEY



David J. Kyros

Director of the United States Patent and Trademark Office

United States of America

United States Patent and Trademark Office

KARE FOR ALL KRITTERS

Reg. No. 4,153,233

HERZON, RANDALL GARRETT (UNITED STATES INDIVIDUAL)
1819 H STREET
EUREKA, CA 95501

Registered June 5, 2012

Int. Cl.: 45

FOR: PET SITTING, IN CLASS 45 (U.S. CLS. 100 AND 101).

SERVICE MARK

FIRST USE 0-0-1999; IN COMMERCE 0-0-1999.

PRINCIPAL REGISTER

THE MARK CONSISTS OF STANDARD CHARACTERS WITHOUT CLAIM TO ANY PARTICULAR FONT, STYLE, SIZE, OR COLOR.

NO CLAIM IS MADE TO THE EXCLUSIVE RIGHT TO USE "CARE" AND "CRITTERS", APART FROM THE MARK AS SHOWN.

SER. NO. 85-412,873, FILED 9-1-2011.

KEVIN DINALLO, EXAMINING ATTORNEY



David J. Kybas

Director of the United States Patent and Trademark Office

United States of America

United States Patent and Trademark Office

PET MENTALIST

Reg. No. 4,153,234

HERZON, RANDALL GARRETT (UNITED STATES INDIVIDUAL)
1819 H STREET
EUREKA, CA 95501

Registered June 5, 2012

Int. Cl.: 41

FOR: PET TRAINING SERVICES, IN CLASS 41 (U.S. CLS. 100, 101 AND 107).

SERVICE MARK

FIRST USE 0-0-1999; IN COMMERCE 0-0-1999.

PRINCIPAL REGISTER

THE MARK CONSISTS OF STANDARD CHARACTERS WITHOUT CLAIM TO ANY PARTICULAR FONT, STYLE, SIZE, OR COLOR.

NO CLAIM IS MADE TO THE EXCLUSIVE RIGHT TO USE "PET", APART FROM THE MARK AS SHOWN.

SER. NO. 85-412,875, FILED 9-1-2011.

KEVIN DINALLO, EXAMINING ATTORNEY



David J. Kybas

Director of the United States Patent and Trademark Office

United States of America

United States Patent and Trademark Office



Reg. No. 4,153,235

Registered June 5, 2012

Int. Cl.: 35

SERVICE MARK

PRINCIPAL REGISTER

EVENPRO MARKETING GROUP, LLC (PUERTO RICO LIMITED LIABILITY COMPANY)
STREET A #416 MARIO JULIA, MATADERO WARD
SAN JUAN, PUERTO RICO 00922

FOR: ADVERTISING AND MARKETING SERVICES, NAMELY, PROMOTING THE GOODS AND SERVICES OF OTHERS; ARRANGING AND CONDUCTING SPECIAL EVENTS FOR COMMERCIAL, PROMOTIONAL OR ADVERTISING PURPOSES, IN CLASS 35 (U.S. CLS. 100, 101 AND 102).

FIRST USE 11-30-1992; IN COMMERCE 11-30-1992.

NO CLAIM IS MADE TO THE EXCLUSIVE RIGHT TO USE "MARKETING GROUP", APART FROM THE MARK AS SHOWN.

THE COLOR(S) LIGHT BLUE, DARK BLUE, YELLOW AND GREEN IS/ARE CLAIMED AS A FEATURE OF THE MARK.

THE MARK CONSISTS OF THE WORD "EVENPRO" IN LIGHT BLUE AT THE TOP AND DARK BLUE AT THE BOTTOM. AT THE BOTTOM ARE THE WORDS "MARKETING GROUP" IN DARK BLUE. TO THE RIGHT IS A STYLIZED LETTER "E" IN DARK BLUE, GREEN AND YELLOW.

SER. NO. 85-413,431, FILED 9-1-2011.

SIMON TENG, EXAMINING ATTORNEY



David J. Kyffers

Director of the United States Patent and Trademark Office

United States of America

United States Patent and Trademark Office

Paintoholics LLC

Reg. No. 4,153,236

PAINTOHOOLICS LLC (FLORIDA LIMITED LIABILITY COMPANY)
7232 LANDMARK DRIVE
SPRING HILL, FL 34606

Registered June 5, 2012

Int. Cl.: 37

FOR: PAINTING OF INTERIOR AND EXTERIOR OF RESIDENTIAL AND COMMERCIAL STRUCTURES, IN CLASS 37 (U.S. CLS. 100, 103 AND 106).

SERVICE MARK

FIRST USE 8-0-2010; IN COMMERCE 8-0-2010.

PRINCIPAL REGISTER

THE MARK CONSISTS OF STANDARD CHARACTERS WITHOUT CLAIM TO ANY PARTICULAR FONT, STYLE, SIZE, OR COLOR.

NO CLAIM IS MADE TO THE EXCLUSIVE RIGHT TO USE "LLC", APART FROM THE MARK AS SHOWN.

SER. NO. 85-413,492, FILED 9-1-2011.

ELI HELLMAN, EXAMINING ATTORNEY



David J. Kyffers

Director of the United States Patent and Trademark Office

United States of America

United States Patent and Trademark Office

Aliaxis

Reg. No. 4,153,237

Registered June 5, 2012

Int. Cls.: 11, 17, 19 and 35

TRADEMARK

SERVICE MARK

PRINCIPAL REGISTER

ALIAxis S.A. (BELGIUM CORPORATION)
270 AVENUE DE TERVUREN
BRUSSELS, BELGIUM 1150

FOR: SYSTEM FOR THE DISTRIBUTION OF COMPRESSED AIR FOR COMMERCIAL AND INDUSTRIAL USE COMPRISED OF PIPES, FITTINGS AND VALVES; HEATED AND CHILLED WATER DISTRIBUTION SYSTEM FOR RESIDENTIAL, COMMERCIAL, AND INDUSTRIAL USE COMPRISED OF PIPES, FITTINGS AND VALVES; SEWAGE DISPOSAL SYSTEM COMPRISED PIPES, FITTINGS AND VALVES; SANITATION EQUIPMENT, NAMELY, WASTE OUTLETS, FLUSHING DEVICES, AND WATER CLOSET FILLING VALVES; IRRIGATING EQUIPMENT, NAMELY, IRRIGATION SPRINKLERS, SPRAY NOZZLES AND COMPLETE MICRO-IRRIGATION UNITS FOR AGRICULTURAL USE; VENTILATING EXHAUST FANS, IN CLASS 11 (U.S. CLS. 13, 21, 23, 31 AND 34).

FOR: RUBBER AND PRODUCTS MADE OF RUBBER, NAMELY, RUBBER GASKETS FOR PIPING; PLASTIC FLEXIBLE PIPES AND PLASTIC FITTINGS, NAMELY, COUPLINGS AND JUNCTIONS, IN CLASS 17 (U.S. CLS. 1, 5, 12, 13, 35 AND 50).

FOR: NON-METALLIC BUILDING MATERIALS, NAMELY, FOLDING DOORS, PLASTIC PLINTHS; ROOFING ACCESSORIES, NAMELY, ROOF RIDGES AND EAVES, NON-METALLIC RIGID PIPES FOR BUILDING OR INDUSTRY, NAMELY, PIPING FOR WATER DISTRIBUTION, SEWAGE, DRAINAGE, IRRIGATION, AND RAINWATER; NON-METALLIC RAIN GUTTERS AND DRAINAGE CHANNELS; AND VENTILATION DEVICES, NAMELY, NON-METAL VENTS FOR COMMERCIAL BUILDING VENTILATION, IN CLASS 19 (U.S. CLS. 1, 12, 33 AND 50).

FOR: BUSINESS MANAGEMENT OF INDUSTRIAL OR COMMERCIAL ENTERPRISES IN THE FIELD OF BUILDING MATERIALS, IN CLASS 35 (U.S. CLS. 100, 101 AND 102).

OWNER OF BENELUX REG. NO. 0737401, DATED 3-28-2003, EXPIRES 3-28-2013.

THE COLOR(S) DARK BLUE AND LIGHT BLUE IS/ARE CLAIMED AS A FEATURE OF THE MARK.

OWNER OF U.S. REG. NO. 2,991,694.



David J. Kyjars

Director of the United States Patent and Trademark Office

Reg. No. 4,153,237 THE MARK CONSISTS OF THE WORD "ALIAxis" IN DARK BLUE LETTERS PRECEDED BY A STYLIZED "O" WITH THE LEFT PORTION OF THE "O" IN DARK BLUE AND THE RIGHT PORTION OF THE "O" IN LIGHT BLUE.

THE WORD(S) APPEARING IN THE MARK HAS NO MEANING IN A FOREIGN LANGUAGE.

SER. NO. 85-414,235, FILED 9-2-2011.

DAVID TAYLOR, EXAMINING ATTORNEY

United States of America

United States Patent and Trademark Office

Advance Beatz

Reg. No. 4,153,238

Registered June 5, 2012

Int. Cl.: 41

SERVICE MARK

PRINCIPAL REGISTER

BRINSON, AVIN (UNITED STATES INDIVIDUAL)
348 CHINA GROVE RD
RUSTON, LA 71270

FOR: MUSIC PRODUCTION SERVICES, IN CLASS 41 (U.S. CLS. 100, 101 AND 107).

FIRST USE 1-1-2007; IN COMMERCE 7-10-2007.

THE MARK CONSISTS OF STANDARD CHARACTERS WITHOUT CLAIM TO ANY PARTICULAR FONT, STYLE, SIZE, OR COLOR.

NO CLAIM IS MADE TO THE EXCLUSIVE RIGHT TO USE "BEATS", APART FROM THE MARK AS SHOWN.

SER. NO. 85-414,384, FILED 9-2-2011.

ANGELA DUONG, EXAMINING ATTORNEY



David J. Kyffers

Director of the United States Patent and Trademark Office

United States of America

United States Patent and Trademark Office

Disc-off.com

Reg. No. 4,153,239

Registered June 5, 2012

Int. Cl.: 28

TRADEMARK

PRINCIPAL REGISTER

ROCK WALL CORPORATION (ARIZONA CORPORATION), DBA DISC-OFF
15801 SOUTH 25TH WAY
PHOENIX, AZ 85048

FOR: GAME APPARATUS, NAMELY, BASES, BATS, AND BALLS FOR PLAYING INDOOR AND OUTDOOR GAMES, IN CLASS 28 (U.S. CLS. 22, 23, 38 AND 50).

FIRST USE 1-0-2011; IN COMMERCE 1-0-2011.

THE MARK CONSISTS OF STANDARD CHARACTERS WITHOUT CLAIM TO ANY PARTICULAR FONT, STYLE, SIZE, OR COLOR.

SER. NO. 85-414,555, FILED 9-2-2011.

BARBARA BROWN, EXAMINING ATTORNEY



David J. Kybas

Director of the United States Patent and Trademark Office

United States of America

United States Patent and Trademark Office

STUPID TEXT DEALS

Reg. No. 4,153,240

VOGLER ENTERPRISES, INC. (MISSOURI CORPORATION)
503 S. MCCLEARY ROAD
EXCELSIOR SPRINGS, MO 64024

Registered June 5, 2012

Int. Cl.: 35

FOR: WHOLESALE STORE SERVICES FEATURING CONSUMER ELECTRONICS, IN CLASS 35 (U.S. CLS. 100, 101 AND 102).

SERVICE MARK

FIRST USE 8-30-2011; IN COMMERCE 8-30-2011.

PRINCIPAL REGISTER

THE MARK CONSISTS OF STANDARD CHARACTERS WITHOUT CLAIM TO ANY PARTICULAR FONT, STYLE, SIZE, OR COLOR.

OWNER OF U.S. REG. NO. 3,393,860.

NO CLAIM IS MADE TO THE EXCLUSIVE RIGHT TO USE "TEXT DEALS", APART FROM THE MARK AS SHOWN.

SER. NO. 85-414,572, FILED 9-2-2011.

SOPHIA S. KIM, EXAMINING ATTORNEY



David J. Kybas

Director of the United States Patent and Trademark Office

United States of America

United States Patent and Trademark Office



Reg. No. 4,153,241

Registered June 5, 2012

Int. Cl.: 44

SERVICE MARK

PRINCIPAL REGISTER

KYRIAKAKIS DENTAL INCORPORATED (HAWAII CORPORATION), DBA GEMINI DENTAL
1953 BERETANIA STREET
UNIT 3A
HONOLULU, HI 96826

FOR: DENTIST SERVICES; MEDICAL CONSULTATIONS PROVIDED VIA PHONE, ONLINE CHAT OR VIDEOCONFERENCING; MEDICAL TESTING FOR DIAGNOSTIC OR TREATMENT PURPOSES; MEDICAL TESTING FOR DIAGNOSTIC OR TREATMENT PURPOSES IN THE FIELD OF DENTISTRY; PROVIDING A WEBSITE FEATURING INFORMATION FOR DENTISTS ON THE SUBJECT OF TREATMENTS AND PROCEDURES RELATED TO DENTISTRY, IN CLASS 44 (U.S. CLS. 100 AND 101).

FIRST USE 1-1-2011; IN COMMERCE 5-1-2011.

NO CLAIM IS MADE TO THE EXCLUSIVE RIGHT TO USE "DENTAL CENTER", APART FROM THE MARK AS SHOWN.

THE COLOR(S) OCEAN BLUE IS/ARE CLAIMED AS A FEATURE OF THE MARK.

THE MARK CONSISTS OF THE WORD "GEMINI" CENTERED AND CAPITALIZED OVER THE WORDS "DENTAL CENTER" WHICH ARE ALSO CENTERED AND CAPITALIZED AND BOTH LINES BENEATH A STYLIZED IMAGE OF A TOOTH WHICH ALSO BEARS RESEMBLANCE TO THE LETTER "G". BOTH WORDS AND DESIGN ARE IN COLOR OCEAN BLUE.

SER. NO. 85-414,594, FILED 9-2-2011.

SOPHIA S. KIM, EXAMINING ATTORNEY



David J. Kyffers

Director of the United States Patent and Trademark Office

United States of America

United States Patent and Trademark Office

Siltlon

Reg. No. 4,153,242

Registered June 5, 2012

Int. Cl.: 28

TRADEMARK

PRINCIPAL REGISTER

HAESUNG ENTERPRISE CO., LTD. (REPUBLIC OF KOREA CORPORATION)
1684-1, SONGJEONG-DONG, GANGSEO-GU
BUSAN, REPUBLIC OF KOREA 618-270

FOR: FISHING LINES; FISHING TACKLE, IN CLASS 28 (U.S. CLS. 22, 23, 38 AND 50).

FIRST USE 1-1-2000; IN COMMERCE 1-1-2000.

THE WORDING "SILTLO" HAS NO MEANING IN A FOREIGN LANGUAGE.

SER. NO. 85-414,661, FILED 9-2-2011.

ROBIN MITTLER, EXAMINING ATTORNEY



David J. Kybas

Director of the United States Patent and Trademark Office

United States of America

United States Patent and Trademark Office

WHEAT WACKER INDIA-STYLE WHEAT ALE

Reg. No. 4,153,243

BLACK DIAMOND BREWING COMPANY, INC. (CALIFORNIA CORPORATION)
2470 BATES AVE.
CONCORD, CA 94520

Registered June 5, 2012

Int. Cl.: 32

FOR: BEER, ALE, LAGER, STOUT AND PORTER, IN CLASS 32 (U.S. CLS. 45, 46 AND 48).

TRADEMARK

FIRST USE 5-2-2011; IN COMMERCE 7-12-2011.

PRINCIPAL REGISTER

THE MARK CONSISTS OF STANDARD CHARACTERS WITHOUT CLAIM TO ANY PARTICULAR FONT, STYLE, SIZE, OR COLOR.

NO CLAIM IS MADE TO THE EXCLUSIVE RIGHT TO USE "INDIA-STYLE WHEAT ALE", APART FROM THE MARK AS SHOWN.

SER. NO. 85-414,694, FILED 9-2-2011.

BARBARA RUTLAND, EXAMINING ATTORNEY



David J. Kyffers

Director of the United States Patent and Trademark Office

United States of America

United States Patent and Trademark Office

EXSUM

Reg. No. 4,153,244

Registered June 5, 2012

Int. Cl.: 28

TRADEMARK

PRINCIPAL REGISTER

HAESUNG ENTERPRISE CO., LTD. (REPUBLIC OF KOREA CORPORATION)
1684-1, SONGJEONG-DONG, GANGSEO-GU
BUSAN, REPUBLIC OF KOREA 618-270

FOR: FISHING LINES; FISHING TACKLE, IN CLASS 28 (U.S. CLS. 22, 23, 38 AND 50).

FIRST USE 7-1-2007; IN COMMERCE 7-1-2007.

THE MARK CONSISTS OF THE WORD "EXSUM" IN STYLIZED FONT.

THE WORDING "EXSUM" HAS NO MEANING IN A FOREIGN LANGUAGE.

SER. NO. 85-414,699, FILED 9-2-2011.

ROBIN MITTLER, EXAMINING ATTORNEY



David J. Kyffers

Director of the United States Patent and Trademark Office

United States of America

United States Patent and Trademark Office

JUMP AROUND PARTY RENTALS

Reg. No. 4,153,245

Registered June 5, 2012

Int. Cls.: 41 and 43

SERVICE MARK

PRINCIPAL REGISTER

JUMP AROUND PARTY RENTALS, LLC (NEW YORK LIMITED LIABILITY COMPANY)
3023 EWELL PLACE
WANTAGH, NY 11793

FOR: RENTAL OF PARTY EQUIPMENT, NAMELY, INFLATABLE BOUNCE PLAY HOUSES,
IN CLASS 41 (U.S. CLS. 100, 101 AND 107).

FIRST USE 1-1-2010; IN COMMERCE 1-1-2010.

FOR: RENTAL OF PARTY EQUIPMENT, NAMELY, TENTS, TABLES, AND CHAIRS AND
EQUIPMENT TO MAKE SPECIALTY FOOD ITEMS SUCH AS COTTON CANDY, POPCORN,
AND SNOW CONES, IN CLASS 43 (U.S. CLS. 100 AND 101).

FIRST USE 1-1-2010; IN COMMERCE 1-1-2010.

THE MARK CONSISTS OF STANDARD CHARACTERS WITHOUT CLAIM TO ANY PAR-
TICULAR FONT, STYLE, SIZE, OR COLOR.

NO CLAIM IS MADE TO THE EXCLUSIVE RIGHT TO USE "PARTY RENTALS", APART
FROM THE MARK AS SHOWN.

SER. NO. 85-414,784, FILED 9-3-2011.

CHRISTOPHER SIDOTI, EXAMINING ATTORNEY



David J. Kybas

Director of the United States Patent and Trademark Office

United States of America

United States Patent and Trademark Office

GRAFFITI FONTS

Reg. No. 4,153,246

Registered June 5, 2012

Int. Cl.: 9

TRADEMARK

PRINCIPAL REGISTER

NAPOLITANO MATTHEW J (UNITED STATES INDIVIDUAL), DBA HIGHGROUND INDUSTRIES
1138 PARK GLEN CT.
MILPITAS, CA 95035

FOR: DATA CARRIERS CONTAINING STORED TYPOGRAPHIC TYPEFACES; DOWNLOADABLE PRINTING FONTS; PRINTING FONTS THAT CAN BE DOWNLOADED PROVIDED BY MEANS OF ELECTRONIC TRANSMISSION; TYPEFACE FONTS RECORDED ON MAGNETIC MEDIA, IN CLASS 9 (U.S. CLS. 21, 23, 26, 36 AND 38).

FIRST USE 1-5-1999; IN COMMERCE 8-1-2000.

THE MARK CONSISTS OF STANDARD CHARACTERS WITHOUT CLAIM TO ANY PARTICULAR FONT, STYLE, SIZE, OR COLOR.

OWNER OF U.S. REG. NO. 110,611.

NO CLAIM IS MADE TO THE EXCLUSIVE RIGHT TO USE "FONTS", APART FROM THE MARK AS SHOWN.

SEC. 2(F).

SER. NO. 85-414,800, FILED 9-3-2011.

KHANH LE, EXAMINING ATTORNEY



David J. Kyffers

Director of the United States Patent and Trademark Office

United States of America

United States Patent and Trademark Office

DOGI

Reg. No. 4,153,247

Registered June 5, 2012

Int. Cl.: 25

TRADEMARK

PRINCIPAL REGISTER

CANALES MARES, FRANCISCO JAVIER (MEXICO INDIVIDUAL)
BLVD. VASCO DE QUIROGA # 1712
COL. SAN MANUEL LEÓN
GUANAJUATO, MEXICO 37259

FOR: BELTS; BLOUSES; CAPS; DRESSES; GLOVES; HATS; JACKETS; PANTS; SHIRTS;
SHOES; SKIRTS; SOCKS; SWEATERS; SWEATSHIRTS; SWIM WEAR; T-SHIRTS;
TRACKSUITS; UNDERWEAR; VESTS, IN CLASS 25 (U.S. CLS. 22 AND 39).

FIRST USE 8-23-2011; IN COMMERCE 9-2-2011.

THE MARK CONSISTS OF STANDARD CHARACTERS WITHOUT CLAIM TO ANY PARTICULAR FONT, STYLE, SIZE, OR COLOR.

OWNER OF U.S. REG. NOS. 2,996,584, 3,010,079, AND 3,846,391.

SER. NO. 85-414,996, FILED 9-5-2011.

KYLE PEETE, EXAMINING ATTORNEY



David J. Kybas

Director of the United States Patent and Trademark Office

United States of America

United States Patent and Trademark Office

Novagel Soil Stabilizing Polymer

Reg. No. 4,153,248

Registered June 5, 2012

Int. Cl.: 1

TRADEMARK

PRINCIPAL REGISTER

GEO-TECH SERVICES, LLC (DELAWARE CORPORATION)
220 N. ZAPATA HWY. #11A-449A
220 N. ZAPATA HWY. #11A-449A
LAREDO, TX 78043

FOR: ACRYLIC POLYMER POWDERS; CHEMICAL ADDITIVES FOR DRILLING MUDS,
IN CLASS 1 (U.S. CLS. 1, 5, 6, 10, 26 AND 46).

FIRST USE 9-1-2000; IN COMMERCE 10-1-2000.

THE MARK CONSISTS OF STANDARD CHARACTERS WITHOUT CLAIM TO ANY PAR-
TICULAR FONT, STYLE, SIZE, OR COLOR.

NO CLAIM IS MADE TO THE EXCLUSIVE RIGHT TO USE "SOIL STABILIZING POLYMER",
APART FROM THE MARK AS SHOWN.

THE WORDING "NOVAGEL" HAS NO MEANING IN A FOREIGN LANGUAGE.

SER. NO. 85-415,056, FILED 9-5-2011.

WARREN L. OLANDRIA, EXAMINING ATTORNEY



David J. Kyfos

Director of the United States Patent and Trademark Office

United States of America

United States Patent and Trademark Office

Terragel Polymer Drilling Slurry

Reg. No. 4,153,249

Registered June 5, 2012

Int. Cl.: 1

TRADEMARK

PRINCIPAL REGISTER

GEO-TECH SERVICES, LLC (DELAWARE CORPORATION)
220 N. ZAPATA HWY. #11A-449A
220 N. ZAPATA HWY. #11A-449A
LAREDO, TX 78043

FOR: ACRYLIC POLYMER POWDERS; CHEMICAL ADDITIVES FOR DRILLING MUDS,
IN CLASS 1 (U.S. CLS. 1, 5, 6, 10, 26 AND 46).

FIRST USE 4-1-2011; IN COMMERCE 4-7-2011.

THE MARK CONSISTS OF STANDARD CHARACTERS WITHOUT CLAIM TO ANY PAR-
TICULAR FONT, STYLE, SIZE, OR COLOR.

NO CLAIM IS MADE TO THE EXCLUSIVE RIGHT TO USE "POLYMER DRILLING SLURRY",
APART FROM THE MARK AS SHOWN.

THE WORDING "TERRAGEL" HAS NO MEANING IN A FOREIGN LANGUAGE.

SER. NO. 85-415,071, FILED 9-5-2011.

WARREN L. OLANDRIA, EXAMINING ATTORNEY



David J. Kyffers

Director of the United States Patent and Trademark Office

United States of America

United States Patent and Trademark Office

LEGACY CENTER

Reg. No. 4,153,250

CLARK, MR. DAVID (UNITED STATES INDIVIDUAL)
3000 VERSAILLES ROAD
FRANKFORT, KY 40601

Registered June 5, 2012

Int. Cl.: 45

FOR: FUNERAL ARRANGEMENT SERVICES; FUNERAL HOMES; FUNERAL SERVICES
ACCOMPANYING CREMATION, IN CLASS 45 (U.S. CLS. 100 AND 101).

SERVICE MARK

FIRST USE 5-1-2010; IN COMMERCE 5-1-2010.

PRINCIPAL REGISTER

THE MARK CONSISTS OF STANDARD CHARACTERS WITHOUT CLAIM TO ANY PAR-
TICULAR FONT, STYLE, SIZE, OR COLOR.

NO CLAIM IS MADE TO THE EXCLUSIVE RIGHT TO USE "CENTER", APART FROM THE
MARK AS SHOWN.

SER. NO. 85-415,102, FILED 9-5-2011.

BARNEY CHARLON, EXAMINING ATTORNEY



David J. Kybas

Director of the United States Patent and Trademark Office

United States of America

United States Patent and Trademark Office

CeliacAid

Reg. No. 4,153,251

Registered June 5, 2012

Int. Cl.: 5

TRADEMARK

PRINCIPAL REGISTER

BLANCO, MARIO (UNITED STATES INDIVIDUAL), DBA CELIACAID
9961 WORKMAN AVENUE
TEMPLE CITY, CA 91780

FOR: DIETARY AND NUTRITIONAL SUPPLEMENTS, DIETARY AND NUTRITIONAL SUPPLEMENTS CONTAINING NATURAL ENZYMES FOR INDIVIDUALS WITH SPRUE OR CELIAC DISEASE, DIETARY FOOD SUPPLEMENTS, DIETARY SUPPLEMENT BEVERAGE FOR INDIVIDUALS WITH SPRUE OR CELIAC DISEASE, ENZYME FOOD SUPPLEMENTS, ALL FOR USE IN PATIENTS WITH CELIAC DISEASE, IN CLASS 5 (U.S. CLS. 6, 18, 44, 46, 51 AND 52).

FIRST USE 11-1-2010; IN COMMERCE 9-1-2011.

THE MARK CONSISTS OF STANDARD CHARACTERS WITHOUT CLAIM TO ANY PARTICULAR FONT, STYLE, SIZE, OR COLOR.

SER. NO. 85-415,157, FILED 9-6-2011.

CIMMERIAN COLEMAN, EXAMINING ATTORNEY



David J. Kyros

Director of the United States Patent and Trademark Office

United States of America

United States Patent and Trademark Office

PINTA

Reg. No. 4,153,252

Registered June 5, 2012

Int. Cl.: 17

TRADEMARK

PRINCIPAL REGISTER

GOLTERMAN & SABO, INC. (MISSOURI CORPORATION)
3555 SCARLET OAK BLVD.
ST. LOUIS, MO 63122

FOR: SOUNDPROOFING MATERIALS FOR BUILDINGS, IN CLASS 17 (U.S. CLS. 1, 5, 12, 13, 35 AND 50).

FIRST USE 1-1-1999; IN COMMERCE 1-1-1999.

THE MARK CONSISTS OF STANDARD CHARACTERS WITHOUT CLAIM TO ANY PARTICULAR FONT, STYLE, SIZE, OR COLOR.

THE ENGLISH TRANSLATION OF "PINTA" IN THE MARK IS "PINT".

SER. NO. 85-415,632, FILED 9-6-2011.

KELLY TRUSILO, EXAMINING ATTORNEY



David J. Kybas

Director of the United States Patent and Trademark Office

United States of America

United States Patent and Trademark Office

PIERRE LOTI WINE BAR & RESTAURANT

Reg. No. 4,153,253

Registered June 5, 2012

Int. Cl.: 43

SERVICE MARK

PRINCIPAL REGISTER

H.O.C. WINE INC. (NEW YORK CORPORATION)
53 IRVING PLACE
NEW YORK, NY 10003

FOR: BAR AND RESTAURANT SERVICES; RESTAURANT AND BAR SERVICES; RESTAURANT SERVICES, INCLUDING SIT-DOWN SERVICE OF FOOD AND TAKE-OUT RESTAURANT SERVICES; WINE BARS, IN CLASS 43 (U.S. CLS. 100 AND 101).

FIRST USE 10-26-2007; IN COMMERCE 10-26-2007.

THE MARK CONSISTS OF STANDARD CHARACTERS WITHOUT CLAIM TO ANY PARTICULAR FONT, STYLE, SIZE, OR COLOR.

NO CLAIM IS MADE TO THE EXCLUSIVE RIGHT TO USE "WINE BAR & RESTAURANT", APART FROM THE MARK AS SHOWN.

THE NAME "PIERRE LOTI" DOES NOT IDENTIFY A LIVING INDIVIDUAL.

SER. NO. 85-416,143, FILED 9-6-2011.

JACQUELINE A. LAVINE, EXAMINING ATTORNEY



David J. Kyros

Director of the United States Patent and Trademark Office

United States of America

United States Patent and Trademark Office



Reg. No. 4,153,254

Registered June 5, 2012

Int. Cl.: 35

SERVICE MARK

PRINCIPAL REGISTER

SCHOOL NUTRITION ASSOCIATION (VIRGINIA NON-PROFIT CORPORATION)
120 WATERFRONT STREET, STE 300
OXON HILL, MD 20745

FOR: PROMOTING PUBLIC AWARENESS OF THE NEED TO EMPHASIZE THE BENEFITS OF SCHOOL MEALS, TO IMPROVE GOOD NUTRITION FOR STUDENTS AND TO IMPROVE THE PERCEPTION OF SCHOOL FOODSERVICE, IN CLASS 35 (U.S. CLS. 100, 101 AND 102).

FIRST USE 8-0-2010; IN COMMERCE 8-0-2010.

NO CLAIM IS MADE TO THE EXCLUSIVE RIGHT TO USE "HEALTHY SCHOOL MEALS", APART FROM THE MARK AS SHOWN.

THE COLOR(S) DARK ORANGE, LIGHT ORANGE AND WHITE IS/ARE CLAIMED AS A FEATURE OF THE MARK.

THE MARK CONSISTS OF A STYLIZED WHITE TRAY DESIGN WITH DARK ORANGE OUTLINES CONTAINING THE DARK ORANGE WORD "TRAY" ABOVE THE LIGHT ORANGE WORD "TALK" TO THE LEFT OF THE WHITE WORDING "COMMUNITIES FOR HEALTHY SCHOOL MEALS" AGAINST A DARK ORANGE RECTANGLE. A DARK ORANGE FORK APPEARS TO THE LEFT OF THE TRAY, AND A DARK ORANGE SPOON APPEARS TO THE RIGHT OF THE TRAY.

SER. NO. 85-416,290, FILED 9-7-2011.

IRA J. GOODSaid, EXAMINING ATTORNEY



David J. Kybas

Director of the United States Patent and Trademark Office

United States of America

United States Patent and Trademark Office



Reg. No. 4,153,255

Registered June 5, 2012

Int. Cl.: 41

SERVICE MARK

PRINCIPAL REGISTER

CEDAR BAY ENTERTAINMENT LLC (DELAWARE LIMITED LIABILITY COMPANY)
3235 W STATE HIGHWAY 76
BRANSON, MO 65616

FOR: MUSEUM SERVICES; MUSEUMS, IN CLASS 41 (U.S. CLS. 100, 101 AND 107).

FIRST USE 4-29-2011; IN COMMERCE 4-29-2011.

NO CLAIM IS MADE TO THE EXCLUSIVE RIGHT TO USE THE IMAGE OF THE FLAG, "100 YEARS 1912-2012" "BRANSON MISSOURI", "COURAGE", "RESPECT", "HONOR", APART FROM THE MARK AS SHOWN.

THE MARK CONSISTS OF A CIRCULAR DESIGN CONTAINING A ROSE AND A FLAG IMAGE. THE TEXT "TITANIC" IS WRITTEN UNDER THE FLAG, "100" IS WRITTEN UNDER THE WORD "TITANIC", THE WORD "YEARS" IS WRITTEN UNDER THE "100", AND THE DATES "1912-2012" ARE WRITTEN UNDER THE WORD "YEARS". THERE IS A ROSE TO THE BOTTOM RIGHT OF THE SECOND "0" IN "100". THE WORDS "COURAGE RESPECT HONOR BRANSON MISSOURI" ARE WRITTEN AROUND THE OUTSIDE OF THE CIRCLE. THESE WORDS ARE SEPARATED BY STARS.

SER. NO. 85-416,318, FILED 9-7-2011.

INGA ERVIN, EXAMINING ATTORNEY



David J. Kyffers

Director of the United States Patent and Trademark Office

United States of America

United States Patent and Trademark Office



Reg. No. 4,153,256

Registered June 5, 2012

Int. Cl.: 1

TRADEMARK

PRINCIPAL REGISTER

ABRO INDUSTRIES, INC. (INDIANA CORPORATION)
3580 BLACKTHORN COURT
SOUTH BEND, IN 46628

FOR: EPOXY RESINS, IN CLASS 1 (U.S. CLS. 1, 5, 6, 10, 26 AND 46).

FIRST USE 1-0-1989; IN COMMERCE 1-0-1989.

THE NAME(S), PORTRAIT(S), AND/OR SIGNATURE(S) SHOWN IN THE MARK IDENTIFIES
KATHRYN E. DEMARAIS, WHOSE CONSENT(S) TO REGISTER IS MADE OF RECORD.

THE MARK CONSISTS OF A WOMAN SITTING DOWN AND REPAIRING A BICYCLE.

SER. NO. 85-416,335, FILED 9-7-2011.

EUGENIA MARTIN, EXAMINING ATTORNEY



David J. Kyffers

Director of the United States Patent and Trademark Office

United States of America

United States Patent and Trademark Office



Reg. No. 4,153,257

Registered June 5, 2012

Int. Cl.: 35

SERVICE MARK

PRINCIPAL REGISTER

THE COLLEGE OF WILLIAM AND MARY IN VIRGINIA (VIRGINIA STATE UNIVERSITY)
105 JAMESTOWN ROAD
WILLIAMSBURG, VA 23185

FOR: PROVIDING INFORMATION IN THE FIELD OF PROMOTING PUBLIC AWARENESS REGARDING ENVIRONMENTAL SUSTAINABILITY ISSUES AT THE UNIVERSITY LEVEL; PROMOTING PUBLIC AWARENESS OF ENVIRONMENTAL SUSTAINABILITY ISSUES AT THE UNIVERSITY LEVEL, IN CLASS 35 (U.S. CLS. 100, 101 AND 102).

FIRST USE 5-1-2010; IN COMMERCE 5-1-2010.

OWNER OF U.S. REG. NOS. 1,638,481, 1,646,897, AND 3,731,123.

THE COLOR(S) GREEN AND YELLOW IS/ARE CLAIMED AS A FEATURE OF THE MARK.

THE MARK CONSISTS OF THE LETTERS "W" AND "M" IN GREEN, OUTLINED IN YELLOW, OFFSET AND PARTIALLY SUPERIMPOSED UPON EACH OTHER, WITH TWO GREEN VEINED LEAVES BEHIND THE "WM" LETTERS.

SER. NO. 85-416,483, FILED 9-7-2011.

RUDY R. SINGLETON, EXAMINING ATTORNEY



David J. Kyffers

Director of the United States Patent and Trademark Office

United States of America

United States Patent and Trademark Office

HumaCarb

Reg. No. 4,153,258

ADVANCING ECO-AGRICULTURE, LLC (OHIO LIMITED LIABILITY COMPANY)
4551 PARKS WEST ROAD
MIDDLEFIELD, OH 44062

Registered June 5, 2012

Int. Cl.: 1

FOR: FERTILIZERS; FERTILIZERS FOR AGRICULTURAL USE; NATURAL FERTILIZERS,
IN CLASS 1 (U.S. CLS. 1, 5, 6, 10, 26 AND 46).

TRADEMARK

FIRST USE 0-0-2010; IN COMMERCE 4-30-2010.

PRINCIPAL REGISTER

THE MARK CONSISTS OF STANDARD CHARACTERS WITHOUT CLAIM TO ANY PAR-
TICULAR FONT, STYLE, SIZE, OR COLOR.

SER. NO. 85-416,682, FILED 9-7-2011.

KATHLEEN LORENZO, EXAMINING ATTORNEY



David J. Kybas

Director of the United States Patent and Trademark Office

United States of America

United States Patent and Trademark Office

IWORK

Reg. No. 4,153,259

Registered June 5, 2012

Int. Cl.: 21

TRADEMARK

PRINCIPAL REGISTER

JPJ INVESTMENT HOLDING CO. (NEVADA CORPORATION)
2533 NORTH CARSON STREET
CARSON CITY, NV 89706

FOR: CLEANING BRUSHES FOR HOUSEHOLD USE, MOPS, AND BROOMS, IN CLASS 21
(U.S. CLS. 2, 13, 23, 29, 30, 33, 40 AND 50).

FIRST USE 7-12-2011; IN COMMERCE 7-12-2011.

THE MARK CONSISTS OF STANDARD CHARACTERS WITHOUT CLAIM TO ANY PARTICULAR FONT, STYLE, SIZE, OR COLOR.

OWNER OF U.S. REG. NO. 3,481,661.

SER. NO. 85-416,732, FILED 9-7-2011.

SHAUNIA CARLYLE, EXAMINING ATTORNEY



David J. Kyffers

Director of the United States Patent and Trademark Office

United States of America

United States Patent and Trademark Office

TOUCHING LIVES, IMPROVING RESULTS

Reg. No. 4,153,260

Registered June 5, 2012

Int. Cls.: 36 and 41

SERVICE MARK

PRINCIPAL REGISTER

FINCOR HOLDINGS, INC. (MICHIGAN CORPORATION)
6215 WEST ST. JOSEPH HIGHWAY
LANSING, MI 48917

FOR: CONDUCTING ASSESSMENTS AND EVALUATIONS IN CONNECTION WITH THE ISSUANCE AND RATING OF LIABILITY INSURANCE POLICIES; CONDUCTING INSURANCE CLAIMS EVALUATION FOR HEALTH CARE PROVIDERS; PROVIDING MEDICAL CLINICAL INSURANCE RISK MANAGEMENT CONSULTING SERVICES; ASSESSING INSURANCE CLAIMS; INSURANCE CLAIMS ADMINISTRATION, IN CLASS 36 (U.S. CLS. 100, 101 AND 102).

FIRST USE 2-0-2010; IN COMMERCE 2-0-2010.

FOR: EDUCATIONAL SERVICES, NAMELY, PROVIDING CONTINUING PROFESSIONAL EDUCATION COURSES IN THE FIELD OF HEALTH CARE AND RISK MANAGEMENT; MENTORING IN THE FIELD OF HEALTH CARE AND RISK MANAGEMENT; CLASSES PROVIDED BY MEANS OF TELECONFERENCING IN THE FIELD OF HEALTH CARE PRACTICE, POLICIES AND PROCEDURES; PROVIDING MOTIVATIONAL AND EDUCATIONAL SPEAKERS; PROVIDING EDUCATIONAL PODCASTS IN THE FIELD OF HEALTH CARE AND RISK MANAGEMENT; TRAINING SERVICES IN THE FIELD OF HEALTH CARE AND RISK MANAGEMENT; ELECTRONIC NEWSLETTERS DELIVERED BY E-MAIL IN THE FIELD OF HEALTH CARE AND RISK MANAGEMENT; ARRANGING AND CONDUCTING EDUCATIONAL CONFERENCES IN THE FIELD OF HEALTH CARE AND RISK MANAGEMENT, IN CLASS 41 (U.S. CLS. 100, 101 AND 107).

FIRST USE 2-0-2010; IN COMMERCE 2-0-2010.

THE MARK CONSISTS OF STANDARD CHARACTERS WITHOUT CLAIM TO ANY PARTICULAR FONT, STYLE, SIZE, OR COLOR.

SER. NO. 85-417,048, FILED 9-7-2011.

JANET LEE, EXAMINING ATTORNEY



David J. Kybas

Director of the United States Patent and Trademark Office

United States of America

United States Patent and Trademark Office



Reg. No. 4,153,261

Registered June 5, 2012

Int. Cl.: 41

SERVICE MARK

PRINCIPAL REGISTER

WAYNE WILLIAMS STUDIO, LLC (CALIFORNIA LIMITED LIABILITY COMPANY)
15423 SUTTON STREET
SHERMAN OAKS, CA 914033809

FOR: ENTERTAINMENT SERVICES, NAMELY, DISPLAYING A SERIES OF FILMS; FILM AND VIDEO FILM PRODUCTION; FILM AND VIDEO PRODUCTION; FILM AND VIDEO PRODUCTION CONSULTING SERVICES; FILM AND VIDEO TAPE FILM PRODUCTION; FILM PRODUCTION; FILM STUDIOS; MEDIA PRODUCTION SERVICES, NAMELY, VIDEO AND FILM PRODUCTION; MOTION PICTURE FILM PRODUCTION; MULTIMEDIA ENTERTAINMENT SERVICES IN THE NATURE OF DEVELOPMENT, PRODUCTION AND POST-PRODUCTION SERVICES IN THE FIELDS OF VIDEO AND FILMS; MULTIMEDIA ENTERTAINMENT SERVICES IN THE NATURE OF RECORDING, PRODUCTION AND POST-PRODUCTION SERVICES IN THE FIELDS OF MUSIC, VIDEO, AND FILMS, IN CLASS 41 (U.S. CLS. 100, 101 AND 107).

FIRST USE 9-7-2011; IN COMMERCE 9-7-2011.

THE MARK CONSISTS OF WORDING "HDSERENESCAPES" IN BOLD BLACK LETTERS AS ONE WORD UNDERLINED IN BLACK, ALSO REFLECTED BELOW ITSELF AS IF ON A LAKE SURFACE, BEFORE A LIGHT MAUVE AND BLUE MOUNTAIN RANGE WITH A RED AND ORANGE SUNSET CLOUD SKY BEHIND AND ABOVE THE MOUNTAIN RANGE.

THE COLOR(S) BLACK, WHITE, LIGHT MAUVE, BLUE, GREY, SUNSET RED AND SUNSET ORANGE IS/ARE CLAIMED AS A FEATURE OF THE MARK.

SER. NO. 85-417,113, FILED 9-7-2011.

JANET LEE, EXAMINING ATTORNEY



David J. Kyros

Director of the United States Patent and Trademark Office

United States of America

United States Patent and Trademark Office

Tanya Tate

Reg. No. 4,153,262

Registered June 5, 2012

Int. Cl.: 41

SERVICE MARK

PRINCIPAL REGISTER

TRACEY PALUMBO (UNITED KINGDOM INDIVIDUAL)
4804 LAUREL CANYON BLVD #250
VALLEY VILLAGE, CA 91607

FOR: ENTERTAINMENT SERVICES IN THE NATURE OF LIVE ACTING AND DANCING PERFORMANCES; MODELING FOR ADULT ENTERTAINMENT PURPOSES; ENTERTAINMENT SERVICES BY A STAR OF ADULT MOVIES IN THE NATURE OF PUBLIC LIVE DANCE AND PERSONAL APPEARANCE PERFORMANCES; ENTERTAINMENT SERVICES, NAMELY, PROVIDING ADULT ENTERTAINMENT VISUAL IMAGES AND LIVE ADULT-ORIENTED ENTERTAINMENT PERFORMANCES VIA A GLOBAL COMPUTER NETWORK; ENTERTAINMENT SERVICES, NAMELY, PROVIDING LIVE AND NON-DOWNLOADABLE PRE-RECORDED ADULT-ORIENTED ENTERTAINMENT PERFORMANCES VIA BROADCAST TELEVISION, SATELLITE, CABLE, RADIO, BROADBAND AND GLOBAL COMPUTER NETWORKS, IN INTERNATIONAL CLASS 41, IN CLASS 41 (U.S. CLS. 100, 101 AND 107).

FIRST USE 12-1-2008; IN COMMERCE 12-1-2008.

THE MARK CONSISTS OF STANDARD CHARACTERS WITHOUT CLAIM TO ANY PARTICULAR FONT, STYLE, SIZE, OR COLOR.

THE NAME(S), PORTRAIT(S), AND/OR SIGNATURE(S) SHOWN IN THE MARK IDENTIFIES A LIVING INDIVIDUAL, WHOSE CONSENT(S) TO REGISTER IS MADE OF RECORD.

SER. NO. 85-417,238, FILED 9-7-2011.

CHRISTOPHER LAW, EXAMINING ATTORNEY



David J. Kypos

Director of the United States Patent and Trademark Office

United States of America
United States Patent and Trademark Office

HANFEISE

Reg. No. 4,153,263

Registered June 5, 2012

Int. Cl.: 25

TRADEMARK

PRINCIPAL REGISTER

HANFEISE INTERNATIONAL FASHION CO., LTD. (CHINA CORPORATION), DBA
HANFEISE INTERNATIONAL CO., LTD.
2ND FLOOR, 2 COMMERCIAL STREET, ZHENKOU
DONGGUAN, GUANGDONG, CHINA

FOR: SHIRT, PANTS, IN CLASS 25 (U.S. CLS. 22 AND 39).

FIRST USE 7-14-2002; IN COMMERCE 7-14-2002.

THE MARK CONSISTS OF STANDARD CHARACTERS WITHOUT CLAIM TO ANY PARTICULAR FONT, STYLE, SIZE, OR COLOR.

SER. NO. 85-417,445, FILED 9-8-2011.

ARETHA SOMERVILLE, EXAMINING ATTORNEY



David J. Kybas

Director of the United States Patent and Trademark Office

United States of America

United States Patent and Trademark Office

Kris Holm

Reg. No. 4,153,264

KRIS HOLM UNICYCLES LTD. (CANADA CORPORATION)
112-6279 EAGLES DRIVE
VANCOUVER, CANADA V6T2K7

Registered June 5, 2012

Int. Cl.: 12

FOR: UNICYCLES AND STRUCTURAL PARTS THEREFOR, IN CLASS 12 (U.S. CLS. 19, 21, 23, 31, 35 AND 44).

TRADEMARK

FIRST USE 1-1-2000; IN COMMERCE 1-1-2000.

PRINCIPAL REGISTER

THE MARK CONSISTS OF STANDARD CHARACTERS WITHOUT CLAIM TO ANY PARTICULAR FONT, STYLE, SIZE, OR COLOR.

THE NAME "KRIS HOLM" IDENTIFIES A LIVING INDIVIDUAL WHOSE CONSENT IS OF RECORD.

SER. NO. 85-417,645, FILED 9-8-2011.

Laurie Kaufman, Examining Attorney



David J. Kybas

Director of the United States Patent and Trademark Office

United States of America

United States Patent and Trademark Office



Reg. No. 4,153,265

Registered June 5, 2012

Int. Cl.: 31

TRADEMARK

PRINCIPAL REGISTER

INTEGRADORA DE FRUTAS FINAS SOCONUSCO S.A. DE C.V. (MEXICO PARTNERSHIP),
TA FRUTAS FINAS SOCONUSCO
CARRETERA A PUERTO MADERO KM.12
TAPACHULA, MEXICO 30700

FOR: FRESH MANGOS PRODUCED IN SOCONUSCO, MEXICO, IN CLASS 31 (U.S. CLS. 1 AND 46).

FIRST USE 2-15-1998; IN COMMERCE 2-15-1998.

OWNER OF U.S. REG. NOS. 3,820,933 AND 3,827,350.

THE COLOR(S) GREEN, RED, YELLOW AND WHITE IS/ARE CLAIMED AS A FEATURE OF THE MARK.

NO CLAIM IS MADE TO THE EXCLUSIVE RIGHT TO USE "PREMIUM MANGOS" AND "FRUTAS FINAS" AND "SOCONUSCO" AND "PREMIUM MANGOS", APART FROM THE MARK AS SHOWN.

THE MARK CONSISTS OF THE WORD "SOCONUSCO" IN WHITE ON A GREEN BACKGROUND, UNDERLINED IN RED BENEATH A GREEN BOWL CONTAINING YELLOW MANGOS AND A RED PYRAMID WITHIN A YELLOW SUN WITH RED RAYS ON A CIRCULAR WHITE BACKGROUND AND THE WORDS "FRUTAS FINAS" IN GREEN AT THE TOP. ON EITHER SIDE IS AN IRREGULAR GREEN DESIGN WITH THE WORDS "PREMIUM MANGOS" IN WHITE, ALL ON A YELLOW BACKGROUND.

THE ENGLISH TRANSLATION OF "FRUTAS FINAS" IN THE MARK IS FINE FRUITS.

SER. NO. 85-417,668, FILED 9-8-2011.

JOHN WILKE, EXAMINING ATTORNEY

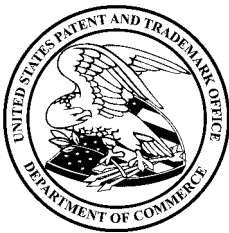

David J. Kyjars

Director of the United States Patent and Trademark Office

United States of America

United States Patent and Trademark Office



Reg. No. 4,153,266

Registered June 5, 2012

Int. Cl.: 25

TRADEMARK

PRINCIPAL REGISTER

AGGRESSIVE COMBATIVES LIMITED (HONG KONG CORPORATION)
SUITE 513, CONCORDIA PLAZA
1 SCIENCE MUSEUM ROAD
KOWLOON, HONG KONG

FOR: ATHLETIC APPAREL, NAMELY, SHIRTS, PANTS, JACKETS, FOOTWEAR, HATS
AND CAPS, ATHLETIC UNIFORMS, IN CLASS 25 (U.S. CLS. 22 AND 39).

FIRST USE 9-8-2011; IN COMMERCE 9-8-2011.

THE MARK CONSISTS OF A DEPICTION OF A MAN FROM HEAD TO TOE WITH SPIKY
HAIR AND OPEN MOUTH.

SER. NO. 85-417,669, FILED 9-8-2011.

SARA BENJAMIN, EXAMINING ATTORNEY



David J. Kybas

Director of the United States Patent and Trademark Office

United States of America

United States Patent and Trademark Office

POPCORN

Reg. No. 4,153,267

Registered June 5, 2012

Int. Cls.: 38 and 42

SERVICE MARK

PRINCIPAL REGISTER

POPCORN, LLC (DELAWARE LIMITED LIABILITY COMPANY)
555 BRYANT STREET # 565
PALO ALTO, CA 94301

FOR: TELECOMMUNICATION SERVICES, NAMELY, PROVIDING ONLINE AND TELECOMMUNICATION FACILITIES FOR REAL-TIME INTERACTION BETWEEN AND AMONG USERS OF COMPUTERS, MOBILE AND HANDHELD COMPUTERS, AND WIRED AND WIRELESS COMMUNICATION DEVICES CONCERNING TOPICS OF GENERAL INTEREST; TELECOMMUNICATION SERVICES, NAMELY, TRANSMISSION OF VOICE, DATA AND VIDEO BY MEANS OF BROADBAND OPTICAL, WIRELESS NETWORKS AND INTERNET TRANSMISSION ENABLING USERS TO SEND AND RECEIVE MESSAGES, VOICE MAIL, ELECTRONIC MAIL AND INSTANT MESSAGES OF GENERAL INTEREST; VOIP SERVICES, NAMELY, ASSIGNMENT OF INDIVIDUAL PHONE NUMBERS TO BE USED IN A VIRTUAL ENVIRONMENT; PROVIDING ON-LINE CHAT ROOMS AND VOICE, TEXT AND ELECTRONIC BULLETIN BOARDS FOR TRANSMISSION OF MESSAGES AMONG USERS IN THE FIELD OF GENERAL INTEREST, IN CLASS 38 (U.S. CLS. 100, 101 AND 104).

FIRST USE 6-1-1995; IN COMMERCE 6-1-1995.

FOR: PROVIDING A WEB HOSTING PLATFORM FOR USERS TO MANAGE THEIR VIRTUAL PHONE NUMBERS VIA ONLINE, WIRELESS OR SHORT MESSAGE SERVICES; COMPUTER SERVICES, NAMELY, CREATING AN ON-LINE COMMUNITY FOR REGISTERED USERS TO PARTICIPATE IN DISCUSSIONS, ENGAGE IN ELECTRONIC COMMUNICATION, FORM VIRTUAL COMMUNITIES, AND ENGAGE IN SOCIAL NETWORKING SERVICES IN TOPICS OF GENERAL INTEREST, IN CLASS 42 (U.S. CLS. 100 AND 101).

FIRST USE 6-1-1995; IN COMMERCE 6-1-1995.

THE MARK CONSISTS OF STANDARD CHARACTERS WITHOUT CLAIM TO ANY PARTICULAR FONT, STYLE, SIZE, OR COLOR.

SER. NO. 85-417,795, FILED 9-8-2011.

PAULA MAHONEY, EXAMINING ATTORNEY



David J. Kyros

Director of the United States Patent and Trademark Office

United States of America

United States Patent and Trademark Office

click  **ride** 

Reg. No. 4,153,268

Registered June 5, 2012

Int. Cl.: 39

SERVICE MARK

PRINCIPAL REGISTER

STANDARD PARKING CORPORATION (DELAWARE CORPORATION)
SUITE 1600
900 N. MICHIGAN AVENUE
CHICAGO, IL 60611

FOR: TRAVEL DEMAND MANAGEMENT SERVICES, NAMELY, PROVIDING INFORMATION ON TRAFFIC MANAGEMENT PLANS, PARKING LOCATIONS, PARKING RESERVATIONS, PUBLIC TRANSPORTATION INFORMATION, REMOTE PARK AND RIDE SHUTTLE INFORMATION TO ARRIVE AT AND DEPART FROM A VENUE OR EVENT; BUS CHARTERING; BUS TRANSPORT; PASSENGER TRANSPORT; TRANSPORT OF PERSONS; TRANSPORTATION INFORMATION; TRANSPORTATION OF PASSENGERS AND PASSENGERS' LUGGAGE; TRANSPORTATION OF PASSENGERS AND/OR GOODS BY BUS; TRANSPORTATION RESERVATION SERVICES, IN CLASS 39 (U.S. CLS. 100 AND 105).

FIRST USE 10-0-2008; IN COMMERCE 10-0-2008.

OWNER OF U.S. REG. NOS. 3,783,140, 3,783,239, AND 4,056,625.

THE MARK CONSISTS OF THE WORD "CLICK", FOLLOWED BY A LEFT-POINTING SHAPE CONTAINING THE WORD "AND", FOLLOWED BY THE WORD "RIDE", FOLLOWED BY A RIGHT-POINTING SHAPE CONTAINING THE WORD "COM".

SER. NO. 85-417,965, FILED 9-8-2011.

ROBERT STRUCK, EXAMINING ATTORNEY



David J. Kybas

Director of the United States Patent and Trademark Office

United States of America

United States Patent and Trademark Office

EIGENSTUDIO

Reg. No. 4,153,269

MH ACOUSTICS, LLC (NEW JERSEY LIMITED LIABILITY COMPANY)
25A SUMMIT AVE.
SUMMIT, NJ 07901

Registered June 5, 2012

Int. Cl.: 9

FOR: SOFTWARE FOR CONTROLLING AND MANAGING MICROPHONE-ARRAY BEAMFORMING FUNCTIONALITY, IN CLASS 9 (U.S. CLS. 21, 23, 26, 36 AND 38).

TRADEMARK

FIRST USE 9-5-2011; IN COMMERCE 9-5-2011.

PRINCIPAL REGISTER

THE MARK CONSISTS OF STANDARD CHARACTERS WITHOUT CLAIM TO ANY PARTICULAR FONT, STYLE, SIZE, OR COLOR.

OWNER OF U.S. REG. NO. 2,818,351.

SER. NO. 85-418,013, FILED 9-8-2011.

ALEXANDER L. POWERS, EXAMINING ATTORNEY



David J. Kybas

Director of the United States Patent and Trademark Office

United States of America

United States Patent and Trademark Office

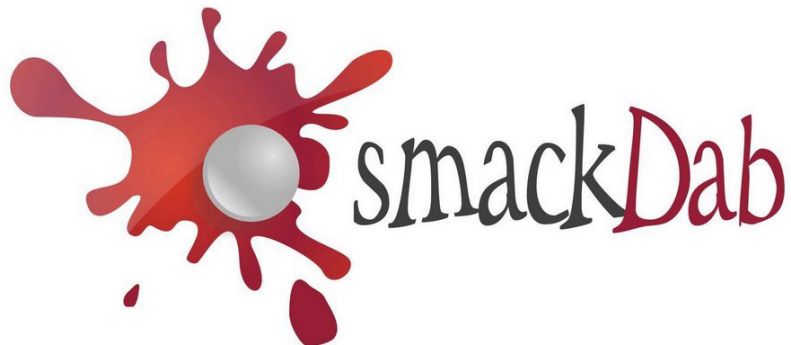

Reg. No. 4,153,270

Registered June 5, 2012

Int. Cl.: 35

SERVICE MARK

PRINCIPAL REGISTER

CONEXUS MEDIA TECHNOLOGIES, INC. (DELAWARE CORPORATION)
216 CHEWTON ROAD
BLOOMFIELD TOWNSHIP, MI 48301

FOR: ADVERTISING, MARKETING AND PROMOTING THE GOODS AND SERVICES OF OTHERS IN DIGITAL FORMAT VIA DISSEMINATION TO ELECTRONIC AND WIRELESS DEVICES, IN CLASS 35 (U.S. CLS. 100, 101 AND 102).

FIRST USE 4-0-2011; IN COMMERCE 4-0-2011.

THE MARK CONSISTS OF THE WORDING "SMACKDAB" WITH THE TERM "SMACK" IN THE COLOR GRAY AND THE TERM "DAB" IN THE COLOR RED. THIS IS ADJACENT TO THE DESIGN OF A SPLAT IN RED AND ORANGE AND A SILVER BALL.

THE COLOR(S) RED, ORANGE, SILVER AND GRAY IS/ARE CLAIMED AS A FEATURE OF THE MARK.

SER. NO. 85-419,016, FILED 9-9-2011.

KAREN BRACEY, EXAMINING ATTORNEY



David J. Kyros

Director of the United States Patent and Trademark Office

United States of America

United States Patent and Trademark Office

SMART TUITION

Reg. No. 4,153,271

Registered June 5, 2012

Int. Cl.: 35

SERVICE MARK

PRINCIPAL REGISTER

SMART, LLC (NEW YORK LIMITED LIABILITY COMPANY)
SUITE 800
ONE WOODBRIDGE CENTER
WOODBIDGE, NJ 07095

FOR: BUSINESS ADMINISTRATION SERVICES FOR EDUCATIONAL INSTITUTIONS, NAMELY, INFORMATION COLLECTION, INFORMATION PROCESSING, AND INFORMATION MANAGEMENT RELATED TO TUITION FOR EDUCATIONAL INSTITUTIONS, ACCOUNTING SERVICES, AND CUSTOMER SERVICES IN THE NATURE OF RESPONDING TO INQUIRIES FROM STUDENTS AND PARENTS ON BEHALF OF EDUCATIONAL INSTITUTIONS, IN CLASS 35 (U.S. CLS. 100, 101 AND 102).

FIRST USE 7-31-1989; IN COMMERCE 7-31-1989.

THE MARK CONSISTS OF STANDARD CHARACTERS WITHOUT CLAIM TO ANY PARTICULAR FONT, STYLE, SIZE, OR COLOR.

NO CLAIM IS MADE TO THE EXCLUSIVE RIGHT TO USE "TUITION", APART FROM THE MARK AS SHOWN.

SER. NO. 85-419,028, FILED 9-9-2011.

BRENDAN MCCAULEY, EXAMINING ATTORNEY



David J. Kybas

Director of the United States Patent and Trademark Office

United States of America

United States Patent and Trademark Office

American High-Income Trust

Reg. No. 4,153,272

Registered June 5, 2012

Int. Cl.: 36

SERVICE MARK

PRINCIPAL REGISTER

AMERICAN HIGH-INCOME MUNICIPAL BOND FUND (DELAWARE TRUST)
ATTN: DAVID M. GIVNER
333 SOUTH HOPE ST., 55TH FLOOR
LOS ANGELES, CA 90071

FOR: FINANCIAL SERVICES, NAMELY, FINANCIAL ANALYSIS, EVALUATION AND CONSULTATION; INVESTMENT MANAGEMENT AND ADVICE; MUTUAL FUND INVESTMENT MANAGEMENT AND DISTRIBUTION; ANNUITY SERVICES, NAMELY, INVESTMENT MANAGEMENT AND DISTRIBUTION OF VARIABLE ANNUITIES; FIDUCIARY SERVICES, NAMELY, SERVING AS TRUSTEE FOR DIRECTED AND DISCRETIONARY TRUST ACCOUNTS; ESTATE PLANNING; AND FINANCIAL ADMINISTRATION OF EMPLOYEE BENEFIT, PENSION AND RETIREMENT PLANS IN CONNECTION THEREWITH, IN CLASS 36 (U.S. CLS. 100, 101 AND 102).

FIRST USE 10-1-1987; IN COMMERCE 10-1-1987.

THE MARK CONSISTS OF STANDARD CHARACTERS WITHOUT CLAIM TO ANY PARTICULAR FONT, STYLE, SIZE, OR COLOR.

OWNER OF U.S. REG. NO. 1,934,518.

NO CLAIM IS MADE TO THE EXCLUSIVE RIGHT TO USE "AMERICAN" AND "TRUST", APART FROM THE MARK AS SHOWN.

SEC. 2(F).

SER. NO. 85-419,180, FILED 9-9-2011.

DOMINICK J. SALEMI, EXAMINING ATTORNEY



David J. Kybas

Director of the United States Patent and Trademark Office

United States of America

United States Patent and Trademark Office

Queen of Color

Reg. No. 4,153,273

Registered June 5, 2012

Int. Cl.: 3

TRADEMARK

PRINCIPAL REGISTER

SHOWSEASON ANIMAL PRODUCTS, LLC (GEORGIA LIMITED LIABILITY COMPANY)
4980 HAMMERMILL RD.
TUCKER, GA 30084

FOR: HAIR COLOR; HAIR COLORANTS; HAIR COLORING PREPARATIONS; HAIR COLORING AND DYES; HAIR DYE; HAIR DYES; NON-MEDICATED GROOMING PREPARATIONS FOR PETS, NAMELY, SEMI-PERMANENT DYE TO BE APPLIED TO FUR FOR FULL COLORING, STREAKING, TIPPING, COLOR DESIGNING AND MULTI-COLORED STYLING, IN CLASS 3 (U.S. CLS. 1, 4, 6, 50, 51 AND 52).

FIRST USE 1-1-2005; IN COMMERCE 1-1-2005.

THE MARK CONSISTS OF STANDARD CHARACTERS WITHOUT CLAIM TO ANY PARTICULAR FONT, STYLE, SIZE, OR COLOR.

NO CLAIM IS MADE TO THE EXCLUSIVE RIGHT TO USE "COLOR", APART FROM THE MARK AS SHOWN.

SER. NO. 85-419,373, FILED 9-9-2011.

STEPHANIE ALI, EXAMINING ATTORNEY



David J. Kyros

Director of the United States Patent and Trademark Office

United States of America

United States Patent and Trademark Office

CIGNIFI

Reg. No. 4,153,274

Registered June 5, 2012

Int. Cl.: 35

SERVICE MARK

PRINCIPAL REGISTER

GMH INTERNATIONAL INC. (DELAWARE CORPORATION), DBA CIGNIFI
21 ELM STREET
BELMONT, MA 02478

FOR: MARKETING SERVICES, NAMELY, CONDUCTING BEHAVIORAL ANALYTICS WITH RESPECT TO MOBILE TELEPHONE USAGE DATA AND PROVIDING CREDIT SCORES, RESPONSE SCORES AND LOYALTY SCORES FOR PROSPECTIVE CONSUMERS OF FINANCIAL PRODUCTS AND SERVICES BASED THEREUPON, IN CLASS 35 (U.S. CLS. 100, 101 AND 102).

FIRST USE 9-7-2011; IN COMMERCE 9-7-2011.

THE MARK CONSISTS OF STANDARD CHARACTERS WITHOUT CLAIM TO ANY PARTICULAR FONT, STYLE, SIZE, OR COLOR.

SER. NO. 85-419,446, FILED 9-9-2011.

KATHERINE STOIDES, EXAMINING ATTORNEY



David J. Kyros

Director of the United States Patent and Trademark Office

United States of America

United States Patent and Trademark Office



Reg. No. 4,153,275

ALFA ELECTRONICS LTD. (GEORGIA CORPORATION)
3193 LOWER UNION HILL RD.
CANTON, GA 30115

Registered June 5, 2012

Int. Cl.: 35

FOR: DISTRIBUTORSHIP SERVICES IN THE FIELD OF ELECTRONIC COMPONENTS, IN CLASS 35 (U.S. CLS. 100, 101 AND 102).

SERVICE MARK

FIRST USE 5-0-2011; IN COMMERCE 5-0-2011.

PRINCIPAL REGISTER

NO CLAIM IS MADE TO THE EXCLUSIVE RIGHT TO USE "ELECTRONICS", APART FROM THE MARK AS SHOWN.

THE MARK CONSISTS OF AN ABSTRACT, SQUARE DESIGN ON THE LEFT AND THE TEXT "ALFA ELECTRONICS" ON THE RIGHT, WITH "ALFA" ABOVE AND "ELECTRONICS" BELOW.

SER. NO. 85-419,475, FILED 9-9-2011.

LINDA ORNDORFF, EXAMINING ATTORNEY



David J. Kyros

Director of the United States Patent and Trademark Office

United States of America

United States Patent and Trademark Office

HEX

Reg. No. 4,153,276

Registered June 5, 2012

Int. Cl.: 35

SERVICE MARK

PRINCIPAL REGISTER

AUGUST HAT COMPANY, INC. (CALIFORNIA CORPORATION)
3051 STURGIS ROAD
OXNARD, CA 93030

FOR: ONLINE RETAIL STORE SERVICES IN THE FIELD OF ACCESSORIES FOR WATCHES AND PERSONAL ELECTRONIC DEVICES; ONLINE RETAIL STORE SERVICES IN THE FIELD OF BACKPACKS, BAGS AND CASES , IN CLASS 35 (U.S. CLS. 100, 101 AND 102).

FIRST USE 11-0-2010; IN COMMERCE 11-0-2010.

THE MARK CONSISTS OF STANDARD CHARACTERS WITHOUT CLAIM TO ANY PARTICULAR FONT, STYLE, SIZE, OR COLOR.

SER. NO. 85-419,487, FILED 9-9-2011.

BARBARA A. GOLD, EXAMINING ATTORNEY



David J. Kyffers

Director of the United States Patent and Trademark Office

United States of America

United States Patent and Trademark Office

THE MODERN HONOLULU

Reg. No. 4,153,277

Registered June 5, 2012

Int. Cl.: 43

SERVICE MARK

PRINCIPAL REGISTER

MODERN MANAGEMENT SERVICES, LLC (HAWAII LIMITED LIABILITY COMPANY)
1860 ALA MOANA BLVD.
HONOLULU, HI 96815

FOR: HOTEL SERVICES, IN CLASS 43 (U.S. CLS. 100 AND 101).

FIRST USE 8-28-2011; IN COMMERCE 8-28-2011.

THE MARK CONSISTS OF STANDARD CHARACTERS WITHOUT CLAIM TO ANY PARTICULAR FONT, STYLE, SIZE, OR COLOR.

NO CLAIM IS MADE TO THE EXCLUSIVE RIGHT TO USE "HONOLULU", APART FROM THE MARK AS SHOWN.

SER. NO. 85-419,514, FILED 9-9-2011.

KIM SAITO, EXAMINING ATTORNEY



David J. Kybas

Director of the United States Patent and Trademark Office

United States of America

United States Patent and Trademark Office

Catch Him & Keep Him

Reg. No. 4,153,278

Registered June 5, 2012

Int. Cl.: 9

TRADEMARK

PRINCIPAL REGISTER

PAGAN, EBEN (UNITED STATES INDIVIDUAL)
5TH FLOOR
3960 HOWARD HUGHES PARKWAY
LAS VEGAS, NV 89169

FOR: DIGITAL MATERIALS, NAMELY, DOWNLOADABLE E-BOOKS, COMPACT DISCS, AND DVDS FEATURING THE SUBJECT OF PERSONAL RELATIONSHIPS AND DATING, IN CLASS 9 (U.S. CLS. 21, 23, 26, 36 AND 38).

FIRST USE 7-6-2005; IN COMMERCE 7-6-2005.

THE MARK CONSISTS OF STANDARD CHARACTERS WITHOUT CLAIM TO ANY PARTICULAR FONT, STYLE, SIZE, OR COLOR.

SER. NO. 85-419,572, FILED 9-10-2011.

ROBIN CHOSID, EXAMINING ATTORNEY



David J. Kyffers

Director of the United States Patent and Trademark Office

United States of America

United States Patent and Trademark Office



Reg. No. 4,153,279

Registered June 5, 2012

Int. Cl.: 44

SERVICE MARK

PRINCIPAL REGISTER

HEALING HEART THERAPY DOGS, INC. (NEBRASKA CORPORATION)
115 COUNTRY CLUB LANE
CRETE, NE 68333

FOR: PROVIDING DOG-ASSISTED EMOTIONAL AND STRESS REDUCTION THERAPY FOR HOSPITAL PATIENTS, NURSING HOME RESIDENTS, RETIREMENT COMMUNITY RESIDENTS, ASSISTED LIVING RESIDENTS, HOSPICE PROGRAM RESIDENTS, INPATIENT AND OUTPATIENT MENTAL HEALTH PROGRAM PATIENTS, SCHOOL CHILDREN, COMMUNITY CENTER PATRONS, AND LIBRARY PATRONS AND OTHERS, IN CLASS 44 (U.S. CLS. 100 AND 101).

FIRST USE 1-25-2005; IN COMMERCE 4-23-2005.

NO CLAIM IS MADE TO THE EXCLUSIVE RIGHT TO USE "DOGS", APART FROM THE MARK AS SHOWN.

THE MARK CONSISTS OF SHAPE OF A HEART WITH AN ADHESIVE BANDAGE DIAGONALLY ACROSS THE UPPER LEFT CORNER; DOG PAW PRINT ON LOWER RIGHT SIDE OF HEART; WORDS "HEALING HEART DOGS" VERTICALLY ALONG RIGHT SIDE OF HEART.

SER. NO. 85-419,592, FILED 9-10-2011.

ANTHONY RINKER, EXAMINING ATTORNEY



David J. Kybas

Director of the United States Patent and Trademark Office

United States of America

United States Patent and Trademark Office

steelcutaudio

Reg. No. 4,153,280

Registered June 5, 2012

Int. Cl.: 41

SERVICE MARK

PRINCIPAL REGISTER

STEEL CUT AUDIO LLC (NEW YORK LIMITED LIABILITY COMPANY)
247 W 76 ST SUITE 6
NEW YORK, NY 10023

FOR: COMPOSITION OF MUSIC FOR OTHERS; CONSULTATION AND ADVICE REGARDING MUSICAL SELECTIONS AND ARRANGEMENTS FOR SOUND RECORDINGS AND LIVE PERFORMANCES; ENTERTAINMENT IN THE NATURE OF VISUAL AND AUDIO PERFORMANCES, AND MUSICAL, VARIETY, NEWS AND COMEDY SHOWS; ENTERTAINMENT IN THE NATURE OF VISUAL AND AUDIO PERFORMANCES, NAMELY, MUSICAL BAND, ROCK GROUP, GYMNASTIC, DANCE, AND BALLET PERFORMANCES; ENTERTAINMENT SERVICES BY A MUSICAL ARTIST AND PRODUCER, NAMELY, MUSICAL COMPOSITION FOR OTHERS AND PRODUCTION OF MUSICAL SOUND RECORDINGS; ENTERTAINMENT SERVICES IN THE NATURE OF RECORDING, PRODUCTION AND POST-PRODUCTION SERVICES IN THE FIELD OF MUSIC; MULTIMEDIA ENTERTAINMENT SERVICES IN THE NATURE OF RECORDING, PRODUCTION AND POST-PRODUCTION SERVICES IN THE FIELDS OF MUSIC, VIDEO, AND FILMS; MUSIC COMPOSITION FOR OTHERS; MUSIC COMPOSITION SERVICES; MUSIC PRODUCTION SERVICES; PRODUCTION OF MUSICAL SOUND RECORDING, IN CLASS 41 (U.S. CLS. 100, 101 AND 107).

FIRST USE 12-12-2009; IN COMMERCE 12-12-2009.

THE MARK CONSISTS OF STANDARD CHARACTERS WITHOUT CLAIM TO ANY PARTICULAR FONT, STYLE, SIZE, OR COLOR.

SER. NO. 85-419,619, FILED 9-10-2011.

STEPHANIE ALI, EXAMINING ATTORNEY



David J. Kyffers

Director of the United States Patent and Trademark Office

United States of America

United States Patent and Trademark Office



Quizzel

Reg. No. 4,153,281

Registered June 5, 2012

Int. Cls.: 16, 25, 28 and 41

TRADEMARK

SERVICE MARK

PRINCIPAL REGISTER

RELENTLESS SOFTWARE LIMITED (UNITED KINGDOM LIMITED COMPANY (LTD.))
ONE AIR STREET
BRIGHTON, UNITED KINGDOM BN13FB

FOR: NEWSPAPERS, PRINTED PERIODICALS IN THE FIELD OF CHILDREN STORIES, COMIC BOOKS, BOOKS IN THE FIELD OF CHILDREN STORIES; STATIONERY, WRITING TABLETS AND WRITING INSTRUMENTS; CRAYONS, MARKERS, COLORED PENCILS, CHALK AND CHALKBOARDS; DECALCOMANIA; POSTERS AND PHOTOGRAPHS; PAPER NAPKINS, PAPER DOILIES, PAPER PLACEMATS, CREPE PAPER, INVITATION CARDS, PAPER TABLE CLOTHS, PAPER CAKE DECORATIONS, IN CLASS 16 (U.S. CLS. 2, 5, 22, 23, 29, 37, 38 AND 50).

FOR: LEISURE WEAR FOR MEN, WOMEN AND CHILDREN, NAMELY, T-SHIRTS, PAJAMAS, TRACK SUITS, JACKET, TROUSERS AND SWEATSHIRT; HATS, SCARVES, BELTS; SLEEPING GARMENTS; BOOTS, SHOES AND SLIPPERS; SKI BOOTS; SWIMWEAR; UNDERWEAR AND LINGERIE, IN CLASS 25 (U.S. CLS. 22 AND 39).

FOR: SOFT SCULPTURE PLUSH TOYS, STUFFED PLUSH DOLLS AND FIGURES; PLAYING CARDS; DECORATIONS FOR CHRISTMAS TREES, IN CLASS 28 (U.S. CLS. 22, 23, 38 AND 50).

FOR: ENTERTAINMENT SERVICES, NAMELY, PRODUCTION AND DISTRIBUTION OF ANIMATED TELEVISION PROGRAMS AND MOTION PICTURES; ENTERTAINMENT SERVICES, NAMELY, LIVE PERFORMANCES IN THE NATURE OF PLAYS, MUSICALS, CONCERTS AND FESTIVALS, IN CLASS 41 (U.S. CLS. 100, 101 AND 107).

OWNER OF UNITED KINGDOM REG. NO. 2577887, DATED 4-8-2011, EXPIRES 4-8-2021.

THE MARK CONSISTS OF THE ARTISTIC RENDERING OF A SQUIRREL APPEARING ABOVE THE STYLIZED WORD "QUIZZEL".

SER. NO. 85-419,862, FILED 9-12-2011.

PAUL E. FAHRENKOPF, EXAMINING ATTORNEY



David J. Kyros

Director of the United States Patent and Trademark Office

United States of America

United States Patent and Trademark Office

FRETTE

Reg. No. 4,153,282

Registered June 5, 2012

Int. Cls.: 3, 8, 18 and 21

TRADEMARK

PRINCIPAL REGISTER

EDMUND FRETTE S.A.R.L. (LUXEMBOURG PRIVATE LIMITED LIABILITY COMPANY)
2, AVENUE CHARLES DE GAULLE
LUXEMBOURG, LUXEMBOURG L1653

FOR: TOILET WATERS; DEODORANTS FOR PERSONAL USE; COSMETICS, NAMELY, CREAMS; LOTIONS AND SKIN OILS FOR THE FACE AND THE BODY; SKIN CLEANSING CREAMS, BODY MILKS, LOTIONS AND SKIN OILS; MAKE-UP CREAMS; BEAUTY MASKS; MAKE-UP REMOVERS; EYE SHADOWS; LIPSTICKS; MASCARA; ROUGE; COSMETIC LINER PENCILS FOR THE EYES AND THE LIPS; BATH AND BODY POWDERS; CREAMS, OILS AND LOTIONS FOR SUN TANNING AND AFTER SUN EXPOSURE; PRE-AND AFTER SHAVE CREAMS AND LOTIONS; TALCUM POWDERS; NON-MEDICATED BATH SALTS; BATH FOAM AND BATH OIL; SKIN CREAMS AND LOTIONS FOR AFTER BATH; HAIR SHAMPOOS AND HAIR LOTIONS; ROOM FRAGRANCES, IN CLASS 3 (U.S. CLS. 1, 4, 6, 50, 51 AND 52).

FOR: CUTLERY, NAMELY, FORKS, SPOONS, AND KNIVES, IN CLASS 8 (U.S. CLS. 23, 28 AND 44).

FOR: UMBRELLAS AND GOODS MADE OF LEATHER OR IMITATION OF LEATHER, NAMELY, WALLETS, PASSPORT CASES, BUSINESS AND CREDIT CARD CASES; WAIST PACKS; LUGGAGE TRUNKS; TRAVELLING BAGS; SUITCASE, CLUTCH BAGS, PURSES, BILLFOLDS, ATTACHÉ CASES, BRIEFCASES, KEY CASES, IN CLASS 18 (U.S. CLS. 1, 2, 3, 22 AND 41).

FOR: SAUCERS, TEA POTS NOT OF PRECIOUS METAL; FLOWER VASES; ACCESSORIES FOR THE BATHROOM, NAMELY, CLEANING CLOTHS FOR GLASSES, SPONGES FOR TOILET PURPOSES AND CLEANING CLOTHS AND SPONGES FOR HOUSEHOLD PURPOSES, SMALL DOMESTIC UTENSILS AND CONTAINERS, NAMELY, ICE BUCKETS, SALT, PEPPER AND MUSTARD CRUET SETS MADE OF NON-PRECIOUS METALS, SALT CELLARS, PEPPER GRINDERS, GRAVY BOATS, EGG HOLDERS, APPLE GRATERS, SERVING TRAYS, BOWLS, ICE PAILS, CRUET SETS MADE OF NON-PRECIOUS METALS, DINNERWARE OF PLASTIC MATERIAL, NAMELY, PLATES, DISHES, COFFEE POTS NOT OF PRECIOUS METAL, DRINKING GLASSES, TUMBLERS, PITCHERS, BOTTLES SOLD EMPTY, CARAFES, DECANTERS, GLASS STORAGE JARS, JUGS, POTS, BOXES, CANISTERS; ACCESSORIES FOR THE BATHROOM, NAMELY, SOAP DISHES, TOWEL RAILS, TOILET TISSUE HOLDERS, TOILET BRUSH HOLDERS, BOXES AND CONTAINERS FOR COTTON PADS, TISSUE AND COSMETICS; WASTE BASKETS; COASTERS NOT OF PAPER



David J. Kyros

Director of the United States Patent and Trademark Office

Reg. No. 4,153,282 AND NOT BEING TABLE LINEN; PLACE MATS NOT OF PAPER AND NOT BEING TABLE LINEN, IN CLASS 21 (U.S. CLS. 2, 13, 23, 29, 30, 33, 40 AND 50).

THE MARK CONSISTS OF STANDARD CHARACTERS WITHOUT CLAIM TO ANY PARTICULAR FONT, STYLE, SIZE, OR COLOR.

OWNER OF ERPN CMNTY TM OFC REG. NO. 002442606, DATED 6-11-2011, EXPIRES 11-8-2021.

OWNER OF U.S. REG. NOS. 1,192,553, 2,672,227 AND OTHERS.

SER. NO. 85-420,096, FILED 9-12-2011.

PATRICIA EVANKO, EXAMINING ATTORNEY

United States of America

United States Patent and Trademark Office

CUASTERISK.COM

Reg. No. 4,153,283

Registered June 5, 2012

Int. Cl.: 35

SERVICE MARK

PRINCIPAL REGISTER

CU* ANSWERS, INC. (MICHIGAN CORPORATION)
6000 28TH STREET, S.E., SUITE 100
GRAND RAPIDS, MI 49546

FOR: BUSINESS CONSULTATION WITH RESPECT TO THE CREATION OF CREDIT UNION SERVICE ORGANIZATIONAL STARTUPS; BUSINESS NETWORKING SERVICES FOR CREDIT UNION SERVICE ORGANIZATIONAL STARTUPS, IN CLASS 35 (U.S. CLS. 100, 101 AND 102).

FIRST USE 5-16-2006; IN COMMERCE 5-16-2006.

THE MARK CONSISTS OF STANDARD CHARACTERS WITHOUT CLAIM TO ANY PARTICULAR FONT, STYLE, SIZE, OR COLOR.

SER. NO. 85-420,434, FILED 9-12-2011.

CHARLES L. JENKINS, EXAMINING ATTORNEY



David J. Kyffers

Director of the United States Patent and Trademark Office

United States of America

United States Patent and Trademark Office



Reg. No. 4,153,284

Registered June 5, 2012

Int. Cl.: 30

TRADEMARK

PRINCIPAL REGISTER

NIBMOR PROJECT, LLC. (NEW YORK LIMITED LIABILITY COMPANY)
223 WALL STREET #142
HUNTINGTON, NY 11743

FOR: CHOCOLATE; CHOCOLATE AND CHOCOLATES; CHOCOLATE BARS; CHOCOLATE CANDIES; CHOCOLATE CONFECTIONS; CHOCOLATE-BASED READY-TO-EAT FOOD BARS; CHOCOLATES AND CHOCOLATE BASED READY TO EAT CANDIES AND SNACKS; CONFECTIONERIES, NAMELY, SNACK FOODS, NAMELY, CHOCOLATE, IN CLASS 30 (U.S. CL. 46).

FIRST USE 6-1-2011; IN COMMERCE 8-12-2011.

NO CLAIM IS MADE TO THE EXCLUSIVE RIGHT TO USE "DARK", APART FROM THE MARK AS SHOWN.

THE COLOR(S) BROWN, WHITE, BEIGE AND KHAKI IS/ARE CLAIMED AS A FEATURE OF THE MARK.

THE MARK CONSISTS OF THE WORDS "DAILY DOSE OF DARK" STACKED ON A GRADED BROWN BACKGROUND. AT THE TOP IS THE WORD "DAILY" IN LARGE BLOCK LETTERS IN THE COLOR WHITE, BENEATH THAT ARE THE WORDS "DOSE OF" IN SLIGHTLY SMALLER BEIGE LETTERS WITH THE WORD "OF" UNDERLINED IN BEIGE, AND ON THE BOTTOM IS "DARK" IN LARGE BLOCK LETTERS IN THE COLOR KHAKI.

SER. NO. 85-420,439, FILED 9-12-2011.

TINA MAI, EXAMINING ATTORNEY



David J. Kyffers

Director of the United States Patent and Trademark Office

United States of America

United States Patent and Trademark Office

INSACO

Reg. No. 4,153,285

Registered June 5, 2012

Int. Cl.: 40

SERVICE MARK

PRINCIPAL REGISTER

INSACO INCORPORATED (PENNSYLVANIA CORPORATION)
1365 CANARY ROAD
QUAKERTOWN, PA 189519006

FOR: MACHINE SHOP SERVICES, NAMELY, MACHINING PARTS FOR OTHERS;
GRINDING OF HARD MATERIALS, NAMELY, ALUMINA, ZIRCONIA, SAPPHIRE,
CARBIDES, NITRIDES, GLASS CERAMICS, TECHNICAL CERAMICS, GLASS AND QUARTZ;
OPTICAL LENS GRINDING AND POLISHING, IN CLASS 40 (U.S. CLS. 100, 103 AND 106).

FIRST USE 12-31-1962; IN COMMERCE 12-31-1962.

THE MARK CONSISTS OF STANDARD CHARACTERS WITHOUT CLAIM TO ANY PARTICULAR FONT, STYLE, SIZE, OR COLOR.

SER. NO. 85-420,447, FILED 9-12-2011.

COLLEEN KEARNEY, EXAMINING ATTORNEY



David J. Kyros

Director of the United States Patent and Trademark Office

United States of America

United States Patent and Trademark Office

NCLAB

Reg. No. 4,153,286

Registered June 5, 2012

Int. Cl.: 42

SERVICE MARK

PRINCIPAL REGISTER

FEMHUB INC. (NEVADA CORPORATION)
5490 TWIN CREEKS DR
RENO, NV 89523

FOR: SOFTWARE AS A SERVICE (SAAS) SERVICES, NAMELY, HOSTING SOFTWARE FOR USE BY OTHERS FOR PROGRAMMING, COMPUTER MODELING AND SCIENTIFIC COMPUTING FOR A WIDE RANGE OF EDUCATIONAL AND RESEARCH APPLICATIONS IN THE NATURE OF BUSINESS PROCESS SIMULATIONS AND TEACHING TOOLS FOR THE CLASSROOM IN THE FIELD OF COMPUTER PROGRAMMING, PHYSICS, MATHEMATICS, BIOLOGY AND GEOLOGY, IN CLASS 42 (U.S. CLS. 100 AND 101).

FIRST USE 1-1-2011; IN COMMERCE 6-1-2011.

THE MARK CONSISTS OF STANDARD CHARACTERS WITHOUT CLAIM TO ANY PARTICULAR FONT, STYLE, SIZE, OR COLOR.

SER. NO. 85-420,518, FILED 9-12-2011.

CHRISTOPHER SIDOTI, EXAMINING ATTORNEY



David J. Kybas

Director of the United States Patent and Trademark Office

United States of America

United States Patent and Trademark Office

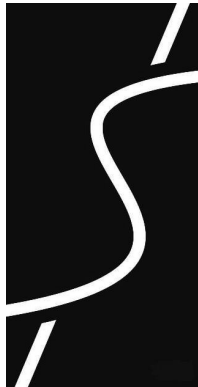

Reg. No. 4,153,287

Registered June 5, 2012

Int. Cls.: 35 and 36

SERVICE MARK

PRINCIPAL REGISTER

DOLLAR FINANCIAL GROUP, INC. (NEW YORK CORPORATION)
1436 LANCASTER AVENUE, SUITE 300
BERWYN, PA 19312

FOR: ELECTRONIC TAX PREPARATION AND FILING SERVICES; PROVIDING ONLINE CONSUMER INFORMATION IN THE FIELD OF FINANCIAL LITERACY, IN CLASS 35 (U.S. CLS. 100, 101 AND 102).

FIRST USE 8-24-2011; IN COMMERCE 8-24-2011.

FOR: CONSUMER FINANCIAL CONSULTATION SERVICES; CONSUMER FINANCIAL SERVICES, NAMELY, RETAIL AND ONLINE CHECK CASHING SERVICES, LOAN FINANCING, MONEY ORDER SERVICES, ELECTRONIC FUNDS TRANSFER SERVICES, BILL PAYMENT SERVICES, FOREIGN CURRENCY EXCHANGE SERVICES, CHECK PROCESSING SERVICES; CONSUMER LENDING SERVICES; FINANCING OF SHORT-TERM CONSUMER LOANS; FINANCING OF TAX REFUND LOANS; PAWN BROKERAGE; CASH ADVANCE SERVICES; DEFERRED BILL PRESENTMENT AND PAYDAY CASH ADVANCE SERVICES; TELEPHONE CALLING CARD SERVICES; PROVIDING MONETARY EXCHANGE SERVICES; MONETARY EXCHANGE SERVICES, NAMELY, EXCHANGING THE GOLD OF OTHERS FOR CASH; ISSUING PRE-PAID DEBIT CARDS, IN CLASS 36 (U.S. CLS. 100, 101 AND 102).

FIRST USE 8-24-2011; IN COMMERCE 8-24-2011.

THE MARK CONSISTS OF A STYLIZED DOLLAR SIGN ON A SOLID RECTANGULAR BACKGROUND.

SER. NO. 85-420,520, FILED 9-12-2011.

REBECCA SMITH, EXAMINING ATTORNEY



David J. Kyros

Director of the United States Patent and Trademark Office

United States of America

United States Patent and Trademark Office



Reg. No. 4,153,288

Registered June 5, 2012

Int. Cl.: 41

SERVICE MARK

PRINCIPAL REGISTER

THE PROTECTION INSTITUTE LLC (SOUTH CAROLINA LIMITED LIABILITY COMPANY)
2904 SEABROOK ISLAND RD.
JOHNS ISLAND, SC 29455

FOR: PROVIDING ON-LINE TRAINING COURSES IN THE FIELD OF SAFETY AND
EMERGENCY RESPONSE TRAINING, IN CLASS 41 (U.S. CLS. 100, 101 AND 107).

FIRST USE 12-20-2001; IN COMMERCE 2-1-2002.

THE MARK CONSISTS OF A GOLD COLORED BADGE WITH TWO BLACK RINGS INSIDE. ON THE VERY OUTSIDE OF THE BADGE THERE IS GOLD FRINGE. THE WORD "PROTECTION" IS WRITTEN IN GOLD LETTERS ON THE TOP OF THE INNER BLACK RING, AND THE WORD "INSTITUTE" IS WRITTEN IN GOLD ON THE BOTTOM OF THE INNER BLACK RING, WITH TWO GOLD STARS IN BETWEEN THE WORDS. THERE IS A GOLD CHAIN-LIKE DETAIL ON THE INSIDE OF THE INNER BLACK RING. OUR COMPANY'S CREST IS LOCATED IN THE VERY CENTER OF THE BADGE: A BLACK AND GOLD SHIELD CONTAINING TWO LION HEADS AND BEHIND THE SHIELD ARE TWO INTERSECTING SWORDS. UNDERNEATH THE BADGE IS A FLOWING BANNER THAT STATES THE LATIN PHRASE, "AMAT VICTORIA CURAM" IN BLACK LETTERS. THE BLACK RECTANGLE REPRESENTS THE BACKGROUND AND IS NOT PART OF THE MARK.

THE COLOR(S) BLACK AND GOLD IS/ARE CLAIMED AS A FEATURE OF THE MARK.

SER. NO. 85-420,546, FILED 9-12-2011.

GRETТА YAO, EXAMINING ATTORNEY



David J. Kybas

Director of the United States Patent and Trademark Office

United States of America

United States Patent and Trademark Office



WINDY CITY
STRATEGIES

Reg. No. 4,153,289

Registered June 5, 2012

Int. Cls.: 35 and 42

SERVICE MARK

PRINCIPAL REGISTER

WINDY CITY STRATEGIES, INC. (ILLINOIS CORPORATION)
2380 ESPLANADE DR.
ALGONQUIN, IL 60110

FOR: ADVERTISING AND MARKETING SERVICES PROVIDED BY MEANS OF INDIRECT METHODS OF MARKETING COMMUNICATIONS, NAMELY, SOCIAL MEDIA, SEARCH ENGINE MARKETING, INQUIRY MARKETING, INTERNET MARKETING, MOBILE MARKETING, BLOGGING AND OTHER FORMS OF PASSIVE, SHARABLE OR VIRAL COMMUNICATIONS CHANNELS; CONSULTING SERVICES IN THE FIELD OF INTERNET MARKETING; PAY PER CLICK (PPC) ADVERTISING MANAGEMENT SERVICES, IN CLASS 35 (U.S. CLS. 100, 101 AND 102).

FIRST USE 10-21-2008; IN COMMERCE 10-21-2008.

FOR: COMPUTER SERVICES, NAMELY, SEARCH ENGINE OPTIMIZATION; CONSULTING SERVICES IN THE FIELD OF SEARCH ENGINE OPTIMIZATION; CREATING AND MAINTAINING BLOGS FOR OTHERS; PROVIDING CUSTOMIZED ON-LINE WEB PAGES AND DATA FEEDS FEATURING USER-DEFINED INFORMATION, WHICH INCLUDES BLOG POSTS, NEW MEDIA CONTENT, OTHER ON-LINE CONTENT, AND ON-LINE WEB LINKS TO OTHER WEBSITES, IN CLASS 42 (U.S. CLS. 100 AND 101).

FIRST USE 10-21-2008; IN COMMERCE 10-21-2008.

NO CLAIM IS MADE TO THE EXCLUSIVE RIGHT TO USE "WINDY CITY STRATEGIES", APART FROM THE MARK AS SHOWN.

THE COLOR(S) BLUE, BLACK, WHITE AND GREY IS/ARE CLAIMED AS A FEATURE OF THE MARK.

THE MARK CONSISTS OF THE BLACK WORDING "WINDY CITY STRATEGIES" IN ALL CAPITAL LETTERING WITH A GRAY CIRCULAR LOGO TO THE LEFT OF THE WORDING THAT DEPICTS THE SKYSCRAPER SKYLINE OF THE CITY OF CHICAGO WITH THE BUILDINGS IN BLACK FADING TO BLUE AS THE BUILDINGS ASCEND AGAINST A BACKGROUND OF BLUE FADING TO WHITE AS IT ASCENDS.

SER. NO. 85-421,239, FILED 9-13-2011.



David J. Kyjars

Director of the United States Patent and Trademark Office

Reg. No. 4,153,289 RAMONA ORTIGA, EXAMINING ATTORNEY

United States of America

United States Patent and Trademark Office



Reg. No. 4,153,290

Registered June 5, 2012

Int. Cl.: 41

SERVICE MARK

PRINCIPAL REGISTER

NEW YORK CHIROPRACTIC COLLEGE (NEW YORK NON-PROFIT CORPORATION)
2360 STATE ROUTE 89
SENECA FALLS, NY 131480800

FOR: EDUCATIONAL SERVICES, NAMELY, DEVELOPING, ARRANGING, AND CONDUCTING EDUCATIONAL CONFERENCES AND PROGRAMS AND PROVIDING COURSES OF INSTRUCTION IN THE FIELD OF CHIROPRACTIC EDUCATION, ACUPUNCTURE, ORIENTAL MEDICINE, APPLIED CLINICAL NUTRITION AND HUMAN ANATOMY AND PHYSIOLOGY INSTRUCTION.; PROVIDING COURSES OF INSTRUCTION AT THE COLLEGE LEVEL, IN CLASS 41 (U.S. CLS. 100, 101 AND 107).

FIRST USE 12-31-2001; IN COMMERCE 12-31-2001.

NO CLAIM IS MADE TO THE EXCLUSIVE RIGHT TO USE "NEW YORK CHIROPRACTIC COLLEGE", "SCIENCE", "ART", "PHILOSOPHY", AND "FOUNDED 1919", APART FROM THE MARK AS SHOWN.

THE MARK CONSISTS OF A CIRCULAR SEAL WITH THE WORDS "NEW YORK CHIROPRACTIC COLLEGE" IN THE TOP AND "FOUNDED 1919" IN THE BOTTOM WITH THE WORDS "VIRTUS ANIMUSQUE" IN A BANNER BELOW THREE IMAGES CONSISTING OF THREE BOOKS STACKED ON TOP OF EACH OTHER READING "SCIENCE", "ART" AND "PHILOSOPHY" ABOVE TWO HANDS HOLDING A LAMP WITH A FLAME AND RAYS OF LIGHT EMANATING FROM IT BELOW AN IMAGE OF A QUILL PAN IN AN INKWELL AND AN UNROLLED SCROLLED DOCUMENT.

SER. NO. 85-421,271, FILED 9-13-2011.

SHARON MEIER, EXAMINING ATTORNEY



David J. Kyjars

Director of the United States Patent and Trademark Office

United States of America

United States Patent and Trademark Office

CLASSIC ANIMAL NUTRITION

Reg. No. 4,153,291

GAK ENTERPRISES, INC. (NEVADA CORPORATION)
3225 MCLEOD DRIVE
LAS VEGAS, NV 89121

Registered June 5, 2012

Int. Cl.: 31

FOR: PET FOOD, IN CLASS 31 (U.S. CLS. 1 AND 46).

TRADEMARK

FIRST USE 12-30-2010; IN COMMERCE 12-30-2010.

PRINCIPAL REGISTER

THE MARK CONSISTS OF STANDARD CHARACTERS WITHOUT CLAIM TO ANY PARTICULAR FONT, STYLE, SIZE, OR COLOR.

NO CLAIM IS MADE TO THE EXCLUSIVE RIGHT TO USE "ANIMAL NUTRITION", APART FROM THE MARK AS SHOWN.

SER. NO. 85-421,279, FILED 9-13-2011.

ANNE MADDEN, EXAMINING ATTORNEY



David J. Kyffers

Director of the United States Patent and Trademark Office

United States of America

United States Patent and Trademark Office

RIZZUTO FOODS

Reg. No. 4,153,292

T.R. RIZZUTO PIZZA CRUST, INC. (WASHINGTON CORPORATION)
3420 EAST RIVERSIDE
SPOKANE, WA 99202

Registered June 5, 2012

Int. Cl.: 30

FOR: STAPLE FOODS, NAMELY, PIZZA CRUST, PIZZA DOUGH AND KITS COMPRISED OF INGREDIENTS FOR PREPARING PIZZA, IN CLASS 30 (U.S. CL. 46).

TRADEMARK

FIRST USE 8-30-2006; IN COMMERCE 8-30-2006.

PRINCIPAL REGISTER

THE MARK CONSISTS OF STANDARD CHARACTERS WITHOUT CLAIM TO ANY PARTICULAR FONT, STYLE, SIZE, OR COLOR.

NO CLAIM IS MADE TO THE EXCLUSIVE RIGHT TO USE "FOODS", APART FROM THE MARK AS SHOWN.

SEC. 2(F).

SER. NO. 85-421,313, FILED 9-13-2011.

RICHARD WHITE, EXAMINING ATTORNEY



David J. Kybas

Director of the United States Patent and Trademark Office

United States of America

United States Patent and Trademark Office



Reg. No. 4,153,293

Registered June 5, 2012

Int. Cl.: 25

TRADEMARK

PRINCIPAL REGISTER

KAPLAN, JEFFREY (UNITED STATES INDIVIDUAL)
POB 11106
FORT LAUDERDALE, FL 33339

FOR: T-SHIRTS, IN CLASS 25 (U.S. CLS. 22 AND 39).

FIRST USE 6-1-2011; IN COMMERCE 6-1-2011.

OWNER OF U.S. REG. NO. 4,062,133.

THE COLOR(S) WHITE, RED, LIGHT BROWN, REDDISH BROWN AND DARK BROWN IS/ARE CLAIMED AS A FEATURE OF THE MARK.

THE MARK CONSISTS OF THE WORDS "IT'S HERE!" IN WHITE LETTERS ON A RED BANNER ALONG WITH THE WORDS "THE ORIGINAL CHIPWICH CHOCOLATE CHIP COOKIE ICE CREAM SANDWICH" IN DARK BROWN LETTERS ALONG WITH AN IMAGE OF A PARTIALLY EATEN ICE CREAM COOKIE SANDWICH WITH CHOCOLATE CHIPS WITH THE COLORS OF WHITE, LIGHT BROWN AND DARK BROWN ALL PLACED ON A CIRCULAR BACKGROUND WITH REDDISH BROWN TONES.

SER. NO. 85-421,384, FILED 9-13-2011.

ERNEST SHOSHO, EXAMINING ATTORNEY



David J. Kypos

Director of the United States Patent and Trademark Office

United States of America

United States Patent and Trademark Office



Reg. No. 4,153,294

Registered June 5, 2012

Int. Cls.: 35 and 45

SERVICE MARK

PRINCIPAL REGISTER

EFMLA, INC. (VIRGINIA CORPORATION)
7406 ALBAN STATION CT.
SPRINGFIELD, VA 22150

FOR: EMPLOYEE ADMINISTRATION SERVICES, IN CLASS 35 (U.S. CLS. 100, 101 AND 102).

FIRST USE 8-18-2011, THE MARK WAS FIRST USED ANYWHERE IN A DIFFERENT FORM OTHER THAN THAT SOUGHT TO BE REGISTERED AT LEAST AS EARLY AS 08/18/2011; IN COMMERCE 8-18-2011, THE MARK WAS FIRST USED IN COMMERCE IN A DIFFERENT FORM OTHER THAN THAT SOUGHT TO BE REGISTERED AT LEAST AS EARLY AS 08/18/2011.

FOR: PROVIDING INFORMATION IN THE FIELD OF WORKPLACE LAW, LEGAL PRACTICES AND LEGAL POLICIES VIA THE INTERNET, IN CLASS 45 (U.S. CLS. 100 AND 101).

FIRST USE 8-18-2011, THE MARK WAS FIRST USED ANYWHERE IN A DIFFERENT FORM OTHER THAN THAT SOUGHT TO BE REGISTERED AT LEAST AS EARLY AS 08/18/2011; IN COMMERCE 8-18-2011, THE MARK WAS FIRST USED IN COMMERCE IN A DIFFERENT FORM OTHER THAN THAT SOUGHT TO BE REGISTERED AT LEAST AS EARLY AS 08/18/2011.

OWNER OF U.S. REG. NO. 4,051,098.

NO CLAIM IS MADE TO THE EXCLUSIVE RIGHT TO USE "E FMLA", APART FROM THE MARK AS SHOWN.

THE STIPPLING IS FOR SHADING PURPOSES ONLY.

THE MARK CONSISTS OF THE LETTER E MADE OF ARROWS WITHIN A SHADED CIRCLE NEXT TO THE LETTERS "FMLA". THE REMAINING WHITE BACKGROUND DOES NOT FORM ANY PART OF THE MARK.

SER. NO. 85-421,473, FILED 9-13-2011.

NORA BUCHANAN WILL, EXAMINING ATTORNEY



David J. Kyros

Director of the United States Patent and Trademark Office

United States of America

United States Patent and Trademark Office



Reg. No. 4,153,295

Registered June 5, 2012

Int. Cl.: 41

SERVICE MARK

PRINCIPAL REGISTER

BARKADA CREATIVE, LLC (ILLINOIS LIMITED LIABILITY COMPANY)
6549 N. ASHLAND, #2S
CHICAGO, IL 60626

FOR: EDUCATIONAL SERVICES, NAMELY, PROVIDING WORKSHOPS AND SEMINARS
IN THE FIELD OF MARKETING AND PUBLIC RELATIONS, IN CLASS 41 (U.S. CLS. 100,
101 AND 107).

FIRST USE 8-1-2011; IN COMMERCE 8-1-2011.

THE MARK CONSISTS OF THE WORDING "BARKA'DA CIRCLE" BISECTED BY A DESIGN
OF A CIRCLE. THE BORDER OF THE CIRCLE IS IRREGULAR LIKE A PAINT BRUSH
STROKE THAT IS BROKEN IN PARTS.

THE ENGLISH TRANSLATION OF "BARKADA" IN THE MARK IS "GROUP OF CLOSE
FRIENDS".

SER. NO. 85-421,504, FILED 9-13-2011.

CORY BOONE, EXAMINING ATTORNEY



David J. Kyffers

Director of the United States Patent and Trademark Office

United States of America

United States Patent and Trademark Office



Reg. No. 4,153,296

KOA PUNA MOTORCYCLE CLUB (HAWAII UNINCORPORATED ASSOCIATION)
91-455 EWA BEACH ROAD
EWA BEACH, HI 96706

Registered June 5, 2012

Int. Cl.: 35

FOR: CLUB SERVICES, NAMELY, PROMOTING THE INTERESTS OF MOTORCYCLE ENTHUSIASM AND FELLOWSHIP, IN CLASS 35 (U.S. CLS. 100, 101 AND 102).

SERVICE MARK

FIRST USE 12-31-1979; IN COMMERCE 12-31-1979.

PRINCIPAL REGISTER

NO CLAIM IS MADE TO THE EXCLUSIVE RIGHT TO USE "PUNA", APART FROM THE MARK AS SHOWN.

THE MARK CONSISTS OF TWO CONCENTRIC CIRCLES WITH LINES EMANATING FROM THE CENTER TO THE INSIDE CIRCLE IN THE NATURE OF SPOKES, AN "X" CONSISTING OF CROSS SPEARS AND BANNERS AT THE TOP AND BOTTOM WITH "KOA" IN THE TOP BANNER AND "PUNA" IN THE BOTTOM BANNER.

THE ENGLISH TRANSLATION OF "KOA" IN THE MARK IS WARRIOR.

SER. NO. 85-421,540, FILED 9-13-2011.

MARTHA SANTOMARTINO, EXAMINING ATTORNEY



David J. Kybas

Director of the United States Patent and Trademark Office

United States of America

United States Patent and Trademark Office

KOA PUNA

Reg. No. 4,153,297

KOA PUNA MOTORCYCLE CLUB (HAWAII UNINCORPORATED ASSOCIATION)
91-455 EWA BEACH ROAD
EWA BEACH, HI 96706

Registered June 5, 2012

Int. Cls.: 25 and 35

FOR: HATS; T-SHIRTS, IN CLASS 25 (U.S. CLS. 22 AND 39).

TRADEMARK

FIRST USE 12-31-1992; IN COMMERCE 12-31-1992.

SERVICE MARK

FOR: CLUB SERVICES, NAMELY, PROMOTING THE INTERESTS OF MOTORCYCLE ENTHUSIASM AND FELLOWSHIP, IN CLASS 35 (U.S. CLS. 100, 101 AND 102).

PRINCIPAL REGISTER

FIRST USE 12-31-1979; IN COMMERCE 12-31-1979.

THE MARK CONSISTS OF STANDARD CHARACTERS WITHOUT CLAIM TO ANY PARTICULAR FONT, STYLE, SIZE, OR COLOR.

NO CLAIM IS MADE TO THE EXCLUSIVE RIGHT TO USE "PUNA", APART FROM THE MARK AS SHOWN.

THE ENGLISH TRANSLATION OF "KOA" IN THE MARK IS WARRIOR.

SER. NO. 85-421,546, FILED 9-13-2011.

MARTHA SANTOMARTINO, EXAMINING ATTORNEY



David J. Kyros

Director of the United States Patent and Trademark Office

United States of America

United States Patent and Trademark Office

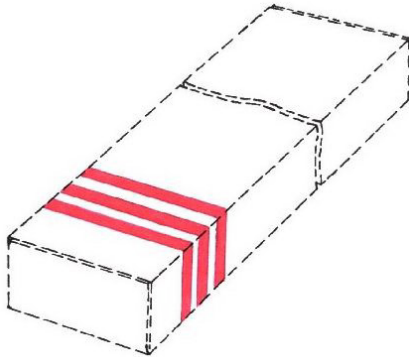

Reg. No. 4,153,298

Registered June 5, 2012

Int. Cl.: 6

TRADEMARK

PRINCIPAL REGISTER

CONTINUOUS COATING CORP. (CALIFORNIA CORPORATION)
520 W. GROVE AVENUE
ORANGE, CA 92865

FOR: BUILDING MATERIAL, NAMELY, DRYWALL TRIM AND CORNER BEADS FOR USE WITH DRYWALL, MADE PRIMARILY OF METAL, IN CLASS 6 (U.S. CLS. 2, 12, 13, 14, 23, 25 AND 50).

FIRST USE 0-0-1969; IN COMMERCE 0-0-1969.

OWNER OF U.S. REG. NOS. 2,996,176, 3,921,518 AND OTHERS.

THE COLOR(S) RED IS/ARE CLAIMED AS A FEATURE OF THE MARK.

THE MARK CONSISTS OF THREE PARALLEL TRANSVERSE RED STRIPES APPLIED ADJACENT TO ONE END OF THE ELONGATED PACKAGING FOR THE GOODS. THE DOTTED LINES ARE INTENDED TO SHOW THE POSITION OF THE MARK AND ARE NOT PART OF THE MARK AS SHOWN.

SEC. 2(F).

SER. NO. 85-421,771, FILED 9-13-2011.

WILLIAM VERHOSEK, EXAMINING ATTORNEY



David J. Kyros

Director of the United States Patent and Trademark Office

United States of America

United States Patent and Trademark Office

... different by design!

Reg. No. 4,153,299

Registered June 5, 2012

Int. Cl.: 42

SERVICE MARK

PRINCIPAL REGISTER

GREENBAUM, KENNETH S (UNITED STATES INDIVIDUAL)
PO BOX 280
BELLEVUE, WA 98009

FOR: COLOR ANALYSIS FOR PURPOSES OF INTERIOR DESIGN; DESIGN OF INTERIOR DECOR; DESIGN OF SPECIALTY INTERIOR AND EXTERIOR ENVIRONMENT SETTINGS; FURNITURE DESIGN SERVICES; INTERIOR DECORATING; INTERIOR DECORATION CONSULTATION; INTERIOR DESIGN SERVICES; INTERIOR DESIGN SERVICES, NAMELY, FURNITURE SELECTION; INTERIOR STYLING SERVICES, IN CLASS 42 (U.S. CLS. 100 AND 101).

FIRST USE 6-1-1986; IN COMMERCE 6-1-1986.

THE MARK CONSISTS OF THE WORDING "DIFFERENT BY DESIGN!" IN A STYLIZED FONT.

SER. NO. 85-421,865, FILED 9-13-2011.

AHSEN KHAN, EXAMINING ATTORNEY



David J. Kybas

Director of the United States Patent and Trademark Office

United States of America

United States Patent and Trademark Office

Grassroots Powdersurfing

Reg. No. 4,153,300

JENSEN, JEREMY LEVI (UNITED STATES INDIVIDUAL), DBA JEREMY JENSEN MEDIA
32 N 400 E

Registered June 5, 2012

LOGAN, UT 84321

Int. Cl.: 28

FOR: SNOWBOARD DECKS, IN CLASS 28 (U.S. CLS. 22, 23, 38 AND 50).

TRADEMARK

FIRST USE 0-0-2007; IN COMMERCE 0-0-2009.

PRINCIPAL REGISTER

THE MARK CONSISTS OF STANDARD CHARACTERS WITHOUT CLAIM TO ANY PARTICULAR FONT, STYLE, SIZE, OR COLOR.

NO CLAIM IS MADE TO THE EXCLUSIVE RIGHT TO USE "POWDERSURFING", APART FROM THE MARK AS SHOWN.

SER. NO. 85-421,988, FILED 9-14-2011.

SKYE YOUNG, EXAMINING ATTORNEY

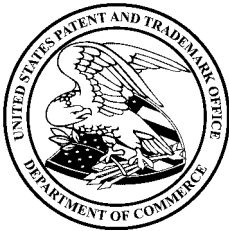

David J. Kybas

Director of the United States Patent and Trademark Office

United States of America

United States Patent and Trademark Office



Reg. No. 4,153,301

MMM HOLDINGS, INC. (PUERTO RICO CORPORATION)
350 CHARDON, SUITE 500
SAN JUAN, PUERTO RICO 009182101

Registered June 5, 2012

Int. Cl.: 41

FOR: EDUCATIONAL SERVICES, NAMELY, CONDUCTING SEMINARS, CONFERENCES, PANELS, EXHIBITIONS AND TRAININGS IN THE FIELD OF HEALTH AND DISTRIBUTION OF COURSE MATERIAL IN CONNECTION THEREWITH, IN CLASS 41 (U.S. CLS. 100, 101 AND 107).

SERVICE MARK

PRINCIPAL REGISTER

FIRST USE 8-19-2011; IN COMMERCE 8-19-2011.

NO CLAIM IS MADE TO THE EXCLUSIVE RIGHT TO USE "PR EHEALTH" AND "EXPO", APART FROM THE MARK AS SHOWN.

THE COLOR(S) LIGHT BLUE, MEDIUM BLUE, DARK BLUE AND BLACK IS/ARE CLAIMED AS A FEATURE OF THE MARK.

THE MARK CONSISTS OF THE WORDS "PR EHEALTH" IN BLACK. UNDER THE WORDS "PR EHEALTH" ARE THE WORDS "CONNECTIVITY EXPO" ALSO IN BLACK. ALL WORDS ARE SURROUNDED WITH THREE STROKE OF PAINT IN COLORS LIGHT BLUE, MEDIUM BLUE AND DARK BLUE; THERE ARE WIDER FROM THE LEFT SIDE UNTIL JOIN IN A THIN DARK BLUE LINE AND FINISHED WITH THREE FINE STROKE OF PAINT.

SER. NO. 85-422,110, FILED 9-14-2011.

SHAUNIA CARLYLE, EXAMINING ATTORNEY



David J. Kyros

Director of the United States Patent and Trademark Office

United States of America

United States Patent and Trademark Office

ROSIE'S THEATER KIDS

Reg. No. 4,153,302

KID RO PRODUCTIONS, INC. (CALIFORNIA CORPORATION)
1500 BROADWAY SUITE 1710
NEW YORK, NY 10036

Registered June 5, 2012

Int. Cl.: 41

FOR: EDUCATION SERVICES, NAMELY, PROVIDING EDUCATIONAL CLASSES FOR CHILDREN WHO MIGHT OTHERWISE NOT HAVE THE OPPORTUNITY IN THE FIELD OF THE ARTS, INCLUDING DANCE, MUSIC, AND THEATER, IN CLASS 41 (U.S. CLS. 100, 101 AND 107).

SERVICE MARK

PRINCIPAL REGISTER

FIRST USE 9-17-2010; IN COMMERCE 9-17-2010.

THE MARK CONSISTS OF STANDARD CHARACTERS WITHOUT CLAIM TO ANY PARTICULAR FONT, STYLE, SIZE, OR COLOR.

OWNER OF U.S. REG. NOS. 2,647,258, 3,843,046 AND OTHERS.

NO CLAIM IS MADE TO THE EXCLUSIVE RIGHT TO USE "THEATER KIDS", APART FROM THE MARK AS SHOWN.

THE NAME(S), PORTRAIT(S), AND/OR SIGNATURE(S) SHOWN IN THE MARK IDENTIFIES ROSIE O'DONNELL, WHOSE CONSENT(S) TO REGISTER IS MADE OF RECORD.

SER. NO. 85-422,133, FILED 9-14-2011.

LINDA ESTRADA, EXAMINING ATTORNEY



David J. Kybas

Director of the United States Patent and Trademark Office

United States of America

United States Patent and Trademark Office

PUBLISHERALLEY

Reg. No. 4,153,303

Registered June 5, 2012

Int. Cl.: 42

SERVICE MARK

PRINCIPAL REGISTER

YANKEE BOOK PEDDLER, INC. (NEW HAMPSHIRE CORPORATION)
999 MAPLE STREET
CONTOOCOOK, NH 03229

FOR: PROVIDING TEMPORARY USE OF ON-LINE NON-DOWNLOADABLE SOFTWARE FOR TRACKING AND ANALYSIS OF BOOK SALES AND GENERATION OF SALES REPORTS, IN CLASS 42 (U.S. CLS. 100 AND 101).

FIRST USE 6-25-2004; IN COMMERCE 6-25-2004.

THE MARK CONSISTS OF STANDARD CHARACTERS WITHOUT CLAIM TO ANY PARTICULAR FONT, STYLE, SIZE, OR COLOR.

OWNER OF U.S. REG. NO. 2,993,944.

SER. NO. 85-422,142, FILED 9-14-2011.

LINDA ESTRADA, EXAMINING ATTORNEY



David J. Kyffers

Director of the United States Patent and Trademark Office

United States of America

United States Patent and Trademark Office

Parts People

Reg. No. 4,153,304

Registered June 5, 2012

Int. Cl.: 9

TRADEMARK

PRINCIPAL REGISTER

PARTS-PEOPLE.COM, INC. (TEXAS CORPORATION)
SUITE 101
2929 LONGHORN BLVD.
AUSTIN, TX 78758

FOR: COMPUTER HARDWARE AND PERIPHERALS, IN CLASS 9 (U.S. CLS. 21, 23, 26, 36 AND 38).

FIRST USE 5-8-2002; IN COMMERCE 5-8-2002.

THE MARK CONSISTS OF STANDARD CHARACTERS WITHOUT CLAIM TO ANY PARTICULAR FONT, STYLE, SIZE, OR COLOR.

NO CLAIM IS MADE TO THE EXCLUSIVE RIGHT TO USE "PARTS", APART FROM THE MARK AS SHOWN.

SER. NO. 85-422,282, FILED 9-14-2011.

LEIGH LOWRY, EXAMINING ATTORNEY



David J. Kyffers

Director of the United States Patent and Trademark Office

United States of America

United States Patent and Trademark Office



Reg. No. 4,153,305

BUILDING BETTER SOLUTIONS GROUP, INC (NEW YORK CORPORATION)
2 TURNBERRY CT
MONROE, NY 10950

Registered June 5, 2012

Int. Cl.: 16

FOR: PLASTIC BAGS FOR PACKING, IN CLASS 16 (U.S. CLS. 2, 5, 22, 23, 29, 37, 38 AND 50).

TRADEMARK

FIRST USE 12-1-2000; IN COMMERCE 12-1-2000.

PRINCIPAL REGISTER

NO CLAIM IS MADE TO THE EXCLUSIVE RIGHT TO USE "PILL BAG", APART FROM THE MARK AS SHOWN.

THE COLOR(S) RED, BLACK, GREY AND WHITE IS/ARE CLAIMED AS A FEATURE OF THE MARK.

THE MARK CONSISTS OF TEN CHARACTER LOGO SPELLING "THEPILLBAG". NINE CHARACTERS ARE RED WITH A BLACK HIGHLIGHT. ONE CHARACTER "I" IS BLACK AND GREY IN THE FORM OF A CAPSULE WITH A WHITE PILL AS A DOT ABOUT THE "I". THREE PILLS AND TWO CAPSULES BELOW THE TEXT.

SER. NO. 85-422,350, FILED 9-14-2011.

DAVID TAYLOR, EXAMINING ATTORNEY



David J. Kyffers

Director of the United States Patent and Trademark Office

United States of America

United States Patent and Trademark Office

SOUTH KENT SCHOOL

Reg. No. 4,153,306

Registered June 5, 2012

Int. Cl.: 41

SERVICE MARK

PRINCIPAL REGISTER

THE SOUTH KENT SCHOOL CORPORATION (CONNECTICUT CORPORATION)
40 BULLS BRIDGE ROAD
SOUTH KENT, CT 06785

FOR: EDUCATIONAL SERVICES, NAMELY, PROVIDING COURSES OF INSTRUCTION AT THE HIGH SCHOOL LEVEL; ENTERTAINMENT IN THE NATURE OF COMPETITIONS IN THE FIELD OF HIGH SCHOOL ATHLETICS, IN CLASS 41 (U.S. CLS. 100, 101 AND 107).

FIRST USE 0-0-1923; IN COMMERCE 0-0-1923.

THE MARK CONSISTS OF STANDARD CHARACTERS WITHOUT CLAIM TO ANY PARTICULAR FONT, STYLE, SIZE, OR COLOR.

NO CLAIM IS MADE TO THE EXCLUSIVE RIGHT TO USE "SCHOOL", APART FROM THE MARK AS SHOWN.

SEC. 2(F).

SER. NO. 85-422,380, FILED 9-14-2011.

JANET LEE, EXAMINING ATTORNEY



David J. Kyros

Director of the United States Patent and Trademark Office

United States of America

United States Patent and Trademark Office



Reg. No. 4,153,307

Registered June 5, 2012

Int. Cl.: 39

SERVICE MARK

PRINCIPAL REGISTER

BACARELLA TRANSPORTATION SERVICES, INC. (CONNECTICUT CORPORATION)
375 BRIDGEPORT AVENUE
SHELTON, CT 06484

FOR: EXPRESS DELIVERY OF GOODS BY LAND AND/OR AIR; TRANSPORT AND DELIVERY OF GOODS; TRANSPORTATION AND DELIVERY SERVICES BY AIR, ROAD, RAIL AND SEA , IN CLASS 39 (U.S. CLS. 100 AND 105).

FIRST USE 9-1-2011; IN COMMERCE 9-1-2011.

OWNER OF U.S. REG. NOS. 2,839,754, 3,404,965, AND 3,404,969.

THE COLOR(S) RED, BLACK, AND WHITE IS/ARE CLAIMED AS A FEATURE OF THE MARK.

NO CLAIM IS MADE TO THE EXCLUSIVE RIGHT TO USE "GLOBAL LOGISTICS", APART FROM THE MARK AS SHOWN.

THE MARK CONSISTS OF TWO LARGE INCOMPLETE OVALS, ONE DIRECTLY WITHIN THE SECOND OVAL WITH NO SPACE BETWEEN THEM, THE OUTSIDE OVAL BEING COMPLETELY SHADED IN RED AND THE INSIDE OVAL BEING COMPLETELY SHADED IN BLACK. CENTERED WITHIN THE OVALS, THE TEXT "BTX" IN BLACK LETTERS AND LARGE, BOLD FONT IS DIRECTLY ABOVE AN OBLONG HORIZONTAL OVAL COMPLETELY SHADED IN WITH RED AND THE WORDS "GLOBAL LOGISTICS" WITHIN THE OVAL IN WHITE LETTERS AND REGULAR FONT. DIRECTLY BENEATH THE OBLONG OVAL IS THE TEXT "WWW.BTXAIR.COM" IN BLACK LETTERS AND REGULAR FONT.

SER. NO. 85-422,579, FILED 9-14-2011.

LAURIE MAYES, EXAMINING ATTORNEY



David J. Kyffers

Director of the United States Patent and Trademark Office

United States of America

United States Patent and Trademark Office



Reg. No. 4,153,308

Registered June 5, 2012

Int. Cl.: 36

SERVICE MARK

PRINCIPAL REGISTER

JHL CAPITAL GROUP LLC (DELAWARE LIMITED LIABILITY COMPANY)
SUITE 1340
900 N. MICHIGAN AVE.
CHICAGO, IL 60611

FOR: FINANCIAL SERVICES, NAMELY, OPERATION AND MANAGEMENT OF HEDGE FUNDS, COMMODITY POOLS AND OTHER COLLECTIVE INVESTMENT VEHICLES, AND TRADING FOR OTHERS OF SECURITIES, OPTIONS, FUTURES, DERIVATIVES, DEBT INSTRUMENTS AND COMMODITIES, IN CLASS 36 (U.S. CLS. 100, 101 AND 102).

FIRST USE 8-1-2006; IN COMMERCE 8-1-2006.

THE MARK CONSISTS OF A SQUARE WITH THE LETTERS "JHL" LOCATED IN THE CENTER OF THE SQUARE.

SER. NO. 85-422,623, FILED 9-14-2011.

TOBY BULLOFF, EXAMINING ATTORNEY



David J. Kyffers

Director of the United States Patent and Trademark Office

United States of America

United States Patent and Trademark Office



Reg. No. 4,153,309

Registered June 5, 2012

Int. Cl.: 36

SERVICE MARK

PRINCIPAL REGISTER

TRI-STATE CONSUMER INSURANCE COMPANY (NEW YORK CORPORATION), DBA
TSC DIRECT
575 JERICHO TURNPIKE
JERICHO, NY 11753

FOR: INSURANCE BROKERAGE AND INSURANCE UNDERWRITING IN THE FIELD OF
AUTOMOBILE, HOMEOWNERS AND RENTERS INSURANCE, IN CLASS 36 (U.S. CLS.
100, 101 AND 102).

FIRST USE 11-0-1995; IN COMMERCE 11-0-1995.

THE MARK CONSISTS OF AN AUTOMOBILE STEERING WHEEL STYLIZED AS AN APPLE
IN THE COLOR RED WITH TWO LEAVES GROWING FROM THE STEM IN THE COLOR
GREEN.

THE COLOR(S) RED AND GREEN IS/ARE CLAIMED AS A FEATURE OF THE MARK.

SER. NO. 85-422,709, FILED 9-14-2011.

B. PARADEWELAI, EXAMINING ATTORNEY



David J. Kyffers

Director of the United States Patent and Trademark Office

United States of America

United States Patent and Trademark Office



Reg. No. 4,153,310

Registered June 5, 2012

Int. Cl.: 41

SERVICE MARK

PRINCIPAL REGISTER

K1 SPEED, INC. (DELAWARE CORPORATION)
17221 VON KARMAN AVE.
IRVINE, CA 92614

FOR: PROVIDING FACILITIES FOR RECREATIONAL ACTIVITIES, NAMELY, GO KART RACING, IN CLASS 41 (U.S. CLS. 100, 101 AND 107).

FIRST USE 12-31-2003; IN COMMERCE 7-31-2004.

THE MARK CONSISTS OF "K1" IN RED OVER "SPEED" IN YELLOW, BOTH INSIDE OF A SPEEDOMETER ICON FORMED FROM BLACK AND RED OVALS AND WHITE MARKS AND AN OVAL GRAY BACKGROUND.

THE COLOR(S) RED, BLACK, GRAY, WHITE, AND YELLOW IS/ARE CLAIMED AS A FEATURE OF THE MARK.

SER. NO. 85-422,731, FILED 9-14-2011.

ZACHARY BELLO, EXAMINING ATTORNEY



David J. Kyffers

Director of the United States Patent and Trademark Office

United States of America

United States Patent and Trademark Office

North

Reg. No. 4,153,311

Registered June 5, 2012

Int. Cl.: 33

TRADEMARK

PRINCIPAL REGISTER

ALBAN VINEYARDS, INC. (CALIFORNIA CORPORATION)
8575 ORCUTT ROAD
ARROYO GRANDE, CA 93420

FOR: RED WINE; WHITE WINE, IN CLASS 33 (U.S. CLS. 47 AND 49).

FIRST USE 9-13-2011; IN COMMERCE 9-13-2011.

THE MARK CONSISTS OF STANDARD CHARACTERS WITHOUT CLAIM TO ANY PARTICULAR FONT, STYLE, SIZE, OR COLOR.

SER. NO. 85-422,840, FILED 9-14-2011.

KATHERINE E. HALMEN, EXAMINING ATTORNEY



David J. Kybas

Director of the United States Patent and Trademark Office

United States of America

United States Patent and Trademark Office



Reg. No. 4,153,312

Registered June 5, 2012

Int. Cl.: 41

SERVICE MARK

PRINCIPAL REGISTER

GOOD SPORT PLUS LTD. (CALIFORNIA CORPORATION)
413 N. OAK STREET
INGLEWOOD, CA 90302

FOR: EDUCATION SERVICES, NAMELY, PROVIDING YOUTH AFTER-SCHOOL ENRICHMENT IN THE FORM OF CLASSES IN THE ARTS, HOMEWORK HELP, ATHLETIC PROGRAMS, AND OUTDOOR EDUCATION ACTIVITIES, NAMELY, ROCK CLIMBING, RAPELLING, HIGH ROPES COURSES, LOW ROPES COURSES, MOUNTAIN BIKING, KAYAKING, CAMPING, BACKPACKING, SURFING, SNORKELING, HIKING, CANYON-EERING, AND WHITEWATER RAFTING, IN CLASS 41 (U.S. CLS. 100, 101 AND 107).

FIRST USE 1-3-2012; IN COMMERCE 1-3-2012.

THE MARK CONSISTS OF THE WORD "ARC" AND A PARTIAL CIRCLE.

SER. NO. 85-422,889, FILED 9-14-2011.

NATALIE POLZER, EXAMINING ATTORNEY



David J. Kyffers

Director of the United States Patent and Trademark Office

United States of America

United States Patent and Trademark Office

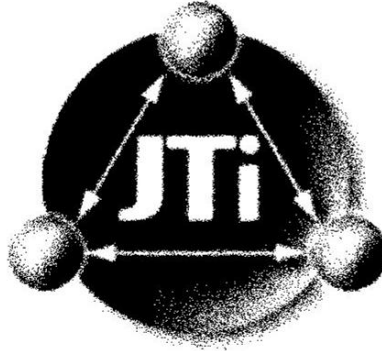

Reg. No. 4,153,313

Registered June 5, 2012

Int. Cl.: 42

SERVICE MARK

PRINCIPAL REGISTER

JOHNSTEK, INC. (FLORIDA CORPORATION)
16171 SW 49 CT
MIRAMAR, FL 33027

FOR: STRATEGIC TECHNOLOGY ENGINEERING, PLANNING, DESIGN AND MANAGEMENT OF INFORMATION TECHNOLOGY SYSTEMS, IN CLASS 42 (U.S. CLS. 100 AND 101).

FIRST USE 5-15-2003; IN COMMERCE 5-15-2003.

THE STIPLING IS FOR SHADING PURPOSES ONLY.

THE MARK CONSISTS OF A LARGE ROUND OBJECT THAT APPEARS AS A GLOBE, WITH THREE SMALLER ROUND ITEMS THAT FORM A TRIANGLE BY THEIR PLACEMENT ON THE TOP AND TWO SIDES OF THE LARGER ROUND OBJECT. THE SMALLER ROUND OBJECTS ARE CONNECTED BY LINES WITH ARROWS ON BOTH ENDS. THE LETTERS "JTI" APPEARS CENTERED IN THE MIDDLE OF THE TRIANGLE.

SER. NO. 85-423,063, FILED 9-14-2011.

ANNE FARRELL, EXAMINING ATTORNEY



David J. Kyros

Director of the United States Patent and Trademark Office

United States of America

United States Patent and Trademark Office

OPTIMA WAXPLUS

Reg. No. 4,153,314

Registered June 5, 2012

Int. Cl.: 9

TRADEMARK

PRINCIPAL REGISTER

MACHEREY-NAGEL & CO. HANDELSGESELLSCHAFT (FED REP GERMANY CORPORATION), DBA MACHEREY-NAGEL
MOE/CZ 11-02
VALENCIENNER STRASSE 11
DUEREN, FED REP GERMANY D-52355

FOR: GAS CHROMATOGRAPHY APPARATUS, IN CLASS 9 (U.S. CLS. 21, 23, 26, 36 AND 38).

FIRST USE 4-1-2011; IN COMMERCE 5-1-2011.

THE MARK CONSISTS OF STANDARD CHARACTERS WITHOUT CLAIM TO ANY PARTICULAR FONT, STYLE, SIZE, OR COLOR.

SER. NO. 85-423,144, FILED 9-15-2011.

GRETТА YAO, EXAMINING ATTORNEY



David J. Kyffers

Director of the United States Patent and Trademark Office

United States of America

United States Patent and Trademark Office

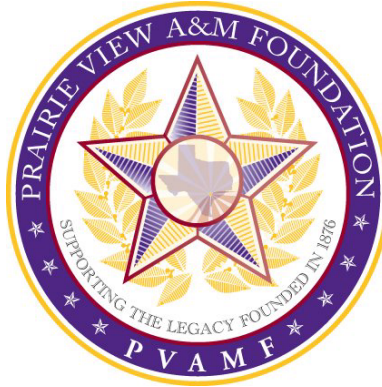

Reg. No. 4,153,315

Registered June 5, 2012

Int. Cl.: 36

SERVICE MARK

PRINCIPAL REGISTER

PRAIRIE VIEW A&M FOUNDATION (TEXAS CORPORATION)
UNIT 1218
54 RAINEY STREET
AUSTIN, TX 78701

FOR: CHARITABLE FOUNDATION SERVICES, NAMELY, CHARITABLE FUNDRAISING,
IN CLASS 36 (U.S. CLS. 100, 101 AND 102).

FIRST USE 3-23-2009; IN COMMERCE 10-31-2010.

NO CLAIM IS MADE TO THE EXCLUSIVE RIGHT TO USE "PRAIRIE VIEW" OR THE DESIGN OF THE STATE OF TEXAS OR "FOUNDATION" OR "FOUNDED IN 1876", APART FROM THE MARK AS SHOWN.

THE COLOR(S) GOLD, PURPLE, RED, BLACK AND WHITE IS/ARE CLAIMED AS A FEATURE OF THE MARK.

THE MARK CONSISTS OF A CIRCLE OUTLINED IN A GOLD RING, FOLLOWED BY A WHITE RING, THEN AN INSIDE PURPLE RING UPON WHICH SITS THE WORDS "PRAIRIE VIEW A&M FOUNDATION" IN WHITE ON THE UPPER PORTION OF THE CIRCLE. THE BOTTOM HALF OF THE PURPLE RING CONSISTS OF FOUR WHITE STARS ON THE LEFT AND FOUR WHITE STARS ON THE RIGHT WITH THE ABBREVIATION "PVAMF" IN WHITE, CENTERED IN BETWEEN THE STARS. THE PURPLE RING IS LINED ON THE INSIDE BY A RED RING. INSIDE THE RED RING IS A WHITE CIRCLE WITH A STAR IN THE CENTER. THE STAR IS OUTLINED IN RED, WITH GOLD, PURPLE AND WHITE ON THE INSIDE, HAVING A RED CIRCLE IN THE MIDDLE OF THE STAR AND A SILHOUETTE OF THE STATE OF TEXAS INSIDE THE STAR'S RED CIRCLE WITH A GOLD DOT HAVING WHITE, GOLD AND PURPLE RAYS EMANATING OUTWARDS FROM THE GOLD DOT. WHITE AND RED RAYS OF LIGHT EMANATE FROM THE SILHOUETTE OF THE STATE OF TEXAS. THE STAR SITS UPON GOLD AND WHITE LAUREL LEAVES. THE WORDS "SUPPORTING THE LEGACY FOUNDED IN 1876" IN BLACK ARE CURVED AT THE BOTTOM OF THE INNER CIRCLE BENEATH THE STAR ON A WHITE BACKGROUND.



David J. Kyros

Director of the United States Patent and Trademark Office

SER. NO. 85-423,160, FILED 9-15-2011.

NAPOLEON SHARMA, EXAMINING ATTORNEY

United States of America

United States Patent and Trademark Office

MY STARBUCKS REWARDS

Reg. No. 4,153,316

Registered June 5, 2012

Int. Cls.: 35 and 36

SERVICE MARK

PRINCIPAL REGISTER

STARBUCKS CORPORATION (WASHINGTON CORPORATION), DBA STARBUCKS COFFEE COMPANY
2401 UTAH AVENUE SOUTH
SEATTLE, WA 98134

FOR: RETAIL STORE SERVICES IN THE FIELD OF COFFEE, TEA, COCOA, PACKAGED AND PREPARED FOODS, ELECTRIC APPLIANCES, NON-ELECTRIC APPLIANCES, HOUSEWARES, KITCHENWARE, BOOKS, MUSICAL RECORDINGS, TOYS, INCLUDING TEDDY BEARS, STUFFED TOYS, PLUSH TOYS, DOLLS AND ACCESSORIES THEREFOR, AND ORNAMENTS, FEATURING A BONUS INCENTIVE PROGRAM FOR CUSTOMERS; ARRANGING AND CONDUCTING INCENTIVE AWARD PROGRAMS TO PROMOTE THE PURCHASE AND SALE OF COFFEE, TEA, COCOA, PACKAGED AND PREPARED FOODS, ELECTRIC APPLIANCES, NON-ELECTRIC APPLIANCES, HOUSEWARES, KITCHENWARE, BOOKS, MUSICAL RECORDINGS, TOYS, INCLUDING TEDDY BEARS, STUFFED TOYS, PLUSH TOYS, DOLLS AND ACCESSORIES THEREFOR, AND ORNAMENTS, IN CLASS 35 (U.S. CLS. 100, 101 AND 102).

FIRST USE 12-26-2009; IN COMMERCE 12-26-2009.

FOR: FINANCIAL SERVICES, NAMELY, DEBIT AND STORED-VALUE CARD SERVICES, IN CLASS 36 (U.S. CLS. 100, 101 AND 102).

FIRST USE 12-26-2009; IN COMMERCE 12-26-2009.

THE MARK CONSISTS OF STANDARD CHARACTERS WITHOUT CLAIM TO ANY PARTICULAR FONT, STYLE, SIZE, OR COLOR.

OWNER OF U.S. REG. NOS. 2,325,182, 3,027,528 AND OTHERS.

NO CLAIM IS MADE TO THE EXCLUSIVE RIGHT TO USE "REWARDS", APART FROM THE MARK AS SHOWN.

SER. NO. 85-423,162, FILED 9-15-2011.

ANDREA K. NADELMAN, EXAMINING ATTORNEY



David J. Kypos

Director of the United States Patent and Trademark Office

United States of America

United States Patent and Trademark Office



ESSENCE HEALING

Reg. No. 4,153,317

ESSENCE HEALING, INC. (MINNESOTA CORPORATION)
13731 JOHNSON MEMORIAL DRIVE
SHAKOPEE, MN 55379

Registered June 5, 2012

Int. Cl.: 44

FOR: HOLISTIC HEALTH SERVICES, IN CLASS 44 (U.S. CLS. 100 AND 101).

SERVICE MARK

FIRST USE 8-29-2011; IN COMMERCE 8-29-2011.

PRINCIPAL REGISTER

NO CLAIM IS MADE TO THE EXCLUSIVE RIGHT TO USE "HEALING", APART FROM THE MARK AS SHOWN.

THE COLOR(S) BLUE AND GOLD IS/ARE CLAIMED AS A FEATURE OF THE MARK.

THE MARK CONSISTS OF THE CAPITAL LETTERS "ESSENCE HEALING" WITH THE TWO CAPITAL "S" LETTERS STRETCHED ABOVE AND BELOW THE TOP AND BOTTOM MARGINS OF THE OTHER CAPITAL LETTERS. ALL CAPITAL LETTERS ARE BLUE IN COLOR. ABOVE THE SPACE BETWEEN THE "E" AND "H" IS A GOLD OUTLINE OF A BIRD'S WINGS, HEAD AND CHEST.

SER. NO. 85-423,226, FILED 9-15-2011.

MARILYN IZZI, EXAMINING ATTORNEY



David J. Kyjars

Director of the United States Patent and Trademark Office

United States of America

United States Patent and Trademark Office

vDesktop

Reg. No. 4,153,318

HORIZON TECHNOLOGY, LLC (CALIFORNIA LIMITED LIABILITY COMPANY)
1 RANCHO CIRCLE
LAKE FOREST, CA 92630

Registered June 5, 2012

Int. Cl.: 42

FOR: COMPUTER SERVICES, NAMELY, CLOUD HOSTING PROVIDER SERVICES, IN CLASS 42 (U.S. CLS. 100 AND 101).

SERVICE MARK

FIRST USE 8-15-2011; IN COMMERCE 8-15-2011.

PRINCIPAL REGISTER

THE MARK CONSISTS OF STANDARD CHARACTERS WITHOUT CLAIM TO ANY PARTICULAR FONT, STYLE, SIZE, OR COLOR.

SER. NO. 85-423,250, FILED 9-15-2011.

DAWN HAN, EXAMINING ATTORNEY



David J. Kybas

Director of the United States Patent and Trademark Office

United States of America

United States Patent and Trademark Office

Elity 70 X Ray

Reg. No. 4,153,319

Registered June 5, 2012

Int. Cl.: 10

TRADEMARK

PRINCIPAL REGISTER

AGUIAR, TOMAS (UNITED STATES INDIVIDUAL)
SUITE G
1460 NW 107 AVE.
MIAMI, FL 33172

FOR: MEDICAL X-RAY APPARATUS, IN CLASS 10 (U.S. CLS. 26, 39 AND 44).

FIRST USE 1-1-1991; IN COMMERCE 1-1-1991.

THE MARK CONSISTS OF STANDARD CHARACTERS WITHOUT CLAIM TO ANY PARTICULAR FONT, STYLE, SIZE, OR COLOR.

NO CLAIM IS MADE TO THE EXCLUSIVE RIGHT TO USE "70" OR "X RAY", APART FROM THE MARK AS SHOWN.

SER. NO. 85-423,257, FILED 9-15-2011.

DAWN HAN, EXAMINING ATTORNEY



David J. Kyffers

Director of the United States Patent and Trademark Office

United States of America

United States Patent and Trademark Office

BRIDGEVAD

Reg. No. 4,153,320

Registered June 5, 2012

Int. Cl.: 10

TRADEMARK

PRINCIPAL REGISTER

CALON CARDIO TECHNOLOGY LTD (UNITED KINGDOM LIMITED LIABILITY COMPANY)
L.SCI.INST., SWANSEA UNIV., SINGLETON PK
SWANSEA, UNITED KINGDOM SA28PP

FOR: SURGICAL AND MEDICAL APPARATUS AND INSTRUMENTS FOR USE IN CARDIAC SURGERY AND PARTS AND FITTINGS SOLD THEREWITH; CARDIAC IMPLANT DEVICES AND HEART PUMPS MADE OF ARTIFICIAL MATERIALS AND PARTS AND FITTINGS SOLD THEREWITH; CANNULAE; CATHETERS, IN CLASS 10 (U.S. CLS. 26, 39 AND 44).

THE MARK CONSISTS OF STANDARD CHARACTERS WITHOUT CLAIM TO ANY PARTICULAR FONT, STYLE, SIZE, OR COLOR.

OWNER OF UNITED KINGDOM REG. NO. 2575179, DATED 6-24-2011, EXPIRES 3-15-2021.

SER. NO. 85-423,267, FILED 9-15-2011.

REBECCA SMITH, EXAMINING ATTORNEY



David J. Kyffers

Director of the United States Patent and Trademark Office

United States of America

United States Patent and Trademark Office

CATHVAD

Reg. No. 4,153,321

Registered June 5, 2012

Int. Cl.: 10

TRADEMARK

PRINCIPAL REGISTER

CALON CARDIO TECHNOLOGY LTD (UNITED KINGDOM LIMITED LIABILITY COMPANY)
L.SCI.INST., SWANSEA UNIV., SINGLETON PK
SWANSEA, UNITED KINGDOM SA28PP

FOR: SURGICAL AND MEDICAL APPARATUS AND INSTRUMENTS FOR USE IN CARDIAC SURGERY AND PARTS AND FITTINGS SOLD THEREWITH; CARDIAC IMPLANT DEVICES AND HEART PUMPS MADE OF ARTIFICIAL MATERIALS AND PARTS AND FITTINGS SOLD THEREWITH; CANNULAE; CATHETERS, IN CLASS 10 (U.S. CLS. 26, 39 AND 44).

THE MARK CONSISTS OF STANDARD CHARACTERS WITHOUT CLAIM TO ANY PARTICULAR FONT, STYLE, SIZE, OR COLOR.

OWNER OF UNITED KINGDOM REG. NO. 2575177, DATED 6-24-2011, EXPIRES 3-15-2021.

SER. NO. 85-423,279, FILED 9-15-2011.

REBECCA SMITH, EXAMINING ATTORNEY



David J. Kyffers

Director of the United States Patent and Trademark Office

United States of America

United States Patent and Trademark Office

DTT 
S U R V E I L L A N C E

Reg. No. 4,153,322

DRIVE THRU TECHNOLOGY, INC. (CALIFORNIA CORPORATION)
1755 NORTH MAIN STREET
LOS ANGELES, CA 90031

Registered June 5, 2012

Int. Cl.: 42

FOR: CUSTOM DESIGN AND DEVELOPMENT OF SURVEILLANCE SYSTEMS AND COMPONENTS THEREOF, IN CLASS 42 (U.S. CLS. 100 AND 101).

SERVICE MARK

FIRST USE 10-1-2001; IN COMMERCE 10-1-2001.

PRINCIPAL REGISTER

OWNER OF U.S. REG. NOS. 2,941,251 AND 2,975,301.

NO CLAIM IS MADE TO THE EXCLUSIVE RIGHT TO USE "SURVEILLANCE", APART FROM THE MARK AS SHOWN.

THE MARK CONSISTS OF THE LETTERS "DTT" IN STYLIZED FONT WITH A SWIRL DESIGN THAT REPRESENTS A FANCIFUL HUMAN EYE TO THE RIGHT OF THE LETTERS "DTT" CENTERED ABOVE THE WORD "SURVEILLANCE".

SER. NO. 85-423,470, FILED 9-15-2011.

RUSS HERMAN, EXAMINING ATTORNEY



David J. Kyfos

Director of the United States Patent and Trademark Office

United States of America

United States Patent and Trademark Office



Reg. No. 4,153,323

Registered June 5, 2012

Int. Cls.: 39, 41 and 45

SERVICE MARK

PRINCIPAL REGISTER

WELCOME HOME RELOCATION, INC. (FLORIDA CORPORATION)
1115 PONCE DE LEON BLVD., SUITE A5
BELLEAIR, FL 33756

FOR: MOVING AND RELOCATION SERVICES, NAMELY, PLANNING AND IMPLEMENTING MOVES OF HOMES AND OFFICES; MOVING AND RELOCATION SERVICES, NAMELY, PLANNING AND IMPLEMENTING MOVES OF HOMES FOR OTHERS; MOVING AND RELOCATION SERVICES, NAMELY, PLANNING AND PROJECT OVERSIGHT OF HOME MOVING FOR OTHERS; FURNITURE MOVING SERVICES; MOVING COMPANY SERVICES; TRANSPORT SERVICES, NAMELY, LOCAL AND INTERSTATE MOVING SERVICES; MOVING OF GOODS; FURNITURE MOVING; TRANSPORTATION OF HOUSEHOLD GOODS BY MOTOR VEHICLE, IN CLASS 39 (U.S. CLS. 100 AND 105).

FIRST USE 1-1-2006; IN COMMERCE 1-1-2006.

FOR: EDUCATIONAL SERVICES, NAMELY, PROVIDING CLASSES, LECTURES, PRESENTATIONS, SEMINARS, TELECLASSES, TELESEMINARS, AND WORKSHOPS IN THE FIELDS OF MOVING AND RELOCATION SERVICES, SPATIAL ORGANIZATION, HOME STAGING, INTERIOR DESIGN, TEMPORARY INTERIOR AND EXTERIOR HOME DECORATION, ESTATE MANAGEMENT, IN-HOME SUPPORT SERVICES, AND ORGANIZING SERVICES FOR BELONGING AND SPACES IN A RESIDENCE OR BUSINESS, AND DISTRIBUTION OF COURSE AND EDUCATIONAL MATERIALS IN CONNECTION THEREWITH IN HARD COPY OR ELECTRONIC FORMAT, IN CLASS 41 (U.S. CLS. 100, 101 AND 107).

FIRST USE 1-1-2006; IN COMMERCE 1-1-2006.

FOR: ORGANIZATIONAL SERVICES FOR HOME OR PERSONAL PURPOSES, NAMELY, ORGANIZING PERSONAL BELONGINGS IN A RESIDENCE; PROVIDING COUNSELING AND CONSULTING SERVICES IN THE FIELD OF SPATIAL ORGANIZATION FOR RESIDENTIAL PURPOSES, NAMELY, COUNSELING AND CONSULTING A RESIDENT REGARDING THE ORGANIZATION OF BELONGINGS AND PHYSICAL SPACES IN A HOME; IN-HOME SUPPORT SERVICES TO SENIOR PERSONS, NAMELY, GERIATRIC CARE MANAGEMENT SERVICES AND PERSONAL AFFAIRS MANAGEMENT SERVICES IN THE NATURE OF THE COORDINATION OF NECESSARY SERVICES AND CARE FOR OLDER INDIVIDUALS; ORGANIZATIONAL SERVICES FOR HOME OR PERSONAL PURPOSES, NAMELY, ORGANIZING CLOSET SPACE, ORGANIZING FURNITURE, ORGANIZING



David J. Kybas

Director of the United States Patent and Trademark Office

Reg. No. 4,153,323 SHELVES, ORGANIZING CABINETS; PROVIDING COUNSELING AND CONSULTING SERVICES IN THE FIELD OF SPATIAL ORGANIZATION FOR PERSONAL PURPOSES, NAMELY, COUNSELING AND CONSULTING AN INDIVIDUAL REGARDING THE ORGANIZATION OF BELONGINGS AND PHYSICAL SPACES IN A RESIDENCY, NAMELY, CLOSET SPACE, DRAWERS, SHELVES, OR CABINETS, IN CLASS 45 (U.S. CLS. 100 AND 101).

FIRST USE 1-1-2006; IN COMMERCE 1-1-2006.

THE MARK CONSISTS OF TWO CONCENTRIC CIRCLES CONSISTING OF AN OUTER CONCENTRIC CIRCLE AND AN INNER CONCENTRIC CIRCLE, SAID OUTER CONCENTRIC CIRCLE PROVIDING A WIDE BORDER FOR SAID INNER CONCENTRIC CIRCLE, AND WHEREIN A SILHOUETTE OF A TWO-DIMENSIONAL HOUSE IS CENTERED WITHIN SAID INNER CONCENTRIC CIRCLE.

SER. NO. 85-423,564, FILED 9-15-2011.

CHRISTINA SOBRAL, EXAMINING ATTORNEY

United States of America

United States Patent and Trademark Office

DTT

Reg. No. 4,153,324

Registered June 5, 2012

Int. Cls.: 9 and 42

TRADEMARK

SERVICE MARK

PRINCIPAL REGISTER

DRIVE THRU TECHNOLOGY, INC. (CALIFORNIA CORPORATION)
1755 NORTH MAIN STREET
LOS ANGELES, CA 90031

FOR: DIGITAL SURVEILLANCE SYSTEMS, NAMELY, A DEDICATED PC BASED DIGITAL VIDEO RECORDER INCLUDING PROPRIETARY LOCAL AND REMOTE SURVEILLANCE SOFTWARE AND COMPONENTS, THEREOF, NAMELY, VIDEO CAMERAS, LENSES, MONITORS AND CABLING, IN CLASS 9 (U.S. CLS. 21, 23, 26, 36 AND 38).

FIRST USE 10-1-2001; IN COMMERCE 10-1-2001.

FOR: CUSTOM DESIGN AND DEVELOPMENT OF SURVEILLANCE SYSTEMS AND COMPONENTS THEREOF, IN CLASS 42 (U.S. CLS. 100 AND 101).

FIRST USE 10-1-2001; IN COMMERCE 10-1-2001.

OWNER OF U.S. REG. NOS. 2,941,251 AND 2,985,301.

THE MARK CONSISTS OF THE LETTERS "DTT" IN STYLIZED FONT WITH A SWIRL DESIGN THAT REPRESENTS A FANCIFUL HUMAN EYE TO THE RIGHT OF THE LETTERS "DTT".

SER. NO. 85-423,598, FILED 9-15-2011.

RUSS HERMAN, EXAMINING ATTORNEY



David J. Kyros

Director of the United States Patent and Trademark Office

United States of America

United States Patent and Trademark Office

Dr. Paul Bearer

Reg. No. 4,153,325

Registered June 5, 2012

Int. Cl.: 41

SERVICE MARK

PRINCIPAL REGISTER

RICHARD KOON (UNITED STATES INDIVIDUAL)
1608 SIXTH STREET, SE
WINTER HAVEN, FL 33880

FOR: ENTERTAINMENT IN THE NATURE OF VISUAL AND AUDIO PERFORMANCES BY AN ACTOR; ENTERTAINMENT SERVICES, NAMELY, PROVIDING WEBCASTS IN THE FIELD OF HORROR VIDEOS, IN CLASS 41 (U.S. CLS. 100, 101 AND 107).

FIRST USE 10-30-2009; IN COMMERCE 10-30-2009.

THE MARK CONSISTS OF STANDARD CHARACTERS WITHOUT CLAIM TO ANY PARTICULAR FONT, STYLE, SIZE, OR COLOR.

THE NAME "DR. PAUL BEARER" DOES NOT IDENTIFY A LIVING INDIVIDUAL.

SER. NO. 85-423,639, FILED 9-15-2011.

TINA BROWN, EXAMINING ATTORNEY



David J. Kyffers

Director of the United States Patent and Trademark Office

United States of America

United States Patent and Trademark Office

netgrocer

Reg. No. 4,153,326

Registered June 5, 2012

Int. Cl.: 35

SERVICE MARK

PRINCIPAL REGISTER

NETGROCER, LLC (DELAWARE LIMITED LIABILITY COMPANY)
SUITE 350
354 MOUNTAIN VIEW DRIVE
COLCHESTER, VT 05446

FOR: COMPUTERIZED ON-LINE ORDERING FEATURING GENERAL MERCHANDISE AND GENERAL CONSUMER GOODS; COMPUTERIZED ON-LINE RETAIL STORE SERVICES IN THE FIELD OF CONSUMER GOODS, NAMELY, GROCERIES; ON-LINE RETAIL STORE SERVICES FEATURING A WIDE VARIETY OF CONSUMER GOODS OF OTHERS, IN CLASS 35 (U.S. CLS. 100, 101 AND 102).

FIRST USE 2-21-1997; IN COMMERCE 2-21-1997.

THE MARK CONSISTS OF STANDARD CHARACTERS WITHOUT CLAIM TO ANY PARTICULAR FONT, STYLE, SIZE, OR COLOR.

SEC. 2(F).

SER. NO. 85-423,730, FILED 9-15-2011.

WANDA KAY PRICE, EXAMINING ATTORNEY



David J. Kyffers

Director of the United States Patent and Trademark Office

United States of America

United States Patent and Trademark Office



Reg. No. 4,153,327

Registered June 5, 2012

Int. Cls.: 16, 41 and 42

TRADEMARK

SERVICE MARK

PRINCIPAL REGISTER

BIG BANG (FRANCE COMPANY)
ZI DE CROLLES
CROLLES, FRANCE 38920

FOR: PUBLICATIONS, NAMELY, BOOKS, BROCHURES, CATALOGUES, PRINTED REVIEWS, AND MAGAZINES, ALL IN THE FIELD OF THE ENVIRONMENT AND SPORTS SAFETY, AND WORKING AT HEIGHTS, IN CLASS 16 (U.S. CLS. 2, 5, 22, 23, 29, 37, 38 AND 50).

FIRST USE 10-0-2007; IN COMMERCE 10-0-2007.

FOR: PROVIDING OF TRAINING AND TEACHING SERVICES IN THE FIELDS OF VERTICALITY, MOUNTAIN CLIMBING AND WORKING IN HIGH PLACES; ORGANIZING, ARRANGING, AND CONDUCTING SPORTING AND ENTERTAINMENT EVENTS, NAMELY, MOUNTAIN CLIMBING EVENTS; ORGANISATION OF EDUCATIONAL EXAMINATIONS, NAMELY, EDUCATIONAL EXAMINATION SERVICES; EDUCATIONAL SERVICES, NAMELY, CONDUCTING OF COLLOQUIUMS, CONGRESSES, CONFERENCES AND SEMINARS IN THE FIELDS OF VERTICALITY, MOUNTAIN CLIMBING AND WORKING IN HIGH PLACES; ORGANISATION OF SPORTS COMPETITIONS, IN CLASS 41 (U.S. CLS. 100, 101 AND 107).

FIRST USE 10-0-2007; IN COMMERCE 10-0-2007.

FOR: SCIENTIFIC RESEARCH IN THE FIELD OF PHYSIOLOGY AND PSYCHOLOGY, RESEARCH AND DEVELOPMENT OF NEW PRODUCTS AND OF TECHNOLOGY IN THE FIELD OF NEW PRACTICES AND TECHNIQUES IN THE FIELD OF VERTICAL ACTIVITIES FOR OTHERS, IN CLASS 42 (U.S. CLS. 100 AND 101).

FIRST USE 10-0-2007; IN COMMERCE 10-0-2007.

PRIORITY CLAIMED UNDER SEC. 44(D) ON ERPN CMNTY TM OFC APPLICATION NO. 009809971, FILED 3-15-2011, REG. NO. 009809971, DATED 8-25-2011, EXPIRES 3-15-2021.

OWNER OF U.S. REG. NOS. 1,185,406, 3,254,633 AND OTHERS.

NO CLAIM IS MADE TO THE EXCLUSIVE RIGHT TO USE "FONDATION", APART FROM THE MARK AS SHOWN.

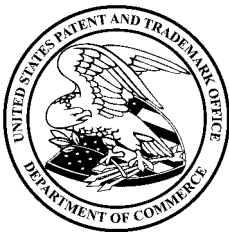

David J. Kyjars

Director of the United States Patent and Trademark Office

Reg. No. 4,153,327 THE MARK CONSISTS OF THE WORDS "PETZL FONDATION" IN STYLIZED FORM, WITH A SPIRAL DESIGN APPEARING BEHIND "PETZL".

THE ENGLISH TRANSLATION OF "FONDATION" IN THE MARK IS "FOUNDATION".

SER. NO. 85-423,803, FILED 9-15-2011.

KATHERINE E. HALMEN, EXAMINING ATTORNEY

United States of America

United States Patent and Trademark Office

CAMP OF CHAMPIONS

Reg. No. 4,153,328

THE SNOBOARD SHOP INC. (CANADA CORPORATION)
8629 DRIFTER WAY
WHISTLER, CANADA BCV0N2B8

Registered June 5, 2012

Int. Cl.: 41

FOR: SPORTS TRAINING SERVICES, EXCLUDING SPORTS TRAINING SERVICES RELATED TO WRESTLING, IN CLASS 41 (U.S. CLS. 100, 101 AND 107).

SERVICE MARK

FIRST USE 7-0-1988; IN COMMERCE 7-0-1988.

PRINCIPAL REGISTER

THE MARK CONSISTS OF STANDARD CHARACTERS WITHOUT CLAIM TO ANY PARTICULAR FONT, STYLE, SIZE, OR COLOR.

OWNER OF U.S. REG. NO. 2,932,171.

NO CLAIM IS MADE TO THE EXCLUSIVE RIGHT TO USE "CAMP", APART FROM THE MARK AS SHOWN.

SER. NO. 85-423,912, FILED 9-15-2011.

BARNEY CHARLON, EXAMINING ATTORNEY



David J. Kyffers

Director of the United States Patent and Trademark Office

United States of America

United States Patent and Trademark Office



Reg. No. 4,153,329

Registered June 5, 2012

Int. Cl.: 43

SERVICE MARK

PRINCIPAL REGISTER

HEALTHY & TASTY VENTURES, LLC (FLORIDA LIMITED LIABILITY COMPANY)
20969 DELGADO TERRACE
BOCA RATON, FL 33433

FOR: RESTAURANT SERVICES; QUICK SERVICE RESTAURANT; FAST CASUAL DINNING,
IN CLASS 43 (U.S. CLS. 100 AND 101).

FIRST USE 6-6-2011; IN COMMERCE 6-6-2011.

NO CLAIM IS MADE TO THE EXCLUSIVE RIGHT TO USE "FRESH AUTHENTIC GRILL"
AND "EST. 2011", APART FROM THE MARK AS SHOWN.

THE MARK CONSISTS OF A DESIGN OF A CIRCLE MADE UP OF LINES INSIDE OF THE CIRCLE. INSIDE OF THE CIRCLE IS A DESIGN OF A CHICKEN WITH PART OF THE CHICKEN RESEMBLING A FLAME. IN THE MIDDLE OF THE CIRCLE IS THE WORD "GRILLIT" AND THE LETTER "I" IN THE WORD "GRILLIT" IS IN LOWER CASE, WITH A FLAME APPEARING ABOVE THE LOWERCASE "I". UNDER THE WORD "GRILLIT" APPEARS THE WORDS "FRESH AUTHENTIC GRILL". BEHIND THE DESIGN OF THE CIRCLE IS A DESIGN OF A BANNER AND ON THE LEFT OF THE BANNER ARE THE LETTERS "EST." AND ON THE RIGHT OF THE BANNER APPEARS THE YEAR "2011".

SER. NO. 85-423,968, FILED 9-15-2011.

DOMINICK J. SALEMI, EXAMINING ATTORNEY



David J. Kybas

Director of the United States Patent and Trademark Office

United States of America

United States Patent and Trademark Office

AwiaTech

Reg. No. 4,153,330

Registered June 5, 2012

Int. Cl.: 35

SERVICE MARK

PRINCIPAL REGISTER

AWIATECH CORPORATION (TEXAS CORPORATION)
11713 JOLLYVILLE ROAD
AUSTIN, TX 78759

FOR: BUSINESS AND TECHNICAL CONSULTING AND INFORMATION SERVICES RELATING TO PRODUCT AND APPLICATION DEVELOPMENT OF WIRELESS SENSOR NETWORKS, NAMELY, ADVISING ENTERPRISES ON COSTS AND AVAILABILITY OF DESIGNING, BUILDING, TESTING, DEPLOYING AND MAINTAINING WIRELESS SENSOR NETWORKS CONSISTING OF COMPUTER HARDWARE ASSOCIATED FIRMWARE AND SOFTWARE THAT RETRIEVE, MEASURE, OR DETECT A PARAMETER, VARIABLE, OR ANY MEASURABLE CONDITION, DETECTABLE EVENT, OR INFORMATION, WHERE EACH DEVICE CAN TRANSMIT VIA WIRED CONNECTIONS OR RADIO WAVES INFORMATION ABOUT THE RETRIEVED, MEASURED, OR DETECTED VALUE TO AT LEAST ONE OTHER DEVICE, IN CLASS 35 (U.S. CLS. 100, 101 AND 102).

FIRST USE 2-23-2011; IN COMMERCE 2-23-2011.

THE MARK CONSISTS OF STANDARD CHARACTERS WITHOUT CLAIM TO ANY PARTICULAR FONT, STYLE, SIZE, OR COLOR.

OWNER OF U.S. REG. NO. 3,984,657.

SER. NO. 85-424,076, FILED 9-15-2011.

CHRISIE B. KING, EXAMINING ATTORNEY



David J. Kyros

Director of the United States Patent and Trademark Office

United States of America

United States Patent and Trademark Office

EMPLOYEE PARTNER

Reg. No. 4,153,331

Registered June 5, 2012

Int. Cl.: 35

SERVICE MARK

PRINCIPAL REGISTER

PRESS GANEY ASSOCIATES, INC (INDIANA CORPORATION)
404 COLUMBIA PLACE
SOUTH BEND
INDIANA, IN 46601

FOR: BUSINESS ANALYSIS AND MANAGEMENT CONSULTING FOR HEALTHCARE PROVIDERS AND RELATED BUSINESSES, ANALYSIS RELATING TO THE BUSINESS MANAGEMENT OF HEALTH CARE FACILITIES; PROVIDING STATISTICAL DATA ON EMPLOYEES AND POTENTIAL EMPLOYEES FOR THE PURPOSE OF INCREASING EMPLOYEE SATISFACTION AND RETENTION, IN CLASS 35 (U.S. CLS. 100, 101 AND 102).

FIRST USE 10-25-2010; IN COMMERCE 10-25-2010.

THE MARK CONSISTS OF STANDARD CHARACTERS WITHOUT CLAIM TO ANY PARTICULAR FONT, STYLE, SIZE, OR COLOR.

OWNER OF U.S. REG. NO. 3,772,658.

NO CLAIM IS MADE TO THE EXCLUSIVE RIGHT TO USE "EMPLOYEE", APART FROM THE MARK AS SHOWN.

SER. NO. 85-424,217, FILED 9-15-2011.

BARBARA BROWN, EXAMINING ATTORNEY



David J. Kybas

Director of the United States Patent and Trademark Office

United States of America

United States Patent and Trademark Office

EAGLE ATM

Reg. No. 4,153,332

EAGLE ATM, LLC (MAINE LIMITED LIABILITY COMPANY), AKA EAGLE ATM
P.O. BOX 17882
PORTLAND, ME 04112

Registered June 5, 2012

Int. Cl.: 9

FOR: AUTOMATED TELLER MACHINES (ATM), IN CLASS 9 (U.S. CLS. 21, 23, 26, 36 AND 38).

TRADEMARK

FIRST USE 2-13-2009; IN COMMERCE 2-13-2009.

PRINCIPAL REGISTER

THE MARK CONSISTS OF STANDARD CHARACTERS WITHOUT CLAIM TO ANY PARTICULAR FONT, STYLE, SIZE, OR COLOR.

NO CLAIM IS MADE TO THE EXCLUSIVE RIGHT TO USE "ATM", APART FROM THE MARK AS SHOWN.

SER. NO. 85-424,239, FILED 9-16-2011.

CAROLINE WOOD, EXAMINING ATTORNEY



David J. Kyffers

Director of the United States Patent and Trademark Office

United States of America

United States Patent and Trademark Office

YouGotListings

Reg. No. 4,153,333

Registered June 5, 2012

Int. Cl.: 42

SERVICE MARK

PRINCIPAL REGISTER

YOU GOT LISTINGS, INC. (DELAWARE CORPORATION)
SUITE 23
100 HANO ST.
ALLSTON, MA 02134

FOR: PROVIDING TEMPORARY USE OF WEB BASED NON-DOWNLOADABLE COMPUTER DATABASE SOFTWARE FOR UPLOADING, SEARCHING, SHARING, MANAGING, AND ADVERTISING OF REAL ESTATE, IN CLASS 42 (U.S. CLS. 100 AND 101).

FIRST USE 1-15-2009; IN COMMERCE 1-15-2009.

THE MARK CONSISTS OF STANDARD CHARACTERS WITHOUT CLAIM TO ANY PARTICULAR FONT, STYLE, SIZE, OR COLOR.

SER. NO. 85-424,439, FILED 9-16-2011.

SANI KHOURI, EXAMINING ATTORNEY



David J. Kybas

Director of the United States Patent and Trademark Office

United States of America

United States Patent and Trademark Office

JUTI

Reg. No. 4,153,334

Registered June 5, 2012

Int. Cl.: 29

TRADEMARK

PRINCIPAL REGISTER

LIVING YOUR BEST LLC (MASSACHUSETTS LIMITED LIABILITY COMPANY)
10 TECHNOLOGY DRIVE #338
HUDSON, MA 01749

FOR: MEAL REPLACEMENT BARS CONSISTING PRIMARILY OF APPLESAUCE AND PEANUT BUTTER, AND ALSO CONTAINING ROLLED OATS AND CHOCOLATE CHIPS, IN CLASS 29 (U.S. CL. 46).

FIRST USE 9-12-2011; IN COMMERCE 9-12-2011.

THE MARK CONSISTS OF STANDARD CHARACTERS WITHOUT CLAIM TO ANY PARTICULAR FONT, STYLE, SIZE, OR COLOR.

THE WORDING "JUTI" HAS NO MEANING IN A FOREIGN LANGUAGE.

SER. NO. 85-424,550, FILED 9-16-2011.

ESTHER BELENKER, EXAMINING ATTORNEY



David J. Kybas

Director of the United States Patent and Trademark Office

United States of America

United States Patent and Trademark Office



Reg. No. 4,153,335

GUIGNARD COMPANY (FLORIDA CORPORATION)
1904 BOOTHE CIRCLE, SUITE 5
LONGWOOD, FL 32750

Registered June 5, 2012

Int. Cl.: 36

FOR: AGENCY SERVICES IN THE FIELD OF BONDS AND OTHER SECURITIES, IN CLASS 36 (U.S. CLS. 100, 101 AND 102).

SERVICE MARK

FIRST USE 6-1-2011; IN COMMERCE 6-1-2011.

PRINCIPAL REGISTER

NO CLAIM IS MADE TO THE EXCLUSIVE RIGHT TO USE "COMPANY SURETY BONDS" AND "BOND", APART FROM THE MARK AS SHOWN.

THE COLOR(S) WHITE, MAROON AND TAN IS/ARE CLAIMED AS A FEATURE OF THE MARK.

THE MARK CONSISTS OF A STYLIZED WHITE CAPITAL "G" WITHIN A MAROON SQUARE. THE WORDS "GUIGNARD COMPANY" ARE TO THE RIGHT OF THE STYLIZED "G". THE WORD "GUIGNARD" IS IN MAROON AND "COMPANY" IS IN TAN. THE WORDS "SURETY BONDS" ARE BENEATH THE WORDS "GUIGNARD COMPANY" AND THE WORDS "AN UNCOMMON BOND" ARE BENEATH THE WORDS "SURETY BONDS", ALL IN TAN UPPER CASE LETTERS.

SER. NO. 85-424,629, FILED 9-16-2011.

FRANK LATTUCA, EXAMINING ATTORNEY



David J. Kyros

Director of the United States Patent and Trademark Office

United States of America

United States Patent and Trademark Office

This Spot

Reg. No. 4,153,336

Registered June 5, 2012

Int. Cl.: 9

BEETLEFARM, LLC (CALIFORNIA LIMITED LIABILITY COMPANY), DBA CUBAN
COUNCIL
T251
461 2ND STREET
SAN FRANCISCO, CA 94107

TRADEMARK

FOR: DOWNLOADABLE SOFTWARE IN THE NATURE OF A MOBILE APPLICATION FOR
LOCATION BASED UTILITY AND ENTERTAINMENT, IN CLASS 9 (U.S. CLS. 21, 23, 26,
36 AND 38).

PRINCIPAL REGISTER

FIRST USE 4-1-2011; IN COMMERCE 9-14-2011.

THE MARK CONSISTS OF STANDARD CHARACTERS WITHOUT CLAIM TO ANY PAR-
TICULAR FONT, STYLE, SIZE, OR COLOR.

SER. NO. 85-424,682, FILED 9-16-2011.

ANN E. SAPPENFIELD, EXAMINING ATTORNEY



David J. Kyffers

Director of the United States Patent and Trademark Office

United States of America

United States Patent and Trademark Office



Reg. No. 4,153,337

Registered June 5, 2012

Int. Cl.: 42

SERVICE MARK

PRINCIPAL REGISTER

TEGA TECHNOLOGIES, LLC (ARIZONA LIMITED LIABILITY COMPANY)
18025 SKY PARK CIRCLE, STE. M
IRVINE, CA 92164

FOR: COMPUTER SOFTWARE DEVELOPMENT IN THE FIELD OF CUSTOMER RELATIONSHIP MANAGEMENT, IN CLASS 42 (U.S. CLS. 100 AND 101).

FIRST USE 10-1-2007; IN COMMERCE 10-1-2007.

NO CLAIM IS MADE TO THE EXCLUSIVE RIGHT TO USE "TECHNOLOGIES", APART FROM THE MARK AS SHOWN.

THE COLOR(S) LIGHT BLUE, BLUE, DARK BLUE AND DARK GREY IS/ARE CLAIMED AS A FEATURE OF THE MARK.

THE MARK CONSISTS OF THE WORD "TEGA" IN CAPITAL LETTERS. THERE IS A SPACE IN BETWEEN EACH LETTER. THE LETTER "E" IN "TEGA" IS COMPOSED OF THREE HORIZONTAL PARALLEL LINES. IT DOES NOT CONTAIN A VERTICAL LINE. THE COLORS AT THE BOTTOM OF THE LETTERS "T" AND "E" SHIFT FROM LIGHT BLUE, TO DARK BLUE, TO BLUE AND THEN LIGHT BLUE. THE COLORS AT THE BOTTOM OF THE LETTERS "G" AND "A" SHIFT FROM DARK BLUE, TO BLUE AND THEN LIGHT BLUE. A PORTION OF EACH LETTER IS REFLECTED AT THE BOTTOM OF THE WORD "TEGA". THE WORD "TECHNOLOGIES" IN CAPITAL LETTERS. IT IS DARK GREY AND IS UNDERNEATH THE WORD "TEGA" AND STARTS HALFWAY BETWEEN THE "T" AND "E". THERE IS A SPACE BETWEEN EACH LETTER IN "TECHNOLOGIES".

SER. NO. 85-424,766, FILED S.R. 9-16-2011 AM. P.R. 10-18-2011.

ANN E. SAPPENFIELD, EXAMINING ATTORNEY



David J. Kybas

Director of the United States Patent and Trademark Office

United States of America

United States Patent and Trademark Office

Great American Canvas Company

Reg. No. 4,153,338

Registered June 5, 2012

Int. Cl.: 18

TRADEMARK

PRINCIPAL REGISTER

URBAN ATTITUDES (NEW YORK LIMITED LIABILITY COMPANY)
13TH FLOOR
212 WEST 35TH STREET
NEW YORK, NY 10001

FOR: BACKPACKS; BACKPACKS, BOOK BAGS, SPORTS BAGS, BUM BAGS, WALLETS AND HANDBAGS; DUFFLE BAGS; FASHION HANDBAGS; HANDBAGS; MILITARY DUFFLE BAGS, GARMENT BAGS FOR TRAVEL, TOTE BAGS, SHOULDER BAGS AND BACKPACKS; TOTE BAGS; WHEELED DUFFLE BAGS; WHEELED TOTE BAGS, IN CLASS 18 (U.S. CLS. 1, 2, 3, 22 AND 41).

FIRST USE 11-0-2003; IN COMMERCE 11-0-2003.

THE MARK CONSISTS OF STANDARD CHARACTERS WITHOUT CLAIM TO ANY PARTICULAR FONT, STYLE, SIZE, OR COLOR.

NO CLAIM IS MADE TO THE EXCLUSIVE RIGHT TO USE "CANVAS COMPANY", APART FROM THE MARK AS SHOWN.

SER. NO. 85-424,788, FILED 9-16-2011.

JACLYN KIDWELL WALKER, EXAMINING ATTORNEY



David J. Kybas

Director of the United States Patent and Trademark Office

United States of America

United States Patent and Trademark Office

DOÑA BELLA

Reg. No. 4,153,339

Registered June 5, 2012

Int. Cl.: 3

TRADEMARK

PRINCIPAL REGISTER

INTRADEVCO INDUSTRIAL S.A. (PERU CORPORATION)
URBANIZACION LA VILLA CHORRILLOS
AV. PRODUCCION NACIONAL NO. 188
LIMA, PERU

FOR: SOAPS; PERFUMERY; COSMETICS; HAIR LOTIONS; SHAMPOOS; HAIR CONDITIONERS; DENTIFRICES, IN CLASS 3 (U.S. CLS. 1, 4, 6, 50, 51 AND 52).

FIRST USE 2-11-2002; IN COMMERCE 5-31-2008.

THE MARK CONSISTS OF STANDARD CHARACTERS WITHOUT CLAIM TO ANY PARTICULAR FONT, STYLE, SIZE, OR COLOR.

OWNER OF PERU REG. NO. 00078323, DATED 2-11-2002, RENEWED AS REG. NO. 00078323, DATED 12-19-2011, EXPIRES 2-11-2022.

THE ENGLISH TRANSLATION OF "DOÑA BELLA" IN THE MARK IS "LADY BEAUTIFUL".

SER. NO. 85-425,043, FILED 9-16-2011.

GEOFFREY FOSDICK, EXAMINING ATTORNEY



David J. Kyros

Director of the United States Patent and Trademark Office

United States of America

United States Patent and Trademark Office

JAMI CAKES

Reg. No. 4,153,340

Registered June 5, 2012

Int. Cl.: 41

SERVICE MARK

PRINCIPAL REGISTER

EPSTEIN, JAMI (UNITED STATES INDIVIDUAL)
839 LARRABEE #11
WEST HOLLYWOOD, CA 90069

FOR: ON-LINE JOURNALS, NAMELY, BLOGS IN THE FIELDS OF FOOD, COOKING, TRAVEL, BAKING, DINING, CELEBRITIES, RECIPES AND NUTRITION; PROVIDING ON-LINE NON-DOWNLOADABLE PUBLICATIONS IN THE NATURE OF NEWSLETTERS AND MAGAZINES FEATURING RECIPES AND EDUCATIONAL INFORMATION IN THE FIELDS OF FOOD, COOKING, TRAVEL, BAKING, DINING, CELEBRITIES, RECIPES AND NUTRITION; EDUCATIONAL SERVICES, NAMELY, PROVIDING ONLINE INSTRUCTION IN THE FIELDS OF FOOD, COOKING, TRAVEL, BAKING, DINING, CELEBRITIES, RECIPES AND NUTRITION VIA AN ONLINE WEBSITE, IN CLASS 41 (U.S. CLS. 100, 101 AND 107).

FIRST USE 6-7-2009; IN COMMERCE 6-7-2009.

THE MARK CONSISTS OF STANDARD CHARACTERS WITHOUT CLAIM TO ANY PARTICULAR FONT, STYLE, SIZE, OR COLOR.

NO CLAIM IS MADE TO THE EXCLUSIVE RIGHT TO USE "CAKES", APART FROM THE MARK AS SHOWN.

THE NAME(S), PORTRAIT(S), AND/OR SIGNATURE(S) SHOWN IN THE MARK IDENTIFIES JAMI EPSTEIN, WHOSE CONSENT(S) TO REGISTER IS MADE OF RECORD.

SER. NO. 85-425,049, FILED 9-16-2011.

ERIN FALK, EXAMINING ATTORNEY



David J. Kybas

Director of the United States Patent and Trademark Office

United States of America

United States Patent and Trademark Office

Mob Ink Tattoos

Reg. No. 4,153,341

Registered June 5, 2012

Int. Cl.: 25

TRADEMARK

PRINCIPAL REGISTER

BALENA, DANNY (UNITED STATES INDIVIDUAL)
6020 SUITE 5, NORTH FEDERAL HIGHWAY
BOCA RATON, FL 33487

FOR: ATHLETIC APPAREL, NAMELY, SHIRTS, PANTS, JACKETS, FOOTWEAR, HATS AND CAPS, ATHLETIC UNIFORMS; BASEBALL CAPS; BELTS FOR CLOTHING; DENIMS; GLOVES AS CLOTHING; HATS; HEADGEAR, NAMELY, BASEBALL HATS, BEANIES; JACKETS; JERSEYS; JOGGING PANTS; MEN'S SOCKS; PANTS; SHIRTS; SHORT SETS; SHORTS; SOCKS; SWEAT PANTS; SWEATERS; SWEATSHIRTS; TANK TOPS; TOPS; UNDERWEAR; WEARABLE GARMENTS AND CLOTHING, NAMELY, SHIRTS; WOMEN'S CLOTHING, NAMELY, SHIRTS, DRESSES, SKIRTS, BLOUSES, IN CLASS 25 (U.S. CLS. 22 AND 39).

FIRST USE 7-20-2005; IN COMMERCE 7-20-2005.

THE MARK CONSISTS OF STANDARD CHARACTERS WITHOUT CLAIM TO ANY PARTICULAR FONT, STYLE, SIZE, OR COLOR.

SER. NO. 85-425,270, FILED 9-16-2011.

JIM RINGLE, EXAMINING ATTORNEY



David J. Kypos

Director of the United States Patent and Trademark Office

United States of America

United States Patent and Trademark Office

PHYSICIAN PARTNER

Reg. No. 4,153,342

Registered June 5, 2012

Int. Cl.: 35

SERVICE MARK

PRINCIPAL REGISTER

PRESS GANEY ASSOCIATES, INC (INDIANA CORPORATION)
404 COLUMBIA PLACE
SOUTH BEND
INDIANA, IN 46601

FOR: BUSINESS ANALYSIS AND MANAGEMENT CONSULTING FOR HEALTHCARE PROVIDERS AND RELATED BUSINESSES, ANALYSIS RELATING TO THE BUSINESS MANAGEMENT OF HEALTH CARE FACILITIES; PROVIDING STATISTICAL DATA ON PHYSICIAN'S AND HOSPITAL'S PERFORMANCE FOR THE PURPOSE OF IMPROVING WORKING RELATIONSHIPS AMONG STAFF, IN CLASS 35 (U.S. CLS. 100, 101 AND 102).

FIRST USE 10-25-2010; IN COMMERCE 10-25-2010.

THE MARK CONSISTS OF STANDARD CHARACTERS WITHOUT CLAIM TO ANY PARTICULAR FONT, STYLE, SIZE, OR COLOR.

OWNER OF U.S. REG. NO. 3,772,658.

NO CLAIM IS MADE TO THE EXCLUSIVE RIGHT TO USE "PHYSICIAN", APART FROM THE MARK AS SHOWN.

SER. NO. 85-425,572, FILED 9-19-2011.

BARBARA BROWN, EXAMINING ATTORNEY



David J. Kyjars

Director of the United States Patent and Trademark Office

United States of America

United States Patent and Trademark Office

BRAND NAMES. CLOSEOUT PRICES.

Reg. No. 4,153,343

CONSOLIDATED PROPERTY HOLDINGS, INC. (NEVADA CORPORATION)
330 E. WARM SPRINGS ROAD
LAS VEGAS, NV 89119

Registered June 5, 2012

Int. Cl.: 35

FOR: RETAIL DEPARTMENT STORE SERVICES, IN CLASS 35 (U.S. CLS. 100, 101 AND 102).

SERVICE MARK

FIRST USE 8-31-2001; IN COMMERCE 8-31-2001.

PRINCIPAL REGISTER

THE MARK CONSISTS OF STANDARD CHARACTERS WITHOUT CLAIM TO ANY PARTICULAR FONT, STYLE, SIZE, OR COLOR.

OWNER OF U.S. REG. NOS. 2,740,584 AND 3,005,201.

SEC. 2(F).

SER. NO. 85-425,642, FILED 9-19-2011.

TASHIA BUNCH, EXAMINING ATTORNEY



David J. Kyffers

Director of the United States Patent and Trademark Office

United States of America

United States Patent and Trademark Office



Reg. No. 4,153,344

Registered June 5, 2012

Int. Cl.: 35

SERVICE MARK

PRINCIPAL REGISTER

OPERATION INTERDEPENDENCE (CALIFORNIA CORPORATION)
STE C5B PMB 147
2830 NORTH AVE
GRAND JUNCTION, CO 81501

FOR: CHARITABLE SERVICES, NAMELY, ORGANIZING AND CONDUCTING VOLUNTEER PROGRAMS AND COMMUNITY SERVICE PROJECTS AIMED AT INCREASING SUPPORT AND MORALE OF MEMBERS OF THE U.S. MILITARY, IN CLASS 35 (U.S. CLS. 100, 101 AND 102).

FIRST USE 12-7-2001; IN COMMERCE 12-7-2001.

THE MARK CONSISTS OF THE STYLIZED LETTERING "O.I.", FEATURING STYLIZED STARS AND HORIZONTAL LINING SO AS TO RESEMBLE A STYLIZED VERSION OF THE UNITED STATES FLAG, SET ABOVE THE STYLIZED WORDING "OPERATION INTERDEPENDENCE", ALL SET ABOVE THE STYLIZED WORDING "WWW.OIDELIVERS.ORG". THE COLOR BLUE APPEARS IN THE BACKGROUND AREA AT TOP OF THE LETTER "O" IN THE LETTERING "O.I." AT THE TOP OF THE MARK; THE COLOR RED APPEARS IN THE THICKER HORIZONTAL LINES AND THE PERIODS IN THE LETTERING "O.I." AT THE TOP OF THE MARK AND IN THE WORDING "WWW.OIDELIVERS.ORG"; THE COLOR WHITE APPEARS IN THE STARS AND THINNER HORIZONTAL LINES IN THE LETTERING "O.I." AT THE TOP OF THE MARK; THE COLOR BLACK APPEARS IN THE SHADING BEHIND THE LETTERING "O.I." AT THE TOP OF THE MARK AND IN THE WORDING "OPERATION INTERDEPENDENCE". THE AREAS SHOWN IN WHITE OUTSIDE OF THE LETTERING "O.I." AT THE TOP OF THE MARK ARE NOT PART OF THE MARK, AND MERELY SHOW THE SURFACE UPON WHICH THE MARK IS AFFIXED.

THE COLOR(S) RED, BLACK, BLUE AND WHITE IS/ARE CLAIMED AS A FEATURE OF THE MARK.

SER. NO. 85-425,757, FILED 9-19-2011.

MICHAEL GAFFAR, EXAMINING ATTORNEY



David J. Kyffers

Director of the United States Patent and Trademark Office

United States of America

United States Patent and Trademark Office

BRAIN TYPING

Reg. No. 4,153,345

NIEDNAGEL, JONATHAN P. (UNITED STATES INDIVIDUAL)
HC 71 BOX 121-1
THORNFIELD, MO 65762

Registered June 5, 2012

Int. Cl.: 42

FOR: PROVIDING A WEBSITE IN THE FIELD OF SCIENTIFIC RESEARCH REGARDING THE HUMAN BRAIN AND HUMAN BEHAVIOR, IN CLASS 42 (U.S. CLS. 100 AND 101).

SERVICE MARK

FIRST USE 12-1-1992; IN COMMERCE 12-1-1992.

PRINCIPAL REGISTER

THE MARK CONSISTS OF STANDARD CHARACTERS WITHOUT CLAIM TO ANY PARTICULAR FONT, STYLE, SIZE, OR COLOR.

OWNER OF U.S. REG. NO. 2,054,087.

NO CLAIM IS MADE TO THE EXCLUSIVE RIGHT TO USE "BRAIN", APART FROM THE MARK AS SHOWN.

SER. NO. 85-426,030, FILED 9-19-2011.

MARK SPARACINO, EXAMINING ATTORNEY



David J. Kyffers

Director of the United States Patent and Trademark Office

United States of America

United States Patent and Trademark Office



Reg. No. 4,153,346

Registered June 5, 2012

Int. Cl.: 37

SERVICE MARK

PRINCIPAL REGISTER

VANTAUZS INCORPORATED (CALIFORNIA CORPORATION), DBA IMAGE PROPERTY SERVICES
2323 WEST MESCAL, SUITE 205
PHOENIX, AZ 85029

FOR: BUILDING MAINTENANCE AND SUPPORT SERVICES, NAMELY, DAY PORTER SERVICES IN THE NATURE OF DAILY MAINTENANCE AND CLEANING, SANITATION AND CLEANING OF THE INTERIOR AND EXTERIOR OF COMMERCIAL PROPERTY, CLEANING OF PARKING LOTS, WINDOW WASHING, CONSTRUCTION SITE CLEANUP AND RESTROOM CLEANING AND SANITATION, IN CLASS 37 (U.S. CLS. 100, 103 AND 106).

FIRST USE 1-3-2011; IN COMMERCE 1-3-2011.

NO CLAIM IS MADE TO THE EXCLUSIVE RIGHT TO USE "PROPERTY SERVICES", APART FROM THE MARK AS SHOWN.

THE COLOR(S) BLUE, GRAY AND WHITE IS/ARE CLAIMED AS A FEATURE OF THE MARK.

THE MARK CONSISTS OF THE WORDING "IMAGE" IN BLUE WITH THE DOT OVER THE LETTER "I" REPRESENTED BY A GRAY AND WHITE CIRCLE AND THE LETTER "I" HAS GRAY SHADOWING. UNDERNEATH THE LETTERS "MAG" IN "IMAGE" APPEARS THE WORDING "PROPERTY SERVICES" IN GRAY AND UNDERNEATH THE LETTER "E" IN "IMAGE" APPEARS THREE GRAY CIRCLES.

SER. NO. 85-426,052, FILED 9-19-2011.

HAI-LY LAM, EXAMINING ATTORNEY



David J. Kyffers

Director of the United States Patent and Trademark Office

United States of America

United States Patent and Trademark Office

THE LITTLE BRATS

Reg. No. 4,153,347

Registered June 5, 2012

Int. Cl.: 41

SERVICE MARK

PRINCIPAL REGISTER

HARMONY HEARTH LLC (MARYLAND LIMITED LIABILITY COMPANY)
P.O. BOX 341511
BETHESDA, MD 208271511

FOR: CHARITABLE SERVICES, NAMELY, PROVIDING BOOKS TO CHILDREN AND FAMILIES, INCLUDING CHILDREN AND FAMILIES OF THE US MILITARY; ENTERTAINMENT SERVICES, NAMELY, LIVE MUSICAL PERFORMANCES, LIVE TELEVISED MUSICAL PERFORMANCES, AND CONDUCTING BOOK SIGNING EVENTS; ANIMATION PRODUCTION SERVICES; EDUCATION SERVICES, NAMELY, PROVIDING CLASSES, SEMINARS, LECTURES AND WORKSHOPS ALL RELATING TO THE DEVELOPMENT OF CHILDREN RAISED WITH PARENTS WHO ARE ACTIVE IN THE MILITARY, IN CLASS 41 (U.S. CLS. 100, 101 AND 107).

FIRST USE 7-17-2011; IN COMMERCE 9-17-2011.

THE MARK CONSISTS OF STANDARD CHARACTERS WITHOUT CLAIM TO ANY PARTICULAR FONT, STYLE, SIZE, OR COLOR.

NO CLAIM IS MADE TO THE EXCLUSIVE RIGHT TO USE "BRATS", APART FROM THE MARK AS SHOWN.

SER. NO. 85-426,075, FILED 9-19-2011.

BERYL GARDNER, EXAMINING ATTORNEY



David J. Kyros

Director of the United States Patent and Trademark Office

United States of America

United States Patent and Trademark Office

SUPERIOR MORGUL CLASSIC

Reg. No. 4,153,348

Registered June 5, 2012

Int. Cls.: 25, 35 and 41

TRADEMARK

SERVICE MARK

PRINCIPAL REGISTER

TOWN OF SUPERIOR, COLORADO (COLORADO MUNICIPAL CORPORATION)
124 EAST COAL CREEK DRIVE
SUPERIOR, CO 80027

FOR: ATHLETIC APPAREL, NAMELY, SHIRTS, PANTS, JACKETS, FOOTWEAR, HATS AND CAPS, ATHLETIC UNIFORMS; COATS; HATS; SHIRTS; SHOES; SHORTS; T-SHIRTS, IN CLASS 25 (U.S. CLS. 22 AND 39).

FIRST USE 5-28-2010; IN COMMERCE 5-28-2010.

FOR: PROMOTIONAL SPONSORSHIP OF CYCLING EVENTS, IN CLASS 35 (U.S. CLS. 100, 101 AND 102).

FIRST USE 5-28-2010; IN COMMERCE 5-28-2010.

FOR: ORGANIZING, ARRANGING, AND CONDUCTING CYCLING EVENTS, IN CLASS 41 (U.S. CLS. 100, 101 AND 107).

FIRST USE 5-28-2010; IN COMMERCE 5-28-2010.

THE MARK CONSISTS OF STANDARD CHARACTERS WITHOUT CLAIM TO ANY PARTICULAR FONT, STYLE, SIZE, OR COLOR.

NO CLAIM IS MADE TO THE EXCLUSIVE RIGHT TO USE "SUPERIOR" AND "CLASSIC", APART FROM THE MARK AS SHOWN.

SER. NO. 85-426,176, FILED 9-19-2011.

CHRISTOPHER LAW, EXAMINING ATTORNEY



David J. Kyros

Director of the United States Patent and Trademark Office

United States of America

United States Patent and Trademark Office

MUEVETE (MOVE) USA

Reg. No. 4,153,349

Registered June 5, 2012

Int. Cl.: 41

NATIONAL ASSOCIATION OF HISPANIC NURSES (WASHINGTON NON-PROFIT CORPORATION)

SUITE 400
1455 PENNSYLVANIA AVENUE, NW
WASHINGTON, DC 20004

SERVICE MARK

PRINCIPAL REGISTER

FOR: EDUCATIONAL SERVICES, NAMELY, TRAINING NURSES IN PROVIDING EDUCATIONAL AND TRAINING SERVICES IN THEIR COMMUNITIES IN THE FIELD OF PREVENTION OR REDUCTION OF OBESITY, IN CLASS 41 (U.S. CLS. 100, 101 AND 107).

FIRST USE 5-31-2010; IN COMMERCE 5-31-2010.

THE MARK CONSISTS OF STANDARD CHARACTERS WITHOUT CLAIM TO ANY PARTICULAR FONT, STYLE, SIZE, OR COLOR.

NO CLAIM IS MADE TO THE EXCLUSIVE RIGHT TO USE "USA", APART FROM THE MARK AS SHOWN.

THE ENGLISH TRANSLATION OF THE WORD "MUEVETE" IN THE MARK IS "MOVE".

SER. NO. 85-426,211, FILED 9-19-2011.

CHRIS WELLS, EXAMINING ATTORNEY



David J. Kyffers

Director of the United States Patent and Trademark Office

United States of America

United States Patent and Trademark Office



Reg. No. 4,153,350

BLUE CROSS BLUE SHIELD OF ALABAMA (ALABAMA CORPORATION)
450 RIVERCHASE PARKWAY EAST
BIRMINGHAM, AL 35298

Registered June 5, 2012

Int. Cl.: 35

FOR: ADMINISTRATION AND MANAGEMENT OF HEALTHCARE REIMBURSEMENT (HRA) PLANS, IN CLASS 35 (U.S. CLS. 100, 101 AND 102).

SERVICE MARK

FIRST USE 7-1-2009; IN COMMERCE 7-1-2009.

PRINCIPAL REGISTER

NO CLAIM IS MADE TO THE EXCLUSIVE RIGHT TO USE "HRA PROVIDER PAID", APART FROM THE MARK AS SHOWN.

THE COLOR(S) BLACK AND GREEN IS/ARE CLAIMED AS A FEATURE OF THE MARK.

THE MARK CONSISTS OF THE WORD "HRA" IN BLACK WITH A GREEN CHECK MARK OVER THE "A" AND THE WORDS "PROVIDER PAID" UNDERNEATH THE "HRA".

SER. NO. 85-426,689, FILED 9-20-2011.

BRETT J. GOLDEN, EXAMINING ATTORNEY



David J. Kyffers

Director of the United States Patent and Trademark Office

United States of America

United States Patent and Trademark Office



Reg. No. 4,153,351

Registered June 5, 2012

Int. Cl.: 38

SERVICE MARK

PRINCIPAL REGISTER

CYCLEVISION NETWORK, INC (ILLINOIS CORPORATION)
1 EAST 8TH STREET, SUITE 703
CHICAGO, IL 60605

FOR: BROADCASTING OF VIDEO AND AUDIO PROGRAMMING OVER THE INTERNET; BROADCASTING OF SPORTS RELATED PROGRAMS; BROADCASTING PROGRAMS VIA A GLOBAL COMPUTER NETWORK; STREAMING OF AUDIO MATERIAL ON THE INTERNET; STREAMING OF VIDEO MATERIAL ON THE INTERNET, IN CLASS 38 (U.S. CLS. 100, 101 AND 104).

FIRST USE 9-20-2011; IN COMMERCE 9-20-2011.

OWNER OF U.S. REG. NO. 3,735,350.

NO CLAIM IS MADE TO THE EXCLUSIVE RIGHT TO USE "NETWORK", APART FROM THE MARK AS SHOWN.

THE MARK CONSISTS OF THE WORDS "CYCLEVISION NETWORK" BELOW THE IMAGE OF A PERSON RIDING ON THE LETTERS "CVN".

SER. NO. 85-426,763, FILED 9-20-2011.

MEGHAN REINHART, EXAMINING ATTORNEY



David J. Kyffers

Director of the United States Patent and Trademark Office

United States of America

United States Patent and Trademark Office



Reg. No. 4,153,352

Registered June 5, 2012

Int. Cl.: 41

SERVICE MARK

PRINCIPAL REGISTER

THE ART OF YING (CALIFORNIA PARTNERSHIP)
9118 WEST THIRD STREET
BEVERLY HILLS, CA 90210

FOR: EDUCATION SERVICES, NAMELY, PROVIDING ON-LINE AND ON-SITE TRAINING, SEMINARS, AND WORKSHOPS IN THE FIELDS OF CHINESE LANGUAGE, PROTOCOL, AND CULTURE, IN CLASS 41 (U.S. CLS. 100, 101 AND 107).

FIRST USE 6-22-2011; IN COMMERCE 6-22-2011.

THE MARK CONSISTS OF THE CHINESE CHARACTER "TO WIN" WITH AN OUTLINE, THE TEXT "THE ART OF YING" IN PAPYRUS FONT BELOW THE CHARACTER, AND THE TEXT "WINNING IN CHINA" IN OPTIMA FONT BELOW "THE ART OF YING".

THE NON-LATIN CHARACTER IN THE MARK TRANSLITERATES TO "YING" AND THIS MEANS "TO WIN" IN ENGLISH.

SER. NO. 85-426,788, FILED 9-20-2011.

TASHIA BUNCH, EXAMINING ATTORNEY



David J. Kyffers

Director of the United States Patent and Trademark Office

United States of America

United States Patent and Trademark Office

Queen of Errands

Reg. No. 4,153,353

Registered June 5, 2012

Int. Cl.: 45

SERVICE MARK

PRINCIPAL REGISTER

MARY JACKSON (UNITED STATES INDIVIDUAL)
C/O ROBERT EDMOND MITTEL
PO 427
PORTLAND, ME 04112

FOR: RUNNING ERRANDS FOR OTHERS, IN CLASS 45 (U.S. CLS. 100 AND 101).

FIRST USE 8-8-2011; IN COMMERCE 8-8-2011.

THE MARK CONSISTS OF STANDARD CHARACTERS WITHOUT CLAIM TO ANY PARTICULAR FONT, STYLE, SIZE, OR COLOR.

NO CLAIM IS MADE TO THE EXCLUSIVE RIGHT TO USE "ERRANDS", APART FROM THE MARK AS SHOWN.

SER. NO. 85-426,808, FILED 9-20-2011.

STEVEN JACKSON, EXAMINING ATTORNEY



David J. Kyros

Director of the United States Patent and Trademark Office

United States of America

United States Patent and Trademark Office



Reg. No. 4,153,354

Registered June 5, 2012

Int. Cl.: 35

SERVICE MARK

PRINCIPAL REGISTER

LEFTHAND DISTRIBUTION LLC (OHIO LIMITED LIABILITY COMPANY)
6969 WORTHINGTON GALENA RD
WORTHINGTON, OH 43085

FOR: ON-LINE WHOLESALE STORES FEATURING GIFT NOVELTIES IN THE FIELD OF SMOKING ACCESSORIES AND DETOXIFICATION BEVERAGES; ON-LINE RETAIL STORE SERVICES FEATURING GIFT NOVELTIES IN THE FIELD OF SMOKING ACCESSORIES AND DETOXIFICATION BEVERAGES, IN CLASS 35 (U.S. CLS. 100, 101 AND 102).

FIRST USE 5-11-2011; IN COMMERCE 7-1-2011.

THE MARK CONSISTS OF THE WORDING "STONEMUFFIN.COM" IN PURPLE AND BLUE BUBBLE GRAFFITI STYLE LETTERS OUTLINED IN BLACK, A PURPLE AND BLUE MUFFIN WITH BLACK AND WHITE EYES REPLACES THE DOT BETWEEN "STONE-MUFFIN" AND "COM".

THE COLOR(S) PURPLE, BLUE, BLACK AND WHITE IS/ARE CLAIMED AS A FEATURE OF THE MARK.

SER. NO. 85-426,895, FILED 9-20-2011.

RONALD MCMORROW, EXAMINING ATTORNEY



David J. Kypos

Director of the United States Patent and Trademark Office

United States of America

United States Patent and Trademark Office

Metal Workout

Reg. No. 4,153,355

Registered June 5, 2012

Int. Cl.: 25

TRADEMARK

PRINCIPAL REGISTER

BIGIO, PABLO (UNITED STATES INDIVIDUAL)
23 JENNIFER COURT
MARLBORO, NJ 07746

FOR: BABY TOPS; HOODED SWEAT SHIRTS; HOODED SWEATSHIRTS; HOODED SWEATSHIRTS FOR BABIES AND CHILDREN; PANTS; SHIRTS FOR INFANTS, BABIES, TODDLERS AND CHILDREN; SHORT-SLEEVED OR LONG-SLEEVED T-SHIRTS; SHORTS; SWEAT SHIRTS; SWEATERS; SWEATSHIRTS; SWEATSHIRTS FOR BABIES AND CHILDREN; T-SHIRTS; T-SHIRTS FOR BABIES AND CHILDREN; TANK TOPS; TANK-TOPS; VESTS, IN CLASS 25 (U.S. CLS. 22 AND 39).

FIRST USE 3-29-2011; IN COMMERCE 4-6-2011.

THE MARK CONSISTS OF STANDARD CHARACTERS WITHOUT CLAIM TO ANY PARTICULAR FONT, STYLE, SIZE, OR COLOR.

NO CLAIM IS MADE TO THE EXCLUSIVE RIGHT TO USE "WORKOUT", APART FROM THE MARK AS SHOWN.

SER. NO. 85-427,051, FILED 9-20-2011.

ELISSA GARBER KON, EXAMINING ATTORNEY



David J. Kyffers

Director of the United States Patent and Trademark Office

United States of America

United States Patent and Trademark Office



Reg. No. 4,153,356

Registered June 5, 2012

Int. Cl.: 41

SERVICE MARK

PRINCIPAL REGISTER

NATIONAL ASSOCIATION OF EMERGENCY MEDICAL TECHNICIANS (MASSACHUSETTS CORPORATION), AKA NAEMT
PO BOX 1400
132-A EAST NORTHSIDE DR.
CLINTON, MS 39056

FOR: EDUCATION SERVICES, NAMELY, DEVELOPING, PREPARING, ORGANIZING AND CONDUCTING MEETINGS IN THE NATURE OF CONFERENCES, WORKSHOPS, SEMINARS AND EDUCATIONAL PROGRAMS, ALL IN THE FIELD OF PRE-HOSPITAL EMERGENCY MEDICAL CARE TREATMENT, IN CLASS 41 (U.S. CLS. 100, 101 AND 107).

FIRST USE 1-1-1975; IN COMMERCE 1-1-1975.

OWNER OF U.S. REG. NOS. 3,954,161 AND 4,024,999.

THE COLOR(S) ROYAL BLUE IS/ARE CLAIMED AS A FEATURE OF THE MARK.

NO CLAIM IS MADE TO THE EXCLUSIVE RIGHT TO USE "EMS PRACTITIONERS" AND THE STAR OF LIFE SYMBOL, APART FROM THE MARK AS SHOWN.

THE MARK CONSISTS OF THE ROYAL BLUE LETTERS "NAEMT" WITH A ROYAL BLUE STAR OF LIFE SYMBOL WHICH INCLUDES A ROD OF ASCELEPIUS SYMBOL WITH A ROYAL BLUE BORDER AT THE END. THE ROYAL BLUE WORDS "SERVING OUR NATION'S EMS PRACTITIONERS" ARE UNDERNEATH THE LETTERS. THE COLOR WHITE REPRESENTS BACKGROUND AND IS NOT PART OF THE MARK.

SER. NO. 85-427,326, FILED 9-20-2011.

TINA MAI, EXAMINING ATTORNEY



David J. Kyjars

Director of the United States Patent and Trademark Office

United States of America

United States Patent and Trademark Office



Reg. No. 4,153,357

SATELLITE WEBSITE CORPORATION (ILLINOIS CORPORATION)
8747 WEST BRYN MAWR, UNIT 403
CHICAGO, IL 60631

Registered June 5, 2012

Int. Cl.: 42

FOR: CONSULTING SERVICES IN THE FIELD OF SEARCH ENGINE OPTIMIZATION;
SEARCH ENGINE OPTIMIZATION, IN CLASS 42 (U.S. CLS. 100 AND 101).

SERVICE MARK

FIRST USE 7-0-2007; IN COMMERCE 7-0-2007.

PRINCIPAL REGISTER

NO CLAIM IS MADE TO THE EXCLUSIVE RIGHT TO USE "SATELLITE WEBSITE AND
TARGETED WEB TRAFFIC", APART FROM THE MARK AS SHOWN.

THE COLOR(S) BLUE, RED AND GREEN IS/ARE CLAIMED AS A FEATURE OF THE MARK.

THE MARK CONSISTS OF THE WORDS "SATELLITE WEBSITE" IN BLUE AND "TARGETED
WEB TRAFFIC" IN RED, THE IMAGE OF A SATELLITE IN RED AND BLUE TO THE RIGHT
OF THE "E" IN "SATELLITE", AND THREE ARROWS POINTING DOWN FROM THE
SATELLITE IN THE COLORS RED, BLUE AND GREEN.

SER. NO. 85-427,382, FILED 9-20-2011.

JENNIFER WILLISTON, EXAMINING ATTORNEY



David J. Kybas

Director of the United States Patent and Trademark Office

United States of America

United States Patent and Trademark Office

RAISE YOUR VOICE

Reg. No. 4,153,358

Registered June 5, 2012

Int. Cls.: 38 and 42

SERVICE MARK

PRINCIPAL REGISTER

RAISE YOUR VOICE, INC. (COLORADO CORPORATION)
480 BISON DRIVE
BOULDER, CO 80302

FOR: TELECOMMUNICATIONS SERVICES, NAMELY, ELECTRONIC TRANSMISSION OF DATA, MESSAGES AND INFORMATION; PROVIDING ONLINE FORUMS FOR COMMUNICATION ON TOPICS OF POLITICAL INTEREST; PROVIDING ONLINE COMMUNICATIONS LINKS WHICH TRANSFER WEB SITE USERS TO OTHER LOCAL AND GLOBAL WEB PAGES; PROVIDING MULTIPLE USER ACCESS TO WEB SITES FOR OTHERS HOSTED ON COMPUTER SERVERS ACCESSIBLE VIA A GLOBAL COMPUTER NETWORK; PROVIDING MULTIPLE USER ACCESS TO THIRD PARTY WEB SITES BY ENABLING USERS TO LOG IN THROUGH A UNIVERSAL USERNAME AND PASSWORD VIA A GLOBAL COMPUTER NETWORK AND OTHER COMMUNICATION NETWORKS; PROVIDING ONLINE CHAT ROOMS AND ELECTRONIC BULLETIN BOARDS FOR TRANSMISSION OF MESSAGES AMONG USERS IN THE FIELD OF POLITICAL INTEREST; AUDIO, TEXT AND VIDEO BROADCASTING SERVICES OVER COMPUTER OR OTHER COMMUNICATION NETWORKS, NAMELY, UPLOADING, POSTING, DISPLAYING, TAGGING, AND ELECTRONICALLY TRANSMITTING DATA, INFORMATION, AUDIO AND VIDEO IMAGES; PROVIDING ACCESS TO COMPUTER DATABASES IN THE FIELDS OF SOCIAL NETWORKING, SOCIAL INTRODUCTION AND POLITICAL ACTIVISM; PROVIDING ACCESS TO COMPUTER, ELECTRONIC AND ONLINE DATABASES, IN CLASS 38 (U.S. CLS. 100, 101 AND 104).

FIRST USE 11-20-2010; IN COMMERCE 11-20-2010.

FOR: PEER-TO-PEER PHOTO SHARING SERVICES, NAMELY, ELECTRONIC TRANSMISSION OF DIGITAL PHOTO FILES AMONG INTERNET USERS, IN CLASS 42 (U.S. CLS. 100 AND 101).

FIRST USE 11-20-2010; IN COMMERCE 11-20-2010.

THE MARK CONSISTS OF STANDARD CHARACTERS WITHOUT CLAIM TO ANY PARTICULAR FONT, STYLE, SIZE, OR COLOR.

SER. NO. 85-427,561, FILED 9-20-2011.

MATTHEW KLINE, EXAMINING ATTORNEY



David J. Kypas

Director of the United States Patent and Trademark Office

United States of America

United States Patent and Trademark Office

SUPRACOR

Reg. No. 4,153,359

Registered June 5, 2012

**Int. Cls.: 12, 20, 21, 27
and 28**

TRADEMARK

PRINCIPAL REGISTER

SUPRACOR, INC. (CALIFORNIA CORPORATION)
2050 CORPORATE COURT
SAN JOSE, CA 95131

FOR: VEHICLE SEAT CUSHIONS; VEHICLE SEATS; WHEELCHAIR CUSHIONS; WHEEL-
CHAIR PADS, IN CLASS 12 (U.S. CLS. 19, 21, 23, 31, 35 AND 44).

FIRST USE 3-7-1990; IN COMMERCE 3-7-1990.

FOR: CUSHIONS; MATTRESS CUSHIONS; MATTRESS TOPPERS; MATTRESSES; PILLOWS;
SINK LINERS, IN CLASS 20 (U.S. CLS. 2, 13, 22, 25, 32 AND 50).

FIRST USE 11-15-1991; IN COMMERCE 11-15-1991.

FOR: EXFOLIATING MITTS; EXFOLIATING PADS, IN CLASS 21 (U.S. CLS. 2, 13, 23, 29,
30, 33, 40 AND 50).

FIRST USE 6-4-2003; IN COMMERCE 6-4-2003.

FOR: ANTI-FATIGUE FLOOR MAT; BATH MATS; BEACH MATS; FLOOR MATS , IN CLASS
27 (U.S. CLS. 19, 20, 37, 42 AND 50).

FIRST USE 12-31-2009; IN COMMERCE 12-31-2009.

FOR: PERSONAL EXERCISE MATS; POOL CUSHIONS; YOGA MATS, IN CLASS 28 (U.S.
CLS. 22, 23, 38 AND 50).

FIRST USE 3-9-2009; IN COMMERCE 3-9-2009.

THE MARK CONSISTS OF STANDARD CHARACTERS WITHOUT CLAIM TO ANY PAR-
TICULAR FONT, STYLE, SIZE, OR COLOR.

OWNER OF U.S. REG. NOS. 1,324,737, 1,749,441 AND OTHERS.

SER. NO. 85-427,684, FILED 9-20-2011.

CHRISTINE MARTIN, EXAMINING ATTORNEY



David J. Kyros

Director of the United States Patent and Trademark Office

United States of America

United States Patent and Trademark Office

YOU CAN FIGHT

Reg. No. 4,153,360

Registered June 5, 2012

Int. Cl.: 28

TRADEMARK

PRINCIPAL REGISTER

UNITED TACTICALS HOLDING LLC (DELAWARE LIMITED LIABILITY COMPANY)
SUITE L5418
4281 EXPRESS LANE
SARASOTA, FL 34238

FOR: MARTIAL ARTS TRAINING EQUIPMENT, IN CLASS 28 (U.S. CLS. 22, 23, 38 AND 50).

FIRST USE 8-1-2011; IN COMMERCE 8-1-2011.

THE MARK CONSISTS OF STANDARD CHARACTERS WITHOUT CLAIM TO ANY PARTICULAR FONT, STYLE, SIZE, OR COLOR.

SER. NO. 85-427,805, FILED 9-21-2011.

ELLEN BURNS, EXAMINING ATTORNEY



David J. Kyffers

Director of the United States Patent and Trademark Office

United States of America

United States Patent and Trademark Office

EF EPI ENGLISH PROFICIENCY INDEX

Reg. No. 4,153,361

Registered June 5, 2012

Int. Cls.: 16, 35 and 41

TRADEMARK

SERVICE MARK

PRINCIPAL REGISTER

SIGNUM INTERNATIONAL S.A.R.L. (LUXEMBOURG LIMITED LIABILITY COMPANY)
22, RUE GOETHE
L-1637 LUXEMBOURG, LUXEMBOURG

FOR: PRINTED MATTER, NAMELY, BOOKLETS, BROCHURES AND LEAFLETS IN THE FIELD OF ENGLISH LANGUAGE PROFICIENCY; PRINTED REPORTS FEATURING INFORMATION ON ENGLISH LANGUAGE PROFICIENCY, IN CLASS 16 (U.S. CLS. 2, 5, 22, 23, 29, 37, 38 AND 50).

FIRST USE 3-23-2011; IN COMMERCE 3-23-2011.

FOR: CREATING INDEXES OF ENGLISH LANGUAGE SKILL LEVELS, BASED ON DATA COLLECTED FROM ONLINE ENGLISH TESTS, FOR BUSINESS PURPOSES, IN CLASS 35 (U.S. CLS. 100, 101 AND 102).

FIRST USE 3-23-2011; IN COMMERCE 3-23-2011.

FOR: EDUCATIONAL SERVICES, NAMELY, PROVIDING INFORMATION ON ENGLISH LANGUAGE PROFICIENCY; RESEARCH IN THE FIELD OF ENGLISH LANGUAGE EDUCATION; PREPARING, ADMINISTERING, AND SCORING STANDARDIZED TESTS IN THE FIELD OF ENGLISH LANGUAGE PROFICIENCY; PROVIDING A WEBSITE FEATURING INFORMATION ON ENGLISH LANGUAGE PROFICIENCY, PUBLICATION AND ON-LINE PUBLICATION OF REPORTS FEATURING INFORMATION ON ENGLISH LANGUAGE PROFICIENCY, IN CLASS 41 (U.S. CLS. 100, 101 AND 107).

FIRST USE 3-23-2011; IN COMMERCE 3-23-2011.

THE MARK CONSISTS OF STANDARD CHARACTERS WITHOUT CLAIM TO ANY PARTICULAR FONT, STYLE, SIZE, OR COLOR.

PRIORITY CLAIMED UNDER SEC. 44(D) ON ERPN CMNTY TM OFC APPLICATION NO. 9830134, FILED 3-22-2011.

OWNER OF U.S. REG. NOS. 2,372,303, 3,953,443 AND OTHERS.

NO CLAIM IS MADE TO THE EXCLUSIVE RIGHT TO USE "ENGLISH PROFICIENCY INDEX", APART FROM THE MARK AS SHOWN.



David J. Kyros

Director of the United States Patent and Trademark Office

Reg. No. 4,153,361 SER. NO. 85-427,946, FILED 9-21-2011.

LEIGH CAROLINE CASE, EXAMINING ATTORNEY

United States of America

United States Patent and Trademark Office

Forgotten Sons Motorcycle Club

Reg. No. 4,153,362

MILLER, RYAN (UNITED STATES INDIVIDUAL)
110 ASHLEY LN.
HAMPSTEAD, NC 28443

Registered June 5, 2012

Int. Cl.: 35

FOR: CLUB SERVICES, NAMELY, PROMOTING THE INTERESTS OF MOTORCYCLE ENTHUSIASTS, IN CLASS 35 (U.S. CLS. 100, 101 AND 102).

SERVICE MARK

FIRST USE 12-1-2007; IN COMMERCE 1-1-2008.

PRINCIPAL REGISTER

THE MARK CONSISTS OF STANDARD CHARACTERS WITHOUT CLAIM TO ANY PARTICULAR FONT, STYLE, SIZE, OR COLOR.

NO CLAIM IS MADE TO THE EXCLUSIVE RIGHT TO USE "MOTORCYCLE CLUB", APART FROM THE MARK AS SHOWN.

SER. NO. 85-427,953, FILED 9-21-2011.

CURTIS FRENCH, EXAMINING ATTORNEY



David J. Kyffers

Director of the United States Patent and Trademark Office

United States of America

United States Patent and Trademark Office

PIPEHORN

Reg. No. 4,153,363

Registered June 5, 2012

Int. Cl.: 9

TRADEMARK

PRINCIPAL REGISTER

UTILITY TOOL COMPANY, INC. (DELAWARE CORPORATION)
2900 COMMERCE BOULEVARD
BIRMINGHAM, AL 35210

FOR: ELECTRONIC UTILITY LOCATING INSTRUMENTS FOR DETERMINING THE LOCATION OF UNDERGROUND OBJECTS AND ANOMALIES IN THOSE OBJECTS, NAMELY, PIPE AND CABLE LOCATORS FOR LOCATING HIDDEN OR BURIED UTILITIES, SUCH AS WATER, SEWER, GAS, POWER, AND COMMUNICATION LINES, AND MAGNETIC DETECTORS FOR LOCATING VALVE BOXES, PROPERTY PINS, MANHOLE COVERS, AND OTHER FERROUS OBJECTS; AND ACCESSORIES, NAMELY, SIGNAL CLAMPS, SIGNAL BEACONS, AND VALVE BOX FINDERS USED WITH THE ABOVE INSTRUMENTS, IN CLASS 9 (U.S. CLS. 21, 23, 26, 36 AND 38).

FIRST USE 12-15-1965; IN COMMERCE 12-15-1965.

THE MARK CONSISTS OF STANDARD CHARACTERS WITHOUT CLAIM TO ANY PARTICULAR FONT, STYLE, SIZE, OR COLOR.

SER. NO. 85-427,977, FILED 9-21-2011.

BILL DAWE, EXAMINING ATTORNEY



David J. Kyros

Director of the United States Patent and Trademark Office

United States of America

United States Patent and Trademark Office

MegaDeck

Reg. No. 4,153,364

Registered June 5, 2012

Int. Cl.: 19

TRADEMARK

PRINCIPAL REGISTER

SIGNATURE SYSTEMS GROUP, LLC (DELAWARE LIMITED LIABILITY COMPANY)
50 EAST 42ND STREET, 14TH FLOOR
NEW YORK, NY 10017

FOR: HEAVY DUTY INTERCONNECTING PLASTIC PANELS FOR GROUND PROTECTION AND ROAD ACCESS, FOR USE IN OILFIELD AND EVENT VENUES TO SUPPORT HEAVY EQUIPMENT, VEHICLES AND STRUCTURES, IN CLASS 19 (U.S. CLS. 1, 12, 33 AND 50).

FIRST USE 3-15-2011; IN COMMERCE 3-15-2011.

THE MARK CONSISTS OF STANDARD CHARACTERS WITHOUT CLAIM TO ANY PARTICULAR FONT, STYLE, SIZE, OR COLOR.

SER. NO. 85-428,038, FILED 9-21-2011.

LINDA POWELL, EXAMINING ATTORNEY



David J. Kyros

Director of the United States Patent and Trademark Office

United States of America

United States Patent and Trademark Office

The Independent Home

Reg. No. 4,153,365

Registered June 5, 2012

Int. Cl.: 42

SERVICE MARK

PRINCIPAL REGISTER

KESSLER MCGUINNESS & ASSOCIATES (MASSACHUSETTS LIMITED LIABILITY COMPANY), DBA KESSLER MCGUINNESS & ASSOCIATES
SUITE 6
1121 WASHINGTON STREET
NEWTON, MA 02465

FOR: ARCHITECTURAL DESIGN IN THE FIELD OF RESIDENTIAL DESIGN, IN CLASS 42 (U.S. CLS. 100 AND 101).

FIRST USE 7-22-2011; IN COMMERCE 7-22-2011.

THE MARK CONSISTS OF STANDARD CHARACTERS WITHOUT CLAIM TO ANY PARTICULAR FONT, STYLE, SIZE, OR COLOR.

NO CLAIM IS MADE TO THE EXCLUSIVE RIGHT TO USE "HOME", APART FROM THE MARK AS SHOWN.

SER. NO. 85-428,214, FILED 9-21-2011.

JENNIFER WILLISTON, EXAMINING ATTORNEY



David J. Kyffers

Director of the United States Patent and Trademark Office

United States of America

United States Patent and Trademark Office

TACTICAL VOLATILITY ROTATION

Reg. No. 4,153,366

Registered June 5, 2012

Int. Cl.: 36

SERVICE MARK

PRINCIPAL REGISTER

TRUCOLOR CAPITAL MANAGEMENT, LLC (DELAWARE LIMITED LIABILITY COMPANY)
1 GATEWAY CENTER, SUITE 812
NEWTON, MA 02482

FOR: INVESTMENT PORTFOLIO STRATEGY, NAMELY, ALLOWS ADJUSTMENTS BASED
UPON MARKET RISKS AND PORTFOLIO EXPOSURE, IN CLASS 36 (U.S. CLS. 100, 101
AND 102).

FIRST USE 11-2-2011; IN COMMERCE 11-2-2011.

THE MARK CONSISTS OF STANDARD CHARACTERS WITHOUT CLAIM TO ANY PAR-
TICULAR FONT, STYLE, SIZE, OR COLOR.

NO CLAIM IS MADE TO THE EXCLUSIVE RIGHT TO USE "VOLATILITY ROTATION",
APART FROM THE MARK AS SHOWN.

SER. NO. 85-428,308, FILED 9-21-2011.

CAROLYN CATALDO, EXAMINING ATTORNEY



David J. Kybas

Director of the United States Patent and Trademark Office

United States of America

United States Patent and Trademark Office

ZAXCOM

Reg. No. 4,153,367

Registered June 5, 2012

Int. Cl.: 9

TRADEMARK

PRINCIPAL REGISTER

ZAXCOM, INC. (NEW JERSEY CORPORATION)
230 W. PARKWAY, UNIT 9
POMPTON PLAINS, NJ 07444

FOR: PORTABLE DIGITAL AUDIO RECORDER AND MIXER FOR COMMERCIAL BROADCAST QUALITY REPRODUCTION; MICROPHONES; RADIO TRANSMITTERS; TRANSCEIVERS; MULTI-TRACK AUDIO MIXERS WITH INTEGRATED AUDIO RECORDER FOR MOTION PICTURE USE; SCIENTIFIC AND ELECTRONIC APPARATUS, NAMELY, CONTROLLERS FOR AUDIO/VISUAL EDITING; APPARATUS FOR BROADCASTING, RECORDING, TRANSMISSION OR REPRODUCTION OF SOUND OR IMAGES; APPARATUS FOR RECORDING, TRANSMISSION, PROCESSING AND REPRODUCTION OF SOUND, IMAGES OR DATA; AUDIO AMPLIFIERS; AUDIO CIRCUIT BOARDS; AUDIO HEADPHONES; AUDIO MIXERS; AUDIO RECORDERS; AUDIO SPEAKERS; ELECTRONIC PRODUCTS FOR THE MANIPULATION OF THE FREQUENCY, TIME, AND AMPLITUDE CHARACTERISTICS OF AUDIO SIGNALS, NAMELY, AUDIO PROCESSORS; RECEIVERS FOR AUDIO; SOUND RECORDING APPARATUS, IN CLASS 9 (U.S. CLS. 21, 23, 26, 36 AND 38).

FIRST USE 11-30-1985; IN COMMERCE 1-31-1986.

THE MARK CONSISTS OF STANDARD CHARACTERS WITHOUT CLAIM TO ANY PARTICULAR FONT, STYLE, SIZE, OR COLOR.

THE WORDING "ZAXCOM" HAS NO MEANING IN A FOREIGN LANGUAGE.

SER. NO. 85-428,406, FILED 9-21-2011.

BILL DAWE, EXAMINING ATTORNEY



David J. Kyros

Director of the United States Patent and Trademark Office

United States of America

United States Patent and Trademark Office

citydog! CLUB

Reg. No. 4,153,368

CITYDOG! CLUB, LLC (CALIFORNIA LIMITED LIABILITY COMPANY)
27204 ROSEMONT LANE
VALENCIA, CA 91354

Registered June 5, 2012

Int. Cl.: 43

FOR: KENNEL SERVICES, NAMELY, BOARDING FOR PETS, IN CLASS 43 (U.S. CLS. 100 AND 101).

SERVICE MARK

FIRST USE 9-1-2011; IN COMMERCE 9-1-2011.

PRINCIPAL REGISTER

THE MARK CONSISTS OF STANDARD CHARACTERS WITHOUT CLAIM TO ANY PARTICULAR FONT, STYLE, SIZE, OR COLOR.

NO CLAIM IS MADE TO THE EXCLUSIVE RIGHT TO USE "CLUB", APART FROM THE MARK AS SHOWN.

SER. NO. 85-428,750, FILED 9-21-2011.

AISHA SALEM, EXAMINING ATTORNEY



David J. Kyffers

Director of the United States Patent and Trademark Office

United States of America

United States Patent and Trademark Office

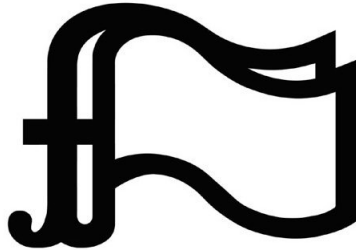

FLAGSTICK
GOLF APPAREL

Reg. No. 4,153,369

Registered June 5, 2012

Int. Cl.: 25

TRADEMARK

PRINCIPAL REGISTER

HARRELL, RODNEY D (UNITED STATES INDIVIDUAL)
6536 MEADOW LARK DRIVE
MONTGOMERY, AL 36116

FOR: ATHLETIC APPAREL, NAMELY, SHIRTS, PANTS, JACKETS, FOOTWEAR, HATS, CAPS, ATHLETIC UNIFORMS, TEE SHIRTS, SWEATSHIRTS, SKIRTS, POLO SHIRTS, AND GLOVES FOR APPAREL, IN CLASS 25 (U.S. CLS. 22 AND 39).

FIRST USE 9-16-2011; IN COMMERCE 9-16-2011.

NO CLAIM IS MADE TO THE EXCLUSIVE RIGHT TO USE "GOLF APPAREL", APART FROM THE MARK AS SHOWN.

THE MARK CONSISTS OF "FLAGSTICK GOLF APPAREL" IN A STYLIZED FONT BENEATH A DESIGN THAT CONSISTS OF A STYLIZED FLAG COMPRISED OF VERTICAL, HORIZONTAL, AND CURVED LINES THAT INTERCONNECT. THE OUTER LEFT VERTICAL LINE WHICH IS WIDER THAN THE OTHER LINES HAS A STRAIGHT HORIZONTAL LINE THAT INTERSECTS THE CENTER OF IT AND MERGES INTO THE MIDDLE OF THE INNER VERTICAL LINE OF THE RECTANGLE WAVE BOX. THE OUTER LEFT VERTICAL LINE AT THE BOTTOM CURVES DOWNWARD TOWARD THE LEFT THEN CURVES BACK UPWARD. THE TOP PORTION OF THE OUTER LEFT VERTICAL LINE CURVES UPWARD TOWARDS THE RIGHT, RUNNING SLIGHTLY ABOVE THE HORIZONTAL TOP WAVE LINE OF THE RECTANGLE WAVE BOX; THEN MERGES WITH A SMALL VERTICAL LINE WHICH CONNECTS WITH THE TOP WAVE LINE OF THE RECTANGLE WAVE BOX. THE SMALL VERTICAL LINE IS SLIGHTLY INSIDE AND A BIT HIGHER THAN THE OUTER RIGHT VERTICAL LINE OF THE RECTANGLE WAVE BOX, WHICH IS LOWER AND EXTENDS A LITTLE FURTHER OUT. THE INNER VERTICAL LINE OF THE RECTANGLE WAVE BOX EXTENDS DOWNWARD CURVING TOWARDS THE LEFT MERGING DIRECTLY INTO THE OUTER LEFT VERTICAL LINE; FORMING AND SLIGHT INWARD INDENTION AT THE BOTTOM CENTER OF THE TWO JOINING LINES. THE TOP AND BOTTOM HORIZONTAL WAVE LINES OF THE RECTANGLE WAVE BOX RUN DIRECTLY PARALLEL MERGING INTO THE INNER AND OUTER RIGHT VERTICAL LINES OF THE RECTANGLE WAVE BOX WITH THE WORDS "FLAGSTICK GOLF APPAREL" UNDERNEATH IT.



David J. Kyjars

SER. NO. 85-428,804, FILED 9-21-2011.

Reg. No. 4,153,369 RENEE MCCRAY, EXAMINING ATTORNEY

United States of America

United States Patent and Trademark Office



Reg. No. 4,153,370

Registered June 5, 2012

Int. Cl.: 25

TRADEMARK

PRINCIPAL REGISTER

STRICKLING, JONATHAN S. (OHIO CORPORATION), DBA THE DRIVE INSIDE
18938 SCOTTSDALE BLVD
SHAKER HTS., OH 44122

FOR: A-SHIRTS; APPAREL FOR DANCERS, NAMELY, TEE SHIRTS, SWEATSHIRTS, PANTS, LEGGINGS, SHORTS AND JACKETS; APRES-SKI SHOES; AQUA SHOES; ATHLETIC APPAREL, NAMELY, SHIRTS, PANTS, JACKETS, FOOTWEAR, HATS AND CAPS, ATHLETIC UNIFORMS; ATHLETIC SHOES; BALLET SHOES; BALLROOM DANCING SHOES; BASEBALL CAPS AND HATS; BASEBALL SHOES; BEACH SHOES; BICYCLE GLOVES; BICYCLING GLOVES; BOAT SHOES; BODY SHIRTS; BOWLING SHOES; BOXING SHOES; BUTTON DOWN SHIRTS; CAMOUFLAGE GLOVES; CAMOUFLAGE PANTS; CAMOUFLAGE SHIRTS; CAMP SHIRTS; CANVAS SHOES; CAPRI PANTS; CARGO PANTS; CLEATS FOR ATTACHMENT TO SPORTS SHOES; CLIMBING SHOES; CLOTHING FOR ATHLETIC USE, NAMELY, PADDED PANTS; CLOTHING FOR ATHLETIC USE, NAMELY, PADDED SHIRTS; CLOTHING FOR BABIES, TODDLERS AND CHILDREN, TREATED WITH FIRE AND HEAT RETARDANTS, NAMELY, PAJAMAS, JACKETS, SHIRTS, PANTS, JUMPERS; COLLARED SHIRTS; COMPRESSION GARMENTS FOR ATHLETIC OR OTHER NON-MEDICAL USE, NAMELY, COMPRESSION SOCKS, LEGGINGS, VESTS, JERSEYS, TROUSERS, SHIRTS; CROSS-COUNTRY GLOVES; CYCLING SHOES; DANCE SHOES; DECK-SHOES; DENIMS; DRESS PANTS; DRESS SHIRTS; DRIVERS; EAR BANDS; EAR MUFFS; EAR WARMERS; FINGERLESS GLOVES; FISHING SHIRTS; FITTED SHOE OR BOOT COVERING TO PROTECT THE SHOES OR BOOT FROM WATER OR OTHER DAMAGE; FOOTBALL SHOES; FUR HATS; FUR MUFFS; GLOVES; GLOVES AS CLOTHING; GLOVES FOR APPAREL; GLOVES FOR PERSONAL HAND CONDITIONING USE; GLOVES INCLUDING THOSE MADE OF SKIN, HIDE OR FUR; GOLF PANTS, SHIRTS AND SKIRTS; GOLF SHIRTS; GOLF SHOES; GYM PANTS; GYMNAS TIC SHOES; HANDBALL SHOES; HAT BANDS; HATS; HATS FOR INFANTS, BABIES, TODDLERS AND CHILDREN; HEADBANDS; HEADBANDS AGAINST SWEATING; HEADBANDS FOR CLOTHING; HEADGEAR, NAMELY, HATS, CAPS; HEEL PIECES FOR SHOES; HOCKEY SHOES; HOODED SWEAT SHIRTS; HUNTING PANTS; HUNTING SHIRTS; INFANTS' SHOES AND BOOTS; INSOLES; JEGGINGS, NAMELY, PANTS THAT ARE PARTIALLY JEANS AND PARTIALLY LEGGINGS; JOGGING PANTS; KNIT SHIRTS; KNITTED GLOVES; LEATHER HATS; LEATHER SHOES; LEG SHIELDING DEVICE, ATTACHABLE TO AND DETACHABLE FROM A PERSON'S PANTS, COMPRISED OF PADDING TO SHIELD THE LEGS FROM FLYING DEBRIS WHEN MOWING WITH A STRING TRIMMER; LEISURE SHOES; LONG-SLEEVED SHIRTS; LOUNGE PANTS; MATERNITY CLOTHING, NAMELY, SHIRTS, PANTS, SHORTS, SHOES; MOISTURE-WICKING SPORTS PANTS; MOISTURE-WICKING SPORTS SHIRTS; MOTORCYCLE GLOVES;



David J. Kybas

Director of the United States Patent and Trademark Office

Reg. No. 4,153,370 MOUNTAINEERING SHOES; MUFFS; NIGHT SHIRTS; NURSE PANTS; OPEN-NECKED SHIRTS; OUTDOOR GLOVES; OVER SHIRTS; PANTS; PARTY HATS; PERSPIRATION ABSORBENT STRAP TO BE USED IN THE BILL OF A HAT; PIQUE SHIRTS; POLO SHIRTS; RAIN HATS; RIDING GLOVES; RIDING SHOES; RUBBER SHOES; RUGBY SHIRTS; RUGBY SHOES; RUNNING PADS THAT STRAP ONTO SHOES; RUNNING SHOES; SANDALS AND BEACH SHOES; SCIENTIFIC AND TECHNOLOGICAL APPAREL, NAMELY, SHIRTS, PANTS, JACKETS, FOOTWEAR, HATS AND CAPS, UNIFORMS; SHIRTS; SHIRTS AND SHORT-SLEEVED SHIRTS; SHIRTS AND SLIPS; SHIRTS FOR INFANTS, BABIES, TODDLERS AND CHILDREN; SHIRTS FOR SUITS; SHOE COVERS FOR USE WHEN WEARING SHOES; SHOE INSERTS FOR PRIMARILY NON-ORTHOPEDIC PURPOSES; SHOE SOLES; SHOE STRAPS; SHOES; SHOES FEATURING SPRING DEVICES, CUSHIONING TECHNOLOGY; SHOES SOLES FOR REPAIR; SHOES WITH HOOK AND PILE FASTENING TAPES; SHORT-SLEEVED OR LONG-SLEEVED T-SHIRTS; SHORT-SLEEVED SHIRTS; SKI AND SNOWBOARD SHOES AND PARTS THEREOF; SKI GLOVES; SKI PANTS; SKIING SHOES; SLEEP PANTS; SLEEP SHIRTS; SNAP CROTCH SHIRTS FOR INFANTS AND TODDLERS; SNOW PANTS; SNOWBOARD GLOVES; SNOWBOARD PANTS; SOCCER SHOES; SPORT SHIRTS; SPORTS CAPS AND HATS; SPORTS PANTS; SPORTS SHIRTS; SPORTS SHIRTS WITH SHORT SLEEVES; STRETCH PANTS; SWEAT PANTS; SWEAT SHIRTS; T-SHIRTS; T-SHIRTS FOR BABIES, ADULTS, CHILDREN, WOMEN, MEN; TAP PANTS; TAP SHOES; TEE SHIRTS; TENNIS SHOES; TOBOGGAN HATS, PANTS AND CAPS; TRACK AND FIELD SHOES; TRACK PANTS; TRAINING SHOES; TRAVEL CLOTHING CONTAINED IN A PACKAGE COMPRISING REVERSIBLE JACKETS, PANTS, SKIRTS, TOPS AND A BELT OR SCARF; TRIATHLON CLOTHING, NAMELY, TRIATHLON TIGHTS, TRIATHLON SHORTS, TRIATHLON SINGLET, TRIATHLON SHIRTS, TRIATHLON SUITS; TURTLE NECK SHIRTS; VOLLEYBALL SHOES; WATER REPELLING LEATHER SHOES AND BOOTS; WATERPROOF JACKETS AND PANTS; WATERPROOF LEATHER SHOES; WATERPROOF LEATHER SHOES AND BOOTS; WEARABLE GARMENTS AND CLOTHING, NAMELY, SHIRTS; WELTS FOR BOOTS AND SHOES; WET SUIT GLOVES; WIND PANTS; WIND SHIRTS; WOMEN'S CLOTHING, NAMELY, SHIRTS, DRESSES, SKIRTS, BLOUSES; WOMEN'S HATS AND HOODS; WOMEN'S SHOES; WOMEN'S SHOES, NAMELY, FOLDABLE FLATS; WOOLLY HATS; WORK SHOES AND BOOTS; WRISTBANDS; WRISTBANDS CONTAINING A COOLING SUBSTANCE TO COOL THE WEARER; YOGA PANTS; YOGA SHIRTS, IN CLASS 25 (U.S. CLS. 22 AND 39).

FIRST USE 1-1-2006; IN COMMERCE 4-18-2008.

OWNER OF U.S. REG. NO. 3,869,684.

THE COLOR(S) WHITE, AND RED IS/ARE CLAIMED AS A FEATURE OF THE MARK.

THE MARK CONSISTS OF STYLIZED LETTERING IN ALL CAPS WITH THE WORD "THE" APPEARING IN THE COLOR WHITE, FOLLOWED THE WORD "DRIVE" APPEARING IN THE COLOR RED, FOLLOWED BY THE WORD "INSIDE" APPEARING IN THE COLOR WHITE. THE STYLIZED WORDING "THE DRIVE INSIDE", FORMS A SHAFT OF AN ARROW. THE HEAD OF THE ARROW IS FORMED BY A STYLIZED CAPITAL LETTER "D" APPEARING TO THE RIGHT OF THE WORDING AND APPEARING IN THE COLOR RED OUTLINED WITH A WHITE BORDER. WITHIN THE STYLIZED LETTER "D" THERE APPEARS A STYLIZED ARROW HEAD DESIGN. THE COLOR BLACK REPRESENTS TRANSPARENT AREAS AND IS NOT PART OF THE MARK.

SER. NO. 85-428,822, FILED 9-21-2011.

GEOFFREY FOSDICK, EXAMINING ATTORNEY

United States of America

United States Patent and Trademark Office

THE HOSPITAL INDICATOR REPORT

Reg. No. 4,153,371

Registered June 5, 2012

Int. Cl.: 35

SERVICE MARK

PRINCIPAL REGISTER

PRESS GANEY ASSOCIATES, INC (INDIANA CORPORATION)
404 COLUMBIA PLACE
SOUTH BEND
INDIANA, IN 46601

FOR: BUSINESS ANALYSIS AND MANAGEMENT CONSULTING FOR HEALTHCARE PROVIDERS AND RELATED BUSINESSES, ANALYSIS RELATING TO THE BUSINESS MANAGEMENT OF HEALTH CARE FACILITIES, IN CLASS 35 (U.S. CLS. 100, 101 AND 102).

FIRST USE 12-31-1995; IN COMMERCE 12-31-1995.

THE MARK CONSISTS OF STANDARD CHARACTERS WITHOUT CLAIM TO ANY PARTICULAR FONT, STYLE, SIZE, OR COLOR.

NO CLAIM IS MADE TO THE EXCLUSIVE RIGHT TO USE "REPORT", APART FROM THE MARK AS SHOWN.

SEC. 2(F).

SER. NO. 85-428,847, FILED 9-22-2011.

AMY HELLA, EXAMINING ATTORNEY



David J. Kyffers

Director of the United States Patent and Trademark Office

United States of America

United States Patent and Trademark Office

PROVIDER PARTNER

Reg. No. 4,153,372

Registered June 5, 2012

Int. Cl.: 35

SERVICE MARK

PRINCIPAL REGISTER

PRESS GANEY ASSOCIATES, INC (INDIANA CORPORATION)
404 COLUMBIA PLACE
SOUTH BEND
INDIANA, IN 46601

FOR: BUSINESS ANALYSIS AND MANAGEMENT CONSULTING FOR HEALTHCARE PROVIDERS AND RELATED BUSINESSES, ANALYSIS RELATING TO THE BUSINESS MANAGEMENT OF HEALTH CARE FACILITIES; PROVIDING STATISTICAL DATA ON PHYSICIAN'S AND EMPLOYEE'S PERFORMANCE AND JOB SATISFACTION FOR THE PURPOSE OF RECRUITING AND RETAINING PERSONNEL, IN CLASS 35 (U.S. CLS. 100, 101 AND 102).

FIRST USE 10-25-2010; IN COMMERCE 10-25-2010.

THE MARK CONSISTS OF STANDARD CHARACTERS WITHOUT CLAIM TO ANY PARTICULAR FONT, STYLE, SIZE, OR COLOR.

NO CLAIM IS MADE TO THE EXCLUSIVE RIGHT TO USE "PROVIDER", APART FROM THE MARK AS SHOWN.

SER. NO. 85-428,879, FILED 9-22-2011.

AMY HELLA, EXAMINING ATTORNEY



David J. Kybas

Director of the United States Patent and Trademark Office

United States of America

United States Patent and Trademark Office

THE INTELLIGENT BUSINESS PROGRAM

Reg. No. 4,153,373

Registered June 5, 2012

Int. Cls.: 35 and 41

SERVICE MARK

PRINCIPAL REGISTER

IBUSINESS SOLUTIONS, INC. (MINNESOTA CORPORATION)
7300 METRO BOULEVARD
SUITE 590
EDINA, MN 55439

FOR: BUSINESS CONSULTING IN THE NATURE OF APPLYING A UNIQUE SET OF INTERDEPENDENT MODELS, TECHNIQUES, AND BEST PRACTICES TO CREATE A HIERARCHY OF PRIORITIES AND ASSESS THE VALUE OF DATA TO ACCELERATE IMPROVEMENTS TO AN ORGANIZATION'S PROCESSES, DECISION-MAKING, AND STRATEGIC OUTCOMES, IN CLASS 35 (U.S. CLS. 100, 101 AND 102).

FIRST USE 1-0-2009; IN COMMERCE 1-0-2009.

FOR: PROFESSIONAL COACHING SERVICES IN THE FIELD OF BUSINESS RELATED TO THE APPLICATION OF A UNIQUE SET OF INTERDEPENDENT MODELS, TECHNIQUES, AND BEST PRACTICES TO CREATE A HIERARCHY OF PRIORITIES AND ASSESS THE VALUE OF DATA TO ACCELERATE IMPROVEMENTS TO AN ORGANIZATION'S PROCESSES, DECISION-MAKING, AND STRATEGIC OUTCOMES, IN CLASS 41 (U.S. CLS. 100, 101 AND 107).

FIRST USE 1-0-2009; IN COMMERCE 1-0-2009.

THE MARK CONSISTS OF STANDARD CHARACTERS WITHOUT CLAIM TO ANY PARTICULAR FONT, STYLE, SIZE, OR COLOR.

NO CLAIM IS MADE TO THE EXCLUSIVE RIGHT TO USE "BUSINESS PROGRAM", APART FROM THE MARK AS SHOWN.

SER. NO. 85-428,947, FILED 9-22-2011.

APRIL HESIK, EXAMINING ATTORNEY



David J. Kyffers

Director of the United States Patent and Trademark Office

United States of America

United States Patent and Trademark Office

COMMUNICATE. INFLUENCE. ANTICIPATE.

Reg. No. 4,153,374

Registered June 5, 2012

Int. Cls.: 35 and 41

SERVICE MARK

PRINCIPAL REGISTER

IBUSINESS SOLUTIONS, INC. (MINNESOTA CORPORATION)
7300 METRO BOULEVARD
SUITE 590
EDINA, MN 55439

FOR: BUSINESS CONSULTING IN THE NATURE OF APPLYING A UNIQUE SET OF INTER-DEPENDENT MODELS, TECHNIQUES, AND BEST PRACTICES TO CREATE A HIERARCHY OF PRIORITIES AND ASSESS THE VALUE OF DATA TO ACCELERATE IMPROVEMENTS TO AN ORGANIZATION'S PROCESSES, DECISION-MAKING, AND STRATEGIC OUTCOMES, IN CLASS 35 (U.S. CLS. 100, 101 AND 102).

FIRST USE 1-0-2009; IN COMMERCE 1-0-2009.

FOR: PROFESSIONAL COACHING SERVICES IN THE FIELD OF BUSINESS RELATED TO THE APPLICATION OF A UNIQUE SET OF INTERDEPENDENT MODELS, TECHNIQUES, AND BEST PRACTICES TO CREATE A HIERARCHY OF PRIORITIES AND ASSESS THE VALUE OF DATA TO ACCELERATE IMPROVEMENTS TO AN ORGANIZATION'S PROCESSES, DECISION-MAKING, AND STRATEGIC OUTCOMES, IN CLASS 41 (U.S. CLS. 100, 101 AND 107).

FIRST USE 1-0-2009; IN COMMERCE 1-0-2009.

THE MARK CONSISTS OF STANDARD CHARACTERS WITHOUT CLAIM TO ANY PARTICULAR FONT, STYLE, SIZE, OR COLOR.

SER. NO. 85-428,952, FILED 9-22-2011.

APRIL HESIK, EXAMINING ATTORNEY



David J. Kyffers

Director of the United States Patent and Trademark Office

United States of America

United States Patent and Trademark Office

NINEVEH

Reg. No. 4,153,375

Registered June 5, 2012

Int. Cl.: 9

TRADEMARK

PRINCIPAL REGISTER

MORRIS, RUFUS (UNITED STATES INDIVIDUAL)
8835 WEDGEFIELD LANE
CICERO, NY 13039

FOR: A SERIES OF AUDIO AND VIDEO RECORDINGS FEATURING FICTIONAL STORIES
IN THE FIELD OF SPIRITUAL AND RELIGIOUS SUBJECT MATTERS, IN CLASS 9 (U.S.
CLS. 21, 23, 26, 36 AND 38).

FIRST USE 9-1-2011; IN COMMERCE 9-1-2011.

THE MARK CONSISTS OF STANDARD CHARACTERS WITHOUT CLAIM TO ANY PAR-
TICULAR FONT, STYLE, SIZE, OR COLOR.

OWNER OF U.S. REG. NO. 3,848,438.

SER. NO. 85-429,116, FILED 9-22-2011.

JOHN WILKE, EXAMINING ATTORNEY



David J. Kyffers

Director of the United States Patent and Trademark Office

United States of America

United States Patent and Trademark Office

HEARBUILDER

Reg. No. 4,153,376

Registered June 5, 2012

Int. Cl.: 41

SERVICE MARK

PRINCIPAL REGISTER

SUPER DUPER INC. (SOUTH CAROLINA CORPORATION), DBA SUPER DUPER PUBLICATIONS
5201 PELHAM ROAD
GREENVILLE, SC 29615

FOR: EDUCATIONAL SERVICES, NAMELY, PROVIDING WORKSHOPS, NATIONAL CONFERENCES, AND TECHNICAL ASSISTANCE IN THE AREA OF ADULT LEARNING, BOTH TO INDIVIDUALS AND INSTITUTIONS, INCLUDING COLLEGES AND UNIVERSITIES, COMMUNITY COLLEGES, SCHOOLS, RECREATION DEPARTMENTS, AND INDEPENDENT AND COMMUNITY GROUPS IN THE AREAS OF AUDIOLOGY, SPEECH, LANGUAGE, VOICE, FLUENCY, AND LITERACY, IN CLASS 41 (U.S. CLS. 100, 101 AND 107).

FIRST USE 12-29-2009; IN COMMERCE 12-29-2009.

THE MARK CONSISTS OF STANDARD CHARACTERS WITHOUT CLAIM TO ANY PARTICULAR FONT, STYLE, SIZE, OR COLOR.

OWNER OF U.S. REG. NOS. 3,716,856 AND 4,031,756.

SER. NO. 85-429,229, FILED 9-22-2011.

SAMUEL E. SHARPER JR., EXAMINING ATTORNEY



David J. Kyffers

Director of the United States Patent and Trademark Office

United States of America

United States Patent and Trademark Office

LIFE ADJUSTMENT TEAM

Reg. No. 4,153,377

Registered June 5, 2012

Int. Cl.: 44

SERVICE MARK

PRINCIPAL REGISTER

D. W. MANAGEMENT ENTERPRISES INC. (CALIFORNIA CORPORATION)
11936 JEFFERSON BLVD. STE B
CULVER CITY, CA 90230

FOR: REHABILITATION PATIENT CARE SERVICES, IN CLASS 44 (U.S. CLS. 100 AND 101).

FIRST USE 1-1-2001; IN COMMERCE 1-1-2001.

THE MARK CONSISTS OF STANDARD CHARACTERS WITHOUT CLAIM TO ANY PARTICULAR FONT, STYLE, SIZE, OR COLOR.

SER. NO. 85-429,406, FILED 9-22-2011.

TIMOTHY FINNEGAN, EXAMINING ATTORNEY



David J. Kybas

Director of the United States Patent and Trademark Office

United States of America

United States Patent and Trademark Office



Reg. No. 4,153,378

Registered June 5, 2012

CERTIFICATION MARK

PRINCIPAL REGISTER

SOLAR RATING & CERTIFICATION CORPORATION (SRCC) (FLORIDA NON-PROFIT CORPORATION)
400 HIGH POINT DRIVE, SUITE 400
COCOA, FL 32926

FOR: SOLAR THERMAL PRODUCTS, NAMELY, SOLAR COLLECTORS, IN CLASS A (U.S. CL. A).

FIRST USE 5-5-2011; IN COMMERCE 5-5-2011.

OWNER OF U.S. REG. NOS. 1,286,639 AND 3,599,538.

THE COLOR(S) BLUE AND WHITE IS/ARE CLAIMED AS A FEATURE OF THE MARK.

NO CLAIM IS MADE TO THE EXCLUSIVE RIGHT TO USE "SOLAR RATING AND CERTIFICATION CORPORATION", "ESTABLISHED 1980" AND "OG-100 CERTIFIED", APART FROM THE MARK AS SHOWN.

THE MARK CONSISTS OF THE WORDS "SOLAR RATING & CERTIFICATION CORPORATION ESTABLISHED 1980" FORMING A CIRCLE AND APPEARING IN WHITE LETTERS; THE LETTERS "SRCC" IN THE COLOR WHITE; THE LETTERS AND NUMBER "OG-100" AND THE WORD "CERTIFIED" IN THE COLOR BLUE; AND, STRAIGHT BLUE LINES WHICH DEPICT RAYS OF THE SUN. THE BACKGROUND OF THE CIRCLE BEHIND THE WHITE LETTERS IS BLUE.

THE CERTIFICATION MARK, AS USED BY AUTHORIZED PERSONS, CERTIFIES THAT THE GOODS CONFORM TO THE DURABILITY AND PERFORMANCE REQUIREMENTS DESIGNATED BY THE CERTIFIER.

SER. NO. 85-429,450, FILED 9-22-2011.

NATALIE POLZER, EXAMINING ATTORNEY



David J. Kyros

Director of the United States Patent and Trademark Office

United States of America

United States Patent and Trademark Office

RETICKR

Reg. No. 4,153,379

Registered June 5, 2012

Int. Cl.: 42

SERVICE MARK

PRINCIPAL REGISTER

RETICKR LLC (TENNESSEE LIMITED LIABILITY COMPANY)
800 MARKET STREET
SUITE 200
CHATTANOOGA, TN 37402

FOR: COMPUTER SERVICES, NAMELY, CREATING ON-LINE VIRTUAL COMMUNITIES FOR REGISTERED USERS TO ORGANIZE GROUPS AND EVENTS, PARTICIPATE IN DISCUSSIONS, AND ENGAGE IN SOCIAL, BUSINESS AND COMMUNITY NETWORKING; COMPUTER SERVICES, NAMELY, HOSTING ELECTRONIC FACILITIES FOR OTHERS FOR ORGANIZING AND CONDUCTING MEETINGS, EVENTS AND INTERACTIVE DISCUSSIONS VIA COMMUNICATION NETWORKS; APPLICATION SERVICE PROVIDER (ASP) SERVICES, NAMELY, HOSTING COMPUTER SOFTWARE APPLICATIONS OF OTHERS; APPLICATION SERVICE PROVIDER (ASP) FEATURING SOFTWARE TO ENABLE OR FACILITATE THE UPLOADING, DOWNLOADING, STREAMING, POSTING, DISPLAYING, BLOGGING, LINKING, SHARING OR OTHERWISE PROVIDING ELECTRONIC MEDIA OR INFORMATION OVER COMMUNICATION NETWORKS; PROVIDING AN ONLINE NETWORK SERVICE THAT ENABLES USERS TO TRANSFER PERSONAL IDENTITY DATA TO AND SHARE PERSONAL IDENTITY DATA WITH AND AMONG MULTIPLE WEBSITES; PROVIDING A WEB SITE FEATURING TECHNOLOGY THAT ENABLES ON-LINE USERS TO CREATE PERSONAL PROFILES FEATURING SOCIAL NETWORKING INFORMATION AND TO TRANSFER AND SHARE SUCH INFORMATION AMONG MULTIPLE WEBSITES; COMPUTER SERVICES, NAMELY, CREATING INDEXES OF INFORMATION, SITES AND OTHER RESOURCES AVAILABLE ON COMPUTER NETWORKS; PROVIDING TEMPORARY USE OF NON-DOWNLOADABLE SOFTWARE APPLICATIONS FOR SOCIAL NETWORKING, CREATING A VIRTUAL COMMUNITY, AND TRANSMISSION OF AUDIO, VIDEO, PHOTOGRAPHIC IMAGES, TEXT, GRAPHICS AND DATA; COMPUTER SERVICES IN THE NATURE OF CUSTOMIZED WEB PAGES FEATURING USER-DEFINED OR SPECIFIED INFORMATION, PERSONAL PROFILES, AUDIO, VIDEO, PHOTOGRAPHIC IMAGES, TEXT, GRAPHICS AND DATA; PEER-TO-BROWSER PHOTO SHARING SERVICES, NAMELY, PROVIDING A WEBSITE FEATURING TECHNOLOGY ENABLING USERS TO UPLOAD, VIEW, AND DOWNLOAD DIGITAL PHOTOS; PROVIDING A WEB SITE FEATURING TECHNOLOGY THAT ENABLES USERS TO UPLOAD AND SHARE VIDEO, PHOTOS, TEXT, GRAPHICS AND DATA; CREATING AND MAINTAINING BLOGS FOR OTHERS; PROVIDING A WEB SITE THAT ALLOWS A USER TO ACCESS VARIOUS SOCIAL MEDIA WEBSITES, CREATE INVITATIONS FOR EVENTS, FOLLOW EVENTS OF OTHERS, AND DO LIVE BROADCASTING WITH CURRENT COMMENTARY, IN CLASS 42 (U.S. CLS. 100 AND 101).



David J. Kyros

Director of the United States Patent and Trademark Office

Reg. No. 4,153,379 FIRST USE 8-10-2011; IN COMMERCE 8-10-2011.

THE MARK CONSISTS OF STANDARD CHARACTERS WITHOUT CLAIM TO ANY PARTICULAR FONT, STYLE, SIZE, OR COLOR.

SER. NO. 85-429,591, FILED 9-22-2011.

JIM RINGLE, EXAMINING ATTORNEY

United States of America

United States Patent and Trademark Office



Reg. No. 4,153,380

Registered June 5, 2012

Int. Cl.: 42

SERVICE MARK

PRINCIPAL REGISTER

RETICKR LLC (TENNESSEE LIMITED LIABILITY COMPANY)
SUITE 200
800 MARKET STREET
CHATTANOOGA, TN 37402

FOR: COMPUTER SERVICES, NAMELY, CREATING ON-LINE VIRTUAL COMMUNITIES FOR REGISTERED USERS TO ORGANIZE GROUPS AND EVENTS, PARTICIPATE IN DISCUSSIONS, AND ENGAGE IN SOCIAL, BUSINESS AND COMMUNITY NETWORKING; COMPUTER SERVICES, NAMELY, HOSTING ELECTRONIC FACILITIES FOR OTHERS FOR ORGANIZING AND CONDUCTING MEETINGS, EVENTS AND INTERACTIVE DISCUSSIONS VIA COMMUNICATION NETWORKS; APPLICATION SERVICE PROVIDER (ASP) SERVICES, NAMELY, HOSTING COMPUTER SOFTWARE APPLICATIONS OF OTHERS; APPLICATION SERVICE PROVIDER (ASP) FEATURING SOFTWARE TO ENABLE OR FACILITATE THE UPLOADING, DOWNLOADING, STREAMING, POSTING, DISPLAYING, BLOGGING, LINKING, SHARING OR OTHERWISE PROVIDING ELECTRONIC MEDIA OR INFORMATION OVER COMMUNICATION NETWORKS; PROVIDING AN ONLINE NETWORK SERVICE THAT ENABLES USERS TO TRANSFER PERSONAL IDENTITY DATA TO AND SHARE PERSONAL IDENTITY DATA WITH AND AMONG MULTIPLE WEBSITES; PROVIDING A WEB SITE FEATURING TECHNOLOGY THAT ENABLES ON-LINE USERS TO CREATE PERSONAL PROFILES FEATURING SOCIAL NETWORKING INFORMATION AND TO TRANSFER AND SHARE SUCH INFORMATION AMONG MULTIPLE WEBSITES; COMPUTER SERVICES, NAMELY, CREATING INDEXES OF INFORMATION, SITES AND OTHER RESOURCES AVAILABLE ON COMPUTER NETWORKS; PROVIDING TEMPORARY USE OF NON-DOWNLOADABLE SOFTWARE APPLICATIONS FOR SOCIAL NETWORKING, CREATING A VIRTUAL COMMUNITY, AND TRANSMISSION OF AUDIO, VIDEO, PHOTOGRAPHIC IMAGES, TEXT, GRAPHICS AND DATA; COMPUTER SERVICES IN THE NATURE OF CUSTOMIZED WEB PAGES FEATURING USER-DEFINED OR SPECIFIED INFORMATION, PERSONAL PROFILES, AUDIO, VIDEO, PHOTOGRAPHIC IMAGES, TEXT, GRAPHICS AND DATA; PEER-TO-BROWSER PHOTO SHARING SERVICES, NAMELY, PROVIDING A WEBSITE FEATURING TECHNOLOGY ENABLING USERS TO UPLOAD, VIEW, AND DOWNLOAD DIGITAL PHOTOS; PROVIDING A WEB SITE FEATURING TECHNOLOGY THAT ENABLES USERS TO UPLOAD AND SHARE VIDEO, PHOTOS, TEXT, GRAPHICS AND DATA; CREATING AND MAINTAINING BLOGS FOR OTHERS; PROVIDING A WEB SITE THAT ALLOWS A USER TO ACCESS VARIOUS SOCIAL MEDIA WEBSITES, CREATE INVITATIONS FOR EVENTS, FOLLOW EVENTS OF OTHERS, AND DO LIVE BROADCASTING WITH CURRENT COMMENTARY, IN CLASS 42 (U.S. CLS. 100 AND 101).



David J. Kappas

Director of the United States Patent and Trademark Office

Reg. No. 4,153,380 FIRST USE 8-10-2011; IN COMMERCE 8-10-2011.

THE MARK CONSISTS OF TWO SPEECH BUBBLES LOCATED SIDE BY SIDE, THE LEFT ONE CONTAINING THE LETTERS "RE" IN WHITE LETTERING WITH GRAY OUTLINING ON A BLUE SURFACE WITH LIGHT BLUE HIGHLIGHTING, AND THE RIGHT ONE CONTAINING THE LETTERS "TICKR" IN WHITE LETTERING WITH GRAY OUTLINING ON AN ORANGE SURFACE WITH LIGHT ORANGE HIGHLIGHTING. BENEATH THE BUBBLES APPEARS A GRAY OVAL SHADOW. THE BACKGROUND OF THE ENTIRE MARK IS TRANSLUCENT.

THE COLOR(S) ORANGE, LIGHT ORANGE, BLUE, LIGHT BLUE, AND GRAY IS/ARE CLAIMED AS A FEATURE OF THE MARK.

SER. NO. 85-429,603, FILED 9-22-2011.

JIM RINGLE, EXAMINING ATTORNEY

United States of America

United States Patent and Trademark Office

The logo for "My Body Count" is displayed on a light gray stippled background. The words "My" and "Body" are written in a cursive script, while "Count" is in a bold, sans-serif font. The "M" in "My", the "B" in "Body", and the "C" in "Count" are capitalized.

Reg. No. 4,153,381

Registered June 5, 2012

Int. Cl.: 44

SERVICE MARK

PRINCIPAL REGISTER

O'KEEFE, TERESA ANN (UNITED STATES INDIVIDUAL)
6 SPA CREEK LANDING
#A3
ANNAPOLIS, MD 21403

FOR: PROVIDING AN INTERACTIVE WEBSITE FEATURING INFORMATION AND LINKS RELATING TO HEALTHY LIVING AND WEIGHT LOSS; PROVIDING MEDICAL PROFILES AND MEDICAL RECORD ANALYSIS AND ASSESSMENTS VIA A WEBSITE THAT ARE DESIGNED TO PROVIDE CUSTOM TAILORED OUTPUTS ABOUT RECOMMENDED RESOURCES AND TREATMENTS ASSOCIATED WITH A DEFINED SET OF SYMPTOMS AND CONCERNS, IN CLASS 44 (U.S. CLS. 100 AND 101).

FIRST USE 9-9-2011; IN COMMERCE 9-9-2011.

THE STIPPLING IS A FEATURE OF THE MARK AND DOES NOT INDICATE COLOR.

THE MARK CONSISTS OF THE WORDS "MY" AND "BODY" ARE IN CURSIVE, RESPECTIVELY ADJACENT TO EACH OTHER WITH NO SPACE. THE COMBINED WORDS "MY-BODY" IS ADJACENT WITH NO SPACE BEFORE THE WORD "COUNT" THAT IS PRESENTED IN A SANS SERIF FONT. THE "M" IN "MY", THE "B" IN "BODY" AND THE "C" IN "COUNT" ARE THE ONLY LETTERS CAPITALIZED. THE ENTIRE MARK APPEARS OVERTOP OF A LIGHTLY STIPPLED BACKGROUND WHICH CREATES SHADING BEHIND THE MARK.

SER. NO. 85-429,678, FILED 9-22-2011.

THOMAS MANOR, EXAMINING ATTORNEY



David J. Kyffers

Director of the United States Patent and Trademark Office

United States of America

United States Patent and Trademark Office

Pepper Pastor Salon

Reg. No. 4,153,382

Registered June 5, 2012

Int. Cl.: 44

SERVICE MARK

PRINCIPAL REGISTER

PASTOR, JENNIFER (UNITED STATES INDIVIDUAL)
3D
160 FRONT ST
NEW YORK, NY 10038

FOR: BEAUTY CONSULTATION SERVICES; HAIR SALON SERVICES; SERVICES OF A MAKE-UP ARTIST, IN CLASS 44 (U.S. CLS. 100 AND 101).

FIRST USE 11-0-1998; IN COMMERCE 4-0-2006.

THE MARK CONSISTS OF STANDARD CHARACTERS WITHOUT CLAIM TO ANY PARTICULAR FONT, STYLE, SIZE, OR COLOR.

NO CLAIM IS MADE TO THE EXCLUSIVE RIGHT TO USE "SALON", APART FROM THE MARK AS SHOWN.

THE NAME "PEPPER PASTOR" IDENTIFIES A LIVING INDIVIDUAL WHOSE CONSENT IS OF RECORD.

SER. NO. 85-429,951, FILED 9-22-2011.

JENNIFER VASQUEZ, EXAMINING ATTORNEY



David J. Kyros

Director of the United States Patent and Trademark Office

United States of America

United States Patent and Trademark Office

THE DAY OF THE WEEK REPORT

Reg. No. 4,153,383

Registered June 5, 2012

Int. Cl.: 35

SERVICE MARK

PRINCIPAL REGISTER

PRESS GANEY ASSOCIATES, INC (INDIANA CORPORATION)
404 COLUMBIA PLACE
SOUTH BEND
INDIANA, IN 46601

FOR: BUSINESS ANALYSIS AND MANAGEMENT CONSULTING FOR HEALTHCARE PROVIDERS AND RELATED BUSINESSES, ANALYSIS RELATING TO THE BUSINESS MANAGEMENT OF HEALTH CARE FACILITIES, IN CLASS 35 (U.S. CLS. 100, 101 AND 102).

FIRST USE 12-31-2003; IN COMMERCE 12-31-2003.

THE MARK CONSISTS OF STANDARD CHARACTERS WITHOUT CLAIM TO ANY PARTICULAR FONT, STYLE, SIZE, OR COLOR.

NO CLAIM IS MADE TO THE EXCLUSIVE RIGHT TO USE "REPORT", APART FROM THE MARK AS SHOWN.

SER. NO. 85-430,007, FILED 9-23-2011.

AMY HELLA, EXAMINING ATTORNEY



David J. Kyros

Director of the United States Patent and Trademark Office

United States of America

United States Patent and Trademark Office

PRESS GANEY PERFORMANCE CONSULTING SUITE

Reg. No. 4,153,384

Registered June 5, 2012

Int. Cl.: 35

SERVICE MARK

PRINCIPAL REGISTER

PRESS GANEY ASSOCIATES, INC (INDIANA CORPORATION)
404 COLUMBIA PLACE
SOUTH BEND
INDIANA, IN 46601

FOR: BUSINESS AND MANAGEMENT CONSULTING FOR HEALTHCARE PROVIDERS AND RELATED BUSINESSES, ANALYSIS RELATING TO THE BUSINESS MANAGEMENT OF HEALTH CARE FACILITIES , IN CLASS 35 (U.S. CLS. 100, 101 AND 102).

FIRST USE 10-25-2010; IN COMMERCE 10-25-2010.

THE MARK CONSISTS OF STANDARD CHARACTERS WITHOUT CLAIM TO ANY PARTICULAR FONT, STYLE, SIZE, OR COLOR.

OWNER OF U.S. REG. NOS. 2,228,347, 3,772,658, AND 4,021,466.

NO CLAIM IS MADE TO THE EXCLUSIVE RIGHT TO USE "PERFORMANCE CONSULTING SUITE", APART FROM THE MARK AS SHOWN.

SER. NO. 85-430,011, FILED 9-23-2011.

AMY HELLA, EXAMINING ATTORNEY



David J. Kyros

Director of the United States Patent and Trademark Office

United States of America

United States Patent and Trademark Office

VALUE-BASED PURCHASING OPTIMIZER

Reg. No. 4,153,385

Registered June 5, 2012

Int. Cl.: 35

SERVICE MARK

PRINCIPAL REGISTER

PRESS GANEY ASSOCIATES, INC (INDIANA CORPORATION)
404 COLUMBIA PLACE
SOUTH BEND
INDIANA, IN 46601

FOR: BUSINESS AND MANAGEMENT CONSULTING FOR HEALTHCARE PROVIDERS AND RELATED BUSINESSES, ANALYSIS RELATING TO THE BUSINESS MANAGEMENT OF HEALTH CARE FACILITIES , IN CLASS 35 (U.S. CLS. 100, 101 AND 102).

FIRST USE 10-25-2010; IN COMMERCE 10-25-2010.

THE MARK CONSISTS OF STANDARD CHARACTERS WITHOUT CLAIM TO ANY PARTICULAR FONT, STYLE, SIZE, OR COLOR.

NO CLAIM IS MADE TO THE EXCLUSIVE RIGHT TO USE "VALUE-BASED PURCHASING", APART FROM THE MARK AS SHOWN.

SER. NO. 85-430,013, FILED 9-23-2011.

AMY HELLA, EXAMINING ATTORNEY



David J. Kyffers

Director of the United States Patent and Trademark Office

United States of America

United States Patent and Trademark Office

OPPORTUNITY ASSESSMENT OPTIMIZER

Reg. No. 4,153,386

Registered June 5, 2012

Int. Cl.: 35

SERVICE MARK

PRINCIPAL REGISTER

PRESS GANEY ASSOCIATES, INC (INDIANA CORPORATION)
404 COLUMBIA PLACE
SOUTH BEND
INDIANA, IN 46601

FOR: BUSINESS AND MANAGEMENT CONSULTING FOR HEALTHCARE PROVIDERS AND RELATED BUSINESSES, ANALYSIS RELATING TO THE BUSINESS MANAGEMENT OF HEALTH CARE FACILITIES , IN CLASS 35 (U.S. CLS. 100, 101 AND 102).

FIRST USE 10-25-2010; IN COMMERCE 10-25-2010.

THE MARK CONSISTS OF STANDARD CHARACTERS WITHOUT CLAIM TO ANY PARTICULAR FONT, STYLE, SIZE, OR COLOR.

NO CLAIM IS MADE TO THE EXCLUSIVE RIGHT TO USE "ASSESSMENT OPTIMIZER", APART FROM THE MARK AS SHOWN.

SER. NO. 85-430,018, FILED 9-23-2011.

NAPOLEON SHARMA, EXAMINING ATTORNEY



David J. Kyffers

Director of the United States Patent and Trademark Office

United States of America

United States Patent and Trademark Office

CLINICAL PERFORMER OPTIMIZER

Reg. No. 4,153,387

Registered June 5, 2012

Int. Cl.: 35

SERVICE MARK

PRINCIPAL REGISTER

PRESS GANEY ASSOCIATES, INC (INDIANA CORPORATION)
404 COLUMBIA PLACE
SOUTH BEND
INDIANA, IN 46601

FOR: BUSINESS AND MANAGEMENT CONSULTING FOR HEALTHCARE PROVIDERS AND RELATED BUSINESSES, ANALYSIS RELATING TO THE BUSINESS MANAGEMENT OF HEALTH CARE FACILITIES , IN CLASS 35 (U.S. CLS. 100, 101 AND 102).

FIRST USE 10-25-2010; IN COMMERCE 10-25-2010.

THE MARK CONSISTS OF STANDARD CHARACTERS WITHOUT CLAIM TO ANY PARTICULAR FONT, STYLE, SIZE, OR COLOR.

NO CLAIM IS MADE TO THE EXCLUSIVE RIGHT TO USE "PERFORMER OPTIMIZER", APART FROM THE MARK AS SHOWN.

SER. NO. 85-430,019, FILED 9-23-2011.

NAPOLEON SHARMA, EXAMINING ATTORNEY



David J. Kyffers

Director of the United States Patent and Trademark Office

United States of America

United States Patent and Trademark Office

PATIENTFLOW OPTIMIZER

Reg. No. 4,153,388

Registered June 5, 2012

Int. Cl.: 35

SERVICE MARK

PRINCIPAL REGISTER

PRESS GANEY ASSOCIATES, INC (INDIANA CORPORATION)
404 COLUMBIA PLACE
SOUTH BEND
INDIANA, IN 46601

FOR: BUSINESS AND MANAGEMENT CONSULTING FOR HEALTHCARE PROVIDERS AND RELATED BUSINESSES, ANALYSIS RELATING TO THE BUSINESS MANAGEMENT OF HEALTH CARE FACILITIES , IN CLASS 35 (U.S. CLS. 100, 101 AND 102).

FIRST USE 10-25-2010; IN COMMERCE 10-25-2010.

THE MARK CONSISTS OF STANDARD CHARACTERS WITHOUT CLAIM TO ANY PARTICULAR FONT, STYLE, SIZE, OR COLOR.

NO CLAIM IS MADE TO THE EXCLUSIVE RIGHT TO USE "OPTIMIZER", APART FROM THE MARK AS SHOWN.

SER. NO. 85-430,031, FILED 9-23-2011.

NAPOLEON SHARMA, EXAMINING ATTORNEY



David J. Kyffers

Director of the United States Patent and Trademark Office

United States of America

United States Patent and Trademark Office

IWS-E.COM

Reg. No. 4,153,389

Registered June 5, 2012

Int. Cl.: 11

TRADEMARK

PRINCIPAL REGISTER

UNIVERSAL HOLDING GROUP, INC. (DELAWARE CORPORATION)
#360
1461 A FIRST AVENUE
NEW YORK, NY 100212209

FOR: SUSTAINABLE ONSITE WATER RECYCLING AND WASTE WATER TREATMENT SYSTEMS; WATER TREATMENT EQUIPMENT, NAMELY, REVERSE OSMOSIS FILTRATION UNITS, IN CLASS 11 (U.S. CLS. 13, 21, 23, 31 AND 34).

FIRST USE 0-0-2005; IN COMMERCE 0-0-2005.

THE MARK CONSISTS OF STANDARD CHARACTERS WITHOUT CLAIM TO ANY PARTICULAR FONT, STYLE, SIZE, OR COLOR.

OWNER OF U.S. REG. NO. 3,672,481.

SER. NO. 85-430,066, FILED 9-23-2011.

BENJAMIN OKEKE, EXAMINING ATTORNEY



David J. Kyros

Director of the United States Patent and Trademark Office

United States of America

United States Patent and Trademark Office



Reg. No. 4,153,390

Registered June 5, 2012

Int. Cls.: 42 and 44

SERVICE MARK

PRINCIPAL REGISTER

TBH TECHNOLOGY LLC (DELAWARE LIMITED LIABILITY COMPANY)
5729 SONOMA DRIVE
SUITE F
PLEASANTON, CA 94566

FOR: PROVIDING TEMPORARY USE OF ON-LINE NON-DOWNLOADABLE SOFTWARE FOR THE DELIVERY OF COLLABORATIVE REHABILITATION AND THERAPEUTIC SERVICES BY PARENTS AND THERAPISTS WORKING WITH INDIVIDUALS DIAGNOSED WITH AUTISM, ATTENTION DEFICIT HYPERACTIVITY DISORDER, CEREBRAL PALSY, LEARNING DISABILITIES, DEVELOPMENTAL DELAYS AND COGNITIVE AND PHYSICAL DISABILITIES, IN CLASS 42 (U.S. CLS. 100 AND 101).

FIRST USE 11-1-2011; IN COMMERCE 11-1-2011.

FOR: HEALTH AND PSYCHOLOGICAL ASSESSMENT SERVICES; BEHAVIORAL HEALTH SERVICES; HEALTH CARE SERVICES, NAMELY, IN-HOME BEHAVIOR MANAGEMENT CONSULTATION SERVICES; HEALTH CARE SERVICES, NAMELY, DESIGN OF IN-HOME BEHAVIORAL PLANS FOR INDIVIDUALS DIAGNOSED WITH AUTISM, ATTENTION DEFICIT HYPERACTIVITY DISORDER, CEREBRAL PALSY, LEARNING DISABILITIES, DEVELOPMENTAL DELAYS AND COGNITIVE AND PHYSICAL DISABILITIES; HEALTH CARE SERVICES, NAMELY, DEVELOPMENT OF BEHAVIOR PLANS FOR INDIVIDUALS DIAGNOSED WITH AUTISM, ATTENTION DEFICIT HYPERACTIVITY DISORDER, CEREBRAL PALSY, LEARNING DISABILITIES, DEVELOPMENTAL DELAYS AND COGNITIVE AND PHYSICAL DISABILITIES; PROVIDING AN INTERNET WEBSITE FEATURING NEWS AND INFORMATION RELATING TO DIAGNOSIS AND TREATMENT OF AUTISM, ATTENTION DEFICIT HYPERACTIVITY DISORDER, CEREBRAL PALSY, LEARNING DISABILITIES, DEVELOPMENTAL DELAYS AND COGNITIVE AND PHYSICAL DISABILITIES, IN CLASS 44 (U.S. CLS. 100 AND 101).

FIRST USE 11-1-2011; IN COMMERCE 11-1-2011.

THE MARK CONSISTS OF A PAIR OF BLUE ELEPHANTS (ADULT AND CHILD) IN FRONT OF A PARTIALLY RISEN ORANGE SUN.

THE COLOR(S) BLUE AND ORANGE IS/ARE CLAIMED AS A FEATURE OF THE MARK.

SER. NO. 85-430,370, FILED 9-23-2011.



David J. Kyros

Director of the United States Patent and Trademark Office

Reg. No. 4,153,390 NICHOLAS COLEMAN, EXAMINING ATTORNEY

United States of America

United States Patent and Trademark Office



Reg. No. 4,153,391

Registered June 5, 2012

Int. Cls.: 41 and 44

SERVICE MARK

PRINCIPAL REGISTER

HEAL2BFREE, LLC (VIRGINIA LIMITED LIABILITY COMPANY)
44050 ASHBURN SHOPPING PLAZA
SUITE 195-611
ASHBURN, VA 20147

FOR: EDUCATIONAL AND ENTERTAINMENT SERVICES, NAMELY, PUBLIC SPEAKING ENGAGEMENTS ON THE TOPIC OF HEALTHY LIFESTYLES, NAMELY, NUTRITION, FITNESS AND STRESS RELIEF, IN CLASS 41 (U.S. CLS. 100, 101 AND 107).

FIRST USE 9-22-2011; IN COMMERCE 9-22-2011.

FOR: HEALTH CONSULTING SERVICES RELATING TO HEALTHY LIFESTYLES, NAMELY, NUTRITION, FITNESS AND STRESS RELIEF, IN CLASS 44 (U.S. CLS. 100 AND 101).

FIRST USE 9-22-2011; IN COMMERCE 9-22-2011.

THE MARK CONSISTS OF A WINGED BIRD SHOWN IN RELIEF AGAINST A BLUE AND GREEN CIRCLE, THE BIRD HAVING YELLOW HIGHLIGHTS. THE LITERAL ELEMENT OF THE MARK, "HEAL 2B FREE", IS DISPOSED UNDER THE GRAPHICAL ELEMENT AND IS RENDERED IN BLUE AND GREEN LETTERING IN A STYLIZED FONT. THE COLOR WHITE IN THE BIRD REPRESENTS TRANSPARENT AREAS AND IS NOT PART OF THE MARK.

THE COLOR(S) BLUE, GREEN AND YELLOW IS/ARE CLAIMED AS A FEATURE OF THE MARK.

SER. NO. 85-430,491, FILED 9-23-2011.

DAVID HOFFMAN, EXAMINING ATTORNEY



David J. Kyros

Director of the United States Patent and Trademark Office

United States of America
United States Patent and Trademark Office

memory
bistro

Reg. No. 4,153,392

MEMORYBISTRO CORPORATION (DELAWARE CORPORATION)
4613 EAST 78 STREET
TULSA, OK 74136

Registered June 5, 2012

Int. Cl.: 45

FOR: INTERNET-BASED SOCIAL NETWORKING SERVICES, IN CLASS 45 (U.S. CLS. 100 AND 101).

SERVICE MARK

FIRST USE 4-1-2011; IN COMMERCE 4-1-2011.

PRINCIPAL REGISTER

THE MARK CONSISTS OF THE WORDS "MEMORYBISTRO" WITH "MEMORY" IN BLUE AND "BISTRO" IN GREEN CONNECTED WITH THREE INTERTWINED GREEN CIRCLES.

THE COLOR(S) BLUE AND GREEN IS/ARE CLAIMED AS A FEATURE OF THE MARK.

SER. NO. 85-430,583, FILED 9-23-2011.

JOHN HWANG, EXAMINING ATTORNEY



David J. Kybas

Director of the United States Patent and Trademark Office

United States of America

United States Patent and Trademark Office



Reg. No. 4,153,393

ELDRIDGE, ARTHUR (UNITED STATES INDIVIDUAL)
220 HARPERS FERRY DR
DAYTONA BEACH, FL 32119

Registered June 5, 2012

Int. Cl.: 41

FOR: EDUCATION SERVICES, NAMELY, PROVIDING CLASSES IN THE FIELD OF SPACE SCIENCE, IN CLASS 41 (U.S. CLS. 100, 101 AND 107).

SERVICE MARK

FIRST USE 1-1-2009; IN COMMERCE 1-1-2009.

PRINCIPAL REGISTER

NO CLAIM IS MADE TO THE EXCLUSIVE RIGHT TO USE "SPACE DISCOVERY INSTITUTE", APART FROM THE MARK AS SHOWN.

THE MARK CONSISTS OF THE STYLIZED TEXT "SPACE" WITH "DISCOVERY INSTITUTE" PLACED DIRECTLY BELOW. AN ARC HORIZON IS IN THE BACKGROUND. THE ARC CROSSES A CHEVRON WHICH REPRESENTS THE "A" IN THE TOP WORD "SPACE".

SER. NO. 85-430,585, FILED 9-23-2011.

KELLY TRUSILO, EXAMINING ATTORNEY



David J. Kybas

Director of the United States Patent and Trademark Office

United States of America

United States Patent and Trademark Office

CHESAPEAKE IRB

Reg. No. 4,153,394

Registered June 5, 2012

Int. Cls.: 41 and 45

SERVICE MARK

PRINCIPAL REGISTER

CHESAPEAKE RESEARCH REVIEW, INC. (MARYLAND CORPORATION)
7063 COLUMBIA GATEWAY DRIVE
SUITE 110
COLUMBIA, MD 210463403

FOR: EDUCATIONAL AND TRAINING SERVICES, NAMELY, PROVIDING LIVE AND ON-LINE SEMINARS, CONFERENCES, WORKSHOPS AND INDIVIDUALIZED TRAINING SESSIONS IN THE FIELD OF HUMAN SUBJECTS RESEARCH, AND DISTRIBUTION OF TRAINING MATERIALS IN CONNECTION THEREWITH, IN CLASS 41 (U.S. CLS. 100, 101 AND 107).

FIRST USE 0-0-2005; IN COMMERCE 0-0-2005.

FOR: PROVIDING INDEPENDENT REVIEW OF CLINICAL TRIALS INVOLVING HUMAN SUBJECTS, NAMELY, REVIEWING RESEARCH PROTOCOLS AND RELATED INFORMATION TO ENSURE PROTECTION OF THE RIGHTS AND WELFARE OF HUMAN SUBJECTS OF RESEARCH; REGULATORY COMPLIANCE CONSULTING SERVICES IN THE FIELD OF INSTITUTIONAL REVIEW BOARD (IRB) OPERATIONS, IN CLASS 45 (U.S. CLS. 100 AND 101).

FIRST USE 0-0-2005; IN COMMERCE 0-0-2005.

THE MARK CONSISTS OF STANDARD CHARACTERS WITHOUT CLAIM TO ANY PARTICULAR FONT, STYLE, SIZE, OR COLOR.

NO CLAIM IS MADE TO THE EXCLUSIVE RIGHT TO USE "IRB", APART FROM THE MARK AS SHOWN.

SEC. 2(F).

SER. NO. 85-430,648, FILED 9-23-2011.

WILLIAM JACKSON, EXAMINING ATTORNEY



David J. Kyffers

Director of the United States Patent and Trademark Office

United States of America

United States Patent and Trademark Office

CHESAPEAKE RESEARCH REVIEW, INC.

Reg. No. 4,153,395

Registered June 5, 2012

Int. Cls.: 41 and 45

SERVICE MARK

PRINCIPAL REGISTER

CHESAPEAKE RESEARCH REVIEW, INC. (MARYLAND CORPORATION)
7063 COLUMBIA GATEWAY DRIVE
SUITE 110
COLUMBIA, MD 210463403

FOR: EDUCATIONAL AND TRAINING SERVICES, NAMELY, PROVIDING LIVE AND ON-LINE SEMINARS, CONFERENCES, WORKSHOPS AND INDIVIDUALIZED TRAINING SESSIONS IN THE FIELD OF HUMAN SUBJECTS RESEARCH, AND DISTRIBUTION OF TRAINING MATERIALS IN CONNECTION THEREWITH, IN CLASS 41 (U.S. CLS. 100, 101 AND 107).

FIRST USE 12-0-1993; IN COMMERCE 12-0-1993.

FOR: PROVIDING INDEPENDENT REVIEW OF CLINICAL TRIALS INVOLVING HUMAN SUBJECTS, NAMELY, REVIEWING RESEARCH PROTOCOLS AND RELATED INFORMATION TO ENSURE PROTECTION OF THE RIGHTS AND WELFARE OF HUMAN SUBJECTS OF RESEARCH; REGULATORY COMPLIANCE CONSULTING SERVICES IN THE FIELD OF INSTITUTIONAL REVIEW BOARD (IRB) OPERATIONS, IN CLASS 45 (U.S. CLS. 100 AND 101).

FIRST USE 12-0-1993; IN COMMERCE 12-0-1993.

THE MARK CONSISTS OF STANDARD CHARACTERS WITHOUT CLAIM TO ANY PARTICULAR FONT, STYLE, SIZE, OR COLOR.

NO CLAIM IS MADE TO THE EXCLUSIVE RIGHT TO USE "RESEARCH REVIEW, INC.", APART FROM THE MARK AS SHOWN.

SEC. 2(F).

SER. NO. 85-430,679, FILED 9-23-2011.

WILLIAM JACKSON, EXAMINING ATTORNEY



David J. Kyffers

Director of the United States Patent and Trademark Office

United States of America

United States Patent and Trademark Office

CLAREHOUSE

Reg. No. 4,153,396

Registered June 5, 2012

Int. Cls.: 43 and 45

SERVICE MARK

PRINCIPAL REGISTER

CLAREHOUSE INC. (OKLAHOMA CORPORATION)
7617 S. MINGO ROAD
TULSA, OK 74133

FOR: PROVIDING TEMPORARY HOUSING ACCOMMODATIONS TO TERMINALLY ILL PERSONS, IN CLASS 43 (U.S. CLS. 100 AND 101).

FIRST USE 10-26-2003; IN COMMERCE 10-26-2003.

FOR: PERSONAL CARE ASSISTANCE OF ACTIVITIES OF DAILY LIVING, SUCH AS BATHING, GROOMING AND PERSONAL MOBILITY PROVIDED TO TERMINALLY ILL PERSONS, IN CLASS 45 (U.S. CLS. 100 AND 101).

FIRST USE 10-26-2003; IN COMMERCE 10-26-2003.

THE MARK CONSISTS OF STANDARD CHARACTERS WITHOUT CLAIM TO ANY PARTICULAR FONT, STYLE, SIZE, OR COLOR.

SER. NO. 85-430,691, FILED 9-23-2011.

KATHERINE CHANG, EXAMINING ATTORNEY



David J. Kyffers

Director of the United States Patent and Trademark Office

United States of America

United States Patent and Trademark Office

BLANKIE & ME

Reg. No. 4,153,397

Registered June 5, 2012

Int. Cls.: 24 and 28

TRADEMARK

PRINCIPAL REGISTER

KAHN LUCAS LANCASTER, INC. (PENNSYLVANIA CORPORATION)
SUITE 600
112 WEST 34TH STREET
NEW YORK, NY 10120

FOR: BABY BLANKETS INCORPORATING A STUFFED ANIMAL HEAD AND ARMS, IN CLASS 24 (U.S. CLS. 42 AND 50).

FIRST USE 8-1-2011; IN COMMERCE 8-1-2011.

FOR: TOYS DESIGNED TO BE ATTACHED TO A BLANKET, NAMELY A STUFFED ANIMAL HEAD AND ARMS THAT ATTACH TO BABY BLANKETS, IN CLASS 28 (U.S. CLS. 22, 23, 38 AND 50).

FIRST USE 8-1-2011; IN COMMERCE 8-1-2011.

THE MARK CONSISTS OF STANDARD CHARACTERS WITHOUT CLAIM TO ANY PARTICULAR FONT, STYLE, SIZE, OR COLOR.

SER. NO. 85-430,705, FILED 9-23-2011.

AMY C. KEAN, EXAMINING ATTORNEY



David J. Kyros

Director of the United States Patent and Trademark Office

United States of America

United States Patent and Trademark Office

A LOVING ALTERNATIVE FOR END-OF-LIFE CARE

Reg. No. 4,153,398

CLAREHOUSE INC. (OKLAHOMA CORPORATION)
7617 S. MINGO ROAD
TULSA, OK 74133

Registered June 5, 2012

Int. Cls.: 43 and 45

FOR: PROVIDING TEMPORARY HOUSING ACCOMMODATIONS TO TERMINALLY ILL PERSONS, IN CLASS 43 (U.S. CLS. 100 AND 101).

SERVICE MARK

FIRST USE 10-26-2003; IN COMMERCE 10-26-2003.

PRINCIPAL REGISTER

FOR: PERSONAL CARE ASSISTANCE OF ACTIVITIES OF DAILY LIVING, SUCH AS BATHING, GROOMING AND PERSONAL MOBILITY PROVIDED TO TERMINALLY ILL PERSONS, IN CLASS 45 (U.S. CLS. 100 AND 101).

FIRST USE 10-26-2003; IN COMMERCE 10-26-2003.

THE MARK CONSISTS OF STANDARD CHARACTERS WITHOUT CLAIM TO ANY PARTICULAR FONT, STYLE, SIZE, OR COLOR.

SER. NO. 85-430,714, FILED 9-23-2011.

KATHERINE CHANG, EXAMINING ATTORNEY



David J. Kyffers

Director of the United States Patent and Trademark Office

United States of America

United States Patent and Trademark Office

DNA

Reg. No. 4,153,399

Registered June 5, 2012

Int. Cl.: 5

TRADEMARK

PRINCIPAL REGISTER

MAGNUM NUTRACEUTICALS INC (CANADA CORPORATION)
101 - 19097 26TH AVENUE
SURREY, CANADA V3S3V7

FOR: AMINO ACIDS FOR NUTRITIONAL PURPOSES, IN CLASS 5 (U.S. CLS. 6, 18, 44, 46, 51 AND 52).

THE MARK CONSISTS OF STANDARD CHARACTERS WITHOUT CLAIM TO ANY PARTICULAR FONT, STYLE, SIZE, OR COLOR.

OWNER OF CANADA REG. NO. TMA793893, DATED 3-25-2011, EXPIRES 3-25-2026.

SER. NO. 85-430,717, FILED 9-23-2011.

CHRISTINA SOBRAL, EXAMINING ATTORNEY



David J. Kappas

Director of the United States Patent and Trademark Office

United States of America

United States Patent and Trademark Office



Southern Frattire
classic fraternity attire

Reg. No. 4,153,400

Registered June 5, 2012

Int. Cl.: 25

TRADEMARK

PRINCIPAL REGISTER

SOUTHERN FRATTIRE (VIRGINIA SOLE PROPRIETORSHIP)
536 GREEN ACRES RD.
BRISTOL, VA 24201

FOR: T-SHIRTS, IN CLASS 25 (U.S. CLS. 22 AND 39).

FIRST USE 8-5-2011; IN COMMERCE 8-12-2011.

NO CLAIM IS MADE TO THE EXCLUSIVE RIGHT TO USE "SOUTHERN FRATTIRE CLASSIC FRATERNITY ATTIRE", APART FROM THE MARK AS SHOWN.

THE COLOR(S) BLUE, BROWN, AND WHITE IS/ARE CLAIMED AS A FEATURE OF THE MARK.

THE MARK CONSISTS OF A STYLIZED BLUE SHIELD OUTLINED IN WHITE CONTAINING THE WHITE STYLIZED LETTERS "SF" WITH TWO BROWN STYLIZED FRATERNITY PADDLES CROSSING DIAGONALLY BEHIND THE SHIELD AND A BLUE AND WHITE STYLIZED BOW TIE DRAPING OVER THE FRATERNITY PADDLES ALL ABOVE THE BLUE STYLIZED WORDING "SOUTHERN FRATTIRE" AND BROWN STYLIZED WORDING "CLASSIC FRATERNITY ATTIRE".

SER. NO. 85-430,884, FILED 9-23-2011.

DAVID TOOLEY, EXAMINING ATTORNEY



David J. Kybas

Director of the United States Patent and Trademark Office

United States of America

United States Patent and Trademark Office

LIGHTHOUSE

Reg. No. 4,153,401

Registered June 5, 2012

Int. Cl.: 40

SERVICE MARK

PRINCIPAL REGISTER

LIGHTHOUSE PRINTING, INC. (ILLINOIS CORPORATION)
19027 S. JODI ROAD, SUITE G
MOKENA, IL 60448

FOR: CUSTOMIZED OFFSET, SILKSCREEN, FLEXOGRAPHIC, AND VARIABLE DATA PRINTING, INCLUDING PRINTING OF COMPANY NAMES AND LOGOS FOR PROMOTIONAL AND ADVERTISING PURPOSES ON THE GOODS OF OTHERS, IN CLASS 40 (U.S. CLS. 100, 103 AND 106).

FIRST USE 7-1-1999; IN COMMERCE 7-1-1999.

THE MARK CONSISTS OF STANDARD CHARACTERS WITHOUT CLAIM TO ANY PARTICULAR FONT, STYLE, SIZE, OR COLOR.

SER. NO. 85-430,902, FILED 9-23-2011.

MARIA-VICTORIA SUAREZ, EXAMINING ATTORNEY



David J. Kybas

Director of the United States Patent and Trademark Office

United States of America

United States Patent and Trademark Office

DuraLife

Reg. No. 4,153,402

Registered June 5, 2012

Int. Cl.: 9

TRADEMARK

PRINCIPAL REGISTER

CARL ZEISS VISION GMBH (FED REP GERMANY LIMITED LIABILITY COMPANY)
TURNSTRASSE 27
AALEN, FED REP GERMANY 73430

FOR: SPECTACLE LENSES AND PARTS THEREOF, IN CLASS 9 (U.S. CLS. 21, 23, 26, 36 AND 38).

THE MARK CONSISTS OF STANDARD CHARACTERS WITHOUT CLAIM TO ANY PARTICULAR FONT, STYLE, SIZE, OR COLOR.

PRIORITY CLAIMED UNDER SEC. 44(D) ON FED REP GERMANY APPLICATION NO. 302011017879, FILED 3-26-2011, REG. NO. 302011017879, DATED 7-7-2011, EXPIRES 3-31-2021.

SER. NO. 85-430,922, FILED 9-23-2011.

MARIA-VICTORIA SUAREZ, EXAMINING ATTORNEY



David J. Kybas

Director of the United States Patent and Trademark Office

United States of America

United States Patent and Trademark Office



Reg. No. 4,153,403

Registered June 5, 2012

Int. Cl.: 25

TRADEMARK

PRINCIPAL REGISTER

FAZIO, NANCY (UNITED STATES INDIVIDUAL)
1812 BEL COURT
INDIALANTIC, FL 32903 AND

BOBB, ASHLEY (UNITED STATES INDIVIDUAL)
1812 BEL COURT
INDIALANTIC, FL 32903

FOR: BATHING SUITS; BEACH COVER-UPS; BLOUSES; COATS; DRESSES; GLOVES; HATS; HEADBANDS; JACKETS; PANTS; SANDALS; SCARFS; SHIRTS; SHOES; SHORTS; SKIRTS; SNEAKERS; SWEATPANTS; SWEATSHIRTS; UNDERWEAR; YOGA PANTS, IN CLASS 25 (U.S. CLS. 22 AND 39).

FIRST USE 3-11-2011; IN COMMERCE 3-11-2011.

NO CLAIM IS MADE TO THE EXCLUSIVE RIGHT TO USE "CREATIONS", APART FROM THE MARK AS SHOWN.

THE MARK CONSISTS OF A MERMAID SITTING UPON A ROCK, FACING OUTWARD, HER BACK TOWARD YOU. HER TAIL IS WRAPPED AROUND A ROCK, AND HER LEFT HAND IS ON HER FOREHEAD, LOOKING OUT. THE MERMAID HAS LONG HAIR TO THE CENTER OF HER BACK, AND THE TEXT "SHESEA CREATIONS" ON THE UPPER RIGHT.

SER. NO. 85-431,183, FILED 9-24-2011.

CURTIS FRENCH, EXAMINING ATTORNEY



David J. Kybas

Director of the United States Patent and Trademark Office

United States of America

United States Patent and Trademark Office



Reg. No. 4,153,404

Registered June 5, 2012

Int. Cl.: 41

SERVICE MARK

PRINCIPAL REGISTER

DYNAMITE GYMNASTICS CENTER, LLC (MARYLAND LIMITED LIABILITY COMPANY)
4956 BOILING BROOK PKWY
ROCKVILLE, MD 20852

FOR: ENTERTAINMENT SERVICES, NAMELY, PARTICIPATION IN GYMNASTICS COMPETITIONS; INSTRUCTION IN THE FIELD OF GYMNASTICS, IN CLASS 41 (U.S. CLS. 100, 101 AND 107).

FIRST USE 8-1-2009; IN COMMERCE 8-1-2009.

NO CLAIM IS MADE TO THE EXCLUSIVE RIGHT TO USE "GYMNASTICS CENTER", APART FROM THE MARK AS SHOWN.

THE MARK CONSISTS OF THE STYLIZED TEXT "DYNAMITE" ABOVE THE STYLIZED TEXT "GYMNASTICS CENTER". THERE IS A LINE REPRESENTING A FUSE STRETCHING FROM THE BOTTOM OF THE LETTER "D" IN DYNAMITE TO THE RIGHT EDGE OF THE TEXT AND ENDS WITH AN STAR THAT REPRESENTS A SPARK. THE SPARK IS COMPRISED OF SIX PRONGS. THE "D" IN DYNAMITE HAS ITS FRONT STRETCHED OUT TO REPRESENT MOTION AND FLEXIBILITY.

SER. NO. 85-431,243, FILED 9-24-2011.

REBECCA SMITH, EXAMINING ATTORNEY



David J. Kybas

Director of the United States Patent and Trademark Office

United States of America

United States Patent and Trademark Office

The Bail Depot Bail Bonds

Reg. No. 4,153,405

Registered June 5, 2012

Int. Cl.: 36

SERVICE MARK

PRINCIPAL REGISTER

THE MCMANUS GROUP, INC. (CALIFORNIA CORPORATION)
P.O. BOX 146
RIVERSIDE, CA 92502

FOR: BAIL BONDING, IN CLASS 36 (U.S. CLS. 100, 101 AND 102).

FIRST USE 1-1-2011; IN COMMERCE 1-1-2011.

THE MARK CONSISTS OF STANDARD CHARACTERS WITHOUT CLAIM TO ANY PARTICULAR FONT, STYLE, SIZE, OR COLOR.

NO CLAIM IS MADE TO THE EXCLUSIVE RIGHT TO USE "BAIL" AND "BAIL BONDS", APART FROM THE MARK AS SHOWN.

SER. NO. 85-431,288, FILED 9-24-2011.

TIMOTHY FINNEGAN, EXAMINING ATTORNEY



David J. Kybas

Director of the United States Patent and Trademark Office

United States of America

United States Patent and Trademark Office

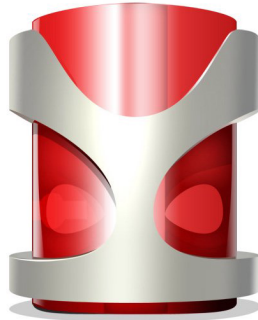

UniAlarm

Reg. No. 4,153,406

Registered June 5, 2012

Int. Cl.: 9

TRADEMARK

PRINCIPAL REGISTER

UNITED TECHNOLOGY ALLIANCE INC. (NEVADA CORPORATION)
2564 WIGWAM PKWY UNIT 90
LAS VEGAS, NV 89074

FOR: ALARM CENTRAL UNITS; ALARM MONITORING SYSTEMS; SECURITY ALARM CONTROLLERS; SECURITY AND FIRE ALARMS, IN CLASS 9 (U.S. CLS. 21, 23, 26, 36 AND 38).

FIRST USE 1-1-2011; IN COMMERCE 1-1-2011.

THE MARK CONSISTS OF 3D RED BARREL WITH RED EYES AND WHITE HIGHLIGHTS IN A 3D SILVER FRAME WITH WHITE HIGHLIGHTS, ABOVE "UNIALARM" IN BLACK FONT.

THE COLOR(S) WHITE, BLACK, RED, AND SILVER IS/ARE CLAIMED AS A FEATURE OF THE MARK.

SER. NO. 85-431,363, FILED 9-25-2011.

LINDA MICKLEBURGH, EXAMINING ATTORNEY



David J. Kyffers

Director of the United States Patent and Trademark Office

United States of America

United States Patent and Trademark Office



Reg. No. 4,153,407

Registered June 5, 2012

Int. Cl.: 41

SERVICE MARK

PRINCIPAL REGISTER

NICO EAST (UNITED STATES INDIVIDUAL)
5700 WEST 6TH STREET #305
LOS ANGELES, CA 90036

FOR: ENTERTAINMENT SERVICES IN THE NATURE OF DEVELOPMENT, CREATION, PRODUCTION AND POST-PRODUCTION SERVICES OF MULTIMEDIA ENTERTAINMENT CONTENT; MULTIMEDIA ENTERTAINMENT SERVICES IN THE NATURE OF RECORDING, PRODUCTION AND POST-PRODUCTION SERVICES IN THE FIELDS OF MUSIC, VIDEO, AND FILMS; PRODUCTION AND DISTRIBUTION OF TELEVISION SHOWS AND MOVIES, IN CLASS 41 (U.S. CLS. 100, 101 AND 107).

FIRST USE 5-5-2011; IN COMMERCE 5-5-2011.

THE MARK CONSISTS OF THE WORD "SEE" IN THE SHAPE OF A LIGHT BULB. UNDER THE WORD "SEE" IS A MOVIE REEL. THE LETTERS "S" AND "E" ARE A COMBINATION OF ORANGE AND YELLOW. THE LETTER "E" AND THE MOVIE REEL ARE SILVER. DIRECTLY UNDER THE MOVIE REEL IS THE TAGLINE, ""STAY TUNED, THERE'S MUCH MORE TO SEE."" THE TAGLINE IS WHITE WITH QUOTATIONS. THE ENTIRE MARK APPEARS ON A BLACK BACKGROUND.

THE COLOR(S) BLACK, ORANGE, YELLOW, SILVER AND WHITE IS/ARE CLAIMED AS A FEATURE OF THE MARK.

SER. NO. 85-431,444, FILED 9-26-2011.

TRACY CROSS, EXAMINING ATTORNEY



David J. Kyffers

Director of the United States Patent and Trademark Office

United States of America

United States Patent and Trademark Office

The Paradise Project

Reg. No. 4,153,408

Registered June 5, 2012

Int. Cl.: 45

SERVICE MARK

PRINCIPAL REGISTER

THE PARADISE PROJECT (CALIFORNIA CORPORATION), DBA THE PARADISE PROJECT
24 S. VENICE BLVD
VENICE, CA 90291

FOR: CHARITABLE OUTREACH SERVICES, NAMELY, PROVIDING COUNSELING SERVICES IN THE FIELD OF RELIGION; PROVIDING A WEBSITE FEATURING INFORMATION ABOUT RELIGIOUS BELIEF SYSTEMS; PROVIDING ON-LINE INFORMATION IN THE FIELD OF SPIRITUALITY, SELF-HELP, AND PERSONAL EMPOWERMENT SUBJECT MATTERS; RELIGIOUS AND SPIRITUAL SERVICES, NAMELY, CONDUCTING RELIGIOUS WORSHIP, MARRIAGE CEREMONIES, BAPTISMAL CEREMONIES, BABY DEDICATIONS, BEREAVEMENT CEREMONIES, AND RELIGIOUS COUNSELING, IN CLASS 45 (U.S. CLS. 100 AND 101).

FIRST USE 1-8-1997; IN COMMERCE 12-1-2000.

THE MARK CONSISTS OF STANDARD CHARACTERS WITHOUT CLAIM TO ANY PARTICULAR FONT, STYLE, SIZE, OR COLOR.

NO CLAIM IS MADE TO THE EXCLUSIVE RIGHT TO USE "PROJECT", APART FROM THE MARK AS SHOWN.

SER. NO. 85-431,453, FILED 9-26-2011.

ROSELLE HERRERA, EXAMINING ATTORNEY



David J. Kyros

Director of the United States Patent and Trademark Office

United States of America

United States Patent and Trademark Office

THE DENTIST'S WIFE

Reg. No. 4,153,409

Registered June 5, 2012

Int. Cl.: 35

SERVICE MARK

PRINCIPAL REGISTER

THE DENTISTS WIFE HOLDINGS LLC (FLORIDA LIMITED LIABILITY COMPANY)
POST OFFICE BOX 505
DUNEDIN, FL 34697

FOR: DISSEMINATION OF ADVERTISING PROGRAMS AND BROCHURES ON HOW TO EXECUTE EVENTS WITHIN A DENTAL OFFICE; DESIGN OF ADVERTISING PROGRAMS AND BROCHURES ON HOW TO EXECUTE EVENTS WITHIN A DENTAL OFFICE FOR OTHERS, IN CLASS 35 (U.S. CLS. 100, 101 AND 102).

FIRST USE 8-10-2009; IN COMMERCE 12-1-2009.

THE MARK CONSISTS OF STANDARD CHARACTERS WITHOUT CLAIM TO ANY PARTICULAR FONT, STYLE, SIZE, OR COLOR.

SER. NO. 85-431,473, FILED 9-26-2011.

Laurie Kaufman, Examining Attorney



David J. Kybas

Director of the United States Patent and Trademark Office

United States of America
United States Patent and Trademark Office

InsideCPA

Reg. No. 4,153,410

BROOKSHIER, RANDALL (UNITED STATES INDIVIDUAL)
9623 E VIA DEL SOL FELIZ
TUCSON, AZ 85748

Registered June 5, 2012

Int. Cl.: 35

FOR: PROVIDING A WEBSITE FEATURING INFORMATION ABOUT ACCOUNTING;
PROVIDING CONSULTATION SERVICES IN THE FIELD OF ACCOUNTING, IN CLASS 35
(U.S. CLS. 100, 101 AND 102).

SERVICE MARK

FIRST USE 8-1-2011; IN COMMERCE 8-11-2011.

PRINCIPAL REGISTER

THE MARK CONSISTS OF STANDARD CHARACTERS WITHOUT CLAIM TO ANY PARTICULAR FONT, STYLE, SIZE, OR COLOR.

SER. NO. 85-431,581, FILED 9-26-2011.

CURTIS FRENCH, EXAMINING ATTORNEY



David J. Kyros

Director of the United States Patent and Trademark Office

United States of America

United States Patent and Trademark Office

TRUX TEX

Reg. No. 4,153,411

Registered June 5, 2012

Int. Cl.: 37

SERVICE MARK

PRINCIPAL REGISTER

VALLEY TIRE CO., INC. (PENNSYLVANIA CORPORATION)
1002 ARENTZEN BLVD.
CHARLEROI, PA 15022

FOR: VEHICLE REPAIR SERVICES, IN CLASS 37 (U.S. CLS. 100, 103 AND 106).

FIRST USE 2-1-2011; IN COMMERCE 2-1-2011.

THE MARK CONSISTS OF STANDARD CHARACTERS WITHOUT CLAIM TO ANY PARTICULAR FONT, STYLE, SIZE, OR COLOR.

NO CLAIM IS MADE TO THE EXCLUSIVE RIGHT TO USE "TRUCKS", APART FROM THE MARK AS SHOWN.

SER. NO. 85-431,714, FILED 9-26-2011.

STEVEN PEREZ, EXAMINING ATTORNEY



David J. Kyffers

Director of the United States Patent and Trademark Office

United States of America

United States Patent and Trademark Office



Reg. No. 4,153,412

Registered June 5, 2012

Int. Cl.: 41

SERVICE MARK

PRINCIPAL REGISTER

PHILLIPS, JAMES L (UNITED STATES INDIVIDUAL)
1 BAYLOR PLAZA
HOUSTON, TX 77009

FOR: ACADEMIC ENRICHMENT PROGRAMS FOR MIDDLE AND HIGH SCHOOL STUDENTS IN THE FIELDS OF SCIENCE AND RESEARCH, IN CLASS 41 (U.S. CLS. 100, 101 AND 107).

FIRST USE 1-1-2005; IN COMMERCE 1-1-2005.

NO CLAIM IS MADE TO THE EXCLUSIVE RIGHT TO USE "SATURDAY MORNING SCIENCE", APART FROM THE MARK AS SHOWN.

THE COLOR(S) BLACK, PURPLE, BLUE, AND GOLD IS/ARE CLAIMED AS A FEATURE OF THE MARK.

THE MARK CONSISTS OF THE SHAPE OF A WEDGE WITH THE POINTED EDGE OF THE WEDGE POINTING DOWN. THE IMAGE IS OUTLINED IN THE COLOR PURPLE WITH A THICKER BLUE LINE THAT IS ADJACENT TO THE PURPLE LINE. THE BACKGROUND COLOR WITHIN THE WEDGE IS A GOLD COLOR AND THERE SMALL SHADOWED DOTS APPEARING IN THE BACKGROUND IMAGE TO ADD TEXTURE TO THE IMAGE. THE LETTERS APPEARING IN THE CENTER OF THE IMAGE ARE THE LETTERS "SMS" IN THE COLOR BLUE WITH THE LETTER "M" SITTING HIGHER ABOVE THE TWO S'S. DIRECTLY BELOW THE "SMS" LETTERS ARE THE WORDS "SATURDAY MORNING SCIENCE" IN THE COLOR BLACK. DIRECTLY UNDER THE WORDS "SATURDAY MORNING SCIENCE" IS A LINE OF DECOR IN THE COLOR BLUE.

SER. NO. 85-431,720, FILED 9-26-2011.

JOHN E. MICHOS, EXAMINING ATTORNEY



David J. Kyffers

Director of the United States Patent and Trademark Office

United States of America

United States Patent and Trademark Office

Unique Breedz

Reg. No. 4,153,413

EVERETT HUBER (UNITED STATES INDIVIDUAL)
P.O. BOX 502
ISLETON, CA 95641

Registered June 5, 2012

Int. Cl.: 16

FOR: POSTERS, IN CLASS 16 (U.S. CLS. 2, 5, 22, 23, 29, 37, 38 AND 50).

TRADEMARK

FIRST USE 11-15-2010; IN COMMERCE 11-15-2010.

PRINCIPAL REGISTER

THE MARK CONSISTS OF STANDARD CHARACTERS WITHOUT CLAIM TO ANY PARTICULAR FONT, STYLE, SIZE, OR COLOR.

SER. NO. 85-431,770, FILED 9-26-2011.

ALAIN LAPTER, EXAMINING ATTORNEY



David J. Kyffers

Director of the United States Patent and Trademark Office

United States of America

United States Patent and Trademark Office

HAUTE POLISH

Reg. No. 4,153,414

JE MATADI, INC. (TEXAS CORPORATION)
12802 CAPRICORN DRIVE
STAFFORD, TX 77477

Registered June 5, 2012

Int. Cl.: 3

FOR: NAIL POLISH; NAIL CARE PREPARATIONS; NAIL ART STICKERS; FINGERNAIL EMBELLISHMENTS, IN CLASS 3 (U.S. CLS. 1, 4, 6, 50, 51 AND 52).

TRADEMARK

FIRST USE 9-8-2011; IN COMMERCE 9-8-2011.

PRINCIPAL REGISTER

THE MARK CONSISTS OF STANDARD CHARACTERS WITHOUT CLAIM TO ANY PARTICULAR FONT, STYLE, SIZE, OR COLOR.

NO CLAIM IS MADE TO THE EXCLUSIVE RIGHT TO USE "POLISH", APART FROM THE MARK AS SHOWN.

SER. NO. 85-431,893, FILED 9-26-2011.

NELSON SNYDER, EXAMINING ATTORNEY



David J. Kyffers

Director of the United States Patent and Trademark Office

United States of America

United States Patent and Trademark Office

CLUB MODIANO

Reg. No. 4,153,415

Registered June 5, 2012

Int. Cl.: 34

TRADEMARK

PRINCIPAL REGISTER

BBK TOBACCO & FOODS, LLP (ARIZONA LIMITED LIABILITY LIMITED PARTNERSHIP),
DBA HBI INTERNATIONAL
3315 W. BUCKEYE ROAD
PHOENIX, AZ 85009

FOR: CIGARETTE PAPER; CIGARETTE PAPERS; CIGARETTE ROLLING PAPERS, IN
CLASS 34 (U.S. CLS. 2, 8, 9 AND 17).

FIRST USE 9-22-2011; IN COMMERCE 9-22-2011.

THE MARK CONSISTS OF STANDARD CHARACTERS WITHOUT CLAIM TO ANY PAR-
TICULAR FONT, STYLE, SIZE, OR COLOR.

SER. NO. 85-431,938, FILED 9-26-2011.

EDWARD FENNESSY, EXAMINING ATTORNEY



David J. Kyffers

Director of the United States Patent and Trademark Office

United States of America

United States Patent and Trademark Office

AMERICAN SOCIOLOGICAL ASSOCIATION

Reg. No. 4,153,416

Registered June 5, 2012

Int. Cl.: 35

SERVICE MARK

PRINCIPAL REGISTER

AMERICAN SOCIOLOGICAL ASSOCIATION (D.C. NON-PROFIT ASSOCIATION)
SUITE 600
1430 K STREET, NW
WASHINGTON, DC 20005

FOR: ASSOCIATION SERVICES, NAMELY, PROMOTING THE INTERESTS OF SOCIOLOGISTS BY ADVANCING SOCIOLOGY AS A SCIENTIFIC DISCIPLINE AND PROFESSION SERVING THE PUBLIC GOOD, IN CLASS 35 (U.S. CLS. 100, 101 AND 102).

FIRST USE 8-0-1959; IN COMMERCE 8-0-1959.

THE MARK CONSISTS OF STANDARD CHARACTERS WITHOUT CLAIM TO ANY PARTICULAR FONT, STYLE, SIZE, OR COLOR.

NO CLAIM IS MADE TO THE EXCLUSIVE RIGHT TO USE "ASSOCIATION", APART FROM THE MARK AS SHOWN.

SEC. 2(F).

SER. NO. 85-432,202, FILED 9-26-2011.

TEJBIR SINGH, EXAMINING ATTORNEY



David J. Kybas

Director of the United States Patent and Trademark Office

United States of America

United States Patent and Trademark Office

MUSCLE MACHINES

Reg. No. 4,153,417

Registered June 5, 2012

Int. Cl.: 28

TRADEMARK

PRINCIPAL REGISTER

SCHULTZ, BRUCE (UNITED STATES INDIVIDUAL), DBA BODYLINES
22425 VENTURA BOULEVARD #101
WOODLAND HILLS, CA 91364

FOR: TOY VEHICLES, IN CLASS 28 (U.S. CLS. 22, 23, 38 AND 50).

FIRST USE 6-0-1999; IN COMMERCE 1-0-2000.

THE MARK CONSISTS OF STANDARD CHARACTERS WITHOUT CLAIM TO ANY PARTICULAR FONT, STYLE, SIZE, OR COLOR.

OWNER OF U.S. REG. NOS. 2,844,104 AND 2,868,108.

NO CLAIM IS MADE TO THE EXCLUSIVE RIGHT TO USE "MACHINES", APART FROM THE MARK AS SHOWN.

SEC. 2(F).

SER. NO. 85-432,389, FILED 9-26-2011.

DAVID I, EXAMINING ATTORNEY



David J. Kyffers

Director of the United States Patent and Trademark Office

United States of America

United States Patent and Trademark Office



Reg. No. 4,153,418

Registered June 5, 2012

Int. Cl.: 12

TRADEMARK

PRINCIPAL REGISTER

PURE FIX CYCLES, LLC (CALIFORNIA LIMITED LIABILITY COMPANY)
1000 CHESTNUT STREET
BURBANK, CA 91506

FOR: BICYCLE FRAMES, IN CLASS 12 (U.S. CLS. 19, 21, 23, 31, 35 AND 44).

FIRST USE 12-19-2010; IN COMMERCE 1-12-2011.

NO CLAIM IS MADE TO THE EXCLUSIVE RIGHT TO USE "CYCLES", APART FROM THE MARK AS SHOWN.

THE MARK CONSISTS OF THE MARK BEGINS WITH A TWO PIECE "WING" POSITIONED TO THE LEFT OF THE INITIAL TEXT. THE "WING" WOULD BE A LEFT HAND SIDE WING OPENING UP TO THE LEFT. THE WING IS FOLLOWED BY THE WORDS "PURE FIX" IN A SLIGHTLY LARGER TEXT SIZE. THEN UNDERNEATH THE "PURE" IS THE WORD "CYCLES" IN A SMALLER TEXT SIZE EQUAL TO THE LENGTH OF ALMOST HALF OF THE WORD "PURE".

SER. NO. 85-432,473, FILED 9-27-2011.

FLORENTINA BLANDU, EXAMINING ATTORNEY



David J. Kyffers

Director of the United States Patent and Trademark Office

United States of America

United States Patent and Trademark Office

FRIENDLY SONGS

Reg. No. 4,153,419

Registered June 5, 2012

Int. Cl.: 9

TRADEMARK

PRINCIPAL REGISTER

KMCONSOLIDATED, LLC (SOUTH CAROLINA LIMITED LIABILITY COMPANY)
1811 TAYLOR DRIVE
GILBERT, SC 29054

FOR: PRE-RECORDED CDS FEATURING MUSIC; COMPUTER SOFTWARE FOR PRODUCING MUSIC CDS, IN CLASS 9 (U.S. CLS. 21, 23, 26, 36 AND 38).

FIRST USE 1-1-2000; IN COMMERCE 5-19-2005.

THE MARK CONSISTS OF STANDARD CHARACTERS WITHOUT CLAIM TO ANY PARTICULAR FONT, STYLE, SIZE, OR COLOR.

NO CLAIM IS MADE TO THE EXCLUSIVE RIGHT TO USE "SONGS", APART FROM THE MARK AS SHOWN.

SER. NO. 85-432,497, FILED 9-27-2011.

FLORENTINA BLANDU, EXAMINING ATTORNEY



David J. Kyffers

Director of the United States Patent and Trademark Office

United States of America

United States Patent and Trademark Office

PALISADES

Reg. No. 4,153,420

Registered June 5, 2012

Int. Cls.: 35 and 44

SERVICE MARK

PRINCIPAL REGISTER

PALISADES CORPORATION (WASHINGTON CORPORATION)
C/O VICTOR CASTLEBERRY
4625 BONNIE DR.
SPOKANE, WA 99224

FOR: CHARITABLE SERVICES, NAMELY, ORGANIZING, DEVELOPING AND CONDUCTING PROJECTS TO PROMOTE CONSERVATION AND RESPONSIBLE USE OF PARKS AND PUBLIC LANDS; PUBLIC ADVOCACY TO PROMOTE AWARENESS OF SPOKANE PARKS DEPARTMENT ISSUES, IN CLASS 35 (U.S. CLS. 100, 101 AND 102).

FIRST USE 12-30-2000; IN COMMERCE 12-30-2001.

FOR: HABITATION RESTORATION SERVICES, NAMELY, TRAIL MAINTENANCE FOR OTHERS, CLEANING, MAINTENANCE AND IMPROVEMENT OF PARKS AND PUBLIC LANDS, AND MAINTENANCE OF OLD GROWTH FOREST ECOSYSTEM AND WATERSHED FOR OTHERS, IN CLASS 44 (U.S. CLS. 100 AND 101).

FIRST USE 12-30-2000; IN COMMERCE 12-30-2001.

THE MARK CONSISTS OF STANDARD CHARACTERS WITHOUT CLAIM TO ANY PARTICULAR FONT, STYLE, SIZE, OR COLOR.

OWNER OF U.S. REG. NO. 3,367,914.

SER. NO. 85-432,503, FILED 9-27-2011.

ALLISON SCHRODY, EXAMINING ATTORNEY



David J. Kyros

Director of the United States Patent and Trademark Office

United States of America

United States Patent and Trademark Office

DASOUL

Reg. No. 4,153,421

NOWELL, ANDREW M (D.C. SOLE PROPRIETORSHIP), DBA DASOUL
1715 NEW JERSEY AVE NW
WASHINGTON, DC 20001

Registered June 5, 2012

Int. Cl.: 25

FOR: BASEBALL CAPS AND HATS; BRIEFS; COLLARED SHIRTS; MEN'S SUITS; MEN'S UNDERWEAR; PANTS; POLO SHIRTS; T-SHIRTS, IN CLASS 25 (U.S. CLS. 22 AND 39).

TRADEMARK

FIRST USE 3-1-2000; IN COMMERCE 3-1-2000.

PRINCIPAL REGISTER

THE MARK CONSISTS OF STANDARD CHARACTERS WITHOUT CLAIM TO ANY PARTICULAR FONT, STYLE, SIZE, OR COLOR.

SER. NO. 85-432,528, FILED 9-27-2011.

CHRISTOPHER SIDOTI, EXAMINING ATTORNEY



David J. Kybas

Director of the United States Patent and Trademark Office

United States of America

United States Patent and Trademark Office



Reg. No. 4,153,422

Registered June 5, 2012

Int. Cls.: 16 and 44

TRADEMARK

SERVICE MARK

PRINCIPAL REGISTER

ENDO PHARMACEUTICALS INC. (DELAWARE CORPORATION)
100 ENDO BOULEVARD
CHADDS FORD, PA 19317

FOR: PRINTED EDUCATIONAL MATERIALS ON THE SUBJECT OF TESTOSTERONE DEFICIENCY, IN CLASS 16 (U.S. CLS. 2, 5, 22, 23, 29, 37, 38 AND 50).

FIRST USE 2-28-2011; IN COMMERCE 2-28-2011.

FOR: PROVIDING ONLINE INFORMATION ON THE SUBJECT OF TESTOSTERONE DEFICIENCY, IN CLASS 44 (U.S. CLS. 100 AND 101).

FIRST USE 2-28-2011; IN COMMERCE 2-28-2011.

OWNER OF U.S. REG. NO. 3,951,680.

THE COLOR(S) WHITE, ORANGE, RED, AND GREY IS/ARE CLAIMED AS A FEATURE OF THE MARK.

NO CLAIM IS MADE TO THE EXCLUSIVE RIGHT TO USE "(TESTOSTERONE) GEL CIII", APART FROM THE MARK AS SHOWN.

THE MARK CONSISTS OF THE LITERAL ELEMENT OF THE MARK "FORTESTA (TESTOSTERONE) GEL CIII", WHICH IS SHOWN IN WHITE EXCEPT FOR "GEL" WHICH IS SHOWN IN ORANGE. THE LITERAL ELEMENT IS SHOWN AGAINST A RED BACKGROUND AND THE ENTIRE MARK IS SURROUNDED BY ALTERNATING GREY LINES IN THE FORM OF A PARALLELOGRAM.

SER. NO. 85-432,595, FILED 9-27-2011.

SOPHIA S. KIM, EXAMINING ATTORNEY

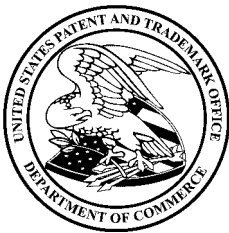

David J. Kyjars

Director of the United States Patent and Trademark Office

United States of America

United States Patent and Trademark Office



XTRABACKUP

Reg. No. 4,153,423

Registered June 5, 2012

Int. Cl.: 9

TRADEMARK

PRINCIPAL REGISTER

PERCONA, INC. (WASHINGTON CORPORATION)
#179
550-M RITCHIE HIGHWAY
SEVERNA PARK, MD 21146

FOR: DOWNLOADABLE COMPUTER SOFTWARE FOR USE IN DATA PROTECTION, BACKUP, MIGRATION, RECOVERY AND RESTORATION, IN CLASS 9 (U.S. CLS. 21, 23, 26, 36 AND 38).

FIRST USE 9-7-2011, THE MARK WAS FIRST USED ANYWHERE IN A DIFFERENT FORM OTHER THAN THAT SOUGHT TO BE REGISTERED AT LEAST AS EARLY AS 03/05/2009; IN COMMERCE 9-7-2011, THE MARK WAS FIRST USED IN COMMERCE IN A DIFFERENT FORM OTHER THAN THAT SOUGHT TO BE REGISTERED AT LEAST AS EARLY AS 03/05/2009.

NO CLAIM IS MADE TO THE EXCLUSIVE RIGHT TO USE "XTRABACKUP", APART FROM THE MARK AS SHOWN.

THE MARK CONSISTS OF THE SIDE PROFILE OF A LION'S HEAD ON A CIRCLE ABOVE THE WORD "XTRABACKUP".

SER. NO. 85-432,596, FILED 9-27-2011.

KATINA MISTER, EXAMINING ATTORNEY



David J. Kybas

Director of the United States Patent and Trademark Office

United States of America

United States Patent and Trademark Office

Recursion

Reg. No. 4,153,424

Registered June 5, 2012

Int. Cls.: 9 and 42

TRADEMARK

SERVICE MARK

PRINCIPAL REGISTER

RECURSION VENTURES (DELAWARE LIMITED LIABILITY COMPANY)
1388 OCEAN PARKWAY
BROOKLYN, NY 11230

FOR: COMPUTER SOFTWARE AND HARDWARE FOR GUARDING AGAINST ATTACK, SURVEILLANCE, ESPIONAGE, THEFT, EXPOSURE, DAMAGE, AND UNAUTHORIZED ENTRY AND FOR MAINTAINING THE STATUS AND INTEGRITY OF OBJECTS AND INFORMATION, IN CLASS 9 (U.S. CLS. 21, 23, 26, 36 AND 38).

FIRST USE 8-31-2011; IN COMMERCE 8-31-2011.

FOR: DESIGN AND DEVELOPMENT OF ELECTRONIC DATA SECURITY SYSTEMS, IN CLASS 42 (U.S. CLS. 100 AND 101).

FIRST USE 8-31-2011; IN COMMERCE 8-31-2011.

THE MARK CONSISTS OF STANDARD CHARACTERS WITHOUT CLAIM TO ANY PARTICULAR FONT, STYLE, SIZE, OR COLOR.

SER. NO. 85-432,829, FILED 9-27-2011.

SHAUNIA CARLYLE, EXAMINING ATTORNEY



David J. Kybas

Director of the United States Patent and Trademark Office

United States of America

United States Patent and Trademark Office



Reg. No. 4,153,425

JOHNSTON, MARIANA A (UNITED STATES INDIVIDUAL)
1001 WHISPER RIDGE TRAIL
BOZEMAN, MT 59715

Registered June 5, 2012

Int. Cl.: 41

FOR: ENTERTAINMENT SERVICES IN THE NATURE OF LIVE MUSICAL PERFORMANCES,
IN CLASS 41 (U.S. CLS. 100, 101 AND 107).

SERVICE MARK

FIRST USE 9-6-2011; IN COMMERCE 9-23-2011.

PRINCIPAL REGISTER

NO CLAIM IS MADE TO THE EXCLUSIVE RIGHT TO USE "MONTANA ROADHOUSE BAND" AND THE DESIGN OF THE STATE OF MONTANA, APART FROM THE MARK AS SHOWN.

THE COLOR(S) BLACK, BROWN, GOLD, YELLOW, AND WHITE IS/ARE CLAIMED AS A FEATURE OF THE MARK.

THE MARK CONSISTS OF THE WORD "MONTANA" IN GOLD WITH A BLACK BORDER, A BENT BLACK ARROW BORDERED WITH YELLOW AND WHITE LIGHTS AND A YELLOW BORDER AND OVERLAIN WITH THE WORD "ROADHOUSE" IN GOLD, AND THE WORD "BAND" IN GOLD WITH A BLACK BORDER, ALL OVERLAYING A DESIGN OF THE STATE OF MONTANA IN BROWN WITH A BLACK BORDER.

SER. NO. 85-432,930, FILED 9-27-2011.

TINA MAI, EXAMINING ATTORNEY



David J. Kyffers

Director of the United States Patent and Trademark Office

United States of America

United States Patent and Trademark Office



THE CARTOON BANK

A New Yorker Magazine Company

Reg. No. 4,153,426

Registered June 5, 2012

Int. Cl.: 16

TRADEMARK

PRINCIPAL REGISTER

ADVANCE MAGAZINE PUBLISHERS INC. (NEW YORK CORPORATION)
FOUR TIMES SQUARE
NEW YORK, NY 10036

FOR: BOOKS AND MAGAZINES ALL FEATURING CARTOONS AND COMICS; CALENDARS, STATIONERY, NOTE PADS, POSTCARDS, IN CLASS 16 (U.S. CLS. 2, 5, 22, 23, 29, 37, 38 AND 50).

FIRST USE 1-1-2007; IN COMMERCE 1-1-2007.

OWNER OF U.S. REG. NOS. 1,453,170, 3,033,725 AND OTHERS.

NO CLAIM IS MADE TO THE EXCLUSIVE RIGHT TO USE "CARTOON" AND "MAGAZINE COMPANY", APART FROM THE MARK AS SHOWN.

THE MARK CONSISTS OF IMAGE OF A PENGUIN WEARING A TOP HAT AND HOLDING A MONOCLE, IMAGE OF A MAN WEARING A TOP HAT AND HOLDING A MONOCLE AND THE WORDS THE CARTOON BANK A NEW YORKER MAGAZINE COMPANY.

SER. NO. 85-433,122, FILED 9-27-2011.

TRACY FLETCHER, EXAMINING ATTORNEY



David J. Kybas

Director of the United States Patent and Trademark Office

United States of America

United States Patent and Trademark Office



Reg. No. 4,153,427

Registered June 5, 2012

Int. Cl.: 45

SERVICE MARK

PRINCIPAL REGISTER

EVANS, LAURA (UNITED STATES INDIVIDUAL)
1209 N EVERETT ST
GLENDALE, CA 91207

FOR: LICENSING OF INTELLECTUAL PROPERTY; LICENSING OF INTELLECTUAL PROPERTY, NAMELY, REPRODUCTION RIGHTS FOR DIGITAL AND DIGITIZED MATERIAL INCLUDING PHOTOGRAPHS, STOCK PHOTOGRAPHS, ARCHIVAL PHOTOGRAPHS, ART REPRODUCTIONS, FILM, VIDEO, ANIMATION, GRAPHIC DESIGNS, CLIP ART, NEWS IMAGES, AUDIO DATA AND ILLUSTRATIONS; LICENSING OF DIGITAL AND DIGITIZED MATERIAL INCLUDING PHOTOGRAPHS, STOCK PHOTOGRAPHS, ARCHIVAL PHOTOGRAPHS, ART REPRODUCTIONS, FILM, VIDEO, ANIMATION, GRAPHIC DESIGNS, CLIP ART, NEWS IMAGES, AUDIO DATA AND ILLUSTRATIONS TO OTHERS VIA THE INTERNET, IN CLASS 45 (U.S. CLS. 100 AND 101).

FIRST USE 6-1-2011; IN COMMERCE 6-1-2011.

THE MARK CONSISTS OF THE WORD "ÜBER" IN BLACK LETTERS LOCATED IN A RED RECTANGLE WITH ROUNDED CORNERS AND A LIGHTER RED HIGHLIGHT ALONG THE TOP THIRD AND A DROP SHADOW IN GRAY UNDER THE RECTANGLE.

THE COLOR(S) RED, BLACK AND GRAY IS/ARE CLAIMED AS A FEATURE OF THE MARK.

THE ENGLISH TRANSLATION OF "ÜBER" IN THE MARK IS "SUPERIOR", "ELITE", "THE ULTIMATE".

SER. NO. 85-433,173, FILED 9-27-2011.

APRIL ROACH, EXAMINING ATTORNEY



David J. Kyjars

Director of the United States Patent and Trademark Office

United States of America

United States Patent and Trademark Office

BOOM WIRELESS

Reg. No. 4,153,428

Registered June 5, 2012

Int. Cl.: 9

TRADEMARK

PRINCIPAL REGISTER

ZIYA BUSINESS INC (GEORGIA CORPORATION), DBA Z-CELL
SUITE B
1745 CHURCH STREET
DECATUR, GA 30033

FOR: BATTERIES AND BATTERY CHARGERS; BATTERY CHARGERS; CARRYING CASES FOR CELL PHONES; CELL PHONE BATTERY CHARGERS; CELL PHONE BATTERY CHARGERS FOR USE IN VEHICLES, IN CLASS 9 (U.S. CLS. 21, 23, 26, 36 AND 38).

FIRST USE 4-3-2011; IN COMMERCE 4-3-2011.

THE MARK CONSISTS OF STANDARD CHARACTERS WITHOUT CLAIM TO ANY PARTICULAR FONT, STYLE, SIZE, OR COLOR.

NO CLAIM IS MADE TO THE EXCLUSIVE RIGHT TO USE "WIRELESS", APART FROM THE MARK AS SHOWN.

SER. NO. 85-433,578, FILED 9-27-2011.

DAVID ELTON, EXAMINING ATTORNEY



David J. Kyffers

Director of the United States Patent and Trademark Office

United States of America

United States Patent and Trademark Office

CRM SWITCH

Reg. No. 4,153,429

LEXNET CONSULTING GROUP (CALIFORNIA CORPORATION)
PO BOX 29129
SAN FRANCISCO, CA 94129

Registered June 5, 2012

Int. Cl.: 42

FOR: DATA MIGRATION SERVICES, IN CLASS 42 (U.S. CLS. 100 AND 101).

SERVICE MARK

FIRST USE 1-1-2006; IN COMMERCE 1-1-2006.

PRINCIPAL REGISTER

THE MARK CONSISTS OF STANDARD CHARACTERS WITHOUT CLAIM TO ANY PARTICULAR FONT, STYLE, SIZE, OR COLOR.

NO CLAIM IS MADE TO THE EXCLUSIVE RIGHT TO USE "CRM", APART FROM THE MARK AS SHOWN.

SER. NO. 85-433,589, FILED 9-27-2011.

SEAN CROWLEY, EXAMINING ATTORNEY



David J. Kyros

Director of the United States Patent and Trademark Office

United States of America

United States Patent and Trademark Office



Reg. No. 4,153,430

MEEKO LLC (FLORIDA LIMITED LIABILITY COMPANY), DBA GREEN EYE AUTO PARTS
4750 N POWERLINE RD STE A
POMPANO BEACH, FL 33073

Registered June 5, 2012

Int. Cl.: 35

FOR: COMPUTERIZED ON-LINE RETAIL STORE SERVICES IN THE FIELD OF AUTOMOTIVE PARTS, IN CLASS 35 (U.S. CLS. 100, 101 AND 102).

SERVICE MARK

FIRST USE 9-27-2011; IN COMMERCE 9-27-2011.

PRINCIPAL REGISTER

NO CLAIM IS MADE TO THE EXCLUSIVE RIGHT TO USE "AUTO PARTS", APART FROM THE MARK AS SHOWN.

THE COLOR(S) DARK GREEN, LIGHT GREEN, AND BLACK IS/ARE CLAIMED AS A FEATURE OF THE MARK.

THE MARK CONSISTS OF THE LETTER "G" WITH AN "E" ON THE INSIDE, IN LIGHT GREEN, THEN THE WORDING "GREEN EYE" IN DARK GREEN FADING TO BLACK ON THE BOTTOM, AND THE WORDING "AUTO PARTS" AT THE BOTTOM IN LIGHT GREEN.

SER. NO. 85-433,769, FILED 9-28-2011.

TEJBIR SINGH, EXAMINING ATTORNEY



David J. Kyros

Director of the United States Patent and Trademark Office

United States of America

United States Patent and Trademark Office

WE'VE GOT IT!

Reg. No. 4,153,431

DISCOUNT STEEL, INC. (MINNESOTA CORPORATION)
216-27TH AVENUE NORTH
MINNEAPOLIS, MN 55441

Registered June 5, 2012

Int. Cl.: 35

FOR: ONLINE RETAIL STORE SERVICES FEATURING RAW METAL IN UNFINISHED FORM FOR USE IN FURTHER MANUFACTURE, IN CLASS 35 (U.S. CLS. 100, 101 AND 102).

SERVICE MARK

FIRST USE 0-0-2000; IN COMMERCE 0-0-2000.

PRINCIPAL REGISTER

THE MARK CONSISTS OF STANDARD CHARACTERS WITHOUT CLAIM TO ANY PARTICULAR FONT, STYLE, SIZE, OR COLOR.

SER. NO. 85-433,834, FILED 9-28-2011.

DAWN FELDMAN, EXAMINING ATTORNEY



David J. Kybas

Director of the United States Patent and Trademark Office

United States of America

United States Patent and Trademark Office



Reg. No. 4,153,432

Registered June 5, 2012

Int. Cl.: 41

SERVICE MARK

PRINCIPAL REGISTER

PITTSBURGH THREE RIVERS MARATHON, INC. (PENNSYLVANIA NON-PROFIT CORPORATION)
310 GRANT STREET, THIRD FLOOR
PITTSBURGH, PA 15219

FOR: ATHLETIC AND SPORTS EVENT SERVICES, NAMELY, ORGANIZING AND CONDUCTING FOOT RACES, IN CLASS 41 (U.S. CLS. 100, 101 AND 107).

FIRST USE 8-0-2008; IN COMMERCE 8-0-2008.

OWNER OF U.S. REG. NO. 3,776,530.

THE COLOR(S) GOLD, BLACK AND WHITE IS/ARE CLAIMED AS A FEATURE OF THE MARK.

NO CLAIM IS MADE TO THE EXCLUSIVE RIGHT TO USE "PITTSBURGH MARATHON", APART FROM THE MARK AS SHOWN.

THE MARK CONSISTS OF AN IMAGE OF A BRIDGE IN GOLD WITH A BLACK BACKGROUND AND THE WORDING "PITTSBURGH" IN WHITE AND "MARATHON" IN GOLD, BOTH ON A BLACK BACKGROUND, UNDER THE BRIDGE.

SER. NO. 85-433,845, FILED 9-28-2011.

BRENDAN REGAN, EXAMINING ATTORNEY



David J. Kybas

Director of the United States Patent and Trademark Office

United States of America

United States Patent and Trademark Office



george

Reg. No. 4,153,433

Registered June 5, 2012

Int. Cl.: 29

TRADEMARK

PRINCIPAL REGISTER

ZOE'S MEATS (CALIFORNIA CORPORATION), DBA YIORYO
1326 ROSS STREET
PETALUMA, CA 94954

FOR: BLENDED OIL; COOKING OIL; EDIBLE OILS; INFUSED OILS FOR COOKING; OIL, NAMELY, OLIVE OIL IMPORTED FROM EUROPE; OLIVE OILS; SALAD OIL, IN CLASS 29 (U.S. CL. 46).

FIRST USE 9-26-2011; IN COMMERCE 9-26-2011.

THE MARK CONSISTS OF LOWERCASE GREEK LETTER GAMMA IN BURNT ORANGE, THE WORD "GEORGE" IN LOWERCASE BLACK.

THE COLOR(S) BURNT ORANGE, BLACK IS/ARE CLAIMED AS A FEATURE OF THE MARK.

SER. NO. 85-433,857, FILED 9-28-2011.

MARK SPARACINO, EXAMINING ATTORNEY



David J. Kyros

Director of the United States Patent and Trademark Office

United States of America

United States Patent and Trademark Office

ABLE HARDWARE THE INDUSTRIAL EDGE

Reg. No. 4,153,434

DISCOUNT STEEL, INC. (MINNESOTA CORPORATION)
216-27TH AVENUE NORTH
MINNEAPOLIS, MN 55441

Registered June 5, 2012

Int. Cl.: 35

FOR: ONLINE RETAIL STORE SERVICES FEATURING HARDWARE AND INDUSTRIAL SUPPLIES, IN CLASS 35 (U.S. CLS. 100, 101 AND 102).

SERVICE MARK

FIRST USE 12-0-2007; IN COMMERCE 12-0-2007.

PRINCIPAL REGISTER

THE MARK CONSISTS OF STANDARD CHARACTERS WITHOUT CLAIM TO ANY PARTICULAR FONT, STYLE, SIZE, OR COLOR.

NO CLAIM IS MADE TO THE EXCLUSIVE RIGHT TO USE "HARDWARE" AND "INDUSTRIAL", APART FROM THE MARK AS SHOWN.

SER. NO. 85-433,869, FILED 9-28-2011.

DAWN FELDMAN, EXAMINING ATTORNEY



David J. Kyros

Director of the United States Patent and Trademark Office

United States of America

United States Patent and Trademark Office

PITTSBURGH MARATHON

Reg. No. 4,153,435

Registered June 5, 2012

**Int. Cls.: 9, 14, 16, 18, 21
and 25**

TRADEMARK

PRINCIPAL REGISTER

PITTSBURGH THREE RIVERS MARATHON, INC. (PENNSYLVANIA NON-PROFIT CORPORATION)
310 GRANT STREET, THIRD FLOOR
PITTSBURGH, PA 15219

FOR: DECORATIVE MAGNETS, IN CLASS 9 (U.S. CLS. 21, 23, 26, 36 AND 38).

FIRST USE 5-0-2009; IN COMMERCE 5-0-2009.

FOR: MEDALS FOR USE AS AWARDS; TROPHIES OF PRECIOUS METALS, IN CLASS 14 (U.S. CLS. 2, 27, 28 AND 50).

FIRST USE 5-0-2009; IN COMMERCE 5-0-2009.

FOR: CARDS BEARING UNIVERSAL GREETINGS; DECALS; EVENT PROGRAMS; LETTERHEAD PAPER; POSTCARDS; POSTERS; STICKERS; TEMPORARY TATTOOS, IN CLASS 16 (U.S. CLS. 2, 5, 22, 23, 29, 37, 38 AND 50).

FIRST USE 5-0-2009; IN COMMERCE 5-0-2009.

FOR: BACKPACKS , IN CLASS 18 (U.S. CLS. 1, 2, 3, 22 AND 41).

FIRST USE 5-0-2009; IN COMMERCE 5-0-2009.

FOR: CUPS AND MUGS, IN CLASS 21 (U.S. CLS. 2, 13, 23, 29, 30, 33, 40 AND 50).

FIRST USE 5-0-2009; IN COMMERCE 5-0-2009.

FOR: HATS; JACKETS; MONEY BELTS; POLO SHIRTS; SHORTS; SWEATPANTS; SWEATSHIRTS; T-SHIRTS, IN CLASS 25 (U.S. CLS. 22 AND 39).

FIRST USE 5-0-2009; IN COMMERCE 5-0-2009.

THE MARK CONSISTS OF STANDARD CHARACTERS WITHOUT CLAIM TO ANY PARTICULAR FONT, STYLE, SIZE, OR COLOR.

OWNER OF U.S. REG. NO. 3,776,530.



David J. Kybas

Director of the United States Patent and Trademark Office

Reg. No. 4,153,435 NO CLAIM IS MADE TO THE EXCLUSIVE RIGHT TO USE "PITTSBURGH", APART FROM THE MARK AS SHOWN.

SER. NO. 85-434,127, FILED 9-28-2011.

BRENDAN REGAN, EXAMINING ATTORNEY

United States of America

United States Patent and Trademark Office

LapRaft

Reg. No. 4,153,436

Registered June 5, 2012

Int. Cl.: 9

TRADEMARK

PRINCIPAL REGISTER

RICH, TIMOTHY C. (UNITED STATES INDIVIDUAL)
230 KINGS RIDGE RD.
WAKEFIELD, RI 02879

FOR: CUSHIONED SUPPORT BASE SPECIALLY ADAPTED TO PROP UP LAPTOP COMPUTERS; PLASTIC MOLDED SUPPORT BASE SPECIALLY ADAPTED TO PROP UP LAPTOP COMPUTERS, IN CLASS 9 (U.S. CLS. 21, 23, 26, 36 AND 38).

FIRST USE 9-1-2011; IN COMMERCE 9-27-2011.

THE MARK CONSISTS OF STANDARD CHARACTERS WITHOUT CLAIM TO ANY PARTICULAR FONT, STYLE, SIZE, OR COLOR.

SER. NO. 85-434,201, FILED 9-28-2011.

RONALD MCMORROW, EXAMINING ATTORNEY



David J. Kyros

Director of the United States Patent and Trademark Office

United States of America

United States Patent and Trademark Office

217 FILMS

Reg. No. 4,153,437

A.E.M. HOLDINGS LTD. (CONNECTICUT CORPORATION)
237 HILLSIDE ROAD
ASHFORD, CT 06278

Registered June 5, 2012

Int. Cl.: 9

FOR: AUDIOVISUAL RECORDINGS FEATURING DOCUMENTARY CONTENT, IN CLASS 9 (U.S. CLS. 21, 23, 26, 36 AND 38).

TRADEMARK

FIRST USE 0-0-2006; IN COMMERCE 0-0-2006.

PRINCIPAL REGISTER

THE MARK CONSISTS OF STANDARD CHARACTERS WITHOUT CLAIM TO ANY PARTICULAR FONT, STYLE, SIZE, OR COLOR.

NO CLAIM IS MADE TO THE EXCLUSIVE RIGHT TO USE "FILMS", APART FROM THE MARK AS SHOWN.

SER. NO. 85-434,252, FILED 9-28-2011.

MATTHEW PAPPAS, EXAMINING ATTORNEY



David J. Kyffers

Director of the United States Patent and Trademark Office

United States of America

United States Patent and Trademark Office

217 RECORDS

Reg. No. 4,153,438

A.E.M. HOLDINGS LTD. (CONNECTICUT CORPORATION)
237 HILLSIDE ROAD
ASHFORD, MA 06278

Registered June 5, 2012

Int. Cl.: 9

FOR: MUSICAL SOUND RECORDINGS, SOUND RECORDINGS FEATURING NARRATIVE AND SPOKEN WORD, SUCH AS POETRY, IN CLASS 9 (U.S. CLS. 21, 23, 26, 36 AND 38).

TRADEMARK

FIRST USE 0-0-2001; IN COMMERCE 0-0-2001.

PRINCIPAL REGISTER

THE MARK CONSISTS OF STANDARD CHARACTERS WITHOUT CLAIM TO ANY PARTICULAR FONT, STYLE, SIZE, OR COLOR.

NO CLAIM IS MADE TO THE EXCLUSIVE RIGHT TO USE "RECORDS", APART FROM THE MARK AS SHOWN.

SER. NO. 85-434,269, FILED 9-28-2011.

MATTHEW PAPPAS, EXAMINING ATTORNEY



David J. Kypas

Director of the United States Patent and Trademark Office

United States of America

United States Patent and Trademark Office

GenderRender

Reg. No. 4,153,439

Registered June 5, 2012

Int. Cl.: 5

TRADEMARK

PRINCIPAL REGISTER

GENERAL GENETICS, INC. (TEXAS CORPORATION)
7500 VISCOUNT BLVD., SUITE 186
EL PASO, TX 79925

FOR: TEST KITS THAT DETERMINE THE SEX OF A FETUS, IN CLASS 5 (U.S. CLS. 6, 18, 44, 46, 51 AND 52).

FIRST USE 2-12-2007; IN COMMERCE 2-12-2007.

THE MARK CONSISTS OF THE WORDING "GENDERRENDER" WITH ALL LETTERS IN BLACK EXCEPT FOR THE "G" IN "GENDER", WHICH IS BLUE WITH AN ARROW EXTENDING DOWNWARDS FROM THE "G", SUGGESTING THE GENDER SYMBOL FOR MALE; AND THE FIRST "R" IN "RENDER" WHICH IS PINK WITH A CROSS EXTENDING FROM THE TOP OF THE "R" SUGGESTING THE GENDER SYMBOL FOR FEMALE.

THE COLOR(S) BLUE, PINK, AND BLACK IS/ARE CLAIMED AS A FEATURE OF THE MARK.

SER. NO. 85-434,283, FILED 9-28-2011.

ELLEN BURNS, EXAMINING ATTORNEY



David J. Kyros

Director of the United States Patent and Trademark Office

United States of America

United States Patent and Trademark Office

Painted Neighbors

Reg. No. 4,153,440

Registered June 5, 2012

Int. Cl.: 9

TRADEMARK

PRINCIPAL REGISTER

COLE, ANDREW (UNITED STATES INDIVIDUAL)
APT. 703
5951 WELLESLEY PARK DRIVE
BOCA RATON, FL 33433

FOR: COMPACT DISCS FEATURING MUSIC; DIGITAL MUSIC DOWNLOADABLE FROM THE INTERNET; DVDS FEATURING MUSIC; SOUND RECORDINGS FEATURING MUSIC , IN CLASS 9 (U.S. CLS. 21, 23, 26, 36 AND 38).

FIRST USE 10-29-2008; IN COMMERCE 3-14-2010.

THE MARK CONSISTS OF STANDARD CHARACTERS WITHOUT CLAIM TO ANY PARTICULAR FONT, STYLE, SIZE, OR COLOR.

SER. NO. 85-434,294, FILED 9-28-2011.

LINDA M. KING, EXAMINING ATTORNEY



David J. Kyffers

Director of the United States Patent and Trademark Office

United States of America

United States Patent and Trademark Office

MICREMA

Reg. No. 4,153,441

Registered June 5, 2012

Int. Cl.: 35

SERVICE MARK

PRINCIPAL REGISTER

LA DUNI CONCEPTS, LLC (TEXAS LIMITED LIABILITY COMPANY)
4620 MCKINNEY AVENUE
DALLAS, TX 75205

FOR: RETAIL STORE SERVICES FEATURING SELF-SERVE SPECIALTY BESPOKE FROZEN DESSERTS, NAMELY, YOGURT, ICE CREAM, CUSTARD, GELATO, MILK AND SORBET, IN CLASS 35 (U.S. CLS. 100, 101 AND 102).

FIRST USE 11-30-2010; IN COMMERCE 11-30-2010.

THE MARK CONSISTS OF STANDARD CHARACTERS WITHOUT CLAIM TO ANY PARTICULAR FONT, STYLE, SIZE, OR COLOR.

OWNER OF U.S. REG. NO. 4,076,464.

THE ENGLISH TRANSLATION OF "MI CREMA" IN THE MARK IS "MY CREAM".

SER. NO. 85-434,322, FILED 9-28-2011.

FONG HSU, EXAMINING ATTORNEY



David J. Kyffers

Director of the United States Patent and Trademark Office

United States of America

United States Patent and Trademark Office

VOOH

Reg. No. 4,153,442

Registered June 5, 2012

Int. Cl.: 38

SERVICE MARK

PRINCIPAL REGISTER

GREAT OUTDOOR NETWORK, INC. (FLORIDA CORPORATION)
10380 SW VILLAGE CENTER DRIVE
PORT ST. LUCIE, FL 34987

FOR: PROVIDING VIDEO CONFERENCING AND VIDEO BROADCASTING OVER THE INTERNET, IN CLASS 38 (U.S. CLS. 100, 101 AND 104).

FIRST USE 1-5-2011; IN COMMERCE 1-5-2011.

THE MARK CONSISTS OF THE WORD "VOOH", WITH THE LETTERS "OO" HAVING A LINE ABOVE THEM, ALL IN YELLOW.

THE COLOR(S) YELLOW IS/ARE CLAIMED AS A FEATURE OF THE MARK.

SER. NO. 85-434,343, FILED 9-28-2011.

FONG HSU, EXAMINING ATTORNEY



David J. Kyffers

Director of the United States Patent and Trademark Office

United States of America

United States Patent and Trademark Office

vivint.

Reg. No. 4,153,443

VIVINT, INC. (UTAH CORPORATION)
4931 NORTH 300 WEST
PROVO, UT 84604

Registered June 5, 2012

Int. Cl.: 21

FOR: BEVERAGEWARE, IN CLASS 21 (U.S. CLS. 2, 13, 23, 29, 30, 33, 40 AND 50).

TRADEMARK

FIRST USE 2-1-2011; IN COMMERCE 2-1-2011.

PRINCIPAL REGISTER

THE MARK CONSISTS OF THE TERM "VIVINT" FOLLOWED BY A PERIOD IN THE COLOR ORANGE.

THE COLOR(S) ORANGE IS/ARE CLAIMED AS A FEATURE OF THE MARK.

SER. NO. 85-434,450, FILED 9-28-2011.

GENE MACIOL, EXAMINING ATTORNEY



David J. Kyffers

Director of the United States Patent and Trademark Office

United States of America

United States Patent and Trademark Office

LVH

Reg. No. 4,153,444

Registered June 5, 2012

Int. Cls.: 41 and 43

SERVICE MARK

PRINCIPAL REGISTER

COLONY RESORTS LVH ACQUISITIONS, LLC (NEVADA LIMITED LIABILITY COMPANY)
C/O THE LAS VEGAS HILTON
3000 PARADISE ROAD
LAS VEGAS, NV 89109

FOR: CASINOS AND CASINO GAMING; WAGERING SERVICES; ENTERTAINMENT,
NAMELY, LIVE PERFORMANCES BY MUSICAL BANDS , IN CLASS 41 (U.S. CLS. 100,
101 AND 107).

FIRST USE 1-1-2012; IN COMMERCE 1-1-2012.

FOR: HOTEL, RESTAURANT, LOUNGE AND BAR SERVICES; ARENA SERVICES, NAMELY,
PROVIDING FACILITIES FOR SPORTS, CONCERTS, CONVENTIONS, AND EXHIBITIONS,
IN CLASS 43 (U.S. CLS. 100 AND 101).

FIRST USE 1-1-2012; IN COMMERCE 1-1-2012.

THE MARK CONSISTS OF STANDARD CHARACTERS WITHOUT CLAIM TO ANY PAR-
TICULAR FONT, STYLE, SIZE, OR COLOR.

SER. NO. 85-434,477, FILED 9-28-2011.

TOBY BULLOFF, EXAMINING ATTORNEY



David J. Kyros

Director of the United States Patent and Trademark Office

United States of America

United States Patent and Trademark Office

LVH LAS VEGAS HOTEL & CASINO

Reg. No. 4,153,445

Registered June 5, 2012

Int. Cls.: 41 and 43

SERVICE MARK

PRINCIPAL REGISTER

COLONY RESORTS LVH ACQUISITIONS, LLC (NEVADA LIMITED LIABILITY COMPANY)
C/O THE LAS VEGAS HILTON
3000 PARADISE ROAD
LAS VEGAS, NV 89109

FOR: CASINOS AND CASINO GAMING; WAGERING SERVICES; ENTERTAINMENT,
NAMELY, LIVE PERFORMANCES BY MUSICAL BANDS , IN CLASS 41 (U.S. CLS. 100,
101 AND 107).

FIRST USE 1-1-2012; IN COMMERCE 1-1-2012.

FOR: HOTEL, RESTAURANT, LOUNGE AND BAR SERVICES; ARENA SERVICES, NAMELY,
PROVIDING FACILITIES FOR SPORTS, CONCERTS, CONVENTIONS, AND EXHIBITIONS,
IN CLASS 43 (U.S. CLS. 100 AND 101).

FIRST USE 1-1-2012; IN COMMERCE 1-1-2012.

THE MARK CONSISTS OF STANDARD CHARACTERS WITHOUT CLAIM TO ANY PAR-
TICULAR FONT, STYLE, SIZE, OR COLOR.

NO CLAIM IS MADE TO THE EXCLUSIVE RIGHT TO USE "LAS VEGAS HOTEL & CASINO",
APART FROM THE MARK AS SHOWN.

SER. NO. 85-434,490, FILED 9-28-2011.

TOBY BULLOFF, EXAMINING ATTORNEY



David J. Kypos

Director of the United States Patent and Trademark Office

United States of America

United States Patent and Trademark Office

First Ladies of Rock

Reg. No. 4,153,446

KIELB, FRANK (UNITED STATES INDIVIDUAL)

Registered June 5, 2012

P.O. BOX 626
BROOMALL, PA 19008

Int. Cl.: 41

FOR: ENTERTAINMENT, NAMELY, LIVE PERFORMANCES BY A MUSICAL BAND, IN CLASS 41 (U.S. CLS. 100, 101 AND 107).

SERVICE MARK

FIRST USE 8-1-2011; IN COMMERCE 8-1-2011.

PRINCIPAL REGISTER

THE MARK CONSISTS OF STANDARD CHARACTERS WITHOUT CLAIM TO ANY PARTICULAR FONT, STYLE, SIZE, OR COLOR.

NO CLAIM IS MADE TO THE EXCLUSIVE RIGHT TO USE "ROCK", APART FROM THE MARK AS SHOWN.

SER. NO. 85-434,524, FILED 9-28-2011.

LUCY ARANT, EXAMINING ATTORNEY



David J. Kybas

Director of the United States Patent and Trademark Office

United States of America

United States Patent and Trademark Office

iLounge

Reg. No. 4,153,447

Registered June 5, 2012

Int. Cl.: 9

TRADEMARK

PRINCIPAL REGISTER

ILOUNGE, INC. (CALIFORNIA CORPORATION)
19 SPYROCK
IRVINE, CA 92602

FOR: ELECTRONIC PUBLICATIONS, NAMELY, GUIDES, MANUALS, NEWSLETTERS, BOOKS, MAGAZINES FEATURING INFORMATION IN THE FIELDS OF PORTABLE AND HANDHELD DIGITAL ELECTRONIC DEVICES FOR RECORDING, ORGANIZING, TRANSMITTING, MANIPULATING, AND REVIEWING TEXT, DATA, AUDIO, IMAGE AND VIDEO FILES, IN CLASS 9 (U.S. CLS. 21, 23, 26, 36 AND 38).

FIRST USE 4-5-2005; IN COMMERCE 4-5-2005.

THE MARK CONSISTS OF STANDARD CHARACTERS WITHOUT CLAIM TO ANY PARTICULAR FONT, STYLE, SIZE, OR COLOR.

OWNER OF U.S. REG. NOS. 3,828,914, 4,060,798 AND OTHERS.

SER. NO. 85-434,528, FILED 9-28-2011.

ALAIN LAPTER, EXAMINING ATTORNEY



David J. Kyros

Director of the United States Patent and Trademark Office

United States of America

United States Patent and Trademark Office



Reg. No. 4,153,448

Registered June 5, 2012

Int. Cl.: 41

SERVICE MARK

PRINCIPAL REGISTER

PRETTY BIRD PICTURES, INC. (CALIFORNIA CORPORATION)
9905 JEFFERSON BOULEVARD
CULVER CITY, CA 90232

FOR: ENTERTAINMENT MEDIA PRODUCTION SERVICES FOR MOTION PICTURES, TELEVISION AND INTERNET; ENTERTAINMENT SERVICES IN THE NATURE OF DEVELOPMENT, CREATION, PRODUCTION AND POST-PRODUCTION SERVICES OF MULTIMEDIA ENTERTAINMENT CONTENT; MULTIMEDIA ENTERTAINMENT SERVICES IN THE NATURE OF DEVELOPMENT, PRODUCTION AND POST-PRODUCTION SERVICES IN THE FIELDS OF VIDEO AND FILMS; ENTERTAINMENT SERVICES, NAMELY, PRODUCTION OF SPECIAL EFFECTS INCLUDING MODEL-MAKING SERVICES, COMPUTER-GENERATED IMAGERY AND COMPUTER-GENERATED GRAPHICS FOR THE PRODUCTION OF MOTION PICTURES AND VIDEOS; PROVISION OF INFORMATION RELATING TO TELEVISION, MOTION PICTURE, AND FILM; AND FILM AND VIDEO PRODUCTION CONSULTING SERVICES, IN CLASS 41 (U.S. CLS. 100, 101 AND 107).

FIRST USE 1-0-2008; IN COMMERCE 1-0-2008.

OWNER OF U.S. REG. NO. 4,084,063.

THE MARK CONSISTS OF A STYLIZED TALON TO THE LEFT OF THE STYLIZED WORD "PRETTYBIRD".

SER. NO. 85-434,536, FILED 9-28-2011.

DAVID TOOLEY, EXAMINING ATTORNEY



David J. Kybas

Director of the United States Patent and Trademark Office

United States of America

United States Patent and Trademark Office



Reg. No. 4,153,449

Registered June 5, 2012

Int. Cls.: 35 and 39

SERVICE MARK

PRINCIPAL REGISTER

KENTON COUNTY AIRPORT BOARD (UNITED STATES MUNICIPAL CORPORATION),
DBA CINCINNATI/NORTHERN KENTUCKY INTERNATIONAL AIRPORT
P.O. BOX 752000
CINCINNATI, OH 45275

FOR: MANAGEMENT OF AIRPORT OPERATIONS AND PASSENGER TRANSPORTATION SERVICES, IN CLASS 35 (U.S. CLS. 100, 101 AND 102).

FIRST USE 10-17-2011; IN COMMERCE 10-17-2011.

FOR: AIRPORT SERVICES FOR PASSENGERS, AIR CARRIERS AND AIRCRAFT OPERATORS; AIRPORT PASSENGER CHECK-IN SERVICES; AIRPORT BAGGAGE CHECK-IN SERVICES; TRANSIT LOUNGE FACILITIES FOR PASSENGER RELAXATION; VEHICLE PARKING SERVICES; VALET PARKING; PARKING GARAGE SERVICES; PARKING LOT SERVICES; PROVIDING FACILITIES FOR RENTAL OF CARS AND CAR RENTAL RESERVATIONS; AND TRANSPORT OF PASSENGERS VIA CARS, BUSES, VANS AND SHUTTLES, IN CLASS 39 (U.S. CLS. 100 AND 105).

FIRST USE 10-17-2011; IN COMMERCE 10-17-2011.

OWNER OF U.S. REG. NOS. 2,985,794, 3,114,581 AND OTHERS.

THE COLOR(S) BLUE AND GREEN IS/ARE CLAIMED AS A FEATURE OF THE MARK.

NO CLAIM IS MADE TO THE EXCLUSIVE RIGHT TO USE "CVG", APART FROM THE MARK AS SHOWN.

THE MARK CONSISTS OF THE LETTERS "CVG" HORIZONTALLY SHOWN IN BLUE WITH A STYLIZED ROAD IN GREEN EMANATING FROM THE LOWER TRUNCATED PORTION OF THE LETTER "V" AND BISECTING THE LETTER "G".

SEC. 2(F).

SER. NO. 85-434,568, FILED 9-28-2011.

WILLIAM VERHOSEK, EXAMINING ATTORNEY



David J. Kyffers

Director of the United States Patent and Trademark Office

United States of America

United States Patent and Trademark Office

Hallmark Luxury Vinyl

Reg. No. 4,153,450

Registered June 5, 2012

Int. Cl.: 19

TRADEMARK

PRINCIPAL REGISTER

HALLMARK HARDWOODS, INC. (CALIFORNIA CORPORATION)
2051 S. LYNX PLACE
ONTARIO, CA 91761

FOR: VINYL FLOORING, VINYL TILES, WOODEN FLOORING AND NON-METAL FLOORS,
IN CLASS 19 (U.S. CLS. 1, 12, 33 AND 50).

FIRST USE 7-31-2011; IN COMMERCE 7-31-2011.

THE MARK CONSISTS OF STANDARD CHARACTERS WITHOUT CLAIM TO ANY PAR-
TICULAR FONT, STYLE, SIZE, OR COLOR.

OWNER OF U.S. REG. NOS. 3,289,349 AND 3,289,376.

NO CLAIM IS MADE TO THE EXCLUSIVE RIGHT TO USE "LUXURY VINYL", APART
FROM THE MARK AS SHOWN.

SER. NO. 85-434,639, FILED 9-28-2011.

ERIN FALK, EXAMINING ATTORNEY



David J. Kybas

Director of the United States Patent and Trademark Office

United States of America

United States Patent and Trademark Office

valuemark hardwoods

Reg. No. 4,153,451

HALLMARK HARDWOODS, INC. (CALIFORNIA CORPORATION)
2051 S. LYNX PLACE
ONTARIO, CA 91761

Registered June 5, 2012

Int. Cl.: 19

FOR: VINYL FLOORING, VINYL TILES, WOODEN FLOORING AND NON-METAL FLOORS,
IN CLASS 19 (U.S. CLS. 1, 12, 33 AND 50).

TRADEMARK

FIRST USE 3-1-2010; IN COMMERCE 3-1-2010.

PRINCIPAL REGISTER

THE MARK CONSISTS OF STANDARD CHARACTERS WITHOUT CLAIM TO ANY PARTICULAR FONT, STYLE, SIZE, OR COLOR.

NO CLAIM IS MADE TO THE EXCLUSIVE RIGHT TO USE "HARDWOODS", APART FROM THE MARK AS SHOWN.

SER. NO. 85-434,663, FILED 9-28-2011.

ERIN FALK, EXAMINING ATTORNEY



David J. Kybas

Director of the United States Patent and Trademark Office

United States of America

United States Patent and Trademark Office

Hallmark Floors

Reg. No. 4,153,452

Registered June 5, 2012

Int. Cl.: 19

TRADEMARK

PRINCIPAL REGISTER

HALLMARK HARDWOODS, INC. (CALIFORNIA CORPORATION)
2051 S. LYNX PLACE
ONTARIO, CA 91761

FOR: VINYL FLOORING, VINYL TILES, WOODEN FLOORING AND NON-METAL FLOORS,
IN CLASS 19 (U.S. CLS. 1, 12, 33 AND 50).

FIRST USE 9-1-2011; IN COMMERCE 9-1-2011.

THE MARK CONSISTS OF STANDARD CHARACTERS WITHOUT CLAIM TO ANY PAR-
TICULAR FONT, STYLE, SIZE, OR COLOR.

OWNER OF U.S. REG. NOS. 3,289,349 AND 3,289,376.

NO CLAIM IS MADE TO THE EXCLUSIVE RIGHT TO USE "FLOORS", APART FROM THE
MARK AS SHOWN.

SER. NO. 85-434,689, FILED 9-28-2011.

ERIN FALK, EXAMINING ATTORNEY



David J. Kyffers

Director of the United States Patent and Trademark Office

United States of America

United States Patent and Trademark Office

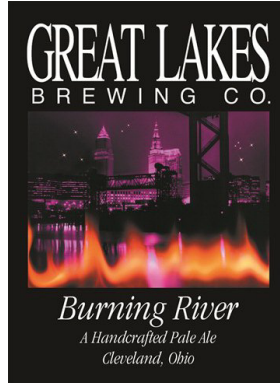

Reg. No. 4,153,453

Registered June 5, 2012

Int. Cl.: 32

TRADEMARK

PRINCIPAL REGISTER

THE GREAT LAKES BREWING CO. (OHIO CORPORATION)
2516 MARKET AVENUE
CLEVELAND, OH 44113

FOR: BEER, IN CLASS 32 (U.S. CLS. 45, 46 AND 48).

FIRST USE 7-29-1992; IN COMMERCE 7-29-1992.

OWNER OF U.S. REG. NOS. 3,722,359 AND 3,769,756.

THE COLOR(S) BLACK, WHITE, MAGENTA, ORANGE AND YELLOW IS/ARE CLAIMED AS A FEATURE OF THE MARK.

NO CLAIM IS MADE TO THE EXCLUSIVE RIGHT TO USE "BREWING CO." "A HAND-CRAFTED PALE ALE" AND "CLEVELAND, OHIO", APART FROM THE MARK AS SHOWN.

THE MARK CONSISTS OF A BLACK RECTANGLE BACKGROUND WITH THE WORDING "GREAT LAKES BREWING CO. BURNING RIVER A HAND CRAFTED PALE ALE CLEVELAND, OHIO" IN WHITE, ALONG WITH A GRAPHIC IMAGE OF A MAGENTA AND BLACK CITY SKYLINE BEHIND ORANGE AND YELLOW FLAMES.

SER. NO. 85-435,018, FILED 9-29-2011.

TASHIA BUNCH, EXAMINING ATTORNEY



David J. Kyffers

Director of the United States Patent and Trademark Office

United States of America

United States Patent and Trademark Office



Reg. No. 4,153,454

CANDICE BOEHM (UNITED STATES INDIVIDUAL)
145 TARBOX BROWN DRIVE
BUDA, TX 78610

Registered June 5, 2012

Int. Cl.: 25

FOR: NURSING APPAREL, NAMELY, A NURSING COVER-UP, IN CLASS 25 (U.S. CLS. 22 AND 39).

TRADEMARK

FIRST USE 6-1-2011; IN COMMERCE 6-1-2011.

PRINCIPAL REGISTER

THE MARK CONSISTS OF STYLIZED ARMS IN HEART SHAPE HOLDING STYLIZED BABY INSIDE.

SER. NO. 85-435,057, FILED 9-29-2011.

SAMUEL E. SHARPER JR., EXAMINING ATTORNEY



David J. Kyffers

Director of the United States Patent and Trademark Office

United States of America

United States Patent and Trademark Office



Reg. No. 4,153,455

Registered June 5, 2012

Int. Cl.: 25

TRADEMARK

PRINCIPAL REGISTER

RAUCUS NATURE, INC. (ILLINOIS CORPORATION)
280 KINGSBRIDGE ROAD
ELK GROVE VILLIAGE, IL 60007

FOR: MEN'S AND WOMEN'S CLOTHING AND ACCESSORIES, NAMELY, T-SHIRTS, LONG SLEEVE SHIRTS, JACKETS, DRESS SHIRTS, HATS, WINTER HATS, SWEATSHIRTS, SWEATERS, VESTS, DENIMS, BELTS, SCARVES AND HEADBANDS, IN CLASS 25 (U.S. CLS. 22 AND 39).

FIRST USE 4-0-2010; IN COMMERCE 4-0-2010.

THE MARK CONSISTS OF THE STYLIZED LOWER-CASED LETTERS "R" AND "N". THE "R" IS LARGER BY COMPARISON, AND THE ARCH OF THE "R" STRETCHES OVER THE TOP OF THE LETTER "N". THE BOTTOM OF THE LETTER "N" IS INTERRUPTED BY A STRIPE THAT SEPARATES THAT SECTION FROM THE REST OF THE LETTER.

SER. NO. 85-435,066, FILED 9-29-2011.

LINDA LAVACHE, EXAMINING ATTORNEY



David J. Kybas

Director of the United States Patent and Trademark Office

United States of America

United States Patent and Trademark Office

raucusnature
cure for the common clothes | medicate daily

Reg. No. 4,153,456

RAUCUS NATURE, INC. (ILLINOIS CORPORATION)
280 KINGSBRIDGE ROAD
ELK GROVE VILLAGE, IL 60007

Registered June 5, 2012

Int. Cl.: 25

FOR: MEN'S AND WOMEN'S CLOTHING AND ACCESSORIES, NAMELY, T-SHIRTS, LONG SLEEVE SHIRTS, JACKETS, DRESS SHIRTS, HATS, WINTER HATS, SWEATSHIRTS, SWEATERS, VESTS, DENIMS, BELTS, SCARVES AND HEADBANDS, IN CLASS 25 (U.S. CLS. 22 AND 39).

TRADEMARK

PRINCIPAL REGISTER

FIRST USE 4-0-2010; IN COMMERCE 4-0-2010.

THE MARK CONSISTS OF THE WORDS "RAUCUS NATURE" IN STYLIZED LETTERS, WITH A DIERESIS OVER THE TOP OF THE LETTER "U" IN THE WORD "NATURE". THE WORDS "CURE FOR THE COMMON CLOTHES MEDICATE DAILY" ARE UNDERNEATH THE WORDS "RAUCUS NATURE." THE WORDS "CURE FOR THE COMMON CLOTHES" ARE SEPARATED FROM THE WORDS "MEDICATE DAILY" BY A VERTICAL LINE.

SER. NO. 85-435,090, FILED 9-29-2011.

LINDA LAVACHE, EXAMINING ATTORNEY



David J. Kyjars

Director of the United States Patent and Trademark Office

United States of America

United States Patent and Trademark Office

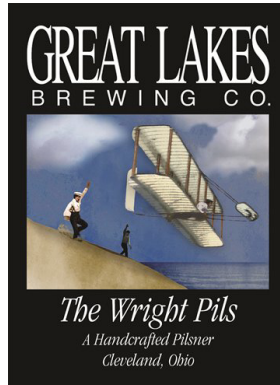

Reg. No. 4,153,457

Registered June 5, 2012

Int. Cl.: 32

TRADEMARK

PRINCIPAL REGISTER

THE GREAT LAKES BREWING CO. (OHIO CORPORATION)
2516 MARKET AVENUE
CLEVELAND, OH 44113

FOR: BEER, IN CLASS 32 (U.S. CLS. 45, 46 AND 48).

FIRST USE 12-15-2009; IN COMMERCE 12-15-2009.

OWNER OF U.S. REG. NO. 3,722,359.

THE COLOR(S) BLACK, WHITE, BLUE AND BROWN IS/ARE CLAIMED AS A FEATURE OF THE MARK.

NO CLAIM IS MADE TO THE EXCLUSIVE RIGHT TO USE "BREWING CO.", "PILS" "A HANDCRAFTED PILSNER" AND "CLEVELAND, OHIO", APART FROM THE MARK AS SHOWN.

THE MARK CONSISTS OF A BLACK RECTANGLE BACKGROUND WITH THE WORDING "GREAT LAKES BREWING CO. THE WRIGHT PILS A HANDCRAFTED PILSNER CLEVELAND, OHIO" IN WHITE LETTERING, AND A GRAPHIC DEPICTING A WHITE AIRCRAFT WITH A PERSON ON BOARD, TWO PEOPLE WEARING BLACK AND WHITE CLOTHING STANDING ON A BROWN BEACH, BLUE WATER AND A BLUE SKY WITH WHITE CLOUDS.

SER. NO. 85-435,145, FILED 9-29-2011.

TASHIA BUNCH, EXAMINING ATTORNEY



David J. Kyros

Director of the United States Patent and Trademark Office

United States of America

United States Patent and Trademark Office

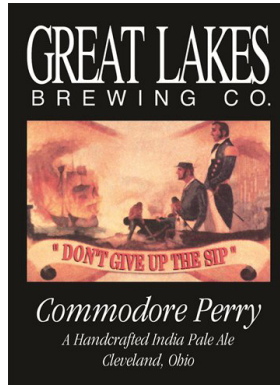

Reg. No. 4,153,458

Registered June 5, 2012

Int. Cl.: 32

TRADEMARK

PRINCIPAL REGISTER

THE GREAT LAKES BREWING CO. (OHIO CORPORATION)
2516 MARKET AVENUE
CLEVELAND, OH 44113

FOR: BEER, IN CLASS 32 (U.S. CLS. 45, 46 AND 48).

FIRST USE 11-3-1994; IN COMMERCE 11-3-1994.

OWNER OF U.S. REG. NOS. 3,721,837 AND 3,722,359.

THE COLOR(S) BLACK, WHITE, BEIGE, RED, BLUE AND GOLD IS/ARE CLAIMED AS A FEATURE OF THE MARK.

NO CLAIM IS MADE TO THE EXCLUSIVE RIGHT TO USE "BREWING CO.", "A HAND-CRAFTED INDIA PALE ALE CLEVELAND, OHIO" AND "CLEVELAND, OHIO", APART FROM THE MARK AS SHOWN.

THE MARK CONSISTS OF A BLACK RECTANGLE BACKGROUND, WHITE LETTERING IN THE WORDS "GREAT LAKES BREWING CO. COMMODORE PERRY A HANDCRAFTED INDIA PALE ALE CLEVELAND, OHIO" AND A GRAPHIC IMAGE DEPICTING PEOPLE WEARING BLUE, GOLD AND WHITE UNIFORMS, A BEIGE SHIP AND A BEIGE BANNER BEARING THE PHRASE "DON'T GIVE UP THE SHIP" IN RED LETTERS.

SER. NO. 85-435,175, FILED 9-29-2011.

TASHIA BUNCH, EXAMINING ATTORNEY



David J. Kybas

Director of the United States Patent and Trademark Office

United States of America

United States Patent and Trademark Office

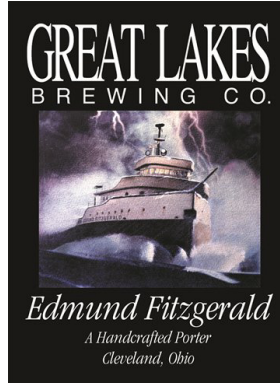

Reg. No. 4,153,459

Registered June 5, 2012

Int. Cl.: 32

TRADEMARK

PRINCIPAL REGISTER

THE GREAT LAKES BREWING CO. (OHIO CORPORATION)
2516 MARKET AVENUE
CLEVELAND, OH 44113

FOR: BEER, IN CLASS 32 (U.S. CLS. 45, 46 AND 48).

FIRST USE 8-19-1992; IN COMMERCE 8-19-1992.

OWNER OF U.S. REG. NOS. 3,549,698 AND 3,722,359.

THE COLOR(S) BLACK, WHITE, BLUE AND PURPLE IS/ARE CLAIMED AS A FEATURE OF THE MARK.

NO CLAIM IS MADE TO THE EXCLUSIVE RIGHT TO USE "BREWING CO.", "A HAND-CRAFTED PORTER" AND "CLEVELAND, OHIO", APART FROM THE MARK AS SHOWN.

THE MARK CONSISTS OF A BLACK RECTANGLE BACKGROUND WITH WHITE LETTERS IN THE WORDS "GREAT LAKES BREWING CO. EDMUND FITZGERALD A HANDCRAFTED PORTER CLEVELAND, OHIO" AND A GRAPHIC SHOWING A BLACK AND WHITE SHIP IN BLUE AND WHITE WATER AND PURPLE AND WHITE STREAKS OF LIGHTNING.

SER. NO. 85-435,260, FILED 9-29-2011.

TASHIA BUNCH, EXAMINING ATTORNEY



David J. Kyjars

Director of the United States Patent and Trademark Office

United States of America

United States Patent and Trademark Office

STAR (Strategic Technology Adviser & Resources)

Reg. No. 4,153,460

LENAGHAN, DONNA (UNITED STATES INDIVIDUAL)
8900 N.W. 194TH TERRACE
HIALEAH, FL 33018

Registered June 5, 2012

Int. Cl.: 41

FOR: TEACHING AND TRAINING IN BUSINESS, INDUSTRY AND INFORMATION TECHNOLOGY; TRAINING IN THE FIELD OF DESIGN, ADVERTISING AND COMMUNICATION TECHNOLOGIES, IN CLASS 41 (U.S. CLS. 100, 101 AND 107).

SERVICE MARK

FIRST USE 4-2-2010; IN COMMERCE 4-2-2010.

PRINCIPAL REGISTER

THE MARK CONSISTS OF STANDARD CHARACTERS WITHOUT CLAIM TO ANY PARTICULAR FONT, STYLE, SIZE, OR COLOR.

NO CLAIM IS MADE TO THE EXCLUSIVE RIGHT TO USE "STRATEGIC TECHNOLOGY ADVISER & RESOURCES", APART FROM THE MARK AS SHOWN.

SER. NO. 85-435,268, FILED 9-29-2011.

JOHN DALIER, EXAMINING ATTORNEY



David J. Kyros

Director of the United States Patent and Trademark Office

United States of America

United States Patent and Trademark Office

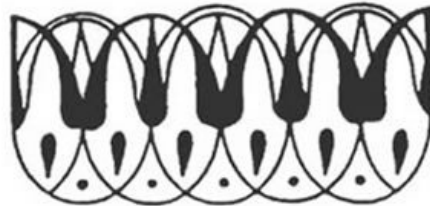

Reg. No. 4,153,461

Registered June 5, 2012

Int. Cl.: 36

SERVICE MARK

PRINCIPAL REGISTER

DAUGHTERS OF PENELOPE FOUNDATION INCORPORATION (D.C. CORPORATION)
SUITE 500
1909 Q STREET, NW
WASHINGTON, DC 20009

FOR: CHARITABLE FOUNDATION SERVICES, NAMELY, PROVIDING FINANCIAL ASSISTANCE FOR PROGRAMS AND SERVICES OF OTHERS; CHARITABLE FUNDRAISING, IN CLASS 36 (U.S. CLS. 100, 101 AND 102).

FIRST USE 12-31-1983; IN COMMERCE 12-31-1983.

THE MARK CONSISTS OF A FANCIFUL GEOMETRIC FIGURE THAT INCLUDES REPEATING AND OVERLAPPING OVAL SHAPES.

SER. NO. 85-435,363, FILED 9-29-2011.

MATTHEW EINSTEIN, EXAMINING ATTORNEY



David J. Kybas

Director of the United States Patent and Trademark Office

United States of America

United States Patent and Trademark Office

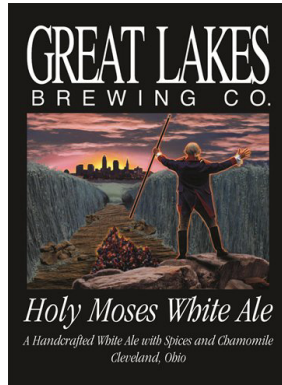

Reg. No. 4,153,462

Registered June 5, 2012

Int. Cl.: 32

TRADEMARK

PRINCIPAL REGISTER

THE GREAT LAKES BREWING CO. (OHIO CORPORATION)
2516 MARKET AVENUE
CLEVELAND, OH 44113

FOR: BEER, IN CLASS 32 (U.S. CLS. 45, 46 AND 48).

FIRST USE 6-24-1994; IN COMMERCE 6-24-1994.

OWNER OF U.S. REG. NO. 3,722,359.

THE COLOR(S) BLACK, WHITE, BROWN, GRAY, BLUE, ORANGE, YELLOW AND PINK IS/ARE CLAIMED AS A FEATURE OF THE MARK.

NO CLAIM IS MADE TO THE EXCLUSIVE RIGHT TO USE "BREWING CO.", "WHITE ALE", "A HANDCRAFTED WHITE ALE WITH SPICES AND CHAMOMILE" AND "CLEVELAND, OHIO", APART FROM THE MARK AS SHOWN.

THE MARK CONSISTS OF A BLACK RECTANGLE BACKGROUND WITH WHITE LETTERS IN THE WORDS "GREAT LAKES BREWING CO. HOLY MOSES WHITE ALE A HANDCRAFTED WHITE ALE WITH SPICES AND CHAMOMILE CLEVELAND, OHIO" AND A GRAPHIC IMAGE OF A MAN HOLDING A ROD AND STANDING, ARMS OUTSTRETCHED, ON A GRAY ROCK WITH TWO WALLS OF BLUE WATER FORMING A BROWN PATH ON WHICH A CROWD OF PEOPLE IS WALKING TOWARD A SILHOUETTE OF A CITY IN FRONT OF A YELLOW AND ORANGE SUNSET BENEATH A PINK AND GRAY SKY.

SER. NO. 85-435,372, FILED 9-29-2011.

TASHIA BUNCH, EXAMINING ATTORNEY



David J. Kyros

Director of the United States Patent and Trademark Office

United States of America

United States Patent and Trademark Office

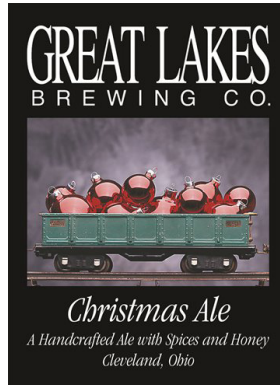

Reg. No. 4,153,463

Registered June 5, 2012

Int. Cl.: 32

TRADEMARK

PRINCIPAL REGISTER

THE GREAT LAKES BREWING CO. (OHIO CORPORATION)
2516 MARKET AVENUE
CLEVELAND, OH 44113

FOR: BEER, IN CLASS 32 (U.S. CLS. 45, 46 AND 48).

FIRST USE 8-19-1992; IN COMMERCE 8-19-1992.

OWNER OF U.S. REG. NO. 3,722,359.

THE COLOR(S) BLACK, WHITE, GRAY, RED, SILVER AND BLUE IS/ARE CLAIMED AS A FEATURE OF THE MARK.

NO CLAIM IS MADE TO THE EXCLUSIVE RIGHT TO USE "BREWING CO.", "CHRISTMAS ALE", "A HANDCRAFTED ALE WITH SPICES AND HONEY" AND "CLEVELAND, OHIO", APART FROM THE MARK AS SHOWN.

THE MARK CONSISTS OF A BLACK RECTANGLE BACKGROUND WITH WHITE LETTERS IN THE WORDS "GREAT LAKES BREWING CO. CHRISTMAS ALE A HANDCRAFTED ALE WITH SPICES AND HONEY CLEVELAND, OHIO" AND A GRAPHIC SHOWING A TOY TRAIN CAR IN BLUE ON A TRACK FILLED WITH RED AND SILVER ORNAMENTS OVER A BACKGROUND OF GRAY.

SER. NO. 85-435,418, FILED 9-29-2011.

TASHIA BUNCH, EXAMINING ATTORNEY



David J. Kybas

Director of the United States Patent and Trademark Office

United States of America

United States Patent and Trademark Office



Reg. No. 4,153,464

Registered June 5, 2012

Int. Cl.: 37

SERVICE MARK

PRINCIPAL REGISTER

GROSS, KEITH (UNITED STATES INDIVIDUAL)
PO BOX 133301
ATLANTA, GA 30333 AND

MARR, SCOTT (UNITED STATES INDIVIDUAL)
PO BOX 133301
ATLANTA, GA 30333

FOR: CLEANING OF BUILDINGS; VEHICLE CLEANING, IN CLASS 37 (U.S. CLS. 100, 103 AND 106).

FIRST USE 0-0-2009; IN COMMERCE 0-0-2009.

NO CLAIM IS MADE TO THE EXCLUSIVE RIGHT TO USE "FLEET CLEAN", APART FROM THE MARK AS SHOWN.

THE COLOR(S) GREEN, BLUE AND BLACK IS/ARE CLAIMED AS A FEATURE OF THE MARK.

THE MARK CONSISTS OF TWO ARROWS IN GREEN AND BLUE THAT FORM A CIRCLE AROUND THE STYLIZED WORDS "FLEET CLEAN" IN BLACK.

SER. NO. 85-435,650, FILED 9-29-2011.

NAAKWAMA ANKRAH, EXAMINING ATTORNEY



David J. Kyros

Director of the United States Patent and Trademark Office

United States of America

United States Patent and Trademark Office



Decision Simulation
VIRTUAL CASES. REAL RESULTS.

Reg. No. 4,153,465

Registered June 5, 2012

Int. Cl.: 9

TRADEMARK

PRINCIPAL REGISTER

DECISION SIMULATION, LLC (PENNSYLVANIA LIMITED LIABILITY COMPANY)
1820 MASTERS WAY
CHADDS FORD, PA 19317

FOR: WEB-BASED DECISION SIMULATION PLATFORM, NAMELY, COMPUTER SOFTWARE PLATFORM, WHICH IS DOWNLOADED FROM A WEBSITE, FOR DEVELOPING AND ASSESSING DECISION-MAKING SKILLS, IN CLASS 9 (U.S. CLS. 21, 23, 26, 36 AND 38).

FIRST USE 7-10-2010; IN COMMERCE 7-10-2010.

NO CLAIM IS MADE TO THE EXCLUSIVE RIGHT TO USE "DECISION SIMULATION" AND "VIRTUAL CASES", APART FROM THE MARK AS SHOWN.

THE COLOR(S) LIGHT BLUE, DARK BLUE, BLACK AND GRAY IS/ARE CLAIMED AS A FEATURE OF THE MARK.

THE MARK CONSISTS OF 3 SEPARATE SQUARES IN LINE AT AN ANGLE FROM RIGHT TO LEFT, WITH THE TOP AND LEFT OUTSIDE OF EACH BOX A LIGHT BLUE COLOR AND THE BOTTOM AND RIGHT INSIDE OF EACH BOX A DARK BLUE COLOR, AND THE WORDS "DECISION SIMULATION", IN BLACK, BOLD FONT, DIRECTLY TO THE RIGHT OF THE BOXES, AND WITH THE SENTENCES, IN CAPITAL LETTERS "VIRTUAL CASES. REAL RESULTS" IN GRAY ENTERED UNDER THE WORDS "DECISION SIMULATION".

SER. NO. 85-435,679, FILED 9-29-2011.

MEGHAN REINHART, EXAMINING ATTORNEY



David J. Kyjars

Director of the United States Patent and Trademark Office

United States of America

United States Patent and Trademark Office



Reg. No. 4,153,466

Registered June 5, 2012

Int. Cl.: 5

TRADEMARK

PRINCIPAL REGISTER

KLIMENKO, ELENA (UNITED STATES INDIVIDUAL)
9TH FLOOR
12 W 27TH STREET 9TH FLOOR
NEW YORK, NY 10001

FOR: NUTRITIONAL SHAKES FOR USE AS A MEAL SUBSTITUTE, IN CLASS 5 (U.S. CLS. 6, 18, 44, 46, 51 AND 52).

FIRST USE 5-0-2011; IN COMMERCE 9-22-2011.

NO CLAIM IS MADE TO THE EXCLUSIVE RIGHT TO USE "BEST BREAKFAST FOR YOUR HEALTH", APART FROM THE MARK AS SHOWN.

THE COLOR(S) YELLOW, WHITE, RED AND ORANGE IS/ARE CLAIMED AS A FEATURE OF THE MARK.

THE MARK CONSISTS OF A YELLOW CIRCLE WITH YELLOW RAYS COMING OUT OF IT DEPICTING A SUN. IN THE MIDDLE OF THE SUN, THERE ARE THE WORDS "BEST BREAKFAST" SLIGHTLY SLANTING UPWARD FROM LEFT TO RIGHT. THE WORD "BEST" IS IN STYLIZED ORANGE WRITING WITH A WHITE OUTLINE. THE WORD "BREAKFAST", WHICH IS BELOW THE WORD "BEST", IS IN STYLIZED RED WRITING WITH A WHITE OUTLINE. THE WORDS "FOR YOUR HEALTH." APPEAR IN RED AND FOLLOW THE CURVE UNDER THE SUN.

SER. NO. 85-435,684, FILED 9-29-2011.

MEGHAN REINHART, EXAMINING ATTORNEY



David J. Kybas

Director of the United States Patent and Trademark Office

United States of America

United States Patent and Trademark Office

DNA Health Institute

Reg. No. 4,153,467

Registered June 5, 2012

Int. Cl.: 3

TRADEMARK

PRINCIPAL REGISTER

DNA HEALTH INSTITUTE, CRYOGENIC DIVISION, LLC (CALIFORNIA LIMITED LIABILITY COMPANY)
4562 WESTINGHOUSE, SUITE B
VENTURA, CA 93003

FOR: NON-MEDICATED SKIN CARE PREPARATIONS, IN CLASS 3 (U.S. CLS. 1, 4, 6, 50, 51 AND 52).

FIRST USE 12-1-1998; IN COMMERCE 12-1-1998.

THE MARK CONSISTS OF STANDARD CHARACTERS WITHOUT CLAIM TO ANY PARTICULAR FONT, STYLE, SIZE, OR COLOR.

NO CLAIM IS MADE TO THE EXCLUSIVE RIGHT TO USE "HEALTH INSTITUTE", APART FROM THE MARK AS SHOWN.

SER. NO. 85-435,760, FILED 9-29-2011.

MIDGE BUTLER, EXAMINING ATTORNEY



David J. Kyffers

Director of the United States Patent and Trademark Office

United States of America

United States Patent and Trademark Office

ALASKA K-LEX

Reg. No. 4,153,468

Registered June 5, 2012

Int. Cl.: 5

TRADEMARK

PRINCIPAL REGISTER

SEA HAWK CORP. (CALIFORNIA CORPORATION)
639 WEST LONGDEN AVE.
ARCADIA, CA 91007

FOR: DIETARY AND NUTRITIONAL SUPPLEMENTS; DIETARY FOOD SUPPLEMENTS; DIETARY SUPPLEMENTS; FOOD SUPPLEMENTS; GUMMY VITAMINS; HEALTH FOOD SUPPLEMENTS; MINERAL FOOD SUPPLEMENTS; MINERAL NUTRITIONAL SUPPLEMENTS; MIXED VITAMIN PREPARATIONS; MULTI-VITAMIN PREPARATIONS; NUTRACEUTICALS FOR USE AS A DIETARY SUPPLEMENT; NUTRITIONAL SUPPLEMENTS; PRENATAL VITAMINS; VITAMIN AND MINERAL SUPPLEMENTS; VITAMIN PREPARATIONS; VITAMIN SUPPLEMENTS; VITAMIN TABLETS; VITAMINS; VITAMINS AND VITAMIN PREPARATIONS, IN CLASS 5 (U.S. CLS. 6, 18, 44, 46, 51 AND 52).

FIRST USE 11-1-2002; IN COMMERCE 11-1-2002.

THE MARK CONSISTS OF STANDARD CHARACTERS WITHOUT CLAIM TO ANY PARTICULAR FONT, STYLE, SIZE, OR COLOR.

SER. NO. 85-435,768, FILED 9-29-2011.

ADA HAN, EXAMINING ATTORNEY



David J. Kyros

Director of the United States Patent and Trademark Office

United States of America

United States Patent and Trademark Office

workforward center

Reg. No. 4,153,469

Registered June 5, 2012

Int. Cls.: 9 and 42

TRADEMARK

SERVICE MARK

PRINCIPAL REGISTER

MÉTIER, LTD. (DELAWARE CORPORATION)
WWW.METIER.COM
50 SANTA ROSA AVENUE, 5TH FLOOR
SANTA ROSA, CA 95404

FOR: COMPUTER SOFTWARE FOR PROJECT MANAGEMENT AND PLANNING FOR USE IN BUSINESS MANAGEMENT , IN CLASS 9 (U.S. CLS. 21, 23, 26, 36 AND 38).

FIRST USE 6-1-2011; IN COMMERCE 6-1-2011.

FOR: COMPUTER SOFTWARE CONSULTING AND IMPLEMENTATION FOR OTHERS IN THE FIELDS OF PROJECT MANAGEMENT PLANNING AND PORTFOLIO MANAGEMENT PLANNING FOR USE IN BUSINESS MANAGEMENT, IN CLASS 42 (U.S. CLS. 100 AND 101).

FIRST USE 6-1-2011; IN COMMERCE 6-1-2011.

THE MARK CONSISTS OF STANDARD CHARACTERS WITHOUT CLAIM TO ANY PARTICULAR FONT, STYLE, SIZE, OR COLOR.

OWNER OF U.S. REG. NOS. 3,339,276 AND 3,356,074.

NO CLAIM IS MADE TO THE EXCLUSIVE RIGHT TO USE "CENTER", APART FROM THE MARK AS SHOWN.

SER. NO. 85-435,801, FILED 9-29-2011.

ANDREW LEASER, EXAMINING ATTORNEY



David J. Kyros

Director of the United States Patent and Trademark Office

United States of America

United States Patent and Trademark Office

BLACK & WHITE SEVENS

Reg. No. 4,153,470

Registered June 5, 2012

Int. Cl.: 9

TRADEMARK

PRINCIPAL REGISTER

BALLY GAMING, INC. (NEVADA CORPORATION), DBA BALLY TECHNOLOGIES
ATT: LEGAL DEPARTMENT
6601 SOUTH BERMUDA ROAD
LAS VEGAS, NV 89119

FOR: GAMING MACHINES, NAMELY, DEVICES WHICH ACCEPT A WAGER AND GAMING SOFTWARE THAT GENERATES OR DISPLAYS OUTCOMES FOR GAMING MACHINES, IN CLASS 9 (U.S. CLS. 21, 23, 26, 36 AND 38).

FIRST USE 9-2-2004; IN COMMERCE 9-2-2004.

THE MARK CONSISTS OF STANDARD CHARACTERS WITHOUT CLAIM TO ANY PARTICULAR FONT, STYLE, SIZE, OR COLOR.

OWNER OF U.S. REG. NO. 4,049,376.

NO CLAIM IS MADE TO THE EXCLUSIVE RIGHT TO USE "SEVENS", APART FROM THE MARK AS SHOWN.

SER. NO. 85-435,857, FILED 9-29-2011.

ELLEN PERKINS, EXAMINING ATTORNEY



David J. Kybas

Director of the United States Patent and Trademark Office

United States of America

United States Patent and Trademark Office

Jill Teeple
DESIGN

Reg. No. 4,153,471

TEEPLES, JILL (UNITED STATES INDIVIDUAL)
1502 LOMA DRIVE #8
HERMOSA BEACH, CA 90254

Registered June 5, 2012

Int. Cl.: 42

FOR: GRAPHIC ART DESIGN; WEB SITE DESIGN; WEB SITE DEVELOPMENT FOR OTHERS, IN CLASS 42 (U.S. CLS. 100 AND 101).

SERVICE MARK

FIRST USE 9-23-2011; IN COMMERCE 9-23-2011.

PRINCIPAL REGISTER

NO CLAIM IS MADE TO THE EXCLUSIVE RIGHT TO USE "DESIGN", APART FROM THE MARK AS SHOWN.

THE COLOR(S) GRAY AND RED IS/ARE CLAIMED AS A FEATURE OF THE MARK.

THE NAME(S), PORTRAIT(S), AND/OR SIGNATURE(S) SHOWN IN THE MARK IDENTIFIES "JILL TEEPLES", WHOSE CONSENT(S) TO REGISTER IS MADE OF RECORD.

THE MARK CONSISTS OF THE STYLIZED WORDS "JILL TEEPLES" IN GRAY APPEARING ABOVE THE STYLIZED WORD "DESIGN" IN RED.

SER. NO. 85-435,911, FILED 9-29-2011.

MARIA-VICTORIA SUAREZ, EXAMINING ATTORNEY



David J. Kybas

Director of the United States Patent and Trademark Office

United States of America

United States Patent and Trademark Office

LESLIE NIELSEN

Reg. No. 4,153,472

Registered June 5, 2012

Int. Cl.: 9

TRADEMARK

PRINCIPAL REGISTER

2ND BEST LLC (DELAWARE LIMITED LIABILITY COMPANY)
C/O GRANT, TANI, BARASH & ALTMAN LLC
9100 WILSHIRE BOULEVARD, SUITE 1000W
BEVERLY HILLS, CA 90212

FOR: MOTION PICTURE FILMS FEATURING COMEDY, DRAMA, ACTION, ADVENTURE AND/OR ANIMATION; PRE-RECORDED VIDEO DISCS FEATURING COMEDY, DRAMA, ACTION, ADVENTURE AND/OR ANIMATION; DOWNLOADABLE VIDEO RECORDINGS FEATURING COMEDY, DRAMA, ACTION, ADVENTURE AND/OR ANIMATION, IN CLASS 9 (U.S. CLS. 21, 23, 26, 36 AND 38).

FIRST USE 0-0-1956; IN COMMERCE 0-0-1956.

THE MARK CONSISTS OF STANDARD CHARACTERS WITHOUT CLAIM TO ANY PARTICULAR FONT, STYLE, SIZE, OR COLOR.

THE NAME(S), PORTRAIT(S), AND/OR SIGNATURE(S) SHOWN IN THE MARK DOES NOT IDENTIFY A PARTICULAR LIVING INDIVIDUAL.

SER. NO. 85-435,912, FILED 9-29-2011.

MARIA-VICTORIA SUAREZ, EXAMINING ATTORNEY



David J. Kyffers

Director of the United States Patent and Trademark Office

United States of America

United States Patent and Trademark Office

OLIVER TWIST

Reg. No. 4,153,473

Registered June 5, 2012

Int. Cl.: 33

TRADEMARK

PRINCIPAL REGISTER

KEIRAN WYATT-NICOLLE (GREAT BRITAIN INDIVIDUAL)
48 HIGH STREET SAINT PETER PORT
GUERNSEY, UNITED KINGDOM GY12JU

FOR: ALCOHOLIC BEVERAGES EXCEPT BEERS; GIN, IN CLASS 33 (U.S. CLS. 47 AND 49).

THE MARK CONSISTS OF STANDARD CHARACTERS WITHOUT CLAIM TO ANY PARTICULAR FONT, STYLE, SIZE, OR COLOR.

OWNER OF UNITED KINGDOM REG. NO. 2577120, DATED 3-31-2011, EXPIRES 3-31-2021.

THE NAME "OLIVER TWIST" DOES NOT IDENTIFY A LIVING INDIVIDUAL.

SER. NO. 85-435,996, FILED 9-30-2011.

CHRISIE B. KING, EXAMINING ATTORNEY



David J. Kyffers

Director of the United States Patent and Trademark Office

United States of America

United States Patent and Trademark Office



Reg. No. 4,153,474

Registered June 5, 2012

Int. Cl.: 30

TRADEMARK

PRINCIPAL REGISTER

POPPED.LLC (NEVADA LIMITED LIABILITY COMPANY)
9480 S EASTERN AVE SUITE 110
LAS VEGAS, NV 89123

FOR: GOURMET POPPED POPCORN, IN CLASS 30 (U.S. CL. 46).

FIRST USE 4-1-2011; IN COMMERCE 8-9-2011.

NO CLAIM IS MADE TO THE EXCLUSIVE RIGHT TO USE "POPPED", APART FROM THE MARK AS SHOWN.

THE MARK CONSISTS OF THE STYLIZED WORDS "POPPED". THE LETTER "O" IS IN THE FORM OF A CHEF'S HAT.

SER. NO. 85-436,042, FILED 9-30-2011.

COLLEEN KEARNEY, EXAMINING ATTORNEY



David J. Kybas

Director of the United States Patent and Trademark Office

United States of America

United States Patent and Trademark Office



Reg. No. 4,153,475

FORT WORTH CREW CHARITIES, INC. (TEXAS NON-PROFIT 501(3)(C))
P.O. BOX 100842
FORT WORTH, TX 76185

Registered June 5, 2012

Int. Cl.: 36

FOR: CHARITABLE FUNDRAISING SERVICES BY MEANS OF ORGANIZING AND CONDUCTING SPECIAL EVENTS, IN CLASS 36 (U.S. CLS. 100, 101 AND 102).

SERVICE MARK

FIRST USE 9-1-2011; IN COMMERCE 9-1-2011.

PRINCIPAL REGISTER

NO CLAIM IS MADE TO THE EXCLUSIVE RIGHT TO USE "CHARITIES, INC.", "FORTH WORTH" AND "CHARITIES, INC.", APART FROM THE MARK AS SHOWN.

THE MARK CONSISTS OF THE STYLIZED LETTER AND WORDS "FWC CHARITIES, INC. FORT WORTH CREW CHARITIES, INC.". AN IMAGE OF TWO WOMEN WEARING DRESSES HANGING FROM THE LETTER "W".

SER. NO. 85-436,043, FILED 9-30-2011.

COLLEEN KEARNEY, EXAMINING ATTORNEY



David J. Kybas

Director of the United States Patent and Trademark Office

United States of America

United States Patent and Trademark Office

GETTING YOU THERE

Reg. No. 4,153,476

Registered June 5, 2012

Int. Cls.: 35 and 41

SERVICE MARK

PRINCIPAL REGISTER

DESTINATION ATHLETE LLC (NEW JERSEY LIMITED LIABILITY COMPANY)
5 FOX CHASE TURN
PITTS TOWN, NJ 08867

FOR: RETAIL STORE AND ON-LINE RETAIL STORE SERVICES FEATURING CLOTHING, SPORTS BAGS, SPORTS EQUIPMENT, VITAMINS, SUPPLEMENTS, PRINTED BOOKS, MAGAZINES AND TRAINING MATERIALS IN THE FIELD OF SPORTS, TOWELS, PENNANTS, PROTECTIVE CLOTHING AND HEADWEAR, LIGHTING EQUIPMENT, EYEWEAR, WALL BOARDS, BACKPACKS, DUFFLE BAGS, LUGGAGE, TOTE BAGS, VELOCITY RADAR DETECTORS, ANALGESICS, INSECT REPELLANT, SKIN CLEANSERS, PRE-RECORDED DVDS FEATURING INFORMATION ABOUT SPORTS, CLIP BOARDS, NOTE BOOKS, BEAN BAGS, WHISTLES, DOCUMENT, STATIONERY-TYPE AND BRIEFCASE-TYPE PORTFOLIOS, PENALTY FLAGS, SNACKS, OVER THE COUNTER DRUGS AND HERBAL REMEDIES AND EDUCATIONAL BOOKS, MAGAZINES AND TRAINING MATERIALS IN THE FIELD OF SPORTS, IN CLASS 35 (U.S. CLS. 100, 101 AND 102).

FIRST USE 7-0-2008; IN COMMERCE 7-0-2008.

FOR: EDUCATION SERVICES, NAMELY, PROVIDING TUTORING IN THE FIELD OF ATHLETIC TRAINING, ATHLETIC COACHING, SPORTS MEDICINE, PHYSICAL FITNESS, PHYSICAL THERAPY, NUTRITION AND SPORTS PARENTING, IN CLASS 41 (U.S. CLS. 100, 101 AND 107).

FIRST USE 7-0-2008; IN COMMERCE 7-0-2008.

THE MARK CONSISTS OF STANDARD CHARACTERS WITHOUT CLAIM TO ANY PARTICULAR FONT, STYLE, SIZE, OR COLOR.

SER. NO. 85-436,062, FILED 9-30-2011.

DAVID YONTEF, EXAMINING ATTORNEY



David J. Kypos

Director of the United States Patent and Trademark Office

United States of America

United States Patent and Trademark Office

Jersey Surf

Reg. No. 4,153,477

Registered June 5, 2012

Int. Cl.: 25

TRADEMARK

PRINCIPAL REGISTER

JERSEY SURF INC., A NEW JERSEY NOT FOR PROFIT CORP (NEW JERSEY CORPORATION)
SUITE 201
32 MILL STREET
MOUNT HOLLY, NJ 08060

FOR: CLOTHING, NAMELY, CAPS, T-SHIRTS, AND SWEATSHIRTS, IN CLASS 25 (U.S. CLS. 22 AND 39).

FIRST USE 1-1-1990; IN COMMERCE 1-1-1990.

THE MARK CONSISTS OF STANDARD CHARACTERS WITHOUT CLAIM TO ANY PARTICULAR FONT, STYLE, SIZE, OR COLOR.

SEC. 2(F).

SER. NO. 85-436,063, FILED 9-30-2011.

MATTHEW KLINE, EXAMINING ATTORNEY



David J. Kyffers

Director of the United States Patent and Trademark Office

United States of America

United States Patent and Trademark Office



ALLEGORY STUDIOS

Reg. No. 4,153,478

Registered June 5, 2012

Int. Cl.: 35

SERVICE MARK

PRINCIPAL REGISTER

ALLEGORY STUDIOS, INC. (MARYLAND CORPORATION)
SUITE C
184 EDIE ROAD
SARATOGA SPRINGS, NY 12866

FOR: BRANDING SERVICES, NAMELY, CONSULTING, DEVELOPMENT, MANAGEMENT AND MARKETING OF BRANDS FOR BUSINESSES; DEVELOPMENT OF MARKETING STRATEGIES, CONCEPTS AND TACTICS, NAMELY, AUDIENCE DEVELOPMENT, BRAND AWARENESS, ONLINE COMMUNITY BUILDING AND DIGITAL WORD OF MOUTH COMMUNICATIONS, IN CLASS 35 (U.S. CLS. 100, 101 AND 102).

FIRST USE 6-1-2008; IN COMMERCE 6-1-2008.

NO CLAIM IS MADE TO THE EXCLUSIVE RIGHT TO USE "ALLEGORY STUDIOS", APART FROM THE MARK AS SHOWN.

THE MARK CONSISTS OF THE LETTER "A" IN STYLIZED FONT PRIMARILY DISPLAYED WITHIN A CIRCLE ABOVE THE STYLIZED WORDS "ALLEGORY STUDIOS".

SER. NO. 85-436,124, FILED 9-30-2011.

DAVID YONTEF, EXAMINING ATTORNEY



David J. Kyffers

Director of the United States Patent and Trademark Office

United States of America

United States Patent and Trademark Office



Reg. No. 4,153,479

Registered June 5, 2012

**Int. Cls.: 35, 36, 41, 43,
44 and 45**

SERVICE MARK

PRINCIPAL REGISTER

COVENANT HOUSE (NEW YORK CORPORATION)
5 PENN PLAZA, 3RD FLOOR
NEW YORK, NY 10001

FOR: PUBLIC ADVOCACY TO PROMOTE AWARENESS OF THE ISSUES FACING HOMELESS YOUTH, IN CLASS 35 (U.S. CLS. 100, 101 AND 102).

FIRST USE 6-0-2008; IN COMMERCE 6-0-2008.

FOR: CHARITABLE FUNDRAISING, IN CLASS 36 (U.S. CLS. 100, 101 AND 102).

FIRST USE 6-0-2008; IN COMMERCE 6-0-2008.

FOR: PROVIDING COURSES OF INSTRUCTION AT THE ELEMENTARY, INTERMEDIATE, AND HIGH SCHOOL LEVEL; PROVIDING INFORMATION ABOUT EDUCATION; VOCATIONAL GUIDANCE, IN CLASS 41 (U.S. CLS. 100, 101 AND 107).

FIRST USE 6-0-2008; IN COMMERCE 6-0-2008.

FOR: CHARITABLE SERVICES, NAMELY, PROVIDING TEMPORARY SHELTER FOR THE HOMELESS; SUPPLYING MEALS TO THE HOMELESS OR UNDERPRIVILEGED, IN CLASS 43 (U.S. CLS. 100 AND 101).

FIRST USE 6-0-2008; IN COMMERCE 6-0-2008.

FOR: CHEMICAL DEPENDENCY AND SUBSTANCE ABUSE TREATMENT SERVICES; MEDICAL COUNSELING; MEDICAL SERVICES; MENTAL HEALTH SERVICES, IN CLASS 44 (U.S. CLS. 100 AND 101).

FIRST USE 6-0-2008; IN COMMERCE 6-0-2008.

FOR: CHARITABLE OUTREACH SERVICES, NAMELY, PROVIDING COUNSELING SERVICES IN THE FIELD OF RELIGION; CHARITABLE SERVICES, NAMELY, PROVIDING CLOTHING TO NEEDY PERSONS; CHRISTIAN MINISTRY SERVICES; LEGAL SERVICES, IN CLASS 45 (U.S. CLS. 100 AND 101).

FIRST USE 6-0-2008; IN COMMERCE 6-0-2008.



David J. Kyros

Director of the United States Patent and Trademark Office

Reg. No. 4,153,479 THE MARK CONSISTS OF A BIRD DESIGN, ABOVE AN OUTREACHED HAND. THE BIRD IS DEPICTED AGAINST FOUR SHADED SQUARES SEPARATED BY A WHITE BORDER. A SUN DESIGN APPEARS IN THE UPPER RIGHT HAND CORNER OF THE MARK.

SER. NO. 85-436,147, FILED 9-30-2011.

JERI J. FICKES, EXAMINING ATTORNEY

United States of America

United States Patent and Trademark Office

THE LOVE BOAT

Reg. No. 4,153,480

Registered June 5, 2012

Int. Cl.: 9

TRADEMARK

PRINCIPAL REGISTER

AARON SPELLING PRODUCTIONS INC. (CALIFORNIA CORPORATION)
4024 RADFORD AVENUE
STUDIO CITY, CA 91604

FOR: LASER DISCS, DIGITAL VIDEO DISCS, DIGITAL VERSATILE DISCS AND DVDS,
ALL FEATURING PRE-RECORDED ENTERTAINMENT IN THE NATURE OF COMEDY
TELEVISION SERIES EPISODES, IN CLASS 9 (U.S. CLS. 21, 23, 26, 36 AND 38).

FIRST USE 3-31-2008; IN COMMERCE 3-31-2008.

THE MARK CONSISTS OF STANDARD CHARACTERS WITHOUT CLAIM TO ANY PAR-
TICULAR FONT, STYLE, SIZE, OR COLOR.

OWNER OF U.S. REG. NOS. 1,691,972, 3,659,314 AND OTHERS.

SER. NO. 85-436,154, FILED 9-30-2011.

LINDA LAVACHE, EXAMINING ATTORNEY



David J. Kyffers

Director of the United States Patent and Trademark Office

United States of America

United States Patent and Trademark Office

TRADE PLUS

Reg. No. 4,153,481

COLLINS AUTO GROUP, LLC (KENTUCKY LIMITED LIABILITY COMPANY)
4220 BARDSTOWN ROAD
LOUISVILLE, KY 40218

Registered June 5, 2012

Int. Cl.: 35

FOR: ADVERTISING, MARKETING AND PROMOTION SERVICES IN THE FIELD OF LEASING AND PURCHASING AUTOMOBILES, IN CLASS 35 (U.S. CLS. 100, 101 AND 102).

SERVICE MARK

FIRST USE 2-26-1999; IN COMMERCE 2-26-1999.

PRINCIPAL REGISTER

THE MARK CONSISTS OF STANDARD CHARACTERS WITHOUT CLAIM TO ANY PARTICULAR FONT, STYLE, SIZE, OR COLOR.

NO CLAIM IS MADE TO THE EXCLUSIVE RIGHT TO USE "TRADE", APART FROM THE MARK AS SHOWN.

SER. NO. 85-436,262, FILED 9-30-2011.

JAY BESCH, EXAMINING ATTORNEY



David J. Kybas

Director of the United States Patent and Trademark Office

United States of America

United States Patent and Trademark Office

Majesty's Buddy Bites

Reg. No. 4,153,482

Registered June 5, 2012

Int. Cl.: 5

TRADEMARK

PRINCIPAL REGISTER

MAJESTY'S ANIMAL NUTRITION (OREGON CORPORATION)
60973 CREEKSTONE LOOP
BEND, OR 97702

FOR: NUTRITIONAL SUPPLEMENTS FOR HIPS AND JOINTS, SKIN AND COATS OF DOGS,
IN CLASS 5 (U.S. CLS. 6, 18, 44, 46, 51 AND 52).

FIRST USE 1-1-2007; IN COMMERCE 1-1-2007.

THE MARK CONSISTS OF STANDARD CHARACTERS WITHOUT CLAIM TO ANY PAR-
TICULAR FONT, STYLE, SIZE, OR COLOR.

NO CLAIM IS MADE TO THE EXCLUSIVE RIGHT TO USE "BITES", APART FROM THE
MARK AS SHOWN.

SER. NO. 85-436,271, FILED 9-30-2011.

JAY BESCH, EXAMINING ATTORNEY



David J. Kyros

Director of the United States Patent and Trademark Office

United States of America

United States Patent and Trademark Office



Reg. No. 4,153,483

Registered June 5, 2012

Int. Cl.: 35

SERVICE MARK

PRINCIPAL REGISTER

CHICAGO-SOFT, LTD (ILLINOIS CORPORATION), DBA SPORTSCAR VINTAGE RACING ASSOCIATION
1 MAPLE STREET
HANOVER, NH 03755

FOR: ASSOCIATION SERVICES, NAMELY, PROMOTING THE INTEREST OF OWNERS AND DRIVERS OF VINTAGE SPORTS CARS, IN CLASS 35 (U.S. CLS. 100, 101 AND 102).

FIRST USE 1-1-1993; IN COMMERCE 1-1-1993.

NO CLAIM IS MADE TO THE EXCLUSIVE RIGHT TO USE "SPORTSCAR VINTAGE RACING ASSOCIATION", APART FROM THE MARK AS SHOWN.

THE MARK CONSISTS OF A SMALL CHECKERED FLAG ABOVE AND BELOW THE LETTERS "SVRA" ON A SOLID BACKGROUND ENCIRCLED WITH THE WORDS "SPORTSCAR VINTAGE RACING ASSOCIATION" WITH TWO MORE CONCENTRIC CIRCLES FORMING THE OUTER EDGE.

SER. NO. 85-436,334, FILED 9-30-2011.

JAMES LOVELACE, EXAMINING ATTORNEY



David J. Kyffers

Director of the United States Patent and Trademark Office

United States of America

United States Patent and Trademark Office

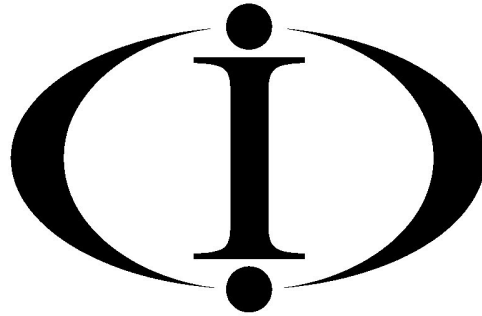

INTERNATIONAL RETAIL & SUPPLY CHAIN DATALYTICS, LLC.

Reg. No. 4,153,484

Registered June 5, 2012

Int. Cl.: 35

SERVICE MARK

PRINCIPAL REGISTER

HEFFNER, CARL (UNITED STATES INDIVIDUAL)
1702 STOUT DRIVE
SPRINGDALE, AR 72762

FOR: BUSINESS MANAGEMENT CONSULTING WITH RELATION TO STRATEGY, MARKETING, PRODUCTION, PERSONNEL AND RETAIL SALE MATTERS; LOGISTICS MANAGEMENT IN THE FIELD OF RETAIL STORE AND GROCERY STORE SERVICES, IN CLASS 35 (U.S. CLS. 100, 101 AND 102).

FIRST USE 1-1-2011; IN COMMERCE 1-1-2011.

NO CLAIM IS MADE TO THE EXCLUSIVE RIGHT TO USE "INTERNATIONAL RETAIL & SUPPLY CHAIN" AND "LLC", APART FROM THE MARK AS SHOWN.

THE MARK CONSISTS OF A DOUBLE ENDED LOWER CASE "I" WITH A "D" SWOOSH IN EITHER SIDE. BELOW THERE IS THE STYLIZED TEXT "INTERNATIONAL RETAIL & SUPPLY CHAIN DATALYTICS, LLC."

SER. NO. 85-436,427, FILED 9-30-2011.

DEBORAH LOBO, EXAMINING ATTORNEY



David J. Kyjars

Director of the United States Patent and Trademark Office

United States of America

United States Patent and Trademark Office



Reg. No. 4,153,485

Registered June 5, 2012

Int. Cl.: 41

SERVICE MARK

PRINCIPAL REGISTER

PETRO-DRILL CORPORATION (TEXAS CORPORATION)
10333HARWIN DR. SUITE #540
HOUSTON, TX 77036

FOR: ANALYZING EDUCATIONAL TESTS SCORES AND DATA FOR OTHERS; ARRANGING AND CONDUCTING EDUCATIONAL CONFERENCES; BUSINESS TRAINING IN THE FIELD OF PETROLEUM OPERATIONS, OPERATIONS MANAGEMENT, COMPUTER TECHNOLOGIES, RELATED AREAS; CAREER COUNSELING, NAMELY, PROVIDING ADVICE CONCERNING EDUCATION OPTIONS TO PURSUE CAREER OPPORTUNITIES; COMPUTER EDUCATION TRAINING SERVICES; CONDUCTING EDUCATIONAL EXHIBITIONS IN THE NATURE OF PETROLEUM EXPLORATION AND DEVELOPMENT; CONTINUING EDUCATION SERVICES, NAMELY, PROVIDING LIVE AND ON-LINE CONTINUING PROFESSIONAL EDUCATION SEMINARS IN THE FIELD OF PETROLEUM EXPLORATION AND DEVELOPMENT; DEVELOPING EDUCATIONAL MANUALS FOR OTHERS IN THE FIELD OF PETROLEUM EXPLORATION AND DEVELOPMENT; EDUCATING AT UNIVERSITY OR COLLEGES; EDUCATION SERVICES IN THE NATURE OF COURSES AT THE UNIVERSITY LEVEL; EDUCATION SERVICES, NAMELY, MENTORING IN THE FIELD OF PETROLEUM EXPLORATION AND DEVELOPMENT; EDUCATION SERVICES, NAMELY, PROVIDING CAREER RE-TRAINING CLASSES, SEMINARS, CONFERENCES, WORKSHOPS IN THE FIELDS OF PETROLEUM ENGINEERING, OIL DRILLING, OIL RIG SAFETY, DRILLING SAFETY, DRILLING EQUIPMENT, PETROLEUM PROCESSING AND PRODUCTION, RESERVOIR ANALYSIS, PETROLEUM EXPLORATION, DRILLING MECHANICS, OIL RIG OPERATIONS; EDUCATION SERVICES, NAMELY, PROVIDING LIVE AND ON-LINE RESEARCH, ANALYSIS, TESTING, CONSULTATION IN THE FIELD OF PETROLEUM EXPLORATION AND DEVELOPMENT; EDUCATION SERVICES, NAMELY, PROVIDING RESEARCH, ANALYSIS, TESTING, CONSULTATION IN THE FIELD OF PETROLEUM EXPLORATION AND DEVELOPMENT; EDUCATIONAL COUNSELING SERVICES TO ASSIST STUDENTS IN PLANNING AND PREPARING FOR FURTHER EDUCATION; EDUCATIONAL COURSE MONITORING, NAMELY, TRACKING STUDENT PERFORMANCE; EDUCATIONAL EXAMINATION SERVICES; EDUCATIONAL SERVICES IN THE NATURE OF PETROLEUM RELATED SCHOOLS; EDUCATIONAL SERVICES, NAMELY, CONDUCTING PROGRAMS IN THE FIELD OF PETROLEUM EXPLORATION AND DEVELOPMENT; EDUCATIONAL SERVICES, NAMELY, CONDUCTING CLASSES, SEMINARS, CONFERENCES, WORKSHOPS IN THE FIELDS OF PETROLEUM ENGINEERING, OIL DRILLING, OIL RIG SAFETY, DRILLING SAFETY, DRILLING EQUIPMENT, PETROLEUM PROCESSING AND PRODUCTION, RESERVOIR ANALYSIS, PETROLEUM EXPLORATION, DRILLING MECHANICS, OIL RIG OPERATIONS AND DISTRIBUTION



David J. Kappas

Director of the United States Patent and Trademark Office

Reg. No. 4,153,485 OF TRAINING MATERIALS IN CONNECTION THEREWITH; EDUCATIONAL SERVICES, NAMELY, CONDUCTING RESEARCH, ANALYSIS, TESTING, CONSULTATION IN THE FIELD OF PETROLEUM EXPLORATION AND DEVELOPMENT; EDUCATIONAL SERVICES, NAMELY, CONDUCTING RESEARCH, ANALYSIS, TESTING, CONSULTATION IN THE FIELD OF PETROLEUM EXPLORATION AND DEVELOPMENT AND DISTRIBUTION OF COURSE MATERIAL IN CONNECTION THEREWITH; EDUCATIONAL SERVICES, NAMELY, CONDUCTING RESEARCH, ANALYSIS, TESTING, CONSULTATION IN THE FIELD OF PETROLEUM EXPLORATION AND DEVELOPMENT AND DISTRIBUTION OF TRAINING MATERIAL IN CONNECTION THEREWITH; EDUCATIONAL SERVICES, NAMELY, CONDUCTING RESEARCH, ANALYSIS, TESTING, CONSULTATION IN THE FIELD OF PETROLEUM EXPLORATION AND DEVELOPMENT AND DISTRIBUTION OF EDUCATIONAL MATERIALS IN CONNECTION THEREWITH; EDUCATIONAL SERVICES, NAMELY, DEVELOPING CURRICULUM FOR OTHERS IN THE FIELD OF PETROLEUM EXPLORATION AND DEVELOPMENT; EDUCATIONAL SERVICES, NAMELY, DEVELOPING, ARRANGING, AND CONDUCTING EDUCATIONAL CONFERENCES AND PROGRAMS AND PROVIDING COURSES OF INSTRUCTION IN THE FIELD OF PETROLEUM EXPLORATION AND DEVELOPMENT; EDUCATIONAL SERVICES, NAMELY, PROVIDING CONTINUING PROFESSIONAL EDUCATION COURSES IN THE FIELD OF PETROLEUM EXPLORATION AND DEVELOPMENT; EDUCATIONAL SERVICES, NAMELY, PROVIDING DISPLAYS AND EXHIBITS IN THE FIELD OF PETROLEUM EXPLORATION AND DEVELOPMENT; EDUCATIONAL SERVICES, NAMELY, PROVIDING EDUCATIONAL SPEAKERS IN THE FIELD OF PETROLEUM EXPLORATION AND DEVELOPMENT; EDUCATIONAL SERVICES, NAMELY, PROVIDING INTERNSHIPS AND APPRENTICESHIPS IN THE FIELD OF PETROLEUM EXPLORATION AND DEVELOPMENT; EDUCATIONAL SERVICES, NAMELY, PROVIDING INTERNSHIPS AND EXCHANGE PROGRAMS IN THE FIELDS OF PETROLEUM EXPLORATION AND DEVELOPMENT; EDUCATIONAL SERVICES, NAMELY, PROVIDING ON-LINE RESEARCH, ANALYSIS, TESTING, CONSULTATION IN THE FIELD OF PETROLEUM EXPLORATION AND DEVELOPMENT; EDUCATIONAL SERVICES, NAMELY, PROVIDING ONLINE INSTRUCTION IN THE FIELD OF PETROLEUM EXPLORATION AND DEVELOPMENT VIA AN ONLINE WEBSITE; EDUCATIONAL TESTING SERVICES; PROVIDING AN IN-PERSON RESEARCH, ANALYSIS, TESTING, CONSULTATION FORUM IN THE FIELD OF PETROLEUM EXPLORATION AND DEVELOPMENT; PROVIDING EDUCATIONAL ASSESSMENT SERVICES; PROVIDING EDUCATIONAL DEMONSTRATIONS; PROVIDING EDUCATIONAL MENTORING SERVICES AND PROGRAMS IN THE FIELD OF PETROLEUM EXPLORATION AND DEVELOPMENT; PROVIDING ON-LINE TRAINING RESEARCH, ANALYSIS, TESTING, CONSULTATION IN THE FIELD OF PETROLEUM EXPLORATION AND DEVELOPMENT; TRAINING IN THE USE AND OPERATION OF DRILLING MACHINERY AND OIL RIGS; TRAINING IN THE USE OF DRILLING EQUIPMENT; TRAINING SERVICES IN THE FIELD OF PETROLEUM EXPLORATION AND DEVELOPMENT, IN CLASS 41 (U.S. CLS. 100, 101 AND 107).

FIRST USE 8-1-2011; IN COMMERCE 8-1-2011.

NO CLAIM IS MADE TO THE EXCLUSIVE RIGHT TO USE "CORPORATION", APART FROM THE MARK AS SHOWN.

THE COLOR(S) BLUE AND GREEN IS/ARE CLAIMED AS A FEATURE OF THE MARK.

THE MARK CONSISTS OF LARGE, BLUE, BOLD, CAPITAL LETTERS WORDING "PETR", IN TIMES NEW ROMAN FONT, FOLLOWED BY A BLUE WATER DROPLET SUPERIMPOSED IN FRONT AND SLIGHTLY TO THE RIGHT OF A COLORLESS SILHOUETTE OF AN ERLNMEYER FLASK, SUPERIMPOSED IN FRONT AND SLIGHTLY TO THE RIGHT OF A GREEN GRIDDED SPHERE ROTATED 21 DEGREES COUNTERCLOCKWISE, FOLLOWED BY A BLUE DASH, THEN LARGE BLUE, BOLD, CAPITAL LETTERS WORDING "DR", IN TIMES NEW ROMAN FONT, FOLLOWED BY A GREEN DRILL BIT SET BELOW A SMALL BLUE OCTAGON WITH THE SMALL, COLORLESS, BOLD, CAPITAL LETTERS WORDING "GV", IN TIMES NEW ROMAN FONT CENTERED WITHIN THE OCTAGON. THE DRILL BIT IS FOLLOWED BY LARGE BLUE, BOLD, CAPITAL LETTERS WORDING

Reg. No. 4,153,485 LL IN TIMES NEW ROMAN FONT. THE GLOBE IS A PICTURE REPRESENTATION OF THE CAPITAL LETTER "O". THE DRILL BIT IS A PICTURE REPRESENTATION OF THE BOTTOM LINE SECTION OF A LOWER CASE LETTER I, AND THE OCTAGON IS PICTURE REPRESENTATION OF THE TOP DOT SECTION OF A LOWER CASE LETTER "I". ALL OF THE PREVIOUSLY DESCRIBED ELEMENTS ARE UNDERLINED BY A THIN BLUE LINE, FOLLOWED BY A SMALL, BLUE, ITALICIZED, WORDING "CORPORATION", IN TIMES NEW ROMAN FONT.

SER. NO. 85-436,452, FILED 9-30-2011.

MIDGE BUTLER, EXAMINING ATTORNEY

United States of America

United States Patent and Trademark Office

TECO DIAGNOSTICS

Reg. No. 4,153,486

TECO DIAGNOSTICS (CALIFORNIA CORPORATION)
1268 N. LAKEVIEW ST
ANAHEIM, CA 92807

Registered June 5, 2012

Int. Cl.: 5

FOR: CHEMICAL REAGENTS FOR MEDICAL OR VETERINARY PURPOSES, IN CLASS 5
(U.S. CLS. 6, 18, 44, 46, 51 AND 52).

TRADEMARK

FIRST USE 10-1-1992; IN COMMERCE 10-1-1992.

PRINCIPAL REGISTER

THE MARK CONSISTS OF STANDARD CHARACTERS WITHOUT CLAIM TO ANY PARTICULAR FONT, STYLE, SIZE, OR COLOR.

NO CLAIM IS MADE TO THE EXCLUSIVE RIGHT TO USE "DIAGNOSTICS", APART FROM THE MARK AS SHOWN.

SER. NO. 85-436,511, FILED 9-30-2011.

CHARLES L. JENKINS, EXAMINING ATTORNEY



David J. Kybas

Director of the United States Patent and Trademark Office

United States of America

United States Patent and Trademark Office

BETA ANALYTIC

Reg. No. 4,153,487

Registered June 5, 2012

Int. Cl.: 42

SERVICE MARK

PRINCIPAL REGISTER

BETA ANALYTIC, INC. (FLORIDA CORPORATION)
4985 SW 74TH COURT
MIAMI, FL 33155

FOR: RADIOCARBON DATING SERVICES, IN CLASS 42 (U.S. CLS. 100 AND 101).

FIRST USE 11-27-1979; IN COMMERCE 11-27-1979.

THE MARK CONSISTS OF STANDARD CHARACTERS WITHOUT CLAIM TO ANY PARTICULAR FONT, STYLE, SIZE, OR COLOR.

OWNER OF U.S. REG. NO. 3,484,619.

NO CLAIM IS MADE TO THE EXCLUSIVE RIGHT TO USE "ANALYTIC", APART FROM THE MARK AS SHOWN.

SER. NO. 85-436,585, FILED 9-30-2011.

MARGERY A. TIERNEY, EXAMINING ATTORNEY



David J. Kyffers

Director of the United States Patent and Trademark Office

United States of America

United States Patent and Trademark Office



Reg. No. 4,153,488

Registered June 5, 2012

Int. Cl.: 43

SERVICE MARK

PRINCIPAL REGISTER

LAKSHMI INC (TENNESSEE CORPORATION), DBA YOGO -N- SWEETS
SUITE 101
3800 HACKS CROSS RD
MEMPHIS, TN 38125

FOR: FAST-FOOD RESTAURANTS; ICE CREAM SHOP SERVICES IN THE NATURE OF A RESTAURANT; SELF SERVICE RESTAURANTS, IN CLASS 43 (U.S. CLS. 100 AND 101).

FIRST USE 4-15-2011; IN COMMERCE 5-1-2011.

THE MARK CONSISTS OF LETTER "Y" IS CAPITAL IN GREEN WITH A PINK SWIRL IN BETWEEN, THE LETTERS "YOGO" ALL IN GREEN WITH ONLY "Y" AND "G" CAPITAL, THE LETTER "O" IN GREEN WITH A PINK CHERRY TAIL AND PINK FILLED CIRCLE IN MIDDLE, "-N- SWEETS" ALL IN PINK, "-N-" HAVING DASHES ON BOTH SIDES IN PINK.

THE COLOR(S) PINK AND GREEN IS/ARE CLAIMED AS A FEATURE OF THE MARK.

SER. NO. 85-436,675, FILED 9-30-2011.

BRIDGETT SMITH, EXAMINING ATTORNEY



David J. Kybas

Director of the United States Patent and Trademark Office

United States of America

United States Patent and Trademark Office



Reg. No. 4,153,489

Registered June 5, 2012

Int. Cl.: 41

SERVICE MARK

PRINCIPAL REGISTER

FALK, KEVIN A (UNITED STATES INDIVIDUAL)
4021 RICHMOND ST. #3
SAN DIEGO, CA 92103

FOR: RENTAL OF PORTABLE PHOTOGRAPHY AND/OR VIDEOGRAPHY BOOTHS FOR TAKING OF PICTURES AND VIDEOS; VIDEOGRAPHY SERVICES; WEDDING PHOTOGRAPHY SERVICES, IN CLASS 41 (U.S. CLS. 100, 101 AND 107).

FIRST USE 11-15-2009; IN COMMERCE 8-1-2011.

NO CLAIM IS MADE TO THE EXCLUSIVE RIGHT TO USE "WEDDING STUDIO", APART FROM THE MARK AS SHOWN.

THE MARK CONSISTS OF THE LETTERS "XOXO WEDDING STUDIO" WITH THE "XOXO" BEING IN A BOLD ROUNDED BALLOON LIKE FONT ABOVE AND THE STYLIZED WORDING "WEDDING STUDIO".

SER. NO. 85-436,700, FILED 9-30-2011.

ELI HELLMAN, EXAMINING ATTORNEY



David J. Kyros

Director of the United States Patent and Trademark Office

United States of America

United States Patent and Trademark Office



Reg. No. 4,153,490

Registered June 5, 2012

Int. Cl.: 28

TRADEMARK

PRINCIPAL REGISTER

PLAYZONE INC (CALIFORNIA CORPORATION)
#209
12140 ARTESIA BLVD
ARTESIA, CA 92832

FOR: DIE-CAST TOY CARS, IN CLASS 28 (U.S. CLS. 22, 23, 38 AND 50).

FIRST USE 5-1-2009; IN COMMERCE 10-1-2009.

NO CLAIM IS MADE TO THE EXCLUSIVE RIGHT TO USE "WHEELS" , APART FROM THE MARK AS SHOWN.

THE MARK CONSISTS OF THE STYLIZED TEXT "MONSTER" ABOVE THE STYLIZED TEXT "WHEELS".

SER. NO. 85-436,706, FILED 9-30-2011.

MARC LEIPZIG, EXAMINING ATTORNEY



David J. Kyffers

Director of the United States Patent and Trademark Office

United States of America

United States Patent and Trademark Office

BLACKHAWK INDUSTRIAL

Reg. No. 4,153,491

BLACKHAWK INDUSTRIAL DISTRIBUTION, INC. (DELAWARE CORPORATION)
5460 SOUTH GARNETT ROAD, SUITE G
TULSA, OK 74146

Registered June 5, 2012

Int. Cl.: 39

FOR: DISTRIBUTION SERVICES, NAMELY, DELIVERY OF INDUSTRIAL SUPPLIES, IN CLASS 39 (U.S. CLS. 100 AND 105).

SERVICE MARK

FIRST USE 8-18-2009; IN COMMERCE 9-1-2010.

PRINCIPAL REGISTER

THE MARK CONSISTS OF STANDARD CHARACTERS WITHOUT CLAIM TO ANY PARTICULAR FONT, STYLE, SIZE, OR COLOR.

NO CLAIM IS MADE TO THE EXCLUSIVE RIGHT TO USE "INDUSTRIAL", APART FROM THE MARK AS SHOWN.

SER. NO. 85-436,713, FILED 9-30-2011.

DEBORAH LOBO, EXAMINING ATTORNEY



David J. Kybas

Director of the United States Patent and Trademark Office

United States of America

United States Patent and Trademark Office

little blue studio

Reg. No. 4,153,492

Registered June 5, 2012

Int. Cl.: 35

SERVICE MARK

PRINCIPAL REGISTER

HIGH, MARIA LOUISE (UNITED STATES INDIVIDUAL), DBA LITTEL BLUE STUDIO
221 E. BIDDLE STREET
BALTIMORE, MD 21202

FOR: ARRANGING AND CONDUCTING TRADE SHOW EXHIBITIONS IN THE FIELD OF JEWELRY AND CUSTOM JEWELRY; ON-LINE RETAIL STORE SERVICES FEATURING JEWELRY AND CUSTOM JEWELRY, IN CLASS 35 (U.S. CLS. 100, 101 AND 102).

FIRST USE 4-30-2009; IN COMMERCE 4-30-2009.

THE MARK CONSISTS OF STANDARD CHARACTERS WITHOUT CLAIM TO ANY PARTICULAR FONT, STYLE, SIZE, OR COLOR.

NO CLAIM IS MADE TO THE EXCLUSIVE RIGHT TO USE "STUDIO", APART FROM THE MARK AS SHOWN.

SER. NO. 85-436,763, FILED 9-30-2011.

WILLIAM ROSSMAN, EXAMINING ATTORNEY



David J. Kyffers

Director of the United States Patent and Trademark Office

United States of America

United States Patent and Trademark Office

little blue studio

Reg. No. 4,153,493

Registered June 5, 2012

Int. Cls.: 14 and 26

TRADEMARK

PRINCIPAL REGISTER

HIGH, MARIA LOUISE (UNITED STATES INDIVIDUAL), DBA LITTLE BLUE STUDIO
221 E. BIDDLE STREET
BALTIMORE, MD 21202

FOR: BRACELETS; BROOCHES; JEWELRY; JEWELRY, NAMELY, ARM CUFFS; NECKLACES; PENDANTS; PINS BEING JEWELRY; RINGS, IN CLASS 14 (U.S. CLS. 2, 27, 28 AND 50).

FIRST USE 5-31-2010; IN COMMERCE 5-31-2010.

FOR: FABRIC APPLIQUES; HAIR ACCESSORIES, NAMELY, HAIR PINS, HAIR CLIPS, HAIR BANDS, AND HAIR ORNAMENTS IN THE FORM OF COMBS; SHOE ORNAMENTS NOT OF PRECIOUS METAL, IN CLASS 26 (U.S. CLS. 37, 39, 40, 42 AND 50).

FIRST USE 5-31-2010; IN COMMERCE 5-31-2010.

THE MARK CONSISTS OF STANDARD CHARACTERS WITHOUT CLAIM TO ANY PARTICULAR FONT, STYLE, SIZE, OR COLOR.

NO CLAIM IS MADE TO THE EXCLUSIVE RIGHT TO USE "STUDIO" , APART FROM THE MARK AS SHOWN.

SER. NO. 85-436,782, FILED 9-30-2011.

WILLIAM ROSSMAN, EXAMINING ATTORNEY



David J. Kypos

Director of the United States Patent and Trademark Office

United States of America

United States Patent and Trademark Office

FAMILY PAWS

Reg. No. 4,153,494

Registered June 5, 2012

Int. Cl.: 44

SERVICE MARK

PRINCIPAL REGISTER

FAMILY PAWS LLC (NORTH CAROLINA LIMITED LIABILITY COMPANY)
141 BRANNIGAN PLACE
CARY, NC 27511

FOR: CONSULTATION SERVICES IN THE FIELD OF PET BEHAVIOR, IN CLASS 44 (U.S. CLS. 100 AND 101).

FIRST USE 6-0-2002; IN COMMERCE 6-0-2002.

THE MARK CONSISTS OF STANDARD CHARACTERS WITHOUT CLAIM TO ANY PARTICULAR FONT, STYLE, SIZE, OR COLOR.

NO CLAIM IS MADE TO THE EXCLUSIVE RIGHT TO USE "FAMILY", APART FROM THE MARK AS SHOWN.

SER. NO. 85-436,809, FILED 9-30-2011.

EDWARD NELSON, EXAMINING ATTORNEY



David J. Kyffers

Director of the United States Patent and Trademark Office

United States of America

United States Patent and Trademark Office

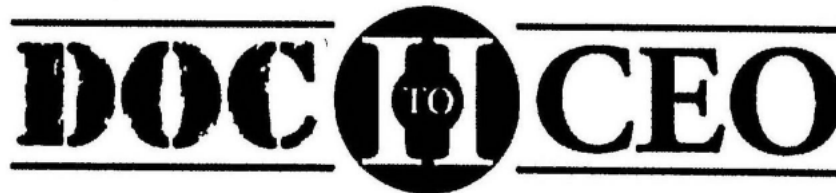

Reg. No. 4,153,495

Registered June 5, 2012

Int. Cl.: 41

SERVICE MARK

PRINCIPAL REGISTER

2ND CHANCE ENTERPRISES, LLC (MINNESOTA LIMITED LIABILITY COMPANY)
14165 PLYMOUTH AVENUE
BURNSVILLE, MN 55337

FOR: ELECTRONIC MAGAZINE PUBLISHING SERVICES FOR OTHERS; PROVIDING ONLINE E-ZINES IN THE FIELD OF JOB ADVANCEMENT EDUCATION AND REHABILITATION WHICH FEATURE ARTICLES, BLOGS, VIDEOS, PHOTOGRAPHS AND EDUCATIONAL MATERIALS VIA WIRELESS MOBILE DEVICES, SATELLITES, CABLE AND GLOBAL COMPUTER NETWORKS, IN CLASS 41 (U.S. CLS. 100, 101 AND 107).

FIRST USE 6-25-2011; IN COMMERCE 6-25-2011.

THE MARK CONSISTS OF THE STYLIZED LETTERS "DOC" TO THE LEFT, AND "CEO" TO THE RIGHT, BOTH WITH HORIZONTAL LINES DIRECTLY ABOVE AND BELOW THE LETTERS, WITH A CIRCLE DESIGN IN THE MIDDLE WHICH CONTAINS THE ROMAN NUMERALS "II" AND WITHIN THE "II" IS THE WORD "TO".

THE WORDING "DOCII TOCEO" HAS NO MEANING IN A FOREIGN LANGUAGE.

SER. NO. 85-436,814, FILED 9-30-2011.

LAURA KOVALSKY, EXAMINING ATTORNEY



David J. Kyjars

Director of the United States Patent and Trademark Office

United States of America

United States Patent and Trademark Office

HAWAIIABERA

Reg. No. 4,153,496

Registered June 5, 2012

Int. Cl.: 25

TRADEMARK

PRINCIPAL REGISTER

ROBERT ROBINSON (UNITED STATES INDIVIDUAL)
7019 WILD GROVE AVE
DALLAS, TX 75214

FOR: WEARABLE GARMENTS AND CLOTHING, NAMELY, SHIRTS, IN CLASS 25 (U.S. CLS. 22 AND 39).

FIRST USE 1-1-2009; IN COMMERCE 1-1-2009.

THE MARK CONSISTS OF STANDARD CHARACTERS WITHOUT CLAIM TO ANY PARTICULAR FONT, STYLE, SIZE, OR COLOR.

SER. NO. 85-436,872, FILED 9-30-2011.

WILLIAM JACKSON, EXAMINING ATTORNEY



David J. Kybas

Director of the United States Patent and Trademark Office

United States of America

United States Patent and Trademark Office



Reg. No. 4,153,497

Registered June 5, 2012

Int. Cl.: 43

SERVICE MARK

PRINCIPAL REGISTER

VIEIRA, DAVID (UNITED STATES INDIVIDUAL)
P.O. BOX 5168
WEST HILLS, CA 91308 AND

VIEIRA, PETRA (UNITED STATES INDIVIDUAL)
P.O. BOX 5168
WEST HILLS, CA 91308

FOR: RESTAURANT SERVICES; CARRY OUT RESTAURANT SERVICES; CATERING SERVICES, IN CLASS 43 (U.S. CLS. 100 AND 101).

FIRST USE 3-1-2004; IN COMMERCE 3-1-2004.

NO CLAIM IS MADE TO THE EXCLUSIVE RIGHT TO USE "PIZZA", APART FROM THE MARK AS SHOWN.

THE MARK CONSISTS OF A CONCENTRIC CIRCLE DESIGN, THE WORDS "ROCK & ROLL PIZZA" WITH CERTAIN STAR ELEMENTS AND A LETTER "R" IN THE CENTER OF ONE OF THE CIRCLES.

SEC. 2(F) AS TO "ROCK & ROLL PIZZA".

SER. NO. 85-436,883, FILED 9-30-2011.

DEBORAH LOBO, EXAMINING ATTORNEY



David J. Kybas

Director of the United States Patent and Trademark Office

United States of America

United States Patent and Trademark Office

Support for Life

Reg. No. 4,153,498

Registered June 5, 2012

Int. Cl.: 44

SERVICE MARK

PRINCIPAL REGISTER

MELMED CENTER (ARIZONA PROFESSIONAL LIMITED LIABILITY COMPANY)
#940
4848 E CACTUS RD.
SCOTTSDALE, AZ 85254

FOR: HEALTH CARE CLINIC SERVICES PROVIDING MEDICAL EVALUATIONS, MENTAL HEALTH COUNSELING, LIFESTYLE WELLNESS COUNSELING, WELLNESS, NUTRITION, OCCUPATIONAL THERAPY, BODY FITNESS THERAPY, AND NEUROFEEDBACK THERAPY CARE TO THOSE WHO NEED SUPPORT FOR DEALING WITH LIFE'S CHALLENGES BROUGHT UPON BY CLINICAL BEHAVIORAL, EDUCATIONAL AND DEVELOPMENTAL DISORDERS, IN CLASS 44 (U.S. CLS. 100 AND 101).

FIRST USE 6-1-2011; IN COMMERCE 8-1-2011.

THE MARK CONSISTS OF STANDARD CHARACTERS WITHOUT CLAIM TO ANY PARTICULAR FONT, STYLE, SIZE, OR COLOR.

SER. NO. 85-436,905, FILED 9-30-2011.

AMY HELLA, EXAMINING ATTORNEY



David J. Kyjars

Director of the United States Patent and Trademark Office

United States of America

United States Patent and Trademark Office



Reg. No. 4,153,499

SAN DIEGO HYDROPONICS & ORGANICS (CALIFORNIA CORPORATION)
4122 NAPIER ST.
SAN DIEGO, CA 92110

Registered June 5, 2012

Int. Cl.: 44

FOR: ON-LINE HYDROPONIC GROWING ADVICE; PROVIDING A WEBSITE FEATURING INFORMATION, INCLUDING CHAT SESSIONS AND QUESTION AND ANSWER SESSIONS, ABOUT GARDENING; PROVIDING GARDENING INFORMATION ON-LINE, IN CLASS 44 (U.S. CLS. 100 AND 101).

SERVICE MARK

PRINCIPAL REGISTER

FIRST USE 3-1-2011; IN COMMERCE 3-1-2011.

NO CLAIM IS MADE TO THE EXCLUSIVE RIGHT TO USE "ASK A GROWER", APART FROM THE MARK AS SHOWN.

THE MARK CONSISTS OF THE WORDS "ASK A GROWER" TO THE LEFT OF A WORM WITH A CURLED UP TAIL WEARING A FARMER OR SCARECROW STYLE HAT WITH OVERSIZED SPECTACLES AND A MOUTH READING FROM A BOOK.

SER. NO. 85-436,926, FILED 9-30-2011.

KEVIN DINALLO, EXAMINING ATTORNEY



David J. Kyros

Director of the United States Patent and Trademark Office

United States of America

United States Patent and Trademark Office

VINE STREET TILE STUDIOS

Reg. No. 4,153,500

HAMILTON PARKER COMPANY, LLC (OHIO LIMITED LIABILITY COMPANY)
1865 LEONARD AVENUE
COLUMBUS, OH 43219

Registered June 5, 2012

Int. Cl.: 19

FOR: TILES, NAMELY, CERAMIC, GLASS, PORCELAIN, AND NATURAL STONE TILES
FOR WALLS AND FLOORS, IN CLASS 19 (U.S. CLS. 1, 12, 33 AND 50).

TRADEMARK

FIRST USE 7-0-2010; IN COMMERCE 1-0-2011.

PRINCIPAL REGISTER

THE MARK CONSISTS OF STANDARD CHARACTERS WITHOUT CLAIM TO ANY PAR-
TICULAR FONT, STYLE, SIZE, OR COLOR.

NO CLAIM IS MADE TO THE EXCLUSIVE RIGHT TO USE "TILE STUDIOS", APART FROM
THE MARK AS SHOWN.

SER. NO. 85-436,938, FILED 9-30-2011.

MEGHAN REINHART, EXAMINING ATTORNEY



David J. Kybas

Director of the United States Patent and Trademark Office

United States of America

United States Patent and Trademark Office

NATUS

Reg. No. 4,153,501

Registered June 5, 2012

Int. Cls.: 9 and 10

TRADEMARK

PRINCIPAL REGISTER

NATUS MEDICAL INCORPORATED (DELAWARE CORPORATION)
1501 INDUSTRIAL ROAD
SAN CARLOS, CA 94070

FOR: COMPUTER SOFTWARE, NAMELY, A SUITE OF DATA MANAGEMENT SOFTWARE FOR PROCESSING MEDICAL DATA, PATIENT DATA, AND DEMOGRAPHIC DATA, NAMELY, DATA EXPORTING, DATA SEARCHING, AUTOMATED REPORT GENERATING; COMPUTER SOFTWARE, NAMELY, CASE MANAGEMENT SOFTWARE FOR AUTOMATING COLLECTION AND PROCESSING OF MEDICAL DATA, PATIENT DATA, AND DEMOGRAPHIC DATA, AND FOR MANAGING CALL LOGS, GENERATING CUSTOM REPORTS AND PHYSICIAN AND PARENT NOTIFICATION LETTERS, AUDIT TRAILS, FREEFORM NOTEBOOKS, AND COMPLETE CASE HISTORY FILES; COMPUTER SOFTWARE AND HARDWARE, NAMELY, DATA COLLECTION AND REPORTING SOFTWARE AND HARDWARE FOR COLLECTING AND REPORTING SLEEP STUDY RESULTS AND STATISTICS THROUGH A NETWORK; EARPHONES, NAMELY, EARPHONE PADS FOR SECURE AND COMFORTABLE ATTACHMENT; TAPE MEASURE INCLUDING INCHES AND CENTIMETERS FOR SURFACE AND PRACTICAL MEASUREMENTS; AUDIO CABLES; AUDIO-FREQUENCY TRANSFORMERS; EARPHONE ACCESSORIES, NAMELY, EARPHONE CUSHIONS, EARPHONE PADS, CORD MANAGEMENT SYSTEMS, EARPHONE CASES, AND EARPHONE EXTENSION CORDS; COMPUTER SOFTWARE AND HARDWARE, NAMELY, DATA COLLECTION AND REPORTING SOFTWARE AND HARDWARE FOR COLLECTING AND REPORTING OTOACOUSTIC EMISSIONS; ELECTRODE JUMPER CABLES, IN CLASS 9 (U.S. CLS. 21, 23, 26, 36 AND 38).

FIRST USE 10-31-1989; IN COMMERCE 10-31-1989.

FOR: ELECTROENCEPHALOGRAPHY KIT CONSISTING OF A WEARABLE AMPLIFIER AND TRANSMITTER; ELECTROENCEPHALOGRAPHY SIGNAL AMPLIFIER AND DATA TRANSMITTING DEVICE; MEDICAL HEARING INSTRUMENTS AND PARTS OF SUCH DEVICES; MEDICAL TESTING DEVICES FOR MEASURING HEARING LOSS IN PATIENTS, NAMELY, AUDIOMETERS; PROBES FOR MEDICAL PURPOSES; ELECTRODES FOR MEDICAL USE; MEDICAL EQUIPMENT ACCESSORIES, NAMELY, ELECTRODIAGNOSTIC AUTOMATED CONSTANT CURRENT SINUSOID WAVEFORM NEUROSELECTIVE SENSORY NERVE TESTING DEVICES, NAMELY, DISPOSABLE ELECTRODES, IN CLASS 10 (U.S. CLS. 26, 39 AND 44).

FIRST USE 10-31-1989; IN COMMERCE 10-31-1989.

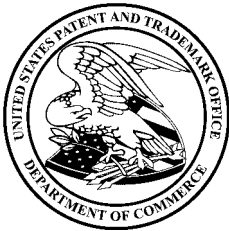

David J. Kyjars

Director of the United States Patent and Trademark Office

Reg. No. 4,153,501 THE MARK CONSISTS OF STANDARD CHARACTERS WITHOUT CLAIM TO ANY PARTICULAR FONT, STYLE, SIZE, OR COLOR.

OWNER OF U.S. REG. NO. 1,637,520.

SER. NO. 85-437,060, FILED 9-30-2011.

MICHAEL KEATING, EXAMINING ATTORNEY

United States of America

United States Patent and Trademark Office

The Righteous Conversations Project

Reg. No. 4,153,502

Registered June 5, 2012

Int. Cl.: 41

SERVICE MARK

PRINCIPAL REGISTER

REMEMBER US: THE HOLOCAUST BNAI MITZVAH PROJECT (CALIFORNIA CORPORATION)

NO. 182

1112 MONTANA AVE.

SANTA MONICA, CA 90403

FOR: EDUCATION SERVICES, NAMELY, PROVIDING WORKSHOPS AND FORUMS IN THE FIELD OF HOLOCAUST REMEMBRANCE AND TEEN/SURVIVOR RELATIONSHIPS AND COLLABORATIONS; EDUCATIONAL SERVICES, NAMELY, CONDUCTING PROGRAMS IN THE FIELD OF TEEN EMPOWERMENT THROUGH COLLABORATION WITH HOLOCAUST SURVIVORS, IN CLASS 41 (U.S. CLS. 100, 101 AND 107).

FIRST USE 2-16-2011; IN COMMERCE 2-16-2011.

THE MARK CONSISTS OF STANDARD CHARACTERS WITHOUT CLAIM TO ANY PARTICULAR FONT, STYLE, SIZE, OR COLOR.

NO CLAIM IS MADE TO THE EXCLUSIVE RIGHT TO USE "PROJECT", APART FROM THE MARK AS SHOWN.

SER. NO. 85-437,111, FILED 10-1-2011.

DAVID HOFFMAN, EXAMINING ATTORNEY



David J. Kyffers

Director of the United States Patent and Trademark Office

United States of America

United States Patent and Trademark Office

Amate Life

Reg. No. 4,153,503

AMATE LIFE (DELAWARE LIMITED LIABILITY COMPANY)
20762 HAMPSHIRE PL
LEXINGTON PARK, MD 20653

Registered June 5, 2012

Int. Cl.: 5

FOR: DIETARY AND NUTRITIONAL SUPPLEMENTS USED FOR WEIGHT LOSS, IN CLASS 5 (U.S. CLS. 6, 18, 44, 46, 51 AND 52).

TRADEMARK

FIRST USE 6-1-2011; IN COMMERCE 10-1-2011.

PRINCIPAL REGISTER

THE MARK CONSISTS OF STANDARD CHARACTERS WITHOUT CLAIM TO ANY PARTICULAR FONT, STYLE, SIZE, OR COLOR.

THE ENGLISH TRANSLATION OF THE WORD "AMATE" IN THE MARK IS "LOVE YOURSELF".

SER. NO. 85-437,119, FILED 10-1-2011.

BRIAN PINO, EXAMINING ATTORNEY



David J. Kybas

Director of the United States Patent and Trademark Office

United States of America

United States Patent and Trademark Office

FIN-MAN

Reg. No. 4,153,504

Registered June 5, 2012

Int. Cls.: 9 and 45

TRADEMARK

SERVICE MARK

PRINCIPAL REGISTER

GLOBAL PROMOTIONS, INC. (FLORIDA CORPORATION)
4134 PERRY PLACE
NEW PORT RICHEY, FL 346523152

FOR: ELECTRONIC DEVICES USED TO LOCATE LOST ARTICLES EMPLOYING THE GLOBAL POSITIONING SYSTEM OR CELLULAR COMMUNICATION NETWORKS; VEHICLE LOCATOR AND RECOVERY DEVICE PROGRAMMED TO USE GLOBAL POSITIONING SYSTEMS (GPS) AND CELLULAR TELECOMMUNICATIONS; VEHICLE TRACKING DEVICES COMPRISED OF CELLULAR RADIO MODULES, COMPUTER SOFTWARE AND COMPUTER HARDWARE, SENSORS, TRANSMITTERS, RECEIVERS AND GLOBAL POSITIONING SATELLITE RECEIVERS, ALL FOR USE IN CONNECTION WITH VEHICLE TRACKING, VEHICLE MONITORING AND ANTI-THEFT VEHICLE ALARMS, IN CLASS 9 (U.S. CLS. 21, 23, 26, 36 AND 38).

FIRST USE 9-11-2008, THE MARK WAS FIRST USED ANYWHERE IN A DIFFERENT FORM OTHER THAN THAT SOUGHT TO BE REGISTERED AT LEAST AS EARLY AS 09/11/2008; IN COMMERCE 4-7-2009, THE MARK WAS FIRST USED IN COMMERCE IN A DIFFERENT FORM OTHER THAN THAT SOUGHT TO BE REGISTERED AT LEAST AS EARLY AS 04/07/2009.

FOR: STOLEN VEHICLE RECOVERY SERVICES; STOLEN VEHICLE TRACKING, IN CLASS 45 (U.S. CLS. 100 AND 101).

FIRST USE 9-11-2008, THE MARK WAS FIRST USED ANYWHERE IN A DIFFERENT FORM OTHER THAN THAT SOUGHT TO BE REGISTERED AT LEAST AS EARLY AS 09/11/2008 ; IN COMMERCE 4-7-2009, THE MARK WAS FIRST USED IN COMMERCE IN A DIFFERENT FORM OTHER THAN THAT SOUGHT TO BE REGISTERED AT LEAST AS EARLY AS 04/07/2009.

THE MARK CONSISTS OF STANDARD CHARACTERS WITHOUT CLAIM TO ANY PARTICULAR FONT, STYLE, SIZE, OR COLOR.

SER. NO. 85-437,142, FILED 10-1-2011.

MARGARET POWER, EXAMINING ATTORNEY



David J. Kyros

Director of the United States Patent and Trademark Office

United States of America

United States Patent and Trademark Office

Nick Carter Green

Reg. No. 4,153,505

Registered June 5, 2012

Int. Cl.: 41

SERVICE MARK

PRINCIPAL REGISTER

GREEN, NICHOLAS TYLER (UNITED STATES INDIVIDUAL)
605 N. PINECREST RD.
BOLLINGBROOK, IL 60440

FOR: ENTERTAINMENT, NAMELY, LIVE MUSIC CONCERTS AND PERFORMANCES BY A MUSICAL ARTIST; PROVIDING A WEBSITE ON A GLOBAL COMPUTER NETWORK FEATURING INFORMATION ON A MUSICAL ARTIST AND HIS MUSICAL PERFORMANCES, PICTURES, TOUR INFORMATION, BIOGRAPHIES AND PERSONAL APPEARANCES; PROVIDING A WEBSITE ON A GLOBAL COMPUTER NETWORK FEATURING NON-DOWNLOADABLE PLAYBACK OF MUSIC AND NON-DOWNLOADABLE SAMPLE MUSIC VIDEO CLIPS, IN CLASS 41 (U.S. CLS. 100, 101 AND 107).

FIRST USE 4-1-2010; IN COMMERCE 4-1-2010.

THE MARK CONSISTS OF STANDARD CHARACTERS WITHOUT CLAIM TO ANY PARTICULAR FONT, STYLE, SIZE, OR COLOR.

THE NAME(S), PORTRAIT(S), AND/OR SIGNATURE(S) SHOWN IN THE MARK IDENTIFIES "NICHOLAS TYLER GREEN", WHOSE CONSENT(S) TO REGISTER IS MADE OF RECORD.

SER. NO. 85-437,159, FILED 10-1-2011.

DANIEL CAPSHAW, EXAMINING ATTORNEY



David J. Kybas

Director of the United States Patent and Trademark Office

United States of America

United States Patent and Trademark Office

SCIENCE + LAW

Reg. No. 4,153,506

Registered June 5, 2012

Int. Cl.: 45

SERVICE MARK

PRINCIPAL REGISTER

SYNTHESIS INTELLECTUAL PROPERTY, LLC (ILLINOIS LIMITED LIABILITY COMPANY),
AKA SYNTHESIS IP
1555 SHERMAN AVE. #258
1555 SHERMAN AVE. #258
EVANSTON, IL 60201

FOR: LEGAL SERVICES, IN CLASS 45 (U.S. CLS. 100 AND 101).

FIRST USE 8-19-2011; IN COMMERCE 8-19-2011.

THE MARK CONSISTS OF STANDARD CHARACTERS WITHOUT CLAIM TO ANY PARTICULAR FONT, STYLE, SIZE, OR COLOR.

NO CLAIM IS MADE TO THE EXCLUSIVE RIGHT TO USE "LAW", APART FROM THE MARK AS SHOWN.

SER. NO. 85-437,165, FILED 10-1-2011.

LEIGH CAROLINE CASE, EXAMINING ATTORNEY



David J. Kyjars

Director of the United States Patent and Trademark Office

United States of America

United States Patent and Trademark Office



Reg. No. 4,153,507

Registered June 5, 2012

Int. Cl.: 45

SERVICE MARK

PRINCIPAL REGISTER

MICHIGAN CHRISTIAN CAMPUS MINISTRIES, INC. (MICHIGAN CORPORATION), DBA
HIS HOUSE CHRISTIAN FELLOWSHIP
1171 TROWBRIDGE ROAD
EAST LANSING, MI 48823

FOR: CHARITABLE OUTREACH SERVICES, NAMELY, PROVIDING COUNSELING SERVICES IN THE FIELD OF RELIGION; CHRISTIAN MINISTRY SERVICES; COUNSELING SERVICES IN THE FIELD OF CHRISTIAN CONDUCT IN PERSONAL RELATIONSHIPS; PROVIDING A WEB SITE FEATURING INFORMATION ABOUT RELIGION, IN CLASS 45 (U.S. CLS. 100 AND 101).

FIRST USE 7-9-2010, THE MARK WAS FIRST USED ANYWHERE IN A DIFFERENT FORM OTHER THAN THAT SOUGHT TO BE REGISTERED AT LEAST AS EARLY AS 09/30/1976.; IN COMMERCE 7-9-2010, THE MARK WAS FIRST USED IN COMMERCE IN A DIFFERENT FORM OTHER THAN THAT SOUGHT TO BE REGISTERED AT LEAST AS EARLY AS 09/30/1976. .

NO CLAIM IS MADE TO THE EXCLUSIVE RIGHT TO USE "CHRISTIAN FELLOWSHIP", APART FROM THE MARK AS SHOWN.

THE MARK CONSISTS OF STYLIZED TEXT "HIS HOUSE" IN LARGE LETTERS WITH THE LAST THREE LETTERS PARTIALLY SURROUNDED BY A HOUSE DESIGN WITH STYLIZED TEXT "CHRISTIAN FELLOWSHIP" IN SMALLER LETTERS APPEARING DIRECTLY BELOW THE FIRST PORTION OF THE "HIS HOUSE" STYLIZED TEXT.

SER. NO. 85-437,193, FILED 10-1-2011.

DAVID HOFFMAN, EXAMINING ATTORNEY



David J. Kyjars

Director of the United States Patent and Trademark Office

United States of America

United States Patent and Trademark Office

YOU CAN DO ANYTHING

Reg. No. 4,153,508

Registered June 5, 2012

Int. Cl.: 41

SERVICE MARK

PRINCIPAL REGISTER

YOU CAN DO ANYTHING LLC (VIRGINIA LIMITED LIABILITY COMPANY)
P.O. BOX 7
ALDIE, VA 20105

FOR: PROVIDING A WEBSITE FEATURING BLOGS AND NON-DOWNLOADABLE PUBLICATIONS IN THE NATURE OF ARTICLES AND NEWSLETTERS IN THE FIELD OF EMPOWERING INDIVIDUALS TO ACHIEVE THEIR DREAMS, IN CLASS 41 (U.S. CLS. 100, 101 AND 107).

FIRST USE 9-27-2011; IN COMMERCE 9-27-2011.

THE MARK CONSISTS OF STANDARD CHARACTERS WITHOUT CLAIM TO ANY PARTICULAR FONT, STYLE, SIZE, OR COLOR.

SER. NO. 85-437,245, FILED 10-1-2011.

HAI-LY LAM, EXAMINING ATTORNEY



David J. Kybas

Director of the United States Patent and Trademark Office

United States of America

United States Patent and Trademark Office

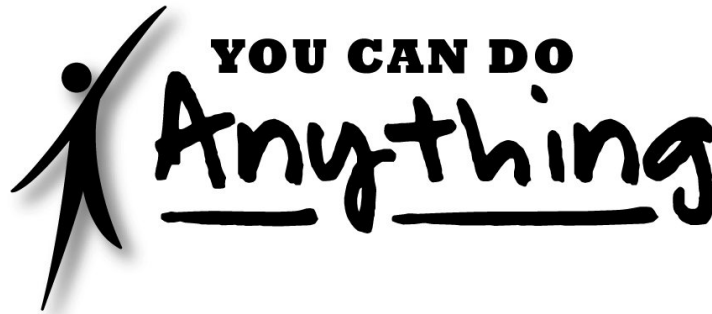

Reg. No. 4,153,509

Registered June 5, 2012

Int. Cl.: 41

SERVICE MARK

PRINCIPAL REGISTER

YOU CAN DO ANYTHING LLC (VIRGINIA LIMITED LIABILITY COMPANY)
P.O. BOX 7
ALDIE, VA 20105

FOR: PROVIDING A WEBSITE FEATURING BLOGS AND NON-DOWNLOADABLE PUBLICATIONS IN THE NATURE OF ARTICLES AND NEWSLETTERS IN THE FIELD OF EMPOWERING INDIVIDUALS TO ACHIEVE THEIR DREAMS, IN CLASS 41 (U.S. CLS. 100, 101 AND 107).

FIRST USE 9-27-2011; IN COMMERCE 9-27-2011.

THE MARK CONSISTS OF THE WORDS "YOU CAN DO ANYTHING" WITH THE WORD "ANYTHING" UNDERLINED AND NEXT TO A STICK-FIGURE RAISING AN ARM AND WITH A SLIGHT SHADOW.

SER. NO. 85-437,247, FILED 10-1-2011.

HAI-LY LAM, EXAMINING ATTORNEY



David J. Kyffers

Director of the United States Patent and Trademark Office

United States of America

United States Patent and Trademark Office

THE BACK ORTHOTIC

Reg. No. 4,153,510

Registered June 5, 2012

Int. Cl.: 10

TRADEMARK

PRINCIPAL REGISTER

BACKJOY ORTHOTICS, LLC (CALIFORNIA LIMITED LIABILITY COMPANY)
25852 MC BEAN PARKWAY SUITE 508
VALENCIA, CA 91355

FOR: ORTHOPEDIC SEAT CUSHIONS, IN CLASS 10 (U.S. CLS. 26, 39 AND 44).

FIRST USE 7-17-2005; IN COMMERCE 7-17-2005.

THE MARK CONSISTS OF STANDARD CHARACTERS WITHOUT CLAIM TO ANY PARTICULAR FONT, STYLE, SIZE, OR COLOR.

OWNER OF U.S. REG. NO. 3,077,985.

NO CLAIM IS MADE TO THE EXCLUSIVE RIGHT TO USE "ORTHOTIC", APART FROM THE MARK AS SHOWN.

SEC. 2(F).

SER. NO. 85-437,305, FILED 10-2-2011.

JIM RINGLE, EXAMINING ATTORNEY



David J. Kyffers

Director of the United States Patent and Trademark Office

United States of America

United States Patent and Trademark Office

COOL TROPICS RIPS SLUSH

Reg. No. 4,153,511

Registered June 5, 2012

Int. Cl.: 32

TRADEMARK

PRINCIPAL REGISTER

TROPICAL PARADISE, INC. (NEW YORK CORPORATION)
213 BURLINGTON ROAD
SUITE 123
BEDFORD, MA 01730

FOR: CONCENTRATES FOR MAKING FRUIT DRINKS; FROZEN FRUIT BEVERAGES; FROZEN FRUIT DRINKS; FROZEN FRUIT-BASED BEVERAGES; FRUIT DRINKS; FRUIT-BASED BEVERAGES; FRUIT-FLAVORED BEVERAGES; NON-ALCOHOLIC BEVERAGES CONTAINING FRUIT JUICES; NON-ALCOHOLIC FRUIT JUICE BEVERAGES; PREPARATIONS FOR MAKING BEVERAGES, NAMELY, FRUIT DRINKS, IN CLASS 32 (U.S. CLS. 45, 46 AND 48).

FIRST USE 9-10-2008; IN COMMERCE 9-10-2008.

THE MARK CONSISTS OF STANDARD CHARACTERS WITHOUT CLAIM TO ANY PARTICULAR FONT, STYLE, SIZE, OR COLOR.

OWNER OF U.S. REG. NOS. 2,159,021 AND 4,083,186.

NO CLAIM IS MADE TO THE EXCLUSIVE RIGHT TO USE "SLUSH", APART FROM THE MARK AS SHOWN.

SER. NO. 85-437,417, FILED 10-3-2011.

REBECCA GILBERT, EXAMINING ATTORNEY



David J. Kybas

Director of the United States Patent and Trademark Office

United States of America

United States Patent and Trademark Office

SAMBALLA

Reg. No. 4,153,512

Registered June 5, 2012

Int. Cl.: 33

TRADEMARK

PRINCIPAL REGISTER

SAZERAC COMPANY, INC. (LOUISIANA CORPORATION)
3850 N. CAUSEWAY BLVD., SUITE 1695
METAIRIE, LA 70002

FOR: LIQUEURS, SAMBUCA, IN CLASS 33 (U.S. CLS. 47 AND 49).

FIRST USE 9-0-1988; IN COMMERCE 9-0-1988.

THE MARK CONSISTS OF STANDARD CHARACTERS WITHOUT CLAIM TO ANY PARTICULAR FONT, STYLE, SIZE, OR COLOR.

THE WORD(S) "SAMBALLA" HAS NO MEANING IN A FOREIGN LANGUAGE.

SER. NO. 85-437,422, FILED 10-3-2011.

KIMBERLY PERRY, EXAMINING ATTORNEY



David J. Kyffers

Director of the United States Patent and Trademark Office

United States of America

United States Patent and Trademark Office

THE HUB OF BOSTON LAW

Reg. No. 4,153,513

BOSTON BAR ASSOCIATION (MASSACHUSETTS NON-PROFIT CORPORATION)
16 BEACON STREET
BOSTON, MA 02108

Registered June 5, 2012

Int. Cl.: 35

FOR: ASSOCIATION SERVICES, NAMELY, PROMOTING THE INTERESTS OF THE LEGAL PROFESSION, IN CLASS 35 (U.S. CLS. 100, 101 AND 102).

SERVICE MARK

FIRST USE 9-2-2011; IN COMMERCE 9-2-2011.

PRINCIPAL REGISTER

THE MARK CONSISTS OF STANDARD CHARACTERS WITHOUT CLAIM TO ANY PARTICULAR FONT, STYLE, SIZE, OR COLOR.

NO CLAIM IS MADE TO THE EXCLUSIVE RIGHT TO USE "BOSTON LAW", APART FROM THE MARK AS SHOWN.

SER. NO. 85-437,466, FILED 10-3-2011.

KELLY BOULTON, EXAMINING ATTORNEY



David J. Kyros

Director of the United States Patent and Trademark Office

United States of America

United States Patent and Trademark Office



Reg. No. 4,153,514

Registered June 5, 2012

Int. Cl.: 7

TRADEMARK

PRINCIPAL REGISTER

ADVANT-EDGE PAVING EQUIPMENT, LLC (NEW YORK LIMITED LIABILITY COMPANY)
33 OLD NISKAYUNA ROAD
LOUDONVILLE, NY 12211

FOR: ATTACHMENT FOR ASPHALT PAVING MACHINES, NAMELY, PAVEMENT EDGERS,
IN CLASS 7 (U.S. CLS. 13, 19, 21, 23, 31, 34 AND 35).

FIRST USE 9-10-2011; IN COMMERCE 9-10-2011.

NO CLAIM IS MADE TO THE EXCLUSIVE RIGHT TO USE "ROAD SAFETY", APART FROM
THE MARK AS SHOWN.

THE MARK CONSISTS OF TWO CONCENTRIC CIRCLES IN WHICH THE STYLIZED
WORDS "ROAD SAFETY WARRIOR" IS WRITTEN INSIDE THE OUTER CIRCLE. AN IMAGE
OF ZEUS (A BEARDED MAN) HOLDING A LIGHTNING BOLT IS IN THE CENTER OF THE
INNER CIRCLE.

SER. NO. 85-437,486, FILED 10-3-2011.

KELLY BOULTON, EXAMINING ATTORNEY



David J. Kyffers

Director of the United States Patent and Trademark Office

United States of America

United States Patent and Trademark Office

NORTHEAST ELECTRICAL DISTRIBUTORS

Reg. No. 4,153,515

Registered June 5, 2012

Int. Cl.: 35

SERVICE MARK

PRINCIPAL REGISTER

SONEPAR DISTRIBUTION NEW ENGLAND, INC. (DELAWARE CORPORATION)
135 WILL DRIVE
CANTON, MA 02021

FOR: DISTRIBUTORSHIP SERVICES IN THE FIELDS OF LIGHTING AND ELECTRICAL SUPPLIES, SAFETY PRODUCTS, TOOLS AND FASTENERS, ENERGY AND SOLAR ENERGY PRODUCTS, TELECOMMUNICATION AND DATA COMMUNICATION PRODUCTS, INDUSTRIAL AUTOMATION PRODUCTS, AND RELATED PRODUCTS AND MATERIALS, FOR THE RESIDENTIAL, COMMERCIAL, INDUSTRIAL AND INSTITUTIONAL MARKETS; ONLINE RETAIL AND WHOLESALE STORE SERVICES FEATURING LIGHTING AND ELECTRICAL SUPPLIES, SAFETY PRODUCTS, TOOLS AND FASTENERS, ENERGY AND SOLAR ENERGY PRODUCTS, TELECOMMUNICATION AND DATA COMMUNICATION PRODUCTS, INDUSTRIAL AUTOMATION PRODUCTS, AND RELATED PRODUCTS AND MATERIALS, IN CLASS 35 (U.S. CLS. 100, 101 AND 102).

FIRST USE 3-0-1999; IN COMMERCE 3-0-1999.

THE MARK CONSISTS OF STANDARD CHARACTERS WITHOUT CLAIM TO ANY PARTICULAR FONT, STYLE, SIZE, OR COLOR.

OWNER OF U.S. REG. NO. 2,394,432.

NO CLAIM IS MADE TO THE EXCLUSIVE RIGHT TO USE "ELECTRICAL DISTRIBUTORS", APART FROM THE MARK AS SHOWN.

SEC. 2(F).

SER. NO. 85-437,520, FILED 10-3-2011.

SHANNON TWOHIG, EXAMINING ATTORNEY



David J. Kypos

Director of the United States Patent and Trademark Office

United States of America

United States Patent and Trademark Office

VALUEIDEAS

Reg. No. 4,153,516

Registered June 5, 2012

Int. Cl.: 35

SERVICE MARK

PRINCIPAL REGISTER

MATHUR ENTERPRISES, L.L.C. (ILLINOIS LIMITED LIABILITY COMPANY), DBA
VALUEIDEAS
9438 MEADOWSWEET DRIVE
BELVIDERE, IL 61008

FOR: BUSINESS CONSULTING SERVICES RELATING TO PRODUCT DISTRIBUTION, OPERATIONS MANAGEMENT SERVICES, LOGISTICS, REVERSE LOGISTICS, SUPPLY CHAIN, AND PRODUCTION SYSTEMS AND DISTRIBUTION SOLUTIONS; BUSINESS CONSULTING SERVICES RELATING TO THE INTEGRATION OF THE AREAS OF BUSINESS PROCESS TECHNOLOGY, ORGANIZATIONAL LEARNING, CHANGE MANAGEMENT, AND OPERATIONAL SUSTAINABILITY; BUSINESS CONSULTING SERVICES, NAMELY, PROVIDING ASSISTANCE IN DEVELOPMENT OF BUSINESS STRATEGIES AND CREATIVE IDEATION; BUSINESS MANAGEMENT CONSULTING AND ADVISORY SERVICES; BUSINESS MANAGEMENT CONSULTING WITH RELATION TO STRATEGY, MARKETING, PRODUCTION, PERSONNEL AND RETAIL SALE MATTERS; BUSINESS ORGANIZATION AND MANAGEMENT CONSULTING; BUSINESS SERVICES, NAMELY, STRUCTURING, OPTIMIZING AND CHANGE MANAGEMENT CONSULTING RELATED TO CORPORATE IN-HOUSE INTELLECTUAL PROPERTY DEPARTMENTS AND INTELLECTUAL PROPERTY ASSET MANAGEMENT PROGRAMS; CONSULTING SERVICES IN THE FIELD OF MANAGING INTELLECTUAL PROPERTIES; MANAGEMENT CONSULTING AND ADVISORY SERVICES IN THE AREAS OF CORPORATE GROWTH STRATEGY, INNOVATION AND GROWTH PROCESSES, ORGANIZATIONAL TRANSFORMATION, AND TALENT MANAGEMENT AND DEVELOPMENT STRATEGIES; PROVIDING BUSINESS MANAGEMENT INFORMATION IN CONNECTION WITH CONSULTING AND ADVISORY SERVICES IN THE FIELD OF STRATEGIC PLANNING, IN CLASS 35 (U.S. CLS. 100, 101 AND 102).

FIRST USE 11-2-1999; IN COMMERCE 9-3-2000.

THE MARK CONSISTS OF STANDARD CHARACTERS WITHOUT CLAIM TO ANY PARTICULAR FONT, STYLE, SIZE, OR COLOR.

SER. NO. 85-437,524, FILED 10-3-2011.

Laurie Kaufman, Examining Attorney



David J. Kyffers

Director of the United States Patent and Trademark Office

United States of America

United States Patent and Trademark Office

We Are Halloween

Reg. No. 4,153,517

Registered June 5, 2012

Int. Cl.: 35

SERVICE MARK

PRINCIPAL REGISTER

CITCO ENTERPRISES (CALIFORNIA CORPORATION)
5964 BERKELEY RD
GOLETA, CA 93117

FOR: RETAIL STORE AND ONLINE ORDERING SERVICES IN THE HALLOWEEN MERCHANDISE FIELD, IN CLASS 35 (U.S. CLS. 100, 101 AND 102).

FIRST USE 3-15-2009; IN COMMERCE 3-15-2009.

THE MARK CONSISTS OF STANDARD CHARACTERS WITHOUT CLAIM TO ANY PARTICULAR FONT, STYLE, SIZE, OR COLOR.

OWNER OF U.S. REG. NO. 3,937,834.

NO CLAIM IS MADE TO THE EXCLUSIVE RIGHT TO USE "HALLOWEEN", APART FROM THE MARK AS SHOWN.

SER. NO. 85-437,525, FILED 10-3-2011.

EDWARD NELSON, EXAMINING ATTORNEY



David J. Kyffers

Director of the United States Patent and Trademark Office

United States of America

United States Patent and Trademark Office



FLUIDCAST

Reg. No. 4,153,518

Registered June 5, 2012

Int. Cl.: 38

SERVICE MARK

PRINCIPAL REGISTER

VOD MEDIA TECH, INC. (TEXAS CORPORATION)
#B305
2200 YARBROUGH AVE.
EL PASO, TX 79925

FOR: ONLINE VIDEO ON-DEMAND TRANSMISSION SERVICES, NAMELY, THE ONLINE DELIVERY OF MOVIES, TELEVISION PROGRAMS AND OTHER VIDEO CONTENT FOR OTHERS OVER PUBLIC AND PRIVATE COMPUTER NETWORKS, IN CLASS 38 (U.S. CLS. 100, 101 AND 104).

FIRST USE 3-12-2010; IN COMMERCE 7-22-2010.

THE MARK CONSISTS OF A STYLIZED EYE-DROP CONTAINING A FILMSTRIP WITHIN ITS BORDERS. THE EYE-DROP IS FALLING DOWNWARDS TOWARDS A BIT OF ABSTRACT GRASS OR GROUND. TO THE CENTER RIGHT OF THE EYE-DROP IS THE WORDING "FLUIDCAST" IN HIGHLY STYLIZED CAPITAL LETTERS.

SER. NO. 85-437,567, FILED 10-3-2011.

JILL C. ALT, EXAMINING ATTORNEY



David J. Kybas

Director of the United States Patent and Trademark Office

United States of America

United States Patent and Trademark Office

VALUELAB

Reg. No. 4,153,519

Registered June 5, 2012

Int. Cl.: 35

SERVICE MARK

PRINCIPAL REGISTER

MATHUR ENTERPRISES, L.L.C. (ILLINOIS LIMITED LIABILITY COMPANY), DBA
VALUEIDEAS
9438 MEADOWSWEET DRIVE
BELVIDERE, IL 61008

FOR: BUSINESS CONSULTING SERVICES RELATING TO PRODUCT DISTRIBUTION, OPERATIONS MANAGEMENT SERVICES, LOGISTICS, REVERSE LOGISTICS, SUPPLY CHAIN, AND PRODUCTION SYSTEMS AND DISTRIBUTION SOLUTIONS; BUSINESS CONSULTING SERVICES RELATING TO THE INTEGRATION OF THE AREAS OF BUSINESS PROCESS TECHNOLOGY, ORGANIZATIONAL LEARNING, CHANGE MANAGEMENT, AND OPERATIONAL SUSTAINABILITY; BUSINESS CONSULTING SERVICES, NAMELY, PROVIDING ASSISTANCE IN DEVELOPMENT OF BUSINESS STRATEGIES AND CREATIVE IDEATION; BUSINESS MANAGEMENT CONSULTING AND ADVISORY SERVICES; BUSINESS MANAGEMENT CONSULTING WITH RELATION TO STRATEGY, MARKETING, PRODUCTION, PERSONNEL AND RETAIL SALE MATTERS; BUSINESS ORGANIZATION AND MANAGEMENT CONSULTING; BUSINESS SERVICES, NAMELY, STRUCTURING, OPTIMIZING AND CHANGE MANAGEMENT CONSULTING RELATED TO CORPORATE IN-HOUSE INTELLECTUAL PROPERTY DEPARTMENTS AND INTELLECTUAL PROPERTY ASSET MANAGEMENT PROGRAMS; CONSULTING SERVICES IN THE FIELD OF MANAGING INTELLECTUAL PROPERTIES; MANAGEMENT CONSULTING AND ADVISORY SERVICES IN THE AREAS OF CORPORATE GROWTH STRATEGY, INNOVATION AND GROWTH PROCESSES, ORGANIZATIONAL TRANSFORMATION, AND TALENT MANAGEMENT AND DEVELOPMENT STRATEGIES; PROVIDING BUSINESS MANAGEMENT INFORMATION IN CONNECTION WITH CONSULTING AND ADVISORY SERVICES IN THE FIELD OF STRATEGIC PLANNING, IN CLASS 35 (U.S. CLS. 100, 101 AND 102).



FIRST USE 9-3-2000; IN COMMERCE 9-3-2000.

THE MARK CONSISTS OF STANDARD CHARACTERS WITHOUT CLAIM TO ANY PARTICULAR FONT, STYLE, SIZE, OR COLOR.

SER. NO. 85-437,581, FILED 10-3-2011.

Laurie Kaufman, Examining Attorney

David J. Kyffers

Director of the United States Patent and Trademark Office

United States of America

United States Patent and Trademark Office

PRIVATE PLANROOM PLUS

Reg. No. 4,153,520

Registered June 5, 2012

Int. Cl.: 9

TRADEMARK

PRINCIPAL REGISTER

THE BUILDERS EXCHANGE, INC. (OHIO CORPORATION)
9555 ROCKSIDE ROAD SUITE 300
VALLEY VIEW, OH 44125

FOR: COMPUTER SOFTWARE FOR STORING, SEARCHING AND ANALYZING INFORMATION ABOUT BUILDING CONSTRUCTION PROJECTS, IN CLASS 9 (U.S. CLS. 21, 23, 26, 36 AND 38).

FIRST USE 10-31-2006; IN COMMERCE 7-31-2009.

THE MARK CONSISTS OF STANDARD CHARACTERS WITHOUT CLAIM TO ANY PARTICULAR FONT, STYLE, SIZE, OR COLOR.

NO CLAIM IS MADE TO THE EXCLUSIVE RIGHT TO USE "PLAN ROOM", APART FROM THE MARK AS SHOWN.

SER. NO. 85-437,611, FILED 10-3-2011.

DOUGLAS LEE, EXAMINING ATTORNEY



David J. Kyffers

Director of the United States Patent and Trademark Office

United States of America

United States Patent and Trademark Office



Reg. No. 4,153,521

Registered June 5, 2012

Int. Cl.: 30

TRADEMARK

PRINCIPAL REGISTER

CAMANO ISLAND MANAGEMENT, INC. (WASHINGTON CORPORATION)
BUILDING B
848 N. SUNRISE BLVD.
CAMANO ISLAND, WA 98282

FOR: BEVERAGES MADE OF COFFEE; CANDY; COCOA; COCOA MIXES; COCOA POWDER; COFFEE; COFFEE AND COFFEE SUBSTITUTES; COFFEE BASED BEVERAGES; COFFEE BEANS; COFFEE FLAVORED SYRUP USED IN MAKING FOOD BEVERAGES; ESPRESSO; ESPRESSO DRINKS; GROUND COFFEE BEANS; HERBAL TEA; TEA; TEA-BASED BEVERAGES, IN CLASS 30 (U.S. CL. 46).

FIRST USE 0-0-2005; IN COMMERCE 0-0-2005.

OWNER OF U.S. REG. NOS. 2,956,036 AND 3,000,798.

NO CLAIM IS MADE TO THE EXCLUSIVE RIGHT TO USE "CAMANO ISLAND" AND "COFFEE ROASTERS", APART FROM THE MARK AS SHOWN.

THE MARK CONSISTS OF THE TERMS "CAMANO ISLAND COFFEE ROASTERS" IN A CIRCULAR DESIGN AROUND AN IMAGE OF A BAY NEAR ISLANDS WITH TWO STEAMING MUGS.

SER. NO. 85-437,628, FILED 10-3-2011.

JULIE VEPPUMTHARA, EXAMINING ATTORNEY



David J. Kyjars

Director of the United States Patent and Trademark Office

United States of America

United States Patent and Trademark Office



Reg. No. 4,153,522

Registered June 5, 2012

Int. Cl.: 41

SERVICE MARK

PRINCIPAL REGISTER

MITCHELL'S MARTIAL ARTS, INC. (MARYLAND CORPORATION)
1305 S. DIVISION STREET
SALISBURY, MD 21804

FOR: DAY CAMP SERVICES; ENTERTAINMENT SERVICES IN THE NATURE OF LIVE MIXED MARTIAL ARTS (MMA) EVENTS; ENTERTAINMENT SERVICES, NAMELY, PARTICIPATION IN MARTIAL ARTS; MARTIAL ARTS INSTRUCTION; OPERATING OF MARTIAL ARTS' SCHOOLS; OPERATING OF MARTIAL ARTS' STUDIOS; PROVIDING GENERAL FITNESS AND MIXED MARTIAL ARTS FACILITIES THAT REQUIRE MEMBERSHIPS AND ARE FOCUSED IN THE FIELDS OF GENERAL FITNESS, EXERCISE, AND MIXED MARTIAL ARTS, IN CLASS 41 (U.S. CLS. 100, 101 AND 107).

FIRST USE 1-1-2006; IN COMMERCE 1-1-2006.

NO CLAIM IS MADE TO THE EXCLUSIVE RIGHT TO USE "MARTIAL ARTS", APART FROM THE MARK AS SHOWN.

THE MARK CONSISTS OF TWO FIGURES PERFORMING A DEFENSIVE MARTIAL ARTS MOVE SURROUNDED BY A CIRCLE, AND IN WRITING NEXT TO THE CIRCLE IS WRITING, "MITCHELL'S MARTIAL ARTS".

SER. NO. 85-437,660, FILED 10-3-2011.

TASHIA BUNCH, EXAMINING ATTORNEY



David J. Kyros

Director of the United States Patent and Trademark Office

United States of America

United States Patent and Trademark Office

Photography by David's Bridal

Reg. No. 4,153,523

Registered June 5, 2012

Int. Cl.: 41

SERVICE MARK

PRINCIPAL REGISTER

DBD, INC. (DELAWARE CORPORATION)
1001 WASHINGTON STREET
CONSHOHOCKEN, PA 19428

FOR: PHOTOGRAPHY SERVICES, IN CLASS 41 (U.S. CLS. 100, 101 AND 107).

FIRST USE 6-1-2011; IN COMMERCE 6-1-2011.

THE MARK CONSISTS OF STANDARD CHARACTERS WITHOUT CLAIM TO ANY PARTICULAR FONT, STYLE, SIZE, OR COLOR.

OWNER OF U.S. REG. NOS. 2,817,374, 3,483,957 AND OTHERS.

NO CLAIM IS MADE TO THE EXCLUSIVE RIGHT TO USE "PHOTOGRAPHY" OR "BRIDAL", APART FROM THE MARK AS SHOWN.

SER. NO. 85-437,699, FILED 10-3-2011.

ANDREA HACK, EXAMINING ATTORNEY

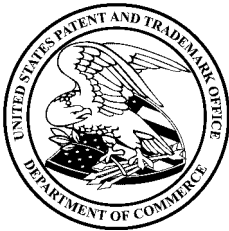

David J. Kyffers

Director of the United States Patent and Trademark Office

United States of America

United States Patent and Trademark Office



SUFU

SOCIETY OF
URODYNAMICS,
FEMALE PELVIC MEDICINE &
UROGENITAL RECONSTRUCTION

Reg. No. 4,153,524

Registered June 5, 2012

**COLLECTIVE
MEMBERSHIP**

PRINCIPAL REGISTER

SOCIETY OF URODYNAMICS, FEMALE PELVIC MEDICINE & UROGENITAL
RECONSTRUCTION (MISSOURI CORPORATION)
SUITE 520
1100 E. WOODFIELD RD.
SCHAUMBURG, IL 60173

FOR: INDICATING MEMBERSHIP IN A SOCIETY OF MEDICAL PROFESSIONALS, IN
CLASS 200 (U.S. CL. 200).

FIRST USE 9-0-2011; IN COMMERCE 9-0-2011.

NO CLAIM IS MADE TO THE EXCLUSIVE RIGHT TO USE "SOCIETY OF URODYNAMICS,
FEMALE PELVIC MEDICINE & UROGENITAL RECONSTRUCTION", APART FROM THE
MARK AS SHOWN.

THE MARK CONSISTS OF THE STYLIZED WORDING "SUFU SOCIETY URODYNAMICS
FEMALE PELVIC MEDICINE & UROGENITAL RECONSTRUCTION" AND DESIGN. THE
DESIGN CONSISTS OF A STYLIZED HUMAN FIGURE WITHIN 2 SQUARES. TO THE
RIGHT OF THE DESIGN ARE THE LETTERS "SUFU" WHICH ARE UNDERLINED. BELOW
"SUFU," IN STACKED FORMATION, IS THE WORDING "SOCIETY OF" ABOVE THE TERM
"URODYNAMICS" ABOVE THE WORDING "FEMALE PELVIC MEDICINE &" ABOVE THE
WORDING "UROGENITAL RECONSTRUCTION."

SER. NO. 85-437,728, FILED 10-3-2011.

MARLENE BELL, EXAMINING ATTORNEY



David J. Kyjars

Director of the United States Patent and Trademark Office

United States of America

United States Patent and Trademark Office



Reg. No. 4,153,525

Registered June 5, 2012

Int. Cl.: 41

SERVICE MARK

PRINCIPAL REGISTER

MITCHELL'S MARTIAL ARTS, INC. (MARYLAND CORPORATION)
1305 S. DIVISION STREET
SALISBURY, MD 21804

FOR: EDUCATIONAL AND ENTERTAINMENT SERVICES FOR CHILDREN, NAMELY, PROVIDING INTERACTIVE PLAY AREAS, INSTRUCTIONAL CLASSES IN THE FIELD OF MARTIAL ARTS AND SOCIAL GATHERINGS FOR CHILDREN; ENTERTAINMENT SERVICES IN THE NATURE OF LIVE MIXED MARTIAL ARTS (MMA) EVENTS; MARTIAL ARTS INSTRUCTION; PROVIDING FACILITIES FOR RECREATION ACTIVITIES; PROVIDING GENERAL FITNESS AND MIXED MARTIAL ARTS FACILITIES THAT REQUIRE MEMBERSHIPS AND ARE FOCUSED IN THE FIELDS OF GENERAL FITNESS, EXERCISE, AND MIXED MARTIAL ARTS, IN CLASS 41 (U.S. CLS. 100, 101 AND 107).

FIRST USE 1-1-2008; IN COMMERCE 1-1-2008.

NO CLAIM IS MADE TO THE EXCLUSIVE RIGHT TO USE "CAMP" AND "MARTIALARTS", APART FROM THE MARK AS SHOWN.

THE COLOR(S) GREY, WHITE, AND RED IS/ARE CLAIMED AS A FEATURE OF THE MARK.

THE MARK CONSISTS OF THE WORD "CAMPX" IN GREY WITH AN EXAGGERATED "X", UNDERLINED BY A RED BAR THAT CONTAINS THE WORDS, "MITCHELL'S MARTIAL ARTS" IN WHITE.

SER. NO. 85-437,746, FILED 10-3-2011.

TASHIA BUNCH, EXAMINING ATTORNEY



David J. Kyros

Director of the United States Patent and Trademark Office

United States of America

United States Patent and Trademark Office

athenaCoordinator

Reg. No. 4,153,526

Registered June 5, 2012

Int. Cls.: 35 and 42

SERVICE MARK

PRINCIPAL REGISTER

ATHENAHEALTH, INC. (DELAWARE CORPORATION)
311 ARSENAL STREET
WATERTOWN, MA 02472

FOR: PHYSICIAN ORDER SUPPORT SERVICES AND MEDICAL PRACTICE MANAGEMENT SERVICES RELATING TO MEDICAL TESTS AND PROCEDURES, NAMELY, VERIFYING PATIENT ELIGIBILITY AND BENEFITS, HANDLING SCHEDULING REQUESTS, OBTAINING INSURANCE PRE-CERTIFICATIONS, HANDLING PATIENT PRE-REGISTRATIONS, AND COLLECTING SELF-PAY BALANCES FROM PATIENTS, IN CLASS 35 (U.S. CLS. 100, 101 AND 102).

FIRST USE 8-31-2011; IN COMMERCE 8-31-2011.

FOR: SOFTWARE AS A SERVICE (SAAS) SERVICES FEATURING SOFTWARE FOR USE IN COMMUNICATIONS BETWEEN PHYSICIANS AND OTHER PARTICIPANTS IN THE HEALTH CARE SYSTEM WITH RESPECT TO ORDERS FOR MEDICAL TESTS AND PROCEDURES, IN CLASS 42 (U.S. CLS. 100 AND 101).

FIRST USE 8-31-2011; IN COMMERCE 8-31-2011.

THE MARK CONSISTS OF STANDARD CHARACTERS WITHOUT CLAIM TO ANY PARTICULAR FONT, STYLE, SIZE, OR COLOR.

OWNER OF U.S. REG. NOS. 2,737,126, 2,737,212 AND OTHERS.

SER. NO. 85-437,761, FILED 10-3-2011.

TASHIA BUNCH, EXAMINING ATTORNEY



David J. Kybas

Director of the United States Patent and Trademark Office

United States of America

United States Patent and Trademark Office

Direct Top Feed

Reg. No. 4,153,527

WAYNE E WOLF (UNITED STATES INDIVIDUAL), DBA MODULARHYDRO
909 STAR PINE
LAS VEGAS, NV 89144

Registered June 5, 2012

Int. Cl.: 21

FOR: HYDROPONIC GARDEN KIT FOR HOME USE COMPRISING GROWING CONTAINERS AND ALSO INCLUDING HYDROPONIC FERTILIZERS, SEEDS, SUBSTRATE, DRAIN COMPONENTS, A BOOK AND STARTING CLASS OF DVD AND CD INSTRUCTIONAL MATERIALS, IN CLASS 21 (U.S. CLS. 2, 13, 23, 29, 30, 33, 40 AND 50).

TRADEMARK

PRINCIPAL REGISTER

FIRST USE 12-1-2010; IN COMMERCE 12-1-2010.

THE MARK CONSISTS OF STANDARD CHARACTERS WITHOUT CLAIM TO ANY PARTICULAR FONT, STYLE, SIZE, OR COLOR.

NO CLAIM IS MADE TO THE EXCLUSIVE RIGHT TO USE "TOP FEED", APART FROM THE MARK AS SHOWN.

SER. NO. 85-437,768, FILED 10-3-2011.

ERNEST SHOSHO, EXAMINING ATTORNEY



David J. Kyffers

Director of the United States Patent and Trademark Office

United States of America

United States Patent and Trademark Office



Reg. No. 4,153,528

Registered June 5, 2012

Int. Cl.: 43

SERVICE MARK

PRINCIPAL REGISTER

HOP DODDY, LLC (ARIZONA LIMITED LIABILITY COMPANY)
SUITE 250
15279 N. SCOTTSDALE RD
SCOTTSDALE, AZ 85254

FOR: RESTAURANT AND BAR SERVICES, IN CLASS 43 (U.S. CLS. 100 AND 101).

FIRST USE 1-2-2011; IN COMMERCE 4-1-2011.

NO CLAIM IS MADE TO THE EXCLUSIVE RIGHT TO USE "2010", APART FROM THE MARK AS SHOWN.

THE MARK CONSISTS OF THE OUTLINE OF A COW'S HEAD WITH A STALK OF HOPS IN ITS MOUTH, WITH THE CAPITAL LETTERS "H", "D" UNDERNEATH THE HEAD, WITH THE NUMBERS "2" AND "0" TO THE LEFT OF THE "H" AND THE NUMBERS "1" AND "0" TO THE RIGHT OF THE "D".

SER. NO. 85-437,801, FILED 10-3-2011.

STEVEN PEREZ, EXAMINING ATTORNEY



David J. Kyffers

Director of the United States Patent and Trademark Office

United States of America

United States Patent and Trademark Office

An Investment in Latino Youth

Reg. No. 4,153,529

Registered June 5, 2012

Int. Cl.: 41

SERVICE MARK

PRINCIPAL REGISTER

ASPIRA ASSOCIATION, INC. (NEW YORK CORPORATION)
SUITE 800
1444 I STREET, NW
WASHINGTON, DC 20005

FOR: EDUCATIONAL SERVICES, NAMELY, AN EDUCATION PROGRAM IN THE NATURE OF CONDUCTING WORKSHOPS, ARRANGING CONFERENCES, CONDUCTING CLASSES DESIGNED TO FOSTER THE EDUCATIONAL AND LEADERSHIP DEVELOPMENT OF OTHERS, IN CLASS 41 (U.S. CLS. 100, 101 AND 107).

FIRST USE 12-1-1987; IN COMMERCE 12-1-1987.

THE MARK CONSISTS OF STANDARD CHARACTERS WITHOUT CLAIM TO ANY PARTICULAR FONT, STYLE, SIZE, OR COLOR.

NO CLAIM IS MADE TO THE EXCLUSIVE RIGHT TO USE "LATINO YOUTH", APART FROM THE MARK AS SHOWN.

SER. NO. 85-437,821, FILED 10-3-2011.

LINDA LAVACHE, EXAMINING ATTORNEY



David J. Kyros

Director of the United States Patent and Trademark Office

United States of America

United States Patent and Trademark Office

Lighthouse Ladies

Reg. No. 4,153,530

Registered June 5, 2012

Int. Cl.: 41

SERVICE MARK

PRINCIPAL REGISTER

ACCELERANT INCORPORATED (FLORIDA CORPORATION), DBA STINGRAY TACKLE
COMPANY
1405 NORTH ALTERNATE A1A
JUPITER, FL 33469

FOR: ORGANIZATION OF SPORT FISHING COMPETITIONS, IN CLASS 41 (U.S. CLS. 100,
101 AND 107).

FIRST USE 1-1-2011; IN COMMERCE 1-1-2011.

THE MARK CONSISTS OF STANDARD CHARACTERS WITHOUT CLAIM TO ANY PAR-
TICULAR FONT, STYLE, SIZE, OR COLOR.

NO CLAIM IS MADE TO THE EXCLUSIVE RIGHT TO USE "LADIES", APART FROM THE
MARK AS SHOWN.

SER. NO. 85-437,837, FILED 10-3-2011.

LINDA LAVACHE, EXAMINING ATTORNEY



David J. Kyros

Director of the United States Patent and Trademark Office

United States of America

United States Patent and Trademark Office

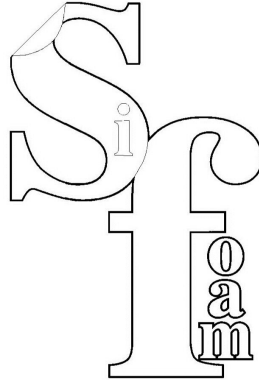

Reg. No. 4,153,531

Registered June 5, 2012

Int. Cl.: 10

TRADEMARK

PRINCIPAL REGISTER

ROGERS, BARBARA (UNITED STATES INDIVIDUAL)
SUITE E252
2505 ANTHEM VILLAGE DR.
HENDERSON, NV 89052

FOR: URETHANE-BASED FOAM THERAPEUTIC APPARATUS FOR ORTHOPEDIC PURPOSES, IN CLASS 10 (U.S. CLS. 26, 39 AND 44).

FIRST USE 9-1-2004; IN COMMERCE 9-1-2004.

THE MARK CONSISTS OF AN UPPERCASE STYLIZED LETTER "S". INSIDE THE "S" IS A LOWERCASE "I". BELOW AND TO THE RIGHT OF THE "S" IS A LARGE LOWERCASE "F". TO THE RIGHT OF THE "F" ARE THE STYLIZED LETTERS "OAM" ARRANGED VERTICALLY.

SER. NO. 85-437,848, FILED 10-3-2011.

LINDA LAVACHE, EXAMINING ATTORNEY



David J. Kybas

Director of the United States Patent and Trademark Office

United States of America

United States Patent and Trademark Office

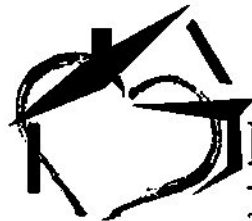

Home Health Care
of Florida

There is a difference...you deserve the best!

Reg. No. 4,153,532

Registered June 5, 2012

Int. Cl.: 44

SERVICE MARK

PRINCIPAL REGISTER

HOME HEALTH CARE OF FLORIDA (FLORIDA LIMITED LIABILITY COMPANY)
STE 103
4501 N. WICKHAM ROAD
MELBOURNE, FL 32935

FOR: HOME HEALTH CARE SERVICES; HOME-VISIT NURSING CARE, IN CLASS 44 (U.S. CLS. 100 AND 101).

FIRST USE 8-1-2011; IN COMMERCE 8-1-2011.

NO CLAIM IS MADE TO THE EXCLUSIVE RIGHT TO USE "HOME HEALTH CARE OF FLORIDA", APART FROM THE MARK AS SHOWN.

THE MARK CONSISTS OF AN IMAGE OF A HEART WITH AN OUTLINE OF A HOUSE OVERLAPPING IT. THE STYLIZED TEXT "HOME HEALTH CARE" IS TO THE RIGHT. BELOW THIS TEXT IS THE STYLIZED TEXT "OF FLORIDA" WITH A HORIZONTAL LINE TO THE LEFT. UNDERNEATH IS THE STYLIZED TEXT "THERE IS A DIFFERENCE...YOU DESERVE THE BEST!".

SER. NO. 85-437,850, FILED 10-3-2011.

LINDA LAVACHE, EXAMINING ATTORNEY



David J. Kybas

Director of the United States Patent and Trademark Office

United States of America

United States Patent and Trademark Office

SpyPeeps

Reg. No. 4,153,533

Registered June 5, 2012

Int. Cl.: 42

SERVICE MARK

PRINCIPAL REGISTER

CYBERSPACE TO PARADISE, INC. (FLORIDA CORPORATION)
1642 N VOLUSIA AVE
#101
ORANGE CITY, FL 32763

FOR: PROVIDING A WEBSITE FEATURING A SEARCH ENGINE FOR SEARCHING FOR THE CURRENT LOCATIONS, PUBLIC RECORDS AND ONLINE RECORDS, SUCH AS ONLINE SOCIAL NETWORK RECORDS, OF PEOPLE, IN CLASS 42 (U.S. CLS. 100 AND 101).

FIRST USE 8-1-2011; IN COMMERCE 8-1-2011.

THE MARK CONSISTS OF THE STYLIZED TEXT "SPYPEEPS" WITH THE LETTERS "EE" IN "PEEPS" OUTLINED ON EACH SIDE BY THREE PARTIAL RINGS FORMING A STYLIZED DESIGN OF BINOCULARS.

SER. NO. 85-437,853, FILED 10-3-2011.

ZHALEH DELANEY, EXAMINING ATTORNEY



David J. Kyros

Director of the United States Patent and Trademark Office

United States of America

United States Patent and Trademark Office



Reg. No. 4,153,534

Registered June 5, 2012

Int. Cl.: 37

SERVICE MARK

PRINCIPAL REGISTER

DE LA MORA, ROBERT (UNITED STATES INDIVIDUAL)
#202
9426 NANCE AVENUE
DOWNEY, CA 90241

FOR: FLOOR TREATMENT SERVICES, NAMELY, APPLICATION OF CHEMICAL PREPARATIONS TO FLOORS TO MAKE THEM SLIP-RESISTANT FOR SAFETY PURPOSES, IN CLASS 37 (U.S. CLS. 100, 103 AND 106).

FIRST USE 3-17-2011; IN COMMERCE 3-17-2011.

NO CLAIM IS MADE TO THE EXCLUSIVE RIGHT TO USE "SAFE", APART FROM THE MARK AS SHOWN.

THE STIPPLING IS FOR SHADING PURPOSES ONLY.

THE MARK CONSISTS OF A ROUNDED RECTANGLE CONTAINING THE STYLIZED TEXT "SAFE ZONES" IN WHICH THE LETTER "S" IS MADE OF TWO STYLIZED CURVES. ANOTHER ROUNDED RECTANGLE APPEARS BEHIND AND UNDERNEATH THE FIRST, AND DISPLAYS THE STYLIZED TEXT "CREATORS OF SAFER SOLUTIONS".

SER. NO. 85-437,891, FILED 10-3-2011.

MAYUR VAGHANI, EXAMINING ATTORNEY



David J. Kybas

Director of the United States Patent and Trademark Office

United States of America

United States Patent and Trademark Office



Reg. No. 4,153,535

Registered June 5, 2012

Int. Cl.: 30

TRADEMARK

PRINCIPAL REGISTER

MADAVA SUGAR MAPLE, LLC (DELAWARE LIMITED LIABILITY COMPANY)
47 MCCOURT ROAD
DOVER PLAINS, NY 12522

FOR: MAPLE SYRUP AND MAPLE SUGAR, IN CLASS 30 (U.S. CL. 46).

FIRST USE 6-10-2011; IN COMMERCE 6-10-2011.

THE MARK CONSISTS OF A DESIGN IN THE SHAPE OF A CROWN.

SER. NO. 85-437,896, FILED 10-3-2011.

JENNIFER WILLISTON, EXAMINING ATTORNEY



David J. Kybas

Director of the United States Patent and Trademark Office

United States of America

United States Patent and Trademark Office

DEROYAL IMPROVING CARE. IMPROVING BUSINESS.

Reg. No. 4,153,536

DEROYAL INDUSTRIES, INC. (TENNESSEE CORPORATION)
200 DEBUSK LANE
POWELL, TN 37849

Registered June 5, 2012

Int. Cl.: 35

FOR: PROVIDING RECOMMENDATIONS OF MEDICAL SUPPLIES TO CONSUMERS FOR COMMERCIAL PURPOSES, NAMELY, RECOMMENDATIONS RELATED TO THE COST-EFFECTIVE SELECTION AND USE OF MEDICAL SUPPLIES, AND CONSULTATION RELATED THERETO, IN CLASS 35 (U.S. CLS. 100, 101 AND 102).

SERVICE MARK

PRINCIPAL REGISTER

FIRST USE 2-1-2010; IN COMMERCE 1-15-2011.

THE MARK CONSISTS OF STANDARD CHARACTERS WITHOUT CLAIM TO ANY PARTICULAR FONT, STYLE, SIZE, OR COLOR.

OWNER OF U.S. REG. NOS. 2,727,248, 4,067,910 AND OTHERS.

SER. NO. 85-437,981, FILED 10-3-2011.

FONG HSU, EXAMINING ATTORNEY



David J. Kybas

Director of the United States Patent and Trademark Office

United States of America
United States Patent and Trademark Office

service
office

Reg. No. 4,153,537

SERVICE OFFICE & SUPPLY, INC. (KANSAS CORPORATION), AKA SERVICE OFFICE
908 HALL ST.
COFFEYVILLE, KS 67337

Registered June 5, 2012

Int. Cl.: 35

FOR: RETAIL STORE AND ON-LINE RETAIL STORE SERVICES FEATURING OFFICE
SUPPLIES, IN CLASS 35 (U.S. CLS. 100, 101 AND 102).

SERVICE MARK

FIRST USE 6-1-2011; IN COMMERCE 7-1-2011.

PRINCIPAL REGISTER

NO CLAIM IS MADE TO THE EXCLUSIVE RIGHT TO USE "OFFICE", APART FROM THE
MARK AS SHOWN.

THE COLOR(S) BLUE, GREEN, AND RED IS/ARE CLAIMED AS A FEATURE OF THE
MARK.

THE MARK CONSISTS OF THE WORD "SERVICE" IN LOWERCASE BLUE LETTERING
RESTING ON TOP OF (IN ORDER FROM LEFT TO RIGHT) ONE RED SQUARE WITH
ROUNDED CORNERS, ONE GREEN SQUARE WITH ROUNDED CORNERS, ONE BLUE
SQUARE WITH ROUNDED CORNERS, AND THE WORD "OFFICE" IN LOWERCASE RED
LETTERING.

SER. NO. 85-437,982, FILED 10-3-2011.

AMY KELLY, EXAMINING ATTORNEY



David J. Kyffers

Director of the United States Patent and Trademark Office

United States of America

United States Patent and Trademark Office

IMPROVING CARE. IMPROVING
BUSINESS.

Reg. No. 4,153,538

Registered June 5, 2012

Int. Cl.: 35

SERVICE MARK

PRINCIPAL REGISTER

DEROYAL INDUSTRIES, INC. (TENNESSEE CORPORATION)
200 DEBUSK LANE
POWELL, TN 37849

FOR: PROVIDING RECOMMENDATIONS OF MEDICAL SUPPLIES TO CONSUMERS FOR COMMERCIAL PURPOSES, NAMELY, RECOMMENDATIONS RELATED TO THE COST-EFFECTIVE SELECTION AND USE OF MEDICAL SUPPLIES, AND CONSULTATION RELATED THERETO, IN CLASS 35 (U.S. CLS. 100, 101 AND 102).

FIRST USE 2-1-2010; IN COMMERCE 1-15-2011.

THE MARK CONSISTS OF STANDARD CHARACTERS WITHOUT CLAIM TO ANY PARTICULAR FONT, STYLE, SIZE, OR COLOR.

OWNER OF U.S. REG. NO. 4,067,910.

SER. NO. 85-438,003, FILED 10-3-2011.

FONG HSU, EXAMINING ATTORNEY



David J. Kyffers

Director of the United States Patent and Trademark Office

United States of America

United States Patent and Trademark Office

SCRIPPS HEALTH

Reg. No. 4,153,539

SCRIPPSHEALTH (CALIFORNIA CORPORATION)
4275 CAMPUS POINT COURT
SAN DIEGO, CA 92121

Registered June 5, 2012

Int. Cl.: 36

FOR: MANAGEMENT AND LEASING OF REAL ESTATE, IN CLASS 36 (U.S. CLS. 100, 101 AND 102).

SERVICE MARK

FIRST USE 5-18-1995; IN COMMERCE 5-18-1995.

PRINCIPAL REGISTER

THE MARK CONSISTS OF STANDARD CHARACTERS WITHOUT CLAIM TO ANY PARTICULAR FONT, STYLE, SIZE, OR COLOR.

OWNER OF U.S. REG. NOS. 2,066,118, 3,072,949 AND OTHERS.

NO CLAIM IS MADE TO THE EXCLUSIVE RIGHT TO USE "HEALTH", APART FROM THE MARK AS SHOWN.

SER. NO. 85-438,038, FILED 10-3-2011.

JASON BLAIR, EXAMINING ATTORNEY



David J. Kyros

Director of the United States Patent and Trademark Office

United States of America

United States Patent and Trademark Office



Reg. No. 4,153,540

Registered June 5, 2012

Int. Cl.: 30

TRADEMARK

PRINCIPAL REGISTER

MADECASSE, LLC (NEW YORK LIMITED LIABILITY COMPANY)
33 FLATBUSH AVENUE
5TH FLOOR
BROOKLYN, NY 11217

FOR: CHOCOLATE BARS, VANILLA EXTRACT, VANILLA BEANS, VANILLA SUGAR,
VANILLA POWDER, IN CLASS 30 (U.S. CL. 46).

FIRST USE 12-1-2008; IN COMMERCE 12-1-2008.

OWNER OF U.S. REG. NO. 3,739,368.

THE MARK CONSISTS OF THE SILHOUETTE OF A MAN WEARING A HAT AND WALKING
WITH A POLE OVER HIS SHOULDER FROM WHICH HANGS TWO BAGS, ONE AT EACH
END.

SER. NO. 85-438,085, FILED 10-3-2011.

PRISCILLA MILTON, EXAMINING ATTORNEY



David J. Kyffers

Director of the United States Patent and Trademark Office

United States of America

United States Patent and Trademark Office

POST-MOD

Reg. No. 4,153,541

BEAKS OF EAGLES (CALIFORNIA PARTNERSHIP)
695 ELKHORN ROAD
ROYAL OAKS, CA 95076

Registered June 5, 2012

Int. Cl.: 25

FOR: WOMEN'S CLOTHING, NAMELY, SHIRTS, DRESSES, SKIRTS, BLOUSES, IN CLASS 25 (U.S. CLS. 22 AND 39).

TRADEMARK

FIRST USE 4-12-2011; IN COMMERCE 8-14-2011.

PRINCIPAL REGISTER

THE MARK CONSISTS OF STANDARD CHARACTERS WITHOUT CLAIM TO ANY PARTICULAR FONT, STYLE, SIZE, OR COLOR.

SER. NO. 85-438,100, FILED 10-3-2011.

JENNIFER VASQUEZ, EXAMINING ATTORNEY



David J. Kybas

Director of the United States Patent and Trademark Office

United States of America

United States Patent and Trademark Office

ULTRASMOOTH

Reg. No. 4,153,542

EPSON AMERICA, INC. (CALIFORNIA CORPORATION)
3840 KILROY AIRPORT WAY
LONG BEACH, CA 90806

Registered June 5, 2012

Int. Cl.: 16

FOR: SPECIALTY PAPER FOR INK JET PRINTERS, IN CLASS 16 (U.S. CLS. 2, 5, 22, 23, 29, 37, 38 AND 50).

TRADEMARK

FIRST USE 10-31-2003; IN COMMERCE 10-31-2003.

PRINCIPAL REGISTER

THE MARK CONSISTS OF STANDARD CHARACTERS WITHOUT CLAIM TO ANY PARTICULAR FONT, STYLE, SIZE, OR COLOR.

OWNER OF U.S. REG. NO. 3,022,241.

SER. NO. 85-438,137, FILED 10-3-2011.

BENJAMIN OKEKE, EXAMINING ATTORNEY



David J. Kyros

Director of the United States Patent and Trademark Office

United States of America

United States Patent and Trademark Office

Smart Ride

Reg. No. 4,153,543

CODEMASS, INC. (CALIFORNIA CORPORATION)
860 GREEN STREET
SAN FRANCISCO, CA 94133

Registered June 5, 2012

Int. Cl.: 9

FOR: COMPUTER SOFTWARE FOR USE IN ACCESSING AND DISPLAYING PUBLIC TRANSIT INFORMATION, IN CLASS 9 (U.S. CLS. 21, 23, 26, 36 AND 38).

TRADEMARK

FIRST USE 9-23-2010; IN COMMERCE 9-23-2010.

PRINCIPAL REGISTER

THE MARK CONSISTS OF STANDARD CHARACTERS WITHOUT CLAIM TO ANY PARTICULAR FONT, STYLE, SIZE, OR COLOR.

NO CLAIM IS MADE TO THE EXCLUSIVE RIGHT TO USE "SMART", APART FROM THE MARK AS SHOWN.

SER. NO. 85-438,139, FILED 10-3-2011.

BENJAMIN OKEKE, EXAMINING ATTORNEY



David J. Kybas

Director of the United States Patent and Trademark Office

United States of America

United States Patent and Trademark Office

SEW CREEPY

Reg. No. 4,153,544

BEAKS OF EAGLES (CALIFORNIA PARTNERSHIP)
695 ELKHORN ROAD
ROYAL OAKS, CA 95076

Registered June 5, 2012

Int. Cl.: 25

FOR: WOMEN'S CLOTHING, NAMELY, SHIRTS, DRESSES, SKIRTS, BLOUSES, IN CLASS 25 (U.S. CLS. 22 AND 39).

TRADEMARK

FIRST USE 4-12-2011; IN COMMERCE 8-14-2011.

PRINCIPAL REGISTER

THE MARK CONSISTS OF STANDARD CHARACTERS WITHOUT CLAIM TO ANY PARTICULAR FONT, STYLE, SIZE, OR COLOR.

SER. NO. 85-438,156, FILED 10-3-2011.

JENNIFER VASQUEZ, EXAMINING ATTORNEY



David J. Kybas

Director of the United States Patent and Trademark Office

United States of America

United States Patent and Trademark Office

The Boston Globe

Reg. No. 4,153,545

Registered June 5, 2012

Int. Cl.: 41

SERVICE MARK

PRINCIPAL REGISTER

NYT MANAGEMENT SERVICES, INC. (DELAWARE CORPORATION)
620 EIGHTH AVENUE
NEW YORK, NY 10018

FOR: PROVIDING ON-LINE NON-DOWNLOADABLE NEWSPAPERS; PROVIDING ON-LINE PUBLICATIONS IN THE NATURE OF NEWSPAPERS IN THE FIELD OF GENERAL INTEREST, IN CLASS 41 (U.S. CLS. 100, 101 AND 107).

FIRST USE 9-12-2011; IN COMMERCE 9-12-2011.

THE MARK CONSISTS OF STANDARD CHARACTERS WITHOUT CLAIM TO ANY PARTICULAR FONT, STYLE, SIZE, OR COLOR.

OWNER OF U.S. REG. NOS. 199,549, 199,556, AND 721,044.

NO CLAIM IS MADE TO THE EXCLUSIVE RIGHT TO USE "BOSTON", APART FROM THE MARK AS SHOWN.

SER. NO. 85-438,234, FILED 10-3-2011.

LANA PHAM, EXAMINING ATTORNEY



David J. Kyros

Director of the United States Patent and Trademark Office

United States of America

United States Patent and Trademark Office

POLITE POST

Reg. No. 4,153,546

Registered June 5, 2012

Int. Cl.: 41

SERVICE MARK

PRINCIPAL REGISTER

GOODING, MELISSA (UNITED STATES INDIVIDUAL)
890 WEST END AVENUE, # 9B
NEW YORK, NY 10025

FOR: ENTERTAINMENT AND EDUCATIONAL SERVICES, NAMELY, PROVIDING A WEBSITE FEATURING INFORMATION IN THE FIELDS OF SOCIAL ETIQUETTE AND CORRESPONDENCE, IN CLASS 41 (U.S. CLS. 100, 101 AND 107).

FIRST USE 3-24-2010; IN COMMERCE 7-1-2011.

THE MARK CONSISTS OF STANDARD CHARACTERS WITHOUT CLAIM TO ANY PARTICULAR FONT, STYLE, SIZE, OR COLOR.

NO CLAIM IS MADE TO THE EXCLUSIVE RIGHT TO USE "POST", APART FROM THE MARK AS SHOWN.

SER. NO. 85-438,236, FILED 10-3-2011.

LESLEY LAMOTHE, EXAMINING ATTORNEY



David J. Kybas

Director of the United States Patent and Trademark Office

United States of America

United States Patent and Trademark Office

THE MOST TRUSTED AIRSOFT RETAILER IN AMERICA

Reg. No. 4,153,547

AIRSOFT ZONE CORPORATION (CALIFORNIA CORPORATION)
5012 4TH STREET
IRWINDALE, CA 91706

Registered June 5, 2012

Int. Cl.: 35

FOR: ON-LINE RETAIL STORE SERVICES FEATURING AIRSOFT GUNS, AIRSOFT GEAR AND AIRSOFT ACCESSORIES, IN CLASS 35 (U.S. CLS. 100, 101 AND 102).

SERVICE MARK

FIRST USE 8-0-2011; IN COMMERCE 8-0-2011.

PRINCIPAL REGISTER

THE MARK CONSISTS OF STANDARD CHARACTERS WITHOUT CLAIM TO ANY PARTICULAR FONT, STYLE, SIZE, OR COLOR.

NO CLAIM IS MADE TO THE EXCLUSIVE RIGHT TO USE "RETAILER" AND "AMERICA", APART FROM THE MARK AS SHOWN.

SER. NO. 85-438,251, FILED 10-3-2011.

PAUL MORENO, EXAMINING ATTORNEY



David J. Kyffers

Director of the United States Patent and Trademark Office

United States of America

United States Patent and Trademark Office

KRISIMAGERY

Reg. No. 4,153,548

OGILVIE, KRISTY (UNITED STATES INDIVIDUAL)
2552 WILSHIRE CIRCLE
SALT LAKE CITY, UT 84109

Registered June 5, 2012

Int. Cl.: 42

FOR: COMPUTER SERVICES, NAMELY, ELECTRONIC IMAGING OF PHOTOGRAPHS AND ARTWORK, IN CLASS 42 (U.S. CLS. 100 AND 101).

SERVICE MARK

FIRST USE 10-3-2011; IN COMMERCE 10-3-2011.

PRINCIPAL REGISTER

THE MARK CONSISTS OF STANDARD CHARACTERS WITHOUT CLAIM TO ANY PARTICULAR FONT, STYLE, SIZE, OR COLOR.

THE NAME(S), PORTRAIT(S), AND/OR SIGNATURE(S) SHOWN IN THE MARK IDENTIFIES KRISTY OGILVIE, WHOSE CONSENT(S) TO REGISTER IS MADE OF RECORD.

SER. NO. 85-438,259, FILED 10-3-2011.

JUSTINE D. PARKER, EXAMINING ATTORNEY



David J. Kybas

Director of the United States Patent and Trademark Office

United States of America

United States Patent and Trademark Office



Reg. No. 4,153,549

Registered June 5, 2012

Int. Cl.: 30

TRADEMARK

PRINCIPAL REGISTER

MAHALAXMI EXPORTS FZE (UNITED ARAB EMIR. CORPORATION)
7TH FLOOR , 708 , FAIRMONT HOTEL TOWER
SH. ZAYED ROAD
DUBAI, UNITED ARAB EMIR.

FOR: RICE; TEA, IN CLASS 30 (U.S. CL. 46).

FIRST USE 11-15-2010; IN COMMERCE 11-15-2010.

OWNER OF U.S. REG. NO. 3,915,265.

THE MARK CONSISTS OF THE STYLIZED WORDING "GOLESTAN" APPEARING WITHIN AN ORNAMENTAL FRAME WITH A FILIGREED BORDER.

THE ENGLISH TRANSLATION OF "GOLESTAN" IN THE MARK IS "FLOWER GARDEN".

SER. NO. 85-438,344, FILED 10-4-2011.

GEOFFREY FOSDICK, EXAMINING ATTORNEY



David J. Kyros

Director of the United States Patent and Trademark Office

United States of America

United States Patent and Trademark Office

SAFETY DELIVERED

Reg. No. 4,153,550

LEE, ERIC (UNITED STATES INDIVIDUAL)
508 E. FRANK ST.
KALAMAZOO, MI 49007

Registered June 5, 2012

Int. Cl.: 6

FOR: METAL RAILINGS FOR STAIRS, LANDINGS, BALCONIES, PATIOS, IN CLASS 6
(U.S. CLS. 2, 12, 13, 14, 23, 25 AND 50).

TRADEMARK

FIRST USE 8-10-2010; IN COMMERCE 9-19-2011.

PRINCIPAL REGISTER

THE MARK CONSISTS OF STANDARD CHARACTERS WITHOUT CLAIM TO ANY PARTICULAR FONT, STYLE, SIZE, OR COLOR.

NO CLAIM IS MADE TO THE EXCLUSIVE RIGHT TO USE "SAFETY", APART FROM THE MARK AS SHOWN.

SER. NO. 85-438,360, FILED 10-4-2011.

KRISTIN DAHLING, EXAMINING ATTORNEY



David J. Kybas

Director of the United States Patent and Trademark Office

United States of America

United States Patent and Trademark Office

ASIS ASSETS PROTECTION COURSE

Reg. No. 4,153,551

Registered June 5, 2012

Int. Cl.: 41

SERVICE MARK

PRINCIPAL REGISTER

ASIS INTERNATIONAL, INC. (DELAWARE CORPORATION)
1625 PRINCE STREET
ALEXANDRIA, VA 22314

FOR: EDUCATIONAL SERVICES, NAMELY, ARRANGING AND CONDUCTING CLASSES, SEMINARS AND WORKSHOPS IN THE FIELD OF INDUSTRIAL SECURITY AND SECURITY MANAGEMENT, IN CLASS 41 (U.S. CLS. 100, 101 AND 107).

FIRST USE 0-0-1970; IN COMMERCE 0-0-1970.

THE MARK CONSISTS OF STANDARD CHARACTERS WITHOUT CLAIM TO ANY PARTICULAR FONT, STYLE, SIZE, OR COLOR.

OWNER OF U.S. REG. NOS. 1,438,384, 2,923,780 AND OTHERS.

NO CLAIM IS MADE TO THE EXCLUSIVE RIGHT TO USE "ASSETS PROTECTION COURSE", APART FROM THE MARK AS SHOWN.

SER. NO. 85-438,393, FILED 10-4-2011.

PATRICIA EVANKO, EXAMINING ATTORNEY

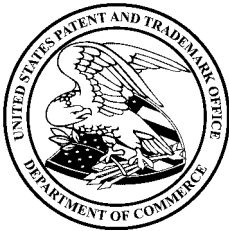

David J. Kyjars

Director of the United States Patent and Trademark Office

United States of America

United States Patent and Trademark Office

POOP BUSTERS

Reg. No. 4,153,552

Registered June 5, 2012

Int. Cl.: 37

SERVICE MARK

PRINCIPAL REGISTER

FRAZIER, DEBORAH (UNITED STATES INDIVIDUAL)
764 LITTLER DR. SE
RIO RANCHO, NM 87124

FOR: PET WASTE REMOVAL SERVICES, IN CLASS 37 (U.S. CLS. 100, 103 AND 106).

FIRST USE 10-1-1985; IN COMMERCE 10-15-1985.

THE MARK CONSISTS OF STANDARD CHARACTERS WITHOUT CLAIM TO ANY PARTICULAR FONT, STYLE, SIZE, OR COLOR.

NO CLAIM IS MADE TO THE EXCLUSIVE RIGHT TO USE "POOP", APART FROM THE MARK AS SHOWN.

SER. NO. 85-438,409, FILED 10-4-2011.

MICHAEL WEBSTER, EXAMINING ATTORNEY



David J. Kyffers

Director of the United States Patent and Trademark Office

United States of America

United States Patent and Trademark Office

Bangkok City

Reg. No. 4,153,553

BANGKOK CITY, INC. (TEXAS CORPORATION)
4301 BRYAN ST. #101
DALLAS, TX 75204

Registered June 5, 2012

Int. Cl.: 43

FOR: RESTAURANT SERVICES, INCLUDING SIT-DOWN SERVICE OF FOOD AND TAKE-OUT RESTAURANT SERVICES, IN CLASS 43 (U.S. CLS. 100 AND 101).

SERVICE MARK

FIRST USE 6-1-1989; IN COMMERCE 6-1-1989.

PRINCIPAL REGISTER

THE MARK CONSISTS OF STANDARD CHARACTERS WITHOUT CLAIM TO ANY PARTICULAR FONT, STYLE, SIZE, OR COLOR.

NO CLAIM IS MADE TO THE EXCLUSIVE RIGHT TO USE "BANGKOK", APART FROM THE MARK AS SHOWN.

SER. NO. 85-438,465, FILED 10-4-2011.

DAVID MURRAY, EXAMINING ATTORNEY



David J. Kyros

Director of the United States Patent and Trademark Office

United States of America

United States Patent and Trademark Office

KO OLINA

Reg. No. 4,153,554

Registered June 5, 2012

Int. Cls.: 39, 41, 43 and 44

SERVICE MARK

PRINCIPAL REGISTER

KO OLINA INTANGIBLES, LLC (HAWAII LIMITED LIABILITY COMPANY)
SUITE 2500
1100 ALAKEA STREET
HONOLULU, HI 96813

FOR: MARINA SERVICES, PLEASURE BOAT CRUISES, AND BOAT CHARTERING;
TRANSPORTATION SERVICES BY AUTOMOBILE, LIMOUSINE, BUS AND VAN , IN
CLASS 39 (U.S. CLS. 100 AND 105).

FIRST USE 11-28-1999; IN COMMERCE 11-28-1999.

FOR: GOLF AND TENNIS CLUB SERVICES, ORGANIZING AND CONDUCTING GOLF
TOURNAMENTS AND TENNIS TOURNAMENTS; ORGANIZING BICYCLING, FISHING,
AND SAILING COMPETITIONS; PROVIDING ENTERTAINMENT EXHIBITIONS IN THE
NATURE OF LUAUS, BEACH PARTIES, CABARET AND LIVE THEATRICAL-TYPE PER-
FORMANCES; AND SPECIAL EVENT PLANNING FOR SOCIAL ENTERTAINMENT PUR-
POSES; HEALTH CLUB SERVICES, NAMELY, PROVIDING INSTRUCTION AND EQUIP-
MENT IN THE FIELD OF PHYSICAL EXERCISE, IN CLASS 41 (U.S. CLS. 100, 101 AND
107).

FIRST USE 11-28-1999; IN COMMERCE 11-28-1999.

FOR: HOTEL SERVICES; RESORT LODGING SERVICES, RESTAURANT, CATERING,
COCKTAIL LOUNGE AND BAR SERVICES; PROVIDING MEETING, CONFERENCE AND
CONVENTION FACILITIES, IN CLASS 43 (U.S. CLS. 100 AND 101).

FIRST USE 11-28-1999; IN COMMERCE 11-28-1999.

FOR: HEALTH SPA SERVICES, NAMELY, PROVIDING FACIAL, HAIR, SKIN AND BODY
TREATMENTS; MASSAGE SERVICES; MANICURE AND PEDICURE SERVICES; BEAUTY
SALON SERVICES; GROUNDS MANAGEMENT AND UPKEEP, NAMELY, LANDSCAPE
GARDENING DESIGN FOR OTHERS, IN CLASS 44 (U.S. CLS. 100 AND 101).

FIRST USE 11-28-1999; IN COMMERCE 11-28-1999.

THE MARK CONSISTS OF STANDARD CHARACTERS WITHOUT CLAIM TO ANY PAR-
TICULAR FONT, STYLE, SIZE, OR COLOR.



David J. Kyjars

Director of the United States Patent and Trademark Office

Reg. No. 4,153,554 OWNER OF U.S. REG. NOS. 2,558,187 AND 3,511,155.

THE ENGLISH TRANSLATION OF "KO OLINA" IS "PLACE OF JOY".

SER. NO. 85-438,469, FILED 10-4-2011.

CHRISTINE MARTIN, EXAMINING ATTORNEY

United States of America

United States Patent and Trademark Office

AMERICAN ASSOCIATION OF PROFESSIONAL LANDMEN

Reg. No. 4,153,555

Registered June 5, 2012

Int. Cl.: 35

SERVICE MARK

PRINCIPAL REGISTER

AMERICAN ASSOCIATION OF PROFESSIONAL LANDMEN (TEXAS CORPORATION)
4100 FOSSIL CREEK BOULEVARD
FORT WORTH, TX 76137

FOR: TRADE ASSOCIATION SERVICES, NAMELY, PROMOTING THE INTERESTS OF OIL AND GAS RESOURCE EXPLORERS AND DEVELOPERS, IN CLASS 35 (U.S. CLS. 100, 101 AND 102).

FIRST USE 0-0-1992; IN COMMERCE 0-0-1992.

THE MARK CONSISTS OF STANDARD CHARACTERS WITHOUT CLAIM TO ANY PARTICULAR FONT, STYLE, SIZE, OR COLOR.

OWNER OF U.S. REG. NO. 1,850,968.

NO CLAIM IS MADE TO THE EXCLUSIVE RIGHT TO USE "ASSOCIATION", APART FROM THE MARK AS SHOWN.

SEC. 2(F).

SER. NO. 85-438,515, FILED 10-4-2011.

TINA MAI, EXAMINING ATTORNEY



David J. Kybas

Director of the United States Patent and Trademark Office

United States of America

United States Patent and Trademark Office

WE ARE LIVING PROOF

Reg. No. 4,153,556

Registered June 5, 2012

Int. Cl.: 3

TRADEMARK

PRINCIPAL REGISTER

LIVING PROOF, INC. (DELAWARE CORPORATION)
301 BINNEY STREET
CAMBRIDGE, MA 02142

FOR: COSMETICS AND COSMETIC PREPARATIONS; HAIR CARE PREPARATIONS; NON-MEDICATED TOILETRIES, IN CLASS 3 (U.S. CLS. 1, 4, 6, 50, 51 AND 52).

FIRST USE 1-18-2012; IN COMMERCE 1-18-2012.

THE MARK CONSISTS OF STANDARD CHARACTERS WITHOUT CLAIM TO ANY PARTICULAR FONT, STYLE, SIZE, OR COLOR.

OWNER OF U.S. REG. NO. 3,667,819.

SER. NO. 85-438,533, FILED 10-4-2011.

KAREN BRACEY, EXAMINING ATTORNEY



David J. Kyffers

Director of the United States Patent and Trademark Office

United States of America

United States Patent and Trademark Office

WAG IN. WAG OUT.

Reg. No. 4,153,557

BUBBLES PET SPA (CALIFORNIA LIMITED LIABILITY COMPANY)
2390 CRENSHAW BLVD. #726
TORRANCE, CA 90501

Registered June 5, 2012

Int. Cl.: 44

FOR: PET DENTIST SERVICES; PET GROOMING SERVICES; PROVIDING SELF-SERVICE PET GROOMING FACILITIES; PROVIDING SELF-SERVICE PET WASHING FACILITIES, IN CLASS 44 (U.S. CLS. 100 AND 101).

SERVICE MARK

FIRST USE 10-1-2006; IN COMMERCE 10-1-2006.

PRINCIPAL REGISTER

THE MARK CONSISTS OF STANDARD CHARACTERS WITHOUT CLAIM TO ANY PARTICULAR FONT, STYLE, SIZE, OR COLOR.

SER. NO. 85-438,544, FILED 10-4-2011.

ANTHONY RINKER, EXAMINING ATTORNEY



David J. Kyffers

Director of the United States Patent and Trademark Office

United States of America

United States Patent and Trademark Office

HIPERPAV

Reg. No. 4,153,558

Registered June 5, 2012

Int. Cl.: 9

TRADEMARK

PRINCIPAL REGISTER

THE TRANSTEC GROUP, INC. (TEXAS CORPORATION)
6111 BALCONES DRIVE
AUSTIN, TX 78731

FOR: COMPUTER SOFTWARE FOR CONCRETE PAVEMENT ANALYSIS, IN CLASS 9 (U.S. CLS. 21, 23, 26, 36 AND 38).

FIRST USE 3-16-1996, THE MARK WAS FIRST USED ANYWHERE IN A DIFFERENT FORM OTHER THAN THAT SOUGHT TO BE REGISTERED AT LEAST AS EARLY AS 03/16/1996; IN COMMERCE 8-24-1998, THE MARK WAS FIRST USED IN COMMERCE IN A DIFFERENT FORM OTHER THAN THAT SOUGHT TO BE REGISTERED AT LEAST AS EARLY AS 08/24/1998.

THE MARK CONSISTS OF STANDARD CHARACTERS WITHOUT CLAIM TO ANY PARTICULAR FONT, STYLE, SIZE, OR COLOR.

OWNER OF U.S. REG. NO. 2,401,850.

SER. NO. 85-438,575, FILED 10-4-2011.

ANTHONY RINKER, EXAMINING ATTORNEY



David J. Kybas

Director of the United States Patent and Trademark Office

United States of America

United States Patent and Trademark Office



Reg. No. 4,153,559

Registered June 5, 2012

Int. Cl.: 35

SERVICE MARK

PRINCIPAL REGISTER

SUNSET SLEEP CENTER INC. (NORTH CAROLINA CORPORATION)
11125 HWY. 17
WILMINGTON, NC 28411

FOR: RETAIL STORE SERVICES FEATURING FURNITURE, MATTRESSES AND FUTONS,
IN CLASS 35 (U.S. CLS. 100, 101 AND 102).

FIRST USE 12-1-1985; IN COMMERCE 12-1-1985.

OWNER OF U.S. REG. NO. 2,918,584.

NO CLAIM IS MADE TO THE EXCLUSIVE RIGHT TO USE "BEDS", APART FROM THE
MARK AS SHOWN.

THE MARK CONSISTS OF A LITERAL ELEMENT CONSISTING OF "FRED'S BEDS" AP-
PEARING INSIDE OF A DESIGN ELEMENT CONSISTING OF A STYLIZED FORM OF BED.

SER. NO. 85-438,589, FILED 10-4-2011.

SHANNON TWOHIG, EXAMINING ATTORNEY



David J. Kyffers

Director of the United States Patent and Trademark Office

United States of America

United States Patent and Trademark Office

spexton

Reg. No. 4,153,560

Registered June 5, 2012

Int. Cl.: 14

TRADEMARK

PRINCIPAL REGISTER

MCPHERSON, NATHAN (UNITED STATES INDIVIDUAL), DBA SPEXTON JEWELRY
3009 S IRVINGTON AVE
TULSA, OK 74114

FOR: JEWELRY, IN CLASS 14 (U.S. CLS. 2, 27, 28 AND 50).

FIRST USE 2-1-2004; IN COMMERCE 2-1-2004.

THE MARK CONSISTS OF STANDARD CHARACTERS WITHOUT CLAIM TO ANY PARTICULAR FONT, STYLE, SIZE, OR COLOR.

SER. NO. 85-438,608, FILED 10-4-2011.

SHANNON TWOHIG, EXAMINING ATTORNEY



David J. Kyffers

Director of the United States Patent and Trademark Office

United States of America

United States Patent and Trademark Office

Petmetric

Reg. No. 4,153,561

ANDRASIK, BENJAMIN D (UNITED STATES INDIVIDUAL), DBA PETMETRIC
8342 CAPEL DR
PASADENA, MD 21122

Registered June 5, 2012

Int. Cl.: 45

FOR: PROVIDING AN ON-LINE COMPUTER DATABASE FOR ASSISTING IN THE LOCATING OF LOST PETS, IN CLASS 45 (U.S. CLS. 100 AND 101).

SERVICE MARK

FIRST USE 4-25-2009; IN COMMERCE 4-25-2009.

PRINCIPAL REGISTER

THE MARK CONSISTS OF STANDARD CHARACTERS WITHOUT CLAIM TO ANY PARTICULAR FONT, STYLE, SIZE, OR COLOR.

SER. NO. 85-438,635, FILED 10-4-2011.

COURTNEY ALVAREZ, EXAMINING ATTORNEY



David J. Kybas

Director of the United States Patent and Trademark Office

United States of America

United States Patent and Trademark Office

PROSKORE

Reg. No. 4,153,562

Registered June 5, 2012

Int. Cl.: 35

SERVICE MARK

PRINCIPAL REGISTER

STARTUP FLORIDA INC. (FLORIDA CORPORATION)
1990 MAIN STREET PH 19
SARASOTA, FL 34236

FOR: PROVIDING SALES LEADS TO OTHERS IN THE FIELD OF BUSINESS GOODS AND SERVICES; ONLINE BUSINESS NETWORKING SERVICES; PROVIDING INFORMATION RELATING TO SERVICES, EVENTS AND ACTIVITIES IN A PARTICULAR GEOGRAPHIC REGION IN THE FIELDS OF CAREER DEVELOPMENT, BUSINESS DEVELOPMENT, RELATIONSHIP BUILDING AND SOCIAL NETWORKING; PROFESSIONAL TO PROFESSIONAL NETWORKING SERVICES, NAMELY, ON-LINE PROFESSIONAL NETWORKING SERVICES; BUSINESS DEVELOPMENT SERVICES; NAMELY, CONDUCTING DISCUSSION GROUPS IN THE FIELDS OF CAREER DEVELOPMENT, BUSINESS DEVELOPMENT, RELATIONSHIP BUILDING AND SOCIAL NETWORKING; ADVERTISING AND MARKETING SERVICES, NAMELY, PROMOTING THE GOODS AND SERVICES OF OTHERS; PROVIDING AN ONLINE SEARCHABLE DATABASE FEATURING CAREER AND BUSINESS OPPORTUNITIES; PROMOTING THE GOODS AND SERVICES OF OTHERS VIA A GLOBAL COMPUTER NETWORK, IN CLASS 35 (U.S. CLS. 100, 101 AND 102).

FIRST USE 9-1-2011; IN COMMERCE 9-1-2011.

THE MARK CONSISTS OF STANDARD CHARACTERS WITHOUT CLAIM TO ANY PARTICULAR FONT, STYLE, SIZE, OR COLOR.

SER. NO. 85-438,639, FILED 10-4-2011.

LUCY ARANT, EXAMINING ATTORNEY



David J. Kyffers

Director of the United States Patent and Trademark Office

United States of America

United States Patent and Trademark Office



Reg. No. 4,153,563

GOLDEN STAR INC. (MISSOURI CORPORATION)
4770 N. BELLEVIEW AVE., STE. 209
KANSAS CITY, MO 64116

Registered June 5, 2012

Int. Cls.: 5, 21 and 24

FOR: MICROFIBER TOWEL IMPREGNATED WITH AN ANTIMICROBIAL TREATMENT,
IN CLASS 5 (U.S. CLS. 6, 18, 44, 46, 51 AND 52).

TRADEMARK

FIRST USE 8-4-2011; IN COMMERCE 8-4-2011.

PRINCIPAL REGISTER

FOR: MOPS, IN CLASS 21 (U.S. CLS. 2, 13, 23, 29, 30, 33, 40 AND 50).

FIRST USE 8-4-2011; IN COMMERCE 8-4-2011.

FOR: TOWELS MADE OF TEXTILE MATERIALS, IN CLASS 24 (U.S. CLS. 42 AND 50).

FIRST USE 8-4-2011; IN COMMERCE 8-4-2011.

THE MARK CONSISTS OF A DESIGN OF HALF A CIRCLE WITH FOUR TRIANGLES, WITH
A ROUND STYLIZED CIRCLE WITHIN THE TRIANGLES, AND THE STYLIZED WORDING
"MIMA" TO THE RIGHT.

SER. NO. 85-438,672, FILED 10-4-2011.

TEJBIR SINGH, EXAMINING ATTORNEY



David J. Kyros

Director of the United States Patent and Trademark Office

United States of America

United States Patent and Trademark Office

Iron Butterflies Collection

Reg. No. 4,153,564

Registered June 5, 2012

Int. Cl.: 16

TRADEMARK

PRINCIPAL REGISTER

THE WHITE DOVE GROUP INC (TENNESSEE CORPORATION), DBA WHITE DOVE
165 INDIAN LAKE ROAD
HENDERSONVILLE, TN 37075

FOR: CARDS BEARING UNIVERSAL GREETINGS; CARDS, NAMELY, A SERIES OF INDIVIDUAL GRAPHIC BUTTERFLY CARDS, EACH WITH A UNIQUE MESSAGES OF INSPIRATION AND ENCOURAGEMENT ENCLOSED, IN CLASS 16 (U.S. CLS. 2, 5, 22, 23, 29, 37, 38 AND 50).

FIRST USE 1-1-2005; IN COMMERCE 1-1-2005.

THE MARK CONSISTS OF STANDARD CHARACTERS WITHOUT CLAIM TO ANY PARTICULAR FONT, STYLE, SIZE, OR COLOR.

NO CLAIM IS MADE TO THE EXCLUSIVE RIGHT TO USE "COLLECTION", APART FROM THE MARK AS SHOWN.

SER. NO. 85-438,677, FILED 10-4-2011.

KRISTIN DAHLING, EXAMINING ATTORNEY



David J. Kybas

Director of the United States Patent and Trademark Office

United States of America
United States Patent and Trademark Office

pagoda
BOX

Reg. No. 4,153,565

PAGODA BOX, INC. (DELAWARE CORPORATION)
22 N. 2ND E.
REXBURG, ID 83440

Registered June 5, 2012

Int. Cl.: 42

FOR: COMPUTER SERVICES, NAMELY, HOSTING COMPUTER SOFTWARE APPLICATIONS OF OTHERS AND WEBSITES, COMPUTER PROGRAMMING SERVICES, AND RENTAL OF DATABASE SERVERS, IN CLASS 42 (U.S. CLS. 100 AND 101).

SERVICE MARK

FIRST USE 1-24-2011; IN COMMERCE 2-0-2011.

PRINCIPAL REGISTER

THE MARK CONSISTS OF THE WORDS "PAGODA BOX" IN A STYLIZED FORMAT.

SER. NO. 85-438,679, FILED 10-4-2011.

BARNEY CHARLON, EXAMINING ATTORNEY



David J. Kyffers

Director of the United States Patent and Trademark Office

United States of America

United States Patent and Trademark Office

PAGODA BOX

Reg. No. 4,153,566

Registered June 5, 2012

Int. Cl.: 42

SERVICE MARK

PRINCIPAL REGISTER

PAGODA BOX, INC. (DELAWARE CORPORATION)
22 N. 2ND E.
REXBURG, ID 83440

FOR: COMPUTER SERVICES, NAMELY, HOSTING COMPUTER SOFTWARE APPLICATIONS OF OTHERS AND WEBSITES, COMPUTER PROGRAMMING SERVICES, AND RENTAL OF DATABASE SERVERS, IN CLASS 42 (U.S. CLS. 100 AND 101).

FIRST USE 1-24-2011; IN COMMERCE 2-0-2011.

THE MARK CONSISTS OF STANDARD CHARACTERS WITHOUT CLAIM TO ANY PARTICULAR FONT, STYLE, SIZE, OR COLOR.

SER. NO. 85-438,682, FILED 10-4-2011.

BARNEY CHARLON, EXAMINING ATTORNEY



David J. Kybas

Director of the United States Patent and Trademark Office

United States of America

United States Patent and Trademark Office

POWERFUL IDEAS PROVEN RESULTS

Reg. No. 4,153,567

Registered June 5, 2012

Int. Cl.: 41

THE BOARD OF REGENTS OF THE UNIVERSITY OF WISCONSIN SYSTEM (WISCONSIN CORPORATION)
1860 VAN HISE HALL
1220 LINDEN DRIVE
MADISON, WI 53706

SERVICE MARK

PRINCIPAL REGISTER

FOR: EDUCATIONAL SERVICES, NAMELY, PROVIDING COURSES OF INSTRUCTION, LECTURES, WORKSHOPS, SEMINARS AND CONFERENCES AT THE UNIVERSITY LEVEL EXCLUDING THE FIELD OF TIME MANAGEMENT AND STUDY SKILLS; ENTERTAINMENT SERVICES, NAMELY, ORGANIZING SPORTS COMPETITIONS, PROVIDING PUBLIC LECTURES IN THE FIELDS OF ART, NURSING, BUSINESS, ARCHITECTURE AND URBAN PLANNING, SOCIAL WELFARE, EDUCATOR TRAINING, HEALTH SCIENCES, INFORMATION STUDIES, NATURAL SCIENCES, SOCIAL SCIENCES, HUMANITIES, COMMUNICATIONS, CONTINUING EDUCATION, ENGINEERING AND APPLIED SCIENCES, ARRANGING AND CONDUCTING OF CONCERTS, ART EXHIBITIONS, AND MUSICAL AND THEATRICAL PERFORMANCES, IN CLASS 41 (U.S. CLS. 100, 101 AND 107).

FIRST USE 5-1-2011; IN COMMERCE 5-1-2011.

THE MARK CONSISTS OF STANDARD CHARACTERS WITHOUT CLAIM TO ANY PARTICULAR FONT, STYLE, SIZE, OR COLOR.

SER. NO. 85-438,683, FILED 10-4-2011.

ZHALEH DELANEY, EXAMINING ATTORNEY



David J. Kyffers

Director of the United States Patent and Trademark Office

United States of America

United States Patent and Trademark Office



Reg. No. 4,153,568

Registered June 5, 2012

Int. Cl.: 39

SERVICE MARK

PRINCIPAL REGISTER

COMBINED ENERGY SERVICES (NEW YORK CORPORATION)
PO BOX 1388 - 216 E. BROADWAY
MONTICELLO, NY 12701

FOR: FUEL DELIVERY SERVICES FEATURING HEATING OIL AND PROPANE, IN CLASS
39 (U.S. CLS. 100 AND 105).

FIRST USE 12-1-1983; IN COMMERCE 12-1-1983.

SER. NO. 85-438,773, FILED 10-4-2011.

MARK RADEMACHER, EXAMINING ATTORNEY

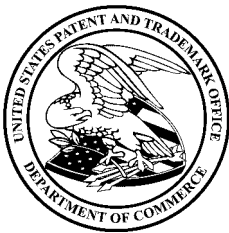

David J. Kyffers

Director of the United States Patent and Trademark Office

United States of America

United States Patent and Trademark Office

JQUERY

Reg. No. 4,153,569

Registered June 5, 2012

Int. Cl.: 9

TRADEMARK

PRINCIPAL REGISTER

SOFTWARE FREEDOM CONSERVANCY (NEW YORK CORPORATION)
137 MONTAGUE STREET SUITE 380
BROOKLYN, NY 11201

FOR: DOWNLOADABLE COMPUTER SOFTWARE FOR THE SCRIPTING OF MARKUP LANGUAGE.; WEB SITE DEVELOPMENT SOFTWARE, IN CLASS 9 (U.S. CLS. 21, 23, 26, 36 AND 38).

FIRST USE 1-16-2006; IN COMMERCE 1-16-2006.

THE MARK CONSISTS OF STANDARD CHARACTERS WITHOUT CLAIM TO ANY PARTICULAR FONT, STYLE, SIZE, OR COLOR.

SER. NO. 85-438,842, FILED 10-4-2011.

KATHLEEN LORENZO, EXAMINING ATTORNEY



David J. Kyffers

Director of the United States Patent and Trademark Office

United States of America

United States Patent and Trademark Office

SMACZNY

Reg. No. 4,153,570

Registered June 5, 2012

Int. Cl.: 29

TRADEMARK

PRINCIPAL REGISTER

KERIVAN, JAMES (ILLINOIS SOLE PROPRIETORSHIP), DBA INTRA CUSTOM
DISTRIBUTORS
18N614 WOODCREST LANE
WEST DUNDEE, IL 60118

FOR: CHEESE, IN CLASS 29 (U.S. CL. 46).

FIRST USE 7-12-2002; IN COMMERCE 7-12-2002.

THE MARK CONSISTS OF STANDARD CHARACTERS WITHOUT CLAIM TO ANY PARTICULAR FONT, STYLE, SIZE, OR COLOR.

THE ENGLISH TRANSLATION OF "SMACZNY" IN THE MARK IS "TASTY".

SEC. 2(F).

SER. NO. 85-438,865, FILED 10-4-2011.

SIMON TENG, EXAMINING ATTORNEY



David J. Kybas

Director of the United States Patent and Trademark Office

United States of America

United States Patent and Trademark Office

THE HACKER ACADEMY

Reg. No. 4,153,571

MAD SECURITY, LLC (NEVADA LIMITED LIABILITY COMPANY)
2360 CORPORATE CIRCLE, STE. 400
HENDERSON, NV 89074

Registered June 5, 2012

Int. Cl.: 41

FOR: TRAINING SERVICES IN THE FIELD OF COMPUTER SECURITY, IN CLASS 41 (U.S. CLS. 100, 101 AND 107).

SERVICE MARK

FIRST USE 0-0-2005; IN COMMERCE 0-0-2005.

PRINCIPAL REGISTER

THE MARK CONSISTS OF STANDARD CHARACTERS WITHOUT CLAIM TO ANY PARTICULAR FONT, STYLE, SIZE, OR COLOR.

NO CLAIM IS MADE TO THE EXCLUSIVE RIGHT TO USE "ACADEMY", APART FROM THE MARK AS SHOWN.

SEC. 2(F).

SER. NO. 85-438,877, FILED 10-4-2011.

SIMON TENG, EXAMINING ATTORNEY



David J. Kybas

Director of the United States Patent and Trademark Office

United States of America

United States Patent and Trademark Office

ISEL

Reg. No. 4,153,572

Registered June 5, 2012

Int. Cl.: 4

TRADEMARK

PRINCIPAL REGISTER

I.S.E.L., INC. (FLORIDA CORPORATION)
5266 HIGHWAY AVENUE
JACKSONVILLE, FL 32254

FOR: SYNTHETIC AND SEMI-SYNTHETIC LUBRICANTS FOR THE AUTOMOTIVE AND INDUSTRIAL MARKETS, IN CLASS 4 (U.S. CLS. 1, 6 AND 15).

FIRST USE 5-0-1993; IN COMMERCE 5-0-1993.

THE MARK CONSISTS OF STANDARD CHARACTERS WITHOUT CLAIM TO ANY PARTICULAR FONT, STYLE, SIZE, OR COLOR.

OWNER OF U.S. REG. NO. 3,542,547.

SER. NO. 85-438,884, FILED 10-4-2011.

SIMON TENG, EXAMINING ATTORNEY



David J. Kyffers

Director of the United States Patent and Trademark Office

United States of America

United States Patent and Trademark Office

Polish Delight

Reg. No. 4,153,573

Registered June 5, 2012

Int. Cl.: 29

TRADEMARK

PRINCIPAL REGISTER

KERIVAN, JAMES (ILLINOIS SOLE PROPRIETORSHIP), DBA INTRA CUSTOM
DISTRIBUTORS
18N614 WOODCREST LANE
WEST DUNDEE, IL 60118

FOR: CHEESE, IN CLASS 29 (U.S. CL. 46).

FIRST USE 7-12-1978; IN COMMERCE 7-12-1978.

THE MARK CONSISTS OF STANDARD CHARACTERS WITHOUT CLAIM TO ANY PARTICULAR FONT, STYLE, SIZE, OR COLOR.

NO CLAIM IS MADE TO THE EXCLUSIVE RIGHT TO USE "POLISH", APART FROM THE MARK AS SHOWN.

SER. NO. 85-438,888, FILED 10-4-2011.

SIMON TENG, EXAMINING ATTORNEY



David J. Kyffers

Director of the United States Patent and Trademark Office

United States of America

United States Patent and Trademark Office

TELMETRICS

Reg. No. 4,153,574

Registered June 5, 2012

Int. Cl.: 35

SERVICE MARK

PRINCIPAL REGISTER

TELMETRICS, INC. (CANADA CORPORATION)
2680 SKYMARK AVE, SUITE 900
MISSISSAUGA, ONTARIO, CANADA L4W5L6

FOR: MEASURING THE EFFECTIVENESS AND VALUE OF ADVERTISING MEDIA BY COUNTING THE NUMBER OF TELEPHONE CALLS PLACED BY THE PUBLIC IN RESPONSE TO A PARTICULAR ADVERTISEMENT, IN CLASS 35 (U.S. CLS. 100, 101 AND 102).

FIRST USE 12-5-2003; IN COMMERCE 6-20-2005.

THE MARK CONSISTS OF STANDARD CHARACTERS WITHOUT CLAIM TO ANY PARTICULAR FONT, STYLE, SIZE, OR COLOR.

OWNER OF U.S. REG. NOS. 2,974,762 AND 3,505,362.

SEC. 2(F).

SER. NO. 85-438,940, FILED 10-4-2011.

KATHLEEN LORENZO, EXAMINING ATTORNEY



David J. Kyffers

Director of the United States Patent and Trademark Office

United States of America

United States Patent and Trademark Office

MOTIV METALS

Reg. No. 4,153,575

Registered June 5, 2012

Int. Cl.: 35

SERVICE MARK

PRINCIPAL REGISTER

MOTIV METALS, LLC (PENNSYLVANIA LIMITED LIABILITY COMPANY)
316 STATION STREET, SUITE 200
BRIDGEVILLE, PA 15017

FOR: INDEPENDENT SALES REPRESENTATIVES IN THE FIELD OF METALS, IN CLASS 35 (U.S. CLS. 100, 101 AND 102).

FIRST USE 9-29-2011; IN COMMERCE 9-29-2011.

THE MARK CONSISTS OF STANDARD CHARACTERS WITHOUT CLAIM TO ANY PARTICULAR FONT, STYLE, SIZE, OR COLOR.

NO CLAIM IS MADE TO THE EXCLUSIVE RIGHT TO USE "METALS", APART FROM THE MARK AS SHOWN.

SER. NO. 85-438,944, FILED 10-4-2011.

JILL PRATER, EXAMINING ATTORNEY



David J. Kybas

Director of the United States Patent and Trademark Office

United States of America

United States Patent and Trademark Office



Reg. No. 4,153,576

Registered June 5, 2012

Int. Cl.: 37

SERVICE MARK

PRINCIPAL REGISTER

BURMAN ENTERPRISES, INC. (MISSOURI CORPORATION), DBA FIRE STOP AMERICA
6280 KNOX INDUSTRIAL DRIVE
ST. LOUIS, MO 63139

FOR: INSTALLATION OF FIRE RETARDANT COMPOSITIONS IN COMMERCIAL, INDUSTRIAL AND RESIDENTIAL BUILDINGS, TO INHIBIT THE SCOPE OF FIRE, IN CLASS 37 (U.S. CLS. 100, 103 AND 106).

FIRST USE 2-1-2009; IN COMMERCE 2-1-2009.

NO CLAIM IS MADE TO THE EXCLUSIVE RIGHT TO USE "FIRE STOP AMERICA", APART FROM THE MARK AS SHOWN.

THE COLOR(S) RED, WHITE AND BLACK IS/ARE CLAIMED AS A FEATURE OF THE MARK.

THE MARK CONSISTS OF AN OCTAGONAL SHAPE, WITH A RED BORDER SURROUNDING A BLACK INTERIOR BACKGROUND, UPON WHICH THE WORDS "FIRE" AND "AMERICA" APPEAR IN RED UPPERCASE LETTERS, ATOP AND BELOW THE WORD "STOP" WHICH IS IN LARGER LETTERS, BORDERED IN RED, WHICH HAVE A GRADUATED SHADING FROM TOTAL RED TO THE LEFT, TO WHITE ON THE RIGHT.

SER. NO. 85-438,979, FILED 10-4-2011.

EDWARD FENNESSY, EXAMINING ATTORNEY



David J. Kyffers

Director of the United States Patent and Trademark Office

United States of America

United States Patent and Trademark Office

TOWN & COUNTRY TOYS

Reg. No. 4,153,577

SMITH, JAMES H. (UNITED STATES INDIVIDUAL)
14723 OTSEGO STREET
SHERMAN OAKS, CA 91403

Registered June 5, 2012

Int. Cl.: 28

FOR: TOY BUILDINGS AND ACCESSORIES THEREFOR, IN CLASS 28 (U.S. CLS. 22, 23, 38 AND 50).

TRADEMARK

FIRST USE 10-3-2011; IN COMMERCE 10-3-2011.

PRINCIPAL REGISTER

THE MARK CONSISTS OF STANDARD CHARACTERS WITHOUT CLAIM TO ANY PARTICULAR FONT, STYLE, SIZE, OR COLOR.

NO CLAIM IS MADE TO THE EXCLUSIVE RIGHT TO USE "TOYS", APART FROM THE MARK AS SHOWN.

SER. NO. 85-439,052, FILED 10-4-2011.

ANNE E. GUSTASON, EXAMINING ATTORNEY



David J. Kyffers

Director of the United States Patent and Trademark Office

United States of America

United States Patent and Trademark Office

T FACTOR

Reg. No. 4,153,578

Registered June 5, 2012

Int. Cl.: 5

TRADEMARK

PRINCIPAL REGISTER

KINGFISHER MEDIA, LLC (DELAWARE LIMITED LIABILITY COMPANY)
312 WEST 6100 SOUTH
MURRAY, UT 84107

FOR: DIETARY SUPPLEMENTS, IN CLASS 5 (U.S. CLS. 6, 18, 44, 46, 51 AND 52).

FIRST USE 6-20-2011; IN COMMERCE 6-20-2011.

THE MARK CONSISTS OF STANDARD CHARACTERS WITHOUT CLAIM TO ANY PARTICULAR FONT, STYLE, SIZE, OR COLOR.

OWNER OF U.S. REG. NO. 4,059,062.

SER. NO. 85-439,132, FILED 10-4-2011.

ELISSA GARBER KON, EXAMINING ATTORNEY



David J. Kybas

Director of the United States Patent and Trademark Office

United States of America

United States Patent and Trademark Office

THE YES MAN CAN.

Reg. No. 4,153,579

Registered June 5, 2012

Int. Cl.: 37

SERVICE MARK

PRINCIPAL REGISTER

AMERICAN RESIDENTIAL SERVICES LLC (DELAWARE LIMITED LIABILITY COMPANY)
SUITE 201
965 RIDGE LAKE BOULEVARD
MEMPHIS, TN 38120

FOR: PLUMBING SERVICES, NAMELY, INSTALLATION, MAINTENANCE AND REPAIR;
AIR CONDITIONING SERVICES, NAMELY, INSTALLATION, MAINTENANCE AND REPAIR,
IN CLASS 37 (U.S. CLS. 100, 103 AND 106).

FIRST USE 12-0-2010; IN COMMERCE 12-0-2010.

THE MARK CONSISTS OF STANDARD CHARACTERS WITHOUT CLAIM TO ANY PARTICULAR FONT, STYLE, SIZE, OR COLOR.

OWNER OF U.S. REG. NO. 4,064,816.

SER. NO. 85-439,146, FILED 10-4-2011.

DAVID ELTON, EXAMINING ATTORNEY



David J. Kyffers

Director of the United States Patent and Trademark Office

United States of America

United States Patent and Trademark Office

FUC VIC

Reg. No. 4,153,580

Registered June 5, 2012

Int. Cl.: 25

TRADEMARK

PRINCIPAL REGISTER

BRIDGET MARSH (UNITED STATES INDIVIDUAL)
2 BEATRICE DRIVE
ROCHESTER, NY 14625

FOR: JERSEYS; SHIRTS; SWEAT JACKETS; SWEAT SHIRTS; T-SHIRTS, IN CLASS 25 (U.S. CLS. 22 AND 39).

FIRST USE 9-29-2011; IN COMMERCE 10-4-2011.

THE MARK CONSISTS OF THE LETTERS "FU" OVER THE LETTERS "VI" ALL NEXT TO THE LETTER "C".

SER. NO. 85-439,174, FILED 10-4-2011.

JAY FLOWERS, EXAMINING ATTORNEY



David J. Kyffers

Director of the United States Patent and Trademark Office

United States of America

United States Patent and Trademark Office

CAPTAIN RECRUITER

Reg. No. 4,153,581

Registered June 5, 2012

Int. Cl.: 35

SERVICE MARK

PRINCIPAL REGISTER

CAPTAIN RECRUITER LLC (CALIFORNIA LIMITED LIABILITY COMPANY)
588 SUTTER STREET, STE 405
SAN FRANCISCO, CA 94102

FOR: EMPLOYMENT HIRING, RECRUITING, PLACEMENT, STAFFING AND CAREER NETWORKING SERVICES; EXECUTIVE RECRUITING SERVICES; PERSONNEL PLACEMENT AND RECRUITMENT, IN CLASS 35 (U.S. CLS. 100, 101 AND 102).

FIRST USE 2-14-2006; IN COMMERCE 2-14-2006.

THE MARK CONSISTS OF STANDARD CHARACTERS WITHOUT CLAIM TO ANY PARTICULAR FONT, STYLE, SIZE, OR COLOR.

NO CLAIM IS MADE TO THE EXCLUSIVE RIGHT TO USE "RECRUITER", APART FROM THE MARK AS SHOWN.

SER. NO. 85-439,204, FILED 10-4-2011.

CAROLINE WOOD, EXAMINING ATTORNEY



David J. Kyros

Director of the United States Patent and Trademark Office

United States of America

United States Patent and Trademark Office

West & Associates

Reg. No. 4,153,582

Registered June 5, 2012

Int. Cl.: 45

SERVICE MARK

PRINCIPAL REGISTER

WEST & ASSOCIATES, A PC (CALIFORNIA CORPORATION)
SUITE 209
2815 MITCHELL DRIVE
WALNUT CREEK, CA 94598

FOR: LEGAL SERVICES, IN CLASS 45 (U.S. CLS. 100 AND 101).

FIRST USE 2-11-2004; IN COMMERCE 6-24-2005.

THE MARK CONSISTS OF STANDARD CHARACTERS WITHOUT CLAIM TO ANY PARTICULAR FONT, STYLE, SIZE, OR COLOR.

NO CLAIM IS MADE TO THE EXCLUSIVE RIGHT TO USE "ASSOCIATES", APART FROM THE MARK AS SHOWN.

SER. NO. 85-439,208, FILED 10-4-2011.

CAROLINE WOOD, EXAMINING ATTORNEY



David J. Kyjars

Director of the United States Patent and Trademark Office

United States of America

United States Patent and Trademark Office

CUBESERV

Reg. No. 4,153,583

Registered June 5, 2012

Int. Cl.: 9

TRADEMARK

PRINCIPAL REGISTER

SECTOR 42 TECHNOLOGIES INC. (CANADA CORPORATION)
15, GAMELIN STREET, SUITE 506, GATINEAU
QUEBEC, CANADA J8Y6N5

FOR: COMPUTER PROGRAMS FOR PROVIDING A MULTI-POINT DATA BROADCASTING NETWORK FOR INTERACTIVE ELECTRONIC DELIVERY OF TEXTUAL AND GRAPHICAL INFORMATION USING A DIGITAL COMMUNICATION PLATFORM IN THE FIELDS OF DATABASE MANAGEMENT, BROADCASTING AND COMMUNICATIONS AND INSTRUCTION MANUALS SOLD AS A UNIT, IN CLASS 9 (U.S. CLS. 21, 23, 26, 36 AND 38).

FIRST USE 5-0-1998; IN COMMERCE 5-0-1998.

THE MARK CONSISTS OF STANDARD CHARACTERS WITHOUT CLAIM TO ANY PARTICULAR FONT, STYLE, SIZE, OR COLOR.

SER. NO. 85-439,258, FILED 10-4-2011.

ANDREA BUTLER, EXAMINING ATTORNEY



David J. Kyros

Director of the United States Patent and Trademark Office

United States of America

United States Patent and Trademark Office

CUBESTOR

Reg. No. 4,153,584

Registered June 5, 2012

Int. Cl.: 9

TRADEMARK

PRINCIPAL REGISTER

SECTOR 42 TECHNOLOGIES INC. (CANADA CORPORATION)
15, GAMELIN STREET, SUITE 506, GATINEAU
QUEBEC, CANADA J8Y6N5

FOR: COMPUTER PROGRAMS FOR PROVIDING A MULTI-POINT DATA BROADCASTING NETWORK FOR INTERACTIVE ELECTRONIC DELIVERY OF TEXTUAL AND GRAPHICAL INFORMATION USING A DIGITAL COMMUNICATION PLATFORM IN THE FIELDS OF DATABASE MANAGEMENT, BROADCASTING AND COMMUNICATIONS AND INSTRUCTION MANUALS SOLD AS A UNIT, IN CLASS 9 (U.S. CLS. 21, 23, 26, 36 AND 38).

FIRST USE 5-0-1998; IN COMMERCE 5-0-1998.

THE MARK CONSISTS OF STANDARD CHARACTERS WITHOUT CLAIM TO ANY PARTICULAR FONT, STYLE, SIZE, OR COLOR.

SER. NO. 85-439,265, FILED 10-4-2011.

ANDREA BUTLER, EXAMINING ATTORNEY



David J. Kyros

Director of the United States Patent and Trademark Office

United States of America

United States Patent and Trademark Office

CUBEWERX

Reg. No. 4,153,585

Registered June 5, 2012

Int. Cl.: 9

TRADEMARK

PRINCIPAL REGISTER

SECTOR 42 TECHNOLOGIES INC. (CANADA CORPORATION)
15, GAMELIN STREET, SUITE 506, GATINEAU
QUEBEC, CANADA J8Y6N5

FOR: COMPUTER PROGRAMS FOR PROVIDING A MULTI-POINT DATA BROADCASTING NETWORK FOR INTERACTIVE ELECTRONIC DELIVERY OF TEXTUAL AND GRAPHICAL INFORMATION USING A DIGITAL COMMUNICATION PLATFORM IN THE FIELDS OF DATABASE MANAGEMENT, BROADCASTING AND COMMUNICATIONS AND INSTRUCTION MANUALS SOLD AS A UNIT, IN CLASS 9 (U.S. CLS. 21, 23, 26, 36 AND 38).

FIRST USE 5-0-1998; IN COMMERCE 5-0-1998.

THE MARK CONSISTS OF STANDARD CHARACTERS WITHOUT CLAIM TO ANY PARTICULAR FONT, STYLE, SIZE, OR COLOR.

SER. NO. 85-439,270, FILED 10-4-2011.

ANDREA BUTLER, EXAMINING ATTORNEY



David J. Kyffers

Director of the United States Patent and Trademark Office

United States of America

United States Patent and Trademark Office

Bumblebee Bakeshop

Reg. No. 4,153,586

Registered June 5, 2012

Int. Cl.: 30

BUMBLEBEE CELEBRATIONS LLC (CALIFORNIA LIMITED LIABILITY COMPANY), DBA
BUMBLEBEE BAKESHOP
SUITE O
2315 DIVISADERO ST.
SAN FRANCISCO, CA 94115

TRADEMARK

FOR: CAKE MIXES, NAMELY, CAKE BASES; CAKES; COOKIE MIXES; CUP CAKES; EDIBLE CAKE DECORATIONS; EDIBLE DECORATIONS FOR CAKES; ICED CAKES; SPONGE CAKES; VEGAN CAKES; VEGAN CUP CAKES, IN CLASS 30 (U.S. CL. 46).

PRINCIPAL REGISTER

FIRST USE 10-18-2006; IN COMMERCE 10-18-2006.

THE MARK CONSISTS OF STANDARD CHARACTERS WITHOUT CLAIM TO ANY PARTICULAR FONT, STYLE, SIZE, OR COLOR.

NO CLAIM IS MADE TO THE EXCLUSIVE RIGHT TO USE "BAKESHOP", APART FROM THE MARK AS SHOWN.

SER. NO. 85-439,285, FILED 10-4-2011.

THEODORE MCBRIDE, EXAMINING ATTORNEY



David J. Kyffers

Director of the United States Patent and Trademark Office

United States of America

United States Patent and Trademark Office

My Editor

Reg. No. 4,153,587

Registered June 5, 2012

Int. Cl.: 42

VANTAGE LEARNING (USA), LLC (DELAWARE LIMITED LIABILITY COMPANY), DBA
VANTAGE LEARNING
KENNETH J. LAFIANDRA, GENERAL COUNSEL
6805 ROUTE 202
NEW HOPE, PA 18938

SERVICE MARK

PRINCIPAL REGISTER

FOR: SOFTWARE AS A SERVICE (SAAS) SERVICES FEATURING SOFTWARE FOR IDENTIFYING STUDENTS' COGNITIVE LEVEL AND ACADEMIC ABILITIES AND TO IMPROVE LEARNING AND ACADEMIC PERFORMANCE THROUGH THE USE OF WRITTEN ESSAYS IN RESPONSE TO WRITING PROMPTS, AND BY IDENTIFYING CHARACTERISTICS OF A PARTICULAR STUDENT, AND BY IDENTIFYING POSSIBLE ERRORS IN GRAMMAR, MECHANICS, STYLE, AND LANGUAGE USAGE, AND PROVIDING RECOMMENDATIONS FOR IMPROVEMENT ALL THROUGH CLOUD COMPUTING, IN CLASS 42 (U.S. CLS. 100 AND 101).

FIRST USE 5-2-2001; IN COMMERCE 5-2-2001.

THE MARK CONSISTS OF STANDARD CHARACTERS WITHOUT CLAIM TO ANY PARTICULAR FONT, STYLE, SIZE, OR COLOR.

NO CLAIM IS MADE TO THE EXCLUSIVE RIGHT TO USE "EDITOR", APART FROM THE MARK AS SHOWN.

SER. NO. 85-439,359, FILED 10-5-2011.

EDWARD FENNESSY, EXAMINING ATTORNEY



David J. Kyros

Director of the United States Patent and Trademark Office

United States of America

United States Patent and Trademark Office

gameplay

Reg. No. 4,153,588

Registered June 5, 2012

Int. Cl.: 35

SERVICE MARK

PRINCIPAL REGISTER

GAMEPLAY LLC (MICHIGAN LIMITED LIABILITY COMPANY)
STE# 210
9278 GENERAL DR.
PLYMOUTH, MI 48170

FOR: RETAIL STORE SERVICES FEATURING VIDEO GAMES AND ACCESSORIES, IN CLASS 35 (U.S. CLS. 100, 101 AND 102).

FIRST USE 7-1-2011; IN COMMERCE 7-1-2011.

NO CLAIM IS MADE TO THE EXCLUSIVE RIGHT TO USE "GAMEPLAY", APART FROM THE MARK AS SHOWN.

THE MARK CONSISTS OF THE STYLIZED TEXT "GAMEPLAY" WITH A TRIANGLE FOR THE SPACE INSIDE THE LETTER "P".

SER. NO. 85-439,406, FILED 10-5-2011.

TASHIA BUNCH, EXAMINING ATTORNEY



David J. Kyros

Director of the United States Patent and Trademark Office

United States of America

United States Patent and Trademark Office

Peace, Love And Little Donuts

Reg. No. 4,153,589

Registered June 5, 2012

Int. Cl.: 35

SERVICE MARK

PRINCIPAL REGISTER

PEACE, LOVE AND LITTLE DONUTS (PENNSYLVANIA LIMITED LIABILITY COMPANY)
219 PARLIAMENT DR.
MOON TOWNSHIP, PA 15108

FOR: RETAIL BAKERY AND DONUT SHOPS, IN CLASS 35 (U.S. CLS. 100, 101 AND 102).

FIRST USE 8-8-2009; IN COMMERCE 8-8-2009.

THE MARK CONSISTS OF STANDARD CHARACTERS WITHOUT CLAIM TO ANY PARTICULAR FONT, STYLE, SIZE, OR COLOR.

NO CLAIM IS MADE TO THE EXCLUSIVE RIGHT TO USE "LITTLE DONUTS", APART FROM THE MARK AS SHOWN.

SER. NO. 85-439,413, FILED 10-5-2011.

COLLEEN DOMBROW, EXAMINING ATTORNEY



David J. Kyffers

Director of the United States Patent and Trademark Office

United States of America

United States Patent and Trademark Office



HEARTS
WITH HELPING HANDS
LIFE IS ABOUT GOALS, OBJECTIVE AND STRATEGIES

Reg. No. 4,153,590

Registered June 5, 2012

Int. Cl.: 44

C LA FUNCH CONSULTING (NEVADA CORPORATION), DBA HEARTS WITH HELPING HANDS
#148
800 N. RAINBOW BLVD
LAS VEGAS, NV 89107

SERVICE MARK

FOR: MENTAL HEALTH THERAPY SERVICES; PROVIDING MENTAL REHABILITATION FACILITIES, IN CLASS 44 (U.S. CLS. 100 AND 101).

PRINCIPAL REGISTER

FIRST USE 10-1-2010; IN COMMERCE 10-1-2010.

THE STIPPLING IS FOR SHADING PURPOSES ONLY.

THE MARK CONSISTS OF A STYLIZED CIRCLE CONTAINING MANY HANDS, SOME SHADED, REACHING UP TOWARD A HEART IN THE CENTER OF THE CIRCLE. UNDER THE CIRCLE IS THE STYLIZED TEXT "HEARTS" ABOVE THE STYLIZED TEXT "WITH HELPING HANDS". BELOW THIS PHRASE IS THE STYLIZED, PARTIALLY SHADED, TEXT "LIFE IS ABOUT GOALS, OBJECTIVE AND STRATEGIES" WHICH IS SURROUNDED BY A DOUBLE-LINED RECTANGLE.

SER. NO. 85-439,421, FILED 10-5-2011.

VIVIAN MICZNIK FIRST, EXAMINING ATTORNEY



David J. Kybas

Director of the United States Patent and Trademark Office

United States of America

United States Patent and Trademark Office

ASCENDUM

Reg. No. 4,153,591

Registered June 5, 2012

Int. Cl.: 42

SERVICE MARK

PRINCIPAL REGISTER

ASCENDUM SOLUTIONS, LLC (OHIO LIMITED LIABILITY COMPANY)
10290 ALLIANCE ROAD
CINCINNATI, OH 45242

FOR: INFORMATION TECHNOLOGY SERVICES AND SUPPORT, NAMELY, APPLICATION SOFTWARE DEVELOPMENT, SOFTWARE DEVELOPMENT, TESTING AND QUALITY ASSURANCE, WEBSITE DEVELOPMENT FOR OTHERS, USER INTERFACE AND USER EXPERIENCE (UI/UX) SOFTWARE DESIGN, REMOTE AND ON-SITE INFRASTRUCTURE MANAGEMENT SERVICES FOR MONITORING, ADMINISTRATION AND MANAGEMENT OF PUBLIC AND PRIVATE CLOUD COMPUTING IT AND APPLICATION SYSTEMS, REMOTE AND ON-SITE ADMINISTRATION AND HOSTING OF IN-HOUSE AND HOSTED DATA CENTER DEVICES, DATABASES AND SOFTWARE APPLICATIONS, IN THE FIELDS OF LOAN AND TITLE SETTLEMENT SERVICES, CUSTOMER CARE SERVICES, AND BACK OFFICE SERVICES, IN CLASS 42 (U.S. CLS. 100 AND 101).

FIRST USE 1-1-2001; IN COMMERCE 1-1-2001.

THE MARK CONSISTS OF STANDARD CHARACTERS WITHOUT CLAIM TO ANY PARTICULAR FONT, STYLE, SIZE, OR COLOR.

SER. NO. 85-439,430, FILED 10-5-2011.

TASHIA BUNCH, EXAMINING ATTORNEY



David J. Kyros

Director of the United States Patent and Trademark Office

United States of America

United States Patent and Trademark Office

TED RX

Reg. No. 4,153,592

Registered June 5, 2012

Int. Cl.: 35

SERVICE MARK

PRINCIPAL REGISTER

WELLFOUNT, CORPORATION (INDIANA CORPORATION), DBA WELLFOUNT PHARMACY
5751 WEST 73RD STREET
INDIANAPOLIS, IN 46278

FOR: ADMINISTERING PHARMACY REIMBURSEMENT PROGRAMS AND SERVICES;
PHARMACEUTICAL SERVICES, NAMELY, PROCESSING ONLINE AND TELEPHONE
PRESCRIPTION ORDERS IN RETAIL AND CENTRAL FILL PHARMACIES, IN CLASS 35
(U.S. CLS. 100, 101 AND 102).

FIRST USE 9-15-2011; IN COMMERCE 9-15-2011.

THE MARK CONSISTS OF STANDARD CHARACTERS WITHOUT CLAIM TO ANY PAR-
TICULAR FONT, STYLE, SIZE, OR COLOR.

NO CLAIM IS MADE TO THE EXCLUSIVE RIGHT TO USE "RX", APART FROM THE MARK
AS SHOWN.

SER. NO. 85-439,444, FILED 10-5-2011.

MARILYN IZZI, EXAMINING ATTORNEY



David J. Kybas

Director of the United States Patent and Trademark Office

United States of America

United States Patent and Trademark Office



Reg. No. 4,153,593

Registered June 5, 2012

Int. Cl.: 35

SERVICE MARK

PRINCIPAL REGISTER

WELLFOUNT, CORPORATION (INDIANA CORPORATION), DBA WELLFOUNT PHARMACY
5751 WEST 73RD STREET
INDIANAPOLIS, IN 46278

FOR: ADMINISTERING PHARMACY REIMBURSEMENT PROGRAMS AND SERVICES;
PHARMACEUTICAL SERVICES, NAMELY, PROCESSING ONLINE AND TELEPHONE
PRESCRIPTION ORDERS IN RETAIL AND CENTRAL FILL PHARMACIES, IN CLASS 35
(U.S. CLS. 100, 101 AND 102).

FIRST USE 9-15-2011; IN COMMERCE 9-15-2011.

NO CLAIM IS MADE TO THE EXCLUSIVE RIGHT TO USE "RX", APART FROM THE MARK
AS SHOWN.

THE COLOR(S) BLUE AND GREEN IS/ARE CLAIMED AS A FEATURE OF THE MARK.

THE MARK CONSISTS OF THE LETTERING "TED" AND "RX", WHERE "TED" IS
RENDERED IN BLUE LOWERCASE LETTERS WITH AN BLUE ARC EXTENDING FROM
THE CROSSBAR OF THE LETTER "T" OVER THE LETTER "E" AND TERMINATING IN A
GREEN DOT NEAR THE LETTER "D". ANOTHER BLUE ARC EXTENDS FROM THE BULB
OF THE LETTER "D" UNDER THE LETTER "E" AND TERMINATES IN A GREEN DOT
NEAR THE LETTER "T". THE PRESCRIPTION SYMBOL "RX" IS RENDERED IN GREEN
UNDERNEATH THE LETTER "D".

SER. NO. 85-439,447, FILED 10-5-2011.

MARILYN IZZI, EXAMINING ATTORNEY



David J. Kyjars

Director of the United States Patent and Trademark Office

United States of America

United States Patent and Trademark Office

want2vape

Reg. No. 4,153,594

DCW REHABS, LLC (FLORIDA LIMITED LIABILITY COMPANY)
P.O. BOX 342
ALFORD, FL 32420

Registered June 5, 2012

Int. Cl.: 34

FOR: ELECTRONIC CIGARETTES FOR USE AS AN ALTERNATIVE TO TRADITIONAL CIGARETTES, IN CLASS 34 (U.S. CLS. 2, 8, 9 AND 17).

TRADEMARK

FIRST USE 1-1-2010; IN COMMERCE 1-1-2010.

PRINCIPAL REGISTER

THE MARK CONSISTS OF STANDARD CHARACTERS WITHOUT CLAIM TO ANY PARTICULAR FONT, STYLE, SIZE, OR COLOR.

SER. NO. 85-439,489, FILED 10-5-2011.

B. PARADEWELAI, EXAMINING ATTORNEY



David J. Kyffers

Director of the United States Patent and Trademark Office

United States of America

United States Patent and Trademark Office

eme creative

Reg. No. 4,153,595

BRYANT JR., CURTIS G. (UNITED STATES INDIVIDUAL)
1131 ADAMS STREET
LINCOLN, NE 68521

Registered June 5, 2012

Int. Cl.: 35

FOR: ADVERTISING, MARKETING AND PROMOTION SERVICES; BRANDING SERVICES, NAMELY, CONSULTING, DEVELOPMENT, MANAGEMENT AND MARKETING OF BRANDS FOR BUSINESSES; MARKETING CONSULTING, IN CLASS 35 (U.S. CLS. 100, 101 AND 102).

SERVICE MARK

PRINCIPAL REGISTER

FIRST USE 5-1-2008; IN COMMERCE 5-1-2008.

THE STIPPLING IS A FEATURE OF THE MARK.

THE MARK CONSISTS OF THE STYLIZED WORDS "EME" WRITTEN IN REVERSE AND "CREATIVE". THE STIPPLING APPEARING IN THE WORD "EME" IS CLAIMED AS A FEATURE OF THE MARK

SER. NO. 85-439,491, FILED 10-5-2011.

B. PARADEWELAI, EXAMINING ATTORNEY



David J. Kyros

Director of the United States Patent and Trademark Office

United States of America

United States Patent and Trademark Office



Reg. No. 4,153,596

Registered June 5, 2012

Int. Cls.: 44 and 45

SERVICE MARK

PRINCIPAL REGISTER

HEADWAY EMOTIONAL HEALTH SERVICES (MINNESOTA CORPORATION)
6425 NICOLLET AVENUE SOUTH
RICHFIELD, MN 55423

FOR: PSYCHIATRIC SERVICES; PSYCHIATRIC CONSULTATION AND THERAPY; PROVIDING INFORMATION TO PATIENTS IN THE FIELD OF ADMINISTERING MEDICATIONS; MENTAL HEALTH SERVICES; PROVIDING INFORMATION IN THE FIELD OF PARENTING CONCERNING THE HEALTH OF CHILDREN AND FAMILIES; ANGER MANAGEMENT MENTAL HEALTH THERAPY; YOUTH MENTAL HEALTH COUNSELING ON THE TOPICS OF DEPRESSION AND ANXIETY; YOUTH PSYCHOLOGICAL COUNSELING; FAMILY MENTAL HEALTH COUNSELING ON THE TOPICS OF DEPRESSION AND ANXIETY; FAMILY PSYCHOLOGICAL COUNSELING, IN CLASS 44 (U.S. CLS. 100 AND 101).

FIRST USE 7-1-2011; IN COMMERCE 7-1-2011.

FOR: PROVIDING EMOTIONAL SUPPORT COUNSELING FOR VICTIMS OF BATTERY, ABUSE, AND SEXUAL ABUSE; YOUTH COUNSELING ON THE TOPICS OF INTERPERSONAL RELATIONSHIPS; FAMILY COUNSELING ON THE TOPICS OF INTERPERSONAL RELATIONSHIPS, IN CLASS 45 (U.S. CLS. 100 AND 101).

FIRST USE 7-1-2011; IN COMMERCE 7-1-2011.

NO CLAIM IS MADE TO THE EXCLUSIVE RIGHT TO USE "EMOTIONAL HEALTH SERVICES", APART FROM THE MARK AS SHOWN.

THE MARK CONSISTS OF THE WORDING "HEADWAY EMOTIONAL HEALTH SERVICES" TO THE RIGHT OF A LINE DRAWING OF A HEAD AND ARROW.

SER. NO. 85-439,495, FILED 10-5-2011.

JAMES LOVELACE, EXAMINING ATTORNEY



David J. Kyros

Director of the United States Patent and Trademark Office

United States of America

United States Patent and Trademark Office

OAKLAND UNIVERSITY

Reg. No. 4,153,597

Registered June 5, 2012

Int. Cls.: 25 and 41

TRADEMARK

SERVICE MARK

PRINCIPAL REGISTER

OAKLAND UNIVERSITY (MICHIGAN CONSTITUTIONAL BODY CORPORATE)
OAKLAND UNIVERSITY
ROCHESTER, MI 483094401

FOR: CLOTHING, NAMELY, SHIRTS, T-SHIRTS, POLO SHIRTS, PANTS, JACKETS, SWEAT SHIRTS, SWEAT PANTS, GLOVES, SWEATERS, HATS, CAPS, BASEBALL CAPS AND HATS, VISORS, SOCKS, UNDERWEAR, NIGHTGOWNS, PAJAMAS, AND CHILDREN'S AND INFANT'S APPAREL, NAMELY, JUMPERS, OVERALL SLEEPWEAR, PAJAMAS, ROMPERS, ONE-PIECE GARMENTS, CLOTH BIBS, AND BOOTIES, IN CLASS 25 (U.S. CLS. 22 AND 39).

FIRST USE 9-24-1986; IN COMMERCE 9-24-1986.

FOR: EDUCATION SERVICES IN THE NATURE OF PROVIDING COURSES OF INSTRUCTION AT THE UNIVERSITY AND POST-GRADUATE LEVELS AND DISTRIBUTING COURSE MATERIALS IN CONNECTION THEREWITH AND PROVIDING EDUCATIONAL SPEAKERS; ENTERTAINMENT SERVICES IN THE NATURE OF LIVE PERFORMANCES BY MUSICAL BANDS, LIVE PERFORMANCES BY SINGERS, LIVE MUSIC CONCERTS, ORCHESTRA PERFORMANCES, THEATER PRODUCTIONS, DANCE PRODUCTIONS, DRAMATIC PERFORMANCES, AND CULTURAL EVENTS; ENTERTAINMENT IN THE NATURE OF COMPETITIONS IN THE FIELD OF ATHLETICS, NAMELY, BASEBALL GAMES, BASKETBALL GAMES, FOOTBALL GAMES, HOCKEY GAMES, GOLF TOURNAMENTS, GYMNASTIC PERFORMANCES AND MATCHES, TENNIS TOURNAMENTS, SOCCER MATCHES, TRACK AND FIELD COMPETITIONS, WEIGHT LIFTING COMPETITIONS, AND WRESTLING COMPETITIONS, IN CLASS 41 (U.S. CLS. 100, 101 AND 107).

FIRST USE 9-24-1986; IN COMMERCE 9-24-1986.

THE MARK CONSISTS OF STANDARD CHARACTERS WITHOUT CLAIM TO ANY PARTICULAR FONT, STYLE, SIZE, OR COLOR.

OWNER OF U.S. REG. NOS. 2,342,613, 2,610,056 AND OTHERS.

NO CLAIM IS MADE TO THE EXCLUSIVE RIGHT TO USE "UNIVERSITY" FOR INTERNATIONAL CLASS 41, APART FROM THE MARK AS SHOWN.

SEC. 2(F).



David J. Kyros

Director of the United States Patent and Trademark Office

Reg. No. 4,153,597 SER. NO. 85-439,540, FILED 10-5-2011.

ROBIN CHOSID, EXAMINING ATTORNEY

United States of America
United States Patent and Trademark Office

TouchPure

Reg. No. 4,153,598

COX, THOMAS M (UNITED STATES INDIVIDUAL)
4120 DOUGLAS BLVD 306-358
GRANITE BAY, CA 95746

Registered June 5, 2012

Int. Cl.: 9

FOR: COMPUTER SOFTWARE FOR APPLICATION AND DATABASE INTEGRATION, IN CLASS 9 (U.S. CLS. 21, 23, 26, 36 AND 38).

TRADEMARK

FIRST USE 11-19-2009; IN COMMERCE 11-19-2009.

PRINCIPAL REGISTER

THE MARK CONSISTS OF STANDARD CHARACTERS WITHOUT CLAIM TO ANY PARTICULAR FONT, STYLE, SIZE, OR COLOR.

SER. NO. 85-439,548, FILED 10-5-2011.

ANDREW RHIM, EXAMINING ATTORNEY



David J. Kybas

Director of the United States Patent and Trademark Office

United States of America

United States Patent and Trademark Office

UNCLAIMED BAGGAGE CENTER

Reg. No. 4,153,599

Registered June 5, 2012

Int. Cls.: 35 and 41

SERVICE MARK

PRINCIPAL REGISTER

OCS, INCORPORATED (ALABAMA CORPORATION), FORMERLY UNCLAIMED BAGGAGE CENTER, INC.
509 W. WILLOW STREET
SCOTTSBORO, AL 35768

FOR: RETAIL DEPARTMENT STORE SERVICES; ONLINE RETAIL DEPARTMENT STORE SERVICES; WHOLESALE AND RETAIL STORE SERVICES FEATURING A WIDE VARIETY OF GOODS, IN CLASS 35 (U.S. CLS. 100, 101 AND 102).

FIRST USE 3-15-1970; IN COMMERCE 3-15-1970.

FOR: ENTERTAINMENT SERVICES IN THE NATURE OF RECORDING, PRODUCTION AND POST-PRODUCTION SERVICES IN THE FIELD OF VIDEO; PRODUCTION AND DISTRIBUTION OF VIDEO RECORDINGS FEATURING SHOPPING, FASHION, ENTERTAINMENT, AND RETAIL SERVICES; DISTRIBUTION OF VIDEO RECORDINGS FEATURING SHOPPING, FASHION, ENTERTAINMENT, AND RETAIL SERVICES VIA THE INTERNET, IN CLASS 41 (U.S. CLS. 100, 101 AND 107).

FIRST USE 9-25-2007; IN COMMERCE 9-25-2007.

THE MARK CONSISTS OF STANDARD CHARACTERS WITHOUT CLAIM TO ANY PARTICULAR FONT, STYLE, SIZE, OR COLOR.

OWNER OF U.S. REG. NO. 2,630,115.

NO CLAIM IS MADE TO THE EXCLUSIVE RIGHT TO USE "CENTER", APART FROM THE MARK AS SHOWN.

SEC. 2(F).

SER. NO. 85-439,578, FILED 10-5-2011.

MARK T. MULLEN, EXAMINING ATTORNEY



David J. Kyffers

Director of the United States Patent and Trademark Office

United States of America

United States Patent and Trademark Office



Reg. No. 4,153,600

Registered June 5, 2012

Int. Cls.: 35 and 41

SERVICE MARK

PRINCIPAL REGISTER

OCS, INCORPORATED (ALABAMA CORPORATION), FORMERLY UNCLAIMED BAGGAGE CENTER, INC.
509 W. WILLOW STREET
SCOTTSBORO, AL 35768

FOR: RETAIL DEPARTMENT STORE SERVICES; ONLINE RETAIL DEPARTMENT STORE SERVICES; WHOLESALE AND RETAIL STORE SERVICES FEATURING A WIDE VARIETY OF GOODS, IN CLASS 35 (U.S. CLS. 100, 101 AND 102).

FIRST USE 9-1-2010; IN COMMERCE 10-6-2010.

FOR: ENTERTAINMENT SERVICES IN THE NATURE OF RECORDING, PRODUCTION AND POST-PRODUCTION SERVICES IN THE FIELD OF VIDEO; PRODUCTION AND DISTRIBUTION OF VIDEO RECORDINGS FEATURING SHOPPING, FASHION, ENTERTAINMENT, AND RETAIL SERVICES; DISTRIBUTION OF VIDEO RECORDINGS FEATURING SHOPPING, FASHION, ENTERTAINMENT, AND RETAIL SERVICES VIA THE INTERNET, IN CLASS 41 (U.S. CLS. 100, 101 AND 107).

FIRST USE 9-1-2010; IN COMMERCE 10-6-2010.

OWNER OF U.S. REG. NO. 2,630,115.

NO CLAIM IS MADE TO THE EXCLUSIVE RIGHT TO USE "CENTER", APART FROM THE MARK AS SHOWN.

THE MARK CONSISTS OF A TILTED SUITCASE WITH A HANDLE. A CURVED TAPERED LINE RUNS FROM BELOW THE HANDLE TO THE RIGHT SIDE OF THE SUITCASE. THE TERM "UNCLAIMED" APPEARS BENEATH IT. UNDER THAT IS THE TERM "BAGGAGE" AND BELOW THAT IS THE TERM "CENTER". NEAR THE BOTTOM OF THE SUITCASE, A CURVED TAPERED LINE RUNS FROM THE LEFT TO THE BOTTOM RIGHT CORNER OF THE SUITCASE.

SEC. 2(F) AS TO "UNCLAIMED BAGGAGE CENTER".

SER. NO. 85-439,586, FILED 10-5-2011.

MARK T. MULLEN, EXAMINING ATTORNEY



David J. Kyros

Director of the United States Patent and Trademark Office

United States of America
United States Patent and Trademark Office



Reg. No. 4,153,601

Registered June 5, 2012

Int. Cl.: 44

SERVICE MARK

PRINCIPAL REGISTER

JASON M. GRINTER, D.D.S., P.C. (ILLINOIS CORPORATION)
#202
1550 W. CORNELIA AVE.
CHICAGO, IL 60657

FOR: DENTIST SERVICES, IN CLASS 44 (U.S. CLS. 100 AND 101).

FIRST USE 7-14-2011; IN COMMERCE 7-14-2011.

THE MARK CONSISTS OF A CIRCLE CONTAINING THE OUTLINE OF A TOOTH, THIS CIRCLE SERVES AS THE LETTER "O" IN THE WORD "ONSITE".

SER. NO. 85-439,589, FILED 10-5-2011.

NAPOLEON SHARMA, EXAMINING ATTORNEY



David J. Kybas

Director of the United States Patent and Trademark Office

United States of America

United States Patent and Trademark Office



Reg. No. 4,153,602

Registered June 5, 2012

Int. Cl.: 41

SERVICE MARK

PRINCIPAL REGISTER

THOMPKINS MARKETING LLC (TEXAS LIMITED LIABILITY COMPANY)
7322 SOUTHWEST FREEWAY, SUITE 2010
HOUSTON, TX 77074

FOR: ENTERTAINMENT, NAMELY, A TELEVISION TALK SHOW IN THE FIELDS OF BUSINESS, ENTERTAINMENT, NEWS, POLITICS, AND LIFE TOPICS, IN CLASS 41 (U.S. CLS. 100, 101 AND 107).

FIRST USE 1-1-2011; IN COMMERCE 1-1-2011.

THE MARK CONSISTS OF A SILHOUETTE OF TWO WOMEN'S HEADS IN WHITE WITH PINK HAIR, PINK SUNGLASSES, AND PINK LIPS BETWEEN TWO SILVER AND BLACK MICROPHONES ABOVE THE WORDS "THE GOSSIPING HEIFERS" WITH THE WORDS "THE" AND "HEIFERS" IN BLACK AND THE WORD "GOSSIPING" IN PINK ABOVE THE WORDS "THERE IS NO GOSSIP LIKE HEIFER GOSSIP" IN WHITE ON A SILVER BACKGROUND.

THE COLOR(S) PINK, SILVER, BLACK AND WHITE IS/ARE CLAIMED AS A FEATURE OF THE MARK.

SER. NO. 85-439,603, FILED 10-5-2011.

JOHN WILKE, EXAMINING ATTORNEY



David J. Kybas

Director of the United States Patent and Trademark Office

United States of America

United States Patent and Trademark Office

TIXNIX

Reg. No. 4,153,603

TACITLOGIC, INC. (CALIFORNIA CORPORATION)
3570 E 12TH AVE, #206
DENVER, CO 80206

Registered June 5, 2012

Int. Cl.: 45

FOR: LEGAL SERVICES, NAMELY, PROVIDING ADVICE AND REFERRALS TO CONSUMERS FOR TRAFFIC VIOLATIONS, IN CLASS 45 (U.S. CLS. 100 AND 101).

SERVICE MARK

FIRST USE 4-1-2004; IN COMMERCE 4-1-2004.

PRINCIPAL REGISTER

THE MARK CONSISTS OF STANDARD CHARACTERS WITHOUT CLAIM TO ANY PARTICULAR FONT, STYLE, SIZE, OR COLOR.

SER. NO. 85-439,605, FILED 10-5-2011.

ANNE E. GUSTASON, EXAMINING ATTORNEY



David J. Kybas

Director of the United States Patent and Trademark Office

United States of America

United States Patent and Trademark Office



Reg. No. 4,153,604

Registered June 5, 2012

Int. Cl.: 36

SERVICE MARK

PRINCIPAL REGISTER

SOCIAL ESQUIRE (FLORIDA LIMITED LIABILITY COMPANY)
2351 SOUTH DOUGLAS ROAD
MIAMI, FL 33145

FOR: CHARITABLE SERVICES, NAMELY, ORGANIZING FUNDRAISING SERVICES AND EVENTS TO RAISE FUNDS IN THE FIELD OF BREAST CANCER AND OTHER WOMEN'S HEALTH ISSUES, IN CLASS 36 (U.S. CLS. 100, 101 AND 102).

FIRST USE 10-1-2011; IN COMMERCE 10-1-2011.

NO CLAIM IS MADE TO THE EXCLUSIVE RIGHT TO USE "LUNCHEON", APART FROM THE MARK AS SHOWN.

THE COLOR(S) WHITE, PINK, DARK GRAY IS/ARE CLAIMED AS A FEATURE OF THE MARK.

THE MARK CONSISTS OF A PINK CIRCLE WITH A WHITE GAVEL IN THE CIRCLE. THE GAVEL HAS A PINK RIBBON ON IT. TO THE RIGHT OF THE CIRCLE DESIGN IS THE WORDING "THE PINK GAVEL LUNCHEON", WITH THE WORD "PINK" APPEARING IN THE COLOR PINK AND THE REST OF THE WORDING IN DARK GRAY.

SER. NO. 85-439,662, FILED 10-5-2011.

SHAILA SETTLES, EXAMINING ATTORNEY



David J. Kyjars

Director of the United States Patent and Trademark Office

United States of America

United States Patent and Trademark Office

GET OUT CHATTANOOGA

Reg. No. 4,153,605

Registered June 5, 2012

Int. Cls.: 16 and 41

TRADEMARK

SERVICE MARK

PRINCIPAL REGISTER

CHATTANOOGA PUBLISHING COMPANY (TENNESSEE CORPORATION)
400 EAST 11TH STREET
CHATTANOOGA, TN 37402

FOR: MAGAZINES IN THE FIELD OF OUTDOOR RECREATION, IN CLASS 16 (U.S. CLS. 2, 5, 22, 23, 29, 37, 38 AND 50).

FIRST USE 10-1-2011; IN COMMERCE 10-1-2011.

FOR: PROVIDING ON-LINE MAGAZINES IN THE FIELD OF OUTDOOR RECREATION, IN CLASS 41 (U.S. CLS. 100, 101 AND 107).

FIRST USE 10-1-2011; IN COMMERCE 10-1-2011.

THE MARK CONSISTS OF STANDARD CHARACTERS WITHOUT CLAIM TO ANY PARTICULAR FONT, STYLE, SIZE, OR COLOR.

NO CLAIM IS MADE TO THE EXCLUSIVE RIGHT TO USE "CHATTANOOGA", APART FROM THE MARK AS SHOWN.

SER. NO. 85-439,664, FILED 10-5-2011.

SHAILA SETTLES, EXAMINING ATTORNEY



David J. Kyros

Director of the United States Patent and Trademark Office

United States of America

United States Patent and Trademark Office



Reg. No. 4,153,606

Registered June 5, 2012

Int. Cl.: 9

TRADEMARK

PRINCIPAL REGISTER

STRICKLAND, RICHARD, D. (UNITED STATES INDIVIDUAL)
241 COMMODORE LOOP
MOORESVILLE, NC 28117

FOR: COMPUTER SOFTWARE FOR ACCESSING INFORMATION IN THE NATURE OF DIGITAL ELECTRICAL SIGNALS FROM AUTOMOTIVE POWERTRAIN CENTRAL PROCESSING UNITS, IN CLASS 9 (U.S. CLS. 21, 23, 26, 36 AND 38).

FIRST USE 4-6-2011; IN COMMERCE 7-17-2011.

NO CLAIM IS MADE TO THE EXCLUSIVE RIGHT TO USE "DRIVE", APART FROM THE MARK AS SHOWN.

THE COLOR(S) GREY, ORANGE, DARK GREY, BLACK, WHITE AND BLUE IS/ARE CLAIMED AS A FEATURE OF THE MARK.

THE MARK CONSISTS OF A CIRCULAR SHAPE STEERING WHEEL WITH 3 SPOKES IN GREY COLOR. IN THE CENTER OF THE STEERING WHEEL WHERE THE 3 SPOKES INTERSECT IS AN ORANGE SQUARE WITH ROUNDED CORNERS OUTLINED IN BLACK COLOR. CENTERED IN THE ORANGE SQUARE IS A CAPITAL LETTER "D" IN DARK GREY COLOR. TO THE RIGHT OF THE IMAGE IS THE WORD "DRIVE", WITH ARIAL FONT, ITALIC STYLE AND WHITE COLOR. ALL OF THE FOREGOING APPEAR ON A BLUE RECTANGULAR BACKGROUND.

SER. NO. 85-439,666, FILED 10-5-2011.

APRIL ROACH, EXAMINING ATTORNEY



David J. Kybas

Director of the United States Patent and Trademark Office

United States of America

United States Patent and Trademark Office

VELOSMITH

Reg. No. 4,153,607

Registered June 5, 2012

Int. Cl.: 35

SERVICE MARK

PRINCIPAL REGISTER

VELOSMITH BICYCLE STUDIO, INC. (ILLINOIS CORPORATION)
805 RIDGE ROAD
WILLMETTE, IL 60091

FOR: RETAIL STORE SERVICES OF BICYCLES, BICYCLE PARTS AND ACCESSORIES;
RETAIL STORE SERVICES OF CUSTOM DESIGNED AND BIOMECHANICALLY FITTED
BICYCLES, IN CLASS 35 (U.S. CLS. 100, 101 AND 102).

FIRST USE 3-26-2011; IN COMMERCE 4-10-2011.

THE MARK CONSISTS OF STANDARD CHARACTERS WITHOUT CLAIM TO ANY PAR-
TICULAR FONT, STYLE, SIZE, OR COLOR.

SER. NO. 85-439,801, FILED 10-5-2011.

MARK SPARACINO, EXAMINING ATTORNEY



David J. Kyffers

Director of the United States Patent and Trademark Office

United States of America

United States Patent and Trademark Office

CAB KING

Reg. No. 4,153,608

REENTEL INTERNATIONAL INC. (ILLINOIS CORPORATION)
808 BURR OAK DR.
WESTMONT, IL 60559

Registered June 5, 2012

Int. Cl.: 7

FOR: POWER OPERATED GRINDING AND POLISHING MACHINES, IN CLASS 7 (U.S. CLS. 13, 19, 21, 23, 31, 34 AND 35).

TRADEMARK

FIRST USE 4-15-2008; IN COMMERCE 12-16-2008.

PRINCIPAL REGISTER

THE MARK CONSISTS OF STANDARD CHARACTERS WITHOUT CLAIM TO ANY PARTICULAR FONT, STYLE, SIZE, OR COLOR.

NO CLAIM IS MADE TO THE EXCLUSIVE RIGHT TO USE "CAB", APART FROM THE MARK AS SHOWN.

SER. NO. 85-439,802, FILED 10-5-2011.

APRIL ROACH, EXAMINING ATTORNEY



David J. Kyffers

Director of the United States Patent and Trademark Office

United States of America

United States Patent and Trademark Office

Sign PostMan

Reg. No. 4,153,609

SIGN POSTMAN, LLC (FLORIDA LIMITED LIABILITY COMPANY)
P.O. BOX 90586
LAKELAND, FL 33804

Registered June 5, 2012

Int. Cl.: 35

FOR: RENTAL OF SIGNS FOR ADVERTISING PURPOSES, IN CLASS 35 (U.S. CLS. 100, 101 AND 102).

SERVICE MARK

FIRST USE 9-1-2008; IN COMMERCE 9-1-2008.

PRINCIPAL REGISTER

THE MARK CONSISTS OF STANDARD CHARACTERS WITHOUT CLAIM TO ANY PARTICULAR FONT, STYLE, SIZE, OR COLOR.

NO CLAIM IS MADE TO THE EXCLUSIVE RIGHT TO USE "SIGN", APART FROM THE MARK AS SHOWN.

SER. NO. 85-439,815, FILED 10-5-2011.

KAREN SEVERSON, EXAMINING ATTORNEY



David J. Kybas

Director of the United States Patent and Trademark Office

United States of America

United States Patent and Trademark Office

PIANO WORLD

Reg. No. 4,153,610

Registered June 5, 2012

Int. Cls.: 35 and 38

SERVICE MARK

PRINCIPAL REGISTER

BAXTER, FRANK (UNITED STATES INDIVIDUAL), DBA PIANO WORLD
9925 ULMERTON ROAD, #227
LARGO, FL 33771

FOR: ADVERTISING AND DIRECTORY SERVICES, NAMELY, PROMOTING THE SERVICES OF OTHERS BY PROVIDING A WEB PAGE FEATURING LINKS TO THE WEBSITES OF OTHERS; COMPUTERIZED ON-LINE RETAIL STORE SERVICES IN THE FIELD OF PIANOS, TUNERS, PIANO PARTS, AND NEW AND USED PIANOS; PROVIDING AN INTERNET WEBSITE PORTAL FEATURING LINKS TO MUSIC-RELATED MERCHANDISE FOR RETAIL PURPOSES; PROVIDING AN ON-LINE COMPUTER DATABASE FEATURING TRADE INFORMATION IN THE FIELD OF PIANOS, PIANO LESSONS, TUNERS, DEALERS, TEACHERS, MOVERS, PIANO REPAIRS, PIANO RESTORATIONS, PIANO PARTS AND NEW AND USED PIANOS; PROVIDING CONSUMER INFORMATION IN THE FIELD OF PIANOS, PIANO LESSONS, TUNERS, DEALERS, TEACHERS, MOVERS, PIANO REPAIRS, PIANO RESTORATIONS, PIANO PARTS AND NEW AND USED PIANOS, IN CLASS 35 (U.S. CLS. 100, 101 AND 102).

FIRST USE 4-1-1999; IN COMMERCE 4-1-1999.

FOR: PROVIDING AN ON-LINE FORUM FOR THE DISCUSSION OF PIANO-RELATED TOPICS; PROVIDING AN ON-LINE ELECTRONIC BULLETIN BOARD FOR TRANSMISSION OF MESSAGES AMONG COMPUTER USERS CONCERNING PIANO-RELATED TOPICS, IN CLASS 38 (U.S. CLS. 100, 101 AND 104).

FIRST USE 4-1-1999; IN COMMERCE 4-1-1999.

THE MARK CONSISTS OF STANDARD CHARACTERS WITHOUT CLAIM TO ANY PARTICULAR FONT, STYLE, SIZE, OR COLOR.

NO CLAIM IS MADE TO THE EXCLUSIVE RIGHT TO USE "PIANO", APART FROM THE MARK AS SHOWN.

SER. NO. 85-439,852, FILED 10-5-2011.

MICHAEL SOUDERS, EXAMINING ATTORNEY



David J. Kyros

Director of the United States Patent and Trademark Office

United States of America

United States Patent and Trademark Office

CEJA

Reg. No. 4,153,611

Registered June 5, 2012

Int. Cl.: 41

SERVICE MARK

PRINCIPAL REGISTER

CEJA VINEYARDS, INC. (CALIFORNIA CORPORATION)
1012 LAS AMIGAS ROAD
NAPA, CA 94559

FOR: ENTERTAINMENT SERVICES, NAMELY, WINE TASTINGS AND WINE AND FOOD PAIRINGS, IN CLASS 41 (U.S. CLS. 100, 101 AND 107).

FIRST USE 4-0-2005; IN COMMERCE 4-0-2005.

THE MARK CONSISTS OF STANDARD CHARACTERS WITHOUT CLAIM TO ANY PARTICULAR FONT, STYLE, SIZE, OR COLOR.

OWNER OF U.S. REG. NO. 3,414,209.

SEC. 2(F).

SER. NO. 85-439,871, FILED 10-5-2011.

KATHRYN COWARD, EXAMINING ATTORNEY



David J. Kyros

Director of the United States Patent and Trademark Office

United States of America

United States Patent and Trademark Office

NINE INNINGS OF NETWORKING

Reg. No. 4,153,612 AMERICAN BASEBALL COMPANY LLC (NEW JERSEY LIMITED LIABILITY COMPANY)
Registered June 5, 2012 2 STADIUM WAY
LAKEWOOD, NJ 08701

Int. Cl.: 35 FOR: JOB PLACEMENT, NAMELY, ORGANIZING AND CONDUCTING NETWORKING
EVENTS, IN CLASS 35 (U.S. CLS. 100, 101 AND 102).

SERVICE MARK FIRST USE 4-29-2009; IN COMMERCE 4-29-2009.

PRINCIPAL REGISTER THE MARK CONSISTS OF STANDARD CHARACTERS WITHOUT CLAIM TO ANY PAR-
TICULAR FONT, STYLE, SIZE, OR COLOR.

NO CLAIM IS MADE TO THE EXCLUSIVE RIGHT TO USE "NETWORKING", APART FROM
THE MARK AS SHOWN.

SER. NO. 85-439,874, FILED 10-5-2011.

JOHN HWANG, EXAMINING ATTORNEY



David J. Kybas

Director of the United States Patent and Trademark Office

United States of America

United States Patent and Trademark Office

Theme Blvd

Reg. No. 4,153,613

Registered June 5, 2012

Int. Cl.: 42

SERVICE MARK

PRINCIPAL REGISTER

BOBICH, JASON (UNITED STATES INDIVIDUAL)
SUITE T
130 W. INT'L AIRPORT RD.
ANCHORAGE, AK 99518

FOR: WEBSITE DESIGN AND DEVELOPMENT FOR OTHERS, IN CLASS 42 (U.S. CLS. 100 AND 101).

FIRST USE 5-1-2009; IN COMMERCE 5-1-2009.

THE MARK CONSISTS OF STANDARD CHARACTERS WITHOUT CLAIM TO ANY PARTICULAR FONT, STYLE, SIZE, OR COLOR.

NO CLAIM IS MADE TO THE EXCLUSIVE RIGHT TO USE "THEME", APART FROM THE MARK AS SHOWN.

SER. NO. 85-439,877, FILED 10-5-2011.

CHRISTINE MARTIN, EXAMINING ATTORNEY



David J. Kybas

Director of the United States Patent and Trademark Office

United States of America

United States Patent and Trademark Office

WHIRLPOOL

Reg. No. 4,153,614

Registered June 5, 2012

Int. Cl.: 7

TRADEMARK

PRINCIPAL REGISTER

WHIRLPOOL PROPERTIES, INC. (MICHIGAN CORPORATION)
SUITE 101
500 RENAISSANCE DRIVE
ST. JOSEPH, MI 49085

FOR: COMPUTER APPLICATION SOFTWARE SOLD AS AN INTEGRAL COMPONENT OF CLOTHES WASHING MACHINES, NAMELY, SOFTWARE FOR PROVIDING INFORMATION ON STAINS AND OTHER LAUNDRY ISSUES AND FOR PROVIDING TECHNICAL ASSISTANCE FOR USE OF THE CLOTHES WASHERS, IN CLASS 7 (U.S. CLS. 13, 19, 21, 23, 31, 34 AND 35).

FIRST USE 8-16-2010; IN COMMERCE 8-16-2010.

THE MARK CONSISTS OF STANDARD CHARACTERS WITHOUT CLAIM TO ANY PARTICULAR FONT, STYLE, SIZE, OR COLOR.

OWNER OF U.S. REG. NOS. 2,733,456, 3,947,935 AND OTHERS.

SER. NO. 85-439,896, FILED 10-5-2011.

ELLEN B. AWRICH, EXAMINING ATTORNEY



David J. Kyffers

Director of the United States Patent and Trademark Office

United States of America

United States Patent and Trademark Office



Reg. No. 4,153,615

Registered June 5, 2012

Int. Cl.: 36

SERVICE MARK

PRINCIPAL REGISTER

SKYWARD PARTNERS, LLC (WASHINGTON LIMITED LIABILITY COMPANY)
P.O. BOX 818
WASHOUGAL, WA 98671

FOR: PROVIDING MONETARY EXCHANGE SERVICES, NAMELY, EXCHANGING GOLD OF OTHERS FOR CASH, IN CLASS 36 (U.S. CLS. 100, 101 AND 102).

FIRST USE 8-1-2011; IN COMMERCE 8-1-2011.

THE MARK CONSISTS OF A HAND WITHIN AN OVAL SHAPED DESIGN, HAVING AN INDEX FINGER POINTING UPWARDS WITH A 12 POINT STAR DESIGN AT THE TIP OF THE INDEX FINGER.

SER. NO. 85-439,912, FILED 10-5-2011.

AMY ALFIERI, EXAMINING ATTORNEY



David J. Kybas

Director of the United States Patent and Trademark Office

United States of America

United States Patent and Trademark Office

Bling Time

Reg. No. 4,153,616

Registered June 5, 2012

Int. Cl.: 14

TRADEMARK

PRINCIPAL REGISTER

BLING TIME, LLC (IOWA LIMITED LIABILITY COMPANY)
1314 NORTHEAST 28TH STREET
ANKENY, IA 50021

FOR: JEWELRY, IN CLASS 14 (U.S. CLS. 2, 27, 28 AND 50).

FIRST USE 11-1-2010; IN COMMERCE 11-1-2010.

THE MARK CONSISTS OF STANDARD CHARACTERS WITHOUT CLAIM TO ANY PARTICULAR FONT, STYLE, SIZE, OR COLOR.

NO CLAIM IS MADE TO THE EXCLUSIVE RIGHT TO USE "BLING", APART FROM THE MARK AS SHOWN.

SER. NO. 85-439,990, FILED 10-5-2011.

MARC LEIPZIG, EXAMINING ATTORNEY



David J. Kyffers

Director of the United States Patent and Trademark Office

United States of America

United States Patent and Trademark Office

Bling Time Interchangeable Accessories

Reg. No. 4,153,617

Registered June 5, 2012

Int. Cl.: 14

TRADEMARK

PRINCIPAL REGISTER

BLING TIME, LLC (IOWA LIMITED LIABILITY COMPANY)
1314 NORTHEAST 28TH STREET
ANKENY, IA 50021

FOR: JEWELRY, IN CLASS 14 (U.S. CLS. 2, 27, 28 AND 50).

FIRST USE 11-1-2010; IN COMMERCE 11-1-2010.

THE MARK CONSISTS OF STANDARD CHARACTERS WITHOUT CLAIM TO ANY PARTICULAR FONT, STYLE, SIZE, OR COLOR.

NO CLAIM IS MADE TO THE EXCLUSIVE RIGHT TO USE "BLING" AND "INTERCHANGEABLE ACCESSORIES", APART FROM THE MARK AS SHOWN.

SER. NO. 85-440,012, FILED 10-5-2011.

MARC LEIPZIG, EXAMINING ATTORNEY



David J. Kyffers

Director of the United States Patent and Trademark Office

United States of America

United States Patent and Trademark Office

Midwest Equity Mortgage

Reg. No. 4,153,618

Registered June 5, 2012

Int. Cl.: 36

SERVICE MARK

PRINCIPAL REGISTER

MIDWEST EQUITY MORTGAGE, LLC (ILLINOIS LIMITED LIABILITY COMPANY), DBA
MIDWEST EQUITY MORTGAGE
2015 SPRING ROAD, STE 330
OAK BROOK, IL 60523

FOR: MORTGAGE BANKING; MORTGAGE BANKING SERVICES, NAMELY, ORIGINATION,
ACQUISITION, SERVICING, SECURITIZATION AND BROKERAGE OF MORTGAGE LOANS;
MORTGAGE LENDING, IN CLASS 36 (U.S. CLS. 100, 101 AND 102).

FIRST USE 1-1-2007; IN COMMERCE 1-1-2007.

THE MARK CONSISTS OF STANDARD CHARACTERS WITHOUT CLAIM TO ANY PAR-
TICULAR FONT, STYLE, SIZE, OR COLOR.

NO CLAIM IS MADE TO THE EXCLUSIVE RIGHT TO USE "EQUITY MORTGAGE", APART
FROM THE MARK AS SHOWN.

SEC. 2(F).

SER. NO. 85-440,027, FILED 10-5-2011.

KIM MONINGHOFF, EXAMINING ATTORNEY



David J. Kyffers

Director of the United States Patent and Trademark Office

United States of America

United States Patent and Trademark Office

KNOCKOUT CHAMPIONSHIP

Reg. No. 4,153,619

DARREN MATSUBARA (UNITED STATES INDIVIDUAL)
147 TALL RUFF DRIVE
LAS VEGAS, NV 89148

Registered June 5, 2012

Int. Cl.: 41

FOR: ARRANGING AND CONDUCTING ATHLETIC COMPETITIONS; ENTERTAINMENT SERVICES, NAMELY, ORGANIZING AND CONDUCTING AN ARRAY OF ATHLETIC EVENTS RENDERED LIVE AND RECORDED FOR THE PURPOSE OF DISTRIBUTION THROUGH BROADCAST MEDIA, IN CLASS 41 (U.S. CLS. 100, 101 AND 107).

SERVICE MARK

PRINCIPAL REGISTER

FIRST USE 9-26-2011; IN COMMERCE 9-26-2011.

THE MARK CONSISTS OF STANDARD CHARACTERS WITHOUT CLAIM TO ANY PARTICULAR FONT, STYLE, SIZE, OR COLOR.

NO CLAIM IS MADE TO THE EXCLUSIVE RIGHT TO USE "CHAMPIONSHIP", APART FROM THE MARK AS SHOWN.

SER. NO. 85-440,074, FILED 10-5-2011.

APRIL ROACH, EXAMINING ATTORNEY



David J. Kyros

Director of the United States Patent and Trademark Office

United States of America

United States Patent and Trademark Office

Veracity Community Foundation

Reg. No. 4,153,620

Registered June 5, 2012

Int. Cl.: 36

SERVICE MARK

PRINCIPAL REGISTER

VERACITY PAYMENT SOLUTIONS (GEORGIA CORPORATION)
SUITE 200
500 NORTHRIDGE ROAD
ATLANTA, GA 30350

FOR: CHARITABLE FOUNDATION SERVICES, NAMELY, PROVIDING CONTRIBUTION TO CHARITABLE GRANT ACCOUNTS FROM PAYMENT PROCESSING FEES, PROGRAMS AND SERVICES, IN CLASS 36 (U.S. CLS. 100, 101 AND 102).

FIRST USE 2-21-2008; IN COMMERCE 2-21-2008.

THE MARK CONSISTS OF STANDARD CHARACTERS WITHOUT CLAIM TO ANY PARTICULAR FONT, STYLE, SIZE, OR COLOR.

NO CLAIM IS MADE TO THE EXCLUSIVE RIGHT TO USE "COMMUNITY FOUNDATION", APART FROM THE MARK AS SHOWN.

SER. NO. 85-440,085, FILED 10-5-2011.

JAMES A. RAUEN, EXAMINING ATTORNEY



David J. Kyfos

Director of the United States Patent and Trademark Office

United States of America

United States Patent and Trademark Office

Chief Greenbud

Reg. No. 4,153,621

HARNETT, SHAWN (UNITED STATES INDIVIDUAL)
PO BOX 120853
NASHVILLE, TN 37212

Registered June 5, 2012

Int. Cls.: 9 and 25

FOR: AUDIO RECORDINGS FEATURING MUSIC, IN CLASS 9 (U.S. CLS. 21, 23, 26, 36 AND 38).

TRADEMARK

FIRST USE 1-1-2007; IN COMMERCE 3-1-2008.

PRINCIPAL REGISTER

FOR: T-SHIRTS , IN CLASS 25 (U.S. CLS. 22 AND 39).

FIRST USE 1-1-2007; IN COMMERCE 3-1-2008.

THE MARK CONSISTS OF STANDARD CHARACTERS WITHOUT CLAIM TO ANY PARTICULAR FONT, STYLE, SIZE, OR COLOR.

"CHIEF GREENBUD" IDENTIFIES THE STAGE NAME OF SHAWN HARNETT, A LIVING INDIVIDUAL WHOSE CONSENT IS OF RECORD.

SER. NO. 85-440,129, FILED 10-5-2011.

LINDSEY RUBIN, EXAMINING ATTORNEY



David J. Kyros

Director of the United States Patent and Trademark Office

United States of America

United States Patent and Trademark Office

Symphony Payment Suite

Reg. No. 4,153,622

Registered June 5, 2012

Int. Cl.: 36

SERVICE MARK

PRINCIPAL REGISTER

VERACITY PAYMENT SOLUTIONS (GEORGIA CORPORATION)
SUITE 200
500 NORTHRIDGE
ATLANTA, GA 30350

FOR: MERCHANT SERVICES, NAMELY, PAYMENT TRANSACTION PROCESSING SERVICES, IN CLASS 36 (U.S. CLS. 100, 101 AND 102).

FIRST USE 10-4-2011; IN COMMERCE 10-4-2011.

THE MARK CONSISTS OF STANDARD CHARACTERS WITHOUT CLAIM TO ANY PARTICULAR FONT, STYLE, SIZE, OR COLOR.

NO CLAIM IS MADE TO THE EXCLUSIVE RIGHT TO USE "PAYMENT SUITE", APART FROM THE MARK AS SHOWN.

SER. NO. 85-440,136, FILED 10-5-2011.

JAMES A. RAUEN, EXAMINING ATTORNEY



David J. Kyros

Director of the United States Patent and Trademark Office

United States of America

United States Patent and Trademark Office

Qwik Slate

Reg. No. 4,153,623

Registered June 5, 2012

Int. Cl.: 19

TRADEMARK

PRINCIPAL REGISTER

QWIK SLATE, INC. (VERMONT CORPORATION)
1075 FERNCLIFF ROAD
POULTNEY, VT 05765

FOR: SLATE AND TILE ROOFING INSTALLATION SYSTEMS IN THE NATURE OF PLASTIC MOUNTING STRIPS AND METAL FASTENING HOOKS, IN CLASS 19 (U.S. CLS. 1, 12, 33 AND 50).

FIRST USE 9-28-2011; IN COMMERCE 9-28-2011.

THE MARK CONSISTS OF STANDARD CHARACTERS WITHOUT CLAIM TO ANY PARTICULAR FONT, STYLE, SIZE, OR COLOR.

NO CLAIM IS MADE TO THE EXCLUSIVE RIGHT TO USE "SLATE", APART FROM THE MARK AS SHOWN.

SER. NO. 85-440,183, FILED 10-5-2011.

JULIE VEPPUMTHARA, EXAMINING ATTORNEY



David J. Kyffers

Director of the United States Patent and Trademark Office

United States of America

United States Patent and Trademark Office



Reg. No. 4,153,624

Registered June 5, 2012

Int. Cl.: 3

TRADEMARK

PRINCIPAL REGISTER

KJAER WEIS, KIRSTEN (DENMARK INDIVIDUAL)
APT. #303
1 WALL STREET COURT
NEW YORK, NY 10005

FOR: COSMETICS, IN CLASS 3 (U.S. CLS. 1, 4, 6, 50, 51 AND 52).

FIRST USE 9-9-2010; IN COMMERCE 9-9-2010.

THE MARK CONSISTS OF THE STYLIZED REPRESENTATION OF THE LETTERS "KW".

SER. NO. 85-440,208, FILED 10-5-2011.

DAVID YONTEF, EXAMINING ATTORNEY



David J. Kyffers

Director of the United States Patent and Trademark Office

United States of America

United States Patent and Trademark Office

QWIK



Slate

Reg. No. 4,153,625

Registered June 5, 2012

Int. Cl.: 19

TRADEMARK

PRINCIPAL REGISTER

QWIK SLATE, INC. (VERMONT CORPORATION)
1075 FERNCLIFF ROAD
POULTNEY, VT 05765

FOR: SLATE AND TILE ROOFING INSTALLATION SYSTEMS IN THE NATURE OF PLASTIC MOUNTING STRIPS AND METAL FASTENING HOOKS, IN CLASS 19 (U.S. CLS. 1, 12, 33 AND 50).

FIRST USE 9-28-2011; IN COMMERCE 9-28-2011.

NO CLAIM IS MADE TO THE EXCLUSIVE RIGHT TO USE "SLATE", APART FROM THE MARK AS SHOWN.

THE MARK CONSISTS OF THE LITERAL ELEMENT "QWIK" CENTERED ABOVE A DESIGN ELEMENT AND THE LITERAL ELEMENT "SLATE" CENTERED BELOW THE DESIGN ELEMENT. THE DESIGN ELEMENT CONSISTS OF AN UPPER PORTION DEFINED BY A LARGER RIGHT TRIANGLE AND A SMALLER RIGHT TRIANGLE ARRANGED TO FORM TWO UPPER CORNERS OF A RECTANGULAR OUTLINE. A FIRST LARGER CHEVRON IS LOCATED BELOW THE TRIANGLES AND TRUNCATED AT ITS RIGHT END, AND A SECOND SMALLER CHEVRON IS LOCATED BELOW THE FIRST CHEVRON AND TRUNCATED AT ITS RIGHT END. THE TRIANGLES AND CHEVRONS DEFINE A RECTANGULAR OUTLINE WITH A RIGHT TRIANGULAR SPACE LOCATED BELOW THE SECOND CHEVRON.

SER. NO. 85-440,210, FILED 10-5-2011.

JULIE VEPPUMTHARA, EXAMINING ATTORNEY



David J. Kyffers

Director of the United States Patent and Trademark Office

United States of America

United States Patent and Trademark Office

A-PLAY CLUB

Reg. No. 4,153,626

AFFINITY GAMING, LLC (NEVADA LIMITED LIABILITY COMPANY)
3440 W. RUSSELL ROAD
LAS VEGAS, NV 89118

Registered June 5, 2012

Int. Cl.: 35

FOR: CUSTOMER LOYALTY SERVICES, NAMELY, ADMINISTRATION OF CUSTOMER LOYALTY PROGRAMS FEATURING LOYALTY COUPONS AND LOYALTY POINTS THAT PROVIDE CASINO BENEFITS TO REWARD REPEAT CUSTOMERS, IN CLASS 35 (U.S. CLS. 100, 101 AND 102).

SERVICE MARK

PRINCIPAL REGISTER

FIRST USE 10-3-2011; IN COMMERCE 10-3-2011.

THE MARK CONSISTS OF STANDARD CHARACTERS WITHOUT CLAIM TO ANY PARTICULAR FONT, STYLE, SIZE, OR COLOR.

NO CLAIM IS MADE TO THE EXCLUSIVE RIGHT TO USE "CLUB", APART FROM THE MARK AS SHOWN.

SER. NO. 85-440,237, FILED 10-5-2011.

KATHERINE E. HALMEN, EXAMINING ATTORNEY



David J. Kyros

Director of the United States Patent and Trademark Office

United States of America

United States Patent and Trademark Office

A-PLAY CLUB

Reg. No. 4,153,627

AFFINITY GAMING, LLC (NEVADA LIMITED LIABILITY COMPANY)
3440 W. RUSSELL ROAD
LAS VEGAS, NV 89118

Registered June 5, 2012

Int. Cl.: 41

FOR: CASINOS; PROVIDING CASINO SERVICES FEATURING A CASINO PLAYERS REWARDS PROGRAM, IN CLASS 41 (U.S. CLS. 100, 101 AND 107).

SERVICE MARK

FIRST USE 10-3-2011; IN COMMERCE 10-3-2011.

PRINCIPAL REGISTER

THE MARK CONSISTS OF STANDARD CHARACTERS WITHOUT CLAIM TO ANY PARTICULAR FONT, STYLE, SIZE, OR COLOR.

NO CLAIM IS MADE TO THE EXCLUSIVE RIGHT TO USE "CLUB", APART FROM THE MARK AS SHOWN.

SER. NO. 85-440,245, FILED 10-5-2011.

KATHERINE E. HALMEN, EXAMINING ATTORNEY



David J. Kybas

Director of the United States Patent and Trademark Office

United States of America

United States Patent and Trademark Office



Reg. No. 4,153,628

Registered June 5, 2012

Int. Cl.: 43

SERVICE MARK

PRINCIPAL REGISTER

SD AUTO, LLC (NORTH CAROLINA LIMITED LIABILITY COMPANY)
12 COLLEGE STREET
ASHEVILLE, NC 28801

FOR: BAR AND RESTAURANT SERVICES; CAFE AND RESTAURANT SERVICES; CARRY-OUT RESTAURANTS; CATERING SERVICES; RESTAURANT SERVICES, IN CLASS 43 (U.S. CLS. 100 AND 101).

FIRST USE 7-27-2000; IN COMMERCE 7-27-2000.

OWNER OF U.S. REG. NO. 3,299,086.

NO CLAIM IS MADE TO THE EXCLUSIVE RIGHT TO USE "CAFE", APART FROM THE MARK AS SHOWN.

THE MARK CONSISTS OF A TREE WITH THE WORDS "TUPELO HONEY CAFE" INSIDE AND A JALOPY UNDERNEATH THE BRANCHES.

SER. NO. 85-440,253, FILED 10-5-2011.

TEJBIR SINGH, EXAMINING ATTORNEY



David J. Kybas

Director of the United States Patent and Trademark Office

United States of America

United States Patent and Trademark Office



Reg. No. 4,153,629

Registered June 5, 2012

Int. Cls.: 30 and 43

TRADEMARK

SERVICE MARK

PRINCIPAL REGISTER

CHICKEN IN A BARREL BBQ (HAWAII SOLE PROPRIETORSHIP)
5015 EMMALANI DRIVE
PRINCEVILLE, HI 96722

FOR: BARBECUE SAUCE; DRY SPICE RUB FOR MEATS AND FISH, IN CLASS 30 (U.S. CL. 46).

FIRST USE 5-31-2010; IN COMMERCE 9-23-2011.

FOR: BAR AND RESTAURANT SERVICES; CAFETERIA AND RESTAURANT SERVICES; CARRY-OUT RESTAURANTS, IN CLASS 43 (U.S. CLS. 100 AND 101).

FIRST USE 5-31-2010; IN COMMERCE 6-28-2010.

THE MARK CONSISTS OF A STYLIZED CHICKEN WEARING SWIM TRUNKS AND STANDING ON A SURF BOARD. THE CHICKEN IS EMERGING FROM A WAVE OF WATER, WITH WAVE FOAM APPEARING BELOW THE WAVE AND EXTENDING BEYOND THE LOWER RIGHT PORTION OF A RECTANGLE CARRIER. A CLOUD APPEARS IN THE UPPER RIGHT PORTION OF THE RECTANGLE.

SER. NO. 85-440,290, FILED 10-5-2011.

KAREN SEVERSON, EXAMINING ATTORNEY



David J. Kyjars

Director of the United States Patent and Trademark Office

United States of America

United States Patent and Trademark Office

Mobile apps for businesses made easy

Reg. No. 4,153,630

Registered June 5, 2012

Int. Cl.: 42

SERVICE MARK

PRINCIPAL REGISTER

BIZNESS APPS (CALIFORNIA LIMITED LIABILITY COMPANY)
SUITE B
234 W. 3RD ST.
CHICO, CA 95928

FOR: PROVIDING TEMPORARY USE OF ON-LINE NON-DOWNLOADABLE SOFTWARE DEVELOPMENT TOOLS FOR USERS TO BE ABLE TO CREATE THEIR OWN COMPUTER SOFTWARE APPLICATION FOR MOBILE PHONES , IN CLASS 42 (U.S. CLS. 100 AND 101).

FIRST USE 6-1-2010; IN COMMERCE 6-1-2010.

THE MARK CONSISTS OF STANDARD CHARACTERS WITHOUT CLAIM TO ANY PARTICULAR FONT, STYLE, SIZE, OR COLOR.

NO CLAIM IS MADE TO THE EXCLUSIVE RIGHT TO USE "MOBILE APPS FOR BUSINESSES", APART FROM THE MARK AS SHOWN.

SER. NO. 85-440,303, FILED 10-5-2011.

MATTHEW MCDOWELL, EXAMINING ATTORNEY



David J. Kyros

Director of the United States Patent and Trademark Office

United States of America

United States Patent and Trademark Office



Reg. No. 4,153,631

Registered June 5, 2012

Int. Cl.: 41

SERVICE MARK

PRINCIPAL REGISTER

ST. NORBERT COLLEGE, INC. (WISCONSIN CORPORATION)
100 GRANT STREET
DE PERE, WI 54115

FOR: EDUCATIONAL SERVICES, NAMELY, PROVIDING COURSES OF INSTRUCTION, CONDUCTING LECTURES, WORKSHOPS, SEMINARS AND CONFERENCES, ALL AT THE COLLEGE LEVEL, AND CONDUCTING EXTENSION COURSES AT THE COLLEGE OR HIGHER LEVEL AND COMMUNITY SERVICE WORKSHOPS AND LECTURE WORKSHOPS IN THE FIELDS OF HUMANITIES AND FINE ARTS, NATURAL SCIENCES, SOCIAL SCIENCES AND INTERNATIONAL STUDIES; ENTERTAINMENT IN THE NATURE OF HOCKEY, FOOTBALL, BASEBALL, BASKETBALL, SOCCER, VOLLEYBALL, SOFTBALL, TRACK, GOLF AND CROSS COUNTRY GAMES/MEETS, THEATER PRODUCTIONS, PUBLIC LECTURES IN THE FIELDS OF HUMANITIES AND FINE ARTS, NATURAL SCIENCES, SOCIAL SCIENCES AND INTERNATIONAL STUDIES, ART EXHIBITIONS, LIVE MUSIC CONCERTS, DANCE AND BALLET PERFORMANCES, AND MOTION PICTURE THEATER SERVICES, IN CLASS 41 (U.S. CLS. 100, 101 AND 107).

FIRST USE 9-1-2007; IN COMMERCE 9-1-2007.

OWNER OF U.S. REG. NO. 2,997,410.

THE MARK CONSISTS OF A KNIGHT ON A HORSE WITH A SHIELD CONTAINING THE LETTERS "SNC" IN ONE HAND AND A LANCE IN THE OTHER HAND, AS IF CHARGING IN BATTLE.

SER. NO. 85-440,379, FILED 10-5-2011.

DOMINICK J. SALEMI, EXAMINING ATTORNEY



David J. Kyffers

Director of the United States Patent and Trademark Office

United States of America

United States Patent and Trademark Office

TOTAL  IRA

Reg. No. 4,153,632

Registered June 5, 2012

Int. Cl.: 36

SERVICE MARK

PRINCIPAL REGISTER

INSPIRAFS, INC. (PENNSYLVANIA CORPORATION), DBA TOTAL IRA
SUITE 101
8 PENN CENTER WEST
PITTSBURGH, PA 15276

FOR: FINANCIAL ADMINISTRATION OF RETIREMENT PLANS; FINANCIAL PLANNING FOR RETIREMENT; INDIVIDUAL RETIREMENT ACCOUNT SERVICES; MUTUAL FUND INVESTMENT; ON-LINE FINANCIAL PLANNING SERVICES; PROVIDING INFORMATION IN THE FIELD OF PERSONAL FINANCE; SECURITIES TRADING AND INVESTING SERVICES FOR OTHERS VIA THE INTERNET, IN CLASS 36 (U.S. CLS. 100, 101 AND 102).

FIRST USE 2-18-2010; IN COMMERCE 2-18-2010.

NO CLAIM IS MADE TO THE EXCLUSIVE RIGHT TO USE "IRA", APART FROM THE MARK AS SHOWN.

THE MARK CONSISTS OF THE WORDS "TOTAL" AND "IRA", SEPARATED BY THREE STYLIZED, INTERMESHED GEARS.

SER. NO. 85-440,463, FILED 10-6-2011.

KATHERINE CHANG, EXAMINING ATTORNEY



David J. Kybas

Director of the United States Patent and Trademark Office

United States of America

United States Patent and Trademark Office

The Beasley Firm, LLC

Reg. No. 4,153,633

Registered June 5, 2012

Int. Cl.: 45

SERVICE MARK

PRINCIPAL REGISTER

THE BEASLEY FIRM, LLC (PENNSYLVANIA LIMITED LIABILITY COMPANY)
1125 WALNUT ST.
PHILADELPHIA, PA 19107

FOR: LEGAL SERVICES, IN CLASS 45 (U.S. CLS. 100 AND 101).

FIRST USE 1-22-2003; IN COMMERCE 1-22-2003.

THE MARK CONSISTS OF STANDARD CHARACTERS WITHOUT CLAIM TO ANY PARTICULAR FONT, STYLE, SIZE, OR COLOR.

NO CLAIM IS MADE TO THE EXCLUSIVE RIGHT TO USE "FIRM, LLC", APART FROM THE MARK AS SHOWN.

SEC. 2(F).

SER. NO. 85-440,466, FILED 10-6-2011.

B. PARADEWELAI, EXAMINING ATTORNEY



David J. Kybas

Director of the United States Patent and Trademark Office

United States of America

United States Patent and Trademark Office

BORN ATHLETE

Reg. No. 4,153,634

ATHLETIC ALL PURPOSE PRODUCTS, L.L.C. (MICHIGAN LIMITED LIABILITY COMPANY)
P.O. BOX 48088
OAK PARK, MI 48237

Registered June 5, 2012

Int. Cl.: 25

FOR: CLOTHING, NAMELY, HATS, SHIRTS, PANTS, SHORTS, JACKETS, SWEATERS, SOCKS, JERSEYS, SPORT BRAS, SKIRTS, DRESSES, HEADBANDS AND VISORS, PADDED ARM SLEEVES AND WRISTBANDS, IN CLASS 25 (U.S. CLS. 22 AND 39).

TRADEMARK

FIRST USE 3-8-1995; IN COMMERCE 1-13-1997.

PRINCIPAL REGISTER

THE MARK CONSISTS OF STANDARD CHARACTERS WITHOUT CLAIM TO ANY PARTICULAR FONT, STYLE, SIZE, OR COLOR.

SER. NO. 85-440,467, FILED 10-6-2011.

MICHAEL KEATING, EXAMINING ATTORNEY



David J. Kybas

Director of the United States Patent and Trademark Office

United States of America

United States Patent and Trademark Office



Reg. No. 4,153,635

Registered June 5, 2012

Int. Cl.: 36

SERVICE MARK

PRINCIPAL REGISTER

VENTURE PACIFIC INSURANCE SERVICES, INC. (CALIFORNIA CORPORATION)
#270
27201 PUERTA REAL
MISSION VIEJA, CA 92691

FOR: CLAIMS ADMINISTRATION SERVICES IN THE FIELD OF HEALTH INSURANCE; CONSULTING AND INFORMATION CONCERNING INSURANCE; INSURANCE ADMINISTRATION; INSURANCE AGENCIES; INSURANCE AND FINANCIAL INFORMATION AND CONSULTANCY SERVICES, IN CLASS 36 (U.S. CLS. 100, 101 AND 102).

FIRST USE 8-1-2010; IN COMMERCE 8-1-2010.

NO CLAIM IS MADE TO THE EXCLUSIVE RIGHT TO USE "BUY SECURITY GUARD INSURANCE.COM", APART FROM THE MARK AS SHOWN.

THE COLOR(S) GREEN, WHITE, BLACK AND GRAY IS/ARE CLAIMED AS A FEATURE OF THE MARK.

THE MARK CONSISTS OF BLACK AND GRAY HUMAN SILHOUETTE WITH A GREEN BUBBLE WITH "BUY" IN STYLIZED WHITE FONT WITHIN IT. BELOW THIS IS "SECURITYGUARD" IN BLACK STYLIZED FONT WITH "INSURANCE.COM" IN GREEN STYLIZED FONT BELOW THAT.

SER. NO. 85-440,494, FILED 10-6-2011.

MARK RADEMACHER, EXAMINING ATTORNEY



David J. Kybas

Director of the United States Patent and Trademark Office

United States of America

United States Patent and Trademark Office

BATES TROY QUALITY DRY CLEANING

Reg. No. 4,153,636

BATES TROY, INC. (NEW YORK CORPORATION)
151 LAUREL AVENUE
BINGHAMTON, NY 13901

Registered June 5, 2012

Int. Cl.: 37

FOR: HEALTHCARE LINEN SERVICES, NAMELY, DRY CLEANING AND LAUNDRY SERVICES, IN CLASS 37 (U.S. CLS. 100, 103 AND 106).

SERVICE MARK

FIRST USE 1-1-2005; IN COMMERCE 9-27-2011.

PRINCIPAL REGISTER

THE MARK CONSISTS OF STANDARD CHARACTERS WITHOUT CLAIM TO ANY PARTICULAR FONT, STYLE, SIZE, OR COLOR.

NO CLAIM IS MADE TO THE EXCLUSIVE RIGHT TO USE "QUALITY DRY CLEANING", APART FROM THE MARK AS SHOWN.

THE NAME "BATES TROY" DOES NOT IDENTIFY A LIVING INDIVIDUAL.

SER. NO. 85-440,495, FILED 10-6-2011.

BRIAN PINO, EXAMINING ATTORNEY



David J. Kyffers

Director of the United States Patent and Trademark Office

United States of America

United States Patent and Trademark Office

Shut Up + Run

Reg. No. 4,153,637

RISDON, ELIZABETH (UNITED STATES INDIVIDUAL)
1185 PURDUE DRIVE
LONGMONT, CO 80503

Registered June 5, 2012

Int. Cl.: 41

FOR: COACHING IN THE FIELD OF SPORTS; ON-LINE JOURNALS, NAMELY, BLOGS
FEATURING THE SUBJECT OF RUNNING, IN CLASS 41 (U.S. CLS. 100, 101 AND 107).

SERVICE MARK

FIRST USE 1-0-2009; IN COMMERCE 1-0-2009.

PRINCIPAL REGISTER

THE MARK CONSISTS OF STANDARD CHARACTERS WITHOUT CLAIM TO ANY PAR-
TICULAR FONT, STYLE, SIZE, OR COLOR.

NO CLAIM IS MADE TO THE EXCLUSIVE RIGHT TO USE "RUN", APART FROM THE
MARK AS SHOWN.

SER. NO. 85-440,525, FILED 10-6-2011.

MELISSA VALLILLO, EXAMINING ATTORNEY



David J. Kybas

Director of the United States Patent and Trademark Office

United States of America

United States Patent and Trademark Office

BOOKBOTTLES

Reg. No. 4,153,638

Registered June 5, 2012

Int. Cl.: 43

SERVICE MARK

PRINCIPAL REGISTER

BOOKBOTTLES, LLC (MINNESOTA LIMITED LIABILITY COMPANY)
1430 COMMERCE STREET #305
ROSEVILLE, MN 55113

FOR: RESERVATION SERVICES, NAMELY, PROVIDING ON-LINE COCKTAIL AND TABLE SERVICE RESERVATIONS AT NIGHT CLUBS, BARS, RESTAURANTS AND LOUNGES FOR OTHERS; PROVIDING A WEBSITE FEATURING INFORMATION AND REVIEWS ABOUT NIGHT CLUBS, BARS AND COCKTAIL LOUNGES, IN CLASS 43 (U.S. CLS. 100 AND 101).

FIRST USE 8-27-2011; IN COMMERCE 8-27-2011.

THE MARK CONSISTS OF STANDARD CHARACTERS WITHOUT CLAIM TO ANY PARTICULAR FONT, STYLE, SIZE, OR COLOR.

SER. NO. 85-440,613, FILED 10-6-2011.

REBECCA SMITH, EXAMINING ATTORNEY



David J. Kybas

Director of the United States Patent and Trademark Office

United States of America

United States Patent and Trademark Office

CLOUDZOOKA

Reg. No. 4,153,639

ZOOKAWARE, LLC (ARIZONA LIMITED LIABILITY COMPANY)
1918 N. HIGHLEY ROAD
MESA, AZ 85205

Registered June 5, 2012

Int. Cl.: 9

FOR: COMPUTER SOFTWARE FOR STORING FILES IN THE CLOUD, IN CLASS 9 (U.S. CLS. 21, 23, 26, 36 AND 38).

TRADEMARK

FIRST USE 5-1-2011; IN COMMERCE 5-1-2011.

PRINCIPAL REGISTER

THE MARK CONSISTS OF STANDARD CHARACTERS WITHOUT CLAIM TO ANY PARTICULAR FONT, STYLE, SIZE, OR COLOR.

OWNER OF U.S. REG. NO. 3,391,016.

SER. NO. 85-440,616, FILED 10-6-2011.

SUSAN STIGLITZ, EXAMINING ATTORNEY



David J. Kybas

Director of the United States Patent and Trademark Office

United States of America

United States Patent and Trademark Office

M1-X

Reg. No. 4,153,640

Registered June 5, 2012

Int. Cl.: 28

TRADEMARK

PRINCIPAL REGISTER

TGIB MARKETING INC. (NEW YORK CORPORATION)
1250 SCOTTSVILLE ROAD, SUITE 3
ROCHESTER, NY 14624

FOR: GOLF CLUBS, IN CLASS 28 (U.S. CLS. 22, 23, 38 AND 50).

FIRST USE 8-0-1991; IN COMMERCE 8-0-1991.

THE MARK CONSISTS OF STANDARD CHARACTERS WITHOUT CLAIM TO ANY PARTICULAR FONT, STYLE, SIZE, OR COLOR.

SER. NO. 85-440,632, FILED 10-6-2011.

JOHN HWANG, EXAMINING ATTORNEY



David J. Kybas

Director of the United States Patent and Trademark Office

United States of America

United States Patent and Trademark Office

ZOOKIT

Reg. No. 4,153,641

ZOOKAWARE, LLC (ARIZONA LIMITED LIABILITY COMPANY)
1918 N. HIGHLEY ROAD
MESA, AZ 85205

Registered June 5, 2012

Int. Cl.: 9

FOR: COMPUTER SOFTWARE FOR STORING IMAGES AND PROGRAMS IN THE CLOUD,
IN CLASS 9 (U.S. CLS. 21, 23, 26, 36 AND 38).

TRADEMARK

FIRST USE 5-1-2011; IN COMMERCE 5-1-2011.

PRINCIPAL REGISTER

THE MARK CONSISTS OF STANDARD CHARACTERS WITHOUT CLAIM TO ANY PARTICULAR FONT, STYLE, SIZE, OR COLOR.

OWNER OF U.S. REG. NO. 3,391,016.

SER. NO. 85-440,645, FILED 10-6-2011.

SUSAN STIGLITZ, EXAMINING ATTORNEY



David J. Kybas

Director of the United States Patent and Trademark Office

United States of America

United States Patent and Trademark Office

ESV

Reg. No. 4,153,642

Registered June 5, 2012

Int. Cl.: 9

TRADEMARK

PRINCIPAL REGISTER

GOOD NEWS PUBLISHERS (ILLINOIS NON-PROFIT CORPORATION)
1300 CRESCENT ST.
WHEATON, IL 60187

FOR: DOWNLOADABLE SOFTWARE IN THE NATURE OF A MOBILE APPLICATION FOR PROVIDING INFORMATION IN THE FIELD OF RELIGION, IN CLASS 9 (U.S. CLS. 21, 23, 26, 36 AND 38).

FIRST USE 3-16-2011; IN COMMERCE 3-16-2011.

THE MARK CONSISTS OF STANDARD CHARACTERS WITHOUT CLAIM TO ANY PARTICULAR FONT, STYLE, SIZE, OR COLOR.

OWNER OF U.S. REG. NOS. 3,008,631, 3,746,835 AND OTHERS.

SER. NO. 85-440,648, FILED 10-6-2011.

MICHAEL TANNER, EXAMINING ATTORNEY



David J. Kyffers

Director of the United States Patent and Trademark Office

United States of America

United States Patent and Trademark Office

Reddle Valley

Reg. No. 4,153,643

Registered June 5, 2012

Int. Cl.: 33

TRADEMARK

PRINCIPAL REGISTER

KMBJ INC. (CALIFORNIA CORPORATION)
150 N SANTA ANITA AVE. STE 220
ARCADIA, CA 91006

FOR: WINE, IN CLASS 33 (U.S. CLS. 47 AND 49).

FIRST USE 3-2-2011; IN COMMERCE 8-15-2011.

THE MARK CONSISTS OF STANDARD CHARACTERS WITHOUT CLAIM TO ANY PARTICULAR FONT, STYLE, SIZE, OR COLOR.

SER. NO. 85-440,649, FILED 10-6-2011.

DORITT L. CARROLL, EXAMINING ATTORNEY



David J. Kyros

Director of the United States Patent and Trademark Office

United States of America
United States Patent and Trademark Office

REGZOOKA

Reg. No. 4,153,644

ZOOKAWARE, LLC (ARIZONA LIMITED LIABILITY COMPANY)
1918 N. HIGHLEY ROAD
MESA, AZ 85205

Registered June 5, 2012

Int. Cl.: 9

FOR: COMPUTER SOFTWARE FOR USE IN DIAGNOSIS, REPAIR AND CONFIGURATION OF COMPUTERS, SOFTWARE AND COMPUTER PERIPHERALS, IN CLASS 9 (U.S. CLS. 21, 23, 26, 36 AND 38).

TRADEMARK

FIRST USE 11-4-2010; IN COMMERCE 11-4-2010.

PRINCIPAL REGISTER

THE MARK CONSISTS OF STANDARD CHARACTERS WITHOUT CLAIM TO ANY PARTICULAR FONT, STYLE, SIZE, OR COLOR.

OWNER OF U.S. REG. NO. 3,391,016.

SER. NO. 85-440,656, FILED 10-6-2011.

SUSAN STIGLITZ, EXAMINING ATTORNEY



David J. Kyffers

Director of the United States Patent and Trademark Office

United States of America

United States Patent and Trademark Office

DEKEU[®]United

Reg. No. 4,153,645

DELTA KAPPA EPSILON FRATERNITY (NEW YORK CORPORATION)
P.O. BOX 8360
ANN ARBOR, MI 48107

Registered June 5, 2012

Int. Cl.: 45

FOR: ON-LINE SOCIAL NETWORKING SERVICES, IN CLASS 45 (U.S. CLS. 100 AND 101).

SERVICE MARK

FIRST USE 9-0-2011; IN COMMERCE 9-0-2011.

PRINCIPAL REGISTER

THE MARK CONSISTS OF STANDARD CHARACTERS WITHOUT CLAIM TO ANY PARTICULAR FONT, STYLE, SIZE, OR COLOR.

SER. NO. 85-440,661, FILED 10-6-2011.

CARYN GLASSER, EXAMINING ATTORNEY



David J. Kyffers

Director of the United States Patent and Trademark Office

United States of America

United States Patent and Trademark Office



Reg. No. 4,153,646

Registered June 5, 2012

Int. Cls.: 35 and 36

SERVICE MARK

PRINCIPAL REGISTER

OPERATION STARS & STRIPES, INC. (GEORGIA CHARITABLE, NON-PROFIT CORPORATION)
483 OLD CANTON RD., STE. 100
MARIETTA, GA 30068

FOR: CHARITABLE SERVICES, NAMELY, ORGANIZING AND CONDUCTING VOLUNTEER PROGRAMS AND COMMUNITY SERVICE PROJECTS AIMED AT INCREASING SUPPORT AND MORALE OF FAMILIES OF DECEASED WAR VETERANS, WAR VETERANS, CURRENT MEMBERS AND FUTURE MEMBERS OF THE U.S. MILITARY; CHARITABLE SERVICES, NAMELY, ORGANIZING AND CONDUCTING VOLUNTEER PROGRAMS AND COMMUNITY SERVICE PROJECTS AIMED AT INCREASING SUPPORT AND MORALE OF MEMBERS OF THE U.S. MILITARY, IN CLASS 35 (U.S. CLS. 100, 101 AND 102).

FIRST USE 7-4-2001; IN COMMERCE 8-20-2001.

FOR: ACCEPTING AND ADMINISTERING MONETARY CHARITABLE CONTRIBUTIONS TO ASSIST UNITED STATES SERVICE PERSONS SERVING IN COMBAT ZONES OR WOUNDED AND IN MILITARY HOSPITALS, IN CLASS 36 (U.S. CLS. 100, 101 AND 102).

FIRST USE 7-4-2001; IN COMMERCE 8-20-2001.

NO CLAIM IS MADE TO THE EXCLUSIVE RIGHT TO USE "INC.", APART FROM THE MARK AS SHOWN.

THE COLOR(S) BLUE, RED AND WHITE IS/ARE CLAIMED AS A FEATURE OF THE MARK.

THE MARK CONSISTS OF A BLUE, FIVE POINTED STAR WITH COLOR SATURATION IN THE MIDDLE OF THE STAR, FADING TOWARD THE EDGES. TO THE LEFT OF THE STAR ARE A RED, CURVED, TAPERED TRAIL ABOVE A WHITE SPACE AND THEN A WIDER BLUE, CURVED TRAIL THAT OVERLAPS WITH THE LEFTMOST POINT OF THE STAR. BOTH TRAILS ARE DARKER IN COLOR CLOSER TO THE STAR. BELOW THE STAR AND TRAILS IS THE WORD "OPERATION" IN A BLUE STENCIL FONT. BELOW "OPERATION" ARE THE WORDS "STARS & STRIPES, INC." "STARS" IS IN RED, IN THE SAME STENCIL FONT IN A LARGER SIZE. "& STRIPES" IS IN THE SAME FONT AND SIZE, BUT IN BLUE. "INC." IS ALSO IN A BLUE STENCIL FONT, BUT IS MUCH SMALLER. BELOW THE LITERAL ELEMENTS ARE TWO THIN HORIZONTAL LINES, THE TOP RED, THE BOTTOM BLUE, WITH A WHITE SPACE BETWEEN.



David J. Kyjars

Director of the United States Patent and Trademark Office

Reg. No. 4,153,646 SER. NO. 85-440,663, FILED 10-6-2011.

KATHLEEN LORENZO, EXAMINING ATTORNEY

United States of America

United States Patent and Trademark Office

WORTHY OF THE INVESTMENT

Reg. No. 4,153,647

Registered June 5, 2012

Int. Cl.: 37

SERVICE MARK

PRINCIPAL REGISTER

CHRISTOPHER CLEMENTE (UNITED STATES INDIVIDUAL)
11465 SUNSET HILLS ROAD, 4TH FLOOR
RESTON, VA 20190

FOR: CONSTRUCTION SERVICES, NAMELY, PLANNING, LAYING OUT, DEVELOPING, AND CONSTRUCTING RESIDENTIAL COMMUNITIES, MULTIFAMILY RESIDENTIAL COMMUNITIES, AND COMMERCIAL BUILDINGS, IN CLASS 37 (U.S. CLS. 100, 103 AND 106).

FIRST USE 12-31-1991; IN COMMERCE 12-31-1991.

THE MARK CONSISTS OF STANDARD CHARACTERS WITHOUT CLAIM TO ANY PARTICULAR FONT, STYLE, SIZE, OR COLOR.

SER. NO. 85-440,737, FILED 10-6-2011.

NANCY CLARKE, EXAMINING ATTORNEY



David J. Kybas

Director of the United States Patent and Trademark Office

United States of America

United States Patent and Trademark Office

SWIM

Reg. No. 4,153,648

Registered June 5, 2012

Int. Cl.: 19

TRADEMARK

PRINCIPAL REGISTER

MODULAR ARTS, INC. (WASHINGTON CORPORATION)
4215 23RD AVENUE WEST
SEATTLE, WA 98199

FOR: NON-METALLIC BUILDING MATERIALS, NAMELY, GYPSUM-BASED PANELS AND TILES, IN CLASS 19 (U.S. CLS. 1, 12, 33 AND 50).

FIRST USE 9-0-2007; IN COMMERCE 9-0-2007.

THE MARK CONSISTS OF STANDARD CHARACTERS WITHOUT CLAIM TO ANY PARTICULAR FONT, STYLE, SIZE, OR COLOR.

SER. NO. 85-440,740, FILED 10-6-2011.

DAVID C. REIHNER, EXAMINING ATTORNEY



David J. Kybas

Director of the United States Patent and Trademark Office

United States of America

United States Patent and Trademark Office

DBT

Reg. No. 4,153,649

Registered June 5, 2012

Int. Cl.: 25

TRADEMARK

PRINCIPAL REGISTER

DBT WORLDWIDE, LLC (INDIANA LIMITED LIABILITY COMPANY)
12719 TOUCHDOWN DRIVE
FISHERS, IN 46037

FOR: T-SHIRTS, IN CLASS 25 (U.S. CLS. 22 AND 39).

FIRST USE 12-1-2009; IN COMMERCE 12-1-2009.

THE MARK CONSISTS OF STANDARD CHARACTERS WITHOUT CLAIM TO ANY PARTICULAR FONT, STYLE, SIZE, OR COLOR.

SER. NO. 85-440,747, FILED 10-6-2011.

ERNEST SHOSHO, EXAMINING ATTORNEY



David J. Kyffers

Director of the United States Patent and Trademark Office

United States of America

United States Patent and Trademark Office



Reg. No. 4,153,650

Registered June 5, 2012

Int. Cl.: 9

TRADEMARK

PRINCIPAL REGISTER

PRODISC TECHNOLOGY INC. (TAIWAN CORPORATION)
1F., NO.39, BAOQING ST., XINDIAN DIST.
NEW TAIPEI CITY, TAIWAN 23143

FOR: BLANK FLOPPY DISKS FOR COMPUTERS; OPTICAL DISKS; DISKS FOR CLEANING COMPUTER DISK DRIVES; COMPUTER MEMORIES; LIGHT EMITTING DIODES; BLANK VIDEO DISKS; BLANK COMPACT DISKS; . COMPACT DISKS CONTAINING COMPUTER PROGRAMS FOR OPERATING SYSTEMS, MANAGING DATABASES AND WORD PROCESSING; TELECONFERENCING SYSTEMS, NAMELY, DIGITAL CAMERAS, PHOTOGRAPH CATCH CARDS, MICROPHONES AND EARPHONES; BATTERIES; DISPLAY MAGNIFIER TO ENLARGE PORTIONS OF A SCREEN FOR CREATING MORE READABLE VIEW; ANTI-SHATTER ACRYLIC PROTECTOR SHIELDS FOR COMPUTER MONITORS; TELEVISION SCREEN PROTECTORS IN THE NATURE OF ACRYLIC SHIELDS TO BE MOUNTED OVER TELEVISION SCREENS, IN CLASS 9 (U.S. CLS. 21, 23, 26, 36 AND 38).

FIRST USE 1-1-1999; IN COMMERCE 1-1-2000.

OWNER OF U.S. REG. NO. 2,546,257.

SER. NO. 85-440,761, FILED 10-6-2011.

MARK RADEMACHER, EXAMINING ATTORNEY



David J. Kybas

Director of the United States Patent and Trademark Office

United States of America

United States Patent and Trademark Office

SEA WATCH

Reg. No. 4,153,651

Registered June 5, 2012

Int. Cl.: 43

SERVICE MARK

PRINCIPAL REGISTER

SEA WATCH RESORT, LLC (SOUTH CAROLINA LIMITED LIABILITY COMPANY)
2105 FARLOW STREET
MYRTLE BEACH, SC 29577

FOR: HOTEL SERVICES; RESORT LODGING SERVICES, IN CLASS 43 (U.S. CLS. 100 AND 101).

FIRST USE 9-9-1997; IN COMMERCE 9-9-1997.

THE MARK CONSISTS OF STANDARD CHARACTERS WITHOUT CLAIM TO ANY PARTICULAR FONT, STYLE, SIZE, OR COLOR.

OWNER OF U.S. REG. NO. 2,500,302.

SER. NO. 85-440,772, FILED 10-6-2011.

ALYSSA STEEL, EXAMINING ATTORNEY



David J. Kyffers

Director of the United States Patent and Trademark Office

United States of America

United States Patent and Trademark Office

DomainContext

Reg. No. 4,153,652

Registered June 5, 2012

Int. Cl.: 45

SERVICE MARK

PRINCIPAL REGISTER

DOMAINCONTEXT INC. (DELAWARE CORPORATION)
501 SILVERSIDE RD
105
WILMINGTON, DE 198091376

FOR: AUTHENTICATION, ISSUANCE AND VALIDATION OF DIGITAL CERTIFICATES;
DOMAIN NAME REGISTRATION SERVICES, IN CLASS 45 (U.S. CLS. 100 AND 101).

FIRST USE 8-8-2007; IN COMMERCE 3-2-2009.

THE MARK CONSISTS OF STANDARD CHARACTERS WITHOUT CLAIM TO ANY PARTICULAR FONT, STYLE, SIZE, OR COLOR.

SER. NO. 85-440,773, FILED 10-6-2011.

MICHAEL GAAFAR, EXAMINING ATTORNEY



David J. Kyffers

Director of the United States Patent and Trademark Office

United States of America

United States Patent and Trademark Office

DUKK THE WOODCHUCK GAME

Reg. No. 4,153,653

MAY WILHELM, LLC (ARIZONA LIMITED LIABILITY COMPANY)
3608 W. COCHISE DR.
PHOENIX, AZ 85051

Registered June 5, 2012

Int. Cl.: 28

FOR: GAMES, NAMELY, KUBB; WOODEN PIECES FOR PLAYING A YARD GAME, IN CLASS 28 (U.S. CLS. 22, 23, 38 AND 50).

TRADEMARK

FIRST USE 7-9-2011; IN COMMERCE 7-9-2011.

PRINCIPAL REGISTER

THE MARK CONSISTS OF STANDARD CHARACTERS WITHOUT CLAIM TO ANY PARTICULAR FONT, STYLE, SIZE, OR COLOR.

NO CLAIM IS MADE TO THE EXCLUSIVE RIGHT TO USE "GAME", APART FROM THE MARK AS SHOWN.

SER. NO. 85-440,812, FILED 10-6-2011.

MARK RADEMACHER, EXAMINING ATTORNEY



David J. Kybas

Director of the United States Patent and Trademark Office

United States of America

United States Patent and Trademark Office

JUST A RUMOR

Reg. No. 4,153,654

ALL ACCESS APPAREL, INC. (CALIFORNIA CORPORATION)
1515 GAGE ROAD
MONTEBELLO, CA 90640

Registered June 5, 2012

Int. Cl.: 25

FOR: BOTTOMS; DRESSES; JACKETS; LINGERIE; SCARVES; TOPS, IN CLASS 25 (U.S. CLS. 22 AND 39).

TRADEMARK

FIRST USE 7-0-2011; IN COMMERCE 7-0-2011.

PRINCIPAL REGISTER

THE MARK CONSISTS OF STANDARD CHARACTERS WITHOUT CLAIM TO ANY PARTICULAR FONT, STYLE, SIZE, OR COLOR.

SER. NO. 85-440,813, FILED 10-6-2011.

RUSS HERMAN, EXAMINING ATTORNEY



David J. Kybas

Director of the United States Patent and Trademark Office

United States of America

United States Patent and Trademark Office

Biokeen

Reg. No. 4,153,655

Registered June 5, 2012

Int. Cl.: 35

SERVICE MARK

PRINCIPAL REGISTER

BIOKEEN INC. (CALIFORNIA CORPORATION)
1227 FULTON STREET
PALO ALTO, CA 94301

FOR: PROVIDING AN ON-LINE SEARCHABLE DATABASE FEATURING CLASSIFIED AD LISTINGS AND EMPLOYMENT OPPORTUNITIES, IN CLASS 35 (U.S. CLS. 100, 101 AND 102).

FIRST USE 8-26-2010; IN COMMERCE 8-26-2010.

THE MARK CONSISTS OF STANDARD CHARACTERS WITHOUT CLAIM TO ANY PARTICULAR FONT, STYLE, SIZE, OR COLOR.

SER. NO. 85-440,835, FILED 10-6-2011.

JOHN HWANG, EXAMINING ATTORNEY



David J. Kybas

Director of the United States Patent and Trademark Office

United States of America

United States Patent and Trademark Office

STONE STREET CAPITAL

Reg. No. 4,153,656

Registered June 5, 2012

Int. Cl.: 36

SERVICE MARK

PRINCIPAL REGISTER

STONE STREET CAPITAL, LLC (MARYLAND LIMITED LIABILITY COMPANY)
SUITE 500
7316 WISCONSIN AVENUE
BETHESDA, MD 20814

FOR: FINANCIAL SERVICES, NAMELY, PURCHASE OF LOTTERY OR CONTEST WINNINGS, SLOT JACKPOT PRIZES, ANNUITIES, AND INSURANCE SETTLEMENTS , IN CLASS 36 (U.S. CLS. 100, 101 AND 102).

FIRST USE 11-1-2004, THE MARK WAS FIRST USED ANYWHERE IN A DIFFERENT FORM OTHER THAN THAT SOUGHT TO BE REGISTERED AT LEAST AS EARLY AS 01/01/2000.; IN COMMERCE 11-1-2004, THE MARK WAS FIRST USED IN COMMERCE IN A DIFFERENT FORM OTHER THAN THAT SOUGHT TO BE REGISTERED AT LEAST AS EARLY AS 01/01/2000..

THE MARK CONSISTS OF STANDARD CHARACTERS WITHOUT CLAIM TO ANY PARTICULAR FONT, STYLE, SIZE, OR COLOR.

OWNER OF U.S. REG. NO. 3,899,823.

NO CLAIM IS MADE TO THE EXCLUSIVE RIGHT TO USE "CAPITAL", APART FROM THE MARK AS SHOWN.

SER. NO. 85-440,838, FILED 10-6-2011.

KIM MONINGHOFF, EXAMINING ATTORNEY



David J. Kyros

Director of the United States Patent and Trademark Office

United States of America

United States Patent and Trademark Office

Rhythmic Circus

Reg. No. 4,153,657

Registered June 5, 2012

Int. Cls.: 9 and 41

TRADEMARK

SERVICE MARK

PRINCIPAL REGISTER

RHYTHMIC CIRCUS, LLC. (MINNESOTA LIMITED LIABILITY COMPANY), DBA
RHYTHMIC CIRCUS
12333 EVERGREEN ST. NW
COON RAPIDS, MN 55448

FOR: AUDIO AND VIDEO RECORDINGS FEATURING MUSIC AND ARTISTIC PERFORMANCES; MUSICAL SOUND RECORDINGS; MUSICAL VIDEO RECORDINGS; PRE-RECORDED CDS, VIDEO TAPES, LASER DISKS AND DVDS FEATURING LIVE MUSICAL AND DANCE PERFORMANCES.; VIDEO RECORDINGS FEATURING MUSICAL AND DANCE PERFORMANCES.; VISUAL AND AUDIO RECORDINGS FEATURING MUSICAL AND DANCE PERFORMANCES, IN CLASS 9 (U.S. CLS. 21, 23, 26, 36 AND 38).

FIRST USE 1-11-2009; IN COMMERCE 1-11-2009.

FOR: DANCE EVENTS; DANCE INSTRUCTION; DANCE INSTRUCTION FOR CHILDREN; EDUCATION SERVICES, NAMELY, PROVIDING CLASSES AND INSTRUCTION IN THE FIELD OF DANCE; ENTERTAINMENT IN THE NATURE OF DANCE PERFORMANCES; ENTERTAINMENT IN THE NATURE OF VISUAL AND AUDIO PERFORMANCES, NAMELY, MUSICAL BAND, ROCK GROUP, GYMNASTIC, DANCE, AND BALLET PERFORMANCES; ENTERTAINMENT SERVICES IN THE NATURE OF LIVE MUSICAL PERFORMANCES; ENTERTAINMENT, NAMELY, LIVE MUSIC CONCERTS; ENTERTAINMENT, NAMELY, LIVE PERFORMANCES BY A MUSICAL BAND; LIVE PERFORMANCES BY A MUSICAL GROUP, IN CLASS 41 (U.S. CLS. 100, 101 AND 107).

FIRST USE 1-11-2009; IN COMMERCE 1-11-2009.

THE MARK CONSISTS OF STANDARD CHARACTERS WITHOUT CLAIM TO ANY PARTICULAR FONT, STYLE, SIZE, OR COLOR.

SER. NO. 85-440,839, FILED 10-6-2011.

DOMINIC FATHY, EXAMINING ATTORNEY



David J. Kyffers

Director of the United States Patent and Trademark Office

United States of America

United States Patent and Trademark Office

BluFi

Reg. No. 4,153,658

Registered June 5, 2012

Int. Cl.: 36

SERVICE MARK

PRINCIPAL REGISTER

BLUFI LENDING CORPORATION (CALIFORNIA CORPORATION)
190
1808 ASTON AVENUE
CARLSBAD, CA 92008

FOR: MORTGAGE LENDING, IN CLASS 36 (U.S. CLS. 100, 101 AND 102).

FIRST USE 1-20-2009; IN COMMERCE 1-20-2009.

THE MARK CONSISTS OF STANDARD CHARACTERS WITHOUT CLAIM TO ANY PARTICULAR FONT, STYLE, SIZE, OR COLOR.

SER. NO. 85-440,848, FILED 10-6-2011.

MICHELE SWAIN, EXAMINING ATTORNEY



David J. Kybas

Director of the United States Patent and Trademark Office

United States of America

United States Patent and Trademark Office

AIM HIGH! TIPS

Reg. No. 4,153,659

Registered June 5, 2012

Int. Cl.: 45

SERVICE MARK

PRINCIPAL REGISTER

BRADLEY IAN BERGER (UNITED STATES INDIVIDUAL)
45 HEDGEROW LANE
MANALAPAN, NJ 07726

FOR: PROVIDING A WEB SITE FEATURING INFORMATION AND CONTENT IN THE FIELDS OF PERSONAL RELATIONSHIPS, PERSONAL GROWTH AND MOTIVATION, AND SELF-FULFILLMENT, IN CLASS 45 (U.S. CLS. 100 AND 101).

FIRST USE 8-0-2011; IN COMMERCE 8-0-2011.

THE MARK CONSISTS OF STANDARD CHARACTERS WITHOUT CLAIM TO ANY PARTICULAR FONT, STYLE, SIZE, OR COLOR.

OWNER OF U.S. REG. NO. 3,124,414.

NO CLAIM IS MADE TO THE EXCLUSIVE RIGHT TO USE "TIPS", APART FROM THE MARK AS SHOWN.

SER. NO. 85-440,856, FILED 10-6-2011.

JOHN HWANG, EXAMINING ATTORNEY



David J. Kyffers

Director of the United States Patent and Trademark Office

United States of America

United States Patent and Trademark Office

AIM HIGH! 101 TIPS

Reg. No. 4,153,660

BRADLEY IAN BERGER (UNITED STATES INDIVIDUAL)
45 HEDGEROW LANE
MANALAPAN, NJ 07726

Registered June 5, 2012

Int. Cl.: 45

FOR: PROVIDING A WEB SITE FEATURING INFORMATION AND CONTENT IN THE FIELDS OF PERSONAL RELATIONSHIPS, PERSONAL GROWTH AND MOTIVATION, AND SELF-FULFILLMENT, IN CLASS 45 (U.S. CLS. 100 AND 101).

SERVICE MARK

FIRST USE 8-0-2011; IN COMMERCE 8-0-2011.

PRINCIPAL REGISTER

THE MARK CONSISTS OF STANDARD CHARACTERS WITHOUT CLAIM TO ANY PARTICULAR FONT, STYLE, SIZE, OR COLOR.

OWNER OF U.S. REG. NO. 3,124,414.

NO CLAIM IS MADE TO THE EXCLUSIVE RIGHT TO USE "101 TIPS", APART FROM THE MARK AS SHOWN.

SER. NO. 85-440,873, FILED 10-6-2011.

JOHN HWANG, EXAMINING ATTORNEY



David J. Kybas

Director of the United States Patent and Trademark Office

United States of America

United States Patent and Trademark Office



Reg. No. 4,153,661

BATES TROY, INC. (NEW YORK CORPORATION)
151 LAUREL AVENUE
BINGHAMTON, NY 13905

Registered June 5, 2012

Int. Cl.: 37

FOR: DRY CLEANING AND LAUNDRY SERVICES, IN CLASS 37 (U.S. CLS. 100, 103 AND 106).

SERVICE MARK

FIRST USE 12-31-1969; IN COMMERCE 9-27-2011.

PRINCIPAL REGISTER

THE NAME "BATES TROY" DOES NOT IDENTIFY A LIVING INDIVIDUAL.

THE MARK CONSISTS OF A FLOWER-LIKE IMAGE TO THE LEFT OF THE WORDS "BATES TROY" AND A WATER-LIKE DESIGN UNDER THE FLOWER AND THE WORDS.

SER. NO. 85-440,894, FILED 10-6-2011.

BRIAN PINO, EXAMINING ATTORNEY



David J. Kybas

Director of the United States Patent and Trademark Office

United States of America

United States Patent and Trademark Office

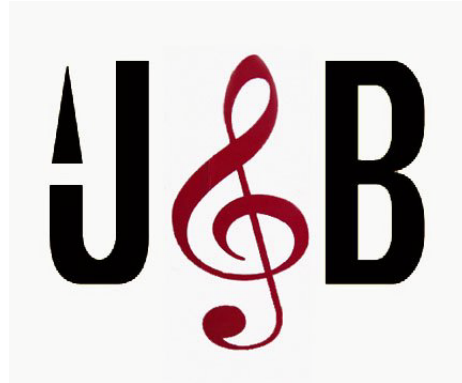

Reg. No. 4,153,662

Registered June 5, 2012

Int. Cl.: 9

TRADEMARK

PRINCIPAL REGISTER

BERNARDO SHTEREMBERG (UNITED STATES INDIVIDUAL)
1800 N. W. 95 AVE.
DORAL, FL 33172

FOR: APPARATUS AND INSTRUMENTS FOR RECORDING, TRANSMISSION, AND REPRODUCTION OF SOUND, NAMELY, STEREO SYSTEMS, SPEAKERS, AMPLIFIERS, SOUNDS REPRODUCTION EQUIPMENT, TUNERS, MICROPHONES, WIRELESS MICROPHONES, HEADPHONES, RADIOS, RECEIVERS; ELECTRICAL AND ELECTRONIC DEVICES, NAMELY, POWER ADAPTERS, CONNECTORS, POWER SUPPLIES, SWITCHES, ANTENNAS, BREAD BOARDS, CABLES, CAPACITORS, CONVERTERS, TRANSFORMERS, AND WOOFERS, IN CLASS 9 (U.S. CLS. 21, 23, 26, 36 AND 38).

FIRST USE 1-1-1984; IN COMMERCE 5-1-1984.

THE MARK CONSISTS OF THE LETTER "J" IN BLACK, FOLLOWED BY A PINK TREBLE CLEF MUSICAL NOTE SYMBOL, FOLLOWED BY THE LETTER "B" IN BLACK. ABOVE THE FIRST PORTION OF THE CURVE OF THE BLACK LETTER "J" IS A BLACK TRIANGLE.

THE COLOR(S) BLACK AND PINK IS/ARE CLAIMED AS A FEATURE OF THE MARK.

SER. NO. 85-440,898, FILED 10-6-2011.

DANNEAN HETZEL, EXAMINING ATTORNEY



David J. Kybas

Director of the United States Patent and Trademark Office

United States of America

United States Patent and Trademark Office

CLICKDIMENSIONS

Reg. No. 4,153,663

Registered June 5, 2012

Int. Cl.: 42

SERVICE MARK

PRINCIPAL REGISTER

CLICKDIMENSIONS, LLC (GEORGIA LIMITED LIABILITY COMPANY)
5354 REDFIELD RD.
DUNWOODY, GA 30338

FOR: SOFTWARE AS A SERVICE (SAAS) SERVICES FEATURING SOFTWARE IN THE FIELD OF E-MAIL MARKETING AND MARKETING ANALYTICS, IN CLASS 42 (U.S. CLS. 100 AND 101).

FIRST USE 6-0-2010; IN COMMERCE 9-0-2010.

THE MARK CONSISTS OF STANDARD CHARACTERS WITHOUT CLAIM TO ANY PARTICULAR FONT, STYLE, SIZE, OR COLOR.

SER. NO. 85-440,900, FILED 10-6-2011.

KATHRYN COWARD, EXAMINING ATTORNEY



David J. Kyros

Director of the United States Patent and Trademark Office

United States of America

United States Patent and Trademark Office

I LIKE IT WILD!

Reg. No. 4,153,664

Registered June 5, 2012

Int. Cl.: 35

SERVICE MARK

PRINCIPAL REGISTER

THE WILDERNESS SOCIETY (D.C. CORPORATION)
1615 M STREET, NW
WASHINGTON, DC 20036

FOR: PUBLIC ADVOCACY TO PROMOTE AWARENESS OF ENVIRONMENTAL CONSERVATION AND THE IMPORTANCE OF PROTECTING PUBLIC LANDS, IN CLASS 35 (U.S. CLS. 100, 101 AND 102).

FIRST USE 2-2-2011; IN COMMERCE 2-2-2011.

THE MARK CONSISTS OF STANDARD CHARACTERS WITHOUT CLAIM TO ANY PARTICULAR FONT, STYLE, SIZE, OR COLOR.

SER. NO. 85-440,921, FILED 10-6-2011.

ROBIN CHOSID, EXAMINING ATTORNEY



David J. Kyffers

Director of the United States Patent and Trademark Office

United States of America

United States Patent and Trademark Office

Work Fit. Live Fit.

Reg. No. 4,153,665

Registered June 5, 2012

Int. Cl.: 41

SERVICE MARK

PRINCIPAL REGISTER

FIT COMPANY INSTITUTE LLC (TEXAS LIMITED LIABILITY COMPANY)
#226
300 NORTH LAMAR BLVD.
AUSTIN, TX 78703

FOR: PROVIDING RECOGNITION AND INCENTIVES TO COMPANIES BY WAY OF AWARDS TO DEMONSTRATE EXCELLENCE IN THEIR EFFORTS IN IMPLEMENTING FITNESS AND HEALTH PROGRAMS AND CREATING COMPANY CULTURES THAT PRIORITIZE FITNESS AND HEALTH; ARRANGING AND CONDUCTING RACES AND FITNESS COMPETITIONS FOR COMPANIES, THEIR EMPLOYEES AND EXECUTIVES; ARRANGING AND PROVIDING LIVE AND ON-LINE SEMINARS, CLASSES AND CONFERENCES IN THE FIELD OF FITNESS AND HEALTH PROGRAM DEVELOPMENT AT COMPANIES AND THE DEVELOPMENT OF COMPANY CULTURE THAT PRIORITIZES FITNESS AND HEALTH, IN CLASS 41 (U.S. CLS. 100, 101 AND 107).

FIRST USE 9-9-2011; IN COMMERCE 9-9-2011.

THE MARK CONSISTS OF STANDARD CHARACTERS WITHOUT CLAIM TO ANY PARTICULAR FONT, STYLE, SIZE, OR COLOR.

SER. NO. 85-440,923, FILED 10-6-2011.

KELLY TRUSILO, EXAMINING ATTORNEY



David J. Kyros

Director of the United States Patent and Trademark Office

United States of America

United States Patent and Trademark Office

SEXSIE

Reg. No. 4,153,666

Registered June 5, 2012

Int. Cl.: 25

TRADEMARK

PRINCIPAL REGISTER

WESTLAND, DEVON (UNITED STATES INDIVIDUAL)
6 CAYUGA AVE.
MASHPEE, MA 02649

FOR: BANDANAS; BATHING SUITS; BOOTS; BRAS; BUTTON DOWN SHIRTS; CAPRIS; COLLARED SHIRTS; CREW NECKS; FLIP FLOPS; HATS; HOODED SWEATSHIRTS; JACKETS; JEANS; LONG-SLEEVED SHIRTS; POLO SHIRTS; SHOES; SNEAKERS; SWEATPANTS; T-SHIRTS; TIES; VESTS, IN CLASS 25 (U.S. CLS. 22 AND 39).

FIRST USE 9-25-2011; IN COMMERCE 9-25-2011.

THE MARK CONSISTS OF STANDARD CHARACTERS WITHOUT CLAIM TO ANY PARTICULAR FONT, STYLE, SIZE, OR COLOR.

SER. NO. 85-440,924, FILED 10-6-2011.

MICHAEL TANNER, EXAMINING ATTORNEY



David J. Kyffers

Director of the United States Patent and Trademark Office

United States of America

United States Patent and Trademark Office

KANGOL

Reg. No. 4,153,667

Registered June 5, 2012

Int. Cl.: 25

TRADEMARK

PRINCIPAL REGISTER

KANGOL LIMITED (UNITED KINGDOM COMPANY)
UNIT A, BROOK PARK EAST
SHIREBROOK, UNITED KINGDOM NG208RY

FOR: FOOTWEAR; CLOTHING, NAMELY, SHIRTS, SWEATSHIRTS, SWEATERS, PANTS, SHORTS, JACKETS, VESTS, COATS, HATS, GLOVES, UNDERWEAR, GAITERS, SCARVES, SOCKS, AND BELTS; WETSUITS; HEADGEAR, NAMELY, HATS AND CAPS; BALACLAVAS, IN CLASS 25 (U.S. CLS. 22 AND 39).

THE MARK CONSISTS OF STANDARD CHARACTERS WITHOUT CLAIM TO ANY PARTICULAR FONT, STYLE, SIZE, OR COLOR.

OWNER OF ERPN CMNTY TM OFC REG. NO. 007106751, DATED 5-7-2009, EXPIRES 7-29-2018.

OWNER OF U.S. REG. NOS. 535,357, 3,017,272 AND OTHERS.

SER. NO. 85-440,935, FILED 10-6-2011.

MICHAEL KEATING, EXAMINING ATTORNEY



David J. Kybas

Director of the United States Patent and Trademark Office

United States of America

United States Patent and Trademark Office

Daxwell

Reg. No. 4,153,668

Registered June 5, 2012

Int. Cls.: 8, 10 and 21

TRADEMARK

PRINCIPAL REGISTER

DAXWELL, LLC (TEXAS LIMITED LIABILITY COMPANY)
SUITE 500
2825 WILCREST DRIVE
HOUSTON, TX 77042

FOR: DISPOSABLE CUTLERY SUCH AS FORKS, KNIVES, TEASPOONS, SOUPOONS,
TASTER SPOONS, SPORKS, SODASPOONS , IN CLASS 8 (U.S. CLS. 23, 28 AND 44).

FIRST USE 1-1-2011; IN COMMERCE 1-1-2011.

FOR: DISPOSABLE GLOVES MADE OF NITRILE, LATEX, VINYL, SYNTHETIC AND
POLYETHYLENE FOR MEDICAL USE, IN CLASS 10 (U.S. CLS. 26, 39 AND 44).

FIRST USE 1-1-2011; IN COMMERCE 1-1-2011.

FOR: DISPOSABLE GLOVES MADE OF NITRILE, LATEX, VINYL, SYNTHETIC AND
POLYETHYLENE FOR GENERAL AND FOOD SERVICE USE, IN CLASS 21 (U.S. CLS. 2,
13, 23, 29, 30, 33, 40 AND 50).

FIRST USE 1-1-2011; IN COMMERCE 1-1-2011.

THE MARK CONSISTS OF STANDARD CHARACTERS WITHOUT CLAIM TO ANY PAR-
TICULAR FONT, STYLE, SIZE, OR COLOR.

THE WORDING "DAXWELL" HAS NO MEANING IN A FOREIGN LANGUAGE.

SER. NO. 85-440,973, FILED 10-6-2011.

WON TEAK OH, EXAMINING ATTORNEY



David J. Kypos

Director of the United States Patent and Trademark Office

United States of America

United States Patent and Trademark Office



Reg. No. 4,153,669

Registered June 5, 2012

Int. Cl.: 14

TRADEMARK

PRINCIPAL REGISTER

TGS JEWELERS, LLC (NEW YORK LIMITED LIABILITY COMPANY)
150 AERIAL WAY
SYOSSET, NY 11791

FOR: JEWELRY, IN CLASS 14 (U.S. CLS. 2, 27, 28 AND 50).

FIRST USE 10-5-2011; IN COMMERCE 10-5-2011.

SER. NO. 85-440,981, FILED 10-6-2011.

CHRISTINE MARTIN, EXAMINING ATTORNEY



David J. Kyffers

Director of the United States Patent and Trademark Office

United States of America

United States Patent and Trademark Office

GREEN ZONE



Reg. No. 4,153,670

Registered June 5, 2012

Int. Cl.: 6

TRADEMARK

PRINCIPAL REGISTER

SUNLOGICS ENERGY SOLUTIONS, LLC (CALIFORNIA LIMITED LIABILITY COMPANY)
1401 F STREET
SUITE 300
MODESTO, CA 95354

FOR: METAL STRUCTURES FOR MOUNTING SOLAR PANELS, IN CLASS 6 (U.S. CLS. 2, 12, 13, 14, 23, 25 AND 50).

FIRST USE 7-21-2010; IN COMMERCE 7-21-2010.

OWNER OF U.S. REG. NO. 4,040,764.

NO CLAIM IS MADE TO THE EXCLUSIVE RIGHT TO USE "GREEN", APART FROM THE MARK AS SHOWN.

THE MARK CONSISTS OF THE STYLIZED WORDS "GREEN ZONE" WITH A DRAWING OF THE SUN SERVING AS THE "O" IN "ZONE".

SER. NO. 85-440,993, FILED 10-6-2011.

JULIE WATSON, EXAMINING ATTORNEY



David J. Kypos

Director of the United States Patent and Trademark Office

United States of America

United States Patent and Trademark Office

LOGAN

Reg. No. 4,153,671

Registered June 5, 2012

Int. Cl.: 41

SERVICE MARK

PRINCIPAL REGISTER

SYX SERVICES INC. (DELAWARE CORPORATION)
7795 WEST FLAGLER STREET
SUITE 35
MIAMI, FL 33144

FOR: PROVIDING LIVE ONLINE INSTRUCTION AS TO THE USE OF COMPUTERS, COMPUTER SOFTWARE PROGRAMS AND ELECTRONICS, AND IN USING ONLINE SERVICES FOR ONLINE SHOPPING VIA APPLICANT'S ONLINE RETAIL STORE SERVICES FEATURING COMPUTERS, COMPUTER SOFTWARE PROGRAMS AND ELECTRONICS, ACCESSED ON SERVERS VIA THE WORLDWIDE WEB, IN CLASS 41 (U.S. CLS. 100, 101 AND 107).

FIRST USE 3-5-2007; IN COMMERCE 3-5-2007.

THE MARK CONSISTS OF STANDARD CHARACTERS WITHOUT CLAIM TO ANY PARTICULAR FONT, STYLE, SIZE, OR COLOR.

SER. NO. 85-440,995, FILED 10-6-2011.

MARK T. MULLEN, EXAMINING ATTORNEY



David J. Kyffers

Director of the United States Patent and Trademark Office

United States of America
United States Patent and Trademark Office

BUBBA

Reg. No. 4,153,672

Registered June 5, 2012

Int. Cl.: 43

SERVICE MARK

PRINCIPAL REGISTER

BUBBA FOODS, LLC (DELAWARE LIMITED LIABILITY COMPANY)
4339 ROOSEVELT BOULEVARD, SUITE 400
JACKSONVILLE, FL 32210

FOR: RESTAURANT AND BAR SERVICES, IN CLASS 43 (U.S. CLS. 100 AND 101).

FIRST USE 6-21-2011; IN COMMERCE 6-21-2011.

OWNER OF U.S. REG. NOS. 2,659,731, 2,901,596, AND 3,941,200.

THE MARK CONSISTS OF THE WORD "BUBBA" IN STYLIZED LETTERING.

SER. NO. 85-441,007, FILED 10-6-2011.

NATALIE POLZER, EXAMINING ATTORNEY



David J. Kybas

Director of the United States Patent and Trademark Office

United States of America

United States Patent and Trademark Office

Heartivation

Reg. No. 4,153,673

Registered June 5, 2012

Int. Cl.: 35

SERVICE MARK

PRINCIPAL REGISTER

HEARTIVATION, LLC (CONNECTICUT LIMITED LIABILITY COMPANY)
#268
1127 HIGH RIDGE ROAD
STAMFORD, CT 06905

FOR: PROMOTING THE GOODS AND SERVICES OF OTHERS BY PROVIDING A WEBSITE FEATURING COUPONS, REBATES, PRICE-COMPARISON INFORMATION, PRODUCT REVIEWS, LINKS TO THE RETAIL WEBSITES OF OTHERS, AND DISCOUNT INFORMATION, IN CLASS 35 (U.S. CLS. 100, 101 AND 102).

FIRST USE 10-5-2011; IN COMMERCE 10-6-2011.

THE MARK CONSISTS OF STANDARD CHARACTERS WITHOUT CLAIM TO ANY PARTICULAR FONT, STYLE, SIZE, OR COLOR.

SER. NO. 85-441,011, FILED 10-6-2011.

KRISTIN DAHLING, EXAMINING ATTORNEY



David J. Kyffers

Director of the United States Patent and Trademark Office

United States of America

United States Patent and Trademark Office

DREAM CAKES

Reg. No. 4,153,674

Registered June 5, 2012

Int. Cl.: 30

TRADEMARK

PRINCIPAL REGISTER

MAGGIEMOO'S FRANCHISE BRANDS, LLC (DELAWARE LIMITED LIABILITY COMPANY)
SUITE 170
1346 OAKBROOK DRIVE
NORCROSS, GA 30093

FOR: ICE CREAM CAKES, IN CLASS 30 (U.S. CL. 46).

FIRST USE 8-15-2004; IN COMMERCE 8-15-2004.

THE MARK CONSISTS OF STANDARD CHARACTERS WITHOUT CLAIM TO ANY PARTICULAR FONT, STYLE, SIZE, OR COLOR.

OWNER OF U.S. REG. NOS. 3,004,377, 3,065,581, AND 3,227,284.

NO CLAIM IS MADE TO THE EXCLUSIVE RIGHT TO USE "CAKES", APART FROM THE MARK AS SHOWN.

SER. NO. 85-441,020, FILED 10-6-2011.

KHANH LE, EXAMINING ATTORNEY



David J. Kybas

Director of the United States Patent and Trademark Office

United States of America

United States Patent and Trademark Office

ATLA CPLI

Reg. No. 4,153,675

Registered June 5, 2012

Int. Cl.: 41

SERVICE MARK

PRINCIPAL REGISTER

AMERICAN THEOLOGICAL LIBRARY ASSOCIATION (ILLINOIS CORPORATION)
SUITE 2100
300 SOUTH WACKER DRIVE
CHICAGO, IL 60606

FOR: PROVIDING AN ONLINE ELECTRONIC COMPUTER DATABASE FEATURING EDUCATIONAL INFORMATION IN THE ACADEMIC FIELD OF RELIGION, NAMELY, AN INDEX OF RELIGIOUS WRITINGS AND ABSTRACTS THEREOF VIA A GLOBAL COMPUTER NETWORK, IN CLASS 41 (U.S. CLS. 100, 101 AND 107).

FIRST USE 9-1-2011; IN COMMERCE 9-1-2011.

THE MARK CONSISTS OF STANDARD CHARACTERS WITHOUT CLAIM TO ANY PARTICULAR FONT, STYLE, SIZE, OR COLOR.

OWNER OF U.S. REG. NOS. 2,240,601, 2,938,062 AND OTHERS.

SER. NO. 85-441,054, FILED 10-6-2011.

APRIL ROACH, EXAMINING ATTORNEY



David J. Kyffers

Director of the United States Patent and Trademark Office

United States of America

United States Patent and Trademark Office

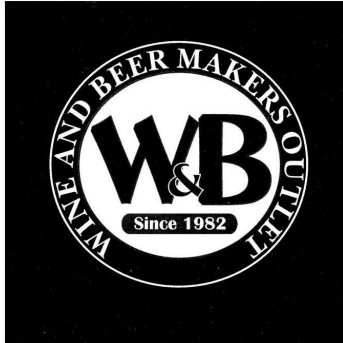

Reg. No. 4,153,676

Registered June 5, 2012

Int. Cl.: 35

SERVICE MARK

PRINCIPAL REGISTER

WINE MASTERS ACADEMY, INC (PENNSYLVANIA CORPORATION)
5584 APPLEBUTTER HILL ROAD
COOPERSBURG, PA 18036

FOR: RETAIL STORE SERVICES FEATURING WINE AND BEER MAKING KITS, ONLINE
RETAIL STORE SERVICES FEATURING WINE AND BEER MAKING KITS , IN CLASS 35
(U.S. CLS. 100, 101 AND 102).

FIRST USE 7-12-2010; IN COMMERCE 7-12-2010.

NO CLAIM IS MADE TO THE EXCLUSIVE RIGHT TO USE "WINE AND BEER MAKERS
OUTLET" AND "SINCE 1982", APART FROM THE MARK AS SHOWN.

THE MARK CONSISTS OF CIRCLE WITH THE WORDS "W&B" IN THE CENTER AND THE
WORDS "SINCE 1982" BELOW THEM. SURROUNDING THIS IS ANOTHER CIRCLE AND
THE WORDS "WINE AND BEER MAKERS OUTLET" IS WRITTEN IN BETWEEN THE TWO
CIRCLES.

SER. NO. 85-441,056, FILED 10-6-2011.

SETH A. RAPPAPORT, EXAMINING ATTORNEY



David J. Kybas

Director of the United States Patent and Trademark Office

United States of America

United States Patent and Trademark Office

CURT

Reg. No. 4,153,677

Registered June 5, 2012

Int. Cl.: 35

SERVICE MARK

PRINCIPAL REGISTER

THE CONSTRUCTION USERS ROUNDTABLE (OHIO CORPORATION)
SUITE 210
4100 EXECUTIVE PARK DRIVE
CINCINNATI, OH 452414023

FOR: TRADE ASSOCIATION SERVICES, NAMELY, PROMOTING THE INTERESTS OF THE CONSTRUCTION INDUSTRY, IN CLASS 35 (U.S. CLS. 100, 101 AND 102).

FIRST USE 6-26-2000; IN COMMERCE 6-26-2000.

THE MARK CONSISTS OF STANDARD CHARACTERS WITHOUT CLAIM TO ANY PARTICULAR FONT, STYLE, SIZE, OR COLOR.

SER. NO. 85-441,104, FILED 10-6-2011.

FRANK LATTUCA, EXAMINING ATTORNEY



David J. Kybas

Director of the United States Patent and Trademark Office

United States of America

United States Patent and Trademark Office

CHETA

Reg. No. 4,153,678

Registered June 5, 2012

Int. Cl.: 9

TRADEMARK

PRINCIPAL REGISTER

COUNTRY HEDGING, INC. (DELAWARE CORPORATION)
5500 CENEX DRIVE
INVER GROVE HEIGHTS, MN 55077

FOR: COMPUTER SOFTWARE FOR USE WITH THE INVESTMENT AND TRADING OF
COMMODITIES, THE CHARTING OF COMMODITY PRICES AND COMMODITY QUOTES,
IN CLASS 9 (U.S. CLS. 21, 23, 26, 36 AND 38).

FIRST USE 9-1-2011; IN COMMERCE 9-13-2011.

THE MARK CONSISTS OF STANDARD CHARACTERS WITHOUT CLAIM TO ANY PAR-
TICULAR FONT, STYLE, SIZE, OR COLOR.

OWNER OF U.S. REG. NO. 3,448,266.

SER. NO. 85-441,126, FILED 10-6-2011.

WILLIAM BRECKENFELD, EXAMINING ATTORNEY



David J. Kyffers

Director of the United States Patent and Trademark Office

United States of America

United States Patent and Trademark Office

HEROIC

Reg. No. 4,153,679

Registered June 5, 2012

Int. Cl.: 25

TRADEMARK

PRINCIPAL REGISTER

HEROIC RACING APPAREL, LLC (NEW YORK LIMITED LIABILITY COMPANY)
5014 206TH STREET
OAKLAND GARDENS, NY 11364

FOR: JACKETS; SHIRTS; SWEATSHIRTS; T-SHIRTS, IN CLASS 25 (U.S. CLS. 22 AND 39).

FIRST USE 1-1-2008; IN COMMERCE 1-1-2008.

THE MARK CONSISTS OF STANDARD CHARACTERS WITHOUT CLAIM TO ANY PARTICULAR FONT, STYLE, SIZE, OR COLOR.

OWNER OF U.S. REG. NO. 3,645,590.

SER. NO. 85-441,142, FILED 10-6-2011.

ALEX KEAM, EXAMINING ATTORNEY



David J. Kyros

Director of the United States Patent and Trademark Office

United States of America

United States Patent and Trademark Office

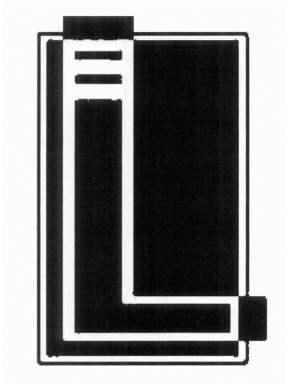

Reg. No. 4,153,680

Registered June 5, 2012

Int. Cl.: 35

SERVICE MARK

PRINCIPAL REGISTER

LOTHAMER FRANCHISE CORPORATION (MICHIGAN CORPORATION)
215 SOUTH WASHINGTON SQUARE, SUITE 100
LANSING, MI 48933

FOR: TAX AND TAXATION PLANNING, ADVICE, INFORMATION AND CONSULTANCY SERVICES, IN CLASS 35 (U.S. CLS. 100, 101 AND 102).

FIRST USE 1-1-2002; IN COMMERCE 1-1-2002.

THE MARK CONSISTS OF THE LETTER "L" IN BLOCK FORM WITH THREE HORIZONTAL LINES AT THE TOP OF THE VERTICAL LEG OF THE "L" CONTAINED SUBSTANTIALLY WITHIN A RECTANGLE SURROUNDING THE BLOCK "L".

SER. NO. 85-441,176, FILED 10-6-2011.

NAAKWAMA ANKRAH, EXAMINING ATTORNEY



David J. Kyffers

Director of the United States Patent and Trademark Office

United States of America

United States Patent and Trademark Office

TOUCH A LIFE COLLECTION

Reg. No. 4,153,681

Registered June 5, 2012

Int. Cl.: 14

TRADEMARK

PRINCIPAL REGISTER

UNIVERSAL PACIFIC DIAMONDS & JEWELRY , LLC (NEW YORK LIMITED LIABILITY COMPANY)
SUITE 1515
579 FIFTH AVENUE
NEW YORK, NY 10017

FOR: DIAMOND JEWELRY; GEMSTONE JEWELRY, IN CLASS 14 (U.S. CLS. 2, 27, 28 AND 50).

FIRST USE 3-1-2011; IN COMMERCE 4-4-2011.

THE MARK CONSISTS OF STANDARD CHARACTERS WITHOUT CLAIM TO ANY PARTICULAR FONT, STYLE, SIZE, OR COLOR.

NO CLAIM IS MADE TO THE EXCLUSIVE RIGHT TO USE "COLLECTION", APART FROM THE MARK AS SHOWN.

SER. NO. 85-441,178, FILED 10-6-2011.

ALEX KEAM, EXAMINING ATTORNEY



David J. Kybas

Director of the United States Patent and Trademark Office

United States of America

United States Patent and Trademark Office

SP-R

Reg. No. 4,153,682

HEROIC RACING APPAREL, LLC (NEW YORK LIMITED LIABILITY COMPANY)
5014 206TH STREET
OAKLAND GARDENS, NY 11364

Registered June 5, 2012

Int. Cl.: 25

FOR: MOTORCYCLE GLOVES; RIDING GLOVES, IN CLASS 25 (U.S. CLS. 22 AND 39).

TRADEMARK

FIRST USE 1-1-2008; IN COMMERCE 1-1-2008.

PRINCIPAL REGISTER

THE MARK CONSISTS OF STANDARD CHARACTERS WITHOUT CLAIM TO ANY PARTICULAR FONT, STYLE, SIZE, OR COLOR.

SER. NO. 85-441,179, FILED 10-6-2011.

ALEX KEAM, EXAMINING ATTORNEY



David J. Kybas

Director of the United States Patent and Trademark Office

United States of America

United States Patent and Trademark Office

KLINOL

Reg. No. 4,153,683

Registered June 5, 2012

Int. Cl.: 3

TRADEMARK

PRINCIPAL REGISTER

COSMETICS & CLEANERS INTERNATIONAL, LLC (FLORIDA LIMITED LIABILITY COMPANY)
8385 NW 74TH STREET
MEDLEY, FL 33166

FOR: DETERGENTS FOR HOUSEHOLD USE, IN CLASS 3 (U.S. CLS. 1, 4, 6, 50, 51 AND 52).

FIRST USE 1-1-2005; IN COMMERCE 10-1-2011.

THE MARK CONSISTS OF THE WORDING "KLINOL" IN NAVY BLUE OUTLINED IN BLACK.

THE COLOR(S) NAVY BLUE AND BLACK IS/ARE CLAIMED AS A FEATURE OF THE MARK.

SER. NO. 85-441,184, FILED 10-6-2011.

ALEX KEAM, EXAMINING ATTORNEY



David J. Kyffers

Director of the United States Patent and Trademark Office

United States of America

United States Patent and Trademark Office

Noonday Picante

Reg. No. 4,153,684

Registered June 5, 2012

Int. Cl.: 30

TRADEMARK

PRINCIPAL REGISTER

SMITH, BOBBY (UNITED STATES INDIVIDUAL)
14330 HIGHMEADOW DR
TYLER, TX 75703

FOR: HOT SAUCE; PICANTE SAUCE; SPICES, IN CLASS 30 (U.S. CL. 46).

FIRST USE 11-1-2009; IN COMMERCE 11-1-2009.

THE MARK CONSISTS OF STANDARD CHARACTERS WITHOUT CLAIM TO ANY PARTICULAR FONT, STYLE, SIZE, OR COLOR.

NO CLAIM IS MADE TO THE EXCLUSIVE RIGHT TO USE "PICANTE", APART FROM THE MARK AS SHOWN.

SER. NO. 85-441,202, FILED 10-6-2011.

LINDA POWELL, EXAMINING ATTORNEY



David J. Kyffers

Director of the United States Patent and Trademark Office

United States of America

United States Patent and Trademark Office

HOTCOATING

Reg. No. 4,153,685

KLEBCHEMIE M.G. BECKER GMBH & CO. KG (FED REP GERMANY CORPORATION)
MAX-BECKER STRASSE 4
WEINGARTEN/BADEN, FED REP GERMANY D-76356

Registered June 5, 2012

Int. Cls.: 1 and 2

FOR: ADHESIVES AND GLUES FOR USE IN INDUSTRIAL FIELDS, IN CLASS 1 (U.S. CLS. 1, 5, 6, 10, 26 AND 46).

TRADEMARK

FIRST USE 8-26-2004; IN COMMERCE 8-26-2004.

PRINCIPAL REGISTER

FOR: POLYMER LACQUERS FOR USE IN THE INDUSTRIAL FIELD FOR USE ON WOOD AND WOOD-DERIVED PRODUCTS, IN CLASS 2 (U.S. CLS. 6, 11 AND 16).

FIRST USE 8-26-2004; IN COMMERCE 8-26-2004.

THE MARK CONSISTS OF STANDARD CHARACTERS WITHOUT CLAIM TO ANY PARTICULAR FONT, STYLE, SIZE, OR COLOR.

SEC. 2(F).

SER. NO. 85-441,309, FILED 10-6-2011.

RENEE MCCRAY, EXAMINING ATTORNEY



David J. Kyros

Director of the United States Patent and Trademark Office

United States of America

United States Patent and Trademark Office

MAH JONGG MADNESS

Reg. No. 4,153,686

STOCK DISTRIBUTORS, INC. (FLORIDA CORPORATION)
5750 CARRIAGE DRIVE
SARASOTA, FL 34243

Registered June 5, 2012

Int. Cl.: 41

FOR: ENTERTAINMENT SERVICES IN THE NATURE OF CONDUCTING CHINESE TILE GAME TOURNAMENTS; CONDUCTING AND PROVIDING FACILITIES FOR SPECIAL EVENTS FEATURING CHINESE TILE GAME TOURNAMENTS; ORGANIZATION OF CHINESE TILE GAME TOURNAMENTS, IN CLASS 41 (U.S. CLS. 100, 101 AND 107).

SERVICE MARK

PRINCIPAL REGISTER

FIRST USE 12-1-1985; IN COMMERCE 12-1-1985.

THE MARK CONSISTS OF STANDARD CHARACTERS WITHOUT CLAIM TO ANY PARTICULAR FONT, STYLE, SIZE, OR COLOR.

NO CLAIM IS MADE TO THE EXCLUSIVE RIGHT TO USE "MAH JONG", APART FROM THE MARK AS SHOWN.

SER. NO. 85-441,351, FILED 10-6-2011.

LOURDES AYALA, EXAMINING ATTORNEY



David J. Kyros

Director of the United States Patent and Trademark Office

United States of America

United States Patent and Trademark Office

ETHNO-MEDICINE PRESERVATION PROJECT

Reg. No. 4,153,687

ETHNOMEDICINE PRESERVATION PROJECT (COLORADO NON-PROFIT CORPORATION)
1070 MAIN STREET
BOULDER, CO 80302

Registered June 5, 2012

Int. Cl.: 35

FOR: ASSOCIATION SERVICES, NAMELY, PROMOTING THE INTERESTS OF DOCTORS, ETHNOBOTANISTS, HERBALISTS AND BUSINESS WHICH PRESERVE THE TRADITIONAL KNOWLEDGE OF MEDICINAL PLANTS AND THEIR USES, IN CLASS 35 (U.S. CLS. 100, 101 AND 102).

SERVICE MARK

PRINCIPAL REGISTER

FIRST USE 10-15-1993; IN COMMERCE 10-15-1993.

THE MARK CONSISTS OF STANDARD CHARACTERS WITHOUT CLAIM TO ANY PARTICULAR FONT, STYLE, SIZE, OR COLOR.

NO CLAIM IS MADE TO THE EXCLUSIVE RIGHT TO USE "PROJECT", APART FROM THE MARK AS SHOWN.

SEC. 2(F) AS TO ETHNO-MEDICINE PRESERVATION.

SER. NO. 85-441,360, FILED 10-6-2011.

SANI KHOURI, EXAMINING ATTORNEY



David J. Kyffers

Director of the United States Patent and Trademark Office

United States of America

United States Patent and Trademark Office

Teramasu

Reg. No. 4,153,688

Registered June 5, 2012

Int. Cls.: 14, 18 and 25

TRADEMARK

PRINCIPAL REGISTER

TERAMASU.COM LLC (NORTH CAROLINA LIMITED LIABILITY COMPANY), DBA
TERAMASU ACCESSORIES
611 DRUID RD E. SUITE 403
CLEARWATER, FL 33756 AND

TERAMASU LLC (NORTH CAROLINA LIMITED LIABILITY COMPANY)
601 CHEROKEE RD 1-G
PINEHURST, NC 28374

FOR: JEWELRY, IN CLASS 14 (U.S. CLS. 2, 27, 28 AND 50).

FIRST USE 11-1-1999; IN COMMERCE 11-1-1999.

FOR: PURSES, IN CLASS 18 (U.S. CLS. 1, 2, 3, 22 AND 41).

FIRST USE 11-1-1999; IN COMMERCE 11-1-1999.

FOR: SCARFS, IN CLASS 25 (U.S. CLS. 22 AND 39).

FIRST USE 11-1-1999; IN COMMERCE 11-1-1999.

THE MARK CONSISTS OF STANDARD CHARACTERS WITHOUT CLAIM TO ANY PARTICULAR FONT, STYLE, SIZE, OR COLOR.

SER. NO. 85-441,382, FILED 10-6-2011.

WON TEAK OH, EXAMINING ATTORNEY



David J. Kyffers

Director of the United States Patent and Trademark Office

United States of America

United States Patent and Trademark Office



Reg. No. 4,153,689

Registered June 5, 2012

Int. Cl.: 41

DREAM BELIEVE KNOW IT FOUNDATION (PENNSYLVANIA NON-PROFIT CORPORATION), AKA DBK
APT. 2
44 YATES STREET
FORTY FORT, PA 18704

SERVICE MARK

PRINCIPAL REGISTER

FOR: CONDUCTING WORKSHOPS AND SEMINARS IN EMOTIONAL MANAGEMENT, COMMUNICATION SKILLS, CONFLICT RESOLUTION METHODS, SELF-ESTEEM, AND GOAL-SETTING SKILLS FOR STUDENTS AND TEACHERS; EDUCATIONAL SERVICES, NAMELY, CONDUCTING COURSES, PROGRAMS, WORKSHOPS AND SEMINARS IN THE FIELD OF EMOTIONAL MANAGEMENT, COMMUNICATION SKILLS, CONFLICT RESOLUTION METHODS, SELF-ESTEEM, AND GOAL-SETTING SKILLS FOR STUDENTS AND TEACHERS AND DISTRIBUTION OF TRAINING MATERIAL IN CONNECTION THEREWITH, IN CLASS 41 (U.S. CLS. 100, 101 AND 107).

FIRST USE 4-2-2011; IN COMMERCE 4-2-2011.

NO CLAIM IS MADE TO THE EXCLUSIVE RIGHT TO USE "BULLY" , APART FROM THE MARK AS SHOWN.

THE MARK CONSISTS OF THE WORDING "CAUTION NO BULLY ZONE" ARRANGED WITHIN AN OCTAGONAL SHAPE, WITH THE WORDS APPEARING IN DESCENDING ORDER WITHIN THE SHAPE, AND WITH THE WORD "CAUTION" AT THE TOP AND THE WORD "ZONE" AT THE BOTTOM. ALL WORDS ARE IN STANDARD FONTS WITH THE EXCEPTION OF THE TERM "BULLY" THAT APPEARS ON LOWER CASE LETTERS AND IN STYLIZED FORMAT. THERE IS ALSO A HORIZONTAL LINE THAT SEPARATES THE WORD "CAUTION" FROM THE OTHER WORDS IN THE MARK.

SER. NO. 85-441,387, FILED 10-6-2011.

MICHELE SWAIN, EXAMINING ATTORNEY



David J. Kyjars

Director of the United States Patent and Trademark Office

United States of America

United States Patent and Trademark Office

DaShen

Reg. No. 4,153,690

LUCA MOSCHINI (ITALY INDIVIDUAL)
PO BOX 864
ASHLAND, OR 97520

Registered June 5, 2012

Int. Cl.: 44

FOR: BODYWORK THERAPY, IN CLASS 44 (U.S. CLS. 100 AND 101).

SERVICE MARK

FIRST USE 10-2-2011; IN COMMERCE 10-2-2011.

PRINCIPAL REGISTER

THE MARK CONSISTS OF STANDARD CHARACTERS WITHOUT CLAIM TO ANY PARTICULAR FONT, STYLE, SIZE, OR COLOR.

THE ENGLISH TRANSLATION OF "DASHEN" IN THE MARK IS GREAT SPIRIT.

SER. NO. 85-441,389, FILED 10-6-2011.

LOURDES AYALA, EXAMINING ATTORNEY



David J. Kybas

Director of the United States Patent and Trademark Office

United States of America

United States Patent and Trademark Office

EVILEGGPLANT STUDIOS

Reg. No. 4,153,691

Registered June 5, 2012

Int. Cl.: 9

TRADEMARK

PRINCIPAL REGISTER

EVILEGGPLANT STUDIOS SARL (LEBANON LIMITED LIABILITY COMPANY)
REAL ESTATE 245
JBEIL, LEBANON

FOR: DOWNLOADABLE ELECTRONIC GAME VIA THE INTERNET AND WIRELESS DEVICES; ELECTRONIC GAME SOFTWARE; ELECTRONIC GAME SOFTWARE FOR CELLULAR TELEPHONES; ELECTRONIC GAME SOFTWARE FOR HANDHELD ELECTRONIC DEVICES; ELECTRONIC GAME SOFTWARE FOR WIRELESS DEVICES; VIDEO GAME SOFTWARE, IN CLASS 9 (U.S. CLS. 21, 23, 26, 36 AND 38).

FIRST USE 3-27-2011; IN COMMERCE 10-6-2011.

THE MARK CONSISTS OF STANDARD CHARACTERS WITHOUT CLAIM TO ANY PARTICULAR FONT, STYLE, SIZE, OR COLOR.

NO CLAIM IS MADE TO THE EXCLUSIVE RIGHT TO USE "STUDIOS", APART FROM THE MARK AS SHOWN.

SER. NO. 85-441,405, FILED 10-6-2011.

YAT SYE, LEE, EXAMINING ATTORNEY



David J. Kyros

Director of the United States Patent and Trademark Office

United States of America

United States Patent and Trademark Office



Reg. No. 4,153,692

Registered June 5, 2012

Int. Cl.: 9

TRADEMARK

PRINCIPAL REGISTER

EVILEGGPLANT STUDIOS SARL (LEBANON LIMITED LIABILITY COMPANY)
REAL ESTATE 245
JBEIL, LEBANON

FOR: DOWNLOADABLE ELECTRONIC GAMES VIA THE INTERNET AND WIRELESS DEVICES; ELECTRONIC GAME SOFTWARE; ELECTRONIC GAME SOFTWARE FOR CELLULAR TELEPHONES; ELECTRONIC GAME SOFTWARE FOR HANDHELD ELECTRONIC DEVICES; ELECTRONIC GAME SOFTWARE FOR WIRELESS DEVICES, IN CLASS 9 (U.S. CLS. 21, 23, 26, 36 AND 38).

FIRST USE 3-27-2011; IN COMMERCE 10-6-2011.

THE MARK CONSISTS OF AN ANTHROPOMORPHIC EGGPLANT WITH EVIL LOOKING EYES, A DARK CAPE, AND WHOSE STEM IS SHAPED LIKE A DEVIL'S TAIL.

SER. NO. 85-441,409, FILED 10-6-2011.

YAT SYE, LEE, EXAMINING ATTORNEY



David J. Kyffers

Director of the United States Patent and Trademark Office

United States of America

United States Patent and Trademark Office

PROMOTION STORE

Reg. No. 4,153,693

Registered June 5, 2012

Int. Cl.: 40

SERVICE MARK

PRINCIPAL REGISTER

PROMOTION STORE, LLC (FLORIDA LIMITED LIABILITY COMPANY)
800 BELLE TERRE PKWY., SUITE 200-113
PALM COAST, FL 32164

FOR: CUSTOMIZED IMPRINTING OF APPAREL, PERSONAL AND OFFICE ACCESSORIES, SPORTING GOODS, GLASSWARE, LUGGAGE AND CARRYING BAGS, STATIONERY, AND JEWELRY WITH MESSAGES AND COMPANY NAMES AND LOGOS, IN CLASS 40 (U.S. CLS. 100, 103 AND 106).

FIRST USE 9-16-1998; IN COMMERCE 9-16-1998.

THE MARK CONSISTS OF STANDARD CHARACTERS WITHOUT CLAIM TO ANY PARTICULAR FONT, STYLE, SIZE, OR COLOR.

NO CLAIM IS MADE TO THE EXCLUSIVE RIGHT TO USE "PROMOTION", APART FROM THE MARK AS SHOWN.

SEC. 2(F).

SER. NO. 85-441,418, FILED 10-6-2011.

ELISSA GARBER KON, EXAMINING ATTORNEY



David J. Kyffers

Director of the United States Patent and Trademark Office

United States of America

United States Patent and Trademark Office



Reg. No. 4,153,694

Registered June 5, 2012

Int. Cl.: 41

SERVICE MARK

PRINCIPAL REGISTER

SHAUGHNESSY, THOMAS J (UNITED STATES INDIVIDUAL)
709 5TH STREET N.E.
RIO RANCHO, NM 87124

FOR: RENTAL OF CAMERAS, IN CLASS 41 (U.S. CLS. 100, 101 AND 107).

FIRST USE 8-19-2008; IN COMMERCE 8-22-2008.

OWNER OF U.S. REG. NO. 4,036,475.

NO CLAIM IS MADE TO THE EXCLUSIVE RIGHT TO USE "NEW MEXICO FILM RENTALS", APART FROM THE MARK AS SHOWN.

THE MARK CONSISTS OF A ZIA SUN SYMBOL MADE FROM 35 MM FILM STRIPS WITH A 35 MM FILM REEL IN THE MIDDLE, FORMING A CROSS SHAPE; THE STYLIZED TEXT "NEW MEXICO" APPEARS ON THE LEFT HAND CORNER AND THE STYLIZED TEXT "FILM RENTALS" APPEARS ON THE LOWER RIGHT HAND CORNER.

SER. NO. 85-441,430, FILED 10-6-2011.

KATHY DE JONGE, EXAMINING ATTORNEY



David J. Kyros

Director of the United States Patent and Trademark Office

United States of America

United States Patent and Trademark Office



Reg. No. 4,153,695

Registered June 5, 2012

Int. Cl.: 9

TRADEMARK

PRINCIPAL REGISTER

CARMAN DEV GROUP LLC - VEHAWK SERIES (UTAH LIMITED LIABILITY COMPANY)
P.O. BOX 551
DRAPER, UT 84020

FOR: COMPUTER APPLICATION SOFTWARE FOR MOBILE PHONES, NAMELY, SOFTWARE FOR CAPTURING USE OF THE CELL PHONE WHILE IN THE CAR, INCLUDING CALLS MADE AND RECEIVED, AND TEXT MESSAGE SENT AND RECEIVED, WHILE ALSO BEING ABLE TO TRACK TRIP DISTANCES WHILE DRIVING, AND HARD STOPS AND ACCELERATIONS, ALL OF WHICH ARE SENT TO A SERVER TO BE STORED AND USED TO REVIEW, IN CLASS 9 (U.S. CLS. 21, 23, 26, 36 AND 38).

FIRST USE 4-30-2011; IN COMMERCE 8-1-2011.

THE MARK CONSISTS OF A SYMBOL OF A HAWK AS THE LETTER "W" IN THE WORD "VEHAWK". BELOW THE WORD "VEHAWK" IS THE TAG LINE "TAKING SAFETY MOBILE".

SER. NO. 85-441,432, FILED 10-6-2011.

JOHN GARTNER, EXAMINING ATTORNEY



David J. Kyffers

Director of the United States Patent and Trademark Office

United States of America

United States Patent and Trademark Office

Shut Up and Do It!

Reg. No. 4,153,696

Registered June 5, 2012

Int. Cl.: 41

SERVICE MARK

PRINCIPAL REGISTER

GARCIA, RICHARD (UNITED STATES INDIVIDUAL)
27 LE MANS
MISSION VIEJO, CA 92692

FOR: EDUCATIONAL AND ENTERTAINMENT SERVICES, NAMELY, PROGRAMS ABOUT PERSONAL IMPROVEMENT ACCESSIBLE BY RADIO, TELEVISION, SATELLITE, AUDIO, VIDEO, WEBSITE, AND COMPUTER NETWORKS ; EDUCATIONAL AND ENTERTAINMENT SERVICES, NAMELY, THE PRESENTATION OF SEMINARS, WORKSHOPS, WORKBOOKS AND COURSE MATERIAL DISTRIBUTED THEREWITH, PANEL DISCUSSIONS AND ONGOING TELEVISION AND RADIO SHOWS ALL IN THE FIELD OF PERSONAL IMPROVEMENT ; EDUCATIONAL SERVICES, NAMELY, CONDUCTING CLASSES AND SEMINARS IN THE FIELD OF PERSONAL IMPROVEMENT, IN CLASS 41 (U.S. CLS. 100, 101 AND 107).

FIRST USE 1-1-2010; IN COMMERCE 1-15-2011.

THE MARK CONSISTS OF STANDARD CHARACTERS WITHOUT CLAIM TO ANY PARTICULAR FONT, STYLE, SIZE, OR COLOR.

SER. NO. 85-441,446, FILED 10-6-2011.

DARRYL SPRUILL, EXAMINING ATTORNEY



David J. Kypos

Director of the United States Patent and Trademark Office

United States of America

United States Patent and Trademark Office



Reg. No. 4,153,697

Registered June 5, 2012

Int. Cl.: 9

TRADEMARK

PRINCIPAL REGISTER

NEW ENDIAN LLC (NEW YORK LIMITED LIABILITY COMPANY), DBA NEW ENDIAN
PO BOX 2369
ASTORIA, NY 11102

FOR: COMPUTER APPLICATION SOFTWARE FOR MOBILE PHONES, NAMELY, SOFTWARE FOR FILM AND TELEVISION PRODUCTION, IN CLASS 9 (U.S. CLS. 21, 23, 26, 36 AND 38).

FIRST USE 8-24-2011; IN COMMERCE 8-24-2011.

NO CLAIM IS MADE TO THE EXCLUSIVE RIGHT TO USE "ENDIAN", APART FROM THE MARK AS SHOWN.

THE MARK CONSISTS OF AN EGG SHAPE SURROUNDING THE WORDS, "NEW ENDIAN" IN LOWER CASE LETTERS IN LANE-UPPER REGULAR FONT. THE BIG END OF THE EGG IS ON THE RIGHT. "NEW" APPEARS SMALLER AND INDENTED ABOVE "ENDIAN". THE "E" AND THE "IA" IN "ENDIAN" ARE UNDERLINED.

SER. NO. 85-441,478, FILED S.R. 10-6-2011 AM. P.R. 10-6-2011.

MAYUR VAGHANI, EXAMINING ATTORNEY



David J. Kybas

Director of the United States Patent and Trademark Office

United States of America

United States Patent and Trademark Office

DR. K'S DETAILWERKES

Reg. No. 4,153,698

Registered June 5, 2012

Int. Cl.: 3

TRADEMARK

PRINCIPAL REGISTER

TURN3 CREATIVE, INC. (CALIFORNIA CORPORATION)
PO BOX 661476
ARCADIA, CA 91006

FOR: ALL-PURPOSE CLEANERS; AUTOMOBILE AND CAR WAX PREPARATIONS; AUTOMOBILE CLEANERS; AUTOMOBILE POLISH; AUTOMOBILE POLISHES; AUTOMOBILE TIRE CLEANING AND POLISHING PREPARATIONS; AUTOMOBILE WAX; AUTOMOBILE, TIRE, GLASS AND WHEEL CLEANING PREPARATIONS, IN CLASS 3 (U.S. CLS. 1, 4, 6, 50, 51 AND 52).

FIRST USE 6-1-2011; IN COMMERCE 9-26-2011.

THE MARK CONSISTS OF STANDARD CHARACTERS WITHOUT CLAIM TO ANY PARTICULAR FONT, STYLE, SIZE, OR COLOR.

THE NAME SHOWN IN THE MARK DOES NOT IDENTIFY A PARTICULAR LIVING INDIVIDUAL.

SER. NO. 85-441,543, FILED 10-7-2011.

TINA BROWN, EXAMINING ATTORNEY



David J. Kyros

Director of the United States Patent and Trademark Office

United States of America

United States Patent and Trademark Office

Xtreme Energy Xtreme Weight Loss

Reg. No. 4,153,699

Registered June 5, 2012

Int. Cl.: 5

TRADEMARK

PRINCIPAL REGISTER

MARTIN, SCOTT W (UNITED STATES INDIVIDUAL)
2097 WALKER LANE
HOLLADAY, UT 84117

FOR: DIETARY AND NUTRITIONAL SUPPLEMENTS; DIETARY AND NUTRITIONAL SUPPLEMENTS USED FOR WEIGHT LOSS; DIETARY FOOD SUPPLEMENTS; DIETARY SUPPLEMENTAL DRINKS; DIETARY SUPPLEMENTAL DRINKS IN THE NATURE OF VITAMIN AND MINERAL BEVERAGES; DIETARY SUPPLEMENTS FOR HUMAN CONSUMPTION; HEALTH FOOD SUPPLEMENTS; HERBAL SUPPLEMENTS; HERBAL SUPPLEMENTS FOR BOOSTING ENERGY AND BOOSTING WEIGHT LOSS; NATURAL HERBAL SUPPLEMENTS, IN CLASS 5 (U.S. CLS. 6, 18, 44, 46, 51 AND 52).

FIRST USE 9-10-2008; IN COMMERCE 10-18-2008.

THE MARK CONSISTS OF STANDARD CHARACTERS WITHOUT CLAIM TO ANY PARTICULAR FONT, STYLE, SIZE, OR COLOR.

NO CLAIM IS MADE TO THE EXCLUSIVE RIGHT TO USE "ENERGY" AND "WEIGHT LOSS", APART FROM THE MARK AS SHOWN.

SER. NO. 85-441,561, FILED 10-7-2011.

MICHAEL WIENER, EXAMINING ATTORNEY



David J. Kyros

Director of the United States Patent and Trademark Office

United States of America

United States Patent and Trademark Office

SHOE LOVERS CARE

Reg. No. 4,153,700

DSW SHOE WAREHOUSE, INC. (MISSOURI CORPORATION)
810 DSW DRIVE
COLUMBUS, OH 43219

Registered June 5, 2012

Int. Cl.: 35

FOR: CHARITABLE SERVICES, NAMELY, ORGANIZING AND CONDUCTING VOLUNTEER PROGRAMS AND COMMUNITY SERVICE PROJECTS, IN CLASS 35 (U.S. CLS. 100, 101 AND 102).

SERVICE MARK

FIRST USE 11-0-2009; IN COMMERCE 11-0-2009.

PRINCIPAL REGISTER

THE MARK CONSISTS OF STANDARD CHARACTERS WITHOUT CLAIM TO ANY PARTICULAR FONT, STYLE, SIZE, OR COLOR.

SER. NO. 85-441,569, FILED 10-7-2011.

DAWN FELDMAN, EXAMINING ATTORNEY



David J. Kybas

Director of the United States Patent and Trademark Office

United States of America

United States Patent and Trademark Office



Reg. No. 4,153,701

Registered June 5, 2012

Int. Cl.: 20

TRADEMARK

PRINCIPAL REGISTER

TYSON HOLDINGS LIMITED (BR. VIRGIN ISLANDS LIMITED LIABILITY COMPANY)
TRUSTNET CHAMBERS, P.O. BOX 3444
ROAD TOWN, TORTOLA
BRITISH VIRGIN ISLANDS, BR. VIRGIN ISLANDS

FOR: BEDS; BENCHES; BOLSTERS; COFFINS; CUSHIONS; DECORATIONS OF PLASTIC FOR FOODSTUFFS; FURNITURE; FURNITURE FITTINGS, NOT OF METAL; MATTRESSES; NON-METAL BINS; NON-METAL NAME PLATES; PET CUSHIONS; PICTURE FRAMES; PILLOWS; SLATTED INDOOR BLINDS; SOFAS; WARDROBES; WOOD BEDSTEADS; WORKS OF ART OF WOOD, WAX, PLASTER OR PLASTIC, IN CLASS 20 (U.S. CLS. 2, 13, 22, 25, 32 AND 50).

FIRST USE 2-2-1989; IN COMMERCE 4-26-1989.

OWNER OF U.S. REG. NO. 1,634,096.

THE NON-LATIN CHARACTERS IN THE MARK TRANSLITERATE TO HAI MA PAI AND THIS MEANS SEA HORSE BRAND IN ENGLISH.

THE MARK CONSISTS OF THE LETTERS "SEAHORSE" AND CHINESE CHARACTERS WITH A DESIGN OF SEA HORSE UNDERLINED.

THE ENGLISH TRANSLATION OF "SEA HORSE" IN THE MARK IS AN ANIMAL CALLED SEA HORSE.

SER. NO. 85-441,575, FILED 10-7-2011.

DAWN FELDMAN, EXAMINING ATTORNEY



David J. Kyros

Director of the United States Patent and Trademark Office

United States of America
United States Patent and Trademark Office

ARCHPORT

Reg. No. 4,153,702

Registered June 5, 2012

Int. Cl.: 25

TRADEMARK

PRINCIPAL REGISTER

NEW MANAGEMENT, INC. (CALIFORNIA CORPORATION)
2812 CUTLER AVE.
FREMONT, CA 94536

FOR: FOOTWEAR, IN CLASS 25 (U.S. CLS. 22 AND 39).

FIRST USE 7-31-2000; IN COMMERCE 7-31-2000.

THE MARK CONSISTS OF STANDARD CHARACTERS WITHOUT CLAIM TO ANY PARTICULAR FONT, STYLE, SIZE, OR COLOR.

SER. NO. 85-441,591, FILED 10-7-2011.

CHRISTOPHER LAW, EXAMINING ATTORNEY



David J. Kybas

Director of the United States Patent and Trademark Office

United States of America

United States Patent and Trademark Office

Project Select

Reg. No. 4,153,703

LINZER PRODUCTS CORP. (NEW YORK CORPORATION)
248 WYANDANCH AVENUE
WEST BABYLON, NY 11704

Registered June 5, 2012

Int. Cl.: 16

FOR: PAINT BRUSHES, PAINT ROLLERS, PAINT ROLLER HANDLES, PAINT PADS, IN CLASS 16 (U.S. CLS. 2, 5, 22, 23, 29, 37, 38 AND 50).

TRADEMARK

FIRST USE 0-0-2004; IN COMMERCE 0-0-2004.

PRINCIPAL REGISTER

OWNER OF U.S. REG. NO. 3,010,618.

THE MARK CONSISTS OF THE WORDS "PROJECT SELECT". THE WORD "PROJECT" APPEARS IN BLOCK LETTERS AND THE WORD "SELECT" APPEARS IN SCRIPT.

SER. NO. 85-441,592, FILED 10-7-2011.

EMILY CARLSEN, EXAMINING ATTORNEY



David J. Kyffers

Director of the United States Patent and Trademark Office

United States of America

United States Patent and Trademark Office



Reg. No. 4,153,704

Registered June 5, 2012

Int. Cl.: 25

TRADEMARK

PRINCIPAL REGISTER

NEW MANAGEMENT, INC. (CALIFORNIA CORPORATION)
2812 CUTLER AVE.
FREMONT, CA 94536

FOR: FOOTWEAR, IN CLASS 25 (U.S. CLS. 22 AND 39).

FIRST USE 5-18-2001; IN COMMERCE 5-18-2001.

THE MARK CONSISTS OF AN IMAGE OF A PERSON CONSISTING OF TWO JOINED IDENTICAL CURVES AND A CIRCLE ABOVE THE JUNCTURE.

SER. NO. 85-441,593, FILED 10-7-2011.

CHRISTOPHER LAW, EXAMINING ATTORNEY



David J. Kybas

Director of the United States Patent and Trademark Office

United States of America

United States Patent and Trademark Office

FRIENDSHIP HOSPITAL FOR ANIMALS

Reg. No. 4,153,705

FRIENDSHIP HOSPITAL FOR ANIMALS, INC. (D.C. CORPORATION)
4105 BRANDYWINE ST., NW
WASHINGTON, DC 20016

Registered June 5, 2012

Int. Cl.: 44

FOR: VETERINARY SERVICES, IN CLASS 44 (U.S. CLS. 100 AND 101).

SERVICE MARK

FIRST USE 12-31-1936; IN COMMERCE 12-31-1936.

PRINCIPAL REGISTER

THE MARK CONSISTS OF STANDARD CHARACTERS WITHOUT CLAIM TO ANY PARTICULAR FONT, STYLE, SIZE, OR COLOR.

NO CLAIM IS MADE TO THE EXCLUSIVE RIGHT TO USE "HOSPITAL FOR ANIMALS", APART FROM THE MARK AS SHOWN.

SER. NO. 85-441,600, FILED 10-7-2011.

AMY KERTGATE, EXAMINING ATTORNEY



David J. Kyffers

Director of the United States Patent and Trademark Office

United States of America

United States Patent and Trademark Office

FRIENDSHIP TO GO

Reg. No. 4,153,706

FRIENDSHIP HOSPITAL FOR ANIMALS, INC. (D.C. CORPORATION)
4105 BRANDYWINE ST., NW
WASHINGTON, DC 20016

Registered June 5, 2012

Int. Cl.: 44

FOR: MOBILE IN-HOME VETERINARY SERVICES, IN CLASS 44 (U.S. CLS. 100 AND 101).

SERVICE MARK

FIRST USE 10-1-2011; IN COMMERCE 10-1-2011.

PRINCIPAL REGISTER

THE MARK CONSISTS OF STANDARD CHARACTERS WITHOUT CLAIM TO ANY PARTICULAR FONT, STYLE, SIZE, OR COLOR.

SER. NO. 85-441,602, FILED 10-7-2011.

AMY KERTGATE, EXAMINING ATTORNEY



David J. Kybas

Director of the United States Patent and Trademark Office

United States of America

United States Patent and Trademark Office

GORGEOUS GLO

Reg. No. 4,153,707

VENTURE VI, LLC (NORTH CAROLINA LIMITED LIABILITY COMPANY)
1626 QUEENS ROAD WEST
CHARLOTTE, NC 282072434

Registered June 5, 2012

Int. Cl.: 44

FOR: SKIN TANNING SERVICE FOR HUMANS FOR COSMETIC PURPOSES, IN CLASS 44
(U.S. CLS. 100 AND 101).

SERVICE MARK

FIRST USE 10-1-2010; IN COMMERCE 10-1-2010.

PRINCIPAL REGISTER

THE MARK CONSISTS OF STANDARD CHARACTERS WITHOUT CLAIM TO ANY PARTICULAR FONT, STYLE, SIZE, OR COLOR.

SER. NO. 85-441,610, FILED 10-7-2011.

MATTHEW EINSTEIN, EXAMINING ATTORNEY



David J. Kyros

Director of the United States Patent and Trademark Office

United States of America

United States Patent and Trademark Office

ARIVA

Reg. No. 4,153,708

Registered June 5, 2012

Int. Cl.: 35

SERVICE MARK

PRINCIPAL REGISTER

1ST CHAIR SKIN CARE, INC. (ILLINOIS CORPORATION), DBA ARIVA
345 NORTH LEWIS AVENUE
OGLESBY, IL 61348

FOR: ON-LINE RETAIL STORE SERVICES FEATURING BEAUTY PRODUCTS, NAMELY, PERSONAL CARE PRODUCTS, COSMETICS, TOILETRIES, BATH AND BODY PRODUCTS, FRAGRANCES, NAIL CARE PRODUCTS, SKIN CARE PREPARATIONS, HAIR CARE PREPARATIONS, TEETH WHITENING PRODUCTS, CANDLES, TANNING LOTIONS, AND DIETARY SUPPLEMENTS; AND RETAIL STORE SERVICES FEATURING BEAUTY PRODUCTS, NAMELY, PERSONAL CARE PRODUCTS, COSMETICS, TOILETRIES, BATH AND BODY PRODUCTS, FRAGRANCES, NAIL CARE PRODUCTS, SKIN CARE PREPARATIONS, HAIR CARE PREPARATIONS, TEETH WHITENING PRODUCTS, CANDLES, TANNING LOTIONS, AND DIETARY SUPPLEMENTS, IN CLASS 35 (U.S. CLS. 100, 101 AND 102).

FIRST USE 2-0-2004; IN COMMERCE 2-0-2004.

THE MARK CONSISTS OF STANDARD CHARACTERS WITHOUT CLAIM TO ANY PARTICULAR FONT, STYLE, SIZE, OR COLOR.

SER. NO. 85-441,623, FILED 10-7-2011.

EMILY CHUO, EXAMINING ATTORNEY



David J. Kypos

Director of the United States Patent and Trademark Office

United States of America

United States Patent and Trademark Office

POWERRAIL

Reg. No. 4,153,709

POWERRAIL DISTRIBUTION INC. (DELAWARE CORPORATION)
205 CLARK ROAD
DURYEA, PA 18642

Registered June 5, 2012

Int. Cl.: 35

FOR: RETAIL STORE SERVICES FEATURING LOCOMOTIVE AND RAIL INDUSTRY PARTS AND ACCESSORIES, IN CLASS 35 (U.S. CLS. 100, 101 AND 102).

SERVICE MARK

FIRST USE 3-30-2003; IN COMMERCE 3-30-2003.

PRINCIPAL REGISTER

THE MARK CONSISTS OF STANDARD CHARACTERS WITHOUT CLAIM TO ANY PARTICULAR FONT, STYLE, SIZE, OR COLOR.

SER. NO. 85-441,624, FILED 10-7-2011.

GEOFFREY FOSDICK, EXAMINING ATTORNEY



David J. Kyros

Director of the United States Patent and Trademark Office

United States of America

United States Patent and Trademark Office



Reg. No. 4,153,710

Registered June 5, 2012

Int. Cl.: 37

SERVICE MARK

PRINCIPAL REGISTER

HEAT-N-AIR GUYS (PENNSYLVANIA CORPORATION)
P.O. BOX 683
DARBY, PA 19023

FOR: AIR DUCT CLEANING SERVICES; BOILER CLEANING AND REPAIR; INSTALLATION AND REPAIR OF HEATING, VENTILATING AND AIR CONDITIONING EQUIPMENT, IN CLASS 37 (U.S. CLS. 100, 103 AND 106).

FIRST USE 7-1-2011; IN COMMERCE 7-1-2011.

NO CLAIM IS MADE TO THE EXCLUSIVE RIGHT TO USE "HEAT-N-AIR", APART FROM THE MARK AS SHOWN.

THE MARK CONSISTS OF A CARICATURE OF TWO MEN STANDING SIDE BY SIDE ABOVE A RECTANGULAR SHAPED LOZENGE WITH THE WORDS "HEAT-N-AIR GUYS" IN A STYLIZED FONT.

SER. NO. 85-441,628, FILED 10-7-2011.

EMILY CHUO, EXAMINING ATTORNEY



David J. Kybas

Director of the United States Patent and Trademark Office

United States of America

United States Patent and Trademark Office

ARIVA

Reg. No. 4,153,711

1ST CHAIR SKIN CARE, INC. (ILLINOIS CORPORATION), DBA ARIVA
345 NORTH LEWIS AVENUE
OGLESBY, IL 61348

Registered June 5, 2012

Int. Cl.: 44

FOR: BEAUTY AND SKIN CARE SALON, NAMELY, HAIR SALON SERVICES, MANICURE AND PEDICURE SERVICES, TANNING SERVICES; HEALTH SPA SERVICES, NAMELY, COSMETIC FACE AND BODY CARE SERVICES, MASSAGE, IN CLASS 44 (U.S. CLS. 100 AND 101).

SERVICE MARK

PRINCIPAL REGISTER

FIRST USE 2-0-2004; IN COMMERCE 2-0-2004.

THE MARK CONSISTS OF STANDARD CHARACTERS WITHOUT CLAIM TO ANY PARTICULAR FONT, STYLE, SIZE, OR COLOR.

SER. NO. 85-441,640, FILED 10-7-2011.

EMILY CHUO, EXAMINING ATTORNEY



David J. Kyffers

Director of the United States Patent and Trademark Office

United States of America

United States Patent and Trademark Office

SKIN1

Reg. No. 4,153,712

Registered June 5, 2012

Int. Cl.: 35

SERVICE MARK

PRINCIPAL REGISTER

SKIN1, INC. (ILLINOIS CORPORATION)
345 NORTH LEWIS AVENUE
OGLESBY, IL 61348

FOR: ON-LINE RETAIL STORE SERVICES FEATURING BEAUTY PRODUCTS, NAMELY, PERSONAL CARE PRODUCTS, COSMETICS, TOILETRIES, BATH AND BODY PRODUCTS, FRAGRANCES, NAIL CARE PRODUCTS, SKIN CARE PREPARATIONS, HAIR CARE PREPARATIONS, AND TEETH WHITENING PRODUCTS; CANDLES; TANNING LOTIONS; AND DIETARY SUPPLEMENTS; AND RETAIL STORE SERVICES FEATURING BEAUTY PRODUCTS, NAMELY, PERSONAL CARE PRODUCTS, COSMETICS, TOILETRIES, BATH AND BODY PRODUCTS, FRAGRANCES, NAIL CARE PRODUCTS, SKIN CARE PREPARATIONS, HAIR CARE PREPARATIONS, AND TEETH WHITENING PRODUCTS; CANDLES; TANNING LOTIONS; AND DIETARY SUPPLEMENTS, IN CLASS 35 (U.S. CLS. 100, 101 AND 102).

FIRST USE 3-0-2001; IN COMMERCE 3-0-2001.

THE MARK CONSISTS OF STANDARD CHARACTERS WITHOUT CLAIM TO ANY PARTICULAR FONT, STYLE, SIZE, OR COLOR.

OWNER OF U.S. REG. NO. 3,346,708.

SER. NO. 85-441,646, FILED 10-7-2011.

VIVIAN MICZNIK FIRST, EXAMINING ATTORNEY



David J. Kyros

Director of the United States Patent and Trademark Office

United States of America

United States Patent and Trademark Office

EPOWERRAIL

Reg. No. 4,153,713

POWERRAIL DISTRIBUTION INC. (DELAWARE CORPORATION)
205 CLARK ROAD
DURYEA, PA 18642

Registered June 5, 2012

Int. Cl.: 35

FOR: RETAIL STORE SERVICES FEATURING LOCOMOTIVE AND RAIL INDUSTRY PARTS AND ACCESSORIES, IN CLASS 35 (U.S. CLS. 100, 101 AND 102).

SERVICE MARK

FIRST USE 3-30-2003; IN COMMERCE 3-30-2003.

PRINCIPAL REGISTER

THE MARK CONSISTS OF STANDARD CHARACTERS WITHOUT CLAIM TO ANY PARTICULAR FONT, STYLE, SIZE, OR COLOR.

SER. NO. 85-441,657, FILED 10-7-2011.

GEOFFREY FOSDICK, EXAMINING ATTORNEY



David J. Kybas

Director of the United States Patent and Trademark Office

United States of America

United States Patent and Trademark Office

Monster Trucks XL Tour

Reg. No. 4,153,714

SUPER T EVENTS, LLC (WISCONSIN LIMITED LIABILITY COMPANY)
1258 MONTEREY TRAIL
DE PERE, WI 54115

Registered June 5, 2012

Int. Cl.: 41

FOR: ENTERTAINMENT SERVICES IN THE NATURE OF AUTOMOBILE RACING AND EXHIBITIONS, IN CLASS 41 (U.S. CLS. 100, 101 AND 107).

SERVICE MARK

FIRST USE 1-1-2008; IN COMMERCE 1-1-2008.

PRINCIPAL REGISTER

THE MARK CONSISTS OF STANDARD CHARACTERS WITHOUT CLAIM TO ANY PARTICULAR FONT, STYLE, SIZE, OR COLOR.

NO CLAIM IS MADE TO THE EXCLUSIVE RIGHT TO USE "MONSTER TRUCKS" AND "TOUR", APART FROM THE MARK AS SHOWN.

SER. NO. 85-441,666, FILED 10-7-2011.

LINDA LAVACHE, EXAMINING ATTORNEY



David J. Kybas

Director of the United States Patent and Trademark Office

United States of America

United States Patent and Trademark Office

CYPRESS

Reg. No. 4,153,715

Registered June 5, 2012

Int. Cls.: 24 and 27

TRADEMARK

PRINCIPAL REGISTER

MONARCH TOWEL COMPANY, INC. (NEW JERSEY CORPORATION)
737 CORTLAND STREET
PERTH AMBOY, NJ 08861

FOR: BED LINENS, NAMELY, BED SHEETS, PILLOWCASES, PILLOW SHAMS, AND DUVET COVERS; BATH LINENS, NAMELY, BATH TOWELS, BATH SHEETS, HAND TOWELS, WASH CLOTHS, FACE CLOTHS, TOWEL WRAPS, IN CLASS 24 (U.S. CLS. 42 AND 50).

FIRST USE 2-18-2004; IN COMMERCE 2-18-2004.

FOR: BATH MATS AND BATH RUGS, IN CLASS 27 (U.S. CLS. 19, 20, 37, 42 AND 50).

FIRST USE 6-30-2005; IN COMMERCE 6-30-2005.

THE MARK CONSISTS OF STANDARD CHARACTERS WITHOUT CLAIM TO ANY PARTICULAR FONT, STYLE, SIZE, OR COLOR.

OWNER OF U.S. REG. NO. 1,957,109.

SER. NO. 85-441,676, FILED 10-7-2011.

KATHLEEN LORENZO, EXAMINING ATTORNEY



David J. Kyros

Director of the United States Patent and Trademark Office

United States of America

United States Patent and Trademark Office

GEO-BLUE WOOD

Reg. No. 4,153,716

Registered June 5, 2012

Int. Cl.: 19

TRADEMARK

PRINCIPAL REGISTER

BLUE WORLD CRETE, INC (FLORIDA CORPORATION)
3840 WEST HILLSBOROUGH BLVD #303
DEERFIELD BEACH, FL 33442

FOR: CEMENT MORTAR, IN CLASS 19 (U.S. CLS. 1, 12, 33 AND 50).

FIRST USE 9-15-2011; IN COMMERCE 9-15-2011.

THE MARK CONSISTS OF STANDARD CHARACTERS WITHOUT CLAIM TO ANY PARTICULAR FONT, STYLE, SIZE, OR COLOR.

NO CLAIM IS MADE TO THE EXCLUSIVE RIGHT TO USE "WOOD", APART FROM THE MARK AS SHOWN.

SER. NO. 85-441,688, FILED 10-7-2011.

JIM RINGLE, EXAMINING ATTORNEY



David J. Kybas

Director of the United States Patent and Trademark Office

United States of America

United States Patent and Trademark Office

VIM

Reg. No. 4,153,717

Registered June 5, 2012

Int. Cl.: 42

SERVICE MARK

PRINCIPAL REGISTER

VERISOLV TECHNOLOGIES, INC. (VIRGINIA CORPORATION)
SUITE 304
607 HERNDON PARKWAY
HERNDON, VA 20170

FOR: INTERNET PROTOCOL (IP) ADDRESS VERIFICATION SERVICES, IN CLASS 42 (U.S. CLS. 100 AND 101).

FIRST USE 9-9-2005; IN COMMERCE 9-9-2005.

THE MARK CONSISTS OF STANDARD CHARACTERS WITHOUT CLAIM TO ANY PARTICULAR FONT, STYLE, SIZE, OR COLOR.

SER. NO. 85-441,698, FILED 10-7-2011.

DANNEAN HETZEL, EXAMINING ATTORNEY



David J. Kyffers

Director of the United States Patent and Trademark Office

United States of America

United States Patent and Trademark Office



Reg. No. 4,153,718

Registered June 5, 2012

Int. Cl.: 41

SERVICE MARK

PRINCIPAL REGISTER

MCINTYRE, MARTY (UNITED STATES INDIVIDUAL), TA GARQUEST
7228 RATTLESNAKE TR.
BELTON, TX 76513

FOR: FISHING GUIDE SERVICES; PROVIDING INFORMATION ON RECREATIONAL FISHING HOTSPOTS; PROVIDING INFORMATION ON RECREATIONAL FISHING, NAMELY, WHERE TO FIND CERTAIN KINDS OF FISH FOR FISHING PURPOSES, IN CLASS 41 (U.S. CLS. 100, 101 AND 107).

FIRST USE 1-1-1998; IN COMMERCE 1-1-1998.

THE MARK CONSISTS OF THE LETTERS "GARQUEST" IN A STYLIZED FORM CONTAINED WITHIN THE STYLIZED OUTLINE OF A GAR FISH.

SER. NO. 85-441,708, FILED 10-7-2011.

COURTNEY ALVAREZ, EXAMINING ATTORNEY



David J. Kybas

Director of the United States Patent and Trademark Office

United States of America

United States Patent and Trademark Office

BAKER SHEET

Reg. No. 4,153,719

Registered June 5, 2012

Int. Cl.: 18

TRADEMARK

PRINCIPAL REGISTER

THE CURVON CORPORATION (NEW JERSEY CORPORATION)
34 APPLE STREET
TINTON FALLS, NJ 07724

FOR: HORSE BLANKETS, IN CLASS 18 (U.S. CLS. 1, 2, 3, 22 AND 41).

FIRST USE 12-1-1999; IN COMMERCE 12-1-1999.

THE MARK CONSISTS OF STANDARD CHARACTERS WITHOUT CLAIM TO ANY PARTICULAR FONT, STYLE, SIZE, OR COLOR.

NO CLAIM IS MADE TO THE EXCLUSIVE RIGHT TO USE "SHEET", APART FROM THE MARK AS SHOWN.

SER. NO. 85-441,719, FILED 10-7-2011.

JORDAN BAKER, EXAMINING ATTORNEY



David J. Kyffers

Director of the United States Patent and Trademark Office

United States of America

United States Patent and Trademark Office

5/A

Reg. No. 4,153,720

Registered June 5, 2012

Int. Cl.: 18

TRADEMARK

PRINCIPAL REGISTER

THE CURVON CORPORATION (NEW JERSEY CORPORATION)
34 APPLE STREET
TINTON FALLS, NJ 07724

FOR: HORSE BLANKETS, HORSE SHEETS, HORSE RAINCOATS; RUN-A-BLANKETS, NAMELY, POST-RACE COVERS FOR HORSES; PROTECTIVE FLY SHEETS FOR HORSES; AND TURNOUTS, NAMELY, COVERS FOR HORSES, IN CLASS 18 (U.S. CLS. 1, 2, 3, 22 AND 41).

FIRST USE 8-1-1990; IN COMMERCE 8-1-1990.

THE MARK CONSISTS OF STANDARD CHARACTERS WITHOUT CLAIM TO ANY PARTICULAR FONT, STYLE, SIZE, OR COLOR.

SER. NO. 85-441,737, FILED 10-7-2011.

JORDAN BAKER, EXAMINING ATTORNEY



David J. Kyffers

Director of the United States Patent and Trademark Office

United States of America

United States Patent and Trademark Office

Preaching the Word

Reg. No. 4,153,721

Registered June 5, 2012

Int. Cl.: 16

TRADEMARK

PRINCIPAL REGISTER

GOOD NEWS PUBLISHERS (ILLINOIS NON-PROFIT CORPORATION)
1300 CRESCENT ST.
WHEATON, IL 60187

FOR: SERIES OF NON-FICTION BOOKS IN THE FIELD OF RELIGION, IN CLASS 16 (U.S. CLS. 2, 5, 22, 23, 29, 37, 38 AND 50).

FIRST USE 0-0-1988; IN COMMERCE 0-0-1988.

THE MARK CONSISTS OF STANDARD CHARACTERS WITHOUT CLAIM TO ANY PARTICULAR FONT, STYLE, SIZE, OR COLOR.

SER. NO. 85-441,745, FILED 10-7-2011.

MICHAEL TANNER, EXAMINING ATTORNEY



David J. Kybas

Director of the United States Patent and Trademark Office

United States of America

United States Patent and Trademark Office

No More Pencils Down

Reg. No. 4,153,722

Registered June 5, 2012

Int. Cl.: 42

SERVICE MARK

PRINCIPAL REGISTER

WEBFILINGS LLC (CALIFORNIA LIMITED LIABILITY COMPANY), FORMERLY WEB
FILINGS, LLC
2625 N. LOOP DR. SUITE 2130
AMES, IA 50010

FOR: PROVIDING TEMPORARY USE OF ONLINE NON-DOWNLOADABLE SOFTWARE
FOR USE IN CREATING AND FILING REGULATORY SUBMISSIONS, IN CLASS 42 (U.S.
CLS. 100 AND 101).

FIRST USE 8-12-2011; IN COMMERCE 8-12-2011.

THE MARK CONSISTS OF STANDARD CHARACTERS WITHOUT CLAIM TO ANY PAR-
TICULAR FONT, STYLE, SIZE, OR COLOR.

SER. NO. 85-441,749, FILED 10-7-2011.

EDWARD FENNESSY, EXAMINING ATTORNEY



David J. Kyffers

Director of the United States Patent and Trademark Office

United States of America

United States Patent and Trademark Office

BAKER

Reg. No. 4,153,723

Registered June 5, 2012

Int. Cl.: 18

TRADEMARK

PRINCIPAL REGISTER

THE CURVON CORPORATION (NEW JERSEY CORPORATION)
34 APPLE STREET
TINTON FALLS, NJ 07724

FOR: HORSE BLANKETS, HORSE SHEETS, HORSE RAINCOATS; RUN-A-BLANKETS, NAMELY, POST-RACE COVERS FOR HORSES; PROTECTIVE FLY SHEETS FOR HORSES, IN CLASS 18 (U.S. CLS. 1, 2, 3, 22 AND 41).

FIRST USE 8-1-1990; IN COMMERCE 8-1-1990.

THE MARK CONSISTS OF STANDARD CHARACTERS WITHOUT CLAIM TO ANY PARTICULAR FONT, STYLE, SIZE, OR COLOR.

SER. NO. 85-441,750, FILED 10-7-2011.

JORDAN BAKER, EXAMINING ATTORNEY



David J. Kybas

Director of the United States Patent and Trademark Office

United States of America

United States Patent and Trademark Office

MGC MORTGAGE

Reg. No. 4,153,724

Registered June 5, 2012

Int. Cl.: 36

SERVICE MARK

PRINCIPAL REGISTER

MGC MORTGAGE, INC. (TEXAS CORPORATION)
7195 DALLAS PARKWAY
PLANO, TX 75024

FOR: FINANCIAL SERVICES, NAMELY, BANKING SERVICES; MORTGAGE BANKING SERVICES, NAMELY, ORIGINATION, ACQUISITION, SERVICING, SECURITIZATION AND BROKERAGE OF MORTGAGE LOANS, IN CLASS 36 (U.S. CLS. 100, 101 AND 102).

FIRST USE 1-17-2008; IN COMMERCE 1-17-2008.

THE MARK CONSISTS OF STANDARD CHARACTERS WITHOUT CLAIM TO ANY PARTICULAR FONT, STYLE, SIZE, OR COLOR.

NO CLAIM IS MADE TO THE EXCLUSIVE RIGHT TO USE "MORTGAGE", APART FROM THE MARK AS SHOWN.

SER. NO. 85-441,755, FILED 10-7-2011.

EDWARD FENNESSY, EXAMINING ATTORNEY



David J. Kyros

Director of the United States Patent and Trademark Office

United States of America

United States Patent and Trademark Office

Doublemate

Reg. No. 4,153,725

GLEN A. MCCOY (UNITED STATES INDIVIDUAL)
1415 NEW YORK AVE
GLEN ALLEN, VA 23060

Registered June 5, 2012

Int. Cl.: 28

FOR: BOARD GAMES, IN CLASS 28 (U.S. CLS. 22, 23, 38 AND 50).

TRADEMARK

FIRST USE 1-1-2004; IN COMMERCE 1-1-2004.

PRINCIPAL REGISTER

THE MARK CONSISTS OF STANDARD CHARACTERS WITHOUT CLAIM TO ANY PARTICULAR FONT, STYLE, SIZE, OR COLOR.

SER. NO. 85-441,757, FILED 10-7-2011.

ELLEN B. AWRICH, EXAMINING ATTORNEY



David J. Kybas

Director of the United States Patent and Trademark Office

United States of America

United States Patent and Trademark Office

BULLET

Reg. No. 4,153,726

Registered June 5, 2012

Int. Cl.: 30

TRADEMARK

PRINCIPAL REGISTER

REUNION ISLAND COFFEE LIMITED (CANADA CORPORATION)
2421 ROYAL WINDSOR DRIVE
OAKVILLE, ONTARIO, CANADA L6J7X6

FOR: ROASTED GROUND COFFEE AND ROASTED WHOLE BEAN COFFEE, IN CLASS
30 (U.S. CL. 46).

FIRST USE 5-1-2009; IN COMMERCE 5-1-2009.

THE MARK CONSISTS OF STANDARD CHARACTERS WITHOUT CLAIM TO ANY PAR-
TICULAR FONT, STYLE, SIZE, OR COLOR.

SER. NO. 85-441,759, FILED 10-7-2011.

NAPOLEON SHARMA, EXAMINING ATTORNEY



David J. Kybas

Director of the United States Patent and Trademark Office

United States of America

United States Patent and Trademark Office

CANNONBALL

Reg. No. 4,153,727

REUNION ISLAND COFFEE LIMITED (CANADA CORPORATION)
2421 ROYAL WINDSOR DRIVE
OAKVILLE, ONTARIO, CANADA L6J7X6

Registered June 5, 2012

Int. Cl.: 30

FOR: ROASTED GROUND COFFEE AND ROASTED WHOLE BEAN COFFEE, IN CLASS 30 (U.S. CL. 46).

TRADEMARK

FIRST USE 12-1-2010; IN COMMERCE 12-1-2010.

PRINCIPAL REGISTER

THE MARK CONSISTS OF STANDARD CHARACTERS WITHOUT CLAIM TO ANY PARTICULAR FONT, STYLE, SIZE, OR COLOR.

SER. NO. 85-441,767, FILED 10-7-2011.

NAPOLEON SHARMA, EXAMINING ATTORNEY



David J. Kyffers

Director of the United States Patent and Trademark Office

United States of America

United States Patent and Trademark Office

FIREFLY

Reg. No. 4,153,728

Registered June 5, 2012

Int. Cl.: 30

TRADEMARK

PRINCIPAL REGISTER

REUNION ISLAND COFFEE LIMITED (CANADA CORPORATION)
2421 ROYAL WINDSOR DRIVE
OAKVILLE, ONTARIO, CANADA L6J7X6

FOR: ROASTED GROUND COFFEE AND ROASTED WHOLE BEAN COFFEE, IN CLASS
30 (U.S. CL. 46).

FIRST USE 7-1-2011; IN COMMERCE 7-1-2011.

THE MARK CONSISTS OF STANDARD CHARACTERS WITHOUT CLAIM TO ANY PAR-
TICULAR FONT, STYLE, SIZE, OR COLOR.

SER. NO. 85-441,774, FILED 10-7-2011.

NAPOLEON SHARMA, EXAMINING ATTORNEY



David J. Kybas

Director of the United States Patent and Trademark Office

United States of America

United States Patent and Trademark Office

PRICEWAITER

Reg. No. 4,153,729

Registered June 5, 2012

Int. Cl.: 35

SERVICE MARK

PRINCIPAL REGISTER

PRICE WAITER, LLC (TENNESSEE LIMITED LIABILITY COMPANY)
426 MARKET STREET
CHATTANOOGA, TN 37402

FOR: GOODS OR SERVICES PRICE QUOTATIONS; PROVIDING A WEB SITE WHEREBY BUYERS OF GOODS OR SERVICES LOCATE AND RECEIVE QUOTATIONS FROM MULTIPLE COMPETITIVE SOURCES AND SELLERS OF GOODS OR SERVICES IDENTIFY AND BID ON MULTIPLE NEW SALES OPPORTUNITIES, IN CLASS 35 (U.S. CLS. 100, 101 AND 102).

FIRST USE 4-28-2011; IN COMMERCE 4-28-2011.

THE MARK CONSISTS OF STANDARD CHARACTERS WITHOUT CLAIM TO ANY PARTICULAR FONT, STYLE, SIZE, OR COLOR.

SER. NO. 85-441,803, FILED 10-7-2011.

FRANK LATTUCA, EXAMINING ATTORNEY



David J. Kyffers

Director of the United States Patent and Trademark Office

United States of America

United States Patent and Trademark Office

 Name Your Price

Reg. No. 4,153,730

Registered June 5, 2012

Int. Cl.: 9

TRADEMARK

PRINCIPAL REGISTER

PRICE WAITER, LLC (TENNESSEE LIMITED LIABILITY COMPANY)
426 MARKET STREET
CHATTANOOGA, TN 37402

FOR: COMPUTER PROGRAM FOR GENERATING BIDS FOR THE GOODS OF OTHERS BY PROVIDING AN INTERACTIVE FEATURE THAT A RETAILER OR SELLER OF GOODS CAN DISPLAY ON A WEB SITE IN ASSOCIATION WITH THE GOODS THROUGH WHICH A POTENTIAL BUYER OF SUCH GOODS CAN MAKE A CUSTOM OFFER FOR THE PURCHASE OF THE GOODS AND RECEIVE ACCEPTANCE OR REJECTION FROM THE SELLER, IN CLASS 9 (U.S. CLS. 21, 23, 26, 36 AND 38).

FIRST USE 4-28-2011; IN COMMERCE 4-28-2011.

NO CLAIM IS MADE TO THE EXCLUSIVE RIGHT TO USE "NAME YOUR PRICE", APART FROM THE MARK AS SHOWN.

THE MARK CONSISTS OF A MOUSTACHE DESIGN FOLLOWED BY THE WORDS "NAME YOUR PRICE".

SER. NO. 85-441,811, FILED 10-7-2011.

FRANK LATTUCA, EXAMINING ATTORNEY



David J. Kyffers

Director of the United States Patent and Trademark Office

United States of America

United States Patent and Trademark Office

Baker Blanket

Reg. No. 4,153,731

Registered June 5, 2012

Int. Cl.: 18

TRADEMARK

PRINCIPAL REGISTER

THE CURVON CORPORATION (NEW JERSEY CORPORATION)
34 APPLE STREET
TINTON FALLS, NJ 07724

FOR: HORSE BLANKETS, IN CLASS 18 (U.S. CLS. 1, 2, 3, 22 AND 41).

FIRST USE 12-1-1999; IN COMMERCE 12-1-1999.

THE MARK CONSISTS OF STANDARD CHARACTERS WITHOUT CLAIM TO ANY PARTICULAR FONT, STYLE, SIZE, OR COLOR.

NO CLAIM IS MADE TO THE EXCLUSIVE RIGHT TO USE "BLANKET", APART FROM THE MARK AS SHOWN.

SER. NO. 85-441,816, FILED 10-7-2011.

JORDAN BAKER, EXAMINING ATTORNEY



David J. Kyffers

Director of the United States Patent and Trademark Office

United States of America

United States Patent and Trademark Office

Farmer's Pride

Reg. No. 4,153,732

STOVER, COREY (UNITED STATES INDIVIDUAL)
10681 HWY 111
ANACOCO, LA 71403

Registered June 5, 2012

Int. Cl.: 1

FOR: PLANT GROWTH NUTRIENTS, IN CLASS 1 (U.S. CLS. 1, 5, 6, 10, 26 AND 46).

TRADEMARK

FIRST USE 4-20-2011; IN COMMERCE 4-20-2011.

PRINCIPAL REGISTER

THE MARK CONSISTS OF STANDARD CHARACTERS WITHOUT CLAIM TO ANY PARTICULAR FONT, STYLE, SIZE, OR COLOR.

SER. NO. 85-441,857, FILED 10-7-2011.

ELLEN B. AWRICH, EXAMINING ATTORNEY



David J. Kyffers

Director of the United States Patent and Trademark Office

United States of America

United States Patent and Trademark Office

LIQUID MOTION

Reg. No. 4,153,733

Registered June 5, 2012

Int. Cl.: 41

SERVICE MARK

PRINCIPAL REGISTER

JANOVER, JENNIFER (UNITED STATES INDIVIDUAL)
13 MAIL COACH DRIVE
NORWALK, CT 06850

FOR: PROVIDING FITNESS INSTRUCTION CLASSES; PROVIDING PERSONAL WELL-BEING AND WOMEN EMPOWERMENT CLASSES, IN CLASS 41 (U.S. CLS. 100, 101 AND 107).

FIRST USE 12-5-2009; IN COMMERCE 12-5-2009.

THE MARK CONSISTS OF STANDARD CHARACTERS WITHOUT CLAIM TO ANY PARTICULAR FONT, STYLE, SIZE, OR COLOR.

SER. NO. 85-441,865, FILED 10-7-2011.

BRIAN CALLAGHAN, EXAMINING ATTORNEY



David J. Kyffers

Director of the United States Patent and Trademark Office

United States of America

United States Patent and Trademark Office



Reg. No. 4,153,734

Registered June 5, 2012

Int. Cls.: 18 and 25

TRADEMARK

PRINCIPAL REGISTER

LANGE, MIA P. (BAHAMAS INDIVIDUAL)
5610 NE TRIESTE WAY
BOCA RATON, FL 33487

FOR: EVENING HANDBAGS; FASHION HANDBAGS; HANDBAGS, IN CLASS 18 (U.S. CLS. 1, 2, 3, 22 AND 41).

FIRST USE 10-1-2010; IN COMMERCE 10-1-2010.

FOR: BELTS; GLOVES; HEADBANDS; JACKETS; JEANS; LEGGINGS; PANTS; SHOES; SKIRTS; SKIRTS AND DRESSES; STOCKINGS; T-SHIRTS; TUNICS, IN CLASS 25 (U.S. CLS. 22 AND 39).

FIRST USE 10-1-2010; IN COMMERCE 10-1-2010.

THE MARK CONSISTS OF TWO CAPITAL LETTER F'S FACING EACH OTHER CREATING A CAPITAL M.

SER. NO. 85-441,873, FILED 10-7-2011.

ELI HELLMAN, EXAMINING ATTORNEY



David J. Kyros

Director of the United States Patent and Trademark Office

United States of America

United States Patent and Trademark Office

Floppets

Reg. No. 4,153,735

Registered June 5, 2012

Int. Cl.: 26

TRADEMARK

PRINCIPAL REGISTER

ZYDECO STUDIOS (ILLINOIS PARTNERSHIP)
#200
2033 N. MILWAUKEE AVE
RIVERWOODS, IL 60015

FOR: ORNAMENTAL NOVELTY BUTTONS, IN CLASS 26 (U.S. CLS. 37, 39, 40, 42 AND 50).

FIRST USE 7-15-2010; IN COMMERCE 6-1-2011.

THE MARK CONSISTS OF STANDARD CHARACTERS WITHOUT CLAIM TO ANY PARTICULAR FONT, STYLE, SIZE, OR COLOR.

SER. NO. 85-441,874, FILED 10-7-2011.

ELI HELLMAN, EXAMINING ATTORNEY



David J. Kybas

Director of the United States Patent and Trademark Office

United States of America

United States Patent and Trademark Office

Your Marketplace For Your Workspace

Reg. No. 4,153,736

DOBBS, KENNETH J (UNITED STATES INDIVIDUAL)
505 S. CALHOUN ROAD
BROOKFIELD, WI 53005

Registered June 5, 2012

Int. Cl.: 35

FOR: ON-LINE RETAIL STORE SERVICES FEATURING OFFICE FURNITURE, IN CLASS
35 (U.S. CLS. 100, 101 AND 102).

SERVICE MARK

FIRST USE 12-1-2011; IN COMMERCE 12-1-2011.

PRINCIPAL REGISTER

THE MARK CONSISTS OF STANDARD CHARACTERS WITHOUT CLAIM TO ANY PAR-
TICULAR FONT, STYLE, SIZE, OR COLOR.

SER. NO. 85-441,878, FILED 10-7-2011.

JOHN DALIER, EXAMINING ATTORNEY



David J. Kybas

Director of the United States Patent and Trademark Office

United States of America

United States Patent and Trademark Office

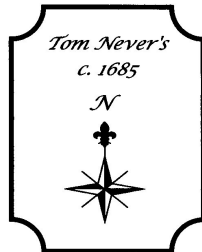

Reg. No. 4,153,737

Registered June 5, 2012

Int. Cl.: 25

TRADEMARK

PRINCIPAL REGISTER

GRABOWSKI, CAREY (UNITED STATES INDIVIDUAL)
46 IVANHOE STREET
CRANSTON, RI 02910

FOR: POLO SHIRTS, IN CLASS 25 (U.S. CLS. 22 AND 39).

FIRST USE 4-15-2010; IN COMMERCE 7-1-2010.

THE NAME "TOM NEVER" OR "TOM NEVER'S" DOES NOT IDENTIFY A LIVING INDIVIDUAL.

THE MARK CONSISTS OF A FRAME WITH THE STYLIZED TEXT "TOM NEVER'S C. 1685 N". BELOW THERE IS A COMPASS WITH A FLEUR DE LIS ON THE TOP.

SER. NO. 85-441,908, FILED 10-7-2011.

HANNO RITTNER, EXAMINING ATTORNEY



David J. Kyffers

Director of the United States Patent and Trademark Office

United States of America

United States Patent and Trademark Office

Alaska Origin

Reg. No. 4,153,738

Registered June 5, 2012

Int. Cl.: 25

TRADEMARK

PRINCIPAL REGISTER

SWOPE, GAILE (UNITED STATES INDIVIDUAL)
2214 RAVEN ROAD
DOUGLAS, AK 99801

FOR: BANDANAS; BASEBALL CAPS AND HATS; COATS; HATS; HOODED SWEATSHIRTS; JACKETS; KNITTED CAPS; LONG-SLEEVED SHIRTS; MOISTURE-WICKING SPORTS SHIRTS; NIGHT SHIRTS; POLO SHIRTS; SHIRTS; SHIRTS FOR INFANTS, BABIES, TODDLERS AND CHILDREN; SWEAT PANTS; SWEATERS; SWEATSHIRTS; TEE SHIRTS; UNDERWEAR; VISORS, IN CLASS 25 (U.S. CLS. 22 AND 39).

FIRST USE 5-2-2009; IN COMMERCE 7-7-2010.

THE MARK CONSISTS OF STANDARD CHARACTERS WITHOUT CLAIM TO ANY PARTICULAR FONT, STYLE, SIZE, OR COLOR.

NO CLAIM IS MADE TO THE EXCLUSIVE RIGHT TO USE "ALASKA", APART FROM THE MARK AS SHOWN.

SER. NO. 85-441,944, FILED 10-7-2011.

CURTIS FRENCH, EXAMINING ATTORNEY



David J. Kyffers

Director of the United States Patent and Trademark Office

United States of America
United States Patent and Trademark Office

 **EMBARQ**

Reg. No. 4,153,739

Registered June 5, 2012

Int. Cl.: 39

SERVICE MARK

PRINCIPAL REGISTER

WORLD RESOURCES INSTITUTE (DELAWARE NON-PROFIT CORPORATION)
SUITE 800
10 G STREET, NE
WASHINGTON, DC 20002

FOR: CONSULTATION SERVICES IN THE FIELD OF URBAN TRANSPORTATION AND MOBILITY, NAMELY, WORKING WITH OTHERS TO IDENTIFY AND ANALYZE URBAN TRANSPORTATION AND MOBILITY PROBLEMS, IN CLASS 39 (U.S. CLS. 100 AND 105).

FIRST USE 5-27-2011; IN COMMERCE 5-27-2011.

OWNER OF U.S. REG. NO. 3,135,860.

THE MARK CONSISTS OF A STYLIZED BOX AND ARROW DESIGN TO THE LEFT OF THE WORD "EMBARQ".

SER. NO. 85-441,952, FILED 10-7-2011.

CURTIS FRENCH, EXAMINING ATTORNEY



David J. Kyjars

Director of the United States Patent and Trademark Office

United States of America

United States Patent and Trademark Office



Reg. No. 4,153,740

Registered June 5, 2012

Int. Cl.: 45

SERVICE MARK

PRINCIPAL REGISTER

REY'WA, LLC (CALIFORNIA LIMITED LIABILITY COMPANY)
1714 FRANKLIN ST., 100-389
OAKLAND, CA 94612

FOR: PROVIDING A WEB SITE FEATURING INFORMATION AND CONTENT IN THE FIELDS OF PERSONAL RELATIONSHIPS, PERSONAL GROWTH AND MOTIVATION, AND SELF-FULFILLMENT, IN CLASS 45 (U.S. CLS. 100 AND 101).

FIRST USE 4-5-2011; IN COMMERCE 4-5-2011.

THE MARK CONSISTS OF A STRETCHING STICK FIGURE CONTAINED WITHIN A CIRCLE.

SER. NO. 85-441,953, FILED 10-7-2011.

CURTIS FRENCH, EXAMINING ATTORNEY



David J. Kybas

Director of the United States Patent and Trademark Office

United States of America

United States Patent and Trademark Office

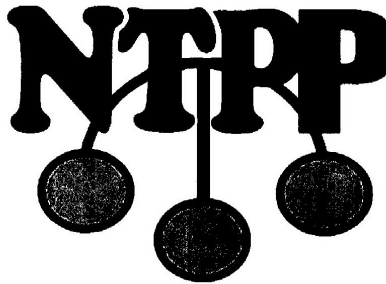

Reg. No. 4,153,741

Registered June 5, 2012

Int. Cl.: 36

SERVICE MARK

PRINCIPAL REGISTER

NARANJA PAWN, INC. (FLORIDA CORPORATION)
732 S. KROME AVE
HOMESTEAD, FL 33030

FOR: PAWN SHOPS, IN CLASS 36 (U.S. CLS. 100, 101 AND 102).

FIRST USE 2-1-2011; IN COMMERCE 2-1-2011.

NO CLAIM IS MADE TO THE EXCLUSIVE RIGHT TO USE THE REPRESENTATION OF THE PAWNBROKER SYMBOL, APART FROM THE MARK AS SHOWN.

THE MARK CONSISTS OF THE STYLIZED TEXT "NTPP" WITH A PAWNBALL SYMBOL SHADOWED UNDERNEATH.

SER. NO. 85-441,958, FILED 10-7-2011.

MICHAEL KEATING, EXAMINING ATTORNEY



David J. Kyffers

Director of the United States Patent and Trademark Office

United States of America

United States Patent and Trademark Office

RDH eVillage

Reg. No. 4,153,742

Registered June 5, 2012

Int. Cl.: 44

SERVICE MARK

PRINCIPAL REGISTER

PENNWELL CORPORATION (OKLAHOMA CORPORATION)
1421 SOUTH SHERIDAN ROAD
TULSA, OK 74112

FOR: PROVIDING INFORMATION ONLINE IN THE FIELD OF DENTAL HYGIENE, IN CLASS 44 (U.S. CLS. 100 AND 101).

FIRST USE 3-31-2005; IN COMMERCE 3-31-2005.

OWNER OF U.S. REG. NOS. 1,998,227, 3,708,168, AND 3,721,296.

SEC. 2(F) AS TO "RDH".

SER. NO. 85-441,959, FILED 10-7-2011.

KIM MONINGHOFF, EXAMINING ATTORNEY



David J. Kyffers

Director of the United States Patent and Trademark Office

United States of America

United States Patent and Trademark Office

The logo for "Glukies" features the word "Glukies" in a bold, stylized, blackletter font. The letter "i" is replaced by a circular image of a cookie with a grid pattern on its top surface.

Reg. No. 4,153,743

Registered June 5, 2012

Int. Cl.: 5

TRADEMARK

PRINCIPAL REGISTER

GLUKIES (NEW JERSEY LIMITED LIABILITY COMPANY)
126 BURNET CRESCENT
ROBBINSVILLE, NJ 08691

FOR: GLUTEN-FREE FOOD TO ACCOMMODATE SPECIAL MEDICAL AND HEALTH CONDITIONS, IN CLASS 5 (U.S. CLS. 6, 18, 44, 46, 51 AND 52).

FIRST USE 11-13-2010; IN COMMERCE 12-0-2010.

THE MARK CONSISTS OF THE STYLIZED WORD "GLUKIES". AN IMAGE OF A COOKIE AS THE DOT IN THE LETTER "I".

SER. NO. 85-441,969, FILED 10-7-2011.

ELLEN B. AWRICH, EXAMINING ATTORNEY



David J. Kybas

Director of the United States Patent and Trademark Office

United States of America

United States Patent and Trademark Office

ENVIROTIP

Reg. No. 4,153,744

Registered June 5, 2012

Int. Cl.: 7

TRADEMARK

PRINCIPAL REGISTER

HAYNES CORPORATION (MICHIGAN CORPORATION)
3581 MERCANTILE AVENUE
NAPLES, FL 34104

FOR: FUEL INJECTORS, IN CLASS 7 (U.S. CLS. 13, 19, 21, 23, 31, 34 AND 35).

FIRST USE 0-0-2009; IN COMMERCE 1-1-2009.

THE MARK CONSISTS OF STANDARD CHARACTERS WITHOUT CLAIM TO ANY PARTICULAR FONT, STYLE, SIZE, OR COLOR.

SER. NO. 85-441,991, FILED 10-7-2011.

LINDA MICKLEBURGH, EXAMINING ATTORNEY



David J. Kybas

Director of the United States Patent and Trademark Office

United States of America

United States Patent and Trademark Office

**iCARE**
MANAGED SERVICES

Reg. No. 4,153,745

THE I.T. WORKSHOP, L.L.C. (ARIZONA LIMITED LIABILITY COMPANY)
890 W. ELLIOT ROAD, SUITE 110
GILBERT, AZ 85233

Registered June 5, 2012

Int. Cl.: 37

FOR: COMPUTER HARDWARE INSTALLATION AND REPAIR, INCLUDING MOBILE PERFORMANCE OF SUCH SERVICES ON CUSTOMER PREMISES; COMPUTER INSTALLATION AND REPAIR; INSTALLATION AND REPAIR OF COMPUTER HARDWARE; INSTALLATION OF COMPUTER NETWORKING HARDWARE; INSTALLATION OF COMPUTER SYSTEMS; INSTALLATION, MAINTENANCE AND REPAIR OF COMPUTER HARDWARE; INSTALLATION, REPAIR AND MAINTENANCE OF COMPUTERS AND COMPUTER PERIPHERALS; MAINTENANCE AND REPAIR OF COMPUTER HARDWARE; MAINTENANCE AND REPAIR OF COMPUTER NETWORKING HARDWARE; MAINTENANCE OF COMPUTER HARDWARE; MAINTENANCE OF COMPUTER HARDWARE SYSTEMS; REPAIR OF COMPUTER HARDWARE; REPAIR OF DAMAGED COMPUTERS; REPAIR OR MAINTENANCE OF COMPUTERS; TECHNICAL SUPPORT SERVICES, NAMELY, TROUBLESHOOTING IN THE NATURE OF THE REPAIR OF COMPUTER HARDWARE; UPDATING OF COMPUTER HARDWARE; UPGRADING OF COMPUTER HARDWARE, IN CLASS 37 (U.S. CLS. 100, 103 AND 106).

SERVICE MARK

PRINCIPAL REGISTER

FIRST USE 9-9-2011; IN COMMERCE 9-9-2011.

NO CLAIM IS MADE TO THE EXCLUSIVE RIGHT TO USE "MANAGED SERVICES", APART FROM THE MARK AS SHOWN.

THE MARK CONSISTS OF AN ON OFF BUTTON ABOVE THE "I" IN "ICARE" THAT IS ABOVE "MANAGED SERVICES".

SER. NO. 85-442,005, FILED 10-7-2011.

JAMES STEIN, EXAMINING ATTORNEY



David J. Kyros

Director of the United States Patent and Trademark Office

United States of America

United States Patent and Trademark Office

PUT UP A TREE. LIFT UP A
CHILD.

Reg. No. 4,153,746

PEARL MINISTRIES, INC. (GEORGIA NON-PROFIT CORPORATION)
P. O. BOX 610537
BIRMINGHAM, AL 35261

Registered June 5, 2012

Int. Cls.: 35 and 36

FOR: MAIL ORDER SERVICES FEATURING GIFTS AND SUNDRIES; ON-LINE RETAIL STORE SERVICES FEATURING GIFTS AND SUNDRIES; WHOLESALE AND RETAIL STORE SERVICES FEATURING GIFTS AND SUNDRIES; ALL OF THE FOREGOING EXCLUDING FRESH FRUIT, IN CLASS 35 (U.S. CLS. 100, 101 AND 102).

SERVICE MARK

PRINCIPAL REGISTER

FIRST USE 5-1-2010; IN COMMERCE 5-1-2010.

FOR: CHARITABLE FUNDRAISING SERVICES, IN CLASS 36 (U.S. CLS. 100, 101 AND 102).

FIRST USE 5-1-2010; IN COMMERCE 5-1-2010.

THE MARK CONSISTS OF STANDARD CHARACTERS WITHOUT CLAIM TO ANY PARTICULAR FONT, STYLE, SIZE, OR COLOR.

SER. NO. 85-442,008, FILED 10-7-2011.

KAREN BRACEY, EXAMINING ATTORNEY



David J. Kyros

Director of the United States Patent and Trademark Office

United States of America

United States Patent and Trademark Office

Klarify

Reg. No. 4,153,747

Registered June 5, 2012

Int. Cl.: 42

SERVICE MARK

PRINCIPAL REGISTER

VERIGREEN ENERGY & LIGHT SOLUTIONS, LLC (VIRGINIA LIMITED LIABILITY COMPANY)
23129 STOCKHAM WAY
ASHBURN, VA 20148

FOR: PROVIDING ON-LINE NON-DOWNLOADABLE COMPUTER SOFTWARE THAT PROVIDES REAL-TIME, INTEGRATED BUSINESS MANAGEMENT INTELLIGENCE BY COMBINING INFORMATION FROM VARIOUS DATABASES AND PRESENTING IT IN AN EASY-TO-UNDERSTAND USER INTERFACE, IN CLASS 42 (U.S. CLS. 100 AND 101).

FIRST USE 9-6-2011; IN COMMERCE 10-6-2011.

THE MARK CONSISTS OF STANDARD CHARACTERS WITHOUT CLAIM TO ANY PARTICULAR FONT, STYLE, SIZE, OR COLOR.

SER. NO. 85-442,010, FILED 10-7-2011.

EMILY CHUO, EXAMINING ATTORNEY



David J. Kybas

Director of the United States Patent and Trademark Office

United States of America

United States Patent and Trademark Office

BUY AN ORNAMENT. BLESS A
CHILD.

Reg. No. 4,153,748

PEARL MINISTRIES, INC. (GEORGIA NON-PROFIT CORPORATION)
P. O. BOX 610537
BIRMINGHAM, AL 35261

Registered June 5, 2012

Int. Cls.: 35 and 36

FOR: MAIL ORDER SERVICES FEATURING GIFTS AND SUNDRIES; ON-LINE RETAIL STORE SERVICES FEATURING GIFTS AND SUNDRIES; WHOLESALE AND RETAIL STORE SERVICES FEATURING GIFTS AND SUNDRIES; ALL OF THE FOREGOING EXCLUDING FRESH FRUIT, IN CLASS 35 (U.S. CLS. 100, 101 AND 102).

SERVICE MARK

PRINCIPAL REGISTER

FIRST USE 5-1-2010; IN COMMERCE 5-1-2010.

FOR: CHARITABLE FUNDRAISING SERVICES, IN CLASS 36 (U.S. CLS. 100, 101 AND 102).

FIRST USE 5-1-2010; IN COMMERCE 5-1-2010.

THE MARK CONSISTS OF STANDARD CHARACTERS WITHOUT CLAIM TO ANY PARTICULAR FONT, STYLE, SIZE, OR COLOR.

SER. NO. 85-442,016, FILED 10-7-2011.

KAREN BRACEY, EXAMINING ATTORNEY



David J. Kyros

Director of the United States Patent and Trademark Office

United States of America

United States Patent and Trademark Office

SCARLETT JEWELS

Reg. No. 4,153,749

SCARLETT DESIGNS, INC. (NEW YORK CORPORATION)
158-40 90TH ST
HOWARD BEACH, NY 11414

Registered June 5, 2012

Int. Cl.: 14

FOR: BRACELETS; EARRINGS; JEWELRY; NECKLACES, IN CLASS 14 (U.S. CLS. 2, 27, 28 AND 50).

TRADEMARK

FIRST USE 4-0-2011; IN COMMERCE 4-0-2011.

PRINCIPAL REGISTER

THE MARK CONSISTS OF STANDARD CHARACTERS WITHOUT CLAIM TO ANY PARTICULAR FONT, STYLE, SIZE, OR COLOR.

NO CLAIM IS MADE TO THE EXCLUSIVE RIGHT TO USE "JEWELS", APART FROM THE MARK AS SHOWN.

SER. NO. 85-442,017, FILED 10-7-2011.

BRIAN PINO, EXAMINING ATTORNEY



David J. Kybas

Director of the United States Patent and Trademark Office

United States of America

United States Patent and Trademark Office

Pistashio

Reg. No. 4,153,750

Registered June 5, 2012

Int. Cl.: 42

SERVICE MARK

PRINCIPAL REGISTER

BRIDGE WORKER'S UNION, INC. (DELAWARE CORPORATION)
1000
45 MAIN STREET
BROOKLYN, NY 11201

FOR: PROVIDING TEMPORARY USE OF A WEB-BASED SOFTWARE APPLICATION FOR SAVING, ORGANIZING, AND DISCOVERING PERSONAL INTERESTS, IN CLASS 42 (U.S. CLS. 100 AND 101).

FIRST USE 8-26-2011; IN COMMERCE 8-26-2011.

THE MARK CONSISTS OF STANDARD CHARACTERS WITHOUT CLAIM TO ANY PARTICULAR FONT, STYLE, SIZE, OR COLOR.

SER. NO. 85-442,034, FILED 10-7-2011.

KATHERINE CONNOLLY, EXAMINING ATTORNEY



David J. Kybas

Director of the United States Patent and Trademark Office

United States of America

United States Patent and Trademark Office



Reg. No. 4,153,751

Registered June 5, 2012

Int. Cl.: 40

SERVICE MARK

PRINCIPAL REGISTER

RENEWABLE ENERGY DEVELOPMENT CORPORATION (UTAH CORPORATION), DBA
REDCO
922 W. BAXTER DR., SUITE 200
SOUTH JORDAN, UT 84095

FOR: ENERGY GENERATION SERVICES; GENERATION OF ENERGY, IN CLASS 40 (U.S.
CLS. 100, 103 AND 106).

FIRST USE 11-0-2008; IN COMMERCE 11-0-2008.

THE MARK CONSISTS OF THREE LEAFS ARRANGED IN AN EQUILATERAL TRIANGLE
PATTERN FROM THE TIP OF A BLADE TO THE PETIOLE OF ANOTHER, A LIGHT BLUE
LEAF ON THE UPPER LEFT LEG, GREEN ON THE UPPER RIGHT LEG AND ORANGE ON
THE BOTTOM LEG.

THE COLOR(S) LIGHT BLUE, GREEN AND ORANGE IS/ARE CLAIMED AS A FEATURE
OF THE MARK.

SER. NO. 85-442,035, FILED 10-7-2011.

AMY KELLY, EXAMINING ATTORNEY



David J. Kyros

Director of the United States Patent and Trademark Office

United States of America

United States Patent and Trademark Office

PEGAWORLD

Reg. No. 4,153,752

PEGASYSTEMS INC. (MASSACHUSETTS CORPORATION)
101 MAIN STREET
CAMBRIDGE, MA 02142

Registered June 5, 2012

Int. Cl.: 35

FOR: ARRANGING AND CONDUCTING BUSINESS CONFERENCES; PROMOTING AND CONDUCTING TRADE SHOWS IN THE FIELD OF USING COMPUTER SOFTWARE FOR BUSINESS PROCESS MANAGEMENT, CUSTOMER RELATIONSHIP MANAGEMENT AND CASE MANAGEMENT, IN CLASS 35 (U.S. CLS. 100, 101 AND 102).

SERVICE MARK

PRINCIPAL REGISTER

FIRST USE 10-18-2006; IN COMMERCE 10-18-2006.

THE MARK CONSISTS OF STANDARD CHARACTERS WITHOUT CLAIM TO ANY PARTICULAR FONT, STYLE, SIZE, OR COLOR.

OWNER OF U.S. REG. NOS. 2,799,071, 3,247,526 AND OTHERS.

SER. NO. 85-442,061, FILED 10-7-2011.

EMILY CARLSEN, EXAMINING ATTORNEY



David J. Kyffers

Director of the United States Patent and Trademark Office

United States of America

United States Patent and Trademark Office

LINOLIN

Reg. No. 4,153,753

Registered June 5, 2012

Int. Cl.: 5

TRADEMARK

PRINCIPAL REGISTER

LEAN-SLIM, LLC (NEVADA LIMITED LIABILITY COMPANY)
6935 ALIANTE PKWY # 104-322
LAS VEGAS, NV 89084

FOR: SUPPLEMENTS, NAMELY, DIETARY FOOD SUPPLEMENTS, DIETARY SUPPLEMENTS, FOOD SUPPLEMENTS, HERBAL SUPPLEMENTS, MEAL REPLACEMENT AND DIETARY SUPPLEMENT DRINK MIXES, MINERAL NUTRITIONAL SUPPLEMENTS, MINERAL SUPPLEMENTS, NUTRITIONAL SUPPLEMENTS, NUTRITIONAL SUPPLEMENT DRINK MIX, VITAMIN AND MINERAL SUPPLEMENTS, AND VITAMIN SUPPLEMENTS; MEAL REPLACEMENT BARS, IN CLASS 5 (U.S. CLS. 6, 18, 44, 46, 51 AND 52).

FIRST USE 1-2-2007; IN COMMERCE 1-2-2007.

THE MARK CONSISTS OF STANDARD CHARACTERS WITHOUT CLAIM TO ANY PARTICULAR FONT, STYLE, SIZE, OR COLOR.

SER. NO. 85-442,062, FILED 10-7-2011.

KATHLEEN LORENZO, EXAMINING ATTORNEY



David J. Kybas

Director of the United States Patent and Trademark Office

United States of America

United States Patent and Trademark Office

Sequin

Reg. No. 4,153,754

SEQUIN, LLC (MINNESOTA LIMITED LIABILITY COMPANY)
234 W. 39TH STREET, 10TH FLOOR
NEW YORK, NY 10018

Registered June 5, 2012

Int. Cl.: 35

FOR: RETAIL STORE SERVICES FEATURING JEWELRY; ON-LINE STORE SERVICES
FEATURING JEWELRY, IN CLASS 35 (U.S. CLS. 100, 101 AND 102).

SERVICE MARK

FIRST USE 12-1-2009; IN COMMERCE 12-1-2009.

PRINCIPAL REGISTER

OWNER OF U.S. REG. NOS. 3,094,990 AND 3,969,376.

THE MARK CONSISTS OF THE WORD "SEQUIN" IN STYLIZED LETTERS.

SER. NO. 85-442,070, FILED 10-7-2011.

JANICE L. MCMORROW, EXAMINING ATTORNEY



David J. Kybas

Director of the United States Patent and Trademark Office

United States of America

United States Patent and Trademark Office

PRISM

Reg. No. 4,153,755

Registered June 5, 2012

Int. Cl.: 16

TRADEMARK

PRINCIPAL REGISTER

21ST EDITIONS, INC. (MASSACHUSETTS CORPORATION)
9 NEW VENTURE DRIVE - UNIT 1
SOUTH DENNIS, MA 02660

FOR: A SERIES OF BOOKS AND WRITTEN ARTICLES IN THE FIELD OF SPORTS, ENTERTAINMENT AND FINE ARTS PHOTOGRAPHY, IN CLASS 16 (U.S. CLS. 2, 5, 22, 23, 29, 37, 38 AND 50).

FIRST USE 9-1-2010; IN COMMERCE 1-5-2011.

THE MARK CONSISTS OF STANDARD CHARACTERS WITHOUT CLAIM TO ANY PARTICULAR FONT, STYLE, SIZE, OR COLOR.

SER. NO. 85-442,071, FILED 10-7-2011.

JANICE L. MCMORROW, EXAMINING ATTORNEY



David J. Kybas

Director of the United States Patent and Trademark Office

United States of America

United States Patent and Trademark Office

CAUGHT ON FILM

Reg. No. 4,153,756

Registered June 5, 2012

Int. Cl.: 41

SERVICE MARK

PRINCIPAL REGISTER

THE UNGAR GROUP, LLC (INDIANA LIMITED LIABILITY COMPANY), DBA U/S SPORTS
ADVISORS
SUITE 450
250 E. 96TH STREET
INDIANAPOLIS, IN 46240

FOR: ENTERTAINMENT SERVICES, NAMELY CONDUCTING CONTESTS, IN CLASS 41
(U.S. CLS. 100, 101 AND 107).

FIRST USE 12-3-2010; IN COMMERCE 12-3-2010.

THE MARK CONSISTS OF STANDARD CHARACTERS WITHOUT CLAIM TO ANY PAR-
TICULAR FONT, STYLE, SIZE, OR COLOR.

SER. NO. 85-442,088, FILED 10-7-2011.

FRANK LATTUCA, EXAMINING ATTORNEY



David J. Kyffers

Director of the United States Patent and Trademark Office

United States of America

United States Patent and Trademark Office

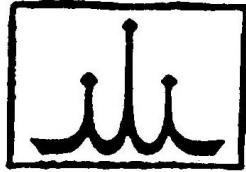

CREDOR

Reg. No. 4,153,757

Registered June 5, 2012

Int. Cl.: 14

TRADEMARK

PRINCIPAL REGISTER

SEIKO HOLDINGS KABUSHIKI KAISHA (JAPAN CORPORATION), TA SEIKO HOLDINGS CORPORATION
5-11, GINZA 4-CHOME, CHUO-KU
TOKYO, JAPAN

FOR: WATCHES, STOP WATCHES; WATCH STRAPS; WATCH BRACELETS; WATCH CASES; WATCH PARTS, NAMELY, WATCH DIALS AND WATCH CROWNS; JEWELRY AND IMITATION JEWELRY, IN CLASS 14 (U.S. CLS. 2, 27, 28 AND 50).

OWNER OF JAPAN REG. NO. 1767376, DATED 5-30-1985, EXPIRES 5-30-2015.

OWNER OF U.S. REG. NOS. 3,008,318, 3,065,560, AND 3,391,425.

THE MARK CONSISTS OF THE STYLIZED TERM "CREDOR" BELOW A RECTANGLE WITH A CURVED LINE DESIGN WITH THREE CRESTS EACH TOPPED BY A SMALL DIAMOND.

SER. NO. 85-442,099, FILED 10-7-2011.

HOWARD B. LEVINE, EXAMINING ATTORNEY



David J. Kyffers

Director of the United States Patent and Trademark Office

United States of America

United States Patent and Trademark Office

LASTING IMPRINT

Reg. No. 4,153,758

LASTING IMPRINT, INC. (MINNESOTA NON-PROFIT ORGANIZATION)
P.O. BOX 261
MANKATO, MN 56002

Registered June 5, 2012

Int. Cls.: 35 and 36

FOR: PROMOTING PUBLIC AWARENESS OF CONGENITAL HEART DEFECTS, IN CLASS 35 (U.S. CLS. 100, 101 AND 102).

SERVICE MARK

FIRST USE 4-27-2011; IN COMMERCE 4-27-2011.

PRINCIPAL REGISTER

FOR: CHARITABLE SERVICES, NAMELY, ORGANIZING FUNDRAISING SERVICES AND EVENTS TO RAISE FUNDS IN THE FIELD OF CONGENITAL HEART DEFECTS, IN CLASS 36 (U.S. CLS. 100, 101 AND 102).

FIRST USE 5-21-2011; IN COMMERCE 5-21-2011.

THE MARK CONSISTS OF STANDARD CHARACTERS WITHOUT CLAIM TO ANY PARTICULAR FONT, STYLE, SIZE, OR COLOR.

SER. NO. 85-442,133, FILED 10-7-2011.

KATHLEEN LORENZO, EXAMINING ATTORNEY



David J. Kybas

Director of the United States Patent and Trademark Office

United States of America

United States Patent and Trademark Office

Nottibianche

Reg. No. 4,153,759

DILLARDS (DELAWARE CORPORATION)
1600 CANTRELL ROAD
LITTLE ROCK, AR 72201

Registered June 5, 2012

Int. Cl.: 25

FOR: BOXER SHORTS; GOWNS; NIGHT GOWNS; NIGHT SHIRTS; PAJAMAS; ROBES;
SLEEP PANTS; SLEEP SHIRTS; TANK TOPS, IN CLASS 25 (U.S. CLS. 22 AND 39).

TRADEMARK

FIRST USE 12-1-2006; IN COMMERCE 12-1-2006.

PRINCIPAL REGISTER

THE MARK CONSISTS OF STANDARD CHARACTERS WITHOUT CLAIM TO ANY PARTICULAR FONT, STYLE, SIZE, OR COLOR.

THE ENGLISH TRANSLATION OF THE MARK IS "WHITE NIGHTS".

SER. NO. 85-442,164, FILED 10-7-2011.

REBECCA SMITH, EXAMINING ATTORNEY



David J. Kybas

Director of the United States Patent and Trademark Office

United States of America

United States Patent and Trademark Office



Reg. No. 4,153,760

Registered June 5, 2012

Int. Cls.: 35 and 42

SERVICE MARK

PRINCIPAL REGISTER

LOOSE LEAF CONCEPTS, LLC (PENNSYLVANIA LIMITED LIABILITY COMPANY)
3303 CAPRI DRIVE
PHILADELPHIA, PA 19145

FOR: ADVERTISING SERVICES, NAMELY, CREATING CORPORATE LOGOS FOR OTHERS;
ADVERTISING, MARKETING AND PROMOTION SERVICES; BRANDING SERVICES,
NAMELY, CONSULTING, DEVELOPMENT, MANAGEMENT AND MARKETING OF
BRANDS FOR BUSINESSES, IN CLASS 35 (U.S. CLS. 100, 101 AND 102).

FIRST USE 12-31-2007; IN COMMERCE 12-31-2007.

FOR: GRAPHIC DESIGN SERVICES; WEBSITE DESIGN AND DEVELOPMENT FOR OTHERS,
IN CLASS 42 (U.S. CLS. 100 AND 101).

FIRST USE 12-31-2007; IN COMMERCE 12-31-2007.

THE MARK CONSISTS OF THE LETTERS "LLC" IN A STYLIZED FONT.

SER. NO. 85-442,175, FILED 10-7-2011.

TINA BROWN, EXAMINING ATTORNEY



David J. Kybas

Director of the United States Patent and Trademark Office

United States of America

United States Patent and Trademark Office

FilmBot

Reg. No. 4,153,761

Registered June 5, 2012

Int. Cls.: 41 and 42

SERVICE MARK

PRINCIPAL REGISTER

FRIEND, MAX DANIEL (UNITED STATES INDIVIDUAL)
1548 GREENE AVE. APT. 2
BROOKLYN, NY 11237

FOR: ENTERTAINMENT SERVICES, NAMELY, PROVIDING ON-LINE REVIEWS OF MOVIES AND SPECIAL SCREENING EVENTS; PROVIDING A WEB SITE WHERE USERS CAN POST RATINGS, REVIEWS AND RECOMMENDATIONS ON EVENTS AND ACTIVITIES IN THE FIELD OF ENTERTAINMENT AND EDUCATION; PROVIDING INFORMATION AND ARTICLES IN THE FIELD OF FILM, FILMMAKING, AND ENTERTAINMENT VIA A GLOBAL COMPUTER NETWORK; PROVIDING RATINGS FOR TELEVISION, MOVIE, MUSIC, VIDEO AND VIDEO GAME CONTENT, IN CLASS 41 (U.S. CLS. 100, 101 AND 107).

FIRST USE 11-30-2010; IN COMMERCE 7-1-2011.

FOR: PROVIDING A WEBSITE FEATURING A MEDIA AGGREGATOR AND SEARCH ENGINE FOR INTERNET CONTENT , IN CLASS 42 (U.S. CLS. 100 AND 101).

FIRST USE 11-30-2010; IN COMMERCE 7-1-2011.

THE MARK CONSISTS OF STANDARD CHARACTERS WITHOUT CLAIM TO ANY PARTICULAR FONT, STYLE, SIZE, OR COLOR.

SER. NO. 85-442,178, FILED 10-7-2011.

SALLY SHIH, EXAMINING ATTORNEY



David J. Kybas

Director of the United States Patent and Trademark Office

United States of America

United States Patent and Trademark Office



Reg. No. 4,153,762

Registered June 5, 2012

Int. Cl.: 9

TRADEMARK

PRINCIPAL REGISTER

SAMYA TECHNOLOGY CO., LTD. (TAIWAN CORPORATION)
2F, NO.61
LANE 770, GUANGFU ROAD, BADE CITY
TAOYUAN COUNTY 33460, TAIWAN

FOR: BATTERIES, IN CLASS 9 (U.S. CLS. 21, 23, 26, 36 AND 38).

FIRST USE 8-1-2011; IN COMMERCE 9-30-2011.

NO CLAIM IS MADE TO THE EXCLUSIVE RIGHT TO USE "POWER", APART FROM THE MARK AS SHOWN.

THE MARK CONSISTS OF THE WORDS "POWER INSIDE" WITHIN A BROKEN OVAL LIKE CONTOUR WITH A LIGHTNING LIKE BOLT DESIGN PASSING THROUGH THE PERIPHERY OF THE OVAL LIKE CONTOUR.

SER. NO. 85-442,183, FILED 10-7-2011.

SALLY SHIH, EXAMINING ATTORNEY



David J. Kyros

Director of the United States Patent and Trademark Office

United States of America

United States Patent and Trademark Office

Do Yoga Anywhere

Reg. No. 4,153,763

JAMIE TARA-ANN GETZWILLER (UNITED STATES INDIVIDUAL)
P.O. BOX 815
SONOITA, AZ 85637

Registered June 5, 2012

Int. Cl.: 28

FOR: MITTENS AND GLOVES WITH NON-SLIP PADS FOR THE HANDS AND FEET FOR USE IN YOGA, IN CLASS 28 (U.S. CLS. 22, 23, 38 AND 50).

TRADEMARK

FIRST USE 2-1-2010; IN COMMERCE 2-1-2010.

PRINCIPAL REGISTER

THE MARK CONSISTS OF STANDARD CHARACTERS WITHOUT CLAIM TO ANY PARTICULAR FONT, STYLE, SIZE, OR COLOR.

NO CLAIM IS MADE TO THE EXCLUSIVE RIGHT TO USE "YOGA", APART FROM THE MARK AS SHOWN.

SER. NO. 85-442,191, FILED 10-7-2011.

KATHERINE CHANG, EXAMINING ATTORNEY



David J. Kybas

Director of the United States Patent and Trademark Office

United States of America

United States Patent and Trademark Office

ADVANCE BEAUTY COLLEGE

Reg. No. 4,153,764

Registered June 5, 2012

Int. Cls.: 41 and 44

SERVICE MARK

PRINCIPAL REGISTER

ADVANCE BEAUTY COLLEGE, LLC (MISSOURI LIMITED LIABILITY COMPANY)
202 EAST MAIN STREET
WARRENTON, MO 63383

FOR: EDUCATIONAL SERVICES, NAMELY, CONDUCTING CLASSES IN THE FIELD OF COSMETOLOGY, ESTHETICS, AND NAIL CARE AND DISTRIBUTION OF COURSE MATERIAL IN CONNECTION THEREWITH, IN CLASS 41 (U.S. CLS. 100, 101 AND 107).

FIRST USE 1-7-2003; IN COMMERCE 7-21-2003.

FOR: SALON SERVICES, NAMELY, COSMETOLOGY SERVICES, HAIR CUTTING, STYLING, COLOR AND TREATMENT SERVICES; MANICURES AND PEDICURES; AND ESTHETICS SERVICES, NAMELY, FACIALS, SKIN TREATMENTS AND THERAPIES AND HAIR REMOVAL, IN CLASS 44 (U.S. CLS. 100 AND 101).

FIRST USE 1-7-2003; IN COMMERCE 7-21-2003.

THE MARK CONSISTS OF STANDARD CHARACTERS WITHOUT CLAIM TO ANY PARTICULAR FONT, STYLE, SIZE, OR COLOR.

NO CLAIM IS MADE TO THE EXCLUSIVE RIGHT TO USE "BEAUTY COLLEGE", APART FROM THE MARK AS SHOWN.

SER. NO. 85-442,196, FILED 10-7-2011.

JESSICA A. POWERS, EXAMINING ATTORNEY



David J. Kypos

Director of the United States Patent and Trademark Office

United States of America

United States Patent and Trademark Office

BLUEPRINT FOR A PERINATAL PALLIATIVE CARE PROGRAM

Reg. No. 4,153,765

Registered June 5, 2012

Int. Cl.: 41

SERVICE MARK

PRINCIPAL REGISTER

GUNDERSEN LUTHERAN MEDICAL FOUNDATION, INC. (WISCONSIN CORPORATION)
1836 SOUTH AVENUE
LA CROSSE, WI 54601

FOR: EDUCATIONAL SERVICES, NAMELY, PROVIDING SEMINARS, CONFERENCES, WORKSHOPS, AND PRESENTATIONS IN THE FIELD OF INFANT END-OF-LIFE PLANNING, INFANT END-OF-LIFE CARE, AND COUNSELING FOR PARENTS OF CRITICALLY ILL INFANTS; TRAINING OF OTHERS IN THE FIELD OF PROVIDING INFORMATION AND ADVICE TO PROSPECTIVE PARENTS REGARDING CARE OF, AND PLANNING FOR, CRITICALLY ILL INFANTS, IN CLASS 41 (U.S. CLS. 100, 101 AND 107).

FIRST USE 0-0-2009; IN COMMERCE 0-0-2009.

THE MARK CONSISTS OF STANDARD CHARACTERS WITHOUT CLAIM TO ANY PARTICULAR FONT, STYLE, SIZE, OR COLOR.

NO CLAIM IS MADE TO THE EXCLUSIVE RIGHT TO USE "FOR A PERINATAL PALLIATIVE CARE PROGRAM", APART FROM THE MARK AS SHOWN.

SER. NO. 85-442,209, FILED 10-7-2011.

LAURIE KAUFMAN, EXAMINING ATTORNEY



David J. Kyffers

Director of the United States Patent and Trademark Office

United States of America

United States Patent and Trademark Office

CRITICAL CONNECT

Reg. No. 4,153,766

CRITICAL MASS MEDIA, INC. (OHIO CORPORATION)
200 EAST BASSE
SAN ANTONIO, TX 78209

Registered June 5, 2012

Int. Cl.: 9

FOR: DOWNLOADABLE COMPUTER SOFTWARE FOR VIEWING AND MANIPULATING
MARKETING RESEARCH RESULTS, IN CLASS 9 (U.S. CLS. 21, 23, 26, 36 AND 38).

TRADEMARK

FIRST USE 7-20-2011; IN COMMERCE 7-20-2011.

PRINCIPAL REGISTER

THE MARK CONSISTS OF STANDARD CHARACTERS WITHOUT CLAIM TO ANY PAR-
TICULAR FONT, STYLE, SIZE, OR COLOR.

SER. NO. 85-442,211, FILED 10-7-2011.

GISELLE AGOSTO, EXAMINING ATTORNEY



David J. Kybas

Director of the United States Patent and Trademark Office

United States of America

United States Patent and Trademark Office

ELAINE STEVEN BEAUTY COLLEGE

Reg. No. 4,153,767

Registered June 5, 2012

Int. Cls.: 41 and 44

SERVICE MARK

PRINCIPAL REGISTER

ELAINE STEVEN BEAUTY COLLEGE, INC. (MISSOURI CORPORATION)
10420 W. FLORISSANT AVE.
ST. LOUIS, MO 63136

FOR: EDUCATIONAL SERVICES, NAMELY, CONDUCTING CLASSES IN THE FIELD OF COSMETOLOGY, ESTHETICS, AND NAIL CARE AND DISTRIBUTION OF COURSE MATERIAL IN CONNECTION THEREWITH, IN CLASS 41 (U.S. CLS. 100, 101 AND 107).

FIRST USE 0-0-1962; IN COMMERCE 10-10-2001.

FOR: SALON SERVICES, NAMELY, COSMETOLOGY SERVICES, HAIR CUTTING, STYLING, COLOR AND TREATMENT SERVICES; MANICURES AND PEDICURES; AND ESTHETICS SERVICES, NAMELY, FACIALS, SKIN TREATMENTS AND THERAPIES AND HAIR REMOVAL, IN CLASS 44 (U.S. CLS. 100 AND 101).

FIRST USE 0-0-1962; IN COMMERCE 10-10-2001.

THE MARK CONSISTS OF STANDARD CHARACTERS WITHOUT CLAIM TO ANY PARTICULAR FONT, STYLE, SIZE, OR COLOR.

NO CLAIM IS MADE TO THE EXCLUSIVE RIGHT TO USE "BEAUTY COLLEGE", APART FROM THE MARK AS SHOWN.

THE NAME(S), PORTRAIT(S), AND/OR SIGNATURE(S) SHOWN IN THE MARK DOES NOT IDENTIFY A PARTICULAR LIVING INDIVIDUAL.

SER. NO. 85-442,215, FILED 10-7-2011.

GISELLE AGOSTO, EXAMINING ATTORNEY



David J. Kypos

Director of the United States Patent and Trademark Office

United States of America

United States Patent and Trademark Office

PEBBLE BEACH

Reg. No. 4,153,768

HOME DYNAMIX, LLC (NEW JERSEY LIMITED LIABILITY COMPANY)
ONE CAROL PLACE
MOONACHIE, NJ 07074

Registered June 5, 2012

Int. Cl.: 27

FOR: CARPETS, RUGS, MATS AND MATTING, LINOLEUM FOR COVERING EXISTING FLOORS, IN CLASS 27 (U.S. CLS. 19, 20, 37, 42 AND 50).

TRADEMARK

FIRST USE 8-5-2008; IN COMMERCE 8-5-2008.

PRINCIPAL REGISTER

THE MARK CONSISTS OF STANDARD CHARACTERS WITHOUT CLAIM TO ANY PARTICULAR FONT, STYLE, SIZE, OR COLOR.

SER. NO. 85-442,216, FILED 10-7-2011.

TINA BROWN, EXAMINING ATTORNEY



David J. Kyffers

Director of the United States Patent and Trademark Office

United States of America

United States Patent and Trademark Office

We can work it out.

Reg. No. 4,153,769

ANASTASI & ASSOCIATE, P.A. (MINNESOTA CORPORATION)
14985 60TH STREET N
STILLWATER, MN 55082

Registered June 5, 2012

Int. Cl.: 45

FOR: LEGAL SERVICES, IN CLASS 45 (U.S. CLS. 100 AND 101).

SERVICE MARK

FIRST USE 1-1-2011; IN COMMERCE 1-1-2011.

PRINCIPAL REGISTER

THE MARK CONSISTS OF STANDARD CHARACTERS WITHOUT CLAIM TO ANY PARTICULAR FONT, STYLE, SIZE, OR COLOR.

SER. NO. 85-442,223, FILED 10-7-2011.

GISELLE AGOSTO, EXAMINING ATTORNEY



David J. Kyffers

Director of the United States Patent and Trademark Office

United States of America
United States Patent and Trademark Office

LOOPLANE

Reg. No. 4,153,770

Registered June 5, 2012

Int. Cl.: 45

SERVICE MARK

PRINCIPAL REGISTER

LOOPLANE.COM, LLC (NEVADA LIMITED LIABILITY COMPANY)
2831 ST. ROSE PARKWAY
HENDERSON, NV 89052

FOR: ONLINE SOCIAL NETWORKING SERVICES IN THE FIELD OF CULTURE, HEALTH, ENTERTAINMENT, SOCIAL ISSUES, AND SOCIAL EVENTS, IN CLASS 45 (U.S. CLS. 100 AND 101).

FIRST USE 8-0-2010; IN COMMERCE 8-0-2010.

THE MARK CONSISTS OF STANDARD CHARACTERS WITHOUT CLAIM TO ANY PARTICULAR FONT, STYLE, SIZE, OR COLOR.

SER. NO. 85-442,228, FILED 10-7-2011.

ALYSSA STEEL, EXAMINING ATTORNEY



David J. Kyffers

Director of the United States Patent and Trademark Office

United States of America

United States Patent and Trademark Office



Reg. No. 4,153,771

Registered June 5, 2012

Int. Cls.: 35 and 41

SERVICE MARK

PRINCIPAL REGISTER

305 FILMS, INC (FLORIDA CORPORATION)
2ND FLOOR
8000 BISCAYNE BLVD.
MIAMI, FL 33138

FOR: PRODUCTION OF TELEVISION COMMERCIALS AND POST-PRODUCTION EDITING SERVICES FOR VIDEO AND AUDIO COMMERCIALS, IN CLASS 35 (U.S. CLS. 100, 101 AND 102).

FIRST USE 2-28-2006; IN COMMERCE 2-28-2006.

FOR: MULTIMEDIA ENTERTAINMENT SERVICES IN THE NATURE OF DEVELOPMENT, PRODUCTION AND POST-PRODUCTION SERVICES IN THE FIELDS OF VIDEO, FILMS, COMMERCIALS, TELEVISION PROGRAMS, MUSIC AND MULTI-MEDIA ENTERTAINMENT, IN CLASS 41 (U.S. CLS. 100, 101 AND 107).

FIRST USE 2-28-2006; IN COMMERCE 2-28-2006.

NO CLAIM IS MADE TO THE EXCLUSIVE RIGHT TO USE "FLORIDA", "FILMS", "MIAMI" AND THE GEOGRAPHICAL REPRESENTATION OF THE STATE OF FLORIDA , APART FROM THE MARK AS SHOWN.

THE MARK CONSISTS OF THE IMAGE OF A LICENSE PLATE, WITH THE WORD "FLORIDA" APPEARING AT THE TOP, THE WORDS "305 FILMS" APPEARING IN THE MIDDLE AND THE WORD "MIAMI" APPEARING AT THE BOTTOM, WITH THE OUTLINE OF THE STATE OF FLORIDA APPEARING IN THE BACKGROUND.

SER. NO. 85-442,230, FILED 10-7-2011.

TOBY BULLOFF, EXAMINING ATTORNEY



David J. Kypos

Director of the United States Patent and Trademark Office

United States of America

United States Patent and Trademark Office



CJC ENTERTAINMENT

Reg. No. 4,153,772

Registered June 5, 2012

Int. Cl.: 41

SERVICE MARK

PRINCIPAL REGISTER

EPHRIAM, CHARLES (UNITED STATES INDIVIDUAL)
P.O. BOX 62942
LOS ANGELES, CA 900620942 AND

EPHRIAM, JESTIN (UNITED STATES INDIVIDUAL)
P.O. BOX 62942
LOS ANGELES, CA 900620942 AND

EPHRIAM, CHRISTIAN (UNITED STATES INDIVIDUAL)
P.O. BOX 62942
LOS ANGELES, CA 900620942

FOR: ANIMATION PRODUCTION SERVICES; ENTERTAINMENT SERVICES, NAMELY, MULTIMEDIA PRODUCTION SERVICES, IN CLASS 41 (U.S. CLS. 100, 101 AND 107).

FIRST USE 12-8-2008; IN COMMERCE 12-8-2008.

NO CLAIM IS MADE TO THE EXCLUSIVE RIGHT TO USE "ENTERTAINMENT", APART FROM THE MARK AS SHOWN.

THE MARK CONSISTS OF STYLIZED WHITE LETTERING "C J C" OVERLYING A SOLID BLACK OVAL, WHICH IS CENTERED ABOVE HORIZONTALLY-EXTENDING WORDS "CJC ENTERTAINMENT" THAT HAVE A HORIZONTAL SOLID BLACK LINE EXTENDING ENTIRELY ABOVE AND BELOW SUCH WORDS.

SER. NO. 85-442,248, FILED 10-7-2011.

ANNE E. GUSTASON, EXAMINING ATTORNEY



David J. Kybas

Director of the United States Patent and Trademark Office

United States of America

United States Patent and Trademark Office



Reg. No. 4,153,773

BRAY, MICHAEL S. (UNITED STATES INDIVIDUAL)
265 NEW ROAD
SOMERS POINT, NJ 08244

Registered June 5, 2012

Int. Cl.: 21

FOR: BEER JUGS; GLASS JARS, IN CLASS 21 (U.S. CLS. 2, 13, 23, 29, 30, 33, 40 AND 50).

TRADEMARK

FIRST USE 7-13-2011; IN COMMERCE 7-13-2011.

PRINCIPAL REGISTER

NO CLAIM IS MADE TO THE EXCLUSIVE RIGHT TO USE "BREWS", APART FROM THE MARK AS SHOWN.

THE MARK CONSISTS OF THE STYLIZED WORDING "PASSION BREWS" AND THE STYLIZED LETTERS "PB" IN A CIRCULAR DESIGN WITH IRREGULAR EXTERIOR, WITH TWO FIVE-POINT STARS AND LAUREL LEAVES OR BRANCHES AROUND THE CIRCULAR DESIGN.

SER. NO. 85-442,249, FILED 10-7-2011.

LINDA LAVACHE, EXAMINING ATTORNEY



David J. Kybas

Director of the United States Patent and Trademark Office

United States of America

United States Patent and Trademark Office

kukads

Reg. No. 4,153,774

Registered June 5, 2012

Int. Cl.: 35

SERVICE MARK

PRINCIPAL REGISTER

CLICKHOSTELS LLC (NEW YORK LIMITED LIABILITY COMPANY)
2576 BROADWAY #293
NEW YORK, NY 10025

FOR: PROVIDING AN INTERACTIVE REAL ESTATE WEBSITE WHICH PROMOTES HOUSING AND APARTMENT PROPERTIES THROUGH OFFERING PROSPECTIVE TENANTS VIDEO WALK THROUGHs, PROPERTY DESCRIPTIONS, TEXT, PRICE, LOCATION, MAPS AND OTHER INFORMATION THAT WOULD BE INFLUENTIAL TO A PROSPECTIVE TENANT IN MAKING A RENTAL DECISION, IN CLASS 35 (U.S. CLS. 100, 101 AND 102).

FIRST USE 1-1-2010; IN COMMERCE 1-1-2010.

THE MARK CONSISTS OF STANDARD CHARACTERS WITHOUT CLAIM TO ANY PARTICULAR FONT, STYLE, SIZE, OR COLOR.

SER. NO. 85-442,263, FILED 10-7-2011.

ANDREA K. NADELMAN, EXAMINING ATTORNEY



David J. Kyffers

Director of the United States Patent and Trademark Office

United States of America

United States Patent and Trademark Office



Reg. No. 4,153,775

JILL L. LESHIN (UNITED STATES INDIVIDUAL), DBA THE TRAVELING TUTOR, LLC
6015 EAST PERSHING AVENUE
SCOTTSDALE, AZ 85254

Registered June 5, 2012

Int. Cl.: 41

FOR: EDUCATION SERVICES IN THE NATURE OF EARLY CHILDHOOD INSTRUCTION,
IN CLASS 41 (U.S. CLS. 100, 101 AND 107).

SERVICE MARK

FIRST USE 5-0-2011; IN COMMERCE 8-17-2011.

PRINCIPAL REGISTER

NO CLAIM IS MADE TO THE EXCLUSIVE RIGHT TO USE "PRE K ACADEMY", APART
FROM THE MARK AS SHOWN.

THE COLOR(S) RED, DARK RED, WHITE, GREEN, BLUE AND LIGHT BLUE IS/ARE
CLAIMED AS A FEATURE OF THE MARK.

THE MARK CONSISTS OF THE WORD "PRE" IN WHITE WITH A RED AND DARK RED
RECTANGLE AS THE BACKGROUND, THE LETTER "K" IN GREEN LOCATED IN THE
MIDDLE OF THE MARK, AND THE WORD "ACADEMY" IN WHITE WITHIN A BLUE AND
LIGHT BLUE ANGULAR CRAYON.

SER. NO. 85-442,267, FILED 10-7-2011.

ANDREA K. NADELMAN, EXAMINING ATTORNEY



David J. Kyros

Director of the United States Patent and Trademark Office

United States of America

United States Patent and Trademark Office

Bats, Birds, & More

Reg. No. 4,153,776

Registered June 5, 2012

Int. Cl.: 37

SERVICE MARK

PRINCIPAL REGISTER

ARNOLD, ERIC M (UNITED STATES INDIVIDUAL), DBA BATS, BIRDS, & MORE
5600 WINDFALL ROAD
MEDINA, OH 44256

FOR: ANIMAL CONTROL SERVICES, NAMELY, LARGE BIRD CONTROL, CAPTURING, AND TRAPPING; PEST CONTROL; PEST CONTROL AND EXTERMINATION OTHER THAN FOR AGRICULTURAL PURPOSES, IN CLASS 37 (U.S. CLS. 100, 103 AND 106).

FIRST USE 1-1-2004; IN COMMERCE 1-1-2004.

THE MARK CONSISTS OF STANDARD CHARACTERS WITHOUT CLAIM TO ANY PARTICULAR FONT, STYLE, SIZE, OR COLOR.

NO CLAIM IS MADE TO THE EXCLUSIVE RIGHT TO USE "BATS, BIRDS", APART FROM THE MARK AS SHOWN.

SER. NO. 85-442,273, FILED 10-7-2011.

ANDREA K. NADELMAN, EXAMINING ATTORNEY



David J. Kyros

Director of the United States Patent and Trademark Office

United States of America

United States Patent and Trademark Office

ANIKA INTERNATIONAL

Reg. No. 4,153,777

LASHAWNDA ANIKA LEE ROBBINS (UNITED STATES INDIVIDUAL)
617 HARRY DAVIS LANE
MINNEAPOLIS, MN 55411

Registered June 5, 2012

Int. Cl.: 3

FOR: BLUSH; COSMETIC PREPARATIONS FOR SKIN CARE; COSMETICS AND MAKE-UP; EYE LINER; EYE MAKE-UP; EYE SHADOW; FACE POWDER; FOUNDATION; LIP GLOSS; LIP LINER; LIPSTICK; NAIL POLISH; NON-MEDICATED SKIN CARE PREPARATIONS, IN CLASS 3 (U.S. CLS. 1, 4, 6, 50, 51 AND 52).

TRADEMARK

PRINCIPAL REGISTER

FIRST USE 5-31-2004; IN COMMERCE 8-31-2004.

THE MARK CONSISTS OF STANDARD CHARACTERS WITHOUT CLAIM TO ANY PARTICULAR FONT, STYLE, SIZE, OR COLOR.

NO CLAIM IS MADE TO THE EXCLUSIVE RIGHT TO USE "INTERNATIONAL", APART FROM THE MARK AS SHOWN.

SER. NO. 85-442,288, FILED 10-7-2011.

JAMES A. RAUEN, EXAMINING ATTORNEY



David J. Kybas

Director of the United States Patent and Trademark Office

United States of America

United States Patent and Trademark Office

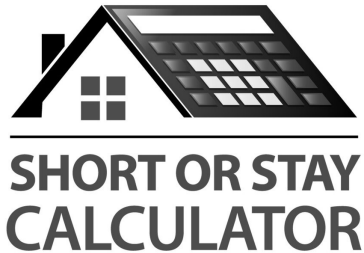

Reg. No. 4,153,778

Registered June 5, 2012

Int. Cl.: 36

SERVICE MARK

PRINCIPAL REGISTER

FONDER CONSULTING, LLC (ARIZONA LIMITED LIABILITY COMPANY), DBA DIRECT
BUSINESS MARKETING
10822 E FLORIAN AVE
MESA, AZ 85208

FOR: PROVIDING ON-LINE FINANCIAL CALCULATORS, IN CLASS 36 (U.S. CLS. 100,
101 AND 102).

FIRST USE 8-12-2011; IN COMMERCE 8-12-2011.

NO CLAIM IS MADE TO THE EXCLUSIVE RIGHT TO USE "CALCULATOR", APART FROM
THE MARK AS SHOWN.

THE MARK CONSISTS OF A HOUSE ROOF FEATURING A CHIMNEY ON THE LEFT SIDE
PEAKED OVER A FOUR-PANED WINDOW, THE RIGHT SIDE OF THE ROOF BEING DE-
PICTED AS A STYLIZED CALCULATOR; A HORIZONTAL LINE POSITIONED BENEATH
THE ROOF; AND THE WORDS "SHORT OR STAY CALCULATOR" POSITIONED BENEATH
THE HORIZONTAL LINE.

SER. NO. 85-442,289, FILED 10-7-2011.

JAMES A. RAUEN, EXAMINING ATTORNEY



David J. Kybas

Director of the United States Patent and Trademark Office

United States of America

United States Patent and Trademark Office

Behind Panty Lines

Reg. No. 4,153,779

BAXTER, JENNIFER B. (UNITED STATES INDIVIDUAL)
3460 KINGSBORO ROAD, NE, #648
ATLANTA, GA 30326

Registered June 5, 2012

Int. Cl.: 44

FOR: PROVIDING INFORMATION BEARING ON WOMEN'S HEALTH, IN CLASS 44 (U.S. CLS. 100 AND 101).

SERVICE MARK

FIRST USE 10-6-2011; IN COMMERCE 10-6-2011.

PRINCIPAL REGISTER

THE MARK CONSISTS OF STANDARD CHARACTERS WITHOUT CLAIM TO ANY PARTICULAR FONT, STYLE, SIZE, OR COLOR.

SER. NO. 85-442,292, FILED 10-7-2011.

JAMES A. RAUEN, EXAMINING ATTORNEY



David J. Kybas

Director of the United States Patent and Trademark Office

United States of America

United States Patent and Trademark Office

ILPRadio

Reg. No. 4,153,780

DADDI, LLC (OHIO LIMITED LIABILITY COMPANY), DBA ILPRADIO
8221 GREEN TREE CT
REYNOLDSBURG, OH 43068

Registered June 5, 2012

Int. Cl.: 25

FOR: ATHLETIC APPAREL, NAMELY, SHIRTS, PANTS, JACKETS, FOOTWEAR, HATS AND CAPS, ATHLETIC UNIFORMS; ATHLETIC FOOTWEAR; ATHLETIC SHOES; BASEBALL CAPS; HATS; HOODED SWEATSHIRTS; SHORT-SLEEVED OR LONG-SLEEVED T-SHIRTS; SWEATSHIRTS; T-SHIRTS, IN CLASS 25 (U.S. CLS. 22 AND 39).

TRADEMARK

PRINCIPAL REGISTER

FIRST USE 9-20-2011; IN COMMERCE 9-27-2011.

THE MARK CONSISTS OF STANDARD CHARACTERS WITHOUT CLAIM TO ANY PARTICULAR FONT, STYLE, SIZE, OR COLOR.

SER. NO. 85-442,295, FILED 10-7-2011.

JAMES A. RAUEN, EXAMINING ATTORNEY



David J. Kybas

Director of the United States Patent and Trademark Office

United States of America

United States Patent and Trademark Office

MY CONCIERGE NURSES

Reg. No. 4,153,781

MY CONCIERGE NURSE, LLC (NEBRASKA LIMITED LIABILITY COMPANY)
11415 IOWA CIRCLE
OMAHA, NE 68142

Registered June 5, 2012

Int. Cl.: 44

FOR: CONSULTING SERVICES AND ADVISING INDIVIDUALS IN THE FIELD OF HEALTH CARE, IN CLASS 44 (U.S. CLS. 100 AND 101).

SERVICE MARK

FIRST USE 7-14-2010; IN COMMERCE 8-16-2010.

PRINCIPAL REGISTER

THE MARK CONSISTS OF STANDARD CHARACTERS WITHOUT CLAIM TO ANY PARTICULAR FONT, STYLE, SIZE, OR COLOR.

NO CLAIM IS MADE TO THE EXCLUSIVE RIGHT TO USE "CONCIERGE NURSES", APART FROM THE MARK AS SHOWN.

SER. NO. 85-442,303, FILED 10-7-2011.

JAMES A. RAUEN, EXAMINING ATTORNEY



David J. Kybas

Director of the United States Patent and Trademark Office

United States of America

United States Patent and Trademark Office

SUPER PEEL

Reg. No. 4,153,782

Registered June 5, 2012

Int. Cl.: 21

TRADEMARK

PRINCIPAL REGISTER

EXO PRODUCTS, INC. (NEW YORK CORPORATION)
9 REED LANE
CLIFTON PARK, NY 12065

FOR: PIZZA PEELS, IN CLASS 21 (U.S. CLS. 2, 13, 23, 29, 30, 33, 40 AND 50).

FIRST USE 5-18-2001; IN COMMERCE 5-18-2001.

THE MARK CONSISTS OF STANDARD CHARACTERS WITHOUT CLAIM TO ANY PARTICULAR FONT, STYLE, SIZE, OR COLOR.

NO CLAIM IS MADE TO THE EXCLUSIVE RIGHT TO USE "PEEL", APART FROM THE MARK AS SHOWN.

SEC. 2(F).

SER. NO. 85-442,324, FILED 10-7-2011.

LINDA ORNDORFF, EXAMINING ATTORNEY



David J. Kyffers

Director of the United States Patent and Trademark Office

United States of America

United States Patent and Trademark Office

ARMS

Reg. No. 4,153,783

Registered June 5, 2012

Int. Cl.: 35

AFFILIATES RISK MANAGEMENT SERVICES, INC. (NEW YORK NON-PROFIT CORPORATION)

10TH FLOOR
434 WEST 33RD STREET
NEW YORK, NY 10001

SERVICE MARK

FOR: BUSINESS RISK MANAGEMENT SERVICES, IN CLASS 35 (U.S. CLS. 100, 101 AND 102).

PRINCIPAL REGISTER

FIRST USE 7-7-2001; IN COMMERCE 7-7-2001.

THE MARK CONSISTS OF STANDARD CHARACTERS WITHOUT CLAIM TO ANY PARTICULAR FONT, STYLE, SIZE, OR COLOR.

SER. NO. 85-442,337, FILED 10-7-2011.

DAVID COLLIER, EXAMINING ATTORNEY



David J. Kybas

Director of the United States Patent and Trademark Office

United States of America

United States Patent and Trademark Office

CLARION PARTNERS

Reg. No. 4,153,784

CLARION PARTNERS, LLC (NEW YORK LIMITED LIABILITY COMPANY)
230 PARK AVENUE
NEW YORK, NY 10169

Registered June 5, 2012

Int. Cl.: 36

FOR: REAL ESTATE INVESTMENT MANAGEMENT AND ADVISORY SERVICES, IN CLASS 36 (U.S. CLS. 100, 101 AND 102).

SERVICE MARK

FIRST USE 10-0-1997; IN COMMERCE 10-0-1997.

PRINCIPAL REGISTER

THE MARK CONSISTS OF STANDARD CHARACTERS WITHOUT CLAIM TO ANY PARTICULAR FONT, STYLE, SIZE, OR COLOR.

NO CLAIM IS MADE TO THE EXCLUSIVE RIGHT TO USE "PARTNERS", APART FROM THE MARK AS SHOWN.

SER. NO. 85-442,346, FILED 10-7-2011.

AISHA CLARKE, EXAMINING ATTORNEY



David J. Kybas

Director of the United States Patent and Trademark Office

United States of America

United States Patent and Trademark Office

*Saying we'll take care
of you isn't enough.*
Doing it is what counts.



Reg. No. 4,153,785

CRAIN CONSTRUCTION, INC. (TENNESSEE CORPORATION)
2525 WINFORD AVENUE
NASHVILLE, TN 37211

Registered June 5, 2012

Int. Cl.: 37

FOR: BUILDING CONSTRUCTION SERVICES; GENERAL CONSTRUCTION CONTRACTING,
IN CLASS 37 (U.S. CLS. 100, 103 AND 106).

SERVICE MARK

FIRST USE 9-30-2011; IN COMMERCE 9-30-2011.

PRINCIPAL REGISTER

NO CLAIM IS MADE TO THE EXCLUSIVE RIGHT TO USE "CONSTRUCTION", APART
FROM THE MARK AS SHOWN.

THE MARK CONSISTS OF THE WORDS "SAYING WE'LL TAKE CARE OF YOU ISN'T
ENOUGH." AND "DOING IT IS WHAT COUNTS." IN STYLIZED FONT SEPARATED BY A
VERTICAL LINE FROM THE STYLIZED WORDS "CRAIN CONSTRUCTION" AND A
STYLIZED RENDERING OF TWO CRANE BIRDS SURROUNDED BY A SQUARE OUTLINE
ALL AGAINST A LARGER SQUARE.

SER. NO. 85-442,349, FILED 10-7-2011.

DAVID YONTEF, EXAMINING ATTORNEY



David J. Kypos

Director of the United States Patent and Trademark Office

United States of America

United States Patent and Trademark Office



Reg. No. 4,153,786

MARUKYU CO., LTD. (JAPAN CORPORATION)
2-4-1 AKAHORI, OKEGAWA-SHI
SAITAMA, JAPAN

Registered June 5, 2012

Int. Cl.: 28

FOR: FISHING TACKLE; PACKAGED FREEZE-DRIED FISHING BAIT; ARTIFICIAL FISHING BAIT; FISH ATTRACTANTS, IN CLASS 28 (U.S. CLS. 22, 23, 38 AND 50).

TRADEMARK

FIRST USE 1-1-1998; IN COMMERCE 8-18-2009.

PRINCIPAL REGISTER

OWNER OF U.S. REG. NOS. 3,715,518 AND 3,720,164.

THE NON-LATIN CHARACTERS IN THE MARK TRANSLITERATE TO "MARUKYU" AND THIS MEANS "ROUND NINE" IN ENGLISH.

THE MARK CONSISTS OF A DARK RECTANGLE ON WHICH ARE SUPERIMPOSED, FROM LEFT TO RIGHT, A DARK DIAMOND WITH A LIGHT OUTLINE, AN OVAL WITH A LIGHT OUTLINE, A CIRCLE, WITH A LIGHT OUTLINE AND LIGHT INTERIOR, CONTAINING A CHINESE CHARACTER, AND LIGHT KATAKANA CHARACTERS, ALL TO THE LEFT OF A DRAWING OF A CHILD, HOLDING A FISHING POLE IN ONE HAND AND FISH IN THE OTHER HAND, AND WEARING A BASEBALL CAP BEARING THE WORD "MARUKYU".

THE ENGLISH TRANSLATION OF "MARUKYU" IN THE MARK IS "ROUND NINE".

SER. NO. 85-442,391, FILED 10-7-2011.

JORDAN BAKER, EXAMINING ATTORNEY



David J. Kybas

Director of the United States Patent and Trademark Office

United States of America

United States Patent and Trademark Office

TELNET

Reg. No. 4,153,787

Registered June 5, 2012

Int. Cls.: 11 and 40

TRADEMARK

SERVICE MARK

PRINCIPAL REGISTER

FRESH CREEK TECHNOLOGIES, INC. (DELAWARE CORPORATION)
SUITE 2
1384 POMPTON AVENUE
CEDAR GROVE, NJ 07009

FOR: SEPARATORS FOR THE CLEANING AND PURIFICATION OF LIQUIDS; SUSTAINABLE ONSITE WATER RECYCLING AND WASTEWATER TREATMENT SYSTEMS; WASTE WATER PURIFICATION APPARATUS, INSTALLATIONS AND TANKS; WASTE WATER PURIFICATION UNITS; WATER PURIFICATION AND FILTRATION APPARATUS; WATER PURIFICATION, SEDIMENTATION AND FILTRATION APPARATUS FOR CLARIFICATION, THICKENING AND FILTRATION OF WATER, WASTE WATER AND INDUSTRIAL WATER; WATER TREATMENT APPARATUS, NAMELY, CLARIFICATION AND THICKENING MACHINES FOR USE IN TREATMENT OF LIQUIDS IN THE NATURE OF WATER, WASTE WATER AND INDUSTRIAL WATER; WATER TREATMENT EQUIPMENT, NAMELY, WATER FILTRATION UNITS, IN CLASS 11 (U.S. CLS. 13, 21, 23, 31 AND 34).

FIRST USE 3-30-2011; IN COMMERCE 4-14-2011.

FOR: CUSTOM BUILDING OF WASTE WATER PURIFICATION UNITS; CUSTOM CONSTRUCTION OF FLOATABLES REMOVAL SYSTEMS FOR WASTE WATER; CUSTOM MANUFACTURE OF WASTE WATER TRASH AND FLOATABLES CONTROL UNITS; MANUFACTURE OF GENERAL PRODUCT LINES IN THE FIELD OF WASTE WATER, STORMWATER AND URBAN RUNOFF PURIFICATION AND TRASH REMOVAL UNITS TO THE ORDER AND SPECIFICATION OF OTHERS; MANUFACTURE OF MANAGEMENT OF DISCHARGE SYSTEM UNITS FOR WASTE WATER TREATMENT TO ORDER AND/OR SPECIFICATION OF OTHERS; MANUFACTURING SERVICES FOR OTHERS IN THE FIELD OF REMOVING TRASH AND FLOATABLES FROM WASTE WATER AND STORMWATER RUNOFF FOR MUNICIPALITIES, INDUSTRIAL AND COMMERCIAL SOURCES; RECYCLING OF WASTE AND TRASH; TREATMENT OF WASTE WATER; WASTE MANAGEMENT; WASTE TREATMENT; WASTE WATER TREATMENT SERVICES; WASTE WATER TREATMENT SERVICES FOR INDUSTRIAL PURPOSES; WATER TREATMENT AND PURIFICATION; WATER TREATMENT SERVICES, IN CLASS 40 (U.S. CLS. 100, 103 AND 106).

FIRST USE 3-30-2011; IN COMMERCE 4-14-2011.



David J. Kyffers

Director of the United States Patent and Trademark Office

Reg. No. 4,153,787 THE MARK CONSISTS OF STANDARD CHARACTERS WITHOUT CLAIM TO ANY PARTICULAR FONT, STYLE, SIZE, OR COLOR.

SER. NO. 85-442,399, FILED 10-7-2011.

KAPIL BHANOT, EXAMINING ATTORNEY

United States of America

United States Patent and Trademark Office

VOW TO GET ORGANIZED

Reg. No. 4,153,788

Registered June 5, 2012

Int. Cl.: 35

SERVICE MARK

PRINCIPAL REGISTER

THE CONTAINER STORE, INC. (TEXAS CORPORATION)
500 FREEPORT PARKWAY
COPPELL, TX 75019

FOR: GIFT REGISTRY SERVICES, IN CLASS 35 (U.S. CLS. 100, 101 AND 102).

FIRST USE 10-3-2011; IN COMMERCE 10-3-2011.

THE MARK CONSISTS OF STANDARD CHARACTERS WITHOUT CLAIM TO ANY PARTICULAR FONT, STYLE, SIZE, OR COLOR.

SER. NO. 85-442,452, FILED 10-7-2011.

RONALD MCMORROW, EXAMINING ATTORNEY



David J. Kyffers

Director of the United States Patent and Trademark Office

United States of America

United States Patent and Trademark Office

STREAM LINE

Reg. No. 4,153,789

LIVE EYEWEAR, INC. (CALIFORNIA CORPORATION)
3490 BROAD STREET
SAN LUIS OBISPO, CA 93401

Registered June 5, 2012

Int. Cl.: 9

FOR: EYEWEAR, NAMELY, SUNGLASSES, EYEGASSES AND OPHTHALMIC FRAMES
AND CASES THEREFOR, IN CLASS 9 (U.S. CLS. 21, 23, 26, 36 AND 38).

TRADEMARK

FIRST USE 2-1-2004; IN COMMERCE 2-1-2004.

PRINCIPAL REGISTER

THE MARK CONSISTS OF STANDARD CHARACTERS WITHOUT CLAIM TO ANY PAR-
TICULAR FONT, STYLE, SIZE, OR COLOR.

SER. NO. 85-442,460, FILED 10-7-2011.

CHRISTOPHER BUONGIORNO, EXAMINING ATTORNEY



David J. Kybas

Director of the United States Patent and Trademark Office

United States of America

United States Patent and Trademark Office

Escape Hatcher

Reg. No. 4,153,790

Registered June 5, 2012

Int. Cl.: 41

SERVICE MARK

PRINCIPAL REGISTER

BAKER, SUSAN M (UNITED STATES INDIVIDUAL)
10856 OTSEGO STREET
NORTH HOLLYWOOD, CA 91601

FOR: ON-LINE JOURNALS, NAMELY, BLOGS FEATURING ENTREPRENEURSHIP AND BUSINESS START-UP; PERSONAL COACHING SERVICES IN THE FIELD OF ENTREPRENEURSHIP AND BUSINESS START-UP; PROVIDING GROUP COACHING IN THE FIELD OF ENTREPRENEURSHIP AND BUSINESS START-UP, IN CLASS 41 (U.S. CLS. 100, 101 AND 107).

FIRST USE 11-29-2006; IN COMMERCE 5-1-2009.

THE MARK CONSISTS OF STANDARD CHARACTERS WITHOUT CLAIM TO ANY PARTICULAR FONT, STYLE, SIZE, OR COLOR.

SER. NO. 85-442,492, FILED 10-7-2011.

DOMINIC J. FERRAIUOLO, EXAMINING ATTORNEY



David J. Kyffers

Director of the United States Patent and Trademark Office

United States of America

United States Patent and Trademark Office

JAUNT

Reg. No. 4,153,791

Registered June 5, 2012

Int. Cl.: 25

TRADEMARK

PRINCIPAL REGISTER

GELLER, ANA L. (BRAZIL INDIVIDUAL)
15 BROAD STREET, #2212
NEW YORK, NY 10005

FOR: CLOTHING; NAMELY, TEE SHIRTS, SHIRTS, TANK TOPS, SWEATERS, VESTS, DRESSES, SKIRTS, JACKETS, COATS, JEANS, PANTS, HATS, SWIMSUITS AND LINGERIE, IN CLASS 25 (U.S. CLS. 22 AND 39).

FIRST USE 2-2-2011; IN COMMERCE 2-2-2011.

THE MARK CONSISTS OF STANDARD CHARACTERS WITHOUT CLAIM TO ANY PARTICULAR FONT, STYLE, SIZE, OR COLOR.

SER. NO. 85-442,494, FILED 10-7-2011.

DOMINIC J. FERRAIUOLO, EXAMINING ATTORNEY



David J. Kybas

Director of the United States Patent and Trademark Office

United States of America

United States Patent and Trademark Office

IMAGE

Reg. No. 4,153,792

Registered June 5, 2012

Int. Cl.: 9

TRADEMARK

PRINCIPAL REGISTER

KLIPSCH GROUP, INC. (INDIANA CORPORATION)
SUITE 200
3502 WOODVIEW TRACE
INDIANAPOLIS, IN 46268

FOR: HEADPHONES; HEADSETS FOR USE WITH PHONES, PDAS, COMPUTERS, GAMING CONSOLES, AND TABLETS, IN CLASS 9 (U.S. CLS. 21, 23, 26, 36 AND 38).

FIRST USE 11-0-2007; IN COMMERCE 11-0-2007.

THE MARK CONSISTS OF STANDARD CHARACTERS WITHOUT CLAIM TO ANY PARTICULAR FONT, STYLE, SIZE, OR COLOR.

SER. NO. 85-442,499, FILED 10-7-2011.

DOMINIC J. FERRAIUOLO, EXAMINING ATTORNEY



David J. Kyffers

Director of the United States Patent and Trademark Office

United States of America

United States Patent and Trademark Office

ACCESS SCIENCES

Reg. No. 4,153,793

Registered June 5, 2012

Int. Cl.: 25

TRADEMARK

PRINCIPAL REGISTER

ACCESS SCIENCES CORPORATION (TEXAS CORPORATION)
SUITE 1450
1900 WEST LOOP SOUTH
HOUSTON, TX 77027

FOR: CLOTHING, NAMELY, SHIRTS, POLO SHIRTS, BLOUSES, T-SHIRTS, SWEATERS, VESTS, PANTS, SHORTS, SKIRTS, JACKETS; AND HEADGEAR, NAMELY, HATS AND CAPS, IN CLASS 25 (U.S. CLS. 22 AND 39).

FIRST USE 10-10-2003; IN COMMERCE 10-10-2003.

THE MARK CONSISTS OF STANDARD CHARACTERS WITHOUT CLAIM TO ANY PARTICULAR FONT, STYLE, SIZE, OR COLOR.

SER. NO. 85-442,504, FILED 10-7-2011.

BRIDGETT SMITH, EXAMINING ATTORNEY



David J. Kyffers

Director of the United States Patent and Trademark Office

United States of America

United States Patent and Trademark Office

MINI SLIM

Reg. No. 4,153,794

LIVE EYEWEAR, INC. (CALIFORNIA CORPORATION)
3490 BROAD STREET
SAN LUIS OBISPO, CA 93401

Registered June 5, 2012

Int. Cl.: 9

FOR: EYEWEAR, NAMELY, SUNGLASSES, EYEGASSES AND OPHTHALMIC FRAMES
AND CASES THEREFOR, IN CLASS 9 (U.S. CLS. 21, 23, 26, 36 AND 38).

TRADEMARK

FIRST USE 10-1-2002; IN COMMERCE 10-1-2002.

PRINCIPAL REGISTER

THE MARK CONSISTS OF STANDARD CHARACTERS WITHOUT CLAIM TO ANY PAR-
TICULAR FONT, STYLE, SIZE, OR COLOR.

SER. NO. 85-442,507, FILED 10-7-2011.

CHRISTOPHER BUONGIORNO, EXAMINING ATTORNEY



David J. Kybas

Director of the United States Patent and Trademark Office

United States of America

United States Patent and Trademark Office

Nature Locks

Reg. No. 4,153,795

Registered June 5, 2012

Int. Cl.: 26

TRADEMARK

PRINCIPAL REGISTER

MOORE, DIANA (UNITED STATES INDIVIDUAL)
18117 COACHMANS ROAD
GERMANTOWN, MD 20874

FOR: HAIR EXTENSIONS; WIGS, HAIRPIECES, AND ADD-IN AND ADD-ON HAIR ACCESSORIES CONSTRUCTED PRIMARILY OF SYNTHETIC AND/OR HUMAN HAIR, IN CLASS 26 (U.S. CLS. 37, 39, 40, 42 AND 50).

FIRST USE 10-18-2010; IN COMMERCE 10-18-2010.

THE MARK CONSISTS OF STANDARD CHARACTERS WITHOUT CLAIM TO ANY PARTICULAR FONT, STYLE, SIZE, OR COLOR.

NO CLAIM IS MADE TO THE EXCLUSIVE RIGHT TO USE "LOCKS", APART FROM THE MARK AS SHOWN.

SER. NO. 85-442,510, FILED 10-7-2011.

RONALD MCMORROW, EXAMINING ATTORNEY



David J. Kybas

Director of the United States Patent and Trademark Office

United States of America

United States Patent and Trademark Office



Reg. No. 4,153,796

COHEN, DANIEL (UNITED STATES INDIVIDUAL)
707 SILVER SPUR RD, SUITE 202
ROLLING HILLS ESTATES, CA 90274

Registered June 5, 2012

Int. Cl.: 36

FOR: REAL ESTATE AGENCIES; REAL ESTATE BROKERAGE, IN CLASS 36 (U.S. CLS. 100, 101 AND 102).

SERVICE MARK

FIRST USE 8-13-2011; IN COMMERCE 8-13-2011.

PRINCIPAL REGISTER

NO CLAIM IS MADE TO THE EXCLUSIVE RIGHT TO USE "HOMES", APART FROM THE MARK AS SHOWN.

THE MARK CONSISTS OF THE IMAGE OF A PALM TREE WITH A RIBBON ABOVE THE STYLIZED WORDING "PALOS VERDES HOMES".

SEC. 2(F) AS TO "PALOS VERDES HOMES".

SER. NO. 85-442,535, FILED 10-7-2011.

BRIDGETT SMITH, EXAMINING ATTORNEY



David J. Kyros

Director of the United States Patent and Trademark Office

United States of America

United States Patent and Trademark Office



ACCOUNTING CONNECTIONS

Reg. No. 4,153,797

ACCOUNTING CONNECTIONS, LLC (WASHINGTON LIMITED LIABILITY COMPANY)
3811 62ND AVE. E
FIFE, WA 98424

Registered June 5, 2012

Int. Cl.: 35

FOR: ACCOUNTING SERVICES; TAX PREPARATION, IN CLASS 35 (U.S. CLS. 100, 101 AND 102).

SERVICE MARK

FIRST USE 1-1-2007; IN COMMERCE 1-1-2007.

PRINCIPAL REGISTER

NO CLAIM IS MADE TO THE EXCLUSIVE RIGHT TO USE "ACCOUNTING" AND "LLC", APART FROM THE MARK AS SHOWN.

THE MARK CONSISTS OF THE FIRST "L" OF THE TEXT "LLC" DISPLAYED ON THE LEFT SIDE OF THE LETTER "A" IN THE FORM OF CALLIGRAPHY, THE SECOND "L" IS THE RIGHT SIDE OF THE "A" AND HAS A SMALL ANGLE FOLLOWED BY THE CAPITAL "C", AND THE TEXT "ACCOUNTING CONNECTIONS" AT THE BOTTOM.

SER. NO. 85-442,537, FILED 10-7-2011.

GIANCARLO CASTRO, EXAMINING ATTORNEY



David J. Kybas

Director of the United States Patent and Trademark Office

United States of America

United States Patent and Trademark Office

SLIM LINE

Reg. No. 4,153,798

LIVE EYEWEAR, INC. (CALIFORNIA CORPORATION)
3490 BROAD STREET
SAN LUIS OBISPO, CA 93401

Registered June 5, 2012

Int. Cl.: 9

FOR: EYEWEAR, NAMELY, SUNGLASSES, EYEGASSES AND OPHTHALMIC FRAMES
AND CASES THEREFOR, IN CLASS 9 (U.S. CLS. 21, 23, 26, 36 AND 38).

TRADEMARK

FIRST USE 3-1-2002; IN COMMERCE 3-1-2002.

PRINCIPAL REGISTER

THE MARK CONSISTS OF STANDARD CHARACTERS WITHOUT CLAIM TO ANY PAR-
TICULAR FONT, STYLE, SIZE, OR COLOR.

SER. NO. 85-442,539, FILED 10-7-2011.

CHRISTOPHER BUONGIORNO, EXAMINING ATTORNEY



David J. Kyffers

Director of the United States Patent and Trademark Office

United States of America

United States Patent and Trademark Office

Applied Storytelling for companies, products and brands.

Reg. No. 4,153,799

Registered June 5, 2012

Int. Cl.: 35

SERVICE MARK

PRINCIPAL REGISTER

APPLIED STORYTELLING, INC. (CALIFORNIA CORPORATION)
#204
5625 COLLEGE AVE.
OAKLAND, CA 94618

FOR: BRANDING SERVICES, NAMELY, CONSULTING, DEVELOPMENT, MANAGEMENT AND MARKETING OF BRANDS FOR BUSINESSES, IN CLASS 35 (U.S. CLS. 100, 101 AND 102).

FIRST USE 10-1-1996; IN COMMERCE 10-1-1996.

THE MARK CONSISTS OF STANDARD CHARACTERS WITHOUT CLAIM TO ANY PARTICULAR FONT, STYLE, SIZE, OR COLOR.

SER. NO. 85-442,554, FILED 10-7-2011.

AISHA CLARKE, EXAMINING ATTORNEY



David J. Kyjars

Director of the United States Patent and Trademark Office

United States of America

United States Patent and Trademark Office

DUTCH HARBOR BREEZE

Reg. No. 4,153,800

Registered June 5, 2012

Int. Cl.: 33

TRADEMARK

PRINCIPAL REGISTER

YOGD, LLC (OREGON LIMITED LIABILITY COMPANY)
UNIT C
35855 INDUSTRIAL WAY
SAINT HELENS, OR 97051

FOR: DISTILLED SPIRITS, IN CLASS 33 (U.S. CLS. 47 AND 49).

FIRST USE 3-18-2011; IN COMMERCE 3-18-2011.

THE MARK CONSISTS OF STANDARD CHARACTERS WITHOUT CLAIM TO ANY PARTICULAR FONT, STYLE, SIZE, OR COLOR.

SER. NO. 85-442,564, FILED 10-7-2011.

MICHAEL WIENER, EXAMINING ATTORNEY



David J. Kyffers

Director of the United States Patent and Trademark Office

United States of America

United States Patent and Trademark Office

GOOD MORNING GLORY

Reg. No. 4,153,801

Registered June 5, 2012

Int. Cl.: 33

TRADEMARK

PRINCIPAL REGISTER

YOGD, LLC (OREGON LIMITED LIABILITY COMPANY)
UNIT C
35855 INDUSTRIAL WAY
SAINT HELENS, OR 97051

FOR: DISTILLED SPIRITS, IN CLASS 33 (U.S. CLS. 47 AND 49).

FIRST USE 3-18-2011; IN COMMERCE 3-18-2011.

THE MARK CONSISTS OF STANDARD CHARACTERS WITHOUT CLAIM TO ANY PARTICULAR FONT, STYLE, SIZE, OR COLOR.

SER. NO. 85-442,568, FILED 10-7-2011.

MICHAEL WIENER, EXAMINING ATTORNEY



David J. Kybas

Director of the United States Patent and Trademark Office

United States of America

United States Patent and Trademark Office



Reg. No. 4,153,802

Registered June 5, 2012

Int. Cl.: 30

TRADEMARK

PRINCIPAL REGISTER

WALKER, JON (UNITED STATES INDIVIDUAL)
1355 CORVADURA ST.
GRAHAM, TX 76450

FOR: SALSA, IN CLASS 30 (U.S. CL. 46).

FIRST USE 2-1-1997; IN COMMERCE 2-1-1997.

NO CLAIM IS MADE TO THE EXCLUSIVE RIGHT TO USE "SALSA", APART FROM THE MARK AS SHOWN.

THE MARK CONSISTS OF THE STYLIZED WORDS "JUAN'S SALSA". THE LETTER "J" IS IN THE FORM OF A SLANTED JALAPENO PEPPER.

SER. NO. 85-442,575, FILED 10-7-2011.

VIVIAN MICZNIK FIRST, EXAMINING ATTORNEY



David J. Kybas

Director of the United States Patent and Trademark Office

United States of America

United States Patent and Trademark Office

Magic Fountain Homemade Ice Cream

Reg. No. 4,153,803

FOUNTAIN OF MAGIC, INC. (NEW YORK CORPORATION)
9825 MAIN ROAD
MATTITUCK, NY 11952

Registered June 5, 2012

Int. Cl.: 43

FOR: ICE CREAM PARLORS, IN CLASS 43 (U.S. CLS. 100 AND 101).

SERVICE MARK

FIRST USE 3-29-2007; IN COMMERCE 3-29-2007.

PRINCIPAL REGISTER

THE MARK CONSISTS OF STANDARD CHARACTERS WITHOUT CLAIM TO ANY PARTICULAR FONT, STYLE, SIZE, OR COLOR.

NO CLAIM IS MADE TO THE EXCLUSIVE RIGHT TO USE "HOMEMADE ICE CREAM", APART FROM THE MARK AS SHOWN.

SER. NO. 85-442,584, FILED 10-7-2011.

NAPOLEON SHARMA, EXAMINING ATTORNEY



David J. Kyros

Director of the United States Patent and Trademark Office

United States of America

United States Patent and Trademark Office

WIDE LINE

Reg. No. 4,153,804

LIVE EYEWEAR, INC. (CALIFORNIA CORPORATION)
3490 BROAD STREET
SAN LUIS OBISPO, CA 93401

Registered June 5, 2012

Int. Cl.: 9

FOR: EYEWEAR, NAMELY, SUNGLASSES, EYEGASSES AND OPHTHALMIC FRAMES
AND CASES THEREFOR, IN CLASS 9 (U.S. CLS. 21, 23, 26, 36 AND 38).

TRADEMARK

FIRST USE 3-1-2006; IN COMMERCE 3-1-2006.

PRINCIPAL REGISTER

THE MARK CONSISTS OF STANDARD CHARACTERS WITHOUT CLAIM TO ANY PAR-
TICULAR FONT, STYLE, SIZE, OR COLOR.

SER. NO. 85-442,594, FILED 10-7-2011.

CHRISTOPHER BUONGIORNO, EXAMINING ATTORNEY



David J. Kybas

Director of the United States Patent and Trademark Office

United States of America

United States Patent and Trademark Office

d(-_-)b
TEAMBACKPACK

Reg. No. 4,153,805

Registered June 5, 2012

Int. Cl.: 41

SERVICE MARK

PRINCIPAL REGISTER

TEAMBACKPACK (CALIFORNIA PARTNERSHIP)
768 BRIDGE CREEK DR
SAN RAMON, CA 94582

FOR: ENTERTAINMENT, NAMELY, LIVE PERFORMANCES BY A MUSICAL BAND, IN CLASS 41 (U.S. CLS. 100, 101 AND 107).

FIRST USE 1-1-2010; IN COMMERCE 1-1-2010.

THE MARK CONSISTS OF THE EMOTICON: "D(-----)B", THE "D" AND THE "B" REPRESENT HEADPHONES ON A FACE, AND UNDER THIS IS THE WORD "TEAMBACKPACK".

SER. NO. 85-442,634, FILED 10-7-2011.

SHAUNIA CARLYLE, EXAMINING ATTORNEY



David J. Kyffers

Director of the United States Patent and Trademark Office

United States of America

United States Patent and Trademark Office

Waldo Wellness Group

Reg. No. 4,153,806

Registered June 5, 2012

Int. Cl.: 44

SERVICE MARK

PRINCIPAL REGISTER

WALDO WELLNESS GROUP (MISSOURI CORPORATION)
7210 WORNALL RD.
KANSAS CITY, MO 64114

FOR: HEALTH SERVICES, NAMELY, PROVIDING MEDICAL NEUROPATHY TREATMENT, CHIROPRACTIC SERVICES, AND PHYSICAL THERAPY, IN CLASS 44 (U.S. CLS. 100 AND 101).

FIRST USE 6-0-2011; IN COMMERCE 6-0-2011.

THE MARK CONSISTS OF STANDARD CHARACTERS WITHOUT CLAIM TO ANY PARTICULAR FONT, STYLE, SIZE, OR COLOR.

NO CLAIM IS MADE TO THE EXCLUSIVE RIGHT TO USE "WELLNESS GROUP", APART FROM THE MARK AS SHOWN.

SER. NO. 85-442,636, FILED 10-7-2011.

JUDITH HELFMAN, EXAMINING ATTORNEY



David J. Kybas

Director of the United States Patent and Trademark Office

United States of America

United States Patent and Trademark Office

GUMGUM

Reg. No. 4,153,807

Registered June 5, 2012

Int. Cl.: 35

SERVICE MARK

PRINCIPAL REGISTER

GUMGUM, INC. (DELAWARE CORPORATION)
530 WILSHIRE BOULEVARD, SUITE 305
SANTA MONICA, CA 90401

FOR: ONLINE ADVERTISING SERVICES, NAMELY, PROVIDING IN-IMAGE ADVERTISING FOR OTHERS USED FOR AD OVERLAY ON IMAGES; ONLINE ADVERTISING SERVICES IN THE NATURE OF PROVIDING CONTEXTUAL ADS, DISPLAY ADS AND FLASH ADS FOR OTHERS, IN CLASS 35 (U.S. CLS. 100, 101 AND 102).

FIRST USE 6-0-2007; IN COMMERCE 6-0-2007.

THE MARK CONSISTS OF STANDARD CHARACTERS WITHOUT CLAIM TO ANY PARTICULAR FONT, STYLE, SIZE, OR COLOR.

SER. NO. 85-442,640, FILED 10-7-2011.

MAYUR VAGHANI, EXAMINING ATTORNEY



David J. Kyjars

Director of the United States Patent and Trademark Office

United States of America

United States Patent and Trademark Office

Dome Cleaning

Reg. No. 4,153,808

Registered June 5, 2012

Int. Cl.: 37

SERVICE MARK

PRINCIPAL REGISTER

DOME CLEANING, INC. (CALIFORNIA CORPORATION)
131 STILLMAN STREET
SAN FRANCISCO, CA 94107

FOR: CLEANING OF BUILDINGS; JANITORIAL SERVICES, IN CLASS 37 (U.S. CLS. 100, 103 AND 106).

FIRST USE 1-1-2009; IN COMMERCE 1-1-2009.

THE MARK CONSISTS OF STANDARD CHARACTERS WITHOUT CLAIM TO ANY PARTICULAR FONT, STYLE, SIZE, OR COLOR.

NO CLAIM IS MADE TO THE EXCLUSIVE RIGHT TO USE "CLEANING", APART FROM THE MARK AS SHOWN.

SER. NO. 85-442,659, FILED 10-7-2011.

EDWARD FENNESSY, EXAMINING ATTORNEY



David J. Kyffers

Director of the United States Patent and Trademark Office

United States of America

United States Patent and Trademark Office

VTaaS

Reg. No. 4,153,809

Registered June 5, 2012

Int. Cl.: 42

SERVICE MARK

PRINCIPAL REGISTER

DRZAL, JEREMY (UNITED STATES INDIVIDUAL)
2408 BUTLER WAY
ROUND ROCK, TX 78665

FOR: COMPUTER SERVICES, NAMELY, CREATING AN ON-LINE VIRTUAL COMMUNITY FOR REGISTERED USERS TO INTERACT WITH EACH OTHER FOR PURPOSE OF LEARNING, VIEW INFORMATIONAL MATERIAL, ENGAGE IN SOCIAL NETWORKING, PARTICIPATE IN DISCUSSIONS, FORM VIRTUAL COMMUNITIES, EXPLORE CAREER SERVICES, ENGAGE IN INTERACTIVE COMMUNICATIONS AND INTERACT WITH COMPANIES HAVING A VIRTUAL PRESENCE, IN CLASS 42 (U.S. CLS. 100 AND 101).

FIRST USE 6-1-2011; IN COMMERCE 6-1-2011.

THE MARK CONSISTS OF STANDARD CHARACTERS WITHOUT CLAIM TO ANY PARTICULAR FONT, STYLE, SIZE, OR COLOR.

SER. NO. 85-442,665, FILED 10-7-2011.

SUE LAWRENCE, EXAMINING ATTORNEY



David J. Kyffers

Director of the United States Patent and Trademark Office

United States of America

United States Patent and Trademark Office

BIB
eauty | n reast

Reg. No. 4,153,810

Registered June 5, 2012

Int. Cl.: 25

TRADEMARK

PRINCIPAL REGISTER

ROBERTSON, JARRUN TERON (UNITED STATES INDIVIDUAL)
SUITE 101
311 N. MITSCHER AVE.
KINGSVILLE, TX 78363

FOR: DRESSES; HATS; HOODED SWEAT SHIRTS; JACKETS; SHIRTS; SHOES; SHORTS;
SWEAT PANTS; SWIM SUITS; UNDERGARMENTS; YOGA PANTS, IN CLASS 25 (U.S. CLS.
22 AND 39).

FIRST USE 8-5-2011; IN COMMERCE 8-8-2011.

THE MARK CONSISTS OF ALL LETTERS AND SYMBOLS IN PAINT BRUSH FONT. THE
LETTER "B" IS IN ALL CAPS WHILE "EAUTY" ARE LOWER CASE, THE LETTER "I" IS
IN ALL CAPS WHILE THE LETTER "N" IS LOWER CASE, THE LETTER "B" IS IN ALL
CAPS WHILE THE LETTERS "REAST" ARE LOWER CASE, AND A MILITARY STYLED
CHAIN SHAPED INTO A HEART WITH 1 270 WINCHESTERS BULLETS AT THE END OF
EACH CHAIN.

SER. NO. 85-442,682, FILED 10-7-2011.

EUGENIA MARTIN, EXAMINING ATTORNEY



David J. Kyffers

Director of the United States Patent and Trademark Office

United States of America

United States Patent and Trademark Office

SOSbeacon

Reg. No. 4,153,811

Registered June 5, 2012

Int. Cls.: 9 and 42

TRADEMARK

SERVICE MARK

PRINCIPAL REGISTER

SOSBEACON INC. (CALIFORNIA CORPORATION)
1415 SUMMIT ROAD
BERKELEY, CA 94708

FOR: COMPUTER APPLICATION SOFTWARE FOR MOBILE PHONES, NAMELY, SOFTWARE FOR EMERGENCY BROADCASTING FOR INDIVIDUALS AND SCHOOLS, IN CLASS 9 (U.S. CLS. 21, 23, 26, 36 AND 38).

FIRST USE 1-11-2010; IN COMMERCE 1-11-2010.

FOR: SOFTWARE AS A SERVICE (SAAS) SERVICES FEATURING SOFTWARE FOR EMERGENCY BROADCASTING FOR INDIVIDUALS AND SCHOOLS, IN CLASS 42 (U.S. CLS. 100 AND 101).

FIRST USE 1-11-2010; IN COMMERCE 1-11-2010.

THE MARK CONSISTS OF STANDARD CHARACTERS WITHOUT CLAIM TO ANY PARTICULAR FONT, STYLE, SIZE, OR COLOR.

SER. NO. 85-442,696, FILED 10-7-2011.

MARK SPARACINO, EXAMINING ATTORNEY



David J. Kyffers

Director of the United States Patent and Trademark Office

United States of America

United States Patent and Trademark Office

ICB

Reg. No. 4,153,812

Registered June 5, 2012

Int. Cl.: 5

TRADEMARK

PRINCIPAL REGISTER

ROCKY MOUNTAIN TISSUE BANK (COLORADO NON-PROFIT CORPORATION)
SUITE 390
2993 S PEORIA ST.
AURORA, CO 80014

FOR: HUMAN ALLOGRAFT TISSUE, IN CLASS 5 (U.S. CLS. 6, 18, 44, 46, 51 AND 52).

FIRST USE 9-30-2011; IN COMMERCE 9-30-2011.

THE MARK CONSISTS OF STANDARD CHARACTERS WITHOUT CLAIM TO ANY PARTICULAR FONT, STYLE, SIZE, OR COLOR.

SER. NO. 85-442,701, FILED 10-7-2011.

SANJEEV VOHRA, EXAMINING ATTORNEY



David J. Kybas

Director of the United States Patent and Trademark Office

United States of America

United States Patent and Trademark Office



Golden Class

Reg. No. 4,153,813

Registered June 5, 2012

Int. Cl.: 37

SERVICE MARK

PRINCIPAL REGISTER

GOLDEN CLASS AUTO ENTERPRISES INC. (CALIFORNIA CORPORATION)
870 W. CIENAGA AVENUE, UNIT 2
SAN DIMAS, CA 91773

FOR: AUTOMOTIVE CONVERSION SERVICES, NAMELY, SUPERCHARGING, TURBOCHARGING, PERFORMANCE UPGRADES OF AUTOMOBILES; AUTOMOBILE ELECTRIC APPLIANCES UPGRADE, AUTOMOBILE INTERIOR AND EXTERIOR CUSTOMIZATION; AUTOMOBILE MAINTENANCE AND REPAIR SERVICES, IN CLASS 37 (U.S. CLS. 100, 103 AND 106).

FIRST USE 9-1-2011; IN COMMERCE 9-1-2011.

THE MARK CONSISTS OF THE WORDS "GOLDEN CLASS" IN BLACK. TO THE LEFT, IS A BLUE CIRCLE WITH SILVER LININGS. THE LETTER "G" IN GOLD IS DISPLAYED IN THE MIDDLE OF THE CIRCLE AND IS SURROUNDED BY A RING OF GOLD TRIANGULAR SHAPES. UNDERNEATH THE LETTER "G" IS THE WORD "CLASS" IN BLUE WITH A SILVER BANNER BEHIND IT.

THE COLOR(S) BLUE, GOLD, SILVER AND BLACK IS/ARE CLAIMED AS A FEATURE OF THE MARK.

SER. NO. 85-442,704, FILED 10-7-2011.

MICHAEL WIENER, EXAMINING ATTORNEY



David J. Kyros

Director of the United States Patent and Trademark Office

United States of America

United States Patent and Trademark Office



Reg. No. 4,153,814

Registered June 5, 2012

Int. Cl.: 12

TRADEMARK

PRINCIPAL REGISTER

ULTRA RACING (M) SDN. BHD (MALAYSIA SENDIRIAN BERHAD (SDN BHD))
NO. 25, JALAN BUKIT PERMAI UTAMA 3
KUALA LUMPUR, MALAYSIA

FOR: AUTOMOBILE STRUCTURAL PARTS FOR RACING PURPOSES, NAMELY, FUEL STORAGE SYSTEMS AND COMPONENT PARTS; VEHICLE ROLL BARS, IN CLASS 12 (U.S. CLS. 19, 21, 23, 31, 35 AND 44).

FIRST USE 1-3-2008; IN COMMERCE 11-11-2008.

NO CLAIM IS MADE TO THE EXCLUSIVE RIGHT TO USE "RACING", APART FROM THE MARK AS SHOWN.

THE COLOR(S) BLACK AND RED IS/ARE CLAIMED AS A FEATURE OF THE MARK.

THE MARK CONSISTS OF THE STYLIZED LETTER "U", IN BLACK CONNECTED TO THE STYLIZED LETTER "R" IN RED, BESIDES THE WORD "ULTRA", ABOVE THE WORD "RACING" IN STYLIZED BLACK LETTERS.

SER. NO. 85-442,722, FILED 10-7-2011.

KRISTIN DAHLING, EXAMINING ATTORNEY



David J. Kyffers

Director of the United States Patent and Trademark Office

United States of America

United States Patent and Trademark Office

HUMANOFORT

Reg. No. 4,153,815

Registered June 5, 2012

Int. Cl.: 5

TRADEMARK

PRINCIPAL REGISTER

DELZEG INC (CALIFORNIA CORPORATION)
2711 ALL VIEW WAY
BELMONT, CA 94002

FOR: NUTRITIONAL SUPPLEMENTS; DIETARY SUPPLEMENTS, IN CLASS 5 (U.S. CLS. 6, 18, 44, 46, 51 AND 52).

FIRST USE 11-20-1993; IN COMMERCE 3-1-2000.

THE MARK CONSISTS OF STANDARD CHARACTERS WITHOUT CLAIM TO ANY PARTICULAR FONT, STYLE, SIZE, OR COLOR.

THE WORDING "HUMANOFORT" HAS NO MEANING IN A FOREIGN LANGUAGE.

SER. NO. 85-442,741, FILED 10-8-2011.

H. M. FISHER, EXAMINING ATTORNEY



David J. Kybas

Director of the United States Patent and Trademark Office

United States of America

United States Patent and Trademark Office

THE PROPER BARBERSHOP

Reg. No. 4,153,816

Registered June 5, 2012

Int. Cl.: 44

SERVICE MARK

PRINCIPAL REGISTER

MOREY, VINCENT (UNITED STATES INDIVIDUAL)
431 SOUTH BURNSIDE AVE
#6H
LOS ANGELES, CA 90036

FOR: BARBER SHOP SERVICES, IN CLASS 44 (U.S. CLS. 100 AND 101).

FIRST USE 12-18-2009; IN COMMERCE 4-1-2010.

THE MARK CONSISTS OF STANDARD CHARACTERS WITHOUT CLAIM TO ANY PARTICULAR FONT, STYLE, SIZE, OR COLOR.

NO CLAIM IS MADE TO THE EXCLUSIVE RIGHT TO USE "BARBERSHOP", APART FROM THE MARK AS SHOWN.

SER. NO. 85-442,750, FILED 10-8-2011.

H. M. FISHER, EXAMINING ATTORNEY



David J. Kybas

Director of the United States Patent and Trademark Office

United States of America

United States Patent and Trademark Office

NorthStar VETS

Reg. No. 4,153,817

Registered June 5, 2012

Int. Cl.: 44

SERVICE MARK

PRINCIPAL REGISTER

NORTHSTAR VETS (NEW JERSEY LIMITED LIABILITY COMPANY), FORMERLY
VETERINARY SURGICAL AND DIAGNOSTIC SPECIALISTS
315 ROBBINSVILLE-AlLENTOWN ROAD
ROBBINSVILLE, NJ 08691

FOR: VETERINARY EMERGENCY AND TRAUMA SERVICES; VETERINARY SPECIALTY
SERVICES PROVIDING ADVANCED MEDICAL, DIAGNOSTIC OR SURGICAL SERVICES
FOR ANIMALS, IN CLASS 44 (U.S. CLS. 100 AND 101).

FIRST USE 3-28-2009; IN COMMERCE 4-6-2009.

THE MARK CONSISTS OF STANDARD CHARACTERS WITHOUT CLAIM TO ANY PAR-
TICULAR FONT, STYLE, SIZE, OR COLOR.

OWNER OF U.S. REG. NO. 3,714,696.

NO CLAIM IS MADE TO THE EXCLUSIVE RIGHT TO USE "VETS", APART FROM THE
MARK AS SHOWN.

SER. NO. 85-442,753, FILED 10-8-2011.

H. M. FISHER, EXAMINING ATTORNEY



David J. Kyffers

Director of the United States Patent and Trademark Office

United States of America

United States Patent and Trademark Office

15 MINUTES. EASY TO MAKE.
MANY TO LOVE.

Reg. No. 4,153,818

GARDETTO'S BAKERY, INC. (WISCONSIN CORPORATION)
NUMBER ONE GENERAL MILLS BLVD.
MINNEAPOLIS, MN 55426

Registered June 5, 2012

Int. Cl.: 30

FOR: PROCESSED CEREAL-BASED FOOD TO BE USED AS A BREAKFAST FOOD, SNACK FOOD OR INGREDIENT FOR MAKING OTHER FOODS, IN CLASS 30 (U.S. CL. 46).

TRADEMARK

FIRST USE 9-0-2010; IN COMMERCE 9-0-2010.

PRINCIPAL REGISTER

THE MARK CONSISTS OF STANDARD CHARACTERS WITHOUT CLAIM TO ANY PARTICULAR FONT, STYLE, SIZE, OR COLOR.

SER. NO. 85-442,757, FILED 10-8-2011.

NAKIA HENRY, EXAMINING ATTORNEY



David J. Kybas

Director of the United States Patent and Trademark Office

United States of America

United States Patent and Trademark Office

My Tutor

Reg. No. 4,153,819

Registered June 5, 2012

Int. Cl.: 42

SERVICE MARK

PRINCIPAL REGISTER

VANTAGE LEARNING (USA), LLC (DELAWARE LIMITED LIABILITY COMPANY), DBA
VANTAGE LEARNING
KENNETH J. LAFIANDRA, GENERAL COUNSEL
6805 ROUTE 202
NEW HOPE, PA 18938

FOR: SOFTWARE AS A SERVICE (SAAS) SERVICES FEATURING SOFTWARE FOR IDENTIFYING STUDENTS' COGNITIVE LEVEL AND ACADEMIC ABILITIES AND TO HELP IMPROVE LEARNING AND ACADEMIC PERFORMANCE THROUGH THE USE OF WRITTEN ESSAYS IN RESPONSE TO WRITING PROMPTS AND BY PROVIDING STUDENTS WITH PRESCRIPTIVE REVISION PLANS THAT INCLUDE EXAMPLES TO HELP FOCUS ACTIVITIES ON PARTICULAR STRENGTHS AND WEAKNESSES ALL THROUGH CLOUD COMPUTING, IN CLASS 42 (U.S. CLS. 100 AND 101).

FIRST USE 5-2-2001; IN COMMERCE 5-2-2001.

THE MARK CONSISTS OF STANDARD CHARACTERS WITHOUT CLAIM TO ANY PARTICULAR FONT, STYLE, SIZE, OR COLOR.

NO CLAIM IS MADE TO THE EXCLUSIVE RIGHT TO USE "TUTOR", APART FROM THE MARK AS SHOWN.

SER. NO. 85-442,771, FILED 10-8-2011.

EDWARD FENNESSY, EXAMINING ATTORNEY



David J. Kyffers

Director of the United States Patent and Trademark Office

United States of America

United States Patent and Trademark Office

spicester

Reg. No. 4,153,820

FOZZY NETWORKS, LLC (FLORIDA LIMITED LIABILITY COMPANY), DBA SPICESTER
836 NE 7TH TER. STE 6
CAPE CORAL, FL 33909

Registered June 5, 2012

Int. Cl.: 3

FOR: AROMATIC POTPOURRIS; POTPOURRI, IN CLASS 3 (U.S. CLS. 1, 4, 6, 50, 51 AND 52).

TRADEMARK

FIRST USE 7-1-2011; IN COMMERCE 9-1-2011.

PRINCIPAL REGISTER

THE MARK CONSISTS OF STANDARD CHARACTERS WITHOUT CLAIM TO ANY PARTICULAR FONT, STYLE, SIZE, OR COLOR.

SER. NO. 85-442,772, FILED 10-8-2011.

H. M. FISHER, EXAMINING ATTORNEY



David J. Kybas

Director of the United States Patent and Trademark Office

United States of America

United States Patent and Trademark Office

CLEVVVER

Reg. No. 4,153,821

Registered June 5, 2012

Int. Cls.: 38 and 41

SERVICE MARK

PRINCIPAL REGISTER

CLEVVVER MEDIA, LLC (NEVADA LIMITED LIABILITY COMPANY)
7260 W. AZURE DR. STE 140-212
LAS VEGAS, NV 89130

FOR: BROADCASTING SERVICES NAMELY PROVIDING ACCESS TO AUDIO, VISUAL, AND MULTIMEDIA CONTENT VIA A VIDEO-ON-DEMAND TRANSMISSION SERVICES VIA THE INTERNET; TRANSMISSION OF AUDIO, VISUAL, AND MULTIMEDIA CONTENT VIA THE INTERNET; PROVIDING AN ON-LINE FORUM FOR DISCUSSION VIA TRANSMISSION OF MESSAGES AMONG COMPUTER USERS CONCERNING ON-GOING VIDEO PROGRAMS IN THE FIELDS OF NEWS, COMEDY, STYLE, ENTERTAINMENT, CELEBRITY NEWS, MOTION PICTURES, AND VARIETY, IN CLASS 38 (U.S. CLS. 100, 101 AND 104).

FIRST USE 2-14-2006; IN COMMERCE 2-14-2006.

FOR: ENTERTAINMENT SERVICES, NAMELY, RECORDING AND PRODUCTION OF ON-GOING VIDEO PROGRAMS IN THE FIELDS OF NEWS, COMEDY, STYLE, ENTERTAINMENT, CELEBRITY NEWS, MOTION PICTURES, AND VARIETY; PROVIDING A WEBSITE FEATURING ON-GOING VIDEO PROGRAMS IN THE FIELDS OF NEWS, COMEDY, STYLE, ENTERTAINMENT, CELEBRITY NEWS, MOTION PICTURES, AND VARIETY; PROVIDING ON-LINE JOURNALS, NAMELY, BLOGS FEATURING ON-GOING VIDEO PROGRAMS IN THE FIELDS OF NEWS, COMEDY, STYLE, ENTERTAINMENT, CELEBRITY NEWS, MOTION PICTURES, AND VARIETY, IN CLASS 41 (U.S. CLS. 100, 101 AND 107).

FIRST USE 2-14-2006; IN COMMERCE 2-14-2006.

THE MARK CONSISTS OF STANDARD CHARACTERS WITHOUT CLAIM TO ANY PARTICULAR FONT, STYLE, SIZE, OR COLOR.

SER. NO. 85-442,785, FILED 10-8-2011.

ALLISON SCHRODY, EXAMINING ATTORNEY



David J. Kypos

Director of the United States Patent and Trademark Office

United States of America

United States Patent and Trademark Office

CLEVVERTV

Reg. No. 4,153,822

Registered June 5, 2012

Int. Cls.: 38 and 41

SERVICE MARK

PRINCIPAL REGISTER

CLEVVET MEDIA, LLC (NEVADA LIMITED LIABILITY COMPANY)
7260 W. AZURE DR. STE 140-212
LAS VEGAS, NV 89130

FOR: BROADCASTING SERVICES NAMELY PROVIDING ACCESS TO AUDIO, VISUAL, AND MULTIMEDIA CONTENT VIA A VIDEO-ON-DEMAND TRANSMISSION SERVICES VIA THE INTERNET; TRANSMISSION OF AUDIO, VISUAL, AND MULTIMEDIA CONTENT VIA THE INTERNET; PROVIDING AN ON-LINE FORUM FOR DISCUSSION VIA TRANSMISSION OF MESSAGES AMONG COMPUTER USERS CONCERNING ON-GOING VIDEO PROGRAMS IN THE FIELDS OF NEWS, COMEDY, STYLE, ENTERTAINMENT, CELEBRITY NEWS, MOTION PICTURES, AND VARIETY, IN CLASS 38 (U.S. CLS. 100, 101 AND 104).

FIRST USE 3-17-2008; IN COMMERCE 3-17-2008.

FOR: ENTERTAINMENT SERVICES, NAMELY, RECORDING AND PRODUCTION OF ON-GOING VIDEO PROGRAMS IN THE FIELDS OF NEWS, COMEDY, STYLE, ENTERTAINMENT, CELEBRITY NEWS, MOTION PICTURES, AND VARIETY; PROVIDING A WEBSITE FEATURING ON-GOING VIDEO PROGRAMS IN THE FIELDS OF NEWS, COMEDY, STYLE, ENTERTAINMENT, CELEBRITY NEWS, MOTION PICTURES, AND VARIETY; PROVIDING ON-LINE JOURNALS, NAMELY, BLOGS FEATURING ON-GOING VIDEO PROGRAMS IN THE FIELDS OF NEWS, COMEDY, STYLE, ENTERTAINMENT, CELEBRITY NEWS, MOTION PICTURES, AND VARIETY, IN CLASS 41 (U.S. CLS. 100, 101 AND 107).

FIRST USE 3-17-2008; IN COMMERCE 3-17-2008.

THE MARK CONSISTS OF STANDARD CHARACTERS WITHOUT CLAIM TO ANY PARTICULAR FONT, STYLE, SIZE, OR COLOR.

SER. NO. 85-442,790, FILED 10-8-2011.

ALLISON SCHRODY, EXAMINING ATTORNEY



David J. Kyffers

Director of the United States Patent and Trademark Office

United States of America

United States Patent and Trademark Office

Starself

Reg. No. 4,153,823

Registered June 5, 2012

Int. Cl.: 45

SERVICE MARK

PRINCIPAL REGISTER

RICHARD ALESSANDRO DICLEMENTE (UNITED STATES INDIVIDUAL), DBA STARSELF
3 RICHEYVILLE ROAD
RICHEYVILLE, PA 15358

FOR: ASTROLOGY CONSULTATION, IN CLASS 45 (U.S. CLS. 100 AND 101).

FIRST USE 12-10-2003; IN COMMERCE 12-10-2003.

THE MARK CONSISTS OF STANDARD CHARACTERS WITHOUT CLAIM TO ANY PARTICULAR FONT, STYLE, SIZE, OR COLOR.

SER. NO. 85-442,791, FILED 10-8-2011.

APRIL ROACH, EXAMINING ATTORNEY



David J. Kybas

Director of the United States Patent and Trademark Office

United States of America

United States Patent and Trademark Office

vaganga

Reg. No. 4,153,824

GEISTWERK, LLC (NEVADA LIMITED LIABILITY COMPANY)
2678 PIANTINO CIR
SAN DIEGO, CA 92108

Registered June 5, 2012

Int. Cl.: 39

FOR: TRAVEL AGENCY SERVICES, NAMELY, MAKING RESERVATIONS AND BOOKINGS FOR TRANSPORTATION, IN CLASS 39 (U.S. CLS. 100 AND 105).

SERVICE MARK

FIRST USE 4-21-2008; IN COMMERCE 4-21-2009.

PRINCIPAL REGISTER

THE MARK CONSISTS OF STANDARD CHARACTERS WITHOUT CLAIM TO ANY PARTICULAR FONT, STYLE, SIZE, OR COLOR.

SER. NO. 85-442,793, FILED 10-8-2011.

TARA PATE, EXAMINING ATTORNEY



David J. Kybas

Director of the United States Patent and Trademark Office

United States of America

United States Patent and Trademark Office

SFMAI

Reg. No. 4,153,825

Registered June 5, 2012

Int. Cl.: 41

SERVICE MARK

PRINCIPAL REGISTER

SOCIETY FOR MARTIAL ARTS INSTRUCTION (NEW YORK NON-PROFIT CORPORATION)
THIRD FLOOR
4 WEST 18TH STREET
NEW YORK, NY 10011

FOR: INSTRUCTION IN THE FIELD OF SOMATIC EDUCATION; MARTIAL ARTS INSTRUCTION, IN CLASS 41 (U.S. CLS. 100, 101 AND 107).

FIRST USE 11-17-2003; IN COMMERCE 11-17-2003.

THE MARK CONSISTS OF STANDARD CHARACTERS WITHOUT CLAIM TO ANY PARTICULAR FONT, STYLE, SIZE, OR COLOR.

SER. NO. 85-442,800, FILED 10-8-2011.

CYNTHIA TRIPI, EXAMINING ATTORNEY



David J. Kyros

Director of the United States Patent and Trademark Office

United States of America

United States Patent and Trademark Office

Bettertogether

Reg. No. 4,153,826

Registered June 5, 2012

Int. Cl.: 16

TRADEMARK

PRINCIPAL REGISTER

REINFELDT, SUSAN (UNITED STATES INDIVIDUAL)
1204 WATERSTONE BLVD.
FRANKLIN, TN 37069

FOR: RELIGIOUS BOOKS, IN CLASS 16 (U.S. CLS. 2, 5, 22, 23, 29, 37, 38 AND 50).

FIRST USE 9-1-2011; IN COMMERCE 9-1-2011.

THE MARK CONSISTS OF STANDARD CHARACTERS WITHOUT CLAIM TO ANY PARTICULAR FONT, STYLE, SIZE, OR COLOR.

SER. NO. 85-442,803, FILED 10-8-2011.

SEAN CROWLEY, EXAMINING ATTORNEY



David J. Kyffers

Director of the United States Patent and Trademark Office

United States of America

United States Patent and Trademark Office

Cacti

Reg. No. 4,153,827

Registered June 5, 2012

Int. Cl.: 9

TRADEMARK

PRINCIPAL REGISTER

CACTI GROUP, INC. (MICHIGAN CORPORATION)
333 ROLLING MEADOWS DR.
ANN ARBOR, MI 48103

FOR: COMPUTER SOFTWARE FOR USE IN MONITORING AND REPORTING THE AVAILABILITY AND OPERATIONAL STATE OF COMPUTER SYSTEMS, COMPUTER SOFTWARE, NETWORK OPERATING SYSTEMS, AND NETWORK SERVICES, IN CLASS 9 (U.S. CLS. 21, 23, 26, 36 AND 38).

FIRST USE 12-1-2001; IN COMMERCE 8-1-2004.

THE MARK CONSISTS OF STANDARD CHARACTERS WITHOUT CLAIM TO ANY PARTICULAR FONT, STYLE, SIZE, OR COLOR.

SER. NO. 85-442,810, FILED 10-8-2011.

EUGENIA MARTIN, EXAMINING ATTORNEY



David J. Kyffers

Director of the United States Patent and Trademark Office

United States of America

United States Patent and Trademark Office

Wholesome Healers

Reg. No. 4,153,828

PEPI, GRETCHEN (UNITED STATES INDIVIDUAL), DBA WHOLESOME HEALERS
P.O. BOX 351
SHREWSBURY, MA 01545

Registered June 5, 2012

Int. Cl.: 3

FOR: AROMATIC PREPARATIONS, NAMELY, LOTIONS, CREAMS, AND SOAPS, IN CLASS
3 (U.S. CLS. 1, 4, 6, 50, 51 AND 52).

TRADEMARK

FIRST USE 0-0-2011; IN COMMERCE 0-0-2011.

PRINCIPAL REGISTER

THE MARK CONSISTS OF STANDARD CHARACTERS WITHOUT CLAIM TO ANY PAR-
TICULAR FONT, STYLE, SIZE, OR COLOR.

SER. NO. 85-442,811, FILED 10-8-2011.

DORITT L. CARROLL, EXAMINING ATTORNEY



David J. Kyros

Director of the United States Patent and Trademark Office

United States of America

United States Patent and Trademark Office

Stabilix

Reg. No. 4,153,829

Registered June 5, 2012

Int. Cl.: 42

SERVICE MARK

PRINCIPAL REGISTER

STABILIX CORPORATION (CALIFORNIA CORPORATION)
PMB 206
20770 HWY. 281 NORTH, SUITE 108
SAN ANTONIO, TX 78258

FOR: DEVELOPING AND UPDATING COMPUTER SOFTWARE, IN CLASS 42 (U.S. CLS. 100 AND 101).

FIRST USE 11-1-2001; IN COMMERCE 11-1-2001.

THE MARK CONSISTS OF STANDARD CHARACTERS WITHOUT CLAIM TO ANY PARTICULAR FONT, STYLE, SIZE, OR COLOR.

SER. NO. 85-442,814, FILED 10-8-2011.

JACQUELINE A. LAVINE, EXAMINING ATTORNEY



David J. Kybas

Director of the United States Patent and Trademark Office

United States of America

United States Patent and Trademark Office

MATH CONCERT

Reg. No. 4,153,830

WWW.LETTERMATCH.COM LLC (WISCONSIN LIMITED LIABILITY COMPANY)
7010 W. MELVINA STREET
MILWAUKEE, WI 53216

Registered June 5, 2012

Int. Cl.: 35

FOR: COMPUTERIZED ON-LINE RETAIL STORE SERVICES IN THE FIELD OF MATH
FACT DRILLS ON DVD, IN CLASS 35 (U.S. CLS. 100, 101 AND 102).

SERVICE MARK

FIRST USE 8-23-2011; IN COMMERCE 10-5-2011.

PRINCIPAL REGISTER

THE MARK CONSISTS OF STANDARD CHARACTERS WITHOUT CLAIM TO ANY PAR-
TICULAR FONT, STYLE, SIZE, OR COLOR.

NO CLAIM IS MADE TO THE EXCLUSIVE RIGHT TO USE "MATH", APART FROM THE
MARK AS SHOWN.

SER. NO. 85-442,826, FILED 10-8-2011.

B. PARADEWELAI, EXAMINING ATTORNEY



David J. Kybas

Director of the United States Patent and Trademark Office

United States of America
United States Patent and Trademark Office

VINHEART

Reg. No. 4,153,831

LA GROU, JOHN (UNITED STATES INDIVIDUAL), DBA VINHEART
4200 DAYSPRING CT
PLACERVILLE, CA 95667

Registered June 5, 2012

Int. Cl.: 36

FOR: CHARITABLE FUNDRAISING SERVICES, IN CLASS 36 (U.S. CLS. 100, 101 AND 102).

SERVICE MARK

FIRST USE 10-8-2011; IN COMMERCE 10-8-2011.

PRINCIPAL REGISTER

THE MARK CONSISTS OF STANDARD CHARACTERS WITHOUT CLAIM TO ANY PARTICULAR FONT, STYLE, SIZE, OR COLOR.

SER. NO. 85-442,830, FILED 10-8-2011.

ALAIN LAPTER, EXAMINING ATTORNEY



David J. Kyfos

Director of the United States Patent and Trademark Office

United States of America

United States Patent and Trademark Office

Redi-Med

Reg. No. 4,153,832

NEIDIG HEALTH CARE LTD (OHIO PARTNERSHIP), DBA MEDI-WISE LTC PHARMACY
415 SOUTH RIVER STREET
NEWCOMERSTOWN, OH 43832

Registered June 5, 2012

Int. Cl.: 35

FOR: INSTITUTIONAL RETAIL PHARMACY SERVICES, IN CLASS 35 (U.S. CLS. 100, 101 AND 102).

SERVICE MARK

FIRST USE 5-11-2011; IN COMMERCE 5-24-2011.

PRINCIPAL REGISTER

THE MARK CONSISTS OF STANDARD CHARACTERS WITHOUT CLAIM TO ANY PARTICULAR FONT, STYLE, SIZE, OR COLOR.

SER. NO. 85-442,855, FILED 10-9-2011.

GIANCARLO CASTRO, EXAMINING ATTORNEY



David J. Kybas

Director of the United States Patent and Trademark Office

United States of America

United States Patent and Trademark Office

Life is Lacrosse

Reg. No. 4,153,833

Registered June 5, 2012

Int. Cl.: 25

TRADEMARK

PRINCIPAL REGISTER

LAX GAL, LLC (FLORIDA LIMITED LIABILITY COMPANY)
5130 TILDENS GROVE BLVD.
WINDERMERE, FL 34786

FOR: A-SHIRTS; ANKLE SOCKS; ATHLETIC APPAREL, NAMELY, SHIRTS, PANTS, JACKETS, FOOTWEAR, HATS AND CAPS, ATHLETIC UNIFORMS; HATS; LONG-SLEEVED SHIRTS; MOISTURE-WICKING SPORTS SHIRTS; NIGHT SHIRTS; SHIRTS AND SHORT-SLEEVED SHIRTS; SHORT-SLEEVED OR LONG-SLEEVED T-SHIRTS; SHORT-SLEEVED SHIRTS; SOCKS; SPORT SHIRTS; SPORTS CAPS AND HATS; SPORTS SHIRTS; SPORTS SHIRTS WITH SHORT SLEEVES; SWEAT SHIRTS; T-SHIRTS; TEE SHIRTS, IN CLASS 25 (U.S. CLS. 22 AND 39).

FIRST USE 11-23-2009; IN COMMERCE 11-23-2009.

THE MARK CONSISTS OF STANDARD CHARACTERS WITHOUT CLAIM TO ANY PARTICULAR FONT, STYLE, SIZE, OR COLOR.

SER. NO. 85-442,859, FILED 10-9-2011.

GIANCARLO CASTRO, EXAMINING ATTORNEY



David J. Kyffers

Director of the United States Patent and Trademark Office

United States of America

United States Patent and Trademark Office

Cydara

Reg. No. 4,153,834

Registered June 5, 2012

Int. Cl.: 41

SERVICE MARK

PRINCIPAL REGISTER

WHITE PAPER ENTERTAINMENT LLC (MICHIGAN LIMITED LIABILITY COMPANY)
1241 RUNAWAY BAY DR STE 2C
LANSING, MI 48917

FOR: ENTERTAINMENT IN THE NATURE OF VISUAL AND AUDIO PERFORMANCES,
AND MUSICAL, VARIETY, NEWS AND COMEDY SHOWS, IN CLASS 41 (U.S. CLS. 100,
101 AND 107).

FIRST USE 6-12-1988; IN COMMERCE 6-11-2007.

THE MARK CONSISTS OF STANDARD CHARACTERS WITHOUT CLAIM TO ANY PAR-
TICULAR FONT, STYLE, SIZE, OR COLOR.

SER. NO. 85-442,867, FILED 10-9-2011.

GIANCARLO CASTRO, EXAMINING ATTORNEY



David J. Kyffers

Director of the United States Patent and Trademark Office

United States of America

United States Patent and Trademark Office

TRUE ARTIST

Reg. No. 4,153,835

Registered June 5, 2012

Int. Cl.: 25

TRADEMARK

PRINCIPAL REGISTER

MACK, RHIANNA (UNITED STATES INDIVIDUAL)
419 LEMON DRIVE
ARLINGTON, TX 76018

FOR: HATS; SHIRTS, IN CLASS 25 (U.S. CLS. 22 AND 39).

FIRST USE 0-0-2009; IN COMMERCE 0-0-2009.

THE MARK CONSISTS OF STANDARD CHARACTERS WITHOUT CLAIM TO ANY PARTICULAR FONT, STYLE, SIZE, OR COLOR.

SER. NO. 85-442,881, FILED 10-9-2011.

ROBIN CHOSID, EXAMINING ATTORNEY



David J. Kyffers

Director of the United States Patent and Trademark Office

United States of America

United States Patent and Trademark Office

The Graphic Mind

Reg. No. 4,153,836

Registered June 5, 2012

Int. Cl.: 42

SERVICE MARK

PRINCIPAL REGISTER

LAWRENCE Q. MARKX (UNITED STATES INDIVIDUAL)
PO BOX 1529
CHRISTMAS, FL 32709

FOR: COMPUTER AIDED DESIGN FOR OTHERS; COMPUTER AIDED GRAPHIC DESIGN; COMPUTER GRAPHICS DESIGN SERVICES; COMPUTER WEBSITE DESIGN; CONSULTANCY WITH REGARD TO WEBPAGE DESIGN; CREATING AND DESIGNING WEB PAGES FOR OTHERS; CREATING, DESIGNING AND MAINTAINING WEB SITES; CREATION, DESIGN, DEVELOPMENT AND MAINTENANCE OF WEB SITES FOR THIRD PARTIES; DESIGN AND CREATING WEB SITES FOR OTHERS; DESIGN OF HOME PAGES AND WEB SITES; DESIGN OF HOMEPAGES AND WEBSITES; DESIGN OF TEXTILES; DESIGN SERVICES FOR PACKAGING; DESIGN SKETCHING OF PACKAGING, CONTAINERS, DINNERWARE AND TABLE UTENSILS; DESIGNING AND DEVELOPING WEBPAGES ON THE INTERNET; DESIGNING INTERNET SITES FOR OTHERS; DESIGNING OF PACKAGING AND WRAPPING MATERIALS; DESIGNING THEME GRAPHICS AND MULTIMEDIA SHOWS FOR CONVENTIONS, PRODUCT LAUNCHES, TRADE SHOWS, KEY NOTE ADDRESSES AND AWARD CEREMONIES FOR OTHERS; DESIGNING WEB PAGES FOR OTHERS; DESIGNING WEBSITES FOR ADVERTISING PURPOSES; DESIGNING WEBSITES FOR OTHERS; DEVELOPMENT, DESIGN AND UPDATING OF HOME PAGES; FASHION DESIGN CONSULTING SERVICES; GRAPHIC ART DESIGN; GRAPHIC ARTS DESIGNING; GRAPHIC DESIGN; GRAPHIC DESIGN SERVICES; HOMEPAGE AND WEBPAGE DESIGN; NEW PRODUCT DESIGN SERVICES; PACKAGING DESIGN; PACKAGING DESIGN FOR OTHERS; TATTOO DESIGN SERVICES; VISUAL DESIGN SERVICES IN THE NATURE OF DESIGNING VISUAL ELEMENTS FOR ON-LINE, BROADCAST, PRINT, OUTDOOR AND OTHER COMMUNICATION MEDIA; WEB SITE DESIGN; WEBSITE DESIGN AND DEVELOPMENT FOR OTHERS, IN CLASS 42 (U.S. CLS. 100 AND 101).



FIRST USE 5-16-2005; IN COMMERCE 5-16-2005.

THE MARK CONSISTS OF STANDARD CHARACTERS WITHOUT CLAIM TO ANY PARTICULAR FONT, STYLE, SIZE, OR COLOR.

NO CLAIM IS MADE TO THE EXCLUSIVE RIGHT TO USE "GRAPHIC", APART FROM THE MARK AS SHOWN.

SER. NO. 85-442,886, FILED 10-9-2011.

David J. Kyros

Director of the United States Patent and Trademark Office

Reg. No. 4,153,836 STEVEN R. FINE, EXAMINING ATTORNEY

United States of America

United States Patent and Trademark Office

Moonsung

Reg. No. 4,153,837

Registered June 5, 2012

Int. Cl.: 16

TRADEMARK

PRINCIPAL REGISTER

REYNOLDS, JONATHAN HAL (UNITED STATES INDIVIDUAL)
WWW.LIVEFREEDREAMFAR.COM
4266 COTTON BELT PARKWAY
MCGREGOR, TX 76657

FOR: SERIES OF FICTION BOOKS, IN CLASS 16 (U.S. CLS. 2, 5, 22, 23, 29, 37, 38 AND 50).

FIRST USE 3-1-2004; IN COMMERCE 10-1-2004.

THE MARK CONSISTS OF STANDARD CHARACTERS WITHOUT CLAIM TO ANY PARTICULAR FONT, STYLE, SIZE, OR COLOR.

SER. NO. 85-442,888, FILED 10-9-2011.

STEVEN R. FINE, EXAMINING ATTORNEY



David J. Kybas

Director of the United States Patent and Trademark Office

United States of America

United States Patent and Trademark Office

LEIHUT

Reg. No. 4,153,838

Registered June 5, 2012

Int. Cl.: 35

SERVICE MARK

PRINCIPAL REGISTER

STORYMANAGER, INC. (HAWAII CORPORATION)
1012 18TH AVE.
1012 18TH AVE.
HONOLULU, HI 96816

FOR: ON-LINE RETAIL GIFT SHOPS, IN CLASS 35 (U.S. CLS. 100, 101 AND 102).

FIRST USE 10-5-2011; IN COMMERCE 10-5-2011.

THE MARK CONSISTS OF STANDARD CHARACTERS WITHOUT CLAIM TO ANY PARTICULAR FONT, STYLE, SIZE, OR COLOR.

SER. NO. 85-442,906, FILED 10-9-2011.

EMILY CARLSEN, EXAMINING ATTORNEY



David J. Kybas

Director of the United States Patent and Trademark Office

United States of America

United States Patent and Trademark Office

The Peaceful Pack

Reg. No. 4,153,839

Registered June 5, 2012

Int. Cls.: 41, 43 and 44

SERVICE MARK

PRINCIPAL REGISTER

THE PEACEFUL PACK, INC. (NEW YORK CORPORATION)
64 CHEEVER PL
BROOKLYN, NY 11231

FOR: DOG TRAINING; KENNEL SERVICES, NAMELY, DOG TRAINING SERVICES; PET OBEDIENCE TRAINING SERVICES; PET TRAINING SERVICES; PROVIDING INFORMATION AND ADVICE IN THE FIELD OF PET TRAINING, IN CLASS 41 (U.S. CLS. 100, 101 AND 107).

FIRST USE 5-1-2011; IN COMMERCE 6-15-2011.

FOR: KENNEL SERVICES, NAMELY, BOARDING FOR PETS; PET BOARDING SERVICES; PET DAY CARE SERVICES, IN CLASS 43 (U.S. CLS. 100 AND 101).

FIRST USE 5-1-2011; IN COMMERCE 6-15-2011.

FOR: CONSULTATION SERVICES IN THE FIELD OF PET BEHAVIOR; DOG WALKING SERVICES; PET CARE SERVICES, NAMELY, DOG WALKING, DOG BATHING AND NON-MEDICATED PET GROOMING; PET CARE SERVICES, NAMELY, DOG WALKING, DOG BATHING, NON-MEDICATED PET GROOMING AND IN-HOME MEDICAL CARE, IN CLASS 44 (U.S. CLS. 100 AND 101).

FIRST USE 5-1-2011; IN COMMERCE 6-15-2011.

THE MARK CONSISTS OF STANDARD CHARACTERS WITHOUT CLAIM TO ANY PARTICULAR FONT, STYLE, SIZE, OR COLOR.

SER. NO. 85-442,935, FILED 10-9-2011.

TARAH HARDY, EXAMINING ATTORNEY



David J. Kyros

Director of the United States Patent and Trademark Office

United States of America

United States Patent and Trademark Office



Reg. No. 4,153,840

Registered June 5, 2012

Int. Cls.: 41, 43 and 44

SERVICE MARK

PRINCIPAL REGISTER

THE PEACEFUL PACK, INC. (NEW YORK CORPORATION)
64 CHEEVER PL
BROOKLYN, NY 11231

FOR: DOG TRAINING; KENNEL SERVICES, NAMELY, DOG TRAINING SERVICES; PET OBEDIENCE TRAINING SERVICES; PET TRAINING SERVICES; PROVIDING INFORMATION AND ADVICE IN THE FIELD OF PET TRAINING, IN CLASS 41 (U.S. CLS. 100, 101 AND 107).

FIRST USE 5-1-2011; IN COMMERCE 6-15-2011.

FOR: KENNEL SERVICES, NAMELY, BOARDING FOR PETS; PET BOARDING SERVICES; PET DAY CARE SERVICES, IN CLASS 43 (U.S. CLS. 100 AND 101).

FIRST USE 5-1-2011; IN COMMERCE 6-15-2011.

FOR: CONSULTATION SERVICES IN THE FIELD OF PET BEHAVIOR; DOG WALKING SERVICES; PET CARE SERVICES, NAMELY, DOG WALKING, DOG BATHING AND NON-MEDICATED PET GROOMING; PET CARE SERVICES, NAMELY, DOG WALKING, DOG BATHING, NON-MEDICATED PET GROOMING AND IN-HOME MEDICAL CARE, IN CLASS 44 (U.S. CLS. 100 AND 101).

FIRST USE 5-1-2011; IN COMMERCE 6-15-2011.

THE MARK CONSISTS OF THE SILHOUETTE OF A MAN IN NAVY BLUE WALKING THREE DOGS AND HOLDING THEIR LEASHES, WITH ONE DOG AND LEASH IN YELLOW/GREEN, ONE DOG AND LEASH IN GRAY, AND ONE DOG AND LEASH IN LIGHT BLUE.

THE COLOR(S) NAVY BLUE, GREEN/YELLOW, GRAY, AND LIGHT BLUE IS/ARE CLAIMED AS A FEATURE OF THE MARK.

SER. NO. 85-442,941, FILED 10-9-2011.

TARAH HARDY, EXAMINING ATTORNEY



David J. Kyros

Director of the United States Patent and Trademark Office

United States of America

United States Patent and Trademark Office

The Big Game

Reg. No. 4,153,841

DINNING, BRIAN RAY (UNITED STATES INDIVIDUAL), DBA THE BIG GAME TV SHOW
PO BOX 305
STOYSTOWN, PA 15563

Registered June 5, 2012

Int. Cl.: 41

FOR: EDUCATIONAL AND ENTERTAINMENT SERVICES, NAMELY, A CONTINUING PROGRAM ABOUT HUNTING AND SPORTSMANSHIP ACCESSIBLE BY RADIO, TELEVISION, SATELLITE, AUDIO, VIDEO AND COMPUTER NETWORKS, IN CLASS 41 (U.S. CLS. 100, 101 AND 107).

SERVICE MARK

PRINCIPAL REGISTER

FIRST USE 10-15-2010; IN COMMERCE 10-1-2011.

THE MARK CONSISTS OF STANDARD CHARACTERS WITHOUT CLAIM TO ANY PARTICULAR FONT, STYLE, SIZE, OR COLOR.

SER. NO. 85-442,949, FILED 10-9-2011.

TARAH HARDY, EXAMINING ATTORNEY



David J. Kyffers

Director of the United States Patent and Trademark Office

United States of America

United States Patent and Trademark Office

SPARKLING WINE OF THE STARS

Reg. No. 4,153,842

Registered June 5, 2012

Int. Cl.: 33

TRADEMARK

PRINCIPAL REGISTER

OLIVER EUGENE ANDERSON (UNITED STATES INDIVIDUAL)
3550 PARADISE ROAD
SUITE 177
LAS VEGAS, NV 89169 AND

CHARLES LORENZO HAYES (UNITED STATES INDIVIDUAL)
16033 BOLSA CHICA STREET
SUITE 104
HUNTINGTON BEACH, CA 92649

FOR: NATURAL SPARKLING WINES; SPARKLING WINES; TABLE WINES; WHITE WINE,
IN CLASS 33 (U.S. CLS. 47 AND 49).

FIRST USE 5-20-2011; IN COMMERCE 5-20-2011.

THE MARK CONSISTS OF STANDARD CHARACTERS WITHOUT CLAIM TO ANY PAR-
TICULAR FONT, STYLE, SIZE, OR COLOR.

NO CLAIM IS MADE TO THE EXCLUSIVE RIGHT TO USE "SPARKLING WINE", APART
FROM THE MARK AS SHOWN.

SER. NO. 85-442,955, FILED 10-9-2011.

ODESSA BIBBINS, EXAMINING ATTORNEY



David J. Kyros

Director of the United States Patent and Trademark Office

United States of America

United States Patent and Trademark Office

LILY'S LAUNDRY

Reg. No. 4,153,843

NEIL, LAURA (UNITED STATES INDIVIDUAL), DBA LILY'S LAUNDRY
PO BOX 5726
LA QUINTA, CA 92248

Registered June 5, 2012

Int. Cls.: 25 and 41

FOR: CHILDREN'S AND INFANT CLOTHING, NAMELY, SHIRTS, PANTS, DRESSES, BLOOMERS, SKIRTS, AND BATHING SUITS, IN CLASS 25 (U.S. CLS. 22 AND 39).

TRADEMARK

FIRST USE 12-5-2007; IN COMMERCE 12-5-2007.

SERVICE MARK

FOR: ONLINE JOURNALS, NAMELY, BLOGS FEATURING ENTERTAINING GUEST, COOKING, HOME DECOR, FASHION, IN CLASS 41 (U.S. CLS. 100, 101 AND 107).

PRINCIPAL REGISTER

FIRST USE 5-20-2008; IN COMMERCE 5-20-2008.

THE MARK CONSISTS OF STANDARD CHARACTERS WITHOUT CLAIM TO ANY PARTICULAR FONT, STYLE, SIZE, OR COLOR.

SER. NO. 85-442,956, FILED 10-9-2011.

ODESSA BIBBINS, EXAMINING ATTORNEY



David J. Kybas

Director of the United States Patent and Trademark Office

United States of America

United States Patent and Trademark Office



Reg. No. 4,153,844

Registered June 5, 2012

Int. Cls.: 9 and 25

TRADEMARK

PRINCIPAL REGISTER

ASKARI, KWAME S. (UNITED STATES INDIVIDUAL)
556 TIFT STREET, SUITE B
ATLANTA, GA 30310

FOR: MUSICAL SOUND RECORDINGS, IN CLASS 9 (U.S. CLS. 21, 23, 26, 36 AND 38).

FIRST USE 1-1-2009; IN COMMERCE 1-1-2009.

FOR: BASEBALL CAPS AND HATS , IN CLASS 25 (U.S. CLS. 22 AND 39).

FIRST USE 1-1-2009; IN COMMERCE 1-1-2009.

NO CLAIM IS MADE TO THE EXCLUSIVE RIGHT TO USE "MUSIC" (LIMITED TO IC 009),
APART FROM THE MARK AS SHOWN.

THE COLOR(S) ORANGE, BLACK AND WHITE IS/ARE CLAIMED AS A FEATURE OF THE
MARK.

THE MARK CONSISTS OF STYLIZED DEPICTION OF THE WORD "REBEL" WRITTEN IN
ORANGE AND OUTLINED IN BLACK AND STYLIZED DEPICTION OF THE WORD "MUSIC"
WRITTEN IN WHITE AND OUTLINED IN BLACK.

SER. NO. 85-442,958, FILED 10-9-2011.

ODESSA BIBBINS, EXAMINING ATTORNEY



David J. Kyffers

Director of the United States Patent and Trademark Office

United States of America

United States Patent and Trademark Office

BECAUSE THERE IS STILL HOPE.

Reg. No. 4,153,845

Registered June 5, 2012

Int. Cls.: 35, 41 and 44

SERVICE MARK

PRINCIPAL REGISTER

THE CHICAGO LIGHTHOUSE FOR PEOPLE WHO ARE BLIND OR VISUALLY IMPAIRED
(ILLINOIS NON-PROFIT CORPORATION)
1850 W. ROOSEVELT RD.
CHICAGO, IL 606081298

FOR: DISTRIBUTORSHIP IN THE FIELD OF PRODUCTS FOR THE BLIND AND VISUALLY IMPAIRED; CHARITABLE SERVICES, NAMELY, PROVIDING COUNSELING AND ASSISTANCE TO BLIND AND VISUALLY IMPAIRED PEOPLE IN PREPARING FOR AND SECURING EMPLOYMENT; BUSINESS CONSULTATION SERVICES IN THE NATURE OF PROVIDING RECOMMENDATIONS FOR APPROPRIATE ADAPTATIONS WHEN HIRING OR RETAINING AN EMPLOYEE WHO IS BLIND OR VISUALLY IMPAIRED, IN CLASS 35 (U.S. CLS. 100, 101 AND 102).

FIRST USE 6-17-2011; IN COMMERCE 6-17-2011.

FOR: EDUCATIONAL SERVICES, NAMELY, PROVIDING CLASSES TO BLIND, VISUALLY IMPAIRED AND MULTI-DISABLED CHILDREN IN THE FIELD OF SOCIAL INTERACTION, PHYSICAL THERAPY, PERSONAL HYGIENE AND PRE-VOCATIONAL SKILLS; EDUCATION SERVICES, NAMELY, PROVIDING TUTORIAL SESSIONS TO PARENTS IN THE FIELD OF TEACHING PHYSICAL SKILLS AND MOTIVATING BLIND AND VISUALLY IMPAIRED CHILDREN; CAREER COUNSELING FOR BLIND AND VISUALLY IMPAIRED PEOPLE; EDUCATIONAL SERVICES, NAMELY, PROVIDING TRAINING TO BLIND AND VISUALLY IMPAIRED ADULTS WITH DEVELOPMENTAL DISABILITIES IN THE FIELD OF INDEPENDENT LIVING SKILLS, IDENTIFYING MONEY AND BASIC ACADEMICS; VOCATIONAL EDUCATION FOR BLIND AND VISUALLY IMPAIRED PEOPLE IN THE FIELD OF ADJUSTMENT TO LOSS OF SIGHT, BASIC ACADEMIC SKILLS AND JOB-READINESS TRAINING; CHARITABLE SERVICES, NAMELY, LENDING BRAILLE AND LARGE PRINT TEXTBOOKS AND WORKBOOKS, BRAILLE WORKBOOK AND OTHER NON-COMPUTER-RELATED INSTRUCTIONAL TOOL FOR TEACHING BRAILLE, VOICE RECORDERS, MAGNIFIERS, BRAILLE PRODUCTS, NAMELY, VARIOUS TYPES OF BRAILLE PAPER IN PAPER AND PLASTIC, ELECTRIC AND MANUAL BRAILLE WRITERS, BRAILLE EMBOSSERS, CLOSED CIRCUIT TELEVISIONS, LIGHT BOXES, OPTICAL AIDS, VOICE SYNTHESIZERS FOR VOICE RECORDING AND PLAYBACK TO BLIND AND VISUALLY IMPAIRED STUDENTS; TRAINING FOR BLIND AND VISUALLY IMPAIRED SENIORS IN THE USE OF COMPUTERS, IN CLASS 41 (U.S. CLS. 100, 101 AND 107).



David J. Kappas

Director of the United States Patent and Trademark Office

FIRST USE 6-17-2011; IN COMMERCE 6-17-2011.

Reg. No. 4,153,845 FOR: OPTOMETRY SERVICES; PSYCHOLOGICAL COUNSELING; CHARITABLE SERVICES, NAMELY, PROVIDING OPTOMETRY SERVICES AND PSYCHOLOGICAL COUNSELING FOR THOSE IN NEED, IN CLASS 44 (U.S. CLS. 100 AND 101).

FIRST USE 11-17-2010; IN COMMERCE 11-17-2010.

THE MARK CONSISTS OF STANDARD CHARACTERS WITHOUT CLAIM TO ANY PARTICULAR FONT, STYLE, SIZE, OR COLOR.

SER. NO. 85-443,035, FILED 10-10-2011.

TINA MAI, EXAMINING ATTORNEY

United States of America
United States Patent and Trademark Office

CRUSHIQ

Reg. No. 4,153,846

Registered June 5, 2012

Int. Cls.: 35 and 41

SERVICE MARK

PRINCIPAL REGISTER

CRUSHIQ, LLC (NORTH CAROLINA LIMITED LIABILITY COMPANY)
7032 WRIGHTSVILLE AVENUE, SUITE 201
WILMINGTON, NC 28403

FOR: BUSINESS SERVICES, NAMELY, SOCIAL MEDIA STRATEGY AND MARKETING CONSULTANCY FOCUSING ON CREATING AND EXTENDING BRAND STRATEGIES BY BUILDING VIRALLY ENGAGING MARKETING SOLUTIONS, IN CLASS 35 (U.S. CLS. 100, 101 AND 102).

FIRST USE 9-28-2011; IN COMMERCE 9-28-2011.

FOR: EDUCATIONAL SERVICES, NAMELY, PROVIDING LIVE AND ON-LINE TRAINING, CONFERENCES AND WORKSHOPS IN THE FIELD OF SOCIAL MEDIA STRATEGY AND MARKETING AND DISTRIBUTION OF EDUCATIONAL MATERIALS IN CONNECTION THEREWITH, IN CLASS 41 (U.S. CLS. 100, 101 AND 107).

FIRST USE 9-28-2011; IN COMMERCE 9-28-2011.

THE MARK CONSISTS OF STANDARD CHARACTERS WITHOUT CLAIM TO ANY PARTICULAR FONT, STYLE, SIZE, OR COLOR.

SER. NO. 85-443,045, FILED 10-10-2011.

AMY KELLY, EXAMINING ATTORNEY



David J. Kyjars

Director of the United States Patent and Trademark Office

United States of America

United States Patent and Trademark Office



SPORTSBALLER

Reg. No. 4,153,847

Registered June 5, 2012

Int. Cl.: 41

SERVICE MARK

PRINCIPAL REGISTER

SPORTSBALLER LLC (NEVADA LIMITED LIABILITY COMPANY)
#104
195 HWY 50
STATELINE, NV 89449

FOR: ENTERTAINMENT SERVICES IN THE NATURE OF A FANTASY SPORTS WEBSITE FOR USERS TO PLACE BETS, IN CLASS 41 (U.S. CLS. 100, 101 AND 107).

FIRST USE 7-1-2011; IN COMMERCE 7-1-2011.

THE MARK CONSISTS OF A CIRCLE WITH A STYLIZED "S" IN THE CENTER. BELOW THE CIRCLE IS THE STYLIZED TEXT "SPORTSBALLER".

SER. NO. 85-443,068, FILED 10-10-2011.

LESLIE RICHARDS, EXAMINING ATTORNEY



David J. Kybas

Director of the United States Patent and Trademark Office

United States of America

United States Patent and Trademark Office

ANACREON

Reg. No. 4,153,848

MOROMISATO, GEORGE (UNITED STATES INDIVIDUAL)
1366 ENCHANTED WAY
SAN MATEO, CA 94402

Registered June 5, 2012

Int. Cl.: 9

FOR: COMPUTER GAME SOFTWARE, IN CLASS 9 (U.S. CLS. 21, 23, 26, 36 AND 38).

TRADEMARK

FIRST USE 1-1-1990; IN COMMERCE 1-1-1990.

PRINCIPAL REGISTER

THE MARK CONSISTS OF STANDARD CHARACTERS WITHOUT CLAIM TO ANY PARTICULAR FONT, STYLE, SIZE, OR COLOR.

SER. NO. 85-443,091, FILED 10-10-2011.

CHRISTINE MARTIN, EXAMINING ATTORNEY



David J. Kyffers

Director of the United States Patent and Trademark Office

United States of America

United States Patent and Trademark Office

HAYER ANALYTICS

Reg. No. 4,153,849

HAYER ANALYTICS, INC. (NEW YORK CORPORATION)
60 EAST 42ND STREET
NEW YORK, NY 10017

Registered June 5, 2012

Int. Cl.: 35

FOR: COMPILING OF INFORMATION INTO COMPUTER DATABASES; MANAGEMENT AND COMPILATION OF COMPUTERIZED DATABASES; PROVIDING DATABASES FEATURING INTERNATIONAL ECONOMIC AND FINANCIAL INFORMATION, IN CLASS 35 (U.S. CLS. 100, 101 AND 102).

SERVICE MARK

PRINCIPAL REGISTER

FIRST USE 10-31-1978; IN COMMERCE 6-30-1979.

THE MARK CONSISTS OF STANDARD CHARACTERS WITHOUT CLAIM TO ANY PARTICULAR FONT, STYLE, SIZE, OR COLOR.

NO CLAIM IS MADE TO THE EXCLUSIVE RIGHT TO USE "ANALYTICS", APART FROM THE MARK AS SHOWN.

SER. NO. 85-443,095, FILED 10-10-2011.

MICHAEL WIENER, EXAMINING ATTORNEY



David J. Kyros

Director of the United States Patent and Trademark Office

United States of America

United States Patent and Trademark Office



Reg. No. 4,153,850

Registered June 5, 2012

Int. Cl.: 35

SERVICE MARK

PRINCIPAL REGISTER

CROSSMARK, INC. (DELAWARE CORPORATION)
5100 LEGACY DRIVE
PLANO, TX 75024

FOR: MEASUREMENT, MODELING, ASSESSMENT AND ANALYSIS OF A BRAND'S SALES, PERFORMANCE, AND STRATEGY AT RETAIL, IN CLASS 35 (U.S. CLS. 100, 101 AND 102).

FIRST USE 4-14-2011; IN COMMERCE 4-14-2011.

NO CLAIM IS MADE TO THE EXCLUSIVE RIGHT TO USE "RETAIL BRAND HEALTH", APART FROM THE MARK AS SHOWN.

THE MARK CONSISTS OF A SPHERE WITH A BAR CODE ON THE SURFACE TO THE LEFT OF THE WORDS "RETAIL BRANDHEALTH", WITH "RETAIL" ABOVE "BRANDHEALTH" AND "BRAND" IN BOLD, AND AN ARCH OF INCREASING WIDTH FROM THE TOP-RIGHT OF THE SPHERE TO THE TOP-RIGHT OF "RETAIL".

SER. NO. 85-443,104, FILED 10-10-2011.

MARK RADEMACHER, EXAMINING ATTORNEY



David J. Kyfos

Director of the United States Patent and Trademark Office

United States of America

United States Patent and Trademark Office



Reg. No. 4,153,851

Registered June 5, 2012

Int. Cl.: 35

SERVICE MARK

PRINCIPAL REGISTER

CROSSMARK, INC. (DELAWARE CORPORATION)
5100 LEGACY DRIVE
PLANO, TX 75024

FOR: BUSINESS PLANNING PROCESS PROVIDING ASSISTANCE, ADVISORY SERVICES AND CONSULTANCY FOR MANUFACTURERS WITH REGARD TO PLANNING AND MANAGEMENT OF RETAIL SALES, IN CLASS 35 (U.S. CLS. 100, 101 AND 102).

FIRST USE 4-14-2011; IN COMMERCE 4-14-2011.

THE MARK CONSISTS OF A SPHERE WITH A COMPASS ROSE ON THE SURFACE TO THE LEFT OF THE WORD "CROSSVIEW", WITH THE WORD "VIEW" IN BOLD, AND AN ARCH OF INCREASING WIDTH FROM THE TOP-RIGHT OF THE SPHERE TO ABOVE THE MIDDLE OF "CROSSVIEW".

SER. NO. 85-443,110, FILED 10-10-2011.

MARK RADEMACHER, EXAMINING ATTORNEY



David J. Kybas

Director of the United States Patent and Trademark Office

United States of America

United States Patent and Trademark Office

CROSSVIEW

Reg. No. 4,153,852

Registered June 5, 2012

Int. Cl.: 35

SERVICE MARK

PRINCIPAL REGISTER

CROSSMARK, INC. (DELAWARE CORPORATION)
5100 LEGACY DRIVE
PLANO, TX 75024

FOR: BUSINESS PLANNING PROCESS PROVIDING ASSISTANCE, ADVISORY SERVICES AND CONSULTANCY FOR MANUFACTURERS WITH REGARD TO PLANNING AND MANAGEMENT OF RETAIL SALES, IN CLASS 35 (U.S. CLS. 100, 101 AND 102).

FIRST USE 4-14-2011; IN COMMERCE 4-14-2011.

THE MARK CONSISTS OF STANDARD CHARACTERS WITHOUT CLAIM TO ANY PARTICULAR FONT, STYLE, SIZE, OR COLOR.

SER. NO. 85-443,112, FILED 10-10-2011.

MARK RADEMACHER, EXAMINING ATTORNEY



David J. Kyros

Director of the United States Patent and Trademark Office

United States of America

United States Patent and Trademark Office

INTUITIVE

Reg. No. 4,153,853

Registered June 5, 2012

Int. Cl.: 42

SERVICE MARK

PRINCIPAL REGISTER

INTUITIVE RESEARCH AND TECHNOLOGY CORPORATION (TEXAS CORPORATION)
BLDG. 2, SUITE 205
5030 BRADFORD DRIVE
HUNTSVILLE, AL 35805

FOR: SCIENTIFIC RESEARCH AND RELATED CONSULTING SERVICES RENDERED TO GOVERNMENT AND PRIVATE INDUSTRY IN THE AREAS OF NATIONAL SECURITY TECHNOLOGY, NATIONAL DEFENSE, DESIGN AND INTEGRATION, TEST AND EVALUATION, LOGISTICS, FACILITIES ENGINEERING, DEFENSE COMMUNICATIONS, SPACE TRANSPORTATION AND EXPLORATION, SPACE SYSTEMS ANALYSIS, SECURITY SYSTEMS AND SUPPORT, INFORMATION AND COMMUNICATIONS, SYSTEMS ENGINEERING, ENGINEERING ANALYSIS, SYSTEMS SIMULATION AND ANALYSIS, MODELING AND SIMULATION OF PHYSICAL PHENOMENA, TEST PLANNING, TEST REQUIREMENTS ANALYSIS, TEST RESULTS ANALYSIS, SYSTEMS SAFETY AND SURVIVABILITY, ENVIRONMENTAL ANALYSIS, INFORMATION SYSTEMS MANAGEMENT, SOFTWARE ENGINEERING SERVICES, SYSTEMS INTEGRATION SERVICES, DATABASE DEVELOPMENT, CUSTOM SOFTWARE DESIGN AND DEVELOPMENT, MANUFACTURING AND PRODUCTION SYSTEMS ANALYSIS AND SUPPORT, IN CLASS 42 (U.S. CLS. 100 AND 101).

FIRST USE 6-30-1999; IN COMMERCE 6-30-1999.

THE MARK CONSISTS OF STANDARD CHARACTERS WITHOUT CLAIM TO ANY PARTICULAR FONT, STYLE, SIZE, OR COLOR.

SER. NO. 85-443,116, FILED 10-10-2011.

GRETTA YAO, EXAMINING ATTORNEY



David J. Kyjars

Director of the United States Patent and Trademark Office

United States of America

United States Patent and Trademark Office

ON MY Q

Reg. No. 4,153,854

Registered June 5, 2012

Int. Cl.: 41

SERVICE MARK

PRINCIPAL REGISTER

THE UNGAR GROUP, LLC (INDIANA LIMITED LIABILITY COMPANY), DBA U/S SPORTS
ADVISORS
SUITE 450
250 E. 96TH STREET
INDIANAPOLIS, IN 46240

FOR: ENTERTAINMENT SERVICES, NAMELY CONDUCTING CONTESTS, IN CLASS 41
(U.S. CLS. 100, 101 AND 107).

FIRST USE 9-2-2011; IN COMMERCE 9-2-2011.

THE MARK CONSISTS OF STANDARD CHARACTERS WITHOUT CLAIM TO ANY PAR-
TICULAR FONT, STYLE, SIZE, OR COLOR.

SER. NO. 85-443,121, FILED 10-10-2011.

FRANK LATTUCA, EXAMINING ATTORNEY



David J. Kyros

Director of the United States Patent and Trademark Office

United States of America

United States Patent and Trademark Office

ECAREPAK

Reg. No. 4,153,855

CANON U.S.A., INC. (NEW YORK CORPORATION)
ONE CANON PLAZA
LAKE SUCCESS, NY 110429979

Registered June 5, 2012

Int. Cl.: 36

FOR: EXTENDED WARRANTY SERVICES, NAMELY, SERVICE CONTRACTS, IN CLASS 36 (U.S. CLS. 100, 101 AND 102).

SERVICE MARK

FIRST USE 1-12-2011; IN COMMERCE 1-12-2011.

PRINCIPAL REGISTER

THE MARK CONSISTS OF STANDARD CHARACTERS WITHOUT CLAIM TO ANY PARTICULAR FONT, STYLE, SIZE, OR COLOR.

OWNER OF U.S. REG. NO. 2,375,899.

SER. NO. 85-443,128, FILED 10-10-2011.

JEFFERY COWARD, EXAMINING ATTORNEY



David J. Kybas

Director of the United States Patent and Trademark Office

United States of America

United States Patent and Trademark Office



Reg. No. 4,153,856

Registered June 5, 2012

Int. Cls.: 41 and 44

SERVICE MARK

PRINCIPAL REGISTER

THE 6TH MAN FOUNDATION (MARYLAND FOUNDATION)
P.O. BOX 215
CLARKSBURG, MD 20871

FOR: EDUCATION SERVICES, NAMELY, PROVIDING PRE-KINDERGARTEN THROUGH 12TH GRADE CLASSROOM INSTRUCTION AT INTERNATIONAL SCHOOLS, IN CLASS 41 (U.S. CLS. 100, 101 AND 107).

FIRST USE 8-1-2005; IN COMMERCE 9-1-2005.

FOR: MEDICAL SERVICES, IN CLASS 44 (U.S. CLS. 100 AND 101).

FIRST USE 8-1-2005; IN COMMERCE 9-1-2005.

THE MARK CONSISTS OF THE STYLIZED WORDS "WE ARE PROJECT CONTACT". AN IMAGE OF A GLOBE WITH THE OUTLINE OF THE AFRICA CONTINENT IN THE CENTER. GRASS TO THE LEFT SIDE OF THE GLOBE AND A TREE TO THE RIGHT.

SER. NO. 85-443,134, FILED 10-10-2011.

MARK SHINER, EXAMINING ATTORNEY



David J. Kyffers

Director of the United States Patent and Trademark Office

United States of America

United States Patent and Trademark Office

Brachiosaurus

Reg. No. 4,153,857

Registered June 5, 2012

Int. Cl.: 9

TRADEMARK

PRINCIPAL REGISTER

HEAVY MEDITATIONS, LLC (NEW YORK LIMITED LIABILITY COMPANY)
10 CHESHIRE COURT
BAYPORT, NY 11705

FOR: SOUND RECORDINGS FEATURING MUSIC, IN CLASS 9 (U.S. CLS. 21, 23, 26, 36 AND 38).

FIRST USE 2-15-2008; IN COMMERCE 1-1-2011.

THE MARK CONSISTS OF STANDARD CHARACTERS WITHOUT CLAIM TO ANY PARTICULAR FONT, STYLE, SIZE, OR COLOR.

SER. NO. 85-443,137, FILED 10-10-2011.

GRETТА YAO, EXAMINING ATTORNEY



David J. Kyffers

Director of the United States Patent and Trademark Office

United States of America

United States Patent and Trademark Office

PEI

Reg. No. 4,153,858

Registered June 5, 2012

Int. Cl.: 9

TRADEMARK

PRINCIPAL REGISTER

PENNWELL CORPORATION (OKLAHOMA CORPORATION)
1421 SOUTH SHERIDAN ROAD
TULSA, OK 74112

FOR: ELECTRONIC DOWNLOADABLE MAGAZINE IN THE FIELD OF POWER ENGINEERING, IN CLASS 9 (U.S. CLS. 21, 23, 26, 36 AND 38).

FIRST USE 5-31-2004; IN COMMERCE 5-31-2004.

OWNER OF U.S. REG. NOS. 1,788,863, 3,980,990 AND OTHERS.

SER. NO. 85-443,138, FILED 10-10-2011.

KIM MONINGHOFF, EXAMINING ATTORNEY



David J. Kyffers

Director of the United States Patent and Trademark Office

United States of America

United States Patent and Trademark Office



Reg. No. 4,153,859

Registered June 5, 2012

Int. Cl.: 45

SERVICE MARK

PRINCIPAL REGISTER

MOUNTAIN TOP MINISTRIES WORLDWIDE INC. (FLORIDA CORPORATION)
496 SW RING COURT
LAKE CITY, FL 32025

FOR: CHRISTIAN MINISTRY SERVICES, IN CLASS 45 (U.S. CLS. 100 AND 101).

FIRST USE 9-1-2011; IN COMMERCE 9-1-2011.

NO CLAIM IS MADE TO THE EXCLUSIVE RIGHT TO USE "MINISTRIES" AND "WORLDWIDE", APART FROM THE MARK AS SHOWN.

THE MARK CONSISTS OF A STYLIZED IMAGE OF A MOUNTAIN WITH THE STYLIZED TEXT "MOUNTAIN TOP MINISTRIES WORLDWIDE" WRITTEN BENEATH THE MOUNTAIN; ALL ENCASED IN A CIRCLE.

SER. NO. 85-443,142, FILED 10-10-2011.

GRETТА YAO, EXAMINING ATTORNEY



David J. Kyffers

Director of the United States Patent and Trademark Office

United States of America

United States Patent and Trademark Office

GoldDust

Reg. No. 4,153,860

Registered June 5, 2012

Int. Cl.: 25

TRADEMARK

PRINCIPAL REGISTER

DINGWELL, VANESSA (UNITED STATES INDIVIDUAL)
4622 LOLETA AVE
LOS ANGELES, CA 90041 AND

ZAL, ROXANA (UNITED STATES INDIVIDUAL)
4622 LOLETA AVE
LOS ANGELES, CA 90041

FOR: BLOUSES; DRESSES; KAFTANS; SKIRTS; TUNICS, IN CLASS 25 (U.S. CLS. 22 AND 39).

FIRST USE 6-18-2001; IN COMMERCE 6-18-2001.

THE MARK CONSISTS OF STANDARD CHARACTERS WITHOUT CLAIM TO ANY PARTICULAR FONT, STYLE, SIZE, OR COLOR.

SER. NO. 85-443,176, FILED 10-10-2011.

REBECCA POVARCHUK, EXAMINING ATTORNEY



David J. Kyros

Director of the United States Patent and Trademark Office

United States of America

United States Patent and Trademark Office

DEMAIZ

Reg. No. 4,153,861

Registered June 5, 2012

Int. Cl.: 29

TRADEMARK

PRINCIPAL REGISTER

SERGIO RICARDO DIAZ FLORES (HONDURAS INDIVIDUAL)
CALLE PRINCIPAL A-20, COL. IBERIA
TEGUCIGALPA DC, HONDURAS

FOR: PLANTAIN CHIPS, IN CLASS 29 (U.S. CL. 46).

FIRST USE 7-9-2008; IN COMMERCE 10-30-2010.

THE MARK CONSISTS OF STANDARD CHARACTERS WITHOUT CLAIM TO ANY PARTICULAR FONT, STYLE, SIZE, OR COLOR.

THE ENGLISH TRANSLATION OF "DE MAIZ" IS "OF CORN".

SER. NO. 85-443,180, FILED 10-10-2011.

REBECCA POVARCHUK, EXAMINING ATTORNEY



David J. Kyros

Director of the United States Patent and Trademark Office

United States of America

United States Patent and Trademark Office

Ballade Sports

Reg. No. 4,153,862

Registered June 5, 2012

Int. Cl.: 37

SERVICE MARK

PRINCIPAL REGISTER

DOAN, ALEX (UNITED STATES INDIVIDUAL)
13851 A BETTER WAY
STE D
GARDEN GROVE AVENUE, CA 92843

FOR: MECHANIC SERVICES, IN CLASS 37 (U.S. CLS. 100, 103 AND 106).

FIRST USE 8-1-2009; IN COMMERCE 8-1-2009.

THE MARK CONSISTS OF STANDARD CHARACTERS WITHOUT CLAIM TO ANY PARTICULAR FONT, STYLE, SIZE, OR COLOR.

NO CLAIM IS MADE TO THE EXCLUSIVE RIGHT TO USE "SPORTS", APART FROM THE MARK AS SHOWN.

SER. NO. 85-443,185, FILED 10-10-2011.

BRIAN CALLAGHAN, EXAMINING ATTORNEY



David J. Kyros

Director of the United States Patent and Trademark Office

United States of America

United States Patent and Trademark Office

MINERAGE

Reg. No. 4,153,863

Registered June 5, 2012

Int. Cl.: 3

TRADEMARK

PRINCIPAL REGISTER

PMC TRADE EXPORT & IMPORT CORP. (FLORIDA CORPORATION)
#16
4005 N.W. 114TH AVENUE
DORAL, FL 33178

FOR: COSMETIC PREPARATIONS FOR SKIN RENEWAL, IN CLASS 3 (U.S. CLS. 1, 4, 6, 50, 51 AND 52).

FIRST USE 10-8-2009; IN COMMERCE 10-8-2009.

THE MARK CONSISTS OF STANDARD CHARACTERS WITHOUT CLAIM TO ANY PARTICULAR FONT, STYLE, SIZE, OR COLOR.

SER. NO. 85-443,201, FILED 10-10-2011.

MARK T. MULLEN, EXAMINING ATTORNEY



David J. Kyffers

Director of the United States Patent and Trademark Office

United States of America

United States Patent and Trademark Office



Reg. No. 4,153,864

Registered June 5, 2012

Int. Cl.: 28

TRADEMARK

PRINCIPAL REGISTER

PASCUA, VANCE J. (UNITED STATES INDIVIDUAL)
PO BOX 348
HANAPEPE, HI 96716

FOR: BODY BOARDS; PADDLE BOARDS; SURF BOARDS, IN CLASS 28 (U.S. CLS. 22, 23, 38 AND 50).

FIRST USE 9-0-2011; IN COMMERCE 9-0-2011.

OWNER OF U.S. REG. NO. 3,326,359.

NO CLAIM IS MADE TO THE EXCLUSIVE RIGHT TO USE THE DESIGN OF THE STATE OF HAWAII, APART FROM THE MARK AS SHOWN.

THE MARK CONSISTS OF A CIRCULAR DESIGN CONTAINING THE WORDS "AINOFEA". ABOVE THIS TERM IS THE DESIGN OF A WAVE AND TO THE RIGHT OF THIS IS THE DESIGN OF HAWAII. MORE WAVES APPEAR BENEATH THIS DESIGN AND THERE IS A DESIGN OF A PADDLE BOARDER RIDING A WAVE. TO THE LEFT OF THIS ARE SEVERAL ARROWS POINTING BOTH UP AND DOWN FROM THE DESIGN OF TWO EYES AND A NOSE.

THE WORDING "AINOFEA" HAS NO MEANING IN A FOREIGN LANGUAGE.

SER. NO. 85-443,219, FILED 10-10-2011.

AHSEN KHAN, EXAMINING ATTORNEY



David J. Kybas

Director of the United States Patent and Trademark Office

United States of America

United States Patent and Trademark Office

Be Lov'esh

Reg. No. 4,153,865

JANEL CIRKL (UNITED STATES INDIVIDUAL)
8854 WENTWORTH AVE S
BLOOMINGTON, MN 55420

Registered June 5, 2012

Int. Cl.: 25

FOR: HATS; HOODED SWEATSHIRTS; SHIRTS; SHORT-SLEEVED OR LONG-SLEEVED T-SHIRTS; SWEATERS; SWEATSHIRTS; T-SHIRTS, IN CLASS 25 (U.S. CLS. 22 AND 39).

TRADEMARK

FIRST USE 6-12-2008; IN COMMERCE 6-12-2008.

PRINCIPAL REGISTER

THE MARK CONSISTS OF STANDARD CHARACTERS WITHOUT CLAIM TO ANY PARTICULAR FONT, STYLE, SIZE, OR COLOR.

SER. NO. 85-443,228, FILED 10-10-2011.

MARGERY A. TIERNEY, EXAMINING ATTORNEY



David J. Kybas

Director of the United States Patent and Trademark Office

United States of America

United States Patent and Trademark Office



Reg. No. 4,153,866

Registered June 5, 2012

Int. Cl.: 35

SERVICE MARK

PRINCIPAL REGISTER

DUNCAN MEADOWS (CALIFORNIA SOLE PROPRIETORSHIP)
250 BONITA GLEN DRIVE APT C24
CHULA VISTA, CA 91910

FOR: ON-LINE WHOLESALE AND RETAIL STORE SERVICES FEATURING COMPUTERS AND COMPUTER SUPPLIES, NAMELY, DESKTOP COMPUTERS, LAPTOPS, HARD DRIVES, MOTHERBOARDS, VIDEO CARDS, AND POWER SUPPLIES; RETAIL STORE AND ON-LINE RETAIL STORE SERVICES FEATURING COMPUTERS AND COMPUTER SUPPLIES, NAMELY, DESKTOP COMPUTERS, LAPTOPS, HARD DRIVES, MOTHERBOARDS, VIDEO CARDS, AND POWER SUPPLIES; WHOLESALE AND RETAIL STORE SERVICES FEATURING COMPUTERS AND COMPUTER SUPPLIES, NAMELY, DESKTOP COMPUTERS, LAPTOPS, HARD DRIVES, MOTHERBOARDS, VIDEO CARDS, AND POWER SUPPLIES, IN CLASS 35 (U.S. CLS. 100, 101 AND 102).

FIRST USE 11-23-2010; IN COMMERCE 10-7-2011.

NO CLAIM IS MADE TO THE EXCLUSIVE RIGHT TO USE "CYBER", APART FROM THE MARK AS SHOWN.

THE MARK CONSISTS OF AN IMAGE THAT DEPICTS A DESIGN WITH WINGS, IN BETWEEN THE WINGS IS A TRIANGLE SHAPE WITH FIVE POINTED EDGES AT THE BOTTOM OF THE TRIANGLE. THE WORDING "CYBER COMBUSTION" IS IN STYLIZED FONT AND IS PLACED UNDER THE WINGS AND ON TOP OF THE TRIANGLE SHAPE.

SER. NO. 85-443,233, FILED 10-10-2011.

BRIAN CALLAGHAN, EXAMINING ATTORNEY



David J. Kyros

Director of the United States Patent and Trademark Office

United States of America

United States Patent and Trademark Office

HAYER ANALYTICS

Reg. No. 4,153,867

Registered June 5, 2012

Int. Cl.: 38

SERVICE MARK

PRINCIPAL REGISTER

HAYER ANALYTICS, INC. (NEW YORK CORPORATION)
60 EAST 42ND STREET
NEW YORK, NY 10017

FOR: PROVIDING ACCESS TO DATABASES, IN CLASS 38 (U.S. CLS. 100, 101 AND 104).

FIRST USE 10-31-1978; IN COMMERCE 6-30-1979.

THE MARK CONSISTS OF STANDARD CHARACTERS WITHOUT CLAIM TO ANY PARTICULAR FONT, STYLE, SIZE, OR COLOR.

NO CLAIM IS MADE TO THE EXCLUSIVE RIGHT TO USE "ANALYTICS", APART FROM THE MARK AS SHOWN.

SER. NO. 85-443,240, FILED 10-10-2011.

MICHAEL WIENER, EXAMINING ATTORNEY



David J. Kybas

Director of the United States Patent and Trademark Office

United States of America

United States Patent and Trademark Office

Fo Thirty

Reg. No. 4,153,868

Registered June 5, 2012

Int. Cl.: 25

TRADEMARK

PRINCIPAL REGISTER

SWAG OUTDOORS (MISSISSIPPI LIMITED LIABILITY COMPANY)
1118 WESLEY DRIVE
JACKSON, MS 39209

FOR: HATS; SHIRTS, IN CLASS 25 (U.S. CLS. 22 AND 39).

FIRST USE 1-2-2011; IN COMMERCE 3-30-2011.

THE MARK CONSISTS OF STANDARD CHARACTERS WITHOUT CLAIM TO ANY PARTICULAR FONT, STYLE, SIZE, OR COLOR.

SER. NO. 85-443,254, FILED 10-10-2011.

ELLEN PERKINS, EXAMINING ATTORNEY



David J. Kyffers

Director of the United States Patent and Trademark Office

United States of America

United States Patent and Trademark Office

TAME

Reg. No. 4,153,869

RHOADES, CONNIE (UNITED STATES INDIVIDUAL)
219 W. COMMERCIAL STREET, SUITE 104
SPRINGFIELD, MO 65803

Registered June 5, 2012

Int. Cl.: 16

FOR: MAGAZINES FEATURING INFORMATION ON PETS, PET SUPPLIES AND PET CARE,
IN CLASS 16 (U.S. CLS. 2, 5, 22, 23, 29, 37, 38 AND 50).

TRADEMARK

FIRST USE 3-31-2009; IN COMMERCE 3-31-2009.

PRINCIPAL REGISTER

THE MARK CONSISTS OF STANDARD CHARACTERS WITHOUT CLAIM TO ANY PAR-
TICULAR FONT, STYLE, SIZE, OR COLOR.

SER. NO. 85-443,262, FILED 10-10-2011.

ROBIN CHOSID, EXAMINING ATTORNEY



David J. Kybas

Director of the United States Patent and Trademark Office

United States of America

United States Patent and Trademark Office

EDIBLE MONTEREY BAY

Reg. No. 4,153,870

Registered June 5, 2012

Int. Cl.: 16

TRADEMARK

PRINCIPAL REGISTER

EDIBLE COMMUNITIES, INC. (MONTANA CORPORATION)
629 STATE STREET, SUITE 203
SANTA BARBARA, CA 93101

FOR: MAGAZINES FEATURING TOURISM, CULINARY AND AGRICULTURE INDUSTRIES AND PUBLICATIONS, NAMELY, MAGAZINES AND NEWSLETTERS DEALING WITH CONNECTING CONSUMERS WITH LOCAL GROWERS, FOOD RETAILERS, CHEFS AND FOOD ARTISANS, IN CLASS 16 (U.S. CLS. 2, 5, 22, 23, 29, 37, 38 AND 50).

FIRST USE 3-11-2011; IN COMMERCE 3-11-2011.

THE MARK CONSISTS OF STANDARD CHARACTERS WITHOUT CLAIM TO ANY PARTICULAR FONT, STYLE, SIZE, OR COLOR.

OWNER OF U.S. REG. NOS. 3,599,996, 3,664,700, AND 3,839,047.

NO CLAIM IS MADE TO THE EXCLUSIVE RIGHT TO USE "MONTEREY BAY", APART FROM THE MARK AS SHOWN.

SER. NO. 85-443,268, FILED 10-10-2011.

MARILYN IZZI, EXAMINING ATTORNEY



David J. Kyjars

Director of the United States Patent and Trademark Office

United States of America

United States Patent and Trademark Office

SNEAKERHEAD

Reg. No. 4,153,871

Registered June 5, 2012

Int. Cl.: 35

SERVICE MARK

PRINCIPAL REGISTER

DEVICOM INTERNATIONAL, INC. (CALIFORNIA CORPORATION), DBA SNEAKERHEAD
16724 MARQUARDT AVENUE
CERRITOS, CA 90703

FOR: ON-LINE RETAIL STORE SERVICES FEATURING SHOES, BOOTS, WATCHES,
SOCKS, SUNGLASSES, T-SHIRTS, KNIVES, BAGS AND BACKPACKS, IN CLASS 35 (U.S.
CLS. 100, 101 AND 102).

FIRST USE 3-1-2003; IN COMMERCE 3-1-2003.

THE MARK CONSISTS OF STANDARD CHARACTERS WITHOUT CLAIM TO ANY PAR-
TICULAR FONT, STYLE, SIZE, OR COLOR.

OWNER OF U.S. REG. NO. 3,355,451.

SER. NO. 85-443,279, FILED 10-10-2011.

KATHERINE CONNOLLY, EXAMINING ATTORNEY



David J. Kyros

Director of the United States Patent and Trademark Office

United States of America

United States Patent and Trademark Office

LOUDER THAN WORDS

Reg. No. 4,153,872

Registered June 5, 2012

Int. Cl.: 45

THE UNGAR GROUP, LLC (INDIANA LIMITED LIABILITY COMPANY), DBA U/S SPORTS
ADVISORS
SUITE 450
250 E. 96TH STREET
INDIANAPOLIS, IN 46240

SERVICE MARK

FOR: PROVIDING AND COLLECTING INFORMATION VIA THE INTERNET CONCERNING
INDIVIDUAL ACTS OF KINDNESS TO OTHERS, IN CLASS 45 (U.S. CLS. 100 AND 101).

PRINCIPAL REGISTER

FIRST USE 5-18-2010; IN COMMERCE 5-18-2010.

THE MARK CONSISTS OF STANDARD CHARACTERS WITHOUT CLAIM TO ANY PAR-
TICULAR FONT, STYLE, SIZE, OR COLOR.

SER. NO. 85-443,322, FILED 10-10-2011.

FRANK LATTUCA, EXAMINING ATTORNEY



David J. Kyffers

Director of the United States Patent and Trademark Office

United States of America

United States Patent and Trademark Office

MUrgency

Reg. No. 4,153,873

Registered June 5, 2012

Int. Cl.: 38

SERVICE MARK

PRINCIPAL REGISTER

ALPHATREK, INC. (MARYLAND CORPORATION)
1800 NEW HAMPSHIRE AVENUE
ASHTON, MD 20861

FOR: AUDIO AND VIDEO BROADCASTING SERVICES OVER THE INTERNET; CELLULAR TELEPHONE SERVICES; COMMUNICATION SERVICES, NAMELY, ELECTRONIC TRANSMISSION OF DATA AND DOCUMENTS AMONG USERS OF COMPUTERS; COMMUNICATION SERVICES, NAMELY, PROVIDING ELECTRONIC TRANSMISSION OF INFORMATION STORED IN A DATABASE VIA INTERACTIVELY COMMUNICATING COMPUTER SYSTEMS; COMMUNICATION SERVICES, NAMELY, TRANSMISSION OF VOICE, AUDIO, VISUAL IMAGES AND DATA BY TELECOMMUNICATIONS NETWORKS, WIRELESS COMMUNICATION NETWORKS, THE INTERNET, INFORMATION SERVICES NETWORKS AND DATA NETWORKS; COMMUNICATIONS SERVICES, NAMELY, TRANSMITTING STREAMED SOUND AND AUDIOVISUAL RECORDINGS VIA THE INTERNET; COMPUTER TELEPHONY SERVICES; COMPUTERISED TELEPHONY SERVICES; CONSULTING IN THE FIELD OF TELECOMMUNICATION SERVICES, NAMELY, TRANSMISSION OF VOICE, DATA, AND DOCUMENTS VIA TELECOMMUNICATIONS NETWORKS; PROVIDING TELEPHONE CONFERENCING SERVICES; PROVISION OF VIDEO CONFERENCING SERVICES; STREAMING OF AUDIO MATERIAL ON THE INTERNET; STREAMING OF VIDEO MATERIAL ON THE INTERNET; TELECOMMUNICATION SERVICES, NAMELY, TRANSMISSION OF VOICE, DATA AND DOCUMENTS, IN THE FIELD OF SEARCH AND RESCUE OPERATIONS AND FIRE FIGHTING OPERATIONS; TELECOMMUNICATION SERVICES, NAMELY, TRANSMISSION OF VOICE, DATA, GRAPHICS, IMAGES, AUDIO AND VIDEO BY MEANS OF TELECOMMUNICATIONS NETWORKS, WIRELESS COMMUNICATION NETWORKS, AND THE INTERNET; TELECOMMUNICATION SERVICES, NAMELY, TRANSMISSION OF VOICE, DATA, GRAPHICS, SOUND AND VIDEO BY MEANS OF BROADBAND POWER LINE OR WIRELESS NETWORKS; TELECOMMUNICATIONS SERVICES, NAMELY, WIRELESS TELEPHONY AND WIRELESS BROADBAND COMMUNICATIONS SERVICES FOR THE TRANSMISSION OF VOICE AND DATA; VIDEO CONFERENCING SERVICES, IN CLASS 38 (U.S. CLS. 100, 101 AND 104).



David J. Kappas

Director of the United States Patent and Trademark Office

FIRST USE 3-11-2011; IN COMMERCE 10-6-2011.

THE MARK CONSISTS OF STANDARD CHARACTERS WITHOUT CLAIM TO ANY PARTICULAR FONT, STYLE, SIZE, OR COLOR.

Reg. No. 4,153,873 SER. NO. 85-443,347, FILED 10-10-2011.

TARAH HARDY, EXAMINING ATTORNEY

United States of America

United States Patent and Trademark Office

fetchmates

Reg. No. 4,153,874

Registered June 5, 2012

Int. Cl.: 44

SERVICE MARK

PRINCIPAL REGISTER

FETCH MATES PET SERVICES INCORPORATED (NEW YORK CORPORATION), DBA
FETCH MATES PET SERVICES INCORPORATED
12 DESBROSSES STREET
NEW YORK, NY 10013

FOR: PET CARE SERVICES, NAMELY, DOG WALKING, DOG BATHING AND NON-MEDICATED PET GROOMING , IN CLASS 44 (U.S. CLS. 100 AND 101).

FIRST USE 5-14-2010; IN COMMERCE 5-14-2010.

THE MARK CONSISTS OF STANDARD CHARACTERS WITHOUT CLAIM TO ANY PARTICULAR FONT, STYLE, SIZE, OR COLOR.

SER. NO. 85-443,354, FILED 10-10-2011.

SEAN CROWLEY, EXAMINING ATTORNEY



David J. Kyros

Director of the United States Patent and Trademark Office

United States of America

United States Patent and Trademark Office



Reg. No. 4,153,875

Registered June 5, 2012

Int. Cl.: 12

TRADEMARK

PRINCIPAL REGISTER

KARPIEL, JAN (POLAND INDIVIDUAL)
DROGA DO DANIELA 3
ZAKOPANE, POLAND 34500

FOR: TRICYCLES, IN CLASS 12 (U.S. CLS. 19, 21, 23, 31, 35 AND 44).

FIRST USE 3-10-2011; IN COMMERCE 7-21-2011.

THE MARK CONSISTS OF A DARK SILVER, STYLIZED, CAPITAL "C", SHAPED TO RESEMBLE A HELMET WITH A FIN, ENCLOSING A LIGHT SILVER, CAPITAL "G", WHICH PROTRUDES INTO A DARK SILVER, STYLIZED, LOWER CASE "C", SHAPED TO RESEMBLE A C-CLIP.

THE COLOR(S) DARK SILVER, LIGHT SILVER IS/ARE CLAIMED AS A FEATURE OF THE MARK.

SER. NO. 85-443,363, FILED 10-10-2011.

AISHA SALEM, EXAMINING ATTORNEY



David J. Kybas

Director of the United States Patent and Trademark Office

United States of America

United States Patent and Trademark Office

CARING IS OUR CALLING

Reg. No. 4,153,876

Registered June 5, 2012

Int. Cl.: 41

SERVICE MARK

PRINCIPAL REGISTER

CALIFORNIA HOSPITAL ASSOCIATION (CALIFORNIA CORPORATION)
1215 K STREET, SUITE 800
SACRAMENTO, CA 95814

FOR: EDUCATION SERVICES, NAMELY, PROVIDING WORKSHOPS, SEMINARS, AND CLASSES IN THE FIELD OF HEALTH, PUBLIC HEALTH, HOSPITALS AND HEALTHCARE; PUBLIC ADVOCACY TO PROMOTE AWARENESS OF HEALTH, PUBLIC HEALTH, HOSPITALS AND HEALTHCARE; PROVIDING NEWSLETTERS IN THE FIELD OF HEALTH, PUBLIC HEALTH, HOSPITALS AND HEALTHCARE VIA E-MAIL, IN CLASS 41 (U.S. CLS. 100, 101 AND 107).

FIRST USE 9-22-2011; IN COMMERCE 9-22-2011.

THE MARK CONSISTS OF STANDARD CHARACTERS WITHOUT CLAIM TO ANY PARTICULAR FONT, STYLE, SIZE, OR COLOR.

SER. NO. 85-443,367, FILED 10-10-2011.

AISHA SALEM, EXAMINING ATTORNEY



David J. Kybas

Director of the United States Patent and Trademark Office

United States of America

United States Patent and Trademark Office

TECHUNTER

Reg. No. 4,153,877

Registered June 5, 2012

Int. Cl.: 18

TRADEMARK

PRINCIPAL REGISTER

GANDER MOUNTAIN COMPANY (MINNESOTA CORPORATION)
SUITE 1300
180 EAST FIFTH STREET
ST. PAUL, MN 55101

FOR: LUGGAGE, BACKPACKS, WAIST PACKS, AND ALL PURPOSE SPORTS BAGS, IN CLASS 18 (U.S. CLS. 1, 2, 3, 22 AND 41).

FIRST USE 6-30-2009; IN COMMERCE 6-30-2009.

THE MARK CONSISTS OF STANDARD CHARACTERS WITHOUT CLAIM TO ANY PARTICULAR FONT, STYLE, SIZE, OR COLOR.

OWNER OF U.S. REG. NO. 3,761,540.

SER. NO. 85-443,369, FILED 10-10-2011.

AISHA SALEM, EXAMINING ATTORNEY



David J. Kyffers

Director of the United States Patent and Trademark Office

United States of America

United States Patent and Trademark Office

FlatMax

Reg. No. 4,153,878

Registered June 5, 2012

Int. Cl.: 11

TRADEMARK

PRINCIPAL REGISTER

MAXLITE, INC. (NEW JERSEY CORPORATION)
12 YORK AVE
WEST CALDWELL, NJ 07006

FOR: ELECTRIC LIGHTING FIXTURES, IN CLASS 11 (U.S. CLS. 13, 21, 23, 31 AND 34).

FIRST USE 5-15-2011; IN COMMERCE 9-26-2011.

THE MARK CONSISTS OF STANDARD CHARACTERS WITHOUT CLAIM TO ANY PARTICULAR FONT, STYLE, SIZE, OR COLOR.

SER. NO. 85-443,372, FILED 10-10-2011.

ANTHONY RINKER, EXAMINING ATTORNEY



David J. Kybas

Director of the United States Patent and Trademark Office

United States of America

United States Patent and Trademark Office

BLACKDIVINE

Reg. No. 4,153,879

Registered June 5, 2012

Int. Cl.: 42

SERVICE MARK

PRINCIPAL REGISTER

BLACKDIVINE (NEW YORK LIMITED LIABILITY COMPANY)
60 BROAD STREET, SUITE 3502
NEW YORK, NY 10004

FOR: COMPUTER SOFTWARE DEVELOPMENT IN THE FIELD OF WEBSITE DESIGN AND DESIGN OF SOFTWARE APPLICATIONS IN THE FIELD OF SOCIAL NETWORKING, IN CLASS 42 (U.S. CLS. 100 AND 101).

FIRST USE 11-0-2008; IN COMMERCE 6-0-2009.

THE MARK CONSISTS OF STANDARD CHARACTERS WITHOUT CLAIM TO ANY PARTICULAR FONT, STYLE, SIZE, OR COLOR.

SER. NO. 85-443,383, FILED 10-10-2011.

CHRISTOPHER SIDOTI, EXAMINING ATTORNEY



David J. Kybas

Director of the United States Patent and Trademark Office

United States of America

United States Patent and Trademark Office



Reg. No. 4,153,880

ALPHA SIGMA ALPHA (MISSOURI CORPORATION)
9002 VINCENNES CIRCLE
INDIANAPOLIS, IN 46268

Registered June 5, 2012

Int. Cl.: 35

FOR: ASSOCIATION SERVICES, NAMELY, ORGANIZING CHAPTERS OF A SORORITY AND PROMOTING THE INTERESTS OF MEMBERS THEREOF, IN CLASS 35 (U.S. CLS. 100, 101 AND 102).

SERVICE MARK

FIRST USE 9-0-2011; IN COMMERCE 9-0-2011.

PRINCIPAL REGISTER

OWNER OF U.S. REG. NOS. 645,901, 4,019,289 AND OTHERS.

THE MARK CONSISTS OF A FANCIFUL DIAMOND SHAPED DESIGN WITHIN A LARGER DIAMOND SHAPED DESIGN ALONG WITH THE WORDING "ALPHA SIGMA ALPHA DEVELOPING WOMEN OF POISE AND PURPOSE".

SER. NO. 85-443,397, FILED 10-10-2011.

MICHAEL SOUDERS, EXAMINING ATTORNEY



David J. Kyros

Director of the United States Patent and Trademark Office

United States of America

United States Patent and Trademark Office

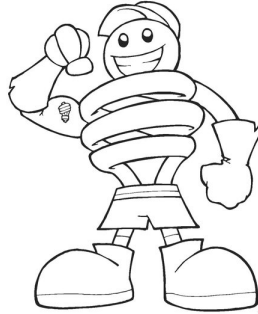

Reg. No. 4,153,881

Registered June 5, 2012

Int. Cls.: 37 and 41

ADVANCED ENERGY EFFICIENCY AND ENVIRONMENTAL QUALITY (ARIZONA LIMITED LIABILITY COMPANY)
SUITE 100
1743 S HORNE
MESA, AZ 85204

SERVICE MARK

FOR: RESIDENTIAL AND BUILDING CONSTRUCTION CONSULTING; RESIDENTIAL AND COMMERCIAL BUILDING CONSTRUCTION, IN CLASS 37 (U.S. CLS. 100, 103 AND 106).

PRINCIPAL REGISTER

FIRST USE 4-0-2010; IN COMMERCE 4-0-2010.

FOR: TEACHING AND TRAINING IN BUSINESS, INDUSTRY AND INFORMATION TECHNOLOGY, IN CLASS 41 (U.S. CLS. 100, 101 AND 107).

FIRST USE 4-0-2010; IN COMMERCE 4-0-2010.

THE MARK CONSISTS OF CFL LIGHT BULB MAN WITH BULB AS BODY WITH HEAD, EYES, MOUTH, ARMS, RIGHT STRONG ARM WITH CFL TATTOO, WEARING HAT, GLOVES, SHORTS, AND SHOES.

SER. NO. 85-443,400, FILED 10-10-2011.

EDWARD FENNESSY, EXAMINING ATTORNEY



David J. Kypos

Director of the United States Patent and Trademark Office

United States of America

United States Patent and Trademark Office

SPEEDSET

Reg. No. 4,153,882

Registered June 5, 2012

Int. Cl.: 17

TRADEMARK

PRINCIPAL REGISTER

ENCORE RAIL SYSTEMS, INC. (ILLINOIS CORPORATION)
6235 S. OAK PARK AVENUE
CHICAGO, IL 60638

FOR: POLYMER-BASED COMPOUNDS FOR USE IN THE MAINTENANCE, PRESERVATION AND REPAIR OF NON-METAL RAILROAD TIES, IN CLASS 17 (U.S. CLS. 1, 5, 12, 13, 35 AND 50).

FIRST USE 12-0-2010; IN COMMERCE 12-0-2010.

THE MARK CONSISTS OF STANDARD CHARACTERS WITHOUT CLAIM TO ANY PARTICULAR FONT, STYLE, SIZE, OR COLOR.

SER. NO. 85-443,408, FILED 10-10-2011.

WENDY JUN, EXAMINING ATTORNEY



David J. Kyffers

Director of the United States Patent and Trademark Office

United States of America

United States Patent and Trademark Office



Reg. No. 4,153,883

Registered June 5, 2012

Int. Cl.: 17

TRADEMARK

PRINCIPAL REGISTER

ENCORE RAIL SYSTEMS, INC. (ILLINOIS CORPORATION)
6235 S. OAK PARK AVENUE
CHICAGO, IL 60638

FOR: POLYMER-BASED COMPOUNDS FOR USE IN THE MAINTENANCE, PRESERVATION AND REPAIR OF NON-METAL RAILROAD TIES, IN CLASS 17 (U.S. CLS. 1, 5, 12, 13, 35 AND 50).

FIRST USE 12-0-2010; IN COMMERCE 12-0-2010.

THE MARK CONSISTS OF AN EIGHT-RAYED STAR WITHIN A ROUNDED PARALLELOGRAM, FOLLOWED BY THE SINGLE WORD "SPEEDSET" WITH THE PORTION "SPEED" SHOWN IN OUTLINE LETTERS WITH A CAPITAL "S", AND WITH THE PORTION "SET" SHOWN IN SOLID LETTERS WITH A CAPITAL "S".

SER. NO. 85-443,411, FILED 10-10-2011.

WENDY JUN, EXAMINING ATTORNEY



David J. Kyros

Director of the United States Patent and Trademark Office

United States of America

United States Patent and Trademark Office



Reg. No. 4,153,884

Registered June 5, 2012

Int. Cl.: 41

SERVICE MARK

PRINCIPAL REGISTER

JESSICA OLTMANS (UNITED STATES INDIVIDUAL)
C/O SEAFIT STUDIO
31654 RANCHO VIEJO ROAD, SUITE A
SAN JUAN CAPISTRANO, CA 92675

FOR: HEALTH CLUB SERVICES, NAMELY, PROVIDING INSTRUCTION AND EQUIPMENT IN THE FIELD OF PHYSICAL EXERCISE; PHYSICAL FITNESS STUDIO SERVICES, NAMELY, PROVIDING GROUP EXERCISE INSTRUCTION, EQUIPMENT, AND FACILITIES; PROVIDING FITNESS AND EXERCISE FACILITIES; PROVIDING FITNESS AND EXERCISE STUDIO SERVICES, NAMELY, PILATES INSTRUCTION AND TRAINING, IN CLASS 41 (U.S. CLS. 100, 101 AND 107).

FIRST USE 6-26-2010; IN COMMERCE 6-26-2010.

THE MARK CONSISTS OF A WOMAN INSIDE OF A WAVE ICON.

SER. NO. 85-443,412, FILED 10-10-2011.

LINDA MICKLEBURGH, EXAMINING ATTORNEY



David J. Kyffers

Director of the United States Patent and Trademark Office

United States of America

United States Patent and Trademark Office

HANDYMAN SHOW

Reg. No. 4,153,885

Registered June 5, 2012

Int. Cl.: 41

SERVICE MARK

PRINCIPAL REGISTER

H & S ASSOCIATES, INC. (MICHIGAN CORPORATION)
H & S ASSOCIATES, INC.
1224 RANKIN STREET
TROY, MI 48083

FOR: ENTERTAINMENT SERVICES, NAMELY, PROVIDING AN ON-GOING RADIO PROGRAM IN THE FIELD OF HOME IMPROVEMENT, IN CLASS 41 (U.S. CLS. 100, 101 AND 107).

FIRST USE 6-22-2002; IN COMMERCE 6-22-2002.

THE MARK CONSISTS OF STANDARD CHARACTERS WITHOUT CLAIM TO ANY PARTICULAR FONT, STYLE, SIZE, OR COLOR.

NO CLAIM IS MADE TO THE EXCLUSIVE RIGHT TO USE "SHOW", APART FROM THE MARK AS SHOWN.

SEC. 2(F).

SER. NO. 85-443,421, FILED 10-10-2011.

BRENDAN MCCAULEY, EXAMINING ATTORNEY



David J. Kyffers

Director of the United States Patent and Trademark Office

United States of America

United States Patent and Trademark Office

Brooke Leaf

Reg. No. 4,153,886

Registered June 5, 2012

Int. Cl.: 14

TRADEMARK

PRINCIPAL REGISTER

CARELLE LTD. (NEW YORK CORPORATION)
2 WEST 46TH STREET
NEW YORK, NY 10036

FOR: JEWELRY, IN CLASS 14 (U.S. CLS. 2, 27, 28 AND 50).

FIRST USE 3-1-2011; IN COMMERCE 5-1-2011.

THE MARK CONSISTS OF STANDARD CHARACTERS WITHOUT CLAIM TO ANY PARTICULAR FONT, STYLE, SIZE, OR COLOR.

SER. NO. 85-443,422, FILED 10-10-2011.

JULIE WATSON, EXAMINING ATTORNEY



David J. Kybas

Director of the United States Patent and Trademark Office

United States of America

United States Patent and Trademark Office

Kalyn's Kitchen

Reg. No. 4,153,887

KALYN DENNY (UNITED STATES INDIVIDUAL), DBA KALYN'S KITCHEN
936 BLAINE AVENUE
SALT LAKE CITY, UT 841057211

Registered June 5, 2012

Int. Cl.: 41

FOR: ON-LINE JOURNALS, NAMELY, BLOGS FEATURING RECIPES AND COOKING
ADVICE, IN CLASS 41 (U.S. CLS. 100, 101 AND 107).

SERVICE MARK

FIRST USE 4-1-2005; IN COMMERCE 4-1-2005.

PRINCIPAL REGISTER

THE MARK CONSISTS OF STANDARD CHARACTERS WITHOUT CLAIM TO ANY PAR-
TICULAR FONT, STYLE, SIZE, OR COLOR.

SER. NO. 85-443,432, FILED 10-10-2011.

EUGENIA MARTIN, EXAMINING ATTORNEY



David J. Kybas

Director of the United States Patent and Trademark Office

United States of America

United States Patent and Trademark Office

TAGASAURIS

Reg. No. 4,153,888

Registered June 5, 2012

Int. Cl.: 42

SERVICE MARK

PRINCIPAL REGISTER

TAGASAURIS, INC. (DELAWARE CORPORATION)
232 EAST 12TH STREET, APT. 4B.
NEW YORK, NY 10003

FOR: COMPUTER SERVICES, NAMELY, PROVIDING AN ONLINE PORTAL FEATURING NON-DOWNLOADABLE SOFTWARE FOR SEARCHING, IDENTIFYING, CATEGORIZING, ANNOTATING, ATTRIBUTING, TAGGING, LABELING, ORGANIZING AND CURATING ONLINE MEDIA, IMAGES AND KNOWLEDGE WORK; PROVIDING AN INTERACTIVE WEBSITE FEATURING TECHNOLOGY FOR SEARCHING, IDENTIFYING, CATEGORIZING, ANNOTATING, ATTRIBUTING, TAGGING, LABELING, ORGANIZING AND CURATING ONLINE MEDIA, IMAGES AND KNOWLEDGE WORK; APPLICATION SERVICE PROVIDER (ASP) FEATURING SOFTWARE FOR SEARCHING, IDENTIFYING, CATEGORIZING, ANNOTATING, ATTRIBUTING, TAGGING, LABELING, ORGANIZING AND CURATING ONLINE MEDIA, IMAGES AND KNOWLEDGE WORK; KNOWLEDGE WORK DEVELOPMENT, MANAGEMENT AND CURATION SERVICES, IN CLASS 42 (U.S. CLS. 100 AND 101).

FIRST USE 3-26-2010; IN COMMERCE 3-26-2010.

THE MARK CONSISTS OF STANDARD CHARACTERS WITHOUT CLAIM TO ANY PARTICULAR FONT, STYLE, SIZE, OR COLOR.

SER. NO. 85-443,449, FILED 10-10-2011.

GEOFFREY FOSDICK, EXAMINING ATTORNEY



David J. Kyffers

Director of the United States Patent and Trademark Office

United States of America

United States Patent and Trademark Office

LAKE SIDE PRIDE

Reg. No. 4,153,889

Registered June 5, 2012

Int. Cl.: 41

SERVICE MARK

PRINCIPAL REGISTER

LAKE SIDE PRIDE MUSIC ENSEMBLES, INC. (ILLINOIS CORPORATION)
1333 W. DEVON AVENUE, SUITE 105
CHICAGO, IL 60660

FOR: ENTERTAINMENT SERVICES IN THE NATURE OF LIVE MUSICAL PERFORMANCES,
AND PRODUCTION OF MUSICAL SOUND RECORDINGS, IN CLASS 41 (U.S. CLS. 100,
101 AND 107).

FIRST USE 12-21-1997; IN COMMERCE 12-21-1997.

THE MARK CONSISTS OF STANDARD CHARACTERS WITHOUT CLAIM TO ANY PAR-
TICULAR FONT, STYLE, SIZE, OR COLOR.

SER. NO. 85-443,453, FILED 10-10-2011.

GEOFFREY FOSDICK, EXAMINING ATTORNEY



David J. Kyffers

Director of the United States Patent and Trademark Office

United States of America

United States Patent and Trademark Office

INTERPRO

Reg. No. 4,153,890

INTERPRO TECHNOLOGY, INC. (MICHIGAN CORPORATION)
722 W. UNIVERSITY DRIVE
ROCHESTER, MI 483071851

Registered June 5, 2012

Int. Cl.: 42

FOR: CUSTOMIZED SOFTWARE DEVELOPMENT SERVICES, IN CLASS 42 (U.S. CLS. 100 AND 101).

SERVICE MARK

FIRST USE 11-7-1991; IN COMMERCE 11-7-1991.

PRINCIPAL REGISTER

THE MARK CONSISTS OF STANDARD CHARACTERS WITHOUT CLAIM TO ANY PARTICULAR FONT, STYLE, SIZE, OR COLOR.

SER. NO. 85-443,454, FILED 10-10-2011.

NATALIE POLZER, EXAMINING ATTORNEY



David J. Kybas

Director of the United States Patent and Trademark Office

United States of America

United States Patent and Trademark Office

AKUAKU

Reg. No. 4,153,891

FIERRES, INC. (PUERTO RICO CORPORATION)
ROBERTO H TODD AVE. 801
SAN JUAN, PUERTO RICO 00907

Registered June 5, 2012

Int. Cl.: 25

FOR: A-SHIRTS; CLOTHING FOR BABIES, TODDLERS AND CHILDREN, TREATED WITH FIRE AND HEAT RETARDANTS, NAMELY, PAJAMAS, JACKETS, SHIRTS, PANTS, JUMPERS; DENIMS; PANTS; PIQUE SHIRTS; POLO SHIRTS; SPORT SHIRTS; SPORTS PANTS; T-SHIRTS, IN CLASS 25 (U.S. CLS. 22 AND 39).

TRADEMARK

PRINCIPAL REGISTER

FIRST USE 4-1-1998; IN COMMERCE 4-1-1998.

THE MARK CONSISTS OF STANDARD CHARACTERS WITHOUT CLAIM TO ANY PARTICULAR FONT, STYLE, SIZE, OR COLOR.

THE WORDING "AKUAKU" HAS NO MEANING IN A FOREIGN LANGUAGE.

SER. NO. 85-443,476, FILED 10-10-2011.

TARAH HARDY, EXAMINING ATTORNEY



David J. Kyffers

Director of the United States Patent and Trademark Office

United States of America

United States Patent and Trademark Office

SPEEDSLEEVE

Reg. No. 4,153,892

Registered June 5, 2012

Int. Cl.: 12

TRADEMARK

PRINCIPAL REGISTER

DSR PARTNERS, LLC (PENNSYLVANIA LIMITED LIABILITY COMPANY)
335 EAST BRUBAKER VALLEY RD
LITITZ, PA 17543

FOR: BICYCLE ACCESSORY, NAMELY AN ELASTICIZED STRAP FOR SECURING FOOD PACKAGES AND OTHER ITEMS TO A BICYCLE IN A MANNER ALLOWING CONVENIENT ACCESS FOR A BICYCLE RIDER, IN CLASS 12 (U.S. CLS. 19, 21, 23, 31, 35 AND 44).

FIRST USE 12-1-2010; IN COMMERCE 1-1-2011.

THE MARK CONSISTS OF STANDARD CHARACTERS WITHOUT CLAIM TO ANY PARTICULAR FONT, STYLE, SIZE, OR COLOR.

SER. NO. 85-443,479, FILED 10-10-2011.

TARAH HARDY, EXAMINING ATTORNEY



David J. Kyros

Director of the United States Patent and Trademark Office

United States of America

United States Patent and Trademark Office

TWISTED NOODLES

Reg. No. 4,153,893

Registered June 5, 2012

Int. Cl.: 43

SERVICE MARK

PRINCIPAL REGISTER

TWISTED NOODLES EXPRESS, CORP. (CALIFORNIA CORPORATION)
7975 SAN MARINO DRIVE
BUENA PARK, CA 90620

FOR: RESTAURANT SERVICES, TAKE OUT FOOD AND CATERING SERVICES, IN CLASS
43 (U.S. CLS. 100 AND 101).

FIRST USE 6-1-2006; IN COMMERCE 2-17-2007.

THE MARK CONSISTS OF STANDARD CHARACTERS WITHOUT CLAIM TO ANY PAR-
TICULAR FONT, STYLE, SIZE, OR COLOR.

NO CLAIM IS MADE TO THE EXCLUSIVE RIGHT TO USE "NOODLES", APART FROM
THE MARK AS SHOWN.

SER. NO. 85-443,492, FILED 10-10-2011.

TINA L. SNAPP, EXAMINING ATTORNEY



David J. Kybas

Director of the United States Patent and Trademark Office

United States of America
United States Patent and Trademark Office

XYBOARD

Reg. No. 4,153,894

CELLCO PARTNERSHIP (DELAWARE PARTNERSHIP), DBA VERIZON WIRELESS
ONE VERIZON WAY
BASKING RIDGE, NJ 079201097

Registered June 5, 2012

Int. Cl.: 9

FOR: TABLET COMPUTER; HAND-HELD COMPUTER; MOBILE COMPUTER, IN CLASS
9 (U.S. CLS. 21, 23, 26, 36 AND 38).

TRADEMARK

FIRST USE 12-9-2011; IN COMMERCE 12-9-2011.

PRINCIPAL REGISTER

THE MARK CONSISTS OF STANDARD CHARACTERS WITHOUT CLAIM TO ANY PAR-
TICULAR FONT, STYLE, SIZE, OR COLOR.

SER. NO. 85-443,497, FILED 10-10-2011.

ROBERT STRUCK, EXAMINING ATTORNEY



David J. Kybas

Director of the United States Patent and Trademark Office

United States of America

United States Patent and Trademark Office

ENERGYmaestro

Reg. No. 4,153,895

Registered June 5, 2012

Int. Cl.: 35

SERVICE MARK

PRINCIPAL REGISTER

MW ENGINEERING SPRL (BELGIUM CORPORATION)
MW ENGINEERING SPRL
RUE GRETRY 129
LIEGE, BELGIUM 4020

FOR: ENERGY MANAGEMENT SERVICE: USING A COMBINATION OF DATA MINING SOFTWARE, PERFORMANCE MANAGEMENT AND CONSULTANCY SERVICES TO OPTIMIZE AND CONTROL ENERGY USAGE IN INDUSTRIAL PLANT OPERATIONS, IN CLASS 35 (U.S. CLS. 100, 101 AND 102).

FIRST USE 10-5-2010; IN COMMERCE 10-5-2010.

THE MARK CONSISTS OF STANDARD CHARACTERS WITHOUT CLAIM TO ANY PARTICULAR FONT, STYLE, SIZE, OR COLOR.

SER. NO. 85-443,498, FILED 10-10-2011.

TINA L. SNAPP, EXAMINING ATTORNEY



David J. Kybas

Director of the United States Patent and Trademark Office

United States of America

United States Patent and Trademark Office

NUBBIN-FINGERS

Reg. No. 4,153,896

Registered June 5, 2012

Int. Cl.: 10

TRADEMARK

PRINCIPAL REGISTER

NORBIS INNOVATIONS COMPANY, LLC (MASSACHUSETTS LIMITED LIABILITY COMPANY)

SUITE #3
59 BABCOCK STREET
BROOKLINE, MA 02446

FOR: MESSAGE APPARATUS; MASSAGING APPARATUS FOR PERSONAL USE, IN CLASS 10 (U.S. CLS. 26, 39 AND 44).

FIRST USE 4-25-2009; IN COMMERCE 2-2-2010.

THE MARK CONSISTS OF STANDARD CHARACTERS WITHOUT CLAIM TO ANY PARTICULAR FONT, STYLE, SIZE, OR COLOR.

SER. NO. 85-443,500, FILED 10-10-2011.

TINA L. SNAPP, EXAMINING ATTORNEY



David J. Kybas

Director of the United States Patent and Trademark Office

United States of America

United States Patent and Trademark Office

DYSE ONE

Reg. No. 4,153,897

Registered June 5, 2012

Int. Cl.: 9

TRADEMARK

PRINCIPAL REGISTER

DEL RIO MARKETING, INC. (CALIFORNIA CORPORATION)
202 E. PALM STREET
EXETER, CA 93221

FOR: AUDIO SPEAKER ENCLOSURES; AUDIO SPEAKERS; BAGS FOR CAMERAS AND PHOTOGRAPHIC EQUIPMENT; CAMERA CASES; CAMERA HANDLES; CARRYING CASES FOR CELL PHONES; CASES FOR MOBILE PHONES; CELL PHONE CASES; CELL PHONE COVERS; CELL PHONE FACEPLATES; HEADPHONES; HEADPHONES INCLUDING ATTACHED LANYARD; MUSIC HEADPHONES; PERSONAL HEADPHONES FOR SOUND TRANSMITTING APPARATUSES; PERSONAL HEADPHONES FOR USE WITH SOUND TRANSMITTING SYSTEMS; PROTECTIVE CARRYING CASES FOR PORTABLE MUSIC PLAYERS, NAMELY, MP3 PLAYERS; STEREO HEADPHONES, IN CLASS 9 (U.S. CLS. 21, 23, 26, 36 AND 38).

FIRST USE 7-1-2011; IN COMMERCE 7-1-2011.

THE MARK CONSISTS OF STANDARD CHARACTERS WITHOUT CLAIM TO ANY PARTICULAR FONT, STYLE, SIZE, OR COLOR.

OWNER OF U.S. REG. NOS. 3,193,806, 3,775,855 AND OTHERS.

SER. NO. 85-443,508, FILED 10-10-2011.

JORDAN BAKER, EXAMINING ATTORNEY



David J. Kyros

Director of the United States Patent and Trademark Office

United States of America

United States Patent and Trademark Office

STABLE PATH

Reg. No. 4,153,898

Registered June 5, 2012

Int. Cl.: 42

SERVICE MARK

PRINCIPAL REGISTER

WIRESPEED NETWORKS, INC. (CALIFORNIA CORPORATION), DBA STABLEPATH
8001 IRVINE CENTER DRIVE, SUITE 400
IRVINE, CA 92618

FOR: COMPUTER CONSULTATION, IN CLASS 42 (U.S. CLS. 100 AND 101).

FIRST USE 2-28-2005; IN COMMERCE 2-28-2005.

THE MARK CONSISTS OF STANDARD CHARACTERS WITHOUT CLAIM TO ANY PARTICULAR FONT, STYLE, SIZE, OR COLOR.

SER. NO. 85-443,524, FILED 10-10-2011.

KATHY DE JONGE, EXAMINING ATTORNEY



David J. Kybas

Director of the United States Patent and Trademark Office

United States of America

United States Patent and Trademark Office

YS PALOOZA

Reg. No. 4,153,899

Registered June 5, 2012

Int. Cl.: 41

SERVICE MARK

PRINCIPAL REGISTER

REAL RESOURCES, INC. (DELAWARE NON-PROFIT CORPORATION)
3530 EAST 28TH STREET
MINNEAPOLIS, MN 55406

FOR: EDUCATIONAL SERVICES, NAMELY, CONDUCTING SEMINARS AND CONFERENCES FOR YOUTH PASTORS AND YOUTH WORKERS IN THE FIELDS OF YOUTH MINISTRY AND DISTRIBUTION OF TRAINING MATERIALS IN CONNECTION THEREWITH, IN CLASS 41 (U.S. CLS. 100, 101 AND 107).

FIRST USE 10-0-2010; IN COMMERCE 10-0-2010.

THE MARK CONSISTS OF STANDARD CHARACTERS WITHOUT CLAIM TO ANY PARTICULAR FONT, STYLE, SIZE, OR COLOR.

SER. NO. 85-443,530, FILED 10-10-2011.

MARK RADEMACHER, EXAMINING ATTORNEY



David J. Kyffers

Director of the United States Patent and Trademark Office

United States of America

United States Patent and Trademark Office

STABLE PATH

Reg. No. 4,153,900

Registered June 5, 2012

Int. Cl.: 42

SERVICE MARK

PRINCIPAL REGISTER

WIRESPEED NETWORKS, INC. (CALIFORNIA CORPORATION), DBA STABLEPATH
8001 IRVINE CENTER DRIVE, SUITE 400
IRVINE, CA 92618

FOR: COMPUTER CONSULTATION, IN CLASS 42 (U.S. CLS. 100 AND 101).

FIRST USE 10-31-2006; IN COMMERCE 10-31-2006.

THE MARK CONSISTS OF THE WORDS "STABLE PATH" WITH AN ARC BETWEEN THEM.

SER. NO. 85-443,535, FILED 10-10-2011.

KATHY DE JONGE, EXAMINING ATTORNEY



David J. Kyffers

Director of the United States Patent and Trademark Office

United States of America

United States Patent and Trademark Office



Reg. No. 4,153,901

Registered June 5, 2012

Int. Cl.: 7

TRADEMARK

PRINCIPAL REGISTER

DEFRANCISCI MACHINE COMPANY LLC (FLORIDA LIMITED LIABILITY COMPANY)
7610 CORAL DRIVE
WEST MELBOURNE, FL 329041102

FOR: MACHINERY FOR USE IN CONNECTION WITH THE MANUFACTURE OF NOODLES
AND PASTA, IN CLASS 7 (U.S. CLS. 13, 19, 21, 23, 31, 34 AND 35).

FIRST USE 1-1-1984; IN COMMERCE 1-1-1984.

THE MARK CONSISTS OF MARK IS COMPRISED OF THE WORD MARK DEMACO IN
BLUE LETTERS BELOW TWO (2) STYLIZED YELLOW ELLIPTICAL DESIGNS.

THE COLOR(S) YELLOW AND BLUE IS/ARE CLAIMED AS A FEATURE OF THE MARK.

SER. NO. 85-443,543, FILED 10-10-2011.

BRIAN NEVILLE, EXAMINING ATTORNEY



David J. Kyffers

Director of the United States Patent and Trademark Office

United States of America

United States Patent and Trademark Office

RESPECT MY KICKS

Reg. No. 4,153,902

PAUL NESBIHAL CLOTHING, LLC (NEW YORK LIMITED LIABILITY COMPANY)
231 WILLOW AVE APT 3L
HOBOKEN, NJ 07030

Registered June 5, 2012

Int. Cl.: 25

FOR: HOODED SWEATSHIRTS; PANTS; SHIRTS; THERMAL SOCKS; THERMAL UNDERWEAR, IN CLASS 25 (U.S. CLS. 22 AND 39).

TRADEMARK

FIRST USE 10-0-2010; IN COMMERCE 10-0-2010.

PRINCIPAL REGISTER

THE MARK CONSISTS OF STANDARD CHARACTERS WITHOUT CLAIM TO ANY PARTICULAR FONT, STYLE, SIZE, OR COLOR.

SER. NO. 85-443,546, FILED 10-10-2011.

BRIAN NEVILLE, EXAMINING ATTORNEY



David J. Kybas

Director of the United States Patent and Trademark Office

United States of America

United States Patent and Trademark Office

PAPER HART

Reg. No. 4,153,903

Registered June 5, 2012

Int. Cl.: 25

TRADEMARK

PRINCIPAL REGISTER

GARRETT, MEREDITH (UNITED STATES INDIVIDUAL)
1909 E. 7TH PLACE
LOS ANGELES, CA 90021

FOR: BELTS; CHILDREN'S AND INFANT'S APPAREL, NAMELY, JUMPERS, OVERALL SLEEPWEAR, PAJAMAS, ROMPERS AND ONE-PIECE GARMENTS; DRESSES; FLEECE TOPS; FOOTWEAR; HEADWEAR; HOODED SWEATSHIRTS; JACKETS; KNIT SHIRTS; LONG-SLEEVED SHIRTS; PANTS; SHIRTS; SHORT-SLEEVED OR LONG-SLEEVED T-SHIRTS; SHORTS; SKIRTS; SOCKS; SWEAT PANTS; SWEAT SHIRTS; SWEATERS; SWIM WEAR; TANK TOPS, IN CLASS 25 (U.S. CLS. 22 AND 39).

FIRST USE 10-30-2009; IN COMMERCE 1-15-2010.

THE MARK CONSISTS OF STANDARD CHARACTERS WITHOUT CLAIM TO ANY PARTICULAR FONT, STYLE, SIZE, OR COLOR.

SER. NO. 85-443,565, FILED 10-10-2011.

DEIRDRE ROBERTSON, EXAMINING ATTORNEY



David J. Kyros

Director of the United States Patent and Trademark Office

United States of America

United States Patent and Trademark Office

DYSE ONE

Reg. No. 4,153,904

DEL RIO MARKETING, INC. (CALIFORNIA CORPORATION)
202 E. PALM STREET
EXETER, CA 93221

Registered June 5, 2012

Int. Cl.: 12

FOR: FITTED AUTOMOTIVE SEAT COVERS, IN CLASS 12 (U.S. CLS. 19, 21, 23, 31, 35 AND 44).

TRADEMARK

FIRST USE 8-3-2011; IN COMMERCE 8-3-2011.

PRINCIPAL REGISTER

THE MARK CONSISTS OF STANDARD CHARACTERS WITHOUT CLAIM TO ANY PARTICULAR FONT, STYLE, SIZE, OR COLOR.

OWNER OF U.S. REG. NOS. 3,193,806, 3,775,855 AND OTHERS.

SER. NO. 85-443,566, FILED 10-10-2011.

JORDAN BAKER, EXAMINING ATTORNEY



David J. Kyros

Director of the United States Patent and Trademark Office

United States of America

United States Patent and Trademark Office

Eat Good. Feel Good.

Reg. No. 4,153,905

Registered June 5, 2012

Int. Cl.: 44

SERVICE MARK

PRINCIPAL REGISTER

WHOLE SHIFT LLC (FLORIDA LIMITED LIABILITY COMPANY)
1612 SAN CHARLES DR
DUNEDIN, FL 34698

FOR: PROVIDING A INTERACTIVE HOLISTIC WEB SITE FEATURING HEALTH INFORMATION AND PATIENT INITIATED, PATIENT AUTHORIZED, FEE-FOR-SERVICE, HOLISTIC APPROACH DISTANCE HEALING SESSIONS BASED ON THE PATIENT'S SPECIFIC SET OF SYMPTOMS, MEDICAL PROFILE AND MEDICAL RECORD ANALYSIS AND PATIENT BENEFIT INFORMATION CONCERNING ORGANIC AND HOLISTIC PRODUCTS AND SERVICES, IN CLASS 44 (U.S. CLS. 100 AND 101).

FIRST USE 6-1-2011; IN COMMERCE 6-1-2011.

THE MARK CONSISTS OF STANDARD CHARACTERS WITHOUT CLAIM TO ANY PARTICULAR FONT, STYLE, SIZE, OR COLOR.

SER. NO. 85-443,576, FILED 10-10-2011.

ARETHA SOMERVILLE, EXAMINING ATTORNEY



David J. Kyros

Director of the United States Patent and Trademark Office

United States of America

United States Patent and Trademark Office

THE WHY? BEHIND THE BUY

Reg. No. 4,153,906

Registered June 5, 2012

Int. Cl.: 16

TRADEMARK

PRINCIPAL REGISTER

ACOSTA, INC. (DELAWARE CORPORATION)
6600 CORPORATE CENTER PARKWAY
JACKSONVILLE, FL 32216

FOR: PUBLICATIONS, NAMELY, BOOKLETS REGARDING SURVEYS RELATED TO SHOPPING BEHAVIOR AND GROCERY SHOPPING TRENDS IN THE FIELD OF CONSUMER PACKAGED GOODS, IN CLASS 16 (U.S. CLS. 2, 5, 22, 23, 29, 37, 38 AND 50).

FIRST USE 9-23-2010; IN COMMERCE 9-23-2010.

THE MARK CONSISTS OF STANDARD CHARACTERS WITHOUT CLAIM TO ANY PARTICULAR FONT, STYLE, SIZE, OR COLOR.

SER. NO. 85-443,585, FILED 10-10-2011.

KAREN SEVERSON, EXAMINING ATTORNEY



David J. Kyros

Director of the United States Patent and Trademark Office

United States of America

United States Patent and Trademark Office

As Cute as it Gets

Reg. No. 4,153,907

THISELTON, DOVE (UNITED STATES INDIVIDUAL), DBA AS CUTE AS IT GETS
160 N. GLASSELL
ORANGE, CA 92866

Registered June 5, 2012

Int. Cl.: 41

FOR: DIGITAL IMAGING SERVICES; PHOTOGRAPHY; PHOTOGRAPHY SERVICES;
PORTRAIT PHOTOGRAPHY, IN CLASS 41 (U.S. CLS. 100, 101 AND 107).

SERVICE MARK

FIRST USE 5-1-2002; IN COMMERCE 5-1-2002.

PRINCIPAL REGISTER

THE MARK CONSISTS OF STANDARD CHARACTERS WITHOUT CLAIM TO ANY PAR-
TICULAR FONT, STYLE, SIZE, OR COLOR.

SER. NO. 85-443,586, FILED 10-10-2011.

MARILYN IZZI, EXAMINING ATTORNEY



David J. Kybas

Director of the United States Patent and Trademark Office

United States of America

United States Patent and Trademark Office

Your Secret Door to Italy

Reg. No. 4,153,908

Registered June 5, 2012

Int. Cl.: 39

SERVICE MARK

PRINCIPAL REGISTER

ITALY HOTLINE PRIVATE AND CUSTOM TOURS LLC (WASHINGTON LIMITED LIABILITY COMPANY), DBA ITALY HOTLINE PRIVATE AND CUSTOM TOURS LLC
5309 KUHN ST
PORT TOWNSEND, WA 98368

FOR: ORGANIZATION OF EXCURSIONS, SIGHTSEEING TOURS, HOLIDAYS, TOURS AND TRAVEL, IN CLASS 39 (U.S. CLS. 100 AND 105).

FIRST USE 11-1-2010; IN COMMERCE 11-1-2010.

THE MARK CONSISTS OF STANDARD CHARACTERS WITHOUT CLAIM TO ANY PARTICULAR FONT, STYLE, SIZE, OR COLOR.

NO CLAIM IS MADE TO THE EXCLUSIVE RIGHT TO USE "ITALY", APART FROM THE MARK AS SHOWN.

SER. NO. 85-443,630, FILED 10-10-2011.

SHANNON TWOHIG, EXAMINING ATTORNEY



David J. Kyffers

Director of the United States Patent and Trademark Office

United States of America

United States Patent and Trademark Office

Moms Helping Moms

Reg. No. 4,153,909

Registered June 5, 2012

Int. Cl.: 39

SERVICE MARK

PRINCIPAL REGISTER

LINKSUS CORPORATION (FLORIDA CORPORATION)
1440 CORAL RIDGE DRIVE, # 156
CORAL SPRINGS, FL 33071

FOR: TRANSPORTATION SERVICES, NAMELY, PROVIDING SHUTTLE SERVICES FOR CHILDREN BY VANS, MINIVANS, CARS, BUSES, AND MINI-BUSES, IN CLASS 39 (U.S. CLS. 100 AND 105).

FIRST USE 9-16-2011; IN COMMERCE 9-16-2011.

THE MARK CONSISTS OF STANDARD CHARACTERS WITHOUT CLAIM TO ANY PARTICULAR FONT, STYLE, SIZE, OR COLOR.

SER. NO. 85-443,632, FILED 10-10-2011.

MICHAEL SOUDERS, EXAMINING ATTORNEY



David J. Kybas

Director of the United States Patent and Trademark Office

United States of America

United States Patent and Trademark Office

ADX

Reg. No. 4,153,910

BROCADE COMMUNICATIONS SYSTEMS, INC. (CALIFORNIA CORPORATION)
130 HOLGER WAY
SAN JOSE, CA 95134

Registered June 5, 2012

Int. Cl.: 9

FOR: COMPUTER NETWORKING HARDWARE; COMPUTER SOFTWARE FOR ADMINISTRATION OF COMPUTER NETWORKS, IN CLASS 9 (U.S. CLS. 21, 23, 26, 36 AND 38).

TRADEMARK

FIRST USE 5-11-2009; IN COMMERCE 5-11-2009.

PRINCIPAL REGISTER

THE MARK CONSISTS OF STANDARD CHARACTERS WITHOUT CLAIM TO ANY PARTICULAR FONT, STYLE, SIZE, OR COLOR.

SER. NO. 85-443,637, FILED 10-10-2011.

ANDREA HACK, EXAMINING ATTORNEY



David J. Kyffers

Director of the United States Patent and Trademark Office

United States of America

United States Patent and Trademark Office

YUKON MAUI

Reg. No. 4,153,911

Registered June 5, 2012

Int. Cl.: 41

SERVICE MARK

PRINCIPAL REGISTER

R. WAVE PARTNERS LLC (HAWAII LIMITED LIABILITY COMPANY)
P.O. BOX 525
KIHEI, HI 96753

FOR: ENTERTAINMENT SERVICES, NAMELY, PROVIDING A WEB SITE FEATURING PHOTOGRAPHIC, VIDEO AND PROSE PRESENTATIONS FEATURING OUTDOOR SPORTING ACTIVITIES ON MAUI, IN CLASS 41 (U.S. CLS. 100, 101 AND 107).

FIRST USE 10-3-2011; IN COMMERCE 10-9-2011.

THE MARK CONSISTS OF STANDARD CHARACTERS WITHOUT CLAIM TO ANY PARTICULAR FONT, STYLE, SIZE, OR COLOR.

NO CLAIM IS MADE TO THE EXCLUSIVE RIGHT TO USE "MAUI", APART FROM THE MARK AS SHOWN.

SER. NO. 85-443,646, FILED 10-10-2011.

JORDAN BAKER, EXAMINING ATTORNEY



David J. Kyffers

Director of the United States Patent and Trademark Office

United States of America

United States Patent and Trademark Office

MAPS
N SAV

Reg. No. 4,153,912

Registered June 5, 2012

Int. Cl.: 42

SERVICE MARK

PRINCIPAL REGISTER

10KINFO, INC. (WASHINGTON CORPORATION)
SUITE 280
13555 SE 36TH STREET
BELLEVUE, WA 98006

FOR: APPLICATION SERVICE PROVIDER (ASP) FEATURING SOFTWARE FOR USE IN KNOWLEDGE MANAGEMENT, NAMELY, SEARCHING AND RETRIEVING INFORMATION FROM FINANCIAL REGULATORY FILING DOCUMENT DATABASES AND COMPUTER NETWORKS, IN CLASS 42 (U.S. CLS. 100 AND 101).

FIRST USE 3-23-2005; IN COMMERCE 3-23-2005.

THE MARK CONSISTS OF THE WORD "MAP" IN BLUE STYLIZED FONT ABOVE THE LETTER "N" IN GREEN STYLIZED FONT. TO THE RIGHT OF THE WORD "MAP" AND LETTER "N" ARE THE LETTERS "SAV" IN RED STYLIZED FONT.

THE COLOR(S) BLUE, GREEN AND RED IS/ARE CLAIMED AS A FEATURE OF THE MARK.

SER. NO. 85-443,666, FILED 10-10-2011.

BARBARA GAYNOR, EXAMINING ATTORNEY



David J. Kybas

Director of the United States Patent and Trademark Office

United States of America

United States Patent and Trademark Office

HDA

Reg. No. 4,153,913

Registered June 5, 2012

Int. Cls.: 35 and 41

SERVICE MARK

PRINCIPAL REGISTER

NATIONAL SPORTING GOODS ASSOCIATION (MISSOURI NON-PROFIT CORPORATION)
SUITE 300
1601 FEEHANVILLE DRIVE
MOUNT PROSPECT, IL 60056

FOR: ASSOCIATION SERVICES, NAMELY PROMOTING THE INTERESTS OF RETAILERS AND DEALERS OF HOCKEY EQUIPMENT; ARRANGING, CONDUCTING AND PROVIDING BUSINESS RESEARCH AND SURVEYS ON THE SUBJECT OF THE HOCKEY EQUIPMENT INDUSTRY; ON-LINE BUYERS GUIDE SERVICE PROVIDING INFORMATION IN THE FIELD OF HOCKEY EQUIPMENT, IN CLASS 35 (U.S. CLS. 100, 101 AND 102).

FIRST USE 8-0-2010; IN COMMERCE 8-0-2010.

FOR: ONLINE PUBLICATIONS IN THE NATURE OF NEWSLETTERS IN THE FIELD OF HOCKEY EQUIPMENT AND THE RETAILING AND DISTRIBUTION THEREOF, IN CLASS 41 (U.S. CLS. 100, 101 AND 107).

FIRST USE 9-0-2010; IN COMMERCE 9-0-2010.

THE MARK CONSISTS OF STANDARD CHARACTERS WITHOUT CLAIM TO ANY PARTICULAR FONT, STYLE, SIZE, OR COLOR.

SER. NO. 85-443,670, FILED 10-10-2011.

TASNEEM HUSSAIN, EXAMINING ATTORNEY



David J. Kybas

Director of the United States Patent and Trademark Office

United States of America

United States Patent and Trademark Office

LIFE + FLOOR

Reg. No. 4,153,914

Registered June 5, 2012

Int. Cl.: 19

TRADEMARK

PRINCIPAL REGISTER

MNY GROUP, LLC (MINNESOTA LIMITED LIABILITY COMPANY)
SUITE 173
7809 SOUTHTOWN CENTER
BLOOMINGTON, MN 55431

FOR: RUBBER AND SYNTHETIC NON-METAL TILES FOR USE ON INDOOR AND OUT-DOOR FLOORS, IN CLASS 19 (U.S. CLS. 1, 12, 33 AND 50).

FIRST USE 7-17-2011; IN COMMERCE 9-6-2011.

NO CLAIM IS MADE TO THE EXCLUSIVE RIGHT TO USE "FLOOR", APART FROM THE MARK AS SHOWN.

THE COLOR(S) RED, WHITE AND BLUE IS/ARE CLAIMED AS A FEATURE OF THE MARK.

THE MARK CONSISTS OF A LARGE WHITE RECTANGLE THAT IS WIDER THAN IT IS TALL WITH THE WORDS "LIFE" AND "FLOOR" IN THE COLOR BLUE APPEARING IN THE MIDDLE OF THE RECTANGLE WITH A RED CROSS IN THE MIDDLE OF THE TWO WORDS, WITH THE CROSS MADE UP OF FOUR SQUARE RED TILES WITH A WHITE TILE IN THE MIDDLE OF THE CROSS.

SER. NO. 85-443,672, FILED 10-10-2011.

TASNEEM HUSSAIN, EXAMINING ATTORNEY



David J. Kyros

Director of the United States Patent and Trademark Office

United States of America

United States Patent and Trademark Office

AMT

Reg. No. 4,153,915

Registered June 5, 2012

Int. Cl.: 7

TRADEMARK

PRINCIPAL REGISTER

AMERICAN MACHINE AND TOOL CO., INC. OF PENNSYLVANIA (DELAWARE CORPORATION)
400 SPRING STREET
ROYERSFORD, PA 19468

FOR: POSITIVE DISPLACEMENT PUMPS, IN CLASS 7 (U.S. CLS. 13, 19, 21, 23, 31, 34 AND 35).

FIRST USE 9-0-1977; IN COMMERCE 9-0-1977.

THE MARK CONSISTS OF STANDARD CHARACTERS WITHOUT CLAIM TO ANY PARTICULAR FONT, STYLE, SIZE, OR COLOR.

OWNER OF U.S. REG. NOS. 894,080 AND 1,652,136.

SER. NO. 85-443,680, FILED 10-10-2011.

TINA BROWN, EXAMINING ATTORNEY



David J. Kyffers

Director of the United States Patent and Trademark Office

United States of America

United States Patent and Trademark Office

MAKE TRAINING STICK

Reg. No. 4,153,916

CARNES AND ASSOCIATES, INC. (MISSOURI CORPORATION)
7251 PRINCETON AVE.
ST. LOUIS, MO 63130

Registered June 5, 2012

Int. Cl.: 41

FOR: EDUCATIONAL SERVICES, NAMELY, ORGANIZING, DEVELOPING, AND CONDUCTING WORKSHOPS AND ONLINE TRAINING INSTRUCTIONS FOR THE PURPOSE OF TEACHING JOB TRAINERS AND HR PROFESSIONALS HOW TO CONDUCT MORE EFFECTIVE JOB TRAINING, IN CLASS 41 (U.S. CLS. 100, 101 AND 107).

SERVICE MARK

PRINCIPAL REGISTER

FIRST USE 0-0-2006, THE MARK WAS FIRST USED ANYWHERE IN A DIFFERENT FORM OTHER THAN THAT SOUGHT TO BE REGISTERED AT LEAST AS EARLY AS 00/00/1991.; IN COMMERCE 0-0-2006, THE MARK WAS FIRST USED IN COMMERCE IN A DIFFERENT FORM OTHER THAN THAT SOUGHT TO BE REGISTERED AT LEAST AS EARLY AS 00/00/1991..

THE MARK CONSISTS OF STANDARD CHARACTERS WITHOUT CLAIM TO ANY PARTICULAR FONT, STYLE, SIZE, OR COLOR.

SER. NO. 85-443,744, FILED 10-10-2011.

JASON BLAIR, EXAMINING ATTORNEY



David J. Kyros

Director of the United States Patent and Trademark Office

United States of America
United States Patent and Trademark Office

Terracon

Reg. No. 4,153,917

Registered June 5, 2012

Int. Cls.: 16 and 42

TRADEMARK

SERVICE MARK

PRINCIPAL REGISTER

TT COMPANIES, INC. (DELAWARE CORPORATION), FORMERLY TERRACON, INC.
16000 COLLEGE BOULEVARD
LENEXA, KS 66219

FOR: HOUSE ORGANS IN THE FIELD OF ENGINEERING, IN CLASS 16 (U.S. CLS. 2, 5, 22, 23, 29, 37, 38 AND 50).

FIRST USE 1-1-1980; IN COMMERCE 4-1-1980.

FOR: ENGINEERING CONSULTING SERVICES, IN CLASS 42 (U.S. CLS. 100 AND 101).

FIRST USE 1-1-1980; IN COMMERCE 4-1-1980.

THE MARK CONSISTS OF THE WORD "TERRACON", WITH THE CAPITAL LETTER "T" APPEARING AS A STYLIZED "T" MADE UP OF TWO PARALLEL VERTICAL LINES WHICH CURVE AT THE TOP OF THE "T" AND THEN DIVERGE INTO TWO HORIZONTAL LINES THAT PROCEED IN OPPOSITE DIRECTIONS, ONE RIGHT AND ONE LEFT.

SER. NO. 85-443,770, FILED 10-10-2011.

STEVEN JACKSON, EXAMINING ATTORNEY



David J. Kypos

Director of the United States Patent and Trademark Office

United States of America

United States Patent and Trademark Office

AuthorBee

Reg. No. 4,153,918

Registered June 5, 2012

Int. Cl.: 42

SERVICE MARK

PRINCIPAL REGISTER

BRADLEY, STEPHEN T. (UNITED STATES INDIVIDUAL), DBA AUTHORBEE
252 FARMINGVILLE RD
RIDGEFIELD, CT 06877

FOR: PROVIDING A WEB-BASED SERVICE FEATURING TECHNOLOGY THAT ENABLES USERS TO MANAGE THE PRODUCTION AND PUBLICATION OF ELECTRONIC BOOKS (E-BOOKS) AND RELATED DIGITAL CONTENT AND OFFER THEM FOR SALE TO THE GENERAL PUBLIC, IN CLASS 42 (U.S. CLS. 100 AND 101).

FIRST USE 5-3-2011; IN COMMERCE 6-10-2011.

THE MARK CONSISTS OF STANDARD CHARACTERS WITHOUT CLAIM TO ANY PARTICULAR FONT, STYLE, SIZE, OR COLOR.

SER. NO. 85-443,782, FILED 10-10-2011.

BRENDAN REGAN, EXAMINING ATTORNEY



David J. Kybas

Director of the United States Patent and Trademark Office

United States of America

United States Patent and Trademark Office

VISION

Reg. No. 4,153,919

Registered June 5, 2012

Int. Cl.: 9

TRADEMARK

PRINCIPAL REGISTER

AMERICAN AIMERS, INC. (KANSAS CORPORATION)
3529 W. 6TH AVE.
EMPORIA, KS 66801

FOR: VEHICLE HEADLIGHT AIMING SYSTEM COMPRISING AN IMAGE SENSOR WHICH MEASURES THE LIGHT INTENSITY OF A HEADLIGHT LIGHT BEAM, A COMPUTER TO DETERMINE HEADLIGHT AIMING ACCURACY, AND A VISUAL DISPLAY APPARATUS TO DISPLAY THE ILLUMINATION PATTERN OF THE HEADLIGHT LIGHT BEAM, IN CLASS 9 (U.S. CLS. 21, 23, 26, 36 AND 38).

FIRST USE 1-8-1993; IN COMMERCE 1-8-1993.

THE MARK CONSISTS OF STANDARD CHARACTERS WITHOUT CLAIM TO ANY PARTICULAR FONT, STYLE, SIZE, OR COLOR.

OWNER OF U.S. REG. NO. 1,808,385.

SER. NO. 85-443,800, FILED 10-10-2011.

DORITT L. CARROLL, EXAMINING ATTORNEY



David J. Kybas

Director of the United States Patent and Trademark Office

United States of America

United States Patent and Trademark Office

hislut

Reg. No. 4,153,920

Registered June 5, 2012

Int. Cl.: 45

SERVICE MARK

PRINCIPAL REGISTER

HAJI, BEHNAM (IRAN INDIVIDUAL)
18/128
LUMPINI VILLE BANGKHAE ROAD BANGKHEA
BANGKOK, THAILAND

FOR: INTERNET BASED SOCIAL NETWORKING, INTRODUCTION, AND DATING SERVICES, IN CLASS 45 (U.S. CLS. 100 AND 101).

FIRST USE 10-7-2010; IN COMMERCE 10-7-2010.

THE MARK CONSISTS OF STANDARD CHARACTERS WITHOUT CLAIM TO ANY PARTICULAR FONT, STYLE, SIZE, OR COLOR.

SER. NO. 85-443,822, FILED 10-10-2011.

RONALD MCMORROW, EXAMINING ATTORNEY



David J. Kybas

Director of the United States Patent and Trademark Office

United States of America

United States Patent and Trademark Office

QUANTUM RELOAD

Reg. No. 4,153,921

Registered June 5, 2012

Int. Cl.: 41

SERVICE MARK

PRINCIPAL REGISTER

FATHIPOUR, MO (UNITED STATES INDIVIDUAL)
4808 EXCELENTE DRIVE
WOODLAND HILLS, CA 91364

FOR: ENTERTAINMENT IN THE NATURE OF POKER TOURNAMENTS; ENTERTAINMENT SERVICES, NAMELY, CONDUCTING LIVE POKER GAMES, IN CLASS 41 (U.S. CLS. 100, 101 AND 107).

FIRST USE 10-10-2011; IN COMMERCE 10-10-2011.

THE MARK CONSISTS OF STANDARD CHARACTERS WITHOUT CLAIM TO ANY PARTICULAR FONT, STYLE, SIZE, OR COLOR.

SER. NO. 85-443,841, FILED 10-10-2011.

ZHALEH DELANEY, EXAMINING ATTORNEY



David J. Kyros

Director of the United States Patent and Trademark Office

United States of America

United States Patent and Trademark Office

LEEFH2

Reg. No. 4,153,922

Registered June 5, 2012

Int. Cl.: 11

TRADEMARK

PRINCIPAL REGISTER

HNO GREEN FUELS , INC (NEVADA CORPORATION)
32947 COZY WAY
TEMECULA, CA 92592

FOR: HYDROGEN-GENERATION EQUIPMENT AND COMPONENTS, NAMELY, HYDROGEN GENERATORS, HYDROGEN PURIFIERS, HYDROGEN PURIFICATION MEMBRANES, FUEL PROCESSORS, AND STEAM REFORMERS , IN CLASS 11 (U.S. CLS. 13, 21, 23, 31 AND 34).

FIRST USE 5-1-2010; IN COMMERCE 7-5-2011.

THE MARK CONSISTS OF STANDARD CHARACTERS WITHOUT CLAIM TO ANY PARTICULAR FONT, STYLE, SIZE, OR COLOR.

SER. NO. 85-443,848, FILED 10-10-2011.

BARBARA BROWN, EXAMINING ATTORNEY



David J. Kyjars

Director of the United States Patent and Trademark Office

United States of America

United States Patent and Trademark Office



ON THE DOT
THE PERFECT SPOT

Reg. No. 4,153,923

Registered June 5, 2012

Int. Cl.: 16

TRADEMARK

PRINCIPAL REGISTER

ON THE DOT LLC (OREGON LIMITED LIABILITY COMPANY)
3126 SE 10TH AVENUE
PORTLAND, OR 97202

FOR: BOXES OF CARDBOARD OR PAPER; BOXES, CARTONS, STORAGE CONTAINERS,
AND PACKAGING CONTAINERS MADE OF PAPER OR CARDBOARD; CARDBOARD
BOXES , IN CLASS 16 (U.S. CLS. 2, 5, 22, 23, 29, 37, 38 AND 50).

FIRST USE 9-20-2011; IN COMMERCE 9-20-2011.

THE MARK CONSISTS OF STYLIZED BUTTERFLY ON MOON SHAPE BACKGROUND
WITH TEXT ON THE DOT THE PERFECT SPOT.

SER. NO. 85-443,851, FILED 10-10-2011.

DAVID TAYLOR, EXAMINING ATTORNEY



David J. Kyffers

Director of the United States Patent and Trademark Office

United States of America

United States Patent and Trademark Office

BeFit

Reg. No. 4,153,924

Registered June 5, 2012

Int. Cl.: 9

TRADEMARK

PRINCIPAL REGISTER

BEFIT COLLECTIVE LLC (COLORADO LIMITED LIABILITY COMPANY)
8200 GRANDVIEW AVE.
ARVADA, CO 80002

FOR: COMPUTER APPLICATION SOFTWARE FOR MOBILE PHONES, NAMELY, SOFTWARE FOR TRACKING AND RECORDING INDIVIDUAL HEALTH RELATED PARAMETERS; COMPUTER APPLICATION SOFTWARE FOR MOBILE PHONE OPERATING SYSTEMS, NAMELY, SOFTWARE FOR TRACKING AND RECORDING INDIVIDUAL HEALTH RELATED DATA, IN CLASS 9 (U.S. CLS. 21, 23, 26, 36 AND 38).

FIRST USE 10-5-2011; IN COMMERCE 10-10-2011.

THE MARK CONSISTS OF STANDARD CHARACTERS WITHOUT CLAIM TO ANY PARTICULAR FONT, STYLE, SIZE, OR COLOR.

SER. NO. 85-443,875, FILED 10-10-2011.

CHRISTOPHER BUONGIORNO, EXAMINING ATTORNEY



David J. Kyffers

Director of the United States Patent and Trademark Office

United States of America

United States Patent and Trademark Office

PlateMe

Reg. No. 4,153,925

Registered June 5, 2012

Int. Cl.: 9

TRADEMARK

PRINCIPAL REGISTER

PLATEME CORPORATION (DELAWARE CORPORATION)
9098 W. CHURCH STREET
DES PLAINES, IL 60016

FOR: COMPUTER SOFTWARE, NAMELY, SOFTWARE DEVELOPMENT TOOLS FOR THE CREATION OF MOBILE INTERNET APPLICATIONS AND CLIENT INTERFACES, IN CLASS 9 (U.S. CLS. 21, 23, 26, 36 AND 38).

FIRST USE 4-1-2011; IN COMMERCE 6-1-2011.

THE MARK CONSISTS OF STANDARD CHARACTERS WITHOUT CLAIM TO ANY PARTICULAR FONT, STYLE, SIZE, OR COLOR.

SER. NO. 85-443,881, FILED 10-11-2011.

SHAUNIA CARLYLE, EXAMINING ATTORNEY



David J. Kyros

Director of the United States Patent and Trademark Office

United States of America

United States Patent and Trademark Office



Reg. No. 4,153,926

Registered June 5, 2012

Int. Cl.: 9

TRADEMARK

PRINCIPAL REGISTER

CEN JIEQIANG (CHINA INDIVIDUAL)
NO.29,CHANGXING LANE 2, XIABEICHANGXING,
JIUJIANG TOWN, NANHAI DISTRICT,
FOSHAN,GUANGDONG, CHINA

FOR: ANTI-DAZZLE SPECTACLES; DISPLAY PROTECTOR TO PROVIDE SHADE AND PRIVACY FOR ELECTRONIC DEVICES HAVING SCREENS; DIVING GOGGLES; DUST PROTECTIVE GOGGLES AND MASKS; FILTERS FOR RESPIRATORY MASKS; GOGGLES FOR SCUBA DIVING; GOGGLES FOR SPORTS; MOTORCYCLE GOGGLES; NIGHT VISION GOGGLES; NOSE GUARDS WHICH CAN BE WORN BY ATTACHMENT TO EYEWEAR SUCH AS SUNGLASSES AND SKI GOGGLES; PROTECTING MASKS; PROTECTION AND SAFETY APPARATUS, NAMELY, INFLATABLE FLOTATION DEVICES; PROTECTIVE FACE MASKS NOT FOR MEDICAL PURPOSES; PROTECTIVE FACE-SHIELDS FOR PROTECTIVE HELMETS; PROTECTIVE HELMETS; PROTECTIVE SPORTS HELMET ACCESSORIES THAT ATTACH TO THE HELMETS, NAMELY, MOUTH GUARDS, EAR PADS, THROAT PROTECTORS, CHIN STRAPS, FACE MASKS, JAW PADS AND EYE SHIELDS; PROTECTIVE SUITS FOR AVIATORS; RESPIRATORS OTHER THAN FOR ARTIFICIAL RESPIRATION; SAFETY GOGGLES; SAFETY RESTRAINTS; SCUBA GOGGLES; SKI GOGGLES; SNOW GOGGLES; SOLDERERS' HELMETS; SPECTACLES; SWIMMING GOGGLES, IN CLASS 9 (U.S. CLS. 21, 23, 26, 36 AND 38).

FIRST USE 6-21-2006; IN COMMERCE 6-21-2006.

THE MARK CONSISTS OF STYLIZED LETTERS JDS IN AN OVAL.

SER. NO. 85-443,884, FILED 10-11-2011.

ROBERT STRUCK, EXAMINING ATTORNEY



David J. Kypos

Director of the United States Patent and Trademark Office

United States of America

United States Patent and Trademark Office

WINDA

Reg. No. 4,153,927

Registered June 5, 2012

Int. Cl.: 12

TRADEMARK

PRINCIPAL REGISTER

SHANDONG WANDA BOTO TYRE CO., LTD. (CHINA LIMITED LIABILITY COMPANY)
NO. 68, YONGSHEN ROAD, KENLI COUNTY,
DONGYING, SHANDONG, CHINA

FOR: BAND BRAKES FOR LAND VEHICLES; BICYCLES; ENGINES FOR LAND VEHICLES; FUNICULAR RAILCARS; GOODS HANDLING CARTS; HUBS FOR VEHICLE WHEELS (MOTORCYCLES); INNER TUBES; INNER TUBES; INNER TUBES; INNER TUBES FOR BICYCLES; INNER TUBES FOR CYCLES; INNER TUBES FOR VEHICLE TIRES; LAND VEHICLE PARTS, NAMELY, WHEELS; PNEUMATIC TYRES AND INNER TUBES FOR MOTORCYCLES; SLEIGHS; TIRE TUBES FOR VEHICLES; TIRES; TIRES; TIRES FOR CHILDREN'S BICYCLES; TIRES FOR LAND VEHICLES; TIRES FOR VEHICLES; TREAD USED TO RETREAD TIRES; TREADS FOR RETREADING TIRES FOR CIVIL ENGINEERING VEHICLES; TREADS FOR RETREADING TYRES; TREADS FOR RETREADING TYRES FOR FORESTRY VEHICLES; TREADS FOR RETREADING TYRES FOR VEHICLES USED IN THE CIVIL ENGINEERING INDUSTRY; TYRES AND INNER TUBES FOR THE WHEELS OF FORESTRY VEHICLES; VEHICLE WHEEL HUB ASSEMBLIES; VEHICLE WHEEL RIM PROTECTORS; VEHICLE WHEEL RIMS; VEHICLE WHEELS; WHEEL RIMS; WHEELS; WHEELS; WHEELS FOR BICYCLES, CYCLES, IN CLASS 12 (U.S. CLS. 19, 21, 23, 31, 35 AND 44).

FIRST USE 7-21-2009; IN COMMERCE 7-21-2009.

THE MARK CONSISTS OF STYLIZED LETTERS WINDA.

SER. NO. 85-443,918, FILED 10-11-2011.

TEJBIR SINGH, EXAMINING ATTORNEY



David J. Kybas

Director of the United States Patent and Trademark Office

United States of America

United States Patent and Trademark Office

ADVIROGUARD

Reg. No. 4,153,928

Registered June 5, 2012

Int. Cl.: 42

SERVICE MARK

PRINCIPAL REGISTER

EARTHTEC SOLUTIONS LLC (NEW JERSEY LIMITED LIABILITY COMPANY)
2079B EAST WHEAT ROAD
VINELAND, NJ 08361

FOR: PROVIDING TEMPORARY USE OF NON-DOWNLOADABLE SOFTWARE FOR ANALYZING SOIL, WATER, AIR AND WEATHER DATA, IN CLASS 42 (U.S. CLS. 100 AND 101).

FIRST USE 3-7-2011; IN COMMERCE 3-7-2011.

THE MARK CONSISTS OF STANDARD CHARACTERS WITHOUT CLAIM TO ANY PARTICULAR FONT, STYLE, SIZE, OR COLOR.

SER. NO. 85-443,937, FILED 10-11-2011.

KATHERINE CONNOLLY, EXAMINING ATTORNEY



David J. Kyffers

Director of the United States Patent and Trademark Office

United States of America

United States Patent and Trademark Office



Reg. No. 4,153,929

Registered June 5, 2012

Int. Cl.: 39

SERVICE MARK

PRINCIPAL REGISTER

KOVALLI, IREN (UNITED STATES INDIVIDUAL)
398 EAST DANIA BEACH BLVD., # 466
DANIA BEACH, FL 33004 AND

MCVAY, GARY (UNITED STATES INDIVIDUAL)
1470 NORTHEAST 123RD STREET, PH-7
NORTH MIAMI, FL 33161

FOR: ELECTRONIC STORAGE OF FILES AND DOCUMENTS; PHYSICAL STORAGE OF ELECTRONICALLY-STORED DATA OR DOCUMENTS, IN CLASS 39 (U.S. CLS. 100 AND 105).

FIRST USE 9-27-2011; IN COMMERCE 9-27-2011.

THE MARK CONSISTS OF THE LETTERS "WH" IN AN OUTLINED CIRCLE TO THE LEFT OF THE UNDERLINED WORD "WILLHOLDER".

SER. NO. 85-443,945, FILED 10-11-2011.

JANICE KIM, EXAMINING ATTORNEY



David J. Kybas

Director of the United States Patent and Trademark Office

United States of America

United States Patent and Trademark Office

UNCLE SLAM

Reg. No. 4,153,930

HANDELABRA STUDIO LLC (OHIO LIMITED LIABILITY COMPANY)
2478 FENWICK ROAD
UNIVERSITY HEIGHTS, OH 44118

Registered June 5, 2012

Int. Cl.: 9

FOR: DOWNLOADABLE SOFTWARE IN THE NATURE OF A MOBILE APPLICATION FOR ENTERTAINMENT PURPOSES, NAMELY, FIGHTING VIDEO GAME SOFTWARE WHERE PLAYERS ENGAGE IN SIMULATED BOXING AND FIGHTING; VIDEO GAME SOFTWARE, IN CLASS 9 (U.S. CLS. 21, 23, 26, 36 AND 38).

TRADEMARK

PRINCIPAL REGISTER

FIRST USE 12-16-2011; IN COMMERCE 12-16-2011.

THE MARK CONSISTS OF STANDARD CHARACTERS WITHOUT CLAIM TO ANY PARTICULAR FONT, STYLE, SIZE, OR COLOR.

SER. NO. 85-443,983, FILED 10-11-2011.

MICHAEL GAAFAR, EXAMINING ATTORNEY



David J. Kyffers

Director of the United States Patent and Trademark Office

United States of America

United States Patent and Trademark Office



Reg. No. 4,153,931

Registered June 5, 2012

Int. Cl.: 41

SERVICE MARK

PRINCIPAL REGISTER

FIT ESTEEM, LLC (NEW JERSEY LIMITED LIABILITY COMPANY)
PO BOX 686
SOUTH ORANGE, NJ 07079

FOR: FITNESS SERVICES, NAMELY, PHYSICAL FITNESS INSTRUCTION AND PERSONAL FITNESS TRAINING; CONDUCTING WORKSHOPS AND SEMINARS IN THE FIELD OF PHYSICAL FITNESS; CONSULTING SERVICES IN THE FIELD OF PHYSICAL FITNESS; EDUCATIONAL SERVICES, NAMELY, PROVIDING SPEAKING SERVICES IN THE FIELD OF PHYSICAL FITNESS, IN CLASS 41 (U.S. CLS. 100, 101 AND 107).

FIRST USE 7-1-2011; IN COMMERCE 7-1-2011.

NO CLAIM IS MADE TO THE EXCLUSIVE RIGHT TO USE "BEING FIT" AND "FIT", APART FROM THE MARK AS SHOWN.

THE COLOR(S) BLACK, RED AND WHITE IS/ARE CLAIMED AS A FEATURE OF THE MARK.

THE MARK CONSISTS OF THE WORDING "THE FEELING YOU GET FROM BEING FIT" IN WHITE LETTERING AT THE TOP OF THE MARK IN CURVILINEAR SHAPE, BORDERED ABOVE AND BELOW BY A CURVILINEAR WHITE LINE. IN THE MIDDLE OF THE MARK IS THE LETTERING "FE" IN RED STYLIZED LOWER CASE FONT. UNDER THE "FE" IS THE WORDING "FIT ESTEEM" IN WHITE BORDERED UNDERNEATH BY TWO CURVILINEAR WHITE LINES. THE ENTIRE MARK IS PRESENTED AGAINST A BLACK BACKGROUND.

SER. NO. 85-443,990, FILED 10-11-2011.

ODESSA BIBBINS, EXAMINING ATTORNEY



David J. Kybas

Director of the United States Patent and Trademark Office

United States of America

United States Patent and Trademark Office

You're my Steam and I'm your Punk

Reg. No. 4,153,932

CORO, PETER (UNITED STATES INDIVIDUAL)
3315 CASTERA AVE.
GLENDALE, CA 91208

Registered June 5, 2012

Int. Cl.: 25

FOR: DRESS SHIRTS; HATS; PANTS; SHIRTS; SHOES; SOCKS; SWEATERS; T-SHIRTS;
TIES, IN CLASS 25 (U.S. CLS. 22 AND 39).

TRADEMARK

FIRST USE 4-22-1999; IN COMMERCE 5-18-2010.

PRINCIPAL REGISTER

THE MARK CONSISTS OF STANDARD CHARACTERS WITHOUT CLAIM TO ANY PAR-
TICULAR FONT, STYLE, SIZE, OR COLOR.

SER. NO. 85-443,996, FILED 10-11-2011.

CHRIS WELLS, EXAMINING ATTORNEY



David J. Kybas

Director of the United States Patent and Trademark Office

United States of America

United States Patent and Trademark Office



Reg. No. 4,153,933

Registered June 5, 2012

Int. Cl.: 9

TRADEMARK

PRINCIPAL REGISTER

RETROFITNESS IP, LLC (NEW JERSEY LIMITED LIABILITY COMPANY)
43 COUNTY ROAD 537 W
COLTS NECK, NJ 07722

FOR: PRE-RECORDED VIDEO PROGRAMS PROVIDING PHYSICAL FITNESS EXERCISE INSTRUCTION IN VARIOUS TRAINING REGIMENS, IN CLASS 9 (U.S. CLS. 21, 23, 26, 36 AND 38).

FIRST USE 9-1-2011; IN COMMERCE 9-1-2011.

THE MARK CONSISTS OF THE WORDS RETRO ON DEMAND IN STYLIZED SCRIPT WITH AN ARROW IN THE SHAPE OF A RING LOOPED AROUND THE WORDS AT THEIR APPROXIMATE CENTER, THEIR LOWER PORTION OF THE WORD RETRO AND THE ARROW APPEAR IN RED FADING AT THE CENTER TO ORANGE FADING TOWARD THE TOP TO YELLOW, THE WORDS ON DEMAND APPEAR IN YELLOW, WITH ALL WORDS AND THE ARROW OUTLINED IN BLACK.

THE COLOR(S) RED, ORANGE, YELLOW AND BLACK IS/ARE CLAIMED AS A FEATURE OF THE MARK.

SER. NO. 85-443,997, FILED 10-11-2011.

CHRIS WELLS, EXAMINING ATTORNEY



David J. Kyffers

Director of the United States Patent and Trademark Office

United States of America

United States Patent and Trademark Office

WATER MANAGEMENT TECHNOLOGIES

Reg. No. 4,153,934

Registered June 5, 2012

Int. Cl.: 11

TRADEMARK

PRINCIPAL REGISTER

WATER MANAGEMENT TECHNOLOGIES, INC. (FLORIDA CORPORATION)
10400 N.W. 33RD STREET
MIAMI, FL 33172

FOR: WATER TREATMENT SYSTEM IN THE NATURE OF DECONTAMINATION VESSELS COMPRISED OF REDUNDANT OXIDIZERS USING OXYGEN AND OZONE TO REDUCE OR ELIMINATE BACTERIA AND VIRUSES AND IMPROVE THE CLARITY OF WATER, IN CLASS 11 (U.S. CLS. 13, 21, 23, 31 AND 34).

FIRST USE 1-1-1999; IN COMMERCE 1-1-1999.

THE MARK CONSISTS OF STANDARD CHARACTERS WITHOUT CLAIM TO ANY PARTICULAR FONT, STYLE, SIZE, OR COLOR.

SEC. 2(F).

SER. NO. 85-444,000, FILED 10-11-2011.

CHRIS WELLS, EXAMINING ATTORNEY



David J. Kyffers

Director of the United States Patent and Trademark Office

United States of America

United States Patent and Trademark Office

D N K

Reg. No. 4,153,935

Registered June 5, 2012

Int. Cl.: 25

TRADEMARK

PRINCIPAL REGISTER

DUMB LUCK DESIGNS (FLORIDA LIMITED LIABILITY COMPANY)
#1505
1590 WOODBINE TRAIL
PALM BEACH GARDENS, FL 33418

FOR: DRESS SHIRTS; HATS; HOODED SWEAT SHIRTS; JACKETS; POLO SHIRTS; SHORTS;
SWEAT SHIRTS; SWIM SUITS; T-SHIRTS; TANK TOPS; TROUSERS , IN CLASS 25 (U.S.
CLS. 22 AND 39).

FIRST USE 6-0-2011; IN COMMERCE 9-0-2011.

THE MARK CONSISTS OF THE STYLIZED TEXT "D NK". THERE IS AN IMAGE OF A
SPADE BETWEEN THE LETTERS "D" AND "N".

SER. NO. 85-444,012, FILED 10-11-2011.

ESTHER A. BORSUK, EXAMINING ATTORNEY



David J. Kyffers

Director of the United States Patent and Trademark Office

United States of America

United States Patent and Trademark Office



Reg. No. 4,153,936

Registered June 5, 2012

Int. Cl.: 35

SERVICE MARK

PRINCIPAL REGISTER

AHOLD LICENSING SARL (SWITZERLAND LIMITED LIABILITY COMPANY)
2 RUE JEAN-PETITOT
GENEVA, SWITZERLAND 1204

FOR: SUPERMARKETS, IN CLASS 35 (U.S. CLS. 100, 101 AND 102).

FIRST USE 7-8-2011; IN COMMERCE 7-8-2011.

OWNER OF U.S. REG. NOS. 3,551,711, 3,984,359 AND OTHERS.

THE COLOR(S) BLACK, WHITE, YELLOW, ORANGE, PURPLE, AND GREEN IS/ARE CLAIMED AS A FEATURE OF THE MARK.

THE MARK CONSISTS OF A SHIELD DESIGN OUTLINED IN AN OUTER BLACK LINE AND AN INNER WHITE LINE. THE TOP THIRD IS BLACK, AND FEATURES FOUR WEDGE DESIGNS OUTLINED IN WHITE, DEPICTED IN FOUR DIFFERENT COLORS IN VARYING SIZES AND DEGREES OF ROTATION. THE YELLOW WEDGE IS LARGEST AND PORTRAYED AS HORIZONTAL. THE ORANGE WEDGE IS SMALLER THAN THE YELLOW, AND APPEARS AT AN APPROXIMATELY 45 DEGREE ANGLE. THE PURPLE WEDGE IS SMALLER THAN THE ORANGE, AND IS PORTRAYED AS VERTICAL. THE GREEN WEDGE IS SMALLEST, AND APPEARS AT AN APPROXIMATELY 135 DEGREE ANGLE; I.E., BOTH THE ORANGE AND PURPLE WEDGES ARE DISPOSED APPROXIMATELY 45 DEGREES FROM THE YELLOW WEDGE. NEXT TO THE WEDGES DESIGN IS THE PHRASE "STOP & SHOP" IN WHITE. THE LOWER TWO-THIRDS OF THE SHIELD IS WHITE, FEATURING THE PHRASE "LOCAL ROUTE" IN BLACK.



SER. NO. 85-444,013, FILED 10-11-2011.

KELLY BOULTON, EXAMINING ATTORNEY

David J. Kybas

Director of the United States Patent and Trademark Office

United States of America

United States Patent and Trademark Office

SiteWrench

Reg. No. 4,153,937

Registered June 5, 2012

Int. Cl.: 42

SERVICE MARK

PRINCIPAL REGISTER

SAVAGE, JACOB W (UNITED STATES INDIVIDUAL)
SUITE 102
8337 CORDOVA ROAD
CORDOVA, TN 38016

FOR: TEMPORARY USE OF ON-LINE NON-DOWNLOADABLE SOFTWARE USED FOR DEVELOPING AND MAINTAINING WEB SITES, SOCIAL NETWORK ACCOUNTS AND MOBILE APPLICATIONS, IN CLASS 42 (U.S. CLS. 100 AND 101).

FIRST USE 1-1-2003; IN COMMERCE 1-1-2003.

THE MARK CONSISTS OF STANDARD CHARACTERS WITHOUT CLAIM TO ANY PARTICULAR FONT, STYLE, SIZE, OR COLOR.

SER. NO. 85-444,043, FILED 10-11-2011.

SUSAN LESLIE DUBOIS, EXAMINING ATTORNEY



David J. Kyjars

Director of the United States Patent and Trademark Office

United States of America

United States Patent and Trademark Office

Quonix

Reg. No. 4,153,938

Registered June 5, 2012

Int. Cl.: 42

SERVICE MARK

PRINCIPAL REGISTER

QUONIX NETWORKS, INC. (PENNSYLVANIA CORPORATION)
PO BOX 60607
KING OF PRUSSIA, PA 19406

FOR: COMPUTER CO-LOCATION SERVICES, NAMELY, PROVIDING FACILITIES FOR THE LOCATION OF COMPUTER SERVERS WITH THE EQUIPMENT OF OTHERS, IN CLASS 42 (U.S. CLS. 100 AND 101).

FIRST USE 6-1-2007; IN COMMERCE 6-1-2007.

THE MARK CONSISTS OF STANDARD CHARACTERS WITHOUT CLAIM TO ANY PARTICULAR FONT, STYLE, SIZE, OR COLOR.

SER. NO. 85-444,049, FILED 10-11-2011.

MARY CRAWFORD, EXAMINING ATTORNEY



David J. Kyros

Director of the United States Patent and Trademark Office

United States of America

United States Patent and Trademark Office



Reg. No. 4,153,939

Registered June 5, 2012

Int. Cl.: 42

SERVICE MARK

PRINCIPAL REGISTER

SYMPHONIC SOURCE (TEXAS CORPORATION)
10456 COUNTESS DR.
DALLAS, TX 75229

FOR: CLOUD COMPUTING FEATURING SOFTWARE FOR USE IN DATA CLEANSING AND DE-DUPLICATION, IN CLASS 42 (U.S. CLS. 100 AND 101).

FIRST USE 8-1-2011; IN COMMERCE 8-30-2011.

THE STIPLING IS FOR SHADING PURPOSES.

THE MARK CONSISTS OF AN IMAGE OF A DINGO/DOG WEARING A COWBOY HAT AND A NECKLACE WITH TEETH HANGING ON IT. DOG IS SITTING ON A CLOUD WITH A COILED ROPE UNDER ITS FRONT PAWS.

SER. NO. 85-444,053, FILED 10-11-2011.

JASON BLAIR, EXAMINING ATTORNEY



David J. Kybas

Director of the United States Patent and Trademark Office

United States of America

United States Patent and Trademark Office

chases down and eliminates
duplicate data

Reg. No. 4,153,940

Registered June 5, 2012

Int. Cl.: 42

SERVICE MARK

PRINCIPAL REGISTER

SYMPHONIC SOURCE (TEXAS CORPORATION)
10456 COUNTESS DR.
DALLAS, TX 75229

FOR: CLOUD COMPUTING FEATURING SOFTWARE FOR USE IN CUSTOMER RELATIONSHIP MANAGEMENT (CRM) DATABASE MANAGEMENT, DEDUPLICATION, AND DATA CLEANSING, IN CLASS 42 (U.S. CLS. 100 AND 101).

FIRST USE 8-1-2011; IN COMMERCE 8-30-2011.

THE MARK CONSISTS OF STANDARD CHARACTERS WITHOUT CLAIM TO ANY PARTICULAR FONT, STYLE, SIZE, OR COLOR.

NO CLAIM IS MADE TO THE EXCLUSIVE RIGHT TO USE "ELIMINATES DUPLICATE DATA", APART FROM THE MARK AS SHOWN.

SER. NO. 85-444,058, FILED 10-11-2011.

JASON BLAIR, EXAMINING ATTORNEY



David J. Kyros

Director of the United States Patent and Trademark Office

United States of America

United States Patent and Trademark Office

EVERCHURCH

Reg. No. 4,153,941

Registered June 5, 2012

Int. Cl.: 42

SERVICE MARK

PRINCIPAL REGISTER

SAVAGE, JACOB W (UNITED STATES INDIVIDUAL)
SUITE 102
8337 CORDOVA ROAD
CORDOVA, TN 38016

FOR: TEMPORARY USE OF ON-LINE NON-DOWNLOADABLE SOFTWARE USED FOR DEVELOPING AND MAINTAINING WEB SITES, SOCIAL NETWORK ACCOUNTS AND MOBILE APPLICATIONS, IN CLASS 42 (U.S. CLS. 100 AND 101).

FIRST USE 1-1-2011; IN COMMERCE 1-1-2011.

THE MARK CONSISTS OF STANDARD CHARACTERS WITHOUT CLAIM TO ANY PARTICULAR FONT, STYLE, SIZE, OR COLOR.

SER. NO. 85-444,061, FILED 10-11-2011.

SUSAN LESLIE DUBOIS, EXAMINING ATTORNEY



David J. Kybas

Director of the United States Patent and Trademark Office

United States of America

United States Patent and Trademark Office

HAVERSELECT

Reg. No. 4,153,942

Registered June 5, 2012

Int. Cl.: 42

SERVICE MARK

PRINCIPAL REGISTER

HAVER ANALYTICS, INC. (NEW YORK CORPORATION)
60 EAST 42ND STREET
NEW YORK, NY 10017

FOR: PROVIDING TEMPORARY USE OF A WEB-BASED SOFTWARE APPLICATION FOR RETRIEVAL AND USE OF DATABASES FEATURING INTERNATIONAL ECONOMIC AND FINANCIAL INFORMATION, IN CLASS 42 (U.S. CLS. 100 AND 101).

FIRST USE 12-31-1998; IN COMMERCE 12-31-1998.

THE MARK CONSISTS OF STANDARD CHARACTERS WITHOUT CLAIM TO ANY PARTICULAR FONT, STYLE, SIZE, OR COLOR.

SER. NO. 85-444,062, FILED 10-11-2011.

MICHAEL WIENER, EXAMINING ATTORNEY



David J. Kybas

Director of the United States Patent and Trademark Office

United States of America

United States Patent and Trademark Office

TOTAL

Reg. No. 4,153,943

Registered June 5, 2012

Int. Cl.: 34

TRADEMARK

PRINCIPAL REGISTER

KENTASH, LLC (NEW JERSEY LIMITED LIABILITY COMPANY), DBA NJ SMOKES
287 ROUTE 520
MORGANVILLE, NJ 07751

FOR: ELECTRONIC CIGARETTES, IN CLASS 34 (U.S. CLS. 2, 8, 9 AND 17).

FIRST USE 4-19-2011; IN COMMERCE 4-19-2011.

THE MARK CONSISTS OF STANDARD CHARACTERS WITHOUT CLAIM TO ANY PARTICULAR FONT, STYLE, SIZE, OR COLOR.

SER. NO. 85-444,074, FILED 10-11-2011.

KIMBERLY PERRY, EXAMINING ATTORNEY



David J. Kybas

Director of the United States Patent and Trademark Office

United States of America

United States Patent and Trademark Office

DELIVR

Reg. No. 4,153,944

Registered June 5, 2012

Int. Cl.: 42

SERVICE MARK

PRINCIPAL REGISTER

DELIVR (DELAWARE CORPORATION)
606 JOHNSON AVENUE, SUITE 25
BOHEMIA, NY 11716

FOR: PROVIDING A WEB HOSTING PLATFORM FOR THE PURPOSES OF CREATING AND TRACKING ONLINE AND OFFLINE ADVERTISING AND MARKETING PROGRAMS THAT INCLUDE SHORT URLS, 2D BARCODES, SHORT CODES, NEAR FIELD COMMUNICATION (NFC) TAGS, AND PHONE CALLS, IN CLASS 42 (U.S. CLS. 100 AND 101).

FIRST USE 4-22-2008; IN COMMERCE 4-22-2008.

THE MARK CONSISTS OF STANDARD CHARACTERS WITHOUT CLAIM TO ANY PARTICULAR FONT, STYLE, SIZE, OR COLOR.

SER. NO. 85-444,077, FILED 10-11-2011.

KIMBERLY PERRY, EXAMINING ATTORNEY



David J. Kybas

Director of the United States Patent and Trademark Office

United States of America

United States Patent and Trademark Office

BLACKSTONE ACCELERATES GROWTH

Reg. No. 4,153,945

Registered June 5, 2012

Int. Cls.: 35 and 36

SERVICE MARK

PRINCIPAL REGISTER

BLACKSTONE TM L.L.C. (DELAWARE LIMITED LIABILITY COMPANY)
345 PARK AVENUE
NEW YORK, NY 10154

FOR: CHARITABLE SERVICES, NAMELY, PROVIDING EXPERTISE IN THE NATURE OF ASSISTANCE AND ADVICE REGARDING BUSINESS ORGANIZATION AND MANAGEMENT TO STRENGTHEN LOCAL ENTREPRENEURSHIP PROGRAMS, IN CLASS 35 (U.S. CLS. 100, 101 AND 102).

FIRST USE 10-7-2011; IN COMMERCE 10-7-2011.

FOR: CHARITABLE SERVICES, NAMELY, FUNDING LOCAL ENTREPRENEURSHIP PROGRAMS, IN CLASS 36 (U.S. CLS. 100, 101 AND 102).

FIRST USE 10-7-2011; IN COMMERCE 10-7-2011.

THE MARK CONSISTS OF STANDARD CHARACTERS WITHOUT CLAIM TO ANY PARTICULAR FONT, STYLE, SIZE, OR COLOR.

OWNER OF U.S. REG. NOS. 1,986,927, 2,198,568, AND 2,374,887.

SER. NO. 85-444,079, FILED 10-11-2011.

EMILY CHUO, EXAMINING ATTORNEY



David J. Kybas

Director of the United States Patent and Trademark Office

United States of America

United States Patent and Trademark Office

COMEY & SHEPHERD

Reg. No. 4,153,946

Registered June 5, 2012

Int. Cl.: 36

SERVICE MARK

PRINCIPAL REGISTER

COMEY & SHEPHERD HOLDING COMPANY, INC. (OHIO CORPORATION)
6901 WOOSTER PIKE
CINCINNATI, OH 45227

FOR: REAL ESTATE BROKERAGE, IN CLASS 36 (U.S. CLS. 100, 101 AND 102).

FIRST USE 12-31-1953; IN COMMERCE 12-31-1953.

THE MARK CONSISTS OF STANDARD CHARACTERS WITHOUT CLAIM TO ANY PARTICULAR FONT, STYLE, SIZE, OR COLOR.

SER. NO. 85-444,085, FILED 10-11-2011.

ROBERT STRUCK, EXAMINING ATTORNEY



David J. Kybas

Director of the United States Patent and Trademark Office

United States of America

United States Patent and Trademark Office

CrowdNe.ws

Reg. No. 4,153,947

Registered June 5, 2012

Int. Cl.: 42

SERVICE MARK

PRINCIPAL REGISTER

MEDIA SPOON, LLC (MASSACHUSETTS LIMITED LIABILITY COMPANY)
32 CHURCH STREET
SALEM, MA 01970

FOR: PROVIDING CUSTOMIZED ON-LINE WEB PAGES AND DATA FEEDS FEATURING USER-DEFINED INFORMATION, WHICH INCLUDES BLOG POSTS, NEW MEDIA CONTENT, OTHER ON-LINE CONTENT, AND ON-LINE WEB LINKS TO OTHER WEBSITES, IN CLASS 42 (U.S. CLS. 100 AND 101).

FIRST USE 10-3-2011; IN COMMERCE 10-3-2011.

THE MARK CONSISTS OF STANDARD CHARACTERS WITHOUT CLAIM TO ANY PARTICULAR FONT, STYLE, SIZE, OR COLOR.

SER. NO. 85-444,096, FILED 10-11-2011.

MICHAEL GAAFAR, EXAMINING ATTORNEY



David J. Kyffers

Director of the United States Patent and Trademark Office

United States of America

United States Patent and Trademark Office

RENT-A-CENTER

Reg. No. 4,153,948

Registered June 5, 2012

Int. Cl.: 36

SERVICE MARK

PRINCIPAL REGISTER

RENT-A-CENTER WEST, INC. (DELAWARE CORPORATION)
5501 HEADQUARTERS DRIVE
PLANO, TX 75024

FOR: LEASE PURCHASING AND RENTAL TO OWN OF FURNITURE, APPLIANCES,
CONSUMER ELECTRONICS, HOME ENTERTAINMENT PRODUCTS, AND COMPUTERS,
IN CLASS 36 (U.S. CLS. 100, 101 AND 102).

FIRST USE 9-0-1978; IN COMMERCE 9-0-1978.

THE MARK CONSISTS OF STANDARD CHARACTERS WITHOUT CLAIM TO ANY PAR-
TICULAR FONT, STYLE, SIZE, OR COLOR.

OWNER OF U.S. REG. NOS. 1,264,550, 2,876,244 AND OTHERS.

SER. NO. 85-444,100, FILED 10-11-2011.

DAVID MURRAY, EXAMINING ATTORNEY



David J. Kyros

Director of the United States Patent and Trademark Office

United States of America

United States Patent and Trademark Office

Nationwide Lifts

Reg. No. 4,153,949

Registered June 5, 2012

Int. Cl.: 37

SERVICE MARK

PRINCIPAL REGISTER

S & H ENTERPRISES, INC. (NEW YORK CORPORATION), DBA NATIONWIDE LIFTS
11 BROAD STREET
GLENS FALLS, NY 12801

FOR: ELEVATOR AND DUMBWAITER INSTALLATION, MAINTENANCE AND REPAIR,
IN CLASS 37 (U.S. CLS. 100, 103 AND 106).

FIRST USE 5-0-2003; IN COMMERCE 5-0-2003.

THE MARK CONSISTS OF STANDARD CHARACTERS WITHOUT CLAIM TO ANY PAR-
TICULAR FONT, STYLE, SIZE, OR COLOR.

OWNER OF U.S. REG. NO. 2,962,691.

NO CLAIM IS MADE TO THE EXCLUSIVE RIGHT TO USE "LIFTS", APART FROM THE
MARK AS SHOWN.

SEC. 2(F).

SER. NO. 85-444,111, FILED 10-11-2011.

TEJBIR SINGH, EXAMINING ATTORNEY



David J. Kybas

Director of the United States Patent and Trademark Office

United States of America

United States Patent and Trademark Office

SUREGRIP

Reg. No. 4,153,950

Registered June 5, 2012

Int. Cl.: 11

TRADEMARK

PRINCIPAL REGISTER

DE' LONGHI BENELUX S.A. (LUXEMBOURG CORPORATION)
11 RUE BEAUMONT, L-1219
LUXEMBOURG, LUXEMBOURG

FOR: ELECTRIC COFFEE MAKERS; ELECTRIC COFFEE PERCOLATORS; ELECTRIC ESPRESSO MACHINES; ELECTRIC KETTLES; ELECTRIC TOASTERS, IN CLASS 11 (U.S. CLS. 13, 21, 23, 31 AND 34).

THE MARK CONSISTS OF STANDARD CHARACTERS WITHOUT CLAIM TO ANY PARTICULAR FONT, STYLE, SIZE, OR COLOR.

OWNER OF ERPN CMNTY TM OFC REG. NO. 003064417, DATED 8-22-2005, EXPIRES 2-21-2013.

SER. NO. 85-444,114, FILED 10-11-2011.

ELLEN BURNS, EXAMINING ATTORNEY



David J. Kyffers

Director of the United States Patent and Trademark Office

United States of America

United States Patent and Trademark Office

fwoosh

Reg. No. 4,153,951

Registered June 5, 2012

Int. Cl.: 41

SERVICE MARK

PRINCIPAL REGISTER

PAUL G. WOLF (UNITED STATES INDIVIDUAL)
KONGEAAVAENGET 77
ESBJERG V, DENMARK 6710

FOR: ENTERTAINMENT SERVICES, NAMELY, PROVIDING PODCASTS IN THE FIELD OF POP CULTURE, WHICH INCLUDES HORROR, ANIMATION, ANIME, MANGA, TOYS, COLLECTIBLE CARD GAMES, VIDEO GAMES, WEBCOMICS AND FANTASY NOVELS; PROVIDING ON-LINE MAGAZINES IN THE FIELD OF POP CULTURE, WHICH INCLUDES HORROR, ANIMATION, ANIME, MANGA, TOYS, COLLECTIBLE CARD GAMES, VIDEO GAMES, WEBCOMICS AND FANTASY NOVELS, IN CLASS 41 (U.S. CLS. 100, 101 AND 107).

FIRST USE 10-0-2002; IN COMMERCE 10-0-2002.

THE MARK CONSISTS OF STANDARD CHARACTERS WITHOUT CLAIM TO ANY PARTICULAR FONT, STYLE, SIZE, OR COLOR.

SER. NO. 85-444,122, FILED 10-11-2011.

GINA FINK, EXAMINING ATTORNEY



David J. Kybas

Director of the United States Patent and Trademark Office

United States of America

United States Patent and Trademark Office

fwoosh

Reg. No. 4,153,952

Registered June 5, 2012

Int. Cl.: 38

SERVICE MARK

PRINCIPAL REGISTER

PAUL G. WOLF (UNITED STATES INDIVIDUAL)
KONGEAAVAENGET 77
ESBJERG V, DENMARK 6710

FOR: PROVIDING AN ON-LINE FORUM FOR POP CULTURE, WHICH INCLUDES HORROR, ANIMATION, ANIME, MANGA, TOYS, COLLECTIBLE CARD GAMES, VIDEO GAMES, WEBCOMICS AND FANTASY NOVELS , IN CLASS 38 (U.S. CLS. 100, 101 AND 104).

FIRST USE 10-0-2002; IN COMMERCE 10-0-2002.

THE MARK CONSISTS OF STANDARD CHARACTERS WITHOUT CLAIM TO ANY PARTICULAR FONT, STYLE, SIZE, OR COLOR.

SER. NO. 85-444,127, FILED 10-11-2011.

GINA FINK, EXAMINING ATTORNEY



David J. Kybas

Director of the United States Patent and Trademark Office

United States of America

United States Patent and Trademark Office

FIT ESTEEM

Reg. No. 4,153,953

Registered June 5, 2012

Int. Cl.: 41

SERVICE MARK

PRINCIPAL REGISTER

FIT ESTEEM, LLC (NEW JERSEY LIMITED LIABILITY COMPANY)
PO BOX 686
SOUTH ORANGE, NJ 07079

FOR: FITNESS SERVICES, NAMELY, PHYSICAL FITNESS INSTRUCTION AND PERSONAL FITNESS TRAINING; CONDUCTING WORKSHOPS AND SEMINARS IN THE FIELD OF PHYSICAL FITNESS; CONSULTING SERVICES IN THE FIELD OF PHYSICAL FITNESS; EDUCATIONAL SERVICES, NAMELY, PROVIDING SPEAKING SERVICES IN THE FIELD OF PHYSICAL FITNESS, IN CLASS 41 (U.S. CLS. 100, 101 AND 107).

FIRST USE 5-1-1999; IN COMMERCE 5-1-1999.

THE MARK CONSISTS OF STANDARD CHARACTERS WITHOUT CLAIM TO ANY PARTICULAR FONT, STYLE, SIZE, OR COLOR.

NO CLAIM IS MADE TO THE EXCLUSIVE RIGHT TO USE "FIT", APART FROM THE MARK AS SHOWN.

SER. NO. 85-444,134, FILED 10-11-2011.

ODESSA BIBBINS, EXAMINING ATTORNEY



David J. Kyros

Director of the United States Patent and Trademark Office

United States of America

United States Patent and Trademark Office

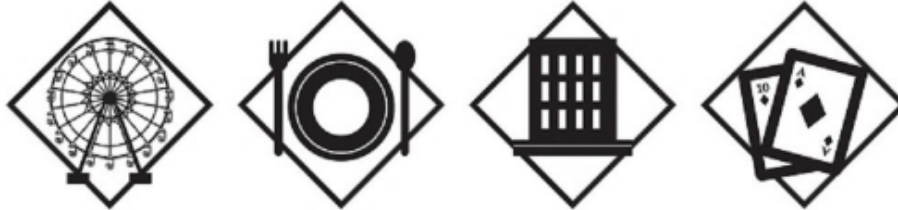

Reg. No. 4,153,954

Registered June 5, 2012

Int. Cl.: 43

SERVICE MARK

PRINCIPAL REGISTER

LANDRY'S TRADEMARK, INC. (DELAWARE CORPORATION)
1510 WEST LOOP SOUTH
HOUSTON, TX 77027

FOR: RESTAURANT AND BAR SERVICES, IN CLASS 43 (U.S. CLS. 100 AND 101).

FIRST USE 2-1-2008; IN COMMERCE 2-1-2008.

OWNER OF U.S. REG. NO. 2,994,063.

THE MARK CONSISTS OF FOUR DIAMOND-SHAPED BOXES WITH DEPICTIONS OF A FERRIS WHEEL; A PLACE SETTING WITH PLATE, FORK AND SPOON; A BUILDING; AND PLAYING CARDS.

SER. NO. 85-444,151, FILED 10-11-2011.

MICHAEL SOUDERS, EXAMINING ATTORNEY



David J. Kyffers

Director of the United States Patent and Trademark Office

United States of America

United States Patent and Trademark Office

We print the dots in Communication

Reg. No. 4,153,955

Registered June 5, 2012

Int. Cl.: 40

SERVICE MARK

PRINCIPAL REGISTER

CARDINAL COLORGROUP PRINTING CORPORATION (ILLINOIS CORPORATION)
1270 ARDMORE AVENUE
ITASCA, IL 60143

FOR: PRINTING, IN CLASS 40 (U.S. CLS. 100, 103 AND 106).

FIRST USE 8-22-2011; IN COMMERCE 8-22-2011.

THE MARK CONSISTS OF STANDARD CHARACTERS WITHOUT CLAIM TO ANY PARTICULAR FONT, STYLE, SIZE, OR COLOR.

SER. NO. 85-444,155, FILED 10-11-2011.

LAURIE KAUFMAN, EXAMINING ATTORNEY



David J. Kybas

Director of the United States Patent and Trademark Office

United States of America

United States Patent and Trademark Office

PRECISION+SPEED+ACCESS=CONFIDENCE

Reg. No. 4,153,956

HAYER ANALYTICS, INC. (NEW YORK CORPORATION)
60 EAST 42ND STREET
NEW YORK, NY 10017

Registered June 5, 2012

Int. Cl.: 38

FOR: PROVIDING ACCESS TO DATABASES, IN CLASS 38 (U.S. CLS. 100, 101 AND 104).

SERVICE MARK

FIRST USE 9-30-2001; IN COMMERCE 9-30-2001.

PRINCIPAL REGISTER

THE MARK CONSISTS OF STANDARD CHARACTERS WITHOUT CLAIM TO ANY PARTICULAR FONT, STYLE, SIZE, OR COLOR.

SER. NO. 85-444,158, FILED 10-11-2011.

MICHAEL WIENER, EXAMINING ATTORNEY



David J. Kybas

Director of the United States Patent and Trademark Office

United States of America
United States Patent and Trademark Office

Adfish

Reg. No. 4,153,957

Registered June 5, 2012

Int. Cl.: 35

SERVICE MARK

PRINCIPAL REGISTER

TRANCOS, INC. (CALIFORNIA CORPORATION)
SUITE NO. 170
6800 KOLL CENTER PARKWAY
PLEASANTON, CA 94566

FOR: ADVERTISING AND MARKETING SERVICES, NAMELY, PROMOTING THE GOODS AND SERVICES OF OTHERS, IN CLASS 35 (U.S. CLS. 100, 101 AND 102).

FIRST USE 11-6-2001; IN COMMERCE 11-6-2001.

THE MARK CONSISTS OF AN ANIMATED WAVE ICON ON THE LEFT AND THE TEXT "ADFISH" ON THE RIGHT.

SER. NO. 85-444,160, FILED 10-11-2011.

Laurie Kaufman, Examining Attorney



David J. Kyros

Director of the United States Patent and Trademark Office

United States of America

United States Patent and Trademark Office

SALBAKOS

Reg. No. 4,153,958

Registered June 5, 2012

Int. Cl.: 24

TRADEMARK

PRINCIPAL REGISTER

MAKROTEKS TEXTILE, LLC (CONNECTICUT LIMITED LIABILITY COMPANY)
56 MURPHY DRIVE
ROCKY HILL, CT 06067

FOR: BATH TOWELS; BEACH TOWELS; CHILDREN'S TOWELS; FACE TOWELS; FACE TOWELS OF TEXTILES; FOOTBALL TOWELS; GOLF TOWELS; HAND TOWELS; HAND TOWELS OF TEXTILE; HAND-TOWELS MADE OF TEXTILE FABRICS; HOODED TOWELS; HOUSEHOLD LINEN, INCLUDING FACE TOWELS; KITCHEN TOWELS; LARGE BATH TOWELS; MOISTURE ABSORBENT MICROFIBER TEXTILE FABRICS FOR USE IN THE MANUFACTURE OF ATHLETIC APPAREL, NAMELY, SHIRTS, PANTS, SHORTS, JACKETS, BAGS, TOWELS AND ATHLETIC UNIFORMS; TEA TOWELS; TERRY TOWELS; TOWEL SETS; TOWEL SHEET; TOWELS; TOWELS; TOWELS MADE OF TEXTILE MATERIALS; TOWELS THAT MAY BE WORN AS A DRESS OR SIMILAR GARMENT; TURKISH TOWEL, IN CLASS 24 (U.S. CLS. 42 AND 50).

FIRST USE 3-3-2011; IN COMMERCE 3-3-2011.

THE MARK CONSISTS OF STANDARD CHARACTERS WITHOUT CLAIM TO ANY PARTICULAR FONT, STYLE, SIZE, OR COLOR.

SER. NO. 85-444,163, FILED 10-11-2011.

LAURIE KAUFMAN, EXAMINING ATTORNEY



David J. Kyros

Director of the United States Patent and Trademark Office

United States of America

United States Patent and Trademark Office

Where Great Pizza Begins

Reg. No. 4,153,959

VENICE BAKING COMPANY (CALIFORNIA CORPORATION)
134 MAIN STREET
EL SEGUNDO, CA 90245

Registered June 5, 2012

Int. Cl.: 30

FOR: FROZEN PIZZA DOUGH ; PAR-BAKED PIZZA CRUST ; GLUTEN-FREE PIZZA CRUST,
IN CLASS 30 (U.S. CL. 46).

TRADEMARK

FIRST USE 3-1-1953; IN COMMERCE 7-1-1962.

PRINCIPAL REGISTER

THE MARK CONSISTS OF STANDARD CHARACTERS WITHOUT CLAIM TO ANY PARTICULAR FONT, STYLE, SIZE, OR COLOR.

SER. NO. 85-444,165, FILED 10-11-2011.

COLLEEN DOMBROW, EXAMINING ATTORNEY



David J. Kybas

Director of the United States Patent and Trademark Office

United States of America

United States Patent and Trademark Office

Planomart

Reg. No. 4,153,960

Registered June 5, 2012

Int. Cl.: 9

TRADEMARK

PRINCIPAL REGISTER

WOLVERT, TERRY D (UNITED STATES INDIVIDUAL)
28560 SW CASCADE LOOP
WILSONVILLE, OR 97070

FOR: COMPUTER SOFTWARE TO AUTOMATE DATA WAREHOUSING, IN CLASS 9 (U.S. CLS. 21, 23, 26, 36 AND 38).

FIRST USE 1-10-2010; IN COMMERCE 11-1-2010.

THE MARK CONSISTS OF STANDARD CHARACTERS WITHOUT CLAIM TO ANY PARTICULAR FONT, STYLE, SIZE, OR COLOR.

SER. NO. 85-444,168, FILED 10-11-2011.

MELISSA VALLILLO, EXAMINING ATTORNEY



David J. Kybas

Director of the United States Patent and Trademark Office

United States of America

United States Patent and Trademark Office

COMPASS ROSE

Reg. No. 4,153,961

Registered June 5, 2012

Int. Cl.: 6

TRADEMARK

PRINCIPAL REGISTER

NORTH COUNTRY WIND BELLS, INC. (MAINE CORPORATION)
544 STATE ROUTE 32
ROUND POND, ME 045643728

FOR: METAL BELLS, IN CLASS 6 (U.S. CLS. 2, 12, 13, 14, 23, 25 AND 50).

FIRST USE 9-12-2011; IN COMMERCE 10-6-2011.

THE MARK CONSISTS OF STANDARD CHARACTERS WITHOUT CLAIM TO ANY PARTICULAR FONT, STYLE, SIZE, OR COLOR.

SER. NO. 85-444,172, FILED 10-11-2011.

SEAN CROWLEY, EXAMINING ATTORNEY



David J. Kyffers

Director of the United States Patent and Trademark Office

United States of America

United States Patent and Trademark Office

PINUPS FOR PATRIOTS

Reg. No. 4,153,962

Registered June 5, 2012

Int. Cl.: 16

TRADEMARK

PRINCIPAL REGISTER

STARS AND STRIPES MARKETING LLC (CALIFORNIA LIMITED LIABILITY COMPANY)
1423 MALLARD DRIVE
JOHNSTOWN, CO 80534

FOR: CALENDARS; PHOTOGRAPHS; POSTERS, IN CLASS 16 (U.S. CLS. 2, 5, 22, 23, 29, 37, 38 AND 50).

FIRST USE 9-15-2010; IN COMMERCE 9-15-2010.

THE MARK CONSISTS OF THE STYLIZED TEXT "PINUPS FOR" WITH THE LETTER "I" MAKING THE SILHOUETTE OF A PINUP GIRL. BELOW THERE IS THE STYLIZED TEXT "PATRIOTS".

SER. NO. 85-444,174, FILED 10-11-2011.

MELISSA VALLILLO, EXAMINING ATTORNEY



David J. Kybas

Director of the United States Patent and Trademark Office

United States of America

United States Patent and Trademark Office

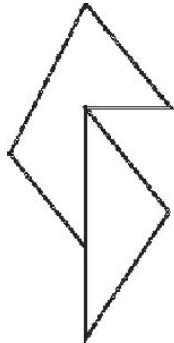

COUPONGY.COM

Reg. No. 4,153,963

Registered June 5, 2012

Int. Cl.: 35

SERVICE MARK

PRINCIPAL REGISTER

COUPONGY, INC. (FLORIDA CORPORATION)
13901 SUTTON PARK DR. S. SUITE 230
JACKSONVILLE, FL 32224

FOR: ONLINE ADVERTISING AND PROMOTIONAL SERVICES, IN CLASS 35 (U.S. CLS. 100, 101 AND 102).

FIRST USE 10-4-2011; IN COMMERCE 10-4-2011.

THE MARK CONSISTS OF A TRIANGLE SHAPED DESIGN ON THE LEFT AND THE TERM "COUPONGY.COM" ON THE RIGHT. THE DESIGN CONTAINS THREE TRIANGLES IN AN INCOMPLETE DIAMOND CONFIGURATION. THE TERM "COUPONGY.COM" IS IN CAPITAL LETTERS AND IS DOUBLE UNDERLINED WITH A THICK SOLID LINE ABOVE A THIN SOLID LINE.

SER. NO. 85-444,188, FILED 10-11-2011.

JEFFREY LOOK, EXAMINING ATTORNEY



David J. Kybas

Director of the United States Patent and Trademark Office

United States of America

United States Patent and Trademark Office



Reg. No. 4,153,964

CRESCENT TIDE LLC (MINNESOTA LIMITED LIABILITY COMPANY)
764 TRANSFER RD
SAINT PAUL, MN 55114

Registered June 5, 2012

Int. Cl.: 45

FOR: FUNERAL HOMES; FUNERAL SERVICES ACCOMPANYING CREMATION, IN CLASS 45 (U.S. CLS. 100 AND 101).

SERVICE MARK

FIRST USE 2-20-2011; IN COMMERCE 3-1-2011.

PRINCIPAL REGISTER

NO CLAIM IS MADE TO THE EXCLUSIVE RIGHT TO USE "FUNERALS CREMATION", APART FROM THE MARK AS SHOWN.

THE MARK CONSISTS OF A SKETCHED CRESCENT SHAPED IN A HALF MOON WITH THE BOTTOM HALF HAVING THE APPEARANCE OF A REFLECTION OF THE TOP HALF. TO THE RIGHT THERE IS THE STYLIZED TEXT "CRESCENTTIDE FUNERALS CREMATION".

SER. NO. 85-444,228, FILED 10-11-2011.

HANNO RITTNER, EXAMINING ATTORNEY



David J. Kybas

Director of the United States Patent and Trademark Office

United States of America

United States Patent and Trademark Office

MODERN ALCHEMY

Reg. No. 4,153,965

MONTES DE OCA, CARLYN (UNITED STATES INDIVIDUAL)
130 GREENFIELD AVENUE, SUITE 2
SAN ANSELMO, CA 94960

Registered June 5, 2012

Int. Cl.: 44

FOR: ACUPUNCTURE SERVICES; NUTRITION COUNSELING; WELLNESS AND HEALTH-RELATED CONSULTING SERVICES, IN CLASS 44 (U.S. CLS. 100 AND 101).

SERVICE MARK

FIRST USE 12-6-2005; IN COMMERCE 12-6-2005.

PRINCIPAL REGISTER

THE MARK CONSISTS OF STANDARD CHARACTERS WITHOUT CLAIM TO ANY PARTICULAR FONT, STYLE, SIZE, OR COLOR.

SER. NO. 85-444,230, FILED 10-11-2011.

CHRISIE B. KING, EXAMINING ATTORNEY



David J. Kybas

Director of the United States Patent and Trademark Office

United States of America

United States Patent and Trademark Office



Reg. No. 4,153,966

Registered June 5, 2012

Int. Cls.: 35 and 39

SERVICE MARK

PRINCIPAL REGISTER

VALLEY SOLUTIONS, INC. (OHIO CORPORATION), DBA TOWING.COM
SUITE 1
12 W. BENSON ST.
CINCINNATI, OH 45215

FOR: ON-LINE ADVERTISING SERVICES FOR OTHERS; ON-LINE RETAIL STORE SERVICES FEATURING CLOTHING AND AUTOMOTIVE PRODUCTS AND EQUIPMENT , IN CLASS 35 (U.S. CLS. 100, 101 AND 102).

FIRST USE 7-0-2007; IN COMMERCE 7-0-2007.

FOR: VEHICLE TOWING, IN CLASS 39 (U.S. CLS. 100 AND 105).

FIRST USE 7-0-2007; IN COMMERCE 7-0-2007.

THE MARK CONSISTS OF A STYLIZED "G" WITH A SMALL DOT ON THE UPPER RIGHT HAND SIDE.

SER. NO. 85-444,248, FILED 10-11-2011.

MARILYN IZZI, EXAMINING ATTORNEY



David J. Kybas

Director of the United States Patent and Trademark Office

United States of America

United States Patent and Trademark Office

EXPLORE TOURS

Reg. No. 4,153,967

Registered June 5, 2012

Int. Cls.: 39 and 43

SERVICE MARK

PRINCIPAL REGISTER

EXPLORE TOURS, LLC (ALASKA LIMITED LIABILITY COMPANY)
999 EAST TUDOR ROAD, SUITE 200
ANCHORAGE, AK 99503

FOR: ARRANGING AND COORDINATING TRAVEL ARRANGEMENTS FOR INDIVIDUALS AND GROUPS; BOOKING SEATS FOR TRAVEL FOR INDIVIDUALS AND GROUPS; AND ARRANGING TRAVEL TOURS AND CRUISES, IN CLASS 39 (U.S. CLS. 100 AND 105).

FIRST USE 12-31-1999; IN COMMERCE 12-31-1999.

FOR: BOOKING TEMPORARY LODGING FOR INDIVIDUALS AND GROUPS, IN CLASS 43 (U.S. CLS. 100 AND 101).

FIRST USE 12-31-1999; IN COMMERCE 12-31-1999.

THE MARK CONSISTS OF STANDARD CHARACTERS WITHOUT CLAIM TO ANY PARTICULAR FONT, STYLE, SIZE, OR COLOR.

NO CLAIM IS MADE TO THE EXCLUSIVE RIGHT TO USE "TOURS", APART FROM THE MARK AS SHOWN.

SER. NO. 85-444,259, FILED 10-11-2011.

MICHAEL LITZAU, EXAMINING ATTORNEY



David J. Kybas

Director of the United States Patent and Trademark Office

United States of America

United States Patent and Trademark Office

JC'S GIRLS

Reg. No. 4,153,968

Registered June 5, 2012

Int. Cl.: 45

SERVICE MARK

PRINCIPAL REGISTER

BROWN, SHERI (UNITED STATES INDIVIDUAL)
241 JOYCE STREET
EL CAJON, CA 92020 AND

SCHER, THERESA (UNITED STATES INDIVIDUAL)
241 JOYCE STREET
EL CAJON, CA 92020

FOR: CHRISTIAN MINISTRY SERVICES, IN CLASS 45 (U.S. CLS. 100 AND 101).

FIRST USE 8-1-2006; IN COMMERCE 3-1-2009.

THE MARK CONSISTS OF STANDARD CHARACTERS WITHOUT CLAIM TO ANY PARTICULAR FONT, STYLE, SIZE, OR COLOR.

NO CLAIM IS MADE TO THE EXCLUSIVE RIGHT TO USE "GIRLS", APART FROM THE MARK AS SHOWN.

SER. NO. 85-444,263, FILED 10-11-2011.

LINDA E. BLOHM, EXAMINING ATTORNEY



David J. Kyros

Director of the United States Patent and Trademark Office

United States of America

United States Patent and Trademark Office

DLX

Reg. No. 4,153,969

Registered June 5, 2012

Int. Cl.: 9

TRADEMARK

PRINCIPAL REGISTER

HAYER ANALYTICS, INC. (NEW YORK CORPORATION)
60 EAST 42ND STREET
NEW YORK, NY 10017

FOR: DATABASE MANAGEMENT SOFTWARE FOR STORAGE, MAINTENANCE, MANIPULATION AND USE OF INTERNATIONAL ECONOMIC AND FINANCIAL DATA, IN CLASS 9 (U.S. CLS. 21, 23, 26, 36 AND 38).

FIRST USE 4-30-1987; IN COMMERCE 10-31-1987.

THE MARK CONSISTS OF STANDARD CHARACTERS WITHOUT CLAIM TO ANY PARTICULAR FONT, STYLE, SIZE, OR COLOR.

SER. NO. 85-444,266, FILED 10-11-2011.

MICHAEL WIENER, EXAMINING ATTORNEY



David J. Kybas

Director of the United States Patent and Trademark Office

United States of America

United States Patent and Trademark Office

Incomercials

Reg. No. 4,153,970

Registered June 5, 2012

Int. Cl.: 35

SERVICE MARK

PRINCIPAL REGISTER

GOTTSCHALK, DAVE (UNITED STATES INDIVIDUAL), DBA INCOMERCIALS LLC
652 SOUTH EMERSON
DENVER, CO 80209

FOR: ADVERTISEMENT FOR OTHERS ON THE INTERNET; ADVERTISING AND COMMERCIAL INFORMATION SERVICES, VIA THE INTERNET; ADVERTISING AND MARKETING SERVICES PROVIDED BY MEANS OF INDIRECT METHODS OF MARKETING COMMUNICATIONS, NAMELY, SOCIAL MEDIA, SEARCH ENGINE MARKETING, INQUIRY MARKETING, INTERNET MARKETING, MOBILE MARKETING, BLOGGING AND OTHER FORMS OF PASSIVE, SHARABLE OR VIRAL COMMUNICATIONS CHANNELS; ADVERTISING ON THE INTERNET FOR OTHERS; ADVERTISING SERVICES, NAMELY, PROMOTING PROPERTIES FOR SALE BY OWNER VIA THE INTERNET; ADVICE AND INFORMATION ABOUT CUSTOMER SERVICES AND PRODUCT MANAGEMENT AND PRICES ON INTERNET SITES IN CONNECTION WITH PURCHASES MADE OVER THE INTERNET; AN INTERACTIVE WEB SITE FOR USERS TO REVIEW AND RATE INTERNET CONTENT, PEOPLE, COMPANIES, PRODUCTS AND/OR SERVICES UTILIZING A SOFTWARE APPLICATION TO AWARD POINTS WHEREBY WEB SITE USERS ARE ELIGIBLE TO EXCHANGE POINTS EARNED FOR PROMOTIONAL ITEMS CONSISTING OF COUPONS, REBATES, DISCOUNTS OR SPECIAL OFFERINGS ON GOODS AND/OR SERVICE PROVIDED BY WEB SITE SPONSORS; AUCTIONEERING PROVIDED ON THE INTERNET; BUSINESS ADMINISTRATION SERVICES FOR PROCESSING SALES MADE ON THE INTERNET; BUSINESS MANAGEMENT CONSULTANCY, ALSO VIA THE INTERNET; BUSINESS SERVICES, NAMELY, FREIGHT INFORMATION MANAGEMENT SERVICES, SHIPMENT PROCESSING, PREPARING SHIPPING DOCUMENTS AND INVOICES, TRACKING DOCUMENTS, PACKAGES AND FREIGHT OVER COMPUTER NETWORKS, INTRANETS AND INTERNETS; COMPILATION OF ADVERTISEMENTS FOR USE AS WEB PAGES ON THE INTERNET; COMPUTER SERVICES, NAMELY, ADDRESS CHANGE NOTIFICATION SERVICES IN THE NATURE OF POSTING NOTIFICATIONS OF CHANGES OF ADDRESSES FOR BUSINESSES VIA THE INTERNET; CONSULTING SERVICES IN THE FIELD OF INTERNET MARKETING; DESIGN OF INTERNET ADVERTISING; DISSEMINATION OF ADVERTISING FOR OTHERS VIA THE INTERNET; FACILITATING THE EXCHANGE OF NEEDED INFORMATION FOR FINANCIAL COMPENSATION VIA THE INTERNET; INFORMATION MANAGEMENT SERVICES, NAMELY, SHIPMENT PROCESSING, PREPARING SHIPPING DOCUMENTS AND INVOICES, TRACKING DOCUMENTS, PACKAGES AND FREIGHT OVER COMPUTER NETWORKS, INTRANETS AND INTERNETS; INFORMATION, ADVISORY AND CONSULTANCY SERVICES RELATING TO BUSINESS AND MANAGEMENT OR BUSINESS ADMINISTRATION, INCLUDING SUCH SERVICES PROVIDED ON



David J. Kappas

Director of the United States Patent and Trademark Office

Reg. No. 4,153,970 LINE OR VIA THE INTERNET; INSURANCE LEAD COLLECTION AND MATCHING SERVICES, NAMELY, MATCHING CONSUMER REQUESTS FOR INSURANCE POLICY QUOTES COLLECTED OVER THE INTERNET TO PRE-QUALIFIED INSURANCE BROKERS, AGENTS AND AGENCIES INTERESTED IN THOSE REQUESTS; INTERNET ADVERTISING SERVICES; MANAGEMENT OF ADVERTISING THROUGH A COMMAND AND CONTROL CENTER FOR BOTH MOVIE THEATRE ON-SCREEN ADVERTISING AND OVER THE INTERNET; MARKET MANIPULATION RESEARCH AND ANALYSIS, WHETHER OR NOT VIA THE INTERNET; ON-LINE AUCTIONEERING SERVICES VIA THE INTERNET; ON-LINE BUSINESS RESEARCH SERVICE THAT ALLOWS THE USER TO ANALYZE OPINION TRENDS CONTAINED IN DOCUMENTS ON THE INTERNET; ON-LINE TRADING SERVICES IN WHICH SELLER POSTS PRODUCTS TO BE AUCTIONED AND BIDDING IS DONE VIA THE INTERNET; ONLINE MEDIA MONITORING SERVICES USING COMPUTER SOFTWARE TO AUTOMATICALLY MONITOR INTERNET WEBSITES AND ONLINE PUBLICATIONS FOR CUSTOMER-SPECIFIED TOPICS AND TO CAPTURE RELEVANT CONTENT ON THOSE TOPICS, AND PROVIDING DOCUMENTATION AND ANALYSIS OF THAT ONLINE CONTENT TO OTHERS FOR BUSINESS PURPOSES; ORGANISATION OF INTERNET AUCTIONS; PROMOTING THE GOODS AND SERVICES OF OTHERS BY MEANS OF DISTRIBUTING ADVERTISING ON THE INTERNET; PROMOTING VISUAL AND PERFORMING ARTS EVENTS BY MEANS OF PROVIDING AN ONLINE EVENTS CALENDAR, ORIGINAL ARTICLES, INTERVIEWS, AND INFORMATION ABOUT ART, ARTISTS AND ARTS EVENTS VIA AN INTERNET WEB SITE, ALL FOR PROMOTIONAL PURPOSES; PROVIDING A SEARCHABLE INTERNET DATABASE OF POTENTIAL HOME BUYERS WITH THE PURPOSE OF MATCHING HOME BUYERS WITH HOME SELLERS; PROVIDING A SEARCHABLE ON-LINE ADVERTISING WEBSITE AND GUIDE FEATURING THE GOODS AND SERVICES OF OTHER VENDORS VIA THE INTERNET; PROVIDING A SEARCHABLE ONLINE ADVERTISING WEBSITE AND INFORMATIONAL GUIDE FEATURING THE GOODS AND SERVICES OF OTHER VENDORS VIA THE INTERNET IN THE FIELD OF INTERNET MARKETING; PROVIDING A SECURED ACCESS DATABASE VIA THE INTERNET THROUGH WHICH DOCUMENTS AND IMAGES CAN BE VIEWED, COPIED, AND PRINTED FOR PURPOSES OF CONDUCTING CORPORATE TRANSACTIONS; PROVIDING AN INTERNET WEBSITE FEATURING NEWS AND INFORMATION IN THE FIELD OF NATIONAL AND INTERNATIONAL POLITICS; PROVIDING AN INTERNET WEBSITE FEATURING NEWS AND INFORMATION IN THE FIELD OF NATURAL RESOURCE MANAGEMENT RELATING TO THE ENVIRONMENT AND PUBLIC LANDS; PROVIDING AN INTERNET WEBSITE PORTAL FEATURING LINKS TO MUSIC-RELATED MERCHANDISE FOR RETAIL PURPOSES; PROVIDING AN INTERNET WEBSITE PORTAL FEATURING PROMOTION AND ADVERTISING FOR HOME SERVICE PROVIDERS AND PRODUCT MANUFACTURERS; PROVIDING AN INTERNET-BASED DATABASE OF PATIENT MEDICAL INFORMATION DESIGNED TO FACILITATE PATIENT-AUTHORIZED, HIPAA-COMPLIANT SHARING AND MAINTENANCE OF PATIENT MEDICAL INFORMATION AMONGST A PATIENT'S DOCTORS SUCH THAT THIS INFORMATION CAN BE DIRECTLY INSERTED INTO THE DOCTOR'S MEDICAL REPORTS AS A MEANS OF INCREASING MEDICAL RECORD GENERATION EFFICIENCY AND ACCURACY; PROVIDING AN ON-LINE COMMERCIAL INFORMATION DIRECTORY ON THE INTERNET; PROVIDING AND RENTAL OF ADVERTISING SPACE ON THE INTERNET; PROVIDING BUSINESS INFORMATION, ALSO VIA INTERNET, THE CABLE NETWORK OR OTHER FORMS OF DATA TRANSFER; PROVIDING BUSINESS INFORMATION, NAMELY, COMMERCIAL CORPORATE AND STATISTICAL INFORMATION PROVIDED ON-LINE FROM A COMPUTER DATABASE OR THE INTERNET; PROVIDING CONSUMER PRODUCT INFORMATION VIA THE INTERNET; PROVIDING INFORMATION ABOUT AUTOMOBILES FOR SALE BY MEANS OF THE INTERNET; PROVIDING INFORMATION IN THE FIELD OF AVIATION FUEL MANAGEMENT VIA THE INTERNET, NAMELY, THE AMOUNT OF FUEL LOADED ONTO AIRCRAFT AND MAINTAINING OPERATIONAL CONTROL OF FUEL AVAILABLE AND DELIVERED TO AIRCRAFT; PROVIDING INFORMATION IN THE FIELD OF NURSING CAREERS VIA THE INTERNET; PROVIDING INFORMATION PERTAINING TO PROCUREMENT, BUYING, SELLING AND TENDERING INFORMATION AND OPPORTUNITIES RELATING TO GOODS, SERVICES, AND CONSTRUCTION VIA COMPUTER, COMPUTER NETWORKS, TELEPHONE, THE INTERNET OR ELECTRONIC MAIL; RESELLER SERVICES,

Reg. No. 4,153,970 NAMELY, DISTRIBUTORSHIP SERVICES IN THE FIELD OF CABLE AND DSL TELEVISION AND INTERNET ENTERTAINMENT PRODUCTS AND SERVICES; SUBSCRIPTION TO A TELEMATICS, TELEPHONE OR COMPUTER SERVICE; THE BRINGING TOGETHER OF CONSUMERS AND PROVIDERS OF A VARIETY OF GOODS AND SERVICES IN THE FIELD OF ATHLETICS FOR COMMERCIAL PURPOSES VIA THE INTERNET; THE BRINGING TOGETHER, FOR THE BENEFIT OF OTHERS, OF A VARIETY OF GOODS AND SERVICES, ENABLING CUSTOMERS TO CONVENIENTLY VIEW AND PURCHASE THOSE GOODS AND SERVICES FROM AN INTERNET WEB SITE PARTICULARLY SPECIALIZING IN THE MARKETING OF THE SALE OF GOODS AND SERVICES OF OTHERS, IN CLASS 35 (U.S. CLS. 100, 101 AND 102).

FIRST USE 3-1-2011; IN COMMERCE 4-1-2011.

THE MARK CONSISTS OF STANDARD CHARACTERS WITHOUT CLAIM TO ANY PARTICULAR FONT, STYLE, SIZE, OR COLOR.

SER. NO. 85-444,267, FILED 10-11-2011.

TEJBIR SINGH, EXAMINING ATTORNEY

United States of America

United States Patent and Trademark Office

Global Village Kids

Reg. No. 4,153,971

GLOBAL VILLAGE KIDS, LLC (CALIFORNIA LIMITED LIABILITY COMPANY)
4111 CALAVO DRIVE
LA MESA, CA 91941

Registered June 5, 2012

Int. Cl.: 9

FOR: CHILDREN'S EDUCATIONAL MUSIC CDS AND DVDS, IN CLASS 9 (U.S. CLS. 21, 23, 26, 36 AND 38).

TRADEMARK

FIRST USE 12-15-2003; IN COMMERCE 12-15-2003.

PRINCIPAL REGISTER

THE MARK CONSISTS OF STANDARD CHARACTERS WITHOUT CLAIM TO ANY PARTICULAR FONT, STYLE, SIZE, OR COLOR.

OWNER OF U.S. REG. NO. 3,317,076.

NO CLAIM IS MADE TO THE EXCLUSIVE RIGHT TO USE "KIDS", APART FROM THE MARK AS SHOWN.

SER. NO. 85-444,276, FILED 10-11-2011.

KATHERINE CHANG, EXAMINING ATTORNEY



David J. Kyffers

Director of the United States Patent and Trademark Office

United States of America

United States Patent and Trademark Office

DRESSED UP

Reg. No. 4,153,972

Registered June 5, 2012

Int. Cl.: 30

TRADEMARK

PRINCIPAL REGISTER

J & A, LLC (COLORADO LIMITED LIABILITY COMPANY)
UNIT 15
3094 BOOTH FALLS ROAD
VAIL, CO 81657

FOR: SALAD DRESSINGS, IN CLASS 30 (U.S. CL. 46).

FIRST USE 7-10-2011; IN COMMERCE 7-10-2011.

THE MARK CONSISTS OF STANDARD CHARACTERS WITHOUT CLAIM TO ANY PARTICULAR FONT, STYLE, SIZE, OR COLOR.

SER. NO. 85-444,287, FILED 10-11-2011.

DAVID I, EXAMINING ATTORNEY



David J. Kyfos

Director of the United States Patent and Trademark Office

United States of America

United States Patent and Trademark Office

KMIX

Reg. No. 4,153,973

DE' LONGHI BENELUX S.A. (LUXEMBOURG CORPORATION)
11 RUE BEAUMONT, L-1219
LUXEMBOURG, LUXEMBOURG

Registered June 5, 2012

Int. Cl.: 11

FOR: ELECTRIC COFFEE MAKERS; ELECTRIC KETTLES; ELECTRIC TOASTERS, IN CLASS 11 (U.S. CLS. 13, 21, 23, 31 AND 34).

TRADEMARK

FIRST USE 11-1-2009; IN COMMERCE 10-1-2011.

PRINCIPAL REGISTER

THE MARK CONSISTS OF STANDARD CHARACTERS WITHOUT CLAIM TO ANY PARTICULAR FONT, STYLE, SIZE, OR COLOR.

SER. NO. 85-444,291, FILED 10-11-2011.

ELLEN BURNS, EXAMINING ATTORNEY



David J. Kybas

Director of the United States Patent and Trademark Office

United States of America

United States Patent and Trademark Office



Reg. No. 4,153,974

Registered June 5, 2012

Int. Cl.: 35

SERVICE MARK

PRINCIPAL REGISTER

CHOICE PROPERTY RESOURCES, INC. (OHIO CORPORATION)
SUITE 302
300 WEST SPRING STREET
COLUMBUS, OH 43215

FOR: BUSINESS CONSULTATION PROVIDED TO OWNERS AND MANAGERS OF MULTI-FAMILY RESIDENCES TO SIMPLIFY MOVING-IN FOR RESIDENTS AND TO PROMOTE GENERATION OF NON-RENT REVENUE USING A REVENUE SHARING PROGRAM BASED ON SPENDING ACTIVITY FOR SERVICES MARKETED BY PROPERTY PERSONNEL, IN CLASS 35 (U.S. CLS. 100, 101 AND 102).

FIRST USE 1-31-2004; IN COMMERCE 1-31-2004.

NO CLAIM IS MADE TO THE EXCLUSIVE RIGHT TO USE "PROPERTY RESOURCES, INC.", APART FROM THE MARK AS SHOWN.

THE MARK CONSISTS OF A HOUSE ROOF AND WINDOW DESIGN ABOVE THE TEXT "CHOICE PROPERTY RESOURCES, INC.".

SER. NO. 85-444,292, FILED 10-11-2011.

TINA MAI, EXAMINING ATTORNEY



David J. Kybas

Director of the United States Patent and Trademark Office

United States of America

United States Patent and Trademark Office

Medi-Sheen

Reg. No. 4,153,975

Registered June 5, 2012

Int. Cl.: 3

COMPLETE SOLUTIONS TECHNOLOGIES, LLC (NEW JERSEY LIMITED LIABILITY COMPANY)
214 WEST MAIN STREET
SUITE L-5
MOORESTOWN, NJ 08057

TRADEMARK

PRINCIPAL REGISTER

FOR: STAIN REMOVER AND RUST REMOVING PREPARATIONS FOR USE ON STAINLESS STEEL SURGICAL INSTRUMENTS, WASHERS, AND STEAM STERILIZERS , IN CLASS 3 (U.S. CLS. 1, 4, 6, 50, 51 AND 52).

FIRST USE 1-1-2011; IN COMMERCE 1-1-2011.

THE MARK CONSISTS OF STANDARD CHARACTERS WITHOUT CLAIM TO ANY PARTICULAR FONT, STYLE, SIZE, OR COLOR.

SER. NO. 85-444,299, FILED 10-11-2011.

ROBERT C. CLARK JR., EXAMINING ATTORNEY



David J. Kyffers

Director of the United States Patent and Trademark Office

United States of America

United States Patent and Trademark Office

CHOICE PROPERTY RESOURCES

Reg. No. 4,153,976

Registered June 5, 2012

Int. Cl.: 35

SERVICE MARK

PRINCIPAL REGISTER

CHOICE PROPERTY RESOURCES, INC. (OHIO CORPORATION)
SUITE 302
300 WEST SPRING STREET
COLUMBUS, OH 43215

FOR: BUSINESS CONSULTATION PROVIDED TO OWNERS AND MANAGERS OF MULTI-FAMILY RESIDENCES TO SIMPLIFY MOVING-IN FOR RESIDENTS AND TO PROMOTE GENERATION OF NON-RENT REVENUE USING A REVENUE SHARING PROGRAM BASED ON SPENDING ACTIVITY FOR SERVICES MARKETED BY PROPERTY PERSONNEL, IN CLASS 35 (U.S. CLS. 100, 101 AND 102).

FIRST USE 1-4-1999; IN COMMERCE 1-4-1999.

THE MARK CONSISTS OF STANDARD CHARACTERS WITHOUT CLAIM TO ANY PARTICULAR FONT, STYLE, SIZE, OR COLOR.

NO CLAIM IS MADE TO THE EXCLUSIVE RIGHT TO USE "PROPERTY RESOURCES", APART FROM THE MARK AS SHOWN.

SER. NO. 85-444,312, FILED 10-11-2011.

TINA MAI, EXAMINING ATTORNEY



David J. Kybas

Director of the United States Patent and Trademark Office

United States of America

United States Patent and Trademark Office

AEF

Reg. No. 4,153,977

Registered June 5, 2012

Int. Cl.: 36

SERVICE MARK

PRINCIPAL REGISTER

ARIZONA EDUCATIONAL FOUNDATION, INC. (ARIZONA CORPORATION)
6155 E. INDIAN SCHOOL ROAD, #106
SCOTTSDALE, AZ 85251

FOR: CHARITABLE FOUNDATION SERVICES, NAMELY, FUNDING PROGRAMS THAT RECOGNIZE EXCELLENCE IN EDUCATION AND ENHANCE THE CAPABILITIES OF SCHOOL DISTRICTS TO: STRENGTHEN THE TEACHING PROFESSION, DESIGN HIGH QUALITY CURRICULA AND STIMULATE STUDENT ACHIEVEMENT, IN CLASS 36 (U.S. CLS. 100, 101 AND 102).

FIRST USE 9-30-1987; IN COMMERCE 9-30-1987.

THE MARK CONSISTS OF STANDARD CHARACTERS WITHOUT CLAIM TO ANY PARTICULAR FONT, STYLE, SIZE, OR COLOR.

SER. NO. 85-444,320, FILED 10-11-2011.

KAREN K. BUSH, EXAMINING ATTORNEY



David J. Kybas

Director of the United States Patent and Trademark Office

United States of America

United States Patent and Trademark Office



GIVING SOLES

Reg. No. 4,153,978

SHOEBACCA, LTD. (TEXAS LIMITED PARTNERSHIP)
2205 EAST PIONEER ROAD
IRVING, TX 75061

Registered June 5, 2012

Int. Cl.: 36

FOR: CHARITABLE FUNDRAISING SERVICES BY MEANS OF COLLECTING AND DONATING SHOES, IN CLASS 36 (U.S. CLS. 100, 101 AND 102).

SERVICE MARK

FIRST USE 5-26-2011; IN COMMERCE 5-26-2011.

PRINCIPAL REGISTER

THE MARK CONSISTS OF THE WORDS "GIVING SOLES" BELOW A HAND IMPRINT WITH A SHOE PRINT OUTLINE WITHIN THE HAND IMPRINT.

SER. NO. 85-444,326, FILED 10-11-2011.

NAAKWAMA ANKRAH, EXAMINING ATTORNEY



David J. Kybas

Director of the United States Patent and Trademark Office

United States of America

United States Patent and Trademark Office

AEF

Reg. No. 4,153,979

Registered June 5, 2012

Int. Cl.: 41

SERVICE MARK

PRINCIPAL REGISTER

ARIZONA EDUCATIONAL FOUNDATION, INC. (ARIZONA CORPORATION)
6155 E. INDIAN SCHOOL ROAD, #106
SCOTTSDALE, AZ 85251

FOR: PROVIDING RECOGNITION AND INCENTIVES BY THE WAY OF AWARDS AND CONTESTS TO DEMONSTRATE EXCELLENCE IN THE FIELD OF EDUCATION; EDUCATIONAL SERVICES, NAMELY, PROVIDING CONTINUING PROFESSIONAL EDUCATION COURSES FOR EDUCATORS AND SCHOOL ADMINISTRATORS; EDUCATION SERVICES IN THE NATURE OF CLASSES IN THE FIELD OF LEADERSHIP DEVELOPMENT FOR EDUCATORS AND SCHOOL ADMINISTRATORS; ENTERTAINMENT AND EDUCATION IN THE NATURE OF COMPETITIONS IN THE FIELD OF SPELLING; ENTERTAINMENT AND EDUCATION IN THE NATURE OF COMPETITIONS IN THE FIELD OF WRITING; ARRANGING AND CONDUCTING ACADEMIC COMPETITIONS, IN CLASS 41 (U.S. CLS. 100, 101 AND 107).

FIRST USE 9-30-1987; IN COMMERCE 9-30-1987.

THE MARK CONSISTS OF STANDARD CHARACTERS WITHOUT CLAIM TO ANY PARTICULAR FONT, STYLE, SIZE, OR COLOR.

SER. NO. 85-444,333, FILED 10-11-2011.

KAREN K. BUSH, EXAMINING ATTORNEY



David J. Kyffers

Director of the United States Patent and Trademark Office

United States of America

United States Patent and Trademark Office

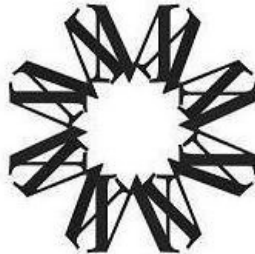

Reg. No. 4,153,980

Registered June 5, 2012

Int. Cl.: 41

SERVICE MARK

PRINCIPAL REGISTER

MATER ACADEMY, INC. (FLORIDA CORPORATION)
7901 N.W. 98TH STREET
HIALEAH GARDENS, FL 33016

FOR: EDUCATION SERVICES, NAMELY, PROVIDING KINDERGARTEN THROUGH 12TH GRADE (K-12) CLASSROOM INSTRUCTION; EDUCATIONAL SERVICES IN THE NATURE OF CHARTER SCHOOLS, IN CLASS 41 (U.S. CLS. 100, 101 AND 107).

FIRST USE 4-9-2008; IN COMMERCE 4-9-2008.

THE MARK CONSISTS OF THE DESIGN OF INTERLOCKING LETTERS "M" FORMING A CIRCLE.

SER. NO. 85-444,344, FILED 10-11-2011.

MARC LEIPZIG, EXAMINING ATTORNEY



David J. Kyros

Director of the United States Patent and Trademark Office

United States of America

United States Patent and Trademark Office

UNISCRAPER

Reg. No. 4,153,981

Registered June 5, 2012

Int. Cl.: 27

TRADEMARK

PRINCIPAL REGISTER

UNIFIRST CORPORATION (MASSACHUSETTS CORPORATION)
68 JONSPIN ROAD
WILMINGTON, MA 01887

FOR: FLOOR MATS, IN CLASS 27 (U.S. CLS. 19, 20, 37, 42 AND 50).

FIRST USE 6-0-2005; IN COMMERCE 6-0-2005.

THE MARK CONSISTS OF STANDARD CHARACTERS WITHOUT CLAIM TO ANY PARTICULAR FONT, STYLE, SIZE, OR COLOR.

SER. NO. 85-444,360, FILED 10-11-2011.

CORY BOONE, EXAMINING ATTORNEY



David J. Kybas

Director of the United States Patent and Trademark Office

United States of America

United States Patent and Trademark Office

WHERE'S YOUR JEW CREW?

Reg. No. 4,153,982

JESSICA MORENO (UNITED STATES INDIVIDUAL)
12258 ROCKLEDGE CIRCLE
BOCA RATON, FL 33428

Registered June 5, 2012

Int. Cl.: 45

FOR: ONLINE SOCIAL NETWORKING SERVICES IN THE FIELD OF JEWISH CULTURAL AND RELIGIOUS ACTIVITIES PROVIDED VIA A WEBSITE, IN CLASS 45 (U.S. CLS. 100 AND 101).

SERVICE MARK

FIRST USE 10-10-2011; IN COMMERCE 10-10-2011.

PRINCIPAL REGISTER

THE MARK CONSISTS OF STANDARD CHARACTERS WITHOUT CLAIM TO ANY PARTICULAR FONT, STYLE, SIZE, OR COLOR.

SER. NO. 85-444,385, FILED 10-11-2011.

NAAKWAMA ANKRAH, EXAMINING ATTORNEY



David J. Kyffers

Director of the United States Patent and Trademark Office

United States of America

United States Patent and Trademark Office

OUDDADA WADDA

Reg. No. 4,153,983

DIRK HOFFIUS (UNITED STATES INDIVIDUAL)
3000 BONNELL AVE. SE
GRAND RAPIDS, MI 49506

Registered June 5, 2012

Int. Cl.: 25

FOR: CLOTHING, NAMELY, SHIRTS, T-SHIRTS, AND HATS; OUTERWEAR, NAMELY, JACKETS, SWEATERS AND SWEATSHIRTS, IN CLASS 25 (U.S. CLS. 22 AND 39).

TRADEMARK

FIRST USE 7-15-2011; IN COMMERCE 7-15-2011.

PRINCIPAL REGISTER

THE MARK CONSISTS OF STANDARD CHARACTERS WITHOUT CLAIM TO ANY PARTICULAR FONT, STYLE, SIZE, OR COLOR.

SER. NO. 85-444,438, FILED 10-11-2011.

MICHAEL GAAFAR, EXAMINING ATTORNEY



David J. Kyffers

Director of the United States Patent and Trademark Office

United States of America

United States Patent and Trademark Office

W-A-Y Program Widening Advancements for Youth

Reg. No. 4,153,984

Registered June 5, 2012

Int. Cl.: 41

SERVICE MARK

PRINCIPAL REGISTER

W-A-Y WIDENING ADVANCEMENTS FOR YOUTH (MICHIGAN NON-PROFIT CORPORATION)
369 MAIN STREET
BELLEVILLE, MI 48111

FOR: EDUCATION SERVICES, NAMELY, PROVIDING LIVE AND ON-LINE CLASSES IN THE FIELD OF GENERAL K-12 EDUCATION, IN CLASS 41 (U.S. CLS. 100, 101 AND 107).

FIRST USE 7-1-2011; IN COMMERCE 7-1-2011.

THE MARK CONSISTS OF STANDARD CHARACTERS WITHOUT CLAIM TO ANY PARTICULAR FONT, STYLE, SIZE, OR COLOR.

OWNER OF U.S. REG. NO. 4,057,136.

NO CLAIM IS MADE TO THE EXCLUSIVE RIGHT TO USE "PROGRAM", APART FROM THE MARK AS SHOWN.

SER. NO. 85-444,455, FILED 10-11-2011.

TARAH HARDY, EXAMINING ATTORNEY



David J. Kyros

Director of the United States Patent and Trademark Office

United States of America

United States Patent and Trademark Office

VITASONIK

Reg. No. 4,153,985

Registered June 5, 2012

Int. Cl.: 10

TRADEMARK

PRINCIPAL REGISTER

TECILLA COS-MED UG (FED REP GERMANY UG (HAFTUNGSBESCHRANKT))
SCHLESISCHE STR. 50
GERETSRIED, FED REP GERMANY 82538

FOR: ULTRASOUND APPARATUS FOR MEDICAL PURPOSES; ULTRASOUND APPARATUS
FOR COSMETIC PURPOSES, IN CLASS 10 (U.S. CLS. 26, 39 AND 44).

THE MARK CONSISTS OF STANDARD CHARACTERS WITHOUT CLAIM TO ANY PAR-
TICULAR FONT, STYLE, SIZE, OR COLOR.

OWNER OF ERPN CMNTY TM OFC REG. NO. 009406083, DATED 3-4-2011, EXPIRES 9-28-
2020.

SER. NO. 85-444,458, FILED 10-11-2011.

KIM MONINGHOFF, EXAMINING ATTORNEY



David J. Kybas

Director of the United States Patent and Trademark Office

United States of America

United States Patent and Trademark Office

GIVING SOLES

Reg. No. 4,153,986

SHOEBACCA, LTD. (TEXAS LIMITED PARTNERSHIP)
2205 EAST PIONEER ROAD
IRVING, TX 75061

Registered June 5, 2012

Int. Cl.: 36

FOR: CHARITABLE FUNDRAISING SERVICES BY MEANS OF COLLECTING AND DONATING SHOES, IN CLASS 36 (U.S. CLS. 100, 101 AND 102).

SERVICE MARK

FIRST USE 5-26-2011; IN COMMERCE 5-26-2011.

PRINCIPAL REGISTER

THE MARK CONSISTS OF STANDARD CHARACTERS WITHOUT CLAIM TO ANY PARTICULAR FONT, STYLE, SIZE, OR COLOR.

SER. NO. 85-444,464, FILED 10-11-2011.

NAAKWAMA ANKRAH, EXAMINING ATTORNEY



David J. Kybas

Director of the United States Patent and Trademark Office

United States of America

United States Patent and Trademark Office

THE LATIN BREED

Reg. No. 4,153,987

Registered June 5, 2012

Int. Cl.: 41

SERVICE MARK

PRINCIPAL REGISTER

LATIN BREED, INC. (TEXAS CORPORATION)
6356 MEADOW LAKES DRIVE
NORTH RICHLAND HILLS, TX 76180

FOR: ENTERTAINMENT SERVICES IN THE NATURE OF RECORDING, PRODUCTION AND POST-PRODUCTION SERVICES IN THE FIELD OF MUSIC; ENTERTAINMENT, NAMELY, LIVE MUSIC CONCERTS; ENTERTAINMENT, NAMELY, LIVE PERFORMANCES BY A MUSICAL BAND; LIVE PERFORMANCES BY A MUSICAL GROUP, IN CLASS 41 (U.S. CLS. 100, 101 AND 107).

FIRST USE 12-31-1969; IN COMMERCE 12-31-1969.

THE MARK CONSISTS OF STANDARD CHARACTERS WITHOUT CLAIM TO ANY PARTICULAR FONT, STYLE, SIZE, OR COLOR.

NO CLAIM IS MADE TO THE EXCLUSIVE RIGHT TO USE "LATIN", APART FROM THE MARK AS SHOWN.

SER. NO. 85-444,471, FILED 10-11-2011.

KIM MONINGHOFF, EXAMINING ATTORNEY



David J. Kybas

Director of the United States Patent and Trademark Office

United States of America

United States Patent and Trademark Office

SkinSmart Dermatology

Reg. No. 4,153,988

Registered June 5, 2012

Int. Cl.: 44

ELIZABETH F. CALLAHAN, M.D., LLC (FLORIDA LIMITED LIABILITY COMPANY), DBA
SKINSMART DERMATOLOGY
SUITE 204
7879 COOPER CREEK BLVD
BRADENTON, FL 34201

SERVICE MARK

FOR: DERMATOLOGY SERVICES, IN CLASS 44 (U.S. CLS. 100 AND 101).

PRINCIPAL REGISTER

FIRST USE 12-3-2004; IN COMMERCE 12-3-2004.

THE MARK CONSISTS OF STANDARD CHARACTERS WITHOUT CLAIM TO ANY PARTICULAR FONT, STYLE, SIZE, OR COLOR.

OWNER OF U.S. REG. NOS. 3,298,825, 3,429,170, AND 3,723,775.

NO CLAIM IS MADE TO THE EXCLUSIVE RIGHT TO USE "DERMATOLOGY", APART FROM THE MARK AS SHOWN.

SER. NO. 85-444,472, FILED 10-11-2011.

DORITT L. CARROLL, EXAMINING ATTORNEY



David J. Kyros

Director of the United States Patent and Trademark Office

United States of America

United States Patent and Trademark Office

OPTITEMP

Reg. No. 4,153,989

Registered June 5, 2012

Int. Cl.: 11

TRADEMARK

PRINCIPAL REGISTER

DE' LONGHI BENELUX S.A. (LUXEMBOURG CORPORATION)
11 RUE BEAUMONT, L-1219
LUXEMBOURG, LUXEMBOURG

FOR: ELECTRIC COFFEE MAKERS; ELECTRIC KETTLES; ELECTRIC TOASTERS, IN CLASS 11 (U.S. CLS. 13, 21, 23, 31 AND 34).

THE MARK CONSISTS OF STANDARD CHARACTERS WITHOUT CLAIM TO ANY PARTICULAR FONT, STYLE, SIZE, OR COLOR.

OWNER OF ERPN CMNTY TM OFC REG. NO. 004066205, DATED 1-16-2006, EXPIRES 10-8-2014.

SER. NO. 85-444,483, FILED 10-11-2011.

ELLEN BURNS, EXAMINING ATTORNEY



David J. Kybas

Director of the United States Patent and Trademark Office

United States of America

United States Patent and Trademark Office

YOUTH OUTDOOR SAFARI DAY

Reg. No. 4,153,990

Registered June 5, 2012

Int. Cl.: 41

SERVICE MARK

PRINCIPAL REGISTER

SAFARI CLUB INTERNATIONAL, LOS ANGELES AND ORANGE COUNTY CHAPTERS
(CALIFORNIA JOINT VENTURE)
PO BOX 3508
SAFARI CLUB INTERNATIONAL - OC CHAPTER
MISSION VIEJO, CA 92690

FOR: EDUCATION SERVICES, NAMELY, PROVIDING PARTICIPATORY EXHIBITIONS IN THE FIELD OF OUTDOOR ACTIVITIES, NAMELY, ARCHERY, BB GUNS, KAYAKING, FISHING, FALCONRY, SHOOTING, LASER SHOT, MAKING GAME CALLS, PAINTING DUCK DECOYS, PAINTBALL GAMES, IDENTIFYING ANIMALS, AND HORSEBACK RIDING, IN CLASS 41 (U.S. CLS. 100, 101 AND 107).

FIRST USE 7-31-1999; IN COMMERCE 7-31-1999.

THE MARK CONSISTS OF STANDARD CHARACTERS WITHOUT CLAIM TO ANY PARTICULAR FONT, STYLE, SIZE, OR COLOR.

NO CLAIM IS MADE TO THE EXCLUSIVE RIGHT TO USE "YOUTH OUTDOOR" AND "DAY", APART FROM THE MARK AS SHOWN.

SER. NO. 85-444,495, FILED 10-11-2011.

LINDA LAVACHE, EXAMINING ATTORNEY



David J. Kyros

Director of the United States Patent and Trademark Office

United States of America

United States Patent and Trademark Office

SUCCESS PROMISE

Reg. No. 4,153,991

Registered June 5, 2012

Int. Cl.: 41

SERVICE MARK

PRINCIPAL REGISTER

WESTON DISTANCE LEARNING, INC. (COLORADO CORPORATION)
2001 LOWE ST.
FT. COLLINS, CO 80525

FOR: EDUCATIONAL SERVICES, NAMELY, CONDUCTING COURSES IN THE FIELD OF CAREER DEVELOPMENT AND JOB PLACEMENT AND DISTRIBUTION OF COURSE MATERIAL IN CONNECTION THEREWITH, IN CLASS 41 (U.S. CLS. 100, 101 AND 107).

FIRST USE 10-6-2011; IN COMMERCE 10-6-2011.

THE MARK CONSISTS OF STANDARD CHARACTERS WITHOUT CLAIM TO ANY PARTICULAR FONT, STYLE, SIZE, OR COLOR.

SER. NO. 85-444,500, FILED 10-11-2011.

LESLIE RICHARDS, EXAMINING ATTORNEY



David J. Kybas

Director of the United States Patent and Trademark Office

United States of America

United States Patent and Trademark Office

HomeHop

Reg. No. 4,153,992

Registered June 5, 2012

Int. Cl.: 43

SERVICE MARK

PRINCIPAL REGISTER

HOMEHOP (NEW YORK LIMITED LIABILITY COMPANY)
305 W. BROADWAY
SUITE 205
NEW YORK, NY 10013

FOR: AGENCY SERVICES FOR THE RESERVATION OF TEMPORARY ACCOMMODATION; ARRANGING TEMPORARY HOUSING ACCOMMODATIONS; BED AND BREAKFAST INN SERVICES; PROVIDE A WEBSITE FOR MAKING RESERVATIONS AND BOOKING OF ECO-LODGING; PROVIDING PERSONALIZED INFORMATION ABOUT HOTELS AND TEMPORARY ACCOMMODATIONS FOR TRAVEL VIA THE INTERNET; PROVIDING TEMPORARY ACCOMMODATION; PROVIDING TEMPORARY HOUSING ACCOMMODATIONS; PROVIDING TEMPORARY LODGING SERVICES IN THE NATURE OF A CONDOMINIUM HOTEL; PROVIDING TRAVEL LODGING INFORMATION SERVICES AND TRAVEL LODGING BOOKING AGENCY SERVICES FOR TRAVELERS; RENTAL OF PRIVATE MANSIONS AS TEMPORARY LIVING ACCOMMODATIONS FOR VACATION STAYS; RENTAL OF ROOMS AS TEMPORARY LIVING ACCOMMODATIONS; RESERVATION OF ROOMS FOR TRAVELLERS; SERVICES FOR THE RESERVATION OF ROOMS; TOURIST HOMES; TRAVEL AGENCY SERVICES, NAMELY, MAKING RESERVATIONS AND BOOKING FOR TEMPORARY LODGING; TRAVEL AGENCY SERVICES, NAMELY, MAKING RESERVATIONS AND BOOKING FOR TEMPORARY LODGING FOR OTHER TRAVEL AGENCIES, TRAVEL SUPPLIERS, AND CORPORATIONS, VIA ON-LINE COMPUTER NETWORKS, IN CLASS 43 (U.S. CLS. 100 AND 101).

FIRST USE 6-17-2011; IN COMMERCE 7-29-2011.

THE MARK CONSISTS OF STANDARD CHARACTERS WITHOUT CLAIM TO ANY PARTICULAR FONT, STYLE, SIZE, OR COLOR.

SER. NO. 85-444,507, FILED 10-11-2011.

RONALD MCMORROW, EXAMINING ATTORNEY



David J. Kyros

Director of the United States Patent and Trademark Office

United States of America

United States Patent and Trademark Office

HIDDEN BARREL

Reg. No. 4,153,993

Registered June 5, 2012

Int. Cl.: 35

SERVICE MARK

PRINCIPAL REGISTER

LION NATHAN USA, INC. (CALIFORNIA CORPORATION)
7500 COLLEGE BLVD, SUITE 700
OVERLAND PARK, KS 66210

FOR: WHOLESALE AND RETAIL STORE SERVICES AND ONLINE AND MAIL ORDER
RETAIL AND WHOLESALE STORE SERVICES FEATURING WINES; ONLINE BUYERS'
GUIDE SERVICES PROVIDING INFORMATION ABOUT WINES; PROMOTING THE GOODS
OF OTHERS, NAMELY, PROVIDING INFORMATION REGARDING DISCOUNTS, COUPONS
AND SPECIAL OFFERS ON WINES; BUYERS' CLUB SERVICES; CUSTOMER LOYALTY
SERVICES FOR COMMERCIAL, PROMOTIONAL, AND/OR ADVERTISING PURPOSES, IN
CLASS 35 (U.S. CLS. 100, 101 AND 102).

FIRST USE 1-1-2011; IN COMMERCE 1-1-2011.

THE MARK CONSISTS OF STANDARD CHARACTERS WITHOUT CLAIM TO ANY PAR-
TICULAR FONT, STYLE, SIZE, OR COLOR.

SER. NO. 85-444,521, FILED 10-11-2011.

TINA MAI, EXAMINING ATTORNEY



David J. Kybas

Director of the United States Patent and Trademark Office

United States of America

United States Patent and Trademark Office

THERMOGEN

Reg. No. 4,153,994

Registered June 5, 2012

Int. Cl.: 11

TRADEMARK

PRINCIPAL REGISTER

DE' LONGHI BENELUX S.A. (LUXEMBOURG CORPORATION)
11 RUE BEAUMONT, L-1219
LUXEMBOURG, LUXEMBOURG

FOR: ELECTRIC COFFEE MAKERS; ELECTRIC KETTLES; ELECTRIC TOASTERS, IN CLASS 11 (U.S. CLS. 13, 21, 23, 31 AND 34).

THE MARK CONSISTS OF STANDARD CHARACTERS WITHOUT CLAIM TO ANY PARTICULAR FONT, STYLE, SIZE, OR COLOR.

OWNER OF ERPN CMNTY TM OFC REG. NO. 004063723, DATED 1-17-2006, EXPIRES 10-6-2014.

SER. NO. 85-444,544, FILED 10-11-2011.

ELLEN BURNS, EXAMINING ATTORNEY



David J. Kyros

Director of the United States Patent and Trademark Office

United States of America

United States Patent and Trademark Office

Friends thru Friends

Reg. No. 4,153,995

Registered June 5, 2012

Int. Cl.: 42

SERVICE MARK

PRINCIPAL REGISTER

EASY APP OVEN, LLC (GEORGIA LIMITED LIABILITY COMPANY)
P.O. BOX 656
ALPHARETTA, GA 30009

FOR: PROVIDING A WEBSITE FEATURING TECHNOLOGY THAT ENABLES USERS TO MEET OTHER USERS THROUGH A FRIEND'S ONLINE NETWORK OF CONTACTS, IN CLASS 42 (U.S. CLS. 100 AND 101).

FIRST USE 9-30-2011; IN COMMERCE 9-30-2011.

THE MARK CONSISTS OF STANDARD CHARACTERS WITHOUT CLAIM TO ANY PARTICULAR FONT, STYLE, SIZE, OR COLOR.

SER. NO. 85-444,549, FILED 10-11-2011.

ELLEN BURNS, EXAMINING ATTORNEY



David J. Kyffers

Director of the United States Patent and Trademark Office

United States of America

United States Patent and Trademark Office

Hooray for Boobies!

Reg. No. 4,153,996

Registered June 5, 2012

Int. Cl.: 25

TRADEMARK

PRINCIPAL REGISTER

HOORAY FOR BOOBIES!, INC. (NEW YORK NON-PROFIT CORPORATION)
255 WEST 43RD STREET, APT. 427
NEW YORK, NY 10036

FOR: APPAREL FOR DANCERS, NAMELY, TEE SHIRTS, SWEATSHIRTS, PANTS, LEGGINGS, SHORTS AND JACKETS; ATHLETIC APPAREL, NAMELY, SHIRTS, PANTS, JACKETS, FOOTWEAR, HATS AND CAPS, ATHLETIC UNIFORMS; CHILDREN'S AND INFANT'S APPAREL, NAMELY, JUMPERS, OVERALL SLEEPWEAR, PAJAMAS, ROMPERS AND ONE-PIECE GARMENTS, IN CLASS 25 (U.S. CLS. 22 AND 39).

FIRST USE 3-31-2006; IN COMMERCE 11-2-2010.

THE MARK CONSISTS OF STANDARD CHARACTERS WITHOUT CLAIM TO ANY PARTICULAR FONT, STYLE, SIZE, OR COLOR.

OWNER OF U.S. REG. NO. 3,772,696.

SER. NO. 85-444,560, FILED 10-11-2011.

JOHN DWYER, EXAMINING ATTORNEY



David J. Kyros

Director of the United States Patent and Trademark Office

United States of America

United States Patent and Trademark Office

(((Hidden Barrel

Reg. No. 4,153,997

Registered June 5, 2012

Int. Cl.: 35

SERVICE MARK

PRINCIPAL REGISTER

LION NATHAN USA, INC. (CALIFORNIA CORPORATION)
7500 COLLEGE BLVD, SUITE 700
OVERLAND PARK, KS 66210

FOR: WHOLESALE AND RETAIL STORE SERVICES AND ONLINE AND MAIL ORDER RETAIL AND WHOLESALE STORE SERVICES FEATURING WINES; ONLINE BUYERS' GUIDE SERVICES PROVIDING INFORMATION ABOUT WINES; PROMOTING THE GOODS OF OTHERS, NAMELY, PROVIDING INFORMATION REGARDING DISCOUNTS, COUPONS AND SPECIAL OFFERS ON WINES; BUYERS' CLUB SERVICES; CUSTOMER LOYALTY SERVICES FOR COMMERCIAL, PROMOTIONAL, AND/OR ADVERTISING PURPOSES, IN CLASS 35 (U.S. CLS. 100, 101 AND 102).

FIRST USE 1-1-2011; IN COMMERCE 1-1-2011.

THE MARK CONSISTS OF THE WORDS "HIDDEN BARREL" IN A STYLIZED FONT, TO THE LEFT OF WHICH ARE FIVE ARCS THAT FORM THAT SHAPE OF A STYLIZED BARREL.

SER. NO. 85-444,563, FILED 10-11-2011.

TINA MAI, EXAMINING ATTORNEY



David J. Kypos

Director of the United States Patent and Trademark Office

United States of America

United States Patent and Trademark Office

GUARANTEED CAR! GUARANTEED CREDIT! SAME DAY!

Reg. No. 4,153,998

NACIONAL NAME HOLDING, LLC (MISSOURI LIMITED LIABILITY COMPANY)
PO BOX 730
BRIDGETON, MO 63044

Registered June 5, 2012

Int. Cls.: 35, 36 and 37

FOR: AUTOMOBILE DEALERSHIP SERVICES, IN CLASS 35 (U.S. CLS. 100, 101 AND 102).

FIRST USE 4-1-2008; IN COMMERCE 4-1-2008.

SERVICE MARK

FOR: FINANCIAL SERVICES, NAMELY, FINANCING FOR AUTO LOANS, IN CLASS 36
(U.S. CLS. 100, 101 AND 102).

PRINCIPAL REGISTER

FIRST USE 4-1-2008; IN COMMERCE 4-1-2008.

FOR: AUTOMOBILE REPAIR SERVICES, IN CLASS 37 (U.S. CLS. 100, 103 AND 106).

FIRST USE 4-1-2008; IN COMMERCE 4-1-2008.

THE MARK CONSISTS OF STANDARD CHARACTERS WITHOUT CLAIM TO ANY PARTICULAR FONT, STYLE, SIZE, OR COLOR.

SER. NO. 85-444,568, FILED 10-11-2011.

TINA MAI, EXAMINING ATTORNEY



David J. Kybas

Director of the United States Patent and Trademark Office

United States of America

United States Patent and Trademark Office

SCHUYLKILL BANKS

Reg. No. 4,153,999

Registered June 5, 2012

Int. Cls.: 39 and 41

SERVICE MARK

PRINCIPAL REGISTER

SCHUYLKILL RIVER DEVELOPMENT CORPORATION (PENNSYLVANIA NON-PROFIT CORPORATION)
UNIT B
129 SOUTH 30TH STREET
PHILADELPHIA, PA 19104

FOR: CONDUCTING SIGHTSEEING TOURS FOR OTHERS; TOUR GUIDE SERVICES; KAYAK AND BOAT TOURS FOR OTHERS , IN CLASS 39 (U.S. CLS. 100 AND 105).

FIRST USE 8-31-2005; IN COMMERCE 10-31-2005.

FOR: RECREATIONAL PARK SERVICES; PROVIDING FACILITIES FOR RECREATION ACTIVITIES, IN CLASS 41 (U.S. CLS. 100, 101 AND 107).

FIRST USE 8-31-2005; IN COMMERCE 10-31-2005.

THE MARK CONSISTS OF STANDARD CHARACTERS WITHOUT CLAIM TO ANY PARTICULAR FONT, STYLE, SIZE, OR COLOR.

OWNER OF U.S. REG. NO. 3,443,141.

SEC. 2(F).

SER. NO. 85-444,575, FILED 10-11-2011.

TINA MAI, EXAMINING ATTORNEY



David J. Kybas

Director of the United States Patent and Trademark Office

United States of America

United States Patent and Trademark Office

COWHOUSE

Reg. No. 4,154,000

Registered June 5, 2012

Int. Cl.: 33

TRADEMARK

PRINCIPAL REGISTER

LION NATHAN USA, INC. (CALIFORNIA CORPORATION)
7500 COLLEGE BLVD, SUITE 700
OVERLAND PARK, KS 66210

FOR: WINES, IN CLASS 33 (U.S. CLS. 47 AND 49).

FIRST USE 10-1-2005; IN COMMERCE 10-1-2005.

THE MARK CONSISTS OF STANDARD CHARACTERS WITHOUT CLAIM TO ANY PARTICULAR FONT, STYLE, SIZE, OR COLOR.

SER. NO. 85-444,576, FILED 10-11-2011.

TINA MAI, EXAMINING ATTORNEY



David J. Kybas

Director of the United States Patent and Trademark Office

United States of America

United States Patent and Trademark Office



Reg. No. 4,154,001

Registered June 5, 2012

Int. Cls.: 9, 33 and 43

TRADEMARK

SERVICE MARK

PRINCIPAL REGISTER

LION-WINE PTY LTD (AUSTRALIA PROPRIETARY LIMITED COMPANY (P/L OR PTY. LTD.))
LEVEL 7, 68 YORK STREET
SYDNEY, NSW 2000, AUSTRALIA

FOR: LABELS CARRYING MAGNETICALLY, OPTICALLY, OR ELECTRONICALLY RECORDED OR ENCODED INFORMATION; DOWNLOADABLE SOFTWARE IN THE NATURE OF A MOBILE APPLICATION FOR SCANNING BARCODES TO OBTAIN INFORMATION ABOUT WINES, WINE MAKING AND WINE TASTING, IN CLASS 9 (U.S. CLS. 21, 23, 26, 36 AND 38).

FIRST USE 9-1-2010; IN COMMERCE 9-1-2010.

FOR: WINES, IN CLASS 33 (U.S. CLS. 47 AND 49).

FIRST USE 9-1-2010; IN COMMERCE 9-1-2010.

FOR: PROVIDING INFORMATION ABOUT WINE CHARACTERISTICS ONLINE AND USING HAND-HELD TECHNOLOGY THAT ACCESSES BARCODES; PROVIDING AN ONLINE DATABASE IN THE FIELD OF WINE CHARACTERISTICS, IN CLASS 43 (U.S. CLS. 100 AND 101).

FIRST USE 9-1-2010; IN COMMERCE 9-1-2010.

THE MARK CONSISTS OF A KEY HOLE, THE CENTER OF WHICH IS CUT OUT IN THE SHAPE OF A STYLIZED WINE GLASS.

SER. NO. 85-444,599, FILED 10-11-2011.

SALLY SHIH, EXAMINING ATTORNEY



David J. Kybas

Director of the United States Patent and Trademark Office

United States of America

United States Patent and Trademark Office

RDU

Reg. No. 4,154,002

HPI, LLC (TEXAS LIMITED LIABILITY COMPANY)
15503 W HARDY RD
HOUSTON, TX 77060

Registered June 5, 2012

Int. Cl.: 9

FOR: AUTOMATED PROCESS CONTROL SYSTEM, NAMELY, MICRO-PROCESSOR BASED HARDWARE AND SOFTWARE USED TO MONITOR THE STATUS OF INDUSTRIAL MACHINERY, NAMELY TURBINES, GENERATORS AND COMPRESSORS, IN CLASS 9 (U.S. CLS. 21, 23, 26, 36 AND 38).

TRADEMARK

PRINCIPAL REGISTER

FIRST USE 0-0-2007; IN COMMERCE 0-0-2007.

THE MARK CONSISTS OF STANDARD CHARACTERS WITHOUT CLAIM TO ANY PARTICULAR FONT, STYLE, SIZE, OR COLOR.

SER. NO. 85-444,610, FILED 10-11-2011.

GIANCARLO CASTRO, EXAMINING ATTORNEY



David J. Kybas

Director of the United States Patent and Trademark Office

United States of America

United States Patent and Trademark Office

RNU

Reg. No. 4,154,003

HPI, LLC (TEXAS LIMITED LIABILITY COMPANY)
15503 W HARDY RD
HOUSTON, TX 77060

Registered June 5, 2012

Int. Cl.: 9

FOR: AUTOMATED PROCESS CONTROL SYSTEM, NAMELY, MICRO-PROCESSOR BASED HARDWARE AND SOFTWARE USED TO MONITOR THE STATUS OF INDUSTRIAL MACHINERY, NAMELY TURBINES, GENERATORS AND COMPRESSORS, IN CLASS 9 (U.S. CLS. 21, 23, 26, 36 AND 38).

TRADEMARK

PRINCIPAL REGISTER

FIRST USE 0-0-2007; IN COMMERCE 0-0-2007.

THE MARK CONSISTS OF STANDARD CHARACTERS WITHOUT CLAIM TO ANY PARTICULAR FONT, STYLE, SIZE, OR COLOR.

SER. NO. 85-444,616, FILED 10-11-2011.

GIANCARLO CASTRO, EXAMINING ATTORNEY



David J. Kybas

Director of the United States Patent and Trademark Office

United States of America
United States Patent and Trademark Office

TRUSCRIBE

Reg. No. 4,154,004

Registered June 5, 2012

Int. Cls.: 41 and 42

SERVICE MARK

PRINCIPAL REGISTER

PURCELL ROAD MEDIA, LLC (WISCONSIN LIMITED LIABILITY COMPANY)
6404 PURCELL ROAD
BELLEVILLE, WI 53508

FOR: AUDIO AND VIDEO PRODUCTION SERVICES, NAMELY, CREATING AND PRODUCING ANIMATED VIDEO BROADCASTS, VIDEO SCRIBING, AND AUDIO PRODUCTION FOR VIDEO, IN CLASS 41 (U.S. CLS. 100, 101 AND 107).

FIRST USE 3-23-2011; IN COMMERCE 4-13-2011.

FOR: GRAPHIC ILLUSTRATION AND DRAWING SERVICES, NAMELY, CREATING INFOGRAPHICS, ANIMATED GRAPHICS, ILLUSTRATIONS AND GRAPHICS FOR VIDEO AND PRINT, IN CLASS 42 (U.S. CLS. 100 AND 101).

FIRST USE 3-23-2011; IN COMMERCE 4-13-2011.

THE MARK CONSISTS OF STANDARD CHARACTERS WITHOUT CLAIM TO ANY PARTICULAR FONT, STYLE, SIZE, OR COLOR.

SER. NO. 85-444,621, FILED 10-11-2011.

ESTHER A. BORSUK, EXAMINING ATTORNEY



David J. Kyros

Director of the United States Patent and Trademark Office

United States of America

United States Patent and Trademark Office

Make Beautiful Things

Reg. No. 4,154,005

Registered June 5, 2012

Int. Cl.: 35

SERVICE MARK

PRINCIPAL REGISTER

ONYX CREATIVE GROUP, INC. (FLORIDA CORPORATION)
2617-2 MAHAN DRIVE
TALLAHASSEE, FL 32308

FOR: ADVERTISING SERVICES, IN CLASS 35 (U.S. CLS. 100, 101 AND 102).

FIRST USE 8-1-2010; IN COMMERCE 8-1-2011.

THE MARK CONSISTS OF STANDARD CHARACTERS WITHOUT CLAIM TO ANY PARTICULAR FONT, STYLE, SIZE, OR COLOR.

SER. NO. 85-444,629, FILED 10-11-2011.

KIM MONINGHOFF, EXAMINING ATTORNEY



David J. Kybas

Director of the United States Patent and Trademark Office

United States of America

United States Patent and Trademark Office

WATER CHANGES EVERYTHING

Reg. No. 4,154,006

Registered June 5, 2012

Int. Cl.: 36

SERVICE MARK

PRINCIPAL REGISTER

CHARITY GLOBAL, INC. (NEW YORK CORPORATION)
200 VARICK STREET, SUITE 201
NEW YORK, NY 10014

FOR: CHARITABLE FUNDRAISING SERVICES; PROVIDING FINANCIAL ASSISTANCE FOR COMMUNITY DEVELOPMENT; PROVIDING INFORMATION PERTAINING TO FINANCIAL ASSISTANCE FOR COMMUNITY DEVELOPMENT; PROVIDING INFORMATION PERTAINING TO FINANCIAL ASSISTANCE FOR COMMUNITY DEVELOPMENT VIA A GLOBAL COMMUNICATIONS NETWORK, IN CLASS 36 (U.S. CLS. 100, 101 AND 102).

FIRST USE 0-0-2007; IN COMMERCE 0-0-2007.

THE MARK CONSISTS OF STANDARD CHARACTERS WITHOUT CLAIM TO ANY PARTICULAR FONT, STYLE, SIZE, OR COLOR.

SER. NO. 85-444,635, FILED 10-11-2011.

KIM MONINGHOFF, EXAMINING ATTORNEY



David J. Kybas

Director of the United States Patent and Trademark Office

United States of America

United States Patent and Trademark Office

EMPAR

Reg. No. 4,154,007

Registered June 5, 2012

Int. Cl.: 9

LAPOINT BLASE IND. INC. (MISSOURI CORPORATION), DBA EWR WEATHER RADAR
SUITE 112
336 LEFFINGWELL AVENUE
KIRKWOOD, MO 63122

FOR: RADAR, IN CLASS 9 (U.S. CLS. 21, 23, 26, 36 AND 38).

TRADEMARK

FIRST USE 10-1-2011; IN COMMERCE 10-1-2011.

PRINCIPAL REGISTER

THE MARK CONSISTS OF THE WORD "EMPAR" WITH THE "E" APPEARING IN RED AND THE "MPAR" APPEARING IN BLACK.

THE COLOR(S) RED AND BLACK IS/ARE CLAIMED AS A FEATURE OF THE MARK.

SER. NO. 85-444,665, FILED 10-11-2011.

NICHOLAS ALTREE, EXAMINING ATTORNEY



David J. Kybas

Director of the United States Patent and Trademark Office

United States of America

United States Patent and Trademark Office

MYSTERIUM

Reg. No. 4,154,008

DUCLAW BREWERY LLC (MARYLAND LIMITED LIABILITY COMPANY)
16A BEL AIR SOUTH PARKWAY
BEL AIR, MD 21015

Registered June 5, 2012

Int. Cl.: 32

FOR: BEER, ALE AND PORTER, IN CLASS 32 (U.S. CLS. 45, 46 AND 48).

TRADEMARK

FIRST USE 5-1-2006; IN COMMERCE 5-1-2006.

PRINCIPAL REGISTER

THE MARK CONSISTS OF STANDARD CHARACTERS WITHOUT CLAIM TO ANY PARTICULAR FONT, STYLE, SIZE, OR COLOR.

SER. NO. 85-444,674, FILED 10-11-2011.

WILLIAM ROSSMAN, EXAMINING ATTORNEY



David J. Kyfos

Director of the United States Patent and Trademark Office

United States of America

United States Patent and Trademark Office

ENVIROPRO

Reg. No. 4,154,009

Registered June 5, 2012

Int. Cl.: 11

TRADEMARK

PRINCIPAL REGISTER

KENALL MANUFACTURING COMPANY (ILLINOIS CORPORATION)
ATTN: B THORNBURY
1020 LAKESIDE DRIVE
GURNEE, IL 60031

FOR: ELECTRIC LIGHTING FIXTURES; ELECTRIC LUMINAIRES, IN CLASS 11 (U.S. CLS. 13, 21, 23, 31 AND 34).

FIRST USE 9-15-2011; IN COMMERCE 9-15-2011.

THE MARK CONSISTS OF STANDARD CHARACTERS WITHOUT CLAIM TO ANY PARTICULAR FONT, STYLE, SIZE, OR COLOR.

SER. NO. 85-444,675, FILED 10-11-2011.

GIANCARLO CASTRO, EXAMINING ATTORNEY



David J. Kyffers

Director of the United States Patent and Trademark Office

United States of America

United States Patent and Trademark Office

IT DRAINS OR IT'S FREE

Reg. No. 4,154,010

Registered June 5, 2012

Int. Cl.: 37

SERVICE MARK

PRINCIPAL REGISTER

RESCUE RESPONSE GROUP INC (CALIFORNIA CORPORATION), DBA MR. DRAIN INC
SUITE 12
4231 BUSINESS CENTER DR # 12
FREMONT, CA 94538

FOR: PLUMBING CONTRACTOR SERVICES, IN CLASS 37 (U.S. CLS. 100, 103 AND 106).

FIRST USE 1-1-2000; IN COMMERCE 1-1-2000.

THE MARK CONSISTS OF STANDARD CHARACTERS WITHOUT CLAIM TO ANY PARTICULAR FONT, STYLE, SIZE, OR COLOR.

SER. NO. 85-444,679, FILED 10-11-2011.

WARREN L. OLANDRIA, EXAMINING ATTORNEY



David J. Kyffers

Director of the United States Patent and Trademark Office

United States of America

United States Patent and Trademark Office

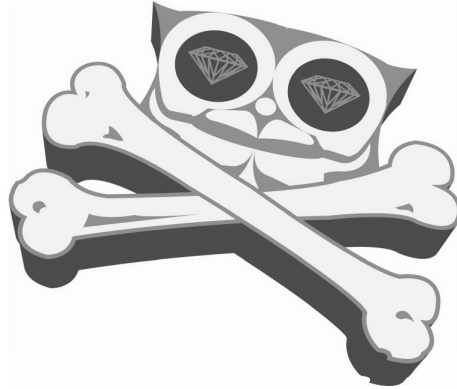

Reg. No. 4,154,011

Registered June 5, 2012

Int. Cl.: 25

TRADEMARK

PRINCIPAL REGISTER

NOCTIS INK, LLC (ARIZONA LIMITED LIABILITY COMPANY)
225 E CARTER DR.
TEMPE, AZ 85282

FOR: MEN'S AND WOMEN'S CLOTHING, NAMELY, SHIRTS, PANTS, SWEATSHIRTS,
UNDERWEAR, SOCKS AND HATS, IN CLASS 25 (U.S. CLS. 22 AND 39).

FIRST USE 10-10-2011; IN COMMERCE 10-10-2011.

THE MARK CONSISTS OF A STYLIZED OWL HEAD OVER CROSSED BONES. THE PUPILS
IN THE OWL'S EYES ARE COMPRISED OF STYLIZED DIAMONDS.

SER. NO. 85-444,684, FILED 10-11-2011.

NANCY CLARKE, EXAMINING ATTORNEY



David J. Kyffers

Director of the United States Patent and Trademark Office

United States of America

United States Patent and Trademark Office

Capture the Passion!

Reg. No. 4,154,012

Registered June 5, 2012

Int. Cl.: 41

SERVICE MARK

PRINCIPAL REGISTER

CLUVER, RENNIE (UNITED STATES INDIVIDUAL)
14588 STATE HIGHWAY 54
CLINTON, IL 61727

FOR: ENTERTAINMENT, NAMELY, A CONTINUING OUTDOOR DOCUMENTARY SHOW BROADCAST OVER TELEVISION; VIDEO PRODUCTION SERVICES, IN CLASS 41 (U.S. CLS. 100, 101 AND 107).

FIRST USE 8-16-2010; IN COMMERCE 12-14-2010.

THE MARK CONSISTS OF STANDARD CHARACTERS WITHOUT CLAIM TO ANY PARTICULAR FONT, STYLE, SIZE, OR COLOR.

SER. NO. 85-444,699, FILED 10-11-2011.

SHARON MEIER, EXAMINING ATTORNEY



David J. Kybas

Director of the United States Patent and Trademark Office

United States of America

United States Patent and Trademark Office



Reg. No. 4,154,013

SHOLTIS, STEVEN (UNITED STATES INDIVIDUAL)
2201 FRANCISCO DR. 140-457
EL DORADO HILLS, CA 95762

Registered June 5, 2012

Int. Cl.: 35

FOR: OPERATING ON-LINE MARKETPLACES FOR SELLERS OF GOODS AND/OR SERVICES, IN CLASS 35 (U.S. CLS. 100, 101 AND 102).

SERVICE MARK

FIRST USE 1-1-2008; IN COMMERCE 1-1-2008.

PRINCIPAL REGISTER

THE MARK CONSISTS OF THE STYLIZED WORD AND NUMBER "WISH4". THE TAIL OF THE NUMBER "4" EXTENDS TO MAKE A RECTANGULAR SHAPED BOX.

SER. NO. 85-444,702, FILED 10-11-2011.

SHARON MEIER, EXAMINING ATTORNEY



David J. Kybas

Director of the United States Patent and Trademark Office

United States of America

United States Patent and Trademark Office

THE AMERICAN STILL LIFE COLLECTION

Reg. No. 4,154,014

THE COUNTRY VINTNER (VIRGINIA CORPORATION)
12305 NORTH LAKERIDGE PARKWAY
ASHLAND, VA 23005

Registered June 5, 2012

Int. Cl.: 35

FOR: WHOLESALE STORE SERVICES FEATURING SPIRITS, IN CLASS 35 (U.S. CLS. 100, 101 AND 102).

SERVICE MARK

FIRST USE 1-28-2011; IN COMMERCE 1-28-2011.

PRINCIPAL REGISTER

THE MARK CONSISTS OF STANDARD CHARACTERS WITHOUT CLAIM TO ANY PARTICULAR FONT, STYLE, SIZE, OR COLOR.

NO CLAIM IS MADE TO THE EXCLUSIVE RIGHT TO USE "AMERICAN" AND "COLLECTION", APART FROM THE MARK AS SHOWN.

SER. NO. 85-444,703, FILED 10-11-2011.

JENNIFER VASQUEZ, EXAMINING ATTORNEY



David J. Kybas

Director of the United States Patent and Trademark Office

United States of America

United States Patent and Trademark Office



Reg. No. 4,154,015

Registered June 5, 2012

Int. Cl.: 35

SERVICE MARK

PRINCIPAL REGISTER

THE COUNTRY VINTNER (VIRGINIA CORPORATION)
12305 NORTH LAKERIDGE PARKWAY
ASHLAND, VA 23005

FOR: WHOLESALE STORE SERVICES FEATURING SPIRITS, IN CLASS 35 (U.S. CLS. 100, 101 AND 102).

FIRST USE 1-28-2011; IN COMMERCE 1-28-2011.

NO CLAIM IS MADE TO THE EXCLUSIVE RIGHT TO USE "AMERICAN" AND "COLLECTION", APART FROM THE MARK AS SHOWN.

THE COLOR(S) MAROON AND WHITE IS/ARE CLAIMED AS A FEATURE OF THE MARK.

THE MARK CONSISTS OF A MAROON SQUARE, WITH A WHITE SQUARE OUTLINE INSIDE, WITH STRANDS OF WHEAT IN THE CENTER, THEN THE WORDS "THE AMERICAN," THEN UNDERNEATH THE WORDS "STILL LIFE," THEN THE WORD "COLLECTION" UNDERNEATH ALL IN WHITE LETTERING, THEN A BOLD WHITE LINE UNDERNEATH ALL.

SER. NO. 85-444,708, FILED 10-11-2011.

JENNIFER VASQUEZ, EXAMINING ATTORNEY



David J. Kybas

Director of the United States Patent and Trademark Office

United States of America

United States Patent and Trademark Office

DeadTown

Reg. No. 4,154,016

Registered June 5, 2012

Int. Cl.: 25

TRADEMARK

PRINCIPAL REGISTER

THE BETTER FOR BRIAN FOUNDATION (OKLAHOMA CORPORATION), DBA DEADTOWN CLOTHING COMPANY
P.O. BOX 631
SAND SPRINGS, OK 74063

FOR: ATHLETIC APPAREL, NAMELY, SHIRTS, JACKETS, HATS AND CAPS, HOODED SWEAT SHIRTS; LONG-SLEEVED SHIRTS; OPEN-NECKED SHIRTS; SHIRT FRONTS; SHIRTS; SHIRTS AND SHORT-SLEEVED SHIRTS; SHIRTS FOR INFANTS, BABIES, TODDLERS AND CHILDREN; SHORT-SLEEVED OR LONG-SLEEVED T-SHIRTS; SHORT-SLEEVED SHIRTS; SHORTS; SPORT SHIRTS; SPORTS SHIRTS WITH SHORT SLEEVES; SWEAT SHIRTS; T-SHIRTS; TEE SHIRTS, IN CLASS 25 (U.S. CLS. 22 AND 39).

FIRST USE 4-1-2011; IN COMMERCE 4-1-2011.

THE MARK CONSISTS OF THE WORD "DEADTOWN" IN STYLIZED LETTERS.

SER. NO. 85-444,770, FILED 10-11-2011.

SANJEEV VOHRA, EXAMINING ATTORNEY



David J. Kyffers

Director of the United States Patent and Trademark Office

United States of America

United States Patent and Trademark Office

The Minus Touch

Reg. No. 4,154,017

Registered June 5, 2012

Int. Cl.: 25

TRADEMARK

PRINCIPAL REGISTER

VA BIEN INTERNATIONAL, INC. (PUERTO RICO CORPORATION)
STATE ROAD 156, HC02 BOX 12193
AGUAS BUENAS, PUERTO RICO 00703

FOR: LINGERIE; SHAPEWEAR, NAMELY, GIRDLES, BRAS, BRIEFS, SHORTS, BODY BRIEFERS, BODY SLIMMERS, IN CLASS 25 (U.S. CLS. 22 AND 39).

FIRST USE 1-1-2006; IN COMMERCE 1-1-2006.

THE MARK CONSISTS OF STANDARD CHARACTERS WITHOUT CLAIM TO ANY PARTICULAR FONT, STYLE, SIZE, OR COLOR.

SER. NO. 85-444,784, FILED 10-11-2011.

RON FAIRBANKS, EXAMINING ATTORNEY



David J. Kyros

Director of the United States Patent and Trademark Office

United States of America

United States Patent and Trademark Office

1837

Reg. No. 4,154,018

TIFFANY (NJ) LLC (DELAWARE LIMITED LIABILITY COMPANY)
15 SYLVAN WAY
PARSIPPANY, NJ 07054

Registered June 5, 2012

**Int. Cls.: 9, 14, 16, 18, 21,
26, 28 and 34**

FOR: SUNGLASSES; CELLULAR PHONE ACCESSORY CHARMS; COMPASSES; TAPE MEASURES, IN CLASS 9 (U.S. CLS. 21, 23, 26, 36 AND 38).

FIRST USE 10-0-1999; IN COMMERCE 10-0-1999.

TRADEMARK

FOR: JEWELRY; CUFFLINKS; KEY RINGS OF PRECIOUS METAL, IN CLASS 14 (U.S. CLS. 2, 27, 28 AND 50).

PRINCIPAL REGISTER

FIRST USE 9-0-1996; IN COMMERCE 9-0-1996.

FOR: BOOKMARKS; PEN STANDS; CALENDARS; LETTER OPENERS OF PRECIOUS METAL; PAPERWEIGHTS; PENS; MONEY CLIPS, IN CLASS 16 (U.S. CLS. 2, 5, 22, 23, 29, 37, 38 AND 50).

FIRST USE 2-0-1997; IN COMMERCE 2-0-1997.

FOR: BUSINESS CARD CASES; LUGGAGE TAGS, IN CLASS 18 (U.S. CLS. 1, 2, 3, 22 AND 41).

FIRST USE 10-0-2005; IN COMMERCE 10-0-2005.

FOR: HAIR COMBS; COCKTAIL SHAKERS; NAPKIN RINGS OF PRECIOUS METAL; PILL BOXES FOR PERSONAL USE; CUPS, IN CLASS 21 (U.S. CLS. 2, 13, 23, 29, 30, 33, 40 AND 50).

FIRST USE 10-0-1999; IN COMMERCE 10-0-1999.

FOR: COLLAR STAYS, IN CLASS 26 (U.S. CLS. 37, 39, 40, 42 AND 50).

FIRST USE 12-0-2001; IN COMMERCE 12-0-2001.

FOR: TOY WHISTLES, IN CLASS 28 (U.S. CLS. 22, 23, 38 AND 50).



David J. Kyros

Director of the United States Patent and Trademark Office

Reg. No. 4,154,018 FIRST USE 11-0-2006; IN COMMERCE 11-0-2006.

FOR: CIGAR CASES OF PRECIOUS METAL, IN CLASS 34 (U.S. CLS. 2, 8, 9 AND 17).

FIRST USE 4-0-1998; IN COMMERCE 4-0-1998.

THE MARK CONSISTS OF STANDARD CHARACTERS WITHOUT CLAIM TO ANY PARTICULAR FONT, STYLE, SIZE, OR COLOR.

SER. NO. 85-444,796, FILED 10-11-2011.

ANDREW LEASER, EXAMINING ATTORNEY

United States of America

United States Patent and Trademark Office



Reg. No. 4,154,019

Registered June 5, 2012

Int. Cl.: 35

SERVICE MARK

PRINCIPAL REGISTER

THE ALUMINUM ASSOCIATION INC. (VIRGINIA CORPORATION)
1525 WILSON BOULEVARD, SUITE 600
ARLINGTON, VA 22209

FOR: PROMOTING PUBLIC AWARENESS OF ALUMINUM AS A RECYCLABLE MATERIAL,
IN CLASS 35 (U.S. CLS. 100, 101 AND 102).

FIRST USE 8-14-2011; IN COMMERCE 8-14-2011.

NO CLAIM IS MADE TO THE EXCLUSIVE RIGHT TO USE "CAN" OR THE RECYCLING
SYMBOL, APART FROM THE MARK AS SHOWN.

THE MARK CONSISTS OF AN OUTLINE SHAPE OF AN ALUMINUM CAN, TAB OPEN,
CONTAINING THE WORDS "CAN CRUSADE". IN EACH OF THE WORDS, THE "A" HAS
BEEN REPLACED WITH A RECYCLING SYMBOL.

SER. NO. 85-444,798, FILED 10-11-2011.

ANDREW LEASER, EXAMINING ATTORNEY



David J. Kybas

Director of the United States Patent and Trademark Office

United States of America

United States Patent and Trademark Office

ZEROWASTEUSA

Reg. No. 4,154,020

ZERO WASTE ENERGY SYSTEMS USA LLC (MISSISSIPPI LIMITED LIABILITY COMPANY)
152 MCCARTY ROAD
JACKSON, MS 39212

Registered June 5, 2012

Int. Cl.: 35

FOR: VALUE-ADDED RESELLER SERVICES, NAMELY, DISTRIBUTORSHIP SERVICES
FEATURING INDUSTRIAL RECYCLING PROCESSING AND HANDLING EQUIPMENT ,
IN CLASS 35 (U.S. CLS. 100, 101 AND 102).

SERVICE MARK

FIRST USE 9-8-2011; IN COMMERCE 9-8-2011.

PRINCIPAL REGISTER

THE MARK CONSISTS OF STANDARD CHARACTERS WITHOUT CLAIM TO ANY PAR-
TICULAR FONT, STYLE, SIZE, OR COLOR.

SER. NO. 85-444,801, FILED 10-11-2011.

ANDREW LEASER, EXAMINING ATTORNEY



David J. Kybas

Director of the United States Patent and Trademark Office

United States of America

United States Patent and Trademark Office

CORPORATE *Finesse*

Reg. No. 4,154,021

Registered June 5, 2012

Int. Cl.: 35

SERVICE MARK

PRINCIPAL REGISTER

SHIRLEY, DEBORAH (UNITED STATES INDIVIDUAL)
105 SHAW STREET SOUTH
LAFAYETTE, GA 30728

FOR: BUSINESS MANAGEMENT CONSULTATION IN THE FIELD OF EXECUTIVE AND LEADERSHIP DEVELOPMENT; CORPORATE IMAGE CONSULTING SERVICES, IN CLASS 35 (U.S. CLS. 100, 101 AND 102).

FIRST USE 3-1-1982; IN COMMERCE 3-1-1982.

NO CLAIM IS MADE TO THE EXCLUSIVE RIGHT TO USE "CORPORATE", APART FROM THE MARK AS SHOWN.

THE MARK CONSISTS OF THE STYLIZED TEXT "CORPORATE" IN ALL CAPS. THE STYLIZED TEXT "FINESSE" IS CENTERED BELOW THAT IN LARGE SCRIPT WITH THE CAPITAL "F" SLIGHTLY OVERLAPPING AND INTERTWINING WITH SOME OF THE LETTERS FROM "CORPORATE" ABOVE IT.

SER. NO. 85-444,806, FILED 10-11-2011.

ANDREW LEASER, EXAMINING ATTORNEY



David J. Kyros

Director of the United States Patent and Trademark Office

United States of America

United States Patent and Trademark Office

Lenstar

Reg. No. 4,154,022

Registered June 5, 2012

Int. Cls.: 9, 36 and 42

TRADEMARK

SERVICE MARK

PRINCIPAL REGISTER

ISGN CORPORATION (DELAWARE CORPORATION)
3220 TILLMAN DRIVE, SUITE 301
BENSALEM, PA 19020

FOR: COMPUTER SOFTWARE FOR PROVIDING AN ON-LINE DATABASE IN THE FIELD OF TRANSACTION PROCESSING TO UPLOAD TRANSACTIONAL DATA, PROVIDE STATISTICAL ANALYSIS, AND PRODUCE NOTIFICATIONS AND REPORTS; COMPUTER SOFTWARE FOR MORTGAGE ORIGINATION, CONSTRUCTION LENDING, FORECLOSURE AND DEFAULT MANAGEMENT, SETTLEMENT SERVICES, SERVICING, AND FORECLOSURE ATTORNEY REFERRAL, IN CLASS 9 (U.S. CLS. 21, 23, 26, 36 AND 38).

FIRST USE 12-1-1995; IN COMMERCE 12-1-1995.

FOR: APPRAISAL AND EVALUATION OF REAL ESTATE; APPRAISAL OF REAL ESTATE; FINANCIAL SERVICES, NAMELY, ARRANGING OF MODIFIED LOAN TERMS DESIGNED TO PREVENT HOME FORECLOSURE; FINANCIAL SERVICES, NAMELY, LOAN DEFAULT MITIGATION SERVICES; FINANCIAL SERVICES, NAMELY, LOSS MITIGATION SERVICES FOR UNDER- OR NON-PERFORMING MORTGAGE LOANS; FINANCIAL SERVICES, NAMELY, MORTGAGE REFINANCING; MORTGAGE BANKING; MORTGAGE BANKING SERVICES, NAMELY, ORIGINATION, ACQUISITION, SERVICING, SECURITIZATION AND BROKERAGE OF MORTGAGE LOANS; MORTGAGE BROKERAGE; MORTGAGE FORECLOSURE SERVICES; REAL ESTATE APPRAISAL; REAL ESTATE ESCROW SERVICES; REAL ESTATE SERVICES TO STOP FORECLOSURE, NAMELY, MORTGAGE DEBT MANAGEMENT; REAL ESTATE SERVICES, NAMELY, MASS APPRAISALS; REAL ESTATE TITLE INSURANCE UNDERWRITING SERVICES; REAL ESTATE VALUATION SERVICES; REAL ESTATE VALUATIONS, IN CLASS 36 (U.S. CLS. 100, 101 AND 102).

FIRST USE 12-1-1995; IN COMMERCE 12-1-1995.

FOR: COMPUTER SERVICES, NAMELY, ACTING AS AN APPLICATION SERVICE PROVIDER IN THE FIELD OF INFORMATION MANAGEMENT TO HOST COMPUTER APPLICATION SOFTWARE FOR THE PURPOSE OF MORTGAGE PROCESSING; COMPUTER SOFTWARE DEVELOPMENT IN THE FIELD OF MOBILE APPLICATIONS; DESIGN AND DEVELOPMENT OF COMPUTER SOFTWARE; SOFTWARE AS A SERVICE (SAAS) SERVICES FEATURING SOFTWARE FOR MORTGAGE PROCESSING; SOFTWARE AS A SERVICE (SAAS) SERVICES FEATURING SOFTWARE IN THE FIELD OF MORTGAGE PROCESSING, IN CLASS 42 (U.S. CLS. 100 AND 101).



David J. Kyros

Director of the United States Patent and Trademark Office

Reg. No. 4,154,022 FIRST USE 12-1-1995; IN COMMERCE 12-1-1995.

THE MARK CONSISTS OF STANDARD CHARACTERS WITHOUT CLAIM TO ANY PARTICULAR FONT, STYLE, SIZE, OR COLOR.

SER. NO. 85-444,814, FILED 10-11-2011.

ANDREW LEASER, EXAMINING ATTORNEY

United States of America

United States Patent and Trademark Office



Reg. No. 4,154,023

Registered June 5, 2012

Int. Cl.: 25

TRADEMARK

PRINCIPAL REGISTER

FREEDUMS (CALIFORNIA SOLE PROPRIETORSHIP)
29502 DRIFTWOOD LN
RANCHO PALOS VERDES, CA 90275

FOR: APPAREL FOR DANCERS, NAMELY, TEE SHIRTS, SWEATSHIRTS, PANTS, LEGGINGS, SHORTS AND JACKETS; ATHLETIC APPAREL, NAMELY, SHIRTS, PANTS, JACKETS, FOOTWEAR, HATS AND CAPS, ATHLETIC UNIFORMS; BASEBALL CAPS AND HATS; BUTTON DOWN SHIRTS; DRESS PANTS; DRESS SHIRTS; DRESS SUITS; GOLF SHIRTS; HATS FOR INFANTS, BABIES, TODDLERS AND CHILDREN; HEADGEAR, NAMELY, ADJUSTABLE CAPS; HOODED SWEAT SHIRTS; MEN'S DRESS SOCKS; MEN'S SOCKS; SOCKS; SPORTS CAPS AND HATS; TIES, IN CLASS 25 (U.S. CLS. 22 AND 39).

FIRST USE 6-1-2010; IN COMMERCE 7-1-2010.

THE MARK CONSISTS OF A CONCENTRIC RING, WITH A STYLIZED "F". THE STYLIZED "F" IS ENCASED IN A CIRCLE, WHICH IS SURROUNDED BY A SMALLER CIRCULAR RING.

SER. NO. 85-444,816, FILED 10-11-2011.

ANDREW LEASER, EXAMINING ATTORNEY



David J. Kyffers

Director of the United States Patent and Trademark Office

United States of America

United States Patent and Trademark Office

LIVING IN THE ENDTIMES

Reg. No. 4,154,024

Registered June 5, 2012

Int. Cl.: 41

SERVICE MARK

PRINCIPAL REGISTER

GXP CONSULTING LLC (CALIFORNIA LIMITED LIABILITY COMPANY), DBA GXP
CONSULTING LLC
1475 40TH AVENUE
SAN FRANCISCO, CA 94122

FOR: ENTERTAINMENT SERVICES, NAMELY, THE PROVISION OF CONTINUING RADIO AND TELEVISION PROGRAMS, SEGMENTS, MOVIES, MUSIC, AND VARIETY SHOWS FEATURING NEWS, TEACHING, COMMENTARY, DELIVERED BY TELEVISION, RADIO, SATELLITE, THE INTERNET, OR LIVE, IN CLASS 41 (U.S. CLS. 100, 101 AND 107).

FIRST USE 9-20-2011; IN COMMERCE 9-20-2011.

THE MARK CONSISTS OF STANDARD CHARACTERS WITHOUT CLAIM TO ANY PARTICULAR FONT, STYLE, SIZE, OR COLOR.

SER. NO. 85-444,821, FILED 10-11-2011.

RON FAIRBANKS, EXAMINING ATTORNEY



David J. Kybas

Director of the United States Patent and Trademark Office

United States of America

United States Patent and Trademark Office



Reg. No. 4,154,025

Registered June 5, 2012

Int. Cl.: 9

TRADEMARK

PRINCIPAL REGISTER

MAGNATROL VALVE CORPORATION (NEW JERSEY CORPORATION)
67 5TH AVENUE
HAWTHORNE, NJ 07507

FOR: SOLENOID VALVES, IN CLASS 9 (U.S. CLS. 21, 23, 26, 36 AND 38).

FIRST USE 3-20-1963; IN COMMERCE 3-20-1963.

THE MARK CONSISTS OF AN "M" IN WHITE WITH A "V" OVER THE "M" IN WHITE. A BLACK VERTICAL ARROW WITH A SPIRAL STEM POINTS DOWNWARD THROUGH THE "MV" BUT DOES NOT OVERLAY THE "MV." THE MV IS SHOWN ON A BLACK POLYGON.

SER. NO. 85-444,822, FILED 10-11-2011.

RON FAIRBANKS, EXAMINING ATTORNEY



David J. Kyffers

Director of the United States Patent and Trademark Office

United States of America

United States Patent and Trademark Office

ACTISTRETCH

Reg. No. 4,154,026

Registered June 5, 2012

Int. Cl.: 5

TRADEMARK

PRINCIPAL REGISTER

GEOFROY, DAVID R (VENEZUELA INDIVIDUAL)
6020 NW 99TH AVE, SUITE 215
DORAL, FL 33178

FOR: BANDAGES FOR DRESSINGS, IN CLASS 5 (U.S. CLS. 6, 18, 44, 46, 51 AND 52).

FIRST USE 1-1-2006; IN COMMERCE 1-1-2006.

THE MARK CONSISTS OF STANDARD CHARACTERS WITHOUT CLAIM TO ANY PARTICULAR FONT, STYLE, SIZE, OR COLOR.

SER. NO. 85-444,830, FILED 10-11-2011.

RON FAIRBANKS, EXAMINING ATTORNEY



David J. Kyffers

Director of the United States Patent and Trademark Office

United States of America

United States Patent and Trademark Office

SPIDDIT

Reg. No. 4,154,027

RAHMAN, IBRAHIM L (UNITED STATES INDIVIDUAL)
21811 45TH PLACE SOUTH
KENT, WA 98032

Registered June 5, 2012

Int. Cls.: 38 and 41

FOR: TELECOMMUNICATION SERVICES, NAMELY, TRANSMISSION OF VOICE, DATA, GRAPHICS, IMAGES, AUDIO AND VIDEO BY MEANS OF TELECOMMUNICATIONS NETWORKS, WIRELESS COMMUNICATION NETWORKS, AND THE INTERNET, IN CLASS 38 (U.S. CLS. 100, 101 AND 104).

SERVICE MARK

PRINCIPAL REGISTER

FIRST USE 5-0-2011; IN COMMERCE 7-0-2011.

FOR: COMPOSITION OF MUSIC FOR OTHERS; ENTERTAINMENT SERVICES, NAMELY, ARRANGING AND CONDUCTING OF COMPETITIONS FOR WRITERS, MUSICIANS, SONG WRITERS AND GENERAL INTEREST USERS; ENTERTAINMENT SERVICES, NAMELY, PROVIDING NON-DOWNLOADABLE PLAYBACK OF MUSIC VIA GLOBAL COMMUNICATIONS NETWORKS; ENTERTAINMENT SERVICES, NAMELY, PROVIDING TEMPORARY USE OF NON-DOWNLOADABLE INTERACTIVE GAMES; ON-LINE JOURNALS, NAMELY, BLOGS FEATURING THE FIELDS OF ENTERTAINMENT, EDUCATION, SOCIAL, POLITICAL, CULTURAL, ECONOMIC, SCIENTIFIC AND GENERAL INTEREST; PROVIDING A DATABASE FEATURING INFORMATION ABOUT ARTISTS; PROVIDING A WEBSITE FEATURING INFORMATION IN THE FIELD OF MUSIC AND ENTERTAINMENT; SONG WRITING SERVICES, IN CLASS 41 (U.S. CLS. 100, 101 AND 107).

FIRST USE 5-0-2011; IN COMMERCE 7-0-2011.

THE MARK CONSISTS OF STANDARD CHARACTERS WITHOUT CLAIM TO ANY PARTICULAR FONT, STYLE, SIZE, OR COLOR.

SER. NO. 85-444,853, FILED 10-11-2011.

SANJEEV VOHRA, EXAMINING ATTORNEY



David J. Kyros

Director of the United States Patent and Trademark Office

United States of America

United States Patent and Trademark Office

LCY CHEMICAL CORP.

Reg. No. 4,154,028

Registered June 5, 2012

Int. Cl.: 17

TRADEMARK

PRINCIPAL REGISTER

LCY ELASTOMERS LP (TEXAS LIMITED PARTNERSHIP)
4803 DECKER DRIVE
BAYTOWN, TX 77024

FOR: THERMOPLASTIC RUBBER; THERMOPLASTIC ELASTOMER RESINS IN PELLET, CRUMB, OR POWDER FORM FOR USE IN FURTHER MANUFACTURE, IN CLASS 17 (U.S. CLS. 1, 5, 12, 13, 35 AND 50).

FIRST USE 7-0-2010; IN COMMERCE 7-0-2010.

THE MARK CONSISTS OF STANDARD CHARACTERS WITHOUT CLAIM TO ANY PARTICULAR FONT, STYLE, SIZE, OR COLOR.

OWNER OF U.S. REG. NOS. 2,999,899 AND 3,929,079.

NO CLAIM IS MADE TO THE EXCLUSIVE RIGHT TO USE "CHEMICAL CORP.", APART FROM THE MARK AS SHOWN.

SER. NO. 85-444,874, FILED 10-11-2011.

SANJEEV VOHRA, EXAMINING ATTORNEY



David J. Kyfos

Director of the United States Patent and Trademark Office

United States of America

United States Patent and Trademark Office

360° INSIGHT

Reg. No. 4,154,029

Registered June 5, 2012

Int. Cl.: 45

SERVICE MARK

PRINCIPAL REGISTER

HILLARD HEINTZE, LLC (ILLINOIS LIMITED LIABILITY COMPANY)
SUITE 1730
30 SOUTH WACKER DRIVE
CHICAGO, IL 60606

FOR: INVESTIGATION OR SURVEILLANCE ON BACKGROUND PROFILES; PERSONAL BACKGROUND INVESTIGATIONS; PRE-EMPLOYMENT BACKGROUND INVESTIGATION SERVICES; PRIVATE INVESTIGATION; SECURITY CONSULTANCY; SECURITY INSPECTION SERVICES FOR OTHERS; SECURITY SERVICES FOR INDIVIDUALS AND BUSINESS PERSONS TRAVELING INTERNATIONALLY AND DOMESTICALLY, NAMELY, PROVIDING FOREIGN COUNTRY SECURITY BRIEFINGS, EMBASSY INFORMATION FOR SECURITY PURPOSES AND SECURITY REPORTS; SECURITY SERVICES, NAMELY, PROVIDING EXECUTIVE PROTECTION; SECURITY SERVICES, NAMELY, PROVIDING SECURITY ASSESSMENTS FOR BUSINESSES AND GOVERNMENTAL AGENCIES; SECURITY SERVICES, NAMELY, PROVIDING SECURITY ASSESSMENTS OF PHYSICAL LOCATIONS, INFORMATION SYSTEMS, AND WORKING ENVIRONMENTS; SECURITY SERVICES, NAMELY, THREAT SIMULATION VULNERABILITY ANALYSIS AND MITIGATION AND EMERGENCY AND CRISIS RESPONSE, IN CLASS 45 (U.S. CLS. 100 AND 101).

FIRST USE 4-8-2010; IN COMMERCE 4-8-2010.

THE MARK CONSISTS OF STANDARD CHARACTERS WITHOUT CLAIM TO ANY PARTICULAR FONT, STYLE, SIZE, OR COLOR.

SER. NO. 85-444,927, FILED 10-11-2011.

ELLEN PERKINS, EXAMINING ATTORNEY



David J. Kyros

Director of the United States Patent and Trademark Office

United States of America

United States Patent and Trademark Office



Reg. No. 4,154,030

Registered June 5, 2012

Int. Cl.: 45

SERVICE MARK

PRINCIPAL REGISTER

HILLARD HEINTZE, LLC (ILLINOIS LIMITED LIABILITY COMPANY)
SUITE 1730
30 SOUTH WACKER DRIVE
CHICAGO, IL 60606

FOR: INVESTIGATION OR SURVEILLANCE ON BACKGROUND PROFILES; PERSONAL BACKGROUND INVESTIGATIONS; PRE-EMPLOYMENT BACKGROUND INVESTIGATION SERVICES; PRIVATE INVESTIGATION; SECURITY CONSULTANCY; SECURITY INSPECTION SERVICES FOR OTHERS; SECURITY SERVICES FOR INDIVIDUALS AND BUSINESS PERSONS TRAVELING INTERNATIONALLY AND DOMESTICALLY, NAMELY, PROVIDING FOREIGN COUNTRY SECURITY BRIEFINGS, EMBASSY INFORMATION FOR SECURITY PURPOSES AND SECURITY REPORTS; SECURITY SERVICES, NAMELY, PROVIDING EXECUTIVE PROTECTION; SECURITY SERVICES, NAMELY, PROVIDING SECURITY ASSESSMENTS FOR BUSINESSES AND GOVERNMENTAL AGENCIES; SECURITY SERVICES, NAMELY, THREAT SIMULATION VULNERABILITY ANALYSIS AND MITIGATION AND EMERGENCY AND CRISIS RESPONSE, IN CLASS 45 (U.S. CLS. 100 AND 101).

FIRST USE 8-12-2009; IN COMMERCE 8-12-2009.

THE MARK CONSISTS OF STYLIZED IMAGE OF A SHIELD.

SER. NO. 85-444,955, FILED 10-11-2011.

ELLEN PERKINS, EXAMINING ATTORNEY



David J. Kyjars

Director of the United States Patent and Trademark Office

United States of America

United States Patent and Trademark Office

Pimpsnhosenfest

Reg. No. 4,154,031

Registered June 5, 2012

Int. Cl.: 32

TRADEMARK

PRINCIPAL REGISTER

BARLEY AND HOPS TAVERN (CALIFORNIA PARTNERSHIP)
PO BOX 501
OCCIDENTAL, CA 95465

FOR: BEER, IN CLASS 32 (U.S. CLS. 45, 46 AND 48).

FIRST USE 9-1-2011; IN COMMERCE 10-9-2011.

THE MARK CONSISTS OF STANDARD CHARACTERS WITHOUT CLAIM TO ANY PARTICULAR FONT, STYLE, SIZE, OR COLOR.

SER. NO. 85-444,959, FILED 10-11-2011.

ELLEN PERKINS, EXAMINING ATTORNEY



David J. Kybas

Director of the United States Patent and Trademark Office

United States of America

United States Patent and Trademark Office

LITTLE BIRD BAKING COMPANY

Reg. No. 4,154,032

Registered June 5, 2012

Int. Cl.: 30

TRADEMARK

PRINCIPAL REGISTER

DAVISSON, DJ (UNITED STATES INDIVIDUAL)
1227 140TH STREET NE
MARYSVILLE, WA 98271

FOR: BAKERY GOODS, NAMELY, BROWNIES, CHEESECAKES, CINNAMON ROLLS, COFFEE CAKES, COOKIES, PECAN ROLLS, PIES, AND SCONES, IN CLASS 30 (U.S. CL. 46).

FIRST USE 11-7-2010; IN COMMERCE 9-6-2011.

THE MARK CONSISTS OF STANDARD CHARACTERS WITHOUT CLAIM TO ANY PARTICULAR FONT, STYLE, SIZE, OR COLOR.

NO CLAIM IS MADE TO THE EXCLUSIVE RIGHT TO USE "BAKING COMPANY", APART FROM THE MARK AS SHOWN.

SER. NO. 85-444,973, FILED 10-11-2011.

CARYN GLASSER, EXAMINING ATTORNEY



David J. Kybas

Director of the United States Patent and Trademark Office

United States of America

United States Patent and Trademark Office

CHEMSTREAM



Reg. No. 4,154,033

Registered June 5, 2012

Int. Cls.: 1 and 40

TRADEMARK

SERVICE MARK

PRINCIPAL REGISTER

CHEMSTREAM, INC. (PENNSYLVANIA CORPORATION)
166 COMMERCE DRIVE
STOYSTOWN, PA 15563

FOR: CHEMICALS FOR USE IN PURIFICATION OF WATER, IN CLASS 1 (U.S. CLS. 1, 5, 6, 10, 26 AND 46).

FIRST USE 7-31-1997; IN COMMERCE 6-30-2007.

FOR: WATER TREATMENT AND PURIFICATION; WATER TREATMENT SERVICES, IN CLASS 40 (U.S. CLS. 100, 103 AND 106).

FIRST USE 7-31-1997; IN COMMERCE 6-30-2007.

THE MARK CONSISTS OF THE DESIGNATION "CHEMSTREAM", BENEATH WHICH ARE THREE HORIZONTAL WAVY LINES, WITH THREE WATER DROPLETS SUPERIMPOSED OVER THE SAID WAVY LINES.

SER. NO. 85-445,041, FILED 10-12-2011.

MARK T. MULLEN, EXAMINING ATTORNEY

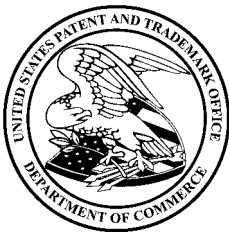

David J. Kybas

Director of the United States Patent and Trademark Office

United States of America

United States Patent and Trademark Office

MANARCHY

Reg. No. 4,154,034

BRIAN J. PLACHTA (UNITED STATES INDIVIDUAL)
2701 SINCLAIR N.E.
GRAND RAPIDS, MI 49503

Registered June 5, 2012

Int. Cl.: 45

FOR: CHRISTIAN MINISTRY SERVICES, IN CLASS 45 (U.S. CLS. 100 AND 101).

SERVICE MARK

FIRST USE 1-1-2010; IN COMMERCE 9-9-2011.

PRINCIPAL REGISTER

THE MARK CONSISTS OF STANDARD CHARACTERS WITHOUT CLAIM TO ANY PARTICULAR FONT, STYLE, SIZE, OR COLOR.

SER. NO. 85-445,044, FILED 10-12-2011.

AISHA SALEM, EXAMINING ATTORNEY



David J. Kybas

Director of the United States Patent and Trademark Office

United States of America

United States Patent and Trademark Office



Reg. No. 4,154,035

STEC, INC. (SOUTH CAROLINA CORPORATION)
1600 OLD DENVER ROAD
ANDERSON, SC 29625

Registered June 5, 2012

Int. Cl.: 35

FOR: RETAIL STORE SERVICES FEATURING LANDSCAPING AND TURF EQUIPMENT,
IN CLASS 35 (U.S. CLS. 100, 101 AND 102).

SERVICE MARK

FIRST USE 1-1-2010; IN COMMERCE 1-1-2010.

PRINCIPAL REGISTER

OWNER OF U.S. REG. NO. 3,856,657.

NO CLAIM IS MADE TO THE EXCLUSIVE RIGHT TO USE "SPECIALIZED TURF EQUIPMENT COMPANY", APART FROM THE MARK AS SHOWN.

THE MARK CONSISTS OF THE STYLIZED WORDING "STEC SPECIALIZED TURF EQUIPMENT COMPANY" AND STYLIZED DESIGN OF GRASS.

SER. NO. 85-445,050, FILED 10-12-2011.

BRIAN PINO, EXAMINING ATTORNEY



David J. Kyffers

Director of the United States Patent and Trademark Office

United States of America

United States Patent and Trademark Office

COOL IN SCHOOL

Reg. No. 4,154,036

Registered June 5, 2012

Int. Cl.: 28

TRADEMARK

PRINCIPAL REGISTER

SUPER DUPER, INC. (SOUTH CAROLINA CORPORATION), DBA SUPER DUPER PUBLICATIONS
5201 PELHAM RD.
GREENVILLE, SC 29615

FOR: BOARD GAME FOR USE AS TEACHING AND MOTIVATIONAL AID THAT DEALS PRIMARILY WITH COMMUNICATION AND SOCIAL SKILLS DEVELOPMENT IN THE FIELD OF SPEECH AND LANGUAGE FOR USE BY THE GENERAL PUBLIC, PUBLIC AND PRIVATE TEACHERS, HEALTH PROFESSIONALS OR THERAPISTS, IN CLASS 28 (U.S. CLS. 22, 23, 38 AND 50).

FIRST USE 6-24-2011; IN COMMERCE 6-24-2011.

THE MARK CONSISTS OF STANDARD CHARACTERS WITHOUT CLAIM TO ANY PARTICULAR FONT, STYLE, SIZE, OR COLOR.

SER. NO. 85-445,108, FILED 10-12-2011.

JENNY PARK, EXAMINING ATTORNEY



David J. Kybas

Director of the United States Patent and Trademark Office

United States of America

United States Patent and Trademark Office



Reg. No. 4,154,037

Registered June 5, 2012

Int. Cls.: 16 and 35

TRADEMARK

SERVICE MARK

PRINCIPAL REGISTER

YOU'RE CLUELESS, INC. (ILLINOIS CORPORATION)
2145 TANGLEWOOD COURT
HIGHLAND PARK, IL 60035

FOR: NOTE, GREETING AND ANNOUNCEMENT CARDS FEATURING PICTURES AND HUMOROUS PHRASES, IN CLASS 16 (U.S. CLS. 2, 5, 22, 23, 29, 37, 38 AND 50).

FIRST USE 5-0-2011; IN COMMERCE 5-0-2011.

FOR: ONLINE RETAIL STORE SERVICES FEATURING APPAREL, BEVERAGEWARE, AND E-CARDS AND CARDS FEATURING PICTURES AND HUMOROUS PHRASES, IN CLASS 35 (U.S. CLS. 100, 101 AND 102).

FIRST USE 5-0-2011; IN COMMERCE 5-0-2011.

THE MARK CONSISTS OF THE WORDS "YOU'RE CLUELESS" INSIDE A CLOUD. EIGHT CIRCLES OF VARYING SIZES APPEAR TO THE RIGHT.

SER. NO. 85-445,135, FILED 10-12-2011.

TINA MAI, EXAMINING ATTORNEY



David J. Kybas

Director of the United States Patent and Trademark Office

United States of America

United States Patent and Trademark Office

MGENOME

Reg. No. 4,154,038

Registered June 5, 2012

Int. Cl.: 35

SERVICE MARK

PRINCIPAL REGISTER

EXCO INTOUCH LTD. (UNITED KINGDOM LIMITED COMPANY (LTD.))
PISHIOBURY HOUSE
PISHIOBURY DRIVE
SAWBRIDGEWORTH, HERTS, UNITED KINGDOM CM210AF

FOR: COLLECTING AND ANALYZING DATA FOR OTHERS REGARDING THE CAPABILITIES AND FUNCTIONALITY OF MOBILE DEVICES, INCLUDING DEVICE, USER AND/OR PERIPHERAL INTERFACE DATA; BUSINESS ADVISORY SERVICES, NAMELY, SELECTING DEVICE COMPLIANT SOFTWARE APPLICATIONS FOR OTHERS BASED ON THE CAPABILITIES AND FUNCTIONALITY OF THE MOBILE DEVICE, IN CLASS 35 (U.S. CLS. 100, 101 AND 102).

FIRST USE 9-30-2011; IN COMMERCE 9-30-2011.

THE MARK CONSISTS OF STANDARD CHARACTERS WITHOUT CLAIM TO ANY PARTICULAR FONT, STYLE, SIZE, OR COLOR.

SER. NO. 85-445,141, FILED 10-12-2011.

LUCY ARANT, EXAMINING ATTORNEY



David J. Kyffers

Director of the United States Patent and Trademark Office

United States of America
United States Patent and Trademark Office

strategic
expressions
.....

Reg. No. 4,154,039

STRATEGIC EXPRESSIONS, LLC (VIRGINIA LIMITED LIABILITY COMPANY)
7014 TREK WAY
GAINESVILLE, VA 20155

Registered June 5, 2012

Int. Cl.: 38

FOR: CONSULTING SERVICES IN THE FIELD OF COMMUNICATIONS, IN CLASS 38 (U.S. CLS. 100, 101 AND 104).

SERVICE MARK

FIRST USE 9-1-2011; IN COMMERCE 9-1-2011.

PRINCIPAL REGISTER

THE MARK CONSISTS OF THE STYLIZED TEXT "STRATEGIC" ABOVE THE STYLIZED TEXT "EXPRESSIONS". UNDER THE WORD "EXPRESSIONS" ARE SIX DOTS IN A ROW.

SER. NO. 85-445,146, FILED 10-12-2011.

LUCY ARANT, EXAMINING ATTORNEY



David J. Kybas

Director of the United States Patent and Trademark Office

United States of America

United States Patent and Trademark Office

NOVASPAN

Reg. No. 4,154,040

Registered June 5, 2012

Int. Cl.: 24

TRADEMARK

PRINCIPAL REGISTER

NOVAVALL SYSTEMS, INC. (NEVADA CORPORATION)
885B SOUTH PICKETT STREET
ALEXANDRIA, VA 22304

FOR: WIDE-SPAN TEXTILE FABRICS FOR USE ON LARGE AREAS AND CEILINGS, AND
DIGITAL PRINTING, IN CLASS 24 (U.S. CLS. 42 AND 50).

FIRST USE 12-0-2007; IN COMMERCE 12-0-2007.

THE MARK CONSISTS OF STANDARD CHARACTERS WITHOUT CLAIM TO ANY PAR-
TICULAR FONT, STYLE, SIZE, OR COLOR.

OWNER OF U.S. REG. NO. 1,832,756.

SER. NO. 85-445,164, FILED 10-12-2011.

LINDA E. BLOHM, EXAMINING ATTORNEY



David J. Kybas

Director of the United States Patent and Trademark Office

United States of America

United States Patent and Trademark Office

OncProTech

Reg. No. 4,154,041

ONCPROTECH LLC (MICHIGAN LIMITED LIABILITY COMPANY)
2254 BELMONT ROAD
ANN ARBOR, MI 48104

Registered June 5, 2012

Int. Cl.: 42

FOR: BIOTECHNOLOGY RESEARCH AND DEVELOPMENT, IN CLASS 42 (U.S. CLS. 100 AND 101).

SERVICE MARK

FIRST USE 9-1-2011; IN COMMERCE 9-1-2011.

PRINCIPAL REGISTER

THE MARK CONSISTS OF STANDARD CHARACTERS WITHOUT CLAIM TO ANY PARTICULAR FONT, STYLE, SIZE, OR COLOR.

SER. NO. 85-445,174, FILED 10-12-2011.

WILLIAM BRECKENFELD, EXAMINING ATTORNEY



David J. Kyffers

Director of the United States Patent and Trademark Office

United States of America

United States Patent and Trademark Office

The Art of Play

Reg. No. 4,154,042

PARK PLACE RECREATION DESIGNS, INC. (TEXAS CORPORATION)
4225 WOODBURN
SAN ANTONIO, TX 78218

Registered June 5, 2012

Int. Cl.: 28

FOR: PLAYGROUND EQUIPMENT, NAMELY, CLIMBING UNITS, IN CLASS 28 (U.S. CLS. 22, 23, 38 AND 50).

TRADEMARK

FIRST USE 6-1-2011; IN COMMERCE 8-21-2011.

PRINCIPAL REGISTER

THE MARK CONSISTS OF STANDARD CHARACTERS WITHOUT CLAIM TO ANY PARTICULAR FONT, STYLE, SIZE, OR COLOR.

SER. NO. 85-445,178, FILED 10-12-2011.

WILLIAM BRECKENFELD, EXAMINING ATTORNEY



David J. Kyros

Director of the United States Patent and Trademark Office

United States of America

United States Patent and Trademark Office

ENTERATE

Reg. No. 4,154,043

Registered June 5, 2012

Int. Cl.: 36

SERVICE MARK

PRINCIPAL REGISTER

ENTERATE INSURANCE, LLC (FLORIDA LIMITED LIABILITY COMPANY)
SUITE 202
8000 NW 7 STREET
MIAMI, FL 33126

FOR: INSURANCE AGENCIES; INSURANCE AGENCIES IN THE FIELD OF AUTO INSURANCE, HOME INSURANCE, RENTER'S INSURANCE, LIFE INSURANCE, MEDICAL INSURANCE, COMMERCIAL INSURANCE, AND EMPLOYEE BENEFITS; INSURANCE BROKERAGE SERVICES; INSURANCE CONSULTANCY; INSURANCE INFORMATION, IN CLASS 36 (U.S. CLS. 100, 101 AND 102).

FIRST USE 6-2-2011; IN COMMERCE 8-30-2011.

THE MARK CONSISTS OF STANDARD CHARACTERS WITHOUT CLAIM TO ANY PARTICULAR FONT, STYLE, SIZE, OR COLOR.

THE ENGLISH TRANSLATION OF "ENTERATE" IN THE MARK IS TO KNOW.

SER. NO. 85-445,179, FILED 10-12-2011.

WILLIAM BRECKENFELD, EXAMINING ATTORNEY



David J. Kypos

Director of the United States Patent and Trademark Office

United States of America

United States Patent and Trademark Office

OCCUPATION

Reg. No. 4,154,044

Registered June 5, 2012

Int. Cl.: 32

TRADEMARK

PRINCIPAL REGISTER

MAD SCIENTISTS BREWING PARTNERS LLC (NEW YORK LIMITED LIABILITY COMPANY), DBA SIXPOINT CRAFT ALES
40 VAN DYKE STREET
BROOKLYN, NY 11231

FOR: BEER, IN CLASS 32 (U.S. CLS. 45, 46 AND 48).

FIRST USE 10-1-2011; IN COMMERCE 10-1-2011.

THE MARK CONSISTS OF STANDARD CHARACTERS WITHOUT CLAIM TO ANY PARTICULAR FONT, STYLE, SIZE, OR COLOR.

SER. NO. 85-445,200, FILED 10-12-2011.

KAREN BRACEY, EXAMINING ATTORNEY



David J. Kyffers

Director of the United States Patent and Trademark Office

United States of America

United States Patent and Trademark Office

FIDA

Reg. No. 4,154,045

Registered June 5, 2012

Int. Cls.: 35 and 41

SERVICE MARK

PRINCIPAL REGISTER

NATIONAL SPORTING GOODS ASSOCIATION (MISSOURI NON-PROFIT CORPORATION)
SUITE 300
1601 FEEHANVILLE DRIVE
MOUNT PROSPECT, IL 60056

FOR: ASSOCIATION SERVICES, NAMELY, PROMOTING THE INTERESTS OF SPECIALTY FITNESS DEALERS AND THE FITNESS INDUSTRY , IN CLASS 35 (U.S. CLS. 100, 101 AND 102).

FIRST USE 7-0-2010; IN COMMERCE 7-0-2010.

FOR: ARRANGING AND CONDUCTING SEMINARS, WORKSHOPS, CLASSES, AND SYMPOSIA IN THE FIELD OF THE FITNESS INDUSTRY AND THE RETAIL SALES OF FITNESS EQUIPMENT, IN CLASS 41 (U.S. CLS. 100, 101 AND 107).

FIRST USE 9-0-2011; IN COMMERCE 9-0-2011.

THE MARK CONSISTS OF STANDARD CHARACTERS WITHOUT CLAIM TO ANY PARTICULAR FONT, STYLE, SIZE, OR COLOR.

SER. NO. 85-445,388, FILED 10-12-2011.

TASNEEM HUSSAIN, EXAMINING ATTORNEY



David J. Kyros

Director of the United States Patent and Trademark Office

United States of America

United States Patent and Trademark Office

YOUR FUTURE IS > EVER.

Reg. No. 4,154,046

Registered June 5, 2012

Int. Cl.: 35

SERVICE MARK

PRINCIPAL REGISTER

UNITEDHEALTH GROUP INCORPORATED (MINNESOTA CORPORATION)
MN008-T202
9900 BREN ROAD EAST
MINNETONKA, MN 55343

FOR: EMPLOYMENT COUNSELING AND RECRUITING SERVICES; PROVIDING ON-LINE EMPLOYMENT INFORMATION REGARDING RECRUITING, CAREER ADVICE, CAREER EVENTS, RESUME ADVICE, INTERVIEW TIPS, JOB RESOURCES, JOB LISTINGS, AND INTERNSHIPS; PROVIDING AN INTERACTIVE WEBSITE OFFERING RECRUITMENT, EMPLOYMENT, AND CAREER DEVELOPMENT INFORMATION; PROVIDING AN ON-LINE SEARCHABLE DATABASE FEATURING EMPLOYMENT OPPORTUNITIES AND CONTENT ABOUT EMPLOYMENT OPPORTUNITIES; PROVIDING A SERVICE THAT ALLOWS FOR INDIVIDUALS TO SPEAK DIRECTLY WITH A RECRUITER THROUGH E-MAILS, LIVE CHAT, AND SOCIAL MEDIA CHANNELS, IN CLASS 35 (U.S. CLS. 100, 101 AND 102).

FIRST USE 2-0-2009; IN COMMERCE 2-0-2009.

THE MARK CONSISTS OF STANDARD CHARACTERS WITHOUT CLAIM TO ANY PARTICULAR FONT, STYLE, SIZE, OR COLOR.

SER. NO. 85-445,400, FILED 10-12-2011.

ERNEST SHOSHO, EXAMINING ATTORNEY



David J. Kyffers

Director of the United States Patent and Trademark Office

United States of America

United States Patent and Trademark Office

START A CAREER THAT IS >
YOUR EXPECTATIONS.

Reg. No. 4,154,047

Registered June 5, 2012

Int. Cl.: 35

SERVICE MARK

PRINCIPAL REGISTER

UNITEDHEALTH GROUP INCORPORATED (MINNESOTA CORPORATION)
MN008-T202
9900 BREN ROAD EAST
MINNETONKA, MN 55343

FOR: EMPLOYMENT COUNSELING AND RECRUITING SERVICES; PROVIDING ON-LINE EMPLOYMENT INFORMATION REGARDING RECRUITING, CAREER ADVICE, CAREER EVENTS, RESUME ADVICE, INTERVIEW TIPS, JOB RESOURCES, JOB LISTINGS, AND INTERNSHIPS; PROVIDING AN INTERACTIVE WEBSITE OFFERING RECRUITMENT, EMPLOYMENT, AND CAREER DEVELOPMENT INFORMATION; PROVIDING AN ON-LINE SEARCHABLE DATABASE FEATURING EMPLOYMENT OPPORTUNITIES AND CONTENT ABOUT EMPLOYMENT OPPORTUNITIES; PROVIDING A SERVICE THAT ALLOWS FOR INDIVIDUALS TO SPEAK DIRECTLY WITH A RECRUITER THROUGH E-MAILS, LIVE CHAT, AND SOCIAL MEDIA CHANNELS, IN CLASS 35 (U.S. CLS. 100, 101 AND 102).

FIRST USE 2-0-2009; IN COMMERCE 2-0-2009.

THE MARK CONSISTS OF STANDARD CHARACTERS WITHOUT CLAIM TO ANY PARTICULAR FONT, STYLE, SIZE, OR COLOR.

SER. NO. 85-445,409, FILED 10-12-2011.

ERNEST SHOSHO, EXAMINING ATTORNEY



David J. Kyffers

Director of the United States Patent and Trademark Office

United States of America

United States Patent and Trademark Office

>THERE'S SOMETHING GREATER
AT WORK HERE

Reg. No. 4,154,048

Registered June 5, 2012

Int. Cl.: 35

SERVICE MARK

PRINCIPAL REGISTER

UNITEDHEALTH GROUP INCORPORATED (MINNESOTA CORPORATION)
MN008-T202
9900 BREN ROAD EAST
MINNETONKA, MN 55343

FOR: EMPLOYMENT COUNSELING AND RECRUITING SERVICES; PROVIDING ON-LINE EMPLOYMENT INFORMATION REGARDING RECRUITING, CAREER ADVICE, CAREER EVENTS, RESUME ADVICE, INTERVIEW TIPS, JOB RESOURCES, JOB LISTINGS, AND INTERNSHIPS; PROVIDING AN INTERACTIVE WEBSITE OFFERING RECRUITMENT, EMPLOYMENT, AND CAREER DEVELOPMENT INFORMATION; PROVIDING AN ON-LINE SEARCHABLE DATABASE FEATURING EMPLOYMENT OPPORTUNITIES AND CONTENT ABOUT EMPLOYMENT OPPORTUNITIES; PROVIDING A SERVICE THAT ALLOWS FOR INDIVIDUALS TO SPEAK DIRECTLY WITH A RECRUITER THROUGH E-MAILS, LIVE CHAT, AND SOCIAL MEDIA CHANNELS, IN CLASS 35 (U.S. CLS. 100, 101 AND 102).

FIRST USE 2-0-2009; IN COMMERCE 2-0-2009.

THE MARK CONSISTS OF STANDARD CHARACTERS WITHOUT CLAIM TO ANY PARTICULAR FONT, STYLE, SIZE, OR COLOR.

SER. NO. 85-445,411, FILED 10-12-2011.

ERNEST SHOSHO, EXAMINING ATTORNEY



David J. Kyffers

Director of the United States Patent and Trademark Office

United States of America

United States Patent and Trademark Office

SIDECOM

Reg. No. 4,154,049

Registered June 5, 2012

Int. Cl.: 9

TRADEMARK

PRINCIPAL REGISTER

HILL-ROM SERVICES, INC. (INDIANA CORPORATION)
1069 STATE ROUTE 46 EAST
BATESVILLE, IN 47006

FOR: COMBINATION ELECTRIC BED POSITIONING CONTROL AND COMMUNICATION SYSTEM COMPRISING PATIENT OPERABLE PUSH-BUTTON HEAD AND KNEE ELECTRIC BED CONTROLS AND NURSE CALL SIGNAL WITH AVAILABLE ACCESSORIES, NAMELY, TELEVISION AND RADIO CONTROLS AND SPEAKERS, AN INTERCOM FOR INTRA-HOSPITAL COMMUNICATION, AND ROOM LIGHTING CONTROLS, ALL INTEGRATED INTO AND SOLD AS A COMPONENT OF A SIDEGUARD TO BE USED ON ELECTRIC HOSPITAL BEDS, IN CLASS 9 (U.S. CLS. 21, 23, 26, 36 AND 38).

FIRST USE 5-18-1979; IN COMMERCE 5-18-1979.

THE MARK CONSISTS OF STANDARD CHARACTERS WITHOUT CLAIM TO ANY PARTICULAR FONT, STYLE, SIZE, OR COLOR.

OWNER OF U.S. REG. NO. 1,172,970.

SER. NO. 85-445,555, FILED 10-12-2011.

JORDAN BAKER, EXAMINING ATTORNEY



David J. Kyffers

Director of the United States Patent and Trademark Office

United States of America

United States Patent and Trademark Office

OMG KLEEN

Reg. No. 4,154,050

Registered June 5, 2012

Int. Cl.: 37

SERVICE MARK

PRINCIPAL REGISTER

OMG KLEEN, LLC (TEXAS LIMITED LIABILITY COMPANY)
1801 13TH STREET
LUBBOCK, TX 79401

FOR: CLEANING OF BUILDINGS; CLEANING OF INDUSTRIAL PREMISES; CLEANING OF RESIDENTIAL HOUSES; REAL ESTATE PROPERTY CLEANING, REPAIR AND MAINTENANCE SERVICES, IN CLASS 37 (U.S. CLS. 100, 103 AND 106).

FIRST USE 8-19-2011; IN COMMERCE 10-1-2011.

THE MARK CONSISTS OF STANDARD CHARACTERS WITHOUT CLAIM TO ANY PARTICULAR FONT, STYLE, SIZE, OR COLOR.

NO CLAIM IS MADE TO THE EXCLUSIVE RIGHT TO USE "CLEAN", APART FROM THE MARK AS SHOWN.

SER. NO. 85-445,562, FILED 10-12-2011.

JORDAN BAKER, EXAMINING ATTORNEY



David J. Kyros

Director of the United States Patent and Trademark Office

United States of America

United States Patent and Trademark Office

The Wishing Word

Reg. No. 4,154,051

Registered June 5, 2012

Int. Cl.: 35

SERVICE MARK

PRINCIPAL REGISTER

THE WISHING WORD INC. (TEXAS CORPORATION)
582 FALCONWOOD DRIVE
SAN MARCOS, TX 78666

FOR: PROJECT MANAGEMENT SERVICES FOR OTHERS IN THE FIELDS OF LANGUAGE TRANSLATION, CUSTOM WRITING, TEXT ADAPTATION, INTERPRETING AND PROOFREADING; WRITING OF PUBLICITY TEXTS, IN CLASS 35 (U.S. CLS. 100, 101 AND 102).

FIRST USE 9-1-2011; IN COMMERCE 9-1-2011.

THE MARK CONSISTS OF STANDARD CHARACTERS WITHOUT CLAIM TO ANY PARTICULAR FONT, STYLE, SIZE, OR COLOR.

SER. NO. 85-445,595, FILED 10-12-2011.

JULIE VEPPUMTHARA, EXAMINING ATTORNEY



David J. Kybas

Director of the United States Patent and Trademark Office

United States of America

United States Patent and Trademark Office

MAGICAL FLAVORS

Reg. No. 4,154,052

Registered June 5, 2012

Int. Cl.: 30

TRADEMARK

PRINCIPAL REGISTER

HAIDER, SAM (CANADA INDIVIDUAL)
6-295 QUEEN STREET EAST
#282
BRAMPTON, ONTARIO, CANADA L6W4S6

FOR: FROZEN YOGURT MIXES, FROZEN YOGURT, FLAVOR MIXES FOR FROZEN YOGURT, IN CLASS 30 (U.S. CL. 46).

FIRST USE 2-1-2011; IN COMMERCE 2-1-2011.

THE MARK CONSISTS OF STANDARD CHARACTERS WITHOUT CLAIM TO ANY PARTICULAR FONT, STYLE, SIZE, OR COLOR.

NO CLAIM IS MADE TO THE EXCLUSIVE RIGHT TO USE "FLAVORS", APART FROM THE MARK AS SHOWN.

SER. NO. 85-445,613, FILED 10-12-2011.

KELLY TRUSILO, EXAMINING ATTORNEY



David J. Kyjars

Director of the United States Patent and Trademark Office

United States of America

United States Patent and Trademark Office

SEE THE LIGHT

Reg. No. 4,154,053

Registered June 5, 2012

Int. Cl.: 41

SERVICE MARK

PRINCIPAL REGISTER

CORNING CABLE SYSTEMS BRANDS, INC. (DELAWARE CORPORATION)
SUITE 278-B
103 FOULK ROAD
WILMINGTON, DE 19803

FOR: TRAINING SERVICES IN THE FIELD OF FIBER OPTIC TECHNOLOGY, IN CLASS 41 (U.S. CLS. 100, 101 AND 107).

FIRST USE 8-3-2010; IN COMMERCE 8-3-2010.

THE MARK CONSISTS OF STANDARD CHARACTERS WITHOUT CLAIM TO ANY PARTICULAR FONT, STYLE, SIZE, OR COLOR.

SER. NO. 85-445,646, FILED 10-12-2011.

JOHN GARTNER, EXAMINING ATTORNEY



David J. Kybas

Director of the United States Patent and Trademark Office

United States of America

United States Patent and Trademark Office

HYPERSTUDIO

Reg. No. 4,154,054

THE SOFTWARE MACKIEV COMPANY (NEVADA CORPORATION)
30-31 UNION WHARF
BOSTON, MA 02109

Registered June 5, 2012

Int. Cl.: 9

FOR: COMPUTER PROGRAM FOR AUTHORING AND RUNNING HYPERMEDIA APPLICATIONS, IN CLASS 9 (U.S. CLS. 21, 23, 26, 36 AND 38).

TRADEMARK

FIRST USE 10-10-1988; IN COMMERCE 10-10-1988.

PRINCIPAL REGISTER

THE MARK CONSISTS OF STANDARD CHARACTERS WITHOUT CLAIM TO ANY PARTICULAR FONT, STYLE, SIZE, OR COLOR.

SER. NO. 85-445,666, FILED 10-12-2011.

STEVEN JACKSON, EXAMINING ATTORNEY



David J. Kybas

Director of the United States Patent and Trademark Office

United States of America

United States Patent and Trademark Office

VALLEY GREEN NATURALS

Reg. No. 4,154,055

Registered June 5, 2012

Int. Cl.: 3

TRADEMARK

PRINCIPAL REGISTER

VALLEY GREEN NATURALS, LLC (VIRGINIA LIMITED LIABILITY COMPANY)
6188 GEORGETOWN ROAD
BROAD RUN, VA 20137

FOR: BATH CREAM; BATH GELS; BATH LOTION; BATH OILS AND BATH SALTS; BATH OILS FOR COSMETIC PURPOSES; BATH SALTS; BATH SOAPS; BEAUTY SOAP; BODY LOTIONS; BODY OILS; CLEANSING CREAMS; COSMETIC CREAMS; COSMETIC CREAMS FOR SKIN CARE; COSMETIC HAND CREAMS; COSMETIC NOURISHING CREAMS; COSMETIC SOAPS; CREAM SOAPS; FACE AND BODY CREAMS; FACE CREAMS; FACE CREAMS FOR COSMETIC USE; FACIAL CREAMS; HAND CREAM; HAND LOTIONS; LIP CREAM; MOISTURIZING CREAMS; MOISTURIZING PREPARATIONS FOR THE SKIN; NON-MEDICATED SKIN CARE CREAMS AND LOTIONS; NON-MEDICATED SKIN CARE PREPARATIONS, NAMELY, CREAMS, LOTIONS, GELS, TONERS, CLEANERS AND PEELS; SHOWER CREAMS; SHOWER GELS; SKIN AND BODY TOPICAL LOTIONS, CREAMS AND OILS FOR COSMETIC USE; SKIN CLEANSING CREAM; SKIN CREAMS; SKIN MOISTURIZER; SOAPS FOR PERSONAL USE, IN CLASS 3 (U.S. CLS. 1, 4, 6, 50, 51 AND 52).

FIRST USE 11-0-2008; IN COMMERCE 11-0-2008.

THE MARK CONSISTS OF STANDARD CHARACTERS WITHOUT CLAIM TO ANY PARTICULAR FONT, STYLE, SIZE, OR COLOR.

NO CLAIM IS MADE TO THE EXCLUSIVE RIGHT TO USE "GREEN NATURALS", APART FROM THE MARK AS SHOWN.

SER. NO. 85-445,674, FILED 10-12-2011.

CARYN GLASSER, EXAMINING ATTORNEY



David J. Kyros

Director of the United States Patent and Trademark Office

United States of America

United States Patent and Trademark Office

AMFORWARD

Reg. No. 4,154,056

Registered June 5, 2012

Int. Cl.: 39

SERVICE MARK

PRINCIPAL REGISTER

AMBOY TECHNOLOGIES LLC (OREGON LIMITED LIABILITY COMPANY)
A100
12759 NE WHITAKER WAY
PORTLAND, OR 97230

FOR: WAREHOUSING SERVICES, NAMELY, STORAGE, DISTRIBUTION, PICK-UP, PACKING, AND SHIPPING OF DOCUMENTS, PACKAGES, RAW MATERIALS, AND OTHER FREIGHT FOR OTHERS, IN CLASS 39 (U.S. CLS. 100 AND 105).

FIRST USE 11-24-2010; IN COMMERCE 10-10-2011.

THE MARK CONSISTS OF STANDARD CHARACTERS WITHOUT CLAIM TO ANY PARTICULAR FONT, STYLE, SIZE, OR COLOR.

SER. NO. 85-445,680, FILED 10-12-2011.

RONALD MCMORROW, EXAMINING ATTORNEY



David J. Kybas

Director of the United States Patent and Trademark Office

United States of America

United States Patent and Trademark Office



Reg. No. 4,154,057

Registered June 5, 2012

Int. Cl.: 37

SERVICE MARK

PRINCIPAL REGISTER

SANDRIDGE ENERGY, INC. (OKLAHOMA CORPORATION)
123 ROBER S. KERR AVENUE
OKLAHOMA CITY, OK 73102

FOR: OIL AND GAS DRILLING, IN CLASS 37 (U.S. CLS. 100, 103 AND 106).

FIRST USE 9-16-2011; IN COMMERCE 9-16-2011.

OWNER OF U.S. REG. NOS. 3,496,460, 3,915,139 AND OTHERS.

THE COLOR(S) RED AND BLACK IS/ARE CLAIMED AS A FEATURE OF THE MARK.

THE MARK CONSISTS OF THREE CURVED RED LINES THAT CHANGE TO BLACK WHEN THE LINES WAVE OVER TO SHOW THE REVERSE SIDE AND BELOW APPEARS THE WORDING "SANDRIDGE" IN BLACK; THE COLOR WHITE IS NOT CLAIMED AS PART OF THE MARK AND REPRESENTS TRANSPARENT BACKGROUND.

SER. NO. 85-445,693, FILED 10-12-2011.

AMY KELLY, EXAMINING ATTORNEY



David J. Kybas

Director of the United States Patent and Trademark Office

United States of America

United States Patent and Trademark Office

DermaSens

Reg. No. 4,154,058

Registered June 5, 2012

Int. Cl.: 3

TRADEMARK

PRINCIPAL REGISTER

VALLEY GREEN NATURALS, LLC (VIRGINIA LIMITED LIABILITY COMPANY)
6188 GEORGETOWN ROAD
BROAD RUN, VA 20137

FOR: BATH AND SHOWER GELS AND SALTS NOT FOR MEDICAL PURPOSES; BATH OILS AND BATH SALTS; MOISTURIZING CREAMS; NON-MEDICATED BODY SOAKS; SKIN MOISTURIZER, IN CLASS 3 (U.S. CLS. 1, 4, 6, 50, 51 AND 52).

FIRST USE 11-0-2008; IN COMMERCE 11-0-2008.

THE MARK CONSISTS OF STANDARD CHARACTERS WITHOUT CLAIM TO ANY PARTICULAR FONT, STYLE, SIZE, OR COLOR.

SER. NO. 85-445,700, FILED 10-12-2011.

CARYN GLASSER, EXAMINING ATTORNEY



David J. Kyffers

Director of the United States Patent and Trademark Office

United States of America

United States Patent and Trademark Office

WOMEN'S GLOBAL LEADERSHIP CONFERENCE

Reg. No. 4,154,059

Registered June 5, 2012

Int. Cl.: 35

SERVICE MARK

PRINCIPAL REGISTER

GULF PUBLISHING COMPANY (DELAWARE CORPORATION)
SUITE 1020
2 GREENWAY PLAZA
HOUSTON, TX 77046

FOR: ARRANGING AND CONDUCTING CONFERENCES FOR THE ENERGY INDUSTRY,
IN CLASS 35 (U.S. CLS. 100, 101 AND 102).

FIRST USE 5-31-2005; IN COMMERCE 5-31-2005.

THE MARK CONSISTS OF STANDARD CHARACTERS WITHOUT CLAIM TO ANY PAR-
TICULAR FONT, STYLE, SIZE, OR COLOR.

NO CLAIM IS MADE TO THE EXCLUSIVE RIGHT TO USE "CONFERENCE", APART FROM
THE MARK AS SHOWN.

SEC. 2(F).

SER. NO. 85-445,711, FILED 10-12-2011.

KEVON CHISOLM, EXAMINING ATTORNEY



David J. Kyros

Director of the United States Patent and Trademark Office

United States of America

United States Patent and Trademark Office

T1

Reg. No. 4,154,060

Registered June 5, 2012

Int. Cl.: 7

TRADEMARK

PRINCIPAL REGISTER

WIELAND DENTAL + TECHNIK GMBH & CO. KG (FED REP GERMANY LIMITED
PARTNERSHIP WITH A LIMITED LIABILITY AS GENERAL PARTNER)
SCHWENNINGER STRASSE 13
PFORZHEIM, FED REP GERMANY 75179

FOR: MACHINES FOR THE TREATMENT OF CERAMICS, PLASTICS, METALS, METAL ALLOYS AND THE LIKE FOR DENTAL USE, IN PARTICULAR MILLING AND GRINDING MACHINES; MACHINE TOOLS FOR THE AFOREMENTIONED MACHINES, IN PARTICULAR MILLING AND GRINDING TOOLS; TOOL HOLDERS AS PARTS OF MACHINES AND WORK PIECE HOLDERS AS PARTS OF MACHINES FOR THE AFOREMENTIONED GOODS, IN CLASS 7 (U.S. CLS. 13, 19, 21, 23, 31, 34 AND 35).

FIRST USE 2-28-2010; IN COMMERCE 2-28-2010.

THE MARK CONSISTS OF STANDARD CHARACTERS WITHOUT CLAIM TO ANY PARTICULAR FONT, STYLE, SIZE, OR COLOR.

SER. NO. 85-445,714, FILED 10-12-2011.

KEVON CHISOLM, EXAMINING ATTORNEY



David J. Kybas

Director of the United States Patent and Trademark Office

United States of America

United States Patent and Trademark Office

Cool Clarity!

Reg. No. 4,154,061

Registered June 5, 2012

Int. Cl.: 3

TRADEMARK

PRINCIPAL REGISTER

VALLEY GREEN NATURALS, LLC (VIRGINIA LIMITED LIABILITY COMPANY)
6188 GEORGETOWN ROAD
BROAD RUN, VA 20137

FOR: COSMETIC CREAMS FOR SKIN CARE; FACE AND BODY BEAUTY CREAMS; FACE CREAMS FOR COSMETIC USE; FACIAL CLEANSERS; MOISTURIZING CREAMS; NON-MEDICATED SKIN TONERS; SKIN CLEANSERS; SKIN MOISTURIZER; SKIN TONERS; TONERS, IN CLASS 3 (U.S. CLS. 1, 4, 6, 50, 51 AND 52).

FIRST USE 11-0-2008; IN COMMERCE 11-0-2008.

THE MARK CONSISTS OF STANDARD CHARACTERS WITHOUT CLAIM TO ANY PARTICULAR FONT, STYLE, SIZE, OR COLOR.

SER. NO. 85-445,719, FILED 10-12-2011.

CARYN GLASSER, EXAMINING ATTORNEY



David J. Kyffers

Director of the United States Patent and Trademark Office

United States of America

United States Patent and Trademark Office

PERSONALITY ASSETS

Reg. No. 4,154,062

MACOMBER, LESLIE (UNITED STATES INDIVIDUAL)
2009 W. CANYON DRIVE
COEUR DE ALENE, ID 83816

Registered June 5, 2012

Int. Cl.: 41

FOR: PROFESSIONAL COACHING SERVICES IN THE FIELD OF EMPLOYMENT, IN CLASS 41 (U.S. CLS. 100, 101 AND 107).

SERVICE MARK

FIRST USE 7-1-2011; IN COMMERCE 7-1-2011.

PRINCIPAL REGISTER

THE MARK CONSISTS OF STANDARD CHARACTERS WITHOUT CLAIM TO ANY PARTICULAR FONT, STYLE, SIZE, OR COLOR.

SER. NO. 85-445,724, FILED 10-12-2011.

BENJAMIN OKEKE, EXAMINING ATTORNEY



David J. Kyros

Director of the United States Patent and Trademark Office

United States of America

United States Patent and Trademark Office

Gardener's Glee!

Reg. No. 4,154,063

Registered June 5, 2012

Int. Cl.: 3

TRADEMARK

PRINCIPAL REGISTER

VALLEY GREEN NATURALS, LLC (VIRGINIA LIMITED LIABILITY COMPANY)
6188 GEORGETOWN ROAD
BROAD RUN, VA 20137

FOR: HAND CREAM; HAND LOTIONS, IN CLASS 3 (U.S. CLS. 1, 4, 6, 50, 51 AND 52).

FIRST USE 11-0-2008; IN COMMERCE 11-0-2008.

THE MARK CONSISTS OF STANDARD CHARACTERS WITHOUT CLAIM TO ANY PARTICULAR FONT, STYLE, SIZE, OR COLOR.

SER. NO. 85-445,730, FILED 10-12-2011.

CARYN GLASSER, EXAMINING ATTORNEY



David J. Kyffers

Director of the United States Patent and Trademark Office

United States of America
United States Patent and Trademark Office

ESCALADE

Reg. No. 4,154,064

Registered June 5, 2012

Int. Cl.: 34

TRADEMARK

PRINCIPAL REGISTER

XIKAR, INC. (KANSAS CORPORATION)
3305 TERRACE STREET
KANSAS CITY, MO 64111

FOR: CIGAR AND CIGARETTE LIGHTERS, IN CLASS 34 (U.S. CLS. 2, 8, 9 AND 17).

FIRST USE 7-17-2011; IN COMMERCE 7-17-2011.

THE MARK CONSISTS OF STANDARD CHARACTERS WITHOUT CLAIM TO ANY PARTICULAR FONT, STYLE, SIZE, OR COLOR.

SER. NO. 85-445,756, FILED 10-12-2011.

CHRISTOPHER BUONGIORNO, EXAMINING ATTORNEY



David J. Kybas

Director of the United States Patent and Trademark Office

United States of America

United States Patent and Trademark Office

ALPHABET MARATHON

Reg. No. 4,154,065

Registered June 5, 2012

Int. Cl.: 41

SERVICE MARK

PRINCIPAL REGISTER

WELLNESS, INC. (MASSACHUSETTS CORPORATION)
790 BOYLSTON STREET
BOSTON, MA 02199

FOR: EDUCATIONAL AND ENTERTAINMENT SERVICES, NAMELY, ORGANIZING AND CONDUCTING CHILDREN'S EVENTS IN THE FIELD OF LITERACY AND PHYSICAL FITNESS; EDUCATIONAL SERVICES, NAMELY, TRAINING FOR LITERACY AND PHYSICAL AND MENTAL FITNESS, IN CLASS 41 (U.S. CLS. 100, 101 AND 107).

FIRST USE 5-9-2008; IN COMMERCE 5-9-2008.

THE MARK CONSISTS OF STANDARD CHARACTERS WITHOUT CLAIM TO ANY PARTICULAR FONT, STYLE, SIZE, OR COLOR.

OWNER OF U.S. REG. NOS. 2,706,022, 3,307,663 AND OTHERS.

SER. NO. 85-445,779, FILED 10-12-2011.

JAMES LOVELACE, EXAMINING ATTORNEY



David J. Kybas

Director of the United States Patent and Trademark Office

United States of America

United States Patent and Trademark Office

PhotoPulse

Reg. No. 4,154,066

RUF, GARY (UNITED STATES INDIVIDUAL)
5205 E. EXPOSITION AVE, #111
DENVER, CO 80246

Registered June 5, 2012

Int. Cl.: 10

FOR: ELECTRONIC LIGHT THERAPY APPARATUS FOR THE SKIN, IN CLASS 10 (U.S. CLS. 26, 39 AND 44).

TRADEMARK

FIRST USE 9-15-2011; IN COMMERCE 9-15-2011.

PRINCIPAL REGISTER

THE MARK CONSISTS OF STANDARD CHARACTERS WITHOUT CLAIM TO ANY PARTICULAR FONT, STYLE, SIZE, OR COLOR.

SER. NO. 85-445,791, FILED 10-12-2011.

ALICIA COLLINS, EXAMINING ATTORNEY



David J. Kybas

Director of the United States Patent and Trademark Office

United States of America

United States Patent and Trademark Office

THIRD SKY

Reg. No. 4,154,067

Registered June 5, 2012

Int. Cls.: 41 and 42

SERVICE MARK

PRINCIPAL REGISTER

THIRD SKY, INC. (DELAWARE CORPORATION)
2601 BLANDING AVE, SUITE C362
ALAMEDA, CA 94501

FOR: EDUCATIONAL SERVICES, NAMELY, CONDUCTING CLASSES, SEMINARS, CONFERENCES, AND WORKSHOPS IN THE FIELDS OF INFORMATION TECHNOLOGY SERVICES AND DISTRIBUTION OF TRAINING MATERIALS IN CONNECTION THEREWITH; IT TRAINING SERVICES, IN CLASS 41 (U.S. CLS. 100, 101 AND 107).

FIRST USE 7-18-2002; IN COMMERCE 7-18-2002.

FOR: INFORMATION TECHNOLOGY CONSULTATION; IT CONSULTING SERVICES; PLANNING, DESIGN AND MANAGEMENT OF INFORMATION TECHNOLOGY SYSTEMS, IN CLASS 42 (U.S. CLS. 100 AND 101).

FIRST USE 7-18-2002; IN COMMERCE 7-18-2002.

THE MARK CONSISTS OF STANDARD CHARACTERS WITHOUT CLAIM TO ANY PARTICULAR FONT, STYLE, SIZE, OR COLOR.

SER. NO. 85-445,812, FILED 10-12-2011.

DAVID C. REIHNER, EXAMINING ATTORNEY



David J. Kypos

Director of the United States Patent and Trademark Office

United States of America

United States Patent and Trademark Office

HALL ENGINEERING GROUP

Reg. No. 4,154,068

HALL ENGINEERING GROUP, INC. (FLORIDA CORPORATION)
14499 N. DALE MABRY HWY, SUITE 179
TAMPA, FL 336182042

Registered June 5, 2012

Int. Cl.: 42

FOR: CONSULTING IN THE FIELDS OF ENGINEERING AND ARCHITECTURE; ENGINEERING; ENGINEERING DESIGN SERVICES, IN CLASS 42 (U.S. CLS. 100 AND 101).

SERVICE MARK

FIRST USE 7-1-2007; IN COMMERCE 7-1-2007.

PRINCIPAL REGISTER

THE MARK CONSISTS OF STANDARD CHARACTERS WITHOUT CLAIM TO ANY PARTICULAR FONT, STYLE, SIZE, OR COLOR.

OWNER OF U.S. REG. NO. 3,495,181.

NO CLAIM IS MADE TO THE EXCLUSIVE RIGHT TO USE "ENGINEERING GROUP", APART FROM THE MARK AS SHOWN.

SER. NO. 85-445,828, FILED 10-12-2011.

CHRISTOPHER LAW, EXAMINING ATTORNEY



David J. Kyfos

Director of the United States Patent and Trademark Office

United States of America

United States Patent and Trademark Office



Reg. No. 4,154,069

Registered June 5, 2012

Int. Cl.: 33

TRADEMARK

PRINCIPAL REGISTER

ROUND HILL CELLARS (CALIFORNIA CORPORATION), DBA RUTHERFORD WINE
COMPANY
1680 SILVERADO TRAIL
ST. HELENA, CA 94574

FOR: ALCOHOLIC BEVERAGES EXCEPT BEERS, IN CLASS 33 (U.S. CLS. 47 AND 49).

FIRST USE 4-30-2010; IN COMMERCE 4-30-2010.

THE MARK CONSISTS OF THE IMAGE OF A LADY BUG INSIDE A CIRCLE.

SER. NO. 85-445,858, FILED 10-12-2011.

ROBERT C. CLARK JR., EXAMINING ATTORNEY



David J. Kybas

Director of the United States Patent and Trademark Office

United States of America

United States Patent and Trademark Office

Vibe On It

Reg. No. 4,154,070

Registered June 5, 2012

Int. Cl.: 38

SERVICE MARK

PRINCIPAL REGISTER

GKRADIO, LLC (OHIO LIMITED LIABILITY COMPANY), DBA GOOD KARMA RADIO
8221 GREEN TREE CT
REYNOLDSBURG, OH 43068

FOR: INTERNET RADIO BROADCASTING SERVICES, IN CLASS 38 (U.S. CLS. 100, 101 AND 104).

FIRST USE 9-30-2011; IN COMMERCE 10-2-2011.

THE MARK CONSISTS OF STANDARD CHARACTERS WITHOUT CLAIM TO ANY PARTICULAR FONT, STYLE, SIZE, OR COLOR.

NO CLAIM IS MADE TO THE EXCLUSIVE RIGHT TO USE "VIBE", APART FROM THE MARK AS SHOWN.

SER. NO. 85-445,876, FILED 10-12-2011.

ALAIN LAPTER, EXAMINING ATTORNEY



David J. Kyffers

Director of the United States Patent and Trademark Office

United States of America

United States Patent and Trademark Office



Reg. No. 4,154,071

Registered June 5, 2012

Int. Cl.: 9

TRADEMARK

PRINCIPAL REGISTER

ELLISON GLASSWORKS LLC (ILLINOIS LIMITED LIABILITY COMPANY)
540 N. LAKESHORE DRIVE, APT 423
CHICAGO, IL 60611

FOR: SUNGLASSES, IN CLASS 9 (U.S. CLS. 21, 23, 26, 36 AND 38).

FIRST USE 5-15-2011; IN COMMERCE 5-15-2011.

THE MARK CONSISTS OF THE STYLIZED WORD "ELLISON", WITH AN IMAGE OF A BIRD ABOVE THE LETTERS "LL". THE LETTERS "LL" ARE USED AS THE BIRD'S LEGS.

SER. NO. 85-445,881, FILED 10-12-2011.

ANDREW RHIM, EXAMINING ATTORNEY



David J. Kyffers

Director of the United States Patent and Trademark Office

United States of America

United States Patent and Trademark Office

LIFESTYLE ENGINEER

Reg. No. 4,154,072

PYBUS, TREVOR (UNITED KINGDOM INDIVIDUAL)
2 SPRING ROAD
MARKET WEIGHTON, UNITED KINGDOM

Registered June 5, 2012

Int. Cl.: 44

FOR: HYPNOSIS SERVICES, IN CLASS 44 (U.S. CLS. 100 AND 101).

SERVICE MARK

FIRST USE 8-16-2011; IN COMMERCE 8-16-2011.

PRINCIPAL REGISTER

THE MARK CONSISTS OF STANDARD CHARACTERS WITHOUT CLAIM TO ANY PARTICULAR FONT, STYLE, SIZE, OR COLOR.

SER. NO. 85-445,900, FILED 10-12-2011.

SETH A. RAPPAPORT, EXAMINING ATTORNEY



David J. Kybas

Director of the United States Patent and Trademark Office

United States of America

United States Patent and Trademark Office

firo

Reg. No. 4,154,073

Registered June 5, 2012

Int. Cl.: 25

TRADEMARK

PRINCIPAL REGISTER

TITAN SPORT TECH CO., LTD. (TAIWAN CORPORATION)
NO. 32, ANSHUN E. 5TH ST., BEITUN DIST.
TAICHUNG CITY, TAIWAN 40668

FOR: SOCKS, IN CLASS 25 (U.S. CLS. 22 AND 39).

FIRST USE 1-1-2011; IN COMMERCE 10-12-2011.

THE MARK CONSISTS OF THE FOUR LETTERS OF "FIRO". FOR LETTER "F", THE PROTRUDING PORTION OF THE LEFT SIDE OF THE HORIZONTAL LINE IS OMITTED; FOR LETTER "I", IT IS IN ITS REGULAR FONT STYLE WITH A CYLINDER BENEATH A DOT; FOR LETTER "R", THE PROTRUDING PORTION OF THE LEFT SIDE OF THIS LETTER IS OMITTED; FOR LETTER "O", ITS SHAPE IS DISTORTED INTO THE SHAPE SIMILAR TO THE LEAF WITH TWO POINTED CORNER ON THE UPPER-RIGHT AND THE BOTTOM-LEFT.

SER. NO. 85-445,911, FILED 10-12-2011.

GEORGE LORENZO, EXAMINING ATTORNEY



David J. Kybas

Director of the United States Patent and Trademark Office

United States of America

United States Patent and Trademark Office

GIRL WITH CURVES

Reg. No. 4,154,074

Registered June 5, 2012

Int. Cl.: 41

SERVICE MARK

PRINCIPAL REGISTER

AWASTHI, TANESHA (UNITED STATES INDIVIDUAL), DBA GIRL WITH CURVES
371 ELAN VILLAGE LANE, UNIT 220
SAN JOSE, CA 95134

FOR: ON-LINE JOURNALS, NAMELY, BLOGS FEATURING COMMENTARY AND INFORMATION ON PERSONAL STYLE, ASSEMBLY OF PERSONAL OUTFITS, AND FASHION SHOPPING ADVICE, IN CLASS 41 (U.S. CLS. 100, 101 AND 107).

FIRST USE 2-13-2011; IN COMMERCE 2-13-2011.

THE MARK CONSISTS OF STANDARD CHARACTERS WITHOUT CLAIM TO ANY PARTICULAR FONT, STYLE, SIZE, OR COLOR.

SER. NO. 85-445,928, FILED 10-12-2011.

GRETТА YAO, EXAMINING ATTORNEY



David J. Kyffers

Director of the United States Patent and Trademark Office

United States of America

United States Patent and Trademark Office



Reg. No. 4,154,075

Registered June 5, 2012

Int. Cl.: 42

SERVICE MARK

PRINCIPAL REGISTER

PETEXEC (COLORADO CORPORATION)
1670 PAONIA STREET
COLORADO SPRINGS, CO 80915

FOR: PROVIDING TEMPORARY USE OF ON-LINE NON-DOWNLOADABLE SOFTWARE FOR USE IN BUSINESS MANAGEMENT OPERATIONS, NAMELY, DATABASE MANAGEMENT FOR PET DAYCARE AND SERVICES INDUSTRY OF SALES, REVENUES, PURCHASES, RECORD KEEPING, USE FOR APPOINTMENT SCHEDULING, AND INTEGRATED BUSINESS MANAGEMENT INTELLIGENCE, IN CLASS 42 (U.S. CLS. 100 AND 101).

FIRST USE 10-30-2006; IN COMMERCE 10-30-2006.

THE MARK CONSISTS OF THE STYLIZED WORDS "PETEXEC". AN IMAGE OF A DOG WEARING A TIE HOLDING A BRIEFCASE IN HIS MOUTH ABOVE THE TEXT.

SER. NO. 85-445,935, FILED 10-12-2011.

SANDRA BUJA, EXAMINING ATTORNEY



David J. Kyffers

Director of the United States Patent and Trademark Office

United States of America

United States Patent and Trademark Office

Where You Now Have a Friend Who's a Doctor

Reg. No. 4,154,076

Registered June 5, 2012

Int. Cl.: 44

SERVICE MARK

PRINCIPAL REGISTER

NEIL F. NEIMARK, M.D., INC. (CALIFORNIA CORPORATION)
SUITE 207
4980 BARRANCA PKWY
IRVINE, CA 92604

FOR: MEDICAL SERVICES, IN CLASS 44 (U.S. CLS. 100 AND 101).

FIRST USE 5-1-2011; IN COMMERCE 5-1-2011.

THE MARK CONSISTS OF STANDARD CHARACTERS WITHOUT CLAIM TO ANY PARTICULAR FONT, STYLE, SIZE, OR COLOR.

SER. NO. 85-445,939, FILED 10-12-2011.

DAWN FELDMAN, EXAMINING ATTORNEY



David J. Kybas

Director of the United States Patent and Trademark Office

United States of America

United States Patent and Trademark Office

Charming Celebrations

Reg. No. 4,154,077

JEWEL KADE HOLDINGS LLC (UTAH LIMITED LIABILITY COMPANY)
345 S. MAIN STREET
ALPINE, UT 84004

Registered June 5, 2012

Int. Cl.: 9

FOR: DOWNLOADABLE ELECTRONIC NEWSLETTERS DELIVERED BY E-MAIL IN THE FIELD OF JEWELRY, IN CLASS 9 (U.S. CLS. 21, 23, 26, 36 AND 38).

TRADEMARK

FIRST USE 12-31-2009; IN COMMERCE 12-31-2009.

PRINCIPAL REGISTER

THE MARK CONSISTS OF STANDARD CHARACTERS WITHOUT CLAIM TO ANY PARTICULAR FONT, STYLE, SIZE, OR COLOR.

SER. NO. 85-445,944, FILED 10-12-2011.

DAWN FELDMAN, EXAMINING ATTORNEY



David J. Kybas

Director of the United States Patent and Trademark Office

United States of America

United States Patent and Trademark Office

SHADY LADY

Reg. No. 4,154,078

TAQSEEM, INC. (CALIFORNIA CORPORATION)
5710 AUBURN BLVD., SUITE 8
SACRAMENTO, CA 95841

Registered June 5, 2012

Int. Cl.: 34

FOR: HOOKAH TOBACCO; MOLASSES TOBACCO; PIPE TOBACCO; TOBACCO TINS, IN CLASS 34 (U.S. CLS. 2, 8, 9 AND 17).

TRADEMARK

FIRST USE 8-1-2011; IN COMMERCE 8-1-2011.

PRINCIPAL REGISTER

THE MARK CONSISTS OF STANDARD CHARACTERS WITHOUT CLAIM TO ANY PARTICULAR FONT, STYLE, SIZE, OR COLOR.

SER. NO. 85-445,947, FILED 10-12-2011.

SEAN CROWLEY, EXAMINING ATTORNEY



David J. Kyros

Director of the United States Patent and Trademark Office

United States of America

United States Patent and Trademark Office

 **LECTROTRUCK** 

Reg. No. 4,154,079

Registered June 5, 2012

Int. Cl.: 12

TRADEMARK

PRINCIPAL REGISTER

INNOVATIVE MOVING SYSTEMS (WISCONSIN CORPORATION)
P.O. BOX 700169
310 S 10TH ST.
OOSTBURG, WI 53070

FOR: A MECHANICAL, BATTERY POWERED, TWO WHEEL HAND TRUCK WITH LIFTING CAPABILITIES UP TO 1500 LBS, IN CLASS 12 (U.S. CLS. 19, 21, 23, 31, 35 AND 44).

FIRST USE 7-23-2010; IN COMMERCE 9-1-2010.

THE MARK CONSISTS OF THE STYLIZED TEXT "LECTROTRUCK" IN ARIAL BOLD FONT WITH METALLIC LOOKING EFFECTS AND FLANKED BY A LIGHTNING BOLT BEFORE THE FIRST LETTER "L" AND AFTER THE LAST LETTER "K".

SER. NO. 85-445,948, FILED 10-12-2011.

ROBERT STRUCK, EXAMINING ATTORNEY



David J. Kyffers

Director of the United States Patent and Trademark Office

United States of America

United States Patent and Trademark Office

REDAPT

Reg. No. 4,154,080

Registered June 5, 2012

Int. Cl.: 42

SERVICE MARK

PRINCIPAL REGISTER

REDAPT, INC. (TEXAS CORPORATION)
12226 134TH CT NE
BUILDING D
REDMOND, WA 98052

FOR: IT CONSULTING SERVICES; PLANNING AND DEVELOPMENT OF ELECTRONIC COMMUNICATIONS NETWORKS; TECHNOLOGICAL CONSULTATION IN THE TECHNOLOGY FIELD OF CLOUD PLATFORMS, COMPUTER HARDWARE SYSTEMS, AND ELECTRONIC DATA STORAGE, IN CLASS 42 (U.S. CLS. 100 AND 101).

FIRST USE 10-0-1999; IN COMMERCE 10-0-1999.

THE MARK CONSISTS OF STANDARD CHARACTERS WITHOUT CLAIM TO ANY PARTICULAR FONT, STYLE, SIZE, OR COLOR.

OWNER OF U.S. REG. NOS. 3,442,791, 3,442,792, AND 3,446,865.

SER. NO. 85-445,950, FILED 10-12-2011.

CURTIS FRENCH, EXAMINING ATTORNEY



David J. Kybas

Director of the United States Patent and Trademark Office

United States of America

United States Patent and Trademark Office



Reg. No. 4,154,081

Registered June 5, 2012

Int. Cl.: 9

TRADEMARK

PRINCIPAL REGISTER

DEBRA A. HORTON (UNITED STATES INDIVIDUAL)
P.O. BOX 921
BRANSON, MO 65615 AND

DONALD L. WRIGHT (UNITED STATES INDIVIDUAL)
P.O. BOX 921
BRANSON, MO 65615

FOR: PRE-RECORDED CDS FEATURING INSTRUMENTAL AND VOCAL MUSIC, COMEDY, AND RECORDINGS OF LIVE MUSICAL AND COMEDY PERFORMANCES; PRE-RECORDED DVDS FEATURING INSTRUMENTAL AND VOCAL MUSIC, COMEDY, AND RECORDINGS OF LIVE MUSICAL AND COMEDY PERFORMANCES, IN CLASS 9 (U.S. CLS. 21, 23, 26, 36 AND 38).

FIRST USE 8-1-2007; IN COMMERCE 8-1-2007.

OWNER OF U.S. REG. NOS. 3,108,960 AND 3,757,523.

THE COLOR(S) BLACK, WHITE, RED, BLUE, GREEN, YELLOW, AND ORANGE IS/ARE CLAIMED AS A FEATURE OF THE MARK.

THE MARK CONSISTS OF A HEADSTOCK OF A GUITAR IN BLACK AND BLUE WITH "BRANSON ON THE ROAD" IN WHITE AT THE TOP. BELOW IS A STYLIZED MARQUEE IN BLUE AND GREEN AND OUTLINED IN BLACK WITH "BRANSON" IN YELLOW IN THE MIDDLE. MUSIC NOTES APPEAR ON EACH SIDE IN ORANGE AND OUTLINED IN BLACK; CONCENTRIC STARS IN RED, BLACK, AND YELLOW ARE IN THE MIDDLE. A VIOLIN ON THE LEFT AND BANJO ON THE RIGHT ARE IN BLACK, WHITE, AND ORANGE. UNDERNEATH IS A WHITE MARQUEE OUTLINED WITH YELLOW LIGHTS AND THE WORDING "ON THE ROAD" IN BLACK.

SER. NO. 85-445,981, FILED 10-12-2011.

MARK SPARACINO, EXAMINING ATTORNEY



David J. Kyffers

Director of the United States Patent and Trademark Office

United States of America

United States Patent and Trademark Office

ADVENTURE RUN

Reg. No. 4,154,082

GOTFREDSON, MICHAEL B. (UNITED STATES INDIVIDUAL)
1770 COLGATE CIRCLE
LA JOLLA, CA 92037

Registered June 5, 2012

Int. Cl.: 41

FOR: ORGANIZING, ARRANGING, AND CONDUCTING RUNNING EVENTS, IN CLASS 41 (U.S. CLS. 100, 101 AND 107).

SERVICE MARK

FIRST USE 2-1-2011; IN COMMERCE 2-1-2011.

PRINCIPAL REGISTER

THE MARK CONSISTS OF STANDARD CHARACTERS WITHOUT CLAIM TO ANY PARTICULAR FONT, STYLE, SIZE, OR COLOR.

NO CLAIM IS MADE TO THE EXCLUSIVE RIGHT TO USE "RUN", APART FROM THE MARK AS SHOWN.

SER. NO. 85-446,005, FILED 10-12-2011.

LUCY ARANT, EXAMINING ATTORNEY



David J. Kyros

Director of the United States Patent and Trademark Office

United States of America

United States Patent and Trademark Office

REDAPT

Reg. No. 4,154,083

Registered June 5, 2012

Int. Cl.: 9

TRADEMARK

PRINCIPAL REGISTER

REDAPT, INC. (TEXAS CORPORATION)
12226 134TH CT NE
BUILDING D
REDMOND, WA 98052

FOR: COMPUTER HARDWARE AND PERIPHERALS; NETWORK ACCESS SERVER
HARDWARE, IN CLASS 9 (U.S. CLS. 21, 23, 26, 36 AND 38).

FIRST USE 10-0-1999; IN COMMERCE 10-0-1999.

THE MARK CONSISTS OF STANDARD CHARACTERS WITHOUT CLAIM TO ANY PAR-
TICULAR FONT, STYLE, SIZE, OR COLOR.

OWNER OF U.S. REG. NOS. 3,442,791, 3,442,792, AND 3,446,865.

SER. NO. 85-446,013, FILED 10-12-2011.

CURTIS FRENCH, EXAMINING ATTORNEY



David J. Kyros

Director of the United States Patent and Trademark Office

United States of America

United States Patent and Trademark Office



Reg. No. 4,154,084

Registered June 5, 2012

Int. Cl.: 43

SERVICE MARK

PRINCIPAL REGISTER

BASEY DEVELOPMENT, INC (INDIANA CORPORATION)
4352 E SR 38 PO 123
MARKLEVILLE, IN 46056

FOR: RESTAURANT SERVICES, IN CLASS 43 (U.S. CLS. 100 AND 101).

FIRST USE 6-1-2011; IN COMMERCE 6-1-2011.

NO CLAIM IS MADE TO THE EXCLUSIVE RIGHT TO USE "HAMBURGER" OR "SINCE 2011", APART FROM THE MARK AS SHOWN.

THE MARK CONSISTS OF THE STYLIZED TEXT "HAMBURGER HIGH SINCE 2011" WRITTEN AT AN ANGLE BELOW A SHIELD. THE SHIELD HAS PICTURE OF A HAMBURGER ON THE SHIELD. LYING ON TOP OF THE SHIELD TOWARDS THE BOTTOM IS A RIBBON. THE WORD "HIGH" IS SMALLER AND IS ON A RIBBON AND THE WORD "HAMBURGER" IS MUCH LARGER AND SITS ON TOP OF THE RIBBON. THERE ARE THREE STARS AROUND THE SHIELD. THE STARS ARE LOCATED TWO TO THE LEFT AND ONE TO THE RIGHT. THE WORD "HIGH" HAS A STAR AT THE LEFT AND A STAR TO THE RIGHT OF THE WORD LOCATED ON THE RIBBON. THE WORDS "SINCE 2011" APPEAR DIRECTLY BELOW THE RIBBON.

SER. NO. 85-446,034, FILED 10-12-2011.

GEOFFREY FOSDICK, EXAMINING ATTORNEY



David J. Kyros

Director of the United States Patent and Trademark Office

United States of America

United States Patent and Trademark Office

aerostream

Reg. No. 4,154,085

Registered June 5, 2012

Int. Cl.: 21

TRADEMARK

PRINCIPAL REGISTER

STEMPNOWSKI, RICHARD (UNITED KINGDOM INDIVIDUAL)
10105 HATTERAS COURT
FORT MYERS, FL 33919

FOR: HYDROPONIC GARDEN KIT FOR HOME USE COMPRISING GROWING CONTAINERS AND ALSO INCLUDING HYDROPONIC FERTILIZERS, SEEDS, SUBSTRATE, DRAIN COMPONENTS, A BOOK AND STARTING CLASS OF DVD AND CD INSTRUCTIONAL MATERIALS, IN CLASS 21 (U.S. CLS. 2, 13, 23, 29, 30, 33, 40 AND 50).

FIRST USE 3-28-2011; IN COMMERCE 10-10-2011.

THE MARK CONSISTS OF STANDARD CHARACTERS WITHOUT CLAIM TO ANY PARTICULAR FONT, STYLE, SIZE, OR COLOR.

SER. NO. 85-446,062, FILED 10-12-2011.

WILLIAM VERHOSEK, EXAMINING ATTORNEY



David J. Kybas

Director of the United States Patent and Trademark Office

United States of America

United States Patent and Trademark Office

bango!

Reg. No. 4,154,086

Registered June 5, 2012

Int. Cl.: 43

SERVICE MARK

PRINCIPAL REGISTER

BANGO CATERING FRANCHISE INTERNATIONAL GROUP LIMITED (HONG KONG CORPORATION)
UNIT 1303,13\F, BEVERLY HOUSE
93-107 LOCKHART ROAD
WANCHAI, HONG KONG

FOR: CAFE SERVICES; CAFETERIA SERVICES; CANTEEN SERVICES; CRECHE SERVICES; PROVIDING CAMPGROUND FACILITIES; PROVISION OF CONFERENCE, EXHIBITION AND MEETING FACILITIES; RETIREMENT HOMES; SNACK BAR SERVICES; TAKE-OUT RESTAURANT SERVICES; TEA ROOMS, IN CLASS 43 (U.S. CLS. 100 AND 101).

FIRST USE 3-17-2009; IN COMMERCE 3-17-2009.

THE MARK CONSISTS OF STYLIZED WORD "BANGO!".

SER. NO. 85-446,115, FILED 10-12-2011.

HANNO RITTNER, EXAMINING ATTORNEY



David J. Kybas

Director of the United States Patent and Trademark Office

United States of America

United States Patent and Trademark Office



Reg. No. 4,154,087

Registered June 5, 2012

Int. Cl.: 28

TRADEMARK

PRINCIPAL REGISTER

QIU WENRUI (CHINA INDIVIDUAL)
DONGHU NINGCHUAN EAST ROAD, FENGXIANG ST
NO.4, BLDG 3, SEC 2 CHENGJIANG GARDEN
CHENGHAI DIST, SHANTOU, CHINA

FOR: BALLS FOR GAMES; ELECTRIC ACTION TOYS; ELECTRONIC TOY VEHICLES;
PARLOUR GAMES; RADIO CONTROLLED TOY VEHICLES; SCALE MODEL VEHICLES;
TOY AIRPLANES; TOY PISTOLS; TOY SCOOTERS; TOY VEHICLES, IN CLASS 28 (U.S.
CLS. 22, 23, 38 AND 50).

FIRST USE 5-1-2002; IN COMMERCE 2-5-2008.

THE MARK CONSISTS OF TWO STYLIZED LETTERS "JD" WHERE A FOUR POINTED
STAR FORMING THE SPACE OF THE LETTER "D", AND THE WORDS "JIN XING DA" AT
THE BOTTOM WHICH ARE IN SMALLER FONT SIZE.

THE WORDING "JD JIN XING DA" HAS NO MEANING IN A FOREIGN LANGUAGE.

SER. NO. 85-446,120, FILED 10-12-2011.

DAVID MURRAY, EXAMINING ATTORNEY



David J. Kyros

Director of the United States Patent and Trademark Office

United States of America
United States Patent and Trademark Office

ELFOLIFT

Reg. No. 4,154,088

ELEVATOR BOUTIQUE LLC (CALIFORNIA LIMITED LIABILITY COMPANY)
SUITE B-110, 8687 MELROSE AVENUE
WEST HOLLYWOOD, CA 90069

Registered June 5, 2012

Int. Cl.: 7

FOR: ELEVATORS; ELEVATORS AND PARTS OF ELEVATORS; ELEVATORS AND PARTS THEREOF, IN CLASS 7 (U.S. CLS. 13, 19, 21, 23, 31, 34 AND 35).

TRADEMARK

FIRST USE 7-3-2004; IN COMMERCE 7-1-2011.

PRINCIPAL REGISTER

THE MARK CONSISTS OF STANDARD CHARACTERS WITHOUT CLAIM TO ANY PARTICULAR FONT, STYLE, SIZE, OR COLOR.

SER. NO. 85-446,136, FILED 10-13-2011.

B. PARADEWELAI, EXAMINING ATTORNEY



David J. Kyffers

Director of the United States Patent and Trademark Office

United States of America

United States Patent and Trademark Office

SUPERMEC

Reg. No. 4,154,089

ELEVATOR BOUTIQUE LLC (CALIFORNIA LIMITED LIABILITY COMPANY)
SUITE B-110, 8687 MELROSE AVENUE
WEST HOLLYWOOD, CA 90069

Registered June 5, 2012

Int. Cl.: 7

FOR: ELEVATORS; ELEVATORS AND PARTS OF ELEVATORS; ELEVATORS AND PARTS THEREOF, IN CLASS 7 (U.S. CLS. 13, 19, 21, 23, 31, 34 AND 35).

TRADEMARK

FIRST USE 1-1-2005; IN COMMERCE 9-1-2011.

PRINCIPAL REGISTER

THE MARK CONSISTS OF STANDARD CHARACTERS WITHOUT CLAIM TO ANY PARTICULAR FONT, STYLE, SIZE, OR COLOR.

SER. NO. 85-446,142, FILED 10-13-2011.

B. PARADEWELAI, EXAMINING ATTORNEY



David J. Kyffers

Director of the United States Patent and Trademark Office

United States of America

United States Patent and Trademark Office

WKL WORLD KICKBOXING LEAGUE

Reg. No. 4,154,090

WORLD KICKBOXING LEAGUE (FLORIDA CORPORATION)

Registered June 5, 2012

#2007

Int. Cl.: 41

2555 COLLINS AV
MIAMI BEACH, FL 33140

SERVICE MARK

FOR: TIMING OF SPORTS EVENTS; ORGANIZING, ARRANGING, AND CONDUCTING KICKBOXING EVENTS; PROVIDING INFORMATION RELATING TO SPORTS AND SPORTING EVENTS, IN CLASS 41 (U.S. CLS. 100, 101 AND 107).

PRINCIPAL REGISTER

FIRST USE 1-1-2002; IN COMMERCE 1-1-2002.

THE MARK CONSISTS OF STANDARD CHARACTERS WITHOUT CLAIM TO ANY PARTICULAR FONT, STYLE, SIZE, OR COLOR.

NO CLAIM IS MADE TO THE EXCLUSIVE RIGHT TO USE "WORLD KICKBOXING LEAGUE", APART FROM THE MARK AS SHOWN.

SER. NO. 85-446,175, FILED 10-13-2011.

JOHN HWANG, EXAMINING ATTORNEY



David J. Kybas

Director of the United States Patent and Trademark Office

United States of America

United States Patent and Trademark Office

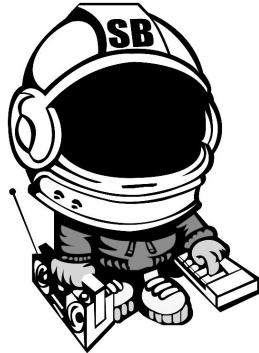

Reg. No. 4,154,091

Registered June 5, 2012

Int. Cl.: 25

TRADEMARK

PRINCIPAL REGISTER

SKY B NATION LLC (INDIANA LIMITED LIABILITY COMPANY)
9330 NORWOOD TRAILS DRIVE
HOUSTON, TX 77050

FOR: ATHLETIC APPAREL, NAMELY, SHIRTS, PANTS, JACKETS, FOOTWEAR, HATS
AND CAPS, ATHLETIC UNIFORMS, IN CLASS 25 (U.S. CLS. 22 AND 39).

FIRST USE 1-1-2007; IN COMMERCE 1-1-2007.

THE MARK CONSISTS OF A STYLIZED IMAGE OF A PERSON IN AN ASTRONAUT SUIT
HOLDING A RADIO AND A KEYBOARD WITH THE LETTERS "SB" AT THE TOP OF THE
HELMET.

SER. NO. 85-446,217, FILED 10-13-2011.

MAYUR VAGHANI, EXAMINING ATTORNEY



David J. Kybas

Director of the United States Patent and Trademark Office

United States of America

United States Patent and Trademark Office

BIMINI BREEZE

Reg. No. 4,154,092

DAN'S FAN CITY, INC. (FLORIDA CORPORATION)
300 DUNBAR AVENUE
OLDSMAR, FL 34677

Registered June 5, 2012

Int. Cl.: 11

FOR: CEILING FANS, IN CLASS 11 (U.S. CLS. 13, 21, 23, 31 AND 34).

TRADEMARK

FIRST USE 10-1-1988; IN COMMERCE 10-1-1988.

PRINCIPAL REGISTER

THE MARK CONSISTS OF STANDARD CHARACTERS WITHOUT CLAIM TO ANY PARTICULAR FONT, STYLE, SIZE, OR COLOR.

SER. NO. 85-446,227, FILED 10-13-2011.

JAMES A. RAUEN, EXAMINING ATTORNEY



David J. Kyffers

Director of the United States Patent and Trademark Office

United States of America

United States Patent and Trademark Office

FFGA.COM

Reg. No. 4,154,093

Registered June 5, 2012

Int. Cl.: 36

SERVICE MARK

PRINCIPAL REGISTER

FIRST FINANCIAL ADMINISTRATORS, INC. (TEXAS CORPORATION)
5TH FLOOR
515 N. SAM HOUSTON PARKWAY EAST
HOUSTON, TX 77060

FOR: INSURANCE BROKERAGE SERVICES IN THE FIELD OF LIFE, HEALTH, DISABILITY AND ANNUITIES; ADMINISTRATION OF EMPLOYEE BENEFIT PLANS CONCERNING INSURANCE AND FINANCE, IN CLASS 36 (U.S. CLS. 100, 101 AND 102).

FIRST USE 10-1-2011; IN COMMERCE 10-1-2011.

THE MARK CONSISTS OF STANDARD CHARACTERS WITHOUT CLAIM TO ANY PARTICULAR FONT, STYLE, SIZE, OR COLOR.

SER. NO. 85-446,247, FILED 10-13-2011.

INGA ERVIN, EXAMINING ATTORNEY



David J. Kybas

Director of the United States Patent and Trademark Office

United States of America

United States Patent and Trademark Office

CABLE CARFAITS

Reg. No. 4,154,094

Registered June 5, 2012

Int. Cl.: 30

TRADEMARK

PRINCIPAL REGISTER

INTERNATIONAL FRANCHISE INC. (CANADA CORPORATION)
210 SHIELDS COURT
MARKHAM, ONTARIO, CANADA L3R8V2

FOR: ICE CREAM DESSERTS, NAMELY, PARFAITS, IN CLASS 30 (U.S. CL. 46).

FIRST USE 12-31-1984; IN COMMERCE 12-31-1984.

THE MARK CONSISTS OF STANDARD CHARACTERS WITHOUT CLAIM TO ANY PARTICULAR FONT, STYLE, SIZE, OR COLOR.

SER. NO. 85-446,312, FILED 10-13-2011.

KATHERINE CHANG, EXAMINING ATTORNEY



David J. Kyjars

Director of the United States Patent and Trademark Office

United States of America

United States Patent and Trademark Office

AMERICA'S MASTER HANDYMAN

Reg. No. 4,154,095

Registered June 5, 2012

Int. Cl.: 41

SERVICE MARK

PRINCIPAL REGISTER

H & S ASSOCIATES, INC. (MICHIGAN CORPORATION)
1224 RANKIN STREET
TROY, MI 48083

FOR: ENTERTAINMENT SERVICES, NAMELY, PROVIDING AN ON-GOING RADIO PROGRAM IN THE FIELD OF HOME IMPROVEMENT, IN CLASS 41 (U.S. CLS. 100, 101 AND 107).

FIRST USE 5-30-1996; IN COMMERCE 5-30-1996.

THE MARK CONSISTS OF STANDARD CHARACTERS WITHOUT CLAIM TO ANY PARTICULAR FONT, STYLE, SIZE, OR COLOR.

SEC. 2(F).

SER. NO. 85-446,352, FILED 10-13-2011.

BRENDAN MCCAULEY, EXAMINING ATTORNEY



David J. Kybas

Director of the United States Patent and Trademark Office

United States of America

United States Patent and Trademark Office

The Mother Loaf

Reg. No. 4,154,096

THE MEATLOAF BAKERY LLC (ILLINOIS LIMITED LIABILITY COMPANY)
2464 NORTH CLARK STREET
CHICAGO, IL 60614

Registered June 5, 2012

Int. Cl.: 29

FOR: PREPARED READY-TO-EAT ENTREES CONSISTING PRIMARILY OF MEAT, IN CLASS 29 (U.S. CL. 46).

TRADEMARK

FIRST USE 12-10-2008; IN COMMERCE 12-10-2008.

PRINCIPAL REGISTER

THE MARK CONSISTS OF STANDARD CHARACTERS WITHOUT CLAIM TO ANY PARTICULAR FONT, STYLE, SIZE, OR COLOR.

SER. NO. 85-446,363, FILED 10-13-2011.

CHARLES L. JENKINS, EXAMINING ATTORNEY



David J. Kyros

Director of the United States Patent and Trademark Office

United States of America

United States Patent and Trademark Office

Loaf-A-Roma

Reg. No. 4,154,097

THE MEATLOAF BAKERY LLC (ILLINOIS LIMITED LIABILITY COMPANY)
2464 NORTH CLARK STREET
CHICAGO, IL 60614

Registered June 5, 2012

Int. Cl.: 29

FOR: PREPARED READY-TO-EAT ENTREES CONSISTING PRIMARILY OF MEAT, IN CLASS 29 (U.S. CL. 46).

TRADEMARK

FIRST USE 12-10-2008; IN COMMERCE 12-10-2008.

PRINCIPAL REGISTER

THE MARK CONSISTS OF STANDARD CHARACTERS WITHOUT CLAIM TO ANY PARTICULAR FONT, STYLE, SIZE, OR COLOR.

SER. NO. 85-446,462, FILED 10-13-2011.

CHARLES L. JENKINS, EXAMINING ATTORNEY



David J. Kybas

Director of the United States Patent and Trademark Office

United States of America

United States Patent and Trademark Office

Trustables

Reg. No. 4,154,098

GUTEKUNST, BRENT L (UNITED STATES INDIVIDUAL)
407 W. SPRUCE ST
SAN DIEGO, CA 92103

Registered June 5, 2012

Int. Cl.: 42

FOR: COMPUTER SERVICES, NAMELY, CREATING AN ON-LINE COMMUNITY FOR REGISTERED USERS TO RAISE FUNDS FROM THEIR SOCIAL NETWORK FOR EDUCATIONAL PURPOSES, IN CLASS 42 (U.S. CLS. 100 AND 101).

SERVICE MARK

FIRST USE 9-14-2011; IN COMMERCE 9-14-2011.

PRINCIPAL REGISTER

THE MARK CONSISTS OF STANDARD CHARACTERS WITHOUT CLAIM TO ANY PARTICULAR FONT, STYLE, SIZE, OR COLOR.

SER. NO. 85-446,544, FILED 10-13-2011.

BRIDGETT SMITH, EXAMINING ATTORNEY



David J. Kyros

Director of the United States Patent and Trademark Office

United States of America

United States Patent and Trademark Office

PLATESAFE

Reg. No. 4,154,099

CAMISASCA AUTOMOTIVE MANUFACTURING, INC. (CALIFORNIA CORPORATION)
20352 HERMANA CIRCLE
LAKE FOREST, CA 92630

Registered June 5, 2012

Int. Cl.: 12

FOR: KIT FEATURING LICENSE PLATE FRAME, FRAME LENS AND FRAME CAPS, IN CLASS 12 (U.S. CLS. 19, 21, 23, 31, 35 AND 44).

TRADEMARK

FIRST USE 9-16-2011; IN COMMERCE 9-16-2011.

PRINCIPAL REGISTER

THE MARK CONSISTS OF STANDARD CHARACTERS WITHOUT CLAIM TO ANY PARTICULAR FONT, STYLE, SIZE, OR COLOR.

SER. NO. 85-447,042, FILED 10-13-2011.

KEVON CHISOLM, EXAMINING ATTORNEY



David J. Kybas

Director of the United States Patent and Trademark Office

United States of America

United States Patent and Trademark Office

BUGMASTER

Reg. No. 4,154,100

SHELTER-PRO, LLC (KENTUCKY LIMITED LIABILITY COMPANY)
P.O. BOX 337
STEARNS, KY 42647

Registered June 5, 2012

Int. Cl.: 25

FOR: CAMOUFLAGE CLOTHING, NAMELY, PANTS, TOPS AND HOODS, IN CLASS 25
(U.S. CLS. 22 AND 39).

TRADEMARK

FIRST USE 12-31-2004; IN COMMERCE 12-31-2004.

PRINCIPAL REGISTER

THE MARK CONSISTS OF STANDARD CHARACTERS WITHOUT CLAIM TO ANY PARTICULAR FONT, STYLE, SIZE, OR COLOR.

SER. NO. 85-447,070, FILED 10-13-2011.

JENNIFER MARTIN, EXAMINING ATTORNEY



David J. Kybas

Director of the United States Patent and Trademark Office

United States of America

United States Patent and Trademark Office

Dream Cookies

Reg. No. 4,154,101

Registered June 5, 2012

Int. Cl.: 30

TRADEMARK

PRINCIPAL REGISTER

MADRONA SPECIALTY FOODS, LLC (WASHINGTON LIMITED LIABILITY COMPANY)
18475 OLYMPIC AVE. S.
TUKWILA, WA 98188

FOR: COOKIES, IN CLASS 30 (U.S. CL. 46).

FIRST USE 6-1-2002; IN COMMERCE 6-1-2002.

THE MARK CONSISTS OF STANDARD CHARACTERS WITHOUT CLAIM TO ANY PARTICULAR FONT, STYLE, SIZE, OR COLOR.

NO CLAIM IS MADE TO THE EXCLUSIVE RIGHT TO USE "COOKIES", APART FROM THE MARK AS SHOWN.

SER. NO. 85-447,125, FILED 10-13-2011.

ARETHA SOMERVILLE, EXAMINING ATTORNEY



David J. Kyffers

Director of the United States Patent and Trademark Office

United States of America

United States Patent and Trademark Office

AudioSync

Reg. No. 4,154,102

Registered June 5, 2012

Int. Cl.: 10

TRADEMARK

PRINCIPAL REGISTER

STARKEY LABORATORIES, INC. (MINNESOTA CORPORATION)
6600 WASHINGTON AVENUE SOUTH
ATTN: LEGAL DEPARTMENT
EDEN PRAIRIE, MN 55344

FOR: BIOMEDICAL APPARATUS, NAMELY, HEARING AIDS AND PARTS THEREOF, IN CLASS 10 (U.S. CLS. 26, 39 AND 44).

FIRST USE 1-1-2009; IN COMMERCE 1-1-2009.

THE MARK CONSISTS OF STANDARD CHARACTERS WITHOUT CLAIM TO ANY PARTICULAR FONT, STYLE, SIZE, OR COLOR.

SER. NO. 85-447,206, FILED 10-13-2011.

MAYUR VAGHANI, EXAMINING ATTORNEY



David J. Kyffers

Director of the United States Patent and Trademark Office

United States of America

United States Patent and Trademark Office



Reg. No. 4,154,103

Registered June 5, 2012

Int. Cl.: 9

TRADEMARK

PRINCIPAL REGISTER

SOUTH BAY TRADING INC. (CALIFORNIA CORPORATION)
605 SOUTH MILLIKEN AVE., SUITE E
ONTARIO, CA 91761

FOR: EYEWEAR, IN CLASS 9 (U.S. CLS. 21, 23, 26, 36 AND 38).

FIRST USE 10-13-2011; IN COMMERCE 10-13-2011.

THE MARK CONSISTS OF A BUTTERFLY DESIGN.

SER. NO. 85-447,226, FILED 10-13-2011.

GEORGE LORENZO, EXAMINING ATTORNEY



David J. Kyffers

Director of the United States Patent and Trademark Office

United States of America

United States Patent and Trademark Office

Bliss

Reg. No. 4,154,104

Registered June 5, 2012

Int. Cls.: 9 and 10

TRADEMARK

PRINCIPAL REGISTER

CHOU, BELLE (UNITED STATES INDIVIDUAL)
33278 CENTRAL AVE. #102
UNION CITY, CA 94587

FOR: DISPOSABLE LATEX GLOVES FOR LABORATORY USE; DISPOSABLE PLASTIC GLOVES FOR LABORATORY USE, IN CLASS 9 (U.S. CLS. 21, 23, 26, 36 AND 38).

FIRST USE 2-5-2010; IN COMMERCE 3-11-2010.

FOR: DENTAL GLOVES; GLOVES FOR MEDICAL PURPOSES; GLOVES FOR MEDICAL USE; GLOVES FOR USE IN HOSPITALS; LATEX MEDICAL GLOVES; MEDICAL EXAMINATION GLOVES; MEDICAL GLOVES; NITRILE GLOVES FOR MEDICAL USE; PROTECTIVE GLOVES FOR MEDICAL USE; SURGICAL GLOVES, IN CLASS 10 (U.S. CLS. 26, 39 AND 44).

FIRST USE 2-5-2010; IN COMMERCE 3-11-2010.

THE MARK CONSISTS OF STANDARD CHARACTERS WITHOUT CLAIM TO ANY PARTICULAR FONT, STYLE, SIZE, OR COLOR.

SER. NO. 85-447,239, FILED 10-13-2011.

APRIL HESIK, EXAMINING ATTORNEY



David J. Kyros

Director of the United States Patent and Trademark Office

United States of America

United States Patent and Trademark Office

VERY VOLATILE

Reg. No. 4,154,105

Registered June 5, 2012

Int. Cl.: 25

TRADEMARK

PRINCIPAL REGISTER

PALOS VERDES FOOTWEAR, INC. (CALIFORNIA CORPORATION)
1010 SANDHILL ROAD
CARSON, CA 90746

FOR: FOOTWEAR, IN CLASS 25 (U.S. CLS. 22 AND 39).

FIRST USE 9-23-2005; IN COMMERCE 9-23-2005.

THE MARK CONSISTS OF STANDARD CHARACTERS WITHOUT CLAIM TO ANY PARTICULAR FONT, STYLE, SIZE, OR COLOR.

OWNER OF U.S. REG. NOS. 2,336,325 AND 3,003,984.

SER. NO. 85-447,273, FILED 10-13-2011.

INGA ERVIN, EXAMINING ATTORNEY



David J. Kyffers

Director of the United States Patent and Trademark Office

United States of America

United States Patent and Trademark Office



Reg. No. 4,154,106

SOOK HAN LIM (MALAYSIA INDIVIDUAL), AKA MADDIE LIM
NO. 220, FLOOR 1-3, TAIKANG ROAD
SHANGHAI, CHINA 200025

Registered June 5, 2012

Int. Cl.: 25

FOR: WOMEN'S CLOTHING, NAMELY, SHIRTS, DRESSES, SKIRTS, BLOUSES, IN CLASS
25 (U.S. CLS. 22 AND 39).

TRADEMARK

FIRST USE 10-1-2011; IN COMMERCE 10-1-2011.

PRINCIPAL REGISTER

THE MARK CONSISTS OF INTERLOCKING WITH TWO "L"'S.

SER. NO. 85-447,285, FILED 10-13-2011.

B. PARADEWELAI, EXAMINING ATTORNEY



David J. Kyffers

Director of the United States Patent and Trademark Office

United States of America
United States Patent and Trademark Office

LAMORAGA

Reg. No. 4,154,107

ANDALUSIAN GOURMET CONCEPT S.L. (SPAIN CORPORATION)
MARQUEZ DE LARIOS 1, 10 IZQUIERDA
MÁLAGA, SPAIN 29007

Registered June 5, 2012

Int. Cl.: 43

FOR: HOTEL ACCOMMODATION SERVICES; PROVIDING TEMPORARY HOUSING ACCOMMODATIONS; RESTAURANT SERVICES, IN CLASS 43 (U.S. CLS. 100 AND 101).

SERVICE MARK

THE MARK CONSISTS OF STANDARD CHARACTERS WITHOUT CLAIM TO ANY PARTICULAR FONT, STYLE, SIZE, OR COLOR.

PRINCIPAL REGISTER

OWNER OF ERPN CMNTY TM OFC REG. NO. 9345588, DATED 12-30-2010, EXPIRES 1-9-2020.

THE WORDING "LAMORAGA" HAS NO MEANING IN A FOREIGN LANGUAGE.

SER. NO. 85-447,288, FILED 10-13-2011.

MICHAEL KEATING, EXAMINING ATTORNEY



David J. Kyros

Director of the United States Patent and Trademark Office

United States of America

United States Patent and Trademark Office

international style icon

Reg. No. 4,154,108

Registered June 5, 2012

Int. Cl.: 25

TRADEMARK

PRINCIPAL REGISTER

CHANTELLE K. OLUWABUNMI ABDUL (NIGERIA INDIVIDUAL)
234 FIFTH AVENUE, 4TH FL C/O VANEL LAW
NEW YORK, NY 10001

FOR: ATHLETIC APPAREL, NAMELY, SHIRTS, PANTS, JACKETS, FOOTWEAR, HATS AND CAPS, ATHLETIC UNIFORMS; ATHLETIC SHOES; BELTS FOR CLOTHING; BOAT SHOES; BOTTOMS; BUTTON DOWN SHIRTS; CANVAS SHOES; DENIMS; DRESS PANTS; DRESS SHIRTS; DRIVERS; GLOVES AS CLOTHING; GOLF SHIRTS; GYM PANTS; HATS; HOODS; JACKETS; JERSEYS; LEATHER SHOES; MEN'S AND WOMEN'S JACKETS, COATS, TROUSERS, VESTS; PANTS; SANDALS AND BEACH SHOES; SHOES; SHORT SETS; TIES; TOPS; TRAVEL CLOTHING CONTAINED IN A PACKAGE COMPRISING REVERSIBLE JACKETS, PANTS, SKIRTS, TOPS AND A BELT OR SCARF; WEARABLE GARMENTS AND CLOTHING, NAMELY, SHIRTS; WOMEN'S CLOTHING, NAMELY, SHIRTS, DRESSES, SKIRTS, BLOUSES; WOMEN'S SHOES, IN CLASS 25 (U.S. CLS. 22 AND 39).

FIRST USE 10-1-2011; IN COMMERCE 10-1-2011.

THE MARK CONSISTS OF STANDARD CHARACTERS WITHOUT CLAIM TO ANY PARTICULAR FONT, STYLE, SIZE, OR COLOR.

NO CLAIM IS MADE TO THE EXCLUSIVE RIGHT TO USE "INTERNATIONAL", APART FROM THE MARK AS SHOWN.

SER. NO. 85-447,384, FILED 10-14-2011.

MICHAEL ENGEL, EXAMINING ATTORNEY



David J. Kybas

Director of the United States Patent and Trademark Office

United States of America

United States Patent and Trademark Office



Reg. No. 4,154,109

Registered June 5, 2012

Int. Cl.: 35

SERVICE MARK

PRINCIPAL REGISTER

BIKEPATH COUNTRY, INC. (NEW YORK CORPORATION)
SUITE 104
2649 STRANG BLVD.
YORKTOWN HEIGHTS, NY 10598

FOR: PROVIDING ADVERTISING SPACE ON OUTDOOR BILLBOARDS AND IN KIOSKS LOCATED ON BIKE PATHS AND WALKWAYS; PROVIDING ADVERTISING, MARKETING AND PROMOTIONAL SERVICES, NAMELY, DEVELOPMENT OF ADVERTISING CAMPAIGNS USING OUTDOOR BILLBOARDS AND IN KIOSKS LOCATED ON BIKE PATHS AND WALKWAYS, IN CLASS 35 (U.S. CLS. 100, 101 AND 102).

FIRST USE 1-31-2011; IN COMMERCE 1-31-2011.

THE MARK CONSISTS OF TWO GRAY LINES REPRESENTING A ROAD OR BIKE PATH WITH A WHITE LINE IN THE MIDDLE OF THE TWO GRAY LINES AND A GREEN OUTER LINE ON THE LEFT.

THE COLOR(S) GRAY, WHITE AND GREEN IS/ARE CLAIMED AS A FEATURE OF THE MARK.

SER. NO. 85-447,493, FILED 10-14-2011.

BENJAMIN OKEKE, EXAMINING ATTORNEY



David J. Kybas

Director of the United States Patent and Trademark Office

United States of America

United States Patent and Trademark Office

Vanessa's

Reg. No. 4,154,110

ADVANCE SALES GROUP, INC. (CALIFORNIA CORPORATION)
5116 TRIGGS ST.
LOS ANGELES, CA 90022

Registered June 5, 2012

Int. Cl.: 25

FOR: BRAS; CAMISOLES; LADIES' UNDERWEAR; PAJAMA BOTTOMS; PAJAMAS; SHIRTS AND SLIPS; THERMAL UNDERWEAR; WEARABLE GARMENTS AND CLOTHING, NAMELY, SHIRTS, IN CLASS 25 (U.S. CLS. 22 AND 39).

TRADEMARK

FIRST USE 6-1-2011; IN COMMERCE 6-1-2011.

PRINCIPAL REGISTER

THE MARK CONSISTS OF STANDARD CHARACTERS WITHOUT CLAIM TO ANY PARTICULAR FONT, STYLE, SIZE, OR COLOR.

OWNER OF U.S. REG. NO. 3,096,190.

THE NAME "VANESSA" DOES NOT IDENTIFY A LIVING INDIVIDUAL.

SER. NO. 85-447,553, FILED 10-14-2011.

TASNEEM HUSSAIN, EXAMINING ATTORNEY



David J. Kybas

Director of the United States Patent and Trademark Office

United States of America

United States Patent and Trademark Office



Reg. No. 4,154,111

Registered June 5, 2012

Int. Cl.: 33

TRADEMARK

PRINCIPAL REGISTER

THOMAS HINE & CO (FRANCE COMPANY)
16 QUAI DE L'ORANGERIE
JARNAC, FRANCE 16200

FOR: GRAPE BRANDY DISTILLED IN THE COGNAC REGION OF FRANCE IN COMPLIANCE WITH THE LAWS AND REGULATIONS OF THE FRENCH GOVERNMENT, IN CLASS 33 (U.S. CLS. 47 AND 49).

FIRST USE 12-31-2006; IN COMMERCE 5-24-2011.

NO CLAIM IS MADE TO THE EXCLUSIVE RIGHT TO USE "COGNAC FONDEE EN 1838" AND "VSOP", APART FROM THE MARK AS SHOWN.

THE COLOR(S) GREEN, GOLD AND RED IS/ARE CLAIMED AS A FEATURE OF THE MARK.

THE MARK CONSISTS OF THE WORDS "MAISON MONNET COGNAC FONDEE EN 1838" IN GOLD APPEARING ON CIRCULAR ENCLOSURE IN GOLD WITH A SALAMANDER IN GREEN ON A GREEN CIRCULAR ENCLOSURE, THE LETTERS "VSOP" IN GOLD AND RED AND GREEN OUTER CIRCLE.

THE ENGLISH TRANSLATION OF "MAISON" IN THE MARK IS "HOUSE" AND THE ENGLISH TRANSLATION OF "FONDEE EN" IN THE MARK IS "ESTABLISHED IN".

SER. NO. 85-447,842, FILED 10-14-2011.

KIMBERLY PERRY, EXAMINING ATTORNEY



David J. Kyros

Director of the United States Patent and Trademark Office

United States of America

United States Patent and Trademark Office

CRM for the Rest of Us

Reg. No. 4,154,112

Registered June 5, 2012

Int. Cl.: 9

TRADEMARK

PRINCIPAL REGISTER

PANASUK, CURTIS (UNITED STATES INDIVIDUAL)
189 GLASGOW LANE
SAN CARLOS, CA 94070

FOR: COMPUTER SOFTWARE FOR CREATING SEARCHABLE DATABASES OF INFORMATION AND DATA FOR USE IN CUSTOMER RELATIONSHIP MANAGEMENT, IN CLASS 9 (U.S. CLS. 21, 23, 26, 36 AND 38).

FIRST USE 10-1-2009; IN COMMERCE 10-1-2009.

THE MARK CONSISTS OF STANDARD CHARACTERS WITHOUT CLAIM TO ANY PARTICULAR FONT, STYLE, SIZE, OR COLOR.

NO CLAIM IS MADE TO THE EXCLUSIVE RIGHT TO USE "CRM", APART FROM THE MARK AS SHOWN.

SER. NO. 85-448,269, FILED 10-14-2011.

BRIDGETT SMITH, EXAMINING ATTORNEY



David J. Kyffers

Director of the United States Patent and Trademark Office

United States of America

United States Patent and Trademark Office

KOMATSU CARE

Reg. No. 4,154,113

KOMATSU AMERICA CORP. (GEORGIA CORPORATION)
1701 W. GOLF ROAD
ROLLING MEADOWS, IL 60008

Registered June 5, 2012

Int. Cl.: 37

FOR: MAINTENANCE AND REPAIR OF CONSTRUCTION EQUIPMENT, IN CLASS 37 (U.S. CLS. 100, 103 AND 106).

SERVICE MARK

FIRST USE 5-3-2011; IN COMMERCE 5-3-2011.

PRINCIPAL REGISTER

THE MARK CONSISTS OF STANDARD CHARACTERS WITHOUT CLAIM TO ANY PARTICULAR FONT, STYLE, SIZE, OR COLOR.

NO CLAIM IS MADE TO THE EXCLUSIVE RIGHT TO USE "CARE", APART FROM THE MARK AS SHOWN.

THE ENGLISH TRANSLATION OF "KOMATSU" IN THE MARK IS A SMALL OR TINY PINE TREE.

SER. NO. 85-448,577, FILED 10-17-2011.

NAPOLEON SHARMA, EXAMINING ATTORNEY



David J. Kyffers

Director of the United States Patent and Trademark Office

United States of America

United States Patent and Trademark Office



Reg. No. 4,154,114

KOMATSU AMERICA CORP. (GEORGIA CORPORATION)
1701 W. GOLF ROAD
ROLLING MEADOWS, IL 60008

Registered June 5, 2012

Int. Cl.: 37

FOR: MAINTENANCE AND REPAIR OF CONSTRUCTION EQUIPMENT, IN CLASS 37 (U.S. CLS. 100, 103 AND 106).

SERVICE MARK

FIRST USE 5-3-2011; IN COMMERCE 5-3-2011.

PRINCIPAL REGISTER

NO CLAIM IS MADE TO THE EXCLUSIVE RIGHT TO USE "CARE", APART FROM THE MARK AS SHOWN.

THE MARK CONSISTS OF A DEPICTION OF A WRENCH ALONG THE LEFT HAND SIDE OF THE WORD "KOMATSU" ABOVE THE WORD "CARE" WITH A HORIZONTAL LINE ABOVE THE WORD "KOMATSU" AND A HORIZONTAL LINE BELOW THE WORD "CARE".

THE ENGLISH TRANSLATION OF "KOMATSU" IN THE MARK IS A SMALL OR TINY PINE TREE.

SER. NO. 85-448,590, FILED 10-17-2011.

NAPOLEON SHARMA, EXAMINING ATTORNEY



David J. Kybas

Director of the United States Patent and Trademark Office

United States of America

United States Patent and Trademark Office

THE NEW INGREDIENT AND RECIPE FOR SIMPLY SENSATIONAL CHOCOLATE CHIP COOKIES

Reg. No. 4,154,115

SIMPLY MORSELS, LLC (WASHINGTON LIMITED LIABILITY COMPANY)
1839 12TH AVE NE
ISSAQUAH, WA 98029

Registered June 5, 2012

Int. Cl.: 30

FOR: COOKIE DOUGH; COOKIE MIXES; COOKIE PIES; COOKIES; FROZEN COOKIE DOUGH; VEGAN COOKIES, IN CLASS 30 (U.S. CL. 46).

TRADEMARK

FIRST USE 10-16-2011; IN COMMERCE 10-16-2011.

PRINCIPAL REGISTER

THE MARK CONSISTS OF STANDARD CHARACTERS WITHOUT CLAIM TO ANY PARTICULAR FONT, STYLE, SIZE, OR COLOR.

NO CLAIM IS MADE TO THE EXCLUSIVE RIGHT TO USE "CHOCOLATE CHIP COOKIES", APART FROM THE MARK AS SHOWN.

SER. NO. 85-448,935, FILED 10-17-2011.

FRANK LATTUCA, EXAMINING ATTORNEY



David J. Kybas

Director of the United States Patent and Trademark Office

United States of America

United States Patent and Trademark Office



Reg. No. 4,154,116

Registered June 5, 2012

Int. Cl.: 28

TRADEMARK

PRINCIPAL REGISTER

HO-B MAX (NORTH CAROLINA LIMITED LIABILITY COMPANY)
5409 CENTERVILLE LANE
DURHAM, NC 27713

FOR: RADIO CONTROLLED TOY VEHICLES, IN CLASS 28 (U.S. CLS. 22, 23, 38 AND 50).

FIRST USE 4-1-2011; IN COMMERCE 4-1-2011.

THE MARK CONSISTS OF A STYLIZED "H" IN THE SHAPE OF A HUMAN WITH HORIZONTAL LINES FOR FEET AND HANDS. ABOVE THE FIGURE IS A CIRCLE RESEMBLING AN EYE SURROUNDED BY VARIEGATED OUTWARD REACHING TRIANGLES FORMING LASHES. OVER THE TOP OF THE IMAGE IS THE WORDING "HO-B MAX".

SER. NO. 85-448,936, FILED 10-17-2011.

TARAH HARDY, EXAMINING ATTORNEY



David J. Kyffers

Director of the United States Patent and Trademark Office

United States of America

United States Patent and Trademark Office



Reg. No. 4,154,117

Registered June 5, 2012

Int. Cls.: 9 and 19

TRADEMARK

PRINCIPAL REGISTER

SOLADIGM, INC. (DELAWARE CORPORATION)
195 SOUTH MILPITAS BOULEVARD
MILPITAS, CA 95035

FOR: ELECTRONIC CONTROLLER FOR ADJUSTING AND CONTROLLING GLASS PANELS,
IN CLASS 9 (U.S. CLS. 21, 23, 26, 36 AND 38).

FIRST USE 1-11-2011; IN COMMERCE 1-11-2011.

FOR: WINDOWS, NAMELY, GLASS PANELS FOR BUILDING CONSTRUCTION, IN CLASS
19 (U.S. CLS. 1, 12, 33 AND 50).

FIRST USE 1-11-2011; IN COMMERCE 1-11-2011.

THE MARK CONSISTS OF TWO HALF CIRCLES WITHIN A CIRCLE SURROUNDED BY
TWELVE TRIANGLES.

SER. NO. 85-448,958, FILED 10-17-2011.

WENDY JUN, EXAMINING ATTORNEY



David J. Kybas

Director of the United States Patent and Trademark Office

United States of America

United States Patent and Trademark Office

BrillBaby

Reg. No. 4,154,118

Registered June 5, 2012

Int. Cl.: 41

SERVICE MARK

PRINCIPAL REGISTER

BRILLKIDS, INC. (BR. VIRGIN ISLANDS CORPORATION)
17A WORLD TRUST TOWER
50 STANLEY STREET
CENTRAL, HONG KONG

FOR: EDUCATIONAL SERVICES, NAMELY, PROVIDING INSTRUCTION ON METHODS OF TEACHING CHILDREN, IN CLASS 41 (U.S. CLS. 100, 101 AND 107).

FIRST USE 10-28-2006; IN COMMERCE 10-28-2006.

THE MARK CONSISTS OF STANDARD CHARACTERS WITHOUT CLAIM TO ANY PARTICULAR FONT, STYLE, SIZE, OR COLOR.

SER. NO. 85-449,406, FILED 10-18-2011.

ODESSA BIBBINS, EXAMINING ATTORNEY



David J. Kyffers

Director of the United States Patent and Trademark Office

United States of America

United States Patent and Trademark Office

HEALTHTRONICS

Reg. No. 4,154,119

Registered June 5, 2012

Int. Cl.: 44

SERVICE MARK

PRINCIPAL REGISTER

HEALTHTRONICS, INC. (GEORGIA CORPORATION)
C/O ENDO PHARMACEUTICALS INC.
100 ENDO BOULEVARD
CHADDS FORD, PA 19317

FOR: MEDICAL AND UROLOGICAL IMAGING SERVICES; UROLOGICAL AND ORTHOPAEDIC HEALTH CARE SERVICES, NAMELY, PROVIDING PERSONNEL AND OPERATING INFRASTRUCTURES FOR LITHOTRIPSY, ORTHOTRIPSY, AND CRYOTHERAPY TREATMENTS TO HOSPITALS AND OTHER HEALTH CARE SETTINGS AS WELL AS PROVIDING TREATMENTS FOR BENIGN AND CANCEROUS CONDITIONS OF THE PROSTATE, IN CLASS 44 (U.S. CLS. 100 AND 101).

FIRST USE 2-0-1996; IN COMMERCE 2-0-1996.

THE MARK CONSISTS OF STANDARD CHARACTERS WITHOUT CLAIM TO ANY PARTICULAR FONT, STYLE, SIZE, OR COLOR.

OWNER OF U.S. REG. NOS. 2,500,166, 3,157,553 AND OTHERS.

SER. NO. 85-449,506, FILED 10-18-2011.

KEVIN CORWIN, EXAMINING ATTORNEY



David J. Kyffers

Director of the United States Patent and Trademark Office

United States of America

United States Patent and Trademark Office

Task Factory

Reg. No. 4,154,120

Registered June 5, 2012

Int. Cl.: 9

PRAGMATIC WORKS SOFTWARE, INC (FLORIDA CORPORATION), DBA PRAGMATIC
WORKS
SUITE 216
400 COLLEGE DRIVE
MIDDLEBURG, FL 32068

TRADEMARK

FOR: COMPUTER SOFTWARE FOR APPLICATION AND DATABASE INTEGRATION, IN
CLASS 9 (U.S. CLS. 21, 23, 26, 36 AND 38).

PRINCIPAL REGISTER

FIRST USE 5-1-2009; IN COMMERCE 9-4-2009.

THE MARK CONSISTS OF STANDARD CHARACTERS WITHOUT CLAIM TO ANY PAR-
TICULAR FONT, STYLE, SIZE, OR COLOR.

SER. NO. 85-449,595, FILED 10-18-2011.

HENRY S. ZAK, EXAMINING ATTORNEY



David J. Kyffers

Director of the United States Patent and Trademark Office

United States of America

United States Patent and Trademark Office

WILD 777 FAMOUS

Reg. No. 4,154,121

Registered June 5, 2012

Int. Cl.: 9

TRADEMARK

PRINCIPAL REGISTER

BALLY GAMING, INC. (NEVADA CORPORATION), DBA BALLY TECHNOLOGIES
ATTN: LAW DEPT.
6601 SOUTH BERMUDA ROAD
LAS VEGAS, NV 89119

FOR: GAMING MACHINES, NAMELY, DEVICES WHICH ACCEPT A WAGER AND GAMING SOFTWARE THAT GENERATES OR DISPLAYS OUTCOMES FOR GAMING MACHINES, IN CLASS 9 (U.S. CLS. 21, 23, 26, 36 AND 38).

FIRST USE 5-15-2004; IN COMMERCE 5-15-2004.

THE MARK CONSISTS OF STANDARD CHARACTERS WITHOUT CLAIM TO ANY PARTICULAR FONT, STYLE, SIZE, OR COLOR.

OWNER OF U.S. REG. NOS. 1,894,972 AND 3,351,363.

NO CLAIM IS MADE TO THE EXCLUSIVE RIGHT TO USE "777", APART FROM THE MARK AS SHOWN.

SER. NO. 85-449,723, FILED 10-18-2011.

ELLEN PERKINS, EXAMINING ATTORNEY



David J. Kyffers

Director of the United States Patent and Trademark Office

United States of America

United States Patent and Trademark Office

Mama Mojo Guitars

Reg. No. 4,154,122

Registered June 5, 2012

Int. Cl.: 15

TRADEMARK

PRINCIPAL REGISTER

BLUESWOMEN WORKS, LLC (DELAWARE LIMITED LIABILITY COMPANY)
#101
18879 FORGOTTEN HARBOR COURT
REHOBOTH BEACH, DE 19971

FOR: GUITARS; MUSICAL INSTRUMENTS, IN CLASS 15 (U.S. CLS. 2, 21 AND 36).

FIRST USE 12-15-2009; IN COMMERCE 9-29-2010.

THE MARK CONSISTS OF STANDARD CHARACTERS WITHOUT CLAIM TO ANY PARTICULAR FONT, STYLE, SIZE, OR COLOR.

NO CLAIM IS MADE TO THE EXCLUSIVE RIGHT TO USE "GUITARS", APART FROM THE MARK AS SHOWN.

SER. NO. 85-449,933, FILED 10-18-2011.

KATHERINE STOIDES, EXAMINING ATTORNEY



David J. Kybas

Director of the United States Patent and Trademark Office

United States of America

United States Patent and Trademark Office

MILLS FLEET FARM

Reg. No. 4,154,123

Registered June 5, 2012

Int. Cl.: 21

TRADEMARK

PRINCIPAL REGISTER

FLEET WHOLESALE SUPPLY CO., INC. (WISCONSIN CORPORATION)
1300 SOUTH LYNNDALE DRIVE
APPLETON, WI 54914

FOR: PAILS, IN CLASS 21 (U.S. CLS. 2, 13, 23, 29, 30, 33, 40 AND 50).

FIRST USE 7-14-2008; IN COMMERCE 7-14-2008.

THE MARK CONSISTS OF STANDARD CHARACTERS WITHOUT CLAIM TO ANY PARTICULAR FONT, STYLE, SIZE, OR COLOR.

OWNER OF U.S. REG. NOS. 3,863,272, 4,026,271 AND OTHERS.

SER. NO. 85-449,957, FILED 10-18-2011.

MARY ROSSMAN, EXAMINING ATTORNEY



David J. Kyros

Director of the United States Patent and Trademark Office

United States of America
United States Patent and Trademark Office

FACEBOSS

Reg. No. 4,154,124

JOY MM DELAWARE, INC. (DELAWARE CORPORATION)
2751 CENTERVILLE ROAD, SUITE 342
WILMINGTON, DE 19808

Registered June 5, 2012

Int. Cl.: 9

FOR: COMPUTER SOFTWARE PLATFORMS FOR CONTROLLING MINING MACHINERY;
ELECTRICAL CONTROLLERS FOR CONTROLLING MINING MACHINERY; COMPUTER
SOFTWARE FOR CONTROLLING MINING MACHINERY, IN CLASS 9 (U.S. CLS. 21, 23,
26, 36 AND 38).

TRADEMARK

PRINCIPAL REGISTER

FIRST USE 11-30-2006; IN COMMERCE 11-30-2006.

THE MARK CONSISTS OF STANDARD CHARACTERS WITHOUT CLAIM TO ANY PAR-
TICULAR FONT, STYLE, SIZE, OR COLOR.

OWNER OF U.S. REG. NO. 3,645,802.

SER. NO. 85-450,174, FILED 10-18-2011.

ALEXANDER L. POWERS, EXAMINING ATTORNEY



David J. Kyffers

Director of the United States Patent and Trademark Office

United States of America

United States Patent and Trademark Office

STUDIOCODE

Reg. No. 4,154,125

Registered June 5, 2012

Int. Cls.: 35 and 41

SERVICE MARK

PRINCIPAL REGISTER

SPORTSTEC LIMITED (AUSTRALIA CORPORATION)
19-22/6A PROSPERITY PARADE
WARRIEWOOD, NSW, AUSTRALIA 2102

FOR: ADVERTISING AND MARKETING; BUSINESS CONSULTATION; DATA PROCESSING SERVICES; ON-LINE ADVERTISING ON COMPUTER NETWORKS; RETAIL STORE AND ON-LINE RETAIL STORE SERVICES FEATURING COMPUTER SOFTWARE, IN CLASS 35 (U.S. CLS. 100, 101 AND 102).

FIRST USE 6-30-2004; IN COMMERCE 6-30-2004.

FOR: BUSINESS TRAINING IN THE FIELD OF TECHNOLOGY; VIDEO EDITING, IN CLASS 41 (U.S. CLS. 100, 101 AND 107).

FIRST USE 6-30-2004; IN COMMERCE 10-5-2005.

THE MARK CONSISTS OF STANDARD CHARACTERS WITHOUT CLAIM TO ANY PARTICULAR FONT, STYLE, SIZE, OR COLOR.

OWNER OF U.S. REG. NO. 3,453,494.

SER. NO. 85-450,276, FILED 10-18-2011.

FRANK LATTUCA, EXAMINING ATTORNEY



David J. Kybas

Director of the United States Patent and Trademark Office

United States of America

United States Patent and Trademark Office



Reg. No. 4,154,126

KRISTEN J. HAFNER (UNITED STATES INDIVIDUAL)
2945 TOWNSGATE ROAD, SUITE 200
WESTLAKE VILLAGE, CA 91362

Registered June 5, 2012

Int. Cl.: 36

FOR: FINANCIAL ADVISORY AND CONSULTANCY SERVICES, IN CLASS 36 (U.S. CLS. 100, 101 AND 102).

SERVICE MARK

FIRST USE 9-13-2010; IN COMMERCE 9-22-2010.

PRINCIPAL REGISTER

NO CLAIM IS MADE TO THE EXCLUSIVE RIGHT TO USE "FINANCIAL", APART FROM THE MARK AS SHOWN.

THE COLOR(S) GREY, BLACK AND BLUE IS/ARE CLAIMED AS A FEATURE OF THE MARK.

THE MARK CONSISTS OF THE WORDING "FINANCIAL" IN GRAY IN THE TOP LINE, THE WORDING "MOXIE" IN BLACK IN THE MIDDLE LINE, AND THE WORDING "EXPERIENCE THE POWER OF PLANNING" IN BLACK IN THE BOTTOM LINE. THE CENTER OF THE SMALL LETTER "A" IN "FINANCIAL" IS FILLED IN THE COLOR BLUE. THE LETTER "I" IN "MOXIE" IS REPRESENTED BY A SLANTED BLUE TEAR DROP.

SER. NO. 85-450,294, FILED 10-18-2011.

WENDY JUN, EXAMINING ATTORNEY



David J. Kyjars

Director of the United States Patent and Trademark Office

United States of America

United States Patent and Trademark Office

SUMMIT

Reg. No. 4,154,127

Registered June 5, 2012

Int. Cl.: 28

TRADEMARK

PRINCIPAL REGISTER

EBSCO INDUSTRIES, INC. (DELAWARE CORPORATION)
LEGAL SERVICES
PO BOX 1943
BIRMINGHAM, AL 35201

FOR: TREE STANDS FOR HUNTING AND TREE STAND STRUCTURAL PARTS AND ACCESSORIES THEREFOR; SAFETY BODY HARNESS USED BY HUNTERS IN CONJUNCTION WITH TREE STANDS; HUNTING BLINDS, IN CLASS 28 (U.S. CLS. 22, 23, 38 AND 50).

FIRST USE 1-1-1981; IN COMMERCE 1-1-1981.

THE MARK CONSISTS OF STANDARD CHARACTERS WITHOUT CLAIM TO ANY PARTICULAR FONT, STYLE, SIZE, OR COLOR.

OWNER OF U.S. REG. NOS. 3,223,714, 3,771,461 AND OTHERS.

SER. NO. 85-450,486, FILED 10-18-2011.

KYLE PEETE, EXAMINING ATTORNEY



David J. Kybas

Director of the United States Patent and Trademark Office

United States of America

United States Patent and Trademark Office

GMATE

Reg. No. 4,154,128

Registered June 5, 2012

Int. Cls.: 5 and 10

TRADEMARK

PRINCIPAL REGISTER

PHILOSYS INC (DELAWARE CORPORATION)
SUITE 218
304 PARK AVE SOUTH
NEW YORK, NY 10010

FOR: MEDICAL DIAGNOSTIC REAGENTS; TEST STRIPS FOR MEASURING BLOOD GLUCOSE LEVELS, IN CLASS 5 (U.S. CLS. 6, 18, 44, 46, 51 AND 52).

FIRST USE 10-1-2009; IN COMMERCE 10-1-2009.

FOR: APPARATUS FOR TAKING BLOOD; APPARATUS FOR TAKING BLOOD SAMPLES; BLOOD DRAWING APPARATUS; BLOOD GLUCOSE METER; CARRYING CASE SPECIFICALLY ADAPTED FOR CARRYING DIABETIC SUPPLIES, NAMELY, BLOOD GLUCOSE METER, TESTING STRIPS AND ALSO INCLUDING INSULIN AND OTHER RELATED APPARATUS; DEVICES FOR MONITORING BLOOD GLUCOSE FOR MEDICAL PURPOSES; LANCETS; MEDICAL TEST KITS FOR DIABETES MONITORING FOR HOME USE, IN CLASS 10 (U.S. CLS. 26, 39 AND 44).

FIRST USE 10-1-2009; IN COMMERCE 10-1-2009.

THE MARK CONSISTS OF STANDARD CHARACTERS WITHOUT CLAIM TO ANY PARTICULAR FONT, STYLE, SIZE, OR COLOR.

SER. NO. 85-450,721, FILED 10-19-2011.

MIDGE BUTLER, EXAMINING ATTORNEY



David J. Kybas

Director of the United States Patent and Trademark Office

United States of America

United States Patent and Trademark Office

Foods You Love That Love You Back!

Reg. No. 4,154,129

KOYA'S IP (NEVADA LIMITED LIABILITY COMPANY)
13950 NORTHWEST PASSAGE, APT 104
MARINA DEL REY, CA 90292

Registered June 5, 2012

Int. Cl.: 35

FOR: RETAIL STORE SERVICES FEATURING HEALTHY LIFESTYLE FOODS, IN CLASS
35 (U.S. CLS. 100, 101 AND 102).

SERVICE MARK

FIRST USE 7-1-2006; IN COMMERCE 7-1-2006.

PRINCIPAL REGISTER

THE MARK CONSISTS OF STANDARD CHARACTERS WITHOUT CLAIM TO ANY PAR-
TICULAR FONT, STYLE, SIZE, OR COLOR.

SER. NO. 85-450,752, FILED 10-19-2011.

JILL PRATER, EXAMINING ATTORNEY



David J. Kyros

Director of the United States Patent and Trademark Office

United States of America

United States Patent and Trademark Office

GARDEN RUSH

Reg. No. 4,154,130

Registered June 5, 2012

Int. Cls.: 29 and 32

TRADEMARK

PRINCIPAL REGISTER

POOR RICHARD'S DISTRIBUTING CORPORATION (CANADA CORPORATION)
2820 HUNTINGTON PLACE
PORT COQUITLAM, BC, CANADA V3C4T3

FOR: DRIED FRUITS, FRUIT AND SOY BASED SNACK FOOD, FRUIT CHIPS, FRUIT LEATHERS, FRUIT BASED SNACK FOOD, GARDEN SALADS, DRIED VEGETABLES, PROTEIN BASED, NUTRIENT DENSE SNACK BARS, IN CLASS 29 (U.S. CL. 46).

FIRST USE 2-2-2004; IN COMMERCE 2-2-2004.

FOR: FLAVORED WATERS, FRUIT DRINKS, FRUIT JUICE, SMOOTHIES, SPORTS DRINKS, PREPARATIONS FOR MAKING SPORTS DRINKS, IN CLASS 32 (U.S. CLS. 45, 46 AND 48).

FIRST USE 2-2-2004; IN COMMERCE 2-2-2004.

THE MARK CONSISTS OF STANDARD CHARACTERS WITHOUT CLAIM TO ANY PARTICULAR FONT, STYLE, SIZE, OR COLOR.

SER. NO. 85-451,402, FILED 10-19-2011.

EUGENIA MARTIN, EXAMINING ATTORNEY



David J. Kyros

Director of the United States Patent and Trademark Office

United States of America

United States Patent and Trademark Office

SEA SPRAY

Reg. No. 4,154,131

Registered June 5, 2012

Int. Cl.: 33

TRADEMARK

PRINCIPAL REGISTER

DAVIDS PINOT VINEYARDS, INC. (CALIFORNIA CORPORATION), DBA SEA SMOKE
CELLARS
1604 NORTH O STREET
LOMPOC, CA 93436

FOR: WINES, IN CLASS 33 (U.S. CLS. 47 AND 49).

FIRST USE 10-17-2011; IN COMMERCE 10-17-2011.

THE MARK CONSISTS OF STANDARD CHARACTERS WITHOUT CLAIM TO ANY PARTICULAR FONT, STYLE, SIZE, OR COLOR.

SER. NO. 85-451,421, FILED 10-19-2011.

DEBORAH LOBO, EXAMINING ATTORNEY



David J. Kybas

Director of the United States Patent and Trademark Office

United States of America

United States Patent and Trademark Office

UGLY POOL GUY

Reg. No. 4,154,132

Registered June 5, 2012

Int. Cl.: 37

SERVICE MARK

PRINCIPAL REGISTER

UGLY POOLS USA, INC. (DELAWARE CORPORATION)
PMB 621 SUITE 1
7558 WEST THUNDERBIRD ROAD
PEORIA, AZ 85381

FOR: RENOVATION, CONSTRUCTION AND REPAIR SERVICES IN THE FIELD OF SWIMMING POOLS, SPAS AND TUBS, IN CLASS 37 (U.S. CLS. 100, 103 AND 106).

FIRST USE 9-0-2003; IN COMMERCE 9-0-2003.

THE MARK CONSISTS OF STANDARD CHARACTERS WITHOUT CLAIM TO ANY PARTICULAR FONT, STYLE, SIZE, OR COLOR.

NO CLAIM IS MADE TO THE EXCLUSIVE RIGHT TO USE "POOL", APART FROM THE MARK AS SHOWN.

SER. NO. 85-451,608, FILED 10-19-2011.

LUCY ARANT, EXAMINING ATTORNEY



David J. Kybas

Director of the United States Patent and Trademark Office

United States of America

United States Patent and Trademark Office

77KIDS BY AMERICAN EAGLE

Reg. No. 4,154,133

Registered June 5, 2012

Int. Cl.: 9

TRADEMARK

PRINCIPAL REGISTER

RETAIL ROYALTY COMPANY (NEVADA CORPORATION)
101 CONVENTION CENTER
LAS VEGAS, NV 89109

FOR: DOWNLOADABLE SOFTWARE IN THE NATURE OF A MOBILE DEVICE APPLICATION PROVIDING CUSTOMERS AN ENHANCED SHOPPING EXPERIENCE FEATURING TREND INFORMATION, PRODUCT REVIEWS AND RECOMMENDATIONS, SPECIAL OFFERS AND LOYALTY PROGRAM POINTS AND THE ABILITY TO SCAN PRODUCTS FOR PURCHASE, IN CLASS 9 (U.S. CLS. 21, 23, 26, 36 AND 38).

FIRST USE 10-6-2011; IN COMMERCE 10-6-2011.

THE MARK CONSISTS OF STANDARD CHARACTERS WITHOUT CLAIM TO ANY PARTICULAR FONT, STYLE, SIZE, OR COLOR.

OWNER OF U.S. REG. NOS. 3,674,435, 3,999,176 AND OTHERS.

SER. NO. 85-451,694, FILED 10-20-2011.

VIVIAN MICZNIK FIRST, EXAMINING ATTORNEY



David J. Kybas

Director of the United States Patent and Trademark Office

United States of America

United States Patent and Trademark Office



Reg. No. 4,154,134

Registered June 5, 2012

Int. Cl.: 35

SERVICE MARK

PRINCIPAL REGISTER

FLASHVIC, INC. (FLORIDA CORPORATION)
#1607
18101 COLLINS AVE
SUNNY ISLES, FL 33160

FOR: ONLINE WEB SITE PROVIDING INFORMATION ABOUT THE GOODS AND SERVICES OF OTHERS, NAMELY, BARGAIN PRICING INFORMATION AND SPECIAL OFFERS INCLUDING COUPONS AND PROMOTIONAL OFFERS, IN CLASS 35 (U.S. CLS. 100, 101 AND 102).

FIRST USE 9-1-2010; IN COMMERCE 2-15-2011.

OWNER OF U.S. REG. NOS. 3,079,440 AND 3,672,871.

NO CLAIM IS MADE TO THE EXCLUSIVE RIGHT TO USE "COUPON", APART FROM THE MARK AS SHOWN.

THE MARK CONSISTS OF THE STYLIZED TEXT "COUPON" ABOVE THE STYLIZED TEXT "CRAZE". A RIPPED PRICE TAG HANGS OFF THE "C" IN "COUPON" AND FEATURES A STYLIZED DOLLAR SIGN (\$).

SER. NO. 85-451,734, FILED 10-20-2011.

FLORENTINA BLANDU, EXAMINING ATTORNEY



David J. Kyros

Director of the United States Patent and Trademark Office

United States of America

United States Patent and Trademark Office



BI
DOCUMENTER

Reg. No. 4,154,135

Registered June 5, 2012

Int. Cl.: 9

PRAGMATIC WORKS SOFTWARE, INC (FLORIDA CORPORATION), DBA PRAGMATIC WORKS
SUI TE 216
400 COLLEGE DRIVE
MIDDLEBURG, FL 32068

TRADEMARK

FOR: COMPUTER SOFTWARE FOR APPLICATION AND DATABASE INTEGRATION, IN CLASS 9 (U.S. CLS. 21, 23, 26, 36 AND 38).

PRINCIPAL REGISTER

FIRST USE 4-1-2009; IN COMMERCE 4-1-2009.

NO CLAIM IS MADE TO THE EXCLUSIVE RIGHT TO USE " BI DOCUMENTER", APART FROM THE MARK AS SHOWN.

THE COLOR(S) GREY, LIGHT BLUE, SKY BLUE, BLACK AND LIME GREEN IS/ARE CLAIMED AS A FEATURE OF THE MARK.

THE MARK CONSISTS OF A GREY CUBE WITH GRAPH INSIDE CONTAINING GRADIENT LIGHT BLUE COLOR, SKY BLUE CIRCLE IN THE CENTER OF CUBE WITH OBLONG GREY AND LIME GREEN CYLINDER ATTACHED THAT RESEMBLES A MAGNIFYING GLASS, LOCATED TO THE RIGHT OUTSIDE OF CUBE, "BI" WORDING IN BLACK STACKED ON TOP OF LIME GREEN WORDING "DOCUMENTER".



SER. NO. 85-452,104, FILED 10-20-2011.

HENRY S. ZAK, EXAMINING ATTORNEY

David J. Kybas

Director of the United States Patent and Trademark Office

United States of America

United States Patent and Trademark Office

SIP BACK AND RELAX

Reg. No. 4,154,136

Registered June 5, 2012

Int. Cl.: 43

SERVICE MARK

PRINCIPAL REGISTER

FIREBIRDS INTERNATIONAL LLC (NORTH CAROLINA LIMITED LIABILITY COMPANY)
SUITE 450
13850 BALLANTYNE CORPORATE PARK
CHARLOTTE, NC 28277

FOR: RESTAURANT AND BAR SERVICES, IN CLASS 43 (U.S. CLS. 100 AND 101).

FIRST USE 1-0-2011; IN COMMERCE 1-0-2011.

THE MARK CONSISTS OF STANDARD CHARACTERS WITHOUT CLAIM TO ANY PARTICULAR FONT, STYLE, SIZE, OR COLOR.

SER. NO. 85-452,113, FILED 10-20-2011.

BRENDAN REGAN, EXAMINING ATTORNEY



David J. Kyffers

Director of the United States Patent and Trademark Office

United States of America

United States Patent and Trademark Office

JOIN US FOR FIREWORKS EVERY NIGHT

Reg. No. 4,154,137

Registered June 5, 2012

Int. Cl.: 43

SERVICE MARK

PRINCIPAL REGISTER

FIREBIRDS INTERNATIONAL LLC (NORTH CAROLINA LIMITED LIABILITY COMPANY)
SUITE 450
13850 BALLANTYNE CORPORATE PARK
CHARLOTTE, NC 28277

FOR: RESTAURANT AND BAR SERVICES, IN CLASS 43 (U.S. CLS. 100 AND 101).

FIRST USE 4-0-2011; IN COMMERCE 4-0-2011.

THE MARK CONSISTS OF STANDARD CHARACTERS WITHOUT CLAIM TO ANY PARTICULAR FONT, STYLE, SIZE, OR COLOR.

SER. NO. 85-452,124, FILED 10-20-2011.

BRENDAN REGAN, EXAMINING ATTORNEY



David J. Kybas

Director of the United States Patent and Trademark Office

United States of America

United States Patent and Trademark Office

DIVINE RETRIBUTION

Reg. No. 4,154,138

Registered June 5, 2012

Int. Cl.: 32

TRADEMARK

PRINCIPAL REGISTER

DUCLAW BREWERY LLC (MARYLAND LIMITED LIABILITY COMPANY)
16A BEL AIR SOUTH PARKWAY
BEL AIR, MD 21015

FOR: BEER, ALE AND PORTER, IN CLASS 32 (U.S. CLS. 45, 46 AND 48).

FIRST USE 9-1-2011; IN COMMERCE 9-1-2011.

THE MARK CONSISTS OF STANDARD CHARACTERS WITHOUT CLAIM TO ANY PARTICULAR FONT, STYLE, SIZE, OR COLOR.

SER. NO. 85-452,372, FILED 10-20-2011.

WILLIAM ROSSMAN, EXAMINING ATTORNEY



David J. Kyffers

Director of the United States Patent and Trademark Office

United States of America

United States Patent and Trademark Office

AN AMERICAN TRADITION THAT WORKS

Reg. No. 4,154,139

Registered June 5, 2012

Int. Cl.: 35

SERVICE MARK

PRINCIPAL REGISTER

AMERICAN PUBLIC POWER ASSOCIATION (D.C. CORPORATION)
1875 CONNECTICUT AVENUE, N.W. SUITE 1200
WASHINGTON, DC 200095715

FOR: ASSOCIATION SERVICES, NAMELY, PROMOTING THE INTERESTS OF GOVERNMENTALLY-OWNED, LOCALLY-CONTROLLED ELECTRIC UTILITY MEMBERS BY PROMOTING PUBLIC AWARENESS OF THE BENEFITS OF GOVERNMENTALLY-OWNED AND LOCALLY-CONTROLLED NOT-FOR-PROFIT UTILITY COMPANIES, IN CLASS 35 (U.S. CLS. 100, 101 AND 102).

FIRST USE 12-31-1996; IN COMMERCE 12-31-1996.

THE MARK CONSISTS OF STANDARD CHARACTERS WITHOUT CLAIM TO ANY PARTICULAR FONT, STYLE, SIZE, OR COLOR.

OWNER OF U.S. REG. NO. 3,217,367.

SER. NO. 85-452,430, FILED 10-20-2011.

LEIGH CAROLINE CASE, EXAMINING ATTORNEY



David J. Kyffers

Director of the United States Patent and Trademark Office

United States of America

United States Patent and Trademark Office

ULTRA ADVANTAGE

Reg. No. 4,154,140

PET KENNEL COMPANY, LLC (INDIANA LIMITED LIABILITY COMPANY)
3815 N 900 E
VAN BUREN, IN 46991

Registered June 5, 2012

Int. Cl.: 31

FOR: DOG FOOD, NAMELY, MEAT BASED DOG FOOD WITH OMEGA VITAMINS, IN CLASS 31 (U.S. CLS. 1 AND 46).

TRADEMARK

FIRST USE 5-4-2004; IN COMMERCE 5-4-2004.

PRINCIPAL REGISTER

THE MARK CONSISTS OF STANDARD CHARACTERS WITHOUT CLAIM TO ANY PARTICULAR FONT, STYLE, SIZE, OR COLOR.

OWNER OF U.S. REG. NO. 3,042,697.

SER. NO. 85-452,509, FILED 10-20-2011.

TIMOTHY FINNEGAN, EXAMINING ATTORNEY



David J. Kybas

Director of the United States Patent and Trademark Office

United States of America

United States Patent and Trademark Office

TRIO

Reg. No. 4,154,141

Registered June 5, 2012

Int. Cl.: 36

SERVICE MARK

PRINCIPAL REGISTER

CASCADIA EQUITY LEASING, LLC (WASHINGTON LIMITED LIABILITY COMPANY)
SUITE 100
1100 DEXTER AVENUE NORTH
SEATTLE, WA 98109

FOR: RESIDENTIAL LEASE FINANCING SERVICES, IN CLASS 36 (U.S. CLS. 100, 101 AND 102).

FIRST USE 2-15-2009; IN COMMERCE 2-15-2009.

THE MARK CONSISTS OF STANDARD CHARACTERS WITHOUT CLAIM TO ANY PARTICULAR FONT, STYLE, SIZE, OR COLOR.

SER. NO. 85-452,569, FILED 10-20-2011.

GINA HAYES, EXAMINING ATTORNEY



David J. Kyffers

Director of the United States Patent and Trademark Office

United States of America

United States Patent and Trademark Office

Warmenfath

Reg. No. 4,154,142

Registered June 5, 2012

Int. Cl.: 9

MCCORMACK, JOHN F. (CALIFORNIA SOLE PROPRIETORSHIP), DBA RAINBOW
ELECTRONICS
SUITE G
5800 MADISON AVENUE
SACRAMENTO, CA 95841

TRADEMARK

FOR: MICRO AMPLIFIERS, NAMELY, AUDIO AMPLIFIERS, GUITAR AMPLIFIERS AND
MICROPHONE PRE-AMPLIFIERS, IN CLASS 9 (U.S. CLS. 21, 23, 26, 36 AND 38).

PRINCIPAL REGISTER

FIRST USE 1-24-2004; IN COMMERCE 1-24-2004.

THE MARK CONSISTS OF STANDARD CHARACTERS WITHOUT CLAIM TO ANY PAR-
TICULAR FONT, STYLE, SIZE, OR COLOR.

SER. NO. 85-452,621, FILED 10-20-2011.

DANIEL CAPSHAW, EXAMINING ATTORNEY



David J. Kyffers

Director of the United States Patent and Trademark Office

United States of America

United States Patent and Trademark Office

HARVESTOR

I N V E S T M E N T S

Reg. No. 4,154,143

Registered June 5, 2012

Int. Cl.: 14

DOVE, TROY V. (CALIFORNIA LIMITED LIABILITY COMPANY), DBA HARVESTOR INVESTMENTS
SUITE 411
80 W. SIERRA MADRE, BLVD.
SIERRA MADRE, CA 91024

TRADEMARK

FOR: COLLECTIBLE COINS; NON-MONETARY COINS; PRECIOUS METALS, NAMELY, GOLD, SILVER, PLATINUM, PALLADIUM, IN CLASS 14 (U.S. CLS. 2, 27, 28 AND 50).

PRINCIPAL REGISTER

FIRST USE 3-15-2010; IN COMMERCE 3-26-2010.

NO CLAIM IS MADE TO THE EXCLUSIVE RIGHT TO USE "INVESTMENTS", APART FROM THE MARK AS SHOWN.

THE COLOR(S) BLACK, WHITE, AND GOLDEN-ORANGE IS/ARE CLAIMED AS A FEATURE OF THE MARK.

THE MARK CONSISTS OF THE WORDING "HARVESTOR INVESTMENTS" IN BLACK WITH A GOLDEN-ORANGE COLORED CIRCLE IN PLACE OF THE "O" IN WHICH A WHITE HEAD OF WHEAT IS CENTERED.

SER. NO. 85-452,719, FILED 10-21-2011.

TEJBIR SINGH, EXAMINING ATTORNEY



David J. Kybas

Director of the United States Patent and Trademark Office

United States of America

United States Patent and Trademark Office

DELUXE

Reg. No. 4,154,144

Registered June 5, 2012

Int. Cl.: 30

TRADEMARK

PRINCIPAL REGISTER

COLLIN STREET BAKERY, INC (TEXAS CORPORATION)
401 WEST SEVENTH AVENUE
CORNICANA, TX 75110

FOR: FRUITCAKE, IN CLASS 30 (U.S. CL. 46).

FIRST USE 11-1-1912; IN COMMERCE 11-1-1912.

THE MARK CONSISTS OF STANDARD CHARACTERS WITHOUT CLAIM TO ANY PARTICULAR FONT, STYLE, SIZE, OR COLOR.

OWNER OF U.S. REG. NO. 93,826.

SER. NO. 85-452,980, FILED 10-21-2011.

SANDRA BUJA, EXAMINING ATTORNEY



David J. Kyffers

Director of the United States Patent and Trademark Office

United States of America

United States Patent and Trademark Office

SUNKIST NUTRITION BUREAU

Reg. No. 4,154,145

Registered June 5, 2012

Int. Cl.: 35

SERVICE MARK

PRINCIPAL REGISTER

SUNKIST GROWERS, INC. (CALIFORNIA CORPORATION)
14130 RIVERSIDE DRIVE
SHERMAN OAKS, CA 91423

FOR: PROMOTING THE INTERESTS OF THE CITRUS INDUSTRY BY DISTRIBUTING AND OTHERWISE PROVIDING ACCESS TO PROMOTIONAL AND EDUCATIONAL NEWS MATERIALS IN MATTERS OF DIET AND NUTRITION ASSOCIATED WITH FRESH ORANGES, GRAPEFRUIT, LEMONS, AND OTHER CITRUS FRUITS, IN CLASS 35 (U.S. CLS. 100, 101 AND 102).

FIRST USE 8-1-2003; IN COMMERCE 8-1-2003.

THE MARK CONSISTS OF STANDARD CHARACTERS WITHOUT CLAIM TO ANY PARTICULAR FONT, STYLE, SIZE, OR COLOR.

OWNER OF U.S. REG. NOS. 72,087, 2,749,729 AND OTHERS.

NO CLAIM IS MADE TO THE EXCLUSIVE RIGHT TO USE "NUTRITION BUREAU", APART FROM THE MARK AS SHOWN.

SER. NO. 85-453,196, FILED 10-21-2011.

ANDREA HACK, EXAMINING ATTORNEY



David J. Kyros

Director of the United States Patent and Trademark Office

United States of America

United States Patent and Trademark Office

QUIKDRIVE

Reg. No. 4,154,146

STRYKER CORPORATION (MICHIGAN CORPORATION)
2825 AIRVIEW BOULEVARD
KALAMAZOO, MI 49002

Registered June 5, 2012

Int. Cl.: 10

FOR: SURGICAL INSTRUMENTS FOR ORTHOPEDIC SURGERY, NAMELY, SCREW-DRIVERS, BATTERY PACKS, TRAYS, IN CLASS 10 (U.S. CLS. 26, 39 AND 44).

TRADEMARK

FIRST USE 9-5-2007; IN COMMERCE 9-5-2007.

PRINCIPAL REGISTER

THE MARK CONSISTS OF STANDARD CHARACTERS WITHOUT CLAIM TO ANY PARTICULAR FONT, STYLE, SIZE, OR COLOR.

SER. NO. 85-453,343, FILED 10-21-2011.

ALYSSA STEEL, EXAMINING ATTORNEY



David J. Kybas

Director of the United States Patent and Trademark Office

United States of America

United States Patent and Trademark Office

The Little Kitchen

Reg. No. 4,154,147

JULIE DEILY (UNITED STATES INDIVIDUAL)
836 BERKSHIRE DR
ROCKLEDGE, FL 32955

Registered June 5, 2012

Int. Cl.: 41

FOR: ON-LINE JOURNALS, NAMELY, BLOGS FEATURING RECIPES, COOKING, AND RELATED INFORMATION, IN CLASS 41 (U.S. CLS. 100, 101 AND 107).

SERVICE MARK

FIRST USE 12-5-2009; IN COMMERCE 12-7-2009.

PRINCIPAL REGISTER

THE MARK CONSISTS OF STANDARD CHARACTERS WITHOUT CLAIM TO ANY PARTICULAR FONT, STYLE, SIZE, OR COLOR.

NO CLAIM IS MADE TO THE EXCLUSIVE RIGHT TO USE "KITCHEN", APART FROM THE MARK AS SHOWN.

SER. NO. 85-453,729, FILED 10-21-2011.

FRANK LATTUCA, EXAMINING ATTORNEY



David J. Kyros

Director of the United States Patent and Trademark Office

United States of America

United States Patent and Trademark Office

Intelligrate

Reg. No. 4,154,148

Registered June 5, 2012

Int. Cl.: 42

SERVICE MARK

PRINCIPAL REGISTER

IVOGHLI, SEAN (UNITED STATES INDIVIDUAL)
PO BOX 4048
MISSION VIEJO, CA 92690

FOR: COMPUTER COMPATIBILITY SERVICES, NAMELY, DATA MAPPING; COMPUTER SOFTWARE DEVELOPMENT AND COMPUTER PROGRAMMING DEVELOPMENT FOR OTHERS; COMPUTER SYSTEMS INTEGRATION SERVICES; DATA MIGRATION SERVICES; DATA WAREHOUSING; DESIGN AND DEVELOPMENT OF COMPUTER SOFTWARE; DEVELOPMENT AND CREATION OF COMPUTER PROGRAMMES FOR DATA PROCESSING; INTEGRATION OF COMPUTER SYSTEMS AND NETWORKS; IT INTEGRATION SERVICES; WRITING OF DATA PROCESSING PROGRAMS, IN CLASS 42 (U.S. CLS. 100 AND 101).

FIRST USE 8-5-2011; IN COMMERCE 9-12-2011.

THE MARK CONSISTS OF STANDARD CHARACTERS WITHOUT CLAIM TO ANY PARTICULAR FONT, STYLE, SIZE, OR COLOR.

SER. NO. 85-453,906, FILED 10-22-2011.

WILLIAM VERHOSEK, EXAMINING ATTORNEY



David J. Kyros

Director of the United States Patent and Trademark Office

United States of America

United States Patent and Trademark Office

CHERKEES

Reg. No. 4,154,149

EELTOWN ENTERPRISES, LLC (FLORIDA LIMITED LIABILITY COMPANY)
111 SECOND AVE. N.E., SUITE 900
ST. PETERSBURG, FL 33701

Registered June 5, 2012

Int. Cl.: 29

FOR: MEAT AND POTATO-BASED DRIED SNACK FOODS FLAVORED AS BEEF JERKY,
IN CLASS 29 (U.S. CL. 46).

TRADEMARK

FIRST USE 8-31-2011; IN COMMERCE 8-31-2011.

PRINCIPAL REGISTER

THE MARK CONSISTS OF STANDARD CHARACTERS WITHOUT CLAIM TO ANY PAR-
TICULAR FONT, STYLE, SIZE, OR COLOR.

SER. NO. 85-454,245, FILED 10-24-2011.

WENDY JUN, EXAMINING ATTORNEY



David J. Kybas

Director of the United States Patent and Trademark Office

United States of America

United States Patent and Trademark Office

BEEF JERKY, MEET POTATO CHIP

Reg. No. 4,154,150

EELTOWN ENTERPRISES, LLC (FLORIDA LIMITED LIABILITY COMPANY)
111 SECOND AVE. N.E., SUITE 900
ST. PETERSBURG, FL 33701

Registered June 5, 2012

Int. Cl.: 29

FOR: MEAT AND POTATO-BASED DRIED SNACK FOODS FLAVORED AS BEEF JERKY,
IN CLASS 29 (U.S. CL. 46).

TRADEMARK

FIRST USE 8-31-2011; IN COMMERCE 8-31-2011.

PRINCIPAL REGISTER

THE MARK CONSISTS OF STANDARD CHARACTERS WITHOUT CLAIM TO ANY PAR-
TICULAR FONT, STYLE, SIZE, OR COLOR.

SER. NO. 85-454,261, FILED 10-24-2011.

WENDY JUN, EXAMINING ATTORNEY



David J. Kybas

Director of the United States Patent and Trademark Office

United States of America

United States Patent and Trademark Office

Tweeka

Reg. No. 4,154,151

Registered June 5, 2012

Int. Cl.: 33

TRADEMARK

PRINCIPAL REGISTER

GUTEKUNST, BRENT L (UNITED STATES INDIVIDUAL)
TWEKA
407 W. SPRUCE ST
SAN DIEGO, CA 92103

FOR: SPIRITS AND LIQUEURS, IN CLASS 33 (U.S. CLS. 47 AND 49).

FIRST USE 7-4-2006; IN COMMERCE 7-4-2006.

THE MARK CONSISTS OF STANDARD CHARACTERS WITHOUT CLAIM TO ANY PARTICULAR FONT, STYLE, SIZE, OR COLOR.

SER. NO. 85-454,358, FILED 10-24-2011.

BRIDGETT SMITH, EXAMINING ATTORNEY



David J. Kybas

Director of the United States Patent and Trademark Office

United States of America

United States Patent and Trademark Office

MEN'S HEALTH

Reg. No. 4,154,152

Registered June 5, 2012

Int. Cl.: 9

TRADEMARK

PRINCIPAL REGISTER

RODALE INC. (PENNSYLVANIA CORPORATION)
33 EAST MINOR STREET
EMMAUS, PA 180980099

FOR: DOWNLOADABLE SOFTWARE IN THE NATURE OF A MOBILE APPLICATION FOR PROVIDING INFORMATION IN THE FIELDS OF HEALTH, FITNESS, DIET, EXERCISE, LIFESTYLE AND NUTRITION, IN CLASS 9 (U.S. CLS. 21, 23, 26, 36 AND 38).

FIRST USE 9-0-2011; IN COMMERCE 9-0-2011.

THE MARK CONSISTS OF STANDARD CHARACTERS WITHOUT CLAIM TO ANY PARTICULAR FONT, STYLE, SIZE, OR COLOR.

OWNER OF U.S. REG. NOS. 2,245,025, 2,344,140, AND 3,101,437.

SEC. 2(F).

SER. NO. 85-454,485, FILED 10-24-2011.

FLORENTINA BLANDU, EXAMINING ATTORNEY



David J. Kyjars

Director of the United States Patent and Trademark Office

United States of America

United States Patent and Trademark Office

WOMEN'S HEALTH

Reg. No. 4,154,153

Registered June 5, 2012

Int. Cl.: 9

TRADEMARK

PRINCIPAL REGISTER

RODALE INC. (PENNSYLVANIA CORPORATION)
33 EAST MINOR STREET
EMMAUS, PA 180980099

FOR: DOWNLOADABLE SOFTWARE IN THE NATURE OF A MOBILE APPLICATION FOR PROVIDING INFORMATION IN THE FIELDS OF HEALTH, FITNESS, DIET, EXERCISE, LIFESTYLE AND NUTRITION, IN CLASS 9 (U.S. CLS. 21, 23, 26, 36 AND 38).

FIRST USE 9-0-2011; IN COMMERCE 9-0-2011.

THE MARK CONSISTS OF STANDARD CHARACTERS WITHOUT CLAIM TO ANY PARTICULAR FONT, STYLE, SIZE, OR COLOR.

OWNER OF U.S. REG. NOS. 3,064,599, 3,410,559, AND 3,802,497.

SEC. 2(F).

SER. NO. 85-454,536, FILED 10-24-2011.

FLORENTINA BLANDU, EXAMINING ATTORNEY



David J. Kybas

Director of the United States Patent and Trademark Office

United States of America

United States Patent and Trademark Office



Reg. No. 4,154,154

Registered June 5, 2012

Int. Cl.: 9

TRADEMARK

PRINCIPAL REGISTER

HERZENBERG, JANET (UNITED STATES INDIVIDUAL)
8 W 127TH STREET, #2
NEW YORK, NY 10027

FOR: AUDIO AND VIDEO RECORDINGS FEATURING MUSIC AND ARTISTIC PERFORMANCES, IN CLASS 9 (U.S. CLS. 21, 23, 26, 36 AND 38).

FIRST USE 1-1-2003; IN COMMERCE 1-1-2003.

THE MARK IS ONE CONTINUOUS LINE WHICH FORMS A HEART DESIGN THAT IS CONNECTED TO AN INFINITY SYMBOL OR A BOW AT THE BASE OF THE HEART AS SHOWN IN THE MARK.

SER. NO. 85-454,595, FILED 10-24-2011.

LIEF MARTIN, EXAMINING ATTORNEY



David J. Kyffers

Director of the United States Patent and Trademark Office

United States of America

United States Patent and Trademark Office

SPRIM

Reg. No. 4,154,155

Registered June 5, 2012

Int. Cls.: 35 and 42

SERVICE MARK

PRINCIPAL REGISTER

SPRIM USA (CALIFORNIA CORPORATION), DBA SPRIM USA
STE.1175
235 PINE ST.
SAN FRANCISCO, CA 94112

FOR: BUSINESS CONSULTATION IN THE FIELD OF CLINICAL TRIALS AND HEALTH PRODUCT INNOVATION, IN CLASS 35 (U.S. CLS. 100, 101 AND 102).

FIRST USE 0-0-2002; IN COMMERCE 0-0-2002.

FOR: MEDICAL AND SCIENTIFIC RESEARCH, NAMELY, CONDUCTING CLINICAL TRIALS; PROVIDING MEDICAL AND SCIENTIFIC RESEARCH INFORMATION IN THE FIELD OF CLINICAL TRIALS; PROVIDING MEDICAL AND SCIENTIFIC RESEARCH INFORMATION IN THE FIELD OF PHARMACEUTICALS AND CLINICAL TRIALS, IN CLASS 42 (U.S. CLS. 100 AND 101).

FIRST USE 0-0-2002; IN COMMERCE 0-0-2002.

THE MARK CONSISTS OF STANDARD CHARACTERS WITHOUT CLAIM TO ANY PARTICULAR FONT, STYLE, SIZE, OR COLOR.

THE WORDING "SPRIM" HAS NO MEANING IN A FOREIGN LANGUAGE.

SER. NO. 85-454,688, FILED 10-24-2011.

CHRISTOPHER BUONGIORNO, EXAMINING ATTORNEY



David J. Kybas

Director of the United States Patent and Trademark Office

United States of America

United States Patent and Trademark Office

ClearStar Innovator

Reg. No. 4,154,156

Registered June 5, 2012

Int. Cl.: 45

SERVICE MARK

PRINCIPAL REGISTER

CLEARSTAR, INC. (DELAWARE CORPORATION)
6525 SHILOH ROAD, STE D-300
ALPHARETTA, GA 30005

FOR: BACKGROUND INVESTIGATION AND RESEARCH SERVICES; BACKGROUND INVESTIGATION SERVICES; DETECTIVE INVESTIGATIONS; DMV RECORD INVESTIGATION SERVICES; DRUG, ALCOHOL AND DNA SCREENING FOR SECURITY AND EMPLOYMENT PURPOSES; EMPLOYEE MISCONDUCT INVESTIGATION SERVICES; EMPLOYMENT BACKGROUND SCREENING, NAMELY, BACKGROUND SCREENING OF CURRENT EMPLOYEES OF OTHERS; INVESTIGATION OF ASSETS, CREDIT REPORTS, FISCAL ASSESSMENTS, AND COLLECTION REPORTS FOR SECURITY OR AUTHENTICATION PURPOSES; INVESTIGATION OR SURVEILLANCE ON BACKGROUND PROFILES; INVESTIGATION SERVICES RELATED TO INSURANCE CLAIMS; MONITORING OF CREDIT REPORTS, THE INTERNET, AND PUBLIC RECORDS TO FACILITATE THE DETECTION AND PREVENTION OF IDENTITY THEFT AND FRAUD; ON-LINE IDENTITY RELIABILITY INVESTIGATION IN THE FIELD OF ON-LINE DATING AND CLAIMS MADE ABOUT AGE, GENDER; PERSONAL BACKGROUND INVESTIGATIONS; PRE-EMPLOYMENT BACKGROUND INVESTIGATION SERVICES; PRE-EMPLOYMENT BACKGROUND SCREENING; PRIVATE INVESTIGATION; PROVIDING AN INTERACTIVE WEB SITE THAT FACILITATES THE VERIFICATION OF A PERSON'S BACKGROUND CREDENTIALS; PUBLIC RECORD INVESTIGATION SERVICES; VERIFYING AND MONITORING THE SECURITY CREDENTIALS OF EVENT STAFF FOR VARIOUS PRIVATE AND PUBLIC SPORTS OR ENTERTAINMENT EVENTS, IN CLASS 45 (U.S. CLS. 100 AND 101).



FIRST USE 8-4-2011; IN COMMERCE 10-5-2011.

THE MARK CONSISTS OF STANDARD CHARACTERS WITHOUT CLAIM TO ANY PARTICULAR FONT, STYLE, SIZE, OR COLOR.

SER. NO. 85-455,195, FILED 10-25-2011.

SUSAN STIGLITZ, EXAMINING ATTORNEY

David J. Kybas

Director of the United States Patent and Trademark Office

United States of America

United States Patent and Trademark Office



Reg. No. 4,154,157

Registered June 5, 2012

Int. Cl.: 42

SERVICE MARK

PRINCIPAL REGISTER

SYMPHONIC SOURCE (TEXAS CORPORATION)
10456 COUNTESS DR.
DALLAS, TX 75229

FOR: CLOUD COMPUTING FEATURING SOFTWARE FOR USE DATA CLEANSING OF IN CUSTOMER RELATIONSHIP MANAGEMENT (CRM) APPLICATIONS, IN CLASS 42 (U.S. CLS. 100 AND 101).

FIRST USE 8-1-2011; IN COMMERCE 8-30-2011.

THE STIPLING IS FOR SHADING PURPOSES ONLY.

THE MARK CONSISTS OF A DINGO/DOG WEARING A COWBOY HAT AND A NECKLACE WITH TEETH HANGING ON IT. THE DOG IS STANDING ON ITS HIND LEGS, LEANING FORWARD, HOLDING A LASSO IN ITS HANDS. THE LASSO FORMS A LOOP BEHIND THE DOG'S HEAD.

SER. NO. 85-455,216, FILED 10-25-2011.

JASON BLAIR, EXAMINING ATTORNEY



David J. Kybas

Director of the United States Patent and Trademark Office

United States of America

United States Patent and Trademark Office

LITTLE MASTERS

Reg. No. 4,154,158

Registered June 5, 2012

Int. Cl.: 2

TRADEMARK

PRINCIPAL REGISTER

ROCK PAINT DISTRIBUTING CORP. (WISCONSIN CORPORATION)
P.O. BOX 482
MILTON, WI 53563

FOR: PAINTS, IN CLASS 2 (U.S. CLS. 6, 11 AND 16).

FIRST USE 3-17-1997; IN COMMERCE 3-17-1997.

THE MARK CONSISTS OF STANDARD CHARACTERS WITHOUT CLAIM TO ANY PARTICULAR FONT, STYLE, SIZE, OR COLOR.

OWNER OF U.S. REG. NO. 3,889,629.

SER. NO. 85-455,354, FILED 10-25-2011.

B. PARADEWELAI, EXAMINING ATTORNEY



David J. Kybas

Director of the United States Patent and Trademark Office

United States of America

United States Patent and Trademark Office

PELPRENE

Reg. No. 4,154,159

Registered June 5, 2012

Int. Cl.: 1

TRADEMARK

PRINCIPAL REGISTER

TOYO BOSEKI KABUSHIKI KAISHA (JAPAN JOINT STOCK COMPANY), TA TOYOBO
CO., LTD.
2-8, DOJIMA HAMA 2-CHOME
KITA-KU, OSAKA, JAPAN

FOR: UNPROCESSED PLASTICS, NAMELY, THERMOPLASTIC POLYESTER ELASTOMER,
IN CLASS 1 (U.S. CLS. 1, 5, 6, 10, 26 AND 46).

THE MARK CONSISTS OF STANDARD CHARACTERS WITHOUT CLAIM TO ANY PAR-
TICULAR FONT, STYLE, SIZE, OR COLOR.

OWNER OF JAPAN REG. NO. 5407714, DATED 4-22-2011, EXPIRES 4-22-2021.

SER. NO. 85-455,501, FILED 10-25-2011.

ROBIN CHOSID, EXAMINING ATTORNEY



David J. Kyros

Director of the United States Patent and Trademark Office

United States of America

United States Patent and Trademark Office

Air**m**atrixx

Reg. No. 4,154,160

Registered June 5, 2012

Int. Cl.: 25

TRADEMARK

PRINCIPAL REGISTER

CHANG, JAIME (TAIWAN INDIVIDUAL)
NO.29, FUYIN RD., HOULI DIST.
TAICHUNG CITY 421, TAIWAN

FOR: ATHLETIC SHOES; BEACH FOOTWEAR; BEACH SHOES; BELTS FOR CLOTHING; BOOTS; CANVAS SHOES; CAPS; CHILDREN'S HEADWEAR; FOOTWEAR; FOOTWEAR FOR MEN AND WOMEN; HATS; HEADWEAR; INNER SOLES; LEATHER SHOES; LEISURE SHOES; LEISURE SUITS; PANTS; SANDALS; SHIRTS; SHOES; SLIPPERS; SOCKS AND STOCKINGS; SOLES; SOLES FOR FOOTWEAR; T-SHIRTS; TROUSERS; WAIST BELTS; WOMEN'S SHOES, IN CLASS 25 (U.S. CLS. 22 AND 39).

FIRST USE 9-21-2011; IN COMMERCE 9-21-2011.

THE MARK CONSISTS OF THE WORD "AIRMATRIX". THE LETTER "M" IS REPLACED WITH A POKER FACE.

SER. NO. 85-455,523, FILED 10-25-2011.

B. PARADEWELAI, EXAMINING ATTORNEY



David J. Kybas

Director of the United States Patent and Trademark Office

United States of America

United States Patent and Trademark Office

MEDTALENT

Reg. No. 4,154,161

Registered June 5, 2012

Int. Cl.: 41

SERVICE MARK

PRINCIPAL REGISTER

MEDAXIOM CARDIOLOGY, LLC (FLORIDA LIMITED LIABILITY COMPANY)
2050 KINGS CIRCLE SOUTH
NEPTUNE BEACH, FL 32266

FOR: EDUCATIONAL SERVICES, NAMELY, PROVIDING LIVE AND ONLINE LEADERSHIP CLASSES IN THE FIELD OF MEDICINE; PROVIDING LIVE AND ONLINE COURSES IN THE FIELD OF MEDICAL LEADERSHIP DEVELOPMENT; PROVIDING LIVE AND ONLINE COURSES FOR HOSPITAL LEADERS AND PHYSICIANS TO IMPROVE THEIR COMMUNICATION, LEADERSHIP, MANAGEMENT AND ORGANIZATIONAL SKILLS, IN CLASS 41 (U.S. CLS. 100, 101 AND 107).

FIRST USE 7-1-2011; IN COMMERCE 7-1-2011.

THE MARK CONSISTS OF STANDARD CHARACTERS WITHOUT CLAIM TO ANY PARTICULAR FONT, STYLE, SIZE, OR COLOR.

SER. NO. 85-455,524, FILED 10-25-2011.

NAPOLEON SHARMA, EXAMINING ATTORNEY



David J. Kyffers

Director of the United States Patent and Trademark Office

United States of America

United States Patent and Trademark Office

NU-FLAME

Reg. No. 4,154,162

SRMX CAPITAL, LLC (FLORIDA LIMITED LIABILITY COMPANY)
635 W. MICHIGAN STREET
ORLANDO, FL 32805

Registered June 5, 2012

Int. Cl.: 11

FOR: FIREPLACES, IN CLASS 11 (U.S. CLS. 13, 21, 23, 31 AND 34).

TRADEMARK

FIRST USE 10-24-2011; IN COMMERCE 10-24-2011.

PRINCIPAL REGISTER

THE MARK CONSISTS OF STANDARD CHARACTERS WITHOUT CLAIM TO ANY PARTICULAR FONT, STYLE, SIZE, OR COLOR.

SER. NO. 85-455,574, FILED 10-25-2011.

TARAH HARDY, EXAMINING ATTORNEY



David J. Kyffers

Director of the United States Patent and Trademark Office

United States of America

United States Patent and Trademark Office

CONSUMMATE AGS

Reg. No. 4,154,163

ALANDA LLC (NEW JERSEY LIMITED LIABILITY COMPANY)
4 DONSEN LANE
SCOTCH PLAINS, NJ 07076

Registered June 5, 2012

Int. Cl.: 42

FOR: SOFTWARE AS A SERVICE (SAAS) SERVICES, NAMELY, HOSTING SOFTWARE FOR USE BY OTHERS FOR USE IN AGGREGATE SPEND TRACKING AND MANAGEMENT, IN CLASS 42 (U.S. CLS. 100 AND 101).

SERVICE MARK

FIRST USE 9-0-2010; IN COMMERCE 9-0-2010.

PRINCIPAL REGISTER

THE MARK CONSISTS OF STANDARD CHARACTERS WITHOUT CLAIM TO ANY PARTICULAR FONT, STYLE, SIZE, OR COLOR.

SER. NO. 85-455,580, FILED 10-25-2011.

RUSS HERMAN, EXAMINING ATTORNEY



David J. Kyros

Director of the United States Patent and Trademark Office

United States of America

United States Patent and Trademark Office

CETALUS

Reg. No. 4,154,164

Registered June 5, 2012

Int. Cls.: 35 and 45

SERVICE MARK

PRINCIPAL REGISTER

CETALUS LLC (MASSACHUSETTS LIMITED LIABILITY COMPANY)
300 BRICKSTONE SQUARE
SUITE 201
ANDOVER, MA 01810

FOR: BUSINESS MANAGEMENT CONSULTING IN THE FIELD OF STRATEGY AND MARKETING OF HEALTH-RELATED PRODUCTS OF OTHERS, IN CLASS 35 (U.S. CLS. 100, 101 AND 102).

FIRST USE 6-22-2005; IN COMMERCE 6-22-2005.

FOR: PROVIDING PATENT AND INDUSTRIAL PROPERTY LICENSING CONSULTATION FOR TECHNOLOGY OWNERS OF HEALTH RELATED PRODUCTS SEEKING TO EXPLOIT THE TECHNOLOGY TO THIRD-PARTY USERS THEREOF AND FOR POTENTIAL CONSUMERS OF PROPRIETARY TECHNOLOGY OF HEALTH RELATED PRODUCTS SEEKING TO ACQUIRE PROPRIETARY TECHNOLOGY FROM ITS OWNERS, IN CLASS 45 (U.S. CLS. 100 AND 101).

FIRST USE 6-22-2005; IN COMMERCE 6-22-2005.

THE MARK CONSISTS OF STANDARD CHARACTERS WITHOUT CLAIM TO ANY PARTICULAR FONT, STYLE, SIZE, OR COLOR.

OWNER OF U.S. REG. NOS. 3,296,642 AND 3,398,012.

SER. NO. 85-455,596, FILED 10-25-2011.

TARAH HARDY, EXAMINING ATTORNEY



David J. Kyffers

Director of the United States Patent and Trademark Office

United States of America

United States Patent and Trademark Office

LIFE POLICY
PAYOUT



Turn your life insurance policy into cash

Reg. No. 4,154,165

Registered June 5, 2012

Int. Cl.: 36

SERVICE MARK

PRINCIPAL REGISTER

VESPERA LIFE, LLC (DELAWARE LIMITED LIABILITY COMPANY)
PMB #104
43 SOUTH POMPANO PARKWAY
POMPANO BEACH, FL 33069

FOR: INSURANCE SERVICES, NAMELY, VIATICAL SETTLEMENT SERVICES, LIFE SETTLEMENT SERVICES FOR INSURANCE POLICYHOLDERS, AND SENIOR SETTLEMENT SERVICES FOR INSURANCE POLICYHOLDERS; VIATICAL SETTLEMENT SERVICES, IN CLASS 36 (U.S. CLS. 100, 101 AND 102).

FIRST USE 10-4-2011; IN COMMERCE 10-20-2011.

NO CLAIM IS MADE TO THE EXCLUSIVE RIGHT TO USE "LIFE POLICY PAYOUT", APART FROM THE MARK AS SHOWN.

THE MARK CONSISTS OF THE WORDS "LIFE POLICY PAYOUT" WITH A PARTIALLY EXPOSED SUN TO THE UPPER RIGHT HAND CORNER OF THE WORD "PAYOUT". THE WORDS "TURN YOUR LIFE INSURANCE POLICY INTO CASH" ARE BELOW THE WORD "PAYOUT".

SER. NO. 85-455,726, FILED 10-25-2011.

BENJAMIN OKEKE, EXAMINING ATTORNEY



David J. Kyjars

Director of the United States Patent and Trademark Office

United States of America

United States Patent and Trademark Office

OBERGOOD

Reg. No. 4,154,166

Registered June 5, 2012

Int. Cl.: 29

TRADEMARK

PRINCIPAL REGISTER

PRINCESS & THE P, LLC (MARYLAND LIMITED LIABILITY COMPANY)
30 JUNIPER CIRCLE
SHEPHERDSTOWN, WV 25443

FOR: CHEESE, IN CLASS 29 (U.S. CL. 46).

FIRST USE 12-0-2009; IN COMMERCE 12-0-2009.

THE MARK CONSISTS OF STANDARD CHARACTERS WITHOUT CLAIM TO ANY PARTICULAR FONT, STYLE, SIZE, OR COLOR.

SER. NO. 85-455,809, FILED 10-25-2011.

KATHERINE E. HALMEN, EXAMINING ATTORNEY



David J. Kyros

Director of the United States Patent and Trademark Office

United States of America

United States Patent and Trademark Office

R U Nutz

Reg. No. 4,154,167

Registered June 5, 2012

Int. Cl.: 30

TRADEMARK

PRINCIPAL REGISTER

UMPQUA OATS, INC. (OREGON CORPORATION)
780 NW GARDEN VALLEY BLVD., SUITE 230
ROSEBURG, OR 97471

FOR: OATMEAL, IN CLASS 30 (U.S. CL. 46).

FIRST USE 3-10-2009; IN COMMERCE 3-10-2009.

THE MARK CONSISTS OF STANDARD CHARACTERS WITHOUT CLAIM TO ANY PARTICULAR FONT, STYLE, SIZE, OR COLOR.

SER. NO. 85-455,945, FILED 10-25-2011.

JESSICA A. POWERS, EXAMINING ATTORNEY



David J. Kybas

Director of the United States Patent and Trademark Office

United States of America

United States Patent and Trademark Office

JK Studio

Reg. No. 4,154,168

JEWEL KADE HOLDINGS LLC (UTAH LIMITED LIABILITY COMPANY)
345 S MAIN STREET
ALPINE, UT 84004

Registered June 5, 2012

Int. Cl.: 42

FOR: PROVIDING JEWELRY DESIGN SERVICES VIA THE INTERNET, IN CLASS 42 (U.S. CLS. 100 AND 101).

SERVICE MARK

FIRST USE 10-18-2011; IN COMMERCE 10-18-2011.

PRINCIPAL REGISTER

THE MARK CONSISTS OF STANDARD CHARACTERS WITHOUT CLAIM TO ANY PARTICULAR FONT, STYLE, SIZE, OR COLOR.

NO CLAIM IS MADE TO THE EXCLUSIVE RIGHT TO USE "STUDIO", APART FROM THE MARK AS SHOWN.

SER. NO. 85-455,979, FILED 10-25-2011.

DAWN FELDMAN, EXAMINING ATTORNEY



David J. Kybas

Director of the United States Patent and Trademark Office

United States of America

United States Patent and Trademark Office

LOOK OUR WAY

Reg. No. 4,154,169

TORERO SPECIALTY PRODUCTS, LLC (CALIFORNIA LIMITED LIABILITY COMPANY)
222 E. HUNTINGTON DR. # 225
MONROVIA, CA 91016

Registered June 5, 2012

Int. Cl.: 20

FOR: INFLATABLE PLASTIC SIGNS; INFLATABLE PUBLICITY OBJECTS, IN CLASS 20
(U.S. CLS. 2, 13, 22, 25, 32 AND 50).

TRADEMARK

FIRST USE 8-30-2010; IN COMMERCE 8-30-2010.

PRINCIPAL REGISTER

THE MARK CONSISTS OF STANDARD CHARACTERS WITHOUT CLAIM TO ANY PARTICULAR FONT, STYLE, SIZE, OR COLOR.

SER. NO. 85-456,042, FILED 10-25-2011.

CURTIS FRENCH, EXAMINING ATTORNEY



David J. Kybas

Director of the United States Patent and Trademark Office

United States of America

United States Patent and Trademark Office

My e-BAnC

Reg. No. 4,154,170

BAC FLORIDA BANK (FLORIDA CORPORATION)
169 MIRACLE MILE, R-10
CORAL GABLES, FL 33134

Registered June 5, 2012

Int. Cl.: 36

FOR: ONLINE BANKING SERVICES, IN CLASS 36 (U.S. CLS. 100, 101 AND 102).

SERVICE MARK

FIRST USE 11-30-2010; IN COMMERCE 11-30-2010.

PRINCIPAL REGISTER

THE MARK CONSISTS OF STANDARD CHARACTERS WITHOUT CLAIM TO ANY PARTICULAR FONT, STYLE, SIZE, OR COLOR.

NO CLAIM IS MADE TO THE EXCLUSIVE RIGHT TO USE "E-BANK", APART FROM THE MARK AS SHOWN.

SER. NO. 85-456,271, FILED 10-26-2011.

NAPOLEON SHARMA, EXAMINING ATTORNEY



David J. Kyffers

Director of the United States Patent and Trademark Office

United States of America

United States Patent and Trademark Office

Laboratory Recon

Reg. No. 4,154,171

RURO INCORPORATED (DELAWARE CORPORATION), DBA RURO INC.
321 BALLENGER CENTER DR, SUITE 102
FREDERICK, MD 21703

Registered June 5, 2012

Int. Cl.: 9

FOR: COMPUTER SOFTWARE FOR LABORATORY INFORMATION MANAGEMENT, IN CLASS 9 (U.S. CLS. 21, 23, 26, 36 AND 38).

TRADEMARK

FIRST USE 1-1-2011; IN COMMERCE 5-1-2011.

PRINCIPAL REGISTER

THE MARK CONSISTS OF STANDARD CHARACTERS WITHOUT CLAIM TO ANY PARTICULAR FONT, STYLE, SIZE, OR COLOR.

NO CLAIM IS MADE TO THE EXCLUSIVE RIGHT TO USE "LABORATORY", APART FROM THE MARK AS SHOWN.

SER. NO. 85-456,408, FILED 10-26-2011.

TASNEEM HUSSAIN, EXAMINING ATTORNEY



David J. Kybas

Director of the United States Patent and Trademark Office

United States of America

United States Patent and Trademark Office

VARIETY ARABIA

Reg. No. 4,154,172

Registered June 5, 2012

Int. Cls.: 9 and 41

TRADEMARK

SERVICE MARK

PRINCIPAL REGISTER

REED ELSEVIER PROPERTIES INC. (DELAWARE CORPORATION)
SUITE 501
1105 NORTH MARKET STREET
WILMINGTON, DE 19801

FOR: DOWNLOADABLE ELECTRONIC PUBLICATIONS, NAMELY, MAGAZINES IN THE FIELD OF ENTERTAINMENT, IN CLASS 9 (U.S. CLS. 21, 23, 26, 36 AND 38).

FIRST USE 10-3-2011; IN COMMERCE 10-3-2011.

FOR: PROVIDING ON LINE NEWS AND INFORMATION RELATING TO THE ENTERTAINMENT INDUSTRY, IN CLASS 41 (U.S. CLS. 100, 101 AND 107).

FIRST USE 10-3-2011; IN COMMERCE 10-3-2011.

THE MARK CONSISTS OF STANDARD CHARACTERS WITHOUT CLAIM TO ANY PARTICULAR FONT, STYLE, SIZE, OR COLOR.

OWNER OF U.S. REG. NOS. 1,350,618, 2,417,890, AND 2,476,922.

NO CLAIM IS MADE TO THE EXCLUSIVE RIGHT TO USE "ARABIA", APART FROM THE MARK AS SHOWN.

SER. NO. 85-456,536, FILED 10-26-2011.

MATTHEW KLINE, EXAMINING ATTORNEY



David J. Kyros

Director of the United States Patent and Trademark Office

United States of America

United States Patent and Trademark Office

FAIRWINDS

Reg. No. 4,154,173

Registered June 5, 2012

Int. Cl.: 30

TRADEMARK

PRINCIPAL REGISTER

JBR, INC. (CALIFORNIA CORPORATION)
1731 AVIATION BOULEVARD
LINCOLN, CA 95648

FOR: COFFEE, IN CLASS 30 (U.S. CL. 46).

FIRST USE 0-0-1976; IN COMMERCE 0-0-1976.

THE MARK CONSISTS OF STANDARD CHARACTERS WITHOUT CLAIM TO ANY PARTICULAR FONT, STYLE, SIZE, OR COLOR.

SER. NO. 85-456,567, FILED 10-26-2011.

GIANCARLO CASTRO, EXAMINING ATTORNEY



David J. Kybas

Director of the United States Patent and Trademark Office

United States of America

United States Patent and Trademark Office

LawGenie

Reg. No. 4,154,174

Registered June 5, 2012

Int. Cl.: 45

SERVICE MARK

PRINCIPAL REGISTER

BOURBEAU & BONILLA, LLP (MASSACHUSETTS LIMITED LIABILITY PARTNERSHIP)
36 MERRILL RD.
HULL, MA 02045

FOR: PROVIDING A WEB SITE FEATURING LAW-RELATED NEWS, STORIES, AND LEGAL RESOURCES AND PROVIDING LINKS TO WEB SITES FEATURING LAW-RELATED NEWS, STORIES, AND LEGAL RESOURCES, IN CLASS 45 (U.S. CLS. 100 AND 101).

FIRST USE 1-29-1999; IN COMMERCE 1-29-1999.

THE MARK CONSISTS OF STANDARD CHARACTERS WITHOUT CLAIM TO ANY PARTICULAR FONT, STYLE, SIZE, OR COLOR.

SER. NO. 85-457,136, FILED 10-26-2011.

DAVID C. REIHNER, EXAMINING ATTORNEY



David J. Kyros

Director of the United States Patent and Trademark Office

United States of America

United States Patent and Trademark Office



Reg. No. 4,154,175

Registered June 5, 2012

Int. Cl.: 16

TRADEMARK

PRINCIPAL REGISTER

CELLMARK PAPER, INC. (DELAWARE CORPORATION)
80 WASHINGTON STREET
NORWALK, CT 06854

FOR: A GLOSS-COATED WOOD-FREE PAPER, IN CLASS 16 (U.S. CLS. 2, 5, 22, 23, 29, 37, 38 AND 50).

FIRST USE 9-1-2010; IN COMMERCE 9-1-2010.

NO CLAIM IS MADE TO THE EXCLUSIVE RIGHT TO USE "GLOSS", APART FROM THE MARK AS SHOWN.

THE COLOR(S) BLACK, RED AND BLUE IS/ARE CLAIMED AS A FEATURE OF THE MARK.

THE MARK CONSISTS OF THE WORD "INEO" IN LOWER CASE LETTERS, WITH THE "I" APPEARING IN BLACK, AND THE "NEO" APPEARING IN RED. THE "N" IN "NEO" IS NOT FULLY FORMED, BUT RATHER MESHES WITH THE "I" SUCH THAT THE "I" AND THE "N" APPEAR TO BE MERGED TOGETHER. UNDERNEATH THE "O" IN "INEO" IS THE WORD "GLOSS" IN BLUE. THERE IS A SINGLE BLUE LINE DIRECTLY UNDERNEATH THE WORD "GLOSS" THAT RUNS THE LENGTH OF THE WORD "INEO".

SER. NO. 85-458,165, FILED 10-27-2011.

NORA BUCHANAN WILL, EXAMINING ATTORNEY



David J. Kyros

Director of the United States Patent and Trademark Office

United States of America

United States Patent and Trademark Office

VILKON
INTERNATIONAL SHIPPING & LOGISTICS

Reg. No. 4,154,176

Registered June 5, 2012

Int. Cls.: 35 and 39

SERVICE MARK

PRINCIPAL REGISTER

VILKON N.A., INC. (WASHINGTON CORPORATION), DBA VILKON NORTH AMERICA
SUITE 301
19550 INTERNATIONAL BLVD
SEATAC, WA 98188

FOR: FREIGHT LOGISTICS MANAGEMENT; TRANSPORTATION LOGISTICS SERVICES, NAMELY, ARRANGING THE TRANSPORTATION OF GOODS FOR OTHERS AS WELL AS PLANNING AND SCHEDULING SHIPMENTS FOR USERS OF TRANSPORTATION SERVICES; BUSINESS MANAGEMENT ADVISORY AND CONSULTATION IN THE FIELD OF TRANSPORTATION LOGISTICS, IN CLASS 35 (U.S. CLS. 100, 101 AND 102).

FIRST USE 9-1-2011; IN COMMERCE 9-1-2011.

FOR: SUPPLY CHAIN LOGISTICS AND REVERSE LOGISTICS SERVICES, NAMELY, STORAGE, TRANSPORTATION AND DELIVERY OF GOODS, DOCUMENTS, PACKAGES, RAW MATERIALS, AND OTHER FREIGHT FOR OTHERS BY AIR, RAIL, SHIP OR TRUCK, IN CLASS 39 (U.S. CLS. 100 AND 105).

FIRST USE 9-1-2011; IN COMMERCE 9-1-2011.

NO CLAIM IS MADE TO THE EXCLUSIVE RIGHT TO USE "INTERNATIONAL SHIPPING & LOGISTICS", APART FROM THE MARK AS SHOWN.

THE COLOR(S) RED, WHITE AND BLUE IS/ARE CLAIMED AS A FEATURE OF THE MARK.

THE MARK CONSISTS OF RED CAPITAL LETTERS "VILK" FOLLOWED BY A BLUE CIRCLE WITH A WHITE SMALL CARGO SHIP AND A WHITE WAVE, FOLLOWED BY A RED CAPITAL LETTER "N" ON THE MAIN LINE WITH "INTERNATIONAL SHIPPING & LOGISTICS" IN RED LETTERING.

SER. NO. 85-458,319, FILED 10-27-2011.

PAUL E. FAHRENKOPF, EXAMINING ATTORNEY

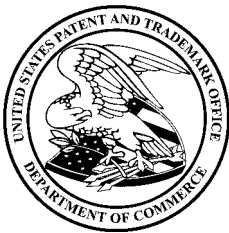

David J. Kyffers

Director of the United States Patent and Trademark Office

United States of America

United States Patent and Trademark Office

SCORPION TABLES

Reg. No. 4,154,177

ANTHONY F. BERARDI III (UNITED STATES INDIVIDUAL), DBA SCORPION TABLES
1729 CLEARVIEW ROAD
POTTSTOWN, PA 19464

Registered June 5, 2012

Int. Cl.: 10

FOR: SPECIALIZED CHIROPRACTIC TABLE USED FOR POSTURAL CORRECTIONS, IN CLASS 10 (U.S. CLS. 26, 39 AND 44).

TRADEMARK

FIRST USE 8-0-2010; IN COMMERCE 8-0-2010.

PRINCIPAL REGISTER

THE MARK CONSISTS OF STANDARD CHARACTERS WITHOUT CLAIM TO ANY PARTICULAR FONT, STYLE, SIZE, OR COLOR.

NO CLAIM IS MADE TO THE EXCLUSIVE RIGHT TO USE "TABLES", APART FROM THE MARK AS SHOWN.

SER. NO. 85-458,404, FILED 10-27-2011.

SEAN CROWLEY, EXAMINING ATTORNEY



David J. Kybas

Director of the United States Patent and Trademark Office

United States of America

United States Patent and Trademark Office

LASSALE

Reg. No. 4,154,178

Registered June 5, 2012

Int. Cl.: 14

TRADEMARK

PRINCIPAL REGISTER

SEIKO HOLDINGS KABUSHIKI KAISHA (JAPAN CORPORATION), TA SEIKO HOLDINGS CORPORATION
5-11, GINZA 4-CHOME, CHUO-KU
TOKYO, JAPAN

FOR: WATCHES, STOP WATCHES, WATCH STRAPS, WATCH BRACELETS, WATCH CASES AND STRUCTURAL PARTS THEREOF, IN CLASS 14 (U.S. CLS. 2, 27, 28 AND 50).

THE MARK CONSISTS OF STANDARD CHARACTERS WITHOUT CLAIM TO ANY PARTICULAR FONT, STYLE, SIZE, OR COLOR.

OWNER OF JAPAN REG. NO. 1748120, DATED 2-27-1985, EXPIRES 2-27-2015.

OWNER OF U.S. REG. NOS. 3,014,553 AND 3,094,656.

SER. NO. 85-460,372, FILED 10-31-2011.

HOWARD B. LEVINE, EXAMINING ATTORNEY



David J. Kyros

Director of the United States Patent and Trademark Office

United States of America

United States Patent and Trademark Office

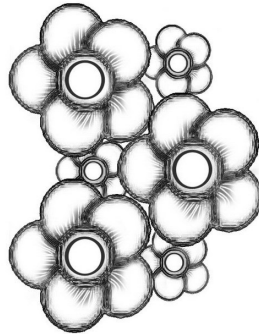

Reg. No. 4,154,179

Registered June 5, 2012

Int. Cl.: 9

TRADEMARK

PRINCIPAL REGISTER

SOUTH BAY TRADING INC. (CALIFORNIA CORPORATION)
605 SOUTH MILLIKEN AVE , SUITE E
ONTARIO, CA 91761

FOR: EYEWEAR, IN CLASS 9 (U.S. CLS. 21, 23, 26, 36 AND 38).

FIRST USE 10-27-2011; IN COMMERCE 10-27-2011.

THE MARK CONSISTS OF A CLUSTER OF SIX, FIVE-PETAL FLOWERS.

SER. NO. 85-460,419, FILED 10-31-2011.

GEORGE LORENZO, EXAMINING ATTORNEY



David J. Kyffers

Director of the United States Patent and Trademark Office

United States of America

United States Patent and Trademark Office

TRAVEL SMART

Reg. No. 4,154,180

CONAIR CORPORATION (DELAWARE CORPORATION)
ONE CUMMINGS POINT ROAD
STAMFORD, CT 06902

Registered June 5, 2012

Int. Cl.: 21

FOR: BATTERY-OPERATED LINT REMOVERS, IN CLASS 21 (U.S. CLS. 2, 13, 23, 29, 30, 33, 40 AND 50).

TRADEMARK

FIRST USE 12-0-2010; IN COMMERCE 12-0-2010.

PRINCIPAL REGISTER

THE MARK CONSISTS OF STANDARD CHARACTERS WITHOUT CLAIM TO ANY PARTICULAR FONT, STYLE, SIZE, OR COLOR.

OWNER OF U.S. REG. NOS. 1,583,354, 3,049,403 AND OTHERS.

NO CLAIM IS MADE TO THE EXCLUSIVE RIGHT TO USE "TRAVEL", APART FROM THE MARK AS SHOWN.

SER. NO. 85-460,786, FILED 10-31-2011.

CHARLES L. JENKINS, EXAMINING ATTORNEY



David J. Kybas

Director of the United States Patent and Trademark Office

United States of America

United States Patent and Trademark Office

Meatloaf-A-Go-Go

Reg. No. 4,154,181

THE MEATLOAF BAKERY LLC (ILLINOIS LIMITED LIABILITY COMPANY)
2464 NORTH CLARK STREET
CHICAGO, IL 60614

Registered June 5, 2012

Int. Cl.: 43

FOR: MOBILE CAFE SERVICES FOR PROVIDING FOOD AND DRINK, IN CLASS 43 (U.S. CLS. 100 AND 101).

SERVICE MARK

FIRST USE 10-5-2011; IN COMMERCE 10-5-2011.

PRINCIPAL REGISTER

THE MARK CONSISTS OF STANDARD CHARACTERS WITHOUT CLAIM TO ANY PARTICULAR FONT, STYLE, SIZE, OR COLOR.

SER. NO. 85-461,460, FILED 11-1-2011.

CHARLES L. JENKINS, EXAMINING ATTORNEY



David J. Kybas

Director of the United States Patent and Trademark Office

United States of America

United States Patent and Trademark Office

EVOX IMAGES

Reg. No. 4,154,182

Registered June 5, 2012

Int. Cl.: 45

SERVICE MARK

PRINCIPAL REGISTER

EVOX PRODUCTIONS, LLC (CALIFORNIA LIMITED LIABILITY COMPANY)
2363 E. PACIFICA PLACE
RANCHO DOMINGUEZ, CA 90220

FOR: LICENSING OF STOCK IMAGES AND VIDEO RELATING TO AUTOMOBILES AND THE AUTOMOTIVE INDUSTRY, IN CLASS 45 (U.S. CLS. 100 AND 101).

FIRST USE 4-1-2011; IN COMMERCE 4-1-2011.

OWNER OF U.S. REG. NOS. 2,007,892, 3,649,661, AND 3,765,883.

THE COLOR(S) ORANGE, BLACK AND WHITE IS/ARE CLAIMED AS A FEATURE OF THE MARK.

NO CLAIM IS MADE TO THE EXCLUSIVE RIGHT TO USE "IMAGES", APART FROM THE MARK AS SHOWN.

THE MARK CONSISTS OF BLACK CAPITAL LETTERS THAT SAY "EVOX IMAGES" AGAINST A WHITE BACKGROUND. THE "O" IN THE WORD "EVOX" HAS AN ORANGE TRIANGLE SHAPED DESIGN THAT RUNS THROUGH THE CENTER OF THE "O" AND COMES TO A POINT JUST BEYOND AND UNDER THE BORDER OF THE TOP OF THE "O".

SER. NO. 85-461,776, FILED 11-1-2011.

JERI J. FICKES, EXAMINING ATTORNEY



David J. Kybas

Director of the United States Patent and Trademark Office

United States of America

United States Patent and Trademark Office

TROPICAL GETAWAY

Reg. No. 4,154,183

Registered June 5, 2012

Int. Cl.: 16

TRADEMARK

PRINCIPAL REGISTER

MEADWESTVACO CORPORATION (DELAWARE CORPORATION)
501 SOUTH 5TH STREET
LAW DEPT - 9TH FLOOR
RICHMOND, VA 232190501

FOR: CALENDARS, IN CLASS 16 (U.S. CLS. 2, 5, 22, 23, 29, 37, 38 AND 50).

FIRST USE 8-4-2009; IN COMMERCE 8-4-2009.

THE MARK CONSISTS OF STANDARD CHARACTERS WITHOUT CLAIM TO ANY PARTICULAR FONT, STYLE, SIZE, OR COLOR.

SER. NO. 85-462,201, FILED 11-2-2011.

HANNO RITTNER, EXAMINING ATTORNEY



David J. Kybas

Director of the United States Patent and Trademark Office

United States of America

United States Patent and Trademark Office

TIFFANY SOLESTE

Reg. No. 4,154,184

Registered June 5, 2012

Int. Cl.: 14

TRADEMARK

PRINCIPAL REGISTER

TIFFANY (NJ) LLC (DELAWARE LIMITED LIABILITY COMPANY)
15 SYLVAN WAY
PARSIPPANY, NJ 07054

FOR: JEWELRY; RINGS, IN CLASS 14 (U.S. CLS. 2, 27, 28 AND 50).

FIRST USE 12-0-2010; IN COMMERCE 12-0-2010.

THE MARK CONSISTS OF STANDARD CHARACTERS WITHOUT CLAIM TO ANY PARTICULAR FONT, STYLE, SIZE, OR COLOR.

OWNER OF U.S. REG. NOS. 1,228,409, 3,860,347 AND OTHERS.

THE NAME "TIFFANY SOLESTE" DOES NOT IDENTIFY A LIVING INDIVIDUAL.

THE WORDING "SOLESTE" HAS NO MEANING IN A FOREIGN LANGUAGE.

SER. NO. 85-462,553, FILED 11-2-2011.

ANDREW LEASER, EXAMINING ATTORNEY



David J. Kyros

Director of the United States Patent and Trademark Office

United States of America

United States Patent and Trademark Office

GOMO

Reg. No. 4,154,185

Registered June 5, 2012

Int. Cls.: 35 and 42

SERVICE MARK

PRINCIPAL REGISTER

GOOGLE INC. (CALIFORNIA CORPORATION)
1600 AMPHITHEATRE PARKWAY
MOUNTAIN VIEW, CA 94043

FOR: PROMOTING THE GOODS AND SERVICES OF OTHERS BY PROVIDING A WEBSITE FEATURING WAYS TO IMPROVE THE EFFECTIVENESS OF ADVERTISING DISSEMINATED VIA A GLOBAL COMPUTER NETWORK AND DISPLAYED ON PDAS, AND WIRELESS AND CELLULAR HAND-HELD DEVICES, IN CLASS 35 (U.S. CLS. 100, 101 AND 102).

FIRST USE 10-27-2011; IN COMMERCE 11-1-2011.

FOR: PROVIDING ONLINE NON-DOWNLOADABLE SOFTWARE FOR OPTIMIZING WEBSITE NAVIGATION; TECHNICAL SUPPORT AND CONSULTING SERVICES RELATED TO THE FOREGOING, IN CLASS 42 (U.S. CLS. 100 AND 101).

FIRST USE 11-1-2011; IN COMMERCE 11-1-2011.

THE MARK CONSISTS OF STANDARD CHARACTERS WITHOUT CLAIM TO ANY PARTICULAR FONT, STYLE, SIZE, OR COLOR.

SER. NO. 85-463,479, FILED 11-3-2011.

DANNEAN HETZEL, EXAMINING ATTORNEY



David J. Kybas

Director of the United States Patent and Trademark Office

United States of America

United States Patent and Trademark Office

Nobody Knows

Reg. No. 4,154,186

Registered June 5, 2012

Int. Cl.: 25

TRADEMARK

PRINCIPAL REGISTER

SHIN, KEVIN (UNITED STATES INDIVIDUAL)
4583 LAMBETH COURT
CARLSBAD, CA 92010

FOR: BLOUSES; DRESSES; HOODED SWEAT SHIRTS; JACKETS; PANTS; SHORT-SLEEVED OR LONG-SLEEVED T-SHIRTS; SHORTS; SKIRTS; SOCKS; SWEATERS; T-SHIRTS; TANK-TOPS, IN CLASS 25 (U.S. CLS. 22 AND 39).

FIRST USE 8-8-2011; IN COMMERCE 8-8-2011.

THE MARK CONSISTS OF STANDARD CHARACTERS WITHOUT CLAIM TO ANY PARTICULAR FONT, STYLE, SIZE, OR COLOR.

SER. NO. 85-463,644, FILED 11-3-2011.

APRIL ROACH, EXAMINING ATTORNEY



David J. Kyffers

Director of the United States Patent and Trademark Office

United States of America

United States Patent and Trademark Office

Preferred Oil



Reg. No. 4,154,187

Registered June 5, 2012

Int. Cls.: 39 and 40

SERVICE MARK

PRINCIPAL REGISTER

MAHONEY LIMITED PARTNERSHIP (ILLINOIS LIMITED PARTNERSHIP)
1819 MOEN AVENUE
JOLIET, IL 60436

FOR: DISTRIBUTION SERVICES, NAMELY, DELIVERY OF COOKING OIL AND SHORTENINGS, IN CLASS 39 (U.S. CLS. 100 AND 105).

FIRST USE 3-1-2009; IN COMMERCE 3-1-2009.

FOR: FRYER OIL RECYCLING, IN CLASS 40 (U.S. CLS. 100, 103 AND 106).

FIRST USE 3-1-2009; IN COMMERCE 3-1-2009.

OWNER OF U.S. REG. NO. 3,517,897.

NO CLAIM IS MADE TO THE EXCLUSIVE RIGHT TO USE "OIL", APART FROM THE MARK AS SHOWN.

THE MARK CONSISTS OF THE WORD "PREFERRED" APPEARING BEFORE AN OIL DROP AND THE WORD "OIL".

SER. NO. 85-463,815, FILED 11-3-2011.

MICHAEL WEBSTER, EXAMINING ATTORNEY



David J. Kyros

Director of the United States Patent and Trademark Office

United States of America

United States Patent and Trademark Office

CITYLIFE

Reg. No. 4,154,188

Registered June 5, 2012

Int. Cl.: 45

SERVICE MARK

PRINCIPAL REGISTER

THE NAVIGATORS (COLORADO NON-PROFIT CORPORATION)
3820 NORTH 30TH STREET
COLORADO SPRINGS, CO 80904

FOR: EVANGELISTIC MINISTERIAL SERVICES, IN CLASS 45 (U.S. CLS. 100 AND 101).

FIRST USE 1-31-2008; IN COMMERCE 1-31-2008.

THE MARK CONSISTS OF STANDARD CHARACTERS WITHOUT CLAIM TO ANY PARTICULAR FONT, STYLE, SIZE, OR COLOR.

SER. NO. 85-464,142, FILED 11-3-2011.

GEORGE LORENZO, EXAMINING ATTORNEY



David J. Kyffers

Director of the United States Patent and Trademark Office

United States of America

United States Patent and Trademark Office

CITYLIFE

Reg. No. 4,154,189

Registered June 5, 2012

Int. Cl.: 16

TRADEMARK

PRINCIPAL REGISTER

THE NAVIGATORS (COLORADO NON-PROFIT CORPORATION)
3820 NORTH 30TH STREET
COLORADO SPRINGS, CO 80904

FOR: PRINTED MATERIALS, NAMELY, ARTICLES, BIBLE STUDIES, AND NEWSLETTERS
IN THE FIELD OF CHRISTIAN RELIGION, IN CLASS 16 (U.S. CLS. 2, 5, 22, 23, 29, 37, 38
AND 50).

FIRST USE 1-31-2008; IN COMMERCE 1-31-2008.

THE MARK CONSISTS OF STANDARD CHARACTERS WITHOUT CLAIM TO ANY PAR-
TICULAR FONT, STYLE, SIZE, OR COLOR.

SER. NO. 85-464,145, FILED 11-3-2011.

GEORGE LORENZO, EXAMINING ATTORNEY



David J. Kyffers

Director of the United States Patent and Trademark Office

United States of America

United States Patent and Trademark Office

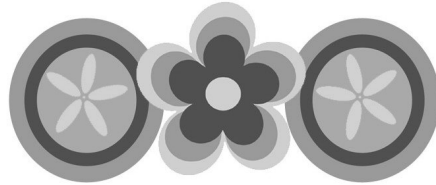

Reg. No. 4,154,190

Registered June 5, 2012

Int. Cl.: 9

TRADEMARK

PRINCIPAL REGISTER

SOUTH BAY TRADING INC. (CALIFORNIA CORPORATION)
605 SOUTH MILLIKEN AVE , SUITE E
ONTARIO, CA 91761

FOR: EYEWEAR, IN CLASS 9 (U.S. CLS. 21, 23, 26, 36 AND 38).

FIRST USE 10-27-2011; IN COMMERCE 10-27-2011.

THE MARK CONSISTS OF FLOWER DESIGNS.

SER. NO. 85-464,198, FILED 11-3-2011.

GEORGE LORENZO, EXAMINING ATTORNEY



David J. Kyffers

Director of the United States Patent and Trademark Office

United States of America

United States Patent and Trademark Office



WHOLE PLANET FOUNDATION MICROLOAN A MONTH FUND

Reg. No. 4,154,191

Registered June 5, 2012

Int. Cl.: 36

SERVICE MARK

PRINCIPAL REGISTER

WHOLE FOODS MARKET IP, L.P. (DELAWARE LIMITED PARTNERSHIP)
550 BOWIE STREET, 6TH FLOOR
AUSTIN, TX 78703

FOR: CHARITABLE FUNDRAISING; ACCEPTING AND ADMINISTERING MONETARY CHARITABLE CONTRIBUTIONS; PHILANTHROPIC AND ELEEMOSYNARY SERVICES CONCERNING MONETARY DONATIONS, GRANTS AND FINANCIAL SUPPORT FOR ECONOMIC DEVELOPMENT PROJECTS IN DEVELOPING COUNTRIES, IN CLASS 36 (U.S. CLS. 100, 101 AND 102).

FIRST USE 11-0-2010; IN COMMERCE 11-0-2010.

OWNER OF U.S. REG. NOS. 3,410,427, 3,584,701 AND OTHERS.

NO CLAIM IS MADE TO THE EXCLUSIVE RIGHT TO USE "FOUNDATION" OR "FUND", APART FROM THE MARK AS SHOWN.

THE MARK CONSISTS OF A DEPICTION OF A HAND HOLDING A COIN, STACKED ABOVE THE WORDING "WHOLE PLANET FOUNDATION" AND "MICROLOAN A MONTH FUND".

SER. NO. 85-464,942, FILED 11-4-2011.

IRA J. GOODSID, EXAMINING ATTORNEY



David J. Kyffers

Director of the United States Patent and Trademark Office

United States of America

United States Patent and Trademark Office



WHOLE PLANET FOUNDATION TEN THOUSAND DOLLAR FUND

Reg. No. 4,154,192

Registered June 5, 2012

Int. Cl.: 36

SERVICE MARK

PRINCIPAL REGISTER

WHOLE FOODS MARKET IP, L.P. (DELAWARE LIMITED PARTNERSHIP)
550 BOWIE STREET, 6TH FLOOR
AUSTIN, TX 78703

FOR: CHARITABLE FUNDRAISING; ACCEPTING AND ADMINISTERING MONETARY CHARITABLE CONTRIBUTIONS; PHILANTHROPIC AND ELEEMOSYNARY SERVICES CONCERNING MONETARY DONATIONS, GRANTS AND FINANCIAL SUPPORT FOR ECONOMIC DEVELOPMENT PROJECTS IN DEVELOPING COUNTRIES, IN CLASS 36 (U.S. CLS. 100, 101 AND 102).

FIRST USE 9-0-2009; IN COMMERCE 9-0-2009.

OWNER OF U.S. REG. NOS. 3,410,427, 3,584,701 AND OTHERS.

NO CLAIM IS MADE TO THE EXCLUSIVE RIGHT TO USE "FOUNDATION" OR "TEN THOUSAND DOLLAR FUND", APART FROM THE MARK AS SHOWN.

THE MARK CONSISTS OF A DEPICTION OF TWO HANDS, APPEARING ABOVE THE WORDING "WHOLE PLANET FOUNDATION" AND "TEN THOUSAND DOLLAR FUND".

SER. NO. 85-464,964, FILED 11-4-2011.

IRA J. GOODSaid, EXAMINING ATTORNEY



David J. Kyffers

Director of the United States Patent and Trademark Office

United States of America

United States Patent and Trademark Office



WHOLE PLANET FOUNDATION
SUPPLIER ALLIANCE
FOR MICROCREDIT

Reg. No. 4,154,193

Registered June 5, 2012

Int. Cl.: 36

SERVICE MARK

PRINCIPAL REGISTER

WHOLE FOODS MARKET IP, L.P. (DELAWARE LIMITED PARTNERSHIP)
550 BOWIE STREET, 6TH FLOOR
AUSTIN, TX 78703

FOR: CHARITABLE FUNDRAISING; ACCEPTING AND ADMINISTERING MONETARY CHARITABLE CONTRIBUTIONS; PHILANTHROPIC AND ELEEMOSYNARY SERVICES CONCERNING MONETARY DONATIONS, GRANTS AND FINANCIAL SUPPORT FOR ECONOMIC DEVELOPMENT PROJECTS IN DEVELOPING COUNTRIES, IN CLASS 36 (U.S. CLS. 100, 101 AND 102).

FIRST USE 7-0-2007; IN COMMERCE 7-0-2007.

OWNER OF U.S. REG. NOS. 3,410,427, 3,584,701 AND OTHERS.

NO CLAIM IS MADE TO THE EXCLUSIVE RIGHT TO USE "FOUNDATION" OR "SUPPLIER ALLIANCE FOR MICROCREDIT", APART FROM THE MARK AS SHOWN.

THE MARK CONSISTS OF A DEPICTION OF TWO WINGED HANDS FORMING A HANDSHAKE, STACKED ABOVE "WHOLE PLANET FOUNDATION", "SUPPLIER ALLIANCE" AND "FOR MICROCREDIT".

SER. NO. 85-464,985, FILED 11-4-2011.

IRA J. GOODSID, EXAMINING ATTORNEY



David J. Kyros

Director of the United States Patent and Trademark Office

United States of America

United States Patent and Trademark Office

LIVE LAUGH TAN

Reg. No. 4,154,194

Registered June 5, 2012

Int. Cl.: 18

TRADEMARK

PRINCIPAL REGISTER

AUSTRALIAN GOLD, LLC (INDIANA LIMITED LIABILITY COMPANY)
6270 CORPORATE DRIVE
INDIANAPOLIS, IN 46278

FOR: TOTE BAGS, IN CLASS 18 (U.S. CLS. 1, 2, 3, 22 AND 41).

FIRST USE 10-23-2010; IN COMMERCE 10-23-2010.

THE MARK CONSISTS OF STANDARD CHARACTERS WITHOUT CLAIM TO ANY PARTICULAR FONT, STYLE, SIZE, OR COLOR.

SER. NO. 85-465,713, FILED 11-7-2011.

EDWARD FENNESSY, EXAMINING ATTORNEY



David J. Kyffers

Director of the United States Patent and Trademark Office

United States of America

United States Patent and Trademark Office

RENT-A-CENTER

Reg. No. 4,154,195

Registered June 5, 2012

Int. Cl.: 35

SERVICE MARK

PRINCIPAL REGISTER

RENT-A-CENTER WEST, INC. (DELAWARE CORPORATION)
5501 HEADQUARTERS DRIVE
PLANO, TX 75024

FOR: RETAIL STORE SERVICES FEATURING FURNITURE, APPLIANCES, CONSUMER ELECTRONICS, HOME ENTERTAINMENT PRODUCTS, AND COMPUTERS, IN CLASS 35 (U.S. CLS. 100, 101 AND 102).

FIRST USE 9-0-1978; IN COMMERCE 9-0-1978.

THE MARK CONSISTS OF STANDARD CHARACTERS WITHOUT CLAIM TO ANY PARTICULAR FONT, STYLE, SIZE, OR COLOR.

OWNER OF U.S. REG. NOS. 1,264,550, 2,876,244 AND OTHERS.

SER. NO. 85-466,404, FILED 11-7-2011.

DAVID MURRAY, EXAMINING ATTORNEY



David J. Kyros

Director of the United States Patent and Trademark Office

United States of America

United States Patent and Trademark Office

RAC ACCEPTANCE

Reg. No. 4,154,196

RENT-A-CENTER WEST, INC. (DELAWARE CORPORATION)
5501 HEADQUARTERS DRIVE
PLANO, TX 75024

Registered June 5, 2012

Int. Cl.: 36

FOR: LEASE PURCHASING AND RENTAL-TO-OWN OF ELECTRONICS AND HOME APPLIANCES, IN CLASS 36 (U.S. CLS. 100, 101 AND 102).

SERVICE MARK

FIRST USE 12-21-2010; IN COMMERCE 12-21-2010.

PRINCIPAL REGISTER

THE MARK CONSISTS OF STANDARD CHARACTERS WITHOUT CLAIM TO ANY PARTICULAR FONT, STYLE, SIZE, OR COLOR.

OWNER OF U.S. REG. NOS. 3,161,654 AND 3,346,229.

SER. NO. 85-466,418, FILED 11-7-2011.

DAVID MURRAY, EXAMINING ATTORNEY



David J. Kyros

Director of the United States Patent and Trademark Office

United States of America

United States Patent and Trademark Office

CERAMAPEEK

Reg. No. 4,154,197

Registered June 5, 2012

Int. Cl.: 17

TRADEMARK

PRINCIPAL REGISTER

PROFESSIONAL PLASTICS, INC. (CALIFORNIA CORPORATION)
1810 E. VALENCIA DR.
FULLERTON, CA 92831

FOR: PLASTIC MATERIAL, NAMELY, PLASTIC COMPOSITE MATERIAL IN THE FORM OF FILMS, PROFILES, BOARDS, SHEETS, BLOCKS, RODS, TUBES, PLATES, POWDERS, AND PELLETS FOR USE IN MANUFACTURING, IN CLASS 17 (U.S. CLS. 1, 5, 12, 13, 35 AND 50).

FIRST USE 12-31-2001; IN COMMERCE 12-31-2001.

THE MARK CONSISTS OF STANDARD CHARACTERS WITHOUT CLAIM TO ANY PARTICULAR FONT, STYLE, SIZE, OR COLOR.

SER. NO. 85-467,734, FILED 11-8-2011.

DOMINICK J. SALEMI, EXAMINING ATTORNEY



David J. Kyros

Director of the United States Patent and Trademark Office

United States of America

United States Patent and Trademark Office

KAPTREX

Reg. No. 4,154,198

Registered June 5, 2012

Int. Cl.: 17

TRADEMARK

PRINCIPAL REGISTER

PROFESSIONAL PLASTICS, INC. (CALIFORNIA CORPORATION)
1810 E. VALENCIA DR.
FULLERTON, CA 92831

FOR: PLASTIC MATERIAL, NAMELY, PLASTIC COMPOSITE MATERIAL IN THE FORM OF FILMS, PROFILES, BOARDS, SHEETS, BLOCKS, RODS, TUBES, PLATES, POWDERS, AND PELLETS FOR USE IN MANUFACTURING, IN CLASS 17 (U.S. CLS. 1, 5, 12, 13, 35 AND 50).

FIRST USE 12-31-2001; IN COMMERCE 12-31-2001.

THE MARK CONSISTS OF STANDARD CHARACTERS WITHOUT CLAIM TO ANY PARTICULAR FONT, STYLE, SIZE, OR COLOR.

SER. NO. 85-467,742, FILED 11-8-2011.

DOMINICK J. SALEMI, EXAMINING ATTORNEY



David J. Kyros

Director of the United States Patent and Trademark Office

United States of America

United States Patent and Trademark Office

LAST STEPS

Reg. No. 4,154,199

Registered June 5, 2012

Int. Cl.: 41

SERVICE MARK

PRINCIPAL REGISTER

GUNDERSEN LUTHERAN MEDICAL FOUNDATION, INC. (WISCONSIN CORPORATION)
1836 SOUTH AVENUE
LACROSSE, WI 54601

FOR: EDUCATIONAL SERVICES, NAMELY, PROVIDING CLASSES, SEMINARS, CONFERENCES, WORKSHOPS, AND PRESENTATIONS IN THE FIELD OF ADVANCE HEALTHCARE PLANNING, EMERGENCY CARE, NURSING HOME PLACEMENT, END-OF-LIFE PLANNING, AND THE DRAFTING OF ADVANCE HEALTHCARE DIRECTIVES, LIVING WILLS, AND HEALTHCARE POWERS OF ATTORNEY, AND DISTRIBUTION OF TRAINING MATERIALS IN CONNECTION THEREWITH; TRAINING OF OTHERS IN THE FIELD OF PROVIDING INFORMATION AND ADVICE TO PATIENTS RELATING TO ADVANCE HEALTHCARE PLANNING, EMERGENCY CARE, NURSING HOME PLACEMENT, END-OF-LIFE PLANNING, AND THE DRAFTING OF ADVANCE HEALTHCARE DIRECTIVES, LIVING WILLS, AND HEALTHCARE POWERS OF ATTORNEY, IN CLASS 41 (U.S. CLS. 100, 101 AND 107).

FIRST USE 6-0-2010; IN COMMERCE 6-0-2010.

THE MARK CONSISTS OF STANDARD CHARACTERS WITHOUT CLAIM TO ANY PARTICULAR FONT, STYLE, SIZE, OR COLOR.

OWNER OF U.S. REG. NO. 3,925,084.

NO CLAIM IS MADE TO THE EXCLUSIVE RIGHT TO USE "STEPS", APART FROM THE MARK AS SHOWN.

SER. NO. 85-473,137, FILED 11-15-2011.

Laurie Kaufman, Examining Attorney



David J. Kyjars

Director of the United States Patent and Trademark Office

United States of America

United States Patent and Trademark Office

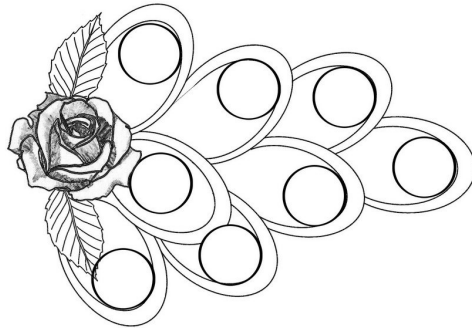

Reg. No. 4,154,200

Registered June 5, 2012

Int. Cl.: 9

TRADEMARK

PRINCIPAL REGISTER

SOUTH BAY TRADING INC. (CALIFORNIA CORPORATION)
605 SOUTH MILLIKEN AVE , SUITE E
ONTARIO, CA 91761

FOR: EYEWEAR, IN CLASS 9 (U.S. CLS. 21, 23, 26, 36 AND 38).

FIRST USE 11-4-2011; IN COMMERCE 11-4-2011.

THE MARK CONSISTS OF A ROSE WITH TWO LEAVES ATTACHED TO PEACOCK FEATHERS.

SER. NO. 85-473,582, FILED 11-15-2011.

GEORGE LORENZO, EXAMINING ATTORNEY



David J. Kybas

Director of the United States Patent and Trademark Office

United States of America

United States Patent and Trademark Office

KEY-PER

Reg. No. 4,154,201

FOSSIL, INC. (DELAWARE CORPORATION)
901 S. CENTRAL EXPRESSWAY
RICHARDSON, TX 75080

Registered June 5, 2012

Int. Cl.: 18

FOR: HANDBAGS, WALLETS, PURSES, TOTE BAGS, COIN PURSES, TRAVEL BAGS SOLD EMPTY, COSMETIC BAGS SOLD EMPTY, IN CLASS 18 (U.S. CLS. 1, 2, 3, 22 AND 41).

TRADEMARK

FIRST USE 6-25-2009; IN COMMERCE 6-25-2009.

PRINCIPAL REGISTER

THE MARK CONSISTS OF STANDARD CHARACTERS WITHOUT CLAIM TO ANY PARTICULAR FONT, STYLE, SIZE, OR COLOR.

SER. NO. 85-474,228, FILED 11-16-2011.

LEIGH LOWRY, EXAMINING ATTORNEY



David J. Kybas

Director of the United States Patent and Trademark Office

United States of America

United States Patent and Trademark Office

SIG551-A1

Reg. No. 4,154,202

Registered June 5, 2012

Int. Cl.: 13

TRADEMARK

PRINCIPAL REGISTER

SIG SAUER INC. (DELAWARE CORPORATION)
18 INDUSTRIAL DRIVE
EXETER, NH 03833

FOR: RIFLES, IN CLASS 13 (U.S. CLS. 2 AND 9).

FIRST USE 9-27-2011; IN COMMERCE 9-27-2011.

THE MARK CONSISTS OF STANDARD CHARACTERS WITHOUT CLAIM TO ANY PARTICULAR FONT, STYLE, SIZE, OR COLOR.

SER. NO. 85-475,005, FILED 11-17-2011.

TARAH HARDY, EXAMINING ATTORNEY



David J. Kybas

Director of the United States Patent and Trademark Office

United States of America

United States Patent and Trademark Office

DJ Kevin Brown

Reg. No. 4,154,203

Registered June 5, 2012

Int. Cl.: 41

SERVICE MARK

PRINCIPAL REGISTER

BROWN, KEVIN (UNITED STATES INDIVIDUAL)
3702 N. GRANITE REEF ROAD
SCOTTSDALE, AZ 85251

FOR: DISC JOCKEY SERVICES; MUSIC PRODUCTION AND REMIXING SERVICES; ENTERTAINMENT IN THE NATURE OF LIVE MUSICAL PERFORMANCES, IN CLASS 41 (U.S. CLS. 100, 101 AND 107).

FIRST USE 1-1-1988; IN COMMERCE 1-1-1988.

THE MARK CONSISTS OF STANDARD CHARACTERS WITHOUT CLAIM TO ANY PARTICULAR FONT, STYLE, SIZE, OR COLOR.

NO CLAIM IS MADE TO THE EXCLUSIVE RIGHT TO USE "DJ", APART FROM THE MARK AS SHOWN.

THE NAME "KEVIN BROWN" IDENTIFIES A LIVING INDIVIDUAL WHOSE CONSENT IS OF RECORD.

SER. NO. 85-475,217, FILED 11-17-2011.

HOWARD B. LEVINE, EXAMINING ATTORNEY



David J. Kyros

Director of the United States Patent and Trademark Office

United States of America

United States Patent and Trademark Office

SOLIDARITY SLEEP OUT: CEO EDITION

Reg. No. 4,154,204

COVENANT HOUSE (NEW YORK CORPORATION)
5 PENN PLAZA, 3RD FLOOR
NEW YORK, NY 10001

Registered June 5, 2012

Int. Cls.: 35 and 36

FOR: PROMOTING PUBLIC AWARENESS OF YOUTH HOMELESSNESS, IN CLASS 35
(U.S. CLS. 100, 101 AND 102).

SERVICE MARK

FIRST USE 9-0-2011; IN COMMERCE 9-0-2011.

PRINCIPAL REGISTER

FOR: CHARITABLE FUNDRAISING, IN CLASS 36 (U.S. CLS. 100, 101 AND 102).

FIRST USE 9-0-2011; IN COMMERCE 9-0-2011.

THE MARK CONSISTS OF STANDARD CHARACTERS WITHOUT CLAIM TO ANY PARTICULAR FONT, STYLE, SIZE, OR COLOR.

OWNER OF U.S. REG. NO. 4,067,038.

NO CLAIM IS MADE TO THE EXCLUSIVE RIGHT TO USE "SLEEP OUT" AND "CEO EDITION", APART FROM THE MARK AS SHOWN.

SER. NO. 85-476,137, FILED 11-18-2011.

JERI J. FICKES, EXAMINING ATTORNEY



David J. Kybas

Director of the United States Patent and Trademark Office

United States of America

United States Patent and Trademark Office

SAFE HYDRAULICS

Reg. No. 4,154,205

THE GATES CORPORATION (DELAWARE CORPORATION)
1551 WEWATTA STREET
DENVER, CO 80202

Registered June 5, 2012

Int. Cl.: 41

FOR: EDUCATIONAL SERVICES, NAMELY, CONDUCTING PRESENTATIONS, SEMINARS, AND WORKSHOPS IN THE FIELD OF SAFE ASSEMBLY, INSTALLATION AND USE OF HYDRAULIC HOSE AND COUPLINGS AND DISTRIBUTION OF TRAINING MATERIALS IN CONNECTION THEREWITH, IN CLASS 41 (U.S. CLS. 100, 101 AND 107).

SERVICE MARK

PRINCIPAL REGISTER

FIRST USE 12-31-1994; IN COMMERCE 5-31-1995.

THE MARK CONSISTS OF STANDARD CHARACTERS WITHOUT CLAIM TO ANY PARTICULAR FONT, STYLE, SIZE, OR COLOR.

SEC. 2(F).

SER. NO. 85-476,634, FILED 11-18-2011.

LINDA ORNDORFF, EXAMINING ATTORNEY



David J. Kyffers

Director of the United States Patent and Trademark Office

United States of America

United States Patent and Trademark Office

LUMENPULSE

Reg. No. 4,154,206

LUMENPULSE LIGHTING, INC. (CANADA CORPORATION)
1751 RUE RICHARDSON
MONTREAL, QUEBEC, CANADA H3K1G6

Registered June 5, 2012

Int. Cl.: 9

FOR: LIGHTING CONTROL APPARATUS, NAMELY, REMOTE CONTROLLER AND CONTROL PANEL, IN CLASS 9 (U.S. CLS. 21, 23, 26, 36 AND 38).

TRADEMARK

FIRST USE 1-31-2010; IN COMMERCE 1-31-2010.

PRINCIPAL REGISTER

THE MARK CONSISTS OF STANDARD CHARACTERS WITHOUT CLAIM TO ANY PARTICULAR FONT, STYLE, SIZE, OR COLOR.

OWNER OF U.S. REG. NO. 4,071,210.

SER. NO. 85-477,921, FILED 11-21-2011.

DORITT L. CARROLL, EXAMINING ATTORNEY



David J. Kybas

Director of the United States Patent and Trademark Office

United States of America

United States Patent and Trademark Office

Naked Fish

Reg. No. 4,154,207

DUCLAW BREWERY LLC (MARYLAND LIMITED LIABILITY COMPANY)
16A BEL AIR SOUTH PARKWAY
BEL AIR, MD 21015

Registered June 5, 2012

Int. Cl.: 32

FOR: BEER, ALE, LAGER, STOUT AND PORTER, IN CLASS 32 (U.S. CLS. 45, 46 AND 48).

TRADEMARK

FIRST USE 12-1-2001; IN COMMERCE 12-1-2001.

PRINCIPAL REGISTER

THE MARK CONSISTS OF STANDARD CHARACTERS WITHOUT CLAIM TO ANY PARTICULAR FONT, STYLE, SIZE, OR COLOR.

SER. NO. 85-479,749, FILED 11-23-2011.

WILLIAM ROSSMAN, EXAMINING ATTORNEY



David J. Kyffers

Director of the United States Patent and Trademark Office

United States of America

United States Patent and Trademark Office

FIP YOUR SCHOOL

Reg. No. 4,154,208

Registered June 5, 2012

Int. Cl.: 41

SERVICE MARK

PRINCIPAL REGISTER

BATTELLE FOR KIDS (OHIO NON-PROFIT CORPORATION)
SUITE 500
1160 DUBLIN RD
COLUMBUS, OH 43215

FOR: EDUCATION SERVICES, NAMELY, PROVIDING LIVE AND ON-LINE LEARNING MODULES FOR TEACHERS, SCHOOLS AND SCHOOL DISTRICTS IN THE FIELD OF PROFESSIONAL DEVELOPMENT AND IMPROVEMENT, IN CLASS 41 (U.S. CLS. 100, 101 AND 107).

FIRST USE 10-1-2011; IN COMMERCE 11-1-2011.

THE MARK CONSISTS OF STANDARD CHARACTERS WITHOUT CLAIM TO ANY PARTICULAR FONT, STYLE, SIZE, OR COLOR.

SER. NO. 85-480,534, FILED 11-23-2011.

MARC LEIPZIG, EXAMINING ATTORNEY



David J. Kyffers

Director of the United States Patent and Trademark Office

United States of America

United States Patent and Trademark Office



Reg. No. 4,154,209

Registered June 5, 2012

Int. Cl.: 9

TRADEMARK

PRINCIPAL REGISTER

SOUTH BAY TRADING INC. (CALIFORNIA CORPORATION)
605 SOUTH MILLIKEN AVE , SUITE E
ONTARIO, CA 91761

FOR: EYEWEAR, IN CLASS 9 (U.S. CLS. 21, 23, 26, 36 AND 38).

FIRST USE 11-16-2011; IN COMMERCE 11-16-2011.

THE MARK CONSISTS OF A PAW PRINT WITH A HEART SHAPE INSIDE.

SER. NO. 85-480,943, FILED 11-25-2011.

GEORGE LORENZO, EXAMINING ATTORNEY



David J. Kyffers

Director of the United States Patent and Trademark Office

United States of America

United States Patent and Trademark Office



Reg. No. 4,154,210

Registered June 5, 2012

Int. Cls.: 25, 41 and 43

TRADEMARK

SERVICE MARK

PRINCIPAL REGISTER

STRIKE HOLDINGS LLC (DELAWARE LIMITED LIABILITY COMPANY)
215 PARK AVENUE SOUTH, SUITE 1800
NEW YORK, NY 10003

FOR: CLOTHING, NAMELY, SHIRTS, BOWLING SHIRTS, COLLARED SHIRTS, T-SHIRTS, SWEAT SHIRTS, TURTLENECK SWEATERS, MOCKNECK TURTLENECK SWEATERS, AND SWEATERS; FOOTWEAR, NAMELY, BOWLING SHOES AND BOOTS, AND HEADWEAR, NAMELY, HATS AND CAPS, IN CLASS 25 (U.S. CLS. 22 AND 39).

FIRST USE 11-0-2010; IN COMMERCE 11-0-2010.

FOR: ENTERTAINMENT SERVICES, NAMELY, BOWLING ALLEY SERVICES, IN CLASS 41 (U.S. CLS. 100, 101 AND 107).

FIRST USE 11-0-2010; IN COMMERCE 11-0-2010.

FOR: BAR AND RESTAURANT SERVICES, IN CLASS 43 (U.S. CLS. 100 AND 101).

FIRST USE 11-0-2010; IN COMMERCE 11-0-2010.

OWNER OF U.S. REG. NOS. 2,797,780, 2,797,781, AND 3,579,942.

NO CLAIM IS MADE TO THE EXCLUSIVE RIGHT TO USE "LANES", APART FROM THE MARK AS SHOWN.

THE MARK CONSISTS OF THE WORD "BOWLMOR" IN A STYLIZED FORM AND BELOW IT THE WORD "LANES" IN BLOCK LETTERS WITH STRAIGHT LINES ON EITHER SIDE.

SER. NO. 85-482,606, FILED 11-29-2011.

ALEXANDER L. POWERS, EXAMINING ATTORNEY



David J. Kyffers

Director of the United States Patent and Trademark Office

United States of America

United States Patent and Trademark Office

AIM HIGH! TIPS JUKEBOX

Reg. No. 4,154,211

Registered June 5, 2012

Int. Cl.: 45

SERVICE MARK

PRINCIPAL REGISTER

BRADLEY IAN BERGER (UNITED STATES INDIVIDUAL)
45 HEDGEROW LANE
MANALAPAN, NJ 07726

FOR: PROVIDING A WEB SITE FEATURING INFORMATION AND CONTENT IN THE FIELDS OF PERSONAL RELATIONSHIPS, PERSONAL GROWTH AND MOTIVATION, AND SELF-FULFILLMENT, IN CLASS 45 (U.S. CLS. 100 AND 101).

FIRST USE 10-0-2011; IN COMMERCE 10-0-2011.

THE MARK CONSISTS OF STANDARD CHARACTERS WITHOUT CLAIM TO ANY PARTICULAR FONT, STYLE, SIZE, OR COLOR.

OWNER OF U.S. REG. NO. 3,124,414.

NO CLAIM IS MADE TO THE EXCLUSIVE RIGHT TO USE "TIPS", APART FROM THE MARK AS SHOWN.

SER. NO. 85-486,214, FILED 12-2-2011.

JOHN HWANG, EXAMINING ATTORNEY



David J. Kybas

Director of the United States Patent and Trademark Office

United States of America

United States Patent and Trademark Office



Reg. No. 4,154,212

Registered June 5, 2012

Int. Cl.: 28

TRADEMARK

PRINCIPAL REGISTER

KARSTEN MANUFACTURING CORPORATION (ARIZONA CORPORATION)
2201 WEST DESERT COVE
PHOENIX, AZ 85029

FOR: HEAD COVERS FOR GOLF CLUBS; HAT CLIPS FOR HOLDING GOLF BALL MARKERS; GOLF BALL MARKERS; DIVOT REPAIR TOOL FOR GOLFERS, IN CLASS 28 (U.S. CLS. 22, 23, 38 AND 50).

FIRST USE 7-0-1981; IN COMMERCE 7-0-1981.

OWNER OF U.S. REG. NOS. 895,415, 1,037,513, AND 3,264,204.

THE MARK CONSISTS OF A MAN WITH A GOLF CLUB WITH A GOLF BALL ATTACHED TO GOLF CLUB.

SER. NO. 85-486,309, FILED 12-2-2011.

Laurie Mayes, Examining Attorney



David J. Kyffers

Director of the United States Patent and Trademark Office

United States of America

United States Patent and Trademark Office

SHAKETAAILS

Reg. No. 4,154,213

Registered June 5, 2012

Int. Cl.: 33

TRADEMARK

PRINCIPAL REGISTER

PASSION FOOD SIX, LLC (D.C. LIMITED LIABILITY COMPANY), DBA BURGER TAP
AND SHAKE
1010 MASSACHUSETTS AVE NW #1213
WASHINGTON, DC 20001

FOR: ALCOHOLIC BEVERAGES, NAMELY, MILKSHAKES CONTAINING ALCOHOL, IN
CLASS 33 (U.S. CLS. 47 AND 49).

FIRST USE 8-1-2011; IN COMMERCE 8-1-2011.

THE MARK CONSISTS OF STANDARD CHARACTERS WITHOUT CLAIM TO ANY PAR-
TICULAR FONT, STYLE, SIZE, OR COLOR.

SER. NO. 85-486,853, FILED 12-5-2011.

LOURDES AYALA, EXAMINING ATTORNEY



David J. Kyros

Director of the United States Patent and Trademark Office

United States of America

United States Patent and Trademark Office



Reg. No. 4,154,214

Registered June 5, 2012

Int. Cl.: 30

TRADEMARK

PRINCIPAL REGISTER

KELLOGG NORTH AMERICA COMPANY (DELAWARE CORPORATION)
ONE KELLOGG SQUARE
PO BOX 3599
BATTLE CREEK, MI 490163599

FOR: PROCESSED CEREAL-BASED FOOD TO BE USED AS A BREAKFAST FOOD, SNACK FOOD OR INGREDIENT FOR MAKING OTHER FOODS, IN CLASS 30 (U.S. CL. 46).

FIRST USE 11-30-2010; IN COMMERCE 11-30-2010.

OWNER OF U.S. REG. NOS. 1,341,183 AND 2,192,246.

THE COLOR(S) GREEN, RED, GOLD AND WHITE IS/ARE CLAIMED AS A FEATURE OF THE MARK.

THE MARK CONSISTS OF A RIGHT FACING PROFILE OF A ROOSTER, WITH THE BODY SHOWN IN THE COLOR GREEN, THE BEAK IN THE COLOR GOLD, THE COCKSCOMB AND THE WATTLE IN THE COLOR RED AND THE EYE IN THE SHAPE OF A CIRCLE IN THE COLOR WHITE.

SER. NO. 85-487,978, FILED 12-6-2011.

MELISSA VALLILLO, EXAMINING ATTORNEY



David J. Kyffers

Director of the United States Patent and Trademark Office

United States of America

United States Patent and Trademark Office



Reg. No. 4,154,215

Registered June 5, 2012

Int. Cl.: 30

TRADEMARK

PRINCIPAL REGISTER

KELLOGG NORTH AMERICA COMPANY (DELAWARE CORPORATION)
ONE KELLOGG SQUARE
PO BOX 3599
BATTLE CREEK, MI 490163599

FOR: PROCESSED CEREAL-BASED FOOD TO BE USED AS A BREAKFAST FOOD, SNACK FOOD OR INGREDIENT FOR MAKING OTHER FOODS, IN CLASS 30 (U.S. CL. 46).

FIRST USE 11-30-2010; IN COMMERCE 11-30-2010.

OWNER OF U.S. REG. NOS. 1,341,183 AND 2,192,246.

THE COLOR(S) GREEN, RED, GOLD AND WHITE IS/ARE CLAIMED AS A FEATURE OF THE MARK.

THE MARK CONSISTS OF A LEFT FACING PROFILE OF A ROOSTER, WITH THE BODY SHOWN IN THE COLOR GREEN, THE BEAK IN THE COLOR GOLD, THE COCKSCOMB AND THE WATTLE IN THE COLOR RED AND THE EYE IN THE SHAPE OF A CIRCLE IN THE COLOR WHITE.

SER. NO. 85-488,026, FILED 12-6-2011.

MELISSA VALLILLO, EXAMINING ATTORNEY



David J. Kyjars

Director of the United States Patent and Trademark Office

United States of America

United States Patent and Trademark Office

MR. KATE

Reg. No. 4,154,216

Registered June 5, 2012

Int. Cl.: 41

SERVICE MARK

PRINCIPAL REGISTER

ALBRECHT, KATE (UNITED STATES INDIVIDUAL), DBA MR. KATE
1508 S. SHENANDOAH STREET, #2
LOS ANGELES, CA 90035

FOR: EDUCATIONAL AND ENTERTAINMENT SERVICES, NAMELY, PERSONAL APPEARANCES BY AN ENTERTAINER FEATURING LIVE SPEAKING ENGAGEMENTS, INTERNET APPEARANCES, RADIO APPEARANCES, TELEVISION APPEARANCES, AND MOVIE APPEARANCES; EDUCATIONAL SERVICES, NAMELY, PROVIDING LIVE AND ONLINE SEMINARS, CLASSES AND EVENTS, WORKSHOPS AND CONFERENCES IN THE FIELDS OF FASHION, HOME DECOR, COOKING AND HEALTH, IN CLASS 41 (U.S. CLS. 100, 101 AND 107).

FIRST USE 8-25-2009; IN COMMERCE 8-25-2009.

THE MARK CONSISTS OF STANDARD CHARACTERS WITHOUT CLAIM TO ANY PARTICULAR FONT, STYLE, SIZE, OR COLOR.

THE NAME(S), PORTRAIT(S), AND/OR SIGNATURE(S) SHOWN IN THE MARK IDENTIFIES "KATE" MACKENZIE ALBRECHT, WHOSE CONSENT(S) TO REGISTER IS MADE OF RECORD.

SER. NO. 85-488,254, FILED 12-6-2011.

MARK RADEMACHER, EXAMINING ATTORNEY



David J. Kypos

Director of the United States Patent and Trademark Office

United States of America

United States Patent and Trademark Office



Reg. No. 4,154,217

Registered June 5, 2012

Int. Cl.: 18

TRADEMARK

PRINCIPAL REGISTER

KARSTEN MANUFACTURING CORPORATION (ARIZONA CORPORATION)
2201 WEST DESERT COVE
PHOENIX, AZ 85029

FOR: BACKPACKS; TRAVEL BAGS; MESSENGER BAGS; CARRY-ALL AND CARRY-ON BAGS; SHOE BAGS FOR TRAVEL; LEATHER AND CLOTH POUCHES FOR VALUABLES, IN CLASS 18 (U.S. CLS. 1, 2, 3, 22 AND 41).

FIRST USE 0-0-2001; IN COMMERCE 0-0-2001.

OWNER OF U.S. REG. NOS. 895,415, 1,037,513, AND 3,264,204.

THE MARK CONSISTS OF A MAN WITH A GOLF CLUB WITH A GOLF BALL ATTACHED TO GOLF CLUB.

SER. NO. 85-488,664, FILED 12-6-2011.

Laurie Mayes, Examining Attorney



David J. Kybas

Director of the United States Patent and Trademark Office

United States of America

United States Patent and Trademark Office

HOOK, LINE & DINNER

Reg. No. 4,154,218

Registered June 5, 2012

Int. Cl.: 41

SERVICE MARK

PRINCIPAL REGISTER

COOKING CHANNEL, LLC (DELAWARE LIMITED LIABILITY COMPANY)
1180 AVENUE OF THE AMERICAS
NEW YORK, NY 10036

FOR: EDUCATIONAL AND ENTERTAINMENT SERVICES, NAMELY, A CONTINUING PROGRAM ABOUT FOOD AND COOKING, ACCESSIBLE BY RADIO, TELEVISION, CABLE, FIBER OPTIC NETWORKS, WIRELESS NETWORKS, SATELLITE, AUDIO VIDEO, AND COMPUTER NETWORKS, IN CLASS 41 (U.S. CLS. 100, 101 AND 107).

FIRST USE 11-4-2010; IN COMMERCE 11-4-2010.

THE MARK CONSISTS OF STANDARD CHARACTERS WITHOUT CLAIM TO ANY PARTICULAR FONT, STYLE, SIZE, OR COLOR.

SER. NO. 85-489,091, FILED 12-7-2011.

MICHAEL GAAFAR, EXAMINING ATTORNEY



David J. Kyffers

Director of the United States Patent and Trademark Office

United States of America

United States Patent and Trademark Office

CAFE MOX

Reg. No. 4,154,219

Registered June 5, 2012

Int. Cls.: 41 and 43

SERVICE MARK

PRINCIPAL REGISTER

CARD KINGDOM, INC. (WASHINGTON CORPORATION)
5105 LEARY AVE NW
SEATTLE, WA 98107

FOR: ENTERTAINMENT SERVICES, NAMELY, ARRANGING AND CONDUCTING OF COMPETITIONS FOR CARD GAMES AND ROLE PLAYING GAMES; INSTRUCTION IN THE FIELD OF CARD GAMES AND ROLE PLAYING GAMES; PROVIDING FACILITIES FOR CARD GAME AND ROLE PLAYING GAME TOURNAMENTS, IN CLASS 41 (U.S. CLS. 100, 101 AND 107).

FIRST USE 5-1-2011; IN COMMERCE 7-28-2011.

FOR: BAR SERVICES; RESTAURANT AND CAFE SERVICES, IN CLASS 43 (U.S. CLS. 100 AND 101).

FIRST USE 5-1-2011; IN COMMERCE 7-28-2011.

THE MARK CONSISTS OF STANDARD CHARACTERS WITHOUT CLAIM TO ANY PARTICULAR FONT, STYLE, SIZE, OR COLOR.

NO CLAIM IS MADE TO THE EXCLUSIVE RIGHT TO USE "CAFE", APART FROM THE MARK AS SHOWN.

SER. NO. 85-491,079, FILED 12-8-2011.

ADA HAN, EXAMINING ATTORNEY



David J. Kybas

Director of the United States Patent and Trademark Office

United States of America

United States Patent and Trademark Office



Reg. No. 4,154,220

Registered June 5, 2012

Int. Cl.: 28

TRADEMARK

PRINCIPAL REGISTER

EGRANDBUY, INC (CALIFORNIA CORPORATION)
321 VINELAND AVE
INDUSTRY, CA 91746

FOR: REMOTE CONTROL TOYS, NAMELY, CARS, TRUCKS, BUGGIES, AND ACCESSORIES THEREFOR; REMOTE CONTROLLED HOBBY MODEL CARS, TRUCKS, BUGGIES, AND ACCESSORIES THEREFOR, IN CLASS 28 (U.S. CLS. 22, 23, 38 AND 50).

FIRST USE 1-1-2011; IN COMMERCE 1-1-2011.

THE MARK CONSISTS OF STYLIZED WORDS "IRON TRACK" WITH SHADE INSIDE THE WORD "IRON".

SER. NO. 85-491,656, FILED 12-9-2011.

JULIE WATSON, EXAMINING ATTORNEY



David J. Kyros

Director of the United States Patent and Trademark Office

United States of America

United States Patent and Trademark Office



Reg. No. 4,154,221

Registered June 5, 2012

Int. Cl.: 9

TRADEMARK

PRINCIPAL REGISTER

KABBALAH CENTRE INTERNATIONAL, INC. (CALIFORNIA CORPORATION)
1062 S. ROBERTSON BLVD.
LOS ANGELES, CA 90035

FOR: DIGITAL MATERIALS, NAMELY, CDS, DVDS, DOWNLOADABLE AUDIO FILES FEATURING RELIGION AND SPIRITUALITY; DIGITAL MEDIA, NAMELY, PRE-RECORDED DVDS, DOWNLOADABLE AUDIO AND VIDEO RECORDINGS, AND CDS FEATURING AND PROMOTING RELIGION AND SPIRITUALITY, IN CLASS 9 (U.S. CLS. 21, 23, 26, 36 AND 38).

FIRST USE 5-1-2001; IN COMMERCE 5-1-2001.

OWNER OF U.S. REG. NOS. 2,218,620, 3,998,231 AND OTHERS.

THE MARK CONSISTS OF A STYLIZED LION DESIGN.

SER. NO. 85-491,798, FILED 12-9-2011.

ELISSA GARBER KON, EXAMINING ATTORNEY



David J. Kyffers

Director of the United States Patent and Trademark Office

United States of America

United States Patent and Trademark Office

THE WORLD PEACE BANKING KIOSK

Reg. No. 4,154,222

HERRERA, ORLANDO A. (UNITED STATES INDIVIDUAL)
2751 S. OCEAN DRIVE, SUITE 805-S
HOLLYWOOD, FL 33019 AND

Registered June 5, 2012

Int. Cl.: 36

GOLDMEER, CONSTANCE (UNITED STATES INDIVIDUAL)
2751 S. OCEAN DRIVE, SUITE 705-S
HOLLYWOOD, FL 33019 AND

SERVICE MARK

PRINCIPAL REGISTER

THE WORLD PEACE PROGRAM, LLC (FLORIDA LIMITED LIABILITY COMPANY)
2751 S. OCEAN DRIVE, SUITE 705-S
HOLLYWOOD, FL 33019

FOR: BANKING AND FINANCING SERVICES; BANKING SERVICES; BANKING SERVICES FEATURING THE PROVISION OF CERTIFICATES OF DEPOSIT; CREDIT CARD AND DEBIT CARD SERVICES, IN CLASS 36 (U.S. CLS. 100, 101 AND 102).

FIRST USE 9-1-2011; IN COMMERCE 9-1-2011.

THE MARK CONSISTS OF STANDARD CHARACTERS WITHOUT CLAIM TO ANY PARTICULAR FONT, STYLE, SIZE, OR COLOR.

SER. NO. 85-492,260, FILED 12-10-2011.

JENNIFER VASQUEZ, EXAMINING ATTORNEY



David J. Kyros

Director of the United States Patent and Trademark Office

United States of America

United States Patent and Trademark Office

LIVE LIFE UNFILTERED

Reg. No. 4,154,223

Registered June 5, 2012

Int. Cl.: 32

TRADEMARK

PRINCIPAL REGISTER

ANHEUSER-BUSCH, LLC (MISSOURI LIMITED LIABILITY COMPANY)
ONE BUSCH PLACE
ST. LOUIS, MO 63118

FOR: BEER, IN CLASS 32 (U.S. CLS. 45, 46 AND 48).

FIRST USE 3-31-2011; IN COMMERCE 3-31-2011.

THE MARK CONSISTS OF STANDARD CHARACTERS WITHOUT CLAIM TO ANY PARTICULAR FONT, STYLE, SIZE, OR COLOR.

SER. NO. 85-492,562, FILED 12-12-2011.

NANCY CLARKE, EXAMINING ATTORNEY



David J. Kybas

Director of the United States Patent and Trademark Office

United States of America

United States Patent and Trademark Office



Reg. No. 4,154,224

Registered June 5, 2012

Int. Cl.: 35

SERVICE MARK

PRINCIPAL REGISTER

DSW SHOE WAREHOUSE, INC. (MISSOURI CORPORATION)
810 DSW DRIVE
COLUMBUS, OH 43219

FOR: ON-LINE RETAIL STORE SERVICES FEATURING SHOES, HANDBAGS AND ACCESSORIES; RETAIL STORE SERVICES FEATURING SHOES, HANDBAGS AND ACCESSORIES, IN CLASS 35 (U.S. CLS. 100, 101 AND 102).

FIRST USE 12-0-2010; IN COMMERCE 12-0-2010.

THE MARK CONSISTS OF THE WORD "HOLLY" IN RED SCRIPT ABOVE THE WORDS "THE HOLIDAY ELF" IN BLACK SCRIPT, WITH A SPRIG OF TWO GREEN HOLLY LEAVES AND RED BERRIES ON THE RIGHT OF THE WORDS.

THE COLOR(S) RED, GREEN AND BLACK IS/ARE CLAIMED AS A FEATURE OF THE MARK.

SER. NO. 85-493,664, FILED 12-13-2011.

DAWN FELDMAN, EXAMINING ATTORNEY



David J. Kyros

Director of the United States Patent and Trademark Office

United States of America

United States Patent and Trademark Office

ANIMARKETING

Reg. No. 4,154,225

Registered June 5, 2012

Int. Cl.: 35

SERVICE MARK

PRINCIPAL REGISTER

TIME FRAME PHOTOGRAPHY & ART ILLUSTRATION (COLORADO PARTNERSHIP)
P.O. BOX 17292
BOULDER, CO 80308

FOR: PROVIDING BUSINESS MARKETING CONSULTING SERVICES WHICH FEATURE THE CREATION AND PREPARATION OF ADVERTISEMENTS AND PROMOTIONAL MATERIALS FOR OTHERS THAT CONTAIN DIGITAL ANIMATION WHICH MAY BE VIEWED BY COMPUTER OR OTHER ELECTRONIC MEANS, IN CLASS 35 (U.S. CLS. 100, 101 AND 102).

FIRST USE 4-7-2004; IN COMMERCE 4-7-2004.

THE MARK CONSISTS OF STANDARD CHARACTERS WITHOUT CLAIM TO ANY PARTICULAR FONT, STYLE, SIZE, OR COLOR.

SER. NO. 85-495,222, FILED 12-14-2011.

TASHIA BUNCH, EXAMINING ATTORNEY



David J. Kyffers

Director of the United States Patent and Trademark Office

United States of America

United States Patent and Trademark Office



Reg. No. 4,154,226

Registered June 5, 2012

Int. Cls.: 16 and 40

TRADEMARK

SERVICE MARK

PRINCIPAL REGISTER

CRABAR/GBF, INC. (DELAWARE CORPORATION)
2441 PRESIDENTIAL PARKWAY
MIDLOTHIAN, TX 76065

FOR: ENVELOPES; FORMS, NAMELY, ORDER FORMS, REGISTER FORMS, BUSINESS FORMS, CUSTOM CONTINUOUS FORMS AND PARTIALLY PRINTED FORMS, IN CLASS 16 (U.S. CLS. 2, 5, 22, 23, 29, 37, 38 AND 50).

FIRST USE 10-0-1986; IN COMMERCE 10-0-1986.

FOR: PRINTING SERVICES, IN CLASS 40 (U.S. CLS. 100, 103 AND 106).

FIRST USE 10-0-1986; IN COMMERCE 10-0-1986.

THE MARK CONSISTS OF STYLIZED LETTER "W" IN FRONT OF A CIRCLE THAT HAS A PATTERN THAT FADES FROM DARK ON TOP TO LIGHT ON BOTTOM.

SER. NO. 85-496,491, FILED 12-15-2011.

FRANK LATTUCA, EXAMINING ATTORNEY



David J. Kybas

Director of the United States Patent and Trademark Office

United States of America

United States Patent and Trademark Office

BOYDS WHEELS

Reg. No. 4,154,227

Registered June 5, 2012

Int. Cl.: 12

TRADEMARK

PRINCIPAL REGISTER

CODDINGTON, BOYD LEE (UNITED STATES INDIVIDUAL)
5201 NW 60TH TERRACE
KANSAS CITY, MO 64151

FOR: WHEEL RIMS, IN CLASS 12 (U.S. CLS. 19, 21, 23, 31, 35 AND 44).

FIRST USE 12-1-1979; IN COMMERCE 1-1-1984.

THE MARK CONSISTS OF STANDARD CHARACTERS WITHOUT CLAIM TO ANY PARTICULAR FONT, STYLE, SIZE, OR COLOR.

NO CLAIM IS MADE TO THE EXCLUSIVE RIGHT TO USE "WHEELS", APART FROM THE MARK AS SHOWN.

SER. NO. 85-497,160, FILED 12-16-2011.

BRENDAN REGAN, EXAMINING ATTORNEY



David J. Kyffers

Director of the United States Patent and Trademark Office

United States of America

United States Patent and Trademark Office

FRENZY ALERT

Reg. No. 4,154,228

DSW SHOE WAREHOUSE, INC. (MISSOURI CORPORATION)
810 DSW DRIVE
COLUMBUS, OH 43219

Registered June 5, 2012

Int. Cl.: 35

FOR: RETAIL AND ON-LINE RETAIL STORE SERVICES FEATURING FOOTWEAR, HANDBAGS AND ACCESSORIES; PROVIDING INCENTIVE AWARD PROGRAMS FOR CUSTOMERS THROUGH THE ISSUANCE AND PROCESSING OF LOYALTY AWARDS FOR PURCHASE OF COMPANY'S GOODS, IN CLASS 35 (U.S. CLS. 100, 101 AND 102).

SERVICE MARK

PRINCIPAL REGISTER

FIRST USE 9-0-2010; IN COMMERCE 9-0-2010.

THE MARK CONSISTS OF STANDARD CHARACTERS WITHOUT CLAIM TO ANY PARTICULAR FONT, STYLE, SIZE, OR COLOR.

SER. NO. 85-498,816, FILED 12-19-2011.

DAWN FELDMAN, EXAMINING ATTORNEY



David J. Kyjars

Director of the United States Patent and Trademark Office

United States of America

United States Patent and Trademark Office

LEADAMERICA

Reg. No. 4,154,229

Registered June 5, 2012

Int. Cl.: 41

SERVICE MARK

PRINCIPAL REGISTER

NATIONAL YOUTH EDUCATION COUNCIL, LLC (FLORIDA LIMITED LIABILITY COMPANY)
SUITE 301
1515 SOUTH FEDERAL HIGHWAY
BOCA RATON, FL 33432

FOR: EDUCATIONAL AND TRAINING SERVICES, NAMELY, CONDUCTING WORKSHOPS AND SEMINARS IN THE FIELD OF MILITARY, GOVERNMENTAL, LAW, MEDICAL AND BUSINESS FOR MIDDLE SCHOOL AND HIGH SCHOOL STUDENTS, IN CLASS 41 (U.S. CLS. 100, 101 AND 107).

FIRST USE 10-15-2002; IN COMMERCE 10-15-2002.

THE MARK CONSISTS OF STANDARD CHARACTERS WITHOUT CLAIM TO ANY PARTICULAR FONT, STYLE, SIZE, OR COLOR.

OWNER OF U.S. REG. NO. 3,993,782.

SER. NO. 85-499,700, FILED 12-20-2011.

LEIGH LOWRY, EXAMINING ATTORNEY



David J. Kyros

Director of the United States Patent and Trademark Office

United States of America

United States Patent and Trademark Office

MEDFOX

Reg. No. 4,154,230

Registered June 5, 2012

Int. Cls.: 35, 41 and 44

SERVICE MARK

PRINCIPAL REGISTER

LIVON LABORATORIES, INC. (NEVADA CORPORATION)
2566 WILLIAMSBURG STREET
HENDERSON, NV 89052

FOR: PROMOTING PUBLIC AWARENESS OF HEALTH AND WELLNESS; AND ONLINE RETAIL STORE SERVICES FEATURING BOOKS AND MOVIES IN MULTI-MEDIA FORMATS , IN CLASS 35 (U.S. CLS. 100, 101 AND 102).

FIRST USE 8-31-2011; IN COMMERCE 8-31-2011.

FOR: MULTIMEDIA PUBLISHING OF BOOKS AND ELECTRONIC PUBLICATIONS, IN CLASS 41 (U.S. CLS. 100, 101 AND 107).

FIRST USE 8-31-2011; IN COMMERCE 8-31-2011.

FOR: PROVIDING INFORMATION, NEWS, AND COMMENTARY IN THE FIELD OF NUTRITION, HEALTH, AND WELLNESS, IN CLASS 44 (U.S. CLS. 100 AND 101).

FIRST USE 8-31-2011; IN COMMERCE 8-31-2011.

THE MARK CONSISTS OF STANDARD CHARACTERS WITHOUT CLAIM TO ANY PARTICULAR FONT, STYLE, SIZE, OR COLOR.

SER. NO. 85-502,641, FILED 12-22-2011.

AMY HELLA, EXAMINING ATTORNEY



David J. Kyffers

Director of the United States Patent and Trademark Office

United States of America

United States Patent and Trademark Office

MINI MELTS

Reg. No. 4,154,231

Registered June 5, 2012

Int. Cl.: 30

TRADEMARK

PRINCIPAL REGISTER

MINI MELTS, INC. (FLORIDA CORPORATION)
245 ASYLUM STREET
NORWICH, CT 06360

FOR: ICE CREAM, IN CLASS 30 (U.S. CL. 46).

FIRST USE 7-2-1996; IN COMMERCE 7-2-1996.

THE MARK CONSISTS OF STANDARD CHARACTERS WITHOUT CLAIM TO ANY PARTICULAR FONT, STYLE, SIZE, OR COLOR.

NO CLAIM IS MADE TO THE EXCLUSIVE RIGHT TO USE "MINI", APART FROM THE MARK AS SHOWN.

SER. NO. 85-502,968, FILED 12-23-2011.

ALICE BENMAMAN, EXAMINING ATTORNEY



David J. Kyffers

Director of the United States Patent and Trademark Office

United States of America

United States Patent and Trademark Office

PartnerOptions

Reg. No. 4,154,232

Registered June 5, 2012

Int. Cl.: 36

SERVICE MARK

PRINCIPAL REGISTER

THE CHUBB CORPORATION (NEW JERSEY CORPORATION)
P.O. BOX 1615 MOUNTAIN VIEW ROAD
WARREN, NJ 07061

FOR: DIRECT MARKETING AND DIRECT MARKETING CONSULTATION SERVICES FOR OTHERS IN RELATION TO INSURANCE, IN SUPPORT OF PRIVATE LABEL INSURANCE OFFERING, IN CLASS 36 (U.S. CLS. 100, 101 AND 102).

FIRST USE 6-10-2010; IN COMMERCE 6-10-2010.

THE MARK CONSISTS OF STANDARD CHARACTERS WITHOUT CLAIM TO ANY PARTICULAR FONT, STYLE, SIZE, OR COLOR.

SER. NO. 85-508,493, FILED 1-4-2012.

DANIEL CAPSHAW, EXAMINING ATTORNEY



David J. Kyros

Director of the United States Patent and Trademark Office

United States of America

United States Patent and Trademark Office

CLARION CALLS

Reg. No. 4,154,233

CLARION PARTNERS, LLC (NEW YORK LIMITED LIABILITY COMPANY)
230 PARK AVENUE
NEW YORK, NY 10169

Registered June 5, 2012

Int. Cls.: 9, 16 and 41

FOR: DOWNLOADABLE ELECTRONIC NEWSLETTERS IN THE FIELD OF REAL ESTATE INVESTMENTS, IN CLASS 9 (U.S. CLS. 21, 23, 26, 36 AND 38).

TRADEMARK

FIRST USE 9-0-2006; IN COMMERCE 9-0-2006.

SERVICE MARK

FOR: PRINTED MATTER, NAMELY, NEWSLETTERS IN THE FIELD OF REAL ESTATE INVESTMENTS, IN CLASS 16 (U.S. CLS. 2, 5, 22, 23, 29, 37, 38 AND 50).

PRINCIPAL REGISTER

FIRST USE 1-0-2001; IN COMMERCE 1-0-2001.

FOR: ON-LINE ELECTRONIC NEWSLETTERS DELIVERED BY E-MAIL IN THE FIELD OF REAL ESTATE INVESTMENTS, IN CLASS 41 (U.S. CLS. 100, 101 AND 107).

FIRST USE 9-0-2006; IN COMMERCE 9-0-2006.

THE MARK CONSISTS OF STANDARD CHARACTERS WITHOUT CLAIM TO ANY PARTICULAR FONT, STYLE, SIZE, OR COLOR.

SER. NO. 85-510,464, FILED 1-6-2012.

AISHA CLARKE, EXAMINING ATTORNEY



David J. Kybas

Director of the United States Patent and Trademark Office

United States of America

United States Patent and Trademark Office

CLOVER BREWED

Reg. No. 4,154,234

Registered June 5, 2012

Int. Cl.: 30

TRADEMARK

PRINCIPAL REGISTER

STARBUCKS CORPORATION (WASHINGTON CORPORATION), DBA STARBUCKS COFFEE
COMPANY
2401 UTAH AVENUE SOUTH
SEATTLE, WA 98134

FOR: COFFEE; BEVERAGES MADE OF COFFEE, IN CLASS 30 (U.S. CL. 46).

FIRST USE 3-31-2009; IN COMMERCE 3-31-2009.

THE MARK CONSISTS OF STANDARD CHARACTERS WITHOUT CLAIM TO ANY PARTICULAR FONT, STYLE, SIZE, OR COLOR.

OWNER OF U.S. REG. NO. 3,277,646.

NO CLAIM IS MADE TO THE EXCLUSIVE RIGHT TO USE "BREWED", APART FROM THE MARK AS SHOWN.

SER. NO. 85-510,602, FILED 1-6-2012.

KEVIN DINALLO, EXAMINING ATTORNEY



David J. Kybas

Director of the United States Patent and Trademark Office

United States of America

United States Patent and Trademark Office

NUPRO FREEDOM

Reg. No. 4,154,235

Registered June 5, 2012

Int. Cl.: 10

TRADEMARK

PRINCIPAL REGISTER

DENTSPLY INTERNATIONAL INC. (DELAWARE CORPORATION)
221 WEST PHILADELPHIA STREET
YORK, PA 174050872

FOR: DENTAL INSTRUMENTS, NAMELY, DISPOSABLE PROPHY ANGLES, IN CLASS 10
(U.S. CLS. 26, 39 AND 44).

FIRST USE 9-30-2011; IN COMMERCE 9-30-2011.

THE MARK CONSISTS OF STANDARD CHARACTERS WITHOUT CLAIM TO ANY PARTICULAR FONT, STYLE, SIZE, OR COLOR.

OWNER OF U.S. REG. NOS. 962,204, 3,522,236 AND OTHERS.

SER. NO. 85-510,725, FILED 1-6-2012.

APRIL HESIK, EXAMINING ATTORNEY



David J. Kybas

Director of the United States Patent and Trademark Office

United States of America

United States Patent and Trademark Office

Pass Me SafeLee

Reg. No. 4,154,236

Registered June 5, 2012

Int. Cl.: 16

TRADEMARK

PRINCIPAL REGISTER

LEE MEMORIAL HEALTH SYSTEM (FLORIDA A POLITICAL SUBDIVISION OF THE STATE OF FLORIDA)
9800 S. HEALTHPARK DRIVE, SUITE 210
FORT MYERS, FL 33908

FOR: PRINTED INSTRUCTIONAL, EDUCATIONAL, AND TEACHING MATERIALS IN THE FIELD OF MEDICAL RECORD KEEPING, PATIENT INTAKE INFORMATION, MEDICAL ASSESSMENT AND EVALUATION, IN CLASS 16 (U.S. CLS. 2, 5, 22, 23, 29, 37, 38 AND 50).

FIRST USE 12-1-2008; IN COMMERCE 12-1-2008.

THE MARK CONSISTS OF STANDARD CHARACTERS WITHOUT CLAIM TO ANY PARTICULAR FONT, STYLE, SIZE, OR COLOR.

SER. NO. 85-517,059, FILED 1-16-2012.

ANDREA K. NADELMAN, EXAMINING ATTORNEY



David J. Kyffers

Director of the United States Patent and Trademark Office

United States of America

United States Patent and Trademark Office

POOLCORP

Reg. No. 4,154,237

Registered June 5, 2012

Int. Cl.: 35

SERVICE MARK

PRINCIPAL REGISTER

ALLIANCE TRADING, INC. (DELAWARE CORPORATION)
109 NORTHPARK BOULEVARD
COVINGTON, LA 70433

FOR: ADVERTISING, MARKETING AND PROMOTION SERVICES, IN CLASS 35 (U.S. CLS. 100, 101 AND 102).

FIRST USE 9-16-2002; IN COMMERCE 12-31-2002.

THE MARK CONSISTS OF STANDARD CHARACTERS WITHOUT CLAIM TO ANY PARTICULAR FONT, STYLE, SIZE, OR COLOR.

SEC. 2(F).

SER. NO. 85-975,036, FILED 6-23-2010.

DOMINIC J. FERRAIUOLO, EXAMINING ATTORNEY



David J. Kyffers

Director of the United States Patent and Trademark Office

United States of America

United States Patent and Trademark Office

THE ORIGINAL BROOKLYN WATER BOTTLING CO.

Reg. No. 4,154,238

Registered June 5, 2012

Int. Cl.: 32

TRADEMARK

PRINCIPAL REGISTER

THE ORIGINAL BROOKLYN WATER BAGEL CO., INC. (FLORIDA CORPORATION)
5355 TOWN CENTER DRIVE, SUITE #702
BOCA RATON, FL 33486

FOR: BOTTLED DRINKING WATER; BOTTLED WATER; DRINKING WATER; WATER
BEVERAGES; FLAVORED WATER, IN CLASS 32 (U.S. CLS. 45, 46 AND 48).

FIRST USE 8-11-2009; IN COMMERCE 8-11-2009.

THE MARK CONSISTS OF STANDARD CHARACTERS WITHOUT CLAIM TO ANY PAR-
TICULAR FONT, STYLE, SIZE, OR COLOR.

OWNER OF U.S. REG. NO. 4,014,959.

NO CLAIM IS MADE TO THE EXCLUSIVE RIGHT TO USE "WATER BOTTLING CO.",
APART FROM THE MARK AS SHOWN.

SEC. 2(F).

SER. NO. 85-975,716, FILED 2-4-2011.

AMEEN IMAM, EXAMINING ATTORNEY



David J. Kyffers

Director of the United States Patent and Trademark Office

United States of America

United States Patent and Trademark Office

Bram Stoker

Reg. No. 4,154,239

Registered June 5, 2012

Int. Cl.: 9

TRADEMARK

PRINCIPAL REGISTER

BRAM STOKER LLC (DELAWARE LIMITED LIABILITY COMPANY)
331 KERSHAW ST. S.E.
AIKEN, SC 29801

FOR: DOWNLOADABLE COMPUTER SOFTWARE FOR MOBILE DEVICE IN THE NATURE OF AN APPLICATION TO VIEW AND READ AN INTERACTIVE BOOK, IN CLASS 9 (U.S. CLS. 21, 23, 26, 36 AND 38).

FIRST USE 9-10-2010; IN COMMERCE 9-16-2010.

THE MARK CONSISTS OF STANDARD CHARACTERS WITHOUT CLAIM TO ANY PARTICULAR FONT, STYLE, SIZE, OR COLOR.

THE NAME(S), PORTRAIT(S), AND/OR SIGNATURE(S) SHOWN IN THE MARK DOES NOT IDENTIFY A PARTICULAR LIVING INDIVIDUAL.

SER. NO. 85-976,229, FILED 2-25-2011.

CHARISMA HAMPTON, EXAMINING ATTORNEY



David J. Kyffers

Director of the United States Patent and Trademark Office

United States of America

United States Patent and Trademark Office

YOUR IDENTITY IS COUNTING ON YOU

Reg. No. 4,154,240

Registered June 5, 2012

Int. Cls.: 35, 36 and 45

SERVICE MARK

PRINCIPAL REGISTER

INTERSECTIONS INC. (DELAWARE CORPORATION)
3901 STONECROFT BLVD.
CHANTILLY, VA 20151

FOR: MONITORING CONSUMER CREDIT REPORTS; CREDIT CARD REGISTRATION SERVICES; CREDIT CARD CANCELLATION SERVICES FOR LOST OR STOLEN CARDS; CREDIT CARD MONITORING SERVICES FOR LOST OR STOLEN CARDS, IN CLASS 35 (U.S. CLS. 100, 101 AND 102).

FIRST USE 1-0-2010; IN COMMERCE 1-0-2010.

FOR: PROVIDING IDENTITY THEFT INSURANCE UNDERWRITTEN BY OTHERS; PROVIDING CREDIT REPORTING DATA MAINTAINED BY OTHERS; OBTAINING CREDIT INFORMATION AND OTHER PUBLIC AND PERSONAL FINANCIAL INFORMATION FOR USE IN PROVIDING REPORTS ON CREDIT RISKS DUE TO IDENTITY THEFT, CREDIT MANAGEMENT SERVICES, NAMELY, ASSISTANCE WITH RESTORING CREDIT DAMAGED BY IDENTITY THEFT, IN CLASS 36 (U.S. CLS. 100, 101 AND 102).

FIRST USE 1-0-2010; IN COMMERCE 1-0-2010.

FOR: IDENTITY THEFT PROTECTION AND IDENTITY FRAUD PROTECTION SERVICES; PERSONAL INFORMATION AND FINANCIAL IDENTITY MONITORING; FRAUD RESOLUTION ASSISTANCE, NAMELY, PROVIDING ADVICE AND CONSULTATION IN THE FIELD OF IDENTITY THEFT AND DATA THEFT; IDENTITY THEFT AND FRAUD PROTECTION SERVICES, NAMELY, INTERNET SURVEILLANCE OF FINANCIAL AND PERSONAL INFORMATION; MONITORING THE INTERNET, PUBLIC RECORDS, PRIVATE AND PUBLIC ELECTRONIC DATABASES TO FACILITATE THE DETECTION AND PREVENTION OF IDENTITY THEFT AND FRAUD; PROVIDING ONLINE RESOURCES IN THE FIELD OF IDENTITY THEFT PROTECTION; PROVIDING A SECURE INTERACTIVE WEBSITE CONCERNING NOTIFICATIONS OF POTENTIAL FRAUD AND POTENTIAL IDENTITY THEFT; FRAUD DETECTION AND PREVENTION SERVICES IN THE NATURE OF ARRANGING SECURE AUTHENTICATION OF PERSONAL DATA IN REQUESTS TO OPEN BANKING, CREDIT, CREDIT CARD, INSURANCE, LOAN, AND OTHER FINANCIAL ACCOUNTS, IN CLASS 45 (U.S. CLS. 100 AND 101).

FIRST USE 1-0-2010; IN COMMERCE 1-0-2010.



David J. Kyjars

Director of the United States Patent and Trademark Office

Reg. No. 4,154,240 THE MARK CONSISTS OF STANDARD CHARACTERS WITHOUT CLAIM TO ANY PARTICULAR FONT, STYLE, SIZE, OR COLOR.

SER. NO. 85-976,666, FILED 8-18-2010.

EDWARD NELSON, EXAMINING ATTORNEY

United States of America

United States Patent and Trademark Office

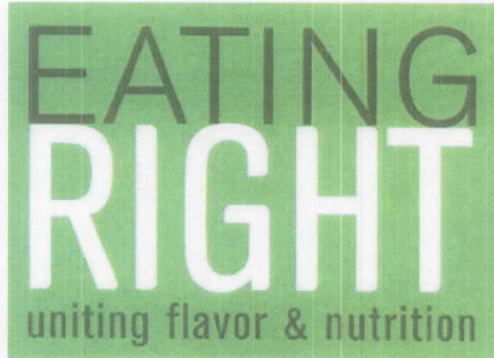

Reg. No. 4,154,241

Registered June 5, 2012

Int. Cls.: 30 and 35

TRADEMARK

SERVICE MARK

PRINCIPAL REGISTER

SAFEWAY INC. (DELAWARE CORPORATION)
5918 STONERIDGE MALL ROAD
PLEASANTON, CA 94588

FOR: FROZEN, PREPARED OR PACKAGED ENTREES AND MEALS CONSISTING PRIMARILY OF PASTA OR RICE; PASTA; BAKERY GOODS; BREAKFAST CEREALS, CANDIES; FLOUR-BASED, CORN-BASED OR GRAIN-BASED CHIPS; FROZEN CONFECTIONS, FROZEN YOGURT, ICE CREAM FOOD AND BEVERAGE PRODUCTS; MACARONI AND CHEESE; NOODLES, SAUCE, AND SEASONING TOPPINGS COMBINED IN UNITARY PACKAGES; FROZEN AND PREPARED PIZZAS; SALAD DRESSINGS; SAUCES; SANDWICHES; COOKIES; CRACKERS; GRANOLA-BASED SNACK BARS; OATMEAL; GRAIN-BASED FOOD BARS ALSO CONTAINING DRIED FRUIT; MUFFINS; BREAD AND WAFFLES, IN CLASS 30 (U.S. CL. 46).

FIRST USE 9-13-2009; IN COMMERCE 9-13-2009.

FOR: RETAIL GROCERY STORE SERVICES, IN CLASS 35 (U.S. CLS. 100, 101 AND 102).

FIRST USE 3-24-2007; IN COMMERCE 3-24-2007.

THE COLOR GREEN APPEARS IN THE BACKGROUND OF THE ENTIRE MARK, AND IN THE WORDING "EATING" AND "UNITING FLAVOR & NUTRITION"; THE COLOR WHITE APPEARS IN THE WORDING "RIGHT".

THE COLOR(S) GREEN AND WHITE IS/ARE CLAIMED AS A FEATURE OF THE MARK.

SN 76-669,345, FILED 11-21-2006.

KEVON CHISOLM, EXAMINING ATTORNEY

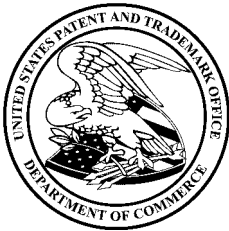

David J. Kybas

Director of the United States Patent and Trademark Office

United States of America

United States Patent and Trademark Office

NUROTRON

Reg. No. 4,154,242

Registered June 5, 2012

Int. Cls.: 9 and 10

TRADEMARK

PRINCIPAL REGISTER

NUROTRON BIOTECHNOLOGY, INC. (CALIFORNIA CORPORATION)
184 TECHNOLOGY DRIVE, SUITE 205
IRVINE, CA 92618

FOR: COMPUTER SOFTWARE FOR OPERATING EYE IMPLANTS, HEARING AIDS, AND COCHLEAR IMPLANTS, IN CLASS 9 (U.S. CLS. 21, 23, 26, 36 AND 38).

FIRST USE 3-15-2007; IN COMMERCE 8-31-2008.

FOR: MEDICAL DEVICES, NAMELY, EYE IMPLANTS, HEARING AIDS, COCHLEAR IMPLANTS AND COMPUTER OPERATING SOFTWARE SOLD AS A UNIT, IN CLASS 10 (U.S. CLS. 26, 39 AND 44).

FIRST USE 3-15-2007; IN COMMERCE 8-31-2008.

THE MARK CONSISTS OF STANDARD CHARACTERS WITHOUT CLAIM TO ANY PARTICULAR FONT, STYLE, SIZE, OR COLOR.

SN 76-679,311, FILED 7-9-2007.

MICHAEL WEBSTER, EXAMINING ATTORNEY



David J. Kypos

Director of the United States Patent and Trademark Office

United States of America

United States Patent and Trademark Office

FRED & BARREL

Reg. No. 4,154,243

Registered June 5, 2012

Int. Cl.: 16

TRADEMARK

PRINCIPAL REGISTER

FRED & BARREL, INC. (MARYLAND CORPORATION)
14140 BRIGHTON DAM ROAD
CLARKSVILLE, MD 21029

FOR: PRINTED MATTER, NAMELY, COMIC BOOKS; SERIES OF FICTION WORKS,
NAMELY, NOVELS AND BOOKS, IN CLASS 16 (U.S. CLS. 2, 5, 22, 23, 29, 37, 38 AND 50).

FIRST USE 12-20-2011; IN COMMERCE 2-11-2012.

THE MARK CONSISTS OF STANDARD CHARACTERS WITHOUT CLAIM TO ANY PAR-
TICULAR FONT, STYLE, SIZE, OR COLOR.

SN 76-681,925, FILED 9-17-2007.

KAREN SEVERSON, EXAMINING ATTORNEY



David J. Kybas

Director of the United States Patent and Trademark Office

United States of America
United States Patent and Trademark Office

NK-92

Reg. No. 4,154,244

KLINGEMANN, HANS (CANADA INDIVIDUAL)
ONE NASSAU STREET
BOSTON, MA 02111

Registered June 5, 2012

Int. Cl.: 1

FOR: CELLS FOR SCIENTIFIC, LABORATORY OR MEDICAL RESEARCH, IN CLASS 1
(U.S. CLS. 1, 5, 6, 10, 26 AND 46).

TRADEMARK

FIRST USE 6-1-1994; IN COMMERCE 6-1-1994.

PRINCIPAL REGISTER

THE MARK CONSISTS OF STANDARD CHARACTERS WITHOUT CLAIM TO ANY PARTICULAR FONT, STYLE, SIZE, OR COLOR.

SN 76-690,929, FILED 6-30-2008.

HELENE LIWINSKI, EXAMINING ATTORNEY



David J. Kybas

Director of the United States Patent and Trademark Office

United States of America

United States Patent and Trademark Office

ELLI

Reg. No. 4,154,245

Registered June 5, 2012

Int. Cl.: 11

TRADEMARK

PRINCIPAL REGISTER

REV-A-SHELF COMPANY, LLC (KENTUCKY LIMITED LIABILITY COMPANY)
2409 PLANTSIDE DRIVE
JEFFERSONTOWN, KY 40299

FOR: LOW VOLTAGE LED COMMERCIAL AND RESIDENTIAL ELECTRIC LIGHTING
FIXTURES AND ASSOCIATED MOUNTING STRUCTURES, SOLD AS A UNIT, IN CLASS
11 (U.S. CLS. 13, 21, 23, 31 AND 34).

FIRST USE 11-30-2009; IN COMMERCE 11-30-2009.

THE MARK CONSISTS OF STANDARD CHARACTERS WITHOUT CLAIM TO ANY PAR-
TICULAR FONT, STYLE, SIZE, OR COLOR.

SN 76-695,977, FILED 2-25-2009.

SALLY SHIH, EXAMINING ATTORNEY



David J. Kybas

Director of the United States Patent and Trademark Office

United States of America

United States Patent and Trademark Office

LENS ON TALENT

Reg. No. 4,154,246

Registered June 5, 2012

Int. Cls.: 36 and 41

SERVICE MARK

PRINCIPAL REGISTER

JOHNSON & JOHNSON (NEW JERSEY CORPORATION)
ONE JOHNSON & JOHNSON PLAZA
NEW BRUNSWICK, NJ 089337001

FOR: FINANCIAL SPONSORSHIP OF AMATEUR FILMMAKING VIA ON-GOING TELEVISION AND CABLE TELEVISION PROGRAMS, IN CLASS 36 (U.S. CLS. 100, 101 AND 102).

FIRST USE 6-23-2011; IN COMMERCE 6-23-2011.

FOR: ENTERTAINMENT SERVICES, NAMELY, CONDUCTING CONTESTS IN THE FIELD OF FILMMAKING, SPECIFICALLY, VIDEOGRAPHY, OFFERED VIA A WEBSITE, IN CLASS 41 (U.S. CLS. 100, 101 AND 107).

FIRST USE 6-23-2011; IN COMMERCE 6-23-2011.

THE MARK CONSISTS OF STANDARD CHARACTERS WITHOUT CLAIM TO ANY PARTICULAR FONT, STYLE, SIZE, OR COLOR.

SN 76-696,329, FILED 3-16-2009.

DAVID COLLIER, EXAMINING ATTORNEY



David J. Kyros

Director of the United States Patent and Trademark Office

United States of America

United States Patent and Trademark Office

EZAMA

Reg. No. 4,154,247

Registered June 5, 2012

Int. Cls.: 28 and 41

TRADEMARK

SERVICE MARK

PRINCIPAL REGISTER

WORLD MAGIC INTERNATIONAL (W.M.I) AVV (ARUBA CORPORATION)
ADRIAAN LACLE BOULEVARD 7
ORANJESTAD, ARUBA

FOR: MAGIC TRICKS, NAMELY, CONJURER'S BOXES, MAGIC KITS, CONSISTING
PRIMARILY OF MAGIC TRICKS, NOVELTY ITEMS, ETC , IN CLASS 28 (U.S. CLS. 22, 23,
38 AND 50).

FIRST USE 6-15-2011; IN COMMERCE 6-15-2011.

FOR: CONDUCTING ENTERTAINMENT EXHIBITIONS IN THE NATURE OF MAGIC
SHOWS; ENTERTAINMENT IN THE NATURE OF MAGIC SHOWS, IN CLASS 41 (U.S. CLS.
100, 101 AND 107).

FIRST USE 6-15-2011; IN COMMERCE 6-15-2011.

THE MARK CONSISTS OF STANDARD CHARACTERS WITHOUT CLAIM TO ANY PAR-
TICULAR FONT, STYLE, SIZE, OR COLOR.

PRIORITY CLAIMED UNDER SEC. 44(D) ON EUROPEAN UNION APPLICATION NO.
8,720,443, FILED 11-30-2009.

SN 76-701,440, FILED 2-1-2010.

INGA ERVIN, EXAMINING ATTORNEY



David J. Kyffers

Director of the United States Patent and Trademark Office

United States of America

United States Patent and Trademark Office

COLOR PROJECTIONS

Reg. No. 4,154,248

HENRY DONEGER ASSOCIATES, INC. (NEW YORK CORPORATION)
463 SEVENTH AVENUE
NEW YORK, NY 10018

Registered June 5, 2012

Int. Cl.: 42

FOR: CONSULTING SERVICES, NAMELY, COLOR ANALYSIS FOR PURPOSES OF USE IN APPAREL, HOME, CONSUMER GOODS, INTERIOR DESIGN, AND AUTOMOTIVE FIELDS, IN CLASS 42 (U.S. CLS. 100 AND 101).

SERVICE MARK

FIRST USE 3-19-2012; IN COMMERCE 3-19-2012.

PRINCIPAL REGISTER

THE MARK CONSISTS OF STANDARD CHARACTERS WITHOUT CLAIM TO ANY PARTICULAR FONT, STYLE, SIZE, OR COLOR.

NO CLAIM IS MADE TO THE EXCLUSIVE RIGHT TO USE "COLOR", APART FROM THE MARK AS SHOWN.

SN 76-701,641, FILED 2-16-2010.

ANNE E. GUSTASON, EXAMINING ATTORNEY



David J. Kyffers

Director of the United States Patent and Trademark Office

United States of America

United States Patent and Trademark Office



Reg. No. 4,154,249

Registered June 5, 2012

Int. Cls.: 6 and 41

TRADEMARK

SERVICE MARK

PRINCIPAL REGISTER

LOVELOCKS AT LOVER'S GATE (UTAH PARTNERSHIP)
321 NORTH MALL DRIVE
SUITE X102
ST. GEORGE, UT 84770

FOR: METAL NON-JEWELRY LOCKS; METAL GATES; METAL NON-JEWELRY KEYLESS LOCKS, IN CLASS 6 (U.S. CLS. 2, 12, 13, 14, 23, 25 AND 50).

FIRST USE 6-18-2010; IN COMMERCE 8-18-2010.

FOR: SPECIAL EVENT PLANNING FOR SOCIAL ENTERTAINMENT PURPOSES; AND PARTY AND WEDDING PLANNING SERVICE, IN CLASS 41 (U.S. CLS. 100, 101 AND 107).

FIRST USE 6-18-2010; IN COMMERCE 8-18-2010.

THE MARK CONSISTS OF THE WORD "LOVELOCKS", WHERE THE FIRST "L" OF THE WORD APPEARS BACK-TO-BACK WITH A BACKWARDS "L"; THE TWO ADJACENT "L" S APPEAR LOCKED BY A STYLIZED LOCK DESIGN WHERE THE BOTTOM PORTION OF THE LOCK IS IN THE SHAPE OF A HEART.

SN 76-702,701, FILED 4-29-2010.

MARC LEIPZIG, EXAMINING ATTORNEY



David J. Kybas

Director of the United States Patent and Trademark Office

United States of America

United States Patent and Trademark Office

INNER BOOTIE

Reg. No. 4,154,250

Registered June 5, 2012

Int. Cl.: 21

MIAMICA OF NEW YORK, INC., A DIVISION OF SHALOM INTERNATIONAL, CORP.
(NEW JERSEY CORPORATION)
1050 AMBOY AVENUE
SUITE 1
PERTH AMBOY, NJ 08861

TRADEMARK

PRINCIPAL REGISTER

FOR: INNER SUPPORT FOR MEN AND WOMEN'S BOOTS, NAMELY, INFLATABLE BOOT SHAPERS IN THE NATURE OF INFLATABLE SHOE-TREES MADE OF PLASTIC, AND FOR USE WHEN SAID PRODUCTS ARE NOT BEING WORN, IN CLASS 21 (U.S. CLS. 2, 13, 23, 29, 30, 33, 40 AND 50).

FIRST USE 9-21-2010; IN COMMERCE 9-21-2010.

THE MARK CONSISTS OF STANDARD CHARACTERS WITHOUT CLAIM TO ANY PARTICULAR FONT, STYLE, SIZE, OR COLOR.

SN 76-703,591, FILED 6-30-2010.

JAMES STEIN, EXAMINING ATTORNEY



David J. Kyffers

Director of the United States Patent and Trademark Office

United States of America

United States Patent and Trademark Office



Reg. No. 4,154,251

Registered June 5, 2012

Int. Cl.: 3

TRADEMARK

PRINCIPAL REGISTER

MAYBE TONIGHT, INC. (FLORIDA CORPORATION)
6424 CARTMEL LANE
WINDERMERE, FL 34786

FOR: INTIMACY KIT CONTAINING PERSONAL FEMININE HYGIENE PRODUCTS, NAMELY, A KIT COMPRISED PRIMARILY OF FEMININE HYGIENE CLEANSING TOWELETTES AND ALSO COSMETICS, PERSONAL LUBRICANTS, AND CONDOMS, IN CLASS 3 (U.S. CLS. 1, 4, 6, 50, 51 AND 52).

FIRST USE 12-9-2011; IN COMMERCE 12-9-2011.

THE DESIGN CONSISTS OF A STYLIZED QUESTION MARK AND A PAIR OF WOMAN'S LIPS IN PLACE OF THE STANDARD DOT.

SN 76-704,514, FILED 9-16-2010.

REBECCA POVARCHUK, EXAMINING ATTORNEY



David J. Kybas

Director of the United States Patent and Trademark Office

United States of America

United States Patent and Trademark Office

MIZMAAR

Reg. No. 4,154,252

Registered June 5, 2012

Int. Cl.: 5

TRADEMARK

PRINCIPAL REGISTER

MIRZA, ASMA (UNITED STATES INDIVIDUAL)
600 PARK AVENUE
PISCATAWAY, NJ 08854

FOR: DIETARY AND NUTRITIONAL SUPPLEMENTS FOR PROVIDING AND MAINTAINING HEALTHY HAIR; NUTRITIONAL SUPPLEMENTS FOR MEDICAL USE; NUTRITIONAL ADDITIVES FOR MEDICAL PURPOSES USED IN FOOD PRODUCTS FOR HUMAN CONSUMPTION; NUTRITIONAL ADDITIVES FOR MEDICAL PURPOSES AND DIETARY SUPPLEMENTS FOR HUMAN CONSUMPTION FOR PROVIDING AND MAINTAINING HEALTHY HAIR; DIETARY AND NUTRITIONAL SUPPLEMENTS FOR STIMULATING HAIR GROWTH, AND PREVENTING HAIR LOSS; DIETARY AND NUTRITIONAL SUPPLEMENTS TO PREVENT AND REVERSE GRAYING HAIR, IN CLASS 5 (U.S. CLS. 6, 18, 44, 46, 51 AND 52).

FIRST USE 2-16-2012; IN COMMERCE 2-16-2012.

THE MARK CONSISTS OF STANDARD CHARACTERS WITHOUT CLAIM TO ANY PARTICULAR FONT, STYLE, SIZE, OR COLOR.

SN 76-705,249, FILED 11-8-2010.

JAMES GRIFFIN, EXAMINING ATTORNEY



David J. Kyffers

Director of the United States Patent and Trademark Office

United States of America

United States Patent and Trademark Office

INSTACAB

Reg. No. 4,154,253

COLUMBIA ELEVATOR PRODUCTS CO., INC. (NEW YORK CORPORATION)
380 HORACE STREET
BRIDGEPORT, CT 06610

Registered June 5, 2012

Int. Cl.: 7

FOR: ELEVATOR CAR ENCLOSURES, IN CLASS 7 (U.S. CLS. 13, 19, 21, 23, 31, 34 AND 35).

TRADEMARK

FIRST USE 2-14-2012; IN COMMERCE 2-14-2012.

PRINCIPAL REGISTER

THE MARK CONSISTS OF STANDARD CHARACTERS WITHOUT CLAIM TO ANY PARTICULAR FONT, STYLE, SIZE, OR COLOR.

OWNER OF U.S. REG. NO. 2,120,289.

SN 76-705,289, FILED 11-10-2010.

RENEE SERVANCE, EXAMINING ATTORNEY



David J. Kyffers

Director of the United States Patent and Trademark Office

United States of America

United States Patent and Trademark Office

PRORIDE

Reg. No. 4,154,254

HENNESSY INDUSTRIES, INC. (DELAWARE CORPORATION)
1601 J.P. HENNESSY DRIVE
LAVERGNE, TN 370861986

Registered June 5, 2012

Int. Cl.: 9

FOR: VEHICLE WHEEL BALANCING MACHINES, IN CLASS 9 (U.S. CLS. 21, 23, 26, 36 AND 38).

TRADEMARK

FIRST USE 9-15-2011; IN COMMERCE 9-15-2011.

PRINCIPAL REGISTER

THE MARK CONSISTS OF STANDARD CHARACTERS WITHOUT CLAIM TO ANY PARTICULAR FONT, STYLE, SIZE, OR COLOR.

SN 76-705,532, FILED 12-1-2010.

TINA MAI, EXAMINING ATTORNEY



David J. Kyffers

Director of the United States Patent and Trademark Office

United States of America

United States Patent and Trademark Office

MISS HORTENCIA'S ORIGINAL MEXICAN

Reg. No. 4,154,255

EL PEKA FOODS LLC (CONNECTICUT PARTNERSHIP)
P. O. BOX 346
NEW LONDON, CT 06320

Registered June 5, 2012

Int. Cl.: 30

FOR: HOT SAUCE, IN CLASS 30 (U.S. CL. 46).

TRADEMARK

FIRST USE 9-28-2011; IN COMMERCE 10-17-2011.

PRINCIPAL REGISTER

THE MARK CONSISTS OF STANDARD CHARACTERS WITHOUT CLAIM TO ANY PARTICULAR FONT, STYLE, SIZE, OR COLOR.

NO CLAIM IS MADE TO THE EXCLUSIVE RIGHT TO USE "ORIGINAL MEXICAN", APART FROM THE MARK AS SHOWN.

MISS HORTENCIA DOES NOT IDENTIFY A LIVING INDIVIDUAL.

SN 76-705,636, FILED 12-9-2010.

HOWARD SMIGA, EXAMINING ATTORNEY



David J. Kyffers

Director of the United States Patent and Trademark Office

United States of America

United States Patent and Trademark Office

PRESTIGE EDGE

Reg. No. 4,154,256

Registered June 5, 2012

Int. Cl.: 25

TRADEMARK

PRINCIPAL REGISTER

GRIP COLLECTIONS, INC. (NEW YORK CORPORATION)
2ND FLOOR
14B 53RD STREET
BROOKLYN, NY 11232

FOR: LADIES GARMENTS, NAMELY, FOUNDATION GARMENTS; LADIES SLEEPWEAR; INTIMATE APPAREL, NAMELY, BRAS AND PANTIES AND LINGERIE; SLIPPERS, AND SOCKS, IN CLASS 25 (U.S. CLS. 22 AND 39).

FIRST USE 11-14-2011; IN COMMERCE 11-14-2011.

THE MARK CONSISTS OF STANDARD CHARACTERS WITHOUT CLAIM TO ANY PARTICULAR FONT, STYLE, SIZE, OR COLOR.

SN 76-705,862, FILED 1-3-2011.

MARLENE BELL, EXAMINING ATTORNEY



David J. Kybas

Director of the United States Patent and Trademark Office

United States of America

United States Patent and Trademark Office

NWL IMPACT 7S

Reg. No. 4,154,257

Registered June 5, 2012

Int. Cl.: 36

SERVICE MARK

PRINCIPAL REGISTER

NATIONAL WESTERN LIFE INSURANCE COMPANY (COLORADO CORPORATION)
850 EAST ANDERSON LANE
AUSTIN, TX 787521602

FOR: ANNUITY UNDERWRITING SERVICES, IN CLASS 36 (U.S. CLS. 100, 101 AND 102).

FIRST USE 8-31-2011; IN COMMERCE 8-31-2011.

THE MARK CONSISTS OF STANDARD CHARACTERS WITHOUT CLAIM TO ANY PARTICULAR FONT, STYLE, SIZE, OR COLOR.

OWNER OF U.S. REG. NOS. 2,589,454, 2,744,049, AND OTHERS.

SN 76-706,706, FILED 3-9-2011.

APRIL HESIK, EXAMINING ATTORNEY



David J. Kybas

Director of the United States Patent and Trademark Office

United States of America

United States Patent and Trademark Office

NWL IMPACT 10

Reg. No. 4,154,258

Registered June 5, 2012

Int. Cl.: 36

SERVICE MARK

PRINCIPAL REGISTER

NATIONAL WESTERN LIFE INSURANCE COMPANY (COLORADO CORPORATION)
850 EAST ANDERSON LANE
AUSTIN, TX 787521602

FOR: ANNUITY UNDERWRITING SERVICES, IN CLASS 36 (U.S. CLS. 100, 101 AND 102).

FIRST USE 3-31-2011; IN COMMERCE 3-31-2011.

THE MARK CONSISTS OF STANDARD CHARACTERS WITHOUT CLAIM TO ANY PARTICULAR FONT, STYLE, SIZE, OR COLOR.

OWNER OF U.S. REG. NOS. 2,589,454, 2,744,049, AND OTHERS.

SN 76-706,707, FILED 3-9-2011.

APRIL HESIK, EXAMINING ATTORNEY



David J. Kyros

Director of the United States Patent and Trademark Office

United States of America

United States Patent and Trademark Office

NWL IMPACT 7

Reg. No. 4,154,259

Registered June 5, 2012

Int. Cl.: 36

SERVICE MARK

PRINCIPAL REGISTER

NATIONAL WESTERN LIFE INSURANCE COMPANY (COLORADO CORPORATION)
850 EAST ANDERSON LANE
AUSTIN, TX 787521602

FOR: ANNUITY UNDERWRITING SERVICES, IN CLASS 36 (U.S. CLS. 100, 101 AND 102).

FIRST USE 3-31-2011; IN COMMERCE 3-31-2011.

THE MARK CONSISTS OF STANDARD CHARACTERS WITHOUT CLAIM TO ANY PARTICULAR FONT, STYLE, SIZE, OR COLOR.

OWNER OF U.S. REG. NOS. 2,589,454, 2,744,049, AND OTHERS.

SN 76-706,708, FILED 3-9-2011.

APRIL HESIK, EXAMINING ATTORNEY



David J. Kyffers

Director of the United States Patent and Trademark Office

United States of America

United States Patent and Trademark Office

EL SABOR DE QUISQUEYA

Reg. No. 4,154,260

TROPICAL CHEESE INDUSTRIES, INC. (NEW JERSEY CORPORATION)
450-452 FAYETTE STREET
PERTH AMBOY, NJ 08861

Registered June 5, 2012

Int. Cl.: 29

FOR: CHEESES, MEATS, DRINKABLE YOGURTS, AND DAIRY CREAMS, IN CLASS 29
(U.S. CL. 46).

TRADEMARK

FIRST USE 7-10-2011; IN COMMERCE 7-10-2011.

PRINCIPAL REGISTER

THE MARK CONSISTS OF STANDARD CHARACTERS WITHOUT CLAIM TO ANY PARTICULAR FONT, STYLE, SIZE, OR COLOR.

OWNER OF U.S. REG. NOS. 2,298,804, 3,481,153, AND OTHERS.

NO CLAIM IS MADE TO THE EXCLUSIVE RIGHT TO USE "QUISQUEYA", APART FROM THE MARK AS SHOWN.

THE ENGLISH TRANSLATION OF THE MARK IS "THE FLAVOR OF QUISQUEYA".

SN 76-706,812, FILED 3-15-2011.

TAMARA FRAZIER, EXAMINING ATTORNEY



David J. Kybas

Director of the United States Patent and Trademark Office

United States of America

United States Patent and Trademark Office

FLAVOR OF QUISQUEYA

Reg. No. 4,154,261

TROPICAL CHEESE INDUSTRIES, INC. (NEW JERSEY CORPORATION)
450-452 FAYETTE STREET
PERTH AMBOY, NJ 08861

Registered June 5, 2012

Int. Cl.: 29

FOR: CHEESES, MEATS, DRINKABLE YOGURTS, AND DAIRY CREAMS, IN CLASS 29
(U.S. CL. 46).

TRADEMARK

FIRST USE 7-10-2011; IN COMMERCE 7-10-2011.

PRINCIPAL REGISTER

THE MARK CONSISTS OF STANDARD CHARACTERS WITHOUT CLAIM TO ANY PARTICULAR FONT, STYLE, SIZE, OR COLOR.

OWNER OF U.S. REG. NOS. 2,298,804, 3,481,153, AND OTHERS.

NO CLAIM IS MADE TO THE EXCLUSIVE RIGHT TO USE "QUISQUEYA", APART FROM THE MARK AS SHOWN.

SN 76-706,813, FILED 3-15-2011.

TAMARA FRAZIER, EXAMINING ATTORNEY



David J. Kybas

Director of the United States Patent and Trademark Office

United States of America
United States Patent and Trademark Office

HOSTER

Reg. No. 4,154,262

Registered June 5, 2012

Int. Cl.: 25

TRADEMARK

PRINCIPAL REGISTER

MAYS TFJ REALTY, L.L.C. (NEW YORK LIMITED LIABILITY COMPANY)
112 WEST 34TH STREET, SUITE 1901
NEW YORK, NY 10120

FOR: PANTS, SHIRTS, SKIRTS, BLOUSES, JEANS, UNDERWEAR, HOSIERY, HATS,
SCARVES, GLOVES, JACKETS, SWEATERS AND FOOTWEAR, IN CLASS 25 (U.S. CLS.
22 AND 39).

FIRST USE 9-0-2011; IN COMMERCE 9-0-2011.

THE MARK CONSISTS OF STANDARD CHARACTERS WITHOUT CLAIM TO ANY PAR-
TICULAR FONT, STYLE, SIZE, OR COLOR.

SN 76-706,980, FILED 3-28-2011.

JEFFERY COWARD, EXAMINING ATTORNEY



David J. Kyros

Director of the United States Patent and Trademark Office

United States of America

United States Patent and Trademark Office

LIVE LIFE NUTRITIOUSLY

Reg. No. 4,154,263

Registered June 5, 2012

Int. Cl.: 43

SERVICE MARK

PRINCIPAL REGISTER

SWIZZLES HOLDINGS, LLC (CONNECTICUT LIMITED LIABILITY COMPANY)
855 MAIN STREET, 5TH FLOOR
BRIDGEPORT, CT 06601

FOR: RESTAURANT SERVICES, IN CLASS 43 (U.S. CLS. 100 AND 101).

FIRST USE 4-15-2011; IN COMMERCE 4-15-2011.

THE MARK CONSISTS OF STANDARD CHARACTERS WITHOUT CLAIM TO ANY PARTICULAR FONT, STYLE, SIZE, OR COLOR.

SN 76-706,990, FILED 3-28-2011.

JACLYN KIDWELL WALKER, EXAMINING ATTORNEY



David J. Kybas

Director of the United States Patent and Trademark Office

United States of America

United States Patent and Trademark Office

SUPERMAX

Reg. No. 4,154,264

Registered June 5, 2012

Int. Cl.: 5

TRADEMARK

PRINCIPAL REGISTER

COOPER, FRANK, J. (UNITED STATES INDIVIDUAL)
18437 MT. LANGLEY ST
#M
FOUNTAIN VALLEY, CA 92708

FOR: MENTHOLATED ANALGESIC SPRAY, MENTHOLATED ANALGESIC CREAM,
MENTHOLATED ANALGESIC GEL, IN CLASS 5 (U.S. CLS. 6, 18, 44, 46, 51 AND 52).

FIRST USE 1-9-2012; IN COMMERCE 1-9-2012.

THE MARK CONSISTS OF STANDARD CHARACTERS WITHOUT CLAIM TO ANY PAR-
TICULAR FONT, STYLE, SIZE, OR COLOR.

SN 76-707,159, FILED 4-8-2011.

DAVID C. REIHNER, EXAMINING ATTORNEY



David J. Kyros

Director of the United States Patent and Trademark Office

United States of America

United States Patent and Trademark Office

REDIFORM

Reg. No. 4,154,265

BENCHMARK, LLC (WASHINGTON LIMITED LIABILITY COMPANY)
7357 SNAKE RIVER ROAD
ASOTIN, WA 99402

Registered June 5, 2012

Int. Cl.: 19

FOR: NON-METAL CASTING FORMS FOR CONCRETE, IN CLASS 19 (U.S. CLS. 1, 12, 33 AND 50).

TRADEMARK

FIRST USE 1-21-2011; IN COMMERCE 1-21-2011.

PRINCIPAL REGISTER

THE MARK CONSISTS OF STANDARD CHARACTERS WITHOUT CLAIM TO ANY PARTICULAR FONT, STYLE, SIZE, OR COLOR.

SN 76-707,177, FILED 4-8-2011.

JAMES MACFARLANE, EXAMINING ATTORNEY



David J. Kyffers

Director of the United States Patent and Trademark Office

United States of America

United States Patent and Trademark Office

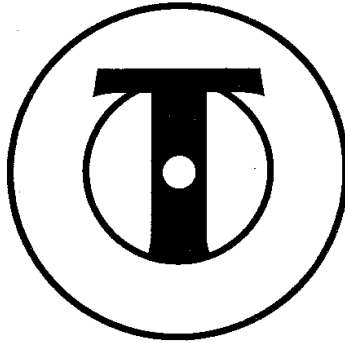

Reg. No. 4,154,266

Registered June 5, 2012

Int. Cl.: 9

TRADEMARK

PRINCIPAL REGISTER

RUSS, YOACHIM C. (UNITED STATES INDIVIDUAL)
1029 TIMBER CREEK DRIVE
ANNAPOLIS, MD 21403

FOR: TELESCOPIC SIGHTS, OPTICAL LENS GUN SCOPES; OPTICAL LENS SIGHTS FOR FIREARMS; SPOTTING SCOPES; LASER RANGEFINDERS; COMPONENT OF OPTICAL LENS SIGHTS IN THE NATURE OF A USER-DEFINED AIMING ENHANCEMENT FEATURE WITHIN THE OPTICAL LENS SCOPE DISPLAY, IN CLASS 9 (U.S. CLS. 21, 23, 26, 36 AND 38).

FIRST USE 7-14-2011; IN COMMERCE 7-14-2011.

THE MARK CONSISTS OF A TARGET DESIGN COMPRISED OF TWO CONCENTRIC CIRCLES, WITH A LETTER "T" IN THE CENTER AND A CIRCLE IN THE MIDDLE OF THE LETTER "T".

SN 76-707,530, FILED 5-9-2011.

LINDSEY RUBIN, EXAMINING ATTORNEY



David J. Kyffers

Director of the United States Patent and Trademark Office

United States of America

United States Patent and Trademark Office

THZ-VASE

Reg. No. 4,154,267

Registered June 5, 2012

Int. Cl.: 9

TRADEMARK

PRINCIPAL REGISTER

J.A. WOOLLAM CO., INC. (NEBRASKA CORPORATION)
645 M ST.
LINCOLN, NE 68508

FOR: EQUIPMENT, NAMELY, ELLIPSOMETER BASED APPARATUS FOR MEASURING THICKNESS, TEMPERATURE CAUSED EFFECTS, AND OPTICAL PROPERTIES OF SEMICONDUCTORS, DISK DRIVES, MAGNETIC DATA STORAGE MEDIA, OPTICAL DATA STORAGE MEDIA, THIN FILMS, MULTIPLE LAYER FILMS AND COATINGS ON SUBSTRATES, AND COMPUTER PROGRAMS NECESSARY FOR CONTROLLING THE ELLIPSOMETER BASED APPARATUS AND FOR ANALYZING ACQUIRED ELLIPSOMETRIC DATA, IN CLASS 9 (U.S. CLS. 21, 23, 26, 36 AND 38).

FIRST USE 12-2-2011; IN COMMERCE 12-2-2011.

THE MARK CONSISTS OF STANDARD CHARACTERS WITHOUT CLAIM TO ANY PARTICULAR FONT, STYLE, SIZE, OR COLOR.

OWNER OF U.S. REG. NOS. 2,349,099, 2,534,923, AND OTHERS.

SN 76-707,791, FILED 5-31-2011.

KAPIL BHANOT, EXAMINING ATTORNEY



David J. Kyros

Director of the United States Patent and Trademark Office

United States of America

United States Patent and Trademark Office

CREIGHTON EDGE

Reg. No. 4,154,268

CREIGHTON UNIVERSITY (NEBRASKA CORPORATION)
2500 CALIFORNIA PLAZA
OMAHA, NE 68178

Registered June 5, 2012

Int. Cl.: 41

FOR: EDUCATIONAL SERVICES, NAMELY, PROVIDING INSTRUCTION AT THE COLLEGE AND POST-GRADUATE LEVEL, IN CLASS 41 (U.S. CLS. 100, 101 AND 107).

SERVICE MARK

FIRST USE 10-23-2011; IN COMMERCE 10-23-2011.

PRINCIPAL REGISTER

THE MARK CONSISTS OF STANDARD CHARACTERS WITHOUT CLAIM TO ANY PARTICULAR FONT, STYLE, SIZE, OR COLOR.

OWNER OF U.S. REG. NO. 2,938,718.

SN 76-709,130, FILED 9-19-2011.

KAREN K. BUSH, EXAMINING ATTORNEY



David J. Kybas

Director of the United States Patent and Trademark Office

United States of America

United States Patent and Trademark Office

UP ALL NIGHT

Reg. No. 4,154,269

Registered June 5, 2012

Int. Cl.: 33

TRADEMARK

PRINCIPAL REGISTER

TASTY COCKTAILS, LLC (NEVADA LIMITED LIABILITY COMPANY)
1323 PANINI DRIVE
HENDERSON, NV 89052

FOR: DRINKS, NAMELY, ALCOHOLIC BEVERAGES CONTAINING FRUIT, WINE, RUM, FLAVOR INFUSED WHISKEY, WINE COOLERS, DISTILLED SPIRITS AND FLAVORED BREWED MALT BEVERAGES, IN CLASS 33 (U.S. CLS. 47 AND 49).

FIRST USE 7-10-2010; IN COMMERCE 7-10-2010.

THE MARK CONSISTS OF STANDARD CHARACTERS WITHOUT CLAIM TO ANY PARTICULAR FONT, STYLE, SIZE, OR COLOR.

SN 76-979,202, FILED 9-13-2010.

JEFFREY LOOK, EXAMINING ATTORNEY



David J. Kyros

Director of the United States Patent and Trademark Office

United States of America

United States Patent and Trademark Office



Reg. No. 4,154,270

Registered June 5, 2012

Int. Cl.: 35

SERVICE MARK

PRINCIPAL REGISTER

IDEAL PROMOTIONS, INC. (ILLINOIS CORPORATION)
4212 W. IRVING PARK ROAD
CHICAGO, IL 60641

FOR: BUSINESS MANAGEMENT AND MARKETING CONSULTING SERVICES FOR ALCOHOLIC BEVERAGE MANUFACTURERS AND RETAILERS, IN THE FIELD OF RETAIL ALCOHOLIC BEVERAGE SALES, IN CLASS 35 (U.S. CLS. 100, 101 AND 102).

FIRST USE 12-31-2007; IN COMMERCE 12-31-2007.

NO CLAIM IS MADE TO THE EXCLUSIVE RIGHT TO USE "BEVERAGE NETWORK", APART FROM THE MARK AS SHOWN.

THE COLOR(S) RED, ORANGE, YELLOW, BLACK, AND WHITE IS/ARE CLAIMED AS A FEATURE OF THE MARK.

THE MARK CONSISTS OF AN ARRAY OF BOTTLES. BELOW THE BOTTLES ARE THE WORDS "IDEAL" AND "BEVERAGE NETWORK" IN WHITE RECTANGULAR SHAPES OUTLINED IN BLACK. THE COLOR RED APPEARS IN THE SECOND AND FOURTH BOTTLE DESIGN, THE COLOR ORANGE APPEARS IN THE THIRD AND SIXTH BOTTLE DESIGN, THE COLOR YELLOW APPEARS IN THE FIRST AND FIFTH BOTTLE DESIGN, THE COLOR WHITE APPEARS ON EACH BOTTLE AS A MEANS OF SHOWING THEIR CONTOURS, AND THE COLOR BLACK APPEARS IN THE TEXT "IDEAL BEVERAGE NETWORK".

SN 77-058,934, FILED 12-7-2006.

LAURA HAMMEL, EXAMINING ATTORNEY



David J. Kyros

Director of the United States Patent and Trademark Office

United States of America

United States Patent and Trademark Office

BIG FISH CANDY CO.

Reg. No. 4,154,271

Registered June 5, 2012

Int. Cl.: 30

TRADEMARK

PRINCIPAL REGISTER

BIG FISH CANDY COMPANY LLC (NEW YORK LIMITED LIABILITY COMPANY)
SUITE 96
333 CENTRAL PARK WEST
NEW YORK, NY 10005

FOR: CANDY; CHOCOLATE CANDIES; TOFFEES; CARAMELS; MARSHMALLOWS;
CHOCOLATE COVERED MARSHMALLOW COOKIES; LOLLIPOPS; LICORICE; TRUFFLES;
GANACHE CANDIES; MOLDED CHOCOLATES WITH FILLINGS; GUMMY CANDIES;
CHOCOLATE COVERED CANDY BARS; CHOCOLATE COVERED NOUGAT BARS; MINTS,
IN CLASS 30 (U.S. CL. 46).

FIRST USE 8-16-2011; IN COMMERCE 8-16-2011.

THE MARK CONSISTS OF STANDARD CHARACTERS WITHOUT CLAIM TO ANY PARTICULAR FONT, STYLE, SIZE, OR COLOR.

NO CLAIM IS MADE TO THE EXCLUSIVE RIGHT TO USE "CANDY", APART FROM THE MARK AS SHOWN.

SN 77-099,075, FILED 2-5-2007.

LEIGH CAROLINE CASE, EXAMINING ATTORNEY



David J. Kyffers

Director of the United States Patent and Trademark Office

United States of America

United States Patent and Trademark Office

AVENTINO

Reg. No. 4,154,272

LEAR CORPORATION (DELAWARE CORPORATION)
21557 TELEGRAPH ROAD
SOUTHFIELD, MI 48033

Registered June 5, 2012

Int. Cls.: 12 and 24

FOR: SEAT COVERS FOR VEHICLES; FITTED VEHICLE COVERS; COVERS FOR VEHICLE INTERIORS, NAMELY, COVERS FOR STEERING WHEELS, GEAR SHIFTS, DASHBOARD COVERS, CONSOLES AND ARMRESTS; UPHOLSTERY FOR VEHICLES PREPARED WITH THE USE OF LEATHER, IN CLASS 12 (U.S. CLS. 19, 21, 23, 31, 35 AND 44).

TRADEMARK

PRINCIPAL REGISTER

FIRST USE 1-8-2007; IN COMMERCE 1-8-2007.

FOR: UNFITTED COVERS FOR SEATING FURNITURE NOT OF PAPER AND PREPARED WITH THE USE OF LEATHER, IN CLASS 24 (U.S. CLS. 42 AND 50).

FIRST USE 1-8-2007; IN COMMERCE 1-8-2007.

THE MARK CONSISTS OF STANDARD CHARACTERS WITHOUT CLAIM TO ANY PARTICULAR FONT, STYLE, SIZE, OR COLOR.

THE TERM "AVENTINO" HAS NO MEANING IN A FOREIGN LANGUAGE.

SN 77-172,306, FILED 5-3-2007.

TRACY FLETCHER, EXAMINING ATTORNEY



David J. Kybas

Director of the United States Patent and Trademark Office

United States of America

United States Patent and Trademark Office

MasterCard MoneySend

Reg. No. 4,154,273

Registered June 5, 2012

Int. Cl.: 36

SERVICE MARK

PRINCIPAL REGISTER

MASTERCARD INTERNATIONAL INCORPORATED (DELAWARE CORPORATION)
2000 PURCHASE STREET
PURCHASE, NY 10577

FOR: FINANCIAL SERVICES IN THE NATURE OF PERSONAL BANKING AND MONEY TRANSFER SERVICES IN THE NATURE OF WEB-BASED MONEY TRANSFERS PROVIDED BY MEANS OF A GLOBAL COMPUTER NETWORK; PROVIDING MONETARY PAYMENT SERVICES TO CONSUMERS AND BUSINESSES VIA A GLOBAL COMPUTER NETWORK IN THE NATURE OF PERSON TO PERSON, PERSON TO BUSINESS AND BUSINESS TO BUSINESS PAYMENTS; ELECTRONIC FINANCIAL CLEARING HOUSE SERVICES; ELECTRONIC PAYMENT, NAMELY, ELECTRONIC PROCESSING AND TRANSMISSION OF BILL PAYMENT DATA; STORED VALUE ELECTRONIC PURSE SERVICES, NAMELY, PROVIDING ON-LINE STORED VALUE ACCOUNTS IN AN ELECTRONIC ENVIRONMENT; PROVIDING ELECTRONIC FUNDS AND CURRENCY TRANSFER SERVICES; ELECTRONIC PAYMENT SERVICES FOR PERSONAL BANKING IN THE NATURE OF ELECTRONIC FUNDS TRANSFER AND FINANCIAL CLEARINGHOUSE SERVICES VIA A GLOBAL COMPUTER NETWORK; ELECTRONIC BILL PAYMENT; CLEARING AND RECONCILING FINANCIAL TRANSACTIONS VIA A GLOBAL COMPUTER NETWORK; PERSON-TO-PERSON AND PERSON-TO-BUSINESS MONEY TRANSFER SERVICES TRANSACTED BY MEANS OF A COMPUTER NETWORK; BILL PAYMENT REMITTANCE SERVICES; ELECTRONIC TRANSFER OF MONEY FROM CUSTOMER TO CUSTOMER; CHEQUE VERIFICATION SERVICES; THE PROVISION OF FINANCIAL INFORMATION FOR THE SUPPORT OF RETAIL SERVICES PROVIDED ON-LINE, THROUGH NETWORKS OR OTHER ELECTRONIC MEANS USING ELECTRONICALLY DIGITIZED INFORMATION, IN THE NATURE OF BILL REMITTANCE AND PAYMENT DATA; ELECTRONIC BILL PAYMENT SERVICES PROVIDED THROUGH A WEBSITE; ON-LINE BANKING; FINANCIAL SERVICES IN THE NATURE OF WEB-BASED MONEY TRANSFER PROVIDED OVER THE TELEPHONE AND BY MEANS OF A GLOBAL COMPUTER NETWORK OR THE INTERNET, IN CLASS 36 (U.S. CLS. 100, 101 AND 102).



FIRST USE 11-1-2007; IN COMMERCE 11-1-2007.

OWNER OF U.S. REG. NOS. 1,186,117, 2,321,914, AND OTHERS.

David J. Kyjars

Director of the United States Patent and Trademark Office

THE MARK CONSISTS OF THE WORDING "MASTERCARD", WITH THE WORDING "MONEYSSEND" APPEARING AS ONE WORD, DIRECTLY BELOW THE WORDING "MASTERCARD".

Reg. No. 4,154,273 SN 77-183,804, FILED 5-17-2007.

CHRISTINE COOPER, EXAMINING ATTORNEY

United States of America

United States Patent and Trademark Office

AVID

Reg. No. 4,154,274

Registered June 5, 2012

Int. Cl.: 35

SERVICE MARK

PRINCIPAL REGISTER

AVID TECHNOLOGY, INC. (DELAWARE CORPORATION)
ATTN: TRADEMARK ADMINISTRATOR
75 NETWORK DRIVE
BURLINGTON, MA 01803

FOR: BUSINESS CONSULTING AND INFORMATION SERVICES IN THE FIELDS OF COMPUTER HARDWARE, COMPUTER SOFTWARE, COMPUTER PERIPHERALS, ENTERTAINMENT, MUSIC, AUDIO, TELEVISION, FILM, BROADCAST, VIDEO, GAMING, 3D, SPECIAL EFFECTS AND ANIMATION; BUSINESS RESEARCH AND SURVEYS IN THE FIELDS OF COMPUTER HARDWARE, COMPUTER SOFTWARE, COMPUTER PERIPHERALS, ENTERTAINMENT, MUSIC, AUDIO, TELEVISION, FILM, BROADCAST, VIDEO, GAMING, 3D, SPECIAL EFFECTS AND ANIMATION; ON-LINE RETAIL STORE SERVICES FEATURING COMPUTER HARDWARE, COMPUTER SOFTWARE, PERIPHERALS, MUSICAL INSTRUMENTS, AUDIO EQUIPMENT, AND VIDEO EQUIPMENT, IN CLASS 35 (U.S. CLS. 100, 101 AND 102).

FIRST USE 4-0-1996; IN COMMERCE 4-0-1996.

THE MARK CONSISTS OF STANDARD CHARACTERS WITHOUT CLAIM TO ANY PARTICULAR FONT, STYLE, SIZE, OR COLOR.

SN 77-217,843, FILED 6-28-2007.

DAWN FELDMAN, EXAMINING ATTORNEY



David J. Kybas

Director of the United States Patent and Trademark Office

United States of America

United States Patent and Trademark Office

Green Squad

Reg. No. 4,154,275

Registered June 5, 2012

Int. Cl.: 35

SERVICE MARK

PRINCIPAL REGISTER

THE GREEN SQUAD, INC. (FLORIDA CORPORATION)
905 M.L.K. JR. DR.
SUITE 250
TARPON SPRINGS, FL 34689

FOR: DISTRIBUTORSHIP, RETAIL STORE AND ONLINE RETAIL STORE SERVICES IN THE FIELD OF ENERGY EFFICIENT AND ENVIRONMENTALLY FRIENDLY PRODUCTS, NAMELY, TANKLESS HOT WATER HEATERS, ENERGY RECOVERY UNITS, HIGH EFFICIENCY AIR CONDITIONING UNITS, AIR AND WATER FILTERS, SOLAR HEATING UNITS, INSULATED WINDOWS, TINTED WINDOWS, WINDOW FILM, FOAM INSULATION, RECYCLED CLOTHING AND PAPER PRODUCTS, INSULATED ROOFING, ATTIC FANS AND VENTS, SOLAR ROOF FANS, WIND ENERGY GENERATORS, LOW FLOW TOILETS AND SINK FAUCETS, INSULATED DOORS, WEATHER STRIPPING, ENERGY EFFICIENT LIGHTING, COMPACT FLUORESCENT LIGHT BULBS, LOW WATER LANDSCAPING SYSTEMS, ZEROSCAPE LANDSCAPING SYSTEMS, LOW WATER IRRIGATION SYSTEMS, DRIP AND MAT IRRIGATIONS SYSTEMS, NON TOXIC CLEANING PRODUCTS FOR CLOTHES, BATHROOMS, KITCHENS AND FLOORS, FERTILIZERS AND PEST CONTROL CHEMICALS AND BUILDING PRODUCTS, NAMELY, PAINT, FLOORING, CARPET, TILES; CONSULTATION SERVICES RELATED TO ENERGY EFFICIENT PRODUCTS IN THE NATURE OF TANKLESS HOT WATER HEATERS, ENERGY RECOVERY UNITS, HIGH EFFICIENCY AIR CONDITIONING UNITS, AIR AND WATER FILTERS, SOLAR HEATING UNITS, INSULATED WINDOWS, TINTED WINDOWS, WINDOW FILM, FOAM INSULATION, RECYCLED CLOTHING AND PAPER PRODUCTS, INSULATED ROOFING, ATTIC FANS AND VENTS, SOLAR ROOF FANS, WIND ENERGY GENERATORS, LOW FLOW TOILETS AND SINK FAUCETS, INSULATED DOORS, WEATHER STRIPPING, ENERGY EFFICIENT LIGHTING, COMPACT FLUORESCENT LIGHT BULBS, LOW WATER LANDSCAPING SYSTEMS, ZEROSCAPE LANDSCAPING SYSTEMS, LOW WATER IRRIGATION SYSTEMS, DRIP AND MAT IRRIGATIONS SYSTEMS, NON TOXIC CLEANING PRODUCTS FOR CLOTHES, BATHROOMS, KITCHENS AND FLOORS, FERTILIZERS AND PEST CONTROL CHEMICALS AND BUILDING PRODUCTS, NAMELY, PAINT, FLOORING, CARPET, TILES, IN CLASS 35 (U.S. CLS. 100, 101 AND 102).

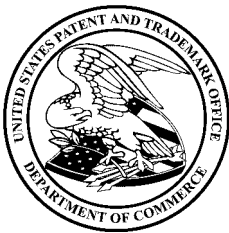

David J. Kyros

Director of the United States Patent and Trademark Office

FIRST USE 10-5-2011; IN COMMERCE 10-5-2011.

THE MARK CONSISTS OF STANDARD CHARACTERS WITHOUT CLAIM TO ANY PARTICULAR FONT, STYLE, SIZE, OR COLOR.

Reg. No. 4,154,275 NO CLAIM IS MADE TO THE EXCLUSIVE RIGHT TO USE "GREEN", APART FROM THE MARK AS SHOWN.

SN 77-240,225, FILED 7-27-2007.

KAREN BRACEY, EXAMINING ATTORNEY

United States of America

United States Patent and Trademark Office

بترو رابغ

Reg. No. 4,154,276

Registered June 5, 2012

Int. Cl.: 1

TRADEMARK

PRINCIPAL REGISTER

SUMITOMO CHEMICAL CO., LTD. (JAPAN CORPORATION)
27-1, SHINKAWA 2-CHOME, CHUO-KU
TOKYO, JAPAN 104-8260

FOR: ARTIFICIAL RESIN, UNPROCESSED PLASTICS IN THE FORM OF POWDER, GRANULES, LIQUID OR PASTE; CHEMICALS USED IN INDUSTRIAL MATERIALS OR PRODUCTS, PLANTS, LABORATORIES, AND PHOTOGRAPHY, NAMELY, ETHYLENE GLYCOL AND PROPYLENE OXIDE; CHEMICALS USED IN AGRICULTURE, HORTICULTURE AND FORESTRY, NAMELY, ETHYLENE GLYCOL AND PROPYLENE OXIDE, IN CLASS 1 (U.S. CLS. 1, 5, 6, 10, 26 AND 46).

FIRST USE 4-4-2009; IN COMMERCE 4-4-2010.

THE MARK CONSISTS OF BLACK ARABIC LETTERING.

THE ENGLISH TRANSLITERATION OF THE NON-LATIN WORDING IN THE MARK IS "PETRORABIGH".

THE ENGLISH TRANSLATION OF THE ARABIC LETTERING IN THE MARK IS PETRORABIGH.

SN 77-252,957, FILED 8-10-2007.

RAUL CORDOVA, EXAMINING ATTORNEY



David J. Kypos

Director of the United States Patent and Trademark Office

United States of America

United States Patent and Trademark Office

ALBANY GOLF & BEACH CLUB

Reg. No. 4,154,277

Registered June 5, 2012

Int. Cl.: 41

SERVICE MARK

PRINCIPAL REGISTER

PARK RIDGE SECURITIES CORP. (BAHAMAS CORPORATION)
P.O. BOX N7776
LYFORD CAY, NEW PROVIDENCE, BAHAMAS

FOR: HEALTH CLUB SERVICES, NAMELY, PROVIDING INSTRUCTION AND EQUIPMENT IN THE FIELD OF PHYSICAL EXERCISE; PROVIDING GOLF COURSE FACILITIES, PROVIDING GOLF INSTRUCTION AND ENTERTAINMENT IN THE NATURE OF GOLF TOURNAMENTS, AND PROVIDING EDUCATIONAL SERVICES, NAMELY, CONDUCTING SEMINARS, WORKSHOPS AND CLASSES IN THE FIELD OF GOLF; PROVIDING PHYSICAL FITNESS INFORMATION AND CONSULTATION, IN CLASS 41 (U.S. CLS. 100, 101 AND 107).

FIRST USE 10-4-2010; IN COMMERCE 10-4-2010.

THE MARK CONSISTS OF STANDARD CHARACTERS WITHOUT CLAIM TO ANY PARTICULAR FONT, STYLE, SIZE, OR COLOR.

NO CLAIM IS MADE TO THE EXCLUSIVE RIGHT TO USE "GOLF & BEACH CLUB", APART FROM THE MARK AS SHOWN.

SN 77-263,879, FILED 8-24-2007.

BARBARA RUTLAND, EXAMINING ATTORNEY



David J. Kybas

Director of the United States Patent and Trademark Office

United States of America

United States Patent and Trademark Office

BLUE CHAIR BAY

Reg. No. 4,154,278

Registered June 5, 2012

Int. Cl.: 25

TRADEMARK

PRINCIPAL REGISTER

CHESNEY, KENNY (UNITED STATES INDIVIDUAL)
C/O GREENBERG TRAUIG, LLP
3290 NORTHSIDE PARKWAY, SUITE 400
ATLANTA, GA 30327

FOR: CLOTHING, NAMELY, BATHING SUITS, BEACHWEAR, BLOUSES, DRESSES, JACKETS, PANTS, POLO SHIRTS, SHORTS, SWEATSHIRTS, SWIMWEAR, FOOTWEAR, IN CLASS 25 (U.S. CLS. 22 AND 39).

FIRST USE 2-0-2010; IN COMMERCE 2-0-2010.

THE MARK CONSISTS OF STANDARD CHARACTERS WITHOUT CLAIM TO ANY PARTICULAR FONT, STYLE, SIZE, OR COLOR.

SN 77-269,582, FILED 8-31-2007.

DEBRA LEE, EXAMINING ATTORNEY



David J. Kybas

Director of the United States Patent and Trademark Office

United States of America

United States Patent and Trademark Office

TUFF CONNECT

Reg. No. 4,154,279

WESTEK ELECTRONICS, INC. (CALIFORNIA CORPORATION)
314 WESTRIDGE DR.
WATSONVILLE, CA 95076

Registered June 5, 2012

Int. Cl.: 9

FOR: ELECTRICAL COMMUNICATION CORD WITH PLUGS, IN CLASS 9 (U.S. CLS. 21, 23, 26, 36 AND 38).

TRADEMARK

FIRST USE 10-5-2011; IN COMMERCE 10-5-2011.

PRINCIPAL REGISTER

THE MARK CONSISTS OF STANDARD CHARACTERS WITHOUT CLAIM TO ANY PARTICULAR FONT, STYLE, SIZE, OR COLOR.

NO CLAIM IS MADE TO THE EXCLUSIVE RIGHT TO USE "CONNECT", APART FROM THE MARK AS SHOWN.

SN 77-289,651, FILED 9-26-2007.

ELIZABETH HUGHITT, EXAMINING ATTORNEY



David J. Kyffers

Director of the United States Patent and Trademark Office

United States of America

United States Patent and Trademark Office

infobook

Reg. No. 4,154,280

Registered June 5, 2012

Int. Cls.: 35, 38, 41, and 42

SERVICE MARK

PRINCIPAL REGISTER

FELLERS, JAMES D. (UNITED STATES INDIVIDUAL)
16535 AVARANCHE WAY
ROUND ROCK, TX 78681

FOR: ADVERTISING SERVICES, NAMELY, PROMOTING THE GOODS AND SERVICES OF OTHERS BY PREPARING AND PLACING ADVERTISEMENTS IN DIRECTORY LISTING DATABASES ACCESSED THROUGH A GLOBAL INFORMATION NETWORK; PROVIDING RETAIL STORE INFORMATION, SHOPPERS GUIDE INFORMATION AND BUSINESS LISTINGS BY ELECTRONIC MEANS; COMPUTER SERVICES, NAMELY, PROVIDING INFORMATION VIA A GLOBAL COMPUTER INFORMATION NETWORK IN THE FIELD OF COMMERCIAL INFORMATION DIRECTORIES ABOUT BUSINESSES AND INDIVIDUALS, IN CLASS 35 (U.S. CLS. 100, 101 AND 102).

FIRST USE 3-9-2012; IN COMMERCE 3-9-2012.

FOR: TELECOMMUNICATIONS SERVICES, NAMELY, ELECTRONIC TRANSMISSION OF DATA, IMAGES, AND DOCUMENTS VIA COMPUTER TERMINALS AND AUDIOVISUAL EQUIPMENT; PREPAID LONG DISTANCE TELEPHONE COMMUNICATION SERVICES; ELECTRONIC MAIL SERVICES; AND FACSIMILE TRANSMISSION; PROVIDING WORK-GROUP COMMUNICATION SERVICES OVER COMPUTER NETWORKS; PROVIDING MULTIPLE USER ACCESS TO PROPRIETARY COLLECTIONS OF INFORMATION BY MEANS OF GLOBAL COMPUTER INFORMATION NETWORKS; CABLE AND SATELLITE TELEVISION BROADCASTING, IN CLASS 38 (U.S. CLS. 100, 101 AND 104).

FIRST USE 3-9-2012; IN COMMERCE 3-9-2012.

FOR: PROVIDING INFORMATION IN THE FIELD OF MUSIC, ARTS, CULTURE AND HISTORY VIA COMPUTER NETWORKS; PROVIDING NEWS IN THE NATURE OF CURRENT EVENTS REPORTING; ENTERTAINMENT SERVICES IN THE NATURE OF CABLE AND SATELLITE TELEVISION PROGRAMMING; ARRANGING LIVE CONCERTS, TELEVISION AWARD SHOWS, AND SEMINARS, IN CLASS 41 (U.S. CLS. 100, 101 AND 107).

FIRST USE 3-9-2012; IN COMMERCE 3-9-2012.

FOR: COMPUTER SERVICES, NAMELY, PROVIDING CUSTOMIZED ONLINE WEB PAGES FEATURING USER-DEFINED INFORMATION, SEARCH ENGINES AND ONLINE WEB LINKS TO NEWS, WEATHER, SPORTS, CURRENT EVENTS, REFERENCE MATERIALS,



David J. Kyjars

Director of the United States Patent and Trademark Office

Reg. No. 4,154,280 AND CUSTOMIZED E-MAIL MESSAGES, CONCERNING USER-DEFINED TOPICS OF GENERAL INTEREST; GRAPHIC ART SERVICES FOR USE IN THE DEVELOPMENT OF WEB PAGES; PROVIDING SOFTWARE INTERFACES AVAILABLE OVER A NETWORK IN ORDER TO CREATE A PERSONALIZED ON-LINE INFORMATION SERVICE; EXTRACTION AND RETRIEVAL OF INFORMATION AND DATA MINING BY MEANS OF GLOBAL COMPUTER NETWORKS; CREATING INDEXES OF INFORMATION, INDEXES OF WEB SITES AND INDEXES OF OTHER INFORMATION SOURCES IN CONNECTION WITH GLOBAL COMPUTER NETWORKS, IN CLASS 42 (U.S. CLS. 100 AND 101).

FIRST USE 3-9-2012; IN COMMERCE 3-9-2012.

THE MARK CONSISTS OF A CIRCLE UPON WHICH A STYLIZED LOWER-CASE LETTER "I" IS SUPERIMPOSED; THE STYLIZED LETTER "I" WITHIN THE CIRCLE IS FOLLOWED BY A STYLIZED LOWERCASE "N", WHICH STRADDLES THE OUTER EDGE OF THE CIRCLE, FOLLOWED BY THE STYLIZED LETTERS "F", "O", "B", "O", "O", "K", RESPECTIVELY.

SN 77-305,668, FILED 10-17-2007.

ALEXANDER L. POWERS, EXAMINING ATTORNEY

United States of America

United States Patent and Trademark Office

MARK NASON

Reg. No. 4,154,281

SKECHERS U.S.A., INC. II (DELAWARE CORPORATION)
228 MANHATTAN BEACH BLVD.
MANHATTAN BEACH, CA 90266

Registered June 5, 2012

Int. Cl.: 18

FOR: LEATHER BAGS, NAMELY, PURSES, HANDBAGS, WALLETS, DUFFLE BAGS, AND MESSENGER BAGS, IN CLASS 18 (U.S. CLS. 1, 2, 3, 22 AND 41).

TRADEMARK

FIRST USE 7-3-2007; IN COMMERCE 7-3-2007.

PRINCIPAL REGISTER

THE MARK CONSISTS OF STANDARD CHARACTERS WITHOUT CLAIM TO ANY PARTICULAR FONT, STYLE, SIZE, OR COLOR.

OWNER OF U.S. REG. NOS. 2,865,769 AND 3,133,663.

THE NAME(S), PORTRAIT(S), AND/OR SIGNATURE(S) SHOWN IN THE MARK IDENTIFIES "MARK NASON", WHOSE CONSENT(S) TO REGISTER IS SUBMITTED.

SN 77-323,915, FILED 11-7-2007.

JESSICA A. POWERS, EXAMINING ATTORNEY



David J. Kyros

Director of the United States Patent and Trademark Office

United States of America

United States Patent and Trademark Office

ECOSMART

Reg. No. 4,154,282

Registered June 5, 2012

Int. Cl.: 9

TRADEMARK

PRINCIPAL REGISTER

TARGUS GROUP INTERNATIONAL, INC. (DELAWARE CORPORATION)
1211 N. MILLER STREET
ANAHEIM, CA 92806

FOR: COMPUTER CARRYING CASES; MESSENGER BAGS ESPECIALLY DESIGNED FOR HOLDING LAPTOPS AND NOTEBOOK COMPUTERS; BACKPACKS ESPECIALLY ADAPTED FOR HOLDING LAPTOPS AND NOTEBOOK COMPUTERS, IN CLASS 9 (U.S. CLS. 21, 23, 26, 36 AND 38).

FIRST USE 6-5-2009; IN COMMERCE 6-5-2009.

THE MARK CONSISTS OF STANDARD CHARACTERS WITHOUT CLAIM TO ANY PARTICULAR FONT, STYLE, SIZE, OR COLOR.

SN 77-334,056, FILED 11-20-2007.

GIANCARLO CASTRO, EXAMINING ATTORNEY



David J. Kybas

Director of the United States Patent and Trademark Office

United States of America

United States Patent and Trademark Office

The logo for NADAKS features a stylized design on the left consisting of a grid of vertical bars. The central bar is red, while the others are black. To the right of this design, the word "NADAKS" is written in a bold, black, sans-serif font.

Reg. No. 4,154,283

NA, CHUN KYUN (REPUBLIC OF KOREA INDIVIDUAL)
422-4, SINDANG 2-DONG, JUNG-GU
SEOUL, REPUBLIC OF KOREA 100-834

Registered June 5, 2012

Int. Cl.: 25

FOR: SHOES, IN CLASS 25 (U.S. CLS. 22 AND 39).

TRADEMARK

FIRST USE 8-15-2011; IN COMMERCE 10-21-2011.

PRINCIPAL REGISTER

THE MARK CONSISTS OF THE FANCIFUL WORD "NADAKS" WITH A DESIGN ELEMENT IN FRONT AND A STYLIZED "K" MAKING A FANCIFUL STICK PERSON. THE COLOR BLACK APPEARS IN THE LETTERS "NADA" AND "S", AND IN THE OUTER PERIMETER OF THE DESIGN TO THE LEFT OF THE WORDING "NADAKS". THE COLOR RED APPEARS IN THE PORTION OF THE DESIGN ELEMENT TO THE LEFT OF THE WORDING "NADAKS". THE LETTER "K" WHICH FORMS A FANCIFUL STICK PERSON APPEARS IN THE COLOR BLACK.

THE COLOR(S) RED AND BLACK IS/ARE CLAIMED AS A FEATURE OF THE MARK.

SN 77-339,376, FILED 11-28-2007.

NANCY CLARKE, EXAMINING ATTORNEY



David J. Kyffers

Director of the United States Patent and Trademark Office

United States of America

United States Patent and Trademark Office

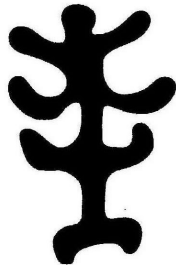

Step by Step

Reg. No. 4,154,284

Registered June 5, 2012

Int. Cl.: 28

TRADEMARK

PRINCIPAL REGISTER

STARRY LTD. (HONG KONG PRIVATE LIMITED COMPANY)
4B, 12 SHIPYARD LANE
QUARRY BAY, HONG KONG

FOR: TOYS AND RELATED GOODS, NAMELY, TOY VEHICLES, RIDE-ON TOYS, TOY CARS, BOARD GAMES, TOY BUILDING BRICKS, DOLLS AND TOY FIGURES AND ACCESSORIES FOR THE AFORESAID, BEAN BAG DOLLS, DOLL PLAYSETS, MUSICAL TOYS, BATH TOYS, INFLATABLE TOYS, PLUSH AND CLOTH TOYS, SPORT BALLS, BALLS FOR GAMES, BALLOONS, HAND HELD BATTERY OPERATED GAMES, PUZZLES, EDUCATIONAL TOYS, NAMELY, MANIPULATIVE BLOCKS FOR DISPLAYING PATTERNS AND GROUPINGS, ELECTRONIC EDUCATIONAL GAME MACHINES FOR CHILDREN, MANIPULATIVE GAMES, TOY ROBOTS, MECHANICAL TOYS, TOY MOBILES, CHILDREN'S MULTIPLE ACTIVITY TOYS, ELECTRIC ACTION TOYS, ELECTRONIC GAMES, NAMELY, ELECTRONIC GAMES OTHER THAN THOSE ADAPTED FOR USE WITH TELEVISION RECEIVERS ONLY, RADIO-CONTROLLED TOY VEHICLES, BATTERY OPERATED REMOTE CONTROLLED TOY VEHICLES, CARD GAMES, ELECTRONICALLY OPERATED INTERACTIVE TOY FIGURES, SCALE MODEL FIGURES, SCALE MODEL VEHICLES, PARTS AND FITTINGS FOR THE AFORESAID, IN CLASS 28 (U.S. CLS. 22, 23, 38 AND 50).

FIRST USE 12-22-2011; IN COMMERCE 12-22-2011.

SN 77-339,801, FILED 11-29-2007.

BRIAN NEVILLE, EXAMINING ATTORNEY



David J. Kyffers

Director of the United States Patent and Trademark Office

United States of America

United States Patent and Trademark Office

BELLEZZA

Reg. No. 4,154,285

Registered June 5, 2012

Int. Cl.: 19

TRADEMARK

PRINCIPAL REGISTER

KRONOTEX U.S.A. HOLDINGS, INC. (DELAWARE CORPORATION)
810 TECHNOLOGY DRIVE
BARNWELL, SC 29812

FOR: LAMINATE FLOORING, IN CLASS 19 (U.S. CLS. 1, 12, 33 AND 50).

FIRST USE 1-31-2008; IN COMMERCE 1-31-2008.

THE MARK CONSISTS OF STANDARD CHARACTERS WITHOUT CLAIM TO ANY PARTICULAR FONT, STYLE, SIZE, OR COLOR.

THE FOREIGN WORDING IN THE MARK TRANSLATES INTO ENGLISH AS BEAUTIFUL.

SN 77-365,075, FILED 1-6-2008.

STEVEN R. FINE, EXAMINING ATTORNEY



David J. Kyffers

Director of the United States Patent and Trademark Office

United States of America

United States Patent and Trademark Office

MUSIC WORLD KIDS

Reg. No. 4,154,286

Registered June 5, 2012

Int. Cl.: 9

TRADEMARK

PRINCIPAL REGISTER

KNOWLES, MATHEW (UNITED STATES INDIVIDUAL)
1505 HADLEY STREET
HOUSTON, TX 77002

FOR: CDS AND CD-ROMS FEATURING ANIMATED CHARACTERS; DVDS, PRE-RECORDED VIDEO CASSETTES, DIGITAL VIDEO DISCS, DIGITAL VERSATILE DISCS, DOWNLOADABLE AUDIO AND VIDEO RECORDINGS, DVDS, AND HIGH DEFINITION DIGITAL DISKS FEATURING ENTERTAINMENT COMPRISING OF MUSICAL PERFORMANCES, DRAMATIC PERFORMANCES AND COMEDIC PERFORMANCES, IN CLASS 9 (U.S. CLS. 21, 23, 26, 36 AND 38).

FIRST USE 11-4-2008; IN COMMERCE 11-0-2008.

THE MARK CONSISTS OF STANDARD CHARACTERS WITHOUT CLAIM TO ANY PARTICULAR FONT, STYLE, SIZE, OR COLOR.

NO CLAIM IS MADE TO THE EXCLUSIVE RIGHT TO USE "KIDS" AND "MUSIC", APART FROM THE MARK AS SHOWN.

SN 77-377,989, FILED 1-22-2008.

ANGELA M. MICHELI, EXAMINING ATTORNEY



David J. Kybas

Director of the United States Patent and Trademark Office

United States of America

United States Patent and Trademark Office

APPLIED BIOSYSTEMS

Reg. No. 4,154,287

Registered June 5, 2012

Int. Cl.: 5

TRADEMARK

PRINCIPAL REGISTER

APPLIED BIOSYSTEMS, LLC (DELAWARE COMPANY)
850 LINCOLN CENTRE DRIVE
FOSTER CITY, CA 94404

FOR: DIAGNOSTIC REAGENTS AND KITS COMPRISED OF DIAGNOSTIC REAGENTS FOR CLINICAL OR MEDICAL LABORATORY USE; MEDICAL DIAGNOSTIC REAGENTS AND KITS COMPRISED OF MEDICAL DIAGNOSTIC REAGENTS; CLINICAL MEDICAL REAGENTS AND KITS COMPRISED OF CLINICAL MEDICAL REAGENTS, IN CLASS 5 (U.S. CLS. 6, 18, 44, 46, 51 AND 52).

FIRST USE 7-1-2011; IN COMMERCE 7-1-2011.

THE MARK CONSISTS OF STANDARD CHARACTERS WITHOUT CLAIM TO ANY PARTICULAR FONT, STYLE, SIZE, OR COLOR.

OWNER OF U.S. REG. NOS. 2,260,626, 2,369,769, AND OTHERS.

SN 77-379,613, FILED 1-24-2008.

JANICE L. MCMORROW, EXAMINING ATTORNEY



David J. Kyjars

Director of the United States Patent and Trademark Office

United States of America

United States Patent and Trademark Office

Rum Creek

Reg. No. 4,154,288

Registered June 5, 2012

Int. Cl.: 33

TRADEMARK

PRINCIPAL REGISTER

BISON CAPITAL LLC (FLORIDA LIMITED LIABILITY COMPANY)
SUITE 200
735 E VENICE AVE
VENICE, FL 34285

FOR: DISTILLED SPIRITS, IN CLASS 33 (U.S. CLS. 47 AND 49).

FIRST USE 11-14-2011; IN COMMERCE 11-14-2011.

THE MARK CONSISTS OF STANDARD CHARACTERS WITHOUT CLAIM TO ANY PARTICULAR FONT, STYLE, SIZE, OR COLOR.

NO CLAIM IS MADE TO THE EXCLUSIVE RIGHT TO USE "RUM", APART FROM THE MARK AS SHOWN.

SN 77-381,274, FILED 1-25-2008.

WON TEAK OH, EXAMINING ATTORNEY



David J. Kybas

Director of the United States Patent and Trademark Office

United States of America

United States Patent and Trademark Office

VERITIX

Reg. No. 4,154,289

Registered June 5, 2012

Int. Cl.: 42

SERVICE MARK

PRINCIPAL REGISTER

FLASH SEATS VERTICAL ALLIANCE LLC (DELAWARE LIMITED LIABILITY COMPANY)
1500 WEST THIRD STREET, SUITE 500
CLEVELAND, OH 44113

FOR: CONSULTING SERVICES IN THE FIELD OF DESIGN, SELECTION, IMPLEMENTATION AND USE OF SOFTWARE SYSTEMS FOR OTHERS IN THE FIELD OF DISPENSING OF TICKETS TO ENTERTAINMENT AND SPORTING EVENTS VIA THE INTERNET, IN CLASS 42 (U.S. CLS. 100 AND 101).

FIRST USE 2-29-2012; IN COMMERCE 2-29-2012.

THE MARK CONSISTS OF STANDARD CHARACTERS WITHOUT CLAIM TO ANY PARTICULAR FONT, STYLE, SIZE, OR COLOR.

SN 77-385,263, FILED 1-31-2008.

BERNICE MIDDLETON, EXAMINING ATTORNEY



David J. Kybas

Director of the United States Patent and Trademark Office

United States of America

United States Patent and Trademark Office

REPORT SIGNATURE

Reg. No. 4,154,290

THE TOPLINE CORPORATION (WASHINGTON CORPORATION)
13150 SOUTHEAST 32ND STREET
BELLEVUE, WA 980054436

Registered June 5, 2012

Int. Cl.: 14

FOR: WOMEN'S JEWELRY; WOMEN'S WATCHES, IN CLASS 14 (U.S. CLS. 2, 27, 28 AND 50).

TRADEMARK

FIRST USE 7-0-2010; IN COMMERCE 7-0-2010.

PRINCIPAL REGISTER

THE MARK CONSISTS OF STANDARD CHARACTERS WITHOUT CLAIM TO ANY PARTICULAR FONT, STYLE, SIZE, OR COLOR.

OWNER OF U.S. REG. NOS. 2,169,637, 3,246,085, AND 3,358,128.

SN 77-396,001, FILED 2-13-2008.

GILBERT SWIFT, EXAMINING ATTORNEY



David J. Kyffers

Director of the United States Patent and Trademark Office

United States of America

United States Patent and Trademark Office

OMKASA

Reg. No. 4,154,291

Registered June 5, 2012

Int. Cls.: 24 and 35

TRADEMARK

SERVICE MARK

PRINCIPAL REGISTER

OMKASA (COLORADO LIMITED LIABILITY COMPANY)
10711, PINEWALK WAY
HIGHLANDS RANCH, CO 80130

FOR: TEXTILES AND TEXTILE GOODS, NAMELY, CUSHION COVERS, PILLOW COVERS; DRAPERIES; THROWS; TAPESTRIES OF TEXTILE; TABLE LINEN, NAMELY, PLACE MATS, TABLE RUNNERS, NAPKINS, COASTERS, FABRIC NAPKIN RINGS, FABRICS FOR TEXTILE USE; WALL HANGINGS OF TEXTILE, CURTAINS OF TEXTILE, IN CLASS 24 (U.S. CLS. 42 AND 50).

FIRST USE 4-7-2012; IN COMMERCE 4-7-2012.

FOR: ONLINE RETAIL STORE SERVICES FEATURING CURTAINS, DRAPERIES, THROWS, CUSHIONS, PILLOWS, PLACE MATS, TABLE RUNNERS, COASTERS, NAPKINS, NAPKIN RINGS, PURSES, HAND BAGS, SHAWLS, JEWELRY OF PRECIOUS METAL, STONES AND GEMSTONES, IN CLASS 35 (U.S. CLS. 100, 101 AND 102).

FIRST USE 4-7-2012; IN COMMERCE 4-7-2012.

THE MARK CONSISTS OF STANDARD CHARACTERS WITHOUT CLAIM TO ANY PARTICULAR FONT, STYLE, SIZE, OR COLOR.

THE WORDING "OMKASA" HAS NO MEANING IN A FOREIGN LANGUAGE.

SN 77-396,891, FILED 2-14-2008.

DOMINIC J. FERRAIUOLO, EXAMINING ATTORNEY



David J. Kyros

Director of the United States Patent and Trademark Office

United States of America

United States Patent and Trademark Office

BORN FREE

Reg. No. 4,154,292

Registered June 5, 2012

Int. Cl.: 29

TRADEMARK

PRINCIPAL REGISTER

RADLO FOODS LLC (MASSACHUSETTS LIMITED LIABILITY COMPANY)
313 PLEASANT STREET
WATERTOWN, MA 02472

FOR: POULTRY AND DAIRY PRODUCTS, NAMELY, MILK, IN CLASS 29 (U.S. CL. 46).

FIRST USE 12-19-2011; IN COMMERCE 12-19-2011.

THE MARK CONSISTS OF STANDARD CHARACTERS WITHOUT CLAIM TO ANY PARTICULAR FONT, STYLE, SIZE, OR COLOR.

OWNER OF U.S. REG. NO. 2,741,175.

SN 77-398,168, FILED 2-15-2008.

CHRISTINE MARTIN, EXAMINING ATTORNEY



David J. Kyffers

Director of the United States Patent and Trademark Office

United States of America

United States Patent and Trademark Office



Reg. No. 4,154,293

Registered June 5, 2012

Int. Cls.: 36, 41, 42, and 44

SERVICE MARK

PRINCIPAL REGISTER

COOL EARTH ACTION (ENGLAND COMPANY)
71 SOUTH AUDLEY STREET
LONDON, UNITED KINGDOM W1K1JA

FOR: CHARITABLE SERVICES, NAMELY, PROVIDING FINANCIAL SUPPORT TO PEOPLE FROM DISADVANTAGED COUNTRIES FOR THE PURPOSE OF FACILITATING EDUCATIONAL OPPORTUNITIES; CHARITABLE SERVICES, NAMELY, GRANTING FUNDS TO SCHOOLS; CHARITABLE FUNDRAISING SERVICES FOR CONSERVATION AND PROTECTION OF THE ENVIRONMENT AND RAINFORESTS; PROVISION OF CHARITABLE FUNDRAISING SERVICES IN RELATION TO CARBON OFFSETTING; COMMODITIES TRADING FOR OTHERS; TRADING OF EMISSIONS ALLOWANCES AND OTHER EMISSIONS AND ENVIRONMENTAL COMMODITIES FOR OTHERS; COMMODITIES INVESTMENT ADVICE SERVICES; PROVISION OF PRICING INFORMATION OF COMMODITIES; CAPITAL INVESTMENT SERVICES; INVESTMENT OF FUNDS FOR OTHERS; TRADING IN THE FIELDS OF OPTIONS, STOCKS, EMISSIONS ALLOWANCES, AND EQUITIES; FINANCING OF ACQUISITIONS; INFORMATION, ADVISORY AND CONSULTANCY SERVICES RELATING TO THE AFORESAID SERVICES; INFORMATION, ADVISORY AND CONSULTANCY SERVICES RELATING TO THE AFORESAID SERVICES PROVIDED ON-LINE FROM A COMPUTER DATABASE OR THE INTERNET, IN CLASS 36 (U.S. CLS. 100, 101 AND 102).

FIRST USE 3-16-2009; IN COMMERCE 3-16-2009.



FOR: EDUCATIONAL SERVICES, NAMELY, PROVIDING CLASSES, SEMINARS, AND WORKSHOPS RELATING TO CONSERVATION AND PROTECTION OF THE ENVIRONMENT AND RAINFORESTS, AND DISTRIBUTION OF COURSE MATERIALS RELATING TO CONSERVATION AND PROTECTION OF THE ENVIRONMENT AND RAINFORESTS, INCLUDING INSTRUCTIONAL MANUALS; INFORMATION, ADVISORY AND CONSULTANCY SERVICES RELATING TO THE AFORESAID SERVICES; INFORMATION, ADVISORY AND CONSULTANCY SERVICES RELATING TO THE AFORESAID SERVICES PROVIDED ON-LINE FROM A COMPUTER DATABASE OR THE INTERNET, IN CLASS 41 (U.S. CLS. 100, 101 AND 107).

FIRST USE 3-16-2009; IN COMMERCE 3-16-2009.

David J. Kappas

Director of the United States Patent and Trademark Office

FOR: PROVIDING SCIENTIFIC INFORMATION RELATING TO ENVIRONMENTAL CONSERVATION AND ISSUES INCLUDING ENVIRONMENTAL IMPACT ANALYSIS; INFORM-

Reg. No. 4,154,293 ATION SERVICES RELATING TO ENVIRONMENTAL AWARENESS, NAMELY, PROVIDING A WEBSITE FEATURING INFORMATION ABOUT GLOBAL WARMING AND ITS EFFECT ON NATURE AND THE ENVIRONMENT; SCIENTIFIC RESEARCH RELATING TO ENVIRONMENTAL ISSUES; SCIENTIFIC RESEARCH RELATING TO AGRICULTURAL, HORTICULTURAL AND FORESTRY ISSUES; PROVIDING SCIENTIFIC INFORMATION SERVICES RELATING TO CARBON OFFSETTING; SCIENTIFIC RESEARCH RELATING TO CARBON OFFSETTING; INFORMATION, ADVISORY AND CONSULTANCY SERVICES RELATING TO THE AFORESAID SERVICES; INFORMATION, ADVISORY AND CONSULTANCY SERVICES RELATING TO THE AFORESAID SERVICES PROVIDED ON-LINE FROM A COMPUTER DATABASE OR THE INTERNET, IN CLASS 42 (U.S. CLS. 100 AND 101).

FIRST USE 3-16-2009; IN COMMERCE 3-16-2009.

FOR: AGRICULTURAL, HORTICULTURAL AND FORESTRY SERVICES RELATING TO CONSERVATION AND PROTECTION OF THE ENVIRONMENT AND RAINFORESTS, NAMELY, THE CULTIVATION, TREATMENT AND CARE OF LAND, TREES, AND PLANTS; INFORMATION, ADVISORY AND CONSULTANCY SERVICES RELATING TO THE AFORESAID SERVICES PROVIDED ON-LINE FROM A COMPUTER DATABASE OR THE INTERNET, IN CLASS 44 (U.S. CLS. 100 AND 101).

FIRST USE 3-16-2009; IN COMMERCE 3-16-2009.

THE MARK CONSISTS OF THE WORDS "COOL" AND "EARTH" WITH THE COLOR BLUE APPEARING IN THE LETTERS "COO" AND THE BRANCH DESIGN, AND THE COLOR GREEN APPEARING IN THE WORD "EARTH" AND IN THE CIRCULAR TREE DESIGN.

THE COLOR(S) BLUE AND GREEN IS/ARE CLAIMED AS A FEATURE OF THE MARK.

SN 77-400,589, FILED 2-19-2008.

SUNG IN, EXAMINING ATTORNEY

United States of America

United States Patent and Trademark Office



Reg. No. 4,154,294

Registered June 5, 2012

Int. Cl.: 25

TRADEMARK

PRINCIPAL REGISTER

VC COLLECTION LIMITED (HONG KONG CORPORATION)
ONE HARBOURFRONT, HUNGHOM
18 TAK FUNG STREET, UNIT 1506, 15/F
KOWLOON, HONG KONG

FOR: CLOTHING, NAMELY, DRESSES, COATS, GOWNS, GLOVES, FOOTWEAR,
HEADGEAR, NAMELY, CAPS AND HATS, IN CLASS 25 (U.S. CLS. 22 AND 39).

FIRST USE 6-4-2007; IN COMMERCE 6-13-2007.

THE MARK CONSISTS OF THE LETTERS "V" AND "C" STYLIZED.

SN 77-405,873, FILED 2-26-2008.

EDWARD FENNESSY, EXAMINING ATTORNEY



David J. Kyffers

Director of the United States Patent and Trademark Office

United States of America

United States Patent and Trademark Office



Reg. No. 4,154,295

Registered June 5, 2012

Int. Cl.: 28

TRADEMARK

PRINCIPAL REGISTER

HERSCH AND COMPANY (CALIFORNIA PARTNERSHIP)
SUITE 2440
1900 AVENUE OF THE STARS
LOS ANGELES, CA 90067

FOR: BOARD GAMES; PARLOUR GAMES, IN CLASS 28 (U.S. CLS. 22, 23, 38 AND 50).

FIRST USE 10-14-2011; IN COMMERCE 10-14-2011.

THE MARK CONSISTS OF A RED BACKGROUND SQUARE. THE LETTER "Y" IS WHITE.
THE LETTER "Y" IS SURROUNDED BY THE COLOR BLACK.

THE COLOR(S) RED, WHITE AND BLACK IS/ARE CLAIMED AS A FEATURE OF THE
MARK.

SN 77-412,772, FILED 3-4-2008.

LANA PHAM, EXAMINING ATTORNEY



David J. Kybas

Director of the United States Patent and Trademark Office

United States of America

United States Patent and Trademark Office

GUEST READY

Reg. No. 4,154,296

Registered June 5, 2012

Int. Cl.: 25

TRADEMARK

PRINCIPAL REGISTER

SYSCO GUEST SUPPLY, LLC (DELAWARE LIMITED LIABILITY COMPANY)
4301 US HIGHWAY 1
MONMOUTH JUNCTION, NJ 08852

FOR: ROBES; SLIPPERS, IN CLASS 25 (U.S. CLS. 22 AND 39).

FIRST USE 3-8-2011; IN COMMERCE 3-8-2011.

THE MARK CONSISTS OF STANDARD CHARACTERS WITHOUT CLAIM TO ANY PARTICULAR FONT, STYLE, SIZE, OR COLOR.

SN 77-413,290, FILED 3-5-2008.

JENNIFER VASQUEZ, EXAMINING ATTORNEY



David J. Kybas

Director of the United States Patent and Trademark Office

United States of America

United States Patent and Trademark Office

ANGEL FALLS

Reg. No. 4,154,297

Registered June 5, 2012

Int. Cls.: 9 and 41

TRADEMARK

SERVICE MARK

PRINCIPAL REGISTER

NOVALOGIC, INC. (CALIFORNIA CORPORATION)
23805 STUART RANCH ROAD, SUITE 100
MALIBU, CA 92065

FOR: COMPUTER AND VIDEO GAME SOFTWARE, COMPUTER PROGRAMS RECORDED ON CD-ROMS AND COMPACT DISCS FEATURING COMPUTER GAMES; ACCESSORIES FOR PLAYING ELECTRONIC COMPUTER GAMES, NAMELY, GAME CONTROLLERS, CUSTOM COVERS FOR GAME CONSOLES, COMPUTER CASES AND PERIPHERAL DEVICES, IN CLASS 9 (U.S. CLS. 21, 23, 26, 36 AND 38).

FIRST USE 10-14-2011; IN COMMERCE 10-14-2011.

FOR: ENTERTAINMENT SERVICES, NAMELY, PROVIDING ON-LINE COMPUTER GAMES, IN CLASS 41 (U.S. CLS. 100, 101 AND 107).

FIRST USE 10-14-2011; IN COMMERCE 10-14-2011.

THE MARK CONSISTS OF STANDARD CHARACTERS WITHOUT CLAIM TO ANY PARTICULAR FONT, STYLE, SIZE, OR COLOR.

SN 77-413,611, FILED 3-5-2008.

ODESSA BIBBINS, EXAMINING ATTORNEY



David J. Kyros

Director of the United States Patent and Trademark Office

United States of America

United States Patent and Trademark Office

COPACABANA

Reg. No. 4,154,298

APOC RESTAURANT, INC. (NEW YORK CORPORATION)
C/O 268 WEST 47TH STREET
NEW YORK, NY 10036

Registered June 5, 2012

Int. Cl.: 21

FOR: COFFEE CUPS, TEA CUPS AND MUGS, IN CLASS 21 (U.S. CLS. 2, 13, 23, 29, 30, 33, 40 AND 50).

TRADEMARK

FIRST USE 12-1-2011; IN COMMERCE 12-1-2011.

PRINCIPAL REGISTER

THE MARK CONSISTS OF STANDARD CHARACTERS WITHOUT CLAIM TO ANY PARTICULAR FONT, STYLE, SIZE, OR COLOR.

OWNER OF U.S. REG. NOS. 1,210,093 AND 1,280,161.

SN 77-432,880, FILED 3-27-2008.

WILLIAM ROSSMAN, EXAMINING ATTORNEY



David J. Kybas

Director of the United States Patent and Trademark Office

United States of America

United States Patent and Trademark Office

PROMETRIC



Reg. No. 4,154,299

Registered June 5, 2012

Int. Cl.: 35

SERVICE MARK

PRINCIPAL REGISTER

PROMETRIC INC. (DELAWARE CORPORATION)
1501 S. CLINTON STREET
BALTIMORE, MD 21224

FOR: COMPUTERIZED DATABASE MANAGEMENT SERVICES IN THE FIELD OF TEST QUESTION INVENTORY AND USAGE; STATISTICAL INFORMATION SERVICES IN THE FIELDS OF EDUCATIONAL, PROFESSIONAL, AND VOCATIONAL TESTING AND TEST QUESTION VALIDITY, IN CLASS 35 (U.S. CLS. 100, 101 AND 102).

FIRST USE 9-0-2008; IN COMMERCE 9-0-2008.

OWNER OF U.S. REG. NO. 2,276,211.

SN 77-435,466, FILED 3-31-2008.

B. PARADEWELAI, EXAMINING ATTORNEY



David J. Kybas

Director of the United States Patent and Trademark Office

United States of America

United States Patent and Trademark Office

D23

Reg. No. 4,154,300

DISNEY ENTERPRISES, INC. (DELAWARE CORPORATION)
500 SOUTH BUENA VISTA STREET
BURBANK, CA 91521

Registered June 5, 2012

Int. Cl.: 16

FOR: DIARIES; WRITING PAPER; PENS; WRITING IMPLEMENTS; ART PRINTS; PRINTED CERTIFICATES, IN CLASS 16 (U.S. CLS. 2, 5, 22, 23, 29, 37, 38 AND 50).

TRADEMARK

FIRST USE 8-31-2011; IN COMMERCE 8-31-2011.

PRINCIPAL REGISTER

THE MARK CONSISTS OF STANDARD CHARACTERS WITHOUT CLAIM TO ANY PARTICULAR FONT, STYLE, SIZE, OR COLOR.

SN 77-435,727, FILED 3-31-2008.

HEATHER BIDDULPH, EXAMINING ATTORNEY



David J. Kybas

Director of the United States Patent and Trademark Office

United States of America

United States Patent and Trademark Office

ARO

Reg. No. 4,154,301

Registered June 5, 2012

Int. Cl.: 10

TRADEMARK

PRINCIPAL REGISTER

ARO MEDICAL, LLC (UNITED STATES LIMITED LIABILITY COMPANY)
119 SANDRA LANE
NORTH ANDOVER, MA 01845

FOR: SPINAL IMPLANTS COMPOSED OF ARTIFICIAL MATERIAL; SURGICAL INSTRUMENTS FOR USE IN ORTHOPEDIC AND SPINAL SURGERY, IN CLASS 10 (U.S. CLS. 26, 39 AND 44).

FIRST USE 9-20-2011; IN COMMERCE 9-20-2011.

THE MARK CONSISTS OF STANDARD CHARACTERS WITHOUT CLAIM TO ANY PARTICULAR FONT, STYLE, SIZE, OR COLOR.

SN 77-442,615, FILED 4-8-2008.

TOBY BULLOFF, EXAMINING ATTORNEY



David J. Kybas

Director of the United States Patent and Trademark Office

United States of America

United States Patent and Trademark Office

MOCHA BRIDE

Reg. No. 4,154,302

Registered June 5, 2012

Int. Cl.: 16

TRADEMARK

PRINCIPAL REGISTER

GABBIDON, ANDREW (UNITED STATES INDIVIDUAL)
222-15 100TH ROAD
QUEENS VILLAGE, NY 11429 AND

GABBIDON, KISHA (UNITED STATES INDIVIDUAL)
222-15 100TH ROAD
QUEENS VILLAGE, NY 11429

FOR: GENERAL FEATURE MAGAZINES; BRIDAL MAGAZINES; MULTICULTURAL MAGAZINES, IN CLASS 16 (U.S. CLS. 2, 5, 22, 23, 29, 37, 38 AND 50).

FIRST USE 3-24-2012; IN COMMERCE 3-24-2012.

THE MARK CONSISTS OF STANDARD CHARACTERS WITHOUT CLAIM TO ANY PARTICULAR FONT, STYLE, SIZE, OR COLOR.

NO CLAIM IS MADE TO THE EXCLUSIVE RIGHT TO USE "BRIDE", APART FROM THE MARK AS SHOWN.

SN 77-452,883, FILED 4-20-2008.

CORY BOONE, EXAMINING ATTORNEY



David J. Kyros

Director of the United States Patent and Trademark Office

United States of America

United States Patent and Trademark Office



Reg. No. 4,154,303

Registered June 5, 2012

Int. Cl.: 42

SERVICE MARK

PRINCIPAL REGISTER

SCISBO, LLC (DELAWARE LIMITED LIABILITY COMPANY)
SUITE 1200
1000 N WEST STREET
WILMINGTON, DE 19801

FOR: PROVIDING TEMPORARY USE OF NON-DOWNLOADABLE COMPUTER SOFTWARE FOR WIRELESS DEVICES THAT ALLOWS USERS TO ACCESS INFORMATION, IN CLASS 42 (U.S. CLS. 100 AND 101).

FIRST USE 3-30-2012; IN COMMERCE 3-30-2012.

THE MARK CONSISTS OF THE WORD "SCISBO" IN STYLIZED LETTERING AND THE LOGO ALSO INCLUDES TWO INTERLOCKING "C" SHAPES WITH A DROP SHADOW.

SN 77-457,643, FILED 4-24-2008.

CHRISTOPHER BUONGIORNO, EXAMINING ATTORNEY



David J. Kyffers

Director of the United States Patent and Trademark Office

United States of America

United States Patent and Trademark Office

DEVELOPMENT
EXPERIENCES

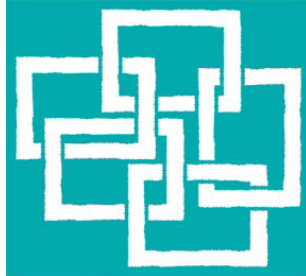

BLUEPRINT

Reg. No. 4,154,304

Registered June 5, 2012

Int. Cl.: 35

SERVICE MARK

PRINCIPAL REGISTER

ALBERTSSON, CANDICE (UNITED STATES INDIVIDUAL)
SUITE 7
15 WEBSTER STREET
NORTH TONAWANDA, NY 14120

FOR: BUSINESS CONSULTING SERVICES, NAMELY, THE IDENTIFICATION AND DEFINING OF EXPERIENCES REQUIRED FOR SUCCESS WITHIN A BUSINESS ORGANIZATION; BUSINESS CONSULTING SERVICES, NAMELY, THE IDENTIFICATION, EVALUATION, AND DEVELOPMENT OF KEY EMPLOYEES WITHIN A BUSINESS ORGANIZATION; BUSINESS CONSULTING SERVICES, NAMELY, THE DEVELOPMENT, EVALUATION, AND FACILITATION OF MANAGERIAL SUCCESSION PLANNING WITHIN A BUSINESS ORGANIZATION; AND BUSINESS CONSULTING SERVICES, NAMELY, THE DEVELOPMENT, EVALUATION, AND FACILITATION OF SUCCESSION MANAGEMENT PROCESSES WITHIN A BUSINESS ORGANIZATION, IN CLASS 35 (U.S. CLS. 100, 101 AND 102).

FIRST USE 12-12-2011; IN COMMERCE 12-12-2011.

THE COLOR WHITE IN THE BACKGROUND AND IN THE DESIGN OF THE INTERLOCKING SQUARES, THE COLOR BLUE APPEARS IN THE LARGER SQUARE BACKGROUND BETWEEN THE WORDING, AND THE COLOR BLACK APPEARS IN THE WORDING "DEVELOPMENT EXPERIENCES BLUEPRINT".

THE COLOR(S) WHITE, BLUE AND BLACK IS/ARE CLAIMED AS A FEATURE OF THE MARK.

SN 77-459,698, FILED 4-28-2008.

TASNEEM HUSSAIN, EXAMINING ATTORNEY



David J. Kybas

Director of the United States Patent and Trademark Office

United States of America

United States Patent and Trademark Office

ALBERTSSON
CONSULTING



leadership
development

Reg. No. 4,154,305

Registered June 5, 2012

Int. Cl.: 35

SERVICE MARK

PRINCIPAL REGISTER

ALBERTSSON, CANDICE (UNITED STATES INDIVIDUAL)
SUITE 7
15 WEBSTER STREET
NORTH TONAWANDA, NY 14120

FOR: BUSINESS CONSULTING SERVICES, NAMELY, THE IDENTIFICATION, EVALUATION, DEVELOPMENT AND SUCCESSION OF EMPLOYEES WITHIN A BUSINESS ORGANIZATION; BUSINESS CONSULTING SERVICES, NAMELY, THE DEVELOPMENT OF A STRATEGIC PLAN, FRAMEWORK, METHOD OR PROCESS FOR THE IDENTIFICATION, EVALUATION, DEVELOPMENT AND SUCCESSION OF EMPLOYEES WITHIN A BUSINESS ORGANIZATION; BUSINESS CONSULTING SERVICES, NAMELY, THE IDENTIFICATION OF COMPETENCIES AND EXPERIENCES REQUIRED FOR SUCCESS OF EMPLOYEES WITHIN A BUSINESS ORGANIZATION; BUSINESS CONSULTING SERVICES, NAMELY, THE DESIGN AND DEVELOPMENT OF PROGRAMS, PROCESSES AND TOOLS TO EVALUATE AND DEVELOP INDIVIDUAL EMPLOYEES' COMPETENCIES AND EXPERIENCES WITHIN A BUSINESS ORGANIZATION; BUSINESS CONSULTING SERVICES, NAMELY, THE DESIGN AND DEVELOPMENT OF PROGRAMS, PROCESSES AND TOOLS TO IDENTIFY, EVALUATE AND DEVELOP HIGH POTENTIAL AND KEY EMPLOYEES WITHIN A BUSINESS ORGANIZATION; BUSINESS CONSULTING SERVICES, NAMELY, THE DESIGN AND DEVELOPMENT OF PROGRAMS, PROCESSES AND TOOLS TO IDENTIFY, EVALUATE AND DEVELOP BEST SUITED CANDIDATES FOR POSITIONS WITHIN A BUSINESS ORGANIZATION; BUSINESS CONSULTING SERVICES, NAMELY, THE DESIGNING, DEVELOPING, ANALYZING, EVALUATING AND FACILITATING SUCCESSION PLANNING AND SUCCESSION MANAGEMENT PROCESSES AND TOOLS WITHIN A BUSINESS ORGANIZATION; BUSINESS CONSULTING SERVICES, NAMELY, THE DESIGNING, DEVELOPING AND FACILITATING TEAMBUILDING EXERCISES AND EVENTS WITHIN A BUSINESS ORGANIZATION, IN CLASS 35 (U.S. CLS. 100, 101 AND 102).

FIRST USE 12-12-2011; IN COMMERCE 12-12-2011.

NO CLAIM IS MADE TO THE EXCLUSIVE RIGHT TO USE "CONSULTING" AND "LEADERSHIP DEVELOPMENT", APART FROM THE MARK AS SHOWN.

THE COLOR(S) WHITE, BLUE AND BLACK IS/ARE CLAIMED AS A FEATURE OF THE MARK.



David J. Kyjars

Director of the United States Patent and Trademark Office

Reg. No. 4,154,305 THE COLOR WHITE IS IN THE BACKGROUND AND IN THE DESIGN OF THE STYLIZED ARROWHEAD, THE COLOR BLUE APPEARS IN THE LARGE SQUARE BACKGROUND BETWEEN THE WORDING, AND THE COLOR BLACK APPEARS IN THE WORDING "ALBERTSSON CONSULTING LEADERSHIP DEVELOPMENT".

SN 77-459,742, FILED 4-28-2008.

TASNEEM HUSSAIN, EXAMINING ATTORNEY

United States of America

United States Patent and Trademark Office



true.

Reg. No. 4,154,306

TRUE TEXTILES, INC. (DELAWARE CORPORATION)
5300 CORPORATE GROVE DRIVE SE, SUITE 250
GRAND RAPIDS, MI 49512

Registered June 5, 2012

Int. Cl.: 24

FOR: FABRIC FOR USE IN THE MANUFACTURE OF VEHICLES AND OFFICE FURNITURE,
IN CLASS 24 (U.S. CLS. 42 AND 50).

TRADEMARK

FIRST USE 7-25-2011; IN COMMERCE 7-25-2011.

PRINCIPAL REGISTER

SN 77-459,892, FILED 4-28-2008.

TINA L. SNAPP, EXAMINING ATTORNEY

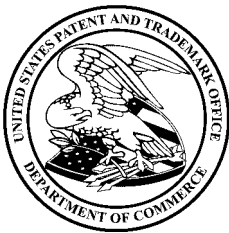

David J. Kybas

Director of the United States Patent and Trademark Office

United States of America

United States Patent and Trademark Office

Comfort Candle Co.

Reg. No. 4,154,307

Registered June 5, 2012

Int. Cl.: 4

TRADEMARK

PRINCIPAL REGISTER

THE COMFORT CANDLE COMPANY, L.C. (TEXAS LIMITED LIABILITY COMPANY)
164 CAMINO DEL RESERVE
COMFORT, TX 78013

FOR: CANDLES; SCENTED CANDLES, IN CLASS 4 (U.S. CLS. 1, 6 AND 15).

FIRST USE 12-0-2008; IN COMMERCE 12-0-2008.

NO CLAIM IS MADE TO THE EXCLUSIVE RIGHT TO USE "CANDLE CO.", APART FROM THE MARK AS SHOWN.

THE MARK CONSISTS OF THE LITERAL ELEMENT "COMFORT CANDLE CO." IN A STYLIZED FONT.

SN 77-467,541, FILED 5-7-2008.

ANGELA DUONG, EXAMINING ATTORNEY



David J. Kyffers

Director of the United States Patent and Trademark Office

United States of America

United States Patent and Trademark Office

MADE OF AMERICA

Reg. No. 4,154,308

JOHN B. STETSON COMPANY (DELAWARE CORPORATION)
86 HUDSON STREET
HOBOKEN, NJ 07030

Registered June 5, 2012

Int. Cl.: 3

FOR: FRAGRANCES; PERSONAL CARE PRODUCTS, NAMELY, AFTER-SHAVE, IN CLASS 3 (U.S. CLS. 1, 4, 6, 50, 51 AND 52).

TRADEMARK

FIRST USE 2-0-2012; IN COMMERCE 2-0-2012.

PRINCIPAL REGISTER

THE MARK CONSISTS OF STANDARD CHARACTERS WITHOUT CLAIM TO ANY PARTICULAR FONT, STYLE, SIZE, OR COLOR.

SN 77-478,167, FILED 5-19-2008.

MARK RADEMACHER, EXAMINING ATTORNEY



David J. Kyffers

Director of the United States Patent and Trademark Office

United States of America

United States Patent and Trademark Office

LIPURA

Reg. No. 4,154,309

Registered June 5, 2012

Int. Cl.: 3

TRADEMARK

PRINCIPAL REGISTER

JONES, DENNIS R. (UNITED STATES INDIVIDUAL)
1025 EXECUTIVE BLVD., STE: 112
CHESAPEAKE, VA 23320

FOR: LIP BALM, IN CLASS 3 (U.S. CLS. 1, 4, 6, 50, 51 AND 52).

FIRST USE 1-3-2011; IN COMMERCE 3-1-2011.

THE MARK CONSISTS OF STANDARD CHARACTERS WITHOUT CLAIM TO ANY PARTICULAR FONT, STYLE, SIZE, OR COLOR.

THE MARK "LIPURA" HAS NO MEANING IN A FOREIGN LANGUAGE

SN 77-489,570, FILED 6-3-2008.

DAVID HOFFMAN, EXAMINING ATTORNEY



David J. Kyfos

Director of the United States Patent and Trademark Office

United States of America

United States Patent and Trademark Office

ReadyEditor

Reg. No. 4,154,310

Registered June 5, 2012

Int. Cl.: 41

SERVICE MARK

PRINCIPAL REGISTER

SHASHINKA, LINDA (UNITED STATES INDIVIDUAL)
227 SANDY SPRINGS PLACE-D-264
SANDY SPRINGS, GA 30328

FOR: CUSTOM WRITING SERVICES; PUBLICATION AND EDITING OF PRINTED MATTER; WRITING OF ARTICLES FOR JOURNALS OTHER THAN FOR ADVERTISING OR PUBLICITY; WRITING OF ARTICLES FOR PERIODICALS OTHER THAN FOR ADVERTISING OR PUBLICITY; WRITING OF ARTICLES FOR PROFESSIONAL JOURNALS OTHER THAN FOR ADVERTISING OR PUBLICITY; WRITING OF TEXTS; WRITING OF TEXTS OTHER THAN PUBLICITY TEXTS; WRITTEN TEXT EDITING, IN CLASS 41 (U.S. CLS. 100, 101 AND 107).

FIRST USE 1-3-2005; IN COMMERCE 1-3-2005.

THE MARK CONSISTS OF STANDARD CHARACTERS WITHOUT CLAIM TO ANY PARTICULAR FONT, STYLE, SIZE, OR COLOR.

SN 77-489,700, FILED S.R. 6-3-2008; AM. P.R. 3-17-2009.

SUZANNE BLANE, EXAMINING ATTORNEY



David J. Kyffers

Director of the United States Patent and Trademark Office

United States of America

United States Patent and Trademark Office

HILL COUNTRY ESSENTIALS

Reg. No. 4,154,311

Registered June 5, 2012

Int. Cl.: 5

TRADEMARK

PRINCIPAL REGISTER

HEB GROCERY COMPANY, LP (TEXAS LIMITED PARTNERSHIP)
CORPORATE LAW DEPARTMENT
646 SOUTH MAIN
SAN ANTONIO, TX 78204

FOR: ACNE TREATMENT PREPARATIONS, NAMELY, LOTIONS, CREAMS AND TONERS,
ANTI-CAVITY DENTAL COATING PREPARATIONS CONTAINING FLUORIDE, IN CLASS
5 (U.S. CLS. 6, 18, 44, 46, 51 AND 52).

FIRST USE 8-5-2008; IN COMMERCE 8-5-2008.

THE MARK CONSISTS OF STANDARD CHARACTERS WITHOUT CLAIM TO ANY PAR-
TICULAR FONT, STYLE, SIZE, OR COLOR.

OWNER OF U.S. REG. NOS. 2,151,066, 2,890,694, AND OTHERS.

SN 77-490,701, FILED 6-4-2008.

DAVID COLLIER, EXAMINING ATTORNEY



David J. Kyffers

Director of the United States Patent and Trademark Office

United States of America

United States Patent and Trademark Office

UNIVERSITY OF THE YELLOWSTONE

Reg. No. 4,154,312

MONTANA STATE UNIVERSITY (MONTANA STATE UNIVERSITY)
211 MONTANA HALL
BOZEMAN, MT 597172420

Registered June 5, 2012

Int. Cl.: 36

FOR: FUND RAISING SERVICES FOR UNIVERSITY AND COLLEGE EDUCATION AND RESEARCH, IN CLASS 36 (U.S. CLS. 100, 101 AND 102).

SERVICE MARK

FIRST USE 5-5-2011; IN COMMERCE 1-27-2012.

PRINCIPAL REGISTER

THE MARK CONSISTS OF STANDARD CHARACTERS WITHOUT CLAIM TO ANY PARTICULAR FONT, STYLE, SIZE, OR COLOR.

NO CLAIM IS MADE TO THE EXCLUSIVE RIGHT TO USE "UNIVERSITY", APART FROM THE MARK AS SHOWN.

SN 77-496,319, FILED 6-11-2008.

WILLIAM BRECKENFELD, EXAMINING ATTORNEY



David J. Kyros

Director of the United States Patent and Trademark Office

United States of America

United States Patent and Trademark Office

BATTLE TESTED

Reg. No. 4,154,313

Registered June 5, 2012

Int. Cls.: 28 and 35

TRADEMARK

SERVICE MARK

PRINCIPAL REGISTER

KEE ACTION SPORTS I LLC (DELAWARE LIMITED LIABILITY COMPANY)
570 MANTUA BOULEVARD
SEWELL, NJ 08080

FOR: PAINTBALL MARKER GUNS; PAINTBALL MARKER GUN PARTS AND ACCESSORIES, NAMELY, PAINTBALL MARKER BARRELS; PAINTBALL SPORT EQUIPMENT, NAMELY, PAINTBALL LOADERS, PAINTBALL HARNESES, PAINTBALL SPORT GLOVES, PAINTBALL SPORT VESTS, AND PAINTBALL SPORT CHEST PROTECTORS, IN CLASS 28 (U.S. CLS. 22, 23, 38 AND 50).

FIRST USE 7-0-2008; IN COMMERCE 7-0-2008.

FOR: WHOLESALE DISTRIBUTORSHIPS IN THE FIELD OF PAINTBALL SPORT EQUIPMENT, IN CLASS 35 (U.S. CLS. 100, 101 AND 102).

FIRST USE 7-0-2008; IN COMMERCE 7-0-2008.

THE MARK CONSISTS OF STANDARD CHARACTERS WITHOUT CLAIM TO ANY PARTICULAR FONT, STYLE, SIZE, OR COLOR.

SN 77-498,591, FILED 6-13-2008.

KATHY DE JONGE, EXAMINING ATTORNEY



David J. Kybas

Director of the United States Patent and Trademark Office

United States of America

United States Patent and Trademark Office

ALPS

Reg. No. 4,154,314

Registered June 5, 2012

Int. Cl.: 42

SERVICE MARK

PRINCIPAL REGISTER

PURE A.L.P.S. LLC (DELAWARE LIMITED LIABILITY COMPANY)
201 HOUSATONIC AVENUE
NEW MILFORD, CT 06776

FOR: DESIGN OF APPARATUS AND MACHINES FOR FILLING PURPOSES; DESIGN AND DEVELOPMENT OF PLASTIC BOTTLES, BABY BOTTLES, DISPENSERS AND CONTAINERS FOR STORING AND DISPENSING FOOD AND BEVERAGES, IN CLASS 42 (U.S. CLS. 100 AND 101).

FIRST USE 5-4-2007; IN COMMERCE 5-4-2007.

THE MARK CONSISTS OF STANDARD CHARACTERS WITHOUT CLAIM TO ANY PARTICULAR FONT, STYLE, SIZE, OR COLOR.

SN 77-502,977, FILED 6-19-2008.

GINA FINK, EXAMINING ATTORNEY



David J. Kybas

Director of the United States Patent and Trademark Office

United States of America

United States Patent and Trademark Office

Three Springs Bottling Company

Reg. No. 4,154,315

Registered June 5, 2012

Int. Cls.: 32 and 33

TRADEMARK

PRINCIPAL REGISTER

BISON CAPITAL LLC (FLORIDA LIMITED LIABILITY COMPANY)
SUITE 200
735 E VENICE AVE
VENICE, FL 34285

FOR: NON-ALCOHOLIC MALT BEVERAGES, NON-ALCOHOLIC COCKTAILS, AND BOTTLED WATER, IN CLASS 32 (U.S. CLS. 45, 46 AND 48).

FIRST USE 11-14-2011; IN COMMERCE 11-14-2011.

FOR: DISTILLED SPIRITS, IN CLASS 33 (U.S. CLS. 47 AND 49).

FIRST USE 10-24-2011; IN COMMERCE 10-24-2011.

THE MARK CONSISTS OF STANDARD CHARACTERS WITHOUT CLAIM TO ANY PARTICULAR FONT, STYLE, SIZE, OR COLOR.

NO CLAIM IS MADE TO THE EXCLUSIVE RIGHT TO USE "BOTTLING COMPANY", APART FROM THE MARK AS SHOWN.

SN 77-505,100, FILED 6-23-2008.

WILLIAM VERHOSEK, EXAMINING ATTORNEY



David J. Kyros

Director of the United States Patent and Trademark Office

United States of America

United States Patent and Trademark Office

TEXAS EMBASSY

Reg. No. 4,154,316

GOODRICH, ROBERT (UNITED STATES INDIVIDUAL)
P.O. BOX 1400
AMARILLO, TX 79105

Registered June 5, 2012

Int. Cl.: 35

FOR: PROMOTING PUBLIC AWARENESS OF TEXAS CULTURE, HISTORY AND LANDMARKS, IN CLASS 35 (U.S. CLS. 100, 101 AND 102).

SERVICE MARK

FIRST USE 3-24-2007; IN COMMERCE 3-24-2007.

PRINCIPAL REGISTER

THE MARK CONSISTS OF STANDARD CHARACTERS WITHOUT CLAIM TO ANY PARTICULAR FONT, STYLE, SIZE, OR COLOR.

OWNER OF U.S. REG. NO. 2,958,097.

NO CLAIM IS MADE TO THE EXCLUSIVE RIGHT TO USE "TEXAS", APART FROM THE MARK AS SHOWN.

SN 77-506,975, FILED 6-24-2008.

RONALD AIKENS, EXAMINING ATTORNEY



David J. Kybas

Director of the United States Patent and Trademark Office

United States of America

United States Patent and Trademark Office

WINTERHAVEN FARMS

Reg. No. 4,154,317

Registered June 5, 2012

Int. Cl.: 33

TRADEMARK

PRINCIPAL REGISTER

CHATAM INTERNATIONAL INCORPORATED (DELAWARE CORPORATION)
1105 N. MARKET STREET
SUITE 1300
WILMINGTON, DE 19801

FOR: PREPARED ALCOHOLIC COCKTAIL, IN CLASS 33 (U.S. CLS. 47 AND 49).

FIRST USE 10-23-2008; IN COMMERCE 10-23-2008.

THE MARK CONSISTS OF STANDARD CHARACTERS WITHOUT CLAIM TO ANY PARTICULAR FONT, STYLE, SIZE, OR COLOR.

SN 77-508,814, FILED 6-26-2008.

ROBERT C. CLARK JR., EXAMINING ATTORNEY



David J. Kybas

Director of the United States Patent and Trademark Office

United States of America

United States Patent and Trademark Office



1797

PRANTL

MUENCHEN

Reg. No. 4,154,318

Registered June 5, 2012

Int. Cls.: 16 and 35

TRADEMARK

SERVICE MARK

PRINCIPAL REGISTER

DEVEDIA HOLDINGS, INC. (DELAWARE CORPORATION)
1511 SWANN STREET, NW
WASHINGTON, DC 20009

FOR: ART PAPER; OFFICE PAPER STATIONERY; PAINT BRUSHES; PAPER AND CARD-BOARD; PAPER STOCK; PARCHMENT PAPER; POSTCARD PAPER; PRINTED PAPER SIGNS; STATIONERY WRITING PAPER AND ENVELOPES, IN CLASS 16 (U.S. CLS. 2, 5, 22, 23, 29, 37, 38 AND 50).

FIRST USE 1-1-1995; IN COMMERCE 1-1-1995.

FOR: ADVERTISING AND BUSINESS MANAGEMENT CONSULTANCY; RETAIL GIFT SHOPS; RETAIL JEWELRY STORES; RETAIL STORE SERVICES FEATURING PAPER GOODS, PRECIOUS METALS, ALLOYS AND OTHER CONSUMER GOODS IN THE STATIONERY AND JEWELRY SECTORS, IN CLASS 35 (U.S. CLS. 100, 101 AND 102).

FIRST USE 1-1-1995; IN COMMERCE 1-1-1995.

NO CLAIM IS MADE TO THE EXCLUSIVE RIGHT TO USE "1797" AND "MUENCHEN", APART FROM THE MARK AS SHOWN.

THE MARK CONSISTS OF THE WORDING "1797 PRANTL MUENCHEN" IN A STYLIZED FONT BENEATH A DESIGN COMPRISING TWO HERALDIC LIONS WEARING CROWNS AND STANDING UPRIGHT ON AN ORNAMENTAL LEAFY DESIGN ON EITHER SIDE OF A SHIELD-LIKE CREST AND A CROWN. UPON THE CREST ARE FOUND DEPICTIONS OF LIONS AND GEOMETRIC DESIGNS. THE COAT OF ARMS DEPICTED IN THE MARK HAS NO MEANING OTHER THAN TRADEMARK SIGNIFICANCE.

THE ENGLISH TRANSLATION OF "MUENCHEN" IS "MUNICH".

SN 77-509,775, FILED 6-27-2008.

RENEE MCCRAY, EXAMINING ATTORNEY



David J. Kyffers

Director of the United States Patent and Trademark Office

United States of America

United States Patent and Trademark Office

A stylized, handwritten logo in cursive script. The word "Claudia" is written in a large, flowing font, with a long horizontal line extending from the end of the word. Below this line, the word "Hagn" is written in a smaller, more compact cursive font.

Reg. No. 4,154,319

Registered June 5, 2012

Int. Cls.: 24 and 25

TRADEMARK

PRINCIPAL REGISTER

HAGN, CLAUDIA (FED REP GERMANY INDIVIDUAL)
HARBURGER STR. 17
ROSENGARTEN, FED REP GERMANY 21224

FOR: TEXTILES AND TEXTILE GOODS, NAMELY, BED COVERS, BED SPREADS, BED SHEETS, TABLE CLOTH COVERS AND NAPKINS NOT OF PAPER; CURTAINS; HOME TEXTILE PRODUCTS, NAMELY, DRAPERY; FABRICS FOR TEXTILE USE; GOODS OF TERRY-TOWELING, NAMELY, TERRY TOWELS, IN CLASS 24 (U.S. CLS. 42 AND 50).

FIRST USE 1-0-2011; IN COMMERCE 1-0-2012.

FOR: CLOTHING, NAMELY, BATH ROBES, SWIMWEAR, SHIRTS, T-SHIRTS, LINGERIE, TROUSERS, LEGGINGS, BOXER SHORTS, FOOTWEAR AND HEADWEAR, IN CLASS 25 (U.S. CLS. 22 AND 39).

FIRST USE 1-0-2011; IN COMMERCE 1-0-2012.

THE NAME "CLAUDIA HAGN" IDENTIFIES A LIVING INDIVIDUAL WHOSE CONSENT IS OF RECORD.

SN 77-513,117, FILED 7-2-2008.

ARETHA SOMERVILLE, EXAMINING ATTORNEY

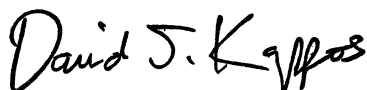
A handwritten signature in black ink, reading "David J. Kyffers". The signature is written in a cursive, slightly slanted style.

Director of the United States Patent and Trademark Office

United States of America

United States Patent and Trademark Office

ELECTROCRAFT COMPLETEPOWER

Reg. No. 4,154,320

Registered June 5, 2012

Int. Cls.: 7, 9, and 12

TRADEMARK

PRINCIPAL REGISTER

ELECTROCRAFT, INC. (DELAWARE CORPORATION)
1 PROGRESS DRIVE
DOVER, NH 03820

FOR: INTEGRATED MOTOR DRIVES, OTHER THAN FOR LAND VEHICLES, IN CLASS 7 (U.S. CLS. 13, 19, 21, 23, 31, 34 AND 35).

FIRST USE 3-12-2012; IN COMMERCE 3-12-2012.

FOR: ELECTRIC CIRCUITS FOR THE CONTROL AND REGULATION OF ELECTRIC MOTORS; ELECTRIC CONTROLS FOR ELECTRIC MOTORS; MOTOR SPEED CONTROLS; SERVO DRIVES, NAMELY, ELECTRONIC SERVO MOTOR CONTROLS; AMPLIFIERS FOR ELECTRIC MOTORS; POSITION CONTROLS FOR ELECTRIC MOTORS; ELECTRIC MOTOR SPEED SENSORS; STEPPING CONTROLS FOR ELECTRIC MOTORS; STEPPING DRIVES, NAMELY, ELECTRONIC STEPPER MOTOR CONTROLS, IN CLASS 9 (U.S. CLS. 21, 23, 26, 36 AND 38).

FIRST USE 1-0-2007; IN COMMERCE 1-0-2007.

FOR: INTEGRATED MOTOR DRIVES, FOR LAND VEHICLES, IN CLASS 12 (U.S. CLS. 19, 21, 23, 31, 35 AND 44).

FIRST USE 3-12-2012; IN COMMERCE 3-12-2012.

THE MARK CONSISTS OF STANDARD CHARACTERS WITHOUT CLAIM TO ANY PARTICULAR FONT, STYLE, SIZE, OR COLOR.

OWNER OF U.S. REG. NOS. 1,572,910, 2,752,092, AND 2,758,207.

SN 77-521,121, FILED 7-14-2008.

SAMUEL E. SHARPER JR., EXAMINING ATTORNEY



David J. Kybas

Director of the United States Patent and Trademark Office

United States of America

United States Patent and Trademark Office

ELECTROCRAFT DIRECTPOWER

Reg. No. 4,154,321

Registered June 5, 2012

Int. Cls.: 7 and 12

TRADEMARK

PRINCIPAL REGISTER

ELECTROCRAFT, INC. (DELAWARE CORPORATION)
1 PROGRESS DRIVE
DOVER, NH 03820

FOR: DC MOTORS, DC GEAR MOTORS, DC MOTOR GENERATORS, DC SERVO MOTORS,
OTHER THAN FOR LAND VEHICLES, IN CLASS 7 (U.S. CLS. 13, 19, 21, 23, 31, 34 AND 35).

FIRST USE 12-0-2009; IN COMMERCE 12-0-2009.

FOR: DC MOTORS, DC GEAR MOTORS, FOR LAND VEHICLES, IN CLASS 12 (U.S. CLS.
19, 21, 23, 31, 35 AND 44).

FIRST USE 12-0-2009; IN COMMERCE 10-0-2011.

THE MARK CONSISTS OF STANDARD CHARACTERS WITHOUT CLAIM TO ANY PAR-
TICULAR FONT, STYLE, SIZE, OR COLOR.

OWNER OF U.S. REG. NOS. 1,572,910, 2,752,092, AND 2,758,207.

SN 77-521,122, FILED 7-14-2008.

SAMUEL E. SHARPER JR., EXAMINING ATTORNEY



David J. Kybas

Director of the United States Patent and Trademark Office

United States of America

United States Patent and Trademark Office

ELECTROCRAFT MOBILEPOWER

Reg. No. 4,154,322

Registered June 5, 2012

Int. Cls.: 7 and 12

TRADEMARK

PRINCIPAL REGISTER

ELECTROCRAFT, INC. (DELAWARE CORPORATION)
1 PROGRESS DRIVE
DOVER, NH 03820

FOR: MACHINE TRANSAXLE DRIVES, GEARBOXES, OTHER THAN FOR LAND VEHICLES,
IN CLASS 7 (U.S. CLS. 13, 19, 21, 23, 31, 34 AND 35).

FIRST USE 2-0-2012; IN COMMERCE 2-0-2012.

FOR: MACHINE TRANSAXLE DRIVES, GEARBOXES, FOR LAND VEHICLES, IN CLASS
12 (U.S. CLS. 19, 21, 23, 31, 35 AND 44).

FIRST USE 2-0-2012; IN COMMERCE 2-0-2012.

THE MARK CONSISTS OF STANDARD CHARACTERS WITHOUT CLAIM TO ANY PAR-
TICULAR FONT, STYLE, SIZE, OR COLOR.

OWNER OF U.S. REG. NOS. 1,572,910, 2,752,092, AND 2,758,207.

SN 77-521,124, FILED 7-14-2008.

SAMUEL E. SHARPER JR., EXAMINING ATTORNEY



David J. Kyros

Director of the United States Patent and Trademark Office

United States of America

United States Patent and Trademark Office

ELECTROCRAFT RAPIDPOWER

Reg. No. 4,154,323

Registered June 5, 2012

Int. Cls.: 7 and 12

TRADEMARK

PRINCIPAL REGISTER

ELECTROCRAFT, INC. (DELAWARE CORPORATION)
1 PROGRESS DRIVE
DOVER, NH 03820

FOR: BRUSHLESS MOTORS, BRUSHLESS GEAR MOTORS, BRUSHLESS SERVO MOTORS, INTEGRATED BRUSHLESS MOTOR DRIVES, OTHER THAN FOR LAND VEHICLES , IN CLASS 7 (U.S. CLS. 13, 19, 21, 23, 31, 34 AND 35).

FIRST USE 3-13-2012; IN COMMERCE 3-13-2012.

FOR: BRUSHLESS MOTORS, BRUSHLESS GEAR MOTORS, INTEGRATED BRUSHLESS MOTOR DRIVES, FOR LAND VEHICLES, IN CLASS 12 (U.S. CLS. 19, 21, 23, 31, 35 AND 44).

FIRST USE 3-13-2012; IN COMMERCE 3-13-2012.

THE MARK CONSISTS OF STANDARD CHARACTERS WITHOUT CLAIM TO ANY PARTICULAR FONT, STYLE, SIZE, OR COLOR.

OWNER OF U.S. REG. NOS. 1,572,910, 2,752,092, AND 2,758,207.

SN 77-521,125, FILED 7-14-2008.

SAMUEL E. SHARPER JR., EXAMINING ATTORNEY



David J. Kybas

Director of the United States Patent and Trademark Office

United States of America

United States Patent and Trademark Office

ELECTROCRAFT TORQUEPOWER

Reg. No. 4,154,324

Registered June 5, 2012

Int. Cls.: 7 and 12

TRADEMARK

PRINCIPAL REGISTER

ELECTROCRAFT, INC. (DELAWARE CORPORATION)
1 PROGRESS DRIVE
DOVER, NH 03820

FOR: STEPPING MOTORS, OTHER THAN FOR LAND VEHICLES, IN CLASS 7 (U.S. CLS. 13, 19, 21, 23, 31, 34 AND 35).

FIRST USE 3-12-2012; IN COMMERCE 3-12-2012.

FOR: STEPPING MOTORS, FOR LAND VEHICLES, IN CLASS 12 (U.S. CLS. 19, 21, 23, 31, 35 AND 44).

FIRST USE 3-12-2012; IN COMMERCE 3-12-2012.

THE MARK CONSISTS OF STANDARD CHARACTERS WITHOUT CLAIM TO ANY PARTICULAR FONT, STYLE, SIZE, OR COLOR.

OWNER OF U.S. REG. NOS. 1,572,910, 2,752,092, AND 2,758,207.

SN 77-521,130, FILED 7-14-2008.

SAMUEL E. SHARPER JR., EXAMINING ATTORNEY



David J. Kybas

Director of the United States Patent and Trademark Office

United States of America

United States Patent and Trademark Office



Compaction Technologies, Inc.
Make an Impact...Compact

Reg. No. 4,154,325

Registered June 5, 2012

Int. Cl.: 40

SERVICE MARK

PRINCIPAL REGISTER

COMPACTION TECHNOLOGIES, INC. (MINNESOTA CORPORATION)
1171 NORTHLAND DRIVE, SUITE 121
MENDOTA HEIGHTS, MN 55120

FOR: CONSULTING SERVICES IN THE FIELD OF WASTE MANAGEMENT, IN CLASS 40
(U.S. CLS. 100, 103 AND 106).

FIRST USE 2-2-2007; IN COMMERCE 2-8-2008.

NO CLAIM IS MADE TO THE EXCLUSIVE RIGHT TO USE "COMPACTION TECHNOLOGIES,
INC", APART FROM THE MARK AS SHOWN.

THE MARK CONSISTS OF TWO WINDING ARROWS APPEARING NEXT TO THE WORDS
"COMPACTION TECHNOLOGIES, INC. MAKE AN IMPACT".

SN 77-528,395, FILED 7-22-2008.

REBECCA SMITH, EXAMINING ATTORNEY



David J. Kybas

Director of the United States Patent and Trademark Office

United States of America

United States Patent and Trademark Office

SPARVAX

Reg. No. 4,154,326

Registered June 5, 2012

Int. Cl.: 5

TRADEMARK

PRINCIPAL REGISTER

PHARMATHENE, INC. (DELAWARE CORPORATION)
ONE PARK PLACE
SUITE 450
ANNAPOLIS, MD 21401

FOR: PHARMACEUTICAL PREPARATIONS FOR TREATMENT AND PREVENTION OF INFECTIOUS DISEASE; PHARMACEUTICAL PREPARATIONS FOR TREATMENT AND PREVENTION OF ANTHRAX; VACCINES FOR TREATMENT AND PREVENTION OF INFECTIOUS DISEASE; VACCINES FOR TREATMENT AND PREVENTION OF ANTHRAX; PHARMACEUTICAL PREPARATIONS FOR COUNTERACTING, DETERRING, OR AS A DEFENSE AGAINST BIOLOGICAL OR CHEMICAL WEAPONS, IN CLASS 5 (U.S. CLS. 6, 18, 44, 46, 51 AND 52).

FIRST USE 2-21-2012; IN COMMERCE 2-21-2012.

THE MARK CONSISTS OF STANDARD CHARACTERS WITHOUT CLAIM TO ANY PARTICULAR FONT, STYLE, SIZE, OR COLOR.

SN 77-528,587, FILED 7-22-2008.

LAURIE MAYES, EXAMINING ATTORNEY



David J. Kypos

Director of the United States Patent and Trademark Office

United States of America

United States Patent and Trademark Office

Blooming Diffuser

Reg. No. 4,154,327

GAINES GROUP, LLC (TEXAS LIMITED LIABILITY COMPANY)
2901 W. SAM HOUSTON PKWY
HOUSTON, TX 77043

Registered June 5, 2012

Int. Cls.: 3 and 5

FOR: ROOM FRAGRANCE REFILLS FOR NON-ELECTRIC ROOM FRAGRANCE DISPENSERS; ROOM FRAGRANCES, IN CLASS 3 (U.S. CLS. 1, 4, 6, 50, 51 AND 52).

TRADEMARK

FIRST USE 1-1-2010; IN COMMERCE 1-1-2010.

PRINCIPAL REGISTER

FOR: ROOM FRESHENERS, IN CLASS 5 (U.S. CLS. 6, 18, 44, 46, 51 AND 52).

FIRST USE 1-1-2010; IN COMMERCE 1-1-2010.

THE MARK CONSISTS OF STANDARD CHARACTERS WITHOUT CLAIM TO ANY PARTICULAR FONT, STYLE, SIZE, OR COLOR.

NO CLAIM IS MADE TO THE EXCLUSIVE RIGHT TO USE "DIFFUSER", APART FROM THE MARK AS SHOWN.

SN 77-531,727, FILED 7-25-2008.

LAURIE KAUFMAN, EXAMINING ATTORNEY



David J. Kybas

Director of the United States Patent and Trademark Office

United States of America

United States Patent and Trademark Office

FLOAT FIRE

Reg. No. 4,154,328

ECLIPSE, INC. (ILLINOIS CORPORATION)
1665 ELMWOOD
ROCKFORD, IL 61103

Registered June 5, 2012

Int. Cl.: 11

FOR: AUXILIARY HEATING SYSTEM COMPOSED OF INDUSTRIAL GAS BURNERS, GAS AND AIR PRESSURE REGULATORS AND ELECTRONIC CONTROLS, IN CLASS 11 (U.S. CLS. 13, 21, 23, 31 AND 34).

TRADEMARK

FIRST USE 0-0-2007; IN COMMERCE 0-0-2007.

PRINCIPAL REGISTER

THE MARK CONSISTS OF STANDARD CHARACTERS WITHOUT CLAIM TO ANY PARTICULAR FONT, STYLE, SIZE, OR COLOR.

SN 77-535,059, FILED 7-30-2008.

DAVID I, EXAMINING ATTORNEY



David J. Kyffers

Director of the United States Patent and Trademark Office

United States of America
United States Patent and Trademark Office

TRUEDRY

Reg. No. 4,154,329

Registered June 5, 2012

Int. Cl.: 11

TRADEMARK

PRINCIPAL REGISTER

HONEYWELL INTERNATIONAL INC. (DELAWARE CORPORATION)
101 COLUMBIA ROAD
MORRISTOWN, NJ 07962

FOR: DEHUMIDIFIERS, IN CLASS 11 (U.S. CLS. 13, 21, 23, 31 AND 34).

FIRST USE 7-28-2008; IN COMMERCE 7-28-2008.

THE MARK CONSISTS OF STANDARD CHARACTERS WITHOUT CLAIM TO ANY PARTICULAR FONT, STYLE, SIZE, OR COLOR.

SN 77-536,296, FILED 7-31-2008.

DAVID TAYLOR, EXAMINING ATTORNEY



David J. Kybas

Director of the United States Patent and Trademark Office

United States of America

United States Patent and Trademark Office

TONY DIPARMA

Reg. No. 4,154,330

CALAMARI, INC. (MASSACHUSETTS CORPORATION)
335 MAIN STREET
WEST YARMOUTH, MA 02673

Registered June 5, 2012

Int. Cl.: 43

FOR: RESTAURANT AND BAR SERVICES, IN CLASS 43 (U.S. CLS. 100 AND 101).

SERVICE MARK

FIRST USE 3-16-2012; IN COMMERCE 3-16-2012.

PRINCIPAL REGISTER

THE MARK CONSISTS OF STANDARD CHARACTERS WITHOUT CLAIM TO ANY PARTICULAR FONT, STYLE, SIZE, OR COLOR.

THE NAME(S), PORTRAIT(S), AND/OR SIGNATURE(S) SHOWN IN THE MARK DOES NOT IDENTIFY A PARTICULAR LIVING INDIVIDUAL.

SN 77-538,985, FILED 8-5-2008.

GEORGE LORENZO, EXAMINING ATTORNEY



David J. Kybas

Director of the United States Patent and Trademark Office

United States of America

United States Patent and Trademark Office

ECHOS

Reg. No. 4,154,331

Registered June 5, 2012

Int. Cl.: 9

TRADEMARK

PRINCIPAL REGISTER

PARADIGM GEOPHYSICAL CORP. (DELAWARE CORPORATION)
TWO MEMORIAL PLAZA
820 GESSNER, SUITE 400
HOUSTON, TX 77024

FOR: COMPUTER SOFTWARE, NAMELY, COMPUTER PROGRAMS THAT PROCESS SEISMIC DATA FOR USE IN CREATING TWO DIMENSIONAL AND THREE DIMENSIONAL IMAGES OF THE SUBSURFACE OF THE EARTH FOR USE IN RELATION TO EXPLORATION AND PRODUCTION OF OIL AND GAS, IN CLASS 9 (U.S. CLS. 21, 23, 26, 36 AND 38).

FIRST USE 9-11-2009; IN COMMERCE 9-11-2009.

THE MARK CONSISTS OF STANDARD CHARACTERS WITHOUT CLAIM TO ANY PARTICULAR FONT, STYLE, SIZE, OR COLOR.

SN 77-539,033, FILED 8-5-2008.

LAURA HAMMEL, EXAMINING ATTORNEY



David J. Kyffers

Director of the United States Patent and Trademark Office

United States of America

United States Patent and Trademark Office

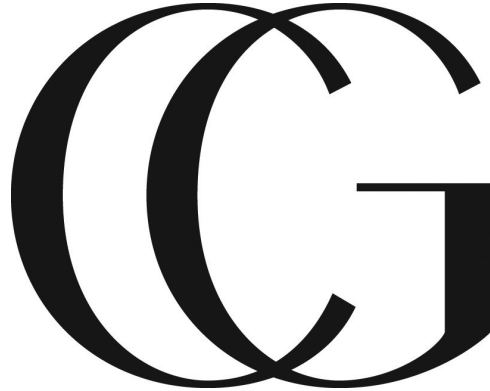

Reg. No. 4,154,332

Registered June 5, 2012

Int. Cl.: 8

TRADEMARK

PRINCIPAL REGISTER

NOXELL CORPORATION (MARYLAND CORPORATION)
11050 YORK ROAD
HUNT VALLEY, MD 210302098

FOR: TWEEZERS, CLIPPERS, NIPPERS, SCISSORS; NAIL FILES; MANICURE SETS; PEDI-
CURE SETS, IN CLASS 8 (U.S. CLS. 23, 28 AND 44).

FIRST USE 12-15-2011; IN COMMERCE 12-15-2011.

OWNER OF U.S. REG. NOS. 1,021,850, 3,201,578, AND OTHERS.

THE MARK CONSISTS OF OVERLAPPING STYLIZED LETTERS "C" AND "G".

SN 77-541,431, FILED 8-7-2008.

RAUL CORDOVA, EXAMINING ATTORNEY



David J. Kybas

Director of the United States Patent and Trademark Office

United States of America

United States Patent and Trademark Office

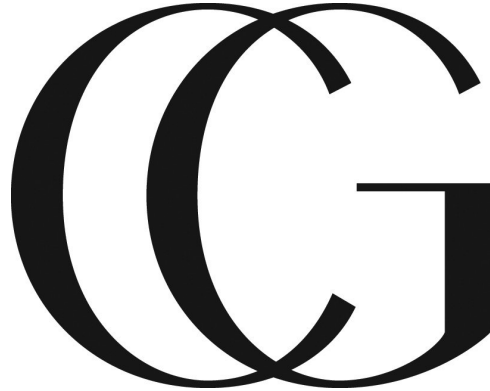

Reg. No. 4,154,333

Registered June 5, 2012

Int. Cl.: 8

TRADEMARK

PRINCIPAL REGISTER

NOXELL CORPORATION (MARYLAND CORPORATION)
11050 YORK ROAD
HUNT VALLEY, MD 21030

FOR: EYELASH CURLERS, IN CLASS 8 (U.S. CLS. 23, 28 AND 44).

FIRST USE 12-15-2011; IN COMMERCE 12-15-2011.

OWNER OF U.S. REG. NOS. 1,021,850, 3,201,578, AND OTHERS.

THE MARK CONSISTS OF OVERLAPPING STYLIZED LETTERS "C" AND "G".

SN 77-541,473, FILED 8-7-2008.

RAUL CORDOVA, EXAMINING ATTORNEY



David J. Kyffers

Director of the United States Patent and Trademark Office

United States of America

United States Patent and Trademark Office

NETPROPAGATE

Reg. No. 4,154,334

Registered June 5, 2012

Int. Cl.: 9

TRADEMARK

PRINCIPAL REGISTER

NETPROPAGATE CORPORATION (CALIFORNIA CORPORATION)
6033 WEST CENTURY BLVD.
SUITE 1200
LOS ANGELES, CA 90045

FOR: COMMUNICATION SOFTWARE FOR PROVIDING ACCESS TO THE INTERNET; COMMUNICATIONS SOFTWARE FOR CONNECTING NETWORK USERS; COMPUTER E-COMMERCE SOFTWARE TO ALLOW USERS TO PERFORM ELECTRONIC BUSINESS TRANSACTIONS VIA A GLOBAL COMPUTER NETWORK; COMPUTER HARDWARE AND SOFTWARE FOR SETTING UP AND CONFIGURING LOCAL AREA NETWORKS; COMPUTER HARDWARE AND SOFTWARE FOR SETTING UP AND CONFIGURING WIDE AREA NETWORKS; COMPUTER HARDWARE AND SOFTWARE SYSTEM FOR REMOTELY MONITORING ENVIRONMENTAL CONDITIONS AND CONTROLLING DEVICES WITHIN A BUILDING, FACILITY, GROUNDS, OR DESIGNATED SPATIAL AREA; COMPUTER PROGRAMS FOR SEARCHING THE CONTENTS OF COMPUTERS AND COMPUTER NETWORKS BY REMOTE CONTROL; COMPUTER SOFTWARE FOR ACCESSING INFORMATION DIRECTORIES THAT MAY BE DOWNLOADED FROM THE GLOBAL COMPUTER NETWORK; COMPUTER SOFTWARE FOR ADMINISTRATION OF COMPUTER LOCAL AREA NETWORKS; COMPUTER SOFTWARE FOR ADMINISTRATION OF COMPUTER NETWORKS; COMPUTER SOFTWARE FOR WIRELESS CONTENT DELIVERY; COMPUTER SOFTWARE, NAMELY, SOFTWARE DEVELOPMENT TOOLS FOR THE CREATION OF MOBILE INTERNET APPLICATIONS AND CLIENT INTERFACES; COMPUTER STORAGE DEVICES, NAMELY, HIGH-SPEED STORAGE SUBSYSTEMS FOR STORAGE AND BACKUP OF ELECTRONIC DATA EITHER LOCALLY OR VIA A TELECOMMUNICATIONS NETWORK; CONTINGENCY RESPONSE COMMUNICATION SYSTEM DESIGNED TO PROVIDE RADIO INTEROPERABILITY, STREAMING VIDEO, WIRELESS INTERNET, AND VOIP PHONE; FACILITIES MANAGEMENT SOFTWARE, NAMELY, SOFTWARE TO CONTROL BUILDING ENVIRONMENT, ACCESS AND SECURITY SYSTEMS; HOME AND OFFICE AUTOMATION SYSTEMS COMPRISING WIRELESS AND WIRED CONTROLLERS, CONTROLLED DEVICES, AND SOFTWARE FOR LIGHTING, HVAC, SECURITY, SAFETY AND OTHER HOME AND OFFICE MONITORING AND CONTROL APPLICATIONS; INTERNET PHONES; INTERNET SERVERS; INTEROPERABLE COMMUNICATION SYSTEM DESIGNED TO PROVIDE RADIO, STREAMING VIDEO, WIRELESS INTERNET, AND VOIP PHONE; NETWORK ACCESS SERVER OPERATING SOFTWARE; SOFTWARE FOR ENSURING THE SECURITY OF ELECTRONIC MAIL; TELECOMMUNICATIONS HARDWARE AND SOFTWARE FOR MONITORING AND ALERTING REMOTE SENSOR STATUS VIA THE INTERNET, IN CLASS 9 (U.S. CLS. 21, 23, 26, 36 AND 38).



David J. Kappas

Director of the United States Patent and Trademark Office

Reg. No. 4,154,334 FIRST USE 9-29-2011; IN COMMERCE 9-29-2011.

THE MARK CONSISTS OF STANDARD CHARACTERS WITHOUT CLAIM TO ANY PARTICULAR FONT, STYLE, SIZE, OR COLOR.

SN 77-543,720, FILED 8-11-2008.

CHARISMA HAMPTON, EXAMINING ATTORNEY

United States of America

United States Patent and Trademark Office

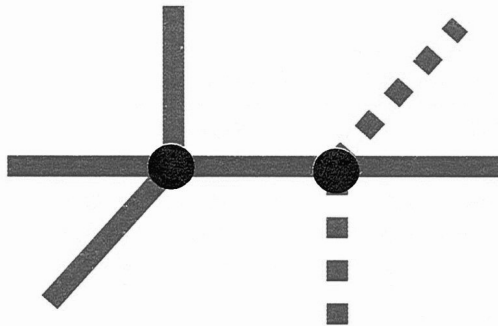

Reg. No. 4,154,335

Registered June 5, 2012

Int. Cl.: 9

TRADEMARK

PRINCIPAL REGISTER

NETPROPAGATE CORPORATION (CALIFORNIA CORPORATION)
6033 WEST CENTURY BLVD.
SUITE 1200
LOS ANGELES, CA 90045

FOR: COMMUNICATION SOFTWARE FOR PROVIDING ACCESS TO THE INTERNET; COMMUNICATIONS SOFTWARE FOR CONNECTING NETWORK USERS; COMPUTER E-COMMERCE SOFTWARE TO ALLOW USERS TO PERFORM ELECTRONIC BUSINESS TRANSACTIONS VIA A GLOBAL COMPUTER NETWORK; COMPUTER HARDWARE AND SOFTWARE FOR SETTING UP AND CONFIGURING LOCAL AREA NETWORKS; COMPUTER HARDWARE AND SOFTWARE FOR SETTING UP AND CONFIGURING WIDE AREA NETWORKS; COMPUTER HARDWARE AND SOFTWARE SYSTEM FOR REMOTELY MONITORING ENVIRONMENTAL CONDITIONS AND CONTROLLING DEVICES WITHIN A BUILDING, FACILITY, GROUNDS, OR DESIGNATED SPATIAL AREA; COMPUTER PROGRAMS FOR SEARCHING THE CONTENTS OF COMPUTERS AND COMPUTER NETWORKS BY REMOTE CONTROL; COMPUTER SOFTWARE FOR ACCESSING INFORMATION DIRECTORIES THAT MAY BE DOWNLOADED FROM THE GLOBAL COMPUTER NETWORK; COMPUTER SOFTWARE FOR ADMINISTRATION OF COMPUTER LOCAL AREA NETWORKS; COMPUTER SOFTWARE FOR ADMINISTRATION OF COMPUTER NETWORKS; COMPUTER SOFTWARE FOR WIRELESS CONTENT DELIVERY; COMPUTER SOFTWARE, NAMELY, SOFTWARE DEVELOPMENT TOOLS FOR THE CREATION OF MOBILE INTERNET APPLICATIONS AND CLIENT INTERFACES; COMPUTER STORAGE DEVICES, NAMELY, HIGH-SPEED STORAGE SUBSYSTEMS FOR STORAGE AND BACKUP OF ELECTRONIC DATA EITHER LOCALLY OR VIA A TELECOMMUNICATIONS NETWORK; CONTINGENCY RESPONSE COMMUNICATION SYSTEM DESIGNED TO PROVIDE RADIO INTEROPERABILITY, STREAMING VIDEO, WIRELESS INTERNET, AND VOIP PHONE; FACILITIES MANAGEMENT SOFTWARE, NAMELY, SOFTWARE TO CONTROL BUILDING ENVIRONMENT, ACCESS AND SECURITY SYSTEMS; HOME AND OFFICE AUTOMATION SYSTEMS COMPRISING WIRELESS AND WIRED CONTROLLERS, CONTROLLED DEVICES, AND SOFTWARE FOR LIGHTING, HVAC, SECURITY, SAFETY AND OTHER HOME AND OFFICE MONITORING AND CONTROL APPLICATIONS; INTERNET PHONES; INTERNET SERVERS; INTEROPERABLE COMMUNICATION SYSTEM DESIGNED TO PROVIDE RADIO, STREAMING VIDEO, WIRELESS INTERNET, AND VOIP PHONE; NETWORK ACCESS SERVER OPERATING SOFTWARE; SOFTWARE FOR ENSURING THE SECURITY OF ELECTRONIC MAIL; TELECOMMUNICATIONS HARDWARE AND SOFTWARE FOR MONITORING AND ALERTING REMOTE SENSOR STATUS VIA THE INTERNET, IN CLASS 9 (U.S. CLS. 21, 23, 26, 36 AND 38).



David J. Kappas

Director of the United States Patent and Trademark Office

Reg. No. 4,154,335 FIRST USE 9-29-2011; IN COMMERCE 9-29-2011.

THE MARK CONSISTS OF A SOLID HORIZONTAL LINE INTERSECTED TWICE AT ONE-THIRD AND AT TWO-THIRDS OF ITS LENGTH BY A VERTICAL LINE AND A SOLID CIRCLE. THE BOTTOM HALF OF THE LEFTMOST VERTICAL LINE ANGLES LEFT AT 45 DEGREES. THE TOP HALF OF THE RIGHTMOST VERTICAL LINE ANGLES RIGHT AT 45 DEGREES. THE RIGHTMOST VERTICAL LINE CONSISTS OF SQUARED DOTS.

SN 77-543,732, FILED 8-11-2008.

CHARISMA HAMPTON, EXAMINING ATTORNEY

United States of America

United States Patent and Trademark Office

ZEUS

Reg. No. 4,154,336

Registered June 5, 2012

Int. Cl.: 5

TRADEMARK

PRINCIPAL REGISTER

FMC CORPORATION (DELAWARE CORPORATION), DBA FMC CORPORATION,
1735 MARKET STREET
PHILADELPHIA, PA 19103

FOR: PREPARATIONS FOR THE DESTRUCTION OF VERMIN AND WEEDS, PESTICIDES,
HERBICIDES, AND FUNGICIDES, IN CLASS 5 (U.S. CLS. 6, 18, 44, 46, 51 AND 52).

FIRST USE 2-16-2012; IN COMMERCE 2-16-2012.

THE MARK CONSISTS OF STANDARD CHARACTERS WITHOUT CLAIM TO ANY PAR-
TICULAR FONT, STYLE, SIZE, OR COLOR.

SN 77-543,844, FILED 8-11-2008.

LAURA KOVALSKY, EXAMINING ATTORNEY



David J. Kybas

Director of the United States Patent and Trademark Office

United States of America

United States Patent and Trademark Office

VALFLEX

Reg. No. 4,154,337

VALSPAR SOURCING, INC. (MINNESOTA CORPORATION)
P.O. BOX 1461
MINNEAPOLIS, MN 55440

Registered June 5, 2012

Int. Cl.: 2

FOR: COATINGS IN THE NATURE OF COATINGS FOR METAL SUBSTRATES, IN CLASS 2 (U.S. CLS. 6, 11 AND 16).

TRADEMARK

FIRST USE 5-6-2009; IN COMMERCE 5-6-2009.

PRINCIPAL REGISTER

THE MARK CONSISTS OF STANDARD CHARACTERS WITHOUT CLAIM TO ANY PARTICULAR FONT, STYLE, SIZE, OR COLOR.

SN 77-546,099, FILED 8-13-2008.

RUDY R. SINGLETON, EXAMINING ATTORNEY



David J. Kyfos

Director of the United States Patent and Trademark Office

United States of America

United States Patent and Trademark Office

A TOUCH DIFFERENT

Reg. No. 4,154,338

Registered June 5, 2012

Int. Cl.: 25

TRADEMARK

PRINCIPAL REGISTER

BERKSHIRE BLANKET INC. (MASSACHUSETTS CORPORATION)
44 EAST MAIN STREET
WARE, MA 01082

FOR: ROBES AND WEARABLE WRAPS, IN CLASS 25 (U.S. CLS. 22 AND 39).

FIRST USE 5-0-2011; IN COMMERCE 5-0-2011.

THE MARK CONSISTS OF STANDARD CHARACTERS WITHOUT CLAIM TO ANY PARTICULAR FONT, STYLE, SIZE, OR COLOR.

SN 77-547,569, FILED 8-14-2008.

RENEE SERVANCE, EXAMINING ATTORNEY



David J. Kyfos

Director of the United States Patent and Trademark Office

United States of America

United States Patent and Trademark Office

HDI-LINK

Reg. No. 4,154,339

Registered June 5, 2012

Int. Cl.: 9

TRADEMARK

PRINCIPAL REGISTER

DDI GLOBAL CORP. (CALIFORNIA CORPORATION)
1220 N. SIMON CIRCLE
ANAHEIM, CA 92806

FOR: PRINTED CIRCUIT BOARDS, IN CLASS 9 (U.S. CLS. 21, 23, 26, 36 AND 38).

FIRST USE 8-14-2008; IN COMMERCE 3-26-2012.

THE MARK CONSISTS OF STANDARD CHARACTERS WITHOUT CLAIM TO ANY PARTICULAR FONT, STYLE, SIZE, OR COLOR.

SN 77-547,587, FILED 8-14-2008.

HOWARD B. LEVINE, EXAMINING ATTORNEY



David J. Kyffers

Director of the United States Patent and Trademark Office

United States of America

United States Patent and Trademark Office

DPSMV

Reg. No. 4,154,340

Registered June 5, 2012

Int. Cl.: 9

TRADEMARK

PRINCIPAL REGISTER

DDI GLOBAL CORP. (CALIFORNIA CORPORATION)
1220 SIMON CIRCLE
ANAHEIM, CA 92806

FOR: PRINTED CIRCUIT BOARDS, IN CLASS 9 (U.S. CLS. 21, 23, 26, 36 AND 38).

FIRST USE 8-14-2008; IN COMMERCE 3-26-2012.

THE MARK CONSISTS OF STANDARD CHARACTERS WITHOUT CLAIM TO ANY PARTICULAR FONT, STYLE, SIZE, OR COLOR.

SN 77-547,608, FILED 8-14-2008.

HOWARD B. LEVINE, EXAMINING ATTORNEY



David J. Kyffers

Director of the United States Patent and Trademark Office

United States of America

United States Patent and Trademark Office

CENTIMENT

Reg. No. 4,154,341

Registered June 5, 2012

Int. Cl.: 9

TRADEMARK

PRINCIPAL REGISTER

POULIN HOLDINGS LLC (NEW HAMPSHIRE LIMITED LIABILITY COMPANY)
P.O. BOX 15664
BOSTON, MA 02215

FOR: SOFTWARE THAT PROVIDES ASSET TRADING RECOMMENDATIONS; SOFTWARE THAT PROVIDES ASSET TRADING AND ASSET TRADING RECOMMENDATIONS; SOFTWARE FOR ANALYZING LINGUISTIC DATA SOURCES, IN CLASS 9 (U.S. CLS. 21, 23, 26, 36 AND 38).

FIRST USE 12-31-2011; IN COMMERCE 12-31-2011.

THE MARK CONSISTS OF STANDARD CHARACTERS WITHOUT CLAIM TO ANY PARTICULAR FONT, STYLE, SIZE, OR COLOR.

SN 77-548,199, FILED 8-15-2008.

MATTHEW KLINE, EXAMINING ATTORNEY



David J. Kyffers

Director of the United States Patent and Trademark Office

United States of America

United States Patent and Trademark Office

JAMMIES BY HÉLÈNE LAURÉ

Reg. No. 4,154,342

FREIXE, HÉLÈNE LAURÉ (FRANCE INDIVIDUAL)
315 EAST 68TH STREET
NEW YORK, NY 10065

Registered June 5, 2012

Int. Cl.: 25

FOR: SLEEPWEAR, IN CLASS 25 (U.S. CLS. 22 AND 39).

TRADEMARK

FIRST USE 4-13-2012; IN COMMERCE 4-13-2012.

PRINCIPAL REGISTER

THE MARK CONSISTS OF STANDARD CHARACTERS WITHOUT CLAIM TO ANY PARTICULAR FONT, STYLE, SIZE, OR COLOR.

NO CLAIM IS MADE TO THE EXCLUSIVE RIGHT TO USE "JAMMIES", APART FROM THE MARK AS SHOWN.

SN 77-551,941, FILED 8-20-2008.

STEVEN JACKSON, EXAMINING ATTORNEY



David J. Kybas

Director of the United States Patent and Trademark Office

United States of America

United States Patent and Trademark Office

READYBAR

Reg. No. 4,154,343

ALIZZANO, LLC (DELAWARE LIMITED LIABILITY COMPANY)
463 23RD STREET
SANTA MONICA, CA 90402

Registered June 5, 2012

Int. Cl.: 35

FOR: RETAIL BAKERY SHOPS; TAKE-OUT BAKERY SERVICES, IN CLASS 35 (U.S. CLS. 100, 101 AND 102).

SERVICE MARK

FIRST USE 1-1-2008; IN COMMERCE 1-1-2008.

PRINCIPAL REGISTER

THE MARK CONSISTS OF STANDARD CHARACTERS WITHOUT CLAIM TO ANY PARTICULAR FONT, STYLE, SIZE, OR COLOR.

SN 77-552,944, FILED 8-21-2008.

MICHAEL WEBSTER, EXAMINING ATTORNEY



David J. Kyffers

Director of the United States Patent and Trademark Office

United States of America

United States Patent and Trademark Office

CAUSE COLA

Reg. No. 4,154,344

Registered June 5, 2012

Int. Cl.: 32

TRADEMARK

PRINCIPAL REGISTER

PRUFROCK LLC (NEW JERSEY LIMITED LIABILITY COMPANY)
540 NORTH ROSSMORE AVE, #101
LOS ANGELES, CA 90004

FOR: SOFT DRINKS, NAMELY, CARBONATED SOFT DRINKS, LOW CALORIE SOFT DRINKS, NON-CARBONATED SOFT DRINKS, COLAS, NON-ALCOHOLIC CARBONATED BEVERAGES AND NON-ALCOHOLIC FRUIT JUICE BEVERAGES; FRUIT JUICES AND FRUIT DRINKS; COFFEE-FLAVORED AND TEA-FLAVORED SOFT DRINK, IN CLASS 32 (U.S. CLS. 45, 46 AND 48).

FIRST USE 4-9-2012; IN COMMERCE 4-9-2012.

THE MARK CONSISTS OF STANDARD CHARACTERS WITHOUT CLAIM TO ANY PARTICULAR FONT, STYLE, SIZE, OR COLOR.

NO CLAIM IS MADE TO THE EXCLUSIVE RIGHT TO USE "COLA", APART FROM THE MARK AS SHOWN.

SN 77-553,643, FILED 8-22-2008.

MELISSA VALLILLO, EXAMINING ATTORNEY



David J. Kyros

Director of the United States Patent and Trademark Office

United States of America

United States Patent and Trademark Office

EcoBridge

Reg. No. 4,154,345

Registered June 5, 2012

Int. Cls.: 37 and 42

SERVICE MARK

PRINCIPAL REGISTER

FIGG ENGINEERING GROUP (FLORIDA CORPORATION)
424 N. CALHOUN STREET
TALLAHASSEE, FL 32301

FOR: CONSTRUCTION SERVICES, NAMELY, PLANNING, LAYING OUT AND CUSTOM CONSTRUCTION OF BRIDGES, IN CLASS 37 (U.S. CLS. 100, 103 AND 106).

FIRST USE 4-12-2012; IN COMMERCE 4-12-2012.

FOR: DESIGN AND ENGINEERING SERVICES IN THE FIELD OF BRIDGES, IN CLASS 42 (U.S. CLS. 100 AND 101).

FIRST USE 4-12-2012; IN COMMERCE 4-12-2012.

THE MARK CONSISTS OF STANDARD CHARACTERS WITHOUT CLAIM TO ANY PARTICULAR FONT, STYLE, SIZE, OR COLOR.

SN 77-555,075, FILED 8-25-2008.

JORDAN BAKER, EXAMINING ATTORNEY



David J. Kyros

Director of the United States Patent and Trademark Office

United States of America

United States Patent and Trademark Office

PARTY DRAGON

Reg. No. 4,154,346

Registered June 5, 2012

Int. Cl.: 28

TRADEMARK

PRINCIPAL REGISTER

PARTYDRAGON LIMITED (HONG KONG CORPORATION)
1-3 PEDDER STREET
CENTRAL, HONG KONG

FOR: LATEX BALLOONS, IN CLASS 28 (U.S. CLS. 22, 23, 38 AND 50).

FIRST USE 9-14-2011; IN COMMERCE 9-14-2011.

THE MARK CONSISTS OF STANDARD CHARACTERS WITHOUT CLAIM TO ANY PARTICULAR FONT, STYLE, SIZE, OR COLOR.

NO CLAIM IS MADE TO THE EXCLUSIVE RIGHT TO USE "PARTY", APART FROM THE MARK AS SHOWN.

SN 77-558,809, FILED 8-29-2008.

MAUREEN DALL, EXAMINING ATTORNEY



David J. Kyffers

Director of the United States Patent and Trademark Office

United States of America

United States Patent and Trademark Office

PURSE PONCHO

Reg. No. 4,154,347

Registered June 5, 2012

Int. Cl.: 18

TRADEMARK

PRINCIPAL REGISTER

PRUFROCK LLC (NEW JERSEY LIMITED LIABILITY COMPANY)
540 NORTH ROSSMORE AVE, #101
LOS ANGELES, CA 90004

FOR: FITTED AND UNFITTED PURSE, HANDBAG AND CLUTCH COVERING TO PROTECT THE PURSE, HANDBAG AND CLUTCH FROM WATER OR OTHER DAMAGE, IN CLASS 18 (U.S. CLS. 1, 2, 3, 22 AND 41).

FIRST USE 4-3-2012; IN COMMERCE 4-3-2012.

THE MARK CONSISTS OF STANDARD CHARACTERS WITHOUT CLAIM TO ANY PARTICULAR FONT, STYLE, SIZE, OR COLOR.

NO CLAIM IS MADE TO THE EXCLUSIVE RIGHT TO USE "PURSE", APART FROM THE MARK AS SHOWN.

SN 77-559,722, FILED 9-1-2008.

MELISSA VALLILLO, EXAMINING ATTORNEY



David J. Kyros

Director of the United States Patent and Trademark Office

United States of America

United States Patent and Trademark Office

Show to Glow

Reg. No. 4,154,348

OLTMANN, STEVEN W. (UNITED STATES INDIVIDUAL)
3103 MCCUE RD.
STERLING, IL 61081

Registered June 5, 2012

Int. Cl.: 11

FOR: CHEMICALLY-ACTIVATED LIGHT STICKS, IN CLASS 11 (U.S. CLS. 13, 21, 23, 31 AND 34).

TRADEMARK

FIRST USE 3-1-2012; IN COMMERCE 3-1-2012.

PRINCIPAL REGISTER

THE MARK CONSISTS OF STANDARD CHARACTERS WITHOUT CLAIM TO ANY PARTICULAR FONT, STYLE, SIZE, OR COLOR.

SN 77-559,768, FILED 9-1-2008.

STEVEN PEREZ, EXAMINING ATTORNEY



David J. Kybas

Director of the United States Patent and Trademark Office

United States of America

United States Patent and Trademark Office

DynaTune

Reg. No. 4,154,349

Registered June 5, 2012

Int. Cl.: 9

TRADEMARK

PRINCIPAL REGISTER

ENTERPRISEDB CORPORATION (DELAWARE CORPORATION)
34 CROSBY DRIVE
SUITE 100
BEDFORD, MA 01730

FOR: COMPUTER SOFTWARE FOR INFORMATION PROCESSING, NAMELY, DATABASE MANAGEMENT AND DEVELOPMENT, IN CLASS 9 (U.S. CLS. 21, 23, 26, 36 AND 38).

FIRST USE 8-24-2006; IN COMMERCE 8-24-2006.

THE MARK CONSISTS OF STANDARD CHARACTERS WITHOUT CLAIM TO ANY PARTICULAR FONT, STYLE, SIZE, OR COLOR.

SN 77-560,094, FILED 9-2-2008.

TINA L. SNAPP, EXAMINING ATTORNEY



David J. Kyjars

Director of the United States Patent and Trademark Office

United States of America

United States Patent and Trademark Office

HYGROMIX

Reg. No. 4,154,350

ELI LILLY AND COMPANY (INDIANA CORPORATION)
LILLY CORPORATE CENTER
INDIANAPOLIS, IN 46285

Registered June 5, 2012

Int. Cl.: 5

FOR: ANTIBIOTIC ANTHELMINTIC USED TO CONTROL AND ELIMINATE WORMS IN SWINE AND POULTRY, IN CLASS 5 (U.S. CLS. 6, 18, 44, 46, 51 AND 52).

TRADEMARK

FIRST USE 3-21-2012; IN COMMERCE 3-21-2012.

PRINCIPAL REGISTER

THE MARK CONSISTS OF STANDARD CHARACTERS WITHOUT CLAIM TO ANY PARTICULAR FONT, STYLE, SIZE, OR COLOR.

SN 77-560,292, FILED 9-2-2008.

KRISTINA MORRIS, EXAMINING ATTORNEY



David J. Kyjars

Director of the United States Patent and Trademark Office

United States of America

United States Patent and Trademark Office

HIGHGROUND

Reg. No. 4,154,351

Registered June 5, 2012

Int. Cl.: 9

TRADEMARK

PRINCIPAL REGISTER

STRATEGIC SYSTEMS & TECHNOLOGY CORP. (FLORIDA CORPORATION)
2235 PADDOCKS PARKWAY, SUITE 250
SUWANEE, GA 30024

FOR: COMPUTER SOFTWARE FOR WORK ORDER MANAGEMENT RELATING TO FACILITIES PROJECTS, REPAIRS, FIELD SERVICE, AND PREVENTATIVE MAINTENANCE, IN CLASS 9 (U.S. CLS. 21, 23, 26, 36 AND 38).

FIRST USE 2-13-2012; IN COMMERCE 2-13-2012.

THE MARK CONSISTS OF STANDARD CHARACTERS WITHOUT CLAIM TO ANY PARTICULAR FONT, STYLE, SIZE, OR COLOR.

SN 77-564,542, FILED 9-8-2008.

SIMON TENG, EXAMINING ATTORNEY



David J. Kybas

Director of the United States Patent and Trademark Office

United States of America

United States Patent and Trademark Office

EAST MEETS WEST

Reg. No. 4,154,352

Registered June 5, 2012

Int. Cl.: 41

SERVICE MARK

PRINCIPAL REGISTER

PATERSON, PAGE (UNITED STATES INDIVIDUAL)
1317 MIDDLESOUND LOOP RD.
WILMINGTON, NC 28411

FOR: PROVIDING ON-LINE TRAINING TO WESTERN HEALTHCARE PRACTITIONERS
IN THE FORM OF COURSES, SEMINARS AND WORKSHOPS IN THE FIELD OF EASTERN
MEDICINE, IN CLASS 41 (U.S. CLS. 100, 101 AND 107).

FIRST USE 1-6-2012; IN COMMERCE 1-6-2012.

THE MARK CONSISTS OF STANDARD CHARACTERS WITHOUT CLAIM TO ANY PAR-
TICULAR FONT, STYLE, SIZE, OR COLOR.

SN 77-564,560, FILED 9-8-2008.

KIMBERLY PERRY, EXAMINING ATTORNEY



David J. Kyffers

Director of the United States Patent and Trademark Office

United States of America

United States Patent and Trademark Office

!NMULT

Reg. No. 4,154,353

Registered June 5, 2012

Int. Cl.: 9

TRADEMARK

PRINCIPAL REGISTER

IMI INNOVATIONS, INC. (DELAWARE CORPORATION)
556 SOUTH MAIN STREET
NAPERVILLE, IL 60540

FOR: COMPUTER SOFTWARE THAT EXPANDS THE HUMAN-COMPUTER INTERFACE BY ALLOWING SIMULTANEOUS AND INDEPENDENT MULTIPLE INPUTS FROM MULTIPLE CONTROL SOURCES; SOFTWARE DEVELOPMENT KIT CONSISTING PRIMARILY OF SOFTWARE AND SAMPLE SOURCE CODE FOR THE DEVELOPMENT OF COMPUTER SOFTWARE THAT EXPANDS THE HUMAN-COMPUTER INTERFACE BY ALLOWING SIMULTANEOUS AND INDEPENDENT MULTIPLE INPUTS FROM MULTIPLE CONTROL SOURCES, IN CLASS 9 (U.S. CLS. 21, 23, 26, 36 AND 38).

FIRST USE 4-1-2012; IN COMMERCE 4-1-2012.

THE MARK CONSISTS OF STANDARD CHARACTERS WITHOUT CLAIM TO ANY PARTICULAR FONT, STYLE, SIZE, OR COLOR.

SN 77-564,962, FILED 9-8-2008.

B. PARADEWELAI, EXAMINING ATTORNEY



David J. Kypos

Director of the United States Patent and Trademark Office

United States of America

United States Patent and Trademark Office

INMULT

Reg. No. 4,154,354

Registered June 5, 2012

Int. Cl.: 9

TRADEMARK

PRINCIPAL REGISTER

IMI INNOVATIONS, INC. (DELAWARE CORPORATION)
556 SOUTH MAIN STREET
NAPERVILLE, IL 60540

FOR: COMPUTER SOFTWARE FOR USE IN EXPANDING THE HUMAN-COMPUTER INTERFACE BY ALLOWING SIMULTANEOUS AND INDEPENDENT MULTIPLE INPUTS FROM MULTIPLE CONTROL SOURCES; SOFTWARE DEVELOPMENT KIT CONSISTING PRIMARILY OF SOFTWARE AND SAMPLE SOURCE CODE FOR THE DEVELOPMENT OF COMPUTER SOFTWARE THAT EXPANDS THE HUMAN-COMPUTER INTERFACE BY ALLOWING SIMULTANEOUS AND INDEPENDENT MULTIPLE INPUTS FROM MULTIPLE CONTROL SOURCES, IN CLASS 9 (U.S. CLS. 21, 23, 26, 36 AND 38).

FIRST USE 4-1-2012; IN COMMERCE 4-1-2012.

THE MARK CONSISTS OF STANDARD CHARACTERS WITHOUT CLAIM TO ANY PARTICULAR FONT, STYLE, SIZE, OR COLOR.

SN 77-564,965, FILED 9-8-2008.

B. PARADEWELAI, EXAMINING ATTORNEY



David J. Kyffers

Director of the United States Patent and Trademark Office

United States of America

United States Patent and Trademark Office

BRISK

Reg. No. 4,154,355

Registered June 5, 2012

Int. Cl.: 42

SERVICE MARK

PRINCIPAL REGISTER

BRISTOL-MYERS SQUIBB COMPANY (DELAWARE CORPORATION)
345 PARK AVENUE
NEW YORK, NY 10154

FOR: MEDICAL AND SCIENTIFIC RESEARCH, NAMELY, CONDUCTING CLINICAL TRIALS AND CLINICAL STUDIES RELATING TO PHARMACEUTICAL PREPARATIONS FOR HUMAN USE, IN CLASS 42 (U.S. CLS. 100 AND 101).

FIRST USE 2-28-2009; IN COMMERCE 2-28-2009.

THE MARK CONSISTS OF STANDARD CHARACTERS WITHOUT CLAIM TO ANY PARTICULAR FONT, STYLE, SIZE, OR COLOR.

SN 77-567,795, FILED 9-11-2008.

DOMINICK J. SALEMI, EXAMINING ATTORNEY



David J. Kybas

Director of the United States Patent and Trademark Office

United States of America

United States Patent and Trademark Office



Reg. No. 4,154,356

Registered June 5, 2012

Int. Cls.: 9, 35, and 38

TRADEMARK

SERVICE MARK

PRINCIPAL REGISTER

SMARTDRIVE SYSTEMS, INC. (DELAWARE CORPORATION)
9276 SCRANTON ROAD, SUITE 500
SAN DIEGO, CA 92121

FOR: VIDEO, AUDIO AND EVENT DIAGNOSTIC RECORDERS FOR USE IN VEHICLES; VIDEO, AUDIO AND EVENT RECORDERS FOR THE PURPOSE OF RECORDING, ANALYZING, SCORING OR TRENDING DRIVER BEHAVIOR AND INFORMATION; VIDEO, AUDIO AND EVENT RECORDERS FOR THE PURPOSE OF RECORDING, DOWNLOADING AND TRANSMITTING VEHICLE, DRIVING AND DRIVER INFORMATION, IN CLASS 9 (U.S. CLS. 21, 23, 26, 36 AND 38).

FIRST USE 4-6-2008; IN COMMERCE 5-23-2008.

FOR: TRACKING, LOCATING AND MONITORING OF VEHICLES FOR COMMERCIAL PURPOSES; INFORMATION AND DATA COMPILING AND ANALYZING RELATING TO BUSINESS MANAGEMENT, SPECIFICALLY FOR THE REVIEW AND RATING OF RECORDED VIDEO, AUDIO AND EVENT INFORMATION CONCERNING VEHICLES, VEHICLE DRIVING BEHAVIOR AND DRIVER INFORMATION FOR FLEET MANAGERS, OWNERS AND VEHICLE MANUFACTURERS, IN CLASS 35 (U.S. CLS. 100, 101 AND 102).

FIRST USE 4-6-2008; IN COMMERCE 5-23-2008.

FOR: ON-LINE DELIVERY VIA A GLOBAL COMPUTER NETWORK OF RECORDED VIDEO, AUDIO AND EVENT INFORMATION CONCERNING VEHICLES, VEHICLE DRIVING BEHAVIOR AND DRIVER INFORMATION FOR FLEET MANAGERS, OWNERS AND VEHICLE MANUFACTURERS, IN CLASS 38 (U.S. CLS. 100, 101 AND 104).

FIRST USE 4-6-2008; IN COMMERCE 5-23-2008.

OWNER OF U.S. REG. NOS. 3,819,803 AND 3,823,581.

THE MARK CONSISTS OF THE WORDING "SMARTDRIVE" TO THE RIGHT OF A SQUIGGLE DESIGN WITH THE APPEARANCE OF A DIVIDED ROADWAY.

SN 77-569,029, FILED 9-12-2008.

ANDREA HACK, EXAMINING ATTORNEY



David J. Kappas

Director of the United States Patent and Trademark Office

United States of America

United States Patent and Trademark Office

Goddess Union

Reg. No. 4,154,357

VENA, DEBORAH (UNITED STATES INDIVIDUAL)
P.O. BOX 40-2577
HESPERIA, CA 923402577

Registered June 5, 2012

Int. Cl.: 25

FOR: T-SHIRTS, HATS; JACKETS; PANTS; SHOES, IN CLASS 25 (U.S. CLS. 22 AND 39).

TRADEMARK

FIRST USE 4-2-2011; IN COMMERCE 5-1-2011.

PRINCIPAL REGISTER

THE MARK CONSISTS OF STANDARD CHARACTERS WITHOUT CLAIM TO ANY PARTICULAR FONT, STYLE, SIZE, OR COLOR.

SN 77-574,028, FILED 9-19-2008.

MICHAEL LITZAU, EXAMINING ATTORNEY



David J. Kyffers

Director of the United States Patent and Trademark Office

United States of America

United States Patent and Trademark Office



Reg. No. 4,154,358

Registered June 5, 2012

Int. Cl.: 21

TRADEMARK

PRINCIPAL REGISTER

BAR NND RANCHES, LLC (NEW MEXICO LIMITED LIABILITY COMPANY)
P.O. BOX 1684
MIDLAND, TX 79702

FOR: MUGS; THERMAL INSULATED CONTAINERS FOR FOOD OR BEVERAGE, IN CLASS
21 (U.S. CLS. 2, 13, 23, 29, 30, 33, 40 AND 50).

FIRST USE 9-30-2008; IN COMMERCE 12-15-2011.

THE MARK CONSISTS OF A FANCIFUL DEER WITH ANTLERS HOLDING A COFFEE
MUG WHICH HAS THE WORDS "UNGULATTE".

SN 77-582,572, FILED 9-30-2008.

JOHN GARTNER, EXAMINING ATTORNEY



David J. Kybas

Director of the United States Patent and Trademark Office

United States of America

United States Patent and Trademark Office

THE CUTTING EDGE OF BEAUTY

Reg. No. 4,154,359

Registered June 5, 2012

Int. Cl.: 41

SERVICE MARK

PRINCIPAL REGISTER

ANSON & HIGGINS PLASTIC SURGERY ASSOCIATES, LLP (NEVADA LIMITED LIABILITY PARTNERSHIP)
7135 W. SAHARA, SUITE 200
LAS VEGAS, NV 89117

FOR: EDUCATIONAL AND ENTERTAINMENT SERVICES, NAMELY, A CONTINUING PROGRAM ABOUT COSMETIC AND PLASTIC SURGERY ACCESSIBLE BY AUDIO, VIDEO AND COMPUTER NETWORKS, IN CLASS 41 (U.S. CLS. 100, 101 AND 107).

FIRST USE 2-0-2012; IN COMMERCE 2-0-2012.

THE MARK CONSISTS OF STANDARD CHARACTERS WITHOUT CLAIM TO ANY PARTICULAR FONT, STYLE, SIZE, OR COLOR.

SN 77-582,652, FILED 9-30-2008.

KATHLEEN LORENZO, EXAMINING ATTORNEY



David J. Kybas

Director of the United States Patent and Trademark Office

United States of America

United States Patent and Trademark Office

BEAUTY'S CUTTING EDGE

Reg. No. 4,154,360

Registered June 5, 2012

Int. Cl.: 41

SERVICE MARK

PRINCIPAL REGISTER

ANSON & HIGGINS PLASTIC SURGERY ASSOCIATES, LLP (NEVADA LIMITED LIABILITY PARTNERSHIP)
7135 W. SAHARA, SUITE 200
LAS VEGAS, NV 89117

FOR: EDUCATIONAL AND ENTERTAINMENT SERVICES, NAMELY, A CONTINUING PROGRAM ABOUT COSMETIC AND PLASTIC SURGERY ACCESSIBLE BY AUDIO, VIDEO AND COMPUTER NETWORKS, IN CLASS 41 (U.S. CLS. 100, 101 AND 107).

FIRST USE 2-0-2012; IN COMMERCE 2-0-2012.

THE MARK CONSISTS OF STANDARD CHARACTERS WITHOUT CLAIM TO ANY PARTICULAR FONT, STYLE, SIZE, OR COLOR.

SN 77-582,661, FILED 9-30-2008.

KATHLEEN LORENZO, EXAMINING ATTORNEY



David J. Kybas

Director of the United States Patent and Trademark Office

United States of America

United States Patent and Trademark Office

got breastmilk?

Reg. No. 4,154,361

Registered June 5, 2012

Int. Cl.: 25

TRADEMARK

PRINCIPAL REGISTER

CALIFORNIA MILK PROCESSOR BOARD (CALIFORNIA STATE INSTRUMENTALITY)
SUITE 202
101 SOUTH EL CAMINO REAL
SAN CLEMENTE, CA 92672

FOR: CLOTHING, NAMELY, T-SHIRTS, SHIRTS, SHORT-SLEEVED SHIRTS, INFANT
BODYSUITS, AND INFANT UNDERWEAR, IN CLASS 25 (U.S. CLS. 22 AND 39).

FIRST USE 12-31-2011; IN COMMERCE 12-31-2011.

OWNER OF U.S. REG. NOS. 1,903,870 AND 2,689,741.

NO CLAIM IS MADE TO THE EXCLUSIVE RIGHT TO USE "BREASTMILK", APART FROM
THE MARK AS SHOWN.

THE MARK CONSISTS OF THE WORDING "GOT BREASTMILK?" IN ALL LOWER CASE
LETTERS IN PHENIX AMERICAN FONT.

SN 77-586,468, FILED 10-6-2008.

EMILY CHUO, EXAMINING ATTORNEY



David J. Kyffers

Director of the United States Patent and Trademark Office

United States of America

United States Patent and Trademark Office

WHYGELATO.COM

Reg. No. 4,154,362

Registered June 5, 2012

Int. Cls.: 16 and 25

TRADEMARK

PRINCIPAL REGISTER

PREGEL AMERICA, INC. (NORTH CAROLINA CORPORATION)
4450 FORTUNE AVENUE NW
CONCORD, NC 28027

FOR: GROCERY BAGS, PENS, BANNERS, BUMPER STICKERS, DECALS, PAMPHLETS
IN THE FIELD OF DESSERTS, BROCHURES IN THE FIELD OF DESSERTS, TEMPORARY
TATTOOS, IN CLASS 16 (U.S. CLS. 2, 5, 22, 23, 29, 37, 38 AND 50).

FIRST USE 8-0-2008; IN COMMERCE 8-0-2008.

FOR: T-SHIRTS, HATS, IN CLASS 25 (U.S. CLS. 22 AND 39).

FIRST USE 8-0-2008; IN COMMERCE 8-0-2008.

THE MARK CONSISTS OF STANDARD CHARACTERS WITHOUT CLAIM TO ANY PAR-
TICULAR FONT, STYLE, SIZE, OR COLOR.

SN 77-589,526, FILED 10-9-2008.

CHRIS WELLS, EXAMINING ATTORNEY



David J. Kyros

Director of the United States Patent and Trademark Office

United States of America

United States Patent and Trademark Office

HEALTH VILLAGE

Reg. No. 4,154,363

ADVENTIST HEALTH SYSTEM/SUNBELT, INC. (FLORIDA CORPORATION)
111 N. ORLANDO AVE.
ORLANDO, FL 32789

Registered June 5, 2012

Int. Cl.: 43

FOR: RESTAURANT AND CAFÉ SERVICES; CONVENTION, EXHIBITION AND MEETING FACILITIES SERVICES, IN CLASS 43 (U.S. CLS. 100 AND 101).

SERVICE MARK

FIRST USE 2-24-2012; IN COMMERCE 2-24-2012.

PRINCIPAL REGISTER

THE MARK CONSISTS OF STANDARD CHARACTERS WITHOUT CLAIM TO ANY PARTICULAR FONT, STYLE, SIZE, OR COLOR.

SN 77-589,566, FILED 10-9-2008.

CHARLOTTE CORWIN, EXAMINING ATTORNEY



David J. Kybas

Director of the United States Patent and Trademark Office

United States of America

United States Patent and Trademark Office

PROXISCAN

Reg. No. 4,154,364

Registered June 5, 2012

Int. Cl.: 10

TRADEMARK

PRINCIPAL REGISTER

HYBRIDYNE IMAGING TECHNOLOGIES, INC. (PENNSYLVANIA CORPORATION)
18 CENTURY PARK WEST, SUITE 300
C/O LARSEN ALLEN
BLUE BELL, PA 194222327

FOR: MEDICAL DEVICES, NAMELY, PROBES FOR THE DIAGNOSIS AND TREATMENT
OF CANCER, IN CLASS 10 (U.S. CLS. 26, 39 AND 44).

FIRST USE 5-18-2011; IN COMMERCE 5-18-2011.

THE MARK CONSISTS OF STANDARD CHARACTERS WITHOUT CLAIM TO ANY PAR-
TICULAR FONT, STYLE, SIZE, OR COLOR.

SN 77-592,038, FILED 10-14-2008.

ANDREA K. NADELMAN, EXAMINING ATTORNEY



David J. Kybas

Director of the United States Patent and Trademark Office

United States of America

United States Patent and Trademark Office

HYDROLINE

Reg. No. 4,154,365

Registered June 5, 2012

Int. Cls.: 9 and 11

TRADEMARK

PRINCIPAL REGISTER

PURELINE, LLC (WYOMING LIMITED LIABILITY COMPANY)
2710 THOMES AVENUE
CHEYENNE, WY 82001

FOR: ELECTRONIC WATER METERS FOR USE IN GROUNDWATER QUALITY SAMPLING,
IN CLASS 9 (U.S. CLS. 21, 23, 26, 36 AND 38).

FIRST USE 3-0-2009; IN COMMERCE 3-0-2009.

FOR: GROUNDWATER FILTERS FOR USE IN GROUNDWATER QUALITY SAMPLING,
IN CLASS 11 (U.S. CLS. 13, 21, 23, 31 AND 34).

FIRST USE 3-0-2009; IN COMMERCE 3-0-2009.

THE MARK CONSISTS OF STANDARD CHARACTERS WITHOUT CLAIM TO ANY PAR-
TICULAR FONT, STYLE, SIZE, OR COLOR.

SN 77-599,622, FILED 10-24-2008.

LESLEY LAMOTHE, EXAMINING ATTORNEY



David J. Kyros

Director of the United States Patent and Trademark Office

United States of America

United States Patent and Trademark Office

ZYPREXA RELPREVV

Reg. No. 4,154,366

ELI LILLY AND COMPANY (INDIANA CORPORATION)
LILLY CORPORATE CENTER
INDIANAPOLIS, IN 46285

Registered June 5, 2012

Int. Cl.: 5

FOR: PHARMACEUTICAL PREPARATIONS, NAMELY, ANTIPSYCHOTICS, IN CLASS 5
(U.S. CLS. 6, 18, 44, 46, 51 AND 52).

TRADEMARK

FIRST USE 3-30-2010; IN COMMERCE 3-30-2010.

PRINCIPAL REGISTER

THE MARK CONSISTS OF STANDARD CHARACTERS WITHOUT CLAIM TO ANY PARTICULAR FONT, STYLE, SIZE, OR COLOR.

OWNER OF U.S. REG. NO. 2,072,867.

THE MARK HAS NO MEANING IN A FOREIGN LANGUAGE.

SN 77-601,955, FILED 10-28-2008.

DEIRDRE ROBERTSON, EXAMINING ATTORNEY



David J. Kyjars

Director of the United States Patent and Trademark Office

United States of America

United States Patent and Trademark Office

DONNA KARAN

Reg. No. 4,154,367

Registered June 5, 2012

Int. Cl.: 8

TRADEMARK

PRINCIPAL REGISTER

GABRIELLE STUDIO, INC. (NEW YORK CORPORATION)
550 SEVENTH AVENUE
NEW YORK, NY 10018

FOR: FLATWARE AND TABLEWARE, NAMELY, FORKS, KNIVES AND SPOONS MADE OF STAINLESS STEEL, CAKE CUTTERS, CHEESE SLICERS, IN CLASS 8 (U.S. CLS. 23, 28 AND 44).

FIRST USE 10-0-2010; IN COMMERCE 10-0-2010.

THE MARK CONSISTS OF STANDARD CHARACTERS WITHOUT CLAIM TO ANY PARTICULAR FONT, STYLE, SIZE, OR COLOR.

OWNER OF U.S. REG. NOS. 2,142,132, 3,014,041, AND 3,069,157.

THE NAME "DONNA KARAN" IDENTIFIES A LIVING INDIVIDUAL WHOSE CONSENT IS OF RECORD.

SN 77-603,069, FILED 10-29-2008.

SUZANNE BLANE, EXAMINING ATTORNEY



David J. Kyffers

Director of the United States Patent and Trademark Office

United States of America

United States Patent and Trademark Office

DONNA KARAN

Reg. No. 4,154,368

Registered June 5, 2012

Int. Cl.: 21

TRADEMARK

PRINCIPAL REGISTER

GABRIELLE STUDIO, INC. (NEW YORK CORPORATION)
550 SEVENTH AVENUE
NEW YORK, NY 10018

FOR: DINNERWARE, NAMELY, PLATES, DISHES, CHARGERS, BOWLS, CUPS AND SAUCERS; STEMWARE, BEVERAGEWARE; DECANTERS; SERVING PLATTERS AND TRAYS NOT OF PRECIOUS METAL; MUGS; SUGAR BOWLS AND CREAMERS, NAMELY, CONTAINERS FOR SERVING CREAM NOT MADE OF PRECIOUS METAL; NON-ELECTRIC TEA POTS; CANDLESTICK HOLDERS NOT OF PRECIOUS METAL, VASES, IN CLASS 21 (U.S. CLS. 2, 13, 23, 29, 30, 33, 40 AND 50).

FIRST USE 10-0-2010; IN COMMERCE 10-0-2010.

THE MARK CONSISTS OF STANDARD CHARACTERS WITHOUT CLAIM TO ANY PARTICULAR FONT, STYLE, SIZE, OR COLOR.

OWNER OF U.S. REG. NOS. 2,142,132, 3,014,041, AND 3,069,157.

THE NAME "DONNA KARAN" IDENTIFIES A LIVING INDIVIDUAL WHOSE CONSENT IS OF RECORD.

SN 77-603,074, FILED 10-29-2008.

SUZANNE BLANE, EXAMINING ATTORNEY



David J. Kyffers

Director of the United States Patent and Trademark Office

United States of America

United States Patent and Trademark Office

WOLVERINE ICS

Reg. No. 4,154,369

Registered June 5, 2012

Int. Cl.: 25

TRADEMARK

PRINCIPAL REGISTER

WOLVERINE WORLD WIDE, INC. (DELAWARE CORPORATION)
9341 COURTLAND DRIVE NE
ROCKFORD, MI 49351

FOR: FOOTWEAR, IN CLASS 25 (U.S. CLS. 22 AND 39).

FIRST USE 10-21-2011; IN COMMERCE 10-21-2011.

THE MARK CONSISTS OF STANDARD CHARACTERS WITHOUT CLAIM TO ANY PARTICULAR FONT, STYLE, SIZE, OR COLOR.

SN 77-608,127, FILED 11-5-2008.

ROBIN CHOSID, EXAMINING ATTORNEY



David J. Kyffers

Director of the United States Patent and Trademark Office

United States of America

United States Patent and Trademark Office

Reuse

Reg. No. 4,154,370

Registered June 5, 2012

Int. Cl.: 16

TRADEMARK

PRINCIPAL REGISTER

ARMSTRONG, STEPHEN GEOFFREY (CANADA INDIVIDUAL)
43 MCRAE DRIVE
TORONTO, CANADA M4G1S2

FOR: SINGLE-USE, DISPOSABLE PLASTIC GARBAGE BAGS; SINGLE-USE, DISPOSABLE PLASTIC TRASH BAGS; SINGLE-USE, DISPOSABLE TRASH BAGS; SINGLE-USE, DISPOSABLE PLASTIC TRASH CAN LINERS, IN CLASS 16 (U.S. CLS. 2, 5, 22, 23, 29, 37, 38 AND 50).

FIRST USE 3-0-2009; IN COMMERCE 3-0-2009.

THE MARK CONSISTS OF STANDARD CHARACTERS WITHOUT CLAIM TO ANY PARTICULAR FONT, STYLE, SIZE, OR COLOR.

SN 77-613,460, FILED 11-13-2008.

TRACY FLETCHER, EXAMINING ATTORNEY



David J. Kybas

Director of the United States Patent and Trademark Office

United States of America

United States Patent and Trademark Office

RELADYNE

Reg. No. 4,154,371

Registered June 5, 2012

**Int. Cls.: 4, 35, 37, 40, 41,
and 42**

TRADEMARK

SERVICE MARK

PRINCIPAL REGISTER

RELADYNE, LLC (DELAWARE LIMITED LIABILITY COMPANY)
SUITE 420
50 E BUSINESS WAY
SHARONVILLE, OH 45241

FOR: ALL PURPOSE LUBRICANTS; AUTOMOBILE, TRUCK AND HEAVY EQUIPMENT LUBRICANTS; LUBRICANTS FOR INDUSTRIAL MACHINERY; LUBRICANTS FOR AIR-CRAFT ENGINES; INDUSTRIAL LUBRICANTS, IN CLASS 4 (U.S. CLS. 1, 6 AND 15).

FIRST USE 11-9-2010; IN COMMERCE 11-9-2010.

FOR: DISTRIBUTORSHIP SERVICES IN THE FIELD OF LUBRICANTS, SPECIALTY LUBRICATION PRODUCTS, SPECIALTY LUBRICATION RELATED PRODUCTS AND LUBRICATION RELIABILITY RELATED PRODUCTS FOR OTHERS, IN CLASS 35 (U.S. CLS. 100, 101 AND 102).

FIRST USE 11-9-2010; IN COMMERCE 11-9-2010.

FOR: MAINTENANCE SERVICES IN THE FIELD OF LUBRICATION AND EQUIPMENT RELIABILITY; LUBRICATION MAINTENANCE, NAMELY, FLUID FILTRATION AND FLUSHING SERVICE; CONSULTATION AND ADVISORY SERVICES RELATING TO LUBRICANTS AND LUBRICATION OF MACHINERY AND ENGINES, IN CLASS 37 (U.S. CLS. 100, 103 AND 106).

FIRST USE 11-9-2010; IN COMMERCE 11-9-2010.

FOR: CUSTOM MANUFACTURE OF LUBRICANTS, SPECIALTY LUBRICATION PRODUCTS AND SPECIALTY LUBRICATION RELATED PRODUCTS FOR OTHERS, IN CLASS 40 (U.S. CLS. 100, 103 AND 106).

FIRST USE 11-9-2010; IN COMMERCE 11-9-2010.

FOR: ONLINE AND CLASSROOM LUBRICATION AND EQUIPMENT RELIABILITY TRAINING SERVICES, IN CLASS 41 (U.S. CLS. 100, 101 AND 107).

FIRST USE 11-9-2010; IN COMMERCE 11-9-2010.



David J. Kyjars

Director of the United States Patent and Trademark Office

Reg. No. 4,154,371 FOR: LABORATORY TESTING AND ANALYSIS OF LUBRICANTS AND LUBRICATION RELATED FLUIDS FOR THE PURPOSE OF IDENTIFYING EFFECTIVENESS AND IMPROVEMENT OPPORTUNITIES; TESTING SERVICES, NAMELY, THERMAL IMAGING, VIBRATION ANALYSIS AND ULTRASOUND TESTING TO DETERMINE LUBRICATION SUFFICIENCY AND EFFICIENCY; CUSTOM DESIGN AND ENGINEERING OF CUSTOMIZED FLUID FILTRATION AND FLUSHING SERVICES FOR OTHERS; CUSTOM DESIGN AND ENGINEERING OF LUBRICANTS, SPECIALTY LUBRICATION PRODUCTS, SPECIALTY LUBRICATION RELATED PRODUCTS AND LUBRICATION RELIABILITY PRODUCTS FOR OTHERS; CUSTOMIZED DESIGN AND ENGINEERING OF LUBRICATION AND RELIABILITY SERVICES FOR COMMERCIAL AND INDUSTRIAL CUSTOMERS; CUSTOMIZED DESIGN AND ENGINEERING OF EQUIPMENT RELIABILITY PRODUCTS AND SERVICES FOR COMMERCIAL AND INDUSTRIAL CUSTOMERS, IN CLASS 42 (U.S. CLS. 100 AND 101).

FIRST USE 11-9-2010; IN COMMERCE 11-9-2010.

THE MARK CONSISTS OF STANDARD CHARACTERS WITHOUT CLAIM TO ANY PARTICULAR FONT, STYLE, SIZE, OR COLOR.

SN 77-616,021, FILED 11-17-2008.

TRACY CROSS, EXAMINING ATTORNEY

United States of America

United States Patent and Trademark Office

YOFO

Reg. No. 4,154,372

Registered June 5, 2012

Int. Cl.: 9

TRADEMARK

PRINCIPAL REGISTER

JOHN VONS LLC (DELAWARE LIMITED LIABILITY COMPANY)
131 AVENUE A, #14
NEW YORK, NY 10009

FOR: ACCESSORIES FOR ELECTRONICS, NAMELY, GRIP, HOLDER AND STAND ALL SOLD AS A UNIT FOR USE WITH MOBILE PHONES, MP3 PLAYERS, AND PORTABLE MEDIA PLAYERS, IN CLASS 9 (U.S. CLS. 21, 23, 26, 36 AND 38).

FIRST USE 9-20-2011; IN COMMERCE 10-11-2011.

THE MARK CONSISTS OF STANDARD CHARACTERS WITHOUT CLAIM TO ANY PARTICULAR FONT, STYLE, SIZE, OR COLOR.

THE WORDING "YOFO" HAS NO MEANING IN A FOREIGN LANGUAGE.

SN 77-621,316, FILED 11-25-2008.

LINDA ESTRADA, EXAMINING ATTORNEY



David J. Kyffers

Director of the United States Patent and Trademark Office

United States of America
United States Patent and Trademark Office

TigerStrike

Reg. No. 4,154,373

FIRESTORM EMERGENCY SERVICES LTD. (NEVADA CORPORATION)
3100 MURIEL DRIVE
RIVERSIDE, CA 92509

Registered June 5, 2012

Int. Cl.: 9

FOR: RADIO RECEIVER, NAMELY, DIRECTION FINDER, IN CLASS 9 (U.S. CLS. 21, 23, 26, 36 AND 38).

TRADEMARK

FIRST USE 1-15-2012; IN COMMERCE 1-15-2012.

PRINCIPAL REGISTER

THE MARK CONSISTS OF STANDARD CHARACTERS WITHOUT CLAIM TO ANY PARTICULAR FONT, STYLE, SIZE, OR COLOR.

SN 77-627,177, FILED 12-5-2008.

LEIGH CAROLINE CASE, EXAMINING ATTORNEY



David J. Kybas

Director of the United States Patent and Trademark Office

United States of America

United States Patent and Trademark Office

SUBCHONDROPLASTY

Reg. No. 4,154,374

Registered June 5, 2012

Int. Cl.: 10

TRADEMARK

PRINCIPAL REGISTER

KNEE CREATIONS, LLC (DELAWARE LIMITED LIABILITY COMPANY)
900 AIRPORT ROAD
WEST CHESTER, PA 19380

FOR: MEDICAL AND SURGICAL INSTRUMENTS FOR USE IN ORTHOPEDIC SURGERY;
SURGICAL ACCESS DEVICES; MEDICAL AND SURGICAL KITS CONTAINING MEDICAL
AND SURGICAL INSTRUMENTS FOR USE IN ORTHOPEDIC SURGERY AND SURGICAL
ACCESS DEVICES, IN CLASS 10 (U.S. CLS. 26, 39 AND 44).

FIRST USE 2-29-2012; IN COMMERCE 2-29-2012.

THE MARK CONSISTS OF STANDARD CHARACTERS WITHOUT CLAIM TO ANY PAR-
TICULAR FONT, STYLE, SIZE, OR COLOR.

SN 77-629,996, FILED 12-10-2008.

REBECCA EISINGER, EXAMINING ATTORNEY



David J. Kybas

Director of the United States Patent and Trademark Office

United States of America

United States Patent and Trademark Office

SEE IT POP

Reg. No. 4,154,375

Registered June 5, 2012

Int. Cl.: 30

TRADEMARK

PRINCIPAL REGISTER

CONAGRA FOODS RDM, INC. (DELAWARE CORPORATION)
ONE CONAGRA DRIVE
OMAHA, NE 68102

FOR: UNPOPPED POPCORN, IN CLASS 30 (U.S. CL. 46).

FIRST USE 1-25-2011; IN COMMERCE 2-7-2011.

THE MARK CONSISTS OF STANDARD CHARACTERS WITHOUT CLAIM TO ANY PARTICULAR FONT, STYLE, SIZE, OR COLOR.

SN 77-639,573, FILED 12-24-2008.

JACLYN KIDWELL WALKER, EXAMINING ATTORNEY



David J. Kyffers

Director of the United States Patent and Trademark Office

United States of America

United States Patent and Trademark Office

LA GRANJA

Reg. No. 4,154,376

Registered June 5, 2012

Int. Cl.: 33

TRADEMARK

PRINCIPAL REGISTER

QUEENSWAY INVESTMENT HOLDINGS, LLC (DELAWARE LIMITED LIABILITY COMPANY)
13363 PORTOFINO DRIVE
DEL MAR, CA 92014

FOR: WINES, IN CLASS 33 (U.S. CLS. 47 AND 49).

FIRST USE 12-20-2011; IN COMMERCE 12-20-2011.

THE MARK CONSISTS OF STANDARD CHARACTERS WITHOUT CLAIM TO ANY PARTICULAR FONT, STYLE, SIZE, OR COLOR.

THE ENGLISH TRANSLATION OF "LA GRANJA" IS "THE FARM".

SN 77-640,481, FILED 12-29-2008.

DAVID I, EXAMINING ATTORNEY



David J. Kyfos

Director of the United States Patent and Trademark Office

United States of America

United States Patent and Trademark Office

LIFE BOOK

Reg. No. 4,154,377

Registered June 5, 2012

Int. Cl.: 25

TRADEMARK

PRINCIPAL REGISTER

H.H. BROWN SHOE COMPANY, INC. (DELAWARE CORPORATION)
124 W. PUTNAM AVENUE
GREENWICH, CT 06830

FOR: FOOTWEAR AND CLOTHING, NAMELY, BELTS, DRESSES, GLOVES, JACKETS, NECKWEAR, NIGHTWEAR, PANTS, SUITS, SWIMWEAR, SKIRTS, TOPS, BOTTOMS, UNDERWEAR, HEADWEAR, UNIFORMS, SHIRTS, SWEATSHIRTS, SWEATPANTS, SHORTS, SWEATERS, COATS, WRISTBANDS, SOCKS, HOSIERY, T-SHIRTS, SCARVES, CAPS, VESTS, AND PULLOVERS, IN CLASS 25 (U.S. CLS. 22 AND 39).

FIRST USE 6-9-2009; IN COMMERCE 6-9-2009.

THE MARK CONSISTS OF STANDARD CHARACTERS WITHOUT CLAIM TO ANY PARTICULAR FONT, STYLE, SIZE, OR COLOR.

SN 77-646,218, FILED 1-9-2009.

TINA L. SNAPP, EXAMINING ATTORNEY



David J. Kyffers

Director of the United States Patent and Trademark Office

United States of America

United States Patent and Trademark Office

ASSURANT PROPERTY ADVANTAGE

Reg. No. 4,154,378

Registered June 5, 2012

Int. Cls.: 36, 37, and 42

SERVICE MARK

PRINCIPAL REGISTER

ASSURANT, INC. (DELAWARE CORPORATION)
ONE CHASE MANHATTAN PLAZA, 41ST FLOOR
NEW YORK, NY 10005

FOR: FINANCIAL SERVICES, NAMELY, MORTGAGE SERVICING; PROPERTY APPRAISAL AND VALUATION SERVICES ON BEHALF OF MORTGAGE LENDERS INVOLVED WITH UNDER- OR NON-PERFORMING MORTGAGE LOANS, PRE- AND POST-MORTGAGE FORECLOSURE SERVICES; REAL ESTATE MANAGEMENT SERVICES, NAMELY, EVICTION SERVICE AND PROPERTY PRESERVATION SERVICES ON BEHALF OF MORTGAGE LENDERS INVOLVED WITH UNDER- OR NON-PERFORMING MORTGAGE LOANS, PRE- AND POST-MORTGAGE FORECLOSURE SERVICES, IN CLASS 36 (U.S. CLS. 100, 101 AND 102).

FIRST USE 10-8-2008; IN COMMERCE 10-8-2008.

FOR: REAL ESTATE MANAGEMENT SERVICES, NAMELY, MAINTENANCE, RESTORATION, REHABILITATION, AND PRESERVATION OF COMMERCIAL AND RESIDENTIAL REAL ESTATE THAT IS IN A STATE OF FORECLOSURE, IN CLASS 37 (U.S. CLS. 100, 103 AND 106).

FIRST USE 10-8-2008; IN COMMERCE 10-8-2008.

FOR: DAMAGED PROPERTY INSPECTION OF COMMERCIAL AND RESIDENTIAL REAL ESTATE; INSPECTION OF COMMERCIAL AND RESIDENTIAL REAL ESTATE THAT IS IN A STATE OF FORECLOSURE; VERIFICATION OF OCCUPANCY AND RELATED INSPECTION SERVICES FOR COMMERCIAL AND RESIDENTIAL REAL ESTATE, IN CLASS 42 (U.S. CLS. 100 AND 101).

FIRST USE 10-8-2008; IN COMMERCE 10-8-2008.

THE MARK CONSISTS OF STANDARD CHARACTERS WITHOUT CLAIM TO ANY PARTICULAR FONT, STYLE, SIZE, OR COLOR.

OWNER OF U.S. REG. NOS. 2,543,367, 3,124,333, AND OTHERS.

NO CLAIM IS MADE TO THE EXCLUSIVE RIGHT TO USE "PROPERTY", APART FROM THE MARK AS SHOWN.



David J. Kyros

Director of the United States Patent and Trademark Office

Reg. No. 4,154,378 SN 77-648,050, FILED 1-13-2009.

PAULA MAHONEY, EXAMINING ATTORNEY

United States of America

United States Patent and Trademark Office

TRANSNET

Reg. No. 4,154,379

Registered June 5, 2012

Int. Cl.: 9

TRADEMARK

PRINCIPAL REGISTER

ETEL S.A. (SWITZERLAND CORPORATION)
13, RUE DE LA GARE
CH-2112 MOTIERS, SWITZERLAND

FOR: ELECTRONIC CONTROLLERS FOR ELECTRONIC MOTORS FOR POSITIONING AN OBJECT, NAMELY, COMMUNICATION CONNECTORS AND INTERFACES FOR TRANSMITTING SIGNALS FROM HAND CONTROLS TO MOTION CONTROL DEVICES, IN CLASS 9 (U.S. CLS. 21, 23, 26, 36 AND 38).

FIRST USE 1-1-2009; IN COMMERCE 1-1-2009.

THE MARK CONSISTS OF STANDARD CHARACTERS WITHOUT CLAIM TO ANY PARTICULAR FONT, STYLE, SIZE, OR COLOR.

OWNER OF SWITZERLAND REG. NO. 563581, DATED 11-6-2007, EXPIRES 6-21-2017.

SN 77-649,590, FILED 1-14-2009.

KATHLEEN LORENZO, EXAMINING ATTORNEY



David J. Kybas

Director of the United States Patent and Trademark Office

United States of America

United States Patent and Trademark Office

BIONEST SOLO

Reg. No. 4,154,380

Registered June 5, 2012

Int. Cl.: 11

TRADEMARK

PRINCIPAL REGISTER

BIONEST TECHNOLOGIES INC. (CANADA CORPORATION)
55, 12IÈME RUE
GRAND-MÈRE, CANADA G9T5L4

FOR: ADVANCED WASTEWATER TREATMENT SYSTEMS, IN CLASS 11 (U.S. CLS. 13, 21, 23, 31 AND 34).

FIRST USE 6-2-2010; IN COMMERCE 6-11-2010.

THE MARK CONSISTS OF STANDARD CHARACTERS WITHOUT CLAIM TO ANY PARTICULAR FONT, STYLE, SIZE, OR COLOR.

PRIORITY CLAIMED UNDER SEC. 44(D) ON CANADA APPLICATION NO. 1,424,349, FILED 1-13-2009, REG. NO. TMA785034, DATED 12-15-2010, EXPIRES 12-15-2025.

OWNER OF U.S. REG. NOS. 3,142,548 AND 3,317,353.

NO CLAIM IS MADE TO THE EXCLUSIVE RIGHT TO USE "SOLO", APART FROM THE MARK AS SHOWN.

SN 77-649,602, FILED 1-14-2009.

EVELYN BRADLEY, EXAMINING ATTORNEY



David J. Kyros

Director of the United States Patent and Trademark Office

United States of America

United States Patent and Trademark Office

Hard Bodii

Reg. No. 4,154,381

LATHAM JR, CHARLES W (UNITED STATES INDIVIDUAL)
7512 ROCK ST.
CHARLESTON, SC 29420

Registered June 5, 2012

Int. Cl.: 25

FOR: TEE SHIRTS, ATHLETIC PANTS, ATHLETIC SHORTS, POLO SHIRTS, DRESS SHIRTS, DENIM PANTS, SWEAT PANTS, SWEAT SHIRTS, HOODED SWEAT SHIRTS, HOODED TEE SHIRTS, ATHLETIC JACKETS, BASEBALL CAPS, CASUAL SHIRTS, BOXER SHORTS, UNDERWEAR, SOCKS, COLLARED SHIRTS, IN CLASS 25 (U.S. CLS. 22 AND 39).

TRADEMARK

PRINCIPAL REGISTER

FIRST USE 1-20-2009; IN COMMERCE 1-25-2009.

THE MARK CONSISTS OF STANDARD CHARACTERS WITHOUT CLAIM TO ANY PARTICULAR FONT, STYLE, SIZE, OR COLOR.

SN 77-650,393, FILED 1-15-2009.

LINDA LAVACHE, EXAMINING ATTORNEY



David J. Kyros

Director of the United States Patent and Trademark Office

United States of America

United States Patent and Trademark Office

I AM NOT A VIRGIN

Reg. No. 4,154,382

HERON, PETER, C (IRELAND INDIVIDUAL), DBA I AM NOT A VIRGIN,
92 HORATIO, APT 2N
NEW YORK, NY 10014

Registered June 5, 2012

Int. Cl.: 25

FOR: JEANS, IN CLASS 25 (U.S. CLS. 22 AND 39).

TRADEMARK

FIRST USE 3-10-2012; IN COMMERCE 3-10-2012.

PRINCIPAL REGISTER

THE MARK CONSISTS OF STANDARD CHARACTERS WITHOUT CLAIM TO ANY PARTICULAR FONT, STYLE, SIZE, OR COLOR.

SN 77-654,366, FILED 1-22-2009.

REBECCA SMITH, EXAMINING ATTORNEY



David J. Kybas

Director of the United States Patent and Trademark Office

United States of America

United States Patent and Trademark Office

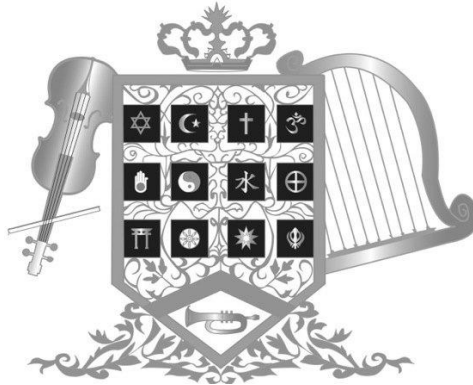

Reg. No. 4,154,383

Registered June 5, 2012

Int. Cl.: 41

SERVICE MARK

PRINCIPAL REGISTER

LITEMAN, GODNI AMIR (ISRAEL INDIVIDUAL)
115 EAST 57TH STREET SUITE 520
NEW YORK, NY 10122

FOR: ENTERTAINMENT IN THE NATURE OF ORCHESTRA PERFORMANCES; ENTERTAINMENT IN THE NATURE OF VISUAL AND AUDIO PERFORMANCES, NAMELY, MUSICAL BAND, ROCK GROUP, GYMNASTIC, DANCE, AND BALLET PERFORMANCES; ENTERTAINMENT SERVICES IN THE NATURE OF LIVE MUSICAL PERFORMANCES; ENTERTAINMENT SERVICES, NAMELY, PROVIDING A WEB SITE FEATURING PHOTOGRAPHIC, AUDIO, VIDEO AND PROSE PRESENTATIONS FEATURING MUSIC AND DANCE PERFORMANCE; ENTERTAINMENT SERVICES, NAMELY, PROVIDING A WEB SITE FEATURING MUSICAL PERFORMANCES, MUSICAL VIDEOS, RELATED FILM CLIPS, PHOTOGRAPHS, AND OTHER MULTIMEDIA MATERIALS FEATURING MUSIC AND DANCE PERFORMANCES; ENTERTAINMENT SERVICES, NAMELY, PROVIDING PRERECORDED MUSIC, INFORMATION IN THE FIELD OF MUSIC, AND COMMENTARY AND ARTICLES ABOUT MUSIC, ALL ON-LINE VIA A GLOBAL COMPUTER NETWORK; ENTERTAINMENT, NAMELY, LIVE PERFORMANCES BY A MUSICAL BAND; ENTERTAINMENT, NAMELY, PRODUCTION OF CDS, DVDS, AUDIO AND VIDEO, IN CLASS 41 (U.S. CLS. 100, 101 AND 107).

FIRST USE 1-1-2010; IN COMMERCE 1-1-2011.



David J. Kappas

Director of the United States Patent and Trademark Office

THE MARK CONSISTS OF VIOLIN ON THE LEFT, A HARP ON THE RIGHT AND IN BETWEEN THEM A FIVE-SIDED SHAPE CONTAINING TWELVE SQUARES AND A SCROLL/FLORAL BACKGROUND DESIGN AND DIAMOND SHAPE AT THE BOTTOM CONTAINING A HORN; A CROWN APPEARS AT THE TOP OF THE MARK AND A SCROLL/FLORAL DESIGN APPEARS AT THE BOTTOM; THE FOLLOWING CULTURAL/RELIGIOUS SYMBOLS APPEAR WITHIN THE TWELVE SQUARES: THE STAR OF DAVID, REPRESENTING JUDAISM; THE CRESCENT AND STAR, REPRESENTING ISLAM; THE CROSS, REPRESENTING CHRISTIANITY; THE OM CHARACTER, REPRESENTING HINDUISM; THE HAND, REPRESENTING JAINISM; THE YIN AND YANG, REPRESENTING TAOISM; THE CHINESE CHARACTER, REPRESENTING CONFUCIANISM; THE INSCRIBED CIRCLE, REPRESENTING PAGANISM; THE PAGODA SYMBOL, REPRESENTING SHINTOISM; THE FLOWER INSCRIBED IN A CIRCLE, REPRESENTING BUDDHISM; THE 9-POINTED STARBURST, REPRESENTING BAHAI; AND THE KHANDA (A DOUBLE-EDGED SWORD SURROUNDED BY A CIRCLE AND TWO SWORDS ON THE OUTSIDE), REPRESENTING SIKHISM.

Reg. No. 4,154,383 SN 77-655,612, FILED 1-23-2009.

MEGHAN REINHART, EXAMINING ATTORNEY

United States of America

United States Patent and Trademark Office

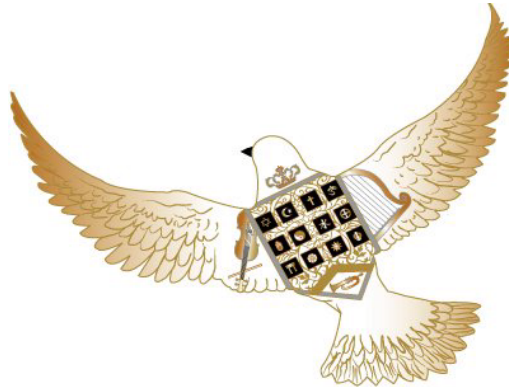

Reg. No. 4,154,384

Registered June 5, 2012

Int. Cl.: 41

SERVICE MARK

PRINCIPAL REGISTER

LITEMAN, GODNI AMIR (ISRAEL INDIVIDUAL)
SUITE 520
115 EAST 57TH STREET
NEW YORK, NY 10122

FOR: ENTERTAINMENT IN THE NATURE OF ORCHESTRA PERFORMANCES; ENTERTAINMENT IN THE NATURE OF VISUAL AND AUDIO PERFORMANCES, NAMELY, MUSICAL BAND, ROCK GROUP, GYMNASIAC, DANCE, AND BALLET PERFORMANCES; ENTERTAINMENT SERVICES IN THE NATURE OF LIVE MUSICAL PERFORMANCES; ENTERTAINMENT SERVICES, NAMELY, PROVIDING A WEB SITE FEATURING PHOTOGRAPHIC, AUDIO, VIDEO AND PROSE PRESENTATIONS FEATURING MUSIC AND DANCE PERFORMANCE; ENTERTAINMENT SERVICES, NAMELY, PROVIDING A WEB SITE FEATURING MUSICAL PERFORMANCES, MUSICAL VIDEOS, RELATED FILM CLIPS, PHOTOGRAPHS, AND OTHER MULTIMEDIA MATERIALS FEATURING MUSIC AND DANCE PERFORMANCES; ENTERTAINMENT SERVICES, NAMELY, PROVIDING PRERECORDED MUSIC, INFORMATION IN THE FIELD OF MUSIC, AND COMMENTARY AND ARTICLES ABOUT MUSIC, ALL ON-LINE VIA A GLOBAL COMPUTER NETWORK; ENTERTAINMENT, NAMELY, LIVE PERFORMANCES BY A MUSICAL BAND; ENTERTAINMENT, NAMELY, PRODUCTION OF CDS, DVDS, AUDIO AND VIDEO, IN CLASS 41 (U.S. CLS. 100, 101 AND 107).

FIRST USE 1-1-2010; IN COMMERCE 1-1-2011.



David J. Kappas

Director of the United States Patent and Trademark Office

THE MARK CONSISTS OF A BIRD WITH WINGS SPREAD OPEN CARRYING A CROWN ON ITS HEAD AND A COAT OF ARMS DESIGN CONTAINING THE FOLLOWING ON ITS BACK: A VIOLIN ON THE LEFT, A HARP ON THE RIGHT AND IN BETWEEN THEM A FIVE-SIDED SHAPE CONTAINING TWELVE SQUARES, A SCROLL/FLORAL BACKGROUND DESIGN AND DIAMOND SHAPE AT THE BOTTOM CONTAINING A HORN; A SCROLL/FLORAL DESIGN APPEARS BELOW THE FIVE-SIDED SHAPE; THE FOLLOWING CULTURAL/RELIGIOUS SYMBOLS APPEAR WITHIN THE TWELVE SQUARES: THE STAR OF DAVID, REPRESENTING JUDAISM; THE CRESCENT AND STAR, REPRESENTING ISLAM; THE CROSS, REPRESENTING CHRISTIANITY; THE OM CHARACTER, REPRESENTING HINDUISM; THE HAND, REPRESENTING JAINISM; THE YIN AND YANG, REPRESENTING TAOISM; THE CHINESE CHARACTER, REPRESENTING CONFUCIANISM; THE INSCRIBED CIRCLE, REPRESENTING PAGANISM; THE PAGODA SYMBOL, REPRESENTING SHINTOISM; THE FLOWER INSCRIBED IN A CIRCLE, REPRESENTING BUDDHISM; THE 9-POINTED STARBURST, REPRESENTING BAHAI; AND THE KHANDA

Reg. No. 4,154,384 (A DOUBLE-EDGED SWORD SURROUNDED BY A CIRCLE AND TWO SWORDS ON THE OUTSIDE), REPRESENTING SIKHISM. THE COLOR GREY APPEARS IN THE OUTLINE OF THE VIOLIN AND HARP AND IN THE HARP STRINGS; THE COLOR SILVER APPEARS IN THE FIVE-SIDED SHAPE, THE VIOLIN, THE CROWN AND THE HORN; THE COLOR BLACK APPEARS IN THE TWELVE SQUARE AND IN THE BIRD'S BEAKS; THE COLOR GOLD APPEARS IN THE VIOLIN, CROWN, HORN, HARP AND BIRD DESIGNS, IN TWO SIDES OF THE DIAMOND SHAPE AND IN THE CULTURAL/RELIGIOUS SYMBOLS/DESIGNS; THE COLOR COPPER APPEARS IN THE VIOLIN, CROWN, HORN, HARP AND BIRD DESIGNS; THE COLOR WHITE APPEARS IN THE CULTURAL/RELIGIOUS SYMBOLS/DESIGNS, IN THE CROWN, IN THE VIOLIN, IN THE BIRD DESIGN AND AS A BACKGROUND COLOR IN THE FIVE-SIDED DESIGN.

THE COLOR(S) GOLD, SILVER, BLACK, COPPER, GREY AND WHITE IS/ARE CLAIMED AS A FEATURE OF THE MARK.

SN 77-655,657, FILED 1-23-2009.

MEGHAN REINHART, EXAMINING ATTORNEY

United States of America

United States Patent and Trademark Office

A FREE BIRD

Reg. No. 4,154,385

Registered June 5, 2012

Int. Cl.: 41

SERVICE MARK

PRINCIPAL REGISTER

LITEMAN, GODNI AMIR (ISRAEL INDIVIDUAL)
15 EAST 57TH STREET
SUITE 520
NEW YORK, NY 10122

FOR: ENTERTAINMENT IN THE NATURE OF ORCHESTRA PERFORMANCES; ENTERTAINMENT IN THE NATURE OF VISUAL AND AUDIO PERFORMANCES, NAMELY, MUSICAL BAND, ROCK GROUP, GYMNASTIC, DANCE, AND BALLET PERFORMANCES; ENTERTAINMENT SERVICES IN THE NATURE OF LIVE MUSICAL PERFORMANCES; ENTERTAINMENT SERVICES, NAMELY, PROVIDING A WEB SITE FEATURING PHOTOGRAPHIC, AUDIO, VIDEO AND PROSE PRESENTATIONS FEATURING MUSIC AND DANCE PERFORMANCE; ENTERTAINMENT SERVICES, NAMELY, PROVIDING A WEB SITE FEATURING MUSICAL PERFORMANCES, MUSICAL VIDEOS, RELATED FILM CLIPS, PHOTOGRAPHS, AND OTHER MULTIMEDIA MATERIALS FEATURING MUSIC AND DANCE PERFORMANCES; ENTERTAINMENT SERVICES, NAMELY, PROVIDING PRERECORDED MUSIC, INFORMATION IN THE FIELD OF MUSIC, AND COMMENTARY AND ARTICLES ABOUT MUSIC, ALL ON-LINE VIA A GLOBAL COMPUTER NETWORK; ENTERTAINMENT, NAMELY, LIVE PERFORMANCES BY A MUSICAL BAND; ENTERTAINMENT, NAMELY, PRODUCTION OF CDS, DVDS, AUDIO AND VIDEO, IN CLASS 41 (U.S. CLS. 100, 101 AND 107).

FIRST USE 1-1-2010; IN COMMERCE 1-1-2010.

THE MARK CONSISTS OF STANDARD CHARACTERS WITHOUT CLAIM TO ANY PARTICULAR FONT, STYLE, SIZE, OR COLOR.

SN 77-655,664, FILED 1-23-2009.

MEGHAN REINHART, EXAMINING ATTORNEY



David J. Kyffers

Director of the United States Patent and Trademark Office

United States of America

United States Patent and Trademark Office



Reg. No. 4,154,386

CENTRIC GROUP, LLC (MISSOURI LIMITED LIABILITY COMPANY)
1260 ANDES BOULEVARD
ST. LOUIS, MO 63132

Registered June 5, 2012

Int. Cl.: 30

FOR: CRACKERS, BAGELS, BREAD, FIG BARS, PIZZA KITS CONSISTING OF MICROWAVABLE PIZZA CRUSTS AND SAUCES, IN CLASS 30 (U.S. CL. 46).

TRADEMARK

FIRST USE 6-0-2009; IN COMMERCE 6-0-2009.

PRINCIPAL REGISTER

NO CLAIM IS MADE TO THE EXCLUSIVE RIGHT TO USE "SNACKS", APART FROM THE MARK AS SHOWN.

THE MARK CONSISTS OF FOUR CONCENTRIC OVALS WITH THE WORDING "GOLDEN VALLEY" ON THE UPPER PORTION OF THE OVAL AND THE WORD "SNACKS" ON THE LOWER PORTION. THE WORDING "A TASTE OF HOME" IS DIVIDED IN THE MIDDLE BY A DESIGN FEATURING FOUR STALKS OF GRAIN OR WHEAT.

SN 77-656,811, FILED 1-26-2009.

LOURDES AYALA, EXAMINING ATTORNEY



David J. Kyros

Director of the United States Patent and Trademark Office

United States of America

United States Patent and Trademark Office

MIQ

Reg. No. 4,154,387

Registered June 5, 2012

Int. Cls.: 16 and 42

TRADEMARK

SERVICE MARK

PRINCIPAL REGISTER

FERRING B.V. (NETHERLANDS COMPANY)
POLARIS AVENUE 144
2132 JX HOOFDORP, NETHERLANDS

FOR: QUESTIONNAIRES FOR USE IN OBTAINING INFORMATION ABOUT, IDENTIFYING, DIAGNOSING, AND TREATING MENORRHAGIA, IN CLASS 16 (U.S. CLS. 2, 5, 22, 23, 29, 37, 38 AND 50).

FIRST USE 3-2-2012; IN COMMERCE 3-2-2012.

FOR: PROVIDING AN ON-LINE QUESTIONNAIRE FOR USE IN OBTAINING INFORMATION ABOUT, IDENTIFYING, DIAGNOSING AND TREATING MENORRHAGIA, IN CLASS 42 (U.S. CLS. 100 AND 101).

FIRST USE 3-2-2012; IN COMMERCE 3-2-2012.

THE MARK CONSISTS OF STANDARD CHARACTERS WITHOUT CLAIM TO ANY PARTICULAR FONT, STYLE, SIZE, OR COLOR.

SN 77-656,964, FILED 1-26-2009.

JANICE L. MCMORROW, EXAMINING ATTORNEY



David J. Kybas

Director of the United States Patent and Trademark Office

United States of America

United States Patent and Trademark Office

CELLDOX

Reg. No. 4,154,388

NORTHEAST PATHOLOGISTS INC. (MISSOURI CORPORATION)
6470 INTERSTATE COURT
HANNIBAL, MO 63401

Registered June 5, 2012

Int. Cl.: 44

FOR: MEDICAL SERVICES BY PATHOLOGISTS, NAMELY, DRUG USE SCREENING SERVICES, IN CLASS 44 (U.S. CLS. 100 AND 101).

SERVICE MARK

FIRST USE 12-31-2010; IN COMMERCE 12-31-2010.

PRINCIPAL REGISTER

THE MARK CONSISTS OF STANDARD CHARACTERS WITHOUT CLAIM TO ANY PARTICULAR FONT, STYLE, SIZE, OR COLOR.

SN 77-660,776, FILED 1-31-2009.

BRIAN CALLAGHAN, EXAMINING ATTORNEY



David J. Kyros

Director of the United States Patent and Trademark Office

United States of America

United States Patent and Trademark Office

RENSOW

Reg. No. 4,154,389

RENSOW HEALTH CARE SUPPLIES INCORPORATED (NEW YORK CORPORATION)
57-00 49TH PLACE
MASPETH, NY 11378

Registered June 5, 2012

**Int. Cls.: 3, 5, 10, 21, 24,
25, and 35**

FOR: HOUSE MARK FOR NON-MEDICATED PERSONAL HYGIENE AND PERSONAL CARE PRODUCTS AND PREPARATIONS, NAMELY, DENTURE CLEANSERS, EMERY BOARDS, MOUTH WASH, NAIL POLISH REMOVER PADS, SUN BLOCK PREPARATIONS, TALCUM POWDER, TOOTHPASTE; CLEANING PREPARATIONS; LAUNDRY PREPARATIONS, NAMELY, LAUNDRY DETERGENTS, LAUNDRY SOAPS, FABRIC SOFTENERS, LAUNDRY PRE-SOAK, LAUNDRY STARCH AND LAUNDRY BLEACH, IN CLASS 3 (U.S. CLS. 1, 4, 6, 50, 51 AND 52).

TRADEMARK

SERVICE MARK

PRINCIPAL REGISTER

FIRST USE 3-1-2009; IN COMMERCE 3-1-2009.

FOR: HOUSE MARK FOR MEDICATED, MEDICAL PHARMACEUTICAL, DENTAL AND SANITARY PRODUCTS AND PREPARATIONS, NAMELY, ANTI-FUNGAL CREAMS AND POWDERS, WOUND CARE PRODUCTS NAMELY, DRESSINGS, NYLON STRIPS FOR USE AS BANDAGES FOR DRESSINGS, COTTON BALLS AND COTTON SWABS FOR MEDICAL USE, TOPICAL FIRST AID GEL, TOPICAL GEL FOR MEDICAL AND THERAPEUTIC TREATMENT OF WOUND CARE; SANITARY BELTS, SANITARY PADS, TAMPONS, ORAL WOUND RINSE, PRE-MOISTENED MEDICAL WIPES, AIR DEODORIZERS, DISINFECTANTS FOR HYGIENIC AND SANITARY PURPOSES, DISINFECTANTS FOR MEDICAL INSTRUMENTS, INCONTINENCE GARMENTS AND PADS, ADULT DIAPERS; INCONTINENCE CLOTH DIAPERS FOR HOSPITAL PATIENTS; NUTRITIONAL AND DIETARY VITAMINS AND SUPPLEMENTS IN POWDER, TABLET AND LIQUID FORM; DISINFECTANTS FOR MEDICAL USE; DENTAL ADHESIVES; NASAL SPRAY PREPARATIONS, PLASTIC BANDAGES IN THE NATURE OF BANDAGES FOR DRESSINGS, IN CLASS 5 (U.S. CLS. 6, 18, 44, 46, 51 AND 52).

FIRST USE 3-1-2009; IN COMMERCE 3-1-2009.

FOR: HOUSE MARK FOR SURGICAL, MEDICAL AND DENTAL APPARATUS, INSTRUMENTS, APPLIANCES, AND SUPPLIES, NAMELY, ABDOMINAL BELTS, OXYGEN TUBING AND BAGS, BLOOD LANCETS, SPECIMEN CONTAINERS, ORAL AND RECTAL THERMOMETERS, ABSORBENT SURGICAL SPONGES, EMESIS BASINS AND COVERS, PLASTIC BANDAGES IN THE NATURE OF COMPRESSION BANDAGES, ENEMA KITS COMPRISED OF PLASTIC BUCKET, TUBE, PLASTIC CLAMP, CASTILE SOAP PACKET, AND MOISTURE-



David J. Kyros

Director of the United States Patent and Trademark Office

Reg. No. 4,154,389 PROOF UNDERPAD; BED PAN COVERS, HAND PROTECTORS FOR MEDICAL USE IN THE NATURE OF WRIST AND HAND SUPPORTS AND POSITIONERS, PROTECTIVE GLOVES AND SHIELDS TO PROTECT THE HAND FROM SPLASHING LIQUIDS, STRETCHERS AND BELTS FOR MEDICAL PURPOSES, SINGLE USE COLD AND HOT COMPRESSES, BIO-HAZARD BAGS FOR STORING MEDICAL WASTE, SHARPS CONTAINERS, URINE COLLECTOR FOR MEDICAL USE AND MEDICAL SPECIMEN CONTAINER; MEDICAL SPECIMEN COLLECTORS, DENTURE CONTAINERS; ELASTIC BANDAGES; ELASTIC WRAPS IN THE NATURE OF COMPRESSION BANDAGES; ABDOMINAL PADS, PADDING FOR ORTHOPEDIC CASTS; INCONTINENCE UNDERPADS USED FOR BEDDING; SAFETY ALARMS FOR MEDICAL USE IN THE NATURE OF PATIENT MONITORING SENSORS AND ALARMS; SURGICAL SHOE COVERS; MEDICAL WEARING APPAREL, NAMELY, CAPS, SHOES AND GLOVES; BODY MASS INDEX CALCULATORS IN THE NATURE OF CALIPERS; SAFETY ALARMS FOR PERSONAL USE, NAMELY, PATIENT MONITORING SENSORS AND ALARMS, IN CLASS 10 (U.S. CLS. 26, 39 AND 44).

FIRST USE 3-1-2009; IN COMMERCE 3-1-2009.

FOR: HOUSE MARK FOR PITCHERS, TUMBLERS, DISPENSERS FOR PRODUCTS IN LIQUID, PASTE, OR GEL FORM, NAMELY, SOAP DISPENSERS, SOAP HOLDERS, TOILET PAPER HOLDERS, SOAP HOLDERS, PLASTIC PLATES, PLASTIC CUPS; HOUSEHOLD AND COOKING UTENSILS, NAMELY, WIRE BASKETS, SPATULAS, TURNERS, STRAINERS, SIEVES, SKIMMERS, TONGS, POURING AND STRAINING SPOUTS; TOOTHBRUSH HOLDERS; HAIR BRUSHES AND COMBS; LINT REMOVERS, NAMELY, LINT BRUSHES; HAIR BRUSHES AND COMBS, BATTERY-OPERATING LINT REMOVERS; ELECTRIC LINT REMOVERS; ABSORBENT BATH SPONGES; ABSORBENT CLEANING SPONGES; PATIENT UTENSILS, NAMELY, CARAFES, TRAYS, PITCHERS, TUMBLERS, DRINKING GLASSES, AND PLATES; TOOTHBRUSHES, IN CLASS 21 (U.S. CLS. 2, 13, 23, 29, 30, 33, 40 AND 50).

FIRST USE 3-1-2009; IN COMMERCE 3-1-2009.

FOR: HOUSE MARK FOR TOWELS, UNDERPADS USED IN BEDDING, GAUZE FABRICS, IN CLASS 24 (U.S. CLS. 42 AND 50).

FIRST USE 3-1-2009; IN COMMERCE 3-1-2009.

FOR: HOUSE MARK FOR INFANT CLOTH DIAPERS FOR USE IN HOSPITALS, NOT FOR MEDICAL USE; FOOTWEAR, HEADWEAR AND GLOVES AS CLOTHING FOR USE BY HOSPITAL PATIENTS AND PERSONNEL, NOT FOR MEDICAL USE, IN CLASS 25 (U.S. CLS. 22 AND 39).

FIRST USE 3-1-2009; IN COMMERCE 3-1-2009.

FOR: RETAIL AND WHOLESALE STORE SERVICES FEATURING HEALTHCARE, MEDICAL, NURSING, PHARMACEUTICAL AND HOUSEHOLD PRODUCTS; MAIL ORDER CATALOGUE STORE SERVICES AND ONLINE STORE SERVICES FEATURING HEALTHCARE, MEDICAL, NURSING, PHARMACEUTICAL AND HOUSEHOLD PRODUCTS, IN CLASS 35 (U.S. CLS. 100, 101 AND 102).

FIRST USE 3-1-2009; IN COMMERCE 3-1-2009.

THE MARK CONSISTS OF STANDARD CHARACTERS WITHOUT CLAIM TO ANY PARTICULAR FONT, STYLE, SIZE, OR COLOR.

OWNER OF U.S. REG. NO. 2,665,622.

SN 77-663,096, FILED 2-4-2009.

Reg. No. 4,154,389 APRIL HESIK, EXAMINING ATTORNEY

United States of America

United States Patent and Trademark Office

FOZZIE BEAR

Reg. No. 4,154,390

Registered June 5, 2012

Int. Cl.: 28

TRADEMARK

PRINCIPAL REGISTER

THE MUPPETS STUDIO, LLC (DELAWARE LIMITED LIABILITY COMPANY)
500 SOUTH BUENA VISTA STREET
BURBANK, CA 91521

FOR: DOLLS, IN CLASS 28 (U.S. CLS. 22, 23, 38 AND 50).

FIRST USE 10-31-2011; IN COMMERCE 10-31-2011.

THE MARK CONSISTS OF STANDARD CHARACTERS WITHOUT CLAIM TO ANY PARTICULAR FONT, STYLE, SIZE, OR COLOR.

NO CLAIM IS MADE TO THE EXCLUSIVE RIGHT TO USE "BEAR", APART FROM THE MARK AS SHOWN.

SN 77-666,779, FILED 2-9-2009.

DANNEAN HETZEL, EXAMINING ATTORNEY



David J. Kyffers

Director of the United States Patent and Trademark Office

United States of America

United States Patent and Trademark Office

CONSLVR

Reg. No. 4,154,391

Registered June 5, 2012

Int. Cl.: 9

TRADEMARK

PRINCIPAL REGISTER

M.E.P. CAD, INC. (NEVADA CORPORATION)
2464 E. LAKERIDGE SHORES
RENO, NV 89512

FOR: COMPUTER SOFTWARE FOR RECOGNIZING AND RESOLVING CONFLICTS BETWEEN VISUAL OBJECTS IN VISUAL DISPLAY SOFTWARE, IN CLASS 9 (U.S. CLS. 21, 23, 26, 36 AND 38).

FIRST USE 8-5-2011; IN COMMERCE 8-5-2011.

THE MARK CONSISTS OF STANDARD CHARACTERS WITHOUT CLAIM TO ANY PARTICULAR FONT, STYLE, SIZE, OR COLOR.

SN 77-673,881, FILED 2-19-2009.

ANDREA BUTLER, EXAMINING ATTORNEY



David J. Kyffers

Director of the United States Patent and Trademark Office

United States of America

United States Patent and Trademark Office



Reg. No. 4,154,392

Registered June 5, 2012

Int. Cls.: 41 and 44

SERVICE MARK

PRINCIPAL REGISTER

GENERATIONS COMMUNITY WELLNESS CENTERS (CALIFORNIA CORPORATION)
SUITE 109
1250 OAKMEAD PARKWAY
SUNNYVALE, CA 94085

FOR: PROVIDING INFORMATION ON PHYSICAL FITNESS AND EXERCISE VIA OPTICAL AND ELECTRONIC COMMUNICATIONS NETWORKS, IN CLASS 41 (U.S. CLS. 100, 101 AND 107).

FIRST USE 12-19-2011; IN COMMERCE 12-19-2011.

FOR: PROVIDING INFORMATION CONCERNING NUTRITION AND LIFESTYLE WELLNESS VIA OPTICAL AND ELECTRONIC COMMUNICATIONS NETWORKS, IN CLASS 44 (U.S. CLS. 100 AND 101).

FIRST USE 11-9-2011; IN COMMERCE 11-9-2011.

THE MARK CONSISTS OF A STYLIZED LETTER "G" INSIDE A CIRCLE WITH A DOT INSIDE THE "G".

SN 77-675,902, FILED 2-23-2009.

REBECCA SMITH, EXAMINING ATTORNEY



David J. Kyros

Director of the United States Patent and Trademark Office

United States of America

United States Patent and Trademark Office

SKECHERS SHAPE-UPS

Reg. No. 4,154,393

Registered June 5, 2012

Int. Cl.: 25

TRADEMARK

PRINCIPAL REGISTER

SKECHERS U.S.A., INC. II (DELAWARE CORPORATION)
228 MANHATTAN BEACH BLVD.
MANHATTAN BEACH, CA 90266

FOR: FOOTWEAR, IN CLASS 25 (U.S. CLS. 22 AND 39).

FIRST USE 11-14-2008; IN COMMERCE 11-14-2008.

THE MARK CONSISTS OF STANDARD CHARACTERS WITHOUT CLAIM TO ANY PARTICULAR FONT, STYLE, SIZE, OR COLOR.

OWNER OF U.S. REG. NOS. 1,851,977, 2,362,883, AND OTHERS.

SN 77-677,565, FILED 2-24-2009.

DEIRDRE ROBERTSON, EXAMINING ATTORNEY



David J. Kybas

Director of the United States Patent and Trademark Office

United States of America

United States Patent and Trademark Office

ENVIROCARE

Reg. No. 4,154,394

Registered June 5, 2012

Int. Cls.: 20 and 24

TRADEMARK

PRINCIPAL REGISTER

KICKBALL CONCEPTS LLC (DELAWARE LIMITED LIABILITY COMPANY)
P. O. BOX 1038
GREAT FALLS, VA 220661038

FOR: MATTRESSES AND PILLOWS, IN CLASS 20 (U.S. CLS. 2, 13, 22, 25, 32 AND 50).

FIRST USE 10-9-2009; IN COMMERCE 10-9-2009.

FOR: BEDDING ARTICLES, NAMELY, BED LINENS, MATTRESS PADS, MATTRESS TICKING FABRIC, BED SKIRTS, BED SHEETS, COMFORTERS, PILLOW CASES, PILLOW SHAMS AND BED SPREADS, IN CLASS 24 (U.S. CLS. 42 AND 50).

FIRST USE 3-15-2012; IN COMMERCE 3-15-2012.

THE MARK CONSISTS OF STANDARD CHARACTERS WITHOUT CLAIM TO ANY PARTICULAR FONT, STYLE, SIZE, OR COLOR.

SN 77-680,128, FILED 2-27-2009.

MAYUR VAGHANI, EXAMINING ATTORNEY



David J. Kyros

Director of the United States Patent and Trademark Office

United States of America

United States Patent and Trademark Office

TONY ROBBINS

Reg. No. 4,154,395

Registered June 5, 2012

Int. Cls.: 9 and 41

TRADEMARK

SERVICE MARK

PRINCIPAL REGISTER

ROBBINS RESEARCH INTERNATIONAL, INC. (NEVADA CORPORATION)
930 S. ANDREASEN DRIVE, SUITE H
ESCONDIDO, CA 92029

FOR: AUDIO AND VIDEO RECORDINGS IN THE FIELD OF PERSONAL IMPROVEMENT, FINANCIAL IMPROVEMENT AND SALES TRAINING , IN CLASS 9 (U.S. CLS. 21, 23, 26, 36 AND 38).

FIRST USE 0-0-1980; IN COMMERCE 0-0-1980.

FOR: EDUCATIONAL SERVICES, NAMELY, CONDUCTING CLASSES AND SEMINARS IN THE FIELDS OF PERSONAL IMPROVEMENT, FINANCIAL IMPROVEMENT AND SALES TRAINING, IN CLASS 41 (U.S. CLS. 100, 101 AND 107).

FIRST USE 0-0-1980; IN COMMERCE 0-0-1980.

THE MARK CONSISTS OF STANDARD CHARACTERS WITHOUT CLAIM TO ANY PARTICULAR FONT, STYLE, SIZE, OR COLOR.

OWNER OF U.S. REG. NOS. 2,305,962 AND 3,354,887.

THE NAME "TONY ROBBINS" IDENTIFIES A LIVING INDIVIDUAL WHOSE CONSENT IS OF RECORD.

SN 77-680,528, FILED 2-27-2009.

GEORGE LORENZO, EXAMINING ATTORNEY



David J. Kyros

Director of the United States Patent and Trademark Office

United States of America

United States Patent and Trademark Office



Reg. No. 4,154,396

Registered June 5, 2012

Int. Cls.: 14, 18, and 25

TRADEMARK

PRINCIPAL REGISTER

SERENA WILLIAMS (UNITED STATES INDIVIDUAL)
C/O GARVEY SCHUBERT BARER
100 WALL STREET, TWENTIETH FLOOR
NEW YORK, NY 10005

FOR: JEWELRY, NAMELY, BRACELETS, CHARMS, EARRINGS, NECKLACES, PENDANTS AND RINGS, IN CLASS 14 (U.S. CLS. 2, 27, 28 AND 50).

FIRST USE 4-0-2009; IN COMMERCE 4-0-2009.

FOR: LEATHER AND NON-LEATHER PURSES, TOTE BAGS AND CLUTCHES, IN CLASS 18 (U.S. CLS. 1, 2, 3, 22 AND 41).

FIRST USE 4-0-2009; IN COMMERCE 4-0-2009.

FOR: CLOTHING, NAMELY, BELTS, CARDIGANS, DRESSES, SCARVES, SWEATERS AND WRAPS; AND FOOTWEAR, NAMELY, FLIP-FLOPS, IN CLASS 25 (U.S. CLS. 22 AND 39).

FIRST USE 4-0-2009; IN COMMERCE 4-0-2009.

THE NAME "SERENA WILLIAMS" IDENTIFIES A LIVING INDIVIDUAL WHOSE CONSENT IS OF RECORD.

THE MARK CONSISTS OF A STYLIZED HEART WITH THE PHRASE "SERENA WILLIAMS" TO THE RIGHT AND "SIGNATURE STATEMENT" TO THE BOTTOM LEFT OF THE DESIGN.

SN 77-681,525, FILED 3-2-2009.

JASON TURNER, EXAMINING ATTORNEY



David J. Kybas

Director of the United States Patent and Trademark Office

United States of America

United States Patent and Trademark Office

SNOWDAY

Reg. No. 4,154,397

Registered June 5, 2012

Int. Cl.: 32

TRADEMARK

PRINCIPAL REGISTER

NEW BELGIUM BREWING COMPANY, INC. (COLORADO CORPORATION)
500 LINDEN STREET
FORT COLLINS, CO 80524

FOR: BEER, IN CLASS 32 (U.S. CLS. 45, 46 AND 48).

FIRST USE 11-4-2011; IN COMMERCE 11-4-2011.

THE MARK CONSISTS OF STANDARD CHARACTERS WITHOUT CLAIM TO ANY PARTICULAR FONT, STYLE, SIZE, OR COLOR.

SN 77-681,763, FILED 3-2-2009.

ELLEN PERKINS, EXAMINING ATTORNEY



David J. Kybas

Director of the United States Patent and Trademark Office

United States of America

United States Patent and Trademark Office

REALITYCOMFORTZONE

Reg. No. 4,154,398

EMAT CAPITAL MANAGEMENT, INC. (CALIFORNIA CORPORATION)
7474 N. FIGUEROA ST., SUITE A
LOS ANGELES, CA 90041

Registered June 5, 2012

Int. Cl.: 36

FOR: INVESTMENT SERVICES, NAMELY, ASSET ACQUISITION, CONSULTATION, DEVELOPMENT AND MANAGEMENT SERVICES, IN CLASS 36 (U.S. CLS. 100, 101 AND 102).

SERVICE MARK

FIRST USE 2-23-2012; IN COMMERCE 2-23-2012.

PRINCIPAL REGISTER

THE MARK CONSISTS OF STANDARD CHARACTERS WITHOUT CLAIM TO ANY PARTICULAR FONT, STYLE, SIZE, OR COLOR.

SN 77-685,196, FILED 3-6-2009.

KATHRYN COWARD, EXAMINING ATTORNEY



David J. Kybas

Director of the United States Patent and Trademark Office

United States of America

United States Patent and Trademark Office

IT'S YOUR PLANET

Reg. No. 4,154,399

Registered June 5, 2012

Int. Cl.: 20

TRADEMARK

PRINCIPAL REGISTER

RICHARDS HOMEWARES, INC. (OREGON CORPORATION)
10675 N. LOMBARD ST.
PORTLAND, OR 97203

FOR: CLOTHES HANGERS, IN CLASS 20 (U.S. CLS. 2, 13, 22, 25, 32 AND 50).

FIRST USE 6-30-2009; IN COMMERCE 6-30-2009.

THE MARK CONSISTS OF STANDARD CHARACTERS WITHOUT CLAIM TO ANY PARTICULAR FONT, STYLE, SIZE, OR COLOR.

SN 77-685,307, FILED 3-6-2009.

FONG HSU, EXAMINING ATTORNEY



David J. Kyffers

Director of the United States Patent and Trademark Office

United States of America

United States Patent and Trademark Office



Reg. No. 4,154,400

Registered June 5, 2012

Int. Cl.: 25

TRADEMARK

PRINCIPAL REGISTER

ACADEMI LLC (DELAWARE LIMITED LIABILITY COMPANY)
P.O. BOX 1029
MOYOCK, NC 27958

FOR: SHIRTS; T-SHIRTS, IN CLASS 25 (U.S. CLS. 22 AND 39).

FIRST USE 4-30-2009; IN COMMERCE 4-30-2009.

THE MARK CONSISTS OF STYLIZED LETTERING OF THE NAME "XE".

SN 77-687,408, FILED 3-10-2009.

SANI KHOURI, EXAMINING ATTORNEY



David J. Kyffers

Director of the United States Patent and Trademark Office

United States of America

United States Patent and Trademark Office

DISNEY FANTASY

Reg. No. 4,154,401

DISNEY ENTERPRISES, INC. (DELAWARE CORPORATION)
500 SOUTH BUENA VISTA STREET
BURBANK, CA 91521

Registered June 5, 2012

Int. Cl.: 43

FOR: PROVIDING RESORT LODGING, RESTAURANT, RENTAL OF ROOMS ONBOARD SHIPS, IN CLASS 43 (U.S. CLS. 100 AND 101).

SERVICE MARK

FIRST USE 3-31-2012; IN COMMERCE 3-31-2012.

PRINCIPAL REGISTER

THE MARK CONSISTS OF STANDARD CHARACTERS WITHOUT CLAIM TO ANY PARTICULAR FONT, STYLE, SIZE, OR COLOR.

SN 77-687,726, FILED 3-10-2009.

GEOFFREY FOSDICK, EXAMINING ATTORNEY



David J. Kyros

Director of the United States Patent and Trademark Office

United States of America

United States Patent and Trademark Office

DISNEY FANTASY

Reg. No. 4,154,402

Registered June 5, 2012

Int. Cl.: 39

SERVICE MARK

PRINCIPAL REGISTER

DISNEY ENTERPRISES, INC. (DELAWARE CORPORATION)
500 SOUTH BUENA VISTA STREET
BURBANK, CA 91521

FOR: PASSENGER CRUISE SHIP SERVICES, IN CLASS 39 (U.S. CLS. 100 AND 105).

FIRST USE 3-31-2012; IN COMMERCE 3-31-2012.

THE MARK CONSISTS OF STANDARD CHARACTERS WITHOUT CLAIM TO ANY PARTICULAR FONT, STYLE, SIZE, OR COLOR.

SN 77-687,747, FILED 3-10-2009.

GEOFFREY FOSDICK, EXAMINING ATTORNEY



David J. Kybas

Director of the United States Patent and Trademark Office

United States of America

United States Patent and Trademark Office

CRAFTING MAMA

Reg. No. 4,154,403

COOKING MAMA LIMITED (CHINA CORPORATION)
ROOM 501, 5F 113 ARGYLE STREET, MONGKOK
KOWLOON, HONG KONG, CHINA

Registered June 5, 2012

Int. Cl.: 41

FOR: PROVIDING ON-LINE COMPUTER GAMES, IN CLASS 41 (U.S. CLS. 100, 101 AND 107).

SERVICE MARK

FIRST USE 1-31-2012; IN COMMERCE 1-31-2012.

PRINCIPAL REGISTER

THE MARK CONSISTS OF STANDARD CHARACTERS WITHOUT CLAIM TO ANY PARTICULAR FONT, STYLE, SIZE, OR COLOR.

SN 77-688,116, FILED 3-11-2009.

JEAN IM, EXAMINING ATTORNEY



David J. Kybas

Director of the United States Patent and Trademark Office

United States of America

United States Patent and Trademark Office

SONICBEAT

Reg. No. 4,154,404

OLYMPUS MEDICAL SYSTEMS CORP. (JAPAN JOINT STOCK COMPANY)
43-2, HATAGAYA 2-CHOME, SHIBUYA-KU
TOKYO, JAPAN

Registered June 5, 2012

Int. Cl.: 10

FOR: MEDICAL AND SURGICAL APPARATUS AND INSTRUMENTS, NAMELY, ULTRASONIC ENERGY DEVICES AND SURGICAL KNIVES AND SCISSORS THAT INCISE AND COAGULATE BY USING ULTRASONIC TECHNOLOGY, IN CLASS 10 (U.S. CLS. 26, 39 AND 44).

TRADEMARK

PRINCIPAL REGISTER

FIRST USE 3-1-2012; IN COMMERCE 3-1-2012.

THE MARK CONSISTS OF STANDARD CHARACTERS WITHOUT CLAIM TO ANY PARTICULAR FONT, STYLE, SIZE, OR COLOR.

SN 77-694,959, FILED 3-19-2009.

DANIEL CAPSHAW, EXAMINING ATTORNEY



David J. Kyffers

Director of the United States Patent and Trademark Office

United States of America

United States Patent and Trademark Office

TYJA

Reg. No. 4,154,405

Registered June 5, 2012

Int. Cls.: 18 and 24

TRADEMARK

PRINCIPAL REGISTER

TYJA CORPORATION (NEW YORK CORPORATION)
400 BURMAN BLVD.
CALVERTON, NY 11933

FOR: DUFFLE BAGS, IN CLASS 18 (U.S. CLS. 1, 2, 3, 22 AND 41).

FIRST USE 12-0-2010; IN COMMERCE 1-3-2011.

FOR: TEAM EMBELLISHED TOWELS; SPORT TOWELS, IN CLASS 24 (U.S. CLS. 42 AND 50).

FIRST USE 3-0-2010; IN COMMERCE 1-0-2011.

THE MARK CONSISTS OF STANDARD CHARACTERS WITHOUT CLAIM TO ANY PARTICULAR FONT, STYLE, SIZE, OR COLOR.

SN 77-695,049, FILED 3-19-2009.

ESTHER A. BORSUK, EXAMINING ATTORNEY



David J. Kyros

Director of the United States Patent and Trademark Office

United States of America

United States Patent and Trademark Office

M-PHY

Reg. No. 4,154,406

Registered June 5, 2012

Int. Cls.: 35 and 42

SERVICE MARK

PRINCIPAL REGISTER

MIPI ALLIANCE, INC. (DELAWARE CORPORATION)
445 HOES LANE
PISCATAWAY, NJ 08854

FOR: BUSINESS SERVICES, NAMELY, BUSINESS CONSULTING SERVICES; ASSOCIATION SERVICES, NAMELY, PROMOTING THE INTERESTS OF MOBILE COMMUNICATIONS DEVICES COMPANIES; ADVERTISING SERVICES FOR OTHERS, NAMELY, PROMOTING A STANDARD FOR AN INTERFACE BETWEEN COMPUTER CHIPS AND PERIPHERAL DEVICES, IN CLASS 35 (U.S. CLS. 100, 101 AND 102).

FIRST USE 2-3-2005; IN COMMERCE 4-26-2007.

FOR: DEVELOPING TECHNICAL SPECIFICATIONS FOR MOBILE COMMUNICATIONS DEVICES, NAMELY, A STANDARD FOR AN INTERFACE BETWEEN COMPUTER CHIPS AND PERIPHERAL DEVICES; IMPLEMENTING TECHNICAL SPECIFICATIONS FOR MOBILE COMMUNICATIONS DEVICES, NAMELY, A STANDARD FOR AN INTERFACE BETWEEN COMPUTER CHIPS AND PERIPHERAL DEVICES; DESIGNING TECHNICAL SPECIFICATIONS FOR MOBILE COMMUNICATIONS DEVICES, NAMELY, A STANDARD FOR AN INTERFACE BETWEEN COMPUTER CHIPS AND PERIPHERAL DEVICES; CONSULTING ON TECHNICAL SPECIFICATIONS FOR MOBILE COMMUNICATIONS DEVICES, NAMELY, A STANDARD FOR AN INTERFACE BETWEEN COMPUTER CHIPS AND PERIPHERAL DEVICES, IN CLASS 42 (U.S. CLS. 100 AND 101).

FIRST USE 2-3-2005; IN COMMERCE 4-26-2007.

THE MARK CONSISTS OF STANDARD CHARACTERS WITHOUT CLAIM TO ANY PARTICULAR FONT, STYLE, SIZE, OR COLOR.

SN 77-695,709, FILED 3-20-2009.

DOMINIC J. FERRAIUOLO, EXAMINING ATTORNEY

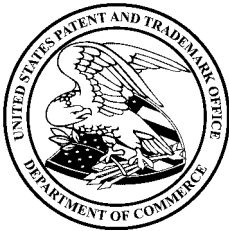

David J. Kybas

Director of the United States Patent and Trademark Office

United States of America

United States Patent and Trademark Office

BIKINI BOTTOM

Reg. No. 4,154,407

BIKINI BOTTOM BAR & GRILL, LLC (ILLINOIS LIMITED LIABILITY COMPANY)
647 PHILIP DRIVE
BARTLETT, IL 60103

Registered June 5, 2012

Int. Cl.: 43

FOR: BAR AND RESTAURANT SERVICES, IN CLASS 43 (U.S. CLS. 100 AND 101).

SERVICE MARK

FIRST USE 3-20-2012; IN COMMERCE 3-20-2012.

PRINCIPAL REGISTER

THE MARK CONSISTS OF STANDARD CHARACTERS WITHOUT CLAIM TO ANY PARTICULAR FONT, STYLE, SIZE, OR COLOR.

SN 77-697,369, FILED 3-23-2009.

CHRISTINE COOPER, EXAMINING ATTORNEY



David J. Kybas

Director of the United States Patent and Trademark Office

United States of America

United States Patent and Trademark Office

SMART SLEEVE

Reg. No. 4,154,408

CAROLON COMPANY (NORTH CAROLINA CORPORATION)
601 FORUM PARKWAY
RURAL HALL, NC 27045

Registered June 5, 2012

Int. Cl.: 10

FOR: MEDICAL LIMB OR BODY GARMENT CONTAINING SENSORS FOR MONITORING HEALTH PARAMETERS, IN CLASS 10 (U.S. CLS. 26, 39 AND 44).

TRADEMARK

FIRST USE 2-15-2012; IN COMMERCE 2-15-2012.

PRINCIPAL REGISTER

THE MARK CONSISTS OF STANDARD CHARACTERS WITHOUT CLAIM TO ANY PARTICULAR FONT, STYLE, SIZE, OR COLOR.

NO CLAIM IS MADE TO THE EXCLUSIVE RIGHT TO USE "SLEEVE", APART FROM THE MARK AS SHOWN.

SN 77-697,579, FILED 3-24-2009.

FLORENTINA BLANDU, EXAMINING ATTORNEY



David J. Kyros

Director of the United States Patent and Trademark Office

United States of America

United States Patent and Trademark Office

PHANTOM LEGACY

Reg. No. 4,154,409

Registered June 5, 2012

Int. Cls.: 6 and 19

TRADEMARK

PRINCIPAL REGISTER

PHANTOM MFG. (INT'L) LTD (CANADA CORPORATION)
30451 SIMPSON ROAD
ABBOTSFORD, CANADA V2T6C7

FOR: METAL SCREENS, NAMELY, RETRACTABLE INSECT SCREENS AND SUNSCREENS FOR DOORS, WINDOWS, AND SKYLIGHTS, IN CLASS 6 (U.S. CLS. 2, 12, 13, 14, 23, 25 AND 50).

FIRST USE 2-17-2012; IN COMMERCE 2-17-2012.

FOR: NON-METAL SCREENS, NAMELY, RETRACTABLE INSECT SCREENS AND SUNSCREENS FOR DOORS, WINDOWS, AND SKYLIGHTS, IN CLASS 19 (U.S. CLS. 1, 12, 33 AND 50).

FIRST USE 2-17-2012; IN COMMERCE 2-17-2012.

THE MARK CONSISTS OF STANDARD CHARACTERS WITHOUT CLAIM TO ANY PARTICULAR FONT, STYLE, SIZE, OR COLOR.

PRIORITY CLAIMED UNDER SEC. 44(D) ON CANADA APPLICATION NO. 1422537, FILED 12-19-2008.

OWNER OF U.S. REG. NOS. 1,983,857, 2,266,669, AND OTHERS.

SN 77-702,180, FILED 3-30-2009.

MATTHEW MCDOWELL, EXAMINING ATTORNEY



David J. Kybas

Director of the United States Patent and Trademark Office

United States of America

United States Patent and Trademark Office

PLAZA RETAIL

Reg. No. 4,154,410

Registered June 5, 2012

Int. Cl.: 9

TRADEMARK

PRINCIPAL REGISTER

QUALCOMM INCORPORATED (DELAWARE CORPORATION)
5775 MOREHOUSE DRIVE
SAN DIEGO, CA 92121

FOR: COMPUTER SOFTWARE, NAMELY, COMPUTER SOFTWARE DEVELOPMENT TOOLS; COMPUTER SOFTWARE USED TO FACILITATE INTERFACES BETWEEN COMPUTER SOFTWARE OR COMPUTER HARDWARE USED IN WIRELESS COMMUNICATION DEVICES, OR WITHIN NETWORKS EMPLOYING WIRELESS AND NON-WIRELESS COMMUNICATION DEVICES; COMPUTER SOFTWARE APPLICATIONS FOR CERTIFYING THAT OTHER COMPUTER SOFTWARE APPLICATIONS MEET CERTAIN STANDARDS; COMPUTER SOFTWARE USED TO INTERPRET INFORMATION, AND TO INTEGRATE, INTERPRET AND ORGANIZE DATA BETWEEN DIFFERENT WIRELESS OR NON-WIRELESS DEVICES AND COMPUTER SOFTWARE APPLICATIONS; COMPUTER SOFTWARE FOR DEVELOPING AND MANAGING DISTRIBUTED APPLICATION COMPUTER SOFTWARE IN A WIRELESS OR MIXED NETWORK EMPLOYING WIRELESS AND NON-WIRELESS COMMUNICATION INTERFACES; COMPUTER SOFTWARE FOR USE IN ADVERTISING AND MARKETING, NAMELY, PROMOTING THE GOODS AND SERVICES OF OTHERS; COMPUTER SOFTWARE FOR DISSEMINATION OF ADVERTISING FOR OTHERS VIA AN ON-LINE COMMUNICATIONS NETWORK ON THE INTERNET; COMPUTER SOFTWARE FOR MARKETING, ADVERTISING AND PROMOTING THE RETAIL GOODS AND SERVICES OF OTHERS TO WIRELESS COMMUNICATION DEVICES OR COMPUTERS, IN CLASS 9 (U.S. CLS. 21, 23, 26, 36 AND 38).

FIRST USE 10-2-2009; IN COMMERCE 10-2-2009.

THE MARK CONSISTS OF STANDARD CHARACTERS WITHOUT CLAIM TO ANY PARTICULAR FONT, STYLE, SIZE, OR COLOR.

NO CLAIM IS MADE TO THE EXCLUSIVE RIGHT TO USE "RETAIL", APART FROM THE MARK AS SHOWN.

SN 77-702,274, FILED 3-30-2009.

TINA MAI, EXAMINING ATTORNEY



David J. Kyros

Director of the United States Patent and Trademark Office

United States of America

United States Patent and Trademark Office

Vistaprint

Reg. No. 4,154,411

Registered June 5, 2012

**Int. Cls.: 9, 16, 18, 20, 21,
25, 35, 38, 40, and 42**

VISTAPRINT LIMITED (BERMUDA CORPORATION)
22 VICTORIA STREET
CANON'S COURT
HAMILTON, BERMUDA HM 12

FOR: MOUSE PADS; DECORATIVE MAGNETS, IN CLASS 9 (U.S. CLS. 21, 23, 26, 36 AND 38).

TRADEMARK

FIRST USE 6-1-2008; IN COMMERCE 6-1-2008.

SERVICE MARK

FOR: PRINTED PRODUCTS, NAMELY, BUSINESS CARDS, STATIONERY, FOLDERS, CUSTOM BROCHURES AND INFORMATIONAL FLYERS CONTAINING INFORMATION SUPPLIED BY OTHERS, INFORMATIONAL RACK CARDS, ADDRESS LABELS, ENVELOPES, LETTERHEAD, POSTCARDS, DECALS, POSTERS, CALENDARS, NOTE PADS, NOTE CARDS, CALLING CARDS, GIFT TAGS, BANK CHECKS, ANNOUNCEMENT CARDS, HOLIDAY CARDS, THANK YOU CARDS, INVITATIONS AND SIGNS; BUSINESS CARD HOLDERS; NOTE PAD HOLDERS; RUBBER STAMPS; STAMP INK PADS; PENS, IN CLASS 16 (U.S. CLS. 2, 5, 22, 23, 29, 37, 38 AND 50).

PRINCIPAL REGISTER

FIRST USE 6-1-2008; IN COMMERCE 6-1-2008.

FOR: TOTE BAGS, IN CLASS 18 (U.S. CLS. 1, 2, 3, 22 AND 41).

FIRST USE 4-6-2009; IN COMMERCE 4-6-2009.

FOR: PLASTIC KEY CHAINS; PLASTIC BANNERS, IN CLASS 20 (U.S. CLS. 2, 13, 22, 25, 32 AND 50).

FIRST USE 1-13-2009; IN COMMERCE 1-13-2009.

FOR: MUGS, IN CLASS 21 (U.S. CLS. 2, 13, 23, 29, 30, 33, 40 AND 50).

FIRST USE 8-5-2009; IN COMMERCE 8-5-2009.

FOR: HATS; SHIRTS, IN CLASS 25 (U.S. CLS. 22 AND 39).

FIRST USE 6-1-2008; IN COMMERCE 6-1-2008.



David J. Kyros

Director of the United States Patent and Trademark Office

Reg. No. 4,154,411 FOR: DIRECT MAIL ADVERTISING SERVICES; WRITING OF ADVERTISING AND MARKETING TEXT FOR OTHERS, IN CLASS 35 (U.S. CLS. 100, 101 AND 102).

FIRST USE 6-1-2008; IN COMMERCE 6-1-2008.

FOR: E-MAIL SERVICES, IN CLASS 38 (U.S. CLS. 100, 101 AND 104).

FIRST USE 3-13-2009; IN COMMERCE 3-13-2009.

FOR: PRINTING SERVICES; PRINTING OF IMAGES ONTO PAPER OR MERCHANDISE, IN CLASS 40 (U.S. CLS. 100, 103 AND 106).

FIRST USE 6-1-2008; IN COMMERCE 6-1-2008.

FOR: GRAPHIC DESIGN SERVICES; PROVIDING TEMPORARY USE OF ONLINE SOFTWARE TOOLS FOR USE IN DESIGNING AND ORDERING ELECTRONIC AND PRINTED PRODUCTS; WEBSITE HOSTING SERVICES; LOGO DESIGN SERVICES, IN CLASS 42 (U.S. CLS. 100 AND 101).

FIRST USE 6-1-2008; IN COMMERCE 6-1-2008.

OWNER OF U.S. REG. NOS. 2,978,792, 3,183,063, AND OTHERS.

THE MARK CONSISTS OF THREE ARCHES ABOVE THE WORD "VISTAPRINT".

SN 77-706,349, FILED 4-3-2009.

LAURIE KAUFMAN, EXAMINING ATTORNEY

United States of America

United States Patent and Trademark Office

BIG GIRLS NEED LOVE TOO

Reg. No. 4,154,412

KIMBERLY KEARNEY (UNITED STATES INDIVIDUAL)
17126 SATICOY STREET SUITE, #235
VAN NUYS, CA 91406

Registered June 5, 2012

Int. Cl.: 41

FOR: ENTERTAINMENT SERVICES, NAMELY, AN ON-GOING SERIES FEATURING PLUS SIZED PEOPLE LOOKING FOR LOVE PROVIDED THROUGH TELEVISION, WEBCASTS, PODCASTS AND FILM , IN CLASS 41 (U.S. CLS. 100, 101 AND 107).

SERVICE MARK

FIRST USE 3-13-2012; IN COMMERCE 3-13-2012.

PRINCIPAL REGISTER

THE MARK CONSISTS OF STANDARD CHARACTERS WITHOUT CLAIM TO ANY PARTICULAR FONT, STYLE, SIZE, OR COLOR.

SN 77-707,681, FILED 4-6-2009.

MICHELLE DUBOIS, EXAMINING ATTORNEY



David J. Kyros

Director of the United States Patent and Trademark Office

United States of America

United States Patent and Trademark Office

Believe It. Be It.

Reg. No. 4,154,413

BIBIT, LLC (DELAWARE LIMITED LIABILITY COMPANY)
14404 NORTH DAKOTA STREET
SPOKANE, WA 99208

Registered June 5, 2012

Int. Cl.: 25

FOR: ATHLETIC APPAREL, NAMELY, SHIRTS, PANTS, JACKETS, FOOTWEAR, HATS AND CAPS, ATHLETIC UNIFORMS, IN CLASS 25 (U.S. CLS. 22 AND 39).

TRADEMARK

FIRST USE 4-1-2012; IN COMMERCE 4-1-2012.

PRINCIPAL REGISTER

THE MARK CONSISTS OF STANDARD CHARACTERS WITHOUT CLAIM TO ANY PARTICULAR FONT, STYLE, SIZE, OR COLOR.

SN 77-709,819, FILED 4-8-2009.

JORDAN BAKER, EXAMINING ATTORNEY



David J. Kybas

Director of the United States Patent and Trademark Office

United States of America

United States Patent and Trademark Office

BABYSITTING MAMA

Reg. No. 4,154,414

COOKING MAMA LIMITED (CHINA CORPORATION)
5F 113 ARGYLE STREET; ROOM 501; MONGKOK
KOWLOON, HONG KONG, CHINA

Registered June 5, 2012

Int. Cl.: 41

FOR: PROVIDING ON-LINE COMPUTER GAMES, IN CLASS 41 (U.S. CLS. 100, 101 AND 107).

SERVICE MARK

FIRST USE 1-31-2012; IN COMMERCE 1-31-2012.

PRINCIPAL REGISTER

THE MARK CONSISTS OF STANDARD CHARACTERS WITHOUT CLAIM TO ANY PARTICULAR FONT, STYLE, SIZE, OR COLOR.

NO CLAIM IS MADE TO THE EXCLUSIVE RIGHT TO USE "BABYSITTING", APART FROM THE MARK AS SHOWN.

SN 77-715,158, FILED 4-16-2009.

JEAN IM, EXAMINING ATTORNEY



David J. Kybas

Director of the United States Patent and Trademark Office

United States of America

United States Patent and Trademark Office

GET HYDRATED

Reg. No. 4,154,415

REPUBLIC OF TEA, INC., THE (CALIFORNIA CORPORATION)
#5 HAMILTON LANDING, SUITE 100
NOVATO, CA 94949

Registered June 5, 2012

Int. Cl.: 5

FOR: HERB TEAS FOR MEDICINAL PURPOSES, IN CLASS 5 (U.S. CLS. 6, 18, 44, 46, 51 AND 52).

TRADEMARK

FIRST USE 4-2-2012; IN COMMERCE 4-2-2012.

PRINCIPAL REGISTER

THE MARK CONSISTS OF STANDARD CHARACTERS WITHOUT CLAIM TO ANY PARTICULAR FONT, STYLE, SIZE, OR COLOR.

OWNER OF U.S. REG. NOS. 3,596,054, 3,596,056, AND OTHERS.

SN 77-715,341, FILED 4-16-2009.

KIMBERLY PERRY, EXAMINING ATTORNEY



David J. Kyffers

Director of the United States Patent and Trademark Office

United States of America

United States Patent and Trademark Office

NEUROBLAST

Reg. No. 4,154,416

NEUROBRANDS LLC (CALIFORNIA LIMITED LIABILITY COMPANY)
501 SANTA MONICA BLVD., 2ND FLOOR
SANTA MONICA, CA 90401

Registered June 5, 2012

Int. Cls.: 5 and 32

FOR: DIETARY AND NUTRITIONAL SUPPLEMENTS; DIETARY BEVERAGE SUPPLEMENTS FOR HUMAN CONSUMPTION, IN CLASS 5 (U.S. CLS. 6, 18, 44, 46, 51 AND 52).

TRADEMARK

FIRST USE 3-9-2009; IN COMMERCE 10-3-2011.

PRINCIPAL REGISTER

FOR: NON-ALCOHOLIC BEVERAGES, NAMELY, CARBONATED BEVERAGES AND ENERGY DRINKS, IN CLASS 32 (U.S. CLS. 45, 46 AND 48).

FIRST USE 3-9-2009; IN COMMERCE 10-3-2011.

THE MARK CONSISTS OF STANDARD CHARACTERS WITHOUT CLAIM TO ANY PARTICULAR FONT, STYLE, SIZE, OR COLOR.

SN 77-715,898, FILED 4-17-2009.

JUDITH HELFMAN, EXAMINING ATTORNEY



David J. Kybas

Director of the United States Patent and Trademark Office

United States of America

United States Patent and Trademark Office

ELEMENT

Reg. No. 4,154,417

FEDERAL APD INCORPORATED (MICHIGAN CORPORATION)
28100 CABOT DRIVE, SUITE 200
NOVI, MI 48377

Registered June 5, 2012

Int. Cl.: 9

FOR: FACILITY MANAGEMENT SOFTWARE FOR CONTROL OF BUILDING SYSTEMS, CONTROL DEVICES AND FUNCTIONS, SECURITY MONITORING AND FACILITY MANAGEMENT AND OPERATION, IN CLASS 9 (U.S. CLS. 21, 23, 26, 36 AND 38).

TRADEMARK

FIRST USE 3-0-2011; IN COMMERCE 12-20-2011.

PRINCIPAL REGISTER

THE MARK CONSISTS OF STANDARD CHARACTERS WITHOUT CLAIM TO ANY PARTICULAR FONT, STYLE, SIZE, OR COLOR.

SN 77-716,045, FILED 4-17-2009.

IRA J. GOODSaid, EXAMINING ATTORNEY



David J. Kyros

Director of the United States Patent and Trademark Office

United States of America

United States Patent and Trademark Office

Coldguide

Reg. No. 4,154,418

Registered June 5, 2012

Int. Cl.: 11

TRADEMARK

PRINCIPAL REGISTER

DELO INDUSTRIAL ADHESIVES LLC (DELAWARE LIMITED LIABILITY COMPANY)
400 OSER AVE.
SUITE 1650
HAUPPAUGE, NY 11788

FOR: LAMPS, IN CLASS 11 (U.S. CLS. 13, 21, 23, 31 AND 34).

FIRST USE 1-1-2010; IN COMMERCE 3-19-2012.

THE MARK CONSISTS OF STANDARD CHARACTERS WITHOUT CLAIM TO ANY PARTICULAR FONT, STYLE, SIZE, OR COLOR.

SN 77-719,240, FILED 4-22-2009.

KATHERINE CONNOLLY, EXAMINING ATTORNEY



David J. Kyffers

Director of the United States Patent and Trademark Office

United States of America

United States Patent and Trademark Office

BÜNDE

Reg. No. 4,154,419

Registered June 5, 2012

Int. Cl.: 25

TRADEMARK

PRINCIPAL REGISTER

COLUMBIA INSURANCE COMPANY (NEBRASKA CORPORATION)
3024 HARNEY STREET
OMAHA, NE 68131

FOR: FOOTWEAR AND CLOTHING, NAMELY, BELTS, DRESSES, GLOVES, JACKETS, NECKWEAR, NIGHTWEAR, PANTS, SUITS, SWIMWEAR, SKIRTS, TOPS, BOTTOMS, UNDERWEAR, HEADWEAR, UNIFORMS, SHIRTS, SWEATSHIRTS, SWEATPANTS, SHORTS, SWEATERS, COATS, WRISTBANDS, SOCKS, HOSIERY, T-SHIRTS, SCARVES, CAPS, VESTS, AND PULLOVERS, IN CLASS 25 (U.S. CLS. 22 AND 39).

FIRST USE 6-9-2009; IN COMMERCE 6-9-2009.

THE MARK CONSISTS OF STANDARD CHARACTERS WITHOUT CLAIM TO ANY PARTICULAR FONT, STYLE, SIZE, OR COLOR.

THE WORDING "BÜNDE" HAS NO MEANING IN A FOREIGN LANGUAGE.

SN 77-729,215, FILED 5-5-2009.

DOMINIC FATHY, EXAMINING ATTORNEY



David J. Kyffers

Director of the United States Patent and Trademark Office

United States of America

United States Patent and Trademark Office

HEAVENLY STRANDS

Reg. No. 4,154,420

Registered June 5, 2012

Int. Cl.: 3

TRADEMARK

PRINCIPAL REGISTER

BEAUTY SPECIALS LLC (CALIFORNIA LIMITED LIABILITY COMPANY)
P.O. BOX 2294
ORANGE, CA 92859

FOR: 3-IN-1 HAIR SHAMPOOS; AROMATHERAPY BODY CARE PRODUCTS, NAMELY, BODY LOTION, SHOWER GEL, CUTICLE CREAM, SHAMPOO, CONDITIONER, NON-MEDICATED LIP BALM, SOAP, BODY POLISH, BODY AND FOOT SCRUB AND NON-MEDICATED FOOT CREAM; BABY SHAMPOO; HAIR RINSES; HAIR SHAMPOO; HAIR SHAMPOOS AND CONDITIONERS; HAIR STYLING FIXATIVE IN THE NATURE OF HAIR WAX; HAIR STYLING GEL; HAIR STYLING PREPARATIONS; HAIR STYLING SPRAY; SHAMPOO-CONDITIONERS; SHAMPOOS; SHAMPOOS FOR BABIES; STYLING CLAY FOR HAIR; STYLING FOAM FOR HAIR; STYLING GELS; STYLING LOTIONS; STYLING MOUSSE; STYLING PASTE FOR HAIR, IN CLASS 3 (U.S. CLS. 1, 4, 6, 50, 51 AND 52).

FIRST USE 6-29-2010; IN COMMERCE 6-29-2010.

THE MARK CONSISTS OF STANDARD CHARACTERS WITHOUT CLAIM TO ANY PARTICULAR FONT, STYLE, SIZE, OR COLOR.

SN 77-732,074, FILED 5-7-2009.

CHRISTOPHER BUONGIORNO, EXAMINING ATTORNEY



David J. Kyros

Director of the United States Patent and Trademark Office

United States of America

United States Patent and Trademark Office

ADJUSTAFIL

Reg. No. 4,154,421

LOUISVILLE BEDDING COMPANY (DELAWARE CORPORATION)
10400 BUNSEN WAY
LOUISVILLE, KY 40299

Registered June 5, 2012

Int. Cl.: 20

FOR: PILLOWS AND BED PILLOWS THAT FEATURE A UNIQUE PLUSH MATERIAL FOR SUPPORT AND RESILIENCY, IN CLASS 20 (U.S. CLS. 2, 13, 22, 25, 32 AND 50).

TRADEMARK

FIRST USE 9-4-2009; IN COMMERCE 9-4-2009.

PRINCIPAL REGISTER

THE MARK CONSISTS OF STANDARD CHARACTERS WITHOUT CLAIM TO ANY PARTICULAR FONT, STYLE, SIZE, OR COLOR.

SN 77-737,341, FILED 5-14-2009.

LOURDES AYALA, EXAMINING ATTORNEY



David J. Kybas

Director of the United States Patent and Trademark Office

United States of America

United States Patent and Trademark Office



PARIS HILTON

Reg. No. 4,154,422

Registered June 5, 2012

Int. Cl.: 21

TRADEMARK

PRINCIPAL REGISTER

HILTON, PARIS (UNITED STATES INDIVIDUAL)
250 N. CANON DRIVE
2ND FLOOR
BEVERLY HILLS, CA 90210

FOR: HAIR BRUSHES AND HAIR COMBS, IN CLASS 21 (U.S. CLS. 2, 13, 23, 29, 30, 33, 40 AND 50).

FIRST USE 12-2-2009; IN COMMERCE 12-2-2009.

OWNER OF U.S. REG. NOS. 3,059,587, 3,550,627, AND OTHERS.

THE NAME(S), PORTRAIT(S), AND/OR SIGNATURE(S) SHOWN IN THE MARK IDENTIFIES "PARIS HILTON", WHOSE CONSENT(S) TO REGISTER IS MADE OF RECORD.

THE MARK CONSISTS OF A CROWN DESIGN WITH A STYLIZED "P" AND DIAMOND PERIOD DESIGN, A SWIRL DESIGN ON EACH SIDE OF THE "P" AND THE WORDS "PARIS HILTON".

SN 77-740,209, FILED 5-19-2009.

JENNIFER VASQUEZ, EXAMINING ATTORNEY



David J. Kybas

Director of the United States Patent and Trademark Office

United States of America

United States Patent and Trademark Office

MIAMI MARLINS

Reg. No. 4,154,423

Registered June 5, 2012

Int. Cl.: 41

SERVICE MARK

PRINCIPAL REGISTER

MIAMI MARLINS, L.P. (DELAWARE LIMITED PARTNERSHIP)
501 MARLINS WAY
MIAMI, FL 33125

FOR: ENTERTAINMENT SERVICES, NAMELY, ORGANIZING AND CONDUCTING AN ARRAY OF ATHLETIC EVENTS RENDERED LIVE AND RECORDED FOR DISTRIBUTION THROUGH BROADCAST MEDIA; BASEBALL CAMPS, CLINICS; ORGANIZING AND CONDUCTING SPORTS CONTESTS AND SWEEPSTAKES; PRODUCTION AND PROVISION OF ON-GOING TELEVISION, INTERNET AND RADIO PROGRAMS IN THE FIELD OF SPORTS; PROVIDING NEWS, INFORMATION, POD CASTS, WEB CASTS, ONLINE NEWSLETTERS, AND ONLINE JOURNALS, NAMELY, BLOGS, ALL OF THE FOREGOING IN THE FIELD OF SPORTS; ORGANIZING COMMUNITY SPORTING AND CULTURAL EVENTS; ENTERTAINMENT IN THE NATURE OF LIVE PERFORMANCES BY COSTUMED MASCOTS, CHEERLEADERS AND DANCE GROUPS; FAN CLUBS; FESTIVALS FEATURING A VARIETY OF SPORTS AND ENTERTAINMENT ACTIVITIES; PROVIDING SPORTS FACILITIES, IN CLASS 41 (U.S. CLS. 100, 101 AND 107).

FIRST USE 9-26-2011; IN COMMERCE 9-26-2011.

THE MARK CONSISTS OF STANDARD CHARACTERS WITHOUT CLAIM TO ANY PARTICULAR FONT, STYLE, SIZE, OR COLOR.

OWNER OF U.S. REG. NOS. 1,807,380, 1,909,332, AND OTHERS.

NO CLAIM IS MADE TO THE EXCLUSIVE RIGHT TO USE "MIAMI", APART FROM THE MARK AS SHOWN.

SN 77-745,136, FILED 5-27-2009.

JAMES LOVELACE, EXAMINING ATTORNEY



David J. Kypos

Director of the United States Patent and Trademark Office

United States of America

United States Patent and Trademark Office

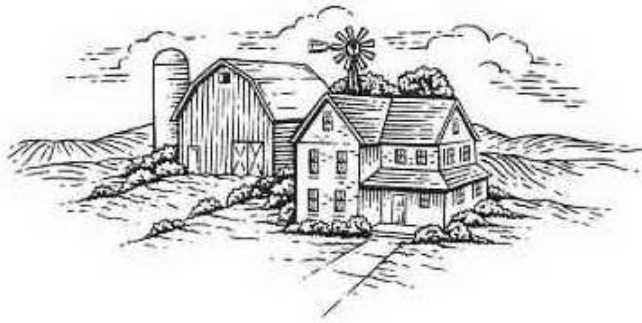

Reg. No. 4,154,424

Registered June 5, 2012

**Int. Cls.: 3, 4, 6, 8, 16, 29,
30, 31, and 32**

TRADEMARK

PRINCIPAL REGISTER

IGA, INC. (DELAWARE CORPORATION)
8745 W. HIGGINS ROAD SUITE 350
CHICAGO, IL 60631

FOR: ALL-PURPOSE DETERGENT FOR HOUSEHOLD USE; FABRIC SOFTENER SHEETS; CLEANING PREPARATIONS, NAMELY, LAUNDRY SOAPS AND DETERGENTS, LIQUID FABRIC SOFTENER, ALL-PURPOSE HOUSEHOLD CLEANERS, DISHWASHING LIQUID DETERGENTS, AUTOMATIC DISHWASHING DETERGENT, LIQUID WINDOW CLEANING SOLUTIONS AND GLASS CLEANERS, LAUNDRY BLEACH, GENERAL PURPOSE CLEANING, DISH DETERGENT; ANTIBACTERIAL SOAP; BABY WIPES, IN CLASS 3 (U.S. CLS. 1, 4, 6, 50, 51 AND 52).

FIRST USE 3-1-2011; IN COMMERCE 3-1-2011.

FOR: CHARCOAL LIGHTER FLUID, IN CLASS 4 (U.S. CLS. 1, 6 AND 15).

FIRST USE 3-1-2011; IN COMMERCE 3-1-2011.

FOR: ALUMINUM FOIL, IN CLASS 6 (U.S. CLS. 2, 12, 13, 14, 23, 25 AND 50).

FIRST USE 3-1-2011; IN COMMERCE 3-1-2011.

FOR: PLASTIC FORKS AND PLASTIC SPOONS, IN CLASS 8 (U.S. CLS. 23, 28 AND 44).

FIRST USE 3-1-2011; IN COMMERCE 3-1-2011.

FOR: PLASTIC WRAP, PAPER TOWELS, PAPER NAPKINS, PAPER FILTERS FOR COFFEE MAKERS; LUNCH BAGS; TRASH, GARBAGE AND KITCHEN TRASH BAGS; LAWN AND LEAF DISPOSAL BAGS; SANDWICH AND FREEZER BAGS; FOOD STORAGE BAGS; BATHROOM AND FACIAL TISSUE; MAGAZINES IN THE FIELD OF GROCERIES PUBLISHED PERIODICALLY, IN CLASS 16 (U.S. CLS. 2, 5, 22, 23, 29, 37, 38 AND 50).

FIRST USE 3-1-2011; IN COMMERCE 3-1-2011.

FOR: BLANCHED, SHELLLED, ROASTED AND PROCESSED NUTS; RAISINS; FROZEN, CUT, PROCESSED, PRESERVED, DRIED, CANNED, AND COOKED FRUITS AND VEGETABLES; ONION RINGS; CRANBERRY SAUCE; PICKLES; FRUIT SALAD; PEANUT BUTTER;



David J. Kappas

Director of the United States Patent and Trademark Office

Reg. No. 4,154,424 JELLIES, JAMS AND FRUIT PRESERVES; APPLESAUCE; BOLOGNA; BOUILLON; SOUPS, SOUP MIXES, BROTHS, SOUP BROTHS; SAUERKRAUT; BREAKFAST SAUSAGE LINKS, SAUSAGES AND BRATWURST; BACON AND BACON BITS; BUTTER; MARGARINE; VEGETABLE BASED SPREADS; CHILI WITH AND WITHOUT BEANS; FLAKED COCONUT; COOKING OIL, COOKING OIL SPRAY; VEGETABLE AND ANIMAL SHORTENING; EDIBLE OIL; VEGETABLE OIL; OLIVE OIL; COTTAGE CHEESE; SOUR CREAM; EGGS; TOMATO PASTE AND PUREE; NON DAIRY CREAMER; DIPS AND SNACK DIPS; FRUIT-BASED SNACK FOOD; PROCESSED EDIBLE SEEDS; FRUIT BASED FILLINGS FOR PIES AND CAKES; MILK AND DAIRY PRODUCTS EXCLUDING ICE CREAM, ICE MILK AND FROZEN YOGURT; EVAPORATED AND CONDENSED MILK; MILK POWDER; YOGURT; CHEESE; CHEESE FOOD; CREAM CHEESE; CHEESE SPREAD; POTATO CHIPS; WHIPPED CREAM; WHIPPED TOPPING; MEAT; LUNCHEON MEATS; HAM; BEEF, BEEF STEW; CORNED BEEF AND CORNED BEEF HASH; CHICKEN AND POULTRY; CORN DOGS; FISH, FISH FILLETS, FRANKFURTERS; CANNED PORK AND BEANS; INSTANT POTATOES, FRIED POTATOES, FRENCH FRIED POTATOES; SALADS EXCEPT MACARONI, RICE AND PASTA SALAD; PREPARED CHICKEN SALAD, PREPARED POTATO SALAD, AND COLE SLAW; SEAFOOD; TUNA FISH; CANNED GOODS, NAMELY, FRUITS, BERRIES, VEGETABLES, FOWL, MEATS; FROZEN GOODS, NAMELY, FRUIT, BERRIES, VEGETABLES, VEGETABLE JUICES FOR COOKING, MEAT, FOWL, SOUPS, FRUIT-BASED FILLING FOR PIES; SALTED, SMOKED AND SPICED GOODS, NAMELY, FISH, CHICKEN AND MEATS; PREPARED DEVILLED MEAT AND SAUSAGE; CONDIMENTS, NAMELY, PICKLES, PROCESSED OLIVES AND PROCESSED PIMENTOS; CHEESE; EVAPORATED MILK; PRESERVES AND MARMALADES; SALAD OIL; BAKED BEANS, IN CLASS 29 (U.S. CL. 46).

FIRST USE 3-1-2011; IN COMMERCE 3-1-2011.

FOR: STARCH, SALT, CANDY; CAMELS, CANDY MINTS, BUBBLE GUM; BAGELS, BREAD, ROLLS AND BUNS; ENGLISH MUFFINS; BREAD CRUMBS AND BREAD DOUGH; BREADSTICKS; GARLIC BREAD, BREADSTICKS AND TOAST; BISCUITS AND BUTTER BISCUITS; PASTRIES; CONFECTIONERY BAKING CHIPS FOR BAKING; MIXES FOR BAKERY GOODS; CAKE MIXES; EDIBLE CAKE DECORATIONS; FROSTINGS BAKING SODA; BAKING POWDER; ICE CREAM; ICE CREAM BARS, ICE CREAM SANDWICHES AND FUDGE BARS; SHERBET; FROZEN YOGURT; CONES FOR ICE CREAM; FLAVORED AND SWEETENED GELATINS; BREAKFAST CEREALS; OATMEAL; PROCESSED OATS; SPICES, CHILI POWDER, CINNAMON, CINNAMON POWDER; GARLIC POWDER AND SALT; SALT; PEPPER; SEASONINGS, SEASONING MIXES; SLOPPY JOE SEASONING MIX; VANILLA EXTRACT; COFFEE, TEA, ICED TEA, TEA BAGS, SUGAR, RICE, PASTA, NOODLES, FLOUR; FLOUR MIXES; CORN MEAL; SUGAR SUBSTITUTE; COOKIES; WAFERS; CRACKERS; CHEESE FLAVORED SNACKS, NAMELY, CHEESE CURLS AND CHEESE PUFFS; CHEESE FLAVORED PUFFED CORN SNACKS; GRAIN-BASED FOOD BARS ALSO CONTAINING FRUIT; GRANOLA BASED SNACK BARS; SALAD DRESSINGS; GRAVIES AND GRAVY MIXES; SAUCES; SAUCE MIXES; CHEESE SAUCE; MARINADES; GRITS AND HOMINY GRITS; HOMINY; HONEY; MUSTARD; KETCHUP; MAYONNAISE; VINEGAR; SALAD DRESSINGS; SALSA; MACARONI AND CHEESE; MARSHMALLOWS; PANCAKES AND PANCAKE MIXES; WAFFLES; WAFFLE MIXES; PIE CRUST; PUDDINGS AND PUDDING MIXES; TOPPING SYRUP; CHOCOLATE SYRUP; CORN SYRUP; MAPLE SYRUP; TACO SHELLS; FROZEN, MIXES FOR MAKING COMBINED NOODLE OR RICE AND SAUCE DISHES; PIZZA, PREPARED PIZZAS AND BITE-SIZED PIZZA APPETIZERS; MICROWAVE POPCORN, RICE-BASED SNACK FOODS; STUFFING MIXES CONTAINING BREAD; FOOD FLAVORING EXTRACTS; CORNMEAL; CHOCOLATE POWDER FOR MAKING HOT CHOCOLATE; SAUCES; CONDIMENTS, NAMELY, PICKLE RELISHES; UNPOPPED POPCORN, IN CLASS 30 (U.S. CL. 46).

FIRST USE 3-1-2011; IN COMMERCE 3-1-2011.

FOR: PET FOOD, CAT LITTER; FRESH FRUITS AND VEGETABLES, IN CLASS 31 (U.S. CLS. 1 AND 46).

Reg. No. 4,154,424 FIRST USE 3-1-2011; IN COMMERCE 3-1-2011.

FOR: GINGER ALE, SOFT DRINKS AND CARBONATED WATERS; CANNED, BOTTLED AND FROZEN GOODS, NAMELY, POWDERED SOFT DRINKS, FRUIT JUICES AS COCKTAIL MIXES, VEGETABLE JUICE, IN CLASS 32 (U.S. CLS. 45, 46 AND 48).

FIRST USE 3-1-2011; IN COMMERCE 3-1-2011.

THE MARK CONSISTS OF A FARM HOUSE, BARN AND SILO, WITH A WINDMILL BEHIND THE FARM HOUSE, ALL ON HILLY LAND WITH CLOUDS IN THE BACKGROUND.

SN 77-746,016, FILED 5-27-2009.

MATTHEW MCDOWELL, EXAMINING ATTORNEY

United States of America

United States Patent and Trademark Office



Reg. No. 4,154,425

Registered June 5, 2012

**Int. Cls.: 3, 6, 8, 16, 29,
30, 31, and 32**

TRADEMARK

PRINCIPAL REGISTER

IGA, INC. (DELAWARE CORPORATION)
8745 W. HIGGINS ROAD SUITE 350
CHICAGO, IL 60631

FOR: ALL-PURPOSE DETERGENT FOR HOUSEHOLD USE; FABRIC SOFTENER SHEETS; CLEANING PREPARATIONS, NAMELY, LAUNDRY SOAPS AND DETERGENTS, LIQUID FABRIC SOFTENER, ALL-PURPOSE HOUSEHOLD CLEANERS, DISHWASHING LIQUID DETERGENTS, AUTOMATIC DISHWASHING DETERGENT, LIQUID WINDOW CLEANING SOLUTIONS AND GLASS CLEANERS, LAUNDRY BLEACH, GENERAL PURPOSE CLEANING, DISH DETERGENT; ANTIBACTERIAL SOAP; BABY WIPES, IN CLASS 3 (U.S. CLS. 1, 4, 6, 50, 51 AND 52).

FIRST USE 3-1-2011; IN COMMERCE 3-1-2011.

FOR: ALUMINUM FOIL, IN CLASS 6 (U.S. CLS. 2, 12, 13, 14, 23, 25 AND 50).

FIRST USE 3-1-2011; IN COMMERCE 3-1-2011.

FOR: PLASTIC FORKS AND PLASTIC SPOONS, IN CLASS 8 (U.S. CLS. 23, 28 AND 44).

FIRST USE 3-1-2011; IN COMMERCE 3-1-2011.

FOR: PLASTIC WRAP, PAPER BAGS AND PAPER SACKS; PAPER TOWELS, PAPER NAPKINS, DISPOSABLE DIAPERS; PAPER FILTERS FOR COFFEE MAKERS; LUNCH BAGS; TRASH, GARBAGE AND KITCHEN TRASH BAGS; LAWN AND LEAF DISPOSAL BAGS; SANDWICH AND FREEZER BAGS; FOOD STORAGE BAGS; BATHROOM AND FACIAL TISSUE; ADHESIVE TAPE FOR STATIONERY OR HOUSEHOLD PURPOSES; MAGAZINES IN THE FIELD OF GROCERIES PUBLISHED PERIODICALLY; DISPOSABLE WIPES NOT IMPREGNATED WITH CHEMICALS OR COMPOUNDS FOR HOUSEHOLD USE, IN CLASS 16 (U.S. CLS. 2, 5, 22, 23, 29, 37, 38 AND 50).

FIRST USE 3-1-2011; IN COMMERCE 3-1-2011.

FOR: BLANCHED, SHELLED, ROASTED AND PROCESSED NUTS; RAISINS; FROZEN, CUT, PROCESSED, PRESERVED, DRIED, CANNED, AND COOKED FRUITS AND VEGETABLES; ONION RINGS; CRANBERRY SAUCE; PICKLES; FRUIT SALAD; PEANUT BUTTER; JELLIES, JAMS AND FRUIT PRESERVES; APPLESAUCE; BOLOGNA; BOUILLON; SOUPS,



David J. Kybas

Director of the United States Patent and Trademark Office

Reg. No. 4,154,425 SOUP MIXES, BROTHS, SOUP BROTHS; SAUERKRAUT; BREAKFAST SAUSAGE LINKS, SAUSAGES AND BRATWURST; BACON AND BACON BITS; BUTTER; MARGARINE; VEGETABLE BASED SPREADS; CHILI WITH AND WITHOUT BEANS; FLAKED COCONUT; COOKING OIL, COOKING OIL SPRAY; VEGETABLE AND ANIMAL SHORTENING; EDIBLE OIL; VEGETABLE OIL; OLIVE OIL; COTTAGE CHEESE; SOUR CREAM; EGGS; TOMATO PASTE AND PUREE; NON DAIRY CREAMER; DIPS AND SNACK DIPS; FRUIT-BASED SNACK FOOD; PROCESSED EDIBLE SEEDS; FRUIT BASED FILLINGS FOR PIES AND CAKES; MILK AND DAIRY PRODUCTS EXCLUDING ICE CREAM, ICE MILK AND FROZEN YOGURT; EVAPORATED AND CONDENSED MILK; MILK POWDER; YOGURT; CHEESE; CHEESE FOOD; CREAM CHEESE; CHEESE SPREAD; POTATO CHIPS; WHIPPED CREAM; WHIPPED TOPPING; MEAT; LUNCHEON MEATS; HAM; BEEF, BEEF STEW; CORNED BEEF AND CORNED BEEF HASH; CHICKEN AND POULTRY; CORN DOGS; FISH, FISH FILLETS, FRANKFURTERS; CANNED PORK AND BEANS; INSTANT POTATOES, FRIED POTATOES, FRENCH FRIED POTATOES; SALADS EXCEPT MACARONI, RICE AND PASTA SALAD; PREPARED CHICKEN SALAD, PREPARED POTATO SALAD, AND COLE SLAW; SEAFOOD; TUNA FISH; CANNED GOODS, NAMELY, FRUITS, BERRIES, VEGETABLES, FOWL, MEATS; FROZEN GOODS, NAMELY, FRUIT, BERRIES, VEGETABLES, VEGETABLE JUICES FOR COOKING, MEAT, FOWL, SOUPS, FRUIT-BASED FILLING FOR PIES; SALTED, SMOKED AND SPICED GOODS, NAMELY, FISH, CHICKEN AND MEATS; PREPARED DEVILLED MEAT AND SAUSAGE; CONDIMENTS, NAMELY, PICKLES, PROCESSED OLIVES AND PROCESSED PIMENTOS; CHEESE; EVAPORATED MILK; PRESERVES AND MARMALADES; SALAD OIL; BAKED BEANS, IN CLASS 29 (U.S. CL. 46).

FIRST USE 3-1-2011; IN COMMERCE 3-1-2011.

FOR: STARCH, NAMELY, SALT, CANDY; CARAMELS, CANDY MINTS, BUBBLE GUM; BAGELS, BREAD, ROLLS AND BUNS; ENGLISH MUFFINS; BREAD CRUMBS AND BREAD DOUGH; BREADSTICKS; GARLIC BREAD, BREADSTICKS AND TOAST; BISCUITS AND BUTTER BISCUITS; PASTRIES; CONFECTIONERY BAKING CHIPS FOR BAKING; MIXES FOR BAKERY GOODS; CAKE MIXES; EDIBLE CAKE DECORATIONS; FROSTINGS BAKING SODA; BAKING POWDER; ICE CREAM; ICE CREAM BARS, ICE CREAM SANDWICHES AND FUDGE BARS; SHERBET; FROZEN YOGURT; CONES FOR ICE CREAM; FLAVORED AND SWEETENED GELATINS; BREAKFAST CEREALS; OATMEAL; PROCESSED OATS; SPICES, CHILI POWDER, CINNAMON, CINNAMON POWDER; GARLIC POWDER AND SALT; SALT; PEPPER; SEASONINGS, SEASONING MIXES; SLOPPY JOE SEASONING MIX; VANILLA EXTRACT; COFFEE, TEA, ICED TEA, TEA BAGS, SUGAR, RICE, PASTA, NOODLES, FLOUR; FLOUR MIXES; CORN MEAL; SUGAR SUBSTITUTE; COOKIES; WAFERS; CRACKERS; CHEESE FLAVORED SNACKS, NAMELY, CHEESE CURLS AND CHEESE PUFFS; CHEESE FLAVORED PUFFED CORN SNACKS; GRAIN-BASED FOOD BARS ALSO CONTAINING FRUIT; GRANOLA BASED SNACK BARS; SALAD DRESSINGS; GRAVIES AND GRAVY MIXES; SAUCES; SAUCE MIXES; CHEESE SAUCE; MARINADES; GRITS AND HOMINY GRITS; HOMINY; HONEY; MUSTARD; KETCHUP; MAYONNAISE; VINEGAR; SALAD DRESSINGS; SALSA; MACARONI AND CHEESE; MARSHMALLOWS; PANCAKES AND PANCAKE MIXES; WAFFLES; WAFFLE MIXES; PIE CRUST; PUDDINGS AND PUDDING MIXES; TOPPING SYRUP; CHOCOLATE SYRUP; CORN SYRUP; MAPLE SYRUP; TACO SHELLS; FROZEN, MIXES FOR MAKING COMBINED NOODLE OR RICE AND SAUCE DISHES; PIZZA, PREPARED PIZZAS AND BITE-SIZED PIZZA APPETIZERS; MICROWAVE POPCORN, RICE-BASED SNACK FOODS; STUFFING MIXES CONTAINING BREAD; FOOD FLAVORING EXTRACTS; CORNMEAL; CHOCOLATE POWDER FOR MAKING HOT CHOCOLATE; SAUCES; CONDIMENTS, NAMELY, PICKLE RELISHES; UNPOPPED POPCORN, IN CLASS 30 (U.S. CL. 46).

FIRST USE 3-1-2011; IN COMMERCE 3-1-2011.

FOR: PET FOOD, CAT LITTER; FRESH FRUITS AND VEGETABLES , IN CLASS 31 (U.S. CLS. 1 AND 46).

FIRST USE 3-1-2011; IN COMMERCE 3-1-2011.

Reg. No. 4,154,425 FOR: GINGER ALE, SOFT DRINKS AND CARBONATED WATERS; CANNED, BOTTLED AND FROZEN GOODS, NAMELY, POWDERED SOFT DRINKS, FRUIT JUICES AS COCKTAIL MIXES, VEGETABLE JUICE, IN CLASS 32 (U.S. CLS. 45, 46 AND 48).

FIRST USE 3-1-2011; IN COMMERCE 3-1-2011.

OWNER OF U.S. REG. NOS. 997,353, 1,095,531, AND OTHERS.

THE COLOR(S) RED, WHITE AND BLACK IS/ARE CLAIMED AS A FEATURE OF THE MARK.

THE MARK CONSISTS OF THE WORDING "IGA" IN WHITE CONTAINED IN AN OVAL WITH A RED BACKGROUND WITH A WHITE BORDER AND BLACK OUTLINING THAT IS THICKER AT THE BOTTOM RIGHT OF THE OVAL. THERE ARE WHITE RAYS EMANATING FROM BEHIND THE OVAL DESIGN ELEMENT. THE RAYS ARE OUTLINED IN BLACK TO DEFINE THIS FEATURE ONLY AND THE COLOR BLACK IS NOT CLAIMED AS A FEATURE OF THIS PORTION OF THE MARK.

SN 77-746,027, FILED 5-27-2009.

MATTHEW MCDOWELL, EXAMINING ATTORNEY

United States of America

United States Patent and Trademark Office

LEMORA

Reg. No. 4,154,426

FUTURE FRUIT, LLC (CALIFORNIA LIMITED LIABILITY COMPANY)
35801 ROAD 132
VISALIA, CA 93292

Registered June 5, 2012

Int. Cl.: 31

FOR: FRESH CITRUS FRUIT, IN CLASS 31 (U.S. CLS. 1 AND 46).

TRADEMARK

FIRST USE 2-10-2012; IN COMMERCE 2-10-2012.

PRINCIPAL REGISTER

THE MARK CONSISTS OF STANDARD CHARACTERS WITHOUT CLAIM TO ANY PARTICULAR FONT, STYLE, SIZE, OR COLOR.

THE WORDING "LEMORA" HAS NO MEANING IN A FOREIGN LANGUAGE.

SN 77-746,058, FILED 5-27-2009.

MELISSA VALLILLO, EXAMINING ATTORNEY



David J. Kybas

Director of the United States Patent and Trademark Office

United States of America

United States Patent and Trademark Office

Frederick Buechner

Reg. No. 4,154,427

Registered June 5, 2012

Int. Cls.: 16 and 28

FREDERICK BUECHNER LITERARY ASSETS, LLC (VERMONT LIMITED LIABILITY CORPORATION)
30 BRATTLE STREET
C/O DAVID ALTSHULER
CAMBRIDGE, MA 02138

TRADEMARK

PRINCIPAL REGISTER

FOR: A SERIES OF NON-FICTION BOOKS IN THE FIELD OF RELIGION, MORALITY AND SELF-AWARENESS; SERIES OF FICTION BOOKS; PERIODIC NEWSLETTERS IN THE FIELD OF RELIGION, MORALITY AND SELF AWARENESS; PRINTED INSTRUCTIONAL AND TEACHING MATERIALS, NAMELY, WORKBOOKS IN THE FIELD OF RELIGION, MORALITY AND SELF AWARENESS; BOOKMARKS; POSTERS; CALENDARS; MAPS; GREETING CARDS; POSTCARDS; PAPER PENNANTS; STICKER ALBUMS; STICKERS; DECALS; STATIONERY; NOTEBOOKS; PENCILS; PENS; CASES FOR PENCILS AND PENS; ERASERS; CRAYONS; MARKERS; COLORED PENCILS; PAINTING SETS FOR CHILDREN; DRAFTING RULERS AND DRAWING RULERS; CHECK BOOK COVERS; ADDRESS BOOKS; CHILDREN'S BOOKS; PUZZLE BOOKS; SCRAP BOOKS; DIARIES; CHILDREN'S ACTIVITY BOOKS; COLORING BOOKS; COMPOSITION BOOKS, PAPER BOOK COVERS; ART PRINTS; PAPER SHOPPING BAGS; PAPER TABLECLOTHS; PAPER PARTY FAVORS; PAPER PARTY DECORATIONS, NAMELY, PAPER NAPKINS, PAPER DOILIES, PAPER PLACE MATS, CREPE PAPER, PRINTED INVITATIONS, PAPER CAKE DECORATIONS; WRAPPING PAPER; PHOTOGRAPH ALBUMS, IN CLASS 16 (U.S. CLS. 2, 5, 22, 23, 29, 37, 38 AND 50).

FIRST USE 2-1-2012; IN COMMERCE 2-1-2012.

FOR: PLAYING CARDS, IN CLASS 28 (U.S. CLS. 22, 23, 38 AND 50).

FIRST USE 2-1-2012; IN COMMERCE 2-1-2012.

THE NAME(S), PORTRAIT(S), AND/OR SIGNATURE(S) SHOWN IN THE MARK IDENTIFIES A LIVING INDIVIDUAL, WHOSE CONSENT(S) TO REGISTER IS MADE OF RECORD.

THE MARK CONSISTS OF STYLIZED LETTERS "FREDERICK BUECHNER".

SN 77-746,406, FILED 5-28-2009.

SOPHIA S. KIM, EXAMINING ATTORNEY



David J. Kyros

Director of the United States Patent and Trademark Office

United States of America

United States Patent and Trademark Office

VITAPASTE

Reg. No. 4,154,428

GOLDEN PRODUCTS LLC. (NEW YORK LIMITED LIABILITY COMPANY)
159-21 CROSS BAY BLVD.
HOWARD BEACH, NY 11414

Registered June 5, 2012

Int. Cl.: 3

FOR: ORAL HYGIENE PRODUCTS, NAMELY, DENTIFRICES AND TOOTHPASTE, IN CLASS 3 (U.S. CLS. 1, 4, 6, 50, 51 AND 52).

TRADEMARK

FIRST USE 3-29-2012; IN COMMERCE 3-29-2012.

PRINCIPAL REGISTER

THE MARK CONSISTS OF STANDARD CHARACTERS WITHOUT CLAIM TO ANY PARTICULAR FONT, STYLE, SIZE, OR COLOR.

OWNER OF U.S. REG. NOS. 3,532,755, 3,607,044, AND OTHERS.

SN 77-748,759, FILED 6-1-2009.

MICHELLE DUBOIS, EXAMINING ATTORNEY



David J. Kyros

Director of the United States Patent and Trademark Office

United States of America

United States Patent and Trademark Office

MUTTNATION FOUNDATION

Reg. No. 4,154,429

Registered June 5, 2012

Int. Cl.: 45

SERVICE MARK

PRINCIPAL REGISTER

LAMBERT, MIRANDA (UNITED STATES INDIVIDUAL)
C/O GREENBERG TRAUIG, LLP
3290 NORTHSIDE PARKWAY, SUITE 400
ATLANTA, GA 30327

FOR: ADOPTION SERVICES FOR DOMESTIC ANIMALS, IN CLASS 45 (U.S. CLS. 100 AND 101).

FIRST USE 12-22-2009; IN COMMERCE 12-22-2009.

THE MARK CONSISTS OF STANDARD CHARACTERS WITHOUT CLAIM TO ANY PARTICULAR FONT, STYLE, SIZE, OR COLOR.

NO CLAIM IS MADE TO THE EXCLUSIVE RIGHT TO USE "FOUNDATION", APART FROM THE MARK AS SHOWN.

SN 77-752,252, FILED 6-4-2009.

JUSTINE D. PARKER, EXAMINING ATTORNEY



David J. Kyros

Director of the United States Patent and Trademark Office

United States of America

United States Patent and Trademark Office

CRIMSAFE-S-CAPE

Reg. No. 4,154,430

Registered June 5, 2012

Int. Cl.: 6

TRADEMARK

PRINCIPAL REGISTER

IPH INTERNATIONAL PTY. LTD. (AUSTRALIA CORPORATION)
1 BLANCK STREET
ORMEAU, QUEENSLAND, AUSTRALIA 4208

FOR: MESH SCREENS OF METAL FOR USE AS SECURITY SCREENS AND INSECT SCREENS FOR WINDOWS; MESH DOORS OF METAL IN THE NATURE OF SECURITY DOORS, DOORS FOR INSECT SCREENING; PREFABRICATED BUILDING ASSEMBLY KITS COMPRISING MESH SCREENS OF METAL FOR USE AS SECURITY SCREENS AND INSECT SCREENS FOR WINDOWS AND DOORS, AND FRAMES OF IRON, STEEL, NON-FERROUS METALS AND THEIR ALLOYS; MESH DOORS AND WINDOWS OF METAL IN THE NATURE OF QUICK RELEASE SECURITY DOORS AND SECURITY WINDOWS TO ALLOW EXITING FROM A BUILDING, IN CLASS 6 (U.S. CLS. 2, 12, 13, 14, 23, 25 AND 50).

FIRST USE 11-30-2010; IN COMMERCE 11-30-2010.

THE MARK CONSISTS OF STANDARD CHARACTERS WITHOUT CLAIM TO ANY PARTICULAR FONT, STYLE, SIZE, OR COLOR.

OWNER OF U.S. REG. NOS. 3,671,032 AND 3,671,033.

SN 77-756,600, FILED 6-10-2009.

SIMON TENG, EXAMINING ATTORNEY



David J. Kybas

Director of the United States Patent and Trademark Office

United States of America

United States Patent and Trademark Office

JUANES

Reg. No. 4,154,431

Registered June 5, 2012

Int. Cl.: 25

TRADEMARK

PRINCIPAL REGISTER

LA HERRADURA LTD. (UNITED KINGDOM LIMITED PARTNERSHIP)
SUITE 18
260 CRANDON BLVD.
KEY BISCAYNE, FL 33149

FOR: BELTS; CAPS; HEADWEAR; JACKETS; JERSEYS; PANTS; PULLOVERS; SHIRTS;
SHORTS; SWEATERS; T-SHIRTS; TOPS, IN CLASS 25 (U.S. CLS. 22 AND 39).

FIRST USE 3-1-2005; IN COMMERCE 3-1-2005.

THE MARK CONSISTS OF STANDARD CHARACTERS WITHOUT CLAIM TO ANY PAR-
TICULAR FONT, STYLE, SIZE, OR COLOR.

OWNER OF U.S. REG. NOS. 3,291,984, 3,320,709, AND 3,421,609.

"JUANES" IDENTIFIES JUAN ESTEBAN ARISTIZABAL VASQUEZ, A LIVING INDIVIDUAL
WHOSE CONSENT IS OF RECORD.

SN 77-758,808, FILED 6-12-2009.

LINDA ESTRADA, EXAMINING ATTORNEY



David J. Kyros

Director of the United States Patent and Trademark Office

United States of America

United States Patent and Trademark Office

MTE

MediTourExpo

Reg. No. 4,154,432

Registered June 5, 2012

Int. Cl.: 41

SERVICE MARK

PRINCIPAL REGISTER

MEDITOUREXPO LLC (NEVADA LIMITED LIABILITY COMPANY)
STE. 220
2780 S. JONES BOULEVARD
LAS VEGAS, NV 89146

FOR: ORGANIZING AND CONDUCTING EXHIBITIONS, CONFERENCES, MEETINGS, SYMPOSIA, SEMINARS, WORKSHOPS, CLASSES, LECTURES, DEMONSTRATIONS AND AUDIO AND VISUAL PRESENTATIONS IN THE FIELDS OF MEDICINE, HEALTH CARE AND MEDICAL TOURISM; MEDICAL AND HEALTH CARE TRAINING; PROVIDING ON-LINE PUBLICATIONS IN THE NATURE OF JOURNALS, BLOGS AND BULLETINS IN THE FIELDS OF MEDICINE, HEALTH CARE AND MEDICAL TOURISM VIA A GLOBAL COMPUTER NETWORK AND WIRELESS COMMUNICATIONS NETWORK, IN CLASS 41 (U.S. CLS. 100, 101 AND 107).

FIRST USE 5-23-2011; IN COMMERCE 5-23-2011.

THE MARK CONSISTS OF THE TEXT "MTE" WITH A STYLIZED CENTER LINE FOR THE "E", A LINE UNDERNEATH THE TEXT, AND THE TEXT "MEDITOUREXPO" BELOW IT.

SN 77-760,732, FILED 6-16-2009.

ANN E. SAPPENFIELD, EXAMINING ATTORNEY



David J. Kyros

Director of the United States Patent and Trademark Office

United States of America

United States Patent and Trademark Office

Alpen Zauber

Reg. No. 4,154,433

Registered June 5, 2012

Int. Cl.: 30

TRADEMARK

PRINCIPAL REGISTER

REAL KOSHER ICE CREAM, INC. (NEW YORK CORPORATION)
3614 15TH AVE.
BROOKLYN, NY 11218

FOR: ICE CREAM, IN CLASS 30 (U.S. CL. 46).

FIRST USE 2-8-2012; IN COMMERCE 2-8-2012.

THE MARK CONSISTS OF STANDARD CHARACTERS WITHOUT CLAIM TO ANY PARTICULAR FONT, STYLE, SIZE, OR COLOR.

THE ENGLISH TRANSLATION OF "ALPEN ZAUBER" IN THE MARK IS "ALPINE MAGIC".

SN 77-764,853, FILED 6-22-2009.

BRIAN CALLAGHAN, EXAMINING ATTORNEY



David J. Kyffers

Director of the United States Patent and Trademark Office

United States of America

United States Patent and Trademark Office

BEACH MONEY

Reg. No. 4,154,434

EXIT STRATEGY INC. (NEVADA CORPORATION)
811 W. ALDINE #S
CHICAGO, IL 60657

Registered June 5, 2012

Int. Cl.: 41

FOR: LIVE CLASSES, WORKSHOPS, AND SEMINARS IN THE FIELD OF NETWORK MARKETING, LEADERSHIP, WEALTH CREATION, ENTREPRENEURSHIP, BUILDING BUSINESS RELATIONSHIPS, CHARITABLE GIVING, AND PHILANTHROPY, IN CLASS 41 (U.S. CLS. 100, 101 AND 107).

SERVICE MARK

PRINCIPAL REGISTER

FIRST USE 4-16-2012; IN COMMERCE 4-16-2012.

THE MARK CONSISTS OF STANDARD CHARACTERS WITHOUT CLAIM TO ANY PARTICULAR FONT, STYLE, SIZE, OR COLOR.

SN 77-767,982, FILED 6-25-2009.

ANGELA M. MICHELLI, EXAMINING ATTORNEY



David J. Kybas

Director of the United States Patent and Trademark Office

United States of America

United States Patent and Trademark Office

TENDER FOOT

Reg. No. 4,154,435

Registered June 5, 2012

Int. Cl.: 1

TRADEMARK

PRINCIPAL REGISTER

VOGEL SEED & FERTILIZER, INC. (WISCONSIN CORPORATION), DBA SPRING VALLEY
TURF PRODUCTS,
1891 SPRING VALLEY ROAD
JACKSON, WI 53037

FOR: CHEMICAL PREPARATION FOR MELTING ICE AND SNOW, IN CLASS 1 (U.S. CLS.
1, 5, 6, 10, 26 AND 46).

FIRST USE 11-8-2011; IN COMMERCE 11-8-2011.

THE MARK CONSISTS OF STANDARD CHARACTERS WITHOUT CLAIM TO ANY PAR-
TICULAR FONT, STYLE, SIZE, OR COLOR.

SN 77-768,212, FILED 6-25-2009.

KIMBERLY PERRY, EXAMINING ATTORNEY



David J. Kyffers

Director of the United States Patent and Trademark Office

United States of America

United States Patent and Trademark Office

RESPONSEDX: GASTRIC

Reg. No. 4,154,436

Registered June 5, 2012

Int. Cls.: 42 and 44

SERVICE MARK

PRINCIPAL REGISTER

RESPONSE GENETICS, INC. (DELAWARE CORPORATION)
1640 MARENGO STREET, SUITE 620
LOS ANGELES, CA 90033

FOR: MEDICAL RESEARCH; SCIENTIFIC RESEARCH AND DEVELOPMENT; PROVIDING SCIENTIFIC RESEARCH INFORMATION IN THE FIELD OF PHARMACEUTICALS AND CLINICAL TRIALS; PROVIDING AN ON-LINE COMPUTER DATABASE FOR OTHERS IN THE FIELDS OF MEDICINE DEVELOPMENT, SCIENTIFIC RESEARCH INFORMATION IN THE FIELD OF CANCER DIAGNOSIS, SCIENTIFIC RESEARCH INFORMATION IN THE FIELD OF CLINICAL TRIAL DESIGN AND SCIENTIFIC RESEARCH INFORMATION IN THE FIELD OF BIOTECHNOLOGY; PRODUCT DEVELOPMENT SERVICES FOR OTHERS IN THE BIOMEDICAL, GENOMICS, PHARMACOGENOMICS, DIAGNOSTIC, CLINICAL TRIAL DESIGN AND BIOTECHNOLOGY FIELD, IN CLASS 42 (U.S. CLS. 100 AND 101).

FIRST USE 6-1-2009; IN COMMERCE 6-1-2009.

FOR: PROVIDING MEDICAL DIAGNOSTIC TESTING SERVICES FOR DIAGNOSTIC AND PROGNOSTIC PURPOSES; AND PROVIDING MEDICAL INFORMATION, IN CLASS 44 (U.S. CLS. 100 AND 101).

FIRST USE 6-1-2009; IN COMMERCE 6-1-2009.

THE MARK CONSISTS OF STANDARD CHARACTERS WITHOUT CLAIM TO ANY PARTICULAR FONT, STYLE, SIZE, OR COLOR.

NO CLAIM IS MADE TO THE EXCLUSIVE RIGHT TO USE "GASTRIC", APART FROM THE MARK AS SHOWN.

SN 77-768,260, FILED 6-25-2009.

KATINA MISTER, EXAMINING ATTORNEY



David J. Kyjars

Director of the United States Patent and Trademark Office

United States of America

United States Patent and Trademark Office

ECO-NOMICAL

Reg. No. 4,154,437

NEW WAVE ENVIRO PRODUCTS, INC. (NEVADA CORPORATION)
6595 S. DAYTON ST., SUITE 1000
GREENWOOD VILLAGE, CO 80111

Registered June 5, 2012

Int. Cl.: 21

FOR: BOTTLES, SOLD EMPTY; DRINKING FLASKS; DRINKING VESSELS, IN CLASS 21
(U.S. CLS. 2, 13, 23, 29, 30, 33, 40 AND 50).

TRADEMARK

FIRST USE 6-29-2009; IN COMMERCE 6-29-2009.

PRINCIPAL REGISTER

THE MARK CONSISTS OF STANDARD CHARACTERS WITHOUT CLAIM TO ANY PARTICULAR FONT, STYLE, SIZE, OR COLOR.

SN 77-770,641, FILED 6-29-2009.

ALLISON SCHRODY, EXAMINING ATTORNEY



David J. Kybas

Director of the United States Patent and Trademark Office

United States of America

United States Patent and Trademark Office

GROW FOOD

Reg. No. 4,154,438

Registered June 5, 2012

Int. Cls.: 16 and 28

TRADEMARK

PRINCIPAL REGISTER

PEDI-BEAR, LLC (PENNSYLVANIA LIMITED LIABILITY COMPANY)
2281 STAFFORDSHIRE ROAD
FURLONG, PA 18925

FOR: PRINTED INSTRUCTIONAL, EDUCATIONAL, AND TEACHING MATERIALS, NAMELY, COURSE BOOKS, WORK BOOKS, AND TEACHING ACTIVITY GUIDES IN THE FIELD OF NUTRITION; PRINTED MATERIALS, NAMELY, BOOKS IN THE FIELD OF NUTRITION; CALENDARS AND FLASH CARDS, AND NONE OF THE FOREGOING RELATED TO THE GROWING OF FOOD, IN CLASS 16 (U.S. CLS. 2, 5, 22, 23, 29, 37, 38 AND 50).

FIRST USE 3-2-2012; IN COMMERCE 3-2-2012.

FOR: PUZZLES; EDUCATIONAL TOYS FOR THE PURPOSE OF TEACHING CHILDREN ABOUT PROPER NUTRITION, AND NONE OF THE FOREGOING RELATED TO THE GROWING OF FOOD, IN CLASS 28 (U.S. CLS. 22, 23, 38 AND 50).

FIRST USE 3-2-2012; IN COMMERCE 3-2-2012.

THE MARK CONSISTS OF STANDARD CHARACTERS WITHOUT CLAIM TO ANY PARTICULAR FONT, STYLE, SIZE, OR COLOR.

NO CLAIM IS MADE TO THE EXCLUSIVE RIGHT TO USE "FOOD", APART FROM THE MARK AS SHOWN.

SN 77-772,747, FILED 7-1-2009.

RUDY R. SINGLETON, EXAMINING ATTORNEY



David J. Kyros

Director of the United States Patent and Trademark Office

United States of America

United States Patent and Trademark Office

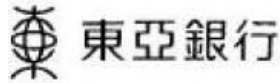

Reg. No. 4,154,439

Registered June 5, 2012

Int. Cls.: 16 and 36

TRADEMARK

SERVICE MARK

PRINCIPAL REGISTER

THE BANK OF EAST ASIA, LIMITED (HONG KONG CORPORATION)
10 DES VOEUX ROAD
CENTRAL HONG KONG, HONG KONG

FOR: PRINTED MATTER AND PRINTED PUBLICATIONS, NAMELY, NEWSLETTERS RELATING TO BANKING AND FINANCIAL SERVICES, IN CLASS 16 (U.S. CLS. 2, 5, 22, 23, 29, 37, 38 AND 50).

FIRST USE 4-8-1990; IN COMMERCE 4-8-1990.

FOR: LOAN FINANCING; BANK DEPOSITORY SERVICES, NAMELY, CHECKING ACCOUNT SERVICES, CERTIFICATE OF DEPOSIT ACCOUNT SERVICES AND MONEY MARKET ACCOUNT SERVICES, IN CLASS 36 (U.S. CLS. 100, 101 AND 102).

FIRST USE 4-8-1990; IN COMMERCE 4-8-1990.

OWNER OF U.S. REG. NOS. 1,439,475, 3,081,200, AND OTHERS.

THE NON-LATIN CHARACTERS IN THE MARK TRANSLITERATE TO TUNG NGA NGAN HONG IN CANTONESE AND DONG YA YIN HANG IN MANDARIN AND THIS MEANS "THE BANK OF EAST ASIA" IN ENGLISH.

SEC. 2(F) AS TO "TUNG NGA NGAN HONG" IN CANTONESE AND "DONG YA YIN HANG" IN MANDARIN AND THAT TRANSLATE INTO ENGLISH AS "BANK OF EAST ASIA".

NO CLAIM IS MADE TO THE EXCLUSIVE RIGHT TO USE THE NON-LATIN CHARACTERS IN THE MARK WHOSE TRANSLITERATION IS "NGAN HONG" IN CANTONESE AND "YIN HANG" IN MANDARIN, AND WHICH TRANSLATE INTO ENGLISH AS "BANK", APART FROM THE MARK AS SHOWN.

THE MARK CONSISTS OF A DESIGN OF A STYLIZED GLOBE WITH THE CHINESE CHARACTERS FOR THE WORDS THE BANK OF EAST ASIA .

THE ENGLISH TRANSLATION OF FOREIGN WORDING IN THE MARK IS "THE BANK OF EAST ASIA".

SN 77-773,932, FILED 7-2-2009.



David J. Kyros

Director of the United States Patent and Trademark Office

Reg. No. 4,154,439 JOHN KELLY, EXAMINING ATTORNEY

United States of America

United States Patent and Trademark Office

BEATRIZ CILANTRO SALSA

Reg. No. 4,154,440

Registered June 5, 2012

Int. Cl.: 30

BEATRIZ CILANTRO SALSA CORP. (FLORIDA CORPORATION)
SUITE #3-C
1320 N.W. 18TH AVENUE
DELRAY BEACH, FL 33445

FOR: SALSA CONTAINING CILANTRO, IN CLASS 30 (U.S. CL. 46).

TRADEMARK

FIRST USE 3-9-2012; IN COMMERCE 3-9-2012.

PRINCIPAL REGISTER

THE MARK CONSISTS OF STANDARD CHARACTERS WITHOUT CLAIM TO ANY PARTICULAR FONT, STYLE, SIZE, OR COLOR.

NO CLAIM IS MADE TO THE EXCLUSIVE RIGHT TO USE "CILANTRO SALSA", APART FROM THE MARK AS SHOWN.

THE NAME "BEATRIZ RAMIREZ" IDENTIFIES A LIVING INDIVIDUAL WHOSE CONSENT IS OF RECORD.

SN 77-777,332, FILED 7-9-2009.

JAY BESCH, EXAMINING ATTORNEY



David J. Kyros

Director of the United States Patent and Trademark Office

United States of America

United States Patent and Trademark Office

WPP GROUP TECHNOLOGY SERVICES

Reg. No. 4,154,441

WPP PROPERTIES (DELAWARE PARTNERSHIP)
100 PARK AVENUE
NEW YORK, NY 10017

Registered June 5, 2012

Int. Cls.: 35 and 42

FOR: PROVIDING BUSINESS CONSULTING SERVICES IN THE FIELD OF INFORMATION TECHNOLOGY, IN CLASS 35 (U.S. CLS. 100, 101 AND 102).

SERVICE MARK

FIRST USE 12-15-2010; IN COMMERCE 12-15-2010.

PRINCIPAL REGISTER

FOR: PROVIDING INFORMATION TECHNOLOGY INFRASTRUCTURE AND TECHNICAL SUPPORT SERVICES, NAMELY, TROUBLESHOOTING IN THE NATURE OF DIAGNOSING COMPUTER HARDWARE AND SOFTWARE PROBLEMS, AND REMOTE AND ON-SITE INFRASTRUCTURE MANAGEMENT SERVICES FOR MONITORING, ADMINISTRATION AND MANAGEMENT OF PUBLIC AND PRIVATE CLOUD COMPUTING IT AND APPLICATION SYSTEMS, IN CLASS 42 (U.S. CLS. 100 AND 101).

FIRST USE 12-15-2010; IN COMMERCE 12-15-2010.

THE MARK CONSISTS OF STANDARD CHARACTERS WITHOUT CLAIM TO ANY PARTICULAR FONT, STYLE, SIZE, OR COLOR.

OWNER OF U.S. REG. NO. 3,224,489.

NO CLAIM IS MADE TO THE EXCLUSIVE RIGHT TO USE "GROUP TECHNOLOGY SERVICES", APART FROM THE MARK AS SHOWN.

SN 77-783,932, FILED 7-17-2009.

SCOTT BIBB, EXAMINING ATTORNEY



David J. Kybas

Director of the United States Patent and Trademark Office

United States of America
United States Patent and Trademark Office

FIRSTRATE

Reg. No. 4,154,442

TIM BORN (UNITED STATES INDIVIDUAL)
1018 LINCOLNSHIRE DR.
CHAMPAIGN, IL 61821

Registered June 5, 2012

Int. Cl.: 9

FOR: DOWNLOADABLE COMPUTER-READABLE ELECTRIC GENERATOR RELATED ELECTRONIC DATA FILES, NAMELY, DATA FILES FEATURING FUEL TYPE, FUEL COST AND CALCULATED COST PER MW-HR, FOR USE WITH COMPUTER SOFTWARE, IN CLASS 9 (U.S. CLS. 21, 23, 26, 36 AND 38).

TRADEMARK

PRINCIPAL REGISTER

FIRST USE 12-1-2011; IN COMMERCE 12-1-2011.

THE MARK CONSISTS OF STANDARD CHARACTERS WITHOUT CLAIM TO ANY PARTICULAR FONT, STYLE, SIZE, OR COLOR.

SN 77-785,471, FILED 7-21-2009.

KAELIE KUNG, EXAMINING ATTORNEY



David J. Kybas

Director of the United States Patent and Trademark Office

United States of America

United States Patent and Trademark Office

FLAT-OUT BACKEN'

Reg. No. 4,154,443

FLAT-OUT BACKEN' (IDAHO PARTNERSHIP)

Registered June 5, 2012

P.O. BOX 45
BLACKFOOT, ID 83221

Int. Cl.: 11

FOR: FOLDING CAMPING WOOD COOK STOVE, IN CLASS 11 (U.S. CLS. 13, 21, 23, 31 AND 34).

TRADEMARK

FIRST USE 1-2-2012; IN COMMERCE 1-15-2012.

PRINCIPAL REGISTER

THE MARK CONSISTS OF STANDARD CHARACTERS WITHOUT CLAIM TO ANY PARTICULAR FONT, STYLE, SIZE, OR COLOR.

SN 77-793,828, FILED 7-30-2009.

JEFF DEFORD, EXAMINING ATTORNEY



David J. Kybas

Director of the United States Patent and Trademark Office

United States of America

United States Patent and Trademark Office

FRAGILE DREAMS: FAREWELL RUINS OF THE MOON

Reg. No. 4,154,444

NAMCO BANDAI GAMES INC. (JAPAN CORPORATION)
4-5-15 HIGASHI SHINAGAWA, SHINAGAWA-KU
TOKYO, JAPAN 1408590

Registered June 5, 2012

Int. Cl.: 9

FOR: COMPUTER GAME PROGRAMS; COMPUTER GAME SOFTWARE; INTERACTIVE MULTIMEDIA COMPUTER GAME PROGRAMS; DOWNLOADABLE COMPUTER GAME SOFTWARE USED AND PLAYED ON HOME CONSOLES; AND VIDEO GAME SOFTWARE, IN CLASS 9 (U.S. CLS. 21, 23, 26, 36 AND 38).

TRADEMARK

PRINCIPAL REGISTER

FIRST USE 3-16-2010; IN COMMERCE 3-16-2010.

THE MARK CONSISTS OF STANDARD CHARACTERS WITHOUT CLAIM TO ANY PARTICULAR FONT, STYLE, SIZE, OR COLOR.

SN 77-796,765, FILED 8-4-2009.

WILLIAM BRECKENFELD, EXAMINING ATTORNEY



David J. Kyros

Director of the United States Patent and Trademark Office

United States of America

United States Patent and Trademark Office

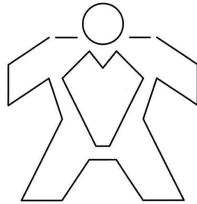

Reg. No. 4,154,445

Registered June 5, 2012

Int. Cl.: 25

TRADEMARK

PRINCIPAL REGISTER

SINGLETON, WILLIAM (UNITED STATES INDIVIDUAL)
897 CAMBRIDGE
CLEVELAND HEIGHTS, OH 44094

FOR: WEARING APPAREL, NAMELY, HATS, DRESS SHIRTS, SPORT SHIRTS, KNIT SHIRTS, SWEATSHIRTS, T-SHIRTS, AND PULL-OVER SHIRTS, IN CLASS 25 (U.S. CLS. 22 AND 39).

FIRST USE 2-0-2012; IN COMMERCE 2-0-2012.

THE MARK CONSISTS OF HUMAN-SHAPED FIGURE.

SN 77-797,620, FILED 8-5-2009.

JUSTINE D. PARKER, EXAMINING ATTORNEY



David J. Kybas

Director of the United States Patent and Trademark Office

United States of America

United States Patent and Trademark Office

MYTHOS

Reg. No. 4,154,446

Registered June 5, 2012

Int. Cl.: 9

TRADEMARK

PRINCIPAL REGISTER

HANBITSOFT, INC. (REPUBLIC OF KOREA CORPORATION)
5TH FLOOR, KOREA BUILDING
SINDORIM-DONG, GURO-GU
SEOUL, REPUBLIC OF KOREA 152887

FOR: COMPUTER GAME SOFTWARE; VIDEO GAME SOFTWARE, IN CLASS 9 (U.S. CLS. 21, 23, 26, 36 AND 38).

FIRST USE 2-0-2012; IN COMMERCE 2-0-2012.

THE MARK CONSISTS OF STANDARD CHARACTERS WITHOUT CLAIM TO ANY PARTICULAR FONT, STYLE, SIZE, OR COLOR.

SN 77-797,862, FILED 8-5-2009.

SUSAN STIGLITZ, EXAMINING ATTORNEY



David J. Kyffers

Director of the United States Patent and Trademark Office

United States of America

United States Patent and Trademark Office

MYTHOS

Reg. No. 4,154,447

Registered June 5, 2012

Int. Cl.: 41

SERVICE MARK

PRINCIPAL REGISTER

HANBITSOFT, INC. (REPUBLIC OF KOREA CORPORATION)
5TH FLOOR, KOREA BUILDING
SINDORIM-DONG, GURO-GU
SEOUL, REPUBLIC OF KOREA 152887

FOR: ENTERTAINMENT SERVICES, NAMELY, PROVIDING AN ON-LINE COMPUTER GAME, IN CLASS 41 (U.S. CLS. 100, 101 AND 107).

FIRST USE 2-0-2012; IN COMMERCE 2-0-2012.

THE MARK CONSISTS OF STANDARD CHARACTERS WITHOUT CLAIM TO ANY PARTICULAR FONT, STYLE, SIZE, OR COLOR.

SN 77-797,868, FILED 8-5-2009.

SUSAN STIGLITZ, EXAMINING ATTORNEY



David J. Kyros

Director of the United States Patent and Trademark Office

United States of America

United States Patent and Trademark Office



Reg. No. 4,154,448

Registered June 5, 2012

Int. Cls.: 9, 37, and 42

TRADEMARK

SERVICE MARK

PRINCIPAL REGISTER

P4Q ELECTRONICS, S.L. (SPAIN LIMITED LIABILITY COMPANY)
MÓDULO 27
CTRA. BILBAO BALMASEDA KM.9
ALONSOTEGI (VIZCAYA), SPAIN 48810

FOR: ELECTRIC AND ELECTRONIC CIRCUITS, ELECTRIC CONTROL APPARATUS AND DEVICES, NAMELY, ELECTRIC CONTROL DEVICES FOR HEATING AND ENERGY MANAGEMENT AND ELECTRIC CONTROL PANELS; MEASUREMENT DATA TRANSMISSION, NAMELY, ELECTRONICAL SENSORS FOR MEASURING SOLAR RADIATION AND INSTRUMENTS FOR MEASURING LENGTH; PHOTOVOLTAIC INSTALLATION CONTROLLERS AND SOLAR CONTROLLERS, NAMELY, ELECTRIC CONTROLLERS, IN CLASS 9 (U.S. CLS. 21, 23, 26, 36 AND 38).

FIRST USE 5-31-1999; IN COMMERCE 1-31-2009.

FOR: INSTALLATION AND MAINTENANCE OF ELECTRONIC CIRCUITS, INSTALLATION AND MAINTENANCE OF ELECTRONIC CONTROL SYSTEMS FOR MACHINES, INSTALLATION AND MAINTENANCE OF RADIATION-MEASURING INSTRUMENTS AND RESISTANCE MEASURING INSTRUMENTS, INSTALLATION AND MAINTENANCE OF PHOTOVOLTAIC INSTALLATIONS, INSTALLATION AND MAINTENANCE OF CONTROLLERS AND SOLAR CONTROLLERS, NAMELY, ELECTRIC CONTROLLERS, IN CLASS 37 (U.S. CLS. 100, 103 AND 106).

FIRST USE 5-31-1999; IN COMMERCE 1-31-2009.

FOR: TECHNICAL DESIGN SERVICES, NAMELY, STRUCTURAL ENGINEERING DESIGN SERVICES; ELECTRONIC CIRCUITS ENGINEERING PROJECTS AND ELECTRONIC CONTROL APPARATUS AND DEVICES ENGINEERING PROJECTS AND MEASUREMENT DATA TRANSMISSION ENGINEERING PROJECTS, NAMELY, ENGINEERING; PHOTOVOLTAIC INSTALLATION CONTROLLERS AND SOLAR CONTROLLERS, NAMELY, TECHNICAL PLANNING OF PHOTOVOLTAIC INSTALLATIONS AND TECHNICAL PLANNING OF SOLAR THERMAL INSTALLATIONS, ENGINEERING SERVICES FOR OTHERS IN THE FIELD OF ENERGY EFFICIENCY; COMPUTER SOFTWARE DESIGN AND DEVELOPMENT, IN CLASS 42 (U.S. CLS. 100 AND 101).

FIRST USE 5-31-1999; IN COMMERCE 1-31-2009.



David J. Kybas

Director of the United States Patent and Trademark Office

Reg. No. 4,154,448 THE MARK CONSISTS OF TWO TRIANGLES IN BLUE FACING IN OPPOSITE DIRECTIONS FOLLOWED BY THE LETTERS "P4Q" IN BLUE.

THE COLOR(S) BLUE IS/ARE CLAIMED AS A FEATURE OF THE MARK.

SN 77-798,891, FILED 8-6-2009.

WILLIAM ROSSMAN, EXAMINING ATTORNEY

United States of America

United States Patent and Trademark Office

SELVA MAYA

Reg. No. 4,154,449

Registered June 5, 2012

Int. Cls.: 30 and 40

TRADEMARK

SERVICE MARK

PRINCIPAL REGISTER

GARCIA, BERNARDO BALDERRAMA (MEXICO INDIVIDUAL)
LEYVA E HIDALGO, CENTRO, LOS MOCHIS
SINALOA, MEXICO 81200

FOR: COFFEE BEANS, NAMELY, GROUND COFFEE BEANS, ROASTED COFFEE BEANS AND WHOLE COFFEE BEANS; COFFEE BEVERAGES; COFFEE-BASED BEVERAGES; GREEN COFFEE; CAFFEINE-FREE COFFEE, IN CLASS 30 (U.S. CL. 46).

FIRST USE 5-6-2010; IN COMMERCE 9-1-2011.

FOR: COFFEE ROASTING AND PROCESSING, IN CLASS 40 (U.S. CLS. 100, 103 AND 106).

FIRST USE 7-19-2011; IN COMMERCE 9-1-2011.

THE MARK CONSISTS OF STANDARD CHARACTERS WITHOUT CLAIM TO ANY PARTICULAR FONT, STYLE, SIZE, OR COLOR.

SN 77-804,423, FILED 8-13-2009.

THOMAS MANOR, EXAMINING ATTORNEY

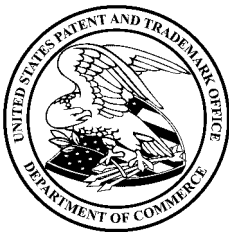

David J. Kyros

Director of the United States Patent and Trademark Office

United States of America

United States Patent and Trademark Office

56

Reg. No. 4,154,450

Registered June 5, 2012

Int. Cl.: 41

SERVICE MARK

PRINCIPAL REGISTER

MICHAEL WALTRIP RACING HOLDINGS, LLC (NORTH CAROLINA LIMITED LIABILITY COMPANY)
20310 CHARTWELL CENTER DRIVE
CORNELIUS, NC 28031

FOR: ENTERTAINMENT SERVICES IN THE NATURE OF PARTICIPATING IN PROFESSIONAL AUTOMOBILE RACES AND AUTO RACING EXHIBITIONS, IN CLASS 41 (U.S. CLS. 100, 101 AND 107).

FIRST USE 8-1-2009; IN COMMERCE 1-1-2010.

THE MARK CONSISTS OF STANDARD CHARACTERS WITHOUT CLAIM TO ANY PARTICULAR FONT, STYLE, SIZE, OR COLOR.

SN 77-805,776, FILED 8-17-2009.

EDWARD NELSON, EXAMINING ATTORNEY



David J. Kybas

Director of the United States Patent and Trademark Office

United States of America

United States Patent and Trademark Office

SIZZLING RUBIES

Reg. No. 4,154,451

IGT (NEVADA CORPORATION)
9295 PROTOTYPE DRIVE
RENO, NV 895218986

Registered June 5, 2012

Int. Cl.: 9

FOR: GAMING MACHINES, NAMELY, DEVICES WHICH ACCEPT A WAGER, IN CLASS 9 (U.S. CLS. 21, 23, 26, 36 AND 38).

TRADEMARK

FIRST USE 12-23-2011; IN COMMERCE 12-23-2011.

PRINCIPAL REGISTER

THE MARK CONSISTS OF STANDARD CHARACTERS WITHOUT CLAIM TO ANY PARTICULAR FONT, STYLE, SIZE, OR COLOR.

OWNER OF U.S. REG. NOS. 2,050,175 AND 3,555,314.

SN 77-807,404, FILED 8-18-2009.

THEODORE MCBRIDE, EXAMINING ATTORNEY



David J. Kybas

Director of the United States Patent and Trademark Office

United States of America

United States Patent and Trademark Office

TREASURY ONLINE PLUS

Reg. No. 4,154,452

Registered June 5, 2012

Int. Cls.: 35, 36, and 45

SERVICE MARK

PRINCIPAL REGISTER

WELLS FARGO & COMPANY (DELAWARE CORPORATION)
SIXTH AND MARQUETTE
1700 WELLS FARGO CENTER, MAC N9305-176
MINNEAPOLIS, MN 55479

FOR: ACCOUNTS RECEIVABLE MANAGEMENT SERVICES; ACCOUNTS RECEIVABLE SERVICES; ADMINISTRATION AND RECONCILIATION OF ACCOUNTS ON BEHALF OF OTHERS; PREPARATION OF FINANCIAL REPORTS FOR OTHERS, NAMELY, PROVISION OF CONSOLIDATED REPORTS AND DOCUMENT IMAGES OF BANKING AND FINANCIAL ACTIVITY, IN CLASS 35 (U.S. CLS. 100, 101 AND 102).

FIRST USE 10-17-2011; IN COMMERCE 2-21-2012.

FOR: BANKING SERVICES; FINANCIAL SERVICES, NAMELY, CASH MANAGEMENT SERVICES, TREASURY MANAGEMENT SERVICES; ACCOUNTS PAYABLE DEBITING SERVICES; FOREIGN EXCHANGE SERVICES, NAMELY, FOREIGN EXCHANGE TRANSACTIONS, FOREIGN EXCHANGE INFORMATION SERVICES; ONLINE BUSINESS BANKING SERVICES; ELECTRONIC FUNDS TRANSFER SERVICES, IN CLASS 36 (U.S. CLS. 100, 101 AND 102).

FIRST USE 10-17-2011; IN COMMERCE 2-21-2012.

FOR: PROVIDING FRAUD DETECTION SERVICES IN THE FIELD OF ELECTRONIC FUNDS TRANSFER AND ELECTRONIC CHECK TRANSACTIONS, IN CLASS 45 (U.S. CLS. 100 AND 101).

FIRST USE 10-17-2011; IN COMMERCE 2-21-2012.

THE MARK CONSISTS OF STANDARD CHARACTERS WITHOUT CLAIM TO ANY PARTICULAR FONT, STYLE, SIZE, OR COLOR.

NO CLAIM IS MADE TO THE EXCLUSIVE RIGHT TO USE "TREASURY ONLINE", APART FROM THE MARK AS SHOWN.

SN 77-808,734, FILED 8-20-2009.

CARYN GLASSER, EXAMINING ATTORNEY



David J. Kyros

Director of the United States Patent and Trademark Office

United States of America

United States Patent and Trademark Office

WINDSONG PRODUCTIONS

Reg. No. 4,154,453

Registered June 5, 2012

Int. Cls.: 35 and 41

SERVICE MARK

PRINCIPAL REGISTER

WIND SONG PRODUCTIONS (CALIFORNIA PARTNERSHIP)
7676 N. PALM AVENUE, STE. 104
FRESNO, CA 93711

FOR: ADVERTISING SERVICES, NAMELY, PROMOTING AND MARKETING THE GOODS AND SERVICES OF OTHERS THROUGH ALL COMMUNICATION MEDIA; PUBLIC RELATIONS; RESELLER SERVICES, NAMELY, DISTRIBUTORSHIP SERVICES FEATURING PROMOTIONAL PRODUCTS IN THE AUTOMOTIVE, CIVIC EDUCATION, HEALTH AND BEAUTY, HOME BUILDERS, HOME IMPROVEMENT, MEDICAL, RESTAURANT, AND RETAIL UTILITIES FIELDS; PRODUCT MERCHANDISING; PROVIDING MARKETING AND PROMOTION OF SPECIAL EVENTS FOR OTHERS; CONSUMER MARKETING RESEARCH AND CONSULTING RELATED THERETO; CONSUMER MARKETING RESEARCH IN THE AUTOMOTIVE, BUSINESS TO BUSINESS, EDUCATION, GAMING/ENTERTAINMENT, HEALTH AND BEAUTY, HOME BUILDERS, HOME IMPROVEMENT, MEDICAL, RESTAURANTS, RETAIL, UTILITIES, AND CIVIC INDUSTRIES AND CONSULTING RELATED THERETO; ADVERTISING SERVICES, NAMELY, THE PRODUCTION OF ADVERTISING MATTER, COMMERCIALS, AND PROMOTIONAL PRESENTATIONS IN THE NATURE OF MUSIC COMPOSITIONS AND AUDIO-VISUAL MATERIAL; CONSULTING SERVICES RELATED TO THE SELECTION OF AUDIO AND AUDIO-VISUAL MEDIA FOR ADVERTISING AND MARKETING PURPOSES; PRODUCTION OF ORIGINAL AND SYNDICATED PROMOTIONAL MATERIALS FOR CASINOS, IN CLASS 35 (U.S. CLS. 100, 101 AND 102).

FIRST USE 9-27-2011; IN COMMERCE 9-27-2011.

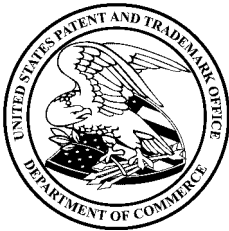

FOR: ARRANGING AND CONDUCTING SPECIAL EVENTS FOR OTHERS; ENTERTAINMENT SERVICES IN THE NATURE OF CREATION, PRODUCTION, POST-PRODUCTION, AND ARRANGEMENT OF MUSIC COMPOSITIONS AND AUDIO AND AUDIO-VISUAL MATERIAL; PRODUCTION OF VIDEO; PRODUCTION OF MOTION PICTURES, SHORT FILMS, TELEVISIONS SERIES, AND MADE FOR TELEVISION MOTION PICTURES; PHOTOGRAPHY SERVICES, IN CLASS 41 (U.S. CLS. 100, 101 AND 107).

FIRST USE 8-1-2011; IN COMMERCE 8-1-2011.

THE MARK CONSISTS OF STANDARD CHARACTERS WITHOUT CLAIM TO ANY PARTICULAR FONT, STYLE, SIZE, OR COLOR.

David J. Kyros

Director of the United States Patent and Trademark Office

Reg. No. 4,154,453 NO CLAIM IS MADE TO THE EXCLUSIVE RIGHT TO USE "PRODUCTIONS", APART FROM THE MARK AS SHOWN.

SN 77-809,555, FILED 8-20-2009.

MARGARET POWER, EXAMINING ATTORNEY

United States of America

United States Patent and Trademark Office

Bloody Mary Christmas

Reg. No. 4,154,454

Registered June 5, 2012

Int. Cl.: 32

TRADEMARK

PRINCIPAL REGISTER

DRINKOLOGY, LLC (TEXAS LIMITED LIABILITY COMPANY)
6115 REVERE PLACE
DALLAS, TX 75214

FOR: NON-ALCOHOLIC COCKTAIL MIX, IN CLASS 32 (U.S. CLS. 45, 46 AND 48).

FIRST USE 10-15-2011; IN COMMERCE 12-20-2011.

THE MARK CONSISTS OF STANDARD CHARACTERS WITHOUT CLAIM TO ANY PARTICULAR FONT, STYLE, SIZE, OR COLOR.

NO CLAIM IS MADE TO THE EXCLUSIVE RIGHT TO USE "BLOODY MARY", APART FROM THE MARK AS SHOWN.

SN 77-810,944, FILED 8-24-2009.

SUSAN LESLIE DUBOIS, EXAMINING ATTORNEY



David J. Kyffers

Director of the United States Patent and Trademark Office

United States of America

United States Patent and Trademark Office

CHIVALROUS CULTURE

Reg. No. 4,154,455

Registered June 5, 2012

Int. Cl.: 25

TRADEMARK

PRINCIPAL REGISTER

RUN ATHLETICS INTERNATIONAL, LLC (NEW YORK LIMITED LIABILITY COMPANY)
29 WEST 56TH STREET
NEW YORK, NY 10019

FOR: FOOTWEAR AND WEARING APPAREL, NAMELY, POLO SHIRTS, T-SHIRTS, HOODED JACKETS, TRACK JACKETS, SWEAT SHIRTS, JACKETS, TOPS, AND SWEATERS, IN CLASS 25 (U.S. CLS. 22 AND 39).

FIRST USE 9-1-2010; IN COMMERCE 9-1-2010.

THE MARK CONSISTS OF STANDARD CHARACTERS WITHOUT CLAIM TO ANY PARTICULAR FONT, STYLE, SIZE, OR COLOR.

SN 77-812,378, FILED 8-25-2009.

ODESSA BIBBINS, EXAMINING ATTORNEY



David J. Kybas

Director of the United States Patent and Trademark Office

United States of America

United States Patent and Trademark Office

LOVE ALL - SERVE ALL

Reg. No. 4,154,456

Registered June 5, 2012

Int. Cl.: 43

SERVICE MARK

PRINCIPAL REGISTER

HARD ROCK CAFE INTERNATIONAL (USA), INC (FLORIDA CORPORATION)
6100 OLD PARK LANE
ORLANDO, FL 32835

FOR: HOTEL SERVICES, IN CLASS 43 (U.S. CLS. 100 AND 101).

FIRST USE 6-30-2007; IN COMMERCE 6-30-2007.

THE MARK CONSISTS OF STANDARD CHARACTERS WITHOUT CLAIM TO ANY PARTICULAR FONT, STYLE, SIZE, OR COLOR.

OWNER OF U.S. REG. NO. 1,713,000.

SN 77-814,340, FILED 8-27-2009.

SEAN CROWLEY, EXAMINING ATTORNEY



David J. Kybas

Director of the United States Patent and Trademark Office

United States of America

United States Patent and Trademark Office

NAVAJO NATION GAMING ENTERPRISE

Reg. No. 4,154,457

Registered June 5, 2012

Int. Cls.: 37 and 41

NAVAJO NATION GAMING ENTERPRISE (UNITED STATES WHOLLY OWNED TRIBAL ENTERPRISE ORGANIZED UNDER THE LAWS OF THE NAVAJO NATION, A FEDERALLY RECOGNIZED INDIAN TRIBE)
P.O. BOX 1700
CHURCH ROCK, NM 87311

SERVICE MARK

FOR: REAL ESTATE DEVELOPMENT OF CASINOS, GAMING FACILITIES AND RESORTS, IN CLASS 37 (U.S. CLS. 100, 103 AND 106).

PRINCIPAL REGISTER

FIRST USE 9-0-2006; IN COMMERCE 9-0-2006.

FOR: PROVIDING CASINOS AND GAMING FACILITIES, IN CLASS 41 (U.S. CLS. 100, 101 AND 107).

FIRST USE 11-19-2008; IN COMMERCE 11-19-2008.

THE MARK CONSISTS OF STANDARD CHARACTERS WITHOUT CLAIM TO ANY PARTICULAR FONT, STYLE, SIZE, OR COLOR.

NO CLAIM IS MADE TO THE EXCLUSIVE RIGHT TO USE "GAMING ENTERPRISE", APART FROM THE MARK AS SHOWN.

SN 77-814,567, FILED 8-27-2009.

KATHY DE JONGE, EXAMINING ATTORNEY



David J. Kybas

Director of the United States Patent and Trademark Office

United States of America

United States Patent and Trademark Office

Trade Embassy

Reg. No. 4,154,458

Registered June 5, 2012

Int. Cl.: 35

SERVICE MARK

PRINCIPAL REGISTER

LE, TRAMERICA Q. (CALIFORNIA SOLE PROPRIETORSHIP), DBA TRADE EMBASSY,
10304 WATERIDGE CIRCLE #261
SAN DIEGO, CA 92121

FOR: PROVIDING A SEARCHABLE ON-LINE ADVERTISING GUIDE FEATURING THE GOODS AND SERVICES OF OTHER ON-LINE VENDORS ON THE INTERNET; PROVIDING ON-LINE VIDEO BUSINESS DIRECTORY; PROVIDING BUSINESS SERVICES, NAMELY, TELEPRESENCE ENVIRONMENTS OF OTHERS; PROVIDING AN ON-LINE ELECTRONIC DATABASE ON GLOBAL COMPUTER NETWORKS FEATURING BUSINESS INFORMATION IN THE FIELDS OF INFORMATION TECHNOLOGY, BUSINESS MANAGEMENT SERVICES INCLUDING PROMOTION OF BRAND IDENTITY, BRANDING STRATEGY, ACCOUNTING, FINANCIAL MANAGEMENT SERVICES, MARKETING, BUSINESS PROJECT MANAGEMENT, AND BUSINESS DEVELOPMENT; PROVIDING ON-LINE ADVERTISING, MARKETING, AND PROMOTIONAL SERVICES; PROVIDING BUSINESS INFORMATION, ON-LINE ADVERTISING ON COMPUTER COMMUNICATION NETWORKS, SERVICES RELATING TO THE ANALYSIS, EVALUATION, CREATION, PROTECTION OF INTELLECTUAL PROPERTY RIGHTS AND BRAND ESTABLISHMENT OF TRADEMARKS, TRADE NAMES AND DOMAIN NAMES; PROJECT MANAGEMENT SERVICES FOR OTHERS IN THE FIELDS OF LANGUAGE TRANSLATION, CUSTOM WRITING, TEXT ADAPTATION, INTERPRETING AND PROOFREADING; FOREIGN AND GLOBAL TRADE CONSULTATION; PROVIDING ONLINE VIRTUAL WORLDS RETAIL STORE SERVICES FEATURING VIRTUAL GOODS, CONDUCTING EVENT PLANNINGS AND TRADE SHOWS IN THE FIELD OF INTELLECTUAL PROPERTY, INTERNATIONAL TRADE, IMPORT, EXPORT, TOURISM, EDUCATION, INFORMATION TECHNOLOGY, HEALTHCARE, BUSINESS MANAGEMENT SERVICES INCLUDING PROMOTION OF BRAND IDENTITY, BRANDING STRATEGY, MARKETING, BUSINESS PROJECT MANAGEMENT, AND BUSINESS DEVELOPMENT, BUSINESS NETWORKING VIA SOCIAL MEDIA NETWORKS AND PROVIDING AN ON-LINE ELECTRONIC DATABASE ON GLOBAL COMPUTER NETWORKS FEATURING BUSINESS INFORMATION IN THE FIELDS OF INTELLECTUAL PROPERTY, INTERNATIONAL TRADE, IMPORT/EXPORT POLICIES, IMPORT/EXPORT FOREIGN AUTHORITIES, FOREIGN CURRENCIES, INTERNATIONAL IMPORT/EXPORT COMPANIES, INTERNATIONAL TRADE REPRESENTATIVES, INTERNATIONAL TRADE SHOWS, INTERNATIONAL CONVENTION FACILITIES AND INTERNATIONAL TRADE HOUSES, FOREIGN EMBASSIES, FOREIGN TRADE ORGANIZATIONS AND ASSOCIATIONS, FOREIGN TRADE DEVELOPMENT ORGANIZATIONS AND FOREIGN CHAMBERS OF COMMERCE, HEALTHCARE, EDUCATION, INFORMATION TECHNOLOGY AND TOURISM; COMPUTER SERVICES, NAMELY, PROVIDING AN ON-LINE ELECTRONIC DATABASE ON GLOBAL



David J. Kyros

Director of the United States Patent and Trademark Office

Reg. No. 4,154,458 COMPUTER NETWORKS FEATURING BUSINESS INFORMATION IN THE FIELDS OF INTERNATIONAL TRADE, INTERNATIONAL AND NATIONAL CUSTOMS REGULATIONS, INTERNATIONAL TAX REGULATIONS AND INTERNATIONAL SHIPPING REGULATIONS, IN CLASS 35 (U.S. CLS. 100, 101 AND 102).

FIRST USE 1-24-2005; IN COMMERCE 7-15-2005.

THE MARK CONSISTS OF STANDARD CHARACTERS WITHOUT CLAIM TO ANY PARTICULAR FONT, STYLE, SIZE, OR COLOR.

NO CLAIM IS MADE TO THE EXCLUSIVE RIGHT TO USE "TRADE", APART FROM THE MARK AS SHOWN.

SN 77-818,019, FILED 9-1-2009.

CAROLYN CATALDO, EXAMINING ATTORNEY

United States of America

United States Patent and Trademark Office

MAC & JAC

Reg. No. 4,154,459

Registered June 5, 2012

Int. Cl.: 24

TRADEMARK

PRINCIPAL REGISTER

KMJ BBRAND HOLDINGS LLC (NEW YORK LIMITED LIABILITY COMPANY)
SUITE 1107
1370 BROADWAY
NEW YORK, NY 10018

FOR: BATH LINEN; BATH TOWELS; BED BLANKETS; BED COVERS; BED LINEN; BED SHEETS; BED SKIRTS; BED SPREADS; BLANKET THROWS; COMFORTERS; CURTAIN TIE-BACKS; CURTAINS AND TOWELS; DINING LINENS; DRAPERY; DUVET COVERS; KITCHEN LINENS; KITCHEN TOWELS; PILLOW CASES; PILLOW COVERS; PILLOW SHAMS; SHOWER CURTAINS; TABLE LINEN; THROWS, IN CLASS 24 (U.S. CLS. 42 AND 50).

FIRST USE 6-0-2010; IN COMMERCE 6-0-2010.

THE MARK CONSISTS OF STANDARD CHARACTERS WITHOUT CLAIM TO ANY PARTICULAR FONT, STYLE, SIZE, OR COLOR.

OWNER OF U.S. REG. NOS. 1,984,545, 3,027,545, AND 3,123,450.

THE NAME "MAC & JAC" DOES NOT IDENTIFY A LIVING INDIVIDUAL.

SN 77-818,585, FILED 9-2-2009.

DARRYL SPRUILL, EXAMINING ATTORNEY



David J. Kyffers

Director of the United States Patent and Trademark Office

United States of America

United States Patent and Trademark Office

BUCK

Reg. No. 4,154,460

Registered June 5, 2012

Int. Cls.: 35 and 41

SERVICE MARK

PRINCIPAL REGISTER

ELBO, INC. (DELAWARE CORPORATION)
625 WESTPORT PARKWAY
GRAPEVINE, TX 76051

FOR: RETAIL STORE SERVICES AND ONLINE RETAIL STORE SERVICES PROVIDED VIA A GLOBAL COMPUTER NETWORK FEATURING NEW AND USED COMPUTER, VIDEO AND ELECTRONIC GAMES, VIDEOS, DVDS, MOVIES, BOOKS, MAGAZINES, STRATEGY GUIDES, COMPUTER HARDWARE, COMPUTER ACCESSORIES, TOYS AND ACTION FIGURES; PROMOTING THE SALE OF NEW AND USED COMPUTER, VIDEO AND ELECTRONIC GAMES, VIDEOS, DVDS, MOVIES, BOOKS, MAGAZINES, STRATEGY GUIDES, COMPUTER HARDWARE, COMPUTER ACCESSORIES, TOYS AND ACTION FIGURES THROUGH THE ADMINISTRATION OF A CUSTOMER INCENTIVE AWARD AND DISCOUNT PROGRAM, IN CLASS 35 (U.S. CLS. 100, 101 AND 102).

FIRST USE 3-8-2012; IN COMMERCE 3-8-2012.

FOR: PROVIDING A WEB SITE CONTAINING ENTERTAINMENT INFORMATION, NAMELY, PROVIDING INFORMATION ABOUT NEW AND USED COMPUTER, VIDEO AND ELECTRONIC GAMES, VIDEO GAME CONSOLES, HAND-HELD VIDEO GAME PLAYERS, DIGITAL MEDIA PLAYERS AND RECORDERS, VIDEOS, DVDS, MOVIES, ROLE-PLAYING CARDS GAMES, GAME CARDS, BOOKS AND MAGAZINES FEATURING COMPUTER GAMES, STRATEGY GUIDES FOR COMPUTER GAMES, COMPUTER GAME HARDWARE, COMPUTER GAME ACCESSORIES, TOYS AND ACTION FIGURES; ENTERTAINMENT SERVICES, NAMELY, CONDUCTING CONTESTS AND SWEEPSTAKES AND CONDUCTING CONTESTS AND SWEEPSTAKES OVER A GLOBAL COMPUTER NETWORK, IN CLASS 41 (U.S. CLS. 100, 101 AND 107).

FIRST USE 3-8-2012; IN COMMERCE 3-8-2012.

THE MARK CONSISTS OF STANDARD CHARACTERS WITHOUT CLAIM TO ANY PARTICULAR FONT, STYLE, SIZE, OR COLOR.

SN 77-818,890, FILED 9-2-2009.

REBECCA SMITH, EXAMINING ATTORNEY



David J. Kyros

Director of the United States Patent and Trademark Office

United States of America

United States Patent and Trademark Office

ECOCONSERVE

Reg. No. 4,154,461

Registered June 5, 2012

Int. Cl.: 11

TRADEMARK

PRINCIPAL REGISTER

MAYTAG PROPERTIES, LLC (MICHIGAN LIMITED LIABILITY COMPANY)
500 RENAISSANCE DRIVE
SUITE 101
ST. JOSEPH, MI 49085

FOR: CLOTHES DRYERS, IN CLASS 11 (U.S. CLS. 13, 21, 23, 31 AND 34).

FIRST USE 10-21-2009; IN COMMERCE 10-21-2009.

THE MARK CONSISTS OF STANDARD CHARACTERS WITHOUT CLAIM TO ANY PARTICULAR FONT, STYLE, SIZE, OR COLOR.

SN 77-823,508, FILED 9-10-2009.

LINDSEY RUBIN, EXAMINING ATTORNEY



David J. Kybas

Director of the United States Patent and Trademark Office

United States of America

United States Patent and Trademark Office

ROUGHNECK

Reg. No. 4,154,462

Registered June 5, 2012

Int. Cls.: 7, 8, 9, and 12

TRADEMARK

PRINCIPAL REGISTER

NORTHERN TOOL & EQUIPMENT COMPANY, INC. (MINNESOTA CORPORATION)
2800 SOUTHCROSS DRIVE WEST
BURNSVILLE, MN 55306

FOR: FUEL TRANSFER PUMPS FOR LAND VEHICLES; BATTERY-POWERED AND PNEUMATIC GREASE GUNS; POWER-OPERATED GREASE AND FUEL HOSE REELS; POWER-OPERATED GREASE PUMPS; POWER-OPERATED OIL PUMPS FOR LAND VEHICLES; POWER-OPERATED FUEL PUMPS FOR LAND VEHICLES; PNEUMATIC GREASE GUN ACCESSORIES, NAMELY, GREASE DISPENSERS, GREASE VALVES AND GREASE NOZZLES; POWER-OPERATED OIL PUMP ACCESSORIES, NAMELY, OIL DISPENSERS, OIL VALVES AND OIL NOZZLES, IN CLASS 7 (U.S. CLS. 13, 19, 21, 23, 31, 34 AND 35).

FIRST USE 8-31-2011; IN COMMERCE 8-31-2011.

FOR: HAND-OPERATED GREASE, OIL AND FUEL PUMPS; HAND-OPERATED GREASE GUNS; HAND-OPERATED GREASE AND FUEL HOSE REELS; HAND TOOLS, NAMELY, WASTE OIL DRAINS, IN CLASS 8 (U.S. CLS. 23, 28 AND 44).

FIRST USE 8-31-2011; IN COMMERCE 8-31-2011.

FOR: FUEL METERS, IN CLASS 9 (U.S. CLS. 21, 23, 26, 36 AND 38).

FIRST USE 8-31-2011; IN COMMERCE 8-31-2011.

FOR: FUEL CARTS, IN CLASS 12 (U.S. CLS. 19, 21, 23, 31, 35 AND 44).

FIRST USE 8-31-2011; IN COMMERCE 8-31-2011.

THE MARK CONSISTS OF STANDARD CHARACTERS WITHOUT CLAIM TO ANY PARTICULAR FONT, STYLE, SIZE, OR COLOR.

OWNER OF U.S. REG. NOS. 1,178,879 AND 3,028,748.

SN 77-823,699, FILED 9-10-2009.

AMY KERTGATE, EXAMINING ATTORNEY



David J. Kypos

Director of the United States Patent and Trademark Office

United States of America

United States Patent and Trademark Office

C⁴ = CREATIVE
COMMUNITY *in*
CRITICAL
CARE

Reg. No. 4,154,463

SOCIETY OF CRITICAL CARE MEDICINE (CALIFORNIA NON-PROFIT CORPORATION)
500 MIDWAY DRIVE
MOUNT PROSPECT, IL 600565811

Registered June 5, 2012

Int. Cl.: 44

FOR: PROVIDING AN INTERACTIVE WEBSITE FEATURING INFORMATION IN THE
FIELD OF HEALTHCARE, IN CLASS 44 (U.S. CLS. 100 AND 101).

SERVICE MARK

FIRST USE 12-21-2010; IN COMMERCE 12-21-2010.

PRINCIPAL REGISTER

THE MARK CONSISTS OF THE STYLIZED WORDS "C⁴ = CREATIVE COMMUNITY IN
CRITICAL CARE".

SN 77-824,780, FILED 9-11-2009.

ANGELA M. MICHELI, EXAMINING ATTORNEY



David J. Kyros

Director of the United States Patent and Trademark Office

United States of America

United States Patent and Trademark Office



Reg. No. 4,154,464

Registered June 5, 2012

Int. Cl.: 35

SERVICE MARK

PRINCIPAL REGISTER

KARL BISSINGER, INC. (MISSOURI CORPORATION)
3983 GRATIOT STREET
ST. LOUIS, MO 63110

FOR: RETAIL CANDY STORES, IN CLASS 35 (U.S. CLS. 100, 101 AND 102).

FIRST USE 1-0-2011; IN COMMERCE 1-0-2011.

OWNER OF U.S. REG. NOS. 438,968, 2,788,791, AND 2,923,071.

NO CLAIM IS MADE TO THE EXCLUSIVE RIGHT TO USE "CHOCOLATE", APART FROM THE MARK AS SHOWN.

THE MARK CONSISTS OF A STYLIZED LETTER "B" WITHIN A CIRCLE DESIGN WITH SCROLLWORK, AND THE WORDING "BISSINGER'S A CHOCOLATE EXPERIENCE", FRAMED BY SCROLLWORK.

SN 77-825,708, FILED 9-14-2009.

SAMUEL E. SHARPER JR., EXAMINING ATTORNEY



David J. Kyros

Director of the United States Patent and Trademark Office

United States of America

United States Patent and Trademark Office

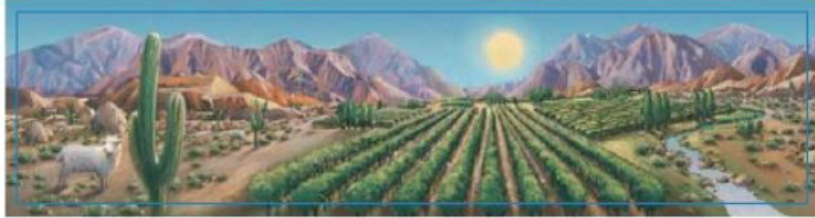

MICHEL TORINO CUMA

Reg. No. 4,154,465

Registered June 5, 2012

Int. Cl.: 33

TRADEMARK

PRINCIPAL REGISTER

GRUPO PENAFLOR S.A. (ARGENTINA JOINT STOCK COMPANY)
ARENALES 460, VICENTE LÓPEZ
BUENOS AIRES, ARGENTINA

FOR: WINES, IN CLASS 33 (U.S. CLS. 47 AND 49).

FIRST USE 11-15-2006; IN COMMERCE 9-1-2007.

OWNER OF U.S. REG. NO. 1,975,823.

THE COLOR(S) BLUE, YELLOW, GREEN, WHITE AND BROWN IS/ARE CLAIMED AS A FEATURE OF THE MARK.

THE NAME(S), PORTRAIT(S), AND/OR SIGNATURE(S) SHOWN IN THE MARK DOES NOT IDENTIFY A PARTICULAR LIVING INDIVIDUAL.

THE MARK CONSISTS OF A BLUE SKY WITH A YELLOW SUN, A BLUE AND BROWN MOUNTAIN RANGE IN THE BACKGROUND, WITH ROWS OF GREEN PLANTS AND CACTI, A WHITE SHEEP ON THE LEFT AND A BLUE STREAM ON THE RIGHT, ALL ENCASED IN A BLUE RECTANGLE, ABOVE THE WORDING "MICHEL TORINO CUMA" IN BROWN IN A WHITE RECTANGLE WITH BLUE OUTLINES UNDERNEATH THE DESIGN PORTION.

SN 77-826,686, FILED 9-15-2009.

JANET LEE, EXAMINING ATTORNEY



David J. Kybas

Director of the United States Patent and Trademark Office

United States of America

United States Patent and Trademark Office

THE GROUNDS GUYS

Reg. No. 4,154,466

DWYER FRANCHISING LLC (TEXAS LIMITED LIABILITY COMPANY)
1010-1020 NORTH UNIVERSITY PARKS DRIVE
WACO, TX 76707

Registered June 5, 2012

Int. Cls.: 37, 39, and 44

FOR: SNOW REMOVAL SERVICES, IN CLASS 37 (U.S. CLS. 100, 103 AND 106).

FIRST USE 4-30-2011; IN COMMERCE 4-30-2011.

SERVICE MARK

FOR: JUNK, TRASH AND DEBRIS REMOVAL, IN CLASS 39 (U.S. CLS. 100 AND 105).

PRINCIPAL REGISTER

FIRST USE 4-30-2011; IN COMMERCE 4-30-2011.

FOR: TREE CARE SERVICES; LANDSCAPE DESIGN; LANDSCAPE GARDENING; HORTICULTURAL SERVICES, NAMELY, INSTALLING SOD AND LAWN AND VEGETATION FERTILIZATION AND TREATMENT, IN CLASS 44 (U.S. CLS. 100 AND 101).

FIRST USE 4-30-2011; IN COMMERCE 4-30-2011.

THE MARK CONSISTS OF STANDARD CHARACTERS WITHOUT CLAIM TO ANY PARTICULAR FONT, STYLE, SIZE, OR COLOR.

NO CLAIM IS MADE TO THE EXCLUSIVE RIGHT TO USE "GROUNDS", APART FROM THE MARK AS SHOWN.

SN 77-828,101, FILED 9-16-2009.

KATHERINE CONNOLLY, EXAMINING ATTORNEY



David J. Kybas

Director of the United States Patent and Trademark Office

United States of America

United States Patent and Trademark Office



Reg. No. 4,154,467

Registered June 5, 2012

Int. Cls.: 30 and 43

TRADEMARK

SERVICE MARK

PRINCIPAL REGISTER

SPOON IT UP FROZEN YOGURT, LLC (NEVADA LIMITED LIABILITY COMPANY)
C/O LYNN HOLLER, ZION, SYNEK & ASSOC.
4141 ROCKSIDE ROAD, SUITE 150
INDEPENDENCE, OH 44131

FOR: DESSERTS, NAMELY, FROZEN YOGURT, YOGURT-BASED FROZEN CONFECTIONS, FROZEN YOGURT SHAKES, FROZEN YOGURT PIES AND CAKES; FROZEN CONFECTIONS, IN CLASS 30 (U.S. CL. 46).

FIRST USE 2-8-2010; IN COMMERCE 2-8-2010.

FOR: RESTAURANT SERVICES FEATURING FROZEN CONFECTIONS, NAMELY, SELF-SERVE FROZEN YOGURT AND SHAVED ICE, IN CLASS 43 (U.S. CLS. 100 AND 101).

FIRST USE 2-8-2010; IN COMMERCE 2-8-2010.

NO CLAIM IS MADE TO THE EXCLUSIVE RIGHT TO USE "FROZEN YOGURT", APART FROM THE MARK AS SHOWN.

THE COLOR(S) BLUE, GREEN, LIGHT PINK AND DARK PINK IS/ARE CLAIMED AS A FEATURE OF THE MARK.

THE MARK CONSISTS OF THE STYLIZED WORDING "SPOON IT UP! FROZEN YOGURT" AND DESIGN. THE WORDS "SPOON IT UP!" ARE BLUE WITH A GREEN BORDER AND CENTERED IN A GREEN OVAL. PART OF THE OVAL IS FORMED BY THE WORDING "FROZEN YOGURT" IN THE COLOR GREEN. THE "P" IN "SPOON" IS A BLUE SPOON FEATURING A LIGHT AND DARK PINK SWIRL.

SN 77-829,550, FILED 9-18-2009.

BERYL GARDNER, EXAMINING ATTORNEY



David J. Kyros

Director of the United States Patent and Trademark Office

United States of America

United States Patent and Trademark Office

Excel

Reg. No. 4,154,468

Registered June 5, 2012

Int. Cl.: 17

TRADEMARK

PRINCIPAL REGISTER

ERICKSON INTERNATIONAL LLC (NEVADA LIMITED LIABILITY COMPANY), AKA
AMERICAN STANDARD WINDOW FILM,
3135 MARCO ST.
LAS VEGAS, NV 89115

FOR: HEAT REFLECTIVE PLASTIC FILM TO BE APPLIED TO GLASS OF THE WINDOWS;
LAMINATED PLASTIC FILMS FOR USE ON GLASS OF THE WINDOWS; PLASTIC FILM
THAT IS TINTED FOR USE ON AUTO WINDOWS; TINTED, LAMINATED AND REFLECTIVE
PLASTIC FILMS FOR USE ON AUTO WINDOWS, IN CLASS 17 (U.S. CLS. 1, 5, 12, 13, 35
AND 50).

FIRST USE 10-1-2009; IN COMMERCE 10-1-2009.

THE MARK CONSISTS OF STANDARD CHARACTERS WITHOUT CLAIM TO ANY PAR-
TICULAR FONT, STYLE, SIZE, OR COLOR.

SN 77-831,263, FILED 9-21-2009.

C. DIONNE CLYBURN, EXAMINING ATTORNEY



David J. Kyffers

Director of the United States Patent and Trademark Office

United States of America

United States Patent and Trademark Office

CHEESE ZOMBIES

Reg. No. 4,154,469

Registered June 5, 2012

Int. Cl.: 30

TRADEMARK

PRINCIPAL REGISTER

DUMPLOADS ON US (CALIFORNIA CORPORATION)
1271 BOULEVARD WAY
WALNUT CREEK, CA 94595

FOR: FILLED BAKERY PRODUCTS, IN CLASS 30 (U.S. CL. 46).

FIRST USE 9-22-2009; IN COMMERCE 2-28-2012.

THE MARK CONSISTS OF STANDARD CHARACTERS WITHOUT CLAIM TO ANY PARTICULAR FONT, STYLE, SIZE, OR COLOR.

NO CLAIM IS MADE TO THE EXCLUSIVE RIGHT TO USE "CHEESE", APART FROM THE MARK AS SHOWN.

SN 77-832,075, FILED 9-22-2009.

RONALD AIKENS, EXAMINING ATTORNEY



David J. Kyros

Director of the United States Patent and Trademark Office

United States of America

United States Patent and Trademark Office

GLOVE BRANDERS

Reg. No. 4,154,470

Registered June 5, 2012

Int. Cl.: 25

TRADEMARK

PRINCIPAL REGISTER

BLAKENSHIP, BRAD (UNITED STATES INDIVIDUAL)
2727 LBJ FREEWAY
STE. 915
DALLAS, TX 75234

FOR: APPAREL AND ACCESSORIES CUSTOMIZED FOR SELECTED BRANDS, NAMELY, GLOVES AND SHIRTS, IN CLASS 25 (U.S. CLS. 22 AND 39).

FIRST USE 7-1-2009; IN COMMERCE 1-1-2010.

THE MARK CONSISTS OF STANDARD CHARACTERS WITHOUT CLAIM TO ANY PARTICULAR FONT, STYLE, SIZE, OR COLOR.

NO CLAIM IS MADE TO THE EXCLUSIVE RIGHT TO USE "GLOVE", APART FROM THE MARK AS SHOWN.

SN 77-832,273, FILED 9-22-2009.

HOWARD SMIGA, EXAMINING ATTORNEY



David J. Kybas

Director of the United States Patent and Trademark Office

United States of America

United States Patent and Trademark Office

EVENTSHOPPER

Reg. No. 4,154,471

Registered June 5, 2012

Int. Cl.: 42

SERVICE MARK

PRINCIPAL REGISTER

OUTBOX TECHNOLOGY CRB INC. (CANADA CORPORATION)
3575 ST-LAURENT BOULEVARD, SUITE 800
MONTREAL, QUEBEC, CANADA H2X2T7

FOR: PROVIDING ONLINE NON-DOWNLOADABLE COMPUTER SOFTWARE USED AS TICKET ORDERING INTERFACES VIA A HOSTED PLATFORM TO MARKET, MANAGE AND PROCESS TICKET SALES AND RESERVATIONS IN REAL-TIME IN A MULTI-LANGUAGE, MULTI-CURRENCY ENVIRONMENT, IN CLASS 42 (U.S. CLS. 100 AND 101).

FIRST USE 0-0-2008; IN COMMERCE 0-0-2008.

THE MARK CONSISTS OF STANDARD CHARACTERS WITHOUT CLAIM TO ANY PARTICULAR FONT, STYLE, SIZE, OR COLOR.

SN 77-835,079, FILED 9-25-2009.

EVELYN BRADLEY, EXAMINING ATTORNEY



David J. Kyffers

Director of the United States Patent and Trademark Office

United States of America

United States Patent and Trademark Office

SHOW YOUR HORNS

Reg. No. 4,154,472

MINNESOTA VIKINGS FOOTBALL, LLC (DELAWARE LIMITED LIABILITY COMPANY)
9520 VIKING DRIVE
EDEN PRAIRIE, MN 55344

Registered June 5, 2012

**Int. Cls.: 16, 24, 28, 36,
and 41**

FOR: STICKERS, PRINTED TICKETS TO SPORTS GAMES AND EVENTS; PAPER PARTY DECORATIONS, SOUVENIR PROGRAMS FOR SPORTS EVENTS, IN CLASS 16 (U.S. CLS. 2, 5, 22, 23, 29, 37, 38 AND 50).

TRADEMARK

FIRST USE 6-0-2009; IN COMMERCE 6-0-2009.

SERVICE MARK

FOR: TOWELS, IN CLASS 24 (U.S. CLS. 42 AND 50).

PRINCIPAL REGISTER

FIRST USE 6-0-2009; IN COMMERCE 6-0-2009.

FOR: PAPER PARTY HATS, IN CLASS 28 (U.S. CLS. 22, 23, 38 AND 50).

FIRST USE 6-0-2009; IN COMMERCE 6-0-2009.

FOR: CHARITABLE FUNDRAISING SERVICES; PHILANTHROPIC SERVICES CONCERNING MONETARY DONATIONS; CHARITABLE FUNDRAISING SERVICES AND PHILANTHROPIC SERVICES CONCERNING MONETARY DONATIONS IN SUPPORT OF EDUCATIONAL AND COMMUNITY NEEDS; CHARITABLE AND PHILANTHROPIC FUNDRAISING SERVICES IN CONNECTION WITH PROFESSIONAL FOOTBALL GAMES AND EXHIBITIONS, IN CLASS 36 (U.S. CLS. 100, 101 AND 102).

FIRST USE 6-0-2009; IN COMMERCE 6-0-2009.

FOR: ENTERTAINMENT SERVICES, NAMELY, PRESENTATIONS IN THE NATURE OF PROFESSIONAL FOOTBALL GAMES AND EXHIBITIONS, IN CLASS 41 (U.S. CLS. 100, 101 AND 107).

FIRST USE 6-0-2009; IN COMMERCE 6-0-2009.

THE MARK CONSISTS OF STANDARD CHARACTERS WITHOUT CLAIM TO ANY PARTICULAR FONT, STYLE, SIZE, OR COLOR.

SN 77-835,404, FILED 9-25-2009.



David J. Kybas

Director of the United States Patent and Trademark Office

Reg. No. 4,154,472 JASON TURNER, EXAMINING ATTORNEY

United States of America

United States Patent and Trademark Office

THINK INSIDE THE BOX

Reg. No. 4,154,473

SHMIRSHKY UNIVERSAL, LLC (DELAWARE LIMITED LIABILITY COMPANY)
P.O. BOX 181697
CORONADO, CA 92178

Registered June 5, 2012

Int. Cl.: 25

FOR: CLOTHING, NAMELY, WOMEN'S EXERCISE CLOTHES, NAMELY, FITNESS TOPS, SHIRTS, IN CLASS 25 (U.S. CLS. 22 AND 39).

TRADEMARK

FIRST USE 3-2-2010; IN COMMERCE 3-2-2010.

PRINCIPAL REGISTER

THE MARK CONSISTS OF STANDARD CHARACTERS WITHOUT CLAIM TO ANY PARTICULAR FONT, STYLE, SIZE, OR COLOR.

SN 77-837,032, FILED 9-29-2009.

SUNG IN, EXAMINING ATTORNEY



David J. Kyros

Director of the United States Patent and Trademark Office

United States of America

United States Patent and Trademark Office



Reg. No. 4,154,474

Registered June 5, 2012

Int. Cls.: 16 and 25

TRADEMARK

PRINCIPAL REGISTER

SHMIRSHKY UNIVERSAL, LLC (DELAWARE LIMITED LIABILITY COMPANY)
P.O. BOX 181697
CORONADO, CA 92178

FOR: PRINTED MATTER, NAMELY, BOOKS IN THE FIELD OF WOMEN'S ISSUES, AND STATIONERY, IN CLASS 16 (U.S. CLS. 2, 5, 22, 23, 29, 37, 38 AND 50).

FIRST USE 3-2-2010; IN COMMERCE 3-2-2010.

FOR: CLOTHING, NAMELY, WOMEN'S EXERCISE CLOTHES, NAMELY, FITNESS TOPS, SHIRTS, IN CLASS 25 (U.S. CLS. 22 AND 39).

FIRST USE 3-2-2010; IN COMMERCE 3-2-2010.

THE MARK CONSISTS OF A POLYGONAL PATCH OF SCROLLWORK RESEMBLING HAIR WITH THE LETTER "S" INSIDE.

SN 77-837,644, FILED 9-29-2009.

SUNG IN, EXAMINING ATTORNEY



David J. Kypos

Director of the United States Patent and Trademark Office

United States of America

United States Patent and Trademark Office

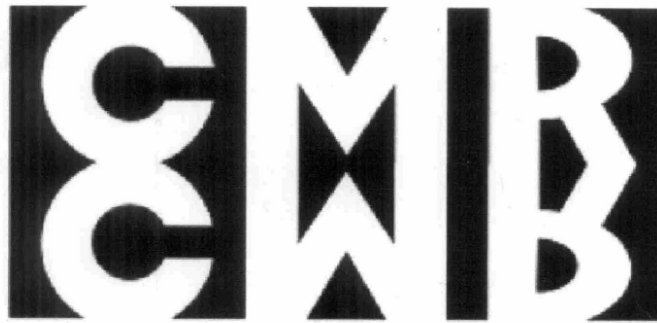

Reg. No. 4,154,475

Registered June 5, 2012

Int. Cls.: 40 and 42

SERVICE MARK

PRINCIPAL REGISTER

CORRELATED MAGNETICS RESEARCH, LLC (ALABAMA LIMITED LIABILITY COMPANY)
125 PETER LANE
NEW HOPE, AL 35760

FOR: CUSTOM MANUFACTURE OF MAGNETS FOR OTHERS, IN CLASS 40 (U.S. CLS. 100, 103 AND 106).

FIRST USE 10-2-2009; IN COMMERCE 10-2-2009.

FOR: CUSTOM DESIGN OF MAGNETS FOR OTHERS, IN CLASS 42 (U.S. CLS. 100 AND 101).

FIRST USE 10-2-2009; IN COMMERCE 10-2-2009.

THE MARK CONSISTS OF THE LETTERS "CMR" IN A STYLIZED FORM WITH ITS MIRRORED REFLECTION BELOW.

SN 77-838,223, FILED 9-30-2009.

KEVIN DINALLO, EXAMINING ATTORNEY



David J. Kybas

Director of the United States Patent and Trademark Office

United States of America
United States Patent and Trademark Office

Hoverfield

Reg. No. 4,154,476

Registered June 5, 2012

Int. Cl.: 9

TRADEMARK

PRINCIPAL REGISTER

CORRELATED MAGNETICS RESEARCH, LLC (ALABAMA LIMITED LIABILITY COMPANY)
125 PETER LANE
NEW HOPE, AL 35760

FOR: MAGNETS; COMPUTER SOFTWARE AND COMPUTER PROGRAMS FOR DETERMINING, MANIPULATING, AND PROGRAMMING THE MAGNETIC FIELDS OF MAGNETS OR MAGNETIC STRUCTURES , IN CLASS 9 (U.S. CLS. 21, 23, 26, 36 AND 38).

FIRST USE 11-0-2009; IN COMMERCE 3-31-2010.

THE MARK CONSISTS OF STANDARD CHARACTERS WITHOUT CLAIM TO ANY PARTICULAR FONT, STYLE, SIZE, OR COLOR.

SN 77-838,444, FILED 9-30-2009.

KEVIN DINALLO, EXAMINING ATTORNEY



David J. Kybas

Director of the United States Patent and Trademark Office

United States of America

United States Patent and Trademark Office

VITACHOLINE

Reg. No. 4,154,477

BALCHEM CORPORATION (MARYLAND CORPORATION)
52 SUNRISE PARK ROAD
NEW HAMPTON, NY 109580600

Registered June 5, 2012

Int. Cl.: 5

FOR: CHOLINE AS AN ESSENTIAL NUTRIENT FOR USE IN FOODS AND NUTRIENT SUPPLEMENTS, IN CLASS 5 (U.S. CLS. 6, 18, 44, 46, 51 AND 52).

TRADEMARK

FIRST USE 3-31-2012; IN COMMERCE 3-31-2012.

PRINCIPAL REGISTER

THE MARK CONSISTS OF STANDARD CHARACTERS WITHOUT CLAIM TO ANY PARTICULAR FONT, STYLE, SIZE, OR COLOR.

SN 77-838,560, FILED 9-30-2009.

EDWARD NELSON, EXAMINING ATTORNEY



David J. Kyros

Director of the United States Patent and Trademark Office

United States of America

United States Patent and Trademark Office



Reg. No. 4,154,478

Registered June 5, 2012

Int. Cl.: 11

TRADEMARK

PRINCIPAL REGISTER

MAYTAG PROPERTIES, LLC (MICHIGAN LIMITED LIABILITY COMPANY)
500 RENAISSANCE DRIVE
SUITE 101
ST. JOSEPH, MI 49085

FOR: CLOTHES DRYERS, IN CLASS 11 (U.S. CLS. 13, 21, 23, 31 AND 34).

FIRST USE 10-21-2009; IN COMMERCE 10-21-2009.

THE MARK CONSISTS OF A LEAF DESIGN.

SN 77-839,919, FILED 10-2-2009.

LINDSEY RUBIN, EXAMINING ATTORNEY



David J. Kyffers

Director of the United States Patent and Trademark Office

United States of America

United States Patent and Trademark Office



Reg. No. 4,154,479

Registered June 5, 2012

Int. Cl.: 7

TRADEMARK

PRINCIPAL REGISTER

MAYTAG PROPERTIES, LLC (MICHIGAN LIMITED LIABILITY COMPANY)
500 RENAISSANCE DRIVE
SUITE 101
ST. JOSEPH, MI 49085

FOR: CLOTHES WASHING MACHINES, IN CLASS 7 (U.S. CLS. 13, 19, 21, 23, 31, 34 AND 35).

FIRST USE 10-12-2009; IN COMMERCE 10-21-2009.

THE MARK CONSISTS OF LEAF DESIGN.

SN 77-839,923, FILED 10-2-2009.

LINDSEY RUBIN, EXAMINING ATTORNEY



David J. Kyffers

Director of the United States Patent and Trademark Office

United States of America

United States Patent and Trademark Office



Reg. No. 4,154,480

Registered June 5, 2012

Int. Cls.: 16 and 41

TRADEMARK

SERVICE MARK

PRINCIPAL REGISTER

FREEMAN, ALGEANIA WARREN (UNITED STATES INDIVIDUAL)
9922 N. WILD TURKEY ROW
MCCORDSVILLE, IN 46055

FOR: NOTE PADS, NOTE BOOKS, POSTERS, POSTCARDS, GREETING CARDS, PRINTED MATTER, NAMELY, BOOKS CONCERNING PERSONAL AND SPIRITUAL GROWTH AND LIFE IMPROVEMENT FOR WOMEN, STATIONERY, PENS, AND BOOK MARKS, IN CLASS 16 (U.S. CLS. 2, 5, 22, 23, 29, 37, 38 AND 50).

FIRST USE 3-16-2012; IN COMMERCE 3-16-2012.

FOR: EDUCATIONAL SERVICES, NAMELY, CONDUCTING CLASSES, SEMINARS, CONFERENCE, WORKSHOPS IN THE FIELD OF PERSONAL AND SPIRITUAL GROWTH AND LIFE PLANNING, IN CLASS 41 (U.S. CLS. 100, 101 AND 107).

FIRST USE 3-16-2012; IN COMMERCE 3-16-2012.

THE MARK CONSISTS OF THE STYLIZED WORDING "STEP UP SISTER", WITH THE SILHOUETTE OF A WOMAN CLIMBING STEPS ABOVE THE LETTER "P" IN "STEP" AND THE LETTER "U" IN "UP".

SN 77-840,335, FILED 10-2-2009.

BARBARA GAYNOR, EXAMINING ATTORNEY



David J. Kybas

Director of the United States Patent and Trademark Office

United States of America

United States Patent and Trademark Office

POWERHOUSE

Reg. No. 4,154,481

Registered June 5, 2012

Int. Cl.: 19

TRADEMARK

PRINCIPAL REGISTER

THE DOW CHEMICAL COMPANY (DELAWARE CORPORATION)
TRADEMARK & COPYRIGHT PRACTICE GROUP
2030 DOW CENTER
MIDLAND, MI 48674

FOR: NON-METAL ROOFING SHINGLES FOR USE IN BUILDING AND CONSTRUCTION,
IN CLASS 19 (U.S. CLS. 1, 12, 33 AND 50).

FIRST USE 1-27-2012; IN COMMERCE 1-27-2012.

THE MARK CONSISTS OF STANDARD CHARACTERS WITHOUT CLAIM TO ANY PAR-
TICULAR FONT, STYLE, SIZE, OR COLOR.

SN 77-842,021, FILED 10-6-2009.

JANICE L. MCMORROW, EXAMINING ATTORNEY



David J. Kybas

Director of the United States Patent and Trademark Office

United States of America

United States Patent and Trademark Office

Bal Seal Canted Coil Spring

Reg. No. 4,154,482

BAL SEAL ENGINEERING (CALIFORNIA CORPORATION)
19650 PAULING
FOOTHILL RANCH, CA 926102610

Registered June 5, 2012

Int. Cl.: 6

FOR: METAL HARDWARE, NAMELY, CANTED COIL SPRINGS FOR USE IN CONNECTORS, NAMELY, ELECTRICAL, MEDICAL, AND MECHANICAL CONNECTORS , IN CLASS 6 (U.S. CLS. 2, 12, 13, 14, 23, 25 AND 50).

TRADEMARK

FIRST USE 7-27-2011; IN COMMERCE 7-27-2011.

PRINCIPAL REGISTER

THE MARK CONSISTS OF STANDARD CHARACTERS WITHOUT CLAIM TO ANY PARTICULAR FONT, STYLE, SIZE, OR COLOR.

OWNER OF U.S. REG. NO. 2,924,860.

NO CLAIM IS MADE TO THE EXCLUSIVE RIGHT TO USE "SEAL" AND "CANTED COIL SPRING", APART FROM THE MARK AS SHOWN.

SN 77-843,748, FILED 10-7-2009.

ERIN FALK, EXAMINING ATTORNEY



David J. Kyros

Director of the United States Patent and Trademark Office

United States of America

United States Patent and Trademark Office



Reg. No. 4,154,483

Registered June 5, 2012

Int. Cl.: 6

TRADEMARK

PRINCIPAL REGISTER

LF, LLC (DELAWARE LIMITED LIABILITY COMPANY)
P.O. BOX 39
MOUNT MOURNE, NC 28123

FOR: METAL CHAINS; NON-ELECTRIC CABLES MADE OF METAL; ACCESSORIES FOR USE WITH CHAIN AND ROPE, NAMELY, CLAMPS, FERRULE AND STOPS, GRAB HOOKS, CARABINERS, QUICK LINKS, PULLEYS, EYES, SWIVELS, SAFETY LATCH SLIP HOOKS, ROPE TIGHTENERS, CLINCHES, AND HITCH RINGS ALL MADE OF METAL, IN CLASS 6 (U.S. CLS. 2, 12, 13, 14, 23, 25 AND 50).

FIRST USE 8-0-2011; IN COMMERCE 8-0-2011.

THE MARK CONSISTS OF A FLYING HAWK WITH THE WORDS "BLUE HAWK" TO THE RIGHT OF THE IMAGE.

SN 77-846,545, FILED 10-12-2009.

KIM SAITO, EXAMINING ATTORNEY



David J. Kyffers

Director of the United States Patent and Trademark Office

United States of America

United States Patent and Trademark Office

UPTAKE MEDICAL

Reg. No. 4,154,484

Registered June 5, 2012

Int. Cl.: 44

SERVICE MARK

PRINCIPAL REGISTER

UPTAKE MEDICAL CORPORATION (DELAWARE CORPORATION)
1924 FIRST AVENUE, 3RD FLOOR
SEATTLE, WA 98101

FOR: PROVIDING MEDICAL INFORMATION AND TREATMENT PLANS IN THE FIELD OF EMPHYSEMA AND CHRONIC OBSTRUCTIVE PULMONARY DISEASE, IN CLASS 44 (U.S. CLS. 100 AND 101).

FIRST USE 10-24-2011; IN COMMERCE 10-24-2011.

THE MARK CONSISTS OF STANDARD CHARACTERS WITHOUT CLAIM TO ANY PARTICULAR FONT, STYLE, SIZE, OR COLOR.

NO CLAIM IS MADE TO THE EXCLUSIVE RIGHT TO USE "MEDICAL", APART FROM THE MARK AS SHOWN.

SN 77-847,593, FILED 10-13-2009.

BRIDGETT SMITH, EXAMINING ATTORNEY



David J. Kyros

Director of the United States Patent and Trademark Office

United States of America

United States Patent and Trademark Office

POTBELLY SANDWICH SHOP

Reg. No. 4,154,485

Registered June 5, 2012

Int. Cl.: 25

TRADEMARK

PRINCIPAL REGISTER

POTBELLY SANDWICH WORKS, LLC (ILLINOIS LIMITED LIABILITY COMPANY)
23RD FLOOR
222 MERCHANDISE MART PLAZA
CHICAGO, IL 60654

FOR: HATS, CAPS, SHIRTS, T-SHIRTS AND POLO SHIRTS, IN CLASS 25 (U.S. CLS. 22 AND 39).

FIRST USE 3-16-2012; IN COMMERCE 3-16-2012.

THE MARK CONSISTS OF STANDARD CHARACTERS WITHOUT CLAIM TO ANY PARTICULAR FONT, STYLE, SIZE, OR COLOR.

OWNER OF U.S. REG. NOS. 2,178,589, 2,332,173, AND OTHERS.

SN 77-852,416, FILED 10-20-2009.

KATHERINE CONNOLLY, EXAMINING ATTORNEY



David J. Kyffers

Director of the United States Patent and Trademark Office

United States of America

United States Patent and Trademark Office



Reg. No. 4,154,486

Registered June 5, 2012

Int. Cl.: 37

SERVICE MARK

PRINCIPAL REGISTER

DECIMUS, JEAN D (UNITED STATES INDIVIDUAL)
#1F
1157 EAST 87TH STREET
BROOKLYN, NY 11236

FOR: INSTALLATION, MAINTENANCE AND REPAIR OF HEATING, VENTILATION, AIR CONDITIONING, AND REFRIGERATION (HVAC/R) SYSTEMS, IN CLASS 37 (U.S. CLS. 100, 103 AND 106).

FIRST USE 1-1-2009; IN COMMERCE 1-1-2009.

NO CLAIM IS MADE TO THE EXCLUSIVE RIGHT TO USE "H.V.A.C.", APART FROM THE MARK AS SHOWN.

THE MARK CONSISTS OF "FRESH START H.V.A.C. F S ONE" INSIDE A DOUBLE CIRCLE. "FRESH START H.V.A.C." APPEARS IN A CIRCULAR FASHION BETWEEN THE FIRST AND SECOND CIRCLE, WHILE "F S ONE" APPEARS IN STYLIZED FORM WITHIN THE FIRST CIRCLE. A STAR WITH FOUR RADIATING LINES IS DEPICTED AT THE UPPER LEFT OF THE LETTER "F" IN "F S ONE".

SN 77-854,818, FILED 10-22-2009.

MATTHEW PAPPAS, EXAMINING ATTORNEY



David J. Kappas

Director of the United States Patent and Trademark Office

United States of America

United States Patent and Trademark Office



Reg. No. 4,154,487

RUBLE, SCOTT, J (UNITED STATES INDIVIDUAL)
211 ROOSEVELT TER.
SANTA CRUZ, CA 95060

Registered June 5, 2012

Int. Cl.: 28

FOR: PADDLE SURFBOARDS; PADDLES FOR USE WITH SURFBOARDS; STAND-UP SURF PADDLES; SURF PADDLES, IN CLASS 28 (U.S. CLS. 22, 23, 38 AND 50).

TRADEMARK

FIRST USE 1-25-2012; IN COMMERCE 1-25-2012.

PRINCIPAL REGISTER

NO CLAIM IS MADE TO THE EXCLUSIVE RIGHT TO USE "PADDLE SURF", APART FROM THE MARK AS SHOWN.

THE MARK CONSISTS OF A STAND UP PADDLE SURFER HOLDING A PADDLE AND SURFING A WAVE ABOVE THE WORD "COVEWATER" ABOVE THE WORDS "PADDLE" AND "SURF" WITH A SINGLE LINE DIAMOND BETWEEN THE WORDS "PADDLE" AND "SURF" WITH A PADDLE BLADE AND A SHORT PORTION OF A PADDLE SHAFT INSIDE OF IT.

SN 77-855,302, FILED 10-22-2009.

SARA BENJAMIN, EXAMINING ATTORNEY



David J. Kybas

Director of the United States Patent and Trademark Office

United States of America

United States Patent and Trademark Office

SLEEP SHIELD

Reg. No. 4,154,488

FABRICTECH 2000, LLC (NEW JERSEY LIMITED LIABILITY COMPANY)
218 LITTLE FALLS RD, SUITE #2
CEDAR GROVE, NJ 07009

Registered June 5, 2012

Int. Cl.: 24

FOR: MATTRESS COVERS, BOX SPRING COVERS, AND PILLOW COVERS, IN CLASS 24
(U.S. CLS. 42 AND 50).

TRADEMARK

FIRST USE 3-0-2011; IN COMMERCE 3-0-2011.

PRINCIPAL REGISTER

THE MARK CONSISTS OF STANDARD CHARACTERS WITHOUT CLAIM TO ANY PARTICULAR FONT, STYLE, SIZE, OR COLOR.

SN 77-857,985, FILED 10-27-2009.

JAY BESCH, EXAMINING ATTORNEY



David J. Kyros

Director of the United States Patent and Trademark Office

United States of America

United States Patent and Trademark Office

NORTH SHORE-LIJ ELECTRONIC HEALTH RECORD

Reg. No. 4,154,489

Registered June 5, 2012

Int. Cls.: 9 and 35

TRADEMARK

SERVICE MARK

PRINCIPAL REGISTER

NORTH SHORE-LONG ISLAND JEWISH HEALTH SYSTEM, INC. (NEW YORK CORPORATION)
145 COMMUNITY DRIVE
GREAT NECK, NY 11021

FOR: SOFTWARE FOR PROVIDING A SECURE WEBSITE FEATURING PATIENT MEDICAL RECORDS, IN CLASS 9 (U.S. CLS. 21, 23, 26, 36 AND 38).

FIRST USE 1-1-2010; IN COMMERCE 1-1-2010.

FOR: MEDICAL INFORMATION SERVICES, NAMELY, PROVIDING A SECURE WEBSITE FEATURING PATIENT MEDICAL RECORDS; CONSULTING SERVICES RELATED TO IMPLEMENTING AND UPDATING A DATABASE FOR PATIENT MEDICAL RECORDS, IN CLASS 35 (U.S. CLS. 100, 101 AND 102).

FIRST USE 3-30-2011; IN COMMERCE 3-30-2011.

THE MARK CONSISTS OF STANDARD CHARACTERS WITHOUT CLAIM TO ANY PARTICULAR FONT, STYLE, SIZE, OR COLOR.

NO CLAIM IS MADE TO THE EXCLUSIVE RIGHT TO USE "ELECTRONIC HEALTH RECORD", APART FROM THE MARK AS SHOWN.

SN 77-860,665, FILED 10-29-2009.

SUSAN STIGLITZ, EXAMINING ATTORNEY



David J. Kyros

Director of the United States Patent and Trademark Office

United States of America

United States Patent and Trademark Office

SITTER ELITE

Reg. No. 4,154,490

J.T. POSEY COMPANY (CALIFORNIA CORPORATION)
5635 PECK ROAD
ARCADIA, CA 910060020

Registered June 5, 2012

Int. Cl.: 10

FOR: MONITORS FOR DETECTING PATIENT MOVEMENT, IN CLASS 10 (U.S. CLS. 26, 39 AND 44).

TRADEMARK

FIRST USE 3-30-2012; IN COMMERCE 3-30-2012.

PRINCIPAL REGISTER

THE MARK CONSISTS OF STANDARD CHARACTERS WITHOUT CLAIM TO ANY PARTICULAR FONT, STYLE, SIZE, OR COLOR.

OWNER OF U.S. REG. NO. 2,443,288.

SN 77-861,817, FILED 10-30-2009.

TOBY BULLOFF, EXAMINING ATTORNEY



David J. Kyffers

Director of the United States Patent and Trademark Office

United States of America

United States Patent and Trademark Office

DECADENT

Reg. No. 4,154,491

Registered June 5, 2012

Int. Cl.: 33

TRADEMARK

PRINCIPAL REGISTER

UNITED STATES DISTILLED PRODUCTS COMPANY (MINNESOTA CORPORATION)
1607 SOUTH 12TH STREET
PRINCETON, MN 55371

FOR: DISTILLED SPIRITS, IN CLASS 33 (U.S. CLS. 47 AND 49).

FIRST USE 2-29-2012; IN COMMERCE 2-29-2012.

THE MARK CONSISTS OF STANDARD CHARACTERS WITHOUT CLAIM TO ANY PARTICULAR FONT, STYLE, SIZE, OR COLOR.

SN 77-866,219, FILED 11-5-2009.

ELLEN PERKINS, EXAMINING ATTORNEY



David J. Kybas

Director of the United States Patent and Trademark Office

United States of America

United States Patent and Trademark Office

IE

Reg. No. 4,154,492

Registered June 5, 2012

Int. Cls.: 9, 16, and 18

TRADEMARK

PRINCIPAL REGISTER

THE OFFICE CLUB, INC. (CALIFORNIA CORPORATION)
6600 NORTH MILITARY TRAIL
BOCA RATON, FL 33496

FOR: COMPUTER HARDWARE AND ACCESSORIES, NAMELY, KEYPADS, KEYBOARDS, COMPUTER MOUSE, MOUSE PADS, WRIST RESTS, FLASH DRIVES, FLASH CARDS, FLOPPY DISK DRIVES, NETWORK CARDS, WIRELESS DSL ROUTERS, USB HUBS, NOTEBOOK COMPUTER COOLING PADS, COMPUTER INTERCONNECT CABLES, ELECTRONIC CARD READERS, LAPTOP ROLLING AND CARRYING CASES, BATTERIES, BATTERY CHARGERS, POWER ADAPTERS FOR COMPUTERS, EXTERNAL AUDIO COMPUTER SPEAKERS, COMPUTER MICROPHONE, COMPUTER EARPHONES; ELECTRONIC PERSONAL ORGANIZER; USB CABLES, ELECTRICAL POWER DISTRIBUTION UNITS, NAMELY, OUTLET POWER STRIP, IN CLASS 9 (U.S. CLS. 21, 23, 26, 36 AND 38).

FIRST USE 7-24-2009; IN COMMERCE 7-24-2009.

FOR: STATIONERY PRODUCTS AND DESKTOP ACCESSORIES, NAMELY, DESK PADS, BINDERS, WRITING PADS, NOTEBOOKS, LEGAL PADS, PERSONAL ORGANIZERS, BUSINESS FORMS AND MEMO PADS, PAPER EXPANDING FILES, APPOINTMENT BOOKS, DAILY AND DESKTOP PLANNERS, PADFOLIOS, NOTE PADS, BLANK BUSINESS JOURNALS, BLANK JOURNALS, WRITING JOURNAL SHEETS, CALENDARS AND DIARIES, TELEPHONE NUMBER AND ADDRESS BOOKS AND EMBROIDERY DESIGN PATTERNS PRINTED ON PAPER; DESKTOP BUSINESS CARD AND CREDIT CARD HOLDERS; PASSPORT CASES, COVERS AND HOLDERS; PEN AND PENCIL CUPS AND HOLDERS; TRAYS, NAMELY, FILE TRAYS, LETTER TRAYS, PEN AND PENCIL TRAYS; FILE BOXES FOR STORAGE OF MAGAZINES; PAPER CLIP HOLDERS; BOOK ENDS; HOLDERS FOR DESK ACCESSORIES; OFFICE SUPPLIES, NAMELY, BINDER CLIPS, PAPER CLIPS, PAPER FASTENERS, THUMB TACKS, PAPER CLIP HOLDER, STAPLES, STAPLERS, RUBBER BANDS, RUBBER ERASERS, MARKERS, HIGHLIGHTING PENS AND HIGHLIGHTING MARKERS, OFFICE HOLE PUNCHERS, SCISSORS, DESKTOP REVOLVING ROTARY CARD FILES, CARD FILES, PAPER EXPANDING FILES, FOLDERS, DOCUMENT PLASTIC COVERS, DOCUMENT PORTFOLIOS, CLIP BOARDS AND PLASTIC ENVELOPES FOR STATIONERY USE, IN CLASS 16 (U.S. CLS. 2, 5, 22, 23, 29, 37, 38 AND 50).

FIRST USE 7-24-2009; IN COMMERCE 7-24-2009.



David J. Kyjars

Director of the United States Patent and Trademark Office

Reg. No. 4,154,492 FOR: BAGS, NAMELY, TOTE BAGS, WHEELED CASES AND BAGS, MESSENGER BAGS, DUFFEL BAGS, LUGGAGE, TRAVEL BAGS, BACKPACKS, CARRY-ON BAGS, BOOK BAGS, HANDBAGS; BRIEFCASES, CARRYING CASES, KEY CASES, BUSINESS CASES, BUSINESS CARD CASES AND HOLDERS, DOCUMENT CASES, CREDIT CARD CASES, PURSES AND WALLETS, LUGGAGE TAGS, TRAVEL CASES, COSMETIC CASES SOLD EMPTY, TOILETRY CASES SOLD EMPTY, NON-MOTORIZED CARTS FOR LUGGAGE AND BAGS, AND UMBRELLAS, IN CLASS 18 (U.S. CLS. 1, 2, 3, 22 AND 41).

FIRST USE 7-24-2009; IN COMMERCE 7-24-2009.

THE MARK CONSISTS OF STANDARD CHARACTERS WITHOUT CLAIM TO ANY PARTICULAR FONT, STYLE, SIZE, OR COLOR.

SN 77-868,918, FILED 11-10-2009.

ROSELLE HERRERA, EXAMINING ATTORNEY

United States of America

United States Patent and Trademark Office



Reg. No. 4,154,493

Registered June 5, 2012

Int. Cls.: 9, 16, and 18

TRADEMARK

PRINCIPAL REGISTER

THE OFFICE CLUB, INC. (CALIFORNIA CORPORATION)
6600 NORTH MILITARY TRAIL
BOCA RATON, FL 33496

FOR: COMPUTER HARDWARE AND ACCESSORIES, NAMELY, KEYPADS, KEYBOARDS, COMPUTER MOUSE, MOUSE PADS, WRIST RESTS, FLASH DRIVES, FLASH CARDS, FLOPPY DISK DRIVES, NETWORK CARDS, WIRELESS DSL ROUTERS, USB HUBS, NOTEBOOK COMPUTER COOLING PADS, COMPUTER INTERCONNECT CABLES, ELECTRONIC CARD READERS, LAPTOP ROLLING AND CARRYING CASES, BATTERIES, BATTERY CHARGERS, POWER ADAPTERS FOR COMPUTERS, EXTERNAL AUDIO COMPUTER SPEAKERS, COMPUTER MICROPHONE, COMPUTER EARPHONES; ELECTRONIC PERSONAL ORGANIZER; USB CABLE; ELECTRICAL POWER DISTRIBUTION UNITS, NAMELY, OUTLET POWER STRIP, IN CLASS 9 (U.S. CLS. 21, 23, 26, 36 AND 38).

FIRST USE 7-24-2009; IN COMMERCE 7-24-2009.

FOR: STATIONERY PRODUCTS AND DESKTOP ACCESSORIES, NAMELY, DESK PADS, BINDERS, WRITING PADS, NOTEBOOKS, LEGAL PADS, PERSONAL ORGANIZERS, BUSINESS FORMS AND MEMO PADS, PAPER EXPANDING FILES, APPOINTMENT BOOKS, DAILY AND DESKTOP PLANNERS, PADFOLIOS, NOTE PADS, BLANK BUSINESS JOURNALS, BLANK JOURNALS, WRITING JOURNAL SHEETS, CALENDARS AND DIARIES, TELEPHONE NUMBER AND ADDRESS BOOKS AND EMBROIDERY DESIGN PATTERNS PRINTED ON PAPER; DESKTOP BUSINESS CARD AND CREDIT CARD HOLDERS; PASSPORT CASES, COVERS AND HOLDERS; PEN AND PENCIL CUPS AND HOLDERS; TRAYS, NAMELY, FILE TRAYS, LETTER TRAYS, PEN AND PENCIL TRAYS; FILE BOXES FOR STORAGE OF MAGAZINES; PAPER CLIP HOLDERS; BOOK ENDS; HOLDERS FOR DESK ACCESSORIES; OFFICE SUPPLIES, NAMELY, BINDER CLIPS, PAPER CLIPS, PAPER FASTENERS, THUMB TACKS, PAPER CLIP HOLDER, STAPLES, STAPLERS, RUBBER BANDS, RUBBER ERASERS, MARKERS, HIGHLIGHTING PENS AND HIGHLIGHTING MARKERS, OFFICE HOLE PUNCHERS, SCISSORS, DESKTOP REVOLVING ROTARY CARD FILES, CARD FILES, PAPER EXPANDING FILES, FOLDERS, DOCUMENT PLASTIC COVERS, DOCUMENT PORTFOLIOS, CLIP BOARDS AND PLASTIC ENVELOPES FOR STATIONERY USE, IN CLASS 16 (U.S. CLS. 2, 5, 22, 23, 29, 37, 38 AND 50).

FIRST USE 7-24-2009; IN COMMERCE 7-24-2009.



David J. Kappas

Director of the United States Patent and Trademark Office

Reg. No. 4,154,493 FOR: BAGS, NAMELY, TOTE BAGS, WHEELED CASES AND BAGS, MESSENGER BAGS, DUFFEL BAGS, LUGGAGE, TRAVEL BAGS, BACKPACKS, CARRY-ON BAGS, BOOK BAGS, HANDBAGS; BRIEFCASES, CARRYING CASES, KEY CASES, BUSINESS CASES, BUSINESS CARD CASES AND HOLDERS, DOCUMENT CASES, CREDIT CARD CASES, PURSES AND WALLETS, LUGGAGE TAGS, TRAVEL CASES, COSMETIC CASES SOLD EMPTY, TOILETRY CASES SOLD EMPTY, NON-MOTORIZED CARTS FOR LUGGAGE AND BAGS, AND UMBRELLAS, IN CLASS 18 (U.S. CLS. 1, 2, 3, 22 AND 41).

FIRST USE 7-24-2009; IN COMMERCE 7-24-2009.

THE MARK CONSISTS OF THE LETTERS "IE" IN APPEARING INSIDE A BOX.

SN 77-868,922, FILED 11-10-2009.

ROSELLE HERRERA, EXAMINING ATTORNEY

United States of America

United States Patent and Trademark Office

THE SMART COUNSEL LAW SCHOOL FOR DOCTORS

Reg. No. 4,154,494

Registered June 5, 2012

Int. Cl.: 41

SERVICE MARK

PRINCIPAL REGISTER

SMART COUNSEL, LLC (PENNSYLVANIA LIMITED LIABILITY COMPANY)
550 EAST PITTSBURGH STREET
GREENSBURG, PA 15601

FOR: CONTINUING EDUCATION SERVICES, NAMELY, PROVIDING LIVE, ON-LINE, WORKSHOPS, AND TELE-SEMINARS AND, CONTINUING PROFESSION EDUCATION SEMINARS IN THE LEGAL FIELD AND MEDICAL FIELDS, AND DISTRIBUTING EDUCATIONAL MATERIALS IN THE FIELD OF CONTINUING PROFESSION EDUCATION IN THE LEGAL AND MEDICAL FIELDS IN CONNECTION THEREWITH, IN CLASS 41 (U.S. CLS. 100, 101 AND 107).

FIRST USE 3-26-2012; IN COMMERCE 3-26-2012.

THE MARK CONSISTS OF STANDARD CHARACTERS WITHOUT CLAIM TO ANY PARTICULAR FONT, STYLE, SIZE, OR COLOR.

NO CLAIM IS MADE TO THE EXCLUSIVE RIGHT TO USE "COUNSEL LAW SCHOOL FOR DOCTORS", APART FROM THE MARK AS SHOWN.

SN 77-870,665, FILED 11-11-2009.

LINDA POWELL, EXAMINING ATTORNEY



David J. Kyjars

Director of the United States Patent and Trademark Office

United States of America

United States Patent and Trademark Office

THE SMART COUNSEL LAW SCHOOL FOR NURSES

Reg. No. 4,154,495

Registered June 5, 2012

Int. Cl.: 41

SERVICE MARK

PRINCIPAL REGISTER

SMART COUNSEL, LLC (PENNSYLVANIA LIMITED LIABILITY COMPANY)
550 EAST PITTSBURGH STREET
GREENSBURG, PA 15601

FOR: CONTINUING EDUCATION SERVICES, NAMELY, PROVIDING LIVE, ON-LINE, WORKSHOPS, AND TELE-SEMINARS AND, CONTINUING PROFESSION EDUCATION SEMINARS IN THE LEGAL FIELD AND MEDICAL FIELDS, AND DISTRIBUTING EDUCATIONAL MATERIALS IN THE FIELD OF CONTINUING PROFESSION EDUCATION IN THE LEGAL AND MEDICAL FIELDS IN CONNECTION THEREWITH, IN CLASS 41 (U.S. CLS. 100, 101 AND 107).

FIRST USE 3-27-2012; IN COMMERCE 3-27-2012.

THE MARK CONSISTS OF STANDARD CHARACTERS WITHOUT CLAIM TO ANY PARTICULAR FONT, STYLE, SIZE, OR COLOR.

NO CLAIM IS MADE TO THE EXCLUSIVE RIGHT TO USE "COUNSEL LAW SCHOOL FOR NURSES", APART FROM THE MARK AS SHOWN.

SN 77-870,669, FILED 11-11-2009.

LINDA POWELL, EXAMINING ATTORNEY



David J. Kybas

Director of the United States Patent and Trademark Office

United States of America

United States Patent and Trademark Office

THE SMART COUNSEL MEDICAL SCHOOL FOR ATTORNEYS

Reg. No. 4,154,496

Registered June 5, 2012

Int. Cl.: 41

SERVICE MARK

PRINCIPAL REGISTER

SMART COUNSEL, LLC (PENNSYLVANIA LIMITED LIABILITY COMPANY)
550 EAST PITTSBURGH STREET
GREENSBURG, PA 15601

FOR: CONTINUING EDUCATION SERVICES, NAMELY, PROVIDING LIVE, ON-LINE, WORKSHOPS, AND TELE-SEMINARS AND, CONTINUING PROFESSION EDUCATION SEMINARS IN THE LEGAL FIELD AND MEDICAL FIELDS, AND DISTRIBUTING EDUCATIONAL MATERIALS IN THE FIELD OF CONTINUING PROFESSION EDUCATION IN THE LEGAL AND MEDICAL FIELDS IN CONNECTION THEREWITH, IN CLASS 41 (U.S. CLS. 100, 101 AND 107).

FIRST USE 3-26-2012; IN COMMERCE 3-26-2012.

THE MARK CONSISTS OF STANDARD CHARACTERS WITHOUT CLAIM TO ANY PARTICULAR FONT, STYLE, SIZE, OR COLOR.

NO CLAIM IS MADE TO THE EXCLUSIVE RIGHT TO USE "COUNSEL MEDICAL SCHOOL FOR ATTORNEYS", APART FROM THE MARK AS SHOWN.

SN 77-870,675, FILED 11-11-2009.

LINDA POWELL, EXAMINING ATTORNEY



David J. Kyjars

Director of the United States Patent and Trademark Office

United States of America

United States Patent and Trademark Office

FUNTIME SAVINGS

Reg. No. 4,154,497

Registered June 5, 2012

Int. Cl.: 35

SERVICE MARK

PRINCIPAL REGISTER

SEMPRIS, LLC (DELAWARE LIMITED LIABILITY COMPANY)
SUITE 700
10900 WAYZATA BOULEVARD
MINNEAPOLIS, MN 55305

FOR: BUYING CLUB SERVICES; PROMOTING THE SALE OF THE GOODS AND SERVICES OF OTHERS THROUGH THE DISTRIBUTION OF DISCOUNT OFFERS, IN CLASS 35 (U.S. CLS. 100, 101 AND 102).

FIRST USE 3-1-2012; IN COMMERCE 3-1-2012.

THE MARK CONSISTS OF STANDARD CHARACTERS WITHOUT CLAIM TO ANY PARTICULAR FONT, STYLE, SIZE, OR COLOR.

OWNER OF U.S. REG. NO. 3,514,891.

NO CLAIM IS MADE TO THE EXCLUSIVE RIGHT TO USE "SAVINGS", APART FROM THE MARK AS SHOWN.

SN 77-871,710, FILED 11-12-2009.

SHAUNIA CARLYLE, EXAMINING ATTORNEY



David J. Kyros

Director of the United States Patent and Trademark Office

United States of America

United States Patent and Trademark Office

SIMPLY POTATOES STEAMABLES

Reg. No. 4,154,498

Registered June 5, 2012

Int. Cl.: 29

TRADEMARK

PRINCIPAL REGISTER

MICHAEL FOODS OF DELAWARE, INC. (DELAWARE CORPORATION)
SUITE 300
301 CARLSON PARKWAY
MINNEAPOLIS, MN 55305

FOR: MICROWAVABLE PROCESSED POTATOES PURCHASED REFRIGERATED, IN CLASS 29 (U.S. CL. 46).

FIRST USE 1-31-2012; IN COMMERCE 1-31-2012.

THE MARK CONSISTS OF STANDARD CHARACTERS WITHOUT CLAIM TO ANY PARTICULAR FONT, STYLE, SIZE, OR COLOR.

OWNER OF U.S. REG. NOS. 1,596,986, 1,766,860, AND 2,374,745.

NO CLAIM IS MADE TO THE EXCLUSIVE RIGHT TO USE "POTATOES STEAMABLES", APART FROM THE MARK AS SHOWN.

SN 77-871,860, FILED 11-13-2009.

BARNEY CHARLON, EXAMINING ATTORNEY



David J. Kybas

Director of the United States Patent and Trademark Office

United States of America

United States Patent and Trademark Office

INNOVATING FOR SUSTAINABLE INFRASTRUCTURE

Reg. No. 4,154,499

Registered June 5, 2012

Int. Cl.: 42

SERVICE MARK

PRINCIPAL REGISTER

INNOVYZE, INC. (CALIFORNIA CORPORATION)
380 INTERLOCKEN CRESCENT
SUITE 200
BROOMFIELD, CO 80021

FOR: DESIGN AND DEVELOPMENT OF COMPUTER SOFTWARE FOR OTHERS FOR USE IN A VARIETY OF FIELDS AND APPLICATIONS, NAMELY, ENGINEERING APPLICATIONS, CONSTRUCTION DESIGN APPLICATIONS, PROJECT PLANNING AND MANAGEMENT APPLICATIONS, ENVIRONMENTAL ENGINEERING APPLICATIONS, QUALITY CONTROL APPLICATIONS, WATER TREATMENT AND DISTRIBUTION APPLICATIONS, AND HYDROPOWER DESIGN AND CONTROL APPLICATIONS; PROVIDING CONSULTING SERVICES TO OTHERS IN THE DESIGN, SELECTION, IMPLEMENTATION AND THE USE OF SOFTWARE SYSTEMS FOR USE IN A VARIETY OF FIELDS, INDUSTRIES AND APPLICATIONS, NAMELY, ENGINEERING, CONSTRUCTION, ENVIRONMENTAL ENGINEERING, PROJECT PLANNING AND MANAGEMENT, QUALITY CONTROL, WATER TREATMENT AND DISTRIBUTION, AND HYDROPOWER DESIGN AND CONTROL; PROVIDING COMPUTER SOFTWARE TECHNICAL SUPPORT SERVICES, NAMELY, TROUBLESHOOTING OF COMPUTER SOFTWARE PROBLEMS FOR OTHERS IN A VARIETY OF FIELDS, INDUSTRIES AND APPLICATIONS, NAMELY, ENGINEERING, ENVIRONMENTAL ENGINEERING, PROJECT PLANNING AND MANAGEMENT, QUALITY CONTROL, WATER TREATMENT AND DISTRIBUTION, AND HYDROPOWER DESIGN AND CONTROL, IN CLASS 42 (U.S. CLS. 100 AND 101).

FIRST USE 11-0-2009; IN COMMERCE 11-0-2009.

THE MARK CONSISTS OF STANDARD CHARACTERS WITHOUT CLAIM TO ANY PARTICULAR FONT, STYLE, SIZE, OR COLOR.

SN 77-873,568, FILED 11-16-2009.

JAMES MACFARLANE, EXAMINING ATTORNEY



David J. Kyjars

Director of the United States Patent and Trademark Office

United States of America

United States Patent and Trademark Office



Reg. No. 4,154,500

SASSY STRINGS, LLC (FLORIDA LIMITED LIABILITY COMPANY)
13300-56 S. CLEVELAND AVE.
FT. MYERS, FL 33907

Registered June 5, 2012

Int. Cl.: 26

FOR: HAIR EXTENSIONS, IN CLASS 26 (U.S. CLS. 37, 39, 40, 42 AND 50).

TRADEMARK

FIRST USE 11-17-2009; IN COMMERCE 1-1-2010.

PRINCIPAL REGISTER

NO CLAIM IS MADE TO THE EXCLUSIVE RIGHT TO USE "STRINGS", APART FROM THE MARK AS SHOWN.

THE MARK CONSISTS OF A BUST OF A LADY WITH THE STYLIZED TEXT "SASSY STRINGS" TO THE RIGHT OF THE BUST WITH A HORIZONTAL LINE BELOW THE BUST AND "SASSY STRINGS". BELOW THE LINE, THERE IS THE STYLIZED TEXT "SO AWESOME SOMEONE STOPS YOU".

SN 77-873,798, FILED 11-16-2009.

ANNE FARRELL, EXAMINING ATTORNEY



David J. Kybas

Director of the United States Patent and Trademark Office

United States of America

United States Patent and Trademark Office

FLIP SIDE STORIES

Reg. No. 4,154,501

HOUSEY, AMBER J. (UNITED STATES INDIVIDUAL)
3475 DOROTHEA CT.
TROY, MI 48084

Registered June 5, 2012

Int. Cl.: 16

FOR: CHILDREN'S STORIES, NAMELY, BOOKS AND PRINTED ARTICLES AND PAMPHLETS IN THE FIELD OF LIFE'S LESSONS, IN CLASS 16 (U.S. CLS. 2, 5, 22, 23, 29, 37, 38 AND 50).

TRADEMARK

FIRST USE 6-1-2011; IN COMMERCE 6-1-2011.

PRINCIPAL REGISTER

THE MARK CONSISTS OF STANDARD CHARACTERS WITHOUT CLAIM TO ANY PARTICULAR FONT, STYLE, SIZE, OR COLOR.

NO CLAIM IS MADE TO THE EXCLUSIVE RIGHT TO USE "STORIES", APART FROM THE MARK AS SHOWN.

SN 77-874,203, FILED 11-17-2009.

NAKIA HENRY, EXAMINING ATTORNEY



David J. Kybas

Director of the United States Patent and Trademark Office

United States of America

United States Patent and Trademark Office

MAN IN BLACK

Reg. No. 4,154,502

MAN IN BLACK LLC (TEXAS LIMITED LIABILITY COMPANY)
830 EAST YANDELL
EL PASO, TX 79902

Registered June 5, 2012

Int. Cl.: 33

FOR: DISTILLED SPIRITS, IN CLASS 33 (U.S. CLS. 47 AND 49).

TRADEMARK

FIRST USE 1-28-2012; IN COMMERCE 1-28-2012.

PRINCIPAL REGISTER

THE MARK CONSISTS OF STANDARD CHARACTERS WITHOUT CLAIM TO ANY PARTICULAR FONT, STYLE, SIZE, OR COLOR.

SN 77-875,136, FILED 11-18-2009.

JULIE VEPPUMTHARA, EXAMINING ATTORNEY



David J. Kyros

Director of the United States Patent and Trademark Office

United States of America

United States Patent and Trademark Office

SPORTS FANATICS

Reg. No. 4,154,503

Registered June 5, 2012

Int. Cl.: 35

SERVICE MARK

PRINCIPAL REGISTER

FANATICS, LLC (DELAWARE LIMITED LIABILITY COMPANY)
5245 COMMONWEALTH AVENUE
JACKSONVILLE, FL 32254

FOR: BUSINESS MARKETING CONSULTING SERVICES; CUSTOMER SERVICE IN THE FIELD OF ON-LINE RETAIL STORE SERVICES; ON-LINE RETAIL STORE SERVICES FEATURING SPORTS RELATED AND SPORTS TEAM BRANDED CLOTHING AND MERCHANDISE; ORDER FULFILLMENT SERVICES; PRODUCT MERCHANDISING, IN CLASS 35 (U.S. CLS. 100, 101 AND 102).

FIRST USE 3-21-2012; IN COMMERCE 3-21-2012.

THE MARK CONSISTS OF STANDARD CHARACTERS WITHOUT CLAIM TO ANY PARTICULAR FONT, STYLE, SIZE, OR COLOR.

OWNER OF U.S. REG. NOS. 2,538,045, 3,607,516, AND OTHERS.

NO CLAIM IS MADE TO THE EXCLUSIVE RIGHT TO USE "SPORTS", APART FROM THE MARK AS SHOWN.

SN 77-875,829, FILED 11-18-2009.

CHERYL CLAYTON, EXAMINING ATTORNEY



David J. Kyros

Director of the United States Patent and Trademark Office

United States of America

United States Patent and Trademark Office

BOOTS ON THE GROUND

Reg. No. 4,154,504

Registered June 5, 2012

Int. Cls.: 14, 16, and 25

TRADEMARK

PRINCIPAL REGISTER

ATLANTA ART LICENSING AND MARKETING, INC. (GEORGIA CORPORATION)
3435 BUFORD HIGHWAY, SUITE C
DULUTH, GA 300963550

FOR: JEWELRY, NAMELY, PERSONAL JEWELRY CHARMS, NECKLACES, PENDANTS, LAPEL PINS, TIE TACKS, KEY CHAINS AS JEWELRY, EARRINGS, RINGS, MEDALS, COLLECTIBLE COINS, IN CLASS 14 (U.S. CLS. 2, 27, 28 AND 50).

FIRST USE 2-21-2011; IN COMMERCE 2-21-2011.

FOR: DECALS, IN CLASS 16 (U.S. CLS. 2, 5, 22, 23, 29, 37, 38 AND 50).

FIRST USE 5-31-2010; IN COMMERCE 5-31-2010.

FOR: CLOTHING, NAMELY, T-SHIRTS, HATS, BASEBALL CAPS, POLO SHIRTS, SCARVES, BANDANAS, IN CLASS 25 (U.S. CLS. 22 AND 39).

FIRST USE 5-26-2010; IN COMMERCE 5-26-2010.

THE MARK CONSISTS OF STANDARD CHARACTERS WITHOUT CLAIM TO ANY PARTICULAR FONT, STYLE, SIZE, OR COLOR.

SN 77-880,637, FILED 11-25-2009.

TEJBIR SINGH, EXAMINING ATTORNEY

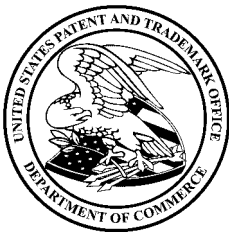

David J. Kybas

Director of the United States Patent and Trademark Office

United States of America

United States Patent and Trademark Office

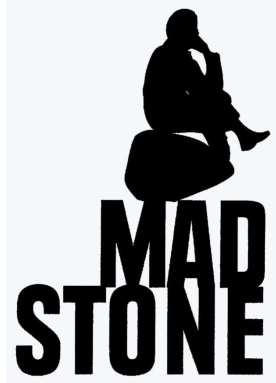

Reg. No. 4,154,505

Registered June 5, 2012

Int. Cl.: 41

SERVICE MARK

PRINCIPAL REGISTER

MADSTONE COMPANY, INC. (NEW YORK CORPORATION)
7 TIMES SQUARE
C/O PRYOR CASHMAN LLP
NEW YORK, NY 10036

FOR: FILM PRODUCTION, IN CLASS 41 (U.S. CLS. 100, 101 AND 107).

FIRST USE 4-0-2008; IN COMMERCE 4-0-2008.

THE MARK CONSISTS OF THE WORD "MAD STONE" BELOW THE DESIGN ELEMENT OF A MAN SITTING ON A ROCK.

SN 77-880,791, FILED 11-25-2009.

TEJBIR SINGH, EXAMINING ATTORNEY



David J. Kybas

Director of the United States Patent and Trademark Office

United States of America

United States Patent and Trademark Office

ARC TECHNOLOGY

Reg. No. 4,154,506

COOK INCORPORATED (INDIANA CORPORATION)
750 DANIELS WAY
BLOOMINGTON, IN 47402

Registered June 5, 2012

Int. Cl.: 10

FOR: DEVICE MIGRATION DETERRENT SYSTEM INCORPORATED AS A FEATURE IN ENDOVASCULAR STENTS, IN CLASS 10 (U.S. CLS. 26, 39 AND 44).

TRADEMARK

FIRST USE 8-0-2011; IN COMMERCE 8-0-2011.

PRINCIPAL REGISTER

THE MARK CONSISTS OF STANDARD CHARACTERS WITHOUT CLAIM TO ANY PARTICULAR FONT, STYLE, SIZE, OR COLOR.

NO CLAIM IS MADE TO THE EXCLUSIVE RIGHT TO USE "TECHNOLOGY", APART FROM THE MARK AS SHOWN.

SN 77-882,873, FILED 12-1-2009.

MICHAEL ENGEL, EXAMINING ATTORNEY



David J. Kybas

Director of the United States Patent and Trademark Office

United States of America

United States Patent and Trademark Office

DOMAIN SURGICAL

Reg. No. 4,154,507

DOMAIN SURGICAL, INC. (DELAWARE CORPORATION)

Registered June 5, 2012

P.O. BOX 58704
SALT LAKE CITY, UT 84158

Int. Cl.: 10

FOR: SURGICAL AND MEDICAL APPARATUS AND INSTRUMENTS FOR USE IN SURGERY, IN CLASS 10 (U.S. CLS. 26, 39 AND 44).

TRADEMARK

FIRST USE 12-15-2011; IN COMMERCE 3-19-2012.

PRINCIPAL REGISTER

THE MARK CONSISTS OF STANDARD CHARACTERS WITHOUT CLAIM TO ANY PARTICULAR FONT, STYLE, SIZE, OR COLOR.

NO CLAIM IS MADE TO THE EXCLUSIVE RIGHT TO USE "SURGICAL", APART FROM THE MARK AS SHOWN.

SN 77-886,514, FILED 12-4-2009.

DOMINICK J. SALEMI, EXAMINING ATTORNEY



David J. Kybas

Director of the United States Patent and Trademark Office

United States of America

United States Patent and Trademark Office

COUPLES PLACE

Reg. No. 4,154,508

Registered June 5, 2012

Int. Cls.: 3, 5, and 45

TRADEMARK

SERVICE MARK

PRINCIPAL REGISTER

JOHNSON & JOHNSON (NEW JERSEY CORPORATION)
ONE JOHNSON & JOHNSON PLAZA
NEW BRUNSWICK, NJ 089337001

FOR: MASSAGE OILS; NON-MEDICATED TOPICAL PREPARATIONS, NAMELY, SPRAYS, GELS AND CREAMS FOR ENHANCING SEXUAL AROUSAL, IN CLASS 3 (U.S. CLS. 1, 4, 6, 50, 51 AND 52).

FIRST USE 12-31-2009; IN COMMERCE 12-31-2009.

FOR: PERSONAL LUBRICANTS; VAGINAL MOISTURIZERS, IN CLASS 5 (U.S. CLS. 6, 18, 44, 46, 51 AND 52).

FIRST USE 12-31-2009; IN COMMERCE 12-31-2009.

FOR: PROVIDING A WEBSITE FEATURING INFORMATION ON ROMANCE AND INTERPERSONAL RELATIONSHIPS, IN CLASS 45 (U.S. CLS. 100 AND 101).

FIRST USE 12-31-2009; IN COMMERCE 12-31-2009.

THE MARK CONSISTS OF STANDARD CHARACTERS WITHOUT CLAIM TO ANY PARTICULAR FONT, STYLE, SIZE, OR COLOR.

SN 77-892,424, FILED 12-14-2009.

SANJEEV VOHRA, EXAMINING ATTORNEY



David J. Kyros

Director of the United States Patent and Trademark Office

United States of America

United States Patent and Trademark Office



Reg. No. 4,154,509

Registered June 5, 2012

Int. Cls.: 29 and 30

TRADEMARK

PRINCIPAL REGISTER

KAM MAN FOOD INC. (NEW JERSEY CORPORATION)
511 OLD POST ROAD
EDISON, NJ 08877

FOR: FROZEN VEGETABLES, NAMELY, EDAMAME, SOY BEANS, BROAD BEANS, BAMBOO SHOOTS, CHINESE SPINACH, MASTER GREENS IN THE NATURE OF MUSTARD GREENS AND COLLARD GREENS, CALTROP, CABBAGE, CARROTS, CORN KERNELS, PEAS, WATER CHESTNUTS, MUSHROOMS, MIXED VEGETABLES, ASTER INDICUS, AND TARO; FROZEN, PROCESSED NUTS, NAMELY, PEELED CHESTNUTS; PROCESSED NUTS; PROCESSED YELLOW EEL STRIP; TOFU, NAMELY, SOYA SHEETS AND SOYA SHEET KNOTS; PROCESSED SOY BEANS; BEAN CURD, NAMELY, SHREDDED BEAN CURD; TOFU, NAMELY, CHICKEN AND VEGETARIAN TOFU CAKES; MEAT, FISH, POULTRY; DRIED BEANS, NAMELY, DRIED RED BEANS, DRIED MUNG BEANS, DRIED SOY BEANS, DRIED BLACK BEANS; DRIED PEANUTS; DRIED JUJUBE FRUITS; DRIED RED DATES; DRIED MUSHROOMS; DRIED BLACK FUNGUS; DRIED EDIBLE SEAWEED; DRIED LOTUS NUTS; PROCESSED ROOTS FOR HUMAN CONSUMPTION, NAMELY, LOTUS ROOTS, IN CLASS 29 (U.S. CL. 46).

FIRST USE 12-0-2009; IN COMMERCE 12-0-2009.

FOR: DRIED EDIBLE SPICES, NAMELY, ANISEED, FIVE SPICE POWDER, PEPPER, MUSTARD, GARLIC, GINGER; BARLEY, NAMELY, CRUSHED BARLEY, HUSKED BARLEY, PEARLED BARLEY, EGG BARLEY, BEAN STICK IN THE NATURE OF BEAN PASTE IN STICK FORM; GLUTEN, IN CLASS 30 (U.S. CL. 46).

FIRST USE 12-0-2009; IN COMMERCE 12-0-2009.

NO CLAIM IS MADE TO THE EXCLUSIVE RIGHT TO USE "SPECIALTY FOODS" AND THE NON-LATIN CHARACTERS THAT MEAN "BRAND", APART FROM THE MARK AS SHOWN.

THE COLOR(S) BLACK, WHITE AND RED IS/ARE CLAIMED AS A FEATURE OF THE MARK.

THE NON-LATIN CHARACTERS IN THE MARK TRANSLITERATE TO "HAO REN PAI" AND THIS MEANS "GOOD PERSON BRAND" IN ENGLISH.



David J. Kybas

Director of the United States Patent and Trademark Office

Reg. No. 4,154,509 THE NAME(S), PORTRAIT(S), AND/OR SIGNATURE(S) SHOWN IN THE MARK IDENTIFIES WELLMAN WU, WHOSE CONSENT(S) TO REGISTER IS MADE OF RECORD.

THE MARK CONSISTS OF A BLACK AND WHITE PORTRAIT OF AN ASIAN MAN WITH GLASSES ON A RED, OVAL-SHAPED BACKGROUND OUTLINED IN WHITE AND RED; AT THE LEFT EDGE OF THE RED OVAL BACKGROUND APPEAR WRITTEN ASIAN CHARACTERS IN THE COLOR WHITE; ABOVE THE OVAL BACKGROUND APPEARS A CURVED RED ARC, ATOP WHICH SITS THE WORDING "WELL MAN" IN THE COLORS BLACK AND WHITE; BENEATH THE RED OVAL DESIGN APPEARS A CURVED RED ARC ATOP WHICH APPEARS THE BLACK WORDING "SPECIALTY FOODS" IN INITIAL CAPS TYPEFACE.

SN 77-893,886, FILED 12-15-2009.

KEVIN CORWIN, EXAMINING ATTORNEY

United States of America

United States Patent and Trademark Office



金門超市

Kam Man Food

Reg. No. 4,154,510

KAM MAN FOOD INC. (NEW JERSEY CORPORATION)
511 OLD POST ROAD
EDISON, NJ 08877

Registered June 5, 2012

Int. Cl.: 35

FOR: RETAIL, WHOLESALE, ONLINE, PHONE AND CATALOG STORE SERVICES FEATURING ASIAN FOOD PRODUCTS, IN CLASS 35 (U.S. CLS. 100, 101 AND 102).

SERVICE MARK

FIRST USE 12-16-2009; IN COMMERCE 12-16-2009.

PRINCIPAL REGISTER

NO CLAIM IS MADE TO THE EXCLUSIVE RIGHT TO USE "FOOD", APART FROM THE MARK AS SHOWN.

THE COLOR(S) BLACK, WHITE AND RED IS/ARE CLAIMED AS A FEATURE OF THE MARK.

THE NON-LATIN CHARACTERS IN THE MARK TRANSLITERATE TO JING MEN CAO SHI AND THIS MEANS THE GOLDEN DOOR OR THE GOLDEN GATE IN ENGLISH.

THE MARK CONSISTS OF FOUR RED ASIAN CHARACTERS APPEARING TO THE RIGHT OF A STYLIZED LOGO OF THE WHITE LETTER "K" APPEARING ON A RED, M-SHAPED BACKGROUND; THE WORDING "KAM MAN FOOD" APPEARS IN BLACK INITIAL CAPS BELOW THE ASIAN CHARACTERS; ALL OF THE AFOREMENTIONED APPEARS ON A WHITE BACKGROUND.



SN 77-893,930, FILED 12-15-2009.

KEVIN CORWIN, EXAMINING ATTORNEY

David J. Kybas

Director of the United States Patent and Trademark Office

United States of America

United States Patent and Trademark Office

KIA UVO

Reg. No. 4,154,511

Registered June 5, 2012

Int. Cl.: 9

TRADEMARK

PRINCIPAL REGISTER

KIA MOTORS AMERICA, INC. (CALIFORNIA CORPORATION)
111 PETERS CANYON ROAD
IRVINE, CA 92606

FOR: APPARATUS IN AUTOMOBILE FOR VIDEO MONITORING AND DISPLAY OF THE REAR OF AUTOMOBILES, NAMELY, AN ON-BOARD AUTOMOBILE SURVEILLANCE SYSTEM COMPRISED OF CAMERAS AND MONITORS; ELECTRONIC CONTROL UNIT IN AUTOMOBILE FOR TRACKING AND DISPLAYING WEAR INFORMATION FOR AUTOMOBILE PARTS; ELECTRONIC CONTROL UNIT IN AUTOMOBILE FOR TRACKING AND DISPLAYING REMOTE DOOR UNLOCK, THEFT DETECTION AND NOTIFICATION STATUS, STOLEN VEHICLE TRACKING, AUTOMATIC NOTIFICATION OF AIR BAG DEPLOYMENT, AND INTERACTING WITH A CUSTOMER SERVICE CENTER; ELECTRONIC CONTROL UNIT IN AUTOMOBILE FOR INTERACTING WITH AN AUTOMOBILE CUSTOMER SERVICE CENTER AND DISPLAYING INFORMATION; DIAGNOSTIC UNITS IN AUTOMOBILES, NAMELY, SENSORS AND DETECTORS FOR USE IN TRACKING, DISPLAYING AND CONTROLLING THE ACTUATION AND OPERATION OF SAFETY APPARATUS AND EQUIPMENT; ELECTRONIC CONTROL UNIT IN AUTOMOBILE FOR NAVIGATION; ELECTRONIC CONTROL UNIT IN AUTOMOBILE FOR RECEIVING, TRANSMITTING, STORING, AND DISPLAYING SOUND, DATA, MUSIC, VIDEO AND TEXT; ELECTRONIC CONTROL UNIT IN AUTOMOBILES FOR USE WITH RADIO AND ELECTRONIC MEDIA PLAYERS; ELECTRONIC CONTROL UNIT IN AUTOMOBILES FOR TRANSMITTING VEHICLE DIAGNOSTIC INFORMATION, FOR TRANSMITTING VEHICLE STATUS INFORMATION TO EMERGENCY AND SERVICE PERSONNEL, FOR RECEIVING AND DISPLAYING TRAFFIC STATUS INFORMATION, AND FOR PROVIDING AND DISPLAYING DIRECTIONAL GUIDANCE INFORMATION, IN CLASS 9 (U.S. CLS. 21, 23, 26, 36 AND 38).



FIRST USE 5-31-2011; IN COMMERCE 5-31-2011.

THE MARK CONSISTS OF STANDARD CHARACTERS WITHOUT CLAIM TO ANY PARTICULAR FONT, STYLE, SIZE, OR COLOR.

THE WORDING "UVO" HAS NO MEANING IN A FOREIGN LANGUAGE.

SN 77-895,034, FILED 12-16-2009.

KIM MONINGHOFF, EXAMINING ATTORNEY

David J. Kyros

Director of the United States Patent and Trademark Office

United States of America

United States Patent and Trademark Office



Reg. No. 4,154,512

Registered June 5, 2012

Int. Cls.: 16, 35, and 41

TRADEMARK

SERVICE MARK

PRINCIPAL REGISTER

LEADERSHIP CONFERENCE ON CIVIL RIGHTS (D.C. NON-PROFIT CORPORATION)
10TH FLOOR
1629 K ST., NW
WASHINGTON, DC 20006

FOR: PRINTED PUBLICATIONS, NAMELY, POLICY BRIEFS, SUMMARIES, REPORTS, BROCHURES, PAMPHLETS, BOOKS AND BOOKLETS ON THE SUBJECTS OF EQUAL RIGHTS AND SOCIAL AND ECONOMIC JUSTICE, IN CLASS 16 (U.S. CLS. 2, 5, 22, 23, 29, 37, 38 AND 50).

FIRST USE 1-21-2010; IN COMMERCE 1-21-2010.

FOR: PUBLIC ADVOCACY SERVICES, NAMELY, PROVIDING RESEARCH IN THE FIELD OF EQUAL RIGHTS AND SOCIAL AND ECONOMIC JUSTICE; PROMOTING THE INTERESTS OF ANYONE WHOSE CIVIL RIGHTS HAVE BEEN THREATENED OR VIOLATED, AND PROMOTING PUBLIC AWARENESS OF SOCIAL AND ECONOMIC EQUALITY, DIVERSITY AND ANTI-DISCRIMINATION POLICIES; PROVIDING PUBLIC ADVOCACY INFORMATION BY MEANS OF EDUCATIONAL TEXTS, MANUALS AND RELATED EDUCATIONAL MATERIALS PROMOTING AWARENESS OF THE NEED FOR NATIONAL POLICIES THAT SUPPORT EQUAL RIGHTS AND SOCIAL AND ECONOMIC JUSTICE; AWARDS PROGRAMS TO PROMOTE PUBLIC AWARENESS OF SOCIAL AND ECONOMIC EQUALITY, DIVERSITY AND ANTI-DISCRIMINATION POLICIES, IN CLASS 35 (U.S. CLS. 100, 101 AND 102).

FIRST USE 2-0-2010; IN COMMERCE 2-0-2010.

FOR: PROVIDING ONLINE PUBLICATIONS IN THE NATURE OF EDUCATIONAL TEXTS, CURRICULA, REPORTS, ARTICLES, AND NEWSLETTERS, ALL IN THE FIELD OF PROMOTING THE NEED FOR NATIONAL POLICIES THAT SUPPORT EQUAL RIGHTS AND SOCIAL AND ECONOMIC JUSTICE; EDUCATIONAL SERVICES, NAMELY, CONDUCTING CLASSES, SEMINARS, PROGRAMS, AND WORKSHOPS IN THE FIELD OF EQUAL RIGHTS AND SOCIAL AND ECONOMIC JUSTICE, AND DISTRIBUTING EDUCATIONAL MATERIALS IN CONNECTION THEREWITH, IN CLASS 41 (U.S. CLS. 100, 101 AND 107).

FIRST USE 2-0-2010; IN COMMERCE 2-0-2010.

THE MARK CONSISTS OF DESIGN OF A BRIDGE.



David J. Kyjars

Director of the United States Patent and Trademark Office

Reg. No. 4,154,512 SN 77-899,006, FILED 12-22-2009.

BARBARA BROWN, EXAMINING ATTORNEY

United States of America

United States Patent and Trademark Office



Reg. No. 4,154,513

DREAMSTAR CASH, S.L. (SPAIN CORPORATION)
C/ CONVENTO, 5 - 1^ÂG
03580 ALTEA (ALICANTE), SPAIN

Registered June 5, 2012

Int. Cls.: 9, 38, and 41

FOR: DOWNLOADABLE VIDEO RECORDINGS FEATURING PORNOGRAPHIC CONTENT DELIVERED VIA THE INTERNET , IN CLASS 9 (U.S. CLS. 21, 23, 26, 36 AND 38).

TRADEMARK

FIRST USE 11-3-2008; IN COMMERCE 11-3-2008.

SERVICE MARK

FOR: ENTERTAINMENT SERVICES AND AMUSEMENTS, NAMELY, VIDEO BROADCASTING SERVICES OVER THE INTERNET OR OTHER COMMUNICATIONS NETWORK FEATURING THE UPLOADED, POSTED AND TAGGED VIDEOS OF OTHERS; VIDEO BROADCASTING SERVICES OVER THE INTERNET OR OTHER COMMUNICATIONS NETWORK, NAMELY, ELECTRONICALLY TRANSMITTING VIDEO CLIPS; INTERNET BROADCASTING SERVICES, IN CLASS 38 (U.S. CLS. 100, 101 AND 104).

PRINCIPAL REGISTER

FIRST USE 11-3-2008; IN COMMERCE 11-3-2008.

FOR: ENTERTAINMENT SERVICES AND AMUSEMENTS, NAMELY, PROVIDING A WEBSITE FEATURING NON-DOWNLOADABLE VIDEOS FEATURING PORNOGRAPHIC CONTENT DELIVERED VIA THE INTERNET, IN CLASS 41 (U.S. CLS. 100, 101 AND 107).

FIRST USE 11-3-2008; IN COMMERCE 11-3-2008.



THE MARK CONSISTS OF A STYLIZED TELEVISION WITH A WINKING SMILING FACE TO THE LEFT OF THE WORDING "4TUBE.COM" IN STYLIZED FONT WITH A TADPOLE ABOVE THE WORD PORTION "4TUB" SWIMMING TOWARDS THE TELEVISION. THE COLOR ORANGE APPEARS IN THE TELEVISION AND THE WORD "TUBE". THE COLOR BLACK APPEARS IN THE OUTLINE OF THE TELEVISION, THE OUTLINE OF THE SMILING FACE, THE INSIDE OF THE MOUTH, THE PUPIL OF THE EYE, AND THE NUMBER "4". THE COLOR RED APPEARS IN THE MOUTH IN THE TONGUE. THE COLOR WHITE APPEARS IN THE FACE, THE OPEN EYE, AND THE TEETH. THE COLOR GRAY APPEARS IN THE TADPOLE, THE WORDING ".COM" AND IN THE SHADOWING AROUND THE MARK.

David J. Kyffers

THE COLOR(S) RED, ORANGE, BLACK, WHITE AND GRAY IS/ARE CLAIMED AS A FEATURE OF THE MARK.

Director of the United States Patent and Trademark Office

Reg. No. 4,154,513 SN 77-899,318, FILED 12-22-2009.

TINA BROWN, EXAMINING ATTORNEY

United States of America

United States Patent and Trademark Office

AT DECADE
DENTAL WE'RE
CARING &
WE'RE
WORKING
HARDER TO
MAKE YOUR
TEETH LAST
LONGER!

Reg. No. 4,154,514

Registered June 5, 2012

Int. Cl.: 44

SERVICE MARK

PRINCIPAL REGISTER

DECADE DENTAL (NEW YORK CORPORATION)
230 MINEOLA BLVD.
MINEOLA, NY 11501

FOR: DENTIST SERVICES, IN CLASS 44 (U.S. CLS. 100 AND 101).

FIRST USE 5-1-2009; IN COMMERCE 5-1-2009.

THE MARK CONSISTS OF STANDARD CHARACTERS WITHOUT CLAIM TO ANY PARTICULAR FONT, STYLE, SIZE, OR COLOR.

OWNER OF U.S. REG. NO. 3,869,478.

NO CLAIM IS MADE TO THE EXCLUSIVE RIGHT TO USE "DENTAL", APART FROM THE MARK AS SHOWN.

SN 77-901,383, FILED 12-28-2009.

JASON LOTT, EXAMINING ATTORNEY



David J. Kyros

Director of the United States Patent and Trademark Office

United States of America

United States Patent and Trademark Office

CROSSFIRE

Reg. No. 4,154,515

Registered June 5, 2012

Int. Cl.: 7

TRADEMARK

PRINCIPAL REGISTER

GABRIEL W. SHARP (UNITED STATES INDIVIDUAL), DBA HAY N' SPRAY,
1328 FM 71 W
TALCO, TX 75487

FOR: POWER-OPERATED SPRAYER, IN CLASS 7 (U.S. CLS. 13, 19, 21, 23, 31, 34 AND 35).

FIRST USE 1-0-2012; IN COMMERCE 1-0-2012.

THE MARK CONSISTS OF STANDARD CHARACTERS WITHOUT CLAIM TO ANY PARTICULAR FONT, STYLE, SIZE, OR COLOR.

SN 77-906,949, FILED 1-7-2010.

SUNG IN, EXAMINING ATTORNEY



David J. Kyfos

Director of the United States Patent and Trademark Office

United States of America

United States Patent and Trademark Office

INSPHERE INTOUCH

Reg. No. 4,154,516

Registered June 5, 2012

Int. Cls.: 36 and 42

SERVICE MARK

PRINCIPAL REGISTER

INSPHERE INSURANCE SOLUTIONS, INC. (DELAWARE CORPORATION)
9151 BOULEVARD 26
NORTH RICHLAND HILLS, TX 76180

FOR: PROVIDING INFORMATION REGARDING AGENT SALES FINANCIAL COMPENSATION FOR INSURANCE AGENTS BY MEANS OF A SUPPORT HOTLINE, IN CLASS 36 (U.S. CLS. 100, 101 AND 102).

FIRST USE 12-0-2009; IN COMMERCE 12-0-2009.

FOR: COMPUTER TECHNOLOGY SUPPORT SERVICES, NAMELY, HELP DESK SERVICES FOR INSURANCE AGENTS BY MEANS OF A SUPPORT HOTLINE, IN CLASS 42 (U.S. CLS. 100 AND 101).

FIRST USE 12-0-2009; IN COMMERCE 12-0-2009.

THE MARK CONSISTS OF STANDARD CHARACTERS WITHOUT CLAIM TO ANY PARTICULAR FONT, STYLE, SIZE, OR COLOR.

SN 77-909,027, FILED 1-11-2010.

KHANH LE, EXAMINING ATTORNEY



David J. Kyros

Director of the United States Patent and Trademark Office

United States of America

United States Patent and Trademark Office



Reg. No. 4,154,517

Registered June 5, 2012

Int. Cl.: 28

TRADEMARK

PRINCIPAL REGISTER

LIFESTYLE BRANDS CORPORATION (CANADA CORPORATION)
C/O COLLECTIVE LICENSING INT'L, LLC
800 ENGLEWOOD PARKWAY, SUITE C200
ENGLEWOOD, CO 80110

FOR: SNOWBOARD DECKS; SNOWBOARDS, AND NOT INCLUDING SOCCER BALLS, RUGBY BALLS, VOLLEYBALLS, FOOTBALLS AND WHISTLES" , IN CLASS 28 (U.S. CLS. 22, 23, 38 AND 50).

FIRST USE 11-1-2009; IN COMMERCE 9-1-2010.

THE MARK CONSISTS OF THE WORD "MITEREDGE" TO THE LEFT OF AND BELOW AN IMAGE OF A MITER RULER.

SN 77-910,808, FILED 1-13-2010.

MATTHEW MCDOWELL, EXAMINING ATTORNEY



David J. Kybas

Director of the United States Patent and Trademark Office

United States of America

United States Patent and Trademark Office



Reg. No. 4,154,518

Registered June 5, 2012

Int. Cls.: 16, 18, and 35

TRADEMARK

SERVICE MARK

PRINCIPAL REGISTER

PENNSYLVANIA LIQUOR CONTROL BOARD (PENNSYLVANIA STATE AGENCY)
NORTHWEST OFFICE BUILDING, SUITE 401
HARRISBURG, PA 17124

FOR: PAPER SHOPPING BAGS; PLASTIC SHOPPING BAGS; GIFT CARDS; MAGAZINES
PUBLISHED PERIODICALLY ON THE SUBJECT OF WINE OR SPIRITS, IN CLASS 16 (U.S.
CLS. 2, 5, 22, 23, 29, 37, 38 AND 50).

FIRST USE 5-31-2010; IN COMMERCE 5-31-2010.

FOR: REUSABLE SHOPPING BAGS, CANVAS SHOPPING BAGS; LEATHER SHOPPING
BAGS; MESH SHOPPING BAGS, IN CLASS 18 (U.S. CLS. 1, 2, 3, 22 AND 41).

FIRST USE 5-31-2010; IN COMMERCE 5-31-2010.

FOR: ONLINE RETAIL STORE AND RETAIL STORE SERVICES FEATURING ALCOHOLIC
BEVERAGES, NAMELY, WINE, DISTILLED SPIRITS AND DISTILLED LIQUOR, IN CLASS
35 (U.S. CLS. 100, 101 AND 102).

FIRST USE 5-31-2010; IN COMMERCE 5-31-2010.

OWNER OF U.S. REG. NO. 3,322,730.

NO CLAIM IS MADE TO THE EXCLUSIVE RIGHT TO USE "FINE WINE", "SELECTION"
AND "UNIQUE VINTAGES AT EXCEPTIONAL VALUES", APART FROM THE MARK AS
SHOWN.

THE MARK CONSISTS OF THE WORDS "FINE WINE & GOOD SPIRITS", "CHAIRMAN'S
SELECTION", AND "UNIQUE VINTAGES AT EXCEPTIONAL VALUES", ALL SHOWN IN
A CIRCULAR SEAL DESIGN. THE LETTERS ARE ALL SHOWN IN UPPERCASE FORM.

SN 77-913,082, FILED 1-15-2010.

GILBERT SWIFT, EXAMINING ATTORNEY



David J. Kyros

Director of the United States Patent and Trademark Office

United States of America

United States Patent and Trademark Office

BABE RUTH

Reg. No. 4,154,519

Registered June 5, 2012

Int. Cl.: 25

TRADEMARK

PRINCIPAL REGISTER

TOSETTI, LINDA (UNITED STATES INDIVIDUAL), DBA LEGAL REPRESENTATIVE FOR
THE HEIRS OF DOROTHY RUTH PIRONE,
44 CARRIAGE DRIVE
DURHAM, CT 06422 AND

STEVENS, JULIA RUTH (UNITED STATES INDIVIDUAL)
242 EATON ROAD
CONWAY, NH 03818 AND

BABE RUTH LEAGUE, INC (NEW JERSEY CORPORATION)
1770 BRUSWICK AVENUE P.O. BOX 5000
TRENTON, NJ 08638

FOR: ATHLETIC APPAREL, NAMELY, SHIRTS, PANTS, JACKETS, HATS AND CAPS,
ATHLETIC UNIFORMS; BOTTOMS; JERSEYS; SHORT SETS; T-SHIRTS; TOPS, IN CLASS
25 (U.S. CLS. 22 AND 39).

FIRST USE 4-11-1986, THE MARK WAS FIRST USED ANYWHERE IN A DIFFERENT FORM
OTHER THAN THAT SOUGHT TO BE REGISTERED AT LEAST AS EARLY AS 04/11/1986.;
IN COMMERCE 4-11-1986, THE MARK WAS FIRST USED IN COMMERCE IN A DIFFERENT
FORM OTHER THAN THAT SOUGHT TO BE REGISTERED AT LEAST AS EARLY AS
04/11/1986..

THE MARK CONSISTS OF STANDARD CHARACTERS WITHOUT CLAIM TO ANY PAR-
TICULAR FONT, STYLE, SIZE, OR COLOR.

SEC. 2(F).

OWNER OF U.S. REG. NOS. 614,107, 1,863,687, AND OTHERS.

SN 77-918,479, FILED 1-22-2010.

THOMAS MANOR, EXAMINING ATTORNEY



David J. Kyros

Director of the United States Patent and Trademark Office

United States of America

United States Patent and Trademark Office

ART UNINHIBITED

Reg. No. 4,154,520

Registered June 5, 2012

Int. Cls.: 2 and 16

TRADEMARK

PRINCIPAL REGISTER

SANFORD, L.P. (ILLINOIS LIMITED PARTNERSHIP)
2707 BUTTERFIELD ROAD, SUITE 100
OAK BROOK, IL 60523

FOR: AEROSOL SPRAY COATINGS USED TO ADD TEXTURE TO A PIECE OF ART OR TO PROVIDE A PROTECTIVE FINISH TO A PIECE OF ART, IN CLASS 2 (U.S. CLS. 6, 11 AND 16).

FIRST USE 7-20-2011; IN COMMERCE 7-20-2011.

FOR: ART PRODUCTS, NAMELY, COLORED PENCILS, ERASERS, CHARCOAL PENCILS, SKETCHING PENCILS, PENCIL SHARPENERS, TORTILLIONS IN THE NATURE OF ARTISTS' TOOLS COMPRISED OF A PAPER PENCIL FOR SMUDGING AND BLENDING ARTISTS' DRAWINGS, PENCIL EXTENDERS, ART MARKERS, ILLUSTRATION MARKERS, COLORLESS ART BLENDING MEDIUM IN THE NATURE OF MARKERS; COLORLESS ART BLENDING MEDIUM IN THE NATURE OF PENCILS, ARTIST'S PASTELS, IN CLASS 16 (U.S. CLS. 2, 5, 22, 23, 29, 37, 38 AND 50).

FIRST USE 7-20-2011; IN COMMERCE 7-20-2011.

THE MARK CONSISTS OF STANDARD CHARACTERS WITHOUT CLAIM TO ANY PARTICULAR FONT, STYLE, SIZE, OR COLOR.

NO CLAIM IS MADE TO THE EXCLUSIVE RIGHT TO USE "ART", APART FROM THE MARK AS SHOWN.

SN 77-919,314, FILED 1-25-2010.

Laurie Mayes, Examining Attorney



David J. Kyjars

Director of the United States Patent and Trademark Office

United States of America

United States Patent and Trademark Office

PREVA

Reg. No. 4,154,521

Registered June 5, 2012

Int. Cls.: 9, 28, and 41

TRADEMARK

SERVICE MARK

PRINCIPAL REGISTER

AMER SPORTS INTERNATIONAL OY (FINLAND CORPORATION)
MAKELANKATU 91
HELSINKI, FINLAND 00610

FOR: INTEGRATED MULTI-MEDIA INFORMATION AND ENTERTAINMENT SYSTEMS AND CONTROL SYSTEMS FOR FITNESS MACHINES, NAMELY, PERSONAL VIEWING SCREENS, VIDEO MONITORS, LIQUID CRYSTAL DISPLAYS, TOUCH SCREEN LIQUID CRYSTAL DISPLAYS, SOUND SYSTEMS COMPRISING, REMOTE CONTROLS, AMPLIFIERS, LOUDSPEAKERS AND COMPONENTS THEREFOR, AUDIO SPEAKERS, PDA ELECTRONIC DOCKING STATIONS, RFID PROGRAMMERS IN THE NATURE OF RF READERS AND ACTIVE AND PASSIVE TAGS, COMPUTER SERIAL AND USB PORTS, INDIVIDUAL ELECTRONIC CONTROLLER FOR CONTROLLING FITNESS MACHINES, ELECTRONIC CONTROLS FOR CONTROLLING FITNESS MACHINES, WIRELESS REMOTE CONTROLS FOR FITNESS MACHINES, TELEVISION RECEIVERS, SINGLE AND MULTI-CHANNEL RECEIVERS AND TRANSMITTERS FOR WIRELESS AND ETHERNET INTERNET CONNECTIVITY, AND HEAD PHONE JACKS IN THE NATURE OF SURFACE MOUNTED ELECTRONIC CONNECTORS, IN CLASS 9 (U.S. CLS. 21, 23, 26, 36 AND 38).

FIRST USE 4-1-2011; IN COMMERCE 6-1-2011.

FOR: EXERCISE EQUIPMENT, NAMELY, UPPER AND LOWER BODY CARDIO-VASCULAR EXERCISE CONDITIONING MACHINES, ELLIPTICAL EXERCISE MACHINES, TREADMILLS, EXERCISE CYCLES, STEPPING MACHINES, ROWING MACHINES, WEIGHT LIFTING MACHINES, TORSO-ROTATION EXERCISE MACHINES, TRUNK EXTENSION/FLEXION EXERCISE MACHINES, EXERCISE BENCHES, AND STRETCHING STATIONS, IN CLASS 28 (U.S. CLS. 22, 23, 38 AND 50).

FIRST USE 4-1-2011; IN COMMERCE 6-1-2011.

FOR: PROVIDING FITNESS TRAINING, NAMELY, WORKING WITH INDIVIDUALS AND THIRD PARTIES TO IDENTIFY, CREATE, DELIVER AND RECORD ONE OR MORE PERSONAL FITNESS GOALS AND MOTIVATIONAL CONTENT, CREATING AND DEFINING A FITNESS PROGRAM OR TRAINING PROTOCOLS TAILORED TO AN INDIVIDUAL'S FITNESS LEVEL AND GOALS, ADJUSTING AN INDIVIDUAL'S FITNESS PROGRAM AND TRAINING PROTOCOL, AND TUTORIALS FOR FITNESS EQUIPMENT USE AND FITNESS PROGRAM IMPLEMENTATION, IN CLASS 41 (U.S. CLS. 100, 101 AND 107).



David J. Kyjars

Director of the United States Patent and Trademark Office

Reg. No. 4,154,521 FIRST USE 4-1-2011; IN COMMERCE 6-1-2011.

THE MARK CONSISTS OF STANDARD CHARACTERS WITHOUT CLAIM TO ANY PARTICULAR FONT, STYLE, SIZE, OR COLOR.

SN 77-919,500, FILED 1-25-2010.

RAMONA ORTIGA, EXAMINING ATTORNEY

United States of America

United States Patent and Trademark Office

Jay Sean

Reg. No. 4,154,522

Registered June 5, 2012

Int. Cls.: 9, 25, and 41

TRADEMARK

SERVICE MARK

PRINCIPAL REGISTER

FATTY LE ROCK LLC (NEW JERSEY LIMITED LIABILITY COMPANY)
I/C/O SEDESH DOOBAY
1091 LAMBERT ROAD
TEANECK, NJ 07666

FOR: PRE-RECORDED AUDIO AND VIDEO GOODS IN THE NATURE OF RECORDS, TAPES, DISCS, AND COMPUTER FILE FORMATS OF MP3, M4A, WMA, WAV, MP4, AVI AND WMV FILES, FEATURING MUSICAL ENTERTAINMENT, IN CLASS 9 (U.S. CLS. 21, 23, 26, 36 AND 38).

FIRST USE 12-30-2003; IN COMMERCE 5-28-2005.

FOR: CLOTHING AND MERCHANDISE, NAMELY, SHIRTS, PANTS FOR MALES AND FEMALES, IN CLASS 25 (U.S. CLS. 22 AND 39).

FIRST USE 12-30-2003; IN COMMERCE 5-28-2005.

FOR: LIVE ARTS AND ENTERTAINMENT PERFORMANCES, NAMELY, MUSICAL PERFORMANCES, IN CLASS 41 (U.S. CLS. 100, 101 AND 107).

FIRST USE 12-30-2003; IN COMMERCE 5-28-2005.

THE MARK CONSISTS OF STANDARD CHARACTERS WITHOUT CLAIM TO ANY PARTICULAR FONT, STYLE, SIZE, OR COLOR.

THE NAME "JAY SEAN" IDENTIFIES A LIVING INDIVIDUAL WHO CONSENTS TO THE REGISTRATION OF THIS MARK.

SN 77-920,893, FILED 1-26-2010.

EUGENIA MARTIN, EXAMINING ATTORNEY



David J. Kyros

Director of the United States Patent and Trademark Office

United States of America

United States Patent and Trademark Office

SCRUM ALLIANCE REP

Reg. No. 4,154,523

Registered June 5, 2012

Int. Cls.: 41 and 42

SERVICE MARK

PRINCIPAL REGISTER

SCRUM ALLIANCE, INC. (COLORADO CORPORATION)
P.O. BOX 40097
INDIANAPOLIS, IN 462400097

FOR: TRAINING, MENTORING, AND TUTORING SERVICES IN THE FIELDS OF PRODUCT DEVELOPMENT, PRODUCT DESIGN, PROJECT MANAGEMENT, PRODUCT DEVELOPMENT CONSULTATION, PRODUCT MANUFACTURING CONSULTATION, COMPUTER SOFTWARE DEVELOPMENT AND COMPUTER SOFTWARE DEVELOPMENT MANAGEMENT; EDUCATIONAL SERVICES, NAMELY, CONDUCTING CLASSES, SEMINARS, AND WORKSHOPS IN THE FIELDS OF PRODUCT DEVELOPMENT, PRODUCT DESIGN, PROJECT MANAGEMENT, PRODUCT DEVELOPMENT CONSULTATION, PRODUCT MANUFACTURING CONSULTATION, COMPUTER SOFTWARE DEVELOPMENT AND COMPUTER SOFTWARE DEVELOPMENT MANAGEMENT, IN CLASS 41 (U.S. CLS. 100, 101 AND 107).

FIRST USE 7-0-2010; IN COMMERCE 7-0-2010.

FOR: PROVIDING INFORMATION IN THE FIELDS OF PRODUCT DEVELOPMENT, PRODUCT DESIGN, SOFTWARE PROJECT MANAGEMENT, PRODUCT DEVELOPMENT CONSULTATION, COMPUTER SOFTWARE DEVELOPMENT AND COMPUTER SOFTWARE DEVELOPMENT MANAGEMENT; ANALYSIS AND EVALUATION OF SOFTWARE PROJECT AND PRODUCT DEVELOPMENT, DESIGN, AND MANAGEMENT PROCESSES UNDERTAKEN BY OTHERS, FOR PURPOSES OF CERTIFICATION, IN CLASS 42 (U.S. CLS. 100 AND 101).

FIRST USE 7-0-2010; IN COMMERCE 7-0-2010.

THE MARK CONSISTS OF STANDARD CHARACTERS WITHOUT CLAIM TO ANY PARTICULAR FONT, STYLE, SIZE, OR COLOR.

SEC. 2(F) AS TO "SCRUM ALLIANCE".

OWNER OF U.S. REG. NOS. 3,529,737, 3,738,535, AND OTHERS.

NO CLAIM IS MADE TO THE EXCLUSIVE RIGHT TO USE "REP", APART FROM THE MARK AS SHOWN.

SN 77-923,574, FILED 1-29-2010.



David J. Kyros

Director of the United States Patent and Trademark Office

Reg. No. 4,154,523 PAM WILLIS, EXAMINING ATTORNEY

United States of America

United States Patent and Trademark Office

SCRUM ALLIANCE REP

Reg. No. 4,154,524

Registered June 5, 2012

**COLLECTIVE
MEMBERSHIP**

PRINCIPAL REGISTER

SCRUM ALLIANCE, INC. (COLORADO CORPORATION)
P.O. BOX 40097
INDIANAPOLIS, IN 462400097

FOR: INDICATING MEMBERSHIP IN A(N) ORGANIZATION OF PRODUCT AND SOFTWARE DEVELOPMENT TRAINERS AND EDUCATORS, IN CLASS 200 (U.S. CL. 200).

FIRST USE 7-0-2010; IN COMMERCE 7-0-2010.

THE MARK CONSISTS OF STANDARD CHARACTERS WITHOUT CLAIM TO ANY PARTICULAR FONT, STYLE, SIZE, OR COLOR.

SEC. 2(F) AS TO "SCRUM ALLIANCE"..

OWNER OF U.S. REG. NOS. 3,529,737, 3,738,535, AND OTHERS.

NO CLAIM IS MADE TO THE EXCLUSIVE RIGHT TO USE "REP", APART FROM THE MARK AS SHOWN.

SN 77-923,582, FILED 1-29-2010.

PAM WILLIS, EXAMINING ATTORNEY



David J. Kyffers

Director of the United States Patent and Trademark Office

United States of America

United States Patent and Trademark Office

FOCUS:

Reg. No. 4,154,525

Registered June 5, 2012

Int. Cl.: 16

TRADEMARK

PRINCIPAL REGISTER

STERLING PUBLISHING CO., INC. (DELAWARE CORPORATION)
387 PARK AVENUE SOUTH
NEW YORK, NY 10016

FOR: PUBLICATIONS, NAMELY, A SERIES OF BOOKS FEATURING PHOTOGRAPHS ON A VARIETY OF THEMES AND TOPICS, IN CLASS 16 (U.S. CLS. 2, 5, 22, 23, 29, 37, 38 AND 50).

FIRST USE 3-31-2010; IN COMMERCE 3-31-2010.

THE MARK CONSISTS OF THE WORD "FOCUS:" WITH THE LETTER "O" FORMING A CAMERA LENS.

SN 77-927,961, FILED 2-4-2010.

MAYUR VAGHANI, EXAMINING ATTORNEY



David J. Kybas

Director of the United States Patent and Trademark Office

United States of America

United States Patent and Trademark Office

CLEARWATER NATIVE PLANT NURSERY

Reg. No. 4,154,526

Registered June 5, 2012

Int. Cl.: 31

TRADEMARK

PRINCIPAL REGISTER

LATTIG, MICHAEL D. (UNITED STATES INDIVIDUAL), DBA CLEARWATER NATIVE NURSERY,
1980 SW 55TH STREET
REDMOND, OR 97756

FOR: LIVE SHRUBS; LIVE TREES; NATURAL PLANTS AND FLOWERS, IN CLASS 31 (U.S. CLS. 1 AND 46).

FIRST USE 6-1-2002; IN COMMERCE 6-1-2002.

THE MARK CONSISTS OF STANDARD CHARACTERS WITHOUT CLAIM TO ANY PARTICULAR FONT, STYLE, SIZE, OR COLOR.

NO CLAIM IS MADE TO THE EXCLUSIVE RIGHT TO USE "NATIVE PLANT NURSERY", APART FROM THE MARK AS SHOWN.

SN 77-929,462, FILED 2-5-2010.

ROBERT STRUCK, EXAMINING ATTORNEY



David J. Kyffers

Director of the United States Patent and Trademark Office

United States of America

United States Patent and Trademark Office

THREE OLIVES SUPERCOLA

Reg. No. 4,154,527

Registered June 5, 2012

Int. Cl.: 33

TRADEMARK

PRINCIPAL REGISTER

PROXIMO SPIRITS, INC. (NEW JERSEY CORPORATION)
333 WASHINGTON STREET
JERSEY CITY, NJ 07302

FOR: VODKA WITH A COLA FLAVOR, IN CLASS 33 (U.S. CLS. 47 AND 49).

FIRST USE 2-6-2012; IN COMMERCE 2-6-2012.

THE MARK CONSISTS OF STANDARD CHARACTERS WITHOUT CLAIM TO ANY PARTICULAR FONT, STYLE, SIZE, OR COLOR.

OWNER OF U.S. REG. NOS. 3,253,658, 3,559,615, AND OTHERS.

SN 77-929,627, FILED 2-5-2010.

TAMARA FRAZIER, EXAMINING ATTORNEY



David J. Kyffers

Director of the United States Patent and Trademark Office

United States of America

United States Patent and Trademark Office

STAGING GRACE

Reg. No. 4,154,528

Registered June 5, 2012

Int. Cl.: 42

SERVICE MARK

PRINCIPAL REGISTER

ABRANOVIC, SUSAN J. (UNITED STATES INDIVIDUAL), FORMERLY LAGROSA, SUSAN J.,
332 FOREST GLEN AVE.
FRANKLIN LAKES, NJ 07417

FOR: HOME STAGING CONSULTATION, NAMELY, TEMPORARY INTERIOR AND EXTERIOR HOME DECORATION CONSULTATION FOR THE PURPOSE OF MAKING HOMES MORE APPEALING TO PROSPECTIVE BUYERS, IN CLASS 42 (U.S. CLS. 100 AND 101).

FIRST USE 2-1-2010; IN COMMERCE 2-15-2012.

THE MARK CONSISTS OF STANDARD CHARACTERS WITHOUT CLAIM TO ANY PARTICULAR FONT, STYLE, SIZE, OR COLOR.

NO CLAIM IS MADE TO THE EXCLUSIVE RIGHT TO USE "STAGING", APART FROM THE MARK AS SHOWN.

SN 77-930,677, FILED 2-8-2010.

REBECCA SMITH, EXAMINING ATTORNEY



David J. Kybas

Director of the United States Patent and Trademark Office

United States of America

United States Patent and Trademark Office

HONEYWELL FIELD ADVISOR

Reg. No. 4,154,529

Registered June 5, 2012

Int. Cl.: 9

TRADEMARK

PRINCIPAL REGISTER

HONEYWELL INTERNATIONAL INC. (DELAWARE CORPORATION)
101 COLUMBIA ROAD
MORRISTOWN, NJ 07962

FOR: COMPUTER HARDWARE; COMPUTER SOFTWARE FOR USE IN CONNECTION WITH INDUSTRIAL PROCESS CONTROL SYSTEMS, NAMELY, SOFTWARE THAT RECORDS, ANALYZES, AND REPORTS WORKFLOW DATA FROM REMOTE LOCATIONS TO PLANT TECHNICIANS, ENGINEERS AND MANAGERS AND MAKES RECOMMENDATIONS FOR INCREASING PRODUCTIVITY, EFFICIENCY, SAFETY, AND RELIABILITY, IN CLASS 9 (U.S. CLS. 21, 23, 26, 36 AND 38).

FIRST USE 6-30-2010; IN COMMERCE 12-31-2011.

THE MARK CONSISTS OF STANDARD CHARACTERS WITHOUT CLAIM TO ANY PARTICULAR FONT, STYLE, SIZE, OR COLOR.

NO CLAIM IS MADE TO THE EXCLUSIVE RIGHT TO USE "FIELD ADVISOR", APART FROM THE MARK AS SHOWN.

SN 77-930,738, FILED 2-8-2010.

EDWARD FENNESSY, EXAMINING ATTORNEY



David J. Kyros

Director of the United States Patent and Trademark Office

United States of America

United States Patent and Trademark Office

B 21

Reg. No. 4,154,530

Registered June 5, 2012

Int. Cl.: 43

SERVICE MARK

PRINCIPAL REGISTER

THE MELTING POT RESTAURANTS, INC. (FLORIDA CORPORATION)
8810 TWIN LAKES BLVD.
TAMPA, FL 33614

FOR: RESTAURANT SERVICES, IN CLASS 43 (U.S. CLS. 100 AND 101).

FIRST USE 1-7-2011; IN COMMERCE 1-7-2011.

THE MARK CONSISTS OF STANDARD CHARACTERS WITHOUT CLAIM TO ANY PARTICULAR FONT, STYLE, SIZE, OR COLOR.

SN 77-931,341, FILED 2-9-2010.

TRACY WHITTAKER-BROWN, EXAMINING ATTORNEY



David J. Kybas

Director of the United States Patent and Trademark Office

United States of America

United States Patent and Trademark Office



Welcome Rewards

Reg. No. 4,154,531

Registered June 5, 2012

Int. Cl.: 35

SERVICE MARK

PRINCIPAL REGISTER

HOTELS.COM, LP (TEXAS LIMITED PARTNERSHIP)
10440 N. CENTRAL EXPRESSWAY
DALLAS, TX 75231

FOR: CONDUCTING INCENTIVE AWARD PROGRAMS TO PROMOTE THE SALE OF ACCOMMODATIONS, HOTEL AND MOTEL ROOMS; CONSUMER LOYALTY SERVICES FOR COMMERCIAL, PROMOTIONAL, AND ADVERTISING PURPOSES, NAMELY, ADMINISTRATION OF FREQUENT TRAVELER PROGRAM; CUSTOMER LOYALTY SERVICES AND CUSTOMER CLUB SERVICES, FOR COMMERCIAL, PROMOTIONAL AND/OR ADVERTISING PURPOSES, IN CLASS 35 (U.S. CLS. 100, 101 AND 102).

FIRST USE 8-0-2009; IN COMMERCE 8-0-2009.

OWNER OF U.S. REG. NOS. 3,719,415 AND 3,723,187.

NO CLAIM IS MADE TO THE EXCLUSIVE RIGHT TO USE "REWARDS", APART FROM THE MARK AS SHOWN.

THE MARK CONSISTS OF THE DESIGN OF A GIFT BOX APPEARING BETWEEN "WELCOME" AND "REWARDS".

SN 77-931,429, FILED 2-9-2010.

LESLEY LAMOTHE, EXAMINING ATTORNEY



David J. Kyros

Director of the United States Patent and Trademark Office

United States of America

United States Patent and Trademark Office

TIKATOK

Reg. No. 4,154,532

BARNESANDNOBLE.COM LLC (DELAWARE LIMITED LIABILITY COMPANY)
76 9TH AVENUE
NEW YORK, NY 10011

Registered June 5, 2012

**Int. Cls.: 9, 16, 41, and
42**

FOR: ELECTRONIC PUBLICATIONS, NAMELY, ELECTRONIC BOOKS ON CHILDREN'S EXPERIENCES AND CREATED BY CHILDREN RECORDED ON COMPUTER MEDIA, IN CLASS 9 (U.S. CLS. 21, 23, 26, 36 AND 38).

TRADEMARK

FIRST USE 10-31-2009; IN COMMERCE 10-31-2009.

SERVICE MARK

FOR: PUBLICATIONS, NAMELY, SERIES OF FICTION BOOKS AND SERIES OF NON-FICTION BOOKS ON CHILDREN'S EXPERIENCES AND CREATED BY CHILDREN, IN CLASS 16 (U.S. CLS. 2, 5, 22, 23, 29, 37, 38 AND 50).

PRINCIPAL REGISTER

FIRST USE 10-31-2009; IN COMMERCE 10-31-2009.

FOR: BOOK PUBLISHING SERVICES; ONLINE ELECTRONIC PUBLISHING OF BOOKS, IN CLASS 41 (U.S. CLS. 100, 101 AND 107).

FIRST USE 10-31-2009; IN COMMERCE 10-31-2009.

FOR: PROVIDING A WEB-BASED SERVICE FEATURING TECHNOLOGY THAT ENABLES USERS TO MANAGE THE PRODUCTION AND PUBLICATION OF ELECTRONIC BOOKS (E-BOOKS), HARD AND SOFTCOVER BOOKS AND RELATED DIGITAL CONTENT AND OFFER THEM FOR SALE TO THE GENERAL PUBLIC, IN CLASS 42 (U.S. CLS. 100 AND 101).

FIRST USE 10-31-2009; IN COMMERCE 10-31-2009.

THE MARK CONSISTS OF STANDARD CHARACTERS WITHOUT CLAIM TO ANY PARTICULAR FONT, STYLE, SIZE, OR COLOR.

THE WORDING "TIKATOK" HAS NO MEANING IN A FOREIGN LANGUAGE.

SN 77-934,299, FILED 2-12-2010.

HOWARD FRIEDMAN, EXAMINING ATTORNEY



David J. Kyros

Director of the United States Patent and Trademark Office

United States of America

United States Patent and Trademark Office



Reg. No. 4,154,533

Registered June 5, 2012

Int. Cls.: 9, 16, 41, and 42

TRADEMARK

SERVICE MARK

PRINCIPAL REGISTER

BARNESANDNOBLE.COM LLC (DELAWARE LIMITED LIABILITY COMPANY)
76 9TH AVENUE
NEW YORK, NY 10011

FOR: ELECTRONIC PUBLICATIONS, NAMELY, ELECTRONIC BOOKS ON CHILDREN'S EXPERIENCES AND CREATED BY CHILDREN RECORDED ON COMPUTER MEDIA, IN CLASS 9 (U.S. CLS. 21, 23, 26, 36 AND 38).

FIRST USE 10-31-2009; IN COMMERCE 10-31-2009.

FOR: PUBLICATIONS, NAMELY, SERIES OF FICTION BOOKS AND SERIES OF NON-FICTION BOOKS ON CHILDREN'S EXPERIENCES AND CREATED BY CHILDREN, IN CLASS 16 (U.S. CLS. 2, 5, 22, 23, 29, 37, 38 AND 50).

FIRST USE 10-31-2009; IN COMMERCE 10-31-2009.

FOR: BOOK PUBLISHING SERVICES; ONLINE ELECTRONIC PUBLISHING OF BOOKS, IN CLASS 41 (U.S. CLS. 100, 101 AND 107).

FIRST USE 10-31-2009; IN COMMERCE 10-31-2009.

FOR: PROVIDING A WEB-BASED SERVICE FEATURING TECHNOLOGY THAT ENABLES USERS TO MANAGE THE PRODUCTION AND PUBLICATION OF ELECTRONIC BOOKS (E-BOOKS), HARD AND SOFTCOVER BOOKS AND RELATED DIGITAL CONTENT AND OFFER THEM FOR SALE TO THE GENERAL PUBLIC, IN CLASS 42 (U.S. CLS. 100 AND 101).

FIRST USE 10-31-2009; IN COMMERCE 10-31-2009.

THE MARK CONSISTS OF THE WORD "TIKATOK" IN WHITE LETTERS WITHIN OVERLAPPING VERTICAL COLORED RECTANGLES, WITH SEVEN RECTANGLES OF DIFFERENT LENGTHS AND COLOR. THE COLORED RECTANGLES ARE ARRANGED AT AN ANGLE AND APPEAR IN THE COLOR ORDER, FROM LEFT TO RIGHT, RED, YELLOW, BLUE, PINK, PURPLE, LIGHT BLUE, AND VIOLET.

THE COLOR(S) RED, YELLOW, BLUE, PINK, PURPLE, LIGHT BLUE, VIOLET AND WHITE IS/ARE CLAIMED AS A FEATURE OF THE MARK.



David J. Kappas

Director of the United States Patent and Trademark Office

Reg. No. 4,154,533 THE WORDING "TIKATOK" HAS NO MEANING IN A FOREIGN LANGUAGE.

SN 77-934,305, FILED 2-12-2010.

HOWARD FRIEDMAN, EXAMINING ATTORNEY

United States of America

United States Patent and Trademark Office

POP UP COUTURE

Reg. No. 4,154,534

JUDY B. SWARTZ (UNITED STATES INDIVIDUAL)
705 HUNTLEY DRIVE
WEST HOLLYWOOD, CA 90069

Registered June 5, 2012

Int. Cl.: 25

FOR: CLOTHING, NAMELY, T-SHIRTS, BLOUSES, DRESSES, JEANS, PANTS, SHORTS, SKIRTS, SWEATERS, VESTS, HATS, IN CLASS 25 (U.S. CLS. 22 AND 39).

TRADEMARK

FIRST USE 9-12-2010; IN COMMERCE 9-12-2010.

PRINCIPAL REGISTER

THE MARK CONSISTS OF STANDARD CHARACTERS WITHOUT CLAIM TO ANY PARTICULAR FONT, STYLE, SIZE, OR COLOR.

NO CLAIM IS MADE TO THE EXCLUSIVE RIGHT TO USE "COUTURE", APART FROM THE MARK AS SHOWN.

SN 77-939,308, FILED 2-18-2010.

KAELIE KUNG, EXAMINING ATTORNEY



David J. Kybas

Director of the United States Patent and Trademark Office

United States of America

United States Patent and Trademark Office

INTEGRA-VOTE

Reg. No. 4,154,535

ADVANCED BALLOT SOLUTIONS LLC (DELAWARE LIMITED LIABILITY COMPANY)
11208 JOHN GAULT BOULEVARD
OMAHA, NE 68137

Registered June 5, 2012

Int. Cl.: 35

FOR: ELECTION DATA PROCESSING SERVICES, NAMELY, PROCESSING OF ELECTION BALLOTS, IN CLASS 35 (U.S. CLS. 100, 101 AND 102).

SERVICE MARK

FIRST USE 8-31-2010; IN COMMERCE 8-31-2010.

PRINCIPAL REGISTER

THE MARK CONSISTS OF STANDARD CHARACTERS WITHOUT CLAIM TO ANY PARTICULAR FONT, STYLE, SIZE, OR COLOR.

SN 77-940,327, FILED 2-19-2010.

ELIZABETH KAJUBI, EXAMINING ATTORNEY



David J. Kybas

Director of the United States Patent and Trademark Office

United States of America

United States Patent and Trademark Office



Reg. No. 4,154,536

Registered June 5, 2012

Int. Cl.: 30

TRADEMARK

PRINCIPAL REGISTER

ODZA, AGIM TONY (UNITED STATES INDIVIDUAL)
SUITE 212
804 SOUTH CENTRAL EXPRESSWAY
ANNA, TX 75409

FOR: SALAD DRESSINGS, IN CLASS 30 (U.S. CL. 46).

FIRST USE 5-0-2010; IN COMMERCE 5-0-2010.

NO CLAIM IS MADE TO THE EXCLUSIVE RIGHT TO USE "HOUSE ITALIAN DRESSING", APART FROM THE MARK AS SHOWN.

THE MARK CONSISTS OF THE PROMINENT WORDING "TONY'S OWN", ABOVE THE WORDING "HOUSE ITALIAN", ABOVE THE WORD "DRESSING", ABOVE THE WORDING "CHI MANGIA BENE VIVE BENE".

THE ENGLISH TRANSLATION OF "CHI MANGIA BENE VIVE BENE" IN THE MARK IS WHO EATS WELL LIVES WELL.

SN 77-940,718, FILED 2-20-2010.

JOHN DWYER, EXAMINING ATTORNEY



David J. Kyros

Director of the United States Patent and Trademark Office

United States of America

United States Patent and Trademark Office

BLOGALICIOUS

Reg. No. 4,154,537

Registered June 5, 2012

Int. Cl.: 41

SERVICE MARK

PRINCIPAL REGISTER

MAMALAW MEDIA GROUP (FLORIDA PARTNERSHIP)
C/O STACEY FERGUSON
1300 XAVERIA DRIVE
SILVER SPRING, MD 20903

FOR: ONLINE JOURNALS, NAMELY, BLOGS FEATURING CONTENT RELATED TO TOPICS CONCERNING WOMEN, MARRIAGE, PARENTING, FAMILY, PERSONAL RELATIONSHIPS, HEALTH, WELLNESS, FITNESS, CAREERS AND WORK-LIFE BALANCE, FASHION, ENTREPRENEURSHIP AND BUSINESS, PERSONAL FINANCE, POLITICS, RELIGION, TECHNOLOGY, TRAVEL AND ENTERTAINMENT, RECREATION, AND ISSUES OF INTEREST TO FEMALE BLOGGERS; PROVIDING INFORMATION, NEWS, AND COMMENTARY IN THE FIELD OF SOCIAL MEDIA, ESSAY FICTION, AND NON-FICTION WRITING, AND JOURNALISM; EDUCATIONAL AND EVENT SERVICES, NAMELY, CONDUCTING SEMINARS, CONFERENCES, WORKSHOPS, AND SOCIAL EVENTS FOCUSING ON DIVERSITY IN SOCIAL MEDIA, MARKETING TO WOMEN OF COLOR, AND TOPICS CONCERNING WOMEN BLOGGERS, IN CLASS 41 (U.S. CLS. 100, 101 AND 107).

FIRST USE 5-0-2009; IN COMMERCE 5-0-2009.

THE MARK CONSISTS OF STANDARD CHARACTERS WITHOUT CLAIM TO ANY PARTICULAR FONT, STYLE, SIZE, OR COLOR.

SN 77-940,935, FILED 2-21-2010.

CHRIS WELLS, EXAMINING ATTORNEY



David J. Kybas

Director of the United States Patent and Trademark Office

United States of America

United States Patent and Trademark Office

ASI

Reg. No. 4,154,538

Registered June 5, 2012

Int. Cl.: 9

TRADEMARK

PRINCIPAL REGISTER

AZZURRO SYSTEMS INTEGRATION LLC (NEW JERSEY LIMITED LIABILITY COMPANY)
260 UNION STREET
NORTHVALE, NJ 07647

FOR: VIDEO AND AUDIO PRODUCTION, POST-PRODUCTION, BROADCAST AND TRANSMISSION EQUIPMENT, NAMELY, VIDEO CAMERAS, TELECINES, ELECTRONIC SWITCHERS FOR AUDIO AND VIDEO SIGNALS, AUDIO MIXERS, DIGITAL-TO-ANALOG AND ANALOG-TO-DIGITAL SIGNAL CONVERTERS, VIDEO GRAPHICS GENERATORS AND ANALOG TO HIGH-DEFINITION CONVERTERS AND MONITORS, IN CLASS 9 (U.S. CLS. 21, 23, 26, 36 AND 38).

FIRST USE 12-31-2008; IN COMMERCE 12-31-2008.

THE MARK CONSISTS OF STANDARD CHARACTERS WITHOUT CLAIM TO ANY PARTICULAR FONT, STYLE, SIZE, OR COLOR.

SN 77-941,218, FILED 2-22-2010.

EDWARD NELSON, EXAMINING ATTORNEY



David J. Kyffers

Director of the United States Patent and Trademark Office

United States of America

United States Patent and Trademark Office

Z MEDIA

Reg. No. 4,154,539

SCHROEDER INDUSTRIES (PENNSYLVANIA CORPORATION)
580 WEST PARK ROAD
LEETSDALE, PA 15056

Registered June 5, 2012

Int. Cl.: 11

FOR: SYNTHETIC FILTERING MEDIA FOR GENERAL INDUSTRIAL USE IN THE PURIFICATION OF AIR AND INDUSTRIAL FLUIDS, IN CLASS 11 (U.S. CLS. 13, 21, 23, 31 AND 34).

TRADEMARK

FIRST USE 3-16-2000; IN COMMERCE 3-16-2000.

PRINCIPAL REGISTER

THE MARK CONSISTS OF STANDARD CHARACTERS WITHOUT CLAIM TO ANY PARTICULAR FONT, STYLE, SIZE, OR COLOR.

NO CLAIM IS MADE TO THE EXCLUSIVE RIGHT TO USE "MEDIA", APART FROM THE MARK AS SHOWN.

THE WORDING "Z MEDIA" HAS NO MEANING IN A FOREIGN LANGUAGE.

SN 77-941,488, FILED 2-22-2010.

HOWARD SMIGA, EXAMINING ATTORNEY



David J. Kybas

Director of the United States Patent and Trademark Office

United States of America

United States Patent and Trademark Office

THINK SAFE, WORK SAFE, BE
SAFE

Reg. No. 4,154,540

Registered June 5, 2012

Int. Cls.: 37 and 40

SERVICE MARK

PRINCIPAL REGISTER

J.V. DRIVER CORPORATION INC. (CANADA CORPORATION)
3601 - 82 AVENUE
LEDUC, ALBERTA, CANADA T9E0H7

FOR: INDUSTRIAL CONSTRUCTION SERVICES, NAMELY, CONSTRUCTION AND MAINTENANCE OF INDUSTRIAL PLANTS, COMMERCIAL BUILDINGS, WAREHOUSES, ROADS AND STREETS; CIVIL AND STRUCTURAL CONSTRUCTION SERVICES, NAMELY, PROVISION OF EARTHWORKS, CONCRETE, REBAR, STRUCTURAL STEEL; ELECTRICAL AND INSTRUMENTATION SERVICES, NAMELY, MAINTENANCE OF OPERATING PLANTS AND GENERAL INDUSTRIAL INSTALLATIONS; REFRACTORY AND TILE INSTALLATION SERVICES; CRANE RENTAL AND LEASING FOR CONSTRUCTION PURPOSES; CONSTRUCTION SUPERVISION, NAMELY, PROVIDING MANPOWER SERVICES; AND CONSTRUCTION PLANNING AND CONSULTING SERVICES, IN CLASS 37 (U.S. CLS. 100, 103 AND 106).

FIRST USE 8-30-2000; IN COMMERCE 3-31-2010.

FOR: CUSTOM FABRICATION OF TANK AND PRESSURE VESSELS, PIPES AND METAL; MACHINE SHOP SERVICES, NAMELY, MACHINING PARTS FOR OTHERS, IN CLASS 40 (U.S. CLS. 100, 103 AND 106).

FIRST USE 8-30-2000; IN COMMERCE 3-31-2010.

THE MARK CONSISTS OF STANDARD CHARACTERS WITHOUT CLAIM TO ANY PARTICULAR FONT, STYLE, SIZE, OR COLOR.

SN 77-941,639, FILED 2-22-2010.

ANNE E. GUSTASON, EXAMINING ATTORNEY



David J. Kyros

Director of the United States Patent and Trademark Office

United States of America
United States Patent and Trademark Office

GEOSEAL

Reg. No. 4,154,541

Registered June 5, 2012

Int. Cl.: 7

TRADEMARK

PRINCIPAL REGISTER

SCHROEDER INDUSTRIES (PENNSYLVANIA CORPORATION)
580 WEST PARK ROAD
LEETSDALE, PA 15056

FOR: FILTER ELEMENT BUSHING FOR RECEIVING A DROP IN FILTER ELEMENT FOR GENERAL INDUSTRIAL USE FOR THE PURIFICATION OF AIR AND INDUSTRIAL FLUIDS; FILTER ASSEMBLY HAVING DROP IN FILTER ELEMENT FOR GENERAL INDUSTRIAL USE FOR THE PURIFICATION OF AIR AND INDUSTRIAL FLUIDS, IN CLASS 7 (U.S. CLS. 13, 19, 21, 23, 31, 34 AND 35).

FIRST USE 12-6-2010; IN COMMERCE 12-6-2010.

THE MARK CONSISTS OF STANDARD CHARACTERS WITHOUT CLAIM TO ANY PARTICULAR FONT, STYLE, SIZE, OR COLOR.

THE WORDING "GEOSEAL" HAS NO MEANING IN A FOREIGN LANGUAGE.

SN 77-942,081, FILED 2-23-2010.

HOWARD SMIGA, EXAMINING ATTORNEY



David J. Kybas

Director of the United States Patent and Trademark Office

United States of America

United States Patent and Trademark Office

FRESHLY WILD SUPER FOODS

Reg. No. 4,154,542

FRESHLY WILD, INC. (OREGON CORPORATION)
1631 NE BROADWAY, PMB 728
PORTLAND, OR 97232

Registered June 5, 2012

Int. Cl.: 29

FOR: VEGETABLE CHIPS AND CRISPS, IN CLASS 29 (U.S. CL. 46).

TRADEMARK

FIRST USE 3-31-2012; IN COMMERCE 3-31-2012.

PRINCIPAL REGISTER

THE MARK CONSISTS OF STANDARD CHARACTERS WITHOUT CLAIM TO ANY PARTICULAR FONT, STYLE, SIZE, OR COLOR.

NO CLAIM IS MADE TO THE EXCLUSIVE RIGHT TO USE "SUPER FOODS", APART FROM THE MARK AS SHOWN.

SN 77-943,082, FILED 2-23-2010.

CAROLINE WOOD, EXAMINING ATTORNEY



David J. Kyffers

Director of the United States Patent and Trademark Office

United States of America

United States Patent and Trademark Office

Healthy CFL

Reg. No. 4,154,543

Registered June 5, 2012

Int. Cl.: 11

TRADEMARK

PRINCIPAL REGISTER

PURELY ENTERPRISES, LLC (TENNESSEE LIMITED LIABILITY COMPANY)
10301 COGDILL ROAD, SUITE 310
KNOXVILLE, TN 37932

FOR: AIR PURIFYING, COMPACT FLUORESCENT LIGHT BULBS THAT INCORPORATE BUILT-IN NEGATIVE ION GENERATORS TO ATTRACT POSITIVELY CHARGED AIRBORNE ALLERGENS FOR THE TREATMENT AND PURIFICATION OF AMBIENT AIR, IN CLASS 11 (U.S. CLS. 13, 21, 23, 31 AND 34).

FIRST USE 11-1-2010; IN COMMERCE 11-1-2010.

THE MARK CONSISTS OF STANDARD CHARACTERS WITHOUT CLAIM TO ANY PARTICULAR FONT, STYLE, SIZE, OR COLOR.

NO CLAIM IS MADE TO THE EXCLUSIVE RIGHT TO USE "CFL", APART FROM THE MARK AS SHOWN.

SN 77-946,266, FILED 2-26-2010.

TIMOTHY FINNEGAN, EXAMINING ATTORNEY



David J. Kyros

Director of the United States Patent and Trademark Office

United States of America

United States Patent and Trademark Office

EZCELLS

Reg. No. 4,154,544

CHANTEST CORPORATION (OHIO CORPORATION)
14656 NEO PARKWAY
CLEVELAND, OH 44128

Registered June 5, 2012

Int. Cl.: 1

FOR: CELLS FOR SCIENTIFIC, LABORATORY OR MEDICAL RESEARCH, IN CLASS 1
(U.S. CLS. 1, 5, 6, 10, 26 AND 46).

TRADEMARK

FIRST USE 4-7-2008; IN COMMERCE 4-7-2008.

PRINCIPAL REGISTER

THE MARK CONSISTS OF STANDARD CHARACTERS WITHOUT CLAIM TO ANY PARTICULAR FONT, STYLE, SIZE, OR COLOR.

SN 77-947,399, FILED 3-1-2010.

AMY HELLA, EXAMINING ATTORNEY



David J. Kybas

Director of the United States Patent and Trademark Office

United States of America

United States Patent and Trademark Office

EVERPOINT

Reg. No. 4,154,545

JOHNSON & JOHNSON (NEW JERSEY CORPORATION)
ONE JOHNSON & JOHNSON PLAZA
NEW BRUNSWICK, NJ 089337001

Registered June 5, 2012

Int. Cl.: 10

FOR: SUTURE NEEDLES AND NEEDLES SOLD AS AN INTEGRAL COMPONENT OF A SUTURE, IN CLASS 10 (U.S. CLS. 26, 39 AND 44).

TRADEMARK

FIRST USE 2-2-2012; IN COMMERCE 2-2-2012.

PRINCIPAL REGISTER

THE MARK CONSISTS OF STANDARD CHARACTERS WITHOUT CLAIM TO ANY PARTICULAR FONT, STYLE, SIZE, OR COLOR.

SN 77-948,178, FILED 3-2-2010.

YAT SYE, LEE, EXAMINING ATTORNEY



David J. Kyffers

Director of the United States Patent and Trademark Office

United States of America

United States Patent and Trademark Office

GEN-7

Reg. No. 4,154,546

Registered June 5, 2012

Int. Cls.: 6 and 40

TRADEMARK

SERVICE MARK

PRINCIPAL REGISTER

AMERICAN MODULAR SYSTEMS, INC. (CALIFORNIA CORPORATION)
787 SPRECKELS AVENUE
MANTECA, CA 95336

FOR: PRE-FABRICATED BUILDINGS OF METAL, IN CLASS 6 (U.S. CLS. 2, 12, 13, 14, 23, 25 AND 50).

FIRST USE 6-1-2009; IN COMMERCE 6-1-2009.

FOR: MANUFACTURE AND ASSEMBLY OF PRE-FABRICATED BUILDINGS FOR OTHERS, IN CLASS 40 (U.S. CLS. 100, 103 AND 106).

FIRST USE 6-1-2009; IN COMMERCE 6-1-2009.

THE MARK CONSISTS OF STANDARD CHARACTERS WITHOUT CLAIM TO ANY PARTICULAR FONT, STYLE, SIZE, OR COLOR.

SN 77-948,805, FILED 3-2-2010.

ALICIA COLLINS, EXAMINING ATTORNEY



David J. Kyros

Director of the United States Patent and Trademark Office

United States of America

United States Patent and Trademark Office

HOPE for Equal Access



Reg. No. 4,154,547

Registered June 5, 2012

Int. Cl.: 44

SERVICE MARK

PRINCIPAL REGISTER

KINSTON COMMUNITY HEALTH CENTER, INC. (NORTH CAROLINA CORPORATION)
324 N. QUEEN STREET
KINSTON, NC 28501

FOR: FEDERALLY FUNDED HEALTH CENTER FEATURING OB-GYN SERVICES, ADULT AND PEDIATRIC HEALTH CARE SERVICES, AND DENTAL SERVICES; CHARITABLE SERVICES, NAMELY, PATIENT ASSISTANCE PROGRAM TO PROVIDE DRUGS FREE OF CHARGE TO LOW-INCOME PATIENTS WITHOUT PRESCRIPTION DRUG COVERAGE, IN CLASS 44 (U.S. CLS. 100 AND 101).

FIRST USE 10-1-2010; IN COMMERCE 10-1-2010.

THE MARK CONSISTS OF A PICTURE OF A FAMILY LOOKING UP AT THE PHRASE "HOPE FOR EQUAL ACCESS" WITH A HEART DESIGN REPRESENTING THE "O" IN "HOPE".

SN 77-951,946, FILED 3-5-2010.

ROBERT STRUCK, EXAMINING ATTORNEY



David J. Kyffers

Director of the United States Patent and Trademark Office

United States of America

United States Patent and Trademark Office



Reg. No. 4,154,548

Registered June 5, 2012

Int. Cl.: 41

SERVICE MARK

PRINCIPAL REGISTER

SNYDER, VIRGINIE (FRANCE INDIVIDUAL)
PO BOX 1333
TOPANGA, CA 91290

FOR: PROVIDING FACILITIES FOR RECREATIONAL ACTIVITIES, NAMELY, A NATURE CONSERVANCY CENTER; PROVIDING FACILITIES FOR EDUCATIONAL TRAINING IN PERSONAL GROWTH AND ENVIRONMENTAL AWARENESS , IN CLASS 41 (U.S. CLS. 100, 101 AND 107).

FIRST USE 9-10-2008; IN COMMERCE 9-10-2008.

NO CLAIM IS MADE TO THE EXCLUSIVE RIGHT TO USE "RANCH", APART FROM THE MARK AS SHOWN.

THE COLOR(S) GREEN AND BURGUNDY IS/ARE CLAIMED AS A FEATURE OF THE MARK.

THE MARK CONSISTS OF A SYCAMORE LEAF WHICH HAS GREENS AND BURGUNDIES AND THE WORDING "ER" AND "EVOLUTION RANCH", ALL IN BURGUNDY. THE STEM OF THE LEAF EXTENDS UPWARD OUT OF THE LETTER "R" IN "ER". THE WORD "EVOLUTION" IS BELOW "ER" AND ABOVE "RANCH", WHICH IS FLANKED BY LINES IN BURGUNDY. THE DESIGN IS BORDERED BY A BURGUNDY RECTANGLE WITH THE TOP SIDE CURVED UPWARD.

SN 77-952,533, FILED 3-7-2010.

KEVIN DINALLO, EXAMINING ATTORNEY



David J. Kyffers

Director of the United States Patent and Trademark Office

United States of America

United States Patent and Trademark Office

AVIVAFIX

Reg. No. 4,154,549

BIO-MEDICAL RESEARCH LIMITED (IRELAND CORPORATION)
BMR HOUSE PARKMORE BUSINESS PARK WEST
GALWAY, IRELAND

Registered June 5, 2012

Int. Cl.: 10

FOR: ELECTROTHERAPY APPARATUS FOR STIMULATING THE MUSCLES AND NERVES OF THE NECK, SHOULDER, ELBOW, WRIST, UPPER BACK, LOWER BACK, HIP, KNEE AND ANKLE AND CONDUCTIVE GARMENTS SPECIALLY ADAPTED FOR USE THEREWITH, IN CLASS 10 (U.S. CLS. 26, 39 AND 44).

TRADEMARK

PRINCIPAL REGISTER

FIRST USE 1-0-2012; IN COMMERCE 1-0-2012.

THE MARK CONSISTS OF STANDARD CHARACTERS WITHOUT CLAIM TO ANY PARTICULAR FONT, STYLE, SIZE, OR COLOR.

SN 77-954,556, FILED 3-9-2010.

JAMES MACFARLANE, EXAMINING ATTORNEY



David J. Kyros

Director of the United States Patent and Trademark Office

United States of America

United States Patent and Trademark Office



Reg. No. 4,154,550

Registered June 5, 2012

Int. Cl.: 10

TRADEMARK

PRINCIPAL REGISTER

ASCENTIA HEALTH, INC. (ILLINOIS CORPORATION)
5330 PARLIAMENT PLACE
ROCKFORD, IL 61107

FOR: MEDICAL DEVICE, NAMELY, INTRA-AURAL DEVICE FOR TREATING TEMPORO-MANDIBULAR JOINT DISORDER; MEDICAL DEVICE, NAMELY, INTRA-AURAL DEVICE FOR TREATING HEADACHES, IN CLASS 10 (U.S. CLS. 26, 39 AND 44).

FIRST USE 4-11-2011; IN COMMERCE 5-3-2011.

NO CLAIM IS MADE TO THE EXCLUSIVE RIGHT TO USE "TMD", APART FROM THE MARK AS SHOWN.

THE COLOR(S) BLUE, BLACK, WHITE AND GREEN IS/ARE CLAIMED AS A FEATURE OF THE MARK.

THE MARK CONSISTS OF THE LETTERS "TMD" PRESENTED IN THE COLOR BLUE FOLLOWED BY THE LETTER "E" IN WHITE WITH A CIRCULAR BLACK BACKGROUND FOLLOWED BY A STYLIZED LETTER "S" IN BLACK. TO THE RIGHT OF THE STYLIZED "S" IS A STYLIZED GREEN CURVED BAND, WHICH IN COMBINATION WITH THE STYLIZED "S", AND CIRCULAR FIELD RESEMBLES AN EAR. GREEN SHADED CIRCLES OF VARYING SIZE ARRANGED IN AN ARC APPEAR ABOVE THE LETTERS "TMD" IN THE MARK.

SN 77-955,133, FILED 3-10-2010.

NATALIE POLZER, EXAMINING ATTORNEY



David J. Kybas

Director of the United States Patent and Trademark Office

United States of America

United States Patent and Trademark Office



Reg. No. 4,154,551

Registered June 5, 2012

Int. Cl.: 19

TRADEMARK

PRINCIPAL REGISTER

UNITED DURALUME PRODUCTS INC. (CALIFORNIA CORPORATION)
350 S RAYMOND AVE
FULLERTON, CA 92831

FOR: BUILDING MATERIALS, NAMELY, MANUFACTURED BRICK VENEER FOR USE ON INTERIOR AND EXTERIOR WALLS, FLOORS AND SURFACES, PATIOS, POOLSIDES AND DRIVEWAYS, IN CLASS 19 (U.S. CLS. 1, 12, 33 AND 50).

FIRST USE 3-1-1981; IN COMMERCE 3-1-1981.

NO CLAIM IS MADE TO THE EXCLUSIVE RIGHT TO USE "PATIOS", APART FROM THE MARK AS SHOWN.

THE COLOR(S) YELLOW, BROWN, BLUE, TAN IS/ARE CLAIMED AS A FEATURE OF THE MARK.

THE MARK CONSISTS OF A YELLOW SUN AND THE SUN'S REFLECTIONS IN YELLOW BOUNCING OFF A BROWN ROOF. BELOW THE ROOF IS THE WORDING "DURACOOOL" IN BLUE AND "PATIOS" IN TAN.

SN 77-955,912, FILED 3-10-2010.

KIM SAITO, EXAMINING ATTORNEY



David J. Kyros

Director of the United States Patent and Trademark Office

United States of America

United States Patent and Trademark Office



Reg. No. 4,154,552

Registered June 5, 2012

Int. Cls.: 41 and 42

SERVICE MARK

PRINCIPAL REGISTER

THE CANCER RESEARCH INSTITUTE (NEW YORK NON-PROFIT CORPORATION)
ONE EXCHANGE PLAZA
55 BROADWAY, SUITE 1802
NEW YORK, NY 10006

FOR: ORGANIZING AND CONDUCTING CONFERENCES REGARDING CANCER VACCINE RESEARCH AND DEVELOPMENT, IN CLASS 41 (U.S. CLS. 100, 101 AND 107).

FIRST USE 2-5-2010; IN COMMERCE 3-18-2010.

FOR: MEDICAL RESEARCH SERVICES IN THE FIELD OF CANCER VACCINE RESEARCH AND DEVELOPMENT, IN CLASS 42 (U.S. CLS. 100 AND 101).

FIRST USE 2-5-2010; IN COMMERCE 3-18-2010.

NO CLAIM IS MADE TO THE EXCLUSIVE RIGHT TO USE "CANCER IMMUNOTHERAPY CONSORTIUM", APART FROM THE MARK AS SHOWN.

THE MARK CONSISTS OF THE CAPITAL LETTERS "CIC". THE DESIGN OF THREE (3) IMMUNE CELLS AND THREE ANTIBODIES APPEAR ALONG THE OUTER RIM OF THE FIRST LETTER "C". FOUR (4) CIRCLES APPEAR ON THE INSIDE OF THE FIRST LETTER "C" IN "CIC". THE WORDS "CANCER IMMUNOTHERAPY CONSORTIUM" APPEAR TO THE RIGHT OF THE LETTERS "CIC". THE FIRST LETTER OF EACH OF THE WORDS "CANCER IMMUNOTHERAPY CONSORTIUM" APPEAR IN CAPITAL LETTERS WHILE THE REST OF EACH WORD APPEAR IN LOWER CASE LETTERS.



SN 77-957,459, FILED 3-12-2010.

MICHELE SWAIN, EXAMINING ATTORNEY

David J. Kyjars

Director of the United States Patent and Trademark Office

United States of America

United States Patent and Trademark Office

ZINDEPENDENCE

Reg. No. 4,154,553

Registered June 5, 2012

Int. Cl.: 33

TRADEMARK

PRINCIPAL REGISTER

SOUTH COAST WINERY, INC. (CALIFORNIA CORPORATION)
P.O. BOX 28739
SANTA ANA, CA 92799

FOR: WINE, IN CLASS 33 (U.S. CLS. 47 AND 49).

FIRST USE 3-20-2012; IN COMMERCE 3-20-2012.

THE MARK CONSISTS OF STANDARD CHARACTERS WITHOUT CLAIM TO ANY PARTICULAR FONT, STYLE, SIZE, OR COLOR.

SN 77-958,578, FILED 3-14-2010.

KHANH LE, EXAMINING ATTORNEY



David J. Kybas

Director of the United States Patent and Trademark Office

United States of America

United States Patent and Trademark Office

FairCompare

Reg. No. 4,154,554

Registered June 5, 2012

Int. Cl.: 35

SERVICE MARK

PRINCIPAL REGISTER

PLANPRESCRIBER, INC. (DELAWARE CORPORATION)
8 CLOCK TOWER PLACE, SUITE 400
MAYNARD, MA 01754

FOR: INSURANCE LEAD COLLECTION AND MATCHING SERVICES, NAMELY, MATCHING CONSUMER REQUESTS FOR INSURANCE POLICY QUOTES COLLECTED OVER THE INTERNET TO PRE-QUALIFIED INSURANCE BROKERS, AGENTS AND AGENCIES INTERESTED IN THOSE REQUESTS; PROMOTION OF FINANCIAL AND INSURANCE SERVICES, ON BEHALF OF THIRD PARTIES; PROVIDING INSURANCE AGENT REFERRALS, IN CLASS 35 (U.S. CLS. 100, 101 AND 102).

FIRST USE 12-19-2011; IN COMMERCE 12-19-2011.

THE MARK CONSISTS OF STANDARD CHARACTERS WITHOUT CLAIM TO ANY PARTICULAR FONT, STYLE, SIZE, OR COLOR.

SN 77-959,817, FILED 3-16-2010.

KAELIE KUNG, EXAMINING ATTORNEY



David J. Kyros

Director of the United States Patent and Trademark Office

United States of America

United States Patent and Trademark Office



Reg. No. 4,154,555

Registered June 5, 2012

Int. Cls.: 16 and 25

TRADEMARK

PRINCIPAL REGISTER

TWIN MAPLES, INC. (RHODE ISLAND CORPORATION)
BEACH AVENUE, #63, BOX 22
BLOCK ISLAND, RI 02807

FOR: PRINTED MATTER, NAMELY, BUMPER STICKERS, INFORMATIONAL FLYERS FEATURING GENERAL FISHING TIPS, FISHING GUIDES AND TIDE CHARTS, IN CLASS 16 (U.S. CLS. 2, 5, 22, 23, 29, 37, 38 AND 50).

FIRST USE 8-0-2008; IN COMMERCE 6-30-2010.

FOR: T-SHIRTS, SWEAT SHIRTS, TOPS, HEADWEAR, ATHLETIC APPAREL, NAMELY, SWEATPANTS, JACKETS; BABY BODYSUITS, ONE PIECE GARMENT FOR CHILDREN AND TODDLERS, BIBS NOT MADE OF PAPER, BOXER SHORTS, IN CLASS 25 (U.S. CLS. 22 AND 39).

FIRST USE 7-3-1981; IN COMMERCE 7-3-1981.

THE MARK CONSISTS OF WORDS "EAT FISH" IN STYLIZED LETTERS.

SN 77-960,136, FILED 3-16-2010.

CHRIS WELLS, EXAMINING ATTORNEY



David J. Kybas

Director of the United States Patent and Trademark Office

United States of America

United States Patent and Trademark Office

WYNDHAM COLLECTION

Reg. No. 4,154,556

VIDA LIFESTYLE, INC. (CALIFORNIA CORPORATION)
7040 LANKERSHIM BLVD.
NORTH HOLLYWOOD, CA 91605

Registered June 5, 2012

Int. Cl.: 11

FOR: SHOWER TUBS, IN CLASS 11 (U.S. CLS. 13, 21, 23, 31 AND 34).

TRADEMARK

FIRST USE 1-16-2012; IN COMMERCE 1-16-2012.

PRINCIPAL REGISTER

THE MARK CONSISTS OF STANDARD CHARACTERS WITHOUT CLAIM TO ANY PARTICULAR FONT, STYLE, SIZE, OR COLOR.

NO CLAIM IS MADE TO THE EXCLUSIVE RIGHT TO USE "COLLECTION", APART FROM THE MARK AS SHOWN.

SN 77-961,211, FILED 3-17-2010.

PAUL MORENO, EXAMINING ATTORNEY



David J. Kyffers

Director of the United States Patent and Trademark Office

United States of America

United States Patent and Trademark Office

Black Olympus Entertainment

Reg. No. 4,154,557

Registered June 5, 2012

Int. Cl.: 41

SERVICE MARK

PRINCIPAL REGISTER

SNOWDEN, DONTRELL (UNITED STATES INDIVIDUAL)
40 CHARLES ST
WESTMINSTER, MD 21157

FOR: MULTIMEDIA ENTERTAINMENT SERVICES IN THE NATURE OF RECORDING, PRODUCTION AND POST-PRODUCTION SERVICES IN THE FIELDS OF MUSIC, VIDEO, AND FILMS, IN CLASS 41 (U.S. CLS. 100, 101 AND 107).

FIRST USE 1-6-2009; IN COMMERCE 9-1-2009.

THE MARK CONSISTS OF STANDARD CHARACTERS WITHOUT CLAIM TO ANY PARTICULAR FONT, STYLE, SIZE, OR COLOR.

NO CLAIM IS MADE TO THE EXCLUSIVE RIGHT TO USE "ENTERTAINMENT", APART FROM THE MARK AS SHOWN.

SN 77-961,678, FILED 3-17-2010.

ESTHER A. BORSUK, EXAMINING ATTORNEY



David J. Kyros

Director of the United States Patent and Trademark Office

United States of America

United States Patent and Trademark Office

LOVE IS LIFE

Reg. No. 4,154,558

HANNA, MICHAEL (UNITED STATES INDIVIDUAL)
9330 SW 136 STREET
MIAMI, FL 33176

Registered June 5, 2012

Int. Cl.: 25

FOR: CLOTHING PRODUCTS, NAMELY, TOPS, BOTTOMS, SKIRTS, PANTS, UNDERWEAR, DRESSES, JACKETS, COATS, BELTS, NECKWEAR, BEACHWEAR, SLEEPWEAR, FOOTWEAR AND HEADWEAR FOR CONSUMERS, IN CLASS 25 (U.S. CLS. 22 AND 39).

TRADEMARK

FIRST USE 3-12-2011; IN COMMERCE 3-27-2011.

PRINCIPAL REGISTER

THE MARK CONSISTS OF STANDARD CHARACTERS WITHOUT CLAIM TO ANY PARTICULAR FONT, STYLE, SIZE, OR COLOR.

SN 77-961,788, FILED 3-18-2010.

ZACHARY BELLO, EXAMINING ATTORNEY



David J. Kyros

Director of the United States Patent and Trademark Office

United States of America

United States Patent and Trademark Office

**finn
grip**

Reg. No. 4,154,559

Registered June 5, 2012

Int. Cl.: 28

TRADEMARK

PRINCIPAL REGISTER

KUUSAMON UISTIN OY (FINLAND CORPORATION)
KEMIJARVENTIE 44-46
KUUSAMO, FINLAND FI-93600

FOR: SKI BINDINGS, IN CLASS 28 (U.S. CLS. 22, 23, 38 AND 50).

FIRST USE 5-8-1987; IN COMMERCE 2-29-2012.

THE MARK CONSISTS OF THE TERMS "FINN" AND "GRIP" EXTENDING HORIZONTALLY AND CONNECTED TO EACH OTHER BUT STAGGERED FROM EACH OTHER IN THE VERTICAL DIRECTION.

SN 77-962,842, FILED 3-18-2010.

KAELIE KUNG, EXAMINING ATTORNEY



David J. Kappas

Director of the United States Patent and Trademark Office

United States of America

United States Patent and Trademark Office

ON TOP AND IN CONTROL

Reg. No. 4,154,560

Registered June 5, 2012

Int. Cl.: 25

TRADEMARK

PRINCIPAL REGISTER

SPANX, INC. (GEORGIA CORPORATION)
SUITE 1700
3344 PEACHTREE ROAD, NE
ATLANTA, GA 30326

FOR: WOMEN'S APPAREL, NAMELY, CAMISOLES, BODY SHAPERS, SHIRTS, IN CLASS 25 (U.S. CLS. 22 AND 39).

FIRST USE 5-10-2010; IN COMMERCE 5-10-2010.

THE MARK CONSISTS OF STANDARD CHARACTERS WITHOUT CLAIM TO ANY PARTICULAR FONT, STYLE, SIZE, OR COLOR.

SN 77-963,384, FILED 3-19-2010.

MARY ROSSMAN, EXAMINING ATTORNEY



David J. Kyffers

Director of the United States Patent and Trademark Office

United States of America

United States Patent and Trademark Office

ROMANCE DIAMOND

Reg. No. 4,154,561

Registered June 5, 2012

Int. Cl.: 14

TRADEMARK

PRINCIPAL REGISTER

KIM INTERNATIONAL MFG. L.P. (TEXAS LIMITED PARTNERSHIP)
SUITE 200
14840 LANDMARK BLVD
DALLAS, TX 75254

FOR: DIAMOND JEWELRY, IN CLASS 14 (U.S. CLS. 2, 27, 28 AND 50).

FIRST USE 9-0-2010; IN COMMERCE 9-0-2010.

THE MARK CONSISTS OF STANDARD CHARACTERS WITHOUT CLAIM TO ANY PARTICULAR FONT, STYLE, SIZE, OR COLOR.

NO CLAIM IS MADE TO THE EXCLUSIVE RIGHT TO USE "DIAMOND", APART FROM THE MARK AS SHOWN.

SN 77-963,854, FILED 3-19-2010.

KIM SAITO, EXAMINING ATTORNEY



David J. Kybas

Director of the United States Patent and Trademark Office

United States of America

United States Patent and Trademark Office

VICTORY'S FAVOR

Reg. No. 4,154,562

Registered June 5, 2012

Int. Cl.: 9

TRADEMARK

PRINCIPAL REGISTER

KONAMI GAMING, INC. (NEVADA CORPORATION)
585 TRADE CENTER DRIVE
LAS VEGAS, NV 89119

FOR: ELECTRONIC GAME PROGRAMS; GAMING EQUIPMENT, NAMELY, SLOT MACHINES WITH OR WITHOUT VIDEO OUTPUT; GAMING MACHINES; MACHINES FOR PLAYING GAMES OF CHANCE; SLOT MACHINES, IN CLASS 9 (U.S. CLS. 21, 23, 26, 36 AND 38).

FIRST USE 10-0-2011; IN COMMERCE 10-0-2011.

THE MARK CONSISTS OF STANDARD CHARACTERS WITHOUT CLAIM TO ANY PARTICULAR FONT, STYLE, SIZE, OR COLOR.

SN 77-964,022, FILED 3-20-2010.

MATTHEW KLINE, EXAMINING ATTORNEY



David J. Kypas

Director of the United States Patent and Trademark Office

United States of America

United States Patent and Trademark Office

QUADO

Reg. No. 4,154,563

QUADO MEDIA INC. (CALIFORNIA CORPORATION)
965 ASTORIA DRIVE
SUNNYVALE, CA 94087

Registered June 5, 2012

Int. Cl.: 9

FOR: DIGITAL BOARD GAMES, NAMELY, ELECTRONIC INTERACTIVE BOARD GAMES FOR USE WITH EXTERNAL MONITORS, IN CLASS 9 (U.S. CLS. 21, 23, 26, 36 AND 38).

TRADEMARK

FIRST USE 9-30-2010; IN COMMERCE 9-30-2010.

PRINCIPAL REGISTER

THE MARK CONSISTS OF STANDARD CHARACTERS WITHOUT CLAIM TO ANY PARTICULAR FONT, STYLE, SIZE, OR COLOR.

THE WORDING "QUADO" HAS NO MEANING IN A FOREIGN LANGUAGE.

SN 77-964,076, FILED 3-20-2010.

SUZANNE BLANE, EXAMINING ATTORNEY



David J. Kyffers

Director of the United States Patent and Trademark Office

United States of America

United States Patent and Trademark Office



Reg. No. 4,154,564

Registered June 5, 2012

Int. Cl.: 29

TRADEMARK

PRINCIPAL REGISTER

BANGKOK INTERNATIONAL CUISINE CO., LTD (THAILAND CORPORATION)
SUKHUMVIT SOI 20, SUKHUMVIT ROAD
8TH FLOOR, REMBRANDT TOWERS 22
KLONG TOEI, BANGKOK, THAILAND 10110

FOR: FROZEN PRE-PACKAGED ENTREES CONSISTING PRIMARILY OF SEAFOOD;
PREPARED ENTREES CONSISTING PRIMARILY OF SEAFOOD; FROZEN ENTREES
CONSISTING PRIMARILY OF MEAT, FISH, POULTRY OR VEGETABLES; FROZEN MEALS
CONSISTING PRIMARILY OF MEAT, FISH, POULTRY OR VEGETABLES; FROZEN VE-
GETABLE-BASED ENTREES, IN CLASS 29 (U.S. CL. 46).

FIRST USE 10-31-2007; IN COMMERCE 5-30-2011.

NO CLAIM IS MADE TO THE EXCLUSIVE RIGHT TO USE "FINE THAI DINING", APART
FROM THE MARK AS SHOWN.

THE COLOR(S) RED, WHITE AND BLACK IS/ARE CLAIMED AS A FEATURE OF THE
MARK.

THE MARK CONSISTS OF STYLIZED LETTERS WITH A DRAWING OF A RED PEPPER.
THE PEPPER STEM AND WORDING APPEAR IN BLACK ON A WHITE BACKGROUND.

SN 77-964,321, FILED 3-21-2010.

H. M. FISHER, EXAMINING ATTORNEY



David J. Kybas

Director of the United States Patent and Trademark Office

United States of America

United States Patent and Trademark Office

MAGICLEAR

Reg. No. 4,154,565

LINMAR TECHNOLOGY INC. (NEW YORK CORPORATION)
1776 59TH STREET
BROOKLYN, NY 11204

Registered June 5, 2012

Int. Cl.: 3

FOR: CONCENTRATE USED FOR CLEANING WINDSHIELDS AND WIPER BLADES, IN CLASS 3 (U.S. CLS. 1, 4, 6, 50, 51 AND 52).

TRADEMARK

FIRST USE 6-15-2010; IN COMMERCE 6-15-2010.

PRINCIPAL REGISTER

THE MARK CONSISTS OF THE WORD "MAGICLEAR" WITH A HORIZONTAL LINE APPEARING ABOVE THE LETTERS "MAGIC" IN THE MARK, AND A HORIZONTAL LINE APPEARING BELOW THE LETTERS "CLEAR" IN THE MARK.

SN 77-965,832, FILED 3-23-2010.

ANTHONY RINKER, EXAMINING ATTORNEY



David J. Kybas

Director of the United States Patent and Trademark Office

United States of America

United States Patent and Trademark Office

VASOTROPIN

Reg. No. 4,154,566

Registered June 5, 2012

Int. Cl.: 5

TRADEMARK

PRINCIPAL REGISTER

GASPARI NUTRITION, INC. (NEW JERSEY CORPORATION)
SUITE 230
575 PROSPECT ST
LAKEWOOD, NJ 08701

FOR: DIETARY AND NUTRITIONAL SUPPLEMENTS, IN CLASS 5 (U.S. CLS. 6, 18, 44, 46, 51 AND 52).

FIRST USE 1-15-2012; IN COMMERCE 1-15-2012.

THE MARK CONSISTS OF STANDARD CHARACTERS WITHOUT CLAIM TO ANY PARTICULAR FONT, STYLE, SIZE, OR COLOR.

SN 77-966,493, FILED 3-23-2010.

NANCY CLARKE, EXAMINING ATTORNEY



David J. Kybas

Director of the United States Patent and Trademark Office

United States of America
United States Patent and Trademark Office

AUCARA

Reg. No. 4,154,567

CHAIN & CHARM, INC. (CALIFORNIA CORPORATION)
817 S. SAN JULIAN STREET PENTHOUSE 1
LOS ANGELES, CA 90014

Registered June 5, 2012

Int. Cl.: 14

FOR: JEWELRY, IN CLASS 14 (U.S. CLS. 2, 27, 28 AND 50).

TRADEMARK

FIRST USE 2-1-2012; IN COMMERCE 2-1-2012.

PRINCIPAL REGISTER

THE MARK CONSISTS OF STANDARD CHARACTERS WITHOUT CLAIM TO ANY PARTICULAR FONT, STYLE, SIZE, OR COLOR.

SN 77-966,517, FILED 3-23-2010.

LANA PHAM, EXAMINING ATTORNEY



David J. Kyros

Director of the United States Patent and Trademark Office

United States of America

United States Patent and Trademark Office

VINCE CAMUTO

Reg. No. 4,154,568

Registered June 5, 2012

**Int. Cls.: 9, 14, 25, and
35**

TRADEMARK

SERVICE MARK

PRINCIPAL REGISTER

CAMUTO CONSULTING, INC. (CONNECTICUT CORPORATION), DBA CAMUTO GROUP,
THIRD FLOOR
411 WEST PUTNAM AVENUE
GREENWICH, CT 06830

FOR: EYEGLASS AND EYEWEAR CASES; EYEGLASS FRAMES; EYEWEAR; EYEWEAR
ACCESSORIES, NAMELY, STRAPS, NECK CORDS, CHAINS AND HEAD STRAPS WHICH
RESTRAIN EYEWEAR FROM MOVEMENT ON A WEARER AND EYEWEAR CASES, IN
CLASS 9 (U.S. CLS. 21, 23, 26, 36 AND 38).

FIRST USE 10-1-2010; IN COMMERCE 2-1-2011.

FOR: JEWELRY, NAMELY, NECKLACES, BRACELETS, EARRINGS, BROOCHES, PINS,
WATCHES, ANKLETS AND RINGS, IN CLASS 14 (U.S. CLS. 2, 27, 28 AND 50).

FIRST USE 3-1-2011; IN COMMERCE 7-1-2011.

FOR: CLOTHING, NAMELY, ATHLETIC SHOES; BATHING SUITS; BEACHWEAR; BELTS;
BLAZERS; BLOUSES; BODY SUITS; BOOTS; BRAS; BRASSIERES; BRIEFS; BUSTIERS;
CAMISOLES; CAPES; CAPS; CAPRI PANTS, CARDIGANS; CARGO PANTS; COATS;
DRESSES; FLIP-FLOPS; FOOTWEAR; GLOVES; HATS; HEADBANDS; HEADWEAR; HO-
SIERY; JACKETS; JEANS; JERSEYS; KNEE HIGHS; LEGGINGS; LINGERIE; LOUNGEWEAR;
MITTENS; NECKWEAR; NEGLIGEEES; NIGHT GOWNS; NIGHT SHIRTS; PAJAMAS;
PANTIES; PANTS; PANTYHOSE; PARKAS; POLO SHIRTS; PULLOVERS; RAINWEAR;
ROBES; SANDALS; SCARVES; SHIRTS; SHOES; SHORTS; SKIRTS; SLACKS; SLEEPWEAR;
SLIPPERS; SOCKS; STOCKINGS; SUITS; SURF WEAR; SWEATERS; SWIMWEAR; TANK
TOPS; TIGHTS; TOPS; T-SHIRTS; TURTLENECKS; UNDERCLOTHES; UNDERWEAR;
VESTS; WRAPS, IN CLASS 25 (U.S. CLS. 22 AND 39).

FIRST USE 7-1-2006; IN COMMERCE 1-1-2006.

FOR: ON-LINE AND IN-STORE RETAIL STORE SERVICES IN THE FIELDS OF CLOTHING,
FOOTWEAR, HANDBAGS AND TOTE BAGS, SMALL LEATHER ACCESSORIES, JEWELRY,
AND EYEWEAR, IN CLASS 35 (U.S. CLS. 100, 101 AND 102).

FIRST USE 7-1-2008; IN COMMERCE 7-1-2008.



David J. Kappas

Director of the United States Patent and Trademark Office

Reg. No. 4,154,568 THE MARK CONSISTS OF STANDARD CHARACTERS WITHOUT CLAIM TO ANY PARTICULAR FONT, STYLE, SIZE, OR COLOR.

OWNER OF U.S. REG. NO. 3,161,347.

THE NAME "VINCE CAMUTO" IDENTIFIES A LIVING INDIVIDUAL WHOSE CONSENT IS OF RECORD.

SN 77-966,527, FILED 3-23-2010.

HEATHER THOMPSON, EXAMINING ATTORNEY

United States of America

United States Patent and Trademark Office



Reg. No. 4,154,569

Registered June 5, 2012

Int. Cl.: 34

TRADEMARK

PRINCIPAL REGISTER

PAN PARAG INDIA LIMITED (INDIA LIMITED CORPORATION)
24/19, BIRHANA ROAD
KOTHARI HOUSE,
KANPUR, INDIA 208001

FOR: CHEWING TOBACCO, IN CLASS 34 (U.S. CLS. 2, 8, 9 AND 17).

FIRST USE 1-22-1996; IN COMMERCE 1-22-1996.

THE MARK CONSISTS OF THE WORDS "PAN PARAG" ACROSS AN ARCHED BANNER.

SN 77-966,530, FILED 3-23-2010.

HEATHER THOMPSON, EXAMINING ATTORNEY



David J. Kybas

Director of the United States Patent and Trademark Office

United States of America

United States Patent and Trademark Office

FIERCE

Reg. No. 4,154,570

Registered June 5, 2012

Int. Cl.: 5

TRADEMARK

PRINCIPAL REGISTER

VALENT U.S.A. CORPORATION (CALIFORNIA CORPORATION)
1600 RIVIERA AVENUE, SUITE 200
WALNUT CREEK, CA 945968025

FOR: HERBICIDE, IN CLASS 5 (U.S. CLS. 6, 18, 44, 46, 51 AND 52).

FIRST USE 3-26-2012; IN COMMERCE 3-26-2012.

THE MARK CONSISTS OF STANDARD CHARACTERS WITHOUT CLAIM TO ANY PARTICULAR FONT, STYLE, SIZE, OR COLOR.

SN 77-967,609, FILED 3-24-2010.

JEAN IM, EXAMINING ATTORNEY



David J. Kyffers

Director of the United States Patent and Trademark Office

United States of America
United States Patent and Trademark Office

iPAR

Reg. No. 4,154,571

MSI, LLC (FLORIDA LIMITED LIABILITY COMPANY), TA MSI-SSL,
1342 SOUTH POWERLINE ROAD
DEERFIELD BEACH, FL 33442

Registered June 5, 2012

Int. Cl.: 11

FOR: LED LIGHT BULBS, IN CLASS 11 (U.S. CLS. 13, 21, 23, 31 AND 34).

TRADEMARK

FIRST USE 9-1-2009; IN COMMERCE 2-1-2010.

PRINCIPAL REGISTER

THE MARK CONSISTS OF STANDARD CHARACTERS WITHOUT CLAIM TO ANY PARTICULAR FONT, STYLE, SIZE, OR COLOR.

SN 77-967,819, FILED 3-24-2010.

DAVID COLLIER, EXAMINING ATTORNEY



David J. Kyffers

Director of the United States Patent and Trademark Office

United States of America
United States Patent and Trademark Office

WILDFOX

Reg. No. 4,154,572

WILDFOX COUTURE IP HOLDINGS, LLC (CALIFORNIA LIMITED LIABILITY COMPANY)
2107 BELLEVUE AVENUE
LOS ANGELES, CA 90026

Registered June 5, 2012

Int. Cl.: 25

FOR: FOOTWEAR, IN CLASS 25 (U.S. CLS. 22 AND 39).

TRADEMARK

FIRST USE 3-0-2012; IN COMMERCE 3-0-2012.

PRINCIPAL REGISTER

THE MARK CONSISTS OF STANDARD CHARACTERS WITHOUT CLAIM TO ANY PARTICULAR FONT, STYLE, SIZE, OR COLOR.

OWNER OF U.S. REG. NO. 3,719,999.

SN 77-967,826, FILED 3-24-2010.

CHRISTINE COOPER, EXAMINING ATTORNEY



David J. Kybas

Director of the United States Patent and Trademark Office

United States of America

United States Patent and Trademark Office

NIOV

Reg. No. 4,154,573

BREATHE TECHNOLOGIES, INC. (DELAWARE CORPORATION)
175 TECHNOLOGY DRIVE, SUITE 100
IRVINE, CA 92618

Registered June 5, 2012

Int. Cl.: 10

FOR: MEDICAL DEVICES TO TREAT RESPIRATORY AND AIRWAY DISORDERS IN INDIVIDUALS, IN CLASS 10 (U.S. CLS. 26, 39 AND 44).

TRADEMARK

FIRST USE 12-0-2011; IN COMMERCE 12-0-2011.

PRINCIPAL REGISTER

THE MARK CONSISTS OF STANDARD CHARACTERS WITHOUT CLAIM TO ANY PARTICULAR FONT, STYLE, SIZE, OR COLOR.

SN 77-967,915, FILED 3-24-2010.

DAVID MILLER, EXAMINING ATTORNEY



David J. Kybas

Director of the United States Patent and Trademark Office

United States of America

United States Patent and Trademark Office



Reg. No. 4,154,574

Registered June 5, 2012

Int. Cl.: 25

TRADEMARK

PRINCIPAL REGISTER

PRINCESS FREE ZONE, INC. (GEORGIA CORPORATION)
2891 TEMPLAR KNIGHT DR.
TUCKER, GA 30084

FOR: PULLOVERS; SHIRTS, IN CLASS 25 (U.S. CLS. 22 AND 39).

FIRST USE 6-11-2011; IN COMMERCE 6-11-2011.

THE MARK CONSISTS OF A CROWN INSIDE THE UNIVERSAL PROHIBITION SYMBOL.

SN 77-968,423, FILED 3-25-2010.

ESTHER BELENKER, EXAMINING ATTORNEY



David J. Kyffers

Director of the United States Patent and Trademark Office

United States of America

United States Patent and Trademark Office

Open Data Bridge

Reg. No. 4,154,575

X PLUS ONE SOLUTIONS, INC. (DELAWARE CORPORATION)
470 PARK AVENUE SOUTH SUITE 7N
NEW YORK, NY 10016

Registered June 5, 2012

Int. Cls.: 9, 35, and 42

FOR: COMPUTER SOFTWARE TO ENABLE THE CREATION, MANAGING, TARGETING, TRACKING, ANALYZING, AND SERVICING OF ADVERTISING AND MARKETING CONTENT AND CAMPAIGNS VIA WEB SITES, ONLINE AND INTERACTIVE MEDIA AND COMPUTER NETWORKS, IN CLASS 9 (U.S. CLS. 21, 23, 26, 36 AND 38).

TRADEMARK

SERVICE MARK

FIRST USE 1-26-2010; IN COMMERCE 1-26-2010.

PRINCIPAL REGISTER

FOR: MANAGING, TARGETING, TRACKING AND ANALYZING MEDIA PLANNING, MEDIA BUYING AND MARKETING EFFORTS OF OTHERS; ADVERTISING AND MARKETING SERVICES, NAMELY, CREATION OF MARKETING TOOLS DESIGNED TO INCREASE A CLIENT COMPANY'S KNOWLEDGE OF CUSTOMER NEEDS, ADVERTISING STRATEGY AND SALES STRATEGY, PREPARATION AND REALIZATION OF MEDIA AND ADVERTISING PLANS AND CONCEPTS, BUSINESS CONSULTATION AND MANAGEMENT REGARDING MARKETING ACTIVITIES AND LAUNCHING OF NEW PRODUCTS, BUSINESS MARKETING CONSULTING SERVICES, CONDUCTING MARKETING STUDIES, DEVELOPMENT OF MARKETING STRATEGIES AND CONCEPTS, MARKETING CONSULTING, STATISTICAL EVALUATIONS OF MARKETING DATA, IN CLASS 35 (U.S. CLS. 100, 101 AND 102).



FIRST USE 1-26-2010; IN COMMERCE 1-26-2010.

FOR: PROVIDING TEMPORARY USE OF ON-LINE NON-DOWNLOADABLE SOFTWARE FOR CREATING, MANAGING, TARGETING, TRACKING, ANALYZING, AND SERVICING MEDIA PLANNING, MEDIA BUYING AND MARKETING EFFORTS OF OTHERS; COMPUTER SERVICES, NAMELY, DESIGN OF COMPUTER SOFTWARE FOR OTHERS; TECHNICAL SUPPORT SERVICES, NAMELY, TROUBLESHOOTING IN THE NATURE OF DIAGNOSING COMPUTER HARDWARE AND SOFTWARE PROBLEMS, IN CLASS 42 (U.S. CLS. 100 AND 101).

David J. Kyjars

FIRST USE 1-26-2010; IN COMMERCE 1-26-2010.

THE MARK CONSISTS OF STANDARD CHARACTERS WITHOUT CLAIM TO ANY PARTICULAR FONT, STYLE, SIZE, OR COLOR.

Director of the United States Patent and Trademark Office

Reg. No. 4,154,575 NO CLAIM IS MADE TO THE EXCLUSIVE RIGHT TO USE "OPEN DATA", APART FROM THE MARK AS SHOWN.

SN 77-968,512, FILED 3-25-2010.

CAROLYN CATALDO, EXAMINING ATTORNEY

United States of America

United States Patent and Trademark Office

BETTER VIEW

Reg. No. 4,154,576

Registered June 5, 2012

Int. Cl.: 9

TRADEMARK

PRINCIPAL REGISTER

GUARINO, JOSEPH M. (UNITED STATES INDIVIDUAL)
446 LAFAYETTE AVENUE
TRENTON, NJ 08610

FOR: AUDIO AND VIDEO RECORDINGS FEATURING MUSIC AND ARTISTIC PERFORMANCES; COMPACT DISCS FEATURING MUSIC; DIGITAL MUSIC DOWNLOADABLE FROM THE INTERNET; DOWNLOADABLE MUSICAL SOUND RECORDINGS; DOWNLOADABLE RING TONES, GRAPHICS AND MUSIC VIA A GLOBAL COMPUTER NETWORK AND WIRELESS DEVICES, IN CLASS 9 (U.S. CLS. 21, 23, 26, 36 AND 38).

FIRST USE 9-1-2011; IN COMMERCE 9-1-2011.

THE MARK CONSISTS OF STANDARD CHARACTERS WITHOUT CLAIM TO ANY PARTICULAR FONT, STYLE, SIZE, OR COLOR.

SN 77-968,552, FILED 3-25-2010.

NANCY CLARKE, EXAMINING ATTORNEY



David J. Kybas

Director of the United States Patent and Trademark Office

United States of America

United States Patent and Trademark Office

FASHION'S NIGHT OUT

Reg. No. 4,154,577

Registered June 5, 2012

Int. Cls.: 41 and 45

SERVICE MARK

PRINCIPAL REGISTER

ADVANCE MAGAZINE PUBLISHERS INC. (NEW YORK CORPORATION)
FOUR TIMES SQUARE
NEW YORK, NY 10036

FOR: ENTERTAINMENT IN THE NATURE OF LIVE MUSICAL PERFORMANCES; FASHION SHOWS; ARRANGING AND CONDUCTING PARTIES AND SPECIAL EVENTS FOR THE PURPOSE OF FASHION AWARENESS, IN CLASS 41 (U.S. CLS. 100, 101 AND 107).

FIRST USE 9-0-2009; IN COMMERCE 9-0-2009.

FOR: PROVIDING A WEBSITE IN THE FIELD OF FASHION, IN CLASS 45 (U.S. CLS. 100 AND 101).

FIRST USE 9-0-2009; IN COMMERCE 9-0-2009.

THE MARK CONSISTS OF STANDARD CHARACTERS WITHOUT CLAIM TO ANY PARTICULAR FONT, STYLE, SIZE, OR COLOR.

NO CLAIM IS MADE TO THE EXCLUSIVE RIGHT TO USE "FASHION'S", APART FROM THE MARK AS SHOWN.

SN 77-980,863, FILED 6-24-2009.

NAKIA HENRY, EXAMINING ATTORNEY



David J. Kyros

Director of the United States Patent and Trademark Office

United States of America

United States Patent and Trademark Office

QUIKSILVER WATERMAN COLLECTION

Reg. No. 4,154,578

Registered June 5, 2012

Int. Cl.: 25

TRADEMARK

PRINCIPAL REGISTER

QUIKSILVER AMERICAS, INC. (CALIFORNIA CORPORATION)
15202 GRAHAM STREET
HUNTINGTON BEACH, CA 92649

FOR: CLOTHING, NAMELY, SHIRTS, T-SHIRTS, SWEATSHIRTS, CASUAL TOPS WITH LONG AND SHORT SLEEVES, TANK TOPS, JACKETS, SWEATERS, PANTS, SWEATPANTS, SHORTS, SWIMWEAR, BOARDSHORTS AND JEANS; FOOTWEAR, NAMELY, SHOES AND SANDALS; HEADWEAR, NAMELY, HATS, BEANIES, CAPS AND VISORS, IN CLASS 25 (U.S. CLS. 22 AND 39).

FIRST USE 11-25-2009; IN COMMERCE 11-25-2009.

THE MARK CONSISTS OF STANDARD CHARACTERS WITHOUT CLAIM TO ANY PARTICULAR FONT, STYLE, SIZE, OR COLOR.

OWNER OF U.S. REG. NOS. 1,431,266, 1,800,150, AND OTHERS.

NO CLAIM IS MADE TO THE EXCLUSIVE RIGHT TO USE "COLLECTION", APART FROM THE MARK AS SHOWN.

SN 77-982,276, FILED 5-20-2009.

LESLEY LAMOTHE, EXAMINING ATTORNEY



David J. Kybas

Director of the United States Patent and Trademark Office

United States of America

United States Patent and Trademark Office



Reg. No. 4,154,579

Registered June 5, 2012

Int. Cl.: 25

TRADEMARK

PRINCIPAL REGISTER

SUMMIT ENTERTAINMENT, LLC (DELAWARE LIMITED LIABILITY COMPANY)
1630 STEWART STREET, SUITE 120
SANTA MONICA, CA 90404

FOR: CLOTHING, NAMELY, T-SHIRTS, SWEATSHIRTS, SHIRTS, AND HOODED SHIRTS;
WRIST BANDS; SCARVES; AND HEADWEAR, IN CLASS 25 (U.S. CLS. 22 AND 39).

FIRST USE 10-1-2009; IN COMMERCE 10-1-2009.

THE MARK CONSISTS OF AN ORNATE CAPITAL "V" HAVING FOUR LEAVES AND A LARGE OVAL-SHAPED JEWEL RESTING ATOP THE "V" AND A SMALLER DIAMOND-SHAPED JEWEL AT THE BOTTOM POINT OF THE "V", WITH THE FURTHER DESIGN OF A CREST NESTLED IN THE CENTER OF THE "V", THE CREST BEING DIVIDED INTO FOUR SECTIONS AND CONTAINING A BIRD IN FLIGHT IN THE TOP RIGHT AND BOTTOM LEFT SECTIONS AND A TREE WITH BARE BRANCHES IN THE TOP LEFT AND BOTTOM RIGHT SECTIONS OF THE DIVIDED CREST.

SN 77-982,919, FILED 6-30-2009.

DEZMONA MIZELLE, EXAMINING ATTORNEY



David J. Kybas

Director of the United States Patent and Trademark Office

United States of America

United States Patent and Trademark Office

BIORADAR

Reg. No. 4,154,580

Registered June 5, 2012

Int. Cl.: 44

SERVICE MARK

PRINCIPAL REGISTER

BOGOCH FAMILY LLC (DELAWARE LIMITED LIABILITY COMPANY)
46 EAST 91 STREET
NEW YORK, NY 10128

FOR: MEDICAL TESTING SERVICES FOR DETECTION OF CHEMICAL AND BIOLOGICAL AGENTS HAZARDOUS OR LETHAL TO BIOLOGICAL ENTITIES, IN CLASS 44 (U.S. CLS. 100 AND 101).

FIRST USE 11-23-2011; IN COMMERCE 11-23-2011.

THE MARK CONSISTS OF STANDARD CHARACTERS WITHOUT CLAIM TO ANY PARTICULAR FONT, STYLE, SIZE, OR COLOR.

SN 77-982,922, FILED 2-13-2007.

MARCIE MILONE, EXAMINING ATTORNEY



David J. Kyffers

Director of the United States Patent and Trademark Office

United States of America

United States Patent and Trademark Office



Reg. No. 4,154,581

Registered June 5, 2012

Int. Cl.: 28

TRADEMARK

PRINCIPAL REGISTER

BELLATOR SPORT WORLDWIDE LLC (DELAWARE LIMITED LIABILITY COMPANY)
372 W. ONTARIO, SUITE 302
CHICAGO, IL 60654

FOR: TRAINING APPARATUS FOR BOXING, MARTIAL ARTS AND SIMILAR SPORTS; BOXING GLOVES; MIXED MARTIAL ARTS GLOVES; SPORTS EQUIPMENT FOR BOXING, MARTIAL ARTS, AND THE LIKE, NAMELY, PROTECTIVE BRAS; EXERCISING EQUIPMENT, NAMELY, WEIGHT LIFTING MACHINES; EXERCISE WEIGHTS; JUMP ROPES; ATHLETIC PROTECTIVE PADS FOR MIXED MARTIAL ARTS, BOXING, WRESTLING AND OTHER MARTIAL ARTS; MEDICINE BALLS; PUNCHING BAGS; PUNCHING BALLS, IN CLASS 28 (U.S. CLS. 22, 23, 38 AND 50).

FIRST USE 12-16-2008; IN COMMERCE 3-5-2010.

NO CLAIM IS MADE TO THE EXCLUSIVE RIGHT TO USE "FIGHTING CHAMPIONSHIPS", APART FROM THE MARK AS SHOWN.

THE COLOR(S) METALLIC GRAY, RED, AND BLACK IS/ARE CLAIMED AS A FEATURE OF THE MARK.

THE MARK CONSISTS OF THE WORD "BELLATOR" IN METALLIC GRAY STYLIZED SCRIPT OUTLINED IN RED, ABOVE THE WORDS "FIGHTING CHAMPIONSHIPS" IN METALLIC GRAY STYLIZED SCRIPT, AND SURROUNDED BY A RED RECTANGULAR BORDER WITH A BLACK BACKGROUND, BELOW A DESIGN OF A MAN WEARING A METALLIC GRAY WARRIOR'S HELMET WITH RED FEATHERS AND A RED STRIPE DOWN THE CENTER AND BLACK SHADOWING, ALL APPEARING WITHIN A METALLIC GRAY AND RED CONCENTRIC OVAL FRAME WITH A BLACK BACKGROUND.

SN 77-982,923, FILED 12-16-2008.

NICHOLAS COLEMAN, EXAMINING ATTORNEY



David J. Kyros

Director of the United States Patent and Trademark Office

United States of America

United States Patent and Trademark Office

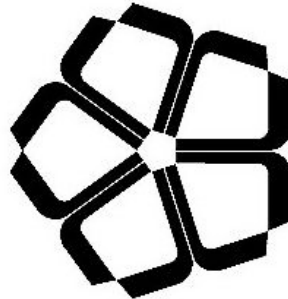

Reg. No. 4,154,582

L2T, INC. (CALIFORNIA CORPORATION)
3025 WEST MISSION ROAD
ALHAMBRA, CA 91803

Registered June 5, 2012

**Int. Cls.: 9, 20, 24, 25, 27,
and 35**

FOR: SUNGLASSES AND CASES FOR SUNGLASSES, IN CLASS 9 (U.S. CLS. 21, 23, 26, 36 AND 38).

FIRST USE 3-22-2010; IN COMMERCE 5-9-2010.

TRADEMARK

FOR: PILLOWS, CUSHIONS, OUTDOOR CUSHIONS, IN CLASS 20 (U.S. CLS. 2, 13, 22, 25, 32 AND 50).

SERVICE MARK

PRINCIPAL REGISTER

FIRST USE 4-25-2008; IN COMMERCE 4-25-2008.

FOR: BED SPREADS, PILLOW CASES, PILLOW SHAMS, BED BLANKETS, TOWELS; TEXTILE FABRICS FOR HOME AND COMMERCIAL INTERIORS, IN CLASS 24 (U.S. CLS. 42 AND 50).

FIRST USE 4-3-2011; IN COMMERCE 4-3-2011.

FOR: WOMEN'S CLOTHING, NAMELY, TOPS, BOTTOMS, DRESSES, SWEATERS, COATS, JACKETS, SKIRTS, SCARVES AND HATS, GLOVES, SWIMWEAR, RAINCOATS, TRENCH COATS; MEN'S CLOTHING, NAMELY, SHIRTS; TIES; BOXER SHORTS; COATS; WAIST-COATS; HATS; JACKETS; TROUSERS; PANTS; ROBES; CARDIGANS; SWEATERS; TOPS; SWIMWEAR; T-SHIRTS; SWEATSHIRTS, IN CLASS 25 (U.S. CLS. 22 AND 39).

FIRST USE 7-7-2009; IN COMMERCE 9-9-2009.

FOR: RUGS, IN CLASS 27 (U.S. CLS. 19, 20, 37, 42 AND 50).

FIRST USE 4-25-2008; IN COMMERCE 4-25-2008.

FOR: RETAIL STORE SERVICES FEATURING CLOTHING, LEATHER GOODS, SUNGLASSES, FABRIC BED AND BATH PRODUCTS, FURNITURE, PATIOWARE, KITCHENWARE, HOME ACCESSORIES, NAMELY, LAMPS, PICTURE FRAMES, MIRRORS, INTERIOR DECORATING BOOKS, GIFT ITEMS; ONLINE RETAIL STORE SERVICES FEATURING CLOTHING, LEATHER GOODS, SUNGLASSES, FABRIC BED AND BATH



David J. Kyros

Director of the United States Patent and Trademark Office

Reg. No. 4,154,582 PRODUCTS, FURNITURE, PATIOWARE, HOME ACCESSORIES, NAMELY, INTERIOR DECORATING BOOKS, GIFT ITEMS, IN CLASS 35 (U.S. CLS. 100, 101 AND 102).

FIRST USE 9-9-2009; IN COMMERCE 9-9-2009.

THE MARK CONSISTS OF A PENTAGONAL FLOWER DESIGN CONSISTING OF 5 SUBSTANTIALLY CLOSED PETALS EACH FORMED BY TWO SOLID LINES RADIATING FROM A CENTRAL PENTAGON, THE SOLID LINES RADIATING OF ADJACENT PETALS EXTENDING FROM AND PERPENDICULAR TO ONE SIDE OF THE CENTRAL PENTAGON, AND THE OUTWARD ENDS OF THE PETALS FORMED BY ALMOST TOUCHING SOLID LINES EXTENDING INWARD FROM THE RADIATING LINES.

SN 77-982,977, FILED 1-28-2010.

COLLEEN DOMBROW, EXAMINING ATTORNEY

United States of America

United States Patent and Trademark Office



Reg. No. 4,154,583

Registered June 5, 2012

**Int. Cls.: 3, 5, 9, 16, 35,
and 38**

TRADEMARK

SERVICE MARK

PRINCIPAL REGISTER

SEVENTH GENERATION, INC. (VERMONT CORPORATION)
60 LAKE STREET
BURLINGTON, VT 05401

FOR: BATH SOAP, TOILET SOAP, LAUNDRY BLEACH, LAUNDRY CLEANING PREPARATIONS, AUTOMATIC DISHWASHER DETERGENTS; DISH WASHING PREPARATIONS, GLASS CLEANING PREPARATIONS, TOILET CLEANING PREPARATIONS, ALL-PURPOSE CLEANING PREPARATIONS, HOUSEHOLD SURFACE CLEANING PREPARATIONS; GLASS CLEANING PREPARATIONS; TUB AND TILE CLEANING PREPARATIONS; SHOWER CLEANING PREPARATIONS; CARPET CLEANERS AND PRE-MOISTENED NON-MEDICATED BABY WIPES, IN CLASS 3 (U.S. CLS. 1, 4, 6, 50, 51 AND 52).

FIRST USE 10-31-2008; IN COMMERCE 10-31-2008.

FOR: FEMININE HYGIENE PADS AND PANTY LINERS; TAMPONS, IN CLASS 5 (U.S. CLS. 6, 18, 44, 46, 51 AND 52).

FIRST USE 10-31-2009; IN COMMERCE 10-31-2009.

FOR: ON-LINE DOWNLOADABLE ELECTRONIC NEWSLETTERS IN THE FIELD OF ENVIRONMENTAL AND SOCIAL INITIATIVES, IMPLICATIONS OF USE OF ENVIRONMENTALLY SENSITIVE PRODUCTS, EARTH-FRIENDLY CONSUMER STRATEGIES AND INITIATIVES AND ENVIRONMENTAL RESOURCES, IN CLASS 9 (U.S. CLS. 21, 23, 26, 36 AND 38).

FIRST USE 3-2-2012; IN COMMERCE 3-2-2012.

FOR: DISPOSABLE DIAPERS; DISPOSABLE CHILDREN'S TRAINING PANTS; NEWSLETTERS IN THE FIELD OF ENVIRONMENTAL AND SOCIAL INITIATIVES, IMPLICATIONS OF USE OF ENVIRONMENTALLY SENSITIVE PRODUCTS, EARTH-FRIENDLY CONSUMER STRATEGIES AND INITIATIVES AND ENVIRONMENTAL RESOURCES, IN CLASS 16 (U.S. CLS. 2, 5, 22, 23, 29, 37, 38 AND 50).

FIRST USE 11-30-2009; IN COMMERCE 11-30-2009.

FOR: ON-LINE RETAIL STORE SERVICES FEATURING HOUSEHOLD CLEANING PRODUCTS, BABY CARE PRODUCTS, HOUSEHOLD TRASH DISPOSAL PRODUCTS,



David J. Kybas

Director of the United States Patent and Trademark Office

Reg. No. 4,154,583 HOUSEHOLD PAPER GOODS, CLOTHING AND PERSONAL CARE PRODUCTS; PROVIDING ON-LINE EDUCATIONAL INFORMATION CONCERNING ENVIRONMENTAL AND SOCIAL INITIATIVES, NAMELY, PROMOTING ENVIRONMENTAL AWARENESS BY DETAILING IMPLICATIONS OF USE OF ENVIRONMENTALLY SENSITIVE PRODUCTS, EARTH-FRIENDLY CONSUMER STRATEGIES AND INITIATIVES AND ENVIRONMENTAL RESOURCES USED FOR POVERTY RELIEF, SOCIAL RESPONSIBILITY AND CONSERVATION; CHARITABLE SERVICES, NAMELY, PROVIDING ONLINE INFORMATION CONCERNING CHARITABLE PROGRAMS, NAMELY, ORGANIZING AND CONDUCTING VOLUNTEER PROGRAM AND COMMUNITY SERVICE PROJECTS, IN CLASS 35 (U.S. CLS. 100, 101 AND 102).

FIRST USE 3-2-2012; IN COMMERCE 3-2-2012.

FOR: PROVIDING ON-LINE FORUMS, CHAT-ROOMS AND MESSAGE BOARDS FOR TRANSMISSION OF MESSAGES AMONG COMPUTER USERS IN THE FIELD OF ENVIRONMENTAL AND SOCIAL INITIATIVES, IMPLICATIONS OF USE OF ENVIRONMENTALLY SENSITIVE PRODUCTS, EARTH-FRIENDLY CONSUMER STRATEGIES AND INITIATIVES AND ENVIRONMENTAL RESOURCES, IN CLASS 38 (U.S. CLS. 100, 101 AND 104).

FIRST USE 4-30-2010; IN COMMERCE 4-30-2010.

OWNER OF U.S. REG. NO. 1,847,543.

THE MARK CONSISTS OF THE WORD ELEMENTS "SEVENTH GENERATION" IN A STYLIZED LEAF WITH A STYLIZED ASTERISK DINGBAT DISPLAYED NEXT TO THE UPPER RIGHT OF THE LEAF.

SN 77-983,069, FILED 1-25-2008.

JASON TURNER, EXAMINING ATTORNEY

United States of America

United States Patent and Trademark Office



Reg. No. 4,154,584

Registered June 5, 2012

Int. Cl.: 39

SERVICE MARK

PRINCIPAL REGISTER

SEARS BRANDS, LLC (ILLINOIS LIMITED LIABILITY COMPANY)
3333 BEVERLY ROAD
HOFFMAN ESTATES, IL 60179

FOR: PERSONAL DELIVERY SERVICES, NAMELY, DELIVERY OF GOODS BY BICYCLE, CAR, TRUCK AND AIR, IN CLASS 39 (U.S. CLS. 100 AND 105).

FIRST USE 4-0-2009; IN COMMERCE 4-0-2009.

THE MARK CONSISTS OF A DESIGN OF AN UPSIDE DOWN SHOPPING CART.

SN 77-983,088, FILED 2-10-2009.

GRETТА YAO, EXAMINING ATTORNEY



David J. Kybas

Director of the United States Patent and Trademark Office

United States of America

United States Patent and Trademark Office



Reg. No. 4,154,585

Registered June 5, 2012

Int. Cl.: 20

TRADEMARK

PRINCIPAL REGISTER

SUMMIT ENTERTAINMENT, LLC (DELAWARE LIMITED LIABILITY COMPANY)
1630 STEWART STREET, SUITE 120
SANTA MONICA, CA 90404

FOR: PLASTIC KEY CHAINS, IN CLASS 20 (U.S. CLS. 2, 13, 22, 25, 32 AND 50).

FIRST USE 6-0-2010; IN COMMERCE 6-0-2010.

THE MARK CONSISTS OF AN ORNATE CAPITAL "V" HAVING FOUR LEAVES AND A LARGE OVAL-SHAPED JEWEL RESTING ATOP THE "V" AND A SMALLER DIAMOND-SHAPED JEWEL AT THE BOTTOM POINT OF THE "V", WITH THE FURTHER DESIGN OF A CREST NESTLED IN THE CENTER OF THE "V", THE CREST BEING DIVIDED INTO FOUR SECTIONS AND CONTAINING A BIRD IN FLIGHT IN THE TOP RIGHT AND BOTTOM LEFT SECTIONS AND A TREE WITH BARE BRANCHES IN THE TOP LEFT AND BOTTOM RIGHT SECTIONS OF THE DIVIDED CREST.

SN 77-983,095, FILED 6-30-2009.

DEZMONA MIZELLE, EXAMINING ATTORNEY



David J. Kyffers

Director of the United States Patent and Trademark Office

United States of America

United States Patent and Trademark Office



Reg. No. 4,154,586

Registered June 5, 2012

Int. Cls.: 9, 35, 38, and 41

TRADEMARK

SERVICE MARK

PRINCIPAL REGISTER

NATIONAL GEOGRAPHIC SOCIETY (D.C. CORPORATION)
1145 17TH STREET, N.W.
WASHINGTON, DC 20036

FOR: PRE-RECORDED DATA CARRIERS, NAMELY, DISCS, TAPES, DIGITAL AUDIO AND VIDEO COMPRESSION SOFTWARE FILES, ALL FEATURING ENTERTAINMENT, CULTURAL OR MUSIC TOPICS; DOWNLOADABLE RING TONES, MUSIC, MP3S, GRAPHICS, IMAGES AND VIDEOS VIA WIRELESS COMMUNICATION DEVICES; PROVIDING DATABASES FEATURING DOWNLOADABLE RECORDED MUSIC FILES, IN CLASS 9 (U.S. CLS. 21, 23, 26, 36 AND 38).

FIRST USE 2-0-2006; IN COMMERCE 2-0-2006.

FOR: RETAIL STORE SERVICES IN THE FIELD OF ENTERTAINMENT, NAMELY, MUSICAL AND AUDIOVISUAL WORKS AND RELATED MERCHANDISE, PHOTOGRAPHS, POSTERS, STICKERS, ARTWORK, SONG TITLES, LYRICS, CONCERT PROGRAMS, MUSIC REVIEWS, BOOKS, IN CLASS 35 (U.S. CLS. 100, 101 AND 102).

FIRST USE 2-0-2006; IN COMMERCE 2-0-2006.

FOR: AUDIO BROADCASTING; CABLE TELEVISION BROADCASTING; DIRECT BROADCAST SATELLITE TELEVISION; TELEVISION BROADCASTING; VIDEO BROADCASTING; RADIO BROADCASTING; RADIO PROGRAMMING; ELECTRONIC TRANSMISSION OF INFORMATION, TEXT, SOUND AND IMAGES; SATELLITE TRANSMISSION SERVICES; CABLE RADIO TRANSMISSION AND BROADCASTING; BROADCASTING AND TRANSMISSION OF RADIO AND TELEVISION PROGRAMS VIA COMPUTER OR COMMUNICATIONS NETWORKS; ELECTRONIC TRANSMISSION OF SOUND, IMAGES AND DATA, INCLUDING STREAMING AUDIO AND VIDEO MATERIAL ACROSS BROAD BAND NETWORKS AND A GLOBAL COMPUTER NETWORK; ELECTRONIC TRANSMISSION VIA COMPUTER OF SOUND, IMAGES, DATA AND RADIO AND TELEVISION PROGRAMS; WIRELESS COMMUNICATION SERVICES, NAMELY, TRANSMISSION OF RING TONES, LOGO GRAPHICS, SOUND, MUSIC, INFORMATION AND DATA TO MOBILE TELEPHONES, WIRELESS DEVICES AND PERSONAL COMMUNICATIONS DEVICES, IN CLASS 38 (U.S. CLS. 100, 101 AND 104).

FIRST USE 2-0-2006; IN COMMERCE 2-0-2006.



David J. Kappas

Director of the United States Patent and Trademark Office

Reg. No. 4,154,586 FOR: PRODUCTION OF TELEVISION AND RADIO PROGRAMS; ON-LINE CONTENT IN THE FIELDS OF MUSIC, CULTURE, ENTERTAINMENT AND EDUCATION, NAMELY, AUDIO FILES, VIDEO FILES, METADATA, GRAPHICS; MUSIC PRODUCTION SERVICES; RECORD LABEL SERVICES, NAMELY, MUSIC RECORD PRODUCTION; PROVIDING ENTERTAINMENT AND EDUCATIONAL INFORMATION ON MUSIC AND CULTURE; RADIO PROGRAMMING, IN CLASS 41 (U.S. CLS. 100, 101 AND 107).

FIRST USE 2-0-2006; IN COMMERCE 2-0-2006.

OWNER OF U.S. REG. NOS. 2,589,756 AND 2,613,378.

THE COLOR(S) YELLOW AND GRAY IS/ARE CLAIMED AS A FEATURE OF THE MARK.

NO CLAIM IS MADE TO THE EXCLUSIVE RIGHT TO USE "MUSIC", APART FROM THE MARK AS SHOWN.

THE MARK CONSISTS OF A RECTANGULAR BORDER DESIGN IN YELLOW THAT APPEARS NEXT TO THE WORDS "NAT GEO MUSIC". THE WORDS "NAT GEO" APPEAR IN LIGHT GRAY WHILE THE WORD "MUSIC" APPEARS IN DARK GRAY.

SN 77-983,109, FILED 8-10-2007.

SCOTT BIBB, EXAMINING ATTORNEY

United States of America

United States Patent and Trademark Office

PENTHOUSE

Reg. No. 4,154,587

Registered June 5, 2012

Int. Cl.: 32

TRADEMARK

PRINCIPAL REGISTER

GENERAL MEDIA COMMUNICATIONS, INC. (NEW YORK CORPORATION)
6800 BROKEN SOUND PARKWAY
BOCA RATON, FL 33487

FOR: NON-ALCOHOLIC BEVERAGES, NAMELY, ENERGY DRINKS, IN CLASS 32 (U.S. CLS. 45, 46 AND 48).

FIRST USE 8-0-2011; IN COMMERCE 8-0-2011.

THE MARK CONSISTS OF STANDARD CHARACTERS WITHOUT CLAIM TO ANY PARTICULAR FONT, STYLE, SIZE, OR COLOR.

OWNER OF U.S. REG. NOS. 880,922, 3,007,070, AND OTHERS.

SN 77-983,118, FILED 3-29-2007.

KIMBERLY FRYE, EXAMINING ATTORNEY



David J. Kyros

Director of the United States Patent and Trademark Office

United States of America

United States Patent and Trademark Office



Reg. No. 4,154,588

Registered June 5, 2012

Int. Cl.: 9

TRADEMARK

PRINCIPAL REGISTER

EMERSON RADIO CORP. (DELAWARE CORPORATION)
3 UNIVERSITY PLAZA
HACKENSACK, NJ 07601

FOR: CAMCORDER, IN CLASS 9 (U.S. CLS. 21, 23, 26, 36 AND 38).

FIRST USE 9-30-2011; IN COMMERCE 9-30-2011.

OWNER OF U.S. REG. NOS. 409,629, 3,497,331, AND OTHERS.

THE MARK CONSISTS OF A STYLIZED FORM OF THE WORD "EMERSON" ALONG WITH A SQUARE DESIGN PARTIALLY SHADED TO FORM A CLEF SYMBOL.

SN 77-983,135, FILED 9-29-2009.

CARYN GLASSER, EXAMINING ATTORNEY



David J. Kyffers

Director of the United States Patent and Trademark Office

United States of America

United States Patent and Trademark Office

plenish

Reg. No. 4,154,589

Registered June 5, 2012

Int. Cl.: 31

TRADEMARK

PRINCIPAL REGISTER

PIONEER HI-BRED INTERNATIONAL, INC. (IOWA CORPORATION)
PO BOX 1014
7100 NW 62ND AVENUE
JOHNSTON, IA 501311014

FOR: AGRICULTURAL SEEDS, IN CLASS 31 (U.S. CLS. 1 AND 46).

FIRST USE 5-3-2011; IN COMMERCE 5-3-2011.

THE MARK CONSISTS OF THE WORD "PLENISH" IN A STYLIZED FORMAT WITH THE LETTERS "P" AND "H" SPROUTING BUDS.

SN 77-983,147, FILED 7-17-2009.

MATTHEW PAPPAS, EXAMINING ATTORNEY



David J. Kypas

Director of the United States Patent and Trademark Office

United States of America

United States Patent and Trademark Office

JOHARA

Reg. No. 4,154,590

Registered June 5, 2012

Int. Cl.: 3

TRADEMARK

PRINCIPAL REGISTER

MAJEED, MUHAMMED (UNITED STATES INDIVIDUAL)
117 COPPERTREE COURT
EDISON, NJ 08820

FOR: (BASED ON USE IN COMMERCE) COSMETICS, IN CLASS 3 (U.S. CLS. 1, 4, 6, 50, 51 AND 52).

FIRST USE 5-15-2001; IN COMMERCE 7-1-2002.

THE MARK CONSISTS OF STANDARD CHARACTERS WITHOUT CLAIM TO ANY PARTICULAR FONT, STYLE, SIZE, OR COLOR.

THE ENGLISH TRANSLATION OF "JOHARA" IS JEWEL.

SN 78-232,029, FILED 3-31-2003.

RON FAIRBANKS, EXAMINING ATTORNEY



David J. Kyffers

Director of the United States Patent and Trademark Office

United States of America

United States Patent and Trademark Office

FLY MILES PLUS

Reg. No. 4,154,591

SAN DIEGO COUNTY CREDIT UNION (CALIFORNIA CORPORATION)
6545 SEQUENCE DRIVE
SAN DIEGO, CA 92121

Registered June 5, 2012

Int. Cls.: 35 and 36

FOR: INCENTIVE AWARD PROGRAM PROMOTING THE USE OF CREDIT CARDS; INCENTIVE AWARD PROGRAM PROMOTING THE SALE OF CREDIT CARDS; PROMOTING THE SERVICES OF OTHERS THROUGH LOYALTY AND INCENTIVE REWARD PROGRAMS AND ON-LINE PROMOTIONS, IN CLASS 35 (U.S. CLS. 100, 101 AND 102).

SERVICE MARK

PRINCIPAL REGISTER

FIRST USE 10-15-2004; IN COMMERCE 10-15-2004.

FOR: FINANCIAL INFORMATION PROVIDED BY ELECTRONIC MEANS; PROVIDING FINANCIAL ACCOUNT MANAGEMENT AND INFORMATION; PROVIDING FINANCIAL ACCOUNT AND DATA MANAGEMENT, NAMELY, PROVIDING AGGREGATION OF INFORMATION ABOUT MULTIPLE FINANCIAL ACCOUNTS AND DATA VIA A GLOBAL COMPUTER NETWORK AND TELECOMMUNICATIONS NETWORKS; ELECTRONIC FINANCIAL TRANSACTION PROCESSING FOR PROGRAM MEMBERS AND PARTICIPATING MERCHANTS, IN CLASS 36 (U.S. CLS. 100, 101 AND 102).

FIRST USE 10-15-2004; IN COMMERCE 10-15-2004.

THE MARK CONSISTS OF STANDARD CHARACTERS WITHOUT CLAIM TO ANY PARTICULAR FONT, STYLE, SIZE, OR COLOR.

OWNER OF U.S. REG. NOS. 2,298,158 AND 2,307,415.

NO CLAIM IS MADE TO THE EXCLUSIVE RIGHT TO USE "PLUS", APART FROM THE MARK AS SHOWN.

SN 78-477,138, FILED 9-1-2004.

MARK SPARACINO, EXAMINING ATTORNEY



David J. Kypos

Director of the United States Patent and Trademark Office

United States of America

United States Patent and Trademark Office

Pool Maid

Reg. No. 4,154,592

Registered June 5, 2012

Int. Cl.: 7

TRADEMARK

PRINCIPAL REGISTER

POOLMAID (USA) INC. (FLORIDA CORPORATION)
4345 N.E. 12TH TR.
OAKLAND PARK, FL 33334

FOR: SWIMMING POOL CLEANERS, NAMELY, POOL VACUUMS; SWIMMING POOL CLEANERS, NAMELY, POOL SWEEPERS, IN CLASS 7 (U.S. CLS. 13, 19, 21, 23, 31, 34 AND 35).

FIRST USE 12-0-1995; IN COMMERCE 12-0-1995.

THE MARK CONSISTS OF STANDARD CHARACTERS WITHOUT CLAIM TO ANY PARTICULAR FONT, STYLE, SIZE, OR COLOR.

NO CLAIM IS MADE TO THE EXCLUSIVE RIGHT TO USE "POOL", APART FROM THE MARK AS SHOWN.

SN 78-670,379, FILED 7-14-2005.

JIM RINGLE, EXAMINING ATTORNEY



David J. Kyffers

Director of the United States Patent and Trademark Office

United States of America

United States Patent and Trademark Office

INFUSION

Reg. No. 4,154,593

Registered June 5, 2012

Int. Cl.: 9

TRADEMARK

PRINCIPAL REGISTER

INVENSYS SYSTEMS, INC. (MASSACHUSETTS CORPORATION)
33 COMMERCIAL STREET
FOXBORO, MA 02035

FOR: COMPUTER-BASED INDUSTRIAL AUTOMATION AND INFORMATION SYSTEM; COMPUTER SOFTWARE AND HARDWARE FOR CONNECTION WITH INDUSTRIAL INSTRUMENTATION INCLUDING VALVES, PUMPS, MOTORS, FLOW MEASUREMENT DEVICES, PRESSURE MEASUREMENT DEVICES, LEVEL MEASUREMENT DEVICES, TEMPERATURE MEASUREMENT DEVICES, CHEMICAL COMPOSITION MEASUREMENT DEVICES, EQUIPMENT CONDITION MONITORING DEVICES; COMPUTER HARDWARE AND SOFTWARE FOR INDUSTRIAL PROCESS CONTROL AND LOGIC CONTROL, COMPUTER HARDWARE AND SOFTWARE FOR INDUSTRIAL OPERATOR CONSOLES, MAINTENANCE CONSOLES, ENGINEERING WORKSTATIONS, SUPERVISION CONSOLES AND MANAGEMENT INTERFACING; COMPUTER-BASED HARDWARE AND SOFTWARE FOR INDUSTRIAL INFORMATION MANAGEMENT INCLUDING PROCESS HISTORIAN, INDUSTRIAL ALARM MANAGEMENT, INDUSTRIAL MODELING AND SIMULATION; COMPUTER-BASED SOFTWARE FOR ADVANCE OPERATIONS AND MAINTENANCE SUPERVISION INCLUDING ADVANCED PROCESS CONTROL, MULTIVARIABLE PREDICTIVE CONTROL, STATISTICAL CONTROL, LINEAR OPTIMIZATION AND NONLINEAR OPTIMIZATION, PREDICTIVE MAINTENANCE, AND PLANT ASSET MANAGEMENT; COMPUTER SOFTWARE FOR THE INTEROPERATION WITH THIRD PARTY INTELLIGENT PLANT DEVICES EXISTING IN THE INDUSTRIAL PLANT INCLUDING DDE DEVICE DRIVERS AND DATA ACQUISITION SERVERS; COMPUTER-BASED SOFTWARE FOR THE INTEROPERATION WITH THIRD PARTY ENTERPRISE BUSINESS SOFTWARE INCLUDING ENTERPRISE MESSAGING SERVICES, WEB SERVICES, AND FILE TRANSFER MECHANISMS, IN CLASS 9 (U.S. CLS. 21, 23, 26, 36 AND 38).



FIRST USE 7-22-2005; IN COMMERCE 9-30-2006.

THE MARK CONSISTS OF STANDARD CHARACTERS WITHOUT CLAIM TO ANY PARTICULAR FONT, STYLE, SIZE, OR COLOR.

SN 78-676,313, FILED 7-22-2005.

MATTHEW KLINE, EXAMINING ATTORNEY

David J. Kypas

Director of the United States Patent and Trademark Office

United States of America

United States Patent and Trademark Office

LRG

Reg. No. 4,154,594

Registered June 5, 2012

Int. Cls.: 16, 24, and 28

TRADEMARK

PRINCIPAL REGISTER

LIFTED RESEARCH GROUP INC. (CALIFORNIA CORPORATION)
P.O. BOX 54668
IRVINE, CA 92619

FOR: PRINTED MATERIAL, NAMELY, STICKERS, CATALOGS FEATURING APPAREL PRODUCTS, BAGS, ACCESSORIES, AND WATCHES, IN CLASS 16 (U.S. CLS. 2, 5, 22, 23, 29, 37, 38 AND 50).

FIRST USE 1-9-2010; IN COMMERCE 1-9-2010.

FOR: BED BLANKETS, TOWELS, IN CLASS 24 (U.S. CLS. 42 AND 50).

FIRST USE 1-9-2010; IN COMMERCE 1-9-2010.

FOR: SPORTING GOODS, NAMELY, SKATEBOARDS AND COMPONENT PARTS THEREOF, SNOWBOARDS AND COMPONENT PARTS THEREOF, SKIMBOARDS, BEACHBALLS, BASKETBALLS, IN CLASS 28 (U.S. CLS. 22, 23, 38 AND 50).

FIRST USE 1-9-2010; IN COMMERCE 1-9-2010.

THE MARK CONSISTS OF STANDARD CHARACTERS WITHOUT CLAIM TO ANY PARTICULAR FONT, STYLE, SIZE, OR COLOR.

OWNER OF U.S. REG. NO. 2,633,832.

SN 78-724,710, FILED 10-1-2005.

DAVID ELTON, EXAMINING ATTORNEY



David J. Kyros

Director of the United States Patent and Trademark Office

United States of America

United States Patent and Trademark Office

Blue

Reg. No. 4,154,595

Registered June 5, 2012

Int. Cl.: 33

TRADEMARK

PRINCIPAL REGISTER

HANSEN, CHRISTOPHER JOHN (UNITED STATES INDIVIDUAL)
499 N.CANON DRIVE
BEVERLY HILLS, CA 90210

FOR: 100% BLUE AGAVE TEQUILA, IN CLASS 33 (U.S. CLS. 47 AND 49).

FIRST USE 5-15-2010; IN COMMERCE 6-10-2010.

THE MARK CONSISTS OF THE STYLIZED WORD "BLUE".

SN 78-745,393, FILED 11-2-2005.

BRIAN PINO, EXAMINING ATTORNEY



David J. Kybas

Director of the United States Patent and Trademark Office

United States of America

United States Patent and Trademark Office

LIP ILLUSION

Reg. No. 4,154,596

Registered June 5, 2012

Int. Cl.: 3

TRADEMARK

PRINCIPAL REGISTER

MALLYGIRL LLC (DELAWARE LIMITED LIABILITY COMPANY)
SUITE 902
901 DULANEY VALLEY ROAD
TOWSON, MD 21204

FOR: COSMETICS AND MAKE UP, NAMELY, LIPSTICK, LIP COLOR AND LIP GLOSS, IN CLASS 3 (U.S. CLS. 1, 4, 6, 50, 51 AND 52).

FIRST USE 9-0-2006; IN COMMERCE 1-0-2007.

THE MARK CONSISTS OF STANDARD CHARACTERS WITHOUT CLAIM TO ANY PARTICULAR FONT, STYLE, SIZE, OR COLOR.

NO CLAIM IS MADE TO THE EXCLUSIVE RIGHT TO USE "LIP", APART FROM THE MARK AS SHOWN.

SN 78-863,934, FILED 4-18-2006.

MATTHEW EINSTEIN, EXAMINING ATTORNEY



David J. Kyffers

Director of the United States Patent and Trademark Office

United States of America

United States Patent and Trademark Office

PHARMA  MEDICO

Reg. No. 4,154,597

Registered June 5, 2012

Int. Cls.: 3 and 5

TRADEMARK

PRINCIPAL REGISTER

PHARMA MEDICO UK LIMITED (UNITED KINGDOM LIMITED COMPANY)
21 ST THOMAS STREET
BRISTOL, UNITED KINGDOM BS1 6JS

FOR: CREAMS, NAMELY, ANTI-AGING CREAMS, ANTI-WRINKLE CREAMS, BEAUTY CREAMS, FACE AND BODY CREAMS, HAIR CREAMS, NON-MEDICATED SCALP TREATMENT CREAM, NON-MEDICATED SKIN CREAMS, SKIN CREAMS; LOTIONS FOR SKIN, HAIR, FACE AND BODY, COSMETICS; NON-MEDICATED TOILETRIES; SUN PROTECTION CREAMS AND SUN-BLOCK LOTIONS; ANTI-WRINKLE AND ANTI-CELLULITE CREAMS AND LOTIONS, IN CLASS 3 (U.S. CLS. 1, 4, 6, 50, 51 AND 52).

FIRST USE 7-1-1997; IN COMMERCE 3-17-2005.

FOR: PHARMACEUTICAL PREPARATIONS AND SUBSTANCES FOR THE TREATMENT OF SKIN PROBLEMS, HAIR LOSS PROBLEMS AND WEIGHT PROBLEMS; CREAMS, NAMELY, MEDICATED BODY AND FACE CREAMS; LOTIONS, NAMELY, MEDICATED BODY AND FACE LOTIONS; MEDICATED SUN PROTECTION CREAMS; MEDICATED ANTI-WRINKLE AND ANTI-CELLULITE CREAMS AND LOTIONS; ANTI-ITCH OINTMENTS, MULTIPURPOSE MEDICATED ANALGESIC BALM AND MENTHOLATED SALVES, IN CLASS 5 (U.S. CLS. 6, 18, 44, 46, 51 AND 52).

FIRST USE 7-1-1997; IN COMMERCE 3-17-2005.

NO CLAIM IS MADE TO THE EXCLUSIVE RIGHT TO USE "PHARMA" AND "MEDICO", APART FROM THE MARK AS SHOWN.

THE MARK CONSISTS OF THE CONFIGURATION OF THE PORTION OF THE MARK COMPRISED OF A CROSS DESIGN IS NOT DISPLAYED IN THE COLOR RED OR A COLORABLE IMITATION THEREOF; AND IS NOT USE AND WILL NOT BE USED IN THE COLOR RED OR A COLORABLE IMITATION THEREOF.

THE ENGLISH TRANSLATION OF THE WORD "MEDICO" IN THE MARK IS "MEDICAL".

SN 78-885,425, FILED 5-17-2006.

RONALD AIKENS, EXAMINING ATTORNEY

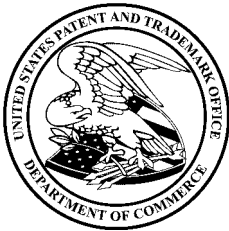

David J. Kyros

Director of the United States Patent and Trademark Office

United States of America

United States Patent and Trademark Office



Reg. No. 4,154,598

Registered June 5, 2012

Int. Cls.: 29, 30, and 32

TRADEMARK

PRINCIPAL REGISTER

UNITED FOOD IMPORT, INC. (NEW JERSEY CORPORATION)
SUITE K
3 CHRIS CT.
DAYTON, NJ 08810

FOR: CANNED COOKED MEAT; DRIED BEANS; DRIED MEAT; FRANKFURTERS ; LENTILS; PICKLES; PROCESSED BEANS; PROCESSED PEPPERS; REFRIED BEANS; STUFFED EGGPLANTS; STUFFED GRAPE LEAVES; GREEN PEPPERS STUFFED WITH RICE, IN CLASS 29 (U.S. CL. 46).

FIRST USE 1-1-2000; IN COMMERCE 1-1-2000.

FOR: FILO LEAVES; PROCESSED GRAINS, NAMELY, RICE, IN CLASS 30 (U.S. CL. 46).

FIRST USE 1-1-2000; IN COMMERCE 1-1-2000.

FOR: APPLE JUICE BEVERAGES; FRUIT JUICES; FRUIT JUICES, NAMELY, APPLE, GRAPE, NECTAR, MANGO, POMEGRANITE, LEMON, KIWI, JUICE; HERBAL JUICES, IN CLASS 32 (U.S. CLS. 45, 46 AND 48).

FIRST USE 6-1-2006; IN COMMERCE 6-1-2006.

OWNER OF U.S. REG. NO. 3,398,369.

THE NON-LATIN CHARACTER(S) IN THE MARK TRANSLITERATE INTO "BASMA", AND THIS MEANS "SMILE" IN ENGLISH.

THE MARK CONSISTS OF 3 ARABIC LETTERS WHICH TRANSLITERATE TO "BASMA" IN THE ROUNDED UPPER PORTION OF A BANNER DESIGN AND THE LATIN LETTERS FOR "BASMA" APPEARING IN THE BOTTOM PORTION OF THE BANNER DESIGN.

THE FOREIGN WORDING IN THE MARK TRANSLATES INTO ENGLISH AS SMILE.

SN 78-892,757, FILED 5-30-2006.

MICHELE SWAIN, EXAMINING ATTORNEY



David J. Kyros

Director of the United States Patent and Trademark Office

United States of America

United States Patent and Trademark Office

iDREAM

Reg. No. 4,154,599

BEST BRANDS CONSUMER PRODUCTS, INC. (NEW JERSEY CORPORATION)
20 WEST 33RD STREET
NEW YORK, NY 10001

Registered June 5, 2012

Int. Cl.: 9

FOR: AUDIO SPEAKERS; HEADPHONES; RADIOS INCORPORATING CLOCKS, IN CLASS
9 (U.S. CLS. 21, 23, 26, 36 AND 38).

TRADEMARK

FIRST USE 5-11-2011; IN COMMERCE 5-11-2011.

PRINCIPAL REGISTER

THE MARK CONSISTS OF STANDARD CHARACTERS WITHOUT CLAIM TO ANY PAR-
TICULAR FONT, STYLE, SIZE, OR COLOR.

SN 78-900,501, FILED 6-5-2006.

LESLIE RICHARDS, EXAMINING ATTORNEY



David J. Kybas

Director of the United States Patent and Trademark Office

United States of America

United States Patent and Trademark Office

HUELER INCOME SOLUTIONS

Reg. No. 4,154,600

Registered June 5, 2012

Int. Cl.: 36

SERVICE MARK

PRINCIPAL REGISTER

HUELER INVESTMENT SERVICES, INC. (MINNESOTA CORPORATION)
10400 VIKING DRIVE
SUITE 190
EDEN PRAIRIE, MN 55344

FOR: INVESTMENT SERVICES, NAMELY, FINANCIAL TRANSACTION PROCESSING AND ANNUITY SERVICES AND PROVIDING ON-LINE FINANCIAL TRANSACTION PROCESSING AND ANNUITY SERVICES, IN CLASS 36 (U.S. CLS. 100, 101 AND 102).

FIRST USE 3-9-2012; IN COMMERCE 3-9-2012.

THE MARK CONSISTS OF STANDARD CHARACTERS WITHOUT CLAIM TO ANY PARTICULAR FONT, STYLE, SIZE, OR COLOR.

SEC. 2(F) AS TO "INCOME SOLUTIONS".

OWNER OF U.S. REG. NO. 2,933,664.

SN 78-964,142, FILED 8-30-2006.

LAURA HAMMEL, EXAMINING ATTORNEY



David J. Kybas

Director of the United States Patent and Trademark Office

United States of America

United States Patent and Trademark Office

CHOOSE TO BE RICH

Reg. No. 4,154,601

CASHFLOW TECHNOLOGIES, INC. (NEVADA CORPORATION)
4330 N. CIVIC CENTER PLAZA, SUITE 101
SCOTTSDALE, AZ 85251

Registered June 5, 2012

Int. Cl.: 41

FOR: PROVIDING ONLINE, NON-DOWNLOADABLE ELECTRONIC PUBLICATIONS, NAMELY, PAMPHLETS, BROCHURES AND NEWSLETTERS, IN THE FIELD OF FINANCIAL EDUCATION, IN CLASS 41 (U.S. CLS. 100, 101 AND 107).

SERVICE MARK

FIRST USE 11-0-2002; IN COMMERCE 11-0-2002.

PRINCIPAL REGISTER

THE MARK CONSISTS OF STANDARD CHARACTERS WITHOUT CLAIM TO ANY PARTICULAR FONT, STYLE, SIZE, OR COLOR.

SN 78-965,495, FILED 8-31-2006.

LINDA LAVACHE, EXAMINING ATTORNEY



David J. Kyros

Director of the United States Patent and Trademark Office

United States of America

United States Patent and Trademark Office

BREATHE NEW HAMPSHIRE

Reg. No. 4,154,602

BREATHE NEW HAMPSHIRE (NEW HAMPSHIRE CORPORATION)
145 HOLLIS STREET, UNIT C
MANCHESTER, NH 03101

Registered June 5, 2012

Int. Cl.: 35

FOR: PROMOTING PUBLIC AWARENESS OF LUNG HEALTH AND THE CAUSES, TREATMENTS AND CURES OF LUNG DISEASES, IN CLASS 35 (U.S. CLS. 100, 101 AND 102).

SERVICE MARK

FIRST USE 7-1-2007; IN COMMERCE 7-1-2007.

PRINCIPAL REGISTER

THE MARK CONSISTS OF STANDARD CHARACTERS WITHOUT CLAIM TO ANY PARTICULAR FONT, STYLE, SIZE, OR COLOR.

NO CLAIM IS MADE TO THE EXCLUSIVE RIGHT TO USE "NEW HAMPSHIRE", APART FROM THE MARK AS SHOWN.

SN 78-972,656, FILED 9-12-2006.

LINDA ESTRADA, EXAMINING ATTORNEY



David J. Kyros

Director of the United States Patent and Trademark Office

United States of America

United States Patent and Trademark Office

(RED)

Reg. No. 4,154,603

Registered June 5, 2012

Int. Cl.: 41

SERVICE MARK

PRINCIPAL REGISTER

THE ONE CAMPAIGN (D.C. NON-PROFIT COMPANY)
1400 EYE STREET NW
WASHINGTON, DC 20005

FOR: ARRANGING AND CONDUCTING EDUCATIONAL CONFERENCES, SYMPOSIUMS AND EXHIBITIONS CONCERNING AIDS IN AFRICA AND OTHER HUMANITARIAN RELIEF EFFORTS; ONLINE JOURNALS, NAMELY, BLOGS DISCUSSING AND FOR THE PURPOSE OF PROMOTING AWARENESS ABOUT AIDS IN AFRICA AND OTHER HUMANITARIAN RELIEF EFFORTS, IN CLASS 41 (U.S. CLS. 100, 101 AND 107).

FIRST USE 10-13-2006; IN COMMERCE 10-13-2006.

THE MARK CONSISTS OF STANDARD CHARACTERS WITHOUT CLAIM TO ANY PARTICULAR FONT, STYLE, SIZE, OR COLOR.

SN 78-980,967, FILED 7-8-2005.

BENJAMIN OKEKE, EXAMINING ATTORNEY



David J. Kyjars

Director of the United States Patent and Trademark Office

United States of America

United States Patent and Trademark Office

PRIVATE SCREENINGS

Reg. No. 4,154,604

RICHARD BROWN (UNITED STATES INDIVIDUAL)
575 AVENUE OF THE AMERICAS
NEW YORK, NY 10011

Registered June 5, 2012

Int. Cl.: 41

FOR: EDUCATIONAL AND ENTERTAINMENT SERVICES, NAMELY, CONDUCTING SEMINARS, DISCUSSIONS AND INTERVIEWS ON FILMMAKING AND THE FILM INDUSTRY, IN CLASS 41 (U.S. CLS. 100, 101 AND 107).

SERVICE MARK

FIRST USE 8-3-1987; IN COMMERCE 10-14-2011.

PRINCIPAL REGISTER

THE MARK CONSISTS OF STANDARD CHARACTERS WITHOUT CLAIM TO ANY PARTICULAR FONT, STYLE, SIZE, OR COLOR.

SN 85-000,378, FILED 3-29-2010.

REBECCA POVARCHUK, EXAMINING ATTORNEY



David J. Kybas

Director of the United States Patent and Trademark Office

United States of America

United States Patent and Trademark Office

SimTouch

Reg. No. 4,154,605

Registered June 5, 2012

Int. Cl.: 9

TRADEMARK

PRINCIPAL REGISTER

HORIZONS INCORPORATED (OHIO CORPORATION)
18531 SOUTH MILES ROAD
CLEVELAND, OH 44128

FOR: INTERFACE DEVICES FOR USE WITH COMPUTERS AND ELECTRONIC DEVICES
FOR NAVIGATION OF MENU LISTS, IN CLASS 9 (U.S. CLS. 21, 23, 26, 36 AND 38).

FIRST USE 5-0-2011; IN COMMERCE 5-0-2011.

THE MARK CONSISTS OF STANDARD CHARACTERS WITHOUT CLAIM TO ANY PAR-
TICULAR FONT, STYLE, SIZE, OR COLOR.

OWNER OF U.S. REG. NO. 3,583,887.

SN 85-001,568, FILED 3-30-2010.

ROBIN CHOSID, EXAMINING ATTORNEY



David J. Kyffers

Director of the United States Patent and Trademark Office

United States of America

United States Patent and Trademark Office

We Cure Confusion

Reg. No. 4,154,606

Registered June 5, 2012

Int. Cls.: 35 and 36

SERVICE MARK

PRINCIPAL REGISTER

PLANPRESCRIBER, INC. (DELAWARE CORPORATION)
8 CLOCK TOWER PLACE, SUITE 400
MAYNARD, MA 01754

FOR: INSURANCE LEAD COLLECTION AND MATCHING SERVICES, NAMELY, MATCHING CONSUMER REQUESTS FOR INSURANCE POLICY QUOTES COLLECTED OVER THE INTERNET TO PRE-QUALIFIED INSURANCE BROKERS, AGENTS AND AGENCIES INTERESTED IN THOSE REQUESTS; PROVIDING INSURANCE AGENT REFERRALS; PROVIDING SALES LEADS FOR THE INSURANCE INDUSTRY, IN CLASS 35 (U.S. CLS. 100, 101 AND 102).

FIRST USE 12-19-2011; IN COMMERCE 12-19-2011.

FOR: CONSULTING AND INFORMATION CONCERNING INSURANCE; INSURANCE CONSULTATION; INSURANCE INFORMATION, IN CLASS 36 (U.S. CLS. 100, 101 AND 102).

FIRST USE 12-19-2011; IN COMMERCE 12-19-2011.

THE MARK CONSISTS OF STANDARD CHARACTERS WITHOUT CLAIM TO ANY PARTICULAR FONT, STYLE, SIZE, OR COLOR.

SN 85-001,804, FILED 3-30-2010.

KAELIE KUNG, EXAMINING ATTORNEY



David J. Kybas

Director of the United States Patent and Trademark Office

United States of America

United States Patent and Trademark Office

ZAPPTA

Reg. No. 4,154,607

REVIVO, ZION (UNITED STATES INDIVIDUAL)
17185 DEVONSHIRE ST. #1
NORTHRIDGE, CA 91325

Registered June 5, 2012

Int. Cl.: 35

FOR: OPERATING ON-LINE MARKETPLACES FOR SELLERS OF GOODS AND/OR SERVICES, IN CLASS 35 (U.S. CLS. 100, 101 AND 102).

SERVICE MARK

FIRST USE 3-1-2012; IN COMMERCE 3-1-2012.

PRINCIPAL REGISTER

THE MARK CONSISTS OF STANDARD CHARACTERS WITHOUT CLAIM TO ANY PARTICULAR FONT, STYLE, SIZE, OR COLOR.

THE WORDING "ZAPPTA" HAS NO MEANING IN A FOREIGN LANGUAGE.

SN 85-001,806, FILED 3-30-2010.

MATTHEW MCDOWELL, EXAMINING ATTORNEY



David J. Kybas

Director of the United States Patent and Trademark Office

United States of America

United States Patent and Trademark Office

SHARE GATE

Reg. No. 4,154,608

CUNNINGHAM, ARGUS I. (UNITED STATES INDIVIDUAL)
BOX 817
FPO AE, ITALY 09622

Registered June 5, 2012

Int. Cl.: 42

FOR: PROVIDING A WEBSITE FEATURING TECHNOLOGY THAT FACILITATES SHAREHOLDERS' ELECTRONIC COMMUNICATION AND SOCIAL MEDIA INTERACTION FOR THE PURPOSE OF IMPROVING CORPORATE GOVERNANCE OVERSIGHT; PROVIDING ON-LINE NON-DOWNLOADABLE SOFTWARE THAT FACILITATES SHAREHOLDERS' ELECTRONIC COMMUNICATION AND SOCIAL MEDIA INTERACTION FOR THE PURPOSE OF IMPROVING CORPORATE GOVERNANCE OVERSIGHT, IN CLASS 42 (U.S. CLS. 100 AND 101).

SERVICE MARK

PRINCIPAL REGISTER

FIRST USE 11-30-2010; IN COMMERCE 11-30-2011.

THE MARK CONSISTS OF STANDARD CHARACTERS WITHOUT CLAIM TO ANY PARTICULAR FONT, STYLE, SIZE, OR COLOR.

SN 85-002,207, FILED 3-30-2010.

BARNEY CHARLON, EXAMINING ATTORNEY



David J. Kyros

Director of the United States Patent and Trademark Office

United States of America

United States Patent and Trademark Office

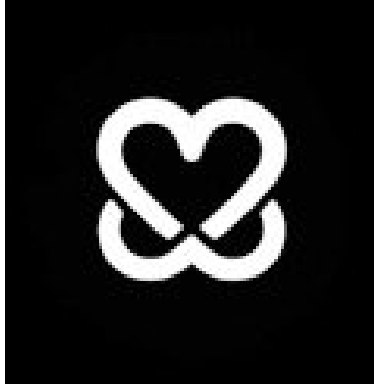

Reg. No. 4,154,609

Registered June 5, 2012

Int. Cl.: 14

TRADEMARK

PRINCIPAL REGISTER

KEEP A BREAST FOUNDATION (CALIFORNIA NON-PROFIT CORPORATION)
2251 LAS PALMAS DR.
CARLSBAD, CA 92011

FOR: JEWELRY, NAMELY, RINGS, WATCHES, IN CLASS 14 (U.S. CLS. 2, 27, 28 AND 50).

FIRST USE 6-6-2011; IN COMMERCE 6-6-2011.

THE MARK CONSISTS OF A HEART SUPERIMPOSED ON TWO HALF CIRCLES REPRESENTING ABSTRACT BREASTS.

SN 85-002,391, FILED 3-30-2010.

ROBIN MITTLER, EXAMINING ATTORNEY



David J. Kyffers

Director of the United States Patent and Trademark Office

United States of America

United States Patent and Trademark Office

Perfect Prep

Reg. No. 4,154,610

JOHN MEZZALINGUA ASSOCIATES, INC. (DELAWARE CORPORATION), DBA PPC,
6176 E. MOLLOY RD.
EAST SYRACUSE, NY 13057

Registered June 5, 2012

Int. Cl.: 9

FOR: CONNECTION CABLES, IN CLASS 9 (U.S. CLS. 21, 23, 26, 36 AND 38).

TRADEMARK

FIRST USE 10-0-2011; IN COMMERCE 10-0-2011.

PRINCIPAL REGISTER

THE MARK CONSISTS OF THE TERMS "PERFECT PREP" SEPARATED BY A DESIGN OF
A CIRCLE INTERSECTED BY AN ARROW.

SN 85-003,568, FILED 3-31-2010.

PAM WILLIS, EXAMINING ATTORNEY



David J. Kyffers

Director of the United States Patent and Trademark Office

United States of America

United States Patent and Trademark Office



KnowledgeWorks

Reg. No. 4,154,611

Registered June 5, 2012

Int. Cls.: 16 and 41

TRADEMARK

SERVICE MARK

PRINCIPAL REGISTER

KNOWLEDGEWORKS FOUNDATION (OHIO CORPORATION)
ONE WEST FOURTH STREET
CINCINNATI, OH 45202

FOR: PRINTED MATERIALS, NAMELY, BOOKS, PAMPHLETS AND NEWSLETTERS IN THE FIELD OF EDUCATION, IN CLASS 16 (U.S. CLS. 2, 5, 22, 23, 29, 37, 38 AND 50).

FIRST USE 5-1-2010; IN COMMERCE 5-1-2010.

FOR: CONSULTING SERVICES IN THE FIELD OF EDUCATION, NAMELY, PROVIDING CONSULTING TO TEACHERS, STAFF AND ADMINISTRATORS IN THE IMPLEMENTATION OF EDUCATIONAL REFORM MODELS; PROVIDING A WEB SITE FEATURING INFORMATION, REPORTS, NEWSLETTERS, EDUCATIONAL RESEARCH, WEBCASTS AND VIDEOS IN THE FIELD OF EDUCATION; EDUCATIONAL RESEARCH SERVICES, IN CLASS 41 (U.S. CLS. 100, 101 AND 107).

FIRST USE 5-1-2010; IN COMMERCE 5-1-2010.

OWNER OF U.S. REG. NO. 2,825,512.

THE MARK CONSISTS OF THE WORD "KNOWLEDGEWORKS" AND ON TOP OF THE WORD "WORKS" IS AN ARTISTIC RENDITION OF A FLAME.

SN 85-003,872, FILED 4-1-2010.

LINDA POWELL, EXAMINING ATTORNEY



David J. Kyjars

Director of the United States Patent and Trademark Office

United States of America

United States Patent and Trademark Office

VAGINAL RENEWAL

Reg. No. 4,154,612

LOTIONS LIMITED, LLC (WISCONSIN LIMITED LIABILITY COMPANY)
600 WILLIAMSON STREET
MADISON, WI 53703

Registered June 5, 2012

Int. Cl.: 10

FOR: ADULT SEXUAL STIMULATION AIDS, NAMELY, VIBRATORS AND ARTIFICIAL STIMULATORS, IN CLASS 10 (U.S. CLS. 26, 39 AND 44).

TRADEMARK

FIRST USE 1-1-2010; IN COMMERCE 11-30-2010.

PRINCIPAL REGISTER

THE MARK CONSISTS OF STANDARD CHARACTERS WITHOUT CLAIM TO ANY PARTICULAR FONT, STYLE, SIZE, OR COLOR.

NO CLAIM IS MADE TO THE EXCLUSIVE RIGHT TO USE "VAGINAL", APART FROM THE MARK AS SHOWN.

SN 85-004,510, FILED 4-1-2010.

NATALIE POLZER, EXAMINING ATTORNEY



David J. Kyffers

Director of the United States Patent and Trademark Office

United States of America

United States Patent and Trademark Office



Reg. No. 4,154,613

Registered June 5, 2012

Int. Cl.: 25

TRADEMARK

PRINCIPAL REGISTER

REYNOSO, DANIEL (UNITED STATES INDIVIDUAL)
3551 BEECHWOOD PLACE
RIVERSIDE, CA 92506 AND

MANZANO, FRANKIE (UNITED STATES INDIVIDUAL)
3551 BEECHWOOD PLACE
RIVERSIDE, CA 92506

FOR: CLOTHING, NAMELY, TEE-SHIRTS, IN CLASS 25 (U.S. CLS. 22 AND 39).

FIRST USE 3-15-2007; IN COMMERCE 1-15-2012.

THE MARK CONSISTS OF THE LETTERS "MMM" STYLIZED.

SN 85-004,732, FILED 4-1-2010.

ELLEN PERKINS, EXAMINING ATTORNEY



David J. Kybas

Director of the United States Patent and Trademark Office

United States of America

United States Patent and Trademark Office

SOUNDGUARD

Reg. No. 4,154,614

Registered June 5, 2012

Int. Cl.: 11

TRADEMARK

PRINCIPAL REGISTER

MAYTAG PROPERTIES, LLC (MICHIGAN LIMITED LIABILITY COMPANY)
500 RENAISSANCE DRIVE
SUITE 101
ST. JOSEPH, MI 49085

FOR: CLOTHES DRYERS, IN CLASS 11 (U.S. CLS. 13, 21, 23, 31 AND 34).

FIRST USE 11-1-2010; IN COMMERCE 11-1-2010.

THE MARK CONSISTS OF STANDARD CHARACTERS WITHOUT CLAIM TO ANY PARTICULAR FONT, STYLE, SIZE, OR COLOR.

SN 85-005,150, FILED 4-2-2010.

ANNE E. GUSTASON, EXAMINING ATTORNEY



David J. Kybas

Director of the United States Patent and Trademark Office

United States of America

United States Patent and Trademark Office

LOCKDOWN

Reg. No. 4,154,615

Registered June 5, 2012

Int. Cls.: 39 and 41

SERVICE MARK

PRINCIPAL REGISTER

CINTAS HOLDINGS, LLC (OHIO LIMITED LIABILITY COMPANY)
6800 CINTAS BOULEVARD
MASON, OH 45040

FOR: ELECTRONIC DOCUMENT STORAGE SERVICES AND DOCUMENT STORAGE SERVICES, IN CLASS 39 (U.S. CLS. 100 AND 105).

FIRST USE 3-31-2010; IN COMMERCE 3-31-2010.

FOR: DIGITAL IMAGING SERVICES, IN CLASS 41 (U.S. CLS. 100, 101 AND 107).

FIRST USE 3-31-2010; IN COMMERCE 3-31-2010.

THE MARK CONSISTS OF STANDARD CHARACTERS WITHOUT CLAIM TO ANY PARTICULAR FONT, STYLE, SIZE, OR COLOR.

SN 85-005,179, FILED 4-2-2010.

EDWARD NELSON, EXAMINING ATTORNEY



David J. Kybas

Director of the United States Patent and Trademark Office

United States of America

United States Patent and Trademark Office

UNSINKABLE DREAM

Reg. No. 4,154,616

PUJOL, JAIME (UNITED STATES INDIVIDUAL)
10250 S.W. 28TH STREET
MIAMI, FL 33165

Registered June 5, 2012

Int. Cl.: 28

FOR: FLOATS FOR RECREATIONAL USE, NAMELY, FOAM FLOATS, IN CLASS 28 (U.S. CLS. 22, 23, 38 AND 50).

TRADEMARK

FIRST USE 8-28-2011; IN COMMERCE 1-20-2012.

PRINCIPAL REGISTER

THE MARK CONSISTS OF STANDARD CHARACTERS WITHOUT CLAIM TO ANY PARTICULAR FONT, STYLE, SIZE, OR COLOR.

SN 85-005,817, FILED 4-4-2010.

JUDITH HELFMAN, EXAMINING ATTORNEY



David J. Kyffers

Director of the United States Patent and Trademark Office

United States of America

United States Patent and Trademark Office



Reg. No. 4,154,617

Registered June 5, 2012

Int. Cl.: 20

TRADEMARK

PRINCIPAL REGISTER

SUMMIT ENTERTAINMENT, LLC (DELAWARE LIMITED LIABILITY COMPANY)
1630 STEWART STREET, SUITE 120
SANTA MONICA, CA 90404

FOR: DREAMCATCHERS; DECORATIVE THROW PILLOWS; KEY CHAINS OF PLASTIC;
PLASTIC BANNERS; AND VINYL APPLIQUES FOR ATTACHMENT TO WINDOWS, MIR-
RORS AND OTHER SOLID SURFACES, IN CLASS 20 (U.S. CLS. 2, 13, 22, 25, 32 AND 50).

FIRST USE 10-1-2009; IN COMMERCE 10-1-2009.

THE MARK CONSISTS OF A CIRCULAR TRIBAL TATTOO DESIGN DEPICTING TWO
WOLVES FACING ONE ANOTHER IN A HOWLING POSITION, SET AMONGST NUMEROUS
INTERWOVEN LINES AND SHAPES AND ALL WITHIN THE CIRCLE.

SN 85-006,914, FILED 4-6-2010.

TRACY FLETCHER, EXAMINING ATTORNEY



David J. Kybas

Director of the United States Patent and Trademark Office

United States of America

United States Patent and Trademark Office



Reg. No. 4,154,618

Registered June 5, 2012

Int. Cl.: 30

TRADEMARK

PRINCIPAL REGISTER

SUMMIT ENTERTAINMENT, LLC (DELAWARE LIMITED LIABILITY COMPANY)
1630 STEWART STREET, SUITE 120
SANTA MONICA, CA 90404

FOR: CANDY AND CHEWING GUM, IN CLASS 30 (U.S. CL. 46).

FIRST USE 10-1-2009; IN COMMERCE 10-1-2009.

THE MARK CONSISTS OF A CIRCULAR TRIBAL TATTOO DESIGN DEPICTING TWO WOLVES FACING ONE ANOTHER IN A HOWLING POSITION, SET AMONGST NUMEROUS INTERWOVEN LINES AND SHAPES AND ALL WITHIN THE CIRCLE.

SN 85-006,924, FILED 4-6-2010.

TRACY FLETCHER, EXAMINING ATTORNEY



David J. Kybas

Director of the United States Patent and Trademark Office

United States of America

United States Patent and Trademark Office



Reg. No. 4,154,619

JOHNSON & JOHNSON (NEW JERSEY CORPORATION)
ONE JOHNSON & JOHNSON PLAZA
NEW BRUNSWICK, NJ 089337001

Registered June 5, 2012

Int. Cl.: 5

FOR: PHARMACEUTICAL PREPARATIONS, NAMELY, ANALGESICS, IN CLASS 5 (U.S. CLS. 6, 18, 44, 46, 51 AND 52).

TRADEMARK

FIRST USE 8-22-2011; IN COMMERCE 8-22-2011.

PRINCIPAL REGISTER

NO CLAIM IS MADE TO THE EXCLUSIVE RIGHT TO USE "HEALTH INFO", APART FROM THE MARK AS SHOWN.

THE MARK CONSISTS OF THE STYLIZED WORD "HI!" INSIDE A CARTOON-STYLE SPEECH BALLOON WITH THE STYLIZED WORDS "HEALTH INFO!" FOLLOWING IT.

SN 85-006,949, FILED 4-6-2010.

CIMMERIAN COLEMAN, EXAMINING ATTORNEY



David J. Kybas

Director of the United States Patent and Trademark Office

United States of America

United States Patent and Trademark Office



Reg. No. 4,154,620

Registered June 5, 2012

Int. Cl.: 5

TRADEMARK

PRINCIPAL REGISTER

JOHNSON & JOHNSON (NEW JERSEY CORPORATION)
ONE JOHNSON & JOHNSON PLAZA
NEW BRUNSWICK, NJ 089337001

FOR: ANALGESICS, IN CLASS 5 (U.S. CLS. 6, 18, 44, 46, 51 AND 52).

FIRST USE 8-22-2011; IN COMMERCE 8-22-2011.

NO CLAIM IS MADE TO THE EXCLUSIVE RIGHT TO USE "HEALTH INFO", APART FROM THE MARK AS SHOWN.

THE COLOR(S) RED AND WHITE IS/ARE CLAIMED AS A FEATURE OF THE MARK.

THE MARK CONSISTS OF THE STYLIZED WORD "HI!" IN WHITE INSIDE A RED CARTOON-STYLE SPEECH BALLOON WITH THE STYLIZED WORDS "HEALTH INFO!" IN RED FOLLOWING IT.

SN 85-006,951, FILED 4-6-2010.

CIMMERIAN COLEMAN, EXAMINING ATTORNEY



David J. Kyffers

Director of the United States Patent and Trademark Office

United States of America

United States Patent and Trademark Office

ECOPRIME

Reg. No. 4,154,621

Registered June 5, 2012

Int. Cls.: 1, 19, and 37

TRADEMARK

SERVICE MARK

PRINCIPAL REGISTER

COLAS (FRANCE SOCIÉTÉ ANONYME (SA))
7, PLACE RENÉ CLAIR
BOULOGNE BILLANCOURT, FRANCE 92100

FOR: CHEMICAL PREPARATIONS FOR STABILIZING SOIL AND AGGREGATES FOR USE IN CONSTRUCTION, REPAIR AND MAINTENANCE OF ROADS, HIGHWAYS AND OTHER TRAFFIC WAYS AND SURFACES; HYDROCARBON-BASED CHEMICAL PREPARATIONS AND EMULSIFIERS FOR STABILIZING SOIL AND AGGREGATES FOR USE IN CONSTRUCTION, REPAIR AND MAINTENANCE OF ROADS, HIGHWAYS AND OTHER TRAFFIC WAYS AND SURFACES, IN CLASS 1 (U.S. CLS. 1, 5, 6, 10, 26 AND 46).

FIRST USE 1-13-2010; IN COMMERCE 1-13-2010.

FOR: NON-METALLIC BITUMINOUS MATERIALS, NAMELY, ASPHALT SEALANTS, BITUMEN EMULSION, BITUMEN ASPHALT, SEALING COAT, ASPHALT AND AGGREGATES COMPOSED OF CRUSHED GRAVEL FOR MAKING AND COATING ROADS AS WELL AS OTHER TRAFFIC WAYS AND SURFACES, IN CLASS 19 (U.S. CLS. 1, 12, 33 AND 50).

FIRST USE 1-13-2010; IN COMMERCE 1-13-2010.

FOR: CONSTRUCTION AND REPAIR SERVICES IN THE FIELD OF ROADS, HIGHWAYS AND OTHER TRAFFIC WAYS AND SURFACES UTILIZING NON-METALLIC BUILDING MATERIALS FOR ROAD SURFACE TREATMENT IN THE NATURE OF CHIP SEALING AGGREGATES, SURFACE DRESSING MADE OF ASPHALT AND BITUMEN, ASPHALT EMULSIONS, WEARING COURSE, OVERLAY, FLOORS, ASPHALT, PITCH AND BITUMEN ASPHALT, IN CLASS 37 (U.S. CLS. 100, 103 AND 106).

FIRST USE 1-13-2010; IN COMMERCE 1-13-2010.

THE MARK CONSISTS OF STANDARD CHARACTERS WITHOUT CLAIM TO ANY PARTICULAR FONT, STYLE, SIZE, OR COLOR.

SN 85-007,607, FILED 4-6-2010.

LINDA ORNDORFF, EXAMINING ATTORNEY



David J. Kyffers

Director of the United States Patent and Trademark Office

United States of America

United States Patent and Trademark Office

SUN-READERS

Reg. No. 4,154,622

Registered June 5, 2012

Int. Cl.: 2

TRADEMARK

PRINCIPAL REGISTER

CASTIEL, MAURICE (UNITED STATES INDIVIDUAL), DBA EUROPEAN & FOREIGN
IMPORTS., INC.,
9740 MANHEIM LANE
LAS VEGAS, NV 89117

FOR: GLASS COATINGS AND TINT LAMINATIONS, IN CLASS 2 (U.S. CLS. 6, 11 AND 16).

FIRST USE 1-1-2011; IN COMMERCE 1-1-2011.

THE MARK CONSISTS OF STANDARD CHARACTERS WITHOUT CLAIM TO ANY PARTICULAR FONT, STYLE, SIZE, OR COLOR.

SN 85-008,765, FILED 4-7-2010.

CHARLOTTE CORWIN, EXAMINING ATTORNEY



David J. Kybas

Director of the United States Patent and Trademark Office

United States of America

United States Patent and Trademark Office

EMOTIONAL AND RELATIONAL INTELLIGENCE (ERQ)

Reg. No. 4,154,623

GROWTH-FOCUSED LIVING, INC. (ARKANSAS CORPORATION)
1450 AVERY PLACE
ROGERS, AR 72758

Registered June 5, 2012

Int. Cl.: 41

FOR: EDUCATIONAL SERVICES, NAMELY, PROVIDING CLASSES, SEMINARS, AND WORKSHOPS IN THE FIELD OF PERSONAL DEVELOPMENT, NAMELY, SELF-IMPROVEMENT, SELF-FULFILLMENT, AND INTERPERSONAL COMMUNICATION, IN CLASS 41 (U.S. CLS. 100, 101 AND 107).

SERVICE MARK

PRINCIPAL REGISTER

FIRST USE 10-26-2011; IN COMMERCE 10-26-2011.

THE MARK CONSISTS OF STANDARD CHARACTERS WITHOUT CLAIM TO ANY PARTICULAR FONT, STYLE, SIZE, OR COLOR.

NO CLAIM IS MADE TO THE EXCLUSIVE RIGHT TO USE "EMOTIONAL AND RELATIONAL INTELLIGENCE", APART FROM THE MARK AS SHOWN.

SN 85-009,558, FILED 4-8-2010.

KATHERINE CONNOLLY, EXAMINING ATTORNEY



David J. Kybas

Director of the United States Patent and Trademark Office

United States of America

United States Patent and Trademark Office

CLICK. RING. KNOCK.

Reg. No. 4,154,624

Registered June 5, 2012

Int. Cl.: 35

SERVICE MARK

PRINCIPAL REGISTER

SUPERMEDIA LLC (DELAWARE LIMITED LIABILITY COMPANY)
2200 W. AIRFIELD DRIVE
DFW AIRPORT, TX 752619810

FOR: DISSEMINATION OF ADVERTISING FOR OTHERS VIA THE INTERNET, NAMELY, BY INCLUDING ADVERTISING IN PROPRIETARY DATABASES FROM WHICH THE GENERAL PUBLIC CAN RETRIEVE IT, VIA PRINT, NAMELY, BY PUBLISHING ADVERTISING IN ALPHABETICAL AND CLASSIFIED TELEPHONE DIRECTORIES, AND VIA DIRECT MAIL, NAMELY, BY MAILING PERSONALLY ADDRESSED ADVERTISING TO RECIPIENTS IN A PARTICULAR GEOGRAPHIC AREA, IN CLASS 35 (U.S. CLS. 100, 101 AND 102).

FIRST USE 1-0-2010; IN COMMERCE 1-0-2010.

THE MARK CONSISTS OF STANDARD CHARACTERS WITHOUT CLAIM TO ANY PARTICULAR FONT, STYLE, SIZE, OR COLOR.

SN 85-013,458, FILED 4-14-2010.

MARILYN IZZI, EXAMINING ATTORNEY



David J. Kyros

Director of the United States Patent and Trademark Office

United States of America

United States Patent and Trademark Office

Smitten

Reg. No. 4,154,625

Registered June 5, 2012

Int. Cl.: 33

TRADEMARK

PRINCIPAL REGISTER

FOUR BRIX, LLC (CALIFORNIA LIMITED LIABILITY COMPANY), DBA FOUR BRIX
WINERY,
P.O. BOX 941395
SIMI VALLEY, CA 93094

FOR: RED WINE; WHITE WINE, IN CLASS 33 (U.S. CLS. 47 AND 49).

FIRST USE 5-1-2010; IN COMMERCE 5-15-2010.

THE MARK CONSISTS OF THE WORD "SMITTEN", WITH A HEART USED TO DOT THE
"I", IS THE NAME BRAND FOR OUR WHITE WINE BLEND.

SN 85-014,606, FILED 4-15-2010.

WILLIAM ROSSMAN, EXAMINING ATTORNEY



David J. Kyros

Director of the United States Patent and Trademark Office

United States of America

United States Patent and Trademark Office

Kikker Kiks

Reg. No. 4,154,626

Registered June 5, 2012

Int. Cl.: 42

SERVICE MARK

PRINCIPAL REGISTER

BENSON, DEBORAH SUE (UNITED STATES INDIVIDUAL), DBA BENTIS COMPANIES, LLC,
12013 ISANTI STREET N.E.
BLAINE, MN 55449 AND

TENTIS, PAMELA JEAN (UNITED STATES INDIVIDUAL), DBA BENTIS COMPANIES, LLC,
9944 WAKE COURT N.E.
CIRCLE PINES, MN 55014

FOR: CUSTOM DESIGN OF APPAREL AND FOOTWEAR ACCESSORIES BASED ON PERSONAL SELECTIONS MADE BY THE CUSTOMER, IN CLASS 42 (U.S. CLS. 100 AND 101).

FIRST USE 8-1-2011; IN COMMERCE 8-1-2011.

THE MARK CONSISTS OF STANDARD CHARACTERS WITHOUT CLAIM TO ANY PARTICULAR FONT, STYLE, SIZE, OR COLOR.

NO CLAIM IS MADE TO THE EXCLUSIVE RIGHT TO USE "KICKS", APART FROM THE MARK AS SHOWN.

THE WORDING "KIKKER" HAS NO MEANING IN A FOREIGN LANGUAGE. IT IS A DELIBERATE MISSPELLING OF "KICKER".

SN 85-016,192, FILED 4-16-2010.

ADA HAN, EXAMINING ATTORNEY



David J. Kyros

Director of the United States Patent and Trademark Office

United States of America

United States Patent and Trademark Office

THE THROW AWAY THAT GOES AWAY

Reg. No. 4,154,627

Registered June 5, 2012

Int. Cl.: 21

TRADEMARK

PRINCIPAL REGISTER

YUMI ECOSOLUTIONS, INC. (DELAWARE CORPORATION)
4 BRUCE LANE
WESTPORT, CT 06880

FOR: BIODEGRADABLE DISPOSABLE DINNERWARE, NAMELY, PLATES, BOWLS, CUPS, TRAYS, LIDS SPECIFICALLY ADAPTED FOR PLATES, BOWLS, CUPS AND TRAYS, SERVING FORKS, SERVING SPOONS, TRAYS, NAMELY, SINGLE AND MULTI-COMPARTMENT TRAYS WITH ATTACHED LIDS, IN CLASS 21 (U.S. CLS. 2, 13, 23, 29, 30, 33, 40 AND 50).

FIRST USE 2-1-2012; IN COMMERCE 2-1-2012.

THE MARK CONSISTS OF STANDARD CHARACTERS WITHOUT CLAIM TO ANY PARTICULAR FONT, STYLE, SIZE, OR COLOR.

SN 85-019,941, FILED 4-21-2010.

TRACY FLETCHER, EXAMINING ATTORNEY



David J. Kyros

Director of the United States Patent and Trademark Office

United States of America

United States Patent and Trademark Office

CHIPWRECKED

Reg. No. 4,154,628

Registered June 5, 2012

Int. Cl.: 41

SERVICE MARK

PRINCIPAL REGISTER

TWENTIETH CENTURY FOX FILM CORPORATION (DELAWARE CORPORATION)
10201 WEST PICO BOULEVARD
LOS ANGELES, CA 90035

FOR: PRODUCTION AND DISTRIBUTION OF MOTION PICTURE FILMS; PROVIDING ON-LINE INFORMATION IN THE FIELD OF MOTION PICTURE FILM AND VIDEO ENTERTAINMENT VIA THE INTERNET; ENTERTAINMENT SERVICES IN THE NATURE OF NON-DOWNLOADABLE VIDEOS AND IMAGES FEATURING MOTION PICTURE FILM AND ENTERTAINMENT TRANSMITTED VIA THE INTERNET AND WIRELESS COMMUNICATION NETWORKS, IN CLASS 41 (U.S. CLS. 100, 101 AND 107).

FIRST USE 11-1-2011; IN COMMERCE 11-1-2011.

THE MARK CONSISTS OF STANDARD CHARACTERS WITHOUT CLAIM TO ANY PARTICULAR FONT, STYLE, SIZE, OR COLOR.

SN 85-020,928, FILED 4-22-2010.

Laurie Kaufman, Examining Attorney



David J. Kyros

Director of the United States Patent and Trademark Office

United States of America

United States Patent and Trademark Office

VEGASWOOD

Reg. No. 4,154,629

Registered June 5, 2012

Int. Cls.: 9 and 41

TRADEMARK

SERVICE MARK

PRINCIPAL REGISTER

VEGAS WOOD INDUSTRIES, INC. (NEVADA CORPORATION)
1240 8TH PLACE
LAS VEGAS, NV 89104

FOR: DOWNLOADABLE MOTION PICTURES AND TELEVISION SHOWS ABOUT ACTION, ADVENTURE, ANIMATION, BIOGRAPHIES, COMEDY, CRIME, DOCUMENTARY SUBJECTS, DRAMA, FAMILY ENTERTAINMENT, FANTASY, FILM-NOIR, HISTORY, HORROR, MUSIC, MUSICALS, MYSTERY, ROMANCE, SCIENCE FICTION, SPORTS, THRILLERS, WARS, AND WESTERNS; DOWNLOADABLE TELEVISION SHOWS, NAMELY, GAME SHOWS, NEWS SHOWS, REALITY TELEVISION SHOWS, TALK SHOWS; MOTION PICTURE FILMS ABOUT ACTION, ADVENTURE, ANIMATION, BIOGRAPHIES, COMEDY, CRIME, DOCUMENTARY SUBJECTS, DRAMA, FAMILY ENTERTAINMENT, FANTASY, FILM-NOIR, HISTORY, HORROR, MUSIC, MUSICALS, MYSTERY, ROMANCE, SCIENCE FICTION, SPORTS, THRILLERS, WARS, AND WESTERNS, IN CLASS 9 (U.S. CLS. 21, 23, 26, 36 AND 38).

FIRST USE 8-3-2004; IN COMMERCE 9-1-2011.

FOR: DISTRIBUTION OF MOTION PICTURE FILMS; ENTERTAINMENT MEDIA PRODUCTION SERVICES FOR MOTION PICTURES, TELEVISION AND INTERNET; ENTERTAINMENT SERVICES, NAMELY, PRODUCTION OF COMPUTER-GENERATED IMAGERY FOR USE IN MOTION PICTURES; ENTERTAINMENT SERVICES, NAMELY, PRODUCTION OF SPECIAL EFFECTS INCLUDING MODEL-MAKING SERVICES AND RELATED PHYSICAL PRODUCTION ELEMENTS FOR USE IN MOTION PICTURES; ENTERTAINMENT SERVICES, NAMELY, PRODUCTION OF SPECIAL EFFECTS INCLUDING MODEL-MAKING SERVICES, COMPUTER-GENERATED IMAGERY AND COMPUTER-GENERATED GRAPHICS FOR THE PRODUCTION OF MOTION PICTURES, VIDEOS, AND MOVIE TRAILERS; MOTION PICTURE FILM PRODUCTION; MOTION PICTURE SONG PRODUCTION; PRODUCTION AND DISTRIBUTION OF INDEPENDENT MOTION PICTURES; PRODUCTION AND DISTRIBUTION OF MOTION PICTURES, IN CLASS 41 (U.S. CLS. 100, 101 AND 107).

FIRST USE 8-3-2004; IN COMMERCE 8-3-2004.

THE MARK CONSISTS OF STANDARD CHARACTERS WITHOUT CLAIM TO ANY PARTICULAR FONT, STYLE, SIZE, OR COLOR.

SN 85-023,565, FILED 4-26-2010.



David J. Kyros

Director of the United States Patent and Trademark Office

Reg. No. 4,154,629 SETH A. RAPPAPORT, EXAMINING ATTORNEY

United States of America

United States Patent and Trademark Office

VICTORY QUEST

Reg. No. 4,154,630

Registered June 5, 2012

Int. Cl.: 9

TRADEMARK

PRINCIPAL REGISTER

ARISTOCRAT TECHNOLOGIES AUSTRALIA PTY LTD (AUSTRALIA CORPORATION)
BUILDING A, PINNACLE OFFICE PARK
85 EPPING ROAD
NORTH RYDE, NSW, AUSTRALIA 2113

FOR: GAMING MACHINES, NAMELY, DEVICES WHICH ACCEPT A WAGER, IN CLASS
9 (U.S. CLS. 21, 23, 26, 36 AND 38).

FIRST USE 1-1-2012; IN COMMERCE 1-1-2012.

THE MARK CONSISTS OF STANDARD CHARACTERS WITHOUT CLAIM TO ANY PAR-
TICULAR FONT, STYLE, SIZE, OR COLOR.

SN 85-023,884, FILED 4-27-2010.

ZACHARY BELLO, EXAMINING ATTORNEY



David J. Kyffers

Director of the United States Patent and Trademark Office

United States of America

United States Patent and Trademark Office

PERFECT MEATLOAF

Reg. No. 4,154,631

ALLSTAR MARKETING GROUP, LLC (NEW YORK LIMITED LIABILITY COMPANY)
2 SKYLINE DRIVE
HAWTHORNE, NY 10532

Registered June 5, 2012

Int. Cl.: 21

FOR: BAKEDWARE, IN CLASS 21 (U.S. CLS. 2, 13, 23, 29, 30, 33, 40 AND 50).

TRADEMARK

FIRST USE 4-25-2011; IN COMMERCE 4-25-2011.

PRINCIPAL REGISTER

THE MARK CONSISTS OF STANDARD CHARACTERS WITHOUT CLAIM TO ANY PARTICULAR FONT, STYLE, SIZE, OR COLOR.

NO CLAIM IS MADE TO THE EXCLUSIVE RIGHT TO USE "MEATLOAF", APART FROM THE MARK AS SHOWN.

SN 85-027,864, FILED 4-30-2010.

NANCY CLARKE, EXAMINING ATTORNEY



David J. Kyffers

Director of the United States Patent and Trademark Office

United States of America

United States Patent and Trademark Office

CASARIVER

Reg. No. 4,154,632

Registered June 5, 2012

Int. Cl.: 42

SERVICE MARK

PRINCIPAL REGISTER

CASARIVER LLC (OHIO LIMITED LIABILITY COMPANY)
21150 KENWOOD AVENUE
ROCKY RIVER, OH 44116

FOR: CONSULTING SERVICES IN THE FIELD OF COMPUTER-BASED INFORMATION SYSTEMS FOR BUSINESSES; CONSULTING SERVICES IN THE FIELD OF IT PROJECT MANAGEMENT; CONSULTING SERVICES IN THE FIELD OF CONFIGURATION MANAGEMENT FOR COMPUTER HARDWARE AND SOFTWARE, IN CLASS 42 (U.S. CLS. 100 AND 101).

FIRST USE 1-9-2012; IN COMMERCE 1-9-2012.

THE MARK CONSISTS OF STANDARD CHARACTERS WITHOUT CLAIM TO ANY PARTICULAR FONT, STYLE, SIZE, OR COLOR.

THE ENGLISH TRANSLATION OF "CASA" IN THE MARK IS "HOUSE".

SN 85-028,236, FILED 5-2-2010.

JEAN IM, EXAMINING ATTORNEY



David J. Kyffers

Director of the United States Patent and Trademark Office

United States of America

United States Patent and Trademark Office

NATURE'S BOUNTY

Reg. No. 4,154,633

Registered June 5, 2012

Int. Cls.: 3 and 31

TRADEMARK

PRINCIPAL REGISTER

HOSLEY INTERNATIONAL, INC. (ILLINOIS CORPORATION)
20530 STONY ISLAND AVE.
LYNWOOD, IL 60411

FOR: POTPOURRI AND FRAGRANCES, IN CLASS 3 (U.S. CLS. 1, 4, 6, 50, 51 AND 52).

FIRST USE 7-0-2011; IN COMMERCE 7-0-2011.

FOR: DRIED FLOWERS, DRIED FLORAL ARRANGEMENTS, DRIED PLANTS, IN CLASS 31 (U.S. CLS. 1 AND 46).

FIRST USE 7-0-2011; IN COMMERCE 7-0-2011.

THE MARK CONSISTS OF STANDARD CHARACTERS WITHOUT CLAIM TO ANY PARTICULAR FONT, STYLE, SIZE, OR COLOR.

SN 85-028,553, FILED 5-3-2010.

HELENE LIWINSKI, EXAMINING ATTORNEY



David J. Kyffers

Director of the United States Patent and Trademark Office

United States of America

United States Patent and Trademark Office

CULTURE PHIT

Reg. No. 4,154,634

Registered June 5, 2012

Int. Cl.: 25

TRADEMARK

PRINCIPAL REGISTER

ZAPPOS IP, INC. (DELAWARE CORPORATION)
2280 CORPORATE CIRCLE
ATTN: TRADEMARKS
HENDERSON, NV 89074

FOR: CLOTHING, NAMELY, COATS; DRESSES; HOSIERY; JACKETS; PANTS; SHIRTS;
SKIRTS; LOUNGE WEAR; SWEATERS; UNDERGARMENTS; SHOES; FOOTWEAR, IN
CLASS 25 (U.S. CLS. 22 AND 39).

FIRST USE 11-8-2011; IN COMMERCE 11-8-2011.

THE MARK CONSISTS OF STANDARD CHARACTERS WITHOUT CLAIM TO ANY PAR-
TICULAR FONT, STYLE, SIZE, OR COLOR.

THE WORDING "CULTURE PHIT" HAS NO MEANING IN A FOREIGN LANGUAGE.

SN 85-029,151, FILED 5-3-2010.

SKYE YOUNG, EXAMINING ATTORNEY



David J. Kyffers

Director of the United States Patent and Trademark Office

United States of America
United States Patent and Trademark Office

DATSCAN

Reg. No. 4,154,635

Registered June 5, 2012

Int. Cl.: 5

TRADEMARK

PRINCIPAL REGISTER

GE HEALTHCARE LIMITED (UNITED KINGDOM PRIVATE COMPANY - LIMITED)
AMERSHAM PLACE, LITTLE CHALFONT
BUCKINGHAMSHIRE, UNITED KINGDOM HP79NA

FOR: CONTRAST MEDIA FOR USE WITH IMAGING MEDICAL EQUIPMENT; DIAGNOSTIC PREPARATIONS FOR MEDICAL PURPOSES , IN CLASS 5 (U.S. CLS. 6, 18, 44, 46, 51 AND 52).

FIRST USE 6-28-2011; IN COMMERCE 6-28-2011.

THE MARK CONSISTS OF STANDARD CHARACTERS WITHOUT CLAIM TO ANY PARTICULAR FONT, STYLE, SIZE, OR COLOR.

SN 85-029,347, FILED 5-4-2010.

LOURDES AYALA, EXAMINING ATTORNEY



David J. Kybas

Director of the United States Patent and Trademark Office

United States of America

United States Patent and Trademark Office

SHEA CHIC

Reg. No. 4,154,636

LEFFINGWELL, APRIL A (UNITED STATES INDIVIDUAL)
12662 SABRE VIEW COVE
SAN DIEGO, CA 92128

Registered June 5, 2012

Int. Cl.: 3

FOR: PERSONAL CARE PREPARATIONS, NAMELY, SKIN MOISTURIZERS, LOTIONS, CREAMS, BALMS, BUTTERS, OILS, SCRUBS, EXFOLIANTS, GELS, AND FRAGRANCE SPRAYS, IN CLASS 3 (U.S. CLS. 1, 4, 6, 50, 51 AND 52).

TRADEMARK

FIRST USE 9-1-2009; IN COMMERCE 9-1-2009.

PRINCIPAL REGISTER

THE MARK CONSISTS OF STANDARD CHARACTERS WITHOUT CLAIM TO ANY PARTICULAR FONT, STYLE, SIZE, OR COLOR.

NO CLAIM IS MADE TO THE EXCLUSIVE RIGHT TO USE "SHEA", APART FROM THE MARK AS SHOWN.

SN 85-031,324, FILED 5-5-2010.

ANTHONY RINKER, EXAMINING ATTORNEY



David J. Kyros

Director of the United States Patent and Trademark Office

United States of America

United States Patent and Trademark Office



Reg. No. 4,154,637

MEDLINE INDUSTRIES, INC. (ILLINOIS CORPORATION)
ONE MEDLINE PLACE
CHICAGO, IL 60060

Registered June 5, 2012

Int. Cl.: 5

FOR: DISPOSABLE ABSORBENT PRODUCTS, NAMELY, PROTECTIVE INCONTINENCE UNDERWEAR, IN CLASS 5 (U.S. CLS. 6, 18, 44, 46, 51 AND 52).

TRADEMARK

FIRST USE 4-30-2010; IN COMMERCE 4-30-2010.

PRINCIPAL REGISTER

OWNER OF U.S. REG. NOS. 1,471,161, 1,762,357, AND 2,925,125.

THE MARK CONSISTS OF THE WORDS "PROTECTION PLUS CLASSIC" IN STYLIZED FONT, A DESIGN OF A TEAR DROP WITH A CROSS LOCATED IN THE CENTER OF THE TEAR DROP, THE TEAR DROP DESIGN LOCATED BETWEEN THE WORDS "PROTECTION" AND "PLUS", AND A RECTANGULAR SHAPE DESIGN LOCATED HORIZONTALLY BELOW THE WORDS "PROTECTION PLUS" AND THE WORD "CLASSIC" LOCATED WITHIN THE RECTANGULAR DESIGN.

SN 85-032,188, FILED 5-6-2010.

MARY ROSSMAN, EXAMINING ATTORNEY



David J. Kyffers

Director of the United States Patent and Trademark Office

United States of America
United States Patent and Trademark Office

VITA-D₃

Reg. No. 4,154,638

SHAKLEE CORPORATION (DELAWARE CORPORATION)
4747 WILLOW ROAD
PLEASANTON, CA 945882740

Registered June 5, 2012

Int. Cl.: 5

FOR: DIETARY AND NUTRITIONAL SUPPLEMENTS CONTAINING VITAMIN D, IN CLASS 5 (U.S. CLS. 6, 18, 44, 46, 51 AND 52).

TRADEMARK

FIRST USE 8-1-2010; IN COMMERCE 8-1-2010.

PRINCIPAL REGISTER

THE MARK CONSISTS OF THE TERM "VITA-D₃" WITH THE "3" BEING IN SUBSCRIPT.

SN 85-035,898, FILED 5-11-2010.

DAVID C. REIHNER, EXAMINING ATTORNEY



David J. Kybas

Director of the United States Patent and Trademark Office

United States of America

United States Patent and Trademark Office

CARBON SCOUT

Reg. No. 4,154,639

SALAS O'BRIEN ENGINEERS, INC. (CALIFORNIA CORPORATION), DBA SALAS O'BRIEN,
305 SOUTH 11TH STREET
SAN JOSE, CA 95112

Registered June 5, 2012

Int. Cl.: 35

FOR: CONSULTING SERVICES IN THE FIELD OF ENERGY USAGE AND MANAGEMENT
AND ENERGY EFFICIENCY, IN CLASS 35 (U.S. CLS. 100, 101 AND 102).

SERVICE MARK

FIRST USE 10-21-2010; IN COMMERCE 11-14-2010.

PRINCIPAL REGISTER

THE MARK CONSISTS OF STANDARD CHARACTERS WITHOUT CLAIM TO ANY PAR-
TICULAR FONT, STYLE, SIZE, OR COLOR.

NO CLAIM IS MADE TO THE EXCLUSIVE RIGHT TO USE "CARBON", APART FROM THE
MARK AS SHOWN.

SN 85-038,023, FILED 5-13-2010.

ELLEN BURNS, EXAMINING ATTORNEY



David J. Kybas

Director of the United States Patent and Trademark Office

United States of America

United States Patent and Trademark Office

CIRCLE OF EDUCATION

Reg. No. 4,154,640

Registered June 5, 2012

Int. Cl.: 41

SERVICE MARK

PRINCIPAL REGISTER

PACIFIC ENTERTAINMENT CORPORATION (CALIFORNIA CORPORATION)
5820 OBERLINE DRIVE, SUITE 203
SAN DIEGO, CA 92121

FOR: EDUCATION SERVICES IN THE NATURE OF EARLY CHILDHOOD INSTRUCTION; EDUCATION SERVICES, NAMELY, PROVIDING LIVE AND ON-LINE CLASSES, SEMINARS, LECTURES AND/OR WORKSHOPS IN THE FIELD OF EARLY LEARNING AND/OR PARENTING; EDUCATIONAL AND ENTERTAINMENT SERVICES, NAMELY, PROVIDING ON-LINE INTERACTIVE CHILDREN'S STORIES; EDUCATIONAL SERVICES, NAMELY, DEVELOPING CURRICULUM FOR EDUCATORS; EDUCATIONAL SERVICES, NAMELY, PROVIDING A CONTINUING PRERECORDED AUDIO PROGRAM IN THE FIELD OF EARLY LEARNING AND/OR PARENTING ACCESSIBLE OVER THE INTERNET; ENTERTAINMENT SERVICES, NAMELY, PROVIDING A WEB SITE FEATURING NON-DOWNLOADABLE MUSICAL PERFORMANCES, MUSICAL VIDEOS, RELATED FILM CLIPS, PHOTOGRAPHS, AND OTHER MULTIMEDIA MATERIALS FEATURING EARLY LEARNING AND/OR PARENTING; ENTERTAINMENT SERVICES, NAMELY, PROVIDING NON-DOWNLOADABLE PLAYBACK OF MUSIC VIA GLOBAL COMMUNICATIONS NETWORKS; ENTERTAINMENT SERVICES, NAMELY, PROVIDING TEMPORARY USE OF NON-DOWNLOADABLE COMPUTER GAMES; ENTERTAINMENT SERVICES, NAMELY, PROVIDING TEMPORARY USE OF NON-DOWNLOADABLE COMPUTER LEARNING GAMES; ENTERTAINMENT SERVICES, NAMELY, PROVIDING TEMPORARY USE OF NON-DOWNLOADABLE INTERACTIVE GAMES; ENTERTAINMENT SERVICES, NAMELY, PROVIDING TEMPORARY USE OF NON-DOWNLOADABLE VIDEO GAMES; INFORMATION IN THE FIELD OF PARENTING CONCERNING EDUCATION OF CHILDREN; ON-LINE ELECTRONIC NEWSLETTERS DELIVERED BY EMAIL IN THE FIELD OF EARLY LEARNING AND/OR PARENTING; PROVIDING A WEBSITE FEATURING EDUCATION AND ENTERTAINMENT FOR CHILDREN; PROVIDING ON-LINE E-ZINES IN THE FIELD OF EARLY LEARNING AND/OR PARENTING; PROVIDING ON-LINE MAGAZINES IN THE FIELD OF EARLY LEARNING AND/OR PARENTING; PROVISION OF INFORMATION IN THE FIELD OF CHILDREN'S EDUCATION; PROVISION OF NON-DOWNLOADABLE FILMS AND TELEVISION PROGRAMMES VIA A VIDEO-ON-DEMAND SERVICE, IN CLASS 41 (U.S. CLS. 100, 101 AND 107).



David J. Kappas

Director of the United States Patent and Trademark Office

FIRST USE 5-0-2009; IN COMMERCE 5-0-2009.

THE MARK CONSISTS OF STANDARD CHARACTERS WITHOUT CLAIM TO ANY PARTICULAR FONT, STYLE, SIZE, OR COLOR.

Reg. No. 4,154,640 NO CLAIM IS MADE TO THE EXCLUSIVE RIGHT TO USE "EDUCATION", APART FROM THE MARK AS SHOWN.

SN 85-040,645, FILED 5-17-2010.

LEIGH CAROLINE CASE, EXAMINING ATTORNEY

United States of America

United States Patent and Trademark Office

EMERIL

Reg. No. 4,154,641

Registered June 5, 2012

Int. Cl.: 11

TRADEMARK

PRINCIPAL REGISTER

MSLO SHARED IP SUB LLC (DELAWARE LIMITED LIABILITY COMPANY)
601 WEST 26TH STREET 10TH FLOOR
C/O MARTHA STEWART LIVING OMNIMEDIA, INC
NEW YORK, NY 10001

FOR: BARBECUE GRILLS; GRILL LIGHTS, NAMELY, LIGHTING FIXTURES FOR GRILLS; ROTISSERIES; WARMING RACKS FOR GRILLS; SMOKER BOXES IN THE NATURE OF BARBECUE SMOKERS; GAS CONVERSION KITS COMPRISED PRIMARILY OF NATURAL GAS REGULATORS AND GRILL BURNER ORIFICES FOR CONVERTING A PROPANE GAS GRILL TO A NATURAL GAS GRILL; ELECTRIC GRIDDLES; BARBECUE ACCESSORIES, NAMELY, CONVECTION PLATES, CERAMIC BRIQUETTES FOR USE IN BARBECUE GRILLS; STRUCTURAL PARTS FOR BARBECUE GRILLS; GRILL GRATES; GRILL ACCESSORIES, NAMELY, FISH RACKS, MEAT RACKS AND VEGETABLE RACKS IN THE NATURE OF WARMING TRAYS; ELECTRIC ROASTERS; ROASTERS POWERED BY PROPANE GAS, IN CLASS 11 (U.S. CLS. 13, 21, 23, 31 AND 34).

FIRST USE 4-1-2011; IN COMMERCE 4-1-2011.

THE MARK CONSISTS OF STANDARD CHARACTERS WITHOUT CLAIM TO ANY PARTICULAR FONT, STYLE, SIZE, OR COLOR.

OWNER OF U.S. REG. NOS. 2,176,213, 2,467,770, AND OTHERS.

THE NAME "EMERIL" IDENTIFIES A LIVING INDIVIDUAL WHOSE CONSENT IS OF RECORD.

SN 85-042,798, FILED 5-19-2010.

NICHOLAS COLEMAN, EXAMINING ATTORNEY



David J. Kybas

Director of the United States Patent and Trademark Office

United States of America
United States Patent and Trademark Office

BAMBINO

Reg. No. 4,154,642

CONAIR CORPORATION (DELAWARE CORPORATION)
ONE CUMMINGS POINT ROAD
STAMFORD, CT 06902

Registered June 5, 2012

Int. Cl.: 11

FOR: HAND-HELD ELECTRIC HAIR DRYERS, IN CLASS 11 (U.S. CLS. 13, 21, 23, 31 AND 34).

TRADEMARK

FIRST USE 10-0-2011; IN COMMERCE 10-0-2011.

PRINCIPAL REGISTER

THE MARK CONSISTS OF STANDARD CHARACTERS WITHOUT CLAIM TO ANY PARTICULAR FONT, STYLE, SIZE, OR COLOR.

THE ENGLISH TRANSLATION OF THE WORD "BAMBINO" IN THE MARK IS BABY.

SN 85-043,392, FILED 5-20-2010.

ALICE BENMAMAN, EXAMINING ATTORNEY



David J. Kybas

Director of the United States Patent and Trademark Office

United States of America

United States Patent and Trademark Office

TYMAX

Reg. No. 4,154,643

Registered June 5, 2012

Int. Cl.: 1

TRADEMARK

PRINCIPAL REGISTER

WESTLAKE LONGVIEW CORPORATION (DELAWARE CORPORATION)
SUITE 600
2801 POST OAK BLVD
HOUSTON, TX 77056

FOR: SYNTHETIC, ADHESIVE RESINS IN PELLET FORM FOR USE IN FURTHER MANUFACTURE, IN CLASS 1 (U.S. CLS. 1, 5, 6, 10, 26 AND 46).

FIRST USE 5-20-2010; IN COMMERCE 5-20-2010.

THE MARK CONSISTS OF STANDARD CHARACTERS WITHOUT CLAIM TO ANY PARTICULAR FONT, STYLE, SIZE, OR COLOR.

SN 85-043,415, FILED 5-20-2010.

KIMBERLY PERRY, EXAMINING ATTORNEY



David J. Kyros

Director of the United States Patent and Trademark Office

United States of America

United States Patent and Trademark Office

A Trend to Healthy Eating

Reg. No. 4,154,644

Registered June 5, 2012

Int. Cls.: 29 and 30

TRADEMARK

PRINCIPAL REGISTER

FUJI FOOD PRODUCTS, INC. (DELAWARE CORPORATION)
14420 BLOOMFIELD AVENUE
SANTA FE SPRINGS, CA 90670

FOR: ASIAN-STYLE PREPARED MEALS CONSISTING PRIMARILY OF MEAT, FISH, POULTRY OR VEGETABLES; INSTANT OR PRE-COOKED SOUP; PREPARED VEGETABLES; ASIAN-STYLE PREPARED APPETIZERS CONSISTING PRIMARILY OF MEAT, FISH, POULTRY OR VEGETABLES, IN CLASS 29 (U.S. CL. 46).

FIRST USE 7-25-2010; IN COMMERCE 7-25-2010.

FOR: ASIAN CONDIMENTS, NAMELY, PREPARED WASABI, PREPARED GINGER, ASIAN SAUCES; SUSHI, IN CLASS 30 (U.S. CL. 46).

FIRST USE 7-25-2010; IN COMMERCE 7-25-2010.

THE MARK CONSISTS OF STANDARD CHARACTERS WITHOUT CLAIM TO ANY PARTICULAR FONT, STYLE, SIZE, OR COLOR.

SN 85-045,410, FILED 5-21-2010.

JULIE GUTTADAURO, EXAMINING ATTORNEY



David J. Kybas

Director of the United States Patent and Trademark Office

United States of America

United States Patent and Trademark Office

TrilliumApps

Reg. No. 4,154,645

Registered June 5, 2012

Int. Cls.: 9 and 42

TRADEMARK

SERVICE MARK

PRINCIPAL REGISTER

HARTE-HANKS DATA TECHNOLOGIES, INC. (DELAWARE CORPORATION)
9601 MCALLISTER FREEWAY
SUITE 610
SAN ANTONIO, TX 78216

FOR: COMPUTER APPLICATION SOFTWARE FOR USE IN CUSTOMIZATION OF DATA MANAGEMENT SOFTWARE, IN CLASS 9 (U.S. CLS. 21, 23, 26, 36 AND 38).

FIRST USE 11-22-2011; IN COMMERCE 11-22-2011.

FOR: PROVIDING A SECURE, WEB-BASED SYSTEM AND ONLINE PORTAL FOR CUSTOMERS TO DOWNLOAD, DESIGN AND EXCHANGE COMPUTER SOFTWARE BUSINESS RULES, PROCESS STEPS, AND PROJECTS FOR USE IN ENHANCING COMPUTER SOFTWARE FUNCTIONALITY IN THE FIELD OF DATA MANAGEMENT SOFTWARE, IN CLASS 42 (U.S. CLS. 100 AND 101).

FIRST USE 11-22-2011; IN COMMERCE 11-22-2011.

THE MARK CONSISTS OF STANDARD CHARACTERS WITHOUT CLAIM TO ANY PARTICULAR FONT, STYLE, SIZE, OR COLOR.

SN 85-049,530, FILED 5-27-2010.

DAVID TAYLOR, EXAMINING ATTORNEY



David J. Kyros

Director of the United States Patent and Trademark Office

United States of America

United States Patent and Trademark Office

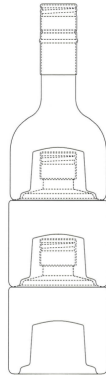

Reg. No. 4,154,646

Registered June 5, 2012

Int. Cl.: 33

VINOS Y LICORES AZTECA. S.A. DE C.V. (MEXICO CORPORATION)
RINCONODA SANTA RITA
RINCONDA DEL GERANIO NO 3544-1A
ZAPOPAN, JALISCO, MEXICO C.P.44120

FOR: TEQUILA, IN CLASS 33 (U.S. CLS. 47 AND 49).

TRADEMARK

FIRST USE 1-1-2010; IN COMMERCE 7-1-2011.

PRINCIPAL REGISTER

THE MARK CONSISTS OF A THREE-DIMENSIONAL CONFIGURATION OF A BOTTLE COMPRISED OF THREE SEPARATE STACKABLE 200 ML BOTTLES CONTAINING THE GOODS. THE BASE OF EACH OF THE BOTTLES CONTAINS A LARGE CONCAVE INDENTION WITH TWO ROUNDED EDGES. THE AREAS DEPICTED IN DOTTED LINES ARE NOT CLAIMED AS A FEATURE OF THE MARK AND ARE ONLY USED TO SHOW THE POSITION OF THE MARK ON THE CONTAINERS FOR THE GOODS.

SN 85-051,783, FILED 6-1-2010.

LEIGH CAROLINE CASE, EXAMINING ATTORNEY



David J. Kybas

Director of the United States Patent and Trademark Office

United States of America

United States Patent and Trademark Office

MERLIN

Reg. No. 4,154,647

PHOENIX ENVIRONMENTAL CARE, LLC (GEORGIA LIMITED LIABILITY COMPANY)
P.O. BOX 370
VALDOSTA, GA 316030370

Registered June 5, 2012

Int. Cl.: 5

FOR: PESTICIDES, NAMELY, AN INSECTICIDE FOR USE IN THE TURF, NURSERY AND ORNAMENTAL MARKETS, IN CLASS 5 (U.S. CLS. 6, 18, 44, 46, 51 AND 52).

TRADEMARK

FIRST USE 7-1-2010; IN COMMERCE 7-1-2010.

PRINCIPAL REGISTER

THE MARK CONSISTS OF STANDARD CHARACTERS WITHOUT CLAIM TO ANY PARTICULAR FONT, STYLE, SIZE, OR COLOR.

SN 85-053,064, FILED 6-2-2010.

NATALIE POLZER, EXAMINING ATTORNEY



David J. Kybas

Director of the United States Patent and Trademark Office

United States of America

United States Patent and Trademark Office

SOLCA

Reg. No. 4,154,648

Registered June 5, 2012

Int. Cls.: 18 and 25

TRADEMARK

PRINCIPAL REGISTER

TRUSTEE OF THE HERMAN FAMILY TRUST (CALIFORNIA TRUST)
8100 MELROSE AVE.
LOS ANGELES, CA 90046

FOR: HANDBAGS; PURSES; WALLETS, IN CLASS 18 (U.S. CLS. 1, 2, 3, 22 AND 41).

FIRST USE 8-0-2009; IN COMMERCE 8-0-2009.

FOR: BLOUSES; COVERUPS; DRESSES; FOOTWEAR; HEADWEAR; JACKETS; PANTS;
SHIRTS; SHORTS; SKIRTS; SOCKS; SWEAT PANTS; SWEAT SHIRTS; SWEATERS; T-
SHIRTS; VESTS, IN CLASS 25 (U.S. CLS. 22 AND 39).

FIRST USE 8-0-2009; IN COMMERCE 8-0-2009.

THE MARK CONSISTS OF STANDARD CHARACTERS WITHOUT CLAIM TO ANY PAR-
TICULAR FONT, STYLE, SIZE, OR COLOR.

SN 85-057,780, FILED 6-8-2010.

CHERYL CLAYTON, EXAMINING ATTORNEY



David J. Kybas

Director of the United States Patent and Trademark Office

United States of America

United States Patent and Trademark Office

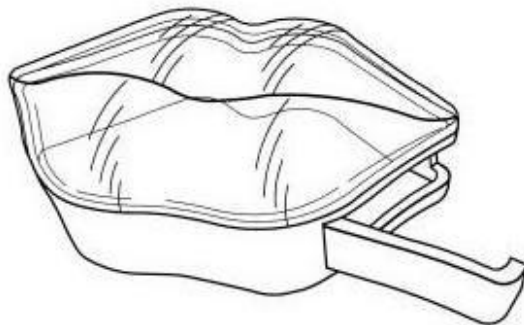

Reg. No. 4,154,649

Registered June 5, 2012

Int. Cl.: 30

TRADEMARK

PRINCIPAL REGISTER

BLANKEN, DOUGLAS P. (UNITED STATES INDIVIDUAL)
59 MORTON WAY
BATESVILLE, IN 47006 AND

BLANKEN, KATHRYN ELOIZA (UNITED STATES INDIVIDUAL)
59 MORTON WAY
BATESVILLE, IN 47006

FOR: CANDY MINTS, IN CLASS 30 (U.S. CL. 46).

FIRST USE 5-13-2011; IN COMMERCE 5-13-2011.

OWNER OF U.S. REG. NO. 3,765,106.

SEC. 2(F).

THE MARK CONSISTS OF THE THREE DIMENSIONAL CONFIGURATION OF THE PACKAGING FOR THE GOODS, NAMELY, A CONTAINER FOR BREATH MINTS HAVING A LOWER RECEPTACLE SECTION AND AN UPPER, TRANSPARENT LID SECTION BOTH OF WHICH ARE LIP-SHAPED. THE UPPER SURFACE OF THE LID SECTION IS CONFIGURED TO RESEMBLE A PAIR OF RAISED LIPS .

SN 85-058,590, FILED 6-9-2010.

SUSAN RICHARDS, EXAMINING ATTORNEY



David J. Kyjars

Director of the United States Patent and Trademark Office

United States of America

United States Patent and Trademark Office

GANDER MTN. TECH CENTER

Reg. No. 4,154,650

Registered June 5, 2012

Int. Cl.: 35

SERVICE MARK

PRINCIPAL REGISTER

GANDER MOUNTAIN COMPANY (MINNESOTA CORPORATION)
SUITE 1300
180 EAST FIFTH STREET
ST. PAUL, MN 55101

FOR: RETAIL SPORTING GOODS STORES, RETAIL MAIL ORDER AND ELECTRONIC CATALOG SERVICES, AND ON-LINE RETAIL STORE SERVICES, EACH FEATURING OUTDOOR SPORTSMAN'S SUPPLIES, HUNTING, FISHING, CAMPING, FITNESS, AND MARINE EQUIPMENT, ELECTRONICS, COMMUNICATION EQUIPMENT, CAMERAS AND ACCESSORIES, VEHICLE ACCESSORIES, FOOTWEAR AND CLOTHING AND APPAREL, IN CLASS 35 (U.S. CLS. 100, 101 AND 102).

FIRST USE 2-11-2011; IN COMMERCE 2-11-2011.

THE MARK CONSISTS OF STANDARD CHARACTERS WITHOUT CLAIM TO ANY PARTICULAR FONT, STYLE, SIZE, OR COLOR.

OWNER OF U.S. REG. NOS. 2,864,302, 3,705,856, AND 3,705,857.

NO CLAIM IS MADE TO THE EXCLUSIVE RIGHT TO USE "TECH CENTER", APART FROM THE MARK AS SHOWN.

SN 85-058,627, FILED 6-9-2010.

CHARLOTTE CORWIN, EXAMINING ATTORNEY



David J. Kybas

Director of the United States Patent and Trademark Office

United States of America

United States Patent and Trademark Office

EXPECT BETTER BANKING

Reg. No. 4,154,651

Registered June 5, 2012

Int. Cl.: 35

SERVICE MARK

PRINCIPAL REGISTER

WEBSTER FINANCIAL CORPORATION (DELAWARE CORPORATION)
145 BANK STREET
WATERBURY, CT 06702

FOR: TAX PLANNING, REPORTING AND CONSULTATION SERVICES; TRUST, ESTATE AND INVESTMENT CUSTODY, ADMINISTRATION, RECORD KEEPING AND REPORTING SERVICES, NAMELY, PREPARING TAX LETTERS, STATEMENTS, SUMMARIES AND REPORTS, AND SHAREHOLDER RECORD KEEPING SERVICES; PROVIDING INFORMATION IN THE FIELD OF TAXES VIA THE INTERNET, GLOBAL NETWORKS, TELEPHONE, FACSIMILE OR OTHER MEANS, IN CLASS 35 (U.S. CLS. 100, 101 AND 102).

FIRST USE 4-1-2010; IN COMMERCE 4-1-2010.

THE MARK CONSISTS OF STANDARD CHARACTERS WITHOUT CLAIM TO ANY PARTICULAR FONT, STYLE, SIZE, OR COLOR.

NO CLAIM IS MADE TO THE EXCLUSIVE RIGHT TO USE "BANKING", APART FROM THE MARK AS SHOWN.

SN 85-059,116, FILED 6-10-2010.

ANTHONY RINKER, EXAMINING ATTORNEY



David J. Kybas

Director of the United States Patent and Trademark Office

United States of America

United States Patent and Trademark Office

TRAXX

Reg. No. 4,154,652

BANOM, INC. (PENNSYLVANIA CORPORATION)
BOX 687
WAYNE, PA 19087

Registered June 5, 2012

Int. Cl.: 9

FOR: PROTECTIVE GLOVES FOR INDUSTRIAL USE, IN CLASS 9 (U.S. CLS. 21, 23, 26, 36 AND 38).

TRADEMARK

FIRST USE 2-22-2012; IN COMMERCE 2-22-2012.

PRINCIPAL REGISTER

THE MARK CONSISTS OF STANDARD CHARACTERS WITHOUT CLAIM TO ANY PARTICULAR FONT, STYLE, SIZE, OR COLOR.

SN 85-060,974, FILED 6-11-2010.

ANGELA DUONG, EXAMINING ATTORNEY



David J. Kybas

Director of the United States Patent and Trademark Office

United States of America

United States Patent and Trademark Office

UNLEASH THE FURY

Reg. No. 4,154,653

APRIL MALMSTEEN (UNITED STATES INDIVIDUAL)
12864 BISCAYNE BLVD. # 369
MIAMI, FL 33181 AND

Registered June 5, 2012

Int. Cl.: 41

YNGWIE MALMSTEEN (UNITED STATES INDIVIDUAL)
12864 BISCAYNE BLVD. # 369
MIAMI, FL 33181

SERVICE MARK

PRINCIPAL REGISTER

FOR: AUDIO RECORDING AND PRODUCTION; DIGITAL VIDEO, AUDIO, AND MULTIMEDIA PUBLISHING SERVICES; ELECTRONIC PUBLISHING SERVICES, NAMELY, PUBLICATION OF TEXT AND GRAPHIC WORKS OF OTHERS ON CDS, DVDS AND ONLINE FEATURING MUSIC, MUSICAL PERFORMANCES AND DRAMATIC WORKS; ENTERTAINMENT IN THE NATURE OF LIVE RADIO PERSONALITY PERFORMANCES; ENTERTAINMENT INFORMATION SERVICES, NAMELY, PROVIDING INFORMATION AND NEWS RELEASES ABOUT A MUSICAL ARTIST; ENTERTAINMENT SERVICES, NAMELY, PROVIDING A WEB SITE FEATURING PHOTOGRAPHIC, VIDEO AND PROSE PRESENTATIONS FEATURING MUSIC, MUSICAL PERFORMANCES AND DRAMATIC WORKS; ENTERTAINMENT SERVICES, NAMELY, PROVIDING INFORMATION BY MEANS OF A GLOBAL COMPUTER NETWORK IN THE FIELDS OF CELEBRITIES, ENTERTAINMENT, AND POPULAR CULTURE; ENTERTAINMENT SERVICES, NAMELY, PROVIDING NON-DOWNLOADABLE PRERECORDED MUSIC, INFORMATION IN THE FIELD OF MUSIC, AND COMMENTARY AND ARTICLES ABOUT MUSIC, ALL ON-LINE VIA A GLOBAL COMPUTER NETWORK; ENTERTAINMENT, NAMELY, LIVE MUSIC CONCERTS; FILM AND VIDEO PRODUCTION; FILM AND VIDEO PRODUCTION CONSULTING SERVICES; MUSIC PUBLISHING SERVICES; PRODUCTION OF AUDIO RECORDING; PRODUCTION OF MUSICAL SOUND RECORDING; PRODUCTION OF SOUND RECORDINGS, IN CLASS 41 (U.S. CLS. 100, 101 AND 107).



FIRST USE 6-1-2005; IN COMMERCE 2-1-2012.

THE MARK CONSISTS OF STANDARD CHARACTERS WITHOUT CLAIM TO ANY PARTICULAR FONT, STYLE, SIZE, OR COLOR.

David J. Kyros

SN 85-062,873, FILED 6-15-2010.

SHARON MEIER, EXAMINING ATTORNEY

United States of America

United States Patent and Trademark Office

DAILY SQUEEZE

Reg. No. 4,154,654

BRACCI, STEPHEN P. (UNITED STATES INDIVIDUAL)
216 EAST 50TH STREET
NEW YORK, NY 10022

Registered June 5, 2012

Int. Cls.: 3 and 5

FOR: NON-MEDICATED SKIN CARE PREPARATIONS; BODY CARE PRODUCTS, NAMELY, BODY LOTION, IN CLASS 3 (U.S. CLS. 1, 4, 6, 50, 51 AND 52).

TRADEMARK

FIRST USE 5-1-2011; IN COMMERCE 5-1-2011.

PRINCIPAL REGISTER

FOR: MEDICATED SKIN CARE PREPARATIONS, IN CLASS 5 (U.S. CLS. 6, 18, 44, 46, 51 AND 52).

FIRST USE 1-15-2007; IN COMMERCE 1-15-2007.

THE MARK CONSISTS OF STANDARD CHARACTERS WITHOUT CLAIM TO ANY PARTICULAR FONT, STYLE, SIZE, OR COLOR.

NO CLAIM IS MADE TO THE EXCLUSIVE RIGHT TO USE "DAILY", APART FROM THE MARK AS SHOWN.

SN 85-063,164, FILED 6-15-2010.

CHRISTINE COOPER, EXAMINING ATTORNEY



David J. Kyros

Director of the United States Patent and Trademark Office

United States of America

United States Patent and Trademark Office



Reg. No. 4,154,655

NANOPORE INSULATION LLC (DELAWARE LIMITED LIABILITY COMPANY)
2501 ALAMO AVENUE, S.E.
ALBUQUERQUE, NM 87106

Registered June 5, 2012

Int. Cl.: 17

FOR: THERMAL INSULATION, NAMELY, VACUUM INSULATION PANELS FOR INSULATING SHIPPING CONTAINERS, PIPING, REFRIGERATION UNITS, COOLERS, ELECTRONIC DEVICES AND CRYOGENIC DEVICES, IN CLASS 17 (U.S. CLS. 1, 5, 12, 13, 35 AND 50).

TRADEMARK

PRINCIPAL REGISTER

FIRST USE 4-20-2011; IN COMMERCE 4-20-2011.

THE MARK CONSISTS OF A SMALLER CIRCLE APPEARING OFF CENTER INSIDE A LARGER CIRCLE, SUPERIMPOSED OVER A POLYGON MADE UP OF SIX HEXAGONS.

SN 85-066,243, FILED 6-18-2010.

JERI J. FICKES, EXAMINING ATTORNEY



David J. Kyjars

Director of the United States Patent and Trademark Office

United States of America

United States Patent and Trademark Office

VIENNESE

Reg. No. 4,154,656

Registered June 5, 2012

Int. Cl.: 25

TRADEMARK

PRINCIPAL REGISTER

COLUMBIA INSURANCE COMPANY (NEBRASKA CORPORATION)
3024 HARNEY STREET
OMAHA, NE 68131

FOR: FOOTWEAR; CLOTHING, NAMELY, BELTS, DRESSES, GLOVES, JACKETS, NECKWEAR, NIGHTWEAR, PANTS, SUITS, SWIMWEAR, SKIRTS, TOPS, BOTTOMS, UNDERWEAR, HEADWEAR, UNIFORMS, SHIRTS, WRISTBANDS, SOCKS, HOSIERY, T-SHIRTS, SWEATSHIRTS, SWEATPANTS, SHORTS, SWEATERS, COATS, SCARVES, CAPS, PULLOVERS, VESTS, IN CLASS 25 (U.S. CLS. 22 AND 39).

FIRST USE 6-9-2010; IN COMMERCE 6-9-2010.

THE MARK CONSISTS OF STANDARD CHARACTERS WITHOUT CLAIM TO ANY PARTICULAR FONT, STYLE, SIZE, OR COLOR.

SN 85-066,862, FILED 6-18-2010.

JOSETTE BEVERLY, EXAMINING ATTORNEY



David J. Kyffers

Director of the United States Patent and Trademark Office

United States of America

United States Patent and Trademark Office

PFM (Pumice Filtration Media)

Reg. No. 4,154,657

Registered June 5, 2012

Int. Cl.: 11

TRADEMARK

PRINCIPAL REGISTER

CR MINERALS LLC (DELAWARE LIMITED LIABILITY COMPANY), DBA CR MINERALS, LLC,
PO BOX 708
SAN JUAN PUEBLO, NM 87566

FOR: WATER PURIFICATION, SEDIMENTATION AND FILTRATION APPARATUS FOR CLARIFICATION, THICKENING AND FILTRATION OF WATER, WASTE WATER AND INDUSTRIAL WATER, IN CLASS 11 (U.S. CLS. 13, 21, 23, 31 AND 34).

FIRST USE 3-30-2011; IN COMMERCE 3-30-2011.

THE MARK CONSISTS OF STANDARD CHARACTERS WITHOUT CLAIM TO ANY PARTICULAR FONT, STYLE, SIZE, OR COLOR.

NO CLAIM IS MADE TO THE EXCLUSIVE RIGHT TO USE "PUMICE FILTRATION MEDIA", APART FROM THE MARK AS SHOWN.

SN 85-067,415, FILED 6-21-2010.

DAVID TAYLOR, EXAMINING ATTORNEY



David J. Kyros

Director of the United States Patent and Trademark Office

United States of America

United States Patent and Trademark Office

ShinMaywa

Reg. No. 4,154,658

Registered June 5, 2012

Int. Cl.: 7

TRADEMARK

PRINCIPAL REGISTER

SHINMAYWA INDUSTRIES, LTD. (JAPAN CORPORATION)
1-1, SHINMEIWA-CHO, TAKARAZUKA-SHI
HYOGO, JAPAN

FOR: AUTOMATIC WIRE PROCESSORS, NAMELY, ELECTRIC WIRE PROCESSING MACHINES; PUMPS, NAMELY, ELECTRIC PUMPS; POWER OPERATED BLOWERS; AERATORS; MIXERS, NAMELY, ELECTRIC MIXERS FOR INDUSTRIAL PURPOSES; SPINDLE MOTORS; DIRECT DRIVE MOTORS, IN CLASS 7 (U.S. CLS. 13, 19, 21, 23, 31, 34 AND 35).

FIRST USE 4-1-1992; IN COMMERCE 4-1-1992.

OWNER OF U.S. REG. NO. 2,109,501.

THE MARK CONSISTS OF THE TERM "SHINMAYWA" IN STYLIZED LETTERING.

THE WORD "SHIN" MEANS "NEW", THE WORD "MAY" MEANS "BRIGHTNESS", AND THE WORD "WA" MEANS "HARMONY OR PEACE."

SN 85-068,481, FILED 6-22-2010.

JESSICA FATHY, EXAMINING ATTORNEY



David J. Kyros

Director of the United States Patent and Trademark Office

United States of America

United States Patent and Trademark Office

NavPress Discipleship Inside Out

Reg. No. 4,154,659

Registered June 5, 2012

Int. Cl.: 16

TRADEMARK

PRINCIPAL REGISTER

THE NAVIGATORS (COLORADO CORPORATION)
3820 N. 30TH STREET
COLORADO SPRINGS, CO 80904

FOR: BROCHURES, BOOKS, BIBLE STUDY GUIDES, BOOKLETS, PAMPHLETS AND CATALOGS IN THE FIELD OF CHRISTIAN MINISTRY, IN CLASS 16 (U.S. CLS. 2, 5, 22, 23, 29, 37, 38 AND 50).

FIRST USE 5-1-2010; IN COMMERCE 5-1-2010.

THE MARK CONSISTS OF STANDARD CHARACTERS WITHOUT CLAIM TO ANY PARTICULAR FONT, STYLE, SIZE, OR COLOR.

OWNER OF U.S. REG. NO. 1,170,131.

NO CLAIM IS MADE TO THE EXCLUSIVE RIGHT TO USE "DISCIPLESHIP", APART FROM THE MARK AS SHOWN.

SN 85-068,528, FILED 6-22-2010.

GINA FINK, EXAMINING ATTORNEY



David J. Kyros

Director of the United States Patent and Trademark Office

United States of America

United States Patent and Trademark Office

COLLABORIZE CLASSROOM

Reg. No. 4,154,660

Registered June 5, 2012

Int. Cls.: 9 and 42

TRADEMARK

SERVICE MARK

PRINCIPAL REGISTER

DEMOCRASOFT, INC. (DELAWARE CORPORATION)
50 OLD COURT HOUSE SQUARE, SUITE 300
SANTA ROSA, CA 95404

FOR: COMPUTER SOFTWARE TO FACILITATE VOTING OVER COMPUTER AND IP COMMUNICATION NETWORKS; COMPUTER SOFTWARE FOR CREATING AN ON-LINE COMMUNITY FOR USERS TO PARTICIPATE IN DISCUSSIONS, GET FEEDBACK FROM OTHER USERS, FORM VIRTUAL COMMUNITIES, ENGAGE IN SOCIAL NETWORKING, AND VOTE ON ISSUES RELEVANT TO THE COMMUNITY, IN CLASS 9 (U.S. CLS. 21, 23, 26, 36 AND 38).

FIRST USE 1-31-2012; IN COMMERCE 1-31-2012.

FOR: PROVIDING TEMPORARY USE OF ONLINE NON-DOWNLOADABLE SOFTWARE TO FACILITATE VOTING OVER COMPUTER AND IP COMMUNICATION NETWORKS; PROVIDING TEMPORARY USE OF ONLINE NON-DOWNLOADABLE SOFTWARE FOR CREATING AN ON-LINE COMMUNITY FOR USERS TO PARTICIPATE IN DISCUSSIONS, GET FEEDBACK FROM OTHER USERS, FORM VIRTUAL COMMUNITIES, ENGAGE IN SOCIAL NETWORKING, AND VOTE ON ISSUES RELEVANT TO THE COMMUNITY; COMPUTER SERVICES, NAMELY, CREATING AN ON-LINE COMMUNITY FOR REGISTERED USERS TO PARTICIPATE IN DISCUSSIONS, GET FEEDBACK FROM THEIR PEERS, FORM VIRTUAL COMMUNITIES, ENGAGE IN SOCIAL NETWORKING, AND VOTE ON ISSUES RELEVANT TO THE COMMUNITY; PROVIDING TEMPORARY USE OF ONLINE NON-DOWNLOADABLE SOFTWARE FOR COMMUNICATION AND COLLABORATION AMONG NETWORK USERS, IN CLASS 42 (U.S. CLS. 100 AND 101).

FIRST USE 9-1-2010; IN COMMERCE 9-1-2010.

THE MARK CONSISTS OF STANDARD CHARACTERS WITHOUT CLAIM TO ANY PARTICULAR FONT, STYLE, SIZE, OR COLOR.

OWNER OF U.S. REG. NO. 3,812,206.

SN 85-068,566, FILED 6-22-2010.

CARYN GLASSER, EXAMINING ATTORNEY



David J. Kyros

Director of the United States Patent and Trademark Office

United States of America

United States Patent and Trademark Office

NavPress Discipleship Inside Out

Reg. No. 4,154,661

Registered June 5, 2012

Int. Cl.: 9

TRADEMARK

PRINCIPAL REGISTER

THE NAVIGATORS (COLORADO CORPORATION)
3820 N. 30TH STREET
COLORADO SPRINGS, CO 80904

FOR: DOWNLOADABLE ELECTRONIC PUBLICATIONS, NAMELY, CATALOGS, NEWS-LETTERS, BOOKS, AND BROCHURES IN THE FIELD OF CHRISTIAN MINISTRY, IN CLASS 9 (U.S. CLS. 21, 23, 26, 36 AND 38).

FIRST USE 5-1-2010; IN COMMERCE 5-1-2010.

THE MARK CONSISTS OF STANDARD CHARACTERS WITHOUT CLAIM TO ANY PARTICULAR FONT, STYLE, SIZE, OR COLOR.

OWNER OF U.S. REG. NO. 1,170,131.

NO CLAIM IS MADE TO THE EXCLUSIVE RIGHT TO USE "DISCIPLESHIP", APART FROM THE MARK AS SHOWN.

SN 85-068,715, FILED 6-22-2010.

GINA FINK, EXAMINING ATTORNEY



David J. Kyros

Director of the United States Patent and Trademark Office

United States of America

United States Patent and Trademark Office

Papa Wheelie's

Reg. No. 4,154,662

Registered June 5, 2012

Int. Cl.: 43

SERVICE MARK

PRINCIPAL REGISTER

VANSICKLE, RICHARD, MARK (UNITED STATES INDIVIDUAL), DBA PAPA WHEELIE'S,
116 W. ILLINOIS ST., STE. 2W
CHICAGO, IL 60654

FOR: CAFE AND RESTAURANT SERVICES, IN CLASS 43 (U.S. CLS. 100 AND 101).

FIRST USE 6-15-2010; IN COMMERCE 1-10-2012.

THE MARK CONSISTS OF STANDARD CHARACTERS WITHOUT CLAIM TO ANY PARTICULAR FONT, STYLE, SIZE, OR COLOR.

SN 85-069,544, FILED 6-23-2010.

REGINA DRUMMOND, EXAMINING ATTORNEY



David J. Kybas

Director of the United States Patent and Trademark Office

United States of America

United States Patent and Trademark Office

SKYPE TO GO

Reg. No. 4,154,663

Registered June 5, 2012

Int. Cl.: 38

SERVICE MARK

PRINCIPAL REGISTER

SKYPE (IRELAND CORPORATION)
70 SIR JOHN ROGERSON'S QUAY
DUBLIN 2, IRELAND

FOR: COMMUNICATION SERVICES, NAMELY, TRANSMISSION OF AUDIO BY MEANS OF TELECOMMUNICATIONS NETWORKS, WIRELESS COMMUNICATION NETWORKS; COMMUNICATION SERVICES ACCESSED BY MEANS OF AN ACCESS NUMBER, NAMELY, TRANSMISSION OF VOICE BY TELECOMMUNICATIONS NETWORKS, WIRELESS COMMUNICATION NETWORKS, IN CLASS 38 (U.S. CLS. 100, 101 AND 104).

FIRST USE 6-8-2007; IN COMMERCE 6-8-2007.

THE MARK CONSISTS OF STANDARD CHARACTERS WITHOUT CLAIM TO ANY PARTICULAR FONT, STYLE, SIZE, OR COLOR.

PRIORITY CLAIMED UNDER SEC. 44(D) ON ERPN CMNTY TM OFC APPLICATION NO. 008782931, FILED 12-24-2009, REG. NO. 008782931, DATED 6-18-2010, EXPIRES 12-24-2019.

OWNER OF U.S. REG. NOS. 3,005,039, 3,403,727, AND 3,773,537.

SN 85-070,119, FILED 6-23-2010.

BARBARA GAYNOR, EXAMINING ATTORNEY



David J. Kyros

Director of the United States Patent and Trademark Office

United States of America

United States Patent and Trademark Office

CF WRESTLING

Reg. No. 4,154,664

Registered June 5, 2012

Int. Cl.: 25

TRADEMARK

PRINCIPAL REGISTER

TREO HOLDINGS, LLC (OHIO LIMITED LIABILITY COMPANY)
576 GEORGESVILLE ROAD
COLUMBUS, OH 43228

FOR: CLOTHING AND APPAREL, NAMELY, SHIRTS, IN CLASS 25 (U.S. CLS. 22 AND 39).

FIRST USE 10-1-2011; IN COMMERCE 10-1-2011.

THE MARK CONSISTS OF STANDARD CHARACTERS WITHOUT CLAIM TO ANY PARTICULAR FONT, STYLE, SIZE, OR COLOR.

OWNER OF U.S. REG. NO. 3,673,010.

NO CLAIM IS MADE TO THE EXCLUSIVE RIGHT TO USE "WRESTLING", APART FROM THE MARK AS SHOWN.

SN 85-071,139, FILED 6-24-2010.

ALEXANDER L. POWERS, EXAMINING ATTORNEY



David J. Kyros

Director of the United States Patent and Trademark Office

United States of America

United States Patent and Trademark Office



Reg. No. 4,154,665

Registered June 5, 2012

Int. Cl.: 35

SERVICE MARK

PRINCIPAL REGISTER

GRACE LITES CORPORATION (CALIFORNIA CORPORATION)
42245 REMINGTON AVENUE, SUITE B17
TEMECULA, CA 92590

FOR: PROCUREMENT, NAMELY, PURCHASING FOR OTHERS OF LIGHTING CONTROLLERS FOR STAGE LIGHTING AND TELEVISION, PROJECTOR LAMPS, REFLECTOR LAMPS, FANCY LAMPS FOR DECORATING, ARCHITECTURAL LIGHTS, MOVING LIGHTS FOR USE IN TELEVISION AND IN PROVIDING CORPORATE PRESENTATIONS; RETAIL STORES FEATURING LIGHTING CONTROLLERS FOR STAGE LIGHTING AND TELEVISION, PROJECTION EQUIPMENT, PROJECTOR LAMPS, REFLECTOR LAMPS, FANCY LAMPS FOR DECORATING, ARCHITECTURAL LIGHTS, MOVING LIGHTS FOR USE IN TELEVISION AND IN PROVIDING CORPORATE PRESENTATIONS, IN CLASS 35 (U.S. CLS. 100, 101 AND 102).

FIRST USE 7-0-2007; IN COMMERCE 7-0-2007.

NO CLAIM IS MADE TO THE EXCLUSIVE RIGHT TO USE "LITES CORPORATION", APART FROM THE MARK AS SHOWN.

THE COLOR(S) RED, BLACK IS/ARE CLAIMED AS A FEATURE OF THE MARK.

THE MARK CONSISTS OF THE WORD "GRACE" IN STYLIZED LETTERS IN RED, AND THE WORDS "LITES CORPORATION" IN BLACK.

SN 85-071,201, FILED 6-24-2010.

ELISSA GARBER KON, EXAMINING ATTORNEY



David J. Kybas

Director of the United States Patent and Trademark Office

United States of America

United States Patent and Trademark Office

Shinetime

Reg. No. 4,154,666

Registered June 5, 2012

Int. Cl.: 25

TRADEMARK

PRINCIPAL REGISTER

LOPEMAN, JAMIE (UNITED STATES INDIVIDUAL)
512 KENSINGTON DRIVE
RICHMOND, IN 47374 AND

JOHNSON, MICHAEL (UNITED STATES INDIVIDUAL)
122 PENNSYLVANIA AVENUE, #503
SENECA, PA 16346

FOR: CLOTHING, NAMELY, BOTTOMS, FLEECE PULLOVERS, HATS, SHORTS, SHORT-SLEEVED OR LONG-SLEEVED T-SHIRTS, TOPS, T-SHIRTS, JERSEYS, IN CLASS 25 (U.S. CLS. 22 AND 39).

FIRST USE 4-1-2010; IN COMMERCE 4-1-2010.

THE MARK CONSISTS OF THE WORD "SHINETIME" IN A PARTICULAR SCRIPT WITH STARS OVER THE LETTERS "T".

SN 85-071,977, FILED 6-25-2010.

JULIE WATSON, EXAMINING ATTORNEY



David J. Kybas

Director of the United States Patent and Trademark Office

United States of America

United States Patent and Trademark Office

Mission: LEAP

Reg. No. 4,154,667

SIMIOSYS, LLC (FLORIDA LIMITED LIABILITY COMPANY)
PO BOX 623262
OVIEDO, FL 327623262

Registered June 5, 2012

Int. Cl.: 9

FOR: COMPUTER SOFTWARE FOR THE DATABASING, VISUALIZATION, MANIPULATION, VIRTUAL REALITY IMMERSION AND INTEGRATION OF GEOGRAPHIC INFORMATION WITH ON-LINE MEMBER COMMUNITIES , IN CLASS 9 (U.S. CLS. 21, 23, 26, 36 AND 38).

TRADEMARK

PRINCIPAL REGISTER

FIRST USE 10-15-2008; IN COMMERCE 7-1-2010.

THE MARK CONSISTS OF STANDARD CHARACTERS WITHOUT CLAIM TO ANY PARTICULAR FONT, STYLE, SIZE, OR COLOR.

SN 85-072,066, FILED 6-25-2010.

RENEE SERVANCE, EXAMINING ATTORNEY



David J. Kyjars

Director of the United States Patent and Trademark Office

United States of America

United States Patent and Trademark Office

WILKINSON HI-RISE

Reg. No. 4,154,668

Registered June 5, 2012

Int. Cls.: 6 and 7

TRADEMARK

PRINCIPAL REGISTER

WHR HOLDINGS, LLC (FLORIDA LIMITED LIABILITY COMPANY)
3001 GREENE STREET
HOLLYWOOD, FL 33020

FOR: METAL BINS, NAMELY, RECYCLING BINS OF METAL FOR COLLECTION OF RECYCLABLE ITEMS, AND TRASH BINS OF METAL; METAL DOORS FOR TRASH CHUTES, NAMELY, INTAKE DOORS AND DISCHARGE DOORS; METAL DOORS FOR LAUNDRY CHUTES NAMELY, INTAKE DOORS AND DISCHARGE DOORS; TRASH CHUTES, NAMELY, METAL TRASH CHUTES IN THE NATURE OF BUILDING MATERIALS; LAUNDRY CHUTES NAMELY, METAL LAUNDRY CHUTES IN THE NATURE OF BUILDING MATERIALS; METAL STORAGE LOCKERS, NAMELY, GENERAL PURPOSE METAL STORAGE LOCKERS FOR INDUSTRIAL OR COMMERCIAL USE; AND METAL WIRE MESH PARTITION WALLS FOR STORAGE LOCKERS, IN CLASS 6 (U.S. CLS. 2, 12, 13, 14, 23, 25 AND 50).

FIRST USE 1-18-2012; IN COMMERCE 1-18-2012.

FOR: TRASH COMPACTORS AND REPLACEMENT PARTS THEREFOR; SORTING MACHINES FOR SORTING RECYCLABLE ITEMS, AND REPLACEMENT PARTS THEREFOR, IN CLASS 7 (U.S. CLS. 13, 19, 21, 23, 31, 34 AND 35).

FIRST USE 1-21-2012; IN COMMERCE 1-21-2012.

THE MARK CONSISTS OF STANDARD CHARACTERS WITHOUT CLAIM TO ANY PARTICULAR FONT, STYLE, SIZE, OR COLOR.

OWNER OF U.S. REG. NO. 2,797,205.

NO CLAIM IS MADE TO THE EXCLUSIVE RIGHT TO USE "HIGH-RISE" , APART FROM THE MARK AS SHOWN.

SN 85-074,006, FILED 6-29-2010.

CHRISTINE COOPER, EXAMINING ATTORNEY



David J. Kyros

Director of the United States Patent and Trademark Office

United States of America

United States Patent and Trademark Office

ICDESKTOP

Reg. No. 4,154,669

Registered June 5, 2012

Int. Cl.: 42

SERVICE MARK

PRINCIPAL REGISTER

ELOYALTY, LLC (COLORADO LIMITED LIABILITY COMPANY)
9197 SOUTH PEORIA STREET
ENGLEWOOD, CO 80112

FOR: SOFTWARE AS A SERVICE (SAAS) SERVICES FEATURING SOFTWARE IN THE FIELD OF CALL CENTER MANAGEMENT, NAMELY, A COMPUTER TELEPHONY INTEGRATION (CTI) APPLICATION TO CONTROL THE AGENT'S PHONE AND PHONE STATE, AND TO ALLOW CONFIGURABLE INTEGRATION WITH OTHER CALL CENTER SOFTWARE, IN CLASS 42 (U.S. CLS. 100 AND 101).

FIRST USE 2-8-2011; IN COMMERCE 2-8-2011.

THE MARK CONSISTS OF STANDARD CHARACTERS WITHOUT CLAIM TO ANY PARTICULAR FONT, STYLE, SIZE, OR COLOR.

SN 85-075,683, FILED 7-1-2010.

GIANCARLO CASTRO, EXAMINING ATTORNEY



David J. Kyros

Director of the United States Patent and Trademark Office

United States of America

United States Patent and Trademark Office

GREEN BALANCE

Reg. No. 4,154,670

BRIDGEWATER, INC. (UTAH CORPORATION)
4282 SOUTH 590 WEST
SALT LAKE CITY, UT 84123

Registered June 5, 2012

Int. Cls.: 1, 3, and 5

FOR: FABRIC PROTECTANTS FOR CARPET, UPHOLSTERY, AND TEXTILES; CHEMICAL ADDITIVES FOR USE IN CLEANING PREPARATIONS FOR CARPET, UPHOLSTERY, AND FABRIC; ALL OF THE FOREGOING ARE ENVIRONMENTALLY FRIENDLY, IN CLASS 1 (U.S. CLS. 1, 5, 6, 10, 26 AND 46).

TRADEMARK

PRINCIPAL REGISTER

FIRST USE 6-21-2010; IN COMMERCE 6-21-2010.

FOR: CLEANING AGENTS AND PREPARATIONS; WASHING AND POLISHING PREPARATIONS; CLEANING PREPARATIONS FOR CARPET, FABRIC AND UPHOLSTERY, NAMELY, CLEANING AGENTS, PRESPRAY CLEANING AGENTS, NEUTRALIZING AGENTS, COLOR BLEED PREVENTATIVE AGENTS, SPOT AND STAIN REMOVERS, AND RINSE AGENTS; WOOD CLEANER FOR CLEANING HARDWOOD FLOORS; ALL OF THE FOREGOING ARE ENVIRONMENTALLY FRIENDLY, IN CLASS 3 (U.S. CLS. 1, 4, 6, 50, 51 AND 52).

FIRST USE 6-21-2010; IN COMMERCE 6-21-2010.

FOR: ENVIRONMENTALLY FRIENDLY HOUSEHOLD AND COMMERCIAL DEODORIZERS FOR CARPET, UPHOLSTERY, FABRIC AND DRAPERIES, IN CLASS 5 (U.S. CLS. 6, 18, 44, 46, 51 AND 52).

FIRST USE 6-21-2010; IN COMMERCE 6-21-2010.

THE MARK CONSISTS OF STANDARD CHARACTERS WITHOUT CLAIM TO ANY PARTICULAR FONT, STYLE, SIZE, OR COLOR.

NO CLAIM IS MADE TO THE EXCLUSIVE RIGHT TO USE "GREEN", APART FROM THE MARK AS SHOWN.

SN 85-077,381, FILED 7-2-2010.

EMILY CARLSEN, EXAMINING ATTORNEY

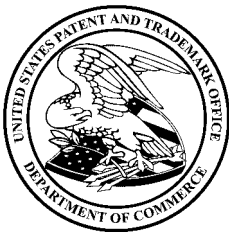

David J. Kyros

Director of the United States Patent and Trademark Office

United States of America

United States Patent and Trademark Office

KRUSH

Reg. No. 4,154,671

Registered June 5, 2012

Int. Cl.: 35

SERVICE MARK

PRINCIPAL REGISTER

KRUSH INC. (DELAWARE CORPORATION)
2 CANAL PARK
CAMBRIDGE, MA 02139

FOR: PROVISION OF A WEB SITE FEATURING COMMERCIAL INFORMATION ON SHOPPING FOR CONSUMERS; ADMINISTRATION OF A PROGRAM FOR ENABLING PARTICIPANTS TO OBTAIN DISCOUNTS ON GOODS AND SERVICES; PROMOTING THE GOODS OF OTHERS, NAMELY, PROVIDING TO CONSUMERS INFORMATION REGARDING DISCOUNTS, COUPONS, REBATES, VOUCHERS AND SPECIAL OFFERS FOR THE GOODS OF OTHERS, IN CLASS 35 (U.S. CLS. 100, 101 AND 102).

FIRST USE 11-1-2010; IN COMMERCE 11-1-2010.

THE MARK CONSISTS OF STANDARD CHARACTERS WITHOUT CLAIM TO ANY PARTICULAR FONT, STYLE, SIZE, OR COLOR.

SN 85-079,228, FILED 7-7-2010.

JEAN IM, EXAMINING ATTORNEY



David J. Kypos

Director of the United States Patent and Trademark Office

United States of America

United States Patent and Trademark Office

QTOPIA

Reg. No. 4,154,672

Registered June 5, 2012

Int. Cls.: 38 and 41

SERVICE MARK

PRINCIPAL REGISTER

QWIZDOM, INC. (WASHINGTON CORPORATION)
12617 MERIDIAN E
PUYALLUP, WA 98373

FOR: PROVIDING AN ON-LINE FORUM FOR SHARING AND TRANSMISSION OF INFORMATION AND ELECTRONIC MEDIA CONCERNING EDUCATION, IN CLASS 38 (U.S. CLS. 100, 101 AND 104).

FIRST USE 2-0-2011; IN COMMERCE 2-0-2011.

FOR: EDUCATION SERVICES, NAMELY, PROVIDING AN ONLINE INTERACTIVE DATABASE FOR TRACKING, MONITORING AND RECORDING STUDENT ACADEMIC PERFORMANCE DATA; PROVIDING ONLINE EDUCATIONAL INFORMATION, NAMELY, COURSE MATERIALS, STUDY AND HOMEWORK EXERCISES, AND TEST QUESTIONS AND QUIZZES IN THE FIELDS OF MATH, SCIENCE, SOCIAL STUDIES, READING AND WRITING; PROVIDING ONLINE EDUCATIONAL PUBLICATIONS, NAMELY, INSTRUCTIONAL, EDUCATIONAL AND TEACHING MATERIALS IN THE FIELDS OF MATH, SCIENCE, SOCIAL STUDIES, READING AND WRITING, IN CLASS 41 (U.S. CLS. 100, 101 AND 107).

FIRST USE 2-0-2011; IN COMMERCE 2-0-2011.

THE MARK CONSISTS OF STANDARD CHARACTERS WITHOUT CLAIM TO ANY PARTICULAR FONT, STYLE, SIZE, OR COLOR.

SN 85-080,903, FILED 7-8-2010.

JOHN SCHUYLER YARD, EXAMINING ATTORNEY



David J. Kyffers

Director of the United States Patent and Trademark Office

United States of America

United States Patent and Trademark Office



Reg. No. 4,154,673

Registered June 5, 2012

Int. Cls.: 7 and 8

TRADEMARK

PRINCIPAL REGISTER

ENGINEERING & RESEARCH ASSOCIATES, INC. (ARIZONA CORPORATION)
100 N. TUCSON BOULEVARD
TUCSON, AZ 85716

FOR: POWER TOOLS, NAMELY, PORTABLE AND FIXED LOCATION INSTRUMENTS FOR FORMING, EXTRUDING, SHAPING OR WELDING THERMOPLASTIC ELEMENTS , IN CLASS 7 (U.S. CLS. 13, 19, 21, 23, 31, 34 AND 35).

FIRST USE 5-31-2011; IN COMMERCE 5-31-2011.

FOR: HAND TOOLS FOR FORMING, EXTRUDING, SHAPING OR WELDING PLASTIC TUBING, IN CLASS 8 (U.S. CLS. 23, 28 AND 44).

FIRST USE 5-31-2011; IN COMMERCE 5-31-2011.

THE MARK CONSISTS OF THE TERM "VANTE" IN COMBINATION WITH A LOGO CONSISTING OF THE LETTER "V" PARTIALLY ENCLOSED WITHIN A LARGER "V" HAVING A ROUNDED TAIL EXTENDING FROM ONE ARM.

THE ENGLISH TRANSLATION OF "VANTE" IN THE MARK IS PRAISE.

SN 85-082,414, FILED 7-12-2010.

TOBY BULLOFF, EXAMINING ATTORNEY



David J. Kyffers

Director of the United States Patent and Trademark Office

United States of America
United States Patent and Trademark Office

ICSPEAK

Reg. No. 4,154,674

ELOYALTY, LLC (COLORADO LIMITED LIABILITY COMPANY)
9197 SOUTH PEORIA STREET
ENGLEWOOD, CO 80112

Registered June 5, 2012

Int. Cl.: 42

FOR: SOFTWARE AS A SERVICE (SAAS) SERVICES FEATURING SOFTWARE IN THE FIELD OF CALL CENTER MANAGEMENT, NAMELY, A CUSTOMER VOICE PORTAL (CVP) APPLICATION THAT ALLOWS A CALLER TO RECORD AND MANAGE AUDIO MESSAGES THROUGH THE TELEPHONE, IN CLASS 42 (U.S. CLS. 100 AND 101).

SERVICE MARK

PRINCIPAL REGISTER

FIRST USE 10-25-2010; IN COMMERCE 10-25-2010.

THE MARK CONSISTS OF STANDARD CHARACTERS WITHOUT CLAIM TO ANY PARTICULAR FONT, STYLE, SIZE, OR COLOR.

SN 85-082,787, FILED 7-12-2010.

GIANCARLO CASTRO, EXAMINING ATTORNEY



David J. Kyros

Director of the United States Patent and Trademark Office

United States of America

United States Patent and Trademark Office

ICINTELLECT

Reg. No. 4,154,675

Registered June 5, 2012

Int. Cl.: 42

SERVICE MARK

PRINCIPAL REGISTER

ELOYALTY, LLC (COLORADO LIMITED LIABILITY COMPANY)
9197 SOUTH PEORIA STREET
ENGLEWOOD, CO 80112

FOR: SOFTWARE AS A SERVICE (SAAS) SERVICES FEATURING SOFTWARE IN THE FIELD OF CALL CENTER MANAGEMENT FOR USE IN CONSOLIDATING, SUMMARIZING AND REPORTING DATA FROM CONTACT CENTER DATA SOURCES, IN CLASS 42 (U.S. CLS. 100 AND 101).

FIRST USE 12-6-2010; IN COMMERCE 12-6-2010.

THE MARK CONSISTS OF STANDARD CHARACTERS WITHOUT CLAIM TO ANY PARTICULAR FONT, STYLE, SIZE, OR COLOR.

SN 85-082,797, FILED 7-12-2010.

GIANCARLO CASTRO, EXAMINING ATTORNEY



David J. Kyros

Director of the United States Patent and Trademark Office

United States of America

United States Patent and Trademark Office

IN THE HOLE

Reg. No. 4,154,676

Registered June 5, 2012

Int. Cl.: 6

TRADEMARK

PRINCIPAL REGISTER

GILBERT, STEPHEN (UNITED STATES INDIVIDUAL)
1015 E. OVERBLUFF ROAD
SPOKANE, WA 99203

FOR: THREADED MOUNT FOR GOLF CART ACCESSORIES COMPRISED OF METAL FASTENERS FOR HOLDING BALL MARKERS, STROKE COUNTERS, GLOVES, HATS, JACKETS, AND SUNGLASSES, IN CLASS 6 (U.S. CLS. 2, 12, 13, 14, 23, 25 AND 50).

FIRST USE 12-1-2011; IN COMMERCE 12-1-2011.

THE MARK CONSISTS OF STANDARD CHARACTERS WITHOUT CLAIM TO ANY PARTICULAR FONT, STYLE, SIZE, OR COLOR.

SN 85-082,904, FILED 7-12-2010.

RAMONA ORTIGA, EXAMINING ATTORNEY



David J. Kyffers

Director of the United States Patent and Trademark Office

United States of America

United States Patent and Trademark Office

THE ALL-IN-ONE NAPTIME SOLUTION

Reg. No. 4,154,677

AKA KIDS, INC. (DELAWARE CORPORATION)
765 NW 122 CT
MIAMI, FL 33182

Registered June 5, 2012

Int. Cls.: 20 and 35

FOR: CHILDREN'S MATS USED FOR SLEEPING; NAP SACKS; SLEEPING BAG PADS; SLEEPING BAGS; SLEEPING MATS, IN CLASS 20 (U.S. CLS. 2, 13, 22, 25, 32 AND 50).

TRADEMARK

FIRST USE 7-1-2011; IN COMMERCE 7-1-2011.

SERVICE MARK

FOR: ON-LINE WHOLESALE AND RETAIL STORE SERVICES FEATURING CHILDREN'S MATS USED FOR SLEEPING, NAP SACKS, SLEEPING BAG PADS, SLEEPING BAGS, SLEEPING MATS CLASS, IN CLASS 35 (U.S. CLS. 100, 101 AND 102).

PRINCIPAL REGISTER

FIRST USE 7-1-2011; IN COMMERCE 7-1-2011.

THE MARK CONSISTS OF STANDARD CHARACTERS WITHOUT CLAIM TO ANY PARTICULAR FONT, STYLE, SIZE, OR COLOR.

SN 85-083,269, FILED 7-13-2010.

ESTHER BELENKER, EXAMINING ATTORNEY



David J. Kybas

Director of the United States Patent and Trademark Office

United States of America

United States Patent and Trademark Office

SUCTIONSEAL

Reg. No. 4,154,678

Registered June 5, 2012

Int. Cl.: 7

TRADEMARK

PRINCIPAL REGISTER

ELECTROLUX HOME CARE PRODUCTS, INC. (DELAWARE CORPORATION)
10200 DAVID TAYLOR DRIVE
CHARLOTTE, NC 28262

FOR: VACUUM CLEANERS, IN CLASS 7 (U.S. CLS. 13, 19, 21, 23, 31, 34 AND 35).

FIRST USE 1-26-2012; IN COMMERCE 1-26-2012.

THE MARK CONSISTS OF STANDARD CHARACTERS WITHOUT CLAIM TO ANY PARTICULAR FONT, STYLE, SIZE, OR COLOR.

SN 85-083,280, FILED 7-13-2010.

RONALD MCMORROW, EXAMINING ATTORNEY



David J. Kyffers

Director of the United States Patent and Trademark Office

United States of America

United States Patent and Trademark Office

ZENVVAULT

Reg. No. 4,154,679

Registered June 5, 2012

Int. Cls.: 9 and 39

TRADEMARK

SERVICE MARK

PRINCIPAL REGISTER

ZERONINES TECHNOLOGY, INC. (COLORADO CORPORATION)
450 EAST HAPPY CANYON ROAD
CASTLE ROCK, CO 80108

FOR: COMPUTER SOFTWARE FOR USE IN THE SAFEGUARDING OF DIGITAL FILES, INCLUDING AUDIO, VIDEO, TEXT, BINARY, STILL IMAGES, GRAPHICS AND MULTI-MEDIA FILES; COMPUTER SOFTWARE THAT PROVIDES WEB-BASED ACCESS TO APPLICATIONS AND SERVICES THROUGH A WEB OPERATING SYSTEM OR PORTAL INTERFACE, IN CLASS 9 (U.S. CLS. 21, 23, 26, 36 AND 38).

FIRST USE 9-13-2010; IN COMMERCE 9-13-2010.

FOR: STORAGE SERVICES FOR ARCHIVING DATABASES, IMAGES AND OTHER ELECTRONIC DATA, IN CLASS 39 (U.S. CLS. 100 AND 105).

FIRST USE 9-13-2010; IN COMMERCE 9-13-2010.

THE MARK CONSISTS OF STANDARD CHARACTERS WITHOUT CLAIM TO ANY PARTICULAR FONT, STYLE, SIZE, OR COLOR.

SN 85-084,376, FILED 7-14-2010.

REBECCA SMITH, EXAMINING ATTORNEY

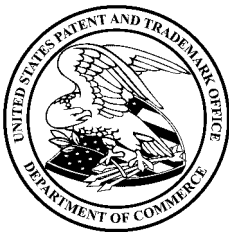

David J. Kyros

Director of the United States Patent and Trademark Office

United States of America

United States Patent and Trademark Office

ZENCODE

Reg. No. 4,154,680

Registered June 5, 2012

Int. Cl.: 9

TRADEMARK

PRINCIPAL REGISTER

ZERONINES TECHNOLOGY, INC. (COLORADO CORPORATION)
450 EAST HAPPY CANYON ROAD
CASTLE ROCK, CO 80108

FOR: COMPUTER SOFTWARE FOR USE IN THE ENCRYPTION AND DECRYPTION OF DIGITAL FILES, INCLUDING AUDIO, VIDEO, TEXT, BINARY, STILL IMAGES, GRAPHICS AND MULTIMEDIA FILES; COMPUTER SOFTWARE FOR USE IN THE SAFEGUARDING OF DIGITAL FILES, INCLUDING AUDIO, VIDEO, TEXT, BINARY, STILL IMAGES, GRAPHICS AND MULTIMEDIA FILES, IN CLASS 9 (U.S. CLS. 21, 23, 26, 36 AND 38).

FIRST USE 9-13-2010; IN COMMERCE 9-13-2010.

THE MARK CONSISTS OF STANDARD CHARACTERS WITHOUT CLAIM TO ANY PARTICULAR FONT, STYLE, SIZE, OR COLOR.

SN 85-084,645, FILED 7-14-2010.

REBECCA SMITH, EXAMINING ATTORNEY



David J. Kyffers

Director of the United States Patent and Trademark Office

United States of America

United States Patent and Trademark Office

xS MAST

Reg. No. 4,154,681

WOOLSLAYER COMPANIES, INC. (OKLAHOMA CORPORATION)
5416 SOUTH YALE
TULSA, OK 74135

Registered June 5, 2012

Int. Cl.: 7

FOR: OIL FIELD EQUIPMENT, NAMELY, EXTENSION MAST CRANE, A SCOPING DOG ASSEMBLY COMPRISED OF A WHEELED BODY MOVEABLE ON A TRACK OR BEAM AND AN EXTENDING AND RETRACTING MECHANISM, IN CLASS 7 (U.S. CLS. 13, 19, 21, 23, 31, 34 AND 35).

TRADEMARK

PRINCIPAL REGISTER

FIRST USE 5-3-2010; IN COMMERCE 10-15-2010.

THE MARK CONSISTS OF STANDARD CHARACTERS WITHOUT CLAIM TO ANY PARTICULAR FONT, STYLE, SIZE, OR COLOR.

NO CLAIM IS MADE TO THE EXCLUSIVE RIGHT TO USE "MAST", APART FROM THE MARK AS SHOWN.

SN 85-085,767, FILED 7-15-2010.

EMILY CARLSEN, EXAMINING ATTORNEY



David J. Kyros

Director of the United States Patent and Trademark Office

United States of America

United States Patent and Trademark Office

FREEZE

Reg. No. 4,154,682

SOMMERS, ALLISON (UNITED STATES INDIVIDUAL)
17520 SW 73 COURT
PALMETTO BAY, FL 33157

Registered June 5, 2012

Int. Cl.: 5

FOR: BOTULINUM TOXIN FOR MEDICAL USE FOR USE IN THE TREATMENT OF EXCESSIVE SWEATING, EXCESSIVE EYE BLINKING, NEUROPATHY PAIN, AND MUSCULAR CRAMPS AND SPASMS, AND FOR USE IN THE PARALYSIS OR WEAKENING OF MUSCLES, IN CLASS 5 (U.S. CLS. 6, 18, 44, 46, 51 AND 52).

TRADEMARK

PRINCIPAL REGISTER

FIRST USE 3-13-2012; IN COMMERCE 3-13-2012.

THE MARK CONSISTS OF STANDARD CHARACTERS WITHOUT CLAIM TO ANY PARTICULAR FONT, STYLE, SIZE, OR COLOR.

SN 85-086,105, FILED 7-16-2010.

GINA FINK, EXAMINING ATTORNEY



David J. Kybas

Director of the United States Patent and Trademark Office

United States of America

United States Patent and Trademark Office



Reg. No. 4,154,683

Registered June 5, 2012

Int. Cls.: 9 and 36

TRADEMARK

SERVICE MARK

PRINCIPAL REGISTER

BC CARD CO., LTD. (REPUBLIC OF KOREA CORPORATION)
1587 SEOCHO-DONG, SEOCHO-GU
SEOUL, REPUBLIC OF KOREA 137-777

FOR: MAGNETICALLY ENCODED CREDIT CARDS; MAGNETICALLY ENCODED DEBIT CARDS; ELECTRONICALLY ENCODED CREDIT CARDS; MAGNETICALLY ENCODED DEBIT CARDS; CASH DISPENSING MACHINES, NAMELY, AUTOMATED TELLER MACHINES (ATM), IN CLASS 9 (U.S. CLS. 21, 23, 26, 36 AND 38).

FIRST USE 7-19-2010; IN COMMERCE 7-19-2010.

FOR: CREDIT CARD, DEBIT CARD, CHARGE CARD, AND STORED VALUE SMART CARD SERVICES; ELECTRONIC CREDIT AND DEBIT TRANSACTIONS, NAMELY, ELECTRONIC TRANSFERS OF MONEY, ELECTRONIC CASH DISBURSEMENT, CASH REPLACEMENT RENDERED BY CREDIT CARDS AND DEBIT CARDS, AND AUTOMATED TELLER MACHINE SERVICES; CREDIT CARD AND DEBIT CARD VERIFICATION, PAYMENT TRANSACTION PROCESSING, CREDIT AND DEBIT CARD AUTHENTICATION AND CREDIT AND DEBIT CARD VERIFICATION SERVICES; CURRENCY EXCHANGE AND TRANSFER OF ELECTRONIC FUNDS, IN CLASS 36 (U.S. CLS. 100, 101 AND 102).

FIRST USE 7-19-2010; IN COMMERCE 7-19-2010.

THE MARK CONSISTS OF THE LETTERS "BC" IN WHITE CONTAINED IN A RED CIRCLE.

THE COLOR(S) RED AND WHITE IS/ARE CLAIMED AS A FEATURE OF THE MARK.

SN 85-087,658, FILED 7-19-2010.

NICHOLAS COLEMAN, EXAMINING ATTORNEY



David J. Kyjars

Director of the United States Patent and Trademark Office

United States of America

United States Patent and Trademark Office

BALE/DONEEN

Reg. No. 4,154,684

BALE/DONEEN METHOD LLC (WASHINGTON LIMITED LIABILITY COMPANY)
507 S. WASHINGTON, SUITE 170
SPOKANE, WA 99204

Registered June 5, 2012

Int. Cl.: 44

FOR: MEDICAL SCREENING; MEDICAL SERVICES, NAMELY, RELATING TO EVALUATION AND TESTING FOR CARDIOVASCULAR DISEASE PREVENTION; MEDICAL TESTING FOR DIAGNOSTIC OR TREATMENT PURPOSES; PROVIDING INFORMATION IN THE FIELD OF CARDIOVASCULAR DISEASE, AND CARDIOVASCULAR DISEASE PREVENTIONS, SCREENING, DIAGNOSIS AND TREATMENT, IN CLASS 44 (U.S. CLS. 100 AND 101).

SERVICE MARK

PRINCIPAL REGISTER

FIRST USE 5-3-2007; IN COMMERCE 5-3-2007.

THE MARK CONSISTS OF STANDARD CHARACTERS WITHOUT CLAIM TO ANY PARTICULAR FONT, STYLE, SIZE, OR COLOR.

SN 85-089,754, FILED 7-21-2010.

SUE LAWRENCE, EXAMINING ATTORNEY



David J. Kyffers

Director of the United States Patent and Trademark Office

United States of America

United States Patent and Trademark Office

BALE/DONEEN

Reg. No. 4,154,685

BALE/DONEEN METHOD LLC (WASHINGTON LIMITED LIABILITY COMPANY)
507 S. WASHINGTON, SUITE 170
SPOKANE, WA 99204

Registered June 5, 2012

Int. Cl.: 41

FOR: EDUCATIONAL SERVICES, NAMELY, PROVIDING INSTRUCTION IN THE NATURE OF CLASSES, COURSES, SEMINARS, WORKSHOPS AND TRAINING IN THE FIELD OF MEDICAL SCREENING AND DIAGNOSIS, IN CLASS 41 (U.S. CLS. 100, 101 AND 107).

SERVICE MARK

FIRST USE 5-3-2007; IN COMMERCE 5-3-2007.

PRINCIPAL REGISTER

THE MARK CONSISTS OF STANDARD CHARACTERS WITHOUT CLAIM TO ANY PARTICULAR FONT, STYLE, SIZE, OR COLOR.

SN 85-089,759, FILED 7-21-2010.

SUE LAWRENCE, EXAMINING ATTORNEY



David J. Kyros

Director of the United States Patent and Trademark Office

United States of America

United States Patent and Trademark Office

BALE/DONEEN METHOD

Reg. No. 4,154,686

Registered June 5, 2012

Int. Cl.: 41

SERVICE MARK

PRINCIPAL REGISTER

BALE/DONEEN METHOD LLC (WASHINGTON LIMITED LIABILITY COMPANY)
507 S. WASHINGTON, SUITE 170
SPOKANE, WA 99204

FOR: EDUCATIONAL SERVICES, NAMELY, PROVIDING INSTRUCTION IN THE NATURE OF CLASSES, COURSES, SEMINARS, WORKSHOPS AND TRAINING IN THE FIELD OF MEDICAL SCREENING AND DIAGNOSIS, IN CLASS 41 (U.S. CLS. 100, 101 AND 107).

FIRST USE 5-3-2007; IN COMMERCE 5-3-2007.

THE MARK CONSISTS OF STANDARD CHARACTERS WITHOUT CLAIM TO ANY PARTICULAR FONT, STYLE, SIZE, OR COLOR.

NO CLAIM IS MADE TO THE EXCLUSIVE RIGHT TO USE "METHOD", APART FROM THE MARK AS SHOWN.

THE WORDING "BALEDONEEN" HAS NO MEANING IN A FOREIGN LANGUAGE.

SN 85-089,763, FILED 7-21-2010.

SUE LAWRENCE, EXAMINING ATTORNEY



David J. Kyjars

Director of the United States Patent and Trademark Office

United States of America

United States Patent and Trademark Office

BALE/DONEEN METHOD

Reg. No. 4,154,687

Registered June 5, 2012

Int. Cl.: 44

SERVICE MARK

PRINCIPAL REGISTER

BALE/DONEEN METHOD LLC (WASHINGTON LIMITED LIABILITY COMPANY)
507 S. WASHINGTON
SPOKANE, WA 99204

FOR: MEDICAL SCREENING; MEDICAL SERVICES, NAMELY, RELATING TO EVALUATION AND TESTING FOR CARDIOVASCULAR DISEASE PREVENTION; MEDICAL TESTING FOR DIAGNOSTIC OR TREATMENT PURPOSES; PROVIDING INFORMATION IN THE FIELD OF CARDIOVASCULAR DISEASE, AND CARDIOVASCULAR DISEASE PREVENTIONS, SCREENING, DIAGNOSIS AND TREATMENT, IN CLASS 44 (U.S. CLS. 100 AND 101).

FIRST USE 5-3-2007; IN COMMERCE 5-3-2007.

THE MARK CONSISTS OF STANDARD CHARACTERS WITHOUT CLAIM TO ANY PARTICULAR FONT, STYLE, SIZE, OR COLOR.

NO CLAIM IS MADE TO THE EXCLUSIVE RIGHT TO USE "METHOD", APART FROM THE MARK AS SHOWN.

SN 85-089,766, FILED 7-21-2010.

SUE LAWRENCE, EXAMINING ATTORNEY



David J. Kybas

Director of the United States Patent and Trademark Office

United States of America

United States Patent and Trademark Office

FRENCH'S STAY FRESH CAN

Reg. No. 4,154,688

Registered June 5, 2012

Int. Cl.: 29

TRADEMARK

PRINCIPAL REGISTER

RECKITT BENCKISER LLC (DELAWARE LIMITED LIABILITY COMPANY)
399 INTERPACE PARKWAY
PARSIPPANY, NJ 07054

FOR: PROCESSED ONIONS, NAMELY, FRENCH FRIED ONIONS, IN CLASS 29 (U.S. CL. 46).

FIRST USE 9-19-2011; IN COMMERCE 9-19-2011.

THE MARK CONSISTS OF STANDARD CHARACTERS WITHOUT CLAIM TO ANY PARTICULAR FONT, STYLE, SIZE, OR COLOR.

OWNER OF U.S. REG. NOS. 545,030, 3,313,754, AND OTHERS.

NO CLAIM IS MADE TO THE EXCLUSIVE RIGHT TO USE "STAY FRESH CAN", APART FROM THE MARK AS SHOWN.

SN 85-091,088, FILED 7-22-2010.

WENDY JUN, EXAMINING ATTORNEY



David J. Kyros

Director of the United States Patent and Trademark Office

United States of America

United States Patent and Trademark Office

Range Buster

Reg. No. 4,154,689

Registered June 5, 2012

Int. Cl.: 5

TRADEMARK

PRINCIPAL REGISTER

WINN, ROBERT T. (UNITED STATES INDIVIDUAL), DBA TEXAS CREEK FARMS,
141 PR 3808
BIG SANDY, TX 75755

FOR: ANIMAL FEED SUPPLEMENTS, IN CLASS 5 (U.S. CLS. 6, 18, 44, 46, 51 AND 52).

FIRST USE 7-24-2010; IN COMMERCE 7-24-2010.

THE MARK CONSISTS OF STANDARD CHARACTERS WITHOUT CLAIM TO ANY PARTICULAR FONT, STYLE, SIZE, OR COLOR.

NO CLAIM IS MADE TO THE EXCLUSIVE RIGHT TO USE "RANGE", APART FROM THE MARK AS SHOWN.

SN 85-092,229, FILED 7-24-2010.

SUSAN STIGLITZ, EXAMINING ATTORNEY



David J. Kybas

Director of the United States Patent and Trademark Office

United States of America

United States Patent and Trademark Office

EDAMAME

Reg. No. 4,154,690

K & COMPANY LLC (DELAWARE LIMITED LIABILITY COMPANY)
2380 MCGEE SUITE #300
KANSAS CITY, MO 64108, MO 64108

Registered June 5, 2012

Int. Cl.: 16

FOR: ART PADS; BRAG BOOKS; MEMORY BOOKS; SCRAP BOOKS; STICKERS, IN CLASS 16 (U.S. CLS. 2, 5, 22, 23, 29, 37, 38 AND 50).

TRADEMARK

FIRST USE 11-30-2011; IN COMMERCE 11-30-2011.

PRINCIPAL REGISTER

THE MARK CONSISTS OF STANDARD CHARACTERS WITHOUT CLAIM TO ANY PARTICULAR FONT, STYLE, SIZE, OR COLOR.

SN 85-092,545, FILED 7-26-2010.

ARETHA SOMERVILLE, EXAMINING ATTORNEY



David J. Kybas

Director of the United States Patent and Trademark Office

United States of America

United States Patent and Trademark Office

ISABELLA GRACE

Reg. No. 4,154,691

K & COMPANY LLC (DELAWARE LIMITED LIABILITY COMPANY)
2380 MCGEE SUITE #300

Registered June 5, 2012

KANSAS CITY, MO 64108, MO 64108

Int. Cl.: 16

FOR: ART PADS; BRAG BOOKS; MEMORY BOOKS; STICKERS, IN CLASS 16 (U.S. CLS. 2, 5, 22, 23, 29, 37, 38 AND 50).

TRADEMARK

FIRST USE 3-15-2012; IN COMMERCE 3-15-2012.

PRINCIPAL REGISTER

THE MARK CONSISTS OF STANDARD CHARACTERS WITHOUT CLAIM TO ANY PARTICULAR FONT, STYLE, SIZE, OR COLOR.

THE NAME "ISABELLA GRACE" DOES NOT IDENTIFY A LIVING INDIVIDUAL.

SN 85-092,554, FILED 7-26-2010.

ARETHA SOMERVILLE, EXAMINING ATTORNEY



David J. Kybas

Director of the United States Patent and Trademark Office

United States of America

United States Patent and Trademark Office

CGA

Reg. No. 4,154,692

Registered June 5, 2012

Int. Cls.: 42 and 45

SERVICE MARK

PRINCIPAL REGISTER

COMPLETE GENOMICS, INC. (DELAWARE CORPORATION)
271 STIERLIN COURT
MOUNTAIN VIEW, CA 94043

FOR: BIOTECHNOLOGY RESEARCH AND DEVELOPMENT SERVICES FOR OTHERS, NAMELY, GENOME SEQUENCING, GENOME MAPPING, GENOME AND NUCLEIC ACID ANALYSIS, GENOME AMPLIFICATION, GENOME SCANNING, AND HIGH PERFORMANCE COMPUTING SERVICES FOR GENOME SEQUENCING, IN CLASS 42 (U.S. CLS. 100 AND 101).

FIRST USE 6-30-2010; IN COMMERCE 6-30-2010.

FOR: LICENSING OF COMPUTER SOFTWARE IN THE FIELD OF GENOME RESEARCH AND DEVELOPMENT, IN CLASS 45 (U.S. CLS. 100 AND 101).

FIRST USE 6-30-2010; IN COMMERCE 6-30-2010.

THE MARK CONSISTS OF STANDARD CHARACTERS WITHOUT CLAIM TO ANY PARTICULAR FONT, STYLE, SIZE, OR COLOR.

SN 85-093,738, FILED 7-27-2010.

DARRYL SPRUILL, EXAMINING ATTORNEY



David J. Kybas

Director of the United States Patent and Trademark Office

United States of America

United States Patent and Trademark Office

THE WONDER YEARS

Reg. No. 4,154,693

Registered June 5, 2012

Int. Cl.: 41

SERVICE MARK

PRINCIPAL REGISTER

NEW WORLD TELEVISION PROGRAMMING (CALIFORNIA CORPORATION)
10201 WEST PICO BOULEVARD
LOS ANGELES, CA 90035

FOR: ENTERTAINMENT SERVICES IN THE NATURE OF A TELEVISION SERIES FEATURING DRAMA; ENTERTAINMENT SERVICES IN THE NATURE OF NON-DOWNLOADABLE VIDEOS FEATURING TELEVISION SHOWS TRANSMITTED VIA THE INTERNET AND WIRELESS COMMUNICATION NETWORKS, IN CLASS 41 (U.S. CLS. 100, 101 AND 107).

FIRST USE 1-31-1998; IN COMMERCE 1-31-1998.

THE MARK CONSISTS OF STANDARD CHARACTERS WITHOUT CLAIM TO ANY PARTICULAR FONT, STYLE, SIZE, OR COLOR.

OWNER OF U.S. REG. NO. 1,580,685.

SN 85-095,293, FILED 7-28-2010.

LIEF MARTIN, EXAMINING ATTORNEY



David J. Kyffers

Director of the United States Patent and Trademark Office

United States of America

United States Patent and Trademark Office

ENGRAVED GARDEN

Reg. No. 4,154,694

Registered June 5, 2012

Int. Cl.: 16

TRADEMARK

PRINCIPAL REGISTER

K & COMPANY LLC (DELAWARE LIMITED LIABILITY COMPANY)
2380 MCGEE SUITE #300
KANSAS CITY, MO 64108, MO 64108

FOR: STICKERS, IN CLASS 16 (U.S. CLS. 2, 5, 22, 23, 29, 37, 38 AND 50).

FIRST USE 2-1-2012; IN COMMERCE 2-1-2012.

THE MARK CONSISTS OF STANDARD CHARACTERS WITHOUT CLAIM TO ANY PARTICULAR FONT, STYLE, SIZE, OR COLOR.

SN 85-095,489, FILED 7-29-2010.

ARETHA SOMERVILLE, EXAMINING ATTORNEY



David J. Kyffers

Director of the United States Patent and Trademark Office

United States of America

United States Patent and Trademark Office

ROADSAFE

Reg. No. 4,154,695

Registered June 5, 2012

Int. Cls.: 37 and 45

SERVICE MARK

PRINCIPAL REGISTER

ROADSAFE HOLDINGS, INC. (DELAWARE CORPORATION)
8750 BRYN MAWR, SUITE 400
CHICAGO, IL 60631

FOR: RENTAL AND INSTALLATION OF CRASH SYSTEMS, NAMELY, TRUCK-MOUNTED IMPACT ATTENUATORS, CRASH CUSHIONS, SAND BARREL ARRAYS, AND WATER-FILLED BARRIERS; AND PAVEMENT MARKING SERVICES AND TRAFFIC SIGN INSTALLATION SERVICES; RENTAL, INSTALLATION AND RELOCATION OF TRAFFIC SAFETY DEVICES, NAMELY, BARRELS, WATER BARRIERS, AND BARRICADES; INSTALLATION AND RELOCATION OF MESSAGE BOARDS AND TRAFFIC SIGNAGE, AND TRAFFIC CONES, WITH ALL OF THE FOREGOING USED FOR THE MANAGEMENT AND CONTROL OF VEHICULAR AND PEDESTRIAN TRAFFIC, IN CLASS 37 (U.S. CLS. 100, 103 AND 106).

FIRST USE 1-0-2008; IN COMMERCE 1-0-2008.

FOR: RENTAL OF TRAFFIC SAFETY DEVICES, NAMELY, MESSAGE BOARDS AND TRAFFIC SIGNAGE, AND TRAFFIC CONES WITH ALL OF THE FOREGOING USED FOR THE MANAGEMENT AND CONTROL OF VEHICULAR AND PEDESTRIAN TRAFFIC, IN CLASS 45 (U.S. CLS. 100 AND 101).

FIRST USE 1-0-2008; IN COMMERCE 1-0-2008.

THE MARK CONSISTS OF STANDARD CHARACTERS WITHOUT CLAIM TO ANY PARTICULAR FONT, STYLE, SIZE, OR COLOR.

OWNER OF U.S. REG. NO. 3,652,009.

SN 85-096,521, FILED 7-30-2010.

ODESSA BIBBINS, EXAMINING ATTORNEY



David J. Kyros

Director of the United States Patent and Trademark Office

United States of America

United States Patent and Trademark Office

ADMIRALS BANK

Reg. No. 4,154,696

Registered June 5, 2012

Int. Cl.: 36

SERVICE MARK

PRINCIPAL REGISTER

ADMIRALS BANK (UNITED STATES FEDERAL SAVINGS ASSOCIATION)
815 RESERVOIR AVENUE
CRANSTON, RI 02910

FOR: FINANCIAL SERVICES, NAMELY, BANKING SERVICES; INTERNET AND ONLINE BANKING SERVICES; PERSONAL AND COMMERCIAL BANKING SERVICES; CHECKING ACCOUNT SERVICES; SAVINGS ACCOUNT SERVICES; DIRECT DEPOSIT SERVICES; DEPOSIT SERVICES IN THE NATURE OF ACCEPTANCE OF DEPOSITS; SAFETY DEPOSIT BOX SERVICES; FINANCIAL TRANSACTION SERVICES, NAMELY, CERTIFICATES OF DEPOSIT; ONLINE BANKING; ONLINE BILL PAYMENT SERVICES; MONEY WIRE TRANSFER SERVICES; AUTOMATED TELLER MACHINE SERVICES; ELECTRONIC FUNDS TRANSFER SERVICES; CERTIFIED CHECK SERVICES; PROVIDING BANK ACCOUNT INFORMATION BY TELEPHONE, INTERNET OR ELECTRONIC MEANS; DEBIT CARD SERVICES; CONSUMER AND COMMERCIAL LENDING SERVICES, NAMELY, PROVIDING, ACQUIRING AND SERVICING COMMERCIAL AND RESIDENTIAL MORTGAGE LOANS (INCLUDING REFINANCINGS), CONSTRUCTION LOANS, HOME IMPROVEMENT LOANS, CAR LOANS, HOME EQUITY LOANS, ISSUING LETTERS OF CREDIT, IN CLASS 36 (U.S. CLS. 100, 101 AND 102).

FIRST USE 11-1-2010; IN COMMERCE 11-1-2010.

THE MARK CONSISTS OF STANDARD CHARACTERS WITHOUT CLAIM TO ANY PARTICULAR FONT, STYLE, SIZE, OR COLOR.

NO CLAIM IS MADE TO THE EXCLUSIVE RIGHT TO USE "BANK" , APART FROM THE MARK AS SHOWN.

SN 85-096,617, FILED 7-30-2010.

RENEE MCCRAY, EXAMINING ATTORNEY



David J. Kyros

Director of the United States Patent and Trademark Office

United States of America

United States Patent and Trademark Office

BEAMSTER

Reg. No. 4,154,697

Registered June 5, 2012

Int. Cl.: 9

TRADEMARK

PRINCIPAL REGISTER

MH ACOUSTICS, LLC (DELAWARE LIMITED LIABILITY COMPANY)
25A SUMMIT AVE
SUMMIT, NJ 07901

FOR: ACOUSTIC TRANSDUCERS, MICROPHONES, AND MICROPHONE ARRAYS, AND SOFTWARE SOLD AS A UNIT THEREWITH; MOBILE, LANDLINE, INTERNET, AND VOICE-OVER-INTERNET-PROTOCOL (VOIP) COMMUNICATIONS APPARATUS; AND HEADSETS, HEADPHONES, EARPIECES, SPEAKERS, AND MICROPHONES FOR COMPUTERS AND FOR MOBILE, LANDLINE, INTERNET, AND VOICE-OVER-INTERNET-PROTOCOL (VOIP) COMMUNICATIONS, IN CLASS 9 (U.S. CLS. 21, 23, 26, 36 AND 38).

FIRST USE 8-13-2010; IN COMMERCE 8-13-2010.

THE MARK CONSISTS OF STANDARD CHARACTERS WITHOUT CLAIM TO ANY PARTICULAR FONT, STYLE, SIZE, OR COLOR.

SN 85-096,738, FILED 7-30-2010.

RUDY R. SINGLETON, EXAMINING ATTORNEY



David J. Kyffers

Director of the United States Patent and Trademark Office

United States of America

United States Patent and Trademark Office

EL TEMERARIO

Reg. No. 4,154,698

Registered June 5, 2012

Int. Cl.: 33

TRADEMARK

PRINCIPAL REGISTER

CIA. MONTERROSAS, S.A. DE C.V. (MEXICO CORPORATION)
LIBRAMIENTO SAN MARCOS NECOXTIA KM.2
TEHUACÁN, C.P.
PUEBLA, MEXICO 75859

FOR: TEQUILA, IN CLASS 33 (U.S. CLS. 47 AND 49).

FIRST USE 8-10-2011; IN COMMERCE 8-10-2011.

THE MARK CONSISTS OF STANDARD CHARACTERS WITHOUT CLAIM TO ANY PARTICULAR FONT, STYLE, SIZE, OR COLOR.

THE ENGLISH TRANSLATION OF "EL TEMERARIO" IN THE MARK IS "THE BOLD".

SN 85-097,053, FILED 7-30-2010.

KATHERINE CHANG, EXAMINING ATTORNEY



David J. Kybas

Director of the United States Patent and Trademark Office

United States of America

United States Patent and Trademark Office

SYNDICATE

Reg. No. 4,154,699

Registered June 5, 2012

Int. Cl.: 9

TRADEMARK

PRINCIPAL REGISTER

ELECTRONIC ARTS INC. (DELAWARE CORPORATION)
209 REDWOOD SHORES PARKWAY
LEGAL DEPARTMENT
REDWOOD CITY, CA 94065

FOR: COMPUTER GAME SOFTWARE; DOWNLOADABLE COMPUTER GAME SOFTWARE
VIA A GLOBAL COMPUTER NETWORK; VIDEO GAME SOFTWARE, IN CLASS 9 (U.S.
CLS. 21, 23, 26, 36 AND 38).

FIRST USE 2-10-2012; IN COMMERCE 2-10-2012.

THE MARK CONSISTS OF STANDARD CHARACTERS WITHOUT CLAIM TO ANY PAR-
TICULAR FONT, STYLE, SIZE, OR COLOR.

SN 85-097,374, FILED 7-30-2010.

DORITT L. CARROLL, EXAMINING ATTORNEY



David J. Kybas

Director of the United States Patent and Trademark Office

United States of America

United States Patent and Trademark Office

DEFINE PETITE OPTICS

Reg. No. 4,154,700

GENAL STRAP, INC. (NEW YORK CORPORATION)
31-00 47TH AVENUE
LONG ISLAND CITY, NY 11101

Registered June 5, 2012

Int. Cl.: 9

FOR: EYE GLASSES; SUNGLASSES; EYE-WEAR FRAMES, IN CLASS 9 (U.S. CLS. 21, 23, 26, 36 AND 38).

TRADEMARK

FIRST USE 8-0-2010; IN COMMERCE 1-0-2011.

PRINCIPAL REGISTER

THE MARK CONSISTS OF STANDARD CHARACTERS WITHOUT CLAIM TO ANY PARTICULAR FONT, STYLE, SIZE, OR COLOR.

NO CLAIM IS MADE TO THE EXCLUSIVE RIGHT TO USE "PETITE OPTICS", APART FROM THE MARK AS SHOWN.

SN 85-099,112, FILED 8-3-2010.

KRISTIN DAHLING, EXAMINING ATTORNEY



David J. Kyffers

Director of the United States Patent and Trademark Office

United States of America

United States Patent and Trademark Office

AGILUS

Reg. No. 4,154,701

Registered June 5, 2012

Int. Cls.: 20 and 40

TRADEMARK

SERVICE MARK

PRINCIPAL REGISTER

CHIPPENHOOK SERVICES, LLC (DELAWARE LIMITED LIABILITY COMPANY)
1825 LAKEWAY DRIVE
SUITE 400
LEWISVILLE, TX 75057

FOR: CABINETS FOR USE IN RETAIL AND COMMERCIAL OUTLETS; DISPLAY CASES, BOARDS, RACKS AND STANDS FOR MERCHANDISE, IN CLASS 20 (U.S. CLS. 2, 13, 22, 25, 32 AND 50).

FIRST USE 2-28-2011; IN COMMERCE 2-29-2012.

FOR: MANUFACTURING SERVICES FOR OTHERS IN THE FIELD OF STORE FIXTURES AND DISPLAYS, MILLWORK, AND CABINETRY FOR USE IN RETAIL AND COMMERCIAL OUTLETS, IN CLASS 40 (U.S. CLS. 100, 103 AND 106).

FIRST USE 2-23-2011; IN COMMERCE 2-23-2011.

THE MARK CONSISTS OF STANDARD CHARACTERS WITHOUT CLAIM TO ANY PARTICULAR FONT, STYLE, SIZE, OR COLOR.

SN 85-099,829, FILED 8-4-2010.

DOMINIC J. FERRAIUOLO, EXAMINING ATTORNEY



David J. Kyros

Director of the United States Patent and Trademark Office

United States of America

United States Patent and Trademark Office

CORSAIR

Reg. No. 4,154,702

Registered June 5, 2012

Int. Cl.: 9

TRADEMARK

PRINCIPAL REGISTER

CORSAIR MEMORY INC. (DELAWARE CORPORATION)
CORSAIR MEMORY INC
46221 LANDING PARKWAY
FREEMONT, CA 94538

FOR: COMPUTER COMPONENTS AND INSTRUCTION MANUALS PACKAGED AND SOLD AS A UNIT THEREWITH, NAMELY, MEMORY MODULES, POWER SUPPLY UNITS, SOLID-STATE DRIVES, LIQUID-COOLING SOLUTIONS FOR CPUS AND MEMORY MODULES, AIR-COOLING SOLUTIONS FOR CPUS AND MEMORY MODULES, FANS, AND CASES AND ENCLOSURES FOR COMPUTERS; COMPUTER PERIPHERALS, COMPUTER HARDWARE, AND INSTRUCTIONS MANUALS PACKAGED AS A UNIT THEREWITH, NAMELY, USB FLASH DRIVES, EXTERNAL SOLID-STATE DRIVES, MICE, KEYBOARDS; COMPUTER PERIPHERALS, COMPUTER HARDWARE, AND INSTRUCTION MANUALS PACKAGED AS A UNIT THEREWITH, NAMELY, JOYSTICKS, GAME CONTROLLERS, STEERING WHEELS, FLIGHT CONTROLLERS, AND SPECIALIZED MICE AND KEYBOARDS USED AS INPUT DEVICES FOR COMPUTER GAMES AND CONSOLE GAMES; COMPUTER HARDWARE, AND INSTRUCTION MANUALS PACKAGED AS A UNIT THEREWITH, NAMELY, HEADSETS, HEADPHONES, AND MULTIMEDIA SPEAKERS, IN CLASS 9 (U.S. CLS. 21, 23, 26, 36 AND 38).

FIRST USE 1-0-1994; IN COMMERCE 1-0-1994.

THE MARK CONSISTS OF STANDARD CHARACTERS WITHOUT CLAIM TO ANY PARTICULAR FONT, STYLE, SIZE, OR COLOR.

OWNER OF U.S. REG. NO. 3,209,882.

SN 85-099,972, FILED 8-4-2010.

REBECCA SMITH, EXAMINING ATTORNEY



David J. Kyros

Director of the United States Patent and Trademark Office

United States of America

United States Patent and Trademark Office

SLIMCELL

Reg. No. 4,154,703

Registered June 5, 2012

Int. Cl.: 3

TRADEMARK

PRINCIPAL REGISTER

ECOPHARMA, LLC (NEW YORK LIMITED LIABILITY COMPANY)
CHRYSLER BUILDING
405 LEXINGTON AVENUE
NEW YORK, NY 10174

FOR: COSMETIC PREPARATIONS FOR SLIMMING PURPOSES, NAMELY, GEL FOR SLIMMING AND CELLULITE REDUCTION, IN CLASS 3 (U.S. CLS. 1, 4, 6, 50, 51 AND 52).

FIRST USE 11-1-2011; IN COMMERCE 11-1-2011.

THE MARK CONSISTS OF STANDARD CHARACTERS WITHOUT CLAIM TO ANY PARTICULAR FONT, STYLE, SIZE, OR COLOR.

SN 85-100,026, FILED 8-4-2010.

RAMONA ORTIGA, EXAMINING ATTORNEY



David J. Kyffers

Director of the United States Patent and Trademark Office

United States of America

United States Patent and Trademark Office



Reg. No. 4,154,704

Registered June 5, 2012

Int. Cl.: 9

TRADEMARK

PRINCIPAL REGISTER

CORSAIR MEMORY INC. (DELAWARE CORPORATION)
CORSAIR MEMORY INC.
46221 LANDING PARKWAY
FREEMONT, CA 94538

FOR: COMPUTER COMPONENTS AND INSTRUCTION MANUALS PACKAGED AND SOLD AS A UNIT THEREWITH, NAMELY, MEMORY MODULES, POWER SUPPLY UNITS, SOLID-STATE DRIVES, LIQUID-COOLING SOLUTIONS FOR CPUS AND MEMORY MODULES, AIR-COOLING SOLUTIONS FOR CPUS AND MEMORY MODULES, FANS, AND CASES AND ENCLOSURES FOR COMPUTERS; COMPUTER PERIPHERALS, COMPUTER HARDWARE, AND INSTRUCTION MANUALS PACKAGED AS A UNIT THEREWITH, NAMELY, USB FLASH DRIVES, EXTERNAL SOLID-STATE DRIVES, MICE, KEYBOARDS; COMPUTER PERIPHERALS, COMPUTER HARDWARE, AND INSTRUCTION MANUALS PACKAGED AS A UNIT THEREWITH, NAMELY, JOYSTICKS, GAME CONTROLLERS, STEERING WHEELS, FLIGHT CONTROLLERS, AND SPECIALIZED MICE AND KEYBOARDS USED AS INPUT DEVICES FOR COMPUTER GAMES AND CONSOLE GAMES; COMPUTER HARDWARE, AND INSTRUCTION MANUALS PACKAGED AS A UNIT THEREWITH, NAMELY, HEADSETS, HEADPHONES, AND MULTIMEDIA SPEAKERS, IN CLASS 9 (U.S. CLS. 21, 23, 26, 36 AND 38).

FIRST USE 1-0-1994; IN COMMERCE 1-0-1994.

OWNER OF U.S. REG. NO. 3,209,882.

THE MARK CONSISTS OF SAILS OFFSET IN FRONT OF EACH OTHER.

SN 85-100,682, FILED 8-5-2010.

REBECCA SMITH, EXAMINING ATTORNEY



David J. Kyffers

Director of the United States Patent and Trademark Office

United States of America

United States Patent and Trademark Office

NATURAL ELEMENTS

Reg. No. 4,154,705

Registered June 5, 2012

Int. Cls.: 8 and 21

TRADEMARK

PRINCIPAL REGISTER

H&H ASIA LTD. (TAIWAN PRIVATE LIMITED COMPANY)
7F-1, NO. 167
FU XING NORTH ROAD
TAIPEI, TAIWAN 10547

FOR: WOODEN COOKING SPOONS; MORTAR AND PESTLES; NON-ELECTRIC HAND-OPERATED FOOD CHOPPERS, IN CLASS 8 (U.S. CLS. 23, 28 AND 44).

FIRST USE 9-0-2008; IN COMMERCE 9-0-2008.

FOR: WOODEN HOUSEHOLD UTENSILS, NAMELY, SPATULAS, TURNERS, KITCHEN TONGS, SERVING SPOONS, MIXING SPOONS, SLOTTED SPOONS; WOKS (NON-ELECTRIC); CHOPPING BOARDS FOR KITCHEN USE; WOODEN CHOPPING BOARDS FOR KITCHEN USE; BAKING DISHES; CASSEROLE DISHES; ROASTING DISHES; SERVING DISHES; BAKE WARE; DISPENSERS FOR PAPER TOWELS; ROLLING PINS; COOKING UTENSILS, NAMELY, SPATULAS, TURNERS, KITCHEN TONGS; LEMON SQUEEZERS; CREAMER PITCHERS; POT LIDS, IN CLASS 21 (U.S. CLS. 2, 13, 23, 29, 30, 33, 40 AND 50).

FIRST USE 9-0-2008; IN COMMERCE 9-0-2008.

THE MARK CONSISTS OF STANDARD CHARACTERS WITHOUT CLAIM TO ANY PARTICULAR FONT, STYLE, SIZE, OR COLOR.

SN 85-101,029, FILED 8-5-2010.

ODESSA BIBBINS, EXAMINING ATTORNEY



David J. Kypos

Director of the United States Patent and Trademark Office

United States of America

United States Patent and Trademark Office

WELCH'S

Reg. No. 4,154,706

Registered June 5, 2012

Int. Cl.: 30

TRADEMARK

PRINCIPAL REGISTER

WELCH'S FOODS INC., A COOPERATIVE (MICHIGAN CORPORATION)
3 CONCORD FARMS
575 VIRGINIA ROAD
CONCORD, MA 01742

FOR: FROZEN CONFECTIONS, IN CLASS 30 (U.S. CL. 46).

FIRST USE 4-0-2010; IN COMMERCE 4-0-2010.

THE MARK CONSISTS OF STANDARD CHARACTERS WITHOUT CLAIM TO ANY PARTICULAR FONT, STYLE, SIZE, OR COLOR.

OWNER OF U.S. REG. NO. 2,682,886.

SN 85-101,260, FILED 8-5-2010.

STEPHANIE ALI, EXAMINING ATTORNEY



David J. Kyjars

Director of the United States Patent and Trademark Office

United States of America

United States Patent and Trademark Office

RU1DESMOINES

Reg. No. 4,154,707

Registered June 5, 2012

Int. Cls.: 35 and 41

SERVICE MARK

PRINCIPAL REGISTER

THE IOWA CLINIC, P.C. (IOWA CORPORATION)
SUITE 321
5950 UNIVERSITY AVENUE
WEST DES MOINES, IA 50266

FOR: ARRANGING AND CONDUCTING OF FAIRS AND EXHIBITIONS FEATURING PRODUCTS AND SERVICES FOR WOMEN FOR COMMERCIAL AND ADVERTISING PURPOSES, NAMELY, EXHIBITIONS SELLING ART, ACCESSORIES, JEWELRY, HEALTH AND WELLNESS PRODUCTS, BATH AND BODY PRODUCTS, SPA SERVICES, AND PURSES, IN CLASS 35 (U.S. CLS. 100, 101 AND 102).

FIRST USE 9-23-2010; IN COMMERCE 9-23-2010.

FOR: EDUCATIONAL ENTERTAINMENT SERVICES, NAMELY, ARRANGING AND CONDUCTING SPECIAL EVENTS FOR WOMEN FOR EDUCATIONAL SOCIAL ENTERTAINMENT PURPOSES, NAMELY, PHOTOGRAPHY CLASSES, COOKING CLASSES, GOLF LESSONS, HEALTHY COOKING AND NUTRITION CLASSES, ART AND CRAFT GLASS DEMONSTRATIONS, WINE TASTING, COSMETIC SURGERY AND SKIN CARE DEMONSTRATIONS, LIVE PILATES DEMONSTRATIONS, LIVE BOTULINUM TOXIN DEMONSTRATIONS, LIVE VEIN THERAPY DEMONSTRATIONS, IN CLASS 41 (U.S. CLS. 100, 101 AND 107).

FIRST USE 9-23-2010; IN COMMERCE 9-23-2010.

THE MARK CONSISTS OF STANDARD CHARACTERS WITHOUT CLAIM TO ANY PARTICULAR FONT, STYLE, SIZE, OR COLOR.

NO CLAIM IS MADE TO THE EXCLUSIVE RIGHT TO USE "DES MOINES", APART FROM THE MARK AS SHOWN.

SN 85-101,819, FILED 8-6-2010.

ROBIN MITTLER, EXAMINING ATTORNEY



David J. Kyffers

Director of the United States Patent and Trademark Office

United States of America

United States Patent and Trademark Office

AGO

Reg. No. 4,154,708

Registered June 5, 2012

Int. Cl.: 36

SERVICE MARK

PRINCIPAL REGISTER

ASSURED GUARANTY LTD. (BERMUDA CORPORATION)
30 WOODBOURNE AVENUE
HAMILTON HM 08, BERMUDA

FOR: INSURANCE SERVICES, NAMELY, UNDERWRITING FINANCIAL GUARANTY INSURANCE AND REINSURANCE FOR MUNICIPAL AND STRUCTURED FINANCE OBLIGATIONS AND MORTGAGE GUARANTY INSURANCE AND REINSURANCE, IN CLASS 36 (U.S. CLS. 100, 101 AND 102).

FIRST USE 3-21-2011; IN COMMERCE 3-21-2011.

THE MARK CONSISTS OF STANDARD CHARACTERS WITHOUT CLAIM TO ANY PARTICULAR FONT, STYLE, SIZE, OR COLOR.

OWNER OF U.S. REG. NOS. 2,998,809 AND 3,330,076.

SN 85-102,070, FILED 8-6-2010.

LINDSEY RUBIN, EXAMINING ATTORNEY



David J. Kyros

Director of the United States Patent and Trademark Office

United States of America
United States Patent and Trademark Office

COMSLAB

Reg. No. 4,154,709

Registered June 5, 2012

Int. Cl.: 6

TRADEMARK

PRINCIPAL REGISTER

BAILEY METAL PRODUCTS LIMITED (CANADA CORPORATION)
1 CALDARI ROAD
CONCORD, ONTARIO, CANADA L4K3Z9

FOR: METAL BUILDING COMPONENTS, NAMELY, PROFILED METAL DECKS FOR USE
IN CONSTRUCTING CONCRETE FLOORS AND ROOFS, IN CLASS 6 (U.S. CLS. 2, 12, 13,
14, 23, 25 AND 50).

FIRST USE 1-7-2010; IN COMMERCE 11-1-2011.

THE MARK CONSISTS OF STANDARD CHARACTERS WITHOUT CLAIM TO ANY PAR-
TICULAR FONT, STYLE, SIZE, OR COLOR.

SN 85-103,224, FILED 8-9-2010.

THEODORE MCBRIDE, EXAMINING ATTORNEY



David J. Kyffers

Director of the United States Patent and Trademark Office

United States of America

United States Patent and Trademark Office

X_oTRA SEAL ONE TO ONE SENSOR

Reg. No. 4,154,710

31, INC. (OHIO CORPORATION)
100 ENTERPRISE DRIVE
NEWCOMERSTOWN, OH 43832

Registered June 5, 2012

Int. Cl.: 9

FOR: VEHICLE SAFETY EQUIPMENT, NAMELY, ELECTRONIC TIRE PRESSURE MONITORS, IN CLASS 9 (U.S. CLS. 21, 23, 26, 36 AND 38).

TRADEMARK

FIRST USE 8-1-2010; IN COMMERCE 8-1-2010.

PRINCIPAL REGISTER

OWNER OF U.S. REG. NOS. 2,188,672 AND 2,249,824.

NO CLAIM IS MADE TO THE EXCLUSIVE RIGHT TO USE "SEAL" AND "SENSOR", APART FROM THE MARK AS SHOWN.

THE MARK CONSISTS OF THE WORDS "XTRA SEAL ONE TO ONE SENSOR" WITH AN ELEVATED SMALL "O" BETWEEN THE LETTERS "X" AND "T" OF THE WORD "XTRA".

SN 85-103,252, FILED 8-9-2010.

EDWARD FENNESSY, EXAMINING ATTORNEY



David J. Kyros

Director of the United States Patent and Trademark Office

United States of America

United States Patent and Trademark Office

G-FORCE

Reg. No. 4,154,711

Registered June 5, 2012

Int. Cl.: 12

TRADEMARK

PRINCIPAL REGISTER

THOR TECH, INC. (NEVADA CORPORATION)
419 WEST PIKE STREET
JACKSON CENTER, OH 45334

FOR: BUSES, IN CLASS 12 (U.S. CLS. 19, 21, 23, 31, 35 AND 44).

FIRST USE 0-0-2010; IN COMMERCE 0-0-2010.

THE MARK CONSISTS OF STANDARD CHARACTERS WITHOUT CLAIM TO ANY PARTICULAR FONT, STYLE, SIZE, OR COLOR.

SN 85-103,385, FILED 8-9-2010.

JILL C. ALT, EXAMINING ATTORNEY



David J. Kyffers

Director of the United States Patent and Trademark Office

United States of America

United States Patent and Trademark Office

ENGAGE

Reg. No. 4,154,712

Registered June 5, 2012

Int. Cl.: 42

SERVICE MARK

PRINCIPAL REGISTER

WILLOW CREEK ASSOCIATION (ILLINOIS NOT-FOR-PROFIT CORPORATION)
67 E. ALGONQUIN ROAD
SOUTH BARRINGTON, IL 60010

FOR: APPLICATION SERVICE PROVIDER, NAMELY, HOSTING, MANAGING, DEVELOPING, AND MAINTAINING APPLICATIONS AND SOFTWARE, FOR USE BY CHURCHES, MINISTRIES, NONPROFIT ORGANIZATIONS, AND INSTITUTIONS IN THE FIELDS OF SPIRITUAL GROWTH AND TRANSFORMATION, IN CLASS 42 (U.S. CLS. 100 AND 101).

FIRST USE 5-5-2010; IN COMMERCE 8-8-2011.

THE MARK CONSISTS OF STANDARD CHARACTERS WITHOUT CLAIM TO ANY PARTICULAR FONT, STYLE, SIZE, OR COLOR.

SN 85-103,420, FILED 8-9-2010.

ELIZABETH HUGHITT, EXAMINING ATTORNEY



David J. Kyros

Director of the United States Patent and Trademark Office

United States of America

United States Patent and Trademark Office



Reg. No. 4,154,713

Registered June 5, 2012

Int. Cls.: 35, 38, and 42

TMP INTELLECTUAL PROPERTY HOLDINGS, LLC (DELAWARE LIMITED LIABILITY COMPANY)
125 BROAD STREET
10TH FLOOR
NEW YORK, NY 10004

SERVICE MARK

PRINCIPAL REGISTER

FOR: ADVERTISING AGENCY SERVICES, NAMELY, DESIGNING, CREATING AND PLACING EMPLOYMENT RECRUITMENT ADVERTISING FOR OTHERS AND FORWARDING RESPONSES TO SUCH ADVERTISING; DESIGNING, CREATING AND PLACING EMPLOYMENT RECRUITMENT ADVERTISING FOR OTHERS; EMPLOYMENT HIRING, RECRUITING, PLACEMENT, STAFFING AND CAREER NETWORKING SERVICES; BUSINESS MARKETING CONSULTING SERVICES; RESEARCH SERVICES IN THE FIELD OF JOB PLACEMENT; DESIGNING AND CONDUCTING EMPLOYMENT RECRUITMENT MARKETING SERVICES AND MARKETING STUDIES SERVICES, DISTRIBUTED VIA INTERACTIVE COMPUTER DATABASES INCLUDING A WEB SITE ON A GLOBAL COMPUTER INFORMATION NETWORK AND SOCIAL NETWORKING WEB SITES; PUBLIC RELATIONS SERVICES; EMPLOYER BRANDING SERVICES, IN CLASS 35 (U.S. CLS. 100, 101 AND 102).

FIRST USE 3-2-2011; IN COMMERCE 3-2-2011.

FOR: ELECTRONIC TRANSMISSION OF ADVERTISEMENTS, RESUMES AND OTHER RESPONSES TO EMPLOYMENT RECRUITMENT ADVERTISING VIA INTERACTIVE AND SOCIAL NETWORKING WEB SITES; ELECTRONIC STORE-AND-FORWARD MESSAGING, IN CLASS 38 (U.S. CLS. 100, 101 AND 104).

FIRST USE 3-2-2011; IN COMMERCE 3-2-2011.

FOR: WEB SITE DESIGN SERVICES, IN CLASS 42 (U.S. CLS. 100 AND 101).

FIRST USE 3-2-2011; IN COMMERCE 3-2-2011.

OWNER OF U.S. REG. NOS. 2,150,279, 2,151,852, AND 2,749,473.

THE MARK CONSISTS OF THE WORDS "TMP WORLDWIDE" AND A SPHERICAL DESIGN.

SN 85-103,470, FILED 8-9-2010.

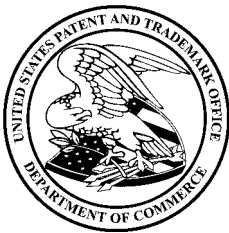

David J. Kyros

Director of the United States Patent and Trademark Office

Reg. No. 4,154,713 ANNE MADDEN, EXAMINING ATTORNEY

United States of America

United States Patent and Trademark Office

THE COTTONTAIL CANDY CO.

Reg. No. 4,154,714

GEBLER, KATHRYN (UNITED STATES INDIVIDUAL)
187 SADDLEBOW RD
BELL CANYON, CA 91307

Registered June 5, 2012

Int. Cl.: 9

FOR: COTTON CANDY VENDING MACHINES, IN CLASS 9 (U.S. CLS. 21, 23, 26, 36 AND 38).

TRADEMARK

FIRST USE 10-15-2010; IN COMMERCE 10-15-2010.

PRINCIPAL REGISTER

THE MARK CONSISTS OF STANDARD CHARACTERS WITHOUT CLAIM TO ANY PARTICULAR FONT, STYLE, SIZE, OR COLOR.

NO CLAIM IS MADE TO THE EXCLUSIVE RIGHT TO USE "CANDY CO.", APART FROM THE MARK AS SHOWN.

SN 85-103,566, FILED 8-9-2010.

TIMOTHY FINNEGAN, EXAMINING ATTORNEY



David J. Kybas

Director of the United States Patent and Trademark Office

United States of America

United States Patent and Trademark Office

GageLok

Reg. No. 4,154,715

Registered June 5, 2012

Int. Cls.: 6 and 14

TRADEMARK

PRINCIPAL REGISTER

COLD FORGED PRODUCTS NO.1 PTY LTD (AUSTRALIA CORPORATION), TA COLD FORGED PRODUCTS,
19 RESOLUTION DRIVE
CARINGBAH, NSW, AUSTRALIA 2229

FOR: METAL FASTENERS, NAMELY, RAIL SCREWS FOR RAILWAY CONSTRUCTION, IN CLASS 6 (U.S. CLS. 2, 12, 13, 14, 23, 25 AND 50).

FIRST USE 10-19-2010; IN COMMERCE 10-19-2010.

FOR: TIE FASTENERS, IN CLASS 14 (U.S. CLS. 2, 27, 28 AND 50).

FIRST USE 10-19-2010; IN COMMERCE 10-19-2010.

THE MARK CONSISTS OF STANDARD CHARACTERS WITHOUT CLAIM TO ANY PARTICULAR FONT, STYLE, SIZE, OR COLOR.

SN 85-103,569, FILED 8-9-2010.

TIMOTHY FINNEGAN, EXAMINING ATTORNEY



David J. Kypos

Director of the United States Patent and Trademark Office

United States of America

United States Patent and Trademark Office

CLICKSUITE

Reg. No. 4,154,716

Registered June 5, 2012

Int. Cls.: 9, 38, 41, and 42

TRADEMARK

SERVICE MARK

PRINCIPAL REGISTER

CLICK SUITE LIMITED (NEW ZEALAND LIMITED LIABILITY COMPANY)
LEVEL 4, 85 VICTORIA STREET
WELLINGTON, NEW ZEALAND

FOR: COMPUTER HARDWARE AND COMPUTER SOFTWARE PROGRAMS FOR THE INTEGRATION OF TEXT, AUDIO, GRAPHICS, STILL IMAGES AND MOVING PICTURES INTO AN INTERACTIVE DELIVERY FOR MULTIMEDIA APPLICATIONS, IN CLASS 9 (U.S. CLS. 21, 23, 26, 36 AND 38).

FIRST USE 1-22-2009; IN COMMERCE 1-3-2009.

FOR: COMMUNICATION SERVICES, NAMELY, ELECTRONIC TRANSMISSION OF DATA AND DOCUMENTS AMONG USERS OF COMPUTERS; COMMUNICATION SERVICES, NAMELY, TRANSMISSION OF VOICE, AUDIO, VISUAL IMAGES AND DATA BY TELECOMMUNICATIONS NETWORKS, WIRELESS COMMUNICATION NETWORKS, THE INTERNET, INFORMATION SERVICES NETWORKS AND DATA NETWORKS; INTERNET SERVICE PROVIDER (ISP); PROVIDING USER ACCESS TO A GLOBAL COMPUTER NETWORK; PROVISION OF ACCESS TO A GLOBAL COMPUTER NETWORK; WEBCASTING SERVICES, IN CLASS 38 (U.S. CLS. 100, 101 AND 104).

FIRST USE 1-22-2009; IN COMMERCE 1-3-2009.

FOR: MULTIMEDIA PUBLISHING OF BOOKS, MAGAZINES, JOURNALS, SOFTWARE, GAMES, MUSIC, AND ELECTRONIC PUBLICATIONS, IN CLASS 41 (U.S. CLS. 100, 101 AND 107).

FIRST USE 1-22-2009; IN COMMERCE 1-3-2009.

FOR: COMPUTER CONSULTATION; COMPUTER HARDWARE AND SOFTWARE CONSULTING SERVICES; COMPUTER HARDWARE AND SOFTWARE DESIGN; CONSULTANCY IN THE FIELD OF SOFTWARE DESIGN; CONSULTANCY WITH REGARD TO WEBPAGE DESIGN; DESIGN AND CREATING WEB SITES FOR OTHERS; DESIGN AND DEVELOPMENT OF COMPUTER HARDWARE AND SOFTWARE; DESIGN AND DEVELOPMENT OF MULTIMEDIA PRODUCTS; DESIGN OF HOME PAGES, COMPUTER SOFTWARE AND WEB SITES; DESIGN, DEVELOPMENT AND IMPLEMENTATION OF SOFTWARE; WEBSITE DESIGN AND DEVELOPMENT FOR OTHERS, IN CLASS 42 (U.S. CLS. 100 AND 101).



David J. Kyros

Director of the United States Patent and Trademark Office

Reg. No. 4,154,716 FIRST USE 1-22-2009; IN COMMERCE 1-3-2009.

THE MARK CONSISTS OF STANDARD CHARACTERS WITHOUT CLAIM TO ANY PARTICULAR FONT, STYLE, SIZE, OR COLOR.

SN 85-103,580, FILED 8-9-2010.

THEODORE MCBRIDE, EXAMINING ATTORNEY

United States of America

United States Patent and Trademark Office

CLICK LESS. LIVE MORE.

Reg. No. 4,154,717

Registered June 5, 2012

Int. Cls.: 35 and 41

SERVICE MARK

PRINCIPAL REGISTER

YELLOWPAGES.COM, LLC (DELAWARE LIMITED LIABILITY COMPANY)
611 N. BRAND BLVD., 5TH FLOOR
GLENDALE, CA 91203

FOR: PROVIDING ADVERTISEMENT SERVICES FOR OTHERS VIA A GLOBAL COMPUTER NETWORK; PROVIDING ONLINE INFORMATION AND COMMUNICATION SERVICES IN THE FORM OF INTERACTIVE DIRECTORIES AND ADVERTISEMENTS OVER A GLOBAL COMPUTER NETWORK, IN CLASS 35 (U.S. CLS. 100, 101 AND 102).

FIRST USE 8-10-2010; IN COMMERCE 8-10-2010.

FOR: PROVIDING AN ONLINE INTERACTIVE DATABASE FEATURING ENTERTAINMENT INFORMATION IN THE FIELDS OF LIVE MUSICAL PERFORMANCES, LIVE THEATRICAL PERFORMANCES, LIVE DRAMATIC PERFORMANCES, MOTION PICTURE FILMS AND SPORTING EVENTS, NAMELY, FOOTBALL, BASEBALL, BASKETBALL, TENNIS, SWIMMING AND MOTOR SPORTS EVENTS; PROVIDING ONLINE NON-DOWNLOADABLE PUBLICATIONS THAT FEATURE ADVERTISEMENTS FOR THE GOODS AND SERVICES OF OTHERS, NAMELY, TELEPHONE DIRECTORIES IN THE FIELDS OF BUSINESS, RESIDENTIAL, COMMERCIAL AND GOVERNMENT, IN CLASS 41 (U.S. CLS. 100, 101 AND 107).

FIRST USE 8-10-2010; IN COMMERCE 8-10-2010.

THE MARK CONSISTS OF STANDARD CHARACTERS WITHOUT CLAIM TO ANY PARTICULAR FONT, STYLE, SIZE, OR COLOR.

SN 85-103,843, FILED 8-10-2010.

ELLEN BURNS, EXAMINING ATTORNEY



David J. Kyros

Director of the United States Patent and Trademark Office

United States of America

United States Patent and Trademark Office

■ ALSUMA ►►

Reg. No. 4,154,718

Registered June 5, 2012

Int. Cl.: 5

TRADEMARK

PRINCIPAL REGISTER

MERIDIAN MEDICAL TECHNOLOGIES, INC. (DELAWARE CORPORATION)
6350 STEVENS FOREST ROAD
SUITE 301
COLUMBIA, MD 21046

FOR: PHARMACEUTICAL PREPARATIONS FOR THE PREVENTION, TREATMENT AND ALLEVIATION OF MIGRAINES AND OTHER FORMS OF HEADACHES; AUTOINJECTORS SOLD FILLED WITH PHARMACEUTICAL PREPARATIONS FOR THE PREVENTION, TREATMENT AND ALLEVIATION OF MIGRAINES AND OTHER FORMS OF HEADACHES, AND PLASTIC CONTAINERS AND CARRYING CASES, SOLD AS A UNIT THEREFOR, IN CLASS 5 (U.S. CLS. 6, 18, 44, 46, 51 AND 52).

FIRST USE 2-28-2011; IN COMMERCE 2-28-2011.

THE MARK CONSISTS OF THE WORD "ALSUMA" CENTERED BETWEEN A SQUARE DESIGN AND AN ARROW DESIGN.

SN 85-104,183, FILED 8-10-2010.

ALICE BENMAMAN, EXAMINING ATTORNEY



David J. Kyros

Director of the United States Patent and Trademark Office

United States of America

United States Patent and Trademark Office

iSkibob

Reg. No. 4,154,719

Registered June 5, 2012

Int. Cl.: 25

TRADEMARK

PRINCIPAL REGISTER

SHROOMBOB, LLC (MONTANA LIMITED LIABILITY COMPANY)
506 NORTH BOZEMAN
BOZEMAN, MT 59715

FOR: SKI WEAR, IN CLASS 25 (U.S. CLS. 22 AND 39).

FIRST USE 4-15-2011; IN COMMERCE 3-17-2012.

THE MARK CONSISTS OF STANDARD CHARACTERS WITHOUT CLAIM TO ANY PARTICULAR FONT, STYLE, SIZE, OR COLOR.

SN 85-104,185, FILED 8-10-2010.

LAURA HAMMEL, EXAMINING ATTORNEY



David J. Kyffers

Director of the United States Patent and Trademark Office

United States of America

United States Patent and Trademark Office

VOICE ADVANTAGE

Reg. No. 4,154,720

HARQEN LLC (WISCONSIN LIMITED LIABILITY COMPANY)
1830 NORTH HUBBARD STREET, SUITE 700
MILWAUKEE, WI 53212

Registered June 5, 2012

Int. Cls.: 35, 38, and 39

FOR: AUDIO ASSET MANAGEMENT, NAMELY, MANAGEMENT OF DATABASES CONTAINING AUDIO DATA, IN CLASS 35 (U.S. CLS. 100, 101 AND 102).

SERVICE MARK

FIRST USE 8-1-2010; IN COMMERCE 8-1-2010.

PRINCIPAL REGISTER

FOR: TRANSMISSION OF AUDIO DATA VIA A GLOBAL COMPUTER NETWORK OR THE INTERNET, IN CLASS 38 (U.S. CLS. 100, 101 AND 104).

FIRST USE 8-1-2010; IN COMMERCE 8-1-2010.

FOR: AUDIO ASSET MANAGEMENT, NAMELY, STORAGE OF ELECTRONIC MEDIA IN THE NATURE OF AUDIO DATA; AUDIO ASSET MANAGEMENT, NAMELY, STORAGE SERVICES FOR ARCHIVING ELECTRONIC AUDIO DATA, IN CLASS 39 (U.S. CLS. 100 AND 105).

FIRST USE 8-1-2010; IN COMMERCE 8-1-2010.

THE MARK CONSISTS OF STANDARD CHARACTERS WITHOUT CLAIM TO ANY PARTICULAR FONT, STYLE, SIZE, OR COLOR.

NO CLAIM IS MADE TO THE EXCLUSIVE RIGHT TO USE "VOICE", APART FROM THE MARK AS SHOWN.

SN 85-104,248, FILED 8-10-2010.

EVELYN BRADLEY, EXAMINING ATTORNEY



David J. Kyros

Director of the United States Patent and Trademark Office

United States of America

United States Patent and Trademark Office

Cellar 426

Reg. No. 4,154,721

ASPIRE CELLARS LLC (NEBRASKA LIMITED LIABILITY COMPANY), DBA CELLAR 426,
1005 PRAIRIE AGATE DRIVE
ASHLAND, NE 68003

Registered June 5, 2012

Int. Cl.: 33

FOR: FRUIT WINE; RED WINE; WHITE WINE; WINE, IN CLASS 33 (U.S. CLS. 47 AND 49).

TRADEMARK

FIRST USE 5-10-2010; IN COMMERCE 3-29-2012.

PRINCIPAL REGISTER

THE MARK CONSISTS OF STANDARD CHARACTERS WITHOUT CLAIM TO ANY PARTICULAR FONT, STYLE, SIZE, OR COLOR.

NO CLAIM IS MADE TO THE EXCLUSIVE RIGHT TO USE "CELLAR", APART FROM THE MARK AS SHOWN.

SN 85-104,618, FILED 8-10-2010.

MIDGE BUTLER, EXAMINING ATTORNEY



David J. Kyffers

Director of the United States Patent and Trademark Office

United States of America

United States Patent and Trademark Office



Reg. No. 4,154,722

PHG ENERGY, LLC (TENNESSEE LIMITED LIABILITY COMPANY)
1245 BRIDGESTONE PARKWAY
LA VERGNE, TN 37086

Registered June 5, 2012

Int. Cl.: 7

FOR: GASIFIERS FOR GENERATING RENEWABLE ENERGY THROUGH GASIFICATION OF BIOMASS PRODUCTS AND REPLACEMENT PARTS THEREOF; GASIFIERS FOR PRODUCING CLEAN GAS FROM CARBON-BASED MATERIALS AND REPLACEMENT PARTS THEREOF, IN CLASS 7 (U.S. CLS. 13, 19, 21, 23, 31, 34 AND 35).

TRADEMARK

PRINCIPAL REGISTER

FIRST USE 11-0-2011; IN COMMERCE 11-0-2011.

NO CLAIM IS MADE TO THE EXCLUSIVE RIGHT TO USE "ENERGY", APART FROM THE MARK AS SHOWN.

THE MARK CONSISTS OF A FLAME DESIGN APPEARING IMMEDIATELY TO THE LEFT OF THE WORDS "PHG ENERGY".

SN 85-104,708, FILED 8-11-2010.

BRENDAN MCCAULEY, EXAMINING ATTORNEY



David J. Kybas

Director of the United States Patent and Trademark Office

United States of America

United States Patent and Trademark Office



Reg. No. 4,154,723

Registered June 5, 2012

Int. Cl.: 14

TRADEMARK

PRINCIPAL REGISTER

NUTZO, LLC (CALIFORNIA LIMITED LIABILITY COMPANY)
11377 WEST OLYMPIC BOULEVARD
C/O MITCHELL SILBERBERG & KNUPP LLP
LOS ANGELES, CA 900641683

FOR: JEWELRY, IN CLASS 14 (U.S. CLS. 2, 27, 28 AND 50).

FIRST USE 1-20-2011; IN COMMERCE 1-20-2011.

"KIARRA KENNEDY" DOES NOT IDENTIFY A LIVING INDIVIDUAL.

THE MARK CONSISTS OF THE STYLIZED WORDS "KIARRA KENNEDY" SEPARATED BY A FANCIFUL DESIGN. THE DESIGN CONSISTS OF TWO STYLIZED LETTER "K"'S WITHIN A HEXAGON WITH A DECORATIVE BORDER. ABOVE THE HEXAGON IS AN ORNAMENTAL DESIGN WITH HEARTS. THE STYLIZED WORDING "WHERE KIDS ARE ROYALTY" APPEARS BELOW.

SN 85-105,564, FILED 8-11-2010.

JESSICA FATHY, EXAMINING ATTORNEY



David J. Kybas

Director of the United States Patent and Trademark Office

United States of America

United States Patent and Trademark Office

JET/MMS

Reg. No. 4,154,724

JARROLD, THOMAS (UNITED STATES INDIVIDUAL)
10 BETHUNE STREET, #3B
NEW YORK, NY 10014 AND

Registered June 5, 2012

Int. Cl.: 35

SCRIVENS, MATTHEW (CANADA INDIVIDUAL)
448 WEST 37TH STREET, PH B
NEW YORK, NY 10018

SERVICE MARK

PRINCIPAL REGISTER

FOR: ADVERTISING AND MARKETING SERVICES; MARKETING SERVICES, NAMELY, PROVIDING MARKETING STRATEGY AND MARKETING COMMUNICATIONS PLANNING IN THE FIELD OF DIGITAL AND BRANDED ENTERTAINMENT FOR OTHERS, NAMELY, THE CREATION, DESIGN, PRODUCTION AND DISTRIBUTION OF ORIGINAL MARKETING CONTENT IN THE FIELDS OF RADIO, TELEVISION, PRINT, ONLINE, SOCIAL AND MOBILE MARKETING, IN CLASS 35 (U.S. CLS. 100, 101 AND 102).

FIRST USE 1-1-2012; IN COMMERCE 1-1-2012.

THE MARK CONSISTS OF STANDARD CHARACTERS WITHOUT CLAIM TO ANY PARTICULAR FONT, STYLE, SIZE, OR COLOR.

SN 85-106,162, FILED 8-12-2010.

SUSAN LESLIE DUBOIS, EXAMINING ATTORNEY



David J. Kyros

Director of the United States Patent and Trademark Office

United States of America

United States Patent and Trademark Office

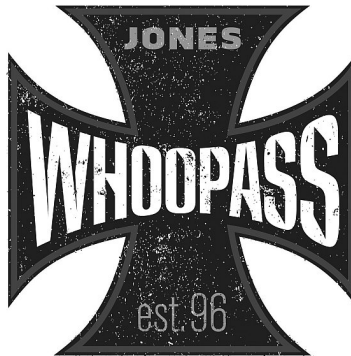

Reg. No. 4,154,725

Registered June 5, 2012

Int. Cl.: 32

TRADEMARK

PRINCIPAL REGISTER

JONES SODA CO. (USA) INC. (WASHINGTON CORPORATION)
1000 1ST AVENUE S.
SUITE 100
SEATTLE, WA 98134

FOR: ENERGY DRINKS, IN CLASS 32 (U.S. CLS. 45, 46 AND 48).

FIRST USE 1-1-2011; IN COMMERCE 1-1-2011.

OWNER OF U.S. REG. NOS. 2,721,730, 3,788,694, AND OTHERS.

NO CLAIM IS MADE TO THE EXCLUSIVE RIGHT TO USE "EST. 96", APART FROM THE MARK AS SHOWN.

THE MARK CONSISTS OF A CROSSLIKE DESIGN WITH THE WORD "JONES" POSITIONED AT A FIRST END OF THE DESIGN, THE WORD "WHOOPASS" POSITIONED IN THE MIDDLE PORTION OF THE DESIGN, AND THE TERM "EST. 96" POSITIONED AT A SECOND END OF THE DESIGN.

SN 85-106,389, FILED 8-12-2010.

BILL DAWE, EXAMINING ATTORNEY



David J. Kyffers

Director of the United States Patent and Trademark Office

United States of America

United States Patent and Trademark Office

HOLLYWOOD AT HOME

Reg. No. 4,154,726

Registered June 5, 2012

Int. Cl.: 41

SERVICE MARK

PRINCIPAL REGISTER

SCRIPPS NETWORKS, LLC (DELAWARE LIMITED LIABILITY COMPANY)
9721 SHERRILL BOULEVARD
KNOXVILLE, TN 37932

FOR: EDUCATIONAL AND ENTERTAINMENT SERVICES, NAMELY, A CONTINUING PROGRAM FEATURING TOURS OF CELEBRITY HOUSES, ACCESSIBLE BY RADIO, TELEVISION, CABLE, FIBER OPTIC NETWORKS, WIRELESS NETWORKS, SATELLITE, AUDIO VIDEO, AND COMPUTER NETWORKS, IN CLASS 41 (U.S. CLS. 100, 101 AND 107).

FIRST USE 4-30-2011; IN COMMERCE 4-30-2011.

THE MARK CONSISTS OF STANDARD CHARACTERS WITHOUT CLAIM TO ANY PARTICULAR FONT, STYLE, SIZE, OR COLOR.

SN 85-106,410, FILED 8-12-2010.

MARK SHINER, EXAMINING ATTORNEY



David J. Kybas

Director of the United States Patent and Trademark Office

United States of America

United States Patent and Trademark Office

DIRTY MINDZ

Reg. No. 4,154,727

Registered June 5, 2012

Int. Cl.: 25

TRADEMARK

PRINCIPAL REGISTER

RAGGIO, JEREMY A (UNITED STATES INDIVIDUAL)
1101 W. AVE M SUITE E
LANCASTER, CA 93534

FOR: ADHESIVE BRAS; ANKLE SOCKS; ANKLETS; ANTI-PERSPIRANT SOCKS; APRONS; ATHLETIC APPAREL, NAMELY, SHIRTS, PANTS, JACKETS, FOOTWEAR, HATS AND CAPS, ATHLETIC UNIFORMS; BABY BODYSUITS; BABY BOTTOMS; BABY DOLL PYJAMAS; BABY LAYETTES FOR CLOTHING; BABY TOPS; BELTS; BOARD SHORTS; BOTTOMS; BOXER SHORTS; BRAS; BUTTON DOWN SHIRTS; CHILDREN'S HEADWEAR; COLLARED SHIRTS; DRESSES; FLEECE SHORTS; FLIP FLOPS; FOOTWEAR; HATS FOR INFANTS, BABIES, TODDLERS AND CHILDREN; HEAD WEAR; HEADWEAR; HOODED SWEAT SHIRTS; INFANT AND TODDLER ONE PIECE CLOTHING; INFANT WEAR; JACKETS; LONG-SLEEVED SHIRTS; ONE PIECE GARMENT FOR INFANTS AND TODDLERS; PAJAMAS; PANTIES, SHORTS AND BRIEFS; PANTS; SHIRTS; SHIRTS FOR INFANTS, BABIES, TODDLERS AND CHILDREN; SHORT-SLEEVED SHIRTS; SHORTS; SOCKS; SPORT SHIRTS; SWEAT JACKETS; SWEAT PANTS; SWEAT SHIRTS; SWEAT SHORTS; SWEAT SUITS; SWIM WEAR; SWIM WEAR FOR GENTLEMEN AND LADIES; SWIMWEAR; T-SHIRTS; TOPS; UNDERWEAR, IN CLASS 25 (U.S. CLS. 22 AND 39).

FIRST USE 10-27-2010; IN COMMERCE 10-27-2010.

THE MARK CONSISTS OF STANDARD CHARACTERS WITHOUT CLAIM TO ANY PARTICULAR FONT, STYLE, SIZE, OR COLOR.

SN 85-106,523, FILED 8-12-2010.

C. DIONNE CLYBURN, EXAMINING ATTORNEY



David J. Kyros

Director of the United States Patent and Trademark Office

United States of America

United States Patent and Trademark Office

FaceIN

Reg. No. 4,154,728

Registered June 5, 2012

Int. Cl.: 9

TRADEMARK

PRINCIPAL REGISTER

LATHEM TIME CORPORATION (GEORGIA CORPORATION)
200 SELIG DRIVE, SW
ATLANTA, GA 30336

FOR: INPUT/OUTPUT DEVICE, NAMELY, AN ELECTRONIC SENSOR FOR BIOMETRIC FACE RECOGNITION FOR TIME AND ATTENDANCE, AND ACCESS CONTROL, IN CLASS 9 (U.S. CLS. 21, 23, 26, 36 AND 38).

FIRST USE 9-1-2010; IN COMMERCE 9-1-2010.

THE MARK CONSISTS OF STANDARD CHARACTERS WITHOUT CLAIM TO ANY PARTICULAR FONT, STYLE, SIZE, OR COLOR.

SN 85-106,767, FILED 8-13-2010.

KATHRYN COWARD, EXAMINING ATTORNEY



David J. Kybas

Director of the United States Patent and Trademark Office

United States of America

United States Patent and Trademark Office

TIFFANY GALLERY

Reg. No. 4,154,729

Registered June 5, 2012

Int. Cl.: 14

TRADEMARK

PRINCIPAL REGISTER

TIFFANY (NJ) LLC (DELAWARE LIMITED LIABILITY COMPANY)
15 SYLVAN WAY
PARSIPPANY, NJ 07054

FOR: WATCHES, IN CLASS 14 (U.S. CLS. 2, 27, 28 AND 50).

FIRST USE 10-0-2011; IN COMMERCE 10-0-2011.

THE MARK CONSISTS OF STANDARD CHARACTERS WITHOUT CLAIM TO ANY PARTICULAR FONT, STYLE, SIZE, OR COLOR.

OWNER OF U.S. REG. NOS. 2,639,539, 3,218,687, AND OTHERS.

NO CLAIM IS MADE TO THE EXCLUSIVE RIGHT TO USE "GALLERY", APART FROM THE MARK AS SHOWN.

SN 85-106,946, FILED 8-13-2010.

CAROLYN CATALDO, EXAMINING ATTORNEY



David J. Kybas

Director of the United States Patent and Trademark Office

United States of America

United States Patent and Trademark Office



Reg. No. 4,154,730

Registered June 5, 2012

Int. Cl.: 1

TRADEMARK

PRINCIPAL REGISTER

FREMONT INDUSTRIES, INC. (MINNESOTA CORPORATION)
4400 VALLEY INDUSTRIAL BLVD. N.
P.O. BOX 67
SHAKOPEE, MN 553791859

FOR: WATER CONDITIONING CHEMICALS FOR USE IN BOILER AND COOLING WATER INSTALLATIONS, IN CLASS 1 (U.S. CLS. 1, 5, 6, 10, 26 AND 46).

FIRST USE 10-8-2010; IN COMMERCE 10-13-2010.

OWNER OF U.S. REG. NO. 1,623,176.

THE COLOR(S) LIGHT BLUE, DARK BLUE AND GREEN IS/ARE CLAIMED AS A FEATURE OF THE MARK.

NO CLAIM IS MADE TO THE EXCLUSIVE RIGHT TO USE "GREEN TECHNOLOGY" AND "INDUSTRIES", APART FROM THE MARK AS SHOWN.

THE MARK CONSISTS OF THE WORDS "FREMONT INDUSTRIES ULTRA GREEN TECHNOLOGY", PLACED WITHIN A GREEN CIRCLE. THE WORDS "FREMONT INDUSTRIES" AND THE WORDS "GREEN TECHNOLOGY" ARE SHOWN IN GREEN. THE WORD "ULTRA" INCORPORATES THE COLORS GREEN, DARK BLUE AND LIGHT BLUE. BETWEEN THE WORDS "FREMONT INDUSTRIES" AND "ULTRA" THERE IS A DEPICTION OF PLANET EARTH IN DARK BLUE AND LIGHT BLUE RESTING WITHIN A GREEN LEAF.

SN 85-107,071, FILED 8-13-2010.

WILLIAM P. SHANAHAN, EXAMINING ATTORNEY



David J. Kyjars

Director of the United States Patent and Trademark Office

United States of America

United States Patent and Trademark Office

D.R.U.G.S.

Reg. No. 4,154,731

Registered June 5, 2012

Int. Cl.: 41

SERVICE MARK

PRINCIPAL REGISTER

MUSIC FROM THE MITTEN, LLC (MICHIGAN LIMITED LIABILITY COMPANY)
8383 WILSHIRE BLVD
C/O THE COLLECTIVE SUITE 1050
BEVERLY HILLS, CA 90211

FOR: ENTERTAINMENT IN THE NATURE OF LIVE PERFORMANCES BY A MUSICAL GROUP, IN CLASS 41 (U.S. CLS. 100, 101 AND 107).

FIRST USE 11-28-2010; IN COMMERCE 11-28-2010.

THE MARK CONSISTS OF STANDARD CHARACTERS WITHOUT CLAIM TO ANY PARTICULAR FONT, STYLE, SIZE, OR COLOR.

SN 85-107,075, FILED 8-13-2010.

TINA L. SNAPP, EXAMINING ATTORNEY



David J. Kyffers

Director of the United States Patent and Trademark Office

United States of America

United States Patent and Trademark Office



Reg. No. 4,154,732

Registered June 5, 2012

Int. Cl.: 1

TRADEMARK

PRINCIPAL REGISTER

FREMONT INDUSTRIES, INC. (MINNESOTA CORPORATION)
4400 VALLEY INDUSTRIAL BLVD. N.
P.O. BOX 67
SHAKOPEE, MN 553791859

FOR: WATER CONDITIONING CHEMICALS FOR USE IN BOILER AND COOLING WATER INSTALLATIONS, IN CLASS 1 (U.S. CLS. 1, 5, 6, 10, 26 AND 46).

FIRST USE 8-6-2010; IN COMMERCE 8-10-2010.

NO CLAIM IS MADE TO THE EXCLUSIVE RIGHT TO USE "GREEN TECHNOLOGY", APART FROM THE MARK AS SHOWN.

THE COLOR(S) LIGHT BLUE, DARK BLUE, GREEN AND WHITE IS/ARE CLAIMED AS A FEATURE OF THE MARK.

THE MARK CONSISTS OF THE WORDS "ULTRA GREEN TECHNOLOGY" PLACED TO THE RIGHT OF A DEPICTION OF PLANET EARTH IN LIGHT BLUE AND DARK BLUE RESTING WITHIN A GREEN LEAF. THE WORD "ULTRA" INCORPORATES THE COLORS LIGHT BLUE TO DARK BLUE TO GREEN RISING FROM THE BOTTOM, AND PLACED OVER THE WORDS "GREEN TECHNOLOGY". THE WORDS "GREEN TECHNOLOGY" ARE DEPICTED IN WHITE AND ARE PLACED WITHIN A GREEN POLYGON.

SN 85-107,103, FILED 8-13-2010.

WILLIAM P. SHANAHAN, EXAMINING ATTORNEY



David J. Kybas

Director of the United States Patent and Trademark Office

United States of America

United States Patent and Trademark Office

Avantext...
sentinel

Reg. No. 4,154,733

Registered June 5, 2012

Int. Cl.: 9

TRADEMARK

PRINCIPAL REGISTER

AVANTEXT, INC. (PENNSYLVANIA CORPORATION)
SUITE C100
625 W. RIDGE PIKE
CONSHOHOCKEN, PA 19428

FOR: COMPUTER SOFTWARE FEATURING REGULATORY INFORMATION REGARDING AIRWORTHINESS FOR THE AERONAUTICAL INDUSTRY AND AVIATORS, IN CLASS 9 (U.S. CLS. 21, 23, 26, 36 AND 38).

FIRST USE 2-6-2012; IN COMMERCE 2-9-2012.

OWNER OF U.S. REG. NO. 3,443,940.

THE MARK CONSISTS OF THE WORD "AVANTEXT" WITH A TRIANGLE SERVING AS THE CROSS IN THE FIRST LETTER "A" FOLLOWED BY THREE DOTS ABOVE THE WORD "SENTINEL" WITH THE LAST DOT COMPRISING THE DOT FOR THE LETTER "I".

SN 85-107,312, FILED 8-13-2010.

DORITT L. CARROLL, EXAMINING ATTORNEY



David J. Kyffers

Director of the United States Patent and Trademark Office

United States of America

United States Patent and Trademark Office

AVANTEXT SENTINEL

Reg. No. 4,154,734

Registered June 5, 2012

Int. Cl.: 9

TRADEMARK

PRINCIPAL REGISTER

AVANTEXT, INC. (PENNSYLVANIA CORPORATION)
SUITE C100
625 W. RIDGE PIKE
CONSHOHOCKEN, PA 19428

FOR: COMPUTER SOFTWARE FEATURING REGULATORY INFORMATION REGARDING AIRWORTHINESS FOR THE AERONAUTICAL INDUSTRY AND AVIATORS, IN CLASS 9 (U.S. CLS. 21, 23, 26, 36 AND 38).

FIRST USE 2-6-2012; IN COMMERCE 2-9-2012.

THE MARK CONSISTS OF STANDARD CHARACTERS WITHOUT CLAIM TO ANY PARTICULAR FONT, STYLE, SIZE, OR COLOR.

OWNER OF U.S. REG. NO. 3,443,940.

SN 85-107,358, FILED 8-13-2010.

DORITT L. CARROLL, EXAMINING ATTORNEY



David J. Kyffers

Director of the United States Patent and Trademark Office

United States of America

United States Patent and Trademark Office

MOONROCK

Reg. No. 4,154,735

PILSZAK, GEORGE H. (UNITED STATES INDIVIDUAL)
977 RIVER DRIVE
FRANKLIN, PA 16323

Registered June 5, 2012

Int. Cl.: 20

FOR: STATUETTES MADE OF PLASTIC, IN CLASS 20 (U.S. CLS. 2, 13, 22, 25, 32 AND 50).

TRADEMARK

FIRST USE 8-0-1997; IN COMMERCE 8-0-1997.

PRINCIPAL REGISTER

THE MARK CONSISTS OF STANDARD CHARACTERS WITHOUT CLAIM TO ANY PARTICULAR FONT, STYLE, SIZE, OR COLOR.

SN 85-108,458, FILED 8-16-2010.

SOPHIA S. KIM, EXAMINING ATTORNEY



David J. Kyffers

Director of the United States Patent and Trademark Office

United States of America

United States Patent and Trademark Office

Suplove

Reg. No. 4,154,736

Registered June 5, 2012

**Int. Cls.: 12, 25, 28, and
41**

JOHNSTON, MATTHEW (AUSTRALIA INDIVIDUAL), DBA SUPLOVE,
A109, #183
1835 NEWPORT BLVD
COSTA MESA, CA 92627

FOR: CANOE PADDLES; KAYAK PADDLES; OUTRIGGER PADDLES , IN CLASS 12 (U.S. CLS. 19, 21, 23, 31, 35 AND 44).

TRADEMARK

FIRST USE 6-1-2009; IN COMMERCE 3-1-2011.

SERVICE MARK

FOR: SURF WEAR, IN CLASS 25 (U.S. CLS. 22 AND 39).

PRINCIPAL REGISTER

FIRST USE 11-30-2008; IN COMMERCE 4-1-2010.

FOR: LEASHES USED IN CONJUNCTION WITH SURFING; PADDLE BOARDS; PADDLE SURFBOARDS; PADDLES FOR USE WITH SURFBOARDS; STAND-UP SURF PADDLES; SURF BOARDS; SURF FINS; SURF PADDLES, IN CLASS 28 (U.S. CLS. 22, 23, 38 AND 50).

FIRST USE 11-30-2008; IN COMMERCE 4-1-2010.

FOR: INSTRUCTION IN THE FIELD OF STAND UP PADDLE; PHYSICAL FITNESS INSTRUCTION; PROVIDING A WEB SITE FEATURING INFORMATION NEEDED FOR THE SPORT OF SURFING, NAMELY, WAVE CONDITIONS, WAVE LOCATIONS AND DURATION OF SURFING SESSION; RENTAL OF SURF BOARDS, IN CLASS 41 (U.S. CLS. 100, 101 AND 107).

FIRST USE 6-1-2009; IN COMMERCE 6-1-2010.

THE MARK CONSISTS OF STANDARD CHARACTERS WITHOUT CLAIM TO ANY PARTICULAR FONT, STYLE, SIZE, OR COLOR.

SN 85-108,719, FILED 8-16-2010.

LINDA M. KING, EXAMINING ATTORNEY



David J. Kyffers

Director of the United States Patent and Trademark Office

United States of America

United States Patent and Trademark Office

Where it's At

Reg. No. 4,154,737

Registered June 5, 2012

Int. Cl.: 14

TRADEMARK

PRINCIPAL REGISTER

A. JAFFE, INC. (NEW YORK CORPORATION)
154 WEST 14TH STREET
NEW YORK, NY 10011

FOR: JEWELRY, IN CLASS 14 (U.S. CLS. 2, 27, 28 AND 50).

FIRST USE 6-1-2011; IN COMMERCE 6-1-2011.

THE MARK CONSISTS OF STANDARD CHARACTERS WITHOUT CLAIM TO ANY PARTICULAR FONT, STYLE, SIZE, OR COLOR.

SN 85-109,011, FILED 8-17-2010.

DANNEAN HETZEL, EXAMINING ATTORNEY



David J. Kyffers

Director of the United States Patent and Trademark Office

United States of America

United States Patent and Trademark Office

RED GATE

Reg. No. 4,154,738

Registered June 5, 2012

Int. Cl.: 33

TRADEMARK

PRINCIPAL REGISTER

DEUTSCHES WEINTOR EG (FED REP GERMANY CORPORATION)
AN DER AHLMÜHLE 1
ILBESHEIM, FED REP GERMANY 76831

FOR: ALCOHOLIC BEVERAGES, NAMELY, WINE, IN CLASS 33 (U.S. CLS. 47 AND 49).

FIRST USE 4-11-2011; IN COMMERCE 4-11-2011.

THE MARK CONSISTS OF STANDARD CHARACTERS WITHOUT CLAIM TO ANY PARTICULAR FONT, STYLE, SIZE, OR COLOR.

NO CLAIM IS MADE TO THE EXCLUSIVE RIGHT TO USE "RED", APART FROM THE MARK AS SHOWN.

SN 85-109,014, FILED 8-17-2010.

ANNE FARRELL, EXAMINING ATTORNEY



David J. Kyffers

Director of the United States Patent and Trademark Office

United States of America

United States Patent and Trademark Office

WHITE GATE

Reg. No. 4,154,739

Registered June 5, 2012

Int. Cl.: 33

TRADEMARK

PRINCIPAL REGISTER

DEUTSCHES WEINTOR EG (FED REP GERMANY CORPORATION)
AN DER AHLMÜHLE 1
ILBESHEIM, FED REP GERMANY 76831

FOR: ALCOHOLIC BEVERAGES, NAMELY, WINE, IN CLASS 33 (U.S. CLS. 47 AND 49).

FIRST USE 4-11-2011; IN COMMERCE 4-11-2011.

THE MARK CONSISTS OF STANDARD CHARACTERS WITHOUT CLAIM TO ANY PARTICULAR FONT, STYLE, SIZE, OR COLOR.

NO CLAIM IS MADE TO THE EXCLUSIVE RIGHT TO USE "WHITE", APART FROM THE MARK AS SHOWN.

SN 85-109,021, FILED 8-17-2010.

ANNE FARRELL, EXAMINING ATTORNEY



David J. Kyffers

Director of the United States Patent and Trademark Office

United States of America

United States Patent and Trademark Office

BE GENUINE

Reg. No. 4,154,740

Registered June 5, 2012

Int. Cl.: 7

TRADEMARK

PRINCIPAL REGISTER

VAN BORTEL AIRCRAFT, INC. (NEW YORK CORPORATION)
4900 SOUTH COLLINS
ARLINGTON MUNICIPAL AIRPORT
ARLINGTON, TX 76018

FOR: AIRCRAFT ENGINES AND PARTS FOR AIRCRAFT ENGINES, NAMELY, AIR FILTERS, OIL FILTERS, SPARK PLUGS, ALTERNATORS, STARTERS, GENERATORS, FUEL PUMPS, VACUUM PUMPS, TURBO CHARGERS, MAGNETOS, ENGINE MOUNTS, FLUID POWER HOSE KITS COMPRISING HOSES AND CLAMPS SOLD AS A UNIT FOR USE IN MACHINERY, FLUID POWER HOSES FOR USE IN MACHINERY, AND EXHAUST SYSTEMS, IN CLASS 7 (U.S. CLS. 13, 19, 21, 23, 31, 34 AND 35).

FIRST USE 10-12-2011; IN COMMERCE 10-12-2011.

THE MARK CONSISTS OF STANDARD CHARACTERS WITHOUT CLAIM TO ANY PARTICULAR FONT, STYLE, SIZE, OR COLOR.

SN 85-109,237, FILED 8-17-2010.

Laurie Kaufman, Examining Attorney



David J. Kyffers

Director of the United States Patent and Trademark Office

United States of America

United States Patent and Trademark Office

Dx Web

Reg. No. 4,154,741

Registered June 5, 2012

Int. Cl.: 42

SERVICE MARK

PRINCIPAL REGISTER

NEXTGEN MANAGEMENT, LLC (DELAWARE LIMITED LIABILITY COMPANY)
6204 LINCOLN AVE.
BALTIMORE, MD 21209

FOR: PROVIDING TEMPORARY USE OF ON-LINE NON-DOWNLOADABLE SOFTWARE FOR ELECTRONICALLY PRESCRIBING MEDICAL AND PHARMACEUTICAL PRESCRIPTIONS OVER A GLOBAL COMPUTER NETWORK, IN CLASS 42 (U.S. CLS. 100 AND 101).

FIRST USE 1-4-2011; IN COMMERCE 1-4-2011.

THE MARK CONSISTS OF STANDARD CHARACTERS WITHOUT CLAIM TO ANY PARTICULAR FONT, STYLE, SIZE, OR COLOR.

SN 85-109,846, FILED 8-17-2010.

ELI HELLMAN, EXAMINING ATTORNEY



David J. Kyffers

Director of the United States Patent and Trademark Office

United States of America

United States Patent and Trademark Office

COOLER COOLANT

Reg. No. 4,154,742

CHEMPLEX AUTOMOTIVE GROUP, INC. (CALIFORNIA CORPORATION)
POST OFFICE BOX 5802
FULLERTON, CA 92838

Registered June 5, 2012

Int. Cl.: 1

FOR: CHEMICAL ADDITIVE FOR RADIATOR PROTECTION, IN CLASS 1 (U.S. CLS. 1, 5, 6, 10, 26 AND 46).

TRADEMARK

FIRST USE 9-14-2010; IN COMMERCE 1-3-2011.

PRINCIPAL REGISTER

THE MARK CONSISTS OF STANDARD CHARACTERS WITHOUT CLAIM TO ANY PARTICULAR FONT, STYLE, SIZE, OR COLOR.

NO CLAIM IS MADE TO THE EXCLUSIVE RIGHT TO USE "COOLANT", APART FROM THE MARK AS SHOWN.

SN 85-110,110, FILED 8-18-2010.

MICHAEL KEATING, EXAMINING ATTORNEY



David J. Kybas

Director of the United States Patent and Trademark Office

United States of America

United States Patent and Trademark Office

STARRS

Reg. No. 4,154,743

TIME CUFFS, LLC (SOUTH CAROLINA LIMITED LIABILITY COMPANY)
4796 LAMBS ROAD
NORTH CHARLESTON, SC 29418

Registered June 5, 2012

Int. Cl.: 20

FOR: PLASTIC HANDCUFFS INCORPORATING DISPOSABLE STRIPS AND A TIME AC-
TUATED CUTTER, IN CLASS 20 (U.S. CLS. 2, 13, 22, 25, 32 AND 50).

TRADEMARK

FIRST USE 5-25-2010; IN COMMERCE 5-16-2011.

PRINCIPAL REGISTER

THE MARK CONSISTS OF STANDARD CHARACTERS WITHOUT CLAIM TO ANY PAR-
TICULAR FONT, STYLE, SIZE, OR COLOR.

SN 85-110,307, FILED 8-18-2010.

KEVIN DINALLO, EXAMINING ATTORNEY



David J. Kyffers

Director of the United States Patent and Trademark Office

United States of America

United States Patent and Trademark Office

WELL GROUNDED

Reg. No. 4,154,744

Registered June 5, 2012

Int. Cl.: 31

TRADEMARK

PRINCIPAL REGISTER

L&M COMPANIES, INC. (NORTH CAROLINA CORPORATION)
2925 HUNTLEIGH DRIVE - SUITE 204
RALEIGH, NC 27604

FOR: FRESH FRUIT AND FRESH VEGETABLES, IN CLASS 31 (U.S. CLS. 1 AND 46).

FIRST USE 10-31-2011; IN COMMERCE 1-1-2012.

THE MARK CONSISTS OF STANDARD CHARACTERS WITHOUT CLAIM TO ANY PARTICULAR FONT, STYLE, SIZE, OR COLOR.

SN 85-110,391, FILED 8-18-2010.

CHRISTOPHER BUONGIORNO, EXAMINING ATTORNEY



David J. Kyffers

Director of the United States Patent and Trademark Office

United States of America

United States Patent and Trademark Office

WELL GROUNDED

Reg. No. 4,154,745

L&M COMPANIES, INC. (NORTH CAROLINA CORPORATION)
2925 HUNTLEIGH DRIVE, SUITE 204
RALEIGH, NC 27604

Registered June 5, 2012

Int. Cls.: 39 and 44

FOR: PACKING FRUITS AND VEGETABLES FOR OTHERS, IN CLASS 39 (U.S. CLS. 100 AND 105).

SERVICE MARK

FIRST USE 10-31-2011; IN COMMERCE 10-31-2011.

PRINCIPAL REGISTER

FOR: CONTRACT FARMING FOR OTHERS, NAMELY, GROWING AND HARVESTING FRUITS AND VEGETABLES FOR OTHERS, IN CLASS 44 (U.S. CLS. 100 AND 101).

FIRST USE 10-31-2011; IN COMMERCE 10-31-2011.

THE MARK CONSISTS OF STANDARD CHARACTERS WITHOUT CLAIM TO ANY PARTICULAR FONT, STYLE, SIZE, OR COLOR.

SN 85-110,448, FILED 8-18-2010.

CHRISTOPHER BUONGIORNO, EXAMINING ATTORNEY



David J. Kybas

Director of the United States Patent and Trademark Office

United States of America

United States Patent and Trademark Office

EARTHFRUITS

Reg. No. 4,154,746

Registered June 5, 2012

Int. Cls.: 29, 30, and 32

YOASIS FRANCHISING SYSTEMS, LLC (UTAH LIMITED LIABILITY COMPANY)
SUITE 300
375 WEST 200 SOUTH
SALT LAKE CITY, UT 84101

FOR: YOGURT; YOGURT-BASED BEVERAGES, IN CLASS 29 (U.S. CL. 46).

TRADEMARK

FIRST USE 7-10-2010; IN COMMERCE 7-10-2010.

PRINCIPAL REGISTER

FOR: FROZEN YOGURT; FROZEN YOGURT CONFECTIONS, IN CLASS 30 (U.S. CL. 46).

FIRST USE 7-30-2010; IN COMMERCE 7-30-2010.

FOR: SMOOTHIES FRUIT BEVERAGES; SMOOTHIES WITH FRUIT PREDOMINATING,
IN CLASS 32 (U.S. CLS. 45, 46 AND 48).

FIRST USE 7-10-2010; IN COMMERCE 7-10-2010.

THE MARK CONSISTS OF STANDARD CHARACTERS WITHOUT CLAIM TO ANY PARTICULAR FONT, STYLE, SIZE, OR COLOR.

SN 85-110,944, FILED 8-19-2010.

COLLEEN KEARNEY, EXAMINING ATTORNEY



David J. Kyros

Director of the United States Patent and Trademark Office

United States of America

United States Patent and Trademark Office

EARTHFRUITS YOGURT

Reg. No. 4,154,747

Registered June 5, 2012

Int. Cls.: 29, 30, and 32

YOASIS FRANCHISING SYSTEMS, LLC (UTAH LIMITED LIABILITY COMPANY)
SUITE 300
375 WEST 200 SOUTH
SALT LAKE CITY, UT 84101

FOR: YOGURT; YOGURT-BASED BEVERAGES, IN CLASS 29 (U.S. CL. 46).

TRADEMARK

FIRST USE 7-10-2010; IN COMMERCE 7-10-2010.

PRINCIPAL REGISTER

FOR: FROZEN YOGURT; FROZEN YOGURT CONFECTIONS, IN CLASS 30 (U.S. CL. 46).

FIRST USE 7-30-2010; IN COMMERCE 7-30-2010.

FOR: SMOOTHIES FRUIT BEVERAGES; SMOOTHIES WITH FRUIT PREDOMINATING,
IN CLASS 32 (U.S. CLS. 45, 46 AND 48).

FIRST USE 7-10-2010; IN COMMERCE 7-10-2010.

THE MARK CONSISTS OF STANDARD CHARACTERS WITHOUT CLAIM TO ANY PARTICULAR FONT, STYLE, SIZE, OR COLOR.

NO CLAIM IS MADE TO THE EXCLUSIVE RIGHT TO USE "YOGURT", APART FROM THE MARK AS SHOWN.

SN 85-110,946, FILED 8-19-2010.

COLLEEN KEARNEY, EXAMINING ATTORNEY



David J. Kyros

Director of the United States Patent and Trademark Office

United States of America

United States Patent and Trademark Office

INTELLITUBE

Reg. No. 4,154,748

ENERGY FOCUS, INC. (DELAWARE CORPORATION)
32000 AURORA ROAD
SOLON, OH 44139

Registered June 5, 2012

Int. Cl.: 11

FOR: LIGHT EMITTING DIODE (LED) LAMPS FOR ENERGY-EFFICIENT REPLACEMENT OF FLUORESCENT LAMPS; LED (LIGHT EMITTING DIODE) LAMPS, IN CLASS 11 (U.S. CLS. 13, 21, 23, 31 AND 34).

TRADEMARK

FIRST USE 12-20-2011; IN COMMERCE 12-20-2011.

PRINCIPAL REGISTER

THE MARK CONSISTS OF STANDARD CHARACTERS WITHOUT CLAIM TO ANY PARTICULAR FONT, STYLE, SIZE, OR COLOR.

SN 85-111,205, FILED 8-19-2010.

JENNIFER VASQUEZ, EXAMINING ATTORNEY



David J. Kyros

Director of the United States Patent and Trademark Office

United States of America

United States Patent and Trademark Office

DEFENDER DRAPES

Reg. No. 4,154,749

Registered June 5, 2012

Int. Cl.: 24

TRADEMARK

PRINCIPAL REGISTER

AMERICAN BLINDS AND DRAPERIES, INC. (CALIFORNIA CORPORATION)
30776 HUNTWOOD AVENUE
HAYWARD, CA 94544

FOR: DRAPES AND CURTAINS; SECURITY DRAPES AND CURTAINS; ANTI-BACTERIAL DRAPES AND CURTAINS; ANTI-MICROBIAL DRAPES AND CURTAINS, IN CLASS 24 (U.S. CLS. 42 AND 50).

FIRST USE 2-9-2009; IN COMMERCE 2-9-2009.

THE MARK CONSISTS OF STANDARD CHARACTERS WITHOUT CLAIM TO ANY PARTICULAR FONT, STYLE, SIZE, OR COLOR.

NO CLAIM IS MADE TO THE EXCLUSIVE RIGHT TO USE "DRAPES", APART FROM THE MARK AS SHOWN.

SN 85-113,513, FILED 8-23-2010.

ALEX KEAM, EXAMINING ATTORNEY



David J. Kyros

Director of the United States Patent and Trademark Office

United States of America

United States Patent and Trademark Office



Reg. No. 4,154,750

Registered June 5, 2012

Int. Cls.: 16 and 41

TRADEMARK

SERVICE MARK

PRINCIPAL REGISTER

SALON DEVELOPMENT, INC. (MINNESOTA CORPORATION), DBA SALON DEVELOPMENT CORPORATION,
1381 SUMMIT AVENUE
ST. PAUL, MN 55105

FOR: PRINTED INSTRUCTIONAL AND TEACHING MATERIAL IN THE FIELDS OF COSMETOLOGY, ESTHIOLOGY, MASSAGE THERAPY, HAIR CARE, BODY AND SKIN CARE, SPA THERAPY, SALON AND SPA MANAGEMENT AND CLIENT RELATIONS, IN CLASS 16 (U.S. CLS. 2, 5, 22, 23, 29, 37, 38 AND 50).

FIRST USE 3-1-2012; IN COMMERCE 3-1-2012.

FOR: EDUCATIONAL SERVICES, NAMELY, PROVIDING CLASSES, SEMINARS AND WORKSHOPS IN THE FIELDS OF COSMETOLOGY, ESTHIOLOGY, MASSAGE THERAPY, HAIR CARE, BODY AND SKIN CARE, SPA THERAPY, SALON AND SPA MANAGEMENT AND CLIENT RELATIONS AND DISTRIBUTION OF COURSE MATERIAL AND WRITTEN CURRICULUM IN CONNECTION THEREWITH, IN CLASS 41 (U.S. CLS. 100, 101 AND 107).

FIRST USE 3-1-2012; IN COMMERCE 3-1-2012.

THE MARK CONSISTS OF THE WORD "STEP" IS ABOVE THE WORD "UP", WITH THE LETTER "S" REPRESENTED AS A DOLLAR SIGN; A HORIZONTAL LINE BELOW THE WORD "UP" CURVES TO EXTEND VERTICALLY AFTER THE WORD "UP" AND TERMINATES WITH AN ARROW; A PERIOD ADJACENT TO THE WORD "UP" SEPARATES THE HORIZONTAL LINE FROM THE VERTICAL LINE; THE WORDS "FAST TRACK TO WEALTH" IS BENEATH THE HORIZONTAL LINE.

SN 85-113,649, FILED 8-23-2010.

KAPIL BHANOT, EXAMINING ATTORNEY



David J. Kybas

Director of the United States Patent and Trademark Office

United States of America

United States Patent and Trademark Office

DYNA-TEK

Reg. No. 4,154,751

DYNA-COATINGS GROUP, LLC (MISSOURI LIMITED LIABILITY COMPANY)
5000 E. 59TH ST.
KANSAS CITY, MO 64130

Registered June 5, 2012

Int. Cl.: 2

FOR: COATINGS, NAMELY, FINISHES FOR EXTERIOR AND INTERIOR USE ON A VARIETY OF SUBSTRATES, IN CLASS 2 (U.S. CLS. 6, 11 AND 16).

TRADEMARK

FIRST USE 12-0-2010; IN COMMERCE 12-0-2010.

PRINCIPAL REGISTER

THE MARK CONSISTS OF STANDARD CHARACTERS WITHOUT CLAIM TO ANY PARTICULAR FONT, STYLE, SIZE, OR COLOR.

SN 85-114,493, FILED 8-24-2010.

GINA HAYES, EXAMINING ATTORNEY



David J. Kyffers

Director of the United States Patent and Trademark Office

United States of America

United States Patent and Trademark Office

LearningElite

Reg. No. 4,154,752

Registered June 5, 2012

Int. Cl.: 35

SERVICE MARK

PRINCIPAL REGISTER

MEDIATEC PUBLISHING, INC. (ILLINOIS CORPORATION)
SUITE 1290
111 E. WACKER DRIVE
CHICAGO, IL 60601

FOR: PROVIDING BUSINESS EVALUATION, ASSESSMENT, AND AWARDS TO PUBLIC, PRIVATE, FOR-PROFIT, NON-FOR-PROFIT, GOVERNMENT, AND ACADEMIC INSTITUTIONS WITH RESPECT TO HOW EFFECTIVELY THOSE ORGANIZATIONS DEVELOP AND TRAIN THEIR WORKFORCE, PARTNERS, AND SUPPLIERS TO DELIVER SIGNIFICANT BUSINESS RESULTS TO THEIR ORGANIZATION, IN CLASS 35 (U.S. CLS. 100, 101 AND 102).

FIRST USE 5-24-2010; IN COMMERCE 9-14-2010.

THE MARK CONSISTS OF STANDARD CHARACTERS WITHOUT CLAIM TO ANY PARTICULAR FONT, STYLE, SIZE, OR COLOR.

SN 85-114,808, FILED 8-24-2010.

DOMINICK J. SALEMI, EXAMINING ATTORNEY



David J. Kyros

Director of the United States Patent and Trademark Office

United States of America

United States Patent and Trademark Office

Via Satellite's Satcom Technology For the Engineer by the Engineer

Reg. No. 4,154,753

ACCESS INTELLIGENCE LLC (DELAWARE LIMITED LIABILITY COMPANY)
4 CHOKE CHERRY ROAD
ROCKVILLE, MD 20850

Registered June 5, 2012

Int. Cl.: 41

FOR: PROVIDING ON-LINE E-ZINES IN THE FIELD OF SATELLITE COMMUNICATIONS,
IN CLASS 41 (U.S. CLS. 100, 101 AND 107).

SERVICE MARK

FIRST USE 10-31-2010; IN COMMERCE 10-31-2010.

PRINCIPAL REGISTER

THE MARK CONSISTS OF STANDARD CHARACTERS WITHOUT CLAIM TO ANY PAR-
TICULAR FONT, STYLE, SIZE, OR COLOR.

NO CLAIM IS MADE TO THE EXCLUSIVE RIGHT TO USE "SATCOM TECHNOLOGY FOR
THE ENGINEER BY THE ENGINEER", APART FROM THE MARK AS SHOWN.

SN 85-115,147, FILED 8-25-2010.

ANGELA M. MICHELI, EXAMINING ATTORNEY



David J. Kybas

Director of the United States Patent and Trademark Office

United States of America

United States Patent and Trademark Office

WILDERNESS SYSTEMS

Reg. No. 4,154,754

Registered June 5, 2012

Int. Cl.: 25

TRADEMARK

PRINCIPAL REGISTER

CONFLUENCE HOLDINGS CORP. (DELAWARE CORPORATION)
111 KAYAKER WAY
EASLEY, SC 29642

FOR: APPAREL, NAMELY, MEN'S AND WOMEN'S PANTS, JACKETS, FOOTWEAR, HATS, CAPS, ATHLETIC SHOES, HAT BANDS, ALL MADE OF NATURAL OR SYNTHETIC MATERIALS OR NEOPRENE, KNIT AND MOISTURE-WICKING LONG SLEEVED AND SHORT SLEEVED SHIRTS AND T-SHIRTS, SLEEP SHIRTS, SPORTS SHIRTS, SWEAT SHIRTS, WIND SHIRTS, SHORTS, SWEAT SHORTS, AND SWIMSUITS, IN CLASS 25 (U.S. CLS. 22 AND 39).

FIRST USE 9-0-2010; IN COMMERCE 9-0-2010.

THE MARK CONSISTS OF STANDARD CHARACTERS WITHOUT CLAIM TO ANY PARTICULAR FONT, STYLE, SIZE, OR COLOR.

OWNER OF U.S. REG. NO. 2,158,103.

SN 85-115,672, FILED 8-25-2010.

LESLIE RICHARDS, EXAMINING ATTORNEY



David J. Kyros

Director of the United States Patent and Trademark Office

United States of America

United States Patent and Trademark Office

iShop-X

Reg. No. 4,154,755

Registered June 5, 2012

Int. Cl.: 16

TRADEMARK

PRINCIPAL REGISTER

TACKETT HOLDINGS, INC. (KENTUCKY CORPORATION), DBA ISHOP-X,
P.O. BOX 1166
HOPKINSVILLE, KY 42241

FOR: HAND TOWELS OF PAPER, IN CLASS 16 (U.S. CLS. 2, 5, 22, 23, 29, 37, 38 AND 50).

FIRST USE 1-0-2010; IN COMMERCE 3-15-2012.

THE MARK CONSISTS OF STANDARD CHARACTERS WITHOUT CLAIM TO ANY PARTICULAR FONT, STYLE, SIZE, OR COLOR.

SN 85-115,689, FILED 8-25-2010.

CHRISTINA SOBRAL, EXAMINING ATTORNEY



David J. Kybas

Director of the United States Patent and Trademark Office

United States of America

United States Patent and Trademark Office

Forever Begins Today

Reg. No. 4,154,756

Registered June 5, 2012

Int. Cl.: 14

TRADEMARK

PRINCIPAL REGISTER

A. JAFFE, INC. (NEW YORK CORPORATION)
154 WEST 14TH STREET
NEW YORK, NY 10011

FOR: JEWELRY, IN CLASS 14 (U.S. CLS. 2, 27, 28 AND 50).

FIRST USE 3-29-2012; IN COMMERCE 3-29-2012.

THE MARK CONSISTS OF STANDARD CHARACTERS WITHOUT CLAIM TO ANY PARTICULAR FONT, STYLE, SIZE, OR COLOR.

SN 85-116,342, FILED 8-26-2010.

DANNEAN HETZEL, EXAMINING ATTORNEY



David J. Kyffers

Director of the United States Patent and Trademark Office

United States of America

United States Patent and Trademark Office

MOVIES THAT MOVE YOU

Reg. No. 4,154,757

Registered June 5, 2012

Int. Cl.: 38

SERVICE MARK

PRINCIPAL REGISTER

SHOWTIME NETWORKS INC. (DELAWARE CORPORATION)
1633 BROADWAY
NEW YORK, NY 10019

FOR: BROADCASTING SERVICES, NAMELY, TRANSMITTING, DOWNLOADING AND STREAMING OF AUDIO, VIDEO AND MULTIMEDIA ENTERTAINMENT CONTENT INCLUDING GRAPHICS, TEXT AND DATA, RENDERED THROUGH THE MEDIA OF TELEVISION, CABLE, SATELLITE, RADIO, TELEPHONE AND BROADBAND SYSTEMS, AND VIA THE INTERNET, PORTABLE AND WIRELESS COMMUNICATION DEVICES, IN CLASS 38 (U.S. CLS. 100, 101 AND 104).

FIRST USE 10-25-2010; IN COMMERCE 10-25-2010.

THE MARK CONSISTS OF STANDARD CHARACTERS WITHOUT CLAIM TO ANY PARTICULAR FONT, STYLE, SIZE, OR COLOR.

NO CLAIM IS MADE TO THE EXCLUSIVE RIGHT TO USE "MOVIES", APART FROM THE MARK AS SHOWN.

SN 85-116,928, FILED 8-26-2010.

SUSAN STIGLITZ, EXAMINING ATTORNEY



David J. Kybas

Director of the United States Patent and Trademark Office

United States of America

United States Patent and Trademark Office



Reg. No. 4,154,758

Registered June 5, 2012

Int. Cl.: 3

TRADEMARK

PRINCIPAL REGISTER

ALEXANDER, ADRIAN (UNITED STATES INDIVIDUAL)
PO BOX 972567
MIAMI, FL 331972567

FOR: BLEACHING PREPARATIONS FOR COSMETIC PURPOSES; BODY AND BEAUTY CARE COSMETICS; CLEANSING CREAMS; COLOGNES, PERFUMES AND COSMETICS; COMPACTS CONTAINING MAKE-UP; CONCEALERS; COSMETIC CREAMS; COSMETIC CREAMS FOR SKIN CARE; COSMETIC MASSAGE CREAMS; COSMETIC PADS; COSMETIC PENCILS; COSMETIC PREPARATIONS; COSMETIC PREPARATIONS, NAMELY, FIRING CREAMS; COSMETIC PREPARATIONS, NAMELY, FIRING LOTIONS; COSMETICS AND COSMETIC PREPARATIONS; COSMETICS AND MAKE-UP; COSMETICS IN GENERAL, INCLUDING PERFUMES; COSMETICS, NAMELY, LIP PRIMER; DEPILATORY WAX; EYE MAKE-UP; EYE MAKE-UP REMOVER; EYEBROW COSMETICS; EYES MAKE-UP; FACE CREAMS FOR COSMETIC USE; FACIAL MAKE-UP; FOUNDATION MAKE-UP; LOTIONS FOR COSMETIC PURPOSES; MAKE UP FOUNDATIONS; MAKE UP REMOVING PREPARATIONS; MAKE-UP; MAKE-UP FOR THE FACE AND BODY; MAKE-UP FOUNDATIONS; MAKE-UP KITS COMPRISED OF FOUNDATION,FACE POWDER, LIP GLOSS, BRUSHES, CONCEALERS, PRIMER, FACE LOTIONS; MAKE-UP PENCILS; MAKE-UP POWDER; MAKE-UP PREPARATIONS; MAKE-UP PREPARATIONS FOR THE FACE AND BODY; MAKE-UP REMOVER; MAKE-UP REMOVING LOTIONS; MAKE-UP REMOVING MILK, GEL, LOTIONS AND CREAMS; MAKE-UP REMOVING MILKS; MAKE-UP REMOVING PREPARATIONS; PRIVATE LABEL COSMETICS, IN CLASS 3 (U.S. CLS. 1, 4, 6, 50, 51 AND 52).

FIRST USE 12-1-2009; IN COMMERCE 12-1-2009.

THE MARK CONSISTS OF TWO CURSIVE LETTERS "L" FROM THE NAME BRAND "LICK & LUCK" ARE BACK TO BACK INSIDE AN INTERSTATE SHAPED SIGN. THE TWO LETTERS "L" WHEN BACK TO BACK LOOKS LIKE THE SHAPE OF AN ANIMALS FACE WITH EYES, EARS, MOUTH, NOSE, MUSTACHE SIMILAR TO THAT OF A CAT'S OR DOG'S FACE. THE "&" SYMBOL INSIDE THE LOGO RESEMBLES THE NOSE. THE WORDING "LICK & LUCK" APPEARS BENEATH THE TWO LETTER "L" DESIGN.



David J. Kyros

SN 85-116,963, FILED 8-26-2010.

C. DIONNE CLYBURN, EXAMINING ATTORNEY

United States of America

United States Patent and Trademark Office

QEP ENERGY

Reg. No. 4,154,759

Registered June 5, 2012

**Int. Cls.: 4, 35, 37, and
42**

QEP RESOURCES, INC. (DELAWARE CORPORATION)
SUITE 500
1050 17TH STREET
DENVER, CO 80265

FOR: NATURAL GAS, LIQUEFIED NATURAL GAS AND CRUDE OIL, IN CLASS 4 (U.S. CLS. 1, 6 AND 15).

TRADEMARK

FIRST USE 7-31-2010; IN COMMERCE 7-31-2010.

SERVICE MARK

FOR: OPERATING OIL AND GAS WELLS FOR OTHERS, IN CLASS 35 (U.S. CLS. 100, 101 AND 102).

PRINCIPAL REGISTER

FIRST USE 7-31-2010; IN COMMERCE 7-31-2010.

FOR: DRILLING AND COMPLETING OIL AND GAS WELLS; EQUIPPING OIL AND GAS WELLS, NAMELY, INSTALLING CASING, TUBING, AND PIPES INTO OIL AND GAS WELLS, IN CLASS 37 (U.S. CLS. 100, 103 AND 106).

FIRST USE 7-31-2010; IN COMMERCE 7-31-2010.

FOR: OIL AND GAS EXPLORATION, IN CLASS 42 (U.S. CLS. 100 AND 101).

FIRST USE 7-31-2010; IN COMMERCE 7-31-2010.

THE MARK CONSISTS OF STANDARD CHARACTERS WITHOUT CLAIM TO ANY PARTICULAR FONT, STYLE, SIZE, OR COLOR.

NO CLAIM IS MADE TO THE EXCLUSIVE RIGHT TO USE "ENERGY", APART FROM THE MARK AS SHOWN.

SN 85-116,982, FILED 8-26-2010.

C. DIONNE CLYBURN, EXAMINING ATTORNEY



David J. Kyros

Director of the United States Patent and Trademark Office

United States of America

United States Patent and Trademark Office

ONTY'S

Reg. No. 4,154,760

Registered June 5, 2012

Int. Cl.: 9

TRADEMARK

PRINCIPAL REGISTER

OSCAR E. ONTIVEROS (UNITED STATES INDIVIDUAL)
4329 ALTURA AVENUE
EL PASO, TX 79903

FOR: CONTROLLERS, NAMELY, ELECTRONIC CONTROLLERS; ELECTRONIC CONTROLLERS FOR ELECTRIC DEVICES; ELECTRONIC CONTROLLERS FOR REDUCING POWER CONSUMPTION, IN CLASS 9 (U.S. CLS. 21, 23, 26, 36 AND 38).

FIRST USE 11-5-2010; IN COMMERCE 11-5-2010.

THE MARK CONSISTS OF STANDARD CHARACTERS WITHOUT CLAIM TO ANY PARTICULAR FONT, STYLE, SIZE, OR COLOR.

SN 85-117,846, FILED 8-27-2010.

ANGELA DUONG, EXAMINING ATTORNEY



David J. Kyffers

Director of the United States Patent and Trademark Office

United States of America

United States Patent and Trademark Office

Golden Wishes

Reg. No. 4,154,761

ROCKET GAMING SYSTEMS, LLC (DELAWARE LIMITED LIABILITY COMPANY)
66201 EAST 290 ROAD
GROVE, OK 74344

Registered June 5, 2012

Int. Cl.: 9

FOR: GAMING MACHINES, NAMELY, BINGO-RELATED GAMES AND SLOT MACHINES,
IN CLASS 9 (U.S. CLS. 21, 23, 26, 36 AND 38).

TRADEMARK

FIRST USE 4-6-2011; IN COMMERCE 6-27-2011.

PRINCIPAL REGISTER

THE MARK CONSISTS OF STANDARD CHARACTERS WITHOUT CLAIM TO ANY PAR-
TICULAR FONT, STYLE, SIZE, OR COLOR.

SN 85-117,993, FILED 8-27-2010.

MICHAEL LITZAU, EXAMINING ATTORNEY



David J. Kyffers

Director of the United States Patent and Trademark Office

United States of America

United States Patent and Trademark Office

SECURUS

Reg. No. 4,154,762

Registered June 5, 2012

Int. Cl.: 45

SERVICE MARK

PRINCIPAL REGISTER

SECURUS TECHNOLOGIES, INC. (DELAWARE CORPORATION)
14651 DALLAS PKWY
6TH FLOOR
DALLAS, TX 75254

FOR: ANALYZING DATA IN COMPUTER DATABASES FOR CRIMINAL ACTIVITY; ANALYZING TELEPHONE CALLING PATTERN DATA IN COMPUTER DATABASES FOR CRIMINAL ACTIVITY; COMPUTERIZED SECURITY SERVICES, NAMELY, ELECTRONIC MONITORING, DETECTING, RECORDING AND REPORTING OF SUSPICIOUS USE OF TELECOMMUNICATIONS SYSTEMS PROVIDED TO INMATES AND RELATED PARTIES; ELECTRONIC MONITORING SERVICES FOR SECURITY PURPOSES IN THE FIELD OF LAW ENFORCEMENT; FRAUD DETECTION SERVICES FOR CORRECTIONAL INSTITUTIONS; SURVEILLANCE SERVICES; PROVIDING INFORMATION CONCERNING POSSIBLE CRIMINAL OR SUSPICIOUS ACTIVITIES OF INDIVIDUALS OR ORGANIZATIONS, IN CLASS 45 (U.S. CLS. 100 AND 101).

FIRST USE 8-6-2004; IN COMMERCE 8-6-2004.

THE MARK CONSISTS OF STANDARD CHARACTERS WITHOUT CLAIM TO ANY PARTICULAR FONT, STYLE, SIZE, OR COLOR.

SN 85-118,341, FILED 8-30-2010.

CAROLYN CATALDO, EXAMINING ATTORNEY



David J. Kyros

Director of the United States Patent and Trademark Office

United States of America

United States Patent and Trademark Office

SECURUS

Reg. No. 4,154,763

Registered June 5, 2012

Int. Cl.: 35

SERVICE MARK

PRINCIPAL REGISTER

SECURUS TECHNOLOGIES, INC. (DELAWARE CORPORATION)
14651 DALLAS PKWY
6TH FLOOR
DALLAS, TX 75254

FOR: TELECOMMUNICATIONS NETWORK MANAGEMENT SERVICES, NAMELY, THE OPERATION AND ADMINISTRATION OF TELECOMMUNICATION SYSTEMS AND NETWORKS FOR OTHERS; ADVERTISING AND MARKETING SERVICES, NAMELY, PROVIDING INFORMATION AS TO THE AVAILABILITY OF TELECOMMUNICATION SERVICES AT CORRECTIONAL INSTITUTIONS; BUSINESS INFORMATION SERVICES/MANAGEMENT, NAMELY, GATHERING, ANALYZING AND REPORTING INFORMATION REGARDING THE FINANCIAL AND USAGE DATA FOR TELECOMMUNICATIONS SYSTEMS PROVIDED TO PRISON INMATES AND RELATED PARTIES, IN CLASS 35 (U.S. CLS. 100, 101 AND 102).

FIRST USE 8-6-2004; IN COMMERCE 8-6-2004.

THE MARK CONSISTS OF STANDARD CHARACTERS WITHOUT CLAIM TO ANY PARTICULAR FONT, STYLE, SIZE, OR COLOR.

SN 85-118,345, FILED 8-30-2010.

CAROLYN CATALDO, EXAMINING ATTORNEY



David J. Kyros

Director of the United States Patent and Trademark Office

United States of America

United States Patent and Trademark Office

SECURUS

Reg. No. 4,154,764

Registered June 5, 2012

Int. Cl.: 38

SERVICE MARK

PRINCIPAL REGISTER

SECURUS TECHNOLOGIES, INC. (DELAWARE CORPORATION)
14651 DALLAS PKWY
6TH FLOOR
DALLAS, TX 75254

FOR: COMMUNICATION SERVICES, NAMELY, TRANSMISSION OF VOICE, AUDIO, VISUAL IMAGES AND DATA BY TELECOMMUNICATIONS NETWORKS, WIRELESS COMMUNICATION NETWORKS, THE INTERNET, INFORMATION SERVICES NETWORKS AND DATA NETWORKS; DATA COMMUNICATION BY ELECTRONIC MAIL; DATA TRANSMISSION AND RECEPTION SERVICES VIA TELECOMMUNICATION MEANS; DELIVERY OF MESSAGES BY ELECTRONIC TRANSMISSION; ELECTRONIC MAIL AND MESSAGING SERVICES; ELECTRONIC MAIL SERVICES; ELECTRONIC VOICE MESSAGING, NAMELY, THE RECORDING AND SUBSEQUENT TRANSMISSION OF VOICE MESSAGES BY TELEPHONE; INFORMATION TRANSMISSION VIA ELECTRONIC COMMUNICATIONS NETWORKS; PREPAID LOCAL AND LONG DISTANCE TELEPHONE SERVICES; PROVIDING FACILITIES AND EQUIPMENT FOR TELEPRESENCE CONFERENCING; PROVIDING TECHNICAL SUPPORT SERVICES REGARDING THE USAGE OF COMMUNICATIONS EQUIPMENT; VOICEMAIL SERVICES, IN CLASS 38 (U.S. CLS. 100, 101 AND 104).

FIRST USE 8-6-2004; IN COMMERCE 8-6-2004.

THE MARK CONSISTS OF STANDARD CHARACTERS WITHOUT CLAIM TO ANY PARTICULAR FONT, STYLE, SIZE, OR COLOR.

SN 85-118,346, FILED 8-30-2010.

CAROLYN CATALDO, EXAMINING ATTORNEY



David J. Kyjars

Director of the United States Patent and Trademark Office

United States of America

United States Patent and Trademark Office

MOBIX

Reg. No. 4,154,765

MOBIX CAR SERVICES LLC (RHODE ISLAND LIMITED LIABILITY COMPANY)
4 SEAVIEW DRIVE
BARRINGTON, RI 02806

Registered June 5, 2012

Int. Cl.: 37

FOR: CONSTRUCTION AND REPAIR SERVICES, NAMELY, ON-SITE CAR REPAIR AND MAINTENANCE, IN CLASS 37 (U.S. CLS. 100, 103 AND 106).

SERVICE MARK

FIRST USE 5-1-2010; IN COMMERCE 9-9-2010.

PRINCIPAL REGISTER

THE MARK CONSISTS OF STANDARD CHARACTERS WITHOUT CLAIM TO ANY PARTICULAR FONT, STYLE, SIZE, OR COLOR.

SN 85-119,336, FILED 8-31-2010.

RONALD MCMORROW, EXAMINING ATTORNEY



David J. Kyffers

Director of the United States Patent and Trademark Office

United States of America

United States Patent and Trademark Office

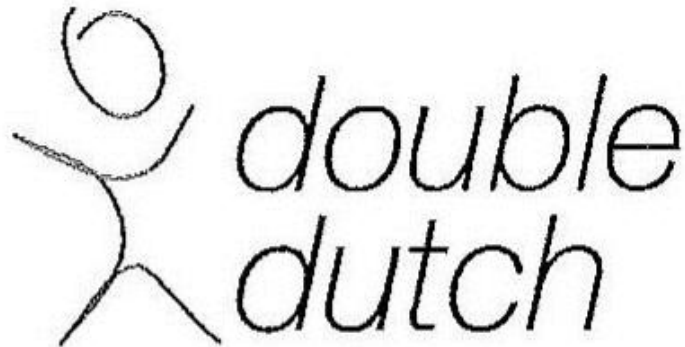

Reg. No. 4,154,766

Registered June 5, 2012

Int. Cl.: 41

SERVICE MARK

PRINCIPAL REGISTER

VERY PERSONAL INCORPORATED (MINNESOTA LIMITED LIABILITY COMPANY), DBA
COMPANYWORKS,
168 EAST 6TH STREET, SUITE 3002
SAINT PAUL, MN 551011994

FOR: TRAINING SERVICES IN THE FIELD OF PERSONNEL DEVELOPMENT AND INDIVIDUAL AND ORGANIZATIONAL MANAGEMENT FOR A WORLD CLASS WORKFORCE, IN CLASS 41 (U.S. CLS. 100, 101 AND 107).

FIRST USE 7-6-2011; IN COMMERCE 7-6-2011.

OWNER OF U.S. REG. NO. 2,882,836.

THE MARK CONSISTS OF A STYLIZED PERSON BESIDE THE WORDS "DOUBLE" ON TOP OF THE WORD "DUTCH".

SN 85-119,597, FILED 8-31-2010.

NICHOLAS COLEMAN, EXAMINING ATTORNEY



David J. Kyffers

Director of the United States Patent and Trademark Office

United States of America

United States Patent and Trademark Office

QRHERE

Reg. No. 4,154,767

Registered June 5, 2012

Int. Cls.: 9 and 42

TRADEMARK

SERVICE MARK

PRINCIPAL REGISTER

QRHERE LLC (TENNESSEE LIMITED LIABILITY COMPANY)
1617-B STOKES LANE
NASHVILLE, TN 37215

FOR: COMPUTER APPLICATION SOFTWARE FOR MOBILE PHONES, PORTABLE MEDIA PLAYERS AND HANDHELD COMPUTERS, NAMELY, SOFTWARE FOR MANAGEMENT, ORGANIZATION, AND TRACKING OF QR CODES AND CONNECTION OF DIGITAL CONTENT TO PRODUCTS, PRODUCT DISPLAYS, PRODUCT AND SERVICE SIGNAGE AND ADVERTISEMENTS, REAL ESTATE PROPERTY SIGNAGE, AND PRINTED MATERIALS USING QR CODES, IN CLASS 9 (U.S. CLS. 21, 23, 26, 36 AND 38).

FIRST USE 1-31-2011; IN COMMERCE 1-31-2011.

FOR: PROVIDING A WEBSITE FEATURING TECHNOLOGY THAT ENABLES USERS TO MANAGE, ORGANIZE, AND TRACK QR CODES AND CONNECT DIGITAL CONTENT TO PRODUCTS, PRODUCT DISPLAYS, PRODUCT AND SERVICE SIGNAGE AND ADVERTISEMENTS, REAL ESTATE PROPERTY SIGNAGE, AND PRINTED MATERIALS USING QR CODES, IN CLASS 42 (U.S. CLS. 100 AND 101).

FIRST USE 4-22-2010; IN COMMERCE 4-22-2010.

THE MARK CONSISTS OF STANDARD CHARACTERS WITHOUT CLAIM TO ANY PARTICULAR FONT, STYLE, SIZE, OR COLOR.

SN 85-119,808, FILED 8-31-2010.

DOMINIC J. FERRAIUOLO, EXAMINING ATTORNEY



David J. Kyros

Director of the United States Patent and Trademark Office

United States of America
United States Patent and Trademark Office

QRHere

Reg. No. 4,154,768

Registered June 5, 2012

Int. Cls.: 9 and 42

TRADEMARK

SERVICE MARK

PRINCIPAL REGISTER

QRHERE LLC (TENNESSEE LIMITED LIABILITY COMPANY)
1617-B STOKES LANE
NASHVILLE, TN 37215

FOR: COMPUTER APPLICATION SOFTWARE FOR MOBILE PHONES, PORTABLE MEDIA PLAYERS AND HANDHELD COMPUTERS, NAMELY, SOFTWARE FOR MANAGEMENT, ORGANIZATION, AND TRACKING OF QR CODES AND CONNECTION OF DIGITAL CONTENT TO PRODUCTS, PRODUCT DISPLAYS, PRODUCT AND SERVICE SIGNAGE AND ADVERTISEMENTS, REAL ESTATE PROPERTY SIGNAGE, AND PRINTED MATERIALS USING QR CODES, IN CLASS 9 (U.S. CLS. 21, 23, 26, 36 AND 38).

FIRST USE 1-31-2011; IN COMMERCE 1-31-2011.

FOR: PROVIDING A WEBSITE FEATURING TECHNOLOGY THAT ENABLES USERS TO MANAGE, ORGANIZE, AND TRACK QR CODES AND CONNECT DIGITAL CONTENT TO PRODUCTS, PRODUCT DISPLAYS, PRODUCT AND SERVICE SIGNAGE AND ADVERTISEMENTS, REAL ESTATE PROPERTY SIGNAGE, AND PRINTED MATERIALS USING QR CODES, IN CLASS 42 (U.S. CLS. 100 AND 101).

FIRST USE 4-22-2010; IN COMMERCE 4-22-2010.

THE MARK CONSISTS OF THE TERM "QRHERE" IN BLUE LETTERS WITH THE TAIL OF THE "Q" ENDING IN AN ORANGE ARROW.

THE COLOR(S) BLUE AND ORANGE IS/ARE CLAIMED AS A FEATURE OF THE MARK.

SN 85-120,026, FILED 8-31-2010.

DOMINIC J. FERRAIUOLO, EXAMINING ATTORNEY



David J. Kyros

Director of the United States Patent and Trademark Office

United States of America

United States Patent and Trademark Office

IMCA

INDEPENDENT Movers Co-op of America

Reg. No. 4,154,769

A. GUMINIAK, JEFFREY (UNITED STATES INDIVIDUAL)
5607 8TH STREET W.
LEHIGH ACRES, FL 33971

Registered June 5, 2012

Int. Cls.: 35 and 39

FOR: ASSOCIATION SERVICES, NAMELY, PROMOTING THE INTERESTS OF MOVING COMPANIES, IN CLASS 35 (U.S. CLS. 100, 101 AND 102).

SERVICE MARK

FIRST USE 3-0-2011; IN COMMERCE 3-0-2011.

PRINCIPAL REGISTER

FOR: MOVING COMPANY SERVICES; STORAGE AND DELIVERY OF GOODS; SUPPLY CHAIN LOGISTICS AND REVERSE LOGISTICS SERVICES, NAMELY, STORAGE, TRANSPORTATION AND DELIVERY OF DOCUMENTS, PACKAGES, RAW MATERIALS, AND OTHER FREIGHT FOR OTHERS BY AIR, RAIL, SHIP OR TRUCK, IN CLASS 39 (U.S. CLS. 100 AND 105).

FIRST USE 3-0-2011; IN COMMERCE 3-0-2011.

NO CLAIM IS MADE TO THE EXCLUSIVE RIGHT TO USE "INDEPENDENT MOVERS CO-OP OF AMERICA", APART FROM THE MARK AS SHOWN.

THE MARK CONSISTS OF THE LARGE LETTERS "IMCA" WITH THE LETTER "A" INCLUDING AN ARROW AND THE WORDING "INDEPENDENT MOVERS CO-OP OF AMERICA" IN SMALLER LETTERING UNDERNEATH.

SN 85-120,484, FILED 9-1-2010.

DOUGLAS LEE, EXAMINING ATTORNEY



David J. Kypos

Director of the United States Patent and Trademark Office

United States of America

United States Patent and Trademark Office

 **ESDeyeguard**

Reg. No. 4,154,770

PTG TOOLS, INC. (MASSACHUSETTS CORPORATION)
37 WESTECH DRIVE
TYNGSBORO, MA 01879

Registered June 5, 2012

Int. Cl.: 9

FOR: PROTECTIVE EYEWEAR AND COMPONENT PARTS THEREOF, IN CLASS 9 (U.S. CLS. 21, 23, 26, 36 AND 38).

TRADEMARK

FIRST USE 1-1-2011; IN COMMERCE 1-1-2011.

PRINCIPAL REGISTER

NO CLAIM IS MADE TO THE EXCLUSIVE RIGHT TO USE "ESDEYEGUARD", APART FROM THE MARK AS SHOWN.

THE MARK CONSISTS OF A LIGHTING BOLT INSIDE A CIRCLE AND THE STYLIZED TEXT "ESDEYEGUARD" WITH A SWOOSH AT THE BOTTOM.

SN 85-120,659, FILED 9-1-2010.

GEORGE LORENZO, EXAMINING ATTORNEY



David J. Kybas

Director of the United States Patent and Trademark Office

United States of America

United States Patent and Trademark Office



Reg. No. 4,154,771

Registered June 5, 2012

Int. Cls.: 42 and 44

SERVICE MARK

PRINCIPAL REGISTER

QUINTILES TRANSNATIONAL CORP. (NORTH CAROLINA CORPORATION)
4820 EMPEROR BOULEVARD
DURHAM, NC 27703

FOR: PROVIDING TEMPORARY USE OF WEB-BASED SOFTWARE APPLICATION FOR PROVIDING ACCESS TO INFORMATION AND DATA IN THE PHARMACEUTICAL, PHARMACOGENOMIC, BIOTECHNICAL AND MEDICAL PRODUCTS AND DEVICES, LIFE SCIENCES, MEDICAL, HEALTH CARE, HEALTH MANAGEMENT AND DISEASE MANAGEMENT FIELDS AND FOR ORGANIZING AND ANALYZING SAID DATA AND INFORMATION AND PREPARING REPORTS THEREFROM; PROVIDING INFORMATION RELATING TO THE DEVELOPMENT AND VALIDATION OF DRUGS, PHARMACEUTICAL PRODUCTS, MEDICAL PRODUCTS, MEDICAL DEVICES AND BIOLOGICS; PROVIDING AN INTERNET WEBSITE PORTAL IN THE FIELDS OF PHARMACEUTICAL RESEARCH, PHARMACOGENOMIC CONSULTATION, BIOTECHNOLOGY CONSULTATION, INVESTIGATIONAL MEDICAL PRODUCTS AND DEVICES, LIFE SCIENCES RESEARCH, AND MEDICAL RESEARCH; PROVIDING AN ONLINE SEARCHABLE DATABASE VIA THE INTERNET IN THE FIELDS OF PHARMACEUTICAL RESEARCH, PHARMACOGENOMIC CONSULTATION, BIOTECHNOLOGY CONSULTATION, INVESTIGATIONAL MEDICAL PRODUCTS AND DEVICES, LIFE SCIENCES RESEARCH, AND MEDICAL RESEARCH, IN CLASS 42 (U.S. CLS. 100 AND 101).

FIRST USE 6-13-2011; IN COMMERCE 6-13-2011.



FOR: PROVIDING AN INTERNET WEBSITE PORTAL IN THE FIELDS OF MEDICAL SERVICES, HEALTH CARE, HEALTH MANAGEMENT AND DISEASE MANAGEMENT; PROVIDING AN ONLINE SEARCHABLE DATABASE VIA THE INTERNET IN THE FIELDS OF MEDICAL SERVICES, HEALTH CARE, HEALTH MANAGEMENT AND DISEASE MANAGEMENT; PROVIDING HEALTH MANAGEMENT AND DISEASE MANAGEMENT INFORMATION TO OTHERS, IN CLASS 44 (U.S. CLS. 100 AND 101).

FIRST USE 6-13-2011; IN COMMERCE 6-13-2011.

OWNER OF U.S. REG. NOS. 1,516,618, 3,565,448, AND OTHERS.

THE COLOR(S) PURPLE AND GRAY IS/ARE CLAIMED AS A FEATURE OF THE MARK.

David J. Kyjars

Director of the United States Patent and Trademark Office

Reg. No. 4,154,771 THE MARK CONSISTS OF A DESIGN COMPRISED OF FIVE ROWS OF DIFFERING NUMBERS OF RANDOMLY ORGANIZED SQUARES IN VARYING SHADES OF PURPLE TO THE LEFT OF THE STYLIZED WORD "QUINTILES" IN GRAY STACKED OVER THE DIFFERENTLY STYLIZED CAPITALIZED WORD "INFOSARIO" IN PURPLE IN A LARGER FONT.

THE MARK HAS NO MEANING IN A FOREIGN LANGUAGE.

SN 85-121,017, FILED 9-1-2010.

DAVID HOFFMAN, EXAMINING ATTORNEY

United States of America

United States Patent and Trademark Office

ASPEN TRAIL

Reg. No. 4,154,772

THOR TECH, INC. (NEVADA CORPORATION)
419 WEST PIKE STREET
JACKSON CENTER, OH 45334

Registered June 5, 2012

Int. Cl.: 12

FOR: RECREATIONAL VEHICLES, NAMELY, TRAVEL TRAILERS, IN CLASS 12 (U.S. CLS. 19, 21, 23, 31, 35 AND 44).

TRADEMARK

FIRST USE 0-0-2010; IN COMMERCE 0-0-2010.

PRINCIPAL REGISTER

THE MARK CONSISTS OF STANDARD CHARACTERS WITHOUT CLAIM TO ANY PARTICULAR FONT, STYLE, SIZE, OR COLOR.

SN 85-121,158, FILED 9-1-2010.

JILL C. ALT, EXAMINING ATTORNEY



David J. Kyffers

Director of the United States Patent and Trademark Office

United States of America

United States Patent and Trademark Office

FRANNYONTHEGO

Reg. No. 4,154,773

FRAN M ALBERT (UNITED STATES INDIVIDUAL), AKA FRANCINE ALBERT,
305 WEST 28TH STREET. 9F
NY, NY 10001

Registered June 5, 2012

Int. Cl.: 45

FOR: ONLINE SOCIAL NETWORKING IN THE FIELD OF FOOD, IN CLASS 45 (U.S. CLS. 100 AND 101).

SERVICE MARK

FIRST USE 7-7-2008; IN COMMERCE 7-7-2008.

PRINCIPAL REGISTER

THE MARK CONSISTS OF STANDARD CHARACTERS WITHOUT CLAIM TO ANY PARTICULAR FONT, STYLE, SIZE, OR COLOR.

"FRANNY" IDENTIFIES THE PSEUDONYM OF "FRAN ALBERT", A LIVING INDIVIDUAL WHOSE CONSENT IS OF RECORD.

SN 85-121,466, FILED 9-2-2010.

CHARLES L. JENKINS, EXAMINING ATTORNEY



David J. Kybas

Director of the United States Patent and Trademark Office

United States of America

United States Patent and Trademark Office

PRECISION STRIPAK

Reg. No. 4,154,774

Registered June 5, 2012

Int. Cls.: 1 and 5

TRADEMARK

PRINCIPAL REGISTER

PRECISION LABORATORIES, INC. (ARIZONA CORPORATION)
415 AIRPARK ROAD
COTTONWOOD, AZ 86326

FOR: CHEMICALLY TREATED COLOR INDICATOR TEST STRIPS FOR MONITORING AQUEOUS SOLUTIONS FOR NON-MEDICAL PURPOSES, IN CLASS 1 (U.S. CLS. 1, 5, 6, 10, 26 AND 46).

FIRST USE 6-21-2011; IN COMMERCE 6-21-2011.

FOR: CHEMICALLY TREATED COLOR INDICATOR STRIPS FOR MONITORING AQUEOUS SOLUTIONS FOR MEDICAL PURPOSES, IN CLASS 5 (U.S. CLS. 6, 18, 44, 46, 51 AND 52).

FIRST USE 6-21-2011; IN COMMERCE 6-21-2011.

THE MARK CONSISTS OF STANDARD CHARACTERS WITHOUT CLAIM TO ANY PARTICULAR FONT, STYLE, SIZE, OR COLOR.

SN 85-122,571, FILED 9-3-2010.

JULIE GUTTADAURO, EXAMINING ATTORNEY



David J. Kyffers

Director of the United States Patent and Trademark Office

United States of America

United States Patent and Trademark Office

SHOPPER ACCELERATION

Reg. No. 4,154,775

SHOPPER SCIENTIST LLC (OREGON LIMITED LIABILITY COMPANY)
1015 SE NORTHWAY ROAD
CORBETT, OR 97019

Registered June 5, 2012

Int. Cl.: 35

FOR: BUSINESS CONSULTING AND INFORMATION SERVICES, IN CLASS 35 (U.S. CLS. 100, 101 AND 102).

SERVICE MARK

FIRST USE 2-1-2012; IN COMMERCE 2-1-2012.

PRINCIPAL REGISTER

THE MARK CONSISTS OF STANDARD CHARACTERS WITHOUT CLAIM TO ANY PARTICULAR FONT, STYLE, SIZE, OR COLOR.

SN 85-123,155, FILED 9-3-2010.

HELENE LIWINSKI, EXAMINING ATTORNEY



David J. Kyffers

Director of the United States Patent and Trademark Office

United States of America

United States Patent and Trademark Office

SHOOTING STARS PORTRAIT STUDIO

Reg. No. 4,154,776

CONSUMER PROGRAMS INCORPORATED (MISSOURI CORPORATION)
1706 WASHINGTON AVE.
ST. LOUIS, MO 63101

Registered June 5, 2012

Int. Cls.: 40 and 41

FOR: PHOTOGRAPHIC SERVICES, NAMELY, PHOTOGRAPHIC ENLARGING, IN CLASS 40 (U.S. CLS. 100, 103 AND 106).

SERVICE MARK

FIRST USE 8-12-2008; IN COMMERCE 8-12-2008.

PRINCIPAL REGISTER

FOR: PORTRAIT PHOTOGRAPHY, PHOTOGRAPHIC SERVICES, NAMELY, PHOTOGRAPHIC CAPTURE, IN CLASS 41 (U.S. CLS. 100, 101 AND 107).

FIRST USE 8-12-2008; IN COMMERCE 8-12-2008.

THE MARK CONSISTS OF STANDARD CHARACTERS WITHOUT CLAIM TO ANY PARTICULAR FONT, STYLE, SIZE, OR COLOR.

NO CLAIM IS MADE TO THE EXCLUSIVE RIGHT TO USE "PORTRAIT STUDIO", APART FROM THE MARK AS SHOWN.

SN 85-123,160, FILED 9-3-2010.

COLLEEN DOMBROW, EXAMINING ATTORNEY



David J. Kyros

Director of the United States Patent and Trademark Office

United States of America

United States Patent and Trademark Office

HIGH GROUND

Reg. No. 4,154,777

EHMKE MANUFACTURING, INC. (PENNSYLVANIA CORPORATION)
4200 MACALESTER STREET
PHILADELPHIA, PA 19124

Registered June 5, 2012

Int. Cls.: 5, 9, and 13

FOR: MEDICAL SUPPLY PACKS AND POUCHES COMPRISED OF FIRST-AID KITS, IN CLASS 5 (U.S. CLS. 6, 18, 44, 46, 51 AND 52).

TRADEMARK

FIRST USE 11-15-2010; IN COMMERCE 11-15-2010.

PRINCIPAL REGISTER

FOR: BAGS, CASES AND POUCHES FOR STORING AND CARRYING PORTABLE ELECTRONICS, NAMELY, PERSONAL DIGITAL ASSISTANTS (PDAS), RADIOS, CELL PHONES, COMMUNICATIONS EQUIPMENT, COMPUTERS, CAMERAS, CAMERA EQUIPMENT, GPS NAVIGATION EQUIPMENT; BODY ARMOR PLATE CARRIERS FOR MILITARY AND LAW ENFORCEMENT OPERATIONS, NAMELY, CARRIER VESTS, HARNESES AND WAIST-BELTS; BODY ARMOR PLATES; ARMOUR-BEARING VESTS, IN CLASS 9 (U.S. CLS. 21, 23, 26, 36 AND 38).

FIRST USE 11-15-2010; IN COMMERCE 11-15-2010.

FOR: MILITARY AND LAW ENFORCEMENT TACTICAL OPERATIONS ACCESSORIES, NAMELY, BELTS, VESTS AND HARNESES USED FOR CARRYING TACTICAL EQUIPMENT, NAMELY, AMMUNITION; WEAPONRY, AMMUNITION, MUNITIONS; TACTICAL EQUIPMENT POUCHES, NAMELY, MAGAZINE POUCHES, GRENADE POUCHES, RIFLE SHELL POUCHES, CARTRIDGE POUCHES; BATON POUCHES, POUCHES FOR WEAPONRY; WEAPON RETENTION SYSTEMS, NAMELY, HOLSTERS; TACTICAL GEAR, NAMELY, RUCKSACKS, POUCHES, AND FIELD BAGS USED FOR CARRYING MILITARY AND FIELD EQUIPMENT, NAMELY, AMMUNITION; POUCHES USED FOR CARRYING AMMUNITION, MUNITIONS, AND WEAPONRY; TACTICAL GEAR, NAMELY, CARRIER VESTS, LOAD-BEARING VESTS, AND LOAD-BEARING WAIST BELTS USED FOR CARRYING ATTACHABLE AMMUNITION BAGS AND POUCHES, IN CLASS 13 (U.S. CLS. 2 AND 9).

FIRST USE 11-15-2010; IN COMMERCE 11-15-2010.

THE MARK CONSISTS OF STANDARD CHARACTERS WITHOUT CLAIM TO ANY PARTICULAR FONT, STYLE, SIZE, OR COLOR.



David J. Kybas

Director of the United States Patent and Trademark Office

Reg. No. 4,154,777 SN 85-123,751, FILED 9-7-2010.

LEIGH CAROLINE CASE, EXAMINING ATTORNEY

United States of America

United States Patent and Trademark Office

Cuff It

Reg. No. 4,154,778

Registered June 5, 2012

Int. Cl.: 26

TRADEMARK

PRINCIPAL REGISTER

HENNESSY, MOLLY DUGAN (UNITED STATES INDIVIDUAL)
3040 PIEDMONT ROAD NE
ATLANTA, GA 30305

FOR: PANTS ACCESSORIES COMPRISED OF SOFT BLEND MATERIALS, NAMELY, PANTS BANDS AND PANTS CLIPS FOR SECURING PANT LEGS TO WEARERS' LEGS, IN CLASS 26 (U.S. CLS. 37, 39, 40, 42 AND 50).

FIRST USE 10-16-2010; IN COMMERCE 10-16-2010.

THE MARK CONSISTS OF STANDARD CHARACTERS WITHOUT CLAIM TO ANY PARTICULAR FONT, STYLE, SIZE, OR COLOR.

SN 85-125,232, FILED 9-8-2010.

ANTHONY RINKER, EXAMINING ATTORNEY



David J. Kybas

Director of the United States Patent and Trademark Office

United States of America

United States Patent and Trademark Office

Cuff It Sportz

Reg. No. 4,154,779

HENNESSY, MOLLY DUGAN (UNITED STATES INDIVIDUAL)
3040 PIEDMONT ROAD NE
ATLANTA, GA 30305

Registered June 5, 2012

Int. Cl.: 26

FOR: PANTS ACCESSORIES COMPRISED OF SOFT BLEND MATERIALS, NAMELY, PANTS BANDS AND PANTS CLIPS FOR SECURING PANT LEGS TO WEARERS' LEGS, IN CLASS 26 (U.S. CLS. 37, 39, 40, 42 AND 50).

TRADEMARK

FIRST USE 10-16-2010; IN COMMERCE 10-16-2010.

PRINCIPAL REGISTER

THE MARK CONSISTS OF STANDARD CHARACTERS WITHOUT CLAIM TO ANY PARTICULAR FONT, STYLE, SIZE, OR COLOR.

NO CLAIM IS MADE TO THE EXCLUSIVE RIGHT TO USE "SPORTS", APART FROM THE MARK AS SHOWN.

SN 85-125,261, FILED 9-8-2010.

ANTHONY RINKER, EXAMINING ATTORNEY



David J. Kybas

Director of the United States Patent and Trademark Office

United States of America

United States Patent and Trademark Office

Cuff It Kidz

Reg. No. 4,154,780

Registered June 5, 2012

Int. Cl.: 26

TRADEMARK

PRINCIPAL REGISTER

HENNESSY, MOLLY DUGAN (UNITED STATES INDIVIDUAL)
3040 PIEDMONT ROAD NE
ATLANTA, GA 30305

FOR: PANTS ACCESSORIES COMPRISED OF SOFT BLEND MATERIALS, NAMELY, PANTS BANDS AND PANTS CLIPS FOR SECURING PANT LEGS TO WEARERS' LEGS, IN CLASS 26 (U.S. CLS. 37, 39, 40, 42 AND 50).

FIRST USE 10-16-2010; IN COMMERCE 10-16-2010.

THE MARK CONSISTS OF STANDARD CHARACTERS WITHOUT CLAIM TO ANY PARTICULAR FONT, STYLE, SIZE, OR COLOR.

NO CLAIM IS MADE TO THE EXCLUSIVE RIGHT TO USE "KIDS", APART FROM THE MARK AS SHOWN.

SN 85-125,275, FILED 9-8-2010.

ANTHONY RINKER, EXAMINING ATTORNEY



David J. Kyffers

Director of the United States Patent and Trademark Office

United States of America

United States Patent and Trademark Office

TURTLE STEEL BUILDINGS

Reg. No. 4,154,781

Registered June 5, 2012

Int. Cl.: 6

TRADEMARK

PRINCIPAL REGISTER

ARLINGTON STEEL BUILDINGS COMPANY LLC (DELAWARE LIMITED LIABILITY COMPANY)
1521 CONCORD PIKE, SUITE 301
WILMINGTON, DE 19803

FOR: PREFABRICATED AND PRE-ENGINEERED STEEL BUILDINGS, IN CLASS 6 (U.S. CLS. 2, 12, 13, 14, 23, 25 AND 50).

FIRST USE 3-15-2012; IN COMMERCE 3-15-2012.

THE MARK CONSISTS OF STANDARD CHARACTERS WITHOUT CLAIM TO ANY PARTICULAR FONT, STYLE, SIZE, OR COLOR.

NO CLAIM IS MADE TO THE EXCLUSIVE RIGHT TO USE "STEEL BUILDINGS", APART FROM THE MARK AS SHOWN.

SN 85-125,978, FILED 9-9-2010.

NAKIA HENRY, EXAMINING ATTORNEY



David J. Kyffers

Director of the United States Patent and Trademark Office

United States of America

United States Patent and Trademark Office

DIP 'EM LOVE 'EM

Reg. No. 4,154,782

Registered June 5, 2012

Int. Cl.: 30

TRADEMARK

PRINCIPAL REGISTER

THE KROGER CO. OF MICHIGAN (MICHIGAN CORPORATION)
40399 GRAND RIVER AVENUE
NOVI, MI 48375

FOR: COOKIES, IN CLASS 30 (U.S. CL. 46).

FIRST USE 2-6-2012; IN COMMERCE 2-6-2012.

THE MARK CONSISTS OF STANDARD CHARACTERS WITHOUT CLAIM TO ANY PARTICULAR FONT, STYLE, SIZE, OR COLOR.

SN 85-126,353, FILED 9-9-2010.

SOPHIA S. KIM, EXAMINING ATTORNEY



David J. Kybas

Director of the United States Patent and Trademark Office

United States of America

United States Patent and Trademark Office

NOURISHINE PLUS

Reg. No. 4,154,783

Registered June 5, 2012

Int. Cl.: 3

TRADEMARK

PRINCIPAL REGISTER

MARY KAY INC. (DELAWARE CORPORATION)
11 TMKB
16251 DALLAS PARKWAY
ADDISON, TX 75001

FOR: COSMETICS, IN CLASS 3 (U.S. CLS. 1, 4, 6, 50, 51 AND 52).

FIRST USE 11-26-2011; IN COMMERCE 11-26-2011.

THE MARK CONSISTS OF STANDARD CHARACTERS WITHOUT CLAIM TO ANY PARTICULAR FONT, STYLE, SIZE, OR COLOR.

OWNER OF U.S. REG. NO. 3,406,988.

SN 85-126,729, FILED 9-10-2010.

AMY KELLY, EXAMINING ATTORNEY



David J. Kyffers

Director of the United States Patent and Trademark Office

United States of America

United States Patent and Trademark Office

QUICKCLEAN

Reg. No. 4,154,784

Registered June 5, 2012

Int. Cl.: 11

TRADEMARK

PRINCIPAL REGISTER

BSH HOME APPLIANCES CORPORATION (DELAWARE CORPORATION)
5551 MCFADDEN AVENUE
HUNTINGTON BEACH, CA 92649

FOR: DOMESTIC COOKING OVEN TOP BASES, ELECTRIC RANGE TOP BASES, GAS RANGE TOP BASES, ELECTRIC COOK TOP BASES, AND GAS COOK TOP BASES, SOLD AS COMPONENTS OF HOUSEHOLD AND KITCHEN MACHINES AND EQUIPMENT, NAMELY, DOMESTIC COOKING OVENS, ELECTRIC AND GAS RANGES, AND ELECTRIC AND GAS COOK TOPS, IN CLASS 11 (U.S. CLS. 13, 21, 23, 31 AND 34).

FIRST USE 8-15-2011; IN COMMERCE 8-15-2011.

THE MARK CONSISTS OF STANDARD CHARACTERS WITHOUT CLAIM TO ANY PARTICULAR FONT, STYLE, SIZE, OR COLOR.

SN 85-126,884, FILED 9-10-2010.

EDWARD FENNESSY, EXAMINING ATTORNEY



David J. Kybas

Director of the United States Patent and Trademark Office

United States of America

United States Patent and Trademark Office

QUICKCLEAN BASE

Reg. No. 4,154,785

Registered June 5, 2012

Int. Cl.: 11

TRADEMARK

PRINCIPAL REGISTER

BSH HOME APPLIANCES CORPORATION (DELAWARE CORPORATION)
5551 MCFADDEN AVENUE
HUNTINGTON BEACH, CA 92649

FOR: DOMESTIC COOKING OVEN TOP BASES, ELECTRIC RANGE TOP BASES, GAS RANGE TOP BASES, ELECTRIC COOK TOP BASES, AND GAS COOK TOP BASES, SOLD AS COMPONENTS OF HOUSEHOLD AND KITCHEN MACHINES AND EQUIPMENT, NAMELY, DOMESTIC COOKING OVENS, ELECTRIC AND GAS RANGES, AND ELECTRIC AND GAS COOK TOPS, IN CLASS 11 (U.S. CLS. 13, 21, 23, 31 AND 34).

FIRST USE 8-15-2011; IN COMMERCE 8-15-2011.

THE MARK CONSISTS OF STANDARD CHARACTERS WITHOUT CLAIM TO ANY PARTICULAR FONT, STYLE, SIZE, OR COLOR.

NO CLAIM IS MADE TO THE EXCLUSIVE RIGHT TO USE "BASE", APART FROM THE MARK AS SHOWN.

SN 85-126,899, FILED 9-10-2010.

EDWARD FENNESSY, EXAMINING ATTORNEY



David J. Kyffers

Director of the United States Patent and Trademark Office

United States of America

United States Patent and Trademark Office



Reg. No. 4,154,786

Registered June 5, 2012

Int. Cls.: 21 and 25

TRADEMARK

PRINCIPAL REGISTER

CREATIVE DISTINCTIONS, LLC (FLORIDA LIMITED LIABILITY COMPANY)
6910 N.W. 12TH STREET
MIAMI, FL 33126

FOR: MUGS, IN CLASS 21 (U.S. CLS. 2, 13, 23, 29, 30, 33, 40 AND 50).

FIRST USE 11-7-2011; IN COMMERCE 11-7-2011.

FOR: CLOTHING, NAMELY, T-SHIRTS, CAPS, IN CLASS 25 (U.S. CLS. 22 AND 39).

FIRST USE 11-7-2011; IN COMMERCE 11-7-2011.

NO CLAIM IS MADE TO THE EXCLUSIVE RIGHT TO USE "MIAMI", APART FROM THE MARK AS SHOWN.

THE MARK CONSISTS OF A HEART SHAPE DESIGN LOCATED ABOVE THE STYLIZED WORD "MIAMI", BOTH SET AGAINST A CIRCULAR BACKGROUND.

SN 85-127,039, FILED 9-10-2010.

TINA L. SNAPP, EXAMINING ATTORNEY



David J. Kybas

Director of the United States Patent and Trademark Office

United States of America

United States Patent and Trademark Office

Brooklyn Prince

Reg. No. 4,154,787

Registered June 5, 2012

Int. Cl.: 9

TRADEMARK

PRINCIPAL REGISTER

UMEGASTAR (NEW YORK CORPORATION)
16 BRONXVILLE GLEN DR. #3-18
BRONXVILLE, NY 10708

FOR: DOWNLOADABLE MUSICAL SOUND RECORDINGS; MUSICAL SOUND RECORDINGS; VIDEO RECORDINGS FEATURING MUSIC, IN CLASS 9 (U.S. CLS. 21, 23, 26, 36 AND 38).

FIRST USE 1-7-2011; IN COMMERCE 3-1-2011.

THE MARK CONSISTS OF STANDARD CHARACTERS WITHOUT CLAIM TO ANY PARTICULAR FONT, STYLE, SIZE, OR COLOR.

NO CLAIM IS MADE TO THE EXCLUSIVE RIGHT TO USE "BROOKLYN", APART FROM THE MARK AS SHOWN.

SN 85-127,345, FILED 9-10-2010.

ROBERT C. CLARK JR., EXAMINING ATTORNEY



David J. Kyffers

Director of the United States Patent and Trademark Office

United States of America

United States Patent and Trademark Office



Reg. No. 4,154,788

EASY-SIT, INC. (WYOMING CORPORATION)
P. O. BOX 2403
CHEYENNE, WY 82003

Registered June 5, 2012

Int. Cl.: 20

FOR: SEATING DEVICE IN THE NATURE OF A STRAP, IN CLASS 20 (U.S. CLS. 2, 13, 22, 25, 32 AND 50).

TRADEMARK

FIRST USE 3-7-2012; IN COMMERCE 3-7-2012.

PRINCIPAL REGISTER

THE MARK CONSISTS OF THE WORD "SWEETSPOT" IN WHITE, STYLIZED SERIF TYPE WITH THE LETTER "O" APPEARING IN PINK AND THE COLOR BLACK APPEARING AS BACKGROUND.

THE COLOR(S) WHITE, BLACK, AND PINK IS/ARE CLAIMED AS A FEATURE OF THE MARK.

SN 85-127,579, FILED 9-11-2010.

YAT SYE, LEE, EXAMINING ATTORNEY



David J. Kybas

Director of the United States Patent and Trademark Office

United States of America

United States Patent and Trademark Office

DEADSTORM PIRATES

Reg. No. 4,154,789

NAMCO BANDAI GAMES INC. (JAPAN CORPORATION)
4-5-15 HIGASHI SHINAGAWA
SHINAGAWA-KU TOKYO, JAPAN 140-8590

Registered June 5, 2012

Int. Cl.: 28

FOR: COIN-OPERATED AMUSEMENT MACHINES, IN CLASS 28 (U.S. CLS. 22, 23, 38 AND 50).

TRADEMARK

FIRST USE 5-24-2010; IN COMMERCE 5-24-2010.

PRINCIPAL REGISTER

THE MARK CONSISTS OF STANDARD CHARACTERS WITHOUT CLAIM TO ANY PARTICULAR FONT, STYLE, SIZE, OR COLOR.

NO CLAIM IS MADE TO THE EXCLUSIVE RIGHT TO USE "PIRATES", APART FROM THE MARK AS SHOWN.

SN 85-129,317, FILED 9-14-2010.

EDWARD FENNESSY, EXAMINING ATTORNEY



David J. Kyros

Director of the United States Patent and Trademark Office

United States of America

United States Patent and Trademark Office



Reg. No. 4,154,790

Registered June 5, 2012

Int. Cls.: 13 and 42

TRADEMARK

SERVICE MARK

PRINCIPAL REGISTER

GT VIRTUAL CONCEPTS LLC (GEORGIA LIMITED LIABILITY COMPANY)
PO BOX 72622
NEWNAN, GA 30271

FOR: FIREARMS AND PARTS THEREOF, IN CLASS 13 (U.S. CLS. 2 AND 9).

FIRST USE 4-1-2012; IN COMMERCE 4-1-2012.

FOR: PROTOTYPING SERVICES, NAMELY, NEW PRODUCT DESIGN SERVICES FEATURING MEDICAL DEVICES AND PARTS THEREOF, FIREARMS AND PARTS THEREOF, PLASTIC PARTS, AND PRECISION PARTS, IN CLASS 42 (U.S. CLS. 100 AND 101).

FIRST USE 4-1-2012; IN COMMERCE 4-1-2012.

THE MARK CONSISTS OF THE STYLIZED LETTERS "G", "T", AND "V" ENCLOSED IN A LETTER "C".

SN 85-129,544, FILED 9-14-2010.

KIM MONINGHOFF, EXAMINING ATTORNEY



David J. Kybas

Director of the United States Patent and Trademark Office

United States of America

United States Patent and Trademark Office

JILL JOANNE

Reg. No. 4,154,791

JILL JOANNE, LLC (CALIFORNIA LIMITED LIABILITY COMPANY)
21163 NEWPORT COAST DR, STE 456
NEWPORT COAST, CA 92657

Registered June 5, 2012

Int. Cl.: 18

FOR: PURSES AND HANDBAGS MADE OF LEATHER AND CLOTH, IN CLASS 18 (U.S. CLS. 1, 2, 3, 22 AND 41).

TRADEMARK

FIRST USE 6-10-2010; IN COMMERCE 3-17-2012.

PRINCIPAL REGISTER

THE MARK CONSISTS OF STANDARD CHARACTERS WITHOUT CLAIM TO ANY PARTICULAR FONT, STYLE, SIZE, OR COLOR.

THE NAME(S), PORTRAIT(S), AND/OR SIGNATURE(S) SHOWN IN THE MARK IDENTIFIES "JILL HANKEY", WHOSE CONSENT(S) TO REGISTER IS MADE OF RECORD.

SN 85-129,754, FILED 9-15-2010.

STEVEN R. FINE, EXAMINING ATTORNEY



David J. Kybas

Director of the United States Patent and Trademark Office

United States of America

United States Patent and Trademark Office

AT&T UC CENTRAL

Reg. No. 4,154,792

Registered June 5, 2012

Int. Cl.: 38

SERVICE MARK

PRINCIPAL REGISTER

AT&T INTELLECTUAL PROPERTY II, L.P. (NEVADA LIMITED PARTNERSHIP)
645 EAST PLUMB LANE
RENO, NV 89502

FOR: TELECOMMUNICATIONS SERVICES, NAMELY, TRANSMISSION OF VOICE AND AUDIO BY MEANS OF TELECOMMUNICATIONS NETWORKS, WIRELESS COMMUNICATION NETWORKS, AND THE INTERNET; PROVIDING INSTANT MESSAGING, EMAIL, WEB CONFERENCING, TELECONFERENCING AND VIDEO TELECONFERENCING SERVICES, IN CLASS 38 (U.S. CLS. 100, 101 AND 104).

FIRST USE 1-26-2012; IN COMMERCE 1-26-2012.

THE MARK CONSISTS OF STANDARD CHARACTERS WITHOUT CLAIM TO ANY PARTICULAR FONT, STYLE, SIZE, OR COLOR.

OWNER OF U.S. REG. NOS. 1,296,936, 1,970,579, AND OTHERS.

NO CLAIM IS MADE TO THE EXCLUSIVE RIGHT TO USE "UC", APART FROM THE MARK AS SHOWN.

SN 85-129,806, FILED 9-15-2010.

JESSICA FATHY, EXAMINING ATTORNEY



David J. Kyffers

Director of the United States Patent and Trademark Office

United States of America

United States Patent and Trademark Office

Better Days _ Better Prospects

Reg. No. 4,154,793

Registered June 5, 2012

Int. Cl.: 45

SERVICE MARK

PRINCIPAL REGISTER

LANDRY, ROBIN (UNITED STATES INDIVIDUAL)
6905 BRENTWOOD DRIVE
UPPER MARLBORO, MD 20772

FOR: PROFESSIONAL RESUME PREPARATION SERVICES, NAMELY, PROVIDING PREPARATION OF PROFESSIONAL RESUMES, COVER LETTERS, LETTERS OF RECOMMENDATION, IN CLASS 45 (U.S. CLS. 100 AND 101).

FIRST USE 3-1-2012; IN COMMERCE 3-1-2012.

THE MARK CONSISTS OF STANDARD CHARACTERS WITHOUT CLAIM TO ANY PARTICULAR FONT, STYLE, SIZE, OR COLOR.

SN 85-130,144, FILED 9-15-2010.

JENNIFER DIXON, EXAMINING ATTORNEY



David J. Kybas

Director of the United States Patent and Trademark Office

United States of America

United States Patent and Trademark Office

DeoBoost

Reg. No. 4,154,794

ARYLESSENCE, INC. (GEORGIA CORPORATION)
1091 LAKE DRIVE
MARIETTA, GA 30066

Registered June 5, 2012

Int. Cl.: 1

FOR: DEODORIZING AND FRAGRANCING CHEMICAL ADDITIVES FOR USE IN THE MANUFACTURING OF HOUSEHOLD, AIR CARE, PERSONAL, INDUSTRIAL, INSTITUTIONAL, AGRICULTURAL AND CONSUMER PRODUCTS, IN CLASS 1 (U.S. CLS. 1, 5, 6, 10, 26 AND 46).

TRADEMARK

PRINCIPAL REGISTER

FIRST USE 10-12-2011; IN COMMERCE 10-12-2011.

THE MARK CONSISTS OF STANDARD CHARACTERS WITHOUT CLAIM TO ANY PARTICULAR FONT, STYLE, SIZE, OR COLOR.

SN 85-131,853, FILED 9-17-2010.

BRENDAN MCCAULEY, EXAMINING ATTORNEY



David J. Kybas

Director of the United States Patent and Trademark Office

United States of America

United States Patent and Trademark Office

COMPTROL

Reg. No. 4,154,795

Registered June 5, 2012

Int. Cls.: 36 and 42

SERVICE MARK

PRINCIPAL REGISTER

OSBORNE PROPERTIES LIMITED PARTNERSHIP (MINNESOTA LIMITED PARTNERSHIP),
DBA KRAUS-ANDERSON INSURANCE,
420 GATEWAY BOULEVARD
BURNSVILLE, MN 55337

FOR: MANAGING WORKERS' COMPENSATION INSURANCE CLAIMS FOR OTHERS;
CONSULTING IN THE FIELD OF WORKERS' COMPENSATION INSURANCE CLAIMS, IN
CLASS 36 (U.S. CLS. 100, 101 AND 102).

FIRST USE 10-31-2009; IN COMMERCE 10-31-2009.

FOR: PROVIDING TEMPORARY USE OF ON-LINE, NON-DOWNLOADABLE SOFTWARE
FOR COLLECTING, ORGANIZING AND ANALYZING WORKERS' COMPENSATION AND
WORKPLACE SAFETY DATA, IN CLASS 42 (U.S. CLS. 100 AND 101).

FIRST USE 10-31-2009; IN COMMERCE 10-31-2009.

THE MARK CONSISTS OF STANDARD CHARACTERS WITHOUT CLAIM TO ANY PAR-
TICULAR FONT, STYLE, SIZE, OR COLOR.

SN 85-132,333, FILED 9-17-2010.

JOHN KELLY, EXAMINING ATTORNEY



David J. Kyros

Director of the United States Patent and Trademark Office

United States of America

United States Patent and Trademark Office

COMPTROL ZERO

Reg. No. 4,154,796

Registered June 5, 2012

Int. Cls.: 36, 41, and 45

SERVICE MARK

PRINCIPAL REGISTER

OSBORNE PROPERTIES LIMITED PARTNERSHIP (MINNESOTA LIMITED PARTNERSHIP),
DBA KRAUS-ANDERSON INSURANCE,
420 GATEWAY BOULEVARD
BURNSVILLE, MN 55337

FOR: INSURANCE CONSULTING IN THE FIELD OF LOSS PREVENTION, IN CLASS 36
(U.S. CLS. 100, 101 AND 102).

FIRST USE 10-31-2009; IN COMMERCE 10-31-2009.

FOR: EDUCATIONAL SERVICES, NAMELY, CONDUCTING WORKPLACE SAFETY
TRAINING, IN CLASS 41 (U.S. CLS. 100, 101 AND 107).

FIRST USE 10-31-2009; IN COMMERCE 10-31-2009.

FOR: CONSULTING IN THE FIELD OF WORKPLACE SAFETY; CONSULTING IN THE
FIELD OF WORKPLACE SAFETY ABOUT WORKPLACE CONDITIONS THAT IMPACT
THE HEALTH AND SAFETY OF EMPLOYEES; REGULATORY COMPLIANCE CONSULTING
IN THE FIELDS OF EMPLOYEE HEALTH AND SAFETY AND WORKPLACE SAFETY;
CONDUCTING WORKPLACE SAFETY INSPECTION AUDITS, IN CLASS 45 (U.S. CLS. 100
AND 101).

FIRST USE 10-31-2009; IN COMMERCE 10-31-2009.

THE MARK CONSISTS OF STANDARD CHARACTERS WITHOUT CLAIM TO ANY PAR-
TICULAR FONT, STYLE, SIZE, OR COLOR.

SN 85-132,367, FILED 9-17-2010.

JOHN KELLY, EXAMINING ATTORNEY



David J. Kyros

Director of the United States Patent and Trademark Office

United States of America

United States Patent and Trademark Office

GLASS WORLD

Reg. No. 4,154,797

Registered June 5, 2012

Int. Cl.: 21

TRADEMARK

PRINCIPAL REGISTER

BRAINSTORMPRODUCTS, LLC (CALIFORNIA LIMITED LIABILITY COMPANY)
SUITE 305
C/O BUCHE AND ASSOCIATES, P.C.
LA JOLLA, CA 92037

FOR: FIGURINES OF GLASS, IN CLASS 21 (U.S. CLS. 2, 13, 23, 29, 30, 33, 40 AND 50).

FIRST USE 3-31-2011; IN COMMERCE 3-31-2011.

THE MARK CONSISTS OF STANDARD CHARACTERS WITHOUT CLAIM TO ANY PARTICULAR FONT, STYLE, SIZE, OR COLOR.

NO CLAIM IS MADE TO THE EXCLUSIVE RIGHT TO USE "GLASS", APART FROM THE MARK AS SHOWN.

SN 85-132,635, FILED 9-17-2010.

BARBARA BROWN, EXAMINING ATTORNEY



David J. Kyffers

Director of the United States Patent and Trademark Office

United States of America

United States Patent and Trademark Office



Reg. No. 4,154,798

Registered June 5, 2012

Int. Cls.: 9, 16, 42, and 45

TRADEMARK

SERVICE MARK

PRINCIPAL REGISTER

U.S. DEPARTMENT OF HEALTH AND HUMAN SERVICES (UNITED STATES AGENCY OF THE UNITED STATES GOVERNMENT)

BLDG 31 RM 2B-50
31 CENTER DRIVE
BETHESDA, MD 20892

FOR: PRE-RECORDED DVDS, CDS, AND DOWNLOADABLE ELECTRONIC MEDIA, NAMELY, E-NEWSLETTERS AND FACT SHEETS FEATURING INFORMATION ON THE SUBJECT OF REDUCING WORKPLACE INJURIES, ILLNESS, AND FATALITIES AND THE TRANSFER AND TRANSLATION OF KNOWLEDGE, INTERVENTIONS, AND TECHNOLOGIES DESIGNED TO REDUCE WORKPLACE INJURIES, ILLNESS, AND FATALITIES, IN CLASS 9 (U.S. CLS. 21, 23, 26, 36 AND 38).

FIRST USE 10-0-2010; IN COMMERCE 10-0-2010.

FOR: PRINTED MATERIALS, NAMELY, A SERIES OF SCIENTIFIC ARTICLES, AND BROCHURES, AND POSTERS FEATURING INFORMATION ON THE SUBJECT OF OCCUPATIONAL SAFETY AND HEALTH RESEARCH AND REDUCTION OF WORKPLACE INJURIES, ILLNESS, AND FATALITIES, AND THE TRANSFER AND TRANSLATION OF KNOWLEDGE, INTERVENTIONS, AND TECHNOLOGIES DESIGNED TO REDUCE WORKPLACE INJURIES, ILLNESS, AND FATALITIES, IN CLASS 16 (U.S. CLS. 2, 5, 22, 23, 29, 37, 38 AND 50).

FIRST USE 7-0-2011; IN COMMERCE 7-0-2011.

FOR: RESEARCH ON OCCUPATIONAL SAFETY AND HEALTH AND THE REDUCTION OF WORKPLACE INJURIES, ILLNESS, AND FATALITIES; PROVIDING A WEBSITE FEATURING INFORMATION ABOUT COMPUTER TECHNOLOGIES DESIGNED TO REDUCE WORKPLACE INJURIES, ILLNESS AND FATALITIES, IN CLASS 42 (U.S. CLS. 100 AND 101).

FIRST USE 5-0-2011; IN COMMERCE 5-0-2011.

FOR: PROVIDING A WEBSITE FEATURING INFORMATION ON WORKPLACE SAFETY, NAMELY, THE INTERPERSONAL COMMUNICATIONS REQUIRED TO TRANSFER AND TRANSLATE KNOWLEDGE BETWEEN INDIVIDUALS AND ADVICE CONCERNING IN-



David J. Kyjars

Director of the United States Patent and Trademark Office

Reg. No. 4,154,798 TERVERTIONS, DESIGNED TO REDUCE WORKPLACE INJURIES, ILLNESS, AND FATALITIES, IN CLASS 45 (U.S. CLS. 100 AND 101).

FIRST USE 9-0-2010; IN COMMERCE 9-0-2010.

THE MARK CONSISTS OF A STYLIZED LOWER CASE "R" CONNECTING TO A LOWER CASE "P" WITH THE NUMBER "2" PRESENTED UNDER THE CURVED PORTION OF THE LETTER "R". BOTH THE "R" AND "P" ARE SHADED WHILE THE "2" IS OUTLINED WITH A PLAIN SINGLE LINE AND UNSHADED.

SN 85-133,255, FILED 9-20-2010.

RENEE SERVANCE, EXAMINING ATTORNEY

United States of America

United States Patent and Trademark Office

PRIMELOCK

Reg. No. 4,154,799

Registered June 5, 2012

Int. Cl.: 17

TRADEMARK

PRINCIPAL REGISTER

ENTEGRIS, INC. (DELAWARE CORPORATION)
129 CONCORD ROAD
BILLERICA, MA 018214600

FOR: FLUOROPOLYMER PLASTIC FITTING FOR THE ATTACHMENT TO PLASTIC TUBING AND PIPE FOR USE IN LABORATORIES AND INDUSTRIAL INSTALLATIONS REQUIRING CHEMICAL RESISTANCE TO AND PURITY OF CONVEYED LIQUIDS, IN CLASS 17 (U.S. CLS. 1, 5, 12, 13, 35 AND 50).

FIRST USE 5-31-2011; IN COMMERCE 5-31-2011.

THE MARK CONSISTS OF STANDARD CHARACTERS WITHOUT CLAIM TO ANY PARTICULAR FONT, STYLE, SIZE, OR COLOR.

SN 85-134,390, FILED 9-21-2010.

YAT SYE, LEE, EXAMINING ATTORNEY



David J. Kybas

Director of the United States Patent and Trademark Office

United States of America

United States Patent and Trademark Office

WINDO

Reg. No. 4,154,800

Registered June 5, 2012

Int. Cl.: 9

TRADEMARK

PRINCIPAL REGISTER

EFI GLOBAL, INC. (DELAWARE CORPORATION)
8811 FM 1960 BYPASS ROAD WEST, SUITE 400
HUMBLE, TX 77338

FOR: MICROMETER GAUGE FOR MEASURING PLANAR SURFACES, IN CLASS 9 (U.S. CLS. 21, 23, 26, 36 AND 38).

FIRST USE 9-0-2009; IN COMMERCE 9-0-2009.

THE MARK CONSISTS OF STANDARD CHARACTERS WITHOUT CLAIM TO ANY PARTICULAR FONT, STYLE, SIZE, OR COLOR.

SN 85-134,644, FILED 9-21-2010.

AMY KELLY, EXAMINING ATTORNEY



David J. Kybas

Director of the United States Patent and Trademark Office

United States of America

United States Patent and Trademark Office

•C•H•A•K•R•A•
by karim rashid

Reg. No. 4,154,801

Registered June 5, 2012

Int. Cl.: 20

TRADEMARK

PRINCIPAL REGISTER

RAYNOR MARKETING LTD. (NEW YORK CORPORATION), DBA THE RAYNOR GROUP,
525 HEMPSTEAD TURNPIKE
WEST HEMPSTEAD, NY 11552

FOR: CHAIRS; OFFICE CHAIRS; SEAT CUSHIONS; SEATING FURNITURE, IN CLASS 20
(U.S. CLS. 2, 13, 22, 25, 32 AND 50).

FIRST USE 1-23-2012; IN COMMERCE 1-23-2012.

THE NAME(S), PORTRAIT(S), AND/OR SIGNATURE(S) SHOWN IN THE MARK IDENTIFIES
"KARIM RASHID", WHOSE CONSENT(S) TO REGISTER IS MADE OF RECORD.

THE MARK CONSISTS OF THE STYLIZED WORD "CHAKRA" WITH A SHADED-IN CIRCLE
CENTERED BEFORE AND AFTER EACH LETTER IN THE WORD AND THE WORDING
"BY KARIM RASHID" DIRECTLY BELOW THE TERM "CHAKRA".

SN 85-135,549, FILED 9-22-2010.

ASMAT KHAN, EXAMINING ATTORNEY



David J. Kybas

Director of the United States Patent and Trademark Office

United States of America

United States Patent and Trademark Office



Reg. No. 4,154,802

Registered June 5, 2012

Int. Cl.: 44

SERVICE MARK

PRINCIPAL REGISTER

DR. G'S FRANCHISING COMPANIES, LLC. (FLORIDA LIMITED LIABILITY COMPANY)
SUITE 800
4380 OAKES ROAD
DAVIE, FL 333142239 AND

JDJ OF MIAMI, INC. (FLORIDA CORPORATION)
SUITE 590
21097 N. E. 27 COURT
AVENTURA, FL 331801246

FOR: MEDICAL CLINICS FEATURING WEIGHT LOSS SOLUTIONS, SERVICES AND PROGRAMS, IN CLASS 44 (U.S. CLS. 100 AND 101).

FIRST USE 8-31-2010; IN COMMERCE 8-31-2010.

NO CLAIM IS MADE TO THE EXCLUSIVE RIGHT TO USE "WEIGHT LOSS & WELLNESS", APART FROM THE MARK AS SHOWN.

THE NAME(S), PORTRAIT(S), AND/OR SIGNATURE(S) SHOWN IN THE MARK IDENTIFIES THE NICKNAME OF DR. CHARLES L. GOLDSMITH, A LIVING INDIVIDUAL, WHOSE CONSENT(S) TO REGISTER IS MADE OF RECORD.

THE MARK CONSISTS OF THE STYLIZED WORDS "DR. G'S" ABOVE THE STYLIZED WORDS "WEIGHTLOSS & WELLNESS".

SN 85-135,580, FILED 9-22-2010.

KIM SAITO, EXAMINING ATTORNEY



David J. Kybas

Director of the United States Patent and Trademark Office

United States of America

United States Patent and Trademark Office

E-PELLET

Reg. No. 4,154,803

Registered June 5, 2012

Int. Cl.: 11

TRADEMARK

PRINCIPAL REGISTER

PROBE INVESTMENTS, INC (LOUISIANA CORPORATION), DBA PROBE INVESTMENTS,
6 BENTON ST.
COVINGTON, LA 70435

FOR: INDUSTRIAL OVEN, NAMELY, A CONVECTION OVEN CONTAINING A CONVEYOR
THAT EXTERNALLY HEATS THE WOOD PELLET VIA AN INFRARED HEATING SOURCE
FOR USE IN A WOOD PELLET PLANT, IN CLASS 11 (U.S. CLS. 13, 21, 23, 31 AND 34).

FIRST USE 1-10-2012; IN COMMERCE 1-15-2012.

THE MARK CONSISTS OF STANDARD CHARACTERS WITHOUT CLAIM TO ANY PAR-
TICULAR FONT, STYLE, SIZE, OR COLOR.

SN 85-136,287, FILED 9-23-2010.

KARANENDRA S. CHHINA, EXAMINING ATTORNEY



David J. Kyros

Director of the United States Patent and Trademark Office

United States of America

United States Patent and Trademark Office

GET PLANKED

Reg. No. 4,154,804

CROSSVILLE, INC. (ILLINOIS CORPORATION)
346 SWEENEY DRIVE
CROSSVILLE, TN 38555

Registered June 5, 2012

Int. Cl.: 19

FOR: CERAMIC AND PORCELAIN TILES OF VARIOUS SIZES AND COLORS AND SHAPED LIKE PLANKS, IN CLASS 19 (U.S. CLS. 1, 12, 33 AND 50).

TRADEMARK

FIRST USE 11-13-2009; IN COMMERCE 12-18-2009.

PRINCIPAL REGISTER

THE MARK CONSISTS OF STANDARD CHARACTERS WITHOUT CLAIM TO ANY PARTICULAR FONT, STYLE, SIZE, OR COLOR.

SN 85-136,708, FILED 9-23-2010.

JENNIFER DIXON, EXAMINING ATTORNEY



David J. Kybas

Director of the United States Patent and Trademark Office

United States of America

United States Patent and Trademark Office



Reg. No. 4,154,805

Registered June 5, 2012

Int. Cl.: 19

TRADEMARK

PRINCIPAL REGISTER

CROSSVILLE, INC. (ILLINOIS CORPORATION)
346 SWEENEY DRIVE
CROSSVILLE, TN 38555

FOR: CERAMIC AND PORCELAIN TILES OF VARIED SIZES AND COLORS AND SHAPED LIKE PLANKS, IN CLASS 19 (U.S. CLS. 1, 12, 33 AND 50).

FIRST USE 11-13-2009; IN COMMERCE 12-18-2009.

THE MARK CONSISTS OF FOUR SHADED HORIZONTAL RECTANGLES REPRESENTING PLANKS STACKED ON TOP OF EACH OTHER AND EACH RECTANGLE SLIGHTLY STAGGERED TO THE RIGHT FROM THE ONE ABOVE IT, WITH THE TERM "GET" ON THE SECOND PLANK DOWN FROM THE TOP, AND THE TERM "PLANKED" ON THE THIRD PLANK DOWN FROM THE TOP.

SN 85-136,749, FILED 9-23-2010.

JENNIFER DIXON, EXAMINING ATTORNEY



David J. Kybas

Director of the United States Patent and Trademark Office

United States of America

United States Patent and Trademark Office

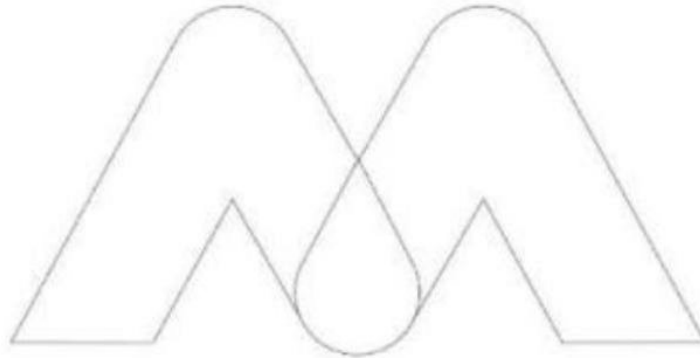

Reg. No. 4,154,806

Registered June 5, 2012

Int. Cl.: 32

TRADEMARK

PRINCIPAL REGISTER

KRAFT FOODS GLOBAL BRANDS LLC (DELAWARE LIMITED LIABILITY COMPANY)
THREE LAKES DRIVE
NORTHFIELD, IL 60093

FOR: PREPARATIONS FOR MAKING BEVERAGES, NAMELY, FRUIT DRINKS, SOFT DRINKS, TEA-FLAVORED DRINKS, FLAVORED WATERS, SPORTS DRINKS AND ENERGY DRINKS , IN CLASS 32 (U.S. CLS. 45, 46 AND 48).

FIRST USE 3-7-2011; IN COMMERCE 3-7-2011.

THE MARK CONSISTS OF A STYLIZED LETTER "M" WITH THE TWO INNER SECTIONS OF THE LETTER INTERSECTING TO FORM A DROP SHAPE IN THE CENTER.

SN 85-136,852, FILED 9-23-2010.

ANNE MADDEN, EXAMINING ATTORNEY



David J. Kyjars

Director of the United States Patent and Trademark Office

United States of America

United States Patent and Trademark Office

HART AND HUNTINGTON

Reg. No. 4,154,807

Registered June 5, 2012

Int. Cls.: 9, 18, 25, and 35

H & H CLOTHING, LLC (NEVADA LIMITED LIABILITY COMPANY)
5295 PROCYON STREET, #120
LAS VEGAS, NV 89118

FOR: SUNGLASSES; PROTECTIVE HELMETS FOR SPORTS; GOGGLES FOR SPORTS, IN CLASS 9 (U.S. CLS. 21, 23, 26, 36 AND 38).

FIRST USE 0-0-2009; IN COMMERCE 0-0-2009.

TRADEMARK

SERVICE MARK

PRINCIPAL REGISTER

FOR: HANDBAGS; TRAVELING BAGS; MESSENGER BAGS; ATHLETIC BAGS; BOOK BAGS; SCHOOL BAGS; ALL-PURPOSE SPORTS BAGS; OVERNIGHT BAGS; LEATHER AND IMITATION LEATHER BAGS; ALL-PURPOSE CARRYING BAGS; BACKPACKS; PURSES; WALLETS, IN CLASS 18 (U.S. CLS. 1, 2, 3, 22 AND 41).

FIRST USE 9-9-2005; IN COMMERCE 9-9-2005.

FOR: CLOTHING, NAMELY, TOPS, BOTTOMS, SHIRTS, TANK TOPS, PANTS, JEANS, SHORTS, SWEAT SHIRTS, JACKETS, BELTS, COATS, JERSEYS, SWEAT PANTS, PULLOVERS, DRESSES, COVER-UPS, PAJAMAS, SLEEP WEAR, INFANT WEAR, BEACHWEAR, LOUNGE WEAR, SWIM WEAR, UNDERCLOTHES, WRIST BANDS, SOCKS, SURF WEAR, GLOVES; HEAD WEAR; FOOTWEAR, IN CLASS 25 (U.S. CLS. 22 AND 39).

FIRST USE 3-28-2004; IN COMMERCE 3-28-2004.



FOR: RETAIL STORE SERVICES AND ONLINE RETAIL STORE SERVICES FEATURING CLOTHING, SPORTSWEAR, HEADWEAR, FOOTWEAR, ACCESSORIES, PRINTED MATTER, POSTERS, BAGS, WALLETS, PURSES, LEATHER GOODS, DECALS, JEWELRY, BELT BUCKLES, SOUVENIR ITEMS, KEY CHAINS; RETAIL STORE AND ONLINE RETAIL STORE FEATURING A WIDE VARIETY OF CONSUMER GOODS OF OTHERS, IN CLASS 35 (U.S. CLS. 100, 101 AND 102).

FIRST USE 3-28-2004; IN COMMERCE 3-28-2004.

David J. Kyros

THE MARK CONSISTS OF STANDARD CHARACTERS WITHOUT CLAIM TO ANY PARTICULAR FONT, STYLE, SIZE, OR COLOR.

SN 85-137,015, FILED 9-23-2010.

Reg. No. 4,154,807 H. M. FISHER, EXAMINING ATTORNEY

United States of America

United States Patent and Trademark Office

IXARIS

Reg. No. 4,154,808

Registered June 5, 2012

Int. Cl.: 42

SERVICE MARK

PRINCIPAL REGISTER

IXARIS SYSTEMS LTD (UNITED KINGDOM LIMITED COMPANY (LTD.))
5TH FLOOR LASENBY HOUSE, 32 KINGLY ST.
LONDON, UNITED KINGDOM W1B5QQ

FOR: DESIGN AND DEVELOPMENT OF COMPUTER HARDWARE AND SOFTWARE, IN
CLASS 42 (U.S. CLS. 100 AND 101).

FIRST USE 11-15-2010; IN COMMERCE 11-15-2010.

THE MARK CONSISTS OF STANDARD CHARACTERS WITHOUT CLAIM TO ANY PAR-
TICULAR FONT, STYLE, SIZE, OR COLOR.

SN 85-137,623, FILED 9-24-2010.

JACLYN KIDWELL WALKER, EXAMINING ATTORNEY



David J. Kybas

Director of the United States Patent and Trademark Office

United States of America

United States Patent and Trademark Office

GET NOTICED GUARANTEE

Reg. No. 4,154,809

Registered June 5, 2012

Int. Cl.: 3

TRADEMARK

PRINCIPAL REGISTER

KELLY VAN GOGH HAIR COLOR COSMETICS, LLC (DELAWARE LIMITED LIABILITY COMPANY)
42 GREENE STREET, FIFTH FLOOR
NEW YORK, NY 10013

FOR: NON-MEDICATED HAIR CARE PREPARATIONS, NAMELY, SHAMPOOS, CONDITIONERS, GELS, COLORANTS, AND TONICS; HAIR CARE KITS COMPRISING NON-MEDICATED HAIR CARE PREPARATIONS, NAMELY, SHAMPOOS, CONDITIONERS, GELS, COLORANTS, AND TONICS, AND HAIR CARE PREPARATION APPLICATION TOOLS, NAMELY, APPLICATORS AND MIXING RECEPTACLES ALL OF WHICH ARE SOLD TOGETHER AS A UNIT, IN CLASS 3 (U.S. CLS. 1, 4, 6, 50, 51 AND 52).

FIRST USE 6-0-2010; IN COMMERCE 6-0-2010.

THE MARK CONSISTS OF STANDARD CHARACTERS WITHOUT CLAIM TO ANY PARTICULAR FONT, STYLE, SIZE, OR COLOR.

SN 85-137,717, FILED 9-24-2010.

APRIL ROACH, EXAMINING ATTORNEY



David J. Kyros

Director of the United States Patent and Trademark Office

United States of America

United States Patent and Trademark Office

THEGREENFERN.COM

Reg. No. 4,154,810

DONOVAN, CATHERINE (UNITED STATES INDIVIDUAL), DBA THEGREENFERN.COM,
PO BOX 2332
NORTHBROOK, IL 600652332

Registered June 5, 2012

Int. Cl.: 41

FOR: PROVIDING A WEBSITE FEATURING INFORMATION IN THE FIELDS OF PARTY
PLANNING AND GARDEN PARTY PLANNING, IN CLASS 41 (U.S. CLS. 100, 101 AND 107).

SERVICE MARK

FIRST USE 12-22-2011; IN COMMERCE 1-1-2012.

PRINCIPAL REGISTER

THE MARK CONSISTS OF STANDARD CHARACTERS WITHOUT CLAIM TO ANY PAR-
TICULAR FONT, STYLE, SIZE, OR COLOR.

SN 85-138,456, FILED 9-26-2010.

CHERYL CLAYTON, EXAMINING ATTORNEY



David J. Kybas

Director of the United States Patent and Trademark Office

United States of America

United States Patent and Trademark Office



Reg. No. 4,154,811

Registered June 5, 2012

Int. Cl.: 1

TRADEMARK

PRINCIPAL REGISTER

SUAN FARMA, INC. (DELAWARE CORPORATION)
140 PORTER STREET
HACKENSACK, NJ 07601

FOR: ORGANIC PLANT FOOD, IN CLASS 1 (U.S. CLS. 1, 5, 6, 10, 26 AND 46).

FIRST USE 11-17-2011; IN COMMERCE 11-17-2011.

NO CLAIM IS MADE TO THE EXCLUSIVE RIGHT TO USE "ORGANIC" OR "GROW", APART FROM THE MARK AS SHOWN.

THE MARK CONSISTS OF A RAINDROP-SHAPED OUTLINE WITH THE WORDING "PERFECT GROW" AT THE BOTTOM. ABOVE THIS WORDING IS THE WORD "ORGANIC" ON A RIBBON. AT THE TOP RIGHT OF THE RAINDROP IS A BUTTERFLY. UNDERNEATH THE RAINDROP IS THE WORDING "ESSENCE OF NATURE".

SN 85-139,132, FILED 9-27-2010.

KIMBERLY FRYE, EXAMINING ATTORNEY



David J. Kybas

Director of the United States Patent and Trademark Office

United States of America

United States Patent and Trademark Office

CLOUD DONE RIGHT

Reg. No. 4,154,812

Registered June 5, 2012

Int. Cl.: 42

SERVICE MARK

PRINCIPAL REGISTER

VISI INCORPORATED (MINNESOTA CORPORATION)
10290 WEST 70TH STREET
EDEN PRAIRIE, MN 55344

FOR: HOSTING THE WEBSITES OF OTHERS; COMPUTER CO-LOCATION SERVICES, NAMELY, PROVIDING FACILITIES FOR THE LOCATION OF COMPUTER SERVERS WITH THE EQUIPMENT OF OTHERS; DISPLAYING THE WEB SITES AND IMAGES OF OTHERS ON A DEDICATED COMPUTER SERVER; E-MAIL SYSTEM DESIGN AND IMPLEMENTATION FOR OTHERS; INFORMATION TECHNOLOGY CONSULTATION; DESIGN, CREATION, HOSTING AND MAINTENANCE OF INTERNET SITES FOR THIRD PARTIES; COMPUTER SERVICES, NAMELY, PROVIDING VIRTUAL AND CLOUD COMPUTING ENVIRONMENTS ACCESSIBLE VIA THE INTERNET AND ORGANIZATIONAL NETWORKS FOR THE PURPOSE OF REMOTE MANAGEMENT IN THE NATURE OF CREATING AND OPERATING ON-LINE COMPUTER APPLICATIONS; PROVIDING A WEB-BASED SYSTEM AND ONLINE PORTAL FOR THIRD PARTIES TO REMOTELY MANAGE, ADMINISTER, MODIFY AND CONTROL VIRTUALIZED COMPUTING RESOURCES, DATA AND SOFTWARE APPLICATIONS IMPLEMENTED VIA DISTRIBUTED COMPUTING ENVIRONMENTS, AND TO REMOTELY MANAGE, ADMINISTER, MODIFY AND CONTROL GEOGRAPHIC DISTRIBUTION OF THE VIRTUALIZED COMPUTING RESOURCES, DATA AND SOFTWARE APPLICATIONS; PROVIDING A WEB-BASED SYSTEM AND ONLINE PORTAL FOR THIRD PARTIES TO REMOTELY MANAGE, ADMINISTER, MODIFY AND CONTROL DISASTER RECOVERY SOLUTIONS RELATING TO THEIR COMPUTER DEVICES, DATA AND SOFTWARE APPLICATIONS; PROVIDING NON-DOWNLOADABLE SOFTWARE, ACCESSIBLE OVER A GLOBAL COMPUTER NETWORK, FOR MANAGING COMPUTER APPLICATIONS AND FOR OPERATING DISTRIBUTED APPLICATIONS AND NETWORKS OF COMPUTERS; AND PROVIDING NON-DOWNLOADABLE SOFTWARE, ACCESSIBLE OVER A GLOBAL COMPUTER NETWORK, FOR ENABLING COMPUTER SYSTEM OPERATORS TO VIRTUALIZE THEIR COMPUTER SYSTEM RESOURCES, MANAGE, ADMINISTER, MODIFY, AND CONTROL THEIR VIRTUALIZED COMPUTING RESOURCES, AND ACCESS VIRTUALIZED GRID AND UTILITY COMPUTING RESOURCES, NAMELY, DISTRIBUTED CLOUD-BASED UTILITY COMPUTING RESOURCES, INFRASTRUCTURE-ON-DEMAND COMPUTING RESOURCES, METERED COMPUTING UTILITY RESOURCES, VIRTUALIZED GLOBALLY DISTRIBUTED COMPUTING RESOURCES, VIRTUALIZED DATACENTER RESOURCES, READY-APPLICATION-STACK COMPUTING RESOURCES, AND HIGH-AVAILABILITY COMPUTING RESOURCES; APPLICATION SERVICE PROVIDER, NAMELY, PROVIDING, HOSTING, MANAGING, DEVELOPING, AND MAINTAINING APPLICATIONS, SOFTWARE, WEBSITES, AND DATABASES FOR OTHERS IN THE



David J. Kappas

Director of the United States Patent and Trademark Office

Reg. No. 4,154,812 FIELDS OF WIRELESS COMMUNICATION, MOBILE INFORMATION ACCESS, AND REMOTE DATA MANAGEMENT FOR WIRELESS DELIVERY OF CONTENT TO HANDHELD COMPUTERS, LAPTOPS AND MOBILE ELECTRONIC DEVICES, IN CLASS 42 (U.S. CLS. 100 AND 101).

FIRST USE 10-4-2009; IN COMMERCE 10-4-2009.

THE MARK CONSISTS OF STANDARD CHARACTERS WITHOUT CLAIM TO ANY PARTICULAR FONT, STYLE, SIZE, OR COLOR.

NO CLAIM IS MADE TO THE EXCLUSIVE RIGHT TO USE "CLOUD" , APART FROM THE MARK AS SHOWN.

SN 85-139,146, FILED 9-27-2010.

JESSICA FATHY, EXAMINING ATTORNEY

United States of America

United States Patent and Trademark Office

CLON IODIS

Reg. No. 4,154,813

Registered June 5, 2012

Int. Cl.: 10

TRADEMARK

PRINCIPAL REGISTER

CLON 3D (NEW MEXICO LIMITED LIABILITY COMPANY)
4630 EUBANK BLVD NE
ALBUQUERQUE, NM 87111

FOR: DIGITAL ORAL IMPRESSION DEVICE FOR TAKING MEASUREMENTS OF TEETH,
IN CLASS 10 (U.S. CLS. 26, 39 AND 44).

FIRST USE 8-1-2009; IN COMMERCE 8-1-2009.

THE MARK CONSISTS OF STANDARD CHARACTERS WITHOUT CLAIM TO ANY PAR-
TICULAR FONT, STYLE, SIZE, OR COLOR.

SN 85-139,198, FILED 9-27-2010.

REBECCA SMITH, EXAMINING ATTORNEY



David J. Kyffers

Director of the United States Patent and Trademark Office

United States of America

United States Patent and Trademark Office

WATER LIFE

Reg. No. 4,154,814

Registered June 5, 2012

Int. Cl.: 28

TRADEMARK

PRINCIPAL REGISTER

AQUA-LEISURE INDUSTRIES, INC. (MASSACHUSETTS CORPORATION)
525 BODWELL STREET
AVON, MA 02322

FOR: INFLATABLE FLOATING RECREATIONAL LOUNGE CHAIRS, CHAIRS, RECLINING CHAIRS AND INFLATABLE TUBES FOR USE IN AND AROUND WATER, IN CLASS 28 (U.S. CLS. 22, 23, 38 AND 50).

FIRST USE 2-0-2011; IN COMMERCE 2-0-2011.

THE MARK CONSISTS OF STANDARD CHARACTERS WITHOUT CLAIM TO ANY PARTICULAR FONT, STYLE, SIZE, OR COLOR.

NO CLAIM IS MADE TO THE EXCLUSIVE RIGHT TO USE "WATER", APART FROM THE MARK AS SHOWN.

SN 85-139,680, FILED 9-28-2010.

KAREN BRACEY, EXAMINING ATTORNEY



David J. Kyros

Director of the United States Patent and Trademark Office

United States of America

United States Patent and Trademark Office

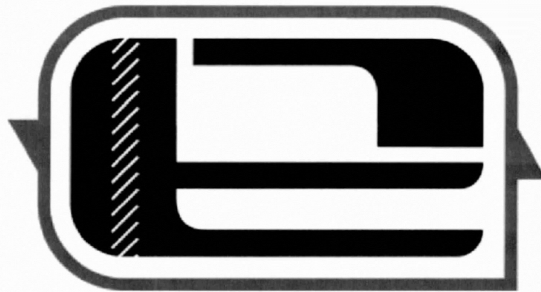

Reg. No. 4,154,815

Registered June 5, 2012

Int. Cls.: 18 and 25

TRADEMARK

PRINCIPAL REGISTER

EMTURN, LLC (DELAWARE LIMITED LIABILITY COMPANY)
C/O VORYS, SATER, SEYMOUR AND PEASE LLP
1909 K STREET, NW, NINTH FLOOR
WASHINGTON, DC 20006

FOR: BACKPACKS, IN CLASS 18 (U.S. CLS. 1, 2, 3, 22 AND 41).

FIRST USE 12-15-2011; IN COMMERCE 12-15-2011.

FOR: FOOTWEAR; HATS; JACKETS; PANTS; SHIRTS; SHORTS; SOCKS; TANK TOPS, IN CLASS 25 (U.S. CLS. 22 AND 39).

FIRST USE 12-15-2011; IN COMMERCE 12-15-2011.

THE MARK CONSISTS OF THE STYLIZED LETTERS "E" AND "T" WITH A DIAGONAL HASH MARK ON THE LEFT HAND SIDE, SURROUNDED BY A STYLIZED BORDER FEATURING TRIANGLES ON THE LEFT AND RIGHT SIDES.

SN 85-139,735, FILED 9-28-2010.

SUNG IN, EXAMINING ATTORNEY



David J. Kyffers

Director of the United States Patent and Trademark Office

United States of America

United States Patent and Trademark Office



Reg. No. 4,154,816

Registered June 5, 2012

Int. Cl.: 28

TRADEMARK

PRINCIPAL REGISTER

YARN GAMES AND MORE, LLC (NORTH CAROLINA LIMITED LIABILITY COMPANY)
1523 41ST AVE
SAN FRANCISCO, CA 94122

FOR: KNITTING GAMES, IN CLASS 28 (U.S. CLS. 22, 23, 38 AND 50).

FIRST USE 1-10-2010; IN COMMERCE 4-15-2011.

THE MARK CONSISTS OF FOUR SHEEP, ONE OF WHICH IS HOLDING KNITTING NEEDLES AND STANDING ABOVE ANOTHER HOLDING YARN AND KNITTING NEEDLES, ANOTHER HOLDING YARN AND ANOTHER HOLDING NOTHING, WITH A BANNER CONTAINING THE WORDING "LAST KNITTER STANDING" AND THE WORDING "A KNITTING GAME".

COLOR IS NOT CLAIMED AS A FEATURE OF THE MARK.

SN 85-139,931, FILED 9-28-2010.

MICHAEL SOUDERS, EXAMINING ATTORNEY



David J. Kyffers

Director of the United States Patent and Trademark Office

United States of America

United States Patent and Trademark Office

DUTY HAPPENS

Reg. No. 4,154,817

Registered June 5, 2012

Int. Cl.: 25

TRADEMARK

PRINCIPAL REGISTER

HEROLDT, SCOTT A. (UNITED STATES INDIVIDUAL)
21018 N 22ND STREET
PHOENIX, AZ 85024

FOR: HATS; JACKETS; PANTS; SHIRTS; SHOES, IN CLASS 25 (U.S. CLS. 22 AND 39).

FIRST USE 1-5-2010; IN COMMERCE 10-9-2010.

THE MARK CONSISTS OF STANDARD CHARACTERS WITHOUT CLAIM TO ANY PARTICULAR FONT, STYLE, SIZE, OR COLOR.

SN 85-140,425, FILED 9-28-2010.

MICHAEL WEBSTER, EXAMINING ATTORNEY



David J. Kybas

Director of the United States Patent and Trademark Office

United States of America

United States Patent and Trademark Office

KAS

Reg. No. 4,154,818

Registered June 5, 2012

Int. Cl.: 25

TRADEMARK

PRINCIPAL REGISTER

LANER, STEVE (UNITED STATES INDIVIDUAL)
23212 SONG BIRD HILLS WAY
PARKER, CO 80138

FOR: CLOTHING, NAMELY, CYCLING JERSEYS, IN CLASS 25 (U.S. CLS. 22 AND 39).

FIRST USE 5-1-2011; IN COMMERCE 5-1-2011.

THE MARK CONSISTS OF THE WORDS "KAS" IN STYLIZED FORM.

SN 85-140,565, FILED 9-29-2010.

JOHN DWYER, EXAMINING ATTORNEY



David J. Kyffers

Director of the United States Patent and Trademark Office

United States of America

United States Patent and Trademark Office

THIRD STREET

Reg. No. 4,154,819

Registered June 5, 2012

Int. Cl.: 32

TRADEMARK

PRINCIPAL REGISTER

COLD SPRING BREWING COMPANY (COLORADO CORPORATION)
219 N. RED RIVER AVENUE
COLD SPRINGS, MN 56320

FOR: BEER, ALE, LAGER, STOUT AND PORTER, IN CLASS 32 (U.S. CLS. 45, 46 AND 48).

FIRST USE 3-1-2012; IN COMMERCE 3-1-2012.

THE MARK CONSISTS OF STANDARD CHARACTERS WITHOUT CLAIM TO ANY PARTICULAR FONT, STYLE, SIZE, OR COLOR.

SN 85-140,828, FILED 9-29-2010.

MARK SHINER, EXAMINING ATTORNEY



David J. Kybas

Director of the United States Patent and Trademark Office

United States of America

United States Patent and Trademark Office

OPT 2 THRIVE

Reg. No. 4,154,820

M&S CRENEAU, INC. (FLORIDA CORPORATION)
4386 FUSHIA CIRCLE SOUTH
PALM BEACH GARDENS, FL 33410

Registered June 5, 2012

Int. Cl.: 5

FOR: DIETARY AND NUTRITIONAL SUPPLEMENTS, IN CLASS 5 (U.S. CLS. 6, 18, 44, 46, 51 AND 52).

TRADEMARK

FIRST USE 9-29-2010; IN COMMERCE 2-19-2012.

PRINCIPAL REGISTER

THE MARK CONSISTS OF STANDARD CHARACTERS WITHOUT CLAIM TO ANY PARTICULAR FONT, STYLE, SIZE, OR COLOR.

SN 85-140,906, FILED 9-29-2010.

JEFFREY LOOK, EXAMINING ATTORNEY



David J. Kybas

Director of the United States Patent and Trademark Office

United States of America

United States Patent and Trademark Office

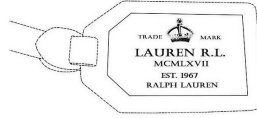

Reg. No. 4,154,821

PRL USA HOLDINGS, INC. (DELAWARE CORPORATION)
550 SEVENTH AVENUE
NEW YORK, NY 10018

Registered June 5, 2012

Int. Cl.: 18

FOR: CARRYING CASES; COSMETIC CASES SOLD EMPTY; HANDBAGS; WALLETS;
WRISTLET BAGS, IN CLASS 18 (U.S. CLS. 1, 2, 3, 22 AND 41).

TRADEMARK

FIRST USE 1-25-2011; IN COMMERCE 1-25-2011.

PRINCIPAL REGISTER

OWNER OF U.S. REG. NOS. 2,042,967, 2,207,011, AND 3,764,868.

NO CLAIM IS MADE TO THE EXCLUSIVE RIGHT TO USE "TRADEMARK AND EST. 1967",
APART FROM THE MARK AS SHOWN.

THE NAME(S), PORTRAIT(S), AND/OR SIGNATURE(S) SHOWN IN THE MARK IDENTIFIES
AN INDIVIDUAL, WHOSE CONSENT(S) TO REGISTER IS MADE OF RECORD.

THE MARK CONSISTS OF A CROWN DESIGN BETWEEN THE WORDS "TRADE" AND
"MARK", ABOVE THE WORDS "LAUREN R.L.", WHICH IS ABOVE THE ROMAN NUMER-
ALS "MCMLXVII", WHICH IS ABOVE "EST. 1967", ABOVE "RALPH LAUREN". ALL OF
THIS IS SURROUNDED BY A SIX-SIDED POLYGON. THE MATTER DEPICTED IN BROKEN
LINES IS NOT PART OF THE MARK AND SERVES ONLY TO SHOW THE POSITION OF
THE MARK.

SN 85-141,103, FILED 9-29-2010.

MICHAEL WEBSTER, EXAMINING ATTORNEY



David J. Kybas

Director of the United States Patent and Trademark Office

United States of America

United States Patent and Trademark Office

ecOHOME
AHFA'S SAFETY, HEALTH AND ENVIRONMENTAL PROGRAM

Reg. No. 4,154,822

Registered June 5, 2012

CERTIFICATION MARK

GOODS

PRINCIPAL REGISTER

AMERICAN HOME FURNISHINGS ALLIANCE, INC. (NORTH CAROLINA CORPORATION)
TENTH FLOOR
317 W. HIGH AVENUE
HIGH POINT, NC 27261

FOR: FURNITURE, IN CLASS A (U.S. CL. A).

FIRST USE 10-0-2010; IN COMMERCE 10-0-2010.

NO CLAIM IS MADE TO THE EXCLUSIVE RIGHT TO USE "SAFETY, HEALTH AND ENVIRONMENTAL PROGRAM", APART FROM THE MARK AS SHOWN.

THE MARK CONSISTS OF THE WORD "ECOHOME" WITH THE NUMBER "3" INSIDE THE FIRST "O" IN "ECOHOME" ON TOP OF THE WORDS "AHFA'S SAFETY, HEALTH AND ENVIRONMENTAL PROGRAM".

THE CERTIFICATION MARK, AS INTENDED TO BE USED BY AUTHORIZED PERSONS, IS INTENDED TO CERTIFY THAT THE GOODS MANUFACTURED UNDER THE CERTIFICATION MARK MEET THE ENVIRONMENTAL STANDARDS SET OUT BY THE CERTIFIER AND THAT THE GOODS ARE OFFERED BY A MEMBER IN GOOD STANDING OF THE CERTIFIER, WHICH MEMBER HAS ADHERED TO THE REGULATIONS AND ENVIRONMENTAL STANDARDS ESTABLISHED BY THE CERTIFIER, AND WHICH MEMBER UNDERTAKES TO RESPECT THE NORMS AND DIRECTIVES DEFINED BY THE CERTIFIER WITH RESPECT TO THE GOODS OFFERED FOR SALE UNDER THE CERTIFICATION MARK.

SN 85-141,143, FILED 9-29-2010.

WILLIAM P. SHANAHAN, EXAMINING ATTORNEY



David J. Kybas

Director of the United States Patent and Trademark Office

United States of America

United States Patent and Trademark Office

MINSETA

Reg. No. 4,154,823

WYETH LLC (DELAWARE LIMITED LIABILITY COMPANY)
FIVE GIRALDA FARMS
MADISON, NJ 07940

Registered June 5, 2012

Int. Cl.: 5

FOR: PHARMACEUTICAL PREPARATIONS FOR THE TREATMENT OF THE CENTRAL NERVOUS SYSTEM, IN CLASS 5 (U.S. CLS. 6, 18, 44, 46, 51 AND 52).

TRADEMARK

FIRST USE 1-25-2012; IN COMMERCE 1-25-2012.

PRINCIPAL REGISTER

THE MARK CONSISTS OF STANDARD CHARACTERS WITHOUT CLAIM TO ANY PARTICULAR FONT, STYLE, SIZE, OR COLOR.

SN 85-142,851, FILED 10-1-2010.

IRA J. GOODSaid, EXAMINING ATTORNEY



David J. Kyffers

Director of the United States Patent and Trademark Office

United States of America

United States Patent and Trademark Office

BASTARDBLASTERS

Reg. No. 4,154,824

Registered June 5, 2012

Int. Cl.: 28

TRADEMARK

PRINCIPAL REGISTER

YIPE MEDIA, INC. (WASHINGTON CORPORATION)
DANIEL RICH, PRESIDENT 12240 LANGWORTH R
OAD S.W.;
ROCHESTER, WA 98579

FOR: CLAY PIGEON TARGETS; NOVELTY ITEMS, NAMELY, CLAY PIGEON TARGETS BEARING CARTOON IMAGES OF POLITICIANS, IN CLASS 28 (U.S. CLS. 22, 23, 38 AND 50).

FIRST USE 12-10-2010; IN COMMERCE 12-10-2010.

THE MARK CONSISTS OF STANDARD CHARACTERS WITHOUT CLAIM TO ANY PARTICULAR FONT, STYLE, SIZE, OR COLOR.

SN 85-143,288, FILED 10-1-2010.

LINDA E. BLOHM, EXAMINING ATTORNEY



David J. Kyjars

Director of the United States Patent and Trademark Office

United States of America

United States Patent and Trademark Office

HEALTHCARE CONNECTS HERE

Reg. No. 4,154,825

Registered June 5, 2012

Int. Cls.: 35 and 42

SERVICE MARK

PRINCIPAL REGISTER

FLATWORLD SOLUTIONS INC. (DELAWARE CORPORATION)
SUITE 200
116 VILLAGE BOULEVARD
PRINCETON, NJ 08540

FOR: ON-LINE BUSINESS NETWORKING SERVICES; BUSINESS SERVICES, NAMELY, COMBINED STRATEGIC GOODS OR SERVICES SOURCING FOR OTHERS , IN CLASS 35 (U.S. CLS. 100, 101 AND 102).

FIRST USE 3-5-2012; IN COMMERCE 3-5-2012.

FOR: SOFTWARE AS A SERVICE (SAAS) SERVICES FEATURING SOFTWARE FOR ON-LINE BUSINESS NETWORKING SERVICES, GOODS OR SERVICES SOURCING, AND SOLICITING BUSINESS ON A GLOBAL COMPUTER NETWORK, IN CLASS 42 (U.S. CLS. 100 AND 101).

FIRST USE 3-5-2012; IN COMMERCE 3-5-2012.

THE MARK CONSISTS OF STANDARD CHARACTERS WITHOUT CLAIM TO ANY PARTICULAR FONT, STYLE, SIZE, OR COLOR.

NO CLAIM IS MADE TO THE EXCLUSIVE RIGHT TO USE "HEALTHCARE", APART FROM THE MARK AS SHOWN.

SN 85-144,943, FILED 10-5-2010.

JOHN LINCOSKI, EXAMINING ATTORNEY



David J. Kybas

Director of the United States Patent and Trademark Office

United States of America

United States Patent and Trademark Office

COMMERCE CONNECTS HERE

Reg. No. 4,154,826

Registered June 5, 2012

Int. Cls.: 35 and 42

SERVICE MARK

PRINCIPAL REGISTER

FLATWORLD SOLUTIONS INC. (DELAWARE CORPORATION)
SUITE 200
116 VILLAGE BOULEVARD
PRINCETON, NJ 08540

FOR: ON-LINE BUSINESS NETWORKING SERVICES; BUSINESS SERVICES, NAMELY, COMBINED STRATEGIC GOODS OR SERVICES SOURCING FOR OTHERS , IN CLASS 35 (U.S. CLS. 100, 101 AND 102).

FIRST USE 9-10-2010; IN COMMERCE 9-10-2010.

FOR: SOFTWARE AS A SERVICE (SAAS) SERVICES FEATURING SOFTWARE FOR ON-LINE BUSINESS NETWORKING SERVICES, GOODS OR SERVICES SOURCING, AND SOLICITING BUSINESS ON A GLOBAL COMPUTER NETWORK, IN CLASS 42 (U.S. CLS. 100 AND 101).

FIRST USE 9-10-2010; IN COMMERCE 9-10-2010.

THE MARK CONSISTS OF STANDARD CHARACTERS WITHOUT CLAIM TO ANY PARTICULAR FONT, STYLE, SIZE, OR COLOR.

NO CLAIM IS MADE TO THE EXCLUSIVE RIGHT TO USE "COMMERCE", APART FROM THE MARK AS SHOWN.

SN 85-144,948, FILED 10-5-2010.

JOHN LINCOSKI, EXAMINING ATTORNEY



David J. Kybas

Director of the United States Patent and Trademark Office

United States of America

United States Patent and Trademark Office

TRADING CONNECTS HERE

Reg. No. 4,154,827

Registered June 5, 2012

Int. Cls.: 35 and 42

SERVICE MARK

PRINCIPAL REGISTER

FLATWORLD SOLUTIONS INC. (DELAWARE CORPORATION)
SUITE 200
116 VILLAGE BOULEVARD
PRINCETON, NJ 08540

FOR: ON-LINE BUSINESS NETWORKING SERVICES; BUSINESS SERVICES, NAMELY, COMBINED STRATEGIC GOODS OR SERVICES SOURCING FOR OTHERS , IN CLASS 35 (U.S. CLS. 100, 101 AND 102).

FIRST USE 3-5-2012; IN COMMERCE 3-5-2012.

FOR: SOFTWARE AS A SERVICE (SAAS) SERVICES FEATURING SOFTWARE FOR ON-LINE BUSINESS NETWORKING SERVICES, GOODS OR SERVICES SOURCING, AND SOLICITING BUSINESS ON A GLOBAL COMPUTER NETWORK, IN CLASS 42 (U.S. CLS. 100 AND 101).

FIRST USE 3-5-2012; IN COMMERCE 3-5-2012.

THE MARK CONSISTS OF STANDARD CHARACTERS WITHOUT CLAIM TO ANY PARTICULAR FONT, STYLE, SIZE, OR COLOR.

NO CLAIM IS MADE TO THE EXCLUSIVE RIGHT TO USE "TRADING", APART FROM THE MARK AS SHOWN.

SN 85-144,951, FILED 10-5-2010.

JOHN LINCOSKI, EXAMINING ATTORNEY



David J. Kyffers

Director of the United States Patent and Trademark Office

United States of America

United States Patent and Trademark Office

BUSINESS CONNECTS HERE

Reg. No. 4,154,828

Registered June 5, 2012

Int. Cls.: 35 and 42

SERVICE MARK

PRINCIPAL REGISTER

FLATWORLD SOLUTIONS INC. (DELAWARE CORPORATION)
SUITE 200
116 VILLAGE BOULEVARD
PRINCETON, NJ 08540

FOR: ON-LINE BUSINESS NETWORKING SERVICES; BUSINESS SERVICES, NAMELY, COMBINED STRATEGIC GOODS OR SERVICES SOURCING FOR OTHERS , IN CLASS 35 (U.S. CLS. 100, 101 AND 102).

FIRST USE 3-5-2012; IN COMMERCE 3-5-2012.

FOR: SOFTWARE AS A SERVICE (SAAS) SERVICES FEATURING SOFTWARE FOR ON-LINE BUSINESS NETWORKING SERVICES, GOODS OR SERVICES SOURCING, AND SOLICITING BUSINESS ON A GLOBAL COMPUTER NETWORK, IN CLASS 42 (U.S. CLS. 100 AND 101).

FIRST USE 3-5-2012; IN COMMERCE 3-5-2012.

THE MARK CONSISTS OF STANDARD CHARACTERS WITHOUT CLAIM TO ANY PARTICULAR FONT, STYLE, SIZE, OR COLOR.

NO CLAIM IS MADE TO THE EXCLUSIVE RIGHT TO USE "BUSINESS", APART FROM THE MARK AS SHOWN.

SN 85-145,021, FILED 10-5-2010.

JOHN LINCOSKI, EXAMINING ATTORNEY



David J. Kyffers

Director of the United States Patent and Trademark Office

United States of America

United States Patent and Trademark Office

TRULY CLEAR

Reg. No. 4,154,829

Registered June 5, 2012

Int. Cl.: 5

TRADEMARK

PRINCIPAL REGISTER

AMERICAN SKIN LABS, INC. (FLORIDA CORPORATION)
10290 WEST ATLANTIC AVE. #480411
DELRAY BEACH, FL 33496

FOR: ACNE MEDICATIONS; ACNE TREATMENT PREPARATIONS; FACE CREAMS AND
CLEANSERS CONTAINING BENZOYL PEROXIDE FOR MEDICAL PURPOSES, NAMELY,
THE TREATMENT OF ACNE, IN CLASS 5 (U.S. CLS. 6, 18, 44, 46, 51 AND 52).

FIRST USE 10-1-2010; IN COMMERCE 11-1-2010.

THE MARK CONSISTS OF STANDARD CHARACTERS WITHOUT CLAIM TO ANY PAR-
TICULAR FONT, STYLE, SIZE, OR COLOR.

NO CLAIM IS MADE TO THE EXCLUSIVE RIGHT TO USE "CLEAR", APART FROM THE
MARK AS SHOWN.

SN 85-145,404, FILED 10-5-2010.

LINDSEY RUBIN, EXAMINING ATTORNEY



David J. Kyros

Director of the United States Patent and Trademark Office

United States of America

United States Patent and Trademark Office

THERACAL LC

Reg. No. 4,154,830

BISCO, INC. (ILLINOIS CORPORATION)
1100 W. IRVING PARK ROAD
SCHAUMBURG, IL 601933569

Registered June 5, 2012

Int. Cl.: 5

FOR: DENTAL MATERIALS, NAMELY, A DENTAL PULP CAPPING AND LINING MATERIAL, IN CLASS 5 (U.S. CLS. 6, 18, 44, 46, 51 AND 52).

TRADEMARK

FIRST USE 12-2-2011; IN COMMERCE 12-2-2011.

PRINCIPAL REGISTER

THE MARK CONSISTS OF STANDARD CHARACTERS WITHOUT CLAIM TO ANY PARTICULAR FONT, STYLE, SIZE, OR COLOR.

NO CLAIM IS MADE TO THE EXCLUSIVE RIGHT TO USE "LC", APART FROM THE MARK AS SHOWN.

SN 85-145,428, FILED 10-5-2010.

JOHN HWANG, EXAMINING ATTORNEY



David J. Kybas

Director of the United States Patent and Trademark Office

United States of America

United States Patent and Trademark Office

PLAYFULL

Reg. No. 4,154,831

Registered June 5, 2012

Int. Cl.: 9

TRADEMARK

PRINCIPAL REGISTER

EASTMAN KODAK COMPANY (NEW JERSEY CORPORATION)
343 STATE STREET
ROCHESTER, NY 14650

FOR: VIDEO CAMERAS, IN CLASS 9 (U.S. CLS. 21, 23, 26, 36 AND 38).

FIRST USE 3-8-2011; IN COMMERCE 3-8-2011.

THE MARK CONSISTS OF STANDARD CHARACTERS WITHOUT CLAIM TO ANY PARTICULAR FONT, STYLE, SIZE, OR COLOR.

SN 85-145,641, FILED 10-5-2010.

JIM RINGLE, EXAMINING ATTORNEY



David J. Kyffers

Director of the United States Patent and Trademark Office

United States of America

United States Patent and Trademark Office



Reg. No. 4,154,832

Registered June 5, 2012

**Int. Cls.: 6, 14, 16, 18, 21,
25, and 41**

BOARD OF REGENTS OF THE UNIVERSITY SYSTEM OF GEORGIA (GEORGIA STATE AGENCY)
270 WASHINGTON STREET, SW
ATLANTA, GA 30334

FOR: METAL KEY CHAINS, IN CLASS 6 (U.S. CLS. 2, 12, 13, 14, 23, 25 AND 50).

FIRST USE 10-1-2011; IN COMMERCE 10-20-2011.

TRADEMARK

FOR: PENDANTS, IN CLASS 14 (U.S. CLS. 2, 27, 28 AND 50).

SERVICE MARK

FIRST USE 10-1-2011; IN COMMERCE 10-20-2011.

PRINCIPAL REGISTER

FOR: PENS, IN CLASS 16 (U.S. CLS. 2, 5, 22, 23, 29, 37, 38 AND 50).

FIRST USE 11-1-2011; IN COMMERCE 11-1-2011.

FOR: MESSENGER BAGS, IN CLASS 18 (U.S. CLS. 1, 2, 3, 22 AND 41).

FIRST USE 9-20-2011; IN COMMERCE 9-25-2011.

FOR: CUPS AND MUGS, IN CLASS 21 (U.S. CLS. 2, 13, 23, 29, 30, 33, 40 AND 50).

FIRST USE 10-11-2011; IN COMMERCE 10-15-2011.

FOR: T-SHIRTS, IN CLASS 25 (U.S. CLS. 22 AND 39).

FIRST USE 10-10-2011; IN COMMERCE 10-15-2011.

FOR: ENTERTAINMENT IN THE NATURE OF COMPETITIONS IN THE FIELD OF ATHLETICS, IN CLASS 41 (U.S. CLS. 100, 101 AND 107).

FIRST USE 9-1-2011; IN COMMERCE 9-1-2011.

THE MARK CONSISTS OF LETTERS "G" AND "C" WITH THE LOWER RIGHT PORTION OF THE LETTER "G" OVERLAPPING THE TOP LEFT PORTION OF THE LETTER "C".



David J. Kybas

Director of the United States Patent and Trademark Office

Reg. No. 4,154,832 SN 85-145,996, FILED 10-6-2010.

SUSAN RICHARDS, EXAMINING ATTORNEY

United States of America

United States Patent and Trademark Office

GEORGIA COLLEGE

Reg. No. 4,154,833

Registered June 5, 2012

**Int. Cls.: 6, 14, 16, 18, 21,
25, and 41**

BOARD OF REGENTS OF THE UNIVERSITY SYSTEM OF GEORGIA (GEORGIA STATE AGENCY)
270 WASHINGTON STREET, SW
ATLANTA, GA 30334

FOR: METAL KEY CHAINS, IN CLASS 6 (U.S. CLS. 2, 12, 13, 14, 23, 25 AND 50).

FIRST USE 10-15-2011; IN COMMERCE 10-30-2011.

TRADEMARK

FOR: PENDANTS, IN CLASS 14 (U.S. CLS. 2, 27, 28 AND 50).

SERVICE MARK

FIRST USE 11-10-2011; IN COMMERCE 11-20-2011.

PRINCIPAL REGISTER

FOR: BINDERS; DECALS; PENS, IN CLASS 16 (U.S. CLS. 2, 5, 22, 23, 29, 37, 38 AND 50).

FIRST USE 10-1-2011; IN COMMERCE 10-20-2011.

FOR: BOOK BAGS, IN CLASS 18 (U.S. CLS. 1, 2, 3, 22 AND 41).

FIRST USE 8-1-2011; IN COMMERCE 8-1-2011.

FOR: CUPS AND MUGS, IN CLASS 21 (U.S. CLS. 2, 13, 23, 29, 30, 33, 40 AND 50).

FIRST USE 11-1-2011; IN COMMERCE 11-15-2011.

FOR: GOLF SHIRTS; HATS; PANTS; SHIRTS; SHORTS; SWEAT SHIRTS; T-SHIRTS, IN CLASS 25 (U.S. CLS. 22 AND 39).

FIRST USE 8-1-2011; IN COMMERCE 8-1-2011.

FOR: EDUCATIONAL SERVICES, NAMELY, PROVIDING COURSES OF INSTRUCTION AT THE UNIVERSITY LEVEL AND DISTRIBUTION OF COURSE MATERIAL IN CONNECTION THEREWITH; ENTERTAINMENT IN THE NATURE OF COMPETITIONS IN THE FIELD OF ATHLETICS, IN CLASS 41 (U.S. CLS. 100, 101 AND 107).

FIRST USE 1-1-1971; IN COMMERCE 1-1-1971.

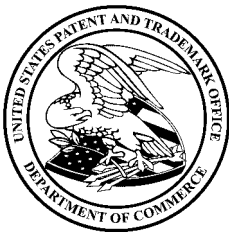

David J. Kyros

Director of the United States Patent and Trademark Office

Reg. No. 4,154,833 THE MARK CONSISTS OF STANDARD CHARACTERS WITHOUT CLAIM TO ANY PARTICULAR FONT, STYLE, SIZE, OR COLOR.

SEC. 2(F) AS TO "GEORGIA".

OWNER OF U.S. REG. NOS. 2,398,983, 3,725,163, AND OTHERS.

NO CLAIM IS MADE TO THE EXCLUSIVE RIGHT TO USE "COLLEGE", APART FROM THE MARK AS SHOWN.

SN 85-146,000, FILED 10-6-2010.

SUSAN RICHARDS, EXAMINING ATTORNEY

United States of America

United States Patent and Trademark Office



Reg. No. 4,154,834

MAGNUS INTERNATIONAL, LLC (CALIFORNIA LIMITED LIABILITY COMPANY)
20256 FUERO DRIVE
WALNUT, CA 91789

Registered June 5, 2012

Int. Cl.: 25

FOR: BELTS; BOXER BRIEFS; CARGO PANTS; HATS; JEANS; SHIRTS; SHOES; SHORTS;
SOCKS; T-SHIRTS; UNDERGARMENTS, IN CLASS 25 (U.S. CLS. 22 AND 39).

TRADEMARK

FIRST USE 2-0-2012; IN COMMERCE 2-0-2012.

PRINCIPAL REGISTER

THE MARK CONSISTS OF THE STYLIZED WORD "MAGNUS".

SN 85-146,212, FILED 10-6-2010.

TRACY WHITTAKER-BROWN, EXAMINING ATTORNEY



David J. Kyffers

Director of the United States Patent and Trademark Office

United States of America

United States Patent and Trademark Office



Reg. No. 4,154,835

Registered June 5, 2012

Int. Cls.: 6 and 7

TRADEMARK

PRINCIPAL REGISTER

CHUN YU WORKS & CO., LTD. (TAIWAN CORPORATION)
1FL., NO. 1-1, CHIA SHING ROAD
KANGSHAN TOWNSHIP
KAOHSIUNG COUNTY, TAIWAN 820

FOR: METAL FASTENERS, NAMELY, NUTS, SCREWS, BOLTS, NAILS AND WASHERS, BRIGHT STEEL BARS, POWER OPERATED SCREW GUNS AND ACCESSORIES IN THE NATURE OF METAL SCREWS, SCREW GUN ATTACHMENTS FOR INSTANT COLLATED SCREW AUTO-FEED ACTION AND COUNTERSINK ADJUSTMENT, METAL SCREW GUN ADAPTERS, IN CLASS 6 (U.S. CLS. 2, 12, 13, 14, 23, 25 AND 50).

FIRST USE 7-16-2011; IN COMMERCE 2-1-2012.

FOR: POWER TOOLS, NAMELY, DRILL HAMMERS, COLLATED SCREW DRIVING SYSTEM COMPRISED OF SCREW GUN ADAPTERS, DRIVING BITS AND EXTENSION POLES, MACHINE PARTS, NAMELY, AIR HOSE COUPLERS, POWER OPERATED SCREW GUNS AND ACCESSORIES IN THE NATURE OF METAL SCREWS, SCREW GUNS, SCREW GUN ATTACHMENTS, SCREW GUN ADAPTERS AND COLLATED SCREWS SOLD AS A UNIT THEREFOR, POWER TOOL ACCESSORIES, NAMELY, HANDLE BAR EXTENSIONS FOR POWER TOOLS, POWER TOOL ACCESSORIES, NAMELY, EXTENSION POLES FOR COLLATED SCREW DRIVING SYSTEM, MACHINES FOR MAKING SCREWS, BOLTS, NUTS, NAILS, WASHERS AND BRIGHT STEEL BARS; METAL FINISHING MACHINES; MACHINE FOR SORTING SCREWS; WORK PROCESSING MACHINES FOR THE THREAD CUTTING OF METALS, IN CLASS 7 (U.S. CLS. 13, 19, 21, 23, 31, 34 AND 35).

FIRST USE 7-16-2011; IN COMMERCE 2-1-2012.

OWNER OF U.S. REG. NO. 1,733,934.

NO CLAIM IS MADE TO THE EXCLUSIVE RIGHT TO USE "LOGISTIC" AND "SINCE 1949", APART FROM THE MARK AS SHOWN.

THE MARK CONSISTS OF AN IMAGE DEPICTING A LION ON TOP OF A CURVED LINE WITH THE WORDING "SINCE 1949" BELOW THE CURVED LINE AND THE WORDING "CHUN YU LOGISTIC" BELOW THE WORDING "SINCE 1949".

THE ENGLISH TRANSLATION OF "CHUN YU" IN THE MARK IS "SPRING RAIN".



David J. Kybas

Director of the United States Patent and Trademark Office

Reg. No. 4,154,835 SN 85-146,278, FILED 10-6-2010.

RAMONA ORTIGA, EXAMINING ATTORNEY

United States of America

United States Patent and Trademark Office

GAUSSTEMPER

Reg. No. 4,154,836

Registered June 5, 2012

Int. Cls.: 6 and 40

TRADEMARK

SERVICE MARK

PRINCIPAL REGISTER

UT BATTELLE, LLC (TENNESSEE LIMITED LIABILITY COMPANY)
ONE BETHEL VALLEY ROAD
P. O. BOX 2008, MS-6258
OAK RIDGE, TN 37831

FOR: A METALLIC ALLOY TREATED USING A THERMO-MAGNETIC PROCESS, IN CLASS 6 (U.S. CLS. 2, 12, 13, 14, 23, 25 AND 50).

FIRST USE 12-8-2011; IN COMMERCE 12-8-2011.

FOR: A PROCESS FOR THERMO-MAGNETICALLY TREATING METALS AND THEIR ALLOYS, IN CLASS 40 (U.S. CLS. 100, 103 AND 106).

FIRST USE 12-8-2011; IN COMMERCE 12-8-2011.

THE MARK CONSISTS OF STANDARD CHARACTERS WITHOUT CLAIM TO ANY PARTICULAR FONT, STYLE, SIZE, OR COLOR.

SN 85-146,594, FILED 10-6-2010.

JOHN WILKE, EXAMINING ATTORNEY



David J. Kyjars

Director of the United States Patent and Trademark Office

United States of America

United States Patent and Trademark Office

TRUESENSE

Reg. No. 4,154,837

GENERAL ELECTRIC COMPANY (NEW YORK CORPORATION)
1 RIVER ROAD
SCHENECTADY, NY 12345

Registered June 5, 2012

Int. Cl.: 42

FOR: CHEMICAL ENGINEERING SERVICES RELATED TO THE TREATMENT OF AQUEOUS SYSTEMS; MONITORING SERVICES OF AQUEOUS SYSTEMS TO ASSESS TREATMENT; DIAGNOSTIC SERVICES OF AQUEOUS SYSTEMS TO ASSESS TREATMENT, IN CLASS 42 (U.S. CLS. 100 AND 101).

SERVICE MARK

PRINCIPAL REGISTER

FIRST USE 2-26-2008; IN COMMERCE 2-26-2008.

THE MARK CONSISTS OF STANDARD CHARACTERS WITHOUT CLAIM TO ANY PARTICULAR FONT, STYLE, SIZE, OR COLOR.

OWNER OF U.S. REG. NO. 3,803,163.

SN 85-147,708, FILED 10-7-2010.

COLLEEN DOMBROW, EXAMINING ATTORNEY



David J. Kyjars

Director of the United States Patent and Trademark Office

United States of America

United States Patent and Trademark Office

TJWOMEN

Reg. No. 4,154,838

Registered June 5, 2012

Int. Cl.: 25

TRADEMARK

PRINCIPAL REGISTER

TOM JAMES COMPANY (TENNESSEE CORPORATION)
263 SEABOARD LANE
FRANKLIN, TN 37067

FOR: WOMEN'S CLOTHING, NAMELY, SUITS, BLOUSES, CAMISOLES, DRESS SHIRTS, PANTS, SKIRTS, SHIRTS, TOP COATS, DRESSES, SWEATERS, JEANS, SHOES, SCARVES, HATS, GLOVES, AND STOCKINGS, IN CLASS 25 (U.S. CLS. 22 AND 39).

FIRST USE 3-6-2012; IN COMMERCE 3-6-2012.

THE MARK CONSISTS OF STANDARD CHARACTERS WITHOUT CLAIM TO ANY PARTICULAR FONT, STYLE, SIZE, OR COLOR.

SN 85-148,340, FILED 10-8-2010.

BERYL GARDNER, EXAMINING ATTORNEY



David J. Kyros

Director of the United States Patent and Trademark Office

United States of America

United States Patent and Trademark Office

EDUCATION CONNECTS HERE

Reg. No. 4,154,839

Registered June 5, 2012

Int. Cls.: 35 and 42

SERVICE MARK

PRINCIPAL REGISTER

FLATWORLD SOLUTIONS INC. (DELAWARE CORPORATION)
SUITE 200
116 VILLAGE BOULEVARD
PRINCETON, NJ 08540

FOR: ON-LINE BUSINESS NETWORKING SERVICES; BUSINESS SERVICES, NAMELY, COMBINED STRATEGIC GOODS OR SERVICES SOURCING FOR OTHERS; ON-LINE PROFESSIONAL NETWORKING SERVICES IN THE FIELD OF EDUCATION, IN CLASS 35 (U.S. CLS. 100, 101 AND 102).

FIRST USE 3-5-2012; IN COMMERCE 3-5-2012.

FOR: SOFTWARE AS A SERVICE (SAAS) SERVICES FEATURING SOFTWARE FOR ON-LINE BUSINESS NETWORKING SERVICES, AND SOLICITING BUSINESS ON A GLOBAL COMPUTER NETWORK; SOFTWARE AS A SERVICE (SAAS) SERVICES FEATURING SOFTWARE FOR ON-LINE SOCIAL NETWORKING IN THE FIELD OF EDUCATION, IN CLASS 42 (U.S. CLS. 100 AND 101).

FIRST USE 3-5-2012; IN COMMERCE 3-5-2012.

THE MARK CONSISTS OF STANDARD CHARACTERS WITHOUT CLAIM TO ANY PARTICULAR FONT, STYLE, SIZE, OR COLOR.

NO CLAIM IS MADE TO THE EXCLUSIVE RIGHT TO USE "EDUCATION", APART FROM THE MARK AS SHOWN.

SN 85-148,630, FILED 10-8-2010.

JOHN LINCOSKI, EXAMINING ATTORNEY



David J. Kybas

Director of the United States Patent and Trademark Office

United States of America

United States Patent and Trademark Office

JOKERS PAY

Reg. No. 4,154,840

Registered June 5, 2012

Int. Cl.: 9

TRADEMARK

PRINCIPAL REGISTER

IGT (NEVADA CORPORATION)
9295 PROTOTYPE DRIVE
RENO, NV 895218986

FOR: GAMING MACHINES, NAMELY, DEVICES WHICH ACCEPT A WAGER, IN CLASS 9 (U.S. CLS. 21, 23, 26, 36 AND 38).

FIRST USE 11-23-2011; IN COMMERCE 11-23-2011.

THE MARK CONSISTS OF STANDARD CHARACTERS WITHOUT CLAIM TO ANY PARTICULAR FONT, STYLE, SIZE, OR COLOR.

OWNER OF U.S. REG. NOS. 2,888,275 AND 3,098,080.

SN 85-148,666, FILED 10-8-2010.

ANTHONY RINKER, EXAMINING ATTORNEY



David J. Kyjars

Director of the United States Patent and Trademark Office

United States of America

United States Patent and Trademark Office



Reg. No. 4,154,841

Registered June 5, 2012

Int. Cl.: 29

TRADEMARK

PRINCIPAL REGISTER

GLOBAL PERFORMANCE GROUP, INC. (ARKANSAS CORPORATION)
109 W. PINE ST.
CABOT, AR 72023

FOR: FROZEN MEALS CONSISTING PRIMARILY OF MEAT, FISH, POULTRY OR VEGETABLES, IN CLASS 29 (U.S. CL. 46).

FIRST USE 11-5-2010; IN COMMERCE 11-5-2010.

NO CLAIM IS MADE TO THE EXCLUSIVE RIGHT TO USE "MEALS-TO-GO FOR 4", APART FROM THE MARK AS SHOWN.

THE MARK CONSISTS OF THE WORDING "MEALS-TO-GO FOR 4" AND DESIGNS WITHIN AN IRREGULAR TRIANGULAR SHAPE. THE WORDING IS IN BLUE WITH WHITE OUTLINES AND "FOR" APPEARS BELOW "MEALS" AND "4" BELOW "FOR." AT THE TOP LEFT OF THE MARK, THERE IS A DIVISION OF THE OVERALL SHAPE INTO A SEMICIRCULAR PURPLE FIELD CONTAINING YELLOW SILVERWARE AND PLATE. THE REST OF THE TRIANGULAR SHAPE IS YELLOW, WITH A GRAY, SQUIGGLING ARROW ON THE LOWER RIGHT PORTION. THE OUTLINES OF THE TRIANGULAR SHAPE AND OTHER DESIGNS ARE BLACK.

SN 85-148,857, FILED 10-8-2010.

CORY BOONE, EXAMINING ATTORNEY



David J. Kyjars

Director of the United States Patent and Trademark Office

United States of America

United States Patent and Trademark Office



Reg. No. 4,154,842

GLOBAL PERFORMANCE GROUP, INC. (ARKANSAS CORPORATION)
109 W. PINE ST.
CABOT, AR 72023

Registered June 5, 2012

Int. Cl.: 29

FOR: FROZEN MEALS CONSISTING PRIMARILY OF MEAT, FISH, OR POULTRY, IN CLASS 29 (U.S. CL. 46).

TRADEMARK

FIRST USE 11-5-2010; IN COMMERCE 11-5-2010.

PRINCIPAL REGISTER

NO CLAIM IS MADE TO THE EXCLUSIVE RIGHT TO USE "FEAST", APART FROM THE MARK AS SHOWN.

THE COLOR(S) BLACK, RED, AND YELLOW IS/ARE CLAIMED AS A FEATURE OF THE MARK.

THE MARK CONSISTS OF THE WORDING "FANTASTIC FEAST" AND DESIGNS WITHIN A RECTANGULAR BORDER WITH A ROUNDED SIDE. THE WORD "FANTASTIC" AND THE RECTANGULAR BORDER ARE BLACK. THE WORD "FEAST" AND THE DOT ABOVE THE "I" ARE RED. THE DOT ABOVE THE "I" ALSO FORMS THE CENTER OF A SUN WITH YELLOW RAYS. THE RECTANGULAR BORDER ENCLOSES A YELLOW BACKGROUND.

SN 85-148,878, FILED 10-8-2010.

CORY BOONE, EXAMINING ATTORNEY



David J. Kyros

Director of the United States Patent and Trademark Office

United States of America

United States Patent and Trademark Office

eyeconic

• com

Reg. No. 4,154,843

Registered June 5, 2012

Int. Cl.: 35

SERVICE MARK

PRINCIPAL REGISTER

VISION SERVICE PLAN (CALIFORNIA CORPORATION), DBA VSP,
MS163
3333 QUALITY DRIVE
RANCHO CORDOVA, CA 95670

FOR: PROVIDING A WEBSITE USED TO PLACE ON-LINE ORDERS FOR OPTOMETRIC MATERIALS, NAMELY, FRAMES FOR SUNGLASSES AND EYEGLASSES AND CONTACT LENSES , IN CLASS 35 (U.S. CLS. 100, 101 AND 102).

FIRST USE 7-18-2011; IN COMMERCE 7-18-2011.

THE MARK CONSISTS OF THE WORD "EYECONIC" SPELLED USING STYLIZED LETTERS WITH THE "I" ALSO FORMING AN EXCLAMATION POINT, THE DOT OF WHICH IS USED AS THE PERIOD IN ".COM", THE LATTER ALSO SPELLED USING STYLIZED LETTERS AND SITUATED IMMEDIATELY BELOW "EYECONIC".

SN 85-149,664, FILED 10-11-2010.

EMILY CHUO, EXAMINING ATTORNEY



David J. Kyffers

Director of the United States Patent and Trademark Office

United States of America

United States Patent and Trademark Office

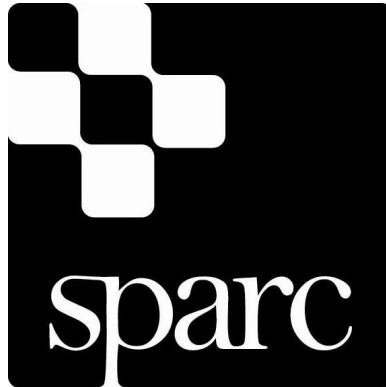

Reg. No. 4,154,844

Registered June 5, 2012

Int. Cl.: 41

SERVICE MARK

PRINCIPAL REGISTER

MMJIP, LLC (CALIFORNIA LIMITED LIABILITY COMPANY)
P. O. BOX 14492
SAN FRANCISCO, CA 94114

FOR: EDUCATIONAL SERVICES, NAMELY, CONDUCTING COURSES, WORKSHOPS, AND SEMINARS IN THE FIELD OF ALTERNATIVE THERAPIES IN HEALTH AND MEDICINE, NAMELY, MEDITATION, SPIRITUALITY, ACUPRESSURE, AYURVEDIC NUTRITION, AND SUPPORT GROUPS FOCUSED ON WOMEN'S ISSUES, HARM REDUCTION, IN CLASS 41 (U.S. CLS. 100, 101 AND 107).

FIRST USE 5-5-2010; IN COMMERCE 5-5-2010.

THE MARK CONSISTS OF ONE BLOCK SURROUNDED BY FOUR OTHERS IN THE UPPER LEFT QUADRANT OF A LARGE SQUARE WITH THE WORD "SPARC" BENEATH.

SN 85-149,743, FILED 10-11-2010.

LINDSEY RUBIN, EXAMINING ATTORNEY



David J. Kybas

Director of the United States Patent and Trademark Office

United States of America

United States Patent and Trademark Office

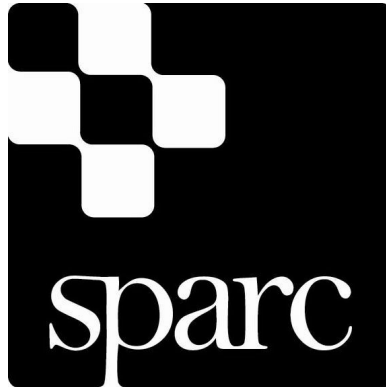

Reg. No. 4,154,845

Registered June 5, 2012

Int. Cl.: 44

SERVICE MARK

PRINCIPAL REGISTER

MMJIP, LLC (CALIFORNIA LIMITED LIABILITY COMPANY)
P. O. BOX 14492
SAN FRANCISCO, CA 94114

FOR: ONLINE MEDICAL CANNABIS RESOURCES, NAMELY, PROVIDING INFORMATION PERTAINING TO THE BENEFITS OF MEDICINAL USE OF CANNABIS, IN CLASS 44 (U.S. CLS. 100 AND 101).

FIRST USE 5-5-2010; IN COMMERCE 5-5-2010.

THE MARK CONSISTS OF ONE BLOCK SURROUNDED BY FOUR OTHERS IN THE UPPER LEFT QUADRANT OF A LARGE SQUARE WITH THE WORD "SPARC" BENEATH.

SN 85-149,753, FILED 10-11-2010.

LINDSEY RUBIN, EXAMINING ATTORNEY



David J. Kybas

Director of the United States Patent and Trademark Office

United States of America

United States Patent and Trademark Office

IDENTITY ATELIER

Reg. No. 4,154,846

Registered June 5, 2012

Int. Cl.: 35

SERVICE MARK

PRINCIPAL REGISTER

IDENTITY ATELIER, LLC (NEW YORK LIMITED LIABILITY COMPANY)
90 WASHINGTON STREET 4K
NEW YORK, NY 10006

FOR: BUSINESS MANAGEMENT, BRAND AND CONCEPT BUILDING, CREATIVE ASSET BUILDING AND PUBLIC RELATIONS SERVICES, NAMELY, THE DEVELOPMENT, EXECUTION, AND MAINTENANCE OF ADVERTISING, MARKETING AND SALES CAMPAIGNS FOR BUSINESSES; BRAND AND REPUTATION MANAGEMENT, NAMELY, MONITORING AND EVALUATING A CLIENT'S BRAND AND REPUTATION AND PROVIDING ARTISTIC, ADVERTISING AND/OR MEDIA RELATIONS SERVICES TO ENHANCE A CLIENT'S BRAND AND REPUTATION AND PROVIDING SPECIFIC CRITERIA FOR PRODUCTS, PACKAGING, LABELING, PHOTOGRAPHY, BRAND DESIGN AND PRODUCT ASSORTMENT STRATEGY; BUSINESS CONSULTATION AND MANAGEMENT REGARDING MARKETING ACTIVITIES AND NEW PRODUCT LAUNCHES, MARKETING SUPPORT FOR EXISTING BRANDS, NAMELY, PROVIDING ADVERTISING AND/OR PUBLIC RELATIONS SERVICES TO SUPPORT ESTABLISHED PRODUCTS OR COMPANIES; PROVIDING BUSINESS MARKETING ADVICE RELATED TO THE ARRANGING, DESIGNING AND CONDUCTING OF TRADE SHOWS, NAMELY, TRADE SHOW BOOTHS, AND TO THE DESIGN OF CONCEPT STORES; BRAND BUILDING, NAMELY, ADVERTISING SERVICES, FEATURING THE CREATION OF BRAND IDENTITY FOR OTHERS THROUGH BOTH TRADITIONAL AND NEW MEDIA; ADVERTISING SERVICES, NAMELY, CREATING LOGOS FOR OTHERS AND DESIGN OF ADVERTISING MATERIALS FOR OTHERS IN THE NATURE OF BUSINESS CARDS, NOTE CARDS, SHOPPING BAGS, BOXES AND PRODUCT PACKAGING; ADVERTISING SERVICES IN THE NATURE OF THE DEVELOPMENT OF ADVERTISING CAMPAIGNS FOR BUSINESSES INVOLVED IN THE SALE OF GOODS AND SERVICES TO OTHERS IN VARIOUS SELLING PLATFORMS, NAMELY, RETAIL, INTERNET, AND DIRECT SALES, IN CLASS 35 (U.S. CLS. 100, 101 AND 102).



FIRST USE 1-0-2011; IN COMMERCE 1-0-2011.

THE MARK CONSISTS OF STANDARD CHARACTERS WITHOUT CLAIM TO ANY PARTICULAR FONT, STYLE, SIZE, OR COLOR.

NO CLAIM IS MADE TO THE EXCLUSIVE RIGHT TO USE "IDENTITY", APART FROM THE MARK AS SHOWN.

SN 85-149,897, FILED 10-11-2010.

David J. Kyffers

Director of the United States Patent and Trademark Office

Reg. No. 4,154,846 JAMES LOVELACE, EXAMINING ATTORNEY

United States of America

United States Patent and Trademark Office

ADVANCE YOUR WORLD.

Reg. No. 4,154,847

Registered June 5, 2012

Int. Cls.: 35, 36, and 42

SERVICE MARK

PRINCIPAL REGISTER

SE2, INC. (KANSAS CORPORATION)
ONE SECURITY BENEFIT PLACE
TOPEKA, KS 66636

FOR: BUSINESS PROCESS OUTSOURCING SERVICES FOR INSURANCE COMPANIES, NAMELY, REGISTERING, SCREENING, AND CREDENTIALING THIRD-PARTY CONTRACTORS IN THE NATURE OF INSURANCE AGENTS AND BROKER-DEALER REPRESENTATIVES; RECEIVING, SORTING, AND HANDLING MAIL ON LIFE INSURANCE POLICIES AND ANNUITY CONTRACTS; BILLING PAYMENTS FOR LIFE INSURANCE POLICIES AND ANNUITY CONTRACTS; RECONCILIATION OF ACCOUNTS ON BEHALF OF OTHERS, NAMELY, RECONCILING PAYMENTS AGAINST BILLINGS ON LIFE INSURANCE POLICIES AND ANNUITY CONTRACTS; DIGITAL COPYING AND DATA PROCESSING IN THE FIELD OF LIFE INSURANCE POLICIES AND ANNUITY CONTRACTS; PREPARING AND MANAGING BUSINESS RECORDS FOR LIFE INSURANCE COMPANIES; OPERATION OF TELEPHONE CALL CENTERS FOR OTHERS; CUSTOMER SERVICE IN THE FIELD OF LIFE INSURANCE POLICIES AND ANNUITY CONTRACTS; REGULATORY COMPLIANCE SERVICES FOR LIFE INSURANCE COMPANIES, NAMELY, DATA COMPILING IN THE FIELD OF LIFE INSURANCE AND ANNUITY CONTRACTS FOR USE BY LIFE INSURANCE COMPANIES TO PREPARE REPORTS TO GOVERNMENT AGENCIES AND INDUSTRY ASSOCIATIONS, IN CLASS 35 (U.S. CLS. 100, 101 AND 102).

FIRST USE 2-0-2011; IN COMMERCE 2-0-2011.



David J. Kyros

Director of the United States Patent and Trademark Office

FOR: INSURANCE ADMINISTRATION, NAMELY, PROCESSING APPLICATIONS FOR NEW AND REPLACEMENT LIFE INSURANCE POLICIES AND ANNUITY CONTRACTS; INSURANCE ADMINISTRATION, NAMELY, ISSUING LIFE INSURANCE POLICIES AND ANNUITY CONTRACTS FOR LIFE INSURANCE COMPANIES; INSURANCE CLAIMS ADMINISTRATION, NAMELY, PROCESSING AND PAYING CLAIMS IN THE FIELD OF LIFE INSURANCE POLICIES AND ANNUITY CONTRACTS; INSURANCE ADMINISTRATION, NAMELY, PROCESSING ORDERS FOR THE ALLOCATION OR REALLOCATION OF VARIABLE ANNUITY OR VARIABLE UNIVERSAL LIFE INSURANCE POLICY ASSETS AMONG FUND INVESTMENT OPTIONS; FINANCIAL SERVICES, NAMELY, CALCULATING AND PAYING COMMISSIONS ON SALES OF LIFE INSURANCE POLICIES AND ANNUITY CONTRACTS FOR OTHERS, IN CLASS 36 (U.S. CLS. 100, 101 AND 102).

FIRST USE 2-0-2011; IN COMMERCE 2-0-2011.

Reg. No. 4,154,847 FOR: DATA CONVERSION OF COMPUTER PROGRAM DATA AND INFORMATION FOR INSURANCE COMPANIES, IN CLASS 42 (U.S. CLS. 100 AND 101).

FIRST USE 2-0-2011; IN COMMERCE 2-0-2011.

THE MARK CONSISTS OF STANDARD CHARACTERS WITHOUT CLAIM TO ANY PARTICULAR FONT, STYLE, SIZE, OR COLOR.

SN 85-150,320, FILED 10-12-2010.

BARBARA GAYNOR, EXAMINING ATTORNEY

United States of America

United States Patent and Trademark Office

FIREAL

Reg. No. 4,154,848

Registered June 5, 2012

Int. Cl.: 2

TRADEMARK

PRINCIPAL REGISTER

MU LEI (CHINA INDIVIDUAL)
273 N. MAGNOLIA AVE.
MONROVIA, CA 91016

FOR: FIRE RESISTANT, FIRE RETARDANT, ANTI-FIRE PAINTS AND COATINGS, IN CLASS 2 (U.S. CLS. 6, 11 AND 16).

FIRST USE 2-1-2012; IN COMMERCE 2-1-2012.

THE MARK CONSISTS OF STANDARD CHARACTERS WITHOUT CLAIM TO ANY PARTICULAR FONT, STYLE, SIZE, OR COLOR.

THE WORDING "FIREAL" HAS NO MEANING IN A FOREIGN LANGUAGE.

SN 85-150,382, FILED 10-12-2010.

LAURA KOVALSKY, EXAMINING ATTORNEY



David J. Kyros

Director of the United States Patent and Trademark Office

United States of America

United States Patent and Trademark Office

SCUBALIFE

Reg. No. 4,154,849

NASE WORLDWIDE, INC. (FLORIDA CORPORATION)
8137 N. MAIN STREET
JACKSONVILLE, FL 32208

Registered June 5, 2012

Int. Cls.: 9, 28, and 39

FOR: SCUBA MASKS, SCUBA SNORKELS, REGULATORS FOR USE IN SCUBA DIVING, BUOYANCY COMPENSATION JACKETS FOR USE IN SCUBA DIVING, PRESSURE GAUGES FOR USE IN SCUBA DIVING, DEPTH GAUGES FOR USE IN SCUBA DIVING, IN CLASS 9 (U.S. CLS. 21, 23, 26, 36 AND 38).

TRADEMARK

SERVICE MARK

FIRST USE 3-16-2012; IN COMMERCE 3-16-2012.

PRINCIPAL REGISTER

FOR: SCUBA FINS, IN CLASS 28 (U.S. CLS. 22, 23, 38 AND 50).

FIRST USE 3-16-2012; IN COMMERCE 3-16-2012.

FOR: ARRANGING SCUBA DIVING TRAVEL TOURS, IN CLASS 39 (U.S. CLS. 100 AND 105).

FIRST USE 3-16-2012; IN COMMERCE 3-16-2012.

THE MARK CONSISTS OF STANDARD CHARACTERS WITHOUT CLAIM TO ANY PARTICULAR FONT, STYLE, SIZE, OR COLOR.

SN 85-150,629, FILED 10-12-2010.

CIMMERIAN COLEMAN, EXAMINING ATTORNEY



David J. Kypos

Director of the United States Patent and Trademark Office

United States of America

United States Patent and Trademark Office

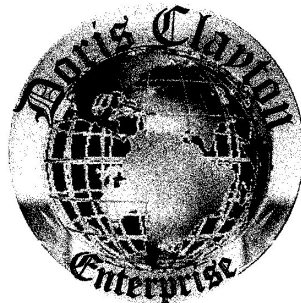

Reg. No. 4,154,850

Registered June 5, 2012

Int. Cl.: 35

SERVICE MARK

PRINCIPAL REGISTER

DORIS CLAYTON ENTERPRISE (NORTH CAROLINA LIMITED LIABILITY COMPANY)
6013 PINK DR
FAYETTEVILLE, NC 28314

FOR: ON-LINE RETAIL STORE SERVICES FEATURING A WIDE VARIETY OF CONSUMER GOODS OF OTHERS, EXCLUDING FOOD ITEMS, IN CLASS 35 (U.S. CLS. 100, 101 AND 102).

FIRST USE 5-1-2011; IN COMMERCE 5-1-2011.

NO CLAIM IS MADE TO THE EXCLUSIVE RIGHT TO USE "ENTERPRISE", APART FROM THE MARK AS SHOWN.

THE NAME "DORIS CLAYTON" IDENTIFIES A LIVING INDIVIDUAL WHOSE CONSENT IS OF RECORD.

THE MARK CONSISTS OF A GLOBE WITH THE STYLIZED TEXT "DORIS CLAYTON ENTERPRISE".

SN 85-151,472, FILED 10-13-2010.

ELIZABETH HUGHITT, EXAMINING ATTORNEY



David J. Kybas

Director of the United States Patent and Trademark Office

United States of America

United States Patent and Trademark Office

BIOLAZ

Reg. No. 4,154,851

Registered June 5, 2012

Int. Cl.: 9

TRADEMARK

PRINCIPAL REGISTER

PARTICLE MEASURING SYSTEMS, INC. (COLORADO CORPORATION)
5475 AIRPORT BOULEVARD
BOULDER, CO 80301

FOR: DETECTORS, NAMELY, DETECTORS FOR DETECTING, COUNTING OR SIZING AIRBORNE MICROBE PARTICLES; REAL-TIME MICROBIAL MONITOR, IN CLASS 9 (U.S. CLS. 21, 23, 26, 36 AND 38).

FIRST USE 11-30-2010; IN COMMERCE 11-30-2010.

THE MARK CONSISTS OF STANDARD CHARACTERS WITHOUT CLAIM TO ANY PARTICULAR FONT, STYLE, SIZE, OR COLOR.

SN 85-151,842, FILED 10-13-2010.

YAT SYE, LEE, EXAMINING ATTORNEY



David J. Kyffers

Director of the United States Patent and Trademark Office

United States of America

United States Patent and Trademark Office

LASIK XTRA

Reg. No. 4,154,852

AVEDRO, INC. (DELAWARE CORPORATION)
230 THIRD AVENUE
WALTHAM, MA 02451

Registered June 5, 2012

Int. Cl.: 44

FOR: SURGERY; LASER VISION SURGERY SERVICES, IN CLASS 44 (U.S. CLS. 100 AND 101).

SERVICE MARK

FIRST USE 1-0-2011; IN COMMERCE 1-0-2011.

PRINCIPAL REGISTER

THE MARK CONSISTS OF STANDARD CHARACTERS WITHOUT CLAIM TO ANY PARTICULAR FONT, STYLE, SIZE, OR COLOR.

NO CLAIM IS MADE TO THE EXCLUSIVE RIGHT TO USE "LASIK", APART FROM THE MARK AS SHOWN.

SN 85-152,906, FILED 10-14-2010.

TRICIA SONNEBORN, EXAMINING ATTORNEY



David J. Kyffers

Director of the United States Patent and Trademark Office

United States of America

United States Patent and Trademark Office

FIRST IN FIBER

Reg. No. 4,154,853

FOOD AND CULINARY TECHNOLOGY GROUP, INC. (NEVADA CORPORATION)
5614E BURBANK RD SE
CALGARY, CANADA

Registered June 5, 2012

Int. Cl.: 30

FOR: BREAD MIXES; BROWNIE MIXES; CAKE MIXES; CAKE MIXES, NAMELY, CAKE BASES; COOKIE MIXES; INSTANT DOUGHNUT MIXES; INSTANT PANCAKE MIXES; MIXES FOR MAKING BAKING BATTERS; MIXES FOR MAKING BREADING; MUFFIN MIXES, IN CLASS 30 (U.S. CL. 46).

TRADEMARK

PRINCIPAL REGISTER

FIRST USE 8-1-2011; IN COMMERCE 8-1-2011.

THE MARK CONSISTS OF STANDARD CHARACTERS WITHOUT CLAIM TO ANY PARTICULAR FONT, STYLE, SIZE, OR COLOR.

SN 85-153,277, FILED 10-15-2010.

THOMAS MANOR, EXAMINING ATTORNEY



David J. Kyros

Director of the United States Patent and Trademark Office

United States of America

United States Patent and Trademark Office

WEAVING NAPE

Reg. No. 4,154,854

SHAKE-N-GO FASHION, INC. (NEW YORK CORPORATION)
83 HARBOR ROAD
PORT WASHINGTON, NY 11050

Registered June 5, 2012

Int. Cl.: 26

FOR: HAIR PRODUCTS, NAMELY, HAIR PIECES, WIGS, HAIR EXTENSIONS, AND PONYTAIL HAIR PIECES, IN CLASS 26 (U.S. CLS. 37, 39, 40, 42 AND 50).

TRADEMARK

FIRST USE 2-8-2011; IN COMMERCE 2-8-2011.

PRINCIPAL REGISTER

THE MARK CONSISTS OF STANDARD CHARACTERS WITHOUT CLAIM TO ANY PARTICULAR FONT, STYLE, SIZE, OR COLOR.

SN 85-153,422, FILED 10-15-2010.

REBECCA GILBERT, EXAMINING ATTORNEY



David J. Kybas

Director of the United States Patent and Trademark Office

United States of America

United States Patent and Trademark Office

GALAXY

Reg. No. 4,154,855

Registered June 5, 2012

Int. Cl.: 36

SERVICE MARK

PRINCIPAL REGISTER

PRIDE MOBILITY PRODUCTS CORPORATION (PENNSYLVANIA CORPORATION)
182 SUSQUEHANNA AVENUE
EXETER, PA 18643

FOR: LENDING AND FINANCING SERVICES, NAMELY, COMMERCIAL FINANCING AND LOAN SERVICES AND COMMERCIAL EQUIPMENT FINANCING SERVICES PROVIDED TO DEALERS IN CONNECTION WITH THE PURCHASE OF PERSONAL MOBILITY PRODUCTS, NAMELY, POWER CHAIRS, SCOOTERS, LIFT CHAIRS, WHEEL CHAIRS AND LIFTS AND RAMPS THEREFOR, FOR RE-SALE OR LEASE TO ELDERLY, INFIRM AND DISABLED PERSONS, IN CLASS 36 (U.S. CLS. 100, 101 AND 102).

FIRST USE 1-31-2011; IN COMMERCE 1-31-2011.

THE MARK CONSISTS OF STANDARD CHARACTERS WITHOUT CLAIM TO ANY PARTICULAR FONT, STYLE, SIZE, OR COLOR.

SN 85-153,639, FILED 10-15-2010.

JAY BESCH, EXAMINING ATTORNEY



David J. Kyros

Director of the United States Patent and Trademark Office

United States of America

United States Patent and Trademark Office

VUE

Reg. No. 4,154,856

KEURIG, INCORPORATED (DELAWARE CORPORATION)
55 WALKERS BROOK DRIVE
READING, MA 01867

Registered June 5, 2012

Int. Cl.: 11

FOR: ELECTRIC COFFEE, TEA AND HOT COCOA BREWING MACHINES FOR DOMESTIC AND COMMERCIAL USE, IN CLASS 11 (U.S. CLS. 13, 21, 23, 31 AND 34).

TRADEMARK

FIRST USE 3-5-2012; IN COMMERCE 3-5-2012.

PRINCIPAL REGISTER

THE MARK CONSISTS OF STANDARD CHARACTERS WITHOUT CLAIM TO ANY PARTICULAR FONT, STYLE, SIZE, OR COLOR.

SN 85-153,994, FILED 10-15-2010.

KIMBERLY PERRY, EXAMINING ATTORNEY



David J. Kybas

Director of the United States Patent and Trademark Office

United States of America

United States Patent and Trademark Office

GALAXY MOBILITY

Reg. No. 4,154,857

Registered June 5, 2012

Int. Cl.: 36

SERVICE MARK

PRINCIPAL REGISTER

PRIDE MOBILITY PRODUCTS CORPORATION (PENNSYLVANIA CORPORATION)
182 SUSQUEHANNA AVENUE
EXETER, PA 18643

FOR: LENDING AND FINANCING SERVICES, NAMELY, COMMERCIAL FINANCING AND LOAN SERVICES AND COMMERCIAL EQUIPMENT FINANCING SERVICES PROVIDED TO DEALERS IN CONNECTION WITH THE PURCHASE OF PERSONAL MOBILITY PRODUCTS, NAMELY, POWER CHAIRS, SCOOTERS, LIFT CHAIRS, WHEEL CHAIRS AND LIFTS AND RAMPS THEREFOR, FOR RE-SALE OR LEASE TO ELDERLY, INFIRM AND DISABLED PERSONS, IN CLASS 36 (U.S. CLS. 100, 101 AND 102).

FIRST USE 1-31-2011; IN COMMERCE 1-31-2011.

THE MARK CONSISTS OF STANDARD CHARACTERS WITHOUT CLAIM TO ANY PARTICULAR FONT, STYLE, SIZE, OR COLOR.

NO CLAIM IS MADE TO THE EXCLUSIVE RIGHT TO USE "MOBILITY", APART FROM THE MARK AS SHOWN.

SN 85-154,496, FILED 10-17-2010.

JAY BESCH, EXAMINING ATTORNEY



David J. Kyros

Director of the United States Patent and Trademark Office

United States of America

United States Patent and Trademark Office

METRIC INSIGHTS

Reg. No. 4,154,858

Registered June 5, 2012

Int. Cl.: 9

TRADEMARK

PRINCIPAL REGISTER

METRIC INSIGHTS, INC. (CALIFORNIA CORPORATION)
1214 STANYAN STREET
SAN FRANCISCO, CA 94117

FOR: BUSINESS INTELLIGENCE SOFTWARE, NAMELY, SOFTWARE FOR USE IN REPORTING, TRENDING, AND ANALYSIS OF DATA STORED IN DATABASES AND ACCESSED THROUGH WEB SERVICES, IN CLASS 9 (U.S. CLS. 21, 23, 26, 36 AND 38).

FIRST USE 4-28-2011; IN COMMERCE 4-28-2011.

THE MARK CONSISTS OF STANDARD CHARACTERS WITHOUT CLAIM TO ANY PARTICULAR FONT, STYLE, SIZE, OR COLOR.

SN 85-154,586, FILED 10-18-2010.

BRENDAN MCCAULEY, EXAMINING ATTORNEY



David J. Kyros

Director of the United States Patent and Trademark Office

United States of America

United States Patent and Trademark Office

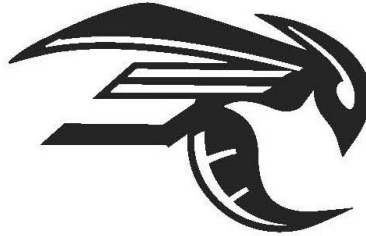

Reg. No. 4,154,859

Registered June 5, 2012

Int. Cl.: 28

TRADEMARK

PRINCIPAL REGISTER

WEAVER'S OUTDOOR, INC. (PENNSYLVANIA CORPORATION)
601 CARLSON ROAD
HUMMELSTOWN, PA 17036

FOR: ARCHERY AND CROSSBOW EQUIPMENT, NAMELY, BOLTS, IN CLASS 28 (U.S. CLS. 22, 23, 38 AND 50).

FIRST USE 5-5-2011; IN COMMERCE 5-5-2011.

OWNER OF U.S. REG. NOS. 1,438,149 AND 3,150,441.

THE MARK CONSISTS OF A STYLIZED REPRESENTATION OF A WASP.

SN 85-156,659, FILED 10-20-2010.

JOHN GARTNER, EXAMINING ATTORNEY



David J. Kyffers

Director of the United States Patent and Trademark Office

United States of America

United States Patent and Trademark Office

SHOWTIME SPORTS NO ONE GETS YOU CLOSER

Reg. No. 4,154,860

Registered June 5, 2012

Int. Cl.: 41

SERVICE MARK

PRINCIPAL REGISTER

SHOWTIME NETWORKS INC. (DELAWARE CORPORATION)
1633 BROADWAY
NEW YORK, NY 10019

FOR: ENTERTAINMENT SERVICES, NAMELY, PRODUCTION AND DISTRIBUTION OF MOTION PICTURES, COMEDY SHOWS, MUSICAL AND DRAMATIC TELEVISION SERIES, DOCUMENTARIES, AND TELEVISION SERIES FEATURING SPORTING EVENTS RENDERED THROUGH THE MEDIA OF TELEVISION, CABLE, SATELLITE, RADIO, TELEPHONE AND BROADBAND SYSTEMS, AND VIA THE INTERNET, PORTABLE AND WIRELESS COMMUNICATION DEVICES; PROVIDING INFORMATION IN THE FIELD OF ENTERTAINMENT RENDERED VIA THE INTERNET, GLOBAL AND WIRELESS COMMUNICATION DEVICES, IN CLASS 41 (U.S. CLS. 100, 101 AND 107).

FIRST USE 6-30-2011; IN COMMERCE 6-30-2011.

THE MARK CONSISTS OF STANDARD CHARACTERS WITHOUT CLAIM TO ANY PARTICULAR FONT, STYLE, SIZE, OR COLOR.

OWNER OF U.S. REG. NOS. 3,412,233, 3,528,037, AND OTHERS.

NO CLAIM IS MADE TO THE EXCLUSIVE RIGHT TO USE "SPORTS", APART FROM THE MARK AS SHOWN.

SN 85-157,008, FILED 10-20-2010.

ELISSA GARBER KON, EXAMINING ATTORNEY



David J. Kyros

Director of the United States Patent and Trademark Office

United States of America

United States Patent and Trademark Office

ELLE BIJOUX

Reg. No. 4,154,861

HACHETTE FILIPACCHI PRESSE (FRANCE CORPORATION)
149-151 RUE ANATOLE FRANCE
LEVALLOIS-PERRET CEDEX, FRANCE 92534

Registered June 5, 2012

Int. Cl.: 14

FOR: COSTUME JEWELLERY, FASHION JEWELLERY, IMITATION JEWELLERY, JEWELLERY AND PRECIOUS STONES IN GENERAL, NECKLACES, PENDANTS, EARRINGS, BRACELETS, BANGLES, RINGS, TRINKETS IN THE NATURE OF RINGS, IN CLASS 14 (U.S. CLS. 2, 27, 28 AND 50).

TRADEMARK

PRINCIPAL REGISTER

FIRST USE 11-30-2011; IN COMMERCE 11-30-2011.

OWNER OF U.S. REG. NOS. 758,137, 2,120,688, AND OTHERS.

THE COLOR(S) RED, WHITE AND BLACK IS/ARE CLAIMED AS A FEATURE OF THE MARK.

NO CLAIM IS MADE TO THE EXCLUSIVE RIGHT TO USE "BIJOUX", APART FROM THE MARK AS SHOWN.

THE MARK CONSISTS OF THE WORD "ELLE" IN WHITE LETTERS ON A RED BACKGROUND AND THE WORD "BIJOUX" IN BLACK LETTERS ON A WHITE BACKGROUND.

THE ENGLISH TRANSLATION OF "ELLE" IN THE MARK IS "SHE".

SN 85-157,949, FILED 10-21-2010.

ERNEST SHOSHO, EXAMINING ATTORNEY



David J. Kyros

Director of the United States Patent and Trademark Office

United States of America

United States Patent and Trademark Office

CISCO SOCIALMINER

Reg. No. 4,154,862

Registered June 5, 2012

Int. Cl.: 9

TRADEMARK

PRINCIPAL REGISTER

CISCO TECHNOLOGY, INC. (CALIFORNIA CORPORATION)
170 WEST TASMAN DRIVE
SAN JOSE, CA 95134

FOR: COMPUTER SOFTWARE FOR BRAND MONITORING AND FOR MANAGEMENT OF CUSTOMER SERVICE, NAMELY, SOFTWARE FOR SEARCHING, ANALYZING AND MONITORING COMMUNITY WEBSITES, BLOGS, AND OTHER ONLINE SOCIAL MEDIA, AND FOR GENERATING INFORMATION AND REPORTS RELATED THERETO, IN CLASS 9 (U.S. CLS. 21, 23, 26, 36 AND 38).

FIRST USE 1-28-2011; IN COMMERCE 1-28-2011.

THE MARK CONSISTS OF STANDARD CHARACTERS WITHOUT CLAIM TO ANY PARTICULAR FONT, STYLE, SIZE, OR COLOR.

OWNER OF U.S. REG. NOS. 3,709,076, 3,759,451, AND OTHERS.

SN 85-158,582, FILED 10-21-2010.

REGINA DRUMMOND, EXAMINING ATTORNEY



David J. Kyros

Director of the United States Patent and Trademark Office

United States of America

United States Patent and Trademark Office

SAZZI

Reg. No. 4,154,863

Registered June 5, 2012

Int. Cl.: 25

TRADEMARK

PRINCIPAL REGISTER

SAZZI FOOTWEAR, LLC (CALIFORNIA LIMITED LIABILITY COMPANY)
419 31ST STREET
SUITE A
NEWPORT BEACH, CA 92663

FOR: CLOTHING, NAMELY, ATHLETIC AND CASUAL OUTERWEAR, NAMELY, CAPES, COATS, JACKETS, PANTS, JEANS, PARKAS, PONCHOS, RAINCOATS, WIND RESISTANT JACKETS, PULLOVERS, SHIRTS, SHORTS, T-SHIRTS AND SOCKS; SWIMWEAR, NAMELY, BATHING SUITS, BRIEFS, AND TRUNKS; GYM WEAR, NAMELY, BODYSUITS, RUNNING SHORTS, SWEATPANTS, SWEAT SHIRTS, TANK-TOPS AND WARM-UP SUITS; CASUAL WEAR, NAMELY, JEANS, KNIT TOPS, PANTS, PULLOVERS, SHIRTS, SHORTS, T-SHIRTS AND VESTS; FOOTWEAR, NAMELY, SNEAKERS, SPORT SHOES, BOOTS, CASUAL SHOES, HIKING BOOTS, WATER SHOES, BOOTIES, NEOPRENE BOOTS, TRAIL HIKING BOOTS, BABY FOOTWEAR, SLIPPERS, THONGS, DRESS SHOES, SKI SHOES, SHOES, SANDALS AND BOOTS; AND HEADGEAR, NAMELY, CAPS, BANDANNAS, VISORS AND HATS, IN CLASS 25 (U.S. CLS. 22 AND 39).

FIRST USE 1-15-2012; IN COMMERCE 1-15-2012.

THE MARK CONSISTS OF STANDARD CHARACTERS WITHOUT CLAIM TO ANY PARTICULAR FONT, STYLE, SIZE, OR COLOR.

SN 85-159,077, FILED 10-22-2010.

BENJAMIN OKEKE, EXAMINING ATTORNEY



David J. Kybas

Director of the United States Patent and Trademark Office

United States of America

United States Patent and Trademark Office

FIREJET

Reg. No. 4,154,864

Registered June 5, 2012

Int. Cl.: 11

TRADEMARK

PRINCIPAL REGISTER

PHOSEON TECHNOLOGY, INC. (OREGON CORPORATION)
7425 NW EVERGREEN PKWY
HILLSBORO, OR 97124

FOR: LIGHT CURING SYSTEMS COMPOSED PRIMARILY OF LIGHT EMITTING DIODES FOR INDUSTRIAL APPLICATIONS; UV CURING SYSTEMS COMPOSED PRIMARILY OF LIGHT EMITTING DIODES, FOR COMMERCIAL APPLICATIONS, NAMELY, FOR CURING INKS, COATINGS, ADHESIVES, AND A VARIETY OF OTHER MATERIALS, IN CLASS 11 (U.S. CLS. 13, 21, 23, 31 AND 34).

FIRST USE 8-0-2010; IN COMMERCE 8-0-2010.

THE MARK CONSISTS OF STANDARD CHARACTERS WITHOUT CLAIM TO ANY PARTICULAR FONT, STYLE, SIZE, OR COLOR.

SN 85-159,098, FILED 10-22-2010.

RENEE SERVANCE, EXAMINING ATTORNEY



David J. Kyffers

Director of the United States Patent and Trademark Office

United States of America

United States Patent and Trademark Office

FIREPOWER

Reg. No. 4,154,865

Registered June 5, 2012

Int. Cl.: 11

TRADEMARK

PRINCIPAL REGISTER

PHOSEON TECHNOLOGY, INC. (OREGON CORPORATION)
7425 NW EVERGREEN PKWY
HILLSBORO, OR 97124

FOR: LIGHT CURING SYSTEMS COMPOSED PRIMARILY OF LIGHT EMITTING DIODES FOR INDUSTRIAL APPLICATIONS; UV CURING SYSTEMS COMPOSED PRIMARILY OF LIGHT EMITTING DIODES, FOR COMMERCIAL APPLICATIONS, NAMELY, FOR CURING INKS, COATINGS, ADHESIVES, AND A VARIETY OF OTHER MATERIALS, IN CLASS 11 (U.S. CLS. 13, 21, 23, 31 AND 34).

FIRST USE 3-5-2012; IN COMMERCE 3-5-2012.

THE MARK CONSISTS OF STANDARD CHARACTERS WITHOUT CLAIM TO ANY PARTICULAR FONT, STYLE, SIZE, OR COLOR.

SN 85-159,134, FILED 10-22-2010.

RENEE SERVANCE, EXAMINING ATTORNEY



David J. Kyffers

Director of the United States Patent and Trademark Office

United States of America

United States Patent and Trademark Office

I SHOULD BE FAMOUS

Reg. No. 4,154,866

Registered June 5, 2012

Int. Cl.: 41

SERVICE MARK

PRINCIPAL REGISTER

RAZI, TARVELLA (UNITED STATES INDIVIDUAL)
5892 LAWSON PEAK WAY
FONTANA, CA 92336

FOR: ENTERTAINMENT SERVICES, NAMELY, AN ON-GOING SERIES FEATURING MUSIC AND A REALITY SHOW COMPETITION IN THE FIELD OF MUSIC PROVIDED THROUGH TELEVISION, INTERNET AND RADIO , IN CLASS 41 (U.S. CLS. 100, 101 AND 107).

FIRST USE 3-31-2008; IN COMMERCE 12-31-2010.

THE MARK CONSISTS OF STANDARD CHARACTERS WITHOUT CLAIM TO ANY PARTICULAR FONT, STYLE, SIZE, OR COLOR.

SN 85-159,651, FILED 10-23-2010.

MARC LEIPZIG, EXAMINING ATTORNEY



David J. Kyffers

Director of the United States Patent and Trademark Office

United States of America

United States Patent and Trademark Office

MEI SC ADVANCE

Reg. No. 4,154,867

Registered June 5, 2012

Int. Cl.: 9

TRADEMARK

PRINCIPAL REGISTER

MEI, INC. (DELAWARE CORPORATION)
1301 WILSON DRIVE
WEST CHESTER, PA 19380

FOR: BILL ACCEPTING AND VALIDATING MACHINES, NAMELY, ELECTRONIC APPARATUS FOR ACCEPTING, DENOMINATING, VALIDATING, STORING, AND POTENTIALLY REJECTING BANK NOTES, IN CLASS 9 (U.S. CLS. 21, 23, 26, 36 AND 38).

FIRST USE 2-0-2012; IN COMMERCE 2-0-2012.

THE MARK CONSISTS OF STANDARD CHARACTERS WITHOUT CLAIM TO ANY PARTICULAR FONT, STYLE, SIZE, OR COLOR.

OWNER OF U.S. REG. NOS. 2,789,405, 2,830,358, AND OTHERS.

SN 85-159,886, FILED 10-24-2010.

JAMES STEIN, EXAMINING ATTORNEY



David J. Kyros

Director of the United States Patent and Trademark Office

United States of America

United States Patent and Trademark Office

A LIGHTER WAY TO STAY HYDRATED

Reg. No. 4,154,868

Registered June 5, 2012

Int. Cl.: 32

TRADEMARK

PRINCIPAL REGISTER

TOPCO HOLDINGS, INC. (WISCONSIN CORPORATION)
7711 GROSS POINT ROAD
SKOKIE, IL 60077

FOR: POWDERS FOR MAKING NON-CARBONATED TEA-FLAVORED BEVERAGES;
POWDERS USED IN THE PREPARATION OF NON-CARBONATED SPORTS AND ENERGY
DRINKS, IN CLASS 32 (U.S. CLS. 45, 46 AND 48).

FIRST USE 3-0-2011; IN COMMERCE 3-0-2011.

THE MARK CONSISTS OF STANDARD CHARACTERS WITHOUT CLAIM TO ANY PAR-
TICULAR FONT, STYLE, SIZE, OR COLOR.

SN 85-160,988, FILED 10-26-2010.

MICHAEL ENGEL, EXAMINING ATTORNEY



David J. Kyros

Director of the United States Patent and Trademark Office

United States of America

United States Patent and Trademark Office

SIMPLE CARE

Reg. No. 4,154,869

Registered June 5, 2012

Int. Cl.: 31

TRADEMARK

PRINCIPAL REGISTER

MEEHL, DR. CHRIS (UNITED STATES INDIVIDUAL)
70 MAIN STREET
LYNNFIELD, MA 01940

FOR: PET FOOD, IN CLASS 31 (U.S. CLS. 1 AND 46).

FIRST USE 4-3-2012; IN COMMERCE 4-3-2012.

THE MARK CONSISTS OF STANDARD CHARACTERS WITHOUT CLAIM TO ANY PARTICULAR FONT, STYLE, SIZE, OR COLOR.

SN 85-161,436, FILED 10-26-2010.

TARAH HARDY, EXAMINING ATTORNEY



David J. Kyffers

Director of the United States Patent and Trademark Office

United States of America

United States Patent and Trademark Office



Northwest Oklahoma Neuroscience and Spine Institute

Reg. No. 4,154,870

Registered June 5, 2012

Int. Cl.: 44

SERVICE MARK

PRINCIPAL REGISTER

UHS OF DELAWARE, INC. (DELAWARE CORPORATION)
367 SOUTH GULPH ROAD
KING OF PRUSSIA, PA 194060958

FOR: HEALTHCARE; MEDICAL SERVICES, IN CLASS 44 (U.S. CLS. 100 AND 101).

FIRST USE 3-19-2012; IN COMMERCE 3-19-2012.

NO CLAIM IS MADE TO THE EXCLUSIVE RIGHT TO USE "NORTHWEST OKLAHOMA NEUROSCIENCE AND SPINE INSTITUTE", APART FROM THE MARK AS SHOWN.

THE MARK CONSISTS OF AN IMAGE OF A PORTION OF THE SPINAL COLUMN IMPOSED OVER AN IMAGE OF THE BRAIN ALL SET AGAINST A RECTANGULAR BACKGROUND, WITH THE WORDS "NORTHWEST OKLAHOMA NEUROSCIENCE AND SPINE INSTITUTE" TO THE RIGHT THEREOF.

SN 85-161,599, FILED 10-26-2010.

DEBRA LEE, EXAMINING ATTORNEY



David J. Kyros

Director of the United States Patent and Trademark Office

United States of America
United States Patent and Trademark Office

MUSCLE MOB
MOTORSPORTS

Reg. No. 4,154,871

WAYMAN, GARY (UNITED STATES INDIVIDUAL)
993 C S SANTA FE AVE
VISTA, CA 92083

Registered June 5, 2012

Int. Cl.: 35

FOR: WHOLESALE AND RETAIL STORE SERVICES AND ON-LINE RETAIL AND WHOLESALE STORE SERVICES FEATURING AUTOMOTIVE PARTS AND CLOTHING, IN CLASS 35 (U.S. CLS. 100, 101 AND 102).

SERVICE MARK

FIRST USE 12-1-2011; IN COMMERCE 12-1-2011.

PRINCIPAL REGISTER

NO CLAIM IS MADE TO THE EXCLUSIVE RIGHT TO USE "MUSCLE" AND "MOTORSPORTS", APART FROM THE MARK AS SHOWN.

THE MARK CONSISTS OF "MUSCLE MOB MOTORSPORTS" IN STYLIZED FONT.

SN 85-162,456, FILED 10-27-2010.

TIMOTHY FINNEGAN, EXAMINING ATTORNEY



David J. Kyros

Director of the United States Patent and Trademark Office

United States of America

United States Patent and Trademark Office

BOLD BLOOMS

Reg. No. 4,154,872

Registered June 5, 2012

Int. Cl.: 1

TRADEMARK

PRINCIPAL REGISTER

SMG BRANDS, INC. (DELAWARE CORPORATION)
1105 N. MARKET STREET, SUITE 1300
WILMINGTON, DE 19801

FOR: PLANT FOOD AND FERTILIZER, IN CLASS 1 (U.S. CLS. 1, 5, 6, 10, 26 AND 46).

FIRST USE 2-17-2012; IN COMMERCE 2-17-2012.

THE MARK CONSISTS OF STANDARD CHARACTERS WITHOUT CLAIM TO ANY PARTICULAR FONT, STYLE, SIZE, OR COLOR.

SN 85-163,052, FILED 10-27-2010.

PAUL MORENO, EXAMINING ATTORNEY



David J. Kyffers

Director of the United States Patent and Trademark Office

United States of America

United States Patent and Trademark Office

TRUTH FOR TODAY

Reg. No. 4,154,873

BEULAH BAPTIST CHURCH OF BENNETT INC. (NORTH CAROLINA CORPORATION)
8454 HOWARD MILL RD
BENNETT, NC 27208

Registered June 5, 2012

Int. Cl.: 41

FOR: ENTERTAINMENT IN THE NATURE OF ON-GOING TELEVISION PROGRAMS IN THE FIELD OF THE CHRISTIAN RELIGION, IN CLASS 41 (U.S. CLS. 100, 101 AND 107).

SERVICE MARK

FIRST USE 1-1-2011; IN COMMERCE 3-6-2011.

PRINCIPAL REGISTER

THE MARK CONSISTS OF STANDARD CHARACTERS WITHOUT CLAIM TO ANY PARTICULAR FONT, STYLE, SIZE, OR COLOR.

SN 85-163,154, FILED 10-27-2010.

ANNE MADDEN, EXAMINING ATTORNEY



David J. Kybas

Director of the United States Patent and Trademark Office

United States of America

United States Patent and Trademark Office



Reg. No. 4,154,874

Registered June 5, 2012

Int. Cl.: 40

SERVICE MARK

PRINCIPAL REGISTER

WILLEMS COMMERCIAL PRINTING, INC. (CALIFORNIA CORPORATION)
2030 S. GOLDEN STATE BLVD
2030 S. GOLDEN STATE BLVD #203
FOWLER, CA 93625

FOR: PRINTING; PRINTING OF ADVERTISING BROCHURES FOR OTHERS, IN CLASS 40
(U.S. CLS. 100, 103 AND 106).

FIRST USE 10-15-2010; IN COMMERCE 10-15-2010.

NO CLAIM IS MADE TO THE EXCLUSIVE RIGHT TO USE "PRINT", APART FROM THE
MARK AS SHOWN.

THE MARK CONSISTS OF A PARROT ILLUSTRATION AND THE WORDS "PARROT
PRINT".

SN 85-164,225, FILED 10-28-2010.

Laurie Kaufman, Examining Attorney



David J. Kyffers

Director of the United States Patent and Trademark Office

United States of America

United States Patent and Trademark Office

ChromaLit

Reg. No. 4,154,875

Registered June 5, 2012

Int. Cls.: 1 and 11

TRADEMARK

PRINCIPAL REGISTER

INTEMATIX CORPORATION (CALIFORNIA CORPORATION)
46430 FREMONT BLVD.
FREMONT, CA 94538

FOR: CHEMICALS, NAMELY, PHOSPHORS AND SCINTILLATORS, NAMELY, SUBSTANCES THAT REACT TO A HIGH ENERGY PARTICLE NOT INTENDED FOR WATCHES AND THEIR PARTS, IN CLASS 1 (U.S. CLS. 1, 5, 6, 10, 26 AND 46).

FIRST USE 4-0-2011; IN COMMERCE 4-0-2011.

FOR: LED (LIGHT EMITTING DIODE) LIGHTING FIXTURES; LED LIGHT BULBS, IN CLASS 11 (U.S. CLS. 13, 21, 23, 31 AND 34).

FIRST USE 4-0-2011; IN COMMERCE 4-0-2011.

THE MARK CONSISTS OF STANDARD CHARACTERS WITHOUT CLAIM TO ANY PARTICULAR FONT, STYLE, SIZE, OR COLOR.

SN 85-165,602, FILED 10-30-2010.

EDWARD NELSON, EXAMINING ATTORNEY



David J. Kypos

Director of the United States Patent and Trademark Office

United States of America

United States Patent and Trademark Office

INVESTING MADE EASIER

Reg. No. 4,154,876

Registered June 5, 2012

Int. Cl.: 36

SERVICE MARK

PRINCIPAL REGISTER

U-HAUL INTERNATIONAL, INC. (NEVADA CORPORATION)
2727 NORTH CENTRAL AVENUE
PHOENIX, AZ 85004

FOR: FINANCIAL AND INVESTMENT SERVICES IN THE NATURE OF AN INVESTMENT SECURITY; FINANCIAL AND INVESTMENT SERVICES, NAMELY, ADMINISTERING THE ISSUANCE AND DISTRIBUTION OF SECURITIES, IN CLASS 36 (U.S. CLS. 100, 101 AND 102).

FIRST USE 2-3-2011; IN COMMERCE 2-3-2011.

THE MARK CONSISTS OF STANDARD CHARACTERS WITHOUT CLAIM TO ANY PARTICULAR FONT, STYLE, SIZE, OR COLOR.

NO CLAIM IS MADE TO THE EXCLUSIVE RIGHT TO USE "INVESTING", APART FROM THE MARK AS SHOWN.

SN 85-166,963, FILED 11-2-2010.

TINA MAI, EXAMINING ATTORNEY



David J. Kyros

Director of the United States Patent and Trademark Office

United States of America

United States Patent and Trademark Office

WiTHIN You Now!

Reg. No. 4,154,877

HILTON, STACEY (UNITED STATES INDIVIDUAL)
2531 E. THACKERY ST
WEST COVINA, CA 91791

Registered June 5, 2012

Int. Cl.: 44

FOR: PSYCHOLOGICAL THERAPY IN THE FIELD OF WEIGHT MANAGEMENT; BEHAVIORAL THERAPY IN THE FIELD OF WEIGHT MANAGEMENT, IN CLASS 44 (U.S. CLS. 100 AND 101).

SERVICE MARK

FIRST USE 7-1-2011; IN COMMERCE 7-1-2011.

PRINCIPAL REGISTER

THE MARK CONSISTS OF STANDARD CHARACTERS WITHOUT CLAIM TO ANY PARTICULAR FONT, STYLE, SIZE, OR COLOR.

SN 85-167,604, FILED 11-2-2010.

ALICE BENMAMAN, EXAMINING ATTORNEY



David J. Kyffers

Director of the United States Patent and Trademark Office

United States of America

United States Patent and Trademark Office

TRUTV PRESENTS: WORLD'S DUMBEST...

Reg. No. 4,154,878

Registered June 5, 2012

Int. Cl.: 9

TRADEMARK

PRINCIPAL REGISTER

COURTROOM TELEVISION NETWORK LLC (NEW YORK LIMITED LIABILITY COMPANY)
600 THIRD AVENUE
NEW YORK, NY 10016

FOR: DOWNLOADABLE TELEVISION PROGRAMS FEATURING COMEDY, DRAMA,
ACTION, ADVENTURE AND/OR REALITY PROVIDED VIA THE INTERNET AND WIRELESS
COMMUNICATIONS NETWORKS, IN CLASS 9 (U.S. CLS. 21, 23, 26, 36 AND 38).

FIRST USE 6-30-2011; IN COMMERCE 6-30-2011.

THE MARK CONSISTS OF STANDARD CHARACTERS WITHOUT CLAIM TO ANY PAR-
TICULAR FONT, STYLE, SIZE, OR COLOR.

OWNER OF U.S. REG. NOS. 3,493,740, 3,664,198, AND 3,669,937.

SN 85-169,458, FILED 11-4-2010.

TAMARA FRAZIER, EXAMINING ATTORNEY



David J. Kybas

Director of the United States Patent and Trademark Office

United States of America

United States Patent and Trademark Office

TRUTV PRESENTS: WORLD'S DUMBEST...

Reg. No. 4,154,879

Registered June 5, 2012

Int. Cl.: 41

SERVICE MARK

PRINCIPAL REGISTER

COURTROOM TELEVISION NETWORK LLC (NEW YORK LIMITED LIABILITY COMPANY)
600 THIRD AVENUE
NEW YORK, NY 10016

FOR: ENTERTAINMENT SERVICES, NAMELY, CONTINUING SCRIPTED AND UNSCRIPTED TELEVISION PROGRAM SERIES IN THE FIELD OF COMEDY, DRAMA, ACTION, ADVENTURE AND/OR REALITY PROVIDED THROUGH CABLE TELEVISION, BROADCAST TELEVISION, INTERNET, VIDEO-ON-DEMAND, AND THROUGH OTHER DISTRIBUTION PLATFORMS; PROVIDING INFORMATION, NAMELY, ENTERTAINMENT INFORMATION OVER THE INTERNET, IN CLASS 41 (U.S. CLS. 100, 101 AND 107).

FIRST USE 6-30-2011; IN COMMERCE 6-30-2011.

THE MARK CONSISTS OF STANDARD CHARACTERS WITHOUT CLAIM TO ANY PARTICULAR FONT, STYLE, SIZE, OR COLOR.

OWNER OF U.S. REG. NOS. 3,493,740, 3,669,937, AND OTHERS.

SN 85-169,483, FILED 11-4-2010.

TAMARA FRAZIER, EXAMINING ATTORNEY



David J. Kyros

Director of the United States Patent and Trademark Office

United States of America

United States Patent and Trademark Office

SMART FILL

Reg. No. 4,154,880

Registered June 5, 2012

Int. Cl.: 9

TRADEMARK

PRINCIPAL REGISTER

SCOTT TECHNOLOGIES, INC. (DELAWARE CORPORATION)
IP LAW DEPARTMENT
1501 YAMATO ROAD
BOCA RATON, FL 33431

FOR: OXYGEN BREATHING UNIT AIR CHARGING SYSTEMS COMPRISED OF A HOUSING AND INTERLINKED PNEUMATIC VALVES FOR CONTROLLING THE FILLING OF SELF-CONTAINED BREATHING APPARATUS CYLINDERS FOR USE BY FIREFIGHTERS, LAW ENFORCEMENT PERSONNEL, EMERGENCY PERSONNEL, HAZARDOUS MATERIALS PERSONNEL, MILITARY PERSONNEL AND INDUSTRIAL PERSONNEL, IN CLASS 9 (U.S. CLS. 21, 23, 26, 36 AND 38).

FIRST USE 2-0-2011; IN COMMERCE 2-0-2011.

THE MARK CONSISTS OF STANDARD CHARACTERS WITHOUT CLAIM TO ANY PARTICULAR FONT, STYLE, SIZE, OR COLOR.

NO CLAIM IS MADE TO THE EXCLUSIVE RIGHT TO USE "SMART", APART FROM THE MARK AS SHOWN.

SN 85-170,391, FILED 11-5-2010.

CARYN GLASSER, EXAMINING ATTORNEY



David J. Kyjars

Director of the United States Patent and Trademark Office

United States of America

United States Patent and Trademark Office

Oracle

Reg. No. 4,154,881

Registered June 5, 2012

Int. Cl.: 9

TRADEMARK

PRINCIPAL REGISTER

TREK BICYCLE CORPORATION (WISCONSIN CORPORATION)
801 WEST MADISON STREET
WATERLOO, WI 53594

FOR: BICYCLE HELMETS, IN CLASS 9 (U.S. CLS. 21, 23, 26, 36 AND 38).

FIRST USE 4-1-2011; IN COMMERCE 12-15-2011.

THE MARK CONSISTS OF STANDARD CHARACTERS WITHOUT CLAIM TO ANY PARTICULAR FONT, STYLE, SIZE, OR COLOR.

SN 85-172,156, FILED 11-9-2010.

REGINA DRUMMOND, EXAMINING ATTORNEY



David J. Kybas

Director of the United States Patent and Trademark Office

United States of America

United States Patent and Trademark Office

VineTalk

Reg. No. 4,154,882

Registered June 5, 2012

Int. Cl.: 41

SERVICE MARK

PRINCIPAL REGISTER

WOLTER, TILL (FED REP GERMANY INDIVIDUAL), DBA VINETALK,
5K
6515 KENNEDY BLVD EAST
WEST NEW YORK, NJ 07093 AND

MCQUEEN, SEAN (UNITED STATES INDIVIDUAL), DBA VINETALK,
D5
31-03 23RD STREET
LONG ISLAND CITY, NY 11106

FOR: EDUCATION SERVICES, NAMELY, PROVIDING LIVE AND ON-LINE COURSES IN THE FIELD OF WINE TASTING AND THE HISTORY OF WINE; EDUCATION SERVICES, NAMELY, PROVIDING MENTORING, TUTORING, CLASSES, SEMINARS AND WORKSHOPS IN THE FIELD OF WINE; PROVIDING ON-LINE VIDEO-LOGS AND BLOGS IN THE FIELD OF WINE; PROVIDING GENERAL INFORMATION IN THE FIELD OF WINE TASTING; ENTERTAINMENT SERVICES, NAMELY, CONDUCTING FILM FESTIVALS IN THE FIELD OF WINE; EDUCATIONAL SERVICES, NAMELY, CONDUCTING WORKSHOPS AND SEMINARS IN THE FIELD OF WINE; BLOGS IN THE FIELD OF WINE; PLANNING ARRANGEMENT OF SHOWING MOVIES ABOUT WINE; ENTERTAINMENT AND EDUCATIONAL SERVICES, NAMELY, THE PRESENTATION OF SEMINARS, WORKSHOPS AND PANEL DISCUSSIONS, AND ONGOING TELEVISION AND RADIO SHOWS ALL IN THE FIELD OF WINE; EDUCATIONAL SERVICES, NAMELY, TEACHER TRAINING IN THE FIELD OF WINE PROVIDED ON A REAL-TIME BASIS DURING CLASSROOM INSTRUCTION; ENTERTAINMENT SERVICES, NAMELY, PROVIDING A WEB SITE FEATURING NON-DOWNLOADABLE MUSICAL PERFORMANCES, MUSICAL VIDEOS, RELATED FILM CLIPS, PHOTOGRAPHS, AND OTHER MULTIMEDIA MATERIALS FEATURING WINE TASTING; ENTERTAINMENT SERVICES, NAMELY, PROVIDING A WEB SITE FEATURING PHOTOGRAPHIC, AUDIO, VIDEO AND PROSE PRESENTATIONS FEATURING WINE TASTING; ORGANIZING COMMUNITY FESTIVALS FEATURING PRIMARILY WINE TASTING AND ALSO PROVIDING FLEA MARKETS, CRAFTS AND FOOD; PROVIDING A WEBSITE FOR PERSONS TO REGISTER FOR SURPRISE EVENTS AND CLASSES FOR THE PURPOSE OF ENTERTAINMENT, IN CLASS 41 (U.S. CLS. 100, 101 AND 107).



David J. Kyjars

Director of the United States Patent and Trademark Office

FIRST USE 1-1-2008; IN COMMERCE 1-1-2011.

THE MARK CONSISTS OF STANDARD CHARACTERS WITHOUT CLAIM TO ANY PARTICULAR FONT, STYLE, SIZE, OR COLOR.

Reg. No. 4,154,882 SN 85-172,433, FILED 11-9-2010.

JOHN DALIER, EXAMINING ATTORNEY

United States of America

United States Patent and Trademark Office

COMENITY

Reg. No. 4,154,883

Registered June 5, 2012

Int. Cls.: 35 and 36

SERVICE MARK

PRINCIPAL REGISTER

ALLIANCE DATA SYSTEMS CORPORATION (DELAWARE CORPORATION)
7500 DALLAS PARKWAY, SUITE 700
PLANO, TX 75024

FOR: PROMOTING THE SALE OF CREDIT CARD ACCOUNTS THROUGH THE ADMINISTRATION OF INCENTIVE AWARD PROGRAMS; PROMOTING THE SALE OF GOODS AND SERVICES OF OTHERS BY AWARDING PURCHASE POINTS FOR CREDIT CARD USE, IN CLASS 35 (U.S. CLS. 100, 101 AND 102).

FIRST USE 11-14-2011; IN COMMERCE 11-14-2011.

FOR: BANKING AND FINANCING SERVICES; CHARGE CARD AND CREDIT CARD SERVICES; CREDIT CARD AND DEBIT CARD SERVICES; CREDIT CARD AND PAYMENT CARD SERVICES; CREDIT CARD PAYMENT PROCESSING SERVICES; CREDIT CARD SERVICES; CREDIT RECOVERY AND COLLECTION; ISSUING OF CREDIT CARDS; PROVIDING CASH AND OTHER REBATES FOR CREDIT CARD USE AS PART OF A CUSTOMER LOYALTY PROGRAM; PROVIDING ELECTRONIC PROCESSING OF ELECTRONIC FUNDS TRANSFER, ACH, CREDIT CARD, DEBIT CARD, ELECTRONIC CHECK AND ELECTRONIC PAYMENTS, IN CLASS 36 (U.S. CLS. 100, 101 AND 102).

FIRST USE 11-14-2011; IN COMMERCE 11-14-2011.

THE MARK CONSISTS OF STANDARD CHARACTERS WITHOUT CLAIM TO ANY PARTICULAR FONT, STYLE, SIZE, OR COLOR.

SN 85-173,323, FILED 11-10-2010.

REBECCA POVARCHUK, EXAMINING ATTORNEY



David J. Kyjars

Director of the United States Patent and Trademark Office

United States of America

United States Patent and Trademark Office

E-Z PIN

Reg. No. 4,154,884

CLARION BATHWARE, INC. (PENNSYLVANIA CORPORATION)
44 AMSLER AVENUE
SHIPPENVILLE, PA 16254

Registered June 5, 2012

Int. Cl.: 11

FOR: SHOWERS AND SHOWER TUBS HAVING SELF-ALIGNING AND ATTACHING FEATURES; SHOWER TUBS WITH SHOWER SURROUNDS, IN CLASS 11 (U.S. CLS. 13, 21, 23, 31 AND 34).

TRADEMARK

FIRST USE 9-15-2011; IN COMMERCE 9-15-2011.

PRINCIPAL REGISTER

THE MARK CONSISTS OF STANDARD CHARACTERS WITHOUT CLAIM TO ANY PARTICULAR FONT, STYLE, SIZE, OR COLOR.

NO CLAIM IS MADE TO THE EXCLUSIVE RIGHT TO USE "PIN", APART FROM THE MARK AS SHOWN.

SN 85-175,505, FILED 11-12-2010.

DAWN HAN, EXAMINING ATTORNEY



David J. Kyros

Director of the United States Patent and Trademark Office

United States of America

United States Patent and Trademark Office



Kijani

Reg. No. 4,154,885

FRANKLIN T.Y. NG (UNITED STATES INDIVIDUAL)
1329 WILLOUGHBY AVE.
BROOKLYN, NY 11237

Registered June 5, 2012

Int. Cl.: 5

FOR: DIETARY FOOD SUPPLEMENTS, MEDICINAL HERBS AND HERBAL TEA FOR MEDICINAL PURPOSES, IN CLASS 5 (U.S. CLS. 6, 18, 44, 46, 51 AND 52).

TRADEMARK

FIRST USE 12-1-2011; IN COMMERCE 12-1-2011.

PRINCIPAL REGISTER

THE MARK CONSISTS OF THE WORDING "KIJANI" AND A LOGO OF A CIRCLE TO ITS LEFT. THERE ARE THREE LEAVES IN THE UPPER PART OF THE CIRCLE AND THREE CARTOON HUMAN FIGURES BENEATH THESE LEAVES.

THE ENGLISH TRANSLATION OF "KIJANI" IN THE MARK IS "BABY NAME", "GREEN" OR "A SINGLE LEAF".

SN 85-175,580, FILED 11-12-2010.

GRETCHEN ULRICH, EXAMINING ATTORNEY



David J. Kyjars

Director of the United States Patent and Trademark Office

United States of America

United States Patent and Trademark Office

FOHAWX

Reg. No. 4,154,886

Registered June 5, 2012

Int. Cl.: 9

TRADEMARK

PRINCIPAL REGISTER

FOHAWX, LLC (NEW JERSEY LIMITED LIABILITY COMPANY)
885 BROADWAY, SUITE 172
BAYONNE, NJ 07002

FOR: ACCESSORIES SPECIALLY DESIGNED FOR ATTACHMENT TO SAFETY HELMETS, NAMELY, NON-METAL DECORATIVE ELEMENTS FOR REMOVABLE FIXTURE TO THE OUTER SURFACE OF SAFETY HELMETS, NAMELY, HAIR-LIKE EXTENSIONS, SPIKE-STYLE HAIR-LIKE EXTENSIONS, PUNK-STYLE HAIR-LIKE EXTENSIONS, WHIMSICAL ORNAMENTAL EXTENSIONS, HORN-LIKE EXTENSIONS, AND TENTACLE-LIKE EXTENSIONS, IN CLASS 9 (U.S. CLS. 21, 23, 26, 36 AND 38).

FIRST USE 7-7-2010; IN COMMERCE 3-10-2012.

THE MARK CONSISTS OF STANDARD CHARACTERS WITHOUT CLAIM TO ANY PARTICULAR FONT, STYLE, SIZE, OR COLOR.

SN 85-176,313, FILED 11-14-2010.

DEBRA LEE, EXAMINING ATTORNEY



David J. Kyros

Director of the United States Patent and Trademark Office

United States of America

United States Patent and Trademark Office

PICALATA KIDS

Reg. No. 4,154,887

Registered June 5, 2012

Int. Cl.: 16

TRADEMARK

PRINCIPAL REGISTER

PICALATA PRODUCTIONS, LLC (FLORIDA LIMITED LIABILITY COMPANY)
90 FORT WADE ROAD
PONTE VEDRA, FL 32081

FOR: CHILDREN'S BOOKS, IN CLASS 16 (U.S. CLS. 2, 5, 22, 23, 29, 37, 38 AND 50).

FIRST USE 2-9-2011; IN COMMERCE 2-9-2011.

THE MARK CONSISTS OF STANDARD CHARACTERS WITHOUT CLAIM TO ANY PARTICULAR FONT, STYLE, SIZE, OR COLOR.

SN 85-176,840, FILED 11-15-2010.

RAMONA ORTIGA, EXAMINING ATTORNEY



David J. Kyffers

Director of the United States Patent and Trademark Office

United States of America

United States Patent and Trademark Office



FOHAWX!

Reg. No. 4,154,888

Registered June 5, 2012

Int. Cl.: 9

TRADEMARK

PRINCIPAL REGISTER

FOHAWX,LLC (NEW JERSEY LIMITED LIABILITY COMPANY)
885 BROADWAY, SUITE 172
BAYONNE, NJ 07002

FOR: ACCESSORIES SPECIALLY DESIGNED FOR ATTACHMENT TO SAFETY HELMETS, NAMELY, NON-METAL DECORATIVE ELEMENTS FOR REMOVABLE FIXTURE TO THE OUTER SURFACE OF SAFETY HELMETS, NAMELY, HAIR-LIKE EXTENSIONS, SPIKE-STYLE HAIR-LIKE EXTENSIONS, PUNK-STYLE HAIR-LIKE EXTENSIONS, WHIMSICAL ORNAMENTAL EXTENSIONS, HORN-LIKE EXTENSIONS, AND TENTACLE-LIKE EXTENSIONS, IN CLASS 9 (U.S. CLS. 21, 23, 26, 36 AND 38).

FIRST USE 7-7-2010; IN COMMERCE 3-10-2012.

THE MARK CONSISTS OF THE WORD "FOHAWX!" IN STYLIZED LETTERING WITH TWO DOTS APPEARING OVER THE LETTER "O", A DESIGN OF AN EYE AND MOUTH APPEARING INSIDE THE LETTER "A", AND A SPIKED HAIR DESIGN APPEARING ABOVE THE LETTER "A".

SN 85-176,993, FILED 11-15-2010.

DEBRA LEE, EXAMINING ATTORNEY



David J. Kyros

Director of the United States Patent and Trademark Office

United States of America

United States Patent and Trademark Office



Reg. No. 4,154,889

Registered June 5, 2012

Int. Cl.: 35

SERVICE MARK

PRINCIPAL REGISTER

YELLOWBOOK INC. (DELAWARE CORPORATION)
398 RXR PLAZA
UNIONDALE, NY 11556

FOR: ONLINE ADVERTISING AND MARKETING SERVICES; BUSINESS MARKETING SERVICES, NAMELY, REPUTATION MANAGEMENT MARKETING AND MONITORING SERVICES FOR BUSINESSES; SOCIAL MEDIA MARKETING CONSULTING SERVICES IN THE FIELD OF SOCIAL MEDIA OPTIMIZATION; BUSINESS MARKETING CONSULTING SERVICES REGARDING THE CAPTURE, MEASUREMENT, EVALUATION, IMPROVEMENT AND COMMUNICATION OF ONLINE BUSINESS REPUTATION INFORMATION AND RELATED BUSINESS INFORMATION WITHIN ONLINE SOCIAL MEDIA, IN CLASS 35 (U.S. CLS. 100, 101 AND 102).

FIRST USE 10-0-2010; IN COMMERCE 10-0-2010.

THE MARK CONSISTS OF THE WORD "CHATTERHUB" AND A DESIGN COMPRISED OF A GROUPING OF THREE CONVERSATION BALLOONS.

SN 85-177,623, FILED 11-16-2010.

STEVEN PEREZ, EXAMINING ATTORNEY



David J. Kyffers

Director of the United States Patent and Trademark Office

United States of America

United States Patent and Trademark Office

BIO LIVE

Reg. No. 4,154,890

Registered June 5, 2012

Int. Cl.: 3

TRADEMARK

PRINCIPAL REGISTER

A.B.C. COMPOUNDING COMPANY, INC. (GEORGIA CORPORATION)
6970 JONESBORO ROAD
MORROW, GA 30260

FOR: CLEANING PREPARATIONS, IN CLASS 3 (U.S. CLS. 1, 4, 6, 50, 51 AND 52).

FIRST USE 12-3-2010; IN COMMERCE 12-3-2010.

THE MARK CONSISTS OF STANDARD CHARACTERS WITHOUT CLAIM TO ANY PARTICULAR FONT, STYLE, SIZE, OR COLOR.

NO CLAIM IS MADE TO THE EXCLUSIVE RIGHT TO USE "LIVE", APART FROM THE MARK AS SHOWN.

SN 85-177,740, FILED 11-16-2010.

JOHN DALIER, EXAMINING ATTORNEY



David J. Kyffers

Director of the United States Patent and Trademark Office

United States of America

United States Patent and Trademark Office

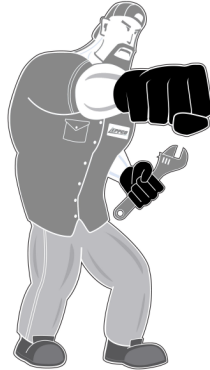

Reg. No. 4,154,891

Registered June 5, 2012

Int. Cls.: 9 and 12

TRADEMARK

PRINCIPAL REGISTER

EPPCO ENTERPRISES, INC. (OHIO CORPORATION)
544 S. GREEN ROAD
CLEVELAND, OH 44121

FOR: PROTECTIVE WORK GLOVES, IN CLASS 9 (U.S. CLS. 21, 23, 26, 36 AND 38).

FIRST USE 10-1-2010; IN COMMERCE 11-1-2011.

FOR: PROTECTIVE MECHANICS FENDER COVERS, IN CLASS 12 (U.S. CLS. 19, 21, 23, 31, 35 AND 44).

FIRST USE 10-1-2010; IN COMMERCE 1-1-2011.

THE MARK CONSISTS OF AN ANIMATED DRAWING OF AN AUTOMOBILE MECHANIC WITH HIS HAT TURNED BACKWARDS. THE WORD "EPPCO" APPEARS ON THE SHIRT POCKET. THE MECHANIC HAS GLOVES ON EACH HAND. ONE HAND IS HOLDING A WRENCH. THE OTHER HAND IS AN EXTENDED FIST.

SN 85-178,238, FILED 11-16-2010.

ARETHA SOMERVILLE, EXAMINING ATTORNEY



David J. Kyffers

Director of the United States Patent and Trademark Office

United States of America

United States Patent and Trademark Office

CRUNCHTIME

Reg. No. 4,154,892

Registered June 5, 2012

Int. Cl.: 30

TRADEMARK

PRINCIPAL REGISTER

THE QUAKER OATS COMPANY (NEW JERSEY CORPORATION)
555 WEST MONROE STREET
CHICAGO, IL 60661

FOR: READY-TO-EAT CEREALS, IN CLASS 30 (U.S. CL. 46).

FIRST USE 2-28-2012; IN COMMERCE 2-28-2012.

THE MARK CONSISTS OF STANDARD CHARACTERS WITHOUT CLAIM TO ANY PARTICULAR FONT, STYLE, SIZE, OR COLOR.

SN 85-180,172, FILED 11-18-2010.

JULIE GUTTADAURO, EXAMINING ATTORNEY



David J. Kybas

Director of the United States Patent and Trademark Office

United States of America

United States Patent and Trademark Office

HEATFREEZE

Reg. No. 4,154,893

Registered June 5, 2012

Int. Cl.: 10

TRADEMARK

PRINCIPAL REGISTER

BENCHMARK BRANDS, INC. (TENNESSEE CORPORATION)
SUITE 200
5250 TRIANGLE PARKWAY
NORCROSS, GA 30092

FOR: HOT AND COLD THERAPY FOOT MASSAGER, IN CLASS 10 (U.S. CLS. 26, 39 AND 44).

FIRST USE 11-19-2010; IN COMMERCE 12-30-2011.

THE MARK CONSISTS OF STANDARD CHARACTERS WITHOUT CLAIM TO ANY PARTICULAR FONT, STYLE, SIZE, OR COLOR.

SN 85-181,356, FILED 11-19-2010.

JAMES GRIFFIN, EXAMINING ATTORNEY



David J. Kyffers

Director of the United States Patent and Trademark Office

United States of America

United States Patent and Trademark Office

Lori Hamilton Enterprises

Reg. No. 4,154,894

Registered June 5, 2012

Int. Cls.: 35 and 41

SERVICE MARK

PRINCIPAL REGISTER

PROSPERITY PRODUCTIONS, INC. (GEORGIA CORPORATION)
520 W 48TH STREET, SUITE 5N
NEW YORK, NY 10036

FOR: MARKETING CONSULTING; MARKETING RESEARCH SERVICES, IN CLASS 35
(U.S. CLS. 100, 101 AND 102).

FIRST USE 4-7-2011; IN COMMERCE 4-7-2011.

FOR: ENTERTAINMENT AND EDUCATIONAL SERVICES, NAMELY, PROVIDING ADVICE
AND INFORMATION FOR MUSIC, VIDEO AND FILM CONCEPT AND SCRIPT DEVELOP-
MENT; MULTIMEDIA ENTERTAINMENT SERVICES IN THE NATURE OF DEVELOPMENT,
PRODUCTION AND POST-PRODUCTION SERVICES IN THE FIELDS OF VIDEO AND
FILMS; PRODUCTION OF TELEVISION PROGRAMS; PRODUCTION OF VIDEO AND
CREATION OF VISUAL EFFECTS FOR OTHERS FOR USE IN DVDS, TELEVISION PRO-
GRAMS AND ON WEB SITES; SCRIPT WRITING SERVICES, IN CLASS 41 (U.S. CLS. 100,
101 AND 107).

FIRST USE 4-7-2011; IN COMMERCE 4-7-2011.

THE MARK CONSISTS OF STANDARD CHARACTERS WITHOUT CLAIM TO ANY PAR-
TICULAR FONT, STYLE, SIZE, OR COLOR.

NO CLAIM IS MADE TO THE EXCLUSIVE RIGHT TO USE "ENTERPRISES", APART FROM
THE MARK AS SHOWN.

THE NAME(S), PORTRAIT(S), AND/OR SIGNATURE(S) SHOWN IN THE MARK IDENTIFIES
"LORI HAMILTON", WHOSE CONSENT(S) TO REGISTER IS MADE OF RECORD.

SN 85-181,977, FILED 11-21-2010.

JOHN KELLY, EXAMINING ATTORNEY



David J. Kypos

Director of the United States Patent and Trademark Office

United States of America

United States Patent and Trademark Office

LA COTE BLANCHE

Reg. No. 4,154,895

Registered June 5, 2012

Int. Cl.: 33

TRADEMARK

PRINCIPAL REGISTER

SOCIETE COOPERATIVE VINICOLE DE LUGNY "L'AURORE" (FRANCE SOCIETE COOPERATIVE AGRICOLE)
RUE DES CHARMES
LUGNY, FRANCE 71260

FOR: WINES; WINES WITH A PROTECTED DESIGNATION OF ORIGIN; WINES WITH A PROTECTED DESIGNATION OF ORIGIN OF BURGUNDY; CHARDONNAY WINES , IN CLASS 33 (U.S. CLS. 47 AND 49).

FIRST USE 9-0-2009; IN COMMERCE 5-31-2011.

THE MARK CONSISTS OF STANDARD CHARACTERS WITHOUT CLAIM TO ANY PARTICULAR FONT, STYLE, SIZE, OR COLOR.

THE ENGLISH TRANSLATION OF "LA COTE BLANCHE" IS "THE WHITE SLOPE".

SN 85-182,457, FILED 11-22-2010.

MARK SHINER, EXAMINING ATTORNEY



David J. Kybas

Director of the United States Patent and Trademark Office

United States of America

United States Patent and Trademark Office

ZEPHYR

Reg. No. 4,154,896

MERCK SHARP & DOHME CORP. (NEW JERSEY CORPORATION)
ONE MERCK DRIVE
WHITEHOUSE STATION, NJ 088890100

Registered June 5, 2012

Int. Cl.: 16

FOR: BOOKLETS AND PAMPHLETS CONCERNING RESPIRATORY ISSUES AND ASTHMA,
IN CLASS 16 (U.S. CLS. 2, 5, 22, 23, 29, 37, 38 AND 50).

TRADEMARK

FIRST USE 3-24-2011; IN COMMERCE 3-24-2011.

PRINCIPAL REGISTER

THE MARK CONSISTS OF STANDARD CHARACTERS WITHOUT CLAIM TO ANY PARTICULAR FONT, STYLE, SIZE, OR COLOR.

SN 85-183,757, FILED 11-23-2010.

ROBERT C. CLARK JR., EXAMINING ATTORNEY



David J. Kybas

Director of the United States Patent and Trademark Office

United States of America

United States Patent and Trademark Office

Claims XO

Reg. No. 4,154,897

Registered June 5, 2012

Int. Cl.: 35

SERVICE MARK

PRINCIPAL REGISTER

CLAIMS-X-CHANGE, LLC (TEXAS LIMITED LIABILITY COMPANY)
2300 INTERNATIONAL LANE
MADISON, WI 53704

FOR: MEDICAL BILLING AND CODING FEATURING MEDICAL PROVIDER CODES USED TO SUBSTANTIATE CLAIMS FOR MEDICAL REIMBURSEMENT IN THE CAFETERIA AND HSA PLANS, IN CLASS 35 (U.S. CLS. 100, 101 AND 102).

FIRST USE 4-30-2010; IN COMMERCE 4-30-2010.

THE MARK CONSISTS OF STANDARD CHARACTERS WITHOUT CLAIM TO ANY PARTICULAR FONT, STYLE, SIZE, OR COLOR.

NO CLAIM IS MADE TO THE EXCLUSIVE RIGHT TO USE "CLAIMS", APART FROM THE MARK AS SHOWN.

SN 85-183,768, FILED 11-23-2010.

REGINA DRUMMOND, EXAMINING ATTORNEY



David J. Kyros

Director of the United States Patent and Trademark Office

United States of America

United States Patent and Trademark Office

MAGIC HAT XTRA BONUS

Reg. No. 4,154,898

CADILLAC JACK, INC. (GEORGIA CORPORATION)
2450 SATELLITE BOULEVARD
DULUTH, GA 30096

Registered June 5, 2012

Int. Cl.: 9

FOR: GAMING DEVICES, NAMELY, GAMING MACHINES, SLOT MACHINES, BINGO MACHINES, WITH OR WITHOUT VIDEO OUTPUT, IN CLASS 9 (U.S. CLS. 21, 23, 26, 36 AND 38).

TRADEMARK

FIRST USE 3-29-2012; IN COMMERCE 3-29-2012.

PRINCIPAL REGISTER

THE MARK CONSISTS OF STANDARD CHARACTERS WITHOUT CLAIM TO ANY PARTICULAR FONT, STYLE, SIZE, OR COLOR.

SN 85-184,080, FILED 11-23-2010.

SHARON MEIER, EXAMINING ATTORNEY



David J. Kyros

Director of the United States Patent and Trademark Office

United States of America

United States Patent and Trademark Office

Patriot Light

Reg. No. 4,154,899

SUNLIGHT MANUFACTURING, INC. (KANSAS CORPORATION)
717 S. MAIN
OTTAWA, KS 66067

Registered June 5, 2012

Int. Cl.: 11

FOR: SOLAR LIGHT FIXTURES, NAMELY, A SOLAR POWERED LIGHT UNIT CONFIGURED AS A FINIAL BALL FOR ATTACHMENT ATOP A FLAG POLE TO DOWNWARDLY ILLUMINATE A FLAG DURING DARKNESS OR DIM LIGHT, IN CLASS 11 (U.S. CLS. 13, 21, 23, 31 AND 34).

TRADEMARK

PRINCIPAL REGISTER

FIRST USE 12-10-2011; IN COMMERCE 12-10-2011.

THE MARK CONSISTS OF STANDARD CHARACTERS WITHOUT CLAIM TO ANY PARTICULAR FONT, STYLE, SIZE, OR COLOR.

NO CLAIM IS MADE TO THE EXCLUSIVE RIGHT TO USE "LIGHT", APART FROM THE MARK AS SHOWN.

SN 85-184,612, FILED 11-24-2010.

ELLEN PERKINS, EXAMINING ATTORNEY



David J. Kyros

Director of the United States Patent and Trademark Office

United States of America

United States Patent and Trademark Office

EAU MODERNE

Reg. No. 4,154,900

Registered June 5, 2012

Int. Cl.: 3

TRADEMARK

PRINCIPAL REGISTER

THIRD MAN, INC. (NEW YORK CORPORATION)
NO. 9
54 W. 10TH ST.
NEW YORK, NY 10011

FOR: COLOGNE; EAU DE TOILETTE; EAU DE COLOGNE; FRAGRANCES FOR PERSONAL USE; PERFUMES; TOILET WATER, IN CLASS 3 (U.S. CLS. 1, 4, 6, 50, 51 AND 52).

FIRST USE 11-0-2011; IN COMMERCE 11-0-2011.

THE MARK CONSISTS OF STANDARD CHARACTERS WITHOUT CLAIM TO ANY PARTICULAR FONT, STYLE, SIZE, OR COLOR.

THE ENGLISH TRANSLATION OF "EAU" IN THE MARK IS "WATER".

SN 85-184,989, FILED 11-24-2010.

AISHA CLARKE, EXAMINING ATTORNEY



David J. Kyffers

Director of the United States Patent and Trademark Office

United States of America

United States Patent and Trademark Office

ARTISTE

Reg. No. 4,154,901

Registered June 5, 2012

Int. Cl.: 23

TRADEMARK

PRINCIPAL REGISTER

HOBBY LOBBY STORES, INC. (OKLAHOMA CORPORATION)
7707 SW 44TH STREET
OKLAHOMA CITY, OK 73179

FOR: EMBROIDERY FLOSS; THREAD, IN CLASS 23 (U.S. CL. 43).

FIRST USE 7-22-2011; IN COMMERCE 7-22-2011.

THE MARK CONSISTS OF STANDARD CHARACTERS WITHOUT CLAIM TO ANY PARTICULAR FONT, STYLE, SIZE, OR COLOR.

SN 85-185,006, FILED 11-24-2010.

DEIRDRE ROBERTSON, EXAMINING ATTORNEY



David J. Kybas

Director of the United States Patent and Trademark Office

United States of America

United States Patent and Trademark Office

GILGAL

Reg. No. 4,154,902

Registered June 5, 2012

Int. Cl.: 33

TRADEMARK

PRINCIPAL REGISTER

GOLAN HEIGHTS WINERY LTD. (ISRAEL CORPORATION)
P.O. BOX 183 KATZRIN
GOLAN HEIGHTS, ISRAEL 12900

FOR: WINE, IN CLASS 33 (U.S. CLS. 47 AND 49).

FIRST USE 4-1-2010; IN COMMERCE 3-1-2011.

THE MARK CONSISTS OF STANDARD CHARACTERS WITHOUT CLAIM TO ANY PARTICULAR FONT, STYLE, SIZE, OR COLOR.

SN 85-186,555, FILED 11-29-2010.

ARETHA SOMERVILLE, EXAMINING ATTORNEY



David J. Kyffers

Director of the United States Patent and Trademark Office

United States of America

United States Patent and Trademark Office

Rx for the Soul

Reg. No. 4,154,903

CHILDS, ANNETTE (UNITED STATES INDIVIDUAL)
5220 BELLAZZA COURT
RENO, NV 89519

Registered June 5, 2012

Int. Cl.: 45

FOR: GRIEF COUNSELING, IN CLASS 45 (U.S. CLS. 100 AND 101).

SERVICE MARK

FIRST USE 10-5-2008; IN COMMERCE 10-5-2008.

PRINCIPAL REGISTER

THE MARK CONSISTS OF STANDARD CHARACTERS WITHOUT CLAIM TO ANY PARTICULAR FONT, STYLE, SIZE, OR COLOR.

SN 85-188,083, FILED 12-1-2010.

TRACY WHITTAKER-BROWN, EXAMINING ATTORNEY



David J. Kybas

Director of the United States Patent and Trademark Office

United States of America

United States Patent and Trademark Office

BushingIQ

Reg. No. 4,154,904

Registered June 5, 2012

Int. Cl.: 9

TRADEMARK

PRINCIPAL REGISTER

GRIDSENSE INC. (CALIFORNIA CORPORATION)
SUITE 110
2568 INDUSTRIAL BLVD.
WEST SACRAMENTO, CA 95691

FOR: AUTOMATED PROCESS CONTROL SYSTEM, NAMELY, MICRO-PROCESSOR BASED HARDWARE AND SOFTWARE SCALABLE ONLINE MONITORING SYSTEM COMPRISED OF ADVANCED SENSOR AND SOFTWARE FOR MONITORING TRANSFORMER BUSHINGS AND LIGHTNING ARRESTORS USED TO MONITOR THE STATUS OF INDUSTRIAL PROCESSES, NAMELY, POWER GENERATION, ELECTRICAL DISTRIBUTION AND OIL AND GAS PROCESSING, IN CLASS 9 (U.S. CLS. 21, 23, 26, 36 AND 38).

FIRST USE 7-20-2010; IN COMMERCE 10-1-2010.

THE MARK CONSISTS OF STANDARD CHARACTERS WITHOUT CLAIM TO ANY PARTICULAR FONT, STYLE, SIZE, OR COLOR.

SN 85-188,227, FILED 12-1-2010.

ANNE MADDEN, EXAMINING ATTORNEY



David J. Kybas

Director of the United States Patent and Trademark Office

United States of America

United States Patent and Trademark Office

DUAL*BLAST

Reg. No. 4,154,905

Registered June 5, 2012

Int. Cl.: 3

TRADEMARK

PRINCIPAL REGISTER

PROCTER & GAMBLE COMPANY, THE (OHIO CORPORATION)
ONE PROCTER & GAMBLE PLAZA
CINCINNATI, OH 45202

FOR: DENTIFRICES AND MOUTHWASHES, IN CLASS 3 (U.S. CLS. 1, 4, 6, 50, 51 AND 52).

FIRST USE 7-25-2011; IN COMMERCE 7-25-2011.

THE MARK CONSISTS OF STANDARD CHARACTERS WITHOUT CLAIM TO ANY PARTICULAR FONT, STYLE, SIZE, OR COLOR.

SN 85-188,419, FILED 12-1-2010.

MICHAEL SOUDERS, EXAMINING ATTORNEY



David J. Kybas

Director of the United States Patent and Trademark Office

United States of America

United States Patent and Trademark Office

BE PROACTIV

Reg. No. 4,154,906

Registered June 5, 2012

**COLLECTIVE
MEMBERSHIP**

PRINCIPAL REGISTER

GUTHY-RENKER LLC (DELAWARE LIMITED LIABILITY COMPANY)
41550 ECLECTIC STREET, SUITE 200
PALM DESERT, CA 92260

FOR: INDICATING MEMBERSHIP IN A CLUB FOR ACNE TREATMENT USERS WHO USE
GUTHY-RENKER LLC'S ACNE TREATMENT PRODUCTS, IN CLASS 200 (U.S. CL. 200).

FIRST USE 7-11-2011; IN COMMERCE 7-0-2011.

THE MARK CONSISTS OF STANDARD CHARACTERS WITHOUT CLAIM TO ANY PAR-
TICULAR FONT, STYLE, SIZE, OR COLOR.

OWNER OF U.S. REG. NOS. 1,890,769, 2,574,142, AND OTHERS.

SN 85-188,659, FILED 12-1-2010.

JUSTINE D. PARKER, EXAMINING ATTORNEY



David J. Kybas

Director of the United States Patent and Trademark Office

United States of America

United States Patent and Trademark Office

BOINGY BEANS

Reg. No. 4,154,907

IGT (NEVADA CORPORATION)
9295 PROTOTYPE DRIVE
RENO, NV 895218986

Registered June 5, 2012

Int. Cl.: 9

FOR: GAMING MACHINES, NAMELY, DEVICES WHICH ACCEPT A WAGER, IN CLASS 9 (U.S. CLS. 21, 23, 26, 36 AND 38).

TRADEMARK

FIRST USE 3-5-2012; IN COMMERCE 3-5-2012.

PRINCIPAL REGISTER

THE MARK CONSISTS OF STANDARD CHARACTERS WITHOUT CLAIM TO ANY PARTICULAR FONT, STYLE, SIZE, OR COLOR.

SN 85-188,660, FILED 12-1-2010.

PATRICIA EVANKO, EXAMINING ATTORNEY



David J. Kybas

Director of the United States Patent and Trademark Office

United States of America

United States Patent and Trademark Office

KMAP

Reg. No. 4,154,908

KINDER MORGAN KANSAS, INC. (KANSAS CORPORATION)
500 DALLAS STREERT, SUITE 1000
HOUSTON, TX 77002

Registered June 5, 2012

Int. Cl.: 42

FOR: CONSULTING SERVICES FOR EVALUATION AND ANALYSIS OF PIPELINE INSPEC-
TION DATA, IN CLASS 42 (U.S. CLS. 100 AND 101).

SERVICE MARK

FIRST USE 4-1-2011; IN COMMERCE 4-1-2011.

PRINCIPAL REGISTER

THE MARK CONSISTS OF STANDARD CHARACTERS WITHOUT CLAIM TO ANY PAR-
TICULAR FONT, STYLE, SIZE, OR COLOR.

SN 85-188,673, FILED 12-1-2010.

SCOTT BIBB, EXAMINING ATTORNEY



David J. Kybas

Director of the United States Patent and Trademark Office

United States of America

United States Patent and Trademark Office

Mr. Look T Transforma

Reg. No. 4,154,909

Registered June 5, 2012

Int. Cl.: 3

TRADEMARK

PRINCIPAL REGISTER

FARIAS VILLARREAL, MARTIN JESUS GERARDO (MEXICO INDIVIDUAL)
12010 ROCKY KNOLL
HOUSTON, TX 77077

FOR: HAIR CARE CREAMS; HAIR CARE LOTIONS; HAIR CARE PREPARATIONS; HAIR COLOR; HAIR COLORANTS; HAIR CONDITIONER; HAIR CONDITIONERS; HAIR CREAMS; HAIR GEL; HAIR GEL AND HAIR MOUSSE; HAIR GELS; HAIR LOTIONS; HAIR MOUSSE; HAIR MOUSSES; HAIR POMADES; HAIR SHAMPOO; HAIR SHAMPOOS AND CONDITIONERS; HAIR SHEEN SPRAY; HAIR SPRAYS AND HAIR GELS; HAIR STYLING GEL; HAIR STYLING PREPARATIONS; HAIR TONIC; HAIR WAX, IN CLASS 3 (U.S. CLS. 1, 4, 6, 50, 51 AND 52).

FIRST USE 6-1-2011; IN COMMERCE 6-1-2011.

THE MARK CONSISTS OF STANDARD CHARACTERS WITHOUT CLAIM TO ANY PARTICULAR FONT, STYLE, SIZE, OR COLOR.

THE ENGLISH TRANSLATION OF THE WORD "TRANSFORMA" IN THE MARK IS TO TRANSFORM.

SN 85-188,983, FILED 12-2-2010.

SUNG IN, EXAMINING ATTORNEY



David J. Kypos

Director of the United States Patent and Trademark Office

United States of America

United States Patent and Trademark Office

POND₂O

Reg. No. 4,154,910

Registered June 5, 2012

Int. Cls.: 2 and 3

TRADEMARK

PRINCIPAL REGISTER

CISCO COMPANIES, THE (INDIANA CORPORATION)
602 N. SHORTRIDGE ROAD
INDIANAPOLIS, IN 46219

FOR: DYES FOR COMMERCIAL AND RESIDENTIAL RETENTION PONDS AND FARM PONDS, IN CLASS 2 (U.S. CLS. 6, 11 AND 16).

FIRST USE 2-20-2012; IN COMMERCE 3-12-2012.

FOR: CHEMICAL CLEANERS FOR USE IN COMMERCIAL AND RESIDENTIAL RETENTION PONDS AND FARM PONDS, IN CLASS 3 (U.S. CLS. 1, 4, 6, 50, 51 AND 52).

FIRST USE 2-29-2012; IN COMMERCE 2-29-2012.

THE MARK CONSISTS OF THE WORD "POND" AND A SUBSCRIPT "2" AND THE LETTER "O" WHICH IS STYLIZED SO THAT IT HAS THE APPEARANCE OF A CIRCLE SURROUNDING A WATER DROPLET. ALL LETTERS AND NUMERALS ARE IN THE COLOR BLUE. THE COLOR WHITE ONLY APPEARS AS BACKGROUND SHADING AND IS NOT PART OF THE MARK.

THE COLOR(S) BLUE IS/ARE CLAIMED AS A FEATURE OF THE MARK.

SN 85-189,452, FILED 12-2-2010.

JAY FLOWERS, EXAMINING ATTORNEY



David J. Kyffers

Director of the United States Patent and Trademark Office

United States of America

United States Patent and Trademark Office

INSPIRATO

Reg. No. 4,154,911

Registered June 5, 2012

**Int. Cls.: 36, 41, 43, 44,
and 45**

SERVICE MARK

PRINCIPAL REGISTER

INSPIRATO, LLC. (DELAWARE CORPORATION)
1637 WAZEE STREET
SUITE 400
DENVER, CO 80202

FOR: REAL ESTATE SERVICES, NAMELY, RENTAL, BROKERAGE, LEASING AND MANAGEMENT OF VACATION HOMES AND COMMERCIAL PROPERTY, IN CLASS 36 (U.S. CLS. 100, 101 AND 102).

FIRST USE 1-1-2011; IN COMMERCE 1-1-2011.

FOR: ENTERTAINMENT AND RECREATION SERVICES, NAMELY, GOLF AND COUNTRY CLUB SERVICES; PHYSICAL FITNESS TRAINING SERVICES; PROVIDING INFORMATION IN BOTH ONLINE AND NON-ONLINE FORM TO OTHERS REGARDING ENTERTAINMENT, SPORTING, AND CULTURAL ACTIVITIES AND EVENTS IN PARTICULAR GEOGRAPHIC AREAS; ARRANGING FOR TICKET RESERVATIONS FOR SHOWS AND OTHER ENTERTAINMENT EVENTS REGARDING ENTERTAINMENT, SPORTING, AND CULTURAL ACTIVITIES AND EVENTS IN PARTICULAR GEOGRAPHIC AREAS; PROVIDING INFORMATION IN BOTH ONLINE AND NON-ONLINE FORM TO OTHERS REGARDING COUNTRY CLUBS, NIGHT CLUBS, IN CLASS 41 (U.S. CLS. 100, 101 AND 107).

FIRST USE 1-1-2011; IN COMMERCE 1-1-2011.

FOR: RESORT LODGING SERVICES, RESORT HOTELS; HEALTH RESORT SERVICES, NAMELY, PROVIDING FOOD AND LODGING THAT SPECIALIZE IN PROMOTING PATRONS' GENERAL HEALTH AND WELL-BEING; VACATION CLUB SERVICES, NAMELY, PROVIDING TEMPORARY LODGING ACCOMMODATIONS; ARRANGING FOR ACCESS TO RESORT AMENITIES, NAMELY, RESTAURANTS; PROVIDING INFORMATION IN BOTH ONLINE AND NON-ONLINE FORM TO OTHERS RELATED TO RESORT LODGING SERVICES, AMENITIES RELATED THERETO, AND THE AVAILABILITY THEREOF; PROVIDING INFORMATION IN BOTH ONLINE AND NON-ONLINE FORM TO OTHERS REGARDING RESTAURANTS, AND OTHER ESTABLISHMENTS FOR THE CONSUMPTION OF FOOD AND DRINK; PROVIDING INFORMATION IN BOTH ONLINE AND NON-ONLINE FORM TO OTHERS REGARDING MEMBERSHIP IN A LUXURY RESIDENCE CLUB FEATURING TEMPORARY ACCOMMODATIONS; PROVIDING INFORMATION IN BOTH ONLINE AND NON-ONLINE FORM TO OTHERS RELATED TO RESORT LODGING SERVICES; PRIVATE RESORT CLUB SERVICES, NAMELY, PROVISION TO CLUB MEMBERS



David J. Kyros

Director of the United States Patent and Trademark Office

Reg. No. 4,154,911 OF TEMPORARY ACCOMMODATIONS IN COMPANY OWNED OR LEASED PRIVATE RESIDENCES, IN CLASS 43 (U.S. CLS. 100 AND 101).

FIRST USE 1-1-2011; IN COMMERCE 1-1-2011.

FOR: HEALTH SPA SERVICES FOR HEALTH AND WELLNESS OF THE BODY AND SPIRIT, IN CLASS 44 (U.S. CLS. 100 AND 101).

FIRST USE 1-1-2011; IN COMMERCE 1-1-2011.

FOR: PERSONAL CONCIERGE SERVICES FOR OTHERS COMPRISING MAKING REQUESTED PERSONAL ARRANGEMENTS AND RESERVATIONS, RUNNING ERRANDS AND PROVIDING CUSTOMER SPECIFIC INFORMATION TO MEET INDIVIDUAL NEEDS, ALL RENDERED IN BUSINESS ESTABLISHMENTS, OFFICE BUILDINGS, HOTELS, RESIDENTIAL COMPLEXES AND HOMES, IN CLASS 45 (U.S. CLS. 100 AND 101).

FIRST USE 1-1-2011; IN COMMERCE 1-1-2011.

THE MARK CONSISTS OF STANDARD CHARACTERS WITHOUT CLAIM TO ANY PARTICULAR FONT, STYLE, SIZE, OR COLOR.

THE ENGLISH TRANSLATION OF "INSPIRATO" IN THE MARK IS "INSPIRED".

SN 85-190,548, FILED 12-3-2010.

GILBERT SWIFT, EXAMINING ATTORNEY

United States of America

United States Patent and Trademark Office



MERENDINO

Cemetery Care

Reg. No. 4,154,912

Registered June 5, 2012

Int. Cls.: 35 and 44

SERVICE MARK

PRINCIPAL REGISTER

MERENDINO CEMETERY CARE, LLC (NEW JERSEY LIMITED LIABILITY COMPANY)
1048 W. BLANCKE STREET
LINDEN, NJ 07036

FOR: FRANCHISING, NAMELY, OFFERING BUSINESS MANAGEMENT ASSISTANCE IN THE ESTABLISHMENT AND/OR OPERATION OF A CEMETERY CARE BUSINESS, PROVIDING FACILITIES MANAGEMENT, INCLUDING LAWN CARE, MONUMENT INSTALLATIONS, MAUSOLEUM MAINTENANCE, BURIALS AND FLORIST SERVICES TO CEMETERIES, IN CLASS 35 (U.S. CLS. 100, 101 AND 102).

FIRST USE 5-1-2010; IN COMMERCE 1-24-2011.

FOR: CEMETERY PLOT BEAUTIFICATION AND MAINTENANCE AND CONTINUAL UP-KEEP OF FAMILY CEMETERY PLOTS; LANDSCAPE GARDENING, IN CLASS 44 (U.S. CLS. 100 AND 101).

FIRST USE 5-1-2010; IN COMMERCE 1-24-2011.

NO CLAIM IS MADE TO THE EXCLUSIVE RIGHT TO USE "CEMETERY CARE", APART FROM THE MARK AS SHOWN.

THE COLOR(S) RED, BLUE AND WHITE IS/ARE CLAIMED AS A FEATURE OF THE MARK.

THE MARK CONSISTS OF A TRIANGULAR FOLDED AMERICAN FLAG BEARING SIX WHITE STARS ON BLUE WITH SHADES OF BLUE IN THE FOLD OF THE FLAG AND PLACED ABOVE THE WORD "MERENDINO" IN BLUE, UNDERLINED IN RED, WITH THE WORDS "CEMETERY CARE" APPEARING IN BLUE BELOW THE RED LINE.

SN 85-190,848, FILED 12-5-2010.

LEIGH CAROLINE CASE, EXAMINING ATTORNEY



David J. Kybas

Director of the United States Patent and Trademark Office

United States of America

United States Patent and Trademark Office

Lisa Lee

Reg. No. 4,154,913

Registered June 5, 2012

Int. Cl.: 14

TRADEMARK

PRINCIPAL REGISTER

RU MINDAN (CHINA INDIVIDUAL)
D37-38, 4/F, TIANYA HONGQIAO JEWELRY MKT
NO.136 FAHUASI STREET, CHONGWEN DISTRICT
BEIJING, 100061, CHINA

FOR: EARRINGS; JEWELRY; NECKLACES; ORNAMENTS OF PRECIOUS METAL; PEARLS;
PRECIOUS METAL ALLOYS; PRECIOUS STONES; RINGS; SEMI-PRECIOUS STONES;
SPINELS, IN CLASS 14 (U.S. CLS. 2, 27, 28 AND 50).

FIRST USE 4-10-2010; IN COMMERCE 4-10-2010.

THE NAME(S), PORTRAIT(S), AND/OR SIGNATURE(S) SHOWN IN THE MARK DOES NOT
IDENTIFY A PARTICULAR LIVING INDIVIDUAL.

THE COLOR(S) BLACK, ORANGE AND GREY IS/ARE CLAIMED AS A FEATURE OF THE
MARK.

THE MARK CONSISTS OF THE WORDS "LISA LEE" IN BLACK COLOR WITH A CIRCULAR
DEVICE BETWEEN THE TWO WORDS. THE CIRCULAR DEVICE HAS AN ORANGE
BACKGROUND AND CONSISTS OF A GREY MOON-SHAPED DEVICE AND A GREY
STYLIZED LETTER "L".

SN 85-191,743, FILED 12-6-2010.

MELISSA VALLILLO, EXAMINING ATTORNEY



David J. Kybas

Director of the United States Patent and Trademark Office

United States of America

United States Patent and Trademark Office

CARBFIGHTER

Reg. No. 4,154,914

WINDMILL HEALTH PRODUCTS, LLC (NEW JERSEY LIMITED LIABILITY COMPANY)
6 HENDERON DR.

Registered June 5, 2012

W. CALDWELL, NJ 07006

Int. Cl.: 5

FOR: DIETARY AND NUTRITIONAL SUPPLEMENTS IN BAR FORM, IN CLASS 5 (U.S. CLS. 6, 18, 44, 46, 51 AND 52).

TRADEMARK

FIRST USE 10-22-2001; IN COMMERCE 10-22-2001.

PRINCIPAL REGISTER

THE MARK CONSISTS OF STANDARD CHARACTERS WITHOUT CLAIM TO ANY PARTICULAR FONT, STYLE, SIZE, OR COLOR.

SN 85-193,113, FILED 12-8-2010.

ASMAT KHAN, EXAMINING ATTORNEY



David J. Kyffers

Director of the United States Patent and Trademark Office

United States of America

United States Patent and Trademark Office

INCOGNITO

Reg. No. 4,154,915

CELSIUS PROPERTY B.V. AMSTERDAM (NL) (SWITZERLAND CORPORATION)
SCHAFFHAUSEN BRANCH SPITALSTRASSE 5
8200 SCHAFFHAUSEN, SWITZERLAND

Registered June 5, 2012

Int. Cl.: 5

FOR: PESTICIDES, FUNGICIDES, INSECTICIDES AND HERBICIDES, IN CLASS 5 (U.S. CLS. 6, 18, 44, 46, 51 AND 52).

TRADEMARK

FIRST USE 6-16-2011; IN COMMERCE 6-16-2011.

PRINCIPAL REGISTER

THE MARK CONSISTS OF STANDARD CHARACTERS WITHOUT CLAIM TO ANY PARTICULAR FONT, STYLE, SIZE, OR COLOR.

SN 85-193,193, FILED 12-8-2010.

PAUL MORENO, EXAMINING ATTORNEY



David J. Kybas

Director of the United States Patent and Trademark Office

United States of America

United States Patent and Trademark Office

Vignature

Reg. No. 4,154,916

Registered June 5, 2012

Int. Cl.: 9

TRADEMARK

PRINCIPAL REGISTER

VIGNATURE, INC. (TEXAS CORPORATION)
5729 LEBANON RD
STE 144-226
FRISCO, TX 75034

FOR: SOFTWARE, NAMELY, ELECTRONIC SIGNATURE CAPTURE SOFTWARE FOR E-COMMERCE TRANSACTIONS; COMPUTER SOFTWARE FOR USE IN IDENTITY AUTHENTICATION, NAMELY, SOFTWARE ENCRYPTION, DATA COLLECTION, AND DOCUMENT CREATION THAT CAPTURES ELECTRONIC SIGNATURES AND ASSOCIATED IMAGES; SOFTWARE FOR MOBILE, CLIENT, AND SERVER COMPUTERS FOR USE IN CREATING, MANAGING, AND DISTRIBUTING ELECTRONIC SIGNATURES; SOFTWARE FOR USE WITH ELECTRONIC DATA VERIFICATION, NAMELY, TO FACILITATE CREATION OF A LEGALLY BINDING ELECTRONIC SIGNATURE TO A DOCUMENT OR FILE FOR COMMUNICATION VIA A GLOBAL COMPUTER NETWORK, IN CLASS 9 (U.S. CLS. 21, 23, 26, 36 AND 38).

FIRST USE 5-4-2011; IN COMMERCE 5-4-2011.

THE MARK CONSISTS OF STANDARD CHARACTERS WITHOUT CLAIM TO ANY PARTICULAR FONT, STYLE, SIZE, OR COLOR.

SN 85-193,624, FILED 12-8-2010.

ERIN FALK, EXAMINING ATTORNEY



David J. Kyffers

Director of the United States Patent and Trademark Office

United States of America

United States Patent and Trademark Office

ETIENNE MARCEL

Reg. No. 4,154,917

Registered June 5, 2012

Int. Cl.: 25

TRADEMARK

PRINCIPAL REGISTER

ETIENNE MARCEL LLC (CALIFORNIA LIMITED LIABILITY COMPANY)
910 S. LOS ANGELES STREET #303, 305-308
LOS ANGELES, CA 90015

FOR: A-SHIRTS; APPAREL FOR DANCERS, NAMELY, TEE SHIRTS, SWEATSHIRTS, PANTS, LEGGINGS, SHORTS AND JACKETS; ATHLETIC APPAREL, NAMELY, SHIRTS, PANTS, JACKETS, FOOTWEAR, HATS AND CAPS, ATHLETIC UNIFORMS; BANDANAS; BANDEAU TOPS; BATHING SUITS; BEACH COVER-UPS; BEACH COVERUPS; BEACH-WEAR; BELTS; BELTS FOR CLOTHING; BELTS MADE OF LEATHER; BLAZERS; BLOUSES; BOMBER JACKETS; BUTTON DOWN SHIRTS; CAPS; CARGO PANTS; COATS; COATS FOR MEN AND WOMEN; COLLARED SHIRTS; CREW NECK SWEATERS; CREW NECKS; CROP TOPS; DENIM JACKETS; DENIMS; HEAVY COATS; HEAVY JACKETS; HOODED PULLOVERS; HOODED SWEAT SHIRTS; HOODED SWEATSHIRTS; JACKETS; JEGGINGS, NAMELY, PANTS THAT ARE PARTIALLY JEANS AND PARTIALLY LEGGINGS; JERSEYS; KNIT JACKETS; KNIT SHIRTS; KNIT SKIRTS; KNIT TOPS; LEATHER COATS; LEATHER JACKETS; LEATHER PANTS; LONG-SLEEVED SHIRTS; MEN'S AND WOMEN'S JACKETS, COATS, TROUSERS, VESTS; OUTER JACKETS; OVER COATS; OVER SHIRTS; POLO KNIT TOPS; POLO SHIRTS; RAIN COATS; RAIN JACKETS; SHIRTS; SHORT-SLEEVED OR LONG-SLEEVED T-SHIRTS; T-SHIRTS; V-NECK SWEATERS, IN CLASS 25 (U.S. CLS. 22 AND 39).

FIRST USE 6-6-2011; IN COMMERCE 8-22-2011.

THE MARK CONSISTS OF STANDARD CHARACTERS WITHOUT CLAIM TO ANY PARTICULAR FONT, STYLE, SIZE, OR COLOR.

THE NAME(S), PORTRAIT(S), AND/OR SIGNATURE(S) SHOWN IN THE MARK DOES NOT IDENTIFY A PARTICULAR LIVING INDIVIDUAL.

SN 85-194,591, FILED 12-9-2010.

SHANNON TWOHIG, EXAMINING ATTORNEY



David J. Kyros

Director of the United States Patent and Trademark Office

United States of America

United States Patent and Trademark Office

CLAIMSMADEEZ

Reg. No. 4,154,918

Registered June 5, 2012

Int. Cl.: 42

SERVICE MARK

PRINCIPAL REGISTER

CLAIMSMADEEZ, INC. (MINNESOTA CORPORATION)
11823 SUMTER COURT NORTH
CHAMPLIN, MN 55316

FOR: PROVIDING A WEBSITE FEATURING TECHNOLOGY THAT ENABLES USERS TO PROACTIVELY IDENTIFY, CATEGORIZE AND ORGANIZE HOME AND BUSINESS INVENTORY FOR INSURANCE CLAIMS PURPOSES , IN CLASS 42 (U.S. CLS. 100 AND 101).

FIRST USE 8-15-2011; IN COMMERCE 8-15-2011.

THE MARK CONSISTS OF STANDARD CHARACTERS WITHOUT CLAIM TO ANY PARTICULAR FONT, STYLE, SIZE, OR COLOR.

SN 85-194,652, FILED 12-9-2010.

CHRISTINE MARTIN, EXAMINING ATTORNEY



David J. Kybas

Director of the United States Patent and Trademark Office

United States of America

United States Patent and Trademark Office

FLEET PHYSICS

Reg. No. 4,154,919

Registered June 5, 2012

Int. Cl.: 12

TRADEMARK

PRINCIPAL REGISTER

PRECISION FLEET BRAKES, INC. (TEXAS CORPORATION)
SUITE D
6301 MANCHACA
AUSTIN, TX 78745

FOR: BRAKE COMPONENTS FOR LAND VEHICLES, NAMELY, DRUMS, ROTORS, PADS,
CALIPERS AND BEARINGS, IN CLASS 12 (U.S. CLS. 19, 21, 23, 31, 35 AND 44).

FIRST USE 10-1-2010; IN COMMERCE 10-1-2010.

THE MARK CONSISTS OF STANDARD CHARACTERS WITHOUT CLAIM TO ANY PAR-
TICULAR FONT, STYLE, SIZE, OR COLOR.

NO CLAIM IS MADE TO THE EXCLUSIVE RIGHT TO USE "FLEET", APART FROM THE
MARK AS SHOWN.

SN 85-196,712, FILED 12-13-2010.

BRENDAN MCCAULEY, EXAMINING ATTORNEY



David J. Kybas

Director of the United States Patent and Trademark Office

United States of America

United States Patent and Trademark Office

Eclectic

Reg. No. 4,154,920

ECLECTIC LLC (CONNECTICUT LIMITED LIABILITY COMPANY)
136 HAVILAND RD.
STAMFORD, CT 06903

Registered June 5, 2012

Int. Cl.: 43

FOR: CATERING SERVICES; RESTAURANT SERVICES, IN CLASS 43 (U.S. CLS. 100 AND 101).

SERVICE MARK

FIRST USE 12-15-2011; IN COMMERCE 12-15-2011.

PRINCIPAL REGISTER

THE MARK CONSISTS OF STANDARD CHARACTERS WITHOUT CLAIM TO ANY PARTICULAR FONT, STYLE, SIZE, OR COLOR.

SN 85-197,329, FILED 12-14-2010.

JOHN DWYER, EXAMINING ATTORNEY



David J. Kybas

Director of the United States Patent and Trademark Office

United States of America

United States Patent and Trademark Office

CONGRATULATIONS

Reg. No. 4,154,921

Registered June 5, 2012

**Int. Cls.: 9, 16, 41, and
45**

TRADEMARK

SERVICE MARK

PRINCIPAL REGISTER

CONGRATS BOOKS INC. (FLORIDA CORPORATION)
SUITE 266
2700 W ATLANTIC BEACH BLVD,
POMPANO BEACH, FL 33069

FOR: COMPUTER AND SOFTWARE PRODUCTS, NAMELY, DOWNLOADABLE ELECTRONIC PUBLICATIONS IN THE NATURE OF A SERIES OF BOOKS IN THE FIELD OF ADVICE AND SELF-HELP FOR CONSUMERS OF ALL AGES; COMPUTER AND SOFTWARE PRODUCTS, NAMELY, ELECTRONIC PUBLICATIONS IN THE NATURE OF A SERIES OF BOOKS IN THE FIELD OF ADVICE AND SELF-HELP RECORDED ON COMPUTER MEDIA FOR CONSUMERS OF ALL AGES; DOWNLOADABLE MULTIMEDIA FILES FEATURING GOAL MAPS, VISUAL AIDS AND WEBINARS IN THE FIELD OF ADVICE AND SELF-HELP FOR CONSUMERS OF ALL AGES, IN CLASS 9 (U.S. CLS. 21, 23, 26, 36 AND 38).

FIRST USE 12-1-2009; IN COMMERCE 12-1-2009.

FOR: SERIES OF PAPER GOODS AND PRINTED MATERIALS, NAMELY, A SERIES OF BOOKS IN THE NATURE OF ADVICE AND SELF-HELP; PRINTED MATTER, NAMELY, CALENDARS, PAPER NOTEBOOKS, PENS, BOOKMARKS; STATIONERY; PLASTIC MATERIALS FOR PACKAGING, NAMELY, GENERAL PURPOSE PLASTIC BAGS FOR CONSUMERS OF ALL AGES, IN CLASS 16 (U.S. CLS. 2, 5, 22, 23, 29, 37, 38 AND 50).

FIRST USE 12-1-2009; IN COMMERCE 12-1-2009.

FOR: EDUCATION AND ENTERTAINMENT SERVICES, NAMELY, PROVIDING SEMINARS IN THE FIELD OF ADVICE AND SELF-HELP; VOCATIONAL GUIDANCE; PROVIDING MOTIVATIONAL AND EDUCATIONAL SPEAKERS; CAREER COUNSELING, IN CLASS 41 (U.S. CLS. 100, 101 AND 107).

FIRST USE 12-1-2009; IN COMMERCE 12-1-2009.

FOR: PROVIDING ADVISORY SERVICES IN THE FIELD OF SELF-IMPROVEMENT, IN CLASS 45 (U.S. CLS. 100 AND 101).

FIRST USE 12-1-2009; IN COMMERCE 12-1-2009.



David J. Kyros

Director of the United States Patent and Trademark Office

Reg. No. 4,154,921 THE MARK CONSISTS OF STANDARD CHARACTERS WITHOUT CLAIM TO ANY PARTICULAR FONT, STYLE, SIZE, OR COLOR.

SN 85-197,987, FILED 12-15-2010.

KAPIL BHANOT, EXAMINING ATTORNEY

United States of America

United States Patent and Trademark Office

Xenolith Medical

Reg. No. 4,154,922

XENOLITH MEDICAL, LTD (ISRAEL LIMITED COMPANY (LTD.))
1 LESHEM ST.
KIRYAT GAT, ISRAEL 82000

Registered June 5, 2012

Int. Cl.: 10

FOR: MEDICAL GUIDEWIRES, IN CLASS 10 (U.S. CLS. 26, 39 AND 44).

TRADEMARK

FIRST USE 7-1-2010; IN COMMERCE 11-1-2011.

PRINCIPAL REGISTER

THE MARK CONSISTS OF STANDARD CHARACTERS WITHOUT CLAIM TO ANY PARTICULAR FONT, STYLE, SIZE, OR COLOR.

NO CLAIM IS MADE TO THE EXCLUSIVE RIGHT TO USE "MEDICAL", APART FROM THE MARK AS SHOWN.

SN 85-198,170, FILED 12-15-2010.

GISELLE AGOSTO, EXAMINING ATTORNEY



David J. Kyffers

Director of the United States Patent and Trademark Office

United States of America

United States Patent and Trademark Office

IT KIT

Reg. No. 4,154,923

V BEAUTE LLC (NEW YORK LIMITED LIABILITY COMPANY)
126 EAST 56TH STREET
NEW YORK, NY 10022

Registered June 5, 2012

Int. Cl.: 3

FOR: COSMETICS; NON-MEDICATED SKIN CARE PRODUCTS, IN CLASS 3 (U.S. CLS. 1, 4, 6, 50, 51 AND 52).

TRADEMARK

FIRST USE 11-1-2011; IN COMMERCE 11-1-2011.

PRINCIPAL REGISTER

THE MARK CONSISTS OF STANDARD CHARACTERS WITHOUT CLAIM TO ANY PARTICULAR FONT, STYLE, SIZE, OR COLOR.

NO CLAIM IS MADE TO THE EXCLUSIVE RIGHT TO USE "KIT", APART FROM THE MARK AS SHOWN.

SN 85-198,665, FILED 12-15-2010.

SUZANNE BLANE, EXAMINING ATTORNEY



David J. Kybas

Director of the United States Patent and Trademark Office

United States of America

United States Patent and Trademark Office



Reg. No. 4,154,924

Registered June 5, 2012

Int. Cl.: 2

TRADEMARK

PRINCIPAL REGISTER

COLOR MAKE, INC (FLORIDA CORPORATION)
11603 WEST OKEECHOBEE ROAD
MIAMI, FL 33135

FOR: DRY INKS; FILLED INK CARTRIDGES; INK CARTRIDGES FOR PRINTERS; INK FOR MULTIFUNCTION ELECTRONIC DEVICES FOR USE IN COPYING, PRINTING, SCANNING, VIDEO CAPTURE OR TRANSMITTING DOCUMENTS AND IMAGES; INK JET CARTRIDGES; INK JET PRINTER INK; INK-DRYING PREPARATIONS SOLD AS A COMPONENT OF INKS; INKS, TONERS AND DYES FOR USE WITH OR ON TEXTILES AND FABRICS; METALLIC INKS; PRINTING INKS, IN CLASS 2 (U.S. CLS. 6, 11 AND 16).

FIRST USE 12-1-2011; IN COMMERCE 1-16-2012.

NO CLAIM IS MADE TO THE EXCLUSIVE RIGHT TO USE "COLOR", APART FROM THE MARK AS SHOWN.

THE COLOR(S) BLUE, MAGENTA, YELLOW, GRAY AND BLACK IS/ARE CLAIMED AS A FEATURE OF THE MARK.

THE MARK CONSIST OF THE STYLIZED WORDING "COLOR MAKE" IN THE COLORS GRAY AND BLACK WITH A PARTIAL REFLECTION OF THE WORD "MAKE" IN GRAY, AND A DESIGN OF A BALL FORMED FROM A MISCELLANEOUS CURVED BLUE SHAPE ON THE RIGHT WITH SEVERAL IRREGULAR CIRCLE-LIKE SHAPES PLACED IN A CURVED PATTERN THAT FORMS THE LEFT SIDE OF THE BALL. THE CIRCLE-LIKE SHAPES APPEAR IN THE COLORS BLUE, MAGENTA, YELLOW, AND BLACK. THERE IS A REFLECTION OF THE BALL THAT APPEARS IN THE COLORS GRAY AND BLUE.

SN 85-198,694, FILED 12-15-2010.

JEAN IM, EXAMINING ATTORNEY



David J. Kyros

Director of the United States Patent and Trademark Office

United States of America

United States Patent and Trademark Office

ARGAN-6

Reg. No. 4,154,925

L'OREAL USA CREATIVE, INC. (DELAWARE CORPORATION)
575 FIFTH AVENUE
NEW YORK, NY 10017

Registered June 5, 2012

Int. Cl.: 3

FOR: HAIR CARE PREPARATION, IN CLASS 3 (U.S. CLS. 1, 4, 6, 50, 51 AND 52).

TRADEMARK

FIRST USE 9-1-2011; IN COMMERCE 9-1-2011.

PRINCIPAL REGISTER

THE MARK CONSISTS OF STANDARD CHARACTERS WITHOUT CLAIM TO ANY PARTICULAR FONT, STYLE, SIZE, OR COLOR.

SN 85-198,777, FILED 12-15-2010.

JOHN HWANG, EXAMINING ATTORNEY



David J. Kyffers

Director of the United States Patent and Trademark Office

United States of America

United States Patent and Trademark Office

2 GINGERS

Reg. No. 4,154,926

Registered June 5, 2012

Int. Cl.: 33

TRADEMARK

PRINCIPAL REGISTER

A KIERAN COLLECTION LLC (MINNESOTA LIMITED LIABILITY COMPANY)
23 SE 4TH STREET, SUITE 217
MINNEAPOLIS, MN 55414

FOR: WHISKEY, IN CLASS 33 (U.S. CLS. 47 AND 49).

FIRST USE 3-16-2011; IN COMMERCE 3-16-2011.

THE MARK CONSISTS OF STANDARD CHARACTERS WITHOUT CLAIM TO ANY PARTICULAR FONT, STYLE, SIZE, OR COLOR.

SN 85-199,355, FILED 12-16-2010.

JUSTINE D. PARKER, EXAMINING ATTORNEY



David J. Kyros

Director of the United States Patent and Trademark Office

United States of America

United States Patent and Trademark Office

POSTBOX

Reg. No. 4,154,927

Registered June 5, 2012

Int. Cls.: 35, 41, and 43

SERVICE MARK

PRINCIPAL REGISTER

MICROSOFT CORPORATION (WASHINGTON CORPORATION)
ONE MICROSOFT WAY
REDMOND, WA 980526399

FOR: ON-LINE BUSINESS DIRECTORIES FEATURING RESTAURANTS, BARS, NIGHTCLUBS, TOURIST ATTRACTIONS, ENTERTAINMENT AND SPORTS EVENTS, SEASONAL AND HOLIDAY EVENTS, IN CLASS 35 (U.S. CLS. 100, 101 AND 102).

FIRST USE 2-2-2011; IN COMMERCE 2-2-2011.

FOR: PROVIDING ONLINE INFORMATION CONCERNING NIGHTCLUBS, TOURIST ATTRACTIONS, SPORTING EVENTS, AND LOCAL ENTERTAINMENT, SEASONAL AND HOLIDAY EVENTS, IN CLASS 41 (U.S. CLS. 100, 101 AND 107).

FIRST USE 2-2-2011; IN COMMERCE 2-2-2011.

FOR: PROVIDING ONLINE INFORMATION CONCERNING RESTAURANTS AND BARS, IN CLASS 43 (U.S. CLS. 100 AND 101).

FIRST USE 2-2-2011; IN COMMERCE 2-2-2011.

THE MARK CONSISTS OF STANDARD CHARACTERS WITHOUT CLAIM TO ANY PARTICULAR FONT, STYLE, SIZE, OR COLOR.

SN 85-200,057, FILED 12-16-2010.

KELLY TRUSILO, EXAMINING ATTORNEY



David J. Kybas

Director of the United States Patent and Trademark Office

United States of America

United States Patent and Trademark Office

DESIGN 'N' DOODLE

Reg. No. 4,154,928

PATCH PRODUCTS, INC. (WISCONSIN CORPORATION)
1400 E. INMAN PARKWAY
BELOIT, WI 53511

Registered June 5, 2012

Int. Cl.: 28

FOR: PLAYSETS FOR MAGNETIC AND DRY ERASE ACTIVITY BOARDS, IN CLASS 28
(U.S. CLS. 22, 23, 38 AND 50).

TRADEMARK

FIRST USE 2-1-2011; IN COMMERCE 2-1-2011.

PRINCIPAL REGISTER

THE MARK CONSISTS OF STANDARD CHARACTERS WITHOUT CLAIM TO ANY PARTICULAR FONT, STYLE, SIZE, OR COLOR.

SN 85-200,133, FILED 12-16-2010.

NAKIA HENRY, EXAMINING ATTORNEY



David J. Kybas

Director of the United States Patent and Trademark Office

United States of America

United States Patent and Trademark Office

SWIVEL

Reg. No. 4,154,929

Registered June 5, 2012

Int. Cl.: 28

TRADEMARK

PRINCIPAL REGISTER

PATCH PRODUCTS, INC. (WISCONSIN CORPORATION)
1400 E. INMAN PARKWAY
BELOIT, WI 53511

FOR: BOARD GAMES; PARLOUR GAMES, IN CLASS 28 (U.S. CLS. 22, 23, 38 AND 50).

FIRST USE 2-1-2011; IN COMMERCE 2-1-2011.

THE MARK CONSISTS OF STANDARD CHARACTERS WITHOUT CLAIM TO ANY PARTICULAR FONT, STYLE, SIZE, OR COLOR.

SN 85-200,509, FILED 12-17-2010.

NAKIA HENRY, EXAMINING ATTORNEY



David J. Kyros

Director of the United States Patent and Trademark Office

United States of America

United States Patent and Trademark Office



Reg. No. 4,154,930

Registered June 5, 2012

Int. Cl.: 42

SERVICE MARK

PRINCIPAL REGISTER

@LEGAL DISCOVERY LLC (DELAWARE LIMITED LIABILITY COMPANY)
2815 HARTLAND ROAD, SUITE 320
FALLS CHURCH, VA 22043

FOR: PROVIDING ON-LINE, TEMPORARY USE OF NON-DOWNLOADABLE COMPUTER PROGRAMS FOR DOCUMENT MANAGEMENT; PROVIDING TEMPORARY USE OF NON-DOWNLOADABLE COMPUTER PROGRAMS FOR SEARCHING THE CONTENTS OF COMPUTERS AND COMPUTER NETWORKS BY REMOTE CONTROL; PROVIDING TEMPORARY USE OF NON-DOWNLOADABLE COMPUTER PROGRAMS FOR USING THE INTERNET AND THE WORLD WIDE WEB; PROVIDING TEMPORARY USE OF NON-DOWNLOADABLE COMPUTER SEARCH ENGINE SOFTWARE; PLATFORM AS A SERVICE (PAAS) FEATURING COMPUTING PLATFORM FOR USE IN ELECTRONIC DISCOVERY DATA PROCESSING, DOCUMENT REVIEW AND PRODUCTION OF DATA IN THE LEGAL INDUSTRY; DATA MINING IN THE NATURE OF DOCUMENT MINING SERVICES, INCLUDING EMAIL THREADING, NEAR DUPLICATE IDENTIFICATION, WORD CLOUD, BATCH MANAGEMENT REVIEW, SUGGESTED REVIEW TAGGING AND ELECTRONIC DISCOVERY COMPUTER PROJECT MANAGEMENT, IN CLASS 42 (U.S. CLS. 100 AND 101).

FIRST USE 10-0-2010; IN COMMERCE 10-0-2010.

OWNER OF U.S. REG. NO. 3,918,483.

THE COLOR(S) ORANGE, CHARCOAL AND GRAY IS/ARE CLAIMED AS A FEATURE OF THE MARK.

NO CLAIM IS MADE TO THE EXCLUSIVE RIGHT TO USE "THE UNIFIED EDISCOVERY PLATFORM", APART FROM THE MARK AS SHOWN.

THE MARK CONSISTS OF A TRANSPARENT "@" SYMBOL ON A SQUARE ORANGE BACKGROUND WITH CURVED CORNERS WITH "CASEPOINT" WITH "CASE" IN CHARCOAL AND "POINT" IN GRAY AND "THE UNIFIED EDISCOVERY PLATFORM" IN CHARCOAL.

SN 85-200,798, FILED 12-17-2010.

GINA FINK, EXAMINING ATTORNEY



David J. Kyros

Director of the United States Patent and Trademark Office

United States of America

United States Patent and Trademark Office

LUMINANCE

Reg. No. 4,154,931

Registered June 5, 2012

Int. Cl.: 11

TRADEMARK

PRINCIPAL REGISTER

AMERICAN DE ROSA LAMPARTS LLC (DELAWARE LIMITED LIABILITY COMPANY)
1945 SOUTH TUBEWAY AVENUE
COMMERCE, CA 90040

FOR: ELECTRIC LIGHTING FIXTURES, IN CLASS 11 (U.S. CLS. 13, 21, 23, 31 AND 34).

FIRST USE 1-1-2012; IN COMMERCE 1-1-2012.

THE MARK CONSISTS OF STANDARD CHARACTERS WITHOUT CLAIM TO ANY PARTICULAR FONT, STYLE, SIZE, OR COLOR.

SN 85-201,057, FILED 12-17-2010.

PATRICIA EVANKO, EXAMINING ATTORNEY



David J. Kyffers

Director of the United States Patent and Trademark Office

United States of America

United States Patent and Trademark Office

FLI

Reg. No. 4,154,932

Registered June 5, 2012

Int. Cl.: 9

TRADEMARK

PRINCIPAL REGISTER

MIDBASS DISTRIBUTION LIMITED (GREAT BRITAIN CORPORATION)
TECH HOUSE, REDDICAP TRADING ESTATE
SUTTON COLDFIELD, ENGLAND B757BU

FOR: APPARATUS FOR RECORDING, TRANSMISSION OR REPRODUCTION OF SOUND OR IMAGES; LOUDSPEAKERS, LOUDSPEAKER AND SOUND SYSTEMS; SOUND AMPLIFIERS, SOUND CONTROL APPARATUS; ELECTRO-MECHANICAL ACOUSTIC CONVERTERS; LOUDSPEAKER ENCLOSURES; AND PARTS, FITTINGS, AND ACCESSORIES FOR THE AFOREMENTIONED GOODS, NAMELY, CABLING, CONNECTORS, REMOTE CONTROLS, POWER CAPACITORS, LINE DRIVERS, DISTRIBUTION BOXES, SOUND DAMPENING, ANTIRESONANCE MATERIALS, LOUDSPEAKER ENCLOSURE PORTS, LOUDSPEAKER ENCLOSURE COSMETIC ENHANCEMENTS AND LOUDSPEAKER ENCLOSURE PROTECTION, IN CLASS 9 (U.S. CLS. 21, 23, 26, 36 AND 38).

FIRST USE 3-31-2005; IN COMMERCE 1-31-2009.

THE MARK CONSISTS OF STANDARD CHARACTERS WITHOUT CLAIM TO ANY PARTICULAR FONT, STYLE, SIZE, OR COLOR.

SN 85-201,257, FILED 12-18-2010.

ARETHA SOMERVILLE, EXAMINING ATTORNEY



David J. Kybas

Director of the United States Patent and Trademark Office

United States of America

United States Patent and Trademark Office

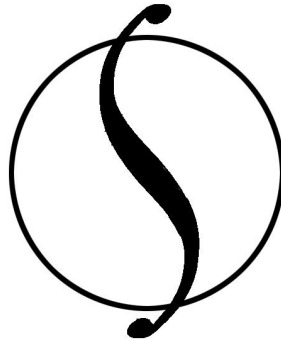

Reg. No. 4,154,933

Registered June 5, 2012

Int. Cl.: 7

TRADEMARK

PRINCIPAL REGISTER

MARK D. BOSSES (UNITED STATES INDIVIDUAL)
505 N.E. SPANISH TRAIL
BOCA RATON, FL 33432

FOR: VACUUM CLEANERS AND THEIR COMPONENTS; BAGS FOR VACUUM CLEANERS;
FILTERS FOR VACUUM CLEANERS, IN CLASS 7 (U.S. CLS. 13, 19, 21, 23, 31, 34 AND 35).

FIRST USE 12-13-2011; IN COMMERCE 12-13-2011.

THE MARK CONSISTS OF A CIRCLE WITH STYLIZED "S" ON FRONT OF THE CIRCLE.

SN 85-201,258, FILED 12-18-2010.

ARETHA SOMERVILLE, EXAMINING ATTORNEY



David J. Kyffers

Director of the United States Patent and Trademark Office

United States of America

United States Patent and Trademark Office

GL

Reg. No. 4,154,934

Registered June 5, 2012

Int. Cl.: 11

TRADEMARK

PRINCIPAL REGISTER

THE MARLEY-WYLAIN COMPANY (DELAWARE CORPORATION)
500 BLAINE STREET
MICHIGAN CITY, IN 46360

FOR: WATER HEATERS, IN CLASS 11 (U.S. CLS. 13, 21, 23, 31 AND 34).

FIRST USE 1-29-2011; IN COMMERCE 1-29-2011.

THE MARK CONSISTS OF STANDARD CHARACTERS WITHOUT CLAIM TO ANY PARTICULAR FONT, STYLE, SIZE, OR COLOR.

SN 85-201,737, FILED 12-20-2010.

LAURIE KAUFMAN, EXAMINING ATTORNEY



David J. Kyffers

Director of the United States Patent and Trademark Office

United States of America

United States Patent and Trademark Office



Reg. No. 4,154,935

DUAL ACOUSTICS LLC (ILLINOIS LIMITED LIABILITY COMPANY)
914 N GROVE AVE
OAK PARK, IL 60302

Registered June 5, 2012

Int. Cl.: 17

FOR: ARCHITECTURAL ACOUSTIC PRODUCTS, NAMELY, SOUND ABSORBERS AND DIFFUSERS, IN CLASS 17 (U.S. CLS. 1, 5, 12, 13, 35 AND 50).

TRADEMARK

FIRST USE 12-27-2010; IN COMMERCE 4-23-2011.

PRINCIPAL REGISTER

NO CLAIM IS MADE TO THE EXCLUSIVE RIGHT TO USE "ACOUSTICS", APART FROM THE MARK AS SHOWN.

THE MARK CONSISTS OF FOUR LINES THAT GET INCREASINGLY LARGER FOLLOWED BY A MIRROR IMAGE OF THOSE FOUR LINES (GETTING DECREASINGLY SMALLER). THE SECOND FOUR LINES ARE ENCASED IN A RECTANGLE WITH ROUNDED CORNERS. TO THE RIGHT OF THE RECTANGLE ARE THE STACKED WORDS "DUAL ACOUSTICS" IN ALL CAPS AND THEY ARE LEFT ALIGNED.

SN 85-202,190, FILED 12-20-2010.

AISHA SALEM, EXAMINING ATTORNEY



David J. Kyjars

Director of the United States Patent and Trademark Office

United States of America

United States Patent and Trademark Office

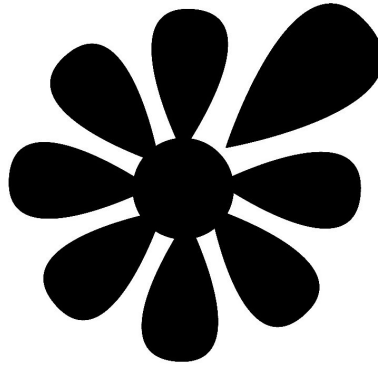

Reg. No. 4,154,936

Registered June 5, 2012

Int. Cls.: 30 and 43

TRADEMARK

SERVICE MARK

PRINCIPAL REGISTER

CULTIVE FRANCHISE, LLC (CALIFORNIA LIMITED LIABILITY COMPANY)
314 HIDALGO PLACE
DAVIS, CA 95616

FOR: FROZEN YOGURT AND FROZEN YOGURT BASED DESSERTS, IN CLASS 30 (U.S. CL. 46).

FIRST USE 2-11-2012; IN COMMERCE 2-11-2012.

FOR: RESTAURANT SERVICES FEATURING FROZEN YOGURT AND FROZEN YOGURT BASED DESSERTS FOR ON AND OFF PREMISES CONSUMPTION, IN CLASS 43 (U.S. CLS. 100 AND 101).

FIRST USE 2-11-2012; IN COMMERCE 2-11-2012.

THE MARK CONSISTS OF A FLOWER WITH EIGHT RADIALLY EXTENDING PEDALS WHEREIN SEVEN ARE THE SAME SIZE AND ONE IS LARGER AND DETACHED FROM THE REMAINDER OF THE FLOWER.

SN 85-202,701, FILED 12-21-2010.

ALEX KEAM, EXAMINING ATTORNEY



David J. Kybas

Director of the United States Patent and Trademark Office

United States of America

United States Patent and Trademark Office

MARSHMALLOW FIRESIDE

Reg. No. 4,154,937

Registered June 5, 2012

Int. Cls.: 3 and 4

TRADEMARK

PRINCIPAL REGISTER

BATH & BODY WORKS BRAND MANAGEMENT, INC. (DELAWARE CORPORATION)
5 LIMITED PARKWAY EAST
REYNOLDSBURG, OH 43068

FOR: ROOM FRAGRANCE REFILLS FOR NON-ELECTRIC AND ELECTRIC ROOM FRAGRANCE DISPENSERS, FRAGRANCES FOR AUTOMOBILES, ROOM FRAGRANCES, HOME FRAGRANCE OILS, FRAGRANCE REEDS, FRAGRANT ROOM SPRAY, IN CLASS 3 (U.S. CLS. 1, 4, 6, 50, 51 AND 52).

FIRST USE 9-5-2011; IN COMMERCE 9-5-2011.

FOR: CANDLES, IN CLASS 4 (U.S. CLS. 1, 6 AND 15).

FIRST USE 9-5-2011; IN COMMERCE 9-5-2011.

THE MARK CONSISTS OF STANDARD CHARACTERS WITHOUT CLAIM TO ANY PARTICULAR FONT, STYLE, SIZE, OR COLOR.

NO CLAIM IS MADE TO THE EXCLUSIVE RIGHT TO USE "MARSHMALLOW", APART FROM THE MARK AS SHOWN.

SN 85-202,865, FILED 12-21-2010.

TINA BROWN, EXAMINING ATTORNEY



David J. Kyffers

Director of the United States Patent and Trademark Office

United States of America

United States Patent and Trademark Office

FIVE FISH BISTRO

Reg. No. 4,154,938

Registered June 5, 2012

Int. Cl.: 43

SERVICE MARK

PRINCIPAL REGISTER

FIVE FISH BISTRO, INC. (WASHINGTON CORPORATION)
SUITE 3400
C/O FOSTER PEPPER PLLC 1111 3RD AVENUE
SEATTLE, WA 98101

FOR: RESTAURANT SERVICES, IN CLASS 43 (U.S. CLS. 100 AND 101).

FIRST USE 1-11-2012; IN COMMERCE 1-11-2012.

THE MARK CONSISTS OF STANDARD CHARACTERS WITHOUT CLAIM TO ANY PARTICULAR FONT, STYLE, SIZE, OR COLOR.

NO CLAIM IS MADE TO THE EXCLUSIVE RIGHT TO USE "FISH BISTRO", APART FROM THE MARK AS SHOWN.

SN 85-203,300, FILED 12-21-2010.

BARNEY CHARLON, EXAMINING ATTORNEY



David J. Kybas

Director of the United States Patent and Trademark Office

United States of America

United States Patent and Trademark Office

ORTHOHELIX UNIVERSITY

Reg. No. 4,154,939

Registered June 5, 2012

Int. Cl.: 41

SERVICE MARK

PRINCIPAL REGISTER

ORTHOHELIX SURGICAL DESIGNS, INC. (DELAWARE CORPORATION)
1065 MEDINA ROAD, SUITE 500
MEDINA, OH 44256

FOR: MEDICAL TRAINING OF HEALTHCARE PROFESSIONALS IN THE FIELD OF ORTHOPEDIC SURGERY; PROVIDING CLASSES TO HEALTHCARE PROFESSIONS IN THE FIELD OF ORTHOPEDIC SURGERY, IN CLASS 41 (U.S. CLS. 100, 101 AND 107).

FIRST USE 3-24-2011; IN COMMERCE 3-24-2011.

THE MARK CONSISTS OF STANDARD CHARACTERS WITHOUT CLAIM TO ANY PARTICULAR FONT, STYLE, SIZE, OR COLOR.

NO CLAIM IS MADE TO THE EXCLUSIVE RIGHT TO USE "UNIVERSITY", APART FROM THE MARK AS SHOWN.

SN 85-203,849, FILED 12-22-2010.

MARK SPARACINO, EXAMINING ATTORNEY



David J. Kyffers

Director of the United States Patent and Trademark Office

United States of America

United States Patent and Trademark Office

SMASHBOX FULL EXPOSURE

Reg. No. 4,154,940

DJF ENTERPRISES (CALIFORNIA CORPORATION)
767 FIFTH AVENUE
NEW YORK, NY 10153

Registered June 5, 2012

Int. Cl.: 3

FOR: COSMETICS, IN CLASS 3 (U.S. CLS. 1, 4, 6, 50, 51 AND 52).

TRADEMARK

FIRST USE 2-24-2011; IN COMMERCE 2-24-2011.

PRINCIPAL REGISTER

THE MARK CONSISTS OF STANDARD CHARACTERS WITHOUT CLAIM TO ANY PARTICULAR FONT, STYLE, SIZE, OR COLOR.

OWNER OF U.S. REG. NOS. 1,763,490 AND 2,392,373.

SN 85-204,013, FILED 12-22-2010.

ALICE BENMAMAN, EXAMINING ATTORNEY



David J. Kyffers

Director of the United States Patent and Trademark Office

United States of America

United States Patent and Trademark Office

PACIFIC RIMS

Reg. No. 4,154,941

Registered June 5, 2012

Int. Cl.: 12

TRADEMARK

PRINCIPAL REGISTER

REYNOLDS CYCLING, L.L.C. (DELAWARE LIMITED LIABILITY COMPANY), DBA PACIFIC RIMS USA,
3392 W. 8600 S.
WEST JORDAN, UT 84088

FOR: BICYCLE WHEELS; BICYCLE WHEEL RIMS; BICYCLE WHEEL HUBS; BICYCLE WHEEL SPOKES; BICYCLE WHEEL SPOKE FASTENERS; BICYCLE WHEEL BRAKE PADS; BICYCLE WHEEL TIRES; BICYCLE WHEEL INNER TUBES; BICYCLE WATER BOTTLE CAGES; BICYCLE WHEEL ACCESSORIES NAMELY, AXLES, AXLE END CAPS, FREEHUB BODIES, GEARS, QUICK RELEASE SKEWERS, RIM STRIPS, TUBELESS RIM TAPE, VALVES, VALVE EXTENDERS, WHEEL BAGS AND CASES, IN CLASS 12 (U.S. CLS. 19, 21, 23, 31, 35 AND 44).

FIRST USE 9-0-2010; IN COMMERCE 9-0-2010.

THE MARK CONSISTS OF STANDARD CHARACTERS WITHOUT CLAIM TO ANY PARTICULAR FONT, STYLE, SIZE, OR COLOR.

SN 85-204,025, FILED 12-22-2010.

RONALD AIKENS, EXAMINING ATTORNEY



David J. Kybas

Director of the United States Patent and Trademark Office

United States of America

United States Patent and Trademark Office

LYNX Hooks

Reg. No. 4,154,942

E3 DESIGN LLC (IDAHO LIMITED LIABILITY COMPANY)
21894 E. HAYDEN LAKE ROAD
HAYDEN LAKE, ID 83835

Registered June 5, 2012

Int. Cl.: 22

FOR: NON-METAL TIE DOWNS WHICH MAY BE CONNECTED TOGETHER IN DIFFERENT LENGTHS AND CONFIGURATIONS, IN CLASS 22 (U.S. CLS. 1, 2, 7, 19, 22, 42 AND 50).

TRADEMARK

FIRST USE 1-9-2012; IN COMMERCE 2-29-2012.

PRINCIPAL REGISTER

THE MARK CONSISTS OF STANDARD CHARACTERS WITHOUT CLAIM TO ANY PARTICULAR FONT, STYLE, SIZE, OR COLOR.

NO CLAIM IS MADE TO THE EXCLUSIVE RIGHT TO USE "HOOKS", APART FROM THE MARK AS SHOWN.

SN 85-204,217, FILED 12-22-2010.

STEVEN PEREZ, EXAMINING ATTORNEY



David J. Kyffers

Director of the United States Patent and Trademark Office

United States of America

United States Patent and Trademark Office

VISTA PRAIRIE COMMUNITIES

Reg. No. 4,154,943

Registered June 5, 2012

Int. Cls.: 43 and 45

SERVICE MARK

PRINCIPAL REGISTER

GOVERNMENTAL AND EDUCATIONAL ASSISTANCE CORP. (ARKANSAS CHARITABLE,
NON-PROFIT CORPORATION)
SUITE 250
415 BLAKE ROAD NORTH
HOPKINS, MN 55343

FOR: PROVIDING ASSISTANCE TO SENIOR CITIZENS SEEKING TO DETERMINE AS-
SISTED LIVING FACILITIES APPROPRIATE FOR THEIR NEEDS; PROVIDING ASSISTED
LIVING FACILITIES; PROVIDING COMMUNITY CENTERS FOR SOCIAL GATHERINGS
AND MEETINGS; RETIREMENT HOMES, IN CLASS 43 (U.S. CLS. 100 AND 101).

FIRST USE 12-1-2011; IN COMMERCE 12-1-2011.

FOR: PERSONAL CARE ASSISTANCE OF ACTIVITIES OF DAILY LIVING, SUCH AS
BATHING, GROOMING AND PERSONAL MOBILITY FOR MENTALLY OR PHYSICALLY
CHALLENGED PEOPLE; PROVIDING NON-MEDICAL ASSISTED LIVING SERVICES FOR
PERSONAL PURPOSES IN THE NATURE OF SCHEDULING APPOINTMENTS, ANSWERING
THE TELEPHONE, CHECKING MESSAGES, MAIL SORTING, MAIL HANDLING, MAIL
RECEIVING AND SECRETARIAL AND CLERICAL SERVICES; PROVIDING NON-MEDICAL
PERSONAL ASSISTANT SERVICES FOR OTHERS IN THE NATURE OF PLANNING, OR-
GANIZING, COORDINATING, ARRANGING AND ASSISTING INDIVIDUALS TO PERFORM
DAILY TASKS, IN CLASS 45 (U.S. CLS. 100 AND 101).

FIRST USE 12-1-2011; IN COMMERCE 12-1-2011.

THE MARK CONSISTS OF STANDARD CHARACTERS WITHOUT CLAIM TO ANY PAR-
TICULAR FONT, STYLE, SIZE, OR COLOR.

NO CLAIM IS MADE TO THE EXCLUSIVE RIGHT TO USE "COMMUNITIES", APART
FROM THE MARK AS SHOWN.

SN 85-204,338, FILED 12-22-2010.

DAVID I, EXAMINING ATTORNEY



David J. Kyros

Director of the United States Patent and Trademark Office

United States of America

United States Patent and Trademark Office

VEGAS HITS ROAD TRIP

Reg. No. 4,154,944

Registered June 5, 2012

Int. Cl.: 9

TRADEMARK

PRINCIPAL REGISTER

BALLY GAMING, INC. (NEVADA CORPORATION), DBA BALLY TECHNOLOGIES,
ATTN: PAMELA BOWSHER, LAW DEPT.
6601 SOUTH BERMUDA ROAD
LAS VEGAS, NV 89119

FOR: COMPUTER GAMING SOFTWARE, GAMING SOFTWARE THAT GENERATES OR
DISPLAYS WAGER OUTCOMES OF GAMING MACHINES, DOWNLOADABLE COMPUTER
GAME SOFTWARE FOR GAMING, GAMING MACHINES, NAMELY, DEVICES THAT AC-
CEPT A WAGER; SLOT MACHINES, IN CLASS 9 (U.S. CLS. 21, 23, 26, 36 AND 38).

FIRST USE 9-16-2011; IN COMMERCE 9-16-2011.

THE MARK CONSISTS OF STANDARD CHARACTERS WITHOUT CLAIM TO ANY PAR-
TICULAR FONT, STYLE, SIZE, OR COLOR.

OWNER OF U.S. REG. NO. 3,908,953.

NO CLAIM IS MADE TO THE EXCLUSIVE RIGHT TO USE "VEGAS", APART FROM THE
MARK AS SHOWN.

SN 85-204,458, FILED 12-22-2010.

THEODORE MCBRIDE, EXAMINING ATTORNEY



David J. Kybas

Director of the United States Patent and Trademark Office

United States of America

United States Patent and Trademark Office

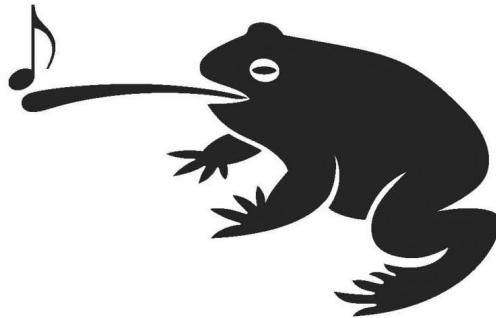

Reg. No. 4,154,945

Registered June 5, 2012

Int. Cls.: 9 and 15

TRADEMARK

PRINCIPAL REGISTER

RIVERA AMPLIFICATION INC. (CALIFORNIA CORPORATION)
508 SOUTH VARNEY STREET
BURBANK, CA 91502

FOR: ELECTRONIC EFFECT PEDALS FOR USE WITH SOUND AMPLIFIERS, IN CLASS 9
(U.S. CLS. 21, 23, 26, 36 AND 38).

FIRST USE 1-18-2011; IN COMMERCE 1-18-2011.

FOR: ELECTRONIC EFFECTS PEDALS FOR USE WITH MUSICAL INSTRUMENTS; FOOT
PEDALS FOR USE IN CONNECTION WITH MUSICAL INSTRUMENTS; GUITAR PEDALS;
SOUND EFFECT PEDALS FOR MUSICAL INSTRUMENTS, IN CLASS 15 (U.S. CLS. 2, 21
AND 36).

FIRST USE 1-18-2011; IN COMMERCE 1-18-2011.

THE MARK CONSISTS OF A TOAD WITH ITS TONGUE EXTENDED, WITH A MUSICAL
NOTE JUST ABOVE THE TIP OF THE TONGUE.

SN 85-204,715, FILED 12-23-2010.

DAVID YONTEF, EXAMINING ATTORNEY



David J. Kyffers

Director of the United States Patent and Trademark Office

United States of America

United States Patent and Trademark Office

Naked Fitness

Reg. No. 4,154,946

METCALF, ANDREA (UNITED STATES INDIVIDUAL)
210 N. RACINE
CHICAGO, IL 60607

Registered June 5, 2012

Int. Cl.: 16

FOR: BOOKS IN THE FIELD OF PHYSICAL FITNESS AND EXERCISE, IN CLASS 16 (U.S. CLS. 2, 5, 22, 23, 29, 37, 38 AND 50).

TRADEMARK

FIRST USE 7-10-2010; IN COMMERCE 1-1-2011.

PRINCIPAL REGISTER

THE MARK CONSISTS OF STANDARD CHARACTERS WITHOUT CLAIM TO ANY PARTICULAR FONT, STYLE, SIZE, OR COLOR.

NO CLAIM IS MADE TO THE EXCLUSIVE RIGHT TO USE "FITNESS", APART FROM THE MARK AS SHOWN.

SN 85-204,716, FILED 12-23-2010.

ANNE MADDEN, EXAMINING ATTORNEY



David J. Kybas

Director of the United States Patent and Trademark Office

United States of America

United States Patent and Trademark Office

FILTHYGRILL

Reg. No. 4,154,947

FILTHY GRILL, INC. (CALIFORNIA CORPORATION)

Registered June 5, 2012

P.O. BOX 883
AGOURA HILLS, CA 91301

Int. Cl.: 37

FOR: CLEANING, REPAIR AND MAINTENANCE SERVICES FOR BARBEQUES, GRILLS,
AND OUTDOOR KITCHENS, IN CLASS 37 (U.S. CLS. 100, 103 AND 106).

SERVICE MARK

FIRST USE 5-0-2004; IN COMMERCE 10-18-2011.

PRINCIPAL REGISTER

THE MARK CONSISTS OF STANDARD CHARACTERS WITHOUT CLAIM TO ANY PAR-
TICULAR FONT, STYLE, SIZE, OR COLOR.

SN 85-204,908, FILED 12-23-2010.

KIM MONINGHOFF, EXAMINING ATTORNEY



David J. Kybas

Director of the United States Patent and Trademark Office

United States of America

United States Patent and Trademark Office

FLI Underground

Reg. No. 4,154,948

Registered June 5, 2012

Int. Cls.: 9, 35, and 42

TRADEMARK

SERVICE MARK

PRINCIPAL REGISTER

MIDBASS DISTRIBUTION LIMITED (GREAT BRITAIN CORPORATION)
TECH HOUSE, REDDICAP TRADING ESTATE
SUTTON COLDFIELD, ENGLAND B757BU

FOR: APPARATUS FOR RECORDING, TRANSMISSION OR REPRODUCTION OF SOUND OR IMAGES; LOUDSPEAKERS, LOUDSPEAKER AND SOUND SYSTEMS; SOUND AMPLIFIERS, SOUND CONTROL APPARATUS; ELECTRO-MECHANICAL ACOUSTIC CONVERTERS; LOUDSPEAKER ENCLOSURES; AND PARTS, FITTINGS, AND ACCESSORIES FOR THE AFOREMENTIONED GOODS, NAMELY, CABLING, CONNECTORS, REMOTE CONTROLS, POWER CAPACITORS, LINE DRIVERS, DISTRIBUTION BOXES, SOUND DAMPENING, ANTIRESONANCE MATERIALS, LOUDSPEAKER ENCLOSURE PORTS, LOUDSPEAKER ENCLOSURE COSMETIC ENHANCEMENTS AND LOUDSPEAKER ENCLOSURE PROTECTION, IN CLASS 9 (U.S. CLS. 21, 23, 26, 36 AND 38).

FIRST USE 12-31-2010; IN COMMERCE 12-31-2010.

FOR: ADVERTISING; BUSINESS MANAGEMENT; BUSINESS ADMINISTRATION; THE BRINGING TOGETHER FOR THE BENEFIT OF OTHERS, OF A VARIETY OF GOODS, ENABLING CUSTOMERS TO CONVENIENTLY VIEW AND PURCHASE THOSE GOODS FROM A RETAIL AUDIO SPECIALIST STORE, OR FROM AN AUDIO SPECIALIST CATALOGUE OR INTERNET WEBSITE SPECIALISING IN THE SALE OF AUDIO EQUIPMENT AND BY MAIL ORDER OR BY MEANS OF TELECOMMUNICATIONS; CONSULTANCY, ADVISORY AND INFORMATION SERVICES TO THE AFOREMENTIONED SERVICES, IN CLASS 35 (U.S. CLS. 100, 101 AND 102).

FIRST USE 12-31-2010; IN COMMERCE 12-31-2010.

FOR: PROVISION OF TECHNICAL INFORMATION AND TECHNICAL ADVICE RELATING TO LOUDSPEAKERS AND AUDIO SYSTEMS; TECHNICAL TESTING SERVICES FOR SOUND SYSTEMS AND LOUDSPEAKER SYSTEMS; RESEARCH AND DESIGN SERVICES FOR LOUDSPEAKERS AND AUDIO SYSTEMS, IN CLASS 42 (U.S. CLS. 100 AND 101).

FIRST USE 12-31-2010; IN COMMERCE 12-31-2010.

THE MARK CONSISTS OF STANDARD CHARACTERS WITHOUT CLAIM TO ANY PARTICULAR FONT, STYLE, SIZE, OR COLOR.



David J. Kyjars

Director of the United States Patent and Trademark Office

Reg. No. 4,154,948 SN 85-205,171, FILED 12-23-2010.

ARETHA SOMERVILLE, EXAMINING ATTORNEY

United States of America

United States Patent and Trademark Office

CABLE COMBER

Reg. No. 4,154,949

Registered June 5, 2012

Int. Cl.: 9

TRADEMARK

PRINCIPAL REGISTER

PREMIER MANUFACTURING GROUP, INC. (CONNECTICUT CORPORATION)
10 MOUNTAIN VIEW DRIVE
SHELTON, CT 06484

FOR: ELECTRICAL DUCTS FOR ELECTRICAL WIRES AND CABLES; RIGID AND FLEXIBLE ELECTRICAL RACEWAYS FOR HOLDING AND ORGANIZING ELECTRICAL WIRES AND CABLES , IN CLASS 9 (U.S. CLS. 21, 23, 26, 36 AND 38).

FIRST USE 3-31-2011; IN COMMERCE 3-31-2011.

THE MARK CONSISTS OF STANDARD CHARACTERS WITHOUT CLAIM TO ANY PARTICULAR FONT, STYLE, SIZE, OR COLOR.

NO CLAIM IS MADE TO THE EXCLUSIVE RIGHT TO USE "CABLE", APART FROM THE MARK AS SHOWN.

SN 85-205,628, FILED 12-25-2010.

DAVID ELTON, EXAMINING ATTORNEY



David J. Kyffers

Director of the United States Patent and Trademark Office

United States of America

United States Patent and Trademark Office

CABLE CANAL

Reg. No. 4,154,950

Registered June 5, 2012

Int. Cl.: 9

TRADEMARK

PRINCIPAL REGISTER

PREMIER MANUFACTURING GROUP, INC. (CONNECTICUT CORPORATION)
10 MOUNTAIN VIEW ROAD
SHELTON, CT 06484

FOR: ELECTRICAL DUCTS FOR ELECTRICAL WIRES AND CABLES; RIGID AND FLEXIBLE ELECTRICAL RACEWAYS FOR HOLDING AND ORGANIZING ELECTRICAL WIRES AND CABLES, IN CLASS 9 (U.S. CLS. 21, 23, 26, 36 AND 38).

FIRST USE 7-7-2011; IN COMMERCE 7-7-2011.

THE MARK CONSISTS OF STANDARD CHARACTERS WITHOUT CLAIM TO ANY PARTICULAR FONT, STYLE, SIZE, OR COLOR.

NO CLAIM IS MADE TO THE EXCLUSIVE RIGHT TO USE "CABLE", APART FROM THE MARK AS SHOWN.

SN 85-205,630, FILED 12-25-2010.

DAVID ELTON, EXAMINING ATTORNEY



David J. Kyffers

Director of the United States Patent and Trademark Office

United States of America

United States Patent and Trademark Office

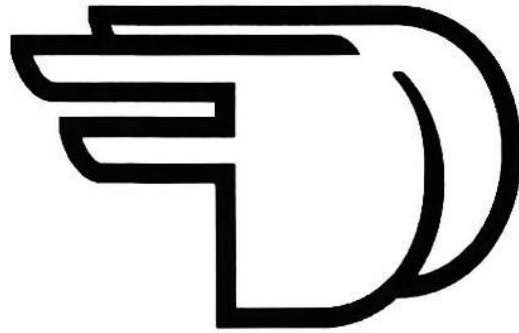

Reg. No. 4,154,951

Registered June 5, 2012

Int. Cl.: 20

TRADEMARK

PRINCIPAL REGISTER

GOODWIN, ROBERT W. (UNITED STATES INDIVIDUAL)
249 DOLPHIN PL
BELLINGHAM, WA 98229

FOR: SEAT CUSHIONS, IN CLASS 20 (U.S. CLS. 2, 13, 22, 25, 32 AND 50).

FIRST USE 1-1-2012; IN COMMERCE 1-1-2012.

THE MARK CONSISTS OF A FOREFRONT LETTER "D" OVER A BACKGROUND "D" WITH TWO LINES EXTENDING FROM THE MIDDLE AND UPPER LEFT SIDE OF THE FOREFRONT "D" AND WITH ONE LINE EXTENDING FROM THE UPPER LEFT SIDE OF THE BACKGROUND "D".

SN 85-206,913, FILED 12-28-2010.

ELLEN PERKINS, EXAMINING ATTORNEY



David J. Kybas

Director of the United States Patent and Trademark Office

United States of America

United States Patent and Trademark Office

THE SAFE MONEY GUY

Reg. No. 4,154,952

Registered June 5, 2012

Int. Cl.: 36

SERVICE MARK

PRINCIPAL REGISTER

BRENNAN AGENCY, INC. (NEVADA CORPORATION)
STE 510
10551 BARKLEY ST
OVERLAND PARK, KS 66212

FOR: INSURANCE BROKERAGE; FINANCIAL PLANNING SERVICES; ESTATE PLANNING SERVICES, IN CLASS 36 (U.S. CLS. 100, 101 AND 102).

FIRST USE 8-1-2011; IN COMMERCE 8-1-2011.

THE MARK CONSISTS OF STANDARD CHARACTERS WITHOUT CLAIM TO ANY PARTICULAR FONT, STYLE, SIZE, OR COLOR.

SN 85-208,920, FILED 1-3-2011.

DAVID ELTON, EXAMINING ATTORNEY



David J. Kyffers

Director of the United States Patent and Trademark Office

United States of America

United States Patent and Trademark Office

DANCE DOT

Reg. No. 4,154,953

Registered June 5, 2012

Int. Cl.: 19

TRADEMARK

PRINCIPAL REGISTER

COVAS, JACQUELINE ANN (UNITED STATES INDIVIDUAL)
92 PINEHURST AVENUE, APT. 1E
NEW YORK, NY 10033 AND

GIRTEN, CODEY (UNITED STATES INDIVIDUAL)
10 OVERLOOK TERRACE, APT. 1C
NEW YORK, NY 10033

FOR: PORTABLE DANCE FLOORS, IN CLASS 19 (U.S. CLS. 1, 12, 33 AND 50).

FIRST USE 9-5-2010; IN COMMERCE 3-23-2011.

THE MARK CONSISTS OF STANDARD CHARACTERS WITHOUT CLAIM TO ANY PARTICULAR FONT, STYLE, SIZE, OR COLOR.

NO CLAIM IS MADE TO THE EXCLUSIVE RIGHT TO USE "DANCE", APART FROM THE MARK AS SHOWN.

SN 85-209,067, FILED 1-3-2011.

JUSTINE D. PARKER, EXAMINING ATTORNEY



David J. Kybas

Director of the United States Patent and Trademark Office

United States of America

United States Patent and Trademark Office

HUMAN INTELLIGENCE

Reg. No. 4,154,954

Registered June 5, 2012

Int. Cl.: 35

SERVICE MARK

PRINCIPAL REGISTER

HUMAN INTELLIGENCE LLC (CONNECTICUT LIMITED LIABILITY COMPANY)
262 TRUMBULL HIGHWAY
LEBANON, CT 06249

FOR: BUSINESS CONSULTING PROVIDED TO BUSINESS, GOVERNMENT, AND THE ENTERTAINMENT INDUSTRY, IN THE NATURE OF PROVIDING HISTORY AND SOCIOECONOMIC INFORMATION ABOUT OTHER COUNTRIES FOR BUSINESS PURPOSES, IN CLASS 35 (U.S. CLS. 100, 101 AND 102).

FIRST USE 12-13-2011; IN COMMERCE 12-13-2011.

THE MARK CONSISTS OF STANDARD CHARACTERS WITHOUT CLAIM TO ANY PARTICULAR FONT, STYLE, SIZE, OR COLOR.

SN 85-209,194, FILED 1-3-2011.

NICHOLAS COLEMAN, EXAMINING ATTORNEY



David J. Kyffers

Director of the United States Patent and Trademark Office

United States of America

United States Patent and Trademark Office

EZDoc

Reg. No. 4,154,955

Registered June 5, 2012

Int. Cl.: 7

TRADEMARK

PRINCIPAL REGISTER

AIRFLOW CATALYST SYSTEMS, INC. (DELAWARE CORPORATION)
SUITE 700
2144 BRIGHTON-HENRIETTA TOWNLINE ROAD
ROCHESTER, NY 14623

FOR: DIESEL EMISSION REDUCTION UNITS FOR ENGINES, NAMELY, CATALYTIC CONVERTERS, IN CLASS 7 (U.S. CLS. 13, 19, 21, 23, 31, 34 AND 35).

FIRST USE 6-3-2011; IN COMMERCE 6-3-2011.

THE MARK CONSISTS OF STANDARD CHARACTERS WITHOUT CLAIM TO ANY PARTICULAR FONT, STYLE, SIZE, OR COLOR.

SN 85-209,301, FILED 1-3-2011.

MARY ROSSMAN, EXAMINING ATTORNEY



David J. Kybas

Director of the United States Patent and Trademark Office

United States of America

United States Patent and Trademark Office

CUISINART CROWN

Reg. No. 4,154,956

Registered June 5, 2012

Int. Cl.: 21

TRADEMARK

PRINCIPAL REGISTER

CONAIR CORPORATION (DELAWARE CORPORATION)
ONE CUMMINGS POINT ROAD
STAMFORD, CT 06902

FOR: NON-ELECTRIC KETTLES, IN CLASS 21 (U.S. CLS. 2, 13, 23, 29, 30, 33, 40 AND 50).

FIRST USE 3-0-2011; IN COMMERCE 3-0-2011.

THE MARK CONSISTS OF STANDARD CHARACTERS WITHOUT CLAIM TO ANY PARTICULAR FONT, STYLE, SIZE, OR COLOR.

OWNER OF U.S. REG. NOS. 1,048,883, 2,313,580, AND OTHERS.

SN 85-209,774, FILED 1-4-2011.

GISELLE AGOSTO, EXAMINING ATTORNEY



David J. Kybas

Director of the United States Patent and Trademark Office

United States of America

United States Patent and Trademark Office

CUISINART PRODIGY

Reg. No. 4,154,957

Registered June 5, 2012

Int. Cl.: 21

TRADEMARK

PRINCIPAL REGISTER

CONAIR CORPORATION (DELAWARE CORPORATION)
ONE CUMMINGS POINT ROAD
STAMFORD, CT 06902

FOR: NON-ELECTRIC KETTLES, IN CLASS 21 (U.S. CLS. 2, 13, 23, 29, 30, 33, 40 AND 50).

FIRST USE 2-0-2011; IN COMMERCE 2-0-2011.

THE MARK CONSISTS OF STANDARD CHARACTERS WITHOUT CLAIM TO ANY PARTICULAR FONT, STYLE, SIZE, OR COLOR.

OWNER OF U.S. REG. NOS. 1,048,883, 2,313,580, AND OTHERS.

SN 85-209,829, FILED 1-4-2011.

GISELLE AGOSTO, EXAMINING ATTORNEY



David J. Kybas

Director of the United States Patent and Trademark Office

United States of America

United States Patent and Trademark Office

HARVARD PLUS

Reg. No. 4,154,958

Registered June 5, 2012

Int. Cls.: 37 and 45

SERVICE MARK

PRINCIPAL REGISTER

HARVARD MAINTENANCE, INC. (NEW YORK CORPORATION)
570 SEVENTH AVENUE
NEW YORK, NY 10018

FOR: CLEANING OF BUILDINGS AND FACILITIES; MAINTENANCE AND RENOVATION OF BUILDINGS AND FACILITIES; JANITORIAL SERVICES; CARPET AND RUG CLEANING AND SHAMPOOING; WINDOW CLEANING; TRASH COLLECTION; WASTE DISPOSAL FOR OTHERS; CLEANING, BUFFING AND POLISHING OF METAL AND STONE; DOOR MAINTENANCE AND REPAIR SERVICES; FURNITURE RESTORATION, REPAIR AND MAINTENANCE; FLOOR SANDING; PEST CONTROL AND EXTERMINATION OTHER THAN FOR AGRICULTURE, IN CLASS 37 (U.S. CLS. 100, 103 AND 106).

FIRST USE 4-27-2011; IN COMMERCE 4-27-2011.

FOR: SECURITY GUARD SERVICES; MONITORING SECURITY SYSTEMS, IN CLASS 45 (U.S. CLS. 100 AND 101).

FIRST USE 4-27-2011; IN COMMERCE 4-27-2011.

OWNER OF U.S. REG. NOS. 2,825,189 AND 2,825,190.

THE COLOR(S) DARK BLUE AND GRAY IS/ARE CLAIMED AS A FEATURE OF THE MARK.

THE MARK CONSISTS OF THE TERM "HARVARD" IN DARK BLUE, WITH THE RIGHT SIDE OF THE "V" EXTENDING ABOVE THE OTHER LETTERS, FOLLOWED BY THE TERM "PLUS" IN GRAY.

SN 85-209,849, FILED 1-4-2011.

PAUL E. FAHRENKOPF, EXAMINING ATTORNEY



David J. Kypos

Director of the United States Patent and Trademark Office

United States of America

United States Patent and Trademark Office



Reg. No. 4,154,959

Registered June 5, 2012

Int. Cls.: 9 and 37

TRADEMARK

SERVICE MARK

PRINCIPAL REGISTER

U-GO STATIONS, INC. (PENNSYLVANIA CORPORATION)
1818 MARKET STREET, 13TH FLOOR
PHILADELPHIA, PA 191033638

FOR: ELECTRICAL APPARATUS, NAMELY, CHARGING STATIONS FOR CHARGING ELECTRIC VEHICLES, IN CLASS 9 (U.S. CLS. 21, 23, 26, 36 AND 38).

FIRST USE 11-0-2010; IN COMMERCE 8-5-2011.

FOR: CHARGING STATION SERVICES FOR ELECTRIC VEHICLES, IN CLASS 37 (U.S. CLS. 100, 103 AND 106).

FIRST USE 3-15-2011; IN COMMERCE 3-15-2011.

NO CLAIM IS MADE TO THE EXCLUSIVE RIGHT TO USE "STATIONS", APART FROM THE MARK AS SHOWN.

THE COLOR(S) BLUE, GREEN, AND BLACK IS/ARE CLAIMED AS A FEATURE OF THE MARK.

THE MARK CONSISTS OF THE WORDING "U GO STATIONS" WITH A CORD AND PLUG DESIGN EXTENDING FROM THE "U" AND INTO THE WORD "GO". THE WORDING "GO STATIONS" IS BLACK. THE LETTER "U" IS BLUE, AND THE PLUG SHADES FROM BLUE INTO GREEN.

SN 85-210,101, FILED 1-4-2011.

DORITT L. CARROLL, EXAMINING ATTORNEY



David J. Kybas

Director of the United States Patent and Trademark Office

United States of America

United States Patent and Trademark Office

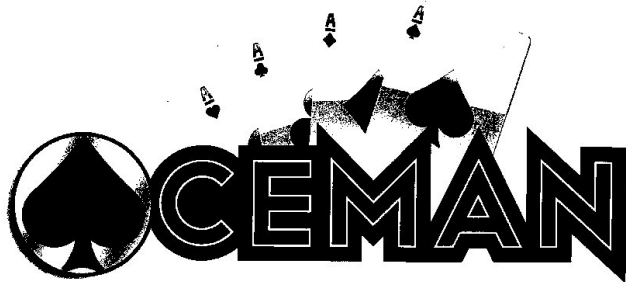

Reg. No. 4,154,960

Registered June 5, 2012

Int. Cl.: 16

TRADEMARK

PRINCIPAL REGISTER

ROBBINS, NORMAN (UNITED STATES INDIVIDUAL)
1034 W. FEDORA AVE
FRESNO, CA 93705

FOR: COMIC BOOKS, IN CLASS 16 (U.S. CLS. 2, 5, 22, 23, 29, 37, 38 AND 50).

FIRST USE 7-9-2011; IN COMMERCE 9-10-2011.

THE MARK CONSISTS OF FOUR "A"'S PLAYING CARDS. BELOW THERE IS A CIRCLE WITH A SPADE AND THE STYLIZED TEXT "ACEMAN".

SN 85-210,700, FILED 1-5-2011.

PATRICIA EVANKO, EXAMINING ATTORNEY



David J. Kybas

Director of the United States Patent and Trademark Office

United States of America

United States Patent and Trademark Office

CUISINART VALOR

Reg. No. 4,154,961

Registered June 5, 2012

Int. Cl.: 21

TRADEMARK

PRINCIPAL REGISTER

CONAIR CORPORATION (DELAWARE CORPORATION)
ONE CUMMINGS POINT ROAD
STAMFORD, CT 06902

FOR: NON-ELECTRIC KETTLES, IN CLASS 21 (U.S. CLS. 2, 13, 23, 29, 30, 33, 40 AND 50).

FIRST USE 2-0-2011; IN COMMERCE 2-0-2011.

THE MARK CONSISTS OF STANDARD CHARACTERS WITHOUT CLAIM TO ANY PARTICULAR FONT, STYLE, SIZE, OR COLOR.

OWNER OF U.S. REG. NOS. 1,048,883, 2,313,580, AND OTHERS.

SN 85-210,742, FILED 1-5-2011.

GISELLE AGOSTO, EXAMINING ATTORNEY



David J. Kyffers

Director of the United States Patent and Trademark Office

United States of America

United States Patent and Trademark Office

DISTINGUISHED ADVISOR CONFERENCE

Reg. No. 4,154,962

Registered June 5, 2012

Int. Cl.: 41

SERVICE MARK

PRINCIPAL REGISTER

KNOWLEDGE BUREAU INC. (CANADA CORPORATION)
187 ST. MARY'S ROAD
WINNIPEG, MANITOBA, CANADA R2H1J2

FOR: EDUCATIONAL SERVICES, NAMELY, CONDUCTING CONFERENCES AND SEMINARS IN THE FIELD OF FINANCIAL PLANNING, IN CLASS 41 (U.S. CLS. 100, 101 AND 107).

FIRST USE 0-0-2004; IN COMMERCE 0-0-2004.

THE MARK CONSISTS OF STANDARD CHARACTERS WITHOUT CLAIM TO ANY PARTICULAR FONT, STYLE, SIZE, OR COLOR.

PRIORITY CLAIMED UNDER SEC. 44(D) ON CANADA APPLICATION NO. 1501312, FILED 10-26-2010.

NO CLAIM IS MADE TO THE EXCLUSIVE RIGHT TO USE "ADVISOR CONFERENCE", APART FROM THE MARK AS SHOWN.

SN 85-211,112, FILED 1-5-2011.

LAURA KOVALSKY, EXAMINING ATTORNEY



David J. Kybas

Director of the United States Patent and Trademark Office

United States of America

United States Patent and Trademark Office

QUICK CASH

Reg. No. 4,154,963

Registered June 5, 2012

Int. Cl.: 9

TRADEMARK

PRINCIPAL REGISTER

GRAND VISION GAMING, LLC (MONTANA LIMITED LIABILITY COMPANY)
P.O. BOX 20956
BILLINGS, MT 59104

FOR: GAMING MACHINES, IN CLASS 9 (U.S. CLS. 21, 23, 26, 36 AND 38).

FIRST USE 2-8-2012; IN COMMERCE 2-8-2012.

THE MARK CONSISTS OF STANDARD CHARACTERS WITHOUT CLAIM TO ANY PARTICULAR FONT, STYLE, SIZE, OR COLOR.

NO CLAIM IS MADE TO THE EXCLUSIVE RIGHT TO USE "CASH", APART FROM THE MARK AS SHOWN.

SN 85-211,453, FILED 1-5-2011.

ANDREA BUTLER, EXAMINING ATTORNEY



David J. Kyffers

Director of the United States Patent and Trademark Office

United States of America

United States Patent and Trademark Office

POWER OF PREPAID

Reg. No. 4,154,964

NETWORK BRANDED PREPAID CARD ASSOCIATION (D.C. NON-PROFIT CORPORATION)
110 CHESTNUT RIDGE ROAD, SUITE 111
MONTVALE, NJ 076451706

Registered June 5, 2012

Int. Cl.: 35

FOR: PROMOTING AND CONDUCTING A TRADE SHOW FOR THE PREPAID AND STORED VALUE INDUSTRY, IN CLASS 35 (U.S. CLS. 100, 101 AND 102).

SERVICE MARK

FIRST USE 9-1-2011; IN COMMERCE 9-1-2011.

PRINCIPAL REGISTER

THE MARK CONSISTS OF STANDARD CHARACTERS WITHOUT CLAIM TO ANY PARTICULAR FONT, STYLE, SIZE, OR COLOR.

NO CLAIM IS MADE TO THE EXCLUSIVE RIGHT TO USE "PREPAID", APART FROM THE MARK AS SHOWN.

SN 85-212,109, FILED 1-6-2011.

H. M. FISHER, EXAMINING ATTORNEY



David J. Kybas

Director of the United States Patent and Trademark Office

United States of America

United States Patent and Trademark Office

PARROTT PARTY PRODUCTIONS

Reg. No. 4,154,965

Registered June 5, 2012

Int. Cl.: 41

SERVICE MARK

PRINCIPAL REGISTER

LINDSAY PARROTT (UNITED STATES INDIVIDUAL)
SUITE 1412
910 S. MICHIGAN AVENUE
CHICAGO, IL 60605

FOR: PARTY PLANNING SERVICES; SPECIAL EVENT PLANNING FOR SOCIAL ENTERTAINMENT PURPOSES, IN CLASS 41 (U.S. CLS. 100, 101 AND 107).

FIRST USE 1-16-2011; IN COMMERCE 1-16-2011.

THE MARK CONSISTS OF STANDARD CHARACTERS WITHOUT CLAIM TO ANY PARTICULAR FONT, STYLE, SIZE, OR COLOR.

NO CLAIM IS MADE TO THE EXCLUSIVE RIGHT TO USE "PARTY PRODUCTIONS", APART FROM THE MARK AS SHOWN.

SN 85-212,275, FILED 1-6-2011.

MARIA-VICTORIA SUAREZ, EXAMINING ATTORNEY



David J. Kybas

Director of the United States Patent and Trademark Office

United States of America

United States Patent and Trademark Office

GET YOUR DIRT ON WE'LL GET
IT OFF

Reg. No. 4,154,966

Registered June 5, 2012

Int. Cl.: 3

TRADEMARK

PRINCIPAL REGISTER

PURE & NATURAL COMPANY (ARIZONA CORPORATION)
19001 NORTH SCOTTSDALE ROAD
MS 04.50
SCOTTSDALE, AZ 85255

FOR: BATH SOAPS; BODY WASH; LIQUID SOAPS, IN CLASS 3 (U.S. CLS. 1, 4, 6, 50, 51 AND 52).

FIRST USE 1-28-2011; IN COMMERCE 1-28-2011.

THE MARK CONSISTS OF STANDARD CHARACTERS WITHOUT CLAIM TO ANY PARTICULAR FONT, STYLE, SIZE, OR COLOR.

SN 85-212,521, FILED 1-7-2011.

DEBRA LEE, EXAMINING ATTORNEY



David J. Kyffers

Director of the United States Patent and Trademark Office

United States of America

United States Patent and Trademark Office



Reg. No. 4,154,967

Registered June 5, 2012

Int. Cl.: 25

TRADEMARK

PRINCIPAL REGISTER

HBI BRANDED APPAREL LIMITED, INC. (DELAWARE CORPORATION)
1000 EAST HANES MILL ROAD
WINSTON-SALEM, NC 27105

FOR: HOSIERY, IN CLASS 25 (U.S. CLS. 22 AND 39).

FIRST USE 9-19-2011; IN COMMERCE 9-19-2011.

OWNER OF U.S. REG. NOS. 847,649, 2,121,985, AND OTHERS.

THE MARK CONSISTS OF THE WORD "HANES" IN LOWER CASE LETTERING NEXT TO THE LETTER "H" IN SCRIPT WRITING.

SN 85-212,765, FILED 1-7-2011.

LINDSEY RUBIN, EXAMINING ATTORNEY



David J. Kyffers

Director of the United States Patent and Trademark Office

United States of America

United States Patent and Trademark Office

AVO

Reg. No. 4,154,968

Registered June 5, 2012

Int. Cl.: 33

TRADEMARK

PRINCIPAL REGISTER

INTERCONTINENTAL PACKAGING CO. (MINNESOTA CORPORATION)
1999 SHEPARD ROAD
ST. PAUL, MN 55116

FOR: WINES, IN CLASS 33 (U.S. CLS. 47 AND 49).

FIRST USE 1-1-2011; IN COMMERCE 3-1-2011.

THE MARK CONSISTS OF STANDARD CHARACTERS WITHOUT CLAIM TO ANY PARTICULAR FONT, STYLE, SIZE, OR COLOR.

THE ENGLISH TRANSLATION OF "AVO" IN THE MARK IS "GRANFATHER" OR "ANCESTOR".

SN 85-213,007, FILED 1-7-2011.

BRENDAN MCCAULEY, EXAMINING ATTORNEY



David J. Kybas

Director of the United States Patent and Trademark Office

United States of America

United States Patent and Trademark Office

CRASCHE

Reg. No. 4,154,969

Registered June 5, 2012

Int. Cl.: 9

TRADEMARK

PRINCIPAL REGISTER

CRASCHE NEW YORK LLC (NEW YORK LIMITED LIABILITY COMPANY)
7600 JERICHO TURNPIKE, SUITE 407
WOODBURY, NY 11797

FOR: PROTECTIVE HEADWEAR FOR PROTECTION AGAINST INJURY TO THE HEAD; PROTECTIVE HEADWEAR FOR SPORTS TO PROTECT AGAINST INJURY TO THE HEAD; SPORTS EQUIPMENT, NAMELY, PROTECTIVE HEADWEAR FOR PROTECTION AGAINST INJURY TO THE HEAD; PROTECTIVE INSERTS FOR SPORTS HEADWEAR TO PROTECT AGAINST INJURY TO THE HEAD; PROTECTIVE HEADWEAR AND PROTECTIVE INSERTS FOR HEADWEAR, ALL FOR PROTECTION AGAINST INJURY TO THE HEAD IN BIKING, CYCLING, SKATE BOARDING, ROLLER SKATING, INLINE SKATING, FIELD HOCKEY, LACROSSE, TOUCH FOOTBALL, FLAG FOOTBALL AND SKIING, IN CLASS 9 (U.S. CLS. 21, 23, 26, 36 AND 38).

FIRST USE 1-29-2012; IN COMMERCE 1-29-2012.

THE MARK CONSISTS OF STANDARD CHARACTERS WITHOUT CLAIM TO ANY PARTICULAR FONT, STYLE, SIZE, OR COLOR.

SN 85-214,152, FILED 1-10-2011.

SAMUEL E. SHARPER JR., EXAMINING ATTORNEY



David J. Kybas

Director of the United States Patent and Trademark Office

United States of America

United States Patent and Trademark Office

MARKET CALIBRATED FRAMEWORK

Reg. No. 4,154,970

Registered June 5, 2012

Int. Cl.: 35

SERVICE MARK

PRINCIPAL REGISTER

BENCHMARK SOLUTIONS HOLDINGS INC. (DELAWARE CORPORATION)
101 PARK AVENUE-7TH FLOOR
NEW YORK, NY 10178

FOR: FINANCIAL SERVICES, NAMELY, ANALYZING MARKET DATA AND PRICING ANALYTICS SERVICES FOR MEASURING THE PERFORMANCE OF FINANCIAL MARKETS FOR ASSET CLASSES WITHIN THE CAPITAL MARKETS, INCLUDING FIXED INCOME PRODUCTS, IN CLASS 35 (U.S. CLS. 100, 101 AND 102).

FIRST USE 7-18-2011; IN COMMERCE 7-18-2011.

THE MARK CONSISTS OF STANDARD CHARACTERS WITHOUT CLAIM TO ANY PARTICULAR FONT, STYLE, SIZE, OR COLOR.

NO CLAIM IS MADE TO THE EXCLUSIVE RIGHT TO USE "MARKET", APART FROM THE MARK AS SHOWN.

SN 85-214,274, FILED 1-10-2011.

ARETHA SOMERVILLE, EXAMINING ATTORNEY



David J. Kybas

Director of the United States Patent and Trademark Office

United States of America

United States Patent and Trademark Office

ENLIGHTENING THE CAPITAL MARKETS

Reg. No. 4,154,971

BENCHMARK SOLUTIONS HOLDINGS INC. (DELAWARE CORPORATION)
101 PARK AVENUE- 7TH FLOOR
NEW YORK, NY 10178

Registered June 5, 2012

Int. Cl.: 35

FOR: FINANCIAL SERVICES, NAMELY, ANALYZING MARKET DATA AND PRICING ANALYTICS SERVICES FOR MEASURING THE PERFORMANCE OF FINANCIAL MARKETS FOR ASSET CLASSES WITHIN THE CAPITAL MARKETS, INCLUDING FIXED INCOME PRODUCTS, IN CLASS 35 (U.S. CLS. 100, 101 AND 102).

SERVICE MARK

PRINCIPAL REGISTER

FIRST USE 1-15-2010; IN COMMERCE 1-15-2010.

THE MARK CONSISTS OF STANDARD CHARACTERS WITHOUT CLAIM TO ANY PARTICULAR FONT, STYLE, SIZE, OR COLOR.

NO CLAIM IS MADE TO THE EXCLUSIVE RIGHT TO USE "CAPITAL MARKETS", APART FROM THE MARK AS SHOWN.

SN 85-214,290, FILED 1-10-2011.

ARETHA SOMERVILLE, EXAMINING ATTORNEY



David J. Kyjars

Director of the United States Patent and Trademark Office

United States of America

United States Patent and Trademark Office

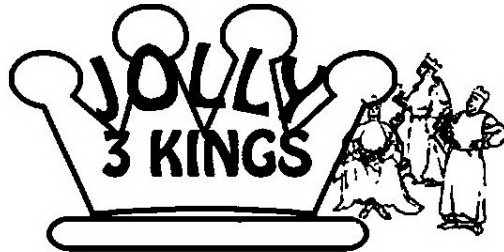

Reg. No. 4,154,972

Registered June 5, 2012

Int. Cl.: 5

TRADEMARK

PRINCIPAL REGISTER

ORIONS THREE KINGS (NEW JERSEY LIMITED LIABILITY COMPANY)
2148 TYLER STREET
UNION, NJ 07083

FOR: HERBAL SUPPLEMENTS, IN CLASS 5 (U.S. CLS. 6, 18, 44, 46, 51 AND 52).

FIRST USE 6-15-2011; IN COMMERCE 6-15-2011.

THE MARK CONSISTS OF THREE KINGS HOLDING HERBS IN THEIR HANDS. THERE IS ALSO A CROWN WITH THE STYLIZED TEXT "JOLLY 3 KINGS".

SN 85-214,296, FILED 1-10-2011.

SUNG IN, EXAMINING ATTORNEY



David J. Kyffers

Director of the United States Patent and Trademark Office

United States of America

United States Patent and Trademark Office

BENCHMARK SOLUTIONS

Reg. No. 4,154,973

BENCHMARK SOLUTIONS HOLDINGS INC. (DELAWARE CORPORATION)
101 PARK AVENUE-7TH FLOOR
NEW YORK, NY 10178

Registered June 5, 2012

Int. Cl.: 35

FOR: FINANCIAL SERVICES, NAMELY, ANALYZING MARKET DATA AND PRICING ANALYTICS SERVICES FOR MEASURING THE PERFORMANCE OF FINANCIAL MARKETS FOR ASSET CLASSES WITHIN THE CAPITAL MARKETS, INCLUDING FIXED INCOME PRODUCTS, IN CLASS 35 (U.S. CLS. 100, 101 AND 102).

SERVICE MARK

PRINCIPAL REGISTER

FIRST USE 11-15-2009; IN COMMERCE 11-15-2009.

THE MARK CONSISTS OF STANDARD CHARACTERS WITHOUT CLAIM TO ANY PARTICULAR FONT, STYLE, SIZE, OR COLOR.

NO CLAIM IS MADE TO THE EXCLUSIVE RIGHT TO USE "SOLUTIONS", APART FROM THE MARK AS SHOWN.

SN 85-214,330, FILED 1-10-2011.

ARETHA SOMERVILLE, EXAMINING ATTORNEY



David J. Kyros

Director of the United States Patent and Trademark Office

United States of America

United States Patent and Trademark Office

Corkcicle

Reg. No. 4,154,974

Registered June 5, 2012

Int. Cl.: 21

TRADEMARK

PRINCIPAL REGISTER

HEWY WINE CHILLERS, LLC (FLORIDA LIMITED LIABILITY COMPANY)
BENJAMIN R HEWITT
2147 ALAMEDA AVE
ORLANDO, FL 32804

FOR: BOTTLE STOPPERS SPECIALLY ADAPTED FOR USE WITH WINE BOTTLES;
COOLERS FOR WINE, IN CLASS 21 (U.S. CLS. 2, 13, 23, 29, 30, 33, 40 AND 50).

FIRST USE 9-20-2011; IN COMMERCE 9-20-2011.

THE MARK CONSISTS OF STANDARD CHARACTERS WITHOUT CLAIM TO ANY PARTICULAR FONT, STYLE, SIZE, OR COLOR.

SN 85-214,510, FILED 1-10-2011.

MARC LEIPZIG, EXAMINING ATTORNEY



David J. Kyffers

Director of the United States Patent and Trademark Office

United States of America

United States Patent and Trademark Office

jaggedfashion

Reg. No. 4,154,975

Registered June 5, 2012

Int. Cl.: 14

TRADEMARK

PRINCIPAL REGISTER

MOCHINSKI, JACOB (WASHINGTON SOLE PROPRIETORSHIP), DBA AIRCRAFTKEEPERS,
P.O. BOX 4383
EVERETT, WA 98204

FOR: CHOKERS; NECKLACES, IN CLASS 14 (U.S. CLS. 2, 27, 28 AND 50).

FIRST USE 8-1-2011; IN COMMERCE 8-1-2011.

THE MARK CONSISTS OF STANDARD CHARACTERS WITHOUT CLAIM TO ANY PARTICULAR FONT, STYLE, SIZE, OR COLOR.

SN 85-214,560, FILED 1-11-2011.

ROSELLE HERRERA, EXAMINING ATTORNEY



David J. Kyros

Director of the United States Patent and Trademark Office

United States of America

United States Patent and Trademark Office

VETPRO

Reg. No. 4,154,976

Registered June 5, 2012

Int. Cls.: 9 and 10

TRADEMARK

PRINCIPAL REGISTER

MIDMARK CORPORATION (OHIO CORPORATION)
60 VISTA DRIVE
VERSAILLES, OH 45380

FOR: OPERATING SOFTWARE FOR X-RAY APPARATUS FOR VETERINARY USE AND ANIMAL PATIENT MONITORING SENSORS, IN CLASS 9 (U.S. CLS. 21, 23, 26, 36 AND 38).

FIRST USE 8-0-2011; IN COMMERCE 8-0-2011.

FOR: X-RAY APPARATUS FOR VETERINARY USE AND OPERATING SOFTWARE SOLD AS A UNIT; ANIMAL PATIENT MONITORING SENSORS AND OPERATING SOFTWARE SOLD AS A UNIT; ACCESSORIES RELATED TO X-RAY APPARATUS FOR VETERINARY USE AND ANIMAL PATIENT MONITORING SENSORS, NAMELY, DIGITAL SENSOR HEADS, MOUNTING PLATES, HANDLES, APPARATUS ARMS, CONTROL PANELS, AND SENSOR CABLING, IN CLASS 10 (U.S. CLS. 26, 39 AND 44).

FIRST USE 8-0-2011; IN COMMERCE 8-0-2011.

THE MARK CONSISTS OF STANDARD CHARACTERS WITHOUT CLAIM TO ANY PARTICULAR FONT, STYLE, SIZE, OR COLOR.

OWNER OF U.S. REG. NO. 3,659,092.

SN 85-214,692, FILED 1-11-2011.

PAULA MAHONEY, EXAMINING ATTORNEY



David J. Kyffers

Director of the United States Patent and Trademark Office

United States of America

United States Patent and Trademark Office

Arms

Reg. No. 4,154,977

Registered June 5, 2012

Int. Cl.: 9

TRADEMARK

PRINCIPAL REGISTER

MITSUBISHI ELECTRIC CORPORATION (JAPAN CORPORATION)
7-3 MARUNOUCHI 2-CHOME
CHIYODA-KU, TOKYO, JAPAN

FOR: SIGNAL PROCESSING APPARATUS FOR TRANSMITTING THE INFORMATION RELATING TO THE OPERATING STATUS AND CONDITIONS OF ELECTRICAL SWITCHGEARS, CIRCUIT BREAKERS AND/OR TRANSFORMERS INSTALLED WITHIN ELECTRICAL POWER PLANT OR ELECTRICAL SUBSTATION TO THE SUPERVISING AND CONTROLLING NETWORK; REMOTE ELECTRONIC APPARATUS FOR THE REMOTE CONTROL OF POWER GENERATING OPERATIONS FOR ELECTRICAL SWITCHGEARS, CIRCUIT BREAKERS AND/OR TRANSFORMERS INSTALLED WITHIN ELECTRICAL POWER PLANT OR ELECTRICAL SUBSTATION, IN CLASS 9 (U.S. CLS. 21, 23, 26, 36 AND 38).

FIRST USE 2-29-2012; IN COMMERCE 2-29-2012.

THE MARK CONSISTS OF STANDARD CHARACTERS WITHOUT CLAIM TO ANY PARTICULAR FONT, STYLE, SIZE, OR COLOR.

SN 85-215,053, FILED 1-11-2011.

DAVID HOFFMAN, EXAMINING ATTORNEY



David J. Kyffers

Director of the United States Patent and Trademark Office

United States of America

United States Patent and Trademark Office

YOU RANG

Reg. No. 4,154,978

Registered June 5, 2012

Int. Cl.: 9

TRADEMARK

PRINCIPAL REGISTER

SERCHLITE MULTIMEDIA (FLORIDA CORPORATION)
6850 VALHALLA WAY
WINDEMERE, FL 34786

FOR: COMPUTER APPLICATION SOFTWARE FOR MOBILE PHONES, NAMELY, SOFTWARE FOR SEARCHING A REAL ESTATE DIRECTORY AND DATABASE FOR CONTRACTORS, REAL ESTATE AGENTS, AND SERVICE PROVIDERS, FOR USE BY ANYONE IN THE REAL ESTATE FIELD OR INTERESTED IN REAL ESTATE, IN CLASS 9 (U.S. CLS. 21, 23, 26, 36 AND 38).

FIRST USE 1-0-2010; IN COMMERCE 1-0-2010.

THE MARK CONSISTS OF STANDARD CHARACTERS WITHOUT CLAIM TO ANY PARTICULAR FONT, STYLE, SIZE, OR COLOR.

SN 85-215,338, FILED 1-11-2011.

JAMES MACFARLANE, EXAMINING ATTORNEY



David J. Kyffers

Director of the United States Patent and Trademark Office

United States of America

United States Patent and Trademark Office



Reg. No. 4,154,979

Registered June 5, 2012

Int. Cl.: 42

SERVICE MARK

PRINCIPAL REGISTER

TRANSURANT, INC. (NEBRASKA CORPORATION)
11311 CHICAGO CIRCLE
OMAHA, NE 68154

FOR: APPLICATION SERVICE PROVIDER (ASP) FEATURING ONLINE REPORTING SOFTWARE FOR USE IN THE FIELD OF HEALTHCARE; PROVIDING TEMPORARY USE OF ON-LINE NONDOWNLOADABLE SOFTWARE AND APPLICATIONS FOR MEDICAL BILLING QUALITY ASSURANCE, STAFF EDUCATION AND SYSTEM OVERSIGHT; PROVIDING TEMPORARY USE OF ON-LINE NONDOWNLOADABLE SOFTWARE AND APPLICATIONS FOR DATA INTEGRITY CHECKING AND COMPARISON, IN CLASS 42 (U.S. CLS. 100 AND 101).

FIRST USE 1-1-2011; IN COMMERCE 10-1-2011.

THE MARK CONSISTS OF THREE WAVY PAPERS WITH 3 VERTICAL BARS GOING FROM SHORTEST ON THE LEFT TO MEDIUM IN THE MIDDLE AND TALLEST ON THE RIGHT. THE BARS HAVE A ZIG ZAG LINE ARROW STRIKING THROUGH THEM THAT REPRESENT AN INCREASE. TO THE RIGHT THERE IS THE STYLIZED TEXT "TRANSURANT INNOVATIVE REPORTING SOLUTIONS FOR HEALTHCARE".

SN 85-215,365, FILED 1-11-2011.

KAPIL BHANOT, EXAMINING ATTORNEY



David J. Kyros

Director of the United States Patent and Trademark Office

United States of America

United States Patent and Trademark Office



Reg. No. 4,154,980

Registered June 5, 2012

Int. Cl.: 29

TRADEMARK

PRINCIPAL REGISTER

PACIFIC COAST PRODUCERS (CALIFORNIA CORPORATION)
631 N. CLUFF AVENUE
LODI, CA 95241

FOR: CANNED FRUITS AND VEGETABLES, IN CLASS 29 (U.S. CL. 46).

FIRST USE 11-1-2011; IN COMMERCE 1-1-2012.

NO CLAIM IS MADE TO THE EXCLUSIVE RIGHT TO USE "MADE FROM FRESH CALIFORNIA TOMATOES" AND THE REPRESENTATION OF THE STATE OF CALIFORNIA, APART FROM THE MARK AS SHOWN.

THE COLOR(S) GREEN, GOLD, WHITE AND BLACK IS/ARE CLAIMED AS A FEATURE OF THE MARK.

THE MARK CONSISTS OF A CIRCLE OUTLINED WITH BLACK, WHICH IS FILLED IN WITH GREEN, WITH A GOLD IMAGE OUTLINED WITH BLACK OF THE STATE OF CALIFORNIA IN THE MIDDLE WITH SUNBURST GOLD COLORS COMING FROM BEHIND IT, AND THE WORDS "MADE FROM FRESH CALIFORNIA TOMATOES" IN THE GREEN AREA.

SN 85-215,929, FILED 1-12-2011.

BARBARA BROWN, EXAMINING ATTORNEY



David J. Kyffers

Director of the United States Patent and Trademark Office

United States of America

United States Patent and Trademark Office



Reg. No. 4,154,981

Registered June 5, 2012

Int. Cls.: 35 and 36

SERVICE MARK

PRINCIPAL REGISTER

DOMINANT BRANDS LLC (NEW YORK LIMITED LIABILITY COMPANY)
28-42 210TH STREET
BAYSIDE, NY 11360

FOR: COMMERCIAL BUSINESS MANAGEMENT, BUSINESS ADMINISTRATION CONSULTANCY, CONSULTING IN THE FIELDS OF BUSINESS ORGANIZATION AND MANAGEMENT, BUSINESS INTERMEDIARY SERVICES AND ADVISORY SERVICES IN THE FIELD OF SELLING PRODUCTS AND RENDERING SERVICES, ACCOUNTING FOR THIRD PARTIES, ECONOMIC FORECASTING AND ANALYSIS, COLLECTION, PREPARATION, COMPOSITION, PROCESSING, ACQUISITION AND PROVISION OF BUSINESS INFORMATION, DATA, STATISTICS, AND INDICES; PROVIDING STATISTICAL INFORMATION, COMPILATION AND PROVISION OF TRADE AND BUSINESS PRICE AND STATISTICAL INFORMATION; PERSONNEL MANAGEMENT, HUMAN CAPITAL MANAGEMENT OUTSOURCING, ORGANIZING AND CONDUCTING TRADE FAIRS AND EXHIBITIONS FOR ECONOMIC AND ADVERTISING PURPOSES, ARRANGING AND CONDUCTING AUCTION SALES, IN CLASS 35 (U.S. CLS. 100, 101 AND 102).

FIRST USE 3-22-2012; IN COMMERCE 3-22-2012.

FOR: INVESTMENT BANKING SERVICES, FINANCIAL ADVISORY SERVICES, AND INVESTMENT ADVISORY SERVICES AND BROKERAGE SERVICES IN THE FIELD OF SECURITIES; FINANCIAL MANAGEMENT, IN CLASS 36 (U.S. CLS. 100, 101 AND 102).

FIRST USE 3-22-2012; IN COMMERCE 3-22-2012.

NO CLAIM IS MADE TO THE EXCLUSIVE RIGHT TO USE "FIRST BOSTON CORPORATION", APART FROM THE MARK AS SHOWN.

THE MARK CONSISTS OF A THREE-MASTED SHIP DESIGN SUPERIMPOSED OVER A GLOBE CIRCUMSCRIBED BY THE WORDS "THE FIRST BOSTON CORPORATION" INSIDE OF A CIRCLE.

SN 85-216,555, FILED 1-13-2011.

TIMOTHY FINNEGAN, EXAMINING ATTORNEY



David J. Kyros

Director of the United States Patent and Trademark Office

United States of America

United States Patent and Trademark Office

FROST-EAZE

Reg. No. 4,154,982

EVRIHOLDER PRODUCTS LLC (INDIANA LIMITED LIABILITY COMPANY)
1500 SOUTH LEWIS STREET
ANAHEIM, CA 92805

Registered June 5, 2012

Int. Cl.: 21

FOR: DECORATING SETS SOLD AS A UNIT COMPRISED OF DECORATING TUBES, COUPLERS AND TIPS FOR BAKED GOODS, NAMELY, CAKES, COOKIES AND CUP-CAKES , IN CLASS 21 (U.S. CLS. 2, 13, 23, 29, 30, 33, 40 AND 50).

TRADEMARK

FIRST USE 6-13-2011; IN COMMERCE 7-18-2011.

PRINCIPAL REGISTER

THE MARK CONSISTS OF STANDARD CHARACTERS WITHOUT CLAIM TO ANY PARTICULAR FONT, STYLE, SIZE, OR COLOR.

SN 85-217,059, FILED 1-13-2011.

KAREN BRACEY, EXAMINING ATTORNEY



David J. Kyros

Director of the United States Patent and Trademark Office

United States of America

United States Patent and Trademark Office



Reg. No. 4,154,983

Registered June 5, 2012

Int. Cl.: 9

TRADEMARK

PRINCIPAL REGISTER

AU OPTRONICS CORP. (TAIWAN CORPORATION)
NO. 1, LI-HSIN RD. 2
SCIENCE-BASED INDUSTRIAL PARK
HSINCHU CITY, TAIWAN

FOR: FLAT PANEL DISPLAY SCREENS; LIQUID CRYSTAL DISPLAYS; LOW TEMPERATURE POLY-SILICON LIQUID CRYSTAL DISPLAYS; ORGANIC LIGHT EMITTING DIODE DISPLAYS; COLOR THIN FILM TRANSISTOR LIQUID CRYSTAL DISPLAYS, IN CLASS 9 (U.S. CLS. 21, 23, 26, 36 AND 38).

FIRST USE 10-21-2005; IN COMMERCE 1-5-2006.

OWNER OF TAIWAN REG. NO. 01260605, DATED 5-1-2007, EXPIRES 4-30-2017.

THE MARK CONSISTS OF STYLIZED LETTERS "AMVA" WITH WAVY HORIZONTAL LINES BELOW THE LETTERS.

THE WORD(S) "AMVA" HAS NO MEANING IN A FOREIGN LANGUAGE.

SN 85-217,243, FILED 1-13-2011.

SALLY SHIH, EXAMINING ATTORNEY



David J. Kyfos

Director of the United States Patent and Trademark Office

United States of America

United States Patent and Trademark Office



Reg. No. 4,154,984

TAKE 'EM OFFS, LTD. (NEW YORK CORPORATION)
75 WEST END AVENUE
NEW YORK, NY 10023

Registered June 5, 2012

Int. Cl.: 25

FOR: CLOTHING, NAMELY, WOMEN'S UNDERWEAR AND BRAS, IN CLASS 25 (U.S. CLS. 22 AND 39).

TRADEMARK

FIRST USE 4-9-2012; IN COMMERCE 4-9-2012.

PRINCIPAL REGISTER

THE MARK CONSISTS OF A STYLIZED LETTER "T".

SN 85-218,184, FILED 1-14-2011.

JAMES LOVELACE, EXAMINING ATTORNEY



David J. Kybas

Director of the United States Patent and Trademark Office

United States of America

United States Patent and Trademark Office

myT

Reg. No. 4,154,985

Registered June 5, 2012

Int. Cl.: 1

TRADEMARK

PRINCIPAL REGISTER

SWIFT BIOSCIENCES, INC. (DELAWARE CORPORATION)
58 PARKLAND PLAZA, SUITE 100
ANN ARBOR, MI 41803

FOR: DIAGNOSTIC REAGENTS FOR CLINICAL OR MEDICAL LABORATORY USE; DIAGNOSTIC REAGENTS FOR IN VITRO USE IN BIOCHEMISTRY, CLINICAL CHEMISTRY AND MICROBIOLOGY; DIAGNOSTIC REAGENTS FOR SCIENTIFIC OR RESEARCH USE, IN CLASS 1 (U.S. CLS. 1, 5, 6, 10, 26 AND 46).

FIRST USE 2-20-2012; IN COMMERCE 2-20-2012.

THE MARK CONSISTS OF STANDARD CHARACTERS WITHOUT CLAIM TO ANY PARTICULAR FONT, STYLE, SIZE, OR COLOR.

SN 85-218,373, FILED 1-14-2011.

RONALD DELGIZZI, EXAMINING ATTORNEY



David J. Kyffers

Director of the United States Patent and Trademark Office

United States of America

United States Patent and Trademark Office

BRIDAL HEADLINES BY CLEVÉ

Reg. No. 4,154,986

Registered June 5, 2012

Int. Cl.: 26

TRADEMARK

PRINCIPAL REGISTER

CLEVELETTE AUSTIN (UNITED STATES INDIVIDUAL)
C/O LAW OFFICES OF CAROL GREEN, P.A.
201 S. BISCAYNE BLVD., 28TH FLOOR
MIAMI, FL 33131

FOR: HAIR ACCESSORIES, NAMELY, HAIR BARRETTES AND HAIR CLIPS, IN CLASS 26
(U.S. CLS. 37, 39, 40, 42 AND 50).

FIRST USE 2-25-2011; IN COMMERCE 2-25-2011.

THE MARK CONSISTS OF STANDARD CHARACTERS WITHOUT CLAIM TO ANY PARTICULAR FONT, STYLE, SIZE, OR COLOR.

NO CLAIM IS MADE TO THE EXCLUSIVE RIGHT TO USE "BRIDAL", APART FROM THE MARK AS SHOWN.

SN 85-218,646, FILED 1-15-2011.

MICHAEL SOUDERS, EXAMINING ATTORNEY



David J. Kyffers

Director of the United States Patent and Trademark Office

United States of America

United States Patent and Trademark Office

MY OWN kidz

Reg. No. 4,154,987

Registered June 5, 2012

Int. Cl.: 14

TRADEMARK

PRINCIPAL REGISTER

MY OWN KIDZ LLC (TEXAS LIMITED LIABILITY COMPANY)
8528 DAVIS BLVD., STE. 134-208
NORTH RICHLAND HILLS, TX 76182

FOR: BRACELETS; BRACELETS AND JEWELRY FEATURING ELECTRONIC CHIPS FOR ATTRACTING ENERGY TO THE BODY WHEREIN THE ELECTRONIC CHIPS INCREASE IN POWER IN THE PRESENCE OF ELECTROMAGNETIC FIELDS, FOR THE PURPOSE OF RE-BALANCING THE HUMAN ENERGY FIELD; CHARMS FOR COLLAR JEWELRY AND BRACELET; CHRONOGRAPHS AS WATCHES; CHRONOGRAPHS FOR USE AS WATCHES; CHRONOMETRIC INSTRUMENTS AND WATCH MOVEMENTS; CLOCK AND WATCH HANDS; CLOCKS AND WATCHES; DIVING WATCHES; DRESS WATCHES; IDENTIFICATION BRACELETS; INEXPENSIVE NON-JEWELRY WATCHES; JEWELLERY AND WATCHES; JEWELRY WATCHES; JEWELRY, NAMELY, BRACELETS, WRISTBANDS AND NECKLACES THAT ALSO PROVIDES NOTIFICATION TO THE WEARER OF A PENDING MEDICAL RELATED TASK; MECHANICAL AND AUTOMATIC WATCHES; PLASTIC BRACELETS IN THE NATURE OF JEWELRY; RUBBER OR SILICON WRISTBANDS IN THE NATURE OF A BRACELET; SPORTS WATCHES; STAINLESS STEEL JEWELRY BRACELETS; WATCH BANDS; WATCH BANDS AND STRAPS; WATCH BRACELETS; WATCH STRAPS; WATCH STRAPS MADE OF METAL OR LEATHER OR PLASTIC; WATCHES; WATCHES AND CLOCKS; WATCHES AND JEWELLERY; WATCHES AND JEWELRY; WATCHES AND STRAPS FOR WATCHES; WATCHES FOR OUTDOOR USE; WATCHES FOR SPORTING USE; WATCHES MADE OF PRECIOUS METALS OR COATED THEREWITH; WATCHES, CLOCKS; WATCHES, CLOCKS, JEWELLERY AND IMITATION JEWELLERY; WATCHES, CLOCKS, JEWELRY AND IMITATION JEWELRY; WOMEN'S WATCHES; WRIST WATCHES, IN CLASS 14 (U.S. CLS. 2, 27, 28 AND 50).

FIRST USE 7-27-2011; IN COMMERCE 7-27-2011.

THE MARK CONSISTS OF STANDARD CHARACTERS WITHOUT CLAIM TO ANY PARTICULAR FONT, STYLE, SIZE, OR COLOR.

NO CLAIM IS MADE TO THE EXCLUSIVE RIGHT TO USE "KIDS", APART FROM THE MARK AS SHOWN.

SN 85-219,025, FILED 1-17-2011.

CHRIS WELLS, EXAMINING ATTORNEY



David J. Kypas

Director of the United States Patent and Trademark Office

United States of America

United States Patent and Trademark Office

MY OWN id

Reg. No. 4,154,988

Registered June 5, 2012

Int. Cl.: 14

TRADEMARK

PRINCIPAL REGISTER

MY OWN KIDZ LLC (TEXAS LIMITED LIABILITY COMPANY)
8528 DAVIS BLVD., STE. 134-208
NORTH RICHLAND HILLS, TX 76182

FOR: BRACELETS; BRACELETS; BRACELETS AND JEWELRY FEATURING ELECTRONIC CHIPS FOR ATTRACTING ENERGY TO THE BODY WHEREIN THE ELECTRONIC CHIPS INCREASE IN POWER IN THE PRESENCE OF ELECTROMAGNETIC FIELDS, FOR THE PURPOSE OF RE-BALANCING THE HUMAN ENERGY FIELD; BRACELETS OF PRECIOUS METAL; CHARMS FOR COLLAR JEWELRY AND BRACELET; CHRONOGRAPHS AS WATCHES; CHRONOGRAPHS FOR USE AS WATCHES; CHRONOMETRIC INSTRUMENTS AND WATCH MOVEMENTS; CLOCKS AND WATCHES; DIVING WATCHES; DRESS WATCHES; IDENTIFICATION BRACELETS; INEXPENSIVE NON-JEWELRY WATCHES; JEWELLERY AND WATCHES; JEWELLERY, CLOCKS AND WATCHES; JEWELRY WATCHES; JEWELRY, NAMELY, BRACELETS, WRISTBANDS AND NECKLACES THAT ALSO PROVIDES NOTIFICATION TO THE WEARER OF A PENDING MEDICAL RELATED TASK; MECHANICAL AND AUTOMATIC WATCHES; PLASTIC BRACELETS IN THE NATURE OF JEWELRY; RUBBER OR SILICON WRISTBANDS IN THE NATURE OF A BRACELET; SLAP BRACELETS; SLAPBAND BRACELETS; SPORTS WATCHES; STAINLESS STEEL JEWELRY BRACELETS; WATCH BANDS; WATCH BANDS AND STRAPS; WATCH BRACELETS; WATCH STRAPS; WATCH STRAPS MADE OF METAL OR LEATHER OR PLASTIC; WATCHES; WATCHES AND CLOCKS; WATCHES AND JEWELLERY; WATCHES AND JEWELRY; WATCHES AND STRAPS FOR WATCHES; WATCHES CONTAINING A GAME FUNCTION; WATCHES CONTAINING AN ELECTRONIC GAME FUNCTION; WATCHES FOR OUTDOOR USE; WATCHES FOR SPORTING USE; WATCHES MADE OF PRECIOUS METALS OR COATED THEREWITH; WATCHES, CLOCKS; WATCHES, CLOCKS, JEWELLERY AND IMITATION JEWELLERY; WATCHES, CLOCKS, JEWELRY AND IMITATION JEWELRY; WOMEN'S WATCHES; WRIST WATCHES, IN CLASS 14 (U.S. CLS. 2, 27, 28 AND 50).



FIRST USE 7-27-2011; IN COMMERCE 7-27-2011.

THE MARK CONSISTS OF STANDARD CHARACTERS WITHOUT CLAIM TO ANY PARTICULAR FONT, STYLE, SIZE, OR COLOR.

David J. Kyros

NO CLAIM IS MADE TO THE EXCLUSIVE RIGHT TO USE "ID", APART FROM THE MARK AS SHOWN.

Reg. No. 4,154,988 SN 85-219,042, FILED 1-17-2011.

CHRIS WELLS, EXAMINING ATTORNEY

United States of America

United States Patent and Trademark Office

ENERGIZE ME

Reg. No. 4,154,989

Registered June 5, 2012

Int. Cl.: 29

TRADEMARK

PRINCIPAL REGISTER

WERNER GOURMET MEAT SNACKS, INC. (OREGON CORPORATION)
2807 3RD STREET
TILLAMOOK, OR 97141

FOR: MEAT-BASED SNACK FOODS, IN CLASS 29 (U.S. CL. 46).

FIRST USE 2-10-2012; IN COMMERCE 2-10-2012.

THE MARK CONSISTS OF STANDARD CHARACTERS WITHOUT CLAIM TO ANY PARTICULAR FONT, STYLE, SIZE, OR COLOR.

SN 85-220,053, FILED 1-18-2011.

ODESSA BIBBINS, EXAMINING ATTORNEY



David J. Kyffers

Director of the United States Patent and Trademark Office

United States of America

United States Patent and Trademark Office

KOH-EFFICIENT

Reg. No. 4,154,990

COOPERSURGICAL, INC. (DELAWARE CORPORATION)
95 CORPORATE DRIVE
TRUMBULL, CT 06611

Registered June 5, 2012

Int. Cl.: 10

FOR: MEDICAL INSTRUMENTS FOR USE IN THE FIELD OF OBSTETRICS AND GYNECOLOGY, NAMELY, A SLEEVE THAT INCORPORATES A COLPOTOMY CUP AND PNEUMO OCCLUSION BALLOON FOR LAPAROSCOPIC HYSTERECTOMY, IN CLASS 10 (U.S. CLS. 26, 39 AND 44).

TRADEMARK

PRINCIPAL REGISTER

FIRST USE 11-8-2010; IN COMMERCE 2-8-2011.

THE MARK CONSISTS OF STANDARD CHARACTERS WITHOUT CLAIM TO ANY PARTICULAR FONT, STYLE, SIZE, OR COLOR.

SN 85-220,060, FILED 1-18-2011.

TRACY FLETCHER, EXAMINING ATTORNEY



David J. Kyros

Director of the United States Patent and Trademark Office

United States of America

United States Patent and Trademark Office

ENERGIZING BEEF JERKY

Reg. No. 4,154,991

Registered June 5, 2012

Int. Cl.: 29

TRADEMARK

PRINCIPAL REGISTER

WERNER GOURMET MEAT SNACKS, INC. (OREGON CORPORATION)
2807 3RD STREET
TILLAMOOK, OR 97141

FOR: MEAT-BASED SNACK FOODS, IN CLASS 29 (U.S. CL. 46).

FIRST USE 2-10-2012; IN COMMERCE 2-10-2012.

THE MARK CONSISTS OF STANDARD CHARACTERS WITHOUT CLAIM TO ANY PARTICULAR FONT, STYLE, SIZE, OR COLOR.

NO CLAIM IS MADE TO THE EXCLUSIVE RIGHT TO USE "BEEF JERKY", APART FROM THE MARK AS SHOWN.

SN 85-220,064, FILED 1-18-2011.

ODESSA BIBBINS, EXAMINING ATTORNEY



David J. Kyffers

Director of the United States Patent and Trademark Office

United States of America

United States Patent and Trademark Office

RFID SAFE

Reg. No. 4,154,992

Registered June 5, 2012

Int. Cl.: 18

TRADEMARK

PRINCIPAL REGISTER

MRM HOLDINGS LIMITED (MAURITIUS LIMITED LIABILITY COMPANY)
ST JAMES COURT, ST. DENIS STREET
SUITE 802
PORT LOUIS, MAURITIUS

FOR: WIRE AND POLYMER REINFORCED ALL-PURPOSE CARRYING BAGS; WIRE AND POLYMER REINFORCED TRAVEL BAGS; LOCKABLE REINFORCED ALL-PURPOSE CARRYING BAGS; LOCKABLE REINFORCED TRAVEL BAGS; LOCKABLE ALL-PURPOSE CARRYING BAGS; LOCKABLE TRAVEL BAGS; BAGS FOR TRAVEL IN THE NATURE OF TRAVEL BAGS; ALL-PURPOSE CARRYING BAGS FOR CAMPING; TRAVEL BAGS FOR CAMPING; BACKPACKS; DAYPACKS; ACROSS BODY PACKS, NAMELY, SLING BAGS THAT EXTEND ACROSS OR ON FRONT OF A BODY; ACROSS BODY TRAVEL PACKS, NAMELY, SLING BAGS THAT EXTEND ACROSS OR ON FRONT OF A BODY; WAIST BAGS; SPORT EQUIPMENT BAGS IN THE NATURE OF ALL PURPOSE SPORT BAGS; LOCKABLE SECURITY TRAVEL BAGS; SECURITY POUCHES OF TEXTILE; SECURITY WALLETS, PURSES AND FANNY PACKS; COURIER BAGS IN THE NATURE OF MESSENGER BAGS; DOCUMENT BAGS IN THE NATURE OF BACKPACKS AND BRIEFCASES; HUNTING BAGS; ALL-PURPOSE CARRYING BAGS FOR SECURING PERSONAL ITEMS; TOTE BAGS FOR SECURING PERSONAL ITEMS; DUFFEL BAGS FOR SECURING PERSONAL ITEMS; WEATHER PROOF LUGGAGE; BAG COVERS AND CONTAINERS, NAMELY, LOCKABLE COVERS TO PROTECT TRAVEL BAGS, IN CLASS 18 (U.S. CLS. 1, 2, 3, 22 AND 41).

FIRST USE 12-0-2011; IN COMMERCE 12-0-2011.

NO CLAIM IS MADE TO THE EXCLUSIVE RIGHT TO USE "RFID", APART FROM THE MARK AS SHOWN.

THE MARK CONSISTS OF THE WORDING "RFID SAFE" WHERE "SAFE" IS UNDER THE LETTERS "RFI" AND A STYLIZED PROPAGATING WAVE DESIGN COMPRISED OF 4 CURVED LINES IS LOCATED UNDER THE LETTER "D". THE MARK IS UNDERLINED.

SN 85-220,759, FILED 1-19-2011.

MATTHEW MCDOWELL, EXAMINING ATTORNEY



David J. Kyros

Director of the United States Patent and Trademark Office

United States of America

United States Patent and Trademark Office

RIVETING

Reg. No. 4,154,993

Registered June 5, 2012

Int. Cl.: 5

TRADEMARK

PRINCIPAL REGISTER

SARAH GRACE LLC (WISCONSIN LIMITED LIABILITY COMPANY)
1612 GREEN VALLEY ROAD
MOUNT HOREB, WI 53572

FOR: MEDICATED MOISTURIZERS, IN CLASS 5 (U.S. CLS. 6, 18, 44, 46, 51 AND 52).

FIRST USE 8-12-2011; IN COMMERCE 8-12-2011.

THE MARK CONSISTS OF STANDARD CHARACTERS WITHOUT CLAIM TO ANY PARTICULAR FONT, STYLE, SIZE, OR COLOR.

SN 85-221,086, FILED 1-19-2011.

GENE MACIOL, EXAMINING ATTORNEY



David J. Kyffers

Director of the United States Patent and Trademark Office

United States of America

United States Patent and Trademark Office

DECISIONKEY

Reg. No. 4,154,994

THE NPD GROUP, INC. (NEW YORK CORPORATION)
900 WEST SHORE ROAD
PORT WASHINGTON, NY 11050

Registered June 5, 2012

Int. Cls.: 35 and 42

FOR: MARKET RESEARCH SERVICES, IN CLASS 35 (U.S. CLS. 100, 101 AND 102).

SERVICE MARK

FIRST USE 3-6-2012; IN COMMERCE 3-6-2012.

PRINCIPAL REGISTER

FOR: PROVIDING NON-DOWNLOADABLE WEB-BASED INTERFACE SOFTWARE FOR ALLOWING CLIENTS TO ACCESS, MANIPULATE, AND PRESENT MARKET RESEARCH DATA, IN CLASS 42 (U.S. CLS. 100 AND 101).

FIRST USE 3-6-2012; IN COMMERCE 3-6-2012.

THE MARK CONSISTS OF STANDARD CHARACTERS WITHOUT CLAIM TO ANY PARTICULAR FONT, STYLE, SIZE, OR COLOR.

SN 85-221,476, FILED 1-19-2011.

CARYN GLASSER, EXAMINING ATTORNEY



David J. Kyjars

Director of the United States Patent and Trademark Office

United States of America

United States Patent and Trademark Office

HOTLOKS

Reg. No. 4,154,995

INNER CIRCLE DESIGNS, LLC (TEXAS LIMITED LIABILITY COMPANY)
4445 PAPER MILL ROAD
MARIETTA, GA 30067

Registered June 5, 2012

Int. Cl.: 14

FOR: JEWELRY FOR ATTACHMENT TO CLOTHING, IN CLASS 14 (U.S. CLS. 2, 27, 28 AND 50).

TRADEMARK

FIRST USE 2-5-2012; IN COMMERCE 2-5-2012.

PRINCIPAL REGISTER

THE MARK CONSISTS OF STANDARD CHARACTERS WITHOUT CLAIM TO ANY PARTICULAR FONT, STYLE, SIZE, OR COLOR.

OWNER OF U.S. REG. NO. 3,626,683.

SN 85-221,682, FILED 1-19-2011.

BRIAN PINO, EXAMINING ATTORNEY



David J. Kybas

Director of the United States Patent and Trademark Office

United States of America

United States Patent and Trademark Office



Reg. No. 4,154,996

Registered June 5, 2012

Int. Cls.: 44 and 45

SERVICE MARK

PRINCIPAL REGISTER

SHARSHERET, INC. (NEW YORK CORPORATION)
SUITE 3A
1086 TEANECK ROAD
TEANECK, NJ 07666

FOR: PROVIDING INFORMATION CONCERNING THE CAUSES, DETECTION, DIAGNOSIS, AND TREATMENT OF BREAST CANCER AND OVARIAN CANCER AND RELATED MEDICAL AND PSYCHOLOGICAL ISSUES TO BREAST AND OVARIAN CANCER PATIENTS AND THEIR FAMILIES, TO THE PUBLIC, AND TO HEALTH-CARE PROFESSIONALS; PROVIDING INFORMATION IN THE FIELD OF BREAST AND OVARIAN CANCER AND RELATED MEDICAL AND PSYCHOLOGICAL ISSUES VIA THE INTERNET; TELEPHONE HOT LINE SERVICES TO PROVIDE MEDICAL INFORMATION IN THE FIELD OF BREAST AND OVARIAN CANCER INCLUDING RELATED PSYCHOLOGICAL ISSUES TO BREAST AND OVARIAN CANCER PATIENTS, IN CLASS 44 (U.S. CLS. 100 AND 101).

FIRST USE 1-4-2011; IN COMMERCE 1-4-2011.

FOR: TELEPHONE HOT LINE SERVICES TO PROVIDE SUPPORTIVE EMOTIONAL COUNSELING TO BREAST AND OVARIAN CANCER PATIENTS; PROVIDING PERSONAL AND EMOTIONAL SUPPORT TO BREAST AND OVARIAN CANCER PATIENTS THROUGH A NETWORK OF BREAST AND OVARIAN CANCER SURVIVORS AND OTHER VOLUNTEERS, IN CLASS 45 (U.S. CLS. 100 AND 101).

FIRST USE 1-4-2011; IN COMMERCE 1-4-2011.

THE MARK CONSISTS OF ONE SMALL RIBBON, ONE MEDIUM RIBBON AND ONE LARGE RIBBON ENCLOSED IN A CIRCLE.

SN 85-221,768, FILED 1-20-2011.

CHRISTINE COOPER, EXAMINING ATTORNEY



David J. Kybas

Director of the United States Patent and Trademark Office

United States of America

United States Patent and Trademark Office

STAR BLUNT

Reg. No. 4,154,997

Registered June 5, 2012

Int. Cl.: 34

TRADEMARK

PRINCIPAL REGISTER

DOMINICAN TOBACCO PRODUCTS LLC (FLORIDA LIMITED LIABILITY COMPANY)
6405 NW 36TH ST
SUITE 120
MIAMI, FL 33166

FOR: CIGAR WRAPS; CIGARILLOS; CIGARS; TOBACCO, IN CLASS 34 (U.S. CLS. 2, 8, 9 AND 17).

FIRST USE 3-25-2010; IN COMMERCE 3-25-2010.

THE MARK CONSISTS OF STANDARD CHARACTERS WITHOUT CLAIM TO ANY PARTICULAR FONT, STYLE, SIZE, OR COLOR.

NO CLAIM IS MADE TO THE EXCLUSIVE RIGHT TO USE "BLUNT", APART FROM THE MARK AS SHOWN.

SN 85-222,527, FILED 1-20-2011.

JULIE WATSON, EXAMINING ATTORNEY



David J. Kyffers

Director of the United States Patent and Trademark Office

United States of America

United States Patent and Trademark Office

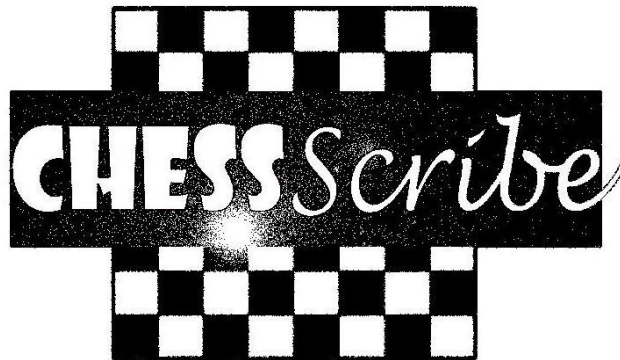

Reg. No. 4,154,998

Registered June 5, 2012

Int. Cl.: 9

TRADEMARK

PRINCIPAL REGISTER

APPICLE (KANSAS LIMITED LIABILITY COMPANY)
13959 W 148TH STREET
OLATHE, KS 66062

FOR: COMPUTER SOFTWARE FOR CHESS NOTATION, IN CLASS 9 (U.S. CLS. 21, 23, 26, 36 AND 38).

FIRST USE 7-30-2011; IN COMMERCE 7-30-2011.

THE STIPLING IS FOR SHADING PURPOSES ONLY.

THE MARK CONSISTS OF A CHESSBOARD, OVERLAID WITH A RECTANGULAR BANNER AND "CHESSSCRIBE" WRITTEN ON IT. A GLOWING LIGHT IS RIGHT BELOW THE TWO "SS" OF THE WORD "CHESS".

SN 85-223,160, FILED 1-21-2011.

KAREN SEVERSON, EXAMINING ATTORNEY



David J. Kybas

Director of the United States Patent and Trademark Office

United States of America

United States Patent and Trademark Office

Lynx

Reg. No. 4,154,999

Registered June 5, 2012

Int. Cl.: 19

TRADEMARK

PRINCIPAL REGISTER

INVIA PAVEMENT TECHNOLOGIES (OKLAHOMA LIMITED LIABILITY COMPANY)
MWV LAW DEPT.
501 SOUTH 5TH ST.
RICHMOND, VA 232190501

FOR: COLD-POUR CRACK FILLING, NAMELY, ASPHALT PAVING COMPOSITIONS USED FOR ASPHALT PAVING, IN CLASS 19 (U.S. CLS. 1, 12, 33 AND 50).

FIRST USE 6-7-2011; IN COMMERCE 6-7-2011.

THE MARK CONSISTS OF STANDARD CHARACTERS WITHOUT CLAIM TO ANY PARTICULAR FONT, STYLE, SIZE, OR COLOR.

SN 85-224,961, FILED 1-24-2011.

ASMAT KHAN, EXAMINING ATTORNEY



David J. Kyros

Director of the United States Patent and Trademark Office

United States of America

United States Patent and Trademark Office

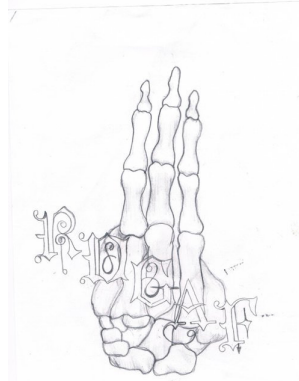

Reg. No. 4,155,000

Registered June 5, 2012

Int. Cl.: 25

TRADEMARK

PRINCIPAL REGISTER

ROTELLINI, BRANDON C. (UNITED STATES INDIVIDUAL)
41605 ELM ST. #133
MURRIETA, CA 92562 AND

BATES, JENNIFER N. (UNITED STATES INDIVIDUAL)
41605 ELM ST. #133
MURRIETA, CA 92562

FOR: ADULT NOVELTY GAG CLOTHING ITEM, NAMELY, SOCKS; BABY LAYETTES FOR CLOTHING; BELTS; BELTS FOR CLOTHING; BELTS MADE OUT OF CLOTH; BIBS NOT OF CLOTH OR PAPER; BOTTOMS; CHILDREN'S AND INFANTS' CLOTH BIBS; CHILDREN'S CLOTH EATING BIBS; CLOTH BIBS; CLOTH BIBS FOR ADULT DINERS; CLOTH BIBS FOR USE BY SENIOR CITIZENS OR PHYSICALLY- OR MENTALLY-CHALLENGED PERSONS; CLOTH DIAPERS; CLOTHING EXTENSION USED TO EXTEND THE NORMAL SIZE RANGE OF CLOTHING ITEMS TO ACCOMMODATE PREGNANCY SIZE CHANGES; CLOTHING FOR ATHLETIC USE, NAMELY, PADDED ELBOW COMPRESSION SLEEVES BEING PART OF AN ATHLETIC GARMENT; CLOTHING FOR ATHLETIC USE, NAMELY, PADDED PANTS; CLOTHING FOR ATHLETIC USE, NAMELY, PADDED SHIRTS; CLOTHING FOR ATHLETIC USE, NAMELY, PADDED SHORTS; CLOTHING FOR BABIES, TODDLERS AND CHILDREN, TREATED WITH FIRE AND HEAT RETARDANTS, NAMELY, PAJAMAS, JACKETS, SHIRTS, PANTS, JUMPERS; CLOTHING FOR WEAR IN JUDO PRACTICES; CLOTHING FOR WEAR IN WRESTLING GAMES; CLOTHING ITEMS, NAMELY, ADHESIVE POCKETS THAT MAY BE AFFIXED DIRECTLY TO THE BODY AS A DECORATIVE PIECE OF CLOTHING WITH UTILITY; CLOTHING ITEMS, NAMELY, ADHESIVE POCKETS THAT MAY BE AFFIXED DIRECTLY TO THE INSIDE OF CLOTHING FOR STORAGE AND SAFEKEEPING OF PERSONAL ITEMS; CLOTHING SHIELDS, NAMELY, PADS APPLIED TO THE UNDERARMS OF SHIRTS, BLOUSES AND SWEATERS; CLOTHING, NAMELY, ARM WARMERS; CLOTHING, NAMELY, ATHLETIC SLEEVES; CLOTHING, NAMELY, BASE LAYERS; CLOTHING, NAMELY, COWLS AND SMOKE RING SCARVES; CLOTHING, NAMELY, FOLK COSTUMES; CLOTHING, NAMELY, HAND-WARMERS; CLOTHING, NAMELY, KHAKIS; CLOTHING, NAMELY, KNEE WARMERS; CLOTHING, NAMELY, MATERNITY BANDS; CLOTHING, NAMELY, NECK TUBES; CLOTHING, NAMELY, THOBES; CLOTHING, NAMELY, WRAP-AROUNDS; CORSETS; DUSTERS; EYESHADES; FABRIC SOLD AS AN INTEGRAL COMPONENT OF FINISHED CLOTHING ITEMS, NAMELY, JERSEYS; FOULARDS; GLOVES AS CLOTHING; HEAD-BANDS FOR CLOTHING; HOODS; INFANT AND TODDLER ONE PIECE CLOTHING; INFANT CLOTH DIAPERS; INSERTS SPECIALLY ADAPTED FOR CLOTH DIAPERS MADE



David J. Kyros

Director of the United States Patent and Trademark Office

Reg. No. 4,155,000 OF BAMBOO; INSERTS SPECIALLY ADAPTED FOR CLOTH DIAPERS MADE OF HEMP; INSERTS SPECIALLY ADAPTED FOR CLOTH DIAPERS MADE OF MICROFIBER; JACKETS; JERSEYS; LEATHER BELTS; MANTLES; MUFFLERS; NON-DISPOSABLE CLOTH TRAINING PANTS; PAPER HATS FOR USE AS CLOTHING ITEMS; PARTS OF CLOTHING, NAMELY, GUSSETS FOR TIGHTS, GUSSETS FOR STOCKINGS, GUSSETS FOR BATHING SUITS, GUSSETS FOR UNDERWEAR, GUSSETS FOR LEOTARDS AND GUSSETS FOR FOOTLETS; PARTS OF CLOTHING, NAMELY, UNDERARM GUSSETS; PARTY HATS; PERSPIRATION ABSORBENT UNDERWEAR CLOTHING; POCKET SQUARES; SHIFTS; SHORT SETS; SHOULDER WRAPS; SHOULDER WRAPS FOR CLOTHING; SWADDLING CLOTHES; TIES; TOPS; TRAVEL CLOTHING CONTAINED IN A PACKAGE COMPRISING REVERSIBLE JACKETS, PANTS, SKIRTS, TOPS AND A BELT OR SCARF; TRIATHLON CLOTHING, NAMELY, TRIATHLON TIGHTS, TRIATHLON SHORTS, TRIATHLON SING-LETS, TRIATHLON SHIRTS, TRIATHLON SUITS; UNDERARM CLOTHING SHIELDS; WEARABLE GARMENTS AND CLOTHING, NAMELY, SHIRTS; WRAPS, IN CLASS 25 (U.S. CLS. 22 AND 39).

FIRST USE 2-5-2012; IN COMMERCE 2-7-2012.

THE MARK CONSISTS OF A SKELETAL BACKWARD FACING HAND CONCEALING THE THUMB AND LITTLE FINGER WHILE EXPOSING THE RING, MIDDLE, AND INDEX FINGERS WITH THE STYLIZED LETTERS "RDGAF" WRITTEN IN A DOWNWARD DIAG-ONAL DIRECTION STARTING WITH THE LETTER "R" IN THE UPPER LEFT CORNER ABOVE THE FOREHAND AND FINISHING WITH THE LETTER "F" ON THE LOWER RIGHT CORNER OF THE FOREHAND.

SN 85-225,038, FILED 1-24-2011.

CHRISTOPHER BUONGIORNO, EXAMINING ATTORNEY

United States of America

United States Patent and Trademark Office

EVERYTHING TO PROVE

Reg. No. 4,155,001

STOKELY-VAN CAMP, INC. (INDIANA CORPORATION)
555 WEST MONROE STREET
CHICAGO, IL 60661

Registered June 5, 2012

Int. Cl.: 41

FOR: ENTERTAINMENT SERVICES, NAMELY, CONTINUING SHOWS BROADCAST OVER TELEVISION AND THE INTERNET THAT CHRONICLE THE JOURNEY OF PROFESSIONAL FOOTBALL PLAYERS THROUGH THEIR FIRST YEAR OF PLAY, IN CLASS 41 (U.S. CLS. 100, 101 AND 107).

SERVICE MARK

PRINCIPAL REGISTER

FIRST USE 1-31-2011; IN COMMERCE 1-31-2011.

THE MARK CONSISTS OF STANDARD CHARACTERS WITHOUT CLAIM TO ANY PARTICULAR FONT, STYLE, SIZE, OR COLOR.

SN 85-225,717, FILED 1-25-2011.

KIM SAITO, EXAMINING ATTORNEY



David J. Kybas

Director of the United States Patent and Trademark Office

United States of America

United States Patent and Trademark Office

HEPALIVE
||| ||| ||| **Forte**

Reg. No. 4,155,002

Registered June 5, 2012

Int. Cl.: 5

TRADEMARK

PRINCIPAL REGISTER

VALL LABORATORIES CONSORTIUM GROUP LLC (FLORIDA LIMITED LIABILITY COMPANY)
12982 SW 89 AV
MIAMI, FL 33176

FOR: NATURAL FOOD SUPPLEMENTS IN THE NATURE OF HERBAL AND BOTANICAL SUPPLEMENTS FOR HUMAN CONSUMPTION; MEDICINAL HERBAL AND BOTANICAL PREPARATIONS IN THE NATURE OF MEDICINES FOR HUMAN CONSUMPTION, IN CLASS 5 (U.S. CLS. 6, 18, 44, 46, 51 AND 52).

FIRST USE 1-1-2009; IN COMMERCE 1-1-2011.

THE MARK CONSISTS OF THE WORD "HEPALIVE FORTE" IN A RECTANGLE WHITE. THE LETTERS "HEPA" IN RED, FOLLOWED BY THE LETTERS "LIVE" IN BLUE UNDERLINED ALL OF THE WORD "HEPALIVE" WITH A RED LINE. ON THE RIGHT HAND SIDE CORNER AT THE BOTTOM THE WORD "FORTE" IN WHITE WITH A BACKGROUND IN RED AND NEXT TO THIS WORD SEVERAL WHITE LINES.

THE COLOR(S) RED, BLUE AND WHITE IS/ARE CLAIMED AS A FEATURE OF THE MARK.

SN 85-226,265, FILED 1-26-2011.

CHRISTINA SOBRAL, EXAMINING ATTORNEY



David J. Kyjars

Director of the United States Patent and Trademark Office

United States of America

United States Patent and Trademark Office



Reg. No. 4,155,003

Registered June 5, 2012

Int. Cl.: 5

TRADEMARK

PRINCIPAL REGISTER

VALL LABORATORIES CONSORTIUM GROUP LLC (FLORIDA LIMITED LIABILITY COMPANY)
12982 SW 89 AV.
MIAMI, FL 33176

FOR: NATURAL FOOD SUPPLEMENTS, NATURAL MEDICINAL HERBAL AND BOTANICAL PREPARATIONS IN THE NATURE OF MEDICINES FOR HUMAN CONSUMPTION, AND VITAMINS, IN CLASS 5 (U.S. CLS. 6, 18, 44, 46, 51 AND 52).

FIRST USE 1-1-2009; IN COMMERCE 10-1-2011.

THE MARK CONSISTS OF WORD "INMUNOLIVE" WHICH IS IN A RECTANGLE WITH A WHITE BACKGROUND. THE LETTERS "INMUNO" ARE IN GREEN FOLLOWED BY THE LETTERS "LIVE" IN WHITE. BEHIND THE LETTERS "LIVE" ARE TWO BLUE CIRCLES OF DIFFERENT SIZES.

THE COLOR(S) GREEN, WHITE AND BLUE IS/ARE CLAIMED AS A FEATURE OF THE MARK.

SN 85-226,273, FILED 1-26-2011.

CHRISTINA SOBRAL, EXAMINING ATTORNEY



David J. Kyjars

Director of the United States Patent and Trademark Office

United States of America

United States Patent and Trademark Office

CREATING TOMORROW'S CLASSICS TODAY!

Reg. No. 4,155,004

Registered June 5, 2012

Int. Cls.: 12 and 37

TRADEMARK

SERVICE MARK

PRINCIPAL REGISTER

SLP PERFORMANCE PARTS, INC. (NEW JERSEY CORPORATION)
1501 INDUSTRIAL WAY NORTH
TOMS RIVER, NJ 08755

FOR: AUTOMOBILES, IN CLASS 12 (U.S. CLS. 19, 21, 23, 31, 35 AND 44).

FIRST USE 8-31-2011; IN COMMERCE 8-31-2011.

FOR: AUTOMOBILE CUSTOMIZATION SERVICES; AUTOMOTIVE UPGRADE SERVICES, NAMELY, SUPERCHARGING, TURBOCHARGING AND PERFORMANCE UPGRADES OF AUTOMOBILES, IN CLASS 37 (U.S. CLS. 100, 103 AND 106).

FIRST USE 8-31-2011; IN COMMERCE 8-31-2011.

THE MARK CONSISTS OF STANDARD CHARACTERS WITHOUT CLAIM TO ANY PARTICULAR FONT, STYLE, SIZE, OR COLOR.

SN 85-226,282, FILED 1-26-2011.

NICHOLAS COLEMAN, EXAMINING ATTORNEY



David J. Kybas

Director of the United States Patent and Trademark Office

United States of America

United States Patent and Trademark Office

MEDICLEAN EZ

Reg. No. 4,155,005

MINNTECH CORPORATION (MINNESOTA CORPORATION)
14605 28TH AVENUE NORTH
MINNEAPOLIS, MN 55447

Registered June 5, 2012

Int. Cl.: 3

FOR: ENZYMATIC DETERGENTS IN THE NATURE OF CLEANING PREPARATIONS FOR USE IN ENDOSCOPE REPROCESSING, IN CLASS 3 (U.S. CLS. 1, 4, 6, 50, 51 AND 52).

TRADEMARK

FIRST USE 6-27-2011; IN COMMERCE 6-27-2011.

PRINCIPAL REGISTER

THE MARK CONSISTS OF STANDARD CHARACTERS WITHOUT CLAIM TO ANY PARTICULAR FONT, STYLE, SIZE, OR COLOR.

SN 85-226,677, FILED 1-26-2011.

NICHOLAS COLEMAN, EXAMINING ATTORNEY



David J. Kybas

Director of the United States Patent and Trademark Office

United States of America

United States Patent and Trademark Office



Reg. No. 4,155,006

Registered June 5, 2012

Int. Cl.: 25

TRADEMARK

PRINCIPAL REGISTER

GET YOUR MOTIVATION ON (ILLINOIS LIMITED LIABILITY COMPANY)
9449 S. KEDZIE AVE
#292
EVERGREEN PARK, IL 60805

FOR: CAPS; FLEECE TOPS; SHIRTS, IN CLASS 25 (U.S. CLS. 22 AND 39).

FIRST USE 10-20-2010; IN COMMERCE 12-27-2010.

THE MARK CONSISTS OF THE STYLIZED TEXT "GYM ON GET YOUR MOTIVATION ON".

SN 85-227,003, FILED 1-26-2011.

LAURIE MAYES, EXAMINING ATTORNEY



David J. Kybas

Director of the United States Patent and Trademark Office

United States of America

United States Patent and Trademark Office



Reg. No. 4,155,007

Registered June 5, 2012

Int. Cl.: 41

SERVICE MARK

PRINCIPAL REGISTER

PASCUA YAQUI TRIBE (UNITED STATES FEDERALLY-RECOGNIZED INDIAN TRIBE)
7474 S. CAMINO DE OESTE
TUCSON, AZ 85746

FOR: PROVIDING CASINO FACILITIES AND CASINO SERVICES; CONDUCTING ENTERTAINMENT SERVICES, NAMELY, LIVE PERFORMANCES BY MUSICAL BANDS, LIVE MUSIC CONCERTS, LIVE APPEARANCES BY PROFESSIONAL ENTERTAINERS, AND LIVE SPORTING EVENTS IN THE NATURE OF BOXING, WRESTLING, AND MIXED MARTIAL ARTS; PROVIDING FACILITIES FOR SPORTING EVENTS AND COMPETITIONS; ORGANIZATION OF SPORTS COMPETITIONS; CONDUCTING ART FESTIVALS AND FAIRS; CONDUCTING CULINARY COMPETITIONS AND EVENTS IN THE NATURE OF CULINARY FESTIVALS; WEDDING PLANNING, COORDINATION AND HOSTING OF WEDDING CEREMONIES AND RECEPTIONS; ARRANGING AND HOSTING SPECIAL ENTERTAINMENT SOCIAL EVENTS, IN CLASS 41 (U.S. CLS. 100, 101 AND 107).

FIRST USE 11-11-2011; IN COMMERCE 11-11-2011.

OWNER OF U.S. REG. NOS. 2,800,090 AND 2,965,247.

THE COLOR(S) BROWN, GOLD, YELLOW, AND RED IS/ARE CLAIMED AS A FEATURE OF THE MARK.

NO CLAIM IS MADE TO THE EXCLUSIVE RIGHT TO USE "CASINO" AND "RESORT SPA CONFERENCE CENTER AMPHITHEATER", APART FROM THE MARK AS SHOWN.

THE MARK CONSISTS OF THE STYLIZED WORDS "CASINO DEL SOL" IN BROWN AND GOLD WITH BROWN AND GOLD OVER-LINING AND UNDERLINING ABOVE THE WORDS "RESORT SPA CONFERENCE CENTER AMPHITHEATER" IN BROWN AND SEPARATED BY GOLD CIRCLES, ALL BELOW A RED DOMED BUILDING WITH BROWN, GOLD AND YELLOW ACCENTS IN FRONT OF BROWN AND GOLD MOUNTAINS AND A YELLOW SUN.

THE ENGLISH TRANSLATION OF "DEL SOL" IN THE MARK IS "OF THE SUN".

SN 85-227,592, FILED 1-27-2011.

KATHLEEN M. VANSTON, EXAMINING ATTORNEY



David J. Kyros

Director of the United States Patent and Trademark Office

United States of America

United States Patent and Trademark Office

CLEAR VISION

Reg. No. 4,155,008

Registered June 5, 2012

Int. Cl.: 10

TRADEMARK

PRINCIPAL REGISTER

MIDMARK CORPORATION (OHIO CORPORATION)
60 VISTA DRIVE
VERSAILLES, OH 45380

FOR: A DIGITAL INTRAORAL SENSOR SYSTEM COMPRISED OF DIGITAL SENSORS, CAMERAS, SOFTWARE, AND INTERFACE DISPLAY MODULES USED TO CAPTURE AND DISPLAY DENTAL IMAGES, IN CLASS 10 (U.S. CLS. 26, 39 AND 44).

FIRST USE 12-0-2011; IN COMMERCE 12-0-2011.

THE MARK CONSISTS OF STANDARD CHARACTERS WITHOUT CLAIM TO ANY PARTICULAR FONT, STYLE, SIZE, OR COLOR.

SN 85-227,955, FILED 1-27-2011.

PAULA MAHONEY, EXAMINING ATTORNEY



David J. Kybas

Director of the United States Patent and Trademark Office

United States of America

United States Patent and Trademark Office

NETT-GROSS GROUP

Reg. No. 4,155,009

Registered June 5, 2012

Int. Cl.: 36

SERVICE MARK

PRINCIPAL REGISTER

AVEN CORPORATION (CALIFORNIA CORPORATION)
SUITE 205
27555 YNEZ ROAD
TEMECULA, CA 92591

FOR: REAL ESTATE MANAGEMENT SERVICES, IN CLASS 36 (U.S. CLS. 100, 101 AND 102).

FIRST USE 9-15-2011; IN COMMERCE 9-15-2011.

THE MARK CONSISTS OF STANDARD CHARACTERS WITHOUT CLAIM TO ANY PARTICULAR FONT, STYLE, SIZE, OR COLOR.

NO CLAIM IS MADE TO THE EXCLUSIVE RIGHT TO USE "GROUP", APART FROM THE MARK AS SHOWN.

SN 85-227,999, FILED 1-27-2011.

SAIMA MAKHDOOM, EXAMINING ATTORNEY



David J. Kyros

Director of the United States Patent and Trademark Office

United States of America

United States Patent and Trademark Office

Sportsideo

Reg. No. 4,155,010

Registered June 5, 2012

Int. Cl.: 42

SERVICE MARK

PRINCIPAL REGISTER

SPORTSIDE, LLC (NEW YORK LIMITED LIABILITY COMPANY)
223 WALL STREET, #135
HUNTINGTON, NY 11743

FOR: PROVIDING A WEBSITE THAT GIVES COMPUTER AND MOBILE DEVICE USERS THE ABILITY TO UPLOAD AND SHARE VIDEOS, MOVIES, PICTURES, IMAGES, TEXT, PHOTOS, AUDIO-CONTENT IN THE FIELD OF SPORTS, IN CLASS 42 (U.S. CLS. 100 AND 101).

FIRST USE 11-21-2011; IN COMMERCE 1-3-2012.

THE MARK CONSISTS OF STANDARD CHARACTERS WITHOUT CLAIM TO ANY PARTICULAR FONT, STYLE, SIZE, OR COLOR.

SN 85-228,163, FILED 1-27-2011.

EVELYN BRADLEY, EXAMINING ATTORNEY



David J. Kybas

Director of the United States Patent and Trademark Office

United States of America

United States Patent and Trademark Office

ILLUMINUP

Reg. No. 4,155,011

Registered June 5, 2012

Int. Cl.: 27

TRADEMARK

PRINCIPAL REGISTER

ILLUMINUP LLC (NEVADA LIMITED LIABILITY COMPANY)
1231 S. BUENA VISTA
SUITE K
SAN JACINTO, CA 92583

FOR: FLOOR MATS; FLOOR MATS FOR USE UNDER AUTOMOBILES; FLOOR MATS FOR VEHICLES, NAMELY, MATS USED TO LIGHT UP FLOOR SURFACES UNDER OR AROUND VEHICLES, IN CLASS 27 (U.S. CLS. 19, 20, 37, 42 AND 50).

FIRST USE 1-15-2011; IN COMMERCE 1-15-2011.

THE MARK CONSISTS OF STANDARD CHARACTERS WITHOUT CLAIM TO ANY PARTICULAR FONT, STYLE, SIZE, OR COLOR.

SN 85-228,744, FILED 1-28-2011.

KATHERINE CHANG, EXAMINING ATTORNEY



David J. Kybas

Director of the United States Patent and Trademark Office

United States of America

United States Patent and Trademark Office

FIST ENTERPRISES

Reg. No. 4,155,012

Registered June 5, 2012

Int. Cls.: 9 and 12

TRADEMARK

PRINCIPAL REGISTER

FIST ENTERPRISES (FLORIDA LIMITED LIABILITY COMPANY)
7996 CRANES POINT WAY
WEST PALM BEACH, FL 33412

FOR: ELECTRICAL APPARATUS, NAMELY, BIOMETRIC SECURITY SYSTEMS CONSISTING ESSENTIALLY OF FINGER PRINT SWIPE APPARATUS AND BIOMETRIC FINGER PRINT LOCKS USED FOR ATM SECURITY, ROOM SECURITY IN HOTELS AND CRUISE SHIPS, HOUSE SECURITY, AND SAFE SECURITY, IN CLASS 9 (U.S. CLS. 21, 23, 26, 36 AND 38).

FIRST USE 1-28-2011; IN COMMERCE 1-30-2012.

FOR: ANTI-THEFT SECURITY DEVICES FOR AUTOMOBILES, MOTORCYCLES, BOATS, CAR STARTER DEVICES WITH FINGERPRINT SWIPE AND FINGERPRINT READER CAPABILITIES; CAR ALARMS, BOAT ALARMS, AND AUTOMOBILE ALARMS, IN CLASS 12 (U.S. CLS. 19, 21, 23, 31, 35 AND 44).

FIRST USE 1-28-2011; IN COMMERCE 1-30-2012.

THE MARK CONSISTS OF STANDARD CHARACTERS WITHOUT CLAIM TO ANY PARTICULAR FONT, STYLE, SIZE, OR COLOR.

NO CLAIM IS MADE TO THE EXCLUSIVE RIGHT TO USE "ENTERPRISES", APART FROM THE MARK AS SHOWN.

SN 85-228,886, FILED 1-28-2011.

JOHN E. MICHOS, EXAMINING ATTORNEY



David J. Kyros

Director of the United States Patent and Trademark Office

United States of America

United States Patent and Trademark Office

GO BRIT!

Reg. No. 4,155,013

BLYTH, ALISON (UNITED STATES INDIVIDUAL)
24 REHOBOTH AVENUE
REHOBOTH BEACH, DE 19971

Registered June 5, 2012

Int. Cls.: 25 and 43

FOR: CLOTHING, NAMELY, TOPS, BOTTOMS, T-SHIRTS, SWEATSHIRTS, JERSEYS, HATS, CAPS, HEADWEAR, IN CLASS 25 (U.S. CLS. 22 AND 39).

TRADEMARK

FIRST USE 3-8-2012; IN COMMERCE 3-8-2012.

SERVICE MARK

FOR: RESTAURANT AND BAR SERVICES, IN CLASS 43 (U.S. CLS. 100 AND 101).

PRINCIPAL REGISTER

FIRST USE 3-8-2012; IN COMMERCE 3-8-2012.

THE MARK CONSISTS OF STANDARD CHARACTERS WITHOUT CLAIM TO ANY PARTICULAR FONT, STYLE, SIZE, OR COLOR.

SN 85-229,387, FILED 1-29-2011.

MATTHEW PAPPAS, EXAMINING ATTORNEY

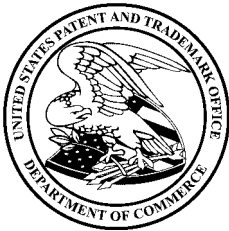

David J. Kypas

Director of the United States Patent and Trademark Office

United States of America

United States Patent and Trademark Office

DARE TO DEFY

Reg. No. 4,155,014

Registered June 5, 2012

Int. Cl.: 25

TRADEMARK

PRINCIPAL REGISTER

TANDARICH, MICHAEL R (UNITED STATES INDIVIDUAL)
282 HICKORY DRIVE
KENNETT SQUARE, PA, PA 19348

FOR: A-SHIRTS; ADHESIVE BRAS; ADULT NOVELTY GAG CLOTHING ITEM, NAMELY, SOCKS; AFTER SKI BOOTS; ALBS; AMERICAN FOOTBALL BIBS; ANGLERS' SHOES; ANKLE BOOTS; ANKLE SOCKS; ANKLETS; ANORAK; ANORAKS; ANTI-PERSPIRANT SOCKS; APPAREL FOR DANCERS, NAMELY, TEE SHIRTS, SWEATSHIRTS, PANTS, LEGGINGS, SHORTS AND JACKETS; APRES-SKI SHOES; APRONS; AQUA SHOES; ARTIFICIAL FLOWER HEADDRESSES; ASCOTS; ATHLETIC APPAREL, NAMELY, SHIRTS, PANTS, JACKETS, FOOTWEAR, HATS AND CAPS, ATHLETIC UNIFORMS; ATHLETIC FOOTWEAR; ATHLETIC SHOES; ATHLETIC TIGHTS; ATHLETIC UNIFORMS; BABUSHKAS; BABY BIBS NOT OF PAPER; BABY BODYSUITS; BABY BOTTOMS; BABY BUNTING; BABY DOLL PYJAMAS; BABY LAYETTES FOR CLOTHING; BABY TOPS; BALACLAVAS; BALL GOWNS; BALLET SHOES; BALLET SLIPPERS; BALLOON PANTS; BALLROOM DANCING SHOES; BALLROOM DANCING UNIFORMS; BANDANAS; BANDEAU TOPS; BANDEAUX; BARBER SMOCKS; BASEBALL CAPS; BASEBALL CAPS AND HATS; BASEBALL SHOES; BASEBALL UNIFORMS; BASELAYER BOTTOMS; BASELAYER TOPS; BASKETBALL SNEAKERS; BATH SLIPPERS; BATHING CAPS; BATHING COSTUMES; BATHING COSTUMES FOR WOMEN; BATHING SUITS; BATHING SUITS FOR MEN; BATHING TRUNKS; BATHROBES; BEACH COVER-UPS; BEACH COVERUPS; BEACH FOOTWEAR; BEACH SHOES; BEACHWEAR; BEANIES; BED JACKETS; BELTS; BELTS FOR CLOTHING; BELTS MADE FROM IMITATION LEATHER; BELTS MADE OF LEATHER; BELTS MADE OUT OF CLOTH; BELTS OF TEXTILE; BELTS THAT ARE DESIGNED TO ACCOMMODATE PREGNANCY SIZE CHANGES; BERETS; BERMUDA SHORTS; BIB OVERALLS; BIB OVERALLS FOR HUNTING; BIB SHORTS; BIB TIGHTS; BIBS NOT OF CLOTH OR PAPER; BIBS NOT OF PAPER; BICYCLE GLOVES; BICYCLING GLOVES; BIKINIS; BLAZERS; BLOOMERS; BLOUSES; BLOUSONS; BOARD SHORTS; BOAS; BOAT SHOES; BODICES; BODY LINEN; BODY SHAPERS; BODY SHIRTS; BODY STOCKINGS; BODY SUITS; BOLEROS; BOLO TIES; BOMBER JACKETS; BONNETS; BOOTIES; BOOTS; BOOTS FOR MOTORCYCLING; BOOTS FOR SPORT; BOTTOMS; BOW TIES; BOWLING SHOES; BOXER BRIEFS; BOXER SHORTS; BOXING SHOES; BOXING SHORTS; BRACES; BRALETTES; BRAS; BRASSIERES; BREECHES; BRIDESMAID DRESSES; BRIEFS; BRIEFS; BUCKET CAPS; BUSTIERS; BUSTLE HOLDER BANDS FOR OBI (OBIAGE); BUSTLES FOR OBI-KNOTS (OBIAGE-SHIN); BUTTON DOWN SHIRTS; BUTTON-FRONT ALOHA SHIRTS; CAFTANS; CAGOULES; CAMISETTES; CAMISOLES; CAMOUFLAGE GLOVES; CAMOUFLAGE JACKETS; CAMOUFLAGE PANTS; CAMOU-



David J. Kyros

Director of the United States Patent and Trademark Office

Reg. No. 4,155,014 FLAGE SHIRTS; CAMOUFLAGE VESTS; CAMP SHIRTS; CANVAS SHOES; CAP PEAKS; CAP VISORS; CAPELETS; CAPES; CAPES FOR USE IN SALONS AND BARBER SHOPS; CAPRI PANTS; CAPRIS; CAPS; CAPS WITH VISORS; CARDIGANS; CARGO PANTS; CASSOCKS; CAT SUITS; CATSUITS; CHAPS; CHASUBLES; CHEF'S COATS; CHEF'S HATS; CHEMISES; CHEMISSETTES; CHILDREN'S AND INFANT'S APPAREL, NAMELY, JUMPERS, OVERALL SLEEPWEAR, PAJAMAS, ROMPERS AND ONE-PIECE GARMENTS; CHILDREN'S AND INFANTS' APPAREL TREATED WITH FIRE AND HEAT RETARDANTS, NAMELY, JUMPERS, OVERALL SLEEPWEAR, PAJAMAS, ROMPERS AND ONE-PIECE GARMENTS; CHILDREN'S AND INFANTS' CLOTH BIBS; CHILDREN'S CLOTH EATING BIBS; CHILDREN'S HEADWEAR; CHOIR ROBES; CLAM DIGGERS; CLEATS FOR ATTACHMENT TO SPORTS SHOES; CLIMBING BOOTS; CLIMBING FOOTWEAR; CLIMBING SHOES; CLOAKS; CLOGS; CLOTH BIBS; CLOTH BIBS FOR ADULT DINERS; CLOTH BIBS FOR USE BY SENIOR CITIZENS OR PHYSICALLY- OR MENTALLY-CHALLENGED PERSONS; CLOTH DIAPERS; CLOTHING EXTENSION USED TO EXTEND THE NORMAL SIZE RANGE OF CLOTHING ITEMS TO ACCOMMODATE PREGNANCY SIZE CHANGES; CLOTHING FOR ATHLETIC USE, NAMELY, PADDED ELBOW COMPRESSION SLEEVES BEING PART OF AN ATHLETIC GARMENT; CLOTHING FOR ATHLETIC USE, NAMELY, PADDED PANTS; CLOTHING FOR ATHLETIC USE, NAMELY, PADDED SHIRTS; CLOTHING FOR ATHLETIC USE, NAMELY, PADDED SHORTS; CLOTHING FOR BABIES, TODDLERS AND CHILDREN, TREATED WITH FIRE AND HEAT RETARDANTS, NAMELY, PAJAMAS, JACKETS, SHIRTS, PANTS, JUMPERS; CLOTHING FOR WEAR IN JUDO PRACTICES; CLOTHING FOR WEAR IN WRESTLING GAMES; CLOTHING ITEMS, NAMELY, ADHESIVE POCKETS THAT MAY BE AFFIXED DIRECTLY TO THE BODY AS A DECORATIVE PIECE OF CLOTHING WITH UTILITY; CLOTHING ITEMS, NAMELY, ADHESIVE POCKETS THAT MAY BE AFFIXED DIRECTLY TO THE INSIDE OF CLOTHING FOR STORAGE AND SAFEKEEPING OF PERSONAL ITEMS; CLOTHING SHIELDS, NAMELY, PADS APPLIED TO THE UNDERARMS OF SHIRTS, BLOUSES AND SWEATERS; CLOTHING, NAMELY, ARM WARMERS; CLOTHING, NAMELY, ATHLETIC SLEEVES; CLOTHING, NAMELY, BASE LAYERS; CLOTHING, NAMELY, COWLS AND SMOKE RING SCARVES; CLOTHING, NAMELY, FOLK COSTUMES; CLOTHING, NAMELY, HAND-WARMERS; CLOTHING, NAMELY, KHAKIS; CLOTHING, NAMELY, KNEE WARMERS; CLOTHING, NAMELY, MATERNITY BANDS; CLOTHING, NAMELY, NECK TUBES; CLOTHING, NAMELY, THOBES; CLOTHING, NAMELY, WRAP-AROUNDS; COATS; COATS FOR MEN AND WOMEN; COATS MADE OF COTTON; COATS OF DENIM; COBBLERS' APRONS; COLLAR PROTECTORS; COLLARED SHIRTS; COLLARS; COMBATIVE SPORTS UNIFORMS; COMBINATIONS; COMPETITORS' NUMBERS OF TEXTILE; COMPRESSION GARMENTS FOR ATHLETIC OR OTHER NON-MEDICAL USE, NAMELY, SOCKS, LEGGINS, JERSEYS, VESTS; CORSELETS; CORSETS; COSTUMES FOR USE IN CHILDREN'S DRESS UP PLAY; COSTUMES FOR USE IN ROLE-PLAYING GAMES; COSTUMES FOR USE IN THE AMUSEMENT INDUSTRY; COVERALLS; COVERUPS; CRAVATES; CRAVATS; CREEPERS; CREW NECK SWEATERS; CREW NECKS; CROP TOPS; CROSS-COUNTRY GLOVES; CROSS-COUNTRY MITTENS; CUFFS; CULOTTES; CUMMERBUNDS; CUSTOM MADE TO MEASURE SUITS FOR MEN AND WOMEN; CYCLING SHOES; CYCLING SHORTS; CYCLISTS' JERSEYS; DANCE COSTUMES; DANCE SHOES; DANCE SLIPPERS; DECK-SHOES; DENIM JACKETS; DENIMS; DETACHABLE NECKPIECES FOR KIMONOS (HANERI); DISPOSABLE SLIPPERS; DISPOSABLE UNDERWEAR; DO RAGS; DOWN JACKETS; DOWN SUITS; DRESS PANTS; DRESS SHIELDS; DRESS SHIRTS; DRESS SUITS; DRESSES; DRESSES MADE FROM SKINS; DRESSES THAT MAY ALSO BE USED AS TOWELS; DRESSING GOWNS; DRESSING GOWNS AND BATH ROBES; DRIVERS; DRY SUITS; DUNGAREES; DUST COATS; DUSTERS; EAR BANDS; EAR MUFFS; EAR WARMERS; EARBANDS; EMBOSSED SOLES AND HEELS OF RUBBER OR OF PLASTIC MATERIALS; ESPADRILLES; EUROPEAN FOOTBALL BIBS; EVENING DRESSES; EVENING GOWNS; EYESHADES; FABRIC BELTS; FABRIC SOLD AS AN INTEGRAL COMPONENT OF FINISHED CLOTHING ITEMS, NAMELY, COVERALLS, BOOTS, SHIRTS, CAPS; FICHUS; FIGURE SKATING CLOTHING, NAMELY, PANTS, HAT, LEGGINS, SWEAT PANTS AND SWEAT SHIRTS, GLOVES; FINISHED TEXTILE LININGS FOR GARMENTS; FISHERMEN'S JACKETS; FISHING SHIRTS; FISHING VESTS; FISHING WADERS; FITTED SHOE OR BOOT COVERING TO PROTECT THE SHOES OR BOOT FROM WATER OR OTHER DAMAGE; FITTED SWIMMING COS-

Reg. No. 4,155,014 TUMES WITH BRA CUPS; FLEECE BOTTOMS; FLEECE PULLOVERS; FLEECE SHORTS; FLEECE TOPS; FLEECE VESTS; FLIGHT SUITS; FLIP FLOPS; FOAM PEDICURE SLIPPERS; FOOTBALL BOOTS; FOOTBALL BOOTS AND STUDS THEREFOR; FOOTBALL SHOES; FOOTIES; FOOTWEAR; FOOTWEAR; FOOTWEAR FOR MEN; FOOTWEAR FOR MEN AND WOMEN; FOOTWEAR FOR TRACK AND FIELD ATHLETICS; FOOTWEAR FOR WOMEN; FOOTWEAR MADE OF WOOD; FOOTWEAR NOT FOR SPORTS; FOOTWEAR, NAMELY, PUMPS; FOOTWEAR, NAMELY, RUBBERS; FOOTWEAR, NAMELY, WORK BOOTS; FOUL WEATHER GEAR; FOULARDS; FOUNDATION GARMENTS; FOUNDATION GARMENTS WORN AROUND THE MIDSECTION OR THIGHS TO KEEP THE STOMACH IN AND CREATE A SLIMMING EFFECT; FROCKS; FULL-LENGTH KIMONOS (NAGAGI); FUR CLOAKS; FUR COATS; FUR COATS AND JACKETS; FUR HATS; FUR JACKETS; FUR MUFFS; FUR STOLES; G-STRINGS; GABERDINES; GAITERS; GAITERS OF LEATHER; GALOSHES; GARTER BELTS; GARTERS; GAUCHOS; GIFT PACKAGES SOLD AS A UNIT CONSISTING PRIMARILY OF A SWEATSHIRT AND ALSO INCLUDING A PHOTO FRAME, A COFFEE MUG, AND A TOTE BAG; GILETS; GIRDLES; GLOVES; GLOVES AS CLOTHING; GLOVES FOR APPAREL; GLOVES FOR PERSONAL HAND CONDITIONING USE; GLOVES INCLUDING THOSE MADE OF SKIN, HIDE OR FUR; GOLF CAPS; GOLF CLEATS; GOLF PANTS, SHIRTS AND SKIRTS; GOLF SHIRTS; GOLF SHOES; GOLF SHORTS; GOLF SPIKES; GOLF TROUSERS; GOWNS; GREATCOATS; GYM BOOTS; GYM PANTS; GYM SHORTS; GYM SUITS; GYMNASTIC SHOES; HALLOWEEN COSTUMES; HALLOWEEN COSTUMES AND MASKS SOLD IN CONNECTION THEREWITH; HALTER TOPS; HANDBALL SHOES; HAT BANDS; HATBANDS; HATS; HATS FOR INFANTS, BABIES, TODDLERS AND CHILDREN; HEAD SCARVES; HEAD SWEATBANDS; HEAD WEAR; HEADBANDS; HEADBANDS AGAINST SWEATING; HEADBANDS FOR CLOTHING; HEADGEAR, NAMELY, CAPS, HEADBANDS AND HATS; HEADWEAR; HEAVY COATS; HEAVY JACKETS; HEEL INSERTS; HEEL PIECES FOR SHOES; HEELS; HIGH RAIN CLOGS (ASHIDA); HIKING BOOTS; HIP-GUARDS ESPECIALLY MADE FOR FISHING; HOCKEY SHOES; HOODED PULLOVERS; HOODED SWEAT SHIRTS; HOODED SWEATSHIRTS; HOODS; HOODS; HORSE-RIDING BOOTS; HOSIERY; HOUSECOATS; HUNTING BOOT BAGS; HUNTING JACKETS; HUNTING PANTS; HUNTING SHIRTS; HUNTING VESTS; INFANT AND TODDLER ONE PIECE CLOTHING; INFANT CLOTH DIAPERS; INFANT DIAPER COVERS; INFANT SLEEPERS; INFANT WEAR; INFANT WEARABLE BLANKETS; INFANTS' SHOES AND BOOTS; INFANTS' TROUSERS; INFANTWEAR; INNER SOLES; INSERTS SPECIALLY ADAPTED FOR CLOTH DIAPERS MADE OF BAMBOO; INSERTS SPECIALLY ADAPTED FOR CLOTH DIAPERS MADE OF HEMP; INSERTS SPECIALLY ADAPTED FOR CLOTH DIAPERS MADE OF MICROFIBER; INSOLES; INSOLES; INSOLES FOR FOOTWEAR; JACKET LINERS; JACKETS; JACKETS AND SOCKS; JANDALS; JAPANESE FOOTWEAR OF RICE STRAW (WARAJI); JAPANESE SLEEPING ROBES (NEMAKI); JAPANESE SPLIT-TOED WORK FOOTWEAR (JIKATABI); JAPANESE STYLE CLOGS AND SANDALS; JAPANESE STYLE SANDALS (ZORI); JAPANESE STYLE SANDALS OF FELT; JAPANESE STYLE SANDALS OF LEATHER; JAPANESE STYLE SOCKS (TABI COVERS); JAPANESE STYLE SOCKS (TABI); JAPANESE STYLE WOODEN CLOGS (GETA); JAPANESE TOE-STRAP SANDALS (ASAURA-ZORI); JEANS; JEGGINGS, NAMELY, PANTS THAT ARE PARTIALLY JEANS AND PARTIALLY LEGGINGS; JERKINS; JERSEYS; JODHPURS; JOGGING OUTFITS; JOGGING PANTS; JOGGING SUITS; JUDO SUITS; JUMP SUITS; JUMPERS; JUMPSUITS; KAFTANS; KARATE SUITS; KENDO OUTFITS; KERCHIEFS; KILTS; KIMONOS; KNEE HIGHS; KNEE-HIGH STOCKINGS; KNICKERS; KNIT BOTTOMS; KNIT DRESSES; KNIT FACE MASKS; KNIT JACKETS; KNIT SHIRTS; KNIT SKIRTS; KNIT TOPS; KNITTED CAPS; KNITTED GLOVES; KNITTED UNDERWEAR; KNOT CAPS; KNOTTED CAPS; LAB COATS; LACE BOOTS; LADIES' BOOTS; LADIES' SUITS; LADIES' UNDERWEAR; LAYETTES; LEATHER BELTS; LEATHER BOOTS; LEATHER COATS; LEATHER HATS; LEATHER HEADWEAR; LEATHER JACKETS; LEATHER PANTS; LEATHER SHIRTS; LEATHER SHOES; LEATHER SKIRTS; LEATHER SLIPPERS; LEATHER VESTS; LEG SHAPERS; LEG SHIELDING DEVICE, ATTACHABLE TO AND DETACHABLE FROM A PERSON'S PANTS, COMPRISED OF PADDING TO SHIELD THE LEGS FROM FLYING DEBRIS WHEN MOWING WITH A STRING TRIMMER; LEG WARMERS; LEG-WARMERS; LEGGINGS; LEGGINS; LEISURE SHOES; LEISURE SUITS; LEOTARDS; LEOTARDS AND TIGHTS FOR WOMEN, MEN AND CHILDREN OF NYLON, COTTON OR

Reg. No. 4,155,014 OTHER TEXTILE FIBERS; LIGHT-REFLECTING COATS; LIGHT-REFLECTING JACKETS; LINGERIE; LINGERIE ACCESSORIES, NAMELY, REMOVABLE SILICONE BREAST ENHANCER PADS USED IN A BRA; LIVERIES; LOAFERS; LONG JACKETS; LONG JOHNS; LONG SLEEVE PULLOVERS; LONG SLEEVED VESTS; LONG UNDERWEAR; LONG-SLEEVED SHIRTS; LOUNGE PANTS; LOUNGEWEAR; LOW WOODEN CLOGS (HIYORI-GETA); LOW WOODEN CLOGS (KOMA-GETA); MAILLOTS; MANIPLES; MANTILLAS; MANTLES; MANTLES; MARTIAL ARTS UNIFORMS; MARTIAL ARTS UNIFORMS, NAMELY, GIS; MASQUERADE COSTUMES; MASQUERADE COSTUMES AND MASKS SOLD IN CONNECTION THEREWITH; MATERNITY BRAS; MATERNITY LEGGINGS, NAMELY, LEGGINGS FEATURING BUILT-IN MATERNITY BANDS; MATERNITY LINGERIE; MATERNITY SLEEPWEAR; MEN'S AND WOMEN'S JACKETS, COATS, TROUSERS, VESTS; MEN'S DRESS SOCKS; MEN'S SOCKS; MEN'S SUITS; MEN'S SUITS, WOMEN'S SUITS; MEN'S UNDERWEAR; METAL FITTINGS FOR JAPANESE STYLE WOODEN CLOGS; MILLINERY, NAMELY, FASCINATORS; MINISKIRTS; MITTENS; MITTENS MODIFIED TO COVER THE HAND AND AN ANIMAL LEASH HANDLE OR OTHER LOOP; MIXED MARTIAL ARTS SUITS; MOCCASINS; MOCK TURTLE-NECK SWEATERS; MOCKNECKS; MOISTURE-WICKING SPORTS BRAS; MOISTURE-WICKING SPORTS PANTS; MOISTURE-WICKING SPORTS SHIRTS; MONEY BELTS; MORNING COATS; MOTORCYCLE GLOVES; MOTORCYCLE JACKETS; MOTORCYCLE RAIN SUITS; MOTORCYCLIST BOOTS; MOUNTAINEERING BOOTS; MOUNTAINEERING SHOES; MUFFLERS; MUFFLERS; MUFFS; MUKLUKS; MULES; MUSCLE TOPS; MUU MUUS; NECK BANDS; NECK GAITERS; NECKERCHIEFS; NECKERCHIEVES; NECKTIES; NECKWEAR; NEGLIGEEES; NIGHT GOWNS; NIGHT SHIRTS; NIGHTCAPS; NIGHTDRESSES; NIGHT-GOWNS; NIGHTTIES; NIGHTSHIRTS; NIGHTWEAR; NIPPLE COVERS, NAMELY, PASTIES; NON-DISPOSABLE CLOTH TRAINING PANTS; NON-SLIP SOLES FOR FOOTWEAR; NON-SLIP SOLES FOR FOOTWEAR, NAMELY, FOR SLIPPERS; NOVELTY HEADWEAR WITH ATTACHED WIGS; NURSE DRESSES; NURSE OVERALLS; NURSE PANTS; NURSE'S APPAREL, NAMELY, COVERALLS AND FROCKS; OBIS; ONE PIECE GARMENT FOR INFANTS AND TODDLERS; ONE-PIECE GARMENTS FOR CHILDREN; ONE-PIECE PLAY SUITS; OPEN-NECKED SHIRTS; OUTDOOR GLOVES; OUTDOOR MITTENS; OUTER JACKETS; OVER COATS; OVER SHIRTS; OVER-TROUSERS; OVERALLS; OVERALLS FOR USE IN SALONS AND BARBER SHOPS; OVERCOATS; OVERSHOES; PADDED JACKETS; PADDING JACKETS; PAJAMA BOTTOMS; PAJAMAS TREATED WITH FIRE AND HEAT RETARDANTS; PANTALOONS; PANTIES; PANTIES, SHORTS AND BRIEFS; PANTS; PANTSUITS; PANTYHOSE; PAPER APRONS; PAPER HATS FOR USE AS CLOTHING ITEMS; PAPER SHOES USED WHEN GOING THROUGH METAL DETECTORS TO KEEP FEET AND SOCKS CLEAN; PARAMENTS; PAREOS; PAREU; PAREUS; PARKAS; PARTS OF CLOTHING, NAMELY, GUSSETS FOR TIGHTS, GUSSETS FOR STOCKINGS, GUSSETS FOR BATHING SUITS, GUSSETS FOR UNDERWEAR, GUSSETS FOR LEOTARDS AND GUSSETS FOR FOOTLETS; PARTS OF CLOTHING, NAMELY, UNDERARM GUSSETS; PARTY HATS; PATIENT SLIPPERS; PEACOATS; PEDAL PUSHERS; PEDICURE SANDALS; PEDICURE SLIPPERS; PEIGNOIRS; PELERINES; PELISSES; PERSPIRATION ABSORBENT STRAP TO BE USED IN THE BILL OF A HAT; PERSPIRATION ABSORBENT UNDERWEAR CLOTHING; PETTI-PANTS; PETTICOATS; PINAFORES; PINNIES IN THE NATURE OF SCRIMMAGE VESTS FOR USE IN SPORTS; PIQUE SHIRTS; PLASTIC APRONS; PLASTIC BABY BIBS; PLAY SUITS; PLEATED SKIRTS FOR FORMAL KIMONOS (HAKAMA); PLIMSOLLS; PLUS FOURS; POCKET SQUARES; POLO KNIT TOPS; POLO SHIRTS; POLYMER CUSTOM CUSHIONED SHOE INSERTS FOR PRIMARILY NON-ORTHOPEDIC PURPOSES; PONCHOS; PRAM SUITS; PROTECTIVE METAL MEMBERS FOR SHOES AND BOOTS; PROTECTIVE NECK AND ARM GUARDS MADE OF NEOPRENE OR OTHER MATERIALS TO PREVENT WETSUIT CHAFING; PULLOVERS; PUMPS; PUTTEES AND GAITERS; PYJAMAS; QUILTED VESTS; RACE NUMBER BELTS THAT HOLD A PAPER NUMBER ON THE RACE PARTICIPANT'S FRONT OR BACK DURING COMPETITION; RAIN BOOTS; RAIN COATS; RAIN HATS; RAIN JACKETS; RAIN SLICKERS; RAIN SUITS; RAIN TROUSERS; RAIN WEAR; RAINCOATS; RAINPROOF JACKETS; RAINWEAR; RASH GUARDS; REDINGOTES; REMOVABLE COLLARS; REVERSIBLE JACKETS; RIDING BOOTS; RIDING COATS; RIDING GLOVES; RIDING SHOES; ROBES; ROMPERS; RUANAS; RUBBER SHOES; RUBBER SOLES FOR JIKATABI; RUBBERS; RUGBY SHIRTS; RUGBY SHOES; RUGBY SHORTS; RUGBY

Reg. No. 4,155,014 TOPS; RUNNING PADS THAT STRAP ONTO SHOES; RUNNING SHOES; RUNNING SUITS; SABOTS; SAILOR SUITS; SALOPETTES; SANDAL-CLOGS; SANDALS; SANDALS AND BEACH SHOES; SAREES; SARIS; SARONGS; SASH BANDS FOR KIMONO (OBI); SASHES; SCARFS; SCARVES; SCHOOL UNIFORMS; SCIENTIFIC AND TECHNOLOGICAL APPAREL, NAMELY, SHIRTS, PANTS, JACKETS, FOOTWEAR, HATS AND CAPS, UNIFORMS; SCRUBS NOT FOR MEDICAL PURPOSES; SEDGE HATS (SUGE-GASA); SERAPES; SHAMPOO CAPES; SHAPEWEAR, NAMELY, LEGGINS, BRAS, GIRDLES, SWEAT PANTS AND SWEAT SHIRTS; SHAWLS; SHAWLS; SHAWLS AND HEADSCARVES; SHAWLS AND STOLE; SHELL JACKETS; SHIFTS; SHIRT FRONTS; SHIRT INSERTS, NAMELY, DICKIES; SHIRT YOKES; SHIRTS; SHIRTS AND SHORT-SLEEVED SHIRTS; SHIRTS AND SLIPS; SHIRTS FOR INFANTS, BABIES, TODDLERS AND CHILDREN; SHIRTS FOR SUITS; SHOE COVERS FOR USE WHEN WEARING SHOES; SHOE DOWELS; SHOE INSERTS FOR PRIMARILY NON-ORTHOPEDIC PURPOSES; SHOE PEGS; SHOE SOLES; SHOE STRAPS; SHOES; SHOES SOLES FOR REPAIR; SHOES WITH HOOK AND PILE FASTENING TAPES; SHORT OVERCOAT FOR KIMONO (HAORI); SHORT PETTICOATS; SHORT SETS; SHORT TROUSERS; SHORT-SLEEVED OR LONG-SLEEVED T-SHIRTS; SHORT-SLEEVED SHIRTS; SHORTALLS; SHORTS; SHOULDER SCARVES; SHOULDER WRAPS; SHOULDER WRAPS FOR CLOTHING; SHOWER CAPS; SHRUGS; SILK SCARVES; SINGLET; SKATING OUTFITS; SKI AND SNOWBOARD SHOES AND PARTS THEREOF; SKI BIBS; SKI BOOT BAGS; SKI BOOT CASES; SKI BOOTS; SKI GLOVES; SKI JACKETS; SKI MASKS; SKI PANTS; SKI SUITS; SKI SUITS FOR COMPETITION; SKI TROUSERS; SKI WEAR; SKIING SHOES; SKIRT SUITS; SKIRTS; SKIRTS AND DRESSES; SKIWEAR; SKOOTERS; SKORTS; SKURT CAPS; SKULLIES; SLACKS; SLEEP MASKS; SLEEP PANTS; SLEEP SHIRTS; SLEEPING GARMENTS; SLEEPWEAR; SLEEPWEAR TREATED WITH FIRE AND HEAT RETARDANTS; SLEEVED OR SLEEVELESS JACKETS; SLEEVELESS JERSEYS; SLEEVES WORN SEPARATE AND APART FROM BLOUSES, SHIRTS AND OTHER TOPS; SLIDING SHORTS; SLIPPOVERS; SLIPPER SOCKS; SLIPPER SOLES; SLIPPERS; SLIPS; SMALL HATS; SMOCKS; SMOKING JACKETS; SNEAKERS; SNOW BOARDING SUITS; SNOW BOOTS; SNOW PANTS; SNOW SUITS; SNOWBOARD BOOTS; SNOWBOARD GLOVES; SNOWBOARD JACKETS; SNOWBOARD MITTENS; SNOWBOARD PANTS; SNOWBOARD TROUSERS; SOCCER BIBS; SOCCER BOOTS; SOCCER SHOES; SOCK SUSPENDERS; SOCKS; SOCKS AND STOCKINGS; SOLES; SOLES FOR FOOTWEAR; SOLES FOR JAPANESE STYLE SANDALS; SPORT COATS; SPORT SHIRTS; SPORT STOCKINGS; SPORTS BRA; SPORTS BRAS; SPORTS CAPS AND HATS; SPORTS JACKETS; SPORTS JERSEYS; SPORTS JERSEYS AND BREECHES FOR SPORTS; SPORTS OVER UNIFORMS; SPORTS OVERUNIFORMS; SPORTS PANTS; SPORTS SHIRTS; SPORTS SHIRTS WITH SHORT SLEEVES; SPORTS VESTS; STILETTO HEELS; STOCKING SUSPENDERS; STOCKINGS; STOCKINGS; STOLE; STRAPLESS BRAS; STRAPS FOR BRAS; STRETCH PANTS; STRING FASTENERS FOR HAORI (HAORI-HIMO); STUDS FOR FOOTBALL BOOTS; STUFF JACKETS; SUEDE JACKETS; SUIT COATS; SUITS; SUITS OF LEATHER; SUN LEGGINGS; SUN SLEEVES; SUN VISORS; SUNDRESSES; SUNSUITS; SURF WEAR; SUSPENDER BELTS; SUSPENDER BELTS FOR MEN; SUSPENDER BELTS FOR WOMEN; SUSPENDERS; SUSPENDERS; SWADDLING CLOTHES; SWEAT BANDS; SWEAT JACKETS; SWEAT PANTS; SWEAT SHIRTS; SWEAT SHORTS; SWEAT SUITS; SWEATBANDS; SWEATERS; SWEATPANTS; SWEATSHIRTS; SWEATSOCKS; SWEATSUITS; SWIM CAPS; SWIM SUITS; SWIM TRUNKS; SWIM WEAR; SWIM WEAR FOR GENTLEMEN AND LADIES; SWIMMING CAPS; SWIMMING CAPS; SWIMMING COSTUMES; SWIMMING TRUNKS; SWIMSUITS; SWIMWEAR; T-SHIRTS; TABARDS; TAILLEURS; TAMS; TANK TOPS; TANK-TOPS; TANKINIS; TAP PANTS; TAP SHOES; TEDDIES; TEE SHIRTS; TENNIS DRESSES; TENNIS SHOES; TENNIS WEAR; TEXTILE DIAPERS; TEXTILE NAPPIES; THERMAL SOCKS; THERMAL UNDERWEAR; THONGS; THONGS; TIES; TIGHTENING-UP STRINGS FOR KIMONOS (DATEJIME); TIGHTS; TIPS FOR FOOTWEAR; TOBOGGAN HATS, PANTS AND CAPS; TOE BOXES; TOE CAPS; TOE STRAPS FOR JAPANESE STYLE SANDALS; TOE STRAPS FOR JAPANESE STYLE WOODEN CLOGS; TOGAS; TONGUE OR PULLSTRAP FOR SHOES AND BOOTS; TOP COATS; TOPCOATS; TOPS; TOQUES; TRACK AND FIELD SHOES; TRACK JACKETS; TRACK PANTS; TRACK SUITS; TRACKSUITS; TRAINING SHOES; TRAINING SUITS; TRAVEL CLOTHING CONTAINED IN A PACKAGE COMPRISING REVERSIBLE JACKETS, PANTS, SKIRTS, TOPS AND A BELT OR SCARF; TREKKING BOOTS; TRENCH

Reg. No. 4,155,014 COATS; TRIATHLON CLOTHING, NAMELY, TRIATHLON TIGHTS, TRIATHLON SHORTS, TRIATHLON SINGLET, TRIATHLON SHIRTS, TRIATHLON SUITS; TROUSERS; TROUSERS FOR SWEATING; TROUSERS OF LEATHER; TRUNKS; TUBE TOPS; TUNICS; TUQUES; TURBANS; TURTLE NECK SHIRTS; TURTLENECK PULLOVERS; TURTLENECK SWEATERS; TURTLENECKS; TUXEDO BELTS; TUXEDOS; TWIN SETS; UNDER GARMENTS; UNDERARM CLOTHING SHIELDS; UNDERCLOTHES; UNDERGARMENT ACCESSORIES, NAMELY, REMOVABLE SILICONE BUTTOCK ENHANCER PADS; UNDERGARMENTS; UNDERGARMENTS, NAMELY, WASPIES; UNDERPANTS; UNDERSHIRTS FOR KIMONOS (JUBAN); UNDERSHIRTS FOR KIMONOS (KOSHIMAKI); UNDERSKIRTS; UNDERWEAR; UNDERWEAR, NAMELY, BOY SHORTS; UNIFORMS; UNION SUITS; UNITARDS; UPPERS FOR JAPANESE STYLE SANDALS; UPPERS OF WOVEN RATTAN FOR JAPANESE STYLE SANDALS; V-NECK SWEATERS; VEILS; VEST EXTENDERS; VESTED SUITS; VESTS; VISCOUS GEL POLYMER SOLD AS A COMPONENT OF FINISHED CUSTOM CUSHIONED FOOTWEAR FOR NON-ORTHOPEDIC PURPOSES AND APPAREL; VISORS; VOLLEYBALL JERSEYS; VOLLEYBALL SHOES; WAIST BANDS; WAIST BELTS; WAIST CINCHERS; WAIST STRINGS FOR KIMONOS (KOSHIMAKI); WAISTBANDS; WAISTCOATS; WALKING SHORTS; WARM UP OUTFITS; WARM UP SUITS; WARM-UP SUITS; WATER PROOF BOOTS; WATER REPELLING BOOTS; WATER REPELLING FOOTWEAR; WATER REPELLING LEATHER BOOTS; WATER REPELLING LEATHER SHOES AND BOOTS; WATER SOCKS; WATERPROOF FOOTWEAR; WATERPROOF JACKETS AND PANTS; WATERPROOF LEATHER BOOTS; WATERPROOF LEATHER SHOES; WATERPROOF LEATHER SHOES AND BOOTS; WEARABLE BLANKETS IN THE NATURE OF BLANKETS WITH SLEEVES; WEARABLE GARMENTS AND CLOTHING, NAMELY, SHIRTS; WEDDING DRESSES; WEDDING GOWNS; WELTS FOR BOOTS AND SHOES; WET SUIT GLOVES; WET SUITS; WET SUITS FOR WATER-SKIING AND SUB-AQUA; WETSUITS; WETSUITS FOR WATER-SKIING; WIMPLES; WIND COATS; WIND PANTS; WIND RESISTANT JACKETS; WIND SHIRTS; WIND VESTS; WIND-JACKETS; WINDCHEATERS; WINDJAMMERS; WINDSHIRTS; WINTER BOOTS; WOMEN'S ATHLETIC TOPS WITH BUILT-IN BRAS; WOMEN'S CEREMONIAL DRESSES; WOMEN'S FOLDABLE SLIPPERS; WOMEN'S HATS AND HOODS; WOMEN'S SHOES; WOMEN'S SHOES, NAMELY, FOLDABLE FLATS; WOMEN'S TOPS, NAMELY, CAMIS; WOMEN'S UNDERWEAR; WOODEN CLOGS; WOODEN MAIN BODIES OF JAPANESE STYLE WOODEN CLOGS; WOODEN SHOES; WOODEN SUPPORTS OF JAPANESE STYLE WOODEN CLOGS; WOOLLEN SOCKS; WOOLLEN TIGHTS; WOOLLY HATS; WORK SHOES AND BOOTS; WORKING OVERALLS; WOVEN BOTTOMS; WOVEN DRESSES; WOVEN OR KNITTED UNDERWEAR; WOVEN SKIRTS; WOVEN TOPS; WRAP BELTS FOR KIMONOS (DATEMAKI); WRAPS; WRIST BANDS; WRISTBANDS; WRISTBANDS CONTAINING A COOLING SUBSTANCE TO COOL THE WEARER; YASHMAGHS; YOGA PANTS; YOGA SHIRTS; ZOOT SUITS; ZORI, IN CLASS 25 (U.S. CLS. 22 AND 39).

FIRST USE 6-0-2008; IN COMMERCE 2-0-2010.

THE MARK CONSISTS OF STANDARD CHARACTERS WITHOUT CLAIM TO ANY PARTICULAR FONT, STYLE, SIZE, OR COLOR.

SN 85-229,731, FILED 1-31-2011.

ZHALEH DELANEY, EXAMINING ATTORNEY

United States of America

United States Patent and Trademark Office

RAZZI

Reg. No. 4,155,015

Registered June 5, 2012

Int. Cl.: 9

TRADEMARK

PRINCIPAL REGISTER

BK FRAMES, CORP. (FLORIDA CORPORATION)
SUITE 14F
5700 COLLINS AVENUE
MIAMI BEACH, FL 33140

FOR: EYEGLOSS FRAMES; EYEGASSES; SUNGLASSES, IN CLASS 9 (U.S. CLS. 21, 23, 26, 36 AND 38).

FIRST USE 2-1-2004; IN COMMERCE 2-1-2004.

THE MARK CONSISTS OF STANDARD CHARACTERS WITHOUT CLAIM TO ANY PARTICULAR FONT, STYLE, SIZE, OR COLOR.

THE ENGLISH TRANSLATION OF "RAZZI" IN THE MARK IS "ROCKETS".

SN 85-230,868, FILED 2-1-2011.

SHAILA SETTLES, EXAMINING ATTORNEY



David J. Kyffers

Director of the United States Patent and Trademark Office

United States of America

United States Patent and Trademark Office



lambs farm
where people grow

Reg. No. 4,155,016

Registered June 5, 2012

**Int. Cls.: 29, 30, 35, 36,
41, and 42**

THE LAMBS FARM, INC. (ILLINOIS NON-PROFIT CORPORATION)
ROUTE 1, BOX 520
14245 W. ROCKLAND ROAD
LIBERTYVILLE, IL 60048

FOR: FRUIT AND TOMATO PRESERVES, JELLY, PEANUT BUTTER AND FRUIT CLUSTERS,
IN CLASS 29 (U.S. CL. 46).

TRADEMARK

FIRST USE 10-12-2010; IN COMMERCE 7-18-2011.

SERVICE MARK

FOR: FLAVORED MUSTARDS, CHOCOLATES, FUDGE, TOFFEE, HONEY AND HONEY
SPREADS, MUFFINS, BREADS, COOKIES, BROWNIES, PIES, CHILI SAUCE, BARBEQUE
SAUCE, PASTA SAUCES AND CANDY, IN CLASS 30 (U.S. CL. 46).

PRINCIPAL REGISTER

FIRST USE 10-12-2010; IN COMMERCE 7-18-2011.

FOR: EMPLOYMENT PLACEMENT SERVICES FOR PERSONS WITH DEVELOPMENTAL
DISABILITIES, IN CLASS 35 (U.S. CLS. 100, 101 AND 102).

FIRST USE 10-12-2010; IN COMMERCE 2-17-2011.

FOR: PROVIDING HOUSING ACCOMMODATIONS FOR PEOPLE WITH DEVELOPMENTAL
DISABILITIES, NAMELY, ADMINISTRATION AND MANAGEMENT OF HOUSING ACCOM-
MODATIONS FOR PEOPLE WITH DEVELOPMENTAL DISABILITIES, IN CLASS 36 (U.S.
CLS. 100, 101 AND 102).

FIRST USE 10-12-2010; IN COMMERCE 2-17-2011.

FOR: PROVIDING LEISURE AND RECREATIONAL ACTIVITIES AND SERVICES, NAMELY,
MINIATURE GOLF AND MINIATURE TRAIN RIDES, CONDUCTING EDUCATIONAL
HOBBY CLASSES; PROVIDING ATHLETICS, NAMELY, ATHLETIC TRAINING SERVICE
AND ARRANGING AND CONDUCTING ATHLETIC COMPETITIONS; PETTING ZOOS;
PONY RIDES; ENTERTAINMENT IN THE NATURE OF AN AMUSEMENT PARK RIDE;
VOCATIONAL SERVICES, NAMELY, JOB TRAINING, IN CLASS 41 (U.S. CLS. 100, 101
AND 107).

FIRST USE 10-12-2010; IN COMMERCE 2-17-2011.



David J. Kybas

Director of the United States Patent and Trademark Office

Reg. No. 4,155,016 FOR: RETAIL SHOPS AND MAIL ORDER SERVICES FEATURING PETS, PET FOODS AND SUPPLIES, GREETING CARDS, BOOKS, HOUSEHOLD ITEMS, CLOTHING, JEWELRY AND BAKED GOODS, IN CLASS 42 (U.S. CLS. 100 AND 101).

FIRST USE 10-12-2010; IN COMMERCE 7-18-2011.

OWNER OF U.S. REG. NO. 1,856,727.

NO CLAIM IS MADE TO THE EXCLUSIVE RIGHT TO USE "FARM", APART FROM THE MARK AS SHOWN.

THE MARK CONSISTS OF A STYLIZED TREE WITH THE WORDS "LAMBS FARM WHERE PEOPLE GROW".

SN 85-231,046, FILED 2-1-2011.

RENEE MCCRAY, EXAMINING ATTORNEY

United States of America

United States Patent and Trademark Office

LOLA KIMONI

Reg. No. 4,155,017

Registered June 5, 2012

Int. Cl.: 25

TRADEMARK

PRINCIPAL REGISTER

LOLA KIMONI INC. (CALIFORNIA CORPORATION)
732 OCAMPO DRIVE
PACIFIC PALISADES, CA 90272

FOR: BEACH COVER-UPS; DRESSES, IN CLASS 25 (U.S. CLS. 22 AND 39).

FIRST USE 1-0-2011; IN COMMERCE 4-0-2011.

THE MARK CONSISTS OF STANDARD CHARACTERS WITHOUT CLAIM TO ANY PARTICULAR FONT, STYLE, SIZE, OR COLOR.

SN 85-231,076, FILED 2-1-2011.

NAAKWAMA ANKRAH, EXAMINING ATTORNEY



David J. Kybas

Director of the United States Patent and Trademark Office

United States of America

United States Patent and Trademark Office



Reg. No. 4,155,018

Registered June 5, 2012

Int. Cls.: 25, 28, and 41

RUGBY XV, INC (CALIFORNIA CORPORATION), AKA RXV, RUGBY XV,
1270 RUBIO STREET
ALTADENA, CA 91001

FOR: HATS; RUGBY SHIRTS; RUGBY SHORTS; SOCKS; TRACKSUITS, IN CLASS 25 (U.S. CLS. 22 AND 39).

TRADEMARK

FIRST USE 11-15-2010; IN COMMERCE 11-15-2010.

SERVICE MARK

FOR: ATHLETIC PROTECTIVE PADS FOR TACKLING; FOOTBALL OR SOCCER GOALS; RUGBY BALLS; SAFETY PADDING FOR GOAL POST UPRIGHTS; SPORTS FIELD EQUIPMENT, NAMELY, CORNER FLAGS, IN CLASS 28 (U.S. CLS. 22, 23, 38 AND 50).

PRINCIPAL REGISTER

FIRST USE 11-15-2010; IN COMMERCE 11-15-2010.

FOR: PROVIDING A WEB SITE FEATURING SPORTING INFORMATION; PROVIDING A WEBSITE CONTAINING INFORMATION RELATING TO THE SPORT OF RUGBY, INCLUDING TEAM INFORMATION, PLAYER STATISTICS AND NEWS, IN CLASS 41 (U.S. CLS. 100, 101 AND 107).

FIRST USE 1-1-2012; IN COMMERCE 1-1-2012.

THE MARK CONSISTS OF TWO STYLIZED HOOKS OR SINGLE BARB ARROW LIKE PATTERNS ONE FROM LEFT TO RIGHT DIRECTION THE OTHER INVERTED AND BEING SHOWN IN A RIGHT TO LEFT DIRECTION WITH THE LETTERS "RXV" BELOW EACH ELEMENT AND LETTERS CAN BE COLORED EITHER AS A GROUP OR INDIVIDUALLY.

SN 85-231,406, FILED 2-1-2011.

JOHN HWANG, EXAMINING ATTORNEY



David J. Kybas

Director of the United States Patent and Trademark Office

United States of America

United States Patent and Trademark Office



Reg. No. 4,155,019

Registered June 5, 2012

Int. Cl.: 33

TRADEMARK

PRINCIPAL REGISTER

MOET HENNESSY USA, INC. (DELAWARE CORPORATION)
85 TENTH AVENUE
NEW YORK, NY 10011

FOR: WINES AND SPARKLING WINES, IN CLASS 33 (U.S. CLS. 47 AND 49).

FIRST USE 8-19-2010; IN COMMERCE 8-19-2010.

OWNER OF U.S. REG. NOS. 2,288,293, 3,029,109, AND OTHERS.

THE MARK CONSISTS OF A BOTTLE LABEL WITH A SOLID BORDER AT THE TOP AND BOTTOM. IN THE CENTER OF THE LABEL IS THE WORD "CHANDON" WITH THE DESIGN OF AN ARC WITH A STAR ON THE END APPEARING BETWEEN THE LETTERS "A" AND "N". THERE IS A THIN LINE ABOVE AND BELOW THE WORD "CHANDON". THE OVERALL SHAPE OF THE LABEL IS RECTANGULAR. THE MIDDLE SECTION THAT CONTAINS THE WORD "CHANDON" EXTENDS HORIZONTALLY BEYOND THE SIDES OF THE RECTANGLE.

THE WORD(S) "CHANDON" HAS NO MEANING IN A FOREIGN LANGUAGE.

SN 85-231,583, FILED 2-1-2011.

APRIL HESIK, EXAMINING ATTORNEY



David J. Kyffers

Director of the United States Patent and Trademark Office

United States of America

United States Patent and Trademark Office

4D FOAM

Reg. No. 4,155,020

UNDER ARMOUR, INC. (MARYLAND CORPORATION)
1020 HULL STREET
BALTIMORE, MD 21230

Registered June 5, 2012

Int. Cl.: 25

FOR: ATHLETIC FOOTWEAR, EXCLUDING CYCLING FOOTWEAR; FOOTWEAR, EXCLUDING CYCLING FOOTWEAR, IN CLASS 25 (U.S. CLS. 22 AND 39).

TRADEMARK

FIRST USE 3-0-2011; IN COMMERCE 3-0-2011.

PRINCIPAL REGISTER

THE MARK CONSISTS OF STANDARD CHARACTERS WITHOUT CLAIM TO ANY PARTICULAR FONT, STYLE, SIZE, OR COLOR.

NO CLAIM IS MADE TO THE EXCLUSIVE RIGHT TO USE "FOAM", APART FROM THE MARK AS SHOWN.

SN 85-231,693, FILED 2-1-2011.

CAROLINE WOOD, EXAMINING ATTORNEY



David J. Kybas

Director of the United States Patent and Trademark Office

United States of America

United States Patent and Trademark Office



Reg. No. 4,155,021

Registered June 5, 2012

Int. Cl.: 40

SERVICE MARK

PRINCIPAL REGISTER

RAY PRODUCTS COMPANY, INC. (CALIFORNIA CORPORATION)
1700 CHABLIS AVENUE
ONTARIO, CA 91761

FOR: THERMOFORMING SERVICES, NAMELY, THERMOFORMING HEAVY GAUGE THERMOPLASTIC MATERIALS TO THE ORDER AND/OR SPECIFICATION OF OTHERS, IN CLASS 40 (U.S. CLS. 100, 103 AND 106).

FIRST USE 2-10-2011; IN COMMERCE 2-10-2011.

OWNER OF U.S. REG. NOS. 930,034 AND 3,760,622.

THE COLOR(S) BLUE, WHITE AND LIGHT GRAY IS/ARE CLAIMED AS A FEATURE OF THE MARK.

NO CLAIM IS MADE TO THE EXCLUSIVE RIGHT TO USE "PRODUCTS CO., INC.", APART FROM THE MARK AS SHOWN.

THE MARK CONSISTS OF THE WORD "RAY" IN THE COLOR WHITE INSIDE A BLUE RECTANGLE; THE WORDS "PRODUCTS CO., INC." ARE ALSO IN WHITE ARE BELOW THE WORD "RAY". A PARTIAL LIGHT GRAY RECTANGLE APPEARS AS A SHADOW BEHIND THE BLUE RECTANGLE ON THE BOTTOM AND RIGHT SIDES.

SN 85-231,828, FILED 2-1-2011.

JEFFREY LOOK, EXAMINING ATTORNEY



David J. Kyros

Director of the United States Patent and Trademark Office

United States of America

United States Patent and Trademark Office

RELAY FIELD DAY

Reg. No. 4,155,022

AMERICAN CANCER SOCIETY, INC. (NEW YORK NON-PROFIT CORPORATION)
250 WILLIAMS STREET
ATLANTA, GA 30303

Registered June 5, 2012

Int. Cls.: 35 and 36

FOR: PROMOTING PUBLIC AWARENESS OF CANCER RESEARCH, EDUCATION, ADVOCACY, PREVENTION, DETECTION, TREATMENT, AND PATIENT AND FAMILY SERVICES, IN CLASS 35 (U.S. CLS. 100, 101 AND 102).

SERVICE MARK

FIRST USE 9-0-2011; IN COMMERCE 9-0-2011.

PRINCIPAL REGISTER

FOR: CHARITABLE FUNDRAISING SERVICES TO SUPPORT CANCER RESEARCH, EDUCATION, ADVOCACY, PREVENTION, DETECTION, TREATMENT, AND PATIENT AND FAMILY SERVICES, IN CLASS 36 (U.S. CLS. 100, 101 AND 102).

FIRST USE 9-0-2011; IN COMMERCE 9-0-2011.

THE MARK CONSISTS OF STANDARD CHARACTERS WITHOUT CLAIM TO ANY PARTICULAR FONT, STYLE, SIZE, OR COLOR.

SEC. 2(F) AS TO "RELAY".

OWNER OF U.S. REG. NOS. 1,907,602, 3,045,212, AND 3,840,251.

SN 85-232,533, FILED 2-2-2011.

JOHN HWANG, EXAMINING ATTORNEY



David J. Kybas

Director of the United States Patent and Trademark Office

United States of America

United States Patent and Trademark Office

RELAY RECESS

Reg. No. 4,155,023

AMERICAN CANCER SOCIETY, INC. (NEW YORK NON-PROFIT CORPORATION)
250 WILLIAMS STREET
ATLANTA, GA 30303

Registered June 5, 2012

Int. Cls.: 35 and 36

FOR: PROMOTING PUBLIC AWARENESS OF CANCER RESEARCH, EDUCATION, ADVOCACY, PREVENTION, DETECTION, TREATMENT, AND PATIENT AND FAMILY SERVICES, IN CLASS 35 (U.S. CLS. 100, 101 AND 102).

SERVICE MARK

FIRST USE 12-0-2011; IN COMMERCE 12-0-2011.

PRINCIPAL REGISTER

FOR: CHARITABLE FUNDRAISING SERVICES TO SUPPORT CANCER RESEARCH, EDUCATION, ADVOCACY, PREVENTION, DETECTION, TREATMENT, AND PATIENT AND FAMILY SERVICES, IN CLASS 36 (U.S. CLS. 100, 101 AND 102).

FIRST USE 12-0-2011; IN COMMERCE 12-0-2011.

THE MARK CONSISTS OF STANDARD CHARACTERS WITHOUT CLAIM TO ANY PARTICULAR FONT, STYLE, SIZE, OR COLOR.

SEC. 2(F) AS TO "RELAY".

OWNER OF U.S. REG. NOS. 1,907,602, 3,045,212, AND 3,840,251.

SN 85-232,549, FILED 2-2-2011.

JOHN HWANG, EXAMINING ATTORNEY



David J. Kybas

Director of the United States Patent and Trademark Office

United States of America

United States Patent and Trademark Office

REVA

Reg. No. 4,155,024

Registered June 5, 2012

Int. Cl.: 32

TRADEMARK

PRINCIPAL REGISTER

TERRY D KROLL (CALIFORNIA CORPORATION), DBA MAXIM MANUFACTURING & MARKETING,
92 ARGONAUT, SUITE 170
ALISO VIEJO, CA 92656

FOR: COCONUT-BASED BEVERAGES; COCONUT-BASED NON-ALCOHOLIC BEVERAGES,
IN CLASS 32 (U.S. CLS. 45, 46 AND 48).

FIRST USE 6-1-2011; IN COMMERCE 6-1-2011.

THE MARK CONSISTS OF STANDARD CHARACTERS WITHOUT CLAIM TO ANY PARTICULAR FONT, STYLE, SIZE, OR COLOR.

SN 85-232,641, FILED 2-2-2011.

JANICE KIM, EXAMINING ATTORNEY



David J. Kybas

Director of the United States Patent and Trademark Office

United States of America

United States Patent and Trademark Office

Carpets of Eden

Reg. No. 4,155,025

Registered June 5, 2012

Int. Cl.: 35

SERVICE MARK

PRINCIPAL REGISTER

CARPETS OF EDEN (COLORADO CORPORATION)
2072 WEST NANTUCKET COURT
LITTLETON, CO 80120

FOR: RETAIL STORES FEATURING CARPET, RUGS, AND RETAIL HOME ACCESSORIES;
WHOLESALE DISTRIBUTORSHIPS FEATURING HOME ACCESSORIES, IN CLASS 35 (U.S.
CLS. 100, 101 AND 102).

FIRST USE 3-15-2011; IN COMMERCE 3-15-2011.

THE MARK CONSISTS OF STANDARD CHARACTERS WITHOUT CLAIM TO ANY PAR-
TICULAR FONT, STYLE, SIZE, OR COLOR.

NO CLAIM IS MADE TO THE EXCLUSIVE RIGHT TO USE "CARPETS", APART FROM
THE MARK AS SHOWN.

SN 85-232,727, FILED 2-2-2011.

GRETCHEN ULRICH, EXAMINING ATTORNEY



David J. Kybas

Director of the United States Patent and Trademark Office

United States of America

United States Patent and Trademark Office

Best Fit Decisions

Reg. No. 4,155,026

AVERY, ERIN (UNITED STATES INDIVIDUAL)
775 RIVER ROAD
FAIR HAVEN, NJ 07704

Registered June 5, 2012

Int. Cl.: 41

FOR: COLLEGE ADMISSION CONSULTING SERVICES, NAMELY, ASSISTING STUDENTS IN FINDING COLLEGES AND UNIVERSITIES AND COMPLETING THE APPLICATION PROCESS; PROVIDING A WEBSITE THAT FEATURES INFORMATION ABOUT ON-LINE HIGHER EDUCATION RESOURCES; PROVIDING INFORMATION ON-LINE RELATING TO HIGHER EDUCATION OPPORTUNITIES AND RESOURCES, IN CLASS 41 (U.S. CLS. 100, 101 AND 107).

SERVICE MARK

PRINCIPAL REGISTER

FIRST USE 12-1-2011; IN COMMERCE 2-1-2012.

THE MARK CONSISTS OF STANDARD CHARACTERS WITHOUT CLAIM TO ANY PARTICULAR FONT, STYLE, SIZE, OR COLOR.

SN 85-232,995, FILED 2-3-2011.

MICHAEL WEBSTER, EXAMINING ATTORNEY



David J. Kyffers

Director of the United States Patent and Trademark Office

United States of America

United States Patent and Trademark Office

DRINK WHAT YOU FEAR!

Reg. No. 4,155,027

Registered June 5, 2012

Int. Cl.: 32

TRADEMARK

PRINCIPAL REGISTER

THE MASTERS OF BEVERAGES, LLC (CALIFORNIA LIMITED LIABILITY COMPANY)
#3
490 E. PRINCELAND COURT
CORONA, CA 92879

FOR: ENERGY DRINKS, IN CLASS 32 (U.S. CLS. 45, 46 AND 48).

FIRST USE 2-24-2011; IN COMMERCE 2-24-2011.

THE MARK CONSISTS OF STANDARD CHARACTERS WITHOUT CLAIM TO ANY PARTICULAR FONT, STYLE, SIZE, OR COLOR.

SN 85-233,757, FILED 2-3-2011.

DAVID COLLIER, EXAMINING ATTORNEY



David J. Kyffers

Director of the United States Patent and Trademark Office

United States of America

United States Patent and Trademark Office

WIDOW MAKER

Reg. No. 4,155,028

Registered June 5, 2012

Int. Cl.: 32

TRADEMARK

PRINCIPAL REGISTER

MASTERS OF BEVERAGES, LLC, THE (CALIFORNIA LIMITED LIABILITY COMPANY)
490 E. PRINCELAND COURT
#3
CORONA, CA 92879

FOR: ENERGY DRINKS, IN CLASS 32 (U.S. CLS. 45, 46 AND 48).

FIRST USE 2-24-2011; IN COMMERCE 2-24-2011.

THE MARK CONSISTS OF STANDARD CHARACTERS WITHOUT CLAIM TO ANY PARTICULAR FONT, STYLE, SIZE, OR COLOR.

SN 85-233,761, FILED 2-3-2011.

DAVID COLLIER, EXAMINING ATTORNEY



David J. Kyffers

Director of the United States Patent and Trademark Office

United States of America

United States Patent and Trademark Office

AQK CATENA INDEX

Reg. No. 4,155,029

Registered June 5, 2012

Int. Cl.: 36

SERVICE MARK

PRINCIPAL REGISTER

KAUFMAN ANALYTICS, LTD. (BAHAMAS CORPORATION)
LTD. REGENT CENTER, SUITE B, SECOND
FLOOR
FREEPORT, BAHAMAS F60452

FOR: INVESTMENT MANAGEMENT SERVICES; INVESTMENT FUND SERVICES, NAMELY,
INVESTMENT OF FUNDS FOR OTHERS; FINANCIAL SERVICES IN THE NATURE OF AN
INVESTMENT SECURITY, IN CLASS 36 (U.S. CLS. 100, 101 AND 102).

FIRST USE 8-22-2011; IN COMMERCE 8-22-2011.

THE MARK CONSISTS OF STANDARD CHARACTERS WITHOUT CLAIM TO ANY PAR-
TICULAR FONT, STYLE, SIZE, OR COLOR.

NO CLAIM IS MADE TO THE EXCLUSIVE RIGHT TO USE "INDEX", APART FROM THE
MARK AS SHOWN.

SN 85-234,019, FILED 2-4-2011.

CHRISTINE MARTIN, EXAMINING ATTORNEY



David J. Kyros

Director of the United States Patent and Trademark Office

United States of America

United States Patent and Trademark Office

TAIFF
e n e r g y

Reg. No. 4,155,030

Registered June 5, 2012

Int. Cl.: 11

TRADEMARK

PRINCIPAL REGISTER

DAIHATSU INDÚSTRIA E COMÉRCIO DE MÓVEIS E APARELHOS DOMÉSTICOS LTDA.
(BRAZIL LIMITED LIABILITY COMPANY)
AV. NAÇÕES UNIDAS 21.314
SÃO PAULO, BRAZIL 04795-000

FOR: HAIR DRYERS, IN CLASS 11 (U.S. CLS. 13, 21, 23, 31 AND 34).

FIRST USE 2-4-2011; IN COMMERCE 2-4-2011.

OWNER OF U.S. REG. NOS. 2,647,308, 2,973,022, AND OTHERS.

THE MARK CONSISTS OF THE WORDS "TAIFF" IN STYLIZED FONT ABOVE THE WORD "ENERGY" SEPARATED BY A LINE WITH THE WORD "TAIFF" APPEARING ABOVE THE "ENE" OF "ENERGY".

SN 85-234,185, FILED 2-4-2011.

DAVID I, EXAMINING ATTORNEY



David J. Kyffers

Director of the United States Patent and Trademark Office

United States of America

United States Patent and Trademark Office

DISTRICT 7

Reg. No. 4,155,031

Registered June 5, 2012

Int. Cl.: 33

TRADEMARK

PRINCIPAL REGISTER

SCHEID VINEYARDS CALIFORNIA INC. (CALIFORNIA CORPORATION)
305 HILLTOWN ROAD
SALINAS, CA 93908

FOR: ALCOHOLIC BEVERAGES EXCEPT BEERS, IN CLASS 33 (U.S. CLS. 47 AND 49).

FIRST USE 1-3-2012; IN COMMERCE 1-3-2012.

THE MARK CONSISTS OF STANDARD CHARACTERS WITHOUT CLAIM TO ANY PARTICULAR FONT, STYLE, SIZE, OR COLOR.

SN 85-234,793, FILED 2-4-2011.

CARYN GLASSER, EXAMINING ATTORNEY



David J. Kyros

Director of the United States Patent and Trademark Office

United States of America

United States Patent and Trademark Office

HIGH GEAR MOTORCYCLE CLUB

Reg. No. 4,155,032

Registered June 5, 2012

Int. Cl.: 25

ALAN J. PIVEN MANAGEMENT GROUP, LLC (NEW YORK LIMITED LIABILITY COMPANY)

APT 15B
341 WEST 24TH STREET
NEW YORK, NY 10011

TRADEMARK

FOR: SHIRTS, IN CLASS 25 (U.S. CLS. 22 AND 39).

PRINCIPAL REGISTER

FIRST USE 4-10-2012; IN COMMERCE 4-10-2012.

THE MARK CONSISTS OF STANDARD CHARACTERS WITHOUT CLAIM TO ANY PARTICULAR FONT, STYLE, SIZE, OR COLOR.

NO CLAIM IS MADE TO THE EXCLUSIVE RIGHT TO USE "MOTORCYCLE CLUB", APART FROM THE MARK AS SHOWN.

SN 85-234,922, FILED 2-4-2011.

JULIE WATSON, EXAMINING ATTORNEY



David J. Kyffers

Director of the United States Patent and Trademark Office

United States of America

United States Patent and Trademark Office

Whats Your Price

Reg. No. 4,155,033

Registered June 5, 2012

Int. Cls.: 41 and 45

SERVICE MARK

PRINCIPAL REGISTER

INFOSTREAM GROUP, INC. (NEVADA CORPORATION)
220 E. FLAMINGO RD
#126
LAS VEGAS, NV 89169

FOR: EDUCATIONAL AND ENTERTAINMENT SERVICES, NAMELY, A CONTINUING PROGRAM ABOUT ON-LINE DATING, MATCHING MAKING, SOCIAL INTRODUCTIONS SERVICES AND SOCIAL NETWORKING ACCESSIBLE BY RADIO, TELEVISION, SATELLITE, AUDIO, VIDEO AND COMPUTER NETWORKS; ENTERTAINMENT SERVICES, NAMELY, NON-DOWNLOADABLE RINGTONES, PRE-RECORDED MUSIC, AND GRAPHICS PRESENTED TO MOBILE COMMUNICATIONS DEVICES VIA A GLOBAL COMPUTER NETWORK AND WIRELESS NETWORKS; PRODUCTION AND DISTRIBUTION OF RADIO PROGRAMS; RADIO PROGRAM SYNDICATION, IN CLASS 41 (U.S. CLS. 100, 101 AND 107).

FIRST USE 4-8-2011; IN COMMERCE 4-8-2011.

FOR: INTERNET-BASED DATING, SOCIAL INTRODUCTION AND SOCIAL NETWORKING SERVICES, IN CLASS 45 (U.S. CLS. 100 AND 101).

FIRST USE 4-8-2011; IN COMMERCE 4-8-2011.

THE MARK CONSISTS OF STANDARD CHARACTERS WITHOUT CLAIM TO ANY PARTICULAR FONT, STYLE, SIZE, OR COLOR.

SN 85-234,943, FILED 2-4-2011.

JAMES LOVELACE, EXAMINING ATTORNEY



David J. Kyros

Director of the United States Patent and Trademark Office

United States of America

United States Patent and Trademark Office



Reg. No. 4,155,034

Registered June 5, 2012

Int. Cl.: 35

SERVICE MARK

PRINCIPAL REGISTER

AVERBUG, ANDRE (BRAZIL INDIVIDUAL)
7841 MUIRFIELD COURT
POTOMAC, MD 20854

FOR: PROVIDING AN INTERACTIVE WEB SITE FOR USERS TO RANK, LIST, RATE, RECOMMEND AND REVIEW PRODUCTS, SERVICES, BUSINESSES, BRANDS, EXPERIENCES, PEOPLE, PLACES, CONTENT AND THINGS; PROVIDING INFORMATION IN THE FIELD OF PUBLIC OPINIONS VIA THE INTERNET; PROVIDING AN ONLINE COMPUTER DATABASE IN THE FIELD OF CONSUMER PRODUCT AND SERVICE REVIEWS, AS WELL AS RANKS AND CLASSIFICATIONS OF BUSINESSES, BRANDS, EXPERIENCES, PEOPLE, PLACES, CONTENT AND THINGS; PROVIDING AN ONLINE COMPUTER DATABASE FOR THE PROVISION OF BUSINESS INTELLIGENCE SERVICES; PROVIDING MARKETING, PROMOTION AND ADVERTISING SERVICES; DISPLAYING ADVERTISEMENTS FOR OTHERS; ELECTRONIC COMMERCE SERVICES, NAMELY, PROVIDING INFORMATION ON PRODUCTS, SERVICES, BUSINESSES, EXPERIENCES, PEOPLE, PLACES, CONTENT AND THINGS VIA THE INTERNET OR OTHER COMPUTER OR COMMUNICATIONS NETWORKS FOR ADVERTISING AND SALES PURPOSES; PROVIDING CONSUMER INFORMATION REGARDING THE SELECTION OF GOODS, SERVICES AND OTHER CONTENT VIA MOBILE TELEPHONES AND DESKTOP AND LAPTOP COMPUTERS; PROVIDING A SEARCHABLE DATABASE IN THE NATURE OF AN ONLINE ADVERTISING GUIDE FEATURING THE GOODS, SERVICES AND OTHER CONTENT OF OTHERS VIA THE INTERNET OR OTHER COMPUTER, MOBILE OR COMMUNICATIONS NETWORKS, IN CLASS 35 (U.S. CLS. 100, 101 AND 102).



FIRST USE 10-4-2011; IN COMMERCE 10-4-2011.

THE MARK CONSISTS OF A STYLIZED FROG DRAWING/ICON, NEXT TO THE WORD "RANKPAD".

SN 85-235,091, FILED 2-5-2011.

C. DIONNE CLYBURN, EXAMINING ATTORNEY

David J. Kyffers

Director of the United States Patent and Trademark Office

United States of America

United States Patent and Trademark Office

GRIP BY HIGH SIERRA

Reg. No. 4,155,035

HIGH SIERRA SPORT COMPANY (ILLINOIS CORPORATION)
880 CORPORATE WOODS PARKWAY
VERNON HILLS, IL 60061

Registered June 5, 2012

Int. Cl.: 18

FOR: ALL PURPOSE SPORT BAGS; BACKPACKS; LUGGAGE; TOTE BAGS, IN CLASS 18
(U.S. CLS. 1, 2, 3, 22 AND 41).

TRADEMARK

FIRST USE 10-0-2010; IN COMMERCE 5-0-2011.

PRINCIPAL REGISTER

THE MARK CONSISTS OF STANDARD CHARACTERS WITHOUT CLAIM TO ANY PARTICULAR FONT, STYLE, SIZE, OR COLOR.

OWNER OF U.S. REG. NOS. 1,193,991, 2,135,635, AND OTHERS.

SN 85-235,393, FILED 2-7-2011.

ELISSA GARBER KON, EXAMINING ATTORNEY



David J. Kybas

Director of the United States Patent and Trademark Office

United States of America

United States Patent and Trademark Office

SAFSLIM

Reg. No. 4,155,036

Registered June 5, 2012

Int. Cl.: 5

TRADEMARK

PRINCIPAL REGISTER

RE-BODY, LLC (DELAWARE LIMITED LIABILITY COMPANY)
700 S. FLORIDA AVE #512
TAMPA, FL 33602

FOR: DIETARY SUPPLEMENTS FOR WEIGHT-LOSS CONTAINING AS A PRIMARY INGREDIENT SAFFLOWER OIL, EXCLUDING POWDERED DRINK MIXES, SHAKES, READY-TO-DRINK BEVERAGES, AND NUTRITIONAL BARS, IN CLASS 5 (U.S. CLS. 6, 18, 44, 46, 51 AND 52).

FIRST USE 2-22-2011; IN COMMERCE 2-22-2011.

THE MARK CONSISTS OF STANDARD CHARACTERS WITHOUT CLAIM TO ANY PARTICULAR FONT, STYLE, SIZE, OR COLOR.

SN 85-235,617, FILED 2-7-2011.

LINDSEY RUBIN, EXAMINING ATTORNEY



David J. Kyros

Director of the United States Patent and Trademark Office

United States of America

United States Patent and Trademark Office

ISC PREMIER EDUCATIONAL SERIES

Reg. No. 4,155,037

Registered June 5, 2012

Int. Cl.: 41

SERVICE MARK

PRINCIPAL REGISTER

REED ELSEVIER PROPERTIES INC. (DELAWARE CORPORATION)
SUITE 501
1105 NORTH MARKET STREET
WILMINGTON, DE 19801

FOR: EDUCATIONAL SERVICES, NAMELY, CONDUCTING CLASSES, SEMINARS, CONFERENCES AND WORKSHOPS IN THE FIELD OF SECURITY BOTH LIVE AND ONLINE, IN CLASS 41 (U.S. CLS. 100, 101 AND 107).

FIRST USE 3-4-2011; IN COMMERCE 3-4-2011.

THE MARK CONSISTS OF STANDARD CHARACTERS WITHOUT CLAIM TO ANY PARTICULAR FONT, STYLE, SIZE, OR COLOR.

OWNER OF U.S. REG. NOS. 1,033,255, 3,377,484, AND OTHERS.

NO CLAIM IS MADE TO THE EXCLUSIVE RIGHT TO USE "PREMIER EDUCATIONAL SERIES", APART FROM THE MARK AS SHOWN.

SN 85-235,747, FILED 2-7-2011.

WILLIAM P. SHANAHAN, EXAMINING ATTORNEY

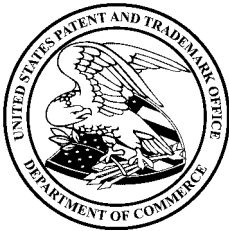

David J. Kyffers

Director of the United States Patent and Trademark Office

United States of America

United States Patent and Trademark Office

The Imagination of Israel

Reg. No. 4,155,038

Registered June 5, 2012

Int. Cl.: 36

SERVICE MARK

PRINCIPAL REGISTER

AMERICAN SOCIETY FOR TECHNION - ISRAEL INSTITUTE OF TECHNOLOGY, INC.
(NEW YORK NON-PROFIT CORPORATION)
55 EAST 59TH STREET
NEW YORK, NY 10022

FOR: CHARITABLE FUNDRAISING SERVICES TO PROMOTE TECHNOLOGICAL EDUCATION AND ORGANIZING FUNDRAISING EVENTS IN FURTHERANCE OF TECHNOLOGICAL EDUCATION, IN CLASS 36 (U.S. CLS. 100, 101 AND 102).

FIRST USE 4-7-2011; IN COMMERCE 4-7-2011.

THE MARK CONSISTS OF STANDARD CHARACTERS WITHOUT CLAIM TO ANY PARTICULAR FONT, STYLE, SIZE, OR COLOR.

NO CLAIM IS MADE TO THE EXCLUSIVE RIGHT TO USE "ISRAEL", APART FROM THE MARK AS SHOWN.

SN 85-235,783, FILED 2-7-2011.

THEODORE MCBRIDE, EXAMINING ATTORNEY



David J. Kyros

Director of the United States Patent and Trademark Office

United States of America

United States Patent and Trademark Office

REVCO

inc.

LIGHTING + ELECTRICAL SUPPLY

Reg. No. 4,155,039

REVCO ELECTRICAL SUPPLY, INC. (NEW YORK CORPORATION)
360 COUNTY ROAD, 39A
SOUTHAMPTON, NY 11969

Registered June 5, 2012

Int. Cl.: 35

FOR: DISTRIBUTION SERVICES, NAMELY, DISTRIBUTORSHIPS IN THE FIELD OF ELECTRIC LIGHTING AND LIGHTING SUPPLIES; RETAIL STORE SERVICES FEATURING ELECTRIC LIGHTING AND LIGHTING SUPPLIES, IN CLASS 35 (U.S. CLS. 100, 101 AND 102).

SERVICE MARK

PRINCIPAL REGISTER

FIRST USE 9-1-2010; IN COMMERCE 9-1-2010.

NO CLAIM IS MADE TO THE EXCLUSIVE RIGHT TO USE "INC. LIGHTING AND ELECTRICAL SUPPLY", APART FROM THE MARK AS SHOWN.

THE MARK CONSISTS OF THE STYLIZED WORDING "REVCO INC." ABOVE THE STYLIZED WORDING "LIGHTING + ELECTRICAL SUPPLY", WHERE THE WORDING "INC." IS INSIDE THE LETTER "C" OF "REVCO".

SN 85-235,816, FILED 2-7-2011.

JAY BESCH, EXAMINING ATTORNEY



David J. Kyffers

Director of the United States Patent and Trademark Office

United States of America

United States Patent and Trademark Office

WASH & ROLL

Reg. No. 4,155,040

Registered June 5, 2012

Int. Cl.: 37

SERVICE MARK

PRINCIPAL REGISTER

WASH & ROLL, LLC (NORTH CAROLINA LIMITED LIABILITY COMPANY)
409 ROGERS VIEW COURT
RALEIGH, NC 27610

FOR: CAR WASH SERVICES, IN CLASS 37 (U.S. CLS. 100, 103 AND 106).

FIRST USE 8-31-2011; IN COMMERCE 8-31-2011.

THE MARK CONSISTS OF STANDARD CHARACTERS WITHOUT CLAIM TO ANY PARTICULAR FONT, STYLE, SIZE, OR COLOR.

NO CLAIM IS MADE TO THE EXCLUSIVE RIGHT TO USE "WASH", APART FROM THE MARK AS SHOWN.

SN 85-236,607, FILED 2-8-2011.

MARLENE BELL, EXAMINING ATTORNEY



David J. Kybas

Director of the United States Patent and Trademark Office

United States of America

United States Patent and Trademark Office



Reg. No. 4,155,041

Registered June 5, 2012

Int. Cl.: 3

TRADEMARK

PRINCIPAL REGISTER

V BEAUTE LLC (NEW YORK LIMITED LIABILITY COMPANY)
126 EAST 56TH STREET
NEW YORK, NY 10022

FOR: COSMETICS; NON-MEDICATED SKIN CARE PRODUCTS, IN CLASS 3 (U.S. CLS. 1, 4, 6, 50, 51 AND 52).

FIRST USE 11-1-2011; IN COMMERCE 11-1-2011.

THE MARK CONSISTS OF THE LETTER "V" IN PURPLE.

THE COLOR(S) PURPLE IS/ARE CLAIMED AS A FEATURE OF THE MARK.

SN 85-236,718, FILED 2-8-2011.

MICHELE SWAIN, EXAMINING ATTORNEY



David J. Kyffers

Director of the United States Patent and Trademark Office

United States of America

United States Patent and Trademark Office

earning employee excellence

Reg. No. 4,155,042

Registered June 5, 2012

Int. Cl.: 35

SERVICE MARK

PRINCIPAL REGISTER

DINIUS, MICHAEL (UNITED STATES INDIVIDUAL), DBA PERFORMANCE MANAGEMENT CONSULTING, LLC,
145 BREMMER STREET
RICHLAND, WA 99352

FOR: CONSULTING SERVICES IN THE FIELDS OF BUSINESS MANAGEMENT, HUMAN RESOURCES, AND BUSINESS ORGANIZATIONAL DESIGN, IN CLASS 35 (U.S. CLS. 100, 101 AND 102).

FIRST USE 2-11-2012; IN COMMERCE 2-11-2012.

THE MARK CONSISTS OF STANDARD CHARACTERS WITHOUT CLAIM TO ANY PARTICULAR FONT, STYLE, SIZE, OR COLOR.

NO CLAIM IS MADE TO THE EXCLUSIVE RIGHT TO USE "EMPLOYEE", APART FROM THE MARK AS SHOWN.

SN 85-237,309, FILED 2-8-2011.

NAAKWAMA ANKRAH, EXAMINING ATTORNEY



David J. Kyros

Director of the United States Patent and Trademark Office

United States of America

United States Patent and Trademark Office

LE CLUZET

Reg. No. 4,155,043

Registered June 5, 2012

Int. Cl.: 33

TRADEMARK

PRINCIPAL REGISTER

INTERCONTINENTAL PACKAGING CO. (MINNESOTA CORPORATION)
1999 SHEPARD ROAD
ST. PAUL, MN 55116

FOR: WINES, IN CLASS 33 (U.S. CLS. 47 AND 49).

FIRST USE 4-1-2011; IN COMMERCE 5-1-2011.

THE MARK CONSISTS OF STANDARD CHARACTERS WITHOUT CLAIM TO ANY PARTICULAR FONT, STYLE, SIZE, OR COLOR.

THE ENGLISH TRANSLATION OF "LE" IN THE MARK IS THE. THE WORDING "CLUZET" HAS NO MEANING IN A FOREIGN LANGUAGE.

SN 85-237,515, FILED 2-9-2011.

BRENDAN MCCAULEY, EXAMINING ATTORNEY



David J. Kybas

Director of the United States Patent and Trademark Office

United States of America

United States Patent and Trademark Office

HAWAIIAN BRAND PIGGY PUPS

Reg. No. 4,155,044

Registered June 5, 2012

Int. Cl.: 30

TRADEMARK

PRINCIPAL REGISTER

GOUVEA'S & PURITY FOODS, INC. (HAWAII CORPORATION)
3049 UALENA STREET #415
HONOLULU, HI 96819

FOR: SAUSAGES WRAPPED IN BREAD, IN CLASS 30 (U.S. CL. 46).

FIRST USE 11-30-2010; IN COMMERCE 12-30-2011.

THE MARK CONSISTS OF STANDARD CHARACTERS WITHOUT CLAIM TO ANY PARTICULAR FONT, STYLE, SIZE, OR COLOR.

NO CLAIM IS MADE TO THE EXCLUSIVE RIGHT TO USE "HAWAIIAN BRAND" OR "PUPS", APART FROM THE MARK AS SHOWN.

SN 85-237,710, FILED 2-9-2011.

ANNE MADDEN, EXAMINING ATTORNEY



David J. Kybas

Director of the United States Patent and Trademark Office

United States of America

United States Patent and Trademark Office

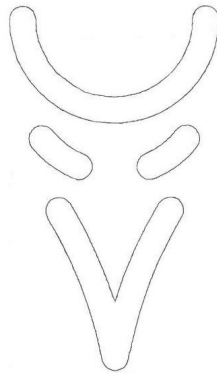

Reg. No. 4,155,045

Registered June 5, 2012

Int. Cl.: 28

TRADEMARK

PRINCIPAL REGISTER

TONY B. WHITESIDE (UNITED STATES INDIVIDUAL)
294 RYAN PATRICK DRIVE
SHEPHERDSVILLE, KY 40165

FOR: REMOTE-CONTROL MODEL AIRCRAFT, REMOTE-CONTROL MODEL HELICOPTERS, AND REPLACEMENT PARTS AND ACCESSORIES FOR THE AFORESAID GOODS, IN CLASS 28 (U.S. CLS. 22, 23, 38 AND 50).

FIRST USE 11-25-2011; IN COMMERCE 12-15-2011.

THE MARK CONSISTS OF AN INVERTED ARCH LOCATED ABOVE TWO SLIGHTLY ARCHED FIGURES AND A "V" SHAPE WITH POINTED END DOWN LOCATED BELOW THE TWO SLIGHTLY ARCHED FIGURES DEPICTING A FACE.

SN 85-237,775, FILED 2-9-2011.

DORITT L. CARROLL, EXAMINING ATTORNEY



David J. Kybas

Director of the United States Patent and Trademark Office

United States of America

United States Patent and Trademark Office



Reg. No. 4,155,046

Registered June 5, 2012

Int. Cl.: 32

TRADEMARK

PRINCIPAL REGISTER

EINSTOK BEER COMPANY, L.P. (CALIFORNIA LIMITED PARTNERSHIP)
#840
15332 ANTIOCH STREET
PACIFIC PALISADES, CA 90272

FOR: BEER, IN CLASS 32 (U.S. CLS. 45, 46 AND 48).

FIRST USE 5-0-2011; IN COMMERCE 5-0-2011.

THE MARK CONSISTS OF A DRAWING DEPICTING A VIKING.

SN 85-237,994, FILED 2-9-2011.

SCOTT BIBB, EXAMINING ATTORNEY



David J. Kybas

Director of the United States Patent and Trademark Office

United States of America

United States Patent and Trademark Office

TOTAL EQUINE

Reg. No. 4,155,047

ANDERSON, R. HARRY (UNITED STATES INDIVIDUAL)
P.O. BOX 3090
WEATHERFORD, TX 76086

Registered June 5, 2012

Int. Cl.: 31

FOR: EXTRUDED HORSE FEED, IN CLASS 31 (U.S. CLS. 1 AND 46).

TRADEMARK

FIRST USE 6-15-2000; IN COMMERCE 7-13-2000.

PRINCIPAL REGISTER

THE MARK CONSISTS OF STANDARD CHARACTERS WITHOUT CLAIM TO ANY PARTICULAR FONT, STYLE, SIZE, OR COLOR.

NO CLAIM IS MADE TO THE EXCLUSIVE RIGHT TO USE "EQUINE", APART FROM THE MARK AS SHOWN.

SN 85-238,063, FILED 2-9-2011.

ALICE BENMAMAN, EXAMINING ATTORNEY



David J. Kybas

Director of the United States Patent and Trademark Office

United States of America

United States Patent and Trademark Office

ELEVATING INSIGHT

Reg. No. 4,155,048

Registered June 5, 2012

Int. Cl.: 9

TRADEMARK

PRINCIPAL REGISTER

GEOEYE IMAGERY COLLECTION SYSTEMS INC. (DELAWARE CORPORATION)
21700 ATLANTIC BOULEVARD
DULLES, VA 20166

FOR: DOWNLOADABLE IMAGES OF THE EARTH; SOFTWARE FOR VIEWING AND MANIPULATING DIGITAL IMAGERY OF THE EARTH, IN CLASS 9 (U.S. CLS. 21, 23, 26, 36 AND 38).

FIRST USE 3-0-2011; IN COMMERCE 3-0-2011.

THE MARK CONSISTS OF STANDARD CHARACTERS WITHOUT CLAIM TO ANY PARTICULAR FONT, STYLE, SIZE, OR COLOR.

SN 85-238,384, FILED 2-9-2011.

FLORENTINA BLANDU, EXAMINING ATTORNEY



David J. Kyffers

Director of the United States Patent and Trademark Office

United States of America

United States Patent and Trademark Office

ELEVATING INSIGHT

Reg. No. 4,155,049

GEOEYE IMAGERY COLLECTION SYSTEMS INC. (DELAWARE CORPORATION)
21700 ATLANTIC BOULEVARD
DULLES, VA 20166

Registered June 5, 2012

Int. Cl.: 16

FOR: POSTERS; PHOTOGRAPHS; CALENDARS; MAPS, IN CLASS 16 (U.S. CLS. 2, 5, 22, 23, 29, 37, 38 AND 50).

TRADEMARK

FIRST USE 12-15-2011; IN COMMERCE 12-15-2011.

PRINCIPAL REGISTER

THE MARK CONSISTS OF STANDARD CHARACTERS WITHOUT CLAIM TO ANY PARTICULAR FONT, STYLE, SIZE, OR COLOR.

SN 85-238,390, FILED 2-9-2011.

FLORENTINA BLANDU, EXAMINING ATTORNEY



David J. Kybas

Director of the United States Patent and Trademark Office

United States of America

United States Patent and Trademark Office

ELEVATING INSIGHT

Reg. No. 4,155,050

Registered June 5, 2012

Int. Cl.: 35

SERVICE MARK

PRINCIPAL REGISTER

GEOEYE IMAGERY COLLECTION SYSTEMS INC. (DELAWARE CORPORATION)
21700 ATLANTIC BOULEVARD
DULLES, VA 20166

FOR: ONLINE RETAIL STORE SERVICES FEATURING IMAGERY OF THE EARTH; SUBSCRIPTION SERVICE TO IMAGERY OF THE EARTH TAKEN BY AIRCRAFT AND SATELLITES , IN CLASS 35 (U.S. CLS. 100, 101 AND 102).

FIRST USE 3-0-2011; IN COMMERCE 3-0-2011.

THE MARK CONSISTS OF STANDARD CHARACTERS WITHOUT CLAIM TO ANY PARTICULAR FONT, STYLE, SIZE, OR COLOR.

SN 85-238,395, FILED 2-9-2011.

FLORENTINA BLANDU, EXAMINING ATTORNEY



David J. Kybas

Director of the United States Patent and Trademark Office

United States of America

United States Patent and Trademark Office

ELEVATING INSIGHT

Reg. No. 4,155,051

Registered June 5, 2012

Int. Cl.: 42

SERVICE MARK

PRINCIPAL REGISTER

GEOEYE IMAGERY COLLECTION SYSTEMS INC. (DELAWARE CORPORATION)
21700 ATLANTIC BOULEVARD
DULLES, VA 20166

FOR: DATABASE DESIGN AND DEVELOPMENT SERVICES; INTERPRETATION OF DIGITAL AERIAL AND SATELLITE IMAGES OF THE EARTH FOR OTHERS; PHOTOGRAMMETRY SERVICES; MAKING MAPS AND SCALE DRAWINGS FROM AERIAL AND SATELLITE PHOTOGRAPHS; PROVIDING A WEBSITE FEATURING ON-LINE SOFTWARE TOOLS FOR IMAGE EDITING AND MANIPULATION; ENGINEERING SERVICES; PROVIDING INFORMATION IN THE FIELDS OF LOCATION INTELLIGENCE AND GEOSPATIAL INTELLIGENCE; RESEARCH AND DEVELOPMENT AND CONSULTATION RELATED THERETO IN THE FIELDS OF GEOSPATIAL INFORMATION AND DATA, GEOCODING INFORMATION, GEOGRAPHIC INFORMATION SYSTEMS, LOCATION INTELLIGENCE, LOCATION-SPECIFIC INFORMATION, AND LOCATION MONITORING; ANALYSIS SERVICES FOR OTHERS, NAMELY, ANALYSIS AND INTEGRATION OF INFORMATION AND DATA IN THE FIELDS OF GEOSPATIAL INFORMATION, HUMAN TERRAIN INFORMATION, SOCIO-CULTURAL INFORMATION, BEHAVIORAL INFORMATION, AND HUMAN FACTORS INFORMATION, AND CONSULTATION RELATED THERETO, IN CLASS 42 (U.S. CLS. 100 AND 101).

FIRST USE 3-0-2011; IN COMMERCE 3-0-2011.

THE MARK CONSISTS OF STANDARD CHARACTERS WITHOUT CLAIM TO ANY PARTICULAR FONT, STYLE, SIZE, OR COLOR.

SN 85-238,408, FILED 2-9-2011.

FLORENTINA BLANDU, EXAMINING ATTORNEY



David J. Kyjars

Director of the United States Patent and Trademark Office

United States of America

United States Patent and Trademark Office



Reg. No. 4,155,052

Registered June 5, 2012

Int. Cls.: 37 and 42

SERVICE MARK

PRINCIPAL REGISTER

EXP GLOBAL INC. (CANADA CORPORATION)
56 QUEEN STREET EAST, SUITE 301
BRAMPTON, ONTARIO, CANADA L6V 4M8

FOR: BUILDING AND ROAD CONSTRUCTION MANAGEMENT SERVICES, IN CLASS 37
(U.S. CLS. 100, 103 AND 106).

FIRST USE 4-4-2011; IN COMMERCE 4-4-2011.

FOR: ENGINEERING AND ARCHITECTURAL CONSULTING; ENGINEERING PROJECT
MANAGEMENT; LANDSCAPE ARCHITECTURAL DESIGN SERVICES; URBAN PLANNING
SERVICES AND LAND SURVEYING SERVICES; CONSULTING SERVICES IN THE FIELD
OF ENVIRONMENTAL ASSESSMENT AND PLANNING, IN CLASS 42 (U.S. CLS. 100 AND
101).

FIRST USE 4-4-2011; IN COMMERCE 4-4-2011.

THE MARK CONSISTS OF THE LETTERS "EXP" WITH A CLUSTER OF CIRCULAR DESIGNS
TO THE TOP LEFT AND A PERIOD AFTER THE LETTER "P".

SN 85-238,767, FILED 2-10-2011.

CIMMERIAN COLEMAN, EXAMINING ATTORNEY



David J. Kybas

Director of the United States Patent and Trademark Office

United States of America

United States Patent and Trademark Office

KERALOCK

Reg. No. 4,155,053

Registered June 5, 2012

Int. Cl.: 3

TRADEMARK

PRINCIPAL REGISTER

CONOPCO, INC. (NEW YORK CORPORATION)
700 SYLVAN AVENUE
ENGLEWOOD CLIFFS, NJ 07632

FOR: HAIR CARE PRODUCTS, NAMELY, HAIR COLORANTS, HAIR DYES, HAIR LOTIONS, HAIR WAVING PREPARATIONS, SHAMPOOS, CONDITIONERS, HAIR SPRAYS, HAIR DRESSINGS, HAIR LACQUERS, HAIR MOUSSES, HAIR GLAZES, HAIR GELS, HAIR MOISTURIZERS, HAIR PRESERVATION TREATMENTS, HAIR OILS, HAIR TONIC, HAIR CREAMS, NON-MEDICATED PREPARATIONS FOR THE BATH AND/OR SHOWER, IN CLASS 3 (U.S. CLS. 1, 4, 6, 50, 51 AND 52).

FIRST USE 12-4-2010; IN COMMERCE 12-4-2010.

THE MARK CONSISTS OF STANDARD CHARACTERS WITHOUT CLAIM TO ANY PARTICULAR FONT, STYLE, SIZE, OR COLOR.

SN 85-238,922, FILED 2-10-2011.

ANNE MADDEN, EXAMINING ATTORNEY



David J. Kyros

Director of the United States Patent and Trademark Office

United States of America

United States Patent and Trademark Office

SPACEMATS

Reg. No. 4,155,054

Registered June 5, 2012

Int. Cls.: 16 and 24

TRADEMARK

PRINCIPAL REGISTER

MARK FRIEL (CANADA INDIVIDUAL)
C/O: 1100 - 8TH AVENUE S.W., SUITE 233
CALGARY, ALBERTA, CANADA T2P3T8

FOR: MAT BOARDS; PAPER FLOOR MATS; PAPER MATS; PAPER PLACE MATS, IN CLASS 16 (U.S. CLS. 2, 5, 22, 23, 29, 37, 38 AND 50).

FIRST USE 9-30-2011; IN COMMERCE 9-30-2011.

FOR: PLACE MATS OF TEXTILE MATERIAL; PLACE MATS, NOT OF PAPER; PLASTIC PLACE MATS; TEXTILE PLACE MATS; VINYL PLACE MATS, IN CLASS 24 (U.S. CLS. 42 AND 50).

FIRST USE 9-30-2011; IN COMMERCE 9-30-2011.

THE MARK CONSISTS OF STANDARD CHARACTERS WITHOUT CLAIM TO ANY PARTICULAR FONT, STYLE, SIZE, OR COLOR.

SN 85-239,109, FILED 2-10-2011.

ERIN FALK, EXAMINING ATTORNEY



David J. Kybas

Director of the United States Patent and Trademark Office

United States of America

United States Patent and Trademark Office

LUXGEN

Reg. No. 4,155,055

LUXGEN MOTOR CO., LTD. (TAIWAN CORPORATION)
NO. 39-1, BOGONGKENG, SANYI TOWNSHIP
MIAOLI COUNTY 367, TAIWAN

Registered June 5, 2012

Int. Cl.: 35

FOR: RETAIL AUTOMOBILE STORES; RETAIL AUTOMOBILE PARTS AND ACCESSORIES
STORES, IN CLASS 35 (U.S. CLS. 100, 101 AND 102).

SERVICE MARK

FIRST USE 8-19-2009; IN COMMERCE 8-19-2009.

PRINCIPAL REGISTER

THE MARK CONSISTS OF THE WORD "LUXGEN" IN STYLIZED FORM.

SN 85-239,603, FILED 2-11-2011.

HENRY S. ZAK, EXAMINING ATTORNEY



David J. Kybas

Director of the United States Patent and Trademark Office

United States of America

United States Patent and Trademark Office

LUXGEN

Reg. No. 4,155,056

Registered June 5, 2012

Int. Cl.: 37

SERVICE MARK

PRINCIPAL REGISTER

LUXGEN MOTOR CO., LTD. (TAIWAN CORPORATION)
NO. 39-1, BOGONGKENG, SANYI TOWNSHIP
MIAOLI COUNTY 367, TAIWAN

FOR: VEHICLE MAINTENANCE AND REPAIR; VEHICLE MAINTENANCE; ANTI-RUST TREATMENT FOR VEHICLES; AUTOMOBILE LUBRICATION; AUTOMOBILE CLEANING AND CAR WASHING; AUTOMOBILE SERVICE STATION SERVICES; MOTOR VEHICLE MAINTENANCE AND REPAIR; TIRE RETREADING; AUTOMOBILE POLISHING; BUFFING AND POLISHING, IN CLASS 37 (U.S. CLS. 100, 103 AND 106).

FIRST USE 8-19-2009; IN COMMERCE 8-19-2009.

THE MARK CONSISTS OF THE WORD "LUXGEN" IN STYLIZED FORM.

SN 85-239,605, FILED 2-11-2011.

HENRY S. ZAK, EXAMINING ATTORNEY



David J. Kyffers

Director of the United States Patent and Trademark Office

United States of America

United States Patent and Trademark Office

GROUP 7

Reg. No. 4,155,057

Registered June 5, 2012

Int. Cl.: 7

TRADEMARK

PRINCIPAL REGISTER

PUROLATOR FILTERS NA LLC (DELAWARE LIMITED LIABILITY COMPANY)
3200 NATAL ROAD
FAYETTEVILLE, NC 28306

FOR: OIL, AIR AND FUEL FILTERS FOR MOTORS AND ENGINES; FILTER ELEMENTS
FOR OIL, AIR AND FUEL FILTERS, IN CLASS 7 (U.S. CLS. 13, 19, 21, 23, 31, 34 AND 35).

FIRST USE 12-31-2009; IN COMMERCE 12-31-2009.

THE MARK CONSISTS OF STANDARD CHARACTERS WITHOUT CLAIM TO ANY PAR-
TICULAR FONT, STYLE, SIZE, OR COLOR.

OWNER OF U.S. REG. NO. 886,320.

SN 85-240,084, FILED 2-11-2011.

CHARLES L. JENKINS, EXAMINING ATTORNEY



David J. Kybas

Director of the United States Patent and Trademark Office

United States of America

United States Patent and Trademark Office



Reg. No. 4,155,058

Registered June 5, 2012

Int. Cl.: 36

SERVICE MARK

PRINCIPAL REGISTER

REBEL BAIL BONDS, INC. (UTAH CORPORATION)
P.O. BOX 198
DUCHESNE, UT 84021

FOR: BAIL BONDING, IN CLASS 36 (U.S. CLS. 100, 101 AND 102).

FIRST USE 12-6-2011; IN COMMERCE 12-6-2011.

THE MARK CONSISTS OF SKULL WITH WINGS.

SN 85-240,270, FILED 2-11-2011.

THEODORE MCBRIDE, EXAMINING ATTORNEY



David J. Kyffers

Director of the United States Patent and Trademark Office

United States of America

United States Patent and Trademark Office

GOODY

Reg. No. 4,155,059

Registered June 5, 2012

Int. Cl.: 32

TRADEMARK

PRINCIPAL REGISTER

ORCA BEVERAGE, INC. (WASHINGTON CORPORATION)
11903 CYRUS WAY # 5
MUKILTEO, WA 98275

FOR: SOFT DRINKS, IN CLASS 32 (U.S. CLS. 45, 46 AND 48).

FIRST USE 10-10-2011; IN COMMERCE 10-13-2011.

THE MARK CONSISTS OF STANDARD CHARACTERS WITHOUT CLAIM TO ANY PARTICULAR FONT, STYLE, SIZE, OR COLOR.

SN 85-240,298, FILED 2-11-2011.

LEIGH CAROLINE CASE, EXAMINING ATTORNEY



David J. Kybas

Director of the United States Patent and Trademark Office

United States of America

United States Patent and Trademark Office

INOLVIDABLE INFANTE

Reg. No. 4,155,060

Registered June 5, 2012

Int. Cl.: 33

TRADEMARK

PRINCIPAL REGISTER

INFANTE INTERNATIONAL (WYOMING CORPORATION)
154 WEST FOOTHILL BLVD
SUITE A-246
UPLAND, CA 91786

FOR: TEQUILA, IN CLASS 33 (U.S. CLS. 47 AND 49).

FIRST USE 2-11-2011; IN COMMERCE 2-11-2011.

THE MARK CONSISTS OF STANDARD CHARACTERS WITHOUT CLAIM TO ANY PARTICULAR FONT, STYLE, SIZE, OR COLOR.

THE ENGLISH TRANSLATION OF THE WORDS "INOLVIDABLE INFANTE" IN THE MARK IS UNFORGETTABLE INFANT.

SN 85-240,443, FILED 2-11-2011.

ALEX KEAM, EXAMINING ATTORNEY



David J. Kybas

Director of the United States Patent and Trademark Office

United States of America

United States Patent and Trademark Office

PROTECT YOUR GAME

Reg. No. 4,155,061

Registered June 5, 2012

Int. Cl.: 18

TRADEMARK

PRINCIPAL REGISTER

MARC ICEBERG (UNITED STATES INDIVIDUAL)
SUITE 204
10602 DEMILO PLACE
ORLANDO, FL 32836

FOR: ALL PURPOSE SPORT BAGS; ALL-PURPOSE ATHLETIC BAGS; ALL-PURPOSE CARRYING BAGS; ALL-PURPOSE REUSABLE CARRYING BAGS; ATHLETIC BAGS; BAGS FOR SPORTS; SPORT BAGS; SPORTS BAGS, IN CLASS 18 (U.S. CLS. 1, 2, 3, 22 AND 41).

FIRST USE 1-26-2011; IN COMMERCE 2-22-2012.

THE MARK CONSISTS OF STANDARD CHARACTERS WITHOUT CLAIM TO ANY PARTICULAR FONT, STYLE, SIZE, OR COLOR.

SN 85-240,569, FILED 2-11-2011.

AMY KERTGATE, EXAMINING ATTORNEY



David J. Kybas

Director of the United States Patent and Trademark Office

United States of America

United States Patent and Trademark Office

PRIORITY

Reg. No. 4,155,062

SAUTER, WENDY A (UNITED STATES INDIVIDUAL)
26292 LOS VIVEROS, APT. F
MISSION VIEJO, CA 92691

Registered June 5, 2012

Int. Cl.: 25

FOR: ATHLETIC APPAREL, NAMELY, SHIRTS, PANTS, JACKETS, FOOTWEAR, HATS AND CAPS, ATHLETIC UNIFORMS, IN CLASS 25 (U.S. CLS. 22 AND 39).

TRADEMARK

FIRST USE 10-19-2011; IN COMMERCE 10-19-2011.

PRINCIPAL REGISTER

THE MARK CONSISTS OF STANDARD CHARACTERS WITHOUT CLAIM TO ANY PARTICULAR FONT, STYLE, SIZE, OR COLOR.

SN 85-240,816, FILED 2-12-2011.

SHANNON TWOHIG, EXAMINING ATTORNEY



David J. Kyffers

Director of the United States Patent and Trademark Office

United States of America

United States Patent and Trademark Office



Reg. No. 4,155,063

Registered June 5, 2012

Int. Cl.: 32

TRADEMARK

PRINCIPAL REGISTER

LEOKADIA PTY LTD. (AUSTRALIA PROPRIETARY LIMITED COMPANY (P/L OR PTY. LTD.))
31 CRESCENT
MANLY, AUSTRALIA NSW2095

FOR: ALCOHOL FREE BEER; ALCOHOLIC BEERS; BEER; BEER WORT; BITTER BEER; BLACK BEER; DARK BEER; DE-ALCOHOLISED BEER; EXTRACTS OF HOPS FOR MAKING BEER; FRUIT BEERS; GINGER BEER; MALT BEER; MALT CONTAINING BEVERAGES IN THE NATURE OF BEERS; MALT-CONTAINING BEVERAGES IN THE NATURE OF NON-ALCOHOLIC MALT COOLERS, AND NOT BEING BEERS; NON-ALCOHOLIC BEERS; PILSNER BEER; SOFT DRINKS IN THE NATURE OF ROOT BEER; AERATED BEVERAGES IN THE NATURE OF NON-ALCOHOLIC SOFT DRINKS AND CIDER; LOW ALCOHOL BEVERAGES CONTAINING NOT MORE THAN 1.15% BY VOLUME OF ALCOHOL, NAMELY, LOW-ALCOHOL BEERS, WINE AND CIDER; SPRING WATER, OTHER THAN FOR MEDICAL PURPOSES; DRINKING WATER OTHER THAN FOR MEDICAL USE; DRINKING WATERS; FRESH FRUIT JUICES; FRUIT JUICES; AERATED DRINKS IN THE NATURE OF FRUIT JUICES AND CIDER; CARBONATED NON-ALCOHOLIC DRINKS IN THE NATURE OF SOFT DRINKS; FRUIT DRINKS; NON-ALCOHOLIC DRINKS OTHER THAN FOR MEDICAL USE IN THE NATURE OF SOFT DRINKS AND CIDER; SOFT DRINKS; NON-MEDICATED SPORTS DRINKS; MINERAL WATER; ALCOHOL FREE DRINKS, IN THE NATURE OF SOFT DRINKS AND CIDER; BOTTLED FRUIT DRINKS; ISOTONIC DRINKS NOT FOR MEDICAL PURPOSES; AERATED MINERAL WATERS; AERATED WATER; BOTTLED WATER NOT FOR MEDICAL PURPOSES; CARBONATED WATER; DRINKING WATER; SODA WATER; DRINKING WATER, NAMELY, TONIC WATER BEING NONMEDICATED BEVERAGES; ORANGE JUICE; LAGER; STOUT, IN CLASS 32 (U.S. CLS. 45, 46 AND 48).



FIRST USE 10-27-2008; IN COMMERCE 1-9-2012.

OWNER OF U.S. REG. NO. 3,705,588.

THE MARK CONSISTS OF A STYLIZED DESIGN OF A BIRD TO THE LEFT OF THE STACKED STYLIZED WORDING "BUDGY SMUGGLER".

SN 85-241,048, FILED 2-13-2011.

HENRY S. ZAK, EXAMINING ATTORNEY

David J. Kypas

Director of the United States Patent and Trademark Office

United States of America

United States Patent and Trademark Office

LITE UP

Reg. No. 4,155,064

V BEAUTE LLC (NEW YORK LIMITED LIABILITY COMPANY)
126 EAST 56TH STREET
NEW YORK, NY 10022

Registered June 5, 2012

Int. Cl.: 3

FOR: COSMETICS AND NON-MEDICATED SKIN CARE PREPARATIONS, IN CLASS 3
(U.S. CLS. 1, 4, 6, 50, 51 AND 52).

TRADEMARK

FIRST USE 11-1-2011; IN COMMERCE 11-1-2011.

PRINCIPAL REGISTER

THE MARK CONSISTS OF STANDARD CHARACTERS WITHOUT CLAIM TO ANY PARTICULAR FONT, STYLE, SIZE, OR COLOR.

SN 85-241,090, FILED 2-13-2011.

MICHAEL GAAFAR, EXAMINING ATTORNEY



David J. Kybas

Director of the United States Patent and Trademark Office

United States of America

United States Patent and Trademark Office



Reg. No. 4,155,065

Registered June 5, 2012

Int. Cl.: 30

TRADEMARK

PRINCIPAL REGISTER

ARETE USA I LLC (NEVADA LIMITED LIABILITY COMPANY)
325 E. 77 STREET, SUITE 6G
NEW YORK, NY 10075

FOR: COFFEE, IN CLASS 30 (U.S. CL. 46).

FIRST USE 11-11-2011; IN COMMERCE 11-11-2011.

THE MARK CONSISTS OF THE LETTERS "V","A","S" IN STYLIZED FONT ABOVE THE WORDS "VALUE ADDED AT THE SOURCE" WITH THE LETTERS "V","A" AND "S" IN BOLD FONT ALL ENCLOSED IN A BORDER IN A FANCIFUL SHAPE.

SN 85-241,377, FILED 2-14-2011.

REBECCA SMITH, EXAMINING ATTORNEY



David J. Kyffers

Director of the United States Patent and Trademark Office

United States of America

United States Patent and Trademark Office



Reg. No. 4,155,066

Registered June 5, 2012

Int. Cl.: 30

TRADEMARK

PRINCIPAL REGISTER

ARETE USA I LLC (NEVADA LIMITED LIABILITY COMPANY)
325 E. 77TH STREET, SUITE 6G
NEW YORK, NY 10075

FOR: COFFEE, IN CLASS 30 (U.S. CL. 46).

FIRST USE 11-11-2011; IN COMMERCE 11-11-2011.

THE MARK CONSISTS OF THE WORD "AZAHAR" WITH A FANCIFUL DESIGN OF A FLOWER IN A SHAPE REMINISCENT OF AN ESPRESSO CUP WITH A HANDLE ABOVE THE WORD AND AN ARCH EXTENDING OVER THE FLORAL DESIGN INSIDE A CIRCLE THAT IS INSIDE A SQUARE BACKGROUND.

SN 85-241,411, FILED 2-14-2011.

REBECCA SMITH, EXAMINING ATTORNEY



David J. Kyffers

Director of the United States Patent and Trademark Office

United States of America

United States Patent and Trademark Office



Reg. No. 4,155,067

Registered June 5, 2012

Int. Cl.: 35

SERVICE MARK

PRINCIPAL REGISTER

REMARK USA, INC. (MINNESOTA CORPORATION)
301 CARLSON PARKWAY
SUITE 305
MINNETONKA, MN 55305

FOR: LEAD GENERATION SERVICES FOR INSURANCE, NAMELY, PROVIDING INFORMATION REGARDING CONSUMERS INTERESTED IN RECEIVING COMPETITIVE QUOTES FOR NEW OR REPLACEMENT INSURANCE TO AGENTS, BROKERS AND INSURERS INTERESTED IN PROVIDING THESE SERVICES, IN CLASS 35 (U.S. CLS. 100, 101 AND 102).

FIRST USE 6-15-2011; IN COMMERCE 6-15-2011.

THE MARK CONSISTS OF A DRAWING OF A STOPWATCH SHOWN IN THE COLOR RED. THE TERM "INSQUOTENOW.COM" BEGINS IN THE CENTER OF THE STOPWATCH DESIGN, WITH THE DOT ABOVE THE LETTER "I" FORMING THE BASE OF THE TIMER HAND. THE TIMER HAND, THE LETTERS "INSQUOTE" AND THE LETTERS ".COM" APPEAR IN THE COLOR BLACK. THE LETTERS "NOW" APPEAR IN THE COLOR RED. BELOW THE TERM "INSQUOTENOW.COM" THE WORDS "STOP WAITING. START SAVING." APPEAR IN THE COLOR RED.

THE COLOR(S) RED AND BLACK IS/ARE CLAIMED AS A FEATURE OF THE MARK.

SN 85-241,538, FILED 2-14-2011.

RAUL CORDOVA, EXAMINING ATTORNEY



David J. Kybas

Director of the United States Patent and Trademark Office

United States of America

United States Patent and Trademark Office

POPARUBA

Reg. No. 4,155,068

POPARUBA, LLC (COLORADO LIMITED LIABILITY COMPANY)
634 GILPIN STREET
DENVER, CO 80218

Registered June 5, 2012

Int. Cl.: 30

FOR: CONFECTIONERY PRODUCTS, NAMELY, PETIT FOURS, CAKES, AND PASTRIES,
IN CLASS 30 (U.S. CL. 46).

TRADEMARK

FIRST USE 1-11-2011; IN COMMERCE 1-11-2011.

PRINCIPAL REGISTER

THE MARK CONSISTS OF STANDARD CHARACTERS WITHOUT CLAIM TO ANY PARTICULAR FONT, STYLE, SIZE, OR COLOR.

SN 85-241,568, FILED 2-14-2011.

LINDA M. KING, EXAMINING ATTORNEY



David J. Kybas

Director of the United States Patent and Trademark Office

United States of America

United States Patent and Trademark Office

LUXE  VAULT

Reg. No. 4,155,069

Registered June 5, 2012

Int. Cl.: 14

TRADEMARK

PRINCIPAL REGISTER

LUXE VAULT LTD. (NEW YORK CORPORATION)
641 FIFTH AVENUE
SUITE 29G
NEW YORK, NY 10022

FOR: JEWELRY, IN CLASS 14 (U.S. CLS. 2, 27, 28 AND 50).

FIRST USE 8-0-2011; IN COMMERCE 8-0-2011.

THE MARK CONSISTS OF A SOLID KEY-HOLE SHAPE BETWEEN THE WORDS "LUXE" AND "VAULT".

SN 85-241,991, FILED 2-14-2011.

JAMES STEIN, EXAMINING ATTORNEY



David J. Kybas

Director of the United States Patent and Trademark Office

United States of America

United States Patent and Trademark Office

SafeLoad Shuttle System

Reg. No. 4,155,070

Registered June 5, 2012

Int. Cl.: 7

TRADEMARK

PRINCIPAL REGISTER

G.A. BRAUN, INC. (NEW YORK CORPORATION)
79 GENERAL IRWIN BLVD.
N. SYRACUSE, NY 13212

FOR: AN AUTOMATED INDUSTRIAL AND COMMERCIAL LAUNDRY HANDLING SYSTEM COMPRISED OF A TRACK AND/OR RAIL MOUNTED SELF PROPELLED AND SELF ALIGNING BULK LAUNDRY RECEIVING AND DISCHARGING CONTAINER FOR TRANSFERRING BULK LAUNDRY ITEMS BETWEEN LARGE COMMERCIAL LAUNDRY WASHING AND DRYING MACHINES INCORPORATING FEATURES AND FACILITIES IN THE NATURE OF AN OPERATORS CAB OR CAGE FOR THE SAFETY AND PROTECTION OF AN ONBOARD OPERATOR, IN CLASS 7 (U.S. CLS. 13, 19, 21, 23, 31, 34 AND 35).

FIRST USE 11-30-2010; IN COMMERCE 6-25-2011.

THE MARK CONSISTS OF STANDARD CHARACTERS WITHOUT CLAIM TO ANY PARTICULAR FONT, STYLE, SIZE, OR COLOR.

NO CLAIM IS MADE TO THE EXCLUSIVE RIGHT TO USE "SHUTTLE SYSTEM", APART FROM THE MARK AS SHOWN.

SN 85-242,248, FILED 2-15-2011.

ALICE BENMAMAN, EXAMINING ATTORNEY



David J. Kyffers

Director of the United States Patent and Trademark Office

United States of America

United States Patent and Trademark Office

ANCESTOR

Reg. No. 4,155,071

Registered June 5, 2012

Int. Cl.: 33

TRADEMARK

PRINCIPAL REGISTER

HALTER WINERY LLC (CALIFORNIA LIMITED LIABILITY COMPANY)
8910 ADELAIDA ROAD
PASO ROBLES, CA 93446

FOR: WINES, IN CLASS 33 (U.S. CLS. 47 AND 49).

FIRST USE 7-1-2005; IN COMMERCE 10-8-2007.

THE MARK CONSISTS OF STANDARD CHARACTERS WITHOUT CLAIM TO ANY PARTICULAR FONT, STYLE, SIZE, OR COLOR.

SN 85-242,499, FILED 2-15-2011.

WILLIAM ROSSMAN, EXAMINING ATTORNEY



David J. Kyffers

Director of the United States Patent and Trademark Office

United States of America

United States Patent and Trademark Office

FME

Reg. No. 4,155,072

FME JEANS, LLC (CALIFORNIA LIMITED LIABILITY COMPANY)
9392 FLICKER WAY
LOS ANGELES, CA 90069

Registered June 5, 2012

Int. Cl.: 25

FOR: APPAREL, NAMELY, JEANS, PANTS, SHORTS, SKIRTS, SHIRTS, CAMISOLES, UNDERGARMENTS, IN CLASS 25 (U.S. CLS. 22 AND 39).

TRADEMARK

FIRST USE 9-28-2011; IN COMMERCE 6-1-2011.

PRINCIPAL REGISTER

THE MARK CONSISTS OF STANDARD CHARACTERS WITHOUT CLAIM TO ANY PARTICULAR FONT, STYLE, SIZE, OR COLOR.

SN 85-242,590, FILED 2-15-2011.

TAMARA FRAZIER, EXAMINING ATTORNEY



David J. Kybas

Director of the United States Patent and Trademark Office

United States of America

United States Patent and Trademark Office

HybridNation

Reg. No. 4,155,073

Registered June 5, 2012

Int. Cl.: 25

TRADEMARK

PRINCIPAL REGISTER

HYBRID NATION (MINNESOTA LIMITED LIABILITY COMPANY)
300 N COLLEGE ST
NORTHFIELD, MN 55057

FOR: HATS; JACKETS; SHIRTS; SWEATSHIRTS, IN CLASS 25 (U.S. CLS. 22 AND 39).

FIRST USE 1-1-2011; IN COMMERCE 5-1-2011.

THE MARK CONSISTS OF STANDARD CHARACTERS WITHOUT CLAIM TO ANY PARTICULAR FONT, STYLE, SIZE, OR COLOR.

SN 85-243,153, FILED 2-15-2011.

KAREN K. BUSH, EXAMINING ATTORNEY



David J. Kyffers

Director of the United States Patent and Trademark Office

United States of America

United States Patent and Trademark Office

DIOSA

Reg. No. 4,155,074

Registered June 5, 2012

Int. Cl.: 33

TRADEMARK

PRINCIPAL REGISTER

DIOSA SPIRITS, LLC (TEXAS LIMITED LIABILITY COMPANY)
SUITE 80
730 W. CHEYENNE AVENUE
N. LAS VEGAS, NV 89030

FOR: TEQUILA, IN CLASS 33 (U.S. CLS. 47 AND 49).

FIRST USE 2-1-2012; IN COMMERCE 2-1-2012.

THE MARK CONSISTS OF STANDARD CHARACTERS WITHOUT CLAIM TO ANY PARTICULAR FONT, STYLE, SIZE, OR COLOR.

THE ENGLISH TRANSLATION OF "DIOSA" IN THE MARK IS "GODDESS, FEMALE GOD OR EXTREMELY BEAUTIFUL WOMAN".

SN 85-243,253, FILED 2-15-2011.

RONALD MCMORROW, EXAMINING ATTORNEY



David J. Kybas

Director of the United States Patent and Trademark Office

United States of America

United States Patent and Trademark Office

SUPERKIDS WELLNESS

Reg. No. 4,155,075

Registered June 5, 2012

Int. Cl.: 41

SERVICE MARK

PRINCIPAL REGISTER

THE BEST OF ORGANIC LLC (MICHIGAN LIMITED LIABILITY COMPANY)
2289 OAKWAY
WEST BLOOMFIELD, MI 46324

FOR: EDUCATION SERVICES, NAMELY, PROVIDING CLASSES, SEMINARS, WORKSHOPS
IN THE FIELD OF HEALTH, NUTRITION, AND LIFESTYLE, IN CLASS 41 (U.S. CLS. 100,
101 AND 107).

FIRST USE 5-0-2009; IN COMMERCE 5-0-2009.

THE MARK CONSISTS OF STANDARD CHARACTERS WITHOUT CLAIM TO ANY PAR-
TICULAR FONT, STYLE, SIZE, OR COLOR.

NO CLAIM IS MADE TO THE EXCLUSIVE RIGHT TO USE "WELLNESS", APART FROM
THE MARK AS SHOWN.

SN 85-243,404, FILED 2-16-2011.

JULIE WATSON, EXAMINING ATTORNEY



David J. Kyros

Director of the United States Patent and Trademark Office

United States of America

United States Patent and Trademark Office

M34

Reg. No. 4,155,076

Registered June 5, 2012

Int. Cl.: 6

TRADEMARK

PRINCIPAL REGISTER

INGOT METAL COMPANY LIMITED (CANADA LIMITED LIABILITY COMPANY)
111 FENMAR DRIVE
NORTH YORK, ONTARIO, CANADA M9L1M3

FOR: ALLOYS USED FOR CASTING; COPPER-BASE ALLOY INGOTS; INGOTS OF COMMON METAL; METAL ALLOYS FOR FURTHER MANUFACTURING; METALS AND METAL ALLOYS, IN CLASS 6 (U.S. CLS. 2, 12, 13, 14, 23, 25 AND 50).

FIRST USE 3-16-2012; IN COMMERCE 3-16-2012.

THE MARK CONSISTS OF STANDARD CHARACTERS WITHOUT CLAIM TO ANY PARTICULAR FONT, STYLE, SIZE, OR COLOR.

SN 85-243,486, FILED 2-16-2011.

JANICE L. MCMORROW, EXAMINING ATTORNEY



David J. Kybas

Director of the United States Patent and Trademark Office

United States of America

United States Patent and Trademark Office

The Nameplate Pundit

Reg. No. 4,155,077

Registered June 5, 2012

Int. Cl.: 40

SERVICE MARK

PRINCIPAL REGISTER

JOSEPH P. WHITE (UNITED STATES INDIVIDUAL)
99 ELLWOOD RD
BERLIN, CT 06037

FOR: CUSTOM MANUFACTURE OF NAMEPLATES, PRODUCT LABELS, AND DECALS TO THE ORDER AND SPECIFICATION OF OTHERS, IN CLASS 40 (U.S. CLS. 100, 103 AND 106).

FIRST USE 2-25-2010; IN COMMERCE 2-25-2010.

THE MARK CONSISTS OF STANDARD CHARACTERS WITHOUT CLAIM TO ANY PARTICULAR FONT, STYLE, SIZE, OR COLOR.

NO CLAIM IS MADE TO THE EXCLUSIVE RIGHT TO USE "NAMEPLATE", APART FROM THE MARK AS SHOWN.

SN 85-243,588, FILED 2-16-2011.

LINDA M. KING, EXAMINING ATTORNEY



David J. Kyros

Director of the United States Patent and Trademark Office

United States of America

United States Patent and Trademark Office

CAMPUS RIVAL

Reg. No. 4,155,078

Registered June 5, 2012

Int. Cl.: 25

TRADEMARK

PRINCIPAL REGISTER

THOMPSON, ROBERT (UNITED STATES INDIVIDUAL)
627 WARREN STREET
2ND FLOOR
BROOKLYN, NY 11217

FOR: BOOTS; COATS; GLOVES; HATS; JEANS; KNIT TOPS; NECKTIES; PANTS; SHIRTS;
SHOES; SHORTS; SNEAKERS; SUITS; SWEATERS; T-SHIRTS; UNDERGARMENTS; WOVEN
TOPS, IN CLASS 25 (U.S. CLS. 22 AND 39).

FIRST USE 1-6-2012; IN COMMERCE 1-6-2012.

THE MARK CONSISTS OF STANDARD CHARACTERS WITHOUT CLAIM TO ANY PAR-
TICULAR FONT, STYLE, SIZE, OR COLOR.

NO CLAIM IS MADE TO THE EXCLUSIVE RIGHT TO USE "CAMPUS", APART FROM THE
MARK AS SHOWN.

SN 85-243,651, FILED 2-16-2011.

TINA L. SNAPP, EXAMINING ATTORNEY



David J. Kybas

Director of the United States Patent and Trademark Office

United States of America

United States Patent and Trademark Office

CONNECTION THROUGH GIVING

Reg. No. 4,155,079

Registered June 5, 2012

Int. Cls.: 35 and 36

SERVICE MARK

PRINCIPAL REGISTER

THE BAILEY COMPANY, LLLP (COLORADO LIMITED LIABILITY LIMITED PARTNERSHIP)
601 CORPORATE CIRCLE
GOLDEN, CO 80401

FOR: CHARITABLE SERVICES, NAMELY, COORDINATION OF NON-MONETARY CONTRIBUTIONS TO CHARITIES AND NON-PROFIT ORGANIZATIONS, IN CLASS 35 (U.S. CLS. 100, 101 AND 102).

FIRST USE 3-10-2011; IN COMMERCE 4-19-2011.

FOR: CHARITABLE FUNDRAISING SERVICES; CHARITABLE SERVICES, NAMELY, ACCEPTING AND ADMINISTERING MONETARY CHARITABLE CONTRIBUTIONS TO CHARITIES AND NON-PROFIT ORGANIZATIONS, IN CLASS 36 (U.S. CLS. 100, 101 AND 102).

FIRST USE 3-10-2011; IN COMMERCE 4-19-2011.

THE MARK CONSISTS OF STANDARD CHARACTERS WITHOUT CLAIM TO ANY PARTICULAR FONT, STYLE, SIZE, OR COLOR.

SN 85-243,662, FILED 2-16-2011.

NATALIE POLZER, EXAMINING ATTORNEY



David J. Kybas

Director of the United States Patent and Trademark Office

United States of America

United States Patent and Trademark Office

VERSARIES

Reg. No. 4,155,080

Registered June 5, 2012

Int. Cl.: 9

TRADEMARK

PRINCIPAL REGISTER

VERSARIES, LLC (OHIO LIMITED LIABILITY COMPANY)
4951 DIXIE HIGHWAY
FAIRFIELD, OH 45014

FOR: COMPUTER APPLICATION SOFTWARE FOR MOBILE DEVICES, MOBILE PHONES, DESKTOP, LAPTOP OR PALMTOP COMPUTERS, NAMELY, SOFTWARE FOR USE IN FACILITATING SOCIAL INTERACTION BETWEEN AND AMONG COMPUTER USERS VIA EMAIL AND COMPUTER NETWORKS REGARDING SOCIAL EVENTS AND OCCASIONS, IN CLASS 9 (U.S. CLS. 21, 23, 26, 36 AND 38).

FIRST USE 6-30-2011; IN COMMERCE 6-30-2011.

THE MARK CONSISTS OF STANDARD CHARACTERS WITHOUT CLAIM TO ANY PARTICULAR FONT, STYLE, SIZE, OR COLOR.

SN 85-243,831, FILED 2-16-2011.

KIMBERLY PERRY, EXAMINING ATTORNEY



David J. Kyjars

Director of the United States Patent and Trademark Office

United States of America

United States Patent and Trademark Office

VERSARY

Reg. No. 4,155,081

Registered June 5, 2012

Int. Cl.: 9

TRADEMARK

PRINCIPAL REGISTER

VERSARIES, LLC (OHIO LIMITED LIABILITY COMPANY)
4951 DIXIE HIGHWAY
FAIRFIELD, OH 45014

FOR: COMPUTER APPLICATION SOFTWARE FOR MOBILE DEVICES, MOBILE PHONES, DESKTOP, LAPTOP OR PALMTOP COMPUTERS, NAMELY, SOFTWARE FOR USE IN FACILITATING SOCIAL INTERACTION BETWEEN AND AMONG COMPUTER USERS VIA EMAIL AND COMPUTER NETWORKS REGARDING SOCIAL EVENTS AND OCCASIONS, IN CLASS 9 (U.S. CLS. 21, 23, 26, 36 AND 38).

FIRST USE 6-30-2011; IN COMMERCE 6-30-2011.

THE MARK CONSISTS OF STANDARD CHARACTERS WITHOUT CLAIM TO ANY PARTICULAR FONT, STYLE, SIZE, OR COLOR.

SN 85-243,838, FILED 2-16-2011.

KIMBERLY PERRY, EXAMINING ATTORNEY



David J. Kyjars

Director of the United States Patent and Trademark Office

United States of America

United States Patent and Trademark Office

PLASTIFINA

Reg. No. 4,155,082

Registered June 5, 2012

Int. Cls.: 16, 17, and 21

TRADEMARK

PRINCIPAL REGISTER

BIOFINA, INC. (CALIFORNIA CORPORATION)
1950 MARK COURT
SUITE 110
CONCORD, CA 94520

FOR: PLASTIC BAGS FOR GENERAL PURPOSE; PLASTIC BAGS FOR UNDERGARMENT DISPOSAL; PLASTIC BUBBLE PACKS; PLASTIC FOOD STORAGE BAGS FOR HOUSEHOLD USE; PLASTIC BAGS FOR HOUSEHOLD USE; PLASTIC PAGES FOR HOLDING CARDS; PLASTIC SANDWICH BAGS; PLASTIC SHEETS AND LABELS FOR WRITING, PRINTING AND MARKING; AND PLASTIC GARBAGE BAGS, IN CLASS 16 (U.S. CLS. 2, 5, 22, 23, 29, 37, 38 AND 50).

FIRST USE 8-23-2011; IN COMMERCE 8-23-2011.

FOR: PLASTIC IN THE FORM OF BARS, PELLETS, RODS, SHEETS AND TUBES FOR GENERAL INDUSTRIAL USE; PLASTIC IN EXTRUDED FORM FOR GENERAL INDUSTRIAL USE; PLASTIC IN THE FORM OF BARS, PELLETS, RODS, SHEETS AND TUBES FOR USE IN MANUFACTURING; PLASTIC PACKING FOR SHIPPING CONTAINERS; PLASTIC SHEETING FOR PREVENTING WEED GROWTH; PLASTIC SHEETING FOR USE AS DROP CLOTHS; PLASTIC TAPE FOR USE IN COMMERCIAL MANUFACTURING, IN CLASS 17 (U.S. CLS. 1, 5, 12, 13, 35 AND 50).

FIRST USE 8-23-2011; IN COMMERCE 8-23-2011.

FOR: PLASTIC GLOVES FOR HOUSEHOLD USE; PLASTIC CUPS, IN CLASS 21 (U.S. CLS. 2, 13, 23, 29, 30, 33, 40 AND 50).

FIRST USE 8-23-2011; IN COMMERCE 8-23-2011.

THE MARK CONSISTS OF STANDARD CHARACTERS WITHOUT CLAIM TO ANY PARTICULAR FONT, STYLE, SIZE, OR COLOR.

SN 85-243,951, FILED 2-16-2011.

BRIAN CALLAGHAN, EXAMINING ATTORNEY

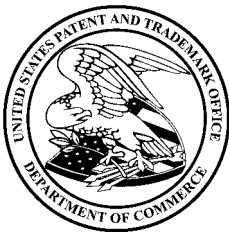

David J. Kyros

Director of the United States Patent and Trademark Office

United States of America

United States Patent and Trademark Office

OPTIONS EXPLORER

Reg. No. 4,155,083

Registered June 5, 2012

Int. Cl.: 42

SERVICE MARK

PRINCIPAL REGISTER

LARSON, GLEN J. (UNITED STATES INDIVIDUAL)
SUITE 150
4775 CENTENNIAL BLVD
COLORADO SPRINGS, CO 80919

FOR: APPLICATION SERVICE PROVIDER (ASP) FEATURING SOFTWARE FOR ELECTRONIC TRADING OF STOCKS AND FOR STOCK PORTFOLIO MANAGEMENT; APPLICATION SERVICE PROVIDER (ASP) FEATURING SOFTWARE FOR INVESTMENT ANALYSIS OF STOCKS AND CREATING INVESTMENT RISK MODELS FOR STOCKS; APPLICATION SERVICE PROVIDER (ASP) FEATURING SOFTWARE FOR PROVIDING ON-LINE ACCESS TO COMMERCIAL EXCHANGES AND MARKETS; AND COMPUTER PROGRAMMING IN THE FIELD OF BUILDING SOPHISTICATED AUTOMATED TRADING TOOLS FOR USE IN TRACKING STOCK PRICES AND STOCK OPPORTUNITIES AND MANAGING RISK, IN CLASS 42 (U.S. CLS. 100 AND 101).

FIRST USE 2-29-2012; IN COMMERCE 2-29-2012.

THE MARK CONSISTS OF STANDARD CHARACTERS WITHOUT CLAIM TO ANY PARTICULAR FONT, STYLE, SIZE, OR COLOR.

NO CLAIM IS MADE TO THE EXCLUSIVE RIGHT TO USE "OPTIONS", APART FROM THE MARK AS SHOWN.

SN 85-243,987, FILED 2-16-2011.

BILL DAWE, EXAMINING ATTORNEY



David J. Kybas

Director of the United States Patent and Trademark Office

United States of America

United States Patent and Trademark Office

SMARTGUARD

Reg. No. 4,155,084

Registered June 5, 2012

Int. Cl.: 28

TRADEMARK

PRINCIPAL REGISTER

QUBICAAMF WORLDWIDE, S.A.R.L. (LUXEMBOURG SOCIÉTÉ À RESPONSABILITÉ
LIMITÉE (SARL))
7 AVENUE GASTON DIDERICH
LUXEMBOURG, LUXEMBOURG L-1420

FOR: BOWLING PINSETTERS AND PARTS THEREFOR, IN CLASS 28 (U.S. CLS. 22, 23, 38
AND 50).

FIRST USE 9-30-2010; IN COMMERCE 2-20-2011.

THE MARK CONSISTS OF STANDARD CHARACTERS WITHOUT CLAIM TO ANY PAR-
TICULAR FONT, STYLE, SIZE, OR COLOR.

OWNER OF U.S. REG. NOS. 1,900,000 AND 2,040,903.

SN 85-244,087, FILED 2-16-2011.

JANET LEE, EXAMINING ATTORNEY



David J. Kybas

Director of the United States Patent and Trademark Office

United States of America

United States Patent and Trademark Office



Reg. No. 4,155,085

Registered June 5, 2012

Int. Cl.: 8

TRADEMARK

PRINCIPAL REGISTER

ACERO Y ARTES DE TOLEDO, S.L. (SPAIN CORPORATION)
CARRETERA MADRID-TOLEDO, KM. 62
OLIAS DEL REY (TOLEDO), SPAIN 45280

FOR: SWORDS, SABRES, DAGGERS, RAPIERS, KNIVES, AXES, MACHETES AND MACES,
IN CLASS 8 (U.S. CLS. 23, 28 AND 44).

FIRST USE 2-28-2011; IN COMMERCE 2-28-2011.

THE MARK CONSISTS OF THE LITERAL ELEMENT "BERMEJO" DISPLAYED USING A SANS-SERIF FONT-TYPE. THE LETTERS "E" IN "BERMEJO" ARE DEPICTED AS TO RESEMBLE TWO SWORDS POINTING DOWNWARD AND CROSSING IN THE MIDDLE. ANOTHER STYLIZED SWORD APPEARS PARALLEL AND ABOVE THE WORD "BERMEJO" WITH A DOT DISPLAYED ON ITS RIGHT. A DOT APPEARS IN THE LETTER "B" AND "J" IN "BERMEJO".

THE ENGLISH TRANSLATION OF "BERMEJO" IN THE MARK IS "REDDISH".

SN 85-244,129, FILED 2-16-2011.

MARK SPARACINO, EXAMINING ATTORNEY



David J. Kyffers

Director of the United States Patent and Trademark Office

United States of America
United States Patent and Trademark Office

MAD GRIP

Reg. No. 4,155,086

Registered June 5, 2012

Int. Cls.: 21 and 28

TRADEMARK

PRINCIPAL REGISTER

GORDINI U.S.A. INC. (VERMONT CORPORATION)
67 ALLEN MARTIN DRIVE
ESSEX JUNCTION, VT 05452

FOR: WORK GLOVES; GARDENING GLOVES; GLOVES FOR HOUSEHOLD PURPOSES;
LIGHT DUTY UTILITY GLOVES, IN CLASS 21 (U.S. CLS. 2, 13, 23, 29, 30, 33, 40 AND 50).

FIRST USE 6-9-2010; IN COMMERCE 6-9-2010.

FOR: FOOTBALL GLOVES, KAYAK GLOVES, WINDSURFING GLOVES, IN CLASS 28
(U.S. CLS. 22, 23, 38 AND 50).

FIRST USE 6-0-2010; IN COMMERCE 6-0-2010.

THE MARK CONSISTS OF STANDARD CHARACTERS WITHOUT CLAIM TO ANY PAR-
TICULAR FONT, STYLE, SIZE, OR COLOR.

OWNER OF U.S. REG. NO. 3,828,668.

NO CLAIM IS MADE TO THE EXCLUSIVE RIGHT TO USE "GRIP", APART FROM THE
MARK AS SHOWN.

SN 85-244,263, FILED 2-16-2011.

KATHLEEN LORENZO, EXAMINING ATTORNEY



David J. Kybas

Director of the United States Patent and Trademark Office

United States of America

United States Patent and Trademark Office

GUIDEMARK

Reg. No. 4,155,087

Registered June 5, 2012

Int. Cl.: 36

SERVICE MARK

PRINCIPAL REGISTER

GENWORTH FINANCIAL WEALTH MANAGEMENT, INC. (CALIFORNIA CORPORATION)
2300 CONTRA COSTA BOULEVARD
SUITE 425
PLEASANT HILL, CA 94523

FOR: FINANCIAL SERVICES, NAMELY, MUTUAL FUND INVESTMENT SERVICES, INVESTMENT ADVISORY SERVICES, WEALTH MANAGEMENT AND FINANCIAL PLANNING SERVICES, AND INVESTMENT CONSULTATION AND ASSET ALLOCATION SERVICES, IN CLASS 36 (U.S. CLS. 100, 101 AND 102).

FIRST USE 3-3-2011; IN COMMERCE 3-3-2011.

THE MARK CONSISTS OF STANDARD CHARACTERS WITHOUT CLAIM TO ANY PARTICULAR FONT, STYLE, SIZE, OR COLOR.

SN 85-244,530, FILED 2-17-2011.

LINDA M. KING, EXAMINING ATTORNEY



David J. Kybas

Director of the United States Patent and Trademark Office

United States of America

United States Patent and Trademark Office

GUIDEPATH

Reg. No. 4,155,088

Registered June 5, 2012

Int. Cl.: 36

SERVICE MARK

PRINCIPAL REGISTER

GENWORTH FINANCIAL WEALTH MANAGEMENT, INC. (CALIFORNIA CORPORATION)
2300 CONTRA COSTA BOULEVARD
SUITE 425
PLEASANT HILL, CA 94523

FOR: FINANCIAL SERVICES, NAMELY, MUTUAL FUND INVESTMENT SERVICES, INVESTMENT ADVISORY SERVICES, WEALTH MANAGEMENT AND FINANCIAL PLANNING SERVICES, AND INVESTMENT CONSULTATION AND ASSET ALLOCATION SERVICES, IN CLASS 36 (U.S. CLS. 100, 101 AND 102).

FIRST USE 3-29-2011; IN COMMERCE 3-29-2011.

THE MARK CONSISTS OF STANDARD CHARACTERS WITHOUT CLAIM TO ANY PARTICULAR FONT, STYLE, SIZE, OR COLOR.

SN 85-244,533, FILED 2-17-2011.

LINDA M. KING, EXAMINING ATTORNEY



David J. Kybas

Director of the United States Patent and Trademark Office

United States of America

United States Patent and Trademark Office

CLEARPATH

Reg. No. 4,155,089

Registered June 5, 2012

Int. Cl.: 12

TRADEMARK

PRINCIPAL REGISTER

BRODA ENTERPRISES INC. (CANADA CORPORATION)
560 BINGEMANS CENTRE DRIVE
KITCHENER, ONTARIO, CANADA N2B3X9

FOR: HEALTHCARE SEATING AND MOBILITY DEVICES, NAMELY, WHEELED CHAIRS,
IN CLASS 12 (U.S. CLS. 19, 21, 23, 31, 35 AND 44).

FIRST USE 6-3-2011; IN COMMERCE 6-24-2011.

THE MARK CONSISTS OF STANDARD CHARACTERS WITHOUT CLAIM TO ANY PAR-
TICULAR FONT, STYLE, SIZE, OR COLOR.

PRIORITY CLAIMED UNDER SEC. 44(D) ON CANADA APPLICATION NO. 1,512,216, FILED
1-21-2011.

SN 85-244,657, FILED 2-17-2011.

JEFFREY LOOK, EXAMINING ATTORNEY



David J. Kybas

Director of the United States Patent and Trademark Office

United States of America

United States Patent and Trademark Office

Woofie Cushion

Reg. No. 4,155,090

Registered June 5, 2012

Int. Cl.: 28

TRADEMARK

PRINCIPAL REGISTER

MULTIPET INTERNATIONAL, INC. (NEW JERSEY CORPORATION)
265 WEST COMMERCIAL AVENUE
MOONACHIE, NJ 07074

FOR: PET TOYS, IN CLASS 28 (U.S. CLS. 22, 23, 38 AND 50).

FIRST USE 2-29-2012; IN COMMERCE 2-29-2012.

THE MARK CONSISTS OF STANDARD CHARACTERS WITHOUT CLAIM TO ANY PARTICULAR FONT, STYLE, SIZE, OR COLOR.

NO CLAIM IS MADE TO THE EXCLUSIVE RIGHT TO USE "CUSHION", APART FROM THE MARK AS SHOWN.

SN 85-244,943, FILED 2-17-2011.

BENJAMIN OKEKE, EXAMINING ATTORNEY



David J. Kybas

Director of the United States Patent and Trademark Office

United States of America
United States Patent and Trademark Office

EXQUINA

Reg. No. 4,155,091

VITALICO LLC (CALIFORNIA LIMITED LIABILITY COMPANY)
4111 KINGRIDGE DRIVE
SAN MATEO, CA 94403

Registered June 5, 2012

Int. Cl.: 30

FOR: FOOD THICKENING AND BINDING AGENTS MADE OF NATURAL PLANT INGREDIENTS, IN CLASS 30 (U.S. CL. 46).

TRADEMARK

FIRST USE 2-0-2008; IN COMMERCE 2-0-2008.

PRINCIPAL REGISTER

THE MARK CONSISTS OF STANDARD CHARACTERS WITHOUT CLAIM TO ANY PARTICULAR FONT, STYLE, SIZE, OR COLOR.

SN 85-245,150, FILED 2-17-2011.

DOUGLAS LEE, EXAMINING ATTORNEY



David J. Kyffers

Director of the United States Patent and Trademark Office

United States of America

United States Patent and Trademark Office

ANTI-FRIZZ BY YUKO

Reg. No. 4,155,092

PHITEN USA, INC. (CALIFORNIA CORPORATION)
980 KNOX STREET
TORRANCE, CA, CA 90502

Registered June 5, 2012

Int. Cl.: 3

FOR: HAIR RELAXING PREPARATIONS, NAMELY, HAIR RELAXING SOLUTIONS, HAIR SHAMPOO, HAIR RINSES, HAIR CONDITIONER AND NON-MEDICATED HAIR TREATMENT PREPARATIONS FOR COSMETIC PURPOSES , IN CLASS 3 (U.S. CLS. 1, 4, 6, 50, 51 AND 52).

TRADEMARK

PRINCIPAL REGISTER

FIRST USE 1-28-2012; IN COMMERCE 1-28-2012.

THE MARK CONSISTS OF STANDARD CHARACTERS WITHOUT CLAIM TO ANY PARTICULAR FONT, STYLE, SIZE, OR COLOR.

NO CLAIM IS MADE TO THE EXCLUSIVE RIGHT TO USE "ANTI-FRIZZ", APART FROM THE MARK AS SHOWN.

THE NAME(S), PORTRAIT(S), AND/OR SIGNATURE(S) SHOWN IN THE MARK IDENTIFIES "YUKO", WHOSE CONSENT(S) TO REGISTER IS MADE OF RECORD.

SN 85-245,459, FILED 2-17-2011.

SIMON TENG, EXAMINING ATTORNEY



David J. Kyros

Director of the United States Patent and Trademark Office

United States of America

United States Patent and Trademark Office

Diet Exchange

Reg. No. 4,155,093

Registered June 5, 2012

Int. Cl.: 35

SERVICE MARK

PRINCIPAL REGISTER

GSENSE INC. (NEVADA CORPORATION)
555 PLEASANTVILLE ROAD N106
BRIARCLIFF MANOR, NY 10510

FOR: AD SERVING, NAMELY, PLACING ADVERTISEMENTS ON WEBSITES FOR OTHERS USING SPECIALIZED COMPUTER SOFTWARE; ADVERTISEMENT AND PUBLICITY SERVICES BY TELEVISION, RADIO, MAIL; ADVERTISEMENT FOR OTHERS ON THE INTERNET; ADVERTISEMENT HOARDING RENTAL; ADVERTISEMENT VIA MOBILE PHONE NETWORKS; ADVERTISING AGENCIES; ADVERTISING AGENCIES PROVIDING THE STRATEGY, DESIGN AND EXECUTION OF PROGRAMS TO PROMOTE BUSINESSES IN THE FOOD AND FOODSERVICE INDUSTRIES; ADVERTISING AGENCIES, NAMELY, PROMOTING THE GOODS AND SERVICES OF OTHERS; ADVERTISING AGENCIES, NAMELY, PROMOTING HEALTH PRODUCTS THROUGH THE DISTRIBUTION OF PRINTED AND AUDIO PROMOTIONAL MATERIALS AND BY RENDERING SALES PROMOTION ADVICE; ADVERTISING AGENCY SPECIALIZING IN THE DESIGN AND EXECUTION OF WORD OF MOUTH, VIRAL, BUZZ AND EXPERIENTIAL MARKETING PROGRAMS; ADVERTISING AND ADVERTISEMENT SERVICES; ADVERTISING AND BUSINESS ADVICE RELATING TO TELEMATICS' SERVICES; ADVERTISING AND BUSINESS MANAGEMENT CONSULTANCY; ADVERTISING AND BUSINESS SERVICES, NAMELY, PROVIDING AN ONLINE WEBSITE WHERE ADVERTISERS, MARKETERS, AND CONTENT PROVIDERS CAN INTERACT WITH USERS FOR ADVERTISING, BRANDING, AND PROMOTING KNOWLEDGE, PRODUCTS, AND SERVICES, AND TRADESHOWS, ON BEHALF OF THEMSELVES AND OTHERS, AND FOR EVALUATING AND RATING THE SAME, ALL THE FOREGOING RELEVANT TO HUMAN ACTIVITIES AFFECTING CLIMATE CHANGE AND RELATED FIELDS; ADVERTISING AND BUSINESS SERVICES, NAMELY, SECURING AIRTIME ON ALL FORMS OF MEDIA COMMUNICATIONS STATIONS, SYSTEMS, NETWORKS, AND SERVICES FOR THE PURPOSE OF PROMOTING THE GOODS AND SERVICES OF OTHERS; ADVERTISING AND COMMERCIAL INFORMATION SERVICES, VIA THE INTERNET; ADVERTISING AND DIRECTORY SERVICES, NAMELY, PROMOTING THE SERVICES OF OTHERS BY PROVIDING A WEB PAGE FEATURING LINKS TO THE WEBSITES OF OTHERS; ADVERTISING AND MARKETING; ADVERTISING AND MARKETING CONSULTANCY; ADVERTISING AND MARKETING SERVICES PROVIDED BY MEANS OF INDIRECT METHODS OF MARKETING COMMUNICATIONS, NAMELY, SOCIAL MEDIA, SEARCH ENGINE MARKETING, INQUIRY MARKETING, INTERNET MARKETING, MOBILE MARKETING, BLOGGING AND OTHER FORMS OF PASSIVE, SHARABLE OR VIRAL COMMUNICATIONS CHANNELS; ADVERTISING AND MARKETING SERVICES, NAMELY, PROMOTING THE GOODS AND SERVICES OF OTHERS; ADVERTISING AND



David J. Kyros

Director of the United States Patent and Trademark Office

Reg. No. 4,155,093 PROMOTING THE GOODS AND SERVICES OF A VISUAL ARTIST; ADVERTISING AND PROMOTION SERVICES AND RELATED CONSULTING; ADVERTISING AND PROMOTIONAL SERVICES; ADVERTISING AND PUBLICITY SERVICES; ADVERTISING AND PUBLICITY SERVICES, NAMELY, PROMOTING THE GOODS, SERVICES, BRAND IDENTITY AND COMMERCIAL INFORMATION AND NEWS OF THIRD PARTIES THROUGH PRINT, AUDIO, VIDEO, DIGITAL AND ON-LINE MEDIUM; ADVERTISING BUSINESS ESPECIALLY IN THE FIELD OF TELEMATIC AND TELEPHONE NETWORKS; ADVERTISING BY TRANSMISSION OF ON-LINE PUBLICITY FOR THIRD PARTIES THROUGH ELECTRONIC COMMUNICATIONS NETWORKS; ADVERTISING CONSULTATION; ADVERTISING COPYWRITING; ADVERTISING FLYER DISTRIBUTION; ADVERTISING IN PERIODICALS, BROCHURES AND NEWSPAPERS; ADVERTISING IN THE POPULAR AND PROFESSIONAL PRESS; ADVERTISING OF COMMERCIAL OR RESIDENTIAL REAL ESTATE; ADVERTISING OF THE PUBLISHED TEXTS OF OTHERS; ADVERTISING ON THE INTERNET FOR OTHERS; ADVERTISING PARTICULARLY SERVICES FOR THE PROMOTION OF GOODS; ADVERTISING RELATING TO PHARMACEUTICAL PRODUCTS AND IN-VIVO IMAGING PRODUCTS; ADVERTISING RELATING TO TRANSPORT AND DELIVERY; ADVERTISING SERVICES; ADVERTISING SERVICES FOR PROMOTING THE BROKERAGE OF STOCKS AND OTHER SECURITIES; ADVERTISING SERVICES OF A RADIO AND TELEVISION ADVERTISING AGENCY; ADVERTISING SERVICES RELATING TO SANDWICHES; ADVERTISING SERVICES, FOR THIRD PARTIES, IN CONNECTION WITH THE COMMERCIALIZATION AND SALE OF PERFUMERY AND COSMETIC ARTICLES, PRODUCTS FOR HOUSEHOLD PURPOSES, OPTICAL PRODUCTS, CLOCKS AND TIMEPIECES, JEWELLERY, FURNISHING ARTICLES; ADVERTISING SERVICES, NAMELY, COST-PER-ACTION ON-LINE ADVERTISING; ADVERTISING SERVICES, NAMELY, CREATING CORPORATE AND BRAND IDENTITY FOR OTHERS; ADVERTISING SERVICES, NAMELY, CREATING CORPORATE LOGOS FOR OTHERS; ADVERTISING SERVICES, NAMELY, CREATING PROMOTIONAL MURALS AND PAINTING SIGNS AND WALLS ADVERTISING THE GOODS AND SERVICES OF OTHERS; ADVERTISING SERVICES, NAMELY, PRODUCTION OF SPECIAL EFFECTS INCLUDING MODEL-MAKING SERVICES, COMPUTER-GENERATED IMAGERY AND COMPUTER-GENERATED GRAPHICS FOR THE PRODUCTION OF COMMERCIALS; ADVERTISING SERVICES, NAMELY, PROMOTING AND MARKETING THE GOODS AND SERVICES OF OTHERS IN THE FIELD OF UPSCALE CHOICES SUCH AS CULTURAL EVENTS, RESTAURANTS, SHOPPING, AND TRAVEL VIA PRINT AND ELECTRONIC MEDIA; ADVERTISING SERVICES, NAMELY, PROMOTING AND MARKETING THE GOODS AND SERVICES OF OTHERS THROUGH ALL PUBLIC COMMUNICATION MEANS; ADVERTISING SERVICES, NAMELY, PROMOTING CAR DEALERSHIPS OF OTHERS; ADVERTISING SERVICES, NAMELY, PROMOTING PROPERTIES FOR SALE BY OWNER VIA THE INTERNET; ADVERTISING SERVICES, NAMELY, PROMOTING THE BOOKS OF OTHERS IN THE FIELD OF LAW BY MEANS OF NEWS AND REVIEWS REGARDING SAME; ADVERTISING SERVICES, NAMELY, PROMOTING THE BRANDS, GOODS AND SERVICES OF OTHERS; ADVERTISING SERVICES, NAMELY, PROMOTING THE FOOD AND WINE OF OTHERS; ADVERTISING SERVICES, NAMELY, PROMOTING THE GIFT CARDS OF OTHERS; ADVERTISING SERVICES, NAMELY, PROMOTING THE POWER SPORTS DEALERSHIPS OF OTHERS; ADVERTISING SERVICES, NAMELY, PROMOTING THE SANDWICHES OF OTHERS; ADVERTISING SERVICES, NAMELY, PROVIDING A WEBSITE FOR THE PROMOTION OF THE BOOKS OF OTHERS IN THE FIELD OF LAW, INCLUDING NEWS AND REVIEWS REGARDING SAME; ADVERTISING SERVICES, NAMELY, PROVIDING ADVERTISING SPACE IN A PERIODICAL; ADVERTISING SERVICES, NAMELY, PROVIDING INFORMATION AS TO THE AVAILABILITY OF INFORMATIONAL PRODUCTS FOR RENT OR PURCHASE; ADVERTISING SERVICES, PUBLIC RELATIONS AND MARKETING SERVICES, NAMELY, PROMOTING AND MARKETING THE GOODS AND SERVICES OF OTHERS THROUGH ALL PUBLIC COMMUNICATION MEANS; ADVERTISING TEXT PUBLICATION SERVICES; ADVERTISING THE SERVICES OF OTHERS VIA WEB PAGES OPTIMIZED FOR ONLINE SEARCH ENGINES; ADVERTISING THROUGH ALL PUBLIC COMMUNICATION MEANS; ADVERTISING VIA ELECTRONIC MEDIA AND SPECIFICALLY THE INTERNET; ADVERTISING, INCLUDING ON-LINE ADVERTISING ON A COMPUTER NETWORK; ADVERTISING, INCLUDING PROMOTION OF PRODUCTS AND SERVICES OF THIRD PARTIES THROUGH SPONSORING

Reg. No. 4,155,093 ARRANGEMENTS AND LICENSE AGREEMENTS RELATING TO INTERNATIONAL SPORTS EVENTS; ADVERTISING, INCLUDING PROMOTION RELATING TO THE SALE OF ARTICLES AND SERVICES FOR THIRD PARTIES BY THE TRANSMISSION OF ADVERTISING MATERIAL AND THE DISSEMINATION OF ADVERTISING MESSAGES ON COMPUTER NETWORKS; ADVERTISING, MARKETING AND PROMOTING THE GOODS AND SERVICES OF OTHERS USING KIOSKS; ADVERTISING, MARKETING AND PROMOTION SERVICES; ADVERTISING, MARKETING AND PROMOTION SERVICES, NAMELY, PROMOTING THE GOODS AND SERVICES OF OTHERS BY PROVIDING CUSTOMIZED EXHIBITS; ADVERTISING, MARKETING AND PROMOTIONAL SERVICES FOR AUTOMOTIVE DEALERSHIPS; ADVERTISING, MARKETING AND PROMOTIONAL SERVICES FOR LIGHT AND HEAVY EQUIPMENT DEALERSHIPS; ADVERTISING, MARKETING AND PROMOTIONAL SERVICES FOR THE DONATION OF HUMAN BLOOD THAT EXACTLY MATCHES THE BLOOD TYPE OF INDIVIDUALS NEEDING TRANSFUSIONS; ADVERTISING, MARKETING AND PROMOTIONAL SERVICES RELATED TO ALL INDUSTRIES FOR THE PURPOSE OF FACILITATING NETWORKING AND SOCIALIZING OPPORTUNITIES FOR BUSINESS PURPOSES; ADVERTISING, PROMOTION AND MARKETING SERVICES BASED ON CONSUMER CREDIT REPORTS AND SCORES OF OTHERS; ADVERTISING, PROMOTION AND MARKETING SERVICES IN THE NATURE OF E-MAIL BLAST CAMPAIGNS FOR OTHERS; AGENCIES FOR ADVERTISING TIME AND SPACE; ANALYSIS OF ADVERTISING RESPONSE; ARRANGING AND CONDUCTING OF FAIRS AND EXHIBITIONS FOR BUSINESS AND ADVERTISING PURPOSES; ARRANGING AND CONDUCTING SPECIAL EVENTS FOR COMMERCIAL, PROMOTIONAL OR ADVERTISING PURPOSES; BANNER ADVERTISING; BUSINESS MANAGEMENT AND CONSULTING SERVICES FOR THE HEALTH CARE INDUSTRY, NAMELY, CUSTOMER SERVICE, ACCOUNTING SERVICES, AND WEB-BASED ADVERTISING AND MARKETING SERVICES; BUSINESS SERVICES, NAMELY, TRACKING AND MONITORING OF CALLS FOR OTHERS IN RESPONSE TO ADVERTISING ADS; CINEMA ADVERTISING; CLASSIFIED ADVERTISING SERVICES; COMPILATION OF ADVERTISEMENTS FOR USE AS WEB PAGES ON THE INTERNET; COMPILATION, PRODUCTION AND DISSEMINATION OF ADVERTISING MATTER; CONDUCTING, ARRANGING AND ORGANIZING TRADE SHOWS AND TRADE FAIRS FOR COMMERCIAL AND ADVERTISING PURPOSES; CONSUMER LOYALTY SERVICES FOR COMMERCIAL, PROMOTIONAL, AND/OR ADVERTISING PURPOSES, NAMELY, ADMINISTRATION OF FREQUENT FLYER PROGRAM THAT ALLOWS MEMBERS TO REDEEM MILES FOR POINTS OR AWARDS OFFERED BY OTHER LOYALTY PROGRAMS; COOPERATIVE ADVERTISING AND MARKETING; COOPERATIVE ADVERTISING AND MARKETING SERVICES BY WAY OF SOLICITATION, CUSTOMER SERVICE AND PROVIDING MARKETING INFORMATION VIA WEB SITES ON A GLOBAL COMPUTER NETWORK; COOPERATIVE ADVERTISING AND MARKETING SERVICES, NAMELY, OFFERING DISCOUNTS TO CLIENTS THROUGH THE JOINT PARTICIPATION OF MEMBER BEAUTY SALONS.; CREATING AND UPDATING ADVERTISING MATERIAL; CREATION OF MARKETING TOOLS DESIGNED TO INCREASE A CLIENT COMPANY'S KNOWLEDGE OF CUSTOMER NEEDS, AND ITS COMPETITORS' PRODUCTS AND SERVICES, PRICING, ADVERTISING STRATEGY AND SALES STRATEGY; CUSTOMER LOYALTY SERVICES AND CUSTOMER CLUB SERVICES, FOR COMMERCIAL, PROMOTIONAL AND/OR ADVERTISING PURPOSES; DESIGN OF ADVERTISING BROCHURES FOR OTHERS; DESIGN OF ADVERTISING FLYERS FOR OTHERS; DESIGN OF ADVERTISING MATERIALS FOR OTHERS; DESIGN OF INTERNET ADVERTISING; DEVELOPING ADVERTISING CAMPAIGNS FOR OTHERS GEARED TOWARD ENVIRONMENTAL ISSUES; DEVELOPMENT, OPERATION AND ADMINISTRATION OF DIGITAL SIGNAGE SYSTEMS AND DIGITAL ADVERTISING SYSTEMS FOR OTHERS, NAMELY, PROVIDING ADVERTISING SPACE BY ELECTRONIC MEANS AND GLOBAL COMPUTER INFORMATION NETWORKS; DIRECT MAIL ADVERTISING SERVICES; DIRECT MARKETING ADVERTISING FOR OTHERS; DISPLAYING ADVERTISEMENTS FOR OTHERS; DISSEMINATION OF ADVERTISEMENTS; DISSEMINATION OF ADVERTISEMENTS AND OF ADVERTISING MATERIAL; DISSEMINATION OF ADVERTISING FOR OTHERS VIA AN ON-LINE COMMUNICATIONS NETWORK ON THE INTERNET; DISSEMINATION OF ADVERTISING FOR OTHERS VIA PUBLIC AND PRIVATE WIRELESS NETWORKS FOR DISPLAY ON MOBILE DEVICES; DISSEMINATION OF ADVERTISING FOR OTHERS VIA THE INTERNET; DISSEMINATION

Reg. No. 4,155,093 OF ADVERTISING MATERIAL; DISSEMINATION OF ADVERTISING MATTER; DISSEMINATION OF ADVERTISING, SCHEDULING AND MANAGING OF TRAINING COURSES AND PROGRAMS FOR OTHERS VIA A GLOBAL COMPUTER NETWORK; DISSEMINATION SERVICES OF ADVERTISEMENT MATTER; DISTRIBUTION AND DISSEMINATION OF ADVERTISING MATERIALS; DISTRIBUTION OF ADVERTISEMENTS AND COMMERCIAL ANNOUNCEMENTS; DISTRIBUTION OF ADVERTISING MAIL AND OF ADVERTISING SUPPLEMENTS ATTACHED TO REGULAR EDITIONS; DISTRIBUTION OF ADVERTISING MATERIAL; DISTRIBUTION OF ADVERTISING MATERIALS; DISTRIBUTION OF PRODUCTS FOR ADVERTISING PURPOSES; ELECTRONIC BILLBOARD ADVERTISING; ELECTRONIC COMMERCE SERVICES, NAMELY, PROVIDING INFORMATION ABOUT PRODUCTS VIA TELECOMMUNICATION NETWORKS FOR ADVERTISING AND SALES PURPOSES; ENTERTAINMENT MARKETING SERVICES, NAMELY, MARKETING, PROMOTION AND ADVERTISING FOR INDEPENDENT RECORDING ARTISTS; ENTERTAINMENT MARKETING SERVICES, NAMELY, MARKETING, PROMOTION AND ADVERTISING FOR RECORDING AND PERFORMING ARTISTS; EVENT PLANNING AND MANAGEMENT FOR MARKETING, BRANDING, PROMOTING OR ADVERTISING THE GOODS AND SERVICES OF OTHERS; INTERNATIONAL BUSINESS CONSULTING SERVICES RELATING TO MERCHANDISE TRADING, HUMAN RESOURCE INTERCHANGE, MANAGEMENT SUPPORT, MARKETING, ADVERTISING, PROMOTION, AND DOMESTIC AND INTERNATIONAL MARKET RESEARCH AND DEVELOPMENT; INTERNET ADVERTISING SERVICES; ISSUING AND UPDATING OF ADVERTISING TEXTS; LAYOUT SERVICES FOR ADVERTISING PURPOSES; MANAGEMENT OF ADVERTISING THROUGH A COMMAND AND CONTROL CENTER FOR BOTH MOVIE THEATRE ON-SCREEN ADVERTISING AND OVER THE INTERNET; MARKETING AND ADVERTISING SERVICES FOR AUTOMOBILE DEALERSHIPS; MARKETING, ADVERTISING AND PROMOTING THE GOODS AND SERVICES OF OTHERS IN THE FIELD OF TRAVEL AND TOURISM, NAMELY, PROVIDING INFORMATION VIA MAIL AND ELECTRONIC MAIL; MARKETING, ADVERTISING, AND PROMOTING THE RETAIL GOODS AND SERVICES OF OTHERS TO WIRELESS ELECTRONIC DEVICES; MARKETING, PROMOTIONAL AND ADVERTISING SERVICES PROVIDED BY MOBILE TELEPHONE CONNECTIONS; MEDIA BUYING ADVICE, NAMELY, ADVISING THE CLIENT HOW MUCH MEDIA TIME, AND AT WHAT TIMES THE CLIENT SHOULD BE PURCHASING ADVERTISING; MEDIA PLANNING, NAMELY, ADVISING THE CLIENT ON THE CORRECT TIMES AND STATIONS TO ADVERTISE BASED ON MEDIA ANALYSIS OF THE MARKET FOR THAT MEDIA; MEDIA PRODUCTION LOCATION SCOUTING SERVICES FOR ADVERTISING PURPOSES; MEDIATION OF ADVERTISING; MODELING FOR ADVERTISING OR SALES PROMOTION; MODELING SERVICES FOR ADVERTISING OR SALES PROMOTION; MUSIC SELECTION SERVICES FOR USE IN ADVERTISING; ON-LINE ADVERTISING AND MARKETING SERVICES; ON-LINE ADVERTISING ON COMPUTER COMMUNICATION NETWORKS; ON-LINE ADVERTISING ON COMPUTER NETWORKS; ON-LINE ADVERTISING SERVICES FOR OTHERS; ONLINE ADVERTISEMENTS; ONLINE ADVERTISING AND PROMOTIONAL SERVICES; ONLINE ADVERTISING VIA A COMPUTER COMMUNICATIONS NETWORK; ORGANISATION AND HOLDING OF FAIRS FOR COMMERCIAL OR ADVERTISING PURPOSES; ORGANISATION OF EXHIBITIONS AND EVENTS FOR COMMERCIAL OR ADVERTISING PURPOSES; ORGANISATION OF EXHIBITIONS FOR COMMERCIAL OR ADVERTISING PURPOSES; ORGANISING EXHIBITIONS FOR COMMERCIAL OR ADVERTISING PURPOSES; ORGANIZATION OF EVENTS, EXHIBITIONS, FAIRS AND SHOWS FOR COMMERCIAL, PROMOTIONAL AND ADVERTISING PURPOSES; ORGANIZATION OF EXHIBITIONS FOR COMMERCIAL OR ADVERTISING PURPOSES; ORGANIZATION OF FAIRS AND EXHIBITIONS FOR COMMERCIAL AND ADVERTISING PURPOSES; ORGANIZATION OF FAIRS FOR COMMERCIAL AND ADVERTISING PURPOSES; ORGANIZING BUSINESS EXPOSITIONS FOR HEALTH PRODUCTS; ORGANIZING EXHIBITIONS FOR COMMERCIAL OR ADVERTISING PURPOSES; OUT-OF-HOME ADVERTISING SERVICES, NAMELY, RENTAL OF ADVERTISING SPACE, AND PREPARING AND PLACING ADVERTISEMENTS FOR OTHERS; PAY PER CLICK (PPC) ADVERTISING MANAGEMENT SERVICES; PLACING ADVERTISEMENTS FOR OTHERS; PLANNING AND CONDUCTING OF TRADE FAIRS, EXHIBITIONS AND PRESENTATIONS FOR ECONOMIC OR ADVERTISING PURPOSES; PREPARATION AND REALIZATION OF MEDIA AND ADVERTISING PLANS AND CON-

Reg. No. 4,155,093 CEPTS; PREPARATION OF CUSTOM ADVERTISEMENTS FOR OTHERS; PREPARATION OF CUSTOM OR NON-CUSTOM ADVERTISING FOR BUSINESSES FOR DISSEMINATION VIA THE WEB, CD OR DVD FOR OPTIONAL UPLOAD OR DOWNLOAD TO A COMPUTER; PREPARING ADVERTISEMENTS FOR OTHERS; PREPARING ADVERTISEMENTS FOR OTHERS, NAMELY, PREPARING VIDEO ADVERTISING AND PROMOTIONAL VIDEOS FOR COMMERCIAL USE VIA THE INTERNET AND TELEVISION, DIGITAL CABLE AND VIDEO-ON-DEMAND OR DOWNLOAD; PREPARING AND PLACING ADVERTISEMENTS FOR OTHERS; PREPARING AND PLACING OF ADVERTISEMENTS; PREPARING AND PLACING OUTDOOR ADVERTISEMENTS FOR OTHERS; PREPARING AUDIOVISUAL PRESENTATIONS FOR USE IN ADVERTISING; PREPARING SPEECHES AND ORAL PRESENTATIONS FOR OTHERS FOR USE IN ADVERTISING; PROCESSING TELEPHONE INQUIRIES REGARDING ADVERTISED GOODS AND SERVICES; PRODUCTION OF ADVERTISING MATTER AND COMMERCIALS; PRODUCTION OF FILM AND TELEVISION ADVERTISING; PROMOTING AND MARKETING THE GOODS AND SERVICES OF OTHERS BY DISTRIBUTING ADVERTISING MATERIAL, COUPONS AND DISCOUNT OFFERS VIA TEXT MESSAGES; PROMOTING AND SHOWCASING THE GOODS OF OTHERS IN THE FIELD OF HEALTH PRODUCTS BY MEANS OF AN ON-LINE SHOPPING SITE WITH LINKS TO THE RETAIL ADVERTISEMENTS OF OTHERS; PROMOTING THE GOODS AND SERVICES OF OTHERS BY DISTRIBUTING ADVERTISING MATERIALS THROUGH A VARIETY OF METHODS; PROMOTING THE GOODS AND SERVICES OF OTHERS BY MEANS OF DISTRIBUTING ADVERTISING ON THE INTERNET; PROMOTING THE GOODS AND SERVICES OF OTHERS BY PREPARING AND PLACING ADVERTISEMENTS IN AN ELECTRONIC MAGAZINE ACCESSED THROUGH A GLOBAL COMPUTER NETWORK; PROMOTING, ADVERTISING AND MARKETING OF THE BRANDS, PRODUCTS, SERVICES OR ONLINE WEBSITES OF INDIVIDUALS, BUSINESSES AND NONPROFIT ORGANIZATIONS; PROMOTING, ADVERTISING AND MARKETING OF THE ON-LINE WEB SITES OF OTHERS; PROMOTING, ADVERTISING AND MARKETING THE ON-LINE DATABASES AND ELECTRONIC PUBLICATIONS OF OTHERS; PROMOTION, ADVERTISING AND MARKETING OF ON-LINE WEBSITES; PROMOTIONAL SERVICES, NAMELY, DISTRIBUTION OF ADVERTISING FLYERS, COUPONS, CATALOGS AND PROMOTIONAL ITEMS OF OTHERS; PROVIDING A SEARCHABLE ON-LINE ADVERTISING WEBSITE AND GUIDE FEATURING THE GOODS AND SERVICES OF OTHER VENDORS VIA THE INTERNET; PROVIDING A SEARCHABLE ONLINE ADVERTISING GUIDE FEATURING THE GOODS AND SERVICES OF ONLINE VENDORS; PROVIDING A SEARCHABLE ONLINE ADVERTISING GUIDE FEATURING THE GOODS AND SERVICES OF OTHER ON-LINE VENDORS ON THE INTERNET; PROVIDING A SEARCHABLE ONLINE ADVERTISING WEBSITE AND INFORMATIONAL GUIDE FEATURING THE GOODS AND SERVICES OF OTHER VENDORS VIA THE INTERNET IN THE FIELD OF HEALTH PRODUCTS; PROVIDING A WEB SITE AT WHICH FITNESS PROFESSIONALS AND FACILITIES CAN POST PROMOTIONAL PROFILES AND RESPOND TO ADVERTISEMENTS FOR THEIR SERVICES; PROVIDING A WEB SITE WHERE USERS CAN POST ITEMS FOR SALE THROUGH ON-LINE CLASSIFIED ADVERTISEMENTS; PROVIDING A WEB SITE WHICH FEATURES ADVERTISEMENTS FOR THE GOODS AND SERVICES OF OTHERS ON A GLOBAL COMPUTER NETWORK; PROVIDING ADVERTISING AND ADVERTISEMENT SERVICES; PROVIDING ADVERTISING SERVICE TO DISTRIBUTE ADVERTISEMENTS FOR DISPLAY ON INTERNET, NAMELY, IN WEBSITES, SOCIAL CONVERSATIONS OVER THE INTERNET, E-MAILS, MICROBLOGS, BLOGS, ELECTRONIC MESSAGES, INSTANT MESSAGES, TEXT MESSAGES, MULTIMEDIA MESSAGES, SOCIAL NETWORKS, STATUS UPDATES, FORUMS, ELECTRONIC BULLETIN BOARDS; PROVIDING ADVERTISING SERVICES; PROVIDING ADVERTISING SERVICES USING 3D AND ANIMATION DESIGNS; PROVIDING ADVERTISING SPACE IN PERIODICALS, NEWSPAPERS AND MAGAZINES; PROVIDING ADVERTISING SPACE ON BILLBOARDS AND IN KIOSKS; PROVIDING ADVERTISING SPACE ON FREE-STANDING VISUAL ADVERTISING SYSTEMS FEATURING THE GOODS AND SERVICES OF OTHERS; PROVIDING ADVERTISING, MARKETING AND PROMOTIONAL SERVICES FOR THE PHARMACEUTICAL AND MEDICAL INDUSTRY; PROVIDING ADVERTISING, MARKETING AND PROMOTIONAL SERVICES FOR THE PHARMACEUTICAL AND MEDICAL PRODUCTS OF OTHERS; PROVIDING ADVERTISING, MARKETING AND PROMOTIONAL SERVICES, NAMELY, DEVELOPMENT

Reg. No. 4,155,093 OF ADVERTISING CAMPAIGNS FOR THE HEALTH INDUSTRY; PROVIDING ADVERTISING, MARKETING AND PROMOTIONAL SERVICES, NAMELY, DEVELOPMENT OF ADVERTISING CAMPAIGNS PROVIDED THROUGH CABLE TELEVISION BROADCAST, WEB CASTS, RADIO BROADCASTS, NEWSPAPERS, MAGAZINES, ONLINE BANNERS, OUTDOOR BILLBOARDS, WILD POSTINGS, BUS AND SUBWAY ADS; PROVIDING AN INTERNET WEB SITE FOR CLASSIFIED ADVERTISING TO BUY AND SELL UKRAINIAN RELATED WARES, ART, ANTIQUES, BOOKS, EMBROIDERY, COSTUMES, COLLECTIBLES, INSTRUMENTS, MEMORABILIA AND OTHER ONE-OF-A-KIND ITEMS; PROVIDING AN INTERNET WEB SITE TO ADVERTISE SERVICES OF INTEREST TO THE UKRAINIAN COMMUNITY IN THE UNITED STATES OF AMERICA AND CANADA AND TO ADVERTISE SERVICES PROVIDED BY INDIVIDUALS OF UKRAINIAN ORIGIN; PROVIDING AN INTERNET WEBSITE PORTAL FEATURING PROMOTION AND ADVERTISING FOR HOME SERVICE PROVIDERS AND PRODUCT MANUFACTURERS; PROVIDING AN ONLINE DIRECTORY INFORMATION SERVICE FEATURING INFORMATION REGARDING VEHICLES IN THE NATURE OF CLASSIFIED ADVERTISEMENTS; PROVIDING AND RENTAL OF ADVERTISING SPACE ON THE INTERNET; PROVIDING ON-LINE BUSINESS INFORMATION OF OTHERS, NAMELY, ADVERTISEMENTS OR SOLICITATIONS; PROVIDING SPACE AT A WEB SITE FOR THE ADVERTISEMENT OF THE GOODS AND SERVICES OF OTHERS; PROVIDING TELEVISION ADVERTISING FOR OTHERS; PROVISION OF ADVERTISING SPACE BY ELECTRONIC MEANS AND GLOBAL INFORMATION NETWORKS; PROVISION OF SPACE ON WEBSITES FOR ADVERTISING GOODS AND SERVICES; PUBLIC RELATIONS, ADVERTISING AND MARKETING SERVICES FOR THE TOURISM AND CONVENTION INDUSTRY, NAMELY, ORGANIZING AND HOSTING SITE INSPECTIONS AND FAMILIARIZATION TOURS FOR WHOLESALERS, TOUR OPERATORS, TRAVEL AGENTS, MEETING AND INCENTIVE TRAVEL PLANNERS AND TRAVEL MEDIA; PUBLISHING OF ADVERTISING TEXTS; REAL ESTATE ADVERTISING SERVICES; RECRUITMENT ADVERTISEMENT SERVICES, NAMELY, POSTING OF CLINICAL TRIAL NOTICES FOR THE PURPOSE OF RECRUITING PATIENTS FOR PARTICIPATION IN CLINICAL TRIALS FOR THE TESTING OF DRUGS; RENTAL OF ADVERTISEMENT SPACE AND ADVERTISING MATERIAL; RENTAL OF ADVERTISING SPACE; RENTAL OF ADVERTISING SPACE ON WEB SITES; RENTAL OF SIGNS FOR ADVERTISING PURPOSES; RENTING OF ADVERTISING SPACES; SERVICES OF ADVERTISING AGENCIES; SERVICES TO DETERMINE THE AUDIENCE AFFECTED BY ADVERTISEMENTS; SPECIAL EVENT PLANNING FOR COMMERCIAL, PROMOTIONAL OR ADVERTISING PURPOSES; SPECIALTY MERCHANDISING SERVICES, NAMELY, PROMOTING THE GOODS AND SERVICES OF OTHERS THROUGH THE DISTRIBUTION OF CUSTOMIZED ADVERTISING MATERIALS, NAMELY, PENS AND CATALOGS; TELEVISION ADVERTISING AGENCIES; VENDOR-ON-PREMISE SERVICES, NAMELY, THE ADMINISTRATION OF THE EMPLOYMENT PROCESS ON-SITE, INCLUDING RESUME REVIEW AND CHECKING, EMPLOYMENT APPLICATION ACQUISITION, ADVERTISING FOR RECRUITMENT, CONDUCT OF INTERVIEWS, AND REFERENCE CHECKING, IN CLASS 35 (U.S. CLS. 100, 101 AND 102).

FIRST USE 7-20-2011; IN COMMERCE 2-20-2012.

THE MARK CONSISTS OF STANDARD CHARACTERS WITHOUT CLAIM TO ANY PARTICULAR FONT, STYLE, SIZE, OR COLOR.

NO CLAIM IS MADE TO THE EXCLUSIVE RIGHT TO USE "DIET", APART FROM THE MARK AS SHOWN.

SN 85-245,490, FILED 2-17-2011.

DEBRA LEE, EXAMINING ATTORNEY

United States of America

United States Patent and Trademark Office

License Anything

Reg. No. 4,155,094

Registered June 5, 2012

Int. Cl.: 35

SERVICE MARK

PRINCIPAL REGISTER

GSENSE INC. (NEVADA CORPORATION)
555 PLEASANTVILLE ROAD N106
BRIARCLIFF MANOR, NY 10510

FOR: AD SERVING, NAMELY, PLACING ADVERTISEMENTS ON WEBSITES FOR OTHERS USING SPECIALIZED COMPUTER SOFTWARE; ADVERTISEMENT AND PUBLICITY SERVICES BY TELEVISION, RADIO, MAIL; ADVERTISEMENT FOR OTHERS ON THE INTERNET; ADVERTISEMENT HOARDING RENTAL; ADVERTISEMENT VIA MOBILE PHONE NETWORKS; ADVERTISING AGENCIES; ADVERTISING AGENCIES PROVIDING THE STRATEGY, DESIGN AND EXECUTION OF PROGRAMS TO PROMOTE BUSINESSES IN THE FOOD AND FOODSERVICE INDUSTRIES; ADVERTISING AGENCIES, NAMELY, PROMOTING THE GOODS AND SERVICES OF OTHERS; ADVERTISING AGENCY SPECIALIZING IN THE DESIGN AND EXECUTION OF WORD OF MOUTH, VIRAL, BUZZ AND EXPERIENTIAL MARKETING PROGRAMS; ADVERTISING AND ADVERTISEMENT SERVICES; ADVERTISING AND BUSINESS ADVICE RELATING TO TELEMATICS' SERVICES; ADVERTISING AND BUSINESS MANAGEMENT CONSULTANCY; ADVERTISING AND BUSINESS SERVICES, NAMELY, PROVIDING AN ONLINE WEBSITE WHERE ADVERTISERS, MARKETERS, AND CONTENT PROVIDERS CAN INTERACT WITH USERS FOR ADVERTISING, BRANDING, AND PROMOTING KNOWLEDGE, PRODUCTS, AND SERVICES, AND TRADESHOWS, ON BEHALF OF THEMSELVES AND OTHERS, AND FOR EVALUATING AND RATING THE SAME, ALL THE FOREGOING RELEVANT TO HUMAN ACTIVITIES AFFECTING CLIMATE CHANGE AND RELATED FIELDS; ADVERTISING AND BUSINESS SERVICES, NAMELY, SECURING AIRTIME ON ALL FORMS OF MEDIA COMMUNICATIONS STATIONS, SYSTEMS, NETWORKS, AND SERVICES FOR THE PURPOSE OF PROMOTING THE GOODS AND SERVICES OF OTHERS; ADVERTISING AND COMMERCIAL INFORMATION SERVICES, VIA THE INTERNET; ADVERTISING AND DIRECTORY SERVICES, NAMELY, PROMOTING THE SERVICES OF OTHERS BY PROVIDING A WEB PAGE FEATURING LINKS TO THE WEBSITES OF OTHERS; ADVERTISING AND MARKETING; ADVERTISING AND MARKETING CONSULTANCY; ADVERTISING AND MARKETING SERVICES PROVIDED BY MEANS OF INDIRECT METHODS OF MARKETING COMMUNICATIONS, NAMELY, SOCIAL MEDIA, SEARCH ENGINE MARKETING, INQUIRY MARKETING, INTERNET MARKETING, MOBILE MARKETING, BLOGGING AND OTHER FORMS OF PASSIVE, SHARABLE OR VIRAL COMMUNICATIONS CHANNELS; ADVERTISING AND MARKETING SERVICES, NAMELY, PROMOTING THE GOODS AND SERVICES OF OTHERS; ADVERTISING AND PROMOTING THE GOODS AND SERVICES OF A VISUAL ARTIST; ADVERTISING AND PROMOTION SERVICES AND RELATED CONSULTING; ADVERTISING AND PROMOTIONAL SERVICES; ADVERT-



David J. Kypas

Director of the United States Patent and Trademark Office

Reg. No. 4,155,094 ISING AND PUBLICITY SERVICES; ADVERTISING AND PUBLICITY SERVICES, NAMELY, PROMOTING THE GOODS, SERVICES, BRAND IDENTITY AND COMMERCIAL INFORMATION AND NEWS OF THIRD PARTIES THROUGH PRINT, AUDIO, VIDEO, DIGITAL AND ON-LINE MEDIUM; ADVERTISING BUSINESS ESPECIALLY IN THE FIELD OF TELEMATIC AND TELEPHONE NETWORKS; ADVERTISING BY TRANSMISSION OF ON-LINE PUBLICITY FOR THIRD PARTIES THROUGH ELECTRONIC COMMUNICATIONS NETWORKS; ADVERTISING CONSULTATION; ADVERTISING COPYWRITING; ADVERTISING FLYER DISTRIBUTION; ADVERTISING IN PERIODICALS, BROCHURES AND NEWSPAPERS; ADVERTISING IN THE POPULAR AND PROFESSIONAL PRESS; ADVERTISING OF COMMERCIAL OR RESIDENTIAL REAL ESTATE; ADVERTISING OF THE PUBLISHED TEXTS OF OTHERS; ADVERTISING ON THE INTERNET FOR OTHERS; ADVERTISING PARTICULARLY SERVICES FOR THE PROMOTION OF GOODS; ADVERTISING RELATING TO PHARMACEUTICAL PRODUCTS AND IN-VIVO IMAGING PRODUCTS; ADVERTISING RELATING TO TRANSPORT AND DELIVERY; ADVERTISING SERVICES; ADVERTISING SERVICES FOR PROMOTING THE BROKERAGE OF STOCKS AND OTHER SECURITIES; ADVERTISING SERVICES OF A RADIO AND TELEVISION ADVERTISING AGENCY; ADVERTISING SERVICES RELATING TO SANDWICHES; ADVERTISING SERVICES, FOR THIRD PARTIES, IN CONNECTION WITH THE COMMERCIALIZATION AND SALE OF PERFUMERY AND COSMETIC ARTICLES, PRODUCTS FOR HOUSEHOLD PURPOSES, OPTICAL PRODUCTS, CLOCKS AND TIMEPIECES, JEWELLERY, FURNISHING ARTICLES; ADVERTISING SERVICES, NAMELY, COST-PER-ACTION ON-LINE ADVERTISING; ADVERTISING SERVICES, NAMELY, CREATING CORPORATE AND BRAND IDENTITY FOR OTHERS; ADVERTISING SERVICES, NAMELY, CREATING CORPORATE LOGOS FOR OTHERS; ADVERTISING SERVICES, NAMELY, CREATING PROMOTIONAL MURALS AND PAINTING SIGNS AND WALLS ADVERTISING THE GOODS AND SERVICES OF OTHERS; ADVERTISING SERVICES, NAMELY, PRODUCTION OF SPECIAL EFFECTS INCLUDING MODEL-MAKING SERVICES, COMPUTER-GENERATED IMAGERY AND COMPUTER-GENERATED GRAPHICS FOR THE PRODUCTION OF COMMERCIALS; ADVERTISING SERVICES, NAMELY, PROMOTING AND MARKETING THE GOODS AND SERVICES OF OTHERS IN THE FIELD OF UPSCALE CHOICES SUCH AS CULTURAL EVENTS, RESTAURANTS, SHOPPING, AND TRAVEL VIA PRINT AND ELECTRONIC MEDIA; ADVERTISING SERVICES, NAMELY, PROMOTING AND MARKETING THE GOODS AND SERVICES OF OTHERS THROUGH ALL PUBLIC COMMUNICATION MEANS; ADVERTISING SERVICES, NAMELY, PROMOTING CAR DEALERSHIPS OF OTHERS; ADVERTISING SERVICES, NAMELY, PROMOTING PROPERTIES FOR SALE BY OWNER VIA THE INTERNET; ADVERTISING SERVICES, NAMELY, PROMOTING THE BOOKS OF OTHERS IN THE FIELD OF LAW BY MEANS OF NEWS AND REVIEWS REGARDING SAME; ADVERTISING SERVICES, NAMELY, PROMOTING THE BRANDS, GOODS AND SERVICES OF OTHERS; ADVERTISING SERVICES, NAMELY, PROMOTING THE FOOD AND WINE OF OTHERS; ADVERTISING SERVICES, NAMELY, PROMOTING THE GIFT CARDS OF OTHERS; ADVERTISING SERVICES, NAMELY, PROMOTING THE POWER SPORTS DEALERSHIPS OF OTHERS; ADVERTISING SERVICES, NAMELY, PROMOTING THE SANDWICHES OF OTHERS; ADVERTISING SERVICES, NAMELY, PROVIDING A WEBSITE FOR THE PROMOTION OF THE BOOKS OF OTHERS IN THE FIELD OF LAW, INCLUDING NEWS AND REVIEWS REGARDING SAME; ADVERTISING SERVICES, NAMELY, PROVIDING ADVERTISING SPACE IN A PERIODICAL; ADVERTISING SERVICES, NAMELY, PROVIDING INFORMATION AS TO THE AVAILABILITY OF MULTIMEDIA PRODUCTS FOR RENT OR PURCHASE; ADVERTISING SERVICES, PUBLIC RELATIONS AND MARKETING SERVICES, NAMELY, PROMOTING AND MARKETING THE GOODS AND SERVICES OF OTHERS THROUGH ALL PUBLIC COMMUNICATION MEANS; ADVERTISING TEXT PUBLICATION SERVICES; ADVERTISING THE SERVICES OF OTHERS VIA WEB PAGES OPTIMIZED FOR ONLINE SEARCH ENGINES; ADVERTISING THROUGH ALL PUBLIC COMMUNICATION MEANS; ADVERTISING VIA ELECTRONIC MEDIA AND SPECIFICALLY THE INTERNET; ADVERTISING, INCLUDING ON-LINE ADVERTISING ON A COMPUTER NETWORK; ADVERTISING, INCLUDING PROMOTION OF PRODUCTS AND SERVICES OF THIRD PARTIES THROUGH SPONSORING ARRANGEMENTS AND LICENSE AGREEMENTS RELATING TO INTERNATIONAL SPORTS EVENTS; ADVERTISING, INCLUDING PROMOTION RELATING TO THE SALE OF ARTICLES AND

Reg. No. 4,155,094 SERVICES FOR THIRD PARTIES BY THE TRANSMISSION OF ADVERTISING MATERIAL AND THE DISSEMINATION OF ADVERTISING MESSAGES ON COMPUTER NETWORKS; ADVERTISING, MARKETING AND PROMOTING THE GOODS AND SERVICES OF OTHERS USING KIOSKS; ADVERTISING, MARKETING AND PROMOTION SERVICES; ADVERTISING, MARKETING AND PROMOTION SERVICES, NAMELY, PROMOTING THE GOODS AND SERVICES OF OTHERS BY PROVIDING CUSTOMIZED EXHIBITS; ADVERTISING, MARKETING AND PROMOTIONAL SERVICES FOR AUTOMOTIVE DEALERSHIPS; ADVERTISING, MARKETING AND PROMOTIONAL SERVICES FOR LIGHT AND HEAVY EQUIPMENT DEALERSHIPS; ADVERTISING, MARKETING AND PROMOTIONAL SERVICES FOR THE DONATION OF HUMAN BLOOD THAT EXACTLY MATCHES THE BLOOD TYPE OF INDIVIDUALS NEEDING TRANSFUSIONS; ADVERTISING, MARKETING AND PROMOTIONAL SERVICES RELATED TO ALL INDUSTRIES FOR THE PURPOSE OF FACILITATING NETWORKING AND SOCIALIZING OPPORTUNITIES FOR BUSINESS PURPOSES; ADVERTISING, PROMOTION AND MARKETING SERVICES BASED ON CONSUMER CREDIT REPORTS AND SCORES OF OTHERS; ADVERTISING, PROMOTION AND MARKETING SERVICES IN THE NATURE OF E-MAIL BLAST CAMPAIGNS FOR OTHERS; ADVERTISING, PROMOTION, AND MARKETING SERVICES IN THE NATURE OF VIRAL MARKETING PROGRAM FOR WEB AND MOBILE PHONE USERS; AGENCIES FOR ADVERTISING TIME AND SPACE; ANALYSIS OF ADVERTISING RESPONSE; ARRANGING AND CONDUCTING OF FAIRS AND EXHIBITIONS FOR BUSINESS AND ADVERTISING PURPOSES; ARRANGING AND CONDUCTING SPECIAL EVENTS FOR COMMERCIAL, PROMOTIONAL OR ADVERTISING PURPOSES; BANNER ADVERTISING; BUSINESS MANAGEMENT AND CONSULTING SERVICES FOR THE HEALTH CARE INDUSTRY, NAMELY, CUSTOMER SERVICE, ACCOUNTING SERVICES, AND WEB-BASED ADVERTISING AND MARKETING SERVICES; BUSINESS SERVICES, NAMELY, TRACKING AND MONITORING OF CALLS FOR OTHERS IN RESPONSE TO ADVERTISING ADS; CINEMA ADVERTISING; CLASSIFIED ADVERTISING SERVICES; COMPILATION OF ADVERTISEMENTS FOR USE AS WEB PAGES ON THE INTERNET; COMPILATION, PRODUCTION AND DISSEMINATION OF ADVERTISING MATTER; CONDUCTING, ARRANGING AND ORGANIZING TRADE SHOWS AND TRADE FAIRS FOR COMMERCIAL AND ADVERTISING PURPOSES; CONSUMER LOYALTY SERVICES FOR COMMERCIAL, PROMOTIONAL, AND/OR ADVERTISING PURPOSES, NAMELY, ADMINISTRATION OF FREQUENT FLYER PROGRAM THAT ALLOWS MEMBERS TO REDEEM MILES FOR POINTS OR AWARDS OFFERED BY OTHER LOYALTY PROGRAMS; COOPERATIVE ADVERTISING AND MARKETING; COOPERATIVE ADVERTISING AND MARKETING SERVICES BY WAY OF SOLICITATION, CUSTOMER SERVICE AND PROVIDING MARKETING INFORMATION VIA WEB SITES ON A GLOBAL COMPUTER NETWORK; COOPERATIVE ADVERTISING AND MARKETING SERVICES, NAMELY, OFFERING DISCOUNTS TO CLIENTS THROUGH THE JOINT PARTICIPATION OF MEMBER BEAUTY SALONS.; CREATING AND UPDATING ADVERTISING MATERIAL; CREATION OF MARKETING TOOLS DESIGNED TO INCREASE A CLIENT COMPANY'S KNOWLEDGE OF CUSTOMER NEEDS, AND ITS COMPETITORS' PRODUCTS AND SERVICES, PRICING, ADVERTISING STRATEGY AND SALES STRATEGY; CUSTOMER LOYALTY SERVICES AND CUSTOMER CLUB SERVICES, FOR COMMERCIAL, PROMOTIONAL AND/OR ADVERTISING PURPOSES; DESIGN OF ADVERTISING BROCHURES FOR OTHERS; DESIGN OF ADVERTISING FLYERS FOR OTHERS; DESIGN OF ADVERTISING MATERIALS FOR OTHERS; DESIGN OF INTERNET ADVERTISING; DEVELOPING ADVERTISING CAMPAIGNS FOR OTHERS GEARED TOWARD ENVIRONMENTAL ISSUES; DEVELOPMENT, OPERATION AND ADMINISTRATION OF DIGITAL SIGNAGE SYSTEMS AND DIGITAL ADVERTISING SYSTEMS FOR OTHERS, NAMELY, PROVIDING ADVERTISING SPACE BY ELECTRONIC MEANS AND GLOBAL COMPUTER INFORMATION NETWORKS; DIRECT MAIL ADVERTISING SERVICES; DIRECT MARKETING ADVERTISING FOR OTHERS; DISPLAYING ADVERTISEMENTS FOR OTHERS; DISSEMINATION OF ADVERTISEMENTS; DISSEMINATION OF ADVERTISEMENTS AND OF ADVERTISING MATERIAL; DISSEMINATION OF ADVERTISING FOR OTHERS VIA AN ON-LINE COMMUNICATIONS NETWORK ON THE INTERNET; DISSEMINATION OF ADVERTISING FOR OTHERS VIA PUBLIC AND PRIVATE WIRELESS NETWORKS FOR DISPLAY ON MOBILE DEVICES; DISSEMINATION OF ADVERTISING FOR OTHERS VIA THE INTERNET; DISSEMINATION OF ADVERTISING MATERIAL;

Reg. No. 4,155,094 DISSEMINATION OF ADVERTISING MATTER; DISSEMINATION OF ADVERTISING, SCHEDULING AND MANAGING OF TRAINING COURSES AND PROGRAMS FOR OTHERS VIA A GLOBAL COMPUTER NETWORK; DISSEMINATION SERVICES OF ADVERTISEMENT MATTER; DISTRIBUTION AND DISSEMINATION OF ADVERTISING MATERIALS; DISTRIBUTION OF ADVERTISEMENTS AND COMMERCIAL ANNOUNCEMENTS; DISTRIBUTION OF ADVERTISING MAIL AND OF ADVERTISING SUPPLEMENTS ATTACHED TO REGULAR EDITIONS; DISTRIBUTION OF ADVERTISING MATERIAL; DISTRIBUTION OF ADVERTISING MATERIALS; DISTRIBUTION OF PRODUCTS FOR ADVERTISING PURPOSES; ELECTRONIC BILLBOARD ADVERTISING; ELECTRONIC COMMERCE SERVICES, NAMELY, PROVIDING INFORMATION ABOUT PRODUCTS VIA TELECOMMUNICATION NETWORKS FOR ADVERTISING AND SALES PURPOSES; ENTERTAINMENT MARKETING SERVICES, NAMELY, MARKETING, PROMOTION AND ADVERTISING FOR INDEPENDENT RECORDING ARTISTS; ENTERTAINMENT MARKETING SERVICES, NAMELY, MARKETING, PROMOTION AND ADVERTISING FOR RECORDING AND PERFORMING ARTISTS; EVENT PLANNING AND MANAGEMENT FOR MARKETING, BRANDING, PROMOTING OR ADVERTISING THE GOODS AND SERVICES OF OTHERS; INTERNATIONAL BUSINESS CONSULTING SERVICES RELATING TO MERCHANDISE TRADING, HUMAN RESOURCE INTERCHANGE, MANAGEMENT SUPPORT, MARKETING, ADVERTISING, PROMOTION, AND DOMESTIC AND INTERNATIONAL MARKET RESEARCH AND DEVELOPMENT; INTERNET ADVERTISING SERVICES; ISSUING AND UPDATING OF ADVERTISING TEXTS; LAYOUT SERVICES FOR ADVERTISING PURPOSES; MANAGEMENT OF ADVERTISING THROUGH A COMMAND AND CONTROL CENTER FOR BOTH MOVIE THEATRE ON-SCREEN ADVERTISING AND OVER THE INTERNET; MARKETING AND ADVERTISING SERVICES FOR AUTOMOBILE DEALERSHIPS; MARKETING, ADVERTISING AND PROMOTING THE GOODS AND SERVICES OF OTHERS IN THE FIELD OF TRAVEL AND TOURISM, NAMELY, PROVIDING INFORMATION VIA MAIL AND ELECTRONIC MAIL; MARKETING, ADVERTISING, AND PROMOTING THE RETAIL GOODS AND SERVICES OF OTHERS TO WIRELESS ELECTRONIC DEVICES; MARKETING, PROMOTIONAL AND ADVERTISING SERVICES PROVIDED BY MOBILE TELEPHONE CONNECTIONS; MEDIA BUYING ADVICE, NAMELY, ADVISING THE CLIENT HOW MUCH MEDIA TIME, AND AT WHAT TIMES THE CLIENT SHOULD BE PURCHASING ADVERTISING; MEDIA PLANNING, NAMELY, ADVISING THE CLIENT ON THE CORRECT TIMES AND STATIONS TO ADVERTISE BASED ON MEDIA ANALYSIS OF THE MARKET FOR THAT MEDIA; MEDIA PRODUCTION LOCATION SCOUTING SERVICES FOR ADVERTISING PURPOSES; MEDIATION OF ADVERTISING; MODELING FOR ADVERTISING OR SALES PROMOTION; MODELING SERVICES FOR ADVERTISING OR SALES PROMOTION; MUSIC SELECTION SERVICES FOR USE IN ADVERTISING; ON-LINE ADVERTISING AND MARKETING SERVICES; ON-LINE ADVERTISING ON COMPUTER COMMUNICATION NETWORKS; ON-LINE ADVERTISING ON COMPUTER NETWORKS; ON-LINE ADVERTISING SERVICES FOR OTHERS; ONLINE ADVERTISEMENTS; ONLINE ADVERTISING AND PROMOTIONAL SERVICES; ONLINE ADVERTISING VIA A COMPUTER COMMUNICATIONS NETWORK; ORGANISATION AND HOLDING OF FAIRS FOR COMMERCIAL OR ADVERTISING PURPOSES; ORGANISATION OF EXHIBITIONS AND EVENTS FOR COMMERCIAL OR ADVERTISING PURPOSES; ORGANISATION OF EXHIBITIONS FOR COMMERCIAL OR ADVERTISING PURPOSES; ORGANISING EXHIBITIONS FOR COMMERCIAL OR ADVERTISING PURPOSES; ORGANIZATION OF EVENTS, EXHIBITIONS, FAIRS AND SHOWS FOR COMMERCIAL, PROMOTIONAL AND ADVERTISING PURPOSES; ORGANIZATION OF EXHIBITIONS FOR COMMERCIAL OR ADVERTISING PURPOSES; ORGANIZATION OF FAIRS AND EXHIBITIONS FOR COMMERCIAL AND ADVERTISING PURPOSES; ORGANIZATION OF FAIRS FOR COMMERCIAL AND ADVERTISING PURPOSES; ORGANIZING BUSINESS EXPOSITIONS FOR ADVERTISING PRODUCTS; ORGANIZING EXHIBITIONS FOR COMMERCIAL OR ADVERTISING PURPOSES; ORGANIZING EXHIBITIONS FOR ADVERTISING PRODUCTS; OUT-OF-HOME ADVERTISING SERVICES, NAMELY, RENTAL OF ADVERTISING SPACE, AND PREPARING AND PLACING ADVERTISEMENTS FOR OTHERS; PAY PER CLICK (PPC) ADVERTISING MANAGEMENT SERVICES; PLACING ADVERTISEMENTS FOR OTHERS; PLANNING AND CONDUCTING OF TRADE FAIRS, EXHIBITIONS AND PRESENTATIONS FOR ECONOMIC OR ADVERTISING PURPOSES; PREPARATION AND REALIZATION OF MEDIA

Reg. No. 4,155,094 AND ADVERTISING PLANS AND CONCEPTS; PREPARATION OF CUSTOM ADVERTISEMENTS FOR OTHERS; PREPARATION OF CUSTOM OR NON-CUSTOM ADVERTISING FOR BUSINESSES FOR DISSEMINATION VIA THE WEB, CD OR DVD FOR OPTIONAL UPLOAD OR DOWNLOAD TO A COMPUTER; PREPARING ADVERTISEMENTS FOR OTHERS; PREPARING ADVERTISEMENTS FOR OTHERS, NAMELY, PREPARING VIDEO ADVERTISING AND PROMOTIONAL VIDEOS FOR COMMERCIAL USE VIA THE INTERNET AND TELEVISION, DIGITAL CABLE AND VIDEO-ON-DEMAND OR DOWNLOAD; PREPARING AND PLACING ADVERTISEMENTS FOR OTHERS; PREPARING AND PLACING OF ADVERTISEMENTS; PREPARING AND PLACING OUTDOOR ADVERTISEMENTS FOR OTHERS; PREPARING AUDIOVISUAL PRESENTATIONS FOR USE IN ADVERTISING; PREPARING SPEECHES AND ORAL PRESENTATIONS FOR OTHERS FOR USE IN ADVERTISING; PROCESSING TELEPHONE INQUIRIES REGARDING ADVERTISED GOODS AND SERVICES; PRODUCTION OF ADVERTISING MATTER AND COMMERCIALS; PRODUCTION OF FILM AND TELEVISION ADVERTISING; PROMOTING AND MARKETING THE GOODS AND SERVICES OF OTHERS BY DISTRIBUTING ADVERTISING MATERIAL, COUPONS AND DISCOUNT OFFERS VIA TEXT MESSAGES; PROMOTING AND SHOWCASING THE GOODS OF OTHERS IN THE FIELD OF ENTERTAINMENT BY MEANS OF AN ON-LINE SHOPPING SITE WITH LINKS TO THE RETAIL ADVERTISEMENTS OF OTHERS; PROMOTING THE GOODS AND SERVICES OF OTHERS BY DISTRIBUTING ADVERTISING MATERIALS THROUGH A VARIETY OF METHODS; PROMOTING THE GOODS AND SERVICES OF OTHERS BY MEANS OF DISTRIBUTING ADVERTISING ON THE INTERNET; PROMOTING THE GOODS AND SERVICES OF OTHERS BY PREPARING AND PLACING ADVERTISEMENTS IN AN ELECTRONIC MAGAZINE ACCESSED THROUGH A GLOBAL COMPUTER NETWORK; PROMOTING, ADVERTISING AND MARKETING OF THE BRANDS, PRODUCTS, SERVICES OR ONLINE WEBSITES OF INDIVIDUALS, BUSINESSES AND NONPROFIT ORGANIZATIONS; PROMOTING, ADVERTISING AND MARKETING OF THE ON-LINE WEB SITES OF OTHERS; PROMOTING, ADVERTISING AND MARKETING THE ON-LINE DATABASES AND ELECTRONIC PUBLICATIONS OF OTHERS; PROMOTION, ADVERTISING AND MARKETING OF ON-LINE WEBSITES; PROMOTIONAL SERVICES, NAMELY, DISTRIBUTION OF ADVERTISING FLYERS, COUPONS, CATALOGS AND PROMOTIONAL ITEMS OF OTHERS; PROVIDING A SEARCHABLE ON-LINE ADVERTISING WEBSITE AND GUIDE FEATURING THE GOODS AND SERVICES OF OTHER VENDORS VIA THE INTERNET; PROVIDING A SEARCHABLE ONLINE ADVERTISING GUIDE FEATURING THE GOODS AND SERVICES OF ONLINE VENDORS; PROVIDING A SEARCHABLE ONLINE ADVERTISING GUIDE FEATURING THE GOODS AND SERVICES OF OTHER ON-LINE VENDORS ON THE INTERNET; PROVIDING A SEARCHABLE ONLINE ADVERTISING WEBSITE AND INFORMATIONAL GUIDE FEATURING THE GOODS AND SERVICES OF OTHER VENDORS VIA THE INTERNET IN THE FIELD OF ENTERTAINMENT; PROVIDING A WEB SITE AT WHICH FITNESS PROFESSIONALS AND FACILITIES CAN POST PROMOTIONAL PROFILES AND RESPOND TO ADVERTISEMENTS FOR THEIR SERVICES; PROVIDING A WEB SITE WHERE USERS CAN POST ITEMS FOR SALE THROUGH ON-LINE CLASSIFIED ADVERTISEMENTS; PROVIDING A WEB SITE WHICH FEATURES ADVERTISEMENTS FOR THE GOODS AND SERVICES OF OTHERS ON A GLOBAL COMPUTER NETWORK; PROVIDING ADVERTISING AND ADVERTISEMENT SERVICES; PROVIDING ADVERTISING SERVICE TO DISTRIBUTE ADVERTISEMENTS FOR DISPLAY ON INTERNET, NAMELY, IN WEBSITES, SOCIAL CONVERSATIONS OVER THE INTERNET, E-MAILS, MICROBLOGS, BLOGS, ELECTRONIC MESSAGES, INSTANT MESSAGES, TEXT MESSAGES, MULTIMEDIA MESSAGES, SOCIAL NETWORKS, STATUS UPDATES, FORUMS, ELECTRONIC BULLETIN BOARDS; PROVIDING ADVERTISING SERVICES; PROVIDING ADVERTISING SERVICES USING 3D AND ANIMATION DESIGNS; PROVIDING ADVERTISING SPACE IN PERIODICALS, NEWSPAPERS AND MAGAZINES; PROVIDING ADVERTISING SPACE ON BILLBOARDS AND IN KIOSKS; PROVIDING ADVERTISING SPACE ON FREE-STANDING VISUAL ADVERTISING SYSTEMS FEATURING THE GOODS AND SERVICES OF OTHERS; PROVIDING ADVERTISING, MARKETING AND PROMOTIONAL SERVICES FOR THE PHARMACEUTICAL AND MEDICAL INDUSTRY; PROVIDING ADVERTISING, MARKETING AND PROMOTIONAL SERVICES FOR THE PHARMACEUTICAL AND MEDICAL PRODUCTS OF OTHERS; PROVIDING ADVERTISING, MARKETING AND PROMOTIONAL

Reg. No. 4,155,094 SERVICES, NAMELY, DEVELOPMENT OF ADVERTISING CAMPAIGNS FOR ONLINE USERS; PROVIDING ADVERTISING, MARKETING AND PROMOTIONAL SERVICES, NAMELY, DEVELOPMENT OF ADVERTISING CAMPAIGNS PROVIDED THROUGH CABLE TELEVISION BROADCAST, WEB CASTS, RADIO BROADCASTS, NEWSPAPERS, MAGAZINES, ONLINE BANNERS, OUTDOOR BILLBOARDS, WILD POSTINGS, BUS AND SUBWAY ADS; PROVIDING AN INTERNET WEB SITE FOR CLASSIFIED ADVERTISING TO BUY AND SELL UKRAINIAN RELATED WARES, ART, ANTIQUES, BOOKS, EMBROIDERY, COSTUMES, COLLECTIBLES, INSTRUMENTS, MEMORABILIA AND OTHER ONE-OF-A-KIND ITEMS; PROVIDING AN INTERNET WEB SITE TO ADVERTISE SERVICES OF INTEREST TO THE UKRAINIAN COMMUNITY IN THE UNITED STATES OF AMERICA AND CANADA AND TO ADVERTISE SERVICES PROVIDED BY INDIVIDUALS OF UKRAINIAN ORIGIN; PROVIDING AN INTERNET WEBSITE PORTAL FEATURING PROMOTION AND ADVERTISING FOR HOME SERVICE PROVIDERS AND PRODUCT MANUFACTURERS; PROVIDING AN ONLINE DIRECTORY INFORMATION SERVICE FEATURING INFORMATION REGARDING VEHICLES IN THE NATURE OF CLASSIFIED ADVERTISEMENTS; PROVIDING AND RENTAL OF ADVERTISING SPACE ON THE INTERNET; PROVIDING ON-LINE BUSINESS INFORMATION OF OTHERS, NAMELY, ADVERTISEMENTS OR SOLICITATIONS; PROVIDING SPACE AT A WEB SITE FOR THE ADVERTISING OF THE GOODS AND SERVICES OF OTHERS; PROVIDING TELEVISION ADVERTISING FOR OTHERS; PROVISION OF ADVERTISING SPACE BY ELECTRONIC MEANS AND GLOBAL INFORMATION NETWORKS; PROVISION OF SPACE ON WEBSITES FOR ADVERTISING GOODS AND SERVICES; PUBLIC RELATIONS, ADVERTISING AND MARKETING SERVICES FOR THE TOURISM AND CONVENTION INDUSTRY, NAMELY, ORGANIZING AND HOSTING SITE INSPECTIONS AND FAMILIARIZATION TOURS FOR WHOLESALERS, TOUR OPERATORS, TRAVEL AGENTS, MEETING AND INCENTIVE TRAVEL PLANNERS AND TRAVEL MEDIA; PUBLISHING OF ADVERTISING TEXTS; REAL ESTATE ADVERTISING SERVICES; RECRUITMENT ADVERTISEMENT SERVICES, NAMELY, POSTING OF CLINICAL TRIAL NOTICES FOR THE PURPOSE OF RECRUITING PATIENTS FOR PARTICIPATION IN CLINICAL TRIALS FOR THE TESTING OF DRUGS; RENTAL OF ADVERTISEMENT SPACE AND ADVERTISING MATERIAL; RENTAL OF ADVERTISING SPACE; RENTAL OF ADVERTISING SPACE ON WEB SITES; RENTAL OF SIGNS FOR ADVERTISING PURPOSES; RENTING OF ADVERTISING SPACES; SERVICES OF ADVERTISING AGENCIES; SERVICES TO DETERMINE THE AUDIENCE AFFECTED BY ADVERTISEMENTS; SPECIAL EVENT PLANNING FOR COMMERCIAL, PROMOTIONAL OR ADVERTISING PURPOSES; SPECIALTY MERCHANDISING SERVICES, NAMELY, PROMOTING THE GOODS AND SERVICES OF OTHERS THROUGH THE DISTRIBUTION OF CUSTOMIZED ADVERTISING MATERIALS, NAMELY, PENS AND CATALOGS; TELEVISION ADVERTISING AGENCIES; VENDOR-ON-PREMISE SERVICES, NAMELY, THE ADMINISTRATION OF THE EMPLOYMENT PROCESS ON-SITE, INCLUDING RESUME REVIEW AND CHECKING, EMPLOYMENT APPLICATION ACQUISITION, ADVERTISING FOR RECRUITMENT, CONDUCT OF INTERVIEWS, AND REFERENCE CHECKING, IN CLASS 35 (U.S. CLS. 100, 101 AND 102).

FIRST USE 8-20-2011; IN COMMERCE 2-24-2012.

THE MARK CONSISTS OF STANDARD CHARACTERS WITHOUT CLAIM TO ANY PARTICULAR FONT, STYLE, SIZE, OR COLOR.

OWNER OF U.S. REG. NO. 3,790,012.

NO CLAIM IS MADE TO THE EXCLUSIVE RIGHT TO USE "LICENSE", APART FROM THE MARK AS SHOWN.

SN 85-245,508, FILED 2-17-2011.

DEBRA LEE, EXAMINING ATTORNEY

United States of America

United States Patent and Trademark Office

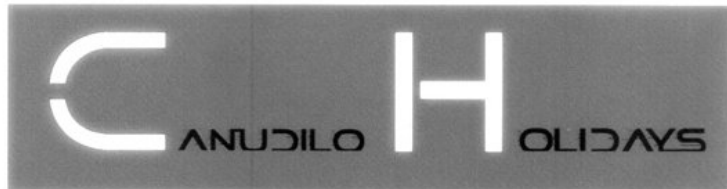

Reg. No. 4,155,095

Registered June 5, 2012

Int. Cl.: 18

TRADEMARK

PRINCIPAL REGISTER

GUANGZHOU CANUDILO FASHION & ACCESSORIES CO., LTD. (CHINA LIMITED COMPANY (LTD.))
ROOM 1310 FULI KEXUN EDIFICE
638 HUANGPU ROAD WEST, TIANHE DISTRICT
GUANGZHOU, GUANGDONG, CHINA

FOR: ATTACHE CASES; BRIEFCASES; BUSINESS CARD CASES; HANDBAGS; KEY CASES; PURSES; SCHOOL SATCHELS; TRAVELLING BAGS; TRAVELLING CASES OF LEATHER; UMBRELLAS, IN CLASS 18 (U.S. CLS. 1, 2, 3, 22 AND 41).

FIRST USE 11-22-2010; IN COMMERCE 2-17-2011.

THE MARK CONSISTS OF THE STYLIZED WORDS "CANUDILO HOLIDAYS" WITH A RECTANGULAR BACKGROUND.

THE WORDING "CANUDILO" HAS NO MEANING IN A FOREIGN LANGUAGE.

SN 85-245,560, FILED 2-17-2011.

LINDA M. KING, EXAMINING ATTORNEY



David J. Kyros

Director of the United States Patent and Trademark Office

United States of America

United States Patent and Trademark Office

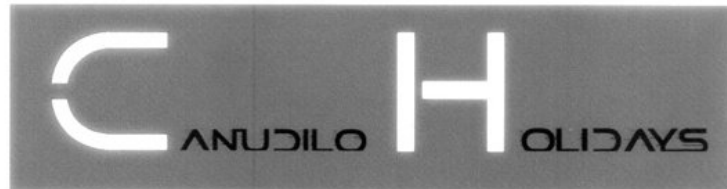

Reg. No. 4,155,096

Registered June 5, 2012

Int. Cl.: 25

TRADEMARK

PRINCIPAL REGISTER

GUANGZHOU CANUDILO FASHION & ACCESSORIES CO., LTD. (CHINA LIMITED COMPANY (LTD.))
ROOM 1310 FULI KEXUN EDIFICE
638 HUANGPU ROAD WEST, TIANHE DISTRICT
GUANGZHOU, GUANGDONG, CHINA

FOR: DRESSES; FOOTWEAR; GIRDLES; HEADWEAR; HOSIERY; JACKETS; LEATHER COATS; NECKTIES; SHIRTS; T-SHIRTS; TROUSERS; UNIFORMS, IN CLASS 25 (U.S. CLS. 22 AND 39).

FIRST USE 11-22-2010; IN COMMERCE 2-17-2011.

THE MARK CONSISTS OF THE STYLIZED WORDS "CANUDILO HOLIDAYS" WITH A RECTANGULAR BACKGROUND.

THE WORDING "CANUDILO" HAS NO MEANING IN A FOREIGN LANGUAGE.

SN 85-245,564, FILED 2-17-2011.

LINDA M. KING, EXAMINING ATTORNEY



David J. Kyros

Director of the United States Patent and Trademark Office

United States of America

United States Patent and Trademark Office

EPICURE

Reg. No. 4,155,097

Registered June 5, 2012

Int. Cl.: 9

TRADEMARK

PRINCIPAL REGISTER

EW STEREOEAST INC. (TEXAS CORPORATION)
9150 WARREN PARKWAY
FRISCO, TX 75035

FOR: LOUDSPEAKERS, IN CLASS 9 (U.S. CLS. 21, 23, 26, 36 AND 38).

FIRST USE 8-22-2011; IN COMMERCE 8-22-2011.

THE MARK CONSISTS OF STANDARD CHARACTERS WITHOUT CLAIM TO ANY PARTICULAR FONT, STYLE, SIZE, OR COLOR.

SN 85-245,586, FILED 2-18-2011.

JOHN LINCOSKI, EXAMINING ATTORNEY



David J. Kybas

Director of the United States Patent and Trademark Office

United States of America

United States Patent and Trademark Office

SCADE LifeCycle

Reg. No. 4,155,098

Registered June 5, 2012

Int. Cl.: 9

TRADEMARK

PRINCIPAL REGISTER

ESTEREL TECHNOLOGIES, INC. (CALIFORNIA CORPORATION)
444 CASTRO STREET
SUITE 818
MOUNTAIN VIEW, CA 94041

FOR: COMPUTER SOFTWARE DEVELOPMENT TOOLS; COMPUTER SOFTWARE FOR USE IN AVIONICS AND COCKPIT DISPLAYS SYSTEMS, IN CLASS 9 (U.S. CLS. 21, 23, 26, 36 AND 38).

FIRST USE 6-30-2011; IN COMMERCE 6-30-2011.

THE MARK CONSISTS OF STANDARD CHARACTERS WITHOUT CLAIM TO ANY PARTICULAR FONT, STYLE, SIZE, OR COLOR.

OWNER OF U.S. REG. NO. 3,144,740.

SN 85-245,667, FILED 2-18-2011.

JESSICA A. POWERS, EXAMINING ATTORNEY



David J. Kyros

Director of the United States Patent and Trademark Office

United States of America

United States Patent and Trademark Office



Reg. No. 4,155,099

TASSERON SENSORS, INC. (DELAWARE CORPORATION)
2401 REACH ROAD
WILLIAMSPORT, PA 17701

Registered June 5, 2012

Int. Cl.: 9

FOR: TEMPERATURE SENSORS; THERMISTORS, IN CLASS 9 (U.S. CLS. 21, 23, 26, 36 AND 38).

TRADEMARK

FIRST USE 2-28-2011; IN COMMERCE 2-28-2011.

PRINCIPAL REGISTER

THE MARK CONSISTS OF A RED, GRAY AND BLACK DIAL OR METER THAT REPRESENTS THE LETTER "Q", FOLLOWED BY "QWIK" IN BLACK, FOLLOWED BY "BOX" IN RED.

THE COLOR(S) RED, GRAY AND BLACK IS/ARE CLAIMED AS A FEATURE OF THE MARK.

SN 85-245,741, FILED 2-18-2011.

HAI-LY LAM, EXAMINING ATTORNEY



David J. Kyffers

Director of the United States Patent and Trademark Office

United States of America

United States Patent and Trademark Office



Reg. No. 4,155,100

TASSERON SENSORS, INC. (DELAWARE CORPORATION)
2401 REACH ROAD
WILLIAMSPORT, PA 17701

Registered June 5, 2012

Int. Cl.: 9

FOR: TEMPERATURE SENSORS; THERMISTORS, IN CLASS 9 (U.S. CLS. 21, 23, 26, 36 AND 38).

TRADEMARK

FIRST USE 2-28-2011; IN COMMERCE 2-28-2011.

PRINCIPAL REGISTER

THE MARK CONSISTS OF A RED, GRAY AND BLACK DIAL OR METER THAT REPRESENTS THE LETTER "Q", FOLLOWED BY "QWIK" IN BLACK, FOLLOWED BY "IMMERSION" IN RED.

THE COLOR(S) RED, GRAY AND BLACK IS/ARE CLAIMED AS A FEATURE OF THE MARK.

SN 85-245,756, FILED 2-18-2011.

HAI-LY LAM, EXAMINING ATTORNEY



David J. Kybas

Director of the United States Patent and Trademark Office

United States of America

United States Patent and Trademark Office



Reg. No. 4,155,101

TASSERON SENSORS, INC. (DELAWARE CORPORATION)
2401 REACH ROAD
WILLIAMSPORT, PA 17701

Registered June 5, 2012

Int. Cl.: 9

FOR: TEMPERATURE SENSORS; THERMISTORS, IN CLASS 9 (U.S. CLS. 21, 23, 26, 36 AND 38).

TRADEMARK

FIRST USE 2-28-2011; IN COMMERCE 2-28-2011.

PRINCIPAL REGISTER

THE MARK CONSISTS OF A RED, GRAY AND BLACK DIAL OR METER THAT REPRESENTS THE LETTER "Q", FOLLOWED BY "QWIK" IN BLACK, FOLLOWED BY "MINI" IN RED.

THE COLOR(S) RED, GRAY AND BLACK IS/ARE CLAIMED AS A FEATURE OF THE MARK.

SN 85-245,762, FILED 2-18-2011.

HAI-LY LAM, EXAMINING ATTORNEY



David J. Kybas

Director of the United States Patent and Trademark Office

United States of America

United States Patent and Trademark Office



Reg. No. 4,155,102

TASSERON SENSORS, INC. (DELAWARE CORPORATION)
2401 REACH ROAD
WILLIAMSPORT, PA 17701

Registered June 5, 2012

Int. Cl.: 9

FOR: TEMPERATURE SENSORS; THERMISTORS, IN CLASS 9 (U.S. CLS. 21, 23, 26, 36 AND 38).

TRADEMARK

FIRST USE 2-28-2011; IN COMMERCE 2-28-2011.

PRINCIPAL REGISTER

THE MARK CONSISTS OF A RED, GRAY AND BLACK DIAL OR METER THAT REPRESENTS THE LETTER "Q", FOLLOWED BY "QWIK" IN BLACK, FOLLOWED BY "OUTDOOR" IN RED.

THE COLOR(S) RED, GRAY AND BLACK IS/ARE CLAIMED AS A FEATURE OF THE MARK.

SN 85-245,767, FILED 2-18-2011.

HAI-LY LAM, EXAMINING ATTORNEY



David J. Kyffers

Director of the United States Patent and Trademark Office

United States of America

United States Patent and Trademark Office



Reg. No. 4,155,103

TASSERON SENSORS, INC. (DELAWARE CORPORATION)
2401 REACH ROAD
WILLIAMSPORT, PA 17701

Registered June 5, 2012

Int. Cl.: 9

FOR: TEMPERATURE SENSORS; THERMISTORS, IN CLASS 9 (U.S. CLS. 21, 23, 26, 36 AND 38).

TRADEMARK

FIRST USE 2-28-2011; IN COMMERCE 2-28-2011.

PRINCIPAL REGISTER

THE MARK CONSISTS OF A RED, GRAY AND BLACK DIAL OR METER THAT REPRESENTS THE LETTER "Q", FOLLOWED BY "QWIK" IN BLACK, FOLLOWED BY "ROOM" IN RED.

THE COLOR(S) RED, GRAY AND BLACK IS/ARE CLAIMED AS A FEATURE OF THE MARK.

SN 85-245,781, FILED 2-18-2011.

HAI-LY LAM, EXAMINING ATTORNEY



David J. Kyffers

Director of the United States Patent and Trademark Office

United States of America

United States Patent and Trademark Office



Reg. No. 4,155,104

TASSERON SENSORS, INC. (DELAWARE CORPORATION)
2401 REACH ROAD
WILLIAMSPORT, PA 17701

Registered June 5, 2012

Int. Cl.: 9

FOR: TEMPERATURE SENSORS; THERMISTORS, IN CLASS 9 (U.S. CLS. 21, 23, 26, 36 AND 38).

TRADEMARK

FIRST USE 2-28-2011; IN COMMERCE 2-28-2011.

PRINCIPAL REGISTER

THE MARK CONSISTS OF A RED, GRAY AND BLACK DIAL OR METER THAT REPRESENTS THE LETTER "Q", FOLLOWED BY "QWIK" IN BLACK, FOLLOWED BY "STRAP" IN RED.

THE COLOR(S) RED, GRAY AND BLACK IS/ARE CLAIMED AS A FEATURE OF THE MARK.

SN 85-245,797, FILED 2-18-2011.

HAI-LY LAM, EXAMINING ATTORNEY



David J. Kybas

Director of the United States Patent and Trademark Office

United States of America

United States Patent and Trademark Office

WHAT AMERICA EATS

Reg. No. 4,155,105

Registered June 5, 2012

Int. Cl.: 16

TRADEMARK

PRINCIPAL REGISTER

ADVANCE MAGAZINE PUBLISHERS INC. (NEW YORK CORPORATION)
FOUR TIMES SQUARE
NEW YORK, NY 10036

FOR: ANNUALLY ISSUED GENERAL INTEREST MAGAZINES FOCUSING ON CULINARY ISSUES; SYNDICATED COLUMNS DEALING WITH CULINARY ISSUES, IN CLASS 16 (U.S. CLS. 2, 5, 22, 23, 29, 37, 38 AND 50).

FIRST USE 10-25-1987; IN COMMERCE 10-25-1987.

THE MARK CONSISTS OF STANDARD CHARACTERS WITHOUT CLAIM TO ANY PARTICULAR FONT, STYLE, SIZE, OR COLOR.

OWNER OF U.S. REG. NO. 2,438,666.

SN 85-245,798, FILED 2-18-2011.

RONALD MCMORROW, EXAMINING ATTORNEY



David J. Kybas

Director of the United States Patent and Trademark Office

United States of America

United States Patent and Trademark Office

YOU CAN COUNT ON US.
GUARANTEED.

Reg. No. 4,155,106

HLT DOMESTIC IP LLC (DELAWARE LIMITED LIABILITY COMPANY)
7930 JONES BRANCH DRIVE, SUITE 1100
MCLEAN, VA 22102

Registered June 5, 2012

Int. Cl.: 43

FOR: HOTEL SERVICES, IN CLASS 43 (U.S. CLS. 100 AND 101).

SERVICE MARK

FIRST USE 3-1-2012; IN COMMERCE 3-1-2012.

PRINCIPAL REGISTER

THE MARK CONSISTS OF STANDARD CHARACTERS WITHOUT CLAIM TO ANY PARTICULAR FONT, STYLE, SIZE, OR COLOR.

NO CLAIM IS MADE TO THE EXCLUSIVE RIGHT TO USE "GUARANTEED", APART FROM THE MARK AS SHOWN.

SN 85-245,974, FILED 2-18-2011.

ANGELA DUONG, EXAMINING ATTORNEY



David J. Kybas

Director of the United States Patent and Trademark Office

United States of America

United States Patent and Trademark Office

REVEAL

Reg. No. 4,155,107

Registered June 5, 2012

Int. Cl.: 44

REVEAL BODY SCULPTING CENTERS, LLC (PENNSYLVANIA LIMITED LIABILITY COMPANY)
TWO PNC PLAZA
28TH FLOOR
PITTSBURGH, PA 15228

SERVICE MARK

FOR: MEDICAL CLINIC PROVIDING LASER FAT REMOVAL TREATMENTS, CELLULITE TREATMENTS, AND BODY CONTOURING, IN CLASS 44 (U.S. CLS. 100 AND 101).

PRINCIPAL REGISTER

FIRST USE 4-14-2011; IN COMMERCE 4-14-2011.

THE MARK CONSISTS OF STANDARD CHARACTERS WITHOUT CLAIM TO ANY PARTICULAR FONT, STYLE, SIZE, OR COLOR.

SN 85-246,079, FILED 2-18-2011.

JASON TURNER, EXAMINING ATTORNEY



David J. Kybas

Director of the United States Patent and Trademark Office

United States of America

United States Patent and Trademark Office

CITRALEMON

Reg. No. 4,155,108

JOSEPH M. MCGRATH (UNITED STATES INDIVIDUAL)
13553 S. LAWLER
CRESTWOOD, IL 60445

Registered June 5, 2012

Int. Cl.: 32

FOR: NON-ALCOHOLIC BEVERAGES, NAMELY, CITRUS FLAVORED ENERGY DRINKS,
IN CLASS 32 (U.S. CLS. 45, 46 AND 48).

TRADEMARK

FIRST USE 4-0-2011; IN COMMERCE 4-0-2011.

PRINCIPAL REGISTER

THE MARK CONSISTS OF STANDARD CHARACTERS WITHOUT CLAIM TO ANY PARTICULAR FONT, STYLE, SIZE, OR COLOR.

SN 85-246,420, FILED 2-18-2011.

AISHA CLARKE, EXAMINING ATTORNEY



David J. Kybas

Director of the United States Patent and Trademark Office

United States of America

United States Patent and Trademark Office

Absolute Light

Reg. No. 4,155,109

Registered June 5, 2012

Int. Cl.: 11

TRADEMARK

PRINCIPAL REGISTER

MEHRKENS , LORI (NEW YORK S CORPORATION), DBA ABOVE ALL LIGHTING & BULBS INC,
44 NOTTINGHAM ROAD
ROCKVILLE CENTRE, NY 11570

FOR: LIGHTING FIXTURES, IN CLASS 11 (U.S. CLS. 13, 21, 23, 31 AND 34).

FIRST USE 2-1-2012; IN COMMERCE 2-1-2012.

THE MARK CONSISTS OF STANDARD CHARACTERS WITHOUT CLAIM TO ANY PARTICULAR FONT, STYLE, SIZE, OR COLOR.

NO CLAIM IS MADE TO THE EXCLUSIVE RIGHT TO USE "LIGHT", APART FROM THE MARK AS SHOWN.

SN 85-246,492, FILED 2-18-2011.

VIVIAN MICZNIK FIRST, EXAMINING ATTORNEY



David J. Kybas

Director of the United States Patent and Trademark Office

United States of America

United States Patent and Trademark Office



Reg. No. 4,155,110

Registered June 5, 2012

Int. Cls.: 35 and 36

SERVICE MARK

PRINCIPAL REGISTER

PRONTO GENERAL AGENCY, LTD (TEXAS CORPORATION)
805 MEDIA LUNA ROAD SUITE 401
BROWNSVILLE, TX 78520

FOR: INCOME TAX CONSULTATION; INCOME TAX PREPARATION; TAX CONSULTATION, IN CLASS 35 (U.S. CLS. 100, 101 AND 102).

FIRST USE 2-23-2012; IN COMMERCE 2-23-2012.

FOR: ARRANGING OF LOANS; FINANCIAL CONSULTANCY AND INSURANCE CONSULTANCY; INSTALLMENT LOANS; INSURANCE AGENCY AND BROKERAGE; INSURANCE BROKERAGE SERVICES; PROVIDING TEMPORARY LOANS, IN CLASS 36 (U.S. CLS. 100, 101 AND 102).

FIRST USE 2-23-2012; IN COMMERCE 2-23-2012.

THE MARK CONSISTS OF AN SUPERHERO IN A STANDING POSE.

SN 85-246,628, FILED 2-18-2011.

LAURIE KAUFMAN, EXAMINING ATTORNEY



David J. Kybas

Director of the United States Patent and Trademark Office

United States of America

United States Patent and Trademark Office

BODY TANTRA

Reg. No. 4,155,111

THOMPSON , LEVI (UNITED STATES INDIVIDUAL)
2499 LAKESHORE DRIVE NE
CONYERS, GA 30012

Registered June 5, 2012

Int. Cl.: 25

FOR: WEARABLE GARMENTS AND CLOTHING, NAMELY, SHIRTS, IN CLASS 25 (U.S. CLS. 22 AND 39).

TRADEMARK

FIRST USE 8-7-2011; IN COMMERCE 2-1-2012.

PRINCIPAL REGISTER

THE MARK CONSISTS OF STANDARD CHARACTERS WITHOUT CLAIM TO ANY PARTICULAR FONT, STYLE, SIZE, OR COLOR.

SN 85-247,006, FILED 2-19-2011.

LINDA MICKLEBURGH, EXAMINING ATTORNEY



David J. Kyros

Director of the United States Patent and Trademark Office

United States of America

United States Patent and Trademark Office

PIRATES OF THE DEEP

Reg. No. 4,155,112

Registered June 5, 2012

Int. Cl.: 9

TRADEMARK

PRINCIPAL REGISTER

WMS GAMING INC. (DELAWARE CORPORATION)
800 SOUTH NORTHPOINT BOULEVARD
WAUKEGAN, IL 60085

FOR: COMPONENTS FOR GAMING MACHINES THAT GENERATE OR DISPLAY WAGER OUTCOMES, NAMELY, CONTROLLERS, DISPLAYS, BUTTON PANELS, BOLSTERS, ELECTRICAL WIRING, AND COMPUTER HARDWARE AND SOFTWARE ASSOCIATED THEREWITH; GAMING MACHINES, NAMELY, DEVICES WHICH ACCEPT A WAGER; GAMING SOFTWARE THAT GENERATES OR DISPLAYS WAGER OUTCOMES OF GAMING MACHINES, IN CLASS 9 (U.S. CLS. 21, 23, 26, 36 AND 38).

FIRST USE 10-4-2011; IN COMMERCE 10-4-2011.

THE MARK CONSISTS OF STANDARD CHARACTERS WITHOUT CLAIM TO ANY PARTICULAR FONT, STYLE, SIZE, OR COLOR.

SN 85-247,336, FILED 2-21-2011.

THEODORE MCBRIDE, EXAMINING ATTORNEY



David J. Kyros

Director of the United States Patent and Trademark Office

United States of America
United States Patent and Trademark Office

ABELINE

Reg. No. 4,155,113

Registered June 5, 2012

Int. Cl.: 25

TRADEMARK

PRINCIPAL REGISTER

SOUTH MOON SALES, INC. (MARYLAND CORPORATION)
619 FRANKLIN AVENUE
BERLIN, MD 21811

FOR: CLOTHING, NAMELY, TOPS, BOTTOMS, UNDERWEAR, FOOTWEAR, DRAWERS, JACKETS, DRESSES, PANTS, SKIRTS, HOSIERY, SOCKS, SCARVES, NECKWEAR, SWIMWEAR, SHORTS, IN CLASS 25 (U.S. CLS. 22 AND 39).

FIRST USE 12-31-2010; IN COMMERCE 4-30-2011.

THE MARK CONSISTS OF STANDARD CHARACTERS WITHOUT CLAIM TO ANY PARTICULAR FONT, STYLE, SIZE, OR COLOR.

SN 85-247,345, FILED 2-21-2011.

RICHARD WHITE, EXAMINING ATTORNEY



David J. Kyros

Director of the United States Patent and Trademark Office

United States of America

United States Patent and Trademark Office

SPEEDCAP

Reg. No. 4,155,114

SPEEDCAP, LLC (NEVADA LIMITED LIABILITY COMPANY)
6069 PINE ROAD
THOMASVILLE, PA 17364

Registered June 5, 2012

Int. Cl.: 25

FOR: HEADGEAR, NAMELY, NOVELTY HATS SHAPED LIKE CARS, IN CLASS 25 (U.S. CLS. 22 AND 39).

TRADEMARK

FIRST USE 2-11-2012; IN COMMERCE 2-11-2012.

PRINCIPAL REGISTER

THE MARK CONSISTS OF STANDARD CHARACTERS WITHOUT CLAIM TO ANY PARTICULAR FONT, STYLE, SIZE, OR COLOR.

SN 85-247,401, FILED 2-21-2011.

JEFFREY LOOK, EXAMINING ATTORNEY



David J. Kybas

Director of the United States Patent and Trademark Office

United States of America

United States Patent and Trademark Office

My Recycle Buddies

Reg. No. 4,155,115

Registered June 5, 2012

Int. Cl.: 41

SERVICE MARK

PRINCIPAL REGISTER

CALLENDER, PAMELA E (UNITED STATES INDIVIDUAL)
209 NORTH RIVERSIDE DRIVE
NEPTUNE, NJ 07753

FOR: EDUCATIONAL SERVICES, NAMELY, PROVIDING ONLINE INSTRUCTION IN THE FIELD OF RECYCLING AND THE ENVIRONMENT VIA AN ONLINE WEBSITE; ENTERTAINMENT SERVICES, NAMELY, PROVIDING A WEBSITE FEATURING GAMES AND PUZZLES; PROVIDING A WEBSITE FEATURING INFORMATION IN THE FIELDS OF EDUCATION AND ENTERTAINMENT FOR CHILDREN, IN CLASS 41 (U.S. CLS. 100, 101 AND 107).

FIRST USE 11-15-2011; IN COMMERCE 11-15-2011.

THE MARK CONSISTS OF STANDARD CHARACTERS WITHOUT CLAIM TO ANY PARTICULAR FONT, STYLE, SIZE, OR COLOR.

NO CLAIM IS MADE TO THE EXCLUSIVE RIGHT TO USE "RECYCLE", APART FROM THE MARK AS SHOWN.

SN 85-247,695, FILED 2-21-2011.

RENEE MCCRAY, EXAMINING ATTORNEY



David J. Kyros

Director of the United States Patent and Trademark Office

United States of America

United States Patent and Trademark Office

PONDEROSA

Reg. No. 4,155,116

Registered June 5, 2012

Int. Cl.: 11

TRADEMARK

PRINCIPAL REGISTER

VOGELZANG INTERNATIONAL CORPORATION (MICHIGAN CORPORATION)
400 WEST 17TH STREET
HOLLAND, MI 49423

FOR: WOOD BURNING STOVES, IN CLASS 11 (U.S. CLS. 13, 21, 23, 31 AND 34).

FIRST USE 1-31-2012; IN COMMERCE 1-31-2012.

THE MARK CONSISTS OF STANDARD CHARACTERS WITHOUT CLAIM TO ANY PARTICULAR FONT, STYLE, SIZE, OR COLOR.

SN 85-247,924, FILED 2-22-2011.

TRACY WHITTAKER-BROWN, EXAMINING ATTORNEY



David J. Kyffers

Director of the United States Patent and Trademark Office

United States of America

United States Patent and Trademark Office

RETRIEVER

Reg. No. 4,155,117

Registered June 5, 2012

Int. Cl.: 31

TRADEMARK

PRINCIPAL REGISTER

TRACTOR SUPPLY CO. OF TEXAS, LP (TEXAS LIMITED PARTNERSHIP)
200 POWELL PLACE
BRENTWOOD, TN 37027

FOR: PET TREATS, IN CLASS 31 (U.S. CLS. 1 AND 46).

FIRST USE 5-31-2006; IN COMMERCE 5-31-2006.

THE MARK CONSISTS OF STANDARD CHARACTERS WITHOUT CLAIM TO ANY PARTICULAR FONT, STYLE, SIZE, OR COLOR.

OWNER OF U.S. REG. NOS. 1,826,539 AND 3,257,566.

SN 85-248,068, FILED 2-22-2011.

SCOTT BIBB, EXAMINING ATTORNEY



David J. Kyffers

Director of the United States Patent and Trademark Office

United States of America

United States Patent and Trademark Office



Reg. No. 4,155,118

Registered June 5, 2012

Int. Cls.: 35 and 37

SERVICE MARK

PRINCIPAL REGISTER

ASSISTED LIVING TECHNOLOGIES, INC. (CONNECTICUT CORPORATION)
74 SOUTH BROAD STREET
MERIDEN, CT 06450

FOR: RETAIL STORE SERVICES FEATURING ACTIVITY MONITORING AND EMERGENCY DETECTION SYSTEMS AND PRODUCTS FOR IN-HOME MONITORING OR ASSISTED LIVING FACILITY MONITORING OF THE ELDERLY OR INFIRM; ON-LINE RETAIL STORE SERVICES FEATURING ACTIVITY MONITORING AND EMERGENCY DETECTION SYSTEMS AND PRODUCTS FOR IN-HOME MONITORING OR ASSISTED LIVING FACILITY MONITORING OF THE ELDERLY OR INFIRM, IN CLASS 35 (U.S. CLS. 100, 101 AND 102).

FIRST USE 10-0-2010; IN COMMERCE 11-14-2010.

FOR: INSTALLATION AND MAINTENANCE OF ACTIVITY MONITORING AND EMERGENCY DETECTION SYSTEMS AND PRODUCTS USED IN THE FIELD OF IN-HOME MONITORING OF THE ELDERLY OR INFIRM, NAMELY, DOOR, CABINET AND BED USE SENSORS, APPLIANCE USE SENSORS, INFRARED MOTION DETECTORS, MOTION SENSING SYSTEMS, MOVEMENT SENSING SYSTEMS, MONITORED MEDICAL PRODUCT DISPENSING DEVICES, SMOKE DETECTORS, BURGLAR DETECTION SYSTEMS, WIRELESS NETWORK DEVICES, REMOTELY MONITORED IN-HOME ACTIVITY MONITORING AND EMERGENCY DETECTION SYSTEMS, IN CLASS 37 (U.S. CLS. 100, 103 AND 106).

FIRST USE 10-0-2010; IN COMMERCE 11-14-2010.

NO CLAIM IS MADE TO THE EXCLUSIVE RIGHT TO USE "ASSISTED LIVING TECHNOLOGIES INC.", APART FROM THE MARK AS SHOWN.

THE COLOR(S) BLACK, WHITE, PURPLE, GREEN, RED, AND ORANGE IS/ARE CLAIMED AS A FEATURE OF THE MARK.

THE MARK CONSISTS OF A HORIZONTAL PURPLE LINE HAVING A SOLID CIRCLE AT ONE END ADJACENT TO THREE UPRIGHT AND SPACED ARCHED SEGMENTS IN GREEN, RED, AND ORANGE COLOR; ABOVE THE HORIZONTAL LINE ARE THE WORDS, "ASSISTED LIVING" IN BLACK; BELOW THE HORIZONTAL LINE ARE THE WORDS, "TECHNOLOGIES INC." IN BLACK WHEREIN INC. IS WRITTEN VERTICALLY NEXT TO THE "S" OF "TECHNOLOGIES". ADDITIONALLY, UNDERNEATH THE WORDS "TECHNO-



David J. Kappas

Director of the United States Patent and Trademark Office

Reg. No. 4,155,118 LOGIES INC." IS AN ELONGATED PURPLE OVAL WITHIN WHICH ARE THE WORDS
"TECHNOLOGY SOLUTIONS FOR AGING IN PLACE" IN WHITE COLOR.

SN 85-248,361, FILED 2-22-2011.

TEJBIR SINGH, EXAMINING ATTORNEY

United States of America

United States Patent and Trademark Office

YO CHILL

Reg. No. 4,155,119

Registered June 5, 2012

Int. Cl.: 35

SERVICE MARK

PRINCIPAL REGISTER

AMIN LAW OFFICES, LTD. (ILLINOIS CORPORATION)
SUITE 950
1900 E. GOLF ROAD
SCHAUMBURG, IL 60173

FOR: SELF-SERVE YOGURT SHOP SERVICES, IN CLASS 35 (U.S. CLS. 100, 101 AND 102).

FIRST USE 1-1-2011; IN COMMERCE 4-9-2011.

THE MARK CONSISTS OF STANDARD CHARACTERS WITHOUT CLAIM TO ANY PARTICULAR FONT, STYLE, SIZE, OR COLOR.

SN 85-248,935, FILED 2-22-2011.

LAKEISHA LEWIS, EXAMINING ATTORNEY



David J. Kybas

Director of the United States Patent and Trademark Office

United States of America

United States Patent and Trademark Office

WEAR KNOT

Reg. No. 4,155,120

ROTARY DRILLING TOOLS USA (TEXAS LIMITED PARTNERSHIP)
9022 VINCIK EHLERT, P.O. BOX 73
BEASLY, TX 77417

Registered June 5, 2012

Int. Cl.: 6

FOR: PIPE, NAMELY, DRILL PIPE FOR USE IN DRILLING OPERATIONS, IN CLASS 6 (U.S. CLS. 2, 12, 13, 14, 23, 25 AND 50).

TRADEMARK

FIRST USE 2-28-2011; IN COMMERCE 2-28-2011.

PRINCIPAL REGISTER

THE MARK CONSISTS OF STANDARD CHARACTERS WITHOUT CLAIM TO ANY PARTICULAR FONT, STYLE, SIZE, OR COLOR.

SN 85-249,200, FILED 2-23-2011.

ODESSA BIBBINS, EXAMINING ATTORNEY



David J. Kyros

Director of the United States Patent and Trademark Office

United States of America

United States Patent and Trademark Office

PRETTY PEAR BRIDE

Reg. No. 4,155,121

Registered June 5, 2012

Int. Cls.: 35 and 41

SERVICE MARK

PRINCIPAL REGISTER

MAKING YOUR EVENT SPECIAL LLC (INDIANA LIMITED LIABILITY COMPANY)
SUITE 117
13295 ILLINOIS STREET
CARMEL, IN 46032

FOR: BUSINESS RESEARCH RELATING TO WEDDING PLANNING; PROVIDING AN ONLINE BUSINESS DIRECTORY INFORMATION SERVICE FEATURING INFORMATION REGARDING VENDORS OF PRODUCTS AND SERVICES RELATED TO WEDDINGS AND ENGAGEMENTS; PROMOTING AND SHOWCASING THE GOODS OF OTHERS IN THE FIELD OF WEDDING PLANNING BY MEANS OF A WEBSITE WITH ADVERTISEMENTS OF OTHERS, IN CLASS 35 (U.S. CLS. 100, 101 AND 102).

FIRST USE 4-24-2011; IN COMMERCE 4-24-2011.

FOR: PROVIDING INFORMATION, ADVICE, AND CONSULTANCY RELATING TO WEDDING PLANNING, IN CLASS 41 (U.S. CLS. 100, 101 AND 107).

FIRST USE 4-24-2011; IN COMMERCE 4-24-2011.

THE MARK CONSISTS OF STANDARD CHARACTERS WITHOUT CLAIM TO ANY PARTICULAR FONT, STYLE, SIZE, OR COLOR.

NO CLAIM IS MADE TO THE EXCLUSIVE RIGHT TO USE "BRIDE", APART FROM THE MARK AS SHOWN.

SN 85-249,284, FILED 2-23-2011.

JASON BLAIR, EXAMINING ATTORNEY



David J. Kybas

Director of the United States Patent and Trademark Office

United States of America

United States Patent and Trademark Office

NONSTOP MOISTURE

Reg. No. 4,155,122

Registered June 5, 2012

Int. Cl.: 3

TRADEMARK

PRINCIPAL REGISTER

PARIS PRESENTS INCORPORATED (ILLINOIS CORPORATION)
3800 SWANSON COURT
GURNEE, IL 60031

FOR: LIP BALM; LIP GLOSS, IN CLASS 3 (U.S. CLS. 1, 4, 6, 50, 51 AND 52).

FIRST USE 2-1-2011; IN COMMERCE 2-1-2011.

THE MARK CONSISTS OF STANDARD CHARACTERS WITHOUT CLAIM TO ANY PARTICULAR FONT, STYLE, SIZE, OR COLOR.

NO CLAIM IS MADE TO THE EXCLUSIVE RIGHT TO USE "MOISTURE", APART FROM THE MARK AS SHOWN.

SN 85-249,380, FILED 2-23-2011.

SCOTT BIBB, EXAMINING ATTORNEY



David J. Kyffers

Director of the United States Patent and Trademark Office

United States of America

United States Patent and Trademark Office

SURVEY PLANET

Reg. No. 4,155,123

Registered June 5, 2012

Int. Cls.: 35 and 42

SERVICE MARK

PRINCIPAL REGISTER

SURVEY PLANET, LLC. (CALIFORNIA LIMITED LIABILITY COMPANY)
2901 OCEAN PARK BLVD., SUITE 215
SANTA MONICA, CA 90405

FOR: MARKET RESEARCH SERVICES; PROVIDING AN INTERACTIVE WEB SITE FEATURING EDUCATIONAL INFORMATION AND TEST QUESTIONS IN THE FIELD OF MARKET RESEARCH, IN CLASS 35 (U.S. CLS. 100, 101 AND 102).

FIRST USE 2-3-2012; IN COMMERCE 2-3-2012.

FOR: HOSTING AN ONLINE COMMUNITY WEBSITE FOR USERS TO PARTICIPATE, CONDUCT AND MANAGE SURVEYS; PROVIDING TEMPORARY USE OF NON-DOWNLOADABLE COMPUTER APPLICATION FOR MOBILE DEVICES FOR CONDUCTING CONSUMER SURVEYS, IN CLASS 42 (U.S. CLS. 100 AND 101).

FIRST USE 2-3-2012; IN COMMERCE 2-3-2012.

THE MARK CONSISTS OF STANDARD CHARACTERS WITHOUT CLAIM TO ANY PARTICULAR FONT, STYLE, SIZE, OR COLOR.

NO CLAIM IS MADE TO THE EXCLUSIVE RIGHT TO USE "SURVEY", APART FROM THE MARK AS SHOWN.

SN 85-249,495, FILED 2-23-2011.

ANNE MADDEN, EXAMINING ATTORNEY



David J. Kybas

Director of the United States Patent and Trademark Office

United States of America

United States Patent and Trademark Office

WHERE THE ANSWERS LIVE

Reg. No. 4,155,124

Registered June 5, 2012

Int. Cls.: 35 and 42

SERVICE MARK

PRINCIPAL REGISTER

SURVEY PLANET, LLC (CALIFORNIA LIMITED LIABILITY COMPANY)
2901 OCEAN PARK BLVD., SUITE 215
SANTA MONICA, CA 90405

FOR: MARKET RESEARCH SERVICES; PROVIDING AN INTERACTIVE WEB SITE FEATURING EDUCATIONAL INFORMATION AND TEST QUESTIONS IN THE FIELD OF MARKET RESEARCH, IN CLASS 35 (U.S. CLS. 100, 101 AND 102).

FIRST USE 2-3-2012; IN COMMERCE 2-3-2012.

FOR: HOSTING AN ONLINE COMMUNITY WEBSITE FOR USERS TO PARTICIPATE, CONDUCT AND MANAGE SURVEYS; PROVIDING TEMPORARY USE OF NON-DOWNLOADABLE COMPUTER APPLICATION FOR MOBILE DEVICES FOR CONDUCTING CONSUMER SURVEYS, IN CLASS 42 (U.S. CLS. 100 AND 101).

FIRST USE 2-3-2012; IN COMMERCE 2-3-2012.

THE MARK CONSISTS OF STANDARD CHARACTERS WITHOUT CLAIM TO ANY PARTICULAR FONT, STYLE, SIZE, OR COLOR.

SN 85-249,505, FILED 2-23-2011.

ANNE MADDEN, EXAMINING ATTORNEY



David J. Kyros

Director of the United States Patent and Trademark Office

United States of America

United States Patent and Trademark Office



Reg. No. 4,155,125

PONCHILLOW (CALIFORNIA LIMITED LIABILITY COMPANY)
234 AVE VISTA DEL OCEANO
SAN CLEMENTE, CA 92672

Registered June 5, 2012

Int. Cl.: 24

FOR: FLEECE PONCHO STYLE BLANKET WITH AN ATTACHED PILLOW, HOOD, POCKETS, AND POUCHES, IN CLASS 24 (U.S. CLS. 42 AND 50).

TRADEMARK

FIRST USE 3-8-2011; IN COMMERCE 7-1-2011.

PRINCIPAL REGISTER

THE MARK CONSISTS OF CLOUDS FILLED WITH LETTERS SPELLING OUT "PONCHILLOW", AND "NEVER FORGET YOUR PILLOW" WRITTEN UNDERNEATH "PONCHILLOW".

SN 85-250,086, FILED 2-23-2011.

DOMINICK J. SALEMI, EXAMINING ATTORNEY



David J. Kybas

Director of the United States Patent and Trademark Office

United States of America

United States Patent and Trademark Office

LOCO-MOTION FITNESS

Reg. No. 4,155,126

SCOTT-REYES, LAURIE (UNITED STATES INDIVIDUAL)
22246 SE 111TH AVE.
HAWTHORNE, FL 32640

Registered June 5, 2012

Int. Cl.: 41

FOR: PHYSICAL FITNESS AND EXERCISE TRAINING SERVICES; PHYSICAL FITNESS INSTRUCTION AND CONSULTATION, IN CLASS 41 (U.S. CLS. 100, 101 AND 107).

SERVICE MARK

FIRST USE 3-1-2012; IN COMMERCE 3-1-2012.

PRINCIPAL REGISTER

THE MARK CONSISTS OF STANDARD CHARACTERS WITHOUT CLAIM TO ANY PARTICULAR FONT, STYLE, SIZE, OR COLOR.

NO CLAIM IS MADE TO THE EXCLUSIVE RIGHT TO USE "FITNESS", APART FROM THE MARK AS SHOWN.

SN 85-250,197, FILED 2-24-2011.

RONALD MCMORROW, EXAMINING ATTORNEY



David J. Kyros

Director of the United States Patent and Trademark Office

United States of America

United States Patent and Trademark Office

PERSONAL eSUITE

Reg. No. 4,155,127

Registered June 5, 2012

Int. Cl.: 36

SERVICE MARK

PRINCIPAL REGISTER

ALLIANCE BANK, N.A. (UNITED STATES NATIONAL BANKING ASSOCIATION)
18TH FLOOR
120 MADISON STREET
SYRACUSE, NY 13202

FOR: ONLINE FINANCIAL SERVICES, NAMELY, BANKING SERVICES, BILL PAYMENT SERVICES, AND FINANCIAL MANAGEMENT SERVICES, IN CLASS 36 (U.S. CLS. 100, 101 AND 102).

FIRST USE 8-19-2011; IN COMMERCE 8-19-2011.

THE MARK CONSISTS OF STANDARD CHARACTERS WITHOUT CLAIM TO ANY PARTICULAR FONT, STYLE, SIZE, OR COLOR.

NO CLAIM IS MADE TO THE EXCLUSIVE RIGHT TO USE "PERSONAL", APART FROM THE MARK AS SHOWN.

SN 85-250,315, FILED 2-24-2011.

CHRISTOPHER BUONGIORNO, EXAMINING ATTORNEY



David J. Kyros

Director of the United States Patent and Trademark Office

United States of America

United States Patent and Trademark Office



Reg. No. 4,155,128

Registered June 5, 2012

Int. Cls.: 35 and 42

SERVICE MARK

PRINCIPAL REGISTER

VOTEBLAST, INC. (DELAWARE CORPORATION)
P.O. BOX 691824
WEST HOLLYWOOD, CA 90069

FOR: ADVERTISING, MARKETING AND PROMOTION SERVICES; MARKETING SERVICES, NAMELY, PROMOTING THE GOODS AND SERVICES OF OTHERS; BRAND IMAGERY CONSULTING SERVICES; MARKET OPINION POLLING STUDIES; CONDUCTING BUSINESS AND MARKET RESEARCH SURVEYS; PROVIDING A SEARCHABLE WEBSITE FEATURING THE GOODS AND SERVICES OF OTHER VENDORS; PROVIDING A WEBSITE WHERE USERS CAN POST RATINGS, REVIEWS AND RECOMMENDATIONS ON PRODUCTS AND SERVICES FOR COMMERCIAL PURPOSES, IN CLASS 35 (U.S. CLS. 100, 101 AND 102).

FIRST USE 11-0-2010; IN COMMERCE 11-0-2010.

FOR: COMPUTER SERVICE, NAMELY, ACTING AS AN APPLICATION SERVICE PROVIDER IN THE FIELD OF INFORMATION MANAGEMENT TO HOST COMPUTER APPLICATION SOFTWARE FOR THE PURPOSE OF DISPLAY, COLLECTION, EDITING, ORGANIZING, MODIFYING, TRANSMISSION, STORAGE AND SHARING OF DATA AND INFORMATION IN THE FIELD OF SURVEY AND OPINION SERVICES, IN CLASS 42 (U.S. CLS. 100 AND 101).

FIRST USE 11-0-2010; IN COMMERCE 11-0-2010.

THE MARK CONSISTS OF A RED FROWN FACE, YELLOW NEUTRAL FACE, GREEN SMILEY FACE, AND BLUE CIRCLE DESIGN WITH STARS. THE COLOR GRAY APPEARS AS A SHADOW REFLECTION BEHIND THE FACES AND CIRCLE IN THE MARK BUT IS NOT CLAIMED AS A FEATURE OF THE MARK.

THE COLOR(S) RED, YELLOW, GREEN AND BLUE IS/ARE CLAIMED AS A FEATURE OF THE MARK.

SN 85-250,333, FILED 2-24-2011.

NATALIE POLZER, EXAMINING ATTORNEY



David J. Kyros

Director of the United States Patent and Trademark Office

United States of America

United States Patent and Trademark Office

VOTEBLAST

Reg. No. 4,155,129

Registered June 5, 2012

Int. Cls.: 35 and 42

SERVICE MARK

PRINCIPAL REGISTER

VOTEBLAST, INC. (DELAWARE CORPORATION)
P.O. BOX 691824
WEST HOLLYWOOD, CA 90069

FOR: ADVERTISING, MARKETING AND PROMOTION SERVICES; MARKETING SERVICES, NAMELY, PROMOTING THE GOODS AND SERVICES OF OTHERS; BRAND IMAGERY CONSULTING SERVICES; MARKET OPINION POLLING STUDIES; CONDUCTING BUSINESS AND MARKET RESEARCH SURVEYS; PROVIDING A SEARCHABLE WEBSITE FEATURING THE GOODS AND SERVICES OF OTHER VENDORS; PROVIDING A WEBSITE WHERE USERS CAN POST RATINGS, REVIEWS AND RECOMMENDATIONS ON PRODUCTS AND SERVICES FOR COMMERCIAL PURPOSES, IN CLASS 35 (U.S. CLS. 100, 101 AND 102).

FIRST USE 11-0-2010; IN COMMERCE 11-0-2010.

FOR: COMPUTER SERVICE, NAMELY, ACTING AS AN APPLICATION SERVICE PROVIDER IN THE FIELD OF INFORMATION MANAGEMENT TO HOST COMPUTER APPLICATION SOFTWARE FOR THE PURPOSE OF DISPLAY, COLLECTION, EDITING, ORGANIZING, MODIFYING, TRANSMISSION, STORAGE AND SHARING OF DATA AND INFORMATION IN THE FIELD OF SURVEY AND OPINION SERVICES, IN CLASS 42 (U.S. CLS. 100 AND 101).

FIRST USE 11-0-2010; IN COMMERCE 11-0-2010.

THE MARK CONSISTS OF STANDARD CHARACTERS WITHOUT CLAIM TO ANY PARTICULAR FONT, STYLE, SIZE, OR COLOR.

SN 85-250,389, FILED 2-24-2011.

NATALIE POLZER, EXAMINING ATTORNEY



David J. Kyjars

Director of the United States Patent and Trademark Office

United States of America

United States Patent and Trademark Office

eClinger

Reg. No. 4,155,130

Registered June 5, 2012

Int. Cl.: 10

TRADEMARK

PRINCIPAL REGISTER

KIM, TAE-WEON (REPUBLIC OF KOREA INDIVIDUAL)
103-102 LG HANGANG XI APT.
430 ICHON-DONG, YONGSAN-GU
SEOUL 140-774, REPUBLIC OF KOREA

FOR: DIGITAL ORTHODONTIC APPLIANCES; ORTHODONTIC APPLIANCES, IN CLASS
10 (U.S. CLS. 26, 39 AND 44).

FIRST USE 2-17-2012; IN COMMERCE 2-17-2012.

THE MARK CONSISTS OF "ECLIGNER" IN STYLIZED FORM WITH AN ARC OF DOTS.

SN 85-250,444, FILED 2-24-2011.

LINDA ESTRADA, EXAMINING ATTORNEY



David J. Kybas

Director of the United States Patent and Trademark Office

United States of America

United States Patent and Trademark Office



Reg. No. 4,155,131

Registered June 5, 2012

Int. Cls.: 35 and 42

SERVICE MARK

PRINCIPAL REGISTER

VOTEBLAST, INC. (DELAWARE CORPORATION)
P.O. BOX 691824
WEST HOLLYWOOD, CA 90069

FOR: ADVERTISING, MARKETING AND PROMOTION SERVICES; MARKETING SERVICES, NAMELY, PROMOTING THE GOODS AND SERVICES OF OTHERS; BRAND IMAGERY CONSULTING SERVICES; MARKET OPINION POLLING STUDIES; CONDUCTING BUSINESS AND MARKET RESEARCH SURVEYS; PROVIDING A SEARCHABLE WEBSITE FEATURING THE GOODS AND SERVICES OF OTHER VENDORS; PROVIDING A WEBSITE WHERE USERS CAN POST RATINGS, REVIEWS AND RECOMMENDATIONS ON PRODUCTS AND SERVICES FOR COMMERCIAL PURPOSES, IN CLASS 35 (U.S. CLS. 100, 101 AND 102).

FIRST USE 11-0-2010; IN COMMERCE 11-0-2010.

FOR: COMPUTER SERVICE, NAMELY, ACTING AS AN APPLICATION SERVICE PROVIDER IN THE FIELD OF INFORMATION MANAGEMENT TO HOST COMPUTER APPLICATION SOFTWARE FOR THE PURPOSE OF DISPLAY, COLLECTION, EDITING, ORGANIZING, MODIFYING, TRANSMISSION, STORAGE AND SHARING OF DATA AND INFORMATION IN THE FIELD OF SURVEY AND OPINION SERVICES, IN CLASS 42 (U.S. CLS. 100 AND 101).

FIRST USE 11-0-2010; IN COMMERCE 11-0-2010.

THE MARK CONSISTS OF A FROWN FACE, NEUTRAL FACE, SMILEY FACE, AND A CIRCLE DESIGN WITH STARS.

SN 85-250,469, FILED 2-24-2011.

NATALIE POLZER, EXAMINING ATTORNEY



David J. Kybas

Director of the United States Patent and Trademark Office

United States of America

United States Patent and Trademark Office

PREMIER VALUE ALLIANCE

Reg. No. 4,155,132

Registered June 5, 2012

Int. Cl.: 35

SERVICE MARK

PRINCIPAL REGISTER

PREMIER VALUE ALLIANCE, LLC (DELAWARE LIMITED LIABILITY COMPANY)
3301 NW BOCA RATON BOULEVARD, SUITE 101
BOCA RATON, FL 33431

FOR: BUYING GROUP AND PROCUREMENT SERVICES, NAMELY, PURCHASING PHARMACEUTICAL PRESCRIPTION PRODUCTS FOR PHARMACIES; PROVIDING INFORMATION PERTAINING TO PROCUREMENT, BUYING, SELLING AND TENDERING INFORMATION AND OPPORTUNITIES RELATING TO PHARMACY RELATED GOODS AND SERVICES VIA COMPUTER, COMPUTER NETWORKS, TELEPHONE, THE INTERNET OR ELECTRONIC MAIL, IN CLASS 35 (U.S. CLS. 100, 101 AND 102).

FIRST USE 2-28-2011; IN COMMERCE 2-28-2011.

THE MARK CONSISTS OF STANDARD CHARACTERS WITHOUT CLAIM TO ANY PARTICULAR FONT, STYLE, SIZE, OR COLOR.

NO CLAIM IS MADE TO THE EXCLUSIVE RIGHT TO USE "ALLIANCE" , APART FROM THE MARK AS SHOWN.

SN 85-250,647, FILED 2-24-2011.

TINA MAI, EXAMINING ATTORNEY



David J. Kyros

Director of the United States Patent and Trademark Office

United States of America

United States Patent and Trademark Office

SS 100

Reg. No. 4,155,133

Registered June 5, 2012

Int. Cl.: 4

TRADEMARK

PRINCIPAL REGISTER

SUNMARKS, LLC (DELAWARE LIMITED LIABILITY COMPANY)
2401 PENNSYLVANIA AVENUE, SUITE 111
WILMINGTON, DE 19806

FOR: FUELS, IN CLASS 4 (U.S. CLS. 1, 6 AND 15).

FIRST USE 4-20-2011; IN COMMERCE 4-20-2011.

THE MARK CONSISTS OF STANDARD CHARACTERS WITHOUT CLAIM TO ANY PARTICULAR FONT, STYLE, SIZE, OR COLOR.

SN 85-250,681, FILED 2-24-2011.

DORITT L. CARROLL, EXAMINING ATTORNEY



David J. Kybas

Director of the United States Patent and Trademark Office

United States of America

United States Patent and Trademark Office

CDC

Reg. No. 4,155,134

Registered June 5, 2012

DIVORCE COACHING, INC. (FLORIDA CORPORATION)
8729 BAY POINTE DRIVE
TAMPA, FL 33615

CERTIFICATION MARK

FOR: PERSONAL DIVORCE COACHING, IN CLASS B (U.S. CL. B).

SERVICES

FIRST USE 6-15-2011; IN COMMERCE 6-20-2011.

PRINCIPAL REGISTER

THE MARK CONSISTS OF STANDARD CHARACTERS WITHOUT CLAIM TO ANY PARTICULAR FONT, STYLE, SIZE, OR COLOR.

THE CERTIFICATION MARK, AS INTENDED TO BE USED BY AUTHORIZED PERSONS, IS INTENDED TO CERTIFY THAT THE PERSON DISPLAYING THE MARK HAS COMPLETED EDUCATION COURSE WORK REQUIREMENTS AND WORK EXPERIENCE REQUIREMENTS OF THE CERTIFIER, HAS COMPLETED EXAMINATIONS ADMINISTERED BY THE CERTIFIER IN A SATISFACTORY MANNER, HAS AGREED TO ADHERE TO THE CERTIFIER'S STANDARDS OF PROFESSIONAL RESPONSIBILITY, CONTINUING EDUCATION AND OTHER POST-CERTIFICATION REQUIREMENTS.

SN 85-250,721, FILED 2-24-2011.

TOBY BULLOFF, EXAMINING ATTORNEY



David J. Kyffers

Director of the United States Patent and Trademark Office

United States of America

United States Patent and Trademark Office

CDC CERTIFIED DIVORCE COACH

Reg. No. 4,155,135

Registered June 5, 2012

DIVORCE COACHING, INC. (FLORIDA CORPORATION)
8729 BAY POINTE DRIVE
TAMPA, FL 33615

CERTIFICATION MARK

FOR: PERSONAL DIVORCE COACHING, IN CLASS B (U.S. CL. B).

SERVICES

FIRST USE 6-15-2011; IN COMMERCE 6-20-2011.

PRINCIPAL REGISTER

THE MARK CONSISTS OF STANDARD CHARACTERS WITHOUT CLAIM TO ANY PARTICULAR FONT, STYLE, SIZE, OR COLOR.

NO CLAIM IS MADE TO THE EXCLUSIVE RIGHT TO USE "CERTIFIED DIVORCE COACH", APART FROM THE MARK AS SHOWN.

THE CERTIFICATION MARK, AS INTENDED TO BE USED BY AUTHORIZED PERSONS, IS INTENDED TO CERTIFY THAT THE PERSON DISPLAYING THE MARK HAS COMPLETED EDUCATION COURSE WORK REQUIREMENTS AND WORK EXPERIENCE REQUIREMENTS OF THE CERTIFIER, HAS COMPLETED EXAMINATIONS ADMINISTERED BY THE CERTIFIER IN A SATISFACTORY MANNER, HAS AGREED TO ADHERE TO THE CERTIFIER'S STANDARDS OF PROFESSIONAL RESPONSIBILITY, CONTINUING EDUCATION AND OTHER POST-CERTIFICATION REQUIREMENTS.

SN 85-250,725, FILED 2-24-2011.

TOBY BULLOFF, EXAMINING ATTORNEY



David J. Kyffers

Director of the United States Patent and Trademark Office

United States of America

United States Patent and Trademark Office

CDC COLLEGE FOR DIVORCE COACHING

Reg. No. 4,155,136

Registered June 5, 2012

Int. Cl.: 41

SERVICE MARK

PRINCIPAL REGISTER

DIVORCE COACHING, INC. (FLORIDA CORPORATION)
8729 BAY POINTE DRIVE
TAMPA, FL 33615

FOR: EDUCATIONAL SERVICES, NAMELY, PROVIDING CLASSES, SEMINARS, WORKSHOPS, WEBINARS IN THE FIELDS OF PERSONAL DIVORCE COACH TRAINING FOR MENTAL HEALTH COUNSELORS, ATTORNEYS, MEDIATORS, AND OTHER PROFESSIONALS, IN CLASS 41 (U.S. CLS. 100, 101 AND 107).

FIRST USE 6-15-2011; IN COMMERCE 6-20-2011.

THE MARK CONSISTS OF STANDARD CHARACTERS WITHOUT CLAIM TO ANY PARTICULAR FONT, STYLE, SIZE, OR COLOR.

NO CLAIM IS MADE TO THE EXCLUSIVE RIGHT TO USE "COLLEGE FOR DIVORCE COACHING", APART FROM THE MARK AS SHOWN.

SN 85-250,736, FILED 2-24-2011.

TOBY BULLOFF, EXAMINING ATTORNEY



David J. Kybas

Director of the United States Patent and Trademark Office

United States of America

United States Patent and Trademark Office

PROMOVERSE

Reg. No. 4,155,137

Registered June 5, 2012

Int. Cls.: 9 and 35

TRADEMARK

SERVICE MARK

PRINCIPAL REGISTER

THE ARELI GROUP, LLC (NEW JERSEY LIMITED LIABILITY COMPANY)
22 SCHAAF ROAD
BLOOMSBURY, NJ 08804

FOR: COMPUTER APPLICATION SOFTWARE FOR MOBILE PHONES AND HANDHELD COMPUTERS, NAMELY, SOFTWARE FOR USE IN DISTRIBUTING ADVERTISING AND PROMOTIONAL INFORMATION, IN CLASS 9 (U.S. CLS. 21, 23, 26, 36 AND 38).

FIRST USE 10-20-2011; IN COMMERCE 10-20-2011.

FOR: ADVERTISING SERVICES, IN CLASS 35 (U.S. CLS. 100, 101 AND 102).

FIRST USE 10-20-2011; IN COMMERCE 10-20-2011.

THE MARK CONSISTS OF STANDARD CHARACTERS WITHOUT CLAIM TO ANY PARTICULAR FONT, STYLE, SIZE, OR COLOR.

SN 85-250,762, FILED 2-24-2011.

ANGELA M. MICHELI, EXAMINING ATTORNEY



David J. Kyros

Director of the United States Patent and Trademark Office

United States of America

United States Patent and Trademark Office

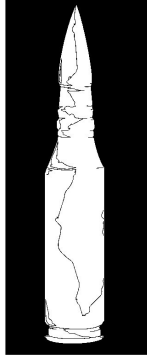

Reg. No. 4,155,138

Registered June 5, 2012

Int. Cl.: 25

TRADEMARK

PRINCIPAL REGISTER

BULLET GEAR LLC (MICHIGAN LIMITED LIABILITY COMPANY)
619 ASHBURNHAM
AUBURN HILLS, MI 48326

FOR: SHIRTS; SWEATERS, IN CLASS 25 (U.S. CLS. 22 AND 39).

FIRST USE 6-20-2011; IN COMMERCE 7-1-2011.

THE MARK CONSISTS OF A DESIGN OF A .50 CALIBER BULLET INSIDE A SQUARE.

SN 85-251,089, FILED 2-24-2011.

CAROLINE WOOD, EXAMINING ATTORNEY



David J. Kybas

Director of the United States Patent and Trademark Office

United States of America

United States Patent and Trademark Office

Generous Art

Reg. No. 4,155,139

Registered June 5, 2012

Int. Cl.: 36

SERVICE MARK

PRINCIPAL REGISTER

GENEROUS ART, LLC (TEXAS LIMITED LIABILITY COMPANY)
1200 E. 2ND ST.
AUSTIN, TX 787024306

FOR: CHARITABLE FUNDRAISING SERVICES BY MEANS OF SELLING ARTWORK TO RAISE FUNDS FOR NON-PROFIT ORGANIZATIONS, IN CLASS 36 (U.S. CLS. 100, 101 AND 102).

FIRST USE 2-28-2011; IN COMMERCE 2-28-2011.

THE MARK CONSISTS OF STANDARD CHARACTERS WITHOUT CLAIM TO ANY PARTICULAR FONT, STYLE, SIZE, OR COLOR.

NO CLAIM IS MADE TO THE EXCLUSIVE RIGHT TO USE "ART", APART FROM THE MARK AS SHOWN.

SN 85-251,101, FILED 2-24-2011.

MARK RADEMACHER, EXAMINING ATTORNEY



David J. Kyffers

Director of the United States Patent and Trademark Office

United States of America

United States Patent and Trademark Office

PRICE INSPECTOR

Reg. No. 4,155,140

Registered June 5, 2012

Int. Cl.: 35

SERVICE MARK

PRINCIPAL REGISTER

BENCHMARK SOLUTIONS HOLDINGS INC. (DELAWARE CORPORATION)
101 PARK AVENUE
7TH FLOOR
NEW YORK, NY 10178

FOR: FINANCIAL SERVICES, NAMELY, ANALYZING MARKET DATA AND PRICING ANALYTICS SERVICES FOR MEASURING THE PERFORMANCE OF FINANCIAL MARKETS FOR ASSET CLASSES WITHIN THE CAPITAL MARKETS, INCLUDING FIXED INCOME PRODUCTS, IN CLASS 35 (U.S. CLS. 100, 101 AND 102).

FIRST USE 7-18-2011; IN COMMERCE 7-18-2011.

THE MARK CONSISTS OF STANDARD CHARACTERS WITHOUT CLAIM TO ANY PARTICULAR FONT, STYLE, SIZE, OR COLOR.

NO CLAIM IS MADE TO THE EXCLUSIVE RIGHT TO USE "PRICE", APART FROM THE MARK AS SHOWN.

SN 85-251,146, FILED 2-24-2011.

ARETHA SOMERVILLE, EXAMINING ATTORNEY



David J. Kyffers

Director of the United States Patent and Trademark Office

United States of America

United States Patent and Trademark Office

YORITO

Reg. No. 4,155,141

RIO GRANDE PRODUCTS, INC. (MARYLAND CORPORATION)
8610 CHERRY LANE, SUITE 41
LAUREL, MD 20707

Registered June 5, 2012

Int. Cl.: 29

FOR: CHEESE; DAIRY-BASED SPREADS, IN CLASS 29 (U.S. CL. 46).

TRADEMARK

FIRST USE 4-4-2011; IN COMMERCE 4-4-2011.

PRINCIPAL REGISTER

THE MARK CONSISTS OF STANDARD CHARACTERS WITHOUT CLAIM TO ANY PARTICULAR FONT, STYLE, SIZE, OR COLOR.

SN 85-251,149, FILED 2-24-2011.

MARK PILARO, EXAMINING ATTORNEY



David J. Kyffers

Director of the United States Patent and Trademark Office

United States of America

United States Patent and Trademark Office

BMARK ATTRIBUTION

Reg. No. 4,155,142

BENCHMARK SOLUTIONS HOLDINGS INC. (DELAWARE CORPORATION)
101 PARK AVENUE 7TH FLOOR
NEW YORK, NY 10178

Registered June 5, 2012

Int. Cl.: 35

FOR: FINANCIAL SERVICES, NAMELY, ANALYZING MARKET DATA AND PRICING ANALYTICS SERVICES FOR MEASURING THE PERFORMANCE OF FINANCIAL MARKETS FOR ASSET CLASSES WITHIN THE CAPITAL MARKETS, INCLUDING FIXED INCOME PRODUCTS, IN CLASS 35 (U.S. CLS. 100, 101 AND 102).

SERVICE MARK

PRINCIPAL REGISTER

FIRST USE 7-18-2011; IN COMMERCE 7-18-2011.

THE MARK CONSISTS OF STANDARD CHARACTERS WITHOUT CLAIM TO ANY PARTICULAR FONT, STYLE, SIZE, OR COLOR.

SN 85-251,152, FILED 2-24-2011.

ARETHA SOMERVILLE, EXAMINING ATTORNEY



David J. Kybas

Director of the United States Patent and Trademark Office

United States of America

United States Patent and Trademark Office

BMARK

Reg. No. 4,155,143

Registered June 5, 2012

Int. Cl.: 35

SERVICE MARK

PRINCIPAL REGISTER

BENCHMARK SOLUTIONS HOLDINGS INC. (DELAWARE CORPORATION)
101 PARK AVENUE
7TH FLOOR
NEW YORK, NY 10178

FOR: FINANCIAL SERVICES, NAMELY, ANALYZING MARKET DATA AND PRICING ANALYTICS SERVICES FOR MEASURING THE PERFORMANCE OF FINANCIAL MARKETS FOR ASSET CLASSES WITHIN THE CAPITAL MARKETS, INCLUDING FIXED INCOME PRODUCTS, IN CLASS 35 (U.S. CLS. 100, 101 AND 102).

FIRST USE 7-18-2011; IN COMMERCE 7-18-2011.

THE MARK CONSISTS OF STANDARD CHARACTERS WITHOUT CLAIM TO ANY PARTICULAR FONT, STYLE, SIZE, OR COLOR.

SN 85-251,157, FILED 2-24-2011.

ARETHA SOMERVILLE, EXAMINING ATTORNEY



David J. Kybas

Director of the United States Patent and Trademark Office

United States of America

United States Patent and Trademark Office

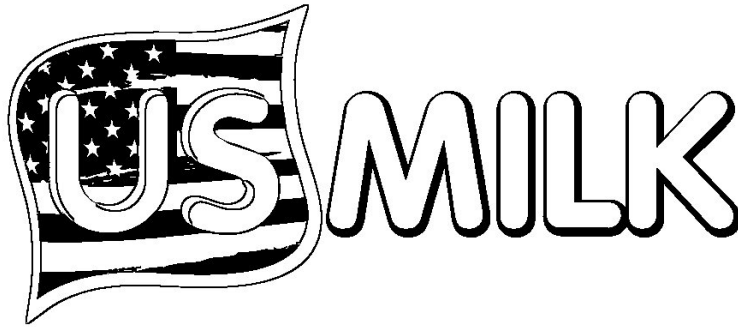

Reg. No. 4,155,144

Registered June 5, 2012

Int. Cl.: 3

TRADEMARK

PRINCIPAL REGISTER

US MILK CORPORATION (CALIFORNIA CORPORATION)
1137 W BRADFORD CIRCLE
CORONA, CA 92882

FOR: COSMETICS, IN CLASS 3 (U.S. CLS. 1, 4, 6, 50, 51 AND 52).

FIRST USE 2-1-2012; IN COMMERCE 2-1-2012.

NO CLAIM IS MADE TO THE EXCLUSIVE RIGHT TO USE "US MILK" , APART FROM THE MARK AS SHOWN.

THE MARK CONSISTS OF A FLAG WITH THE STYLIZED TEXT "US MILK".

SN 85-251,316, FILED 2-24-2011.

CARYN GLASSER, EXAMINING ATTORNEY



David J. Kyffers

Director of the United States Patent and Trademark Office

United States of America

United States Patent and Trademark Office

Aquila

Reg. No. 4,155,145

Registered June 5, 2012

Int. Cl.: 9

TRADEMARK

PRINCIPAL REGISTER

KABUSHIKI KAISHA TOPCON (JAPAN CORPORATION)
75-1, HASUNUMA-CHO, ITABASHI-KU
TOKYO 174-8580, JAPAN

FOR: APPARATUS AND INSTRUMENTS FOR ANALYZING AND INSPECTING SEMICONDUCTOR WAFER, SCANNING ELECTRON MICROSCOPES, OPTICAL MICROSCOPES, INTERFEROMETER, LASER INTERFEROMETER, IN CLASS 9 (U.S. CLS. 21, 23, 26, 36 AND 38).

FIRST USE 10-4-2011; IN COMMERCE 10-4-2011.

THE MARK CONSISTS OF STANDARD CHARACTERS WITHOUT CLAIM TO ANY PARTICULAR FONT, STYLE, SIZE, OR COLOR.

SN 85-251,407, FILED 2-25-2011.

LEIGH CAROLINE CASE, EXAMINING ATTORNEY



David J. Kybas

Director of the United States Patent and Trademark Office

United States of America

United States Patent and Trademark Office



Reg. No. 4,155,146

Registered June 5, 2012

Int. Cl.: 39

SERVICE MARK

PRINCIPAL REGISTER

SAZERAC NORTH AMERICA, INC. (DELAWARE CORPORATION)
1001 WILKINSON BOULEVARD
FRANKFORT, KY 40602

FOR: BOTTLING SERVICES; PACKING, CRATING AND WAREHOUSING SERVICES;
SHIPPING OF GOODS; WAREHOUSING SERVICES, NAMELY, STORAGE, DISTRIBUTION,
PICK-UP, PACKING, AND SHIPPING OF DISTILLED SPIRITS; ARRANGING AND CON-
DUCTING DISTILLERY TOURS, IN CLASS 39 (U.S. CLS. 100 AND 105).

FIRST USE 5-30-2011; IN COMMERCE 5-30-2011.

THE MARK CONSISTS OF THE CAPITAL LETTER "B" IN A CIRCLE TO THE LEFT OF
THE WORD "BARTON", WHICH IS IN ALL CAPS.

SN 85-251,693, FILED 2-25-2011.

GRETТА YAO, EXAMINING ATTORNEY



David J. Kybas

Director of the United States Patent and Trademark Office

United States of America

United States Patent and Trademark Office

mobileEcho

Reg. No. 4,155,147

Registered June 5, 2012

Int. Cl.: 9

TRADEMARK

PRINCIPAL REGISTER

GROUPLOGIC, INC. (DELAWARE CORPORATION)
1100 N. GLEBE ROAD, SUITE 800
ARLINGTON, VA 22201

FOR: COMPUTER SOFTWARE FOR BUSINESSES THAT ALLOWS USERS TO PERFORM ELECTRONIC BUSINESS TRANSACTIONS, COMMUNICATE WITH OTHER USERS, AND ACCESS AND EXCHANGE INFORMATION STORED ON A FILE SERVER VIA MOBILE DEVICES AND TABLET COMPUTERS, IN CLASS 9 (U.S. CLS. 21, 23, 26, 36 AND 38).

FIRST USE 5-23-2011; IN COMMERCE 5-23-2011.

THE MARK CONSISTS OF STANDARD CHARACTERS WITHOUT CLAIM TO ANY PARTICULAR FONT, STYLE, SIZE, OR COLOR.

SN 85-251,706, FILED 2-25-2011.

TINA MAI, EXAMINING ATTORNEY



David J. Kyffers

Director of the United States Patent and Trademark Office

United States of America

United States Patent and Trademark Office

WESTERN RANCH

Reg. No. 4,155,148

Registered June 5, 2012

Int. Cl.: 30

TRADEMARK

PRINCIPAL REGISTER

E. WALDO WARD & SON, INC. (CALIFORNIA CORPORATION)
273 E. HIGHLAND AVE.
SIERRA MADRE, CA 91024

FOR: SAUCES, NAMELY, BARBECUE SAUCE, IN CLASS 30 (U.S. CL. 46).

FIRST USE 6-30-2011; IN COMMERCE 6-30-2011.

THE MARK CONSISTS OF STANDARD CHARACTERS WITHOUT CLAIM TO ANY PARTICULAR FONT, STYLE, SIZE, OR COLOR.

SN 85-251,708, FILED 2-25-2011.

FLORENTINA BLANDU, EXAMINING ATTORNEY



David J. Kyros

Director of the United States Patent and Trademark Office

United States of America

United States Patent and Trademark Office

HAPPY SODA

Reg. No. 4,155,149

Registered June 5, 2012

Int. Cl.: 25

TRADEMARK

PRINCIPAL REGISTER

FORTUNE DYNAMIC INC. (CALIFORNIA CORPORATION)
21923 FERRERO PKY
CITY OF INDUSTRY, CA 91789

FOR: FOOTWEAR, IN CLASS 25 (U.S. CLS. 22 AND 39).

FIRST USE 3-1-2012; IN COMMERCE 3-1-2012.

THE MARK CONSISTS OF STANDARD CHARACTERS WITHOUT CLAIM TO ANY PARTICULAR FONT, STYLE, SIZE, OR COLOR.

OWNER OF U.S. REG. NOS. 2,331,057, 2,931,439, AND 3,531,885.

SN 85-251,714, FILED 2-25-2011.

MATTHEW MCDOWELL, EXAMINING ATTORNEY



David J. Kybas

Director of the United States Patent and Trademark Office

United States of America

United States Patent and Trademark Office

Butterfly Smoke Seal

Reg. No. 4,155,150

Registered June 5, 2012

Int. Cl.: 20

TRADEMARK

PRINCIPAL REGISTER

BUTTERFLY SAFETY PRODUCTS LLC (NEW YORK LIMITED LIABILITY COMPANY)
803B WALDEN AVENUE
BUFFALO, NY 14211

FOR: SMOKE GUARDS, NAMELY, A STUFFED TEXTILE TUBE SMOKE STOPPERS FOR DOORS TO PREVENT THE PASSAGE OF SMOKE, IN CLASS 20 (U.S. CLS. 2, 13, 22, 25, 32 AND 50).

FIRST USE 11-1-2011; IN COMMERCE 11-1-2011.

THE MARK CONSISTS OF STANDARD CHARACTERS WITHOUT CLAIM TO ANY PARTICULAR FONT, STYLE, SIZE, OR COLOR.

NO CLAIM IS MADE TO THE EXCLUSIVE RIGHT TO USE "SMOKE SEAL", APART FROM THE MARK AS SHOWN.

SN 85-252,006, FILED 2-25-2011.

MAYUR VAGHANI, EXAMINING ATTORNEY



David J. Kyffers

Director of the United States Patent and Trademark Office

United States of America

United States Patent and Trademark Office

VANTAGEPORT

Reg. No. 4,155,151

LIBERTY MUTUAL INSURANCE COMPANY (MASSACHUSETTS CORPORATION)
175 BERKELEY STREET
BOSTON, MA 02116

Registered June 5, 2012

Int. Cls.: 36 and 42

FOR: PROVIDING A WEBSITE FEATURING INSURANCE INFORMATION FOR INSURED, AGENTS AND BROKERS, IN CLASS 36 (U.S. CLS. 100, 101 AND 102).

SERVICE MARK

FIRST USE 3-12-2012; IN COMMERCE 3-12-2012.

PRINCIPAL REGISTER

FOR: COMPUTER SERVICES, NAMELY, PROVIDING A WEB-BASED SYSTEM AND ON-LINE PORTAL FEATURING ON-LINE NONDOWNLOADABLE SOFTWARE THAT ENABLES CONSUMERS, AGENTS, AND BROKERS TO ACCESS INFORMATION AND MARKETING MATERIALS IN THE FIELD OF INSURANCE, IN CLASS 42 (U.S. CLS. 100 AND 101).

FIRST USE 3-12-2012; IN COMMERCE 3-12-2012.

THE MARK CONSISTS OF STANDARD CHARACTERS WITHOUT CLAIM TO ANY PARTICULAR FONT, STYLE, SIZE, OR COLOR.

SN 85-252,019, FILED 2-25-2011.

ELLEN PERKINS, EXAMINING ATTORNEY



David J. Kybas

Director of the United States Patent and Trademark Office

United States of America

United States Patent and Trademark Office

AIRFAIR

Reg. No. 4,155,152

Registered June 5, 2012

Int. Cl.: 38

SERVICE MARK

PRINCIPAL REGISTER

READY MOBILE LLC (IOWA LIMITED LIABILITY COMPANY)
955 KACENA ROAD, SUITE A
HIAWATHA, IA 52233

FOR: CELLULAR TELEPHONE TELECOMMUNICATIONS SERVICES PROVIDED VIA PREPAID AIR TIME CELLULAR TELEPHONES AND PREPAID AIR TIME CELLULAR TELEPHONE CALLING CARD SERVICES; CELLULAR TELEPHONE TELECOMMUNICATIONS SERVICES, NAMELY, THE TRANSMISSION OF VOICE, DATA, IMAGES, AUDIO, AND VIDEO VIA TELEPHONE; WIRELESS MOBILE TELEPHONY AND BROADBAND COMMUNICATION SERVICES, IN CLASS 38 (U.S. CLS. 100, 101 AND 104).

FIRST USE 3-0-2011; IN COMMERCE 3-0-2011.

THE MARK CONSISTS OF STANDARD CHARACTERS WITHOUT CLAIM TO ANY PARTICULAR FONT, STYLE, SIZE, OR COLOR.

SN 85-252,102, FILED 2-25-2011.

PRISCILLA MILTON, EXAMINING ATTORNEY



David J. Kyros

Director of the United States Patent and Trademark Office

United States of America

United States Patent and Trademark Office

Age Defense Water Bona Vita Rx

Reg. No. 4,155,153

BONA VITA RX CORPORATION (CALIFORNIA CORPORATION)
890 LAGASCA PLACE
CHULA VISTA, CA 91910

Registered June 5, 2012

Int. Cl.: 32

FOR: BOTTLED DRINKING WATER; DRINKING WATER WITH VITAMINS; ENERGY DRINKS; FLAVORED WATERS, IN CLASS 32 (U.S. CLS. 45, 46 AND 48).

TRADEMARK

FIRST USE 9-1-2010; IN COMMERCE 4-28-2011.

PRINCIPAL REGISTER

THE MARK CONSISTS OF STANDARD CHARACTERS WITHOUT CLAIM TO ANY PARTICULAR FONT, STYLE, SIZE, OR COLOR.

NO CLAIM IS MADE TO THE EXCLUSIVE RIGHT TO USE "WATER", APART FROM THE MARK AS SHOWN.

SN 85-252,307, FILED 2-25-2011.

JOHN E. MICHOS, EXAMINING ATTORNEY



David J. Kybas

Director of the United States Patent and Trademark Office

United States of America

United States Patent and Trademark Office

"The Thrill Seeker" Sage Strong

Reg. No. 4,155,154

Registered June 5, 2012

Int. Cl.: 25

TRADEMARK

PRINCIPAL REGISTER

SHIRK, TRAVIS M. (UNITED STATES INDIVIDUAL)
53 E. BROOKFIELD DR.
LEBANON, PA 17046

FOR: CLOTHING, NAMELY, T-SHIRTS, SWEATSHIRTS, JERSEYS, SHORTS, SWEAT PANTS, JACKETS, GLOVES, NECKTIES, PAJAMAS, ROBES, NIGHT SHIRTS, UNDERWEAR, HEAD BANDS, SWIMSUITS, SHIRTS, TANK TOPS, PANTS, COATS, SWEATERS, SOCKS, BELTS, RAIN WEAR, FOOTWEAR AND HEAD WEAR, IN CLASS 25 (U.S. CLS. 22 AND 39).

FIRST USE 12-3-2011; IN COMMERCE 12-3-2011.

THE MARK CONSISTS OF STANDARD CHARACTERS WITHOUT CLAIM TO ANY PARTICULAR FONT, STYLE, SIZE, OR COLOR.

THE NAME "SAGE STRONG" IDENTIFIES A LIVING INDIVIDUAL WHOSE CONSENT IS OF RECORD.

SN 85-252,426, FILED 2-25-2011.

STEVEN R. FINE, EXAMINING ATTORNEY



David J. Kyros

Director of the United States Patent and Trademark Office

United States of America

United States Patent and Trademark Office

Invisible Sun

Reg. No. 4,155,155

Registered June 5, 2012

Int. Cl.: 25

TRADEMARK

PRINCIPAL REGISTER

REZK, ELINOR C. (UNITED STATES INDIVIDUAL), DBA INVISIBLE SUN,
3229 ALLAIRE ROAD
WALL TOWNSHIP, NJ 07719

FOR: HATS; SCARVES; T-SHIRTS, IN CLASS 25 (U.S. CLS. 22 AND 39).

FIRST USE 9-10-2011; IN COMMERCE 9-10-2011.

THE MARK CONSISTS OF STANDARD CHARACTERS WITHOUT CLAIM TO ANY PARTICULAR FONT, STYLE, SIZE, OR COLOR.

SN 85-252,446, FILED 2-25-2011.

DANNEAN HETZEL, EXAMINING ATTORNEY



David J. Kybas

Director of the United States Patent and Trademark Office

United States of America

United States Patent and Trademark Office



Reg. No. 4,155,156

Registered June 5, 2012

Int. Cl.: 33

TRADEMARK

PRINCIPAL REGISTER

DIOSA SPIRITS, LLC (TEXAS LIMITED LIABILITY COMPANY)
SUITE 80
730 W. CHEYENNE AVENUE
N. LAS VEGAS, NV 89030

FOR: TEQUILA, IN CLASS 33 (U.S. CLS. 47 AND 49).

FIRST USE 2-1-2012; IN COMMERCE 2-1-2012.

THE MARK CONSISTS OF A FANCIFUL DESIGN OF THE SILHOUETTE OF A WOMAN WITH ANGEL'S WINGS.

SN 85-252,449, FILED 2-25-2011.

RONALD MCMORROW, EXAMINING ATTORNEY



David J. Kybas

Director of the United States Patent and Trademark Office

United States of America

United States Patent and Trademark Office

Sphere Control

Reg. No. 4,155,157

Registered June 5, 2012

Int. Cl.: 35

SERVICE MARK

PRINCIPAL REGISTER

WEEKS, RHONDA H. (LOUISIANA LIMITED LIABILITY COMPANY), DBA SPHERE CONTROL,
P.O. BOX 85465
BATON ROUGE, LA 70884

FOR: ADVERTISING AND MARKETING SERVICES PROVIDED BY MEANS OF INDIRECT METHODS OF MARKETING COMMUNICATIONS, NAMELY, SOCIAL MEDIA, SEARCH ENGINE MARKETING, INQUIRY MARKETING, INTERNET MARKETING, MOBILE MARKETING, BLOGGING AND OTHER FORMS OF PASSIVE, SHARABLE OR VIRAL COMMUNICATIONS CHANNELS, IN CLASS 35 (U.S. CLS. 100, 101 AND 102).

FIRST USE 5-1-2011; IN COMMERCE 5-15-2011.

THE MARK CONSISTS OF STANDARD CHARACTERS WITHOUT CLAIM TO ANY PARTICULAR FONT, STYLE, SIZE, OR COLOR.

SN 85-252,455, FILED 2-25-2011.

SUSAN STIGLITZ, EXAMINING ATTORNEY



David J. Kyros

Director of the United States Patent and Trademark Office

United States of America

United States Patent and Trademark Office

LEAGUE ME

Reg. No. 4,155,158

Registered June 5, 2012

Int. Cl.: 25

TRADEMARK

PRINCIPAL REGISTER

COLDWORLD ENTERPRISES (CALIFORNIA JOINT VENTURE)
5417 W. 64TH STREET
LOS ANGELES, CA 90056

FOR: SHIRTS AND SWEAT SHIRTS, IN CLASS 25 (U.S. CLS. 22 AND 39).

FIRST USE 7-1-2010; IN COMMERCE 7-1-2010.

THE MARK CONSISTS OF STANDARD CHARACTERS WITHOUT CLAIM TO ANY PARTICULAR FONT, STYLE, SIZE, OR COLOR.

SN 85-252,854, FILED 2-27-2011.

MEGHAN REINHART, EXAMINING ATTORNEY



David J. Kybas

Director of the United States Patent and Trademark Office

United States of America
United States Patent and Trademark Office

MYFLEET

Reg. No. 4,155,159

Registered June 5, 2012

Int. Cls.: 9, 37, and 42

TRADEMARK

SERVICE MARK

PRINCIPAL REGISTER

GENERAL ELECTRIC COMPANY (NEW YORK CORPORATION)
1 RIVER ROAD
SCHENECTADY, NY 12345

FOR: SOFTWARE FOR POWER PLANT OPTIMIZATION AND PLANT HEALTH OVERVIEW;
HARDWARE FOR POWER PLANT OPTIMIZATION, IN CLASS 9 (U.S. CLS. 21, 23, 26, 36
AND 38).

FIRST USE 3-10-2011; IN COMMERCE 3-10-2011.

FOR: MAINTENANCE SERVICES IN THE FIELD OF POWER PLANT OPTIMIZATION, IN
CLASS 37 (U.S. CLS. 100, 103 AND 106).

FIRST USE 3-10-2011; IN COMMERCE 3-10-2011.

FOR: CONSULTING SERVICES IN THE FIELD OF POWER PLANT OPTIMIZATION; EN-
GINEERING SERVICES IN THE FIELD OF POWER PLANT OPTIMIZATION, IN CLASS 42
(U.S. CLS. 100 AND 101).

FIRST USE 3-10-2011; IN COMMERCE 3-10-2011.

THE MARK CONSISTS OF STANDARD CHARACTERS WITHOUT CLAIM TO ANY PAR-
TICULAR FONT, STYLE, SIZE, OR COLOR.

SN 85-253,046, FILED 2-28-2011.

BRIAN NEVILLE, EXAMINING ATTORNEY



David J. Kyros

Director of the United States Patent and Trademark Office

United States of America

United States Patent and Trademark Office

UNITED EVENT SERVICES

Reg. No. 4,155,160

Registered June 5, 2012

Int. Cls.: 37, 39, and 44

SERVICE MARK

PRINCIPAL REGISTER

UNITED SITE SERVICES, INC. (DELAWARE CORPORATION)
SUITE 4000
200 FRIBERG PARKWAY
WESTBOROUGH, MA 01581

FOR: RENTAL OF TEMPORARY SITE FENCING, IN CLASS 37 (U.S. CLS. 100, 103 AND 106).

FIRST USE 9-8-2011; IN COMMERCE 9-8-2011.

FOR: RENTAL OF STORAGE CONTAINERS AND MOBILE OFFICE TRAILERS FOR EVENTS AND ACTIVITIES, IN CLASS 39 (U.S. CLS. 100 AND 105).

FIRST USE 9-8-2011; IN COMMERCE 9-8-2011.

FOR: RENTAL OF SANITARY FACILITIES AND POTABLE WATER SUPPLY UNITS, IN CLASS 44 (U.S. CLS. 100 AND 101).

FIRST USE 9-8-2011; IN COMMERCE 9-8-2011.

THE MARK CONSISTS OF STANDARD CHARACTERS WITHOUT CLAIM TO ANY PARTICULAR FONT, STYLE, SIZE, OR COLOR.

OWNER OF U.S. REG. NOS. 2,489,124, 2,954,365, AND OTHERS.

NO CLAIM IS MADE TO THE EXCLUSIVE RIGHT TO USE "EVENT SERVICES", APART FROM THE MARK AS SHOWN.

SN 85-253,052, FILED 2-28-2011.

SUSAN STIGLITZ, EXAMINING ATTORNEY



David J. Kybas

Director of the United States Patent and Trademark Office

United States of America

United States Patent and Trademark Office

UNITED AGRICULTURAL SERVICES

Reg. No. 4,155,161

Registered June 5, 2012

Int. Cls.: 37, 39, and 44

SERVICE MARK

PRINCIPAL REGISTER

UNITED SITE SERVICES, INC. (DELAWARE CORPORATION)
SUITE 4000
200 FRIBERG PARKWAY
WESTBOROUGH, MA 01581

FOR: RENTAL OF TEMPORARY SITE FENCING, IN CLASS 37 (U.S. CLS. 100, 103 AND 106).

FIRST USE 1-3-2012; IN COMMERCE 1-3-2012.

FOR: RENTAL OF STORAGE CONTAINERS AND MOBILE OFFICE TRAILERS FOR EVENTS AND ACTIVITIES, IN CLASS 39 (U.S. CLS. 100 AND 105).

FIRST USE 1-3-2012; IN COMMERCE 1-3-2012.

FOR: RENTAL OF SANITARY FACILITIES AND POTABLE WATER SUPPLY UNITS, IN CLASS 44 (U.S. CLS. 100 AND 101).

FIRST USE 1-3-2012; IN COMMERCE 1-3-2012.

THE MARK CONSISTS OF STANDARD CHARACTERS WITHOUT CLAIM TO ANY PARTICULAR FONT, STYLE, SIZE, OR COLOR.

OWNER OF U.S. REG. NOS. 2,489,124, 2,954,365, AND OTHERS.

NO CLAIM IS MADE TO THE EXCLUSIVE RIGHT TO USE "AGRICULTURAL SERVICES", APART FROM THE MARK AS SHOWN.

SN 85-253,100, FILED 2-28-2011.

SUSAN STIGLITZ, EXAMINING ATTORNEY



David J. Kybas

Director of the United States Patent and Trademark Office

United States of America

United States Patent and Trademark Office



Reg. No. 4,155,162

CHEATERVILLE, INC (DELAWARE CORPORATION)
5608 QUIET CLOUD CT
LAS VEGAS, NV 89141

Registered June 5, 2012

Int. Cl.: 42

FOR: COMPUTER SERVICES, NAMELY, CREATING AN ON-LINE COMMUNITY FOR REGISTERED USERS TO PARTICIPATE IN DISCUSSIONS, GET FEEDBACK FROM THEIR PEERS, FORM VIRTUAL COMMUNITIES, AND ENGAGE IN SOCIAL NETWORKING, IN CLASS 42 (U.S. CLS. 100 AND 101).

SERVICE MARK

PRINCIPAL REGISTER

FIRST USE 2-14-2011; IN COMMERCE 2-14-2011.

THE MARK CONSISTS OF THE STYLIZED TEXT "CHEATERVILLE "DON'T BE THE LAST TO KNOW"" WITH A BACKGROUND SKYLINE DESIGN CONSISTING OF BUILDINGS AND BRIDGES AND A CARTOON CHARACTER.

SN 85-253,129, FILED 2-28-2011.

DORITT L. CARROLL, EXAMINING ATTORNEY



David J. Kyros

Director of the United States Patent and Trademark Office

United States of America

United States Patent and Trademark Office

WACKO WESTIE

Reg. No. 4,155,163

CHARETTE, PATRICIA M. (UNITED STATES INDIVIDUAL)
15 COUNTY WAY
BEVERLY, MA 01915

Registered June 5, 2012

Int. Cl.: 25

FOR: MITTENS MODIFIED TO COVER THE HAND AND AN ANIMAL LEASH HANDLE
OR OTHER LOOP, IN CLASS 25 (U.S. CLS. 22 AND 39).

TRADEMARK

FIRST USE 11-19-2011; IN COMMERCE 11-19-2011.

PRINCIPAL REGISTER

THE MARK CONSISTS OF STANDARD CHARACTERS WITHOUT CLAIM TO ANY PARTICULAR FONT, STYLE, SIZE, OR COLOR.

SN 85-253,187, FILED 2-28-2011.

BARBARA BROWN, EXAMINING ATTORNEY



David J. Kybas

Director of the United States Patent and Trademark Office

United States of America

United States Patent and Trademark Office

LOTUS NAILS

Reg. No. 4,155,164

Registered June 5, 2012

Int. Cl.: 3

TRADEMARK

PRINCIPAL REGISTER

WOLF, CARL (UNITED STATES INDIVIDUAL), DBA ATLANTIC BEAUTY SALES,
P.O. BOX 4304
CHERRY HILL, NJ 08034

FOR: ADHESIVES FOR ARTIFICIAL NAILS; COSMETIC PREPARATIONS FOR NAIL DRYING; FALSE NAILS; LOTIONS FOR STRENGTHENING THE NAILS; NAIL ART STICKERS; NAIL BUFFING PREPARATIONS; NAIL CARE KITS COMPRISING NAIL POLISH; NAIL CARE PREPARATIONS; NAIL CARE PREPARATIONS, NAMELY, NAIL SOFTENERS; NAIL CREAM; NAIL ENAMEL REMOVERS; NAIL ENAMELS; NAIL GEL; NAIL GLITTER; NAIL GROOMING PRODUCTS, NAMELY, TIPS, GLUE, LACQUER AND GLITTER; NAIL HARDENERS; NAIL POLISH; NAIL POLISH BASE COAT; NAIL POLISH PROTECTOR IN THE NATURE OF A THIN PLASTIC COVERING APPLIED TO NAILS; NAIL POLISH REMOVERS; NAIL POLISH TOP COAT; NAIL REPAIR PRODUCTS, NAMELY, NAIL WRAPS; NAIL STENCILS; NAIL STRENGTHENERS; NAIL TIPS; NAIL VARNISHES; NON-MEDICATED NAIL CARE PREPARATIONS, IN CLASS 3 (U.S. CLS. 1, 4, 6, 50, 51 AND 52).

FIRST USE 11-18-2011; IN COMMERCE 11-18-2011.

THE MARK CONSISTS OF STANDARD CHARACTERS WITHOUT CLAIM TO ANY PARTICULAR FONT, STYLE, SIZE, OR COLOR.

NO CLAIM IS MADE TO THE EXCLUSIVE RIGHT TO USE "NAILS", APART FROM THE MARK AS SHOWN.

SN 85-253,235, FILED 2-28-2011.

KRISTIN CARLSON, EXAMINING ATTORNEY



David J. Kyffers

Director of the United States Patent and Trademark Office

United States of America

United States Patent and Trademark Office



Reg. No. 4,155,165

Registered June 5, 2012

Int. Cl.: 35

SERVICE MARK

PRINCIPAL REGISTER

FORT WORTH PROMOTIONAL AND DEVELOPMENT FUND (TEXAS NON-PROFIT CORPORATION)
P.O. BOX 8040
FORT WORTH, TX 76124

FOR: PROMOTING THE ECONOMIC DEVELOPMENT OF THE CITY OF FORT WORTH THROUGH TOURISM, CULTURE AND SPECIAL EVENTS, IN CLASS 35 (U.S. CLS. 100, 101 AND 102).

FIRST USE 7-21-2010; IN COMMERCE 7-21-2010.

THE MARK CONSISTS OF AN IMAGE OF A FOOTBALL WITH STYLIZED LONGHORN STEER HORNS ON EACH SIDE OF THE FOOTBALL.

SN 85-253,268, FILED 2-28-2011.

WILLIAM P. SHANAHAN, EXAMINING ATTORNEY



David J. Kybas

Director of the United States Patent and Trademark Office

United States of America

United States Patent and Trademark Office

THAT'S PRO.

Reg. No. 4,155,166

VALSPAR CORPORATION, THE (DELAWARE CORPORATION)
P.O. BOX 1461
MINNEAPOLIS, MN 55440

Registered June 5, 2012

Int. Cl.: 2

FOR: PAINTS; COATINGS IN THE NATURE OF WOOD FINISHES, IN CLASS 2 (U.S. CLS. 6, 11 AND 16).

TRADEMARK

FIRST USE 4-4-2011; IN COMMERCE 4-4-2011.

PRINCIPAL REGISTER

THE MARK CONSISTS OF STANDARD CHARACTERS WITHOUT CLAIM TO ANY PARTICULAR FONT, STYLE, SIZE, OR COLOR.

SN 85-253,411, FILED 2-28-2011.

KEVIN CORWIN, EXAMINING ATTORNEY



David J. Kybas

Director of the United States Patent and Trademark Office

United States of America

United States Patent and Trademark Office

MICROZINQ

Reg. No. 4,155,167

Registered June 5, 2012

Int. Cl.: 40

SERVICE MARK

PRINCIPAL REGISTER

VOIGT & SCHWEITZER, LLC (DELAWARE LIMITED LIABILITY COMPANY)
1000 BUCKEYE PARK ROAD
COLUMBUS, OH 43207

FOR: GALVANIZING, IN CLASS 40 (U.S. CLS. 100, 103 AND 106).

FIRST USE 3-5-2012; IN COMMERCE 3-5-2012.

THE MARK CONSISTS OF STANDARD CHARACTERS WITHOUT CLAIM TO ANY PARTICULAR FONT, STYLE, SIZE, OR COLOR.

OWNER OF U.S. REG. NOS. 2,341,569 AND 2,428,081.

SN 85-253,420, FILED 2-28-2011.

LAURIE KAUFMAN, EXAMINING ATTORNEY



David J. Kyffers

Director of the United States Patent and Trademark Office

United States of America

United States Patent and Trademark Office



Reg. No. 4,155,168

Registered June 5, 2012

Int. Cl.: 33

TRADEMARK

PRINCIPAL REGISTER

JACK JOHN INVESTMENTS, INC. (FLORIDA CORPORATION)
179 NIBLICK ROAD, JADA VINEYARD, #320
PASA ROBLES, CA 93446

FOR: WINES, IN CLASS 33 (U.S. CLS. 47 AND 49).

FIRST USE 2-21-2012; IN COMMERCE 2-21-2012.

THE MARK CONSISTS OF AN UNCLOSED CIRCULAR DESIGN WITH THE WORD "MALSTRIA" IN THE CENTER OF THE CIRCLE AND WITH THE SAME WORD "MALSTRIA" UPSIDE DOWN UNDER "MALSTRIA".

SN 85-253,425, FILED 2-28-2011.

PATRICIA EVANKO, EXAMINING ATTORNEY



David J. Kybas

Director of the United States Patent and Trademark Office

United States of America

United States Patent and Trademark Office

POPSUGAR CITY

Reg. No. 4,155,169

Registered June 5, 2012

Int. Cl.: 35

SERVICE MARK

PRINCIPAL REGISTER

SUGAR PUBLISHING INCORPORATED (DELAWARE CORPORATION)
111 SUTTER STREET, 15TH FLOOR
SAN FRANCISCO, CA 94104

FOR: PROMOTING THE SALE OF GOODS AND SERVICES OF OTHERS THROUGH ELECTRONIC COUPONING, PROMOTIONS AND DISCOUNTS; PROVIDING A SEARCHABLE ON-LINE ADVERTISING WEBSITE AND GUIDE FEATURING THE GOODS AND SERVICES OF OTHERS VIA EMAIL AND THE INTERNET; PROMOTING THE GOODS AND SERVICES OF OTHERS BY PROVIDING A WEBSITE FEATURING COUPONS, REBATES, REVIEWS, LINKS TO THE RETAIL WEBSITES OF OTHERS, AND DISCOUNT INFORMATION, IN CLASS 35 (U.S. CLS. 100, 101 AND 102).

FIRST USE 3-3-2011; IN COMMERCE 3-3-2011.

THE MARK CONSISTS OF STANDARD CHARACTERS WITHOUT CLAIM TO ANY PARTICULAR FONT, STYLE, SIZE, OR COLOR.

OWNER OF U.S. REG. NO. 3,334,918.

SN 85-253,534, FILED 2-28-2011.

ANDREW LEASER, EXAMINING ATTORNEY



David J. Kyros

Director of the United States Patent and Trademark Office

United States of America

United States Patent and Trademark Office

HUSKEE

Reg. No. 4,155,170

Registered June 5, 2012

Int. Cl.: 7

TRADEMARK

PRINCIPAL REGISTER

TRACTOR SUPPLY CO. OF TEXAS, LP (TEXAS LIMITED PARTNERSHIP)
200 POWELL PLACE
BRENTWOOD, TN 37027

FOR: SNOW BLOWERS, IN CLASS 7 (U.S. CLS. 13, 19, 21, 23, 31, 34 AND 35).

FIRST USE 8-30-2008; IN COMMERCE 8-30-2008.

THE MARK CONSISTS OF STANDARD CHARACTERS WITHOUT CLAIM TO ANY PARTICULAR FONT, STYLE, SIZE, OR COLOR.

OWNER OF U.S. REG. NOS. 1,183,496 AND 1,713,048.

SN 85-253,672, FILED 2-28-2011.

KATHLEEN LORENZO, EXAMINING ATTORNEY



David J. Kybas

Director of the United States Patent and Trademark Office

United States of America

United States Patent and Trademark Office

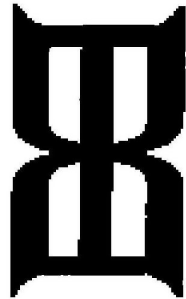

Reg. No. 4,155,171

Registered June 5, 2012

Int. Cls.: 9 and 25

TRADEMARK

PRINCIPAL REGISTER

ADAMS, JASON (UNITED STATES INDIVIDUAL)
P.O. BOX 499
LOGANDALE, NV 89021

FOR: FRAMES FOR SPECTACLES AND SUNGLASSES; LENSES FOR SUNGLASSES;
SUNGLASS CHAINS AND CORDS; SUNGLASSES; SUNGLASSES AND SPECTACLES, IN
CLASS 9 (U.S. CLS. 21, 23, 26, 36 AND 38).

FIRST USE 5-1-2011; IN COMMERCE 8-1-2011.

FOR: FOOTWEAR; HATS; HOODS; JACKETS; LOUNGEWEAR; SHIRTS AND SHORT-
SLEEVED SHIRTS; SHORT-SLEEVED OR LONG-SLEEVED T-SHIRTS; SWEAT PANTS;
SWEAT SHIRTS; TANK TOPS, IN CLASS 25 (U.S. CLS. 22 AND 39).

FIRST USE 5-1-2011; IN COMMERCE 8-1-2011.

THE MARK CONSISTS OF A STYLIZED "X", WITH A LINE VERTICALLY BISECTING
THE "X", AND A LINE CONNECTING EACH TINE OF THE "X" WITH THE TINE IMMEDI-
ATELY PARALLEL.

SN 85-253,775, FILED 2-28-2011.

LINDA MICKLEBURGH, EXAMINING ATTORNEY



David J. Kybas

Director of the United States Patent and Trademark Office

United States of America

United States Patent and Trademark Office

Boner Bee Gone

Reg. No. 4,155,172

BORGREN, THOMAS M (UNITED STATES INDIVIDUAL)
5346 LESTER RIVER ROAD
DULUTH, MN 55804

Registered June 5, 2012

Int. Cl.: 20

FOR: NOVELTY GOODS IN THE NATURE OF A PLACEBO SPRAY USED TO ALTER ONE'S REACTION TO A SITUATION, IN CLASS 20 (U.S. CLS. 2, 13, 22, 25, 32 AND 50).

TRADEMARK

FIRST USE 10-1-2010; IN COMMERCE 9-1-2011.

PRINCIPAL REGISTER

THE MARK CONSISTS OF STANDARD CHARACTERS WITHOUT CLAIM TO ANY PARTICULAR FONT, STYLE, SIZE, OR COLOR.

SN 85-253,861, FILED 2-28-2011.

MIDGE BUTLER, EXAMINING ATTORNEY



David J. Kybas

Director of the United States Patent and Trademark Office

United States of America

United States Patent and Trademark Office



Reg. No. 4,155,173

Registered June 5, 2012

Int. Cl.: 5

TRADEMARK

PRINCIPAL REGISTER

PHYSICIAN'S SCIENCE & NATURE, INC. (CALIFORNIA CORPORATION)
220 NEWPORT CENTER DRIVE SUITE 11-634
NEWPORT BEACH, CA 92660

FOR: DIETARY AND NUTRITIONAL SUPPLEMENTS; LAXATIVES; TOPICAL ANTIBIOTIC, ANALGESIC, SKIN PROTECTANT AND WOUND CARE PREPARATIONS , IN CLASS 5 (U.S. CLS. 6, 18, 44, 46, 51 AND 52).

FIRST USE 10-31-2006; IN COMMERCE 1-30-2007.

THE MARK CONSISTS OF A YELLOW SUNFLOWER WITH BROWN CENTER TO THE RIGHT OF A GREEN LEAF, AND BELOW A MARBLE BEIGE MORTAR AND PESTLE, ALL ON A GRANITE BROWN BACKGROUND.

THE COLOR(S) YELLOW, BROWN, GREEN AND BEIGE IS/ARE CLAIMED AS A FEATURE OF THE MARK.

SN 85-253,959, FILED 2-28-2011.

KAREN K. BUSH, EXAMINING ATTORNEY



David J. Kybas

Director of the United States Patent and Trademark Office

United States of America

United States Patent and Trademark Office

AIJI

Reg. No. 4,155,174

Registered June 5, 2012

Int. Cl.: 25

TRADEMARK

PRINCIPAL REGISTER

LAWRENCE DARNELL STUART (UNITED STATES INDIVIDUAL), DBA FIVE LIONS ENTERTAINMENT,
PO BOX 370411
RESEDA, CA 91337

FOR: ATHLETIC APPAREL, NAMELY, SHIRTS, PANTS, JACKETS, FOOTWEAR, HATS AND CAPS, ATHLETIC UNIFORMS, IN CLASS 25 (U.S. CLS. 22 AND 39).

FIRST USE 9-1-2011; IN COMMERCE 1-1-2012.

THE MARK CONSISTS OF STANDARD CHARACTERS WITHOUT CLAIM TO ANY PARTICULAR FONT, STYLE, SIZE, OR COLOR.

SN 85-253,983, FILED 2-28-2011.

JOHN E. MICHOS, EXAMINING ATTORNEY



David J. Kyros

Director of the United States Patent and Trademark Office

United States of America

United States Patent and Trademark Office

CHINA DREAM

Reg. No. 4,155,175

KONAMI GAMING, INC. (NEVADA CORPORATION)
585 TRADE CENTER DRIVE
LAS VEGAS, NV 89119

Registered June 5, 2012

Int. Cl.: 9

FOR: ELECTRONIC GAME PROGRAMS; GAMING EQUIPMENT, NAMELY, SLOT MACHINES WITH OR WITHOUT VIDEO OUTPUT; GAMING MACHINES; MACHINES FOR PLAYING GAMES OF CHANCE; SLOT MACHINES, IN CLASS 9 (U.S. CLS. 21, 23, 26, 36 AND 38).

TRADEMARK

PRINCIPAL REGISTER

FIRST USE 10-0-2011; IN COMMERCE 10-0-2011.

THE MARK CONSISTS OF STANDARD CHARACTERS WITHOUT CLAIM TO ANY PARTICULAR FONT, STYLE, SIZE, OR COLOR.

OWNER OF U.S. REG. NOS. 3,098,847 AND 3,865,443.

SN 85-254,072, FILED 2-28-2011.

MARK PILARO, EXAMINING ATTORNEY



David J. Kyros

Director of the United States Patent and Trademark Office

United States of America

United States Patent and Trademark Office

HOT TWIN PHOENIXES

Reg. No. 4,155,176

KONAMI GAMING, INC. (NEVADA CORPORATION)
585 TRADE CENTER DRIVE
LAS VEGAS, NV 89119

Registered June 5, 2012

Int. Cl.: 9

FOR: ELECTRONIC GAME PROGRAMS; GAMING EQUIPMENT, NAMELY, SLOT MACHINES WITH OR WITHOUT VIDEO OUTPUT; GAMING MACHINES; MACHINES FOR PLAYING GAMES OF CHANCE; SLOT MACHINES, IN CLASS 9 (U.S. CLS. 21, 23, 26, 36 AND 38).

TRADEMARK

PRINCIPAL REGISTER

FIRST USE 10-0-2011; IN COMMERCE 10-0-2011.

THE MARK CONSISTS OF STANDARD CHARACTERS WITHOUT CLAIM TO ANY PARTICULAR FONT, STYLE, SIZE, OR COLOR.

OWNER OF U.S. REG. NOS. 3,331,650, 3,886,898, AND OTHERS.

SN 85-254,082, FILED 2-28-2011.

MARK PILARO, EXAMINING ATTORNEY



David J. Kyfos

Director of the United States Patent and Trademark Office

United States of America

United States Patent and Trademark Office

CHINA FESTIVAL

Reg. No. 4,155,177

Registered June 5, 2012

Int. Cl.: 9

TRADEMARK

PRINCIPAL REGISTER

KONAMI GAMING, INC. (NEVADA CORPORATION)
585 TRADE CENTER DRIVE
LAS VEGAS, NV 89119

FOR: ELECTRONIC GAME PROGRAMS; GAMING EQUIPMENT, NAMELY, SLOT MACHINES WITH OR WITHOUT VIDEO OUTPUT; GAMING MACHINES; MACHINES FOR PLAYING GAMES OF CHANCE; SLOT MACHINES, IN CLASS 9 (U.S. CLS. 21, 23, 26, 36 AND 38).

FIRST USE 10-0-2011; IN COMMERCE 10-0-2011.

THE MARK CONSISTS OF STANDARD CHARACTERS WITHOUT CLAIM TO ANY PARTICULAR FONT, STYLE, SIZE, OR COLOR.

OWNER OF U.S. REG. NO. 3,865,443.

SN 85-254,098, FILED 2-28-2011.

MARK PILARO, EXAMINING ATTORNEY



David J. Kypos

Director of the United States Patent and Trademark Office

United States of America

United States Patent and Trademark Office

GRAND POWER OF AFRICA

Reg. No. 4,155,178

KONAMI GAMING, INC. (NEVADA CORPORATION)
585 TRADE CENTER DRIVE
LAS VEGAS, NV 89119

Registered June 5, 2012

Int. Cl.: 9

FOR: ELECTRONIC GAME PROGRAMS; GAMING EQUIPMENT, NAMELY, SLOT MACHINES WITH OR WITHOUT VIDEO OUTPUT; GAMING MACHINES; MACHINES FOR PLAYING GAMES OF CHANCE; SLOT MACHINES, IN CLASS 9 (U.S. CLS. 21, 23, 26, 36 AND 38).

TRADEMARK

PRINCIPAL REGISTER

FIRST USE 10-0-2011; IN COMMERCE 10-0-2011.

THE MARK CONSISTS OF STANDARD CHARACTERS WITHOUT CLAIM TO ANY PARTICULAR FONT, STYLE, SIZE, OR COLOR.

OWNER OF U.S. REG. NOS. 2,512,871, 3,321,268, AND OTHERS.

SN 85-254,103, FILED 2-28-2011.

MARK PILARO, EXAMINING ATTORNEY



David J. Kyfos

Director of the United States Patent and Trademark Office

United States of America

United States Patent and Trademark Office

Eat n' Run fitness

Reg. No. 4,155,179

Registered June 5, 2012

Int. Cls.: 41 and 44

SERVICE MARK

PRINCIPAL REGISTER

SPANGLER, MARY (UNITED STATES INDIVIDUAL)
43
411 NORTH EUCLID STREET
FULLERTON, CA 92832

FOR: PERSONAL FITNESS TRAINING SERVICES AND CONSULTANCY, IN CLASS 41 (U.S. CLS. 100, 101 AND 107).

FIRST USE 6-8-2011; IN COMMERCE 6-9-2011.

FOR: DIETARY AND NUTRITIONAL GUIDANCE, IN CLASS 44 (U.S. CLS. 100 AND 101).

FIRST USE 6-8-2011; IN COMMERCE 6-9-2011.

THE MARK CONSISTS OF STANDARD CHARACTERS WITHOUT CLAIM TO ANY PARTICULAR FONT, STYLE, SIZE, OR COLOR.

NO CLAIM IS MADE TO THE EXCLUSIVE RIGHT TO USE "FITNESS", APART FROM THE MARK AS SHOWN.

SN 85-254,319, FILED 3-1-2011.

H. M. FISHER, EXAMINING ATTORNEY



David J. Kyros

Director of the United States Patent and Trademark Office

United States of America

United States Patent and Trademark Office

STARVISION

Reg. No. 4,155,180

Registered June 5, 2012

Int. Cl.: 9

TRADEMARK

PRINCIPAL REGISTER

CONCEPT ENGINEERING GMBH (FED REP GERMANY CORPORATION)
BOETZINGER STR. 29
79111 FREIBURG, FED REP GERMANY

FOR: COMPUTER SOFTWARE, NAMELY, SOFTWARE FOR GENERATING AND DISPLAYING SCHEMATIC REPRESENTATIONS OF ELECTRONIC CIRCUITS, IN CLASS 9 (U.S. CLS. 21, 23, 26, 36 AND 38).

FIRST USE 10-31-2011; IN COMMERCE 10-31-2011.

THE MARK CONSISTS OF STANDARD CHARACTERS WITHOUT CLAIM TO ANY PARTICULAR FONT, STYLE, SIZE, OR COLOR.

SN 85-254,381, FILED 3-1-2011.

KATINA MISTER, EXAMINING ATTORNEY



David J. Kyffers

Director of the United States Patent and Trademark Office

United States of America

United States Patent and Trademark Office

SAASY

Reg. No. 4,155,181

Registered June 5, 2012

Int. Cls.: 35, 36, and 42

SERVICE MARK

PRINCIPAL REGISTER

BRIGHT MARKET, LLC (CALIFORNIA LIMITED LIABILITY COMPANY), DBA
FASTSPRING,
11 WEST VICTORIA STREET, SUITE #207A
SANTA BARBARA, CA 93101

FOR: FACILITATING E-COMMERCE BUSINESS TRANSACTIONS BY PROCESSING ELECTRONIC ORDERS OF PURCHASES OF GOODS AND SERVICES VIA A GLOBAL COMPUTER NETWORK FOR OTHERS; FULFILLMENT OF ELECTRONIC ORDERS FOR SOFTWARE, E-BOOKS, ELECTRONIC GAMES, SOFTWARE AS A SERVICE (SAAS) SERVICES, AND OTHER DIGITAL CONTENT AND PRODUCTS VIA A GLOBAL COMPUTER NETWORK; ON-LINE ORDER FULFILLMENT SERVICES FOR OTHERS; ON-LINE RETAIL STORE SERVICES FEATURING COMPUTER SOFTWARE, E-BOOKS, ELECTRONIC GAMES, SOFTWARE AS A SERVICE (SAAS) SERVICES, AND OTHER DIGITAL CONTENT AND PRODUCTS; ON-LINE MARKETING SERVICES FOR SELLERS OF COMPUTER SOFTWARE, E-BOOKS, ELECTRONIC GAMES, SOFTWARE AS A SERVICE (SAAS) SERVICES, AND OTHER DIGITAL CONTENT AND PRODUCTS, NAMELY, DEVELOPING AND IMPLEMENTING ONLINE MARKETING AND ADVERTISING THROUGH THE USE OF PARTNERSHIPS BETWEEN SOFTWARE PUBLISHERS, DISTRIBUTORS, ADVERTISERS, AFFILIATES AND RESELLERS TO INCREASE SALES AND REVENUES; ADVERTISING, MARKETING AND PROMOTIONAL SERVICES; SUBSCRIPTION MANAGEMENT SERVICES AS A SUBSCRIPTION AGENT BETWEEN PUBLISHERS AND CUSTOMERS FOR E-COMMERCE SERVICES; PROVIDING CROSS-SELLING OPPORTUNITIES TO CUSTOMERS THAT SELL SUBSCRIPTION E-COMMERCE SERVICES AND SOFTWARE AS A SERVICE (SAAS) SERVICES, NAMELY, PROMOTING THE SALE OF GOODS AND SERVICES OF OTHERS BY SUGGESTING COMPLEMENTARY CROSS-SELL GOODS AND SERVICES TO ALREADY PURCHASED GOODS OR SERVICES; ONLINE BILLING; CUSTOMER RELATIONSHIP MANAGEMENT; CUSTOMER SERVICE MANAGEMENT FOR OTHERS; BUSINESS MANAGEMENT SERVICES, NAMELY, CUSTOMER RESPONSE-HANDLING AND PAYMENT SERVICES RELATING TO SUBSCRIPTION E-COMMERCE SERVICES, IN CLASS 35 (U.S. CLS. 100, 101 AND 102).



FIRST USE 3-17-2011; IN COMMERCE 3-17-2011.

David J. Kyros

Director of the United States Patent and Trademark Office

FOR: ELECTRONIC PAYMENT, NAMELY, ELECTRONIC PROCESSING AND TRANSMISSION OF BILL PAYMENT DATA; BILL PAYMENT SERVICES PROVIDED THROUGH A WEBSITE; ONLINE PAYMENT COLLECTION SERVICES FOR OTHERS; PAYMENT PROCESSING SERVICES, NAMELY, CREDIT CARD AND DEBIT CARD TRANSACTION PRO-

Reg. No. 4,155,181 CESSING SERVICES; PROVIDING SECURED CREDIT CARD PAYMENT PROCESSING VIA THE INTERNET; MERCHANT SERVICES, NAMELY, PAYMENT TRANSACTION PROCESSING SERVICES; PROVIDING ELECTRONIC PROCESSING OF CREDIT CARD TRANSACTIONS AND ELECTRONIC PAYMENTS VIA A GLOBAL COMPUTER NETWORK; MERCHANT SERVICES, NAMELY, PAYMENT TRANSACTION PROCESSING SERVICES, IN CLASS 36 (U.S. CLS. 100, 101 AND 102).

FIRST USE 3-17-2011; IN COMMERCE 3-17-2011.

FOR: APPLICATION SERVICE PROVIDER (ASP) FEATURING SOFTWARE FOR E-COMMERCE PAYMENT PROCESSING, MERCHANDISING, SUBSCRIPTION MANAGEMENT, AND FULFILLMENT SERVICES, FOR USE IN THE DISTRIBUTION, PUBLICATION, SALE AND LICENSING OF E-BOOKS, SOFTWARE, ELECTRONIC GAMES, SOFTWARE AS A SERVICE (SAAS) SERVICES, AND OTHER DIGITAL PRODUCTS AND CONTENT; SOFTWARE AS A SERVICE (SAAS) SERVICES, NAMELY, HOSTING SOFTWARE FOR USE BY OTHERS FOR USE WITH E-COMMERCE PAYMENT PROCESSING, MERCHANDISING, SUBSCRIPTION MANAGEMENT, AND FULFILLMENT SERVICES, FOR USE IN THE DISTRIBUTION, PUBLICATION, SALE AND LICENSING OF E-BOOKS, SOFTWARE, ELECTRONIC GAMES, SOFTWARE AS A SERVICE (SAAS) SERVICES, AND OTHER DIGITAL PRODUCTS AND CONTENT; SOFTWARE AS A SERVICE (SAAS) SERVICES FEATURING SOFTWARE FOR USE WITH E-COMMERCE PAYMENT PROCESSING, MERCHANDISING, SUBSCRIPTION MANAGEMENT, AND FULFILLMENT SERVICES, FOR USE IN THE DISTRIBUTION, PUBLICATION, SALE AND LICENSING OF E-BOOKS, SOFTWARE, ELECTRONIC GAMES, SOFTWARE AS A SERVICE (SAAS) SERVICES, AND OTHER DIGITAL PRODUCTS AND CONTENT; SOFTWARE AS A SERVICE (SAAS) SERVICES FEATURING SOFTWARE FOR SUBSCRIPTION SERVICE MANAGEMENT, CUSTOMER SERVICE, AND BILLING AND PAYMENT TRACKING, ANALYSIS, AND MANAGEMENT; DEVELOPING AND HOSTING A SERVER ON A GLOBAL COMPUTER NETWORK FOR THE PURPOSE OF FACILITATING E-COMMERCE VIA SUCH A SERVER; COMPUTER SERVICES, NAMELY, PROVIDING A WEB-BASED SYSTEM AND ONLINE PORTAL FOR CUSTOMERS TO REMOTELY MANAGE, AND MODIFY THEIR END USER COMPUTER DEVICES, DATA AND SOFTWARE APPLICATIONS; COMPUTER SERVICES, NAMELY, COMPUTER SYSTEMS INTEGRATION; CREATION, DESIGN, DEVELOPMENT AND MAINTENANCE OF WEB SITES FOR THIRD PARTIES, NAMELY, CUSTOMIZING A HOSTED WEB PAGE THAT INTEGRATES WITH THE EXISTING WEBSITES OF OTHERS, AND IS DISPLAYED TO CUSTOMERS IN THEIR LOCAL LANGUAGE AND CURRENCY; COMPUTER SERVICES, NAMELY, ACTING AS AN APPLICATION SERVICE PROVIDER IN THE FIELD OF INFORMATION MANAGEMENT TO HOST COMPUTER APPLICATION SOFTWARE FOR THE PURPOSE OF HOSTING ORDER PAGES FOR CUSTOMERS, FOR USE IN THE DISTRIBUTION, PUBLICATION, SALE AND LICENSING OF E-BOOKS, SOFTWARE, ELECTRONIC GAMES, SOFTWARE AS A SERVICE (SAAS) SERVICES, AND OTHER DIGITAL PRODUCTS AND CONTENT; CLOUD COMPUTING FEATURING SOFTWARE FOR USE WITH E-COMMERCE PAYMENT PROCESSING, MERCHANDISING, SUBSCRIPTION MANAGEMENT, AND FULFILLMENT SERVICES, FOR USE IN THE DISTRIBUTION, PUBLICATION, SALE AND LICENSING OF E-BOOKS, SOFTWARE, ELECTRONIC GAMES, SOFTWARE AS A SERVICE (SAAS) SERVICES, AND OTHER DIGITAL PRODUCTS AND CONTENT; DESIGN AND DEVELOPMENT OF COMPUTER SOFTWARE FOR THE IMPROVEMENTS OF PURCHASING FUNCTIONS OF BUSINESSES; DESIGN OF COMPUTER NETWORKS AND SOFTWARE FOR OTHERS FOR THE FACILITATION OF E-COMMERCE BUSINESS TRANSACTIONS; PROVIDING A WEBSITE FEATURING NON-DOWNLOADABLE SOFTWARE FOR E-COMMERCE PAYMENT PROCESSING, MERCHANDISING, SUBSCRIPTION MANAGEMENT, AND FULFILLMENT SERVICES, FOR USE IN THE DISTRIBUTION, PUBLICATION, SALE AND LICENSING OF E-BOOKS, SOFTWARE, ELECTRONIC GAMES, SOFTWARE AS A SERVICE (SAAS) SERVICES, AND OTHER DIGITAL PRODUCTS AND CONTENT; PROVIDING TEMPORARY USE OF A WEB-BASED SOFTWARE APPLICATION FOR E-COMMERCE PAYMENT PROCESSING, MERCHANDISING, SUBSCRIPTION MANAGEMENT, AND FULFILLMENT SERVICES, FOR USE IN THE DISTRIBUTION, PUBLICATION, SALE AND LICENSING OF E-BOOKS, SOFTWARE, ELECTRONIC GAMES,

Reg. No. 4,155,181 SOFTWARE AS A SERVICE (SAAS) SERVICES, AND OTHER DIGITAL PRODUCTS AND CONTENT; PROVIDING TEMPORARY USE OF ON-LINE NON-DOWNLOADABLE SOFTWARE AND APPLICATIONS FOR E-COMMERCE PAYMENT PROCESSING, MERCHANDISING, SUBSCRIPTION MANAGEMENT, AND FULFILLMENT SERVICES, FOR USE IN THE DISTRIBUTION, PUBLICATION, SALE AND LICENSING OF E-BOOKS, SOFTWARE, ELECTRONIC GAMES, SOFTWARE AS A SERVICE (SAAS) SERVICES, AND OTHER DIGITAL PRODUCTS AND CONTENT, IN CLASS 42 (U.S. CLS. 100 AND 101).

FIRST USE 3-17-2011; IN COMMERCE 3-17-2011.

THE MARK CONSISTS OF STANDARD CHARACTERS WITHOUT CLAIM TO ANY PARTICULAR FONT, STYLE, SIZE, OR COLOR.

SN 85-254,658, FILED 3-1-2011.

PAUL MORENO, EXAMINING ATTORNEY

United States of America

United States Patent and Trademark Office

SAASY A FastSpring Service

Reg. No. 4,155,182

Registered June 5, 2012

Int. Cls.: 35, 36, and 42

SERVICE MARK

PRINCIPAL REGISTER

BRIGHT MARKET, LLC (CALIFORNIA LIMITED LIABILITY COMPANY), DBA
FASTSPRING,
11 WEST VICTORIA STREET, SUITE #207A
SANTA BARBARA, CA 93101

FOR: FACILITATING E-COMMERCE BUSINESS TRANSACTIONS BY PROCESSING ELECTRONIC ORDERS OF PURCHASES OF GOODS AND SERVICES VIA A GLOBAL COMPUTER NETWORK FOR OTHERS; FULFILLMENT OF ELECTRONIC ORDERS FOR SOFTWARE, E-BOOKS, ELECTRONIC GAMES, SOFTWARE AS A SERVICE (SAAS) SERVICES, AND OTHER DIGITAL CONTENT AND PRODUCTS VIA A GLOBAL COMPUTER NETWORK; ON-LINE ORDER FULFILLMENT SERVICES FOR OTHERS; ON-LINE RETAIL STORE SERVICES FEATURING COMPUTER SOFTWARE, E-BOOKS, ELECTRONIC GAMES, SOFTWARE AS A SERVICE (SAAS) SERVICES, AND OTHER DIGITAL CONTENT AND PRODUCTS; ON-LINE MARKETING SERVICES FOR SELLERS OF COMPUTER SOFTWARE, E-BOOKS, ELECTRONIC GAMES, SOFTWARE AS A SERVICE (SAAS) SERVICES, AND OTHER DIGITAL CONTENT AND PRODUCTS, NAMELY, DEVELOPING AND IMPLEMENTING ONLINE MARKETING AND ADVERTISING THROUGH THE USE OF PARTNERSHIPS BETWEEN SOFTWARE PUBLISHERS, DISTRIBUTORS, ADVERTISERS, AFFILIATES AND RESELLERS TO INCREASE SALES AND REVENUES; ADVERTISING, MARKETING AND PROMOTIONAL SERVICES; SUBSCRIPTION MANAGEMENT SERVICES AS A SUBSCRIPTION AGENT BETWEEN PUBLISHERS AND CUSTOMERS FOR E-COMMERCE SERVICES; PROVIDING CROSS-SELLING OPPORTUNITIES TO CUSTOMERS THAT SELL SUBSCRIPTION E-COMMERCE SERVICES AND SOFTWARE AS A SERVICE (SAAS) SERVICES, NAMELY, PROMOTING THE SALE OF GOODS AND SERVICES OF OTHERS BY SUGGESTING COMPLEMENTARY CROSS-SELL GOODS AND SERVICES TO ALREADY PURCHASED GOODS OR SERVICES; ONLINE BILLING; CUSTOMER RELATIONSHIP MANAGEMENT; CUSTOMER SERVICE MANAGEMENT FOR OTHERS; BUSINESS MANAGEMENT SERVICES, NAMELY, CUSTOMER RESPONSE-HANDLING AND PAYMENT SERVICES RELATING TO SUBSCRIPTION E-COMMERCE SERVICES, IN CLASS 35 (U.S. CLS. 100, 101 AND 102).



FIRST USE 3-17-2011; IN COMMERCE 3-17-2011.

David J. Kyros

Director of the United States Patent and Trademark Office

FOR: ELECTRONIC PAYMENT, NAMELY, ELECTRONIC PROCESSING AND TRANSMISSION OF BILL PAYMENT DATA; BILL PAYMENT SERVICES PROVIDED THROUGH A WEBSITE; ONLINE PAYMENT COLLECTION SERVICES FOR OTHERS; PAYMENT PROCESSING SERVICES, NAMELY, CREDIT CARD AND DEBIT CARD TRANSACTION PRO-

Reg. No. 4,155,182 CESSING SERVICES; PROVIDING SECURED CREDIT CARD PAYMENT PROCESSING VIA THE INTERNET; MERCHANT SERVICES, NAMELY, PAYMENT TRANSACTION PROCESSING SERVICES; PROVIDING ELECTRONIC PROCESSING OF CREDIT CARD TRANSACTIONS AND ELECTRONIC PAYMENTS VIA A GLOBAL COMPUTER NETWORK; MERCHANT SERVICES, NAMELY, PAYMENT TRANSACTION PROCESSING SERVICES, IN CLASS 36 (U.S. CLS. 100, 101 AND 102).

FIRST USE 3-17-2011; IN COMMERCE 3-17-2011.

FOR: APPLICATION SERVICE PROVIDER (ASP) FEATURING SOFTWARE FOR E-COMMERCE PAYMENT PROCESSING, MERCHANDISING, SUBSCRIPTION MANAGEMENT, AND FULFILLMENT SERVICES, FOR USE IN THE DISTRIBUTION, PUBLICATION, SALE AND LICENSING OF E-BOOKS, SOFTWARE, ELECTRONIC GAMES, SOFTWARE AS A SERVICE (SAAS) SERVICES, AND OTHER DIGITAL PRODUCTS AND CONTENT; SOFTWARE AS A SERVICE (SAAS) SERVICES, NAMELY, HOSTING SOFTWARE FOR USE BY OTHERS FOR USE WITH E-COMMERCE PAYMENT PROCESSING, MERCHANDISING, SUBSCRIPTION MANAGEMENT, AND FULFILLMENT SERVICES, FOR USE IN THE DISTRIBUTION, PUBLICATION, SALE AND LICENSING OF E-BOOKS, SOFTWARE, ELECTRONIC GAMES, SOFTWARE AS A SERVICE (SAAS) SERVICES, AND OTHER DIGITAL PRODUCTS AND CONTENT; SOFTWARE AS A SERVICE (SAAS) SERVICES FEATURING SOFTWARE FOR USE WITH E-COMMERCE PAYMENT PROCESSING, MERCHANDISING, SUBSCRIPTION MANAGEMENT, AND FULFILLMENT SERVICES, FOR USE IN THE DISTRIBUTION, PUBLICATION, SALE AND LICENSING OF E-BOOKS, SOFTWARE, ELECTRONIC GAMES, SOFTWARE AS A SERVICE (SAAS) SERVICES, AND OTHER DIGITAL PRODUCTS AND CONTENT; SOFTWARE AS A SERVICE (SAAS) SERVICES FEATURING SOFTWARE FOR SUBSCRIPTION SERVICE MANAGEMENT, CUSTOMER SERVICE, AND BILLING AND PAYMENT TRACKING, ANALYSIS, AND MANAGEMENT; DEVELOPING AND HOSTING A SERVER ON A GLOBAL COMPUTER NETWORK FOR THE PURPOSE OF FACILITATING E-COMMERCE VIA SUCH A SERVER; COMPUTER SERVICES, NAMELY, PROVIDING A WEB-BASED SYSTEM AND ONLINE PORTAL FOR CUSTOMERS TO REMOTELY MANAGE, AND MODIFY THEIR END USER COMPUTER DEVICES, DATA AND SOFTWARE APPLICATIONS; COMPUTER SERVICES, NAMELY, COMPUTER SYSTEMS INTEGRATION; CREATION, DESIGN, DEVELOPMENT AND MAINTENANCE OF WEB SITES FOR THIRD PARTIES, NAMELY, CUSTOMIZING A HOSTED WEB PAGE THAT INTEGRATES WITH THE EXISTING WEBSITES OF OTHERS, AND IS DISPLAYED TO CUSTOMERS IN THEIR LOCAL LANGUAGE AND CURRENCY; COMPUTER SERVICES, NAMELY, ACTING AS AN APPLICATION SERVICE PROVIDER IN THE FIELD OF INFORMATION MANAGEMENT TO HOST COMPUTER APPLICATION SOFTWARE FOR THE PURPOSE OF HOSTING ORDER PAGES FOR CUSTOMERS, FOR USE IN THE DISTRIBUTION, PUBLICATION, SALE AND LICENSING OF E-BOOKS, SOFTWARE, ELECTRONIC GAMES, SOFTWARE AS A SERVICE (SAAS) SERVICES, AND OTHER DIGITAL PRODUCTS AND CONTENT; CLOUD COMPUTING FEATURING SOFTWARE FOR USE WITH E-COMMERCE PAYMENT PROCESSING, MERCHANDISING, SUBSCRIPTION MANAGEMENT, AND FULFILLMENT SERVICES, FOR USE IN THE DISTRIBUTION, PUBLICATION, SALE AND LICENSING OF E-BOOKS, SOFTWARE, ELECTRONIC GAMES, SOFTWARE AS A SERVICE (SAAS) SERVICES, AND OTHER DIGITAL PRODUCTS AND CONTENT; DESIGN AND DEVELOPMENT OF COMPUTER SOFTWARE FOR THE IMPROVEMENTS OF PURCHASING FUNCTIONS OF BUSINESSES; DESIGN OF COMPUTER NETWORKS AND SOFTWARE FOR OTHERS FOR THE FACILITATION OF E-COMMERCE BUSINESS TRANSACTIONS; PROVIDING A WEBSITE FEATURING NON-DOWNLOADABLE SOFTWARE FOR E-COMMERCE PAYMENT PROCESSING, MERCHANDISING, SUBSCRIPTION MANAGEMENT, AND FULFILLMENT SERVICES, FOR USE IN THE DISTRIBUTION, PUBLICATION, SALE AND LICENSING OF E-BOOKS, SOFTWARE, ELECTRONIC GAMES, SOFTWARE AS A SERVICE (SAAS) SERVICES, AND OTHER DIGITAL PRODUCTS AND CONTENT; PROVIDING TEMPORARY USE OF A WEB-BASED SOFTWARE APPLICATION FOR E-COMMERCE PAYMENT PROCESSING, MERCHANDISING, SUBSCRIPTION MANAGEMENT, AND FULFILLMENT SERVICES, FOR USE IN THE DISTRIBUTION, PUBLICATION, SALE AND LICENSING OF E-BOOKS, SOFTWARE, ELECTRONIC GAMES,

Reg. No. 4,155,182 SOFTWARE AS A SERVICE (SAAS) SERVICES, AND OTHER DIGITAL PRODUCTS AND CONTENT; PROVIDING TEMPORARY USE OF ON-LINE NON-DOWNLOADABLE SOFTWARE AND APPLICATIONS FOR E-COMMERCE PAYMENT PROCESSING, MERCHANDISING, SUBSCRIPTION MANAGEMENT, AND FULFILLMENT SERVICES, FOR USE IN THE DISTRIBUTION, PUBLICATION, SALE AND LICENSING OF E-BOOKS, SOFTWARE, ELECTRONIC GAMES, SOFTWARE AS A SERVICE (SAAS) SERVICES, AND OTHER DIGITAL PRODUCTS AND CONTENT, IN CLASS 42 (U.S. CLS. 100 AND 101).

FIRST USE 3-17-2011; IN COMMERCE 3-17-2011.

THE MARK CONSISTS OF STANDARD CHARACTERS WITHOUT CLAIM TO ANY PARTICULAR FONT, STYLE, SIZE, OR COLOR.

OWNER OF U.S. REG. NO. 3,327,275.

NO CLAIM IS MADE TO THE EXCLUSIVE RIGHT TO USE "SERVICE", APART FROM THE MARK AS SHOWN.

SN 85-254,666, FILED 3-1-2011.

PAUL MORENO, EXAMINING ATTORNEY

United States of America

United States Patent and Trademark Office

ADJUST-E-LUME

Reg. No. 4,155,183

Registered June 5, 2012

Int. Cl.: 11

TRADEMARK

PRINCIPAL REGISTER

B-K LIGHTING, INC. (CALIFORNIA CORPORATION)
40429 BRICKYARD DRIVE
MADERA, CA 93636

FOR: ELECTRIC LIGHTING FIXTURES, IN CLASS 11 (U.S. CLS. 13, 21, 23, 31 AND 34).

FIRST USE 10-15-2011; IN COMMERCE 10-15-2011.

THE MARK CONSISTS OF STANDARD CHARACTERS WITHOUT CLAIM TO ANY PARTICULAR FONT, STYLE, SIZE, OR COLOR.

SN 85-254,686, FILED 3-1-2011.

SUNG IN, EXAMINING ATTORNEY



David J. Kyfos

Director of the United States Patent and Trademark Office

United States of America

United States Patent and Trademark Office

SPIT-FIRE

Reg. No. 4,155,184

ELKHART BRASS MANUFACTURING COMPANY, INC. (INDIANA CORPORATION)
1302 WEST BEARDSLEY
ELKHART, IN 46515

Registered June 5, 2012

Int. Cl.: 9

FOR: FIRE FIGHTING EQUIPMENT, NAMELY, FIRE FIGHTING MONITORS THAT SPRAY
FOAM OR LIQUIDS ON FIRES, IN CLASS 9 (U.S. CLS. 21, 23, 26, 36 AND 38).

TRADEMARK

FIRST USE 4-29-2005; IN COMMERCE 4-29-2005.

PRINCIPAL REGISTER

THE MARK CONSISTS OF STANDARD CHARACTERS WITHOUT CLAIM TO ANY PAR-
TICULAR FONT, STYLE, SIZE, OR COLOR.

SN 85-254,773, FILED 3-1-2011.

MICHAEL TANNER, EXAMINING ATTORNEY



David J. Kyffers

Director of the United States Patent and Trademark Office

United States of America

United States Patent and Trademark Office

光照人

3H-SENDER

Reg. No. 4,155,185

Registered June 5, 2012

Int. Cl.: 30

TRADEMARK

PRINCIPAL REGISTER

ZHANGZHOU GUANGZHAOREN TEA CO., LTD. (CHINA CORPORATION)
DAISHAN VILLAGE, SHAJIAN TOWN
HUA'AN COUNTY, ZHANGZHOU 363800
FUJIAN, CHINA

FOR: COFFEE; TEA; SUGAR; CONFECTIONERY MADE OF SUGAR; HONEY; WHEAT FLOUR FOR FOOD; SAUCES; SEASONINGS; YEAST; FOOD FLAVORINGS; COFFEE SUBSTITUTES (ARTIFICIAL COFFEE OR VEGETABLE PREPARATIONS FOR USE AS COFFEE); TEA-BASED BEVERAGES, IN CLASS 30 (U.S. CL. 46).

FIRST USE 12-1-2005; IN COMMERCE 12-10-2010.

THE MARK CONSISTS OF THE WORDING "3H-SENDER" BENEATH THREE CHINESE CHARACTERS.

THE NON-LATIN CHARACTERS IN THE MARK TRANSLITERATE TO "GUANG ZHAO REN" AND THIS HAS NO MEANING IN A FOREIGN LANGUAGE.

SN 85-254,783, FILED 3-1-2011.

RICHARD WHITE, EXAMINING ATTORNEY



David J. Kyros

Director of the United States Patent and Trademark Office

United States of America

United States Patent and Trademark Office

COPPERHEAD

Reg. No. 4,155,186

ELKHART BRASS MANUFACTURING COMPANY, INC. (INDIANA CORPORATION)
1302 WEST BEARDSLEY
ELKHART, IN 46515

Registered June 5, 2012

Int. Cl.: 9

FOR: FIRE FIGHTING EQUIPMENT, NAMELY, FIRE FIGHTING MONITORS THAT SPRAY FOAM OR LIQUIDS ON FIRES, IN CLASS 9 (U.S. CLS. 21, 23, 26, 36 AND 38).

TRADEMARK

FIRST USE 1-27-2003; IN COMMERCE 1-27-2003.

PRINCIPAL REGISTER

THE MARK CONSISTS OF STANDARD CHARACTERS WITHOUT CLAIM TO ANY PARTICULAR FONT, STYLE, SIZE, OR COLOR.

SN 85-254,797, FILED 3-1-2011.

MICHAEL TANNER, EXAMINING ATTORNEY



David J. Kybas

Director of the United States Patent and Trademark Office

United States of America

United States Patent and Trademark Office

MONTANA

Reg. No. 4,155,187

Registered June 5, 2012

Int. Cl.: 9

TRADEMARK

PRINCIPAL REGISTER

GARMIN SWITZERLAND GMBH (SWITZERLAND GESELLSCHAFT MIT BESCHRÄNKTER
HAFTUNG (GMBH))
MUHLENTALSTRASSE 2
SCHAFFHAUSEN, SWITZERLAND 66062

FOR: HANDHELD SATELLITE NAVIGATIONAL SYSTEM, NAMELY, A GLOBAL POSI-
TIONING SYSTEM (GPS), IN CLASS 9 (U.S. CLS. 21, 23, 26, 36 AND 38).

FIRST USE 6-0-2011; IN COMMERCE 6-0-2011.

THE MARK CONSISTS OF STANDARD CHARACTERS WITHOUT CLAIM TO ANY PAR-
TICULAR FONT, STYLE, SIZE, OR COLOR.

SN 85-254,837, FILED 3-1-2011.

HAI-LY LAM, EXAMINING ATTORNEY



David J. Kybas

Director of the United States Patent and Trademark Office

United States of America

United States Patent and Trademark Office

Aslan Global Management

Reg. No. 4,155,188

Registered June 5, 2012

Int. Cl.: 35

SERVICE MARK

PRINCIPAL REGISTER

ASLAN GLOBAL MANAGEMENT, LLC (FLORIDA LIMITED LIABILITY COMPANY)
6162 SEA GRASS LANE
NAPLES, FL 34116

FOR: BUSINESS CONSULTING SERVICES IN THE AGRICULTURAL FIELD; BUSINESS CONSULTING, MANAGEMENT, PLANNING AND SUPERVISION; MANAGEMENT AND BUSINESS CONSULTING SERVICES IN THE FIELD OF BUSINESS AND AGRICULTURAL ENTERPRISES THAT PROMOTE ECONOMIC, SOCIAL AND SPIRITUAL DEVELOPMENT IN THE THIRD WORLD, IN CLASS 35 (U.S. CLS. 100, 101 AND 102).

FIRST USE 8-1-2011; IN COMMERCE 8-1-2011.

THE MARK CONSISTS OF STANDARD CHARACTERS WITHOUT CLAIM TO ANY PARTICULAR FONT, STYLE, SIZE, OR COLOR.

NO CLAIM IS MADE TO THE EXCLUSIVE RIGHT TO USE "GLOBAL MANAGEMENT", APART FROM THE MARK AS SHOWN.

THE ENGLISH TRANSLATION OF "ASLAN" IN THE MARK IS "LION".

SN 85-254,872, FILED 3-1-2011.

SALLY SHIH, EXAMINING ATTORNEY



David J. Kybas

Director of the United States Patent and Trademark Office

United States of America

United States Patent and Trademark Office

Moto Meccanica

Reg. No. 4,155,189

LUDWICK, MATTHEW (UNITED STATES INDIVIDUAL)
908 NORTH ROSE STREET
BURBANK, CA 91505

Registered June 5, 2012

Int. Cl.: 25

FOR: CLOTHING, NAMELY, LONG AND SHORT SLEEVE T-SHIRTS, LONG AND SHORT SLEEVE SHIRTS, COATS, AND HEADWEAR, IN CLASS 25 (U.S. CLS. 22 AND 39).

TRADEMARK

FIRST USE 2-3-2012; IN COMMERCE 2-3-2012.

PRINCIPAL REGISTER

THE MARK CONSISTS OF STANDARD CHARACTERS WITHOUT CLAIM TO ANY PARTICULAR FONT, STYLE, SIZE, OR COLOR.

THE ENGLISH TRANSLATION OF "MOTO MECCANICA" IN THE MARK IS "MECHANICAL MOTORCYCLE".

SN 85-254,890, FILED 3-1-2011.

GENE MACIOL, EXAMINING ATTORNEY



David J. Kybas

Director of the United States Patent and Trademark Office

United States of America

United States Patent and Trademark Office

WE LIVE CARPET SO YOU CAN
LIVE ON IT

Reg. No. 4,155,190

Registered June 5, 2012

Int. Cls.: 35 and 37

SERVICE MARK

PRINCIPAL REGISTER

MR. CARPET COMPANY (ILLINOIS CORPORATION)
1336 W. BELMONT AVENUE
CHICAGO, IL 60657

FOR: ON-LINE RETAIL STORE AND SHOP-AT-HOME SERVICES, ALL IN THE FIELDS OF CARPETING, FLOORING, FLOOR REFINISHING, STAIR RUNNERS, CUSTOM CLOSETS, AND WINDOW TREATMENTS, IN CLASS 35 (U.S. CLS. 100, 101 AND 102).

FIRST USE 4-2-2012; IN COMMERCE 4-2-2012.

FOR: INSTALLATION SERVICES IN THE FIELDS OF CARPETING, FLOORING, FLOOR REFINISHING, STAIR RUNNERS, CUSTOM CLOSETS, AND WINDOW TREATMENTS, IN CLASS 37 (U.S. CLS. 100, 103 AND 106).

FIRST USE 4-2-2012; IN COMMERCE 4-2-2012.

THE MARK CONSISTS OF STANDARD CHARACTERS WITHOUT CLAIM TO ANY PARTICULAR FONT, STYLE, SIZE, OR COLOR.

SN 85-255,014, FILED 3-1-2011.

GENE MACIOL, EXAMINING ATTORNEY



David J. Kybas

Director of the United States Patent and Trademark Office

United States of America

United States Patent and Trademark Office

king wing a ling

Reg. No. 4,155,191

ARRINDELL, CHARLES (UNITED STATES INDIVIDUAL)
21 DELWOOD DR
OAKVILLE, CT 06779

Registered June 5, 2012

Int. Cl.: 30

FOR: FOOD FLAVORINGS; MARINADES; SAUCES, SEASONINGS, AND SPICES FOR FOOD OR FOOD PRODUCTS; CONDIMENTS IN THE NATURE OF HOT SAUCES; COATINGS AND SEASONINGS FOR FOOD, NAMELY, SEASONED COATING FOR MEAT, FISH, AND POULTRY, IN CLASS 30 (U.S. CL. 46).

TRADEMARK

PRINCIPAL REGISTER

FIRST USE 9-1-2000; IN COMMERCE 11-2-2011.

THE MARK CONSISTS OF STANDARD CHARACTERS WITHOUT CLAIM TO ANY PARTICULAR FONT, STYLE, SIZE, OR COLOR.

SN 85-255,113, FILED 3-1-2011.

JESSICA FATHY, EXAMINING ATTORNEY



David J. Kyros

Director of the United States Patent and Trademark Office

United States of America

United States Patent and Trademark Office

FLUIDSTRETCH

Reg. No. 4,155,192

Registered June 5, 2012

Int. Cl.: 24

SPRINGS CREATIVE PRODUCTS GROUP, LLC (SOUTH CAROLINA LIMITED LIABILITY COMPANY)
300 CHATHAM AVENUE
SUITE 400
ROCK HILL, SC 29730

TRADEMARK

PRINCIPAL REGISTER

FOR: MATTRESS COVERS; BED SHEETS; AND FABRIC FOR COVERING MATTRESSES, NAMELY, POLYESTER AND SPANDEX BLENDED FABRIC FOR USE AS A TEXTILE IN THE MANUFACTURE OF MATTRESSES, FABRICS FOR THE MANUFACTURE OF MATTRESSES AND FABRIC MATTRESS COVERS, IN CLASS 24 (U.S. CLS. 42 AND 50).

FIRST USE 1-0-2012; IN COMMERCE 1-0-2012.

THE MARK CONSISTS OF STANDARD CHARACTERS WITHOUT CLAIM TO ANY PARTICULAR FONT, STYLE, SIZE, OR COLOR.

SN 85-255,340, FILED 3-2-2011.

DAWN FELDMAN, EXAMINING ATTORNEY



David J. Kyffers

Director of the United States Patent and Trademark Office

United States of America

United States Patent and Trademark Office

PEPTISOL

Reg. No. 4,155,193

QUALITY OF LIFE LABORATORIES, INC. (NEW YORK CORPORATION)
2975 WESTCHESTER AVENUE
PURCHASE, NY 10577

Registered June 5, 2012

Int. Cl.: 5

FOR: DIETARY AND NUTRITIONAL SUPPLEMENTS, IN CLASS 5 (U.S. CLS. 6, 18, 44, 46, 51 AND 52).

TRADEMARK

FIRST USE 3-9-2012; IN COMMERCE 3-9-2012.

PRINCIPAL REGISTER

THE MARK CONSISTS OF STANDARD CHARACTERS WITHOUT CLAIM TO ANY PARTICULAR FONT, STYLE, SIZE, OR COLOR.

SN 85-255,414, FILED 3-2-2011.

KEVIN CORWIN, EXAMINING ATTORNEY



David J. Kybas

Director of the United States Patent and Trademark Office

United States of America

United States Patent and Trademark Office

VIGILANT

Reg. No. 4,155,194

Registered June 5, 2012

Int. Cl.: 5

TRADEMARK

PRINCIPAL REGISTER

CHEMTURA CORPORATION (DELAWARE CORPORATION)
199 BENSON ROAD
MIDDLEBURY, CT 06749

FOR: ACARACIDES AND MITICIDES FOR AGRICULTURAL USE, IN CLASS 5 (U.S. CLS. 6, 18, 44, 46, 51 AND 52).

FIRST USE 5-31-2011; IN COMMERCE 5-31-2011.

THE MARK CONSISTS OF STANDARD CHARACTERS WITHOUT CLAIM TO ANY PARTICULAR FONT, STYLE, SIZE, OR COLOR.

OWNER OF U.S. REG. NO. 1,364,123.

SN 85-255,448, FILED 3-2-2011.

KATHLEEN LORENZO, EXAMINING ATTORNEY



David J. Kybas

Director of the United States Patent and Trademark Office

United States of America

United States Patent and Trademark Office

GROUNDSAFE

Reg. No. 4,155,195

Registered June 5, 2012

Int. Cl.: 19

TRADEMARK

PRINCIPAL REGISTER

STATICWORX, INC. (MASSACHUSETTS CORPORATION)
124 WATERTOWN STREET
SUITE 3E
WATERTOWN, MA 02472

FOR: VINYL FLOORING, RUBBER FLOORING, AND EPOXY FLOORING, IN CLASS 19
(U.S. CLS. 1, 12, 33 AND 50).

FIRST USE 2-1-2012; IN COMMERCE 2-1-2012.

THE MARK CONSISTS OF STANDARD CHARACTERS WITHOUT CLAIM TO ANY PARTICULAR FONT, STYLE, SIZE, OR COLOR.

SN 85-255,610, FILED 3-2-2011.

JOHN E. MICHOS, EXAMINING ATTORNEY



David J. Kyffers

Director of the United States Patent and Trademark Office

United States of America

United States Patent and Trademark Office

SASSYSCAPES

Reg. No. 4,155,196

BUSHONG, ELIZABETH, C. (UNITED STATES INDIVIDUAL), DBA LIZ BUSHONG,
1511 KINGS ROW
JOHNSON CITY, TN 37604

Registered June 5, 2012

Int. Cl.: 20

FOR: DINING ROOM TABLES; DISPLAY TABLES, IN CLASS 20 (U.S. CLS. 2, 13, 22, 25, 32 AND 50).

TRADEMARK

FIRST USE 4-21-2011; IN COMMERCE 4-21-2011.

PRINCIPAL REGISTER

THE MARK CONSISTS OF STANDARD CHARACTERS WITHOUT CLAIM TO ANY PARTICULAR FONT, STYLE, SIZE, OR COLOR.

SN 85-255,786, FILED 3-2-2011.

JAMES MACFARLANE, EXAMINING ATTORNEY



David J. Kyffers

Director of the United States Patent and Trademark Office

United States of America

United States Patent and Trademark Office

PASSTOUCH

Reg. No. 4,155,197

PASSTOUCH, LLC (TENNESSEE LIMITED LIABILITY COMPANY)
305 N. SHORE DRIVE
SURF CITY, NC 28445

Registered June 5, 2012

Int. Cl.: 9

FOR: COMPUTER SOFTWARE, NAMELY, GRAPHICAL INTERFACES FOR USER AUTHENTICATION AND IDENTIFICATION, IN CLASS 9 (U.S. CLS. 21, 23, 26, 36 AND 38).

TRADEMARK

FIRST USE 8-13-2011; IN COMMERCE 8-13-2011.

PRINCIPAL REGISTER

THE MARK CONSISTS OF STANDARD CHARACTERS WITHOUT CLAIM TO ANY PARTICULAR FONT, STYLE, SIZE, OR COLOR.

SN 85-255,865, FILED 3-2-2011.

KEVIN DINALLO, EXAMINING ATTORNEY



David J. Kyffers

Director of the United States Patent and Trademark Office

United States of America

United States Patent and Trademark Office

PARALAST

Reg. No. 4,155,198

Registered June 5, 2012

Int. Cl.: 1

TRADEMARK

PRINCIPAL REGISTER

LEICA BIOSYSTEMS RICHMOND, INC. (ILLINOIS CORPORATION)
5205 ROUTE 12, P.O. BOX 528
RICHMOND, IL 60071

FOR: CHEMICAL PREPARATIONS FOR SCIENTIFIC, LABORATORY, MEDICAL LABORATORY AND RESEARCH PURPOSES IN THE NATURE OF CLEARING AGENTS FOR HISTOLOGY AND CYTOLOGY, IN CLASS 1 (U.S. CLS. 1, 5, 6, 10, 26 AND 46).

FIRST USE 10-24-2011; IN COMMERCE 10-24-2011.

THE MARK CONSISTS OF STANDARD CHARACTERS WITHOUT CLAIM TO ANY PARTICULAR FONT, STYLE, SIZE, OR COLOR.

SN 85-255,872, FILED 3-2-2011.

KEVIN DINALLO, EXAMINING ATTORNEY



David J. Kyros

Director of the United States Patent and Trademark Office

United States of America

United States Patent and Trademark Office

REWARDS FOR LIVING LOCALLY

Reg. No. 4,155,199

STREETCARSHOPS.COM, LLC (LOUISIANA LIMITED LIABILITY COMPANY)
42266 JAMIE ROAD
PRAIRIEVILLE, LA 70769

Registered June 5, 2012

Int. Cl.: 35

FOR: ADVERTISING AND MARKETING SERVICES, NAMELY, PROMOTING THE GOODS AND SERVICES OF OTHERS, IN CLASS 35 (U.S. CLS. 100, 101 AND 102).

SERVICE MARK

FIRST USE 5-26-2010; IN COMMERCE 5-26-2010.

PRINCIPAL REGISTER

THE MARK CONSISTS OF STANDARD CHARACTERS WITHOUT CLAIM TO ANY PARTICULAR FONT, STYLE, SIZE, OR COLOR.

SN 85-255,949, FILED 3-2-2011.

LAURIE MAYES, EXAMINING ATTORNEY



David J. Kyffers

Director of the United States Patent and Trademark Office

United States of America

United States Patent and Trademark Office

Artazaar

Reg. No. 4,155,200

ARTAZAAR, LLC (CALIFORNIA LIMITED LIABILITY COMPANY)
5589 VINTAGE CIRCLE
STOCKTON, CA 95219

Registered June 5, 2012

Int. Cl.: 35

FOR: ONLINE RETAIL STORE SERVICES FEATURING MUSICAL SOUND RECORDINGS AND ART; ONLINE AUCTION SERVICES; MARKETING SERVICES, NAMELY, PROMOTING THE GOODS AND SERVICES OF OTHERS, IN CLASS 35 (U.S. CLS. 100, 101 AND 102).

SERVICE MARK

FIRST USE 3-26-2012; IN COMMERCE 3-26-2012.

PRINCIPAL REGISTER

THE MARK CONSISTS OF STANDARD CHARACTERS WITHOUT CLAIM TO ANY PARTICULAR FONT, STYLE, SIZE, OR COLOR.

SN 85-256,259, FILED 3-2-2011.

KIM SAITO, EXAMINING ATTORNEY



David J. Kybas

Director of the United States Patent and Trademark Office

United States of America

United States Patent and Trademark Office



Reg. No. 4,155,201

Registered June 5, 2012

Int. Cl.: 9

TRADEMARK

PRINCIPAL REGISTER

ZHEJIANG DAHUA TECHNOLOGY CO., LTD. (CHINA LIMITED COMPANY (LTD.))
NO.1187, BIN'AN ROAD, BINJIANG DISTRICT
HANGZHOU, CHINA

FOR: ALARM MONITORING SYSTEMS; CAMCORDERS; CARDS WITH INTEGRATED
CIRCUITS; COMPUTER HARDWARE; COMPUTER MONITORS; COMPUTER OPERATING
PROGRAMS, RECORDED; COMPUTER PERIPHERAL DEVICES; THEFT ALARMS; VIDEO
RECORDERS; VIDEO TELEPHONES, IN CLASS 9 (U.S. CLS. 21, 23, 26, 36 AND 38).

FIRST USE 3-12-2001; IN COMMERCE 9-10-2011.

THE MARK CONSISTS OF THE STYLIZED WORD "AJHUA" WITH THE LETTER "A" INSIDE
AN INCOMPLETE CIRCLE.

THE WORDING "AJHUA" HAS NO MEANING IN A FOREIGN LANGUAGE.

SN 85-256,371, FILED 3-2-2011.

JESSICA FATHY, EXAMINING ATTORNEY



David J. Kybas

Director of the United States Patent and Trademark Office

United States of America

United States Patent and Trademark Office

Sconies

Reg. No. 4,155,202

Registered June 5, 2012

Int. Cl.: 30

TRADEMARK

PRINCIPAL REGISTER

CARLSON, BRIAN LESLEY (WISCONSIN SOLE PROPRIETORSHIP)
182 E. PIER ST.
PORT WASHINGTON, WI 53074

FOR: SCONES, IN CLASS 30 (U.S. CL. 46).

FIRST USE 7-30-2011; IN COMMERCE 7-30-2011.

THE MARK CONSISTS OF STANDARD CHARACTERS WITHOUT CLAIM TO ANY PARTICULAR FONT, STYLE, SIZE, OR COLOR.

SN 85-256,477, FILED 3-3-2011.

THEODORE MCBRIDE, EXAMINING ATTORNEY



David J. Kybas

Director of the United States Patent and Trademark Office

United States of America

United States Patent and Trademark Office

THE POWER OF LIGHT, INSIDE

Reg. No. 4,155,203

Registered June 5, 2012

Int. Cl.: 3

TRADEMARK

PRINCIPAL REGISTER

ALETHIA SKIN CARE LLC (DELAWARE LIMITED LIABILITY COMPANY)
SUITE 200
32 PARKING PLACE
ARDMORE, PA 19003

FOR: NON-MEDICATED SKIN CARE PREPARATIONS, NAMELY, CREAMS, LOTIONS, GELS, TONERS, CLEANERS AND PEELS; HAIR CARE PRODUCTS, NAMELY, SHAMPOOS AND CONDITIONERS, IN CLASS 3 (U.S. CLS. 1, 4, 6, 50, 51 AND 52).

FIRST USE 2-14-2011; IN COMMERCE 2-14-2011.

THE MARK CONSISTS OF STANDARD CHARACTERS WITHOUT CLAIM TO ANY PARTICULAR FONT, STYLE, SIZE, OR COLOR.

SN 85-256,821, FILED 3-3-2011.

BARBARA GAYNOR, EXAMINING ATTORNEY



David J. Kybas

Director of the United States Patent and Trademark Office

United States of America

United States Patent and Trademark Office

BRINGING WOO-WOO TO YOU

Reg. No. 4,155,204

MEYER, JAYMIE (UNITED STATES INDIVIDUAL)
202 W. 82ND STREET, 3E
NEW YORK, NY 10024

Registered June 5, 2012

Int. Cl.: 41

FOR: ENTERTAINMENT SERVICES, NAMELY, PROVIDING PODCASTS IN THE FIELDS OF HEALTH CARE AND WELL-BEING, IN CLASS 41 (U.S. CLS. 100, 101 AND 107).

SERVICE MARK

FIRST USE 2-7-2012; IN COMMERCE 2-7-2012.

PRINCIPAL REGISTER

THE MARK CONSISTS OF STANDARD CHARACTERS WITHOUT CLAIM TO ANY PARTICULAR FONT, STYLE, SIZE, OR COLOR.

SN 85-256,848, FILED 3-3-2011.

LAKEISHA LEWIS, EXAMINING ATTORNEY



David J. Kybas

Director of the United States Patent and Trademark Office

United States of America

United States Patent and Trademark Office



Reg. No. 4,155,205

MILLERCOORS LLC (DELAWARE LIMITED LIABILITY COMPANY)
250 SOUTH WACKER DRIVE, SUITE 800
CHICAGO, IL 60606

Registered June 5, 2012

Int. Cl.: 32

FOR: BEER, IN CLASS 32 (U.S. CLS. 45, 46 AND 48).

TRADEMARK

FIRST USE 3-30-2011; IN COMMERCE 3-30-2011.

PRINCIPAL REGISTER

NO CLAIM IS MADE TO THE EXCLUSIVE RIGHT TO USE "RECYCLES" , APART FROM THE MARK AS SHOWN.

THE MARK CONSISTS OF THE SHADED WORD "COORS" WITH A BORDER, IN A STYLIZED SCRIPT, WITH THE WORD "RECYCLES" WITH A SHADED BORDER IN A STYLIZED BLOCK LETTERING TO THE RIGHT OF "COORS" WITH FOUR MOUNTAIN PEAKS IN THE BACKDROP BEHIND THE WORDING.

SN 85-256,867, FILED 3-3-2011.

ODESSA BIBBINS, EXAMINING ATTORNEY



David J. Kyros

Director of the United States Patent and Trademark Office

United States of America

United States Patent and Trademark Office

SMOG BALLS

Reg. No. 4,155,206

Registered June 5, 2012

Int. Cl.: 30

TRADEMARK

PRINCIPAL REGISTER

CIRCLE CITY MARKETING & DISTRIBUTING, INC. (INDIANA CORPORATION)
9700 NORTH MICHIGAN ROAD
CARMEL, IN 46032

FOR: CANDY, IN CLASS 30 (U.S. CL. 46).

FIRST USE 9-25-2011; IN COMMERCE 9-25-2011.

THE MARK CONSISTS OF STANDARD CHARACTERS WITHOUT CLAIM TO ANY PARTICULAR FONT, STYLE, SIZE, OR COLOR.

NO CLAIM IS MADE TO THE EXCLUSIVE RIGHT TO USE "BALLS", APART FROM THE MARK AS SHOWN.

SN 85-256,886, FILED 3-3-2011.

DAVID HOFFMAN, EXAMINING ATTORNEY



David J. Kyffers

Director of the United States Patent and Trademark Office

United States of America

United States Patent and Trademark Office

LEANBAKER'S

Reg. No. 4,155,207

Registered June 5, 2012

Int. Cl.: 30

TRADEMARK

PRINCIPAL REGISTER

ASPEN, MARILYN JEAN (UNITED STATES INDIVIDUAL)
BRAD@DESANDROLAWGROUP.COM
1600 PINEBROOK BLVD., NO F4
PARK CITY, UT 84098

FOR: FOOD PRODUCTS, NAMELY, MIXES FOR BAKERY GOODS, BAKING MIXES FOR MAKING MUFFINS, AND MUFFIN MIXES, IN CLASS 30 (U.S. CL. 46).

FIRST USE 4-18-2011; IN COMMERCE 10-11-2011.

THE MARK CONSISTS OF STANDARD CHARACTERS WITHOUT CLAIM TO ANY PARTICULAR FONT, STYLE, SIZE, OR COLOR.

SN 85-257,019, FILED 3-3-2011.

TRACY WHITTAKER-BROWN, EXAMINING ATTORNEY



David J. Kybas

Director of the United States Patent and Trademark Office

United States of America

United States Patent and Trademark Office

I-STAMP

Reg. No. 4,155,208

Registered June 5, 2012

Int. Cl.: 9

TRADEMARK

PRINCIPAL REGISTER

ZYLOWARE CORPORATION (NEW YORK CORPORATION)
8 SLATER STREET
PORT CHESTER, NY 10573

FOR: OPTICAL FRAMES, IN CLASS 9 (U.S. CLS. 21, 23, 26, 36 AND 38).

FIRST USE 9-30-2011; IN COMMERCE 9-30-2011.

THE MARK CONSISTS OF STANDARD CHARACTERS WITHOUT CLAIM TO ANY PARTICULAR FONT, STYLE, SIZE, OR COLOR.

SN 85-257,023, FILED 3-3-2011.

BARNEY CHARLON, EXAMINING ATTORNEY



David J. Kyffers

Director of the United States Patent and Trademark Office

United States of America

United States Patent and Trademark Office

THE POWER OF KNOWING HOW LIFE WORKS

Reg. No. 4,155,209

Registered June 5, 2012

Int. Cl.: 41

SERVICE MARK

PRINCIPAL REGISTER

SAUNDERS ENTERPRISES, LLC (NEVADA LIMITED LIABILITY COMPANY)
1166 CALCIONE DRIVE
HENDERSON, NV 89011

FOR: EDUCATIONAL SERVICES, NAMELY, CONDUCTING LECTURES, WORKSHOPS
AND SEMINARS IN THE FIELD OF SELF HELP AND PERSONAL AND BUSINESS DEVEL-
OPMENT , IN CLASS 41 (U.S. CLS. 100, 101 AND 107).

FIRST USE 11-17-2011; IN COMMERCE 11-17-2011.

THE MARK CONSISTS OF STANDARD CHARACTERS WITHOUT CLAIM TO ANY PAR-
TICULAR FONT, STYLE, SIZE, OR COLOR.

SN 85-257,047, FILED 3-3-2011.

JACLYN KIDWELL WALKER, EXAMINING ATTORNEY



David J. Kyffers

Director of the United States Patent and Trademark Office

United States of America
United States Patent and Trademark Office

G & G

Reg. No. 4,155,210

Registered June 5, 2012

Int. Cl.: 33

TRADEMARK

PRINCIPAL REGISTER

GLJR WINE LLC (CALIFORNIA LIMITED LIABILITY COMPANY)
P.O. BOX 6048
NAPA, CA 94581

FOR: WINE, IN CLASS 33 (U.S. CLS. 47 AND 49).

FIRST USE 9-15-2011; IN COMMERCE 9-15-2011.

THE MARK CONSISTS OF STANDARD CHARACTERS WITHOUT CLAIM TO ANY PARTICULAR FONT, STYLE, SIZE, OR COLOR.

SN 85-257,112, FILED 3-3-2011.

NELSON SNYDER, EXAMINING ATTORNEY



David J. Kyffers

Director of the United States Patent and Trademark Office

United States of America

United States Patent and Trademark Office

INDEPENDENCE, SIMPLIFIED

Reg. No. 4,155,211

Registered June 5, 2012

Int. Cl.: 36

SERVICE MARK

PRINCIPAL REGISTER

WELLS FARGO & COMPANY (DELAWARE CORPORATION)
1700 WELLS FARGO CENTER, MAC N9305-176
SIXTH AND MARQUETTE
MINNEAPOLIS, MN 55479

FOR: FINANCIAL AND INVESTMENT SERVICES, NAMELY, BROKERAGE SERVICES IN THE FIELDS OF STOCKS, BONDS, OPTIONS, MUTUAL FUNDS, COMMODITIES, FUTURES, AND OTHER SECURITIES; PROPRIETARY TRADING SERVICES, NAMELY, FUND INVESTMENT SERVICES FEATURING THE TRADING OF AN ACCOUNT HOLDER'S SECURITIES ACCORDING TO PREVIOUSLY ESTABLISHED CRITERIA IN ORDER TO MAINTAIN A PREDETERMINED LEVEL OF PAYMENTS TO THE ACCOUNT HOLDER; INVESTMENT BANKING SERVICES; SECURITIES BROKERAGE; EQUITY CAPITAL INVESTMENT SERVICES; PRIVATE PLACEMENTS OF HEDGE FUNDS, PRIVATE EQUITY FUNDS, SECURITIES AND DERIVATIVES FOR OTHERS; INVESTMENT OF FUNDS FOR OTHERS; SECURITIES TRADING AND INVESTING SERVICES FOR OTHERS VIA THE INTERNET; INVESTMENT ADVISORY SERVICES; INVESTMENT CONSULTATION SERVICES; INVESTMENT MANAGEMENT SERVICES; PROVIDING INFORMATION AND ADVICE IN THE FIELD OF FINANCE, FINANCIAL INVESTMENTS, FINANCIAL VALUATIONS, AND THE FINANCIAL ASPECTS OF RETIREMENT THROUGH A GLOBAL COMPUTER NETWORK; FINANCIAL PLANNING; CASH MANAGEMENT ACCOUNT SERVICES; PROVIDING FINANCIAL PORTFOLIO MANAGEMENT SERVICES; PROVIDING AN INTERACTIVE ONLINE COMPUTER DATABASE IN THE FIELD OF FINANCIAL PORTFOLIO MANAGEMENT, FINANCIAL DECISION MAKING, INVESTMENT RESEARCH, MONITORING INVESTMENT VALUE AND PERFORMANCE OF INVESTMENTS, ANALYZING INVESTMENT PERFORMANCE, EVALUATING ASSET ALLOCATION, RISK TOLERANCE, FINANCIAL ALTERNATIVE PLANS, AND INVESTMENT TIME FRAMES, IN CLASS 36 (U.S. CLS. 100, 101 AND 102).

FIRST USE 4-1-2010; IN COMMERCE 4-1-2010.

THE MARK CONSISTS OF STANDARD CHARACTERS WITHOUT CLAIM TO ANY PARTICULAR FONT, STYLE, SIZE, OR COLOR.

SN 85-257,173, FILED 3-3-2011.

HEATHER BIDDULPH, EXAMINING ATTORNEY



David J. Kyros

Director of the United States Patent and Trademark Office

United States of America

United States Patent and Trademark Office

Charity Panda

Reg. No. 4,155,212

CHARITY PANDA, LLC (NEW YORK LIMITED LIABILITY COMPANY)
432 JAY STREET
KATONAH, NY 10536

Registered June 5, 2012

Int. Cl.: 42

FOR: CHARITABLE SERVICES, NAMELY, PROVIDING A WEBSITE THAT FEATURES TECHNOLOGY THAT ENABLES HOSTS OF COMMEMORATIVE OCCASIONS TO INVITE GUESTS, INVITEES AND OTHER INVITATION RECIPIENTS TO DIRECT CONTRIBUTIONS TO CHARITABLE ORGANIZATIONS, IN CLASS 42 (U.S. CLS. 100 AND 101).

SERVICE MARK

PRINCIPAL REGISTER

FIRST USE 11-23-2011; IN COMMERCE 11-23-2011.

THE MARK CONSISTS OF STANDARD CHARACTERS WITHOUT CLAIM TO ANY PARTICULAR FONT, STYLE, SIZE, OR COLOR.

NO CLAIM IS MADE TO THE EXCLUSIVE RIGHT TO USE "CHARITY", APART FROM THE MARK AS SHOWN.

SN 85-257,179, FILED 3-3-2011.

CHARISMA HAMPTON, EXAMINING ATTORNEY



David J. Kyros

Director of the United States Patent and Trademark Office

United States of America

United States Patent and Trademark Office

BUILT TO USE EVERY DAY,
NOT JUST TO STORE AWAY

Reg. No. 4,155,213

Registered June 5, 2012

Int. Cl.: 20

TRADEMARK

PRINCIPAL REGISTER

WESTERN INDUSTRIES, INC. (WISCONSIN CORPORATION)
STROTHER FIELD INDUSTRIAL PARK
FIRST AND B STREET
WINFIELD, KS 67156

FOR: STORAGE AND ORGANIZATION SYSTEMS FOR LAWN AND GARDEN EQUIPMENT, HOUSEHOLD AND GARAGE EQUIPMENT, CAMPING AND HIKING EQUIPMENT, HUNTING AND SPORTING EQUIPMENT, AND CONSTRUCTION AND CONTRACTOR EQUIPMENT, COMPRISING SHELVES, CABINETS, DRAWERS, BASKETS, STORAGE HOOKS, STORAGE BINS, STORAGE CONTAINERS, STORAGE LOCKERS, CUPBOARDS, TOTES, SOLD AS A UNIT, IN CLASS 20 (U.S. CLS. 2, 13, 22, 25, 32 AND 50).

FIRST USE 2-15-2011; IN COMMERCE 2-15-2011.

THE MARK CONSISTS OF STANDARD CHARACTERS WITHOUT CLAIM TO ANY PARTICULAR FONT, STYLE, SIZE, OR COLOR.

SN 85-257,363, FILED 3-3-2011.

HAI-LY LAM, EXAMINING ATTORNEY



David J. Kybas

Director of the United States Patent and Trademark Office

United States of America

United States Patent and Trademark Office

Telcare

Reg. No. 4,155,214

Registered June 5, 2012

Int. Cl.: 10

TRADEMARK

PRINCIPAL REGISTER

TELCARE, INC. (DELAWARE CORPORATION)
2 BETHESDA METRO CENTER, SUITE 1350
BETHESDA, MD 20814

FOR: INTEGRATED HEALTH MONITORING SYSTEM AND ASSOCIATED SOFTWARE FOR TRANSMITTING, PROCESSING, RECEIVING AND DISPLAYING DATA VIA TELECOMMUNICATION AND GLOBAL COMPUTER NETWORKS FOR MEDICAL TREATMENT AND PATIENT REMOTE USE COMPRISING WIRELESS ENABLED MEDICAL DEVICES FOR MONITORING BLOOD GLUCOSE FOR MEDICAL PURPOSES, IN CLASS 10 (U.S. CLS. 26, 39 AND 44).

FIRST USE 2-9-2012; IN COMMERCE 2-9-2012.

THE MARK CONSISTS OF STANDARD CHARACTERS WITHOUT CLAIM TO ANY PARTICULAR FONT, STYLE, SIZE, OR COLOR.

SN 85-257,726, FILED 3-4-2011.

KIMBERLY PERRY, EXAMINING ATTORNEY



David J. Kyros

Director of the United States Patent and Trademark Office

United States of America

United States Patent and Trademark Office

Telcare BGM

Reg. No. 4,155,215

Registered June 5, 2012

Int. Cl.: 10

TRADEMARK

PRINCIPAL REGISTER

TELCARE, INC. (DELAWARE CORPORATION)
2 BETHESDA METRO CENTER
SUITE 1350
BETHESDA, MD 20814

FOR: INTEGRATED HEALTH MONITORING SYSTEM COMPRISING WIRELESS ENABLED BLOOD GLUCOSE MONITORS AND SOFTWARE FOR TRANSMITTING, PROCESSING, RECEIVING AND DISPLAYING DATA VIA TELECOMMUNICATION AND GLOBAL COMPUTER NETWORKS FOR MEDICAL TREATMENT OF DIABETES AND PATIENT REMOTE USE, IN CLASS 10 (U.S. CLS. 26, 39 AND 44).

FIRST USE 2-9-2012; IN COMMERCE 2-9-2012.

THE MARK CONSISTS OF STANDARD CHARACTERS WITHOUT CLAIM TO ANY PARTICULAR FONT, STYLE, SIZE, OR COLOR.

SN 85-257,732, FILED 3-4-2011.

KIMBERLY PERRY, EXAMINING ATTORNEY



David J. Kyffers

Director of the United States Patent and Trademark Office

United States of America

United States Patent and Trademark Office



Reg. No. 4,155,216

Registered June 5, 2012

Int. Cl.: 9

TRADEMARK

PRINCIPAL REGISTER

PASSTOUCH, LLC (TENNESSEE LIMITED LIABILITY COMPANY)
305 N. SHORE DRIVE
SURF CITY, NC 28445

FOR: COMPUTER SOFTWARE, NAMELY, GRAPHICAL INTERFACES FOR USER AUTHENTICATION AND IDENTIFICATION, IN CLASS 9 (U.S. CLS. 21, 23, 26, 36 AND 38).

FIRST USE 8-13-2011; IN COMMERCE 8-13-2011.

THE MARK CONSISTS OF CONTINUOUS SPIRALING CURVE.

SN 85-257,768, FILED 3-4-2011.

KEVIN DINALLO, EXAMINING ATTORNEY



David J. Kybas

Director of the United States Patent and Trademark Office

United States of America

United States Patent and Trademark Office

Rootless Cosmopolitan

Reg. No. 4,155,217

ARTISTIC CAFES INC. (DELAWARE CORPORATION), DBA BON VIVANT CAFE,
6280 RAINBOW DRIVE
SAN JOSE, CA 95129

Registered June 5, 2012

Int. Cl.: 33

FOR: ALCOHOLIC BEVERAGES EXCEPT BEERS, IN CLASS 33 (U.S. CLS. 47 AND 49).

TRADEMARK

FIRST USE 3-1-2012; IN COMMERCE 3-1-2012.

PRINCIPAL REGISTER

THE MARK CONSISTS OF STANDARD CHARACTERS WITHOUT CLAIM TO ANY PARTICULAR FONT, STYLE, SIZE, OR COLOR.

NO CLAIM IS MADE TO THE EXCLUSIVE RIGHT TO USE "COSMOPOLITAN", APART FROM THE MARK AS SHOWN.

SN 85-257,841, FILED 3-4-2011.

KATHERINE CHANG, EXAMINING ATTORNEY



David J. Kybas

Director of the United States Patent and Trademark Office

United States of America

United States Patent and Trademark Office

EYEPOWER

Reg. No. 4,155,218

Registered June 5, 2012

Int. Cl.: 9

TRADEMARK

PRINCIPAL REGISTER

ENERGY EYE, INC. (CALIFORNIA CORPORATION)
13367 KIRKHAM WAY, SUITE 110
POWAY, CA 92064

FOR: OCCUPANCY SENSORS, NAMELY, ELECTRONIC DEVICES WHICH DETECT THE PRESENCE OF OCCUPANTS AND CONTROL THE LIGHTING SYSTEM ACCORDINGLY; RESIDENTIAL AND COMMERCIAL AUTOMATION SYSTEMS COMPRISING WIRELESS AND WIRED CONTROLLERS, CONTROLLED DEVICES, AND SOFTWARE FOR LIGHTING, HVAC, SAFETY AND OTHER MONITORING AND CONTROL APPLICATIONS; FACILITIES MANAGEMENT SOFTWARE, NAMELY, SOFTWARE TO CONTROL BUILDING ENVIRONMENT; ELECTRONIC DEVICES, NAMELY, ENERGY METERS, SUBMETERS, AND RADIO FREQUENCY REPEATERS USED IN LONG RANGE COMMUNICATION, ALL FOR TRACKING AND MONITORING ENERGY USAGE AND SOFTWARE IN THE FIELD OF BUILDING MANAGEMENT FOR USE IN ENERGY AUDITING, ENERGY MONITORING, DATA COLLECTION AND ANALYSIS OF ENERGY CONSUMPTION, ENERGY UTILIZATION AND ENERGY MONITORING, IN CLASS 9 (U.S. CLS. 21, 23, 26, 36 AND 38).

FIRST USE 11-1-2009; IN COMMERCE 11-1-2009.

THE MARK CONSISTS OF STANDARD CHARACTERS WITHOUT CLAIM TO ANY PARTICULAR FONT, STYLE, SIZE, OR COLOR.

OWNER OF U.S. REG. NO. 3,967,353.

SN 85-258,175, FILED 3-4-2011.

AISHA SALEM, EXAMINING ATTORNEY



David J. Kyffers

Director of the United States Patent and Trademark Office

United States of America

United States Patent and Trademark Office

WHOLE WOMAN YOGA

Reg. No. 4,155,219

Registered June 5, 2012

Int. Cl.: 41

SERVICE MARK

PRINCIPAL REGISTER

WHOLE WOMAN, INC. (NEW MEXICO CORPORATION)
418 CENTRAL AVENUE, S.E.
ALBUQUERQUE, NM 87102

FOR: PROVIDING PHYSICAL FITNESS AND EXERCISE SERVICE, NAMELY, YOGA INSTRUCTION, IN CLASS 41 (U.S. CLS. 100, 101 AND 107).

FIRST USE 3-4-2011; IN COMMERCE 4-19-2011.

THE MARK CONSISTS OF STANDARD CHARACTERS WITHOUT CLAIM TO ANY PARTICULAR FONT, STYLE, SIZE, OR COLOR.

OWNER OF U.S. REG. NOS. 3,676,518, 3,918,188, AND OTHERS.

NO CLAIM IS MADE TO THE EXCLUSIVE RIGHT TO USE "WOMAN YOGA", APART FROM THE MARK AS SHOWN.

SN 85-258,315, FILED 3-4-2011.

JERI J. FICKES, EXAMINING ATTORNEY



David J. Kybas

Director of the United States Patent and Trademark Office

United States of America

United States Patent and Trademark Office

THE CAPITOL DEAL

Reg. No. 4,155,220

Registered June 5, 2012

Int. Cl.: 35

SERVICE MARK

PRINCIPAL REGISTER

WP COMPANY LLC (DELAWARE LIMITED LIABILITY COMPANY)
1150 15TH STREET N.W.
WASHINGTON, DC 20071

FOR: PROMOTING THE GOODS AND SERVICES OF OTHERS VIA THE INTERNET AND OTHER ELECTRONIC COMMUNICATIONS NETWORKS BY FEATURING DAILY COUPONS, DISCOUNTS, DEAL OF THE DAY OFFERS, DINING EVENTS AND/OR SPECIAL EVENTS, IN CLASS 35 (U.S. CLS. 100, 101 AND 102).

FIRST USE 3-8-2010; IN COMMERCE 3-8-2010.

THE MARK CONSISTS OF STANDARD CHARACTERS WITHOUT CLAIM TO ANY PARTICULAR FONT, STYLE, SIZE, OR COLOR.

OWNER OF U.S. REG. NOS. 3,966,507 AND 3,970,502.

NO CLAIM IS MADE TO THE EXCLUSIVE RIGHT TO USE "DEAL", APART FROM THE MARK AS SHOWN.

SN 85-258,403, FILED 3-4-2011.

DOUGLAS LEE, EXAMINING ATTORNEY



David J. Kyros

Director of the United States Patent and Trademark Office

United States of America

United States Patent and Trademark Office

PAC-CHOMP

Reg. No. 4,155,221

NAMCO BANDAI GAMES INC. (JAPAN CORPORATION)
4-5-15 HIGASHI SHINAGAWA
SHINAGAWA-KU TOKYO, JAPAN 140-8590

Registered June 5, 2012

Int. Cl.: 9

FOR: COMPUTER GAME PROGRAMS; COMPUTER GAME SOFTWARE; DOWNLOADABLE
COMPUTER GAME PROGRAMS; DOWNLOADABLE COMPUTER GAME SOFTWARE VIA
A GLOBAL COMPUTER NETWORK AND WIRELESS DEVICES; VIDEO GAME SOFTWARE,
IN CLASS 9 (U.S. CLS. 21, 23, 26, 36 AND 38).

TRADEMARK

PRINCIPAL REGISTER

FIRST USE 4-21-2011; IN COMMERCE 4-21-2011.

THE MARK CONSISTS OF STANDARD CHARACTERS WITHOUT CLAIM TO ANY PAR-
TICULAR FONT, STYLE, SIZE, OR COLOR.

SN 85-258,485, FILED 3-4-2011.

EDWARD FENNESSY, EXAMINING ATTORNEY



David J. Kyffers

Director of the United States Patent and Trademark Office

United States of America

United States Patent and Trademark Office

Costa Pacifica

Reg. No. 4,155,222

CANAVATI, GERARDO MARTIN (MEXICO INDIVIDUAL)
252 DR. JOSE LUNA AYALA, SAN JERONIMO
MONTERREY, N. L., MEXICO 66640

Registered June 5, 2012

Int. Cl.: 43

FOR: RESTAURANT AND BAR SERVICES, INCLUDING RESTAURANT CARRYOUT SERVICES, IN CLASS 43 (U.S. CLS. 100 AND 101).

SERVICE MARK

FIRST USE 4-14-2011; IN COMMERCE 4-14-2011.

PRINCIPAL REGISTER

THE MARK CONSISTS OF STANDARD CHARACTERS WITHOUT CLAIM TO ANY PARTICULAR FONT, STYLE, SIZE, OR COLOR.

NO CLAIM IS MADE TO THE EXCLUSIVE RIGHT TO USE "PACIFICA", APART FROM THE MARK AS SHOWN.

SN 85-258,521, FILED 3-4-2011.

MATTHEW MCDOWELL, EXAMINING ATTORNEY



David J. Kybas

Director of the United States Patent and Trademark Office

United States of America

United States Patent and Trademark Office

CHIN SKIN

Reg. No. 4,155,223

Registered June 5, 2012

Int. Cl.: 9

TRADEMARK

PRINCIPAL REGISTER

ROCHHOLZ, ROBERT (UNITED STATES INDIVIDUAL)
819 NORTH ZYLSTRA ROAD
COUPEVILLE, WA 98239

FOR: CHIN STRAPS FOR FOOTBALL HELMETS; PROTECTIVE SPORTS HELMET ACCESSORIES THAT ATTACH TO THE HELMETS, NAMELY, MOUTH GUARDS, EAR PADS, THROAT PROTECTORS, CHIN STRAPS, FACE MASKS, JAW PADS AND EYE SHIELDS, IN CLASS 9 (U.S. CLS. 21, 23, 26, 36 AND 38).

FIRST USE 7-13-2011; IN COMMERCE 7-13-2011.

THE MARK CONSISTS OF STANDARD CHARACTERS WITHOUT CLAIM TO ANY PARTICULAR FONT, STYLE, SIZE, OR COLOR.

NO CLAIM IS MADE TO THE EXCLUSIVE RIGHT TO USE "CHIN", APART FROM THE MARK AS SHOWN.

SN 85-258,924, FILED 3-5-2011.

KAREN K. BUSH, EXAMINING ATTORNEY



David J. Kybas

Director of the United States Patent and Trademark Office

United States of America

United States Patent and Trademark Office

K911 THERAPY DOGS ON CALL

Reg. No. 4,155,224

GRANFORS, MELANIE (UNITED STATES INDIVIDUAL)
5801 223RD PLACE SW
MOUNTLAKE TERRACE, WA 98043

Registered June 5, 2012

Int. Cl.: 44

FOR: PROVIDING PET THERAPY SERVICES FOR PATIENTS AND PEOPLE IN SETTINGS IN THE NATURE OF HOSPITALS AND NURSING HOMES, PUBLIC AND PRIVATE SCHOOLS, LIBRARIES, CHILDREN'S CENTERS AND OTHER AGENCIES, IN CLASS 44 (U.S. CLS. 100 AND 101).

SERVICE MARK

PRINCIPAL REGISTER

FIRST USE 6-1-2011; IN COMMERCE 6-1-2011.

THE MARK CONSISTS OF STANDARD CHARACTERS WITHOUT CLAIM TO ANY PARTICULAR FONT, STYLE, SIZE, OR COLOR.

NO CLAIM IS MADE TO THE EXCLUSIVE RIGHT TO USE "THERAPY DOGS", APART FROM THE MARK AS SHOWN.

SN 85-259,296, FILED 3-7-2011.

KAREN BRACEY, EXAMINING ATTORNEY



David J. Kyjars

Director of the United States Patent and Trademark Office

United States of America

United States Patent and Trademark Office

AKGM

Reg. No. 4,155,225

Registered June 5, 2012

Int. Cl.: 25

TRADEMARK

PRINCIPAL REGISTER

PINCKNEY, CRAIG (UNITED STATES INDIVIDUAL)
11001 DYLAN WALK RD.
#303
CHESTER, VA 23831

FOR: HATS; JACKETS; PANTS; SHIRTS; SHORTS; SWEATSHIRTS; UNDERWEAR, IN CLASS 25 (U.S. CLS. 22 AND 39).

FIRST USE 3-1-2012; IN COMMERCE 3-1-2012.

THE MARK CONSISTS OF STANDARD CHARACTERS WITHOUT CLAIM TO ANY PARTICULAR FONT, STYLE, SIZE, OR COLOR.

SN 85-259,432, FILED 3-7-2011.

TRACY WHITTAKER-BROWN, EXAMINING ATTORNEY



David J. Kyros

Director of the United States Patent and Trademark Office

United States of America

United States Patent and Trademark Office

ZEN HEAT

Reg. No. 4,155,226

Registered June 5, 2012

Int. Cl.: 11

TRADEMARK

PRINCIPAL REGISTER

CARBON FIBER HEATING TECHNOLOGIES, LLC (CONNECTICUT LIMITED LIABILITY COMPANY)
61 EAST MAIN STREET
FORESTVILLE, CT 06010

FOR: CARBON FIBER ELECTRIC HEATERS FOR COMMERCIAL USE SOLD AS AN INTEGRAL COMPONENT OF ELECTRIC COOKWARE, IN CLASS 11 (U.S. CLS. 13, 21, 23, 31 AND 34).

FIRST USE 2-28-2012; IN COMMERCE 2-28-2012.

THE MARK CONSISTS OF STANDARD CHARACTERS WITHOUT CLAIM TO ANY PARTICULAR FONT, STYLE, SIZE, OR COLOR.

NO CLAIM IS MADE TO THE EXCLUSIVE RIGHT TO USE "HEAT", APART FROM THE MARK AS SHOWN.

SN 85-259,536, FILED 3-7-2011.

KATHRYN COWARD, EXAMINING ATTORNEY



David J. Kyros

Director of the United States Patent and Trademark Office

United States of America

United States Patent and Trademark Office

VALLEY FORGE

Reg. No. 4,155,227

Registered June 5, 2012

Int. Cl.: 19

TRADEMARK

PRINCIPAL REGISTER

ROHNEX (NORTH CAROLINA LIMITED LIABILITY COMPANY), AKA ROHNEX LLC,
UNIT 2002
3324 PEACHTREE ROAD, NE
ATLANTA, GA 30236

FOR: LAMINATE FLOORING; UNDERLAY FOR LAMINATE FLOORING; VINYL FLOORING,
IN CLASS 19 (U.S. CLS. 1, 12, 33 AND 50).

FIRST USE 10-1-2011; IN COMMERCE 10-1-2011.

THE MARK CONSISTS OF STANDARD CHARACTERS WITHOUT CLAIM TO ANY PAR-
TICULAR FONT, STYLE, SIZE, OR COLOR.

SN 85-259,643, FILED 3-7-2011.

KATHRYN COWARD, EXAMINING ATTORNEY



David J. Kybas

Director of the United States Patent and Trademark Office

United States of America

United States Patent and Trademark Office

THE 1ST APPLICATION PLATFORM FOR A CONNECTED WORLD

Reg. No. 4,155,228

THINGWORX, INC. (DELAWARE CORPORATION)
350 EAGLEVIEW BLVD, SUITE 150
EXTON, PA 19341

Registered June 5, 2012

Int. Cl.: 9

FOR: SOFTWARE APPLICATION PLATFORM FOR CONNECTING PEOPLE, SERVICES AND DEVICES TO THE INTERNET, IN CLASS 9 (U.S. CLS. 21, 23, 26, 36 AND 38).

TRADEMARK

FIRST USE 2-0-2011; IN COMMERCE 2-0-2011.

PRINCIPAL REGISTER

THE MARK CONSISTS OF STANDARD CHARACTERS WITHOUT CLAIM TO ANY PARTICULAR FONT, STYLE, SIZE, OR COLOR.

NO CLAIM IS MADE TO THE EXCLUSIVE RIGHT TO USE "APPLICATION PLATFORM", APART FROM THE MARK AS SHOWN.

SN 85-259,672, FILED 3-7-2011.

SUSAN RICHARDS, EXAMINING ATTORNEY



David J. Kyros

Director of the United States Patent and Trademark Office

United States of America

United States Patent and Trademark Office

ELEPHINO

Reg. No. 4,155,229

Registered June 5, 2012

Int. Cl.: 32

TRADEMARK

PRINCIPAL REGISTER

RED ROCK BREWING COMPANY (UTAH LIMITED LIABILITY COMPANY)
254 SOUTH 200 WEST
SALT LAKE CITY, UT 84101

FOR: BEER, IN CLASS 32 (U.S. CLS. 45, 46 AND 48).

FIRST USE 2-28-2011; IN COMMERCE 4-7-2011.

THE MARK CONSISTS OF STANDARD CHARACTERS WITHOUT CLAIM TO ANY PARTICULAR FONT, STYLE, SIZE, OR COLOR.

SN 85-259,892, FILED 3-7-2011.

ALEXANDER L. POWERS, EXAMINING ATTORNEY



David J. Kyros

Director of the United States Patent and Trademark Office

United States of America

United States Patent and Trademark Office

Rock The Vine

Reg. No. 4,155,230

Registered June 5, 2012

Int. Cl.: 35

SERVICE MARK

PRINCIPAL REGISTER

GIOVACCHINI, CINDY L. (UNITED STATES INDIVIDUAL)
674 OCEAN VIEW AVENUE
GROVER BEACH, CA 93433

FOR: ADVERTISING, INCLUDING PROMOTION OF PRODUCTS AND SERVICES OF THIRD PARTIES THROUGH SPONSORING ARRANGEMENTS AND LICENCE AGREEMENTS RELATING TO INTERNATIONAL SPORTS EVENTS; BUSINESS MANAGEMENT CONSULTANCY IN THE FIELD OF INSOURCING, NAMELY, ASSISTING BUSINESSES IN THE DEVELOPMENT OF PROCESSES FOR THE ANALYSIS AND THE IMPLEMENTATION OF THE DELEGATION OF OPERATIONS OR JOBS FROM PRODUCTION WITHIN A BUSINESS TO AN INTERNAL ENTITY THAT SPECIALIZES IN THAT OPERATION; HUMAN RESOURCES SERVICES IN THE FIELD OF EDUCATION, NAMELY, RECRUITING AND PLACING TEACHERS AT INTERNATIONAL SCHOOLS; INTERNATIONAL BUSINESS CONSULTING SERVICES RELATING TO MERCHANDISE TRADING, HUMAN RESOURCE INTERCHANGE, MANAGEMENT SUPPORT, MARKETING, ADVERTISING, PROMOTION, AND DOMESTIC AND INTERNATIONAL MARKET RESEARCH AND DEVELOPMENT; LOBBYING SERVICES, NAMELY, PROMOTING THE INTERESTS OF INTERNATIONAL, REAL ESTATE AND NONPROFIT COMPANIES IN THE FIELDS OF POLITICS, LEGISLATION, AND REGULATION; MAIL SERVICES, NAMELY, RECEIVING AND PROCESSING INTERNATIONAL AND DOMESTIC MAIL FOR INFUSION INTO ESTABLISHED POSTAL SERVICES; PROVIDING AN INTERNET WEBSITE FEATURING NEWS AND INFORMATION IN THE FIELD OF NATIONAL AND INTERNATIONAL POLITICS, IN CLASS 35 (U.S. CLS. 100, 101 AND 102).

FIRST USE 1-1-2012; IN COMMERCE 3-13-2012.

THE MARK CONSISTS OF STANDARD CHARACTERS WITHOUT CLAIM TO ANY PARTICULAR FONT, STYLE, SIZE, OR COLOR.

SN 85-259,977, FILED 3-7-2011.

ODESSA BIBBINS, EXAMINING ATTORNEY



David J. Kyffers

Director of the United States Patent and Trademark Office

United States of America

United States Patent and Trademark Office

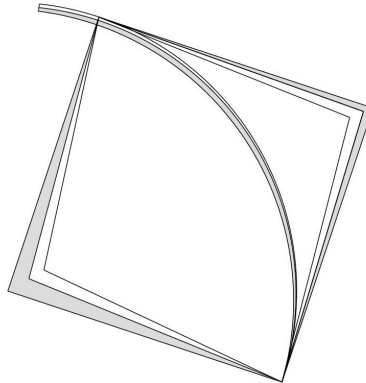

Reg. No. 4,155,231

Registered June 5, 2012

Int. Cl.: 44

SERVICE MARK

PRINCIPAL REGISTER

SQUARE LEAF LANDSCAPE DESIGN LLC (CONNECTICUT LIMITED LIABILITY COMPANY)
P.O. BOX 85
NEW CANAAN, CT 06840

FOR: LANDSCAPE DESIGN, IN CLASS 44 (U.S. CLS. 100 AND 101).

FIRST USE 3-0-2011; IN COMMERCE 3-15-2012.

THE MARK CONSISTS OF A SQUARE SHAPE. THE LEFT BOTTOM CORNER IS ELEVATED OFF THE HORIZON AND PIVOTED FROM THE LOWER RIGHT HAND CORNER BY 17 DEGREES. THE MIDDLE CURVED LINE, IS A FRAGMENT OF A CIRCLE, EXTENDING FROM THE BASE (LOWEST POINT OF THE SQUARE) AND EXTENDING TO THE APEX, (HIGHEST POINT OF THE SQUARE). THE LINE WEIGHT OF PERIMETER VARIES; CONSISTING OF ELONGATED TRIANGLES THAT ARE JOINED TOGETHER.

SN 85-260,131, FILED 3-7-2011.

LINDA LAVACHE, EXAMINING ATTORNEY



David J. Kybas

Director of the United States Patent and Trademark Office

United States of America
United States Patent and Trademark Office

ASSUR_®

Reg. No. 4,155,232

Registered June 5, 2012

Int. Cl.: 9

TRADEMARK

PRINCIPAL REGISTER

ENWAVE OPTRONICS, INC. (CALIFORNIA CORPORATION)
SUITE A
18200 MCDURMOTT STREET
IRVINE, CA 92614

FOR: SPECTROMETERS, AND PARTS AND FITTINGS THEREFOR, IN CLASS 9 (U.S. CLS. 21, 23, 26, 36 AND 38).

FIRST USE 12-2-2009; IN COMMERCE 3-20-2010.

THE MARK CONSISTS OF THE LETTERS: "ASSU" ALL IN CAPS, WITH AN "RX" SYMBOL AT THE END.

SN 85-260,203, FILED 3-7-2011.

JAMES GRIFFIN, EXAMINING ATTORNEY



David J. Kyffers

Director of the United States Patent and Trademark Office

United States of America
United States Patent and Trademark Office

Locals

Reg. No. 4,155,233

Registered June 5, 2012

Int. Cl.: 18

TRADEMARK

PRINCIPAL REGISTER

T.H.Y. AND ASSOCIATES, INC. (HAWAII CORPORATION)
16-151 WILIAMA STREET
KEAAU, HI 96749

FOR: ALL-PURPOSE CARRYING BAGS; ALL-PURPOSE REUSABLE CARRYING BAGS;
ATHLETIC BAGS; BACKPACKS; CLUTCH BAGS; FANNY PACKS; FASHION HANDBAGS;
REUSABLE SHOPPING BAGS; SCHOOL BAGS; SCHOOLCHILDREN'S BACKPACKS;
SHOULDER BAGS; SMALL BACKPACKS; TEXTILE SHOPPING BAGS; TRAVELING BAGS,
IN CLASS 18 (U.S. CLS. 1, 2, 3, 22 AND 41).

FIRST USE 2-1-2012; IN COMMERCE 2-1-2012.

OWNER OF U.S. REG. NO. 3,038,713.

THE MARK CONSISTS OF THE WORD "LOCALS" IN A STYLIZED CURSIVE FONT.

SN 85-260,347, FILED 3-7-2011.

GINA FINK, EXAMINING ATTORNEY



David J. Kybas

Director of the United States Patent and Trademark Office

United States of America

United States Patent and Trademark Office

NEW AMERICAN LUXURY

Reg. No. 4,155,234

GUERRERO HOWE, LLC (ILLINOIS LIMITED LIABILITY COMPANY)
28 E. JACKSON, SUITE 300
CHICAGO, IL 60604

Registered June 5, 2012

Int. Cl.: 16

FOR: MAGAZINES IN THE FIELD OF LUXURY HOMES, LUXURY BUILDINGS, LUXURY GOODS AND LUXURY SERVICES, IN CLASS 16 (U.S. CLS. 2, 5, 22, 23, 29, 37, 38 AND 50).

TRADEMARK

FIRST USE 11-1-2011; IN COMMERCE 11-1-2011.

PRINCIPAL REGISTER

THE MARK CONSISTS OF STANDARD CHARACTERS WITHOUT CLAIM TO ANY PARTICULAR FONT, STYLE, SIZE, OR COLOR.

NO CLAIM IS MADE TO THE EXCLUSIVE RIGHT TO USE "AMERICAN LUXURY", APART FROM THE MARK AS SHOWN.

SN 85-260,374, FILED 3-7-2011.

DANNEAN HETZEL, EXAMINING ATTORNEY



David J. Kybas

Director of the United States Patent and Trademark Office

United States of America

United States Patent and Trademark Office

"JOIN TO SHARE"

Reg. No. 4,155,235

RAAK LLC (ARIZONA LIMITED LIABILITY COMPANY)
2048 E TEAKWOOD PL
CHANDLER, AZ 85286

Registered June 5, 2012

Int. Cl.: 41

FOR: ON-LINE JOURNALS, NAMELY, BLOGS FEATURING USER DEFINED CONTENT,
IN CLASS 41 (U.S. CLS. 100, 101 AND 107).

SERVICE MARK

FIRST USE 2-1-2012; IN COMMERCE 2-1-2012.

PRINCIPAL REGISTER

THE MARK CONSISTS OF THE STYLIZED WORDING ""JOIN TO SHARE"".

SN 85-260,415, FILED 3-7-2011.

GILBERT SWIFT, EXAMINING ATTORNEY



David J. Kyros

Director of the United States Patent and Trademark Office

United States of America

United States Patent and Trademark Office

MODULAR PERIODONTAL THERAPY

Reg. No. 4,155,236

Registered June 5, 2012

Int. Cl.: 44

SERVICE MARK

PRINCIPAL REGISTER

NABORS, THOMAS (UNITED STATES INDIVIDUAL)
162 4TH. AVE. NORTH. STE.100
NASHVILLE, TN 37219

FOR: DENTAL SERVICES, NAMELY, PERFORMING RESTORATIVE AND COSMETIC PROCEDURES, DENTAL HYGIENE SERVICES, PERIODONTAL SERVICES, IN CLASS 44 (U.S. CLS. 100 AND 101).

FIRST USE 1-17-2007; IN COMMERCE 8-26-2011.

THE MARK CONSISTS OF STANDARD CHARACTERS WITHOUT CLAIM TO ANY PARTICULAR FONT, STYLE, SIZE, OR COLOR.

NO CLAIM IS MADE TO THE EXCLUSIVE RIGHT TO USE "PERIODONTAL THERAPY", APART FROM THE MARK AS SHOWN.

SN 85-260,482, FILED 3-8-2011.

SANI KHOURI, EXAMINING ATTORNEY



David J. Kybas

Director of the United States Patent and Trademark Office

United States of America

United States Patent and Trademark Office

BEAUNIQUE

Reg. No. 4,155,237

Registered June 5, 2012

Int. Cl.: 3

TRADEMARK

PRINCIPAL REGISTER

TSAI, JASON LEE (UNITED STATES INDIVIDUAL)
88 MORGAN STREET
APT. 4808
JERSEY CITY, NJ 07302

FOR: ARTIFICIAL EYELASHES; BATH SOAPS IN LIQUID, SOLID OR GEL FORM; BODY LOTION; COSMETIC PREPARATIONS FOR SKIN CARE; EYE MAKE-UP; FRAGRANCES AND PERFUMERY; LIP BALM; LIP GLOSS; LOTIONS FOR FACE AND BODY CARE; MOISTURIZING PREPARATIONS FOR THE SKIN; NAIL CARE PREPARATIONS; NAIL CARE PREPARATIONS, NAMELY, NAIL SOFTENERS; NAIL CREAM; NAIL HARDENERS; NAIL POLISH; NAIL POLISH TOP COAT; NAIL STRENGTHENERS; NAIL-POLISH REMOVERS; NON-MEDICATED LIP CARE PREPARATIONS; NON-MEDICATED PREPARATIONS ALL FOR THE CARE OF SKIN, HAIR AND SCALP; NON-MEDICATED SKIN CARE PREPARATIONS, NAMELY, CREAMS, LOTIONS, GELS, TONERS, CLEANERS AND PEELS; NON-MEDICATED TOILETRIES; SKIN BRONZER; SKIN EMOLLIENTS; SKIN MOISTURIZER; SKIN SOAP, IN CLASS 3 (U.S. CLS. 1, 4, 6, 50, 51 AND 52).

FIRST USE 10-1-2011; IN COMMERCE 10-1-2011.

THE MARK CONSISTS OF STANDARD CHARACTERS WITHOUT CLAIM TO ANY PARTICULAR FONT, STYLE, SIZE, OR COLOR.

SN 85-260,529, FILED 3-8-2011.

STEVEN PEREZ, EXAMINING ATTORNEY



David J. Kyffers

Director of the United States Patent and Trademark Office

United States of America

United States Patent and Trademark Office

1-Seal

Reg. No. 4,155,238

ARTA PLAST AB (SWEDEN CORPORATION)
ANTENNVAGEN 1A
TYRESO, SWEDEN SE-13548

Registered June 5, 2012

Int. Cl.: 20

FOR: PLASTIC CONTAINERS AND COVERS FOR THE FOOD INDUSTRY, IN CLASS 20
(U.S. CLS. 2, 13, 22, 25, 32 AND 50).

TRADEMARK

FIRST USE 1-1-2005; IN COMMERCE 1-1-2005.

PRINCIPAL REGISTER

THE MARK CONSISTS OF STANDARD CHARACTERS WITHOUT CLAIM TO ANY PARTICULAR FONT, STYLE, SIZE, OR COLOR.

SN 85-260,582, FILED 3-8-2011.

DEZMONA MIZELLE, EXAMINING ATTORNEY



David J. Kybas

Director of the United States Patent and Trademark Office

United States of America

United States Patent and Trademark Office



Reg. No. 4,155,239

BEYOND MEDICINE, LLC (FLORIDA LIMITED LIABILITY COMPANY)
218 YORKSHIRE CRESCENT
THOMASVILLE, GA 31792

Registered June 5, 2012

Int. Cl.: 35

FOR: LAWYER REFERRAL SERVICES, NAMELY, PROVIDING DOCTORS NAMES OF LAWYERS SKILLED IN EMPLOYMENT LAW, IN CLASS 35 (U.S. CLS. 100, 101 AND 102).

SERVICE MARK

FIRST USE 3-5-2012; IN COMMERCE 3-5-2012.

PRINCIPAL REGISTER

THE MARK CONSISTS OF HALF OF A SCALES OF JUSTICE COMBINED WITH HALF A CADUCEUS.

SN 85-260,676, FILED 3-8-2011.

KAPIL BHANOT, EXAMINING ATTORNEY



David J. Kybas

Director of the United States Patent and Trademark Office

United States of America

United States Patent and Trademark Office

The Science of Attraction

Reg. No. 4,155,240

Registered June 5, 2012

Int. Cl.: 28

TRADEMARK

PRINCIPAL REGISTER

REQUISITE SOLUTIONS INCORPORATED (ILLINOIS CORPORATION)
2750 N WAYNE, UNIT F
CHICAGO, IL 60614

FOR: EDUCATIONAL TOY MAGNETIC PLAYSETS COMPRISED OF FLEXIBLE AND NON-FLEXIBLE MAGNETS AND MAGNETIC PLAY SURFACES DESIGNED TO HOUSE AND ATTRACT MAGNETS AND MAGNETIC COMPONENTS THAT MAY BE SET UP FOR PORTABLE AND STATIONARY USE, IN CLASS 28 (U.S. CLS. 22, 23, 38 AND 50).

FIRST USE 11-28-2003; IN COMMERCE 3-1-2012.

THE MARK CONSISTS OF STANDARD CHARACTERS WITHOUT CLAIM TO ANY PARTICULAR FONT, STYLE, SIZE, OR COLOR.

SN 85-260,821, FILED 3-8-2011.

JUDITH HELFMAN, EXAMINING ATTORNEY



David J. Kyros

Director of the United States Patent and Trademark Office

United States of America

United States Patent and Trademark Office

DREAM CATCHER

Reg. No. 4,155,241

Registered June 5, 2012

Int. Cl.: 34

TRADEMARK

PRINCIPAL REGISTER

CLARKSVILLE TRADING COMPANY, LLC (VIRGINIA LIMITED LIABILITY COMPANY)
PO BOX 5586
MIDLOTHIAN, VA 23112

FOR: CIGARETTES CONTAINING TOBACCO SUBSTITUTES NOT FOR MEDICAL PURPOSES; HAND-HELD MACHINES FOR INJECTING TOBACCO INTO CIGARETTE TUBES; HAND-ROLLING TOBACCO; HOOKAH TOBACCO; MACHINES ALLOWING SMOKERS TO MAKE CIGARETTES BY THEMSELVES; PIPE TOBACCO; ROLL YOUR OWN TOBACCO; SMOKELESS TOBACCO; SMOKER'S ARTICLES, NAMELY, FILTER TUBES; SMOKING TOBACCO; TOBACCO; TOBACCO, CIGARS AND CIGARETTES, IN CLASS 34 (U.S. CLS. 2, 8, 9 AND 17).

FIRST USE 2-0-2012; IN COMMERCE 2-0-2012.

THE MARK CONSISTS OF STANDARD CHARACTERS WITHOUT CLAIM TO ANY PARTICULAR FONT, STYLE, SIZE, OR COLOR.

SN 85-260,828, FILED 3-8-2011.

BARBARA GAYNOR, EXAMINING ATTORNEY



David J. Kyros

Director of the United States Patent and Trademark Office

United States of America

United States Patent and Trademark Office

RINNATI

Reg. No. 4,155,242

RASOLLI FOOTWEAR CORP. (NEW YORK CORPORATION)
1410 BROADWAY, SUITE 1402
NEW YORK, NY 10118

Registered June 5, 2012

Int. Cl.: 25

FOR: WOMEN'S FOOTWEAR, NAMELY, SHOES, BOOTS, SLIPPERS, SANDALS AND SNEAKERS; WOMEN'S CLOTHING, NAMELY, SHIRTS, BLOUSES, SWEATERS, TEE SHIRTS, SKIRTS, SCARVES, HATS; WOMEN'S LINGERIES, NAMELY, NIGHT GOWNS, PAJAMAS, UNDER PANTS, BRAS, IN CLASS 25 (U.S. CLS. 22 AND 39).

TRADEMARK

PRINCIPAL REGISTER

FIRST USE 9-7-2011; IN COMMERCE 9-7-2011.

THE MARK CONSISTS OF STANDARD CHARACTERS WITHOUT CLAIM TO ANY PARTICULAR FONT, STYLE, SIZE, OR COLOR.

SN 85-260,892, FILED 3-8-2011.

B. PARADEWELAI, EXAMINING ATTORNEY



David J. Kyros

Director of the United States Patent and Trademark Office

United States of America

United States Patent and Trademark Office

The Forevercard

Reg. No. 4,155,243

Registered June 5, 2012

Int. Cls.: 16 and 20

TRADEMARK

PRINCIPAL REGISTER

FOREVERCARDS LLC (FLORIDA LIMITED LIABILITY COMPANY)
1111 NW 48 STEET
FORT LAUDERDALE, FL 33309

FOR: GREETING CARDS; GREETINGS CARDS AND POSTCARDS; MINI PHOTO ALBUMS;
MUSICAL GREETING CARDS; POSTCARDS AND GREETING CARDS; PRINTED GREETING
CARDS WITH ELECTRONIC INFORMATION STORED THEREIN; SCRAPBOOK PAGES,
IN CLASS 16 (U.S. CLS. 2, 5, 22, 23, 29, 37, 38 AND 50).

FIRST USE 8-1-2011; IN COMMERCE 8-1-2011.

FOR: MAGNETIZED PHOTO FRAMES; PAPER PHOTO FRAMES, IN CLASS 20 (U.S. CLS.
2, 13, 22, 25, 32 AND 50).

FIRST USE 8-1-2011; IN COMMERCE 8-1-2011.

THE MARK CONSISTS OF STANDARD CHARACTERS WITHOUT CLAIM TO ANY PAR-
TICULAR FONT, STYLE, SIZE, OR COLOR.

SN 85-261,028, FILED 3-8-2011.

MICHAEL SOUDERS, EXAMINING ATTORNEY



David J. Kybas

Director of the United States Patent and Trademark Office

United States of America

United States Patent and Trademark Office

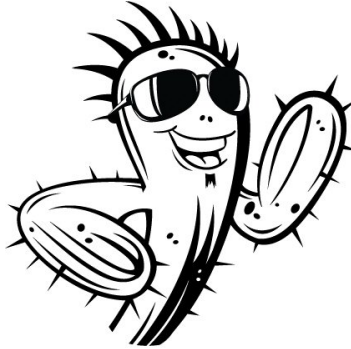

Reg. No. 4,155,244

Registered June 5, 2012

Int. Cl.: 30

TRADEMARK

PRINCIPAL REGISTER

LIDESTRI FOODS, INC. (NEW YORK CORPORATION)
815 WEST WHITNEY ROAD
FAIRPORT, NY 14450

FOR: BARBEQUE SAUCE; CHILI SAUCE; CONDIMENT, NAMELY, PEPPER SAUCE; DIPPING SAUCES; HOT SAUCE; MARINADES; PICANTE SAUCE; READY-MADE SAUCES; SALSA; SAUCES, IN CLASS 30 (U.S. CL. 46).

FIRST USE 1-6-2011; IN COMMERCE 1-6-2011.

THE MARK CONSISTS OF A CARTOON IMAGE OF A CACTUS WITH ANTHROPOMORPHIC QUALITIES, INCLUDING A SMILING FACE, SPINES ON THE TOP OF THE CACTUS CHARACTER'S "HEAD" DEPICTED AS A HUMAN'S SPIKED HAIR, TWO "ARMS" AND THE WEARING OF SUNGLASSES.

SN 85-261,229, FILED 3-8-2011.

JANICE KIM, EXAMINING ATTORNEY



David J. Kybas

Director of the United States Patent and Trademark Office

United States of America

United States Patent and Trademark Office



THREE SIXTY

Reg. No. 4,155,245

LODGING/HOSPITALITY MANAGEMENT CORPORATION (MISSOURI CORPORATION)
111 WESTPORT PLAZA, SUITE 500
ST. LOUIS, MO 63146

Registered June 5, 2012

Int. Cl.: 43

FOR: RESTAURANT, BAR AND CATERING SERVICES, IN CLASS 43 (U.S. CLS. 100 AND 101).

SERVICE MARK

FIRST USE 3-12-2011; IN COMMERCE 7-25-2011.

PRINCIPAL REGISTER

THE MARK CONSISTS OF STYLIZED DISCONNECTING NUMBERS "3", "6", "0" OVERLAPPING ONE ANOTHER WITH A CIRCLE, SYMBOLIC OF A DEGREE SYMBOL, IMMEDIATELY TO THE RIGHT AND MIDDLE OF THE OVERLAPPING NUMBERS WITH THE WORDS "THREE SIXTY" UNDERNEATH THE OVERLAPPING NUMBERS.

SN 85-261,357, FILED 3-8-2011.

PAUL MORENO, EXAMINING ATTORNEY



David J. Kybas

Director of the United States Patent and Trademark Office

United States of America

United States Patent and Trademark Office

REVEAL-A-ZIP

Reg. No. 4,155,246

Registered June 5, 2012

Int. Cl.: 16

TRADEMARK

PRINCIPAL REGISTER

SIERRA PACKAGING & CONVERTING, LLC (NEVADA LIMITED LIABILITY COMPANY)
1400 KLEPPE LANE
SPARKS, NV 89431

FOR: PLASTIC FLEXIBLE PACKAGING BAGS AND POUCHES HAVING A PULL TAB
OPENING AND SOLD IN BULK TO INDUSTRIAL AND COMMERCIAL MANUFACTURERS
FOR MERCHANDISE PACKAGING, IN CLASS 16 (U.S. CLS. 2, 5, 22, 23, 29, 37, 38 AND 50).

FIRST USE 9-30-2011; IN COMMERCE 9-30-2011.

THE MARK CONSISTS OF STANDARD CHARACTERS WITHOUT CLAIM TO ANY PAR-
TICULAR FONT, STYLE, SIZE, OR COLOR.

SN 85-261,507, FILED 3-8-2011.

LINDA POWELL, EXAMINING ATTORNEY



David J. Kyros

Director of the United States Patent and Trademark Office

United States of America

United States Patent and Trademark Office

The Daily Yap

Reg. No. 4,155,247

Registered June 5, 2012

Int. Cl.: 41

SERVICE MARK

PRINCIPAL REGISTER

WINDBAG LIMITED LIABILITY COMPANY (NEW JERSEY LIMITED LIABILITY COMPANY)
6 FAWNVIEW COURT
FREEHOLD, NJ 077288485

FOR: INTERACTIVE ONLINE WEB JOURNALS FEATURING POLITICS AND EVERY DAY LIFE EXPERIENCES, IN CLASS 41 (U.S. CLS. 100, 101 AND 107).

FIRST USE 7-11-2011; IN COMMERCE 7-11-2011.

THE MARK CONSISTS OF STANDARD CHARACTERS WITHOUT CLAIM TO ANY PARTICULAR FONT, STYLE, SIZE, OR COLOR.

NO CLAIM IS MADE TO THE EXCLUSIVE RIGHT TO USE "DAILY", APART FROM THE MARK AS SHOWN.

SN 85-261,601, FILED 3-8-2011.

TAMARA FRAZIER, EXAMINING ATTORNEY



David J. Kyros

Director of the United States Patent and Trademark Office

United States of America

United States Patent and Trademark Office

WHATAPIX

Reg. No. 4,155,248

Registered June 5, 2012

Int. Cls.: 9 and 40

TRADEMARK

SERVICE MARK

PRINCIPAL REGISTER

WHAT A PIX, INC. (TEXAS CORPORATION)
15031 WOODHAM DR., SUITE 370
HOUSTON, TX 770735906

FOR: DOWNLOADABLE SOFTWARE FOR USE IN CREATING PERSONALIZED PHOTO BOOKS, CALENDARS, CARDS, AND POSTERS, IN CLASS 9 (U.S. CLS. 21, 23, 26, 36 AND 38).

FIRST USE 12-10-2009; IN COMMERCE 10-25-2010.

FOR: DIGITAL ON DEMAND PRINTING SERVICES OF PERSONALIZED PHOTO BOOKS, CALENDARS, CARDS, AND POSTERS, IN CLASS 40 (U.S. CLS. 100, 103 AND 106).

FIRST USE 12-10-2009; IN COMMERCE 10-25-2010.

THE MARK CONSISTS OF STANDARD CHARACTERS WITHOUT CLAIM TO ANY PARTICULAR FONT, STYLE, SIZE, OR COLOR.

SN 85-261,851, FILED 3-9-2011.

MICHAEL TANNER, EXAMINING ATTORNEY

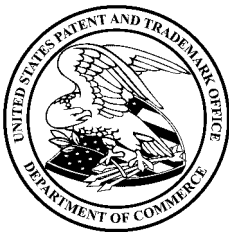

David J. Kyfos

Director of the United States Patent and Trademark Office

United States of America

United States Patent and Trademark Office

whata 

Reg. No. 4,155,249

Registered June 5, 2012

Int. Cls.: 9 and 40

TRADEMARK

SERVICE MARK

PRINCIPAL REGISTER

WHAT A PIX, INC. (TEXAS CORPORATION)
15031 WOODHAM DR., SUITE 370
HOUSTON, TX 770735906

FOR: DOWNLOADABLE SOFTWARE FOR USE IN CREATING PERSONALIZED PHOTO BOOKS, CALENDARS, CARDS, AND POSTERS, IN CLASS 9 (U.S. CLS. 21, 23, 26, 36 AND 38).

FIRST USE 11-1-2010; IN COMMERCE 11-1-2010.

FOR: DIGITAL ON DEMAND PRINTING SERVICES OF PERSONALIZED PHOTO BOOKS, CALENDARS, CARDS, AND POSTERS, IN CLASS 40 (U.S. CLS. 100, 103 AND 106).

FIRST USE 11-1-2010; IN COMMERCE 11-1-2010.

THE MARK CONSISTS OF THE STYLIZED WORD "WHATAPIX" WHEREIN THE TERM "PIX" IS LOCATED INSIDE A SKEWED SQUARE AND THE LETTER "I" IN THE TERM "PIX" IS SHOWN AS AN EXCLAMATION POINT LOCATED BETWEEN THE LETTERS "P" AND THE "X".

SN 85-261,870, FILED 3-9-2011.

MICHAEL TANNER, EXAMINING ATTORNEY



David J. Kyros

Director of the United States Patent and Trademark Office

United States of America

United States Patent and Trademark Office

REACH WITHIN LEAD BEYOND

Reg. No. 4,155,250

FRENCH, CHRISTY L. (UNITED STATES INDIVIDUAL)
111 SAYRE

Registered June 5, 2012

PRINCETON, NJ 08540

Int. Cl.: 41

FOR: PHYSICAL FITNESS INSTRUCTION AND CONSULTATION; YOGA INSTRUCTION,
IN CLASS 41 (U.S. CLS. 100, 101 AND 107).

SERVICE MARK

FIRST USE 11-1-2011; IN COMMERCE 11-1-2011.

PRINCIPAL REGISTER

THE MARK CONSISTS OF STANDARD CHARACTERS WITHOUT CLAIM TO ANY PAR-
TICULAR FONT, STYLE, SIZE, OR COLOR.

SN 85-261,898, FILED 3-9-2011.

PAUL MORENO, EXAMINING ATTORNEY



David J. Kyros

Director of the United States Patent and Trademark Office

United States of America

United States Patent and Trademark Office

REACH WITHIN LEAD BEYOND

Reg. No. 4,155,251

FRENCH, CHRISTY L. (UNITED STATES INDIVIDUAL)
111 SAYRE

Registered June 5, 2012

PRINCETON, NJ 08540

Int. Cl.: 44

FOR: HEALTH, WELLNESS AND NUTRITIONAL CONSULTING, IN CLASS 44 (U.S. CLS. 100 AND 101).

SERVICE MARK

FIRST USE 11-1-2011; IN COMMERCE 11-1-2011.

PRINCIPAL REGISTER

THE MARK CONSISTS OF STANDARD CHARACTERS WITHOUT CLAIM TO ANY PARTICULAR FONT, STYLE, SIZE, OR COLOR.

SN 85-261,903, FILED 3-9-2011.

PAUL MORENO, EXAMINING ATTORNEY



David J. Kybas

Director of the United States Patent and Trademark Office

United States of America
United States Patent and Trademark Office

Swift
BIOSCIENCES

Reg. No. 4,155,252

SWIFT BIOSCIENCES, INC. (DELAWARE CORPORATION)
SUITE 100
58 PARKLAND PLAZA
ANN ARBOR, MI 41803

Registered June 5, 2012

Int. Cl.: 1

FOR: CHEMICAL REAGENTS FOR OTHER THAN MEDICAL AND VETERINARY PURPOSES; REAGENTS FOR RESEARCH PURPOSES; REAGENTS FOR SCIENTIFIC OR MEDICAL RESEARCH USE, IN CLASS 1 (U.S. CLS. 1, 5, 6, 10, 26 AND 46).

TRADEMARK

PRINCIPAL REGISTER

FIRST USE 2-20-2012; IN COMMERCE 2-20-2012.

NO CLAIM IS MADE TO THE EXCLUSIVE RIGHT TO USE "BIOSCIENCES", APART FROM THE MARK AS SHOWN.

THE MARK CONSISTS OF THE WORD "SWIFT" IN LARGE LETTERS, WITH A THIN CURVED LINE RUNNING THROUGH THE LETTERS LEADING TO THE IMAGE OF A FLYING BIRD, BOTH ABOVE THE WORD "BIOSCIENCES" IN SMALLER LETTERS.

SN 85-261,967, FILED 3-9-2011.

DOMINIC J. FERRAIUOLO, EXAMINING ATTORNEY



David J. Kyffers

Director of the United States Patent and Trademark Office

United States of America

United States Patent and Trademark Office

SWIFT BIOSCIENCES

Reg. No. 4,155,253

Registered June 5, 2012

Int. Cl.: 1

TRADEMARK

PRINCIPAL REGISTER

SWIFT BIOSCIENCES, INC. (DELAWARE CORPORATION)
SUITE 100
58 PARKLAND PLAZA
ANN ARBOR, MI 41803

FOR: CHEMICAL REAGENTS FOR OTHER THAN MEDICAL AND VETERINARY PURPOSES; REAGENTS FOR RESEARCH PURPOSES; REAGENTS FOR SCIENTIFIC OR MEDICAL RESEARCH USE , IN CLASS 1 (U.S. CLS. 1, 5, 6, 10, 26 AND 46).

FIRST USE 2-20-2012; IN COMMERCE 2-20-2012.

THE MARK CONSISTS OF STANDARD CHARACTERS WITHOUT CLAIM TO ANY PARTICULAR FONT, STYLE, SIZE, OR COLOR.

NO CLAIM IS MADE TO THE EXCLUSIVE RIGHT TO USE "BIOSCIENCES", APART FROM THE MARK AS SHOWN.

SN 85-261,973, FILED 3-9-2011.

DOMINIC J. FERRAIUOLO, EXAMINING ATTORNEY



David J. Kybas

Director of the United States Patent and Trademark Office

United States of America

United States Patent and Trademark Office

EVERY COMPANY IS A TECHNOLOGY COMPANY

Reg. No. 4,155,254

Registered June 5, 2012

Int. Cl.: 45

SERVICE MARK

PRINCIPAL REGISTER

GUNSTER, YOAKLEY & STEWART, P.A. (FLORIDA CORPORATION)
777 SOUTH FLAGLER DRIVE
SUITE 500 EAST
WEST PALM BEACH, FL 334016194

FOR: LEGAL SERVICES, IN CLASS 45 (U.S. CLS. 100 AND 101).

FIRST USE 3-9-2011; IN COMMERCE 10-14-2011.

THE MARK CONSISTS OF STANDARD CHARACTERS WITHOUT CLAIM TO ANY PARTICULAR FONT, STYLE, SIZE, OR COLOR.

SN 85-262,022, FILED 3-9-2011.

ANGELA M. MICHELI, EXAMINING ATTORNEY



David J. Kybas

Director of the United States Patent and Trademark Office

United States of America

United States Patent and Trademark Office

Scoop-2-Clean

Reg. No. 4,155,255

LMC PARTNERS (CALIFORNIA PARTNERSHIP)
P.O. BOX 5086

Registered June 5, 2012

SOUTH SAN FRANCISCO, CA 94083

Int. Cl.: 21

FOR: SCOOPS FOR THE DISPOSAL OF PET WASTE, IN CLASS 21 (U.S. CLS. 2, 13, 23, 29, 30, 33, 40 AND 50).

TRADEMARK

FIRST USE 10-20-2011; IN COMMERCE 10-20-2011.

PRINCIPAL REGISTER

THE MARK CONSISTS OF STANDARD CHARACTERS WITHOUT CLAIM TO ANY PARTICULAR FONT, STYLE, SIZE, OR COLOR.

SN 85-262,028, FILED 3-9-2011.

ANGELA M. MICHELI, EXAMINING ATTORNEY



David J. Kybas

Director of the United States Patent and Trademark Office

United States of America

United States Patent and Trademark Office

MAKE MY YOURS

Reg. No. 4,155,256

COREBEAUTY, LLC (DELAWARE LIMITED LIABILITY COMPANY)
13554 JADESTONE WAY
SAN DIEGO, CA 92130

Registered June 5, 2012

Int. Cl.: 3

FOR: NON-MEDICATED SKIN CREAMS, NON-MEDICATED SKIN LOTIONS, NON-MEDICATED SKIN SERUMS, IN CLASS 3 (U.S. CLS. 1, 4, 6, 50, 51 AND 52).

TRADEMARK

FIRST USE 3-15-2012; IN COMMERCE 3-15-2012.

PRINCIPAL REGISTER

THE MARK CONSISTS OF STANDARD CHARACTERS WITHOUT CLAIM TO ANY PARTICULAR FONT, STYLE, SIZE, OR COLOR.

SN 85-262,130, FILED 3-9-2011.

JEFFREY LOOK, EXAMINING ATTORNEY



David J. Kybas

Director of the United States Patent and Trademark Office

United States of America

United States Patent and Trademark Office

DJ PM

Reg. No. 4,155,257

Registered June 5, 2012

Int. Cl.: 41

SERVICE MARK

PRINCIPAL REGISTER

CUEVAS, PAUL (UNITED STATES INDIVIDUAL)
29 MONTECILO
FOOTHILL RANCH, CA 92610

FOR: DISC JOCKEYS FOR PARTIES AND SPECIAL EVENTS; MULTIMEDIA ENTERTAINMENT SERVICES IN THE NATURE OF RECORDING, PRODUCTION AND POST-PRODUCTION SERVICES IN THE FIELDS OF MUSIC, VIDEO, AND FILMS, IN CLASS 41 (U.S. CLS. 100, 101 AND 107).

FIRST USE 10-22-2011; IN COMMERCE 10-22-2011.

THE MARK CONSISTS OF STANDARD CHARACTERS WITHOUT CLAIM TO ANY PARTICULAR FONT, STYLE, SIZE, OR COLOR.

NO CLAIM IS MADE TO THE EXCLUSIVE RIGHT TO USE "DJ", APART FROM THE MARK AS SHOWN.

SN 85-262,137, FILED 3-9-2011.

JEFFREY LOOK, EXAMINING ATTORNEY



David J. Kybas

Director of the United States Patent and Trademark Office

United States of America

United States Patent and Trademark Office



Reg. No. 4,155,258

Registered June 5, 2012

Int. Cls.: 3 and 5

TRADEMARK

PRINCIPAL REGISTER

MITCHELL GROUP USA LLC (DELAWARE LIMITED LIABILITY COMPANY)
ONE SOUTHEAST THIRD AVENUE, SUITE 1860
MIAMI, FL 33131

FOR: BAR SOAP; BATH SOAPS; BATH SOAPS IN LIQUID, SOLID OR GEL FORM; BODY CREAMS; BODY LOTIONS; BODY OILS; CONCEALERS FOR FACE AND SKIN; COSMETIC CREAMS FOR SKIN CARE; COSMETIC PREPARATIONS FOR SKIN CARE; COSMETIC PREPARATIONS FOR SKIN RENEWAL; COSMETIC PRODUCTS IN THE FORM OF AEROSOLS FOR SKIN CARE; COSMETIC SOAPS; COSMETIC SUN-PROTECTING PREPARATIONS; COSMETICS; EXFOLIANT CREAMS; EXFOLIANTS FOR SKIN AND FACE; FACE AND BODY CREAMS; FACE AND BODY LOTIONS; FACE CREAMS FOR COSMETIC USE; FACIAL CREAMS; FACIAL LOTION; HAND SOAPS; LIQUID SOAPS FOR HANDS, FACE AND BODY; LOTIONS FOR FACE AND BODY CARE; LOTIONS FOR FACE AND SKIN; NON-MEDICATED ACNE TREATMENT PREPARATIONS; NON-MEDICATED PREPARATIONS ALL FOR THE CARE OF SKIN, HAIR AND SCALP; NON-MEDICATED SKIN CARE CREAMS AND LOTIONS; NON-MEDICATED SKIN CARE PREPARATIONS; NON-MEDICATED SKIN CARE PREPARATIONS, NAMELY, CREAMS, LOTIONS, GELS, TONERS, CLEANERS AND PEELS; NON-MEDICATED SKIN CREAMS; NON-MEDICATED STIMULATING LOTIONS FOR THE SKIN; NON-MEDICATED SUN CARE PREPARATIONS; SKIN ABRASIVE PREPARATIONS; SKIN AND BODY TOPICAL LOTIONS, CREAMS AND OILS FOR COSMETIC USE; SKIN CARE PREPARATION, NAMELY, BODY POLISH; SKIN CARE PREPARATIONS, NAMELY, SKIN PEELS; SKIN CLARIFIERS; SKIN CLEANSERS; SKIN CLEANSING CREAM; SKIN CONDITIONERS; SKIN CONDITIONING CREAMS FOR COSMETIC PURPOSES; SKIN CREAMS; SKIN CREAMS IN LIQUID AND SOLID FORM; SKIN EMOLLIENTS; SKIN FRESHENERS; SKIN LIGHTENERS; SKIN LIGHTENING CREAMS; SKIN LOTIONS; SKIN MASKS; SKIN MOISTURIZER; SKIN SOAP; SKIN TEXTURIZERS; SKIN TONERS; SOAPS FOR BODY CARE; SUN SCREEN; SUN SCREEN PREPARATIONS, IN CLASS 3 (U.S. CLS. 1, 4, 6, 50, 51 AND 52).

FIRST USE 7-0-2004; IN COMMERCE 7-0-2004.

FOR: ACNE TREATMENT PREPARATIONS; MEDICATED LOTIONS FOR FACE AND SKIN; MEDICATED SKIN CARE PREPARATIONS; MEDICATED SKIN CARE PREPARATIONS, NAMELY, CREAMS, LOTIONS, GELS, TONERS, CLEANERS AND PEELS; MEDICINAL CREAMS FOR SKIN CARE, IN CLASS 5 (U.S. CLS. 6, 18, 44, 46, 51 AND 52).

FIRST USE 12-5-2009; IN COMMERCE 12-5-2009.

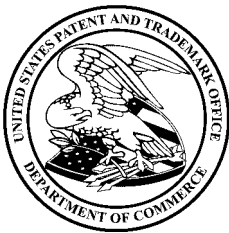

David J. Kyros

Director of the United States Patent and Trademark Office

Reg. No. 4,155,258 OWNER OF U.S. REG. NOS. 3,440,165, 3,756,088, AND OTHERS.

THE MARK CONSISTS OF THE WORD "OMIC" WITH A MACRON ABOVE THE "O" AND A PLUS SIGN (+) AFTER THE "C" SURROUNDED BY A FLATTENED OVAL WITH A HORIZONTAL BAR ABOVE.

SN 85-262,376, FILED 3-9-2011.

JOHN WILKE, EXAMINING ATTORNEY

United States of America

United States Patent and Trademark Office

Baby Unplugged

Reg. No. 4,155,259

ARETE VENTURES, LLC (OHIO LIMITED LIABILITY COMPANY)
4985 WALNUT WOODS LANE
CINCINNATI, OH 45243

Registered June 5, 2012

Int. Cl.: 16

FOR: CHILDREN'S BOOKS, IN CLASS 16 (U.S. CLS. 2, 5, 22, 23, 29, 37, 38 AND 50).

TRADEMARK

FIRST USE 6-1-2011; IN COMMERCE 6-1-2011.

PRINCIPAL REGISTER

THE MARK CONSISTS OF STANDARD CHARACTERS WITHOUT CLAIM TO ANY PARTICULAR FONT, STYLE, SIZE, OR COLOR.

SN 85-262,523, FILED 3-9-2011.

GINA FINK, EXAMINING ATTORNEY



David J. Kybas

Director of the United States Patent and Trademark Office

United States of America

United States Patent and Trademark Office

In tune with tots

Reg. No. 4,155,260

ARETE VENTURES, LLC (OHIO LIMITED LIABILITY COMPANY)
4985 WALNUT WOODS LANE
CINCINNATI, OH 45243

Registered June 5, 2012

Int. Cl.: 16

FOR: CHILDREN'S BOOKS, IN CLASS 16 (U.S. CLS. 2, 5, 22, 23, 29, 37, 38 AND 50).

TRADEMARK

FIRST USE 6-1-2011; IN COMMERCE 6-1-2011.

PRINCIPAL REGISTER

THE MARK CONSISTS OF STANDARD CHARACTERS WITHOUT CLAIM TO ANY PARTICULAR FONT, STYLE, SIZE, OR COLOR.

SN 85-262,536, FILED 3-9-2011.

GINA FINK, EXAMINING ATTORNEY



David J. Kybas

Director of the United States Patent and Trademark Office

United States of America

United States Patent and Trademark Office

EARTH'S LIVING

Reg. No. 4,155,261

Registered June 5, 2012

Int. Cl.: 35

SERVICE MARK

PRINCIPAL REGISTER

LANCASTER, JANET (UNITED STATES INDIVIDUAL), DBA SAVE THE PLANET JANET,
4203 GENESEE AVENUE #103-262
SAN DIEGO, CA 92117

FOR: ON-LINE RETAIL STORE SERVICES FEATURING POWDERED DRINKING CLAY FOR INTERNAL USE; POWDERED CLAY FOR USE AS A SUPPLEMENT; POWDERED CLAY FOR USE IN BATHS, POWDERED CLAY FOR USE AS POULTICES AND FACE MASKS; POWDERED CLAY BASED BODY LOTION; BODY AND FACE CREAM; BODY SOAP; SKIN CARE PRODUCTS, NAMELY, CLEANSERS, EXFOLIANTS, EYE TREATMENTS, TREATMENT MASKS, CRÈAMS, OILS, SOAPS, MOISTURIZERS, HAIR CARE PRODUCTS; BODY PRODUCTS, NAMELY, BATH SALTS, BODY LOTION, FOOT CREAM; CLAY BASED PET PRODUCTS, NAMELY, HOT SPOT HEALER; FLEA POWDER; ON-LINE WHOLESALE AND RETAIL STORE SERVICES FEATURING POWDERED DRINKING CLAY FOR INTERNAL USE; POWDERED CLAY FOR USE AS A SUPPLEMENT; POWDERED CLAY FOR USE IN BATHS, POWDERED CLAY FOR USE AS POULTICES AND FACE MASKS; POWDERED CLAY BASED BODY LOTION; BODY AND FACE CREAM; BODY SOAP; SKIN CARE PRODUCTS, NAMELY, CLEANSERS, EXFOLIANTS, EYE TREATMENTS, TREATMENT MASKS, CRÈAMS, OILS, SOAPS, MOISTURIZERS, HAIR CARE PRODUCTS; BODY PRODUCTS, NAMELY, BATH SALTS, BODY LOTION, FOOT CREAM; CLAY BASED PET PRODUCTS, NAMELY, HOT SPOT HEALER; FLEA POWDER, IN CLASS 35 (U.S. CLS. 100, 101 AND 102).

FIRST USE 3-19-2012; IN COMMERCE 3-19-2012.

THE MARK CONSISTS OF STANDARD CHARACTERS WITHOUT CLAIM TO ANY PARTICULAR FONT, STYLE, SIZE, OR COLOR.

SN 85-262,717, FILED 3-9-2011.

COURTNEY ALVAREZ, EXAMINING ATTORNEY



David J. Kyros

Director of the United States Patent and Trademark Office

United States of America

United States Patent and Trademark Office

Cheval Amour

Reg. No. 4,155,262

Registered June 5, 2012

Int. Cls.: 18, 25, and 35

TRADEMARK

SERVICE MARK

PRINCIPAL REGISTER

CHEVAL AMOUR, INC. (OREGON CORPORATION)
83633 ROCK HILL RD
CRESWELL, OR 97426

FOR: ALL-PURPOSE CARRYING BAGS; BAGS FOR SPORTS; CARRY-ALL BAGS; CARRY-ON BAGS; CLOTHING FOR ANIMALS; CLUTCH BAGS; CLUTCH PURSES; DUFFEL BAGS; HANDBAGS, PURSES AND WALLETS; HOBO BAGS; LEATHER AND IMITATION LEATHER BAGS; LEATHER PURSES; PURSES AND WALLETS; SHOULDER BAGS; TOTE BAGS; TRAVEL BAGS, IN CLASS 18 (U.S. CLS. 1, 2, 3, 22 AND 41).

FIRST USE 3-16-2012; IN COMMERCE 3-16-2012.

FOR: ATHLETIC APPAREL, NAMELY, SHIRTS, PANTS, JACKETS, FOOTWEAR, HATS AND CAPS, ATHLETIC UNIFORMS; BELTS; BUTTON DOWN SHIRTS; COATS; COLLARED SHIRTS; DRESS SHIRTS; JACKETS; LEATHER BELTS; SHOULDER WRAPS; TOPS; WEARABLE GARMENTS AND CLOTHING, NAMELY, SHIRTS; WOMEN'S CLOTHING, NAMELY, SHIRTS, DRESSES, SKIRTS, BLOUSES, IN CLASS 25 (U.S. CLS. 22 AND 39).

FIRST USE 12-7-2011; IN COMMERCE 12-12-2011.

FOR: ON-LINE RETAIL STORE SERVICES FEATURING CLOTHING, IN CLASS 35 (U.S. CLS. 100, 101 AND 102).

FIRST USE 12-7-2011; IN COMMERCE 12-12-2011.

THE MARK CONSISTS OF STANDARD CHARACTERS WITHOUT CLAIM TO ANY PARTICULAR FONT, STYLE, SIZE, OR COLOR.

THE ENGLISH TRANSLATION OF "CHEVAL AMOUR" IN THE MARK IS "HORSE LOVE".

SN 85-262,774, FILED 3-9-2011.

SANDRA BUJA, EXAMINING ATTORNEY



David J. Kyffers

Director of the United States Patent and Trademark Office

United States of America

United States Patent and Trademark Office



Reg. No. 4,155,263

Registered June 5, 2012

Int. Cls.: 18, 25, and 35

TRADEMARK

SERVICE MARK

PRINCIPAL REGISTER

CHEVAL AMOUR, INC. (OREGON CORPORATION)
83633 ROCK HILL RD
CRESWELL, OR 97426

FOR: ALL-PURPOSE CARRYING BAGS; BAGS FOR SPORTS; CARRY-ALL BAGS; CARRY-ON BAGS; CLOTHING FOR ANIMALS; CLUTCH BAGS; CLUTCH PURSES; DUFFLE BAGS; HANDBAGS, PURSES AND WALLETS; HOBO BAGS; LEATHER AND IMITATION LEATHER BAGS; LEATHER PURSES; PURSES AND WALLETS; SHOULDER BAGS; TOTE BAGS; TRAVEL BAGS, IN CLASS 18 (U.S. CLS. 1, 2, 3, 22 AND 41).

FIRST USE 3-16-2012; IN COMMERCE 3-16-2012.

FOR: ATHLETIC APPAREL, NAMELY, SHIRTS, PANTS, JACKETS, FOOTWEAR, HATS AND CAPS, ATHLETIC UNIFORMS; BELTS; BUTTON DOWN SHIRTS; COATS; COLLARED SHIRTS; DRESS SHIRTS; GOLF SHIRTS; HOODED SWEAT SHIRTS; JACKETS; LEATHER BELTS; LONG-SLEEVED SHIRTS; MEN'S AND WOMEN'S JACKETS, COATS, TROUSERS, VESTS; MOISTURE-WICKING SPORTS SHIRTS; OVER COATS; POLO SHIRTS; RAIN COATS; RIDING COATS; SHOULDER SCARVES; SHOULDER WRAPS; SWEAT SHIRTS; T-SHIRTS; TOPS; TRENCH COATS; WEARABLE GARMENTS AND CLOTHING, NAMELY, SHIRTS; WIND COATS; WOMEN'S CLOTHING, NAMELY, SHIRTS, DRESSES, SKIRTS, BLOUSES, IN CLASS 25 (U.S. CLS. 22 AND 39).

FIRST USE 12-7-2011; IN COMMERCE 12-12-2011.

FOR: ON-LINE RETAIL STORE SERVICES FEATURING CLOTHING, IN CLASS 35 (U.S. CLS. 100, 101 AND 102).

FIRST USE 12-7-2011; IN COMMERCE 12-12-2011.

THE MARK CONSISTS OF STYLIZED HORSES PERFORMING LEVADES INCORPORATED INTO A FLEUR-DE-LIS.

SN 85-262,835, FILED 3-9-2011.

SANDRA BUJA, EXAMINING ATTORNEY



David J. Kyros

Director of the United States Patent and Trademark Office

United States of America

United States Patent and Trademark Office

ICE CREAM THAT ROCKS

Reg. No. 4,155,264

Registered June 5, 2012

Int. Cl.: 30

TRADEMARK

PRINCIPAL REGISTER

GO TROPPO, INC. (MASSACHUSETTS CORPORATION)
108 CODMAN ROAD
BROOKLINE, MA 02445

FOR: ICE CREAM; FROZEN YOGURT; ICE CREAM DESSERTS AND FROZEN CONFECTIONS; ICE CREAM PIZZA; CHOCOLATES; BAKERY GOODS; HOT FUDGE; CANDY; CARAMEL; BUTTERSCOTCH; AND FUDGE , IN CLASS 30 (U.S. CL. 46).

FIRST USE 9-0-2004; IN COMMERCE 9-0-2004.

THE MARK CONSISTS OF STANDARD CHARACTERS WITHOUT CLAIM TO ANY PARTICULAR FONT, STYLE, SIZE, OR COLOR.

SN 85-263,042, FILED 3-10-2011.

LESLIE RICHARDS, EXAMINING ATTORNEY



David J. Kybas

Director of the United States Patent and Trademark Office

United States of America

United States Patent and Trademark Office

CMAP

Reg. No. 4,155,265

Registered June 5, 2012

Int. Cl.: 35

SERVICE MARK

PRINCIPAL REGISTER

VILLAGE FARMS L.P. (DELAWARE LIMITED PARTNERSHIP)
7 CHRISTOPHER WAY
EATONTOWN, NJ 07724

FOR: BUSINESS CONSULTING SERVICES RELATING TO MONITORING, CONTROLLING AND MANAGING GREENHOUSE ENVIRONMENTS OF OTHERS, IN CLASS 35 (U.S. CLS. 100, 101 AND 102).

FIRST USE 2-6-2012; IN COMMERCE 2-6-2012.

THE MARK CONSISTS OF STANDARD CHARACTERS WITHOUT CLAIM TO ANY PARTICULAR FONT, STYLE, SIZE, OR COLOR.

SN 85-263,050, FILED 3-10-2011.

KATHLEEN LORENZO, EXAMINING ATTORNEY



David J. Kybas

Director of the United States Patent and Trademark Office

United States of America

United States Patent and Trademark Office

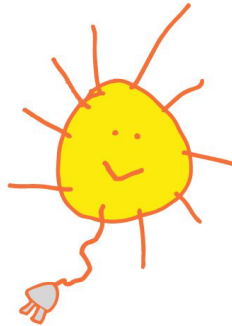

Reg. No. 4,155,266

Registered June 5, 2012

Int. Cl.: 16

TRADEMARK

PRINCIPAL REGISTER

ARETE VENTURES, LLC (OHIO LIMITED LIABILITY COMPANY)
4985 WALNUT WOODS LANE
CINCINNATI, OH 45243

FOR: CHILDREN'S BOOKS, IN CLASS 16 (U.S. CLS. 2, 5, 22, 23, 29, 37, 38 AND 50).

FIRST USE 6-1-2011; IN COMMERCE 6-1-2011.

THE MARK CONSISTS OF A HAND-DRAWN YELLOW SUN, OUTLINED IN ORANGE, WITH ORANGE SUNBEAMS, AND WITH ORANGE EYES AND AN ORANGE SMILE DRAWN IN THE SUN'S CENTER. THE SUNBEAM ON THE LOWER LEFT SIDE ALSO REPRESENTS AN ELECTRIC CORD, AND THERE IS A LIGHT BLUE ELECTRIC PLUG, OUTLINED IN ORANGE, IN THE LOWER LEFT OF THE MARK AT THE END OF THE SUNBEAM/CORD.

THE COLOR(S) YELLOW, ORANGE, LIGHT BLUE IS/ARE CLAIMED AS A FEATURE OF THE MARK.

SN 85-263,061, FILED 3-10-2011.

GINA FINK, EXAMINING ATTORNEY



David J. Kyffers

Director of the United States Patent and Trademark Office

United States of America

United States Patent and Trademark Office

BB&T VANTAGE

Reg. No. 4,155,267

BB&T CORPORATION (NORTH CAROLINA CORPORATION)

Registered June 5, 2012

P.O. BOX 1255
WINSTON-SALEM, NC 271011255

Int. Cl.: 36

FOR: BANKING AND RELATED FINANCIAL SERVICES, NAMELY, CHECKING, DEBIT AND CREDIT CARD SERVICES, IN CLASS 36 (U.S. CLS. 100, 101 AND 102).

SERVICE MARK

FIRST USE 4-11-2011; IN COMMERCE 4-11-2011.

PRINCIPAL REGISTER

THE MARK CONSISTS OF STANDARD CHARACTERS WITHOUT CLAIM TO ANY PARTICULAR FONT, STYLE, SIZE, OR COLOR.

OWNER OF U.S. REG. NOS. 3,091,256, 3,337,198, AND OTHERS.

SN 85-263,123, FILED 3-10-2011.

FLORENTINA BLANDU, EXAMINING ATTORNEY



David J. Kybas

Director of the United States Patent and Trademark Office

United States of America
United States Patent and Trademark Office



Reg. No. 4,155,268

Registered June 5, 2012

Int. Cl.: 19

TRADEMARK

PRINCIPAL REGISTER

DSI - DIMONA SILICA INDUSTRIES LTD (ISRAEL LIMITED COMPANY (LTD.))
SOUTHERN INDUSTRY ZONE, P.O.X 1983
DIMONA, ISRAEL 86119

FOR: NON-METAL BUILDING MATERIALS, NAMELY, ACTIVATED MINERALS USED
AS A STABILIZER IN STONE MASTIC ASPHALT; ASPHALT, IN CLASS 19 (U.S. CLS. 1,
12, 33 AND 50).

FIRST USE 10-31-2010; IN COMMERCE 1-31-2011.

THE MARK CONSISTS OF THE STYLIZED WORD "IBIND" ON AN OVAL.

SN 85-263,138, FILED 3-10-2011.

HOWARD B. LEVINE, EXAMINING ATTORNEY



David J. Kyffers

Director of the United States Patent and Trademark Office

United States of America

United States Patent and Trademark Office

SAMSUNG COMMENT

Reg. No. 4,155,269

Registered June 5, 2012

Int. Cl.: 9

TRADEMARK

PRINCIPAL REGISTER

SAMSUNG ELECTRONICS CO., LTD. (REPUBLIC OF KOREA CORPORATION)
416, MAETAN-DONG, YEONGTONG-GU
SUWON-SI, GYEONGGI-DO, REPUBLIC OF KOREA

FOR: MOBILE PHONES; SMARTPHONES, IN CLASS 9 (U.S. CLS. 21, 23, 26, 36 AND 38).

FIRST USE 8-24-2011; IN COMMERCE 8-24-2011.

THE MARK CONSISTS OF STANDARD CHARACTERS WITHOUT CLAIM TO ANY PARTICULAR FONT, STYLE, SIZE, OR COLOR.

OWNER OF U.S. REG. NOS. 2,929,519, 3,503,660, AND OTHERS.

THE ENGLISH TRANSLATION OF "SAMSUNG" IN THE MARK IS THREE STARS.

SN 85-263,281, FILED 3-10-2011.

JULIE GUTTADAURO, EXAMINING ATTORNEY



David J. Kyjars

Director of the United States Patent and Trademark Office

United States of America

United States Patent and Trademark Office

SAMSUNG CHARACTER

Reg. No. 4,155,270

Registered June 5, 2012

Int. Cl.: 9

TRADEMARK

PRINCIPAL REGISTER

SAMSUNG ELECTRONICS CO., LTD. (REPUBLIC OF KOREA CORPORATION)
416, MAETAN-DONG, YEONGTONG-GU
SUWON-SI, GYEONGGI-DO, REPUBLIC OF KOREA

FOR: MOBILE PHONES; SMARTPHONES, IN CLASS 9 (U.S. CLS. 21, 23, 26, 36 AND 38).

FIRST USE 7-28-2011; IN COMMERCE 7-28-2011.

THE MARK CONSISTS OF STANDARD CHARACTERS WITHOUT CLAIM TO ANY PARTICULAR FONT, STYLE, SIZE, OR COLOR.

OWNER OF U.S. REG. NOS. 2,929,519, 3,503,660, AND OTHERS.

THE ENGLISH TRANSLATION OF "SAMSUNG" IN THE MARK IS THREE STARS.

SN 85-263,338, FILED 3-10-2011.

JULIE GUTTADAURO, EXAMINING ATTORNEY



David J. Kyjars

Director of the United States Patent and Trademark Office

United States of America

United States Patent and Trademark Office

REPLENISH

Reg. No. 4,155,271

Registered June 5, 2012

Int. Cl.: 9

TRADEMARK

PRINCIPAL REGISTER

SAMSUNG ELECTRONICS CO., LTD. (REPUBLIC OF KOREA CORPORATION)
416, MAETAN-DONG, YEONGTONG-GU
SUWON-SI, GYEONGGI-DO, REPUBLIC OF KOREA

FOR: MOBILE PHONES; SMARTPHONES, IN CLASS 9 (U.S. CLS. 21, 23, 26, 36 AND 38).

FIRST USE 4-15-2011; IN COMMERCE 4-15-2011.

THE MARK CONSISTS OF STANDARD CHARACTERS WITHOUT CLAIM TO ANY PARTICULAR FONT, STYLE, SIZE, OR COLOR.

SN 85-263,354, FILED 3-10-2011.

JULIE GUTTADAURO, EXAMINING ATTORNEY



David J. Kybas

Director of the United States Patent and Trademark Office

United States of America

United States Patent and Trademark Office

POP UP POWER

Reg. No. 4,155,272

D & L DISTRIBUTION, LLC (PENNSYLVANIA LIMITED LIABILITY COMPANY)
2213 LEABROOK ROAD
LANCASTER, PA 17601

Registered June 5, 2012

Int. Cl.: 1

FOR: FOLIAR PLANT GROWTH MICRONUTRIENTS FOR AGRICULTURAL CROPS, IN CLASS 1 (U.S. CLS. 1, 5, 6, 10, 26 AND 46).

TRADEMARK

FIRST USE 3-11-2011; IN COMMERCE 3-11-2011.

PRINCIPAL REGISTER

THE MARK CONSISTS OF STANDARD CHARACTERS WITHOUT CLAIM TO ANY PARTICULAR FONT, STYLE, SIZE, OR COLOR.

NO CLAIM IS MADE TO THE EXCLUSIVE RIGHT TO USE "POP UP", APART FROM THE MARK AS SHOWN.

SN 85-263,469, FILED 3-10-2011.

NATALIE POLZER, EXAMINING ATTORNEY



David J. Kybas

Director of the United States Patent and Trademark Office

United States of America

United States Patent and Trademark Office

PATHFINDER PAYMENT SOLUTIONS

Reg. No. 4,155,273

Registered June 5, 2012

Int. Cl.: 36

SERVICE MARK

PRINCIPAL REGISTER

PATHFINDER PAYMENT SOLUTIONS, INC. (MARYLAND CORPORATION)
9693 GERWIG LANE
SUITE A
COLUMBIA, MD 21046

FOR: CREDIT CARD TRANSACTION PROCESSING SERVICES; PAYMENT PROCESSING SERVICES, NAMELY, CREDIT CARD AND DEBIT CARD TRANSACTION PROCESSING SERVICES; PROCESSING ELECTRONIC PAYMENTS MADE THROUGH PREPAID CARDS; PROVIDING ELECTRONIC PROCESSING OF ACH AND CREDIT CARD TRANSACTIONS AND ELECTRONIC PAYMENTS VIA A GLOBAL COMPUTER NETWORK; PROVIDING ELECTRONIC PROCESSING OF CREDIT CARD TRANSACTIONS AND ELECTRONIC PAYMENTS VIA A GLOBAL COMPUTER NETWORK; PROVIDING ELECTRONIC PROCESSING OF ELECTRONIC FUNDS TRANSFER, ACH, CREDIT CARD, DEBIT CARD, ELECTRONIC CHECK AND ELECTRONIC PAYMENTS, IN CLASS 36 (U.S. CLS. 100, 101 AND 102).

FIRST USE 9-19-2011; IN COMMERCE 9-19-2011.

THE MARK CONSISTS OF STANDARD CHARACTERS WITHOUT CLAIM TO ANY PARTICULAR FONT, STYLE, SIZE, OR COLOR.

NO CLAIM IS MADE TO THE EXCLUSIVE RIGHT TO USE "PAYMENT SOLUTIONS", APART FROM THE MARK AS SHOWN.

SN 85-263,692, FILED 3-10-2011.

JAY BESCH, EXAMINING ATTORNEY



David J. Kyros

Director of the United States Patent and Trademark Office

United States of America
United States Patent and Trademark Office

pucker

Reg. No. 4,155,274

JIM BEAM BRANDS CO. (DELAWARE CORPORATION)
510 LAKE COOK ROAD
DEERFIELD, IL 60015

Registered June 5, 2012

Int. Cl.: 33

FOR: ALCOHOLIC BEVERAGES, NAMELY, VODKA, IN CLASS 33 (U.S. CLS. 47 AND 49).

TRADEMARK

FIRST USE 3-29-2011; IN COMMERCE 3-29-2011.

PRINCIPAL REGISTER

OWNER OF U.S. REG. NOS. 2,535,369, 2,638,476, AND 2,665,405.

THE MARK CONSISTS OF THE WORD "PUCKER" WITH THE LETTER "E" IN A STYLIZED LIPS DESIGN.

SN 85-263,720, FILED 3-10-2011.

HEATHER BIDDULPH, EXAMINING ATTORNEY



David J. Kybas

Director of the United States Patent and Trademark Office

United States of America

United States Patent and Trademark Office

THE THIRD DOOR Beyond Competitive Advantage

Reg. No. 4,155,275

Registered June 5, 2012

**Int. Cls.: 9, 16, 35, 38,
and 41**

TRADEMARK

SERVICE MARK

PRINCIPAL REGISTER

STORMES, SEAN (UNITED STATES INDIVIDUAL)
20213 WEST 92ND STREET
LENEXA, KS 66220

FOR: PRERECORDED ELECTRONIC MEDIA, NAMELY, AUDIO AND VIDEO CASSETTES, CDS AND DVDS ALL FEATURING INFORMATION ON BUSINESS, COMMUNICATION, COMMERCIAL SKILLS, FINANCES, LEADERSHIP, MANAGEMENT, MARKETING, MOTIVATION, NEGOTIATION AND SALES TRAINING; DOWNLOADABLE PODCASTS ALL FEATURING INFORMATION ON BUSINESS, COMMUNICATION, COMMERCIAL SKILLS, FINANCES, LEADERSHIP, MANAGEMENT, MARKETING, MOTIVATION, NEGOTIATION AND SALES TRAINING, IN CLASS 9 (U.S. CLS. 21, 23, 26, 36 AND 38).

FIRST USE 4-11-2011; IN COMMERCE 4-11-2011.

FOR: PAPER AND PRINTED MATTER, NAMELY, A SERIES OF ARTICLES FOR PUBLICATION IN BOOKLETS, CATALOGS, GUIDES, HANDOUTS, MAGAZINES, MANUALS AND NEWSLETTERS ALL FEATURING INFORMATION ON BUSINESS, COMMUNICATION, COMMERCIAL SKILLS, FINANCES, LEADERSHIP, MANAGEMENT, MARKETING, MOTIVATION, NEGOTIATION AND SALES TRAINING; FLASH CARDS; PAPERWEIGHTS, PHOTOGRAPHS MOUNTED AND UNMOUNTED; POSTERS; POSTCARDS; PRINTED GREETING CARDS; PRINTED EDUCATIONAL, INSTRUCTIONAL AND TEACHING MATERIALS ALL FEATURING INFORMATION ON BUSINESS, COMMUNICATION, COMMERCIAL SKILLS, FINANCES, LEADERSHIP, MANAGEMENT, MARKETING, MOTIVATION, NEGOTIATION AND SALES TRAINING; SERIES OF NON-FICTION BOOKS ALL FEATURING INFORMATION ON BUSINESS, COMMUNICATION, COMMERCIAL SKILLS, FINANCES, LEADERSHIP, MANAGEMENT, MARKETING, MOTIVATION, NEGOTIATION AND SALES TRAINING; FOLDERS, PENS, PENCILS, STICKERS AND WRITING PADS, IN CLASS 16 (U.S. CLS. 2, 5, 22, 23, 29, 37, 38 AND 50).

FIRST USE 4-11-2011; IN COMMERCE 4-11-2011.

FOR: ARRANGING AND CONDUCTING BUSINESS CONFERENCES AND PROMOTIONAL MARKETING EVENT PLANNING; BUSINESS MARKETING AND MANAGEMENT CONSULTING SERVICES; PROVIDING INFORMATION SERVICES VIA A GLOBAL COMPUTER NETWORK FEATURING INFORMATION ON BUSINESS, COMMUNICATION, COMMERCIAL SKILLS, FINANCES, LEADERSHIP, MANAGEMENT, MARKETING, MOTIVATION, NEGOTIATION AND SALES TRAINING, IN CLASS 35 (U.S. CLS. 100, 101 AND 102).



David J. Kappas

Director of the United States Patent and Trademark Office

Reg. No. 4,155,275 FIRST USE 4-11-2011; IN COMMERCE 4-11-2011.

FOR: VIDEO AND AUDIO TELECONFERENCING SERVICES VIA THE INTERNET; INTERNET COMMUNICATION SERVICES, NAMELY, PODCASTING, BROADCASTING AND WEBCASTING SERVICES ALL FEATURING INFORMATION ON BUSINESS, COMMUNICATION, COMMERCIAL SKILLS, FINANCES, LEADERSHIP, MANAGEMENT, MARKETING, MOTIVATION, NEGOTIATION AND SALES TRAINING; BROADCASTING OF RADIO AND TELEVISION PROGRAMS, IN CLASS 38 (U.S. CLS. 100, 101 AND 104).

FIRST USE 2-15-2012; IN COMMERCE 2-15-2012.

FOR: EDUCATIONAL AND INSTRUCTIONAL SERVICES, NAMELY, CONDUCTING EDUCATIONAL CLASSES, CONFERENCES, RETREATS, SEMINARS AND WORKSHOPS ALL FEATURING INFORMATION ON BUSINESS, COMMUNICATION, COMMERCIAL SKILLS, FINANCES, LEADERSHIP, MANAGEMENT, MARKETING, MOTIVATION, NEGOTIATION AND SALES TRAINING, AND DISTRIBUTING INSTRUCTIONAL MATERIALS IN CONNECTION THEREWITH; ENTERTAINMENT SERVICES, NAMELY, LIVE SPEAKING PERFORMANCES AND SPEAKING ENGAGEMENTS ALL FEATURING INFORMATION ON BUSINESS, COMMUNICATION, COMMERCIAL SKILLS, FINANCES, LEADERSHIP, MANAGEMENT, MARKETING, MOTIVATION, NEGOTIATION AND SALES TRAINING; ENTERTAINMENT SERVICES, NAMELY, PROVIDING PODCASTS FEATURING INFORMATION ON BUSINESS, COMMUNICATION, COMMERCIAL SKILLS, FINANCES, LEADERSHIP, MANAGEMENT, MARKETING, MOTIVATION, NEGOTIATION AND SALES TRAINING, IN CLASS 41 (U.S. CLS. 100, 101 AND 107).

FIRST USE 4-11-2011; IN COMMERCE 4-11-2011.

THE MARK CONSISTS OF STANDARD CHARACTERS WITHOUT CLAIM TO ANY PARTICULAR FONT, STYLE, SIZE, OR COLOR.

SN 85-263,723, FILED 3-10-2011.

TRACY FLETCHER, EXAMINING ATTORNEY

United States of America

United States Patent and Trademark Office

GoldStone

Reg. No. 4,155,276

Registered June 5, 2012

Int. Cl.: 7

TRADEMARK

PRINCIPAL REGISTER

SANC MATERIALS, INC. (CALIFORNIA CORPORATION)
8833 FLOWER ROAD
RANCHO CUCAMONGA, CA 91730

FOR: DIAMOND SAW BLADES FOR USE WITH POWER SAWS AND GRINDERS; DIAMOND POWER-OPERATED GRINDING WHEELS FOR USE WITH GRINDERS, IN CLASS 7 (U.S. CLS. 13, 19, 21, 23, 31, 34 AND 35).

FIRST USE 2-28-2011; IN COMMERCE 2-17-2012.

THE MARK CONSISTS OF THE WORDING "GOLD STONE" WITH A DIAMOND IN THE MIDDLE.

SN 85-263,957, FILED 3-10-2011.

FLORENTINA BLANDU, EXAMINING ATTORNEY



David J. Kybas

Director of the United States Patent and Trademark Office

United States of America

United States Patent and Trademark Office

AIRLINE_009

Reg. No. 4,155,277

Registered June 5, 2012

Int. Cl.: 20

TRADEMARK

PRINCIPAL REGISTER

DISNEY ENTERPRISES, INC. (DELAWARE CORPORATION)
500 SOUTH BUENA VISTA STREET
BURBANK, CA 91521

FOR: FURNITURE, IN CLASS 20 (U.S. CLS. 2, 13, 22, 25, 32 AND 50).

FIRST USE 12-31-2010; IN COMMERCE 12-31-2010.

THE MARK CONSISTS OF STANDARD CHARACTERS WITHOUT CLAIM TO ANY PARTICULAR FONT, STYLE, SIZE, OR COLOR.

SN 85-263,999, FILED 3-10-2011.

DAVID COLLIER, EXAMINING ATTORNEY



David J. Kyffers

Director of the United States Patent and Trademark Office

United States of America

United States Patent and Trademark Office

A PRINCESS WISH

Reg. No. 4,155,278

DISNEY ENTERPRISES, INC. (DELAWARE CORPORATION)
500 SOUTH BUENA VISTA STREET
BURBANK, CA 91521

Registered June 5, 2012

Int. Cl.: 3

FOR: COSMETICS; NON-MEDICATED TOILETRIES; FRAGRANCES; PERFUMES, IN CLASS 3 (U.S. CLS. 1, 4, 6, 50, 51 AND 52).

TRADEMARK

FIRST USE 3-19-2012; IN COMMERCE 3-19-2012.

PRINCIPAL REGISTER

THE MARK CONSISTS OF STANDARD CHARACTERS WITHOUT CLAIM TO ANY PARTICULAR FONT, STYLE, SIZE, OR COLOR.

SN 85-264,439, FILED 3-11-2011.

DAVID COLLIER, EXAMINING ATTORNEY



David J. Kyros

Director of the United States Patent and Trademark Office

United States of America

United States Patent and Trademark Office



Reg. No. 4,155,279

Registered June 5, 2012

Int. Cl.: 14

TRADEMARK

PRINCIPAL REGISTER

SPOON, SANDRA (UNITED STATES INDIVIDUAL)
346 N OLD CAMP LANE
SAHUARITA, AZ 85629

FOR: JEWELRY, IN CLASS 14 (U.S. CLS. 2, 27, 28 AND 50).

FIRST USE 3-1-2011; IN COMMERCE 10-22-2011.

THE MARK CONSISTS OF "WHIMSIES" WRITTEN ACROSS AN OVAL BACKGROUND. "SPOON'S" WRITTEN ON THE TOP PART OF THE OVAL. FILIGREE DESIGNS FILL THE SIDES OF THE OVAL.

SN 85-264,666, FILED 3-11-2011.

DAVID ELTON, EXAMINING ATTORNEY



David J. Kyros

Director of the United States Patent and Trademark Office

United States of America

United States Patent and Trademark Office

Post & Print

Reg. No. 4,155,280

WHITELINE MARKETING, INC. (MICHIGAN CORPORATION), DBA TACK-IT,
14964 178TH AVENUE
GRAND HAVEN, MI 49417

Registered June 5, 2012

Int. Cl.: 35

FOR: PROVIDING A WEB SITE WHERE USERS CAN POST ITEMS FOR SALE THROUGH
ON-LINE CLASSIFIED ADVERTISEMENTS, IN CLASS 35 (U.S. CLS. 100, 101 AND 102).

SERVICE MARK

FIRST USE 7-2-2011; IN COMMERCE 7-2-2011.

PRINCIPAL REGISTER

THE MARK CONSISTS OF STANDARD CHARACTERS WITHOUT CLAIM TO ANY PAR-
TICULAR FONT, STYLE, SIZE, OR COLOR.

SN 85-265,294, FILED 3-11-2011.

TIMOTHY FINNEGAN, EXAMINING ATTORNEY



David J. Kybas

Director of the United States Patent and Trademark Office

United States of America

United States Patent and Trademark Office

HOPPY HOUR

Reg. No. 4,155,281

Registered June 5, 2012

Int. Cl.: 43

SERVICE MARK

PRINCIPAL REGISTER

TWO BEER GUYS LLC (NEW YORK LIMITED LIABILITY COMPANY), DBA GROWLERS
BEER BISTRO,
SUITE 1
1 FIFTH AVENUE
PELHAM, NY 10803

FOR: BAR AND RESTAURANT SERVICES, IN CLASS 43 (U.S. CLS. 100 AND 101).

FIRST USE 7-1-2011; IN COMMERCE 9-5-2011.

THE MARK CONSISTS OF STANDARD CHARACTERS WITHOUT CLAIM TO ANY PARTICULAR FONT, STYLE, SIZE, OR COLOR.

SN 85-265,553, FILED 3-13-2011.

JAMES LOVELACE, EXAMINING ATTORNEY



David J. Kybas

Director of the United States Patent and Trademark Office

United States of America

United States Patent and Trademark Office

Pure Joy Jewelry

Reg. No. 4,155,282

Registered June 5, 2012

Int. Cl.: 14

TRADEMARK

PRINCIPAL REGISTER

PURE JOY JEWELRY (MICHIGAN LIMITED LIABILITY COMPANY)
1390 ERNEST CT.
PONTIAC, MI 48340

FOR: BRACELETS; BROACHES; GEMSTONE JEWELRY; JEWELRY, NAMELY, ANKLETS;
JEWELRY, NAMELY, CROSSES; JEWELRY, NAMELY, MAGNETIC NECKLACES; JEWELRY,
NAMELY, MAGNETIC PENDANTS; JEWELRY, NAMELY, STONE PENDANTS;
STAINLESS STEEL JEWELRY BRACELETS; WOMEN'S JEWELRY, IN CLASS 14 (U.S. CLS.
2, 27, 28 AND 50).

FIRST USE 1-6-2010; IN COMMERCE 1-6-2010.

THE MARK CONSISTS OF STANDARD CHARACTERS WITHOUT CLAIM TO ANY PARTICULAR FONT, STYLE, SIZE, OR COLOR.

NO CLAIM IS MADE TO THE EXCLUSIVE RIGHT TO USE "JEWELRY", APART FROM THE MARK AS SHOWN.

SN 85-265,694, FILED 3-13-2011.

APRIL ROACH, EXAMINING ATTORNEY



David J. Kyffers

Director of the United States Patent and Trademark Office

United States of America

United States Patent and Trademark Office

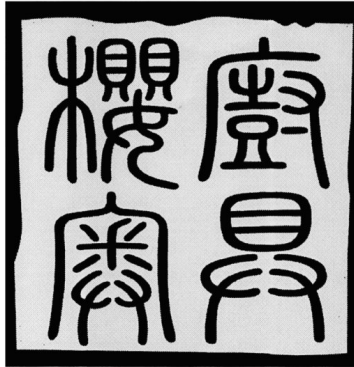

Reg. No. 4,155,283

Registered June 5, 2012

Int. Cl.: 11

TRADEMARK

PRINCIPAL REGISTER

GUANGDONG YINGAO KITCHEN UTENSILS CO., LTD. (CHINA LIMITED COMPANY (LTD.))

NO 1 TECH AREA 3RD ROAD, ZONE C
SHUNDE SCI AND TECH IND PARK, XINGTAN
SHUNDE, FOSHAN, CHINA

FOR: BATHS, BATHTUBS, WHIRLPOOL BATHS AND BATH INSTALLATIONS; ELECTRIC COOKING STOVES; EXTRACTOR HOODS FOR KITCHENS; GAS BURNERS; HYDRANTS; LAMP MANTLES; LAMPS; PIPES FOR HEATING BOILERS; SINKS; STERILIZERS, IN CLASS 11 (U.S. CLS. 13, 21, 23, 31 AND 34).

FIRST USE 5-10-2005; IN COMMERCE 4-15-2008.

NO CLAIM IS MADE TO THE EXCLUSIVE RIGHT TO USE THE NON-LATIN CHARACTERS THAT TRANSLITERATE TO CHU JU, APART FROM THE MARK AS SHOWN.

THE NON-LATIN CHARACTERS IN THE MARK TRANSLITERATE TO "YING"; "AO"; "CHU"; "JU" AND THIS MEANS CHERRY; ABSTRUSE; KITCHEN; UTENSIL IN ENGLISH.

THE MARK CONSISTS OF FOUR CHINESE CHARACTERS APPEARING INSIDE A SHADED SQUARE BACKGROUND.

SN 85-265,718, FILED 3-14-2011.

PAM WILLIS, EXAMINING ATTORNEY



David J. Kyffers

Director of the United States Patent and Trademark Office

United States of America

United States Patent and Trademark Office

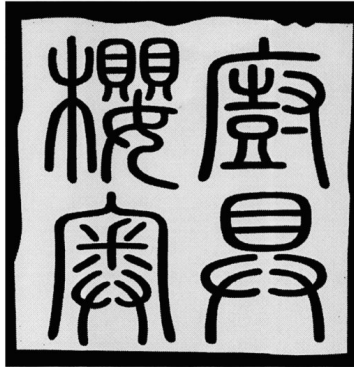

Reg. No. 4,155,284

Registered June 5, 2012

Int. Cl.: 21

TRADEMARK

PRINCIPAL REGISTER

GUANGDONG YINGAO KITCHEN UTENSILS CO., LTD. (CHINA LIMITED COMPANY (LTD.))

NO 1 TECH AREA 3RD ROAD, ZONE C
SHUNDE SCI AND TECH IND PARK, XINGTAN
SHUNDE, FOSHAN, CHINA

FOR: BASINS; CERAMIC SCULPTURES, VASES, VESSELS, BOWLS, PLATES AND POTS; CLEANING BRUSHES FOR HOUSEHOLD USE; CLEANING CLOTHS; CLEANING SPONGES; CONTAINERS FOR HOUSEHOLD OR KITCHEN USE; DRINKING VESSELS; ENAMELLED GLASS; GLASS JARS; HOUSEHOLD UTENSILS, NAMELY, KITCHEN TONGS; HOUSEHOLD UTENSILS, NAMELY, POT AND PAN SCRAPERS, ROLLING PINS, SPATULAS, TURNERS, WHISKS; INSULATED CONTAINERS FOR FOOD OR BEVERAGE FOR DOMESTIC USE; WATER TROUGHS, IN CLASS 21 (U.S. CLS. 2, 13, 23, 29, 30, 33, 40 AND 50).

FIRST USE 5-10-2005; IN COMMERCE 4-15-2008.

NO CLAIM IS MADE TO THE EXCLUSIVE RIGHT TO USE THE NON-LATIN CHARACTERS THAT TRANSLITERATE TO CHU JU, APART FROM THE MARK AS SHOWN.

THE NON-LATIN CHARACTERS IN THE MARK TRANSLITERATE TO YING; AO; CHU; JU AND THIS MEANS CHERRY; ABSTRUSE; KITCHEN; UTENSIL IN ENGLISH.

THE MARK CONSISTS OF FOUR CHINESE CHARACTERS APPEARING INSIDE A SHADED SQUARE BACKGROUND.

SN 85-265,719, FILED 3-14-2011.

PAM WILLIS, EXAMINING ATTORNEY



David J. Kybas

Director of the United States Patent and Trademark Office

United States of America

United States Patent and Trademark Office



Reg. No. 4,155,285

Registered June 5, 2012

Int. Cls.: 29 and 43

TRADEMARK

SERVICE MARK

PRINCIPAL REGISTER

AFC ENTERPRISES, INC. (MINNESOTA CORPORATION)
SUITE 1000
400 PERIMETER CENTER TERRACE
ATLANTA, GA 30346

FOR: PREPARED CHICKEN AND SEAFOOD FOR CONSUMPTION ON AND OFF THE PREMISES, IN CLASS 29 (U.S. CL. 46).

FIRST USE 5-30-2011; IN COMMERCE 5-30-2011.

FOR: RESTAURANT AND CATERING SERVICES, IN CLASS 43 (U.S. CLS. 100 AND 101).

FIRST USE 5-30-2011; IN COMMERCE 5-30-2011.

NO CLAIM IS MADE TO THE EXCLUSIVE RIGHT TO USE "KIDS MEAL", APART FROM THE MARK AS SHOWN.

THE MARK CONSISTS OF THE WORDS "GET UP & GEAUX"! IN STYLIZED LETTERS WITHIN AN OVAL SHAPE, RESTING ON TOP OF A RECTANGLE SHAPE WITH THE WORDS "KIDS MEAL" IN STYLIZED LETTERS WITHIN THE RECTANGLE, WITH A FLEUR DE LYS DOTTING THE "I" IN "KIDS".

SN 85-265,741, FILED 3-14-2011.

DOUGLAS LEE, EXAMINING ATTORNEY



David J. Kybas

Director of the United States Patent and Trademark Office

United States of America

United States Patent and Trademark Office

SMUD Clear Terms

Reg. No. 4,155,286

Registered June 5, 2012

Int. Cl.: 35

SACRAMENTO MUNICIPAL UTILITY DISTRICT (CALIFORNIA MUNICIPAL CORPORATION), AKA SMUD,
P.O. BOX 15830
MS B406
SACRAMENTO, CA 95852

SERVICE MARK

FOR: PROVIDING CONSUMER INFORMATION IN THE FIELD OF PUBLIC UTILITY SERVICES IN THE NATURE OF ELECTRICITY DISTRIBUTION, IN CLASS 35 (U.S. CLS. 100, 101 AND 102).

PRINCIPAL REGISTER

FIRST USE 4-7-2011; IN COMMERCE 4-7-2011.

THE MARK CONSISTS OF STANDARD CHARACTERS WITHOUT CLAIM TO ANY PARTICULAR FONT, STYLE, SIZE, OR COLOR.

SN 85-265,958, FILED 3-14-2011.

GILBERT SWIFT, EXAMINING ATTORNEY



David J. Kyffers

Director of the United States Patent and Trademark Office

United States of America

United States Patent and Trademark Office

LOUISIANA LEAUX

Reg. No. 4,155,287

Registered June 5, 2012

Int. Cls.: 29 and 43

TRADEMARK

SERVICE MARK

PRINCIPAL REGISTER

AFC ENTERPRISES, INC. (MINNESOTA CORPORATION)
SUITE 1000
400 PERIMETER CENTER TERRACE
ATLANTA, GA 30346

FOR: PREPARED CHICKEN AND SEAFOOD FOR CONSUMPTION ON OR OFF THE PREMISES, IN CLASS 29 (U.S. CL. 46).

FIRST USE 5-30-2011; IN COMMERCE 5-30-2011.

FOR: RESTAURANT AND CATERING SERVICES, IN CLASS 43 (U.S. CLS. 100 AND 101).

FIRST USE 5-30-2011; IN COMMERCE 5-30-2011.

THE MARK CONSISTS OF STANDARD CHARACTERS WITHOUT CLAIM TO ANY PARTICULAR FONT, STYLE, SIZE, OR COLOR.

OWNER OF U.S. REG. NOS. 3,681,086, 3,681,087, AND 3,681,089.

NO CLAIM IS MADE TO THE EXCLUSIVE RIGHT TO USE "LOUISIANA", APART FROM THE MARK AS SHOWN.

SN 85-266,120, FILED 3-14-2011.

DOUGLAS LEE, EXAMINING ATTORNEY



David J. Kyros

Director of the United States Patent and Trademark Office

United States of America

United States Patent and Trademark Office



Reg. No. 4,155,288

Registered June 5, 2012

Int. Cls.: 29 and 43

TRADEMARK

SERVICE MARK

PRINCIPAL REGISTER

AFC ENTERPRISES, INC. (MINNESOTA CORPORATION)
SUITE 1000
400 PERIMETER CENTER TERRACE
ATLANTA, GA 30346

FOR: PREPARED CHICKEN AND SEAFOOD FOR CONSUMPTION ON OR OFF THE PREMISES, IN CLASS 29 (U.S. CL. 46).

FIRST USE 5-30-2011; IN COMMERCE 5-30-2011.

FOR: RESTAURANT SERVICES, IN CLASS 43 (U.S. CLS. 100 AND 101).

FIRST USE 5-30-2011; IN COMMERCE 5-30-2011.

OWNER OF U.S. REG. NOS. 3,681,086, 3,681,087, AND 3,681,089.

NO CLAIM IS MADE TO THE EXCLUSIVE RIGHT TO USE "LOUISIANA", APART FROM THE MARK AS SHOWN.

THE MARK CONSISTS OF THE WORDS "LOUISIANA LEAUX GET UP & GEAUX"! DISPLAYED WITHIN A GEOMETRIC SHAPE WITH A FLEUR DE LYS WITHIN A HEART SHAPE ABOVE THE "S" IN "LOUISIANA".

SN 85-266,170, FILED 3-14-2011.

DOUGLAS LEE, EXAMINING ATTORNEY



David J. Kyros

Director of the United States Patent and Trademark Office

United States of America

United States Patent and Trademark Office



Reg. No. 4,155,289

Registered June 5, 2012

Int. Cl.: 3

TRADEMARK

PRINCIPAL REGISTER

THE VERA COMPANY, LLC (GEORGIA LIMITED LIABILITY COMPANY), DBA THE VERA COMPANY,
3411 PIERCE DRIVE, SUITE 200
ATLANTA, GA 30341

FOR: MAKEUP PRODUCTS, NAMELY, MAKEUP POWDER, MAKEUP FOUNDATION, MAKEUP PENCILS, BLUSH, LIPSTICK, LIP GLOSS, EYE SHADOWS, AND NAIL POLISH, IN CLASS 3 (U.S. CLS. 1, 4, 6, 50, 51 AND 52).

FIRST USE 2-9-2012, THE MARK WAS FIRST USED ANYWHERE IN A DIFFERENT FORM OTHER THAN THAT SOUGHT TO BE REGISTERED AT LEAST AS EARLY AS 03/31/1980.; IN COMMERCE 2-9-2012, THE MARK WAS FIRST USED IN COMMERCE IN A DIFFERENT FORM OTHER THAN THAT SOUGHT TO BE REGISTERED AT LEAST AS EARLY AS 07/01/1947..

OWNER OF U.S. REG. NOS. 683,332, 3,703,608, AND OTHERS.

THE NAME(S), PORTRAIT(S), AND/OR SIGNATURE(S) SHOWN IN THE MARK DOES NOT IDENTIFY A PARTICULAR LIVING INDIVIDUAL.

THE MARK CONSISTS OF THE STYLIZED WORDING "VERA".

SN 85-266,260, FILED 3-14-2011.

ALEX KEAM, EXAMINING ATTORNEY



David J. Kyros

Director of the United States Patent and Trademark Office

United States of America

United States Patent and Trademark Office

THE POWER OF 10

Reg. No. 4,155,290

ODL, INCORPORATED (MICHIGAN CORPORATION)
215 EAST ROOSEVELT AVENUE
ZEELAND, MI 49464

Registered June 5, 2012

Int. Cl.: 40

FOR: CUSTOM MANUFACTURE OF WINDOWS, NAMELY, DOORGLASS, IN CLASS 40
(U.S. CLS. 100, 103 AND 106).

SERVICE MARK

FIRST USE 3-20-2011; IN COMMERCE 3-20-2011.

PRINCIPAL REGISTER

THE MARK CONSISTS OF STANDARD CHARACTERS WITHOUT CLAIM TO ANY PARTICULAR FONT, STYLE, SIZE, OR COLOR.

SN 85-266,272, FILED 3-14-2011.

DORITT L. CARROLL, EXAMINING ATTORNEY



David J. Kyros

Director of the United States Patent and Trademark Office

United States of America

United States Patent and Trademark Office

VIDEOTRAVEL

Reg. No. 4,155,291

ADELMAN TRAVEL SYSTEMS, INC. (WISCONSIN CORPORATION)
6980 NORTH PORT WASHINGTON ROAD
MILWAUKEE, WI 53217

Registered June 5, 2012

Int. Cl.: 38

FOR: VIDEO CONFERENCING SERVICES AND CONSULTING SERVICES RELATED TO VIDEOCONFERENCING; PROVIDING TECHNICAL SUPPORT SERVICES REGARDING THE USAGE OF VIDEOCONFERENCING EQUIPMENT, IN CLASS 38 (U.S. CLS. 100, 101 AND 104).

SERVICE MARK

PRINCIPAL REGISTER

FIRST USE 9-0-2011; IN COMMERCE 9-0-2011.

THE MARK CONSISTS OF STANDARD CHARACTERS WITHOUT CLAIM TO ANY PARTICULAR FONT, STYLE, SIZE, OR COLOR.

SN 85-266,396, FILED 3-14-2011.

KEVON CHISOLM, EXAMINING ATTORNEY



David J. Kyffers

Director of the United States Patent and Trademark Office

United States of America

United States Patent and Trademark Office

PREVISE

Reg. No. 4,155,292

HARRINGTON, SEAN PATRICK (UNITED STATES INDIVIDUAL)
PO BOX 1882
PROVINCETOWN, MA 02657

Registered June 5, 2012

Int. Cl.: 3

FOR: NON-MEDICATED SKIN CARE PREPARATIONS, IN CLASS 3 (U.S. CLS. 1, 4, 6, 50, 51 AND 52).

TRADEMARK

FIRST USE 2-9-2012; IN COMMERCE 2-9-2012.

PRINCIPAL REGISTER

THE MARK CONSISTS OF STANDARD CHARACTERS WITHOUT CLAIM TO ANY PARTICULAR FONT, STYLE, SIZE, OR COLOR.

SN 85-266,545, FILED 3-14-2011.

CHERYL CLAYTON, EXAMINING ATTORNEY



David J. Kybas

Director of the United States Patent and Trademark Office

United States of America

United States Patent and Trademark Office

EMPTY THRONE

Reg. No. 4,155,293

Registered June 5, 2012

Int. Cls.: 25 and 41

TRADEMARK

SERVICE MARK

PRINCIPAL REGISTER

BEAN, COLLIN W. (UNITED STATES INDIVIDUAL)
5285 ST. ALBANS BAY ROAD
EXCELSIOR, MN 55331

FOR: CLOTHING, NAMELY, SHIRTS, T-SHIRTS, SWEATSHIRTS, HOODED SWEATSHIRTS, AND JACKETS; HEADGEAR, NAMELY, CAPS, HATS AND BASEBALL CAPS; WRIST BANDS, IN CLASS 25 (U.S. CLS. 22 AND 39).

FIRST USE 3-10-2011; IN COMMERCE 3-10-2011.

FOR: PROVIDING A WEB SITE FEATURING INFORMATION IN THE FIELD OF MUSIC, VIDEO, ENTERTAINMENT, FASHION, AND POPULAR CULTURE; INTERACTIVE ONLINE JOURNAL, NAMELY, A WEB BLOG FEATURING INFORMATION ON MUSIC, VIDEO, ENTERTAINMENT, FASHION AND POPULAR CULTURE, IN CLASS 41 (U.S. CLS. 100, 101 AND 107).

FIRST USE 1-26-2011; IN COMMERCE 1-26-2011.

THE MARK CONSISTS OF STANDARD CHARACTERS WITHOUT CLAIM TO ANY PARTICULAR FONT, STYLE, SIZE, OR COLOR.

SN 85-266,569, FILED 3-14-2011.

WILLIAM VERHOSEK, EXAMINING ATTORNEY



David J. Kyros

Director of the United States Patent and Trademark Office

United States of America

United States Patent and Trademark Office

ATM

Reg. No. 4,155,294

Registered June 5, 2012

Int. Cl.: 33

TRADEMARK

PRINCIPAL REGISTER

MADRONA PROPERTY COMPANY (CALIFORNIA CORPORATION)
#205
35 STILLMAN ST.
SAN FRANCISCO, CA 94107

FOR: WINE, IN CLASS 33 (U.S. CLS. 47 AND 49).

FIRST USE 1-15-2012; IN COMMERCE 1-15-2012.

THE MARK CONSISTS OF STANDARD CHARACTERS WITHOUT CLAIM TO ANY PARTICULAR FONT, STYLE, SIZE, OR COLOR.

SN 85-266,635, FILED 3-14-2011.

FONG HSU, EXAMINING ATTORNEY



David J. Kybas

Director of the United States Patent and Trademark Office

United States of America

United States Patent and Trademark Office

Takiza

Reg. No. 4,155,295

Registered June 5, 2012

Int. Cl.: 43

SERVICE MARK

PRINCIPAL REGISTER

TAKIZA, LLC (TEXAS LIMITED LIABILITY COMPANY)
2014 WINDING VIEW
SAN ANTONIO, TX 78260

FOR: RESTAURANT AND BAR SERVICES, IN CLASS 43 (U.S. CLS. 100 AND 101).

FIRST USE 6-1-2008; IN COMMERCE 3-1-2011.

THE MARK CONSISTS OF STANDARD CHARACTERS WITHOUT CLAIM TO ANY PARTICULAR FONT, STYLE, SIZE, OR COLOR.

SN 85-266,716, FILED 3-14-2011.

HEATHER BIDDULPH, EXAMINING ATTORNEY



David J. Kybas

Director of the United States Patent and Trademark Office

United States of America

United States Patent and Trademark Office

FasciaPro

Reg. No. 4,155,296

ADVANCED WELLNESS (NEW JERSEY CORPORATION)
17 N. MAIN ST
MARLBORO, NJ 07746

Registered June 5, 2012

Int. Cl.: 10

FOR: MASSAGE APPARATUS FOR MEDICAL PURPOSES, IN CLASS 10 (U.S. CLS. 26, 39 AND 44).

TRADEMARK

FIRST USE 4-1-2011; IN COMMERCE 4-1-2011.

PRINCIPAL REGISTER

THE MARK CONSISTS OF STANDARD CHARACTERS WITHOUT CLAIM TO ANY PARTICULAR FONT, STYLE, SIZE, OR COLOR.

SN 85-266,765, FILED 3-14-2011.

GENE MACIOL, EXAMINING ATTORNEY



David J. Kyffers

Director of the United States Patent and Trademark Office

United States of America

United States Patent and Trademark Office

SyncBeats

Reg. No. 4,155,297

Registered June 5, 2012

Int. Cl.: 42

SERVICE MARK

PRINCIPAL REGISTER

NEVAVILLE INC (NEW YORK CORPORATION)
2F
1466 TOWNSEND AVE
BRONX, NY 10452

FOR: COMPUTER SERVICES, NAMELY, CREATING AN ON-LINE COMMUNITY FOR REGISTERED USERS TO PARTICIPATE IN DISCUSSIONS, GET FEEDBACK FROM THEIR PEERS, FORM VIRTUAL COMMUNITIES, AND ENGAGE IN SOCIAL NETWORKING; PROVIDING A WEBSITE ALLOWING USERS TO UPLOAD AND DOWNLOAD MUSIC, IN CLASS 42 (U.S. CLS. 100 AND 101).

FIRST USE 9-11-2011; IN COMMERCE 1-10-2012.

THE MARK CONSISTS OF STANDARD CHARACTERS WITHOUT CLAIM TO ANY PARTICULAR FONT, STYLE, SIZE, OR COLOR.

SN 85-266,795, FILED 3-14-2011.

JILL PRATER, EXAMINING ATTORNEY



David J. Kybas

Director of the United States Patent and Trademark Office

United States of America

United States Patent and Trademark Office

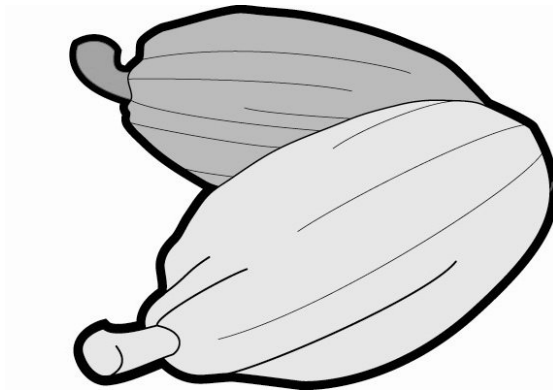

Reg. No. 4,155,298

Registered June 5, 2012

Int. Cl.: 3

TRADEMARK

PRINCIPAL REGISTER

JOHNSON & JOHNSON (NEW JERSEY CORPORATION)
ONE JOHNSON & JOHNSON PLAZA
NEW BRUNSWICK, NJ 089337001

FOR: BODY LOTIONS AND BODY CREAMS, IN CLASS 3 (U.S. CLS. 1, 4, 6, 50, 51 AND 52).

FIRST USE 6-3-2010; IN COMMERCE 6-3-2010.

THE MARK CONSISTS OF IMAGE OF COCOA SHEA BEANS.

SN 85-266,919, FILED 3-15-2011.

TRACY FLETCHER, EXAMINING ATTORNEY



David J. Kybas

Director of the United States Patent and Trademark Office

United States of America

United States Patent and Trademark Office

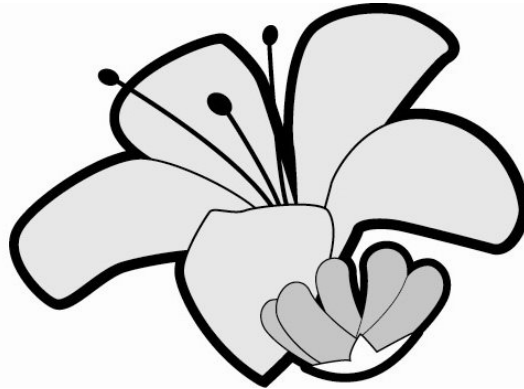

Reg. No. 4,155,299

Registered June 5, 2012

Int. Cl.: 3

TRADEMARK

PRINCIPAL REGISTER

JOHNSON & JOHNSON (NEW JERSEY CORPORATION)
ONE JOHNSON & JOHNSON PLAZA
NEW BRUNSWICK, NJ 089337001

FOR: BODY LOTIONS AND BODY CREAMS, IN CLASS 3 (U.S. CLS. 1, 4, 6, 50, 51 AND 52).

FIRST USE 12-12-2011; IN COMMERCE 12-12-2011.

THE MARK CONSISTS OF IMAGE OF LAVENDER AND JASMINE FLOWER.

SN 85-266,920, FILED 3-15-2011.

TRACY FLETCHER, EXAMINING ATTORNEY



David J. Kyffers

Director of the United States Patent and Trademark Office

United States of America

United States Patent and Trademark Office

STAGE 2 1/2

Reg. No. 4,155,300

BEECH-NUT NUTRITION CORPORATION (NEVADA CORPORATION)
100 HERO DRIVE
AMSTERDAM, NY 12010

Registered June 5, 2012

Int. Cl.: 29

FOR: PUREED FRUITS; PUREED VEGETABLES; PUREED FRUITS AND VEGETABLES,
IN CLASS 29 (U.S. CL. 46).

TRADEMARK

FIRST USE 7-1-2011; IN COMMERCE 7-1-2011.

PRINCIPAL REGISTER

THE MARK CONSISTS OF STANDARD CHARACTERS WITHOUT CLAIM TO ANY PAR-
TICULAR FONT, STYLE, SIZE, OR COLOR.

OWNER OF U.S. REG. NOS. 1,756,410, 1,756,412, AND OTHERS.

SN 85-266,959, FILED 3-15-2011.

DOMINICK J. SALEMI, EXAMINING ATTORNEY



David J. Kyros

Director of the United States Patent and Trademark Office

United States of America

United States Patent and Trademark Office

CHEERFUL CHEEKS

Reg. No. 4,155,301

Registered June 5, 2012

Int. Cl.: 3

TRADEMARK

PRINCIPAL REGISTER

RETAIL ROYALTY COMPANY (NEVADA CORPORATION)
101 CONVENTION CENTER
LAS VEGAS, NV 89109

FOR: COSMETICS, NAMELY, BLUSH, IN CLASS 3 (U.S. CLS. 1, 4, 6, 50, 51 AND 52).

FIRST USE 10-0-2011; IN COMMERCE 10-0-2011.

THE MARK CONSISTS OF STANDARD CHARACTERS WITHOUT CLAIM TO ANY PARTICULAR FONT, STYLE, SIZE, OR COLOR.

NO CLAIM IS MADE TO THE EXCLUSIVE RIGHT TO USE "CHEEKS", APART FROM THE MARK AS SHOWN.

SN 85-267,190, FILED 3-15-2011.

FONG HSU, EXAMINING ATTORNEY



David J. Kyffers

Director of the United States Patent and Trademark Office

United States of America

United States Patent and Trademark Office

MUSPhyto

Reg. No. 4,155,302

Registered June 5, 2012

Int. Cl.: 5

TRADEMARK

PRINCIPAL REGISTER

HEALTH EVER BIO-TECH CO., LTD. (TAIWAN CORPORATION)
11F - 9
#186, SECTION 4, NAN KING EAST RD.
TAIPEI, TAIWAN 10595

FOR: DIETARY AND NUTRITIONAL SUPPLEMENTS, IN CLASS 5 (U.S. CLS. 6, 18, 44, 46, 51 AND 52).

FIRST USE 3-1-2012; IN COMMERCE 3-1-2012.

THE MARK CONSISTS OF STANDARD CHARACTERS WITHOUT CLAIM TO ANY PARTICULAR FONT, STYLE, SIZE, OR COLOR.

OWNER OF U.S. REG. NO. 3,659,202.

SN 85-267,219, FILED 3-15-2011.

H. M. FISHER, EXAMINING ATTORNEY



David J. Kybas

Director of the United States Patent and Trademark Office

United States of America

United States Patent and Trademark Office

SEX SAVVY WOMAN

Reg. No. 4,155,303

Registered June 5, 2012

Int. Cl.: 41

SERVICE MARK

PRINCIPAL REGISTER

DÉSILETS, ELISABETH (CANADA INDIVIDUAL)
3375C KUAUA PLACE
KIHEI, HI 96753

FOR: EDUCATION SERVICES, NAMELY, CONDUCTING SEMINARS, CONFERENCES, WORKSHOPS AND ONLINE COURSES IN THE FIELD OF SEXUALITY AND PSYCHOLOGICAL HEALTH AND WELL-BEING, IN CLASS 41 (U.S. CLS. 100, 101 AND 107).

FIRST USE 3-22-2012; IN COMMERCE 3-22-2012.

THE MARK CONSISTS OF STANDARD CHARACTERS WITHOUT CLAIM TO ANY PARTICULAR FONT, STYLE, SIZE, OR COLOR.

NO CLAIM IS MADE TO THE EXCLUSIVE RIGHT TO USE "SEX" AND "WOMAN", APART FROM THE MARK AS SHOWN.

SN 85-267,303, FILED 3-15-2011.

MARK SPARACINO, EXAMINING ATTORNEY



David J. Kyros

Director of the United States Patent and Trademark Office

United States of America

United States Patent and Trademark Office

PAC-MOTOS

Reg. No. 4,155,304

NAMCO BANDAI GAMES INC. (JAPAN CORPORATION)
4-5-15 HIGASHI SHINAGAWA
SHINAGAWA-KU TOKYO, JAPAN 140-8590

Registered June 5, 2012

Int. Cl.: 9

FOR: COMPUTER GAME PROGRAMS; COMPUTER GAME SOFTWARE; DOWNLOADABLE
COMPUTER GAME PROGRAMS; DOWNLOADABLE COMPUTER GAME SOFTWARE VIA
A GLOBAL COMPUTER NETWORK AND WIRELESS DEVICES; VIDEO GAME SOFTWARE,
IN CLASS 9 (U.S. CLS. 21, 23, 26, 36 AND 38).

TRADEMARK

PRINCIPAL REGISTER

FIRST USE 10-23-2007; IN COMMERCE 10-23-2007.

THE MARK CONSISTS OF STANDARD CHARACTERS WITHOUT CLAIM TO ANY PAR-
TICULAR FONT, STYLE, SIZE, OR COLOR.

SN 85-267,483, FILED 3-15-2011.

EDWARD FENNESSY, EXAMINING ATTORNEY



David J. Kyffers

Director of the United States Patent and Trademark Office

United States of America

United States Patent and Trademark Office

Greystar Bird Safe

Reg. No. 4,155,305

GREYSTAR PRODUCTS, INC. (CALIFORNIA CORPORATION)
30290 RANCHO VIEJO STE 203
SAN JUAN CAPISTRANO, CA 92675

Registered June 5, 2012

Int. Cl.: 21

FOR: BIRD FEEDERS AND SUPPORT POLES SPECIALLY ADAPTED FOR USE WITH BIRD FEEDERS, IN CLASS 21 (U.S. CLS. 2, 13, 23, 29, 30, 33, 40 AND 50).

TRADEMARK

FIRST USE 11-1-2011; IN COMMERCE 4-4-2012.

PRINCIPAL REGISTER

THE MARK CONSISTS OF STANDARD CHARACTERS WITHOUT CLAIM TO ANY PARTICULAR FONT, STYLE, SIZE, OR COLOR.

NO CLAIM IS MADE TO THE EXCLUSIVE RIGHT TO USE "BIRD", APART FROM THE MARK AS SHOWN.

SN 85-267,692, FILED 3-15-2011.

JAMES LOVELACE, EXAMINING ATTORNEY



David J. Kyros

Director of the United States Patent and Trademark Office

United States of America

United States Patent and Trademark Office

VANGLE

Reg. No. 4,155,306

Registered June 5, 2012

Int. Cl.: 42

SERVICE MARK

PRINCIPAL REGISTER

VANGLE CONSULTING LLC (TEXAS LIMITED LIABILITY COMPANY)
8760A RESEARCH BLVD
286
AUSTIN, TX 787586420

FOR: PRODUCT TESTING CONSULTATION RELATING TO STANDARDS AND EUROPEAN DIRECTIVES FOR "CONFORMITÉ EUROPÉENNE" (CE) MARKING AND "ATMOSPHERES EXPLOSIVES" (ATEX) COMPLIANCE AND CERTIFICATION, IN CLASS 42 (U.S. CLS. 100 AND 101).

FIRST USE 4-8-2011; IN COMMERCE 12-21-2011.

THE MARK CONSISTS OF STANDARD CHARACTERS WITHOUT CLAIM TO ANY PARTICULAR FONT, STYLE, SIZE, OR COLOR.

SN 85-267,760, FILED 3-15-2011.

SUNG IN, EXAMINING ATTORNEY



David J. Kyffers

Director of the United States Patent and Trademark Office

United States of America

United States Patent and Trademark Office

YUMZ GOURMET FROZEN YOGURT

Reg. No. 4,155,307

Registered June 5, 2012

Int. Cl.: 25

TRADEMARK

PRINCIPAL REGISTER

YFY, LLC (ILLINOIS LIMITED LIABILITY COMPANY)
3637 TAMARACK CIRCLE
CRYSTAL LAKE, IL 60012

FOR: T-SHIRTS; TOPS; HATS; HEADWEAR, IN CLASS 25 (U.S. CLS. 22 AND 39).

FIRST USE 10-0-2011; IN COMMERCE 10-0-2011.

THE MARK CONSISTS OF STANDARD CHARACTERS WITHOUT CLAIM TO ANY PARTICULAR FONT, STYLE, SIZE, OR COLOR.

OWNER OF U.S. REG. NO. 3,935,658.

SN 85-267,815, FILED 3-15-2011.

SANI KHOURI, EXAMINING ATTORNEY



David J. Kyffers

Director of the United States Patent and Trademark Office

United States of America

United States Patent and Trademark Office



Reg. No. 4,155,308

Registered June 5, 2012

Int. Cl.: 25

TRADEMARK

PRINCIPAL REGISTER

YFY, LLC (ILLINOIS LIMITED LIABILITY COMPANY)
3637 TAMARACK CIRCLE
CRYSTAL LAKE, IL 60012

FOR: HATS; HEADWEAR; T-SHIRTS; TOPS, IN CLASS 25 (U.S. CLS. 22 AND 39).

FIRST USE 10-0-2011; IN COMMERCE 10-0-2011.

OWNER OF U.S. REG. NO. 3,935,658.

THE MARK CONSISTS OF A RECTANGULAR SHAPE ENCLOSING THE DESIGN OF SOFT-SERVE FROZEN YOGURT WITH THE END OF A SPOON STICKING OUT OF IT AND THE STYLIZED TEXT "YUMZ GOURMET FROZEN YOGURT" TO THE RIGHT OF THE DESIGN.

SN 85-267,837, FILED 3-15-2011.

SANI KHOURI, EXAMINING ATTORNEY



David J. Kybas

Director of the United States Patent and Trademark Office

United States of America

United States Patent and Trademark Office

THE ENERGY OF US

Reg. No. 4,155,309

ENERGY LAND CONSULTANTS (OKLAHOMA CORPORATION)
200 E 10TH STREET PLZ
EDMOND, OK 730344761

Registered June 5, 2012

Int. Cl.: 36

FOR: CONSULTING SERVICES IN THE FIELD OF OIL AND GAS INDUSTRY LAND ACQUISITION AND MANAGEMENT, IN CLASS 36 (U.S. CLS. 100, 101 AND 102).

SERVICE MARK

FIRST USE 3-16-2011; IN COMMERCE 3-16-2011.

PRINCIPAL REGISTER

THE MARK CONSISTS OF STANDARD CHARACTERS WITHOUT CLAIM TO ANY PARTICULAR FONT, STYLE, SIZE, OR COLOR.

NO CLAIM IS MADE TO THE EXCLUSIVE RIGHT TO USE "ENERGY", APART FROM THE MARK AS SHOWN.

SN 85-268,076, FILED 3-16-2011.

LINDSEY RUBIN, EXAMINING ATTORNEY



David J. Kyffers

Director of the United States Patent and Trademark Office

United States of America

United States Patent and Trademark Office

WE GET IT DONE

Reg. No. 4,155,310

Registered June 5, 2012

Int. Cls.: 39 and 40

SERVICE MARK

PRINCIPAL REGISTER

PREFERRED FREEZER SERVICES, LLC (DELAWARE LIMITED LIABILITY COMPANY)
ONE MAIN STREET
CHATHAM, NJ 07928

FOR: HANDLING AND STORING OF FOOD, IN CLASS 39 (U.S. CLS. 100 AND 105).

FIRST USE 12-1-2011; IN COMMERCE 12-1-2011.

FOR: FREEZING OF FOOD FOR OTHERS, IN CLASS 40 (U.S. CLS. 100, 103 AND 106).

FIRST USE 12-1-2011; IN COMMERCE 12-1-2011.

THE MARK CONSISTS OF STANDARD CHARACTERS WITHOUT CLAIM TO ANY PARTICULAR FONT, STYLE, SIZE, OR COLOR.

SN 85-268,091, FILED 3-16-2011.

AMY HELLA, EXAMINING ATTORNEY



David J. Kybas

Director of the United States Patent and Trademark Office

United States of America

United States Patent and Trademark Office

LA FEMME DANGEREUSE

Reg. No. 4,155,311

EASTMAN OUTDOORS, INC. (MICHIGAN CORPORATION)
3476 EASTMAN DRIVE
FLUSHING, MI 48433

Registered June 5, 2012

Int. Cl.: 28

FOR: ARROWS, IN CLASS 28 (U.S. CLS. 22, 23, 38 AND 50).

TRADEMARK

FIRST USE 5-0-2011; IN COMMERCE 5-0-2011.

PRINCIPAL REGISTER

THE MARK CONSISTS OF STANDARD CHARACTERS WITHOUT CLAIM TO ANY PARTICULAR FONT, STYLE, SIZE, OR COLOR.

THE ENGLISH TRANSLATION OF "LA FEMME DANGEREUSE" IN THE MARK IS THE DANGEROUS WOMAN.

SN 85-268,266, FILED 3-16-2011.

SANI KHOURI, EXAMINING ATTORNEY



David J. Kyffers

Director of the United States Patent and Trademark Office

United States of America

United States Patent and Trademark Office

MAX SET ULTRA

Reg. No. 4,155,312

Registered June 5, 2012

Int. Cl.: 1

TRADEMARK

PRINCIPAL REGISTER

WILBUR-ELLIS COMPANY (CALIFORNIA CORPORATION)
345 CALIFORNIA STREET
27TH FLOOR
SAN FRANCISCO, CA 94104

FOR: FERTILIZERS, IN CLASS 1 (U.S. CLS. 1, 5, 6, 10, 26 AND 46).

FIRST USE 4-25-2011; IN COMMERCE 4-25-2011.

THE MARK CONSISTS OF STANDARD CHARACTERS WITHOUT CLAIM TO ANY PARTICULAR FONT, STYLE, SIZE, OR COLOR.

OWNER OF U.S. REG. NO. 3,619,370.

SN 85-268,342, FILED 3-16-2011.

JESSICA A. POWERS, EXAMINING ATTORNEY



David J. Kyffers

Director of the United States Patent and Trademark Office

United States of America

United States Patent and Trademark Office



Reg. No. 4,155,313

Registered June 5, 2012

Int. Cl.: 41

SERVICE MARK

PRINCIPAL REGISTER

FIRST CONNECTION, INC. (MARYLAND CORPORATION)
9 NEWPORT DRIVE
FOREST HILL, MD 21015

FOR: EDUCATION SERVICES, NAMELY, PROVIDING CLASSES, SEMINARS, AND WORKSHOPS TO PRESCHOOL TEACHERS AND CHILD CARE PROVIDERS IN THE FIELDS OF CHILD CARE AND PRESCHOOL EDUCATION; EDUCATIONAL SERVICES, NAMELY, PROVIDING CONTINUING PROFESSIONAL EDUCATION COURSES TO PRESCHOOL TEACHERS AND CHILD CARE PROVIDERS IN THE FIELDS OF CHILD CARE AND PRESCHOOL EDUCATION, IN CLASS 41 (U.S. CLS. 100, 101 AND 107).

FIRST USE 3-2-2010; IN COMMERCE 3-2-2010.

NO CLAIM IS MADE TO THE EXCLUSIVE RIGHT TO USE "EDUCATING OUR EDUCATORS", APART FROM THE MARK AS SHOWN.

THE MARK CONSISTS OF TWO SILHOUETTED AND STYLIZED FIGURES OF AN ADULT AND A CHILD. THE WORDS "FIRST CONNECTION" APPEAR TO THE RIGHT OF THE FIGURES AND A DOTTED HORIZONTAL LINE APPEARS BELOW THE WORDS "FIRST CONNECTION" AND CURVES BENEATH THE FIGURES. THE WORDS "EDUCATING OUR EDUCATORS" APPEAR BELOW THE DOTTED LINE.

SN 85-268,482, FILED 3-16-2011.

B. PARADEWELAI, EXAMINING ATTORNEY



David J. Kyros

Director of the United States Patent and Trademark Office

United States of America

United States Patent and Trademark Office

CONNOISSEUR

Reg. No. 4,155,314

Registered June 5, 2012

Int. Cl.: 28

TRADEMARK

PRINCIPAL REGISTER

SRI SPORTS LIMITED (JAPAN CORPORATION)
6-9, WAKINOHAMA-CHO 3-CHOME, CHUO-KU
KOBE-SHI, HYOGO, JAPAN

FOR: GOLF CLUBS, NAMELY, PUTTERS, IN CLASS 28 (U.S. CLS. 22, 23, 38 AND 50).

FIRST USE 7-0-2011; IN COMMERCE 7-0-2011.

THE MARK CONSISTS OF STANDARD CHARACTERS WITHOUT CLAIM TO ANY PARTICULAR FONT, STYLE, SIZE, OR COLOR.

SN 85-268,596, FILED 3-16-2011.

BARBARA BROWN, EXAMINING ATTORNEY



David J. Kyffers

Director of the United States Patent and Trademark Office

United States of America

United States Patent and Trademark Office

Cowboy Bear Ninja

Reg. No. 4,155,315

Registered June 5, 2012

Int. Cl.: 35

SERVICE MARK

PRINCIPAL REGISTER

DRAKE-MCLAUGHLIN, MIGUEL (UNITED STATES INDIVIDUAL)
APARTMENT #1
56 ST. MARKS PLACE
BROOKLYN, NY 112171932 AND

SELKOWITZ, ADRIAN A (UNITED STATES INDIVIDUAL)
447 NORTH 32ND STREET
HARRISBURG, PA 17111

FOR: ADVERTISING AND PUBLICITY SERVICES, NAMELY, PROMOTING THE GOODS, SERVICES, BRAND IDENTITY AND COMMERCIAL INFORMATION AND NEWS OF THIRD PARTIES THROUGH PRINT, AUDIO, VIDEO, DIGITAL AND ON-LINE MEDIUM; POST-PRODUCTION EDITING SERVICES FOR VIDEO AND AUDIO COMMERCIALS; PREPARING ADVERTISEMENTS FOR OTHERS, NAMELY, PREPARING VIDEO ADVERTISING AND PROMOTIONAL VIDEOS FOR COMMERCIAL USE VIA THE INTERNET AND TELEVISION, DIGITAL CABLE AND VIDEO-ON-DEMAND OR DOWNLOAD; PRODUCING AUDIO OR VIDEO INFOMERCIALS; PRODUCING PROMOTIONAL VIDEOTAPES, VIDEO DISCS, AND AUDIO VISUAL RECORDINGS; PROVIDING A WEB SITE FEATURING BUSINESS INFORMATION IN THE FORM OF AUDIO AND VIDEO INTERVIEWS, TRANSCRIPTS AND OTHER EDUCATIONAL MATERIALS, IN CLASS 35 (U.S. CLS. 100, 101 AND 102).

FIRST USE 5-24-2006; IN COMMERCE 1-1-2011.

THE MARK CONSISTS OF STANDARD CHARACTERS WITHOUT CLAIM TO ANY PARTICULAR FONT, STYLE, SIZE, OR COLOR.

SN 85-268,629, FILED 3-16-2011.

THEODORE MCBRIDE, EXAMINING ATTORNEY



David J. Kyros

Director of the United States Patent and Trademark Office

United States of America

United States Patent and Trademark Office



Reg. No. 4,155,316

SMITH, RUSSELL (UNITED STATES INDIVIDUAL)
1111 SONOMA CT.
LONGWOOD, FL 32750

Registered June 5, 2012

Int. Cl.: 25

FOR: CAPS; FOOTWEAR; JEANS; SHORTS; T-SHIRTS, IN CLASS 25 (U.S. CLS. 22 AND 39).

TRADEMARK

FIRST USE 1-1-2009; IN COMMERCE 1-1-2010.

PRINCIPAL REGISTER

THE MARK CONSISTS OF THE STYLIZED LETTERS "KN" INSIDE A CIRCULAR SHAPED DESIGN. THE LETTERS ARE PLACED VERTICALLY.

SN 85-268,806, FILED 3-16-2011.

KHANH LE, EXAMINING ATTORNEY



David J. Kybas

Director of the United States Patent and Trademark Office

United States of America

United States Patent and Trademark Office

The Furry North Carolinian

Reg. No. 4,155,317

SCHULTZ, SHANNON H (UNITED STATES INDIVIDUAL)
12024 JAMES RICHARD DRIVE
CHARLOTTE, NC 28277

Registered June 5, 2012

Int. Cls.: 18, 20, and 28

FOR: ANIMAL LEASHES; COLLARS FOR PETS, IN CLASS 18 (U.S. CLS. 1, 2, 3, 22 AND 41).

TRADEMARK

FIRST USE 3-5-2012; IN COMMERCE 3-21-2012.

PRINCIPAL REGISTER

FOR: BEDS FOR HOUSEHOLD PETS, IN CLASS 20 (U.S. CLS. 2, 13, 22, 25, 32 AND 50).

FIRST USE 3-5-2012; IN COMMERCE 3-21-2012.

FOR: PET TOYS, IN CLASS 28 (U.S. CLS. 22, 23, 38 AND 50).

FIRST USE 3-5-2012; IN COMMERCE 3-21-2012.

THE MARK CONSISTS OF STANDARD CHARACTERS WITHOUT CLAIM TO ANY PARTICULAR FONT, STYLE, SIZE, OR COLOR.

SN 85-269,014, FILED 3-16-2011.

ELI HELLMAN, EXAMINING ATTORNEY



David J. Kybas

Director of the United States Patent and Trademark Office

United States of America

United States Patent and Trademark Office



Reg. No. 4,155,318

Registered June 5, 2012

Int. Cl.: 25

TRADEMARK

PRINCIPAL REGISTER

HAWTHORNE, STEPHANIE (UNITED STATES INDIVIDUAL)
12250 LAMBERT AVE.
EL MONTE, CA 91732

FOR: CLOTHING, NAMELY, T-SHIRTS AND TANK TOPS, IN CLASS 25 (U.S. CLS. 22 AND 39).

FIRST USE 2-28-2012; IN COMMERCE 2-28-2012.

NO CLAIM IS MADE TO THE EXCLUSIVE RIGHT TO USE "VINTAGE", APART FROM THE MARK AS SHOWN.

THE COLOR(S) BLACK, WHITE AND RED IS/ARE CLAIMED AS A FEATURE OF THE MARK.

THE MARK CONSISTS OF A FRONT VIEW OF AN ANTIQUE CAR IN BLACK AND WHITE WITH A RED HEXAGONAL HOOD ORNAMENT LINED IN BLACK AND THE WORDS "SH VINTAGE ROAD" WRITTEN IN RED FONT ACROSS THE RECTANGULAR-SHAPED BUMPER OF THE CAR.

SN 85-269,067, FILED 3-16-2011.

ANTHONY RINKER, EXAMINING ATTORNEY



David J. Kybas

Director of the United States Patent and Trademark Office

United States of America

United States Patent and Trademark Office

UPSHELF

Reg. No. 4,155,319

ECHO DELTA, INC. (NEVADA CORPORATION)
2658 GRIFFITH PARK BLVD. #265
LOS ANGELES, CA 90039

Registered June 5, 2012

Int. Cl.: 20

FOR: SHELVES, NAMELY, A DETACHABLE SHELF ADAPTABLE TO A PATIO UMBRELLA POLE, TENT OR CANOPY POLE, OR OTHER VERTICAL STRUCTURE, FOR USE PRINCIPALLY AS AN ACCESSORY TO OUTDOOR AND PATIO FURNITURE, IN CLASS 20 (U.S. CLS. 2, 13, 22, 25, 32 AND 50).

TRADEMARK

PRINCIPAL REGISTER

FIRST USE 3-10-2012; IN COMMERCE 4-9-2012.

THE MARK CONSISTS OF STANDARD CHARACTERS WITHOUT CLAIM TO ANY PARTICULAR FONT, STYLE, SIZE, OR COLOR.

SN 85-269,124, FILED 3-17-2011.

KELLEY WELLS, EXAMINING ATTORNEY



David J. Kybas

Director of the United States Patent and Trademark Office

United States of America

United States Patent and Trademark Office



Reg. No. 4,155,320

Registered June 5, 2012

Int. Cls.: 8 and 21

TRADEMARK

PRINCIPAL REGISTER

EVERWARE INTERNATIONAL (CALIFORNIA CORPORATION)
667 FOXHAVEN PL, DIAMOND BAR, CA 91765
DIAMOND BAR, CA 917651054

FOR: BIODEGRADABLE CUTLERY, NAMELY, KNIVES, FORKS AND SPOONS; BOXES SPECIALLY ADAPTED FOR THE STORAGE OF CUTLERY AND FLATWARE; CAN OPENERS; CUTLERY; CUTLERY, NAMELY, FORKS, SPOONS, AND KNIVES; EGG SLICERS; FLATWARE; FLATWARE, NAMELY, FORKS, KNIVES, AND SPOONS; HAND TOOLS, NAMELY, SPATULAS; MEAT TENDERIZER, NAMELY, A KITCHEN MALLET; PIZZA CUTTERS; TABLEWARE, NAMELY, KNIVES, FORKS AND SPOONS, IN CLASS 8 (U.S. CLS. 23, 28 AND 44).

FIRST USE 1-1-2010; IN COMMERCE 1-1-2011.

FOR: BASKETS FOR DOMESTIC USE, NOT OF METAL; BASKETS FOR WASTE PAPER LITTERING; BASKETS OF PLASTIC; BREAD BASKETS FOR DOMESTIC USE; FLOWER BASKETS; LAUNDRY BASKETS; PICNIC BASKETS SOLD EMPTY; PLANT BASKETS; PLASTIC HAND-HELD SHOPPING BASKETS; WASTE BASKETS; BAKEWARE; BARWARE, NAMELY, SELTZER BOTTLES; BEVERAGEWARE; BOTTLE OPENERS; BOTTLE STANDS; BOTTLES, SOLD EMPTY; COFFEE MUGS; COOKING UTENSIL, NAMELY, BATTER DISPENSER; COOKING UTENSILS, NAMELY, GRILL COVERS; COOKING UTENSILS, NAMELY, GRILLS; COOKING UTENSILS, NAMELY, WIRE BASKETS; CORKSCREWS; DISPOSABLE PAPERBOARD BAKEWARE; GLASS BEVERAGEWARE; GLASS MUGS; HOUSEHOLD UTENSILS, NAMELY, SERVING SPOONS, MIXING SPOONS, SLOTTED SPOONS, SERVING TURNERS, SERVING LADLES, STRAINERS, ICE CREAM DISHERS, MIXING PADDLES, SERVING TONGS, KITCHEN SPATULAS, ROLLING PINS; ICE SCOOPS; MEAL TRAYS; MUGS; NAPKIN HOLDERS; NATURAL AND SYNTHETIC FIBER COCO LINERS FITTED FOR PLANT BOXES, PLANT POTS, AND PLANT BASKETS; NON-METALLIC TRAYS; PIZZA PEELS; SERVING FORKS; SERVING LADLES; SERVING PITCHERS HAVING A THUMB SHIELD TO PREVENT A WAITER'S THUMB FROM CONTACTING INTERNAL CONTENTS WHILE POURING; SERVING PLATTERS; SERVING SPOONS; SERVING TONGS; SERVING TRAYS; SERVINGWARE FOR SERVING FOOD AND DRINKS; UTENSILS FOR BARBECUES, NAMELY, FORKS, TONGS, TURNERS, IN CLASS 21 (U.S. CLS. 2, 13, 23, 29, 30, 33, 40 AND 50).



David J. Kyjars

Director of the United States Patent and Trademark Office

FIRST USE 1-1-2011; IN COMMERCE 1-1-2011.

Reg. No. 4,155,320 THE MARK CONSISTS OF A STYLIZED LETTERS "EVERWARE" AND A CIRCLE WITH GRADIENT OUTLINE THICKNESS.

SN 85-269,155, FILED 3-17-2011.

SHAILA SETTLES, EXAMINING ATTORNEY

United States of America

United States Patent and Trademark Office

EX02

Reg. No. 4,155,321

Registered June 5, 2012

Int. Cl.: 4

TRADEMARK

PRINCIPAL REGISTER

SUNMARKS, LLC (DELAWARE LIMITED LIABILITY COMPANY)
2401 PENNSYLVANIA AVENUE, SUITE 111
WILMINGTON, DE 19806

FOR: FUELS, IN CLASS 4 (U.S. CLS. 1, 6 AND 15).

FIRST USE 1-18-2011; IN COMMERCE 1-18-2011.

THE MARK CONSISTS OF STANDARD CHARACTERS WITHOUT CLAIM TO ANY PARTICULAR FONT, STYLE, SIZE, OR COLOR.

SN 85-269,314, FILED 3-17-2011.

DORITT L. CARROLL, EXAMINING ATTORNEY



David J. Kybas

Director of the United States Patent and Trademark Office

United States of America

United States Patent and Trademark Office

SoundView

Reg. No. 4,155,322

Registered June 5, 2012

Int. Cl.: 36

SERVICE MARK

PRINCIPAL REGISTER

TUTTLE, KRIS (UNITED STATES INDIVIDUAL)
UNIT 326
1313 WASHINGTON STREET
BOSTON, MA 02118

FOR: EQUITY CAPITAL INVESTMENT; INFORMATION, ADVISORY, CONSULTANCY AND RESEARCH SERVICES RELATING TO FINANCE AND INVESTMENTS, IN CLASS 36 (U.S. CLS. 100, 101 AND 102).

FIRST USE 11-1-2011; IN COMMERCE 3-15-2012.

THE MARK CONSISTS OF STANDARD CHARACTERS WITHOUT CLAIM TO ANY PARTICULAR FONT, STYLE, SIZE, OR COLOR.

SN 85-269,487, FILED 3-17-2011.

COLLEEN KEARNEY, EXAMINING ATTORNEY



David J. Kyros

Director of the United States Patent and Trademark Office

United States of America

United States Patent and Trademark Office

ONEMAIN

Reg. No. 4,155,323

Registered June 5, 2012

Int. Cl.: 36

SERVICE MARK

PRINCIPAL REGISTER

ONEMAIN FINANCIAL HOLDINGS, INC. (DELAWARE CORPORATION)
1209 ORANGE STREET
WILMINGTON, DE 19801

FOR: FINANCIAL SERVICES, NAMELY, CONSUMER LENDING, CREDIT AND FINANCING SERVICES; CREDIT INSURANCE UNDERWRITING SERVICES; MORTGAGE LENDING SERVICES; LOAN SERVICES; INSURANCE SERVICES, NAMELY, UNDERWRITING, BROKERAGE, ADMINISTRATION AND AGENCY SERVICES IN CONNECTION WITH LIFE, ACCIDENT, DISABILITY, PROPERTY AND CASUALTY, HOMEOWNERS, AUTO, CREDIT, DEBT PROTECTION AND FIRE; INSURANCE ACTUARIAL SERVICES, IN CLASS 36 (U.S. CLS. 100, 101 AND 102).

FIRST USE 7-1-2011; IN COMMERCE 7-1-2011.

THE MARK CONSISTS OF STANDARD CHARACTERS WITHOUT CLAIM TO ANY PARTICULAR FONT, STYLE, SIZE, OR COLOR.

PRIORITY CLAIMED UNDER SEC. 44(D) ON ICELAND APPLICATION NO. 25702010, FILED 9-28-2010.

SN 85-269,690, FILED 3-17-2011.

JOHN GARTNER, EXAMINING ATTORNEY



David J. Kyros

Director of the United States Patent and Trademark Office

United States of America

United States Patent and Trademark Office

ONEMAIN FINANCIAL

Reg. No. 4,155,324

Registered June 5, 2012

Int. Cl.: 36

SERVICE MARK

PRINCIPAL REGISTER

ONEMAIN FINANCIAL HOLDINGS, INC. (DELAWARE CORPORATION)
1209 ORANGE STREET
WILMINGTON, DE 19801

FOR: FINANCIAL SERVICES, NAMELY, CONSUMER LENDING, CREDIT AND FINANCING SERVICES; CREDIT INSURANCE UNDERWRITING SERVICES; MORTGAGE LENDING SERVICES; LOAN SERVICES, IN CLASS 36 (U.S. CLS. 100, 101 AND 102).

FIRST USE 7-1-2011; IN COMMERCE 7-1-2011.

THE MARK CONSISTS OF STANDARD CHARACTERS WITHOUT CLAIM TO ANY PARTICULAR FONT, STYLE, SIZE, OR COLOR.

PRIORITY CLAIMED UNDER SEC. 44(D) ON ICELAND APPLICATION NO. 26722010, FILED 10-11-2010.

NO CLAIM IS MADE TO THE EXCLUSIVE RIGHT TO USE "FINANCIAL", APART FROM THE MARK AS SHOWN.

SN 85-269,706, FILED 3-17-2011.

JOHN GARTNER, EXAMINING ATTORNEY



David J. Kyros

Director of the United States Patent and Trademark Office

United States of America

United States Patent and Trademark Office

THE GOODNESS IS BAKED IN.

Reg. No. 4,155,325

Registered June 5, 2012

Int. Cl.: 30

TRADEMARK

PRINCIPAL REGISTER

S-L SNACKS NATIONAL, LLC (NORTH CAROLINA LIMITED LIABILITY COMPANY)
13024 BALLANTYNE CORP. PL., STE. 900
ATTN: LEGAL DEPT.
CHARLOTTE, NC 28277

FOR: CRACKERS, IN CLASS 30 (U.S. CL. 46).

FIRST USE 3-31-2011; IN COMMERCE 3-31-2011.

THE MARK CONSISTS OF STANDARD CHARACTERS WITHOUT CLAIM TO ANY PARTICULAR FONT, STYLE, SIZE, OR COLOR.

SN 85-269,733, FILED 3-17-2011.

ROBERT C. CLARK JR., EXAMINING ATTORNEY



David J. Kybas

Director of the United States Patent and Trademark Office

United States of America

United States Patent and Trademark Office

BABY SLIPPERS

Reg. No. 4,155,326

GREEN FUSE BOTANICALS, INC. (CALIFORNIA CORPORATION)
220 18TH ST.
SANTA MONICA, CA 90402

Registered June 5, 2012

Int. Cl.: 31

FOR: LIVE PLANTS, NAMELY, STREPTOCARPUS, IN CLASS 31 (U.S. CLS. 1 AND 46).

TRADEMARK

FIRST USE 2-1-2012; IN COMMERCE 2-1-2012.

PRINCIPAL REGISTER

THE MARK CONSISTS OF STANDARD CHARACTERS WITHOUT CLAIM TO ANY PARTICULAR FONT, STYLE, SIZE, OR COLOR.

SN 85-270,127, FILED 3-17-2011.

JOHN DWYER, EXAMINING ATTORNEY



David J. Kybas

Director of the United States Patent and Trademark Office

United States of America

United States Patent and Trademark Office



Reg. No. 4,155,327

Registered June 5, 2012

Int. Cl.: 32

TRADEMARK

PRINCIPAL REGISTER

MARKHAM, THOMAS WOODSON (UNITED STATES INDIVIDUAL)
10901 EQUESTRIAN COURT
RESTON, VA 20190

FOR: NON-ALCOHOLIC COCKTAIL MIXES, IN CLASS 32 (U.S. CLS. 45, 46 AND 48).

FIRST USE 2-25-2012; IN COMMERCE 2-26-2012.

THE MARK CONSISTS OF A GLASS WITH A STEM AND THE STEM IS A NECK TO FEET SILHOUETTE OF A WOMAN. THE WOMAN'S ARMS ARE TO HER SIDE WITH HER HANDS ON HER HIPS. THE WORD "TRIM" APPEARS TO THE LEFT OF THE GLASS STEM AND THE WORD "RITA" APPEARS TO THE RIGHT OF THE GLASS STEM. THERE IS A SLICE OF LIME ON THE RIGHT SIDE RIM OF THE GLASS. THERE IS A MEASURING TAPE BELOW THE BASE OF THE GLASS.

SN 85-270,323, FILED 3-18-2011.

ALICE BENMAMAN, EXAMINING ATTORNEY



David J. Kyffers

Director of the United States Patent and Trademark Office

United States of America

United States Patent and Trademark Office

DFLabs

Reg. No. 4,155,328

Registered June 5, 2012

Int. Cl.: 9

TRADEMARK

PRINCIPAL REGISTER

DFLABS S.R.L. (ITALY CORPORATION)
VIA DELLE MACCHINETTE 27
26013 CREMA CR, ITALY

FOR: COMPUTER SOFTWARE FOR USE IN NETWORK SECURITY, INFORMATION SECURITY STRATEGY, INCIDENT/FRAUD PREVENTION AND RESPONSE, DIGITAL FORENSICS, ELECTRONIC LITIGATION DISCOVERY, LITIGATION SUPPORT, INFOSECURITY TRAINING, INTRUSION PREVENTION, AND LOG AND VULNERABILITY MANAGEMENT, IN CLASS 9 (U.S. CLS. 21, 23, 26, 36 AND 38).

FIRST USE 1-1-2004; IN COMMERCE 1-1-2004.

THE MARK CONSISTS OF STANDARD CHARACTERS WITHOUT CLAIM TO ANY PARTICULAR FONT, STYLE, SIZE, OR COLOR.

SN 85-270,406, FILED 3-18-2011.

JASON TURNER, EXAMINING ATTORNEY



David J. Kybas

Director of the United States Patent and Trademark Office

United States of America

United States Patent and Trademark Office

THE LEGEND OF DRIZZT

Reg. No. 4,155,329

WIZARDS OF THE COAST LLC (DELAWARE LIMITED LIABILITY COMPANY)
1027 NEWPORT AVENUE
PAWTUCKET, RI 02862

Registered June 5, 2012

Int. Cl.: 28

FOR: TOYS, GAMES AND PLAYTHINGS, NAMELY, BOARD GAMES AND ACCESSORIES
FOR USE THEREWITH, IN CLASS 28 (U.S. CLS. 22, 23, 38 AND 50).

TRADEMARK

FIRST USE 10-18-2011; IN COMMERCE 10-18-2011.

PRINCIPAL REGISTER

THE MARK CONSISTS OF STANDARD CHARACTERS WITHOUT CLAIM TO ANY PAR-
TICULAR FONT, STYLE, SIZE, OR COLOR.

OWNER OF U.S. REG. NO. 3,512,975.

SN 85-270,510, FILED 3-18-2011.

REBECCA SMITH, EXAMINING ATTORNEY



David J. Kybas

Director of the United States Patent and Trademark Office

United States of America
United States Patent and Trademark Office

RHAPSODY

Reg. No. 4,155,330

Registered June 5, 2012

Int. Cl.: 11

TRADEMARK

PRINCIPAL REGISTER

LENNOX HEARTH PRODUCTS LLC (DELAWARE LIMITED LIABILITY COMPANY)
1508 ELM HILL PIKE
SUITE 108
NASHVILLE, TN 37210

FOR: FIREPLACES, IN CLASS 11 (U.S. CLS. 13, 21, 23, 31 AND 34).

FIRST USE 2-1-2012; IN COMMERCE 2-1-2012.

THE MARK CONSISTS OF STANDARD CHARACTERS WITHOUT CLAIM TO ANY PARTICULAR FONT, STYLE, SIZE, OR COLOR.

SN 85-270,572, FILED 3-18-2011.

DAVID COLLIER, EXAMINING ATTORNEY



David J. Kyffers

Director of the United States Patent and Trademark Office

United States of America

United States Patent and Trademark Office

ANIMATE

Reg. No. 4,155,331

GARCIA, ANTONIO (UNITED STATES INDIVIDUAL)
15136 PADDOCK ST
SYILMAR, CA 91342

Registered June 5, 2012

Int. Cl.: 25

FOR: CLOTHING;, NAMELY, T-SHIRTS, SHIRTS, LONG SLEEVE T-SHIRTS, POLO SHIRTS, SHORTS, PANTS, SWEATERS, SWEATPANTS, SWEATSHIRTS, TANK TOPS, JACKETS, GLOVES; HEADWEAR, NAMELY, HATS, CAPS AND SCARVES; FOOTWEAR, IN CLASS 25 (U.S. CLS. 22 AND 39).

TRADEMARK

PRINCIPAL REGISTER

FIRST USE 6-18-2011; IN COMMERCE 12-17-2011.

THE MARK CONSISTS OF STANDARD CHARACTERS WITHOUT CLAIM TO ANY PARTICULAR FONT, STYLE, SIZE, OR COLOR.

SN 85-270,714, FILED 3-18-2011.

GRETТА YAO, EXAMINING ATTORNEY



David J. Kybas

Director of the United States Patent and Trademark Office

United States of America

United States Patent and Trademark Office

COOL BEANS

Reg. No. 4,155,332

IGT (NEVADA CORPORATION)
9295 PROTOTYPE DRIVE
RENO, NV 895218986

Registered June 5, 2012

Int. Cl.: 9

FOR: GAMING MACHINES, NAMELY, DEVICES WHICH ACCEPT A WAGER, IN CLASS 9 (U.S. CLS. 21, 23, 26, 36 AND 38).

TRADEMARK

FIRST USE 3-5-2012; IN COMMERCE 3-5-2012.

PRINCIPAL REGISTER

THE MARK CONSISTS OF STANDARD CHARACTERS WITHOUT CLAIM TO ANY PARTICULAR FONT, STYLE, SIZE, OR COLOR.

SN 85-270,858, FILED 3-18-2011.

JAMES LOVELACE, EXAMINING ATTORNEY



David J. Kyros

Director of the United States Patent and Trademark Office

United States of America

United States Patent and Trademark Office

ACG UNIVERSITY

Reg. No. 4,155,333

Registered June 5, 2012

Int. Cl.: 41

SERVICE MARK

PRINCIPAL REGISTER

THE ASSOCIATION FOR CORPORATE GROWTH, INC. (ILLINOIS CORPORATION)
SUITE 2760
71 SOUTH WACKER DRIVE
CHICAGO, IL 60606

FOR: EDUCATIONAL SERVICES, NAMELY, CONDUCTING CLASSES, SEMINARS, CONFERENCES, WORKSHOPS IN THE FIELD OF FINANCIAL SERVICES AND DISTRIBUTION OF TRAINING MATERIAL IN CONNECTION THEREWITH, IN CLASS 41 (U.S. CLS. 100, 101 AND 107).

FIRST USE 6-30-2010; IN COMMERCE 6-30-2010.

THE MARK CONSISTS OF STANDARD CHARACTERS WITHOUT CLAIM TO ANY PARTICULAR FONT, STYLE, SIZE, OR COLOR.

OWNER OF U.S. REG. NOS. 2,816,952, 3,514,522, AND OTHERS.

NO CLAIM IS MADE TO THE EXCLUSIVE RIGHT TO USE "UNIVERSITY", APART FROM THE MARK AS SHOWN.

SN 85-271,097, FILED 3-18-2011.

ANDREA HACK, EXAMINING ATTORNEY



David J. Kybas

Director of the United States Patent and Trademark Office

United States of America

United States Patent and Trademark Office

FREEDOM

Reg. No. 4,155,334

Registered June 5, 2012

Int. Cl.: 22

TRADEMARK

PRINCIPAL REGISTER

TREVOR BRAZILE (UNITED STATES INDIVIDUAL)
720 CR 3051
DECATUR, TX 76234

FOR: ROPES, IN CLASS 22 (U.S. CLS. 1, 2, 7, 19, 22, 42 AND 50).

FIRST USE 7-1-2011; IN COMMERCE 7-1-2011.

THE MARK CONSISTS OF STANDARD CHARACTERS WITHOUT CLAIM TO ANY PARTICULAR FONT, STYLE, SIZE, OR COLOR.

SN 85-271,315, FILED 3-18-2011.

ANGELA DUONG, EXAMINING ATTORNEY



David J. Kybas

Director of the United States Patent and Trademark Office

United States of America

United States Patent and Trademark Office

Turquoise Witch Metaphysical

Reg. No. 4,155,335

WILD OWL, VALERIE (UNITED STATES INDIVIDUAL)
10 UNION ST.
HOPEDALE, MA 01747

Registered June 5, 2012

Int. Cl.: 35

FOR: RETAIL STORE SERVICES FEATURING METAPHYSICAL PRODUCTS, IN CLASS 35 (U.S. CLS. 100, 101 AND 102).

SERVICE MARK

FIRST USE 9-10-2011; IN COMMERCE 9-10-2011.

PRINCIPAL REGISTER

THE MARK CONSISTS OF STANDARD CHARACTERS WITHOUT CLAIM TO ANY PARTICULAR FONT, STYLE, SIZE, OR COLOR.

NO CLAIM IS MADE TO THE EXCLUSIVE RIGHT TO USE "METAPHYSICAL", APART FROM THE MARK AS SHOWN.

SN 85-271,361, FILED 3-18-2011.

ROBIN MITTLER, EXAMINING ATTORNEY



David J. Kyffers

Director of the United States Patent and Trademark Office

United States of America

United States Patent and Trademark Office

SLICK STICK

Reg. No. 4,155,336

BIG FISH AMERICA, L.L.C. (IOWA LIMITED LIABILITY COMPANY)
1001 NAYLOR DR. SE
BEMIDJI, MN 56601

Registered June 5, 2012

Int. Cl.: 28

FOR: FISHING TACKLE, IN CLASS 28 (U.S. CLS. 22, 23, 38 AND 50).

TRADEMARK

FIRST USE 2-1-2012; IN COMMERCE 2-2-2012.

PRINCIPAL REGISTER

THE MARK CONSISTS OF STANDARD CHARACTERS WITHOUT CLAIM TO ANY PARTICULAR FONT, STYLE, SIZE, OR COLOR.

NO CLAIM IS MADE TO THE EXCLUSIVE RIGHT TO USE "STICK", APART FROM THE MARK AS SHOWN.

SN 85-271,525, FILED 3-19-2011.

LAURIE MAYES, EXAMINING ATTORNEY



David J. Kyffers

Director of the United States Patent and Trademark Office

United States of America

United States Patent and Trademark Office

STYLE HUNTERS

Reg. No. 4,155,337

Registered June 5, 2012

Int. Cls.: 35 and 42

SERVICE MARK

PRINCIPAL REGISTER

STYLE HUNTERS, LLC (NORTH CAROLINA LIMITED LIABILITY COMPANY)
3993 FOUNTAIN VILLAGE CIRCLE
HIGH POINT, NC 27265

FOR: CONSULTANCY FOR DEVELOPMENT OF CORPORATE BRAND IMAGE FOR TV, VIDEOS, WEB, PRINT, CATALOG, SOCIAL MEDIA, MOBILE, IN CLASS 35 (U.S. CLS. 100, 101 AND 102).

FIRST USE 3-28-2010; IN COMMERCE 3-28-2010.

FOR: PROVIDING CONSULTANCY ON THE DESIGN OF FASHION, WARDROBE AND PROPS FOR THE ENTERTAINMENT AND ADVERTISING INDUSTRIES, IN CLASS 42 (U.S. CLS. 100 AND 101).

FIRST USE 3-28-2010; IN COMMERCE 3-28-2010.

THE MARK CONSISTS OF STANDARD CHARACTERS WITHOUT CLAIM TO ANY PARTICULAR FONT, STYLE, SIZE, OR COLOR.

NO CLAIM IS MADE TO THE EXCLUSIVE RIGHT TO USE "STYLE", APART FROM THE MARK AS SHOWN.

SN 85-271,994, FILED 3-21-2011.

REBECCA POVARCHUK, EXAMINING ATTORNEY



David J. Kybas

Director of the United States Patent and Trademark Office

United States of America

United States Patent and Trademark Office

NERVES OF STEEL

Reg. No. 4,155,338

Registered June 5, 2012

Int. Cl.: 25

TRADEMARK

PRINCIPAL REGISTER

MOREHEAD, JESSE (UNITED STATES INDIVIDUAL)
502 NORTH UNION STREET
STAFFORD, KS 67578

FOR: SHIRTS, IN CLASS 25 (U.S. CLS. 22 AND 39).

FIRST USE 7-6-2011; IN COMMERCE 1-4-2012.

THE MARK CONSISTS OF STANDARD CHARACTERS WITHOUT CLAIM TO ANY PARTICULAR FONT, STYLE, SIZE, OR COLOR.

SN 85-272,128, FILED 3-21-2011.

STEVEN PEREZ, EXAMINING ATTORNEY



David J. Kybas

Director of the United States Patent and Trademark Office

United States of America
United States Patent and Trademark Office

SQOOKIE

Reg. No. 4,155,339

HASTINGS, RAYMOND P. (UNITED STATES INDIVIDUAL)
29 8TH AVE.

Registered June 5, 2012

HADDON HEIGHTS, NJ 08035

Int. Cl.: 30

FOR: BAKED GOODS, NAMELY, COOKIES AND BAKERY DESSERTS, IN CLASS 30 (U.S. CL. 46).

TRADEMARK

FIRST USE 2-2-2012; IN COMMERCE 2-2-2012.

PRINCIPAL REGISTER

THE MARK CONSISTS OF STANDARD CHARACTERS WITHOUT CLAIM TO ANY PARTICULAR FONT, STYLE, SIZE, OR COLOR.

SN 85-272,400, FILED 3-21-2011.

ANGELA M. MICHELI, EXAMINING ATTORNEY



David J. Kybas

Director of the United States Patent and Trademark Office

United States of America

United States Patent and Trademark Office

ISCULPT

Reg. No. 4,155,340

TRACIE MARTYN INTERNATIONAL LLC (NEW YORK LIMITED LIABILITY COMPANY)
101 FIFTH AVENUE
NEW YORK, NY 10003

Registered June 5, 2012

Int. Cl.: 3

FOR: NON-MEDICATED SKIN CARE PREPARATIONS, IN CLASS 3 (U.S. CLS. 1, 4, 6, 50, 51 AND 52).

TRADEMARK

FIRST USE 3-2-2012; IN COMMERCE 3-2-2012.

PRINCIPAL REGISTER

THE MARK CONSISTS OF STANDARD CHARACTERS WITHOUT CLAIM TO ANY PARTICULAR FONT, STYLE, SIZE, OR COLOR.

SN 85-272,475, FILED 3-21-2011.

WARREN L. OLANDRIA, EXAMINING ATTORNEY



David J. Kybas

Director of the United States Patent and Trademark Office

United States of America

United States Patent and Trademark Office

ANGELES DE ORO

Reg. No. 4,155,341

SAN ANTONIO WINERY, INC. (CALIFORNIA CORPORATION)
737 LAMAR STREET
LOS ANGELES, CA 90031

Registered June 5, 2012

Int. Cl.: 33

FOR: DISTILLED SPIRITS, NAMELY, TEQUILA, IN CLASS 33 (U.S. CLS. 47 AND 49).

TRADEMARK

FIRST USE 3-8-2012; IN COMMERCE 3-20-2012.

PRINCIPAL REGISTER

THE MARK CONSISTS OF STANDARD CHARACTERS WITHOUT CLAIM TO ANY PARTICULAR FONT, STYLE, SIZE, OR COLOR.

THE ENGLISH TRANSLATION OF "ANGELES DE ORO" IN THE MARK IS ANGELS OF GOLD.

SN 85-272,490, FILED 3-21-2011.

JULIE GUTTADAURO, EXAMINING ATTORNEY



David J. Kyffers

Director of the United States Patent and Trademark Office

United States of America

United States Patent and Trademark Office

Cometry

Reg. No. 4,155,342

Registered June 5, 2012

Int. Cl.: 41

SERVICE MARK

PRINCIPAL REGISTER

SONGY3, LLC (TEXAS LIMITED LIABILITY COMPANY), DBA LAUGH LEARN COMETRY,
300 CROCKETT STREET, UNIT 100
AUSTIN, TX 78704

FOR: ENTERTAINMENT AND EDUCATION SERVICES IN THE NATURE OF A SERIES OF
LIVE SHOW PERFORMANCES FEATURING COMEDY AND POETRY, IN CLASS 41 (U.S.
CLS. 100, 101 AND 107).

FIRST USE 4-30-2010; IN COMMERCE 4-30-2010.

THE MARK CONSISTS OF STANDARD CHARACTERS WITHOUT CLAIM TO ANY PAR-
TICULAR FONT, STYLE, SIZE, OR COLOR.

SN 85-272,540, FILED 3-21-2011.

MATTHEW MCDOWELL, EXAMINING ATTORNEY



David J. Kybas

Director of the United States Patent and Trademark Office

United States of America

United States Patent and Trademark Office

MIUSTA

Reg. No. 4,155,343

Registered June 5, 2012

Int. Cl.: 9

TRADEMARK

PRINCIPAL REGISTER

ZHONG RENKANG (CHINA INDIVIDUAL)
NO.31 FURONG ROAD, GUSHU VILLAGE
XIXIANG TOWN, BAOAN DISTRICT
SHENZHEN, CHINA

FOR: CAMCORDERS; CASES FOR PHOTOGRAPHIC APPARATUS; CASES FOR POCKET CALCULATORS; CASES FOR TELEPHONES; COMPUTER KEYBOARDS; COMPUTER PERIPHERAL DEVICES; DISTANCE MEASURING APPARATUS; GALVANIC BATTERIES; PERSONAL SECURITY ALARMS; THEFT ALARMS, IN CLASS 9 (U.S. CLS. 21, 23, 26, 36 AND 38).

FIRST USE 3-10-2011; IN COMMERCE 4-22-2011.

THE MARK CONSISTS OF THE STYLIZED WORD "MIUSTA" WITH THE DOT OF THE CHARACTER I REPLACED BY A HEART, AND A HORIZONTAL CURVED BAND CUTTING THE WORD "MIUSTA" INTO TWO PARTS.

THE WORDING "MIUSTA" HAS NO MEANING IN A FOREIGN LANGUAGE.

SN 85-272,936, FILED 3-22-2011.

KIMBERLY PERRY, EXAMINING ATTORNEY



David J. Kyffers

Director of the United States Patent and Trademark Office

United States of America

United States Patent and Trademark Office

MIUSTA

Reg. No. 4,155,344

Registered June 5, 2012

Int. Cl.: 18

TRADEMARK

PRINCIPAL REGISTER

ZHONG RENKANG (CHINA INDIVIDUAL)
NO.31 FURONG ROAD, GUSHU VILLAGE
XIXIANG TOWN, BAOAN DISTRICT
SHENZHEN, CHINA

FOR: ANIMAL SKINS; BAGS FOR PACKAGING OF LEATHER; COLLARS FOR ANIMALS;
LEATHER; LEATHER FOR FURNITURE; LEATHER STRAPS; MOUNTAINEERING STICKS;
TRAVELLING BAGS; UMBRELLAS, IN CLASS 18 (U.S. CLS. 1, 2, 3, 22 AND 41).

FIRST USE 3-10-2011; IN COMMERCE 4-22-2011.

THE MARK CONSISTS OF THE STYLIZED WORD "MIUSTA" WITH THE DOT OF THE
CHARACTER I REPLACED BY A HEART, AND A HORIZONTAL CURVED BAND CUTTING
THE WORD "MIUSTA" INTO TWO PARTS.

THE WORDING "MIUSTA" HAS NO MEANING IN A FOREIGN LANGUAGE.

SN 85-272,942, FILED 3-22-2011.

KIMBERLY PERRY, EXAMINING ATTORNEY



David J. Kyffers

Director of the United States Patent and Trademark Office

United States of America

United States Patent and Trademark Office

45

Reg. No. 4,155,345

BANOM, INC. (PENNSYLVANIA CORPORATION)
BOX 687
WAYNE, PA 19087

Registered June 5, 2012

Int. Cl.: 9

FOR: PROTECTIVE GLOVES FOR INDUSTRIAL USE, IN CLASS 9 (U.S. CLS. 21, 23, 26, 36 AND 38).

TRADEMARK

FIRST USE 2-16-2012; IN COMMERCE 3-5-2012.

PRINCIPAL REGISTER

THE MARK CONSISTS OF STANDARD CHARACTERS WITHOUT CLAIM TO ANY PARTICULAR FONT, STYLE, SIZE, OR COLOR.

SN 85-273,049, FILED 3-22-2011.

CHRIS WELLS, EXAMINING ATTORNEY



David J. Kyffers

Director of the United States Patent and Trademark Office

United States of America

United States Patent and Trademark Office

Cody Road

Reg. No. 4,155,346

MISSISSIPPI RIVER DISTILLING COMPANY (IOWA LIMITED LIABILITY COMPANY)
PO BOX 801
LE CLAIRE, IA 52753

Registered June 5, 2012

Int. Cl.: 33

FOR: BOURBON; BOURBON WHISKY, IN CLASS 33 (U.S. CLS. 47 AND 49).

TRADEMARK

FIRST USE 12-2-2011; IN COMMERCE 12-2-2011.

PRINCIPAL REGISTER

THE MARK CONSISTS OF STANDARD CHARACTERS WITHOUT CLAIM TO ANY PARTICULAR FONT, STYLE, SIZE, OR COLOR.

SN 85-273,121, FILED 3-22-2011.

GILBERT SWIFT, EXAMINING ATTORNEY



David J. Kybas

Director of the United States Patent and Trademark Office

United States of America

United States Patent and Trademark Office

Zen

Reg. No. 4,155,347

DORA'S NATURALS, INC. (NEW YORK CORPORATION)
21 EMPIRE BLVD.
SOUTH HACKENSACK, NJ 07606

Registered June 5, 2012

Int. Cl.: 30

FOR: FLAVORED AND SWEETENED GELATINS AND EDIBLE GELS, NAMELY, FRUIT GELS MADE WITH FRUIT JUICE, IN CLASS 30 (U.S. CL. 46).

TRADEMARK

FIRST USE 8-23-2011; IN COMMERCE 8-23-2011.

PRINCIPAL REGISTER

THE MARK CONSISTS OF STANDARD CHARACTERS WITHOUT CLAIM TO ANY PARTICULAR FONT, STYLE, SIZE, OR COLOR.

SN 85-273,441, FILED 3-22-2011.

JULIE VEPPUMTHARA, EXAMINING ATTORNEY



David J. Kyros

Director of the United States Patent and Trademark Office

United States of America

United States Patent and Trademark Office

GRIPGUARD

Reg. No. 4,155,348

Registered June 5, 2012

Int. Cl.: 1

TRADEMARK

PRINCIPAL REGISTER

COLOMBIAN SWEEPER COMPANY CSC S.A.S (COLOMBIA SOCIETÀ IN ACCOMANDITA
SEMPLICE (SAS))
CARRERA 34#47-23OFICINA 1
BARRANQUILLA, COLOMBIA

FOR: ANTI-SLIP CHEMICAL PREPARATIONS THAT ARE APPLIED TO HORIZONTAL
SURFACES TO PREVENT SLIP AND FALL ACCIDENTS; ADHESIVES AND GLUES FOR
INDUSTRIAL AND COMMERCIAL USE, IN CLASS 1 (U.S. CLS. 1, 5, 6, 10, 26 AND 46).

FIRST USE 7-20-2007; IN COMMERCE 1-20-2009.

THE MARK CONSISTS OF STANDARD CHARACTERS WITHOUT CLAIM TO ANY PAR-
TICULAR FONT, STYLE, SIZE, OR COLOR.

SN 85-274,101, FILED 3-23-2011.

CHARLOTTE CORWIN, EXAMINING ATTORNEY



David J. Kyffers

Director of the United States Patent and Trademark Office

United States of America

United States Patent and Trademark Office



Reg. No. 4,155,349

Registered June 5, 2012

Int. Cl.: 1

TRADEMARK

PRINCIPAL REGISTER

COLOMBIAN SWEEPER COMPANY CSC S.A.S (COLOMBIA SOCIETÁ IN ACCOMANDITA SEMPLICE (SAS))
CARRERA 34#47-23OFICINA 1
BARRANQUILLA, COLOMBIA

FOR: ANTI-SLIP CHEMICAL PREPARATIONS THAT ARE APPLIED TO HORIZONTAL SURFACES TO PREVENT SLIP AND FALL ACCIDENTS; ADHESIVES AND GLUES FOR INDUSTRIAL AND COMMERCIAL USE, IN CLASS 1 (U.S. CLS. 1, 5, 6, 10, 26 AND 46).

FIRST USE 7-20-2007; IN COMMERCE 1-20-2009.

THE MARK CONSISTS OF WORD "GRIPGUARD" WHEREIN THE WORD "GUARD" IS IN WHITE COLOR AND THE DOT ABOVE THE LETTER "I" OF THE WORD "GRIP" IS IN WHITE COLOR AND THE WORD "GRIP" IS IN GREY COLOR; THE LETTERS "GG" IS WRITTEN ABOVE THE WORD "GRIPGUARD" IN WHITE AND GREY COLOR ON THE ORANGE COLOR BACKGROUND AS SHOWN IN THE MARK.

THE COLOR(S) ORANGE, WHITE AND GREY IS/ARE CLAIMED AS A FEATURE OF THE MARK.

SN 85-274,104, FILED 3-23-2011.

CHARLOTTE CORWIN, EXAMINING ATTORNEY



David J. Kybas

Director of the United States Patent and Trademark Office

United States of America

United States Patent and Trademark Office

SITSCREEN

Reg. No. 4,155,350

Registered June 5, 2012

Int. Cl.: 19

TRADEMARK

PRINCIPAL REGISTER

STORM SOLUTIONS, INC. (CONNECTICUT CORPORATION)
105 NORTH MAIN STREET
ESSEX, CT 06426

FOR: NON-METAL WINDOW SCREENS; NONMETAL WIND PROTECTION SCREENS FOR PROTECTING LARGE OPENINGS SUCH AS LANAIS, STORE FRONTS, WINDOWS, ENTRY WAYS AND GARAGES AGAINST STRONG WINDS AND BLOWING DEBRIS, IN CLASS 19 (U.S. CLS. 1, 12, 33 AND 50).

FIRST USE 4-20-2011; IN COMMERCE 12-14-2011.

THE MARK CONSISTS OF STANDARD CHARACTERS WITHOUT CLAIM TO ANY PARTICULAR FONT, STYLE, SIZE, OR COLOR.

SN 85-274,154, FILED 3-23-2011.

HELENE LIWINSKI, EXAMINING ATTORNEY



David J. Kyros

Director of the United States Patent and Trademark Office

United States of America

United States Patent and Trademark Office

FERVOR

Reg. No. 4,155,351

Registered June 5, 2012

Int. Cl.: 33

TRADEMARK

PRINCIPAL REGISTER

VINA CASA SILVA S.A. (CHILE CORPORATION)
HIJUELA NORTE ANGOSTURA S/N, CASILLA 97
SAN FERNANDO, CHILE

FOR: WINE, IN CLASS 33 (U.S. CLS. 47 AND 49).

FIRST USE 3-15-2012; IN COMMERCE 3-15-2012.

THE MARK CONSISTS OF STANDARD CHARACTERS WITHOUT CLAIM TO ANY PARTICULAR FONT, STYLE, SIZE, OR COLOR.

SN 85-274,195, FILED 3-23-2011.

GEORGE LORENZO, EXAMINING ATTORNEY



David J. Kyros

Director of the United States Patent and Trademark Office

United States of America

United States Patent and Trademark Office

PEDCAT

Reg. No. 4,155,352

Registered June 5, 2012

Int. Cl.: 10

TRADEMARK

PRINCIPAL REGISTER

CURVEBEAM, LLC (DELAWARE LIMITED LIABILITY COMPANY)
175 TITUS AVE., SUITE 300
WARRINGTON, PA 18976

FOR: MEDICAL IMAGING DEVICES, NAMELY, COMPACT CONE BEAM COMPUTED TOMOGRAPHY DEVICES FOR 3-D IMAGING OF FEET IN BOTH LOAD BEARING AND NON-LOAD BEARING POSITIONS, IN CLASS 10 (U.S. CLS. 26, 39 AND 44).

FIRST USE 3-1-2012; IN COMMERCE 3-1-2012.

THE MARK CONSISTS OF STANDARD CHARACTERS WITHOUT CLAIM TO ANY PARTICULAR FONT, STYLE, SIZE, OR COLOR.

SN 85-274,658, FILED 3-23-2011.

MATTHEW MCDOWELL, EXAMINING ATTORNEY



David J. Kybas

Director of the United States Patent and Trademark Office

United States of America

United States Patent and Trademark Office



Reg. No. 4,155,353

Registered June 5, 2012

Int. Cl.: 9

TRADEMARK

PRINCIPAL REGISTER

MEDICOMP SYSTEMS, INC. (VIRGINIA CORPORATION)
14500 AVION PARKWAY, SUITE 175
CHANTILLY, VA 20151

FOR: COMPUTER SOFTWARE FOR CONTROLLING AND MANAGING PATIENT MEDICAL INFORMATION, IN CLASS 9 (U.S. CLS. 21, 23, 26, 36 AND 38).

FIRST USE 8-0-2011; IN COMMERCE 8-0-2011.

THE MARK CONSISTS OF A BLUE BOX CONTAINING A STYLIZED CADUCEUS IN LIGHT BLUE AND WHITE SUPERIMPOSED ON AN ANGEL IN WHITE WITH GRAY ON THE BOTTOM.

THE COLOR(S) BLUE, WHITE, LIGHT BLUE AND GRAY IS/ARE CLAIMED AS A FEATURE OF THE MARK.

SN 85-274,880, FILED 3-23-2011.

CHARLES L. JENKINS, EXAMINING ATTORNEY



David J. Kybas

Director of the United States Patent and Trademark Office

United States of America

United States Patent and Trademark Office

ICONIC

Reg. No. 4,155,354

Registered June 5, 2012

Int. Cl.: 21

TRADEMARK

PRINCIPAL REGISTER

BERRY PLASTICS CORPORATION (DELAWARE CORPORATION)
101 OAKLEY STREET
P.O. BOX 959
EVANSVILLE, IN 477060959

FOR: PLASTIC CUPS, IN CLASS 21 (U.S. CLS. 2, 13, 23, 29, 30, 33, 40 AND 50).

FIRST USE 9-0-2011; IN COMMERCE 9-0-2011.

THE MARK CONSISTS OF STANDARD CHARACTERS WITHOUT CLAIM TO ANY PARTICULAR FONT, STYLE, SIZE, OR COLOR.

SN 85-275,491, FILED 3-24-2011.

LINDA MICKLEBURGH, EXAMINING ATTORNEY



David J. Kybas

Director of the United States Patent and Trademark Office

United States of America

United States Patent and Trademark Office

MUTEX

Reg. No. 4,155,355

CORE PRODUCTS GROUP LLC (MICHIGAN LIMITED LIABILITY COMPANY)
35245 SCHOOLCRAFT ROAD
LIVONIA, MI 48150

Registered June 5, 2012

Int. Cl.: 17

FOR: ACOUSTIC SOUND-PROOFING MATERIAL, NAMELY, ACOUSTICAL INSULATION FOR FLOORS, WALLS OR CEILINGS, IN CLASS 17 (U.S. CLS. 1, 5, 12, 13, 35 AND 50).

TRADEMARK

FIRST USE 3-23-2012; IN COMMERCE 3-23-2012.

PRINCIPAL REGISTER

THE MARK CONSISTS OF STANDARD CHARACTERS WITHOUT CLAIM TO ANY PARTICULAR FONT, STYLE, SIZE, OR COLOR.

SN 85-275,803, FILED 3-24-2011.

LINDA E. BLOHM, EXAMINING ATTORNEY



David J. Kybas

Director of the United States Patent and Trademark Office

United States of America

United States Patent and Trademark Office

WURL

Reg. No. 4,155,356

Registered June 5, 2012

Int. Cl.: 14

TRADEMARK

PRINCIPAL REGISTER

BDSRCO, INC. (DELAWARE CORPORATION)
103 FOULK ROAD, SUITE 202
WILMINGTON, DE 19803

FOR: JEWELRY, IN CLASS 14 (U.S. CLS. 2, 27, 28 AND 50).

FIRST USE 10-1-2009; IN COMMERCE 10-1-2009.

THE MARK CONSISTS OF STANDARD CHARACTERS WITHOUT CLAIM TO ANY PARTICULAR FONT, STYLE, SIZE, OR COLOR.

OWNER OF U.S. REG. NOS. 3,386,143 AND 3,742,838.

SN 85-276,029, FILED 3-24-2011.

MATTHEW MCDOWELL, EXAMINING ATTORNEY



David J. Kyffers

Director of the United States Patent and Trademark Office

United States of America

United States Patent and Trademark Office

REEL LEGENDS

Reg. No. 4,155,357

Registered June 5, 2012

Int. Cl.: 9

TRADEMARK

PRINCIPAL REGISTER

BDSRCO, INC. (DELAWARE CORPORATION)
103 FOULK ROAD, SUITE 202
WILMINGTON, DE 19803

FOR: SUNGLASSES, IN CLASS 9 (U.S. CLS. 21, 23, 26, 36 AND 38).

FIRST USE 11-1-2009; IN COMMERCE 11-1-2009.

THE MARK CONSISTS OF STANDARD CHARACTERS WITHOUT CLAIM TO ANY PARTICULAR FONT, STYLE, SIZE, OR COLOR.

OWNER OF U.S. REG. NO. 2,755,158.

SN 85-276,119, FILED 3-24-2011.

MATTHEW MCDOWELL, EXAMINING ATTORNEY



David J. Kyffers

Director of the United States Patent and Trademark Office

United States of America

United States Patent and Trademark Office

PAYMATE

Reg. No. 4,155,358

Registered June 5, 2012

Int. Cl.: 35

SERVICE MARK

PRINCIPAL REGISTER

NEWSOM, LINDA J. (UNITED STATES INDIVIDUAL)
1215 SOVEREIGN ROW
OKLAHOMA CITY, OK 73108

FOR: ADMINISTRATION OF BUSINESS PAYROLL FOR OTHERS; PAYROLL ADMINISTRATION AND MANAGEMENT SERVICES; PAYROLL PREPARATION; PAYROLL PROCESSING SERVICES; WAGE PAYROLL PREPARATION; PAYROLL TAX DEBITING SERVICES; PROFESSIONAL EMPLOYER ORGANIZATION SERVICES IN THE NATURE OF EMPLOYEE LEASING; EMPLOYEE LEASING, IN CLASS 35 (U.S. CLS. 100, 101 AND 102).

FIRST USE 1-1-2012; IN COMMERCE 1-1-2012.

THE MARK CONSISTS OF STANDARD CHARACTERS WITHOUT CLAIM TO ANY PARTICULAR FONT, STYLE, SIZE, OR COLOR.

SN 85-276,134, FILED 3-24-2011.

DANNEAN HETZEL, EXAMINING ATTORNEY



David J. Kyffers

Director of the United States Patent and Trademark Office

United States of America

United States Patent and Trademark Office

COPELAND X-REF

Reg. No. 4,155,359

Registered June 5, 2012

Int. Cl.: 9

TRADEMARK

PRINCIPAL REGISTER

EMERSON CLIMATE TECHNOLOGIES, INC. (DELAWARE CORPORATION)
1675 WEST CAMPBELL ROAD
SIDNEY, OH 453650699

FOR: COMPUTER APPLICATION SOFTWARE FOR MOBILE PHONES AND FOR SMART-
PHONES, NAMELY, COMPUTER SOFTWARE FOR USE IN CROSS REFERENCING COMP-
RESSOR MODEL INFORMATION; DOWNLOADABLE SOFTWARE IN THE NATURE OF
A MOBILE APPLICATION FOR USE IN CROSS REFERENCING COMPRESSOR MODEL
INFORMATION, IN CLASS 9 (U.S. CLS. 21, 23, 26, 36 AND 38).

FIRST USE 9-21-2011; IN COMMERCE 9-21-2011.

THE MARK CONSISTS OF STANDARD CHARACTERS WITHOUT CLAIM TO ANY PAR-
TICULAR FONT, STYLE, SIZE, OR COLOR.

OWNER OF U.S. REG. NOS. 890,471, 3,697,065, AND OTHERS.

SN 85-276,222, FILED 3-24-2011.

MICHAEL TANNER, EXAMINING ATTORNEY



David J. Kyros

Director of the United States Patent and Trademark Office

United States of America

United States Patent and Trademark Office

BLACK-I

Reg. No. 4,155,360

Registered June 5, 2012

Int. Cl.: 9

TRADEMARK

PRINCIPAL REGISTER

BLACK-I TECHNOLOGIES, LLC (FLORIDA LIMITED LIABILITY COMPANY)
10023 BAY HARBOR TERR
BAY HARBOR IS., FL 33154

FOR: COMPUTER UTILITY SOFTWARE; COMPUTER SOFTWARE FOR USE IN MAINTENANCE OF COMPUTER SECURITY AND PREVENTION OF COMPUTER RISKS , IN CLASS 9 (U.S. CLS. 21, 23, 26, 36 AND 38).

FIRST USE 2-18-2012; IN COMMERCE 2-18-2012.

THE MARK CONSISTS OF STANDARD CHARACTERS WITHOUT CLAIM TO ANY PARTICULAR FONT, STYLE, SIZE, OR COLOR.

SN 85-276,449, FILED 3-25-2011.

CHRIS WELLS, EXAMINING ATTORNEY



David J. Kybas

Director of the United States Patent and Trademark Office

United States of America

United States Patent and Trademark Office

SURESTART

Reg. No. 4,155,361

Registered June 5, 2012

Int. Cl.: 9

TRADEMARK

PRINCIPAL REGISTER

CLINICAL INK, INC. (NORTH CAROLINA CORPORATION)
100 N. CHERRY STREET, SUITE 520
WINSTON-SALEM, NC 27101

FOR: COMPUTER SOFTWARE USED TO CAPTURE AND ORGANIZE CLINICAL TRIAL PROTOCOL REQUIREMENTS, DATA FIELD EDIT CHECKS AND ASSOCIATED INFORMATION REQUIRED TO CREATE ELECTRONIC SOURCE DOCUMENTS, IN CLASS 9 (U.S. CLS. 21, 23, 26, 36 AND 38).

FIRST USE 8-9-2011; IN COMMERCE 8-9-2011.

THE MARK CONSISTS OF STANDARD CHARACTERS WITHOUT CLAIM TO ANY PARTICULAR FONT, STYLE, SIZE, OR COLOR.

SN 85-276,567, FILED 3-25-2011.

REBECCA SMITH, EXAMINING ATTORNEY



David J. Kyffers

Director of the United States Patent and Trademark Office

United States of America

United States Patent and Trademark Office

DRIVEN TO MAKE A DIFFERENCE

Reg. No. 4,155,362

Registered June 5, 2012

Int. Cl.: 36

SERVICE MARK

PRINCIPAL REGISTER

UNITED AUTO CREDIT CORPORATION (CALIFORNIA CORPORATION)
18191 VON KARMAN AVENUE, SUITE 300
IRVINE, CA 92612

FOR: LOAN FINANCING SERVICES, IN CLASS 36 (U.S. CLS. 100, 101 AND 102).

FIRST USE 5-18-2011; IN COMMERCE 5-18-2011.

THE MARK CONSISTS OF STANDARD CHARACTERS WITHOUT CLAIM TO ANY PARTICULAR FONT, STYLE, SIZE, OR COLOR.

SN 85-277,064, FILED 3-25-2011.

DANNEAN HETZEL, EXAMINING ATTORNEY



David J. Kybas

Director of the United States Patent and Trademark Office

United States of America

United States Patent and Trademark Office

YOUR FAMILY CROSS

Reg. No. 4,155,363

Registered June 5, 2012

Int. Cl.: 14

TRADEMARK

PRINCIPAL REGISTER

J.S. JOHNSON, LTD. (OHIO LIMITED LIABILITY COMPANY)
5025 ARLINGTON CENTRE BLVD., SUITE 130
COLUMBUS, OH 43220

FOR: JEWELLERY AND PRECIOUS STONES; JEWELRY, IN CLASS 14 (U.S. CLS. 2, 27, 28 AND 50).

FIRST USE 11-17-2011; IN COMMERCE 11-17-2011.

THE MARK CONSISTS OF STANDARD CHARACTERS WITHOUT CLAIM TO ANY PARTICULAR FONT, STYLE, SIZE, OR COLOR.

NO CLAIM IS MADE TO THE EXCLUSIVE RIGHT TO USE "CROSS", APART FROM THE MARK AS SHOWN.

SN 85-277,250, FILED 3-25-2011.

AMY C. KEAN, EXAMINING ATTORNEY



David J. Kappas

Director of the United States Patent and Trademark Office

United States of America

United States Patent and Trademark Office

LIGHTCRAFTERS

Reg. No. 4,155,364

Registered June 5, 2012

Int. Cl.: 9

TRADEMARK

PRINCIPAL REGISTER

S A S SAFETY CORP. (CALIFORNIA CORPORATION)
3031 GARDENIA AVENUE
LONG BEACH, CA 90807

FOR: BIFOCAL MAGNIFYING LENSES WITH BUILT-IN LED LIGHTS, IN CLASS 9 (U.S. CLS. 21, 23, 26, 36 AND 38).

FIRST USE 12-1-2011; IN COMMERCE 12-1-2011.

THE MARK CONSISTS OF STANDARD CHARACTERS WITHOUT CLAIM TO ANY PARTICULAR FONT, STYLE, SIZE, OR COLOR.

SN 85-277,563, FILED 3-25-2011.

STEVEN PEREZ, EXAMINING ATTORNEY



David J. Kybas

Director of the United States Patent and Trademark Office

United States of America

United States Patent and Trademark Office

Sportsona

Reg. No. 4,155,365

Registered June 5, 2012

Int. Cl.: 45

SERVICE MARK

PRINCIPAL REGISTER

HANCE, DONALD (UNITED STATES INDIVIDUAL)
339 SWARTHMORE AVE.
PACIFIC PALISADES, CA 90272

FOR: SOCIAL NETWORKING VIA A WEBSITE, IN CLASS 45 (U.S. CLS. 100 AND 101).

FIRST USE 12-24-2008; IN COMMERCE 10-10-2011.

THE MARK CONSISTS OF STANDARD CHARACTERS WITHOUT CLAIM TO ANY PARTICULAR FONT, STYLE, SIZE, OR COLOR.

SN 85-277,803, FILED 3-26-2011.

JANICE L. MCMORROW, EXAMINING ATTORNEY



David J. Kyffers

Director of the United States Patent and Trademark Office

United States of America
United States Patent and Trademark Office

Amporium

Reg. No. 4,155,366

SZYMANSKI, ERIK (UNITED STATES INDIVIDUAL)
131 WINNING WAY
CANONSBURG, PA 15317

Registered June 5, 2012

Int. Cl.: 35

FOR: PROVIDING ON-LINE DIRECTORY INFORMATION SERVICES ALSO FEATURING
HYPERLINKS TO OTHER WEB SITES, IN CLASS 35 (U.S. CLS. 100, 101 AND 102).

SERVICE MARK

FIRST USE 11-15-2011; IN COMMERCE 3-6-2012.

PRINCIPAL REGISTER

THE MARK CONSISTS OF STANDARD CHARACTERS WITHOUT CLAIM TO ANY PAR-
TICULAR FONT, STYLE, SIZE, OR COLOR.

SN 85-277,817, FILED 3-26-2011.

CHARISMA HAMPTON, EXAMINING ATTORNEY



David J. Kybas

Director of the United States Patent and Trademark Office

United States of America

United States Patent and Trademark Office

Deep from the Dead Sea

Reg. No. 4,155,367

Registered June 5, 2012

Int. Cl.: 3

TRADEMARK

PRINCIPAL REGISTER

CRYSTALLINE HEALTH & BEAUTY FROM THE DEAD SEA LTD (ISRAEL CORPORATION)
CORDOVA 6
TEL AVIV, ISRAEL 62487

FOR: ALOE VERA GEL FOR COSMETIC PURPOSES; ANTI-AGING CREAM; ANTI-AGING CREAMS; ANTI-AGING MOISTURIZER; ANTI-AGING TONER; ANTI-WRINKLE CREAM; ANTI-WRINKLE CREAMS; AROMATIC BODY CARE PRODUCTS, NAMELY, BODY LOTION, SHOWER GEL, CUTICLE CREAM, SHAMPOO, CONDITIONER, NON-MEDICATED LIP BALM, SOAP, BODY POLISH, BODY AND FOOT SCRUB AND NON-MEDICATED FOOT CREAM; BATH AND SHOWER GELS AND SALTS NOT FOR MEDICAL PURPOSES; BATH BEADS; BATH CREAM; BATH CRYSTALS; BATH FIZZIES; BATH FLAKES; BATH FOAM; BATH FOAMS; BATH GEL; BATH GELS; BATH LOTION; BATH MILKS; BATH OIL; BATH OILS; BATH OILS AND BATH SALTS; BATH OILS FOR COSMETIC PURPOSES; BATH SALTS; BATH SOAPS; BATH SOAPS IN LIQUID, SOLID OR GEL FORM; BATHING LOTIONS; BEAUTY LOTIONS; BODY LOTION; BODY LOTIONS; BODY OIL; BODY SCRUB; BUBBLE BATH; COSMETIC BATH SALTS; COSMETIC CREAMS FOR SKIN CARE; COSMETIC OILS; COSMETIC PREPARATIONS FOR BATH AND SHOWER; COSMETIC PREPARATIONS FOR PROTECTING THE SKIN FROM THE SUN'S RAYS; COSMETIC PREPARATIONS FOR SKIN CARE; COSMETIC PREPARATIONS FOR SKIN RENEWAL; COSMETIC SKIN FRESHENERS; COSMETICS IN THE FORM OF MILKS, LOTIONS AND EMULSIONS; CUTICLE CREAM; EXFOLIANTS FOR SKIN CARE; EYE GELS; EYE LOTIONS; FACE AND BODY LOTIONS; FACE MILK AND LOTIONS; FACIAL LOTION; FACIAL SCRUBS; FACIAL WASHES; FOAM BATH; FOOT SCRUBS; FRAGRANCED BODY CARE PREPARATIONS, NAMELY, SALT SCRUB; GIFT BASKETS CONTAINING NON-MEDICATED BATH PREPARATIONS AND COSMETIC PREPARATIONS; HAIR SHAMPOO; HAIR SHAMPOOS AND CONDITIONERS; HAND SCRUBS; LIQUID BATH SOAPS; LIQUID SOAP USED IN FOOT BATH; LOTIONS FOR COSMETIC PURPOSES; LOTIONS FOR FACE AND BODY CARE; MINERAL SALT IN THE NATURE OF BATH SALTS NOT FOR MEDICAL PURPOSES; MOISTURIZING PREPARATIONS FOR THE SKIN; MOISTURIZING SOLUTIONS FOR THE SKIN; NON-MEDICATED ANTI-AGING SERUM; NON-MEDICATED BATH PREPARATIONS; NON-MEDICATED BATH SALTS; NON-MEDICATED BUBBLE BATH PREPARATIONS; NON-MEDICATED FOOT LOTIONS; NON-MEDICATED PREPARATIONS ALL FOR THE CARE OF SKIN, HAIR AND SCALP; NON-MEDICATED SKIN CARE CREAMS AND LOTIONS; NON-MEDICATED SKIN CARE PREPARATION, NAMELY, BODY MIST; NON-MEDICATED SKIN CARE PREPARATIONS; NON-MEDICATED SKIN CARE PREPARATIONS, NAMELY, CREAMS, LOTIONS, GELS, TONERS, CLEANERS AND PEELS; NON-MEDICATED SKIN CREAMS; NON-MEDICATED SKIN CREAMS WITH ESSENTIAL OILS



David J. Kappas

Director of the United States Patent and Trademark Office

Reg. No. 4,155,367 FOR USE IN AROMATHERAPY; NON-MEDICATED STIMULATING LOTIONS FOR THE SKIN; OIL BATHS FOR HAIR CARE; SCENTED BATHING SALTS; SHAMPOO-CONDITIONERS; SHAMPOOS; SHOWER AND BATH FOAM; SHOWER AND BATH GEL; SHOWER GEL; SHOWER GELS; SKIN CARE PREPARATIONS, NAMELY, SKIN PEELS; SKIN CARE PRODUCTS, NAMELY, NON-MEDICATED SKIN SERUM; SKIN CLEANSERS; SKIN CLEANSING CREAM; SKIN CLEANSING LOTION; SKIN CONDITIONERS; SKIN CONDITIONING CREAMS FOR COSMETIC PURPOSES; SKIN CREAM; SKIN CREAMS; SKIN CREAMS IN LIQUID AND IN SOLID FORM; SKIN CREAMS IN LIQUID AND SOLID; SKIN LOTION; SKIN LOTIONS; SKIN MASKS; SKIN MOISTURIZER; SKIN MOISTURIZER MASKS; SKIN MOISTURIZING GEL; SKIN SOAP; SKIN TONERS ALL OF THE FOREGOING GOODS CONSISTING IN WHOLE OR SIGNIFICANT PART OF MINERALS OR OTHER INGREDIENTS FROM THE DEAD SEA, IN CLASS 3 (U.S. CLS. 1, 4, 6, 50, 51 AND 52).

FIRST USE 11-23-2011; IN COMMERCE 12-20-2011.

THE MARK CONSISTS OF STANDARD CHARACTERS WITHOUT CLAIM TO ANY PARTICULAR FONT, STYLE, SIZE, OR COLOR.

NO CLAIM IS MADE TO THE EXCLUSIVE RIGHT TO USE "FROM THE DEAD SEA", APART FROM THE MARK AS SHOWN.

SN 85-278,012, FILED 3-27-2011.

JENNIFER MARTIN, EXAMINING ATTORNEY

United States of America

United States Patent and Trademark Office



Reg. No. 4,155,368

Registered June 5, 2012

Int. Cls.: 2 and 16

TRADEMARK

PRINCIPAL REGISTER

DECOART, INC. (KENTUCKY CORPORATION)
P.O. BOX 297
STANFORD, KY 40484

FOR: PAINTS; VARNISHES, IN CLASS 2 (U.S. CLS. 6, 11 AND 16).

FIRST USE 5-27-2011; IN COMMERCE 5-27-2011.

FOR: ARTISTS' BRUSHES; PAINT BRUSHES; EASELS; CANVAS FOR PAINTING; PATTERNS FOR PAINTING; PRINTED INSTRUCTIONAL, EDUCATIONAL, AND TEACHING MATERIALS IN THE FIELD OF DECORATIVE PAINTING, IN CLASS 16 (U.S. CLS. 2, 5, 22, 23, 29, 37, 38 AND 50).

FIRST USE 5-27-2011; IN COMMERCE 5-27-2011.

NO CLAIM IS MADE TO THE EXCLUSIVE RIGHT TO USE "PAINT", APART FROM THE MARK AS SHOWN.

THE COLOR(S) BROWN, TAN, WHITE, DARK BLUE, LIGHT BLUE, GREEN, PINK, DARK GRAY, LIGHT GRAY AND BLACK IS/ARE CLAIMED AS A FEATURE OF THE MARK.



David J. Kyjars

Director of the United States Patent and Trademark Office

THE MARK CONSISTS OF THE WORD "SOCIAL" IN GREEN LETTERS ABOVE THE WORD "ARTWORKING" WITH THE LETTERS "ARTWORK" IN A DARK GRAY AND THE LETTERS "ING" IN LIGHT GRAY ABOVE A PINK BOX OUTLINED IN GREEN WITH THE WORDS "PAINT CONNECT CREATE" IN WHITE LETTERS WITH THE WORDS SEPARATED BY WHITE DOTS ALL CONTAINED IN THE BOX; TO THE LEFT OF A WORDS "SOCIAL ARTWORKING" IS A FEMALE SILHOUETTE IN PINK HOLDING A PINK PAINT BRUSH AND A PINK PAINT PALETTE IN FRONT OF A FEMALE SILHOUETTE IN GREEN HOLDING A GREEN PAINT BRUSH AND A GREEN PAINT PALETTE, BOTH OF WHICH ARE IN FRONT OF A FIGURE OF A FEMALE PAINTER WITH TAN SKIN, BLACK AND BROWN HAIR AND WEARING A DARK BLUE SHIRT, A LIGHT BLUE SKIRT, AND A WHITE APRON AND HOLDING A LIGHT GRAY PAINT BRUSH AND A LIGHT GRAY PAINT PALETTE WITH PINK, GREEN AND DARK BLUE PAINT THEREON; TO THE RIGHT OF THE WORD "SOCIAL" IS A LIGHT GRAY EASEL HOLDING A PAINTING OF A PINK DRINK IN A BLACK-OUTLINED MARTINI GLASS ON A GREEN BACKGROUND WITH TWO WHITE DOTS ON THE SURFACE OF THE DRINK, PINK BUBBLES ARISING FROM THE DRINK, A BLACK SWIZZLE STICK WITH A DARK BLUE AND BLACK SPHERE ON

Reg. No. 4,155,368 THE SWIZZLE STICK AND THREE WHITE STARBURSTS SURROUNDING THE MARTINI GLASS.

SN 85-278,202, FILED 3-28-2011.

MARY CRAWFORD, EXAMINING ATTORNEY

United States of America

United States Patent and Trademark Office

GLADIATOR

Reg. No. 4,155,369

Registered June 5, 2012

Int. Cl.: 10

TRADEMARK

PRINCIPAL REGISTER

OPTEC USA, INC. (GEORGIA CORPORATION)
975 PROGRESS CIRCLE
LAWRENCEVILLE, GA 30043

FOR: KNEE BRACES FOR MEDICAL USE, IN CLASS 10 (U.S. CLS. 26, 39 AND 44).

FIRST USE 1-13-2012; IN COMMERCE 1-13-2012.

THE MARK CONSISTS OF STANDARD CHARACTERS WITHOUT CLAIM TO ANY PARTICULAR FONT, STYLE, SIZE, OR COLOR.

SN 85-278,203, FILED 3-28-2011.

CHRISTINE COOPER, EXAMINING ATTORNEY



David J. Kyros

Director of the United States Patent and Trademark Office

United States of America

United States Patent and Trademark Office

MORE THAN A LANDLORD. YOUR
PARTNER.

Reg. No. 4,155,370

GENERAL ELECTRIC COMPANY (NEW YORK CORPORATION)
1 RIVER ROAD
SCHENECTADY, NY 12345

Registered June 5, 2012

Int. Cl.: 36

FOR: LEASING OF REAL ESTATE; REAL ESTATE BROKERAGE; REAL ESTATE CONSULTATION; REAL ESTATE MANAGEMENT SERVICES, IN CLASS 36 (U.S. CLS. 100, 101 AND 102).

SERVICE MARK

FIRST USE 3-25-2011; IN COMMERCE 3-25-2011.

PRINCIPAL REGISTER

THE MARK CONSISTS OF STANDARD CHARACTERS WITHOUT CLAIM TO ANY PARTICULAR FONT, STYLE, SIZE, OR COLOR.

SN 85-278,396, FILED 3-28-2011.

BRIAN NEVILLE, EXAMINING ATTORNEY



David J. Kybas

Director of the United States Patent and Trademark Office

United States of America

United States Patent and Trademark Office



Reg. No. 4,155,371

Registered June 5, 2012

Int. Cl.: 35

LOS ANGELES POLICE PROTECTIVE LEAGUE (CALIFORNIA NON-PROFIT CORPORATION)
1308 WEST EIGHTH STREET
SUITE 200
LOS ANGELES, CA 90017

SERVICE MARK

FOR: PROMOTING PUBLIC AWARENESS OF THE IMPORTANCE OF PUBLIC SAFETY AND CRIME PREVENTION, IN CLASS 35 (U.S. CLS. 100, 101 AND 102).

PRINCIPAL REGISTER

FIRST USE 2-17-2011; IN COMMERCE 2-17-2011.

NO CLAIM IS MADE TO THE EXCLUSIVE RIGHT TO USE "PUBLIC SAFETY", APART FROM THE MARK AS SHOWN.

THE MARK CONSISTS OF THE WORDS "PUBLIC SAFETY" ABOVE THE WORD "FIRST" WITH THE PROFILE OF A POLICE OFFICER AND TWO CITIZENS WITHIN THE BOUNDARIES OF A RECTANGULAR BOX.

SN 85-278,413, FILED 3-28-2011.

PAUL MORENO, EXAMINING ATTORNEY



David J. Kyffers

Director of the United States Patent and Trademark Office

United States of America

United States Patent and Trademark Office



Reg. No. 4,155,372

Registered June 5, 2012

Int. Cls.: 14, 21, and 25

TRADEMARK

PRINCIPAL REGISTER

YIANOLATOS, LINDA (UNITED STATES INDIVIDUAL)
165 TURRELL AVENUE
SOUTH ORANGE, NJ 07079

FOR: JEWELRY, IN CLASS 14 (U.S. CLS. 2, 27, 28 AND 50).

FIRST USE 1-25-2012; IN COMMERCE 1-25-2012.

FOR: DRINKING VESSELS, IN CLASS 21 (U.S. CLS. 2, 13, 23, 29, 30, 33, 40 AND 50).

FIRST USE 1-25-2012; IN COMMERCE 1-25-2012.

FOR: HEADWEAR; TOPS, IN CLASS 25 (U.S. CLS. 22 AND 39).

FIRST USE 1-25-2012; IN COMMERCE 1-25-2012.

THE MARK CONSISTS OF SEMICIRCLE FLOWER DESIGN WITH HEART SHAPE AT CENTER SURROUNDED BY THE TERMS "WE ARE ETERNAL WE ARE ETERNAL WE ARE ETERNAL WE ARE ETERNAL".

SN 85-278,473, FILED 3-28-2011.

COLLEEN KEARNEY, EXAMINING ATTORNEY



David J. Kyros

Director of the United States Patent and Trademark Office

United States of America

United States Patent and Trademark Office

vinmota

Reg. No. 4,155,373

MATTHEW LUDWICK (UNITED STATES INDIVIDUAL)
908 NORTH ROSE STREET
BURBANK, CA 91505

Registered June 5, 2012

Int. Cl.: 25

FOR: ATHLETIC APPAREL, NAMELY, SHIRTS, JACKETS, HATS AND CAPS, IN CLASS 25 (U.S. CLS. 22 AND 39).

TRADEMARK

FIRST USE 2-3-2012; IN COMMERCE 2-3-2012.

PRINCIPAL REGISTER

THE MARK CONSISTS OF STANDARD CHARACTERS WITHOUT CLAIM TO ANY PARTICULAR FONT, STYLE, SIZE, OR COLOR.

SN 85-278,483, FILED 3-28-2011.

COLLEEN KEARNEY, EXAMINING ATTORNEY



David J. Kybas

Director of the United States Patent and Trademark Office

United States of America

United States Patent and Trademark Office

LOOK LOCAL

Reg. No. 4,155,374

Registered June 5, 2012

Int. Cl.: 9

TRADEMARK

PRINCIPAL REGISTER

THE 3/50 PROJECT LLC (MINNESOTA LIMITED LIABILITY COMPANY)
4241 LEGEND LANE
GOLDEN VALLEY, MN 55422

FOR: DOWNLOADABLE SOFTWARE FOR MOBILE DEVICES, CELLULAR PHONES, PERSONAL COMMUNICATIONS SERVICE (PCS) PHONES, PERSONAL DIGITAL ASSISTANTS (PDAS), HANDHELD COMPUTERS, COMPUTERS, PORTABLE MEDIA PLAYERS FOR USE IN SEARCHING FOR, RETRIEVING AND BROWSING INFORMATION, WEBSITES AND OTHER RESOURCES AND FOR COMMUNICATING BETWEEN USERS; MOBILE DEVICE SOFTWARE APPLICATION FOR USE IN SEARCHING FOR, RETRIEVING AND BROWSING BUSINESS LISTINGS, WEBSITES, ADDRESSES, TELEPHONE NUMBERS AND OTHER INFORMATION AND FOR ENABLING USERS TO UPLOAD, POST, SHOW, DISPLAY, TAG, BLOG, SHARE OR OTHERWISE PROVIDE ELECTRONIC MEDIA OR INFORMATION OVER THE INTERNET OR OTHER COMMUNICATION NETWORKS, IN CLASS 9 (U.S. CLS. 21, 23, 26, 36 AND 38).

FIRST USE 8-9-2011; IN COMMERCE 8-9-2011.

THE MARK CONSISTS OF STANDARD CHARACTERS WITHOUT CLAIM TO ANY PARTICULAR FONT, STYLE, SIZE, OR COLOR.

NO CLAIM IS MADE TO THE EXCLUSIVE RIGHT TO USE "LOCAL", APART FROM THE MARK AS SHOWN.

SN 85-278,549, FILED 3-28-2011.

SANI KHOURI, EXAMINING ATTORNEY



David J. Kyffers

Director of the United States Patent and Trademark Office

United States of America

United States Patent and Trademark Office

PRETTYTROUBLE

Reg. No. 4,155,375

PRETTYTROUBLE, LLC (PENNSYLVANIA LIMITED LIABILITY COMPANY)
563 SWAPE PIKE
SCHWENKSVILLE, PA 19374

Registered June 5, 2012

Int. Cl.: 16

FOR: GREETING CARDS; NOTE BOOKS; NOTE PADS; PRINTED PAPER SIGNS, IN CLASS 16 (U.S. CLS. 2, 5, 22, 23, 29, 37, 38 AND 50).

TRADEMARK

FIRST USE 2-14-2012; IN COMMERCE 2-14-2012.

PRINCIPAL REGISTER

THE MARK CONSISTS OF STANDARD CHARACTERS WITHOUT CLAIM TO ANY PARTICULAR FONT, STYLE, SIZE, OR COLOR.

SN 85-278,931, FILED 3-28-2011.

MICHAEL WIENER, EXAMINING ATTORNEY



David J. Kybas

Director of the United States Patent and Trademark Office

United States of America

United States Patent and Trademark Office

ESTANZAS

Reg. No. 4,155,376

Registered June 5, 2012

Int. Cl.: 35

SERVICE MARK

PRINCIPAL REGISTER

WORLD TRADE VALLEY, INC (FLORIDA CORPORATION)
STE 204
10901 NW 83 STREET
MIAMI, FL 33178

FOR: PROVIDING A SEARCHABLE ONLINE ADVERTISING WEBSITE AND INFORMATIONAL GUIDE FEATURING THE GOODS AND SERVICES OF OTHER VENDORS VIA THE INTERNET IN THE FIELD OF HOTELS , IN CLASS 35 (U.S. CLS. 100, 101 AND 102).

FIRST USE 4-1-2012; IN COMMERCE 4-1-2012.

THE MARK CONSISTS OF STANDARD CHARACTERS WITHOUT CLAIM TO ANY PARTICULAR FONT, STYLE, SIZE, OR COLOR.

THE WORDING "ESTANZAS" HAS NO MEANING IN A FOREIGN LANGUAGE.

SN 85-279,094, FILED 3-28-2011.

JAMES LOVELACE, EXAMINING ATTORNEY



David J. Kyros

Director of the United States Patent and Trademark Office

United States of America

United States Patent and Trademark Office

OSP ACCENTS

Reg. No. 4,155,377

Registered June 5, 2012

Int. Cl.: 20

TRADEMARK

PRINCIPAL REGISTER

BLUMENTHAL DISTRIBUTING, INC. (CALIFORNIA CORPORATION), DBA OFFICE STAR PRODUCTS, INC.,
1901 SOUTH ARCHIBALD AVENUE
ONTARIO, CA 91761

FOR: OFFICE FURNITURE, IN CLASS 20 (U.S. CLS. 2, 13, 22, 25, 32 AND 50).

FIRST USE 6-7-2011; IN COMMERCE 6-7-2011.

THE MARK CONSISTS OF STANDARD CHARACTERS WITHOUT CLAIM TO ANY PARTICULAR FONT, STYLE, SIZE, OR COLOR.

OWNER OF U.S. REG. NOS. 3,440,465 AND 3,517,819.

NO CLAIM IS MADE TO THE EXCLUSIVE RIGHT TO USE "ACCENTS", APART FROM THE MARK AS SHOWN.

SN 85-279,122, FILED 3-28-2011.

GINA FINK, EXAMINING ATTORNEY



David J. Kyros

Director of the United States Patent and Trademark Office

United States of America

United States Patent and Trademark Office

VITILDERM

Reg. No. 4,155,378

DISPROMEDICA LLC (FLORIDA LIMITED LIABILITY COMPANY)
4640 SW 98 AVE
MIAMI, FL 33165

Registered June 5, 2012

Int. Cl.: 3

FOR: COSMETIC PREPARATIONS FOR BODY CARE, IN CLASS 3 (U.S. CLS. 1, 4, 6, 50, 51 AND 52).

TRADEMARK

FIRST USE 3-15-2012; IN COMMERCE 3-15-2012.

PRINCIPAL REGISTER

THE MARK CONSISTS OF STANDARD CHARACTERS WITHOUT CLAIM TO ANY PARTICULAR FONT, STYLE, SIZE, OR COLOR.

SN 85-279,210, FILED 3-28-2011.

JUDITH HELFMAN, EXAMINING ATTORNEY



David J. Kybas

Director of the United States Patent and Trademark Office

United States of America

United States Patent and Trademark Office

Charitable Giving Made Easy

Reg. No. 4,155,379

Registered June 5, 2012

Int. Cl.: 36

SERVICE MARK

PRINCIPAL REGISTER

DIGITAL PROCESSING SOLUTIONS, INC. (TEXAS CORPORATION)
68 S. SERVICE ROAD, SUITE 100
MELVILLE, NY 11747

FOR: PROVIDING ELECTRONIC PROCESSING OF ELECTRONIC FUNDS TRANSFER, ACH, CREDIT CARD, DEBIT CARD, ELECTRONIC CHECK AND ELECTRONIC PAYMENTS , IN CLASS 36 (U.S. CLS. 100, 101 AND 102).

FIRST USE 2-4-2011; IN COMMERCE 6-14-2011.

THE MARK CONSISTS OF STANDARD CHARACTERS WITHOUT CLAIM TO ANY PARTICULAR FONT, STYLE, SIZE, OR COLOR.

NO CLAIM IS MADE TO THE EXCLUSIVE RIGHT TO USE "CHARITABLE GIVING", APART FROM THE MARK AS SHOWN.

SN 85-279,359, FILED 3-29-2011.

JANET LEE, EXAMINING ATTORNEY



David J. Kyros

Director of the United States Patent and Trademark Office

United States of America

United States Patent and Trademark Office

BLAKE & LAMB

Reg. No. 4,155,380

Registered June 5, 2012

Int. Cl.: 6

TRADEMARK

PRINCIPAL REGISTER

ONEIDA VICTOR, INC., LTD. (OHIO CORPORATION)
P.O. BOX 32398
EUCLID, OH 41132

FOR: WILD ANIMAL TRAPS, IN CLASS 6 (U.S. CLS. 2, 12, 13, 14, 23, 25 AND 50).

FIRST USE 6-23-2011; IN COMMERCE 6-23-2011.

THE MARK CONSISTS OF STANDARD CHARACTERS WITHOUT CLAIM TO ANY PARTICULAR FONT, STYLE, SIZE, OR COLOR.

SN 85-279,377, FILED 3-29-2011.

PAUL MORENO, EXAMINING ATTORNEY



David J. Kybas

Director of the United States Patent and Trademark Office

United States of America
United States Patent and Trademark Office



Reg. No. 4,155,381

Registered June 5, 2012

Int. Cl.: 37

SERVICE MARK

PRINCIPAL REGISTER

NATIONAL ASSOCIATION FOR STOCK CAR AUTO RACING, INC. (FLORIDA CORPORATION)
ATTN: KAREN B. LEETZOW
ONE DAYTONA BOULEVARD
DAYTONA BEACH, FL 32114

FOR: AUTOMOBILE WASHING AND AUTOMOBILE DETAILING SERVICES, IN CLASS 37 (U.S. CLS. 100, 103 AND 106).

FIRST USE 9-15-2011; IN COMMERCE 9-15-2011.

OWNER OF U.S. REG. NOS. 817,553, 1,054,100, AND OTHERS.

NO CLAIM IS MADE TO THE EXCLUSIVE RIGHT TO USE "CAR WASH", APART FROM THE MARK AS SHOWN.

THE MARK CONSISTS OF SLANTED BAR LINES, THE WORDS "NASCAR" AND "CAR WASH" INSIDE AN OVAL DESIGN WITH WATER DROP EFFECT.

SN 85-279,383, FILED 3-29-2011.

SCOTT BIBB, EXAMINING ATTORNEY



David J. Kyffers

Director of the United States Patent and Trademark Office

United States of America

United States Patent and Trademark Office

ADAMANT

Reg. No. 4,155,382

Registered June 5, 2012

Int. Cl.: 9

TRADEMARK

PRINCIPAL REGISTER

CELLCO PARTNERSHIP (DELAWARE PARTNERSHIP), DBA VERIZON WIRELESS,
VC52N058
ONE VERIZON WAY
BASKING RIDGE, NJ 079201097

FOR: WIRELESS TELECOMMUNICATIONS DEVICE FEATURING TRANSMISSION OF VOICE, DATA, IMAGE AND VIDEO, INCLUDING VOICE, TEXT, PICTURE AND VIDEO MESSAGING, INTERNET ACCESS, ACCESS TO NAVIGATION AND DIRECTIONAL SERVICE OVER THE AIR, THE ABILITY TO DOWNLOAD MUSIC, VIDEOS AND APPLICATIONS OVER THE AIR, AND WHICH HAS A MUSIC PLAYER AND A STILL IMAGE AND VIDEO CAMERA, IN CLASS 9 (U.S. CLS. 21, 23, 26, 36 AND 38).

FIRST USE 12-14-2011; IN COMMERCE 12-14-2011.

THE MARK CONSISTS OF STANDARD CHARACTERS WITHOUT CLAIM TO ANY PARTICULAR FONT, STYLE, SIZE, OR COLOR.

SN 85-279,446, FILED 3-29-2011.

GRETCHEN ULRICH, EXAMINING ATTORNEY



David J. Kyffers

Director of the United States Patent and Trademark Office

United States of America

United States Patent and Trademark Office

SHEER COVER

Reg. No. 4,155,383

Registered June 5, 2012

Int. Cl.: 5

TRADEMARK

PRINCIPAL REGISTER

GUTHY-RENKER LLC (DELAWARE LIMITED LIABILITY COMPANY)
41-550 ECLECTIC STREET, SUITE #200
PALM DESERT, CA 92260

FOR: PHARMACEUTICAL PREPARATIONS, NAMELY, VITAMINS, MINERAL SUPPLEMENTS, DIETARY SUPPLEMENTS, NUTRITIONAL SUPPLEMENTS, IN CLASS 5 (U.S. CLS. 6, 18, 44, 46, 51 AND 52).

FIRST USE 1-20-2008; IN COMMERCE 1-20-2008.

THE MARK CONSISTS OF STANDARD CHARACTERS WITHOUT CLAIM TO ANY PARTICULAR FONT, STYLE, SIZE, OR COLOR.

OWNER OF U.S. REG. NOS. 2,729,563 AND 2,823,868.

SN 85-279,748, FILED 3-29-2011.

ANNE E. GUSTASON, EXAMINING ATTORNEY



David J. Kyffers

Director of the United States Patent and Trademark Office

United States of America

United States Patent and Trademark Office

FLORIDA'S WARMEST WELCOME

Reg. No. 4,155,384

Registered June 5, 2012

Int. Cl.: 35

SERVICE MARK

PRINCIPAL REGISTER

CITY OF POMPANO BEACH FLORIDA (FLORIDA MUNICIPAL CORPORATION)
100 WEST ATLANTIC BOULEVARD
POMPANO BEACH, FL 33060

FOR: BUSINESS MARKETING SERVICES, NAMELY, PROMOTING THE ECONOMIC DEVELOPMENT AND TOURISM IN THE CITY OF POMPANO BEACH, FLORIDA , IN CLASS 35 (U.S. CLS. 100, 101 AND 102).

FIRST USE 3-29-2011; IN COMMERCE 3-29-2011.

THE MARK CONSISTS OF STANDARD CHARACTERS WITHOUT CLAIM TO ANY PARTICULAR FONT, STYLE, SIZE, OR COLOR.

NO CLAIM IS MADE TO THE EXCLUSIVE RIGHT TO USE "FLORIDA'S", APART FROM THE MARK AS SHOWN.

SN 85-279,951, FILED 3-29-2011.

BERYL GARDNER, EXAMINING ATTORNEY



David J. Kyros

Director of the United States Patent and Trademark Office

United States of America

United States Patent and Trademark Office

Readerpedia

Reg. No. 4,155,385

Registered June 5, 2012

Int. Cl.: 42

SERVICE MARK

PRINCIPAL REGISTER

PROMETHEUS HOLDINGS, INC. (CALIFORNIA CORPORATION)
22 ANACAPA
SAN CLEMENTE, CA 92673

FOR: COMPUTER SERVICES, NAMELY, CREATING INDEXES OF INFORMATION, SITES, AND OTHER RESOURCES AVAILABLE ON COMPUTER NETWORKS, AND CONVERTING DOCUMENTS FROM PHYSICAL TO ELECTRONIC MEDIA, IN CLASS 42 (U.S. CLS. 100 AND 101).

FIRST USE 12-8-2011; IN COMMERCE 12-8-2011.

THE MARK CONSISTS OF STANDARD CHARACTERS WITHOUT CLAIM TO ANY PARTICULAR FONT, STYLE, SIZE, OR COLOR.

SN 85-280,426, FILED 3-29-2011.

KEVIN CORWIN, EXAMINING ATTORNEY



David J. Kybas

Director of the United States Patent and Trademark Office

United States of America

United States Patent and Trademark Office

ARCISOFT SYSTEMSAVE

Reg. No. 4,155,386

Registered June 5, 2012

Int. Cl.: 9

TRADEMARK

PRINCIPAL REGISTER

ARCISOFT, INC. (CALIFORNIA CORPORATION)
46601 FREMONT BLVD
FREMONT, CA 94538

FOR: COMPUTER SOFTWARE FOR DATA AND SYSTEM PROTECTION, RECOVERY, BACKUP, RESTORATION AND RETRIEVAL, IN CLASS 9 (U.S. CLS. 21, 23, 26, 36 AND 38).

FIRST USE 10-1-2011; IN COMMERCE 10-1-2011.

THE MARK CONSISTS OF STANDARD CHARACTERS WITHOUT CLAIM TO ANY PARTICULAR FONT, STYLE, SIZE, OR COLOR.

OWNER OF U.S. REG. NOS. 2,334,476, 3,091,316, AND OTHERS.

NO CLAIM IS MADE TO THE EXCLUSIVE RIGHT TO USE "SYSTEM SAVE", APART FROM THE MARK AS SHOWN.

SN 85-280,473, FILED 3-29-2011.

SUZANNE BLANE, EXAMINING ATTORNEY



David J. Kyffers

Director of the United States Patent and Trademark Office

United States of America

United States Patent and Trademark Office

Bellflower Mountain Bakery

Reg. No. 4,155,387

Registered June 5, 2012

Int. Cl.: 30

TRADEMARK

PRINCIPAL REGISTER

BROOKSIDE FARMS HOMEMADE (GEORGIA LIMITED LIABILITY COMPANY)
288 HIGHLANDS DRIVE
CLARKESVILLE, GA 30523

FOR: BISCUITS; COOKIES; ROLLS, IN CLASS 30 (U.S. CL. 46).

FIRST USE 3-14-2012; IN COMMERCE 3-14-2012.

THE MARK CONSISTS OF STANDARD CHARACTERS WITHOUT CLAIM TO ANY PARTICULAR FONT, STYLE, SIZE, OR COLOR.

NO CLAIM IS MADE TO THE EXCLUSIVE RIGHT TO USE "BAKERY", APART FROM THE MARK AS SHOWN.

SN 85-280,597, FILED 3-29-2011.

JAMES STEIN, EXAMINING ATTORNEY



David J. Kybas

Director of the United States Patent and Trademark Office

United States of America

United States Patent and Trademark Office

V-360°

Reg. No. 4,155,388

Registered June 5, 2012

Int. Cl.: 11

TRADEMARK

PRINCIPAL REGISTER

ULTRAVIOLET DEVICES, INC. (CALIFORNIA CORPORATION)
26145 TECHNOLOGY DRIVE
VALENCIA, CA 91355

FOR: AIR AND SURFACE DISINFECTION UNITS USING ULTRAVIOLET LAMP FIXTURES,
IN CLASS 11 (U.S. CLS. 13, 21, 23, 31 AND 34).

FIRST USE 9-26-2011; IN COMMERCE 2-27-2012.

THE MARK CONSISTS OF STANDARD CHARACTERS WITHOUT CLAIM TO ANY PAR-
TICULAR FONT, STYLE, SIZE, OR COLOR.

SN 85-280,718, FILED 3-30-2011.

WILLIAM VERHOSEK, EXAMINING ATTORNEY



David J. Kybas

Director of the United States Patent and Trademark Office

United States of America

United States Patent and Trademark Office

WORLDMADE

Reg. No. 4,155,389

Registered June 5, 2012

Int. Cls.: 35 and 42

SERVICE MARK

PRINCIPAL REGISTER

J. WALTER THOMPSON COMPANY (DELAWARE CORPORATION)
466 LEXINGTON AVENUE
NEW YORK, NY 10017

FOR: ADVERTISING AGENCY SERVICES; PUBLIC RELATIONS SERVICES; PUBLICITY SERVICES; DIRECT MARKETING ADVERTISING SERVICES FOR OTHERS; RECRUITMENT ADVERTISING AGENCY SERVICES; MARKETING CONSULTING; MARKET RESEARCH, SURVEYS AND ANALYSIS; MEDIA PLANNING AND BUYING SERVICES, NAMELY, CONSULTING AND ADVISING ON THE APPROPRIATE MEDIA TO ADVERTISE IN, AND PURCHASING MEDIA TIME AND SPACE; PLACING ADVERTISEMENTS FOR OTHERS; SALES PROMOTION SERVICES, NAMELY, PROMOTING THE GOODS AND SERVICES OF VARIOUS INDUSTRIES THROUGH THE DISTRIBUTION OF PROMOTIONAL MATERIALS AND BY RENDERING SALES PROMOTION ADVICE; CUSTOMER RELATIONSHIP MARKETING SERVICES; BUSINESS AND MARKETING CONSULTING SERVICES RELATED TO ADVERTISING, MARKETING AND BRAND DEVELOPMENT; EVENT MARKETING, NAMELY, ARRANGING AND CONDUCTING MARKETING PROMOTIONAL EVENTS FOR OTHERS; DIRECT RESPONSE MARKETING; BUSINESS MARKETING CONSULTING SERVICES RELATING TO BRANDS AND BRAND DEVELOPMENT, ASSESSMENT, ANALYSIS, EXPLOITATION AND PROMOTION; DIGITAL AND INTERACTIVE ADVERTISING; BUSINESS CONSULTING IN THE FIELD OF SPONSORSHIP OF SPORTS AND ENTERTAINMENT EVENTS, IN CLASS 35 (U.S. CLS. 100, 101 AND 102).

FIRST USE 6-1-2011; IN COMMERCE 6-1-2011.



FOR: WEB SITE DESIGN AND DEVELOPMENT SERVICES FOR OTHERS; CONSULTING SERVICES RELATING TO THE CREATION, DEVELOPMENT AND OPERATION OF INTERNET WEBSITES; CONSULTING SERVICES RELATING TO THE USE OF DIGITAL PLATFORMS AND MEDIA IN THE FIELD OF ADVERTISING AND MARKETING; HOSTING INTERNET WEBSITES IN THE FIELD OF ADVERTISING AND MARKETING; GRAPHIC DESIGN SERVICES; RESEARCH AND CONSULTING SERVICES RELATING TO WEBSITE DESIGN, GRAPHIC DESIGN AND PRODUCT AND PACKAGING DESIGN; DESIGN AND DEVELOPMENT OF CONSUMER PRODUCTS AND PACKAGING OF OTHERS; INDUSTRIAL DESIGN SERVICES, IN CLASS 42 (U.S. CLS. 100 AND 101).

FIRST USE 6-1-2011; IN COMMERCE 6-1-2011.

David J. Kyros

Director of the United States Patent and Trademark Office

Reg. No. 4,155,389 THE MARK CONSISTS OF STANDARD CHARACTERS WITHOUT CLAIM TO ANY PARTICULAR FONT, STYLE, SIZE, OR COLOR.

SN 85-281,029, FILED 3-30-2011.

JENNY PARK, EXAMINING ATTORNEY

United States of America

United States Patent and Trademark Office

THE MONDAY LIFE

Reg. No. 4,155,390

Registered June 5, 2012

Int. Cl.: 36

SERVICE MARK

PRINCIPAL REGISTER

MONDAY LIFE, THE (NORTH CAROLINA CORPORATION)
102 FALKNER DRIVE
CHAPEL HILL, NC 27517

FOR: CHARITABLE FUNDRAISING, IN CLASS 36 (U.S. CLS. 100, 101 AND 102).

FIRST USE 11-21-2011; IN COMMERCE 11-21-2011.

THE MARK CONSISTS OF STANDARD CHARACTERS WITHOUT CLAIM TO ANY PARTICULAR FONT, STYLE, SIZE, OR COLOR.

SN 85-281,119, FILED 3-30-2011.

KATHERINE STOIDES, EXAMINING ATTORNEY



David J. Kybas

Director of the United States Patent and Trademark Office

United States of America

United States Patent and Trademark Office

PROVIDING A SOLID DOSE OF INNOVATION

Reg. No. 4,155,391

TIME-CAP LABORATORIES, INC. (NEW YORK CORPORATION)
7 MICHAEL AVENUE
FARMINGDALE, NY 11735

Registered June 5, 2012

Int. Cl.: 40

FOR: CONTRACT MANUFACTURE OF PHARMACEUTICAL PRODUCTS TO THE ORDER
AND SPECIFICATIONS OF OTHERS, IN CLASS 40 (U.S. CLS. 100, 103 AND 106).

SERVICE MARK

FIRST USE 6-1-2011; IN COMMERCE 6-1-2011.

PRINCIPAL REGISTER

THE MARK CONSISTS OF STANDARD CHARACTERS WITHOUT CLAIM TO ANY PAR-
TICULAR FONT, STYLE, SIZE, OR COLOR.

SN 85-281,627, FILED 3-30-2011.

TRACY WHITTAKER-BROWN, EXAMINING ATTORNEY



David J. Kyffers

Director of the United States Patent and Trademark Office

United States of America

United States Patent and Trademark Office

NUTWHATS

Reg. No. 4,155,392

RAST, LISA (UNITED STATES INDIVIDUAL)
11144 E VILLA PARK ST
CHANDLER, AZ 85248

Registered June 5, 2012

Int. Cl.: 30

FOR: CONFECTIONS, NAMELY, BRITTLES, TOFFEES, FUDGE; CHOCOLATE CREATIONS, NAMELY, CHOCOLATE TRUFFLES, LOLLIPOPS, AND CINNAMON AND SUGAR COATED NUTS, IN CLASS 30 (U.S. CL. 46).

TRADEMARK

FIRST USE 10-30-2011; IN COMMERCE 10-30-2011.

PRINCIPAL REGISTER

THE MARK CONSISTS OF STANDARD CHARACTERS WITHOUT CLAIM TO ANY PARTICULAR FONT, STYLE, SIZE, OR COLOR.

SN 85-281,665, FILED 3-30-2011.

CAROLINE WOOD, EXAMINING ATTORNEY



David J. Kybas

Director of the United States Patent and Trademark Office

United States of America

United States Patent and Trademark Office

MADE WHEN YOU'RE READY,
NOT READY-MADE.

Reg. No. 4,155,393

BOB EVANS FARMS, INC. (OHIO CORPORATION)
3776 SOUTH HIGH STREET
COLUMBUS, OH 43207

Registered June 5, 2012

Int. Cl.: 29

FOR: SALADS EXCEPT MACARONI, RICE, AND PASTA SALAD, IN CLASS 29 (U.S. CL. 46).

TRADEMARK

FIRST USE 3-0-2008; IN COMMERCE 3-0-2008.

PRINCIPAL REGISTER

THE MARK CONSISTS OF STANDARD CHARACTERS WITHOUT CLAIM TO ANY PARTICULAR FONT, STYLE, SIZE, OR COLOR.

SN 85-281,763, FILED 3-30-2011.

SUNG IN, EXAMINING ATTORNEY



David J. Kybas

Director of the United States Patent and Trademark Office

United States of America

United States Patent and Trademark Office

SUGARBEET CRUSH

Reg. No. 4,155,394

Registered June 5, 2012

Int. Cls.: 28 and 31

TRADEMARK

PRINCIPAL REGISTER

WILDGAME INNOVATIONS, LLC (LOUISIANA LIMITED LIABILITY COMPANY)
101 CASON ROAD, 1ST FLOOR
BROUSSARD, LA 70518

FOR: DEER ATTRACTANTS IN POWDER FORM, LIQUID FORM OR SOLID BLOCK FORM,
IN CLASS 28 (U.S. CLS. 22, 23, 38 AND 50).

FIRST USE 5-13-2011; IN COMMERCE 5-13-2011.

FOR: DEER FEED IN POWDER FORM, LIQUID FORM OR SOLID BLOCK FORM, IN CLASS
31 (U.S. CLS. 1 AND 46).

FIRST USE 5-13-2011; IN COMMERCE 5-13-2011.

THE MARK CONSISTS OF STANDARD CHARACTERS WITHOUT CLAIM TO ANY PAR-
TICULAR FONT, STYLE, SIZE, OR COLOR.

NO CLAIM IS MADE TO THE EXCLUSIVE RIGHT TO USE "SUGARBEET", APART FROM
THE MARK AS SHOWN.

SN 85-281,836, FILED 3-30-2011.

DOMINIC J. FERRAIUOLO, EXAMINING ATTORNEY



David J. Kyros

Director of the United States Patent and Trademark Office

United States of America

United States Patent and Trademark Office

FLEX THERAPY

Reg. No. 4,155,395

WAHL CLIPPER CORPORATION (ILLINOIS CORPORATION)
2900 NORTH LOCUST STREET
STERLING, IL 61081

Registered June 5, 2012

Int. Cl.: 10

FOR: HAND-HELD MASSAGE APPARATUS, IN CLASS 10 (U.S. CLS. 26, 39 AND 44).

TRADEMARK

FIRST USE 6-0-2011; IN COMMERCE 6-0-2011.

PRINCIPAL REGISTER

THE MARK CONSISTS OF STANDARD CHARACTERS WITHOUT CLAIM TO ANY PARTICULAR FONT, STYLE, SIZE, OR COLOR.

NO CLAIM IS MADE TO THE EXCLUSIVE RIGHT TO USE "THERAPY", APART FROM THE MARK AS SHOWN.

SN 85-282,280, FILED 3-31-2011.

SOPHIA S. KIM, EXAMINING ATTORNEY



David J. Kybas

Director of the United States Patent and Trademark Office

United States of America

United States Patent and Trademark Office

Black Swan

Reg. No. 4,155,396

Registered June 5, 2012

Int. Cl.: 35

SERVICE MARK

PRINCIPAL REGISTER

INTERNATIONAL SECURITIES EXCHANGE, LLC (DELAWARE LIMITED LIABILITY COMPANY)
60 BROAD STREET, 26TH FLOOR
NEW YORK, NY 10004

FOR: COMPILING FINANCIAL, SECURITIES, STOCK EXCHANGE, TRADE AND QUOTE, INDEX VALUE AND OTHER FINANCIAL MARKET INFORMATION FOR BUSINESS PURPOSES, IN CLASS 35 (U.S. CLS. 100, 101 AND 102).

FIRST USE 2-27-2012; IN COMMERCE 2-27-2012.

THE MARK CONSISTS OF STANDARD CHARACTERS WITHOUT CLAIM TO ANY PARTICULAR FONT, STYLE, SIZE, OR COLOR.

SN 85-282,390, FILED 3-31-2011.

WANDA KAY PRICE, EXAMINING ATTORNEY



David J. Kyjars

Director of the United States Patent and Trademark Office

United States of America

United States Patent and Trademark Office

ISE Black Swan

Reg. No. 4,155,397

Registered June 5, 2012

Int. Cl.: 35

SERVICE MARK

PRINCIPAL REGISTER

INTERNATIONAL SECURITIES EXCHANGE, LLC (DELAWARE LIMITED LIABILITY COMPANY)
60 BROAD STREET, 26TH FLOOR
NEW YORK, NY 10004

FOR: COMPILING FINANCIAL, SECURITIES, STOCK EXCHANGE, TRADE AND QUOTE, INDEX VALUE AND OTHER FINANCIAL MARKET INFORMATION FOR BUSINESS PURPOSES, IN CLASS 35 (U.S. CLS. 100, 101 AND 102).

FIRST USE 2-27-2012; IN COMMERCE 2-27-2012.

THE MARK CONSISTS OF STANDARD CHARACTERS WITHOUT CLAIM TO ANY PARTICULAR FONT, STYLE, SIZE, OR COLOR.

SN 85-282,403, FILED 3-31-2011.

WANDA KAY PRICE, EXAMINING ATTORNEY



David J. Kyros

Director of the United States Patent and Trademark Office

United States of America

United States Patent and Trademark Office

DO IT WITH YOUR GLOVES ON

Reg. No. 4,155,398

Registered June 5, 2012

Int. Cls.: 9 and 25

TRADEMARK

PRINCIPAL REGISTER

JMI SPORTSWEAR, PTE. LTD. (SINGAPORE CORPORATION)
10 RAEBURN PARK
SINGAPORE, SINGAPORE 088702

FOR: GLOVES SPECIALLY ADAPTED TO BE USED WITH TOUCH-SENSITIVE DEVICES, NAMELY, TOUCH PADS, TOUCH PANELS AND COMPUTER TOUCH SCREENS; COMPUTER STYLUSES FOR INTERACTING WITH TOUCH-SENSITIVE DEVICES; DEVICES FOR INTERACTING WITH TOUCH-SENSITIVE DEVICES, NAMELY, INSTRUMENTS TO FACILITATE OPERATING THE DEVICES IN THE NATURE OF A STYLUS-TYPE DEVICE ATTACHED TO THE HAND FOR USE IN CONJUNCTION WITH PERSONAL DIGITAL ASSISTANTS, SMARTPHONES AND HANDHELD COMPUTERS, IN CLASS 9 (U.S. CLS. 21, 23, 26, 36 AND 38).

FIRST USE 7-25-2011; IN COMMERCE 7-25-2011.

FOR: CLOTHING, NAMELY, GLOVES INCORPORATING TOUCH-SENSITIVE TECHNOLOGY, IN CLASS 25 (U.S. CLS. 22 AND 39).

FIRST USE 7-25-2011; IN COMMERCE 7-25-2011.

THE MARK CONSISTS OF STANDARD CHARACTERS WITHOUT CLAIM TO ANY PARTICULAR FONT, STYLE, SIZE, OR COLOR.

SN 85-282,488, FILED 3-31-2011.

ROBIN MITTLER, EXAMINING ATTORNEY



David J. Kyros

Director of the United States Patent and Trademark Office

United States of America

United States Patent and Trademark Office

purepractice

Reg. No. 4,155,399

Registered June 5, 2012

Int. Cl.: 38

SERVICE MARK

PRINCIPAL REGISTER

ELECTRONIC REMEDY, INC. (DELAWARE CORPORATION)
20 WESTVIEW RD
NATICK, MA 01760

FOR: ELECTRONIC DATA INTERCHANGE SERVICES IN THE FIELD OF HEALTHCARE TRANSACTIONS SUCH AS CLAIMS, ELIGIBILITY, CLAIM STATUS, ELECTRONIC REMITTANCE ADVICE, PRIOR AUTHORIZATIONS, ATTACHMENTS AND REFERRALS THAT ALLOW DIRECT TRANSACTION AND PAYMENT COMMUNICATIONS BETWEEN HEALTHCARE PROVIDERS AND PAYERS, IN CLASS 38 (U.S. CLS. 100, 101 AND 104).

FIRST USE 1-27-2010; IN COMMERCE 10-19-2011.

THE MARK CONSISTS OF STANDARD CHARACTERS WITHOUT CLAIM TO ANY PARTICULAR FONT, STYLE, SIZE, OR COLOR.

SN 85-282,884, FILED 3-31-2011.

MICHAEL ENGEL, EXAMINING ATTORNEY



David J. Kybas

Director of the United States Patent and Trademark Office

United States of America

United States Patent and Trademark Office

HELLO FLAWLESS OXYGEN WOW

Reg. No. 4,155,400

Registered June 5, 2012

Int. Cl.: 3

TRADEMARK

PRINCIPAL REGISTER

BENEFIT COSMETICS LLC (DELAWARE LIMITED LIABILITY COMPANY)
225 BUSH STREET, 20TH FLOOR
SAN FRANCISCO, CA 94104

FOR: COSMETICS; FOUNDATION, IN CLASS 3 (U.S. CLS. 1, 4, 6, 50, 51 AND 52).

FIRST USE 11-0-2011; IN COMMERCE 2-0-2012.

THE MARK CONSISTS OF STANDARD CHARACTERS WITHOUT CLAIM TO ANY PARTICULAR FONT, STYLE, SIZE, OR COLOR.

OWNER OF U.S. REG. NO. 3,652,510.

NO CLAIM IS MADE TO THE EXCLUSIVE RIGHT TO USE "OXYGEN", APART FROM THE MARK AS SHOWN.

SN 85-282,961, FILED 3-31-2011.

PAM WILLIS, EXAMINING ATTORNEY



David J. Kyros

Director of the United States Patent and Trademark Office

United States of America

United States Patent and Trademark Office

G UNIVERSITY

Reg. No. 4,155,401

Registered June 5, 2012

Int. Cl.: 41

SERVICE MARK

PRINCIPAL REGISTER

GREEN STREET DEVELOPMENT, LLC (ARIZONA LIMITED LIABILITY COMPANY)
8390 E VIA DE VENTURA STE F-110
SCOTTSDALE, AZ 85258

FOR: EDUCATION SERVICES, NAMELY, PROVIDING TUTORIAL SESSIONS IN THE
FIELD OF LEADERSHIP IN ENERGY AND ENVIRONMENTAL DESIGN (LEED), IN CLASS
41 (U.S. CLS. 100, 101 AND 107).

FIRST USE 1-31-2011; IN COMMERCE 1-31-2011.

THE MARK CONSISTS OF STANDARD CHARACTERS WITHOUT CLAIM TO ANY PAR-
TICULAR FONT, STYLE, SIZE, OR COLOR.

NO CLAIM IS MADE TO THE EXCLUSIVE RIGHT TO USE "UNIVERSITY", APART FROM
THE MARK AS SHOWN.

SN 85-283,029, FILED 3-31-2011.

BRENDAN MCCAULEY, EXAMINING ATTORNEY



David J. Kyffers

Director of the United States Patent and Trademark Office

United States of America

United States Patent and Trademark Office

G BUILD

Reg. No. 4,155,402

Registered June 5, 2012

Int. Cl.: 35

SERVICE MARK

PRINCIPAL REGISTER

GREEN STREET DEVELOPMENT, LLC (ARIZONA LIMITED LIABILITY COMPANY)
8390 E VIA DE VENTURA STE F-110
SCOTTSDALE, AZ 85258

FOR: CONSULTATION IN THE FIELD OF ENERGY EFFICIENCY RELATED TO CONSTRUCTION FOR IMPROVING THE ENERGY EFFICIENCY OF EXISTING RESIDENTIAL BUILDINGS, IN CLASS 35 (U.S. CLS. 100, 101 AND 102).

FIRST USE 1-31-2011; IN COMMERCE 1-31-2011.

THE MARK CONSISTS OF STANDARD CHARACTERS WITHOUT CLAIM TO ANY PARTICULAR FONT, STYLE, SIZE, OR COLOR.

NO CLAIM IS MADE TO THE EXCLUSIVE RIGHT TO USE "BUILD", APART FROM THE MARK AS SHOWN.

SN 85-283,037, FILED 3-31-2011.

BRENDAN MCCAULEY, EXAMINING ATTORNEY



David J. Kyros

Director of the United States Patent and Trademark Office

United States of America

United States Patent and Trademark Office



Reg. No. 4,155,403

Registered June 5, 2012

Int. Cl.: 7

TRADEMARK

PRINCIPAL REGISTER

HI-TECH COMPRESSOR & PUMP PRODUCTS, INC. (PENNSYLVANIA CORPORATION)
1113 BRANAGAN DRIVE
TULLYTOWN, PA 19007

FOR: RECIPROCATING COMPRESSOR PISTON ROD PACKING USED TO CONTROL FUGITIVE EMISSIONS, IN CLASS 7 (U.S. CLS. 13, 19, 21, 23, 31, 34 AND 35).

FIRST USE 3-31-2011; IN COMMERCE 5-10-2011.

THE MARK CONSISTS OF A STYLIZED HORIZONTAL LINE/BAR BELOW THE STYLIZED TEXT "EFPACKING".

SN 85-283,058, FILED 3-31-2011.

CIMMERIAN COLEMAN, EXAMINING ATTORNEY



David J. Kybas

Director of the United States Patent and Trademark Office

United States of America

United States Patent and Trademark Office

G HOME

Reg. No. 4,155,404

Registered June 5, 2012

Int. Cl.: 35

SERVICE MARK

PRINCIPAL REGISTER

GREEN STREET DEVELOPMENT, LLC (ARIZONA LIMITED LIABILITY COMPANY)
8390 E VIA DE VENTURA STE F-110
SCOTTSDALE, AZ 85258

FOR: CONSULTATION IN THE FIELD OF ENERGY EFFICIENCY RELATED TO CONSTRUCTION FOR IMPROVING THE ENERGY EFFICIENCY OF EXISTING RESIDENTIAL BUILDINGS, IN CLASS 35 (U.S. CLS. 100, 101 AND 102).

FIRST USE 1-31-2011; IN COMMERCE 1-31-2011.

THE MARK CONSISTS OF STANDARD CHARACTERS WITHOUT CLAIM TO ANY PARTICULAR FONT, STYLE, SIZE, OR COLOR.

NO CLAIM IS MADE TO THE EXCLUSIVE RIGHT TO USE "HOME", APART FROM THE MARK AS SHOWN.

SN 85-283,089, FILED 3-31-2011.

BRENDAN MCCAULEY, EXAMINING ATTORNEY



David J. Kyros

Director of the United States Patent and Trademark Office

United States of America

United States Patent and Trademark Office

TAIL WAGGIN' FUN

Reg. No. 4,155,405

Registered June 5, 2012

Int. Cl.: 28

TRADEMARK

PRINCIPAL REGISTER

INNOVATIVE DESIGN & SOURCING, LLC (CONNECTICUT LIMITED LIABILITY COMPANY)
175 CARMEN ROAD
MILFORD, CT 06460

FOR: TOYS FOR DOMESTIC PETS, IN CLASS 28 (U.S. CLS. 22, 23, 38 AND 50).

FIRST USE 11-14-2011; IN COMMERCE 12-9-2011.

THE MARK CONSISTS OF STANDARD CHARACTERS WITHOUT CLAIM TO ANY PARTICULAR FONT, STYLE, SIZE, OR COLOR.

SN 85-283,368, FILED 4-1-2011.

ERIN FALK, EXAMINING ATTORNEY



David J. Kybas

Director of the United States Patent and Trademark Office

United States of America

United States Patent and Trademark Office

MASTER SHAPE

Reg. No. 4,155,406

L'OREAL USA CREATIVE, INC. (DELAWARE CORPORATION)
575 FIFTH AVENUE
NEW YORK, NY 10017

Registered June 5, 2012

Int. Cl.: 3

FOR: COSMETICS, NAMELY, EYEBROW LINERS AND PENCILS, IN CLASS 3 (U.S. CLS. 1, 4, 6, 50, 51 AND 52).

TRADEMARK

FIRST USE 1-0-2012; IN COMMERCE 1-0-2012.

PRINCIPAL REGISTER

THE MARK CONSISTS OF STANDARD CHARACTERS WITHOUT CLAIM TO ANY PARTICULAR FONT, STYLE, SIZE, OR COLOR.

SN 85-283,435, FILED 4-1-2011.

CHARLOTTE CORWIN, EXAMINING ATTORNEY



David J. Kybas

Director of the United States Patent and Trademark Office

United States of America

United States Patent and Trademark Office

BLACK COUNTESS

Reg. No. 4,155,407

Registered June 5, 2012

Int. Cl.: 33

TRADEMARK

PRINCIPAL REGISTER

VAL DU CHARRON WINES (PTY) LTD (SOUTH AFRICA PROPRIETARY LIMITED
COMPANY (P/L OR PTY. LTD.))
RIALTO ROAD, GRAND MOORINGS PRECINCT
C/O MAZARS, MAZARS HOUSE
CENTURY CITY, SOUTH AFRICA 7441

FOR: ALCOHOLIC BEVERAGES EXCEPT BEERS, IN CLASS 33 (U.S. CLS. 47 AND 49).

FIRST USE 9-1-2011; IN COMMERCE 9-1-2011.

THE MARK CONSISTS OF STANDARD CHARACTERS WITHOUT CLAIM TO ANY PARTICULAR FONT, STYLE, SIZE, OR COLOR.

SN 85-283,470, FILED 4-1-2011.

TAMARA FRAZIER, EXAMINING ATTORNEY



David J. Kybas

Director of the United States Patent and Trademark Office

United States of America

United States Patent and Trademark Office

CRYOSCIENCE by Taylor-Wharton

Reg. No. 4,155,408

Registered June 5, 2012

Int. Cls.: 6 and 11

TRADEMARK

PRINCIPAL REGISTER

TW CRYOGENICS LLC (DELAWARE CORPORATION)
4075 HAMILTON BOULEVARD
THEODORE, AL 36582

FOR: CRYOGENIC PRODUCTS, NAMELY, BULK METAL STORAGE TANKS, METAL LIQUID CYLINDERS AND HIGH PRESSURE CYLINDERS SOLD EMPTY, IN CLASS 6 (U.S. CLS. 2, 12, 13, 14, 23, 25 AND 50).

FIRST USE 3-1-2010; IN COMMERCE 3-1-2010.

FOR: CRYOGENIC PRODUCTS, NAMELY, FREEZERS, REFRIGERATORS AND DEWARS, IN CLASS 11 (U.S. CLS. 13, 21, 23, 31 AND 34).

FIRST USE 3-1-2010; IN COMMERCE 3-1-2010.

THE MARK CONSISTS OF STANDARD CHARACTERS WITHOUT CLAIM TO ANY PARTICULAR FONT, STYLE, SIZE, OR COLOR.

OWNER OF U.S. REG. NO. 2,197,016.

NO CLAIM IS MADE TO THE EXCLUSIVE RIGHT TO USE "CRYOSCIENCE", APART FROM THE MARK AS SHOWN.

SN 85-283,691, FILED 4-1-2011.

MATTHEW MCDOWELL, EXAMINING ATTORNEY



David J. Kyros

Director of the United States Patent and Trademark Office

United States of America

United States Patent and Trademark Office

CRYOSCIENCE

by Taylor-Wharton

Reg. No. 4,155,409

Registered June 5, 2012

Int. Cls.: 6 and 11

TRADEMARK

PRINCIPAL REGISTER

TW CRYOGENICS LLC (DELAWARE CORPORATION)
4075 HAMILTON BOULEVARD
THEODORE, AL 36582

FOR: CRYOGENIC PRODUCTS, NAMELY, BULK METAL STORAGE TANKS, METAL LIQUID CYLINDERS AND HIGH PRESSURE CYLINDERS SOLD EMPTY, IN CLASS 6 (U.S. CLS. 2, 12, 13, 14, 23, 25 AND 50).

FIRST USE 3-1-2010; IN COMMERCE 3-1-2010.

FOR: CRYOGENIC PRODUCTS, NAMELY, FREEZERS, REFRIGERATORS AND DEWARS, IN CLASS 11 (U.S. CLS. 13, 21, 23, 31 AND 34).

FIRST USE 3-1-2010; IN COMMERCE 3-1-2010.

OWNER OF U.S. REG. NO. 2,197,016.

NO CLAIM IS MADE TO THE EXCLUSIVE RIGHT TO USE "CRYOSCIENCE", APART FROM THE MARK AS SHOWN.

THE MARK CONSISTS OF THE WORD "CRYOSCIENCE" WITH THE CENTER OF THE FIRST "C" CONTAINING A SHADED CIRCLE FILLED WITH 14 SMALLER UNSHADED CIRCLES AND THE WORDS "BY TAYLOR-WHARTON" ON THE SECOND LINE OFFSET TO THE RIGHT UNDER "SCIENCE".

SN 85-283,695, FILED 4-1-2011.

MATTHEW MCDOWELL, EXAMINING ATTORNEY

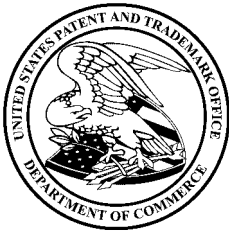

David J. Kybas

Director of the United States Patent and Trademark Office

United States of America

United States Patent and Trademark Office

NEVER SO LITE

Reg. No. 4,155,410

GROUP III INTERNATIONAL LTD., INC. (FLORIDA CORPORATION)
2981 W. MCNAB ROAD
POMPANO BEACH, FL 33069

Registered June 5, 2012

Int. Cl.: 18

FOR: BACKPACKS; BRIEFCASES; CARRY-ON BAGS; HANDBAGS; LUGGAGE; TOTE BAGS, IN CLASS 18 (U.S. CLS. 1, 2, 3, 22 AND 41).

TRADEMARK

FIRST USE 8-9-2011; IN COMMERCE 8-9-2011.

PRINCIPAL REGISTER

THE MARK CONSISTS OF STANDARD CHARACTERS WITHOUT CLAIM TO ANY PARTICULAR FONT, STYLE, SIZE, OR COLOR.

SN 85-283,750, FILED 4-1-2011.

SHAUNIA CARLYLE, EXAMINING ATTORNEY



David J. Kybas

Director of the United States Patent and Trademark Office

United States of America

United States Patent and Trademark Office

GHOUL BOX

Reg. No. 4,155,411

Registered June 5, 2012

Int. Cl.: 9

TRADEMARK

PRINCIPAL REGISTER

MATTEL, INC. (DELAWARE CORPORATION)
M1-1518
333 CONTINENTAL BOULEVARD
EL SEGUNDO, CA 90245

FOR: VIDEO GAME SOFTWARE FOR MOBILE DEVICES AND TABLETS, IN CLASS 9 (U.S. CLS. 21, 23, 26, 36 AND 38).

FIRST USE 2-15-2012; IN COMMERCE 2-15-2012.

THE MARK CONSISTS OF STANDARD CHARACTERS WITHOUT CLAIM TO ANY PARTICULAR FONT, STYLE, SIZE, OR COLOR.

SN 85-283,792, FILED 4-1-2011.

ASMAT KHAN, EXAMINING ATTORNEY



David J. Kyros

Director of the United States Patent and Trademark Office

United States of America

United States Patent and Trademark Office

WNEZBILL

Reg. No. 4,155,412

Registered June 5, 2012

Int. Cl.: 9

TRADEMARK

PRINCIPAL REGISTER

CDOC, INC. (DELAWARE CORPORATION)
11825 N. PENNSYLVANIA STREET
CARMEL, IN 46032

FOR: COMPUTER SOFTWARE FOR USE IN SUPPORTING AN ELECTRONIC INSURANCE APPLICATION SYSTEM, IN CLASS 9 (U.S. CLS. 21, 23, 26, 36 AND 38).

FIRST USE 9-1-2011; IN COMMERCE 9-1-2011.

THE MARK CONSISTS OF STANDARD CHARACTERS WITHOUT CLAIM TO ANY PARTICULAR FONT, STYLE, SIZE, OR COLOR.

SN 85-283,876, FILED 4-1-2011.

MATTHEW KLINE, EXAMINING ATTORNEY



David J. Kappas

Director of the United States Patent and Trademark Office

United States of America

United States Patent and Trademark Office

WNEZAPP2.0

Reg. No. 4,155,413

CDOC, INC. (DELAWARE CORPORATION)
11825 N. PENNSYLVANIA STREET
CARMEL, IN 46032

Registered June 5, 2012

Int. Cl.: 9

FOR: COMPUTER SOFTWARE FOR USE IN SUPPORTING AN ELECTRONIC INSURANCE APPLICATION SYSTEM, IN CLASS 9 (U.S. CLS. 21, 23, 26, 36 AND 38).

TRADEMARK

FIRST USE 9-1-2011; IN COMMERCE 9-1-2011.

PRINCIPAL REGISTER

THE MARK CONSISTS OF STANDARD CHARACTERS WITHOUT CLAIM TO ANY PARTICULAR FONT, STYLE, SIZE, OR COLOR.

SN 85-283,879, FILED 4-1-2011.

MATTHEW KLINE, EXAMINING ATTORNEY



David J. Kappas

Director of the United States Patent and Trademark Office

United States of America

United States Patent and Trademark Office

WNBIZLINK.COM

Reg. No. 4,155,414

Registered June 5, 2012

Int. Cls.: 35 and 36

SERVICE MARK

PRINCIPAL REGISTER

CDOC, INC. (DELAWARE CORPORATION)
11825 N. PENNSYLVANIA STREET
CARMEL, IN 19102

FOR: INSURANCE SERVICES, NAMELY, PROVIDING POLICY RATES AND PRODUCT INFORMATION FOR ALL TYPES OF INSURANCE, PROVIDING FORMS FOR INSURANCE SALES AND INSURANCE CLAIMS, IN CLASS 35 (U.S. CLS. 100, 101 AND 102).

FIRST USE 9-1-2011; IN COMMERCE 9-1-2011.

FOR: PROVIDING ONLINE AND ELECTRONIC PROCESSING OF INSURANCE APPLICATIONS AND ACCESS TO SALES AND PAYMENT DATA OVER A WEB-BASED COMPUTER NETWORK, IN CLASS 36 (U.S. CLS. 100, 101 AND 102).

FIRST USE 9-1-2011; IN COMMERCE 9-1-2011.

THE MARK CONSISTS OF STANDARD CHARACTERS WITHOUT CLAIM TO ANY PARTICULAR FONT, STYLE, SIZE, OR COLOR.

OWNER OF U.S. REG. NOS. 3,263,912, 3,263,914, AND OTHERS.

SN 85-283,904, FILED 4-1-2011.

MATTHEW KLINE, EXAMINING ATTORNEY



David J. Kyros

Director of the United States Patent and Trademark Office

United States of America

United States Patent and Trademark Office

WNEZAPPOINT

Reg. No. 4,155,415

CDOC, INC. (DELAWARE CORPORATION)
11825 N. PENNSYLVANIA STREET
CARMEL, IN 46032

Registered June 5, 2012

Int. Cl.: 35

FOR: BUSINESS SERVICES, NAMELY, PROVIDING ONLINE, NON-DOWNLOADABLE PUBLICATIONS IN THE NATURE OF AN INTERVIEW TEMPLATE FOR USE IN ENTERING INTO CONTRACTUAL RELATIONSHIPS WITH INSURANCE COMPANIES, IN CLASS 35 (U.S. CLS. 100, 101 AND 102).

SERVICE MARK

PRINCIPAL REGISTER

FIRST USE 9-1-2011; IN COMMERCE 9-1-2011.

THE MARK CONSISTS OF STANDARD CHARACTERS WITHOUT CLAIM TO ANY PARTICULAR FONT, STYLE, SIZE, OR COLOR.

OWNER OF U.S. REG. NOS. 3,263,912, 3,263,914, AND OTHERS.

SN 85-283,920, FILED 4-1-2011.

MATTHEW KLINE, EXAMINING ATTORNEY



David J. Kypas

Director of the United States Patent and Trademark Office

United States of America

United States Patent and Trademark Office

WNEZLEAD

Reg. No. 4,155,416

Registered June 5, 2012

Int. Cl.: 35

SERVICE MARK

PRINCIPAL REGISTER

CDOC, INC. (DELAWARE CORPORATION)
11825 N. PENNSYLVANIA STREET
CARMEL, IN 46032

FOR: ADVERTISING AND BUSINESS SERVICES, NAMELY, GENERATION OF INSURANCE SALES MATERIALS FOR USE WITH PROSPECTIVE CLIENTS, IN CLASS 35 (U.S. CLS. 100, 101 AND 102).

FIRST USE 9-1-2011; IN COMMERCE 9-1-2011.

THE MARK CONSISTS OF STANDARD CHARACTERS WITHOUT CLAIM TO ANY PARTICULAR FONT, STYLE, SIZE, OR COLOR.

OWNER OF U.S. REG. NOS. 3,263,912, 3,263,914, AND OTHERS.

SN 85-283,947, FILED 4-1-2011.

MATTHEW KLINE, EXAMINING ATTORNEY



David J. Kyffers

Director of the United States Patent and Trademark Office

United States of America

United States Patent and Trademark Office

RockMesh

Reg. No. 4,155,417

RAW ENERGY MATERIALS CORPORATION (FLORIDA CORPORATION)
1200 SOUTH DIXIE HIGHWAY WEST
POMPANO BEACH, FL 33060

Registered June 5, 2012

Int. Cl.: 19

FOR: NON-METALLIC REINFORCEMENTS FOR CONCRETE BUILDING CONSTRUCTION,
NAMELY, PLATES, RODS, AND BARS, IN CLASS 19 (U.S. CLS. 1, 12, 33 AND 50).

TRADEMARK

FIRST USE 4-11-2011; IN COMMERCE 4-11-2011.

PRINCIPAL REGISTER

THE MARK CONSISTS OF STANDARD CHARACTERS WITHOUT CLAIM TO ANY PAR-
TICULAR FONT, STYLE, SIZE, OR COLOR.

SN 85-284,057, FILED 4-1-2011.

ANDREA HACK, EXAMINING ATTORNEY



David J. Kyros

Director of the United States Patent and Trademark Office

United States of America

United States Patent and Trademark Office

SUNICHEM

Reg. No. 4,155,418

Registered June 5, 2012

Int. Cl.: 42

SERVICE MARK

PRINCIPAL REGISTER

JU, LEI (CHINA INDIVIDUAL)
2400 CHESTNUT ST. APT. 2602
PHILADELPHIA, PA 19103

FOR: CHEMICAL LABORATORIES; CHEMICAL RESEARCH; DEVELOPMENT AND TEST OF CHEMICAL PRODUCTION METHODS; SCIENTIFIC RESEARCH; WORKING ON AND EVALUATION OF CHEMICAL SYNTHESSES, IN CLASS 42 (U.S. CLS. 100 AND 101).

FIRST USE 2-1-2010; IN COMMERCE 2-1-2010.

THE MARK CONSISTS OF STANDARD CHARACTERS WITHOUT CLAIM TO ANY PARTICULAR FONT, STYLE, SIZE, OR COLOR.

THE WORDING "SUNI" HAS NO MEANING IN A FOREIGN LANGUAGE.

SN 85-284,082, FILED 4-1-2011.

HEATHER THOMPSON, EXAMINING ATTORNEY



David J. Kybas

Director of the United States Patent and Trademark Office

United States of America

United States Patent and Trademark Office

RockRebar

Reg. No. 4,155,419

RAW ENERGY MATERIALS CORPORATION (FLORIDA CORPORATION)
1200 SOUTH DIXIE HIGHWAY WEST
POMPANO BEACH, FL 33060

Registered June 5, 2012

Int. Cl.: 19

FOR: NON-METALLIC REINFORCEMENTS FOR CONCRETE BUILDING CONSTRUCTION, NAMELY, PLATES, RODS, AND BARS, IN CLASS 19 (U.S. CLS. 1, 12, 33 AND 50).

TRADEMARK

FIRST USE 6-9-2009; IN COMMERCE 6-9-2009.

PRINCIPAL REGISTER

THE MARK CONSISTS OF STANDARD CHARACTERS WITHOUT CLAIM TO ANY PARTICULAR FONT, STYLE, SIZE, OR COLOR.

SN 85-284,105, FILED 4-1-2011.

ANDREA HACK, EXAMINING ATTORNEY



David J. Kybas

Director of the United States Patent and Trademark Office

United States of America

United States Patent and Trademark Office

TLEX

Reg. No. 4,155,420

Registered June 5, 2012

Int. Cl.: 41

SERVICE MARK

PRINCIPAL REGISTER

INTERNATIONAL ASSOCIATION FOR HUMAN VALUES (D.C. NON-PROFIT ORGANIZATION)
235 ARBORETUM WAY
BURLINGTON, MA 01803

FOR: EDUCATIONAL SERVICES, NAMELY, CONDUCTING WORKSHOPS AND CORPORATE TRAINING IN THE FIELD OF LEADERSHIP DEVELOPMENT AND STRESS MANAGEMENT AND DISTRIBUTION OF COURSE MATERIAL IN CONNECTION THEREWITH; TRAINING SERVICES IN THE FIELD OF LEADERSHIP DEVELOPMENT AND STRESS MANAGEMENT, IN CLASS 41 (U.S. CLS. 100, 101 AND 107).

FIRST USE 1-0-2012; IN COMMERCE 1-0-2012.

THE MARK CONSISTS OF STANDARD CHARACTERS WITHOUT CLAIM TO ANY PARTICULAR FONT, STYLE, SIZE, OR COLOR.

SN 85-284,123, FILED 4-1-2011.

SETH A. RAPPAPORT, EXAMINING ATTORNEY



David J. Kybas

Director of the United States Patent and Trademark Office

United States of America

United States Patent and Trademark Office

Reflex Invisible Score

Reg. No. 4,155,421

ROSENBAUM, KEREN (ISRAEL INDIVIDUAL)
46 NORTHWOOD AVE.
DEMAREST, NJ 07627

Registered June 5, 2012

Int. Cl.: 41

FOR: EDUCATION SERVICES, NAMELY, PROVIDING CLASSES, SEMINARS, WORKSHOPS,
AND LECTURES IN THE FIELD OF MUSIC NOTATION, IN CLASS 41 (U.S. CLS. 100, 101
AND 107).

SERVICE MARK

FIRST USE 2-27-2011; IN COMMERCE 2-27-2011.

PRINCIPAL REGISTER

THE MARK CONSISTS OF STANDARD CHARACTERS WITHOUT CLAIM TO ANY PAR-
TICULAR FONT, STYLE, SIZE, OR COLOR.

SN 85-284,321, FILED 4-1-2011.

JORDAN BAKER, EXAMINING ATTORNEY



David J. Kyros

Director of the United States Patent and Trademark Office

United States of America

United States Patent and Trademark Office

VEGAS ISN'T THE ONLY SIN CITY

Reg. No. 4,155,422

MCGIBNEY, JAMES (UNITED STATES INDIVIDUAL)
5608 QUIET CLOUD CT
LAS VEGAS, NV 89141

Registered June 5, 2012

Int. Cl.: 45

FOR: ON-LINE SOCIAL NETWORKING SERVICES, IN CLASS 45 (U.S. CLS. 100 AND 101).

SERVICE MARK

FIRST USE 11-17-2011; IN COMMERCE 11-17-2011.

PRINCIPAL REGISTER

THE MARK CONSISTS OF STANDARD CHARACTERS WITHOUT CLAIM TO ANY PARTICULAR FONT, STYLE, SIZE, OR COLOR.

SN 85-284,396, FILED 4-1-2011.

JESSICA FATHY, EXAMINING ATTORNEY



David J. Kyffers

Director of the United States Patent and Trademark Office

United States of America

United States Patent and Trademark Office

TRIPLEGIFT

Reg. No. 4,155,423

Registered June 5, 2012

Int. Cl.: 16

TRADEMARK

PRINCIPAL REGISTER

TRIPLEGIFT, INC. (CALIFORNIA CORPORATION)
4696 LARAMIE GATE CT.
PLEASANTON, CA 94566

FOR: GREETING CARDS, IN CLASS 16 (U.S. CLS. 2, 5, 22, 23, 29, 37, 38 AND 50).

FIRST USE 10-1-2011; IN COMMERCE 10-21-2011.

THE MARK CONSISTS OF STANDARD CHARACTERS WITHOUT CLAIM TO ANY PARTICULAR FONT, STYLE, SIZE, OR COLOR.

SN 85-284,455, FILED 4-1-2011.

SHAILA SETTLES, EXAMINING ATTORNEY



David J. Kyffers

Director of the United States Patent and Trademark Office

United States of America

United States Patent and Trademark Office



Reg. No. 4,155,424

Registered June 5, 2012

Int. Cl.: 35

SERVICE MARK

PRINCIPAL REGISTER

DAMIAN ROSS (UNITED STATES INDIVIDUAL), DBA GLOBOOGIE,
3606 BLOCK DR. #312
IRVING, TX 75038

FOR: PROVIDING A SEARCHABLE ONLINE ADVERTISING WEBSITE AND INFORMATIONAL GUIDE FEATURING THE GOODS AND SERVICES OF OTHER VENDORS VIA THE INTERNET IN THE FIELD OF ENTERTAINMENT AND EVENT LISTINGS, IN CLASS 35 (U.S. CLS. 100, 101 AND 102).

FIRST USE 1-2-2012; IN COMMERCE 1-2-2012.

THE MARK CONSISTS OF THE WORD "GLOBOOGIE" IN WHITE, WRITTEN ACROSS A PICTURE OF A BLUE EARTH WITH BLACK CONTINENTS, CENTERED ON A BLACK SQUARE BACKGROUND.

THE COLOR(S) BLUE, BLACK AND WHITE IS/ARE CLAIMED AS A FEATURE OF THE MARK.

SN 85-284,576, FILED 4-2-2011.

DORITT L. CARROLL, EXAMINING ATTORNEY



David J. Kyros

Director of the United States Patent and Trademark Office

United States of America

United States Patent and Trademark Office

ZESTRA BLISS

Reg. No. 4,155,425

Registered June 5, 2012

Int. Cl.: 5

TRADEMARK

PRINCIPAL REGISTER

SEMPRAE LABORATORIES, INC. (DELAWARE CORPORATION)
160 PEHLE AVENUE, PARK 80 EAST
STE. 301
SADDLE BROOK, NJ 07663

FOR: NON-PRESCRIPTION HERBAL SEXUAL AID, NAMELY, GELS FOR USE AS A PERSONAL LUBRICANT, IN CLASS 5 (U.S. CLS. 6, 18, 44, 46, 51 AND 52).

FIRST USE 5-12-2011; IN COMMERCE 5-12-2011.

THE MARK CONSISTS OF STANDARD CHARACTERS WITHOUT CLAIM TO ANY PARTICULAR FONT, STYLE, SIZE, OR COLOR.

OWNER OF U.S. REG. NOS. 3,019,637, 3,222,491, AND 3,741,842.

SN 85-284,911, FILED 4-4-2011.

HELENE LIWINSKI, EXAMINING ATTORNEY



David J. Kyffers

Director of the United States Patent and Trademark Office

United States of America

United States Patent and Trademark Office

YOU ADORE YOUR CURLS

Reg. No. 4,155,426

CONAIR CORPORATION (DELAWARE CORPORATION)
ONE CUMMINGS POINT ROAD
STAMFORD, CT 06902

Registered June 5, 2012

Int. Cl.: 11

FOR: HAND-HELD ELECTRIC HAIR DRYERS, IN CLASS 11 (U.S. CLS. 13, 21, 23, 31 AND 34).

TRADEMARK

FIRST USE 8-0-2011; IN COMMERCE 8-0-2011.

PRINCIPAL REGISTER

THE MARK CONSISTS OF STANDARD CHARACTERS WITHOUT CLAIM TO ANY PARTICULAR FONT, STYLE, SIZE, OR COLOR.

SN 85-285,400, FILED 4-4-2011.

MICHAEL TANNER, EXAMINING ATTORNEY



David J. Kybas

Director of the United States Patent and Trademark Office

United States of America

United States Patent and Trademark Office

ALBANY

Reg. No. 4,155,427

Registered June 5, 2012

Int. Cl.: 41

SERVICE MARK

PRINCIPAL REGISTER

PARK RIDGE SECURITIES CORP. (BAHAMAS CORPORATION)
P.O. BOX N7776
CAY HOUSE, LYFORD CAY
NEW PROVIDENCE, BAHAMAS

FOR: GOLF CLUB SERVICES; GOLF COURSES; PROVIDING GOLF FACILITIES, IN CLASS 41 (U.S. CLS. 100, 101 AND 107).

FIRST USE 10-4-2010; IN COMMERCE 10-4-2010.

THE MARK CONSISTS OF STANDARD CHARACTERS WITHOUT CLAIM TO ANY PARTICULAR FONT, STYLE, SIZE, OR COLOR.

OWNER OF U.S. REG. NOS. 3,578,145 AND 3,912,371.

SN 85-285,545, FILED 4-4-2011.

LINDSEY RUBIN, EXAMINING ATTORNEY



David J. Kybas

Director of the United States Patent and Trademark Office

United States of America

United States Patent and Trademark Office

INTERNUM

Reg. No. 4,155,428

INTERNUM, LLC (DELAWARE LIMITED LIABILITY COMPANY)
3303 KIRBY DRIVE
HOUSTON, TX 77098

Registered June 5, 2012

Int. Cls.: 20 and 35

FOR: FURNITURE, IN CLASS 20 (U.S. CLS. 2, 13, 22, 25, 32 AND 50).

TRADEMARK

FIRST USE 6-30-2011; IN COMMERCE 6-30-2011.

SERVICE MARK

FOR: RETAIL STORES FEATURING FURNITURE AND HOME ACCESSORIES, IN CLASS 35 (U.S. CLS. 100, 101 AND 102).

PRINCIPAL REGISTER

FIRST USE 6-30-2011; IN COMMERCE 6-30-2011.

THE MARK CONSISTS OF STANDARD CHARACTERS WITHOUT CLAIM TO ANY PARTICULAR FONT, STYLE, SIZE, OR COLOR.

SN 85-285,766, FILED 4-4-2011.

SUNG IN, EXAMINING ATTORNEY



David J. Kybas

Director of the United States Patent and Trademark Office

United States of America

United States Patent and Trademark Office



Reg. No. 4,155,429

Registered June 5, 2012

Int. Cl.: 25

TRADEMARK

PRINCIPAL REGISTER

FAYE BENNETT (UNITED STATES INDIVIDUAL)
744 HIGHPOINT WAY
HAYWARD, CA 94541 AND

OCTAVIO BENNETT (UNITED STATES INDIVIDUAL)
744 HIGHPOINT WAY
HAYWARD, CA 94541

FOR: CHILDREN'S AND INFANT'S APPAREL, NAMELY, JUMPERS, OVERALL SLEEP-WEAR, PAJAMAS, ROMPERS AND ONE-PIECE GARMENTS; HATS; T-SHIRTS; T-SHIRTS FOR BABIES, CHILDREN, WOMEN; TANK TOPS; TOPS, IN CLASS 25 (U.S. CLS. 22 AND 39).

FIRST USE 3-15-2012; IN COMMERCE 3-15-2012.

THE STIPLING IS FOR SHADING PURPOSES ONLY.

THE NAME "LOLA BUDS" DOES NOT IDENTIFY A LIVING INDIVIDUAL

THE MARK CONSISTS OF THE WORDS "LOLA BUDS" IN BAUHAUS93 FONT ARCHED ABOVE THE PICTURES OF THE 4 GIRLS. THE FOUR GIRLS ARE STANDING IN FRONT OF A FLOWER. FIRST GIRL FROM THE LEFT IS TAN WITH BLACK HAIR. SHE IS WEARING A LONG DRESS, HAS LONG WAIVE HAIR WITH A FLOWER IN IT. THE SECOND GIRL FROM THE LEFT HAS A AFRO PUFF WITH A RIBBON IN HER HAIR. SHE IS WEARING A SWEATER WITH BUTTONS, A SKIRT, TIGHTS, AND SHOES. THE THIRD GIRL FROM THE LEFT HAS A ANGEL HAIRCUT. SHE IS WEARING A JUMPER WITH POCKET ON FRONT AND A SHIRT UNDERNEATH. SHE HAS A BELT ON AND SHOES. THE FOURTH GIRL FROM THE LEFT HAS LONG HAIR. SHE IS WEARING A SWEATSUIT WITH A POCKET IN FRONT. SHE IS WEARING SHOES.

SN 85-285,986, FILED 4-4-2011.

RUDY R. SINGLETON, EXAMINING ATTORNEY



David J. Kyffers

Director of the United States Patent and Trademark Office

United States of America

United States Patent and Trademark Office

SOME ASSEMBLY INSPIRED

Reg. No. 4,155,430

Registered June 5, 2012

Int. Cl.: 16

TRADEMARK

PRINCIPAL REGISTER

ARETE VENTURES, LLC (OHIO LIMITED LIABILITY COMPANY)
4985 WALNUT WOODS LANE
CINCINNATI, OH 45243

FOR: GIFT BOXES, IN CLASS 16 (U.S. CLS. 2, 5, 22, 23, 29, 37, 38 AND 50).

FIRST USE 5-1-2011; IN COMMERCE 5-1-2011.

THE MARK CONSISTS OF STANDARD CHARACTERS WITHOUT CLAIM TO ANY PARTICULAR FONT, STYLE, SIZE, OR COLOR.

SN 85-286,211, FILED 4-5-2011.

GINA FINK, EXAMINING ATTORNEY



David J. Kyffers

Director of the United States Patent and Trademark Office

United States of America

United States Patent and Trademark Office

H-E-B BUTTER SUPREMES

Reg. No. 4,155,431

Registered June 5, 2012

Int. Cl.: 30

TRADEMARK

PRINCIPAL REGISTER

HEB GROCERY COMPANY, LP (TEXAS LIMITED PARTNERSHIP)
CORPORATE LAW DEPARTMENT
646 SOUTH MAIN
SAN ANTONIO, TX 78204

FOR: CRACKERS, IN CLASS 30 (U.S. CL. 46).

FIRST USE 7-31-2011; IN COMMERCE 7-31-2011.

THE MARK CONSISTS OF STANDARD CHARACTERS WITHOUT CLAIM TO ANY PARTICULAR FONT, STYLE, SIZE, OR COLOR.

OWNER OF U.S. REG. NOS. 1,867,930, 3,873,586, AND OTHERS.

NO CLAIM IS MADE TO THE EXCLUSIVE RIGHT TO USE "BUTTER", APART FROM THE MARK AS SHOWN.

SN 85-286,295, FILED 4-5-2011.

CHRISTINE COOPER, EXAMINING ATTORNEY



David J. Kybas

Director of the United States Patent and Trademark Office

United States of America

United States Patent and Trademark Office

THE 21ST CENTURY TEDDY BEAR

Reg. No. 4,155,432

Registered June 5, 2012

Int. Cl.: 28

TRADEMARK

PRINCIPAL REGISTER

ANDREA M. GRISWELL (UNITED STATES INDIVIDUAL)
1944 MOUNTAIN CREEK DRIVE
STONE MOUNTAIN, GA 30087

FOR: TOYS, NAMELY, PLUSH DOLLS, IN CLASS 28 (U.S. CLS. 22, 23, 38 AND 50).

FIRST USE 3-15-2012; IN COMMERCE 3-15-2012.

THE MARK CONSISTS OF STANDARD CHARACTERS WITHOUT CLAIM TO ANY PARTICULAR FONT, STYLE, SIZE, OR COLOR.

NO CLAIM IS MADE TO THE EXCLUSIVE RIGHT TO USE "TEDDY BEAR", APART FROM THE MARK AS SHOWN.

SN 85-286,408, FILED 4-5-2011.

TIMOTHY FINNEGAN, EXAMINING ATTORNEY



David J. Kybas

Director of the United States Patent and Trademark Office

United States of America

United States Patent and Trademark Office

BIONIX

Reg. No. 4,155,433

MARCO INDUSTRIES INC. (OREGON CORPORATION)
9220 SE STARK STREET
PORTLAND, OR 97216

Registered June 5, 2012

Int. Cl.: 1

FOR: SOIL AMENDMENTS, PLANTING SOIL, POTTING SOIL, PLANT FOODS, GROWING MEDIA FOR PLANTS, IN CLASS 1 (U.S. CLS. 1, 5, 6, 10, 26 AND 46).

TRADEMARK

FIRST USE 10-21-2011; IN COMMERCE 10-21-2011.

PRINCIPAL REGISTER

THE MARK CONSISTS OF STANDARD CHARACTERS WITHOUT CLAIM TO ANY PARTICULAR FONT, STYLE, SIZE, OR COLOR.

SN 85-286,419, FILED 4-5-2011.

TIMOTHY FINNEGAN, EXAMINING ATTORNEY



David J. Kybas

Director of the United States Patent and Trademark Office

United States of America

United States Patent and Trademark Office

GROWINGBLUE

Reg. No. 4,155,434

Registered June 5, 2012

Int. Cls.: 41 and 42

SERVICE MARK

PRINCIPAL REGISTER

VEOLIA WATER AMERICAS, LLC (DELAWARE LIMITED LIABILITY COMPANY)
SUITE 7900
200 E. RANDOLPH STREET
CHICAGO, IL 60601

FOR: EDUCATIONAL SERVICES, NAMELY, PROVIDING EDUCATIONAL SEMINARS IN THE FIELDS OF WATER, WATER ISSUES, DEVELOPMENT, SUSTAINABILITY AND PROTECTION OF WATER RESOURCES ON A LOCAL AND GLOBAL LEVEL, IN CLASS 41 (U.S. CLS. 100, 101 AND 107).

FIRST USE 12-3-2010; IN COMMERCE 5-18-2011.

FOR: PROVIDING A WEBSITE FEATURING ENVIRONMENTAL INFORMATION ABOUT WATER AND WATER ISSUES, DEVELOPMENT, SUSTAINABILITY AND PROTECTION OF WATER RESOURCES ON A LOCAL AND GLOBAL LEVEL, IN CLASS 42 (U.S. CLS. 100 AND 101).

FIRST USE 12-3-2010; IN COMMERCE 5-18-2011.

THE MARK CONSISTS OF STANDARD CHARACTERS WITHOUT CLAIM TO ANY PARTICULAR FONT, STYLE, SIZE, OR COLOR.

SN 85-286,634, FILED 4-5-2011.

RENEE MCCRAY, EXAMINING ATTORNEY



David J. Kybas

Director of the United States Patent and Trademark Office

United States of America

United States Patent and Trademark Office

OFF-ROAD DRIVEN!

Reg. No. 4,155,435

Registered June 5, 2012

Int. Cl.: 12

TRADEMARK

PRINCIPAL REGISTER

TAP WORLDWIDE, LLC (DELAWARE LIMITED LIABILITY COMPANY)
400 WEST ARTESIA BLVD.
COMPTON, CA 90220

FOR: AUTOMOBILE AND TRUCK STRUCTURAL PARTS AND ACCESSORIES SPECIALLY ADAPTED FOR AUTOMOBILES AND TRUCKS, NAMELY, STRUCTURAL PARTS FOR AUTOMOBILES, WHEELS, WHEEL RIMS, TIRES, SHOCK ABSORBERS, SHOCK ABSORBER MOUNTS, SHOCK ABSORBER BRACKETS, PITMAN ARMS, STEERING ARMS, TIRE RODS, STEERING DAMPENERS, SUSPENSION SYSTEMS FOR AUTOMOBILES FEATURING REAR STABILIZER BARS, AUTOMOBILE AND TRUCK BODY PARTS IN THE NATURE OF SIDEBARS, BUMPERS, BRUSH GUARDS, GRILL GUARDS, IN CLASS 12 (U.S. CLS. 19, 21, 23, 31, 35 AND 44).

FIRST USE 5-1-2011; IN COMMERCE 6-1-2011.

THE MARK CONSISTS OF STANDARD CHARACTERS WITHOUT CLAIM TO ANY PARTICULAR FONT, STYLE, SIZE, OR COLOR.

NO CLAIM IS MADE TO THE EXCLUSIVE RIGHT TO USE "OFF-ROAD", APART FROM THE MARK AS SHOWN.

SN 85-286,635, FILED 4-5-2011.

ZHALEH DELANEY, EXAMINING ATTORNEY



David J. Kyros

Director of the United States Patent and Trademark Office

United States of America

United States Patent and Trademark Office

ALWAYS ULTRA THIN SLENDER

Reg. No. 4,155,436

Registered June 5, 2012

Int. Cl.: 5

TRADEMARK

PRINCIPAL REGISTER

THE PROCTER & GAMBLE COMPANY (OHIO CORPORATION)
ONE PROCTER & GAMBLE PLAZA
CINCINNATI, OH 45202

FOR: CATAMENIAL PRODUCTS, NAMELY, MAXI PADS, MINI PADS AND PANTILINERS,
IN CLASS 5 (U.S. CLS. 6, 18, 44, 46, 51 AND 52).

FIRST USE 7-31-2011; IN COMMERCE 7-31-2011.

THE MARK CONSISTS OF STANDARD CHARACTERS WITHOUT CLAIM TO ANY PAR-
TICULAR FONT, STYLE, SIZE, OR COLOR.

OWNER OF U.S. REG. NOS. 1,601,853, 2,470,616, AND 3,538,549.

NO CLAIM IS MADE TO THE EXCLUSIVE RIGHT TO USE "ULTRA THIN", APART FROM
THE MARK AS SHOWN.

SN 85-286,755, FILED 4-5-2011.

ARETHA SOMERVILLE, EXAMINING ATTORNEY



David J. Kyros

Director of the United States Patent and Trademark Office

United States of America

United States Patent and Trademark Office

ATN

Reg. No. 4,155,437

Registered June 5, 2012

Int. Cls.: 36 and 42

SERVICE MARK

PRINCIPAL REGISTER

BLACKROCK, INC. (DELAWARE CORPORATION)
40 EAST 52ND STREET
NEW YORK, NY 10022

FOR: PROVIDING FINANCIAL RISK MANAGEMENT SERVICES; FINANCIAL MANAGEMENT SERVICES AND SECURITIES TRADING; FINANCIAL RESEARCH; FINANCIAL ANALYSIS AND CONSULTING; FINANCIAL INFORMATION, IN CLASS 36 (U.S. CLS. 100, 101 AND 102).

FIRST USE 9-1-2011; IN COMMERCE 9-1-2011.

FOR: TEMPORARY USE OF ONLINE NON-DOWNLOADABLE COMPUTER SOFTWARE FOR USE BY OTHERS IN PROVIDING FINANCIAL SERVICES, NAMELY, FINANCIAL INFORMATION, FINANCIAL MANAGEMENT, SECURITIES TRADING, INVESTMENT MANAGEMENT, AND TRADING FINANCIAL INSTRUMENTS VIA AN ONLINE TRADING PLATFORM; PROVIDING A TRADING PLATFORM FOR PLACING AND EXECUTING ORDERS TO PURCHASE OR SELL SECURITIES, OPTIONS, FUTURES, FOREIGN EXCHANGE AND OTHER FINANCIAL INSTRUMENTS, IN CLASS 42 (U.S. CLS. 100 AND 101).

FIRST USE 9-1-2011; IN COMMERCE 9-1-2011.

THE MARK CONSISTS OF STANDARD CHARACTERS WITHOUT CLAIM TO ANY PARTICULAR FONT, STYLE, SIZE, OR COLOR.

SN 85-287,157, FILED 4-5-2011.

BERNICE MIDDLETON, EXAMINING ATTORNEY



David J. Kyjars

Director of the United States Patent and Trademark Office

United States of America

United States Patent and Trademark Office

POPOPS

Reg. No. 4,155,438

Registered June 5, 2012

Int. Cl.: 45

SERVICE MARK

PRINCIPAL REGISTER

VU, MICHAEL (UNITED STATES INDIVIDUAL)
APT 119
2949 PORTAGE BAY WEST
DAVIS, CA 95616

FOR: ONLINE SOCIAL NETWORKING SERVICES; ONLINE SOCIAL NETWORKING SERVICES IN THE FIELD OF COMMUNITY POLLS AND CROWD SOURCING, IN CLASS 45 (U.S. CLS. 100 AND 101).

FIRST USE 1-1-2012; IN COMMERCE 1-1-2012.

THE MARK CONSISTS OF STANDARD CHARACTERS WITHOUT CLAIM TO ANY PARTICULAR FONT, STYLE, SIZE, OR COLOR.

SN 85-287,314, FILED 4-6-2011.

REBECCA EISINGER, EXAMINING ATTORNEY



David J. Kyros

Director of the United States Patent and Trademark Office

United States of America

United States Patent and Trademark Office

CHORALQUEST

Reg. No. 4,155,439

Registered June 5, 2012

Int. Cl.: 16

TRADEMARK

PRINCIPAL REGISTER

AMERICAN COMPOSERS FORUM (MINNESOTA NON-PROFIT CORPORATION)
332 MINNESOTA STREET
SUITE E145
ST. PAUL, MN 55101

FOR: PRINTED MATTER, NAMELY, SHEET MUSIC AND TEACHING MATERIALS IN THE
FIELD OF MUSIC, IN CLASS 16 (U.S. CLS. 2, 5, 22, 23, 29, 37, 38 AND 50).

FIRST USE 9-1-2011; IN COMMERCE 9-1-2011.

THE MARK CONSISTS OF STANDARD CHARACTERS WITHOUT CLAIM TO ANY PAR-
TICULAR FONT, STYLE, SIZE, OR COLOR.

SN 85-287,409, FILED 4-6-2011.

CHRIS WELLS, EXAMINING ATTORNEY



David J. Kybas

Director of the United States Patent and Trademark Office

United States of America

United States Patent and Trademark Office

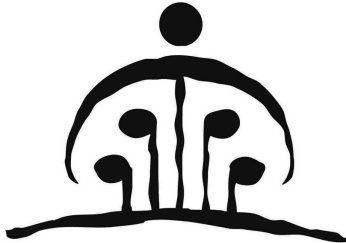

Reg. No. 4,155,440

Registered June 5, 2012

Int. Cl.: 16

TRADEMARK

PRINCIPAL REGISTER

AMERICAN COMPOSERS FORUM (MINNESOTA NON-PROFIT CORPORATION)
332 MINNESOTA STREET
SUITE E145
ST. PAUL, MN 55101

FOR: PRINTED MATTER, NAMELY, SHEET MUSIC AND TEACHING MATERIALS IN THE FIELD OF MUSIC, IN CLASS 16 (U.S. CLS. 2, 5, 22, 23, 29, 37, 38 AND 50).

FIRST USE 9-1-2011; IN COMMERCE 9-1-2011.

THE MARK CONSISTS OF A STYLIZED DRAWING OF FIVE MUSIC NOTES IN A ROW RISING OUT OF THE CENTER OF A LINE WITH A SLIGHT ARCH AND FORMING THE IMAGE OF AN ADULT HUMAN WITH THEIR ARMS AROUND FOUR CHILDREN.

SN 85-287,412, FILED 4-6-2011.

CHRIS WELLS, EXAMINING ATTORNEY



David J. Kybas

Director of the United States Patent and Trademark Office

United States of America

United States Patent and Trademark Office

LUMALOVE

Reg. No. 4,155,441

HANNAH BAJOR (UNITED STATES INDIVIDUAL)
300 WIESE ROAD
CHESHIRE, CT 06410

Registered June 5, 2012

Int. Cl.: 25

FOR: BABY LAYETTES FOR CLOTHING; DRESSES; MATERNITY BRAS; MATERNITY LINGERIE; PANTS; SHIRTS; SKIRTS; SOCKS, IN CLASS 25 (U.S. CLS. 22 AND 39).

TRADEMARK

FIRST USE 3-14-2012; IN COMMERCE 3-14-2012.

PRINCIPAL REGISTER

THE MARK CONSISTS OF STANDARD CHARACTERS WITHOUT CLAIM TO ANY PARTICULAR FONT, STYLE, SIZE, OR COLOR.

OWNER OF U.S. REG. NO. 3,777,763.

SN 85-288,123, FILED 4-6-2011.

GEORGE LORENZO, EXAMINING ATTORNEY



David J. Kyros

Director of the United States Patent and Trademark Office

United States of America

United States Patent and Trademark Office

GREENBLOGIC

Reg. No. 4,155,442

HDS IP HOLDING, LLC (NEVADA LIMITED LIABILITY COMPANY)
P.O. BOX 50401
HENDERSON, NV 89016

Registered June 5, 2012

Int. Cl.: 41

FOR: PROVISION OF ONLINE JOURNALS, NAMELY, BLOGS FEATURING THE EXCHANGE OF INFORMATION ABOUT USE OF ENVIRONMENTALLY FRIENDLY MATERIALS, IN CLASS 41 (U.S. CLS. 100, 101 AND 107).

SERVICE MARK

FIRST USE 5-12-2011; IN COMMERCE 5-12-2011.

PRINCIPAL REGISTER

THE MARK CONSISTS OF STANDARD CHARACTERS WITHOUT CLAIM TO ANY PARTICULAR FONT, STYLE, SIZE, OR COLOR.

NO CLAIM IS MADE TO THE EXCLUSIVE RIGHT TO USE "GREEN", APART FROM THE MARK AS SHOWN.

SN 85-288,548, FILED 4-7-2011.

MAUREEN DALL, EXAMINING ATTORNEY



David J. Kyros

Director of the United States Patent and Trademark Office

United States of America

United States Patent and Trademark Office

OPSASSURE

Reg. No. 4,155,443

Registered June 5, 2012

Int. Cl.: 42

SERVICE MARK

PRINCIPAL REGISTER

CAROLINA CENTER FOR OCCUPATIONAL HEALTH, LLC (SOUTH CAROLINA LIMITED LIABILITY COMPANY)
4600 GOER DRIVE, STE 205
ATTN: HERBERT DRAYTON
NORTH CHARLESTON, SC 29406

FOR: PROVIDING ON-LINE, NON-DOWNLOADABLE, GLOBAL COMMUNICATIONS NETWORK ACCESSIBLE SOFTWARE APPLICATION FOR MANAGEMENT AND ADMINISTRATION SUPPORT SERVICES OF MEDICAL PRACTICE ORGANIZATIONS FOR THE MANAGEMENT OF HEALTHCARE SERVICES AND HEALTH CARE FACILITIES, IN CLASS 42 (U.S. CLS. 100 AND 101).

FIRST USE 6-1-2011; IN COMMERCE 6-1-2011.

THE MARK CONSISTS OF STANDARD CHARACTERS WITHOUT CLAIM TO ANY PARTICULAR FONT, STYLE, SIZE, OR COLOR.

SN 85-288,780, FILED 4-7-2011.

JAMES LOVELACE, EXAMINING ATTORNEY



David J. Kyros

Director of the United States Patent and Trademark Office

United States of America

United States Patent and Trademark Office

FORBIDDEN OYSTERS

Reg. No. 4,155,444

Registered June 5, 2012

Int. Cl.: 31

TRADEMARK

PRINCIPAL REGISTER

GREGORY GARRETT (UNITED STATES INDIVIDUAL)
SUITE 103
11864 CANON BOULEVARD
NEWPORT NEWS, VA 23606

FOR: OYSTERS, IN CLASS 31 (U.S. CLS. 1 AND 46).

FIRST USE 3-19-2012; IN COMMERCE 3-9-2012.

THE MARK CONSISTS OF STANDARD CHARACTERS WITHOUT CLAIM TO ANY PARTICULAR FONT, STYLE, SIZE, OR COLOR.

NO CLAIM IS MADE TO THE EXCLUSIVE RIGHT TO USE "OYSTERS", APART FROM THE MARK AS SHOWN.

SN 85-289,075, FILED 4-7-2011.

TRACY WHITTAKER-BROWN, EXAMINING ATTORNEY



David J. Kybas

Director of the United States Patent and Trademark Office

United States of America

United States Patent and Trademark Office

INSPIRED ENTERTAINING

Reg. No. 4,155,445

EMI YOSHI INC. (NEW JERSEY CORPORATION)
1200 JERSEY AVENUE
NORTH BRUNSWICK, NJ 08902

Registered June 5, 2012

Int. Cls.: 8 and 21

FOR: FLATWARE, NAMELY, FORKS, KNIVES, AND SPOONS, IN CLASS 8 (U.S. CLS. 23, 28 AND 44).

TRADEMARK

FIRST USE 1-18-2012; IN COMMERCE 1-18-2012.

PRINCIPAL REGISTER

FOR: DINNERWARE, NAMELY, PLATES, CUPS, SAUCERS, SERVING TRAYS, BOWLS, TUMBLERS, COFFEE MUGS AND DISPOSABLE BEVERAGEWARE, IN CLASS 21 (U.S. CLS. 2, 13, 23, 29, 30, 33, 40 AND 50).

FIRST USE 8-11-2001; IN COMMERCE 8-11-2001.

THE MARK CONSISTS OF STANDARD CHARACTERS WITHOUT CLAIM TO ANY PARTICULAR FONT, STYLE, SIZE, OR COLOR.

SN 85-289,291, FILED 4-7-2011.

MARK RADEMACHER, EXAMINING ATTORNEY



David J. Kybas

Director of the United States Patent and Trademark Office

United States of America

United States Patent and Trademark Office

Vivick

Reg. No. 4,155,446

Registered June 5, 2012

Int. Cl.: 9

TRADEMARK

PRINCIPAL REGISTER

LUNHE INVESTMENT LTD. (NEVADA LIMITED LIABILITY COMPANY)
3000 PARADISE ROAD
LAS VEGAS, NV 89109

FOR: COMPUTER PERIPHERAL DEVICES; COMPUTER SOFTWARE AND DOWNLOADABLE COMPUTER PROGRAMS FOR USE IN DATABASE MANAGEMENT, USE AS SPREADSHEET AND WORD PROCESSING; NOTEBOOK COMPUTERS; DOWNLOADABLE ELECTRONIC PUBLICATIONS IN THE NATURE OF BOOKS, MAGAZINES, AND MANUALS FOR USE IN DATABASE MANAGEMENT, FOR USE AS A SPREADSHEET, FOR WORD PROCESSING; PERSONAL STEREO; MOUSE PADS; COMPUTER PROGRAMS, NAMELY, DOWNLOADABLE SOFTWARE; PROTECTIVE CASES FOR USE WITH TABLET COMPUTERS AND PORTABLE AND HAND-HELD DIGITAL ELECTRONIC DEVICES; COMPUTER SOFTWARE DEVELOPMENT TOOLS FOR THE CREATION OF MOBILE INTERNET APPLICATIONS AND CLIENT INTERFACES, ELECTRONIC FINANCIAL PLATFORMS THAT ACCOMMODATE MULTIPLE TYPES OF PAYMENT AND DEBT TRANSACTIONS USING AN INTEGRATED MOBILE PHONE, PDA, AND WEB BASED ENVIRONMENT; DOWNLOADABLE COMPUTER PROGRAMS, NAMELY, DOWNLOADABLE ELECTRONIC DATA FILES AND DATABASES, NAMELY, BUSINESS AND TAX FORMS, FOR USE WITH COMPUTER SOFTWARE; DOWNLOADABLE COMPUTER GAME SOFTWARE VIA A GLOBAL COMPUTER NETWORK AND WIRELESS DEVICES; COMPUTER GAME PROGRAMS, IN CLASS 9 (U.S. CLS. 21, 23, 26, 36 AND 38).

FIRST USE 6-10-2011; IN COMMERCE 6-20-2011.

THE MARK CONSISTS OF THE STYLIZED LETTERING "VIVICK".

THE WORDING "VIVICK" HAS NO MEANING IN A FOREIGN LANGUAGE.

SN 85-289,713, FILED 4-8-2011.

DAVID C. REIHNER, EXAMINING ATTORNEY



David J. Kyros

Director of the United States Patent and Trademark Office

United States of America

United States Patent and Trademark Office

Mega Straps

Reg. No. 4,155,447

LIANG, DANIEL (UNITED STATES INDIVIDUAL), AKA LIANG, CHIA TUNG,
13103 ANDY ST.
CERRITOS, CA 90703

Registered June 5, 2012

Int. Cl.: 22

FOR: CARGO AND CARRIER EQUIPMENT FOR VEHICLES, NAMELY, TOW ROPES, TOW STRAPS, RATCHET TIE-DOWN STRAPS, QUICK RELEASE TIE DOWN STRAPS, LASHING STRAPS, AND TARP STRAPS, IN CLASS 22 (U.S. CLS. 1, 2, 7, 19, 22, 42 AND 50).

TRADEMARK

FIRST USE 3-22-2012; IN COMMERCE 3-22-2012.

PRINCIPAL REGISTER

THE MARK CONSISTS OF STANDARD CHARACTERS WITHOUT CLAIM TO ANY PARTICULAR FONT, STYLE, SIZE, OR COLOR.

NO CLAIM IS MADE TO THE EXCLUSIVE RIGHT TO USE "STRAPS", APART FROM THE MARK AS SHOWN.

SN 85-289,721, FILED 4-8-2011.

B. PARADEWELAI, EXAMINING ATTORNEY



David J. Kyros

Director of the United States Patent and Trademark Office

United States of America

United States Patent and Trademark Office

YOUR LIFE DOES NOT HAVE TO BE A SOAP OPERA

Reg. No. 4,155,448

Registered June 5, 2012

Int. Cl.: 16

TRADEMARK

PRINCIPAL REGISTER

RISING PHOENIX ENTERPRISES, INC. (CALIFORNIA CORPORATION)
287 S. ROBERTSON BLVD.
SUITE 463
BEVERLY HILLS, CA 902112810

FOR: A SERIES OF BOOKS AND WRITTEN ARTICLES IN THE FIELD OF SELF-HELP, SPIRITUALITY, AND MOTIVATIONAL TOPICS; BOOKS IN THE FIELD OF SELF-HELP, SPIRITUALITY, AND MOTIVATIONAL TOPICS; EDUCATIONAL BOOKS FEATURING SELF-HELP, SPIRITUALITY, AND MOTIVATIONAL TOPICS; SERIES OF NON-FICTION BOOKS IN THE FIELD OF SELF-HELP, SPIRITUALITY, AND MOTIVATIONAL TOPICS, IN CLASS 16 (U.S. CLS. 2, 5, 22, 23, 29, 37, 38 AND 50).

FIRST USE 3-5-2012; IN COMMERCE 3-5-2012.

THE MARK CONSISTS OF STANDARD CHARACTERS WITHOUT CLAIM TO ANY PARTICULAR FONT, STYLE, SIZE, OR COLOR.

SN 85-289,722, FILED 4-8-2011.

GENE MACIOL, EXAMINING ATTORNEY



David J. Kyros

Director of the United States Patent and Trademark Office

United States of America

United States Patent and Trademark Office

Tie Safe Straps

Reg. No. 4,155,449

Registered June 5, 2012

Int. Cl.: 22

TRADEMARK

PRINCIPAL REGISTER

LIANG, DANIEL (UNITED STATES INDIVIDUAL), AKA LIANG, CHIA TUNG,
13103 ANDY ST.
CERRITOS, CA 90703

FOR: CARGO AND CARRIER EQUIPMENT FOR VEHICLES, NAMELY, TOW ROPES, TOW STRAPS, RATCHET TIE-DOWN STRAPS, QUICK RELEASE TIE DOWN STRAPS, LASHING STRAPS, AND TARP STRAPS, IN CLASS 22 (U.S. CLS. 1, 2, 7, 19, 22, 42 AND 50).

FIRST USE 3-26-2012; IN COMMERCE 3-26-2012.

THE MARK CONSISTS OF STANDARD CHARACTERS WITHOUT CLAIM TO ANY PARTICULAR FONT, STYLE, SIZE, OR COLOR.

NO CLAIM IS MADE TO THE EXCLUSIVE RIGHT TO USE "TIE" AND "STRAPS", APART FROM THE MARK AS SHOWN.

SN 85-289,729, FILED 4-8-2011.

B. PARADEWELAI, EXAMINING ATTORNEY



David J. Kybas

Director of the United States Patent and Trademark Office

United States of America

United States Patent and Trademark Office



kate spade

NEW YORK

Reg. No. 4,155,450

Registered June 5, 2012

Int. Cl.: 18

TRADEMARK

PRINCIPAL REGISTER

KATE SPADE LLC (DELAWARE LIMITED LIABILITY COMPANY)
48 WEST 25TH STREET
NEW YORK, NY 10010

FOR: BACKPACKS; BEACH BAGS; CARD WALLETS; CLUTCH BAGS; CLUTCH PURSES;
COSMETIC BAGS SOLD EMPTY; COSMETIC CASES SOLD EMPTY; CREDIT CARD CASES;
HANDBAGS; KEY BAGS; KEY CASES; KEY WALLETS; LUGGAGE; PURSES; SPORT
BAGS; TOTE BAGS; TRAVEL BAGS; TRAVEL CASES; UMBRELLAS; WALLETS, IN CLASS
18 (U.S. CLS. 1, 2, 3, 22 AND 41).

FIRST USE 1-2-2011; IN COMMERCE 1-2-2011.

OWNER OF U.S. REG. NOS. 3,092,920, 3,271,494, AND OTHERS.

NO CLAIM IS MADE TO THE EXCLUSIVE RIGHT TO USE "NEW YORK", APART FROM
THE MARK AS SHOWN.

THE NAME "KATE SPADE" IDENTIFIES A LIVING INDIVIDUAL WHOSE CONSENT IS
OF RECORD.

THE MARK CONSISTS OF A SPADE DESIGN WITH THE WORDS "KATE SPADE NEW
YORK" UNDERNEATH.

SN 85-289,992, FILED 4-8-2011.

JENNIFER MARTIN, EXAMINING ATTORNEY



David J. Kybas

Director of the United States Patent and Trademark Office

United States of America

United States Patent and Trademark Office



kate spade

NEW YORK

Reg. No. 4,155,451

Registered June 5, 2012

Int. Cl.: 25

TRADEMARK

PRINCIPAL REGISTER

KATE SPADE LLC (DELAWARE LIMITED LIABILITY COMPANY)
48 WEST 25TH STREET
NEW YORK, NY 10010

FOR: BELTS; BLAZERS; BLOUSES; BOTTOMS; BRAS; COATS; DRESSES; FOOTWEAR;
GLOVES; HEADWEAR; HOSIERY; JACKETS; JEANS; KNIT TOPS; LINGERIE; LOUN-
GEWEAR; NECKWEAR; PANTS; SCARVES; SHIRTS; SHORTS; SKIRTS; SLEEPWEAR;
SOCKS; SUITS; SWEATERS; SWIMWEAR; T-SHIRTS; TANK TOPS; TOPS; UNDERWEAR,
IN CLASS 25 (U.S. CLS. 22 AND 39).

FIRST USE 1-2-2012; IN COMMERCE 1-2-2012.

OWNER OF U.S. REG. NOS. 2,578,942, 3,271,494, AND OTHERS.

NO CLAIM IS MADE TO THE EXCLUSIVE RIGHT TO USE "NEW YORK", APART FROM
THE MARK AS SHOWN.

THE NAME "KATE SPADE" IDENTIFIES A LIVING INDIVIDUAL WHOSE CONSENT IS
OF RECORD.

THE MARK CONSISTS OF A SPADE DESIGN WITH THE WORDS "KATE SPADE NEW
YORK" UNDERNEATH.

SN 85-290,002, FILED 4-8-2011.

JENNIFER MARTIN, EXAMINING ATTORNEY



David J. Kybas

Director of the United States Patent and Trademark Office

United States of America

United States Patent and Trademark Office



kate spade

NEW YORK

Reg. No. 4,155,452

Registered June 5, 2012

Int. Cl.: 35

SERVICE MARK

PRINCIPAL REGISTER

KATE SPADE LLC (DELAWARE LIMITED LIABILITY COMPANY)
48 WEST 25TH STREET
NEW YORK, NY 10010

FOR: RETAIL STORE AND ON-LINE RETAIL STORE SERVICES FEATURING APPAREL, FASHION ACCESSORIES, HANDBAGS, JEWELRY, LEATHER GOODS, EYEWEAR, FOOTWEAR, FRAGRANCE AND COSMETICS, AND HOME PRODUCTS, IN CLASS 35 (U.S. CLS. 100, 101 AND 102).

FIRST USE 1-2-2011; IN COMMERCE 1-2-2011.

OWNER OF U.S. REG. NOS. 3,092,920, 3,271,494, AND OTHERS.

NO CLAIM IS MADE TO THE EXCLUSIVE RIGHT TO USE "NEW YORK", APART FROM THE MARK AS SHOWN.

THE NAME "KATE SPADE" IDENTIFIES A LIVING INDIVIDUAL WHOSE CONSENT IS OF RECORD.

THE MARK CONSISTS OF A SPADE DESIGN WITH THE WORDS "KATE SPADE NEW YORK" UNDERNEATH.

SN 85-290,010, FILED 4-8-2011.

JENNIFER MARTIN, EXAMINING ATTORNEY



David J. Kybas

Director of the United States Patent and Trademark Office

United States of America

United States Patent and Trademark Office

PAH SERIES

Reg. No. 4,155,453

Registered June 5, 2012

Int. Cl.: 7

TRADEMARK

PRINCIPAL REGISTER

THE GORMAN-RUPP COMPANY (OHIO CORPORATION)
600 SOUTH AIRPORT ROAD
MANSFIELD, OH 44903

FOR: CENTRIFUGAL PUMPS, IN CLASS 7 (U.S. CLS. 13, 19, 21, 23, 31, 34 AND 35).

FIRST USE 2-15-2012; IN COMMERCE 2-15-2012.

THE MARK CONSISTS OF STANDARD CHARACTERS WITHOUT CLAIM TO ANY PARTICULAR FONT, STYLE, SIZE, OR COLOR.

OWNER OF U.S. REG. NO. 2,316,046.

NO CLAIM IS MADE TO THE EXCLUSIVE RIGHT TO USE "SERIES", APART FROM THE MARK AS SHOWN.

SN 85-290,292, FILED 4-8-2011.

KRISTIN CARLSON, EXAMINING ATTORNEY



David J. Kyros

Director of the United States Patent and Trademark Office

United States of America

United States Patent and Trademark Office

MYCENTERS

Reg. No. 4,155,454

Registered June 5, 2012

Int. Cl.: 44

SERVICE MARK

PRINCIPAL REGISTER

DRS. SPAGNOLI, CROWLEY, MISIEK, FARRELL, FARRELL & NALE, P.A. (NORTH CAROLINA CORPORATION)
8738 UNIVERSITY CITY BLVD.
CHARLOTTE, NC 28213

FOR: MEDICAL SERVICES; DENTAL SERVICES, NAMELY, COSMETIC, IMPLANT AND ORAL SURGERY SERVICES, IN CLASS 44 (U.S. CLS. 100 AND 101).

FIRST USE 11-22-2011; IN COMMERCE 11-22-2011.

THE MARK CONSISTS OF STANDARD CHARACTERS WITHOUT CLAIM TO ANY PARTICULAR FONT, STYLE, SIZE, OR COLOR.

SN 85-290,398, FILED 4-8-2011.

KRISTIN CARLSON, EXAMINING ATTORNEY



David J. Kybas

Director of the United States Patent and Trademark Office

United States of America

United States Patent and Trademark Office

BEACON

Reg. No. 4,155,455

Registered June 5, 2012

Int. Cl.: 31

TRADEMARK

PRINCIPAL REGISTER

J. FRANK SCHMIDT & SON CO. (OREGON CORPORATION)
P.O. BOX 189
BORING, OR 97009

FOR: LIVING ORNAMENTAL TREES, IN CLASS 31 (U.S. CLS. 1 AND 46).

FIRST USE 2-16-2012; IN COMMERCE 2-16-2012.

THE MARK CONSISTS OF STANDARD CHARACTERS WITHOUT CLAIM TO ANY PARTICULAR FONT, STYLE, SIZE, OR COLOR.

SN 85-291,515, FILED 4-11-2011.

GILBERT SWIFT, EXAMINING ATTORNEY



David J. Kybas

Director of the United States Patent and Trademark Office

United States of America

United States Patent and Trademark Office

LONDON TIMES

Reg. No. 4,155,456

Registered June 5, 2012

Int. Cl.: 9

MIAMI TRIBE OF OKLAHOMA BUSINESS DEVELOPMENT AUTHORITY, A TRIBAL
ENTERPRISE OF THE MIAMI TRIBE OF OKLAHOMA (UNITED STATES
FEDERALLY-RECOGNIZED INDIAN TRIBE)
3410 P STREET NW
MIAMI, OK 74344

TRADEMARK

FOR: GAMING MACHINES, NAMELY, BINGO-RELATED GAMES AND SLOT MACHINES
, IN CLASS 9 (U.S. CLS. 21, 23, 26, 36 AND 38).

PRINCIPAL REGISTER

FIRST USE 3-29-2012; IN COMMERCE 4-2-2012.

THE MARK CONSISTS OF STANDARD CHARACTERS WITHOUT CLAIM TO ANY PAR-
TICULAR FONT, STYLE, SIZE, OR COLOR.

SN 85-291,603, FILED 4-11-2011.

KATHY DE JONGE, EXAMINING ATTORNEY



David J. Kyffers

Director of the United States Patent and Trademark Office

United States of America

United States Patent and Trademark Office

DAVID [®] RAPHAEL

Reg. No. 4,155,457

SHIELER TRADING CORP. (NEW YORK CORPORATION)
37 WEST 47TH STREET
NEW YORK, NY 10036

Registered June 5, 2012

Int. Cl.: 14

FOR: JEWELRY, NAMELY, NECKLACES, RINGS, EARRINGS, BRACELETS, PENDANTS AND CUFF LINKS MADE OF GOLD, SILVER, DIAMONDS, PRECIOUS STONES AND SEMI-PRECIOUS STONES; WATCHES , IN CLASS 14 (U.S. CLS. 2, 27, 28 AND 50).

TRADEMARK

FIRST USE 7-1-2011; IN COMMERCE 7-1-2011.

PRINCIPAL REGISTER

THE NAME(S), PORTRAIT(S), AND/OR SIGNATURE(S) SHOWN IN THE MARK IDENTIFIES A LIVING INDIVIDUAL, WHOSE CONSENT(S) TO REGISTER IS MADE OF RECORD.

THE MARK CONSISTS OF THE WORDS "DAVID RAPHAEL" WITH THE LETTERS "D & R" INTERTWINED IN BETWEEN THEM.

SN 85-292,628, FILED 4-12-2011.

ELLEN B. AWRICH, EXAMINING ATTORNEY



David J. Kyros

Director of the United States Patent and Trademark Office

United States of America

United States Patent and Trademark Office

OPEN SCHOOL

Reg. No. 4,155,458

Registered June 5, 2012

Int. Cl.: 42

SERVICE MARK

PRINCIPAL REGISTER

ZIMMEDIA, LLC (NEW YORK LIMITED LIABILITY COMPANY)
37-24 24TH ST. SUITE 343
LONG ISLAND CITY, NY 11101

FOR: COMPUTER SERVICES, NAMELY, HOSTING AN INTERACTIVE WEBSITE THAT ENABLES SCHOOL TEACHERS AND ADMINISTRATORS TO RECORD, ACCESS, REPORT AND MANAGE THEIR STUDENT INFORMATION, PORTFOLIOS AND PERFORMANCE DATA, AND ALLOWS STUDENTS AND PARENTS TO ACCESS SUCH INFORMATION AND DATA IN REAL TIME, IN CLASS 42 (U.S. CLS. 100 AND 101).

FIRST USE 1-0-2012; IN COMMERCE 1-0-2012.

THE MARK CONSISTS OF STANDARD CHARACTERS WITHOUT CLAIM TO ANY PARTICULAR FONT, STYLE, SIZE, OR COLOR.

SN 85-292,968, FILED 4-12-2011.

BILL DAWE, EXAMINING ATTORNEY



David J. Kyffers

Director of the United States Patent and Trademark Office

United States of America

United States Patent and Trademark Office



Reg. No. 4,155,459

Registered June 5, 2012

Int. Cl.: 35

SERVICE MARK

PRINCIPAL REGISTER

URBAN BASEBALL FOUNDATION (D.C. CORPORATION), DBA UBF,
4748 WISCONSIN AVE, NW
WASHINGTON, DC 200164610

FOR: PROMOTING THE INTERESTS OF PEOPLE INVOLVED AND CONCERNED WITH
YOUTH SPORTS, IN CLASS 35 (U.S. CLS. 100, 101 AND 102).

FIRST USE 1-1-2012; IN COMMERCE 1-1-2012.

NO CLAIM IS MADE TO THE EXCLUSIVE RIGHT TO USE "URBAN BASEBALL FOUNDATION" AND THE PICTORIAL MAP OF THE DISTRICT OF COLUMBIA AND "A 501(C)3 DEDICATED TO SUPPORTING INNER-CITY YOUTH BASEBALL", APART FROM THE MARK AS SHOWN.

THE COLOR(S) RED, WHITE, AND BLUE IS/ARE CLAIMED AS A FEATURE OF THE MARK.

THE MARK CONSISTS OF A WHITE MAP OF THE DISTRICT OF COLUMBIA WITH TWO RED BASEBALL THREADS AND SUPERIMPOSED THEREUPON IS "UBF" IN BLUE LETTERING, TO THE RIGHT OF WHICH APPEARS THE WORDING "URBAN BASEBALL FOUNDATION" IN WHITE LETTERING AND BELOW WHICH APPEARS THE WORDING "A 501(C)3 DEDICATED TO SUPPORTING INNER-CITY YOUTH BASEBALL", WHICH APPEARS IN WHITE LETTERING, ALL OF WHICH IS SUPERIMPOSED UPON A BLUE BACKGROUND.

SN 85-293,221, FILED 4-12-2011.

ERIN FALK, EXAMINING ATTORNEY



David J. Kyros

Director of the United States Patent and Trademark Office

United States of America

United States Patent and Trademark Office

People Are the Reason

Reg. No. 4,155,460

THRASHER, BENJAMIN (UNITED STATES INDIVIDUAL)
4003 OLIVE AVE
LONG BEACH, CA 90807

Registered June 5, 2012

Int. Cl.: 25

FOR: JACKETS; PANTS; SHIRTS, IN CLASS 25 (U.S. CLS. 22 AND 39).

TRADEMARK

FIRST USE 10-7-2007; IN COMMERCE 7-15-2010.

PRINCIPAL REGISTER

THE MARK CONSISTS OF STANDARD CHARACTERS WITHOUT CLAIM TO ANY PARTICULAR FONT, STYLE, SIZE, OR COLOR.

SN 85-293,245, FILED 4-12-2011.

DAVID COLLIER, EXAMINING ATTORNEY



David J. Kyffers

Director of the United States Patent and Trademark Office

United States of America

United States Patent and Trademark Office



Reg. No. 4,155,461

Registered June 5, 2012

Int. Cl.: 28

NORTH AMERICAN SOCCER LEAGUE, LLC (DELAWARE LIMITED LIABILITY COMPANY)
C/O MIAMI FC
501 BRICKELL KEY DRIVE, SUITE 407
MIAMI, FL 33131

FOR: SOCCER BALLS, IN CLASS 28 (U.S. CLS. 22, 23, 38 AND 50).

TRADEMARK

FIRST USE 7-4-2011; IN COMMERCE 7-4-2011.

PRINCIPAL REGISTER

NO CLAIM IS MADE TO THE EXCLUSIVE RIGHT TO USE THE GEOGRAPHIC DESIGN OF NORTH AMERICA, APART FROM THE MARK AS SHOWN.

THE MARK CONSISTS OF THE LETTERS "NASL" ABOVE A DESIGN OF A SOCCER BALL WITH STARS AND A DEPICTION OF NORTH AMERICAN WITHIN A SHIELD.

SN 85-293,460, FILED 4-12-2011.

BRENDAN MCCAULEY, EXAMINING ATTORNEY



David J. Kybas

Director of the United States Patent and Trademark Office

United States of America

United States Patent and Trademark Office

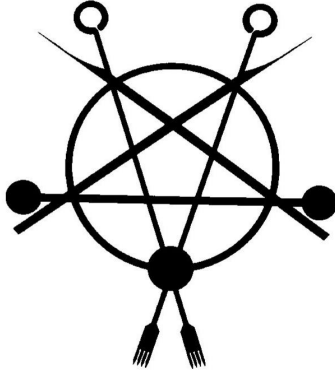

Reg. No. 4,155,462

Registered June 5, 2012

Int. Cl.: 25

TRADEMARK

PRINCIPAL REGISTER

MOLLAHAN, NATHAN (UNITED STATES INDIVIDUAL)
P.O. BOX 33320
PORTLAND, OR 97292

FOR: HATS; HOODED SWEATSHIRTS; JACKETS; LINGERIE; PANTS; SHIRTS; SHOES,
IN CLASS 25 (U.S. CLS. 22 AND 39).

FIRST USE 6-6-2006; IN COMMERCE 6-6-2006.

THE MARK CONSISTS OF A PENTAGRAM DESIGN COMPRISED IN PART OF THE REP-
RESENTATION OF TATTOO NEEDLES, PIERCING NEEDLES AND BODY JEWELRY.

SN 85-294,942, FILED 4-14-2011.

DAVID H. STINE, EXAMINING ATTORNEY



David J. Kyfos

Director of the United States Patent and Trademark Office

United States of America

United States Patent and Trademark Office

ANALYTICS-IN-A-BOX

Reg. No. 4,155,463

Registered June 5, 2012

Int. Cls.: 9 and 42

TRADEMARK

SERVICE MARK

PRINCIPAL REGISTER

TRADINGSCREEN, INC. (DELAWARE CORPORATION)
30 IRVING PLACE, 4TH FLOOR
NEW YORK, NY 10003

FOR: DOWNLOADABLE COMPUTER SOFTWARE FOR USE IN ANALYZING FINANCIAL TRADES AND GENERATING REPORTS BASED ON THAT ANALYSIS, IN CLASS 9 (U.S. CLS. 21, 23, 26, 36 AND 38).

FIRST USE 4-30-2011; IN COMMERCE 4-30-2011.

FOR: PROVIDING ONLINE TOOLS, NAMELY, PROVIDING TEMPORARY USE OF ON-LINE NON-DOWNLOADABLE SOFTWARE DEVELOPMENT TOOLS FOR USE IN ANALYZING FINANCIAL TRADES AND GENERATING REPORTS BASED ON THAT ANALYSIS, IN CLASS 42 (U.S. CLS. 100 AND 101).

FIRST USE 4-30-2011; IN COMMERCE 4-30-2011.

THE MARK CONSISTS OF STANDARD CHARACTERS WITHOUT CLAIM TO ANY PARTICULAR FONT, STYLE, SIZE, OR COLOR.

SN 85-295,065, FILED 4-14-2011.

SETH A. RAPPAPORT, EXAMINING ATTORNEY



David J. Kybas

Director of the United States Patent and Trademark Office

United States of America

United States Patent and Trademark Office

SLOW AGING AT THE CELLULAR LEVEL

Reg. No. 4,155,464

SHAKLEE CORPORATION (DELAWARE CORPORATION)
4747 WILLOW ROAD
PLEASANTON, CA 945882740

Registered June 5, 2012

Int. Cl.: 5

FOR: DIETARY AND NUTRITIONAL SUPPLEMENTS, IN CLASS 5 (U.S. CLS. 6, 18, 44, 46, 51 AND 52).

TRADEMARK

FIRST USE 8-1-2011; IN COMMERCE 8-1-2011.

PRINCIPAL REGISTER

THE MARK CONSISTS OF STANDARD CHARACTERS WITHOUT CLAIM TO ANY PARTICULAR FONT, STYLE, SIZE, OR COLOR.

SN 85-295,111, FILED 4-14-2011.

JOHN HWANG, EXAMINING ATTORNEY



David J. Kybas

Director of the United States Patent and Trademark Office

United States of America

United States Patent and Trademark Office

UPGRADE

Reg. No. 4,155,465

FREEMAN, JERAMY K. (UNITED STATES INDIVIDUAL)
6400 COLLAMER ROAD
EAST SYRACUSE, NY 13057

Registered June 5, 2012

Int. Cl.: 5

FOR: DIETARY AND NUTRITIONAL SUPPLEMENTS, IN CLASS 5 (U.S. CLS. 6, 18, 44, 46, 51 AND 52).

TRADEMARK

FIRST USE 1-0-2011; IN COMMERCE 1-0-2011.

PRINCIPAL REGISTER

THE MARK CONSISTS OF STANDARD CHARACTERS WITHOUT CLAIM TO ANY PARTICULAR FONT, STYLE, SIZE, OR COLOR.

SN 85-295,615, FILED 4-14-2011.

MICHAEL TANNER, EXAMINING ATTORNEY



David J. Kybas

Director of the United States Patent and Trademark Office

United States of America

United States Patent and Trademark Office

JOHNNY FOUND

Reg. No. 4,155,466

L & L MANUFACTURING CO., INC. (CALIFORNIA CORPORATION)
815 N. NASH STREET
EL SEGUNDO, CA 90245

Registered June 5, 2012

Int. Cl.: 25

FOR: CAPS; HOODED SWEATSHIRTS; KNIT TOPS; SWEATERS; SWEATSHIRTS; T-SHIRTS;
TOPS, IN CLASS 25 (U.S. CLS. 22 AND 39).

TRADEMARK

FIRST USE 1-5-2012; IN COMMERCE 1-5-2012.

PRINCIPAL REGISTER

THE MARK CONSISTS OF STANDARD CHARACTERS WITHOUT CLAIM TO ANY PARTICULAR FONT, STYLE, SIZE, OR COLOR.

THE NAME(S), PORTRAIT(S), AND/OR SIGNATURE(S) SHOWN IN THE MARK DOES NOT IDENTIFY A PARTICULAR LIVING INDIVIDUAL.

SN 85-295,660, FILED 4-14-2011.

PATRICIA EVANKO, EXAMINING ATTORNEY



David J. Kybas

Director of the United States Patent and Trademark Office

United States of America

United States Patent and Trademark Office



PassionateSpouse.com

Reg. No. 4,155,467

PASSIONATESPOUSE, INCORPORATED (GEORGIA CORPORATION)
3744 SMITHTOWN ROAD
SUWANEE, GA 30024

Registered June 5, 2012

Int. Cl.: 41

FOR: EDUCATIONAL SERVICES, NAMELY, CONDUCTING SEMINARS AND WORKSHOPS IN THE FIELD OF HEALTHY MARRIAGE RELATIONSHIPS AND DISTRIBUTION OF PRINTED MATERIALS IN CONNECTION THEREWITH IN HARD COPY OR ELECTRONIC FORMAT ON THE SAME TOPICS, IN CLASS 41 (U.S. CLS. 100, 101 AND 107).

SERVICE MARK

PRINCIPAL REGISTER

FIRST USE 1-1-2011; IN COMMERCE 1-1-2011.

THE STIPPLING IS FOR SHADING PURPOSES ONLY.

THE MARK CONSISTS OF AN IMAGE OF A ROSE WITH LEAVES SURROUNDING IT. THE ROSE IMAGE IS TO THE LEFT OF THE WORK PHRASE "PASSIONATESPOUSE.COM". THE ROSE IMAGE IS FOLLOWED TO THE RIGHT BY "PASSIONATESPOUSE.COM", USING FONT TYPE TIMES NEW ROMAN ITALIC, AND CAN BE FOUND IN ANY FONT SIZE.

SN 85-295,683, FILED 4-14-2011.

LOURDES AYALA, EXAMINING ATTORNEY



David J. Kyjars

Director of the United States Patent and Trademark Office

United States of America

United States Patent and Trademark Office

ZEROTIE

Reg. No. 4,155,468

Registered June 5, 2012

Int. Cl.: 25

TRADEMARK

PRINCIPAL REGISTER

PALIDIUM, INC. (MINNESOTA CORPORATION)
7310 132ND STREET NORTH
HUGO, MN 55036

FOR: FOOTWEAR, IN CLASS 25 (U.S. CLS. 22 AND 39).

FIRST USE 3-12-2012; IN COMMERCE 3-12-2012.

THE MARK CONSISTS OF THE WORD "ZEROTIE", THE "O" IN THE WORD BEING FORMED BY THE DESIGN OF A RATCHET WHEEL.

SN 85-295,716, FILED 4-14-2011.

DAVID H. STINE, EXAMINING ATTORNEY



David J. Kybas

Director of the United States Patent and Trademark Office

United States of America

United States Patent and Trademark Office

ICY FEET

Reg. No. 4,155,469

Registered June 5, 2012

Int. Cl.: 10

TRADEMARK

PRINCIPAL REGISTER

SNYDER, KENNETH C. (UNITED STATES INDIVIDUAL)
2629 AUGUSTA DRIVE
WHITEHALL, PA 18052

FOR: A MOLDED ICE PACK ARRANGED FOR ATTACHMENT TO THE FOOT FOR APPLYING COLD THERAPY THERETO FOR TREATING INFLAMMATIONS AND AILMENTS OF THE FOOT, IN CLASS 10 (U.S. CLS. 26, 39 AND 44).

FIRST USE 3-10-2012; IN COMMERCE 3-10-2012.

THE MARK CONSISTS OF STANDARD CHARACTERS WITHOUT CLAIM TO ANY PARTICULAR FONT, STYLE, SIZE, OR COLOR.

NO CLAIM IS MADE TO THE EXCLUSIVE RIGHT TO USE "FEET", APART FROM THE MARK AS SHOWN.

SN 85-295,946, FILED 4-15-2011.

KEVIN DINALLO, EXAMINING ATTORNEY



David J. Kyros

Director of the United States Patent and Trademark Office

United States of America

United States Patent and Trademark Office

FL 20

Reg. No. 4,155,470

Registered June 5, 2012

Int. Cl.: 25

TRADEMARK

PRINCIPAL REGISTER

LF 20, INC. (NEW YORK CORPORATION)
SUITE 335
672 DOGWOOD AVENUE
FRANKLIN SQUARE, NY 11010

FOR: MEN'S, WOMEN'S AND CHILDREN'S CLOTHING, NAMELY, T-SHIRTS, PANTS, SHIRTS, COATS, SWEATSHIRTS, SUITS, KNIT SHIRTS, JEANS, DRESS SHIRTS, VESTS, SWEATERS, SHORTS, SWIMWEAR, JACKETS, RAINWEAR, BLOUSES, DRESSES, SOCKS, HOSIERY, UNDERWEAR, PAJAMAS, SLEEPWEAR, BOXER SHORTS AND WOMEN'S LINGERIE; FASHION ACCESSORIES, NAMELY, BELTS, LEATHER GLOVES, SCARVES, HATS, HEAD BANDS, BANDANAS AND NECK TIES; FOOTWEAR, IN CLASS 25 (U.S. CLS. 22 AND 39).

FIRST USE 12-8-2011; IN COMMERCE 1-4-2012.

THE MARK CONSISTS OF STANDARD CHARACTERS WITHOUT CLAIM TO ANY PARTICULAR FONT, STYLE, SIZE, OR COLOR.

SN 85-296,017, FILED 4-15-2011.

KATHERINE CONNOLLY, EXAMINING ATTORNEY



David J. Kybas

Director of the United States Patent and Trademark Office

United States of America

United States Patent and Trademark Office

FL20

Reg. No. 4,155,471

Registered June 5, 2012

Int. Cl.: 25

TRADEMARK

PRINCIPAL REGISTER

LF 20, INC. (NEW YORK CORPORATION)
SUITE 335
672 DOGWOOD AVENUE
FRANKLIN SQUARE, NY 11010

FOR: MEN'S, WOMEN'S AND CHILDREN'S CLOTHING, NAMELY, T-SHIRTS, PANTS, SHIRTS, COATS, SWEATSHIRTS, SUITS, KNIT SHIRTS, JEANS, DRESS SHIRTS, VESTS, SWEATERS, SHORTS, SWIMWEAR, JACKETS, RAINWEAR, BLOUSES, DRESSES, SOCKS, HOSIERY, UNDERWEAR, PAJAMAS, SLEEPWEAR, BOXER SHORTS AND WOMEN'S LINGERIE; FASHION ACCESSORIES, NAMELY, BELTS, LEATHER GLOVES, SCARVES, HATS, HEAD BANDS, BANDANAS AND NECK TIES; FOOTWEAR, IN CLASS 25 (U.S. CLS. 22 AND 39).

FIRST USE 12-8-2011; IN COMMERCE 1-4-2012.

THE MARK CONSISTS OF THE LETTERS "F" AND "L" AND THE NUMBER "20" IN STYLIZED PRINT.

SN 85-296,070, FILED 4-15-2011.

KATHERINE CONNOLLY, EXAMINING ATTORNEY



David J. Kybas

Director of the United States Patent and Trademark Office

United States of America

United States Patent and Trademark Office

BREW STRONGER. BREW BIGGER. BREW HOTTER

Reg. No. 4,155,472

KEURIG, INCORPORATED (DELAWARE CORPORATION)
55 WALKERS BROOK DRIVE
READING, MA 01867

Registered June 5, 2012

Int. Cl.: 11

FOR: ELECTRIC BREWING MACHINES FOR BREWING BEVERAGES FOR DOMESTIC
AND COMMERCIAL USE, IN CLASS 11 (U.S. CLS. 13, 21, 23, 31 AND 34).

TRADEMARK

FIRST USE 3-5-2012; IN COMMERCE 3-5-2012.

PRINCIPAL REGISTER

THE MARK CONSISTS OF STANDARD CHARACTERS WITHOUT CLAIM TO ANY PAR-
TICULAR FONT, STYLE, SIZE, OR COLOR.

SN 85-296,117, FILED 4-15-2011.

STEVEN PEREZ, EXAMINING ATTORNEY



David J. Kybas

Director of the United States Patent and Trademark Office

United States of America

United States Patent and Trademark Office



Reg. No. 4,155,473

Registered June 5, 2012

Int. Cl.: 25

TRADEMARK

PRINCIPAL REGISTER

DIVALISH DESIGNS, LLC (MARYLAND LIMITED LIABILITY COMPANY)
14123 CASTLE BLVD #402
SILVER SPRING, MD 20904

FOR: WOMEN'S APPAREL, NAMELY, BIKINIS, ONE-PIECE BATHING SUITS, BEACH COVER UPS, PANTIES, BRAS, LINGERIE, PAJAMAS, BOXER BRIEFS, TANK TOP AND BOXER BRIEFS SETS, TANK TOP AND CAPRI SETS, TANK TOP AND SHORTS SETS, SLEEP SHIRTS, TEE SHIRT AND PANTS SETS, CAMISOLE AND CAPRI SETS, LONG SLEEVE SHIRTS AND SHORTS SETS, TEE SHIRTS AND SHORT SETS, TANK TOP AND BOXER BRIEFS SETS, T-SHIRTS, BABY DOLL TEES, TANK TOPS, HALTER TOPS, BLOUSES, JEANS, DENIM SHORTS, CAPRIS, SWEAT PANTS AND SWEAT SHORTS, IN CLASS 25 (U.S. CLS. 22 AND 39).

FIRST USE 6-0-2011; IN COMMERCE 6-0-2011.

NO CLAIM IS MADE TO THE EXCLUSIVE RIGHT TO USE "DESIGNS", APART FROM THE MARK AS SHOWN.

THE MARK CONSISTS OF THE STYLIZED WORDS "DIVALISH DESIGNS". IN-BETWEEN THE WORDS IS A STYLIZED FEMALE DEVIL CARRYING A TRIDENT. SHE IS SURROUNDED BY A HALF RING OF FLAMES. HER TAIL IS IN THE SHAPE OF A HEART WITH AN ARROW AT THE END ALSO DISPLAYING FLAMES.

SN 85-296,679, FILED 4-15-2011.

CHRISTOPHER BUONGIORNO, EXAMINING ATTORNEY



David J. Kybas

Director of the United States Patent and Trademark Office

United States of America

United States Patent and Trademark Office

MYCASH

Reg. No. 4,155,474

PINNACLE ENTERTAINMENT, INC. (DELAWARE CORPORATION)
8918 SPANISH RIDGE AVENUE
LAS VEGAS, NV 89148

Registered June 5, 2012

Int. Cl.: 35

FOR: CUSTOMER LOYALTY SERVICES, NAMELY, CUSTOMER LOYALTY PROGRAMS FEATURING LOYALTY POINTS THAT PROVIDE CASINO, HOTEL, RETAIL, AND RESTAURANT BENEFITS TO REWARD REPEAT CUSTOMERS, IN CLASS 35 (U.S. CLS. 100, 101 AND 102).

SERVICE MARK

PRINCIPAL REGISTER

FIRST USE 4-1-2011; IN COMMERCE 4-1-2011.

THE MARK CONSISTS OF STANDARD CHARACTERS WITHOUT CLAIM TO ANY PARTICULAR FONT, STYLE, SIZE, OR COLOR.

SN 85-296,810, FILED 4-15-2011.

PATRICIA EVANKO, EXAMINING ATTORNEY



David J. Kyros

Director of the United States Patent and Trademark Office

United States of America

United States Patent and Trademark Office



Reg. No. 4,155,475

Registered June 5, 2012

Int. Cl.: 24

TRADEMARK

PRINCIPAL REGISTER

KATE SPADE LLC (DELAWARE LIMITED LIABILITY COMPANY)
48 WEST 25TH STREET
NEW YORK, NY 10010

FOR: BED BLANKETS; BED SHEETS; BED SKIRTS; BED THROWS; BEDSPREADS; COMFORTERS; COVERS FOR CUSHIONS; CRIB BUMPER PADS; CRIB BUMPERS; CRIB CANOPIES; CURTAINS; DRAPERIES; DUST RUFFLES; DUVET COVERS; DUVETS; HANDKERCHIEFS; KITCHEN LINENS; KITCHEN TOWELS; MATTRESS COVERS; MATTRESS PADS; PILLOW COVERS; PILLOW SHAMS; PILLOWCASES; POT HOLDERS; QUILTS; SHOWER CURTAINS; TABLE LINEN, NAMELY, COASTERS, NAPKINS, PLACE MATS AND TABLECLOTHS; TOWELS; WASH CLOTHS, IN CLASS 24 (U.S. CLS. 42 AND 50).

FIRST USE 1-2-2011; IN COMMERCE 1-2-2011.

OWNER OF U.S. REG. NOS. 2,841,312, 3,095,754, AND OTHERS.

NO CLAIM IS MADE TO THE EXCLUSIVE RIGHT TO USE "NEW YORK", APART FROM THE MARK AS SHOWN.

THE NAME "KATE SPADE" IDENTIFIES A LIVING INDIVIDUAL WHOSE CONSENT IS OF RECORD.

THE MARK CONSISTS OF A SPADE DESIGN WITH THE WORDS "KATE SPADE NEW YORK" UNDERNEATH.

SN 85-297,677, FILED 4-18-2011.

JENNIFER MARTIN, EXAMINING ATTORNEY



David J. Kybas

Director of the United States Patent and Trademark Office

United States of America

United States Patent and Trademark Office

THE BLUE TEAM

Reg. No. 4,155,476

Registered June 5, 2012

Int. Cl.: 35

SERVICE MARK

PRINCIPAL REGISTER

FASTENAL IP COMPANY (MINNESOTA CORPORATION)
2001 THEURER BLVD.
WINONA, MN 55987

FOR: WHOLESALE DISTRIBUTORSHIP AND WHOLESALE OUTLET STORES FEATURING FASTENERS, ELECTRICAL TOOLS AND WIRING, GLOVES, PROTECTIVE EYEWEAR, FIRST AID PRODUCTS, BUILDING CONSTRUCTION TOOLS AND EQUIPMENT USED FOR PLUMBING PURPOSES, JANITORIAL EQUIPMENT AND SUPPLIES USED FOR INDUSTRIAL, INSTITUTIONAL AND COMMERCIAL PURPOSES; BUSINESS MANAGEMENT CONSULTING SERVICES IN THE BUILDING CONSTRUCTION TOOLS INDUSTRY; MOBILE VENDING SERVICES IN THE FIELDS OF MAINTENANCE, REPAIR AND OPERATION SUPPLIES AND OFFICE SUPPLIES, IN CLASS 35 (U.S. CLS. 100, 101 AND 102).

FIRST USE 8-24-2011; IN COMMERCE 8-24-2011.

THE MARK CONSISTS OF STANDARD CHARACTERS WITHOUT CLAIM TO ANY PARTICULAR FONT, STYLE, SIZE, OR COLOR.

SN 85-298,010, FILED 4-18-2011.

GIANCARLO CASTRO, EXAMINING ATTORNEY



David J. Kypos

Director of the United States Patent and Trademark Office

United States of America

United States Patent and Trademark Office

Mint McKinley 20,320 Ft. of Freshness

Reg. No. 4,155,477

MINT MCKINLEY LLC (OKLAHOMA LIMITED LIABILITY COMPANY)
116 S. BROADWAY
ADA, OK 74821

Registered June 5, 2012

Int. Cl.: 3

FOR: BREATH MINTS FOR USE AS A BREATH FRESHENER, IN CLASS 3 (U.S. CLS. 1, 4, 6, 50, 51 AND 52).

TRADEMARK

FIRST USE 2-1-2011; IN COMMERCE 5-18-2011.

PRINCIPAL REGISTER

THE MARK CONSISTS OF STANDARD CHARACTERS WITHOUT CLAIM TO ANY PARTICULAR FONT, STYLE, SIZE, OR COLOR.

SN 85-298,180, FILED 4-18-2011.

RON FAIRBANKS, EXAMINING ATTORNEY



David J. Kyffers

Director of the United States Patent and Trademark Office

United States of America

United States Patent and Trademark Office

RICHFACE

Reg. No. 4,155,478

Registered June 5, 2012

Int. Cls.: 25 and 45

TRADEMARK

SERVICE MARK

PRINCIPAL REGISTER

OFL ONLINE FUTURE LTD. (CYPRUS LIMITED LIABILITY COMPANY)
ORPHEOS STREET 2B
NICOSIA, CYPRUS 1070

FOR: BASEBALL CAPS AND HATS; BELTS FOR CLOTHING; CHEMISES; CUSTOM MADE TO MEASURE SUITS FOR MEN AND WOMEN; HATS; MEN'S SUITS; MEN'S SUITS, WOMEN'S SUITS; POLO SHIRTS; SHORT SETS; SOCKS; SPORTS CAPS AND HATS; SPORTS JACKETS; SPORTS JERSEYS; T-SHIRTS; TIES; TOPS; TROUSERS; WOMEN'S CLOTHING, NAMELY, SHIRTS, DRESSES, SKIRTS, BLOUSES, IN CLASS 25 (U.S. CLS. 22 AND 39).

FIRST USE 12-31-2011; IN COMMERCE 12-31-2011.

FOR: CONDUCTING ON-LINE PERSONAL LIFESTYLE PERFORMANCE ASSESSMENTS BASED ON PRINCIPLES OF EMOTIONAL HAPPINESS BY MEANS OF THE USERS' INPUTTED PREFERENCES AND SOCIAL NETWORK; INTERNET BASED SOCIAL NETWORKING, INTRODUCTION, AND DATING SERVICES; INTERNET-BASED DATING, SOCIAL INTRODUCTION AND SOCIAL NETWORKING SERVICES; INTERNET-BASED SOCIAL NETWORKING SERVICES; ONLINE SOCIAL NETWORKING SERVICES PROVIDED THROUGH A COMMUNITY WEBSITE; ONLINE SOCIAL NETWORKING SERVICES PROVIDED THROUGH A FASHION COMMUNITY WEBSITE, IN CLASS 45 (U.S. CLS. 100 AND 101).

FIRST USE 4-1-2012; IN COMMERCE 4-1-2012.

THE MARK CONSISTS OF STANDARD CHARACTERS WITHOUT CLAIM TO ANY PARTICULAR FONT, STYLE, SIZE, OR COLOR.

SN 85-298,479, FILED 4-19-2011.

MICHAEL KEATING, EXAMINING ATTORNEY



David J. Kyros

Director of the United States Patent and Trademark Office

United States of America

United States Patent and Trademark Office



Reg. No. 4,155,479

Registered June 5, 2012

Int. Cl.: 21

TRADEMARK

PRINCIPAL REGISTER

KATE SPADE LLC (DELAWARE LIMITED LIABILITY COMPANY)
48 WEST 25TH STREET
NEW YORK, NY 10010

FOR: BATH ACCESSORIES, NAMELY, CUP HOLDERS; CUPS; LOTION CONTAINERS SOLD EMPTY FOR DOMESTIC USE; SOAP DISHES; SOAP DISPENSERS; SOAP HOLDERS; TOOTHBRUSH HOLDERS; WASTE BASKETS, IN CLASS 21 (U.S. CLS. 2, 13, 23, 29, 30, 33, 40 AND 50).

FIRST USE 1-2-2011; IN COMMERCE 1-2-2011.

OWNER OF U.S. REG. NOS. 2,841,312, 3,095,754, AND OTHERS.

NO CLAIM IS MADE TO THE EXCLUSIVE RIGHT TO USE "NEW YORK", APART FROM THE MARK AS SHOWN.

THE NAME "KATE SPADE" IDENTIFIES A LIVING INDIVIDUAL WHOSE CONSENT IS OF RECORD.

THE MARK CONSISTS OF A SPADE DESIGN WITH THE WORDS "KATE SPADE NEW YORK" UNDERNEATH.

SN 85-298,818, FILED 4-19-2011.

JENNIFER MARTIN, EXAMINING ATTORNEY



David J. Kybas

Director of the United States Patent and Trademark Office

United States of America

United States Patent and Trademark Office

LOOP

Reg. No. 4,155,480

Registered June 5, 2012

Int. Cl.: 21

TRADEMARK

PRINCIPAL REGISTER

BKD ACQUISITION, INC. (DELAWARE CORPORATION)
1111 W. 22ND ST.
SUITE 320
OAKBROOK, IL 60523

FOR: CADDIES FOR HOLDING DIAPERS AND DIAPER-CHANGING ACCESSORIES, IN CLASS 21 (U.S. CLS. 2, 13, 23, 29, 30, 33, 40 AND 50).

FIRST USE 9-25-2011; IN COMMERCE 9-25-2011.

THE MARK CONSISTS OF STANDARD CHARACTERS WITHOUT CLAIM TO ANY PARTICULAR FONT, STYLE, SIZE, OR COLOR.

SN 85-298,926, FILED 4-19-2011.

FLORENTINA BLANDU, EXAMINING ATTORNEY



David J. Kybas

Director of the United States Patent and Trademark Office

United States of America

United States Patent and Trademark Office

MORE THAN JUST GREAT WINGS...

Reg. No. 4,155,481

Registered June 5, 2012

Int. Cl.: 43

SERVICE MARK

PRINCIPAL REGISTER

NATIVE NEW YORKER OF AMERICA, INC. (ARIZONA CORPORATION)
1757 EAST BASELINE
BLDG. 6, #122
GILBERT, AZ 85234

FOR: BAR AND RESTAURANT SERVICES, IN CLASS 43 (U.S. CLS. 100 AND 101).

FIRST USE 2-0-2011; IN COMMERCE 2-0-2011.

THE MARK CONSISTS OF STANDARD CHARACTERS WITHOUT CLAIM TO ANY PARTICULAR FONT, STYLE, SIZE, OR COLOR.

SN 85-299,372, FILED 4-19-2011.

JAY BESCH, EXAMINING ATTORNEY



David J. Kyros

Director of the United States Patent and Trademark Office

United States of America

United States Patent and Trademark Office

VORO

Reg. No. 4,155,482

SHAMOOIL, DANIEL (UNITED STATES INDIVIDUAL)
5 NASSAU DRIVE
GREAT NECK, NY 11021

Registered June 5, 2012

Int. Cl.: 36

FOR: REAL ESTATE BROKERAGE; REAL ESTATE LISTING; REAL ESTATE CONSULTANCY; REAL ESTATE APPRAISAL AND VALUATION; PROVIDING REAL ESTATE LISTINGS AND REAL ESTATE INFORMATION VIA THE INTERNET; LEASING OF REAL ESTATE, IN CLASS 36 (U.S. CLS. 100, 101 AND 102).

SERVICE MARK

PRINCIPAL REGISTER

FIRST USE 4-1-2011; IN COMMERCE 6-1-2011.

THE MARK CONSISTS OF STANDARD CHARACTERS WITHOUT CLAIM TO ANY PARTICULAR FONT, STYLE, SIZE, OR COLOR.

SN 85-299,496, FILED 4-20-2011.

CIMMERIAN COLEMAN, EXAMINING ATTORNEY



David J. Kybas

Director of the United States Patent and Trademark Office

United States of America

United States Patent and Trademark Office

SOGNO D'ITALIA

Reg. No. 4,155,483

Registered June 5, 2012

Int. Cl.: 33

TRADEMARK

PRINCIPAL REGISTER

BANFI PRODUCTS CORPORATION (NEW YORK CORPORATION)
1111 CEDAR SWAMP ROAD
OLD BROOKVILLE, NY 11545

FOR: WINES, IN CLASS 33 (U.S. CLS. 47 AND 49).

FIRST USE 9-0-2011; IN COMMERCE 9-0-2011.

THE MARK CONSISTS OF STANDARD CHARACTERS WITHOUT CLAIM TO ANY PARTICULAR FONT, STYLE, SIZE, OR COLOR.

THE ENGLISH TRANSLATION OF "SOGNO D'ITALIA" IN THE MARK IS DREAM OF ITALY.

SN 85-299,594, FILED 4-20-2011.

JORDAN BAKER, EXAMINING ATTORNEY



David J. Kyffers

Director of the United States Patent and Trademark Office

United States of America

United States Patent and Trademark Office

ART OF EXPLOITATION

Reg. No. 4,155,484

Registered June 5, 2012

Int. Cl.: 41

SERVICE MARK

PRINCIPAL REGISTER

TELECOMMUNICATION SYSTEMS, INC. (MARYLAND CORPORATION)
LEGAL DEPARTMENT
275 WEST STREET, SUITE 400
ANNAPOLIS, MD 21401

FOR: COMPUTER EDUCATION TRAINING SERVICES, IN CLASS 41 (U.S. CLS. 100, 101 AND 107).

FIRST USE 11-6-2006; IN COMMERCE 11-6-2006.

THE MARK CONSISTS OF STANDARD CHARACTERS WITHOUT CLAIM TO ANY PARTICULAR FONT, STYLE, SIZE, OR COLOR.

OWNER OF U.S. REG. NO. 2,431,278.

SN 85-299,764, FILED 4-20-2011.

ROBIN MITTLER, EXAMINING ATTORNEY



David J. Kyffers

Director of the United States Patent and Trademark Office

United States of America

United States Patent and Trademark Office

Weird Vibes

Reg. No. 4,155,485

Registered June 5, 2012

Int. Cl.: 41

SERVICE MARK

PRINCIPAL REGISTER

SHIRLEY BEANS PRODUCTIONS LLC (NEW YORK LIMITED LIABILITY COMPANY)
121 BAXTER ST #17
NEW YORK, NY 10013

FOR: ENTERTAINMENT SERVICES, NAMELY, AN ON-GOING SERIES FEATURING MUSIC PROVIDED THROUGH TELEVISION AND THE INTERNET; ENTERTAINMENT SERVICES, NAMELY, PROVIDING VIDEO PODCASTS IN THE FIELD OF MUSIC; ENTERTAINMENT, NAMELY, A CONTINUING MUSIC SHOW BROADCAST OVER TELEVISION, SATELLITE, AUDIO, AND VIDEO MEDIA, IN CLASS 41 (U.S. CLS. 100, 101 AND 107).

FIRST USE 2-16-2011; IN COMMERCE 7-1-2011.

THE MARK CONSISTS OF STANDARD CHARACTERS WITHOUT CLAIM TO ANY PARTICULAR FONT, STYLE, SIZE, OR COLOR.

SN 85-299,805, FILED 4-20-2011.

TRACY WHITTAKER-BROWN, EXAMINING ATTORNEY



David J. Kybas

Director of the United States Patent and Trademark Office

United States of America

United States Patent and Trademark Office

DOWN LOFT

Reg. No. 4,155,486

Registered June 5, 2012

Int. Cl.: 20

TRADEMARK

PRINCIPAL REGISTER

PACIFIC COAST FEATHER COMPANY (WASHINGTON CORPORATION)
P.O. BOX 80385
SEATTLE, WA 98108

FOR: DOWN PILLOWS, IN CLASS 20 (U.S. CLS. 2, 13, 22, 25, 32 AND 50).

FIRST USE 9-11-2011; IN COMMERCE 9-11-2011.

THE MARK CONSISTS OF STANDARD CHARACTERS WITHOUT CLAIM TO ANY PARTICULAR FONT, STYLE, SIZE, OR COLOR.

NO CLAIM IS MADE TO THE EXCLUSIVE RIGHT TO USE "DOWN", APART FROM THE MARK AS SHOWN.

SN 85-299,860, FILED 4-20-2011.

GEOFFREY FOSDICK, EXAMINING ATTORNEY



David J. Kyffers

Director of the United States Patent and Trademark Office

United States of America

United States Patent and Trademark Office

ART OF EXPLOITATION

Reg. No. 4,155,487

Registered June 5, 2012

Int. Cl.: 42

SERVICE MARK

PRINCIPAL REGISTER

TELECOMMUNICATION SYSTEMS, INC. (MARYLAND CORPORATION)
LEGAL DEPARTMENT
275 WEST STREET, SUITE 400
ANNAPOLIS, MD 21401

FOR: COMPUTER SECURITY CONSULTANCY; COMPUTER SECURITY CONSULTANCY IN THE FIELD OF SCANNING AND PENETRATION TESTING OF COMPUTERS AND NETWORKS TO ASSESS INFORMATION SECURITY VULNERABILITY; COMPUTER SOFTWARE DEVELOPMENT IN THE FIELD OF VULNERABILITY ANALYSIS, IN CLASS 42 (U.S. CLS. 100 AND 101).

FIRST USE 11-6-2006; IN COMMERCE 11-6-2006.

THE MARK CONSISTS OF STANDARD CHARACTERS WITHOUT CLAIM TO ANY PARTICULAR FONT, STYLE, SIZE, OR COLOR.

OWNER OF U.S. REG. NO. 2,431,278.

SN 85-299,914, FILED 4-20-2011.

ROBIN MITTLER, EXAMINING ATTORNEY



David J. Kybas

Director of the United States Patent and Trademark Office

United States of America

United States Patent and Trademark Office

**A NEW
GENICS** 

Reg. No. 4,155,488

Registered June 5, 2012

Int. Cl.: 3

TRADEMARK

PRINCIPAL REGISTER

AVON PRODUCTS, INC. (NEW YORK CORPORATION)
777 THIRD AVENUE
LEGAL DEPARTMENT, 3RD FLOOR
NEW YORK, NY 10017

FOR: EYE CREAM; FACIAL CREAMS, IN CLASS 3 (U.S. CLS. 1, 4, 6, 50, 51 AND 52).

FIRST USE 9-1-2011; IN COMMERCE 9-1-2011.

OWNER OF U.S. REG. NOS. 1,982,608, 3,373,763, AND OTHERS.

THE MARK CONSISTS OF A STYLIZED DESIGN OF A MOLECULE MODEL WITH THE STYLIZED WORDING "A NEW GENICS".

SN 85-299,962, FILED 4-20-2011.

JENNY PARK, EXAMINING ATTORNEY



David J. Kybas

Director of the United States Patent and Trademark Office

United States of America

United States Patent and Trademark Office

TIMBERLINE

Reg. No. 4,155,489

LANX, INC. (DELAWARE CORPORATION)
310 INTERLOCKEN PARKWAY, STE. 120
BROOMFIELD, CO 80021

Registered June 5, 2012

Int. Cl.: 10

FOR: MEDICAL DEVICES, NAMELY, SPINAL IMPLANTS OF ARTIFICIAL MATERIAL;
SURGICAL INSTRUMENTS FOR FACILITATING IMPLANTATION OF SPINAL IMPLANTS,
IN CLASS 10 (U.S. CLS. 26, 39 AND 44).

TRADEMARK

FIRST USE 4-0-2011; IN COMMERCE 4-0-2011.

PRINCIPAL REGISTER

THE MARK CONSISTS OF STANDARD CHARACTERS WITHOUT CLAIM TO ANY PARTICULAR FONT, STYLE, SIZE, OR COLOR.

SN 85-300,141, FILED 4-20-2011.

LINDSEY RUBIN, EXAMINING ATTORNEY



David J. Kybas

Director of the United States Patent and Trademark Office

United States of America

United States Patent and Trademark Office

ITAY MINERAL COSMETICS

Reg. No. 4,155,490

Registered June 5, 2012

Int. Cl.: 3

TRADEMARK

PRINCIPAL REGISTER

DECHNER, ITZHAK (ISRAEL INDIVIDUAL)
6428 BAYBERRY STREET
OAK PARK, CA 91377 AND

DECHNER, DANIEL (ISRAEL INDIVIDUAL)
6428 BAYBERRY STREET
OAK PARK, CA 91377

FOR: COSMETICS AND MAKE-UP; NATURAL MINERAL MAKE-UP, IN CLASS 3 (U.S. CLS. 1, 4, 6, 50, 51 AND 52).

FIRST USE 3-1-2011; IN COMMERCE 7-1-2011.

THE MARK CONSISTS OF STANDARD CHARACTERS WITHOUT CLAIM TO ANY PARTICULAR FONT, STYLE, SIZE, OR COLOR.

NO CLAIM IS MADE TO THE EXCLUSIVE RIGHT TO USE "MINERAL COSMETICS", APART FROM THE MARK AS SHOWN.

SN 85-300,267, FILED 4-20-2011.

MIDGE BUTLER, EXAMINING ATTORNEY



David J. Kyros

Director of the United States Patent and Trademark Office

United States of America

United States Patent and Trademark Office

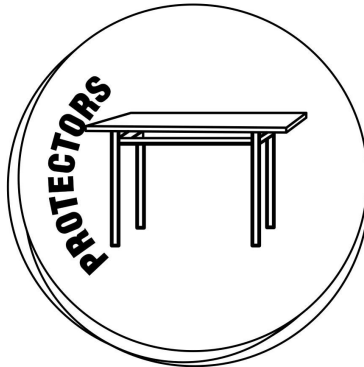

Reg. No. 4,155,491

PRYM CONSUMER USA INC. (SOUTH CAROLINA CORPORATION)

Registered June 5, 2012

P. O. BOX 5028
SPARTANBURG, SC 293045028

Int. Cl.: 24

FOR: SURFACE PROTECTORS IN THE NATURE OF PLASTIC TABLE COVERS; FELT TABLE PADS, IN CLASS 24 (U.S. CLS. 42 AND 50).

TRADEMARK

FIRST USE 2-1-2012; IN COMMERCE 2-1-2012.

PRINCIPAL REGISTER

NO CLAIM IS MADE TO THE EXCLUSIVE RIGHT TO USE "PROTECTORS", APART FROM THE MARK AS SHOWN.

THE MARK CONSISTS OF THE WORDING "PROTECTORS" IN A STYLIZED FONT, TO THE LEFT OF THE DESIGN OF A TABLE, ALL WITHIN A CIRCLE WITH THREE SEPARATE LINES DEPICTING THE LEFT AND BOTTOM EDGES.

SN 85-300,286, FILED 4-20-2011.

JAMES MACFARLANE, EXAMINING ATTORNEY



David J. Kyros

Director of the United States Patent and Trademark Office

United States of America

United States Patent and Trademark Office



Reg. No. 4,155,492

Registered June 5, 2012

Int. Cl.: 35

SERVICE MARK

PRINCIPAL REGISTER

REMAR, INC. (TENNESSEE CORPORATION)
6200 E. DIVISION STREET
LEBANON, TN 37090

FOR: BUSINESS MARKETING AND DIRECT MAIL CONSULTING SERVICES; DIRECT MAIL ADVERTISING SERVICES; ORDER FULFILLMENT SERVICES; TRANSPORTATION LOGISTICS SERVICES, NAMELY, ARRANGING THE TRANSPORTATION OF GOODS FOR OTHERS, IN CLASS 35 (U.S. CLS. 100, 101 AND 102).

FIRST USE 7-1-2011; IN COMMERCE 7-1-2011.

THE MARK CONSISTS OF THE LETTER "R" WITHOUT THE STEM AND IN PLACE OF THE STEM AND OVAL IN THE CENTER OF THE "R" ARE THREE NARROWING SWOOSHES COMING TOGETHER IN THE FRONT CENTER OF THE "R".

SN 85-300,824, FILED 4-21-2011.

RUSS HERMAN, EXAMINING ATTORNEY



David J. Kyffers

Director of the United States Patent and Trademark Office

United States of America

United States Patent and Trademark Office

OPERATION GRAND SLAM

Reg. No. 4,155,493

Registered June 5, 2012

Int. Cl.: 41

SERVICE MARK

PRINCIPAL REGISTER

OPERATION GRAND SLAM (WASHINGTON CORPORATION)
PO BOX 88
WOODINVILLE, WA 98072

FOR: EDUCATION AND ENTERTAINMENT SERVICES; NAMELY, EDUCATIONAL BASEBALL CAMPS FOR GENERAL EDUCATION AND SPECIAL NEEDS CHILDREN, IN CLASS 41 (U.S. CLS. 100, 101 AND 107).

FIRST USE 3-30-2011; IN COMMERCE 1-2-2012.

THE MARK CONSISTS OF STANDARD CHARACTERS WITHOUT CLAIM TO ANY PARTICULAR FONT, STYLE, SIZE, OR COLOR.

SN 85-301,177, FILED 4-21-2011.

DORITT L. CARROLL, EXAMINING ATTORNEY



David J. Kybas

Director of the United States Patent and Trademark Office

United States of America

United States Patent and Trademark Office

EM/4

Reg. No. 4,155,494

Registered June 5, 2012

Int. Cl.: 9

TRADEMARK

PRINCIPAL REGISTER

POWER ASSURE, INC. (DELAWARE CORPORATION)
2390 WALSH AVENUE
SANTA CLARA, CA 95051

FOR: COMPUTER PROGRAMS FOR ENERGY MANAGEMENT AND OPTIMIZATION OF BUILDINGS, DATA CENTERS, COOLING, HEATING, POWER, NETWORK AND INFORMATION TECHNOLOGY EQUIPMENT; AND COMPUTER SOFTWARE FOR MONITORING AND ANALYZING ENERGY CONSUMPTION RELATING TO BUILDINGS, DATA CENTERS, COOLING, HEATING, POWER, NETWORK AND INFORMATION TECHNOLOGY EQUIPMENT, IN CLASS 9 (U.S. CLS. 21, 23, 26, 36 AND 38).

FIRST USE 9-1-2011; IN COMMERCE 9-1-2011.

THE MARK CONSISTS OF STANDARD CHARACTERS WITHOUT CLAIM TO ANY PARTICULAR FONT, STYLE, SIZE, OR COLOR.

SN 85-302,824, FILED 4-23-2011.

STEVEN R. FINE, EXAMINING ATTORNEY



David J. Kyros

Director of the United States Patent and Trademark Office

United States of America

United States Patent and Trademark Office

TIMED RELEASE

Reg. No. 4,155,495

SCHIPPER & COMPANY U.S.A., INC. (CONNECTICUT CORPORATION)
747 BARNUM AVE.
BRIDGEPORT, CT 06608

Registered June 5, 2012

Int. Cl.: 31

FOR: LIVING PLANTS, NAMELY, FLOWER BULBS AND LIVE FLOWERING PLANTS, IN CLASS 31 (U.S. CLS. 1 AND 46).

TRADEMARK

FIRST USE 7-15-2011; IN COMMERCE 7-15-2011.

PRINCIPAL REGISTER

THE MARK CONSISTS OF STANDARD CHARACTERS WITHOUT CLAIM TO ANY PARTICULAR FONT, STYLE, SIZE, OR COLOR.

SN 85-303,216, FILED 4-25-2011.

KATHERINE CONNOLLY, EXAMINING ATTORNEY



David J. Kybas

Director of the United States Patent and Trademark Office

United States of America

United States Patent and Trademark Office

Well Being for Life

Reg. No. 4,155,496

JENKINS, ANNE (UNITED STATES INDIVIDUAL)
7220 AVENIDA ENCINAS #100
CARLSBAD, CA 92011

Registered June 5, 2012

Int. Cl.: 44

FOR: CHIROPRACTIC SERVICES; ENERGY HEALING SERVICES, NAMELY, THERAPEUTIC TOUCH SERVICES; HEALTH CARE SERVICES FOCUSING ON THE SPINE; HEALTH CARE SERVICES, NAMELY, WELLNESS PROGRAMS, IN CLASS 44 (U.S. CLS. 100 AND 101).

SERVICE MARK

FIRST USE 5-30-2011; IN COMMERCE 5-30-2011.

PRINCIPAL REGISTER

THE MARK CONSISTS OF STANDARD CHARACTERS WITHOUT CLAIM TO ANY PARTICULAR FONT, STYLE, SIZE, OR COLOR.

SN 85-303,561, FILED 4-25-2011.

GEOFFREY FOSDICK, EXAMINING ATTORNEY



David J. Kyros

Director of the United States Patent and Trademark Office

United States of America

United States Patent and Trademark Office

BE WHAT'S POSSIBLE

Reg. No. 4,155,497

Registered June 5, 2012

Int. Cl.: 35

SERVICE MARK

PRINCIPAL REGISTER

GAP (APPAREL), LLC (CALIFORNIA LIMITED LIABILITY COMPANY)
2 FOLSOM STREET
SAN FRANCISCO, CA 94105

FOR: CHARITABLE SERVICES, NAMELY, ORGANIZING AND CONDUCTING VOLUNTEER PROGRAMS AND COMMUNITY SERVICE PROJECTS, IN CLASS 35 (U.S. CLS. 100, 101 AND 102).

FIRST USE 7-31-2006; IN COMMERCE 7-31-2006.

THE MARK CONSISTS OF STANDARD CHARACTERS WITHOUT CLAIM TO ANY PARTICULAR FONT, STYLE, SIZE, OR COLOR.

SN 85-304,189, FILED 4-25-2011.

ANNE MADDEN, EXAMINING ATTORNEY



David J. Kybas

Director of the United States Patent and Trademark Office

United States of America

United States Patent and Trademark Office

BE WHAT'S POSSIBLE

Reg. No. 4,155,498

Registered June 5, 2012

Int. Cl.: 36

SERVICE MARK

PRINCIPAL REGISTER

GAP (APPAREL), LLC (CALIFORNIA LIMITED LIABILITY COMPANY)
2 FOLSOM STREET
SAN FRANCISCO, CA 94105

FOR: CHARITABLE FOUNDATION SERVICES, NAMELY, PROVIDING FINANCIAL ASSISTANCE FOR PROGRAMS AND SERVICES OF OTHERS, IN CLASS 36 (U.S. CLS. 100, 101 AND 102).

FIRST USE 7-31-2006; IN COMMERCE 7-31-2006.

THE MARK CONSISTS OF STANDARD CHARACTERS WITHOUT CLAIM TO ANY PARTICULAR FONT, STYLE, SIZE, OR COLOR.

SN 85-304,191, FILED 4-25-2011.

ANNE MADDEN, EXAMINING ATTORNEY



David J. Kyros

Director of the United States Patent and Trademark Office

United States of America

United States Patent and Trademark Office



Reg. No. 4,155,499

Registered June 5, 2012

Int. Cl.: 30

TRADEMARK

PRINCIPAL REGISTER

HERSHEY CHOCOLATE & CONFECTIONERY CORPORATION (DELAWARE CORPORATION)
SUITE 204
4860 ROBB STREET
WHEAT RIDGE, CO 80033

FOR: CANDY, IN CLASS 30 (U.S. CL. 46).

FIRST USE 4-30-2010; IN COMMERCE 4-30-2010.

OWNER OF U.S. REG. NOS. 1,074,163, 3,934,544, AND OTHERS.

THE COLOR(S) ORANGE, BROWN, YELLOW, WHITE AND TAN IS/ARE CLAIMED AS A FEATURE OF THE MARK.

SEC. 2(F) AS TO MINIATURES.

NO CLAIM IS MADE TO THE EXCLUSIVE RIGHT TO USE "PEANUT BUTTER CUPS" AND "WHITE", APART FROM THE MARK AS SHOWN.

THE MARK CONSISTS OF "REESE'S" IN YELLOW STYLIZED SCRIPT LETTERS OUTLINED IN THE COLOR BROWN ABOVE THE WORDS "PEANUT BUTTER CUPS" IN YELLOW LETTERS, A STYLIZED PARTIAL DESIGN LOGO OF AN ELONGATED SIDE OF A PEANUT BUTTER CUP, THE WORDS "WHITE" AND "MINIATURES" IN WHITE LETTERS OUTLINED IN BROWN, A STYLIZED DESIGN OF TWO WHITE PEANUT BUTTER CUPS WITH ONE PARTIALLY EATEN STYLIZED DESIGN OF A PEANUT BUTTER CUP SHOWING TAN FILLING, ALL ON AN ORANGE BACKGROUND. THE DOTTED LINING SHOWN IN THE MARK IS FOR PLACEMENT PURPOSES AND IS NOT A FEATURE OF THE MARK.

SN 85-304,357, FILED 4-25-2011.

KATINA MISTER, EXAMINING ATTORNEY



David J. Kybas

Director of the United States Patent and Trademark Office

United States of America

United States Patent and Trademark Office

WESWORKS

Reg. No. 4,155,500

Registered June 5, 2012

Int. Cl.: 41

SERVICE MARK

PRINCIPAL REGISTER

OHIO FARMERS INSURANCE COMPANY (OHIO CORPORATION)
ONE PARK CIRCLE
WESTFIELD CENTER, OH 44251

FOR: CONSULTING TO COMPANIES IN THE AREA OF TRANSITIONING EMPLOYEES
BACK TO WORK, NAMELY, CAREER COUNSELING, IN CLASS 41 (U.S. CLS. 100, 101
AND 107).

FIRST USE 4-0-2011; IN COMMERCE 6-0-2011.

THE MARK CONSISTS OF STANDARD CHARACTERS WITHOUT CLAIM TO ANY PAR-
TICULAR FONT, STYLE, SIZE, OR COLOR.

OWNER OF U.S. REG. NO. 3,314,556.

SN 85-304,502, FILED 4-26-2011.

VERNA BETH RIRIE, EXAMINING ATTORNEY



David J. Kyffers

Director of the United States Patent and Trademark Office

United States of America

United States Patent and Trademark Office

WESWORKS

Reg. No. 4,155,501

Registered June 5, 2012

Int. Cl.: 44

SERVICE MARK

PRINCIPAL REGISTER

OHIO FARMERS INSURANCE COMPANY (OHIO CORPORATION)
ONE PARK CIRCLE
WESTFIELD CENTER, OH 44251

FOR: CONSULTING TO COMPANIES IN THE AREA OF TRANSITIONING EMPLOYEES
BACK TO WORK, NAMELY, PSYCHOLOGICAL COUNSELING AND PHYSICAL THERAPY,
IN CLASS 44 (U.S. CLS. 100 AND 101).

FIRST USE 4-0-2011; IN COMMERCE 6-0-2011.

THE MARK CONSISTS OF STANDARD CHARACTERS WITHOUT CLAIM TO ANY PAR-
TICULAR FONT, STYLE, SIZE, OR COLOR.

OWNER OF U.S. REG. NO. 3,314,556.

SN 85-304,544, FILED 4-26-2011.

VERNA BETH RIRIE, EXAMINING ATTORNEY



David J. Kybas

Director of the United States Patent and Trademark Office

United States of America

United States Patent and Trademark Office

PIVOTSTONE

Reg. No. 4,155,502

PIVOTSTONE GROUP, LLC (VIRGINIA LIMITED LIABILITY COMPANY)
4927 GADSEN DRIVE
FAIRFAX, VA 22032

Registered June 5, 2012

Int. Cl.: 35

FOR: BUSINESS MANAGEMENT CONSULTING, IN CLASS 35 (U.S. CLS. 100, 101 AND 102).

SERVICE MARK

FIRST USE 3-16-2011; IN COMMERCE 3-16-2011.

PRINCIPAL REGISTER

THE MARK CONSISTS OF STANDARD CHARACTERS WITHOUT CLAIM TO ANY PARTICULAR FONT, STYLE, SIZE, OR COLOR.

SN 85-304,963, FILED 4-26-2011.

ZHALEH DELANEY, EXAMINING ATTORNEY



David J. Kybas

Director of the United States Patent and Trademark Office

United States of America

United States Patent and Trademark Office

DR. GEORGE'S PLAQUE BLAST

Reg. No. 4,155,503

TELEBRANDS CORP. (NEW JERSEY CORPORATION)
79 TWO BRIDGES ROAD
FAIRFIELD, NJ 07004

Registered June 5, 2012

Int. Cl.: 3

FOR: NON-MEDIATED PLAQUE REMOVAL SPRAY FOR PETS, IN CLASS 3 (U.S. CLS. 1, 4, 6, 50, 51 AND 52).

TRADEMARK

FIRST USE 5-31-2011; IN COMMERCE 5-31-2011.

PRINCIPAL REGISTER

THE MARK CONSISTS OF STANDARD CHARACTERS WITHOUT CLAIM TO ANY PARTICULAR FONT, STYLE, SIZE, OR COLOR.

NO CLAIM IS MADE TO THE EXCLUSIVE RIGHT TO USE "PLAQUE", APART FROM THE MARK AS SHOWN.

THE NAME(S), PORTRAIT(S), AND/OR SIGNATURE(S) SHOWN IN THE MARK IDENTIFIES "GEORGE" MADRAY, WHOSE CONSENT(S) TO REGISTER IS MADE OF RECORD.

SN 85-305,078, FILED 4-26-2011.

CHRISTINA SOBRAL, EXAMINING ATTORNEY



David J. Kybas

Director of the United States Patent and Trademark Office

United States of America

United States Patent and Trademark Office

seq.innovation

Reg. No. 4,155,504

Registered June 5, 2012

Int. Cl.: 35

SERVICE MARK

PRINCIPAL REGISTER

BLUESTEM LEARNING, LLC (KANSAS LIMITED LIABILITY COMPANY)
3911 HOMESTEAD DRIVE
PRAIRIE VILLAGE, KS 66208

FOR: BUSINESS MANAGEMENT CONSULTING WITH RELATION TO STRATEGY FOR THIRD SECTOR ORGANIZATIONS, NAMELY, NOT-FOR PROFIT ORGANIZATIONS, AND FOURTH SECTOR ORGANIZATIONS, NAMELY, FOR PROFIT OR FOR BENEFIT ORGANIZATIONS, IN CLASS 35 (U.S. CLS. 100, 101 AND 102).

FIRST USE 3-2-2012; IN COMMERCE 3-2-2012.

THE MARK CONSISTS OF STANDARD CHARACTERS WITHOUT CLAIM TO ANY PARTICULAR FONT, STYLE, SIZE, OR COLOR.

SN 85-305,907, FILED 4-27-2011.

ANNE E. GUSTASON, EXAMINING ATTORNEY



David J. Kyros

Director of the United States Patent and Trademark Office

United States of America

United States Patent and Trademark Office

SHOW DMX NEO

Reg. No. 4,155,505

Registered June 5, 2012

Int. Cl.: 9

TRADEMARK

PRINCIPAL REGISTER

CITY THEATRICAL, INC. (NEW JERSEY CORPORATION)
475 BARELL AVENUE
CARLSTADT, NJ 07072

FOR: RADIO TRANSCEIVERS, IN CLASS 9 (U.S. CLS. 21, 23, 26, 36 AND 38).

FIRST USE 3-12-2012; IN COMMERCE 3-12-2012.

THE MARK CONSISTS OF STANDARD CHARACTERS WITHOUT CLAIM TO ANY PARTICULAR FONT, STYLE, SIZE, OR COLOR.

OWNER OF U.S. REG. NO. 3,607,242.

NO CLAIM IS MADE TO THE EXCLUSIVE RIGHT TO USE "DMX", APART FROM THE MARK AS SHOWN.

SN 85-305,951, FILED 4-27-2011.

CHRISTINE COOPER, EXAMINING ATTORNEY



David J. Kybas

Director of the United States Patent and Trademark Office

United States of America

United States Patent and Trademark Office

SHOW DMX SHOW BABY

Reg. No. 4,155,506

Registered June 5, 2012

Int. Cl.: 9

TRADEMARK

PRINCIPAL REGISTER

CITY THEATRICAL, INC. (NEW JERSEY CORPORATION)
475 BARELL AVENUE
CARLSTADT, NJ 07072

FOR: RADIO TRANSCEIVERS, IN CLASS 9 (U.S. CLS. 21, 23, 26, 36 AND 38).

FIRST USE 1-3-2012; IN COMMERCE 1-3-2012.

THE MARK CONSISTS OF STANDARD CHARACTERS WITHOUT CLAIM TO ANY PARTICULAR FONT, STYLE, SIZE, OR COLOR.

OWNER OF U.S. REG. NO. 3,607,242.

NO CLAIM IS MADE TO THE EXCLUSIVE RIGHT TO USE "DMX", APART FROM THE MARK AS SHOWN.

SN 85-305,958, FILED 4-27-2011.

CHRISTINE COOPER, EXAMINING ATTORNEY



David J. Kybas

Director of the United States Patent and Trademark Office

United States of America

United States Patent and Trademark Office

LILY FARM FRESH

Reg. No. 4,155,507

Registered June 5, 2012

Int. Cl.: 3

TRADEMARK

PRINCIPAL REGISTER

LILY ORGANICS, INC (COLORADO CORPORATION), DBA LILY FARM FRESH SKIN CARE,
12480 E 124TH AVE.
HENDERSON, CO 80640

FOR: SKIN CARE PREPARATIONS, NAMELY, LOTIONS AND CREAMS FOR THE HANDS, FACE AND BODY, ESSENTIAL OILS FOR PERSONAL USE, LIP MOISTURIZERS, SKIN TONERS, SKIN CLEANERS, IN CLASS 3 (U.S. CLS. 1, 4, 6, 50, 51 AND 52).

FIRST USE 2-6-2012; IN COMMERCE 2-6-2012.

THE MARK CONSISTS OF STANDARD CHARACTERS WITHOUT CLAIM TO ANY PARTICULAR FONT, STYLE, SIZE, OR COLOR.

SEC. 2(F) AS TO "LILY".

OWNER OF U.S. REG. NOS. 2,287,469 AND 3,317,402.

SN 85-306,385, FILED 4-27-2011.

DORITT L. CARROLL, EXAMINING ATTORNEY



David J. Kyros

Director of the United States Patent and Trademark Office

United States of America

United States Patent and Trademark Office

S-ENERGY

Reg. No. 4,155,508

Registered June 5, 2012

Int. Cls.: 11 and 37

TRADEMARK

SERVICE MARK

PRINCIPAL REGISTER

SEAI AMERICA, INC. (CALIFORNIA CORPORATION)
18881 VON KARMAN AVENUE, SUITE 760
IRVINE, CA 92612

FOR: HEATING SYSTEMS FOR RESIDENTIAL AND COMMERCIAL BUILDINGS COMPRISED OF BIOMASS BURNERS, BOILERS, VALVES, PIPES, MANIFOLDS, SOLAR PANELS, CONTROL PANELS, SWITCHES AND ELECTRICAL WIRE, ALL SOLD AS A UNIT; HEATING SYSTEMS FOR RESIDENTIAL AND COMMERCIAL BUILDINGS COMPRISED OF BOILERS, VALVES, PIPES, MANIFOLDS, SOLAR PANELS, CONTROL PANEL, SWITCHES AND ELECTRICAL WIRE, ALL SOLD AS A UNIT; PARABOLIC MIRRORS DESIGNED FOR THE COLLECTION OF SOLAR ENERGY; PHOTOVOLTAIC-BASED POWER PLANTS; SOLAR COLLECTORS; SOLAR COLLECTORS FOR HEATING; SOLAR ENERGY BASED COOLING APPARATUS; SOLAR ENERGY RECEIVERS; SOLAR HEAT COLLECTION PANELS; SOLAR LIGHT FIXTURES, NAMELY, INDOOR AND OUTDOOR SOLAR POWERED LIGHTING UNITS AND FIXTURES; SOLAR REACTORS; SOLAR THERMAL AIR SYSTEMS FOR HEATING PURPOSES; SOLAR THERMAL INSTALLATIONS, NAMELY, SOLAR THERMAL MODULES; SOLAR THERMAL-BASED POWER PLANTS; SOLAR WATER HEATERS; SOLAR-POWERED ALL-WEATHER LIGHTS; SOLAR-POWERED COOLING UNITS, IN CLASS 11 (U.S. CLS. 13, 21, 23, 31 AND 34).

FIRST USE 12-21-2011; IN COMMERCE 12-21-2011.



FOR: INSTALLATION AND MAINTENANCE OF PHOTOVOLTAIC INSTALLATIONS; INSTALLATION AND MAINTENANCE OF PHOTOVOLTAIC/SOLAR THERMAL HYBRID INSTALLATIONS; INSTALLATION AND MAINTENANCE OF SOLAR ENERGY BASED POWER PLANTS; INSTALLATION AND MAINTENANCE OF SOLAR THERMAL INSTALLATIONS; INSTALLATION OF SOLAR ENERGY SYSTEMS AND ALTERNATIVE ENERGY PRODUCTS FOR RESIDENTIAL AND COMMERCIAL USE; REPAIR AND INSTALLATION SERVICES, NAMELY, THE INSTALLATION OF HEATING, COOLING AND ENVIRONMENTAL CONTROL SYSTEMS PRIMARILY USING SOLAR ENERGY, RENEWABLE ENERGY RESOURCES AND RAINWATER, IN CLASS 37 (U.S. CLS. 100, 103 AND 106).

FIRST USE 11-9-2011; IN COMMERCE 11-9-2011.

David J. Kyros

THE MARK CONSISTS OF STANDARD CHARACTERS WITHOUT CLAIM TO ANY PARTICULAR FONT, STYLE, SIZE, OR COLOR.

Reg. No. 4,155,508 SN 85-306,502, FILED 4-27-2011.

JACLYN KIDWELL WALKER, EXAMINING ATTORNEY

United States of America

United States Patent and Trademark Office



Reg. No. 4,155,509

Registered June 5, 2012

Int. Cl.: 9

TRADEMARK

PRINCIPAL REGISTER

ALBERT METZ GMBH & CO. KG (FED REP GERMANY GESELLSCHAFT MIT
BESCHRÄNKTER HAFTUNG (GMBH))
OTTILIENWEG 9
BLUMBERG, FED REP GERMANY 78176

FOR: ELECTRICAL TERMINAL BLOCKS, ELECTRICAL HEADERS AND ELECTRICAL PLUGS FOR USE WITH CONNECTION OF PRINTED CIRCUIT BOARDS; ELECTRICAL CONNECTOR PLUGS, ELECTRICAL CONNECTOR SOCKETS, ELECTRICAL CONNECTOR TERMINALS, ELECTRICAL ADAPTERS, ELECTRICAL CONNECTION BOXES, PATCH PANELS FOR DATA AND TELECOMMUNICATION NETWORKS, ELECTRIC RELAYS, ELECTRIC SWITCHES, ELECTRICAL CABLES AND CIRCUIT TESTERS FOR USE DURING INSTALLATION, ALL AFOREMENTIONED GOODS FOR ELECTRICAL NETWORKS AND FIBER OPTIC NETWORKS FOR DATA TRANSMISSION AND TELECOMMUNICATION, IN CLASS 9 (U.S. CLS. 21, 23, 26, 36 AND 38).

FIRST USE 10-4-2011; IN COMMERCE 10-4-2011.

THE MARK CONSISTS OF THE LETTERS "MCQTECH" IN BLACK STYLIZED LETTERING WITH THE LETTER "M" INSIDE A BLUE QUADRILATERAL.

THE COLOR(S) BLACK AND BLUE IS/ARE CLAIMED AS A FEATURE OF THE MARK.

SN 85-307,318, FILED 4-28-2011.

LESLIE RICHARDS, EXAMINING ATTORNEY



David J. Kyros

Director of the United States Patent and Trademark Office

United States of America

United States Patent and Trademark Office

SignCare

Reg. No. 4,155,510

Registered June 5, 2012

Int. Cls.: 6 and 19

TRADEMARK

PRINCIPAL REGISTER

VISUAL GRAPHIC SYSTEMS INC. (NEW YORK CORPORATION)
330 WASHINGTON AVENUE
CARLSTADT, NJ 07072

FOR: NON-LUMINOUS AND NON-MECHANICAL METAL SIGNS, IN CLASS 6 (U.S. CLS. 2, 12, 13, 14, 23, 25 AND 50).

FIRST USE 4-0-2011; IN COMMERCE 4-0-2011.

FOR: NON-LUMINOUS, NON-MECHANICAL SIGNS NOT OF METAL, IN CLASS 19 (U.S. CLS. 1, 12, 33 AND 50).

FIRST USE 9-0-2011; IN COMMERCE 9-0-2011.

THE MARK CONSISTS OF STANDARD CHARACTERS WITHOUT CLAIM TO ANY PARTICULAR FONT, STYLE, SIZE, OR COLOR.

SN 85-308,038, FILED 4-29-2011.

EVELYN BRADLEY, EXAMINING ATTORNEY



David J. Kyros

Director of the United States Patent and Trademark Office

United States of America

United States Patent and Trademark Office



Reg. No. 4,155,511

Registered June 5, 2012

Int. Cl.: 41

SERVICE MARK

PRINCIPAL REGISTER

ROSEN HOTELS AND RESORTS, INC. (FLORIDA CORPORATION)
9840 INTERNATIONAL DRIVE
ORLANDO, FL 32819

FOR: PROVIDING INFORMATION TO LAW ENFORCEMENT AND GOVERNMENTAL AGENCIES THROUGH THE GLOBAL COMPUTER NETWORK CONCERNING FITNESS AND EXERCISE FACILITIES, COMPANIES AND ORGANIZATIONS WHICH OFFER HEALTH, FITNESS AND NUTRITIONAL OPPORTUNITIES TO LAW ENFORCEMENT AT SPECIAL RATES, IN CLASS 41 (U.S. CLS. 100, 101 AND 107).

FIRST USE 2-16-2012; IN COMMERCE 2-16-2012.

NO CLAIM IS MADE TO THE EXCLUSIVE RIGHT TO USE "2011" AND "FIT", APART FROM THE MARK AS SHOWN.

THE COLOR(S) NAVY BLUE AND GREY IS/ARE CLAIMED AS A FEATURE OF THE MARK.

THE MARK CONSISTS OF THE WORDING "FIT DEPUTY", THE WORDING "BUSINESSES DEDICATED TO HELPING DEPUTIES STAY FIT AND HEALTHY" AND THE YEAR "2011" WITHIN A DESIGN OF A BADGE. THE WORDING "BUSINESSES DEDICATED TO HELPING DEPUTIES STAY FIT AND HEALTHY" IS DEPICTED IN A CIRCULAR FORMAT ROUND A STYLIZED DESIGN OF TWO DUMBBELLS, WITH TWO DOTS SEPARATING THE TWO PHRASES. THERE ARE STARS ON BOTH SIDES OF THE CIRCULAR WORDING. THE YEAR "2011" IS ALSO FOUND AT THE BOTTOM OF THE BADGE DESIGN. THE WORDING, THE STARS, THE DUMBBELL DESIGN, THE YEAR, THE CIRCULAR DESIGN AND THE OUTLINE OF THE BADGE ARE NAVY BLUE. THE INTERIOR OF THE BADGE DESIGN IS GREY.

SN 85-308,289, FILED 4-29-2011.

DOMINICK J. SALEMI, EXAMINING ATTORNEY



David J. Kybas

Director of the United States Patent and Trademark Office

United States of America

United States Patent and Trademark Office

VITONOMY

Reg. No. 4,155,512

Registered June 5, 2012

Int. Cls.: 5, 16, 32, and 35

TRADEMARK

SERVICE MARK

PRINCIPAL REGISTER

VITONOMY, LLC (ARIZONA LIMITED LIABILITY COMPANY)
4950 S. 48TH STREET
PHOENIX, AZ 85040

FOR: NUTRITIONAL SUPPLEMENTS, DIETARY SUPPLEMENTS, AND LIQUID DIETARY SUPPLEMENTS; NUTRITIONALLY FORTIFIED FRUIT-BASED BEVERAGES; WEIGHT LOSS PREPARATIONS; HERBAL SUPPLEMENTS, HERBAL EXTRACTS, ENZYMES, VITAMINS AND MINERALS, IN CLASS 5 (U.S. CLS. 6, 18, 44, 46, 51 AND 52).

FIRST USE 8-16-2011; IN COMMERCE 8-16-2011.

FOR: CATALOGS, BROCHURES, AND NEWSLETTERS FEATURING NUTRITIONAL SUPPLEMENTS, DIETARY SUPPLEMENTS, VITAMIN, MINERAL AND HERBAL SUPPLEMENTS, NUTRITIOUS FOODS, SNACKS AND BEVERAGES; NEWSLETTERS AND PRINTED INSTRUCTIONAL AND EDUCATIONAL MATERIALS IN THE FIELDS OF PERSONAL CARE PRODUCTS, HOME CARE PRODUCTS, NUTRITIONAL AND DIETARY SUPPLEMENTS, AND EXERCISE, NUTRITION, FITNESS AND WELLNESS, IN CLASS 16 (U.S. CLS. 2, 5, 22, 23, 29, 37, 38 AND 50).

FIRST USE 8-16-2011; IN COMMERCE 8-16-2011.

FOR: FRUIT-BASED BEVERAGES THAT ARE ALSO NUTRITIONALLY FORTIFIED AND SPORTS DRINKS, IN CLASS 32 (U.S. CLS. 45, 46 AND 48).

FIRST USE 8-16-2011; IN COMMERCE 8-16-2011.

FOR: ONLINE ORDERING SERVICES FEATURING NUTRITIONAL SUPPLEMENTS, DIETARY SUPPLEMENTS, VITAMIN, MINERAL AND HERBAL SUPPLEMENTS, WEIGHT LOSS PRODUCTS, NUTRITIOUS FOODS, BEVERAGES; DISTRIBUTORSHIP SERVICES IN THE FIELDS OF NUTRITIONAL PRODUCTS, PERSONAL CARE PRODUCTS, AND HOME CARE PRODUCTS, IN CLASS 35 (U.S. CLS. 100, 101 AND 102).

FIRST USE 8-16-2011; IN COMMERCE 8-16-2011.

THE MARK CONSISTS OF STANDARD CHARACTERS WITHOUT CLAIM TO ANY PARTICULAR FONT, STYLE, SIZE, OR COLOR.



David J. Kyros

Director of the United States Patent and Trademark Office

Reg. No. 4,155,512 SN 85-308,506, FILED 4-29-2011.

ELIZABETH KAJUBI, EXAMINING ATTORNEY

United States of America

United States Patent and Trademark Office



Reg. No. 4,155,513

Registered June 5, 2012

Int. Cl.: 30

TRADEMARK

PRINCIPAL REGISTER

RAINDANCER COFFEE, LLC (OREGON LIMITED LIABILITY COMPANY)
5319 SW WESTGAGE DR., SUITE 22
PORTLAND, OR 97221

FOR: COFFEE, IN CLASS 30 (U.S. CL. 46).

FIRST USE 3-1-2011; IN COMMERCE 3-1-2011.

NO CLAIM IS MADE TO THE EXCLUSIVE RIGHT TO USE "COFFEE", APART FROM THE MARK AS SHOWN.

THE MARK CONSISTS OF THE DEPICTION OF A PROFILED HEAD OF A PERSON WEARING A HEADDRESS THAT APPEARS ABOVE THE STYLIZED WORDING "RAINDANCER" WHICH APPEARS ABOVE THE STYLIZED WORDING "COFFEE".

SN 85-308,859, FILED 4-29-2011.

MICHAEL TANNER, EXAMINING ATTORNEY



David J. Kybas

Director of the United States Patent and Trademark Office

United States of America

United States Patent and Trademark Office

popituit

Reg. No. 4,155,514

APPTERA, INC. (DELAWARE CORPORATION)
505 N. MATHILDA AVE., SUITE 110
SUNNYVALE, CA 94085

Registered June 5, 2012

Int. Cls.: 9, 35, 38, and 42

FOR: DOWNLOADABLE SOFTWARE IN THE NATURE OF A MOBILE APPLICATION FOR ENHANCING COMMUNICATIONS BETWEEN INDIVIDUALS AND BETWEEN CONSUMERS AND BUSINESSES INCLUDING, BUT NOT LIMITED TO, LEVERAGING VOICE AND DATA CHANNELS SIMULTANEOUSLY, IN CLASS 9 (U.S. CLS. 21, 23, 26, 36 AND 38).

TRADEMARK

FIRST USE 8-2-2011; IN COMMERCE 8-2-2011.

SERVICE MARK

FOR: ADVERTISING AND MARKETING SERVICES PROVIDED BY MEANS OF DIRECT AND INDIRECT METHODS OF MARKETING COMMUNICATIONS, NAMELY, SOCIAL MEDIA, SEARCH ENGINE MARKETING, INQUIRY MARKETING, INTERNET MARKETING, MOBILE MARKETING, GEOGRAPHIC LOCATION BASED MARKETING, BLOGGING AND OTHER FORMS OF PASSIVE, SHARABLE OR VIRAL COMMUNICATIONS CHANNELS, IN CLASS 35 (U.S. CLS. 100, 101 AND 102).

PRINCIPAL REGISTER

FIRST USE 8-2-2011; IN COMMERCE 8-2-2011.

FOR: WIRELESS ELECTRONIC TRANSMISSION SIMULTANEOUSLY OF VOICE SIGNALS, DATA, FACSIMILES, IMAGES AND INFORMATIONS, IN CLASS 38 (U.S. CLS. 100, 101 AND 104).

FIRST USE 8-2-2011; IN COMMERCE 8-2-2011.

FOR: CLOUD COMPUTING FEATURING SOFTWARE FOR USE IN ENHANCING COMMUNICATIONS BETWEEN INDIVIDUALS AND BETWEEN CONSUMERS AND BUSINESSES INCLUDING, BUT NOT LIMITED TO, LEVERAGING VOICE AND DATA CHANNELS SIMULTANEOUSLY; SOFTWARE DEVELOPMENT AND PRODUCT DEVELOPMENT IN THE FIELD OF ENHANCING COMMUNICATIONS BETWEEN INDIVIDUALS AND BETWEEN CONSUMERS AND BUSINESSES INCLUDING, BUT NOT LIMITED TO, LEVERAGING VOICE AND DATA CHANNELS SIMULTANEOUSLY, IN CLASS 42 (U.S. CLS. 100 AND 101).

FIRST USE 8-2-2011; IN COMMERCE 8-2-2011.



David J. Kappas

Director of the United States Patent and Trademark Office

Reg. No. 4,155,514 THE MARK CONSISTS OF "POPTUIT" WITH "POP" IN GREEN WITH THREE GREEN LINES ABOVE THE "O" AND "TUIT" IN GREY.

THE COLOR(S) GREEN AND GREY IS/ARE CLAIMED AS A FEATURE OF THE MARK.

SN 85-309,259, FILED 5-1-2011.

KAREN SEVERSON, EXAMINING ATTORNEY

United States of America

United States Patent and Trademark Office



Reg. No. 4,155,515

Registered June 5, 2012

Int. Cls.: 9, 35, 38, and 42

TRADEMARK

SERVICE MARK

PRINCIPAL REGISTER

APPTERA, INC. (DELAWARE CORPORATION)
505 N. MATHILDA AVE., SUITE 110
SUNNYVALE, CA 94085

FOR: DOWNLOADABLE SOFTWARE IN THE NATURE OF A MOBILE APPLICATION FOR ENHANCING COMMUNICATIONS BETWEEN INDIVIDUALS AND BETWEEN CONSUMERS AND BUSINESSES INCLUDING, BUT NOT LIMITED TO, LEVERAGING VOICE AND DATA CHANNELS SIMULTANEOUSLY, IN CLASS 9 (U.S. CLS. 21, 23, 26, 36 AND 38).

FIRST USE 8-2-2011; IN COMMERCE 8-2-2011.

FOR: ADVERTISING AND MARKETING SERVICES PROVIDED BY MEANS OF DIRECT AND INDIRECT METHODS OF MARKETING COMMUNICATIONS, NAMELY, SOCIAL MEDIA, SEARCH ENGINE MARKETING, INQUIRY MARKETING, INTERNET MARKETING, MOBILE MARKETING, GEOGRAPHIC LOCATION BASED MARKETING, BLOGGING AND OTHER FORMS OF PASSIVE, SHARABLE OR VIRAL COMMUNICATIONS CHANNELS, IN CLASS 35 (U.S. CLS. 100, 101 AND 102).

FIRST USE 8-2-2011; IN COMMERCE 8-2-2011.

FOR: WIRELESS ELECTRONIC TRANSMISSION SIMULTANEOUSLY OF VOICE SIGNALS, DATA, FACSIMILES, IMAGES AND INFORMATIONS, IN CLASS 38 (U.S. CLS. 100, 101 AND 104).

FIRST USE 8-2-2011; IN COMMERCE 8-2-2011.

FOR: CLOUD COMPUTING FEATURING SOFTWARE FOR USE IN ENHANCING COMMUNICATIONS BETWEEN INDIVIDUALS AND BETWEEN CONSUMERS AND BUSINESSES INCLUDING, BUT NOT LIMITED TO, LEVERAGING VOICE AND DATA CHANNELS SIMULTANEOUSLY; SOFTWARE DEVELOPMENT AND PRODUCT DEVELOPMENT IN THE FIELD OF ENHANCING COMMUNICATIONS BETWEEN INDIVIDUALS AND BETWEEN CONSUMERS AND BUSINESSES INCLUDING, BUT NOT LIMITED TO, LEVERAGING VOICE AND DATA CHANNELS SIMULTANEOUSLY, IN CLASS 42 (U.S. CLS. 100 AND 101).

FIRST USE 8-2-2011; IN COMMERCE 8-2-2011.



David J. Kyjars

Director of the United States Patent and Trademark Office

Reg. No. 4,155,515 THE MARK CONSISTS OF THREE OVERLAPPING CIRCLES ARRANGED WITH TWO ON THE BOTTOM AND ONE CENTERED OVER THEM ON THE TOP, WITH THE TOP CIRCLE IN YELLOW WITH A WHITE SMILEY FACE CONSISTING OF TWO EYES AND A SMILE FACING NINETY DEGREES COUNTERCLOCKWISE, THE BOTTOM LEFT CIRCLE IN GREEN WITH A SMALL TRIANGLE ON THE BOTTOM LEFT SIDE CREATING A SPEECH BUBBLE, AND THE BOTTOM RIGHT CIRCLE IN LIGHT BLUE WITH A TRIANGLE ON THE LEFT SIDE TO CREATE A TEARDROP SHAPE AND WITH AN OPEN WHITE CIRCLE CENTERED IN THE LARGER CIRCLE. THE OVERLAP BETWEEN THE YELLOW AND GREEN CIRCLES IS RED WITH A CURVED WHITE LINE SEPARATING THE GREEN AND RED, THE OVERLAP BETWEEN THE YELLOW AND LIGHT BLUE CIRCLES IS ORANGE, THE OVERLAP BETWEEN THE LIGHT BLUE AND GREEN CIRCLES IS DARK BLUE WITH A CURVED WHITE LINE SEPARATING THE DARK BLUE AND LIGHT BLUE, AND THE OVERLAP BETWEEN ALL THREE CIRCLES IS PURPLE.

THE COLOR(S) WHITE, GREEN, RED, YELLOW, ORANGE, LIGHT BLUE, DARK BLUE, AND PURPLE IS/ARE CLAIMED AS A FEATURE OF THE MARK.

SN 85-309,261, FILED 5-1-2011.

KAREN SEVERSON, EXAMINING ATTORNEY

United States of America

United States Patent and Trademark Office



Reg. No. 4,155,516

Registered June 5, 2012

Int. Cl.: 25

TRADEMARK

PRINCIPAL REGISTER

BROWN, PAUL (UNITED STATES INDIVIDUAL)
2137 EAST OCEAN BOULEVARD
NEWPORT BEACH, CA 92661 AND

BROWN, BLAKE (UNITED STATES INDIVIDUAL)
2137 EAST OCEAN BOULEVARD
NEWPORT BEACH, CA 92661

FOR: HATS; JACKETS; SHIRTS; SWEATSHIRTS; T-SHIRTS , IN CLASS 25 (U.S. CLS. 22 AND 39).

FIRST USE 3-22-2012; IN COMMERCE 3-22-2012.

NO CLAIM IS MADE TO THE EXCLUSIVE RIGHT TO USE "BEACH APPAREL", APART FROM THE MARK AS SHOWN.

THE MARK CONSISTS OF A DESIGN OF A BEE INSIDE OF A TRIANGLE WITH THE STYLIZED TEXT "BIG B BEACH APPAREL" WRITTEN INSIDE THE TRIANGLE BORDER.

SN 85-309,690, FILED 5-2-2011.

JACQUELINE A. LAVINE, EXAMINING ATTORNEY



David J. Kybas

Director of the United States Patent and Trademark Office

United States of America

United States Patent and Trademark Office

WARRIOR 100

Reg. No. 4,155,517

Registered June 5, 2012

Int. Cl.: 2

TRADEMARK

PRINCIPAL REGISTER

DDH HOLDINGS, LLC (ALABAMA LIMITED LIABILITY COMPANY)
3333 RICHARD ARRINGTON JR. BLVD, NORTH
BIRMINGHAM, AL 35234

FOR: A HIGH SOLIDS, ABRASION RESISTANT, DIRECT-TO-METAL COATING OR OVERCOAT DESIGNED FOR CORROSION RESISTANCE AND PHYSICAL PROTECTION OF CARBON STEEL FOR USE IN DIRECTIONAL DRILLING, THRUST BORE, AND ROUGH TERRAIN APPLICATIONS, BUT NOT FOR USE AS A COATING FOR TRUCK BEDS, IN CLASS 2 (U.S. CLS. 6, 11 AND 16).

FIRST USE 5-13-2010; IN COMMERCE 10-31-2011.

THE MARK CONSISTS OF STANDARD CHARACTERS WITHOUT CLAIM TO ANY PARTICULAR FONT, STYLE, SIZE, OR COLOR.

SN 85-309,872, FILED 5-2-2011.

MARK RADEMACHER, EXAMINING ATTORNEY



David J. Kyffers

Director of the United States Patent and Trademark Office

United States of America

United States Patent and Trademark Office



Reg. No. 4,155,518

Registered June 5, 2012

Int. Cl.: 18

TRADEMARK

PRINCIPAL REGISTER

GOT SHADES, INC. (CALIFORNIA CORPORATION)
2520 CONTINENTAL AVE.,
EL MONTE, CA 91733

FOR: BACKPACKS; DUFFLE BAGS; HANDBAGS; LUGGAGE; MESSENGER BAGS; PURSES;
SHOULDER BAGS; SUITCASES; TOTE BAGS; WALLETS, IN CLASS 18 (U.S. CLS. 1, 2, 3,
22 AND 41).

FIRST USE 3-18-2010; IN COMMERCE 3-18-2010.

THE MARK CONSISTS OF A CROWNED LION HEAD.

SN 85-310,489, FILED 5-3-2011.

ANTHONY RINKER, EXAMINING ATTORNEY



David J. Kyffers

Director of the United States Patent and Trademark Office

United States of America

United States Patent and Trademark Office



Reg. No. 4,155,519

Registered June 5, 2012

Int. Cl.: 9

TRADEMARK

PRINCIPAL REGISTER

GAOLI (CHINA INDIVIDUAL)
NO. 8 XINGFUBEI ROAD, XINCHENG DISTRICT
XI'AN, SHAANXI PROVINCE, CHINA

FOR: BABY MONITORS; BATTERY MONITORS; COMPUTER MONITORS; COMPUTER PERIPHERAL DEVICES; ELECTRIC ACCUMULATORS; FLASHING SAFETY LIGHTS; FLASHLIGHTS FOR USE IN PHOTOGRAPHY; INTERACTIVE VIDEO GAMES OF VIRTUAL REALITY COMPRISED OF COMPUTER HARDWARE FOR USE WITH AN EXTERNAL MONITOR AND SOFTWARE; LEVEL INDICATORS; OPTICAL CHARACTER READERS; PRESSURE INDICATORS; REMOTE CONTROLS FOR ELECTRO-DYNAMIC APPARATUS; ROTATING LIGHTS; SIGNAL CONDITIONING AND COMMUNICATION DEVICES FOR INDUSTRIAL PROCESS CONTROL; SPEED INDICATORS; TECHNICAL MEASURING, TESTING AND CHECKING APPARATUS AND INSTRUMENTS FOR MEASURING, TESTING AND CHECKING THE TEMPERATURE, PRESSURE, QUANTITY AND CONCENTRATION OF GAS AND LIQUIDS; TELEVISION MONITORS; TEMPERATURE INDICATORS; TRANSMITTERS OF ELECTRONIC SIGNALS; VIDEO MONITORS; WATER LEVEL INDICATORS, IN CLASS 9 (U.S. CLS. 21, 23, 26, 36 AND 38).

FIRST USE 7-15-2009; IN COMMERCE 7-15-2009.

THE MARK CONSISTS OF THE WORDING "MOTOREBEL" AND DESIGN WHICH REPRESENT A MOTORCYCLE.

THE WORDING "MOTOREBEL" HAS NO MEANING IN A FOREIGN LANGUAGE.

SN 85-311,632, FILED 5-4-2011.

JEFF DEFORD, EXAMINING ATTORNEY



David J. Kybas

Director of the United States Patent and Trademark Office

United States of America

United States Patent and Trademark Office

GUTS. GLORY. RAM.

Reg. No. 4,155,520

Registered June 5, 2012

Int. Cl.: 12

TRADEMARK

PRINCIPAL REGISTER

CHRYSLER GROUP LLC (DELAWARE LIMITED LIABILITY COMPANY)
CIMS 485-13-32
1000 CHRYSLER DRIVE
AUBURN HILLS, MI 48326

FOR: MOTOR VEHICLES, NAMELY, PASSENGER AUTOMOBILES, THEIR STRUCTURAL PARTS, TRIM AND BADGES, IN CLASS 12 (U.S. CLS. 19, 21, 23, 31, 35 AND 44).

FIRST USE 6-0-2011; IN COMMERCE 6-0-2011.

THE MARK CONSISTS OF STANDARD CHARACTERS WITHOUT CLAIM TO ANY PARTICULAR FONT, STYLE, SIZE, OR COLOR.

OWNER OF U.S. REG. NOS. 1,169,189, 2,999,082, AND OTHERS.

SN 85-311,779, FILED 5-4-2011.

TINA BROWN, EXAMINING ATTORNEY



David J. Kyffers

Director of the United States Patent and Trademark Office

United States of America

United States Patent and Trademark Office

EAZY SQUEEZY

Reg. No. 4,155,521

Registered June 5, 2012

Int. Cl.: 21

TRADEMARK

PRINCIPAL REGISTER

LUFT INDUSTRIE, INC. (CALIFORNIA CORPORATION)
#406
2355 BROADWAY
OAKLAND, CA 94612

FOR: LIQUID, FLUID, AND LOTION CONTAINERS SOLD EMPTY FOR PERSONAL, FAMILY, AND DOMESTIC USE, IN CLASS 21 (U.S. CLS. 2, 13, 23, 29, 30, 33, 40 AND 50).

FIRST USE 5-1-2011; IN COMMERCE 3-19-2012.

THE MARK CONSISTS OF STANDARD CHARACTERS WITHOUT CLAIM TO ANY PARTICULAR FONT, STYLE, SIZE, OR COLOR.

SN 85-311,946, FILED 5-4-2011.

FRANK LATTUCA, EXAMINING ATTORNEY



David J. Kyffers

Director of the United States Patent and Trademark Office

United States of America

United States Patent and Trademark Office



Reg. No. 4,155,522

Registered June 5, 2012

Int. Cl.: 35

SERVICE MARK

PRINCIPAL REGISTER

MARK C. SCAMMEL, CPA LLC (TEXAS LIMITED LIABILITY COMPANY)
16950 DALLAS PARKWAY, SUITE 109
DALLAS, TX 75075

FOR: ACCOUNTING SERVICES, IN CLASS 35 (U.S. CLS. 100, 101 AND 102).

FIRST USE 6-16-2011; IN COMMERCE 6-16-2011.

THE MARK CONSISTS OF A SHIELD DESIGN. THE SHIELD ELEMENTS ARE GREEN BACKGROUND; A GOLD BANNER IN THE TOP FIELD OF THE SHIELD WITH GREEN LETTERS "M", "C" AND "S" CENTERED; GOLD SYMBOLS EURO, DOLLAR AND YEN CENTERED IN THE CENTER FIELD OF THE SHIELD AND A GOLD SYMBOL POUND IN THE BOTTOM FIELD OF THE SHIELD; A GOLD HORIZONTAL STRIPE CONTAINING SEVEN GREEN CROSSES IN THE BOTTOM FIELD.

THE COLOR(S) GREEN AND GOLD IS/ARE CLAIMED AS A FEATURE OF THE MARK.

SN 85-312,337, FILED 5-4-2011.

MICHAEL WEBSTER, EXAMINING ATTORNEY



David J. Kybas

Director of the United States Patent and Trademark Office

United States of America

United States Patent and Trademark Office

CARVERY CREATIONS

Reg. No. 4,155,523

Registered June 5, 2012

Int. Cl.: 31

TRADEMARK

PRINCIPAL REGISTER

SOCIETE DES PRODUITS NESTLE S.A. (SWITZERLAND SOCIÉTÉ ANONYME (SA))
BRAND IP
CASE POSTALE 353
VEVEY, SWITZERLAND 1800

FOR: PET FOOD, IN CLASS 31 (U.S. CLS. 1 AND 46).

FIRST USE 1-3-2012; IN COMMERCE 1-3-2012.

THE MARK CONSISTS OF STANDARD CHARACTERS WITHOUT CLAIM TO ANY PARTICULAR FONT, STYLE, SIZE, OR COLOR.

SN 85-312,423, FILED 5-4-2011.

WARREN L. OLANDRIA, EXAMINING ATTORNEY



David J. Kybas

Director of the United States Patent and Trademark Office

United States of America
United States Patent and Trademark Office

Kitchen
{à la carte}

Reg. No. 4,155,524

Registered June 5, 2012

Int. Cls.: 8 and 21

TRADEMARK

PRINCIPAL REGISTER

KOHL'S ILLINOIS, INC. (NEVADA CORPORATION)
4340 FOX VALLEY CENTER DRIVE
NEW YORK SQUARE
AURORA, IL 60504

FOR: KITCHEN KNIVES, IN CLASS 8 (U.S. CLS. 23, 28 AND 44).

FIRST USE 0-0-2011; IN COMMERCE 0-0-2011.

FOR: COOKWARE, NAMELY, POTS, PANS, AND LIDS, IN CLASS 21 (U.S. CLS. 2, 13, 23, 29, 30, 33, 40 AND 50).

FIRST USE 0-0-2011; IN COMMERCE 0-0-2011.

NO CLAIM IS MADE TO THE EXCLUSIVE RIGHT TO USE "KITCHEN", APART FROM THE MARK AS SHOWN.

THE MARK CONSISTS OF THE WORD "KITCHEN" ABOVE THE WORDS "À LA CARTE" WHICH ARE WITHIN BRACKETS.

SN 85-312,563, FILED 5-4-2011.

ANGELA M. MICHELI, EXAMINING ATTORNEY



David J. Kybas

Director of the United States Patent and Trademark Office

United States of America

United States Patent and Trademark Office

ONEUP

Reg. No. 4,155,525

Registered June 5, 2012

Int. Cl.: 36

SERVICE MARK

PRINCIPAL REGISTER

ONEXONE FOUNDATION (CANADA CORPORATION)
9500 MEILLER STREET, SUITE 800
MONTREAL, QUEBEC, CANADA H2N2B7

FOR: CHARITABLE FUNDRAISING, IN CLASS 36 (U.S. CLS. 100, 101 AND 102).

FIRST USE 8-0-2011; IN COMMERCE 8-0-2011.

THE MARK CONSISTS OF STANDARD CHARACTERS WITHOUT CLAIM TO ANY PARTICULAR FONT, STYLE, SIZE, OR COLOR.

SN 85-313,003, FILED 5-5-2011.

TAMARA FRAZIER, EXAMINING ATTORNEY



David J. Kybas

Director of the United States Patent and Trademark Office

United States of America

United States Patent and Trademark Office

HYDROCOL

Reg. No. 4,155,526

Registered June 5, 2012

Int. Cl.: 2

TRADEMARK

PRINCIPAL REGISTER

LANXESS DEUTSCHLAND GMBH (FED REP GERMANY GESELLSCHAFT MIT
BESCHRÄNKTER HAFTUNG (GMBH))
D-51369
LEVERKUSEN, FED REP GERMANY

FOR: COLORANTS AND WATER DISPERSED PIGMENTS FOR USE IN COLORING CON-
CRETE AND OTHER CEMENTITIOUS PRODUCTS; PIGMENTS FOR COLORING GARDEN
MULCH, IN CLASS 2 (U.S. CLS. 6, 11 AND 16).

FIRST USE 1-31-2012; IN COMMERCE 1-31-2012.

THE MARK CONSISTS OF STANDARD CHARACTERS WITHOUT CLAIM TO ANY PAR-
TICULAR FONT, STYLE, SIZE, OR COLOR.

SN 85-313,040, FILED 5-5-2011.

LAKEISHA LEWIS, EXAMINING ATTORNEY



David J. Kybas

Director of the United States Patent and Trademark Office

United States of America

United States Patent and Trademark Office

THE MINIBEE

Reg. No. 4,155,527

AU, HAMLIN (UNITED STATES INDIVIDUAL)
415 E 9TH STREET
LITTLE ROCK, AR 72202

Registered June 5, 2012

Int. Cl.: 16

FOR: EDUCATIONAL PUBLICATIONS, NAMELY, BOOKS IN THE FIELD OF MUSIC, IN CLASS 16 (U.S. CLS. 2, 5, 22, 23, 29, 37, 38 AND 50).

TRADEMARK

FIRST USE 11-15-2011; IN COMMERCE 11-15-2011.

PRINCIPAL REGISTER

THE MARK CONSISTS OF STANDARD CHARACTERS WITHOUT CLAIM TO ANY PARTICULAR FONT, STYLE, SIZE, OR COLOR.

SN 85-313,401, FILED 5-5-2011.

DAVID H. STINE, EXAMINING ATTORNEY



David J. Kybas

Director of the United States Patent and Trademark Office

United States of America

United States Patent and Trademark Office

JUBRALEE

Reg. No. 4,155,528

Registered June 5, 2012

Int. Cl.: 25

TRADEMARK

PRINCIPAL REGISTER

BROOKS SPORTS, INC. (WASHINGTON CORPORATION)
19910 NORTH CREEK PARKWAY
SUITE 200
BOTHELL, WA 98011

FOR: CLOTHING, NAMELY, SPORTS BRAS, IN CLASS 25 (U.S. CLS. 22 AND 39).

FIRST USE 4-4-2011; IN COMMERCE 4-4-2011.

THE MARK CONSISTS OF STANDARD CHARACTERS WITHOUT CLAIM TO ANY PARTICULAR FONT, STYLE, SIZE, OR COLOR.

SN 85-313,603, FILED 5-5-2011.

MARK T. MULLEN, EXAMINING ATTORNEY



David J. Kybas

Director of the United States Patent and Trademark Office

United States of America

United States Patent and Trademark Office



Reg. No. 4,155,529

Registered June 5, 2012

Int. Cl.: 20

TRADEMARK

PRINCIPAL REGISTER

PCA DESIGN, INC. (PENNSYLVANIA CORPORATION)
112 KEENER AVE
RED LION, PA 17356

FOR: CHILD SAFETY PRODUCT INDIVIDUALLY COMPRISED OF BOTH METAL AND NON-METAL MATERIALS, NAMELY, A WINDOW-OPENING LIMITING DEVICE, IN CLASS 20 (U.S. CLS. 2, 13, 22, 25, 32 AND 50).

FIRST USE 6-29-2010; IN COMMERCE 6-29-2011.

NO CLAIM IS MADE TO THE EXCLUSIVE RIGHT TO USE "WINDOW", APART FROM THE MARK AS SHOWN.

THE MARK CONSISTS OF A STYLED SHIELD WITH THE STYLIZED TEXT "WINDOW WARDEN".

SN 85-313,735, FILED 5-5-2011.

INGA ERVIN, EXAMINING ATTORNEY



David J. Kybas

Director of the United States Patent and Trademark Office

United States of America

United States Patent and Trademark Office

SMOKEY JOES

Reg. No. 4,155,530

Registered June 5, 2012

Int. Cl.: 33

TRADEMARK

PRINCIPAL REGISTER

JF STROTHMAN DISTILLERY, INC. (COLORADO CORPORATION)
2862 NORTH AVENUE
GRAND JUNCTION, CO 81501

FOR: DISTILLED SPIRITS, IN CLASS 33 (U.S. CLS. 47 AND 49).

FIRST USE 2-11-2012; IN COMMERCE 2-11-2012.

THE MARK CONSISTS OF STANDARD CHARACTERS WITHOUT CLAIM TO ANY PARTICULAR FONT, STYLE, SIZE, OR COLOR.

SN 85-314,614, FILED 5-6-2011.

MATTHEW PAPPAS, EXAMINING ATTORNEY



David J. Kappas

Director of the United States Patent and Trademark Office

United States of America

United States Patent and Trademark Office

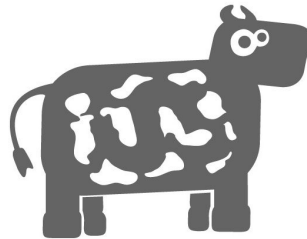

Reg. No. 4,155,531

FIRST AMERICAN FINANCIAL CORPORATION (DELAWARE CORPORATION)
1 FIRST AMERICAN WAY
SANTA ANA, CA 92707

Registered June 5, 2012

Int. Cl.: 35

FOR: PROMOTING THE GOODS AND SERVICES OF OTHERS BY PROVIDING A WEB SITE FEATURING A CUSTOMIZED DISCOUNT PROGRAM AND LINKS TO THE WEB SITES OF OTHERS WHO PARTICIPATE IN THE DISCOUNT PROGRAM, IN CLASS 35 (U.S. CLS. 100, 101 AND 102).

SERVICE MARK

PRINCIPAL REGISTER

FIRST USE 12-5-2011; IN COMMERCE 12-5-2011.

THE MARK CONSISTS OF A DEPICTION OF A COW.

SN 85-314,882, FILED 5-6-2011.

WANDA KAY PRICE, EXAMINING ATTORNEY



David J. Kybas

Director of the United States Patent and Trademark Office

United States of America

United States Patent and Trademark Office

Smart Rest-A-Lid

Reg. No. 4,155,532

TABLETOPS UNLIMITED, INC. (CALIFORNIA CORPORATION)
23000 SOUTH AVALON BLVD.
CARSON, CA 90745

Registered June 5, 2012

Int. Cl.: 21

FOR: HANDLES SOLD AS AN INTEGRAL COMPONENT OF COOKWARE; COOKWARE HANDLES; POTS AND PANS; COOKWARE, NAMELY, STEAMERS, FRYING PANS, CASEROLE DISHES, SAUCE PANS, AND DUTCH OVENS, IN CLASS 21 (U.S. CLS. 2, 13, 23, 29, 30, 33, 40 AND 50).

TRADEMARK

PRINCIPAL REGISTER

FIRST USE 1-17-2012; IN COMMERCE 1-17-2012.

THE MARK CONSISTS OF STANDARD CHARACTERS WITHOUT CLAIM TO ANY PARTICULAR FONT, STYLE, SIZE, OR COLOR.

SN 85-314,953, FILED 5-6-2011.

JORDAN BAKER, EXAMINING ATTORNEY



David J. Kyffers

Director of the United States Patent and Trademark Office

United States of America

United States Patent and Trademark Office



Reg. No. 4,155,533

Registered June 5, 2012

Int. Cl.: 42

SERVICE MARK

PRINCIPAL REGISTER

GOVERNMENT TRANSACTION SERVICES, INC. (VIRGINIA CORPORATION)
8300 BOONE BOULEVARD
SUITE 500
VIENNA, VA 22182

FOR: TRANSACTION PROCESSING, NAMELY, PROVIDING USER AUTHENTICATION SERVICES IN E-COMMERCE TRANSACTIONS, TRANSACTION REPORTING, NAMELY, PROVIDING USER AUTHENTICATION SERVICES IN E-COMMERCE TRANSACTIONS, TRANSACTION COMMUNICATION, NAMELY, PROVIDING USER AUTHENTICATION SERVICES IN E-COMMERCE TRANSACTIONS AND OTHER TRANSACTION INFORMATION SERVICES, NAMELY, PROVIDING USER AUTHENTICATION SERVICES IN E-COMMERCE TRANSACTIONS; CLOUD COMPUTING FEATURING SOFTWARE FOR USE IN ELECTRONIC TRANSACTION PROCESSING IN THE FIELD OF GOVERNMENT TRANSACTIONS; ALL FOR CUSTOMERS ENGAGED IN BUSINESS INTERACTIONS WITH GOVERNMENT, IN CLASS 42 (U.S. CLS. 100 AND 101).

FIRST USE 2-15-2011; IN COMMERCE 2-15-2011.

NO CLAIM IS MADE TO THE EXCLUSIVE RIGHT TO USE "GOVERNMENT TRANSACTION SERVICES, INC.", APART FROM THE MARK AS SHOWN.

THE COLOR(S) RED, WHITE, GRAY, AND BLUE IS/ARE CLAIMED AS A FEATURE OF THE MARK.

THE MARK CONSISTS OF THE WORDING "GOVERNMENT TRANSACTION SERVICES, INC." IN BLUE LETTERS. TO THE LEFT OF THE WORDING IS A DESIGN CONSISTING OF TWO STYLIZED SWIRLS RESEMBLING BOOMERANGS IN MOTION, ONE OF WHICH IS RED WITH A WHITE STRIPE, THE OTHER BLUE WITH A WHITE STRIPE. A VERTICAL BLUE LINE SEPARATES THE WORDING AND DESIGN. A SMALL GRAY SHADOW APPEARS BENEATH THE DESIGN.

SN 85-315,231, FILED 5-8-2011.

JAMES STEIN, EXAMINING ATTORNEY



David J. Kappas

Director of the United States Patent and Trademark Office

United States of America

United States Patent and Trademark Office



Reg. No. 4,155,534

BUTLER, DAVID O. (UNITED STATES INDIVIDUAL)
456 DENISE STREET
TARPON SPRINGS, FL 34689

Registered June 5, 2012

Int. Cl.: 18

FOR: SHOULDER STRAPS; STRAPS FOR CARRYING CASES; STRAPS FOR HANDBAGS;
STRAPS FOR LUGGAGE, IN CLASS 18 (U.S. CLS. 1, 2, 3, 22 AND 41).

TRADEMARK

FIRST USE 7-20-2011; IN COMMERCE 3-8-2012.

PRINCIPAL REGISTER

THE MARK CONSISTS OF THE WORDS "SHOULDER LOK" ARCHED OVER A LOCK.

SN 85-316,103, FILED 5-9-2011.

CARYN GLASSER, EXAMINING ATTORNEY



David J. Kyffers

Director of the United States Patent and Trademark Office

United States of America

United States Patent and Trademark Office

Cinco Five Star Vodka

Reg. No. 4,155,535

AZAR DISTILLING, LLC (TEXAS LIMITED LIABILITY COMPANY)
P.O. BOX 90914
SAN ANTONIO, TX 78209

Registered June 5, 2012

Int. Cl.: 33

FOR: VODKA, IN CLASS 33 (U.S. CLS. 47 AND 49).

TRADEMARK

FIRST USE 10-26-2011; IN COMMERCE 10-26-2011.

PRINCIPAL REGISTER

THE MARK CONSISTS OF STANDARD CHARACTERS WITHOUT CLAIM TO ANY PARTICULAR FONT, STYLE, SIZE, OR COLOR.

NO CLAIM IS MADE TO THE EXCLUSIVE RIGHT TO USE "VODKA", APART FROM THE MARK AS SHOWN.

THE ENGLISH TRANSLATION OF "CINCO" IN THE MARK IS "FIVE".

SN 85-317,316, FILED 5-10-2011.

EMILY CARLSEN, EXAMINING ATTORNEY



David J. Kyros

Director of the United States Patent and Trademark Office

United States of America

United States Patent and Trademark Office

INDAVA

Reg. No. 4,155,536

Registered June 5, 2012

Int. Cl.: 42

SERVICE MARK

PRINCIPAL REGISTER

BELTRAN, RICARDO (MEXICO INDIVIDUAL)
ALFONSO CASO 114 ERMITA
MEXICO CITY, MEXICO

FOR: COMPUTER AND TECHNOLOGICAL PROFESSIONAL SERVICES, NAMELY, IT CONSULTING SERVICES, COMPUTER SOFTWARE SYSTEMS INTEGRATION SERVICES, SOFTWARE DESIGN, REMOTE AND ON-SITE MANAGEMENT OF THE ENTERPRISE INFORMATION TECHNOLOGY SYSTEMS FOR OTHERS, IT PROJECT MANAGEMENT; IT INFRASTRUCTURE DESIGN SERVICES, IT INFRASTRUCTURE MAINTENANCE SERVICES, NAMELY, MAINTENANCE OF COMPUTER SOFTWARE; SOFTWARE DESIGN SERVICES; TECHNOLOGY AUDITING SERVICES, NAMELY, COMPUTER SYSTEMS ANALYSIS SERVICES RELATED TO THE INTEGRITY AND FUNCTIONALITY OF INFORMATION TECHNOLOGY INFRASTRUCTURE, IN CLASS 42 (U.S. CLS. 100 AND 101).

FIRST USE 10-1-2011; IN COMMERCE 10-1-2011.

THE MARK CONSISTS OF STANDARD CHARACTERS WITHOUT CLAIM TO ANY PARTICULAR FONT, STYLE, SIZE, OR COLOR.

SN 85-317,434, FILED 5-10-2011.

DEBRA LEE, EXAMINING ATTORNEY



David J. Kybas

Director of the United States Patent and Trademark Office

United States of America

United States Patent and Trademark Office

VILLA PRIMA

Reg. No. 4,155,537

Registered June 5, 2012

Int. Cl.: 30

TRADEMARK

PRINCIPAL REGISTER

SCHWAN'S IP, LLC (MINNESOTA LIMITED LIABILITY COMPANY)
115 W. COLLEGE DRIVE
MARSHALL, MN 56258

FOR: PIZZA, IN CLASS 30 (U.S. CL. 46).

FIRST USE 5-1-2011; IN COMMERCE 5-1-2011.

THE MARK CONSISTS OF STANDARD CHARACTERS WITHOUT CLAIM TO ANY PARTICULAR FONT, STYLE, SIZE, OR COLOR.

SN 85-317,673, FILED 5-11-2011.

LAURA HAMMEL, EXAMINING ATTORNEY



David J. Kybas

Director of the United States Patent and Trademark Office

United States of America

United States Patent and Trademark Office



Reg. No. 4,155,538

CLEAN FACILITIES GROUP, INC. (MASSACHUSETTS CORPORATION)
846 LEXINGTON STREET, SUITE 2
WALTHAM, MA 02452

Registered June 5, 2012

Int. Cl.: 37

FOR: BUILDING MAINTENANCE AND REPAIR; JANITORIAL SERVICES; LAUNDRY SERVICES, IN CLASS 37 (U.S. CLS. 100, 103 AND 106).

SERVICE MARK

FIRST USE 0-0-2011; IN COMMERCE 0-0-2011.

PRINCIPAL REGISTER

NO CLAIM IS MADE TO THE EXCLUSIVE RIGHT TO USE "CLEAN FACILITIES GROUP, INC.", APART FROM THE MARK AS SHOWN.

THE COLOR(S) GREEN, BLUE AND WHITE IS/ARE CLAIMED AS A FEATURE OF THE MARK.

THE MARK CONSISTS OF A CIRCLE IN BLUE AND GREEN WHICH CONTAINS THE STYLIZED LETTERS "CFG" IN WHITE. A CURVED LINE IN WHITE APPEARS TO GO THROUGH THE LETTER "G". FOUR INTERSECTING LINES IN WHITE FORM AN EIGHT POINTED STAR WHICH TOUCHES THE TOP OF THE CURVED LINE AND APPEARS TO THE RIGHT OF THE LETTER "C" IN "CFG". TO THE RIGHT OF THE CIRCLE ARE THE BLUE STYLIZED WORDS "CLEAN FACILITIES GROUP INC." ABOVE A GREEN LINE.

SN 85-317,687, FILED 5-11-2011.

NELSON SNYDER, EXAMINING ATTORNEY



David J. Kybas

Director of the United States Patent and Trademark Office

United States of America

United States Patent and Trademark Office

TIGER

Reg. No. 4,155,539

Registered June 5, 2012

Int. Cl.: 10

TRADEMARK

PRINCIPAL REGISTER

CORELINK, LLC (MISSOURI LIMITED LIABILITY COMPANY)
10805 SUNSET OFFICE DRIVE, SUITE 300
ST. LOUIS, MO 63127

FOR: MEDICAL DEVICES, NAMELY, SPINAL FIXATION DEVICES, NAMELY, SCREWS, BARS, AND PLATES USED IN SPINAL DISC REPAIR PROCEDURES, IN CLASS 10 (U.S. CLS. 26, 39 AND 44).

FIRST USE 3-21-2012; IN COMMERCE 3-21-2012.

THE MARK CONSISTS OF STANDARD CHARACTERS WITHOUT CLAIM TO ANY PARTICULAR FONT, STYLE, SIZE, OR COLOR.

SN 85-319,127, FILED 5-12-2011.

INGA ERVIN, EXAMINING ATTORNEY



David J. Kybas

Director of the United States Patent and Trademark Office

United States of America

United States Patent and Trademark Office

TAYLOR OWEN

Reg. No. 4,155,540

OWEN, LINDA (UNITED STATES INDIVIDUAL)
PO BOX 1058
GOTHA, FL 34734

Registered June 5, 2012

Int. Cl.: 3

FOR: COSMETICS; MAKE-UP, IN CLASS 3 (U.S. CLS. 1, 4, 6, 50, 51 AND 52).

TRADEMARK

FIRST USE 0-0-2011; IN COMMERCE 0-0-2011.

PRINCIPAL REGISTER

THE MARK CONSISTS OF STANDARD CHARACTERS WITHOUT CLAIM TO ANY PARTICULAR FONT, STYLE, SIZE, OR COLOR.

THE NAME(S), PORTRAIT(S), AND/OR SIGNATURE(S) SHOWN IN THE MARK DOES NOT IDENTIFY A PARTICULAR LIVING INDIVIDUAL.

SN 85-319,619, FILED 5-12-2011.

RENEE MCCRAY, EXAMINING ATTORNEY



David J. Kyffers

Director of the United States Patent and Trademark Office

United States of America

United States Patent and Trademark Office

SHE  **4life**
Survive Hope Empower

Reg. No. 4,155,541

S.H.E. 4.LIFE, LLC (INDIANA LIMITED LIABILITY COMPANY)
3116 NORTH HUNTINGTON ROAD
MARION, IN 46952

Registered June 5, 2012

Int. Cl.: 5

FOR: AIR FRESHENERS, IN CLASS 5 (U.S. CLS. 6, 18, 44, 46, 51 AND 52).

TRADEMARK

FIRST USE 10-31-2011; IN COMMERCE 10-31-2011.

PRINCIPAL REGISTER

THE MARK CONSISTS OF THE WORDS/TERMS "SHE" AND "4LIFE" WITH A RIBBON
DEPICTED THEREBETWEEN, AND THE WORDS "SURVIVE" "HOPE", AND "EMPOWER"
WRITTEN BENEATH.

SN 85-319,728, FILED 5-12-2011.

APRIL HESIK, EXAMINING ATTORNEY



David J. Kybas

Director of the United States Patent and Trademark Office

United States of America

United States Patent and Trademark Office

SHE  **4life**

Survive Hope Empower

Reg. No. 4,155,542

S.H.E. 4.LIFE, LLC (INDIANA LIMITED LIABILITY COMPANY)
3116 NORTH HUNTINGTON ROAD
MARION, IN 46952

Registered June 5, 2012

Int. Cl.: 25

FOR: SPORTSWEAR, NAMELY, T-SHIRTS, SWEATSHIRTS, AND HATS, IN CLASS 25 (U.S. CLS. 22 AND 39).

TRADEMARK

FIRST USE 10-31-2011; IN COMMERCE 10-31-2011.

PRINCIPAL REGISTER

THE MARK CONSISTS OF THE WORDS/TERMS "SHE" AND "4LIFE" WITH A RIBBON DEPICTED THEREBETWEEN, AND THE WORDS "SURVIVE", "HOPE", AND "EMPOWER" WRITTEN BENEATH.

SN 85-319,739, FILED 5-12-2011.

APRIL HESIK, EXAMINING ATTORNEY



David J. Kyros

Director of the United States Patent and Trademark Office

United States of America

United States Patent and Trademark Office

Brodo

Reg. No. 4,155,543

LBC INDUSTRIES (PENNSYLVANIA LIMITED LIABILITY COMPANY)
6097 HIDDEN VALLEY DR.
DOYLESTOWN, PA 18902

Registered June 5, 2012

Int. Cl.: 43

FOR: RESTAURANT SERVICES, IN CLASS 43 (U.S. CLS. 100 AND 101).

SERVICE MARK

FIRST USE 3-1-2012; IN COMMERCE 3-15-2012.

PRINCIPAL REGISTER

THE MARK CONSISTS OF STANDARD CHARACTERS WITHOUT CLAIM TO ANY PARTICULAR FONT, STYLE, SIZE, OR COLOR.

THE ENGLISH TRANSLATION OF THE WORD "BRODO" IN THE MARK IS "BROTH".

SN 85-320,171, FILED 5-13-2011.

HANNO RITTNER, EXAMINING ATTORNEY



David J. Kybas

Director of the United States Patent and Trademark Office

United States of America

United States Patent and Trademark Office

BECAUSE WINNING MATTERS

Reg. No. 4,155,544

BROWN RUDNICK LLP (MASSACHUSETTS LIMITED LIABILITY PARTNERSHIP)
ONE FINANCIAL CENTER
BOSTON, MA 02111

Registered June 5, 2012

Int. Cl.: 45

FOR: LEGAL SERVICES, IN CLASS 45 (U.S. CLS. 100 AND 101).

SERVICE MARK

FIRST USE 5-0-2011; IN COMMERCE 5-0-2011.

PRINCIPAL REGISTER

THE MARK CONSISTS OF STANDARD CHARACTERS WITHOUT CLAIM TO ANY PARTICULAR FONT, STYLE, SIZE, OR COLOR.

SN 85-320,424, FILED 5-13-2011.

RENEE MCCRAY, EXAMINING ATTORNEY



David J. Kyros

Director of the United States Patent and Trademark Office

United States of America

United States Patent and Trademark Office

EXCELLENCE INTEGRITY
CUSTOMIZATION Three forces
above the competition

Reg. No. 4,155,545

TRI-FORCE CONSULTING SERVICES, INC. (PENNSYLVANIA CORPORATION)
650 NORTH CANNON AVENUE
LANSDALE, PA 19446

Registered June 5, 2012

Int. Cl.: 42

FOR: COMPUTER SOFTWARE CONSULTING, IN CLASS 42 (U.S. CLS. 100 AND 101).

SERVICE MARK

FIRST USE 0-0-2010; IN COMMERCE 0-0-2010.

PRINCIPAL REGISTER

THE MARK CONSISTS OF STANDARD CHARACTERS WITHOUT CLAIM TO ANY PARTICULAR FONT, STYLE, SIZE, OR COLOR.

SN 85-321,589, FILED 5-16-2011.

GIANCARLO CASTRO, EXAMINING ATTORNEY



David J. Kybas

Director of the United States Patent and Trademark Office

United States of America

United States Patent and Trademark Office

YOU GET THE IDEA

Reg. No. 4,155,546

Registered June 5, 2012

Int. Cl.: 45

SERVICE MARK

PRINCIPAL REGISTER

DUNLAP CODDING, P.C. (OKLAHOMA CORPORATION)
P.O. BOX 16370
OKLAHOMA CITY, OK 73113

FOR: LEGAL SERVICES, IN CLASS 45 (U.S. CLS. 100 AND 101).

FIRST USE 11-17-2011; IN COMMERCE 11-17-2011.

THE MARK CONSISTS OF STANDARD CHARACTERS WITHOUT CLAIM TO ANY PARTICULAR FONT, STYLE, SIZE, OR COLOR.

SN 85-321,836, FILED 5-16-2011.

WARREN L. OLANDRIA, EXAMINING ATTORNEY



David J. Kyffers

Director of the United States Patent and Trademark Office

United States of America

United States Patent and Trademark Office

Mailsafe

Reg. No. 4,155,547

Registered June 5, 2012

Int. Cl.: 6

TRADEMARK

PRINCIPAL REGISTER

SOLAR GROUP, INC. (DELAWARE CORPORATION)
3556 LAKESHORE DRIVE
BUFFALO, NY 14219

FOR: METAL MAILBOXES, IN CLASS 6 (U.S. CLS. 2, 12, 13, 14, 23, 25 AND 50).

FIRST USE 3-31-2007; IN COMMERCE 3-31-2007.

THE MARK CONSISTS OF STANDARD CHARACTERS WITHOUT CLAIM TO ANY PARTICULAR FONT, STYLE, SIZE, OR COLOR.

OWNER OF U.S. REG. NO. 1,984,693.

SN 85-321,988, FILED 5-16-2011.

ALLISON SCHRODY, EXAMINING ATTORNEY



David J. Kybas

Director of the United States Patent and Trademark Office

United States of America

United States Patent and Trademark Office

ex'treme institute - by Nelly

Reg. No. 4,155,548

VATTEROTT EDUCATIONAL CENTERS, INC. (MISSOURI CORPORATION)
9200 OLIVE BLVD., SUITE 222
OLIVETTE, MO 63132

Registered June 5, 2012

Int. Cl.: 41

FOR: EDUCATIONAL SERVICES, NAMELY, CONDUCTING CLASSES AND PROVIDING POSTSECONDARY EDUCATION AND VOCATIONAL GUIDANCE IN THE FIELD OF SOUND, VIDEO AND PRODUCTION TECHNOLOGY AS IT RELATES TO THE FIELDS OF MUSIC AND ENTERTAINMENT, IN CLASS 41 (U.S. CLS. 100, 101 AND 107).

SERVICE MARK

PRINCIPAL REGISTER

FIRST USE 11-21-2011; IN COMMERCE 11-21-2011.

THE MARK CONSISTS OF STANDARD CHARACTERS WITHOUT CLAIM TO ANY PARTICULAR FONT, STYLE, SIZE, OR COLOR.

"NELLY" IDENTIFIES THE STAGE NAME OF CORNELL I. HAYNES II, A LIVING INDIVIDUAL WHOSE CONSENT IS OF RECORD.

SN 85-322,162, FILED 5-16-2011.

DOMINIC J. FERRAIUOLO, EXAMINING ATTORNEY



David J. Kyffers

Director of the United States Patent and Trademark Office

United States of America

United States Patent and Trademark Office

NASCAR AUTHENTICS

Reg. No. 4,155,549

Registered June 5, 2012

Int. Cl.: 28

NATIONAL ASSOCIATION FOR STOCK CAR AUTO RACING, INC. (HAWAII CORPORATION)
ONE DAYTONA BOULEVARD
ATTN: KAREN B. LEETZOW
DAYTONA BEACH, FL 32114

TRADEMARK

PRINCIPAL REGISTER

FOR: TOYS, GAMES AND PLAYTHINGS, NAMELY, DIE CAST MINIATURE CARS, DIE CAST MINIATURE TRUCKS, DIE CAST MINIATURE CARS CONVERTING INTO OTHER VISUAL TOY FORMS, DIE CAST MINIATURE TRUCKS CONVERTING INTO OTHER VISUAL TOY FORMS, BOARD GAMES, CARD GAMES, ACTION FIGURES, ACTION FIGURE PLAY SETS, ACTION FIGURE PLAY SETS WITH MOVEABLE PARTS AND AUDIO CAPABILITIES, PROTECTIVE CARRYING CASES SPECIALLY ADAPTED FOR HANDHELD VIDEO GAMES, CHARACTER FIGURES, CHARACTER FIGURES WITH MOVEABLE PARTS AND AUDIO CAPABILITIES, TOY BUILDING SETS, ELECTRONIC ACTION TOYS, RACE TRACK PLAY SETS, ELECTRONIC RACE TRACK PLAY SETS, RACE TRACK PLAY SETS WITH REMOVABLE PARTS, REMOTE CONTROL CARS, REMOTE CONTROL TRUCKS, HAND-HELD GAMES OTHER THAN THOSE ADAPTED FOR USE WITH AN EXTERNAL DISPLAY SCREEN OR MONITOR, IN CLASS 28 (U.S. CLS. 22, 23, 38 AND 50).

FIRST USE 1-31-2012; IN COMMERCE 1-31-2012.

THE MARK CONSISTS OF STANDARD CHARACTERS WITHOUT CLAIM TO ANY PARTICULAR FONT, STYLE, SIZE, OR COLOR.

OWNER OF U.S. REG. NOS. 817,553, 1,054,100, AND OTHERS.

NO CLAIM IS MADE TO THE EXCLUSIVE RIGHT TO USE "AUTHENTICS", APART FROM THE MARK AS SHOWN.

SN 85-322,537, FILED 5-17-2011.

SCOTT BIBB, EXAMINING ATTORNEY



David J. Kyffers

Director of the United States Patent and Trademark Office

United States of America

United States Patent and Trademark Office

NASCAR FULL BLAST

Reg. No. 4,155,550

Registered June 5, 2012

Int. Cl.: 28

NATIONAL ASSOCIATION FOR STOCK CAR AUTO RACING, INC. (FLORIDA CORPORATION)
ONE DAYTONA BOULEVARD
ATTN: KAREN B. LEETZOW
DAYTONA BEACH, FL 32114

TRADEMARK

PRINCIPAL REGISTER

FOR: TOYS, GAMES AND PLAYTHINGS, NAMELY, DIE CAST MINIATURE CARS, DIE CAST MINIATURE TRUCKS, DIE CAST MINIATURE CARS CONVERTING INTO OTHER VISUAL TOY FORMS, DIE CAST MINIATURE TRUCKS CONVERTING INTO OTHER VISUAL TOY FORMS, BOARD GAMES, CARD GAMES, ACTION FIGURES, ACTION FIGURE PLAY SETS, ACTION FIGURE PLAY SETS WITH MOVEABLE PARTS AND AUDIO CAPABILITIES, PROTECTIVE CARRYING CASES SPECIALLY ADAPTED FOR HANDHELD VIDEO GAMES, CHARACTER FIGURES, CHARACTER FIGURES WITH MOVEABLE PARTS AND AUDIO CAPABILITIES, TOY BUILDING SETS, ELECTRONIC ACTION TOYS, RACE TRACK PLAY SETS, ELECTRONIC RACE TRACK PLAY SETS, RACE TRACK PLAY SETS WITH REMOVABLE PARTS, REMOTE CONTROL CARS, REMOTE CONTROL TRUCKS, HAND-HELD GAMES OTHER THAN THOSE ADAPTED FOR USE WITH AN EXTERNAL DISPLAY SCREEN OR MONITOR, IN CLASS 28 (U.S. CLS. 22, 23, 38 AND 50).

FIRST USE 1-31-2012; IN COMMERCE 1-31-2012.

THE MARK CONSISTS OF STANDARD CHARACTERS WITHOUT CLAIM TO ANY PARTICULAR FONT, STYLE, SIZE, OR COLOR.

OWNER OF U.S. REG. NOS. 817,553, 1,054,100, AND OTHERS.

SN 85-322,547, FILED 5-17-2011.

SCOTT BIBB, EXAMINING ATTORNEY



David J. Kyffers

Director of the United States Patent and Trademark Office

United States of America

United States Patent and Trademark Office

FLOWERNET

Reg. No. 4,155,551

Registered June 5, 2012

Int. Cl.: 31

TRADEMARK

PRINCIPAL REGISTER

SUNBURST FARMS, INC. (DELAWARE CORPORATION)
2200 NW 70TH AVENUE
MIAMI, FL 33122

FOR: CUT FLOWERS, IN CLASS 31 (U.S. CLS. 1 AND 46).

FIRST USE 8-1-1989; IN COMMERCE 8-1-1989.

THE MARK CONSISTS OF STANDARD CHARACTERS WITHOUT CLAIM TO ANY PARTICULAR FONT, STYLE, SIZE, OR COLOR.

SN 85-323,202, FILED 5-17-2011.

VERNA BETH RIRIE, EXAMINING ATTORNEY



David J. Kyffers

Director of the United States Patent and Trademark Office

United States of America

United States Patent and Trademark Office

SP Affairs

"Your Special and Private Affairs Concierge."

Reg. No. 4,155,552

Registered June 5, 2012

Int. Cl.: 45

SERVICE MARK

PRINCIPAL REGISTER

SP AFFAIRS LLC (NEW JERSEY LIMITED LIABILITY COMPANY)
P.O. BOX 1444
BLOOMFIELD, NJ 07003

FOR: PERSONAL CONCIERGE SERVICES FOR OTHERS COMPRISING MAKING REQUESTED PERSONAL ARRANGEMENTS AND RESERVATIONS, RUNNING ERRANDS AND PROVIDING CUSTOMER SPECIFIC INFORMATION TO MEET INDIVIDUAL NEEDS, ALL RENDERED IN BUSINESS ESTABLISHMENTS, OFFICE BUILDINGS, HOTELS, RESIDENTIAL COMPLEXES AND HOMES, IN CLASS 45 (U.S. CLS. 100 AND 101).

FIRST USE 4-12-2010; IN COMMERCE 4-12-2010.

NO CLAIM IS MADE TO THE EXCLUSIVE RIGHT TO USE "AFFAIRS" AND "YOUR SPECIAL AND PRIVATE AFFAIRS CONCIERGE", APART FROM THE MARK AS SHOWN.

THE MARK CONSISTS OF THE STYLIZED TEXT "SP AFFAIRS "YOUR SPECIAL AND PRIVATE AFFAIRS CONCIERGE.".

SN 85-323,276, FILED 5-17-2011.

KAPIL BHANOT, EXAMINING ATTORNEY



David J. Kyros

Director of the United States Patent and Trademark Office

United States of America

United States Patent and Trademark Office

Gender Effect

Reg. No. 4,155,553

Registered June 5, 2012

Int. Cls.: 35 and 41

SERVICE MARK

PRINCIPAL REGISTER

RENSON GROUP, LTD. (DELAWARE CORPORATION)
1065 S. WISTERIA DRIVE
MALVERN, PA 19355

FOR: CONSULTING SERVICES IN BUSINESS LEADERSHIP DEVELOPMENT AND BUSINESS MANAGEMENT; GENERAL BUSINESS MERCHANDISING SERVICES, NAMELY, MARKETING, IN CLASS 35 (U.S. CLS. 100, 101 AND 102).

FIRST USE 4-21-2011; IN COMMERCE 4-21-2011.

FOR: ARRANGING PROFESSIONAL WORKSHOP AND TRAINING COURSES; BUSINESS EDUCATION AND TRAINING SERVICES, NAMELY, DEVELOPING AND FACILITATING CUSTOMIZED LEADERSHIP AND EXECUTIVE DEVELOPMENT PROGRAMS, PROVIDING EXECUTIVE COACHING SERVICES, AND PROVIDING BUSINESS EDUCATION PROGRAMS TO EMPLOYEES AND EXECUTIVES; BUSINESS EDUCATION AND TRAINING SERVICES, NAMELY, DEVELOPING, AND FACILITATING CUSTOMIZED IN-COMPANY LEADERSHIP AND EXECUTIVE DEVELOPMENT PROGRAMS, PROVIDING EXECUTIVE COACHING SERVICES, AND PROVIDING PUBLIC AND IN-COMPANY KEYNOTE PRESENTATIONS TO BUSINESS LEADERS; BUSINESS TRAINING; BUSINESS TRAINING CONSULTANCY SERVICES; CONTINUING EDUCATION SERVICES, NAMELY, PROVIDING LIVE AND ON-LINE CONTINUING PROFESSIONAL EDUCATION SEMINARS IN THE FIELD OF BUSINESS AND FINANCE, IN CLASS 41 (U.S. CLS. 100, 101 AND 107).

FIRST USE 4-21-2011; IN COMMERCE 4-21-2011.

THE MARK CONSISTS OF STANDARD CHARACTERS WITHOUT CLAIM TO ANY PARTICULAR FONT, STYLE, SIZE, OR COLOR.

SN 85-323,606, FILED 5-18-2011.

MICHELE SWAIN, EXAMINING ATTORNEY



David J. Kyjars

Director of the United States Patent and Trademark Office

United States of America

United States Patent and Trademark Office

SUPERIOR CHEER

Reg. No. 4,155,554

PEARISON, INC. (INDIANA CORPORATION)
8900 HIGHWAY 65
CYNTHIANA, IN 476120428

Registered June 5, 2012

**Int. Cls.: 3, 9, 14, 18, 24,
25, 26, and 28**

FOR: FACIAL MAKE-UP, IN CLASS 3 (U.S. CLS. 1, 4, 6, 50, 51 AND 52).

FIRST USE 1-19-2012; IN COMMERCE 1-19-2012.

TRADEMARK

FOR: MEGAPHONES, IN CLASS 9 (U.S. CLS. 21, 23, 26, 36 AND 38).

PRINCIPAL REGISTER

FIRST USE 1-19-2012; IN COMMERCE 1-19-2012.

FOR: JEWELRY, IN CLASS 14 (U.S. CLS. 2, 27, 28 AND 50).

FIRST USE 1-19-2012; IN COMMERCE 1-19-2012.

FOR: ATHLETIC BAGS, IN CLASS 18 (U.S. CLS. 1, 2, 3, 22 AND 41).

FIRST USE 1-19-2012; IN COMMERCE 1-19-2012.

FOR: CLOTH BANNERS, IN CLASS 24 (U.S. CLS. 42 AND 50).

FIRST USE 1-19-2012; IN COMMERCE 1-19-2012.

FOR: BODY SUITS; BRIEFS; SHOES; SHORTS; SOCKS; T-SHIRTS; UNIFORMS; WARM UP OUTFITS, IN CLASS 25 (U.S. CLS. 22 AND 39).

FIRST USE 1-19-2012; IN COMMERCE 1-19-2012.

FOR: HAIR BOWS, IN CLASS 26 (U.S. CLS. 37, 39, 40, 42 AND 50).

FIRST USE 1-19-2012; IN COMMERCE 1-19-2012.

FOR: CHEERLEADING POM-POMS, IN CLASS 28 (U.S. CLS. 22, 23, 38 AND 50).

FIRST USE 1-19-2012; IN COMMERCE 1-19-2012.



David J. Kyros

Director of the United States Patent and Trademark Office

Reg. No. 4,155,554 THE MARK CONSISTS OF STANDARD CHARACTERS WITHOUT CLAIM TO ANY PARTICULAR FONT, STYLE, SIZE, OR COLOR.

SN 85-324,086, FILED 5-18-2011.

RUSS HERMAN, EXAMINING ATTORNEY

United States of America

United States Patent and Trademark Office

WILD ABOUT SKIN

Reg. No. 4,155,555

Registered June 5, 2012

Int. Cl.: 3

TRADEMARK

PRINCIPAL REGISTER

KYPKE, CAMIE (UNITED STATES INDIVIDUAL), DBA WILD ABOUT SKIN,
7325 WESTERN PLAINS AVE
ABILENE, TX 79606

FOR: COSMETICS FOR SKIN AND BODY REJUVENATION, NAMELY, LOTIONS FOR SKIN AND BODY, TONERS, BODY SCRUBS, BEAUTY SERUMS, SKIN MOISTURIZERS, FACE AND BODY CREAMS, BODY BALMS, OILS FOR COSMETIC PURPOSES, BODY AND FACE POWDERS, FOUNDATIONS, BEAUTY GELS, BODY BUTTERS, NON-MEDICATED OINTMENT FOR TREATMENT OF SUNBURN, MOISTURIZING SOLUTIONS FOR THE SKIN, BODY AND FACIAL MASKS, BLUSH, EYE SHADOWS, LIP STICK, BODY POLISH, SOAPS, BODY SPRAYS, SHAMPOOS, NAIL CARE PREPARATIONS, CONDITIONER, HAIR MOUSSE, NON-MEDICATED LIP CARE PREPARATIONS, EXFOLIANT CREAMS, BATH SALTS, BUBBLE BATH, OIL BATHS FOR HAIR CARE, LIP GLOSSES, NAIL POLISH REMOVERS, SKIN CLEANSERS, EYE LINERS, LIP LINERS, MASCARA, MAKE-UP MINERAL POWDERS, SKIN BRONZERS, LIP PRIMERS, FACIAL CONCEALERS, EYELASH TINTS, BODY SPRAYS, POMADES, SEALS, FOAMS, COSMETIC SUNSCREEN PREPARATIONS, SUN BLOCK, BODY WASH, HAIR RINSES, NAIL LACQUERS, PRE-MOISTENED COSMETIC TOWELETTES, COSMETIC PADS, COSMETIC PREPARATIONS FOR SKIN CARE, IN CLASS 3 (U.S. CLS. 1, 4, 6, 50, 51 AND 52).

FIRST USE 2-6-2012; IN COMMERCE 2-6-2012.

THE MARK CONSISTS OF STANDARD CHARACTERS WITHOUT CLAIM TO ANY PARTICULAR FONT, STYLE, SIZE, OR COLOR.

NO CLAIM IS MADE TO THE EXCLUSIVE RIGHT TO USE "SKIN", APART FROM THE MARK AS SHOWN.

SN 85-324,541, FILED 5-19-2011.

KAPIL BHANOT, EXAMINING ATTORNEY



David J. Kypke

Director of the United States Patent and Trademark Office

United States of America

United States Patent and Trademark Office

FC43

Reg. No. 4,155,556

Registered June 5, 2012

Int. Cl.: 6

TRADEMARK

PRINCIPAL REGISTER

ALCOA INC. (PENNSYLVANIA CORPORATION)
ALCOA CORPORATE CENTER
201 ISABELLA STREET
PITTSBURGH, PA 152125858

FOR: METAL FASTENERS, NAMELY, PANEL FASTENERS, IN CLASS 6 (U.S. CLS. 2, 12, 13, 14, 23, 25 AND 50).

FIRST USE 2-22-2012; IN COMMERCE 2-22-2012.

THE MARK CONSISTS OF STANDARD CHARACTERS WITHOUT CLAIM TO ANY PARTICULAR FONT, STYLE, SIZE, OR COLOR.

SN 85-325,018, FILED 5-19-2011.

CAROLYN CATALDO, EXAMINING ATTORNEY



David J. Kyjars

Director of the United States Patent and Trademark Office

United States of America

United States Patent and Trademark Office

COUCH SHELF IT'S NOT JUST A SHELF

Reg. No. 4,155,557

Registered June 5, 2012

Int. Cl.: 20

TRADEMARK

PRINCIPAL REGISTER

SWALLOW, JAMES (UNITED STATES INDIVIDUAL)
102 S. HEMLOCK AVE.
WOOD DALE, IL 60191

FOR: FURNITURE, IN CLASS 20 (U.S. CLS. 2, 13, 22, 25, 32 AND 50).

FIRST USE 10-20-2011; IN COMMERCE 10-20-2011.

THE MARK CONSISTS OF STANDARD CHARACTERS WITHOUT CLAIM TO ANY PARTICULAR FONT, STYLE, SIZE, OR COLOR.

SN 85-325,022, FILED 5-19-2011.

CAROLYN CATALDO, EXAMINING ATTORNEY



David J. Kybas

Director of the United States Patent and Trademark Office

United States of America

United States Patent and Trademark Office

PUT THE VETERAN BACK IN VETERANS DAY

Reg. No. 4,155,558

Registered June 5, 2012

Int. Cl.: 36

SERVICE MARK

PRINCIPAL REGISTER

WOUNDED WARRIOR PROJECT, INC. (VIRGINIA NON-STOCK CORPORATION)
4899 BELFORT ROAD
SUITE 300
JACKSONVILLE, FL 32256

FOR: CHARITABLE FUNDRAISING SERVICES, IN CLASS 36 (U.S. CLS. 100, 101 AND 102).

FIRST USE 9-7-2011; IN COMMERCE 9-7-2011.

THE MARK CONSISTS OF STANDARD CHARACTERS WITHOUT CLAIM TO ANY PARTICULAR FONT, STYLE, SIZE, OR COLOR.

SN 85-325,682, FILED 5-20-2011.

DAVID C. REIHNER, EXAMINING ATTORNEY



David J. Kybas

Director of the United States Patent and Trademark Office

United States of America

United States Patent and Trademark Office

RELAY SCHOOL OF EDUCATION

Reg. No. 4,155,559

Registered June 5, 2012

Int. Cls.: 35 and 41

SERVICE MARK

PRINCIPAL REGISTER

UNCOMMON KNOWLEDGE AND ACHIEVEMENT, INC. (DELAWARE CORPORATION)
40 W. 20TH ST.
SIXTH FLOOR
NEW YORK, NY 10011

FOR: SUPPORT OF TRAINING PROGRAMS FOR TEACHERS, NAMELY, SCHEDULING AND MANAGING OF TRAINING COURSES AND PROGRAMS, ALL IN THE FIELD OF PROGRAMS FOR TEACHER'S THAT LEAD TO A MASTER'S DEGREE AND STATE CERTIFICATION, AS WELL AS FOR ONGOING TEACHER TRAINING; EMPLOYMENT RECRUITING IN THE FIELD OF QUALIFIED TEACHERS, IN CLASS 35 (U.S. CLS. 100, 101 AND 102).

FIRST USE 2-8-2011; IN COMMERCE 2-8-2011.

FOR: DEVELOPING TRAINING SYSTEMS AND LEARNING METHODOLOGIES FOR OTHERS, NAMELY, TEACHERS, THAT LEAD TO A MASTER'S DEGREE AND STATE CERTIFICATION, AS WELL AS FOR ONGOING TEACHER TRAINING; EDUCATIONAL SERVICES, NAMELY, DEVELOPING CURRICULUM FOR EDUCATION AND FOR TEACHERS; DEVELOPMENT OF ADVANCED LEARNING TECHNOLOGIES AND TEACHING METHODS, IN CLASS 41 (U.S. CLS. 100, 101 AND 107).

FIRST USE 2-8-2011; IN COMMERCE 2-8-2011.

THE MARK CONSISTS OF STANDARD CHARACTERS WITHOUT CLAIM TO ANY PARTICULAR FONT, STYLE, SIZE, OR COLOR.

NO CLAIM IS MADE TO THE EXCLUSIVE RIGHT TO USE "SCHOOL OF EDUCATION", APART FROM THE MARK AS SHOWN.

SN 85-325,713, FILED 5-20-2011.

BARBARA BROWN, EXAMINING ATTORNEY



David J. Kyjars

Director of the United States Patent and Trademark Office

United States of America

United States Patent and Trademark Office

RSE

Reg. No. 4,155,560

Registered June 5, 2012

Int. Cls.: 35 and 41

SERVICE MARK

PRINCIPAL REGISTER

UNCOMMON KNOWLEDGE AND ACHIEVEMENT, INC. (DELAWARE CORPORATION)
40 W. 20TH ST.
SIXTH FLOOR
NEW YORK, NY 10011

FOR: SUPPORT OF TRAINING PROGRAMS FOR TEACHERS, NAMELY, SCHEDULING AND MANAGING OF TRAINING COURSES AND PROGRAMS, ALL IN THE FIELD OF PROGRAMS FOR TEACHER'S THAT LEAD TO A MASTER'S DEGREE AND STATE CERTIFICATION, AS WELL AS FOR ONGOING TEACHER TRAINING; EMPLOYMENT RECRUITING IN THE FIELD OF QUALIFIED TEACHERS, IN CLASS 35 (U.S. CLS. 100, 101 AND 102).

FIRST USE 2-8-2011; IN COMMERCE 2-8-2011.

FOR: DEVELOPING TRAINING SYSTEMS AND LEARNING METHODOLOGIES FOR OTHERS, NAMELY, TEACHERS, THAT LEAD TO A MASTER'S DEGREE AND STATE CERTIFICATION, AS WELL AS FOR ONGOING TEACHER TRAINING; EDUCATIONAL SERVICES, NAMELY, DEVELOPING CURRICULUM FOR EDUCATION AND FOR TEACHERS; DEVELOPMENT OF ADVANCED LEARNING TECHNOLOGIES AND TEACHING METHODS, IN CLASS 41 (U.S. CLS. 100, 101 AND 107).

FIRST USE 2-8-2011; IN COMMERCE 2-8-2011.

THE MARK CONSISTS OF STANDARD CHARACTERS WITHOUT CLAIM TO ANY PARTICULAR FONT, STYLE, SIZE, OR COLOR.

SN 85-325,735, FILED 5-20-2011.

BARBARA BROWN, EXAMINING ATTORNEY



David J. Kyros

Director of the United States Patent and Trademark Office

United States of America

United States Patent and Trademark Office

GRIPPGUARD

Reg. No. 4,155,561

FOX 40 INTERNATIONAL INC. (CANADA CORPORATION)
560 ARVIN AVENUE

Registered June 5, 2012

STONEY CREEK, ONTARIO, CANADA L8E5P1

Int. Cl.: 28

FOR: ATHLETIC EQUIPMENT, NAMELY, MOUTH GUARDS; MOUTH GUARDS FOR ATHLETIC USE, IN CLASS 28 (U.S. CLS. 22, 23, 38 AND 50).

TRADEMARK

FIRST USE 1-1-2011; IN COMMERCE 1-1-2011.

PRINCIPAL REGISTER

THE MARK CONSISTS OF STANDARD CHARACTERS WITHOUT CLAIM TO ANY PARTICULAR FONT, STYLE, SIZE, OR COLOR.

SN 85-325,780, FILED 5-20-2011.

HEATHER BIDDULPH, EXAMINING ATTORNEY



David J. Kyros

Director of the United States Patent and Trademark Office

United States of America

United States Patent and Trademark Office

FLEXXGUARD

Reg. No. 4,155,562

FOX 40 INTERNATIONAL INC. (CANADA CORPORATION)
560 ARVIN AVENUE

Registered June 5, 2012

STONEY CREEK, ONTARIO, CANADA L8E5P1

Int. Cl.: 28

FOR: ATHLETIC EQUIPMENT, NAMELY, MOUTH GUARDS; MOUTH GUARDS FOR ATHLETIC USE, IN CLASS 28 (U.S. CLS. 22, 23, 38 AND 50).

TRADEMARK

FIRST USE 1-1-2011; IN COMMERCE 1-1-2011.

PRINCIPAL REGISTER

THE MARK CONSISTS OF STANDARD CHARACTERS WITHOUT CLAIM TO ANY PARTICULAR FONT, STYLE, SIZE, OR COLOR.

SN 85-325,799, FILED 5-20-2011.

HEATHER BIDDULPH, EXAMINING ATTORNEY



David J. Kybas

Director of the United States Patent and Trademark Office

United States of America

United States Patent and Trademark Office

SNAPTAGZ

Reg. No. 4,155,563

Registered June 5, 2012

Int. Cl.: 26

TRADEMARK

PRINCIPAL REGISTER

SNAPTAGZ, LLC (DELAWARE LIMITED LIABILITY COMPANY)
C/O JASON SHARF
1559 EAST 38TH STREET
BROOKLYN, NY 11234

FOR: CLOTHING ORNAMENT, NAMELY, PLASTIC CLIPS THAT ATTACH TO ALL CLOTHING, IN CLASS 26 (U.S. CLS. 37, 39, 40, 42 AND 50).

FIRST USE 5-6-2011; IN COMMERCE 2-29-2012.

THE MARK CONSISTS OF STANDARD CHARACTERS WITHOUT CLAIM TO ANY PARTICULAR FONT, STYLE, SIZE, OR COLOR.

SN 85-326,357, FILED 5-20-2011.

DAVID I, EXAMINING ATTORNEY



David J. Kyffers

Director of the United States Patent and Trademark Office

United States of America

United States Patent and Trademark Office

domaincloud

Reg. No. 4,155,564

QSOL.COM INC. (CALIFORNIA CORPORATION)

Registered June 5, 2012

P.O. BOX 491967
LOS ANGELES, CA 90049

Int. Cl.: 42

SERVICE MARK

PRINCIPAL REGISTER

FOR: CLOUD COMPUTING FEATURING SOFTWARE FOR USE IN PROVIDING SOFTWARE-AS-A-SERVICE (SAAS), INFRASTRUCTURE-AS-A-SERVICE (IAAS), PLATFORM-AS-A-SERVICE (PAAS) AND DESKTOP-AS-A-SERVICE (DAAS) FUNCTIONS; COMPUTER SERVICES, NAMELY, CLOUD HOSTING PROVIDER SERVICES; COMPUTER SERVICES, NAMELY, INTEGRATION OF PRIVATE AND PUBLIC CLOUD COMPUTING ENVIRONMENTS; CONSULTING SERVICES IN THE FIELD OF CLOUD COMPUTING; PROVIDING VIRTUAL COMPUTER SYSTEMS AND VIRTUAL COMPUTER ENVIRONMENTS THROUGH CLOUD COMPUTING; TECHNICAL CONSULTING SERVICES IN THE FIELDS OF DATA-CENTER ARCHITECTURE, PUBLIC AND PRIVATE CLOUD COMPUTING SOLUTIONS, AND EVALUATION AND IMPLEMENTATION OF INTERNET TECHNOLOGY AND SERVICES; TECHNICAL SUPPORT SERVICES, NAMELY, REMOTE AND ON-SITE INFRASTRUCTURE MANAGEMENT SERVICES FOR MONITORING, ADMINISTRATION AND MANAGEMENT OF PUBLIC AND PRIVATE CLOUD COMPUTING IT AND APPLICATION SYSTEMS, IN CLASS 42 (U.S. CLS. 100 AND 101).

FIRST USE 4-19-2010; IN COMMERCE 4-19-2010.

THE MARK CONSISTS OF STANDARD CHARACTERS WITHOUT CLAIM TO ANY PARTICULAR FONT, STYLE, SIZE, OR COLOR.

SN 85-326,739, FILED 5-21-2011.

NATALIE POLZER, EXAMINING ATTORNEY



David J. Kyffers

Director of the United States Patent and Trademark Office

United States of America

United States Patent and Trademark Office



Reg. No. 4,155,565

PRECISION FOODS, INC. (IOWA CORPORATION)
11457 OLDE CABIN ROAD
ST. LOUIS, MO 63141

Registered June 5, 2012

Int. Cls.: 29 and 30

FOR: SOUP AND SOUP BASE MIXES, IN CLASS 29 (U.S. CL. 46).

TRADEMARK

FIRST USE 6-30-2011; IN COMMERCE 6-30-2011.

PRINCIPAL REGISTER

FOR: FOOD SEASONINGS; FOOD MIXES FOR GRAVIES AND AU JUS , IN CLASS 30 (U.S. CL. 46).

FIRST USE 6-30-2011; IN COMMERCE 6-30-2011.

OWNER OF U.S. REG. NOS. 1,807,762, 2,395,879, AND 4,012,508.

THE MARK CONSISTS OF THE WORDS "ORRINGTON FARMS" OVER A FARM SCENE CONSISTING OF A BARN, SILO, WINDMILL, FENCE AND FIELDS.

SN 85-328,472, FILED 5-24-2011.

MEGHAN REINHART, EXAMINING ATTORNEY



David J. Kyffers

Director of the United States Patent and Trademark Office

United States of America

United States Patent and Trademark Office

BLISTER ARMOUR

Reg. No. 4,155,566

Registered June 5, 2012

Int. Cl.: 5

TRADEMARK

PRINCIPAL REGISTER

MISSION PRODUCT HOLDINGS, INC. (DELAWARE CORPORATION)
185 MADISON AVENUE, 12TH FLOOR
NEW YORK, NY 10016

FOR: MEDICATED PREPARATIONS FOR THE PROTECTION OF SKIN AGAINST PRESSURE AND FRICTION FOR PREVENTION OF BLISTERS AND CALLUSES, IN CLASS 5 (U.S. CLS. 6, 18, 44, 46, 51 AND 52).

FIRST USE 9-9-2011; IN COMMERCE 9-9-2011.

THE MARK CONSISTS OF STANDARD CHARACTERS WITHOUT CLAIM TO ANY PARTICULAR FONT, STYLE, SIZE, OR COLOR.

NO CLAIM IS MADE TO THE EXCLUSIVE RIGHT TO USE "BLISTER", APART FROM THE MARK AS SHOWN.

SN 85-328,871, FILED 5-24-2011.

JESSICA FATHY, EXAMINING ATTORNEY



David J. Kyros

Director of the United States Patent and Trademark Office

United States of America

United States Patent and Trademark Office

YOBOT

Reg. No. 4,155,567

Registered June 5, 2012

Int. Cls.: 7 and 43

TRADEMARK

SERVICE MARK

PRINCIPAL REGISTER

YOTEL LIMITED (UNITED KINGDOM PRIVATE LIMITED COMPANY)
27/28 EASTCASTLE STREET
LONDON W1W 8DH, UNITED KINGDOM

FOR: INDUSTRIAL ROBOTS; INDUSTRIAL ROBOTS FOR STORING LUGGAGE, IN CLASS 7 (U.S. CLS. 13, 19, 21, 23, 31, 34 AND 35).

FIRST USE 6-0-2011; IN COMMERCE 6-0-2011.

FOR: HOTEL SERVICES; MOTEL SERVICES; PROVISION OF TEMPORARY ACCOMMODATION; ARRANGING ACCOMMODATION, NAMELY, MAKING RESERVATIONS AND BOOKING FOR TEMPORARY LODGING; RENTAL OF PORTABLE, SELF-CONTAINED ROOMS USED FOR TEMPORARY ACCOMMODATIONS AND INFORMATION, ADVICE AND CONSULTANCY SERVICES IN RELATION THERETO, IN CLASS 43 (U.S. CLS. 100 AND 101).

FIRST USE 6-0-2011; IN COMMERCE 6-0-2011.

THE MARK CONSISTS OF STANDARD CHARACTERS WITHOUT CLAIM TO ANY PARTICULAR FONT, STYLE, SIZE, OR COLOR.

SN 85-328,909, FILED 5-24-2011.

CHARLES L. JENKINS, EXAMINING ATTORNEY



David J. Kybas

Director of the United States Patent and Trademark Office

United States of America

United States Patent and Trademark Office

DOH YO

Reg. No. 4,155,568

Registered June 5, 2012

Int. Cl.: 43

SERVICE MARK

PRINCIPAL REGISTER

YOTEL LIMITED (UNITED KINGDOM PRIVATE LIMITED COMPANY)
27/28 EASTCASTLE STREET
LONDON, UNITED KINGDOM W1W8DH

FOR: HOTEL SERVICES; MOTEL SERVICES; PROVISION OF TEMPORARY ACCOMMODATION; ARRANGING ACCOMMODATION, NAMELY, MAKING RESERVATIONS AND BOOKING FOR TEMPORARY LODGING; RENTAL OF PORTABLE, SELF-CONTAINED ROOMS USED FOR TEMPORARY ACCOMMODATIONS; BAR AND RESTAURANT SERVICES; SELF-SERVICE RESTAURANTS; TAKE-OUT RESTAURANT SERVICES; CAFE AND CAFETERIA SERVICES; PREPARATION OF FOOD AND BEVERAGES; CATERING SERVICES FOR THE PROVISION OF FOOD AND BEVERAGES; COCKTAIL LOUNGE SERVICES AND INFORMATION, ADVICE AND CONSULTANCY SERVICES IN RELATION THERETO, IN CLASS 43 (U.S. CLS. 100 AND 101).

FIRST USE 6-0-2011; IN COMMERCE 6-0-2011.

THE MARK CONSISTS OF STANDARD CHARACTERS WITHOUT CLAIM TO ANY PARTICULAR FONT, STYLE, SIZE, OR COLOR.

SN 85-328,959, FILED 5-24-2011.

CHARLES L. JENKINS, EXAMINING ATTORNEY



David J. Kypos

Director of the United States Patent and Trademark Office

United States of America

United States Patent and Trademark Office



Lord of the Beans

Reg. No. 4,155,569

Registered June 5, 2012

Int. Cl.: 30

TRADEMARK

PRINCIPAL REGISTER

RD SPECIALTIES LTD (ILLINOIS CORPORATION), DBA RD SPECIALTIES LTD,
2271 SPRUCEWOOD AVE
DES PLAINES, IL 60018

FOR: COFFEE BEANS, IN CLASS 30 (U.S. CL. 46).

FIRST USE 11-1-2011; IN COMMERCE 3-1-2012.

THE MARK CONSISTS OF THE WORDS "LORD OF THE BEANS" IN A STYLIZED MANNER
WITH A DECORATIVE OVAL DESIGN CONTAINING COFFEE BEANS ABOVE IT.

SN 85-329,121, FILED 5-24-2011.

REBECCA SMITH, EXAMINING ATTORNEY



David J. Kybas

Director of the United States Patent and Trademark Office

United States of America

United States Patent and Trademark Office

Tee It Forward

Reg. No. 4,155,570

Registered June 5, 2012

Int. Cl.: 41

SERVICE MARK

PRINCIPAL REGISTER

THE PROFESSIONAL GOLFERS' ASSOCIATION OF AMERICA (FLORIDA CORPORATION)
100 AVENUE OF THE CHAMPIONS
PALM BEACH GARDENS, FL 33418

FOR: EDUCATIONAL AND ENTERTAINMENT SERVICES, NAMELY, PROVIDING INSTRUCTIONAL PROGRAMS IN THE FIELD OF GOLF FOR PLAYERS AT ALL LEVELS AND DISTRIBUTING PRINTED INSTRUCTIONAL AND INFORMATIONAL MATERIALS IN CONNECTION THEREWITH; PROVIDING INSTRUCTION INFORMATION ABOUT THE GAME OF GOLF VIA A WEB SITE ON THE INTERNET, IN CLASS 41 (U.S. CLS. 100, 101 AND 107).

FIRST USE 5-25-2011; IN COMMERCE 6-1-2011.

THE MARK CONSISTS OF STANDARD CHARACTERS WITHOUT CLAIM TO ANY PARTICULAR FONT, STYLE, SIZE, OR COLOR.

SN 85-329,633, FILED 5-25-2011.

GIANCARLO CASTRO, EXAMINING ATTORNEY



David J. Kyffers

Director of the United States Patent and Trademark Office

United States of America

United States Patent and Trademark Office

PNC SMARTACCESS

Reg. No. 4,155,571

THE PNC FINANCIAL SERVICES GROUP, INC. (PENNSYLVANIA CORPORATION)
249 FIFTH AVENUE
PITTSBURGH, PA 15222

Registered June 5, 2012

Int. Cl.: 36

FOR: PREPAID RELOADABLE DEBIT CARD SERVICES, IN CLASS 36 (U.S. CLS. 100, 101 AND 102).

SERVICE MARK

FIRST USE 1-30-2012; IN COMMERCE 1-30-2012.

PRINCIPAL REGISTER

THE MARK CONSISTS OF STANDARD CHARACTERS WITHOUT CLAIM TO ANY PARTICULAR FONT, STYLE, SIZE, OR COLOR.

OWNER OF U.S. REG. NO. 1,416,898.

SN 85-329,942, FILED 5-25-2011.

HELENE LIWINSKI, EXAMINING ATTORNEY



David J. Kybas

Director of the United States Patent and Trademark Office

United States of America

United States Patent and Trademark Office

CLOSER TO MY DREAMS TOUR

Reg. No. 4,155,572

Registered June 5, 2012

Int. Cl.: 41

SERVICE MARK

PRINCIPAL REGISTER

SHAWN GEE (UNITED STATES INDIVIDUAL)
1 PRESIDENTIAL BLVD.
SUITE 320
BALA CYNWYD, PA 19004 AND

JULIUS ERVING III (UNITED STATES INDIVIDUAL)
37 WEST 20TH
SUITE 1004
NEW YORK, NY 10010 AND

TROY CARTER (UNITED STATES INDIVIDUAL)
1 PRESIDENTIAL BLVD.
C/O SUITE 320
BALA CYNWYD, PA 19004

FOR: ENTERTAINMENT, NAMELY, LIVE MUSIC CONCERTS, IN CLASS 41 (U.S. CLS. 100, 101 AND 107).

FIRST USE 6-6-2011; IN COMMERCE 6-6-2011.

THE MARK CONSISTS OF STANDARD CHARACTERS WITHOUT CLAIM TO ANY PARTICULAR FONT, STYLE, SIZE, OR COLOR.

NO CLAIM IS MADE TO THE EXCLUSIVE RIGHT TO USE "TOUR", APART FROM THE MARK AS SHOWN.

SN 85-330,210, FILED 5-25-2011.

DAVID ELTON, EXAMINING ATTORNEY



David J. Kyffers

Director of the United States Patent and Trademark Office

United States of America

United States Patent and Trademark Office

MUFFLERCO

Reg. No. 4,155,573

Registered June 5, 2012

Int. Cl.: 7

TRADEMARK

PRINCIPAL REGISTER

INTEGRADIGM CORPORATION (NEVADA CORPORATION)
SUITE 202
10214 CHESTNUT PLAZA DRIVE
FORT WAYNE, IN 46814

FOR: RECEIVERS FOR EXHAUST AND EMISSION SYSTEMS, NAMELY, MUFFLERS AND SOUND DEADENING DEVICES, IN CLASS 7 (U.S. CLS. 13, 19, 21, 23, 31, 34 AND 35).

FIRST USE 11-28-2010; IN COMMERCE 1-23-2012.

THE MARK CONSISTS OF STANDARD CHARACTERS WITHOUT CLAIM TO ANY PARTICULAR FONT, STYLE, SIZE, OR COLOR.

SN 85-332,046, FILED 5-27-2011.

KHANH LE, EXAMINING ATTORNEY



David J. Kybas

Director of the United States Patent and Trademark Office

United States of America

United States Patent and Trademark Office



Reg. No. 4,155,574

Registered June 5, 2012

Int. Cl.: 25

TRADEMARK

PRINCIPAL REGISTER

STANOJEVIC, DEJAN (UNITED STATES INDIVIDUAL)
7822 LUXOR STREET
DOWNEY, CA 90241

FOR: HATS; SHIRTS; SHORTS; T-SHIRTS, IN CLASS 25 (U.S. CLS. 22 AND 39).

FIRST USE 10-1-2011; IN COMMERCE 1-1-2012.

THE MARK CONSISTS OF THE STYLIZED TEXT "R" IN A BOX.

SN 85-332,134, FILED 5-27-2011.

KEVON CHISOLM, EXAMINING ATTORNEY



David J. Kyffers

Director of the United States Patent and Trademark Office

United States of America

United States Patent and Trademark Office

THE WOODSHED SMOKEHOUSE

Reg. No. 4,155,575

LOVE STYLE CORPORATION (TEXAS CORPORATION)
2406 N. MAIN ST.
FORT WORTH, TX 76164

Registered June 5, 2012

Int. Cl.: 43

FOR: RESTAURANT AND BAR SERVICES, IN CLASS 43 (U.S. CLS. 100 AND 101).

SERVICE MARK

FIRST USE 2-1-2012; IN COMMERCE 2-1-2012.

PRINCIPAL REGISTER

THE MARK CONSISTS OF STANDARD CHARACTERS WITHOUT CLAIM TO ANY PARTICULAR FONT, STYLE, SIZE, OR COLOR.

NO CLAIM IS MADE TO THE EXCLUSIVE RIGHT TO USE "SMOKEHOUSE", APART FROM THE MARK AS SHOWN.

SN 85-332,856, FILED 5-27-2011.

MATTHEW KLINE, EXAMINING ATTORNEY



David J. Kyros

Director of the United States Patent and Trademark Office

United States of America

United States Patent and Trademark Office

Luxēvo

Reg. No. 4,155,576

Registered June 5, 2012

Int. Cl.: 39

SERVICE MARK

PRINCIPAL REGISTER

KHM CONSULTING INC. (OHIO CORPORATION), DBA KHM TRAVEL GROUP,
1152 PEARL ROAD
BRUNSWICK, OH 44212

FOR: TRAVEL CLUBS, IN CLASS 39 (U.S. CLS. 100 AND 105).

FIRST USE 5-31-2011; IN COMMERCE 10-10-2011.

THE MARK CONSISTS OF STANDARD CHARACTERS WITHOUT CLAIM TO ANY PARTICULAR FONT, STYLE, SIZE, OR COLOR.

SN 85-333,854, FILED 5-31-2011.

DEBRA LEE, EXAMINING ATTORNEY



David J. Kyffers

Director of the United States Patent and Trademark Office

United States of America

United States Patent and Trademark Office

INPHO

Reg. No. 4,155,577

Registered June 5, 2012

Int. Cl.: 9

TRADEMARK

PRINCIPAL REGISTER

TRIMBLE NAVIGATION LIMITED (CALIFORNIA CORPORATION)
935 STEWART DRIVE
SUNNYVALE, CA 94085

FOR: COMPUTER SOFTWARE FOR USE IN PHOTOGRAMMETRY, IN CLASS 9 (U.S. CLS. 21, 23, 26, 36 AND 38).

FIRST USE 0-0-1987; IN COMMERCE 0-0-1987.

THE MARK CONSISTS OF STANDARD CHARACTERS WITHOUT CLAIM TO ANY PARTICULAR FONT, STYLE, SIZE, OR COLOR.

SN 85-333,936, FILED 5-31-2011.

DOUGLAS LEE, EXAMINING ATTORNEY



David J. Kyffers

Director of the United States Patent and Trademark Office

United States of America

United States Patent and Trademark Office

ED-FI

Reg. No. 4,155,578

Registered June 5, 2012

Int. Cls.: 35 and 42

SERVICE MARK

PRINCIPAL REGISTER

MICHAEL & SUSAN DELL FOUNDATION (TEXAS NON-PROFIT CORPORATION)
P.O. BOX 163867
AUSTIN, TX 78716

FOR: PROMOTING STANDARD INFORMATION COLLECTION PRACTICES AND FORMATS FOR EDUCATIONAL INSTITUTIONS; BUSINESS SERVICES, NAMELY, FORMULATION OF BEST PRACTICES FOR INFORMATION COLLECTION, FORMATTING, USE, AND REPORTING; COLLECTION AND COMPILATION OF INFORMATION INTO COMPUTER DATABASES IN THE FIELD OF EDUCATIONAL INSTITUTION ADMINISTRATION, IN CLASS 35 (U.S. CLS. 100, 101 AND 102).

FIRST USE 7-1-2011; IN COMMERCE 7-1-2011.

FOR: DEVELOPMENT OF VOLUNTARY STANDARDS FOR DATA IN EDUCATIONAL SETTINGS; DEVELOPMENT OF STANDARD INFORMATION COLLECTION PRACTICES AND FORMATS FOR EDUCATIONAL INSTITUTIONS; DEVELOPING VOLUNTARY STANDARDS FOR INFORMATION PROTOCOLS FOR EDUCATIONAL INSTITUTIONS; SOFTWARE DESIGN AND DEVELOPMENT, IN CLASS 42 (U.S. CLS. 100 AND 101).

FIRST USE 7-1-2011; IN COMMERCE 7-1-2011.

THE MARK CONSISTS OF STANDARD CHARACTERS WITHOUT CLAIM TO ANY PARTICULAR FONT, STYLE, SIZE, OR COLOR.

SN 85-334,028, FILED 5-31-2011.

ANNE E. GUSTASON, EXAMINING ATTORNEY



David J. Kyjars

Director of the United States Patent and Trademark Office

United States of America

United States Patent and Trademark Office

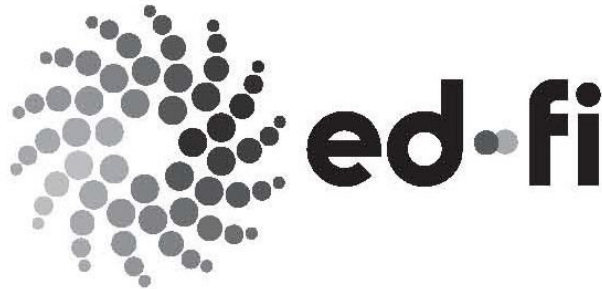

Reg. No. 4,155,579

Registered June 5, 2012

Int. Cls.: 35 and 42

SERVICE MARK

PRINCIPAL REGISTER

MICHAEL & SUSAN DELL FOUNDATION (TEXAS NON-PROFIT CORPORATION)
P.O. BOX 163867
AUSTIN, TX 78716

FOR: PROMOTING STANDARD INFORMATION COLLECTION PRACTICES AND FORMATS FOR EDUCATIONAL INSTITUTIONS; BUSINESS SERVICES, NAMELY, FORMULATION OF BEST PRACTICES FOR INFORMATION COLLECTION, FORMATTING, USE, AND REPORTING; COLLECTION AND COMPILATION OF INFORMATION INTO COMPUTER DATABASES IN THE FIELD OF EDUCATIONAL INSTITUTION ADMINISTRATION, IN CLASS 35 (U.S. CLS. 100, 101 AND 102).

FIRST USE 7-1-2011; IN COMMERCE 7-1-2011.

FOR: DEVELOPMENT OF VOLUNTARY STANDARDS FOR DATA IN EDUCATIONAL SETTINGS; DEVELOPMENT OF STANDARD INFORMATION COLLECTION PRACTICES AND FORMATS FOR EDUCATIONAL INSTITUTIONS; DEVELOPING VOLUNTARY STANDARDS FOR INFORMATION PROTOCOLS FOR EDUCATIONAL INSTITUTIONS; SOFTWARE DESIGN AND DEVELOPMENT, IN CLASS 42 (U.S. CLS. 100 AND 101).

FIRST USE 7-1-2011; IN COMMERCE 7-1-2011.

THE MARK CONSISTS OF A PINWHEEL DESIGN BEFORE THE STYLIZED LETTERING "ED-FI".

SN 85-334,062, FILED 5-31-2011.

ANNE E. GUSTASON, EXAMINING ATTORNEY



David J. Kybas

Director of the United States Patent and Trademark Office

United States of America

United States Patent and Trademark Office

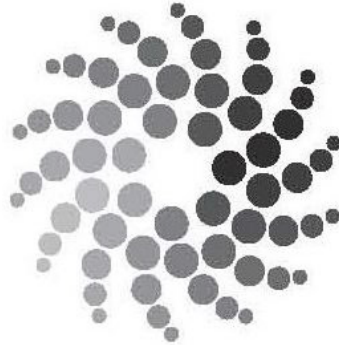

Reg. No. 4,155,580

Registered June 5, 2012

Int. Cls.: 35 and 42

SERVICE MARK

PRINCIPAL REGISTER

MICHAEL & SUSAN DELL FOUNDATION (TEXAS NON-PROFIT CORPORATION)
P.O. BOX 163867
AUSTIN, TX 78716

FOR: PROMOTING STANDARD INFORMATION COLLECTION PRACTICES AND FORMATS FOR EDUCATIONAL INSTITUTIONS; BUSINESS SERVICES, NAMELY, FORMULATION OF BEST PRACTICES FOR INFORMATION COLLECTION, FORMATTING, USE, AND REPORTING; COLLECTION AND COMPILATION OF INFORMATION INTO COMPUTER DATABASES IN THE FIELD OF EDUCATIONAL INSTITUTION ADMINISTRATION, IN CLASS 35 (U.S. CLS. 100, 101 AND 102).

FIRST USE 7-1-2011; IN COMMERCE 7-1-2011.

FOR: DEVELOPMENT OF VOLUNTARY STANDARDS FOR DATA IN EDUCATIONAL SETTINGS; DEVELOPMENT OF STANDARD INFORMATION COLLECTION PRACTICES AND FORMATS FOR EDUCATIONAL INSTITUTIONS; DEVELOPING VOLUNTARY STANDARDS FOR INFORMATION PROTOCOLS FOR EDUCATIONAL INSTITUTIONS; SOFTWARE DESIGN AND DEVELOPMENT, IN CLASS 42 (U.S. CLS. 100 AND 101).

FIRST USE 7-1-2011; IN COMMERCE 7-1-2011.

THE MARK CONSISTS OF A PINWHEEL DESIGN.

SN 85-334,095, FILED 5-31-2011.

ANNE E. GUSTASON, EXAMINING ATTORNEY



David J. Kyjars

Director of the United States Patent and Trademark Office

United States of America

United States Patent and Trademark Office

OPUS ORCHESTRATOR

Reg. No. 4,155,581

HONEYWELL INTERNATIONAL INC. (DELAWARE CORPORATION)
101 COLUMBIA ROAD
MORRISTOWN, NJ 07962

Registered June 5, 2012

Int. Cl.: 35

FOR: PROVIDING AN INTERNET WEBSITE PORTAL TO VIEW ENERGY USAGE MANAGEMENT REPORTS, IN CLASS 35 (U.S. CLS. 100, 101 AND 102).

SERVICE MARK

FIRST USE 10-16-2011; IN COMMERCE 10-16-2011.

PRINCIPAL REGISTER

THE MARK CONSISTS OF STANDARD CHARACTERS WITHOUT CLAIM TO ANY PARTICULAR FONT, STYLE, SIZE, OR COLOR.

SN 85-334,123, FILED 5-31-2011.

LINDA E. BLOHM, EXAMINING ATTORNEY



David J. Kybas

Director of the United States Patent and Trademark Office

United States of America

United States Patent and Trademark Office

NEW ENGLAND LINEN SUPPLY

Reg. No. 4,155,582

Registered June 5, 2012

Int. Cls.: 43 and 45

SERVICE MARK

PRINCIPAL REGISTER

NEW ENGLAND LINEN SUPPLY (RHODE ISLAND CORPORATION)
20 RHODE ISLAND AVENUE
PAWTUCKET, RI 02860

FOR: RENTAL OF TABLE LINENS, IN CLASS 43 (U.S. CLS. 100 AND 101).

FIRST USE 4-29-1959; IN COMMERCE 4-29-1959.

FOR: RENTAL OF CLOTHING; RENTAL OF UNIFORMS, IN CLASS 45 (U.S. CLS. 100 AND 101).

FIRST USE 4-29-1959; IN COMMERCE 4-29-1959.

NO CLAIM IS MADE TO THE EXCLUSIVE RIGHT TO USE "NEW ENGLAND LINEN SUPPLY", APART FROM THE MARK AS SHOWN.

THE MARK CONSISTS OF THE WORDS "NEW ENGLAND LINEN SUPPLY" WITH CAPITALIZATION OF THE INITIAL LETTER OF "NEW" AND "LINEN" AND THE LAST LETTER OF "ENGLAND" AND "SUPPLY" SURROUNDING OPPOSED SCROLLS.

SN 85-335,021, FILED 6-1-2011.

SUSAN RICHARDS, EXAMINING ATTORNEY



David J. Kyros

Director of the United States Patent and Trademark Office

United States of America

United States Patent and Trademark Office

ychux

Reg. No. 4,155,583

Registered June 5, 2012

Int. Cl.: 16

TRADEMARK

PRINCIPAL REGISTER

GRUPO YSANT C.A (VENEZUELA COMPANIA ANONIMA (CA))
CALLE CAICAGUANA URB. LOMA LINDA
EL HATILLO, MIRANDA, VENEZUELA 1083

FOR: ADHESIVE LABELS; ADHESIVE NOTE PADS; ADHESIVE NOTE PAPER; ADHESIVE TAPE DISPENSERS; ADHESIVE TAPES FOR STATIONERY PURPOSES; ADHESIVE-APPLYING MACHINES FOR HOME AND OFFICE USE; ARTISTS' BRUSHES; ARTISTS' PASTELS; ARTISTS' PENCILS; ARTISTS' PENS; AUTOMATIC ADHESIVE DISPENSERS FOR OFFICE USE; BOXES OF CARDBOARD OR PAPER; BOXES, CARTONS, STORAGE CONTAINERS, AND PACKAGING CONTAINERS MADE OF PAPER OR CARDBOARD; BOXES, CONTAINERS, AND CARTONS OF PAPERBOARD OR CARDBOARD FOR COMMERCIAL OR INDUSTRIAL PACKAGING; CANVAS PANELS FOR ARTISTS; CARDBOARD; CORRECTING FLUID FOR TYPE; CRAFT PAPER; CREPE PAPER; CYANOACRYLATE ADHESIVES FOR HOME AND HOBBY USE; DIGITAL PRINTING PAPER; DRAWING PAPER; ELECTRIC PAPER HOLE PERFORATORS BEING OFFICE REQUISITES AND PARTS THEREFOR, NAMELY, BORING BITS, PROTECTION PLATES, AND GRINDERS; ELECTRIC PAPER HOLE PUNCHES; ELECTRIC PAPER HOLE PUNCHES BEING OFFICE REQUISITES AND PARTS THEREFOR, NAMELY, BORING BITS, PROTECTION PLATES, AND GRINDERS; EMBROIDERY DESIGN PATTERNS; ENVELOPE PAPER; FINGER-STALLS; FRANKING MACHINES; GIFT WRAP PAPER; GUMMED PAPER; INK STAMPS; LAMINATED PAPER; LASER PRINTING PAPER; LETTER PAPER; LETTERHEAD PAPER; MAGAZINE PAPER; MARKING STAMPS; NEWSPRINT PAPER; NOTE PAPER; OFFICE REQUISITES, NAMELY, ENVELOPE SEALING MACHINES; PACKING PAPER; PAPER AND CARDBOARD; PAPER BAGS AND SACKS; PAPER BOXES; PAPER CONTAINERS; PAPER EMBOSSERS; PAPER FOLDERS; PAPER FOLDING MACHINES AS OFFICE REQUISITES; PAPER FOR USE IN THE GRAPHIC ARTS INDUSTRY; PAPER GIFT BAGS; PAPER GIFT WRAP; PAPER LABELS; PAPER NAPKINS; PAPER NOTE TABLETS; PAPER NOTEBOOKS; PAPER PARTY DECORATIONS; PAPER PARTY FAVORS; PAPER PLACE MATS; PAPER SIGNBOARDS; PAPER STATIONERY; PAPER TAGS; PAPER TAPES; PAPER TISSUES; PAPER TOWELS; PAPER TRIMMERS; PLASTIC ADHESIVES FOR HOUSEHOLD OR DOMESTIC USE; PLASTIC BAGS FOR PACKAGING; PLASTIC BAGS FOR PACKING; PLASTIC COATED COPYING PAPER; PLASTIC FOILS; PLASTIC GIFT WRAP; PLASTIC OR PAPER BAGS FOR HOUSEHOLD USE; PLASTIC SANDWICH BAGS; PLASTIC SHEETS FOR WRITING, PRINTING, AND MARKING; PLASTIC SHOPPING BAGS; PLASTIC TRANSPARENCIES; PLASTIC TRASH BAGS; PLASTIC WRAP; PLASTIC-COATED COPYING PAPER; PRESSURE SENSITIVE ADHESIVE IMAGES IN THE NATURE OF DOUBLE-SIDED TAPE THAT CAN ADHERE TO A SURFACE ON ONE SIDE AND RECEIVE



David J. Kyros

Director of the United States Patent and Trademark Office

Reg. No. 4,155,583 AND RETAIN DECORATIVE MATERIALS ON AN OPPOSING SIDE FOR DECORATIVE HOUSEHOLD PURPOSES; PRINTED MATTER, NAMELY, PAPER SIGNS, BOOKS, MANUALS, CURRICULUM, NEWSLETTERS, INFORMATIONAL CARDS AND BROCHURES IN THE FIELD OF EDUCATION AND PROFESSIONAL DEVELOPMENT; PRINTED TEACHING MATERIALS IN THE FIELD OF EDUCATION AND PROFESSIONAL DEVELOPMENT; PRINTING BLOCKS; PUNCHES; RUBBER BANDS; RUBBER DOCUMENT STAMPS; RUBBER STAMPS; SELF-ADHESIVE PLASTIC SHEETS FOR LINING SHELVES; SELF-ADHESIVE TAPES FOR STATIONERY AND HOUSEHOLD PURPOSES; STAMP INKS; STAMP PAD INKS; STAMP PADS; STAPLERS; STENCIL PAPER; STENCIL PAPER; STENCILS, IN CLASS 16 (U.S. CLS. 2, 5, 22, 23, 29, 37, 38 AND 50).

FIRST USE 9-1-2011; IN COMMERCE 9-1-2011.

THE MARK CONSISTS OF STANDARD CHARACTERS WITHOUT CLAIM TO ANY PARTICULAR FONT, STYLE, SIZE, OR COLOR.

SN 85-335,684, FILED 6-1-2011.

PAUL MORENO, EXAMINING ATTORNEY

United States of America

United States Patent and Trademark Office

Ychuy 

Reg. No. 4,155,584

Registered June 5, 2012

Int. Cl.: 16

TRADEMARK

PRINCIPAL REGISTER

GRUPO YSANT C.A (VENEZUELA COMPANIA ANONIMA (CA))
CALLE CAICAGUANA URB. LOMA LINDA
EL HATILLO, MIRANDA, VENEZUELA 1083

FOR: ADHESIVE LABELS; ADHESIVE NOTE PADS; ADHESIVE NOTE PAPER; ADHESIVE TAPE DISPENSERS; ADHESIVE TAPES FOR STATIONERY PURPOSES; ADHESIVE-APPLYING MACHINES FOR HOME AND OFFICE USE; ARTISTS' BRUSHES; ARTISTS' PASTELS; ARTISTS' PENCILS; ARTISTS' PENS; AUTOMATIC ADHESIVE DISPENSERS FOR OFFICE USE; BOXES OF CARDBOARD OR PAPER; BOXES, CARTONS, STORAGE CONTAINERS, AND PACKAGING CONTAINERS MADE OF PAPER OR CARDBOARD; BOXES, CONTAINERS, AND CARTONS OF PAPERBOARD OR CARDBOARD FOR COMMERCIAL OR INDUSTRIAL PACKAGING; CANVAS PANELS FOR ARTISTS; CARDBOARD; CORRECTING FLUID FOR TYPE; CRAFT PAPER; CREPE PAPER; CYANOACRYLATE ADHESIVES FOR HOME AND HOBBY USE; DIGITAL PRINTING PAPER; DRAWING PAPER; ELECTRIC PAPER HOLE PERFORATORS BEING OFFICE REQUISITES AND PARTS THEREFOR, NAMELY, BORING BITS, PROTECTION PLATES, AND GRINDERS; ELECTRIC PAPER HOLE PUNCHES; ELECTRIC PAPER HOLE PUNCHES BEING OFFICE REQUISITES AND PARTS THEREFOR, NAMELY, BORING BITS, PROTECTION PLATES, AND GRINDERS; EMBROIDERY DESIGN PATTERNS; ENVELOPE PAPER; FINGER-STALLS; FRANKING MACHINES; GIFT WRAP PAPER; GUMMED PAPER; INK STAMPS; LAMINATED PAPER; LASER PRINTING PAPER; LETTER PAPER; LETTERHEAD PAPER; MAGAZINE PAPER; MARKING STAMPS; NEWSPRINT PAPER; NOTE PAPER; OFFICE REQUISITES, NAMELY, ENVELOPE SEALING MACHINES; PACKING PAPER; PAPER AND CARDBOARD; PAPER BAGS AND SACKS; PAPER BOXES; PAPER CONTAINERS; PAPER EMBOSSERS; PAPER FOLDERS; PAPER FOLDING MACHINES AS OFFICE REQUISITES; PAPER FOR USE IN THE GRAPHIC ARTS INDUSTRY; PAPER GIFT BAGS; PAPER GIFT WRAP; PAPER LABELS; PAPER NAPKINS; PAPER NOTE TABLETS; PAPER NOTEBOOKS; PAPER PARTY DECORATIONS; PAPER PARTY FAVORS; PAPER PLACE MATS; PAPER SIGNBOARDS; PAPER STATIONERY; PAPER TAGS; PAPER TAPES; PAPER TISSUES; PAPER TOWELS; PAPER TRIMMERS; PLASTIC ADHESIVES FOR HOUSEHOLD OR DOMESTIC USE; PLASTIC BAGS FOR PACKAGING; PLASTIC BAGS FOR PACKING; PLASTIC COATED COPYING PAPER; PLASTIC FOILS; PLASTIC GIFT WRAP; PLASTIC OR PAPER BAGS FOR HOUSEHOLD USE; PLASTIC SANDWICH BAGS; PLASTIC SHEETS FOR WRITING, PRINTING, AND MARKING; PLASTIC SHOPPING BAGS; PLASTIC TRANSPARENCIES; PLASTIC TRASH BAGS; PLASTIC WRAP; PLASTIC-COATED COPYING PAPER; PRESSURE SENSITIVE ADHESIVE IMAGES IN THE NATURE OF DOUBLE-SIDED TAPE THAT CAN ADHERE TO A SURFACE ON ONE SIDE AND RECEIVE



David J. Kappas

Director of the United States Patent and Trademark Office

Reg. No. 4,155,584 AND RETAIN DECORATIVE MATERIALS ON AN OPPOSING SIDE FOR DECORATIVE HOUSEHOLD PURPOSES; PRINTED MATTER, NAMELY, PAPER SIGNS, BOOKS, MANUALS, CURRICULUM, NEWSLETTERS, INFORMATIONAL CARDS AND BROCHURES IN THE FIELD OF EDUCATION AND PROFESSIONAL DEVELOPMENT; PRINTED TEACHING MATERIALS IN THE FIELD OF EDUCATION AND PROFESSIONAL DEVELOPMENT; PRINTING BLOCKS; PUNCHES; RUBBER BANDS; RUBBER DOCUMENT STAMPS; RUBBER STAMPS; SELF-ADHESIVE PLASTIC SHEETS FOR LINING SHELVES; SELF-ADHESIVE TAPES FOR STATIONERY AND HOUSEHOLD PURPOSES; STAMP INKS; STAMP PAD INKS; STAMP PADS; STAPLERS; STENCIL PAPER; STENCIL PAPER; STENCILS, IN CLASS 16 (U.S. CLS. 2, 5, 22, 23, 29, 37, 38 AND 50).

FIRST USE 9-1-2011; IN COMMERCE 9-1-2011.

THE MARK CONSISTS OF THE WORD, "YCHUX", IN A STYLISTIC, CYAN FONT, NEXT TO THE STYLISTIC IMAGE OF A BUTTERFLY, ALSO IN CYAN.

THE COLOR(S) CYAN IS/ARE CLAIMED AS A FEATURE OF THE MARK.

SN 85-335,692, FILED 6-1-2011.

PAUL MORENO, EXAMINING ATTORNEY

United States of America

United States Patent and Trademark Office

HYBRID

Reg. No. 4,155,585

Registered June 5, 2012

Int. Cl.: 9

TRADEMARK

PRINCIPAL REGISTER

GREENVITY COMMUNICATIONS, INC. (CALIFORNIA CORPORATION)
673 SOUTH MILPITAS BLVD, SUITE 204
MILPITAS, CA 95035

FOR: SEMICONDUCTOR CHIPS, CIRCUIT BOARDS, IN CLASS 9 (U.S. CLS. 21, 23, 26, 36 AND 38).

FIRST USE 9-0-2011; IN COMMERCE 9-0-2011.

THE MARK CONSISTS OF STANDARD CHARACTERS WITHOUT CLAIM TO ANY PARTICULAR FONT, STYLE, SIZE, OR COLOR.

SN 85-336,170, FILED 6-2-2011.

YAT SYE, LEE, EXAMINING ATTORNEY



David J. Kybas

Director of the United States Patent and Trademark Office

United States of America

United States Patent and Trademark Office

YES! Youth Establishing Strength

Reg. No. 4,155,586

Registered June 5, 2012

Int. Cl.: 41

SERVICE MARK

PRINCIPAL REGISTER

NATIONAL CONFERENCE FOR COMMUNITY AND JUSTICE OF CONNECTICUT AND
WESTERN MASSACHUSETTS, INC. (CONNECTICUT CORPORATION)
1095 DAY HILL ROAD
SUITE 100
WINDSOR, CT 06095

FOR: EDUCATIONAL AND ENTERTAINMENT SERVICES, NAMELY, PROVIDING
PRESENTATIONS, SEMINARS, DISCUSSION GROUPS AND INTERACTIVE AND COLLAB-
ORATIVE ACTIVITIES IN THE FIELD OF BULLYING AND CYBERBULLYING, IN CLASS
41 (U.S. CLS. 100, 101 AND 107).

FIRST USE 10-23-2011; IN COMMERCE 10-23-2011.

THE MARK CONSISTS OF STANDARD CHARACTERS WITHOUT CLAIM TO ANY PAR-
TICULAR FONT, STYLE, SIZE, OR COLOR.

SN 85-336,215, FILED 6-2-2011.

JANICE L. MCMORROW, EXAMINING ATTORNEY



David J. Kyffers

Director of the United States Patent and Trademark Office

United States of America

United States Patent and Trademark Office

TEN BUCK

Reg. No. 4,155,587

Registered June 5, 2012

Int. Cl.: 25

TRADEMARK

PRINCIPAL REGISTER

WOHALI OUTDOORS, LLC (OKLAHOMA LIMITED LIABILITY COMPANY)
1300 N INDUSTRIAL BLVD
CLAREMORE, OK 74017

FOR: FISHING SHIRTS; HUNTING SHIRTS; LONG-SLEEVED SHIRTS; SHIRTS; SHIRTS AND SHORT-SLEEVED SHIRTS; SHORT-SLEEVED OR LONG-SLEEVED T-SHIRTS; SHORT-SLEEVED SHIRTS; SPORT SHIRTS; SPORTS SHIRTS WITH SHORT SLEEVES; SWEAT SHIRTS; T-SHIRTS; TEE SHIRTS; WEARABLE GARMENTS AND CLOTHING, NAMELY, SHIRTS, IN CLASS 25 (U.S. CLS. 22 AND 39).

FIRST USE 6-25-2011; IN COMMERCE 6-25-2011.

THE MARK CONSISTS OF STANDARD CHARACTERS WITHOUT CLAIM TO ANY PARTICULAR FONT, STYLE, SIZE, OR COLOR.

SN 85-336,360, FILED 6-2-2011.

KEVIN CORWIN, EXAMINING ATTORNEY



David J. Kyffers

Director of the United States Patent and Trademark Office

United States of America

United States Patent and Trademark Office

D.Lee Visuals Photography

Reg. No. 4,155,588

THOMAS, DEBBIE (UNITED STATES INDIVIDUAL)
PO BOX 1062
PACIFIC GROVE, CA 93950

Registered June 5, 2012

Int. Cl.: 16

FOR: GREETING CARDS, IN CLASS 16 (U.S. CLS. 2, 5, 22, 23, 29, 37, 38 AND 50).

TRADEMARK

FIRST USE 12-1-2011; IN COMMERCE 12-1-2011.

PRINCIPAL REGISTER

THE MARK CONSISTS OF STANDARD CHARACTERS WITHOUT CLAIM TO ANY PARTICULAR FONT, STYLE, SIZE, OR COLOR.

NO CLAIM IS MADE TO THE EXCLUSIVE RIGHT TO USE "VISUALS PHOTOGRAPHY", APART FROM THE MARK AS SHOWN.

THE NAME(S), PORTRAIT(S), AND/OR SIGNATURE(S) SHOWN IN THE MARK IDENTIFIES DEBBIE LEE THOMAS, WHOSE CONSENT(S) TO REGISTER IS MADE OF RECORD.

SN 85-337,007, FILED 6-3-2011.

DAVID HOFFMAN, EXAMINING ATTORNEY



David J. Kyffers

Director of the United States Patent and Trademark Office

United States of America

United States Patent and Trademark Office

DURASOXX

Reg. No. 4,155,589

Registered June 5, 2012

Int. Cl.: 19

TRADEMARK

PRINCIPAL REGISTER

FILTREXX INTERNATIONAL LLC (OHIO LIMITED LIABILITY COMPANY)
35481 GRAFTON EASTERN ROAD
GRAFTON, OH 44044

FOR: EROSION CONTROL FABRIC, IN CLASS 19 (U.S. CLS. 1, 12, 33 AND 50).

FIRST USE 3-15-2012; IN COMMERCE 3-15-2012.

THE MARK CONSISTS OF STANDARD CHARACTERS WITHOUT CLAIM TO ANY PARTICULAR FONT, STYLE, SIZE, OR COLOR.

SN 85-337,303, FILED 6-3-2011.

MAYUR VAGHANI, EXAMINING ATTORNEY



David J. Kybas

Director of the United States Patent and Trademark Office

United States of America

United States Patent and Trademark Office

ATTENTION POINT

Reg. No. 4,155,590

Registered June 5, 2012

Int. Cl.: 9

TRADEMARK

PRINCIPAL REGISTER

ATTENTION, INC. (VIRGINIA CORPORATION)
5245 ROSELAWN ROAD
ROANOKE, VA 24018

FOR: SOFTWARE FOR ASSESSING ATTENTION IMPAIRMENT, NAMELY, COMPUTER SOFTWARE FOR COMPILING AND ASSESSING MEDICAL DATA OBTAINED FROM CLINICAL DECISION SUPPORT TOOLS; COMPUTER SOFTWARE FOR ASSESSMENT OF ATTENTION IMPAIRMENT, INCLUDING ATTENTION DEFICIT HYPERACTIVITY DISORDER, IN CLASS 9 (U.S. CLS. 21, 23, 26, 36 AND 38).

FIRST USE 3-6-2012; IN COMMERCE 3-6-2012.

THE MARK CONSISTS OF STANDARD CHARACTERS WITHOUT CLAIM TO ANY PARTICULAR FONT, STYLE, SIZE, OR COLOR.

NO CLAIM IS MADE TO THE EXCLUSIVE RIGHT TO USE "ATTENTION", APART FROM THE MARK AS SHOWN.

SN 85-338,763, FILED 6-6-2011.

BILL DAWE, EXAMINING ATTORNEY



David J. Kyffers

Director of the United States Patent and Trademark Office

United States of America

United States Patent and Trademark Office

GlassBlast

Reg. No. 4,155,591

Registered June 5, 2012

Int. Cl.: 3

TRADEMARK

PRINCIPAL REGISTER

STEVEN CAMPS (UNITED STATES INDIVIDUAL), DBA RKG CAMPS,
6942 LAWN HAVEN DRIVE
HUNTINGTON BEACH, CA 92648

FOR: GLASS GRANULES USED AS ABRASIVES IN BLASTING SERVICES, IN CLASS 3
(U.S. CLS. 1, 4, 6, 50, 51 AND 52).

FIRST USE 1-17-2012; IN COMMERCE 1-19-2012.

THE MARK CONSISTS OF STANDARD CHARACTERS WITHOUT CLAIM TO ANY PAR-
TICULAR FONT, STYLE, SIZE, OR COLOR.

SN 85-339,022, FILED 6-6-2011.

SHANNON TWOHIG, EXAMINING ATTORNEY



David J. Kyffers

Director of the United States Patent and Trademark Office

United States of America

United States Patent and Trademark Office

KIRBY MASS ATTACK

Reg. No. 4,155,592

Registered June 5, 2012

Int. Cl.: 9

TRADEMARK

PRINCIPAL REGISTER

NINTENDO OF AMERICA INC. (WASHINGTON CORPORATION)
4600 150TH AVENUE NE
REDMOND, WA 98052

FOR: CARTRIDGES AND MEMORY CARDS FEATURING ENTERTAINMENT, EDUCATIONAL AND INFORMATIONAL CONTENT, NAMELY, VIDEO GAMES AND STORIES; ELECTRONIC GAME PROGRAMS; ELECTRONIC GAME SOFTWARE; VIDEO GAME CARTRIDGES; VIDEO GAME MEMORY CARDS; VIDEO GAME PROGRAMS; VIDEO GAME SOFTWARE, IN CLASS 9 (U.S. CLS. 21, 23, 26, 36 AND 38).

FIRST USE 9-19-2011; IN COMMERCE 9-19-2011.

THE MARK CONSISTS OF STANDARD CHARACTERS WITHOUT CLAIM TO ANY PARTICULAR FONT, STYLE, SIZE, OR COLOR.

SN 85-339,554, FILED 6-7-2011.

B. PARADEWELAI, EXAMINING ATTORNEY



David J. Kybas

Director of the United States Patent and Trademark Office

United States of America

United States Patent and Trademark Office

NATURE AT ITS MOST DELICIOUS

Reg. No. 4,155,593

Registered June 5, 2012

Int. Cl.: 30

TRADEMARK

PRINCIPAL REGISTER

GENERAL MILLS, INC. (DELAWARE CORPORATION)
NUMBER ONE GENERAL MILLS BOULEVARD
MINNEAPOLIS, MN 55426

FOR: READY TO EAT, CEREAL DERIVED FOOD BARS, IN CLASS 30 (U.S. CL. 46).

FIRST USE 3-5-2012; IN COMMERCE 3-5-2012.

THE MARK CONSISTS OF STANDARD CHARACTERS WITHOUT CLAIM TO ANY PARTICULAR FONT, STYLE, SIZE, OR COLOR.

SN 85-339,634, FILED 6-7-2011.

EMILY CARLSEN, EXAMINING ATTORNEY



David J. Kyros

Director of the United States Patent and Trademark Office

United States of America

United States Patent and Trademark Office

IMPROBABLY FRESH

Reg. No. 4,155,594

Registered June 5, 2012

Int. Cl.: 34

TRADEMARK

PRINCIPAL REGISTER

REYNOLDS INNOVATIONS INC. (NORTH CAROLINA CORPORATION)
401 NORTH MAIN STREET
WINSTON-SALEM, NC 27102

FOR: CIGARETTES, IN CLASS 34 (U.S. CLS. 2, 8, 9 AND 17).

FIRST USE 8-29-2011; IN COMMERCE 8-29-2011.

THE MARK CONSISTS OF STANDARD CHARACTERS WITHOUT CLAIM TO ANY PARTICULAR FONT, STYLE, SIZE, OR COLOR.

NO CLAIM IS MADE TO THE EXCLUSIVE RIGHT TO USE "FRESH", APART FROM THE MARK AS SHOWN.

SN 85-339,921, FILED 6-7-2011.

ALLISON SCHRODY, EXAMINING ATTORNEY



David J. Kybas

Director of the United States Patent and Trademark Office

United States of America

United States Patent and Trademark Office



Reg. No. 4,155,595

Registered June 5, 2012

Int. Cl.: 5

TRADEMARK

PRINCIPAL REGISTER

LOUD TRUCK EFG, LLC (WASHINGTON LIMITED LIABILITY COMPANY)
6714 N. PITTSBURG STREET
SPOKANE, WA 99217

FOR: DIETARY FOOD SUPPLEMENTS; VITAMINS, IN CLASS 5 (U.S. CLS. 6, 18, 44, 46, 51 AND 52).

FIRST USE 3-15-2011; IN COMMERCE 3-15-2011.

NO CLAIM IS MADE TO THE EXCLUSIVE RIGHT TO USE "ENERGY GUMMI BEARS", APART FROM THE MARK AS SHOWN.

THE MARK CONSISTS OF A GUMMI BEAR WITH A LIGHTNING BOLT ON ITS FOREHEAD WITH STYLIZED TEXT "ENERGY GUMMI BEARS" DIRECTLY BELOW THE HEAD COVERING PART OF THE GUMMI BEAR BODY.

SN 85-340,016, FILED 6-7-2011.

JOHN LINCOSKI, EXAMINING ATTORNEY



David J. Kybas

Director of the United States Patent and Trademark Office

United States of America

United States Patent and Trademark Office

PANOPTIX

Reg. No. 4,155,596

Registered June 5, 2012

Int. Cl.: 9

TRADEMARK

PRINCIPAL REGISTER

JOHNSON CONTROLS TECHNOLOGY COMPANY (MICHIGAN CORPORATION)
915 EAST 32ND STREET
HOLLAND, MI 49423

FOR: COMPUTER SOFTWARE FOR THE COLLECTION, TRANSMISSION, STORAGE, SHARING, DIAGNOSIS AND REPORTING OF DATA AND INFORMATION RELATED TO BUILDING ENVIRONMENT, ACCESS AND SECURITY SYSTEMS; COMPUTER SOFTWARE FOR THE MEASUREMENT AND VERIFICATION OF CARBON DIOXIDE AND OTHER GREENHOUSE GAS EMISSION OFFSETS; COMPUTER SOFTWARE FOR USE IN DETERMINING ENERGY CONSUMPTION AND PEAK DEMAND SAVINGS; SOFTWARE FOR CONTROLLING BUILDING ENVIRONMENT, ACCESS AND SECURITY SYSTEMS, IN CLASS 9 (U.S. CLS. 21, 23, 26, 36 AND 38).

FIRST USE 10-0-2011; IN COMMERCE 10-0-2011.

THE MARK CONSISTS OF STANDARD CHARACTERS WITHOUT CLAIM TO ANY PARTICULAR FONT, STYLE, SIZE, OR COLOR.

SN 85-340,320, FILED 6-7-2011.

SUSAN LESLIE DUBOIS, EXAMINING ATTORNEY



David J. Kyffers

Director of the United States Patent and Trademark Office

United States of America

United States Patent and Trademark Office



Reg. No. 4,155,597

VEKA INC. (PENNSYLVANIA CORPORATION)
100 VEKA DRIVE
FOMBELL, PA 16123

Registered June 5, 2012

Int. Cl.: 17

FOR: A CO-EXTRUDED PVC PROFILE WHERE THE SUBSTRATE MATERIAL CONSISTS OF PRE-CONSUMER, RECYCLED PVC CONTENT FOR USE IN THE MANUFACTURE OF INDOOR AND OUTDOOR CONSUMER BUILDING PRODUCTS , IN CLASS 17 (U.S. CLS. 1, 5, 12, 13, 35 AND 50).

TRADEMARK

PRINCIPAL REGISTER

FIRST USE 1-25-2012; IN COMMERCE 1-25-2012.

THE MARK CONSISTS OF THE WORDING "DUAL" IN LOWER CASE BLACK LETTERS BEHIND A WHITE BACKGROUND, THE WORDING "EDGE" IN LOWER CASE WHITE LETTERS BEHIND A GREEN BACKGROUND, ABOVE THE LETTER "U" ARE TWO LEAVES, A GREEN AND A WHITE LEAF.

THE COLOR(S) BLACK, WHITE, AND GREEN IS/ARE CLAIMED AS A FEATURE OF THE MARK.

SN 85-340,648, FILED 6-8-2011.

ALLISON SCHRODY, EXAMINING ATTORNEY



David J. Kyros

Director of the United States Patent and Trademark Office

United States of America

United States Patent and Trademark Office

TRANSFORMULA

Reg. No. 4,155,598

PAVEY, LAURA (UNITED STATES INDIVIDUAL)
1606 BROADWAY ST, #2
CINCINNATI, OH 45202

Registered June 5, 2012

Int. Cl.: 44

FOR: HEALTH SPA SERVICES FOR HEALTH AND WELLNESS OF THE BODY AND SPIRIT, IN CLASS 44 (U.S. CLS. 100 AND 101).

SERVICE MARK

FIRST USE 6-1-2011; IN COMMERCE 3-15-2012.

PRINCIPAL REGISTER

THE MARK CONSISTS OF THE STYLIZED TEXT "TRANSFORMULA" IN WHICH THE "LA" AT THE END IS LINKED TOGETHER AND ON A LARGER SCALE THAN THE REST OF THE LETTERS.

SN 85-341,893, FILED 6-9-2011.

JENNIFER DIXON, EXAMINING ATTORNEY



David J. Kybas

Director of the United States Patent and Trademark Office

United States of America

United States Patent and Trademark Office



Reg. No. 4,155,599

Registered June 5, 2012

Int. Cl.: 11

TRADEMARK

PRINCIPAL REGISTER

LIN, AI GUO (CHINA INDIVIDUAL)
812 CHENQUAN RD YANGDAI
JINJIANG CITY, CHINA 362218

FOR: ELECTRIC LIGHT BULBS; FLASHLIGHTS; FLUORESCENT ELECTRIC LIGHT BULBS; LAMP BULBS; LAMPS; LED (LIGHT EMITTING DIODE) LIGHTING FIXTURES; LED (LIGHT EMITTING DIODES) LIGHTING FIXTURES FOR USE IN DISPLAY, COMMERCIAL, INDUSTRIAL, RESIDENTIAL, AND ARCHITECTURAL ACCENT LIGHTING APPLICATIONS; LED LIGHT ASSEMBLIES FOR STREET LIGHTS, SIGNS, COMMERCIAL LIGHTING, AUTOMOBILES, BUILDINGS, AND OTHER ARCHITECTURAL USES; LED LIGHT BULBS; LED LIGHTING FIXTURES FOR INDOOR AND OUTDOOR LIGHTING APPLICATIONS; LED LUMINAIRES; LIGHT BULBS; LIGHTING TUBES; LIGHTS FOR VEHICLES; LUMINAIRES, USING LIGHT EMITTING DIODES (LEDS) AS A LIGHT SOURCE, FOR STREET OR ROADWAY LIGHTING, IN CLASS 11 (U.S. CLS. 13, 21, 23, 31 AND 34).

FIRST USE 1-1-2012; IN COMMERCE 1-1-2012.

THE MARK CONSISTS OF THE STYLIZED LETTERS "FF" FORMING A CHEVRON DESIGN AND UNDERNEATH IS WORDS "FREE FORCE".

SN 85-342,150, FILED 6-9-2011.

MARK T. MULLEN, EXAMINING ATTORNEY



David J. Kybas

Director of the United States Patent and Trademark Office

United States of America

United States Patent and Trademark Office



Reg. No. 4,155,600

Registered June 5, 2012

Int. Cls.: 25 and 28

TRADEMARK

PRINCIPAL REGISTER

SKAGGS, MARK (UNITED STATES INDIVIDUAL)
C1
1890 SW SCENIC HEIGHTS ST
OAK HARBOR, WA 98277

FOR: DRESS SHIRTS; HATS; PANTS; SHORTS; T-SHIRTS, IN CLASS 25 (U.S. CLS. 22 AND 39).

FIRST USE 2-1-2012; IN COMMERCE 2-1-2012.

FOR: KNEE PADS FOR ATHLETIC USE; SKATEBOARDS; SNOWBOARDS; SURFBOARDS, IN CLASS 28 (U.S. CLS. 22, 23, 38 AND 50).

FIRST USE 2-1-2012; IN COMMERCE 2-1-2012.

NO CLAIM IS MADE TO THE EXCLUSIVE RIGHT TO USE "SURF & SKATE", APART FROM THE MARK AS SHOWN.

THE MARK CONSISTS OF AN ELONGATED OVAL CONTAINING THE STYLIZED TEXT "ATOMIC SURF & SKATE". THE WORD "ATOMIC" IS ABOVE THE WORDS "SURF & SKATE". THERE IS A RADIATION SYMBOL ON EACH SIDE OF THE WORD "ATOMIC".

SN 85-342,279, FILED 6-9-2011.

MARLENE BELL, EXAMINING ATTORNEY



David J. Kybas

Director of the United States Patent and Trademark Office

United States of America

United States Patent and Trademark Office

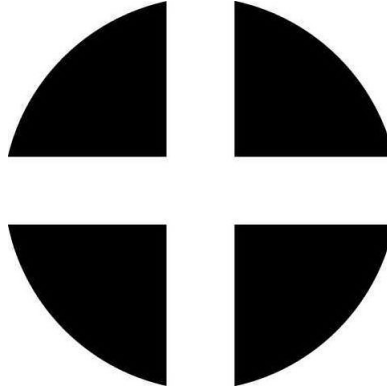

Reg. No. 4,155,601

Registered June 5, 2012

Int. Cls.: 9, 16, 35, and 41

PROFESSIONAL LIABILITY UNDERWRITING SOCIETY (MINNESOTA NON-PROFIT CORPORATION)

5353 WAYZATA BOULEVARD
SUITE 600
MINNEAPOLIS, MN 55416

FOR: DOWNLOADABLE ELECTRONIC PUBLICATIONS IN THE NATURE OF JOURNALS FEATURING INFORMATION IN THE FIELD OF PROFESSIONAL LIABILITY, IN CLASS 9 (U.S. CLS. 21, 23, 26, 36 AND 38).

TRADEMARK

SERVICE MARK

FIRST USE 11-0-2011; IN COMMERCE 11-0-2011.

PRINCIPAL REGISTER

FOR: JOURNALS IN THE FIELD OF PROFESSIONAL LIABILITY, IN CLASS 16 (U.S. CLS. 2, 5, 22, 23, 29, 37, 38 AND 50).

FIRST USE 11-0-2011; IN COMMERCE 11-0-2011.

FOR: ASSOCIATION SERVICES, NAMELY, PROMOTING THE INTERESTS OF THE PROFESSIONAL LIABILITY UNDERWRITING INSURANCE INDUSTRY, IN CLASS 35 (U.S. CLS. 100, 101 AND 102).

FIRST USE 11-0-2011; IN COMMERCE 11-0-2011.

FOR: EDUCATIONAL SERVICES, NAMELY, PROVIDING CONTINUING EDUCATION COURSES IN THE FIELD OF PROFESSIONAL LIABILITY; DISTRIBUTION OF COURSE MATERIALS IN CONNECTION WITH ALL OF THE ABOVE SERVICES; PROVIDING ONLINE JOURNALS FEATURING INFORMATION IN THE FIELD OF PROFESSIONAL LIABILITY, IN CLASS 41 (U.S. CLS. 100, 101 AND 107).

FIRST USE 11-0-2011; IN COMMERCE 11-0-2011.

THE MARK CONSISTS OF A CIRCLE INTERSECTED BY HORIZONTAL AND VERTICAL BANDS WHICH FORM A PLUS SIGN AND DIVIDE THE CIRCLE INTO FOUR QUADRANTS



David J. Kyffers

Director of the United States Patent and Trademark Office

SN 85-342,913, FILED 6-10-2011.

NICHOLAS COLEMAN, EXAMINING ATTORNEY

United States of America

United States Patent and Trademark Office

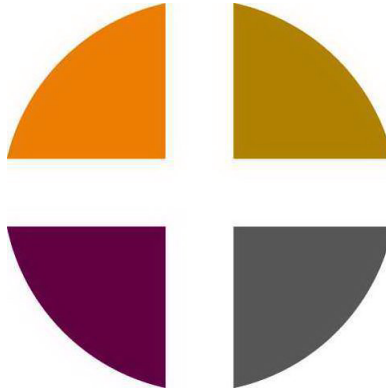

Reg. No. 4,155,602

Registered June 5, 2012

Int. Cls.: 9, 16, 35, and 41

PROFESSIONAL LIABILITY UNDERWRITING SOCIETY (MINNESOTA NON-PROFIT CORPORATION)

5353 WAYZATA BOULEVARD
SUITE 600
MINNEAPOLIS, MN 55416

FOR: DOWNLOADABLE ELECTRONIC PUBLICATIONS IN THE NATURE OF JOURNALS FEATURING INFORMATION IN THE FIELD OF PROFESSIONAL LIABILITY, IN CLASS 9 (U.S. CLS. 21, 23, 26, 36 AND 38).

TRADEMARK

SERVICE MARK

FIRST USE 11-0-2011; IN COMMERCE 11-0-2011.

PRINCIPAL REGISTER

FOR: JOURNALS IN THE FIELD OF PROFESSIONAL LIABILITY, IN CLASS 16 (U.S. CLS. 2, 5, 22, 23, 29, 37, 38 AND 50).

FIRST USE 11-0-2011; IN COMMERCE 11-0-2011.

FOR: ASSOCIATION SERVICES, NAMELY, PROMOTING THE INTERESTS OF THE PROFESSIONAL LIABILITY UNDERWRITING INSURANCE INDUSTRY, IN CLASS 35 (U.S. CLS. 100, 101 AND 102).

FIRST USE 11-0-2011; IN COMMERCE 11-0-2011.

FOR: EDUCATIONAL SERVICES, NAMELY, PROVIDING CONTINUING EDUCATION COURSES IN THE FIELD OF PROFESSIONAL LIABILITY; DISTRIBUTION OF COURSE MATERIALS IN CONNECTION WITH ALL OF THE ABOVE SERVICES; PROVIDING ONLINE JOURNALS FEATURING INFORMATION IN THE FIELD OF PROFESSIONAL LIABILITY, IN CLASS 41 (U.S. CLS. 100, 101 AND 107).

FIRST USE 11-0-2011; IN COMMERCE 11-0-2011.

THE MARK CONSISTS OF A CIRCLE INTERSECTED BY HORIZONTAL AND VERTICAL BANDS WHICH FORM A PLUS SIGN AND DIVIDE THE CIRCLE INTO FOUR QUADRANTS, WITH THE UPPER LEFT QUADRANT IN ORANGE, THE UPPER RIGHT QUADRANT IN GOLD, THE LOWER LEFT QUADRANT IN PURPLE, AND THE LOWER RIGHT QUADRANT IN GREY.



David J. Kybas

Director of the United States Patent and Trademark Office

Reg. No. 4,155,602 THE COLOR(S) ORANGE, GOLD, PURPLE, AND GREY IS/ARE CLAIMED AS A FEATURE OF THE MARK.

SN 85-342,921, FILED 6-10-2011.

NICHOLAS COLEMAN, EXAMINING ATTORNEY

United States of America

United States Patent and Trademark Office

Immuno Gum

Reg. No. 4,155,603

Registered June 5, 2012

Int. Cls.: 5 and 30

TRADEMARK

PRINCIPAL REGISTER

O'NEIL GUM COMPANY, LLC (CALIFORNIA LIMITED LIABILITY COMPANY)
SUITE 139
3334 E. COAST HIGHWAY
CORONA DEL MAR, CA 926252328

FOR: MEDICATED CHEWING GUM, IN CLASS 5 (U.S. CLS. 6, 18, 44, 46, 51 AND 52).

FIRST USE 9-15-2011; IN COMMERCE 10-1-2011.

FOR: CHEWING GUM, IN CLASS 30 (U.S. CL. 46).

FIRST USE 9-15-2011; IN COMMERCE 10-1-2011.

THE MARK CONSISTS OF STANDARD CHARACTERS WITHOUT CLAIM TO ANY PARTICULAR FONT, STYLE, SIZE, OR COLOR.

NO CLAIM IS MADE TO THE EXCLUSIVE RIGHT TO USE "GUM", APART FROM THE MARK AS SHOWN.

SN 85-343,511, FILED 6-10-2011.

JACLYN KIDWELL WALKER, EXAMINING ATTORNEY



David J. Kyros

Director of the United States Patent and Trademark Office

United States of America

United States Patent and Trademark Office

PRECIOUS AND RARE

Reg. No. 4,155,604

LEU, MEI (SINGAPORE INDIVIDUAL)
1458 36TH AVE
SAN FRANCISCO, CA 94122

Registered June 5, 2012

Int. Cl.: 30

FOR: CHOCOLATE, CANDY, IN CLASS 30 (U.S. CL. 46).

TRADEMARK

FIRST USE 8-16-2011; IN COMMERCE 8-16-2011.

PRINCIPAL REGISTER

THE MARK CONSISTS OF STANDARD CHARACTERS WITHOUT CLAIM TO ANY PARTICULAR FONT, STYLE, SIZE, OR COLOR.

SN 85-344,176, FILED 6-13-2011.

FONG HSU, EXAMINING ATTORNEY



David J. Kybas

Director of the United States Patent and Trademark Office

United States of America

United States Patent and Trademark Office



Reg. No. 4,155,605

Registered June 5, 2012

Int. Cls.: 5 and 32

TRADEMARK

PRINCIPAL REGISTER

INSIGHTFUL DEVELOPMENTS, LLC (NEW YORK LIMITED LIABILITY COMPANY)
254 FRANKEL BLVD.
MERRICK, NY 11566

FOR: DIETARY SUPPLEMENTAL DRINKS IN THE NATURE OF VITAMIN AND MINERAL BEVERAGES; NUTRITIONAL SUPPLEMENTS; VITAMIN FORTIFIED BEVERAGES, IN CLASS 5 (U.S. CLS. 6, 18, 44, 46, 51 AND 52).

FIRST USE 3-0-2011; IN COMMERCE 3-0-2011.

FOR: DRINKING WATER WITH VITAMINS; NON-ALCOHOLIC BEVERAGES CONTAINING FRUIT JUICES, IN CLASS 32 (U.S. CLS. 45, 46 AND 48).

FIRST USE 3-0-2011; IN COMMERCE 3-0-2011.

NO CLAIM IS MADE TO THE EXCLUSIVE RIGHT TO USE "OJO", APART FROM THE MARK AS SHOWN.

THE MARK CONSISTS OF THE LETTERS "E", "F", "P", "T", "O", "Z" IN AN EYE CHART FORM OVER THE STYLIZED WORD "OJO".

THE ENGLISH TRANSLATION OF "OJO" IN THE MARK IS "EYE".

SN 85-344,722, FILED 6-13-2011.

ARETHA SOMERVILLE, EXAMINING ATTORNEY



David J. Kybas

Director of the United States Patent and Trademark Office

United States of America

United States Patent and Trademark Office

MediaPad

Reg. No. 4,155,606

Registered June 5, 2012

Int. Cl.: 9

TRADEMARK

PRINCIPAL REGISTER

HUAWEI TECHNOLOGIES CO., LTD. (CHINA CORPORATION)
BANTIAN, LONGGANG DISTRICT
ADMIN. BLDG. HUAWEI TECH. CO., LTD.
SHENZHEN, CHINA

FOR: TABLET COMPUTERS, IN CLASS 9 (U.S. CLS. 21, 23, 26, 36 AND 38).

FIRST USE 6-20-2011; IN COMMERCE 2-3-2012.

THE MARK CONSISTS OF THE TERM "MEDIAPAD" IN A STYLIZED FONT.

SN 85-344,772, FILED 6-13-2011.

MARK SHINER, EXAMINING ATTORNEY



David J. Kybas

Director of the United States Patent and Trademark Office

United States of America
United States Patent and Trademark Office

ATRAPRO

Reg. No. 4,155,607

QUINNOVA PHARMACEUTICALS, INC. (DELAWARE CORPORATION)
2500 YORK ROAD, SUITE 200
JAMISON, PA 18929

Registered June 5, 2012

Int. Cl.: 5

FOR: DERMATOLOGICAL PHARMACEUTICAL PRODUCTS; PHARMACEUTICAL PREPARATIONS FOR TREATING SKIN DISORDERS; PHARMACEUTICAL PREPARATIONS FOR USE IN DERMATOLOGY, IN CLASS 5 (U.S. CLS. 6, 18, 44, 46, 51 AND 52).

TRADEMARK

FIRST USE 1-30-2012; IN COMMERCE 1-30-2012.

PRINCIPAL REGISTER

THE MARK CONSISTS OF STANDARD CHARACTERS WITHOUT CLAIM TO ANY PARTICULAR FONT, STYLE, SIZE, OR COLOR.

SN 85-345,469, FILED 6-14-2011.

ARETHA SOMERVILLE, EXAMINING ATTORNEY



David J. Kyros

Director of the United States Patent and Trademark Office

United States of America

United States Patent and Trademark Office

GPAMaxx

Reg. No. 4,155,608

Registered June 5, 2012

Int. Cl.: 41

SERVICE MARK

PRINCIPAL REGISTER

GPAMAXX LLC (DELAWARE LIMITED LIABILITY COMPANY)
2525 ARAPAHOE AVENUE, SUITE E4-355
BOULDER, CO 80302

FOR: INFORMATION ABOUT EDUCATION, IN CLASS 41 (U.S. CLS. 100, 101 AND 107).

FIRST USE 11-17-2010; IN COMMERCE 5-23-2011.

THE MARK CONSISTS OF STANDARD CHARACTERS WITHOUT CLAIM TO ANY PARTICULAR FONT, STYLE, SIZE, OR COLOR.

SN 85-345,796, FILED 6-14-2011.

JOHN KELLY, EXAMINING ATTORNEY



David J. Kyros

Director of the United States Patent and Trademark Office

United States of America

United States Patent and Trademark Office

QW-K

Reg. No. 4,155,609

Registered June 5, 2012

Int. Cl.: 25

TRADEMARK

PRINCIPAL REGISTER

BROOKS SPORTS, INC. (WASHINGTON CORPORATION)
19910 NORTH CREEK PARKWAY, SUITE 200
BOTHELL, WA 98011

FOR: FOOTWEAR, IN CLASS 25 (U.S. CLS. 22 AND 39).

FIRST USE 5-15-2011; IN COMMERCE 5-15-2011.

THE MARK CONSISTS OF STANDARD CHARACTERS WITHOUT CLAIM TO ANY PARTICULAR FONT, STYLE, SIZE, OR COLOR.

SN 85-346,326, FILED 6-14-2011.

RENEE MCCRAY, EXAMINING ATTORNEY



David J. Kybas

Director of the United States Patent and Trademark Office

United States of America

United States Patent and Trademark Office

Arbalest

Reg. No. 4,155,610

Registered June 5, 2012

Int. Cl.: 36

SERVICE MARK

PRINCIPAL REGISTER

ARBALEST LEGAL FUNDING LLC (COLORADO LIMITED LIABILITY COMPANY)
1113 SPRUCE STREET
SUITE 201
BOULDER, CO 80302

FOR: COMMERCIAL FACTORING, NAMELY, THE BUSINESS OF BUYING EARNED ATTORNEY FEES AT A DISCOUNT, IN CLASS 36 (U.S. CLS. 100, 101 AND 102).

FIRST USE 10-18-2011; IN COMMERCE 10-18-2011.

THE MARK CONSISTS OF STANDARD CHARACTERS WITHOUT CLAIM TO ANY PARTICULAR FONT, STYLE, SIZE, OR COLOR.

SN 85-346,348, FILED 6-14-2011.

NICHOLAS ALTREE, EXAMINING ATTORNEY



David J. Kyffers

Director of the United States Patent and Trademark Office

United States of America

United States Patent and Trademark Office

BAD BABY COMICS

Reg. No. 4,155,611

SANTANA, ANGEL (UNITED STATES INDIVIDUAL)
40 CARLETON RD.
MILLBURY, MA 01527

Registered June 5, 2012

Int. Cl.: 16

FOR: COMIC BOOKS; POSTERS; PRINTED COLLECTOR CARDS MADE OF PAPER, IN CLASS 16 (U.S. CLS. 2, 5, 22, 23, 29, 37, 38 AND 50).

TRADEMARK

FIRST USE 2-15-2011; IN COMMERCE 1-22-2012.

PRINCIPAL REGISTER

THE MARK CONSISTS OF STANDARD CHARACTERS WITHOUT CLAIM TO ANY PARTICULAR FONT, STYLE, SIZE, OR COLOR.

NO CLAIM IS MADE TO THE EXCLUSIVE RIGHT TO USE "COMICS", APART FROM THE MARK AS SHOWN.

SN 85-346,375, FILED 6-15-2011.

GENE MACIOL, EXAMINING ATTORNEY



David J. Kybas

Director of the United States Patent and Trademark Office

United States of America

United States Patent and Trademark Office

C8 SCIENCES

Reg. No. 4,155,612

BECAID, LLC (DELAWARE LIMITED LIABILITY COMPANY)
5 SCIENCE PARK
NEW HAVEN, CT 06519

Registered June 5, 2012

Int. Cl.: 9

FOR: COMPUTER PROGRAMS FEATURING INTERACTIVE COGNITIVE GAMES AND PHYSICAL EXERCISES FOR USE IN IMPROVING COGNITIVE DEVELOPMENT, COGNITIVE FUNCTION AND LEARNING CAPACITY, IN CLASS 9 (U.S. CLS. 21, 23, 26, 36 AND 38).

TRADEMARK

PRINCIPAL REGISTER

FIRST USE 3-3-2012; IN COMMERCE 3-3-2012.

THE MARK CONSISTS OF STANDARD CHARACTERS WITHOUT CLAIM TO ANY PARTICULAR FONT, STYLE, SIZE, OR COLOR.

NO CLAIM IS MADE TO THE EXCLUSIVE RIGHT TO USE "SCIENCES", APART FROM THE MARK AS SHOWN.

SN 85-346,606, FILED 6-15-2011.

STEVEN PEREZ, EXAMINING ATTORNEY



David J. Kyros

Director of the United States Patent and Trademark Office

United States of America

United States Patent and Trademark Office

C-Nav7000

Reg. No. 4,155,613

Registered June 5, 2012

Int. Cl.: 9

TRADEMARK

PRINCIPAL REGISTER

C&C TECHNOLOGIES, INC. (LOUISIANA CORPORATION)
730 EAST KALISTE SALOOM ROAD
LAFAYETTE, LA 70508

FOR: COMPUTER HARDWARE FOR RECEIVING AND PROCESSING GLOBAL NAVIGATION SATELLITE SYSTEMS DATA FOR DERIVING A CORRECTED GLOBAL POSITION, IN CLASS 9 (U.S. CLS. 21, 23, 26, 36 AND 38).

FIRST USE 6-30-2011; IN COMMERCE 6-30-2011.

THE MARK CONSISTS OF STANDARD CHARACTERS WITHOUT CLAIM TO ANY PARTICULAR FONT, STYLE, SIZE, OR COLOR.

OWNER OF U.S. REG. NOS. 3,168,556, 3,989,042, AND 3,992,776.

SN 85-346,642, FILED 6-15-2011.

STEPHANIE ALI, EXAMINING ATTORNEY



David J. Kyros

Director of the United States Patent and Trademark Office

United States of America

United States Patent and Trademark Office

HornyBirds

Reg. No. 4,155,614

Registered June 5, 2012

Int. Cl.: 41

SERVICE MARK

PRINCIPAL REGISTER

RKIP, LLC (FLORIDA LIMITED LIABILITY COMPANY)
10840 SW 113 PLACE
MIAMI, FL 33176

FOR: ENTERTAINMENT SERVICES, NAMELY, PROVIDING A WEB SITE FEATURING PHOTOGRAPHIC, AUDIO, VIDEO AND PROSE PRESENTATIONS FEATURING ADULT-ORIENTED SUBJECT MATTER, IN CLASS 41 (U.S. CLS. 100, 101 AND 107).

FIRST USE 12-1-2011; IN COMMERCE 12-1-2011.

THE MARK CONSISTS OF STANDARD CHARACTERS WITHOUT CLAIM TO ANY PARTICULAR FONT, STYLE, SIZE, OR COLOR.

SN 85-346,647, FILED 6-15-2011.

ANGELA M. MICHELI, EXAMINING ATTORNEY



David J. Kybas

Director of the United States Patent and Trademark Office

United States of America

United States Patent and Trademark Office

VERI PERI

Reg. No. 4,155,615

Registered June 5, 2012

Int. Cl.: 30

TRADEMARK

PRINCIPAL REGISTER

VICTORIOUS SOLUTIONS LLC (NEW YORK LIMITED LIABILITY COMPANY)
1309 LAKES RD
MONROE, NY 10950

FOR: CONDIMENT, NAMELY, PEPPER SAUCE, IN CLASS 30 (U.S. CL. 46).

FIRST USE 1-1-1994; IN COMMERCE 2-1-2012.

THE MARK CONSISTS OF STANDARD CHARACTERS WITHOUT CLAIM TO ANY PARTICULAR FONT, STYLE, SIZE, OR COLOR.

SN 85-346,652, FILED 6-15-2011.

ALEX KEAM, EXAMINING ATTORNEY



David J. Kybas

Director of the United States Patent and Trademark Office

United States of America

United States Patent and Trademark Office

SEEMORE

Reg. No. 4,155,616

MONSTER WORLDWIDE, INC. (DELAWARE CORPORATION)
622 THIRD AVENUE
NEW YORK, NY 10017

Registered June 5, 2012

Int. Cl.: 42

FOR: ONLINE COMPUTER SERVICES, NAMELY, NON-DOWNLOADABLE SOFTWARE FOR UPLOADING AND MANAGING RESUMES, IN CLASS 42 (U.S. CLS. 100 AND 101).

SERVICE MARK

FIRST USE 6-0-2011; IN COMMERCE 6-0-2011.

PRINCIPAL REGISTER

THE MARK CONSISTS OF STANDARD CHARACTERS WITHOUT CLAIM TO ANY PARTICULAR FONT, STYLE, SIZE, OR COLOR.

SN 85-346,731, FILED 6-15-2011.

HEATHER BIDDULPH, EXAMINING ATTORNEY



David J. Kybas

Director of the United States Patent and Trademark Office

United States of America

United States Patent and Trademark Office

BODYDOCK

Reg. No. 4,155,617

Registered June 5, 2012

Int. Cl.: 9

TRADEMARK

PRINCIPAL REGISTER

GID DEVELOPMENT CORPORATION (NEVADA CORPORATION)
3720 PROSPECT AVE.
YORBA LINDA, CA 92886

FOR: COVERS FOR MOBILE DEVICES, NAMELY, MOBILE PHONES, PORTABLE MUSIC PLAYERS, AND PORTABLE TABLET COMPUTER DEVICES, IN CLASS 9 (U.S. CLS. 21, 23, 26, 36 AND 38).

FIRST USE 4-11-2011; IN COMMERCE 4-11-2011.

THE MARK CONSISTS OF STANDARD CHARACTERS WITHOUT CLAIM TO ANY PARTICULAR FONT, STYLE, SIZE, OR COLOR.

SN 85-346,794, FILED 6-15-2011.

DOMINIC J. FERRAIUOLO, EXAMINING ATTORNEY



David J. Kyffers

Director of the United States Patent and Trademark Office

United States of America

United States Patent and Trademark Office

2GREEN

Reg. No. 4,155,618

REGAL BELOIT EPC INC. (WISCONSIN CORPORATION)
200 STATE STREET
BELOIT, WI 53511

Registered June 5, 2012

Int. Cl.: 7

FOR: ELECTRIC MOTORS FOR USE WITH SWIMMING POOL PUMPS, IN CLASS 7 (U.S. CLS. 13, 19, 21, 23, 31, 34 AND 35).

TRADEMARK

FIRST USE 2-11-2011; IN COMMERCE 2-11-2011.

PRINCIPAL REGISTER

THE MARK CONSISTS OF STANDARD CHARACTERS WITHOUT CLAIM TO ANY PARTICULAR FONT, STYLE, SIZE, OR COLOR.

SN 85-346,966, FILED 6-15-2011.

ANGELA DUONG, EXAMINING ATTORNEY



David J. Kybas

Director of the United States Patent and Trademark Office

United States of America

United States Patent and Trademark Office



Reg. No. 4,155,619

LIN, AI GUO (CHINA INDIVIDUAL)
812 CHENQUAN RD YANGDAI
JINJIANG CITY, CHINA 362218

Registered June 5, 2012

Int. Cl.: 25

FOR: BELTS; BOOTS; COATS; FOOTWEAR; HATS; JACKETS; JEANS; SHIRTS; SHOES;
SHORTS; SKIRTS; SLIPPERS; SOCKS; SUITS; TIES, IN CLASS 25 (U.S. CLS. 22 AND 39).

TRADEMARK

FIRST USE 1-1-2012; IN COMMERCE 1-1-2012.

PRINCIPAL REGISTER

THE MARK CONSISTS OF TWO CHEVRONS PATTERN.

SN 85-347,171, FILED 6-15-2011.

MARK T. MULLEN, EXAMINING ATTORNEY



David J. Kybas

Director of the United States Patent and Trademark Office

United States of America

United States Patent and Trademark Office

ignite!
fire crafted food+bar

Reg. No. 4,155,620

DAY CAMINO RESTAURANT LLC (CALIFORNIA LIMITED LIABILITY COMPANY)
1010 69TH STREET
BOULDER, CO 80303

Registered June 5, 2012

Int. Cl.: 43

FOR: RESTAURANT, BAR, COCKTAIL LOUNGE SERVICES, CARRY-OUT RESTAURANT, SIT DOWN FOOD SERVICE, CATERING SERVICES AND RESTAURANTS FEATURING HOME DELIVERY, IN CLASS 43 (U.S. CLS. 100 AND 101).

SERVICE MARK

FIRST USE 7-5-2011; IN COMMERCE 7-5-2011.

PRINCIPAL REGISTER

NO CLAIM IS MADE TO THE EXCLUSIVE RIGHT TO USE "FIRE CRAFTED FOOD+BAR", APART FROM THE MARK AS SHOWN.

THE COLOR(S) RED AND BLACK IS/ARE CLAIMED AS A FEATURE OF THE MARK.

THE MARK CONSISTS OF THE WORDING "IGNITE" IN LOWER CASE WITH AN EXCLAMATION MARK, IN BLACK, BELOW IS THE WORDING "FIRE CRAFTED FOOD+BAR" IN BLACK. ABOVE THE SECOND "I" IN THE WORDING "IGNITE" IS A FLAME IN RED.

SN 85-347,437, FILED 6-15-2011.

ALICE BENMAMAN, EXAMINING ATTORNEY



David J. Kyffers

Director of the United States Patent and Trademark Office

United States of America

United States Patent and Trademark Office

AthElite

Reg. No. 4,155,621

ATHELITE, INC. (DELAWARE CORPORATION)
PO BOX 3093
NEW YORK, NY 10163

Registered June 5, 2012

Int. Cl.: 41

FOR: PROVIDING AN INTERNET WEBSITE PORTAL IN THE FIELD OF ENTERTAINMENT, CULTURAL AND SPORTING EVENTS, IN CLASS 41 (U.S. CLS. 100, 101 AND 107).

SERVICE MARK

FIRST USE 5-1-2011; IN COMMERCE 12-1-2011.

PRINCIPAL REGISTER

THE MARK CONSISTS OF STANDARD CHARACTERS WITHOUT CLAIM TO ANY PARTICULAR FONT, STYLE, SIZE, OR COLOR.

SN 85-347,541, FILED 6-16-2011.

ANN E. SAPPENFIELD, EXAMINING ATTORNEY



David J. Kyros

Director of the United States Patent and Trademark Office

United States of America

United States Patent and Trademark Office

Fluid Dynamics

Reg. No. 4,155,622

COALE, ANSLEY J. (UNITED STATES INDIVIDUAL)
P.O. BOX 175
UKIAH, CA 95482

Registered June 5, 2012

Int. Cl.: 33

FOR: ALCOHOLIC BEVERAGES EXCEPT BEERS; DISTILLED SPIRITS, IN CLASS 33 (U.S. CLS. 47 AND 49).

TRADEMARK

FIRST USE 10-12-2011; IN COMMERCE 10-12-2011.

PRINCIPAL REGISTER

THE MARK CONSISTS OF STANDARD CHARACTERS WITHOUT CLAIM TO ANY PARTICULAR FONT, STYLE, SIZE, OR COLOR.

SN 85-348,397, FILED 6-16-2011.

BERYL GARDNER, EXAMINING ATTORNEY



David J. Kybas

Director of the United States Patent and Trademark Office

United States of America

United States Patent and Trademark Office

The logo for "GOELLIPTICAL" features the word "GO" in a large, bold, sans-serif font, followed by "ELLIPTICAL" in a smaller, bold, sans-serif font. A thick, black, curved line arches over the text, resembling a stylized "G" or a swoosh.

Reg. No. 4,155,623

Registered June 5, 2012

Int. Cl.: 28

TRADEMARK

PRINCIPAL REGISTER

LIMAX INTERNATIONAL INC. (TAIWAN CORPORATION)
11F., NO. 93, SEC. 4,
NANJING E ROAD, SONGSHAN DIST.,
TAIPEI CITY 105, TAIWAN

FOR: ACCESSORIES FOR MANUALLY-OPERATED EXERCISE EQUIPMENT, NAMELY, ACCESSORY ATTACHMENTS TO INCREASE MUSCLE RESISTANCE; ATHLETIC EQUIPMENT, NAMELY, HAND WRAPS; ATHLETIC PROTECTIVE PADS FOR PARTS OF SPORTS SUITS; ELLIPTICAL EXERCISE MACHINES; EXERCISE APPARATUS, NAMELY, SLOSH BARS, MANUALLY OPERATED JOGGING MACHINES, STAIR-STEPPING MACHINES, CHEST EXPANDERS, NECK AND SHOULDER SUPPORTED WEIGHTS FOR TWISTING AND LIFTING EXERCISES; EXERCISE EQUIPMENT, NAMELY, EXERCISE BANDS, TRAINING BARS, ROWING MACHINES (NOT FOR PHYSICAL THERAPY PURPOSES); EXERCISE MACHINES; EXERCISE MACHINES INCORPORATING ELECTRONIC AND VIDEO GAME CONTROLLERS; EXERCISE PLATFORMS; EXERCISE TREADMILLS; EXERCISE WEIGHTS; EXERCISE WRIST WEIGHTS; EXERCISING EQUIPMENT, NAMELY, MANUALLY OPERATED JOGGING MACHINES, POWERED TREADMILLS FOR RUNNING; FITNESS MACHINES AND EQUIPMENT, NAMELY, WEIGHTS, TREADMILLS, ROWING MACHINES, STAIR STEPPING MACHINES, RESISTANCE MACHINES, STATIONARY CYCLES; GIFT BASKETS COMPRISED PRIMARILY OF IMITATION TOYS SPORTS PRODUCTS, NAMELY, TOY GAME BALLS AND ACCESSORIES THEREFOR; MANUALLY-OPERATED EXERCISE EQUIPMENT; PERSONAL EXERCISE MATS; PHYSICAL FITNESS EQUIPMENT, NAMELY, EXERCISE BANDS, TRAINING BARS; STORAGE APPARATUS COMPRISING HOOKS, SUPPORT ARMS, AND SHELVING SPECIALLY ADAPTED FOR SPORTS EQUIPMENT; STORAGE RACKS FOR ATHLETIC EQUIPMENT; TOY MODEL CARS; STATIONARY EXERCISE BICYCLES; BODY-BUILDING APPARATUS, IN CLASS 28 (U.S. CLS. 22, 23, 38 AND 50).



FIRST USE 10-20-2011; IN COMMERCE 10-20-2011.

THE MARK CONSISTS OF THE STYLIZED WORDING "GOELLIPTICAL" WITH A CONCAVE SHAPE PLACED ABOVE AND TO THE RIGHT OF THE WORDING.

David J. Kyros

SN 85-348,437, FILED 6-16-2011.

ESTHER BELENKER, EXAMINING ATTORNEY

United States of America

United States Patent and Trademark Office

ClaimsPartner

Reg. No. 4,155,624

Registered June 5, 2012

Int. Cls.: 35, 36, and 45

SERVICE MARK

PRINCIPAL REGISTER

COMPLIANCE IMPLEMENTATION SERVICES (PENNSYLVANIA LIMITED LIABILITY COMPANY), AKA CIS,
1400 N. PROVIDENCE RD SUITE 3005
MEDIA, PA 19063

FOR: REGULATORY SUBMISSION MANAGEMENT, NAMELY, ASSISTING OTHERS IN PREPARING AND FILING APPLICATIONS FOR MEDICAID CLAIMS AND CLAIMS ADJUSTMENTS; MEDICAL CLAIMS MANAGEMENT SERVICES RELATING TO MEDICAID, NAMELY, RECEIVING, DATA ENTERING, AND RE-PRICING OF TRANSACTIONS THAT ARE ORIGINATED BY PHYSICIANS, HOSPITALS, AND ANCILLARY MEDICAL CARE PROVIDERS; ADMINISTRATIVE PROCESSING OF MEDICAID CLAIMS, IN CLASS 35 (U.S. CLS. 100, 101 AND 102).

FIRST USE 3-29-2010; IN COMMERCE 3-29-2010.

FOR: MEDICAL INSURANCE CASE AND UTILIZATION REVIEW AND INSURANCE CLAIMS ADJUSTMENT SERVICES FOR HEALTHCARE PURCHASERS AND PAYORS AND PROVIDERS AND MEDICARE BENEFICIARIES; PROVIDING A DATABASE FOR TRACKING, MONITORING, AND GENERATING REPORTS ON INFORMATION AND STATISTICS ABOUT PATIENT REIMBURSEMENT AND INSURANCE COVERAGE FOR PHARMACEUTICALS AND MEDICAL DEVICES, IN CLASS 36 (U.S. CLS. 100, 101 AND 102).

FIRST USE 3-29-2010; IN COMMERCE 3-29-2010.

FOR: PROVIDING INFORMATION ON GOVERNMENT MEDICAL AND PHARMACEUTICAL PROGRAMS; REGULATORY COMPLIANCE CONSULTING IN THE FIELD OF MEDICAID CLAIMS PROCESSING, IN CLASS 45 (U.S. CLS. 100 AND 101).

FIRST USE 3-29-2010; IN COMMERCE 3-29-2010.

SN 85-348,441, FILED 6-16-2011.

MARK SHINER, EXAMINING ATTORNEY



David J. Kyffers

Director of the United States Patent and Trademark Office

United States of America

United States Patent and Trademark Office

ScriptPartner

Reg. No. 4,155,625

Registered June 5, 2012

Int. Cls.: 35, 36, and 45

SERVICE MARK

PRINCIPAL REGISTER

COMPLIANCE IMPLEMENTATION SERVICES (PENNSYLVANIA LIMITED LIABILITY COMPANY), AKA CIS,
1400 N. PROVIDENCE RD SUITE 3005
MEDIA, PA 19063

FOR: MANAGED CARE SERVICES, NAMELY, UTILIZATION REVIEW AND PRE-CERTIFICATION SERVICES; PHARMACEUTICAL COST MANAGEMENT SERVICES AND DRUG UTILIZATION REVIEW SERVICE; HEALTH CARE UTILIZATION AND REVIEW SERVICES; ADMINISTERING MEDICATION REIMBURSEMENT PROGRAMS AND SERVICES; MANAGEMENT AND COMPILATION OF COMPUTERIZED DATABASES IN THE FIELD PRESCRIPTIONS AND MEDICINE REIMBURSEMENTS, IN CLASS 35 (U.S. CLS. 100, 101 AND 102).

FIRST USE 7-26-2011; IN COMMERCE 7-27-2011.

FOR: MEDICAL INSURANCE CASE AND UTILIZATION REVIEW AND INSURANCE CLAIMS ADJUSTMENT SERVICES FOR HEALTHCARE PURCHASERS AND PAYORS AND PROVIDERS AND MEDICARE BENEFICIARIES; PROVIDING A DATABASE FOR TRACKING, MONITORING, AND GENERATING REPORTS ON INFORMATION AND STATISTICS ABOUT PATIENT REIMBURSEMENT AND INSURANCE COVERAGE FOR PHARMACEUTICALS AND MEDICAL DEVICES, IN CLASS 36 (U.S. CLS. 100, 101 AND 102).

FIRST USE 7-26-2011; IN COMMERCE 7-27-2011.

FOR: REGULATORY COMPLIANCE CONSULTING IN THE FIELD OF PHARMACEUTICAL, MEDICAL SERVICES, MANAGED CARE AND GOVERNMENT REIMBURSEMENT, IN CLASS 45 (U.S. CLS. 100 AND 101).

FIRST USE 7-26-2011; IN COMMERCE 7-27-2011.

SN 85-348,842, FILED 6-17-2011.

MARK SHINER, EXAMINING ATTORNEY



David J. Kyros

Director of the United States Patent and Trademark Office

United States of America

United States Patent and Trademark Office



Reg. No. 4,155,626

Registered June 5, 2012

**Int. Cls.: 35, 36, 41, 43,
44, and 45**

SERVICE MARK

PRINCIPAL REGISTER

COMMUNITY PARTNERSHIP FOR HOMELESS, INC. (FLORIDA CORPORATION)
1550 N. MIAMI AVE.
MIAMI, FL 33136

FOR: BUSINESS SERVICES, NAMELY, ASSISTING OTHERS IN THE ESTABLISHMENT OF CHARITABLE ORGANIZATIONS; ORGANIZING AND CONDUCTING VOLUNTEER PROGRAMS AND COMMUNITY SERVICE PROJECTS; EMPLOYMENT COUNSELING SERVICES FOR THOSE LIVING IN POVERTY IN THE AREAS OF PREPARING FOR, OBTAINING, MAINTAINING AND ADVANCING IN EMPLOYMENT OPPORTUNITIES, IN CLASS 35 (U.S. CLS. 100, 101 AND 102).

FIRST USE 9-15-2011; IN COMMERCE 9-15-2011.

FOR: CHARITABLE FUND RAISING SERVICES; ACCEPTING AND ADMINISTERING MONETARY CHARITABLE CONTRIBUTIONS, IN CLASS 36 (U.S. CLS. 100, 101 AND 102).

FIRST USE 9-15-2011; IN COMMERCE 9-15-2011.

FOR: CHARITABLE SERVICES, NAMELY, PROVIDING TOYS AND SCHOOL SUPPLIES TO NEEDY CHILDREN; PROVIDING ACADEMIC MENTORING OF SCHOOL AGE CHILDREN; PROVIDING VOCATIONAL TRAINING IN THE FIELDS OF CULINARY ARTS, ENVIRONMENT, NAMELY, HYDROPONICS, AND SECURITY GUARD SERVICES; CHARITABLE SERVICES, NAMELY, PROVIDING BOOKS TO THE INDIGENT, AND VOCATIONAL GUIDANCE AND CAREER COUNSELING TO INDIGENT PERSONS SEEKING EMPLOYMENT, IN CLASS 41 (U.S. CLS. 100, 101 AND 107).

FIRST USE 9-15-2011; IN COMMERCE 9-15-2011.

FOR: CHARITABLE SERVICES, NAMELY, PROVIDING FOOD, BLANKETS, AND HOUSEHOLD FURNISHINGS FOR HOMES IN THE NATURE OF FURNITURE AND UTENSILS, TO NEEDY PERSONS, AND PROVIDING TEMPORARY SHELTER FOR THE HOMELESS, IN CLASS 43 (U.S. CLS. 100 AND 101).

FIRST USE 9-15-2011; IN COMMERCE 9-15-2011.

FOR: CHARITABLE SERVICES, PROVIDING CARE PACKAGES CONSISTING PRIMARILY OF PERSONAL CARE ITEMS, IN CLASS 44 (U.S. CLS. 100 AND 101).



David J. Kybas

Director of the United States Patent and Trademark Office

Reg. No. 4,155,626 FIRST USE 9-15-2011; IN COMMERCE 9-15-2011.

FOR: CHARITABLE SERVICES, NAMELY, PROVIDING LEGAL SERVICES TO HOMELESS PEOPLE, IN CLASS 45 (U.S. CLS. 100 AND 101).

FIRST USE 9-15-2011; IN COMMERCE 9-15-2011.

THE MARK CONSISTS OF THE OUTLINE OF A HOUSE WITH THREE STICK FIGURES WITHIN THE HOUSE REPRESENTING PEOPLE. THE HOUSE AND PEOPLE ARE WITHIN A CIRCLE.

SN 85-349,129, FILED 6-17-2011.

STEVEN PEREZ, EXAMINING ATTORNEY

United States of America

United States Patent and Trademark Office

BELLA IDEALE

Reg. No. 4,155,627

Registered June 5, 2012

Int. Cl.: 14

TRADEMARK

PRINCIPAL REGISTER

J. PAUL BUCHANAN & ASSOCIATES, INC. (CALIFORNIA CORPORATION)
PO BOX 130788
CARLSBAD, CA 920130788

FOR: JEWELLERY; WATCHES, IN CLASS 14 (U.S. CLS. 2, 27, 28 AND 50).

FIRST USE 9-19-2010; IN COMMERCE 2-15-2011.

THE MARK CONSISTS OF STANDARD CHARACTERS WITHOUT CLAIM TO ANY PARTICULAR FONT, STYLE, SIZE, OR COLOR.

THE ENGLISH TRANSLATION OF "BELLA IDEALE" IN THE MARK IS BEAUTIFUL IDEAL.

SN 85-349,588, FILED 6-17-2011.

CIMMERIAN COLEMAN, EXAMINING ATTORNEY



David J. Kyffers

Director of the United States Patent and Trademark Office

United States of America
United States Patent and Trademark Office

LEKITHOS

Reg. No. 4,155,628

Registered June 5, 2012

Int. Cl.: 5

TRADEMARK

PRINCIPAL REGISTER

LEKITHOS, INC. (FLORIDA CORPORATION)
3309 NORTHLAKE BLVD, STE 201
PALM BEACH GARDENS, FL 33403

FOR: DIETARY SUPPLEMENTS, IN CLASS 5 (U.S. CLS. 6, 18, 44, 46, 51 AND 52).

FIRST USE 12-1-2011; IN COMMERCE 12-1-2011.

THE MARK CONSISTS OF STANDARD CHARACTERS WITHOUT CLAIM TO ANY PARTICULAR FONT, STYLE, SIZE, OR COLOR.

THE ENGLISH TRANSLATION OF "LEKITHOS" IN THE MARK IS "YOLK".

SN 85-349,609, FILED 6-17-2011.

ARETHA SOMERVILLE, EXAMINING ATTORNEY



David J. Kyros

Director of the United States Patent and Trademark Office

United States of America

United States Patent and Trademark Office

ridonkulous!

Reg. No. 4,155,629

Registered June 5, 2012

Int. Cls.: 25 and 41

TRADEMARK

SERVICE MARK

PRINCIPAL REGISTER

STANOJEVIC, DEJAN (UNITED STATES INDIVIDUAL)
7822 LUXOR STREET
DOWNEY, CA 90241

FOR: HATS; JACKETS; JEANS; LONG-SLEEVED SHIRTS; SHORTS; SWEATERS; SWIMWEAR; T-SHIRTS; UNDERGARMENTS, IN CLASS 25 (U.S. CLS. 22 AND 39).

FIRST USE 10-1-2011; IN COMMERCE 2-1-2012.

FOR: ENTERTAINMENT IN THE NATURE OF A SCRIPTED ONGOING SITCOM FOR TELEVISION, INTERNET, SATELLITE AND RADIO, IN CLASS 41 (U.S. CLS. 100, 101 AND 107).

FIRST USE 10-1-2011; IN COMMERCE 2-1-2012.

THE MARK CONSISTS OF THE STYLIZED TEXT "RIDONKULOUS!".

SN 85-349,662, FILED 6-17-2011.

KEVON CHISOLM, EXAMINING ATTORNEY



David J. Kybas

Director of the United States Patent and Trademark Office

United States of America

United States Patent and Trademark Office

THE GRAND FUN-ALLEY

Reg. No. 4,155,630

Registered June 5, 2012

Int. Cl.: 28

TRADEMARK

PRINCIPAL REGISTER

BAY TEK GAMES, INC. (WISCONSIN CORPORATION)
1077 EAST GLENBROOK DRIVE
PULASKI, WI 54162

FOR: ARCADE GAMES, NAMELY, A BOWLING GAME FEATURING A COMPUTERIZED SCORING SYSTEM TO TRACK THE SCORES OF MULTIPLE PLAYERS, IN CLASS 28 (U.S. CLS. 22, 23, 38 AND 50).

FIRST USE 2-1-2012; IN COMMERCE 2-1-2012.

THE MARK CONSISTS OF STANDARD CHARACTERS WITHOUT CLAIM TO ANY PARTICULAR FONT, STYLE, SIZE, OR COLOR.

SN 85-350,165, FILED 6-20-2011.

MAYUR VAGHANI, EXAMINING ATTORNEY



David J. Kyros

Director of the United States Patent and Trademark Office

United States of America

United States Patent and Trademark Office



Reg. No. 4,155,631

Registered June 5, 2012

Int. Cl.: 18

TRADEMARK

PRINCIPAL REGISTER

JD KOA ENTERPRISES, LLC (CALIFORNIA LIMITED LIABILITY COMPANY)
300 ROLLING OAKS DR. #126
THOUSAND OAKS, CA 91361

FOR: DOG CLOTHING, IN CLASS 18 (U.S. CLS. 1, 2, 3, 22 AND 41).

FIRST USE 2-20-2012; IN COMMERCE 2-20-2012.

THE MARK CONSISTS OF THE STYLIZED WORD "PUPJAMAS". IMAGES OF SPOTS WITHIN THE LETTERS AND A PAW PRINT OVER THE LETTER "J".

SN 85-350,282, FILED 6-20-2011.

HEATHER BIDDULPH, EXAMINING ATTORNEY



David J. Kyros

Director of the United States Patent and Trademark Office

United States of America

United States Patent and Trademark Office

PARTS ARE JUST PART OF WHAT WE DO

Reg. No. 4,155,632

AUTOZONE PARTS, INC. (NEVADA CORPORATION)
123 SOUTH FRONT STREET
MEMPHIS, TN 38103

Registered June 5, 2012

Int. Cl.: 35

FOR: RETAIL AUTO PARTS STORE SERVICES, IN CLASS 35 (U.S. CLS. 100, 101 AND 102).

SERVICE MARK

FIRST USE 6-27-2011; IN COMMERCE 6-27-2011.

PRINCIPAL REGISTER

THE MARK CONSISTS OF STANDARD CHARACTERS WITHOUT CLAIM TO ANY PARTICULAR FONT, STYLE, SIZE, OR COLOR.

SN 85-350,437, FILED 6-20-2011.

JANET LEE, EXAMINING ATTORNEY



David J. Kyffers

Director of the United States Patent and Trademark Office

United States of America

United States Patent and Trademark Office

LEVEL11

Reg. No. 4,155,633

Registered June 5, 2012

Int. Cl.: 41

SERVICE MARK

PRINCIPAL REGISTER

LEVEL11, LLC (MINNESOTA LIMITED LIABILITY COMPANY)
ATTN: DAVID BAER
7220 WASHINGTON AVE. S.
EDEN PRAIRIE, MN 55344

FOR: ENTERTAINMENT IN THE NATURE OF LIVE PERFORMANCES BY DISC JOCKEYS, MUSICAL ARTISTS, DANCERS AND MASTERS OF CEREMONIES; ENTERTAINMENT IN THE NATURE OF LIGHT SHOWS AND LIGHTING PRODUCTION; ENTERTAINMENT SERVICES, NAMELY, CONDUCTING CONTESTS AND PARTIES; AUDIO RECORDING AND PRODUCTION; MULTIMEDIA ENTERTAINMENT SERVICES IN THE NATURE OF RECORDING, PRODUCTION AND POST-PRODUCTION SERVICES IN THE FIELDS OF MUSIC AND VIDEO; ARRANGING, ORGANIZING, CONDUCTING AND HOSTING NIGHTCLUB ENTERTAINMENT EVENTS, SPECIAL EVENTS FOR SOCIAL ENTERTAINMENT PURPOSES, ENTERTAINMENT EXHIBITIONS AND PRIVATE PARTIES; SPECIAL EVENT PLANNING FOR SOCIAL ENTERTAINMENT PURPOSES; EVENT PLANNING SERVICES FOR SOCIAL ENTERTAINMENT PURPOSES; CONSULTATION IN THE FIELD OF EVENT PLANNING SERVICES FOR SOCIAL ENTERTAINMENT PURPOSES; BOOKING SERVICES FOR ENTERTAINMENT, SPORTING AND CULTURAL EVENTS; EDUCATIONAL SERVICES, NAMELY, CONDUCTING CLASSES, SEMINARS, CONFERENCES AND WORKSHOPS IN THE FIELD OF DISC JOCKEYING AND DISTRIBUTING COURSE MATERIALS IN CONNECTION THEREWITH, IN CLASS 41 (U.S. CLS. 100, 101 AND 107).

FIRST USE 6-1-2011; IN COMMERCE 6-1-2011.

THE MARK CONSISTS OF STANDARD CHARACTERS WITHOUT CLAIM TO ANY PARTICULAR FONT, STYLE, SIZE, OR COLOR.

SN 85-350,700, FILED 6-20-2011.

CHRIS WELLS, EXAMINING ATTORNEY



David J. Kypos

Director of the United States Patent and Trademark Office

United States of America

United States Patent and Trademark Office

GARDENLOVESTONES

Reg. No. 4,155,634

RITCHIE, RYAN (UNITED STATES INDIVIDUAL), DBA GARDEN LOVE STONES,
6520 PLATT AVENUE #312
WEST HILLS, CA 91307

Registered June 5, 2012

Int. Cl.: 19

FOR: NON-PRECIOUS STONES FOR GARDEN OR ORNAMENTAL USE, IN CLASS 19 (U.S. CLS. 1, 12, 33 AND 50).

TRADEMARK

FIRST USE 7-1-2011; IN COMMERCE 7-15-2011.

PRINCIPAL REGISTER

THE MARK CONSISTS OF STANDARD CHARACTERS WITHOUT CLAIM TO ANY PARTICULAR FONT, STYLE, SIZE, OR COLOR.

SN 85-350,800, FILED 6-20-2011.

AMY HELLA, EXAMINING ATTORNEY



David J. Kyffers

Director of the United States Patent and Trademark Office

United States of America

United States Patent and Trademark Office

ALL TERRAIN

Reg. No. 4,155,635

Registered June 5, 2012

Int. Cl.: 9

TRADEMARK

PRINCIPAL REGISTER

DIGITAL INNOVATIONS, LLC (ILLINOIS LIMITED LIABILITY COMPANY)
SUITE 200
3436 N. KENNICOTT AVE
ARLINGTON HEIGHTS, IL 60004

FOR: COMPUTER MICE, IN CLASS 9 (U.S. CLS. 21, 23, 26, 36 AND 38).

FIRST USE 12-1-2011; IN COMMERCE 12-1-2011.

THE MARK CONSISTS OF STANDARD CHARACTERS WITHOUT CLAIM TO ANY PARTICULAR FONT, STYLE, SIZE, OR COLOR.

SN 85-350,994, FILED 6-20-2011.

STEVEN PEREZ, EXAMINING ATTORNEY



David J. Kyffers

Director of the United States Patent and Trademark Office

United States of America

United States Patent and Trademark Office

TANDA ZAP

Reg. No. 4,155,636

Registered June 5, 2012

Int. Cl.: 10

TRADEMARK

PRINCIPAL REGISTER

SYNERON BEAUTY INC. (CANADA CORPORATION)
380 JAMIESON PARKWAY
SUITE #11
CAMBRIDGE, ONTARIO, CANADA N3C 4N4

FOR: MEDICAL AESTHETIC HAND-HELD DEVICE, USING AN LED (LIGHT EMITTING DIODE) SOURCE FOR THERAPEUTIC AND AESTHETIC SKIN TREATMENTS, IN CLASS 10 (U.S. CLS. 26, 39 AND 44).

FIRST USE 6-1-2011; IN COMMERCE 6-1-2011.

THE MARK CONSISTS OF STANDARD CHARACTERS WITHOUT CLAIM TO ANY PARTICULAR FONT, STYLE, SIZE, OR COLOR.

PRIORITY CLAIMED UNDER SEC. 44(D) ON CANADA APPLICATION NO. 1508890, FILED 12-22-2010.

OWNER OF U.S. REG. NO. 3,694,648.

SN 85-351,670, FILED 6-21-2011.

SARA BENJAMIN, EXAMINING ATTORNEY



David J. Kyffers

Director of the United States Patent and Trademark Office

United States of America

United States Patent and Trademark Office

RODEO COLD

Reg. No. 4,155,637

Registered June 5, 2012

Int. Cl.: 32

TRADEMARK

PRINCIPAL REGISTER

RESCH, JACKIE (UNITED STATES INDIVIDUAL), AKA JOHN C. RESCH,
405 PARK AVE F-4
BASALT, CO 81621

FOR: BEER, ALE AND LAGER, IN CLASS 32 (U.S. CLS. 45, 46 AND 48).

FIRST USE 9-9-1996; IN COMMERCE 9-26-1997.

THE MARK CONSISTS OF STANDARD CHARACTERS WITHOUT CLAIM TO ANY PARTICULAR FONT, STYLE, SIZE, OR COLOR.

OWNER OF U.S. REG. NO. 2,068,069.

NO CLAIM IS MADE TO THE EXCLUSIVE RIGHT TO USE "COLD", APART FROM THE MARK AS SHOWN.

SN 85-352,060, FILED 6-21-2011.

LINDSEY RUBIN, EXAMINING ATTORNEY



David J. Kyffers

Director of the United States Patent and Trademark Office

United States of America

United States Patent and Trademark Office

TRIPLESOLVE

Reg. No. 4,155,638

THE CLOROX COMPANY (DELAWARE CORPORATION)
1221 BROADWAY
OAKLAND, CA 94612

Registered June 5, 2012

Int. Cl.: 3

FOR: LAUNDRY ADDITIVES IN THE NATURE OF STAIN REMOVING PREPARATIONS,
IN CLASS 3 (U.S. CLS. 1, 4, 6, 50, 51 AND 52).

TRADEMARK

FIRST USE 12-9-2011; IN COMMERCE 12-9-2011.

PRINCIPAL REGISTER

THE MARK CONSISTS OF STANDARD CHARACTERS WITHOUT CLAIM TO ANY PAR-
TICULAR FONT, STYLE, SIZE, OR COLOR.

SN 85-352,806, FILED 6-22-2011.

JENNIFER DIXON, EXAMINING ATTORNEY



David J. Kybas

Director of the United States Patent and Trademark Office

United States of America

United States Patent and Trademark Office

isight

Reg. No. 4,155,639

Registered June 5, 2012

Int. Cl.: 9

TRADEMARK

PRINCIPAL REGISTER

C & E VISION SERVICES, INC. (CALIFORNIA CORPORATION)
1015 CALLE AMANECER
SAN CLEMENTE, CA 92673

FOR: CONTACT LENSES AND LENSES FOR EYEGLASSES, IN CLASS 9 (U.S. CLS. 21, 23, 26, 36 AND 38).

FIRST USE 12-15-2011; IN COMMERCE 12-15-2011.

THE MARK CONSISTS OF STANDARD CHARACTERS WITHOUT CLAIM TO ANY PARTICULAR FONT, STYLE, SIZE, OR COLOR.

SN 85-353,170, FILED 6-22-2011.

ROBIN MITTLER, EXAMINING ATTORNEY



David J. Kybas

Director of the United States Patent and Trademark Office

United States of America

United States Patent and Trademark Office



Reg. No. 4,155,640

Registered June 5, 2012

Int. Cl.: 30

TRADEMARK

PRINCIPAL REGISTER

SMUSH LLC (NEW JERSEY LIMITED LIABILITY COMPANY)
1333 HUDSON STREET
HOBOKEN, NJ 07030

FOR: ICE CREAM DESSERTS; ICE CREAM SANDWICHES, IN CLASS 30 (U.S. CL. 46).

FIRST USE 5-1-2011; IN COMMERCE 5-1-2011.

NO CLAIM IS MADE TO THE EXCLUSIVE RIGHT TO USE "NY" AND "DESSERTS" , APART FROM THE MARK AS SHOWN.

THE MARK CONSISTS OF A THE STYLIZED IMAGE OF AN ICE CREAM SANDWICH IN THE FORM OF A PENGUIN WEARING A HAT, WITH THE LITERAL ELEMENT "SMUSH" POSITIONED ABOVE THE PENGUIN, AND "THE NY DELI OF DESSERTS" POSITIONED BENEATH. THE PENGUIN IS POSITIONED WITHIN AN INCOMPLETE, SEMI-CIRCULAR SHAPED FIGURE.

SN 85-353,258, FILED 6-22-2011.

KAREN BRACEY, EXAMINING ATTORNEY



David J. Kybas

Director of the United States Patent and Trademark Office

United States of America

United States Patent and Trademark Office



Reg. No. 4,155,641

Registered June 5, 2012

Int. Cl.: 43

TROY SPORTS RESTAURANT, LLC (MICHIGAN LIMITED LIABILITY COMPANY), DBA
JOE KOOL'S BAR & RESTAURANT,
2600 W. BIG BEAVER ROAD
STE. 550
TROY, MI 48084

SERVICE MARK

FOR: RESTAURANT SERVICES; BAR SERVICES; RESTAURANT SERVICES, INCLUDING
SIT-DOWN SERVICE OF FOOD AND TAKE-OUT RESTAURANT SERVICES, IN CLASS 43
(U.S. CLS. 100 AND 101).

PRINCIPAL REGISTER

FIRST USE 7-20-2011; IN COMMERCE 7-20-2011.

THE MARK CONSISTS OF THE WORDS "JOE KOOL'S" IN WHITE, INSIDE A RECTANGLE
WITH A BLUE BACKGROUND, WITH TWO PARTIALLY CURVED SIDES ON THE EACH,
LINED IN RED, PLACED IN THE CENTER OF AN OVAL WITH A BLUE BACKGROUND
CONTAINING AN INNER OVAL WITH A WHITE BACKGROUND, WITH EACH OVAL
LINED IN RED.

THE COLOR(S) WHITE, BLUE, RED IS/ARE CLAIMED AS A FEATURE OF THE MARK.

SN 85-354,258, FILED 6-23-2011.

ODESSA BIBBINS, EXAMINING ATTORNEY



David J. Kyffers

Director of the United States Patent and Trademark Office

United States of America

United States Patent and Trademark Office

tradechex

Reg. No. 4,155,642

LEWIS, THOMAS (UNITED STATES INDIVIDUAL)
4015 KNOLL HILL
SAN ANTONIO, TX 78247

Registered June 5, 2012

Int. Cl.: 35

FOR: ISSUING GIFT CERTIFICATES WHICH MAY THEN BE REDEEMED FOR GOODS OR SERVICES, IN CLASS 35 (U.S. CLS. 100, 101 AND 102).

SERVICE MARK

FIRST USE 6-12-2011; IN COMMERCE 6-12-2011.

PRINCIPAL REGISTER

THE MARK CONSISTS OF STANDARD CHARACTERS WITHOUT CLAIM TO ANY PARTICULAR FONT, STYLE, SIZE, OR COLOR.

SN 85-355,205, FILED 6-24-2011.

B. PARADEWELAI, EXAMINING ATTORNEY



David J. Kyfos

Director of the United States Patent and Trademark Office

United States of America

United States Patent and Trademark Office

DURASUCKER

Reg. No. 4,155,643

Registered June 5, 2012

Int. Cl.: 7

TRADEMARK

PRINCIPAL REGISTER

SUPER PRODUCTS LLC (DELAWARE LIMITED LIABILITY COMPANY)
17000 WEST CLEVELAND AVENUE
NEW BERLIN, WI 53151

FOR: HEAVY DUTY TRUCK MOUNTED INDUSTRIAL VACUUM LOADERS IN THE NATURE OF VACUUM PUMPS AND STRUCTURAL PARTS THEREFOR, IN CLASS 7 (U.S. CLS. 13, 19, 21, 23, 31, 34 AND 35).

FIRST USE 9-23-2011; IN COMMERCE 9-23-2011.

THE MARK CONSISTS OF STANDARD CHARACTERS WITHOUT CLAIM TO ANY PARTICULAR FONT, STYLE, SIZE, OR COLOR.

SN 85-355,224, FILED 6-24-2011.

NICHOLAS COLEMAN, EXAMINING ATTORNEY



David J. Kybas

Director of the United States Patent and Trademark Office

United States of America

United States Patent and Trademark Office

Chefanistas

Reg. No. 4,155,644

Registered June 5, 2012

Int. Cl.: 16

TRADEMARK

PRINCIPAL REGISTER

LEVINE, LORRAINE (UNITED STATES INDIVIDUAL)
901 HARTZELL ST.
PACIFIC PALISADES, CA 90272

FOR: ADDRESS BOOKS; BLANK JOURNALS; BOXES OF PAPER OR CARDBOARD;
CALENDARS; GIFT WRAP PAPER; GREETING CARDS; NOTE CARDS; NOTEPADS; PAPER
BAGS; PRINTED RECIPE CARDS, IN CLASS 16 (U.S. CLS. 2, 5, 22, 23, 29, 37, 38 AND 50).

FIRST USE 3-7-2012; IN COMMERCE 3-7-2012.

THE MARK CONSISTS OF STANDARD CHARACTERS WITHOUT CLAIM TO ANY PAR-
TICULAR FONT, STYLE, SIZE, OR COLOR.

SN 85-355,317, FILED 6-24-2011.

MATTHEW PAPPAS, EXAMINING ATTORNEY



David J. Kypas

Director of the United States Patent and Trademark Office

United States of America

United States Patent and Trademark Office

TURF-N THE WORLD

Reg. No. 4,155,645

SUNDANCE MARKETING SOLUTIONS, INC. (NEVADA CORPORATION)
5348 VEGAS DRIVE, #657
LAS VEGAS, NV 89108

Registered June 5, 2012

Int. Cl.: 27

FOR: ARTIFICIAL TURF; SYNTHETIC GRASS, IN CLASS 27 (U.S. CLS. 19, 20, 37, 42 AND 50).

TRADEMARK

FIRST USE 7-0-2011; IN COMMERCE 7-0-2011.

PRINCIPAL REGISTER

THE MARK CONSISTS OF STANDARD CHARACTERS WITHOUT CLAIM TO ANY PARTICULAR FONT, STYLE, SIZE, OR COLOR.

SN 85-355,931, FILED 6-24-2011.

IRA J. GOODSaid, EXAMINING ATTORNEY



David J. Kybas

Director of the United States Patent and Trademark Office

United States of America

United States Patent and Trademark Office



Reg. No. 4,155,646

SUNDANCE MARKETING SOLUTIONS, INC. (NEVADA CORPORATION)
5348 VEGAS DRIVE, #657
LAS VEGAS, NV 89108

Registered June 5, 2012

Int. Cl.: 27

FOR: ARTIFICIAL TURF; SYNTHETIC GRASS, IN CLASS 27 (U.S. CLS. 19, 20, 37, 42 AND 50).

TRADEMARK

FIRST USE 4-0-2007; IN COMMERCE 10-0-2007.

PRINCIPAL REGISTER

THE MARK CONSISTS OF THE TERM "TURF-N" IN LIGHT SHADED LETTERING AGAINST A DARK SURFBOARD.

SN 85-355,937, FILED 6-24-2011.

IRA J. GOODSaid, EXAMINING ATTORNEY



David J. Kyffers

Director of the United States Patent and Trademark Office

United States of America

United States Patent and Trademark Office

Paisley Tea Co.

Reg. No. 4,155,647

ROSENFELD, RICHARD A. (UNITED STATES INDIVIDUAL)
23400 TWO RIVERS ROAD, SUITE 45
BASALT, CO 81621

Registered June 5, 2012

Int. Cl.: 30

FOR: BLACK TEA; COFFEE AND TEA; HERBAL TEA; ICED TEA; INSTANT TEA; JAPANESE GREEN TEA, IN CLASS 30 (U.S. CL. 46).

TRADEMARK

FIRST USE 2-1-2012; IN COMMERCE 3-17-2012.

PRINCIPAL REGISTER

THE MARK CONSISTS OF STANDARD CHARACTERS WITHOUT CLAIM TO ANY PARTICULAR FONT, STYLE, SIZE, OR COLOR.

NO CLAIM IS MADE TO THE EXCLUSIVE RIGHT TO USE "TEA CO.", APART FROM THE MARK AS SHOWN.

SN 85-355,954, FILED 6-24-2011.

ADA HAN, EXAMINING ATTORNEY



David J. Kyffers

Director of the United States Patent and Trademark Office

United States of America

United States Patent and Trademark Office

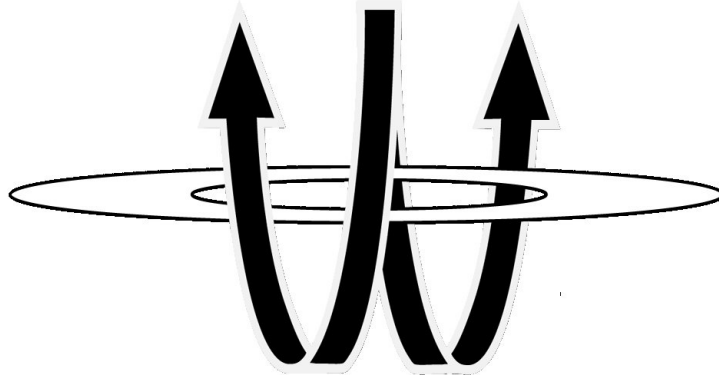

Reg. No. 4,155,648

Registered June 5, 2012

Int. Cl.: 28

TRADEMARK

PRINCIPAL REGISTER

HUBBARD, JODINE (UNITED STATES INDIVIDUAL), DBA THE OTHER SIDE OF GOOD,
6979 SUPERIOR ST. CIR.
SARASOTA, FL 34243

FOR: GAMES, NAMELY, BOARD GAMES; PARTY GAMES; CARD GAMES, IN CLASS 28
(U.S. CLS. 22, 23, 38 AND 50).

FIRST USE 2-12-2009; IN COMMERCE 3-10-2012.

THE MARK CONSISTS OF BLACK LETTER "W" WITH ARROWS AT THE FIRST AND
THIRD UPWARD PART OF THE "W", WHITE OVAL HALO WOUND INSIDE THE FIRST
LEG OF THE "W" AND OUTSIDE THE LAST LEG OF THE "W", INCLUDING WHITE
SHADOWING AROUND THE "W" AND ARROWS.

THE COLOR(S) BLACK AND WHITE IS/ARE CLAIMED AS A FEATURE OF THE MARK.

SN 85-356,361, FILED 6-25-2011.

PAM WILLIS, EXAMINING ATTORNEY



David J. Kybas

Director of the United States Patent and Trademark Office

United States of America

United States Patent and Trademark Office

exEat

Reg. No. 4,155,649

Registered June 5, 2012

Int. Cl.: 43

SERVICE MARK

PRINCIPAL REGISTER

WINDY PIZZA PLUS LLC (RHODE ISLAND LIMITED LIABILITY COMPANY), DBA
EATALIAN CAFE,
15500 S. BROADWAY ST
GARDENA, CA 90248

FOR: BAR AND RESTAURANT SERVICES; CAFE AND RESTAURANT SERVICES; CARRY-
OUT RESTAURANTS; ICE CREAM SHOP SERVICES IN THE NATURE OF A RESTAURANT;
RESTAURANTS; TAKE-OUT RESTAURANT SERVICES, IN CLASS 43 (U.S. CLS. 100 AND
101).

FIRST USE 5-15-2011; IN COMMERCE 5-15-2011.

THE MARK CONSISTS OF STANDARD CHARACTERS WITHOUT CLAIM TO ANY PAR-
TICULAR FONT, STYLE, SIZE, OR COLOR.

SN 85-356,548, FILED 6-27-2011.

MIDGE BUTLER, EXAMINING ATTORNEY



David J. Kyros

Director of the United States Patent and Trademark Office

United States of America

United States Patent and Trademark Office

SELF OR HELP

Reg. No. 4,155,650

Registered June 5, 2012

Int. Cl.: 36

SERVICE MARK

PRINCIPAL REGISTER

ESF FINANCIAL, INC. (CALIFORNIA CORPORATION)
1500 ROSECRANS AVENUE, SUITE 500
MANHATTAN BEACH, CA 90266

FOR: MUTUAL FUND INVESTMENT SERVICES; RETIREMENT FUND INVESTMENT SERVICES; INVESTMENT MANAGEMENT SERVICES; FINANCIAL PLANNING; SECURITIES BROKERAGE SERVICES; MONEY MANAGEMENT; FINANCIAL ANALYSIS; PROVIDING FINANCIAL INFORMATION BY ELECTRONIC MEANS; PROVIDING PERSONALIZED INVESTMENT INFORMATION, INVESTMENT ACCOUNT MANAGEMENT AND SECURITIES BROKERAGE SERVICES, ALL BY MEANS OF WIRELESS COMMUNICATION DEVICES AND BY MEANS OF THE INTERNET; RESEARCH IN THE FIELD OF INVESTMENTS AND FINANCE; SECURITIES BROKERAGE SERVICES PROVIDED TO HOLDERS OF STOCK OPTIONS; FINANCIAL SERVICES, NAMELY, AGENCY SERVICES IN THE FIELD OF SECURITIES; FINANCIAL MARKET INFORMATION SERVICES, NAMELY, COMPILING AND PROVIDING INFORMATION REGARDING SECURITIES; PROVIDING PERSONALIZED INVESTMENT INFORMATION BY ELECTRONIC MAIL; FINANCIAL AND INVESTMENT SERVICES, NAMELY, ASSET AND INVESTMENT ACQUISITION, CONSULTATION, ADVISORY AND DEVELOPMENT AND MANAGEMENT AND BROKERAGE IN THE FIELDS OF STOCKS, BONDS, OPTIONS, COMMODITIES, FUTURES AND OTHER SECURITIES, AND THE INVESTMENT OF FUNDS OF OTHERS, IN CLASS 36 (U.S. CLS. 100, 101 AND 102).

FIRST USE 3-13-2012; IN COMMERCE 3-13-2012.

THE MARK CONSISTS OF STANDARD CHARACTERS WITHOUT CLAIM TO ANY PARTICULAR FONT, STYLE, SIZE, OR COLOR.

SN 85-356,834, FILED 6-27-2011.

BARBARA GAYNOR, EXAMINING ATTORNEY



David J. Kyjars

Director of the United States Patent and Trademark Office

United States of America

United States Patent and Trademark Office

SUMMER SPIRAL

Reg. No. 4,155,651

Registered June 5, 2012

Int. Cl.: 29

TRADEMARK

PRINCIPAL REGISTER

SF INVESTMENTS, INC. (DELAWARE CORPORATION)
103 BAYNARD BUILDING
3411 SILVERSIDE ROAD
WILMINGTON, DE 19810

FOR: HAM, IN CLASS 29 (U.S. CL. 46).

FIRST USE 7-31-2010; IN COMMERCE 7-31-2010.

THE MARK CONSISTS OF STANDARD CHARACTERS WITHOUT CLAIM TO ANY PARTICULAR FONT, STYLE, SIZE, OR COLOR.

NO CLAIM IS MADE TO THE EXCLUSIVE RIGHT TO USE "SPIRAL", APART FROM THE MARK AS SHOWN.

SN 85-356,919, FILED 6-27-2011.

JUDITH HELFMAN, EXAMINING ATTORNEY



David J. Kybas

Director of the United States Patent and Trademark Office

United States of America

United States Patent and Trademark Office

INCREDIBLE DARING

Reg. No. 4,155,652

Registered June 5, 2012

Int. Cl.: 3

TRADEMARK

PRINCIPAL REGISTER

VICTORIA'S SECRET STORES BRAND MANAGEMENT, INC. (DELAWARE CORPORATION)
INTELLECTUAL PROPERTY MANAGER
FOUR LIMITED PARKWAY
REYNOLDSBURG, OH 43068

FOR: BODY LOTION; BODY WASH; EAU DE PARFUM; NON-MEDICATED SKIN CARE
PREPARATION, NAMELY, BODY MIST, IN CLASS 3 (U.S. CLS. 1, 4, 6, 50, 51 AND 52).

FIRST USE 2-5-2012; IN COMMERCE 2-5-2012.

THE MARK CONSISTS OF STANDARD CHARACTERS WITHOUT CLAIM TO ANY PAR-
TICULAR FONT, STYLE, SIZE, OR COLOR.

SN 85-357,177, FILED 6-27-2011.

WON TEAK OH, EXAMINING ATTORNEY



David J. Kyffers

Director of the United States Patent and Trademark Office

United States of America

United States Patent and Trademark Office

2 Love Today Online Dating

Reg. No. 4,155,653

FALCAR LTD. (NEW YORK CORPORATION)
9 FAIR HILLS LANE PO BOX 6
BRIDGEHAMPTON, NY 119320006

Registered June 5, 2012

Int. Cl.: 45

FOR: INTERNET-BASED DATING, SOCIAL INTRODUCTION AND SOCIAL NETWORKING SERVICES, IN CLASS 45 (U.S. CLS. 100 AND 101).

SERVICE MARK

FIRST USE 2-1-2011; IN COMMERCE 2-1-2011.

PRINCIPAL REGISTER

THE MARK CONSISTS OF STANDARD CHARACTERS WITHOUT CLAIM TO ANY PARTICULAR FONT, STYLE, SIZE, OR COLOR.

NO CLAIM IS MADE TO THE EXCLUSIVE RIGHT TO USE "ONLINE DATING", APART FROM THE MARK AS SHOWN.

SN 85-358,326, FILED 6-28-2011.

DAVID ELTON, EXAMINING ATTORNEY



David J. Kyffers

Director of the United States Patent and Trademark Office

United States of America

United States Patent and Trademark Office

No Scratch

Reg. No. 4,155,654

SPORTWORKS NORTHWEST, INC (WASHINGTON CORPORATION)
15540 WOOD-RED RD N E, BLDG A-200
WOODINVILLE, WA 98072

Registered June 5, 2012

Int. Cls.: 6 and 12

FOR: BICYCLE STORAGE RACKS OF METAL, IN CLASS 6 (U.S. CLS. 2, 12, 13, 14, 23, 25 AND 50).

TRADEMARK

FIRST USE 8-1-2011; IN COMMERCE 12-2-2011.

PRINCIPAL REGISTER

FOR: RACKS FOR VEHICLES FOR BICYCLES, IN CLASS 12 (U.S. CLS. 19, 21, 23, 31, 35 AND 44).

FIRST USE 8-1-2011; IN COMMERCE 1-5-2012.

THE MARK CONSISTS OF STANDARD CHARACTERS WITHOUT CLAIM TO ANY PARTICULAR FONT, STYLE, SIZE, OR COLOR.

SN 85-358,754, FILED 6-28-2011.

GRETTA YAO, EXAMINING ATTORNEY



David J. Kyros

Director of the United States Patent and Trademark Office

United States of America

United States Patent and Trademark Office

Sweet-hancer

Reg. No. 4,155,655

Registered June 5, 2012

Int. Cl.: 30

TRADEMARK

PRINCIPAL REGISTER

CALIFORNIA CUSTOM FRUITS AND FLAVORS, INC. (CALIFORNIA CORPORATION),
DBA CALIFORNIA CUSTOM FRUITS AND FLAVORS, INC.,
15800 TAPIA STREET
IRWINDALE, CA 91706

FOR: FLAVOR ENHANCERS USED IN FOOD AND BEVERAGE PRODUCTS, IN CLASS 30
(U.S. CL. 46).

FIRST USE 1-26-2012; IN COMMERCE 2-2-2012.

THE MARK CONSISTS OF STANDARD CHARACTERS WITHOUT CLAIM TO ANY PARTICULAR FONT, STYLE, SIZE, OR COLOR.

SN 85-359,075, FILED 6-29-2011.

CHERYL CLAYTON, EXAMINING ATTORNEY



David J. Kyros

Director of the United States Patent and Trademark Office

United States of America

United States Patent and Trademark Office

SPEED TO MASTERY

Reg. No. 4,155,656

Registered June 5, 2012

Int. Cl.: 41

SERVICE MARK

PRINCIPAL REGISTER

THE FORUM CORPORATION OF NORTH AMERICA (DELAWARE CORPORATION)
265 FRANKLIN STREET
BOSTON, MA 021102113

FOR: EDUCATIONAL SERVICES, NAMELY, PROVIDING WEB-BASED TRAINING AND EDUCATIONAL PROGRAMS IN THE FIELDS OF BUSINESS SKILLS, BUSINESS MANAGEMENT AND SALES, IN CLASS 41 (U.S. CLS. 100, 101 AND 107).

FIRST USE 9-6-2011; IN COMMERCE 9-6-2011.

THE MARK CONSISTS OF STANDARD CHARACTERS WITHOUT CLAIM TO ANY PARTICULAR FONT, STYLE, SIZE, OR COLOR.

SN 85-359,730, FILED 6-29-2011.

ESTHER BELENKER, EXAMINING ATTORNEY



David J. Kybas

Director of the United States Patent and Trademark Office

United States of America

United States Patent and Trademark Office



Reg. No. 4,155,657

Registered June 5, 2012

Int. Cl.: 25

TRADEMARK

PRINCIPAL REGISTER

DOORN DESIGN LLC (MINNESOTA LIMITED LIABILITY COMPANY)
1412 RIVERVIEW DRIVE
STILLWATER, MN 55082

FOR: BASEBALL CAPS; BEANIES; BELTS; BOXER BRIEFS; COATS; HATS; JERSEYS;
PANTS; SHOES; SHORTS; SOCKS; SWEATPANTS; SWEATSHIRTS; T-SHIRTS; TRUNKS;
WARM UP SUITS, IN CLASS 25 (U.S. CLS. 22 AND 39).

FIRST USE 7-1-2011; IN COMMERCE 11-15-2011.

THE MARK CONSISTS OF A DESIGN OF A HOCKEY SKATE.

SN 85-359,829, FILED 6-29-2011.

EVELYN BRADLEY, EXAMINING ATTORNEY



David J. Kybas

Director of the United States Patent and Trademark Office

United States of America

United States Patent and Trademark Office



RACHEL RODIN

Reg. No. 4,155,658

RODIN, RACHEL (UNITED STATES INDIVIDUAL)
595 WEST END AVENUE
NEW YORK, NY 10024

Registered June 5, 2012

Int. Cl.: 45

FOR: ORGANIZATIONAL SERVICES FOR PERSONAL PURPOSES, NAMELY, WARDROBES, CLOSET SPACE AND SHOPPING; PERSONAL FASHION CONSULTING SERVICES; PERSONAL IMAGE CONSULTING SERVICES AND PERSONAL LIFESTYLE CONSULTING SERVICES, IN CLASS 45 (U.S. CLS. 100 AND 101).

SERVICE MARK

PRINCIPAL REGISTER

FIRST USE 7-1-2011; IN COMMERCE 7-1-2011.

THE NAME "RACHEL RODIN" IDENTIFIES A LIVING INDIVIDUAL WHOSE CONSENT IS OF RECORD.

THE MARK CONSISTS OF THE STYLIZED LETTERS "RR" CENTERED WITHIN A CIRCLE WITH THE CIRCLE POSITIONED ABOVE THE WORDING "RACHEL RODIN".

SN 85-359,906, FILED 6-29-2011.

GEORGE LORENZO, EXAMINING ATTORNEY



David J. Kybas

Director of the United States Patent and Trademark Office

United States of America

United States Patent and Trademark Office

SMART COVER

Reg. No. 4,155,659

Registered June 5, 2012

Int. Cl.: 9

TRADEMARK

PRINCIPAL REGISTER

APPLE INC. (CALIFORNIA CORPORATION)
1 INFINITE LOOP
CUPERTINO, CA 95014

FOR: ACCESSORY FOR A HANDHELD MOBILE DIGITAL ELECTRONIC DEVICE THAT FUNCTIONS AS A PROTECTIVE AND DECORATIVE COVER AND A STAND, IN CLASS 9 (U.S. CLS. 21, 23, 26, 36 AND 38).

FIRST USE 3-11-2011; IN COMMERCE 3-11-2011.

THE MARK CONSISTS OF STANDARD CHARACTERS WITHOUT CLAIM TO ANY PARTICULAR FONT, STYLE, SIZE, OR COLOR.

PRIORITY CLAIMED UNDER SEC. 44(D) ON JAMAICA APPLICATION NO. 57174, FILED 1-6-2011.

NO CLAIM IS MADE TO THE EXCLUSIVE RIGHT TO USE "COVER", APART FROM THE MARK AS SHOWN.

SN 85-359,955, FILED 6-29-2011.

KAPIL BHANOT, EXAMINING ATTORNEY



David J. Kyros

Director of the United States Patent and Trademark Office

United States of America

United States Patent and Trademark Office

STRUCSURE

Reg. No. 4,155,660

SMITH & NEPHEW, INC. (DELAWARE CORPORATION)
1450 BROOKS ROAD
MEMPHIS, TN 38116

Registered June 5, 2012

Int. Cl.: 10

FOR: BONE VOID FILLERS MADE FROM ARTIFICIAL MATERIALS; BONE GRAFT IMPLANTS MADE FROM ARTIFICIAL MATERIALS, IN CLASS 10 (U.S. CLS. 26, 39 AND 44).

TRADEMARK

FIRST USE 10-1-2011; IN COMMERCE 10-1-2011.

PRINCIPAL REGISTER

THE MARK CONSISTS OF STANDARD CHARACTERS WITHOUT CLAIM TO ANY PARTICULAR FONT, STYLE, SIZE, OR COLOR.

SN 85-360,188, FILED 6-30-2011.

MIDGE BUTLER, EXAMINING ATTORNEY



David J. Kybas

Director of the United States Patent and Trademark Office

United States of America

United States Patent and Trademark Office

Renewal Care Partners

Reg. No. 4,155,661

O'BRIEN, PATRICK A. (UNITED STATES INDIVIDUAL)
16 WEST 16TH STREET, APARTMENT 6LS
NEW YORK, NY 10011

Registered June 5, 2012

Int. Cl.: 45

FOR: IN-HOME SUPPORT SERVICES TO SENIOR PERSONS, NAMELY, GERIATRIC CARE MANAGEMENT SERVICES IN THE NATURE OF THE COORDINATION OF NECESSARY SERVICES AND PERSONAL CARE FOR OLDER INDIVIDUALS, IN CLASS 45 (U.S. CLS. 100 AND 101).

SERVICE MARK

PRINCIPAL REGISTER

FIRST USE 6-30-2011; IN COMMERCE 6-30-2011.

THE MARK CONSISTS OF STANDARD CHARACTERS WITHOUT CLAIM TO ANY PARTICULAR FONT, STYLE, SIZE, OR COLOR.

NO CLAIM IS MADE TO THE EXCLUSIVE RIGHT TO USE "CARE PARTNERS", APART FROM THE MARK AS SHOWN.

SN 85-360,489, FILED 6-30-2011.

REBECCA SMITH, EXAMINING ATTORNEY



David J. Kyros

Director of the United States Patent and Trademark Office

United States of America

United States Patent and Trademark Office



Reg. No. 4,155,662

Registered June 5, 2012

Int. Cl.: 41

SERVICE MARK

PRINCIPAL REGISTER

FRAUD DOG PRODUCTIONS, LLC (DELAWARE LIMITED LIABILITY COMPANY)
SUITE 1822
511 SE 5TH AVENUE
FT. LAUDERDALE, FL 33301

FOR: ENTERTAINMENT SERVICES IN THE NATURE OF AN ONGOING TELEVISION SHOW ABOUT WRONGFUL AND CRIMINAL ACTIVITIES; EDUCATIONAL SERVICES IN THE NATURE OF SEMINARS, WORKSHOPS, AND PRESENTATIONS IN THE FIELD OF WRONGFUL AND CRIMINAL ACTIVITIES AND PROVIDING WRITTEN MATERIALS IN CONNECTION THEREWITH, IN CLASS 41 (U.S. CLS. 100, 101 AND 107).

FIRST USE 5-0-2011; IN COMMERCE 5-0-2011.

NO CLAIM IS MADE TO THE EXCLUSIVE RIGHT TO USE "FRAUD" AND "PRODUCTIONS", APART FROM THE MARK AS SHOWN.

THE MARK CONSISTS OF THE IMAGE OF A DOG RESTING ATOP THE MARK "FDP" ABOVE "FRAUD DOG PRODUCTIONS".

SN 85-360,814, FILED 6-30-2011.

LAURA HAMMEL, EXAMINING ATTORNEY



David J. Kybas

Director of the United States Patent and Trademark Office

United States of America
United States Patent and Trademark Office

H2H

Reg. No. 4,155,663

Registered June 5, 2012

Int. Cl.: 21

TRADEMARK

PRINCIPAL REGISTER

ADC MARKETING, INC. (WASHINGTON CORPORATION), DBA MAGELLAN GROUP,
LTD.,
225 MARINE DR. STE 300
BLAINE, WA 98230

FOR: KITCHENWARE, NAMELY, ROASTING PAN FOR USE IN OVENS; STOVE-TOP
POPCORN POPPER; BREADING PANS; FOOD PRESS FOR PRESSING MEATS AND
POULTRY WHILE COOKING; PASTRY SCRAPERS; PERFORATED GRILLING PANS; PIE
PANS; RIB COOKING STAND; PERFORATED AND MESH BASKETS FOR STEAMING,
FRYING AND BOILING FOODS; CERAMIC FRY PANS, DUTCH OVENS, SAUTE PANS,
CHICKEN ROASTERS AND SAUCE PANS, IN CLASS 21 (U.S. CLS. 2, 13, 23, 29, 30, 33, 40
AND 50).

FIRST USE 2-1-2011; IN COMMERCE 3-12-2012.

THE MARK CONSISTS OF STANDARD CHARACTERS WITHOUT CLAIM TO ANY PAR-
TICULAR FONT, STYLE, SIZE, OR COLOR.

SN 85-361,098, FILED 6-30-2011.

DOMINIC J. FERRAIUOLO, EXAMINING ATTORNEY



David J. Kyros

Director of the United States Patent and Trademark Office

United States of America

United States Patent and Trademark Office

DISCUS MAXIMUS

Reg. No. 4,155,664

Registered June 5, 2012

Int. Cl.: 28

TRADEMARK

PRINCIPAL REGISTER

PETSPORT USA, INC. (CALIFORNIA CORPORATION)
1160 RAILROAD AVENUE
PITTSBURG, CA 94565

FOR: PET TOYS, IN CLASS 28 (U.S. CLS. 22, 23, 38 AND 50).

FIRST USE 3-7-2012; IN COMMERCE 3-7-2012.

THE MARK CONSISTS OF STANDARD CHARACTERS WITHOUT CLAIM TO ANY PARTICULAR FONT, STYLE, SIZE, OR COLOR.

SN 85-361,210, FILED 6-30-2011.

MARK T. MULLEN, EXAMINING ATTORNEY



David J. Kybas

Director of the United States Patent and Trademark Office

United States of America

United States Patent and Trademark Office

SMART-VIEW

Reg. No. 4,155,665

WERNER PADDLES, INC. (WASHINGTON CORPORATION)
33415 SR 2
SULTAN, WA 98294

Registered June 5, 2012

Int. Cl.: 12

FOR: KAYAK PADDLES, IN CLASS 12 (U.S. CLS. 19, 21, 23, 31, 35 AND 44).

TRADEMARK

FIRST USE 8-4-2011; IN COMMERCE 9-30-2011.

PRINCIPAL REGISTER

THE MARK CONSISTS OF STANDARD CHARACTERS WITHOUT CLAIM TO ANY PARTICULAR FONT, STYLE, SIZE, OR COLOR.

SN 85-361,674, FILED 7-1-2011.

BRIDGETT SMITH, EXAMINING ATTORNEY



David J. Kyffers

Director of the United States Patent and Trademark Office

United States of America

United States Patent and Trademark Office



Reg. No. 4,155,666

Registered June 5, 2012

Int. Cl.: 42

SERVICE MARK

PRINCIPAL REGISTER

APITVA, INC. (TEXAS CORPORATION), DBA LYNXSQUARE,
3RD FLOOR
3925 W. BRAKER LANE
AUSTIN, TX 78759

FOR: PROVIDING A WEBSITE FEATURING TECHNOLOGY THAT ENABLES USERS TO BID ON DIGITALLY AND PHYSICALLY TRANSFERABLE MERCHANDISE WHEREIN AT LEAST TWO USERS SHARE THE MERCHANDISE FOR A SPECIFIED PERIOD OF TIME, IN CLASS 42 (U.S. CLS. 100 AND 101).

FIRST USE 11-1-2011; IN COMMERCE 11-1-2011.

THE MARK CONSISTS OF FOUR SQUARES POSITIONED IN A BACKGROUND. FOUR ARMS SUPER-IMPOSED OVER THE FOUR SQUARES WHEREIN THE FOUR ARMS ARE ARRANGED IN A GENERALLY HUMAN CHAIN CONFIGURATION SYMBOLIZING A SOCIAL CONNECTION. FOUR CIRCULAR HEADS SUPERIMPOSED OVER THE FOUR SQUARES WHEREIN THE FOUR HEADS ARE POSITIONED ADJACENT TO THE FOUR ARMS AND CONFIGURED IN A GENERALLY CIRCULAR PATTERN.

SN 85-362,022, FILED 7-1-2011.

DANNEAN HETZEL, EXAMINING ATTORNEY



David J. Kyros

Director of the United States Patent and Trademark Office

United States of America

United States Patent and Trademark Office

Dime Bags

Reg. No. 4,155,667

ANDUPWARDS, INC. (FLORIDA CORPORATION)
2001 HIGHVIEW FALL PLACE
BRANDON, FL 33510

Registered June 5, 2012

Int. Cl.: 9

FOR: DOWNLOADABLE ELECTRONIC BOOKS FEATURING HUMOROUS FICTIONAL SHORT STORIES, IN CLASS 9 (U.S. CLS. 21, 23, 26, 36 AND 38).

TRADEMARK

FIRST USE 6-11-2011; IN COMMERCE 7-21-2011.

PRINCIPAL REGISTER

THE MARK CONSISTS OF STANDARD CHARACTERS WITHOUT CLAIM TO ANY PARTICULAR FONT, STYLE, SIZE, OR COLOR.

SN 85-362,186, FILED 7-1-2011.

MICHAEL TANNER, EXAMINING ATTORNEY



David J. Kybas

Director of the United States Patent and Trademark Office

United States of America

United States Patent and Trademark Office



Chef Pantelis

Reg. No. 4,155,668

Registered June 5, 2012

**Int. Cls.: 6, 8, 16, 20, 21,
29, 30, 31, 32, and 33**

CEDAR FARMS CO., INC. (PENNSYLVANIA CORPORATION)
2100 HORNIG ROAD
PHILADELPHIA, PA 19116

FOR: ALUMINUM FOIL, IN CLASS 6 (U.S. CLS. 2, 12, 13, 14, 23, 25 AND 50).

FIRST USE 1-1-2012; IN COMMERCE 1-1-2012.

TRADEMARK

FOR: CUTLERY, NAMELY, FORKS, SPOONS, AND KNIVES, IN CLASS 8 (U.S. CLS. 23, 28 AND 44).

PRINCIPAL REGISTER

FIRST USE 1-1-2012; IN COMMERCE 1-1-2012.

FOR: PLASTIC FOOD STORAGE BAGS FOR HOUSEHOLD USE; PLASTIC WRAP; SANDWICH BAGS; TRASH BAGS; TRASH CAN LINERS, IN CLASS 16 (U.S. CLS. 2, 5, 22, 23, 29, 37, 38 AND 50).

FIRST USE 1-1-2012; IN COMMERCE 1-1-2012.

FOR: DRINKING STRAWS; PLASTIC LIDS, IN CLASS 20 (U.S. CLS. 2, 13, 22, 25, 32 AND 50).

FIRST USE 1-1-2012; IN COMMERCE 1-1-2012.

FOR: ABRASIVE PADS FOR KITCHEN AND DOMESTIC PURPOSES; BOWLS; CLEANING SPONGES; DISPOSABLE DINNERWARE, NAMELY, PLATES, BOWLS AND SERVING TRAYS; DISPOSABLE PLASTIC GLOVES FOR USE IN THE FOOD SERVICE INDUSTRY; GLOVES FOR HOUSEHOLD PURPOSES; PAPER AND PLASTIC CUPS; PLASTIC STORAGE CONTAINERS FOR HOUSEHOLD OR DOMESTIC USE; SOAP DISPENSERS; TOOTHPICKS, IN CLASS 21 (U.S. CLS. 2, 13, 23, 29, 30, 33, 40 AND 50).

FIRST USE 1-1-2012; IN COMMERCE 1-1-2012.

FOR: FROZEN MEATS; MOZZARELLA STICKS; CHICKEN BREAST BREADED; CHICKEN FINGERS; CHICKEN NUGGETS; CHICKEN WINGS; EGGS; FRENCH FRIES; FROZEN FRUITS; BREADED VEGETABLES; BEEF BURGER PATTIES; TURKEY BURGER PATTIES; DELI MEATS; MEATBALLS; ONION RINGS; HASH BROWNS; PREPARED FROZEN FOOD



David J. Kyros

Director of the United States Patent and Trademark Office

Reg. No. 4,155,668 ENTREES CONSISTING PRIMARILY OF MEAT, FISH, POULTRY OR VEGETABLES; FROZEN SEAFOOD; FROZEN SOUPS; FROZEN TURKEY; FROZEN VEAL; FROZEN VEGETABLES; BUTTER; BUTTER BLENDS; BUTTER SUBSTITUTES; CHEESES; SPECIALTY CHEESES; CULTURED CHEESES; FRESH MEATS; GROUND MEATS; SMOKED MEATS; COOKED TURKEY; FRESH CHICKEN; BONELESS CHICKEN BREASTS; WHOLE CHICKEN; FRESH TURKEY; BROTH AND SOUP BASE; CANNED AND PACKAGED CHEESE; FRUIT BASED PIE FILLINGS; CANNED FRUIT BASED PIE FILLINGS; JELLY AND PRESERVES; PROCESSED NUTS; EDIBLE OILS AND PREPS, NAMELY, BOUILLON; PICKLES AND PROCESSED PEPPERS; CANNED MEAT; SHORTENINGS; CANNED SOUPS; CANNED TOMATOES; CANNED VEGETABLES; PIZZA TOPPINGS, NAMELY, MEAT AND CHEESE TOPPINGS; DRY TOPPINGS, NAMELY, NUT TOPPINGS; HORS D'OEUVRES AND APPETIZERS EACH MADE PRIMARILY OF MEAT, FISH, POULTRY OR VEGETABLES; SNACKS, NAMELY, CANDIED-FRUIT SNACKS, MEAT-BASED SNACK FOOD, VEGETABLE-BASED SNACK FOODS, NUT-BASED SNACK FOODS, POTATO-BASED SNACK FOODS, POTATO CHIPS, AND TRAIL-MIX CONSISTING PRIMARILY OF PROCESSED NUTS, SEEDS, DRIED FRUIT AND ALSO INCLUDING CHOCOLATE; FROZEN CLAM JUICE; STOCK CUBES; FRESH AND/OR PREPARED FRUIT SALADS, VEGETABLE SALADS AND GARDEN SALADS, IN CLASS 29 (U.S. CL. 46).

FIRST USE 6-1-2011; IN COMMERCE 6-1-2011.

FOR: FROZEN PIES; BAKERY DESSERTS AND CAKES; BREADS AND ROLLS; TORTILLAS; HORS D'OEUVRES AND APPETIZERS EACH MADE PRIMARILY OF PASTA OR RICE; FROZEN DOUGH, NAMELY, COOKIE DOUGH, FROZEN DOUGH FOR USE AS PIZZA, BREAD OR OTHER BREAD-TYPE PRODUCTS; FROZEN PASTA; FROZEN PIZZA; STEAK SANDWICHES; PIZZA TOPPINGS, NAMELY, PIZZA SAUCE; FROZEN PASTRY ITEMS; DRY BAKING ITEMS, NAMELY, BAKING POWDERS, FLOUR, SUGAR AND BAKING SODA; MIXES FOR MAKING BREADS AND BAKING BATTERS; BREAD CRUMBS; BREAKFAST CEREALS, PROCESSED CEREALS; COFFEE; TEA; DRINK MIXES, NAMELY, POWDERED COCOA DRINK MIXES, POWDERED COFFEE DRINK, AND DRINK MIXES FOR MAKING TEA; DRESSINGS FOR FOOD; EXTRACT USED AS FLAVORING; FLOUR; KETCHUP; MAYONNAISE; MUSTARD; BAKING MIXES, NAMELY, CAKE MIXES, COOKIE MIXES, BROWNIE MIXES AND BREAD MIXES; PANCAKE AND WAFFLE MIXES; PASTA DRY; FLAVORED SWEETENED GELATIN AND PUDDING; SAUCES AND GRAVY; SPICES; FOOD SEASONINGS; FOOD FLAVOR BASES, NAMELY, FLAVOR ENHANCERS USED IN FOOD; SYRUPS, NAMELY, CORN SYRUP AND MAPLE SYRUP; VINEGAR; DRY TOPPINGS, NAMELY, CHOCOLATE TOPPINGS; SNACKS, NAMELY, NUTS, GRAIN-BASED SNACK FOODS, CORN-BASED SNACK FOODS, POPCORN, PRETZELS, TORTILLA CHIPS, CHOCOLATE-BASED SNACK FOODS AND CHEESE FLAVORED SNACKS, NAMELY, CHEESE CURLS; FROZEN FOODS, NAMELY, GRAIN AND BREAD BASED APPETIZERS AND HORS D'OEUVRES; BEEF BURGER SANDWICHES; TURKEY BURGER SANDWICHES; PREPARED FROZEN FOOD ENTREES CONSISTING PRIMARILY OF PASTA OR RICE; CHOCOLATE AND CUSTARD PIE FILLINGS; CANNED CHOCOLATE AND CUSTARD BASED PIE FILLINGS; SUGARED NUTS; FRESH AND/OR PREPARED MACARONI SALADS, PASTA SALADS AND RICE SALADS; PROCESSED GRAINS, IN CLASS 30 (U.S. CL. 46).

FIRST USE 6-1-2011; IN COMMERCE 6-1-2011.

FOR: FRESH OLIVES; FRESH PEPPERS; RAW FRESH NUTS; UNPROCESSED CEREALS; UNPROCESSED GRAINS, IN CLASS 31 (U.S. CLS. 1 AND 46).

FIRST USE 1-1-2012; IN COMMERCE 1-1-2012.

FOR: DRINK MIXES, NAMELY, CONCENTRATES, SYRUPS, AND POWDERS FOR MAKING FRUIT DRINKS, FLAVORED WATER AND SOFT DRINKS; FROZEN FRUIT JUICES, SYRUPS FOR MAKING BEVERAGES, IN CLASS 32 (U.S. CLS. 45, 46 AND 48).

FIRST USE 6-1-2011; IN COMMERCE 6-1-2011.

Reg. No. 4,155,668 FOR: COOKING WINES, IN CLASS 33 (U.S. CLS. 47 AND 49).

FIRST USE 1-1-2012; IN COMMERCE 1-1-2012.

THE NAME "CHEF PANTELIS" DOES NOT IDENTIFY THE NAME OF A LIVING INDIVIDUAL.

THE MARK CONSISTS OF A CHEF HOLDING A COVERED SERVING PLATE IN ONE HAND AND A THUMBS-UP WITH THE OTHER HAND. THE IMAGE IS DISPLAYED IN A CIRCULAR BORDER WITH THE STYLIZED WORDING "CHEF PANTELIS" APPEARING IMMEDIATELY BELOW.

SN 85-362,834, FILED 7-5-2011.

LINDA E. BLOHM, EXAMINING ATTORNEY

United States of America

United States Patent and Trademark Office

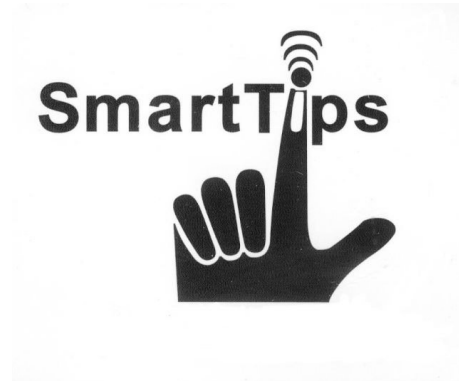

Reg. No. 4,155,669

Registered June 5, 2012

Int. Cl.: 25

TRADEMARK

PRINCIPAL REGISTER

CHEVEUX CORP. (NEW YORK CORPORATION)
38 W. 28 STREET
NEW YORK, NY 10001

FOR: GLOVES WITH FINGER TIPS PERMITTING USE OF TOUCH SCREENS, IN CLASS 25 (U.S. CLS. 22 AND 39).

FIRST USE 8-0-2011; IN COMMERCE 8-0-2011.

THE MARK CONSISTS OF THE WORDING "SMARTTIPS" HAVING ITS CHARACTER "I" OVERLAPPED WITH AN INDEX FINGER OF A HAND DESIGN BELOW AND WITH A SYMBOL OF ELECTROMAGNETIC WAVE ABOVE.

SN 85-363,092, FILED 7-5-2011.

ANGELA DUONG, EXAMINING ATTORNEY



David J. Kybas

Director of the United States Patent and Trademark Office

United States of America

United States Patent and Trademark Office

SMOOTHTECH

Reg. No. 4,155,670

Registered June 5, 2012

Int. Cl.: 16

TRADEMARK

PRINCIPAL REGISTER

MEGA BRANDS INTERNATIONAL, LUXEMBOURG, ZUG BRANCH (LUXEMBOURG CORPORATION)
POSTSTRASSE 6
ZUG, SWITZERLAND CH-6300

FOR: INK FOR WRITING INSTRUMENTS; PENS, IN CLASS 16 (U.S. CLS. 2, 5, 22, 23, 29, 37, 38 AND 50).

FIRST USE 12-0-2011; IN COMMERCE 12-0-2011.

THE MARK CONSISTS OF STANDARD CHARACTERS WITHOUT CLAIM TO ANY PARTICULAR FONT, STYLE, SIZE, OR COLOR.

SN 85-363,185, FILED 7-5-2011.

JENNIFER VASQUEZ, EXAMINING ATTORNEY



David J. Kybas

Director of the United States Patent and Trademark Office

United States of America

United States Patent and Trademark Office

Splash Studio

Reg. No. 4,155,671

HAHN, MARLA R. (UNITED STATES INDIVIDUAL)
133 N. JACKSON, #623
MILWAUKEE, WI 53202

Registered June 5, 2012

Int. Cl.: 41

FOR: EDUCATIONAL AND ENTERTAINMENT SERVICES, NAMELY, CONDUCTING CLASSES IN THE FIELD OF ART AND DISTRIBUTION OF COURSE MATERIALS IN CONNECTION THEREWITH, AND EDUCATION CONSULTING RELATED THERETO, IN CLASS 41 (U.S. CLS. 100, 101 AND 107).

SERVICE MARK

PRINCIPAL REGISTER

FIRST USE 12-23-2011; IN COMMERCE 1-9-2012.

THE MARK CONSISTS OF STANDARD CHARACTERS WITHOUT CLAIM TO ANY PARTICULAR FONT, STYLE, SIZE, OR COLOR.

NO CLAIM IS MADE TO THE EXCLUSIVE RIGHT TO USE "STUDIO", APART FROM THE MARK AS SHOWN.

SN 85-363,374, FILED 7-5-2011.

ANTHONY RINKER, EXAMINING ATTORNEY



David J. Kybas

Director of the United States Patent and Trademark Office

United States of America

United States Patent and Trademark Office

ONWARD PHYSICIAN

Reg. No. 4,155,672

Registered June 5, 2012

Int. Cl.: 42

SERVICE MARK

PRINCIPAL REGISTER

ONWARD SYSTEMS INC. (CALIFORNIA CORPORATION)
STE. 200
20955 PATHFINDER BLVD.
DIAMOND BAR, CA 91765

FOR: SOFTWARE AS A SERVICE (SAAS) SERVICES, NAMELY, HOSTING SOFTWARE FOR USE BY OTHERS FOR THE COLLECTION, EDITING, ORGANIZING, MODIFYING, TRANSMISSION, STORAGE AND SHARING OF DATA AND INFORMATION RELATING TO HEALTH CARE SERVICES; SOFTWARE AS A SERVICE (SAAS) SERVICES, NAMELY, HOSTING SOFTWARE FOR USE BY OTHERS FOR POPULATING, ACCESSING, MANAGING, AND ANALYZING ELECTRONIC HEALTH RECORDS FOR BILLING AND MEDICAL PRACTICE MANAGEMENT, AND MANAGEMENT OF HEALTH CARE SERVICES; SOFTWARE AS A SERVICE (SAAS) SERVICES, NAMELY, HOSTING SOFTWARE FOR USE BY OTHERS FOR MANAGING, ACCESSING, AND ARCHIVING MEDICAL DOCUMENTS, MEDICAL IMAGES, DICTATIONS AND TRANSCRIPTIONS IN THE FIELD OF HEALTH-CARE; SOFTWARE AS A SERVICE (SAAS) SERVICES, NAMELY, HOSTING SOFTWARE FOR USE BY OTHERS FOR PRE-AUTHORIZATION, SUBMISSION, ADJUDICATION, VERIFICATION AND TRACKING OF INSURANCE CLAIMS IN THE FIELD OF HEALTH-CARE, IN CLASS 42 (U.S. CLS. 100 AND 101).

FIRST USE 9-5-2011; IN COMMERCE 9-5-2011.

THE MARK CONSISTS OF STANDARD CHARACTERS WITHOUT CLAIM TO ANY PARTICULAR FONT, STYLE, SIZE, OR COLOR.

NO CLAIM IS MADE TO THE EXCLUSIVE RIGHT TO USE "PHYSICIAN", APART FROM THE MARK AS SHOWN.

SN 85-363,581, FILED 7-5-2011.

DEIRDRE ROBERTSON, EXAMINING ATTORNEY



David J. Kyros

Director of the United States Patent and Trademark Office

United States of America

United States Patent and Trademark Office

ONWARD VET

Reg. No. 4,155,673

Registered June 5, 2012

Int. Cl.: 42

SERVICE MARK

PRINCIPAL REGISTER

ONWARD SYSTEMS INC. (CALIFORNIA CORPORATION)
STE. 200
20955 PATHFINDER BLVD.
DIAMOND BAR, CA 91765

FOR: SOFTWARE AS A SERVICE (SAAS) SERVICES, NAMELY, HOSTING SOFTWARE FOR USE BY OTHERS FOR THE COLLECTION, EDITING, ORGANIZING, MODIFYING, TRANSMISSION, STORAGE AND SHARING OF DATA AND INFORMATION RELATING TO VETERINARY SERVICES; SOFTWARE AS A SERVICE (SAAS) SERVICES, NAMELY, HOSTING SOFTWARE FOR USE BY OTHERS FOR POPULATING, ACCESSING, MANAGING, AND ANALYZING ELECTRONIC HEALTH RECORDS FOR BILLING AND MEDICAL PRACTICE MANAGEMENT, AND MANAGEMENT OF VETERINARY SERVICES; SOFTWARE AS A SERVICE (SAAS) SERVICES, NAMELY, HOSTING SOFTWARE FOR USE BY OTHERS FOR MANAGING, ACCESSING, AND ARCHIVING MEDICAL DOCUMENTS, MEDICAL IMAGES, DICTATIONS AND TRANSCRIPTIONS IN THE FIELD OF VETERINARY; SOFTWARE AS A SERVICE (SAAS) SERVICES, NAMELY, HOSTING SOFTWARE FOR USE BY OTHERS FOR PRE-AUTHORIZATION, SUBMISSION, ADJUDICATION, VERIFICATION AND TRACKING OF INSURANCE CLAIMS IN THE FIELD OF VETERINARY SERVICES, IN CLASS 42 (U.S. CLS. 100 AND 101).

FIRST USE 10-3-2011; IN COMMERCE 10-3-2011.

THE MARK CONSISTS OF STANDARD CHARACTERS WITHOUT CLAIM TO ANY PARTICULAR FONT, STYLE, SIZE, OR COLOR.

NO CLAIM IS MADE TO THE EXCLUSIVE RIGHT TO USE "VET" , APART FROM THE MARK AS SHOWN.

SN 85-363,590, FILED 7-5-2011.

DEIRDRE ROBERTSON, EXAMINING ATTORNEY



David J. Kyros

Director of the United States Patent and Trademark Office

United States of America

United States Patent and Trademark Office

ARTSPOT

Reg. No. 4,155,674

Registered June 5, 2012

Int. Cl.: 9

TRADEMARK

PRINCIPAL REGISTER

DAY, STEPHANIE (UNITED STATES INDIVIDUAL)
1043 W. MAPLEWOOD ST
CHANDLER, AZ 85286

FOR: DOWNLOADABLE COMPUTER APPLICATION SOFTWARE FOR MOBILE PHONES ALLOWING USERS TO PHOTOGRAPH AN OBJECT AND SHARE ITS GEO-LOCATION AND INTERACT WITH OTHER USERS THROUGH POSTING REVIEWS AND COMMENTS TO SOCIAL NETWORKS, SOCIAL GAMING AND GPS-BASED TREASURE HUNTING GAMES WITH VIRTUAL PRIZES AND COUPONS, IN CLASS 9 (U.S. CLS. 21, 23, 26, 36 AND 38).

FIRST USE 8-1-2011; IN COMMERCE 1-15-2012.

THE MARK CONSISTS OF STANDARD CHARACTERS WITHOUT CLAIM TO ANY PARTICULAR FONT, STYLE, SIZE, OR COLOR.

SN 85-363,737, FILED 7-6-2011.

SIMON TENG, EXAMINING ATTORNEY



David J. Kyffers

Director of the United States Patent and Trademark Office

United States of America

United States Patent and Trademark Office

ARTSPOT

Reg. No. 4,155,675

Registered June 5, 2012

Int. Cl.: 9

TRADEMARK

PRINCIPAL REGISTER

DAY, STEPHANIE (UNITED STATES INDIVIDUAL)
1043 W. MAPLEWOOD ST
CHANDLER, AZ 85286

FOR: DOWNLOADABLE COMPUTER APPLICATION SOFTWARE FOR MOBILE PHONES ALLOWING USERS TO PHOTOGRAPH AN OBJECT AND SHARE ITS GEO-LOCATION AND INTERACT WITH OTHER USERS THROUGH POSTING REVIEWS AND COMMENTS TO SOCIAL NETWORKS, SOCIAL GAMING AND GPS-BASED TREASURE HUNTING GAMES WITH VIRTUAL PRIZES AND COUPONS, IN CLASS 9 (U.S. CLS. 21, 23, 26, 36 AND 38).

FIRST USE 8-1-2011; IN COMMERCE 1-15-2012.

THE MARK CONSISTS OF THE WORD "ARTSPOT" WHEREIN THE LETTERS "ART" IS SHADED IN RED COLOR AND THE LETTERS "SPOT" IS SHADED IN GRAY COLOR AND LETTER "O" DEPICTING A RIFLE SCOPE AS SHOWN IN THE MARK.

THE COLOR(S) RED AND GRAY IS/ARE CLAIMED AS A FEATURE OF THE MARK.

SN 85-363,743, FILED 7-6-2011.

SIMON TENG, EXAMINING ATTORNEY



David J. Kyffers

Director of the United States Patent and Trademark Office

United States of America

United States Patent and Trademark Office

A FAN OF!

Reg. No. 4,155,676

Registered June 5, 2012

Int. Cl.: 25

TRADEMARK

PRINCIPAL REGISTER

LEHIGH VALLEY DISCOUNTS & MORE (LVD) (PENNSYLVANIA UNINCORPORATED ASSOCIATION)
1070 TIMBERIDGE LN
ALLENTOWN, PA 18106

FOR: CLOTHING, NAMELY, TOPS, BOTTOMS, HATS, T-SHIRTS, BOXER BRIEFS AND SHORTS, HOODED SWEATSHIRTS, SWEATSHIRTS, POLO SHIRTS, SOCKS, UNDERWEAR, IN CLASS 25 (U.S. CLS. 22 AND 39).

FIRST USE 6-1-2011; IN COMMERCE 6-1-2011.

THE MARK CONSISTS OF STANDARD CHARACTERS WITHOUT CLAIM TO ANY PARTICULAR FONT, STYLE, SIZE, OR COLOR.

SN 85-363,749, FILED 7-6-2011.

SIMON TENG, EXAMINING ATTORNEY



David J. Kyffers

Director of the United States Patent and Trademark Office

United States of America

United States Patent and Trademark Office

COLLEGEBUZZZ

Reg. No. 4,155,677

Registered June 5, 2012

Int. Cl.: 42

SERVICE MARK

PRINCIPAL REGISTER

BROWN, JEFFREY S. (UNITED STATES INDIVIDUAL)
1207 EAST WASHINGTON STREET
GREENVILLE, SC 29601

FOR: COMPUTER SERVICES, NAMELY, CREATING AN ON-LINE COMMUNITY FOR REGISTERED USERS TO PARTICIPATE IN DISCUSSIONS AND FORUMS, GET FEEDBACK FROM AND SHARE ADVICE AND TIPS WITH THEIR PEERS, FORM VIRTUAL COMMUNITIES, ENGAGE IN SOCIAL NETWORKING, SHARE AUDIO, VIDEO, PHOTOGRAPHIC AND PROSE PRESENTATIONS, AND CREATE INTERACTIVE SOFTWARE TOOLS AND CHECKLISTS, IN CLASS 42 (U.S. CLS. 100 AND 101).

FIRST USE 9-4-2011; IN COMMERCE 3-15-2012.

THE MARK CONSISTS OF STANDARD CHARACTERS WITHOUT CLAIM TO ANY PARTICULAR FONT, STYLE, SIZE, OR COLOR.

SN 85-363,764, FILED 7-6-2011.

ELISSA GARBER KON, EXAMINING ATTORNEY



David J. Kybas

Director of the United States Patent and Trademark Office

United States of America

United States Patent and Trademark Office

The power to change life.
The energy to make it
happen.

Reg. No. 4,155,678

NRG ENERGY, INC. (DELAWARE CORPORATION)
211 CARNEGIE CENTER
PRINCETON, NJ 08540

Registered June 5, 2012

**Int. Cls.: 35, 36, 37, and
40**

FOR: ENERGY MANAGEMENT SERVICES, NAMELY, PROVIDING A SERVICE THAT ALLOWS CUSTOMERS TO PURCHASE ENERGY, NAMELY, ELECTRICITY AND RENEWABLE ENERGY; CONSULTATION SERVICES IN THE FIELD OF MANAGING ELECTRIC GENERATION FACILITIES, IN CLASS 35 (U.S. CLS. 100, 101 AND 102).

SERVICE MARK

FIRST USE 12-1-2011; IN COMMERCE 12-1-2011.

PRINCIPAL REGISTER

FOR: BROKERAGE OF ENERGY, NAMELY, ELECTRIC POWER; CONSULTATION SERVICES IN THE FIELD OF COMMODITY TRADING, NAMELY, TRADING OF ELECTRICITY, IN CLASS 36 (U.S. CLS. 100, 101 AND 102).

FIRST USE 11-1-2011; IN COMMERCE 11-1-2011.

FOR: CONSTRUCTION PLANNING AND CUSTOM CONSTRUCTION OF ELECTRIC POWER PLANTS, NAMELY, WIND, SOLAR, COAL FIRED POWER PLANTS AND PLANTS USING BIO-MASS FUELS; INSTALLATION AND MAINTENANCE OF POWER PLANTS, NAMELY, WIND, SOLAR, NUCLEAR, COAL FIRED POWER PLANTS AND PLANTS USING BIO-MASS FUELS, IN CLASS 37 (U.S. CLS. 100, 103 AND 106).

FIRST USE 11-1-2011; IN COMMERCE 11-1-2011.

FOR: CONSULTATION SERVICES IN THE FIELDS OF POWER GENERATION, IN CLASS 40 (U.S. CLS. 100, 103 AND 106).

FIRST USE 11-1-2011; IN COMMERCE 11-1-2011.

THE MARK CONSISTS OF STANDARD CHARACTERS WITHOUT CLAIM TO ANY PARTICULAR FONT, STYLE, SIZE, OR COLOR.

SN 85-363,794, FILED 7-6-2011.

ELIZABETH HUGHITT, EXAMINING ATTORNEY



David J. Kyffers

Director of the United States Patent and Trademark Office

United States of America

United States Patent and Trademark Office

Tele-Ments

Reg. No. 4,155,679

MEYER, BRETT (UNITED STATES INDIVIDUAL)
12682 RAGWEED ST.
SAN DIEGO, CA 92129

Registered June 5, 2012

Int. Cl.: 16

FOR: EDUCATIONAL PUBLICATIONS, NAMELY, TRAINING MANUALS IN THE FIELD OF TELEMEDICINE; INSTRUCTION SHEETS IN THE FIELD OF TELEMEDICINE; MANUALS IN THE FIELD OF TELEMEDICINE; PAMPHLETS IN THE FIELD OF TELEMEDICINE, IN CLASS 16 (U.S. CLS. 2, 5, 22, 23, 29, 37, 38 AND 50).

TRADEMARK

PRINCIPAL REGISTER

FIRST USE 3-16-2012; IN COMMERCE 3-16-2012.

THE MARK CONSISTS OF STANDARD CHARACTERS WITHOUT CLAIM TO ANY PARTICULAR FONT, STYLE, SIZE, OR COLOR.

SN 85-363,936, FILED 7-6-2011.

JAY FLOWERS, EXAMINING ATTORNEY



David J. Kyffers

Director of the United States Patent and Trademark Office

United States of America

United States Patent and Trademark Office

Taste of the OC

Reg. No. 4,155,680

A TASTE OF THE OC, LLC (CALIFORNIA LIMITED LIABILITY COMPANY)
4040 MACARTHUR BLVD. #200
NEWPORT BEACH, CA 92660

Registered June 5, 2012

Int. Cl.: 41

FOR: ARRANGING AND CONDUCTING WINE AND FOOD FESTIVALS IN ORANGE COUNTY, CALIFORNIA, IN CLASS 41 (U.S. CLS. 100, 101 AND 107).

SERVICE MARK

FIRST USE 9-15-2009; IN COMMERCE 6-20-2011.

PRINCIPAL REGISTER

THE MARK CONSISTS OF STANDARD CHARACTERS WITHOUT CLAIM TO ANY PARTICULAR FONT, STYLE, SIZE, OR COLOR.

NO CLAIM IS MADE TO THE EXCLUSIVE RIGHT TO USE "OC", APART FROM THE MARK AS SHOWN.

SN 85-363,946, FILED 7-6-2011.

NAAKWAMA ANKRAH, EXAMINING ATTORNEY



David J. Kyffers

Director of the United States Patent and Trademark Office

United States of America

United States Patent and Trademark Office



Reg. No. 4,155,681

Registered June 5, 2012

Int. Cl.: 20

TRADEMARK

PRINCIPAL REGISTER

TIFFANY ANNE LLC (FLORIDA LIMITED LIABILITY COMPANY)
326 SOUTH BEACH ROAD
HOPE SOUND, FL 33455

FOR: HOME DECOR ITEMS, NAMELY, EMBELLISHED SEASHELLS, IN CLASS 20 (U.S. CLS. 2, 13, 22, 25, 32 AND 50).

FIRST USE 10-1-2011; IN COMMERCE 10-1-2011.

THE NAME "TIFFANY ANNE" PRICE IDENTIFIES A LIVING INDIVIDUAL WHOSE CONSENT IS OF RECORD.

THE MARK CONSISTS OF THE STYLIZED TEXT "TIFFANY ANNE".

SN 85-363,983, FILED 7-6-2011.

HENRY S. ZAK, EXAMINING ATTORNEY



David J. Kybas

Director of the United States Patent and Trademark Office

United States of America

United States Patent and Trademark Office

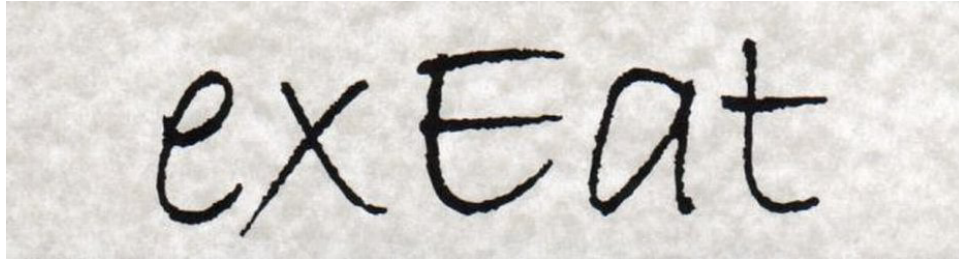

Reg. No. 4,155,682

Registered June 5, 2012

Int. Cl.: 43

SERVICE MARK

PRINCIPAL REGISTER

WINDY PIZZA PLUS LLC (RHODE ISLAND LIMITED LIABILITY COMPANY), DBA
EATALIAN CAFE,
15500 S. BROADWAY
GARDENA, CA 90248

FOR: BAR AND RESTAURANT SERVICES; CAFE AND RESTAURANT SERVICES; ICE CREAM SHOP SERVICES IN THE NATURE OF A RESTAURANT; RESTAURANT AND BAR SERVICES; RESTAURANT AND CAFE SERVICES; RESTAURANT AND CATERING SERVICES; RESTAURANTS, IN CLASS 43 (U.S. CLS. 100 AND 101).

FIRST USE 5-15-2011; IN COMMERCE 5-15-2011.

THE MARK CONSISTS OF THE FANCIFUL WORD "EXEAT" IN BLACK CURSIVE ON A BEIGE BACKGROUND.

THE COLOR(S) BEIGE, AND BLACK IS/ARE CLAIMED AS A FEATURE OF THE MARK.

SN 85-364,122, FILED 7-6-2011.

MIDGE BUTLER, EXAMINING ATTORNEY



David J. Kyros

Director of the United States Patent and Trademark Office

United States of America

United States Patent and Trademark Office

PODNOD

Reg. No. 4,155,683

Registered June 5, 2012

Int. Cl.: 9

TRADEMARK

PRINCIPAL REGISTER

PODNOD INC. (DELAWARE CORPORATION)
1315 OXFORD ST.
BERKELEY, CA 94709

FOR: DOWNLOADABLE SOFTWARE IN THE NATURE OF A MOBILE APPLICATION FOR ASKING FOR SHOPPING ADVICE AND SHARING INFORMATION ABOUT SHOPPING EXPERIENCES, IN CLASS 9 (U.S. CLS. 21, 23, 26, 36 AND 38).

FIRST USE 10-5-2011; IN COMMERCE 10-11-2011.

THE MARK CONSISTS OF STANDARD CHARACTERS WITHOUT CLAIM TO ANY PARTICULAR FONT, STYLE, SIZE, OR COLOR.

SN 85-365,089, FILED 7-7-2011.

TEJBIR SINGH, EXAMINING ATTORNEY



David J. Kyros

Director of the United States Patent and Trademark Office

United States of America

United States Patent and Trademark Office

CredNet

Reg. No. 4,155,684

Registered June 5, 2012

Int. Cl.: 45

SERVICE MARK

PRINCIPAL REGISTER

CREDNET, LLC (FLORIDA LIMITED LIABILITY COMPANY)
11301 CORPORATE BLVD
STE 306
ORLANDO, FL 32817

FOR: VERIFYING AND MONITORING THE CREDENTIALS OF DOCTORS AND OTHER MEDICAL PROFESSIONALS, IN CLASS 45 (U.S. CLS. 100 AND 101).

FIRST USE 10-1-2011; IN COMMERCE 10-1-2011.

THE MARK CONSISTS OF STANDARD CHARACTERS WITHOUT CLAIM TO ANY PARTICULAR FONT, STYLE, SIZE, OR COLOR.

SN 85-365,141, FILED 7-7-2011.

BRIAN NEVILLE, EXAMINING ATTORNEY



David J. Kybas

Director of the United States Patent and Trademark Office

United States of America

United States Patent and Trademark Office

SureSleep 

Reg. No. 4,155,685

Registered June 5, 2012

Int. Cl.: 36

SERVICE MARK

PRINCIPAL REGISTER

4WARRANTY CORPORATION (FLORIDA CORPORATION)
2301 PARK AVENUE
SUITE 402
ORANGE PARK, FL 32073

FOR: PROVIDING WARRANTIES ON BEDS AND MATTRESSES MANUFACTURED BY OTHERS, IN CLASS 36 (U.S. CLS. 100, 101 AND 102).

FIRST USE 7-0-2011; IN COMMERCE 7-0-2011.

THE MARK CONSISTS OF THE WORDS "SURESLLEEP" TO THE LEFT OF THE IMAGE OF A INDIVIDUAL LAYING ON THEIR BACK WITH THEIR LEGS CROSSED.

SN 85-365,147, FILED 7-7-2011.

BRIAN NEVILLE, EXAMINING ATTORNEY



David J. Kybas

Director of the United States Patent and Trademark Office

United States of America

United States Patent and Trademark Office

THIS IS PERSONAL TO US

Reg. No. 4,155,686

JEFFERSON BANK (TEXAS FINANCIAL INSTITUTE)
2900 FREDERICKSBURG ROAD
SAN ANTONIO, TX 78201

Registered June 5, 2012

Int. Cl.: 36

FOR: BANKING AND FINANCING SERVICES; MORTGAGE BANKING; ON-LINE BANKING SERVICES; FINANCIAL SERVICES, NAMELY, WEALTH MANAGEMENT SERVICES, IN CLASS 36 (U.S. CLS. 100, 101 AND 102).

SERVICE MARK

FIRST USE 2-21-2012; IN COMMERCE 2-21-2012.

PRINCIPAL REGISTER

THE MARK CONSISTS OF STANDARD CHARACTERS WITHOUT CLAIM TO ANY PARTICULAR FONT, STYLE, SIZE, OR COLOR.

SN 85-365,148, FILED 7-7-2011.

BRIAN NEVILLE, EXAMINING ATTORNEY



David J. Kyros

Director of the United States Patent and Trademark Office

United States of America

United States Patent and Trademark Office

HERONFIELD ACADEMY

Reg. No. 4,155,687

HERONFIELD ACADEMY (NEW HAMPSHIRE NONPROFIT CORPORATION)
356 EXETER ROAD
HAMPTON FALLS, NH 03844

Registered June 5, 2012

Int. Cl.: 41

FOR: EDUCATIONAL SERVICES, NAMELY, PROVIDING COURSES OF INSTRUCTION AT THE MIDDLE SCHOOL LEVEL, IN CLASS 41 (U.S. CLS. 100, 101 AND 107).

SERVICE MARK

FIRST USE 9-30-2011; IN COMMERCE 9-30-2011.

PRINCIPAL REGISTER

THE MARK CONSISTS OF STANDARD CHARACTERS WITHOUT CLAIM TO ANY PARTICULAR FONT, STYLE, SIZE, OR COLOR.

NO CLAIM IS MADE TO THE EXCLUSIVE RIGHT TO USE "ACADEMY", APART FROM THE MARK AS SHOWN.

SN 85-365,485, FILED 7-7-2011.

WILLIAM ROSSMAN, EXAMINING ATTORNEY



David J. Kyffers

Director of the United States Patent and Trademark Office

United States of America

United States Patent and Trademark Office

FRUITY DRINK TIME!

Reg. No. 4,155,688

Registered June 5, 2012

Int. Cl.: 28

TRADEMARK

PRINCIPAL REGISTER

MATTEL, INC. (DELAWARE CORPORATION)
M1-1518
333 CONTINENTAL BOULEVARD
EL SEGUNDO, CA 90245

FOR: DOLL ACCESSORIES, IN CLASS 28 (U.S. CLS. 22, 23, 38 AND 50).

FIRST USE 3-29-2012; IN COMMERCE 3-29-2012.

THE MARK CONSISTS OF STANDARD CHARACTERS WITHOUT CLAIM TO ANY PARTICULAR FONT, STYLE, SIZE, OR COLOR.

SN 85-365,674, FILED 7-7-2011.

STEPHANIE ALI, EXAMINING ATTORNEY



David J. Kybas

Director of the United States Patent and Trademark Office

United States of America

United States Patent and Trademark Office

WE COLLECT RESULTS

Reg. No. 4,155,689

Registered June 5, 2012

Int. Cl.: 45

SERVICE MARK

PRINCIPAL REGISTER

MARKOFF KRASNY LLC (ILLINOIS LIMITED LIABILITY COMPANY)
#550
29 N. WACKER DRIVE
CHICAGO, IL 60606

FOR: LEGAL SERVICES, IN CLASS 45 (U.S. CLS. 100 AND 101).

FIRST USE 4-1-2011; IN COMMERCE 4-1-2011.

THE MARK CONSISTS OF STANDARD CHARACTERS WITHOUT CLAIM TO ANY PARTICULAR FONT, STYLE, SIZE, OR COLOR.

SN 85-366,114, FILED 7-8-2011.

JOHN HWANG, EXAMINING ATTORNEY



David J. Kybas

Director of the United States Patent and Trademark Office

United States of America

United States Patent and Trademark Office

BEBE TENDER PLUS+

Reg. No. 4,155,690

Registered June 5, 2012

Int. Cl.: 3

TRADEMARK

PRINCIPAL REGISTER

TUPPERWARE PRODUCTS S.A. (SWITZERLAND CORPORATION)
ROUTE DU JURA 37
FRIBOURG, SWITZERLAND CH-1700

FOR: PERFUMERY; SOAPS; TALCUM POWDER; NON-MEDICATED SKIN CARE PREPARATIONS; AND NON-MEDICATED HAIR CARE PREPARATIONS, IN CLASS 3 (U.S. CLS. 1, 4, 6, 50, 51 AND 52).

FIRST USE 3-8-2012; IN COMMERCE 3-8-2012.

THE MARK CONSISTS OF STANDARD CHARACTERS WITHOUT CLAIM TO ANY PARTICULAR FONT, STYLE, SIZE, OR COLOR.

NO CLAIM IS MADE TO THE EXCLUSIVE RIGHT TO USE "BEBE", APART FROM THE MARK AS SHOWN.

THE ENGLISH TRANSLATION OF "BEBE" IN THE MARK IS "BABY."

SN 85-366,192, FILED 7-8-2011.

ANDREW RHIM, EXAMINING ATTORNEY



David J. Kyffers

Director of the United States Patent and Trademark Office

United States of America

United States Patent and Trademark Office

netswipe

Reg. No. 4,155,691

Registered June 5, 2012

Int. Cls.: 9 and 36

TRADEMARK

SERVICE MARK

PRINCIPAL REGISTER

JUMIO INC. (DELAWARE CORPORATION)
1971 LANDINGS DRIVE
MOUNTAIN VIEW, CA 94043

FOR: COMPUTER SOFTWARE FOR PROCESSING ELECTRONIC PAYMENTS AND TRANSFERRING FUNDS TO AND FROM OTHERS AND FOR CREDIT AND DEBIT CARD TRANSACTION PROCESSING, IN CLASS 9 (U.S. CLS. 21, 23, 26, 36 AND 38).

FIRST USE 2-1-2011; IN COMMERCE 3-1-2011.

FOR: FINANCIAL TRANSACTION SERVICES, NAMELY, PROVIDING SECURE AUTHORIZATION AND SECURE PROCESSING SERVICES FOR ELECTRONIC PAYMENTS, CREDIT CARDS, AND DEBIT CARDS, IN CLASS 36 (U.S. CLS. 100, 101 AND 102).

FIRST USE 2-1-2011; IN COMMERCE 3-1-2011.

THE MARK CONSISTS OF THE WORD "NETSWIPE" WITH THE LETTERS "NET" ENCLOSED IN A RECTANGLE.

SN 85-366,748, FILED 7-8-2011.

JOHN WILKE, EXAMINING ATTORNEY



David J. Kyffers

Director of the United States Patent and Trademark Office

United States of America

United States Patent and Trademark Office

VOILA!

Reg. No. 4,155,692

Registered June 5, 2012

Int. Cl.: 42

SERVICE MARK

PRINCIPAL REGISTER

PROGNOSYS BIOSCIENCES, INC. (DELAWARE CORPORATION)
505 COAST BLVD. SOUTH
SUITE 103
LA JOLLA, CA 92037

FOR: BIOLOGICAL, BIOCHEMICAL, OR CHEMICAL RESEARCH AND ANALYSIS; DNA ANALYSIS SERVICES, IN CLASS 42 (U.S. CLS. 100 AND 101).

FIRST USE 10-3-2011; IN COMMERCE 10-3-2011.

THE MARK CONSISTS OF STANDARD CHARACTERS WITHOUT CLAIM TO ANY PARTICULAR FONT, STYLE, SIZE, OR COLOR.

SN 85-366,835, FILED 7-8-2011.

KIMBERLY PERRY, EXAMINING ATTORNEY



David J. Kybas

Director of the United States Patent and Trademark Office

United States of America

United States Patent and Trademark Office



Reg. No. 4,155,693

Registered June 5, 2012

Int. Cls.: 1, 9, and 42

TRADEMARK

SERVICE MARK

PRINCIPAL REGISTER

PROGNOSYS BIOSCIENCES, INC. (DELAWARE CORPORATION)
505 COAST BLVD. SOUTH, SUITE 103
LA JOLLA, CA 92037

FOR: REAGENTS FOR USE IN BIOLOGICAL, BIOCHEMICAL OR CHEMICAL ANALYSIS; REAGENTS FOR CHEMICAL ANALYSES; REAGENTS FOR USE IN SCIENTIFIC APPARATUS FOR BIOLOGICAL ANALYSIS; AND BIOCHEMICAL REAGENTS USED FOR NON-MEDICAL PURPOSES, IN CLASS 1 (U.S. CLS. 1, 5, 6, 10, 26 AND 46).

FIRST USE 6-27-2011; IN COMMERCE 6-27-2011.

FOR: KITS FOR ANALYSIS OF BIOLOGICAL, BIOCHEMICAL OR CHEMICAL MATERIALS, NAMELY, KITS COMPRISING MICROARRAYS, OLIGONUCLEOTIDES, ENZYMES, SEQUENCING REAGENTS, SAMPLE PREPARATION REAGENTS, AND REACTION CHAMBERS, FOR DETECTION AND ANALYSIS OF NORMAL AND VARIANT PROTEINS, INCLUDING QUANTITATION AND/OR ANALYSIS OF ACTIVITY OF PROTEINS AND FOR ANALYSIS OF NORMAL AND VARIANT NUCLEIC ACIDS, INCLUDING THE DETECTION AND QUANTITATION OF SEQUENCE VARIANTS; COMPUTER SOFTWARE FOR ANALYSIS OF BIOLOGICAL, BIOCHEMICAL OR CHEMICAL MATERIALS; APPARATUS AND KITS FOR ANALYSIS OF BIOLOGICAL, BIOCHEMICAL OR CHEMICAL MATERIALS, NAMELY, LABORATORY KITS FOR THE DETECTION OF GENETIC SEQUENCES AND SEQUENCE VARIATIONS IN A BIOLOGICAL SAMPLE FOR RESEARCH USE; COMPUTER SOFTWARE FOR USE IN THE ANALYSIS OF BIOLOGICAL, BIOCHEMICAL OR CHEMICAL MATERIALS, IN CLASS 9 (U.S. CLS. 21, 23, 26, 36 AND 38).

FIRST USE 6-27-2011; IN COMMERCE 6-27-2011.

FOR: BIOLOGICAL, BIOCHEMICAL, OR CHEMICAL RESEARCH AND ANALYSIS; DNA ANALYSIS SERVICES, IN CLASS 42 (U.S. CLS. 100 AND 101).

FIRST USE 6-27-2011; IN COMMERCE 6-27-2011.

THE MARK CONSISTS OF A BLUE X-SHAPED CROSS DESIGN BELOW A BLUE CIRCLE AND ABOVE THREE DIAGONAL GRAY STRIPES.

THE COLOR(S) BLUE AND GRAY IS/ARE CLAIMED AS A FEATURE OF THE MARK.



David J. Kybas

Director of the United States Patent and Trademark Office

Reg. No. 4,155,693 SN 85-366,859, FILED 7-8-2011.

KIMBERLY PERRY, EXAMINING ATTORNEY

United States of America

United States Patent and Trademark Office

Evolving Leadership

Reg. No. 4,155,694

Registered June 5, 2012

Int. Cl.: 41

SERVICE MARK

PRINCIPAL REGISTER

AVANTE LEADERSHIP GROUP, LLC (COLORADO LIMITED LIABILITY COMPANY)
2676 W. ALAMO AVENUE
SUITE 200
LITTLETON, CO 80120

FOR: BUSINESS EDUCATION AND TRAINING SERVICES, NAMELY, DEVELOPING AND FACILITATING CUSTOMIZED LEADERSHIP AND EXECUTIVE DEVELOPMENT PROGRAMS, PROVIDING EXECUTIVE COACHING SERVICES, AND PROVIDING BUSINESS EDUCATION PROGRAMS TO EMPLOYEES AND EXECUTIVES, IN CLASS 41 (U.S. CLS. 100, 101 AND 107).

FIRST USE 3-1-2011; IN COMMERCE 3-1-2011.

THE MARK CONSISTS OF STANDARD CHARACTERS WITHOUT CLAIM TO ANY PARTICULAR FONT, STYLE, SIZE, OR COLOR.

SN 85-367,036, FILED 7-8-2011.

GIANCARLO CASTRO, EXAMINING ATTORNEY



David J. Kyffers

Director of the United States Patent and Trademark Office

United States of America

United States Patent and Trademark Office

THE BELT WAND

Reg. No. 4,155,695

Registered June 5, 2012

Int. Cl.: 42

SERVICE MARK

PRINCIPAL REGISTER

J.H. FENNER & CO. LIMITED (UNITED KINGDOM LIMITED LIABILITY COMPANY)
HESSLEWOOD COUNTRY OFFICE PARK
FERRIBY ROAD
HESSLE, EAST YORKSHIRE, UNITED KINGDOM HU13OPW

FOR: INSPECTION, ANALYSIS, AND EVALUATION OF CUSTOMERS' CONVEYOR BELTS AND RELATED CONVEYOR BELT COMPONENTS AND PROVIDING DETAILED INSPECTION REPORTS RELATED THERETO, WHICH REPORTS ALSO CONTAIN INFORMATION ABOUT RECOMMENDED BELT MAINTENANCE AND REPAIR, IN CLASS 42 (U.S. CLS. 100 AND 101).

FIRST USE 8-12-2010; IN COMMERCE 8-12-2010.

THE MARK CONSISTS OF STANDARD CHARACTERS WITHOUT CLAIM TO ANY PARTICULAR FONT, STYLE, SIZE, OR COLOR.

NO CLAIM IS MADE TO THE EXCLUSIVE RIGHT TO USE "BELT", APART FROM THE MARK AS SHOWN.

SN 85-368,073, FILED 7-11-2011.

KIMBERLY FRYE, EXAMINING ATTORNEY



David J. Kyffers

Director of the United States Patent and Trademark Office

United States of America

United States Patent and Trademark Office

APPRISE HEALTH INSIGHTS

Reg. No. 4,155,696

OREGON HEALTHCARE ENTERPRISES, INC. (OREGON CORPORATION)

Registered June 5, 2012

4000 KRUSE WAY PLACE, #2-100
LAKE OSWEGO, OR 970352543

Int. Cl.: 35

FOR: BUSINESS INFORMATION SERVICES, NAMELY, THE COLLECTION, REVIEW, ANALYSIS, EDITING, VERIFICATION AND REPORTING OF HOSPITAL FINANCIAL, UTILIZATION, AND QUALITY INFORMATION FOR BUSINESS PURPOSES, IN CLASS 35 (U.S. CLS. 100, 101 AND 102).

SERVICE MARK

PRINCIPAL REGISTER

FIRST USE 9-29-2011; IN COMMERCE 9-29-2011.

THE MARK CONSISTS OF STANDARD CHARACTERS WITHOUT CLAIM TO ANY PARTICULAR FONT, STYLE, SIZE, OR COLOR.

NO CLAIM IS MADE TO THE EXCLUSIVE RIGHT TO USE "HEALTH", APART FROM THE MARK AS SHOWN.

SN 85-368,078, FILED 7-11-2011.

RENEE MCCRAY, EXAMINING ATTORNEY



David J. Kyros

Director of the United States Patent and Trademark Office

United States of America

United States Patent and Trademark Office

ROCKET WEASEL

Reg. No. 4,155,697

Registered June 5, 2012

Int. Cl.: 9

TRADEMARK

PRINCIPAL REGISTER

FREEZE TAG, INC. (DELAWARE CORPORATION)
228 WEST MAIN STREET
2ND FLOOR
TUSTIN, CA 92780

FOR: COMPUTER GAME SOFTWARE; VIDEO GAME SOFTWARE; ELECTRONIC GAME PROGRAMS; DOWNLOADABLE ELECTRONIC GAME PROGRAMS; ELECTRONIC GAME SOFTWARE; COMPUTER GAME PROGRAMS; DOWNLOADABLE COMPUTER GAME PROGRAMS; INTERACTIVE GAME PROGRAMS; INTERACTIVE GAME SOFTWARE; COMPUTER AND VIDEO GAME SOFTWARE FOR USE ON ELECTRONIC DEVICES, INCLUDING HANDHELD DEVICES AND WIRELESS DEVICES, IN CLASS 9 (U.S. CLS. 21, 23, 26, 36 AND 38).

FIRST USE 2-2-2012; IN COMMERCE 2-2-2012.

THE MARK CONSISTS OF STANDARD CHARACTERS WITHOUT CLAIM TO ANY PARTICULAR FONT, STYLE, SIZE, OR COLOR.

SN 85-368,208, FILED 7-11-2011.

STEVEN PEREZ, EXAMINING ATTORNEY



David J. Kyffers

Director of the United States Patent and Trademark Office

United States of America

United States Patent and Trademark Office

Need Scoring

Reg. No. 4,155,698

Registered June 5, 2012

Int. Cl.: 35

SERVICE MARK

PRINCIPAL REGISTER

COMPANY DATA TREES, INC. (CALIFORNIA CORPORATION)
102
9707 WAPLES ST
SAN DIEGO, CA 92121

FOR: MARKETING CONSULTING, IN CLASS 35 (U.S. CLS. 100, 101 AND 102).

FIRST USE 7-1-2011; IN COMMERCE 10-10-2011.

THE MARK CONSISTS OF STANDARD CHARACTERS WITHOUT CLAIM TO ANY PARTICULAR FONT, STYLE, SIZE, OR COLOR.

NO CLAIM IS MADE TO THE EXCLUSIVE RIGHT TO USE "SCORING", APART FROM THE MARK AS SHOWN.

SN 85-368,285, FILED 7-11-2011.

JOHN LINCOSKI, EXAMINING ATTORNEY



David J. Kyffers

Director of the United States Patent and Trademark Office

United States of America

United States Patent and Trademark Office



Reg. No. 4,155,699

Registered June 5, 2012

Int. Cl.: 35

SERVICE MARK

PRINCIPAL REGISTER

DANIEL HARI VASWANI (UNITED STATES INDIVIDUAL)
5172 CAPITOLA WAY
UNION CITY, CA 94587

FOR: BUSINESS ADVISORY AND CONSULTANCY SERVICES RELATING TO EXPORT, EXPORT SERVICES, EXPORT PROMOTION INFORMATION AND SERVICES; EXPORT AGENCY SERVICES FOR THE GOODS OF OTHERS; EXPORT AND IMPORT AGENCIES; GOODS IMPORT-EXPORT AGENCIES; IMPORT AND EXPORT AGENCIES, IN CLASS 35 (U.S. CLS. 100, 101 AND 102).

FIRST USE 5-1-2011; IN COMMERCE 8-21-2011.

NO CLAIM IS MADE TO THE EXCLUSIVE RIGHT TO USE "GLOBAL COMMERCE THE SMART WAY", APART FROM THE MARK AS SHOWN.

THE MARK CONSISTS OF A THREE-QUARTERS OVAL SHAPE WITH A BIRD'S HEAD FACING RIGHT WITH A SINGLE EYE IN THE OVAL DESIGN. THE MARK CUTS OFF AT THE BOTTOM WITH A STRAIT LINE CUTTING OFF THE OVAL SHAPE PREMATURELY. THE WORDING "KAGU9" APPEARS IN STYLIZED LETTERS LOCATED IN THE LEFT-CENTER PORTION, AND THE WORDING "GLOBAL COMMERCE THE SMART WAY" IN STYLIZED WRITING LOCATED UNDER THE STRAIT LINE CUTTING OFF THE OVAL SHAPE.

SN 85-368,324, FILED 7-11-2011.

STEPHANIE ALI, EXAMINING ATTORNEY



David J. Kyjars

Director of the United States Patent and Trademark Office

United States of America

United States Patent and Trademark Office

WE RENOVATE. WE SELL. YOU
PROFIT.

Reg. No. 4,155,700

RENOVATION REALTY, INC. (CALIFORNIA CORPORATION)
7777 ALVARADO RD, STE 602
LA MESA, CA 91942

Registered June 5, 2012

Int. Cls.: 35, 36, and 37

FOR: REAL ESTATE ADVERTISING SERVICES; REAL ESTATE MARKETING SERVICES
IN THE FIELD OF RESIDENTIAL PROPERTIES, IN CLASS 35 (U.S. CLS. 100, 101 AND 102).

SERVICE MARK

FIRST USE 9-12-2011; IN COMMERCE 9-12-2011.

PRINCIPAL REGISTER

FOR: APPRAISAL AND EVALUATION OF REAL ESTATE; PROVIDING INFORMATION
IN THE FIELD OF REAL ESTATE VIA THE INTERNET; REAL ESTATE BROKERAGE;
REAL ESTATE CONSULTANCY; REAL ESTATE LISTING, IN CLASS 36 (U.S. CLS. 100,
101 AND 102).

FIRST USE 9-12-2011; IN COMMERCE 9-12-2011.

FOR: CONSTRUCTION AND RENOVATION OF BUILDINGS; PROVIDING INFORMATION
IN THE FIELD OF HOME RENOVATIONS AND REPAIRS, IN CLASS 37 (U.S. CLS. 100, 103
AND 106).

FIRST USE 9-12-2011; IN COMMERCE 9-12-2011.

THE MARK CONSISTS OF STANDARD CHARACTERS WITHOUT CLAIM TO ANY PAR-
TICULAR FONT, STYLE, SIZE, OR COLOR.

SN 85-369,707, FILED 7-12-2011.

KAREN BRACEY, EXAMINING ATTORNEY



David J. Kyffers

Director of the United States Patent and Trademark Office

United States of America

United States Patent and Trademark Office

POETRY IN MOTION

Reg. No. 4,155,701

Registered June 5, 2012

Int. Cl.: 11

TRADEMARK

PRINCIPAL REGISTER

DELTA T CORPORATION (KENTUCKY CORPORATION)
2425 MERCHANT STREET
LEXINGTON, KY 40511

FOR: ELECTRIC FANS, IN CLASS 11 (U.S. CLS. 13, 21, 23, 31 AND 34).

FIRST USE 2-0-2012; IN COMMERCE 2-0-2012.

THE MARK CONSISTS OF STANDARD CHARACTERS WITHOUT CLAIM TO ANY PARTICULAR FONT, STYLE, SIZE, OR COLOR.

SN 85-369,853, FILED 7-13-2011.

BRIDGETT SMITH, EXAMINING ATTORNEY



David J. Kybas

Director of the United States Patent and Trademark Office

United States of America

United States Patent and Trademark Office

Force XR

Reg. No. 4,155,702

NIKON CORPORATION (JAPAN CORPORATION)
12-1, YURAKUCHO 1-CHOME, CHIYODA-KU
TOKYO, JAPAN

Registered June 5, 2012

Int. Cl.: 9

FOR: RIFLESCOPES, IN CLASS 9 (U.S. CLS. 21, 23, 26, 36 AND 38).

TRADEMARK

FIRST USE 11-1-2011; IN COMMERCE 11-1-2011.

PRINCIPAL REGISTER

THE MARK CONSISTS OF STANDARD CHARACTERS WITHOUT CLAIM TO ANY PARTICULAR FONT, STYLE, SIZE, OR COLOR.

SN 85-369,859, FILED 7-13-2011.

ANTHONY RINKER, EXAMINING ATTORNEY



David J. Kybas

Director of the United States Patent and Trademark Office

United States of America

United States Patent and Trademark Office



Reg. No. 4,155,703

Registered June 5, 2012

Int. Cl.: 9

TRADEMARK

PRINCIPAL REGISTER

NIKON CORPORATION (JAPAN CORPORATION)
12-1, YURAKUCHO 1-CHOME, CHIYODA-KU
TOKYO, JAPAN

FOR: RIFLESCOPES, IN CLASS 9 (U.S. CLS. 21, 23, 26, 36 AND 38).

FIRST USE 11-1-2011; IN COMMERCE 11-1-2011.

THE MARK CONSISTS OF A TRIANGULAR SHIELD SHAPE CARRYING THE LARGE STYLIZED LETTER "F" NEXT AND TO THE LEFT OF THE SMALLER CONNECTED LETTERS "XR".

SN 85-369,869, FILED 7-13-2011.

ANTHONY RINKER, EXAMINING ATTORNEY



David J. Kybas

Director of the United States Patent and Trademark Office

United States of America

United States Patent and Trademark Office

CLARESTA

Reg. No. 4,155,704

Registered June 5, 2012

Int. Cl.: 3

TRADEMARK

PRINCIPAL REGISTER

JAFRA COSMETICS INTERNATIONAL, INC. (DELAWARE CORPORATION)
2451 TOWNSGATE ROAD
WESTLAKE VILLAGE, CA 91361

FOR: FRAGRANCES, IN CLASS 3 (U.S. CLS. 1, 4, 6, 50, 51 AND 52).

FIRST USE 1-21-2012; IN COMMERCE 1-21-2012.

THE MARK CONSISTS OF STANDARD CHARACTERS WITHOUT CLAIM TO ANY PARTICULAR FONT, STYLE, SIZE, OR COLOR.

SN 85-370,137, FILED 7-13-2011.

LEIGH CAROLINE CASE, EXAMINING ATTORNEY



David J. Kyffers

Director of the United States Patent and Trademark Office

United States of America

United States Patent and Trademark Office

RESOLUTE

Reg. No. 4,155,705

Registered June 5, 2012

Int. Cl.: 6

TRADEMARK

PRINCIPAL REGISTER

DER SHENG CO., LTD. (TAIWAN CORPORATION)
50-50, WANNIAN LANE, WAN-NIAN LI
YUANLIN TOWNSHIP
CHANGHUA COUNTY, TAIWAN R.O.C.

FOR: METAL CASTERS AND WHEELS FOR METAL CASTERS, IN CLASS 6 (U.S. CLS. 2, 12, 13, 14, 23, 25 AND 50).

FIRST USE 10-21-2010; IN COMMERCE 10-21-2010.

THE MARK CONSISTS OF STYLIZED LETTERS FORMING THE WORD "RESOLUTE".

SN 85-370,254, FILED 7-13-2011.

ESTHER BELENKER, EXAMINING ATTORNEY



David J. Kybas

Director of the United States Patent and Trademark Office

United States of America

United States Patent and Trademark Office

CHALLENGE DRIVES US

Reg. No. 4,155,706

Registered June 5, 2012

Int. Cl.: 45

SERVICE MARK

PRINCIPAL REGISTER

MONTGOMERY, MCCrackEN, WALKER & RHOADS, LLP (PENNSYLVANIA LIMITED LIABILITY PARTNERSHIP)
123 SOUTH BROAD STREET
PHILADELPHIA, PA 19109

FOR: LEGAL SERVICES, IN CLASS 45 (U.S. CLS. 100 AND 101).

FIRST USE 3-1-2012; IN COMMERCE 3-1-2012.

THE MARK CONSISTS OF STANDARD CHARACTERS WITHOUT CLAIM TO ANY PARTICULAR FONT, STYLE, SIZE, OR COLOR.

SN 85-370,302, FILED 7-13-2011.

ALEXANDER L. POWERS, EXAMINING ATTORNEY



David J. Kyros

Director of the United States Patent and Trademark Office

United States of America

United States Patent and Trademark Office

RESOLUTE

Reg. No. 4,155,707

Registered June 5, 2012

Int. Cl.: 20

TRADEMARK

PRINCIPAL REGISTER

DER SHENG CO., LTD. (TAIWAN CORPORATION)
50-50, WANNIAN LANE, WAN-NIAN LI
YUANLIN TOWNSHIP
CHANGHUA COUNTY, TAIWAN R.O.C.

FOR: NON-METAL CASTERS AND WHEELS FOR NON-METAL CASTERS, IN CLASS 20
(U.S. CLS. 2, 13, 22, 25, 32 AND 50).

FIRST USE 10-21-2010; IN COMMERCE 10-21-2010.

THE MARK CONSISTS OF STYLIZED LETTERS FORMING THE WORD "RESOLUTE".

SN 85-370,311, FILED 7-13-2011.

ESTHER BELENKER, EXAMINING ATTORNEY



David J. Kybas

Director of the United States Patent and Trademark Office

United States of America

United States Patent and Trademark Office

Life is a school of compassion

Reg. No. 4,155,708

Registered June 5, 2012

Int. Cl.: 25

TRADEMARK

PRINCIPAL REGISTER

NGUYEN, MAI-TRANG THI (UNITED STATES INDIVIDUAL)
2250 MONROE STREET
#182
SANTA CLARA, CA 95050

FOR: HATS; SCARVES; T-SHIRTS, IN CLASS 25 (U.S. CLS. 22 AND 39).

FIRST USE 4-20-2000; IN COMMERCE 4-20-2000.

THE MARK CONSISTS OF STANDARD CHARACTERS WITHOUT CLAIM TO ANY PARTICULAR FONT, STYLE, SIZE, OR COLOR.

SN 85-370,656, FILED 7-13-2011.

KELLY BOULTON, EXAMINING ATTORNEY



David J. Kybas

Director of the United States Patent and Trademark Office

United States of America

United States Patent and Trademark Office

F4F

Reg. No. 4,155,709

Registered June 5, 2012

Int. Cls.: 41 and 44

SERVICE MARK

PRINCIPAL REGISTER

WEST VIRGINIA UNIVERSITY (WEST VIRGINIA STATE UNIVERSITY)
886 CHESTNUT RIDGE ROAD, PO BOX 6224
MORGANTOWN, WV 26506

FOR: PHYSICAL FITNESS CONSULTATION, FEATURING A MULTIDISCIPLINARY EXERCISE PROGRAM BASED ON THE EVALUATION OF AN INDIVIDUAL'S BODY MASS INDEX, HABITUAL PHYSICAL ACTIVITY AND INFLAMMATORY MARKERS ASSOCIATED WITH RECURRENCE IN OBESE BREAST CANCER SURVIVORS, IN CLASS 41 (U.S. CLS. 100, 101 AND 107).

FIRST USE 3-5-2012; IN COMMERCE 3-5-2012.

FOR: COUNSELING SERVICES IN THE FIELD OF HEALTH AND NUTRITION, NAMELY, PROVIDING DIETARY AND NUTRITIONAL GUIDANCE BASED ON EVALUATING AN INDIVIDUAL'S BODY MASS INDEX, HABITUAL PHYSICAL ACTIVITY AND INFLAMMATORY MARKERS ASSOCIATED WITH RECURRENCE IN OBESE BREAST CANCER SURVIVORS, IN CLASS 44 (U.S. CLS. 100 AND 101).

FIRST USE 3-5-2012; IN COMMERCE 3-5-2012.

THE MARK CONSISTS OF STANDARD CHARACTERS WITHOUT CLAIM TO ANY PARTICULAR FONT, STYLE, SIZE, OR COLOR.

SN 85-371,005, FILED 7-14-2011.

AHSEN KHAN, EXAMINING ATTORNEY



David J. Kyffers

Director of the United States Patent and Trademark Office

United States of America

United States Patent and Trademark Office

SLUMBREW

Reg. No. 4,155,710

Registered June 5, 2012

Int. Cl.: 32

TRADEMARK

PRINCIPAL REGISTER

SOMERVILLE BREWING COMPANY (DELAWARE CORPORATION)
1310 BROADWAY
SOMERVILLE, MA 02144

FOR: BEER, ALE, LAGER, STOUT AND PORTER, IN CLASS 32 (U.S. CLS. 45, 46 AND 48).

FIRST USE 2-4-2011; IN COMMERCE 11-29-2011.

THE MARK CONSISTS OF STANDARD CHARACTERS WITHOUT CLAIM TO ANY PARTICULAR FONT, STYLE, SIZE, OR COLOR.

SN 85-371,112, FILED 7-14-2011.

ALICIA COLLINS, EXAMINING ATTORNEY



David J. Kyffers

Director of the United States Patent and Trademark Office

United States of America

United States Patent and Trademark Office

SOHO SQUARE

Reg. No. 4,155,711

FRANK MORANO (UNITED STATES INDIVIDUAL)
112 KINGHORN STREET
STATEN ISLAND, NY 10312

Registered June 5, 2012

Int. Cl.: 43

FOR: RESTAURANT AND CARRYOUT SERVICES FEATURING PIZZA, IN CLASS 43 (U.S. CLS. 100 AND 101).

SERVICE MARK

FIRST USE 9-1-2011; IN COMMERCE 9-1-2011.

PRINCIPAL REGISTER

THE MARK CONSISTS OF STANDARD CHARACTERS WITHOUT CLAIM TO ANY PARTICULAR FONT, STYLE, SIZE, OR COLOR.

NO CLAIM IS MADE TO THE EXCLUSIVE RIGHT TO USE "SOHO", APART FROM THE MARK AS SHOWN.

SN 85-371,321, FILED 7-14-2011.

EMILY CARLSEN, EXAMINING ATTORNEY



David J. Kybas

Director of the United States Patent and Trademark Office

United States of America

United States Patent and Trademark Office



Reg. No. 4,155,712

L'OREAL USA CREATIVE, INC. (DELAWARE CORPORATION)
575 FIFTH AVENUE
NEW YORK, NY 10017

Registered June 5, 2012

Int. Cl.: 3

FOR: NON-MEDICATED SKIN CARE PREPARATIONS, LIP BALM, AND FACIAL CLEANSING PREPARATIONS, IN CLASS 3 (U.S. CLS. 1, 4, 6, 50, 51 AND 52).

TRADEMARK

FIRST USE 4-2-2012; IN COMMERCE 4-2-2012.

PRINCIPAL REGISTER

OWNER OF U.S. REG. NOS. 3,032,170, 3,670,892, AND OTHERS.

NO CLAIM IS MADE TO THE EXCLUSIVE RIGHT TO USE "NEW YORK CITY", APART FROM THE MARK AS SHOWN.

THE MARK CONSISTS OF A STYLIZED LETTER "K" INCORPORATING A MORTAR AND PESTLE ELEMENT APPEARING INSIDE A WINGED CIRCLE DESIGN WITH THE WORDS "NEW YORK CITY" APPEARING IN A BANNER UNDERNEATH.

SN 85-371,662, FILED 7-14-2011.

JIM RINGLE, EXAMINING ATTORNEY



David J. Kyros

Director of the United States Patent and Trademark Office

United States of America

United States Patent and Trademark Office

CAPITAL DEFENDER FUND

Reg. No. 4,155,713

STRUCTURED INVESTMENT MANAGEMENT, INC. (DELAWARE CORPORATION)
AIFS MEZZANINE, 335 MADISON AVENUE
NEW YORK, NY 10017

Registered June 5, 2012

Int. Cl.: 36

FOR: FUNDS INVESTMENT; INVESTMENT SERVICES, NAMELY, MUTUAL FUND INVESTMENT SERVICES; INVESTMENT OF FUNDS FOR OTHERS; FUNDS INVESTMENT CONSULTATION, IN CLASS 36 (U.S. CLS. 100, 101 AND 102).

SERVICE MARK

FIRST USE 8-31-2011; IN COMMERCE 8-31-2011.

PRINCIPAL REGISTER

THE MARK CONSISTS OF STANDARD CHARACTERS WITHOUT CLAIM TO ANY PARTICULAR FONT, STYLE, SIZE, OR COLOR.

NO CLAIM IS MADE TO THE EXCLUSIVE RIGHT TO USE "CAPITAL" AND "FUND", APART FROM THE MARK AS SHOWN.

SN 85-371,677, FILED 7-14-2011.

SUSAN STIGLITZ, EXAMINING ATTORNEY



David J. Kybas

Director of the United States Patent and Trademark Office

United States of America

United States Patent and Trademark Office

THE REAR VIEW

Reg. No. 4,155,714

Registered June 5, 2012

Int. Cl.: 41

SERVICE MARK

PRINCIPAL REGISTER

SPANX, INC. (GEORGIA CORPORATION)
3344 PEACHTREE ROAD
SUITE 1700, GA 30326

FOR: ONLINE PUBLICATIONS, NAMELY, BLOGS FEATURING NEWS ABOUT CELEBRITIES, FASHION, CLOTHING AND PHILANTHROPY, IN CLASS 41 (U.S. CLS. 100, 101 AND 107).

FIRST USE 7-28-2011; IN COMMERCE 7-28-2011.

THE MARK CONSISTS OF STANDARD CHARACTERS WITHOUT CLAIM TO ANY PARTICULAR FONT, STYLE, SIZE, OR COLOR.

SN 85-372,462, FILED 7-15-2011.

JAMES MACFARLANE, EXAMINING ATTORNEY



David J. Kyros

Director of the United States Patent and Trademark Office

United States of America

United States Patent and Trademark Office

H2O4

Reg. No. 4,155,715

DAVID E. CHILTON (TENNESSEE SOLE PROPRIETORSHIP), DBA DC COMPANY,
1416 FORRESTAL WAY
ANTIOCH, TN 37013

Registered June 5, 2012

Int. Cl.: 32

FOR: FLAVORED WATERS; GLACIAL WATER; MINERAL WATER; SPARKLING WATER;
SPRING WATER, IN CLASS 32 (U.S. CLS. 45, 46 AND 48).

TRADEMARK

FIRST USE 11-1-2011; IN COMMERCE 11-1-2011.

PRINCIPAL REGISTER

THE MARK CONSISTS OF STANDARD CHARACTERS WITHOUT CLAIM TO ANY PAR-
TICULAR FONT, STYLE, SIZE, OR COLOR.

SN 85-372,734, FILED 7-15-2011.

BRIAN NEVILLE, EXAMINING ATTORNEY



David J. Kybas

Director of the United States Patent and Trademark Office

United States of America

United States Patent and Trademark Office

FISHBOWLLA

Reg. No. 4,155,716

Registered June 5, 2012

Int. Cl.: 41

SERVICE MARK

PRINCIPAL REGISTER

MEDIABISTRO.COM INC. (DELAWARE CORPORATION)
9TH FLOOR
50 WASHINGTON STREET
NORWALK, CT 06854

FOR: PROVIDING ON-LINE PUBLICATIONS IN THE NATURE OF A NEWSLETTER AND BLOG IN THE FIELD OF NEWS, MEDIA, ENTERTAINMENT, AND PUBLIC RELATIONS WITH A PRIMARY FOCUS ON THE LOS ANGELES AREA, IN CLASS 41 (U.S. CLS. 100, 101 AND 107).

FIRST USE 1-11-2004; IN COMMERCE 1-11-2004.

THE MARK CONSISTS OF STANDARD CHARACTERS WITHOUT CLAIM TO ANY PARTICULAR FONT, STYLE, SIZE, OR COLOR.

OWNER OF U.S. REG. NO. 3,704,983.

SN 85-372,754, FILED 7-15-2011.

DAVID COLLIER, EXAMINING ATTORNEY



David J. Kyros

Director of the United States Patent and Trademark Office

United States of America

United States Patent and Trademark Office

FISHBOWLDC

Reg. No. 4,155,717

Registered June 5, 2012

Int. Cl.: 41

SERVICE MARK

PRINCIPAL REGISTER

MEDIABISTRO.COM INC. (DELAWARE CORPORATION)
9TH FLOOR
50 WASHINGTON STREET
NORWALK, CT 06854

FOR: PROVIDING ON-LINE PUBLICATIONS IN THE NATURE OF A NEWSLETTER AND BLOG IN THE FIELD OF NEWS, MEDIA, ENTERTAINMENT, AND PUBLIC RELATIONS WITH A PRIMARY FOCUS ON THE WASHINGTON, DC AREA, IN CLASS 41 (U.S. CLS. 100, 101 AND 107).

FIRST USE 1-11-2004; IN COMMERCE 1-11-2004.

THE MARK CONSISTS OF STANDARD CHARACTERS WITHOUT CLAIM TO ANY PARTICULAR FONT, STYLE, SIZE, OR COLOR.

OWNER OF U.S. REG. NO. 3,704,983.

SN 85-372,765, FILED 7-15-2011.

DAVID COLLIER, EXAMINING ATTORNEY



David J. Kyros

Director of the United States Patent and Trademark Office

United States of America

United States Patent and Trademark Office

eHab

Reg. No. 4,155,718

Registered June 5, 2012

Int. Cl.: 44

SERVICE MARK

PRINCIPAL REGISTER

RELEVANT RECOVERY INC (FLORIDA CORPORATION)
3170 N FEDERAL HWY STE 100
LIGHTHOUSE POINT, FL 33064

FOR: SUBSTANCE AND ALCOHOL ABUSE ONLINE REHABILITATION COUNSELING
AND ADDICTION TREATMENT SERVICES, IN CLASS 44 (U.S. CLS. 100 AND 101).

FIRST USE 7-12-2011; IN COMMERCE 10-28-2011.

THE MARK CONSISTS OF STANDARD CHARACTERS WITHOUT CLAIM TO ANY PAR-
TICULAR FONT, STYLE, SIZE, OR COLOR.

THE NAME "EHAB" FORMING THE MARK DOES NOT IDENTIFY A LIVING INDIVIDUAL.

SN 85-373,555, FILED 7-18-2011.

DAVID C. REIHNER, EXAMINING ATTORNEY



David J. Kybas

Director of the United States Patent and Trademark Office

United States of America

United States Patent and Trademark Office

BROOKS ISLAND

Reg. No. 4,155,719

Registered June 5, 2012

Int. Cl.: 20

TRADEMARK

PRINCIPAL REGISTER

TARGET BRANDS, INC. (MINNESOTA CORPORATION)
1000 NICOLLET MALL
MINNEAPOLIS, MN 55403

FOR: OUTDOOR PATIO FURNITURE, IN CLASS 20 (U.S. CLS. 2, 13, 22, 25, 32 AND 50).

FIRST USE 1-1-2012; IN COMMERCE 1-1-2012.

THE MARK CONSISTS OF STANDARD CHARACTERS WITHOUT CLAIM TO ANY PARTICULAR FONT, STYLE, SIZE, OR COLOR.

SN 85-373,840, FILED 7-18-2011.

HELENE LIWINSKI, EXAMINING ATTORNEY



David J. Kyros

Director of the United States Patent and Trademark Office

United States of America

United States Patent and Trademark Office

AIRCOOL

Reg. No. 4,155,720

Registered June 5, 2012

Int. Cl.: 20

TRADEMARK

PRINCIPAL REGISTER

DREAMWELL, LTD. (NEVADA LIMITED LIABILITY COMPANY)
SUITE 12
2215-B RENAISSANCE DRIVE
LAS VEGAS, NV 89119

FOR: MATTRESS COMPONENTS, NAMELY, MATTRESS FOAM, MESH BORDERS, FOAM CORES, ELASTIC GEL MATERIAL LOCATED IN THE TOP UPHOLSTERY LAYER OF MATTRESSES, ALL SOLD AS INTEGRAL COMPONENTS OF A MATTRESS, IN CLASS 20 (U.S. CLS. 2, 13, 22, 25, 32 AND 50).

FIRST USE 7-31-2011; IN COMMERCE 7-31-2011.

THE MARK CONSISTS OF STANDARD CHARACTERS WITHOUT CLAIM TO ANY PARTICULAR FONT, STYLE, SIZE, OR COLOR.

SN 85-373,891, FILED 7-18-2011.

ELISSA GARBER KON, EXAMINING ATTORNEY



David J. Kybas

Director of the United States Patent and Trademark Office

United States of America

United States Patent and Trademark Office

RED DOUGH

Reg. No. 4,155,721

ST. LOUIS COMMUNITY CREDIT UNION (MISSOURI CREDIT UNION)
3651 FOREST PARK AVE.
ST. LOUIS, MO 63108

Registered June 5, 2012

Int. Cl.: 36

FOR: DEBIT CARD SERVICES; ISSUING RELOADABLE PREPAID DEBIT CARDS; CREDIT UNION SERVICES, IN CLASS 36 (U.S. CLS. 100, 101 AND 102).

SERVICE MARK

FIRST USE 11-0-2011; IN COMMERCE 11-0-2011.

PRINCIPAL REGISTER

THE MARK CONSISTS OF STANDARD CHARACTERS WITHOUT CLAIM TO ANY PARTICULAR FONT, STYLE, SIZE, OR COLOR.

NO CLAIM IS MADE TO THE EXCLUSIVE RIGHT TO USE "DOUGH", APART FROM THE MARK AS SHOWN.

SN 85-373,945, FILED 7-18-2011.

JOHN DALIER, EXAMINING ATTORNEY



David J. Kybas

Director of the United States Patent and Trademark Office

United States of America

United States Patent and Trademark Office

VEGAS HOWL-O-WEEKEND

Reg. No. 4,155,722

LAS VEGAS CONVENTION AND VISITORS AUTHORITY (NEVADA STATE AGENCY)
3150 PARADISE ROAD
LAS VEGAS, NV 89109

Registered June 5, 2012

Int. Cl.: 35

FOR: PROMOTING THE LAS VEGAS, NEVADA AREA AS A DESTINATION FOR LEISURE AND VACATION TRAVEL, IN CLASS 35 (U.S. CLS. 100, 101 AND 102).

SERVICE MARK

FIRST USE 10-6-2011; IN COMMERCE 10-6-2011.

PRINCIPAL REGISTER

THE MARK CONSISTS OF STANDARD CHARACTERS WITHOUT CLAIM TO ANY PARTICULAR FONT, STYLE, SIZE, OR COLOR.

NO CLAIM IS MADE TO THE EXCLUSIVE RIGHT TO USE "VEGAS", APART FROM THE MARK AS SHOWN.

SN 85-374,160, FILED 7-18-2011.

JANICE L. MCMORROW, EXAMINING ATTORNEY



David J. Kybas

Director of the United States Patent and Trademark Office

United States of America

United States Patent and Trademark Office

KAOPOLITE

Reg. No. 4,155,723

Registered June 5, 2012

Int. Cl.: 17

TRADEMARK

PRINCIPAL REGISTER

IMERYS KAOLIN, INC. (DELAWARE CORPORATION)
100 MANSELL COURT, SUITE 300
ROSWELL, GA 30078

FOR: MICA, IN CLASS 17 (U.S. CLS. 1, 5, 12, 13, 35 AND 50).

FIRST USE 1-0-2012; IN COMMERCE 1-0-2012.

THE MARK CONSISTS OF STANDARD CHARACTERS WITHOUT CLAIM TO ANY PARTICULAR FONT, STYLE, SIZE, OR COLOR.

OWNER OF U.S. REG. NO. 921,774.

SN 85-374,653, FILED 7-19-2011.

FRED CARL, EXAMINING ATTORNEY



David J. Kyffers

Director of the United States Patent and Trademark Office

United States of America

United States Patent and Trademark Office

RELEVANT RECOVERY

Reg. No. 4,155,724

Registered June 5, 2012

Int. Cl.: 44

SERVICE MARK

PRINCIPAL REGISTER

RELEVANT RECOVERY INC (FLORIDA CORPORATION)
3170 N FEDERAL HWY
SUITE 100
LIGHTHOUSE POINT, FL 33064

FOR: REHABILITATION OF DRUG ADDICTED PATIENTS; REHABILITATION OF ALCOHOL ADDICTED PATIENTS; PROVIDING ON-LINE DRUG AND ALCOHOL ADDICTION RECOVERY COUNSELING SERVICES, IN CLASS 44 (U.S. CLS. 100 AND 101).

FIRST USE 7-12-2011; IN COMMERCE 10-28-2011.

THE MARK CONSISTS OF STANDARD CHARACTERS WITHOUT CLAIM TO ANY PARTICULAR FONT, STYLE, SIZE, OR COLOR.

NO CLAIM IS MADE TO THE EXCLUSIVE RIGHT TO USE "RECOVERY", APART FROM THE MARK AS SHOWN.

SN 85-375,099, FILED 7-19-2011.

DAVID C. REIHNER, EXAMINING ATTORNEY



David J. Kyros

Director of the United States Patent and Trademark Office

United States of America

United States Patent and Trademark Office

THE ANTIDOTE FOR EGO

Reg. No. 4,155,725

Registered June 5, 2012

Int. Cl.: 5

TRADEMARK

PRINCIPAL REGISTER

RETTIG, HEIDI K. (UNITED STATES INDIVIDUAL)
620 S. LOUDOUN STREET
WINCHESTER, VA 22601

FOR: AROMATHERAPY CREAMS FOR RELAXATION AND RELIEVING STRESS; AROMATHERAPY OILS, OTHER THAN ESSENTIAL OILS, FOR TREATING ANXIETY; AROMATHERAPY SPRAYS FOR RELAXATION AND RELIEVING STRESS, IN CLASS 5 (U.S. CLS. 6, 18, 44, 46, 51 AND 52).

FIRST USE 11-0-2011; IN COMMERCE 11-0-2011.

THE MARK CONSISTS OF STANDARD CHARACTERS WITHOUT CLAIM TO ANY PARTICULAR FONT, STYLE, SIZE, OR COLOR.

SN 85-376,139, FILED 7-20-2011.

TINA L. SNAPP, EXAMINING ATTORNEY



David J. Kyjars

Director of the United States Patent and Trademark Office

United States of America

United States Patent and Trademark Office

NEWS fFLASH

Reg. No. 4,155,726

Registered June 5, 2012

Int. Cls.: 9 and 16

TRADEMARK

PRINCIPAL REGISTER

NOVALASH, INC. (TEXAS CORPORATION)
1200 SOUTHMORE BLVD.
HOUSTON, TX 77004

FOR: DOWNLOADABLE ELECTRONIC PUBLICATIONS, NAMELY, A MAGAZINE IN THE FIELD OF COSMETICS FEATURING AN EVENTS CALENDAR, CONTESTS, PROFESSIONAL PROFILES, INDUSTRY INFORMATION AND UPDATES, TRAINING AND CERTIFICATION INFORMATION, AN ONLINE DIRECTORY, PRODUCT CATALOG, PRODUCT HEALTH AND SAFETY INFORMATION, ANSWERS TO FREQUENTLY ASKED QUESTIONS, PHOTOGRAPH GALLERY, ARTICLES, INFORMATION AND ADVERTISEMENTS FOR ARTIFICIAL EYELASHES, FALSE EYELASH EXTENSIONS, ARTIFICIAL EYELASH APPLIQUÉS AND ADHESIVES FOR ATTACHING ARTIFICIAL EYELASHES, IN CLASS 9 (U.S. CLS. 21, 23, 26, 36 AND 38).

FIRST USE 10-31-2008; IN COMMERCE 10-31-2008.

FOR: MAGAZINE IN THE FIELD OF COSMETICS FEATURING AN EVENTS CALENDAR, CONTESTS, PROFESSIONAL PROFILES, INDUSTRY INFORMATION AND UPDATES, TRAINING AND CERTIFICATION INFORMATION, AN ONLINE DIRECTORY, PRODUCT CATALOG, PRODUCT HEALTH AND SAFETY INFORMATION, ANSWERS TO FREQUENTLY ASKED QUESTIONS, PHOTOGRAPH GALLERY, ARTICLES, INFORMATION AND ADVERTISEMENTS FOR ARTIFICIAL EYELASHES, FALSE EYELASH EXTENSIONS, ARTIFICIAL EYELASH APPLIQUÉS AND ADHESIVES FOR ATTACHING ARTIFICIAL EYELASHES, IN CLASS 16 (U.S. CLS. 2, 5, 22, 23, 29, 37, 38 AND 50).

FIRST USE 10-31-2008; IN COMMERCE 10-31-2008.

THE MARK CONSISTS OF THE WORDING "FLASH" IN STYLIZED FONT WITH THE WORD "NEWS" DEPICTED VERTICALLY ALONG THE LETTER "F"

SN 85-376,182, FILED 7-20-2011.

AMY KELLY, EXAMINING ATTORNEY



David J. Kyros

Director of the United States Patent and Trademark Office

United States of America

United States Patent and Trademark Office

Sneaky Rita Margarita Mix

Reg. No. 4,155,727

SNEAKY COCKTAILS, LLC (GEORGIA LIMITED LIABILITY COMPANY)
1190 ROME DRIVE
ROSWELL, GA 30075

Registered June 5, 2012

Int. Cl.: 33

FOR: ALCOHOLIC COCKTAIL MIXES, NAMELY, MARGARITA MIXES, IN CLASS 33 (U.S. CLS. 47 AND 49).

TRADEMARK

FIRST USE 7-1-2011; IN COMMERCE 7-1-2011.

PRINCIPAL REGISTER

THE MARK CONSISTS OF STANDARD CHARACTERS WITHOUT CLAIM TO ANY PARTICULAR FONT, STYLE, SIZE, OR COLOR.

NO CLAIM IS MADE TO THE EXCLUSIVE RIGHT TO USE "MARGARITA MIX", APART FROM THE MARK AS SHOWN.

SN 85-376,831, FILED 7-21-2011.

CAROLINE WOOD, EXAMINING ATTORNEY



David J. Kybas

Director of the United States Patent and Trademark Office

United States of America

United States Patent and Trademark Office

Got Plugging?

Reg. No. 4,155,728

DEERPOINT GROUP, INC. (ILLINOIS CORPORATION)
4339 N. SELLAND AVE.
FRESNO, CA 93722

Registered June 5, 2012

Int. Cl.: 37

FOR: MAINTENANCE OF IRRIGATION SYSTEMS, NAMELY, MAINTENANCE TO PREVENT AND/OR REMEDY PLUGGING IN IRRIGATION SYSTEMS, IN CLASS 37 (U.S. CLS. 100, 103 AND 106).

SERVICE MARK

FIRST USE 1-26-2011; IN COMMERCE 1-26-2011.

PRINCIPAL REGISTER

THE MARK CONSISTS OF STANDARD CHARACTERS WITHOUT CLAIM TO ANY PARTICULAR FONT, STYLE, SIZE, OR COLOR.

NO CLAIM IS MADE TO THE EXCLUSIVE RIGHT TO USE "PLUGGING", APART FROM THE MARK AS SHOWN.

SN 85-377,531, FILED 7-21-2011.

EMILY CARLSEN, EXAMINING ATTORNEY



David J. Kyros

Director of the United States Patent and Trademark Office

United States of America

United States Patent and Trademark Office

DRIVE THRU

Reg. No. 4,155,729

ADVANCEPIERRE FOODS, INC. (DELAWARE CORPORATION)
9990 PRINCETON-GLENDALE ROAD
CINCINNATI, OH 45246

Registered June 5, 2012

Int. Cl.: 30

FOR: FULLY-COOKED SANDWICHES CONTAINING BEEF, CHICKEN OR PORK SOLD FROZEN IN RETAIL GROCERY STORES, IN CLASS 30 (U.S. CL. 46).

TRADEMARK

FIRST USE 11-1-2011; IN COMMERCE 11-1-2011.

PRINCIPAL REGISTER

THE MARK CONSISTS OF STANDARD CHARACTERS WITHOUT CLAIM TO ANY PARTICULAR FONT, STYLE, SIZE, OR COLOR.

SN 85-377,579, FILED 7-21-2011.

ODESSA BIBBINS, EXAMINING ATTORNEY



David J. Kybas

Director of the United States Patent and Trademark Office

United States of America

United States Patent and Trademark Office



Reg. No. 4,155,730

Registered June 5, 2012

Int. Cl.: 25

TRADEMARK

PRINCIPAL REGISTER

HORSEDAD.COM (NEW YORK LIMITED LIABILITY COMPANY)
8350 ROYAL ASCOT CIRCLE
EAST AMHERST, NY 14051

FOR: HATS; SHIRTS, IN CLASS 25 (U.S. CLS. 22 AND 39).

FIRST USE 1-1-2009; IN COMMERCE 6-1-2011.

NO CLAIM IS MADE TO THE EXCLUSIVE RIGHT TO USE ".COM" , APART FROM THE MARK AS SHOWN.

THE MARK CONSISTS OF THE STYLIZED WORDS "HORSE DAD .COM". AN IMAGE OF A HORSE BETWEEN THE WORD "HORSE" AND "DAD".

SN 85-377,795, FILED 7-21-2011.

DEIRDRE ROBERTSON, EXAMINING ATTORNEY



David J. Kybas

Director of the United States Patent and Trademark Office

United States of America

United States Patent and Trademark Office

THE SYNTAX OF SUCCESS

Reg. No. 4,155,731

Registered June 5, 2012

Int. Cl.: 35

SERVICE MARK

PRINCIPAL REGISTER

KURTH, JOHN (UNITED STATES INDIVIDUAL)
PMB 323
5942 EDINGER AVE., STE. 113
HUNTINGTON BEACH, CA 92649

FOR: BUSINESS CONSULTING SERVICES IN THE FIELD OF SALES SCRIPT CREATION,
MODIFICATION AND DELIVERY, IN CLASS 35 (U.S. CLS. 100, 101 AND 102).

FIRST USE 8-0-2011; IN COMMERCE 9-0-2011.

THE MARK CONSISTS OF STANDARD CHARACTERS WITHOUT CLAIM TO ANY PAR-
TICULAR FONT, STYLE, SIZE, OR COLOR.

SN 85-378,005, FILED 7-22-2011.

KAPIL BHANOT, EXAMINING ATTORNEY



David J. Kyros

Director of the United States Patent and Trademark Office

United States of America

United States Patent and Trademark Office

SEIKO PCWIDE

Reg. No. 4,155,732

Registered June 5, 2012

Int. Cl.: 9

TRADEMARK

PRINCIPAL REGISTER

SEIKO HOLDINGS KABUSHIKI KAISHA (JAPAN CORPORATION), TA SEIKO HOLDINGS CORPORATION,
5-11, GINZA 4-CHOME, CHUO-KU
TOKYO, JAPAN

FOR: LENSES FOR EYEGLASSES, IN CLASS 9 (U.S. CLS. 21, 23, 26, 36 AND 38).

FIRST USE 9-1-2011; IN COMMERCE 9-1-2011.

THE MARK CONSISTS OF STANDARD CHARACTERS WITHOUT CLAIM TO ANY PARTICULAR FONT, STYLE, SIZE, OR COLOR.

SN 85-378,649, FILED 7-22-2011.

CHARLES L. JENKINS, EXAMINING ATTORNEY



David J. Kyros

Director of the United States Patent and Trademark Office

United States of America

United States Patent and Trademark Office

SYNTACTICS SALES SCRIPTING

Reg. No. 4,155,733

Registered June 5, 2012

Int. Cl.: 35

SERVICE MARK

PRINCIPAL REGISTER

KURTH, JOHN (UNITED STATES INDIVIDUAL)
PMB 323
5942 EDINGER AVE., STE. 113
HUNTINGTON BEACH, CA 92649

FOR: BUSINESS CONSULTING SERVICES IN THE FIELD OF SALES SCRIPT CREATION,
MODIFICATION AND DELIVERY, IN CLASS 35 (U.S. CLS. 100, 101 AND 102).

FIRST USE 8-0-2011; IN COMMERCE 9-0-2011.

THE MARK CONSISTS OF STANDARD CHARACTERS WITHOUT CLAIM TO ANY PAR-
TICULAR FONT, STYLE, SIZE, OR COLOR.

NO CLAIM IS MADE TO THE EXCLUSIVE RIGHT TO USE "SALES SCRIPTING", APART
FROM THE MARK AS SHOWN.

SN 85-378,751, FILED 7-22-2011.

KAPIL BHANOT, EXAMINING ATTORNEY



David J. Kybas

Director of the United States Patent and Trademark Office

United States of America

United States Patent and Trademark Office

WEALTH IN ORDER

Reg. No. 4,155,734

Registered June 5, 2012

Int. Cl.: 36

SERVICE MARK

PRINCIPAL REGISTER

IMPERA WEALTH MANAGEMENT, LLC (LOUISIANA LIMITED LIABILITY COMPANY)
110 VETERANS MEMORIAL BLVD., SUITE 400
METAIRIE, LA 70005

FOR: INVESTMENT MANAGEMENT; FINANCIAL PORTFOLIO MANAGEMENT; INVESTMENT BROKERAGE; CONSULTING SERVICES IN THE FIELD OF RETIREMENT PLAN ADMINISTRATION; FINANCIAL ADMINISTRATION OF RETIREMENT PLANS; FINANCIAL PLANNING FOR RETIREMENT; ESTATE PLANNING; FINANCIAL PLANNING; INSURANCE INFORMATION AND CONSULTANCY; FINANCIAL RISK MANAGEMENT, IN CLASS 36 (U.S. CLS. 100, 101 AND 102).

FIRST USE 5-31-2011; IN COMMERCE 5-31-2011.

THE MARK CONSISTS OF STANDARD CHARACTERS WITHOUT CLAIM TO ANY PARTICULAR FONT, STYLE, SIZE, OR COLOR.

SN 85-378,843, FILED 7-22-2011.

EMILY CHUO, EXAMINING ATTORNEY



David J. Kybas

Director of the United States Patent and Trademark Office

United States of America

United States Patent and Trademark Office

MyEmploymentLawAdvisor

Reg. No. 4,155,735

Registered June 5, 2012

Int. Cl.: 45

SERVICE MARK

PRINCIPAL REGISTER

HOLLAND & HART LLP (COLORADO LIMITED LIABILITY PARTNERSHIP)
ATTENTION: TRADEMARK DOCKETING
P.O. BOX 8749
DENVER, CO 80201

FOR: LEGAL SERVICES, IN CLASS 45 (U.S. CLS. 100 AND 101).

FIRST USE 11-1-2011; IN COMMERCE 11-1-2011.

THE MARK CONSISTS OF STANDARD CHARACTERS WITHOUT CLAIM TO ANY PARTICULAR FONT, STYLE, SIZE, OR COLOR.

SN 85-380,233, FILED 7-25-2011.

MARK T. MULLEN, EXAMINING ATTORNEY



David J. Kybas

Director of the United States Patent and Trademark Office

United States of America

United States Patent and Trademark Office

BOOT LEGGERS

Reg. No. 4,155,736

RELIANT CORP (VIRGINIA CORPORATION)
110 CARTER DR.
EDISON, NJ 08817

Registered June 5, 2012

Int. Cl.: 21

FOR: BOOT STRETCHERS AND BOOT TREES, NAMELY, BOOT FORM INSERT COMPOSED OF PLASTIC TO HELP A BOOT HOLD ITS SHAPE AND BOOT SHAPER COMPOSED OF PLASTIC TO HELP A BOOT HOLD ITS SHAPE WHEN NOT BEING WORN, IN CLASS 21 (U.S. CLS. 2, 13, 23, 29, 30, 33, 40 AND 50).

TRADEMARK

PRINCIPAL REGISTER

FIRST USE 3-15-2012; IN COMMERCE 3-15-2012.

THE MARK CONSISTS OF STANDARD CHARACTERS WITHOUT CLAIM TO ANY PARTICULAR FONT, STYLE, SIZE, OR COLOR.

NO CLAIM IS MADE TO THE EXCLUSIVE RIGHT TO USE "BOOT", APART FROM THE MARK AS SHOWN.

SN 85-380,272, FILED 7-25-2011.

TIMOTHY FINNEGAN, EXAMINING ATTORNEY



David J. Kyffers

Director of the United States Patent and Trademark Office

United States of America

United States Patent and Trademark Office

STITCHABLES

Reg. No. 4,155,737

JANLYNN CORP. (MASSACHUSETTS CORPORATION)
2070 WESTOVER ROAD
CHICOPEE, MA 01022

Registered June 5, 2012

Int. Cl.: 28

FOR: HOBBY NEEDLECRAFT KITS COMPRISING THREAD, EMBROIDERY FLOSS, YARN, NEEDLES, FABRIC, PLASTIC SHEETS, RIBBONS, PATTERNS, BATTING, FRAMES, MOUNTING BOARDS, BASE BOARDS AND INSTRUCTIONS, IN CLASS 28 (U.S. CLS. 22, 23, 38 AND 50).

TRADEMARK

PRINCIPAL REGISTER

FIRST USE 1-18-2012; IN COMMERCE 1-18-2012.

THE MARK CONSISTS OF STANDARD CHARACTERS WITHOUT CLAIM TO ANY PARTICULAR FONT, STYLE, SIZE, OR COLOR.

SN 85-380,666, FILED 7-26-2011.

INGA ERVIN, EXAMINING ATTORNEY



David J. Kyffers

Director of the United States Patent and Trademark Office

United States of America

United States Patent and Trademark Office



Reg. No. 4,155,738

Registered June 5, 2012

Int. Cl.: 39

SERVICE MARK

PRINCIPAL REGISTER

KHM CONSULTING, INC. (OHIO CORPORATION), DBA KHM TRAVEL GROUP,
1152 PEARL ROAD
BRUNSWICK, OH 44212

FOR: TRAVEL CLUBS, IN CLASS 39 (U.S. CLS. 100 AND 105).

FIRST USE 5-31-2011; IN COMMERCE 10-10-2011.

NO CLAIM IS MADE TO THE EXCLUSIVE RIGHT TO USE "TRAVEL", APART FROM THE MARK AS SHOWN.

THE COLOR(S) BLACK, WHITE, LIGHT GOLD, AND DARK GOLD IS/ARE CLAIMED AS A FEATURE OF THE MARK.

THE MARK CONSISTS OF THE WORD "LUXEVO" IN A BLACK STYLIZED FONT WITH A GOLD GRADIENT OUTLINE. THE LETTER "E" HAS A MACRON OR LATIN LONG MARK APPEARING AS A BLACK HORIZONTAL LINE OVER THE LETTER. A STYLIZED GLOBE WITH WHITE LONGITUDE AND LATITUDE LINES AND WHITE CONTINENTS APPEARS BEHIND THE LETTER "L", FADING FROM DARK GOLD AT THE TOP TO LIGHT GOLD AT THE BOTTOM. THE WORDS "THE EVOLUTION OF TRAVEL" APPEAR IN A BLACK STYLIZED FONT BELOW THE WORD "LUXEVO".

SN 85-381,251, FILED 7-26-2011.

DEBRA LEE, EXAMINING ATTORNEY



David J. Kyros

Director of the United States Patent and Trademark Office

United States of America

United States Patent and Trademark Office

GAY COFFEE

Reg. No. 4,155,739

Registered June 5, 2012

Int. Cl.: 30

TRADEMARK

PRINCIPAL REGISTER

GAY COFFEE (MASSACHUSETTS PARTNERSHIP)
PO BOX 44
WILLIAMSBURG, MA 01096

FOR: COFFEE; GROUND COFFEE BEANS; ROASTED COFFEE BEANS, IN CLASS 30 (U.S. CL. 46).

FIRST USE 11-1-2011; IN COMMERCE 11-1-2011.

THE MARK CONSISTS OF STANDARD CHARACTERS WITHOUT CLAIM TO ANY PARTICULAR FONT, STYLE, SIZE, OR COLOR.

NO CLAIM IS MADE TO THE EXCLUSIVE RIGHT TO USE "COFFEE", APART FROM THE MARK AS SHOWN.

SN 85-384,422, FILED 7-29-2011.

ALICE BENMAMAN, EXAMINING ATTORNEY



David J. Kybas

Director of the United States Patent and Trademark Office

United States of America

United States Patent and Trademark Office



Reg. No. 4,155,740

Registered June 5, 2012

Int. Cl.: 43

SERVICE MARK

PRINCIPAL REGISTER

RLDJ ENTERPRISES, LLC (NEW JERSEY LIMITED LIABILITY COMPANY)
50 SHERWOOD AVENUE
WACHUNG, NJ 07060

FOR: RESTAURANT, IN CLASS 43 (U.S. CLS. 100 AND 101).

FIRST USE 9-1-2011; IN COMMERCE 3-1-2012.

NO CLAIM IS MADE TO THE EXCLUSIVE RIGHT TO USE "JERSEY JOINT" , APART FROM THE MARK AS SHOWN.

THE COLOR(S) WHITE AND GREEN IS/ARE CLAIMED AS A FEATURE OF THE MARK.

THE MARK CONSISTS OF THE FOLLOWING: THE WORDING "JERSEY JOINT" IN WHITE LETTERS SUPERIMPOSED OVER TWO NESTED "J"'S ALSO IN WHITE, AND SET ON A HEXAGONAL GREEN BACKGROUND WITH A WHITE BORDER.

SN 85-384,469, FILED 7-29-2011.

ALICE BENMAMAN, EXAMINING ATTORNEY



David J. Kybas

Director of the United States Patent and Trademark Office

United States of America

United States Patent and Trademark Office

TRAM

Reg. No. 4,155,741

Registered June 5, 2012

Int. Cl.: 10

TRADEMARK

PRINCIPAL REGISTER

MERIT MEDICAL SYSTEMS, INC. (UTAH CORPORATION)
LEGAL DEPARTMENT
1600 WEST MERIT PARKWAY
SOUTH JORDAN, UT 84095

FOR: MEDICAL DEVICES, NAMELY, MANIFOLDS WITH INTEGRATED TRANSDUCERS FOR USE IN TRANSFERRING FLUID AND INVASIVE BLOOD PRESSURE MONITORING, IN CLASS 10 (U.S. CLS. 26, 39 AND 44).

FIRST USE 6-9-2010; IN COMMERCE 6-9-2010.

THE MARK CONSISTS OF STANDARD CHARACTERS WITHOUT CLAIM TO ANY PARTICULAR FONT, STYLE, SIZE, OR COLOR.

SN 85-384,513, FILED 7-29-2011.

MIDGE BUTLER, EXAMINING ATTORNEY



David J. Kyffers

Director of the United States Patent and Trademark Office

United States of America

United States Patent and Trademark Office

EASEBETWEEN

Reg. No. 4,155,742

Registered June 5, 2012

Int. Cl.: 10

TRADEMARK

PRINCIPAL REGISTER

RANIR, LLC (DELAWARE LIMITED LIABILITY COMPANY)
4701 EAST PARIS AVENUE S.E.
GRAND RAPIDS, MI 49512

FOR: DENTAL PICKS, IN CLASS 10 (U.S. CLS. 26, 39 AND 44).

FIRST USE 1-11-2011; IN COMMERCE 1-11-2011.

THE MARK CONSISTS OF STANDARD CHARACTERS WITHOUT CLAIM TO ANY PARTICULAR FONT, STYLE, SIZE, OR COLOR.

OWNER OF U.S. REG. NOS. 2,815,657 AND 3,468,772.

SN 85-384,529, FILED 7-29-2011.

INGA ERVIN, EXAMINING ATTORNEY



David J. Kyffers

Director of the United States Patent and Trademark Office

United States of America

United States Patent and Trademark Office

Timeless Wine Storage

Reg. No. 4,155,743

MARK HART (UNITED STATES INDIVIDUAL)
PO BOX 4812
STATELINE, NV 89449

Registered June 5, 2012

Int. Cl.: 16

FOR: PLASTIC BAGS FOR PRESERVING WINE, IN CLASS 16 (U.S. CLS. 2, 5, 22, 23, 29, 37, 38 AND 50).

TRADEMARK

FIRST USE 7-21-2011; IN COMMERCE 1-19-2012.

PRINCIPAL REGISTER

THE MARK CONSISTS OF STANDARD CHARACTERS WITHOUT CLAIM TO ANY PARTICULAR FONT, STYLE, SIZE, OR COLOR.

NO CLAIM IS MADE TO THE EXCLUSIVE RIGHT TO USE "WINE STORAGE", APART FROM THE MARK AS SHOWN.

SN 85-385,028, FILED 7-29-2011.

MICHAEL ENGEL, EXAMINING ATTORNEY



David J. Kybas

Director of the United States Patent and Trademark Office

United States of America

United States Patent and Trademark Office

Tahoe Vineyards

Reg. No. 4,155,744

MARK HART (UNITED STATES INDIVIDUAL)
PO BOX 4812
STATELINE, NV 89449

Registered June 5, 2012

Int. Cl.: 16

FOR: PLASTIC BAGS FOR PRESERVING WINE, IN CLASS 16 (U.S. CLS. 2, 5, 22, 23, 29, 37, 38 AND 50).

TRADEMARK

FIRST USE 7-21-2011; IN COMMERCE 1-19-2012.

PRINCIPAL REGISTER

THE MARK CONSISTS OF STANDARD CHARACTERS WITHOUT CLAIM TO ANY PARTICULAR FONT, STYLE, SIZE, OR COLOR.

SN 85-385,042, FILED 7-29-2011.

MICHAEL ENGEL, EXAMINING ATTORNEY



David J. Kybas

Director of the United States Patent and Trademark Office

United States of America

United States Patent and Trademark Office

GELATICIAN

Reg. No. 4,155,745

Registered June 5, 2012

Int. Cl.: 16

TRADEMARK

PRINCIPAL REGISTER

MANCIN, SABRINA (ITALY INDIVIDUAL)
1390 S. DIXIE HWY. SUITE 2113
CORAL GABLES, FL 33146 AND

NOCITA, JOHN (UNITED STATES INDIVIDUAL)
1390 S. DIXIE HWY. SUITE 2113
CORAL GABLES, FL 33146

FOR: MAGAZINES FEATURING CULINARY ARTS AND RESTAURANT NEWS; MAGAZINES IN THE FIELD OF ENTREPRENEURSHIP, BUSINESS MANAGEMENT, FOOD PREPARATION; GENERAL FEATURE MAGAZINE IN INNOVATIONS IN FLAVOR, EQUIPMENT, MARKETPLACE STRATEGY AND NEWS IN THE RESTAURANT BUSINESS; GENERAL FEATURE MAGAZINE IN FOOD AND RESTAURANT BUSINESS FEATURING TOPICS OF NEWS AND EVENTS, CELEBRITY ARTICLES, CASE STUDIES, EQUIPMENT AND MACHINERY ESSENTIALS, COOKING LESSONS, TRENDS AND MARKETING NEWS, SELECTING RAW MATERIALS, FOOD PREPARATION TECHNIQUES, IN CLASS 16 (U.S. CLS. 2, 5, 22, 23, 29, 37, 38 AND 50).

FIRST USE 1-17-2012; IN COMMERCE 1-17-2012.

THE MARK CONSISTS OF STANDARD CHARACTERS WITHOUT CLAIM TO ANY PARTICULAR FONT, STYLE, SIZE, OR COLOR.

SN 85-385,505, FILED 7-31-2011.

FLORENTINA BLANDU, EXAMINING ATTORNEY



David J. Kyros

Director of the United States Patent and Trademark Office

United States of America

United States Patent and Trademark Office

YOURS

Reg. No. 4,155,746

Registered June 5, 2012

Int. Cl.: 14

TRADEMARK

PRINCIPAL REGISTER

MARKET AMERICA, INC. (NORTH CAROLINA CORPORATION)
LEGAL DEPARTMENT
1302 PLEASANT RIDGE ROAD
GREENSBORO, NC 27409

FOR: JEWELRY, IN CLASS 14 (U.S. CLS. 2, 27, 28 AND 50).

FIRST USE 9-8-2011; IN COMMERCE 12-12-2011.

THE MARK CONSISTS OF STANDARD CHARACTERS WITHOUT CLAIM TO ANY PARTICULAR FONT, STYLE, SIZE, OR COLOR.

OWNER OF U.S. REG. NO. 3,948,741.

SN 85-385,766, FILED 8-1-2011.

TASHIA BUNCH, EXAMINING ATTORNEY



David J. Kybas

Director of the United States Patent and Trademark Office

United States of America

United States Patent and Trademark Office

YOURS BY LOREN

Reg. No. 4,155,747

Registered June 5, 2012

Int. Cl.: 14

TRADEMARK

PRINCIPAL REGISTER

MARKET AMERICA, INC. (NORTH CAROLINA CORPORATION)
LEGAL DEPARTMENT
1302 PLEASANT RIDGE ROAD
GREENSBORO, NC 27409

FOR: JEWELRY, IN CLASS 14 (U.S. CLS. 2, 27, 28 AND 50).

FIRST USE 9-8-2011; IN COMMERCE 12-12-2011.

THE MARK CONSISTS OF STANDARD CHARACTERS WITHOUT CLAIM TO ANY PARTICULAR FONT, STYLE, SIZE, OR COLOR.

OWNER OF U.S. REG. NO. 3,948,741.

SN 85-385,770, FILED 8-1-2011.

TASHIA BUNCH, EXAMINING ATTORNEY



David J. Kybas

Director of the United States Patent and Trademark Office

United States of America

United States Patent and Trademark Office

Novel Nibble

Reg. No. 4,155,748

Registered June 5, 2012

Int. Cl.: 35

SERVICE MARK

PRINCIPAL REGISTER

MUNSTERER, REBECCA J (UNITED STATES INDIVIDUAL)
37 SUNDBACK LANE
NORWICH, VT 05055

FOR: LITERARY AGENCIES; PROMOTING THE GOODS AND SERVICES OF OTHERS BY PROVIDING A WEBSITE FEATURING A COMPILATION OF LITERARY NOVELS WRITTEN IN THE GENRE OF ONE PAGE PER DAY; PROMOTING, ADVERTISING AND MARKETING OF THE BRANDS, PRODUCTS, SERVICES AND ONLINE WEBSITES OF INDIVIDUALS, BUSINESSES AND NONPROFIT ORGANIZATIONS, IN CLASS 35 (U.S. CLS. 100, 101 AND 102).

FIRST USE 1-1-2012; IN COMMERCE 1-1-2012.

THE MARK CONSISTS OF STANDARD CHARACTERS WITHOUT CLAIM TO ANY PARTICULAR FONT, STYLE, SIZE, OR COLOR.

NO CLAIM IS MADE TO THE EXCLUSIVE RIGHT TO USE "NOVEL", APART FROM THE MARK AS SHOWN.

SN 85-385,814, FILED 8-1-2011.

HANNO RITTNER, EXAMINING ATTORNEY



David J. Kyffers

Director of the United States Patent and Trademark Office

United States of America

United States Patent and Trademark Office

New Jersey's Distinctive Public College

Reg. No. 4,155,749

Registered June 5, 2012

Int. Cl.: 41

SERVICE MARK

PRINCIPAL REGISTER

THE RICHARD STOCKTON COLLEGE OF NEW JERSEY (NEW JERSEY CORPORATION)
JIMMIE LEEDS ROAD
POMONA, NJ 08240

FOR: EDUCATION SERVICES, NAMELY, PROVIDING COURSES OF INSTRUCTION AND TRAINING AT THE UNDERGRADUATE, GRADUATE, POST-GRADUATE, AND PROFESSIONAL LEVELS, AND CONTINUING EDUCATION; MORE SPECIFICALLY PROVIDING (I) UNDERGRADUATE EDUCATIONAL CLASSES AND TRAINING IN THE FIELDS OF ARTS AND HUMANITIES, GENERAL STUDIES, BUSINESS, HEALTH SCIENCES, SOCIAL AND BEHAVIORAL SCIENCE, NATURAL SCIENCES AND MATHEMATICS, WHICH INCLUDES CLASSES IN MARINE SCIENCE, ENVIRONMENTAL STUDIES, INFORMATION SYSTEMS, ENERGY STUDIES, AND THE FIELD OF EDUCATION, PROVIDING CERTIFICATION IN TEACHER EDUCATION, SPECIAL EDUCATION, AND PRE-SCHOOL EDUCATION; (II) GRADUATE, POST-GRADUATE AND PROFESSIONAL PROGRAMS IN THE FIELDS OF STUDY IN PHYSICAL THERAPY, CRIMINAL JUSTICE, HOLOCAUST AND GENOCIDE STUDIES, BUSINESS ADMINISTRATION, NURSING, OCCUPATIONAL THERAPY AND SOCIAL WORK, AND MASTER OF ARTS IN EDUCATION AND INSTRUCTIONAL TECHNOLOGY, AND (III) PROVIDING CONTINUING EDUCATION COURSES IN THE FIELDS OF HEALTH SCIENCE, HUMAN SERVICES AND MANAGEMENT DEVELOPMENT, AND PROFESSIONAL SERVICES; CONDUCTING EDUCATIONAL RESEARCH AT UNDERGRADUATE AND GRADUATE LEVELS IN MARINE SCIENCES AND CONSERVATION, AND IN TOURISM AND THE LOCAL AND STATE ECONOMY AND EDUCATIONAL RESEARCH CONDUCTED IN VARIOUS DISCIPLINES THROUGH GRANTS; ENTERTAINMENT IN THE NATURE OF ORGANIZING AND CONDUCTING ATHLETIC EVENTS AND COMPETITIONS FOR MEN'S AND WOMEN'S SPORTS INCLUDING BASEBALL, SOCCER, BASKETBALL, LACROSSE, TRACK AND FIELD, TENNIS, FIELD HOCKEY, ROWING, SOFTBALL AND CHEERLEADING, CLUB SPORTS AND INTRAMURALS; AND ORGANIZING AND PROVIDING ENTERTAINMENT VENUES FOR PERFORMING ARTS, LECTURES, CONCERTS, AND THEATER PRODUCTIONS, DANCE PERFORMANCES, PUBLIC SPEAKING EVENTS, AND VISUAL, LITERARY AND PERFORMING ARTS PRESENTATIONS, IN CLASS 41 (U.S. CLS. 100, 101 AND 107).



David J. Kappas

Director of the United States Patent and Trademark Office

FIRST USE 3-29-2011; IN COMMERCE 5-0-2011.

THE MARK CONSISTS OF STANDARD CHARACTERS WITHOUT CLAIM TO ANY PARTICULAR FONT, STYLE, SIZE, OR COLOR.

Reg. No. 4,155,749 NO CLAIM IS MADE TO THE EXCLUSIVE RIGHT TO USE "NEW JERSEY'S" OR "PUBLIC COLLEGE", APART FROM THE MARK AS SHOWN.

SN 85-386,208, FILED 8-1-2011.

LEIGH LOWRY, EXAMINING ATTORNEY

United States of America

United States Patent and Trademark Office



Reg. No. 4,155,750

Registered June 5, 2012

Int. Cl.: 1

TRADEMARK

PRINCIPAL REGISTER

TOTAL COAT DE VENEZUELA, C.A. (VENEZUELA CORPORATION)
ZONA INDUSTRIAL LOS ALPES, GALPON 116-52
SECTOR LA GUACAMAYA
VALENCIA, CARABOBO, VENEZUELA

FOR: CHEMICAL ADDITIVES FOR USE IN THE MANUFACTURE OF PROTECTIVE PLASTIC COATINGS; CHEMICALS FOR USE IN INDUSTRY AND SCIENCE; DEGREASING AGENTS; PHOTOGRAPHIC CHEMICALS, IN CLASS 1 (U.S. CLS. 1, 5, 6, 10, 26 AND 46).

FIRST USE 6-12-2002; IN COMMERCE 6-12-2002.

NO CLAIM IS MADE TO THE EXCLUSIVE RIGHT TO USE "COAT", APART FROM THE MARK AS SHOWN.

THE COLOR(S) RED, BLUE AND WHITE IS/ARE CLAIMED AS A FEATURE OF THE MARK.

THE MARK CONSISTS OF THE WORDS "TOTAL COAT" IN STYLIZED LETTERS. THE WORD "TOTAL" APPEARS ABOVE THE WORD "COAT". THE WORD "COAT" APPEARS INSIDE A RECTANGLE. THE COLOR BLUE APPEARS IN THE WORD "TOTAL" AND IN THE RECTANGULAR BACKGROUND OF THE WORD "COAT". THE COLOR WHITE APPEARS IN THE INNER OF THE TWO OUTER BORDERS OF THE WORD "TOTAL" AND IN THE WORD "COAT". THE COLOR RED APPEARS IN THE OUTER BORDER OF THE WORD "TOTAL" AND IN THE HORIZONTAL LINE THAT APPEARS BELOW THE RECTANGLE.

SN 85-386,305, FILED 8-1-2011.

JORDAN BAKER, EXAMINING ATTORNEY



David J. Kypos

Director of the United States Patent and Trademark Office

United States of America

United States Patent and Trademark Office

FASHION GENIUS

Reg. No. 4,155,751

Registered June 5, 2012

Int. Cl.: 42

SERVICE MARK

PRINCIPAL REGISTER

CHARMING DIRECT, INC. (DELAWARE CORPORATION)
1105 NORTH MARKET STREET
WILMINGTON, DE 19801

FOR: PROVIDING TEMPORARY USE OF A NON-DOWNLOADABLE WEB-BASED SOFTWARE APPLICATION THAT OFFERS PERSONALIZED FIT AND STYLE RECOMMENDATIONS FOR CONSUMERS BASED ON USER INPUTS , IN CLASS 42 (U.S. CLS. 100 AND 101).

FIRST USE 9-14-2011; IN COMMERCE 9-14-2011.

THE MARK CONSISTS OF STANDARD CHARACTERS WITHOUT CLAIM TO ANY PARTICULAR FONT, STYLE, SIZE, OR COLOR.

NO CLAIM IS MADE TO THE EXCLUSIVE RIGHT TO USE "FASHION", APART FROM THE MARK AS SHOWN.

SN 85-386,561, FILED 8-2-2011.

ALLISON SCHRODY, EXAMINING ATTORNEY



David J. Kyjars

Director of the United States Patent and Trademark Office

United States of America

United States Patent and Trademark Office

INSTAMANAGER

Reg. No. 4,155,752

BOOKT LLC (FLORIDA LIMITED LIABILITY COMPANY)
2450 HOLLYWOOD BLVD
HOLLYWOOD, FL 33020

Registered June 5, 2012

Int. Cl.: 42

FOR: APPLICATION SERVICE PROVIDER (ASP) FEATURING NON-DOWNLOADABLE SOFTWARE IN THE FIELD OF VACATION BOOKING AND MANAGEMENT, IN CLASS 42 (U.S. CLS. 100 AND 101).

SERVICE MARK

FIRST USE 2-1-2010; IN COMMERCE 4-1-2011.

PRINCIPAL REGISTER

THE MARK CONSISTS OF STANDARD CHARACTERS WITHOUT CLAIM TO ANY PARTICULAR FONT, STYLE, SIZE, OR COLOR.

SN 85-387,013, FILED 8-2-2011.

TRACY WHITTAKER-BROWN, EXAMINING ATTORNEY



David J. Kybas

Director of the United States Patent and Trademark Office

United States of America

United States Patent and Trademark Office

CHOZEN

Reg. No. 4,155,753

Registered June 5, 2012

Int. Cl.: 18

TRADEMARK

PRINCIPAL REGISTER

CHOZEN INC. (NEVADA CORPORATION)
11700 W. CHARLESTON BLVD.
#170-74
LAS VEGAS, NV 89135

FOR: BACKPACKS, BOOK BAGS, SPORTS BAGS, BUM BAGS, WALLETS AND HANDBAGS;
DUFFEL BAGS; LUGGAGE; PURSE CHARMS; PURSES; SUITCASES; TOTE BAGS; UM-
BRELLAS, IN CLASS 18 (U.S. CLS. 1, 2, 3, 22 AND 41).

FIRST USE 3-17-2012; IN COMMERCE 3-17-2012.

THE MARK CONSISTS OF STANDARD CHARACTERS WITHOUT CLAIM TO ANY PAR-
TICULAR FONT, STYLE, SIZE, OR COLOR.

OWNER OF U.S. REG. NOS. 3,525,560, 3,951,808, AND OTHERS.

SN 85-387,615, FILED 8-2-2011.

JENNIFER DIXON, EXAMINING ATTORNEY



David J. Kyros

Director of the United States Patent and Trademark Office

United States of America

United States Patent and Trademark Office

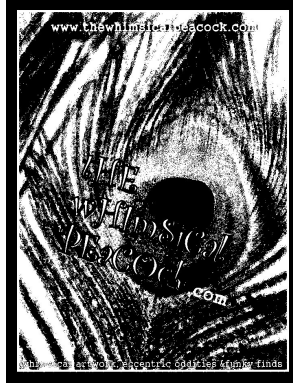

Reg. No. 4,155,754

Registered June 5, 2012

Int. Cl.: 35

SERVICE MARK

PRINCIPAL REGISTER

COLLINS, ASHA (UNITED STATES INDIVIDUAL)
649 S. LAKEMONT AVE
WINTER PARK, FL 32792

FOR: ON-LINE RETAIL STORE SERVICES FEATURING CUSTOM ART GOODS, IN CLASS 35 (U.S. CLS. 100, 101 AND 102).

FIRST USE 8-2-2011; IN COMMERCE 11-20-2011.

THE MARK CONSISTS OF THE STYLIZED WORDS "WWW.THEWHIMSICALPEACOCK.COM THE WHIMSICAL PEACOCK.COM WHIMSICAL ARTWORK, ECCENTRIC ODDITIES & FUNKY FINDS". AN IMAGE OF A PEACOCK FEATHER INSIDE A RECTANGULAR BOX.

SN 85-387,981, FILED 8-3-2011.

REBECCA GILBERT, EXAMINING ATTORNEY



David J. Kybas

Director of the United States Patent and Trademark Office

United States of America

United States Patent and Trademark Office

ORTHOVEND

Reg. No. 4,155,755

Registered June 5, 2012

Int. Cl.: 35

SERVICE MARK

PRINCIPAL REGISTER

WORLD CLASS TECHNOLOGY CORPORATION (OREGON CORPORATION)
1300 NE ALPHA DRIVE
MCMINNVILLE, OR 97128

FOR: VENDING MACHINE SERVICES, IN CLASS 35 (U.S. CLS. 100, 101 AND 102).

FIRST USE 5-11-2011; IN COMMERCE 5-11-2011.

THE MARK CONSISTS OF STANDARD CHARACTERS WITHOUT CLAIM TO ANY PARTICULAR FONT, STYLE, SIZE, OR COLOR.

SN 85-388,516, FILED 8-3-2011.

ANDREA K. NADELMAN, EXAMINING ATTORNEY



David J. Kybas

Director of the United States Patent and Trademark Office

United States of America

United States Patent and Trademark Office

Jack Mikele

Reg. No. 4,155,756

WU, JACK (UNITED STATES INDIVIDUAL)
866 AVE OF THE AMERICAS 10TH FLOOR
NEW YORK, NY 10001

Registered June 5, 2012

Int. Cl.: 9

FOR: EYEGLASS CASES; EYEWEAR; EYEWEAR, NAMELY, SUNGLASSES, EYEGLASSES,
AND EYEGLASS FRAMES, IN CLASS 9 (U.S. CLS. 21, 23, 26, 36 AND 38).

TRADEMARK

FIRST USE 11-5-2011; IN COMMERCE 11-5-2011.

PRINCIPAL REGISTER

THE MARK CONSISTS OF STANDARD CHARACTERS WITHOUT CLAIM TO ANY PAR-
TICULAR FONT, STYLE, SIZE, OR COLOR.

THE NAME(S), PORTRAIT(S), AND/OR SIGNATURE(S) SHOWN IN THE MARK DOES NOT
IDENTIFY A PARTICULAR LIVING INDIVIDUAL.

SN 85-388,756, FILED 8-3-2011.

WON TEAK OH, EXAMINING ATTORNEY



David J. Kyffers

Director of the United States Patent and Trademark Office

United States of America

United States Patent and Trademark Office

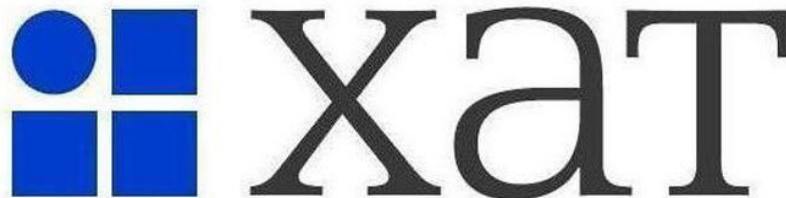

Reg. No. 4,155,757

Registered June 5, 2012

Int. Cl.: 9

TRADEMARK

PRINCIPAL REGISTER

ATLAS PROGRAMMING MANAGEMENT, INC. (CALIFORNIA CORPORATION)
3366 MOUNT DIABLO BOULEVARD #202
LAFAYETTE, CA 94549

FOR: COMPUTER APPLICATION SOFTWARE FOR MOBILE AND STATIONARY COMPUTING DEVICES, NAMELY, SOFTWARE FOR TESTING OF USER PROFICIENCY IN MICROSOFT EXCEL, IN CLASS 9 (U.S. CLS. 21, 23, 26, 36 AND 38).

FIRST USE 2-20-2008; IN COMMERCE 11-1-2011.

THE MARK CONSISTS OF A BLOCK DESIGN CONSISTING OF TWO ROWS OF EQUALLY SIZED EQUALLY SPACED BLUE COLOR SHAPES WHEREIN THE TOP ROW CONSISTS OF A CIRCLE/SQUARE AND THE BOTTOM ROW CONSISTS OF SQUARE/SQUARE POSITIONED DIRECTLY BELOW THE TOP ROW SHAPES AND BLACK BLOCK LETTERS "XAT" POSITIONED TO THE RIGHT OF THE BLOCK DESIGN WHEREIN THE LETTERS CONTAIN A STYLIZED "A" AS SHOWN.

THE COLOR(S) BLUE AND BLACK IS/ARE CLAIMED AS A FEATURE OF THE MARK.

SN 85-388,817, FILED 8-3-2011.

KIMBERLY PERRY, EXAMINING ATTORNEY



David J. Kyros

Director of the United States Patent and Trademark Office

United States of America

United States Patent and Trademark Office

TAQUERIA
laMacro

Reg. No. 4,155,758

Registered June 5, 2012

Int. Cl.: 43

SERVICE MARK

PRINCIPAL REGISTER

OBREGON-BANDA LLC (TEXAS LIMITED LIABILITY COMPANY)
1511 EVERETT ST.
HOUSTON, TX 77009

FOR: RESTAURANT SERVICES, IN CLASS 43 (U.S. CLS. 100 AND 101).

FIRST USE 1-1-2012; IN COMMERCE 1-14-2012.

NO CLAIM IS MADE TO THE EXCLUSIVE RIGHT TO USE "TAQUERIA" , APART FROM THE MARK AS SHOWN.

THE MARK CONSISTS OF THE WORD "TAQUERIA" ABOVE THE WORD "LAMACRO".

THE ENGLISH TRANSLATION OF "TAQUERIA" IN THE MARK IS "TACO RESTAURANT".

SN 85-388,818, FILED 8-3-2011.

KIMBERLY PERRY, EXAMINING ATTORNEY



David J. Kyffers

Director of the United States Patent and Trademark Office

United States of America

United States Patent and Trademark Office

Sip Without Slippin'

Reg. No. 4,155,759

Registered June 5, 2012

Int. Cl.: 25

TRADEMARK

PRINCIPAL REGISTER

BISSLAND, MARVIN (UNITED STATES INDIVIDUAL)
2626 KILN CREEK CIR
MT PLEASANT, SC 29466

FOR: SLIPPERS; SOCKS; T-SHIRTS, IN CLASS 25 (U.S. CLS. 22 AND 39).

FIRST USE 1-11-2012; IN COMMERCE 2-23-2012.

THE MARK CONSISTS OF STANDARD CHARACTERS WITHOUT CLAIM TO ANY PARTICULAR FONT, STYLE, SIZE, OR COLOR.

SN 85-389,366, FILED 8-4-2011.

ANDREA BUTLER, EXAMINING ATTORNEY



David J. Kybas

Director of the United States Patent and Trademark Office

United States of America

United States Patent and Trademark Office

JUMPIN' CHIPS

Reg. No. 4,155,760

KAATZ, EVELYN (UNITED STATES INDIVIDUAL)
25 HARDING AVENUE
BELMONT, MA 02478

Registered June 5, 2012

Int. Cl.: 28

FOR: BOARD GAMES FOR MATHEMATICAL INSTRUCTION, IN CLASS 28 (U.S. CLS. 22, 23, 38 AND 50).

TRADEMARK

FIRST USE 3-13-2012; IN COMMERCE 3-13-2012.

PRINCIPAL REGISTER

THE MARK CONSISTS OF STANDARD CHARACTERS WITHOUT CLAIM TO ANY PARTICULAR FONT, STYLE, SIZE, OR COLOR.

NO CLAIM IS MADE TO THE EXCLUSIVE RIGHT TO USE "CHIPS", APART FROM THE MARK AS SHOWN.

SN 85-389,377, FILED 8-4-2011.

ANDREA BUTLER, EXAMINING ATTORNEY



David J. Kybas

Director of the United States Patent and Trademark Office

United States of America

United States Patent and Trademark Office

Ultra HIGH-5

Reg. No. 4,155,761

Registered June 5, 2012

Int. Cl.: 10

TRADEMARK

PRINCIPAL REGISTER

ULTRA ATHLETE LLC (INDIANA LIMITED LIABILITY COMPANY)
SUITE 220
8520 ALLISON POINT BLVD.
INDIANAPOLIS, IN 46250

FOR: ATHLETIC ANKLE BRACES FOR MEDICAL USE; BRACES FOR LIMBS AND JOINTS,
FOR MEDICAL USE; ORTHOPEDIC BRACES; SUPPORTS FOR ANKLES FOR MEDICAL
USE, IN CLASS 10 (U.S. CLS. 26, 39 AND 44).

FIRST USE 1-23-2012; IN COMMERCE 1-23-2012.

THE MARK CONSISTS OF STANDARD CHARACTERS WITHOUT CLAIM TO ANY PAR-
TICULAR FONT, STYLE, SIZE, OR COLOR.

OWNER OF U.S. REG. NOS. 2,608,148 AND 3,709,532.

SN 85-389,722, FILED 8-4-2011.

HENRY S. ZAK, EXAMINING ATTORNEY



David J. Kyros

Director of the United States Patent and Trademark Office

United States of America

United States Patent and Trademark Office

Ultra Zoom

Reg. No. 4,155,762

Registered June 5, 2012

Int. Cl.: 10

TRADEMARK

PRINCIPAL REGISTER

ULTRA ATHLETE LLC (INDIANA LIMITED LIABILITY COMPANY)
SUITE 220
8520 ALLISON POINT BLVD.
INDIANAPOLIS, IN 46250

FOR: ATHLETIC ANKLE BRACES FOR MEDICAL USE; BRACES FOR LIMBS AND JOINTS, FOR MEDICAL USE; ORTHOPEDIC BRACES; SUPPORTS FOR ANKLES FOR MEDICAL USE, IN CLASS 10 (U.S. CLS. 26, 39 AND 44).

FIRST USE 1-23-2012; IN COMMERCE 1-23-2012.

THE MARK CONSISTS OF STANDARD CHARACTERS WITHOUT CLAIM TO ANY PARTICULAR FONT, STYLE, SIZE, OR COLOR.

OWNER OF U.S. REG. NOS. 2,608,148 AND 3,709,532.

SN 85-389,746, FILED 8-4-2011.

HENRY S. ZAK, EXAMINING ATTORNEY



David J. Kyros

Director of the United States Patent and Trademark Office

United States of America

United States Patent and Trademark Office

Fight Responsibly

Reg. No. 4,155,763

AMERICAN KNOCKOUT WEAR, LLC (VIRGINIA LIMITED LIABILITY COMPANY)
4712 HOPKINS DRIVE
DUMFRIES, VA 22025

Registered June 5, 2012

Int. Cl.: 25

FOR: ATHLETIC APPAREL, NAMELY, SHIRTS, PANTS, JACKETS, FOOTWEAR, HATS
AND CAPS, ATHLETIC UNIFORMS, IN CLASS 25 (U.S. CLS. 22 AND 39).

TRADEMARK

FIRST USE 3-1-2012; IN COMMERCE 3-1-2012.

PRINCIPAL REGISTER

THE MARK CONSISTS OF STANDARD CHARACTERS WITHOUT CLAIM TO ANY PAR-
TICULAR FONT, STYLE, SIZE, OR COLOR.

SN 85-390,679, FILED 8-5-2011.

RONALD MCMORROW, EXAMINING ATTORNEY



David J. Kybas

Director of the United States Patent and Trademark Office

United States of America
United States Patent and Trademark Office

GANDONA

Reg. No. 4,155,764

Registered June 5, 2012

Int. Cl.: 33

TRADEMARK

PRINCIPAL REGISTER

GANDONA, INC. (CALIFORNIA CORPORATION)
1535 SAGE CANYON ROAD
ST. HELENA, CA 94578

FOR: WINE, IN CLASS 33 (U.S. CLS. 47 AND 49).

FIRST USE 2-0-2006; IN COMMERCE 2-29-2012.

THE MARK CONSISTS OF STANDARD CHARACTERS WITHOUT CLAIM TO ANY PARTICULAR FONT, STYLE, SIZE, OR COLOR.

SN 85-391,941, FILED 8-8-2011.

BRIDGETT SMITH, EXAMINING ATTORNEY



David J. Kybas

Director of the United States Patent and Trademark Office

United States of America

United States Patent and Trademark Office

CRPartner

Reg. No. 4,155,765

Registered June 5, 2012

Int. Cls.: 35 and 45

SERVICE MARK

PRINCIPAL REGISTER

COMPLIANCE IMPLEMENTATION SERVICES (PENNSYLVANIA LIMITED LIABILITY COMPANY), AKA CIS,
1400 N. PROVIDENCE RD SUITE 3005
MEDIA, PA 19063

FOR: DATA MANAGEMENT SERVICES IN THE NATURE OF DATA COLLECTION, COMPILATION SYSTEMIZATION, VERIFICATION, AND RECONCILIATION IN THE FIELDS OF PHARMACEUTICAL AND MEDICAL DEVICE SALES FOR BUSINESS PURPOSES; ELECTRONIC DATA COLLECTION AND DATA SUBMISSION SERVICES FOR BUSINESS PURPOSES IN THE FIELDS OF MEDICINE AND HEALTHCARE; RECORD-KEEPING FOR REGULATORY COMPLIANCE PURPOSES IN THE CLINICAL, MEDICAL, AND COMMERCIAL FIELDS, IN CLASS 35 (U.S. CLS. 100, 101 AND 102).

FIRST USE 8-15-2011; IN COMMERCE 8-15-2011.

FOR: REGULATORY COMPLIANCE CONSULTING IN THE FIELD OF PHARMACEUTICALS AND MEDICAL DEVICE SALES; TRACKING AND MONITORING REGULATORY REQUIREMENTS IN THE FIELD OF PHARMACEUTICALS FOR REGULATORY COMPLIANCE PURPOSES; PROVIDING INFORMATION ON GOVERNMENT MEDICAL AND PHARMACEUTICAL PROGRAMS; ANALYSIS OF HEALTH DATA, BILLINGS DATA, AND STATE AND FEDERAL GOVERNMENT REPORTING IN CONNECTION WITH FEDERAL AND STATE COMPLIANCE AND REPORTING OBLIGATIONS, IN CLASS 45 (U.S. CLS. 100 AND 101).

FIRST USE 8-15-2011; IN COMMERCE 8-15-2011.

SN 85-392,021, FILED 8-8-2011.

MARK SHINER, EXAMINING ATTORNEY



David J. Kypos

Director of the United States Patent and Trademark Office

United States of America

United States Patent and Trademark Office

VERY SEXY TOUCH

Reg. No. 4,155,766

Registered June 5, 2012

Int. Cl.: 3

TRADEMARK

PRINCIPAL REGISTER

VICTORIA'S SECRET STORES BRAND MANAGEMENT, INC. (DELAWARE CORPORATION)
INTELLECTUAL PROPERTY MANAGER
FOUR LIMITED PARKWAY
REYNOLDSBURG, OH 43068

FOR: BODY LOTION; EAU DE PARFUM; NON-MEDICATED SKIN CARE PREPARATION,
NAMELY, BODY MIST, IN CLASS 3 (U.S. CLS. 1, 4, 6, 50, 51 AND 52).

FIRST USE 2-10-2012; IN COMMERCE 2-10-2012.

THE MARK CONSISTS OF STANDARD CHARACTERS WITHOUT CLAIM TO ANY PAR-
TICULAR FONT, STYLE, SIZE, OR COLOR.

OWNER OF U.S. REG. NOS. 2,725,765, 3,480,549, AND OTHERS.

SN 85-392,022, FILED 8-8-2011.

JEFFREY LOOK, EXAMINING ATTORNEY



David J. Kyffers

Director of the United States Patent and Trademark Office

United States of America

United States Patent and Trademark Office

WESTWARD LEANING

Reg. No. 4,155,767

Registered June 5, 2012

Int. Cl.: 9

TRADEMARK

PRINCIPAL REGISTER

WESTWARD LEANING (DELAWARE CORPORATION)
330 TOWNSEND STREET #201
SAN FRANCISCO, CA 94107

FOR: SUNGLASSES, IN CLASS 9 (U.S. CLS. 21, 23, 26, 36 AND 38).

FIRST USE 8-1-2011; IN COMMERCE 11-15-2011.

THE MARK CONSISTS OF STANDARD CHARACTERS WITHOUT CLAIM TO ANY PARTICULAR FONT, STYLE, SIZE, OR COLOR.

SN 85-393,045, FILED 8-9-2011.

KELLEY WELLS, EXAMINING ATTORNEY



David J. Kyffers

Director of the United States Patent and Trademark Office

United States of America

United States Patent and Trademark Office



Reg. No. 4,155,768

Registered June 5, 2012

Int. Cl.: 41

SERVICE MARK

PRINCIPAL REGISTER

CABLE NEWS NETWORK, INC. (DELAWARE CORPORATION)
ONE CNN CENTER, 10N
C/O TURNER BROADCASTING SYSTEM, INC.
ATLANTA, GA 30303

FOR: ENTERTAINMENT SERVICES, NAMELY, PROVISION OF ONGOING MULTIMEDIA PROGRAMS IN THE FIELD OF NEWS AND CURRENT EVENTS DISTRIBUTED VIA VARIOUS PLATFORMS ACROSS MULTIPLE FORMS OF TRANSMISSION MEDIA, IN CLASS 41 (U.S. CLS. 100, 101 AND 107).

FIRST USE 10-27-2011; IN COMMERCE 10-27-2011.

OWNER OF U.S. REG. NOS. 3,791,013, 3,804,102, AND OTHERS.

NO CLAIM IS MADE TO THE EXCLUSIVE RIGHT TO USE ".COM", APART FROM THE MARK AS SHOWN.

THE MARK CONSISTS OF A BRACKET WITH THE LETTERS "HLNTV.COM" ENCLOSED.

SN 85-394,305, FILED 8-10-2011.

SHANNON TWOHIG, EXAMINING ATTORNEY



David J. Kyffers

Director of the United States Patent and Trademark Office

United States of America

United States Patent and Trademark Office



Reg. No. 4,155,769

Registered June 5, 2012

Int. Cl.: 38

SERVICE MARK

PRINCIPAL REGISTER

CABLE NEWS NETWORK, INC. (DELAWARE CORPORATION)
ONE CNN CENTER, 10N
C/O TURNER BROADCASTING SYSTEM, INC.
ATLANTA, GA 30303

FOR: CABLE TELEVISION AND SATELLITE BROADCASTING SERVICES, STREAMING OF AUDIO, VIDEO AND AUDIO/VIDEO MATERIALS OVER THE INTERNET, OTHER THAN BROADCAST OF LIVE SPORTING EVENTS OR LIVE COLLEGIATE SPORTING ACTIVITIES AND THE STREAMING OVER THE INTERNET OF LIVE SPORTING EVENTS OR LIVE COLLEGIATE SPORTING ACTIVITIES, IN CLASS 38 (U.S. CLS. 100, 101 AND 104).

FIRST USE 10-27-2011; IN COMMERCE 10-27-2011.

OWNER OF U.S. REG. NOS. 3,791,013, 3,804,102, AND OTHERS.

NO CLAIM IS MADE TO THE EXCLUSIVE RIGHT TO USE ".COM", APART FROM THE MARK AS SHOWN.

THE MARK CONSISTS OF A BRACKET WITH THE LETTERS "HLNTV.COM" ENCLOSED.

SN 85-394,306, FILED 8-10-2011.

SHANNON TWOHIG, EXAMINING ATTORNEY



David J. Kyros

Director of the United States Patent and Trademark Office

United States of America

United States Patent and Trademark Office



Reg. No. 4,155,770

Registered June 5, 2012

Int. Cl.: 18

TRADEMARK

PRINCIPAL REGISTER

BUXTON ACQUISITION CO., L.L.C. (MASSACHUSETTS LIMITED LIABILITY COMPANY)
45 PLAINFIELD STREET
SPRINGFIELD, MA 01102

FOR: SMALL LEATHER GOODS, NAMELY, HANDBAGS, WALLETS, KEY CASES, CHANGE PURSES, COSMETIC BAGS AND POUCHES SOLD EMPTY, TOILETRY CASES SOLD EMPTY, BRIEFCASE-TYPE PORTFOLIOS, BILLFOLDS, LUGGAGE, OVERNIGHT CASES SOLD EMPTY, CREDIT CARD HOLDERS, AND BUSINESS CARD HOLDERS IN THE NATURE OF WALLETS, IN CLASS 18 (U.S. CLS. 1, 2, 3, 22 AND 41).

FIRST USE 2-15-2012; IN COMMERCE 2-15-2012.

THE MARK CONSISTS OF A GRAPHIC DESIGN RESEMBLING A HEART MONITOR SHOWING EXCITED HEART RHYTHMS.

SN 85-394,335, FILED 8-10-2011.

TASHIA BUNCH, EXAMINING ATTORNEY



David J. Kyros

Director of the United States Patent and Trademark Office

United States of America

United States Patent and Trademark Office



Reg. No. 4,155,771

Registered June 5, 2012

Int. Cl.: 37

SERVICE MARK

PRINCIPAL REGISTER

CB OPERATORS, LLC (TEXAS LIMITED LIABILITY COMPANY)
SUITE 100
11825 IH 10 WEST
SAN ANTONIO, TX 78230

FOR: AUTOMOBILE CLEANING AND CAR WASHING, IN CLASS 37 (U.S. CLS. 100, 103 AND 106).

FIRST USE 10-0-2011; IN COMMERCE 10-0-2011.

NO CLAIM IS MADE TO THE EXCLUSIVE RIGHT TO USE "CAR WASH", APART FROM THE MARK AS SHOWN.

THE COLOR(S) BLUE, RED, BLACK, AND WHITE IS/ARE CLAIMED AS A FEATURE OF THE MARK.

THE MARK CONSISTS OF THE WORDS "CLEAR BLUE" IN A BLUE FONT OVER THE WORDS "CAR WASH" IN A SMALLER RED FONT, WITH STYLIZED BLUE AND WHITE BUBBLES ABOVE AND WITHIN THE WORDS "CLEAR BLUE", AND WITH A STYLIZED RED CAR HAVING A BLUE UNDERCARRIAGE, WHITE WHEEL COVERS, WHITE WINDOWS, A WHITE BUMPER IN THE SHAPE OF A SMILE, AND WHITE AND BLACK HEADLIGHTS IN THE SHAPE OF EYES WITH BLACK EYELASHES, THE STYLIZED CAR POSITIONED OVER THE BUBBLES.

SN 85-394,758, FILED 8-10-2011.

GEORGE LORENZO, EXAMINING ATTORNEY



David J. Kypos

Director of the United States Patent and Trademark Office

United States of America

United States Patent and Trademark Office

BatWave

Reg. No. 4,155,772

Registered June 5, 2012

Int. Cl.: 9

TRADEMARK

PRINCIPAL REGISTER

WINEGARD COMPANY (IOWA CORPORATION)
3000 KIRKWOOD STREET
BURLINGTON, IA 52601

FOR: TELEVISION ANTENNAS, IN CLASS 9 (U.S. CLS. 21, 23, 26, 36 AND 38).

FIRST USE 11-0-2011; IN COMMERCE 11-0-2011.

THE MARK CONSISTS OF STANDARD CHARACTERS WITHOUT CLAIM TO ANY PARTICULAR FONT, STYLE, SIZE, OR COLOR.

SN 85-396,384, FILED 8-12-2011.

LUCY ARANT, EXAMINING ATTORNEY



David J. Kyffers

Director of the United States Patent and Trademark Office

United States of America

United States Patent and Trademark Office

AICPA INSIGHTS

Reg. No. 4,155,773

Registered June 5, 2012

Int. Cl.: 41

SERVICE MARK

PRINCIPAL REGISTER

AMERICAN INSTITUTE OF CERTIFIED PUBLIC ACCOUNTANTS (D.C. NON-PROFIT CORPORATION)
1211 AVENUE OF THE AMERICAS
NEW YORK, NY 10036

FOR: ON-LINE JOURNALS, NAMELY, BLOGS FEATURING INFORMATION IN THE FIELDS OF ACCOUNTING AND ACCOUNTANCY; PROVIDING A WEBSITE FEATURING BLOGS AND NON-DOWNLOADABLE PUBLICATIONS IN THE NATURE OF JOURNALS IN THE FIELDS OF ACCOUNTING AND ACCOUNTANCY, IN CLASS 41 (U.S. CLS. 100, 101 AND 107).

FIRST USE 1-28-2011; IN COMMERCE 7-11-2011.

THE MARK CONSISTS OF STANDARD CHARACTERS WITHOUT CLAIM TO ANY PARTICULAR FONT, STYLE, SIZE, OR COLOR.

OWNER OF U.S. REG. NOS. 864,285, 1,683,413, AND OTHERS.

SN 85-396,613, FILED 8-12-2011.

TASNEEM HUSSAIN, EXAMINING ATTORNEY



David J. Kyros

Director of the United States Patent and Trademark Office

United States of America
United States Patent and Trademark Office

Leeject

Reg. No. 4,155,774

ADVANCED TECHNOLOGY & CAPITAL INC. (NEW JERSEY CORPORATION)
5 SYLVAN AVENUE
ENGLEWOOD CLIFFS, NJ 07632

Registered June 5, 2012

Int. Cl.: 10

FOR: SYRINGES FOR DENTAL AND MEDICAL PURPOSES, IN CLASS 10 (U.S. CLS. 26, 39 AND 44).

TRADEMARK

FIRST USE 2-16-2012; IN COMMERCE 2-16-2012.

PRINCIPAL REGISTER

THE MARK CONSISTS OF THE STYLIZED TEXT "LEEJECT".

SN 85-397,131, FILED 8-12-2011.

GEORGE LORENZO, EXAMINING ATTORNEY



David J. Kypos

Director of the United States Patent and Trademark Office

United States of America

United States Patent and Trademark Office

Eco-Jig

Reg. No. 4,155,775

Registered June 5, 2012

Int. Cl.: 28

TRADEMARK

PRINCIPAL REGISTER

YARITZ, BRADLEY JOHN (UNITED STATES INDIVIDUAL), DBA CATCH IT!,
4835 DIVISION AVENUE
WHITE BEAR LAKE, MN 55110

FOR: FISHING TACKLE, IN CLASS 28 (U.S. CLS. 22, 23, 38 AND 50).

FIRST USE 3-15-2011; IN COMMERCE 1-12-2012.

THE MARK CONSISTS OF THE LETTERS IN "ECO-JIG" CONTAIN TWO CAPITALS. ONE "E" AND ONE "J". THE TWO WORDS ARE SEPARATED BY A HYPHEN. ALL TEXT IS IN CALIFORNIAN FB.

SN 85-397,142, FILED 8-12-2011.

JAMES A. RAUEN, EXAMINING ATTORNEY



David J. Kybas

Director of the United States Patent and Trademark Office

United States of America

United States Patent and Trademark Office

GALILI[®]
Jewelry with Personal Touch

Reg. No. 4,155,776

Registered June 5, 2012

Int. Cl.: 14

TRADEMARK

PRINCIPAL REGISTER

G.I. GROUP LLC (NEW YORK LIMITED LIABILITY COMPANY)
11F
15038 UNION TURNPIKE
FLUSHING, NY 11367

FOR: DIAMONDS; JEWELRY, IN CLASS 14 (U.S. CLS. 2, 27, 28 AND 50).

FIRST USE 12-5-2011; IN COMMERCE 12-5-2011.

NO CLAIM IS MADE TO THE EXCLUSIVE RIGHT TO USE "JEWELRY", APART FROM THE MARK AS SHOWN.

THE MARK CONSISTS OF STYLIZED VERSIONS OF THE WORD "GALILI" WITH A LINE UNDERNEATH IT. BELOW THE LINE IS THE STYLIZED WORDING "JEWELRY WITH PERSONAL TOUCH".

SN 85-397,495, FILED 8-14-2011.

LINDA E. BLOHM, EXAMINING ATTORNEY



David J. Kyros

Director of the United States Patent and Trademark Office

United States of America

United States Patent and Trademark Office

HAWTHORNE HILLS

Reg. No. 4,155,777

INTERCONTINENTAL PACKAGING CO. (MINNESOTA CORPORATION)
1999 SHEPARD ROAD
ST. PAUL, MN 55116

Registered June 5, 2012

Int. Cl.: 33

FOR: ALCOHOLIC BEVERAGES EXCEPT BEERS, IN CLASS 33 (U.S. CLS. 47 AND 49).

TRADEMARK

FIRST USE 10-1-2011; IN COMMERCE 12-1-2011.

PRINCIPAL REGISTER

THE MARK CONSISTS OF STANDARD CHARACTERS WITHOUT CLAIM TO ANY PARTICULAR FONT, STYLE, SIZE, OR COLOR.

SN 85-398,858, FILED 8-16-2011.

DANNEAN HETZEL, EXAMINING ATTORNEY



David J. Kybas

Director of the United States Patent and Trademark Office

United States of America

United States Patent and Trademark Office



Reg. No. 4,155,778

Registered June 5, 2012

Int. Cl.: 44

SERVICE MARK

PRINCIPAL REGISTER

PSQUARED PROHEALTH, LLC (CONNECTICUT LIMITED LIABILITY COMPANY)
324 ELM ST., STE. 202 B
MONROE, CT 06468

FOR: HEALTHCARE SERVICES, IN CLASS 44 (U.S. CLS. 100 AND 101).

FIRST USE 8-0-2011; IN COMMERCE 8-0-2011.

THE MARK CONSISTS OF AN ASTERISK DESIGN WITH THE WAVES OF A HEART MONITOR READING IN THE CENTER OF THE ASTERISK DESIGN.

SN 85-399,219, FILED 8-16-2011.

DANNEAN HETZEL, EXAMINING ATTORNEY



David J. Kyfos

Director of the United States Patent and Trademark Office

United States of America

United States Patent and Trademark Office

The Steve Harvey Show

Reg. No. 4,155,779

HARVEY, STEVE (UNITED STATES INDIVIDUAL)
7322 SOUTHWEST FREEWAY, SUITE 2010
HOUSTON, TX 77074

Registered June 5, 2012

Int. Cl.: 41

FOR: ENTERTAINMENT SERVICES IN THE NATURE OF AN ON-GOING TELEVISION TALK SHOW, IN CLASS 41 (U.S. CLS. 100, 101 AND 107).

SERVICE MARK

FIRST USE 9-6-2011; IN COMMERCE 9-6-2011.

PRINCIPAL REGISTER

THE MARK CONSISTS OF STANDARD CHARACTERS WITHOUT CLAIM TO ANY PARTICULAR FONT, STYLE, SIZE, OR COLOR.

OWNER OF U.S. REG. NOS. 3,047,679, 3,482,769, AND OTHERS.

NO CLAIM IS MADE TO THE EXCLUSIVE RIGHT TO USE "SHOW", APART FROM THE MARK AS SHOWN.

THE NAME "STEVE HARVEY" IDENTIFIES A LIVING INDIVIDUAL WHOSE CONSENT IS OF RECORD.

SN 85-399,977, FILED 8-17-2011.

DAVID HOFFMAN, EXAMINING ATTORNEY



David J. Kyffers

Director of the United States Patent and Trademark Office

United States of America

United States Patent and Trademark Office



Reg. No. 4,155,780

Registered June 5, 2012

Int. Cl.: 14

TRADEMARK

PRINCIPAL REGISTER

NEDRY, MADELINE (UNITED STATES INDIVIDUAL)
2564 SOUTHEAST 13TH STREET
POMPANO BEACH, FL 33062

FOR: BRACELETS, IN CLASS 14 (U.S. CLS. 2, 27, 28 AND 50).

FIRST USE 3-1-2012; IN COMMERCE 3-1-2012.

NO CLAIM IS MADE TO THE EXCLUSIVE RIGHT TO USE ".COM" , APART FROM THE MARK AS SHOWN.

THE COLOR(S) BLACK, PINK, PURPLE, BLUE, ORANGE, SILVER, GREEN AND YELLOW IS/ARE CLAIMED AS A FEATURE OF THE MARK.

THE MARK CONSISTS OF THE WORDS "FRIENDLYBANDS .COM LINKING FRIENDS TOGETHER" AND A DESIGN. THE WORDING "FRIENDLY BANDS", ".COM", AND "LINKING FRIENDS TOGETHER" IS PRESENTED IN VARIOUS COLORS OF ORANGE, PINK, PURPLE AND BLUE. THE WORDS "LINKING", "FRIENDS", "TOGETHER" ARE CONNECTED BY SILVER CHAINS. ALL OF THE WORDS EXCEPT FOR ".COM" ARE PRESENTED IN A CIRCULAR FORM. INSIDE OF THE CIRCULAR FORM ARE TWO HANDS HOLDING EACH OTHER. THE LEFT HAND IS WEARING TWO MULTI-COLORED BRACELETS AND THE RIGHT HAND IS WEARING ONE MULTI-COLORED BRACELET; THE BRACELETS CONTAIN THE COLORS PINK, ORANGE, YELLOW, GREEN, AND BLUE. THE HANDS ARE OUTLINED IN BLACK. THE WHITE IN THE HANDS REPRESENTS TRANSPARENCY AND IS NOT CLAIMED AS A FEATURE OF THE MARK.

SN 85-399,978, FILED 8-17-2011.

KIMBERLY FRYE, EXAMINING ATTORNEY



David J. Kybas

Director of the United States Patent and Trademark Office

United States of America

United States Patent and Trademark Office

PÉTALOS ESTÁMPADOS

Reg. No. 4,155,781

Registered June 5, 2012

Int. Cls.: 4 and 5

TRADEMARK

PRINCIPAL REGISTER

S. C. JOHNSON & SON, INC. (WISCONSIN CORPORATION)
1525 HOWE STREET
RACINE, WI 53403

FOR: CANDLES, IN CLASS 4 (U.S. CLS. 1, 6 AND 15).

FIRST USE 2-14-2012; IN COMMERCE 2-14-2012.

FOR: AIR FRESHENERS, IN CLASS 5 (U.S. CLS. 6, 18, 44, 46, 51 AND 52).

FIRST USE 2-16-2012; IN COMMERCE 2-16-2012.

THE MARK CONSISTS OF STANDARD CHARACTERS WITHOUT CLAIM TO ANY PARTICULAR FONT, STYLE, SIZE, OR COLOR.

THE ENGLISH TRANSLATION OF "PÉTALOS ESTÁMPADOS" IN THE MARK IS "STAMPED PETALS".

SN 85-401,130, FILED 8-18-2011.

WILLIAM VERHOSEK, EXAMINING ATTORNEY



David J. Kyros

Director of the United States Patent and Trademark Office

United States of America

United States Patent and Trademark Office

SORBETE DE SOL

Reg. No. 4,155,782

Registered June 5, 2012

Int. Cls.: 4 and 5

TRADEMARK

PRINCIPAL REGISTER

S. C. JOHNSON & SON, INC. (WISCONSIN CORPORATION)
1525 HOWE STREET
RACINE, WI 53403

FOR: CANDLES, IN CLASS 4 (U.S. CLS. 1, 6 AND 15).

FIRST USE 2-7-2012; IN COMMERCE 2-7-2012.

FOR: AIR FRESHENERS, IN CLASS 5 (U.S. CLS. 6, 18, 44, 46, 51 AND 52).

FIRST USE 2-5-2012; IN COMMERCE 2-5-2012.

THE MARK CONSISTS OF STANDARD CHARACTERS WITHOUT CLAIM TO ANY PARTICULAR FONT, STYLE, SIZE, OR COLOR.

THE ENGLISH TRANSLATION OF "SORBETE DE SOL" IN THE MARK IS "SUNSHINE SHERBET".

SN 85-401,139, FILED 8-18-2011.

WILLIAM VERHOSEK, EXAMINING ATTORNEY



David J. Kyros

Director of the United States Patent and Trademark Office

United States of America

United States Patent and Trademark Office

PRADERA MÁGICA

Reg. No. 4,155,783

Registered June 5, 2012

Int. Cls.: 4 and 5

TRADEMARK

PRINCIPAL REGISTER

S. C. JOHNSON & SON, INC. (WISCONSIN CORPORATION)
1525 HOWE STREET
RACINE, WI 53403

FOR: CANDLES, IN CLASS 4 (U.S. CLS. 1, 6 AND 15).

FIRST USE 2-22-2012; IN COMMERCE 2-22-2012.

FOR: AIR FRESHENERS, IN CLASS 5 (U.S. CLS. 6, 18, 44, 46, 51 AND 52).

FIRST USE 2-17-2012; IN COMMERCE 2-17-2012.

THE MARK CONSISTS OF STANDARD CHARACTERS WITHOUT CLAIM TO ANY PARTICULAR FONT, STYLE, SIZE, OR COLOR.

THE ENGLISH TRANSLATION OF "PRADERA MÁGICA" IN THE MARK IS "MAGIC PRAIRIE".

SN 85-401,154, FILED 8-18-2011.

WILLIAM VERHOSEK, EXAMINING ATTORNEY



David J. Kyfos

Director of the United States Patent and Trademark Office

United States of America

United States Patent and Trademark Office

MAGIC MEADOW

Reg. No. 4,155,784

Registered June 5, 2012

Int. Cls.: 4 and 5

TRADEMARK

PRINCIPAL REGISTER

S. C. JOHNSON & SON, INC. (WISCONSIN CORPORATION)
1525 HOWE STREET
RACINE, WI 53403

FOR: CANDLES, IN CLASS 4 (U.S. CLS. 1, 6 AND 15).

FIRST USE 2-22-2012; IN COMMERCE 2-22-2012.

FOR: AIR FRESHENERS, IN CLASS 5 (U.S. CLS. 6, 18, 44, 46, 51 AND 52).

FIRST USE 2-17-2012; IN COMMERCE 2-17-2012.

THE MARK CONSISTS OF STANDARD CHARACTERS WITHOUT CLAIM TO ANY PARTICULAR FONT, STYLE, SIZE, OR COLOR.

SN 85-401,163, FILED 8-18-2011.

WILLIAM VERHOSEK, EXAMINING ATTORNEY



David J. Kybas

Director of the United States Patent and Trademark Office

United States of America

United States Patent and Trademark Office

CPA HORIZONS 2025

Reg. No. 4,155,785

Registered June 5, 2012

Int. Cl.: 35

SERVICE MARK

PRINCIPAL REGISTER

AMERICAN INSTITUTE OF CERTIFIED PUBLIC ACCOUNTANTS (D.C. NON-PROFIT CORPORATION)
1211 AVENUE OF THE AMERICAS
NEW YORK, NY 10036

FOR: ASSOCIATION SERVICES, NAMELY, PROMOTING THE INTERESTS OF ACCOUNTANTS; PROVIDING A WEBSITE FEATURING INFORMATION ABOUT ACCOUNTING AND THE FIELD OF ACCOUNTING; AND PROVIDING INFORMATION AND ADVICE IN THE FIELD OF ACCOUNTANCY, IN CLASS 35 (U.S. CLS. 100, 101 AND 102).

FIRST USE 11-2-2010; IN COMMERCE 1-5-2011.

THE MARK CONSISTS OF STANDARD CHARACTERS WITHOUT CLAIM TO ANY PARTICULAR FONT, STYLE, SIZE, OR COLOR.

NO CLAIM IS MADE TO THE EXCLUSIVE RIGHT TO USE "CPA" AND "2025", APART FROM THE MARK AS SHOWN.

SN 85-402,527, FILED 8-19-2011.

TASNEEM HUSSAIN, EXAMINING ATTORNEY



David J. Kyros

Director of the United States Patent and Trademark Office

United States of America

United States Patent and Trademark Office



Sailors Creme

Reg. No. 4,155,786

KRAS, AMANDA J. (UNITED STATES INDIVIDUAL)
73 S. BAY AVE.
HIGHLANDS, NJ 07732

Registered June 5, 2012

Int. Cl.: 3

FOR: NON-MEDICATED SKIN CARE CREAMS AND LOTIONS, IN CLASS 3 (U.S. CLS. 1, 4, 6, 50, 51 AND 52).

TRADEMARK

FIRST USE 4-3-2012; IN COMMERCE 4-3-2012.

PRINCIPAL REGISTER

NO CLAIM IS MADE TO THE EXCLUSIVE RIGHT TO USE "CREME", APART FROM THE MARK AS SHOWN.

THE MARK CONSISTS OF THE WORDING "SAILORS CREME" IN BLACK WITH THREE BLACK BIRDS FLYING ABOVE THE TEXT.

SN 85-403,187, FILED 8-21-2011.

ALEXANDER L. POWERS, EXAMINING ATTORNEY



David J. Kyffers

Director of the United States Patent and Trademark Office

United States of America

United States Patent and Trademark Office

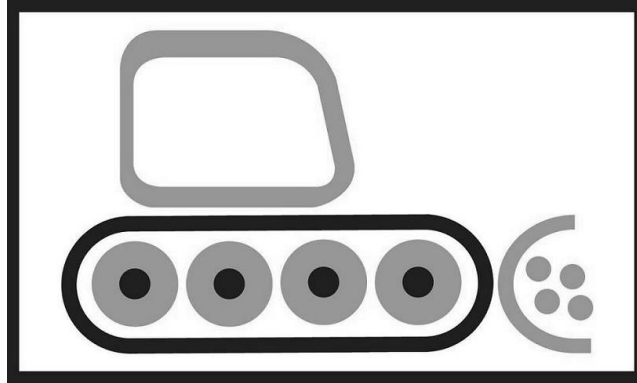

Reg. No. 4,155,787

Registered June 5, 2012

Int. Cl.: 8

TRADEMARK

PRINCIPAL REGISTER

MARCHFIVE, LLC (PENNSYLVANIA LIMITED LIABILITY COMPANY)
8125 EASTERN AVENUE
WYNDMOOR, PA 19038

FOR: HAND OPERATED TOOL IN THE NATURE OF A SCOOP FOR SCOOPING UP TOYS AND PLACING INSIDE TOY BIN FOR QUICK CLEANUP, IN CLASS 8 (U.S. CLS. 23, 28 AND 44).

FIRST USE 3-10-2012; IN COMMERCE 3-10-2012.

THE MARK CONSISTS OF BULLDOZER WITH FOUR WHEELS AND FOUR CIRCULAR DOTS INSIDE OF THE BULLDOZER BIN, ENCLOSED INSIDE SOLID LINED RECTANGULAR BORDER.

SN 85-403,980, FILED 8-22-2011.

ERNEST SHOSHO, EXAMINING ATTORNEY



David J. Kyffers

Director of the United States Patent and Trademark Office

United States of America

United States Patent and Trademark Office



Reg. No. 4,155,788

Registered June 5, 2012

Int. Cl.: 21

TRADEMARK

PRINCIPAL REGISTER

BAMBINOS!, LLC (COLORADO LIMITED LIABILITY COMPANY)
31756 BUFFALO PARK ROAD
EVERGREEN, CO 80439

FOR: MEAL TRAYS, IN CLASS 21 (U.S. CLS. 2, 13, 23, 29, 30, 33, 40 AND 50).

FIRST USE 9-23-2011; IN COMMERCE 9-23-2011.

NO CLAIM IS MADE TO THE EXCLUSIVE RIGHT TO USE "BAMBINOS", APART FROM THE MARK AS SHOWN.

THE COLOR(S) RED, WHITE, BROWN, GREEN AND YELLOW IS/ARE CLAIMED AS A FEATURE OF THE MARK.

THE MARK CONSISTS OF THE STYLIZED WORDING "BAMBINOS!" IN RED BENEATH A DRAWING OF A TORSO OF A CHILD IN WHITE OUTLINED IN BROWN WITH BROWN EYES, HAIR AND MOUTH, WEARING A LIGHT GREEN SHIRT; THE CHILD HAS FOLDED ARMS AND IS LEANING ITS CHIN ON ITS HANDS; BEHIND AND SURROUNDING THE CHILD IS A YELLOW CIRCLE WITH SMALLER YELLOW DOTS EVENLY SPACED AROUND ALL BUT THE LOWER EDGE OF ITS CIRCUMFERENCE SUGGESTIVE OF THE SUN.

THE ENGLISH TRANSLATION OF THE WORD "BAMBINOS" IN THE MARK IS "CHILDREN".

SN 85-404,529, FILED 8-23-2011.

LOURDES AYALA, EXAMINING ATTORNEY



David J. Kyffers

Director of the United States Patent and Trademark Office

United States of America

United States Patent and Trademark Office

Care Hope Cure

Reg. No. 4,155,789

SANFORD (NORTH DAKOTA NON-PROFIT CORPORATION)
801 BROADWAY N.
FARGO, ND 58122

Registered June 5, 2012

Int. Cl.: 36

FOR: CHARITABLE FUNDRAISING, IN CLASS 36 (U.S. CLS. 100, 101 AND 102).

SERVICE MARK

FIRST USE 8-17-2011; IN COMMERCE 8-17-2011.

PRINCIPAL REGISTER

THE MARK CONSISTS OF STANDARD CHARACTERS WITHOUT CLAIM TO ANY PARTICULAR FONT, STYLE, SIZE, OR COLOR.

SN 85-404,691, FILED 8-23-2011.

MICHAEL KEATING, EXAMINING ATTORNEY



David J. Kybas

Director of the United States Patent and Trademark Office

United States of America

United States Patent and Trademark Office

GlassesCOVE

Reg. No. 4,155,790

Registered June 5, 2012

Int. Cl.: 9

TRADEMARK

PRINCIPAL REGISTER

ESES GLOBAL, INC. (NEW YORK CORPORATION)
147 W 35TH STREET #504
NEW YORK, NY 10001

FOR: EYEGLOSS FRAMES; EYEWEAR, NAMELY, SUNGLASSES, EYEGASSES AND OPTHALMIC FRAMES AND CASES THEREFOR; FRAMES FOR SPECTACLES AND SUNGLASSES, IN CLASS 9 (U.S. CLS. 21, 23, 26, 36 AND 38).

FIRST USE 9-0-2011; IN COMMERCE 9-0-2011.

NO CLAIM IS MADE TO THE EXCLUSIVE RIGHT TO USE "GLASSES", APART FROM THE MARK AS SHOWN.

THE MARK CONSISTS OF THE STYLIZED WORDS "GLASSES COVE".

SN 85-406,202, FILED 8-24-2011.

MICHAEL TANNER, EXAMINING ATTORNEY



David J. Kybas

Director of the United States Patent and Trademark Office

United States of America

United States Patent and Trademark Office

simply**smart** 
an NRG service

Reg. No. 4,155,791

Registered June 5, 2012

Int. Cl.: 35

SERVICE MARK

PRINCIPAL REGISTER

NRG ENERGY, INC. (DELAWARE CORPORATION)
211 CARNEGIE CENTER
PRINCETON, NJ 08540

FOR: PROVIDING BACK OFFICE SUPPORT SERVICES FOR GAS AND ELECTRIC COMPANIES AS WELL AS RETAIL ENERGY SUPPLIERS, NAMELY, BILLING SERVICES AND CALL CENTER OPERATIONS FOR OTHERS, IN CLASS 35 (U.S. CLS. 100, 101 AND 102).

FIRST USE 11-1-2011; IN COMMERCE 11-1-2011.

OWNER OF U.S. REG. NOS. 2,182,531, 3,959,771, AND OTHERS.

NO CLAIM IS MADE TO THE EXCLUSIVE RIGHT TO USE "SERVICE", APART FROM THE MARK AS SHOWN.

THE MARK CONSISTS OF THE WORD "SIMPLYSMART" WITH "SMART" BOLDED, FOLLOWED BY A DESIGN OF THREE INTERLOCKING CROSSES WITH LIGHT TO DARK SHADING AND THEN THE WORDS "AN NRG SERVICE" POSITIONED DIRECTLY BELOW.

SN 85-406,300, FILED 8-24-2011.

JANICE L. MCMORROW, EXAMINING ATTORNEY



David J. Kyros

Director of the United States Patent and Trademark Office

United States of America

United States Patent and Trademark Office

SOUR DIPPERS

Reg. No. 4,155,792

Registered June 5, 2012

Int. Cl.: 30

TRADEMARK

PRINCIPAL REGISTER

IMPACT CONFECTIONS, INC. (NEW MEXICO CORPORATION)
10822 W. TOLLER DRIVE, SUITE 350
LITTLETON, CO 80127

FOR: CANDY, IN CLASS 30 (U.S. CL. 46).

FIRST USE 1-1-2012; IN COMMERCE 1-1-2012.

THE MARK CONSISTS OF STANDARD CHARACTERS WITHOUT CLAIM TO ANY PARTICULAR FONT, STYLE, SIZE, OR COLOR.

NO CLAIM IS MADE TO THE EXCLUSIVE RIGHT TO USE "SOUR", APART FROM THE MARK AS SHOWN.

SN 85-406,908, FILED 8-25-2011.

IRA J. GOODSaid, EXAMINING ATTORNEY



David J. Kybas

Director of the United States Patent and Trademark Office

United States of America

United States Patent and Trademark Office

MASTERING CONVERSATIONAL MARKETING

Reg. No. 4,155,793

CEG WORLDWIDE, LLC (CALIFORNIA CORPORATION)
1954 HAYES LANE
SAN MARTIN, CA 95046

Registered June 5, 2012

Int. Cl.: 41

FOR: EDUCATIONAL SERVICES, NAMELY, TRAINING AND COACHING SERVICES DIRECTED TO PROFESSIONAL FINANCIAL ADVISORS, IN THE FIELDS OF FINANCIAL ADVISOR PRACTICE DEVELOPMENT AND ATTRACTING AND RETAINING FINANCIAL ADVISORY CLIENTS, IN CLASS 41 (U.S. CLS. 100, 101 AND 107).

SERVICE MARK

PRINCIPAL REGISTER

FIRST USE 9-27-2011; IN COMMERCE 9-27-2011.

THE MARK CONSISTS OF STANDARD CHARACTERS WITHOUT CLAIM TO ANY PARTICULAR FONT, STYLE, SIZE, OR COLOR.

NO CLAIM IS MADE TO THE EXCLUSIVE RIGHT TO USE "CONVERSATIONAL MARKETING", APART FROM THE MARK AS SHOWN.

SN 85-407,301, FILED 8-25-2011.

JAMES MACFARLANE, EXAMINING ATTORNEY



David J. Kyffers

Director of the United States Patent and Trademark Office

United States of America

United States Patent and Trademark Office



Reg. No. 4,155,794

Registered June 5, 2012

Int. Cl.: 5

TRADEMARK

PRINCIPAL REGISTER

GEAR DOG LLC (GEORGIA LIMITED LIABILITY COMPANY)
4242 STEF LANE NW
KENNESAW, GA 30152

FOR: ANTIBACTERIAL SPRAY; CARPET FRESHENERS AND ODOR ELIMINATORS; CLEANING PREPARATIONS, NAMELY, ODOR ELIMINATORS NOT FOR PERSONAL USE; CLEANING PREPARATIONS, NAMELY, ODOR NEUTRALIZERS NOT FOR PERSONAL USE; ODOR NEUTRALIZING PREPARATIONS FOR GENERAL USE ON VARIOUS SURFACES; ODOR NEUTRALIZING PREPARATIONS FOR USE ON FABRIC, SPORTS EQUIPMENT, SHOES, SPORTS BAGS, IN CLASS 5 (U.S. CLS. 6, 18, 44, 46, 51 AND 52).

FIRST USE 1-18-2012; IN COMMERCE 1-18-2012.

NO CLAIM IS MADE TO THE EXCLUSIVE RIGHT TO USE "GEAR", APART FROM THE MARK AS SHOWN.

THE COLOR(S) BLUE, YELLOW AND BLACK IS/ARE CLAIMED AS A FEATURE OF THE MARK.

THE MARK CONSISTS OF THE WORD "GEAR" STACKED ON TOP OF THE WORD "DOG" IN ALL CAPITAL LETTERS, USING IMPACT FONT. THE WORDS "GEAR" AND "DOG" ARE BLUE TO BLACK IN VERTICAL GRADIENT. THE WORDS "PLAY LIKE A DOG, DON'T SMELL LIKE ONE", IN BLACK COLOR AND IMPACT FONT IS A TAG LINE AND IS BELOW THE STACKED WORDS "GEAR" AND "DOG". A UNIQUE AND STYLIZED YELLOW DOG IS JUMPING THROUGH THE LETTER "O" IN "DOG".

SN 85-408,988, FILED 8-27-2011.

KRISTIN CARLSON, EXAMINING ATTORNEY



David J. Kyros

Director of the United States Patent and Trademark Office

United States of America

United States Patent and Trademark Office

APATHY

Reg. No. 4,155,795

Registered June 5, 2012

Int. Cl.: 5

TRADEMARK

PRINCIPAL REGISTER

RETTIG, HEIDI K. (UNITED STATES INDIVIDUAL)
620 S. LOUDOUN STREET
WINCHESTER, VA 22601

FOR: AROMATHERAPY CREAMS FOR RELAXATION AND RELIEVING STRESS; AROMATHERAPY OILS, OTHER THAN ESSENTIAL OILS, FOR TREATING ANXIETY; AROMATHERAPY SPRAYS FOR RELAXATION AND RELIEVING STRESS, IN CLASS 5 (U.S. CLS. 6, 18, 44, 46, 51 AND 52).

FIRST USE 11-0-2011; IN COMMERCE 11-0-2011.

THE MARK CONSISTS OF STANDARD CHARACTERS WITHOUT CLAIM TO ANY PARTICULAR FONT, STYLE, SIZE, OR COLOR.

SN 85-410,332, FILED 8-30-2011.

TINA L. SNAPP, EXAMINING ATTORNEY



David J. Kyros

Director of the United States Patent and Trademark Office

United States of America

United States Patent and Trademark Office

PASSIVE

Reg. No. 4,155,796

Registered June 5, 2012

Int. Cl.: 5

TRADEMARK

PRINCIPAL REGISTER

RETTIG, HEIDI K. (UNITED STATES INDIVIDUAL)
620 S. LOUDOUN STREET
WINCHESTER, VA 22601

FOR: AROMATHERAPY CREAMS FOR RELAXATION AND RELIEVING STRESS; AROMATHERAPY OILS, OTHER THAN ESSENTIAL OILS, FOR TREATING ANXIETY; AROMATHERAPY SPRAYS FOR RELAXATION AND RELIEVING STRESS, IN CLASS 5 (U.S. CLS. 6, 18, 44, 46, 51 AND 52).

FIRST USE 11-0-2011; IN COMMERCE 11-0-2011.

THE MARK CONSISTS OF STANDARD CHARACTERS WITHOUT CLAIM TO ANY PARTICULAR FONT, STYLE, SIZE, OR COLOR.

SN 85-410,335, FILED 8-30-2011.

TINA L. SNAPP, EXAMINING ATTORNEY



David J. Kyjars

Director of the United States Patent and Trademark Office

United States of America

United States Patent and Trademark Office

AGGRESSIVE

Reg. No. 4,155,797

Registered June 5, 2012

Int. Cl.: 5

TRADEMARK

PRINCIPAL REGISTER

RETTIG, HEIDI K. (UNITED STATES INDIVIDUAL)
620 S. LOUDOUN STREET
WINCHESTER, VA 22601

FOR: AROMATHERAPY CREAMS FOR RELAXATION AND RELIEVING STRESS; AROMATHERAPY OILS, OTHER THAN ESSENTIAL OILS, FOR TREATING ANXIETY; AROMATHERAPY SPRAYS FOR RELAXATION AND RELIEVING STRESS, IN CLASS 5 (U.S. CLS. 6, 18, 44, 46, 51 AND 52).

FIRST USE 11-0-2011; IN COMMERCE 11-0-2011.

THE MARK CONSISTS OF STANDARD CHARACTERS WITHOUT CLAIM TO ANY PARTICULAR FONT, STYLE, SIZE, OR COLOR.

SN 85-410,340, FILED 8-30-2011.

TINA L. SNAPP, EXAMINING ATTORNEY



David J. Kyjars

Director of the United States Patent and Trademark Office

United States of America

United States Patent and Trademark Office



Reg. No. 4,155,798

MAHFUZ, EDUARDO (BRAZIL INDIVIDUAL)
1431 RIVERPLACE BLVD APT 2907
JACKSONVILLE, FL 32207

Registered June 5, 2012

Int. Cl.: 35

FOR: RETAIL STORE SERVICES FEATURING WINES, WINE ACCESSORIES, CHEESES,
AND BREADS, IN CLASS 35 (U.S. CLS. 100, 101 AND 102).

SERVICE MARK

FIRST USE 1-8-2011; IN COMMERCE 4-11-2011.

PRINCIPAL REGISTER

THE MARK CONSISTS OF A GLASS OF WINE WITH THE STYLIZED TEXT "W90+".

SN 85-413,325, FILED 9-1-2011.

MARIA-VICTORIA SUAREZ, EXAMINING ATTORNEY



David J. Kybas

Director of the United States Patent and Trademark Office

United States of America

United States Patent and Trademark Office

URBAN TALES

Reg. No. 4,155,799

Registered June 5, 2012

Int. Cl.: 33

TRADEMARK

PRINCIPAL REGISTER

INTERCONTINENTAL PACKAGING CO. (MINNESOTA CORPORATION)
1999 SHEPARD ROAD
ST. PAUL, MN 55116

FOR: ALCOHOLIC BEVERAGES EXCEPT BEERS, IN CLASS 33 (U.S. CLS. 47 AND 49).

FIRST USE 4-1-2011; IN COMMERCE 5-1-2011.

THE MARK CONSISTS OF STANDARD CHARACTERS WITHOUT CLAIM TO ANY PARTICULAR FONT, STYLE, SIZE, OR COLOR.

SN 85-413,774, FILED 9-2-2011.

DANNEAN HETZEL, EXAMINING ATTORNEY



David J. Kyffers

Director of the United States Patent and Trademark Office

United States of America

United States Patent and Trademark Office

JOEY

Reg. No. 4,155,800

Registered June 5, 2012

Int. Cl.: 9

TRADEMARK

PRINCIPAL REGISTER

DISH NETWORK L.L.C. (COLORADO LIMITED LIABILITY COMPANY)
9601 S. MERIDIAN BLVD.
ENGLEWOOD, CO 80112

FOR: DIGITAL VIDEO RECORDERS; ELECTRONIC APPARATUS AND DEVICES FOR CONTROLLING ACCESS TO PAY-TELEVISION SERVICES; COMMUNICATIONS EQUIPMENT, NAMELY, SIGNAL FREQUENCY RECEIVERS; COMMUNICATIONS EQUIPMENT, NAMELY, SET-TOP BOXES FOR RECEIVING VIDEO PROGRAMMING; TELEVISION RECEIVERS; SATELLITE RECEIVERS; SET-TOP BOXES; UNIVERSAL REMOTE CONTROLS FOR HOME ELECTRONIC DEVICES, NAMELY, TELEVISIONS, VCRS, DVD PLAYERS, DIGITAL VIDEO RECORDERS, SATELLITE RECEIVERS, STEREO RECEIVERS, AND STEREO AMPLIFIERS; ELECTRONIC DEVICES, NAMELY, DIGITAL MEDIA STREAMING DEVICES, IN CLASS 9 (U.S. CLS. 21, 23, 26, 36 AND 38).

FIRST USE 1-9-2012; IN COMMERCE 3-15-2012.

THE MARK CONSISTS OF STANDARD CHARACTERS WITHOUT CLAIM TO ANY PARTICULAR FONT, STYLE, SIZE, OR COLOR.

SN 85-415,484, FILED 9-6-2011.

ANDREW LEASER, EXAMINING ATTORNEY



David J. Kyros

Director of the United States Patent and Trademark Office

United States of America

United States Patent and Trademark Office

HOPPER

Reg. No. 4,155,801

Registered June 5, 2012

Int. Cl.: 9

TRADEMARK

PRINCIPAL REGISTER

DISH NETWORK L.L.C. (COLORADO LIMITED LIABILITY COMPANY)
9601 S. MERIDIAN BLVD.
ENGLEWOOD, CO 80112

FOR: DIGITAL VIDEO RECORDERS; ELECTRONIC APPARATUS AND DEVICES FOR CONTROLLING ACCESS TO PAY-TELEVISION SERVICES; COMMUNICATIONS EQUIPMENT, NAMELY, SET-TOP BOXES FOR RECEIVING VIDEO PROGRAMMING; TELEVISION RECEIVERS; SATELLITE RECEIVERS; SET-TOP BOXES; UNIVERSAL REMOTE CONTROLS FOR HOME ELECTRONIC DEVICES, NAMELY, TELEVISIONS, VCRS, DVD PLAYERS, DIGITAL VIDEO RECORDERS, SATELLITE RECEIVERS, STEREO RECEIVERS, AND STEREO AMPLIFIERS; COMPUTER HARDWARE AND SOFTWARE FOR STREAMING AUDIO, VIDEO, IMAGE AND DATA INFORMATION TO A VARIETY OF NETWORK DEVICES, NAMELY, PERSONAL COMPUTERS, MOBILE PHONES, PERSONAL DIGITAL ASSISTANTS (PDA), AND STAND-ALONE HARDWARE DECODERS, NAMELY, AUDIO DECODERS AND VIDEO DECODERS; ELECTRONIC DEVICES, NAMELY, DIGITAL MEDIA STREAMING DEVICES, IN CLASS 9 (U.S. CLS. 21, 23, 26, 36 AND 38).

FIRST USE 1-9-2012; IN COMMERCE 3-15-2012.

THE MARK CONSISTS OF STANDARD CHARACTERS WITHOUT CLAIM TO ANY PARTICULAR FONT, STYLE, SIZE, OR COLOR.

SN 85-415,859, FILED 9-6-2011.

ANDREW LEASER, EXAMINING ATTORNEY



David J. Kybas

Director of the United States Patent and Trademark Office

United States of America

United States Patent and Trademark Office

TRUE ESCAPE

Reg. No. 4,155,802

Registered June 5, 2012

Int. Cl.: 3

TRADEMARK

PRINCIPAL REGISTER

VICTORIA'S SECRET STORES BRAND MANAGEMENT, INC. (DELAWARE CORPORATION)
FOUR LIMITED PARKWAY
REYNOLDSBURG, OH 43068

FOR: BODY CREAM; BODY LOTION; BODY SCRUB; BODY WASH; NON-MEDICATED
SKIN CARE PREPARATION, NAMELY, BODY MIST, IN CLASS 3 (U.S. CLS. 1, 4, 6, 50, 51
AND 52).

FIRST USE 2-18-2012; IN COMMERCE 2-18-2012.

THE MARK CONSISTS OF STANDARD CHARACTERS WITHOUT CLAIM TO ANY PAR-
TICULAR FONT, STYLE, SIZE, OR COLOR.

SN 85-418,402, FILED 9-9-2011.

JEFFREY LOOK, EXAMINING ATTORNEY



David J. Kybas

Director of the United States Patent and Trademark Office

United States of America

United States Patent and Trademark Office

THE NAME ON EVERYONE'S HIPS

Reg. No. 4,155,803

HANKY PANKY LTD. (NEW YORK CORPORATION)
373 PARK AVENUE
NEW YORK, NY 10016

Registered June 5, 2012

Int. Cl.: 25

FOR: G-STRINGS, THONGS, UNDERPANTS, BRALETTES, BRAS, CAMISOLES, CORSETS, BOYSHORTS, CHEMISES, SLIPS, GOWNS, ROBES, AND SLEEPWEAR, IN CLASS 25 (U.S. CLS. 22 AND 39).

TRADEMARK

FIRST USE 1-20-2012; IN COMMERCE 1-20-2012.

PRINCIPAL REGISTER

THE MARK CONSISTS OF STANDARD CHARACTERS WITHOUT CLAIM TO ANY PARTICULAR FONT, STYLE, SIZE, OR COLOR.

SN 85-418,895, FILED 9-9-2011.

NELSON SNYDER, EXAMINING ATTORNEY



David J. Kybas

Director of the United States Patent and Trademark Office

United States of America
United States Patent and Trademark Office

PALAZZO

Reg. No. 4,155,804

Registered June 5, 2012

Int. Cl.: 12

TRADEMARK

PRINCIPAL REGISTER

THOR TECH, INC. (NEVADA CORPORATION)
419 WEST PIKE STREET
JACKSON CENTER, OH 45334

FOR: MOTOR HOMES, IN CLASS 12 (U.S. CLS. 19, 21, 23, 31, 35 AND 44).

FIRST USE 0-0-2011; IN COMMERCE 0-0-2011.

THE MARK CONSISTS OF STANDARD CHARACTERS WITHOUT CLAIM TO ANY PARTICULAR FONT, STYLE, SIZE, OR COLOR.

SN 85-420,317, FILED 9-12-2011.

JIM RINGLE, EXAMINING ATTORNEY



David J. Kyffers

Director of the United States Patent and Trademark Office

United States of America

United States Patent and Trademark Office

CLOSER TO OUR PATIENTS.
CLOSER TO A CURE.

Reg. No. 4,155,805

Registered June 5, 2012

Int. Cl.: 44

SERVICE MARK

PRINCIPAL REGISTER

H. LEE MOFFITT CANCER CENTER AND RESEARCH INSTITUTE, INC. (FLORIDA CORPORATION), AKA MOFFITT CANCER CENTER,
12902 MAGNOLIA DRIVE
TAMPA, FL 33612

FOR: MEDICAL SERVICES, NAMELY, PROVIDING TREATMENT FOR ONCOLOGICAL CONDITIONS AND MEDICAL TESTING FOR DIAGNOSTIC PURPOSES RELATED TO PERSONALIZED MEDICINE, IN CLASS 44 (U.S. CLS. 100 AND 101).

FIRST USE 10-30-2011; IN COMMERCE 10-30-2011.

THE MARK CONSISTS OF STANDARD CHARACTERS WITHOUT CLAIM TO ANY PARTICULAR FONT, STYLE, SIZE, OR COLOR.

SN 85-420,343, FILED 9-12-2011.

ANTHONY RINKER, EXAMINING ATTORNEY



David J. Kybas

Director of the United States Patent and Trademark Office

United States of America

United States Patent and Trademark Office

SCBT WHOLESALE MORTGAGE

Reg. No. 4,155,806

Registered June 5, 2012

Int. Cl.: 36

SERVICE MARK

PRINCIPAL REGISTER

SCBT FINANCIAL CORPORATION (SOUTH CAROLINA CORPORATION)
520 GERVAIS STREET
COLUMBIA, SC 29201

FOR: MORTGAGE BROKERAGE SERVICES IN THE FIELD OF WHOLESALE MORTGAGE LOANS IN THE SECONDARY MORTGAGE MARKETS, IN CLASS 36 (U.S. CLS. 100, 101 AND 102).

FIRST USE 7-22-2011; IN COMMERCE 7-22-2011.

THE MARK CONSISTS OF STANDARD CHARACTERS WITHOUT CLAIM TO ANY PARTICULAR FONT, STYLE, SIZE, OR COLOR.

OWNER OF U.S. REG. NOS. 2,907,585, 3,748,058, AND OTHERS.

NO CLAIM IS MADE TO THE EXCLUSIVE RIGHT TO USE "WHOLESALE MORTGAGE", APART FROM THE MARK AS SHOWN.

SN 85-426,699, FILED 9-20-2011.

AMY KELLY, EXAMINING ATTORNEY



David J. Kyros

Director of the United States Patent and Trademark Office

United States of America

United States Patent and Trademark Office

FlatWave

Reg. No. 4,155,807

Registered June 5, 2012

Int. Cl.: 9

TRADEMARK

PRINCIPAL REGISTER

WINEGARD COMPANY (IOWA CORPORATION)
3000 KIRKWOOD STREET
BURLINGTON, IA 52601

FOR: TELEVISION ANTENNAS, IN CLASS 9 (U.S. CLS. 21, 23, 26, 36 AND 38).

FIRST USE 11-0-2011; IN COMMERCE 11-0-2011.

THE MARK CONSISTS OF STANDARD CHARACTERS WITHOUT CLAIM TO ANY PARTICULAR FONT, STYLE, SIZE, OR COLOR.

SN 85-426,977, FILED 9-20-2011.

LUCY ARANT, EXAMINING ATTORNEY



David J. Kybas

Director of the United States Patent and Trademark Office

United States of America

United States Patent and Trademark Office

A Taste of Paradise

Reg. No. 4,155,808

THREE ANGELS BROADCASTING NETWORK, INC. (ILLINOIS CORPORATION)
P.O. BOX 220
WEST FRANKFORT, IL 62896

Registered June 5, 2012

Int. Cl.: 41

FOR: EDUCATIONAL AND ENTERTAINMENT SERVICES, NAMELY, A CONTINUING PROGRAM ABOUT COOKING FROM A CHRISTIAN PERSPECTIVE ACCESSIBLE BY RADIO, TELEVISION, SATELLITE, AUDIO, VIDEO AND COMPUTER NETWORKS, IN CLASS 41 (U.S. CLS. 100, 101 AND 107).

SERVICE MARK

PRINCIPAL REGISTER

FIRST USE 1-1-2012; IN COMMERCE 1-1-2012.

THE MARK CONSISTS OF STANDARD CHARACTERS WITHOUT CLAIM TO ANY PARTICULAR FONT, STYLE, SIZE, OR COLOR.

SN 85-434,758, FILED 9-28-2011.

LINDA MICKLEBURGH, EXAMINING ATTORNEY



David J. Kyffers

Director of the United States Patent and Trademark Office

United States of America

United States Patent and Trademark Office

PEACE, LOVE & CUPCAKES

Reg. No. 4,155,809

AUSTRALIAN GOLD, LLC (INDIANA LIMITED LIABILITY COMPANY)
6270 CORPORATE DRIVE
INDIANAPOLIS, IN 46278

Registered June 5, 2012

Int. Cl.: 3

FOR: INDOOR AND OUTDOOR NON-MEDICATED SKIN TANNING PREPARATIONS, IN CLASS 3 (U.S. CLS. 1, 4, 6, 50, 51 AND 52).

TRADEMARK

FIRST USE 11-1-2011; IN COMMERCE 11-1-2011.

PRINCIPAL REGISTER

THE MARK CONSISTS OF STANDARD CHARACTERS WITHOUT CLAIM TO ANY PARTICULAR FONT, STYLE, SIZE, OR COLOR.

SN 85-435,085, FILED 9-29-2011.

MICHAEL SOUDERS, EXAMINING ATTORNEY



David J. Kyffers

Director of the United States Patent and Trademark Office

United States of America

United States Patent and Trademark Office

BUY A PRODUCT THAT PAYS FOR ITSELF

Reg. No. 4,155,810

TUTTLE, DEXTER (UNITED STATES INDIVIDUAL)
3300 W BOLT ST
FORT WORTH, TX 76110

Registered June 5, 2012

Int. Cls.: 1 and 4

FOR: CHEMICAL ADDITIVES FOR USE WITH INTERNAL COMBUSTION ENGINE FUELS,
IN CLASS 1 (U.S. CLS. 1, 5, 6, 10, 26 AND 46).

TRADEMARK

FIRST USE 6-1-2011; IN COMMERCE 9-13-2011.

PRINCIPAL REGISTER

FOR: NON-CHEMICAL ENGINE TREATMENTS AND ADDITIVES FOR GASOLINE AND
DIESEL FUELS, IN CLASS 4 (U.S. CLS. 1, 6 AND 15).

FIRST USE 6-1-2011; IN COMMERCE 9-13-2011.

THE MARK CONSISTS OF STANDARD CHARACTERS WITHOUT CLAIM TO ANY PAR-
TICULAR FONT, STYLE, SIZE, OR COLOR.

SN 85-436,995, FILED 9-30-2011.

RENEE MCCRAY, EXAMINING ATTORNEY



David J. Kyros

Director of the United States Patent and Trademark Office

United States of America

United States Patent and Trademark Office

MI CHIAMO TURCHI

Reg. No. 4,155,811

Registered June 5, 2012

Int. Cl.: 33

TRADEMARK

PRINCIPAL REGISTER

INTERCONTINENTAL PACKAGING CO. (MINNESOTA CORPORATION)
1999 SHEPARD ROAD
ST. PAUL, MN 55116

FOR: ALCOHOLIC BEVERAGES EXCEPT BEERS, IN CLASS 33 (U.S. CLS. 47 AND 49).

FIRST USE 11-1-2011; IN COMMERCE 1-1-2012.

THE MARK CONSISTS OF STANDARD CHARACTERS WITHOUT CLAIM TO ANY PARTICULAR FONT, STYLE, SIZE, OR COLOR.

THE ENGLISH TRANSLATION OF "MI CHIAMO TURCHI" IN THE MARK IS "MY NAME IS TURCHI".

SN 85-438,420, FILED 10-4-2011.

DANNEAN HETZEL, EXAMINING ATTORNEY



David J. Kyros

Director of the United States Patent and Trademark Office

United States of America

United States Patent and Trademark Office

Loyal American Supplemental Series

Reg. No. 4,155,812

Registered June 5, 2012

Int. Cl.: 36

SERVICE MARK

PRINCIPAL REGISTER

LOYAL AMERICAN LIFE INSURANCE COMPANY (OHIO CORPORATION), TA LOYAL AMERICAN LIFE INSURANCE COMPANY,
11200 LAKELINE BLVD., SUITE 100
AUSTIN, TX 78717

FOR: INSURANCE SERVICES, NAMELY, UNDERWRITING, ISSUANCE AND ADMINISTRATION OF SUPPLEMENTAL HEALTH INSURANCE, IN CLASS 36 (U.S. CLS. 100, 101 AND 102).

FIRST USE 11-11-2011; IN COMMERCE 11-11-2011.

THE MARK CONSISTS OF STANDARD CHARACTERS WITHOUT CLAIM TO ANY PARTICULAR FONT, STYLE, SIZE, OR COLOR.

OWNER OF U.S. REG. NO. 2,647,611.

NO CLAIM IS MADE TO THE EXCLUSIVE RIGHT TO USE "AMERICAN" AND "SUPPLEMENTAL SERIES", APART FROM THE MARK AS SHOWN.

SN 85-440,785, FILED 10-6-2011.

MICHELE SWAIN, EXAMINING ATTORNEY



David J. Kyros

Director of the United States Patent and Trademark Office

United States of America

United States Patent and Trademark Office

MARSH BRAND PARTNERS

Reg. No. 4,155,813

Registered June 5, 2012

Int. Cl.: 42

SERVICE MARK

PRINCIPAL REGISTER

MARSH INC. (OHIO CORPORATION)
333 EAST 8TH STREET
CINCINNATI, OH 45202

FOR: DESIGN SERVICES FOR PACKAGING; INNOVATION CONSULTING SERVICES, NAMELY, ADVISING OTHERS IN THE AREAS OF PRODUCT DEVELOPMENT; VISUAL DESIGN SERVICES IN THE NATURE OF DESIGNING VISUAL ELEMENTS FOR ON-LINE, BROADCAST, PRINT, OUTDOOR AND OTHER COMMUNICATION MEDIA; WEBSITE DESIGN AND DEVELOPMENT FOR OTHERS, IN CLASS 42 (U.S. CLS. 100 AND 101).

FIRST USE 1-20-2012; IN COMMERCE 1-20-2012.

THE MARK CONSISTS OF STANDARD CHARACTERS WITHOUT CLAIM TO ANY PARTICULAR FONT, STYLE, SIZE, OR COLOR.

NO CLAIM IS MADE TO THE EXCLUSIVE RIGHT TO USE "BRAND PARTNERS", APART FROM THE MARK AS SHOWN.

SN 85-441,008, FILED 10-6-2011.

TASNEEM HUSSAIN, EXAMINING ATTORNEY



David J. Kyros

Director of the United States Patent and Trademark Office

United States of America

United States Patent and Trademark Office

LUNA FIORE

Reg. No. 4,155,814

INTERCONTINENTAL PACKAGING CO. (MINNESOTA CORPORATION)
1999 SHEPARD ROAD
ST. PAUL, MN 55116

Registered June 5, 2012

Int. Cl.: 33

FOR: ALCOHOLIC BEVERAGES EXCEPT BEERS, IN CLASS 33 (U.S. CLS. 47 AND 49).

TRADEMARK

FIRST USE 11-1-2011; IN COMMERCE 12-1-2011.

PRINCIPAL REGISTER

THE MARK CONSISTS OF STANDARD CHARACTERS WITHOUT CLAIM TO ANY PARTICULAR FONT, STYLE, SIZE, OR COLOR.

THE ENGLISH TRANSLATION OF "LUNA FIORE" IN THE MARK IS "MOON FLOWER".

SN 85-443,446, FILED 10-10-2011.

DANNEAN HETZEL, EXAMINING ATTORNEY



David J. Kyffers

Director of the United States Patent and Trademark Office

United States of America

United States Patent and Trademark Office

ARCDUO

Reg. No. 4,155,815

COOPER TECHNOLOGIES COMPANY (DELAWARE CORPORATION)
600 TRAVIS, SUITE 5600
HOUSTON, TX 77002

Registered June 5, 2012

Int. Cl.: 11

FOR: ELECTRIC LIGHTING FIXTURES, IN CLASS 11 (U.S. CLS. 13, 21, 23, 31 AND 34).

TRADEMARK

FIRST USE 12-11-2011; IN COMMERCE 12-11-2011.

PRINCIPAL REGISTER

THE MARK CONSISTS OF STANDARD CHARACTERS WITHOUT CLAIM TO ANY PARTICULAR FONT, STYLE, SIZE, OR COLOR.

SN 85-444,528, FILED 10-11-2011.

SANJEEV VOHRA, EXAMINING ATTORNEY



David J. Kyffers

Director of the United States Patent and Trademark Office

United States of America

United States Patent and Trademark Office

SPIRITO D'ITALIA

Reg. No. 4,155,816

Registered June 5, 2012

Int. Cl.: 33

TRADEMARK

PRINCIPAL REGISTER

WINERY EXCHANGE, INC. (CALIFORNIA CORPORATION)
500 REDWOOD BLVD., SUITE 200
NOVATO, CA 94947

FOR: ALCOHOLIC BEVERAGES EXCEPT BEERS, IN CLASS 33 (U.S. CLS. 47 AND 49).

FIRST USE 1-0-2012; IN COMMERCE 1-0-2012.

THE MARK CONSISTS OF STANDARD CHARACTERS WITHOUT CLAIM TO ANY PARTICULAR FONT, STYLE, SIZE, OR COLOR.

THE ENGLISH TRANSLATION OF "SPIRITO D'ITALIA" IN THE MARK IS "SPIRIT OF ITALY".

SN 85-446,992, FILED 10-13-2011.

KAELIE KUNG, EXAMINING ATTORNEY



David J. Kyros

Director of the United States Patent and Trademark Office

United States of America

United States Patent and Trademark Office



Reg. No. 4,155,817

Registered June 5, 2012

Int. Cl.: 37

SERVICE MARK

PRINCIPAL REGISTER

8NET, INC. (CALIFORNIA CORPORATION)
13140 ALONDRA BLVD
CERRITOS, CA 90703

FOR: BOTTLE AND CAN COLLECTION FOR RECYCLING; COLLECTION CENTERS FOR METAL CANS AND OTHER RECYCLABLE ITEMS; PAPER AND CARDBOARD COLLECTION FOR RECYCLING, IN CLASS 37 (U.S. CLS. 100, 103 AND 106).

FIRST USE 4-2-2012; IN COMMERCE 4-2-2012.

NO CLAIM IS MADE TO THE EXCLUSIVE RIGHT TO USE "RECYCLING CENTER" AND THE UNIVERSAL SYMBOL FOR RECYCLING, APART FROM THE MARK AS SHOWN.

THE COLOR(S) RED AND GREEN IS/ARE CLAIMED AS A FEATURE OF THE MARK.

THE MARK CONSISTS OF THE WORDING "IN & OUT" WITH THE "I" IN RED AND LOWERCASE, THE "N" IN RED AND UPPERCASE, THE "&" IN GREEN AND SURROUNDED BY THE UNIVERSAL RECYCLING SYMBOL IN GREEN, THE "O" IN RED AND UPPERCASE, THE "UT" IN RED AND LOWERCASE ALL ABOVE THE WORDING "RECYCLING CENTER" IN GREEN AND UNDERLINED IN GREEN.

SN 85-448,454, FILED 10-16-2011.

TASNEEM HUSSAIN, EXAMINING ATTORNEY



David J. Kyffers

Director of the United States Patent and Trademark Office

United States of America

United States Patent and Trademark Office

REAL DEL PEDRO

Reg. No. 4,155,818

Registered June 5, 2012

Int. Cl.: 33

TRADEMARK

PRINCIPAL REGISTER

INTERCONTINENTAL PACKAGING CO. (MINNESOTA CORPORATION)
1999 SHEPARD ROAD
ST. PAUL, MN 55116

FOR: ALCOHOLIC BEVERAGES EXCEPT BEERS, IN CLASS 33 (U.S. CLS. 47 AND 49).

FIRST USE 11-1-2011; IN COMMERCE 12-1-2011.

THE MARK CONSISTS OF STANDARD CHARACTERS WITHOUT CLAIM TO ANY PARTICULAR FONT, STYLE, SIZE, OR COLOR.

THE ENGLISH TRANSLATION OF "REAL DEL PEDRO" IN THE MARK IS "ROYAL OF PETER".

SN 85-449,815, FILED 10-18-2011.

DANNEAN HETZEL, EXAMINING ATTORNEY



David J. Kyffers

Director of the United States Patent and Trademark Office

United States of America

United States Patent and Trademark Office

PRIMA MAZZO

Reg. No. 4,155,819

Registered June 5, 2012

Int. Cl.: 33

TRADEMARK

PRINCIPAL REGISTER

INTERCONTINENTAL PACKAGING CO. (MINNESOTA CORPORATION)
1999 SHEPARD ROAD
ST. PAUL, MN 55116

FOR: ALCOHOLIC BEVERAGES EXCEPT BEERS, IN CLASS 33 (U.S. CLS. 47 AND 49).

FIRST USE 12-1-2011; IN COMMERCE 3-1-2012.

THE MARK CONSISTS OF STANDARD CHARACTERS WITHOUT CLAIM TO ANY PARTICULAR FONT, STYLE, SIZE, OR COLOR.

THE ENGLISH TRANSLATION OF "PRIMA MAZZO" IN THE MARK IS "FIRST DECK".

SN 85-449,820, FILED 10-18-2011.

DANNEAN HETZEL, EXAMINING ATTORNEY



David J. Kybas

Director of the United States Patent and Trademark Office

United States of America

United States Patent and Trademark Office

3D SUN FX

Reg. No. 4,155,820

Registered June 5, 2012

Int. Cl.: 26

TRADEMARK

PRINCIPAL REGISTER

EVA GABOR INTERNATIONAL, LTD. (DELAWARE CORPORATION)
5900 EQUITABLE ROAD
KANSAS CITY, MO 64120

FOR: WIGS, HAIRPIECES, HAIR EXTENSIONS, AND ADD-IN AND ADD-ON HAIR ACCESSORIES CONSTRUCTED PRIMARILY OF SYNTHETIC AND/OR HUMAN HAIR , IN CLASS 26 (U.S. CLS. 37, 39, 40, 42 AND 50).

FIRST USE 11-0-2011; IN COMMERCE 11-0-2011.

THE MARK CONSISTS OF STANDARD CHARACTERS WITHOUT CLAIM TO ANY PARTICULAR FONT, STYLE, SIZE, OR COLOR.

SN 85-451,422, FILED 10-19-2011.

SUNG IN, EXAMINING ATTORNEY



David J. Kyfos

Director of the United States Patent and Trademark Office

United States of America

United States Patent and Trademark Office

DEMON KILLER

Reg. No. 4,155,821

INTERCONTINENTAL PACKAGING CO. (MINNESOTA CORPORATION)
1999 SHEPARD ROAD
ST. PAUL, MN 55116

Registered June 5, 2012

Int. Cl.: 33

FOR: ALCOHOLIC BEVERAGES EXCEPT BEERS, IN CLASS 33 (U.S. CLS. 47 AND 49).

TRADEMARK

FIRST USE 8-1-2010; IN COMMERCE 10-1-2010.

PRINCIPAL REGISTER

THE MARK CONSISTS OF STANDARD CHARACTERS WITHOUT CLAIM TO ANY PARTICULAR FONT, STYLE, SIZE, OR COLOR.

SN 85-456,440, FILED 10-26-2011.

DANNEAN HETZEL, EXAMINING ATTORNEY



David J. Kybas

Director of the United States Patent and Trademark Office

United States of America

United States Patent and Trademark Office

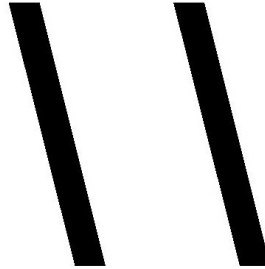

Reg. No. 4,155,822

Registered June 5, 2012

Int. Cl.: 9

TRADEMARK

PRINCIPAL REGISTER

WESTWARD LEANING (DELAWARE CORPORATION)
330 TOWNSEND STREET SUITE 201
SAN FRANCISCO, CA 94107

FOR: SUNGLASSES, IN CLASS 9 (U.S. CLS. 21, 23, 26, 36 AND 38).

FIRST USE 8-1-2011; IN COMMERCE 11-15-2011.

THE MARK CONSISTS OF A DOUBLE BACKSLASH.

SN 85-457,613, FILED 10-27-2011.

KELLEY WELLS, EXAMINING ATTORNEY



David J. Kyffers

Director of the United States Patent and Trademark Office

United States of America

United States Patent and Trademark Office

QT ENERGY SHOT

Reg. No. 4,155,823

Registered June 5, 2012

Int. Cl.: 32

TRADEMARK

PRINCIPAL REGISTER

QUIKTRIP WEST, INC. (KANSAS CORPORATION)
5929 WEST CENTRAL
WICHITA, KS 67277

FOR: SPORTS DRINKS, NAMELY, ENERGY DRINKS, IN CLASS 32 (U.S. CLS. 45, 46 AND 48).

FIRST USE 1-15-2012; IN COMMERCE 1-15-2012.

THE MARK CONSISTS OF STANDARD CHARACTERS WITHOUT CLAIM TO ANY PARTICULAR FONT, STYLE, SIZE, OR COLOR.

OWNER OF U.S. REG. NOS. 1,094,059, 1,926,167, AND OTHERS.

NO CLAIM IS MADE TO THE EXCLUSIVE RIGHT TO USE "ENERGY SHOT", APART FROM THE MARK AS SHOWN.

SN 85-461,230, FILED 11-1-2011.

JOHN WILKE, EXAMINING ATTORNEY



David J. Kybas

Director of the United States Patent and Trademark Office

United States of America

United States Patent and Trademark Office

WINDFLOAT

Reg. No. 4,155,824

PRINCIPLE POWER, INC. (NEVADA CORPORATION)
93 S. JACKSON STREET #63650
SEATTLE, WA 98104

Registered June 5, 2012

Int. Cls.: 7, 37, and 42

FOR: WIND TURBINES AND STRUCTURAL PARTS THEREFOR, IN CLASS 7 (U.S. CLS. 13, 19, 21, 23, 31, 34 AND 35).

TRADEMARK

FIRST USE 8-5-2009; IN COMMERCE 8-5-2009.

SERVICE MARK

FOR: CONSTRUCTION OF WIND TURBINES, IN CLASS 37 (U.S. CLS. 100, 103 AND 106).

PRINCIPAL REGISTER

FIRST USE 8-5-2009; IN COMMERCE 8-5-2009.

FOR: DESIGN FOR OTHERS OF WIND TURBINES, IN CLASS 42 (U.S. CLS. 100 AND 101).

FIRST USE 8-5-2009; IN COMMERCE 8-5-2009.

THE MARK CONSISTS OF STANDARD CHARACTERS WITHOUT CLAIM TO ANY PARTICULAR FONT, STYLE, SIZE, OR COLOR.

SN 85-975,880, FILED 5-5-2010.

DAWN HAN, EXAMINING ATTORNEY



David J. Kyros

Director of the United States Patent and Trademark Office

United States of America

United States Patent and Trademark Office

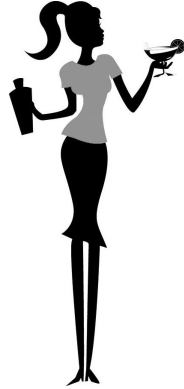

Reg. No. 4,155,825

Registered June 5, 2012

Int. Cl.: 33

TRADEMARK

PRINCIPAL REGISTER

JIM BEAM BRANDS CO. (DELAWARE CORPORATION)
510 LAKE COOK ROAD
DEERFIELD, IL 60015

FOR: ALCOHOLIC COCKTAIL MIXES, IN CLASS 33 (U.S. CLS. 47 AND 49).

FIRST USE 9-23-2009; IN COMMERCE 9-23-2009.

THE MARK CONSISTS OF THE SILHOUETTE OF A WOMAN DRESSED IN A TOP AND A SKIRT, WITH A COCKTAIL SHAKER IN THE RIGHT HAND, AND A COCKTAIL IN THE LEFT HAND.

SN 85-975,974, FILED 9-17-2010.

JAMES STEIN, EXAMINING ATTORNEY



David J. Kybas

Director of the United States Patent and Trademark Office

United States of America

United States Patent and Trademark Office

TO EACH, THEIR OWN

Reg. No. 4,155,826

Registered June 5, 2012

Int. Cl.: 33

TRADEMARK

PRINCIPAL REGISTER

THE WINE GROUP LLC (DELAWARE LIMITED LIABILITY COMPANY)
4596 S. TRACY BOULEVARD
TRACY, CA 95377

FOR: SPIRITS, IN CLASS 33 (U.S. CLS. 47 AND 49).

FIRST USE 2-29-2012; IN COMMERCE 2-29-2012.

THE MARK CONSISTS OF STANDARD CHARACTERS WITHOUT CLAIM TO ANY PARTICULAR FONT, STYLE, SIZE, OR COLOR.

SN 85-976,205, FILED 9-22-2010.

MATTHEW MCDOWELL, EXAMINING ATTORNEY



David J. Kybas

Director of the United States Patent and Trademark Office

United States of America

United States Patent and Trademark Office



Reg. No. 4,155,827

Registered June 5, 2012

Int. Cl.: 14

TRADEMARK

PRINCIPAL REGISTER

AUTODROMO LLC (NEW YORK LIMITED LIABILITY COMPANY)
UNIT 1
62 HICKS STREET
BROOKLYN, NY 11201

FOR: WATCHES, IN CLASS 14 (U.S. CLS. 2, 27, 28 AND 50).

FIRST USE 11-14-2011; IN COMMERCE 11-14-2011.

THE MARK CONSISTS OF TWO INTERSECTING POLYGONAL FIGURES DRAWN TO RESEMBLE A SMALL SEGMENT OF A TIRE TREAD.

SN 85-976,271, FILED 5-23-2011.

CHARLOTTE CORWIN, EXAMINING ATTORNEY



David J. Kybas

Director of the United States Patent and Trademark Office

United States of America

United States Patent and Trademark Office

MONEYHUB

Reg. No. 4,155,828

Registered June 5, 2012

Int. Cl.: 36

SERVICE MARK

PRINCIPAL REGISTER

SEARS BRANDS, LLC (ILLINOIS LIMITED LIABILITY COMPANY)
3333 BEVERLY DRIVE
HOFFMAN ESTATES, IL 60179

FOR: ISSUING STORED VALUE CARDS, IN CLASS 36 (U.S. CLS. 100, 101 AND 102).

FIRST USE 3-1-2012; IN COMMERCE 3-1-2012.

THE MARK CONSISTS OF STANDARD CHARACTERS WITHOUT CLAIM TO ANY PARTICULAR FONT, STYLE, SIZE, OR COLOR.

SN 85-976,422, FILED 7-5-2011.

WON TEAK OH, EXAMINING ATTORNEY



David J. Kyros

Director of the United States Patent and Trademark Office

United States of America

United States Patent and Trademark Office

TEXTAPPEAL

Reg. No. 4,155,829

Registered June 5, 2012

Int. Cl.: 35

SERVICE MARK

PRINCIPAL REGISTER

TEXT APPEAL LIMITED (UNITED KINGDOM LIMITED COMPANY (LTD.))
112 YORK ROAD
LONDON, UNITED KINGDOM SW113RS

FOR: ADVERTISING AGENCIES; CREATION AND DISSEMINATION OF ADVERTISING MATTER; PUBLICITY COLUMNS AND PREPARATION OF MARKETING MATERIALS IN THE NATURE OF FACSIMILES; DIRECT MAIL ADVERTISING; PUBLICATION OF PUBLICITY TEXTS; CONSULTANCY IN THE FIELDS OF MULTILINGUAL MARKETING COMMUNICATIONS, MARKETING, IN CLASS 35 (U.S. CLS. 100, 101 AND 102).

FIRST USE 4-0-2007; IN COMMERCE 4-0-2007.

THE MARK CONSISTS OF STANDARD CHARACTERS WITHOUT CLAIM TO ANY PARTICULAR FONT, STYLE, SIZE, OR COLOR.

SN 85-976,464, FILED 8-11-2010.

KATHLEEN LORENZO, EXAMINING ATTORNEY



David J. Kyjars

Director of the United States Patent and Trademark Office

United States of America

United States Patent and Trademark Office

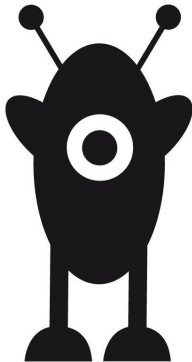

Reg. No. 4,155,830

Registered June 5, 2012

Int. Cls.: 35 and 42

SERVICE MARK

PRINCIPAL REGISTER

SURVEY PLANET, LLC (CALIFORNIA LIMITED LIABILITY COMPANY)
2901 OCEAN PARK BLVD., SUITE 215
SANTA MONICA, CA 90405

FOR: MARKET RESEARCH SERVICES; PROVIDING AN INTERACTIVE WEB SITE FEATURING EDUCATIONAL INFORMATION AND TEST QUESTIONS IN THE FIELD OF MARKET RESEARCH, IN CLASS 35 (U.S. CLS. 100, 101 AND 102).

FIRST USE 2-3-2012; IN COMMERCE 2-3-2012.

FOR: HOSTING AN ONLINE COMMUNITY WEBSITE FOR USERS TO PARTICIPATE IN, CONDUCT AND MANAGE SURVEYS; PROVIDING TEMPORARY USE OF NON-DOWNLOADABLE COMPUTER SOFTWARE APPLICATION FOR MOBILE DEVICES FOR CONDUCTING CONSUMER SURVEYS, IN CLASS 42 (U.S. CLS. 100 AND 101).

FIRST USE 2-3-2012; IN COMMERCE 2-3-2012.

THE MARK CONSISTS OF AN ALIEN FORM HAVING AN OVAL BODY AND A SINGLE EYE.

SN 85-976,512, FILED 6-8-2011.

JAMES LOVELACE, EXAMINING ATTORNEY



David J. Kybas

Director of the United States Patent and Trademark Office

United States of America

United States Patent and Trademark Office



Reg. No. 4,155,831

Registered June 5, 2012

Int. Cl.: 44

SERVICE MARK

PRINCIPAL REGISTER

VERINATA HEALTH, INC. (DELAWARE CORPORATION)
800 SAGINAW DRIVE
REDWOOD CITY, CA 94063

FOR: MEDICAL TESTING FOR DIAGNOSTIC OR TREATMENT PURPOSES, IN CLASS 44
(U.S. CLS. 100 AND 101).

FIRST USE 2-23-2012; IN COMMERCE 2-23-2012.

THE MARK CONSISTS OF TWO ARCS, ONE UPWARD TO THE RIGHT AND THE OTHER
UPWARD TO THE LEFT, AND TWO DOTS.

SN 85-976,535, FILED 4-11-2011.

CHARLOTTE CORWIN, EXAMINING ATTORNEY



David J. Kybas

Director of the United States Patent and Trademark Office

United States of America

United States Patent and Trademark Office

FRANCESCO
RINALDI

Reg. No. 4,155,832

LIDESTRI FOODS, INC. (NEW YORK CORPORATION)
815 WEST WHITNEY ROAD
FAIRPORT, NY 14450

Registered June 5, 2012

Int. Cl.: 29

FOR: BLENDED OIL; CANOLA OIL; COOKING OIL; EDIBLE OIL; NUTRITIONAL OILS
FOR FOOD PURPOSES; OLIVE OIL; VEGETABLE OILS, IN CLASS 29 (U.S. CL. 46).

TRADEMARK

FIRST USE 11-1-2009; IN COMMERCE 11-1-2009.

PRINCIPAL REGISTER

OWNER OF U.S. REG. NOS. 1,354,502, 3,500,657, AND OTHERS.

THE NAME(S), PORTRAIT(S), AND/OR SIGNATURE(S) SHOWN IN THE MARK DOES NOT
IDENTIFY A PARTICULAR LIVING INDIVIDUAL.

THE MARK CONSISTS OF THE WORDING "FRANCESCO RINALDI" IN A STYLIZED FONT.

SN 85-976,538, FILED 3-8-2011.

JANICE KIM, EXAMINING ATTORNEY



David J. Kybas

Director of the United States Patent and Trademark Office

United States of America

United States Patent and Trademark Office

MORTON & HUDSON

Reg. No. 4,155,833

Registered June 5, 2012

Int. Cl.: 18

TRADEMARK

PRINCIPAL REGISTER

MORTON & HUDSON, LLC (CALIFORNIA LIMITED LIABILITY COMPANY)
3525 DEL MAR HTS RD #111
C/O STIEFLER LAW
SAN DIEGO, CA 921302122

FOR: ALL-PURPOSE CARRYING BAGS, CARRY-ALL BAGS, HANDBAGS, PURSES,
SHOULDER BAGS, TOILETRY BAGS, IN CLASS 18 (U.S. CLS. 1, 2, 3, 22 AND 41).

FIRST USE 9-29-2011; IN COMMERCE 9-29-2011.

THE MARK CONSISTS OF STANDARD CHARACTERS WITHOUT CLAIM TO ANY PAR-
TICULAR FONT, STYLE, SIZE, OR COLOR.

SN 85-976,546, FILED 6-21-2011.

SUNG IN, EXAMINING ATTORNEY



David J. Kyffers

Director of the United States Patent and Trademark Office

United States of America

United States Patent and Trademark Office



Reg. No. 4,155,834

Registered June 5, 2012

Int. Cls.: 14, 18, 25, and 41

TRADEMARK

SERVICE MARK

PRINCIPAL REGISTER

PAN AMERICAN WORLD AIRWAYS, INC. (DELAWARE CORPORATION)
44 INDUSTRIAL PARK DRIVE
DOVER, NH 03820

FOR: WATCHES; CUFFLINKS, IN CLASS 14 (U.S. CLS. 2, 27, 28 AND 50).

FIRST USE 5-31-2008; IN COMMERCE 5-31-2008.

FOR: WALLET, IN CLASS 18 (U.S. CLS. 1, 2, 3, 22 AND 41).

FIRST USE 2-28-2010; IN COMMERCE 2-28-2010.

FOR: BELTS, IN CLASS 25 (U.S. CLS. 22 AND 39).

FIRST USE 10-31-2010; IN COMMERCE 10-31-2010.

FOR: ENTERTAINMENT SERVICES IN THE NATURE OF AN ON-GOING DRAMATIC TELEVISION PROGRAM, IN CLASS 41 (U.S. CLS. 100, 101 AND 107).

FIRST USE 9-30-2011; IN COMMERCE 9-30-2011.

OWNER OF U.S. REG. NOS. 3,166,414, 3,171,135, AND OTHERS.

THE MARK CONSISTS OF THE OUTLINE OF A GLOBE WITH THE WORDS "PAN AM" ACROSS IT.

SN 85-976,562, FILED 7-20-2010.

NATALIE POLZER, EXAMINING ATTORNEY



David J. Kybas

Director of the United States Patent and Trademark Office

United States of America

United States Patent and Trademark Office

AVENUE K

Reg. No. 4,155,835

Registered June 5, 2012

Int. Cl.: 35

SERVICE MARK

PRINCIPAL REGISTER

AVENUE K MARKETING, LLC (CALIFORNIA LIMITED LIABILITY COMPANY)
709 MALCOLM AVENUE
LOS ANGELES, CA 90024

FOR: ADVERTISING; ADVERTISING AGENCY; ADVERTISING, PROMOTION AND MARKETING SERVICES FOR OTHERS, AND ADVERTISING FOR OTHERS IN AND ON PARKING FACILITIES AND ON COMMERCIAL PROPERTIES; PRODUCT DEMONSTRATION SERVICES; MARKETING CONSULTING; ADVERTISING, MARKETING AND PROMOTION SERVICES; DEVELOPING ADVERTISING AND PROMOTIONAL CAMPAIGNS FOR BUSINESSES; DEVELOPMENT OF MARKETING STRATEGIES AND CONCEPTS, IN CLASS 35 (U.S. CLS. 100, 101 AND 102).

FIRST USE 8-15-2011; IN COMMERCE 8-15-2011.

THE MARK CONSISTS OF STANDARD CHARACTERS WITHOUT CLAIM TO ANY PARTICULAR FONT, STYLE, SIZE, OR COLOR.

SN 85-976,570, FILED 1-3-2011.

ZHALEH DELANEY, EXAMINING ATTORNEY



David J. Kyros

Director of the United States Patent and Trademark Office

United States of America

United States Patent and Trademark Office

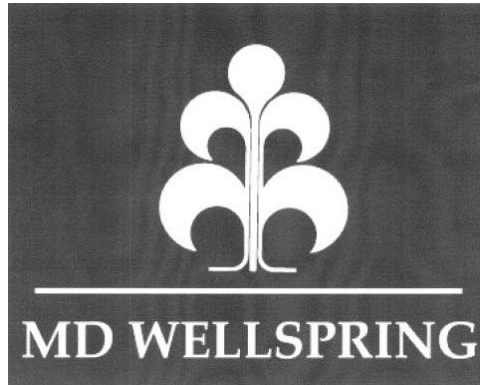

Reg. No. 4,155,836

Registered June 5, 2012

Int. Cl.: 16

TRADEMARK

PRINCIPAL REGISTER

MD WELLSRING, LLC (GEORGIA LIMITED LIABILITY COMPANY)
SUITE F2182
3695 CASCADE ROAD, SW
ATLANTA, GA 30331

FOR: PUBLICATIONS, NAMELY, BOOKS IN THE FIELDS OF SPIRITUAL DEVELOPMENT, DEVOTIONAL TOPICS, PERSONAL DEVELOPMENT, PRAYER, AND RELIGION, IN CLASS 16 (U.S. CLS. 2, 5, 22, 23, 29, 37, 38 AND 50).

FIRST USE 10-31-2010; IN COMMERCE 10-31-2010.

THE MARK CONSISTS OF A HORIZONTAL LINE BELOW WHICH IS THE WORDING "MD WELLSRING" AND ABOVE WHICH IS A DESIGN. THE DESIGN CONSISTS OF A VERTICAL LINE WITH A CIRCULAR SHAPE AT THE TOP. BELOW THE CIRCLE SHAPE AND ON EACH SIDE OF THE VERTICAL LINE ARE TWO SMALL CRESCENT SHAPES AND TWO LARGE CRESCENT SHAPES, WITH THE SMALL CRESCENT SHAPES ABOVE THE TWO LARGE CRESCENT SHAPES. THE SMALL AND LARGE CRESCENT SHAPES ARE SYMMETRICALLY PLACED ON EACH SIDE OF THE VERTICAL LINE AND POINT DOWNWARD.

SN 85-976,588, FILED 6-29-2011.

DOUGLAS LEE, EXAMINING ATTORNEY



David J. Kyffers

Director of the United States Patent and Trademark Office

United States of America

United States Patent and Trademark Office

DISPLAYFLIX

Reg. No. 4,155,837

Registered June 5, 2012

Int. Cls.: 6, 20, 24, and 40

TRADEMARK

SERVICE MARK

PRINCIPAL REGISTER

VISPRONET, INC. (PENNSYLVANIA CORPORATION)
ONE SOUTH MARKET SQUARE
HARRISBURG, PA 17101

FOR: BEARERS AND SUPPORT CONSTRUCTIONS, IN THE FORM OF METAL PIPES AND METAL POLES FOR ADVERTISING SURFACES; METAL POLES, NAMELY, POLES FOR DISPLAYING ADVERTISING AND DECORATIVE BANNERS, FLAGS, DISPLAYS, PANELS, AND THE LIKE; METAL ACCESSORIES FOR METALLIC DISPLAY STANDS FOR PRESENTING PRINTED AND UNPRINTED ADVERTISING MATERIAL, NAMELY, CONNECTORS FOR CONNECTING TWO OR MORE FRAMES OR BASES; METALLIC FRAMEWORK; METALLIC RUNNERS, NAMELY, RAILS FOR FIXING WELT-SEAMED DISPLAY MATERIALS; METAL WALL-MOUNTED BOARDS, PANELS AND PLATES FOR EXHIBITIONS, DISPLAYS AND PARTITIONING , IN CLASS 6 (U.S. CLS. 2, 12, 13, 14, 23, 25 AND 50).

FIRST USE 4-9-2012; IN COMMERCE 4-9-2012.

FOR: NON-METAL POLES, NAMELY, POLES MADE OF SYNTHETIC MATERIAL FOR DISPLAYING ADVERTISING AND DECORATIVE BANNERS, FLAGS, DISPLAYS, PANELS, AND THE LIKE; NON-METALLIC DISPLAY STANDS FOR PRESENTING PRINTED AND UNPRINTED ADVERTISING MATERIAL, MADE OF PLASTIC, REINFORCED PLASTIC OR WOOD; ACCESSORIES FOR THE NON-METAL POLES AND DISPLAY STANDS FOR DISPLAYING ADVERTISING AND DECORATIVE BANNERS, FLAGS, DISPLAYS, PANELS, AND THE LIKE, NAMELY, CLAMPS, ADAPTERS IN THE NATURE OF SPRINGS, HOOKS AND CLIPS, FASTENERS IN THE NATURE OF SCREWS AND DISPLAY BOARDS, PANELS AND PLATES, ALL MADE OF PLASTIC, REINFORCED PLASTIC OR WOOD; NON-METALLIC FRAMEWORKS FOR DISPLAY STANDS FOR PRESENTING PRINTED AND UNPRINTED ADVERTISING MATERIAL MADE OF PLASTIC, REINFORCED PLASTIC OR WOOD; NON-METALLIC FRAME STRIPS IN THE NATURE OF DISPLAY FRAMES FOR PRESENTING ADVERTISING MATERIAL; METALLIC DISPLAY STANDS FOR PRESENTING PRINTED AND UNPRINTED ADVERTISING MATERIAL; METALLIC FRAMEWORK, NAMELY, METAL-BASED DISPLAY STAND FRAMES FOR USE WITH INTERCHANGEABLE BANNERS, FLAGS AND THE LIKE; METALLIC FRAME STRIPS, NAMELY, METAL-BASED DISPLAY FRAMES FOR PRESENTING ADVERTISING MATERIAL, IN CLASS 20 (U.S. CLS. 2, 13, 22, 25, 32 AND 50).

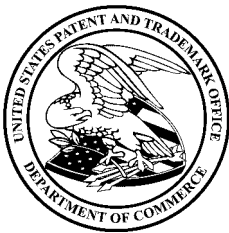

David J. Kyros

Director of the United States Patent and Trademark Office

FIRST USE 4-9-2012; IN COMMERCE 4-9-2012.

Reg. No. 4,155,837 FOR: SINGLE AND MULTI-LAYERED PRINTED AND NOT PRINTED TEXTILES USED FOR ADVERTISING PURPOSES, NAMELY, FLAGS, PENNANTS, STREAMERS, BANNERS AND CLOTH FLAGS WITH DIFFERENT SHAPES FOR INDOOR AND OUTDOOR DECORATION PURPOSES; SINGLE AND MULTI-LAYERED COATED AND NON-COATED TEXTILE FABRICS FOR PRESENTING ADVERTISING MATERIAL, IN CLASS 24 (U.S. CLS. 42 AND 50).

FIRST USE 4-9-2012; IN COMMERCE 4-9-2012.

FOR: PRINTING SERVICES, IN CLASS 40 (U.S. CLS. 100, 103 AND 106).

FIRST USE 4-9-2012; IN COMMERCE 4-9-2012.

THE MARK CONSISTS OF STANDARD CHARACTERS WITHOUT CLAIM TO ANY PARTICULAR FONT, STYLE, SIZE, OR COLOR.

SN 85-976,593, FILED 11-24-2010.

GENE MACIOL, EXAMINING ATTORNEY

United States of America

United States Patent and Trademark Office

INKY

Reg. No. 4,155,838

Registered June 5, 2012

Int. Cls.: 9, 38, and 42

TRADEMARK

SERVICE MARK

PRINCIPAL REGISTER

ARCODE CORPORATION (MARYLAND CORPORATION)
4304 EAST WEST HIGHWAY
BETHESDA, MD 20814

FOR: DOWNLOADABLE SOFTWARE FOR ENSURING THE SECURITY OF ELECTRONIC MAIL; DOWNLOADABLE COMPUTER SEARCH ENGINE SOFTWARE, IN CLASS 9 (U.S. CLS. 21, 23, 26, 36 AND 38).

FIRST USE 10-25-2011; IN COMMERCE 10-25-2011.

FOR: ELECTRONIC MAIL AND MESSAGING SERVICES, IN CLASS 38 (U.S. CLS. 100, 101 AND 104).

FIRST USE 10-25-2011; IN COMMERCE 10-25-2011.

FOR: PROVIDING TEMPORARY USE OF NONDOWNLOADABLE SOFTWARE FOR ENSURING THE SECURITY OF ELECTRONIC MAIL AND FOR USE AS SEARCH ENGINE SOFTWARE, IN CLASS 42 (U.S. CLS. 100 AND 101).

FIRST USE 10-25-2011; IN COMMERCE 10-25-2011.

THE MARK CONSISTS OF STANDARD CHARACTERS WITHOUT CLAIM TO ANY PARTICULAR FONT, STYLE, SIZE, OR COLOR.

SN 85-976,632, FILED 7-8-2011.

ELISSA GARBER KON, EXAMINING ATTORNEY



David J. Kybas

Director of the United States Patent and Trademark Office

United States of America

United States Patent and Trademark Office

Produce for People

Reg. No. 4,155,839

Registered June 5, 2012

Int. Cl.: 31

TRADEMARK

PRINCIPAL REGISTER

C.H. ROBINSON WORLDWIDE, INC. (DELAWARE CORPORATION)
14701 CHARLSON ROAD
EDEN PRAIRIE, MN 55347

FOR: FRESH FRUIT AND FRESH VEGETABLES, IN CLASS 31 (U.S. CLS. 1 AND 46).

FIRST USE 7-1-2011; IN COMMERCE 7-1-2011.

THE MARK CONSISTS OF STANDARD CHARACTERS WITHOUT CLAIM TO ANY PARTICULAR FONT, STYLE, SIZE, OR COLOR.

NO CLAIM IS MADE TO THE EXCLUSIVE RIGHT TO USE "PRODUCE", APART FROM THE MARK AS SHOWN.

SN 85-976,633, FILED 8-24-2010.

KAPIL BHANOT, EXAMINING ATTORNEY



David J. Kyffers

Director of the United States Patent and Trademark Office

United States of America

United States Patent and Trademark Office



Reg. No. 4,155,840

Registered June 5, 2012

Int. Cl.: 18

TRADEMARK

PRINCIPAL REGISTER

SUMMIT ENTERTAINMENT, LLC (DELAWARE LIMITED LIABILITY COMPANY)
1630 STEWART STREET, SUITE 120
SANTA MONICA, CA 90404

FOR: ALL PURPOSE CARRYING CASES; COSMETIC CARRYING CASES SOLD EMPTY;
WALLETS; ALL PURPOSE CARRYING BAGS; BACK PACKS; HANDBAGS; MAKEUP
BAGS SOLD EMPTY; MESSENGER BAGS; PURSES, IN CLASS 18 (U.S. CLS. 1, 2, 3, 22 AND
41).

FIRST USE 10-1-2009; IN COMMERCE 10-1-2009.

THE MARK CONSISTS OF A CIRCULAR TRIBAL TATTOO DESIGN DEPICTING TWO
WOLVES FACING ONE ANOTHER IN A HOWLING POSITION, SET AMONGST NUMEROUS
INTERWOVEN LINES AND SHAPES AND ALL WITHIN THE CIRCLE.

SN 85-976,638, FILED 4-6-2010.

TRACY FLETCHER, EXAMINING ATTORNEY



David J. Kybas

Director of the United States Patent and Trademark Office

United States of America

United States Patent and Trademark Office

I AM DARK AND LOVELY

Reg. No. 4,155,841

L'OREAL USA CREATIVE, INC. (DELAWARE CORPORATION)
575 FIFTH AVENUE
NEW YORK, NY 10017

Registered June 5, 2012

Int. Cl.: 3

FOR: HAIR CARE PREPARATIONS AND HAIR RELAXERS, IN CLASS 3 (U.S. CLS. 1, 4, 6, 50, 51 AND 52).

TRADEMARK

FIRST USE 9-0-2011; IN COMMERCE 9-0-2011.

PRINCIPAL REGISTER

THE MARK CONSISTS OF STANDARD CHARACTERS WITHOUT CLAIM TO ANY PARTICULAR FONT, STYLE, SIZE, OR COLOR.

OWNER OF U.S. REG. NOS. 963,797, 1,393,705, AND 3,262,867.

SN 85-976,658, FILED 11-22-2010.

JOHN HWANG, EXAMINING ATTORNEY



David J. Kybas

Director of the United States Patent and Trademark Office

United States of America

United States Patent and Trademark Office

ORCS MUST DIE

Reg. No. 4,155,842

Registered June 5, 2012

Int. Cls.: 9, 25, and 41

TRADEMARK

SERVICE MARK

PRINCIPAL REGISTER

ROBOT ENTERTAINMENT, INC. (DELAWARE CORPORATION)
5055 W. PARK BLVD., SUITE 600
PLANO, TX 75093

FOR: VIDEO AND COMPUTER GAME PROGRAMS; INTERACTIVE VIDEO GAME PROGRAMS; COMPUTER GAME SOFTWARE FOR USE WITH PERSONAL COMPUTERS AND HOME VIDEO GAME CONSOLES; COMPUTER GAME SOFTWARE FOR USE ON MOBILE AND CELLULAR PHONES, IN CLASS 9 (U.S. CLS. 21, 23, 26, 36 AND 38).

FIRST USE 2-0-2011; IN COMMERCE 2-0-2011.

FOR: ARTICLES OF CLOTHING, NAMELY, SWEATSHIRTS AND HOODED SWEATSHIRTS; T-SHIRTS; HATS; CAPS, IN CLASS 25 (U.S. CLS. 22 AND 39).

FIRST USE 2-0-2011; IN COMMERCE 2-0-2011.

FOR: ENTERTAINMENT SERVICES, NAMELY, PROVIDING ONLINE VIDEO GAMES AND COMPUTER GAMES; ENTERTAINMENT SERVICES, NAMELY, PROVIDING VIDEO GAMES ON-LINE AND IN MOBILE WIRELESS FORM, IN CLASS 41 (U.S. CLS. 100, 101 AND 107).

FIRST USE 2-0-2011; IN COMMERCE 2-0-2011.

THE MARK CONSISTS OF STANDARD CHARACTERS WITHOUT CLAIM TO ANY PARTICULAR FONT, STYLE, SIZE, OR COLOR.

SN 85-976,684, FILED 1-11-2011.

DEBRA LEE, EXAMINING ATTORNEY



David J. Kyros

Director of the United States Patent and Trademark Office

United States of America

United States Patent and Trademark Office

BLUE HARMONY

Reg. No. 4,155,843

Registered June 5, 2012

Int. Cl.: 35

SERVICE MARK

PRINCIPAL REGISTER

WYNDHAM TM CORP. (DELAWARE CORPORATION)
10750 WEST CHARLESTON BLVD., SUITE 130
LAS VEGAS, NV 89135

FOR: RETAIL GIFT SHOP OFFERING TOILETRIES, INCLUDING SOAPS, LOTIONS, HAIR SHAMPOOS AND CONDITIONERS, AND COSMETICS, IN CLASS 35 (U.S. CLS. 100, 101 AND 102).

FIRST USE 10-1-2011; IN COMMERCE 10-1-2011.

THE MARK CONSISTS OF STANDARD CHARACTERS WITHOUT CLAIM TO ANY PARTICULAR FONT, STYLE, SIZE, OR COLOR.

OWNER OF U.S. REG. NO. 3,687,423.

SN 85-976,685, FILED 10-19-2010.

MICHAEL ENGEL, EXAMINING ATTORNEY



David J. Kybas

Director of the United States Patent and Trademark Office

United States of America

United States Patent and Trademark Office

CLOELLE

Reg. No. 4,155,844

Registered June 5, 2012

Int. Cl.: 14

TRADEMARK

PRINCIPAL REGISTER

CLOELLE DESIGNS INC. (CANADA CORPORATION)
1 YORKDALE ROAD
SUITE 402
TORONTO, CANADA M6A3A1

FOR: JEWELRY, IN CLASS 14 (U.S. CLS. 2, 27, 28 AND 50).

FIRST USE 9-14-2010; IN COMMERCE 3-27-2012.

THE MARK CONSISTS OF STANDARD CHARACTERS WITHOUT CLAIM TO ANY PARTICULAR FONT, STYLE, SIZE, OR COLOR.

THE NAME "CLOELLE" DOES NOT IDENTIFY A LIVING INDIVIDUAL.

SN 85-976,686, FILED 9-9-2010.

ELISSA GARBER KON, EXAMINING ATTORNEY



David J. Kybas

Director of the United States Patent and Trademark Office

United States of America

United States Patent and Trademark Office



Reg. No. 4,155,845

Registered June 5, 2012

Int. Cl.: 26

TRADEMARK

PRINCIPAL REGISTER

SUMMIT ENTERTAINMENT, LLC (DELAWARE LIMITED LIABILITY COMPANY)
1630 STEWART STREET, SUITE 120
SANTA MONICA, CA 90404

FOR: ORNAMENTAL NOVELTY BUTTONS, EMBROIDERED PATCHES FOR CLOTHING,
AND ARMBANDS, IN CLASS 26 (U.S. CLS. 37, 39, 40, 42 AND 50).

FIRST USE 10-1-2009; IN COMMERCE 10-1-2009.

THE MARK CONSISTS OF A CIRCULAR TRIBAL TATTOO DESIGN DEPICTING TWO
WOLVES FACING ONE ANOTHER IN A HOWLING POSITION, SET AMONGST NUMEROUS
INTERWOVEN LINES AND SHAPES AND ALL WITHIN THE CIRCLE.

SN 85-976,693, FILED 4-6-2010.

TRACY FLETCHER, EXAMINING ATTORNEY



David J. Kyffers

Director of the United States Patent and Trademark Office

United States of America

United States Patent and Trademark Office



Reg. No. 4,155,846

Registered June 5, 2012

Int. Cl.: 45

SERVICE MARK

PRINCIPAL REGISTER

SUMMIT ENTERTAINMENT, LLC (DELAWARE LIMITED LIABILITY COMPANY)
1630 STEWART STREET, SUITE 120
SANTA MONICA, CA 90404

FOR: LICENSING OF MERCHANDISE AND INTELLECTUAL PROPERTY ASSOCIATED
WITH MOTION PICTURES, IN CLASS 45 (U.S. CLS. 100 AND 101).

FIRST USE 10-1-2009; IN COMMERCE 10-1-2009.

THE MARK CONSISTS OF A CIRCULAR TRIBAL TATTOO DESIGN DEPICTING TWO
WOLVES FACING ONE ANOTHER IN A HOWLING POSITION, SET AMONGST NUMEROUS
INTERWOVEN LINES AND SHAPES AND ALL WITHIN THE CIRCLE.

SN 85-976,694, FILED 4-6-2010.

TRACY FLETCHER, EXAMINING ATTORNEY



David J. Kyffers

Director of the United States Patent and Trademark Office

United States of America

United States Patent and Trademark Office

FLUSHFIT

Reg. No. 4,155,847

PRECISION SET, INC. (TEXAS CORPORATION)
13711 OMEGA
DALLAS, TX 75244

Registered June 5, 2012

Int. Cl.: 14

FOR: JEWELRY, NAMELY, ENGAGEMENT RINGS MADE OF GOLD OR PLATINUM, IN CLASS 14 (U.S. CLS. 2, 27, 28 AND 50).

TRADEMARK

FIRST USE 12-0-2001; IN COMMERCE 12-0-2001.

SUPPLEMENTAL REGISTER

THE MARK CONSISTS OF STANDARD CHARACTERS WITHOUT CLAIM TO ANY PARTICULAR FONT, STYLE, SIZE, OR COLOR.

OWNER OF U.S. REG. NO. 2,852,130.

SER. NO. 76-703,570, FILED P.R. 6-29-2010; AM. S.R. 4-2-2012.

LIEF MARTIN, EXAMINING ATTORNEY



David J. Kyfos

Director of the United States Patent and Trademark Office

United States of America

United States Patent and Trademark Office

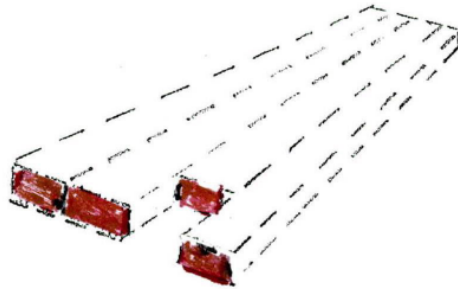

Reg. No. 4,155,848

Registered June 5, 2012

Int. Cl.: 19

TRADEMARK

SUPPLEMENTAL REGISTER

DIXIE MAT & HARDWOOD, INC. (MISSISSIPPI CORPORATION)
216 HERRING ROAD
SANDY HOOK, MS 39478

FOR: HARDWOOD MATS FOR INDUSTRIAL USES, SPECIFICALLY EXCLUDING LUMBER, TIMBER AND PLYWOOD SOLD SEPARATELY AND SPECIFICALLY EXCLUDING FIRE RETARDANT WOOD, IN CLASS 19 (U.S. CLS. 1, 12, 33 AND 50).

FIRST USE 6-1-2006; IN COMMERCE 6-1-2006.

THE MARK CONSISTS OF THE COLOR RED APPLIED TO THE EDGES OF INDUSTRIAL HARDWOOD MATS. THE MATTER SHOWN IN BROKEN LINES ON THE DRAWING SHOWS POSITIONING OF THE MARK ON THE GOODS AND NEITHER THE MATTER SHOWN IN BROKEN LINES NOR THE CONFIGURATION OF THE INDUSTRIAL HARDWOOD MATS IS CLAIMED AS A FEATURE OF THE MARKS.

THE COLOR(S) RED IS/ARE CLAIMED AS A FEATURE OF THE MARK.

SER. NO. 76-705,255, FILED 11-8-2010.

MYRIAH HABEEB, EXAMINING ATTORNEY



David J. Kybas

Director of the United States Patent and Trademark Office

United States of America

United States Patent and Trademark Office

DISCOUNT CLOSETS

Reg. No. 4,155,849

DISCOUNT CLOSETS, INC. (FLORIDA CORPORATION)
10728 SW 188TH STREET
MIAMI, FL 33157

Registered June 5, 2012

Int. Cl.: 37

FOR: CUSTOM BUILDING OF CLOSETS; INSTALLATION OF SHELVING AND CABINETS FOR CLOSETS, IN CLASS 37 (U.S. CLS. 100, 103 AND 106).

SERVICE MARK

FIRST USE 6-1-1998; IN COMMERCE 6-1-1998.

SUPPLEMENTAL REGISTER

THE MARK CONSISTS OF STANDARD CHARACTERS WITHOUT CLAIM TO ANY PARTICULAR FONT, STYLE, SIZE, OR COLOR.

NO CLAIM IS MADE TO THE EXCLUSIVE RIGHT TO USE "CLOSETS", APART FROM THE MARK AS SHOWN.

SER. NO. 76-705,776, FILED P.R. 12-23-2010; AM. S.R. 10-7-2011.

KAPIL BHANOT, EXAMINING ATTORNEY



David J. Kybas

Director of the United States Patent and Trademark Office

United States of America

United States Patent and Trademark Office

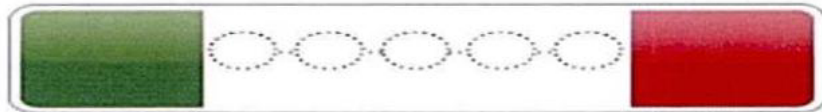

Reg. No. 4,155,850

Registered June 5, 2012

Int. Cl.: 42

SERVICE MARK

SUPPLEMENTAL REGISTER

GRAVITY TECHNOLOGIES (CALIFORNIA CORPORATION)
147 NATOMA STREET
SAN FRANCISCO, CA 94105

FOR: PROVIDING TEMPORARY USE OF ONLINE, NON-DOWNLOADABLE SOFTWARE FOR FACILITATING, MANAGING AND AUGMENTING EMPLOYMENT HIRING, RECRUITING, PLACEMENT AND STAFFING, IN CLASS 42 (U.S. CLS. 100 AND 101).

FIRST USE 1-5-2009; IN COMMERCE 1-5-2009.

THE MARK CONSISTS OF A BLACK OUTER RECTANGLE WITHIN WHICH IS A GREEN RECTANGLE ON THE LEFT AND A RED RECTANGLE ON THE RIGHT. THE ELEMENTS SHOWN IN DOTTED LINES ARE NOT A FEATURE OF THE MARK AND MERELY SHOW THE POSITIONING OF THE MARK. THE COLOR WHITE IS NOT A FEATURE OF THE MARK AND THE WHITE AREAS MERELY REPRESENT THE TRANSPARENT AREAS IN THE MARK.

THE COLOR(S) RED, GREEN AND BLACK IS/ARE CLAIMED AS A FEATURE OF THE MARK.

SER. NO. 76-708,034, FILED P.R. 6-17-2011; AM. S.R. 4-9-2012.

MELISSA VALLILLO, EXAMINING ATTORNEY



David J. Kybas

Director of the United States Patent and Trademark Office

United States of America

United States Patent and Trademark Office

STEM Women of Color Conclave

Reg. No. 4,155,851

GPRA STRATEGIC MANAGEMENT, INC. (MARYLAND CORPORATION)
1613 LEMONTREE LANE
SILVER SPRING, MD 209041441

Registered June 5, 2012

Int. Cl.: 35

FOR: ARRANGING AND CONDUCTING ANNUAL SPECIAL EVENTS FOR BUSINESS PURPOSES, IN CLASS 35 (U.S. CLS. 100, 101 AND 102).

SERVICE MARK

FIRST USE 6-5-2010; IN COMMERCE 6-5-2010.

SUPPLEMENTAL REGISTER

THE MARK CONSISTS OF STANDARD CHARACTERS WITHOUT CLAIM TO ANY PARTICULAR FONT, STYLE, SIZE, OR COLOR.

SER. NO. 76-708,140, FILED P.R. 6-24-2011; AM. S.R. 3-29-2012.

ALYSSA STEEL, EXAMINING ATTORNEY



David J. Kybas

Director of the United States Patent and Trademark Office

United States of America

United States Patent and Trademark Office

néktər
JUICE BAR

Reg. No. 4,155,852

SCHULZE, STEPHEN (UNITED STATES INDIVIDUAL)
18 CAPE ANDOVER
NEWPORT BEACH, CA 92660

Registered June 5, 2012

Int. Cl.: 43

FOR: JUICE AND SMOOTHIE BAR, IN CLASS 43 (U.S. CLS. 100 AND 101).

SERVICE MARK

FIRST USE 10-1-2010; IN COMMERCE 10-1-2010.

SUPPLEMENTAL REGISTER

NO CLAIM IS MADE TO THE EXCLUSIVE RIGHT TO USE "JUICE BAR" , APART FROM THE MARK AS SHOWN.

THE MARK CONSISTS OF THE WORD "NÉKTER" IN LOWER CASE WITH AN ACCENT ABOVE THE FIRST "E" AND WITH THE SECOND "E" APPEARING UPSIDE DOWN AND BACKWARDS; THE WORDS "JUICE BAR" IN UPPER CASE ON THE SECOND LINE AND LOCATED FLUSH RIGHT UNDER THE "KTER" OF THE LINE ABOVE.

SER. NO. 76-708,191, FILED P.R. 6-29-2011; AM. S.R. 4-25-2012.

WILLIAM ROSSMAN, EXAMINING ATTORNEY



David J. Kyfos

Director of the United States Patent and Trademark Office

United States of America

United States Patent and Trademark Office

MESH ELECTRONIC DRUMS

Reg. No. 4,155,853

Registered June 5, 2012

Int. Cl.: 15

ROLAND CORPORATION (JAPAN CORPORATION)
2036-1 NAKAGAWA HOSOE-CHO
KITA-KU HAMAMATSU
SHIZUOKA, JAPAN

FOR: ELECTRONIC DRUMS, IN CLASS 15 (U.S. CLS. 2, 21 AND 36).

TRADEMARK

FIRST USE 3-9-2012; IN COMMERCE 3-9-2012.

SUPPLEMENTAL REGISTER

THE MARK CONSISTS OF STANDARD CHARACTERS WITHOUT CLAIM TO ANY PARTICULAR FONT, STYLE, SIZE, OR COLOR.

NO CLAIM IS MADE TO THE EXCLUSIVE RIGHT TO USE "DRUMS", APART FROM THE MARK AS SHOWN.

SER. NO. 76-708,444, FILED P.R. 7-21-2011; AM. S.R. 3-19-2012.

SUZANNE BLANE, EXAMINING ATTORNEY



David J. Kyros

Director of the United States Patent and Trademark Office

United States of America

United States Patent and Trademark Office

Halifax Stanleys

Reg. No. 4,155,854

Registered June 5, 2012

Int. Cl.: 25

STRYKER-INDIGO PUBLISHING COMPANY, INC. (NEW YORK CORPORATION), DBA
STRYKER-INDIGO NEW YORK,
37 ROLLING LANE
LEVITTOWN, NY 11756

FOR: SPORTS JERSEYS, IN CLASS 25 (U.S. CLS. 22 AND 39).

TRADEMARK

FIRST USE 10-26-2004; IN COMMERCE 11-18-2011.

SUPPLEMENTAL REGISTER

THE MARK CONSISTS OF STANDARD CHARACTERS WITHOUT CLAIM TO ANY PARTICULAR FONT, STYLE, SIZE, OR COLOR.

NO CLAIM IS MADE TO THE EXCLUSIVE RIGHT TO USE "HALIFAX", APART FROM THE MARK AS SHOWN.

SER. NO. 77-416,816, FILED P.R. 3-8-2008; AM. S.R. 3-21-2012.

ALICIA COLLINS, EXAMINING ATTORNEY



David J. Kybas

Director of the United States Patent and Trademark Office

United States of America

United States Patent and Trademark Office

PEOPLE ARE CRAZY

Reg. No. 4,155,855

Registered June 5, 2012

Int. Cl.: 25

BC TOURS, INC. (TENNESSEE CORPORATION)
C/O O'NEIL HAGAMAN
1025 16TH AVE. SOUTH, STE 202
NASHVILLE, TN 37212

FOR: CLOTHING, NAMELY, T-SHIRTS, IN CLASS 25 (U.S. CLS. 22 AND 39).

TRADEMARK

FIRST USE 9-3-2009; IN COMMERCE 9-3-2009.

SUPPLEMENTAL REGISTER

THE MARK CONSISTS OF STANDARD CHARACTERS WITHOUT CLAIM TO ANY PARTICULAR FONT, STYLE, SIZE, OR COLOR.

SER. NO. 77-673,267, FILED P.R. 2-18-2009; AM. S.R. 4-10-2012.

DAVID ELTON, EXAMINING ATTORNEY



David J. Kyfos

Director of the United States Patent and Trademark Office

United States of America

United States Patent and Trademark Office

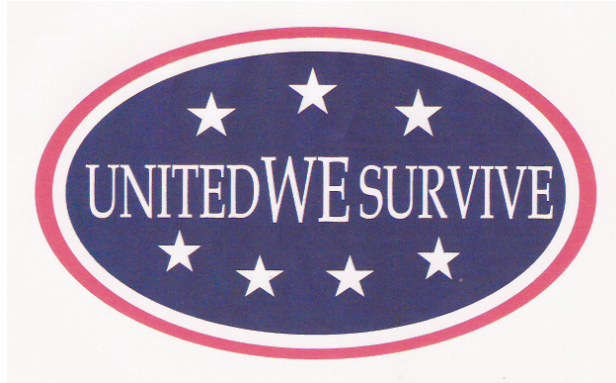

Reg. No. 4,155,856

Registered June 5, 2012

Int. Cl.: 16

TRADEMARK

SUPPLEMENTAL REGISTER

FISHER, STEVEN E (UNITED STATES INDIVIDUAL)
PO BOX 1056
918 CEDAR ST.
BRISTOL, PA 19007

FOR: ALBUMS FOR STICKERS; BUMPER STICKERS; CHILDREN'S WALL STICKERS AND MURALS; DECORATIVE STICKERS FOR HELMETS; STICKER ALBUMS; STICKERS; STICKERS AND DECALCOMANIAS; STICKERS AND STICKER ALBUMS; STICKERS AND TRANSFERS, IN CLASS 16 (U.S. CLS. 2, 5, 22, 23, 29, 37, 38 AND 50).

FIRST USE 7-24-2011; IN COMMERCE 7-24-2011.

THE MARK CONSISTS OF "UNITED WE SURVIVE" IN WHITE WITHIN AN OVAL SHAPE WITH A RED AND WHITE BORDER ON A BLUE BACKGROUND WITH (3) THREE WHITE STARS ON TOP AND (4) FOUR WHITE STARS ON THE BOTTOM WITHIN THE OVAL.

THE COLOR(S) RED, WHITE AND BLUE IS/ARE CLAIMED AS A FEATURE OF THE MARK.

SER. NO. 77-770,312, FILED P.R. 6-29-2009; AM. S.R. 3-27-2012.

TOBY BULLOFF, EXAMINING ATTORNEY



David J. Kybas

Director of the United States Patent and Trademark Office

United States of America

United States Patent and Trademark Office

VINTAJ ARTE METAL

Reg. No. 4,155,857

Registered June 5, 2012

Int. Cl.: 14

TRADEMARK

SUPPLEMENTAL REGISTER

VINTAJ NATURAL BRASS CO. (ILLINOIS CORPORATION)
8933 WEST STAGECOACH TRAIL
GALENA, IL 61036

FOR: JEWELRY FINDINGS; CHARMS; BEADING ACCESSORIES, NAMELY, BEADS FOR MAKING JEWELRY; EMBELLISHMENTS, NAMELY, METAL CHARMS FOR MAKING JEWELRY; EMBELLISHMENTS, NAMELY, METAL JEWELRY CHARMS FOR USE IN CRAFTING; NON-DECORATIVE JEWELRY, NAMELY, METAL JEWELRY BLANKS FOR USE CRAFTING AND MAKING DECORATIVE JEWELRY, IN CLASS 14 (U.S. CLS. 2, 27, 28 AND 50).

FIRST USE 1-1-2011; IN COMMERCE 1-1-2011.

THE MARK CONSISTS OF STANDARD CHARACTERS WITHOUT CLAIM TO ANY PARTICULAR FONT, STYLE, SIZE, OR COLOR.

OWNER OF U.S. REG. NOS. 3,404,254, 3,469,964, AND 3,634,168.

NO CLAIM IS MADE TO THE EXCLUSIVE RIGHT TO USE "ARTE METAL", APART FROM THE MARK AS SHOWN.

SER. NO. 77-816,830, FILED P.R. 8-31-2009; AM. S.R. 8-8-2011.

SUZANNE BLANE, EXAMINING ATTORNEY



David J. Kyros

Director of the United States Patent and Trademark Office

United States of America

United States Patent and Trademark Office

Cars.TV

Reg. No. 4,155,858

Registered June 5, 2012

Int. Cl.: 41

SERVICE MARK

SUPPLEMENTAL REGISTER

BFI BUSINESS FINANCE (CALIFORNIA CORPORATION)
851 EAST HAMILTON AVENUE, 2ND FLOOR
CAMPBELL, CA 95008

FOR: ENTERTAINMENT SERVICES, NAMELY, ONGOING TELEVISION PROGRAMS IN THE FIELD OF AUTOMOBILES; ONGOING TELEVISION PROGRAMS PRESENTED ON THE INTERNET IN THE FIELD OF AUTOMOBILES; PROVIDING ENTERTAINMENT AND INFORMATIONAL PROGRAMMING IN THE FIELD OF AUTOMOBILES ACCESSIBLE BY INTERNET, IN CLASS 41 (U.S. CLS. 100, 101 AND 107).

FIRST USE 11-0-2009; IN COMMERCE 11-0-2009.

THE MARK CONSISTS OF STANDARD CHARACTERS WITHOUT CLAIM TO ANY PARTICULAR FONT, STYLE, SIZE, OR COLOR.

SER. NO. 77-825,790, FILED P.R. 9-14-2009; AM. S.R. 2-24-2012.

ROBERT C. CLARK JR., EXAMINING ATTORNEY



David J. Kyffers

Director of the United States Patent and Trademark Office

United States of America

United States Patent and Trademark Office

arte metal

Reg. No. 4,155,859

Registered June 5, 2012

Int. Cl.: 14

TRADEMARK

SUPPLEMENTAL REGISTER

VINTAJ NATURAL BRASS CO. (ILLINOIS CORPORATION)
8933 WEST STAGECOACH TRAIL
GALENA, IL 61036

FOR: JEWELRY FINDINGS; CHARMS; BEADING ACCESSORIES, NAMELY, BEADS FOR MAKING JEWELRY; EMBELLISHMENTS, NAMELY, METAL CHARMS FOR MAKING JEWELRY; EMBELLISHMENTS, NAMELY, METAL JEWELRY CHARMS FOR USE IN CRAFTING; NON-DECORATIVE JEWELRY, NAMELY, METAL JEWELRY BLANKS FOR USE CRAFTING AND MAKING DECORATIVE JEWELRY, IN CLASS 14 (U.S. CLS. 2, 27, 28 AND 50).

FIRST USE 1-1-2011; IN COMMERCE 1-1-2011.

NO CLAIM IS MADE TO THE EXCLUSIVE RIGHT TO USE "METAL", APART FROM THE MARK AS SHOWN.

THE MARK CONSISTS OF THE WORDS "ARTE METAL" IN A STYLIZED METALLIC FONT.

SER. NO. 77-833,267, FILED P.R. 9-23-2009; AM. S.R. 8-8-2011.

SUZANNE BLANE, EXAMINING ATTORNEY



David J. Kyffers

Director of the United States Patent and Trademark Office

United States of America
United States Patent and Trademark Office

E-mount

Reg. No. 4,155,860

Registered June 5, 2012

Int. Cl.: 9

TRADEMARK

SUPPLEMENTAL REGISTER

SONY CORPORATION (JAPAN CORPORATION)
1-7-1 KONAN, MINATO-KU
TOKYO, JAPAN

FOR: DIGITAL SINGLE-LENS REFLEX CAMERAS, DIGITAL CAMERAS, VIDEO CAMERAS, LENSES, FLASH LIGHTS, TRIPODS, SHOULDER STRAPS FOR CAMERAS, BAGS FOR CAMERAS, RECHARGEABLE BATTERY PACKS FOR DIGITAL CAMERAS, CABLES FOR DIGITAL CAMERAS, AC ADAPTERS FOR DIGITAL CAMERAS, IN CLASS 9 (U.S. CLS. 21, 23, 26, 36 AND 38).

FIRST USE 6-30-2010; IN COMMERCE 6-30-2010.

THE MARK CONSISTS OF STANDARD CHARACTERS WITHOUT CLAIM TO ANY PARTICULAR FONT, STYLE, SIZE, OR COLOR.

SER. NO. 77-852,008, FILED P.R. 10-19-2009; AM. S.R. 7-29-2011.

ZACHARY BELLO, EXAMINING ATTORNEY



David J. Kyffers

Director of the United States Patent and Trademark Office

United States of America

United States Patent and Trademark Office

Media Backbone

Reg. No. 4,155,861

SONY CORPORATION (JAPAN CORPORATION)
1-7-1 KONAN, MINATO-KU
TOKYO, JAPAN

Registered June 5, 2012

Int. Cl.: 9

FOR: COMPUTER SOFTWARE FOR OPERATING VIDEO EDITING DEVICES, IN CLASS 9
(U.S. CLS. 21, 23, 26, 36 AND 38).

TRADEMARK

FIRST USE 4-9-2011; IN COMMERCE 4-9-2011.

SUPPLEMENTAL REGISTER

THE MARK CONSISTS OF STANDARD CHARACTERS WITHOUT CLAIM TO ANY PARTICULAR FONT, STYLE, SIZE, OR COLOR.

SER. NO. 77-921,103, FILED P.R. 1-27-2010; AM. S.R. 4-9-2012.

JENNIFER VASQUEZ, EXAMINING ATTORNEY



David J. Kybas

Director of the United States Patent and Trademark Office

United States of America
United States Patent and Trademark Office

BAMBUSUSA

Reg. No. 4,155,862

BAMBUSUSA SKATEBOARDS, INC (PENNSYLVANIA CORPORATION)
1518 EASTON RD
ROSLYN, PA 19001

Registered June 5, 2012

Int. Cl.: 28

FOR: SKATEBOARDS MADE IN WHOLE OR SIGNIFICANT PART OF BAMBOO, IN CLASS 28 (U.S. CLS. 22, 23, 38 AND 50).

TRADEMARK

FIRST USE 3-1-2010; IN COMMERCE 4-1-2010.

SUPPLEMENTAL REGISTER

THE MARK CONSISTS OF STANDARD CHARACTERS WITHOUT CLAIM TO ANY PARTICULAR FONT, STYLE, SIZE, OR COLOR.

SER. NO. 77-942,227, FILED P.R. 2-23-2010; AM. S.R. 12-3-2010.

NATALIE POLZER, EXAMINING ATTORNEY



David J. Kybas

Director of the United States Patent and Trademark Office

United States of America

United States Patent and Trademark Office

EnergyScore

Reg. No. 4,155,863

ENERGYSCORE, INC (DELAWARE CORPORATION)
171 RAMUNNO CIRCLE
HOCKESSIN, DE 19707

Registered June 5, 2012

Int. Cl.: 35

FOR: CONSULTATION IN THE FIELD OF ENERGY EFFICIENCY; CONSULTING SERVICES IN THE FIELD OF ENERGY USAGE MANAGEMENT AND ENERGY EFFICIENCY; CONSULTING SERVICES IN THE FIELDS OF ENERGY CONSUMPTION AND USAGE CONSERVATION TO IMPROVE ENERGY EFFICIENCY; ENERGY AUDITING, IN CLASS 35 (U.S. CLS. 100, 101 AND 102).

SERVICE MARK

SUPPLEMENTAL REGISTER

FIRST USE 3-15-2009; IN COMMERCE 1-1-2010.

THE MARK CONSISTS OF STANDARD CHARACTERS WITHOUT CLAIM TO ANY PARTICULAR FONT, STYLE, SIZE, OR COLOR.

SER. NO. 77-960,996, FILED P.R. 3-17-2010; AM. S.R. 4-24-2012.

TASNEEM HUSSAIN, EXAMINING ATTORNEY



David J. Kyros

Director of the United States Patent and Trademark Office

United States of America

United States Patent and Trademark Office



Reg. No. 4,155,864

Registered June 5, 2012

Int. Cl.: 18

TRADEMARK

SUPPLEMENTAL REGISTER

PRL USA HOLDINGS, INC. (DELAWARE CORPORATION)
550 SEVENTH AVENUE
NEW YORK, NY 10018

FOR: BAGS, NAMELY, HANDBAGS, DUFFLE BAGS, BRIEFCASES, TOTE BAGS, COSMETIC BAGS SOLD EMPTY, IN CLASS 18 (U.S. CLS. 1, 2, 3, 22 AND 41).

FIRST USE 0-0-1986; IN COMMERCE 0-0-1986.

THE MARK CONSISTS OF THE LETTERS "RL" IN BLACK IN THE BOTTOM LEFT CORNER OF A TARTAN FABRIC DESIGN WITH THREE REPEATING SQUARE DESIGNS. THE TARTAN IS FORMED BY FOUR IMAGES OF THE SQUARE DESIGN WITH THE OUTER BORDER BEING A YELLOW SQUARE THAT CONTAINS A BLACK AND GREEN SQUARE, THAT CONTAINS A BLUE AND BLACK SQUARE. THE "RL" LETTERS APPEAR IN THE UPPER RIGHT QUARTER THREE-PART SQUARE.

THE COLOR(S) YELLOW, GREEN, BLUE AND BLACK IS/ARE CLAIMED AS A FEATURE OF THE MARK.

SER. NO. 77-969,573, FILED P.R. 3-26-2010; AM. S.R. 2-8-2012.

MARK T. MULLEN, EXAMINING ATTORNEY



David J. Kybas

Director of the United States Patent and Trademark Office

United States of America

United States Patent and Trademark Office

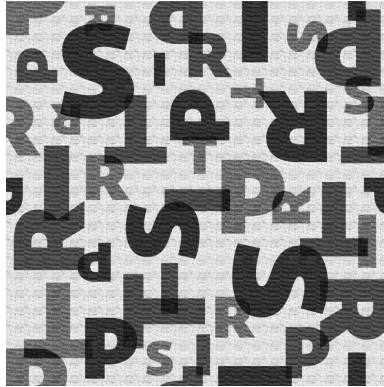

Reg. No. 4,155,865

Registered June 5, 2012

Int. Cl.: 35

SERVICE MARK

SUPPLEMENTAL REGISTER

PENNSYLVANIA LIQUOR CONTROL BOARD (PENNSYLVANIA STATE AGENCY)
NORTHWEST OFFICE BUILDING, SUITE 401
HARRISBURG, PA 17124

FOR: ONLINE RETAIL STORE AND RETAIL STORE SERVICES FEATURING ALCOHOLIC BEVERAGES, NAMELY, WINE, DISTILLED SPIRITS AND DISTILLED LIQUOR, IN CLASS 35 (U.S. CLS. 100, 101 AND 102).

FIRST USE 6-30-2010; IN COMMERCE 6-30-2010.

THE MARK CONSISTS OF THE LETTERS THAT COMPRISE THE WORD "SPIRITS" RANDOMLY SCATTERED AND ROTATED ABOUT 90 DEGREE AXES, BOTH CLOCKWISE AND COUNTERCLOCKWISE. THE LETTERS ARE ALL SHOWN IN UPPERCASE FORM. THE LETTERS AND BACKGROUND ARE TEXTURED AND REPEATING.

SER. NO. 77-982,046, FILED P.R. 1-15-2010; AM. S.R. 12-19-2011.

GILBERT SWIFT, EXAMINING ATTORNEY



David J. Kybas

Director of the United States Patent and Trademark Office

United States of America

United States Patent and Trademark Office

POINT.CLICK.TRANSFER

Reg. No. 4,155,866

Registered June 5, 2012

Int. Cl.: 42

SERVICE MARK

SUPPLEMENTAL REGISTER

GAMING LABORATORIES INTERNATIONAL LLC (DELAWARE LIMITED LIABILITY COMPANY)
600 AIRPORT ROAD
LAKEWOOD, NJ 08701

FOR: ONLINE TESTING, ANALYSIS AND EVALUATION SERVICES EMPLOYING PREVIOUSLY UPLOADED DATA AND SOFTWARE FOR THE PURPOSE OF CERTIFYING GAMING EQUIPMENT OF OTHERS AND ONLINE WEBSITES OF OTHERS BASED UPON THE PREVIOUSLY UPLOADED DATA AND SOFTWARE, IN CLASS 42 (U.S. CLS. 100 AND 101).

FIRST USE 10-23-2008; IN COMMERCE 10-23-2008.

THE MARK CONSISTS OF STANDARD CHARACTERS WITHOUT CLAIM TO ANY PARTICULAR FONT, STYLE, SIZE, OR COLOR.

SER. NO. 85-006,269, FILED P.R. 4-5-2010; AM. S.R. 3-19-2012.

JACLYN KIDWELL WALKER, EXAMINING ATTORNEY



David J. Kybas

Director of the United States Patent and Trademark Office

United States of America

United States Patent and Trademark Office

PEST 411

Reg. No. 4,155,867

ORKIN EXPANSION, INC. (DELAWARE CORPORATION)
1105 NORTH MARKET STREET #1106
WILMINGTON, DE 19899

Registered June 5, 2012

Int. Cl.: 37

FOR: PROVIDING A PORTAL VIA MOBILE DEVICES AND THE INTERNET FEATURING A PEST CONTROL DATABASE FOR IDENTIFICATION OF INSECTS AND RODENTS FROM A LIBRARY OF PICTURES AND FACTS ABOUT SPECIFIC INSECT AND RODENT THREATS AND HABITS, IN CLASS 37 (U.S. CLS. 100, 103 AND 106).

SERVICE MARK

SUPPLEMENTAL REGISTER FIRST USE 4-15-2009; IN COMMERCE 4-15-2009.

THE MARK CONSISTS OF STANDARD CHARACTERS WITHOUT CLAIM TO ANY PARTICULAR FONT, STYLE, SIZE, OR COLOR.

NO CLAIM IS MADE TO THE EXCLUSIVE RIGHT TO USE "PEST", APART FROM THE MARK AS SHOWN.

SER. NO. 85-049,124, FILED P.R. 5-27-2010; AM. S.R. 4-20-2012.

BARBARA BROWN, EXAMINING ATTORNEY



David J. Kybas

Director of the United States Patent and Trademark Office

United States of America

United States Patent and Trademark Office

AERONAUTICAL SYSTEMS

Reg. No. 4,155,868

AERONAUTICAL SYSTEMS, INCORPORATED (VIRGINIA CORPORATION)
43671 TRADE CENTER PLACE, SUITE 100
STERLING, VA 20166

Registered June 5, 2012

Int. Cl.: 37

FOR: REPAIR AND MAINTENANCE OF AIRCRAFT, EACH EXCLUDING AS SUCH RELATES TO UNMANNED DRONES, IN CLASS 37 (U.S. CLS. 100, 103 AND 106).

SERVICE MARK

FIRST USE 10-17-1988; IN COMMERCE 10-17-1988.

SUPPLEMENTAL REGISTER

THE MARK CONSISTS OF STANDARD CHARACTERS WITHOUT CLAIM TO ANY PARTICULAR FONT, STYLE, SIZE, OR COLOR.

OWNER OF U.S. REG. NOS. 4,094,745, 4,120,282, AND OTHERS.

SER. NO. 85-061,330, FILED P.R. 6-12-2010; AM. S.R. 3-28-2012.

JAY FLOWERS, EXAMINING ATTORNEY



David J. Kybas

Director of the United States Patent and Trademark Office

United States of America

United States Patent and Trademark Office

The leader in endoscopic spine surgery

Reg. No. 4,155,869

Registered June 5, 2012

Int. Cl.: 44

SERVICE MARK

SUPPLEMENTAL REGISTER

LASER SPINE INSTITUTE, LLC (FLORIDA LIMITED LIABILITY COMPANY)
3031 N ROCKY POINT DRIVE W
TAMPA, FL 33607

FOR: HEALTHCARE; SURGERY, IN CLASS 44 (U.S. CLS. 100 AND 101).

FIRST USE 1-1-2009; IN COMMERCE 1-1-2009.

THE MARK CONSISTS OF STANDARD CHARACTERS WITHOUT CLAIM TO ANY PARTICULAR FONT, STYLE, SIZE, OR COLOR.

NO CLAIM IS MADE TO THE EXCLUSIVE RIGHT TO USE "ENDOSCOPIC SPINE SURGERY", APART FROM THE MARK AS SHOWN.

SER. NO. 85-064,233, FILED P.R. 6-16-2010; AM. S.R. 4-12-2012.

STEVEN JACKSON, EXAMINING ATTORNEY



David J. Kybas

Director of the United States Patent and Trademark Office

United States of America

United States Patent and Trademark Office

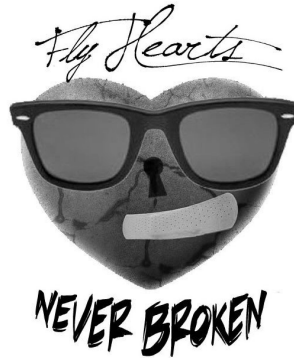

Reg. No. 4,155,870

Registered June 5, 2012

Int. Cl.: 25

TRADEMARK

SUPPLEMENTAL REGISTER

KEITH D. JONES (UNITED STATES INDIVIDUAL)
AUM 372
P.O. BOX 244024
MONTGOMERY, AL 36124 AND

AUBRIAN SMITH (UNITED STATES INDIVIDUAL)
APARTMENT 3205
2201 VAUGHN LAKES BOULEVARD
MONTGOMERY, AL 36117

FOR: WEARING APPAREL, NAMELY, T-SHIRTS, JACKETS, SWEATERS, CAPS, HATS, SWEATSHIRTS, HOODED SWEATSHIRTS, IN CLASS 25 (U.S. CLS. 22 AND 39).

FIRST USE 8-18-2010; IN COMMERCE 8-18-2010.

THE MARK CONSISTS OF THE WORDS "FLY HEARTS" IN THIN CURSIVE WRITING AT THE TOP, WITH THE FIRST LETTER OF EACH WORD CAPITALIZED. JUST BELOW THOSE WORDS IS AN IMAGE OF A HEART WITH CRACKS THROUGHOUT. THE HEART CONTAINS EYEGLASSES NEAR THE TOP ON THE FRONT, A KEYHOLE IN THE MIDDLE ON THE FRONT AND A ADHESIVE BANDAGE BELOW THE KEYHOLE, ON THE FRONT, OVERALL RESEMBLING A HEAD WHEREBY THE EYEGLASSES COVER THE EYES, THE KEYHOLE IS IN THE VICINITY OF A NOSE AND THE ADHESIVE BANDAGE IS IN THE VICINITY OF A MOUTH. BELOW THE HEART ARE THE WORDS "NEVER BROKEN" IN THICK PRINT WITH ALL-CAPITAL LETTERS.

SER. NO. 85-102,912, FILED P.R. 8-9-2010; AM. S.R. 4-25-2012.

CHRIS WELLS, EXAMINING ATTORNEY



David J. Kyros

Director of the United States Patent and Trademark Office

United States of America

United States Patent and Trademark Office

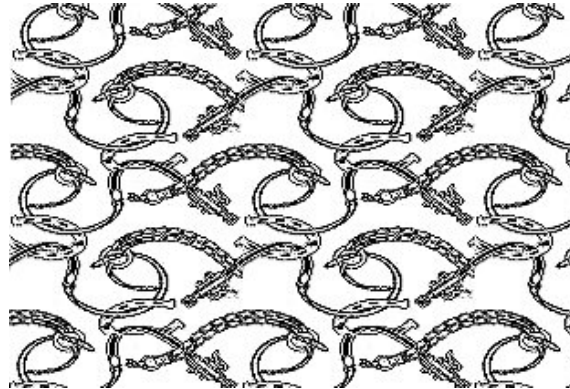

Reg. No. 4,155,871

Registered June 5, 2012

Int. Cl.: 18

TRADEMARK

SUPPLEMENTAL REGISTER

PRL USA HOLDINGS, INC. (DELAWARE CORPORATION)
550 SEVENTH AVENUE
NEW YORK, NY 10018

FOR: HANDBAGS; ACCESSORIES, NAMELY, WALLETS, WRISTLET BAGS, COSMETIC CASES SOLD EMPTY, IN CLASS 18 (U.S. CLS. 1, 2, 3, 22 AND 41).

FIRST USE 8-0-2010; IN COMMERCE 8-0-2010.

THE MARK CONSISTS OF A REPEATING EQUESTRIAN TACK PATTERN COMPRISING OF BRAIDED LEAD SHANKS INTERTWINED WITH HORSESHOES.

SER. NO. 85-120,200, FILED P.R. 8-31-2010; AM. S.R. 9-14-2011.

MICHAEL WEBSTER, EXAMINING ATTORNEY



David J. Kyffers

Director of the United States Patent and Trademark Office

United States of America

United States Patent and Trademark Office

REVENUE CAPTURE SCORECARD

Reg. No. 4,155,872

VALUE FORWARD GROUP, INC. (DELAWARE CORPORATION)
1029 PEACHTREE PARKWAY NORTH #357
PEACHTREE CITY, GA 30269

Registered June 5, 2012

Int. Cl.: 35

FOR: BUSINESS MANAGEMENT CONSULTING RELATING TO ORGANIZATIONAL ASSESSMENT AND IMPROVEMENT IN THE DEPARTMENT OF SALES, MARKETING, STRATEGY, FINANCIAL MANAGEMENT AND OPERATIONS USING FORMULATIONS OF BEST PRACTICES FOR BUSINESS MANAGEMENT; BUSINESS CONSULTING WITH REGARD TO THE INTEGRATION OF SALES, MARKETING, STRATEGY, FINANCIAL MANAGEMENT AND OPERATIONS, IN CLASS 35 (U.S. CLS. 100, 101 AND 102).

SERVICE MARK

SUPPLEMENTAL REGISTER

FIRST USE 11-16-2006; IN COMMERCE 11-16-2006.

THE MARK CONSISTS OF STANDARD CHARACTERS WITHOUT CLAIM TO ANY PARTICULAR FONT, STYLE, SIZE, OR COLOR.

SER. NO. 85-121,645, FILED P.R. 9-2-2010; AM. S.R. 4-19-2012.

SAMUEL E. SHARPER JR., EXAMINING ATTORNEY



David J. Kyros

Director of the United States Patent and Trademark Office

United States of America

United States Patent and Trademark Office

TILE TAKE-BACK

Reg. No. 4,155,873

CROSSVILLE, INC. (ILLINOIS CORPORATION)
346 SWEENEY DRIVE
CROSSVILLE, TN 38555

Registered June 5, 2012

Int. Cls.: 37 and 40

FOR: COLLECTION OF FIRED TILE WASTE, NAMELY, CERAMIC OR PORCELAIN MATERIAL FOR RECYCLING, IN CLASS 37 (U.S. CLS. 100, 103 AND 106).

SERVICE MARK

FIRST USE 6-9-2009; IN COMMERCE 6-9-2009.

SUPPLEMENTAL REGISTER

FOR: RECYCLING OF FIRED TILE WASTE, NAMELY, CERAMIC OR PORCELAIN MATERIAL, IN CLASS 40 (U.S. CLS. 100, 103 AND 106).

FIRST USE 6-9-2009; IN COMMERCE 6-9-2009.

THE MARK CONSISTS OF STANDARD CHARACTERS WITHOUT CLAIM TO ANY PARTICULAR FONT, STYLE, SIZE, OR COLOR.

SER. NO. 85-136,873, FILED P.R. 9-23-2010; AM. S.R. 4-10-2012.

JENNIFER DIXON, EXAMINING ATTORNEY



David J. Kyros

Director of the United States Patent and Trademark Office

United States of America

United States Patent and Trademark Office



Reg. No. 4,155,874

SUNI SCHULZE (UNITED STATES INDIVIDUAL)
P.O. BOX 36001
GREENSBORO, NC 27416

Registered June 5, 2012

Int. Cl.: 25

FOR: MUFFS, IN CLASS 25 (U.S. CLS. 22 AND 39).

TRADEMARK

FIRST USE 3-0-2008; IN COMMERCE 3-0-2008.

SUPPLEMENTAL REGISTER

THE MARK CONSISTS OF A DESIGN OF A MUFF DECORATED WITH FLOWERS AND LEAVES. THE MUTED DIAMOND DESIGNS ON THE SURFACE OF THE MUFF ARE USED TO DEPICT SHADING AND ARE NOT PART OF THE MARK. THE BROKEN LINES DEPICTING THE ZIPPER, ROPE CARRY HANDLE AND FORMING A HAND ARE FOR SHOWING THE POSITION OF THE MARK ON THE GOODS AND ARE NOT CLAIMED AS FEATURES OF THE MARK.

SER. NO. 85-139,049, FILED P.R. 9-27-2010; AM. S.R. 3-12-2012.

VERNA BETH RIRIE, EXAMINING ATTORNEY



David J. Kyffers

Director of the United States Patent and Trademark Office

United States of America
United States Patent and Trademark Office

DAKTARI

Reg. No. 4,155,875

Registered June 5, 2012

Int. Cl.: 10

TRADEMARK

SUPPLEMENTAL REGISTER

DAKTARI DIAGNOSTICS, INC. (DELAWARE CORPORATION)
85 BOLTON STREET
CAMBRIDGE, MA 02140

FOR: MEDICAL DIAGNOSTIC INSTRUMENT, NAMELY, BODY FLUID ANALYZER FOR PROVIDING CELL AND PARTICLE ANALYSIS, DETECTION, OR COUNTING AND FOR REPORTING RESULTS, IN CLASS 10 (U.S. CLS. 26, 39 AND 44).

FIRST USE 3-1-2012; IN COMMERCE 3-1-2012.

THE MARK CONSISTS OF STANDARD CHARACTERS WITHOUT CLAIM TO ANY PARTICULAR FONT, STYLE, SIZE, OR COLOR.

THE ENGLISH TRANSLATION OF "DAKTARI" IN THE MARK IS "DOCTOR".

SER. NO. 85-147,936, FILED P.R. 10-7-2010; AM. S.R. 3-14-2012.

EMILY CARLSEN, EXAMINING ATTORNEY



David J. Kyffers

Director of the United States Patent and Trademark Office

United States of America

United States Patent and Trademark Office



Reg. No. 4,155,876

ROBINSON, TYLER (UNITED STATES INDIVIDUAL)
11731 FOSTER ROAD
LOS ALAMITOS, CA 90720 AND

Registered June 5, 2012

Int. Cl.: 35

HOLDERBAUM, CHRIS (UNITED STATES INDIVIDUAL)
395 EAST 4TH ST. #41
LONG BEACH, CA 90802

SERVICE MARK

SUPPLEMENTAL REGISTER

FOR: ON-LINE RETAIL STORE SERVICES FEATURING GARDENING PRODUCTS; RETAIL STORES FEATURING GARDENING PRODUCTS, IN CLASS 35 (U.S. CLS. 100, 101 AND 102).

FIRST USE 6-6-2010; IN COMMERCE 6-6-2010.

NO CLAIM IS MADE TO THE EXCLUSIVE RIGHT TO USE "SHOP", APART FROM THE MARK AS SHOWN.

THE MARK CONSISTS OF THE STYLIZED WORDING "THE HYDRO SHOP" CONTAINED WITHIN A CONCENTRIC OVAL SHAPED BACKGROUND

SER. NO. 85-160,046, FILED P.R. 10-25-2010; AM. S.R. 4-25-2012.

ANDREA HACK, EXAMINING ATTORNEY



David J. Kybas

Director of the United States Patent and Trademark Office

United States of America

United States Patent and Trademark Office

Florida Law Alliance

Reg. No. 4,155,877

Registered June 5, 2012

Int. Cl.: 45

SERVICE MARK

SUPPLEMENTAL REGISTER

FISHER, RUSHMER, WERRENRATH, DICKSON, TALLEY & DUNLAP, P.A. (FLORIDA INCORPORATED ASSOCIATION), AKA FISHER RUSHMER, 390 NORTH ORANGE AVENUE, SUITE 2200 ORLANDO, FL 328020712

FOR: LEGAL SERVICES, IN CLASS 45 (U.S. CLS. 100 AND 101).

FIRST USE 9-19-2011; IN COMMERCE 10-1-2011.

THE MARK CONSISTS OF STANDARD CHARACTERS WITHOUT CLAIM TO ANY PARTICULAR FONT, STYLE, SIZE, OR COLOR.

NO CLAIM IS MADE TO THE EXCLUSIVE RIGHT TO USE "LAW ALLIANCE", APART FROM THE MARK AS SHOWN.

SER. NO. 85-162,032, FILED P.R. 10-27-2010; AM. S.R. 3-23-2012.

MICHAEL WEBSTER, EXAMINING ATTORNEY



David J. Kybas

Director of the United States Patent and Trademark Office

United States of America

United States Patent and Trademark Office

HOOK & HOLD

Reg. No. 4,155,878

TOWN & COUNTRY LINEN CORP. (NEW YORK CORPORATION)
295 FIFTH AVENUE STE 412
NEW YORK, NY 10016

Registered June 5, 2012

Int. Cl.: 6

FOR: HOOKS MADE OF METAL FOR HANGING A SHOWER CURTAIN AND LINER, HAVING AN ADDITIONAL INTEGRATED ATTACHMENT FOR HANGING A TOWEL OR OTHER ACCESSORIES, IN CLASS 6 (U.S. CLS. 2, 12, 13, 14, 23, 25 AND 50).

TRADEMARK

FIRST USE 3-16-2011; IN COMMERCE 3-16-2011.

SUPPLEMENTAL REGISTER

THE MARK CONSISTS OF STANDARD CHARACTERS WITHOUT CLAIM TO ANY PARTICULAR FONT, STYLE, SIZE, OR COLOR.

NO CLAIM IS MADE TO THE EXCLUSIVE RIGHT TO USE "HOOK", APART FROM THE MARK AS SHOWN.

SER. NO. 85-163,993, FILED P.R. 10-28-2010; AM. S.R. 3-7-2012.

SHANNON TWOHIG, EXAMINING ATTORNEY



David J. Kybas

Director of the United States Patent and Trademark Office

United States of America

United States Patent and Trademark Office

VENUEAGENT

Reg. No. 4,155,879

VENUEAGENT LLC (KENTUCKY LIMITED LIABILITY COMPANY)
3044 SUNDANCE BOULEVARD
BURLINGTON, KY 41005

Registered June 5, 2012

Int. Cls.: 41 and 43

FOR: BOOKING OF ENTERTAINMENT HALLS, IN CLASS 41 (U.S. CLS. 100, 101 AND 107).

SERVICE MARK

FIRST USE 1-1-2011; IN COMMERCE 5-20-2011.

SUPPLEMENTAL REGISTER

FOR: BOOKING OF BANQUET AND SOCIAL FUNCTION FACILITIES FOR SPECIAL OCCASIONS SUCH AS WEDDINGS, IN CLASS 43 (U.S. CLS. 100 AND 101).

FIRST USE 1-1-2011; IN COMMERCE 5-20-2011.

THE MARK CONSISTS OF STANDARD CHARACTERS WITHOUT CLAIM TO ANY PARTICULAR FONT, STYLE, SIZE, OR COLOR.

SER. NO. 85-175,187, FILED P.R. 11-12-2010; AM. S.R. 4-13-2012.

ROBIN CHOSID, EXAMINING ATTORNEY



David J. Kybas

Director of the United States Patent and Trademark Office

United States of America

United States Patent and Trademark Office

REPORTER CONNECTION

Reg. No. 4,155,880

Registered June 5, 2012

Int. Cl.: 42

SERVICE MARK

SUPPLEMENTAL REGISTER

BRADLEY COMMUNICATIONS CORP. (DELAWARE CORPORATION)
FIRST FLOOR
390 REED ROAD
BROOMAIL, PA 19008

FOR: HOSTING AN ONLINE COMMUNITY WEBSITE FEATURING SHARED COMMUNICATION BETWEEN JOURNALISTS AND SOURCES FOR THEIR STORIES, IN CLASS 42 (U.S. CLS. 100 AND 101).

FIRST USE 2-26-2005; IN COMMERCE 12-21-2009.

THE MARK CONSISTS OF STANDARD CHARACTERS WITHOUT CLAIM TO ANY PARTICULAR FONT, STYLE, SIZE, OR COLOR.

NO CLAIM IS MADE TO THE EXCLUSIVE RIGHT TO USE "REPORTER", APART FROM THE MARK AS SHOWN.

SER. NO. 85-183,898, FILED P.R. 11-23-2010; AM. S.R. 3-20-2012.

ROBERT C. CLARK JR., EXAMINING ATTORNEY



David J. Kyffers

Director of the United States Patent and Trademark Office

United States of America

United States Patent and Trademark Office

BIOMED SPECIALTY PHARMACY

Reg. No. 4,155,881

Registered June 5, 2012

Int. Cl.: 42

SERVICE MARK

SUPPLEMENTAL REGISTER

BIOMED HEALTH SOLUTIONS, LLC (MICHIGAN LIMITED LIABILITY COMPANY)
SUITE 5200
87 EAST CANFIELD
DETROIT, MI 48201

FOR: PHARMACEUTICAL DRUG DEVELOPMENT SERVICES, NAMELY, CUSTOMIZING PRESCRIPTION AND NON PRESCRIPTION DRUGS, USING FDA APPROVED DRUGS AND CHEMICALS, AND REDESIGNING OF DOSAGE FORM, STRENGTH AND ROUTE OF ADMINISTRATION BASED ON PRESCRIPTIONS TO MEET NEEDS OF A INDIVIDUAL PATIENTS, IN CLASS 42 (U.S. CLS. 100 AND 101).

FIRST USE 6-4-2009; IN COMMERCE 6-4-2009.

THE MARK CONSISTS OF STANDARD CHARACTERS WITHOUT CLAIM TO ANY PARTICULAR FONT, STYLE, SIZE, OR COLOR.

NO CLAIM IS MADE TO THE EXCLUSIVE RIGHT TO USE "SPECIALTY PHARMACY", APART FROM THE MARK AS SHOWN.

SER. NO. 85-188,290, FILED P.R. 12-1-2010; AM. S.R. 4-3-2012.

SUE LAWRENCE, EXAMINING ATTORNEY



David J. Kyros

Director of the United States Patent and Trademark Office

United States of America

United States Patent and Trademark Office

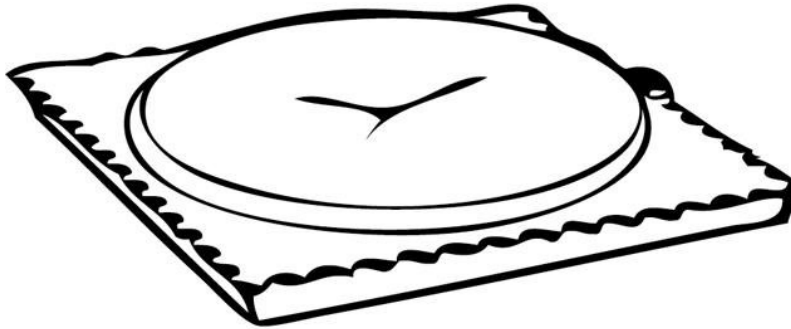

Reg. No. 4,155,882

TIMEHOUSE GMBH (FED REP GERMANY CORPORATION)
HAUPTSTR. 22A

Registered June 5, 2012

EYSTRUP, FED REP GERMANY 27324

Int. Cl.: 14

FOR: JEWELRY, NAMELY, WATCHES AND PRECIOUS STONES, IN CLASS 14 (U.S. CLS. 2, 27, 28 AND 50).

TRADEMARK

FIRST USE 3-1-2001; IN COMMERCE 3-1-2001.

SUPPLEMENTAL REGISTER

THE MARK CONSISTS OF A CONFIGURATION OF A WATCH.

SER. NO. 85-191,589, FILED P.R. 12-6-2010; AM. S.R. 4-4-2012.

MARK SPARACINO, EXAMINING ATTORNEY



David J. Kyffers

Director of the United States Patent and Trademark Office

United States of America

United States Patent and Trademark Office

MENON

Reg. No. 4,155,883

MENON & ASSOCIATES, INC. (CALIFORNIA CORPORATION)
12282 LIBELLE CT
SAN DIEGO, CA 92131

Registered June 5, 2012

Int. Cls.: 4, 9, and 31

FOR: BIOFUEL, IN CLASS 4 (U.S. CLS. 1, 6 AND 15).

FIRST USE 8-9-2011; IN COMMERCE 8-9-2011.

TRADEMARK

FOR: ELECTRONIC BIOTHREAT DETECTORS , IN CLASS 9 (U.S. CLS. 21, 23, 26, 36 AND 38).

SUPPLEMENTAL REGISTER

FIRST USE 5-4-2011; IN COMMERCE 5-4-2011.

FOR: ANIMAL FEED, IN CLASS 31 (U.S. CLS. 1 AND 46).

FIRST USE 8-9-2011; IN COMMERCE 8-9-2011.

THE MARK CONSISTS OF STANDARD CHARACTERS WITHOUT CLAIM TO ANY PARTICULAR FONT, STYLE, SIZE, OR COLOR.

SER. NO. 85-192,689, FILED P.R. 12-7-2010; AM. S.R. 4-4-2012.

KELLY BOULTON, EXAMINING ATTORNEY



David J. Kybas

Director of the United States Patent and Trademark Office

United States of America

United States Patent and Trademark Office

CHEF SET

Reg. No. 4,155,884

SETPOINT HEALTH CORPORATION (DELAWARE CORPORATION)
10 OSSIPPEE RD., SUITE 201
NEWTON UPPER FALLS, MA 02464

Registered June 5, 2012

Int. Cl.: 30

FOR: RICE, SEASONINGS AND FLAVORINGS COMBINED IN UNITARY PACKAGES;
QUINOA, SEASONINGS AND FLAVORINGS COMBINED IN UNITARY PACKAGES;
COUSCOUS, SEASONINGS AND FLAVORINGS COMBINED IN UNITARY PACKAGES, IN
CLASS 30 (U.S. CL. 46).

TRADEMARK

SUPPLEMENTAL REGISTER FIRST USE 8-26-2010; IN COMMERCE 8-26-2010.

THE MARK CONSISTS OF STANDARD CHARACTERS WITHOUT CLAIM TO ANY PARTICULAR FONT, STYLE, SIZE, OR COLOR.

NO CLAIM IS MADE TO THE EXCLUSIVE RIGHT TO USE "SET", APART FROM THE MARK AS SHOWN.

SER. NO. 85-193,933, FILED P.R. 12-9-2010; AM. S.R. 1-11-2012.

BRENDAN MCCAULEY, EXAMINING ATTORNEY



David J. Kyros

Director of the United States Patent and Trademark Office

United States of America

United States Patent and Trademark Office

HOME ACCENTS

Reg. No. 4,155,885

ORCHARD SUPPLY HARDWARE, LLC (DELAWARE LIMITED LIABILITY COMPANY)
6450 VIA DEL ORO
SAN JOSE, CA 95119

Registered June 5, 2012

Int. Cl.: 11

FOR: FAUCETS, IN CLASS 11 (U.S. CLS. 13, 21, 23, 31 AND 34).

TRADEMARK

FIRST USE 4-0-2010; IN COMMERCE 4-0-2010.

SUPPLEMENTAL REGISTER

THE MARK CONSISTS OF STANDARD CHARACTERS WITHOUT CLAIM TO ANY PARTICULAR FONT, STYLE, SIZE, OR COLOR.

NO CLAIM IS MADE TO THE EXCLUSIVE RIGHT TO USE "HOME", APART FROM THE MARK AS SHOWN.

SER. NO. 85-198,426, FILED P.R. 12-15-2010; AM. S.R. 4-16-2012.

AISHA SALEM, EXAMINING ATTORNEY



David J. Kyffers

Director of the United States Patent and Trademark Office

United States of America

United States Patent and Trademark Office

COMPREHENSIVE CLINICAL DEVELOPMENT

Reg. No. 4,155,886

Registered June 5, 2012

Int. Cl.: 35

SERVICE MARK

SUPPLEMENTAL REGISTER

COMPREHENSIVE NEUROSCIENCE, INC. (DELAWARE CORPORATION)
3100 SW 145TH AVE, SUITE NO. 340
MIRAMAR, FL 33207

FOR: BUSINESS MANAGEMENT CONSULTING; COST MANAGEMENT FOR THE HEALTH BENEFIT PLANS OF OTHERS; PHARMACEUTICAL COST MANAGEMENT SERVICES AND DRUG UTILIZATION REVIEW SERVICES, IN CLASS 35 (U.S. CLS. 100, 101 AND 102).

FIRST USE 3-30-2011; IN COMMERCE 3-30-2011.

THE MARK CONSISTS OF STANDARD CHARACTERS WITHOUT CLAIM TO ANY PARTICULAR FONT, STYLE, SIZE, OR COLOR.

OWNER OF U.S. REG. NOS. 3,449,534, 3,449,536, AND OTHERS.

SER. NO. 85-201,170, FILED P.R. 12-17-2010; AM. S.R. 3-30-2012.

ANDREA K. NADELMAN, EXAMINING ATTORNEY



David J. Kyros

Director of the United States Patent and Trademark Office

United States of America

United States Patent and Trademark Office

COMPREHENSIVE CLINICAL DEVELOPMENT

Reg. No. 4,155,887

COMPREHENSIVE NEUROSCIENCE, INC. (DELAWARE CORPORATION)
3100 SW 145TH AVE, SUITE NO. 340
MIRAMAR, FL 33207

Registered June 5, 2012

Int. Cl.: 42

FOR: MEDICAL AND SCIENTIFIC RESEARCH; PHARMACEUTICAL PRODUCT EVALUATION; PHARMACEUTICAL RESEARCH SERVICES, IN CLASS 42 (U.S. CLS. 100 AND 101).

SERVICE MARK

FIRST USE 3-30-2011; IN COMMERCE 3-30-2011.

SUPPLEMENTAL REGISTER

THE MARK CONSISTS OF STANDARD CHARACTERS WITHOUT CLAIM TO ANY PARTICULAR FONT, STYLE, SIZE, OR COLOR.

SER. NO. 85-201,174, FILED P.R. 12-17-2010; AM. S.R. 3-30-2012.

ANDREA K. NADELMAN, EXAMINING ATTORNEY



David J. Kyffers

Director of the United States Patent and Trademark Office

United States of America

United States Patent and Trademark Office

E-QUALITY PRESS

Reg. No. 4,155,888

FISHER, FREDRICK (UNITED STATES INDIVIDUAL)
2604 GRACEWOOD DRIVE
GREENSBORO, NC 27408

Registered June 5, 2012

Int. Cl.: 41

FOR: PUBLICATION OF E-BOOKS, NAMELY, E-BOOKS CONTAINING NOVELS AND/OR STORIES, EITHER SINGLY OR IN COLLECTIONS AND EXCLUDING PUBLICATION OF PRINTED MATERIALS AND ANY AND ALL MATERIALS PERTAINING TO QUALITY OR QUALITY ISSUES, IN CLASS 41 (U.S. CLS. 100, 101 AND 107).

SERVICE MARK

SUPPLEMENTAL REGISTER FIRST USE 3-3-2010; IN COMMERCE 11-24-2010.

THE MARK CONSISTS OF STANDARD CHARACTERS WITHOUT CLAIM TO ANY PARTICULAR FONT, STYLE, SIZE, OR COLOR.

OWNER OF U.S. REG. NO. 3,997,463.

NO CLAIM IS MADE TO THE EXCLUSIVE RIGHT TO USE "PRESS", APART FROM THE MARK AS SHOWN.

SER. NO. 85-203,544, FILED P.R. 12-22-2010; AM. S.R. 4-7-2012.

KATHLEEN M. VANSTON, EXAMINING ATTORNEY



David J. Kybas

Director of the United States Patent and Trademark Office

United States of America

United States Patent and Trademark Office

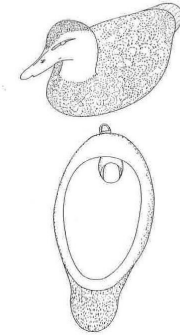

Reg. No. 4,155,889

Registered June 5, 2012

Int. Cl.: 21

TRADEMARK

SUPPLEMENTAL REGISTER

GL & LL OF O.C., LLC (MARYLAND LIMITED LIABILITY COMPANY)
311 TALBOT STREET
OCEAN CITY, MD 21842

FOR: DRINKING CONTAINERS, IN CLASS 21 (U.S. CLS. 2, 13, 23, 29, 30, 33, 40 AND 50).

FIRST USE 8-7-2002; IN COMMERCE 8-7-2002.

THE MARK CONSISTS OF THE CONFIGURATION OF A DRINK CONTAINER IN THE SHAPE OF A DUCK WHICH IS DIVIDED IN THE CENTER AND HOLLOW ON THE INSIDE.

SER. NO. 85-203,799, FILED P.R. 12-22-2010; AM. S.R. 4-17-2012.

TINA BROWN, EXAMINING ATTORNEY



David J. Kyffers

Director of the United States Patent and Trademark Office

United States of America

United States Patent and Trademark Office

TREE RING

Reg. No. 4,155,890

Registered June 5, 2012

Int. Cl.: 16

TRADEMARK

SUPPLEMENTAL REGISTER

TREE RING PENS LLC (MONTANA LIMITED LIABILITY COMPANY)
6107 SKYVIEW DRIVE
MISSOULA, MT 59803

FOR: WRITING INSTRUMENTS, IN CLASS 16 (U.S. CLS. 2, 5, 22, 23, 29, 37, 38 AND 50).

FIRST USE 5-16-2009; IN COMMERCE 3-24-2010.

THE MARK CONSISTS OF STANDARD CHARACTERS WITHOUT CLAIM TO ANY PARTICULAR FONT, STYLE, SIZE, OR COLOR.

SER. NO. 85-204,894, FILED P.R. 12-23-2010; AM. S.R. 4-5-2012.

KATHERINE CHANG, EXAMINING ATTORNEY



David J. Kybas

Director of the United States Patent and Trademark Office

United States of America
United States Patent and Trademark Office

TREE RING

Reg. No. 4,155,891

TREE RING PENS LLC (MONTANA LIMITED LIABILITY COMPANY)
6107 SKYVIEW DRIVE
MISSOULA, MT 59803

Registered June 5, 2012

Int. Cl.: 21

FOR: COASTERS NOT OF PAPER AND NOT BEING TABLE LINEN, IN CLASS 21 (U.S. CLS. 2, 13, 23, 29, 30, 33, 40 AND 50).

TRADEMARK

FIRST USE 7-26-2010; IN COMMERCE 7-26-2010.

SUPPLEMENTAL REGISTER

THE MARK CONSISTS OF STANDARD CHARACTERS WITHOUT CLAIM TO ANY PARTICULAR FONT, STYLE, SIZE, OR COLOR.

SER. NO. 85-204,919, FILED P.R. 12-23-2010; AM. S.R. 4-5-2012.

KATHERINE CHANG, EXAMINING ATTORNEY



David J. Kybas

Director of the United States Patent and Trademark Office

United States of America

United States Patent and Trademark Office

Green Sheets

Reg. No. 4,155,892

NEW ORLEANS EXCHANGE, INC. (DELAWARE CORPORATION)
935 GRAVIER STREET
NEW ORLEANS, NJ 70112

Registered June 5, 2012

Int. Cl.: 35

FOR: CONNECTING BUYERS AND SELLERS OF FINANCIAL ASSETS, IN CLASS 35 (U.S. CLS. 100, 101 AND 102).

SERVICE MARK

FIRST USE 6-1-2009; IN COMMERCE 6-1-2009.

SUPPLEMENTAL REGISTER

THE MARK CONSISTS OF STANDARD CHARACTERS WITHOUT CLAIM TO ANY PARTICULAR FONT, STYLE, SIZE, OR COLOR.

SER. NO. 85-205,620, FILED P.R. 12-25-2010; AM. S.R. 4-12-2012.

ANNE E. GUSTASON, EXAMINING ATTORNEY



David J. Kyros

Director of the United States Patent and Trademark Office

United States of America

United States Patent and Trademark Office

SMART IRON

Reg. No. 4,155,893

Registered June 5, 2012

Int. Cl.: 9

TRADEMARK

SUPPLEMENTAL REGISTER

OLISO, INC. (CALIFORNIA CORPORATION)
498 ALABAMA STREET
SAN FRANCISCO, CA 94560

FOR: ELECTRIC IRONS, IN CLASS 9 (U.S. CLS. 21, 23, 26, 36 AND 38).

FIRST USE 8-30-2009; IN COMMERCE 8-30-2009.

THE MARK CONSISTS OF STANDARD CHARACTERS WITHOUT CLAIM TO ANY PARTICULAR FONT, STYLE, SIZE, OR COLOR.

NO CLAIM IS MADE TO THE EXCLUSIVE RIGHT TO USE "IRON", APART FROM THE MARK AS SHOWN.

SER. NO. 85-207,496, FILED P.R. 12-29-2010; AM. S.R. 4-23-2012.

KELLY BOULTON, EXAMINING ATTORNEY



David J. Kyffers

Director of the United States Patent and Trademark Office

United States of America

United States Patent and Trademark Office

CO-OP MEMBER CENTER

Reg. No. 4,155,894

Registered June 5, 2012

Int. Cl.: 35

SERVICE MARK

SUPPLEMENTAL REGISTER

CU COOPERATIVE SYSTEMS, INC. (CALIFORNIA COOPERATIVE CORPORATION)
9692 HAVEN AVENUE
RANCHO CUCAMONGA, CA 91730

FOR: OUTSOURCING IN THE FIELD OF CREDIT UNION CUSTOMER SERVICE TELEPHONE CALL CENTERS; OPERATION OF TELEPHONE CALL CENTERS FOR CREDIT UNIONS; OUTSOURCING CONSUMER LENDING SERVICES, NAMELY, PROVIDING OUTSOURCED LOAN ORIGINATION AND UNDERWRITING SERVICES FOR CREDIT UNIONS, IN CLASS 35 (U.S. CLS. 100, 101 AND 102).

FIRST USE 11-30-2009; IN COMMERCE 11-30-2009.

THE MARK CONSISTS OF STANDARD CHARACTERS WITHOUT CLAIM TO ANY PARTICULAR FONT, STYLE, SIZE, OR COLOR.

OWNER OF U.S. REG. NOS. 2,497,862, 3,683,476, AND OTHERS.

NO CLAIM IS MADE TO THE EXCLUSIVE RIGHT TO USE "CENTER", APART FROM THE MARK AS SHOWN.

SER. NO. 85-208,982, FILED P.R. 1-3-2011; AM. S.R. 9-26-2011.

CYNTHIA TRIPI, EXAMINING ATTORNEY



David J. Kyros

Director of the United States Patent and Trademark Office

United States of America

United States Patent and Trademark Office

FOR THE KITCHEN!

Reg. No. 4,155,895

FOR THE KITCHEN, LLC (CONNECTICUT LIMITED LIABILITY COMPANY)
2850 MAIN STREET
GLASTONBURY, CT 06033

Registered June 5, 2012

Int. Cl.: 35

FOR: RETAIL STORE SERVICES FEATURING COOKWARE, KITCHENWARE AND DINING-RELATED PRODUCTS, IN CLASS 35 (U.S. CLS. 100, 101 AND 102).

SERVICE MARK

FIRST USE 6-28-2010; IN COMMERCE 6-28-2010.

SUPPLEMENTAL REGISTER

THE MARK CONSISTS OF STANDARD CHARACTERS WITHOUT CLAIM TO ANY PARTICULAR FONT, STYLE, SIZE, OR COLOR.

SER. NO. 85-214,120, FILED P.R. 1-10-2011; AM. S.R. 4-26-2012.

ROBERT C. CLARK JR., EXAMINING ATTORNEY



David J. Kybas

Director of the United States Patent and Trademark Office

United States of America

United States Patent and Trademark Office

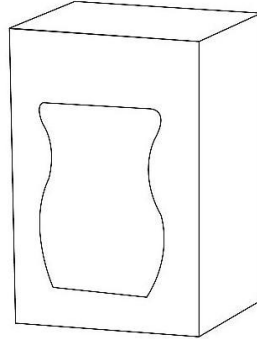

Reg. No. 4,155,896

Registered June 5, 2012

Int. Cl.: 11

TRADEMARK

SUPPLEMENTAL REGISTER

SCENTSY, INC. (IDAHO CORPORATION)
P. O. BOX 1335
MERIDIAN, ID 83680

FOR: FLAMELESS CANDLES; ELECTRIC CANDLE WARMERS, IN CLASS 11 (U.S. CLS. 13, 21, 23, 31 AND 34).

FIRST USE 3-1-2010; IN COMMERCE 3-1-2010.

THE MARK CONSISTS OF A THREE-DIMENSIONAL CONFIGURATION FOR PAPER PACKAGING OF SCENTED WICKLESS CANDLE PRODUCTS AND WARMERS, ROUGHLY RECTANGULAR IN SHAPE WITH STRAIGHT SIDES. THE FRONT OF THE PACKAGING CONTAINS AN IMAGE SHAPED IN A CURVED DESIGN.

SER. NO. 85-217,831, FILED P.R. 1-14-2011; AM. S.R. 7-28-2011.

JANICE KIM, EXAMINING ATTORNEY



David J. Kyros

Director of the United States Patent and Trademark Office

United States of America

United States Patent and Trademark Office

Marine-D3

Reg. No. 4,155,897

NUGENICS INTERNATIONAL, LLC (NEVADA LIMITED LIABILITY COMPANY)
3001 WEST 111TH STREET
CHICAGO, IL 60655

Registered June 5, 2012

Int. Cl.: 5

FOR: VITAMIN AND MINERAL SUPPLEMENTS CONTAINING VITAMIN D3, IN CLASS 5
(U.S. CLS. 6, 18, 44, 46, 51 AND 52).

TRADEMARK

FIRST USE 2-0-2011; IN COMMERCE 2-0-2011.

SUPPLEMENTAL REGISTER

THE MARK CONSISTS OF STANDARD CHARACTERS WITHOUT CLAIM TO ANY PARTICULAR FONT, STYLE, SIZE, OR COLOR.

SER. NO. 85-220,601, FILED P.R. 1-19-2011; AM. S.R. 10-20-2011.

JANICE L. MCMORROW, EXAMINING ATTORNEY



David J. Kybas

Director of the United States Patent and Trademark Office

United States of America

United States Patent and Trademark Office

COLLABORATIVE FOR LEADERSHIP EXCELLENCE

Reg. No. 4,155,898

Registered June 5, 2012

Int. Cl.: 35

COLLABORATIVE FOR LEADERSHIP EXCELLENCE (NEVADA LIMITED LIABILITY COMPANY)
SUITE 2540
230 WEST MONROE STREET
CHICAGO, IL 60606

SERVICE MARK

FOR: BUSINESS AND MANAGEMENT CONSULTING FOR HEALTHCARE PROVIDERS; CONSULTING IN THE FIELDS OF HEALTHCARE OPERATIONS MANAGEMENT , IN CLASS 35 (U.S. CLS. 100, 101 AND 102).

SUPPLEMENTAL REGISTER

FIRST USE 2-28-2011; IN COMMERCE 2-28-2011.

THE MARK CONSISTS OF STANDARD CHARACTERS WITHOUT CLAIM TO ANY PARTICULAR FONT, STYLE, SIZE, OR COLOR.

SER. NO. 85-223,012, FILED P.R. 1-21-2011; AM. S.R. 3-30-2012.

LINDA E. BLOHM, EXAMINING ATTORNEY



David J. Kyffers

Director of the United States Patent and Trademark Office

United States of America

United States Patent and Trademark Office

COLLABORATIVE FOR HOSPITAL EXCELLENCE

Reg. No. 4,155,899

Registered June 5, 2012

Int. Cl.: 35

SERVICE MARK

SUPPLEMENTAL REGISTER

COLLABORATIVE FOR LEADERSHIP EXCELLENCE (NEVADA LIMITED LIABILITY COMPANY)
SUITE 2540
230 WEST MONROE STREET
CHICAGO, IL 60606

FOR: BUSINESS AND MANAGEMENT CONSULTING FOR HEALTHCARE PROVIDERS; CONSULTING IN THE FIELDS OF HEALTHCARE OPERATIONS MANAGEMENT , IN CLASS 35 (U.S. CLS. 100, 101 AND 102).

FIRST USE 2-28-2011; IN COMMERCE 2-28-2011.

THE MARK CONSISTS OF STANDARD CHARACTERS WITHOUT CLAIM TO ANY PARTICULAR FONT, STYLE, SIZE, OR COLOR.

SER. NO. 85-223,015, FILED P.R. 1-21-2011; AM. S.R. 3-30-2012.

LINDA E. BLOHM, EXAMINING ATTORNEY



David J. Kyros

Director of the United States Patent and Trademark Office

United States of America

United States Patent and Trademark Office

FRUITLETS

Reg. No. 4,155,900

PROTICA INC. (DELAWARE CORPORATION)
1002 MACARTHUR RD
WHITEHALL, PA 180527002

Registered June 5, 2012

Int. Cl.: 5

FOR: DIETARY AND NUTRITIONAL SUPPLEMENTS, IN CLASS 5 (U.S. CLS. 6, 18, 44, 46, 51 AND 52).

TRADEMARK

FIRST USE 2-20-2012; IN COMMERCE 2-20-2012.

SUPPLEMENTAL REGISTER

THE MARK CONSISTS OF STANDARD CHARACTERS WITHOUT CLAIM TO ANY PARTICULAR FONT, STYLE, SIZE, OR COLOR.

SER. NO. 85-225,057, FILED P.R. 1-24-2011; AM. S.R. 3-18-2012.

DAVID COLLIER, EXAMINING ATTORNEY



David J. Kybas

Director of the United States Patent and Trademark Office

United States of America

United States Patent and Trademark Office

THE ISO14000 ADVISOR

Reg. No. 4,155,901

Registered June 5, 2012

Int. Cl.: 41

SERVICE MARK

SUPPLEMENTAL REGISTER

QAI TRAINING, LLC (INDIANA LIMITED LIABILITY COMPANY), DBA QAI, LLC,
7830 JOHNSON ROAD
INDIANAPOLIS, IN 46250

FOR: BUSINESS TRAINING AND PROVIDING A WEBSITE FEATURING NON-DOWNLOAD-
ABLE EDUCATIONAL VIDEOS IN THE FIELDS OF BUSINESS TRAINING AND BUSINESS
MANAGEMENT TRAINING, IN CLASS 41 (U.S. CLS. 100, 101 AND 107).

FIRST USE 10-31-2011; IN COMMERCE 10-31-2011.

THE MARK CONSISTS OF STANDARD CHARACTERS WITHOUT CLAIM TO ANY PAR-
TICULAR FONT, STYLE, SIZE, OR COLOR.

SER. NO. 85-231,921, FILED P.R. 2-2-2011; AM. S.R. 11-1-2011.

CHRISTOPHER LAW, EXAMINING ATTORNEY



David J. Kyros

Director of the United States Patent and Trademark Office

United States of America

United States Patent and Trademark Office

SEMICONDUCTOR HALL OF FAME

Reg. No. 4,155,902

RUZYLLO, JERZY (UNITED STATES INDIVIDUAL)
616 ROYAL CIRCLE
STATE COLLEGE, PA 16801

Registered June 5, 2012

Int. Cl.: 41

FOR: ORGANIZATION OF EXHIBITIONS FOR CULTURAL OR EDUCATIONAL PURPOSES,
IN CLASS 41 (U.S. CLS. 100, 101 AND 107).

SERVICE MARK

FIRST USE 1-1-2004; IN COMMERCE 4-1-2012.

SUPPLEMENTAL REGISTER

THE MARK CONSISTS OF STANDARD CHARACTERS WITHOUT CLAIM TO ANY PARTICULAR FONT, STYLE, SIZE, OR COLOR.

NO CLAIM IS MADE TO THE EXCLUSIVE RIGHT TO USE "HALL OF FAME", APART FROM THE MARK AS SHOWN.

SER. NO. 85-232,643, FILED P.R. 2-2-2011; AM. S.R. 4-28-2012.

ROBIN MITTLER, EXAMINING ATTORNEY



David J. Kybas

Director of the United States Patent and Trademark Office

United States of America

United States Patent and Trademark Office

BLACK KIDS ROCK!

Reg. No. 4,155,903

NEPHEW, PAMELA (UNITED STATES INDIVIDUAL)
645 VILLAGE PKWY
FREDERICKSBURG, VA 22406

Registered June 5, 2012

Int. Cl.: 25

FOR: CLOTHING, NAMELY, JACKETS, PANTS, SHORTS, T-SHIRTS, SWEATERS, SCARVES, SWEATPANTS, SWEATSHIRTS, JERSEYS, MITTENS, GLOVES, RAIN WEAR, CAPS, SOCKS, BANDANAS, KNIT HATS, IN CLASS 25 (U.S. CLS. 22 AND 39).

TRADEMARK

FIRST USE 9-17-2011; IN COMMERCE 9-17-2011.

SUPPLEMENTAL REGISTER

THE MARK CONSISTS OF STANDARD CHARACTERS WITHOUT CLAIM TO ANY PARTICULAR FONT, STYLE, SIZE, OR COLOR.

SER. NO. 85-232,862, FILED P.R. 2-3-2011; AM. S.R. 4-24-2012.

FRANK LATTUCA, EXAMINING ATTORNEY



David J. Kyros

Director of the United States Patent and Trademark Office

United States of America

United States Patent and Trademark Office

PROFESSIONAL IMPROVEMENT PROGRAM

Reg. No. 4,155,904

Registered June 5, 2012

Int. Cl.: 41

SERVICE MARK

SUPPLEMENTAL REGISTER

NEW FREEDOM HOLDINGS LLC (ARIZONA LIMITED LIABILITY COMPANY)
P.O. BOX 3172
CAREFREE, AZ 85377

FOR: (BASED ON USE IN COMMERCE) PROVIDING INSTRUCTIONAL SERVICES, NAMELY, WORKSHOPS, SEMINARS, AND CLASSES THAT FOCUS ON GOAL ACHIEVEMENT FOR THERAPISTS; (BASED ON INTENT TO USE) PROVIDING INSTRUCTIONAL SERVICES, NAMELY, WORKSHOPS, SEMINARS, AND CLASSES THAT FOCUS ON GOAL ACHIEVEMENT FOR CORPORATE ENTITIES, IN CLASS 41 (U.S. CLS. 100, 101 AND 107).

FIRST USE 9-12-2006; IN COMMERCE 9-12-2006.

THE MARK CONSISTS OF STANDARD CHARACTERS WITHOUT CLAIM TO ANY PARTICULAR FONT, STYLE, SIZE, OR COLOR.

SER. NO. 85-255,962, FILED P.R. 3-2-2011; AM. S.R. 10-5-2011.

LAURA KOVALSKY, EXAMINING ATTORNEY



David J. Kyros

Director of the United States Patent and Trademark Office

United States of America

United States Patent and Trademark Office

Corporate Researchers Conference

Reg. No. 4,155,905

Registered June 5, 2012

Int. Cl.: 41

SERVICE MARK

SUPPLEMENTAL REGISTER FIRST USE 4-12-2011; IN COMMERCE 4-12-2011.

MARKETING RESEARCH ASSOCIATION, INC. (NEW YORK CORPORATION)
1156 15TH STREET, NW
SUITE 302
WASHINGTON, DC 20005

FOR: EDUCATIONAL SERVICES, NAMELY, CONDUCTING CONFERENCES IN THE FIELD OF MARKETING RESEARCH, SURVEY RESEARCH AND OPINION RESEARCH, IN CLASS 41 (U.S. CLS. 100, 101 AND 107).

THE MARK CONSISTS OF STANDARD CHARACTERS WITHOUT CLAIM TO ANY PARTICULAR FONT, STYLE, SIZE, OR COLOR.

NO CLAIM IS MADE TO THE EXCLUSIVE RIGHT TO USE "CONFERENCE", APART FROM THE MARK AS SHOWN.

SER. NO. 85-263,156, FILED P.R. 3-10-2011; AM. S.R. 7-6-2011.

LESLIE RICHARDS, EXAMINING ATTORNEY



David J. Kyffers

Director of the United States Patent and Trademark Office

United States of America

United States Patent and Trademark Office

Glamping

Reg. No. 4,155,906

Registered June 5, 2012

Int. Cl.: 43

SERVICE MARK

SUPPLEMENTAL REGISTER

THE LAST BEST BEEF, LLC (NEVADA LIMITED LIABILITY COMPANY)
SUITE 830
3993 HOWARD HUGHES PKWY
LAS VEGAS, NV 89169

FOR: EXTENDED-STAY HOTELS; HOTEL ACCOMMODATION SERVICES; HOTEL AND MOTEL SERVICES; HOTEL AND RESTAURANT RESERVATION SERVICES; HOTEL AND RESTAURANT SERVICES; HOTEL SERVICES; HOTEL SERVICES FOR PREFERRED CUSTOMERS; HOTEL, BAR AND RESTAURANT SERVICES; HOTEL, MOTEL, RESTAURANT, BAR AND CATERING SERVICES; HOTEL, RESTAURANT AND BAR SERVICES; HOTEL, RESTAURANT AND CATERING SERVICES; HOTELS; MAKING HOTEL RESERVATIONS FOR OTHERS; RESERVATION OF HOTEL ROOMS FOR TRAVELERS; RESERVATION OF HOTEL ROOMS FOR TRAVELLERS; RESORT HOTELS; RESTAURANT AND HOTEL SERVICES, IN CLASS 43 (U.S. CLS. 100 AND 101).

FIRST USE 6-1-2007; IN COMMERCE 6-1-2007.

THE MARK CONSISTS OF STANDARD CHARACTERS WITHOUT CLAIM TO ANY PARTICULAR FONT, STYLE, SIZE, OR COLOR.

SER. NO. 85-264,016, FILED P.R. 3-10-2011; AM. S.R. 4-9-2012.

DAVID COLLIER, EXAMINING ATTORNEY



David J. Kyros

Director of the United States Patent and Trademark Office

United States of America

United States Patent and Trademark Office

INFERTILITY & REPRODUCTIVE NEWS

Reg. No. 4,155,907

Registered June 5, 2012

Int. Cl.: 35

SERVICE MARK

SUPPLEMENTAL REGISTER

NOVELLUS HEALTHCARE COMMUNICATIONS, LLC (NEW JERSEY LIMITED LIABILITY COMPANY)
241 FORSGATE DRIVE, SUITE 205C
MONROE TOWNSHIP, NJ 08831

FOR: ADVERTISING SERVICES, NAMELY, PROVIDING ADVERTISING SPACE IN PRINT AND ELECTRONIC JOURNALS, MAGAZINES, NEWSLETTERS, FEATURE REPORTS, PRINT AND ELECTRONIC SUPPLEMENTS AND WEB SITES THAT CONCERN INFORMATION IN THE FIELDS OF OBSTETRICS, GYNECOLOGY, INFERTILITY, UROLOGY, ONCOLOGY, REPRODUCTIVE ENDOCRINOLOGY, REPRODUCTIVE MEDICINE AND NURSING, IN CLASS 35 (U.S. CLS. 100, 101 AND 102).

FIRST USE 6-0-2010; IN COMMERCE 1-0-2011.

THE MARK CONSISTS OF STANDARD CHARACTERS WITHOUT CLAIM TO ANY PARTICULAR FONT, STYLE, SIZE, OR COLOR.

SER. NO. 85-267,345, FILED P.R. 3-15-2011; AM. S.R. 3-20-2012.

INGA ERVIN, EXAMINING ATTORNEY



David J. Kybas

Director of the United States Patent and Trademark Office

United States of America

United States Patent and Trademark Office

Tu Color Latino

Reg. No. 4,155,908

Registered June 5, 2012

Int. Cl.: 3

TRADEMARK

SUPPLEMENTAL REGISTER

GOOD BY NATURE LLC (ILLINOIS LIMITED LIABILITY COMPANY)
4731 W 136TH ST
CRESTWOOD, IL 60445

FOR: HAIRCARE PRODUCTS, NAMELY, HAIR COLOR, HAIR SHAMPOO AND CONDITIONERS, HAIR SPRAY, HAIR GEL AND HAIR MOUSSE, IN CLASS 3 (U.S. CLS. 1, 4, 6, 50, 51 AND 52).

FIRST USE 6-1-2009; IN COMMERCE 6-1-2009.

THE MARK CONSISTS OF STANDARD CHARACTERS WITHOUT CLAIM TO ANY PARTICULAR FONT, STYLE, SIZE, OR COLOR.

NO CLAIM IS MADE TO THE EXCLUSIVE RIGHT TO USE "COLOR", APART FROM THE MARK AS SHOWN.

THE ENGLISH TRANSLATION OF "TU COLOR LATINO" IN THE MARK IS "YOUR LATIN COLOR".

SER. NO. 85-267,792, FILED P.R. 3-15-2011; AM. S.R. 12-8-2011.

SCOTT BIBB, EXAMINING ATTORNEY



David J. Kyffers

Director of the United States Patent and Trademark Office

United States of America

United States Patent and Trademark Office

WHEEL WASH

Reg. No. 4,155,909

Registered June 5, 2012

Int. Cl.: 25

TRADEMARK

SUPPLEMENTAL REGISTER

THE BURTON CORPORATION (VERMONT CORPORATION)
80 INDUSTRIAL PARKWAY
BURLINGTON, VT 05401

FOR: CLOTHING, NAMELY, DENIM PANTS AND JACKETS, PANTS, BOARDSHORTS, WALKING SHORTS, WOVEN TOPS, FLANNEL SHIRTS, KNIT TOPS, FLEECE TOPS, TEE SHIRTS, TANK TOPS, JACKETS, AND SWEATERS, IN CLASS 25 (U.S. CLS. 22 AND 39).

FIRST USE 1-15-2011; IN COMMERCE 1-15-2011.

THE MARK CONSISTS OF STANDARD CHARACTERS WITHOUT CLAIM TO ANY PARTICULAR FONT, STYLE, SIZE, OR COLOR.

SER. NO. 85-270,740, FILED P.R. 3-18-2011; AM. S.R. 8-18-2011.

PAUL MORENO, EXAMINING ATTORNEY



David J. Kyffers

Director of the United States Patent and Trademark Office

United States of America

United States Patent and Trademark Office

TENDER VITTLES

Reg. No. 4,155,910

KAPLAN, JEFFREY (UNITED STATES INDIVIDUAL)
POB 11106

Registered June 5, 2012

FORT LAUDERDALE, FL 33339

Int. Cl.: 31

FOR: CAT FOOD, IN CLASS 31 (U.S. CLS. 1 AND 46).

TRADEMARK

FIRST USE 11-10-2011; IN COMMERCE 11-10-2011.

SUPPLEMENTAL REGISTER

THE MARK CONSISTS OF STANDARD CHARACTERS WITHOUT CLAIM TO ANY PARTICULAR FONT, STYLE, SIZE, OR COLOR.

SER. NO. 85-271,648, FILED P.R. 3-20-2011; AM. S.R. 11-14-2011.

JORDAN BAKER, EXAMINING ATTORNEY



David J. Kyffers

Director of the United States Patent and Trademark Office

United States of America

United States Patent and Trademark Office

CORE MEASURE SOLUTION EXCHANGE

Reg. No. 4,155,911

Registered June 5, 2012

Int. Cl.: 38

SERVICE MARK

SUPPLEMENTAL REGISTER

JOINT COMMISSION ON ACCREDITATION OF HEALTHCARE ORGANIZATIONS (ILLINOIS CORPORATION)
ONE RENNAISSANCE BLVD
OAKBROOK TERRACE, IL 60181

FOR: PROVIDING AN ON-LINE FORUM FOR EXCHANGING INFORMATION AMONGST HEALTHCARE PROFESSIONALS , IN CLASS 38 (U.S. CLS. 100, 101 AND 104).

FIRST USE 4-30-2011; IN COMMERCE 4-30-2011.

THE MARK CONSISTS OF STANDARD CHARACTERS WITHOUT CLAIM TO ANY PARTICULAR FONT, STYLE, SIZE, OR COLOR.

NO CLAIM IS MADE TO THE EXCLUSIVE RIGHT TO USE "EXCHANGE", APART FROM THE MARK AS SHOWN.

SER. NO. 85-273,094, FILED P.R. 3-22-2011; AM. S.R. 3-27-2012.

MICHELE SWAIN, EXAMINING ATTORNEY



David J. Kyros

Director of the United States Patent and Trademark Office

United States of America

United States Patent and Trademark Office

RELATIONSHIP MANAGER

Reg. No. 4,155,912

Registered June 5, 2012

Int. Cl.: 35

SERVICE MARK

SUPPLEMENTAL REGISTER

HOOVER'S, INC. (DELAWARE CORPORATION)
5800 AIRPORT BOULEVARD
AUSTIN, TX 78752

FOR: PROVIDING A WEB SITE FEATURING A WIDE VARIETY OF BUSINESS RESEARCH INFORMATION RELATED TO CURRENT BUSINESS NEWS, COMPANY AND INDUSTRY PROFILES, INVESTMENT INFORMATION, JOB SEARCHES, AND RELATED BUSINESS MATTERS; PREPARING MAILING LISTS; BUSINESS MARKETING SERVICES; PROVIDING BUSINESS LEAD GENERATION ACTIVITIES AND SERVICES; CUSTOMER RELATIONSHIP MANAGEMENT SERVICES; SALES PROMOTION SERVICES, IN CLASS 35 (U.S. CLS. 100, 101 AND 102).

FIRST USE 11-3-2008; IN COMMERCE 11-3-2008.

THE MARK CONSISTS OF STANDARD CHARACTERS WITHOUT CLAIM TO ANY PARTICULAR FONT, STYLE, SIZE, OR COLOR.

SER. NO. 85-286,597, FILED P.R. 4-5-2011; AM. S.R. 4-10-2012.

MARK T. MULLEN, EXAMINING ATTORNEY



David J. Kyffers

Director of the United States Patent and Trademark Office

United States of America

United States Patent and Trademark Office

The National Sorting Cow Horse Association

Reg. No. 4,155,913

Registered June 5, 2012

Int. Cl.: 41

SERVICE MARK

SUPPLEMENTAL REGISTER

NATIONAL SORTING COW HORSE ASSOCIATION (MISSOURI LIMITED LIABILITY COMPANY)
1492 HIGHWAY 21
CALEDONIA, MO 63631

FOR: ENTERTAINMENT SERVICES, NAMELY, ARRANGING AND CONDUCTING OF COMPETITIONS FOR RANCH SORTING, IN CLASS 41 (U.S. CLS. 100, 101 AND 107).

FIRST USE 1-1-2009; IN COMMERCE 1-1-2010.

THE MARK CONSISTS OF STANDARD CHARACTERS WITHOUT CLAIM TO ANY PARTICULAR FONT, STYLE, SIZE, OR COLOR.

NO CLAIM IS MADE TO THE EXCLUSIVE RIGHT TO USE "ASSOCIATION", APART FROM THE MARK AS SHOWN.

SER. NO. 85-287,154, FILED P.R. 4-5-2011; AM. S.R. 4-2-2012.

BRIAN PINO, EXAMINING ATTORNEY



David J. Kyjars

Director of the United States Patent and Trademark Office

United States of America

United States Patent and Trademark Office

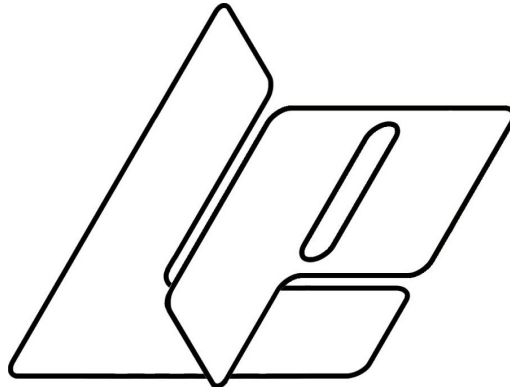

Reg. No. 4,155,914

Registered June 5, 2012

Int. Cl.: 9

TRADEMARK

SUPPLEMENTAL REGISTER

LITHIUM PRODUCTS, LLC (TENNESSEE LIMITED LIABILITY COMPANY)
7501 STRAWBERRY PLAINS PIKE
KNOXVILLE, TN 37924

FOR: LITHIUM-ION AUTOMOBILE BATTERIES, BATTERY CHARGERS FOR LITHIUM-ION AUTOMOBILE BATTERIES, AND BATTERY TRAYS, BOXES, AND TERMINALS THEREFOR, IN CLASS 9 (U.S. CLS. 21, 23, 26, 36 AND 38).

FIRST USE 6-14-2011; IN COMMERCE 6-14-2011.

THE MARK CONSISTS OF THE LETTER "P" SUPERIMPOSED OVER THE LETTER "L".

SER. NO. 85-289,185, FILED P.R. 4-7-2011; AM. S.R. 4-5-2012.

KARANENDRA S. CHHINA, EXAMINING ATTORNEY



David J. Kyffers

Director of the United States Patent and Trademark Office

United States of America

United States Patent and Trademark Office

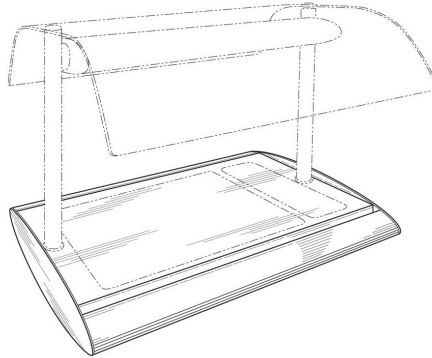

Reg. No. 4,155,915

Registered June 5, 2012

Int. Cl.: 11

TRADEMARK

SUPPLEMENTAL REGISTER

HATCO CORPORATION (WISCONSIN CORPORATION)
635 S. 28TH STREET
MILWAUKEE, WI 53215

FOR: ELECTRIC FOOD WARMERS FOR HOLDING FOOD AT SERVING TEMPERATURE, PORTABLE FOOD WARMERS, HOLDING AND DISPLAY WARMERS, BUFFET WARMERS, HEATED SHELVES, ALL FOR COMMERCIAL USE, IN CLASS 11 (U.S. CLS. 13, 21, 23, 31 AND 34).

FIRST USE 8-19-2008; IN COMMERCE 8-19-2008.

THE MARK CONSISTS OF A THREE-DIMENSIONAL CONFIGURATION FOR AN END PANEL AND BASE SHELF OF A PORTABLE ELECTRIC FOOD WARMER. THE END PANEL HAVING AN ELLIPTICAL SHAPE AND THE SHELF HAVING A TAPERED FRONT EDGE. THE PORTION OF THE MARK SHOWN IN DOTTED LINES IS NOT PART OF THE MARK AND SERVES ONLY TO SHOW POSITIONING OR PLACEMENT OF THE MARK ON THE GOODS.

SER. NO. 85-290,631, FILED P.R. 4-8-2011; AM. S.R. 1-16-2012.

JEFF DEFORD, EXAMINING ATTORNEY



David J. Kyros

Director of the United States Patent and Trademark Office

United States of America
United States Patent and Trademark Office

MANLEY

Reg. No. 4,155,916

K.C. CARPET SERVICE, INC. (ILLINOIS CORPORATION)
11 TURNER AVENUE
ELK GROVE VILLAGE, IL 60007

Registered June 5, 2012

Int. Cl.: 8

FOR: HAND TOOLS FOR USE IN INSTALLING CARPETS, IN CLASS 8 (U.S. CLS. 23, 28 AND 44).

TRADEMARK

FIRST USE 4-12-2011; IN COMMERCE 4-12-2011.

SUPPLEMENTAL REGISTER

THE MARK CONSISTS OF STANDARD CHARACTERS WITHOUT CLAIM TO ANY PARTICULAR FONT, STYLE, SIZE, OR COLOR.

SER. NO. 85-297,861, FILED P.R. 4-18-2011; AM. S.R. 3-27-2012.

MICHAEL WEBSTER, EXAMINING ATTORNEY



David J. Kybas

Director of the United States Patent and Trademark Office

United States of America

United States Patent and Trademark Office

OUTDOOR DOG

Reg. No. 4,155,917

Registered June 5, 2012

Int. Cl.: 18

TRADEMARK

SUPPLEMENTAL REGISTER

ETHICAL PRODUCTS, INC. (NEW JERSEY CORPORATION)
27 FEDERAL PLAZA
BLOOMFIELD, NJ 07003

FOR: PET CLOTHING, IN CLASS 18 (U.S. CLS. 1, 2, 3, 22 AND 41).

FIRST USE 12-0-2011; IN COMMERCE 12-0-2011.

THE MARK CONSISTS OF STANDARD CHARACTERS WITHOUT CLAIM TO ANY PARTICULAR FONT, STYLE, SIZE, OR COLOR.

NO CLAIM IS MADE TO THE EXCLUSIVE RIGHT TO USE "DOG", APART FROM THE MARK AS SHOWN.

SER. NO. 85-300,732, FILED P.R. 4-21-2011; AM. S.R. 2-16-2012.

WARREN L. OLANDRIA, EXAMINING ATTORNEY



David J. Kyffers

Director of the United States Patent and Trademark Office

United States of America

United States Patent and Trademark Office

LEISURE TRAVEL VANS

Reg. No. 4,155,918

Registered June 5, 2012

Int. Cl.: 12

TRADEMARK

SUPPLEMENTAL REGISTER

TRIPLE E CANADA LTD. (CANADA CORPORATION)
301 ROBLIN BOULEVARD, P O BOX 1230
WINKLER MANITOBA, CANADA R6W-4C4

FOR: RECREATIONAL VEHICLES, NAMELY, VANS, MOTOR HOMES, IN CLASS 12 (U.S. CLS. 19, 21, 23, 31, 35 AND 44).

THE MARK CONSISTS OF STANDARD CHARACTERS WITHOUT CLAIM TO ANY PARTICULAR FONT, STYLE, SIZE, OR COLOR.

PRIORITY CLAIMED UNDER SEC. 44(D) ON CANADA APPLICATION NO. 1,505,956, FILED 11-30-2010, REG. NO. TMA817,254, DATED 2-8-2012, EXPIRES 2-8-2027.

NO CLAIM IS MADE TO THE EXCLUSIVE RIGHT TO USE "TRAVEL VANS", APART FROM THE MARK AS SHOWN.

SER. NO. 85-301,256, FILED P.R. 4-21-2011; AM. S.R. 1-30-2012.

LINDA ESTRADA, EXAMINING ATTORNEY



David J. Kybas

Director of the United States Patent and Trademark Office

United States of America

United States Patent and Trademark Office

INFERTILITY & REPRODUCTIVE NEWS

Reg. No. 4,155,919

Registered June 5, 2012

Int. Cl.: 41

SERVICE MARK

SUPPLEMENTAL REGISTER

NOVELLUS HEALTHCARE COMMUNICATIONS, LLC (NEW JERSEY LIMITED LIABILITY COMPANY)
241 FORSGATE DRIVE, SUITE 205C
MONROE TOWNSHIP, NJ 08831

FOR: ONLINE EDUCATIONAL SERVICES, NAMELY, PROVIDING CONTINUING EDUCATION COURSES AND EXAMS IN THE FIELDS OF OBSTETRICS, GYNECOLOGY, INFERTILITY, UROLOGY, ONCOLOGY, REPRODUCTIVE ENDOCRINOLOGY, REPRODUCTIVE MEDICINE AND NURSING VIA A GLOBAL COMPUTER INFORMATION NETWORK; PROVIDING ONLINE INFORMATION ABOUT CONTINUING EDUCATION IN THE FIELDS OF OBSTETRICS, GYNECOLOGY, INFERTILITY, UROLOGY, ONCOLOGY, REPRODUCTIVE ENDOCRINOLOGY, REPRODUCTIVE MEDICINE AND NURSING, IN CLASS 41 (U.S. CLS. 100, 101 AND 107).

FIRST USE 6-0-2010; IN COMMERCE 1-0-2011.

THE MARK CONSISTS OF STANDARD CHARACTERS WITHOUT CLAIM TO ANY PARTICULAR FONT, STYLE, SIZE, OR COLOR.

SER. NO. 85-302,348, FILED P.R. 4-22-2011; AM. S.R. 3-20-2012.

INGA ERVIN, EXAMINING ATTORNEY



David J. Kybas

Director of the United States Patent and Trademark Office

United States of America

United States Patent and Trademark Office

Dr. Interns

Reg. No. 4,155,920

DR. INTERNS, INC. (NEW JERSEY CORPORATION)
10 NORTH STREET
ROBBINSVILLE, NJ 08691

Registered June 5, 2012

Int. Cls.: 41 and 44

FOR: CHARITABLE SERVICES, NAMELY, PROVIDING TRAINING IN THE FIELD OF MEDICAL CARE, HEALTH CARE, AND PATIENT AND COMMUNITY RELATIONS, IN CLASS 41 (U.S. CLS. 100, 101 AND 107).

SERVICE MARK

FIRST USE 12-5-2010; IN COMMERCE 12-5-2010.

SUPPLEMENTAL REGISTER

FOR: CHARITABLE SERVICES, NAMELY, PROVIDING MEDICAL ATTENTION TO THOSE IN DEVELOPING COUNTRIES; CHARITABLE SERVICES, NAMELY, PROVIDING MEDICAL EQUIPMENT AND SERVICES TO UNDERSERVED COMMUNITIES; CHARITABLE SERVICES, NAMELY, PROVIDING MEDICAL SERVICES TO UNDERDEVELOPED COUNTRIES, IN CLASS 44 (U.S. CLS. 100 AND 101).

FIRST USE 12-5-2010; IN COMMERCE 12-5-2010.

THE MARK CONSISTS OF STANDARD CHARACTERS WITHOUT CLAIM TO ANY PARTICULAR FONT, STYLE, SIZE, OR COLOR.

SER. NO. 85-303,759, FILED P.R. 4-25-2011; AM. S.R. 4-10-2012.

JOHN WILKE, EXAMINING ATTORNEY



David J. Kybas

Director of the United States Patent and Trademark Office

United States of America

United States Patent and Trademark Office

HIGH STRENGTH LITE

Reg. No. 4,155,921

NATIONAL GYPSUM PROPERTIES, LLC (DELAWARE LIMITED LIABILITY COMPANY)
2001 REXFORD ROAD
CHARLOTTE, NC 28211

Registered June 5, 2012

Int. Cl.: 19

FOR: WALLBOARD, IN CLASS 19 (U.S. CLS. 1, 12, 33 AND 50).

TRADEMARK

FIRST USE 3-11-2011; IN COMMERCE 3-11-2011.

SUPPLEMENTAL REGISTER

THE MARK CONSISTS OF STANDARD CHARACTERS WITHOUT CLAIM TO ANY PARTICULAR FONT, STYLE, SIZE, OR COLOR.

SER. NO. 85-309,521, FILED P.R. 5-2-2011; AM. S.R. 4-4-2012.

WILLIAM ROSSMAN, EXAMINING ATTORNEY



David J. Kyros

Director of the United States Patent and Trademark Office

United States of America

United States Patent and Trademark Office

EraseMyLaptop

Reg. No. 4,155,922

UPWARD ARROW, LLC (PENNSYLVANIA LIMITED LIABILITY COMPANY)
1725 SOUTH ST
PHILADELPHIA, PA 19146

Registered June 5, 2012

Int. Cl.: 37

FOR: COMPUTER SERVICES, NAMELY, COMPUTER HARDWARE MAINTENANCE AND REFURBISHING SERVICES, NAMELY, ERASING OF FILES, STORAGE MEDIA AND COMPUTER MEMORIES; COMPUTER HARDWARE DISPOSAL, IN CLASS 37 (U.S. CLS. 100, 103 AND 106).

SERVICE MARK

SUPPLEMENTAL REGISTER FIRST USE 12-1-2009; IN COMMERCE 4-5-2010.

THE MARK CONSISTS OF STANDARD CHARACTERS WITHOUT CLAIM TO ANY PARTICULAR FONT, STYLE, SIZE, OR COLOR.

SER. NO. 85-310,042, FILED P.R. 5-2-2011; AM. S.R. 2-16-2012.

JASON TURNER, EXAMINING ATTORNEY



David J. Kyffers

Director of the United States Patent and Trademark Office

United States of America

United States Patent and Trademark Office

COFFEE BAR

Reg. No. 4,155,923

COFFEE BAR 1, LLC (CALIFORNIA LIMITED LIABILITY COMPANY)
1890 BRYANT STREET
SAN FRANCISCO, CA 94110

Registered June 5, 2012

Int. Cl.: 30

FOR: COFFEE; COFFEE BEANS, IN CLASS 30 (U.S. CL. 46).

TRADEMARK

FIRST USE 2-22-2007; IN COMMERCE 12-15-2007.

SUPPLEMENTAL REGISTER

THE MARK CONSISTS OF STANDARD CHARACTERS WITHOUT CLAIM TO ANY PARTICULAR FONT, STYLE, SIZE, OR COLOR.

NO CLAIM IS MADE TO THE EXCLUSIVE RIGHT TO USE "COFFEE", APART FROM THE MARK AS SHOWN.

SER. NO. 85-314,984, FILED P.R. 5-6-2011; AM. S.R. 4-8-2012.

JULIE GUTTADAURO, EXAMINING ATTORNEY



David J. Kyffers

Director of the United States Patent and Trademark Office

United States of America

United States Patent and Trademark Office

AMERICAN RIDER

Reg. No. 4,155,924

AMERICAN RIDER, LLC. (FLORIDA LIMITED PARTNERSHIP)
2750 S.W. 26 AVE. # C-D
MIAMI, FL 33133

Registered June 5, 2012

Int. Cl.: 39

FOR: ARRANGING TRAVEL TOURS; MOTORCYCLE RENTAL; ORGANIZATION OF TRAVEL, IN CLASS 39 (U.S. CLS. 100 AND 105).

SERVICE MARK

FIRST USE 6-8-2009; IN COMMERCE 6-8-2009.

SUPPLEMENTAL REGISTER

THE MARK CONSISTS OF STANDARD CHARACTERS WITHOUT CLAIM TO ANY PARTICULAR FONT, STYLE, SIZE, OR COLOR.

SER. NO. 85-315,608, FILED P.R. 5-9-2011; AM. S.R. 2-6-2012.

ANNE E. GUSTASON, EXAMINING ATTORNEY



David J. Kybas

Director of the United States Patent and Trademark Office

United States of America

United States Patent and Trademark Office

¡JAPIAUAR!

Reg. No. 4,155,925

Registered June 5, 2012

Int. Cl.: 21

TRADEMARK

SUPPLEMENTAL REGISTER

MARK ANTHONY INTERNATIONAL SRL (BARBADOS CORPORATION)
WILDEY ROAD
PARKER HOUSE, WILDEY BUSINESS HOUSE
ST. MICHAEL, BARBADOS

FOR: THERMAL INSULATED BAGS FOR BEVERAGES; THERMAL INSULATED WRAPS
FOR CANS OR BOTTLES, IN CLASS 21 (U.S. CLS. 2, 13, 23, 29, 30, 33, 40 AND 50).

FIRST USE 5-25-2011; IN COMMERCE 5-25-2011.

THE MARK CONSISTS OF STANDARD CHARACTERS WITHOUT CLAIM TO ANY PAR-
TICULAR FONT, STYLE, SIZE, OR COLOR.

THE WORDING "JAPIAUAR" HAS NO MEANING IN A FOREIGN LANGUAGE.

SER. NO. 85-317,774, FILED P.R. 5-11-2011; AM. S.R. 5-1-2012.

CHRISTINE MARTIN, EXAMINING ATTORNEY



David J. Kyffers

Director of the United States Patent and Trademark Office

United States of America

United States Patent and Trademark Office

Hydranencephaly Foundation

Reg. No. 4,155,926

TRIBUS, KAMALA E.R. (UNITED STATES INDIVIDUAL)
4318 WHITELEAF COURT
PENSACOLA, FL 32504

Registered June 5, 2012

Int. Cl.: 41

FOR: EDUCATION SERVICES, NAMELY, PROVIDING TUTORIAL SESSIONS IN THE FIELD(S) OF HYDRANENCEPHALY, IN CLASS 41 (U.S. CLS. 100, 101 AND 107).

SERVICE MARK

FIRST USE 4-28-2011; IN COMMERCE 4-28-2011.

SUPPLEMENTAL REGISTER

THE MARK CONSISTS OF STANDARD CHARACTERS WITHOUT CLAIM TO ANY PARTICULAR FONT, STYLE, SIZE, OR COLOR.

NO CLAIM IS MADE TO THE EXCLUSIVE RIGHT TO USE "FOUNDATION", APART FROM THE MARK AS SHOWN.

SER. NO. 85-323,570, FILED P.R. 5-18-2011; AM. S.R. 3-14-2012.

ZACHARY BELLO, EXAMINING ATTORNEY



David J. Kyffers

Director of the United States Patent and Trademark Office

United States of America

United States Patent and Trademark Office

TERRANO

Reg. No. 4,155,927

Registered June 5, 2012

Int. Cl.: 7

TRADEMARK

SUPPLEMENTAL REGISTER

HORSCH MASCHINEN GMBH (FED REP GERMANY LIMITED LIABILITY COMPANY)
SITZENHOF 1
SCHWANDORF, FED REP GERMANY D-92421

FOR: TRACTOR TOWED AGRICULTURAL IMPLEMENTS, NAMELY, TILLERS, DISC
HARROWS AND CULTIVATORS, IN CLASS 7 (U.S. CLS. 13, 19, 21, 23, 31, 34 AND 35).

THE MARK CONSISTS OF STANDARD CHARACTERS WITHOUT CLAIM TO ANY PAR-
TICULAR FONT, STYLE, SIZE, OR COLOR.

OWNER OF ERPN CMNTY TM OFC REG. NO. 010007128, DATED 11-2-2010, EXPIRES 5-
30-2021.

SER. NO. 85-323,910, FILED P.R. 5-18-2011; AM. S.R. 4-11-2012.

BENJAMIN OKEKE, EXAMINING ATTORNEY



David J. Kyffers

Director of the United States Patent and Trademark Office

United States of America

United States Patent and Trademark Office

HORSCH

Reg. No. 4,155,928

Registered June 5, 2012

Int. Cl.: 7

TRADEMARK

SUPPLEMENTAL REGISTER

HORSCH MASCHINEN GMBH (FED REP GERMANY LIMITED LIABILITY COMPANY)
SITZENHOF 1
SCHWANDORF, FED REP GERMANY D-92421

FOR: TRACTOR TOWED AGRICULTURAL IMPLEMENTS, NAMELY, TILLERS, DISC HARROWS, CULTIVATORS, AGRICULTURAL SEED PLANTING MACHINES AND SEEDERS, IN CLASS 7 (U.S. CLS. 13, 19, 21, 23, 31, 34 AND 35).

THE MARK CONSISTS OF STANDARD CHARACTERS WITHOUT CLAIM TO ANY PARTICULAR FONT, STYLE, SIZE, OR COLOR.

OWNER OF ERPN CMNTY TM OFC REG. NO. 009153479, DATED 11-25-2010, EXPIRES 6-4-2020.

SER. NO. 85-324,597, FILED P.R. 5-19-2011; AM. S.R. 4-11-2012.

BENJAMIN OKEKE, EXAMINING ATTORNEY



David J. Kyros

Director of the United States Patent and Trademark Office

United States of America

United States Patent and Trademark Office

WOUND BUTTER

Reg. No. 4,155,929

ANAGALLIS HERBS LLC (DELAWARE LIMITED LIABILITY COMPANY)
P.O. BOX 1205
CASTLETON, VT 05735

Registered June 5, 2012

Int. Cl.: 5

FOR: HERBAL TOPICAL CREAMS, GELS, SALVES, SPRAYS, POWDER, BALMS, LINIMENT AND OINTMENTS FOR THE RELIEF OF ACHES AND PAIN, IN CLASS 5 (U.S. CLS. 6, 18, 44, 46, 51 AND 52).

TRADEMARK

FIRST USE 9-30-2010; IN COMMERCE 9-30-2010.

SUPPLEMENTAL REGISTER

THE MARK CONSISTS OF STANDARD CHARACTERS WITHOUT CLAIM TO ANY PARTICULAR FONT, STYLE, SIZE, OR COLOR.

SER. NO. 85-325,440, FILED P.R. 5-19-2011; AM. S.R. 2-16-2012.

BILL DAWE, EXAMINING ATTORNEY



David J. Kyffers

Director of the United States Patent and Trademark Office

United States of America

United States Patent and Trademark Office

DUCK-N-DEER CAMO

Reg. No. 4,155,930

SERVICE TOOL CO, LLC (LOUISIANA LIMITED LIABILITY COMPANY)
2501 S. LEWIS ST
NEW IBERIA, LA 70560

Registered June 5, 2012

**Int. Cls.: 6, 8, 9, 11, 13,
18, 20, 21, 22, 25, and 28**

FOR: CAMOUFLAGED METAL TIE DOWN SETS; METAL MOUNTING HARDWARE,
NAMELY, D-RINGS, IN CLASS 6 (U.S. CLS. 2, 12, 13, 14, 23, 25 AND 50).

FIRST USE 3-1-2012; IN COMMERCE 3-1-2012.

TRADEMARK

FOR: KNIVES; MANUALLY OPERATED HAND TOOLS IN THE NATURE OF GUT HOOKS
FOR USE WITH HUNTING; KNIFE SHEATHS; SHARPENING STONES; HAND TOOLS,
NAMELY, SAWS; MACHETES; AXES, IN CLASS 8 (U.S. CLS. 23, 28 AND 44).

SUPPLEMENTAL REGISTER

FIRST USE 3-1-2012; IN COMMERCE 3-1-2012.

FOR: BINOCULARS; EYEWEAR STRAPS; COMPASSES; LASER POINTERS; CELLULAR
AND WIRELESS TELEPHONE HOLDERS; HUNTING SAFETY VESTS; HUNTING ACCESSOR-
IES, NAMELY, SIGNAL WHISTLES, IN CLASS 9 (U.S. CLS. 21, 23, 26, 36 AND 38).

FIRST USE 3-1-2012; IN COMMERCE 3-1-2012.

FOR: FLASHLIGHTS; CLIP LIGHTS, NAMELY, LED LIGHTS INCORPORATED INTO AN
ATTACHABLE CLIP FOR LIGHTING PURPOSES; OUTDOOR LIGHTING PRODUCTS,
NAMELY, HEAD LAMPS; ICE CHESTS, IN CLASS 11 (U.S. CLS. 13, 21, 23, 31 AND 34).

FIRST USE 3-1-2012; IN COMMERCE 3-1-2012.

FOR: HUNTING POUCHES FOR HOLDING AMMUNITION; FIELD BAGS FOR HOLDING
AMMUNITION, IN CLASS 13 (U.S. CLS. 2 AND 9).

FIRST USE 3-1-2012; IN COMMERCE 3-1-2012.

FOR: TOOL BAGS SOLD EMPTY; UMBRELLAS; HUNTING POUCHES FOR HOLDING
GAME; ALL-PURPOSE FIELD BAGS; GENERAL PURPOSE HUNTING POUCHES, IN CLASS
18 (U.S. CLS. 1, 2, 3, 22 AND 41).

FIRST USE 3-1-2012; IN COMMERCE 3-1-2012.

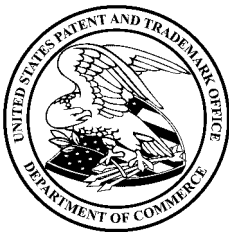

David J. Kyros

Director of the United States Patent and Trademark Office

Reg. No. 4,155,930 FOR: CUSHIONS, IN CLASS 20 (U.S. CLS. 2, 13, 22, 25, 32 AND 50).

FIRST USE 3-1-2012; IN COMMERCE 3-1-2012.

FOR: PORTABLE ICE CHESTS FOR FOOD AND BEVERAGES; PILL CANISTERS FOR PERSONAL USE; PORTABLE INSULATED BEVERAGE CONTAINER HOLDERS FOR PERSONAL USE, IN CLASS 21 (U.S. CLS. 2, 13, 23, 29, 30, 33, 40 AND 50).

FIRST USE 3-1-2012; IN COMMERCE 3-1-2012.

FOR: CORDING; CARGO AND CARRIER EQUIPMENT FOR VEHICLES, NAMELY, LASHING STRAPS, IN CLASS 22 (U.S. CLS. 1, 2, 7, 19, 22, 42 AND 50).

FIRST USE 3-1-2012; IN COMMERCE 3-1-2012.

FOR: CLOTHING AND ACCESSORIES, NAMELY, GLOVES, CAPS, KNIT HATS, RAIN SUITS, HUNTING VESTS , IN CLASS 25 (U.S. CLS. 22 AND 39).

FIRST USE 3-1-2012; IN COMMERCE 3-1-2012.

FOR: HUNTING ACCESSORIES, NAMELY, MARKING TAPE; HUNTING POUCHES FOR HOLDING HUNTING ACCESSORIES, NAMELY, BIRD AND/OR ANIMAL CALLS OR THE LIKE, IN CLASS 28 (U.S. CLS. 22, 23, 38 AND 50).

FIRST USE 3-1-2012; IN COMMERCE 3-1-2012.

THE MARK CONSISTS OF STANDARD CHARACTERS WITHOUT CLAIM TO ANY PARTICULAR FONT, STYLE, SIZE, OR COLOR.

SER. NO. 85-325,677, FILED P.R. 5-20-2011; AM. S.R. 3-9-2012.

MATTHEW PAPPAS, EXAMINING ATTORNEY

United States of America
United States Patent and Trademark Office

Puesto

Mexican Street Food

Reg. No. 4,155,931

MEXICAN STREET FOOD, LLC (CALIFORNIA LIMITED LIABILITY COMPANY)
8899 UNIVERSITY CENTER LANE, SUITE 300
SAN DIEGO, CA 92122

Registered June 5, 2012

Int. Cl.: 43

FOR: RESTAURANT SERVICES, IN CLASS 43 (U.S. CLS. 100 AND 101).

SERVICE MARK

FIRST USE 2-10-2012; IN COMMERCE 2-10-2012.

SUPPLEMENTAL REGISTER

NO CLAIM IS MADE TO THE EXCLUSIVE RIGHT TO USE "MEXICAN STREET FOOD",
APART FROM THE MARK AS SHOWN.

THE MARK CONSISTS OF THE WORD "PUESTO" OVER THE WORDS "MEXICAN STREET
FOOD".

SER. NO. 85-329,143, FILED P.R. 5-24-2011; AM. S.R. 3-6-2012.

DORITT L. CARROLL, EXAMINING ATTORNEY



David J. Kybas

Director of the United States Patent and Trademark Office

United States of America

United States Patent and Trademark Office

CHINA CABLES DIRECT

Reg. No. 4,155,932

Registered June 5, 2012

Int. Cls.: 35 and 40

SERVICE MARK

SUPPLEMENTAL REGISTER

TRAVDOG, INC. (CALIFORNIA CORPORATION), DBA CHINA CABLES DIRECT,
6 JOURNEY, BUILDING 170
ALISO VIEJO, CA 92656

FOR: BUSINESS SERVICES, NAMELY, COMBINED STRATEGIC GOODS OR SERVICES SOURCING, PURCHASING AND IMPORT AGENCY SERVICES IN THE FIELD OF DATA COMMUNICATIONS PRODUCTS FOR OTHERS; BUSINESS PROJECT MANAGEMENT SERVICES FOR OTHERS IN THE FIELD OF DATA COMMUNICATIONS PRODUCTS; MANUFACTURERS' REPRESENTATIVES IN THE FIELD OF DATA COMMUNICATIONS PRODUCTS; DISTRIBUTORSHIP SERVICES IN THE FIELD OF DATA COMMUNICATIONS PRODUCTS; FACTORY BUSINESS AUDITING; PERFORMANCE OF BUSINESS MANAGEMENT SERVICES RELATING TO PRODUCT CREATION, COMPLIANCE, ENGINEERING, QUALITY CONTROL, DISTRIBUTION, IMPORTATION, OPERATIONS MANAGEMENT, LOGISTICS, SUPPLY CHAIN, FINANCING AND PRODUCTION SYSTEMS AND DISTRIBUTION SOLUTIONS; PROVIDING OUTSOURCING OF MANUFACTURING COMPONENTS AND COMPLETED PRODUCTS TO THIRD PARTIES IN THE FIELD OF DATA COMMUNICATIONS PRODUCTS, IN CLASS 35 (U.S. CLS. 100, 101 AND 102).

FIRST USE 5-8-2006; IN COMMERCE 5-8-2006.

FOR: MANUFACTURE OF DATA COMMUNICATIONS PRODUCTS AND ACCESSORIES MADE TO ORDER AND UNDER SPECIFICATION OF THIRD PARTIES; MANUFACTURING FOR OTHERS IN THE FIELD OF DATA COMMUNICATIONS AND DATA COMMUNICATIONS PRODUCTS; CUSTOM AND CONTRACT MANUFACTURING IN THE FIELD OF DATA COMMUNICATIONS PRODUCTS, IN CLASS 40 (U.S. CLS. 100, 103 AND 106).

FIRST USE 5-8-2006; IN COMMERCE 5-8-2006.

THE MARK CONSISTS OF STANDARD CHARACTERS WITHOUT CLAIM TO ANY PARTICULAR FONT, STYLE, SIZE, OR COLOR.

NO CLAIM IS MADE TO THE EXCLUSIVE RIGHT TO USE "CABLES", APART FROM THE MARK AS SHOWN.

SER. NO. 85-330,331, FILED P.R. 5-25-2011; AM. S.R. 4-23-2012.

LYDIA BELZER, EXAMINING ATTORNEY



David J. Kyros

Director of the United States Patent and Trademark Office

United States of America

United States Patent and Trademark Office

THE DOMAIN EXCHANGE

Reg. No. 4,155,933

Registered June 5, 2012

Int. Cl.: 35

SERVICE MARK

SUPPLEMENTAL REGISTER

PROTRADA PTY LTD (AUSTRALIA PROPRIETARY LIMITED COMPANY (P/L OR PTY. LTD.))
LEVEL 9 368 SUSSEX STREET
SYDNEY, AUSTRALIA

FOR: SERVICES RELATING TO THE ANALYSIS, EVALUATION, CREATION AND BRAND ESTABLISHMENT OF DOMAIN NAMES; ON-LINE AUCTION SERVICES FEATURING WEBSITES AND DOMAIN NAMES; BARTER EXCHANGE SERVICES, NAMELY, PROVIDING COMMERCIAL BARTER AND TRADE EXCHANGE OF WEBSITES AND DOMAINS VIA A GLOBAL COMPUTER INFORMATION NETWORK; DOMAIN BUYING AND SELLING SERVICES, NAMELY, FACILITATING THE LISTING OF DOMAINS FOR SALE ON THIRD PARTY PLATFORMS AND THE BIDDING AND BUYING OF DOMAINS FROM THIRD PARTY PLATFORMS, IN CLASS 35 (U.S. CLS. 100, 101 AND 102).

FIRST USE 4-1-2011; IN COMMERCE 5-1-2011.

THE MARK CONSISTS OF STANDARD CHARACTERS WITHOUT CLAIM TO ANY PARTICULAR FONT, STYLE, SIZE, OR COLOR.

NO CLAIM IS MADE TO THE EXCLUSIVE RIGHT TO USE "DOMAIN", APART FROM THE MARK AS SHOWN.

SER. NO. 85-331,234, FILED P.R. 5-26-2011; AM. S.R. 11-10-2011.

KAREN BRACEY, EXAMINING ATTORNEY



David J. Kyros

Director of the United States Patent and Trademark Office

United States of America

United States Patent and Trademark Office

The logo consists of the letters "HD" in a bold, red, sans-serif font. To the right of "HD" is a vertical line, followed by a subscript "2" in a gray font. To the right of the "2" are the letters "PC" in a white, outlined, sans-serif font.

Reg. No. 4,155,934

Registered June 5, 2012

Int. Cl.: 38

SERVICE MARK

SUPPLEMENTAL REGISTER

VELOCITY INTERNATIONAL, INC. (PENNSYLVANIA CORPORATION)
DOMINION TOWER 24TH FLOOR
625 LIBERTY AVENUE
PITTSBURGH, PA 15222

FOR: AUDIO AND VIDEO BROADCASTING SERVICES OVER THE INTERNET; AUDIO AND VIDEO BROADCASTING SERVICES OVER THE INTERNET IN THE FIELD OF PRIVATE EVENT BROADCASTING; BROADCASTING PROGRAMS VIA A GLOBAL COMPUTER NETWORK; INTERNET BROADCASTING SERVICES; VIDEO BROADCASTING; WEBCASTING SERVICES, IN CLASS 38 (U.S. CLS. 100, 101 AND 104).

FIRST USE 2-15-2011; IN COMMERCE 2-15-2011.

THE MARK CONSISTS OF "HD" IN RED LETTERS SEPARATED BY A VERTICAL LINE AND A SUBSCRIPT "2" IN GRAY FROM THE LETTERS "PC" IN WHITE OUTLINED IN BLACK.

THE COLOR(S) RED, WHITE, GRAY, AND BLACK IS/ARE CLAIMED AS A FEATURE OF THE MARK.

SER. NO. 85-331,988, FILED P.R. 5-27-2011; AM. S.R. 4-13-2012.

DORITT L. CARROLL, EXAMINING ATTORNEY



David J. Kyffers

Director of the United States Patent and Trademark Office

United States of America

United States Patent and Trademark Office

EMBEDDED CODER

Reg. No. 4,155,935

THE MATHWORKS, INC. (DELAWARE CORPORATION)
3 APPLE HILL DRIVE
NATICK, MA 01760

Registered June 5, 2012

Int. Cl.: 9

FOR: COMPUTER SOFTWARE FOR GENERATING CODE FOR USE WITH COMPUTER
HARDWARE, IN CLASS 9 (U.S. CLS. 21, 23, 26, 36 AND 38).

TRADEMARK

FIRST USE 4-20-2011; IN COMMERCE 4-20-2011.

SUPPLEMENTAL REGISTER

THE MARK CONSISTS OF STANDARD CHARACTERS WITHOUT CLAIM TO ANY PAR-
TICULAR FONT, STYLE, SIZE, OR COLOR.

SER. NO. 85-332,390, FILED 5-27-2011.

ANGELA DUONG, EXAMINING ATTORNEY



David J. Kyffers

Director of the United States Patent and Trademark Office

United States of America

United States Patent and Trademark Office

Exotic Superfoods

Reg. No. 4,155,936

EXOTIC SUPERFOODS NEW YORK, INC. (NEW YORK CORPORATION)
189-23 39TH AVE
FLUSHING, NY 11358

Registered June 5, 2012

Int. Cls.: 29 and 32

FOR: FRUITS, NAMELY, EXOTIC FRUITS AND COCONUT MEAT THAT ARE FROZEN,
IN CLASS 29 (U.S. CL. 46).

TRADEMARK

FIRST USE 9-14-2006; IN COMMERCE 12-2-2008.

SUPPLEMENTAL REGISTER

FOR: COCONUT WATER; FROZEN FRUIT DRINKS; SMOOTHIES, IN CLASS 32 (U.S. CLS.
45, 46 AND 48).

FIRST USE 9-14-2006; IN COMMERCE 12-2-2008.

THE MARK CONSISTS OF STANDARD CHARACTERS WITHOUT CLAIM TO ANY PAR-
TICULAR FONT, STYLE, SIZE, OR COLOR.

SER. NO. 85-332,463, FILED P.R. 5-27-2011; AM. S.R. 1-30-2012.

ELLEN B. AWRICH, EXAMINING ATTORNEY



David J. Kyros

Director of the United States Patent and Trademark Office

United States of America

United States Patent and Trademark Office

DIRECTIONAL NETWORKS

Reg. No. 4,155,937

Registered June 5, 2012

Int. Cl.: 38

SERVICE MARK

SUPPLEMENTAL REGISTER

DIRECTIONAL NETWORKS, LLC (NORTH CAROLINA LIMITED LIABILITY COMPANY)
2205 CANDUN DR. SUITE E
APEX, NC 27523

FOR: TELECOMMUNICATIONS, NAMELY, SATELLITE TELEVISION BROADCASTING,
WIRED AND WIRELESS INTERNET SERVICE PROVIDER AND IP BASED DATA SERVICES,
NAMELY, VOICE OVER IP SERVICES, IN CLASS 38 (U.S. CLS. 100, 101 AND 104).

FIRST USE 5-5-2011; IN COMMERCE 5-5-2011.

THE MARK CONSISTS OF STANDARD CHARACTERS WITHOUT CLAIM TO ANY PAR-
TICULAR FONT, STYLE, SIZE, OR COLOR.

NO CLAIM IS MADE TO THE EXCLUSIVE RIGHT TO USE "NETWORKS", APART FROM
THE MARK AS SHOWN.

SER. NO. 85-332,934, FILED P.R. 5-27-2011; AM. S.R. 3-15-2012.

JESSICA A. POWERS, EXAMINING ATTORNEY



David J. Kyros

Director of the United States Patent and Trademark Office

United States of America

United States Patent and Trademark Office

aguablanca

Reg. No. 4,155,938

Registered June 5, 2012

Int. Cl.: 32

TRADEMARK

SUPPLEMENTAL REGISTER

SOLORZANO GIL, ALFONSO (MEXICO INDIVIDUAL)
724
ANDRES LOPEZ
IRAPUATO, MEXICO 77006

FOR: FRUIT JUICE CONCENTRATES; FRUIT JUICES, NAMELY, APPLE, AND GRAPE JUICE; MINERAL WATER; SODA WATER; SPRING WATER; TABLE WATER, IN CLASS 32 (U.S. CLS. 45, 46 AND 48).

FIRST USE 4-1-2011; IN COMMERCE 4-1-2011.

THE MARK CONSISTS OF STANDARD CHARACTERS WITHOUT CLAIM TO ANY PARTICULAR FONT, STYLE, SIZE, OR COLOR.

THE ENGLISH TRANSLATION OF "AGUABLANCA" IN THE MARK IS "CLEAR WATER".

SER. NO. 85-334,493, FILED P.R. 5-31-2011; AM. S.R. 9-16-2011.

HANNO RITTNER, EXAMINING ATTORNEY



David J. Kybas

Director of the United States Patent and Trademark Office

United States of America

United States Patent and Trademark Office

INTERNET ENGINE

Reg. No. 4,155,939

Registered June 5, 2012

Int. Cl.: 42

SERVICE MARK

SUPPLEMENTAL REGISTER

INTERNET ENGINE, LLC (ILLINOIS LIMITED LIABILITY COMPANY)
510 NORTH AVENUE
LIBERTYVILLE, IL 60048

FOR: INTERNET OPTIMIZATION SERVICE, NAMELY, DESIGN, CREATION, AND MAINTENANCE OF CUSTOMIZED WEBSITES AND COMPUTER NETWORK SEARCH ENGINES FOR OTHERS, IN CLASS 42 (U.S. CLS. 100 AND 101).

FIRST USE 3-1-2002; IN COMMERCE 3-1-2002.

THE MARK CONSISTS OF STANDARD CHARACTERS WITHOUT CLAIM TO ANY PARTICULAR FONT, STYLE, SIZE, OR COLOR.

OWNER OF U.S. REG. NO. 3,318,024.

NO CLAIM IS MADE TO THE EXCLUSIVE RIGHT TO USE "INTERNET", APART FROM THE MARK AS SHOWN.

SER. NO. 85-334,907, FILED P.R. 6-1-2011; AM. S.R. 4-10-2012.

BARBARA A. GOLD, EXAMINING ATTORNEY



David J. Kyjars

Director of the United States Patent and Trademark Office

United States of America

United States Patent and Trademark Office

RELATIONAL ENERGETICS

Reg. No. 4,155,940

DIANE RICHARDSON (UNITED STATES INDIVIDUAL)
314 CALIFORNIA AVE.
CHATTANOOGA, TN 37415

Registered June 5, 2012

Int. Cl.: 44

FOR: ENERGY HEALING SERVICES, NAMELY, STRESS MANAGEMENT AND STRESS REDUCTION COUNSELING FOR INDIVIDUALS TO ENHANCE THEIR LIVES; MENTAL HEALTH COUNSELING AND PSYCHOTHERAPY AS IT RELATES TO RELATIONSHIPS, IN CLASS 44 (U.S. CLS. 100 AND 101).

SERVICE MARK

SUPPLEMENTAL REGISTER FIRST USE 12-31-2008; IN COMMERCE 12-31-2008.

THE MARK CONSISTS OF STANDARD CHARACTERS WITHOUT CLAIM TO ANY PARTICULAR FONT, STYLE, SIZE, OR COLOR.

SER. NO. 85-337,248, FILED P.R. 6-3-2011; AM. S.R. 3-26-2012.

MARTHA FROMM, EXAMINING ATTORNEY



David J. Kyros

Director of the United States Patent and Trademark Office

United States of America

United States Patent and Trademark Office

DOUBLE-POTENCY FISH OIL PURE

Reg. No. 4,155,941

Registered June 5, 2012

Int. Cl.: 5

TRADEMARK

SUPPLEMENTAL REGISTER

PRIMARY INVESTMENTS GROUP LIMITED (BR. VIRGIN ISLANDS CORPORATION)
P. O. BOX 3444
C/O TRUSTNET CHAMBERS
ROAD TOWN, TORTOLA, BR. VIRGIN ISLANDS

FOR: DIETARY SUPPLEMENTS; FOOD SUPPLEMENTS; NUTRITIONAL SUPPLEMENTS;
VITAMIN SUPPLEMENTS, ALL CONTAINING FISH OIL, IN CLASS 5 (U.S. CLS. 6, 18, 44,
46, 51 AND 52).

FIRST USE 12-6-2011; IN COMMERCE 12-6-2011.

THE MARK CONSISTS OF STANDARD CHARACTERS WITHOUT CLAIM TO ANY PARTICULAR FONT, STYLE, SIZE, OR COLOR.

NO CLAIM IS MADE TO THE EXCLUSIVE RIGHT TO USE "FISH OIL", APART FROM THE MARK AS SHOWN.

SER. NO. 85-340,472, FILED P.R. 6-7-2011; AM. S.R. 3-22-2012.

JEFFERY COWARD, EXAMINING ATTORNEY



David J. Kyros

Director of the United States Patent and Trademark Office

United States of America

United States Patent and Trademark Office

PRETZEL PUFFS

Reg. No. 4,155,942

ESSENTIAL LIVING, LLC (PENNSYLVANIA LIMITED LIABILITY COMPANY)
P.O. BOX 771
WAVERLY, PA 184710771

Registered June 5, 2012

Int. Cl.: 30

FOR: PRETZELS MADE FROM SPROUTED WHOLE GRAIN FLOUR, IN CLASS 30 (U.S. CL. 46).

TRADEMARK

FIRST USE 1-24-2012; IN COMMERCE 1-24-2012.

SUPPLEMENTAL REGISTER

THE MARK CONSISTS OF STANDARD CHARACTERS WITHOUT CLAIM TO ANY PARTICULAR FONT, STYLE, SIZE, OR COLOR.

NO CLAIM IS MADE TO THE EXCLUSIVE RIGHT TO USE "PRETZEL", APART FROM THE MARK AS SHOWN.

SER. NO. 85-342,259, FILED P.R. 6-9-2011; AM. S.R. 3-23-2012.

HENRY S. ZAK, EXAMINING ATTORNEY



David J. Kyffers

Director of the United States Patent and Trademark Office

United States of America

United States Patent and Trademark Office

WET-GLOSS

Reg. No. 4,155,943

GREENFIELD MANUFACTURING, INC. (NEW YORK CORPORATION)
49 GEYSER ROAD
SARATOGA SPRINGS, NY 12866

Registered June 5, 2012

Int. Cl.: 2

FOR: PROTECTIVE COATING FOR METAL, MASONRY, CEMENT AND WOOD, IN CLASS
2 (U.S. CLS. 6, 11 AND 16).

TRADEMARK

FIRST USE 3-14-2012; IN COMMERCE 3-14-2012.

SUPPLEMENTAL REGISTER

THE MARK CONSISTS OF STANDARD CHARACTERS WITHOUT CLAIM TO ANY PARTICULAR FONT, STYLE, SIZE, OR COLOR.

SER. NO. 85-342,924, FILED P.R. 6-10-2011; AM. S.R. 3-14-2012.

MICHELLE DUBOIS, EXAMINING ATTORNEY



David J. Kybas

Director of the United States Patent and Trademark Office

United States of America

United States Patent and Trademark Office

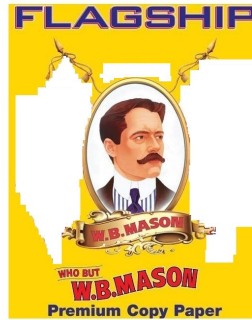

Reg. No. 4,155,944

W.B. MASON CO., INC. (MASSACHUSETTS CORPORATION)
59 CENTRE STREET
BROCKTON, MA 02303

Registered June 5, 2012

Int. Cl.: 16

FOR: COPIER PAPER; COPYING PAPER, IN CLASS 16 (U.S. CLS. 2, 5, 22, 23, 29, 37, 38 AND 50).

TRADEMARK

FIRST USE 3-1-2005; IN COMMERCE 3-1-2005.

SUPPLEMENTAL REGISTER

NO CLAIM IS MADE TO THE EXCLUSIVE RIGHT TO USE "PREMIUM COPY PAPER", APART FROM THE MARK AS SHOWN.

THE COLOR(S) BLUE, BROWN, RED, SKIN TONE, WHITE AND YELLOW IS/ARE CLAIMED AS A FEATURE OF THE MARK.

THE NAME "W.B. MASON" DOES NOT IDENTIFY A LIVING INDIVIDUAL.

THE MARK CONSISTS OF A VERTICAL RECTANGLE IN YELLOW. INSIDE THE RECTANGLE AT THE TOP IS THE WORD "FLAGSHIP" IN BLUE WITH A RED BORDER. BENEATH THIS WORDING IS A WHITE RECTANGULAR SHAPE. BELOW THIS RECTANGLE IS THE BUST OF A MAN WITH THE FACE, NECK AND EAR IN SKIN TONE, A MOUSTACHE IN BROWN, LIPS IN RED, EYES WITH BROWN PUPILS INSIDE THE WHITE OF THE EYES, EYEBROWS IN BROWN, AND HAIR IN BROWN. THE BUST INCLUDES CLOTHING CONSISTING OF A WHITE SHIRT WITH A WHITE COLLAR AND BLUE VERTICAL STRIPS, A BLUE TIE, AND A BROWN JACKET. ALL OF THE BUST AND CLOTHING IS IN A WHITE OVAL PICTURE FRAME, WITH A YELLOW BORDER OUTLINED IN BROWN. ON EACH SIDE OF THE PICTURE IS A WHITE RECTANGULAR SHAPE. EMANATING UPWARDS FROM THE TOP LEFT AND THE TOP RIGHT OF THE OVAL FRAME ARE YELLOW FLAG STRINGS. BELOW THE PICTURE IS A YELLOW AND BROWN RIBBON BANNER WITH THE WORDING "W.B. MASON", IN RED. BELOW THE BANNER IS WITH THE WORDING "WHO BUT" IN RED WITH BLUE LINES ABOVE AND BELOW. BELOW THIS WORDING IS THE WORDING "W.B. MASON" IN RED AND OUTLINED IN BLUE. BELOW THIS WORDING IS THE WORDING "PREMIUM COPY PAPER" IN BLUE.



David J. Kyros

SER. NO. 85-345,441, FILED P.R. 6-14-2011; AM. S.R. 4-10-2012.

MICHAEL WIENER, EXAMINING ATTORNEY

United States of America

United States Patent and Trademark Office

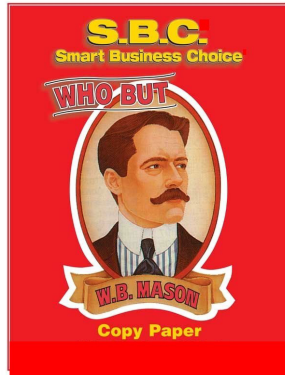

Reg. No. 4,155,945

W.B. MASON CO., INC. (MASSACHUSETTS CORPORATION)
59 CENTRE STREET
BROCKTON, MA 02303

Registered June 5, 2012

Int. Cl.: 16

FOR: COPIER PAPER; COPY PAPER; COPYING PAPER, IN CLASS 16 (U.S. CLS. 2, 5, 22, 23, 29, 37, 38 AND 50).

TRADEMARK

FIRST USE 3-1-2005; IN COMMERCE 3-1-2005.

SUPPLEMENTAL REGISTER

NO CLAIM IS MADE TO THE EXCLUSIVE RIGHT TO USE "BUSINESS" AND "COPY PAPER", APART FROM THE MARK AS SHOWN.

THE COLOR(S) BLUE, BROWN, RED, SKIN TONE, WHITE AND YELLOW IS/ARE CLAIMED AS A FEATURE OF THE MARK.

THE MARK CONSISTS OF A VERTICAL RECTANGLE IN RED. INSIDE THE RECTANGLE AT THE TOP IS THE TERM "SBC" IN YELLOW WITH A BLUE BORDER. BENEATH THIS WORDING IS THE WORDING "SMART BUSINESS CHOICE" IN YELLOW WITH A BLUE BORDER. BENEATH THIS WORDING IS THE BUST OF A MAN WITH THE FACE, NECK AND EAR IN SKIN TONE, A MOUSTACHE IN BROWN, LIPS IN RED, EYES WITH BROWN PUPILS INSIDE THE WHITE OF THE EYES, EYEBROWS IN BROWN, AND HAIR IN BROWN. THE BUST INCLUDES CLOTHING CONSISTING OF A WHITE SHIRT WITH A WHITE COLLAR AND BLUE VERTICAL STRIPS, A BLUE TIE, AND A BROWN JACKET. ALL OF THE BUST AND CLOTHING IS IN A BROWN OVAL PICTURE FRAME, WITH A RED BORDER. BELOW THE PICTURE IS A BROWN RIBBON BANNER WITH THE WORDING "W.B. MASON", IN RED. THE OVAL FRAME AND RIBBON BANNER ARE OUTLINED TOGETHER IN WHITE. BELOW THE BANNER IS WITH THE WORDING "COPY PAPER" IN YELLOW. OVERLAYING THE TOP OF THE OVAL FRAME IS THE WORDING "WHO BUT" IN RED AND OUTLINED IN WHITE, WITH BLUE LINES OUTLINED IN WHITE ABOVE AND BELOW THIS WORDING.



SER. NO. 85-346,092, FILED P.R. 6-14-2011; AM. S.R. 4-10-2012.

David J. Kyros

MICHAEL WIENER, EXAMINING ATTORNEY

United States of America

United States Patent and Trademark Office

GLASSRECYCLED

Reg. No. 4,155,946

WHALEY, TIM (UNITED STATES INDIVIDUAL)
3941 LEGACY DRIVE
PLANO, TX 75023

Registered June 5, 2012

Int. Cl.: 19

FOR: RECYCLED GLASS AND PORCELAIN COUNTER TOPS, FLOOR TILES, DECORATIVE WALL PANELS, IN CLASS 19 (U.S. CLS. 1, 12, 33 AND 50).

TRADEMARK

FIRST USE 9-25-2011; IN COMMERCE 9-25-2011.

SUPPLEMENTAL REGISTER

THE MARK CONSISTS OF STANDARD CHARACTERS WITHOUT CLAIM TO ANY PARTICULAR FONT, STYLE, SIZE, OR COLOR.

SER. NO. 85-346,393, FILED P.R. 6-15-2011; AM. S.R. 4-4-2012.

NAAKWAMA ANKRAH, EXAMINING ATTORNEY



David J. Kyffers

Director of the United States Patent and Trademark Office

United States of America

United States Patent and Trademark Office

Study Water

Reg. No. 4,155,947

SMART PEAKE MEDICAL, L.L.C. (LOUISIANA LIMITED LIABILITY COMPANY)
216 BECKY LANE
LAFAYETTE, LA 70508

Registered June 5, 2012

Int. Cl.: 32

FOR: BOTTLED DRINKING WATER, IN CLASS 32 (U.S. CLS. 45, 46 AND 48).

TRADEMARK

FIRST USE 5-23-2011; IN COMMERCE 5-23-2011.

SUPPLEMENTAL REGISTER

THE MARK CONSISTS OF STANDARD CHARACTERS WITHOUT CLAIM TO ANY PARTICULAR FONT, STYLE, SIZE, OR COLOR.

SER. NO. 85-346,649, FILED P.R. 6-15-2011; AM. S.R. 4-11-2012.

ALEX KEAM, EXAMINING ATTORNEY



David J. Kybas

Director of the United States Patent and Trademark Office

United States of America

United States Patent and Trademark Office



Reg. No. 4,155,948

TEAM TCT, LLC (NEVADA LIMITED LIABILITY COMPANY)
25818 DRYBROOK ROAD,
SPRING, TX 77389

Registered June 5, 2012

Int. Cl.: 41

FOR: VOCATIONAL EDUCATION IN THE FIELDS OF ESL AND MEDICAL CAREERS, IN CLASS 41 (U.S. CLS. 100, 101 AND 107).

SERVICE MARK

FIRST USE 7-6-2009; IN COMMERCE 7-6-2009.

SUPPLEMENTAL REGISTER

NO CLAIM IS MADE TO THE EXCLUSIVE RIGHT TO USE "TRAINING CENTERS", APART FROM THE MARK AS SHOWN.

THE MARK CONSISTS OF AN IMAGE OF A MAP OF THE STATE OF TEXAS THAT IS CASTING A SHADOW ALONG ITS LEFT SIDE. SUPERIMPOSED OVER THE MAP IMAGE ARE THE WORDS "TRAINING CENTERS OF TEXAS".

SER. NO. 85-348,519, FILED P.R. 6-16-2011; AM. S.R. 4-4-2012.

LEIGH CAROLINE CASE, EXAMINING ATTORNEY



David J. Kyffers

Director of the United States Patent and Trademark Office

United States of America

United States Patent and Trademark Office

INDY AROMAS

Reg. No. 4,155,949

Registered June 5, 2012

Int. Cls.: 3 and 4

TRADEMARK

SUPPLEMENTAL REGISTER

OPPORTUNITY BUYS, INC. (INDIANA CORPORATION)
1515 BROOKVILLE CROSSING WAY
INDIANAPOLIS, IN 46239

FOR: AROMATIC OILS, IN CLASS 3 (U.S. CLS. 1, 4, 6, 50, 51 AND 52).

FIRST USE 8-11-2011; IN COMMERCE 8-11-2011.

FOR: CANDLES , IN CLASS 4 (U.S. CLS. 1, 6 AND 15).

FIRST USE 8-11-2011; IN COMMERCE 8-11-2011.

THE MARK CONSISTS OF STANDARD CHARACTERS WITHOUT CLAIM TO ANY PARTICULAR FONT, STYLE, SIZE, OR COLOR.

SER. NO. 85-349,016, FILED P.R. 6-17-2011; AM. S.R. 3-13-2012.

DEBRA LEE, EXAMINING ATTORNEY



David J. Kyffers

Director of the United States Patent and Trademark Office

United States of America

United States Patent and Trademark Office

STOCKWELL

Reg. No. 4,155,950

Registered June 5, 2012

Int. Cl.: 35

SERVICE MARK

SUPPLEMENTAL REGISTER

STOCKWELL COMMUNICATIONS LLP (ENGLAND LIMITED LIABILITY PARTNERSHIP)
25 SOUTHAMPTON BUILDINGS,
LONDON, UNITED KINGDOM WC2A1AL

FOR: ADVERTISING SERVICES; BUSINESS RISK MANAGEMENT CONSULTATION;
CONDUCTING MARKETING STUDIES; MARKET RESEARCH; PUBLIC RELATIONS , IN
CLASS 35 (U.S. CLS. 100, 101 AND 102).

FIRST USE 12-1-2010; IN COMMERCE 5-1-2011.

THE MARK CONSISTS OF STANDARD CHARACTERS WITHOUT CLAIM TO ANY PAR-
TICULAR FONT, STYLE, SIZE, OR COLOR.

PRIORITY CLAIMED UNDER SEC. 44(D) ON UNITED KINGDOM APPLICATION NO.
2567476, FILED 12-20-2010, REG. NO. 2567476, DATED 4-22-2011, EXPIRES 12-20-2020.

SER. NO. 85-349,253, FILED P.R. 6-17-2011; AM. S.R. 4-5-2012.

DOMINIC J. FERRAIUOLO, EXAMINING ATTORNEY



David J. Kyffers

Director of the United States Patent and Trademark Office

United States of America

United States Patent and Trademark Office

PATRON

Reg. No. 4,155,951

Registered June 5, 2012

Int. Cls.: 16 and 41

TRADEMARK

SERVICE MARK

SUPPLEMENTAL REGISTER

RODNEY HAND & ASSOCIATES MARKETING COMMUNICATIONS, LP (TEXAS LIMITED PARTNERSHIP)
P.O. BOX 12121
DALLAS, TX 75225

FOR: MAGAZINES IN THE FIELD OF ARTS, ENTERTAINMENT, AND CULTURE, IN CLASS 16 (U.S. CLS. 2, 5, 22, 23, 29, 37, 38 AND 50).

FIRST USE 11-1-2011; IN COMMERCE 11-1-2011.

FOR: PROVIDING ON-LINE MAGAZINES IN THE FIELD OF ARTS, ENTERTAINMENT AND CULTURE, IN CLASS 41 (U.S. CLS. 100, 101 AND 107).

FIRST USE 11-1-2011; IN COMMERCE 11-1-2011.

THE MARK CONSISTS OF STANDARD CHARACTERS WITHOUT CLAIM TO ANY PARTICULAR FONT, STYLE, SIZE, OR COLOR.

SER. NO. 85-351,764, FILED P.R. 6-21-2011; AM. S.R. 3-28-2012.

WON TEAK OH, EXAMINING ATTORNEY



David J. Kyros

Director of the United States Patent and Trademark Office

United States of America

United States Patent and Trademark Office

SARATOGA OLIVE OIL CO.

Reg. No. 4,155,952

BRAIDWOOD'S, LLC (NEW YORK LIMITED LIABILITY COMPANY)
484 BROADWAY
SARATOGA SPRINGS, NY 12866

Registered June 5, 2012

Int. Cl.: 29

FOR: OLIVE OIL, IN CLASS 29 (U.S. CL. 46).

TRADEMARK

FIRST USE 4-15-2011; IN COMMERCE 4-15-2011.

SUPPLEMENTAL REGISTER

THE MARK CONSISTS OF STANDARD CHARACTERS WITHOUT CLAIM TO ANY PARTICULAR FONT, STYLE, SIZE, OR COLOR.

NO CLAIM IS MADE TO THE EXCLUSIVE RIGHT TO USE "OLIVE OIL CO.", APART FROM THE MARK AS SHOWN.

SER. NO. 85-352,653, FILED P.R. 6-22-2011; AM. S.R. 4-3-2012.

ROBERT C. CLARK JR., EXAMINING ATTORNEY



David J. Kybas

Director of the United States Patent and Trademark Office

United States of America

United States Patent and Trademark Office

PSYCHOLOGICAL SOFTWARE SOLUTIONS

Reg. No. 4,155,953

Registered June 5, 2012

Int. Cls.: 41 and 44

SERVICE MARK

SUPPLEMENTAL REGISTER

PSYCHOLOGICAL SOFTWARE SOLUTIONS, INC. (TEXAS CORPORATION)
SUITE 500
4119 MONTROSE BLVD.
HOUSTON, TX 77006

FOR: EDUCATIONAL COURSE MONITORING, NAMELY, TRACKING, ANALYZING AND
MANAGING STUDENT BEHAVIORAL PERFORMANCE, IN CLASS 41 (U.S. CLS. 100, 101
AND 107).

FIRST USE 9-15-2003; IN COMMERCE 9-15-2003.

FOR: PSYCHOLOGICAL CONSULTATION SERVICES IN THE NATURE OF BEHAVIOR
ANALYSIS SERVICES, NAMELY, MANAGING, TRACKING AND MONITORING STUDENT
BEHAVIOR FOR SCHOOLS, IN CLASS 44 (U.S. CLS. 100 AND 101).

FIRST USE 9-15-2003; IN COMMERCE 9-15-2003.

THE MARK CONSISTS OF STANDARD CHARACTERS WITHOUT CLAIM TO ANY PAR-
TICULAR FONT, STYLE, SIZE, OR COLOR.

SER. NO. 85-352,704, FILED P.R. 6-22-2011; AM. S.R. 4-4-2012.

TRACY WHITTAKER-BROWN, EXAMINING ATTORNEY



David J. Kyros

Director of the United States Patent and Trademark Office

United States of America

United States Patent and Trademark Office

INC. LEGAL

Reg. No. 4,155,954

Registered June 5, 2012

Int. Cl.: 45

SERVICE MARK

SUPPLEMENTAL REGISTER

INC. LEGAL, APC (CALIFORNIA CORPORATION)
701 PALOMAR AIRPORT ROAD, STE 300
CARLSBAD, CA 92011

FOR: LEGAL SERVICES, IN CLASS 45 (U.S. CLS. 100 AND 101).

FIRST USE 5-8-2011; IN COMMERCE 5-8-2011.

THE MARK CONSISTS OF STANDARD CHARACTERS WITHOUT CLAIM TO ANY PARTICULAR FONT, STYLE, SIZE, OR COLOR.

NO CLAIM IS MADE TO THE EXCLUSIVE RIGHT TO USE "LEGAL", APART FROM THE MARK AS SHOWN.

SER. NO. 85-353,383, FILED P.R. 6-22-2011; AM. S.R. 3-28-2012.

ANDREA HACK, EXAMINING ATTORNEY



David J. Kybas

Director of the United States Patent and Trademark Office

United States of America

United States Patent and Trademark Office

AMERICA'S FAMILY DOCTORS

Reg. No. 4,155,955

Registered June 5, 2012

Int. Cl.: 44

SERVICE MARK

SUPPLEMENTAL REGISTER

AMERICA'S FAMILY DOCTORS, PLLC (TENNESSEE LIMITED LIABILITY COMPANY)
SUITE 201
1195 OLD HICKORY BLVD.
BRENTWOOD, TN 37027

FOR: CONSULTING TO INDIVIDUALS AND COMMUNITIES ENGAGED IN GROUP WEIGHT LOSS PROGRAMS; DIETARY AND NUTRITIONAL GUIDANCE; NUTRITION COUNSELING; PHYSICIAN SERVICES; PROVIDING WEIGHT LOSS PROGRAM SERVICES; PROVIDING WELLNESS SERVICES, NAMELY, WEIGHT LOSS PROGRAMS OFFERED AT A WELLNESS CENTER; WEIGHT MANAGEMENT SERVICES, NAMELY, PROVIDING WEIGHT LOSS AND/OR WEIGHT MAINTENANCE PROGRAMS; WEIGHT REDUCTION DIET PLANNING AND SUPERVISION, IN CLASS 44 (U.S. CLS. 100 AND 101).

FIRST USE 7-1-2002; IN COMMERCE 9-23-2003.

THE MARK CONSISTS OF STANDARD CHARACTERS WITHOUT CLAIM TO ANY PARTICULAR FONT, STYLE, SIZE, OR COLOR.

NO CLAIM IS MADE TO THE EXCLUSIVE RIGHT TO USE "FAMILY DOCTORS", APART FROM THE MARK AS SHOWN.

SER. NO. 85-353,512, FILED P.R. 6-22-2011; AM. S.R. 4-4-2012.

JORDAN BAKER, EXAMINING ATTORNEY



David J. Kyros

Director of the United States Patent and Trademark Office

United States of America

United States Patent and Trademark Office

ON DEMAND PACKAGING

Reg. No. 4,155,956

PACKSIZE LLC (UTAH LIMITED LIABILITY COMPANY)
4505 WASATCH BOULEVARD
SALT LAKE CITY, UT 84124

Registered June 5, 2012

Int. Cls.: 7 and 40

FOR: MACHINES FOR PRODUCING CORRUGATED CONTAINERS AT THE MOMENT WHEN NEEDED FOR PACKAGING GOODS , IN CLASS 7 (U.S. CLS. 13, 19, 21, 23, 31, 34 AND 35).

TRADEMARK

FIRST USE 9-1-2011; IN COMMERCE 9-1-2011.

SERVICE MARK

FOR: CUSTOM MANUFACTURE OF CORRUGATED CONTAINERS AT THE MOMENT WHEN NEEDED OUT OF CORRUGATED BOARD, IN CLASS 40 (U.S. CLS. 100, 103 AND 106).

SUPPLEMENTAL REGISTER

FIRST USE 9-1-2011; IN COMMERCE 9-1-2011.

THE MARK CONSISTS OF STANDARD CHARACTERS WITHOUT CLAIM TO ANY PARTICULAR FONT, STYLE, SIZE, OR COLOR.

NO CLAIM IS MADE TO THE EXCLUSIVE RIGHT TO USE "PACKAGING", APART FROM THE MARK AS SHOWN.

SER. NO. 85-353,545, FILED P.R. 6-22-2011; AM. S.R. 4-2-2012.

MICHELE SWAIN, EXAMINING ATTORNEY



David J. Kybas

Director of the United States Patent and Trademark Office

United States of America

United States Patent and Trademark Office

WATER WIG

Reg. No. 4,155,957

Registered June 5, 2012

Int. Cl.: 26

CREATEDHAIR.COM (CALIFORNIA SOLE PROPRIETORSHIP)
SUITE 306
10390 WILSHIRE BLVD.
LOS ANGELES, CA 90024

FOR: WIGS AND HAIR PIECES, IN CLASS 26 (U.S. CLS. 37, 39, 40, 42 AND 50).

TRADEMARK

FIRST USE 11-15-2011; IN COMMERCE 11-15-2011.

SUPPLEMENTAL REGISTER

THE MARK CONSISTS OF STANDARD CHARACTERS WITHOUT CLAIM TO ANY PARTICULAR FONT, STYLE, SIZE, OR COLOR.

NO CLAIM IS MADE TO THE EXCLUSIVE RIGHT TO USE "WIG", APART FROM THE MARK AS SHOWN.

SER. NO. 85-353,621, FILED P.R. 6-22-2011; AM. S.R. 3-29-2012.

RENEE MCCRAY, EXAMINING ATTORNEY



David J. Kyros

Director of the United States Patent and Trademark Office

United States of America

United States Patent and Trademark Office

CHEESE CRINKLES

Reg. No. 4,155,958

Registered June 5, 2012

Int. Cl.: 30

TRADEMARK

SUPPLEMENTAL REGISTER

PHOENIX INTANGIBLES HOLDING COMPANY (DELAWARE CORPORATION)
4005 KENNETT PIKE, SUITE 220
TWO GREENVILLE CROSSING
GREENVILLE, DE 19807

FOR: SNACK FOOD, NAMELY, CHEESE FLAVORED PUFFED CORN SNACKS, IN CLASS
30 (U.S. CL. 46).

FIRST USE 2-0-2012; IN COMMERCE 2-0-2012.

THE MARK CONSISTS OF STANDARD CHARACTERS WITHOUT CLAIM TO ANY PAR-
TICULAR FONT, STYLE, SIZE, OR COLOR.

SER. NO. 85-354,555, FILED P.R. 6-23-2011; AM. S.R. 4-2-2012.

BRIAN PINO, EXAMINING ATTORNEY



David J. Kyffers

Director of the United States Patent and Trademark Office

United States of America

United States Patent and Trademark Office

SNEAKER CON

Reg. No. 4,155,959

SNEAKER CON EVENTS (NEW YORK UNINCORPORATED ASSOCIATION)
400 E. 54TH ST COMM-B
NEW YORK, NY 10012

Registered June 5, 2012

Int. Cl.: 35

FOR: ORGANIZING AND CONDUCTING EXHIBITIONS AND TRADE FAIRS FEATURING SNEAKERS FOR BUSINESS AND PROMOTIONAL PURPOSES, IN CLASS 35 (U.S. CLS. 100, 101 AND 102).

SERVICE MARK

FIRST USE 3-8-2008; IN COMMERCE 3-1-2009.

SUPPLEMENTAL REGISTER

THE MARK CONSISTS OF STANDARD CHARACTERS WITHOUT CLAIM TO ANY PARTICULAR FONT, STYLE, SIZE, OR COLOR.

NO CLAIM IS MADE TO THE EXCLUSIVE RIGHT TO USE "CON", APART FROM THE MARK AS SHOWN.

SER. NO. 85-354,950, FILED P.R. 6-24-2011; AM. S.R. 4-2-2012.

ANDREW LEASER, EXAMINING ATTORNEY



David J. Kyffers

Director of the United States Patent and Trademark Office

United States of America

United States Patent and Trademark Office

FEVER TAGS

Reg. No. 4,155,960

FEVER TAGS, LLC (TEXAS LIMITED LIABILITY COMPANY)
3310 WEST I-40
AMARILLO, TX 79102

Registered June 5, 2012

Int. Cl.: 9

FOR: TEMPERATURE SENSORS USED IN THE MEDICAL FIELD TO MEASURE TEMPERATURE OF MEDICAL SOLUTIONS, IN CLASS 9 (U.S. CLS. 21, 23, 26, 36 AND 38).

TRADEMARK

FIRST USE 11-21-2007; IN COMMERCE 12-15-2009.

SUPPLEMENTAL REGISTER

THE MARK CONSISTS OF STANDARD CHARACTERS WITHOUT CLAIM TO ANY PARTICULAR FONT, STYLE, SIZE, OR COLOR.

SER. NO. 85-355,314, FILED P.R. 6-24-2011; AM. S.R. 4-10-2012.

MELISSA VALLILLO, EXAMINING ATTORNEY



David J. Kybas

Director of the United States Patent and Trademark Office

United States of America

United States Patent and Trademark Office

ORCHID MYST

Reg. No. 4,155,961

GROWTH TECHNOLOGY LTD (UNITED KINGDOM CORPORATION)
GREAT WESTERN WAY
TAUNTON TA2 6BX, UNITED KINGDOM

Registered June 5, 2012

Int. Cl.: 1

FOR: A FOLIAR SPRAY FOR PLANTS CONTAINING MINERAL AND ORGANIC NUTRIENTS AND PURE NATURAL OILS TO ENHANCE LEAF CONDITION, IN CLASS 1 (U.S. CLS. 1, 5, 6, 10, 26 AND 46).

TRADEMARK

FIRST USE 11-30-2010; IN COMMERCE 11-30-2010.

SUPPLEMENTAL REGISTER

THE MARK CONSISTS OF STANDARD CHARACTERS WITHOUT CLAIM TO ANY PARTICULAR FONT, STYLE, SIZE, OR COLOR.

SER. NO. 85-355,419, FILED P.R. 6-24-2011; AM. S.R. 4-9-2012.

MICHAEL WIENER, EXAMINING ATTORNEY



David J. Kyffers

Director of the United States Patent and Trademark Office

United States of America

United States Patent and Trademark Office

eco-friendly
3-D NAP
PREMIUM 3-PLY DINNER NAPKIN

Reg. No. 4,155,962

GENERAL FINANCE SUPPLY SOURCE, INC. (CALIFORNIA CORPORATION)
39 EAST UNION STREET
PASADENA, CA 91103

Registered June 5, 2012

Int. Cl.: 16

FOR: PAPER NAPKINS, IN CLASS 16 (U.S. CLS. 2, 5, 22, 23, 29, 37, 38 AND 50).

TRADEMARK

FIRST USE 6-24-2011; IN COMMERCE 6-24-2011.

SUPPLEMENTAL REGISTER

NO CLAIM IS MADE TO THE EXCLUSIVE RIGHT TO USE "DINNER NAPKIN", APART FROM THE MARK AS SHOWN.

THE COLOR(S) GREEN, BLACK, AND WHITE IS/ARE CLAIMED AS A FEATURE OF THE MARK.

THE MARK CONSISTS OF THE WORDING "ECO-FRIENDLY" IN BLACK. THE WORDING "3-D NAP" APPEARS IN GREEN LETTERS WRITTEN IN A BLOCK STYLE WITH A BLACK AND WHITE BLOCK BASE. THE WORDING "PREMIUM 3-PLY DINNER NAPKIN" APPEARS IN GREEN.

SER. NO. 85-355,590, FILED P.R. 6-24-2011; AM. S.R. 3-28-2012.

DORITT L. CARROLL, EXAMINING ATTORNEY



David J. Kyros

Director of the United States Patent and Trademark Office

United States of America

United States Patent and Trademark Office

BEADNOTES

Reg. No. 4,155,963

NATURE'S CREATIONS, L.L.C. (FLORIDA LIMITED LIABILITY COMPANY)
1032 11TH STREET NORTH
NAPLES, FL 34102

Registered June 5, 2012

Int. Cl.: 14

FOR: JEWELRY, IN CLASS 14 (U.S. CLS. 2, 27, 28 AND 50).

TRADEMARK

FIRST USE 6-14-2011; IN COMMERCE 6-14-2011.

SUPPLEMENTAL REGISTER

THE MARK CONSISTS OF STANDARD CHARACTERS WITHOUT CLAIM TO ANY PARTICULAR FONT, STYLE, SIZE, OR COLOR.

SER. NO. 85-356,251, FILED P.R. 6-25-2011; AM. S.R. 4-11-2012.

DORITT L. CARROLL, EXAMINING ATTORNEY



David J. Kyffers

Director of the United States Patent and Trademark Office

United States of America

United States Patent and Trademark Office

OHIO WINE COUNTRY

Reg. No. 4,155,964

HOUR MEDIA, L.L.C. (MICHIGAN LIMITED LIABILITY COMPANY)
117 W. THIRD STREET
ROYAL OAK, MI 48067

Registered June 5, 2012

Int. Cl.: 16

FOR: PRINTED PERIODICALS FEATURING OHIO TOURISM TOPICS, IN CLASS 16 (U.S. CLS. 2, 5, 22, 23, 29, 37, 38 AND 50).

TRADEMARK

FIRST USE 3-28-2012; IN COMMERCE 3-28-2012.

SUPPLEMENTAL REGISTER

THE MARK CONSISTS OF STANDARD CHARACTERS WITHOUT CLAIM TO ANY PARTICULAR FONT, STYLE, SIZE, OR COLOR.

SER. NO. 85-356,614, FILED P.R. 6-27-2011; AM. S.R. 4-5-2012.

COURTNEY ALVAREZ, EXAMINING ATTORNEY



David J. Kyros

Director of the United States Patent and Trademark Office

United States of America

United States Patent and Trademark Office

THE GUILTY GIRL'S GUIDE

Reg. No. 4,155,965

ADVANCE MAGAZINE PUBLISHERS INC. (NEW YORK CORPORATION)
FOUR TIMES SQUARE
NEW YORK, NY 10036

Registered June 5, 2012

Int. Cl.: 16

FOR: PUBLICATIONS, NAMELY, MAGAZINE COLUMNS IN THE FIELD OF WEDDING PLANNING AND ETIQUETTE, IN CLASS 16 (U.S. CLS. 2, 5, 22, 23, 29, 37, 38 AND 50).

TRADEMARK

FIRST USE 10-1-2010; IN COMMERCE 10-1-2010.

SUPPLEMENTAL REGISTER

THE MARK CONSISTS OF STANDARD CHARACTERS WITHOUT CLAIM TO ANY PARTICULAR FONT, STYLE, SIZE, OR COLOR.

NO CLAIM IS MADE TO THE EXCLUSIVE RIGHT TO USE "GUIDE", APART FROM THE MARK AS SHOWN.

SER. NO. 85-358,087, FILED P.R. 6-28-2011; AM. S.R. 4-4-2012.

EMILY CARLSEN, EXAMINING ATTORNEY



David J. Kyffers

Director of the United States Patent and Trademark Office

United States of America

United States Patent and Trademark Office

THE STRATEGIC FINANCIAL ADVISOR OF LEADING CLOSELY-HELD COMPANIES

Reg. No. 4,155,966

DAVID N. DEUTSCH & COMPANY LLC (DELAWARE LIMITED LIABILITY COMPANY)
250 PARK AVENUE, FL 7
NEW YORK, NY 10177

Registered June 5, 2012

Int. Cls.: 35 and 36

FOR: BUSINESS ACQUISITION AND MERGER CONSULTATION, IN CLASS 35 (U.S. CLS. 100, 101 AND 102).

SERVICE MARK

FIRST USE 1-1-2008; IN COMMERCE 1-1-2008.

SUPPLEMENTAL REGISTER

FOR: FINANCIAL AND INVESTMENT SERVICES, NAMELY, INVESTMENT BANKING, FINANCIAL CONSULTING IN THE FIELD OF MERGERS AND ACQUISITIONS, RAISING CAPITAL FOR COMPANIES AND THEIR OWNERS, FINANCIAL ANALYSIS CONSULTATION, AND INVESTMENT MANAGEMENT AND CONSULTATION, IN CLASS 36 (U.S. CLS. 100, 101 AND 102).

FIRST USE 1-1-2008; IN COMMERCE 1-1-2008.

THE MARK CONSISTS OF STANDARD CHARACTERS WITHOUT CLAIM TO ANY PARTICULAR FONT, STYLE, SIZE, OR COLOR.

SER. NO. 85-360,546, FILED P.R. 6-30-2011; AM. S.R. 4-3-2012.

SARA BENJAMIN, EXAMINING ATTORNEY



David J. Kyros

Director of the United States Patent and Trademark Office

United States of America
United States Patent and Trademark Office

OAT-BATH

Reg. No. 4,155,967

MEEKS, MARY J. (UNITED STATES INDIVIDUAL)
P.O. BOX 548
CORONA, CA 92878

Registered June 5, 2012

Int. Cl.: 3

FOR: NON-MEDICATED PET CARE PREPARATIONS, NAMELY, SHAMPOOS, IN CLASS 3 (U.S. CLS. 1, 4, 6, 50, 51 AND 52).

TRADEMARK

FIRST USE 2-1-2000; IN COMMERCE 2-1-2000.

SUPPLEMENTAL REGISTER

THE MARK CONSISTS OF STANDARD CHARACTERS WITHOUT CLAIM TO ANY PARTICULAR FONT, STYLE, SIZE, OR COLOR.

SER. NO. 85-361,196, FILED P.R. 6-30-2011; AM. S.R. 2-29-2012.

CARYN GLASSER, EXAMINING ATTORNEY



David J. Kyros

Director of the United States Patent and Trademark Office

United States of America

United States Patent and Trademark Office

IHOME PAGE

Reg. No. 4,155,968

Registered June 5, 2012

Int. Cl.: 42

SERVICE MARK

SUPPLEMENTAL REGISTER

IPAYMENT, INC. (DELAWARE CORPORATION)
SUITE 415
40 BURTON HILLS BLVD.
NASHVILLE, TN 37215

FOR: HOSTING WEBSITES ON THE INTERNET; WEBSITE DESIGN AND DEVELOPMENT FOR OTHERS, IN CLASS 42 (U.S. CLS. 100 AND 101).

FIRST USE 1-1-2012; IN COMMERCE 1-1-2012.

THE MARK CONSISTS OF STANDARD CHARACTERS WITHOUT CLAIM TO ANY PARTICULAR FONT, STYLE, SIZE, OR COLOR.

SER. NO. 85-361,991, FILED P.R. 7-1-2011; AM. S.R. 4-3-2012.

RONALD AIKENS, EXAMINING ATTORNEY



David J. Kyffers

Director of the United States Patent and Trademark Office

United States of America

United States Patent and Trademark Office

QUALIFIED BENEFITS

Reg. No. 4,155,969

QBI, LLC (DELAWARE LIMITED LIABILITY COMPANY), DBA QUALIFIED BENEFITS,
21021 VENTURA BLVD., SUITE 100
WOODLAND HILLS, CA 91364

Registered June 5, 2012

Int. Cl.: 36

FOR: FINANCIAL ADMINISTRATION OF RETIREMENT PLANS, IN CLASS 36 (U.S. CLS.
100, 101 AND 102).

SERVICE MARK

FIRST USE 2-0-2010; IN COMMERCE 2-0-2010.

SUPPLEMENTAL REGISTER

THE MARK CONSISTS OF STANDARD CHARACTERS WITHOUT CLAIM TO ANY PAR-
TICULAR FONT, STYLE, SIZE, OR COLOR.

NO CLAIM IS MADE TO THE EXCLUSIVE RIGHT TO USE "BENEFITS", APART FROM
THE MARK AS SHOWN.

SER. NO. 85-363,507, FILED P.R. 7-5-2011; AM. S.R. 4-5-2012.

CHRISTOPHER LAW, EXAMINING ATTORNEY



David J. Kybas

Director of the United States Patent and Trademark Office

United States of America

United States Patent and Trademark Office

Glitter Glue Organizer

Reg. No. 4,155,970

Registered June 5, 2012

Int. Cl.: 21

TRADEMARK

SUPPLEMENTAL REGISTER

SUMMERS RICHELLE J (UNITED STATES INDIVIDUAL)
41083 SANDALWOOD CIR
#M
MURRIETA, CA 92562

FOR: PLASTIC VACUUMED FORMED STORAGE CRAFTING TRAY, IN CLASS 21 (U.S. CLS. 2, 13, 23, 29, 30, 33, 40 AND 50).

FIRST USE 12-5-2010; IN COMMERCE 7-5-2011.

THE MARK CONSISTS OF STANDARD CHARACTERS WITHOUT CLAIM TO ANY PARTICULAR FONT, STYLE, SIZE, OR COLOR.

NO CLAIM IS MADE TO THE EXCLUSIVE RIGHT TO USE "ORGANIZER", APART FROM THE MARK AS SHOWN.

SER. NO. 85-363,516, FILED P.R. 7-5-2011; AM. S.R. 4-10-2012.

INGA ERVIN, EXAMINING ATTORNEY



David J. Kyros

Director of the United States Patent and Trademark Office

United States of America

United States Patent and Trademark Office

NJCASHFORHOMES.COM

Reg. No. 4,155,971

Registered June 5, 2012

Int. Cl.: 36

US MASTERS RESIDENTIAL PROPERTY (USA) FUND (MARYLAND REAL ESTATE INVESTMENT TRUST)
SUITE 210
15 EXCHANGE PLACE
JERSEY CITY, NJ 07302

SERVICE MARK

FOR: REAL ESTATE ACQUISITION SERVICES, IN CLASS 36 (U.S. CLS. 100, 101 AND 102).

SUPPLEMENTAL REGISTER

FIRST USE 7-1-2011; IN COMMERCE 7-1-2011.

THE MARK CONSISTS OF STANDARD CHARACTERS WITHOUT CLAIM TO ANY PARTICULAR FONT, STYLE, SIZE, OR COLOR.

SER. NO. 85-364,519, FILED P.R. 7-6-2011; AM. S.R. 4-6-2012.

SHANNON TWOHIG, EXAMINING ATTORNEY



David J. Kyffers

Director of the United States Patent and Trademark Office

United States of America

United States Patent and Trademark Office

HOCKEY SODA

Reg. No. 4,155,972

BONFIGLIO, JOSEPH (UNITED STATES INDIVIDUAL)
42 NUTHATCH KNOB
GLASTONBURY, CT 06033

Registered June 5, 2012

Int. Cl.: 32

FOR: NON-ALCOHOLIC BEVERAGES, NAMELY, CARBONATED BEVERAGES, ENERGY DRINKS AND SOFT DRINKS, NAMELY, SODA, IN CLASS 32 (U.S. CLS. 45, 46 AND 48).

TRADEMARK

FIRST USE 10-26-2011; IN COMMERCE 10-26-2011.

SUPPLEMENTAL REGISTER

THE MARK CONSISTS OF STANDARD CHARACTERS WITHOUT CLAIM TO ANY PARTICULAR FONT, STYLE, SIZE, OR COLOR.

NO CLAIM IS MADE TO THE EXCLUSIVE RIGHT TO USE "SODA", APART FROM THE MARK AS SHOWN.

SER. NO. 85-366,465, FILED P.R. 7-8-2011; AM. S.R. 3-21-2012.

MEGHAN REINHART, EXAMINING ATTORNEY



David J. Kybas

Director of the United States Patent and Trademark Office

United States of America

United States Patent and Trademark Office

Everything High School Sports

Reg. No. 4,155,973

Registered June 5, 2012

Int. Cl.: 41

SERVICE MARK

SUPPLEMENTAL REGISTER

MACCULLOUGH, SCOTT A. (UNITED STATES INDIVIDUAL), DBA EVERYTHING HIGH SCHOOL SPORTS LLC,
681 S. HOLLYBROOK DRIVE APT. 304
PEMBROKE PINES, FL 33025

FOR: ENTERTAINMENT SERVICES, NAMELY, PROVIDING AN ON-GOING RADIO PROGRAM IN THE FIELD OF HIGH SCHOOL SPORTS; PROVIDING A WEB SITE FEATURING INFORMATION ON YOUTH SPORTS, IN CLASS 41 (U.S. CLS. 100, 101 AND 107).

FIRST USE 7-30-2010; IN COMMERCE 9-20-2010.

THE MARK CONSISTS OF STANDARD CHARACTERS WITHOUT CLAIM TO ANY PARTICULAR FONT, STYLE, SIZE, OR COLOR.

NO CLAIM IS MADE TO THE EXCLUSIVE RIGHT TO USE "HIGH SCHOOL SPORTS", APART FROM THE MARK AS SHOWN.

SER. NO. 85-367,295, FILED P.R. 7-9-2011; AM. S.R. 4-20-2012.

STEVEN JACKSON, EXAMINING ATTORNEY



David J. Kyffers

Director of the United States Patent and Trademark Office

United States of America

United States Patent and Trademark Office

VELOZ

Reg. No. 4,155,974

TEXAS INDUSTRIES, INC. (DELAWARE CORPORATION)
1341 W. MOCKINGBIRD LN.
DALLAS, TX 75247

Registered June 5, 2012

Int. Cl.: 19

FOR: CEMENTITIOUS PLASTER, IN CLASS 19 (U.S. CLS. 1, 12, 33 AND 50).

TRADEMARK

FIRST USE 10-1-2010; IN COMMERCE 10-1-2010.

SUPPLEMENTAL REGISTER

THE MARK CONSISTS OF STANDARD CHARACTERS WITHOUT CLAIM TO ANY PARTICULAR FONT, STYLE, SIZE, OR COLOR.

THE ENGLISH TRANSLATION OF "VELOZ" IN THE MARK IS "FAST".

SER. NO. 85-367,965, FILED P.R. 7-11-2011; AM. S.R. 3-29-2012.

EDWARD NELSON, EXAMINING ATTORNEY



David J. Kyffers

Director of the United States Patent and Trademark Office

United States of America

United States Patent and Trademark Office

Market Dynamics

Reg. No. 4,155,975

GNM GROUP, LLC (TEXAS LIMITED LIABILITY COMPANY)
931 W HEIGHTS HOLLOW LN
HOUSTON, TX 77007

Registered June 5, 2012

Int. Cl.: 9

FOR: DOWNLOADABLE ELECTRONIC PUBLICATIONS IN THE NATURE OF NEWSLETTERS, JOURNALS, MAGAZINES, PAMPHLETS, BROCHURES, AND PERIODICALS AND BOOKS IN THE FIELD OF BUSINESS AND FINANCE, IN CLASS 9 (U.S. CLS. 21, 23, 26, 36 AND 38).

TRADEMARK

SUPPLEMENTAL REGISTER FIRST USE 3-12-2011; IN COMMERCE 3-17-2011.

THE MARK CONSISTS OF STANDARD CHARACTERS WITHOUT CLAIM TO ANY PARTICULAR FONT, STYLE, SIZE, OR COLOR.

SER. NO. 85-371,154, FILED P.R. 7-14-2011; AM. S.R. 4-11-2012.

KATHERINE E. HALMEN, EXAMINING ATTORNEY



David J. Kyffers

Director of the United States Patent and Trademark Office

United States of America

United States Patent and Trademark Office



Reg. No. 4,155,976

EYE CARE AND CURE CORP. (ARIZONA CORPORATION)
4646 S. OVERLAND DRIVE
TUCSON, AZ 85714

Registered June 5, 2012

Int. Cl.: 9

FOR: MEDICAL APPARATUS, NAMELY, POST DILATION SPECTACLES, IN CLASS 9 (U.S. CLS. 21, 23, 26, 36 AND 38).

TRADEMARK

FIRST USE 3-31-2011; IN COMMERCE 3-31-2011.

SUPPLEMENTAL REGISTER

THE MARK CONSISTS OF THE WORK "DIMMERZ" OUTLINED IN LAVENDER AND GOING FROM WHITE, YELLOW, DARK BLUE AND LAVENDER FROM THE LETTER "D" TO THE LETTER "Z" IN A GRADIENT.

THE COLOR(S) WHITE, YELLOW, DARK BLUE, AND LAVENDER IS/ARE CLAIMED AS A FEATURE OF THE MARK.

SER. NO. 85-371,916, FILED P.R. 7-14-2011; AM. S.R. 2-22-2012.

KIMBERLY PERRY, EXAMINING ATTORNEY



David J. Kyros

Director of the United States Patent and Trademark Office

United States of America

United States Patent and Trademark Office

SKYDIVE HAWAII

Reg. No. 4,155,977

SKYDIVING SCHOOL, INC. (HAWAII CORPORATION), DBA SKYDIVE HAWAII,
PO BOX 75520
HONOLULU, HI 96836

Registered June 5, 2012

Int. Cls.: 12 and 18

FOR: PARACHUTES, IN CLASS 12 (U.S. CLS. 19, 21, 23, 31, 35 AND 44).

TRADEMARK

FIRST USE 1-1-2010; IN COMMERCE 1-1-2010.

SUPPLEMENTAL REGISTER

FOR: ALL PURPOSE SPORT BAGS; ALL-PURPOSE ATHLETIC BAGS; ALL-PURPOSE CARRYING BAGS; ATHLETIC BAGS; CARRY-ALL BAGS; SPORT BAGS; TRAVEL BAGS, IN CLASS 18 (U.S. CLS. 1, 2, 3, 22 AND 41).

FIRST USE 7-1-2011; IN COMMERCE 7-1-2011.

THE MARK CONSISTS OF STANDARD CHARACTERS WITHOUT CLAIM TO ANY PARTICULAR FONT, STYLE, SIZE, OR COLOR.

NO CLAIM IS MADE TO THE EXCLUSIVE RIGHT TO USE "SKYDIVE" FOR CLASS 12, APART FROM THE MARK AS SHOWN.

SER. NO. 85-373,394, FILED P.R. 7-18-2011; AM. S.R. 3-4-2012.

TEJBIR SINGH, EXAMINING ATTORNEY



David J. Kypos

Director of the United States Patent and Trademark Office

United States of America

United States Patent and Trademark Office

Green Building Travel

Reg. No. 4,155,978

Registered June 5, 2012

Int. Cl.: 39

SERVICE MARK

SUPPLEMENTAL REGISTER

CLEARWATER BEACH TRAVEL, LLC (FLORIDA LIMITED LIABILITY COMPANY)
#291
140 ISLAND WAY
CLEARWATER BEACH, FL 33767

FOR: TRAVEL AGENCY SERVICES, NAMELY, MAKING RESERVATIONS AND BOOKINGS FOR TRANSPORTATION, IN CLASS 39 (U.S. CLS. 100 AND 105).

FIRST USE 5-14-2011; IN COMMERCE 5-14-2011.

THE MARK CONSISTS OF STANDARD CHARACTERS WITHOUT CLAIM TO ANY PARTICULAR FONT, STYLE, SIZE, OR COLOR.

NO CLAIM IS MADE TO THE EXCLUSIVE RIGHT TO USE "GREEN" AND "TRAVEL", APART FROM THE MARK AS SHOWN.

SER. NO. 85-376,638, FILED P.R. 7-20-2011; AM. S.R. 4-30-2012.

DEZMONA MIZELLE, EXAMINING ATTORNEY



David J. Kybas

Director of the United States Patent and Trademark Office

United States of America

United States Patent and Trademark Office

IACCOUNTING

Reg. No. 4,155,979

Registered June 5, 2012

Int. Cl.: 42

SERVICE MARK

SUPPLEMENTAL REGISTER

IPAYMENT, INC. (DELAWARE CORPORATION)
SUITE 415
40 BURTON HILLS BLVD.
NASHVILLE, TN 37215

FOR: PROVIDING A WEBSITE FEATURING NON-DOWNLOADABLE SOFTWARE FOR THE MANAGEMENT OF INVENTORY; PROVIDING A WEBSITE FEATURING NON-DOWNLOADABLE SOFTWARE USED TO TRACK AND MANAGE ONLINE PAYMENTS AND PAYMENT RECEIVABLES; PROVIDING A WEBSITE FEATURING NON-DOWNLOADABLE SOFTWARE USED TO CONVERT DATA INTO DIFFERENT FILE FORMATS, IN CLASS 42 (U.S. CLS. 100 AND 101).

FIRST USE 1-1-2012; IN COMMERCE 1-1-2012.

THE MARK CONSISTS OF STANDARD CHARACTERS WITHOUT CLAIM TO ANY PARTICULAR FONT, STYLE, SIZE, OR COLOR.

SER. NO. 85-378,911, FILED P.R. 7-22-2011; AM. S.R. 4-3-2012.

RONALD AIKENS, EXAMINING ATTORNEY



David J. Kyffers

Director of the United States Patent and Trademark Office

United States of America

United States Patent and Trademark Office



Reg. No. 4,155,980

Registered June 5, 2012

Int. Cl.: 25

TRADEMARK

SUPPLEMENTAL REGISTER

STYMIE CANINE CANCER FOUNDATION (COLORADO CORPORATION)
3031 S JERICO WAY
AURORA, CO 80013

FOR: SHIRTS, IN CLASS 25 (U.S. CLS. 22 AND 39).

FIRST USE 2-1-2011; IN COMMERCE 2-14-2011.

THE MARK CONSISTS OF A PINK RIBBON ALONG WITH OUR DOGS ACTUAL PAW PRINT ALONG WITH THE WORDING "STYMIE CANINE CANCER FOUNDATION" AND "STYMIECCF.ORG" IN BLACK.

THE COLOR(S) PINK AND BLACK IS/ARE CLAIMED AS A FEATURE OF THE MARK.

SER. NO. 85-379,438, FILED P.R. 7-24-2011; AM. S.R. 4-12-2012.

KIMBERLY PERRY, EXAMINING ATTORNEY



David J. Kybas

Director of the United States Patent and Trademark Office

United States of America

United States Patent and Trademark Office



Reg. No. 4,155,981

Registered June 5, 2012

Int. Cl.: 45

SERVICE MARK

SUPPLEMENTAL REGISTER

BURGER, STEVEN (UNITED STATES INDIVIDUAL)
2233 W. BALBOA BLVD., STE 104-516
NEWPORT BEACH, CA 92663

FOR: RELIGIOUS AND SPIRITUAL SERVICES, PROVIDING A WEBSITE FEATURING INFORMATION ABOUT RELIGIOUS BELIEFS, IN CLASS 45 (U.S. CLS. 100 AND 101).

FIRST USE 1-1-2011; IN COMMERCE 1-1-2011.

NO CLAIM IS MADE TO THE EXCLUSIVE RIGHT TO USE "MINISTRIES", APART FROM THE MARK AS SHOWN.

THE COLOR(S) PURPLE, BLUE, BLACK, WHITE, YELLOW, AND RED IS/ARE CLAIMED AS A FEATURE OF THE MARK.

THE MARK CONSISTS OF AN IMAGE OF THE GALAXY IN WHITE, PURPLE, BLUE AND BLACK WITH CELESTIAL BODIES, STARS, AND NATURAL PHENOMENA, WITH "HIM HEAVENLY INTIMACY MINISTRIES" IN WHITE AT THE TOP LEFT OF THE IMAGE WITH A PURPLE, BLUE, YELLOW AND RED COLORED PHOENIX AT THE RIGHT OF THE WORDS AND "WINDOW TO THE FUTURE" IN WHITE AT THE TOP RIGHT OF THE IMAGE.

SER. NO. 85-381,690, FILED P.R. 7-26-2011; AM. S.R. 3-16-2012.

WON TEAK OH, EXAMINING ATTORNEY

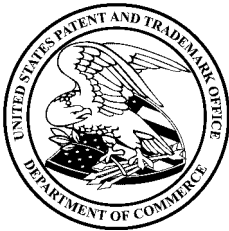

David J. Kybas

Director of the United States Patent and Trademark Office

United States of America

United States Patent and Trademark Office

SGV

Reg. No. 4,155,982

VIRGINIA VIDRIO (UNITED STATES INDIVIDUAL)
14005 LONE STAR STREET
LA PUENTE, CA 91746

Registered June 5, 2012

Int. Cls.: 12 and 35

FOR: BICYCLES, IN CLASS 12 (U.S. CLS. 19, 21, 23, 31, 35 AND 44).

TRADEMARK

FIRST USE 4-1-2009; IN COMMERCE 4-1-2009.

SERVICE MARK

FOR: RETAIL STORES FEATURING BICYCLES, IN CLASS 35 (U.S. CLS. 100, 101 AND 102).

SUPPLEMENTAL REGISTER

FIRST USE 4-1-2009; IN COMMERCE 4-1-2009.

THE MARK CONSISTS OF STANDARD CHARACTERS WITHOUT CLAIM TO ANY PARTICULAR FONT, STYLE, SIZE, OR COLOR.

SER. NO. 85-386,204, FILED P.R. 8-1-2011; AM. S.R. 4-5-2012.

KATHLEEN M. VANSTON, EXAMINING ATTORNEY



David J. Kybas

Director of the United States Patent and Trademark Office

United States of America

United States Patent and Trademark Office

IOCACHE

Reg. No. 4,155,983

Registered June 5, 2012

Int. Cl.: 9

TRADEMARK

SUPPLEMENTAL REGISTER

FUSION-IO, INC. (DELAWARE CORPORATION)
BOX 100
2855 E. COTTONWOOD PARKWAY
SALT LAKE CITY, UT 84121

FOR: COMPUTER SOFTWARE, NAMELY, COMPUTER PROGRAMS FOR CACHING DATA IN A COMPUTER SYSTEM, IN COMPUTER HARDWARE, IN COMPUTER NETWORKS, AND IN VIRTUAL COMPUTING INFRASTRUCTURES; COMPUTER SOFTWARE FOR CONFIGURING, MANAGING, SECURING, OPTIMIZING, MONITORING, STORING, DIAGNOSING, AND ANALYZING OF COMPUTER SYSTEMS, COMPUTER HARDWARE, COMPUTER NETWORKS, AND VIRTUAL COMPUTING INFRASTRUCTURES FOR THE PURPOSE OF CACHING DATA OF COMPUTER HARDWARE, SOFTWARE AND COMMUNICATION NETWORKS FOR BUSINESSES AND INDIVIDUALS; COMPUTER MANAGEMENT SOFTWARE FOR ACQUIRING, PROCESSING AND PRESENTING DATA; COMPUTER SOFTWARE FOR USE IN PERSONAL COMPUTERS, LAPTOPS, PDAS, PERSONAL INFORMATION MANAGER DEVICES, MOBILE TELEPHONES, DIGITAL APPLIANCES, VIRTUAL MACHINES, VIRTUAL APPLIANCES, AND OTHER MOBILE COMPUTING AND COMMUNICATIONS DEVICES, TO MANAGE, ENHANCE AND OPTIMIZE THE COMPUTING RESOURCES OF SUCH DEVICES, IN CLASS 9 (U.S. CLS. 21, 23, 26, 36 AND 38).

FIRST USE 8-30-2011; IN COMMERCE 1-12-2012.

THE MARK CONSISTS OF STANDARD CHARACTERS WITHOUT CLAIM TO ANY PARTICULAR FONT, STYLE, SIZE, OR COLOR.

SER. NO. 85-386,437, FILED P.R. 8-1-2011; AM. S.R. 3-22-2012.

LINDA ORNDORFF, EXAMINING ATTORNEY



David J. Kybas

Director of the United States Patent and Trademark Office

United States of America

United States Patent and Trademark Office

BAMBOO MAUI

Reg. No. 4,155,984

BAMBOO MAUI INC. (HAWAII CORPORATION)
P.O. BOX 1433
WAILUKU, HI 96793

Registered June 5, 2012

Int. Cl.: 35

FOR: RETAIL STORE SERVICES FEATURING BAMBOO FLOORING, FURNITURE, STRUCTURAL PANELS, FENCING, MILLWORK, AND COUNTERTOPS, AS WELL AS HARDWOOD AND CORK FLOORING; FLOORING UNDERLAYMENT, GLUES, AND FINISH MATERIALS; AND ENVIRONMENTALLY CONSCIOUS, SUSTAINABLY HARVESTED FLOORING AND RELATED MATERIALS, IN CLASS 35 (U.S. CLS. 100, 101 AND 102).

SERVICE MARK

SUPPLEMENTAL REGISTER

FIRST USE 1-0-2010; IN COMMERCE 1-0-2010.

THE MARK CONSISTS OF STANDARD CHARACTERS WITHOUT CLAIM TO ANY PARTICULAR FONT, STYLE, SIZE, OR COLOR.

SER. NO. 85-388,667, FILED P.R. 8-3-2011; AM. S.R. 4-6-2012.

REBECCA EISINGER, EXAMINING ATTORNEY



David J. Kyros

Director of the United States Patent and Trademark Office

United States of America

United States Patent and Trademark Office

GOT BOOBS?

Reg. No. 4,155,985

TWIN TIGER ASSETS CORP. (NEVADA CORPORATION)
520 ESPLANADE # B
REDONDO BEACH, CA 90277

Registered June 5, 2012

Int. Cl.: 14

FOR: BRACELETS; RUBBER OR SILICON WRISTBANDS IN THE NATURE OF A BRACE-
LET, IN CLASS 14 (U.S. CLS. 2, 27, 28 AND 50).

TRADEMARK

FIRST USE 7-1-2011; IN COMMERCE 8-5-2011.

SUPPLEMENTAL REGISTER

THE MARK CONSISTS OF STANDARD CHARACTERS WITHOUT CLAIM TO ANY PAR-
TICULAR FONT, STYLE, SIZE, OR COLOR.

SER. NO. 85-393,771, FILED P.R. 8-9-2011; AM. S.R. 4-2-2012.

JAY BESCH, EXAMINING ATTORNEY



David J. Kyros

Director of the United States Patent and Trademark Office

United States of America

United States Patent and Trademark Office

HOLLA IF YA LOVE BOOBIES

Reg. No. 4,155,986

TWIN TIGER ASSETS CORP. (NEVADA CORPORATION)
520 ESPLANADE # B
REDONDO BEACH, CA 90277

Registered June 5, 2012

Int. Cl.: 14

FOR: BRACELETS; RUBBER OR SILICON WRISTBANDS IN THE NATURE OF A BRACELET, IN CLASS 14 (U.S. CLS. 2, 27, 28 AND 50).

TRADEMARK

FIRST USE 7-1-2011; IN COMMERCE 8-5-2011.

SUPPLEMENTAL REGISTER

THE MARK CONSISTS OF STANDARD CHARACTERS WITHOUT CLAIM TO ANY PARTICULAR FONT, STYLE, SIZE, OR COLOR.

SER. NO. 85-393,832, FILED P.R. 8-9-2011; AM. S.R. 4-2-2012.

JAY BESCH, EXAMINING ATTORNEY



David J. Kybas

Director of the United States Patent and Trademark Office

United States of America

United States Patent and Trademark Office

LIVEAUDIO

Reg. No. 4,155,987

Registered June 5, 2012

Int. Cl.: 9

TRADEMARK

SUPPLEMENTAL REGISTER

ALIPHCOM (CALIFORNIA CORPORATION)
99 RHODE ISLAND STREET, 3RD FLOOR
SAN FRANCISCO, CA 94103

FOR: SPEAKER TECHNOLOGY, NAMELY, COMPUTER SOFTWARE FOR ENHANCING THE SOUND QUALITY OF AUDIO EQUIPMENT AND DEVICES; AUDIO SPEAKERS , IN CLASS 9 (U.S. CLS. 21, 23, 26, 36 AND 38).

FIRST USE 8-23-2011; IN COMMERCE 8-23-2011.

THE MARK CONSISTS OF STANDARD CHARACTERS WITHOUT CLAIM TO ANY PARTICULAR FONT, STYLE, SIZE, OR COLOR.

SER. NO. 85-398,452, FILED P.R. 8-15-2011; AM. S.R. 4-5-2012.

SUNG IN, EXAMINING ATTORNEY



David J. Kyffers

Director of the United States Patent and Trademark Office

United States of America

United States Patent and Trademark Office

SPEECH AND ACCENT ACADEMY

Reg. No. 4,155,988

Registered June 5, 2012

Int. Cl.: 41

SERVICE MARK

SUPPLEMENTAL REGISTER

JEFFERY, INC. (FLORIDA CORPORATION)
6538 COLLINS AVE
SUITE 415
MIAMI BEACH, FL 33141

FOR: BUSINESS EDUCATION SERVICES AND TRAINING SERVICES, NAMELY, CLASSES, SEMINARS, WORKSHOPS, PUBLIC PRESENTATIONS, COMMUNICATION SKILLS, BUSINESS WRITING, SPEECH, ARTICULATION AND ACCENT REDUCTION, IN CLASS 41 (U.S. CLS. 100, 101 AND 107).

FIRST USE 5-0-2011; IN COMMERCE 5-0-2011.

THE MARK CONSISTS OF STANDARD CHARACTERS WITHOUT CLAIM TO ANY PARTICULAR FONT, STYLE, SIZE, OR COLOR.

NO CLAIM IS MADE TO THE EXCLUSIVE RIGHT TO USE "ACADEMY", APART FROM THE MARK AS SHOWN.

SER. NO. 85-400,464, FILED P.R. 8-17-2011; AM. S.R. 4-12-2012.

KATINA MISTER, EXAMINING ATTORNEY



David J. Kyros

Director of the United States Patent and Trademark Office

United States of America

United States Patent and Trademark Office

BONDI BEACH

Reg. No. 4,155,989

Registered June 5, 2012

Int. Cl.: 25

TRADEMARK

SUPPLEMENTAL REGISTER

ABERCROMBIE & FITCH TRADING CO. (OHIO CORPORATION)
ATTN: JACOB KRAMER, SENIOR LEGAL COUNSEL
6301 FITCH PATH
NEW ALBANY, OH 43054

FOR: BOTTOMS; TOPS, IN CLASS 25 (U.S. CLS. 22 AND 39).

FIRST USE 2-4-2011; IN COMMERCE 2-4-2011.

THE MARK CONSISTS OF STANDARD CHARACTERS WITHOUT CLAIM TO ANY PARTICULAR FONT, STYLE, SIZE, OR COLOR.

SER. NO. 85-401,002, FILED 8-18-2011.

NORA BUCHANAN WILL, EXAMINING ATTORNEY



David J. Kyros

Director of the United States Patent and Trademark Office

United States of America

United States Patent and Trademark Office

SLIM COCKTAIL

Reg. No. 4,155,990

Registered June 5, 2012

Int. Cl.: 5

TRADEMARK

SUPPLEMENTAL REGISTER

FOR MOR INTERNATIONAL (ARKANSAS CORPORATION)
496 HIGHWAY 64 EAST
CONWAY, AR 72032

FOR: DIETARY AND NUTRITIONAL SUPPLEMENTS; DIETARY FOOD SUPPLEMENTS; DIETARY SUPPLEMENTAL DRINKS; DIETARY SUPPLEMENTS; DIETARY SUPPLEMENTS FOR HUMAN CONSUMPTION; LIQUID NUTRITIONAL SUPPLEMENT; LIQUID VITAMIN SUPPLEMENTS; MINERAL NUTRITIONAL SUPPLEMENTS; NUTRITIONAL SUPPLEMENTS; NUTRITIONAL SUPPLEMENTS, NAMELY, PROBIOTIC COMPOSITIONS; POWDERED NUTRITIONAL SUPPLEMENT DRINK MIX; POWDERED NUTRITIONAL SUPPLEMENT DRINK MIX AND CONCENTRATE; VITAMIN AND MINERAL SUPPLEMENTS; VITAMIN ENRICHED WATER; VITAMIN FORTIFIED BEVERAGES; VITAMINS, IN CLASS 5 (U.S. CLS. 6, 18, 44, 46, 51 AND 52).

FIRST USE 9-1-2011; IN COMMERCE 11-15-2011.

THE MARK CONSISTS OF STANDARD CHARACTERS WITHOUT CLAIM TO ANY PARTICULAR FONT, STYLE, SIZE, OR COLOR.

SER. NO. 85-406,090, FILED P.R. 8-24-2011; AM. S.R. 2-23-2012.

WARREN L. OLANDRIA, EXAMINING ATTORNEY



David J. Kyros

Director of the United States Patent and Trademark Office

United States of America

United States Patent and Trademark Office

Leader P.O.V.

Reg. No. 4,155,991

CODA PARTNERS, INC. (FLORIDA CORPORATION)
37322 MERIDIAN AVENUE
DADE CITY, FL 33525

Registered June 5, 2012

Int. Cl.: 35

FOR: BUSINESS CONSULTING SERVICES IN THE FIELD OF BUSINESS MANAGEMENT, ORGANIZATIONAL AND LEADERSHIP DEVELOPMENT, IN CLASS 35 (U.S. CLS. 100, 101 AND 102).

SERVICE MARK

FIRST USE 2-0-2009; IN COMMERCE 2-0-2009.

SUPPLEMENTAL REGISTER

THE MARK CONSISTS OF STANDARD CHARACTERS WITHOUT CLAIM TO ANY PARTICULAR FONT, STYLE, SIZE, OR COLOR.

SER. NO. 85-412,275, FILED P.R. 8-31-2011; AM. S.R. 3-12-2012.

LAURIE MAYES, EXAMINING ATTORNEY



David J. Kyffers

Director of the United States Patent and Trademark Office

United States of America

United States Patent and Trademark Office

Hip Hop Yoga

Reg. No. 4,155,992

Registered June 5, 2012

Int. Cl.: 41

BEGIER, LYNNE (UNITED STATES INDIVIDUAL)
172 GREEN STREET
172 GREEN STREET
JAMAICA PLAIN, MA 02130

FOR: YOGA INSTRUCTION, IN CLASS 41 (U.S. CLS. 100, 101 AND 107).

SERVICE MARK

FIRST USE 3-1-2008; IN COMMERCE 3-1-2008.

SUPPLEMENTAL REGISTER

THE MARK CONSISTS OF STANDARD CHARACTERS WITHOUT CLAIM TO ANY PARTICULAR FONT, STYLE, SIZE, OR COLOR.

NO CLAIM IS MADE TO THE EXCLUSIVE RIGHT TO USE "YOGA", APART FROM THE MARK AS SHOWN.

SER. NO. 85-413,452, FILED P.R. 9-1-2011; AM. S.R. 3-26-2012.

KRISTIN CARLSON, EXAMINING ATTORNEY



David J. Kybas

Director of the United States Patent and Trademark Office

United States of America

United States Patent and Trademark Office



Reg. No. 4,155,993

Registered June 5, 2012

Int. Cl.: 16

TRADEMARK

SUPPLEMENTAL REGISTER

START THE SHOW, LLC (DELAWARE LIMITED LIABILITY COMPANY)
SUITE 619
4023 KENNETT PIKE
WILMINGTON, DE 19807

FOR: ARTISTS' PENS; BALL PENS; BALL POINT PENS; BALL-POINT PENS; BALLPOINT PENS; BUBBLE PENS; COLORED PENS; DESK STANDS AND HOLDERS FOR PENS, PENCILS, AND INK; ELECTRICAL WOOD BURNING ARTISTS' PENS; FELT MARKING PENS; FELT PENS; FELT WRITING PENS; FELT-TIP PENS; FIBERTIP PENS; FOUNTAIN PEN INK CARTRIDGES; FOUNTAIN PENS; GEL ROLLER PENS; GLITTER PENS FOR STATIONERY PURPOSES; GLUE PENS FOR STATIONERY PURPOSES; HIGHLIGHTER PENS; HIGHLIGHTING PENS; INDIA INK PENS; INK PENS; MARKING PENS; PEN AND PENCIL CASES; PEN AND PENCIL CASES AND BOXES; PEN AND PENCIL HOLDERS; PEN AND PENCIL TRAYS; PEN CASES; PEN CLIPS; PEN HOLDERS; PEN INK CARTRIDGES; PEN INK REFILLS; PEN NIBS; PEN OR PENCIL HOLDERS; PEN RESTS; PEN STANDS; PEN TRAYS; PENCIL OR PEN BOXES; PENS; PENS FOR MARKING; POCKET PEN SHIELDS; POROUS TIP PENS; REFILLS FOR BALLPOINT PENS; ROLLER BALL PENS; SCHOOL SUPPLY KITS CONTAINING VARIOUS COMBINATIONS OF SELECTED SCHOOL SUPPLIES, NAMELY, WRITING INSTRUMENTS, PENS, PENCILS, MECHANICAL PENCILS, ERASERS, MARKERS, CRAYONS, HIGHLIGHTER PENS, FOLDERS, NOTEBOOKS, PAPER, PROTRACTORS, PAPER CLIPS, PENCIL SHARPENERS, WRITING GRIPS, GLUE AND BOOK MARKS; STANDS FOR PEN AND PENCIL; STANDS FOR PENS; STANDS FOR PENS AND PENCILS; STEEL PENS; TIPS FOR BALLPOINT PENS; WRITING PEN KITS COMPRISING PARTS FOR MAKING WRITING PENS; WRITING PENS THAT MAY ALSO BE USED TO PERFORM PEN SPINNING TRICKS, IN CLASS 16 (U.S. CLS. 2, 5, 22, 23, 29, 37, 38 AND 50).



FIRST USE 6-1-2011; IN COMMERCE 6-5-2011.

THE MARK CONSISTS OF THE STYLIZED WORD "DUVALIER" INSIDE A RECTANGLE.

SER. NO. 85-414,899, FILED P.R. 9-4-2011; AM. S.R. 4-6-2012.

LINDA ORNDORFF, EXAMINING ATTORNEY

David J. Kyjars

Director of the United States Patent and Trademark Office

United States of America

United States Patent and Trademark Office

KushCon

Reg. No. 4,155,994

Registered June 5, 2012

Int. Cl.: 41

SERVICE MARK

SUPPLEMENTAL REGISTER

KUSHCON LLC (CALIFORNIA LIMITED LIABILITY COMPANY)
#200
24011 VENTURA BLVD
CALABASAS, CA 91302

FOR: EDUCATION SERVICES, NAMELY, PROVIDING SEMINARS AND CLASSES IN THE FIELD OF MEDICAL MARIJUANA; ENTERTAINMENT, NAMELY, LIVE MUSIC CONCERTS; PROVIDING FACILITIES FOR EDUCATIONAL CONVENTIONS, IN CLASS 41 (U.S. CLS. 100, 101 AND 107).

FIRST USE 10-1-2010; IN COMMERCE 10-1-2010.

THE MARK CONSISTS OF STANDARD CHARACTERS WITHOUT CLAIM TO ANY PARTICULAR FONT, STYLE, SIZE, OR COLOR.

SER. NO. 85-417,844, FILED P.R. 9-8-2011; AM. S.R. 3-22-2012.

ROBERT STRUCK, EXAMINING ATTORNEY



David J. Kybas

Director of the United States Patent and Trademark Office

United States of America

United States Patent and Trademark Office

REAL CITRUS

Reg. No. 4,155,995

Registered June 5, 2012

Int. Cl.: 5

TRADEMARK

SUPPLEMENTAL REGISTER

CLEAN CONTROL CORPORATION (GEORGIA CORPORATION)
P.O. BOX 7444
WARNER ROBINS, GA 31095

FOR: AIR FRESHENERS, IN CLASS 5 (U.S. CLS. 6, 18, 44, 46, 51 AND 52).

FIRST USE 2-4-2012; IN COMMERCE 2-4-2012.

THE MARK CONSISTS OF STANDARD CHARACTERS WITHOUT CLAIM TO ANY PARTICULAR FONT, STYLE, SIZE, OR COLOR.

SER. NO. 85-418,919, FILED P.R. 9-9-2011; AM. S.R. 3-30-2012.

ODESSA BIBBINS, EXAMINING ATTORNEY



David J. Kybas

Director of the United States Patent and Trademark Office

United States of America

United States Patent and Trademark Office

The B2B Prospecting Source

Reg. No. 4,155,996

Registered June 5, 2012

Int. Cl.: 35

SERVICE MARK

SUPPLEMENTAL REGISTER

B2B PROSPECTING, LLC (TEXAS LIMITED LIABILITY COMPANY), DBA THE B2B PROSPECTING SOURCE,
874 HARPER RD, STE 101
KERRVILLE, TX 78028

FOR: APPOINTMENT SCHEDULING SERVICES, IN CLASS 35 (U.S. CLS. 100, 101 AND 102).

FIRST USE 2-1-2011; IN COMMERCE 2-1-2011.

THE MARK CONSISTS OF STANDARD CHARACTERS WITHOUT CLAIM TO ANY PARTICULAR FONT, STYLE, SIZE, OR COLOR.

SER. NO. 85-427,691, FILED P.R. 9-20-2011; AM. S.R. 4-6-2012.

LINDA M. KING, EXAMINING ATTORNEY



David J. Kybas

Director of the United States Patent and Trademark Office

United States of America

United States Patent and Trademark Office

MOTORCYCLE CENTER.COM BLOG

Reg. No. 4,155,997

Registered June 5, 2012

Int. Cl.: 41

SERVICE MARK

SUPPLEMENTAL REGISTER

ASHDON, INC. (NEVADA CORPORATION)
2620 S. MARYLAND PARKWAY, #846
LAS VEGAS, NV 89109

FOR: ON-LINE JOURNALS, NAMELY, BLOGS FEATURING NEWS AND INFORMATION RELATING TO MOTORCYCLES AND THE SPORT OF MOTORCYCLE RIDING; PROVIDING A WEBSITE FEATURING BLOGS AND NON-DOWNLOADABLE PUBLICATIONS IN THE NATURE OF ARTICLES AND NEWS UPDATES IN THE FIELD(S) OF NEWS AND INFORMATION RELATING TO MOTORCYCLES AND THE SPORT OF MOTORCYCLE RIDING; PROVIDING A WEBSITE FEATURING INFORMATION RELATING TO THE SPORT OF NEWS AND INFORMATION RELATING TO MOTORCYCLES AND THE SPORT OF MOTORCYCLE RIDING, IN CLASS 41 (U.S. CLS. 100, 101 AND 107).

FIRST USE 7-1-2010; IN COMMERCE 7-1-2010.

THE MARK CONSISTS OF STANDARD CHARACTERS WITHOUT CLAIM TO ANY PARTICULAR FONT, STYLE, SIZE, OR COLOR.

NO CLAIM IS MADE TO THE EXCLUSIVE RIGHT TO USE "MOTORCYCLE" AND "BLOG", APART FROM THE MARK AS SHOWN.

SER. NO. 85-427,932, FILED P.R. 9-21-2011; AM. S.R. 4-5-2012.

DANIEL CAPSHAW, EXAMINING ATTORNEY



David J. Kyros

Director of the United States Patent and Trademark Office

United States of America

United States Patent and Trademark Office

Infrared Resources

Reg. No. 4,155,998

Registered June 5, 2012

Int. Cls.: 9 and 35

TRADEMARK

SERVICE MARK

SUPPLEMENTAL REGISTER

INFRARED RESOURCES, LLC (OREGON LIMITED LIABILITY COMPANY)
9823 SW 55TH AVE.
PORTLAND, OR 972195841

FOR: ELECTRONIC EQUIPMENT, NAMELY, TRANSFORMERS, BALUNS, CABLES USED IN CONNECTION WITH COMPUTERS, COMPUTER PERIPHERAL DEVICES, TELEVISIONS, AUDIO-VIDEO EQUIPMENT, CLOSED-CIRCUIT TV EQUIPMENT AND TELECOMMUNICATION EQUIPMENT; TRANSMITTERS AND RECEIVERS FOR AUDIO AND VIDEO SIGNALS FOR TRANSMISSION OVER TWISTED PAIR CABLES, IN CLASS 9 (U.S. CLS. 21, 23, 26, 36 AND 38).

FIRST USE 7-30-2009; IN COMMERCE 7-30-2009.

FOR: ON-LINE RETAIL STORE SERVICES FEATURING IR TECHNOLOGY-RELATED PRODUCTS, IN CLASS 35 (U.S. CLS. 100, 101 AND 102).

FIRST USE 7-30-2009; IN COMMERCE 7-30-2009.

THE MARK CONSISTS OF STANDARD CHARACTERS WITHOUT CLAIM TO ANY PARTICULAR FONT, STYLE, SIZE, OR COLOR.

NO CLAIM IS MADE TO THE EXCLUSIVE RIGHT TO USE "INFRARED", APART FROM THE MARK AS SHOWN.

SER. NO. 85-428,581, FILED P.R. 9-21-2011; AM. S.R. 3-21-2012.

DAVID COLLIER, EXAMINING ATTORNEY



David J. Kyros

Director of the United States Patent and Trademark Office

United States of America

United States Patent and Trademark Office

BASIC ESL

Reg. No. 4,155,999

Registered June 5, 2012

Int. Cls.: 9 and 42

TRADEMARK

SERVICE MARK

SUPPLEMENTAL REGISTER

BASIC ESL, INC. (CALIFORNIA CORPORATION)
P.O. BOX 1135
TEMECULA, CA 92593

FOR: COMPUTER SOFTWARE FOR USE IN LEARNING ENGLISH, IN CLASS 9 (U.S. CLS. 21, 23, 26, 36 AND 38).

FIRST USE 5-12-2011; IN COMMERCE 5-12-2011.

FOR: PROVIDING TEMPORARY USE OF ON-LINE NON-DOWNLOADABLE SOFTWARE FOR USE IN LEARNING ENGLISH, IN CLASS 42 (U.S. CLS. 100 AND 101).

FIRST USE 5-12-2011; IN COMMERCE 5-12-2011.

THE MARK CONSISTS OF STANDARD CHARACTERS WITHOUT CLAIM TO ANY PARTICULAR FONT, STYLE, SIZE, OR COLOR.

NO CLAIM IS MADE TO THE EXCLUSIVE RIGHT TO USE "ESL", APART FROM THE MARK AS SHOWN.

SER. NO. 85-430,605, FILED P.R. 9-23-2011; AM. S.R. 4-13-2012.

SANDRA BUJA, EXAMINING ATTORNEY



David J. Kyros

Director of the United States Patent and Trademark Office

United States of America

United States Patent and Trademark Office

ALL NATURAL ROOT TEA

Reg. No. 4,156,000

PALO PRODUCTS LLC (NEW YORK LIMITED LIABILITY COMPANY), DBA PALO TEA,
501 W 121ST ST
NEW YORK, NY 10027

Registered June 5, 2012

Int. Cl.: 30

FOR: BEVERAGES MADE OF TEA; BEVERAGES WITH A TEA BASE; FLAVOURINGS OF TEA; FRUIT TEAS; HERB TEA; HERBAL TEA; ICED TEA; TEA; TEA BAGS; TEA EXTRACTS; TEA FOR INFUSIONS; TEA-BASED BEVERAGES; TEA-BASED BEVERAGES WITH FRUIT FLAVORING, IN CLASS 30 (U.S. CL. 46).

TRADEMARK

SUPPLEMENTAL REGISTER FIRST USE 9-22-2011; IN COMMERCE 9-22-2011.

THE MARK CONSISTS OF STANDARD CHARACTERS WITHOUT CLAIM TO ANY PARTICULAR FONT, STYLE, SIZE, OR COLOR.

NO CLAIM IS MADE TO THE EXCLUSIVE RIGHT TO USE "TEA", APART FROM THE MARK AS SHOWN.

SER. NO. 85-437,379, FILED P.R. 10-3-2011; AM. S.R. 3-23-2012.

INGA ERVIN, EXAMINING ATTORNEY



David J. Kybas

Director of the United States Patent and Trademark Office

United States of America

United States Patent and Trademark Office

LOFTHOUSE

Reg. No. 4,156,001

BLU HOMES, INC. (DELAWARE CORPORATION)
760 MAIN STREET, 2ND FLOOR
WALTHAM, MA 02451

Registered June 5, 2012

Int. Cl.: 19

FOR: MODULAR HOMES, IN CLASS 19 (U.S. CLS. 1, 12, 33 AND 50).

TRADEMARK

FIRST USE 3-10-2012; IN COMMERCE 3-10-2012.

SUPPLEMENTAL REGISTER

THE MARK CONSISTS OF STANDARD CHARACTERS WITHOUT CLAIM TO ANY PARTICULAR FONT, STYLE, SIZE, OR COLOR.

SER. NO. 85-438,661, FILED P.R. 10-4-2011; AM. S.R. 4-6-2012.

JIM RINGLE, EXAMINING ATTORNEY



David J. Kybas

Director of the United States Patent and Trademark Office

United States of America

United States Patent and Trademark Office

THE ESTHETICIAN MENTOR

Reg. No. 4,156,002

WESTON, LORI ANN (UNITED STATES INDIVIDUAL)
83866 PANCHO VILLA DRIVE
INDIO, CA 92203

Registered June 5, 2012

Int. Cl.: 41

FOR: EDUCATION SERVICES, NAMELY, MENTORING IN THE FIELD OF BUSINESS AND BUSINESS MARKETING FOR ESTHETICIANS AND SKIN CARE PROFESSIONALS; EDUCATIONAL AND ENTERTAINMENT SERVICES, NAMELY, PROVIDING MOTIVATIONAL SPEAKING SERVICES IN THE FIELD OF BUSINESS AND BUSINESS MARKETING FOR ESTHETICIANS AND SKIN CARE PROFESSIONALS; EDUCATIONAL SERVICES, NAMELY, CONDUCTING PUBLIC SPEAKING EVENTS, WORKSHOPS AND SEMINARS IN THE FIELDS OF BUSINESS AND BUSINESS MARKETING FOR ESTHETICIANS AND SKIN CARE PROFESSIONALS AND DISTRIBUTION OF TRAINING MATERIALS IN CONNECTION THEREWITH; ON-LINE JOURNALS, NAMELY, BLOGS FEATURING INFORMATION IN THE FIELD OF BUSINESS AND BUSINESS MARKETING FOR ESTHETICIANS AND SKIN CARE PROFESSIONALS; PROFESSIONAL COACHING SERVICES IN THE FIELD OF BUSINESS AND BUSINESS MARKETING FOR ESTHETICIANS AND SKIN CARE PROFESSIONALS; PROVIDING ON-LINE NEWSLETTERS IN THE FIELD OF BUSINESS AND BUSINESS MARKETING FOR ESTHETICIANS AND SKIN CARE PROFESSIONALS, IN CLASS 41 (U.S. CLS. 100, 101 AND 107).

SERVICE MARK

SUPPLEMENTAL REGISTER

FIRST USE 1-20-2012; IN COMMERCE 1-20-2012.

THE MARK CONSISTS OF STANDARD CHARACTERS WITHOUT CLAIM TO ANY PARTICULAR FONT, STYLE, SIZE, OR COLOR.

SER. NO. 85-438,919, FILED P.R. 10-4-2011; AM. S.R. 3-19-2012.

ALLISON SCHRODY, EXAMINING ATTORNEY



David J. Kyros

Director of the United States Patent and Trademark Office

United States of America

United States Patent and Trademark Office

LEAVE OF ABSENCE ADVISOR

Reg. No. 4,156,003

REED GROUP, LTD. (COLORADO CORPORATION)
10155 WESTMOOR DRIVE, SUITE 210
WESTMINSTER, CO 80021

Registered June 5, 2012

Int. Cl.: 42

FOR: PROVIDING TEMPORARY USE OF NON-DOWNLOADABLE COMPUTER SOFTWARE FOR ADMINISTRATION AND MANAGEMENT OF EMPLOYEE LEAVE; CLOUD COMPUTING FEATURING SOFTWARE FOR USE IN ADMINISTRATION AND MANAGEMENT OF EMPLOYEE LEAVE, IN CLASS 42 (U.S. CLS. 100 AND 101).

SERVICE MARK

SUPPLEMENTAL REGISTER FIRST USE 7-26-2011; IN COMMERCE 7-26-2011.

THE MARK CONSISTS OF STANDARD CHARACTERS WITHOUT CLAIM TO ANY PARTICULAR FONT, STYLE, SIZE, OR COLOR.

SER. NO. 85-439,243, FILED P.R. 10-4-2011; AM. S.R. 4-5-2012.

MARC LEIPZIG, EXAMINING ATTORNEY

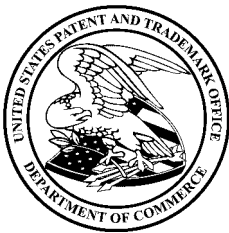

David J. Kyffers

Director of the United States Patent and Trademark Office

United States of America

United States Patent and Trademark Office

DINER SELECTS

Reg. No. 4,156,004

PEI WEI ASIAN DINER, INC. (DELAWARE CORPORATION)
7676 E. PINNACLE PEAK ROAD
SCOTTSDALE, AZ 85255

Registered June 5, 2012

Int. Cl.: 29

FOR: COMBINATION MEAL CONSISTING PRIMARILY OF MEAT, SEAFOOD, POULTRY OR VEGETABLES FOR CONSUMPTION ON OR OFF THE PREMISES, IN CLASS 29 (U.S. CL. 46).

TRADEMARK

FIRST USE 10-10-2011; IN COMMERCE 10-10-2011.

SUPPLEMENTAL REGISTER

THE MARK CONSISTS OF STANDARD CHARACTERS WITHOUT CLAIM TO ANY PARTICULAR FONT, STYLE, SIZE, OR COLOR.

SER. NO. 85-448,097, FILED P.R. 10-14-2011; AM. S.R. 3-20-2012.

CURTIS FRENCH, EXAMINING ATTORNEY



David J. Kybas

Director of the United States Patent and Trademark Office

United States of America

United States Patent and Trademark Office

DINER SELECTS

Reg. No. 4,156,005

PEI WEI ASIAN DINER, INC. (DELAWARE CORPORATION)
7676 E. PINNACLE PEAK ROAD
SCOTTSDALE, AZ 85255

Registered June 5, 2012

Int. Cl.: 30

FOR: COMBINATION MEAL CONSISTING PRIMARILY OF PASTA OR RICE FOR CONSUMPTION ON AND OFF THE PREMISES, IN CLASS 30 (U.S. CL. 46).

TRADEMARK

FIRST USE 10-10-2011; IN COMMERCE 10-10-2011.

SUPPLEMENTAL REGISTER

THE MARK CONSISTS OF STANDARD CHARACTERS WITHOUT CLAIM TO ANY PARTICULAR FONT, STYLE, SIZE, OR COLOR.

SER. NO. 85-448,101, FILED P.R. 10-14-2011; AM. S.R. 3-20-2012.

CURTIS FRENCH, EXAMINING ATTORNEY



David J. Kybas

Director of the United States Patent and Trademark Office

United States of America

United States Patent and Trademark Office

HEALTHY COFFEE

Reg. No. 4,156,006

RAMIREZ MORELES, SELOMITH (MEXICO INDIVIDUAL)
ALVARO OBREGON 145 CENTRO
IRAPUATO, MEXICO

Registered June 5, 2012

Int. Cl.: 5

FOR: DIETARY AND NUTRITIONAL SUPPLEMENTS CONTAINING COFFEE FLAVORED GOJI BERRIES, GUARANA SEEDS AND REISHI FUNGUS, IN CLASS 5 (U.S. CLS. 6, 18, 44, 46, 51 AND 52).

TRADEMARK

FIRST USE 1-2-2006; IN COMMERCE 10-5-2008.

SUPPLEMENTAL REGISTER

THE MARK CONSISTS OF STANDARD CHARACTERS WITHOUT CLAIM TO ANY PARTICULAR FONT, STYLE, SIZE, OR COLOR.

NO CLAIM IS MADE TO THE EXCLUSIVE RIGHT TO USE "COFFEE", APART FROM THE MARK AS SHOWN.

SER. NO. 85-449,386, FILED P.R. 10-17-2011; AM. S.R. 3-7-2012.

ANNE MADDEN, EXAMINING ATTORNEY



David J. Kybas

Director of the United States Patent and Trademark Office

United States of America

United States Patent and Trademark Office

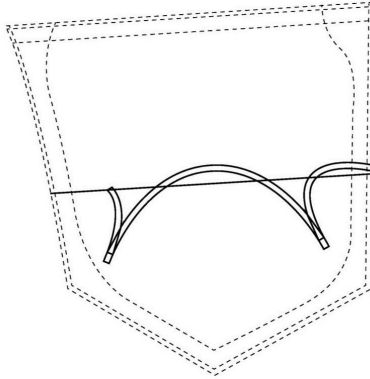

Reg. No. 4,156,007

Registered June 5, 2012

Int. Cl.: 25

TRADEMARK

SUPPLEMENTAL REGISTER

CHILD OF THE INDIGO (CALIFORNIA LIMITED LIABILITY COMPANY)
#402
173 N MARENGO AVE
PASADENA, CA 91101

FOR: CLOTHING, NAMELY, PANTS AND DENIM JEANS, IN CLASS 25 (U.S. CLS. 22 AND 39).

FIRST USE 3-7-2012; IN COMMERCE 3-7-2012.

THE MARK CONSISTS OF A HORIZONTAL LINE EXTENDING ACROSS THE POCKET. BEGINNING ON THE LEFT SIDE OF THE HORIZONTAL LINE, AN ARCH EXTENDS BELOW THE HORIZONTAL LINE AND THEN UP AND OVER THE HORIZONTAL LINE, BEFORE EXTENDING BELOW THE HORIZONTAL LINE AND AGAIN EXTENDING ABOVE THE HORIZONTAL LINE. THE ARCH ENDS ABOVE THE HORIZONTAL LINE AT THE EDGE OF THE POCKET. THE SHAPE OF THE POCKET AND BROKEN LINES FORMING THE POCKET ARE NOT PART OF THE MARK BUT ONLY SERVE TO SHOW POSITION OF THE MARK ON THE GOODS.

SER. NO. 85-451,359, FILED P.R. 10-19-2011; AM. S.R. 3-23-2012.

JESSICA FATHY, EXAMINING ATTORNEY



David J. Kyros

Director of the United States Patent and Trademark Office

United States of America

United States Patent and Trademark Office

VIRTUAL TUMOR BOARD

Reg. No. 4,156,008

Registered June 5, 2012

Int. Cls.: 9 and 41

TRADEMARK

SERVICE MARK

SUPPLEMENTAL REGISTER

INTELLISPHERE, LLC (DELAWARE LIMITED LIABILITY COMPANY)
666 PLAINSBORO ROAD
PLAINSBORO, NJ 08536

FOR: ELECTRONIC DOWNLOADABLE PUBLICATIONS, NAMELY, ARTICLES FOR USE BY MEDICAL PROFESSIONALS IN THE FIELD OF SCIENCE AND MEDICINE, IN CLASS 9 (U.S. CLS. 21, 23, 26, 36 AND 38).

FIRST USE 1-24-2012; IN COMMERCE 1-24-2012.

FOR: PROVIDING A WEBSITE FEATURING RESOURCES, NAMELY, NON-DOWNLOADABLE PUBLICATIONS IN THE NATURE OF ARTICLES IN THE FIELD OF ONCOLOGY, IN CLASS 41 (U.S. CLS. 100, 101 AND 107).

FIRST USE 1-24-2012; IN COMMERCE 1-24-2012.

THE MARK CONSISTS OF STANDARD CHARACTERS WITHOUT CLAIM TO ANY PARTICULAR FONT, STYLE, SIZE, OR COLOR.

SER. NO. 85-451,591, FILED P.R. 10-19-2011; AM. S.R. 4-4-2012.

MARC LEIPZIG, EXAMINING ATTORNEY



David J. Kybas

Director of the United States Patent and Trademark Office

United States of America

United States Patent and Trademark Office

Top it off every time.

Reg. No. 4,156,009

PILOT TRAVEL CENTERS LLC (DELAWARE LIMITED LIABILITY COMPANY)
5508 LONAS DRIVE
KNOXVILLE, TN 37909

Registered June 5, 2012

Int. Cl.: 1

FOR: DIESEL EXHAUST FLUID , IN CLASS 1 (U.S. CLS. 1, 5, 6, 10, 26 AND 46).

TRADEMARK

FIRST USE 9-1-2011; IN COMMERCE 9-1-2011.

SUPPLEMENTAL REGISTER

THE MARK CONSISTS OF STANDARD CHARACTERS WITHOUT CLAIM TO ANY PARTICULAR FONT, STYLE, SIZE, OR COLOR.

SER. NO. 85-451,973, FILED 10-20-2011.

CORY BOONE, EXAMINING ATTORNEY



David J. Kybas

Director of the United States Patent and Trademark Office

United States of America

United States Patent and Trademark Office



Reg. No. 4,156,010

NATIONWIDE CARPET UPHOLSTERY & TILE CLEANING, INC (FLORIDA CORPORATION)
8332 FRESH CREEK
WEST PALM BEACH, FL 33411

Registered June 5, 2012

Int. Cl.: 37

FOR: CARPET CLEANING, IN CLASS 37 (U.S. CLS. 100, 103 AND 106).

SERVICE MARK

FIRST USE 1-20-1999; IN COMMERCE 10-28-2002.

SUPPLEMENTAL REGISTER

NO CLAIM IS MADE TO THE EXCLUSIVE RIGHT TO USE "CARPET & UPHOLSTERY CLEANING", APART FROM THE MARK AS SHOWN.

THE MARK CONSISTS OF AN IMAGE OF THE CONTINENTAL UNITED STATES WITH THE STYLIZED TEXT "NATIONWIDE CARPET & UPHOLSTERY CLEANING" OVERLAPPING IT, WHERE "NATIONWIDE" APPEARS ABOVE "CARPET & UPHOLSTERY CLEANING".

SER. NO. 85-452,568, FILED P.R. 10-20-2011; AM. S.R. 4-25-2012.

B. PARADEWELAI, EXAMINING ATTORNEY



David J. Kybas

Director of the United States Patent and Trademark Office

United States of America

United States Patent and Trademark Office



Reg. No. 4,156,011

MATHEW ARON (UNITED STATES INDIVIDUAL)
2181 WILLOW STREET
SAN DIEGO, CA 92106

Registered June 5, 2012

Int. Cl.: 25

FOR: CLOTHING, NAMELY, SHIRTS, T-SHIRTS, UNDER-SHIRTS, NIGHT-SHIRTS, JERSEYS, UNIFORMS, PANTS, TROUSERS, JEANS, DENIM JEANS, JUMP SUITS, SHORTS, BOXER SHORTS, TOPS, CROP TOPS, TANK TOPS, HALTER TOPS, SWEAT SHIRTS, SWEAT SHORTS, SWEAT PANTS, BLOUSES, VESTS, LEATHER VESTS, JACKETS, LEATHER JACKETS, REVERSIBLE JACKETS, COATS, TURTLENECKS, BEANIES, VISORS, SWEAT BANDS, APRONS, BANDANAS, NECKWEAR, PANTIES, TEDDIES, LEG WARMERS, LEGGINGS, LEOTARDS, BASEBALL CAPS, KNIT HATS, CAPS, BERETS, HATS, HEAD-BANDS, AND HEADWEAR, IN CLASS 25 (U.S. CLS. 22 AND 39).

TRADEMARK

SUPPLEMENTAL REGISTER

FIRST USE 10-10-2011; IN COMMERCE 10-10-2011.

THE MARK CONSISTS OF A STYLIZED HEART WITH ATTACHED STYLIZED WINGS.

SER. NO. 85-453,287, FILED P.R. 10-21-2011; AM. S.R. 3-29-2012.

CHRISTOPHER LAW, EXAMINING ATTORNEY



David J. Kybas

Director of the United States Patent and Trademark Office

United States of America

United States Patent and Trademark Office



Reg. No. 4,156,012

Registered June 5, 2012

Int. Cl.: 25

TRADEMARK

SUPPLEMENTAL REGISTER

MATHEW ARON (UNITED STATES INDIVIDUAL)
2181 WILLOW STREET
SAN DIEGO, CA 92106

FOR: CLOTHING, NAMELY, SHIRTS, T-SHIRTS, UNDER-SHIRTS, NIGHT-SHIRTS, JERSEYS, UNIFORMS, PANTS, TROUSERS, JEANS, DENIM JEANS, JUMP SUITS, SHORTS, BOXER SHORTS, TOPS, CROP TOPS, TANK TOPS, HALTER TOPS, SWEAT SHIRTS, SWEAT SHORTS, SWEAT PANTS, BLOUSES, VESTS, LEATHER VESTS, JACKETS, LEATHER JACKETS, REVERSIBLE JACKETS, COATS, TURTLENECKS, BEANIES, VISORS, SWEAT BANDS, APRONS, BANDANAS, NECKWEAR, PANTIES, TEDDIES, LEG WARMERS, LEGGINGS, LEOTARDS, BASEBALL CAPS, KNIT HATS, CAPS, BERETS, HATS, HEAD-BANDS, AND HEADWEAR, IN CLASS 25 (U.S. CLS. 22 AND 39).

FIRST USE 10-10-2011; IN COMMERCE 10-10-2011.

THE MARK CONSISTS OF A STYLIZED FEMALE FORM.

SER. NO. 85-453,328, FILED P.R. 10-21-2011; AM. S.R. 3-29-2012.

CHRISTOPHER LAW, EXAMINING ATTORNEY



David J. Kyffers

Director of the United States Patent and Trademark Office

United States of America

United States Patent and Trademark Office

Private Wealth Retreat

Reg. No. 4,156,013

Registered June 5, 2012

Int. Cl.: 36

SERVICE MARK

SUPPLEMENTAL REGISTER

BRUNO, STEPHANIE (UNITED STATES INDIVIDUAL)
P. O. BOX 13679
DENVER, CO 80201

FOR: PROVIDING INFORMATION AND ADVICE IN THE FIELD OF FINANCE, FINANCIAL INVESTMENTS, FINANCIAL VALUATIONS, AND THE FINANCIAL ASPECTS OF RETIREMENT; FINANCIAL SERVICES, NAMELY, INVESTMENT ADVICE AND INVESTMENT MANAGEMENT; FINANCIAL SERVICES, NAMELY, PROVIDING CONSULTATION, INFORMATION, AND ADVICE IN THE FIELDS OF WEALTH BUILDING, WEALTH PROTECTION, AND ASSET PROTECTION; INVESTMENT CONSULTATION AND INVESTMENT OF FUNDS FOR OTHERS, INCLUDING PRIVATE AND PUBLIC EQUITY AND DEBT INVESTMENT SERVICES; FINANCIAL ADVICE AND CONSULTANCY SERVICES; FINANCIAL SERVICES, NAMELY, WEALTH MANAGEMENT SERVICES AND PERSONAL FINANCE ADVICE; PROVIDING ADVICE RELATING TO INVESTMENTS AND FINANCIAL GOAL-SETTING, IN CLASS 36 (U.S. CLS. 100, 101 AND 102).

FIRST USE 6-1-2011; IN COMMERCE 6-1-2011.

THE MARK CONSISTS OF STANDARD CHARACTERS WITHOUT CLAIM TO ANY PARTICULAR FONT, STYLE, SIZE, OR COLOR.

NO CLAIM IS MADE TO THE EXCLUSIVE RIGHT TO USE "PRIVATE WEALTH", APART FROM THE MARK AS SHOWN.

SER. NO. 85-453,444, FILED P.R. 10-21-2011; AM. S.R. 3-28-2012.

KIMBERLY FRYE, EXAMINING ATTORNEY



David J. Kybas

Director of the United States Patent and Trademark Office

United States of America

United States Patent and Trademark Office

PACE3P

Reg. No. 4,156,014

Registered June 5, 2012

Int. Cl.: 36

SERVICE MARK

SUPPLEMENTAL REGISTER

DEMETER POWER GROUP, INC. (DELAWARE CORPORATION)
224 DATURA STREET
SUITE 211
WEST PALM BEACH, FL 33401

FOR: FINANCING SERVICES, NAMELY, A THIRD-PARTY OWNERSHIP FINANCING PROGRAM OFFERED TO A PROPERTY OWNER FOR IMPROVEMENTS TO PROPERTY THROUGH A "PROPERTY ASSESSED CLEAN ENERGY" OR "PACE" PROGRAM OR SIMILAR PROGRAM THAT UTILIZES A LOCAL GOVERNMENT'S AUTHORITY TO PROVIDE FINANCING TO A PROPERTY OWNER AND OBTAIN REPAYMENT THROUGH A GOVERNMENTAL ASSESSMENT OR OTHER COLLECTION MECHANISM, IN CLASS 36 (U.S. CLS. 100, 101 AND 102).

FIRST USE 12-8-2011; IN COMMERCE 12-8-2011.

THE MARK CONSISTS OF STANDARD CHARACTERS WITHOUT CLAIM TO ANY PARTICULAR FONT, STYLE, SIZE, OR COLOR.

SER. NO. 85-457,074, FILED P.R. 10-26-2011; AM. S.R. 3-15-2012.

SUSAN LESLIE DUBOIS, EXAMINING ATTORNEY



David J. Kyros

Director of the United States Patent and Trademark Office

United States of America

United States Patent and Trademark Office

AFFORDABLEBUTTONS

Reg. No. 4,156,015

SPRINGBOARD DEVELOPMENT COMPANY INC. (MINNESOTA CORPORATION)
3269 19TH STREET NW
ROCHESTER, MN 55901

Registered June 5, 2012

Int. Cl.: 40

FOR: CUSTOM IMPRINTING OF PIN BACKED BUTTONS WITH MESSAGES; CUSTOM
MANUFACTURE OF PIN BACKED BUTTONS, IN CLASS 40 (U.S. CLS. 100, 103 AND 106).

SERVICE MARK

FIRST USE 9-1-2003; IN COMMERCE 9-1-2003.

SUPPLEMENTAL REGISTER

THE MARK CONSISTS OF STANDARD CHARACTERS WITHOUT CLAIM TO ANY PAR-
TICULAR FONT, STYLE, SIZE, OR COLOR.

OWNER OF U.S. REG. NO. 3,711,517.

SER. NO. 85-457,610, FILED P.R. 10-27-2011; AM. S.R. 3-27-2012.

PAUL MORENO, EXAMINING ATTORNEY



David J. Kybas

Director of the United States Patent and Trademark Office

United States of America

United States Patent and Trademark Office

Glampers

Reg. No. 4,156,016

HANSEN, CATHY (TEXAS JOINT VENTURE), DBA GLAMPERS,
2829 TEXAS AVE.

Registered June 5, 2012

TEXAS CITY, TX 77590 AND

Int. Cl.: 35

LYNELL CRAWFORD (UNITED STATES JOINT VENTURE), DBA GLAMPERS,
2829 TEXAS AVE
TEXAS CITY, TX 77590

SERVICE MARK

SUPPLEMENTAL REGISTER

FOR: CLUB SERVICES, NAMELY, PROMOTING THE INTERESTS OF CAMPING, IN CLASS
35 (U.S. CLS. 100, 101 AND 102).

FIRST USE 2-2-2012; IN COMMERCE 2-2-2012.

THE MARK CONSISTS OF STANDARD CHARACTERS WITHOUT CLAIM TO ANY PARTICULAR FONT, STYLE, SIZE, OR COLOR.

SER. NO. 85-461,774, FILED P.R. 11-1-2011; AM. S.R. 4-5-2012.

DAVID MURRAY, EXAMINING ATTORNEY



David J. Kyfos

Director of the United States Patent and Trademark Office

United States of America

United States Patent and Trademark Office

Diabetes Center of Cape Cod

Reg. No. 4,156,017

CLARK, NATHANIEL G. (UNITED STATES INDIVIDUAL)
34 DAWSON WAY
EAST FALMOUTH, MA 02536

Registered June 5, 2012

Int. Cl.: 44

FOR: MEDICAL SERVICES, IN CLASS 44 (U.S. CLS. 100 AND 101).

SERVICE MARK

FIRST USE 3-1-2012; IN COMMERCE 3-1-2012.

SUPPLEMENTAL REGISTER

THE MARK CONSISTS OF STANDARD CHARACTERS WITHOUT CLAIM TO ANY PARTICULAR FONT, STYLE, SIZE, OR COLOR.

NO CLAIM IS MADE TO THE EXCLUSIVE RIGHT TO USE "DIABETES CENTER", APART FROM THE MARK AS SHOWN.

SER. NO. 85-462,292, FILED P.R. 11-2-2011; AM. S.R. 4-14-2012.

SOPHIA S. KIM, EXAMINING ATTORNEY



David J. Kyffers

Director of the United States Patent and Trademark Office

United States of America

United States Patent and Trademark Office

Corn

Reg. No. 4,156,018

WEISS, DANNA (UNITED STATES INDIVIDUAL)
561 10TH AVE. #31E
NEW YORK, NY 10036

Registered June 5, 2012

Int. Cl.: 25

FOR: ECO FRIENDLY WOMEN'S DRESS LINE, NAMELY, DRESSES, TOPS, PANTS, SKIRTS, SKORTS, JACKETS, COATS, SCARVES, PONCHOS, LEG WARMERS, LEGGINGS, HATS, ALL FEATURING CORN, IN CLASS 25 (U.S. CLS. 22 AND 39).

TRADEMARK

FIRST USE 4-5-2012; IN COMMERCE 4-5-2012.

SUPPLEMENTAL REGISTER

THE MARK CONSISTS OF STANDARD CHARACTERS WITHOUT CLAIM TO ANY PARTICULAR FONT, STYLE, SIZE, OR COLOR.

SER. NO. 85-462,967, FILED P.R. 11-2-2011; AM. S.R. 4-5-2012.

EMILY CHUO, EXAMINING ATTORNEY



David J. Kybas

Director of the United States Patent and Trademark Office

United States of America

United States Patent and Trademark Office

Rancho Santa Fe Magazine

Reg. No. 4,156,019

Registered June 5, 2012

Int. Cls.: 16 and 35

TRADEMARK

SERVICE MARK

SUPPLEMENTAL REGISTER

CHANCELLOR-MADDISON, JACQUELINE JANE (UNITED STATES INDIVIDUAL), DBA
RANCHO SANTA FE MAGAZINE,
PO BOX 8842
RANCHO SANTA FE, CA 92067

FOR: MAGAZINES IN THE FIELD OF RANCHO SANTA FE, CALIFORNIA FEATURING
PHOTOGRAPHS, ARTICLES, AND ADVERTISEMENTS WITH PROFESSIONAL PROFILES,
BUSINESS, FINANCIAL MATTERS, WEALTH MANAGEMENT, LUXURY LIFESTYLE,
AND REAL ESTATE, IN CLASS 16 (U.S. CLS. 2, 5, 22, 23, 29, 37, 38 AND 50).

FIRST USE 7-1-2011; IN COMMERCE 7-15-2011.

FOR: PROVIDING ADVERTISING, MARKETING AND PROMOTIONAL SERVICES,
NAMELY, DEVELOPMENT OF ADVERTISING CAMPAIGNS PROVIDED THROUGH CABLE
TELEVISION BROADCAST, WEB CASTS, RADIO BROADCASTS, NEWSPAPERS,
MAGAZINES, ONLINE BANNERS, OUTDOOR BILLBOARDS, WILD POSTINGS, BUS AND
SUBWAY ADS, IN CLASS 35 (U.S. CLS. 100, 101 AND 102).

FIRST USE 7-1-2011; IN COMMERCE 7-15-2011.

THE MARK CONSISTS OF STANDARD CHARACTERS WITHOUT CLAIM TO ANY PAR-
TICULAR FONT, STYLE, SIZE, OR COLOR.

NO CLAIM IS MADE TO THE EXCLUSIVE RIGHT TO USE "MAGAZINE", APART FROM
THE MARK AS SHOWN.

SER. NO. 85-465,445, FILED P.R. 11-5-2011; AM. S.R. 4-23-2012.

B. PARADEWELAI, EXAMINING ATTORNEY



David J. Kypos

Director of the United States Patent and Trademark Office

United States of America

United States Patent and Trademark Office

KLEAN

Reg. No. 4,156,020

Registered June 5, 2012

Int. Cl.: 3

TRADEMARK

SUPPLEMENTAL REGISTER

NVENTA INCORPORATED (ARIZONA CORPORATION)
LEGAL
POBOX 13778
SCOTTSDALE, AZ 852673778

FOR: ALCOHOL FOR CLEANING PURPOSES; ALL PURPOSE CLEANING PREPARATION WITH DEODORIZING PROPERTIES; ALL PURPOSE CLEANING PREPARATIONS; AMMONIA FOR CLEANING PURPOSES; AROMATIC PREPARATIONS, NAMELY, CLEANING PREPARATIONS FOR USE IN CLEANING AND POLISHING JEWELRY, PRECIOUS METALS, SEMI-PRECIOUS METALS, METALS, PEARLS, DIAMONDS, GEMSTONES, COSTUME JEWELRY, AND FASHION JEWELRY; CLEANING AGENTS AND PREPARATIONS; CLEANING AGENTS FOR CLEANING SURFACES; CLEANING AND POLISHING PAPER; CLEANING AND POLISHING PREPARATIONS; CLEANING AND WASHING PREPARATIONS; CLEANING PREPARATIONS; CLEANING PREPARATIONS CONTAINING VITAMINS, MINERALS, PLANT EXTRACTS AND/OR BOTANICALS, USED TO PRESERVE HARD SURFACES BY RENDERING THE SURFACES FREE OF AGING AGENTS; CLEANING PREPARATIONS FOR CLEANING SURFACES; CLEANING PREPARATIONS FOR HOUSEHOLD PURPOSES; CLEANING PREPARATIONS FOR CLEANING PREPARATIONS FOR USE IN CLEANING AND POLISHING JEWELRY, PRECIOUS METALS, SEMI-PRECIOUS METALS, METALS, PEARLS, DIAMONDS, GEMSTONES, COSTUME JEWELRY, AND FASHION JEWELRY; CLEANING SWABS FOR HOUSEHOLD PURPOSES; CLEANING, POLISHING AND SCOURING PREPARATIONS; CLEANING, SCOURING AND POLISHING PREPARATIONS AND SUBSTANCES; CLEANING, WASHING AND POLISHING PREPARATIONS; CLEANSING AND POLISHING PREPARATIONS; CLOTHS IMPREGNATED WITH A DETERGENT FOR CLEANING; DISPOSABLE WIPES IMPREGNATED WITH CLEANING CHEMICALS OR COMPOUNDS FOR INDUSTRIAL AND COMMERCIAL USE; DRY CLEANING FLUIDS; EYEGLASS LENS CLEANING SOLUTIONS; EYEWEAR CLEANING KITS COMPRISED OF CLEANING FLUID AND A CLEANING CLOTH; GENERAL PURPOSE CLEANING, POLISHING, AND ABRASIVE LIQUIDS AND POWDERS; GUN-CLEANING PREPARATIONS; IMPREGNATED CLEANING CLOTHS; IMPREGNATED CLEANING PADS IMPREGNATED WITH COSMETICS; IMPREGNATED CLEANING PADS IMPREGNATED WITH TOILET PREPARATIONS; IMPREGNATED CLEANING, DUSTING OR POLISHING CLOTHS; IMPREGNATED CLOTHS FOR POLISHING; METAL POLISHING AND CLEANING PREPARATIONS; POLISH FOR MUSICAL INSTRUMENTS; POLISHING POWDERS; POLISHING PREPARATIONS; POLISHING, SCOURING AND ABRASIVE PREPARATIONS; SHINING PREPARATIONS; STONE POLISHING PREPARATIONS, IN CLASS 3 (U.S. CLS. 1, 4, 6, 50, 51 AND 52).



David J. Kyros

Director of the United States Patent and Trademark Office

Reg. No. 4,156,020 FIRST USE 9-11-2011; IN COMMERCE 9-11-2011.

THE MARK CONSISTS OF STANDARD CHARACTERS WITHOUT CLAIM TO ANY PARTICULAR FONT, STYLE, SIZE, OR COLOR.

SER. NO. 85-465,876, FILED P.R. 11-7-2011; AM. S.R. 3-7-2012.

KATHLEEN KOLACZ, EXAMINING ATTORNEY

United States of America

United States Patent and Trademark Office

Sagan

Reg. No. 4,156,021

Registered June 5, 2012

Int. Cl.: 9

TRADEMARK

SUPPLEMENTAL REGISTER

SOFTWINK, INC. (FLORIDA CORPORATION), DBA QUADRANT INFORMATION SECURITY,
4651 SALISBURY ROAD, SUITE 411
JACKSONVILLE, FL 32256

FOR: COMPUTER SOFTWARE AND HARDWARE FOR REAL TIME SECURITY EVENT MANAGEMENT AND ANALYSIS, IN CLASS 9 (U.S. CLS. 21, 23, 26, 36 AND 38).

FIRST USE 6-1-2010; IN COMMERCE 4-1-2011.

THE MARK CONSISTS OF STANDARD CHARACTERS WITHOUT CLAIM TO ANY PARTICULAR FONT, STYLE, SIZE, OR COLOR.

THE WORDING "SAGAN" HAS NO MEANING IN A FOREIGN LANGUAGE.

SER. NO. 85-468,171, FILED P.R. 11-9-2011; AM. S.R. 4-11-2012.

BRIAN PINO, EXAMINING ATTORNEY



David J. Kyffers

Director of the United States Patent and Trademark Office

United States of America

United States Patent and Trademark Office

ScheduleInterpreter

Reg. No. 4,156,022

Registered June 5, 2012

Int. Cl.: 42

SERVICE MARK

SUPPLEMENTAL REGISTER

SCHEDULEINTERPRETER.COM, INC. (KANSAS CORPORATION)
7007 COLLEGE BOULEVARD, SUITE 460
OVERLAND PARK, KS 66211

FOR: CLOUD COMPUTING FEATURING SOFTWARE FOR USE IN SCHEDULING AND MANAGEMENT OF FOREIGN LANGUAGE AND AMERICAN SIGN LANGUAGE INTERPRETING SERVICES, IN CLASS 42 (U.S. CLS. 100 AND 101).

FIRST USE 11-3-2011; IN COMMERCE 11-3-2011.

THE MARK CONSISTS OF THE STYLIZED PHRASE "SCHEDULEINTERPRETER", WITH "S" CAPITALIZED AND "I" CAPITALIZED, NO SPACE BETWEEN THE WORDS, LETTERS IN THE WORD "SCHEDULE" ARE IN ORANGE COLOR, LETTERS IN THE WORD INTERPRETER ARE IN TURQUOISE COLOR.

THE COLOR(S) ORANGE, TURQUOISE IS/ARE CLAIMED AS A FEATURE OF THE MARK.

SER. NO. 85-468,228, FILED 11-9-2011.

TINA L. SNAPP, EXAMINING ATTORNEY



David J. Kybas

Director of the United States Patent and Trademark Office

United States of America

United States Patent and Trademark Office

UNIFIED PURCHASING GROUP

Reg. No. 4,156,023

Registered June 5, 2012

Int. Cl.: 35

SERVICE MARK

SUPPLEMENTAL REGISTER

UNIFIED PURCHASING GROUP, LLC (UTAH LIMITED LIABILITY COMPANY)
901 WEST BAXTER DRIVE
SOUTH JORDAN, UT 84095

FOR: BUSINESS SERVICES, NAMELY, COMBINED STRATEGIC GOODS OR SERVICES SOURCING AND COOPERATIVE PURCHASING FOR OTHERS; ADMINISTERING GROUP PURCHASING PROGRAMS, NAMELY, NEGOTIATING CONTRACTS WITH VENDORS AND SUPPLIERS TO ENABLE ASSOCIATION MEMBERS TO OBTAIN GROUP PURCHASING DISCOUNTS AND ROYALTIES, IN CLASS 35 (U.S. CLS. 100, 101 AND 102).

FIRST USE 1-1-2008; IN COMMERCE 1-1-2008.

THE MARK CONSISTS OF STANDARD CHARACTERS WITHOUT CLAIM TO ANY PARTICULAR FONT, STYLE, SIZE, OR COLOR.

NO CLAIM IS MADE TO THE EXCLUSIVE RIGHT TO USE "PURCHASING GROUP", APART FROM THE MARK AS SHOWN.

SER. NO. 85-471,519, FILED P.R. 11-14-2011; AM. S.R. 4-12-2012.

ALAIN LAPTEK, EXAMINING ATTORNEY



David J. Kyros

Director of the United States Patent and Trademark Office

United States of America

United States Patent and Trademark Office

Pitch Gauge

Reg. No. 4,156,024

Registered June 5, 2012

Int. Cl.: 9

TRADEMARK

SUPPLEMENTAL REGISTER

PROLIFIC METHODS, LLC (GEORGIA LIMITED LIABILITY COMPANY)
1937 NATALIE DRIVE
BETHLEHEM, GA 30620

FOR: COMPUTER APPLICATION SOFTWARE FOR MOBILE DEVICES, NAMELY, SOFTWARE FOR CALCULATING THE DEGREE OF SLOPE SLANT STATED IN INCHES RISE PER FOOT AND THE SIZE OF A ROOF WHEN GIVEN THE LENGTH, WIDTH, PITCH AND CUT LEVEL, IN CLASS 9 (U.S. CLS. 21, 23, 26, 36 AND 38).

FIRST USE 5-1-2010; IN COMMERCE 9-3-2010.

THE MARK CONSISTS OF STANDARD CHARACTERS WITHOUT CLAIM TO ANY PARTICULAR FONT, STYLE, SIZE, OR COLOR.

SER. NO. 85-472,335, FILED P.R. 11-14-2011; AM. S.R. 4-16-2012.

MIDGE BUTLER, EXAMINING ATTORNEY



David J. Kyffers

Director of the United States Patent and Trademark Office

United States of America

United States Patent and Trademark Office

CORE SPECIFIC REVOLUTION

Reg. No. 4,156,025 UFC ULTIMATE FITNESS CENTER LLC. (CALIFORNIA LIMITED LIABILITY COMPANY)
1380 3RD AVE
Registered June 5, 2012 CHULA VISTA, CA 91911

Int. Cl.: 41 FOR: GROUP EXERCISE FITNESS CLASSES; INSTRUCTION OF PHYSICAL FITNESS, IN CLASS 41 (U.S. CLS. 100, 101 AND 107).

SERVICE MARK FIRST USE 6-1-2011; IN COMMERCE 6-1-2011.

SUPPLEMENTAL REGISTER THE MARK CONSISTS OF STANDARD CHARACTERS WITHOUT CLAIM TO ANY PARTICULAR FONT, STYLE, SIZE, OR COLOR.

OWNER OF U.S. REG. NO. 4,103,363.

SER. NO. 85-473,174, FILED P.R. 11-15-2011; AM. S.R. 3-13-2012.

CHARISMA HAMPTON, EXAMINING ATTORNEY



David J. Kyros

Director of the United States Patent and Trademark Office

United States of America

United States Patent and Trademark Office

TRAVEL RESEARCH APPRENTICE

Reg. No. 4,156,026

Registered June 5, 2012

Int. Cl.: 41

SERVICE MARK

SUPPLEMENTAL REGISTER

AMERICAN EXPRESS MARKETING & DEVELOPMENT CORP. (DELAWARE CORPORATION)
200 VESEY STREET
NEW YORK, NY 10285

FOR: BUSINESS TRAINING IN THE FIELD OF TRAVEL SERVICES. PROVIDING EDUCATIONAL MENTORING SERVICES AND PROGRAMS IN THE FIELD OF TRAVEL SERVICES, IN CLASS 41 (U.S. CLS. 100, 101 AND 107).

FIRST USE 10-31-2010; IN COMMERCE 10-31-2010.

THE MARK CONSISTS OF STANDARD CHARACTERS WITHOUT CLAIM TO ANY PARTICULAR FONT, STYLE, SIZE, OR COLOR.

NO CLAIM IS MADE TO THE EXCLUSIVE RIGHT TO USE "APPRENTICE", APART FROM THE MARK AS SHOWN.

SER. NO. 85-474,033, FILED P.R. 11-16-2011; AM. S.R. 2-15-2012.

STEVEN PEREZ, EXAMINING ATTORNEY



David J. Kyros

Director of the United States Patent and Trademark Office

United States of America

United States Patent and Trademark Office



Reg. No. 4,156,027

Registered June 5, 2012

Int. Cl.: 9

TRADEMARK

SUPPLEMENTAL REGISTER

ANSELL LIMITED (AUSTRALIA CORPORATION)
VICTORIA GARDENS, LEVEL 3
678 VICTORIA STREET
RICHMOND, AUSTRALIA 3121

FOR: GLOVES FOR PROTECTION AGAINST ACCIDENTS; PROTECTIVE GLOVES FOR INDUSTRIAL USE; PROTECTIVE WORK GLOVES, IN CLASS 9 (U.S. CLS. 21, 23, 26, 36 AND 38).

FIRST USE 4-8-2006; IN COMMERCE 4-8-2006.

OWNER OF U.S. REG. NO. 3,376,673.

THE COLOR(S) BLACK AND BURGUNDY IS/ARE CLAIMED AS A FEATURE OF THE MARK.

THE MARK CONSISTS OF THE COLOR BLACK AND BURGUNDY APPLIED TO THE ENTIRE SURFACE OF PROTECTIVE GLOVES WHEREIN THE COLOR BLACK APPEARS ON THE FINGER AND HAND PORTION OF THE GLOVES AND THE BURGUNDY APPEARS ON THE CUFFS. THE MATTER SHOWN IN BROKEN LINES ON THE DRAWING SHOWS POSITIONING OF THE MARK ON THE GOODS AND NEITHER OF THE MATTER SHOW IN BROKEN LINES NOR THE CONFIGURATION OF THE GLOVES IS CLAIMED AS A FEATURE OF THE MARK.

SER. NO. 85-474,049, FILED 11-16-2011.

MYRIAH HABEEB, EXAMINING ATTORNEY



David J. Kyffers

Director of the United States Patent and Trademark Office

United States of America

United States Patent and Trademark Office

REVERSE MORTGAGE USA

Reg. No. 4,156,028

Registered June 5, 2012

Int. Cl.: 36

SERVICE MARK

SUPPLEMENTAL REGISTER

REVERSE MORTGAGE USA, INC. (TEXAS CORPORATION)
6500 RIVER PLACE BLVD., BLDG. 1, STE.425
AUSTIN, TX 78730

FOR: MAINTAINING MORTGAGE ESCROW ACCOUNTS; MORTGAGE BANKING; MORTGAGE BANKING SERVICES, NAMELY, ORIGINATION, ACQUISITION, SERVICING, SECURITIZATION AND BROKERAGE OF MORTGAGE LOANS; MORTGAGE BROKERAGE; MORTGAGE LENDING; MORTGAGE PROCUREMENT FOR OTHERS; MORTGAGE SERVICES, NAMELY, BUYER PRE-QUALIFICATION OF MORTGAGES FOR MORTGAGE BROKERS AND BANKS, IN CLASS 36 (U.S. CLS. 100, 101 AND 102).

FIRST USE 9-19-2011; IN COMMERCE 9-19-2011.

THE MARK CONSISTS OF STANDARD CHARACTERS WITHOUT CLAIM TO ANY PARTICULAR FONT, STYLE, SIZE, OR COLOR.

NO CLAIM IS MADE TO THE EXCLUSIVE RIGHT TO USE "REVERSE MORTGAGE", APART FROM THE MARK AS SHOWN.

SER. NO. 85-474,391, FILED 11-16-2011.

MARLENE BELL, EXAMINING ATTORNEY



David J. Kyffers

Director of the United States Patent and Trademark Office

United States of America

United States Patent and Trademark Office

EnterpriseGRC Solutions, Inc.

Reg. No. 4,156,029

BASHAM, ROBIN (UNITED STATES INDIVIDUAL)
534 NORTH 7TH STREET
SAN JOSE, CA 95112

Registered June 5, 2012

Int. Cl.: 45

FOR: REGULATORY COMPLIANCE CONSULTING IN THE FIELD OF ENTERPRISE GOVERNANCE, RISK AND COMPLIANCE (GRC) ARCHITECTURE AND STRATEGY, NAMELY, IMPLEMENTING TEMPLATES AND BASELINE PRODUCTS TOWARDS ACHIEVING ENTERPRISE COMPLIANCE WITH STANDARD FRAMEWORKS AND REGULATIONS, IN CLASS 45 (U.S. CLS. 100 AND 101).

SERVICE MARK

SUPPLEMENTAL REGISTER

FIRST USE 9-3-2011; IN COMMERCE 10-3-2011.

THE MARK CONSISTS OF STANDARD CHARACTERS WITHOUT CLAIM TO ANY PARTICULAR FONT, STYLE, SIZE, OR COLOR.

NO CLAIM IS MADE TO THE EXCLUSIVE RIGHT TO USE "INC.", APART FROM THE MARK AS SHOWN.

SER. NO. 85-475,757, FILED 11-17-2011.

ROBIN MITTLER, EXAMINING ATTORNEY



David J. Kybas

Director of the United States Patent and Trademark Office

United States of America

United States Patent and Trademark Office

THE ATHLETE'S HEADPHONE

Reg. No. 4,156,030

MONSTER, INC. (CALIFORNIA CORPORATION)
455 VALLEY DRIVE
BRISBANE, CA 94005

Registered June 5, 2012

Int. Cl.: 9

FOR: HEADPHONES, IN CLASS 9 (U.S. CLS. 21, 23, 26, 36 AND 38).

TRADEMARK

FIRST USE 9-24-2010; IN COMMERCE 9-24-2010.

SUPPLEMENTAL REGISTER

THE MARK CONSISTS OF STANDARD CHARACTERS WITHOUT CLAIM TO ANY PARTICULAR FONT, STYLE, SIZE, OR COLOR.

NO CLAIM IS MADE TO THE EXCLUSIVE RIGHT TO USE "HEADPHONE", APART FROM THE MARK AS SHOWN.

SER. NO. 85-475,900, FILED P.R. 11-17-2011; AM. S.R. 3-21-2012.

ALEX KEAM, EXAMINING ATTORNEY



David J. Kybas

Director of the United States Patent and Trademark Office

United States of America

United States Patent and Trademark Office

Social Decision Making

Reg. No. 4,156,031

Registered June 5, 2012

Int. Cl.: 42

SERVICE MARK

SUPPLEMENTAL REGISTER

LABATE, MICHAEL N. (UNITED STATES INDIVIDUAL)
757 SOUTH CHADWICK STREET
PHILADELPHIA, PA 19146

FOR: COMPUTER SERVICES, NAMELY, CREATING AN ON-LINE COMMUNITY FOR REGISTERED USERS TO CREATE AND SHARE PUBLIC AND PRIVATE SURVEYS, PARTICIPATE IN PUBLIC AND PRIVATE SURVEYS, ACQUIRE FEEDBACK FROM PARTICIPANTS, PROVIDE FEEDBACK TO PARTICIPANTS, AND ENGAGE IN SOCIAL NETWORKING FOR PURPOSES OF OBTAINING INPUT AND FEEDBACK FROM MULTIPLE PARTICIPANTS, IN CLASS 42 (U.S. CLS. 100 AND 101).

FIRST USE 10-1-2011; IN COMMERCE 10-1-2011.

THE MARK CONSISTS OF STANDARD CHARACTERS WITHOUT CLAIM TO ANY PARTICULAR FONT, STYLE, SIZE, OR COLOR.

SER. NO. 85-478,120, FILED 11-21-2011.

MICHAEL TANNER, EXAMINING ATTORNEY



David J. Kyffers

Director of the United States Patent and Trademark Office

United States of America

United States Patent and Trademark Office

LOW PRICES EVERYDAY AT MATTRESS DEPOT USA

Reg. No. 4,156,032

MATTRESS DEPOT USA, INC (WASHINGTON CORPORATION)
14603 NE 20TH STREET
BELLEVUE, WA 98007

Registered June 5, 2012

Int. Cl.: 35

FOR: RETAIL STORE AND ON-LINE RETAIL STORE SERVICES FEATURING MATTRESSES,
BOX SPRINGS, HEAD BOARDS, BED FRAMES, BUNK BEDS, DAY BEDS, AND SLEEPERS,
IN CLASS 35 (U.S. CLS. 100, 101 AND 102).

SERVICE MARK

FIRST USE 2-1-2009; IN COMMERCE 2-1-2009.

SUPPLEMENTAL REGISTER

THE MARK CONSISTS OF STANDARD CHARACTERS WITHOUT CLAIM TO ANY PAR-
TICULAR FONT, STYLE, SIZE, OR COLOR.

SER. NO. 85-480,029, FILED P.R. 11-23-2011; AM. S.R. 4-6-2012.

LUCY ARANT, EXAMINING ATTORNEY



David J. Kyros

Director of the United States Patent and Trademark Office

United States of America

United States Patent and Trademark Office

SafeHost

Reg. No. 4,156,033

Registered June 5, 2012

Int. Cl.: 42

SERVICE MARK

SUPPLEMENTAL REGISTER

UBISTOR, INC. (ILLINOIS CORPORATION)
1111 PLAZA DRIVE
SUITE 600
SCHAUMBURG, IL 60173

FOR: COMPUTER SERVICES, NAMELY, DATA ENCRYPTION, BACKUP AND RECOVERY,
IN CLASS 42 (U.S. CLS. 100 AND 101).

FIRST USE 11-1-2011; IN COMMERCE 11-1-2011.

THE MARK CONSISTS OF STANDARD CHARACTERS WITHOUT CLAIM TO ANY PAR-
TICULAR FONT, STYLE, SIZE, OR COLOR.

OWNER OF U.S. REG. NOS. 3,137,512, 3,662,189, AND 3,688,444.

SER. NO. 85-481,210, FILED P.R. 11-28-2011; AM. S.R. 3-29-2012.

TASNEEM HUSSAIN, EXAMINING ATTORNEY



David J. Kyros

Director of the United States Patent and Trademark Office

United States of America

United States Patent and Trademark Office

Easter Crosses

Reg. No. 4,156,034

CRT INC. (WEST VIRGINIA CORPORATION), DBA DAVIS DISTRIBUTION SYSTEMS,
#52 QUAKER STATE ROAD
NEWELL, WV 26050

Registered June 5, 2012

Int. Cl.: 35

FOR: WHOLESALE DISTRIBUTORSHIPS FEATURING PLASTIC AND WOODEN CROSSES,
IN CLASS 35 (U.S. CLS. 100, 101 AND 102).

SERVICE MARK

FIRST USE 10-27-2011; IN COMMERCE 10-27-2011.

SUPPLEMENTAL REGISTER

THE MARK CONSISTS OF STANDARD CHARACTERS WITHOUT CLAIM TO ANY PARTICULAR FONT, STYLE, SIZE, OR COLOR.

NO CLAIM IS MADE TO THE EXCLUSIVE RIGHT TO USE "CROSSES", APART FROM THE MARK AS SHOWN.

SER. NO. 85-482,304, FILED P.R. 11-29-2011; AM. S.R. 3-29-2012.

DOMINICK J. SALEMI, EXAMINING ATTORNEY



David J. Kyros

Director of the United States Patent and Trademark Office

United States of America

United States Patent and Trademark Office

REGISTERED FRANCHISE CONSULTANTS

Reg. No. 4,156,035

Registered June 5, 2012

Int. Cl.: 41

AMERICAN BUSINESS ALLIANCE, INC.- (WASHINGTON CORPORATION), AKA BUSINESS ALLIANCE, INC.,
701 5TH AVE
SUITE 3510
SEATTLE, WA 98104

SERVICE MARK

FOR: BUSINESS TRAINING CONSULTANCY SERVICES, IN CLASS 41 (U.S. CLS. 100, 101 AND 107).

SUPPLEMENTAL REGISTER FIRST USE 1-3-2007; IN COMMERCE 1-3-2007.

THE MARK CONSISTS OF STANDARD CHARACTERS WITHOUT CLAIM TO ANY PARTICULAR FONT, STYLE, SIZE, OR COLOR.

SER. NO. 85-482,685, FILED P.R. 11-29-2011; AM. S.R. 3-13-2012.

LAKEISHA LEWIS, EXAMINING ATTORNEY



David J. Kyffers

Director of the United States Patent and Trademark Office

United States of America

United States Patent and Trademark Office

TUG & TOSS BALL

Reg. No. 4,156,036

CANOPY BOOKS LLC (DELAWARE LIMITED LIABILITY COMPANY)
50 CARNATION AVE
FLORAL PARK, NY 11001

Registered June 5, 2012

Int. Cl.: 28

FOR: DOG TOYS; PET TOYS, IN CLASS 28 (U.S. CLS. 22, 23, 38 AND 50).

TRADEMARK

FIRST USE 3-0-2010; IN COMMERCE 3-0-2010.

SUPPLEMENTAL REGISTER

THE MARK CONSISTS OF STANDARD CHARACTERS WITHOUT CLAIM TO ANY PARTICULAR FONT, STYLE, SIZE, OR COLOR.

NO CLAIM IS MADE TO THE EXCLUSIVE RIGHT TO USE "BALL", APART FROM THE MARK AS SHOWN.

SER. NO. 85-484,307, FILED P.R. 11-30-2011; AM. S.R. 3-20-2012.

DAWN HAN, EXAMINING ATTORNEY



David J. Kyffers

Director of the United States Patent and Trademark Office

United States of America

United States Patent and Trademark Office

PAR 3 TOUR

Reg. No. 4,156,037

THE PAR 3 TOUR LLC. (CALIFORNIA LIMITED LIABILITY COMPANY)
10332 DARBY RD.
APPLE VALLEY, CA 92308

Registered June 5, 2012

Int. Cl.: 41

FOR: ENTERTAINMENT IN THE NATURE OF GOLF TOURNAMENTS; ORGANIZATION OF GOLF TOURNAMENT AND COMPETITIONS, IN CLASS 41 (U.S. CLS. 100, 101 AND 107).

SERVICE MARK

FIRST USE 7-11-2011; IN COMMERCE 7-26-2011.

SUPPLEMENTAL REGISTER

THE MARK CONSISTS OF STANDARD CHARACTERS WITHOUT CLAIM TO ANY PARTICULAR FONT, STYLE, SIZE, OR COLOR.

SER. NO. 85-485,476, FILED P.R. 12-2-2011; AM. S.R. 4-13-2012.

DANNEAN HETZEL, EXAMINING ATTORNEY



David J. Kyffers

Director of the United States Patent and Trademark Office

United States of America

United States Patent and Trademark Office

Aluminous

DESIGNS

Reg. No. 4,156,038

DOMINIC'S DOWNTOWN INC. (NEW MEXICO CORPORATION)
198 E. HWY 66
GALLUP, NM 87301

Registered June 5, 2012

Int. Cl.: 14

FOR: HANDCRAFTED NATIVE-AMERICAN INDIAN JEWELRY OUT MADE FROM ALUMINUM METAL, IN CLASS 14 (U.S. CLS. 2, 27, 28 AND 50).

TRADEMARK

FIRST USE 6-1-2011; IN COMMERCE 6-1-2011.

SUPPLEMENTAL REGISTER

THE MARK CONSISTS OF THE STYLIZED TEXT "ALUMINOUS DESIGNS".

SER. NO. 85-485,734, FILED P.R. 12-2-2011; AM. S.R. 4-13-2012.

MARK SPARACINO, EXAMINING ATTORNEY



David J. Kyffers

Director of the United States Patent and Trademark Office

United States of America
United States Patent and Trademark Office

KIGGINS

Reg. No. 4,156,039

SAVE-A-LOT FOOD STORES, LTD. (BERMUDA CORPORATION)
100 CORPORATE OFFICE DRIVE
EARTH CITY, MO 63045

Registered June 5, 2012

Int. Cl.: 30

FOR: BREAKFAST CEREALS, IN CLASS 30 (U.S. CL. 46).

TRADEMARK

FIRST USE 12-20-2011; IN COMMERCE 12-20-2011.

SUPPLEMENTAL REGISTER

THE MARK CONSISTS OF STANDARD CHARACTERS WITHOUT CLAIM TO ANY PARTICULAR FONT, STYLE, SIZE, OR COLOR.

SER. NO. 85-486,403, FILED P.R. 12-2-2011; AM. S.R. 3-27-2012.

ALICIA COLLINS, EXAMINING ATTORNEY



David J. Kyffers

Director of the United States Patent and Trademark Office

United States of America

United States Patent and Trademark Office

GET CLIENTS WITH PRESENTATIONS

Reg. No. 4,156,040

PHILIP LAW INC (CALIFORNIA CORPORATION)
1501 CUMBERLAND LANE
NEWPORT BEACH, CA 92660

Registered June 5, 2012

Int. Cl.: 35

FOR: BUSINESS MANAGEMENT CONSULTING SERVICES TO FINANCIAL INSTITUTIONS AND PROFESSIONAL SERVICE FIRMS IN THE FIELD OF THE CONTENT, DATA-GRAPHICS AND DELIVERY OF ORAL SALES PRESENTATIONS TO PROSPECTIVE CLIENTS, IN CLASS 35 (U.S. CLS. 100, 101 AND 102).

SERVICE MARK

SUPPLEMENTAL REGISTER FIRST USE 11-30-2011; IN COMMERCE 11-30-2011.

THE MARK CONSISTS OF STANDARD CHARACTERS WITHOUT CLAIM TO ANY PARTICULAR FONT, STYLE, SIZE, OR COLOR.

SER. NO. 85-487,744, FILED P.R. 12-6-2011; AM. S.R. 4-11-2012.

GINA FINK, EXAMINING ATTORNEY



David J. Kybas

Director of the United States Patent and Trademark Office

United States of America

United States Patent and Trademark Office

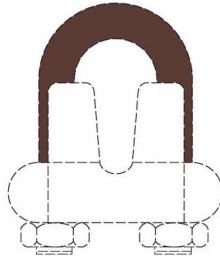

Reg. No. 4,156,041

Registered June 5, 2012

Int. Cl.: 6

TRADEMARK

SUPPLEMENTAL REGISTER

LES CABLES BEN-MOR INC. (CANADA CORPORATION)
1105, RUE LEMIRE ST-HYACINTHE
QUEBEC, CANADA J2T1L8

FOR: METAL WIRE ROPE CLIP, IN CLASS 6 (U.S. CLS. 2, 12, 13, 14, 23, 25 AND 50).

FIRST USE 8-31-2008; IN COMMERCE 8-31-2008.

THE MARK CONSISTS OF THE COLOR BROWN APPLIED TO THE SURFACE OF THE VISIBLE PORTION OF THE THREE-DIMENSIONAL U-BOLT OF A THREE DIMENSIONAL WIRE ROPE CLIP. THE SHAPE OF THE U-BOLT, SHOWN IN DOTTED LINES, IS NOT CLAIMED AS A FEATURE OF THE MARK.

THE COLOR(S) BROWN IS/ARE CLAIMED AS A FEATURE OF THE MARK.

SER. NO. 85-488,037, FILED P.R. 12-6-2011; AM. S.R. 3-12-2012.

EMILY CARLSEN, EXAMINING ATTORNEY



David J. Kyffers

Director of the United States Patent and Trademark Office

United States of America

United States Patent and Trademark Office

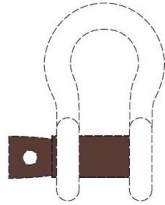

Reg. No. 4,156,042

Registered June 5, 2012

Int. Cl.: 6

TRADEMARK

SUPPLEMENTAL REGISTER

LES CABLES BEN-MOR INC. (CANADA CORPORATION)
1105, RUE LEMIRE ST-HYACINTHE
QUEBEC, CANADA J2T1L8

FOR: METAL SCREW PIN SHACKLE, ROUND PIN SHACKLE AND BOLT TYPE SHACKLE,
IN CLASS 6 (U.S. CLS. 2, 12, 13, 14, 23, 25 AND 50).

FIRST USE 8-31-2008; IN COMMERCE 8-31-2008.

THE MARK CONSISTS OF THE COLOR BROWN APPLIED TO THE SURFACE OF THE
VISIBLE PORTIONS OF THE THREE DIMENSIONAL SHACKLE PIN OF A THREE DIMEN-
SIONAL SHACKLE. THE SHAPE OF THE SHACKLE, SHOWN IN DOTTED LINES, IS NOT
CLAIMED AS A FEATURE OF THE MARK.

THE COLOR(S) BROWN IS/ARE CLAIMED AS A FEATURE OF THE MARK.

SER. NO. 85-488,101, FILED P.R. 12-6-2011; AM. S.R. 3-12-2012.

EMILY CARLSEN, EXAMINING ATTORNEY



David J. Kybas

Director of the United States Patent and Trademark Office

United States of America

United States Patent and Trademark Office

WEIBEL

Reg. No. 4,156,043

Registered June 5, 2012

Int. Cl.: 7

TRADEMARK

SUPPLEMENTAL REGISTER

WIEBEL LIFT AG (SWITZERLAND CORPORATION)
HOLZHÄUSERNSTRASSE 33
MENZINGEN, SWITZERLAND CH-6313

FOR: MECHANICAL LIFTS FOR VIDEO AND FILM PROJECTORS, IN CLASS 7 (U.S. CLS. 13, 19, 21, 23, 31, 34 AND 35).

THE MARK CONSISTS OF STANDARD CHARACTERS WITHOUT CLAIM TO ANY PARTICULAR FONT, STYLE, SIZE, OR COLOR.

OWNER OF ERPN CMNTY TM OFC REG. NO. 1026944, DATED 1-4-2010, EXPIRES 1-4-2020.

SER. NO. 85-489,401, FILED 12-7-2011.

GINA HAYES, EXAMINING ATTORNEY



David J. Kybas

Director of the United States Patent and Trademark Office

United States of America

United States Patent and Trademark Office

VIRTUAL SPA SYSTEM

Reg. No. 4,156,044

SUSSMAN-AUTOMATIC CORPORATION (NEW YORK CORPORATION)
43-20 34TH STREET
LONG ISLAND CITY, NY 11101

Registered June 5, 2012

Int. Cl.: 42

FOR: PROVIDING AN ON-LINE NON-DOWNLOADABLE SOFTWARE PROGRAM THAT ENABLES USERS TO CUSTOM DESIGN RESIDENTIAL STEAM BATHS, SPAS AND ACCESSORIES, IN CLASS 42 (U.S. CLS. 100 AND 101).

SERVICE MARK

FIRST USE 12-7-2011; IN COMMERCE 12-7-2011.

SUPPLEMENTAL REGISTER

THE MARK CONSISTS OF STANDARD CHARACTERS WITHOUT CLAIM TO ANY PARTICULAR FONT, STYLE, SIZE, OR COLOR.

SER. NO. 85-490,011, FILED P.R. 12-7-2011; AM. S.R. 3-29-2012.

CAROLINE WOOD, EXAMINING ATTORNEY



David J. Kyros

Director of the United States Patent and Trademark Office

United States of America

United States Patent and Trademark Office

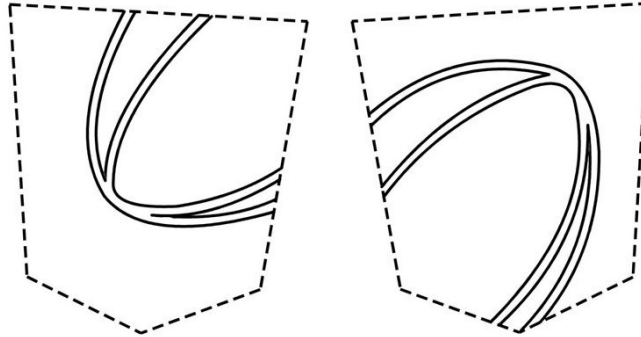

Reg. No. 4,156,045

Registered June 5, 2012

Int. Cl.: 25

TRADEMARK

SUPPLEMENTAL REGISTER

EUCLIDE AVRIDOR (UNITED STATES INDIVIDUAL)
1295 5TH AVENUE #18G
NEW YORK, NY 10029 AND

MYLENE DELATTRE (FRANCE INDIVIDUAL)
1295 5TH AVENUE #18G
NEW YORK, NY 10029

FOR: DENIMS; JEANS; JEGGINGS, NAMELY, PANTS THAT ARE PARTIALLY JEANS AND PARTIALLY LEGGINGS; MEN'S AND WOMEN'S JACKETS, COATS, TROUSERS, VESTS; PANTS; SHIRTS; SHORTS; SKIRTS, IN CLASS 25 (U.S. CLS. 22 AND 39).

FIRST USE 9-6-2011; IN COMMERCE 11-19-2011.

THE MARK CONSISTS OF TWO POCKET DESIGN REPRESENTED BY SOLID LINES. THE BROKEN LINES SURROUNDING THE MARK REPRESENT THE OVERALL SHAPE OF THE POCKET AND SERVE ONLY TO SHOW THE POSITION AND THE PLACEMENT OF THE MARK RELATIVE TO THE OVERALL POCKET.

SER. NO. 85-490,087, FILED P.R. 12-8-2011; AM. S.R. 4-12-2012.

JACLYN KIDWELL WALKER, EXAMINING ATTORNEY



David J. Kyffers

Director of the United States Patent and Trademark Office

United States of America

United States Patent and Trademark Office

Landa Mobile Systems

Reg. No. 4,156,046

LANDA MOBILE SYSTEMS LLC (ARKANSAS LIMITED LIABILITY COMPANY)
997 MCKNIGHT AVE
WEST FORK, AR 72774

Registered June 5, 2012

Int. Cl.: 40

FOR: CUSTOM MANUFACTURE OF PORTABLE COMMUNICATIONS TOWERS ON TRAILERS FOR OTHERS, IN CLASS 40 (U.S. CLS. 100, 103 AND 106).

SERVICE MARK

FIRST USE 9-1-2011; IN COMMERCE 9-1-2011.

SUPPLEMENTAL REGISTER

THE MARK CONSISTS OF STANDARD CHARACTERS WITHOUT CLAIM TO ANY PARTICULAR FONT, STYLE, SIZE, OR COLOR.

NO CLAIM IS MADE TO THE EXCLUSIVE RIGHT TO USE "MOBILE SYSTEMS", APART FROM THE MARK AS SHOWN.

SER. NO. 85-492,365, FILED 12-11-2011.

MICHAEL WEBSTER, EXAMINING ATTORNEY



David J. Kyros

Director of the United States Patent and Trademark Office

United States of America
United States Patent and Trademark Office

BOGNER

Reg. No. 4,156,047

DAVID BOGNER FAMILY FUNERAL HOME INC. (OHIO CORPORATION)
36625 CENTER RIDGE ROAD
NORTH RIDGEVILLE, OH 44039

Registered June 5, 2012

Int. Cls.: 40 and 45

FOR: CREMATION SERVICES, IN CLASS 40 (U.S. CLS. 100, 103 AND 106).

SERVICE MARK

FIRST USE 12-9-2011; IN COMMERCE 12-9-2011.

SUPPLEMENTAL REGISTER

FOR: FUNERAL ARRANGEMENT SERVICES; FUNERAL HOMES; FUNERAL SERVICE UNDERTAKING; FUNERAL SERVICES ACCOMPANYING CREMATION, IN CLASS 45 (U.S. CLS. 100 AND 101).

FIRST USE 12-9-2011; IN COMMERCE 12-9-2011.

THE MARK CONSISTS OF STANDARD CHARACTERS WITHOUT CLAIM TO ANY PARTICULAR FONT, STYLE, SIZE, OR COLOR.

SER. NO. 85-492,525, FILED P.R. 12-12-2011; AM. S.R. 4-25-2012.

JENNIFER DIXON, EXAMINING ATTORNEY



David J. Kybas

Director of the United States Patent and Trademark Office

United States of America

United States Patent and Trademark Office

American Made Dorm

Reg. No. 4,156,048

AMERICAN MADE DORM, LLC (KENTUCKY LIMITED LIABILITY COMPANY)
4965 US HWY. 42, SUITE 1000
LOUISVILLE, KY 40222

Registered June 5, 2012

Int. Cl.: 35

FOR: COMPUTERIZED ON-LINE RETAIL STORE SERVICES IN THE FIELD OF BEDDING, LINENS, AND DORM ROOM DECOR, ALL MANUFACTURED IN THE UNITED STATES OF AMERICA, IN CLASS 35 (U.S. CLS. 100, 101 AND 102).

SERVICE MARK

FIRST USE 10-3-2011; IN COMMERCE 11-15-2011.

SUPPLEMENTAL REGISTER

THE MARK CONSISTS OF STANDARD CHARACTERS WITHOUT CLAIM TO ANY PARTICULAR FONT, STYLE, SIZE, OR COLOR.

NO CLAIM IS MADE TO THE EXCLUSIVE RIGHT TO USE "DORM", APART FROM THE MARK AS SHOWN.

SER. NO. 85-498,260, FILED P.R. 12-18-2011; AM. S.R. 4-6-2012.

JOHN E. MICHOS, EXAMINING ATTORNEY



David J. Kybas

Director of the United States Patent and Trademark Office

United States of America

United States Patent and Trademark Office

INSURED CASH SWEEP

Reg. No. 4,156,049

Registered June 5, 2012

Int. Cl.: 36

SERVICE MARK

SUPPLEMENTAL REGISTER

PROMONTORY INTERFINANCIAL NETWORK, LLC (DELAWARE LIMITED LIABILITY COMPANY)
1515 NORTH COURTHOUSE ROAD
ARLINGTON, VA 22201

FOR: BANKING SERVICES; FINANCIAL SERVICES, NAMELY, ASSISTING FINANCIAL INSTITUTIONS WITH THE MANAGEMENT OF CUSTOMER FUNDS AND FACILITATING THE TRANSFER OF FUNDS BETWEEN FUND SOURCES AND DEPOSIT ACCOUNTS; FINANCIAL SERVICES, NAMELY, THE MANAGEMENT OF DEPOSIT ACCOUNTS AND FACILITATING THE TRANSFER OF FUNDS BETWEEN FUND SOURCES AND DEPOSIT ACCOUNTS; FINANCIAL SERVICES, NAMELY, FUNDS TRANSFER AND TRANSACTION SERVICES; FINANCIAL SERVICES, NAMELY, ALLOCATION OF FUNDS TO AND PLACEMENT OF FUNDS IN DEPOSIT ACCOUNTS; FINANCIAL TRANSACTION SERVICES, NAMELY, MAINTAINING CUSTOMER RECORDS FOR FINANCIAL TRANSACTIONS, CUSTODIAL AND SUB-CUSTODIAL SERVICES, AND SETTLEMENT SERVICES; FDIC INSURANCE CLAIM PROCESSING SERVICES, IN CLASS 36 (U.S. CLS. 100, 101 AND 102).

FIRST USE 0-0-2010; IN COMMERCE 0-0-2010.

THE MARK CONSISTS OF STANDARD CHARACTERS WITHOUT CLAIM TO ANY PARTICULAR FONT, STYLE, SIZE, OR COLOR.

OWNER OF U.S. REG. NO. 4,053,744.

NO CLAIM IS MADE TO THE EXCLUSIVE RIGHT TO USE "CASH SWEEP", APART FROM THE MARK AS SHOWN.

SER. NO. 85-498,932, FILED 12-19-2011.

DAWN FELDMAN, EXAMINING ATTORNEY



David J. Kybas

Director of the United States Patent and Trademark Office

United States of America

United States Patent and Trademark Office

Payano

Reg. No. 4,156,050

PAYANO, ALLEN (UNITED STATES INDIVIDUAL)
226 1ST ST. #3A
JERSEY CITY, NJ 07302

Registered June 5, 2012

Int. Cl.: 35

FOR: ADVERTISING, MARKETING AND PROMOTION SERVICES IN THE FIELD OF DIGITAL AND SOCIAL MEDIA AND FILM PRODUCTION, IN CLASS 35 (U.S. CLS. 100, 101 AND 102).

SERVICE MARK

FIRST USE 12-24-2011; IN COMMERCE 12-24-2011.

SUPPLEMENTAL REGISTER

THE MARK CONSISTS OF STANDARD CHARACTERS WITHOUT CLAIM TO ANY PARTICULAR FONT, STYLE, SIZE, OR COLOR.

SER. NO. 85-500,435, FILED P.R. 12-20-2011; AM. S.R. 4-4-2012.

LEIGH CAROLINE CASE, EXAMINING ATTORNEY



David J. Kybas

Director of the United States Patent and Trademark Office

United States of America

United States Patent and Trademark Office

RAINBOW GLASS BEADS

Reg. No. 4,156,051

COUSIN CORPORATION OF AMERICA (FLORIDA CORPORATION)
12333 ENTERPRISE BLVD
LARGO, FL 33773

Registered June 5, 2012

Int. Cl.: 26

FOR: BEADS FOR HANDICRAFT WORK, IN CLASS 26 (U.S. CLS. 37, 39, 40, 42 AND 50).

FIRST USE 9-1-2000; IN COMMERCE 9-1-2000.

TRADEMARK

THE MARK CONSISTS OF STANDARD CHARACTERS WITHOUT CLAIM TO ANY PARTICULAR FONT, STYLE, SIZE, OR COLOR.

SUPPLEMENTAL REGISTER

NO CLAIM IS MADE TO THE EXCLUSIVE RIGHT TO USE "GLASS BEADS", APART FROM THE MARK AS SHOWN.

SER. NO. 85-500,791, FILED P.R. 12-21-2011; AM. S.R. 4-26-2012.

ELLEN B. AWRICH, EXAMINING ATTORNEY



David J. Kybas

Director of the United States Patent and Trademark Office

United States of America

United States Patent and Trademark Office

Brand-Driven Leadership

Reg. No. 4,156,052

Registered June 5, 2012

Int. Cl.: 35

SERVICE MARK

SUPPLEMENTAL REGISTER

WENDT COMMUNICATION PARTNERS LLC (PENNSYLVANIA LIMITED LIABILITY COMPANY)
5000 RITTER ROAD, SUITE 202
MECHANICSBURG, PA 17055

FOR: ADVERTISING AND MARKETING; ADVERTISING SERVICES, NAMELY, CREATING CORPORATE AND BRAND IDENTITY FOR OTHERS, IN CLASS 35 (U.S. CLS. 100, 101 AND 102).

FIRST USE 7-0-2009; IN COMMERCE 7-0-2009.

THE MARK CONSISTS OF STANDARD CHARACTERS WITHOUT CLAIM TO ANY PARTICULAR FONT, STYLE, SIZE, OR COLOR.

SER. NO. 85-501,873, FILED P.R. 12-22-2011; AM. S.R. 4-4-2012.

BARBARA BROWN, EXAMINING ATTORNEY



David J. Kybas

Director of the United States Patent and Trademark Office

United States of America

United States Patent and Trademark Office

PERFUME FOR LATINAS

Reg. No. 4,156,053

Registered June 5, 2012

Int. Cl.: 3

TRADEMARK

SUPPLEMENTAL REGISTER

PERFUME FOR LATINAS LLC (CALIFORNIA LIMITED LIABILITY COMPANY)
PO BOX 484
ALAMEDA, CA 94501

FOR: AROMATIC ESSENTIAL OILS; AROMATIC OILS; BODY SPRAYS; COLOGNE; COSMETIC OILS; COSMETIC OILS FOR THE EPIDERMIS; EAU DE COLOGNES; EAU DE PARFUM; EAU DE PERFUME; EAU DE TOILETTE; EAU DE TOILETTE AND EAU DE COLOGNE; EAU-DE-COLOGNE; EAU-DE-TOILETTE; EAUX DE COLOGNE; EAUX DE TOILETTE; ESSENTIAL OILS; ESSENTIAL OILS FOR AROMATHERAPY USE; ESSENTIAL OILS FOR PERSONAL USE; ESSENTIAL OILS FOR USE IN MANUFACTURING OF SCENTED PRODUCTS; ETHEREAL ESSENCES; ETHEREAL OILS; FRAGRANCES; FRAGRANCES AND PERFUMERY; FRAGRANCES FOR PERSONAL USE; LIQUID PERFUMES; NATURAL ESSENTIAL OILS; NON-MEDICATED SKIN CARE PREPARATION, NAMELY, BODY MIST; OILS FOR PERFUMES AND SCENTS; PERFUME; PERFUME OILS; PERFUME OILS FOR THE MANUFACTURE OF COSMETIC PREPARATIONS; PERFUMES; PERFUMES AND COLOGNES; SCENTED BODY SPRAY; SCENTED OILS; SYNTHETIC PERFUMERY, IN CLASS 3 (U.S. CLS. 1, 4, 6, 50, 51 AND 52).

FIRST USE 12-20-2011; IN COMMERCE 12-20-2011.

THE MARK CONSISTS OF STANDARD CHARACTERS WITHOUT CLAIM TO ANY PARTICULAR FONT, STYLE, SIZE, OR COLOR.

NO CLAIM IS MADE TO THE EXCLUSIVE RIGHT TO USE "PERFUME", APART FROM THE MARK AS SHOWN.

THE ENGLISH TRANSLATION OF "LATINAS" IN THE MARK IS "WOMEN OF LATIN AMERICAN ORIGIN".

SER. NO. 85-503,166, FILED 12-23-2011.

KATHERINE STOIDES, EXAMINING ATTORNEY



David J. Kyros

Director of the United States Patent and Trademark Office

United States of America

United States Patent and Trademark Office



Reg. No. 4,156,054

ENGSTROM, CHARLES ERIC (UNITED STATES INDIVIDUAL)
11 EDISON DRIVE
MONTAUK, NY 11954

Registered June 5, 2012

Int. Cl.: 29

FOR: OYSTERS, IN CLASS 29 (U.S. CL. 46).

TRADEMARK

FIRST USE 6-13-2011; IN COMMERCE 10-8-2011.

SUPPLEMENTAL REGISTER

NO CLAIM IS MADE TO THE EXCLUSIVE RIGHT TO USE "OYSTERS", APART FROM THE MARK AS SHOWN.

THE MARK CONSISTS OF AN OVAL WITH A GAP AT THE TOP AND THE BOTTOM. WITHIN THE GAP AT THE TOP IS THE STYLIZED TEXT "MONTAUK OYSTER WORKS" ABOVE THE STYLIZED TEXT "MONTAUK, NY". WITHIN THE GAP AT THE BOTTOM IS THE STYLIZED TEXT "OYSTERS". IN THE CENTER OF THE OVAL IS THE STYLIZED TEXT "MTK".

SER. NO. 85-505,149, FILED P.R. 12-28-2011; AM. S.R. 4-26-2012.

TASNEEM HUSSAIN, EXAMINING ATTORNEY



David J. Kyffers

Director of the United States Patent and Trademark Office

United States of America

United States Patent and Trademark Office

CameraTrace

Reg. No. 4,156,055

ACTIVETRAK INC. (OREGON CORPORATION), AKA GADGETTRAK,
208 SW FIRST AVEU SUITE 240
PORTLAND, OR 97204

Registered June 5, 2012

Int. Cls.: 42 and 45

FOR: COMPUTER SERVICES, NAMELY, PROVIDING SEARCH ENGINES FOR OBTAINING DATA ON A GLOBAL COMPUTER NETWORK FOR IDENTIFYING SPECIFIC CAMERAS FROM PHOTOS TAKEN FROM ANY PARTICULAR CAMERA, IN CLASS 42 (U.S. CLS. 100 AND 101).

SERVICE MARK

SUPPLEMENTAL REGISTER FIRST USE 12-20-2011; IN COMMERCE 12-20-2011.

FOR: LOST PROPERTY RETURN, IN CLASS 45 (U.S. CLS. 100 AND 101).

FIRST USE 12-20-2011; IN COMMERCE 12-20-2011.

THE MARK CONSISTS OF STANDARD CHARACTERS WITHOUT CLAIM TO ANY PARTICULAR FONT, STYLE, SIZE, OR COLOR.

SER. NO. 85-506,096, FILED P.R. 12-30-2011; AM. S.R. 4-6-2012.

LINDA POWELL, EXAMINING ATTORNEY



David J. Kyros

Director of the United States Patent and Trademark Office

United States of America

United States Patent and Trademark Office

DOWRY CASTAWAYS

Reg. No. 4,156,056

HOPEGIVERS INTERNATIONAL, INC. (SOUTH CAROLINA CORPORATION)
7300 OLD MOON RD.
COLUMBUS, GA 31909

Registered June 5, 2012

Int. Cl.: 36

FOR: CHARITABLE FUND RAISING SERVICES, IN CLASS 36 (U.S. CLS. 100, 101 AND 102).

SERVICE MARK

FIRST USE 9-19-2011; IN COMMERCE 9-19-2011.

SUPPLEMENTAL REGISTER

THE MARK CONSISTS OF STANDARD CHARACTERS WITHOUT CLAIM TO ANY PARTICULAR FONT, STYLE, SIZE, OR COLOR.

SER. NO. 85-506,223, FILED P.R. 12-30-2011; AM. S.R. 4-6-2012.

STEVEN JACKSON, EXAMINING ATTORNEY



David J. Kyros

Director of the United States Patent and Trademark Office

United States of America

United States Patent and Trademark Office

ECO-IT

Reg. No. 4,156,057

Registered June 5, 2012

Int. Cl.: 42

SERVICE MARK

SUPPLEMENTAL REGISTER

ECO-IT NETWORKING, INC (CALIFORNIA CORPORATION)
SUITE #105
1855 HAMILTON AVE.
SAN JOSE, CA 95125

FOR: COMPUTER SERVICES, NAMELY, CLOUD HOSTING PROVIDER SERVICES; IT CONSULTING SERVICES; IT INTEGRATION SERVICES, IN CLASS 42 (U.S. CLS. 100 AND 101).

FIRST USE 5-15-2008; IN COMMERCE 7-1-2008.

THE MARK CONSISTS OF STANDARD CHARACTERS WITHOUT CLAIM TO ANY PARTICULAR FONT, STYLE, SIZE, OR COLOR.

SER. NO. 85-506,619, FILED P.R. 12-30-2011; AM. S.R. 4-5-2012.

MICHAEL GAAFAR, EXAMINING ATTORNEY



David J. Kyros

Director of the United States Patent and Trademark Office

United States of America

United States Patent and Trademark Office

Doerr Realty

Reg. No. 4,156,058

DOERR REALTY (TEXAS SOLE PROPRIETORSHIP)
7113 SAN PEDRO AVE. #292
SAN ANTONIO, TX 78216

Registered June 5, 2012

Int. Cl.: 36

FOR: REAL ESTATE BROKERAGE, IN CLASS 36 (U.S. CLS. 100, 101 AND 102).

SERVICE MARK

FIRST USE 2-26-2009; IN COMMERCE 2-26-2009.

SUPPLEMENTAL REGISTER

THE MARK CONSISTS OF STANDARD CHARACTERS WITHOUT CLAIM TO ANY PARTICULAR FONT, STYLE, SIZE, OR COLOR.

NO CLAIM IS MADE TO THE EXCLUSIVE RIGHT TO USE "REALTY", APART FROM THE MARK AS SHOWN.

SER. NO. 85-506,646, FILED P.R. 12-30-2011; AM. S.R. 4-9-2012.

DAVID YONTEF, EXAMINING ATTORNEY



David J. Kyffers

Director of the United States Patent and Trademark Office

United States of America

United States Patent and Trademark Office

Carbon**K**free

Reg. No. 4,156,059

Registered June 5, 2012

Int. Cl.: 2

OPALSTONE AUSTRALASIA PTY. LTD. (AUSTRALIA CORPORATION)
SUITE 2
7 HINDE STREET
ASHMORE, AUSTRALIA

FOR: INK JET PRINTER INK, IN CLASS 2 (U.S. CLS. 6, 11 AND 16).

TRADEMARK

FIRST USE 8-1-2011; IN COMMERCE 8-1-2011.

SUPPLEMENTAL REGISTER

THE MARK CONSISTS OF THE WORDING "CARBONKFREE" IN A STYLIZED FONT. THE WORD "CARBON" IS COLORED GRAY. THE LETTER "K" IS COLORED BLACK AND IS IN BOLD. THE WORD "FREE" IS COLORED GREEN.

THE COLOR(S) GRAY, BLACK AND GREEN IS/ARE CLAIMED AS A FEATURE OF THE MARK.

SER. NO. 85-506,799, FILED 12-31-2011.

JAMES GRIFFIN, EXAMINING ATTORNEY



David J. Kyffers

Director of the United States Patent and Trademark Office

United States of America

United States Patent and Trademark Office

BIOMARKERS, PATHWAYS, AND TARGETED THERAPIES

Reg. No. 4,156,060

Registered June 5, 2012

Int. Cls.: 9 and 41

INTELLISPHERE, LLC (DELAWARE LIMITED LIABILITY COMPANY)
BUILDING 300
666 PLAINSBORO ROAD
PLAINSBORO, NJ 08536

FOR: DOWNLOADABLE ELECTRONIC PUBLICATIONS IN THE NATURE OF JOURNALS AND ARTICLES IN THE FIELD OF ONCOLOGY, IN CLASS 9 (U.S. CLS. 21, 23, 26, 36 AND 38).

TRADEMARK

SERVICE MARK

FIRST USE 12-28-2011; IN COMMERCE 12-28-2011.

SUPPLEMENTAL REGISTER

FOR: PROVIDING A WEBSITE FEATURING NON-DOWNLOADABLE PUBLICATIONS IN THE NATURE OF JOURNALS AND ARTICLES IN THE FIELD OF ONCOLOGY, IN CLASS 41 (U.S. CLS. 100, 101 AND 107).

FIRST USE 12-28-2011; IN COMMERCE 12-28-2011.

THE MARK CONSISTS OF STANDARD CHARACTERS WITHOUT CLAIM TO ANY PARTICULAR FONT, STYLE, SIZE, OR COLOR.

SER. NO. 85-507,071, FILED 1-2-2012.

BRIAN CALLAGHAN, EXAMINING ATTORNEY



David J. Kyros

Director of the United States Patent and Trademark Office

United States of America

United States Patent and Trademark Office

INNOVATIONS IN CARDIAC RHYTHM MANAGEMENT

Reg. No. 4,156,061

Registered June 5, 2012

Int. Cl.: 41

SERVICE MARK

SUPPLEMENTAL REGISTER

MEDIASPHERE MEDICAL, LLC (NEW JERSEY LIMITED LIABILITY COMPANY)
1080 N DELAWARE AVE., SUITE 502
PHILADELPHIA, PA 19125

FOR: EDUCATIONAL PUBLICATIONS, NAMELY, PROVIDING AN ON-LINE JOURNAL
IN THE FIELDS OF ELECTROPHYSIOLOGY AND CARDIOLOGY, IN CLASS 41 (U.S. CLS.
100, 101 AND 107).

FIRST USE 0-0-2010; IN COMMERCE 0-0-2010.

THE MARK CONSISTS OF STANDARD CHARACTERS WITHOUT CLAIM TO ANY PAR-
TICULAR FONT, STYLE, SIZE, OR COLOR.

OWNER OF U.S. REG. NO. 4,107,053.

SER. NO. 85-507,133, FILED P.R. 1-2-2012; AM. S.R. 4-8-2012.

CHRIS WELLS, EXAMINING ATTORNEY



David J. Kyffers

Director of the United States Patent and Trademark Office

United States of America

United States Patent and Trademark Office

ToxTRENDS

Reg. No. 4,156,062

Registered June 5, 2012

Int. Cl.: 41

SERVICE MARK

SUPPLEMENTAL REGISTER

TWIN CITIES TOXICOLOGY CONSORTIUM, LLC (MINNESOTA LIMITED LIABILITY COMPANY)
32956 COUNTY 24 BLVD
CANNON FALLS, MN 55009

FOR: EDUCATION SERVICES, NAMELY, PROVIDING LIVE AND ON-LINE CLASSES, SEMINARS, AND WORKSHOPS IN THE FIELD OF CLINICAL AND TACTICAL TOXICOLOGY, IN CLASS 41 (U.S. CLS. 100, 101 AND 107).

FIRST USE 1-1-2012; IN COMMERCE 1-1-2012.

THE MARK CONSISTS OF STANDARD CHARACTERS WITHOUT CLAIM TO ANY PARTICULAR FONT, STYLE, SIZE, OR COLOR.

SER. NO. 85-507,285, FILED 1-2-2012.

ROBIN MITTLER, EXAMINING ATTORNEY



David J. Kybas

Director of the United States Patent and Trademark Office

United States of America

United States Patent and Trademark Office

HOME ARCHITECTS

Reg. No. 4,156,063

SOELLNER, RAND (UNITED STATES INDIVIDUAL)

Registered June 5, 2012

P.O. BOX 907
CASHIERS, NC 28717

Int. Cl.: 42

FOR: ARCHITECTURAL DESIGN SERVICES, IN CLASS 42 (U.S. CLS. 100 AND 101).

SERVICE MARK

FIRST USE 4-27-2010; IN COMMERCE 4-27-2010.

SUPPLEMENTAL REGISTER

THE MARK CONSISTS OF STANDARD CHARACTERS WITHOUT CLAIM TO ANY PARTICULAR FONT, STYLE, SIZE, OR COLOR.

NO CLAIM IS MADE TO THE EXCLUSIVE RIGHT TO USE "ARCHITECTS", APART FROM THE MARK AS SHOWN.

SER. NO. 85-507,793, FILED P.R. 1-3-2012; AM. S.R. 4-12-2012.

JIM RINGLE, EXAMINING ATTORNEY



David J. Kybas

Director of the United States Patent and Trademark Office

United States of America

United States Patent and Trademark Office

super slider

Reg. No. 4,156,064

HAYS, TIM (UNITED STATES INDIVIDUAL)
14829 MIDDLESBOROUGH DR.
MATTHEWS, NC 28104

Registered June 5, 2012

Int. Cl.: 12

FOR: CLUTCH MECHANISMS FOR MOTOR CARS, IN CLASS 12 (U.S. CLS. 19, 21, 23, 31, 35 AND 44).

TRADEMARK

FIRST USE 9-1-2011; IN COMMERCE 9-1-2011.

SUPPLEMENTAL REGISTER

THE MARK CONSISTS OF STANDARD CHARACTERS WITHOUT CLAIM TO ANY PARTICULAR FONT, STYLE, SIZE, OR COLOR.

NO CLAIM IS MADE TO THE EXCLUSIVE RIGHT TO USE "SLIDER", APART FROM THE MARK AS SHOWN.

SER. NO. 85-508,207, FILED P.R. 1-4-2012; AM. S.R. 4-10-2012.

EUGENIA MARTIN, EXAMINING ATTORNEY



David J. Kybas

Director of the United States Patent and Trademark Office

United States of America

United States Patent and Trademark Office

Pay Per Insert

Reg. No. 4,156,065

Registered June 5, 2012

Int. Cl.: 35

SERVICE MARK

SUPPLEMENTAL REGISTER

OMNIBIN (ILLINOIS CORPORATION)
SUITE 167
618 S. NORTHWEST HWY
BARRINGTON, IL 60010

FOR: ADVERTISING AND PROMOTIONAL SERVICES ON BEHALF OF OTHERS; PROMOTIONAL SERVICES, NAMELY, PROMOTING THE GOODS AND SERVICES OF OTHERS THROUGH ELECTRONIC MAIL, CALENDAR LISTINGS, ANNOUNCEMENTS, ALERTS, REMINDERS, SUBSCRIPTIONS, AUDIO, VIDEO AND GRAPHICS OVER THE INTERNET OR OTHER COMMUNICATION NETWORK; DEVELOPING AND PROVIDING MARKETING PROGRAMS FOR ADVERTISERS, MARKETERS, AND CONTENT PROVIDERS; PROVIDING A WEBSITE WHERE ADVERTISERS, MARKETERS, AND CONTENT PROVIDERS CAN REACH, ENGAGE, AND INTERACT WITH ONLINE USERS FOR THE PURPOSES OF PROMOTION OR ADVERTISING, IN CLASS 35 (U.S. CLS. 100, 101 AND 102).

FIRST USE 9-22-2010; IN COMMERCE 10-26-2010.

THE MARK CONSISTS OF STANDARD CHARACTERS WITHOUT CLAIM TO ANY PARTICULAR FONT, STYLE, SIZE, OR COLOR.

SER. NO. 85-508,569, FILED P.R. 1-4-2012; AM. S.R. 4-9-2012.

KATHY DE JONGE, EXAMINING ATTORNEY



David J. Kyros

Director of the United States Patent and Trademark Office

United States of America

United States Patent and Trademark Office

FORCONSTRUCTIONPROS.COM

Reg. No. 4,156,066

CYGNUS BUSINESS MEDIA, INC. (DELAWARE CORPORATION)
1233 JANESVILLE AVENUE
FORT ATKINSON, WI 53538

Registered June 5, 2012

Int. Cl.: 37

FOR: PROVIDING A WEB SITE FEATURING NEWS AND INFORMATION IN THE CONSTRUCTION FIELD, IN CLASS 37 (U.S. CLS. 100, 103 AND 106).

SERVICE MARK

FIRST USE 3-0-2005; IN COMMERCE 3-0-2005.

SUPPLEMENTAL REGISTER

THE MARK CONSISTS OF STANDARD CHARACTERS WITHOUT CLAIM TO ANY PARTICULAR FONT, STYLE, SIZE, OR COLOR.

SER. NO. 85-509,251, FILED 1-5-2012.

DAVID MURRAY, EXAMINING ATTORNEY



David J. Kybas

Director of the United States Patent and Trademark Office

United States of America

United States Patent and Trademark Office

COMPUTER TUTOR GALS

Reg. No. 4,156,067

GABRIELLA SENZA (UNITED STATES INDIVIDUAL)
296 PARK ST. APT 8
HOUSATONIC, MA 01236

Registered June 5, 2012

Int. Cl.: 41

FOR: EDUCATION SERVICES, NAMELY, PROVIDING TUTORING IN THE FIELD OF THE USE OF PERSONAL COMPUTERS, HAND-HELD DEVICES, AND THE INTERNET, IN CLASS 41 (U.S. CLS. 100, 101 AND 107).

SERVICE MARK

FIRST USE 9-1-2011; IN COMMERCE 9-1-2011.

SUPPLEMENTAL REGISTER

THE MARK CONSISTS OF STANDARD CHARACTERS WITHOUT CLAIM TO ANY PARTICULAR FONT, STYLE, SIZE, OR COLOR.

NO CLAIM IS MADE TO THE EXCLUSIVE RIGHT TO USE "COMPUTER TUTOR", APART FROM THE MARK AS SHOWN.

SER. NO. 85-509,595, FILED P.R. 1-5-2012; AM. S.R. 4-10-2012.

DAVID MURRAY, EXAMINING ATTORNEY



David J. Kyros

Director of the United States Patent and Trademark Office

United States of America

United States Patent and Trademark Office

NORTHERN CALIFORNIA FIRE PROTECTION INDUSTRY

Reg. No. 4,156,068

CETANI, MATT (UNITED STATES INDIVIDUAL)
16840 JOLEEN WAY
MORGAN HILL, CA 95037

Registered June 5, 2012

Int. Cl.: 37

FOR: BUILDING CONSTRUCTION SERVICES, NAMELY, INSTALLATION, TESTING, MAINTENANCE, AND REPAIR OF FIRE SPRINKLERS, STANDPIPES, AND FIRE PUMP SYSTEMS, IN CLASS 37 (U.S. CLS. 100, 103 AND 106).

SERVICE MARK

FIRST USE 4-1-2010; IN COMMERCE 4-1-2010.

SUPPLEMENTAL REGISTER

THE MARK CONSISTS OF STANDARD CHARACTERS WITHOUT CLAIM TO ANY PARTICULAR FONT, STYLE, SIZE, OR COLOR.

SER. NO. 85-511,812, FILED P.R. 1-9-2012; AM. S.R. 4-11-2012.

JAY FLOWERS, EXAMINING ATTORNEY



David J. Kyros

Director of the United States Patent and Trademark Office

United States of America

United States Patent and Trademark Office

INTRINSIC VALUATION

Reg. No. 4,156,069

INTRINSIC VALUATION (COLORADO LIMITED LIABILITY COMPANY)
2815 LARIMER ST.
DENVER, CO 80205

Registered June 5, 2012

Int. Cl.: 36

FOR: BUSINESS VALUATION SERVICES NAMELY, TRANSACTION SUPPORT, VALUATIONS FOR FINANCIAL REPORTING, SUCCESSION AND SHAREHOLDER PLANNING, EXPERT OPINIONS, AND CORPORATE TAX COMPLIANCE, IN CLASS 36 (U.S. CLS. 100, 101 AND 102).

SERVICE MARK

SUPPLEMENTAL REGISTER FIRST USE 1-1-2010; IN COMMERCE 1-1-2010.

THE MARK CONSISTS OF STANDARD CHARACTERS WITHOUT CLAIM TO ANY PARTICULAR FONT, STYLE, SIZE, OR COLOR.

SER. NO. 85-513,875, FILED 1-11-2012.

KIMBERLY PERRY, EXAMINING ATTORNEY

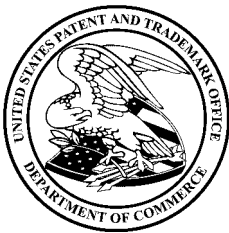

David J. Kyffers

Director of the United States Patent and Trademark Office

United States of America

United States Patent and Trademark Office

ConsumerCentric

Reg. No. 4,156,070

DANDURAND, TROY M (UNITED STATES INDIVIDUAL)
2563 43RD AVE S

Registered June 5, 2012

ST. CLOUD, MN 56301

Int. Cl.: 41

FOR: BUSINESS TRAINING; BUSINESS TRAINING CONSULTANCY SERVICES; BUSINESS TRAINING IN THE FIELD OF SELLING AND SALES TRAINING; EDUCATION SERVICES, NAMELY, PROVIDING CAREER RE-TRAINING SELLING IN THE FIELDS OF SALES TRAINING.; TRAINING COURSES IN STRATEGIC PLANNING RELATING TO ADVERTISING, PROMOTION, MARKETING AND BUSINESS, IN CLASS 41 (U.S. CLS. 100, 101 AND 107).

SERVICE MARK

SUPPLEMENTAL REGISTER

FIRST USE 12-22-2011; IN COMMERCE 12-24-2011.

THE MARK CONSISTS OF STANDARD CHARACTERS WITHOUT CLAIM TO ANY PARTICULAR FONT, STYLE, SIZE, OR COLOR.

SER. NO. 85-514,061, FILED P.R. 1-11-2012; AM. S.R. 4-24-2012.

DANNEAN HETZEL, EXAMINING ATTORNEY



David J. Kyffers

Director of the United States Patent and Trademark Office

United States of America

United States Patent and Trademark Office

OC HEALTHCARE

Reg. No. 4,156,071

BELSITO, JOSEPH (UNITED STATES INDIVIDUAL)
1 ARDMORE STREET
NEW WINDSOR, NY 12553

Registered June 5, 2012

Int. Cl.: 16

FOR: MONTHLY NEWSPAPER FOR GENERAL CIRCULATION, IN CLASS 16 (U.S. CLS. 2, 5, 22, 23, 29, 37, 38 AND 50).

TRADEMARK

FIRST USE 12-1-2011; IN COMMERCE 12-1-2011.

SUPPLEMENTAL REGISTER

THE MARK CONSISTS OF STANDARD CHARACTERS WITHOUT CLAIM TO ANY PARTICULAR FONT, STYLE, SIZE, OR COLOR.

SER. NO. 85-514,812, FILED P.R. 1-12-2012; AM. S.R. 4-27-2012.

FRANK LATTUCA, EXAMINING ATTORNEY



David J. Kybas

Director of the United States Patent and Trademark Office

United States of America

United States Patent and Trademark Office

FRESH & JUICY

Reg. No. 4,156,072

Registered June 5, 2012

Int. Cl.: 29

HARDEE'S FOOD SYSTEMS, INC. (NORTH CAROLINA CORPORATION)
SUITE 1200
100 NORTH BROADWAY
ST. LOUIS, MO 63102

FOR: CHICKEN, IN CLASS 29 (U.S. CL. 46).

TRADEMARK

FIRST USE 4-28-1995; IN COMMERCE 4-28-1995.

SUPPLEMENTAL REGISTER

THE MARK CONSISTS OF STANDARD CHARACTERS WITHOUT CLAIM TO ANY PARTICULAR FONT, STYLE, SIZE, OR COLOR.

SER. NO. 85-516,130, FILED 1-13-2012.

KAREN SEVERSON, EXAMINING ATTORNEY



David J. Kyros

Director of the United States Patent and Trademark Office

United States of America

United States Patent and Trademark Office

Convergent Therapeutics

Reg. No. 4,156,073

Registered June 5, 2012

Int. Cl.: 44

SERVICE MARK

SUPPLEMENTAL REGISTER

ALAN F. BAIN (UNITED STATES INDIVIDUAL), DBA CHICAGO HEALTH AND WELLNESS ALLIANCE,
55 E. WASHINGTON ST. #3305
CHICAGO, IL 60602

FOR: MEDICAL SERVICES FEATURING AN APPROACH TO PATIENTS THAT MELTS HOLISTIC MEDICINE WITH TRADITIONAL MEDICINE, IN CLASS 44 (U.S. CLS. 100 AND 101).

FIRST USE 0-0-2010; IN COMMERCE 0-0-2010.

THE MARK CONSISTS OF STANDARD CHARACTERS WITHOUT CLAIM TO ANY PARTICULAR FONT, STYLE, SIZE, OR COLOR.

NO CLAIM IS MADE TO THE EXCLUSIVE RIGHT TO USE "THERAPEUTICS", APART FROM THE MARK AS SHOWN.

SER. NO. 85-519,360, FILED 1-18-2012.

DAVID MURRAY, EXAMINING ATTORNEY



David J. Kyros

Director of the United States Patent and Trademark Office

United States of America

United States Patent and Trademark Office

TU DEALER VENEZOLANO

Reg. No. 4,156,074

IRENKO AUTO SALES CORP (FLORIDA CORPORATION)
7436 NW 55 STREET
MIAMI, FL 33166

Registered June 5, 2012

Int. Cl.: 35

FOR: AUTOMOBILE DEALERSHIPS, IN CLASS 35 (U.S. CLS. 100, 101 AND 102).

SERVICE MARK

FIRST USE 1-1-2012; IN COMMERCE 1-1-2012.

SUPPLEMENTAL REGISTER

THE MARK CONSISTS OF STANDARD CHARACTERS WITHOUT CLAIM TO ANY PARTICULAR FONT, STYLE, SIZE, OR COLOR.

NO CLAIM IS MADE TO THE EXCLUSIVE RIGHT TO USE "DEALER", APART FROM THE MARK AS SHOWN.

THE ENGLISH TRANSLATION OF "TU DEALER VENEZOLANO" IN THE MARK IS "YOUR VENEZUELAN DEALER".

SER. NO. 85-522,732, FILED P.R. 1-23-2012; AM. S.R. 5-1-2012.

REBECCA GILBERT, EXAMINING ATTORNEY



David J. Kyffers

Director of the United States Patent and Trademark Office

United States of America

United States Patent and Trademark Office

MICRO-GROOVES

Reg. No. 4,156,075

JOHNSON & JOHNSON (NEW JERSEY CORPORATION)
ONE JOHNSON & JOHNSON PLAZA
NEW BRUNSWICK, NJ 089337001

Registered June 5, 2012

Int. Cl.: 21

FOR: DENTAL FLOSS, IN CLASS 21 (U.S. CLS. 2, 13, 23, 29, 30, 33, 40 AND 50).

TRADEMARK

FIRST USE 7-17-2009; IN COMMERCE 7-17-2009.

SUPPLEMENTAL REGISTER

THE MARK CONSISTS OF STANDARD CHARACTERS WITHOUT CLAIM TO ANY PARTICULAR FONT, STYLE, SIZE, OR COLOR.

SER. NO. 85-572,243, FILED P.R. 3-16-2012; AM. S.R. 4-16-2012.

TINA MAI, EXAMINING ATTORNEY



David J. Kyffers

Director of the United States Patent and Trademark Office