

United States of America

United States Patent and Trademark Office

MPOWER

Reg. No. 4,173,280

EMERGENT ADVISORS, INC (DELAWARE CORPORATION)

Registered July 17, 2012

625 THIRD STREET
SAN FRANCISCO, CA 94107

Int. Cl.: 9

FOR: COMPUTER SOFTWARE AND MANUALS SOLD AS A UNIT FOR USE IN THE FIELD OF FINANCE, NAMELY, FOR PROVIDING INFORMATION, ASSISTANCE AND ADVICE FOR FINANCIAL PLANNING, RETIREMENT PLANNING, INVESTMENT AND RISK PROFILE ANALYSIS, PORTFOLIO ALLOCATION, AND SELECTING FINANCIAL INSTRUMENTS AND PRODUCTS OFFERED AND MANAGED BY OTHERS, IN CLASS 9 (U.S. CLS. 21, 23, 26, 36 AND 38).

TRADEMARK

PRINCIPAL REGISTER

FIRST USE 2-18-2000; IN COMMERCE 2-18-2000.

SER. NO. 75-792,639, FILED 9-3-1999.

LINDSEY RUBIN, EXAMINING ATTORNEY



David J. Kybas

Director of the United States Patent and Trademark Office

United States of America

United States Patent and Trademark Office



Reg. No. 4,173,281

UNIGROUP WORLDWIDE, INC. (MISSOURI CORPORATION)
ONE PREMIER DRIVE
FENTON, MO 63026

Registered July 17, 2012

Int. Cls.: 35 and 39

FOR: BUSINESS MANAGEMENT AND CONSULTATION SERVICES, NAMELY, BUSINESS AND PERSONAL RELOCATION SERVICES, AND CONSULTATION TO OTHERS IN THE DEVELOPMENT AND ESTABLISHMENT OF PERSONNEL RELOCATION POLICIES, IN CLASS 35 (U.S. CLS. 100, 101 AND 102).

SERVICE MARK

PRINCIPAL REGISTER

FIRST USE 10-4-2001; IN COMMERCE 10-4-2001.

FOR: TRANSPORTATION OF GOODS OF OTHERS BY MEANS OF TRUCK, VAN AND OTHER VEHICLES; WAREHOUSING AND STORAGE SERVICES; AND FREIGHT FORWARDING SERVICES, IN CLASS 39 (U.S. CLS. 100 AND 105).

FIRST USE 10-4-2001; IN COMMERCE 10-4-2001.

OWNER OF U.S. REG. NOS. 2,206,766, 2,206,767, AND 2,453,218.

NO CLAIM IS MADE TO THE EXCLUSIVE RIGHT TO USE "WORLDWIDE", APART FROM THE MARK AS SHOWN.

SER. NO. 76-338,008, FILED 11-15-2001.

JANICE L. MCMORROW, EXAMINING ATTORNEY



David J. Kyffers

Director of the United States Patent and Trademark Office

United States of America

United States Patent and Trademark Office

WESTY'S

Reg. No. 4,173,282

Registered July 17, 2012

Int. Cl.: 39

SERVICE MARK

PRINCIPAL REGISTER

ARREDONDO & COMPANY, LLC (CONNECTICUT CORPORATION)
METRO CENTER, ONE STATION PLACE
STAMFORD, CT 069026800

FOR: SUPPLYING STORAGE SERVICES, NAMELY WAREHOUSE AND GENERAL STORAGE; PROVIDING STORAGE FACILITIES AND STORAGE SERVICES FOR OTHERS, NAMELY WAREHOUSE STORAGE FACILITIES, INCLUDING CLIMATE CONTROLLED AND NON CLIMATE CONTROLLED SPACES, LOCKER STORAGE SERVICES, AND THE STORAGE OF CONTAINERS FOR THE STORAGE OF GOODS; PROVIDING SELF-STORAGE FACILITIES, NAMELY THE RENTAL OF UNITS IN A BUILDING FOR THE STORAGE OF GOODS OF OTHERS; RENTAL OF MOVING EQUIPMENT AND VEHICLES, NAMELY DOLLIES AND MOVING CARTS, TRAILERS, TRAILER HITCHES AND TOW DOLLIES, MOVING VANS AND TRUCKS FOR MOVING GOODS, AND FURNITURE PADS, ALL OF THE ABOVE, IN CLASS 39 (U.S. CLS. 100 AND 105).

FIRST USE 1-1-1991; IN COMMERCE 1-1-1991.

SER. NO. 76-445,815, FILED 9-3-2002.

KATHLEEN M. VANSTON, EXAMINING ATTORNEY



David J. Kybas

Director of the United States Patent and Trademark Office

United States of America

United States Patent and Trademark Office

WESTY

Reg. No. 4,173,283

Registered July 17, 2012

Int. Cl.: 39

SERVICE MARK

PRINCIPAL REGISTER

ARREDONDO & COMPANY, LLC (CONNECTICUT CORPORATION)
METRO CENTER
ONE STATION PLACE
STAMFORD, CT 069026800

FOR: SUPPLYING STORAGE SERVICES, NAMELY WAREHOUSE AND GENERAL STORAGE; PROVIDING STORAGE FACILITIES AND STORAGE SERVICES FOR OTHERS, NAMELY WAREHOUSE STORAGE FACILITIES, INCLUDING CLIMATE CONTROLLED AND NON CLIMATE CONTROLLED SPACES, LOCKER STORAGE SERVICES, AND THE STORAGE OF CONTAINERS FOR THE STORAGE OF GOODS; PROVIDING SELF-STORAGE FACILITIES, NAMELY THE RENTAL OF UNITS IN A BUILDING FOR THE STORAGE OF GOODS OF OTHERS; RENTAL OF MOVING EQUIPMENT AND VEHICLES, NAMELY DOLLIES AND MOVING CARTS, TRAILERS, TRAILER HITCHES AND TOW DOLLIES, MOVING VANS AND TRUCKS FOR MOVING GOODS, AND FURNITURE PADS, IN CLASS 39 (U.S. CLS. 100 AND 105).

FIRST USE 12-15-1997; IN COMMERCE 12-15-1997.

SER. NO. 76-446,777, FILED 9-3-2002.

KATHLEEN M. VANSTON, EXAMINING ATTORNEY



David J. Kybas

Director of the United States Patent and Trademark Office

United States of America

United States Patent and Trademark Office



Reg. No. 4,173,284

Registered July 17, 2012

Int. Cl.: 39

SERVICE MARK

PRINCIPAL REGISTER

ARREDONDO & COMPANY, LLC (CONNECTICUT CORPORATION)
METRO CENTER
ONE STATION PLACE
STAMFORD, CT 069026800

FOR: SUPPLYING STORAGE SERVICES, NAMELY WAREHOUSE AND GENERAL STORAGE; PROVIDING STORAGE FACILITIES AND STORAGE SERVICES FOR OTHERS, NAMELY WAREHOUSE STORAGE FACILITIES, INCLUDING CLIMATE CONTROLLED AND NON CLIMATE CONTROLLED SPACES, LOCKER STORAGE SERVICES, AND THE STORAGE OF CONTAINERS FOR THE STORAGE OF GOODS; PROVIDING SELF-STORAGE FACILITIES, NAMELY THE RENTAL OF UNITS IN A BUILDING FOR THE STORAGE OF GOODS OF OTHERS; RENTAL OF MOVING EQUIPMENT AND VEHICLES, NAMELY DOLLIES AND MOVING CARTS, TRAILERS, TRAILER HITCHES AND TOW DOLLIES, MOVING VANS AND TRUCKS FOR MOVING GOODS, AND FURNITURE PADS; TRANSPORTATION OF OTHERS GOODS BY TRUCK; STORAGE OF RECORDS, FURNITURE AND VARIOUS OTHER GOODS OF OTHERS, IN CLASS 39 (U.S. CLS. 100 AND 105).

FIRST USE 12-15-1997; IN COMMERCE 12-15-1997.

SER. NO. 76-446,778, FILED 9-3-2002.

JOHN DWYER, EXAMINING ATTORNEY



David J. Kyfos

Director of the United States Patent and Trademark Office

United States of America

United States Patent and Trademark Office

TAYO

Reg. No. 4,173,285

FOOD STEPS INTERNATIONAL INC. (CANADA CORPORATION)
187 TERRACE HILL COURT
KELOWNA, BC, CANADA V1V2T2

Registered July 17, 2012

Int. Cl.: 29

FOR: VEGETABLE BASED FOOD DRINKS, NAMELY, VEGETABLE BASED DAIRY SUBSTITUTE, IN CLASS 29 (U.S. CL. 46).

TRADEMARK

PRIORITY CLAIMED UNDER SEC. 44(D) ON CANADA APPLICATION NO. 1231374, FILED 9-23-2004, REG. NO. TMA807,040, DATED 9-20-2011, EXPIRES 9-20-2026.

PRINCIPAL REGISTER

SER. NO. 76-615,039, FILED 10-6-2004.

JACQUELINE A. LAVINE, EXAMINING ATTORNEY



David J. Kyffers

Director of the United States Patent and Trademark Office

United States of America
United States Patent and Trademark Office

T-WAX

Reg. No. 4,173,286

KENMORE FINANCIAL, INC. (MASSACHUSETTS CORPORATION)
105 CHESTNUT ST., #34
NEEDHAM, MA 02492

Registered July 17, 2012

Int. Cl.: 3

FOR: WAX PREPARATIONS USED FOR BOATS, MOTOR VEHICLES, AND RECREATIONAL VEHICLES, IN CLASS 3 (U.S. CLS. 1, 4, 6, 50, 51 AND 52).

TRADEMARK

FIRST USE 4-1-1998; IN COMMERCE 4-1-1998.

PRINCIPAL REGISTER

THE MARK CONSISTS OF STANDARD CHARACTERS WITHOUT CLAIM TO ANY PARTICULAR FONT, STYLE, SIZE, OR COLOR.

SER. NO. 76-651,371, FILED 12-5-2005.

KAPIL BHANOT, EXAMINING ATTORNEY



David J. Kyffers

Director of the United States Patent and Trademark Office

United States of America

United States Patent and Trademark Office



Reg. No. 4,173,287

CITY OF URBANDALE, IOWA (IOWA MUNICIPAL CORPORATION)
3740 86TH ST.

Registered July 17, 2012

URBANDALE, IA 50322

Int. Cl.: 45

FOR: COMMUNITY BASED ANTI-CRIME PROGRAM, NAMELY, PROVIDING INFORMATION AND CONSULTATION IN THE FIELD OF CRIME PREVENTION FOR NEIGHBORHOOD WATCH GROUPS, IN CLASS 45 (U.S. CLS. 100 AND 101).

SERVICE MARK

FIRST USE 9-23-2009; IN COMMERCE 9-23-2009.

PRINCIPAL REGISTER

NO CLAIM IS MADE TO THE EXCLUSIVE RIGHT TO USE "URBANDALE CRIME", "NEIGHBORHOOD CRIME PREVENTION", "URBANDALE POLICE", "IOWA", AND "POLICE", APART FROM THE MARK AS SHOWN.

THE COLOR(S) BLACK, WHITE, RED, BLUE, YELLOW, AND GOLD IS/ARE CLAIMED AS A FEATURE OF THE MARK.

THE MARK CONSISTS OF A WHITE RECTANGLE BEARING THE WORDING "URBANDALE CRIME EYE" IN BLUE AND "NEIGHBORHOOD CRIME PREVENTION" IN BLACK. TO THE RIGHT OF THE WORDING IS AN ANIMATED FIGURE WITH A CIRCULAR SHAPE. THE FIGURE'S RIGHT HAND IS RED AND THE REMAINDER OF THE FIGURE IS BLACK AND WHITE. IN THE CENTER OF THE FIGURE IS AN EMBLEM BEARING A WHITE EAGLE HEAD WITH A GOLD OUTLINE AND GOLD DETAILING IN THE NECK, A YELLOW BEAK WITH BLUE DETAILS, A BLUE AND WHITE FACE AND A BLACK AND WHITE EYE. BEHIND THE EAGLE IS A YELLOW AND GOLD BADGE BEARING THE WORDING "POLICE" IN BLACK. A BLUE BANNER WITH WHITE AND GOLD OUTLINES AND THE WORDING "INTEGRITY" IN WHITE APPEARS ACROSS THE LOWER PORTION OF THE BADGE AND EAGLE HEAD. BEHIND THE EAGLE HEAD, BADGE, AND BANNER ELEMENTS IS A RED CIRCLE WITH A GOLD OUTLINE SURROUNDED BY A WHITE CIRCLE FEATURING THE WORDING "URBANDALE POLICE IOWA" IN BLACK, AND A GOLD AND YELLOW CIRCLE WITH JAGGED EDGES. THE ENTIRE MARK IS SURROUNDED BY A BLACK OUTLINE.



David J. Kyffers

SER. NO. 76-703,318, FILED 6-9-2010.

MARTHA FROMM, EXAMINING ATTORNEY

United States of America

United States Patent and Trademark Office

CYFLEX

Reg. No. 4,173,288

Registered July 17, 2012

Int. Cl.: 9

TRADEMARK

PRINCIPAL REGISTER

CYBERMETRIX, INC (INDIANA CORPORATION)
2860 NATIONAL ROAD, SUITE A
COLUMBUS, IN 47201

FOR: COMPUTER HARDWARE AND SOFTWARE, FOR USE WITH COMPUTERIZED MONITORING AND TESTING EQUIPMENT, FOR RECEIVING, PROCESSING, TRANSMITTING AND DISPLAYING DATA FOR USE IN THE FIELD OF INTERNAL COMBUSTION ENGINE TESTING AND DEVELOPMENT, IN CLASS 9 (U.S. CLS. 21, 23, 26, 36 AND 38).

FIRST USE 3-6-2007; IN COMMERCE 3-6-2007.

THE MARK CONSISTS OF STANDARD CHARACTERS WITHOUT CLAIM TO ANY PARTICULAR FONT, STYLE, SIZE, OR COLOR.

SER. NO. 76-705,195, FILED 11-2-2010.

CHRISTINA SOBRAL, EXAMINING ATTORNEY



David J. Kyffers

Director of the United States Patent and Trademark Office

United States of America

United States Patent and Trademark Office



Reg. No. 4,173,289

Registered July 17, 2012

Int. Cls.: 11 and 21

TRADEMARK

PRINCIPAL REGISTER

MINDEN GRILL COMPANY (NEVADA CORPORATION)
2222 PARK PLACE, UNIT 2D
MINDEN, NV 89423

FOR: GRILLS, NAMELY, BARBEQUE GRILLS AND GAS RANGE-TOP INDOOR GRILLS AND ELECTRIC RANGE-TOP INDOOR GRILLS; GRILLING ACCESSORIES, NAMELY, WARMING TRAYS, CERAMIC STONE FOR USE IN THE GRILL, CONTAINERS FOR USE WITH THE GRILL, CUTTING BOARD FOR USE WITH THE GRILL, IN CLASS 11 (U.S. CLS. 13, 21, 23, 31 AND 34).

FIRST USE 7-1-2006; IN COMMERCE 7-1-2006.

FOR: GRILLING UTENSILS, NAMELY, GRILLS AND GRILL COVERS, IN CLASS 21 (U.S. CLS. 2, 13, 23, 29, 30, 33, 40 AND 50).

FIRST USE 7-1-2006; IN COMMERCE 7-1-2006.

NO CLAIM IS MADE TO THE EXCLUSIVE RIGHT TO USE "GRILL COMPANY", APART FROM THE MARK AS SHOWN.

THE MARK CONSISTS OF THE WORDING "MINDEN" ABOVE A FLAMES DESIGN APPEARING ABOVE THE WORDING "GRILL COMPANY", ALL SURROUNDED BY A RECTANGLE.

SER. NO. 76-705,295, FILED 11-10-2010.

KAREN K. BUSH, EXAMINING ATTORNEY



David J. Kyffers

Director of the United States Patent and Trademark Office

United States of America

United States Patent and Trademark Office

BIKER'S CHOICE

Reg. No. 4,173,290

Registered July 17, 2012

**Int. Cls.: 1, 4, 7, 9, 11
and 12**

TRADEMARK

PRINCIPAL REGISTER

TUCKER-ROCKY CORPORATION, INC. (DELAWARE CORPORATION)
103 FOULK ROAD, SUITE 202
WILMINGTON, DE 19803

FOR: TRANSMISSION FLUID, IN CLASS 1 (U.S. CLS. 1, 5, 6, 10, 26 AND 46).

FIRST USE 12-0-1998; IN COMMERCE 12-0-1998.

FOR: TRANSMISSION GEAR LUBRICANTS; ENGINE OIL; QUICK CHANGE OIL KITS
COMPRISING ENGINE OIL AND OIL FILTER; CHAIN CASE LUBRICANT, IN CLASS 4
(U.S. CLS. 1, 6 AND 15).

FIRST USE 12-0-1998; IN COMMERCE 12-0-1998.

FOR: AIR FILTERS FOR MOTORCYCLE MOTORS AND ENGINES; ENGINE MUFFLERS,
IN CLASS 7 (U.S. CLS. 13, 19, 21, 23, 31, 34 AND 35).

FIRST USE 12-0-1998; IN COMMERCE 12-0-1998.

FOR: BATTERIES FOR VEHICLES; OIL PRESSURE GAUGES; SPEEDOMETER CABLES,
TACHOMETER CABLES, IN CLASS 9 (U.S. CLS. 21, 23, 26, 36 AND 38).

FIRST USE 12-0-1998; IN COMMERCE 12-0-1998.

FOR: REAR LIGHTS FOR VEHICLES; TAIL LIGHTS FOR VEHICLES, IN CLASS 11 (U.S.
CLS. 13, 21, 23, 31 AND 34).

FIRST USE 12-0-1998; IN COMMERCE 12-0-1998.

FOR: MOTORCYCLE PARTS AND WHEEL ACCESSORIES, NAMELY, AXLE SPACER,
WHEEL SPACER, PULLEY SPACER, CLUTCH PUSHROD, FORK TUBE, TURN SIGNALS,
TURN SIGNAL SWITCH, THROTTLE AND CLUTCH CABLES, HAND GRIPS, HAND
CONTROLS, NAMELY, HANDLE BAR CONTROL LEVERS, REARVIEW MIRRORS, HANDLE
BAR CLAMPS, TRANSMISSION END WIRES, HANDLE BAR WIRE HARNESS, SHOCK
ABSORBERS, TIRES, ENGINE GUARDS, NAMELY, A METAL BUMPER THAT AFFIXES
TO THE FRAME OF THE MOTORCYCLE USED TO PROTECT THE ENGINE PARTS IN THE
EVENT OF A LOW SPEED TIP OVER, KICKSTANDS, BRAKE PADS, THROTTLE CABLES,



David J. Kyffers

Director of the United States Patent and Trademark Office

Reg. No. 4,173,290 CLUTCH CABLES, CHOKE CABLES, IDLE CABLES, BRAKE CABLES, REPLACEMENT HANDLE BAR CONTROL LEVERS, THROTTLE CLAMPS, BRAKE LEVERS, GAS CAPS, FENDERS, SHIFT LEVERS, MOTORCYCLE HANDLEBARS, GAS TANKS, AND DROP SEAT CONVERSION KIT COMPRISED OF THE FRAME, THE SEAT AND THE SIDE PANELS, REAR FRAME SECTION INCLUDING THE BATTERY MOUNTING BOX, FUSE BOX, MOUNT FOR THE TURN SIGNAL MODULE, MOUNTING HARDWARE, BATTERY CABLES, PLASTIC TIE STRAPS AND ZIP TIES TO MAKE STRUCTURAL CHANGES TO AN AUTOMOBILE, IN CLASS 12 (U.S. CLS. 19, 21, 23, 31, 35 AND 44).

FIRST USE 12-0-1998; IN COMMERCE 12-0-1998.

THE MARK CONSISTS OF STANDARD CHARACTERS WITHOUT CLAIM TO ANY PARTICULAR FONT, STYLE, SIZE, OR COLOR.

OWNER OF U.S. REG. NOS. 2,496,626, 2,513,032 AND OTHERS.

NO CLAIM IS MADE TO THE EXCLUSIVE RIGHT TO USE "BIKER'S", APART FROM THE MARK AS SHOWN.

SER. NO. 76-706,977, FILED 3-28-2011.

SCOTT BIBB, EXAMINING ATTORNEY

United States of America

United States Patent and Trademark Office

QUNOL - THE GOLD STANDARD IN COQ10

Reg. No. 4,173,291

QUTEN RESEARCH INSTITUTE, LLC (NEW JERSEY LIMITED LIABILITY CORPORATION)
15A MELANIE LN., STE. 8B
EAST HANOVER, NJ 07936

Registered July 17, 2012

Int. Cl.: 5

FOR: PHARMACEUTICAL PRODUCT, NAMELY, DIETARY SUPPLEMENTS CONTAINING COQ10, IN CLASS 5 (U.S. CLS. 6, 18, 44, 46, 51 AND 52).

TRADEMARK

FIRST USE 3-1-2011; IN COMMERCE 3-1-2011.

PRINCIPAL REGISTER

NO CLAIM IS MADE TO THE EXCLUSIVE RIGHT TO USE "COQ10", APART FROM THE MARK AS SHOWN.

THE WORD(S) "QUNOL" HAS NO MEANING IN A FOREIGN LANGUAGE.

SER. NO. 76-707,235, FILED 4-12-2011.

DEZMONA MIZELLE, EXAMINING ATTORNEY



David J. Kybas

Director of the United States Patent and Trademark Office

United States of America

United States Patent and Trademark Office

Senior Embrace



Reg. No. 4,173,292

SENIOR EMBRACE, LLC. (ILLINOIS LIMITED LIABILITY COMPANY)
4442-WEST TUCKER LANE
WAUKEGAN, IL 60085

Registered July 17, 2012

Int. Cl.: 36

FOR: FINANCIAL SERVICES FOR THIRD PARTIES, NAMELY, UNDERWRITING, ISSUANCE, AND ADMINISTRATION OF ANNUITIES, LIFE INSURANCE, LONG TERM HEALTH CARE INSURANCE, AND MEDICARE SUPPLEMENT INSURANCE, IN CLASS 36 (U.S. CLS. 100, 101 AND 102).

SERVICE MARK

PRINCIPAL REGISTER

FIRST USE 3-21-2011; IN COMMERCE 3-21-2011.

NO CLAIM IS MADE TO THE EXCLUSIVE RIGHT TO USE "SENIOR", APART FROM THE MARK AS SHOWN.

THE MARK CONSISTS OF THE WORDING "SENIOR EMBRACE" ADJACENT TO TWO BOLD LETTER "E"'S FACING EACH OTHER AND INTERLOCKED WITH ONE ANOTHER ON A SQUARE BACKGROUND.

SER. NO. 76-707,297, FILED 4-18-2011.

RONALD MCMORROW, EXAMINING ATTORNEY



David J. Kybas

Director of the United States Patent and Trademark Office

United States of America

United States Patent and Trademark Office



Lightweight
Design Inc.

Reg. No. 4,173,293

LIGHTWEIGHT DESIGN, INC. (PENNSYLVANIA CORPORATION)
635 S. 10TH STREET, UNIT 600
ALLENTOWN, PA 18103

Registered July 17, 2012

Int. Cl.: 42

FOR: PROFESSIONAL ENGINEERING SERVICES, NAMELY, PROVIDING STRUCTURAL DESIGN AND ENGINEERING SERVICES FOR THE FABRIC STRUCTURES AND TENT RENTAL INDUSTRY, IN CLASS 42 (U.S. CLS. 100 AND 101).

SERVICE MARK

FIRST USE 1-1-2011; IN COMMERCE 1-1-2011.

PRINCIPAL REGISTER

NO CLAIM IS MADE TO THE EXCLUSIVE RIGHT TO USE "LIGHTWEIGHT DESIGN INC.", APART FROM THE MARK AS SHOWN.

THE MARK CONSISTS OF THE LETTERS "L","D","I" WITHIN A RECTANGLE TO THE LEFT OF A HORIZONTAL BAR WITH THE WORD "LIGHTWEIGHT" ABOVE THE BAR AND THE WORDS "DESIGN INC." BELOW THE BAR.

SER. NO. 76-707,299, FILED 4-18-2011.

GRETTA YAO, EXAMINING ATTORNEY



David J. Kybas

Director of the United States Patent and Trademark Office

United States of America

United States Patent and Trademark Office



ROSÉ
MOSCATO
SANTERO

Reg. No. 4,173,294

Registered July 17, 2012

Int. Cl.: 33

TRADEMARK

PRINCIPAL REGISTER

SANTERO FRATELLI & C.I.V.A.S.S. SPA (ITALY CORPORATION)
VIA CESARE PAVESE, 28
12058 SANTO STEFANO BELBO -CN, ITALY

FOR: ALCOHOLIC BEVERAGES EXCEPT BEERS, IN CLASS 33 (U.S. CLS. 47 AND 49).

FIRST USE 2-28-1981; IN COMMERCE 2-28-1981.

NO CLAIM IS MADE TO THE EXCLUSIVE RIGHT TO USE "ROSÉ," "MOSCATO" AND "SINCE 1958", APART FROM THE MARK AS SHOWN.

THE MARK CONSISTS OF A SHIELD WITH A LETTER "S" IN THE CENTER AND CROWN ABOVE THE SHIELD. THERE IS A HERALDIC LION ON THE LEFT AND RIGHT SIDES OF THE SHIELD. THERE IS A BANNER CENTERED BELOW THE SHIELD AND LIONS CONTAINING THE WORDING "SINCE 1958". THE WORD "ROSÉ" APPEARS CENTERED BELOW THE BANNER. THE WORD "MOSCATO" APPEARS CENTERED BELOW THE WORD "ROSÉ". THE WORD "SANTERO" APPEARS CENTERED BELOW THE WORD "MOSCATO".

THE ENGLISH TRANSLATION OF "MOSCATO" IN THE MARK IS "MUSCAT". THE WORDING "SANTERO" HAS NO MEANING IN A FOREIGN LANGUAGE.

SER. NO. 76-707,528, FILED 5-9-2011.

TINA BROWN, EXAMINING ATTORNEY



David J. Kybas

Director of the United States Patent and Trademark Office

United States of America

United States Patent and Trademark Office

Turning Green into Green

Reg. No. 4,173,295

Registered July 17, 2012

Int. Cls.: 35 and 42

SERVICE MARK

PRINCIPAL REGISTER

GREEN ASSETS, INC. (DELAWARE CORPORATION)
UPPER LEVEL
106 NORTH TOPSAIL DRIVE, UPPER LEVEL
SURF CITY, NC 28445

FOR: GREENHOUSE GAS INVENTORY SERVICES, NAMELY, BUSINESS MANAGEMENT OF GREENHOUSE GAS EMISSIONS AND REDUCTIONS; BUSINESS CONSULTING RELATED TO IDENTIFYING CARBON OFFSETS AND BUSINESS DEVELOPMENT CONSULTING, ADVERTISING AND MARKETING SERVICES IN THE FIELD OF CARBON OFFSET STRATEGIC SALES PLANS, IN CLASS 35 (U.S. CLS. 100, 101 AND 102).

FIRST USE 0-0-2010; IN COMMERCE 0-0-2010.

FOR: IDENTIFICATION OF AND TRACKING OF GREENHOUSE GAS EMISSIONS AND REDUCTIONS, NAMELY, GREENHOUSE GAS EMISSIONS AND REDUCTIONS MEASURING AND ANALYSIS, IN CLASS 42 (U.S. CLS. 100 AND 101).

FIRST USE 12-31-2010; IN COMMERCE 12-31-2010.

THE MARK CONSISTS OF STANDARD CHARACTERS WITHOUT CLAIM TO ANY PARTICULAR FONT, STYLE, SIZE, OR COLOR.

NO CLAIM IS MADE TO THE EXCLUSIVE RIGHT TO USE "GREEN", APART FROM THE MARK AS SHOWN.

SER. NO. 76-707,882, FILED 6-6-2011.

HAI-LY LAM, EXAMINING ATTORNEY



David J. Kybas

Director of the United States Patent and Trademark Office

United States of America

United States Patent and Trademark Office

REACH!

Reg. No. 4,173,296

Registered July 17, 2012

Int. Cl.: 41

SERVICE MARK

PRINCIPAL REGISTER

REED, JASON (UNITED STATES INDIVIDUAL)
450 NORTHWEST STREET
CARLISLE, PA 17013

FOR: EDUCATIONAL SERVICES, NAMELY, INSTRUCTING CLASSES, SEMINARS, CONFERENCES AND WORKSHOPS FOR ELEMENTARY AND SECONDARY SCHOOL YOUTH IN THE FIELDS OF PHYSICAL FITNESS, PERFORMANCE ARTS, PHOTOGRAPHY, TECHNICAL PERFORMANCE ARTS TRAINING AND PERFORMING ARTS STAGING; VOCATIONAL EDUCATION IN THE FIELDS OF GRAPHIC DESIGN, COSTUME DESIGN, MARKETING, RADIO AND SOUND EQUIPMENT USAGE AND MAINTENANCE; EDUCATIONAL SERVICES, NAMELY, PROVIDING LITERACY TRAINING FOR SCHOOL AGE CHILDREN; PROVIDING EDUCATIONAL MENTORING SERVICES AND PROGRAMS IN THE FIELD OF ACADEMIC STUDIES FOR SCHOOL AGE CHILDREN; EDUCATIONAL SERVICES, NAMELY, PROVIDING AFTER SCHOOL EDUCATIONAL PROGRAMS IN THE FIELD OF ACADEMIC STUDIES AND PERFORMANCE ARTS FOR SCHOOL AGE CHILDREN; AND PROVIDING EDUCATIONAL AND ENTERTAINMENT SERVICES, NAMELY, PROVIDING MOTIVATIONAL AND EDUCATIONAL SPEAKERS AND PERFORMERS, IN CLASS 41 (U.S. CLS. 100, 101 AND 107).

FIRST USE 7-4-2006; IN COMMERCE 8-15-2006.

THE MARK CONSISTS OF STANDARD CHARACTERS WITHOUT CLAIM TO ANY PARTICULAR FONT, STYLE, SIZE, OR COLOR.

SER. NO. 76-707,945, FILED 6-13-2011.

JOHN DALIER, EXAMINING ATTORNEY



David J. Kyffers

Director of the United States Patent and Trademark Office

United States of America

United States Patent and Trademark Office

REACHUSA

Reg. No. 4,173,297

Registered July 17, 2012

Int. Cl.: 41

SERVICE MARK

PRINCIPAL REGISTER

REED, JASON (UNITED STATES INDIVIDUAL)
450 NORTHWEST STREET
CARLISLE, UNITED STATES 17013

FOR: EDUCATIONAL SERVICES, NAMELY, INSTRUCTING CLASSES, SEMINARS, CONFERENCES AND WORKSHOPS FOR ELEMENTARY AND SECONDARY SCHOOL YOUTH IN THE FIELDS OF PHYSICAL FITNESS, PERFORMANCE ARTS, PHOTOGRAPHY, TECHNICAL PERFORMANCE ARTS TRAINING AND PERFORMING ARTS STAGING; VOCATIONAL EDUCATION IN THE FIELDS OF GRAPHIC DESIGN, COSTUME DESIGN, MARKETING, RADIO AND SOUND EQUIPMENT USAGE AND MAINTENANCE; EDUCATIONAL SERVICES, NAMELY, PROVIDING LITERACY TRAINING FOR SCHOOL AGE CHILDREN; PROVIDING EDUCATIONAL MENTORING SERVICES AND PROGRAMS IN THE FIELD OF ACADEMIC STUDIES FOR SCHOOL AGE CHILDREN; EDUCATIONAL SERVICES, NAMELY, PROVIDING AFTER SCHOOL EDUCATIONAL PROGRAMS IN THE FIELD OF ACADEMIC STUDIES AND PERFORMANCE ARTS FOR SCHOOL AGE CHILDREN; AND PROVIDING EDUCATIONAL AND ENTERTAINMENT SERVICES, NAMELY, PROVIDING MOTIVATIONAL AND EDUCATIONAL SPEAKERS AND PERFORMERS, IN CLASS 41 (U.S. CLS. 100, 101 AND 107).

FIRST USE 5-7-2006; IN COMMERCE 6-24-2006.

THE MARK CONSISTS OF STANDARD CHARACTERS WITHOUT CLAIM TO ANY PARTICULAR FONT, STYLE, SIZE, OR COLOR.

SER. NO. 76-707,946, FILED 6-13-2011.

JOHN DALIER, EXAMINING ATTORNEY



David J. Kypos

Director of the United States Patent and Trademark Office

United States of America

United States Patent and Trademark Office

C-BURG HYPE

Reg. No. 4,173,298

Registered July 17, 2012

Int. Cl.: 41

SERVICE MARK

PRINCIPAL REGISTER

REED, JASON (UNITED STATES INDIVIDUAL)
450 NORTHWEST STREET
CARLISLE, PA 17013

FOR: EDUCATIONAL SERVICES, NAMELY, INSTRUCTING CLASSES, SEMINARS, CONFERENCES AND WORKSHOPS FOR ELEMENTARY AND SECONDARY SCHOOL YOUTH IN THE FIELDS OF PHYSICAL FITNESS, PERFORMANCE ARTS, PHOTOGRAPHY, TECHNICAL PERFORMANCE ARTS TRAINING AND PERFORMING ARTS STAGING; VOCATIONAL EDUCATION IN THE FIELDS OF GRAPHIC DESIGN, COSTUME DESIGN, MARKETING, RADIO AND SOUND EQUIPMENT USAGE AND MAINTENANCE; EDUCATIONAL SERVICES, NAMELY, PROVIDING LITERACY TRAINING FOR SCHOOL AGE CHILDREN; PROVIDING EDUCATIONAL MENTORING SERVICES AND PROGRAMS IN THE FIELD OF ACADEMIC STUDIES FOR SCHOOL AGE CHILDREN; EDUCATIONAL SERVICES, NAMELY, PROVIDING AFTER SCHOOL EDUCATIONAL PROGRAMS IN THE FIELD OF ACADEMIC STUDIES AND PERFORMANCE ARTS FOR SCHOOL AGE CHILDREN; AND PROVIDING EDUCATIONAL AND ENTERTAINMENT SERVICES, NAMELY, PROVIDING MOTIVATIONAL AND EDUCATIONAL SPEAKERS AND PERFORMERS, IN CLASS 41 (U.S. CLS. 100, 101 AND 107).

FIRST USE 1-10-2007; IN COMMERCE 1-22-2007.

THE MARK CONSISTS OF STANDARD CHARACTERS WITHOUT CLAIM TO ANY PARTICULAR FONT, STYLE, SIZE, OR COLOR.

SER. NO. 76-707,947, FILED 6-13-2011.

JOHN DALIER, EXAMINING ATTORNEY



David J. Kypos

Director of the United States Patent and Trademark Office

United States of America

United States Patent and Trademark Office

LIL' HYPE

Reg. No. 4,173,299

Registered July 17, 2012

Int. Cl.: 41

SERVICE MARK

PRINCIPAL REGISTER

REED, JASON (UNITED STATES INDIVIDUAL)
450 NORTHWEST STREET
CARLISLE, PA 17013

FOR: EDUCATIONAL SERVICES, NAMELY, INSTRUCTING CLASSES, SEMINARS, CONFERENCES AND WORKSHOPS FOR ELEMENTARY AND SECONDARY SCHOOL YOUTH IN THE FIELDS OF PHYSICAL FITNESS, PERFORMANCE ARTS, PHOTOGRAPHY, TECHNICAL PERFORMANCE ARTS TRAINING AND PERFORMING ARTS STAGING; VOCATIONAL EDUCATION IN THE FIELDS OF GRAPHIC DESIGN, COSTUME DESIGN, MARKETING, RADIO AND SOUND EQUIPMENT USAGE AND MAINTENANCE; EDUCATIONAL SERVICES, NAMELY, PROVIDING LITERACY TRAINING FOR SCHOOL AGE CHILDREN; PROVIDING EDUCATIONAL MENTORING SERVICES AND PROGRAMS IN THE FIELD OF ACADEMIC STUDIES FOR SCHOOL AGE CHILDREN; EDUCATIONAL SERVICES, NAMELY, PROVIDING AFTER SCHOOL EDUCATIONAL PROGRAMS IN THE FIELD OF ACADEMIC STUDIES AND PERFORMANCE ARTS FOR SCHOOL AGE CHILDREN; AND PROVIDING EDUCATIONAL AND ENTERTAINMENT SERVICES, NAMELY, PROVIDING MOTIVATIONAL AND EDUCATIONAL SPEAKERS AND PERFORMERS, IN CLASS 41 (U.S. CLS. 100, 101 AND 107).

FIRST USE 9-21-2007; IN COMMERCE 10-1-2007.

THE MARK CONSISTS OF STANDARD CHARACTERS WITHOUT CLAIM TO ANY PARTICULAR FONT, STYLE, SIZE, OR COLOR.

SER. NO. 76-707,948, FILED 6-13-2011.

JOHN DALIER, EXAMINING ATTORNEY



David J. Kypos

Director of the United States Patent and Trademark Office

United States of America

United States Patent and Trademark Office

SWAGG

Reg. No. 4,173,300

Registered July 17, 2012

Int. Cl.: 41

SERVICE MARK

PRINCIPAL REGISTER

REED, JASON (UNITED STATES INDIVIDUAL)
450 NORTHWEST STREET
CARLISLE, PA 17013

FOR: EDUCATIONAL SERVICES, NAMELY, INSTRUCTING CLASSES, SEMINARS, CONFERENCES AND WORKSHOPS FOR ELEMENTARY AND SECONDARY SCHOOL YOUTH IN THE FIELDS OF PHYSICAL FITNESS, PERFORMANCE ARTS, PHOTOGRAPHY, TECHNICAL PERFORMANCE ARTS TRAINING AND PERFORMING ARTS STAGING; VOCATIONAL EDUCATION IN THE FIELDS OF GRAPHIC DESIGN, COSTUME DESIGN, MARKETING, RADIO AND SOUND EQUIPMENT USAGE AND MAINTENANCE; EDUCATIONAL SERVICES, NAMELY, PROVIDING LITERACY TRAINING FOR SCHOOL AGE CHILDREN; PROVIDING EDUCATIONAL MENTORING SERVICES AND PROGRAMS IN THE FIELD OF ACADEMIC STUDIES FOR SCHOOL AGE CHILDREN; EDUCATIONAL SERVICES, NAMELY, PROVIDING AFTER SCHOOL EDUCATIONAL PROGRAMS IN THE FIELD OF ACADEMIC STUDIES AND PERFORMANCE ARTS FOR SCHOOL AGE CHILDREN; AND PROVIDING EDUCATIONAL AND ENTERTAINMENT SERVICES, NAMELY, PROVIDING MOTIVATIONAL AND EDUCATIONAL SPEAKERS AND PERFORMERS, IN CLASS 41 (U.S. CLS. 100, 101 AND 107).

FIRST USE 1-5-2008; IN COMMERCE 1-22-2008.

THE MARK CONSISTS OF STANDARD CHARACTERS WITHOUT CLAIM TO ANY PARTICULAR FONT, STYLE, SIZE, OR COLOR.

SER. NO. 76-707,949, FILED 6-13-2011.

JOHN DALIER, EXAMINING ATTORNEY



David J. Kypos

Director of the United States Patent and Trademark Office

United States of America

United States Patent and Trademark Office

THE BEST TRACTORS AND EQUIPMENT ON EARTH

Reg. No. 4,173,301

Registered July 17, 2012

Int. Cl.: 35

SERVICE MARK

PRINCIPAL REGISTER

SUMMA HUMMA ENTERPRISES, LLC (NEW HAMPSHIRE LIMITED LIABILITY COMPANY)
10 BITTERN LANE
PO BOX 289
TILTON, NH 03276

FOR: RETAIL STORE SERVICES AND DISTRIBUTORSHIPS FEATURING TRACTORS,
AND AGRICULTURAL MACHINERY AND EQUIPMENT AND ACCESSORIES RELATING
THERE TO , IN CLASS 35 (U.S. CLS. 100, 101 AND 102).

FIRST USE 5-31-2001; IN COMMERCE 5-31-2001.

THE MARK CONSISTS OF STANDARD CHARACTERS WITHOUT CLAIM TO ANY PAR-
TICULAR FONT, STYLE, SIZE, OR COLOR.

OWNER OF U.S. REG. NO. 3,014,215.

SEC. 2(F).

SER. NO. 76-708,516, FILED 7-27-2011.

TARA PATE, EXAMINING ATTORNEY



David J. Kyffers

Director of the United States Patent and Trademark Office

United States of America

United States Patent and Trademark Office

Crop Circle Grow Wheel

Reg. No. 4,173,302

SAUM, JESSIE RAY (UNITED STATES INDIVIDUAL)
1617 SOUTH ORLANDO AVE.
COCOA BEACH, FL 32931

Registered July 17, 2012

Int. Cl.: 7

FOR: POWER-OPERATED ROTARY HYDROPONIC GARDENING MACHINE COMPRISED OF A WHEEL ON A TIMER THAT HOLDS A NUMBER OF INDIVIDUAL GROWING CONTAINERS, WHILE IT ROTATES AROUND A LIGHT THAT IS SUSPENDED IN ITS CATER, IN CLASS 7 (U.S. CLS. 13, 19, 21, 23, 31, 34 AND 35).

TRADEMARK

PRINCIPAL REGISTER

FIRST USE 10-17-2009; IN COMMERCE 10-17-2010.

THE MARK CONSISTS OF STANDARD CHARACTERS WITHOUT CLAIM TO ANY PARTICULAR FONT, STYLE, SIZE, OR COLOR.

NO CLAIM IS MADE TO THE EXCLUSIVE RIGHT TO USE "GROW WHEEL", APART FROM THE MARK AS SHOWN.

SER. NO. 76-708,815, FILED 8-22-2011.

TASNEEM HUSSAIN, EXAMINING ATTORNEY



David J. Kyffers

Director of the United States Patent and Trademark Office

United States of America

United States Patent and Trademark Office

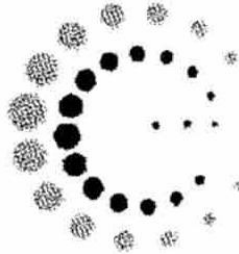

Reg. No. 4,173,303

Registered July 17, 2012

Int. Cl.: 35

SERVICE MARK

PRINCIPAL REGISTER

NASHVILLE ENTREPRENEUR CENTER, THE (TENNESSEE CORPORATION)
105 BROADWAY
NASHVILLE, TN 37201

FOR: BUSINESS DEVELOPMENT SERVICES, NAMELY, PROVIDING START-UP SUPPORT FOR BUSINESSES OF OTHERS; BUSINESS SUPPORT SERVICES, NAMELY, BUSINESS CONSULTING TO FREELANCERS, START-UPS, EXISTING BUSINESSES AND NON-PROFIT ORGANIZATIONS; INCUBATION SERVICES, NAMELY, PROVIDING WORK SPACE CONTAINING BUSINESS EQUIPMENT TO FREELANCERS, START-UPS, EXISTING BUSINESSES AND NON-PROFITS; AND MANAGEMENT SERVICES, NAMELY, ON-LINE BUSINESS DEVELOPMENT SERVICES, NAMELY, PROVIDING START-UP SUPPORT FOR BUSINESSES OF OTHERS, IN CLASS 35 (U.S. CLS. 100, 101 AND 102).

FIRST USE 8-31-2010; IN COMMERCE 8-31-2010.

THE MARK CONSISTS OF SHADED CIRCLES OF VARIOUS SHAPES FORMING TWO INCOMPLETE CONCENTRIC CIRCLES.

SER. NO. 76-708,892, FILED 8-29-2011.

BERNICE MIDDLETON, EXAMINING ATTORNEY



David J. Kybas

Director of the United States Patent and Trademark Office

United States of America

United States Patent and Trademark Office

SUPER SOUND

Reg. No. 4,173,304

Registered July 17, 2012

Int. Cls.: 15 and 28

TRADEMARK

PRINCIPAL REGISTER

EXCITE USA, LP (TEXAS LIMITED LIABILITY PARTNERSHIP)
1430 VALWOOD PARKWAY, SUITE 145
CARROLLTON, TX 75006

FOR: ELECTRONIC MUSICAL KEYBOARDS, IN CLASS 15 (U.S. CLS. 2, 21 AND 36).

FIRST USE 3-0-1992; IN COMMERCE 3-0-1992.

FOR: BATTERY OPERATED ACTION TOYS; DOLLS AND DOLL ACCESSORIES, NAMELY, CLOTHING FOR DOLLS, DOLL ROOMS, DOLL BEDS, DOLL HOUSES, TOY FABRICS AND LINENS FOR DOLLS AND STROLLERS FOR DOLLS; EDUCATIONAL TOYS FOR TEACHING MUSIC PRINCIPLES TO CHILDREN, NAMELY, HAND-HELD MUSIC NOTATION SYMBOLS AND MUSIC RELATED FIGURES, SUCH AS INDIVIDUAL HAND-HELD PIANO KEYS; ELECTRIC ACTION TOYS; ELECTRONIC ACTION SPINNING TOPS; ELECTRONIC LEARNING TOYS; ELECTRONIC NOVELTY TOYS, NAMELY, TOYS THAT ELECTRONICALLY RECORD, PLAY BACK, AND DISTORT OR MANIPULATE VOICES AND SOUNDS; ELECTRONIC TOY VEHICLES; INFLATABLE TOYS, MECHANICAL ACTION TOYS; MUSICAL TOYS; PUNCHING TOYS; RADIO CONTROLLED TOY VEHICLES; REMOTE CONTROL TOYS, NAMELY, CARS, RACE CARS, AIRPLANES, BOATS; STUFFED AND PLUSH TOYS; STUFFED TOY ANIMALS; STUFFED TOY BEARS; STUFFED TOYS; TALKING ELECTRONIC PRESS-DOWN TOYS; TALKING TOYS; TOY BUILDING BLOCKS; TOY GUNS; TOY MODEL GUITARS; TOY MODEL TRAIN SETS; TOY MUSIC BOXES; TOY PIANOS; TOY PISTOLS; TOY ROBOTS; TOY TRAINS AND PARTS AND ACCESSORIES THEREFOR; TOY VEHICLE TRACK SETS AND ROADWAYS AND ACCESSORIES THEREFOR; TOY VEHICLES; TOY XYLOPHONES; WATER SQUIRTING TOYS; ELECTRONIC GAMES FOR THE TEACHING OF CHILDREN; HAND HELD UNITS FOR PLAYING ELECTRONIC GAMES OTHER THAN THOSE ADAPTED FOR USE WITH AN EXTERNAL DISPLAY SCREEN OR MONITOR; TABLETOP GAMES; TABLETOP UNITS FOR PLAYING ELECTRONIC GAMES OTHER THAN IN CONJUNCTION WITH A TELEVISION OR COMPUTER; TOY, NAMELY, BATTERY-POWERED COMPUTER GAME WITH LCD SCREEN WHICH FEATURES ANIMATION AND SOUND EFFECTS, IN CLASS 28 (U.S. CLS. 22, 23, 38 AND 50).



David J. Kyffers

Director of the United States Patent and Trademark Office

FIRST USE 3-0-1992; IN COMMERCE 3-0-1992.

THE MARK CONSISTS OF STANDARD CHARACTERS WITHOUT CLAIM TO ANY PARTICULAR FONT, STYLE, SIZE, OR COLOR.

Reg. No. 4,173,304 OWNER OF U.S. REG. NO. 1,680,466.

NO CLAIM IS MADE TO THE EXCLUSIVE RIGHT TO USE "SOUND", APART FROM THE MARK AS SHOWN.

SER. NO. 76-708,945, FILED 9-2-2011.

LINDA ESTRADA, EXAMINING ATTORNEY

United States of America

United States Patent and Trademark Office

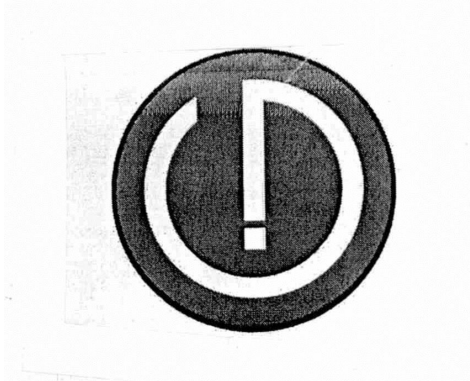

Reg. No. 4,173,305

Registered July 17, 2012

Int. Cl.: 9

TRADEMARK

PRINCIPAL REGISTER

GDI TECHNOLOGY, INC. (FLORIDA CORPORATION)
13601 SW 143 COURT, SUITE 102
MIAMI, FL 33186

FOR: DEVICES TO SPLIT AUDIO AND/OR VIDEO SIGNALS TO MULTIPLE RECEIVING DEVICES, NAMELY, SIGNAL SPLITTERS FOR ELECTRONIC APPARATUS, COAXIAL CABLE, ALTERNATING CURRENT POWER ADAPTERS USED TO CONVERT THE OUTPUT TO DIRECT CURRENT AT REDUCED VOLTAGE, WIRELESS ROUTERS, SATELLITE RECEIVERS, SATELLITE DISHES AND IPTV SET TOP CONVERTERS AND, TELEPHONES FOR USE IN VOICE OVER INTERNET PROTOCOL; INFRARED REMOTE CONTROLS FOR ALL THE AFORESAID GOODS, IN CLASS 9 (U.S. CLS. 21, 23, 26, 36 AND 38).

FIRST USE 9-0-2006; IN COMMERCE 9-0-2006.

OWNER OF U.S. REG. NO. 3,147,320.

THE MARK CONSISTS OF THE LETTERS "GDI" OVER A CIRCLE, WHERE THE LETTERS "D" AND "I" ARE PORTIONS OF THE LETTER "G".

SER. NO. 76-709,358, FILED 10-11-2011.

JULIE VEPPUMTHARA, EXAMINING ATTORNEY



David J. Kybas

Director of the United States Patent and Trademark Office

United States of America

United States Patent and Trademark Office

GDI

Reg. No. 4,173,306

Registered July 17, 2012

Int. Cl.: 9

TRADEMARK

PRINCIPAL REGISTER

GDI TECHNOLOGY, INC. (FLORIDA CORPORATION)
13601 SW 143 COURT, SUITE 102
MIAMI, FL 33186

FOR: DEVICES TO SPLIT AUDIO AND/OR VIDEO SIGNALS TO MULTIPLE RECEIVING DEVICES, NAMELY, SIGNAL SPLITTERS FOR ELECTRONIC APPARATUS, COAXIAL CABLE, ALTERNATING CURRENT POWER ADAPTERS USED TO CONVERT THE OUTPUT TO DIRECT CURRENT AT REDUCED VOLTAGE, WIRELESS ROUTERS, SATELLITE RECEIVERS, SATELLITE DISHES AND IPTV SET TOP CONVERTERS AND, TELEPHONES FOR USE IN VOICE OVER INTERNET PROTOCOL, IN CLASS 9 (U.S. CLS. 21, 23, 26, 36 AND 38).

FIRST USE 9-0-2006; IN COMMERCE 9-0-2006.

THE MARK CONSISTS OF STANDARD CHARACTERS WITHOUT CLAIM TO ANY PARTICULAR FONT, STYLE, SIZE, OR COLOR.

OWNER OF U.S. REG. NO. 3,147,320.

SER. NO. 76-709,360, FILED 10-11-2011.

JULIE VEPPUMTHARA, EXAMINING ATTORNEY



David J. Kyffers

Director of the United States Patent and Trademark Office

United States of America

United States Patent and Trademark Office



Reg. No. 4,173,307

BARSOOMIAN, MICHAEL (UNITED STATES INDIVIDUAL)
5838 BECKFORD AVE
TARZANA, CA 91356

Registered July 17, 2012

Int. Cl.: 25

FOR: CLOTHING, NAMELY, T-SHIRTS, HATS AND PANTIES, IN CLASS 25 (U.S. CLS. 22 AND 39).

TRADEMARK

FIRST USE 5-18-2011; IN COMMERCE 5-18-2011.

PRINCIPAL REGISTER

NO CLAIM IS MADE TO THE EXCLUSIVE RIGHT TO USE "MALIBU", APART FROM THE MARK AS SHOWN.

THE COLOR(S) PINK, WHITE, LIGHT YELLOW AND BLUE IS/ARE CLAIMED AS A FEATURE OF THE MARK.

THE MARK CONSISTS OF THE WORDING "MALIBU BABES" IN STYLIZED LETTERING. A PINK AND WHITE WOMAN DESIGN APPEARS INSIDE A LIGHT YELLOW CIRCLE. A WHITE GLOW APPEARS AT THE TOP OF THE CIRCLE. THE WORD "MALIBU" APPEARS IN WHITE WITH A THICK BLUE BORDER. THE WORD "MALIBU" APPEARS CURVED SLIGHTLY OVERLAPPING THE BOTTOM AREA OF THE CIRCLE AND WOMAN DESIGN. THE WORD "BABES" APPEARS IN PINK UNDERNEATH THE WORD "MALIBU".

SER. NO. 76-709,421, FILED 10-18-2011.

JOHN DWYER, EXAMINING ATTORNEY



David J. Kyros

Director of the United States Patent and Trademark Office

United States of America

United States Patent and Trademark Office



Reg. No. 4,173,308

Registered July 17, 2012

Int. Cl.: 42

SERVICE MARK

PRINCIPAL REGISTER

BACKSTOP SOLUTIONS GROUP, LLC (DELAWARE LIMITED LIABILITY COMPANY)
233 S. WACKER DRIVE, SUITE 3960
CHICAGO, IL 60606

FOR: PROVIDING TEMPORARY USE OF A FULLY CUSTOMIZABLE, PROFESSIONAL DESIGNED WEBSITE, GIVING CLIENTS THE ABILITY TO ADMINISTER THE SITE CONTENT WITHOUT HAVING TO CONTACT PROVIDER, AND ALLOW SECURE, RESTRICTED AND UNRESTRICTED ACCESS TO SITE CONTENT, INCLUDING PAGES AND DOCUMENTS, TO CLIENT REGULATED END-USERS, FOR THE FIELD OF ALTERNATIVE ASSET MANAGEMENT, IN CLASS 42 (U.S. CLS. 100 AND 101).

FIRST USE 8-1-2007; IN COMMERCE 8-1-2007.

NO CLAIM IS MADE TO THE EXCLUSIVE RIGHT TO USE "INVESTOR", APART FROM THE MARK AS SHOWN.

THE COLORS GREEN, GRAY AND WHITE ARE CLAIMED AS A FEATURE OF THE MARK.

THE MARK CONSISTS OF THE WORDING "INVESTORBRIDGE" IN STYLIZED LETTERING. THE WORD "INVESTOR" APPEARS IN GREEN. THE WORD "BRIDGE" APPEARS IN GRAY. A GREEN SQUARE WITH ROUNDED CORNERS APPEARS TO THE LEFT OF THE WORDING "INVESTORBRIDGE". A GRAY OUTLINE APPEARS IN THE SQUARE. TWO ARCHED STRIPS APPEAR INSIDE THE SQUARE GRADUALLY INCREASING FROM THE UPPER LEFT CORNER TOWARDS THE LOWER RIGHT CORNER. THE TOP STRIP APPEARS WHITE. THE LOWER STRIP APPEARS GRAY. A WHITE GLOW APPEARS AT THE TOP OF THE SQUARE.

SER. NO. 76-709,522, FILED 10-25-2011.

NAAKWAMA ANKRAH, EXAMINING ATTORNEY



David J. Kyjars

Director of the United States Patent and Trademark Office

United States of America

United States Patent and Trademark Office

DEVIL DAWGS

Reg. No. 4,173,309

CHICAGO DOGS, LLC. (ILLINOIS LIMITED LIABILITY COMPANY)
1125 REMINGTON ROAD
SCHAUMBURG, IL 60173

Registered July 17, 2012

Int. Cl.: 43

FOR: RESTAURANTS SERVICES FEATURING A HOT DOG STAND, IN CLASS 43 (U.S. CLS. 100 AND 101).

SERVICE MARK

FIRST USE 9-15-2009; IN COMMERCE 9-15-2009.

PRINCIPAL REGISTER

THE MARK CONSISTS OF STANDARD CHARACTERS WITHOUT CLAIM TO ANY PARTICULAR FONT, STYLE, SIZE, OR COLOR.

NO CLAIM IS MADE TO THE EXCLUSIVE RIGHT TO USE "DOGS", APART FROM THE MARK AS SHOWN.

SER. NO. 76-709,683, FILED 11-8-2011.

EVELYN BRADLEY, EXAMINING ATTORNEY



David J. Kyffers

Director of the United States Patent and Trademark Office

United States of America

United States Patent and Trademark Office



Reg. No. 4,173,310

Registered July 17, 2012

Int. Cl.: 35

SERVICE MARK

PRINCIPAL REGISTER

WEST END NEIGHBORS CIVIC ASSOCIATION C/O GERALD ROMANOFF (NEW YORK CORPORATION)
4 OCEANVIEW COURT
LONG BEACH, NY 11561

FOR: ASSOCIATION SERVICES PROMOTING THE INTERESTS OF HOME OWNERS IN THE CITY OF LONG BEACH, NEW YORK, IN CLASS 35 (U.S. CLS. 100, 101 AND 102).

FIRST USE 9-1-2011; IN COMMERCE 9-1-2011.

NO CLAIM IS MADE TO THE EXCLUSIVE RIGHT TO USE "BEAUTIFICATION", APART FROM THE MARK AS SHOWN.

THE COLOR(S) YELLOW, LIGHT BLUE, DARK BLUE AND BLACK IS/ARE CLAIMED AS A FEATURE OF THE MARK.

THE MARK CONSISTS OF THE WORDING IN LOWER CASE "WEST END BEAUTIFICATION" IN BLACK. ABOVE THE NAME IS ONE WAVE IN LIGHT BLUE AND ONE WAVE IN DARK BLUE ON TOP OF EACH OTHER AND A YELLOW SUN OVER THE WAVES.

SER. NO. 76-709,746, FILED 11-16-2011.

ALICE BENMAMAN, EXAMINING ATTORNEY



David J. Kybas

Director of the United States Patent and Trademark Office

United States of America

United States Patent and Trademark Office

WILLIAM VIGNE

Reg. No. 4,173,311

FULKERSON, SAYRE M. (UNITED STATES INDIVIDUAL)
5576 STATE ROUTE 14
DUNDEE, NY 14837

Registered July 17, 2012

Int. Cl.: 33

FOR: WINE, IN CLASS 33 (U.S. CLS. 47 AND 49).

TRADEMARK

FIRST USE 7-15-2011; IN COMMERCE 7-15-2011.

PRINCIPAL REGISTER

THE MARK CONSISTS OF STANDARD CHARACTERS WITHOUT CLAIM TO ANY PARTICULAR FONT, STYLE, SIZE, OR COLOR.

THE NAME "WILLIAM VIGNE" DOES NOT IDENTIFY A LIVING INDIVIDUAL.

SER. NO. 76-709,757, FILED 11-18-2011.

JOHN WILKE, EXAMINING ATTORNEY



David J. Kyffers

Director of the United States Patent and Trademark Office

United States of America

United States Patent and Trademark Office

MUSSEL BAR ROBERT WIEDMAIER

Reg. No. 4,173,312

MARBEC'S MANAGEMENT LLC (D.C. LIMITED LIABILITY COMPANY)
2401 PENNSYLVANIA AVE.
WASHINGTON, DC 20037

Registered July 17, 2012

Int. Cl.: 43

FOR: RESTAURANT AND BAR SERVICES, IN CLASS 43 (U.S. CLS. 100 AND 101).

SERVICE MARK

FIRST USE 8-1-2010; IN COMMERCE 8-1-2010.

PRINCIPAL REGISTER

THE MARK CONSISTS OF STANDARD CHARACTERS WITHOUT CLAIM TO ANY PARTICULAR FONT, STYLE, SIZE, OR COLOR.

NO CLAIM IS MADE TO THE EXCLUSIVE RIGHT TO USE "MUSSEL BAR", APART FROM THE MARK AS SHOWN.

THE NAME "ROBERT WIEDMAIER" IDENTIFIES A LIVING INDIVIDUAL WHOSE CONSENT IS OF RECORD.

SER. NO. 76-709,767, FILED 11-18-2011.

JILL PRATER, EXAMINING ATTORNEY



David J. Kyffers

Director of the United States Patent and Trademark Office

United States of America

United States Patent and Trademark Office



Reg. No. 4,173,313

Registered July 17, 2012

Int. Cl.: 43

SERVICE MARK

PRINCIPAL REGISTER

MARBEC'S MANAGEMENT LLC (D.C. LIMITED LIABILITY COMPANY)
2401 PENNSYLVANIA AVE
WASHINGTON, DC 20037

FOR: RESTAURANT AND BAR SERVICES, IN CLASS 43 (U.S. CLS. 100 AND 101).

FIRST USE 8-1-2010; IN COMMERCE 8-1-2010.

NO CLAIM IS MADE TO THE EXCLUSIVE RIGHT TO USE "MUSSEL BAR", APART FROM THE MARK AS SHOWN.

SER. NO. 76-709,769, FILED 11-18-2011.

JILL PRATER, EXAMINING ATTORNEY



David J. Kybas

Director of the United States Patent and Trademark Office

United States of America

United States Patent and Trademark Office

PICOTOOLS

Reg. No. 4,173,314

Registered July 17, 2012

Int. Cl.: 9

TRADEMARK

PRINCIPAL REGISTER

KRAMER ELECTRONICS, LTD. (ISRAEL COMPANY)
GIVAT SHAUL
3 AM VEOLAMO STREET
JERUSALEM, ISRAEL

FOR: APPARATUS AND INSTRUMENTS FOR VIEWING, RECORDING, TRANSMISSION, PROCESSING AND REPRODUCTION OF DIGITAL OR ANALOG, SOUND OR IMAGES, NAMELY, VIDEO-AUDIO SIGNAL DISTRIBUTORS, AUDIO AND VIDEO SIGNAL SWITCHERS AND MATRIX SWITCHERS, VIDEO-AUDIO ENHANCERS, COLOR PROCESSORS, RF PROCESSORS, SPECIAL EFFECTS GENERATORS, VIDEO ENCODERS AND DECODERS, ELECTRONIC VIDEO SIGNAL SCALERS AND SCAN CONVERTERS, VIDEO STANDARD CONVERTERS, VIDEO TIME BASE CORRECTORS, COMPUTER GENLOCK EQUIPMENT, NAMELY, GENLOCK MESSAGE GENERATORS, COMPUTER-CONTROLLED VIDEO EQUIPMENT, NAMELY, VIDEO MATRIX AND PROCESSING CONTROL PANELS, COMPUTER INTERFACE PRODUCTS, NAMELY, TTL (TRANSISTOR-TRANSISTOR LOGIC) ANALOGUE ENCODERS, TTL (TRANSISTOR-TRANSISTOR LOGIC) TO ANALOGUE CONVERTERS, TTL (TRANSISTOR-TRANSISTOR LOGIC) GENLOCK/ENCODER CARDS, ROOM CONTROL DEVICES, NAMELY, REMOTE CONTROLS FOR TVS, DVDS, VCRS, VIDEO AND DATA PROJECTORS, ELECTRONIC CURTAIN SYSTEMS, RETRACTABLE MOVIE SCREENS, WALL PLATES AND TABLE BUSES WITH INFRA-RED, ETHERNET, WIRELESS COMMUNICATION NETWORK HUBS AND RS-232 CONTROLLING DEVICES, AUDIO SIGNAL DEFECT CORRECTORS, VIDEO LINE AMPLIFIERS, TWISTED PAIR SIGNAL TRANSMITTERS AND RECEIVERS FOR AUDIO AND VIDEO SIGNALS FOR TRANSMISSION OVER TWISTED PAIR SIGNAL CABLES, VIDEO SCREEN SPLITTERS AND VIDEO TIME BASE SIGNAL DELAY CORRECTORS, BLANK MAGNETIC DATA CARRIERS; AND BLANK RECORDING DISCS, IN CLASS 9 (U.S. CLS. 21, 23, 26, 36 AND 38).



THE MARK CONSISTS OF STANDARD CHARACTERS WITHOUT CLAIM TO ANY PARTICULAR FONT, STYLE, SIZE, OR COLOR.

OWNER OF ISRAEL REG. NO. 192290, DATED 3-9-2008, EXPIRES 7-25-2016.

SER. NO. 77-076,027, FILED 1-4-2007.

BENJAMIN OKEKE, EXAMINING ATTORNEY

David J. Kyros

Director of the United States Patent and Trademark Office

United States of America

United States Patent and Trademark Office

European Treasures

Reg. No. 4,173,315

Registered July 17, 2012

Int. Cl.: 25

TRADEMARK

PRINCIPAL REGISTER

WERTEX HOSIERY INC. (CANADA CORPORATION)
1191 BATHURST STREET
TORONTO, CANADA M5R3H4

FOR: HOSIERY PRODUCTS, NAMELY, SOCKS, PANTYHOSE, AND TIGHTS; LINGERIE;
CAMISOLES; AND WOMEN'S UNDERWEAR, IN CLASS 25 (U.S. CLS. 22 AND 39).

THE MARK CONSISTS OF STANDARD CHARACTERS WITHOUT CLAIM TO ANY PAR-
TICULAR FONT, STYLE, SIZE, OR COLOR.

PRIORITY CLAIMED UNDER SEC. 44(D) ON CANADA APPLICATION NO. 1331738, FILED
1-12-2007, REG. NO. TMA817,007, DATED 2-7-2012, EXPIRES 2-7-2027.

NO CLAIM IS MADE TO THE EXCLUSIVE RIGHT TO USE "EUROPEAN", APART FROM
THE MARK AS SHOWN.

SER. NO. 77-161,007, FILED 4-19-2007.

TINA MAI, EXAMINING ATTORNEY



David J. Kyffers

Director of the United States Patent and Trademark Office

United States of America

United States Patent and Trademark Office

Cavalía

Reg. No. 4,173,316

Registered July 17, 2012

**Int. Cls.: 4, 5, 6, 9, 14, 16,
18, 20, 21, 24, 25, 26, 27,
28, 30, 32, 33, 41 and 43**

CAVALIA PRODUCTIONS LIMITED LIABILITY COMPANY (HUNGARY LIMITED LIABILITY COMPANY)

HERMINA UT 17
BUDAPEST, HUNGARY H-1146

FOR: PROMOTIONAL OBJECTS AND SOUVENIRS, NAMELY, CANDLES, IN CLASS 4 (U.S. CLS. 1, 6 AND 15).

TRADEMARK

SERVICE MARK

PRINCIPAL REGISTER

FOR: MEDICATED SHAMPOO AND CONDITIONERS FOR HORSES, PRODUCTS FOR MAINTENANCE OF HORSES, NAMELY, HERBAL ANTI-ITCH AND SORE SKIN OINTMENT FOR PETS, ANIMAL REPELLANTS, ANTIMICROBIAL CLAY, GREASES AND PETROLEUM JELLY FOR MEDICAL OR VETERINARY PURPOSES, ALL PURPOSE DEODORIZING PREPARATIONS, IN CLASS 5 (U.S. CLS. 6, 18, 44, 46, 51 AND 52).

FOR: PROMOTIONAL OBJECTS AND SOUVENIRS, NAMELY, METAL KEY RINGS, BRONZE SCULPTURES, AND EQUIPMENTS, NAMELY, SPURS, IN CLASS 6 (U.S. CLS. 2, 12, 13, 14, 23, 25 AND 50).

FOR: ELECTRONIC PUBLICATION, NAMELY, BOOKS, MANUAL, MAGAZINES, RECORDED ON COMPUTER MEDIA FEATURING MUSIC AND REPRESENTATION OF SHOWS OF ARTISTS AND HORSES, ENTERTAINMENT AUDIO VISUAL AND TELEVISION PROGRAM IN THE EQUESTRIAN FIELD; AUDIO AND VIDEO PRODUCTS, NAMELY, AUDIO COMPACT DISCS, COMPACT DISCS, DIGITAL DISCS, VIDEO DISCS, FLEXIBLE, HARD, LASER OR OPTICAL, PRERECORDED AUDIO COMPACT DISCS, NAMELY, COMPACT AUDIO, COMPACT, DIGITAL POLYVALENT, POLYVALENT VIDEO DISCS, FLEXIBLE, HARD, LASER OR OPTICAL, AUDIO TAPES AND VIDEO, VINYL RECORDS, DIGITAL AUDIO AND VIDEO CASSETTES AND TAPES, VIDEO AND AUDIO RIBBONS ALL FEATURING TRAINING TECHNIQUES FOR HORSES; PRE-RECORDED EDUCATIONAL TELEVISION PROGRAM, NAMELY, AUDIO COMPACT DISCS, COMPACT DISCS, DIGITAL DISCS, VIDEO DISCS, FLEXIBLE, HARD, LASER OR OPTICAL, PRERECORDED AUDIO COMPACT DISCS, NAMELY, COMPACT AUDIO, COMPACT, DIGITAL POLYVALENT, POLYVALENT VIDEO DISCS, FLEXIBLE, HARD, LASER OR OPTICAL, AUDIO TAPES AND VIDEO, VINYL RECORDS, DIGITAL AUDIO AND VIDEO CASSETTES AND TAPES, VIDEO AND AUDIO RIBBONS ALL FEATURING MUSIC AND REPRESENTATION OF SHOWS OF ARTISTS AND HORSES, ENTERTAINMENT AUDIO VISUAL AND TELEVISION PROGRAM; AUDIO-VIDEO PRODUCTS, NAMELY, AUDIO COMPACT DISCS, COMPACT DISCS, DIGITAL DISCS, VIDEO DISCS, FLEXIBLE, HARD, LASER OR OPTICAL



David J. Kyros

Director of the United States Patent and Trademark Office

Reg. No. 4,173,316 PRERECORDED AUDIO COMPACT DISCS, COMPACT AUDIO, COMPACT, DIGITAL POLYVALENT, POLYVALENT VIDEO DISCS, FLEXIBLE, HARD, LASER OR OPTICAL, AUDIO TAPES AND VIDEO, VINYL RECORDS, DIGITAL AUDIO CASSETTES AND TAPES, VIDEO TAPES, VIDEO CASSETTES, VIDEO AND AUDIO RIBBONS FEATURING MUSIC AND REPRESENTATION OF SHOWS OF ARTISTS AND HORSES, ENTERTAINMENT AUDIO VISUAL AND TELEVISION PROGRAM, NAMELY, AUDIO COMPACT DISCS, COMPACT DISCS, DIGITAL DISCS, VIDEO DISCS, FLEXIBLE, HARD, LASER OR OPTICAL PRERECORDED AUDIO COMPACT DISCS, COMPACT AUDIO, COMPACT, DIGITAL POLYVALENT, POLYVALENT VIDEO DISCS, FLEXIBLE, HARD, LASER OR OPTICAL, AUDIO TAPES AND VIDEO, VINYL RECORDS, DIGITAL AUDIO CASSETTES AND TAPES, VIDEO TAPES, VIDEO CASSETTES, VIDEO AND AUDIO RIBBONS FEATURING REHEARSAL TRAINING AND OPERATION OF STABLES AND ENTERTAINMENT SHOW FEATURING HORSES AND/OR ARTISTS; COMPUTER GAMES; MICE CARPETS, NAMELY, MOUSE PADS, IN CLASS 9 (U.S. CLS. 21, 23, 26, 36 AND 38).

FOR: JEWELS, BRACELETS, RINGS, NECKLACES AND ACCESSORIES FOR JEWELS, NAMELY, JEWEL BOXES, EARRINGS AND WATCHES; SMALL ORNAMENTAL PINS; TIE CLIPS, IN CLASS 14 (U.S. CLS. 2, 27, 28 AND 50).

FOR: PAPER PUBLICATIONS, NAMELY, BOOKS, BROCHURES, BOOKLETS, IN THE EQUESTRIAN FIELD, DIARIES, NOTE BOOKS, NOTE PADS, COOKING BOOKS, GREETING CARDS; PRINTED MATTERS, NAMELY, BOOKS IN THE EQUESTRIAN FIELD AND EDUCATIONAL BOOKS FOR COLORING, CALENDARS, POSTCARDS, POSTERS, PROGRAMS, NAMELY, EVENT PROGRAMS, PRINTING PAPER, DRAWINGS, PHOTOGRAPHS FEATURING ARTISTS' AND HORSES' SHOWS; COURSE MATERIALS, TRAINING MATERIALS FOR COWBOYS, HORSE RIDERS, HORSES, ACROBATS AND EQUESTRIAN GROOMS, OFFICIALS, TRAINERS, COACHES AND OTHER PROFESSIONALS, NAMELY, TRAINING MANUALS, COURSE PLANS, EDUCATIONAL LEARNING CARDS, WORKBOOKS, TEXTBOOKS, ACTIVITY BOOKS, STORY BOOKS, TEACHER GUIDES, MANUALS, POSTERS, AND EDUCATIONAL BOOKLETS IN THE EQUESTRIAN FIELD; GIFT BAGS, PAPER BAGS; OFFICE REQUISITES, NAMELY, ADHESIVE TAPE DISPENSERS, FINGERSTALLS, PUNCHES, STAPLERS, PENCILS; ARTWORKS, NAMELY, LITHOGRAPHIC WORKS OF ART AND PAINTINGS AND CALLIGRAPHIC WORKS MADE OF PAPER, WORKS OF ART MADE FROM CUSTOM MANUFACTURED PAPER, STATUETTES MADE OF PAPER, PAINTINGS, LITHOGRAPHS, PHOTOGRAPHS, DRAWINGS; EMBOSSED WORKS, NAMELY, CARDS EMBOSSED WITH FEATURES FOR IDENTIFICATION PURPOSES, EMBOSSED PAPER, EMBOSSED MACHINES FOR OFFICE USE, EMBOSSED TAPE, ENGRAVINGS; PROMOTIONAL OBJECTS AND SOUVENIRS, NAMELY, NON-FICTION NOVELS, ROMANCE NOVELS, NON-FICTION NOVELS, SELF ADHESIVES, NAMELY, ADHESIVE LABELS, ADHESIVE MATERIALS FOR OFFICE USE, ADHESIVE PLASTIC FILM USED FOR MOUNTING IMAGES, ADHESIVES FOR STATIONERY OR HOUSEHOLD PURPOSES; FLAGS MADE OF PAPER; PAPER BANNERS; PAPER TOWELS, TABLE NAPKINS MADE OF PAPER; PROMOTIONAL OBJECTS AND SOUVENIRS, NAMELY, PAPER LABELS FOR T-SHIRTS, PLASTIC SHOPPING BAGS, IN CLASS 16 (U.S. CLS. 2, 5, 22, 23, 29, 37, 38 AND 50).

FOR: BAGS, NAMELY, HANDBAGS, PACKSACKS, TRAVEL, SPORT, AND HOLDALL BAGS; EQUESTRIAN EQUIPMENT AND GOODS, NAMELY, SADDLES, BRIDLES, CARPET SADDLES, RIDING CROPS, HORSE HALTERS; UMBRELLAS; PARASOLS; PROMOTIONAL OBJECTS AND SOUVENIRS, NAMELY, LEATHER EQUESTRIAN EQUIPMENT, NAMELY, REINS, LONGES, GIRTHS, SEAT BAGS, COLLAR HARNESSSES, HARNESSSES, HOOF WRAPS, HAY BAGS; METAL HORSE'S BITS; TRAVEL ACCESSORIES, NAMELY, LUGGAGE IDENTIFICATION LABELS AND TAGS, IN CLASS 18 (U.S. CLS. 1, 2, 3, 22 AND 41).

FOR: PROMOTIONAL OBJECTS AND SOUVENIRS, NAMELY, PICTURE FRAMES, EMBROIDERY FRAMES, FRAMES FOR PAINTINGS, STATUETTES MADE OF WOOD AND PLASTER, IN CLASS 20 (U.S. CLS. 2, 13, 22, 25, 32 AND 50).

Reg. No. 4,173,316 FOR: PRODUCTS FOR MAINTENANCE OF HORSES, NAMELY, BRUSHES; WATER BOTTLES SOLD EMPTY; PROMOTIONAL OBJECTS AND SOUVENIRS, NAMELY, CERAMIC MATERIALS, NAMELY, CERAMIC FIGURINES, CERAMIC SCULPTURES, VASES, VESSELS, BOWLS, PLATES AND POTS, CERAMIC TISSUE BOX COVERS, DECORATIVE CERAMIC TILES NOT FOR USE AS BUILDING MATERIALS, CUTTING BOARDS, DRINKING GLASSES, DRINKING GLASSES FOR ALCOHOL, SOAP BOTTLES SOLD EMPTY, LEATHER COASTERS, PLASTIC COASTERS, MUGS, CUPS, PLATES, IN CLASS 21 (U.S. CLS. 2, 13, 23, 29, 30, 33, 40 AND 50).

FOR: FABRICS, NAMELY, BEDDINGS, NAMELY, BED LINEN, BED SHEETS, BED BLANKETS; PROMOTIONAL OBJECTS AND SOUVENIRS, NAMELY, BANNERS MADE OF TEXTILE, FLAGS MADE OF TEXTILE, BLANKETS, NAMELY, BLANKET THROWS, BLANKETS FOR OUTDOOR USE, CASHMERE BLANKETS, WOOLLEN BLANKETS, PET BLANKETS, TEXTILE TOWELS, TABLE NAPKINS MADE OF TEXTILE TOWELS, IN CLASS 24 (U.S. CLS. 42 AND 50).

FOR: CLOTHING FOR MEN, WOMEN, CHILDREN AND BABIES, NAMELY, JACKETS, CAPS, SWEATSHIRTS, COATS, RAINCOATS, WIND RESISTANT JACKETS, SCARVES, TUQUES, BODICES, HOODED SWEATSHIRTS, EXTERIOR CLOTHING, NAMELY, OUTDOOR GLOVES, OUTDOOR MITTENS, THERMAL UNDERWEAR, EQUESTRIAN CLOTHING, NAMELY, HORSE-RIDING BOOTS, RIDING COATS, RIDING PANTS, RIDING GLOVES; FASHION ACCESSORIES FOR MEN, WOMEN, CHILDREN AND BABIES, NAMELY, TIES; PONCHOS, TROUSERS, SKIRTS, GLOVES, STOCKINGS, DRESSES, DRESSING GOWNS, TWO-PIECES SUITS, UNDERWEAR, SHOES, BOOTS; COSTUMES, NAMELY, MASQUERADE COSTUMES; PROMOTIONAL OBJECTS AND SOUVENIRS, NAMELY, APRONS; EQUESTRIAN LEATHER EQUIPMENT, NAMELY, RIDING BOOTS, IN CLASS 25 (U.S. CLS. 22 AND 39).

FOR: EMBROIDERY; PROMOTIONAL OBJECTS AND SOUVENIRS, NAMELY, MARKING PINS, HAT PINS, CLOTHING PINS, SAMPLES OF EMBROIDERY, NAMELY, EMBROIDERY, EMBROIDERY FOR GARMENTS, EMBROIDERY NEEDLES, IN CLASS 26 (U.S. CLS. 37, 39, 40, 42 AND 50).

FOR: CARPETS, CARPETS FOR WIPING FEET, IN CLASS 27 (U.S. CLS. 19, 20, 37, 42 AND 50).

FOR: GAMES, NAMELY, PLAYING CARDS, PARLOR GAMES, CHECKERS, PUZZLES, COIN OPERATED VIDEO GAMES; TABLE GAMES; TOYS, NAMELY, BATH TOYS, BENDABLE TOYS, CHILDREN'S MULTIPLE ACTIVITY TOYS, INFANT TOYS, PET TOYS, COLLECTABLE TOY FIGURES, ACTION TOYS, NAMELY, BATTERY OPERATED ACTION TOYS, ELECTRONIC ACTION TOYS, ACTIVITIES TOYS FOR CHILDREN AND BABIES, NAMELY, MULTIPLE ACTIVITY TOYS, CONSTRUCTION TOYS, EDUCATIONAL TOYS USED TO DEMONSTRATE EQUESTRIAN SPORTS, CHARACTERS, NAMELY, FANTASY CHARACTER TOYS, TOY FIGURINES, MUSICAL TOYS, DRAWING TOYS, TOYS DESIGNED TO BE ATTACHED TO COTS AND CRIBS, WOODEN HORSES ON WHEELS AND ROCKING HORSES, PLUSH PETS TOYS; PROMOTIONAL OBJECTS AND SOUVENIRS, NAMELY, CHRISTMAS TREE ORNAMENTS, TOY SHIELDS, BALLOONS; SNOW GLOBES, ARTICLES FOR GOLF, NAMELY, COVERS FOR GOLF CLUBS, GOLF BAG COVERS, GOLF BAG TAGS, GOLF BAGS, GOLF BALL MARKERS, GOLF BALLS, GOLF GLOVES, GOLF TEES; EDUCATIONAL CARD GAMES; GAME CARPETS IN THE NATURE OF PLAY MATS FOR CHILDREN CONTAINING GAME PIECES; HORSE RIDING PROTECTION GEAR EXCLUDING HELMETS, NAMELY, ELBOW PROTECTORS, IN CLASS 28 (U.S. CLS. 22, 23, 38 AND 50).

FOR: FOODSTUFFS, NAMELY, CHOCOLATES; PROMOTIONAL OBJECTS AND SOUVENIRS, NAMELY, MACAROONS, IN CLASS 30 (U.S. CL. 46).

Reg. No. 4,173,316 FOR: NON-ALCOHOLIC BEVERAGES, NAMELY, CARBONATED BEVERAGES, FRUIT JUICES, COFFEE-FLAVORED SOFT DRINK, NON-ALCOHOLIC FROZEN FLAVORED BEVERAGES, ENERGY DRINKS, MINERAL AND CARBONATED WATERS, IN CLASS 32 (U.S. CLS. 45, 46 AND 48).

FOR: ALCOHOLIC BEVERAGES, NAMELY, WINES, ALCOHOLIC COCKTAIL MIXES, ALCOHOLIC COFFEE-BASED BEVERAGE, ALCOHOLIC TEA-BASED BEVERAGE, APERITIFS WITH A DISTILLED ALCOHOLIC LIQUOR BASE, PREPARED ALCOHOLIC COCKTAIL, RUM, VODKA, TEQUILA, WHISKY, IN CLASS 33 (U.S. CLS. 47 AND 49).

FOR: EQUESTRIAN SCHOOLS, TRAINING OF HORSES, COWBOYS, HORSE RIDERS, ACROBATS AND EQUESTRIAN GROOMS, OFFICIALS, TRAINERS, COACHES AND OTHER PROFESSIONALS IN THE EQUESTRIAN FIELD; PROVIDING CULTURAL ACTIVITY CENTERS AND EQUESTRIAN COURSES FOR PUBLIC IN GENERAL; EQUESTRIAN ENTERTAINMENT CENTERS; CREATION, PRODUCTION, DISTRIBUTION OF FILMS, 3D FILMS, TELEVISION PROGRAMS, DOCUMENTARIES AND MOVIES; PROVIDING COURSES IN THE EQUESTRIAN FIELD, IN CLASS 41 (U.S. CLS. 100, 101 AND 107).

FOR: PROVIDING HORSE STABLE FACILITIES; EQUESTRIAN CENTERS, NAMELY, HORSE BOARDING, IN CLASS 43 (U.S. CLS. 100 AND 101).

PRIORITY CLAIMED UNDER SEC. 44(D) ON HUNGARY APPLICATION NO. M0604218, FILED 12-22-2006, REG. NO. 193279, DATED 12-22-2006, EXPIRES 12-22-2016.

OWNER OF U.S. REG. NO. 2,992,006.

THE MARK CONSISTS OF THE TERM "CAVALIA" AND THE LETTER "C" IN THE WORDING "CAVALIA" FEATURES THE DESIGN OF A HORSE'S HEAD.

THE WORDING "CAVALIA" HAS NO MEANING IN A FOREIGN LANGUAGE.

SER. NO. 77-167,433, FILED 4-27-2007.

FLORENTINA BLANDU, EXAMINING ATTORNEY

United States of America
United States Patent and Trademark Office

EQUINOX

Reg. No. 4,173,317

EQUINOX HOLDINGS, INC. (DELAWARE CORPORATION)
895 BROADWAY

Registered July 17, 2012

NEW YORK, NY 10003

Int. Cl.: 35

FOR: RETAIL STORES FEATURING A WIDE RANGE OF FITNESS RELATED GOODS, NAMELY CLOTHING, SWIMWEAR AND ACCESSORIES, FOOTWEAR, HATS, GLOVES, ATHLETIC BAGS, SPORTS EQUIPMENT, HEART RATE MONITORS, IN CLASS 35 (U.S. CLS. 100, 101 AND 102).

SERVICE MARK

PRINCIPAL REGISTER

FIRST USE 9-30-1991; IN COMMERCE 12-31-1991.

THE MARK CONSISTS OF STANDARD CHARACTERS WITHOUT CLAIM TO ANY PARTICULAR FONT, STYLE, SIZE, OR COLOR.

OWNER OF U.S. REG. NOS. 1,796,108, 2,074,971 AND OTHERS.

SER. NO. 77-207,988, FILED 6-16-2007.

WON TEAK OH, EXAMINING ATTORNEY



David J. Kyros

Director of the United States Patent and Trademark Office

United States of America

United States Patent and Trademark Office

TAHI

Reg. No. 4,173,318

Registered July 17, 2012

Int. Cl.: 11

TRADEMARK

PRINCIPAL REGISTER

METHVEN LIMITED LTD (NEW ZEALAND LIMITED LIABILITY COMPANY)
447 ROSEBANK ROAD
AVONDALE, NEW ZEALAND 1007

FOR: PLUMBING FITTINGS, NAMELY, SHOWERS AND SHOWER ENCLOSURES, SHOWER BATHS, AND SHOWER MOUNTINGS; SHOWER TAPS, FAUCETS, AND SHOWER MIXERS; HEATING EQUIPMENT, NAMELY, THERMOSTATIC VALVES; SANITARY PIPES BEING PARTS OF SANITARY FACILITIES AND WATER SUPPLY EQUIPMENT, NAMELY, WATER FAUCET AND SHOWER SPOUTS; PLUMBING FITTINGS, NAMELY, VALVES, MANUALLY OPERATED PLUMBING VALVES, TUB CONTROL VALVES, AND STOP COCKS; WATER SUPPLY EQUIPMENT FOR USE IN THE BEAUTY INDUSTRY, NAMELY, HAND-HELD SHOWER HEADS FOR MASSAGE PURPOSES; SHOWER INFUSION APPARATUS AND INSTRUMENTS, NAMELY, APPARATUS AND INSTRUMENTS FOR INFUSING ADDITIVES INTO WATER, IN CLASS 11 (U.S. CLS. 13, 21, 23, 31 AND 34).

FIRST USE 5-6-2008; IN COMMERCE 5-6-2008.

THE MARK CONSISTS OF STANDARD CHARACTERS WITHOUT CLAIM TO ANY PARTICULAR FONT, STYLE, SIZE, OR COLOR.

THE ENGLISH TRANSLATION OF THE WORD "TAHI" IN THE MARK IS "ONE".

SER. NO. 77-247,110, FILED 8-3-2007.

DAVID C. REIHNER, EXAMINING ATTORNEY



David J. Kyros

Director of the United States Patent and Trademark Office

United States of America

United States Patent and Trademark Office

REDNECK MOMMA

Reg. No. 4,173,319

Registered July 17, 2012

Int. Cls.: 16, 30 and 35

TRADEMARK

SERVICE MARK

PRINCIPAL REGISTER

LOW, VALERIE (CANADA INDIVIDUAL), DBA REDNECK MOMMA VENTURES
1355 ELMWOOD DRIVE
PEMBERTON, CANADA V0N2L0

FOR: STATIONERY, NAMELY, BINDERS, GREETING CARDS, CRAYONS, ENVELOPES, ERASERS, FOLDERS, GUEST BOOKS, PRINTED INVITATIONS OR INVITATION CARDS, PAPER LABELS, NOTE PADS, ORGANIZERS, PAPER, PENS, PENCILS, POSTCARDS, STAPLES AND STAPLERS; STICKERS; PRINTED PUBLICATIONS, NAMELY, BOOKS, MAGAZINES AND NEWSLETTERS, FEATURING HUMOR, FICTION AND BIOGRAPHIES, IN CLASS 16 (U.S. CLS. 2, 5, 22, 23, 29, 37, 38 AND 50).

FOR: CONFECTIONERIES, NAMELY, CHOCOLATE BARS, ASSORTED CHOCOLATES, TRUFFLES AND FRUIT JELLY CANDY; SAUCES, NAMELY, BARBECUE, CHEESE, CHOCOLATE, GRAVY, HOT, SOY, PIZZA, SPAGHETTI, TARTAR AND TOMATO; CONDIMENTS, NAMELY, RELISHES, IN CLASS 30 (U.S. CL. 46).

FOR: WHOLESALE, RETAIL STORES SERVICES AND ONLINE ORDERING SERVICES FEATURING JEWELRY, WALLETS, PRE-RECORDED CDS, DVDS AND DOWNLOADABLE FILES, PET ACCESSORIES, CHILDREN'S TOYS, HOUSE WARES, LINENS, STATIONERY, SOUVENIRS AND NOVELTY ITEMS, CONFECTIONERIES, SAUCES, CONDIMENTS, PRINTED PUBLICATIONS, TOOLS AND TOOL BOXES, IN CLASS 35 (U.S. CLS. 100, 101 AND 102).

THE MARK CONSISTS OF STANDARD CHARACTERS WITHOUT CLAIM TO ANY PARTICULAR FONT, STYLE, SIZE, OR COLOR.

PRIORITY CLAIMED UNDER SEC. 44(D) ON CANADA APPLICATION NO. 1347148, FILED 5-11-2007, REG. NO. TMA785032, DATED 12-15-2010, EXPIRES 12-15-2025.

NO CLAIM IS MADE TO THE EXCLUSIVE RIGHT TO USE "MOMMA", APART FROM THE MARK AS SHOWN.

SER. NO. 77-258,527, FILED 8-17-2007.

ZACHARY BELLO, EXAMINING ATTORNEY



David J. Kyffers

Director of the United States Patent and Trademark Office

United States of America

United States Patent and Trademark Office

Fly Zone

Reg. No. 4,173,320

EXQUISITE APPAREL CORP. (NEW YORK CORPORATION)
350 FIFTH AVE
NEW YORK, NY 10021

Registered July 17, 2012

Int. Cl.: 25

FOR: CLOTHING, NAMELY, UNDERWEAR AND BOXERS, IN CLASS 25 (U.S. CLS. 22 AND 39).

TRADEMARK

FIRST USE 8-1-2005; IN COMMERCE 8-1-2005.

PRINCIPAL REGISTER

THE MARK CONSISTS OF STANDARD CHARACTERS WITHOUT CLAIM TO ANY PARTICULAR FONT, STYLE, SIZE, OR COLOR.

SER. NO. 77-323,784, FILED 11-7-2007.

RON FAIRBANKS, EXAMINING ATTORNEY



David J. Kyffers

Director of the United States Patent and Trademark Office

United States of America

United States Patent and Trademark Office



Reg. No. 4,173,321

Registered July 17, 2012

Int. Cls.: 3 and 8

TRADEMARK

PRINCIPAL REGISTER

MAGELLAN TEXTILE HOLDINGS LIMITED (HONG KONG CORPORATION)
UNIT 1001, 10TH FLOOR STAR HOUSE
3 SALISBURY ROAD
TSIMSHATSUI, HONG KONG

FOR: NON-MEDICATED TOILETRIES, COSMETICS, PERFUMERY, ESSENTIAL OILS, SOAPS, HAIR LOTION, DEPILATORY CREAMS, IN CLASS 3 (U.S. CLS. 1, 4, 6, 50, 51 AND 52).

FOR: RAZORS AND REPLACEMENT PARTS THEREFOR, IN CLASS 8 (U.S. CLS. 23, 28 AND 44).

PRIORITY CLAIMED UNDER SEC. 44(D) ON ERPN CMNTY TM OFC APPLICATION NO. 6433601, FILED 11-13-2007, REG. NO. 006433601, DATED 11-16-2011, EXPIRES 11-13-2017.

OWNER OF U.S. REG. NO. 1,102,203.

SER. NO. 77-330,682, FILED 11-15-2007.

ASMAT KHAN, EXAMINING ATTORNEY



David J. Kybas

Director of the United States Patent and Trademark Office

United States of America

United States Patent and Trademark Office



Reg. No. 4,173,322

Registered July 17, 2012

Int. Cls.: 9, 38 and 41

TRADEMARK

SERVICE MARK

PRINCIPAL REGISTER

ASIA TELEVISION LIMITED (HONG KONG LIMITED LIABILITY COMPANY)
TAI PO INDUSTRIAL ESTATE
25-37 DAI SHING STREET
TAI PO, HONG KONG

FOR: PRE-RECORDED COMPACT DISCS, VIDEO TAPES, VIDEO DISCS, LASER DISCS, DIGITAL VIDEO DISCS AND VIDEO COMPACT DISCS FEATURING CULTURAL, EDUCATIONAL, NEWS AND ENTERTAINMENT TOPICS; CINEMATOGRAPHIC FILMS, IN CLASS 9 (U.S. CLS. 21, 23, 26, 36 AND 38).

FOR: TELEVISION BROADCASTING; SATELLITE TELEVISION BROADCASTING; CABLE TELEVISION BROADCASTING; AUDIO AND VIDEO BROADCASTING; VIDEO ON DEMAND TRANSMISSION SERVICES; BROADCASTING PROGRAMS VIA THE INTERNET; NEWS AGENCIES, NAMELY, THE TRANSMISSION OF NEWS ITEMS TO NEWS REPORTING ORGANIZATIONS, IN CLASS 38 (U.S. CLS. 100, 101 AND 104).

FOR: PRODUCTION, DISTRIBUTION AND EXHIBITION OF TELEVISION PROGRAMS; ENTERTAINMENT SERVICES, NAMELY, PRODUCTION OF TELEVISION SERIES AND PROGRAMS; RENTAL OF PRERECORDED TELEVISION SERIES AND PROGRAMS; PRODUCTION OF SHOWS, MUSICAL AND/OR DANCING SHOWS; ORGANIZING COMPETITIONS, NAMELY, BEAUTY CONTESTS, SINGING, TALENT, COMPERE AND COMMENTATOR COMPETITIONS; ARRANGING, CONDUCTING AND PRESENTING LIVE PERFORMANCES, IN CLASS 41 (U.S. CLS. 100, 101 AND 107).

PRIORITY CLAIMED UNDER SEC. 44(D) ON HONG KONG APPLICATION NO. 300969157, FILED 10-9-2007, REG. NO. 300969157, DATED 10-9-2007, EXPIRES 10-8-2017.

THE COLOR(S) RED, RED-ORANGE, ORANGE AND YELLOW IS/ARE CLAIMED AS A FEATURE OF THE MARK.

NO CLAIM IS MADE TO THE EXCLUSIVE RIGHT TO USE "TV", APART FROM THE MARK AS SHOWN.

THE MARK CONSIST OF THE STYLIZED LETTER "A" AND THE UNSTYLIZED SMALLER LETTERS "TV". THE "A" IS SHOWN IN A BLEND OF THE COLORS RED, RED-ORANGE, ORANGE AND YELLOW. THE LETTERS "TV" ARE SHOWN IN RED WITH A DARKER RED SHADING TO MAKE THEM APPEAR THREE-DIMENSIONAL.



David J. Kyjars

Director of the United States Patent and Trademark Office

Reg. No. 4,173,322 SER. NO. 77-358,234, FILED 12-21-2007.

KAREN SEVERSON, EXAMINING ATTORNEY

United States of America

United States Patent and Trademark Office

VIPER

Reg. No. 4,173,323

Registered July 17, 2012

Int. Cl.: 9

TRADEMARK

PRINCIPAL REGISTER

COHERENT, INC. (DELAWARE CORPORATION)
5100 PATRICK HENRY DRIVE
SANTA CLARA, CA 95054

FOR: LASERS FOR USE IN ENTERTAINMENT AND DISPLAY, IN CLASS 9 (U.S. CLS. 21, 23, 26, 36 AND 38).

FIRST USE 11-0-1999; IN COMMERCE 11-0-1999.

THE MARK CONSISTS OF STANDARD CHARACTERS WITHOUT CLAIM TO ANY PARTICULAR FONT, STYLE, SIZE, OR COLOR.

SER. NO. 77-374,668, FILED 1-17-2008.

KATHLEEN LORENZO, EXAMINING ATTORNEY



David J. Kybas

Director of the United States Patent and Trademark Office

United States of America

United States Patent and Trademark Office

ruggit

Reg. No. 4,173,324

Registered July 17, 2012

Int. Cl.: 42

SERVICE MARK

PRINCIPAL REGISTER

ADS-TEC GMBH (FED REP GERMANY CORPORATION)
RAIFFEISENSTRASSE 14
LEINFELDENECHTERDINGEN, FED REP GERMANY 70771

FOR: DEVELOPMENT, UPDATING AND MAINTENANCE OF SOFTWARE, IN PARTICULAR SOFTWARE FOR REMOTE PROTOCOL FOR REAL-TIME OPERATION OF INTERLINKED PRODUCTION LINE SYSTEMS AND PROCESSES, FOR NETWORK CONNECTION BETWEEN A CENTRAL COMPUTER AND TERMINAL DEVICES AND FOR CONTROL DEVICE PRODUCTION TEST STANDS, IN CLASS 42 (U.S. CLS. 100 AND 101).

THE MARK CONSISTS OF STANDARD CHARACTERS WITHOUT CLAIM TO ANY PARTICULAR FONT, STYLE, SIZE, OR COLOR.

PRIORITY CLAIMED UNDER SEC. 44(D) ON ERPN CMNTY TM OFC APPLICATION NO. 006525612, FILED 12-4-2007, REG. NO. 0065256612, DATED 1-23-2009, EXPIRES 12-4-2017.

SER. NO. 77-383,953, FILED 1-30-2008.

DAVID TAYLOR, EXAMINING ATTORNEY



David J. Kypos

Director of the United States Patent and Trademark Office

United States of America

United States Patent and Trademark Office

WHATEVER IT TAKES!

Reg. No. 4,173,325

Registered July 17, 2012

Int. Cls.: 35 and 39

SERVICE MARK

PRINCIPAL REGISTER

SADDLE CREEK CORPORATION (FLORIDA CORPORATION)
3010 SADDLE CREEK ROAD
LAKELAND, FL 33801

FOR: TRANSPORTATION LOGISTICS SERVICES, NAMELY, PLANNING AND SCHEDULING SHIPMENTS FOR USERS OF TRANSPORTATION SERVICES; BUSINESS MANAGEMENT SERVICES, NAMELY, MANAGING LOGISTICS, REVERSE LOGISTICS, SUPPLY CHAIN SERVICES, SUPPLY CHAIN VISIBILITY AND SYNCHRONIZATION, SUPPLY AND DEMAND FORECASTING AND PRODUCT DISTRIBUTION PROCESSES FOR OTHERS, IN CLASS 35 (U.S. CLS. 100, 101 AND 102).

FIRST USE 4-30-1998; IN COMMERCE 4-30-1998.

FOR: FREIGHT TRANSPORTATION BY TRUCK, SUPPLY CHAIN, LOGISTICS AND REVERSE LOGISTICS SERVICES, NAMELY, STORAGE, TRANSPORTATION AND DELIVERY OF DOCUMENTS, PACKAGES, RAW MATERIALS, AND OTHER FREIGHT FOR OTHERS BY AIR, RAIL, SHIP OR TRUCK, IN CLASS 39 (U.S. CLS. 100 AND 105).

FIRST USE 4-30-1998; IN COMMERCE 4-30-1998.

THE MARK CONSISTS OF STANDARD CHARACTERS WITHOUT CLAIM TO ANY PARTICULAR FONT, STYLE, SIZE, OR COLOR.

SER. NO. 77-385,019, FILED 1-31-2008.

NELSON SNYDER, EXAMINING ATTORNEY



David J. Kyfos

Director of the United States Patent and Trademark Office

United States of America

United States Patent and Trademark Office

PERFECTION BOOSTERS

Reg. No. 4,173,326

Registered July 17, 2012

Int. Cls.: 3 and 5

TRADEMARK

PRINCIPAL REGISTER

RECKITT BENCKISER N.V. (NETHERLANDS NAAMLOZE VENNOOTSCHAP (NV))
SIRIUSDREEF 14 - 2132 WT
HOOFDDORP, NETHERLANDS

FOR: PERFUMING PREPARATIONS FOR THE ATMOSPHERE, NAMELY, ROOM FRAGRANCES; PREPARATIONS FOR PERFUMING OR FRAGRANCING THE AIR, NAMELY, POTPOURRI, ESSENTIAL OILS; BLEACHING PREPARATIONS AND DETERGENT SOAPS FOR LAUNDRY USE; LAUNDRY DETERGENTS; DETERGENT SOAPS; LAUNDRY ADDITIVES, NAMELY, LAUNDRY STARCH, LAUNDRY BLEACH, LAUNDRY BLUEING, LAUNDRY PRE-SOAK AND FABRIC SOFTENERS; LAUNDRY PREPARATIONS FOR DRY CLEANERS, NAMELY, DRY CLEANING FLUIDS, SOLVENTS AND SPOT REMOVERS; CARPET CLEANERS; CARPET SHAMPOOS; DECALCIFYING AND DESCALING PREPARATIONS FOR HOUSEHOLD PURPOSES; STAIN REMOVING PREPARATIONS; BLEACHING PREPARATIONS FOR HOUSEHOLD USE; DISHWASHING DETERGENTS; COMBINATION CLEANERS, FRESHENERS AND DEODORIZERS FOR MACHINE DISHWASHERS; RINSE AGENTS FOR MACHINE DISHWASHERS; POLISHING PREPARATIONS FOR KITCHEN AND GLASSWARE; GENERAL PURPOSE CLEANING, POLISHING, SCOURING AND ABRASIVE LIQUIDS, CREAMS, GELS AND POWDERS; ALL AFOREMENTIONED GOODS WITH OR WITHOUT A DISINFECTIVE COMPONENT; CLEANING, SCOURING AND POLISHING ABRASIVE PREPARATIONS; CLOTHS, WIPES, TISSUES AND SPONGES IMPREGNATED WITH CLEANING PREPARATIONS, POLISHING PREPARATIONS, DETERGENT OR DISINFECTANT FOR HOUSEHOLD CLEANING, IN CLASS 3 (U.S. CLS. 1, 4, 6, 50, 51 AND 52).



David J. Kybas

FOR: AIR FRESHENING PREPARATIONS; AIR PURIFYING PREPARATIONS, NAMELY, AIR DEODORANTS; ROOM AIR FRESHENERS; ROOM DEODORANTS; PREPARATIONS FOR NEUTRALIZING ODORS IN CARPETS, TEXTILES, AND IN THE AIR; PHARMACEUTICAL PREPARATIONS FOR WOUNDS; VETERINARY PREPARATIONS, NAMELY, ANTI-OXIDANTS; SANITARY PREPARATIONS FOR MEDICAL USE; ANTI-SEPTIC PREPARATIONS, ANTI-BACTERIAL CLEANERS, DISINFECTING PREPARATIONS FOR HYGIENE PURPOSES, GERMICIDES; INSECTICIDES AND MITICIDES FOR DOMESTIC USE; INSECT REPELLENTS; PREPARATIONS FOR DESTROYING AND REPELLING VERMIN; FUNGICIDES; MEDICATED PREPARATIONS FOR NEUTRALIZING, CONTROLLING OR REDUCING ALLERGENS; CLOTHS, WIPES, TISSUES AND SPONGES IMPREGNATED WITH MEDICATED ANTI-SEPTIC, ANTI-BACTERIAL OR DISINFECTANT PREPARATIONS FOR HYGIENE USE, IN CLASS 5 (U.S. CLS. 6, 18, 44, 46, 51 AND 52).

Reg. No. 4,173,326 THE MARK CONSISTS OF STANDARD CHARACTERS WITHOUT CLAIM TO ANY PARTICULAR FONT, STYLE, SIZE, OR COLOR.

PRIORITY CLAIMED UNDER SEC. 44(D) ON ERPN CMNTY TM OFC APPLICATION NO. 006306526, FILED 9-25-2007, REG. NO. 006306526, DATED 8-29-2008, EXPIRES 9-25-2017.

SER. NO. 77-418,355, FILED 3-11-2008.

JIM RINGLE, EXAMINING ATTORNEY

United States of America

United States Patent and Trademark Office

THIRD MILLENNIUM

Reg. No. 4,173,327

Registered July 17, 2012

Int. Cl.: 34

TRADEMARK

PRINCIPAL REGISTER

STARCO IMPEX, INC. (TEXAS CORPORATION)
2710 S. 11TH STREET
BEAUMONT, TX 77701

FOR: CIGARS, IN CLASS 34 (U.S. CLS. 2, 8, 9 AND 17).

FIRST USE 11-20-1997; IN COMMERCE 11-20-1997.

THE MARK CONSISTS OF STANDARD CHARACTERS WITHOUT CLAIM TO ANY PARTICULAR FONT, STYLE, SIZE, OR COLOR.

OWNER OF U.S. REG. NO. 2,286,101.

SER. NO. 77-459,546, FILED 4-28-2008.

COLLEEN KEARNEY, EXAMINING ATTORNEY



David J. Kyffers

Director of the United States Patent and Trademark Office

United States of America

United States Patent and Trademark Office

Cool the Earth

Reg. No. 4,173,328

Registered July 17, 2012

Int. Cl.: 41

SERVICE MARK

PRINCIPAL REGISTER

CULLEN, CARLEEN E. (CALIFORNIA NON-PROFIT ORGANIZATION)
20 CORTE CORDOVA
GREENBRAE, CA 94904

FOR: EDUCATION SERVICES, NAMELY, PROVIDING A SCHOOL-TO-HOME PROGRAM IN THE FIELDS OF ENVIRONMENT, CONSERVATION, GLOBAL WARMING, CLIMATE CHANGE; EDUCATIONAL SERVICES, NAMELY, CONDUCTING INFORMAL PROGRAMS IN THE FIELDS OF ENVIRONMENT, CONSERVATION, GLOBAL WARMING, CLIMATE CHANGE, USING ON-LINE ACTIVITIES AND INTERACTIVE EXHIBITS, AND PRINTABLE MATERIALS DISTRIBUTED THEREWITH; EDUCATIONAL SERVICES, NAMELY, CONDUCTING PROGRAMS IN THE FIELD OF ENVIRONMENT, CONSERVATION, GLOBAL WARMING, CLIMATE CHANGE, IN CLASS 41 (U.S. CLS. 100, 101 AND 107).

FIRST USE 2-15-2007; IN COMMERCE 2-15-2007.

THE MARK CONSISTS OF STANDARD CHARACTERS WITHOUT CLAIM TO ANY PARTICULAR FONT, STYLE, SIZE, OR COLOR.

SER. NO. 77-466,409, FILED 5-6-2008.

JILL C. ALT, EXAMINING ATTORNEY



David J. Kyffers

Director of the United States Patent and Trademark Office

United States of America

United States Patent and Trademark Office

Fluency

Reg. No. 4,173,329

Registered July 17, 2012

Int. Cl.: 35

SERVICE MARK

PRINCIPAL REGISTER

FLUENCY, INC. (CALIFORNIA CORPORATION)
7220 FAIR OAKS BLVD., STE. D
CARMICHAEL, CA 95608

FOR: PROJECT MANAGEMENT SERVICES FOR OTHERS IN THE FIELDS OF LANGUAGE TRANSLATION, CUSTOM WRITING, TEXT ADAPTATION, INTERPRETING AND PROOFREADING, IN CLASS 35 (U.S. CLS. 100, 101 AND 102).

FIRST USE 4-27-2006; IN COMMERCE 4-27-2006.

THE MARK CONSISTS OF THE WORD "FLUENCY" IN STYLIZED LETTERING; THE TOP PORTION OF THE WORD IS IN LIGHT BLUE, AND THE LOWER PORTION OF THE WORD IS DARK BLUE; THE LIGHT AND DARK PORTIONS OF THE WORD ARE DIVIDED BY A THIN, WHITE, WAVY LINE.

THE COLOR(S) LIGHT BLUE, DARK BLUE, AND WHITE IS/ARE CLAIMED AS A FEATURE OF THE MARK.

SER. NO. 77-471,974, FILED 5-12-2008.

HAI-LY LAM, EXAMINING ATTORNEY



David J. Kyros

Director of the United States Patent and Trademark Office

United States of America

United States Patent and Trademark Office

make it go fluently

Reg. No. 4,173,330

Registered July 17, 2012

Int. Cl.: 35

SERVICE MARK

PRINCIPAL REGISTER

FLUENCY, INC. (CALIFORNIA CORPORATION)
7220 FAIR OAKS BLVD., STE. D
CARMICHAEL, CA 95608

FOR: PROJECT MANAGEMENT SERVICES FOR OTHERS IN THE FIELDS OF LANGUAGE TRANSLATION, CUSTOM WRITING, TEXT ADAPTATION, INTERPRETING AND PROOFREADING, IN CLASS 35 (U.S. CLS. 100, 101 AND 102).

FIRST USE 4-27-2006; IN COMMERCE 4-27-2006.

THE MARK CONSISTS OF STANDARD CHARACTERS WITHOUT CLAIM TO ANY PARTICULAR FONT, STYLE, SIZE, OR COLOR.

SER. NO. 77-472,010, FILED 5-12-2008.

HAI-LY LAM, EXAMINING ATTORNEY



David J. Kyffers

Director of the United States Patent and Trademark Office

United States of America

United States Patent and Trademark Office

TIGRAN

Reg. No. 4,173,331

TIGRAN TECHNOLOGIES AB (SWEDEN JOINT STOCK COMPANY)
MEDEON SCIENCE PARK 205 12
MALMÖ, SWEDEN

Registered July 17, 2012

Int. Cl.: 10

FOR: POROUS TITANIUM GRANULES FOR MEDICAL PURPOSES, NAMELY, BONE RE-GENERATION, IN CLASS 10 (U.S. CLS. 26, 39 AND 44).

TRADEMARK

THE MARK CONSISTS OF STANDARD CHARACTERS WITHOUT CLAIM TO ANY PARTICULAR FONT, STYLE, SIZE, OR COLOR.

PRINCIPAL REGISTER

OWNER OF ERPN CMNTY TM OFC REG. NO. 000691840, DATED 11-24-1997, RENEWED AS REG. NO. 000691840, DATED 11-25-2007, EXPIRES 11-25-2017.

OWNER OF U.S. REG. NO. 2,627,047.

SER. NO. 77-488,491, FILED 6-2-2008.

DAVID HOFFMAN, EXAMINING ATTORNEY



David J. Kyfos

Director of the United States Patent and Trademark Office

United States of America

United States Patent and Trademark Office

CEC SERVICES

Reg. No. 4,173,332

Registered July 17, 2012

Int. Cls.: 37, 40 and 42

SERVICE MARK

PRINCIPAL REGISTER

AKER PROCESS SYSTEMS AS (NORWAY CORPORATION)
POSTBOKS 403
1327 LYSAKER, NORWAY

FOR: BUILDING CONSTRUCTIONS AND REPAIR; INSTALLATION SERVICES, NAMELY, INSTALLATION OF SEPARATORS, PIPES, WIRES, PUMPS, VALVES, FLOW CONTROL MODULES, MANIFOLDS AND TEMPLATES ALL FOR USE IN PETROLEUM DRILLING AND HANDLING; WELL DRILLING; CONSTRUCTION MANAGEMENT; SHIPBUILDING; CONSTRUCTION, MAINTENANCE AND REPAIR OF SHIPYARDS; INSTALLATION, MAINTENANCE AND REPAIR OF OIL DRILLING AND REFINING MACHINERY; INSTALLATION AND MAINTENANCE OF OIL PIPELINES; UNDERWATER BUILDING AND UNDERWATER REPAIR OF OIL DRILLING PLATFORMS AND TANKERS; PLANNING AND ADVISORY SERVICES REGARDING BUILDING AND CONSTRUCTION OF OIL DRILLING, OIL REFINING, AND SHIPBUILDING FACILITIES, IN CLASS 37 (U.S. CLS. 100, 103 AND 106).

FOR: ENVIRONMENTAL REMEDIATION SERVICES, NAMELY, TREATMENT OF PETROLEUM, GAS, SAND AND WATER, IN CLASS 40 (U.S. CLS. 100, 103 AND 106).

FOR: ANALYSIS SERVICES FOR EXPLOITATION OF OIL FIELDS AND OIL EXPLORATION; CONSULTANCY SERVICES IN THE FIELD OF OIL FIELD ENGINEERING, OIL DRILLING, AND PETROLEUM REFINING; CHEMICAL RESEARCH, INVESTIGATION, AND ANALYSIS FOR OTHERS IN THE FIELDS OF PETROLEUM CHEMISTRY; RESEARCH REGARDING MECHANICS OF OIL DRILLING AND OIL REFINING EQUIPMENT FOR OTHERS; COMPUTER PROGRAMMING; UNDERWATER EXPLORATION, IN CLASS 42 (U.S. CLS. 100 AND 101).

THE MARK CONSISTS OF STANDARD CHARACTERS WITHOUT CLAIM TO ANY PARTICULAR FONT, STYLE, SIZE, OR COLOR.

PRIORITY CLAIMED UNDER SEC. 44(D) ON NORWAY APPLICATION NO. 200801235, FILED 2-1-2008, REG. NO. 245816, DATED 5-9-2008, EXPIRES 5-9-2018.

OWNER OF U.S. REG. NO. 2,994,145.

NO CLAIM IS MADE TO THE EXCLUSIVE RIGHT TO USE "SERVICES", APART FROM THE MARK AS SHOWN.



David J. Kybas

Director of the United States Patent and Trademark Office

Reg. No. 4,173,332 SER. NO. 77-504,201, FILED 6-20-2008.

VIVIAN MICZNIK FIRST, EXAMINING ATTORNEY

United States of America

United States Patent and Trademark Office

FIRSTBORN

Reg. No. 4,173,333

Registered July 17, 2012

Int. Cls.: 25 and 28

TRADEMARK

PRINCIPAL REGISTER

DELTA RIM COMPOSITES, INC. (CANADA CORPORATION)
651 BRIDGE STREET
MONTREAL, QUEBEC, CANADA H3K2C8

FOR: CLOTHING, NAMELY, TEE SHIRTS, IN CLASS 25 (U.S. CLS. 22 AND 39).

FOR: SPORTS EQUIPMENT, NAMELY, BODY BOARDS, SKATEBOARDS, IN-LINE ROLLER SKATES, AND ROLLER SKATES; SPORTING GOODS/EQUIPMENT, NAMELY, SKATEBOARD WHEELS, LONGBOARD SKATEBOARD WHEELS, IN-LINE ROLLER SKATE WHEELS, ROLLER SKATE WHEELS, AND LAND LUGE WHEELS, IN CLASS 28 (U.S. CLS. 22, 23, 38 AND 50).

THE MARK CONSISTS OF STANDARD CHARACTERS WITHOUT CLAIM TO ANY PARTICULAR FONT, STYLE, SIZE, OR COLOR.

OWNER OF CANADA REG. NO. TMA809534, DATED 10-19-2011, EXPIRES 10-19-2026.

SER. NO. 77-543,996, FILED 8-11-2008.

AISHA CLARKE, EXAMINING ATTORNEY



David J. Kyffers

Director of the United States Patent and Trademark Office

United States of America

United States Patent and Trademark Office

COSMONAUT PREMIUM VODKA THE SPIRIT OF ADVENTURE

Reg. No. 4,173,334

THE COSMONAUT CORP. (CANADA CORPORATION)
142 ADELAIDE STREET EAST
TORONTO, CANADA M5C1K9

Registered July 17, 2012

Int. Cl.: 33

FOR: VODKA, IN CLASS 33 (U.S. CLS. 47 AND 49).

TRADEMARK

THE MARK CONSISTS OF STANDARD CHARACTERS WITHOUT CLAIM TO ANY PARTICULAR FONT, STYLE, SIZE, OR COLOR.

PRINCIPAL REGISTER

PRIORITY CLAIMED UNDER SEC. 44(D) ON CANADA APPLICATION NO. 1407021, FILED 8-12-2008, REG. NO. TMA803,225, DATED 7-29-2011, EXPIRES 7-29-2026.

NO CLAIM IS MADE TO THE EXCLUSIVE RIGHT TO USE "PREMIUM VODKA", APART FROM THE MARK AS SHOWN.

SER. NO. 77-557,659, FILED 8-28-2008.

DOMINIC FATHY, EXAMINING ATTORNEY



David J. Kyjars

Director of the United States Patent and Trademark Office

United States of America

United States Patent and Trademark Office

ISLAND TROTTERS

Reg. No. 4,173,335

EFFIGI INC. (CANADA CORPORATION)

Registered July 17, 2012

1155 AUTOROUTE 13
LAVAL, QUEBEC, CANADA H7W5J8

Int. Cls.: 18 and 25

FOR: BAGS, NAMELY, SPORTS BAGS, GYM BAGS, BEACH BAGS, DIAPER BAGS, BACKPACKS, HANDBAGS, TRAVEL BAGS, SCHOOL BAGS, SHOE BAGS FOR TRAVEL, FANNY PACKS, HIKING BAGS, SHOULDER BAGS, TOTE BAGS, BABY CARRIERS WORN ON THE BODY, IN CLASS 18 (U.S. CLS. 1, 2, 3, 22 AND 41).

TRADEMARK

PRINCIPAL REGISTER

FOR: CLOTHING IN THE NATURE OF URBAN WEAR, BUSINESS WEAR, CASUAL WEAR, LOUNGEWEAR, CLOTHING FOR GYMNASTICS, EXERCISE CLOTHING, SPORTS CLOTHING, FORMAL WEAR, SLEEPWEAR, RAIN WEAR, OUTERWEAR FOR THE WINTER, SKI WEAR, AND/OR CLOTHING FOR CHILDREN, BABIES AND NEWBORNS, NAMELY, SWEATERS, T-SHIRTS, CAMISOLES, VESTS, CARDIGANS, TURTLENECKS, DRESSES, UNDERWEAR, CULOTTES, MIDRIFF TOPS, SLIPS, PANTS, JEANS, JACKETS, BERMUDA SHORTS, SHORTS, SKIRTS, SUITS, JUMPSUITS, OVERALLS, BLOUSES, BLAZERS, SKI SUITS, OVERCOATS, PARKAS, ANORAKS, RAINCOATS, RAIN SLICKERS, SWEATSHIRTS, HOODED SWEATSHIRTS, JERSEYS, JOGGING OUTFITS, MITTENS, GLOVES, PAJAMAS, NIGHTGOWNS, BABY DOLLS, NIGHTIES, DRESSING GOWNS, BATHROBES, SLEEPING GARMENTS, BABY BIBS NOT OF PAPER, AND LEOTARDS, COATS, SLIPOVERS, POLO SHIRTS, AND BOXER SHORTS; UNDERWEAR; BEACHWEAR; SWIM SUITS; HEADWEAR, NAMELY, HATS, SKULL CAPS, BERETS, HEADBANDS, KERCHIEFS, EAR MUFFS, TOQUES, AND CAPS; FASHION ACCESSORIES, NAMELY, BELTS, SUSPENDERS, NECKTIES, SCARVES, AND BANDANNAS, IN CLASS 25 (U.S. CLS. 22 AND 39).



THE MARK CONSISTS OF STANDARD CHARACTERS WITHOUT CLAIM TO ANY PARTICULAR FONT, STYLE, SIZE, OR COLOR.

PRIORITY CLAIMED UNDER SEC. 44(D) ON CANADA APPLICATION NO. 1393338, FILED 4-29-2008, REG. NO. TMA818725, DATED 2-29-2012, EXPIRES 2-28-2027.

SER. NO. 77-568,483, FILED 9-12-2008.

David J. Kyros

BRENDAN MCCAULEY, EXAMINING ATTORNEY

United States of America

United States Patent and Trademark Office

BRIGHTMESH

Reg. No. 4,173,336

Registered July 17, 2012

Int. Cls.: 35 and 45

SERVICE MARK

PRINCIPAL REGISTER

BRIGHTMESH INC. (CANADA CORPORATION)
45 DUNFIELD AVENUE, SUITE 1220
TORONTO, CANADA M4S2H4

FOR: ONLINE EMPLOYMENT AND RECRUITING SERVICES, NAMELY, PROVIDING SEARCHABLE JOB POSTINGS AND RESUME POSTINGS AND RESUME MATCHING; THE PROVISION OF AN INTERNET WEBSITE PORTAL OFFERING TOOLS AND SERVICES DESIGNED FOR USE BY POTENTIAL EMPLOYERS AND EMPLOYEES, NAMELY, PROVIDING AN ON-LINE SEARCHABLE DATABASE FEATURING EMPLOYMENT OPPORTUNITIES, RESUME POSTING AND MATCHING SERVICES; THE PROVISION OF AN INTERNET WEBSITE PORTAL PERMITTING POTENTIAL EMPLOYERS AND EMPLOYEES TO CREATE PROFILES, ADVERTISE THEIR AVAILABILITY, AND SEARCH FOR POSTINGS; NETWORKING SERVICES, NAMELY, PROVIDING AN INTERNET WEBSITE PORTAL FACILITATING CAREER NETWORKING SERVICES , IN CLASS 35 (U.S. CLS. 100, 101 AND 102).

FIRST USE 11-15-2010; IN COMMERCE 11-15-2010.

FOR: ON-LINE SOCIAL NETWORKING SERVICES, IN CLASS 45 (U.S. CLS. 100 AND 101).

FIRST USE 11-15-2010; IN COMMERCE 11-15-2010.

THE MARK CONSISTS OF STANDARD CHARACTERS WITHOUT CLAIM TO ANY PARTICULAR FONT, STYLE, SIZE, OR COLOR.

PRIORITY CLAIMED UNDER SEC. 44(D) ON CANADA APPLICATION NO. 1400009, FILED 6-17-2008, REG. NO. TMA794713, DATED 4-5-2011, EXPIRES 4-5-2016.

SER. NO. 77-611,313, FILED 11-10-2008.

DAVID I, EXAMINING ATTORNEY



David J. Kypos

Director of the United States Patent and Trademark Office

United States of America

United States Patent and Trademark Office



Reg. No. 4,173,337

Registered July 17, 2012

Int. Cl.: 5

TRADEMARK

PRINCIPAL REGISTER

SUNOPTA INC. (CANADA CORPORATION)
2838 BOVAIRD DRIVE WEST
NORVAL, ONTARIO, CANADA L7A0H2

FOR: VITAMINS; MINERAL SUPPLEMENTS; JUICES AND LIQUID TONICS FOR MEDICINAL PURPOSES, NAMELY, NUTRITIONAL SUPPLEMENT AND PREPARATIONS FOR TREATING FOR COUGH, COLD AND SORE THROAT; POWDERED DRINK MIXES FOR MEDICINAL PURPOSES, NAMELY, NUTRITIONAL SUPPLEMENT AND PREPARATIONS FOR TREATING FOR COUGH AND COLD; COLD REMEDIES IN THE NATURE OF PREPARATIONS FOR TREATING COLDS; LIQUID COUGH/COLD REMEDIES IN THE NATURE OF PREPARATIONS FOR TREATING COUGHS AND COLDS; MEDICATED SALVES FOR TOPICAL APPLICATION FOR RELIEF OF COUGH/COLD SYMPTOMS; COUGH SYRUP; HERBAL AND NATURAL HEALTH PRODUCTS, NAMELY, COUGH DROPS, THROAT LOZENGES, MEDICATED CANDIES, COUGH/THROAT LOZENGES SOLD IN THE FORM OF LOLLIPOPS; MINERAL AND HERBAL EXTRACTS, NAMELY, DIETARY AND NUTRITIONAL SUPPLEMENTS AND PREPARATIONS FOR TREATING COUGHS, COLDS AND SORE THROATS, IN CLASS 5 (U.S. CLS. 6, 18, 44, 46, 51 AND 52).

OWNER OF CANADA REG. NO. TMA813249, DATED 12-2-2011, EXPIRES 12-2-2026.

THE MARK CONSISTS OF THREE PENGUINS.

SER. NO. 77-697,143, FILED 3-23-2009.

SUE LAWRENCE, EXAMINING ATTORNEY



David J. Kyros

Director of the United States Patent and Trademark Office

United States of America

United States Patent and Trademark Office

GO UNDIET

Reg. No. 4,173,338

Registered July 17, 2012

Int. Cls.: 9, 16, 38 and 44

TRADEMARK

SERVICE MARK

PRINCIPAL REGISTER

HEALTHCASTLE NUTRITION INC. (CANADA CORPORATION)
SUITE 606, UNIT 34A, 2755 LOUGHEED HWY
PORT COQUITLAM, BC, CANADA V3B5Y9

FOR: DVDS FEATURING NUTRITION INFORMATION AND PRODUCT REVIEWS; DOWNLOADABLE ELECTRONIC PUBLICATIONS, NAMELY, BOOKS, NEWSLETTERS, INSTRUCTIONAL MATERIALS, ARTICLES, REPORTS, CATALOGUES AND DIRECTORIES IN THE FIELDS OF NUTRITION AND PRODUCT REVIEWS, IN CLASS 9 (U.S. CLS. 21, 23, 26, 36 AND 38).

FOR: BOOKS FEATURING NUTRITIONAL INFORMATION AND PRODUCT REVIEWS, IN CLASS 16 (U.S. CLS. 2, 5, 22, 23, 29, 37, 38 AND 50).

FOR: PROVIDING ONLINE MODERATED FORUMS FOR THE TRANSMISSION OF MESSAGES BETWEEN AND AMONG PARTICIPATING COMPUTER USERS IN THE FIELDS OF NUTRITION AND PRODUCT REVIEWS, IN CLASS 38 (U.S. CLS. 100, 101 AND 104).

FOR: PROVIDING AN INTERACTIVE WEB SITE FEATURING NUTRITIONAL ASSESSMENT INFORMATION, TOOLS AND CALCULATOR, IN CLASS 44 (U.S. CLS. 100 AND 101).

THE MARK CONSISTS OF STANDARD CHARACTERS WITHOUT CLAIM TO ANY PARTICULAR FONT, STYLE, SIZE, OR COLOR.

PRIORITY CLAIMED UNDER SEC. 44(D) ON CANADA APPLICATION NO. 1430131, FILED 3-6-2009, REG. NO. TMA819063, DATED 3-5-2012, EXPIRES 3-5-2027.

SER. NO. 77-697,251, FILED 3-23-2009.

NICHOLAS ALTREE, EXAMINING ATTORNEY



David J. Kypos

Director of the United States Patent and Trademark Office

United States of America

United States Patent and Trademark Office

kanvas

Reg. No. 4,173,339

Registered July 17, 2012

Int. Cls.: 35 and 44

SERVICE MARK

PRINCIPAL REGISTER

KANVAS BEAUTY, INC. (FLORIDA CORPORATION), DBA KANVAS
1123 THOMASVILLE ROAD
TALLAHASSEE, FL 32303

FOR: RETAIL STORE SERVICES FEATURING COSMETIC, BODY AND SKIN CARE PRODUCTS, IN CLASS 35 (U.S. CLS. 100, 101 AND 102).

FIRST USE 12-10-2007; IN COMMERCE 12-10-2007.

FOR: BEAUTY SPA SERVICES, NAMELY, COSMETIC, BODY AND SKIN CARE IN THE NATURE OF FACIALS, MASSAGE, MANICURES, PEDICURES, WAXING, SPRAY TANS, MAKE-UP APPLICATION, IN CLASS 44 (U.S. CLS. 100 AND 101).

FIRST USE 12-10-2007; IN COMMERCE 12-10-2007.

THE MARK CONSISTS OF STANDARD CHARACTERS WITHOUT CLAIM TO ANY PARTICULAR FONT, STYLE, SIZE, OR COLOR.

SER. NO. 77-701,522, FILED 3-28-2009.

STEVEN R. FINE, EXAMINING ATTORNEY



David J. Kypos

Director of the United States Patent and Trademark Office

United States of America
United States Patent and Trademark Office

LIPIDPRO

Reg. No. 4,173,340

Registered July 17, 2012

Int. Cl.: 10

TRADEMARK

PRINCIPAL REGISTER

INFOPIA CO., LTD. (REPUBLIC OF KOREA CORPORATION)
#1603, DONGIL TECHNOTOWN A BLDG., 889-3
KWANYANG2-DONG, DONGAN
ANYANG, KYUNGGI, REPUBLIC OF KOREA

FOR: DEVICES FOR MEASURING CHOLESTEROL FOR MEDICAL DIAGNOSTIC USE;
DEVICE FOR MEDICAL DIAGNOSTIC USE, NAMELY, SAMPLE PREPARATION DEVICE
FOR USE IN DIAGNOSING LIVER DISEASE; DEVICE FOR MEDICAL DIAGNOSTIC USE,
NAMELY, HANDHELD ULTRASOUND UNIT FOR USE IN DIAGNOSING HEART DISEASE,
IN CLASS 10 (U.S. CLS. 26, 39 AND 44).

THE MARK CONSISTS OF STANDARD CHARACTERS WITHOUT CLAIM TO ANY PAR-
TICULAR FONT, STYLE, SIZE, OR COLOR.

PRIORITY CLAIMED UNDER SEC. 44(D) ON REPUBLIC OF KOREA APPLICATION NO.
40-2009-0013, FILED 3-23-2009, REG. NO. 0883750, DATED 10-6-2011, EXPIRES 10-6-2021.

SER. NO. 77-706,790, FILED 4-3-2009.

CYNTHIA TRIPI, EXAMINING ATTORNEY



David J. Kyffers

Director of the United States Patent and Trademark Office

United States of America

United States Patent and Trademark Office

SLUVAX

Reg. No. 4,173,341

NOVARTIS AG (SWITZERLAND CORPORATION)
CH-4002

Registered July 17, 2012

BASEL, SWITZERLAND

Int. Cl.: 5

FOR: VACCINES FOR HUMAN USE, IN CLASS 5 (U.S. CLS. 6, 18, 44, 46, 51 AND 52).

TRADEMARK

THE MARK CONSISTS OF STANDARD CHARACTERS WITHOUT CLAIM TO ANY PARTICULAR FONT, STYLE, SIZE, OR COLOR.

PRINCIPAL REGISTER

OWNER OF SWITZERLAND REG. NO. 586373, DATED 5-4-2009, EXPIRES 5-4-2019.

SER. NO. 77-726,389, FILED 4-30-2009.

THEODORE MCBRIDE, EXAMINING ATTORNEY



David J. Kyffers

Director of the United States Patent and Trademark Office

United States of America

United States Patent and Trademark Office

CORPORATION SERVICE COMPANY

Reg. No. 4,173,342

Registered July 17, 2012

Int. Cls.: 35, 42 and 45

SERVICE MARK

PRINCIPAL REGISTER

CORPORATION SERVICE COMAPNY (DELAWARE CORPORATION)
SUITE 400, 2711 CENTERVILLE ROAD
WILMINGTON, DE 19808

FOR: PROVIDING BUSINESS SERVICES, NAMELY, PROVIDING BUSINESS INFORMATION IN THE FIELD OF BUSINESS ORGANIZATION RELATED TO ORGANIZING BUSINESSES AS LEGAL ENTITIES AND MAINTAINING LEGAL ENTITY STATUS; COMMERCIAL REGISTERED AGENT SERVICES, IN CLASS 35 (U.S. CLS. 100, 101 AND 102).

FIRST USE 0-0-1920; IN COMMERCE 0-0-1920.

FOR: PUBLIC DOCUMENT RETRIEVAL SERVICES, IN CLASS 42 (U.S. CLS. 100 AND 101).

FIRST USE 0-0-1920; IN COMMERCE 0-0-1920.

FOR: PUBLIC DOCUMENT FILING SERVICES, IN CLASS 45 (U.S. CLS. 100 AND 101).

FIRST USE 0-0-1920; IN COMMERCE 0-0-1920.

THE MARK CONSISTS OF STANDARD CHARACTERS WITHOUT CLAIM TO ANY PARTICULAR FONT, STYLE, SIZE, OR COLOR.

NO CLAIM IS MADE TO THE EXCLUSIVE RIGHT TO USE "SERVICE COMPANY", APART FROM THE MARK AS SHOWN.

SEC. 2(F).

SER. NO. 77-728,402, FILED 5-4-2009.

BILL DAWE, EXAMINING ATTORNEY



David J. Kyffers

Director of the United States Patent and Trademark Office

United States of America

United States Patent and Trademark Office

AutoGuard

Reg. No. 4,173,343

LITELINE CORPORATION (CANADA CORPORATION)
8 ABACUS ROAD

Registered July 17, 2012

BRAMPTON, ONTARIO, CANADA L6T5B7

Int. Cl.: 11

FOR: MOTION TRACKING LIGHTING FIXTURES, IN CLASS 11 (U.S. CLS. 13, 21, 23, 31 AND 34).

TRADEMARK

THE MARK CONSISTS OF STANDARD CHARACTERS WITHOUT CLAIM TO ANY PARTICULAR FONT, STYLE, SIZE, OR COLOR.

PRINCIPAL REGISTER

PRIORITY CLAIMED UNDER SEC. 44(D) ON CANADA APPLICATION NO. 1435708, FILED 4-23-2009, REG. NO. TMA813605, DATED 12-7-2011, EXPIRES 2-7-2026.

SER. NO. 77-729,606, FILED 5-5-2009.

AMEEN IMAM, EXAMINING ATTORNEY



David J. Kyffers

Director of the United States Patent and Trademark Office

United States of America

United States Patent and Trademark Office

DR. GREEN SERVICES

Reg. No. 4,173,344

Registered July 17, 2012

Int. Cls.: 37 and 44

SERVICE MARK

PRINCIPAL REGISTER

DR. GREEN SERVICES INC. (CANADA ONTARIO CORPORATION)
475 THOMPSON DRIVE, SUITE #6
CAMBRIDGE, ONTARIO, CANADA N1T2K7

FOR: PEST CONTROL, IN CLASS 37 (U.S. CLS. 100, 103 AND 106).

FOR: LAWN CARE AND MAINTENANCE, IN CLASS 44 (U.S. CLS. 100 AND 101).

THE MARK CONSISTS OF STANDARD CHARACTERS WITHOUT CLAIM TO ANY PARTICULAR FONT, STYLE, SIZE, OR COLOR.

PRIORITY CLAIMED UNDER SEC. 44(D) ON CANADA APPLICATION NO. 1439297, FILED 5-27-2009, REG. NO. TMA775266, DATED 8-23-2010, EXPIRES 8-23-2025.

NO CLAIM IS MADE TO THE EXCLUSIVE RIGHT TO USE "SERVICES", APART FROM THE MARK AS SHOWN.

SER. NO. 77-746,377, FILED 5-28-2009.

C. DIONNE CLYBURN, EXAMINING ATTORNEY



David J. Kybas

Director of the United States Patent and Trademark Office

United States of America

United States Patent and Trademark Office

CATH-SECURE CONTOUR

Reg. No. 4,173,345

Registered July 17, 2012

Int. Cl.: 10

TRADEMARK

PRINCIPAL REGISTER

M.C. JOHNSON CO., INC. (FLORIDA CORPORATION)
8801 BUSINESS PARK DRIVE
SUITE 201
FORT MYERS, FL 33912

FOR: MEDICAL APPARATUS, NAMELY, A DEVICE EXTERNALLY SECURED TO THE SKIN THAT IS USED TO STABILIZE AND TO SECURE MEDICAL TUBES, NAMELY, CATHETERS, IN CLASS 10 (U.S. CLS. 26, 39 AND 44).

FIRST USE 4-6-2009; IN COMMERCE 4-6-2009.

THE MARK CONSISTS OF STANDARD CHARACTERS WITHOUT CLAIM TO ANY PARTICULAR FONT, STYLE, SIZE, OR COLOR.

OWNER OF U.S. REG. NOS. 2,004,849, 4,070,813, AND 4,074,400.

NO CLAIM IS MADE TO THE EXCLUSIVE RIGHT TO USE "CONTOUR", APART FROM THE MARK AS SHOWN.

SER. NO. 77-772,480, FILED 7-1-2009.

BARBARA GAYNOR, EXAMINING ATTORNEY



David J. Kyffers

Director of the United States Patent and Trademark Office

United States of America

United States Patent and Trademark Office

Long Island Vettes

Reg. No. 4,173,346

LONG ISLAND VETTES, LTD. (NEW YORK CORPORATION)
BOX 228

Registered July 17, 2012

EAST MEADOW, NY 115540228

Int. Cl.: 35

FOR: CLUB SERVICES, NAMELY, PROMOTING THE INTERESTS OF MEMBERS IN SPORTS CARS, IN CLASS 35 (U.S. CLS. 100, 101 AND 102).

SERVICE MARK

FIRST USE 2-5-2002; IN COMMERCE 2-5-2002.

PRINCIPAL REGISTER

THE MARK CONSISTS OF STANDARD CHARACTERS WITHOUT CLAIM TO ANY PARTICULAR FONT, STYLE, SIZE, OR COLOR.

SEC. 2(F).

SER. NO. 77-773,462, FILED 7-2-2009.

JAMES A. RAUEN, EXAMINING ATTORNEY



David J. Kybas

Director of the United States Patent and Trademark Office

United States of America

United States Patent and Trademark Office



Reg. No. 4,173,347

Registered July 17, 2012

Int. Cls.: 35, 36 and 45

SERVICE MARK

PRINCIPAL REGISTER

NATIONWIDE CREDIT, INC. (GEORGIA CORPORATION)
2015 VAUGHN ROAD, BUILDING 400
KENNESAW, GA 30144

FOR: BUSINESS PROCESS OUTSOURCING SERVICES IN THE FIELD OF DEBT COLLECTION; CUSTOMER RELATIONSHIP MANAGEMENT; BUSINESS CONSULTING SERVICES IN THE FIELD OF SPEND MANAGEMENT; MANAGEMENT OF TELEPHONE CALL CENTERS FOR OTHERS, IN CLASS 35 (U.S. CLS. 100, 101 AND 102).

FIRST USE 8-1-2000; IN COMMERCE 8-1-2000.

FOR: FINANCIAL SERVICES, NAMELY, COLLECTION AGENCIES, COLLECTION OF DEBT, CREDIT RECOVERY AND COLLECTION, DEBT RECOVERY AND COLLECTION AGENCIES, CONTINGENCY COLLECTION OF DEBTS, MORTGAGE DEBT COLLECTION SERVICES; FIRST PARTY BUSINESS DEBT COLLECTIONS, IN CLASS 36 (U.S. CLS. 100, 101 AND 102).

FIRST USE 8-1-2000; IN COMMERCE 8-1-2000.

FOR: LEGAL SERVICES; SKIP TRACING SERVICES, IN CLASS 45 (U.S. CLS. 100 AND 101).

FIRST USE 8-1-2000; IN COMMERCE 8-1-2000.

OWNER OF U.S. REG. NOS. 1,932,669, 3,144,339, AND 3,429,456.

NO CLAIM IS MADE TO THE EXCLUSIVE RIGHT TO USE "CREDIT, INC.", APART FROM THE MARK AS SHOWN.

THE MARK CONSISTS OF AN ARC DESIGN AND THE WORDING "NCI NATIONWIDE CREDIT, INC.".

SEC. 2(F) AS TO "NATIONWIDE CREDIT, INC.".

SER. NO. 77-796,422, FILED 8-4-2009.

VERNA BETH RIRIE, EXAMINING ATTORNEY



David J. Kyffers

Director of the United States Patent and Trademark Office

United States of America

United States Patent and Trademark Office

MPOWER

Reg. No. 4,173,348

MPOWER COMMUNICATIONS CORP. (NEVADA CORPORATION)
515 S. FLOWER STREET, 47TH FLOOR
LOS ANGELES, CA 900712201

Registered July 17, 2012

Int. Cl.: 38

FOR: LOCAL TELEPHONE SERVICES; LONG DISTANCE TELEPHONE SERVICES; ELECTRONIC VOICE MESSAGING, NAMELY, THE RECORDING, STORAGE, AND SUBSEQUENT TRANSMISSION OF VOICE MESSAGES BY TELEPHONE; TELEPHONE VOICE MESSAGING SERVICES; ELECTRONIC TRANSMISSION OF DATA, IN CLASS 38 (U.S. CLS. 100, 101 AND 104).

SERVICE MARK

PRINCIPAL REGISTER

FIRST USE 1-31-2000; IN COMMERCE 1-31-2000.

THE MARK CONSISTS OF STANDARD CHARACTERS WITHOUT CLAIM TO ANY PARTICULAR FONT, STYLE, SIZE, OR COLOR.

SER. NO. 77-824,161, FILED 9-10-2009.

ADA HAN, EXAMINING ATTORNEY



David J. Kyjars

Director of the United States Patent and Trademark Office

United States of America

United States Patent and Trademark Office

TMEiC

We drive industry

Reg. No. 4,173,349

Registered July 17, 2012

Int. Cls.: 7, 9 and 11

TRADEMARK

PRINCIPAL REGISTER

TOSHIBA MITSUBISHI-ELECTRIC INDUSTRIAL SYSTEMS CORPORATION (JAPAN CORPORATION)
13-16 MITA 3-CHOME, MINATO-KU
TOKYO, JAPAN

FOR: ELECTRIC MOTORS FOR INDUSTRIAL MACHINES; ELECTRIC GENERATORS; ALL BEING NOT FOR AUTOMOTIVE USE, IN CLASS 7 (U.S. CLS. 13, 19, 21, 23, 31, 34 AND 35).

FOR: ELECTRICAL DISTRIBUTION BOXES AND CONSOLES; UNINTERRUPTIBLE ELECTRICAL POWER SUPPLY; ELECTRIC CONVERTERS; ELECTRIC INVERTERS; ELECTRIC RECTIFIERS; ELECTRIC SWITCHES; SOLID STATE ELECTRIC SWITCHES; DYNAMOMETERS; COMPUTERS; DATA PROCESSORS; WIRELESS DATA TRANSMITTERS; PROGRAMMABLE ELECTRICAL CONTROLLERS FOR USE IN THE AUTOMATIC CONTROL OF MECHANICAL AND INDUSTRIAL OPERATIONS IN FACTORIES; ELECTRICAL CONTROLLERS FOR USE IN THE AUTOMATIC OPERATIONS OF INDUSTRIAL MACHINES; ALL BEING NOT FOR AUTOMOTIVE USE, IN CLASS 9 (U.S. CLS. 21, 23, 26, 36 AND 38).

FOR: OZONE GENERATORS FOR INDUSTRIAL USE, IN CLASS 11 (U.S. CLS. 13, 21, 23, 31 AND 34).

OWNER OF JAPAN REG. NO. 5467363, DATED 2-3-2012, EXPIRES 2-3-2022.

THE COLOR(S) BLACK AND RED IS/ARE CLAIMED AS A FEATURE OF THE MARK.

OWNER OF JAPAN REG. NO. 5263477, DATED 9-4-2009, EXPIRES 9-4-2019.

OWNER OF U.S. REG. NO. 3,500,049.

THE MARK CONSISTS OF THE TERM "TMEIC" IN LARGE BLACK FONT ABOVE THE TERMS "WE DRIVE INDUSTRY" IN SMALLER BLACK FONT. THE "I" IN "TMEIC" IS DOTTED WITH A RED TRIANGLE.

SER. NO. 77-830,141, FILED 9-18-2009.

ANTHONY RINKER, EXAMINING ATTORNEY



David J. Kyros

Director of the United States Patent and Trademark Office

United States of America

United States Patent and Trademark Office

EXTRANORMAL

Reg. No. 4,173,350

AZTECA INTERNATIONAL CORPORATION (DELAWARE CORPORATION)
1139 GRAND CENTRAL AVENUE
GLENDALE, CA 91201

Registered July 17, 2012

Int. Cl.: 41

FOR: ONGOING SPANISH LANGUAGE TELEVISION PROGRAMS FEATURING INVESTIGATIONS OF PARANORMAL ACTIVITY AND TELEVISION PROGRAMMING ALL INTENDED FOR SPANISH SPEAKING AUDIENCES, IN CLASS 41 (U.S. CLS. 100, 101 AND 107).

SERVICE MARK

PRINCIPAL REGISTER

FIRST USE 1-1-2008; IN COMMERCE 1-1-2008.

THE MARK CONSISTS OF STANDARD CHARACTERS WITHOUT CLAIM TO ANY PARTICULAR FONT, STYLE, SIZE, OR COLOR.

OWNER OF U.S. REG. NO. 4,076,357.

SER. NO. 77-844,563, FILED 10-8-2009.

MARC LEIPZIG, EXAMINING ATTORNEY



David J. Kyffers

Director of the United States Patent and Trademark Office

United States of America

United States Patent and Trademark Office

Venoscan

Reg. No. 4,173,351

Registered July 17, 2012

Int. Cls.: 9, 10 and 44

TRADEMARK

SERVICE MARK

PRINCIPAL REGISTER

BAUERFEIND AG (FED REP GERMANY AKTIENGESELLSCHAFT)
TRIEBESER STR. 16
ZEULENRODA, FED REP GERMANY 07937

FOR: COMPUTER PROGRAMS AND SOFTWARE FOR SCANNING AND MEASURING VEINS, FOR USE IN ELECTRONIC VEIN SCANNING APPARATUS; ACCESSORIES FOR ELECTRONIC VEIN SCANNING APPARATUS, NAMELY, ELECTRIC CABLES, CAMERAS, LIGHTWAVE SENDING AND RECEIVING PARTS, NAMELY, ELECTRONIC AND OPTO-ELECTRONIC TRANSMITTERS AND RECEIVERS OF ELECTRONIC SIGNALS AND LIGHTWAVES; MEASUREMENT INTERPRETING DEVICES USED TO DETERMINE REFERENCE VALUES FOR DIFFERENT LEVELS OF VEIN OR LYMPH DISEASES, NAMELY, COMPUTERS; DEVICES THAT INTERPRET THE VEIN SCAN RESULTS, NAMELY, COMPUTERS USED WITH SPECIAL SOFTWARE, AND PARTS THEREOF, IN CLASS 9 (U.S. CLS. 21, 23, 26, 36 AND 38).

FOR: MEDICAL APPARATUS AND INSTRUMENTS, NAMELY, ORTHOPEDIC AND PHLEBOLOGIC APPARATUS AND ORTHOPEDIC ARTICLES, IN PARTICULAR ORTHOPEDIC EXERCISE AND REHABILITATION APPARATUS, NAMELY, ORTHOPEDIC DEVICES TO STABILIZE AND EXERCISE SEVERAL PARTS OF THE HUMAN BODY; FORCE AND MOTION ANALYZING APPARATUS FOR PHYSICAL REHABILITATION; ORTHOPEDIC AND PHLEBOLOGIC MEASURING APPARATUS, NAMELY, FOOT PRESSURE MEASURING APPARATUS, APPARATUS FOR MEASURING VEINS, NAMELY, DEVICES FOR MEASURING THE FLUX OR REFLUX OF VEINS BLOOD OR LYMPH LIQUID AND MEASUREMENT OF MUSCLE PUMP ACTIVITIES ON UPPER LEGS; APPARATUS FOR MEASURING THE BODY SHAPE AND THE SHAPE OF PARTS OF THE HUMAN BODY AND THEIR COMPRESSION, NAMELY, FOR MEASURING HUMAN PHYSIOLOGICAL PARAMETERS TO FIND OUT VEIN OR LYMPH DISEASES RESPECTIVELY AND THE NEED OF COMPRESSION TREATMENT; MEDICAL DEVICES, NAMELY, ELECTRONIC VEIN SCANNERS; ADHESIVE RINGS OR PADS, NAMELY, BIOCOMPATIBLE ELECTRODE PADS AND RINGS FOR TRANSFERRING A CONTACT BETWEEN SKIN AND ELECTRONIC PARTS, FOR USE IN MEDICAL DIAGNOSTICS, IN CLASS 10 (U.S. CLS. 26, 39 AND 44).

FOR: PROVIDING AN INTERNET WEB SITE PORTAL IN THE FIELD OF MEDICINE; PROVIDING A WEB SITE IN THE FIELD OF ORTHOPEDIC MEASURING PROCEDURES, IN CLASS 44 (U.S. CLS. 100 AND 101).



David J. Kyjars

Director of the United States Patent and Trademark Office

Reg. No. 4,173,351 THE MARK CONSISTS OF STANDARD CHARACTERS WITHOUT CLAIM TO ANY PARTICULAR FONT, STYLE, SIZE, OR COLOR.

PRIORITY CLAIMED UNDER SEC. 44(D) ON ERPN CMNTY TM OFC APPLICATION NO. 008220196, FILED 4-16-2009, REG. NO. 008220196, DATED 12-23-2009, EXPIRES 4-16-2019.

SER. NO. 77-848,432, FILED 10-14-2009.

EVELYN BRADLEY, EXAMINING ATTORNEY

United States of America

United States Patent and Trademark Office

TANTRUM

Reg. No. 4,173,352

Registered July 17, 2012

Int. Cls.: 3 and 44

TRADEMARK

SERVICE MARK

PRINCIPAL REGISTER

RAPUNZEL HAIR LIMITED (ENGLAND CORPORATION)
7 GRANARD BUSINESS CENTRE
BUNNS LANE, MILL HILL
LONDON, ENGLAND NW72DQ

FOR: (BASED ON 44(E)) BEAUTY CARE COSMETICS; HAIRCARE PRODUCTS AND PREPARATIONS, NAMELY, SHAMPOO, CONDITIONERS, SHAMPOO AND BODY WASH, LEAVE-IN CONDITIONER, DETANGLE SPRAY; HAIRCARE PRODUCTS IN THE FORM OF HAIR SPRAYS; HAIR CARE AGENTS, NAMELY, COLOURED HAIR SPRAY; HAIR CLEANING PREPARATIONS; GELS, MOUSSES, AND NON-MEDICATED BALMS FOR HAIRDRESSING AND HAIRCARE; HAIR LACQUERS; PREPARATIONS IN AEROSOL FORM FOR HAIRDRESSING AND HAIRCARE, NAMELY, SPRAYS FOR HAIR STYLING, GLITTER SPRAYS FOR HAIR STYLING, DETANGLE SPRAY, LEAVE-IN CONDITIONER; HAIR-COLOURING AND HAIR-DECOLOURISING PREPARATIONS; PREPARATIONS FOR WAVING AND SETTING HAIR; NATURAL BODY CARE PRODUCTS FOR THE HAIR, NAMELY, NATURAL SHAMPOO, CONDITIONER, HAIR LOTION, HAIR GEL, HAIR DETANGLER, SWIMMERS SHAMPOO, LEAVE-IN CONDITIONER; OILS FOR USE IN HAIRCARE, NAMELY, HAIR OILS; PERFUMES, EAUX DE TOILETTE; NON-MEDICATED TOILETRIES; BATH AND SHOWER GELS; TOILET SOAPS; DEODORANTS FOR PERSONAL USE; COSMETICS; COSMETIC PREPARATIONS; BEAUTY CREAMS; CREAMS, MILKS, LOTIONS, AND NON-MEDICATED BALMS AND GELS FOR THE FACE, BODY AND HANDS; SKIN CLEANSING PREPARATIONS AND PRODUCTS FOR NON-MEDICAL USE; NON-MEDICATED SKIN CARE PREPARATIONS; SUN-TANNING AND AFTER-SUN PREPARATIONS, NAMELY, MILKS, GELS, OILS, SPRAYS, CREAMS, LOTIONS, BALMS, AND AFTER-SUN LOTION; MAKE-UP PREPARATIONS; BEAUTY FACE PACKS COMPRISING COSMETICS; BEAUTY TONICS FOR APPLICATION TO THE FACE AND BODY; ESSENTIAL OILS, IN CLASS 3 (U.S. CLS. 1, 4, 6, 50, 51 AND 52).

FOR: (BASED UPON 44(E)) HAIRCARE SERVICES, NAMELY, HAIR SALON SERVICES; BEAUTY SERVICES, NAMELY, PERSONAL BEAUTY CONSULTATIONS AND TREATMENTS, NAMELY, HAIR CUTS, NAIL PAINTING; FACIAL TREATMENTS, NAMELY, FACIALS AND FACIAL PEELS; MANICURES, PEDICURES, AND MAKE UP APPLICATION PROVIDED VIA HOME VISITS AND ON-LINE; ADVISORY SERVICES RELATING TO BEAUTY TREATMENTS, NAMELY, HAIR CUTS, NAIL PAINTING, FACIALS AND FACIAL PEELS, MANICURES, PEDICURES, MAKE UP APPLICATION AND MASSAGES, HAIRCARE PROCESSES AND TECHNIQUES, AND SKIN CARE; BEAUTY SALON SERVICES; BEAUTY THERAPY SERVICES, NAMELY, MEDICATED SPA SERVICES, FACIALS AND FACIAL



David J. Kyffers

Director of the United States Patent and Trademark Office

Reg. No. 4,173,352 PEELS, MANICURES, PEDICURES, NAIL PAINTING, MAKE UP APPLICATION AND MASSAGES, AND IN PARTICULAR MINIMALLY AND NON-INVASIVE COSMETIC AND BODY FITNESS THERAPY SERVICES; FACIAL BEAUTY TREATMENT SERVICES, NAMELY, PROVIDING FACIALS AND FACIAL PEELS; INFORMATION AND ADVISORY SERVICES RELATING TO BEAUTY AND HAIRCARE PRODUCTS AND THEIR USE, NAMELY, PROVIDING INFORMATION AND ADVICE CONCERNING SPECIFIC BEAUTY TREATMENTS, NAMELY, HAIR CUTS, NAIL PAINTING, FACIALS AND FACIAL PEELS, MANICURES, PEDICURES, AND MAKE UP APPLICATION, HAIRCARE PROCESSES AND TECHNIQUES, AND SKIN CARE; TECHNICAL, MANAGEMENT, CONSULTANCY, ADVISORY AND INFORMATION SERVICES RELATING TO ALL THE AFORESAID SERVICES, IN CLASS 44 (U.S. CLS. 100 AND 101).

THE MARK CONSISTS OF STANDARD CHARACTERS WITHOUT CLAIM TO ANY PARTICULAR FONT, STYLE, SIZE, OR COLOR.

OWNER OF UNITED KINGDOM REG. NO. 2499048, DATED 2-13-2009, EXPIRES 10-1-2018.

SER. NO. 77-861,019, FILED 10-29-2009.

NAKIA HENRY, EXAMINING ATTORNEY

United States of America

United States Patent and Trademark Office

YESENIA GARCIA Y LAS RECLUSAS

Reg. No. 4,173,353

GARCIA QUINTANA, YESENIA MARISOL (MEXICO INDIVIDUAL)
8712 TUMBLEWEED DR
AUBREY, TX 76227

Registered July 17, 2012

Int. Cl.: 41

FOR: ENTERTAINMENT IN THE NATURE OF LIVE PERFORMANCES BY MUSICAL GROUP, IN CLASS 41 (U.S. CLS. 100, 101 AND 107).

SERVICE MARK

OWNER OF MEXICO REG. NO. 1193384, DATED 10-15-2009, EXPIRES 10-15-2019.

PRINCIPAL REGISTER

THE NAME "YESENIA GARCIA" IDENTIFIES A LIVING INDIVIDUAL WHOSE CONSENT IS OF RECORD.

THE MARK CONSISTS OF THE WORDING "YESENIA GARCIA Y LAS RECLUSAS" IN STYLIZED LETTERS.

THE ENGLISH TRANSLATION OF "YESENIA GARCIA Y LAS RECLUSAS" IN THE MARK IS "YESENIA GARCIA AND THE INMATES".

SER. NO. 77-864,598, FILED 11-4-2009.

STEVEN JACKSON, EXAMINING ATTORNEY



David J. Kypos

Director of the United States Patent and Trademark Office

United States of America

United States Patent and Trademark Office



Reg. No. 4,173,354

9001-6262 QUÉBEC INC. (CANADA CORPORATION)
30, RUE DES GRANDS-LACS

Registered July 17, 2012

SAINT-AUGUSTIN-DE-DESMAURES (QUEBEC), CANADA G3A2E6

Int. Cls.: 9, 12 and 25

FOR: SUNGLASSES AND SPORT GOGGLES FOR USE IN SKIING AND CYCLING; CYCLING, SKATING AND SKI HELMETS; BICYCLE COMPUTERS, NAMELY, BICYCLE SPEEDOMETERS, IN CLASS 9 (U.S. CLS. 21, 23, 26, 36 AND 38).

TRADEMARK

FIRST USE 3-0-2004; IN COMMERCE 3-0-2004.

PRINCIPAL REGISTER

FOR: BICYCLES; PARTS AND ACCESSORIES FOR BICYCLES, NAMELY, HANDLEBARS, HANDLEBAR GRIPS, GRIP TAPES FOR BICYCLE HANDLEBARS, SADDLES, TIRES, PEDALS, FORKS, BICYCLE FRAMES, BICYCLE SUSPENSIONS, WHEELS AND WHEEL RIMS, WATER BOTTLE CAGES, BICYCLE RACKS FOR VEHICLES, STORAGE AND CARRYING BAGS IN THE NATURE OF PANNIER BAGS AFFIXED TO BICYCLES, BELLS FOR BICYCLES, BICYCLE PUMPS AND TIRE REPAIR KITS COMPRISED PREDOMINANTLY OF TIRE PATCHES, ADHESIVE TIRE SEALANT PATCHES AND RUBBER CEMENT, IN CLASS 12 (U.S. CLS. 19, 21, 23, 31, 35 AND 44).

FIRST USE 3-0-2004; IN COMMERCE 3-0-2004.

FOR: CYCLIST SHOES AND OVERSHOES; SPORTSWEAR, CYCLING WEAR, SPEED SKATING WEAR, OUTER WEAR, ALPINE SKIWEAR AND CROSS-COUNTRY SKIWEAR, NAMELY, CYCLING JERSEYS, T-SHIRTS, CAMISOLES, TANK-TOPS, TOPS, TIGHTS, SHORTS, JERSEYS, PANTS, GLOVES, CAPS, BIB-SHORTS, JACKETS, VESTS, DOWNHILL SKI SUITS, ONE-PIECE SUITS IN THE NATURE OF SKI SUITS, LEG WARMERS, ARM WARMERS, KNEE WARMERS IN THE NATURE OF LEG WARMERS, NECK PROTECTORS IN THE NATURE OF NECKWEAR AND NECK GAITERS, RAINCOATS, SCARVES, SLIPPERS, BOOTIES, GAITERS, SOCKS, HATS, SHIRTS, GLOVES, MITTENS, BIKE SHORTS LINED WITH CHAMOIS, UNDERWEAR, SMOCKS, SWEATERS, WIND RESISTANT JACKETS, RAIN JACKETS, SPORT COATS, SNOW SUITS AND PANTS; CHILDREN'S WEAR, NAMELY, CYCLING JERSEYS, JACKETS, T-SHIRTS, PANTS, SHORTS, JEANS, CAPS, VESTS, SWIMSUITS, MITTENS, HATS, SLIPPERS, SCARVES, BOOTS, UNDERWEAR AND SWEATERS; SWIMSUITS, IN CLASS 25 (U.S. CLS. 22 AND 39).

FIRST USE 3-0-2004; IN COMMERCE 3-0-2004.



David J. Kyffers

Director of the United States Patent and Trademark Office

Reg. No. 4,173,354 OWNER OF U.S. REG. NOS. 1,624,959 AND 2,927,290.

THE MARK CONSISTS OF THE STYLIZED LETTERS "LG" TO THE LEFT OF A STYLIZED CHEVRON DESIGN ELEMENT.

SER. NO. 77-877,749, FILED 11-20-2009.

ROBIN MITTLER, EXAMINING ATTORNEY

United States of America

United States Patent and Trademark Office



Reg. No. 4,173,355

Registered July 17, 2012

Int. Cl.: 9

TRADEMARK

PRINCIPAL REGISTER

LG ELECTRONICS INC. (REPUBLIC OF KOREA CORPORATION)
20, YEOUIDO-DONG, YEONGDEUNGPO-GU
SEOUL, REPUBLIC OF KOREA 157-721

FOR: COMPUTER MONITORS; TELEVISION RECEIVERS, IN CLASS 9 (U.S. CLS. 21, 23, 26, 36 AND 38).

PRIORITY CLAIMED UNDER SEC. 44(D) ON REPUBLIC OF KOREA APPLICATION NO. 40-2009-0049, FILED 10-9-2009, REG. NO. 0864189, DATED 5-11-2011, EXPIRES 10-9-2019.

NO CLAIM IS MADE TO THE EXCLUSIVE RIGHT TO USE "NONE DELAY THRU MODE", APART FROM THE MARK AS SHOWN.

THE MARK CONSISTS OF THE WORDS "NONE DELAY" WITH AN ARROW TO THE RIGHT OF THESE TERMS OVER THE WORDS "THRU MODE" ALL WITHIN AN OVERALL RECTANGULAR SHAPED CARRIER.

SER. NO. 77-885,421, FILED 12-3-2009.

REBECCA SMITH, EXAMINING ATTORNEY



David J. Kyffers

Director of the United States Patent and Trademark Office

United States of America

United States Patent and Trademark Office

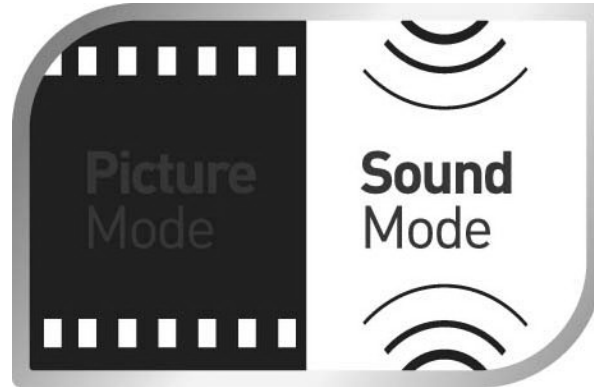

Reg. No. 4,173,356

Registered July 17, 2012

Int. Cl.: 9

TRADEMARK

PRINCIPAL REGISTER

LG ELECTRONICS INC. (REPUBLIC OF KOREA CORPORATION)
20, YEUIDO-DONG, YEONGDEUNGPO-GU
SEOUL, REPUBLIC OF KOREA 157-721

FOR: COMPUTER MONITORS; TELEVISION RECEIVERS, IN CLASS 9 (U.S. CLS. 21, 23, 26, 36 AND 38).

PRIORITY CLAIMED UNDER SEC. 44(D) ON REPUBLIC OF KOREA APPLICATION NO. 40-2009-0049, FILED 10-9-2009, REG. NO. 008730988, DATED 5-4-2010, EXPIRES 10-9-2019.

NO CLAIM IS MADE TO THE EXCLUSIVE RIGHT TO USE "PICTURE MODE SOUND MODE", APART FROM THE MARK AS SHOWN.

THE MARK CONSISTS OF A ROUNDED RECTANGLE BACKGROUND WITH THE WORDS "PICTURE MODE" WRITTEN ON THE LEFT WITH AN IMAGE OF A FILM REEL AROUND IT AND THE WORDS "SOUND MODE" WRITTEN ON THE RIGHT WITH IMAGES OF SOUND WAVES AROUND IT. COLOR IS NOT CLAIMED AS A FEATURE OF THE MARK.

SER. NO. 77-885,426, FILED 12-3-2009.

REBECCA SMITH, EXAMINING ATTORNEY



David J. Kyjars

Director of the United States Patent and Trademark Office

United States of America

United States Patent and Trademark Office

SENTIMAG

Reg. No. 4,173,357

Registered July 17, 2012

Int. Cls.: 10 and 44

TRADEMARK

SERVICE MARK

PRINCIPAL REGISTER

ENDOMAGNETICS LIMITED (UNITED KINGDOM COMPANY)
MILTON ROAD
23 CAMBRIDGE SCIENCE PARK
CAMBRIDGE, UNITED KINGDOM CB40EY

FOR: MEDICAL DIAGNOSTIC APPARATUS, DEVICES AND INSTRUMENTS, NAMELY, NON-INVASIVE MAGNETOMETERS FOR USE IN THE DIAGNOSIS AND STAGING OF CANCERS, IN CLASS 10 (U.S. CLS. 26, 39 AND 44).

FOR: MEDICAL INFORMATION SERVICES FOR THE DIAGNOSIS AND STAGING OF CANCERS USING NON-INVASIVE MAGNETOMETERS, IN CLASS 44 (U.S. CLS. 100 AND 101).

THE MARK CONSISTS OF STANDARD CHARACTERS WITHOUT CLAIM TO ANY PARTICULAR FONT, STYLE, SIZE, OR COLOR.

PRIORITY CLAIMED UNDER SEC. 44(D) ON ERPN CMNTY TM OFC APPLICATION NO. 8729915, FILED 12-2-2009, REG. NO. 8729915, DATED 6-2-2010, EXPIRES 12-2-2019.

SER. NO. 77-885,534, FILED 12-3-2009.

KAREN M. STRYZ, EXAMINING ATTORNEY



David J. Kybas

Director of the United States Patent and Trademark Office

United States of America

United States Patent and Trademark Office

OUT OF THE SHADOWS, INTO THE LIGHT....

Reg. No. 4,173,358

Registered July 17, 2012

Int. Cls.: 35 and 41

SERVICE MARK

PRINCIPAL REGISTER

PATIENTS MUTUAL ASSISTANCE COLLECTIVE CORPORATION (CALIFORNIA CORPORATION)
1840 EMBARCADERO
OAKLAND, CA 94606

FOR: PUBLIC ADVOCACY TO PROMOTE AWARENESS OF THE ROLE OF MEDICAL CANNABIS FOR THE TREATMENT OF CHRONIC HEALTH PROBLEMS, IN CLASS 35 (U.S. CLS. 100, 101 AND 102).

FIRST USE 6-29-2007; IN COMMERCE 7-21-2009.

FOR: EDUCATIONAL SERVICES, NAMELY, PROVIDING CLASSES, SEMINARS, AND WORKSHOPS IN THE FIELDS OF HOLISTIC AND ALTERNATIVE THERAPIES FOR THE TREATMENT OF CHRONIC HEALTH PROBLEMS, IN CLASS 41 (U.S. CLS. 100, 101 AND 107).

FIRST USE 6-29-2007; IN COMMERCE 7-21-2009.

THE MARK CONSISTS OF STANDARD CHARACTERS WITHOUT CLAIM TO ANY PARTICULAR FONT, STYLE, SIZE, OR COLOR.

SER. NO. 77-891,924, FILED 12-11-2009.

ROBERT STRUCK, EXAMINING ATTORNEY



David J. Kyjars

Director of the United States Patent and Trademark Office

United States of America

United States Patent and Trademark Office

UCS

Reg. No. 4,173,359

Registered July 17, 2012

**Int. Cls.: 35, 36, 39, 41
and 42**

SERVICE MARK

PRINCIPAL REGISTER

UNIVERSAL CONSULTING SERVICES, INC. (VIRGINIA CORPORATION)
3975 FAIR RIDGE DRIVE
FAIRFAX, VA 22033

FOR: BUSINESS MANAGEMENT CONSULTATION IN THE FIELDS OF PROGRAM MANAGEMENT AND CONTRACT MANAGEMENT; BUSINESS MANAGEMENT CONSULTING SERVICES FOR THE HEALTHCARE INDUSTRY NAMELY, HEALTHCARE OPERATIONS MANAGEMENT, COST AND PAYMENT MANAGEMENT OF HEALTH CARE; FEDERAL PROCUREMENT SUPPORT SERVICES NAMELY, ANALYSIS AND REDEFINITION OF PURCHASING PROCESSES WITHIN THE FRAMEWORK OF EXPENDITURE RATIONALIZATION PROJECTS FOR FEDERAL, STATE AND LOCAL GOVERNMENTAL ORGANIZATIONS AND GOVERNMENTAL CONTRACTORS; BUSINESS MANAGEMENT CONSULTING SERVICES NAMELY, SUPPLY CHAIN LOGISTICS, REVERSE LOGISTICS SERVICES, AND PLANNING AND SCHEDULING SHIPMENTS OF GOODS FOR FEDERAL, STATE AND LOCAL GOVERNMENTAL ORGANIZATIONS AND GOVERNMENTAL CONTRACTORS; BUSINESS CONSULTING SERVICES IN THE NATURE OF PROVIDING BUSINESS ACQUISITION CONSULTATION TO FEDERAL, STATE AND LOCAL GOVERNMENTAL ORGANIZATIONS AND GOVERNMENTAL CONTRACTORS; BUSINESS CONSULTING SERVICES IN THE NATURE OF PROVIDING HUMAN CAPITAL MANAGEMENT OUTSOURCING SERVICES TO FEDERAL, STATE AND LOCAL GOVERNMENTAL ORGANIZATIONS AND GOVERNMENTAL CONTRACTORS; BUSINESS CONSULTING SERVICES IN THE NATURE OF PROVIDING BUSINESS PROCESS RE-ENGINEERING SERVICES TO FEDERAL, STATE AND LOCAL GOVERNMENTAL ORGANIZATIONS AND GOVERNMENTAL CONTRACTORS; BUSINESS CONSULTING SERVICES IN THE NATURE OF ELECTRONIC COMMERCE SUPPORT SERVICES NAMELY, PROVIDING INFORMATION ABOUT PRODUCTS VIA TELECOMMUNICATION NETWORKS FOR ADVERTISING AND SALES PURPOSES TO FEDERAL, STATE AND LOCAL GOVERNMENTAL ORGANIZATIONS AND GOVERNMENTAL CONTRACTORS, IN CLASS 35 (U.S. CLS. 100, 101 AND 102).

FIRST USE 12-14-2000; IN COMMERCE 12-14-2000.

FOR: PROVIDING FINANCIAL MANAGEMENT CONSULTATION SERVICES TO FEDERAL, STATE AND LOCAL GOVERNMENTAL ORGANIZATIONS AND GOVERNMENTAL CONTRACTORS, IN CLASS 36 (U.S. CLS. 100, 101 AND 102).

FIRST USE 12-14-2000; IN COMMERCE 12-14-2000.



David J. Kyjars

Director of the United States Patent and Trademark Office

Reg. No. 4,173,359 FOR: PROVIDING CONSULTATION IN THE FIELD OF SUPPLY CHAIN LOGISTICS AND REVERSE LOGISTICS SERVICES, NAMELY, STORAGE, TRANSPORTATION AND DELIVERY OF GOODS FOR OTHERS BY AIR, RAIL, SHIP OR TRUCK, IN CLASS 39 (U.S. CLS. 100 AND 105).

FIRST USE 12-14-2000; IN COMMERCE 12-14-2000.

FOR: PROVIDING CONSULTATION IN THE NATURE OF TECHNOLOGICAL TRAINING IN THE FIELDS OF TECHNOLOGICAL SYSTEM INTEGRATION AND DATA ANALYSIS TO FEDERAL, STATE AND LOCAL GOVERNMENTAL ORGANIZATIONS AND GOVERNMENTAL CONTRACTORS, IN CLASS 41 (U.S. CLS. 100, 101 AND 107).

FIRST USE 12-14-2000; IN COMMERCE 12-14-2000.

FOR: TECHNICAL CONSULTATION SERVICES IN THE NATURE OF SOFTWARE DEVELOPMENT AND DATA WAREHOUSING SERVICES FOR FEDERAL, STATE AND LOCAL GOVERNMENTAL ORGANIZATIONS AND GOVERNMENTAL CONTRACTORS, IN CLASS 42 (U.S. CLS. 100 AND 101).

FIRST USE 12-14-2000; IN COMMERCE 12-14-2000.

THE MARK CONSISTS OF STANDARD CHARACTERS WITHOUT CLAIM TO ANY PARTICULAR FONT, STYLE, SIZE, OR COLOR.

SER. NO. 77-892,861, FILED 12-14-2009.

RICHARD WHITE, EXAMINING ATTORNEY

United States of America

United States Patent and Trademark Office



Reg. No. 4,173,360

Registered July 17, 2012

Int. Cl.: 9

TRADEMARK

PRINCIPAL REGISTER

LG ELECTRONICS INC. (REPUBLIC OF KOREA CORPORATION)
20, YEOUIDO-DONG, YEONGDEUNGPO-GU
SEOUL, REPUBLIC OF KOREA 150-721

FOR: COMPUTER MONITORS, IN CLASS 9 (U.S. CLS. 21, 23, 26, 36 AND 38).

PRIORITY CLAIMED UNDER SEC. 44(D) ON REPUBLIC OF KOREA APPLICATION NO.
40-2009-0049, FILED 10-9-2009, REG. NO. 0852538, DATED 2-9-2011, EXPIRES 2-9-2021.

NO CLAIM IS MADE TO THE EXCLUSIVE RIGHT TO USE "ZOOMING", APART FROM
THE MARK AS SHOWN.

SER. NO. 77-899,149, FILED 12-22-2009.

MICHAEL LITZAU, EXAMINING ATTORNEY



David J. Kyffers

Director of the United States Patent and Trademark Office

United States of America

United States Patent and Trademark Office

ETTAN

Reg. No. 4,173,361

SWEDISH MATCH NORTH EUROPE AB (SWEDEN JOINT STOCK COMPANY)
SE-118 85

Registered July 17, 2012

STOCKHOLM, SWEDEN 00

Int. Cl.: 34

FOR: TOBACCO; MATCHES; TOBACCO SUBSTITUTES (NOT FOR MEDICAL PURPOSES);
SNUFF AND TOBACCO ALTERNATIVES IN THE FORM OF PRODUCTS BASED ON VE-
GETABLE FIBERS, FOR ORAL USE NOT FOR CONSUMPTION; SNUFF; TOBACCO FREE
SNUFF; HERBAL SNUFF, IN CLASS 34 (U.S. CLS. 2, 8, 9 AND 17).

TRADEMARK

PRINCIPAL REGISTER

THE MARK CONSISTS OF STANDARD CHARACTERS WITHOUT CLAIM TO ANY PAR-
TICULAR FONT, STYLE, SIZE, OR COLOR.

OWNER OF SWEDEN REG. NO. 353521, DATED 3-22-2002, EXPIRES 3-22-2022.

OWNER OF U.S. REG. NOS. 3,018,073 AND 3,021,119.

THE ENGLISH TRANSLATION OF "ETTAN" IN THE MARK IS "THE FIRST".

SER. NO. 77-899,542, FILED 12-22-2009.

GENE MACIOL, EXAMINING ATTORNEY



David J. Kyffers

Director of the United States Patent and Trademark Office

United States of America

United States Patent and Trademark Office

ICS SYSTEMS, INC

Reg. No. 4,173,362

Registered July 17, 2012

Int. Cls.: 9 and 41

TRADEMARK

SERVICE MARK

PRINCIPAL REGISTER

ICS SYSTEMS, INC. (NEW YORK CORPORATION)
P.O. BOX 12391
HAUPPAUGE, NY 11788

FOR: COMPUTER SOFTWARE FOR CONTROLLING OPERATION OF EQUIPMENT USED TO TEST ELECTRONIC DEVICES, PRIMARILY AUTOMATED TESTING APPARATUS FOR TESTING ANALOG, DIGITAL, VIDEO, MECHANICAL, ELECTRO OPTICS AND RADIO-FREQUENCY ELECTRONIC SYSTEMS, AND FOR TESTING ELECTRONIC DEVICES, PRIMARILY AUTOMATED TESTING APPARATUS FOR ANALOG, DIGITAL, VIDEO, MECHANICAL, ELECTRO OPTICS AND RADIO-FREQUENCY ELECTRONIC SYSTEMS, IN CLASS 9 (U.S. CLS. 21, 23, 26, 36 AND 38).

FIRST USE 6-18-1996; IN COMMERCE 11-0-1996.

FOR: PROVIDING TRAINING TO OTHERS IN THE USE OF COMPUTER SOFTWARE AND GENERATING EDUCATIONAL MATERIALS SUCH AS INSTRUCTION MANUALS FOR FACILITATING THE TRAINING OF OTHERS IN THE USE OF COMPUTER SOFTWARE, IN CLASS 41 (U.S. CLS. 100, 101 AND 107).

FIRST USE 6-18-1996; IN COMMERCE 11-0-1996.

THE MARK CONSISTS OF STANDARD CHARACTERS WITHOUT CLAIM TO ANY PARTICULAR FONT, STYLE, SIZE, OR COLOR.

OWNER OF U.S. REG. NO. 2,557,584.

NO CLAIM IS MADE TO THE EXCLUSIVE RIGHT TO USE "SYSTEMS, INC.", APART FROM THE MARK AS SHOWN.

SER. NO. 77-906,086, FILED 1-6-2010.

THOMAS MANOR, EXAMINING ATTORNEY



David J. Kypos

Director of the United States Patent and Trademark Office

United States of America

United States Patent and Trademark Office

"Family-like Care"



Reg. No. 4,173,363

KIA MOTORS CORPORATION (REPUBLIC OF KOREA CORPORATION)
231, YANGJAE-DONG, SEOCHO-GU
SOUL, REPUBLIC OF KOREA

Registered July 17, 2012

Int. Cl.: 37

FOR: MOTOR VEHICLE MAINTENANCE AND REPAIR; VEHICLE MAINTENANCE, IN CLASS 37 (U.S. CLS. 100, 103 AND 106).

SERVICE MARK

PRIORITY CLAIMED UNDER SEC. 44(D) ON REPUBLIC OF KOREA APPLICATION NO. 41-2009-0031, FILED 12-24-2009, REG. NO. 0210076, DATED 5-6-2011, EXPIRES 5-6-2021.

PRINCIPAL REGISTER

THE COLOR(S) WHITE, GRAY AND RED IS/ARE CLAIMED AS A FEATURE OF THE MARK.

OWNER OF U.S. REG. NOS. 1,723,608, 2,351,320 AND OTHERS.

NO CLAIM IS MADE TO THE EXCLUSIVE RIGHT TO USE "MOTORS SERVICE", APART FROM THE MARK AS SHOWN.

THE MARK CONSISTS OF THE WORDING "FAMILY-LIKE CARE" IN WHITE, THE WORDING "KIA" IN RED INSIDE OF AN OVAL, THE WORDING "KIA MOTORS" IN RED UNDERLINED IN GRAY, AND THE WORDING "SERVICE" IN GRAY. THE MARK APPEARS INSIDE OF A RED RECTANGLE WITH A RED AND WHITE BACKGROUND.

SER. NO. 77-907,431, FILED 1-7-2010.

STEVEN PEREZ, EXAMINING ATTORNEY



David J. Kybas

Director of the United States Patent and Trademark Office

United States of America

United States Patent and Trademark Office

SPLASH ZONE

Reg. No. 4,173,364

MONTEREY BAY AQUARIUM FOUNDATION (CALIFORNIA CORPORATION)
886 CANNERY ROW
MONTEREY, CA 93940

Registered July 17, 2012

Int. Cl.: 35

FOR: RETAIL STORE SERVICES FEATURING BOOKS AND STATIONERY PRODUCTS IN THE FIELDS OF MARINE BIOLOGY AND CONSERVATION OF AQUATIC LIFE, T-SHIRTS, SWEATSHIRTS, AND HATS, TOTE BAGS, MUGS, DECORATIVE HOME FURNISHINGS, JEWELRY, AND AUDIO RECORDINGS, IN CLASS 35 (U.S. CLS. 100, 101 AND 102).

SERVICE MARK

PRINCIPAL REGISTER

FIRST USE 4-0-2000; IN COMMERCE 4-0-2000.

THE MARK CONSISTS OF STANDARD CHARACTERS WITHOUT CLAIM TO ANY PARTICULAR FONT, STYLE, SIZE, OR COLOR.

OWNER OF U.S. REG. NOS. 2,466,455, 2,553,295, AND 3,665,710.

SER. NO. 77-907,758, FILED 1-8-2010.

BRIDGETT SMITH, EXAMINING ATTORNEY



David J. Kyffers

Director of the United States Patent and Trademark Office

United States of America

United States Patent and Trademark Office

BITE ME TOO

Reg. No. 4,173,365

Registered July 17, 2012

Int. Cl.: 16

TRADEMARK

PRINCIPAL REGISTER

PINKY SWEAR PRESS INC. (CANADA CORPORATION)
40 KING STREET WEST
SUITE 2707
TORONTO, ONTARIO, CANADA M5H3Y2

FOR: COOKBOOKS, IN CLASS 16 (U.S. CLS. 2, 5, 22, 23, 29, 37, 38 AND 50).

THE MARK CONSISTS OF STANDARD CHARACTERS WITHOUT CLAIM TO ANY PARTICULAR FONT, STYLE, SIZE, OR COLOR.

PRIORITY CLAIMED UNDER SEC. 44(D) ON CANADA APPLICATION NO. 1462121, FILED 12-8-2009, REG. NO. TMA814,501, DATED 12-21-2011, EXPIRES 12-21-2026.

SER. NO. 77-913,457, FILED 1-16-2010.

TINA L. SNAPP, EXAMINING ATTORNEY



David J. Kyffers

Director of the United States Patent and Trademark Office

United States of America

United States Patent and Trademark Office

Premier
by Dead Sea Premier

Reg. No. 4,173,366

DEAD SEA PREMIER COSMETICS LABORATORIES LTD. (ISRAEL CORPORATION)
5 MODIIN STREET
LOD 71201, ISRAEL

Registered July 17, 2012

Int. Cls.: 3 and 35

FOR: COSMETICS, IN CLASS 3 (U.S. CLS. 1, 4, 6, 50, 51 AND 52).

TRADEMARK

FIRST USE 1-1-1993; IN COMMERCE 1-1-1999.

SERVICE MARK

FOR: RETAIL STORE SERVICES AND ON-LINE RETAIL STORE SERVICES, ALL FEATURING THE SALE OF COSMETICS, IN CLASS 35 (U.S. CLS. 100, 101 AND 102).

PRINCIPAL REGISTER

FIRST USE 1-1-1993; IN COMMERCE 1-1-1999.

THE MARK CONSISTS OF THE WORD "PREMIER" WITH A CAPITALIZED, LARGER, ITALICIZED "P", WHILE THE "REMIER" PORTION OF THE WORD IS IN SMALLER, LOWER CASE LETTERS; UNDERNEATH THE WORD "PREMIER" IS A HORIZONTAL LINE; UNDERNEATH THE HORIZONTAL LINE IS THE TEXT "BY DEAD SEA PREMIER".

SEC. 2(F).

SER. NO. 77-932,788, FILED 2-10-2010.

SARA BENJAMIN, EXAMINING ATTORNEY



David J. Kyros

Director of the United States Patent and Trademark Office

United States of America

United States Patent and Trademark Office

BOYS ARE STUPID, THROW ROCKS AT THEM

Reg. No. 4,173,367

DAVID & GOLIATH, INC. (FLORIDA CORPORATION)
1419 MARTIN LUTHER KING, JR. AVENUE
CLEARWATER, FL 33756

Registered July 17, 2012

Int. Cls.: 16, 18 and 25

FOR: NOTEBOOKS; STICKERS; BOOKS IN THE FIELD OF HUMOR, IN CLASS 16 (U.S. CLS. 2, 5, 22, 23, 29, 37, 38 AND 50).

TRADEMARK

FIRST USE 6-0-2001; IN COMMERCE 6-0-2001.

PRINCIPAL REGISTER

FOR: WALLET, IN CLASS 18 (U.S. CLS. 1, 2, 3, 22 AND 41).

FIRST USE 12-0-2000; IN COMMERCE 12-0-2000.

FOR: CLOTHING, NAMELY, UNDERWEAR, PAJAMAS, BOXER BRIEFS AND BOXER SHORTS, SOCKS, T-SHIRTS, AND TANK TOPS, IN CLASS 25 (U.S. CLS. 22 AND 39).

FIRST USE 1-0-2000; IN COMMERCE 1-0-2000.

THE MARK CONSISTS OF STANDARD CHARACTERS WITHOUT CLAIM TO ANY PARTICULAR FONT, STYLE, SIZE, OR COLOR.

SER. NO. 77-934,946, FILED 2-12-2010.

WILLIAM P. SHANAHAN, EXAMINING ATTORNEY



David J. Kyros

Director of the United States Patent and Trademark Office

United States of America
United States Patent and Trademark Office

Citrus

Reg. No. 4,173,368

GIGAMON LLC (DELAWARE LIMITED LIABILITY COMPANY)
736 S. HILLVIEW DRIVE
MILPITAS, CA 95035

Registered July 17, 2012

Int. Cl.: 9

FOR: SOFTWARE FOR USE IN OPERATING COMPUTER NETWORK SWITCHES, IN CLASS 9 (U.S. CLS. 21, 23, 26, 36 AND 38).

TRADEMARK

FIRST USE 4-30-2009; IN COMMERCE 4-30-2009.

PRINCIPAL REGISTER

THE MARK CONSISTS OF THE WORD "CITRUS" IN STYLIZED FORM WITH A LARGE SHADED CIRCLE FOR THE DOT OVER THE "I".

SER. NO. 77-935,156, FILED 2-12-2010.

BARBARA A. GOLD, EXAMINING ATTORNEY



David J. Kybas

Director of the United States Patent and Trademark Office

United States of America

United States Patent and Trademark Office

BLUEBIRD

Reg. No. 4,173,369

Registered July 17, 2012

Int. Cl.: 33

TRADEMARK

PRINCIPAL REGISTER

HOME TEAM WINES, LLC (CALIFORNIA LIMITED LIABILITY COMPANY)
955 BROADWAY
SONOMA, CA 95476

FOR: WINE, IN CLASS 33 (U.S. CLS. 47 AND 49).

FIRST USE 8-17-2010; IN COMMERCE 8-17-2010.

THE MARK CONSISTS OF STANDARD CHARACTERS WITHOUT CLAIM TO ANY PARTICULAR FONT, STYLE, SIZE, OR COLOR.

SER. NO. 77-954,768, FILED 3-9-2010.

ANDREA K. NADELMAN, EXAMINING ATTORNEY



David J. Kybas

Director of the United States Patent and Trademark Office

United States of America

United States Patent and Trademark Office

440

Reg. No. 4,173,370

AMERISTAR FENCE PRODUCTS, INC. (OKLAHOMA CORPORATION)
POST OFFICE BOX 581000
TULSA, OK 741581000

Registered July 17, 2012

Int. Cl.: 6

FOR: METAL FENCES AND GATES AND STRUCTURAL COMPONENT PARTS THEREOF
FOR RANCHING USE, IN CLASS 6 (U.S. CLS. 2, 12, 13, 14, 23, 25 AND 50).

TRADEMARK

FIRST USE 3-9-2010; IN COMMERCE 3-9-2010.

PRINCIPAL REGISTER

THE MARK CONSISTS OF STANDARD CHARACTERS WITHOUT CLAIM TO ANY PARTICULAR FONT, STYLE, SIZE, OR COLOR.

SER. NO. 77-955,366, FILED 3-10-2010.

DAVID YONTEF, EXAMINING ATTORNEY



David J. Kyffers

Director of the United States Patent and Trademark Office

United States of America

United States Patent and Trademark Office

NORDIC FITNESS SPORTS PARK

Reg. No. 4,173,371

EXEL OYJ (FINLAND PUBLIC LIMITED COMPANY)

Registered July 17, 2012

P.O. BOX 29

MÄNTYHARJU, FINLAND FIN-52701

Int. Cl.: 41

FOR: TRAINING AND INSTRUCTION IN IN-LINE SKATING WITH POLES, SKIING WITH POLES, TREKKING WITH POLES AND WALKING WITH POLES, ORGANIZING, SPONSORING AND HOLDING SPORTS COMPETITIONS IN IN-LINE SKATING WITH POLES AND WALKING WITH POLES, PREPARING CUSTOMIZED TRAINING PROGRAMS FOR INDIVIDUALS; SETTING UP CENTRES FOR TRAINING IN IN-LINE SKATING WITH POLES, SKIING WITH POLES, TREKKING WITH POLES AND WALKING WITH POLES, IN CLASS 41 (U.S. CLS. 100, 101 AND 107).

SERVICE MARK

PRINCIPAL REGISTER

OWNER OF ERPN CMNTY TM OFC REG. NO. 002899482, DATED 1-8-2004, EXPIRES 10-21-2012.

NO CLAIM IS MADE TO THE EXCLUSIVE RIGHT TO USE FITNESS SPORTS PARK, APART FROM THE MARK AS SHOWN.

SER. NO. 78-172,931, FILED 10-10-2002.

AISHA CLARKE, EXAMINING ATTORNEY



David J. Kybas

Director of the United States Patent and Trademark Office

United States of America

United States Patent and Trademark Office

BENDY

Reg. No. 4,173,372

Registered July 17, 2012

Int. Cl.: 28

TRADEMARK

PRINCIPAL REGISTER

MANSELL CONSTRUCTION LIMITED (UNITED KINGDOM CORPORATION)
118 NOEL ROAD WEST ACTON
LONDON, UNITED KINGDOM W3 0JS

FOR: (BASED ON 44(E)) RACKETS FOR TENNIS, SQUASH OR SHUTTLECOCK, AND RACKET COVERS; SPORTS BALLS OF ALL TYPES, SKIS, SKI BINDINGS, SKI POLES AND SKI CASES; ATHLETIC EQUIPMENT, NAMELY, GUARDS FOR THE MOUTH, THE LEG, THE ARM, THE CHEST, AND THE HEAD; PERSONAL EXERCISE MATS, JUMP ROPES, HOCKEY STICKS; HOCKEY GLOVES; RESISTANCE BANDS, IN CLASS 28 (U.S. CLS. 22, 23, 38 AND 50).

THE MARK CONSISTS OF STANDARD CHARACTERS WITHOUT CLAIM TO ANY PARTICULAR FONT, STYLE, SIZE, OR COLOR.

OWNER OF NEW ZEALAND REG. NO. 712099, DATED 12-16-2003, EXPIRES 12-16-2013.

SER. NO. 78-529,144, FILED 12-8-2004.

TEJBIR SINGH, EXAMINING ATTORNEY



David J. Kyffers

Director of the United States Patent and Trademark Office

United States of America

United States Patent and Trademark Office

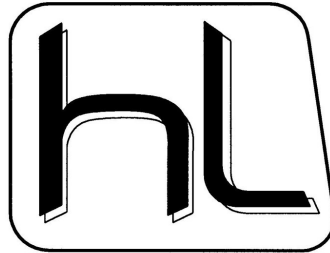

Reg. No. 4,173,373

HANDY BUTTON MACHINE COMPANY (DELAWARE CORPORATION)
1750 NORTH 25TH AVENUE
MELROSE PARK, IL 60160

Registered July 17, 2012

Int. Cl.: 20

FOR: FUTON CONVERTIBLE SLEEPER SOFA; FURNITURE FRAMES FOR SOFAS, CHAIRS, LOVESEATS, RECLINERS, BEDS, AND OTTOMANS; OUTDOOR FURNITURE FRAMES, IN CLASS 20 (U.S. CLS. 2, 13, 22, 25, 32 AND 50).

TRADEMARK

FIRST USE 3-10-2006; IN COMMERCE 3-10-2006.

PRINCIPAL REGISTER

SER. NO. 78-669,636, FILED 7-13-2005.

CURTIS FRENCH, EXAMINING ATTORNEY



David J. Kybas

Director of the United States Patent and Trademark Office

United States of America

United States Patent and Trademark Office

TRULY NAMASTE

Reg. No. 4,173,374

Registered July 17, 2012

Int. Cl.: 3

TRADEMARK

PRINCIPAL REGISTER

LIGHTS OF YOGA, LTD. (OHIO LIMITED LIABILITY CORPORATION)
178 VINCENT STREET
CHAGRIN FALLS, OH 44022

FOR: SKIN CLEANSERS; SKIN CREAM; SKIN LOTION; SKIN SOAP; SKIN MOISTURIZERS;
BODY OIL; BATH OIL; ESSENTIAL OILS; BODY SOAP; HAND SOAP; BODY WASH; BODY
SCRUB; FACIAL SCRUB; SKIN TONERS; AND BATH SALTS, IN CLASS 3 (U.S. CLS. 1, 4,
6, 50, 51 AND 52).

FIRST USE 1-11-2002; IN COMMERCE 2-1-2002.

THE MARK CONSISTS OF STANDARD CHARACTERS WITHOUT CLAIM TO ANY PAR-
TICULAR FONT, STYLE, SIZE, OR COLOR.

THE FOREIGN WORDING IN THE MARK TRANSLATES INTO ENGLISH AS I BOW TO
THE DIVINE IN YOU.

SER. NO. 78-854,612, FILED 4-5-2006.

GIANCARLO CASTRO, EXAMINING ATTORNEY



David J. Kyffers

Director of the United States Patent and Trademark Office

United States of America

United States Patent and Trademark Office

STA-RIGHT

Reg. No. 4,173,375

Registered July 17, 2012

Int. Cl.: 20

TRADEMARK

PRINCIPAL REGISTER

BRAVO FOXTROT HOLDINGS, INC. (ILLINOIS CORPORATION)
3925 STERN AVENUE
ST. CHARLES, IL 60174

FOR: PLASTIC LANDSCAPE EDGING, NAMELY, PLASTIC LANDSCAPE EDGING FOR RESTRAINING LANDSCAPING MATERIALS, IN CLASS 20 (U.S. CLS. 2, 13, 22, 25, 32 AND 50).

FIRST USE 5-31-2006; IN COMMERCE 5-31-2006.

THE MARK CONSISTS OF STANDARD CHARACTERS WITHOUT CLAIM TO ANY PARTICULAR FONT, STYLE, SIZE, OR COLOR.

SER. NO. 78-866,067, FILED 4-20-2006.

KATHERINE E. HALMEN, EXAMINING ATTORNEY



David J. Kyffers

Director of the United States Patent and Trademark Office

United States of America

United States Patent and Trademark Office



Reg. No. 4,173,376

BRAVO FOXTROT HOLDINGS, INC. (ILLINOIS CORPORATION)

Registered July 17, 2012

3925 STERN AVENUE
ST. CHARLES, IL 60174

Int. Cl.: 20

FOR: PLASTIC LANDSCAPE EDGING, NAMELY, PLASTIC LANDSCAPE EDGING FOR RESTRAINING LANDSCAPING MATERIALS, IN CLASS 20 (U.S. CLS. 2, 13, 22, 25, 32 AND 50).

TRADEMARK

FIRST USE 5-31-2006; IN COMMERCE 5-31-2006.

PRINCIPAL REGISTER

NO CLAIM IS MADE TO THE EXCLUSIVE RIGHT TO USE "LANDSCAPE EDGING", APART FROM THE MARK AS SHOWN.

SER. NO. 78-866,071, FILED 4-20-2006.

KATHERINE E. HALMEN, EXAMINING ATTORNEY



David J. Kyffers

Director of the United States Patent and Trademark Office

United States of America

United States Patent and Trademark Office

CAE CENTRIC

Reg. No. 4,173,377

Registered July 17, 2012

Int. Cl.: 42

SERVICE MARK

PRINCIPAL REGISTER

ENGINEERING TECHNOLOGY ASSOCIATES, INC. (MICHIGAN CORPORATION)
SUITE 200
1133 EAST MAPLE ROAD
TROY, MI 48083

FOR: ENGINEERING SERVICES, NAMELY, PRODUCT ANALYSIS AND DESIGN UTILIZING
COMPUTER AIDED ENGINEERING, IN CLASS 42 (U.S. CLS. 100 AND 101).

FIRST USE 1-15-2005; IN COMMERCE 1-15-2005.

THE MARK CONSISTS OF STANDARD CHARACTERS WITHOUT CLAIM TO ANY PAR-
TICULAR FONT, STYLE, SIZE, OR COLOR.

NO CLAIM IS MADE TO THE EXCLUSIVE RIGHT TO USE "CAE", APART FROM THE
MARK AS SHOWN.

SER. NO. 78-946,752, FILED 8-7-2006.

MARK PILARO, EXAMINING ATTORNEY



David J. Kyros

Director of the United States Patent and Trademark Office

United States of America

United States Patent and Trademark Office

HARRY AND HIS BUCKET FULL OF DINOSAURS

Reg. No. 4,173,378

Registered July 17, 2012

Int. Cl.: 9

TRADEMARK

PRINCIPAL REGISTER

CCI ENTERTAINMENT LTD. (CANADA CORPORATION)
18 DUPONT STREET
TORONTO, CANADA M5R 1V2

FOR: FILMS, VIDEO RECORDINGS, AUDIO RECORDINGS, VIDEO DISCS, DVDS, CD-ROMS AND COMPUTER SOFTWARE, ALL CONTAINING ANIMATED CARTOON PROGRAMS; PRE-RECORDED CD-ROMS, DVDS AND GAME CARTRIDGES CONTAINING COMPUTER GAME SOFTWARE; ELECTRONIC GAMES, ALSO KNOWN AS, VIDEO GAME MACHINES FOR USE WITH TELEVISIONS, IN CLASS 9 (U.S. CLS. 21, 23, 26, 36 AND 38).

THE MARK CONSISTS OF STANDARD CHARACTERS WITHOUT CLAIM TO ANY PARTICULAR FONT, STYLE, SIZE, OR COLOR.

PRIORITY CLAIMED UNDER SEC. 44(D) ON CANADA APPLICATION NO. 1239069, FILED 11-30-2004, REG. NO. TMA795,878, DATED 4-18-2011, EXPIRES 4-18-2026.

SER. NO. 78-981,511, FILED 4-25-2005.

ANDREW LEASER, EXAMINING ATTORNEY



David J. Kyffers

Director of the United States Patent and Trademark Office

United States of America

United States Patent and Trademark Office

HARRY AND HIS BUCKET FULL OF DINOSAURS

Reg. No. 4,173,379

Registered July 17, 2012

Int. Cl.: 35

SERVICE MARK

PRINCIPAL REGISTER

CCI ENTERTAINMENT LTD. (CANADA CORPORATION)
18 DUPONT STREET
TORONTO, CANADA M5R 1V2

FOR: ADVERTISING AND PUBLICITY SERVICES, NAMELY, PROMOTING THE SERVICES OF OTHERS RELATING TO ANIMATED FILMS, TELEVISION PROGRAMS AND VIDEO RECORDINGS, IN CLASS 35 (U.S. CLS. 100, 101 AND 102).

THE MARK CONSISTS OF STANDARD CHARACTERS WITHOUT CLAIM TO ANY PARTICULAR FONT, STYLE, SIZE, OR COLOR.

PRIORITY CLAIMED UNDER SEC. 44(D) ON CANADA APPLICATION NO. 1239069, FILED 11-30-2004, REG. NO. TMA795,878, DATED 4-18-2011, EXPIRES 4-18-2026.

SER. NO. 78-981,513, FILED 4-25-2005.

ANDREW LEASER, EXAMINING ATTORNEY



David J. Kybas

Director of the United States Patent and Trademark Office

United States of America

United States Patent and Trademark Office



Reg. No. 4,173,380

Registered July 17, 2012

Int. Cl.: 9

TRADEMARK

PRINCIPAL REGISTER

LEICA MICROSYSTEMS HOLDINGS GMBH (FED REP GERMANY CORPORATION)
ERNST-LEITZ-STRASSE 17-37
35578 WETZLAR, FED REP GERMANY

FOR: SCIENTIFIC RESEARCH APPARATUS AND INSTRUMENTS FOR USE IN LABORATORIES, NAMELY, TEMPERATURE SENSORS; ELECTROTECHNICAL APPARATUS AND INSTRUMENTS, APPARATUS AND INSTRUMENTS FOR MEASURING, FOR FILMING, NAMELY, COORDINATE MEASURING MACHINES USED IN QUALITY CONTROL TO MONITOR MANUFACTURING PROCESSES, ROTARY TABLES, PROBE HEADS, OPTICAL SENSORS, TACTILE SENSORS AND TEMPERATURE SENSORS; OPTICAL APPARATUS AND INSTRUMENTS FOR MEASURING, SIGNALING, MONITORING AND TEACHING, NAMELY, COORDINATE MEASURING MACHINES USED IN QUALITY CONTROL TO MONITOR MANUFACTURING PROCESSES, ROTARY TABLES, AND OPTICAL SENSORS; MEASURING INSTRUMENTS; PHYSICS, OPTICAL, SURVEYING, ELECTRIC, SIGNALING AND CHECKING APPARATUS AND INSTRUMENTS, NAMELY, COORDINATE MEASURING MACHINES USED IN QUALITY CONTROL TO MONITOR MANUFACTURING PROCESSES, ROTARY TABLES, PROBE HEADS, OPTICAL SENSORS, TACTILE SENSORS AND TEMPERATURE SENSORS; THICKNESS AND LENGTH MEASURING INSTRUMENTS, NAMELY, COORDINATE MEASURING MACHINES USED IN QUALITY CONTROL TO MONITOR MANUFACTURING PROCESSES, ROTARY TABLES, PROBE HEADS, OPTICAL SENSORS, AND TACTILE SENSORS, IN CLASS 9 (U.S. CLS. 21, 23, 26, 36 AND 38).



THE COLOR RED APPEARS IN THE CIRCLE PORTION OF THE MARK AND THE COLOR WHITE APPEARS IN THE WORD "LEITZ".

OWNER OF INTERNATIONAL REGISTRATION 0430319 DATED 5-7-1977, EXPIRES 5-7-2017.

THE COLOR(S) RED AND WHITE IS/ARE CLAIMED AS A FEATURE OF THE MARK.

SEC. 2(F).

SER. NO. 79-019,450, FILED 10-25-2005.

STEVEN JACKSON, EXAMINING ATTORNEY

David J. Kybas

Director of the United States Patent and Trademark Office

United States of America

United States Patent and Trademark Office

AM

Reg. No. 4,173,381

Registered July 17, 2012

**Int. Cls.: 3, 9, 14, 16, 18,
24 and 25**

TRADEMARK

PRINCIPAL REGISTER

FASHION ISLAND LIMITED (UNITED KINGDOM LIMITED LIABILITY COMPANY)
SUITE 100,
25 UPPER BROOK STREET LONDON W1K 7QD
UNITED KINGDOM

FOR: PERFUMES, BATH AND BODY PRODUCTS, NAMELY, BODY LOTIONS AND BATH OIL; GIFT SETS CONTAINING BATH AND BODY PRODUCTS, NAMELY, BODY LOTIONS AND BATH OIL; TOILET WATER, PERSONAL DEODORANTS, ESSENTIAL OILS FOR PERSONAL USE, BODY LOTIONS, SHOWER GEL, BUBBLE BATH, BATH OILS, BATH PEARLS, SKIN SOAPS, SHAVING BALMS, SHAVING CREAM, AFTERSHAVE LOTIONS, COSMETIC PENCILS, FOUNDATION MAKE-UP, FACE POWDERS, TALCUM POWDER, ROUGES, LIPSTICKS, MASCARAS, SKIN CLEANSING CREAMS, SKIN CLEANSING LOTIONS, SUN SCREEN PREPARATIONS, FACE CREAMS, BODY CREAMS, HAIR SHAMPOOS, HAIR SPRAYS, HAIR LOTIONS, IN CLASS 3 (U.S. CLS. 1, 4, 6, 50, 51 AND 52).

FOR: OPTICAL PRODUCTS, NAMELY, SPECTACLES AND SUNGLASSES, EYEGGLASS FRAMES, LENSES, AND CASES FOR SPECTACLES AND SUNGLASSES; SPORT GOGGLES FOR USE IN SKIING, SWIMMING, MOTORCYCLING; EYEGGLASS CHAINS, IN CLASS 9 (U.S. CLS. 21, 23, 26, 36 AND 38).

FOR: WATCHES, CHRONOMETERS AND CLOCKS; JEWELRY, PRECIOUS METALS, PRECIOUS STONES; COSTUME JEWELRY, IN CLASS 14 (U.S. CLS. 2, 27, 28 AND 50).

FOR: DRAWINGS; ILLUSTRATIONS; PAINTINGS AND THEIR REPRODUCTIONS; PHOTOGRAPHS; PICTURES; PORTRAITS, PENCIL TRAYS, MAIL TRAYS, DESK BASKETS, WASTEPAPER BASKETS, PENCIL HOLDERS, BOOKENDS, PAPER CONTAINERS, PENCILS, PENS, BOOK HOLDERS, PRINTED PERIODICALS, MAGAZINES AND BOOKS ON THE SUBJECT OF FASHION; CALENDARS; STATIONERY; MEMORANDUM BOOKS; NOTEBOOKS AND DIARIES, IN CLASS 16 (U.S. CLS. 2, 5, 22, 23, 29, 37, 38 AND 50).

FOR: LEATHER AND IMITATIONS OF LEATHER SOLD IN BULK; LEATHER GOODS, NAMELY, HANDBAGS, PURSES, WALLETS, BRIEFCASES, TOILETRY CASES SOLD EMPTY, COSMETIC CASES SOLD EMPTY, ANIMAL SKINS, ANIMAL HIDES; HANDBAGS, LUGGAGE, SHOULDER BAGS, BEACH BAGS, CLUTCH BAGS, ALL PURPOSE SPORT BAGS, ATTACHÉ CASES, SCHOOL BAGS, TOTE BAGS, CREDIT CARD CASES, DOCUMENT CASES, COSMETIC CASES SOLD EMPTY, KEY CASES, KNAPSACKS, RUCKSACKS,



David J. Kybas

Director of the United States Patent and Trademark Office

Reg. No. 4,173,381 BRIEFCASES, LUGGAGE TRUNKS, SUITCASES, UMBRELLAS, PARASOLS, WALKING STICKS, IN CLASS 18 (U.S. CLS. 1, 2, 3, 22 AND 41).

FOR: TEXTILE TABLE COVERS, BEDSPREADS AND BED BLANKETS, AND CURTAINS, IN CLASS 24 (U.S. CLS. 42 AND 50).

FOR: PULLOVERS, GLOVES, CARDIGANS, SWEATERS, TROUSERS, SKIRTS, BLOUSES, JEANS, SUITS AND DRESSES, OVERCOATS, COATS, RAINCOATS, BELTS, NECKWEAR, SOCKS AND STOCKINGS, TIGHTS, VESTS, WAISTCOATS, JUMPERS, BLOUSONS, KNICKERS, ANORAKS, SUSPENDERS, LOUNGEWEAR, UNDERWEAR, BEACHWEAR, SLEEPWEAR, OVERALLS; NONE OF THE FOREGOING TO INCLUDE JACKETS, SHIRTS, T-SHIRTS, CAPS, GYM CLOTHES AND ATHLETIC APPAREL, IN CLASS 25 (U.S. CLS. 22 AND 39).

THE MARK CONSISTS OF THE CHARACTERS "AM" IN FANCY BLOCK CAPITAL LETTERS.

PRIORITY DATE OF 3-9-2009 IS CLAIMED.

OWNER OF INTERNATIONAL REGISTRATION 1005525A DATED 4-20-2009, EXPIRES 4-20-2019.

SER. NO. 79-069,984, FILED 4-20-2009.

JAMES GRIFFIN, EXAMINING ATTORNEY

United States of America

United States Patent and Trademark Office

ME MYSELF AND I

Reg. No. 4,173,382

Registered July 17, 2012

Int. Cl.: 3

TRADEMARK

PRINCIPAL REGISTER

ART OF NOSE (FRANCE SOCIÉTÉ À RESPONSABILITÉ LIMITÉE UNIPERSONNELLE)
23 RUE DES MATYRS
F-75009 PARIS
FRANCE

FOR: PERFUMES, EAU DE PARFUM, EAU-DE-TOILETTE, CONCRETE, NAMELY, PERFUME
IN THE FORM OF WAX, EAU DE COLOGNE, COSMETICS, FACE CREAMS AND MILK
FOR COSMETIC USE, SHOWER GELS, PERFUMES FOR HOME USE, SOAPS, AFTER-
SHAVE LOTIONS SHAVING FOAM, IN CLASS 3 (U.S. CLS. 1, 4, 6, 50, 51 AND 52).

THE MARK CONSISTS OF STANDARD CHARACTERS WITHOUT CLAIM TO ANY PAR-
TICULAR FONT, STYLE, SIZE, OR COLOR.

OWNER OF INTERNATIONAL REGISTRATION 1005650 DATED 2-20-2009, EXPIRES 2-20-
2019.

SER. NO. 79-070,078, FILED 2-20-2009.

ALICE BENMAMAN, EXAMINING ATTORNEY



David J. Kyffers

Director of the United States Patent and Trademark Office

United States of America

United States Patent and Trademark Office

CRISBAG

Reg. No. 4,173,383

Registered July 17, 2012

Int. Cls.: 7, 9, 37 and 42

TRADEMARK

SERVICE MARK

PRINCIPAL REGISTER

CRISPLANT A/S (DENMARK PUBLIC LIMITED COMPANY)
P.O. PEDERSENS VEJ 10
DK-8200 AARHUS N, DENMARK

FOR: MACHINES AND INSTALLATIONS, NAMELY, MACHINES AND INSTALLATIONS FOR FULLY OR PARTIALLY AUTOMATED TRANSPORT, SORTING, STORAGE AND OTHER HANDLING OF BAGGAGE, NAMELY, OF FLIGHT BAGGAGE, CARGO, MAIL, PACKAGES AND OF PRODUCTS AND MATERIALS FOR USE INDUSTRIALLY OR COMMERCIALLY BY USE OF SPECIAL MADE TUBS OR CONTAINERS; INSTALLATIONS AND SYSTEMS COMPRISED OF CONVEYOR MACHINES, CAROUSELS, CHUTES, BUFFER AND CONVEYOR BELTS, CATWALKS, LADDERS, SPIRALS, CAGES, CARRYING CASES, LIFTS AND TUBS FOR DISTRIBUTION AND SORTING BAGGAGE IN AIRPORTS FEATURING FULLY AND PARTIALLY AUTOMATIC LOADING AND UNLOADING MACHINES, INTERNAL INTERMEDIATE STORAGE, AND TRANSPORTATION FUNCTIONS CONTROLLED BY INTERNAL CONTROL SYSTEMS; PARTS AND ACCESSORIES NOT INCLUDED IN OTHER CLASSES FOR THE BEFORE MENTIONED MACHINES AND INSTALLATIONS, NAMELY, CAROUSELS, CHUTES, BUFFER AND CONVEYOR BELTS, LADDERS, SPIRALS, CAGES, CARRYING CASES SPECIALLY ADAPTED FOR THE AFOREMENTIONED GOODS AND, LIFTS, IN CLASS 7 (U.S. CLS. 13, 19, 21, 23, 31, 34 AND 35).

FOR: ELECTRONIC AND ELECTRIC APPARATUS AND INSTRUMENTS FOR WEIGHING, MEASURING, SIGNALING, TRACKING AND CONTROL FOR USE WITH MACHINES, INSTALLATIONS AND SYSTEMS FOR DISTRIBUTION AND HANDLING OF BAGGAGE, CARGO, MAIL, PACKAGES AND PRODUCTS, NAMELY, DISTRIBUTION POWER PANELS, SCALES, HEIGHT AND WIDTH MEASURING INSTRUMENTS, RFID READER, PROGRAMMABLE LOGIC CONTROLLER, DIGITAL INPUT/OUTPUT MODULES, SAFETY STOP COMPONENTS AND ELECTRONIC OPERATION PANELS WITH INDICATOR LAMPS AND PUSH BUTTONS; COMPUTER HARDWARE AND SOFTWARE, NAMELY, FOR ACQUISITION OF DATA AND FOR MANAGEMENT OF COMMUNICATION WITH OTHER COMPUTERS, FOR CONTROL OF THE OPERATION AND OF THE MONITORING THE RELIABILITY OF MACHINES AND INSTALLATIONS AND SYSTEMS FOR TRANSPORTATION AND HANDLING OF BAGGAGE, FOR DISTRIBUTION AND HANDLING OF BAGGAGE, CARGO, MAIL, PACKAGES AND PRODUCTS AND FOR IDENTIFICATION AND TRACKING OF BAGGAGE, CARGO, MAIL, PACKAGES AND PRODUCTS, IN CLASS 9 (U.S. CLS. 21, 23, 26, 36 AND 38).



David J. Kyjars

Director of the United States Patent and Trademark Office

Reg. No. 4,173,383 FOR: INSTALLATION, MAINTENANCE AND REPAIR OF MACHINES, INSTALLATIONS AND SYSTEMS FOR DISTRIBUTION AND HANDLING OF BAGGAGE, CARGO, MAIL, PACKAGES AND PRODUCTS, AND MACHINES FOR TRANSPORTATION SYSTEMS USING TUBS OR CONTAINERS, IN CLASS 37 (U.S. CLS. 100, 103 AND 106).

FOR: TECHNOLOGICAL CONSULTANCY SERVICES RELATING TO DISTRIBUTION AND HANDLING SYSTEMS, INCLUDING PREPARATION OF TECHNICAL REQUIREMENT ANALYSIS; TECHNOLOGICAL DEVELOPMENT AND RESEARCH IN THE FIELD OF DISTRIBUTION AND HANDLING SYSTEMS FOR BAGGAGE, CARGO, PRODUCTS, BOOKS, PACKAGES, MAIL AND INDUSTRIAL PRODUCTS; TECHNICAL ASSISTANCE IN SOFTWARE IMPLEMENTATION IN RELATION TO DISTRIBUTION AND HANDLING SYSTEMS FOR BAGGAGE, CARGO, PRODUCTS, BOOKS, PACKAGES, MAIL AND INDUSTRIAL, IN CLASS 42 (U.S. CLS. 100 AND 101).

THE MARK CONSISTS OF STANDARD CHARACTERS WITHOUT CLAIM TO ANY PARTICULAR FONT, STYLE, SIZE, OR COLOR.

PRIORITY DATE OF 11-13-2008 IS CLAIMED.

OWNER OF INTERNATIONAL REGISTRATION 1008487 DATED 5-1-2009, EXPIRES 5-1-2019.

OWNER OF U.S. REG. NO. 2,528,859.

THE WORDING "CRISBAG" HAS NO MEANING IN A FOREIGN LANGUAGE.

SER. NO. 79-071,203, FILED 5-1-2009.

KRISTINA MORRIS, EXAMINING ATTORNEY

United States of America

United States Patent and Trademark Office

GRUNDIG

Reg. No. 4,173,384

Registered July 17, 2012

**Int. Cls.: 7, 8, 9, 11 and
38**

TRADEMARK

SERVICE MARK

PRINCIPAL REGISTER

GRUNDIG MULTIMEDIA B.V. (NETHERLANDS LIMITED LIABILITY COMPANY)
STRAWINSKYLAAN 3105
NL-1077 ZX AMSTERDAM
NETHERLANDS

FOR: ELECTRIC HOUSEHOLD UTENSILS, KITCHEN MACHINES, KITCHEN UTENSILS, NAMELY, ELECTRIC FRUIT PRESSES FOR HOUSEHOLD USE, ELECTRIC FOOD BLENDERS FOR HOUSEHOLD PURPOSES, MIXERS, ELECTRIC MINCERS, MIXING AND KNEADING MACHINES, ELECTRIC FRUIT PRESSES FOR HOUSEHOLD USE, JUICE EXTRACTORS, JUICE CENTRIFUGES, GRINDING MACHINES, ELECTRIC FOOD SLICERS AND STRUCTURAL PARTS THEREFOR, DISHWASHERS AND STRUCTURAL PARTS THEREFOR; CLOTHES WASHING MACHINES AND STRUCTURAL PARTS THEREFOR; ELECTRIC CLEANING EQUIPMENT FOR HOUSEHOLD USE, NAMELY, VACUUM CLEANERS AND PARTS FOR VACUUM CLEANERS, NAMELY, VACUUM CLEANER NOZZLES, HOSES AND BRUSHES; MILLING MACHINES, CONVEYORS, BLOWING MACHINES, NAMELY, POWER OPERATED BLOWERS; FILTERS FOR ELECTRIC HOUSEHOLD MACHINES, NAMELY, WASHING MACHINE FILTER, DISHWASHER FILTER; COMPRESSORS FOR MACHINES; CENTRIFUGAL PUMPS; PUMP CONTROL VALVES; INDUSTRIAL ROBOTS, IN CLASS 7 (U.S. CLS. 13, 19, 21, 23, 31, 34 AND 35).

FOR: ELECTRICALLY OPERATED TOOLS AND DEVICES, NAMELY, ELECTRIC RAZORS, BEARD TRIMMERS, ELECTRIC DEPILATION APPLIANCES, ELECTRIC HAIR CUTTERS, HAIR CUTTING SCISSORS, MANICURE AND PEDICURE SETS; COMPONENT PADS, CONTAINERS AND CASES SPECIFICALLY ADAPTED FOR ALL AFOREMENTIONED GOODS; MANUALLY OPERATED TOOLS AND DEVICES, NAMELY, MANUALLY OPERATED SHARPENERS; CUTLERY, FORKS AND SPOONS; HANDLES SPECIALLY ADAPTED FOR CUTLERY, FORKS AND SPOONS; CUT-AND-THRUST WEAPONS AND SIDE ARMS, NAMELY, KNUCKLE DUSTERS, IN CLASS 8 (U.S. CLS. 23, 28 AND 44).

FOR: SCIENTIFIC, NAUTICAL, SURVEYING, ELECTRIC, PHOTOGRAPHIC, CINEMATOGRAPHIC, OPTICAL, WEIGHING, MEASURING, SIGNALING, CHECKING (SUPERVISION), LIFE-SAVING AND TEACHING APPARATUS AND INSTRUMENTS, NAMELY, SCALES; AND INSTRUMENTS AND SYSTEMS ARRANGED THEREFROM FOR RECEIVING, RECORDING, TRANSMISSION, PROCESSING, REPRODUCTION OF ANALOG AND DIGITAL VIDEO, ANALOG AND DIGITAL SOUND AND DATA, NAMELY, DVD MACHINES, APPARATUS AND INSTRUMENTS FOR CONNECTION TO THE INTERNET, NAMELY, EXTERNAL MODEMS; APPARATUS FOR TRANSMISSION OF COMMUNICATION, NAMELY,



David J. Kyjars

Director of the United States Patent and Trademark Office

Reg. No. 4,173,384 AERIALS, CAR RADIOS, AV-RECEIVERS; IMAGE GENERATION AND REPRESENTATION DEVICES, NAMELY, CAMERAS FOR REPRESENTATION AND/OR VISUALIZATION OF MOVING PICTURES, STILL PICTURES, ANIMATIONS, AND/OR MULTIMEDIA DATA; TELECOMMUNICATION APPARATUS, NAMELY, TELECOMMUNICATIONS TOWERS THAT UTILIZE CATHODE RAY TUBES, LCD, PLASMA OR TFT TECHNOLOGY, SCREENS OR PICTURE TUBES; EVENT RECORDERS; CD-PLAYERS; DIGITAL CAMERAS; FLAT PANEL DISPLAY SCREENS; DVD PLAYERS; DVD DRIVES; TV SETS WITH PICTURE TUBES, PLASMA SCREENS, AND LCD SCREENS, DIGITAL VIDEO RECORDERS, HIFI STEREO SETS COMPRISED PRIMARILY OF STEREO AMPLIFIERS, STEREO RECEIVERS, STEREO TUNERS; MOBILE TELEPHONES; WIRED TELEPHONES; MONITORS, NAMELY, LCD MONITORS; PROJECTORS; RADIO APPARATUS WITH OR WITHOUT CASSETTE PLAYERS OR CD-PLAYERS; SET-TOP BOXES; RADIOS INCORPORATING CLOCKS; VIDEO TAPE RECORDERS; APPARATUS FOR RECORDING, TRANSMISSION AND REPRODUCTION OF ELECTRONIC OR DIGITAL MUSIC, NAMELY, MP3 PLAYERS; APPARATUS FOR RECORDING, TRANSMISSION AND REPRODUCTION OF RADIO SIGNALS AND DATA SIGNALS, NAMELY, DISPATCH RADIOS; APPARATUS AND SYSTEMS FOR SATELLITE RECEIVING, NAMELY, AERIALS, MOBILE DATA RECEIVERS, SET-TOP BOXES AND ACCESSORIES FOR SET-TOP BOXES, ADAPTERS, ANTENNA PLUGS, DESCRAMBLERS, FILTERING APPARATUS, NAMELY, ANTENNA FILTER; MOUNTING DEVICES FOR MONITORS, ELECTRICAL CABLES, CONVERTERS, LOW NOISE CONVERTERS, MODEMS, INTEGRATED CIRCUIT MODULES, ELECTRIC CIRCUIT MULTISWITCHES, TRANSFORMERS, AMPLIFIERS, DISTRIBUTION TRANSFORMERS; COMPUTER SOFTWARE AND INTERFACES FOR COMPUTERS FOR USE IN SEARCHING, NAVIGATING, STORING, ARRANGING, REPRODUCING AND BROWSING DATA AND DATA FILES AND FOR DATABASE MANAGEMENT; NAVIGATION SYSTEMS FOR VEHICLES COMPRISED PRIMARILY OF GPS; MULTI-MEDIA DEVICES AND APPARATUS, NAMELY, MODEMS; BLANK MAGNETIC DATA CARRIERS IN TAPE OR DISC FORM; BLANK ELECTRONIC, DIGITAL AND OPTICAL RECORDING CARRIERS IN TAPE OR DISC FORM, NAMELY, CD ROM DISC, DVD AND MAGNETO-OPTICAL DISCS; COMMUNICATION TECHNOLOGY APPARATUS AND INSTRUMENTS, NAMELY, AERONAUTICAL RADIO COMMUNICATION MACHINES AND APPARATUS; GENERAL IN-HOUSE COMMUNICATION, NAMELY, TELEPHONE, WALKIE TALKIE, WIRELESS CELLULAR PHONE HEADSETS; OFFICE TECHNOLOGY APPARATUS, NAMELY, PHOTOCOPIERS; ANSWERING MACHINES; DICTATING MACHINES; HEADPHONES; EARPHONES FOR DICTATING MACHINES; SCANNERS; TELECOPIERS AND STRUCTURAL PARTS THEREFOR; COMPUTER HARDWARE AND SOFTWARE MODULES FOR THE INTERNET, FOR RECORDING, CHECKING, DISTRIBUTING, ANALYZING AND REPORTING MEDICAL IMAGES AND INFORMATION; SOFTWARE FOR USE IN VIEWING IMAGES SCANNED BY MEDICAL DIAGNOSTIC IMAGING EQUIPMENT IRRESPECTIVE OF MODALITY OR ANATOMY FOR USE IN MEDICAL DIAGNOSTICS AND TREATMENT; SOFTWARE FOR USE IN MANAGING IMAGES AND INFORMATION IN THE FIELD OF PICTURE ARCHIVING AND COMMUNICATION SYSTEM; COMPUTER SOFTWARE PROGRAMS FOR USE IN DATABASE MANAGEMENT OF MEDICAL RECORDS, SOFTWARE FOR USE IN IMAGE GUIDED AND CARDIAC SURGERY; SOFTWARE USED FOR INTEGRATED VIEWING AND PROCESSING IMAGES AND PATIENT RELATED DATA AT ANY WORK SPOT, AND FOR WORKFLOW ENHANCING IN THE FIELDS OF RADIOGRAPHY AND RADIOLOGY; SOFTWARE TO PERMIT A USER TO RETRIEVE, DISPLAY, AND BROWSE MEDICAL IMAGES AND MEDICAL INFORMATION; COMPUTER SOFTWARE, EMBEDDED COMPUTER SOFTWARE, AND COMPUTER CHIPS, ALL FOR USE FOR ENCODING AND DECODING OF DATA OR INFORMATION AND FOR COPY PROTECTION OR FOR EMBEDDING, VERIFYING AND DETECTING WATERMARKS IN AUDIO, VIDEO AND DATA FILES; TERMINAL APPARATUS FOR INTERNET FOR USE IN MODEMS; APPARATUS FOR INFORMATION PROCESSING, NAMELY, COMPUTER; TELECOMMUNICATION WIRED AND WIRELESS SUBSCRIBER APPARATUS AND INSTRUMENTS, NAMELY, DIGITAL SUBSCRIBER LINE MODEMS AND TRANSCEIVERS; INTERACTIVE VIDEO GAME PROGRAMS ADAPTED FOR USE WITH TELEVISION SETS; VIDEO GAME SOFTWARE; ACCESSORIES FOR ALL THE AFORESAID GOODS, NAMELY, JUNCTION BOXES; ETHERNET ADAPTERS, VOLTAGE TRANSFORMER ADAPTERS, SERIAL PORT ADAPTERS,

Reg. No. 4,173,384 POWER PLUG ADAPTERS, ELECTRIC ACCUMULATORS, ACOUSTIC COUPLERS, BATTERIES, CARD STATIONS IN THE NATURE OF MAGNETIC CODED CARD READERS, DATA TRANSFER UNITS FOR TRANSFERRING DATA FROM ONE DEVICE TO ANOTHER, OPTICAL FILTERS, MOUNTS IN THE NATURE OF MOUNTING RACKS FOR COMPUTER HARDWARE, FOR TELECOMMUNICATIONS HARDWARE, COAXIAL, COMPUTER, ELECTRICAL, ETHERNET CABLES, HEADPHONES, BATTERY CHARGERS, MAGNETS FOR ERASING RECORDED SIGNALS FROM A MEDIA REMNANTS, BLANK MAGNETIC COMPUTER TAPE CASSETTES, MAGNETICALLY ENCODED DEBIT CARDS, MAGNETICALLY ENCODED CREDIT CARDS, MICROPHONES, AUDIO MIXERS, EXTERNAL MODEMS, INTERNAL MODEMS, CABLE MODEMS, INTERNAL AND EXTERNAL POWER SUPPLIES, HAND-OPERATED AND FOOT-OPERATED ELECTRIC SWITCHES, COMPUTER CHIPS, SEMICONDUCTOR CHIPS FOR STORING CIRCUIT DATA, STORAGE CARDS IN THE NATURE OF BLANK SMART CARDS, ELECTRIC PLUGS, ELECTRIC PLUG CARDS FOR ELECTRICALLY LOCKED DOORS; CONVERTERS, AMPLIFIERS, ELECTRICAL DISTRIBUTORS; REMOTE CONTROLS, NAMELY, REMOTE CONTROL RECEIVERS AND REMOTE CONTROL TRANSMITTERS, FOR, TELEVISION SETS, LIGHTING SYSTEMS, STEREOS, DVD PLAYERS, COMPUTERS, COMPUTER GAME MACHINES, SOUND RECORDING APPARATUS, VIDEO DISC PLAYERS, LOUDSPEAKERS, LOUDSPEAKER HORNS; CONTAINERS FOR ENTERTAINMENT ELECTRONIC GOODS AND DEVICES, NAMELY, CASES FOR MOBILE PHONES, NOTEBOOKS, AFORESAID REMOTE CONTROLS, DVD PLAYERS, IN CLASS 9 (U.S. CLS. 21, 23, 26, 36 AND 38).

FOR: ELECTRICAL HOUSEHOLD APPLIANCES, COOKING, BAKING, FRYING, GRILLING, TOASTING, THAWING, AND HOT-KEEPING, NAMELY, ELECTRIC AND GAS RANGES, COOKING OVENS, ELECTRIC HOT PLATES, ELECTRIC AND GAS COOK TOPS WHICH HAVE ONE OR MORE ELECTRIC HOT PLATES OR GAS BURNERS COMBINED IN ONE APPLIANCE; ELECTRIC COOK TOPS WITH COMMON GLASS CERAMIC SURFACES, IMMERSION HEATERS, NAMELY, ELECTRIC COFFEE POTS, DEFROSTING DEVICES, NAMELY, DEFROSTING OVEN IN THE NATURE OF A CONVECTION OVEN FOR DEFROSTING FOOD; LIGHTING DEVICES, NAMELY, ELECTRIC LIGHTING FIXTURES; STEAM GENERATION DEVICES, NAMELY, ELECTRIC FOOD STEAMERS, AIR HUMIDIFIERS; ELECTRICALLY OPERATED VAPOR FILTERS, NAMELY, FILTERS FOR AIR EXTRACTOR HOODS FOR COOKING PLACES OR KITCHENS; VAPOR EXHAUSTING DEVICES, NAMELY, VAPOR EXTRACTOR DEVICES FOR COOKING PLACES OR KITCHENS, NAMELY, EXTRACTOR HOODS; FREEZERS; DEEP FREEZERS, NAMELY, WALK-IN FREEZERS, ICE MAKING MACHINES; ICE CREAM MAKERS; FACIAL SAUNAS; GRILL DEVICES, NAMELY, BARBECUE GRILLS; HAIR DRYERS, HAND DRYERS IN THE NATURE OF ELECTRIC HOT AIR HAND DRYERS; HEATERS, NAMELY, ELECTRIC SPACE HEATERS; HEATER DEVICES, NAMELY, ELECTRIC SPACE HEATERS; STOVES, NAMELY, ELECTRIC STOVES; COOKING DEVICES, NAMELY, ELECTRIC STOVES; OVENS; WATER COOLERS; REFRIGERATORS; VENTILATION DEVICES, NAMELY, ELECTRIC FANS, VENTILATING FANS FOR COMMERCIAL USE, AIR DRYERS, NAMELY, CLOTHES DRYERS, SPIN CLOTHES DRYERS, AND ELECTRIC HOT AIR HAND DRYERS; MICROWAVE DEVICES, NAMELY, MICROWAVE OVENS; CONTROL DEVICES AND REGULATION ACCESSORIES FOR WATER OR GAS UNITS, NAMELY, PRESSURE REGULATORS FOR GAS AND WATER INSTALLATIONS; SANITARY APPARATUS AND PLANTS, NAMELY, STEAM ROOMS; BUBBLING BATHING DEVICES, NAMELY, WHIRLPOOL BATHS; TOAST DEVICES, NAMELY, ELECTRIC GRILLS, ELECTRIC TOASTER OVENS; LAUNDRY DRYERS, NAMELY, ELECTRIC CLOTHES RACK FOR DRYING CLOTHING; WARMTH-RETAINING DEVICES, NAMELY, ELECTRIC FOOD WARMERS; WATER PIPELINE DEVICES, NAMELY, AQUEDUCTS IN THE NATURE OF PIPES BEING PARTS OF SANITARY FACILITIES, IN CLASS 11 (U.S. CLS. 13, 21, 23, 31 AND 34).

FOR: TELECOMMUNICATIONS, NAMELY, AUDIO TELECONFERENCING, TELECOMMUNICATION ACCESS SERVICES, PERSONAL COMMUNICATIONS SERVICES, RENTAL OF TELECOMMUNICATION APPARATUS, PROVIDING ACCESS TO COMPUTER DATABASES, PROVIDING ACCESS TO COMPUTER NETWORKS, INTERACTIVE DELIVERY OF VIDEO OVER DIGITAL NETWORKS FEATURING THE RECORDAL AND PRE-SELEC-

Reg. No. 4,173,384 TION OF PROGRAMS AUTOMATICALLY INITIATED ON THE BASIS OF CUSTOMER VIEWING HABITS/PREFERENCES, PROFESSIONAL CONSULTANCY RELATING TO TELECOMMUNICATIONS, PROVIDING TELECOMMUNICATIONS CONNECTION TO A GLOBAL COMPUTER NETWORK TELECOMMUNICATIONS SERVICES, NAMELY, TRANSMISSION OF PODCASTS; MULTIMEDIA SERVICES, NAMELY, COMMUNICATION BY ELECTRONIC COMPUTER TERMINALS; TRANSMISSION OF INFORMATION AND DATA FROM DATABANKS VIA NATIONAL AND INTERNATIONAL NETWORKS; VIDEO-ON-DEMAND TRANSMISSION SERVICES; TRANSMISSION OF LINGUISTIC SERVICES AND INQUIRY SERVICES, NAMELY, VOICE OVER IP SERVICES; INTERNET SERVICES, NAMELY, INTERNET ACCESS PROVIDER SERVICES; ELECTRONIC MEDIA SERVICES, NAMELY, ELECTRONIC TRANSMISSION OF DATA, SOUND, IMAGES, AUDIO, VIDEO VIA CABLE, SATELLITE, COMPUTERS, COMPUTER NETWORKS, AND TELEPHONE CABLES; ELECTRONIC TRANSMISSION OF INFORMATION BY SATELLITE; ELECTRONIC TRANSMISSION OF ENTERTAINMENT PROGRAMS, NAMELY, CABLE TELEVISION TRANSMISSION; ELECTRONIC TRANSMISSION OF DATA, IMAGES, SPEECH, AND VOICE; RADIO COMMUNICATION SERVICES, NAMELY, BASE RADIO SERVICES AND MOBILE RADIO SERVICES; TELEMATIC SERVICES, NAMELY, TELEMATIC SENDING OF INFORMATION; AUDIO BROADCASTING OF NEWS AND GENERAL INFORMATION; COMMUNICATION SERVICES TO HOTELS AND OTHER BUSINESSES, NAMELY, ELECTRONIC TRANSMISSION OF DATA AND INFORMATION RELATING TO THE SURVEILLANCE AND SUPERVISION OF INDIVIDUALS AND PROPERTIES AND OF SECURITY SYSTEMS, IN CLASS 38 (U.S. CLS. 100, 101 AND 104).

THE MARK CONSISTS OF STANDARD CHARACTERS WITHOUT CLAIM TO ANY PARTICULAR FONT, STYLE, SIZE, OR COLOR.

OWNER OF INTERNATIONAL REGISTRATION 0813040 DATED 3-27-2003, EXPIRES 3-27-2013.

OWNER OF U.S. REG. NO. 1,103,356.

THE WORDING "GRUNDIG" HAS NO MEANING IN A FOREIGN LANGUAGE.

SEC. 2(F).

SER. NO. 79-074,962, FILED 4-15-2009.

B. PARADEWELAI, EXAMINING ATTORNEY

United States of America

United States Patent and Trademark Office

MusicDNA

Reg. No. 4,173,385

Registered July 17, 2012

**Int. Cls.: 15, 35, 36, 38,
39 and 41**

TRADEMARK

SERVICE MARK

PRINCIPAL REGISTER

BACH TECHNOLOGY GMBH (FED REP GERMANY LIMITED LIABILITY COMPANY)
EHRENBERGSTRASSE 31
98693 ILMENAU
FED REP GERMANY

FOR: MUSICAL INSTRUMENTS, NAMELY, ELECTRONIC MUSICAL INSTRUMENTS AND ELECTRONIC MUSICAL DIGITAL KEYBOARDS FOR CREATING DIGITAL REPRESENTATIONS AND EMULATIONS OF MUSICAL INSTRUMENTS, IN CLASS 15 (U.S. CLS. 2, 21 AND 36).

FOR: ADVERTISING SERVICES, PARTICULARLY, ADVERTISING VIA ELECTRONIC MEDIA, IN CLASS 35 (U.S. CLS. 100, 101 AND 102).

FOR: FINANCIAL AFFAIRS, NAMELY, FINANCIAL INFORMATION, MANAGEMENT AND ANALYSIS SERVICES; INVESTMENT TRANSACTION SERVICES, NAMELY, INVESTMENT ADVISORY SERVICES FEATURING INVESTMENT ADVICE AND CONSULTATION IN ART AS AN INVESTMENT, NAMELY, INVESTMENT ADVICE IN THE FIELD OF MUSIC PRODUCTIONS, IN CLASS 36 (U.S. CLS. 100, 101 AND 102).

FOR: TELECOMMUNICATIONS, NAMELY, TELECOMMUNICATION ACCESS SERVICES, AND PROVIDING THIRD PARTY USERS WITH ACCESS TO TELECOMMUNICATION INFRASTRUCTURE; TELECOMMUNICATION VIA THE INTERNET BETWEEN USER GROUPS OR COMMUNITIES, NAMELY, PROVIDING THIRD PARTY USERS, NAMELY, USER GROUPS AND OTHER DIFFERENT USER COMMUNITIES, WITH ACCESS TO TELECOMMUNICATION INFRASTRUCTURE AND THE INTERNET; ELECTRONIC EXCHANGE OF MESSAGES BY MEANS OF CHAT LINES, CHAT ROOMS AND INTERNET FORUMS, NAMELY, PROVIDING CHAT LINES UTILIZING THE INTERNET AND PROVIDING ON-LINE CHAT ROOMS AND ELECTRONIC BULLETIN BOARDS FOR TRANSMISSION OF MESSAGES AMONG USERS IN THE FIELD OF GENERAL INTEREST, IN CLASS 38 (U.S. CLS. 100, 101 AND 104).

FOR: INFORMATION SERVICES RELATING TO TRANSPORTATION, NAMELY, TRAVEL INFORMATION SERVICES, IN CLASS 39 (U.S. CLS. 100 AND 105).

FOR: ENTERTAINMENT SERVICES IN THE NATURE OF MUSICAL PERFORMANCES; EDUCATION SERVICES IN THE NATURE OF MUSIC INSTRUCTION, NAMELY, PROVIDING USERS WITH NEW MUSIC OF INTEREST, AN INDEX OF MUSICIANS, THEIR



David J. Kyffers

Director of the United States Patent and Trademark Office

Reg. No. 4,173,385 MUSIC, AND MUSIC-RELATED EVENTS THAT LINK THE MUSICIANS TO THE LISTENER; EDUCATION SERVICES, NAMELY, EDUCATION IN THE FIELD OF MUSIC DELIVERED FROM AN INSTRUCTOR TO A USER VIA AN ELECTRONIC MEDIA-REPRODUCING DEVICE, IN CLASS 41 (U.S. CLS. 100, 101 AND 107).

THE MARK CONSISTS OF STANDARD CHARACTERS WITHOUT CLAIM TO ANY PARTICULAR FONT, STYLE, SIZE, OR COLOR.

PRIORITY DATE OF 2-16-2009 IS CLAIMED.

OWNER OF INTERNATIONAL REGISTRATION 1025911 DATED 8-14-2009, EXPIRES 8-14-2019.

SER. NO. 79-077,675, FILED 8-14-2009.

RONALD DELGIZZI, EXAMINING ATTORNEY

United States of America

United States Patent and Trademark Office

OOTOO

Reg. No. 4,173,386

Registered July 17, 2012

Int. Cls.: 12, 36 and 42

TRADEMARK

SERVICE MARK

PRINCIPAL REGISTER

DELAFAITE PHILIPPE (FRANCE INDIVIDUAL)
8 BIS RUE D'EAUBONNE
F-95580 MARGENCY
FRANCE

FOR: VEHICLES FOR LOCOMOTION BY LAND, NAMELY, AUTOMOBILES; LIGHT COMMERCIAL VEHICLES IN THE NATURE OF COMMERCIAL CARRIER VEHICLES WITH A GROSS VEHICLE WEIGHT OF UP TO 3.5 TONS, NAMELY, PICKUP TRUCKS, TRUCKS, VANS, AND ALL TERRAIN VEHICLES IN THE NATURE OF THREE WHEELERS; TRUCKS, MOTORBIKES, TRAILERS, MOTORCYCLES, BICYCLES, ELECTRIC VEHICLES IN THE NATURE OF ELECTRIC CARS, ELECTRICS TRAINS, ELECTRIC LORRIES, ELECTRIC AIRPLANES, ELECTRIC BOATS, ELECTRIC MOTORCYCLES AND SCOOTERS; ELECTRIC SPACECRAFT, NAMELY, LUNAR ROVERS, SHUTTLES, ROCKETS; CARAVANS, CAMPERS, TRACTORS; VEHICLES FOR LOCOMOTION BY AIR, NAMELY, AIRPLANES, HELICOPTERS; VEHICLES FOR LOCOMOTION BY WATER NAMELY, BOATS, IN CLASS 12 (U.S. CLS. 19, 21, 23, 31, 35 AND 44).

FOR: FINANCIAL AFFAIRS, NAMELY, BANKING; INSURANCE, NAMELY, INSURANCE UNDERWRITING IN THE FIELDS OF LOCOMOTION AND TRANSPORT; TAX SERVICES, NAMELY, TAX PAYMENT PROCESSING SERVICES WITH REGARD TO AD VALOREM, VAT, FINANCIAL TRANSACTION TAX, TRANSACTION TAX, SALES TAX, CORPORATE TAX IN THE FIELDS OF LOCOMOTION AND TRANSPORT; COMMODITY TRADING IN THE FIELDS OF LOCOMOTION AND TRANSPORT; FINANCIAL RISK MANAGEMENT, FINANCIAL ASSET MANAGEMENT, IN CLASS 36 (U.S. CLS. 100, 101 AND 102).

FOR: DESIGN, RESEARCH, AND DEVELOPMENT OF NEW PRODUCTS FOR OTHERS PROVIDED BY COMPUTER PROGRAMMERS IN THE FIELDS OF LOCOMOTION AND TRANSPORT, IN CLASS 42 (U.S. CLS. 100 AND 101).

THE MARK CONSISTS OF STANDARD CHARACTERS WITHOUT CLAIM TO ANY PARTICULAR FONT, STYLE, SIZE, OR COLOR.

OWNER OF INTERNATIONAL REGISTRATION 1030052 DATED 8-28-2009, EXPIRES 8-28-2019.

SER. NO. 79-079,384, FILED 8-28-2009.



David J. Kyjars

Director of the United States Patent and Trademark Office

Reg. No. 4,173,386 ALLISON HOLTZ, EXAMINING ATTORNEY

United States of America

United States Patent and Trademark Office



Reg. No. 4,173,387

FAI FONDO PER L'AMBIENTE ITALIANO (ITALY FOUNDATION)
VIALE CONI ZUGNA, 5
I-20144 MILANO, ITALY

Registered July 17, 2012

Int. Cls.: 35, 36 and 41

FOR: ADVERTISING; BUSINESS MANAGEMENT; BUSINESS ADMINISTRATION; OFFICE FUNCTIONS, IN CLASS 35 (U.S. CLS. 100, 101 AND 102).

SERVICE MARK

FOR: FUNDRAISING FOR CHARITABLE PURPOSES; PROVIDING FUNDRAISING ACTIVITIES TO SUPPORT ENVIRONMENTAL ISSUES AND INITIATIVES, ART AND HISTORICAL MONUMENTS AND BUILDINGS PRESERVATION, IN CLASS 36 (U.S. CLS. 100, 101 AND 102).

PRINCIPAL REGISTER

FOR: EDUCATION, NAMELY, PROVIDING CLASSES, SEMINARS, WORKSHOPS, LECTURES, TELESEMINARS, TELECLASSES IN THE FIELD OF ART, ART APPRECIATION, ENVIRONMENTAL AWARENESS AND CONSERVATION, HISTORICAL MONUMENT, BUILDING AND STRUCTURE AWARENESS AND PRESERVATION; PROVIDING OF TRAINING IN THE FIELD OF ART, ENVIRONMENTAL AWARENESS AND CONSERVATION, HISTORICAL MONUMENT, BUILDING AND STRUCTURE AWARENESS AND RESTORATION; ENTERTAINMENT IN THE NATURE OF CONDUCTING FAIRS, LIVE PERFORMANCES BY MUSICAL BANDS, ORCHESTRAS, THEATER COMPANIES, PROVIDING VIRTUAL ENVIRONMENTS IN WHICH USERS CAN INTERACT FOR RECREATIONAL, LEISURE OR ENTERTAINMENT PURPOSES; CULTURAL ACTIVITIES, NAMELY, ORGANIZING COMMUNITY CULTURAL EVENTS, ORGANIZING EXHIBITIONS FOR CULTURAL PURPOSES, IN CLASS 41 (U.S. CLS. 100, 101 AND 107).



NO CLAIM IS MADE TO THE EXCLUSIVE RIGHT TO USE "FONDO AMBIENTE ITALIANO", APART FROM THE MARK AS SHOWN.

PRIORITY DATE OF 12-21-2009 IS CLAIMED.

OWNER OF INTERNATIONAL REGISTRATION 1033374 DATED 1-28-2010, EXPIRES 1-28-2020.

David J. Kybas

THE COLOR(S) WHITE, ORANGE AND GREEN IS/ARE CLAIMED AS A FEATURE OF THE MARK.

Reg. No. 4,173,387 THE MARK CONSISTS OF THE WORDING "FAI FONDO AMBIENTE ITALIANO" WITHIN A SQUARE BACKGROUND. TO THE RIGHT OF THE "FAI" IS A POLYGON DESIGN WITH A Y-SHAPED CUT OUT DESIGN IN THE MIDDLE. THE COLOR ORANGE APPEARS IN THE POLYGON DESIGN, THE COLOR WHITE APPEARS IN THE TEXT AND THE COLOR GREEN IS THE COLOR OF THE SQUARE BACKGROUND .

THE ENGLISH TRANSLATION OF "FONDO AMBIENTE ITALIANO" IS "ITALIAN ENVIRONMENT FOUNDATION".

SER. NO. 79-080,595, FILED 1-28-2010.

CARYN GLASSER, EXAMINING ATTORNEY

United States of America

United States Patent and Trademark Office

vitamingrinder

Reg. No. 4,173,388

BUSCH, KLAUS-UWE (FED REP GERMANY INDIVIDUAL)

Registered July 17, 2012

MARCH 67
A-5622 GOLDEGG, AUSTRIA

Int. Cls.: 3, 29, 30 and 32

FOR: BLEACHING PREPARATIONS AND DETERGENT ALL FOR LAUNDRY USE; CLEANING POLISHING, SCOURING AND ABRASIVE PREPARATIONS; SOAPS, NAMELY, TOILET SOAPS, LAUNDRY SOAP; PERFUMERY, ESSENTIAL OILS, COSMETICS, HAIR LOTIONS; DENTIFRICES, IN CLASS 3 (U.S. CLS. 1, 4, 6, 50, 51 AND 52).

TRADEMARK

PRINCIPAL REGISTER

FOR: MEAT, FISH, POULTRY AND GAME; MEAT EXTRACTS; PRESERVED, FROZEN, DRIED AND COOKED FRUITS AND VEGETABLES; JELLIES, JAMS, COMPOTES; EGGS, MILK AND MILK PRODUCTS, EXCLUDING ICE CREAM, ICE MILK AND FROZEN YOGURT; EDIBLE OILS AND FATS, IN CLASS 29 (U.S. CL. 46).

FOR: COFFEE, TEA, COCOA, SUGAR, RICE, TAPIOCA, SAGO, ARTIFICIAL COFFEE IN THE NATURE OF COFFEE SUBSTITUTES; FLOUR AND PREPARATIONS MADE FROM CEREALS, NAMELY, PROCESSED CEREAL, CEREAL BASED SNACK FOOD; BREAD, PASTRY AND CONFECTIONERY, NAMELY, CANDY FONDANTS; ICES; HONEY, TREACLE; YEAST, BAKING-POWDER; SALT, MUSTARD; VINEGAR, SAUCES IN THE NATURE OF CONDIMENTS; SPICES; ICE, IN CLASS 30 (U.S. CL. 46).

FOR: BEERS; MINERAL AND AERATED WATERS AND OTHER NON-ALCOHOLIC DRINKS, NAMELY, SOFT DRINKS; FRUIT DRINKS, FRUIT JUICES; NON-ALCOHOLIC CIDER; SYRUPS AND OTHER PREPARATIONS FOR MAKING BEVERAGES, NAMELY, CONCENTRATES, POWDERS FOR MAKING FRUIT FLAVORED BEVERAGES, IN CLASS 32 (U.S. CLS. 45, 46 AND 48).



THE MARK CONSISTS OF STANDARD CHARACTERS WITHOUT CLAIM TO ANY PARTICULAR FONT, STYLE, SIZE, OR COLOR.

PRIORITY DATE OF 11-6-2009 IS CLAIMED.

OWNER OF INTERNATIONAL REGISTRATION 1041206 DATED 5-6-2010, EXPIRES 5-6-2020.

THE WORDING "VITAMINGRINDER" HAS NO MEANING IN A FOREIGN LANGUAGE.

David J. Kybas

Director of the United States Patent and Trademark Office

Reg. No. 4,173,388 SER. NO. 79-083,473, FILED 5-6-2010.

ANDREA HACK, EXAMINING ATTORNEY

United States of America

United States Patent and Trademark Office

ATS

■ ■ ■ ■ ■ Leichtmetallräder

Reg. No. 4,173,389

RALF SCHMID (FED REP GERMANY INDIVIDUAL)
HALTENRIEDSTRASSE 27

Registered July 17, 2012

MEGGEN, KANTON LUZERN, SWITZERLAND CH6045

Int. Cls.: 12, 37 and 42

FOR: LIGHT METAL RIMS FOR VEHICLE WHEELS, IN CLASS 12 (U.S. CLS. 19, 21, 23, 31, 35 AND 44).

TRADEMARK

FOR: REPAIR OF LIGHT METAL RIMS FOR VEHICLE WHEELS, IN CLASS 37 (U.S. CLS. 100, 103 AND 106).

SERVICE MARK

PRINCIPAL REGISTER

FOR: SCIENTIFIC AND TECHNOLOGICAL SERVICES AND RESEARCH AND DESIGN RELATING THERETO IN THE FIELD OF LIGHT METAL RIMS FOR VEHICLE WHEELS, NAMELY, INDUSTRIAL ANALYSIS AND RESEARCH SERVICES IN THE FIELD OF LIGHT METAL RIMS FOR VEHICLE WHEELS, DESIGN AND DEVELOPMENT OF COMPUTER HARDWARE AND SOFTWARE IN THE FIELD OF LIGHT METAL RIMS FOR VEHICLE WHEELS, IN CLASS 42 (U.S. CLS. 100 AND 101).

NO CLAIM IS MADE TO THE EXCLUSIVE RIGHT TO USE "LEICHTMETALLARÄDER", APART FROM THE MARK AS SHOWN.

PRIORITY DATE OF 11-25-2009 IS CLAIMED.

OWNER OF INTERNATIONAL REGISTRATION 1043658 DATED 5-21-2010, EXPIRES 5-21-2020.



THE MARK CONSISTS OF THE STYLIZED LETTERS "ATS" ABOVE A HORIZONTAL BAR COMPOSED OF FIVE SEGMENTS OF RECTANGLES, EACH ONE SMALLER THAN THE LAST, WITH THE WHOLE DESIGN BEING UNDER THE "A". TO THE RIGHT OF THE BAR AND UNDER THE "ATS" IS THE STYLIZED WORDING "LEICHTMETALLARÄDER".

THE ENGLISH TRANSLATION OF THE FOREIGN WORD(S) IN THE MARK IS: LIGHT METAL WHEELS.

David J. Kyfos

SER. NO. 79-084,447, FILED 5-21-2010.

ANDREA HACK, EXAMINING ATTORNEY

United States of America

United States Patent and Trademark Office

EWM

Reg. No. 4,173,390

Registered July 17, 2012

**Int. Cls.: 6, 7, 8, 9, 17, 20,
40, 41 and 42**

TRADEMARK

SERVICE MARK

PRINCIPAL REGISTER

EWM HIGHTEC WELDING GMBH (FED REP GERMANY LIMITED LIABILITY COMPANY)
DR.-GÜNTHER-HENLE-STR. 8
56271 MÜNDERSBACH
FED REP GERMANY

FOR: INDUSTRIAL SAFETY CABINS MADE OF METAL; WIRE MADE OF METAL, NAMELY, FILLER WIRE; METAL SOLDER; METALLIC POWDER, NAMELY, WELDING POWDER; SOLDERING RODS MADE OF METAL FOR BRAZE SOLDERING, IN CLASS 6 (U.S. CLS. 2, 12, 13, 14, 23, 25 AND 50).

FOR: INDUSTRIAL ROBOTS; ELECTRIC SOLDERING AND WELDING MACHINES; MACHINES INCORPORATING LASERS FOR WELDING, SOLDERING AND CUTTING; ELECTRIC WELDING MACHINES FOR ORBITAL WELDING; CLEANING MACHINES FOR CLEANING METALLIC MATERIALS, NAMELY, FOR CLEANING WELDMENT JOINTS; MACHINES AND MACHINE TOOLS FOR MARKING METALLIC MATERIALS; MACHINES AND MACHINE TOOLS FOR STRIPPING AND FOR RENDERING PASSIVE METALLIC MATERIALS, IN PARTICULAR WELDMENT JOINTS; GRINDING MACHINES FOR GRINDING WELDING ELECTRODES; ELECTRIC PLASMA CUTTERS; PLASMA WELDING MACHINES; ELECTRIC RESISTANCE WELDING MACHINES FOR USE IN RESISTANCE SPOT WELDING AND STUD WELDING; SUCTION MACHINES FOR WELDING FUMES; GAS-OPERATED METAL CUTTING MACHINES; GAS WELDING MACHINES; MACHINES INCORPORATING GAS WARMING DEVICES FOR WARMING METAL PRIOR TO WELDING; ELECTRIC POWER TOOLS FOR METALWORKING, NAMELY, RIGHT ANGLE GRINDERS AND BURR GRINDERS; METAL CUTTING AND PROCESSING MACHINES, NAMELY, DRILLING MACHINES, ELECTRIC HAMMERS, POLISHING HAMMERS, DIE-STAMPING MACHINES, MACHINE SAWS, POWER GRINDERS, AND MACHINE TOOLS FOR BEVEL EDGE FORMING; APPARATUS FOR APPLYING FORMING GAS, BEING PART OF WELDING MACHINES; ELECTRICALLY OPERATED SUCTION TABLES FOR INDUSTRIAL USE; CUTTING TABLES BEING PART OF METALWORKING MACHINES, IN CLASS 7 (U.S. CLS. 13, 19, 21, 23, 31, 34 AND 35).

FOR: MANUALLY OPERATED TOOLS FOR METALWORKING, NAMELY, PLIERS, CUTTING TOOLS, ABRADING TOOLS, MORTISE CHISELS, SCISSORS, HAMMERS, SAWS, PIPE CUTTERS AND WRENCHES, AND TUBE SAWS, IN CLASS 8 (U.S. CLS. 23, 28 AND 44).



David J. Kappas

Director of the United States Patent and Trademark Office

Reg. No. 4,173,390 FOR: LASER WELDING DEVICES AND LASER SOLDERING DEVICES; ELECTRICAL SOLDERING AND WELDING TORCHES; ELECTRICAL SOLDERING AND WELDING TORCHES WITH INERT GAS; SOLAR MODULES FOR GENERATION OF ELECTRIC CURRENT; COMPUTER PROGRAMS FOR THE CONTROL OF WELDING APPARATUS, INDUSTRIAL ROBOTS, WELDING MACHINES AND SOLAR ELECTRICITY MACHINES; MEASURING AND TESTING DEVICES FOR MEASURING THE PHYSICAL PROPERTIES AND PROPER FUNCTION OF SOLDERING AND BLOW TORCHES, WELDING APPARATUS AND SOLAR ELECTRICITY MACHINES; ELECTRICAL SOLDERING MACHINES; ELECTRICAL WELDING MACHINES; ELECTRICAL MACHINES FOR ORBITAL WELDING; OPTO-ELECTRONIC PROTECTIVE MASKS FOR WELDING; TESTING AND MEASURING INSTRUMENTS FOR WELDING TECHNOLOGY, NAMELY, INSTRUMENTS FOR MEASURING DELTA FERRITE AND INSTRUMENTS FOR MEASURING THE REMAINING OXYGEN; PARTS OF ELECTRICAL WELDING APPARATUS, NAMELY, GRIPPERS AND BRUSHES; CONVENTIONAL PROTECTIVE MASKS FOR WELDERS; APPARATUS FOR USE WITH GAS-SHIELDED ELECTRIC ARC WELDERS, NAMELY, FORMING GAS APPARATUS FOR THE PROTECTION OF WELDMENT JOINTS; ELECTRICAL INERT GAS SHIELDED ARC WELDING TORCHES; PROTECTIVE CLOTHING, NAMELY, FLAME RETARDING JACKETS, TROUSERS, COATS, AND WORK SHOES, PROTECTIVE CLOTHING MADE OF LEATHER; SOLAR COLLECTORS FOR GENERATION OF ELECTRIC CURRENT; ELECTRICAL TRANSFORMERS; STORAGE APPARATUS FOR ELECTRICITY, NAMELY, BATTERIES AND CAPACITORS; WELDING ELECTRODES, NAMELY, STICK ELECTRODES, STICK WELDING ELECTRODES FOR TUNGSTEN INERT GAS (TIG) WELDING, SOLID WIRE WELDING ELECTRODES, CORED WIRE ELECTRODES; AUTOMATIC CONTROL APPARATUS FOR INDUSTRIAL ROBOTS, IN CLASS 9 (U.S. CLS. 21, 23, 26, 36 AND 38).

FOR: FIRE CURTAINS, NAMELY, PROTECTION AND SAFETY CURTAINS MADE FROM NON-INFLAMMABLE AND FLAME RESISTANT MATERIALS FOR MOBILE AND STATIONARY USE, IN CLASS 17 (U.S. CLS. 1, 5, 12, 13, 35 AND 50).

FOR: INDUSTRIAL WORK TABLES NOT BEING PARTS OF MACHINES AND NOT BEING SPECIALLY ADAPTED TO HOLD POWERED MACHINERY, IN CLASS 20 (U.S. CLS. 2, 13, 22, 25, 32 AND 50).

FOR: RENTAL OF WELDING AND SOLDERING DEVICES AND MACHINES TOGETHER WITH ACCESSORIES THEREFOR, IN CLASS 40 (U.S. CLS. 100, 103 AND 106).

FOR: ORGANIZATION AND CONDUCTING OF SEMINARS AND TRAINING COURSES FOR BASIC AND ADVANCED TRAINING IN THE AREA OF WELDING AND SOLDERING TECHNOLOGY, IN PARTICULAR IN RELATION TO INDUSTRIAL AUTOMATION, IN CLASS 41 (U.S. CLS. 100, 101 AND 107).

FOR: TECHNICAL CONSULTING IN RELATION TO THE DEVELOPMENT OF POWER SOURCES, WELDING APPARATUS AND MACHINES, AND SOLAR POWER DEVICES; DEVELOPMENT AND RENTAL OF COMPUTER SOFTWARE, IN PARTICULAR FOR WELDING APPARATUS, INDUSTRIAL ROBOTS AND SOLAR POWER DEVICES; DEVELOPMENT OF NEW TECHNOLOGY FOR OTHERS IN THE FIELD OF WELDING AND SOLDERING METHODS, AND IN THE FIELD OF WELDING AND SOLDERING OF MATERIALS FOR SUCH METHODS; RENTAL OF MEASURING AND TESTING APPARATUS FOR WELDING AND METALWORKING TECHNOLOGY, IN CLASS 42 (U.S. CLS. 100 AND 101).

OWNER OF INTERNATIONAL REGISTRATION 1007167 DATED 12-9-2008, EXPIRES 12-9-2018.

SER. NO. 79-084,661, FILED 4-26-2010.

STEVEN R. FINE, EXAMINING ATTORNEY

United States of America

United States Patent and Trademark Office



Reg. No. 4,173,391

Registered July 17, 2012

Int. Cls.: 41 and 42

SERVICE MARK

PRINCIPAL REGISTER

DR. SIBYLLE PETRAK (FED REP GERMANY INDIVIDUAL)
GRENADIERWEG 23
OLDENBURG
FED REP GERMANY 26129

FOR: PROVIDING TRAINING AND INFORMATION IN CONNECTION THEREWITH IN THE FIELD OF SOLAR ENGINEERING, ON THE INTERNET, IN CLASS 41 (U.S. CLS. 100, 101 AND 107).

FOR: SCIENTIFIC RESEARCH, TECHNOLOGICAL CONSULTATION, AND DESIGN, ALL RELATING TO THE USE OF SOLAR ENERGY, SOLAR INSTALLATIONS AND SOLAR POWER STATIONS; TECHNICAL CONSULTANCY FOR CONSUMERS AND BUSINESSES WITH REGARD TO GOODS AND SERVICES FOR SOLAR ENERGY GENERATION; INDUSTRIAL ANALYSIS AND RESEARCH, INCLUDING PLANNING, EVALUATING AND ASSESSMENT SERVICES RELATING TO SOLAR INSTALLATIONS AND SOLAR POWER STATIONS; DESIGN AND DEVELOPMENT OF COMPUTER ALGORITHMS (PROGRAMMING) IN THE FIELD OF SATELLITE REMOTE SENSING, GEOPHYSICAL CALCULATION OF SOLAR RADIATION, SIMULATION OF TECHNICAL SYSTEMS, AND THE FEEDING OF SOLAR POWER AND SOLAR HEATING INTO SUPPLY NETWORKS; DRAWING UP SCIENTIFIC AND TECHNICAL REPORTS RELATING TO SOLAR ENERGY GENERATING INSTALLATIONS, INCLUDING PHOTOVOLTAIC INSTALLATIONS AND SOLAR POWER STATIONS; PLATFORM AS A SERVICE, NAMELY, PROVIDING INTERNET SOFTWARE PLATFORMS FOR MARKETING SERVICES AND FOR THE ADMINISTRATION AND PRESENTATION OF OUTPUT DATA FROM SOLAR ENERGY GENERATING INSTALLATIONS, IN CLASS 42 (U.S. CLS. 100 AND 101).



NO CLAIM IS MADE TO THE EXCLUSIVE RIGHT TO USE "SOLAR", APART FROM THE MARK AS SHOWN.

OWNER OF INTERNATIONAL REGISTRATION 1045417 DATED 6-18-2010, EXPIRES 6-18-2020.

THE COLOR(S) VIOLET, MAGENTA, WHITE, AND TAN IS/ARE CLAIMED AS A FEATURE OF THE MARK.

THE MARK CONSISTS OF THE WORDING "FOCUS SOLAR" IN VIOLET AND A STYLIZED SQUARE DESIGN WITH MAGENTA AND WHITE STRIPES AND TAN SHADOWS.

David J. Kybas

Director of the United States Patent and Trademark Office

Reg. No. 4,173,391 SER. NO. 79-085,138, FILED 6-18-2010.

JOHN E. MICHOS, EXAMINING ATTORNEY

United States of America

United States Patent and Trademark Office



Reg. No. 4,173,392

Registered July 17, 2012

Int. Cl.: 29

TRADEMARK

PRINCIPAL REGISTER

FROMAGERIES BEL SA (FRANCE SOCIETE ANONYME)
16 BOULEVARD MALESHERBES
PARIS, FRANCE F75008

FOR: EGGS, MILK AND DAIRY PRODUCTS OTHER THAN ICE CREAMS, ICE MILK AND FROZEN YOGURT; MILK BEVERAGES WITH MILK PREDOMINATING; EDIBLE OILS AND FATS; CHEESE AND SPECIALTY CHEESE PRODUCTS, NAMELY, CHEESE, CHEESE SPREADS, CHEESE FOOD, COMBINATIONS OF CHEESE AND CRACKERS, CHEESE SUBSTITUTES, CREAMY CHEESES, GRANULAR FRESH CHEESES, ASSORTED FOOD-STUFFS ESSENTIALLY CHEESE-BASED, NAMELY, FOOD PACKAGE COMBINATIONS CONSISTING PRIMARILY OF CHEESE, MEAT AND/OR PROCESSED FRUIT, IN CLASS 29 (U.S. CL. 46).

OWNER OF U.S. REG. NOS. 1,580,290, 3,604,475 AND OTHERS.

OWNER OF INTERNATIONAL REGISTRATION 1025114 DATED 12-7-2009, EXPIRES 12-7-2019.

THE COLOR(S) RED, GREEN, YELLOW AND WHITE IS/ARE CLAIMED AS A FEATURE OF THE MARK.

NO CLAIM IS MADE TO THE EXCLUSIVE RIGHT TO USE "MINI", APART FROM THE MARK AS SHOWN.

THE MARK CONSISTS OF A RED ABSTRACT SHAPE COMPRISING A RED CIRCLE; THE CIRCLE IS SPLIT INTO THREE HORIZONTAL LAYERS, THE UPPER AND LOWER LAYERS IN RED AND THE MIDDLE LAYER IN WHITE; THE TERM "MINI" APPEARS IN THE UPPER PART OF THE LOGO IN RED LETTERS UNDERLINED IN WHITE; A MILK JUG IN GREEN AND WHITE APPEARS IN THE CENTRE OF THE CIRCLE ABOVE THE TERM "BABYBEL" WRITTEN IN RED AND STYLIZED LETTERS; A WHITE DROP APPEARS ABOVE THE RIPPLED EDGING, ABOVE THE MILK JUG; ANOTHER RIPPLE APPEARS IN GREEN UNDER THE TERM "BABYBEL" AND A YELLOW DESIGN REPRESENTING A SUNRISE APPEARS AT THE BOTTOM OF THE MIDDLE PART OF THE CIRCLE.



David J. Kypos

Director of the United States Patent and Trademark Office

SER. NO. 79-085,851, FILED 1-26-2010.

ROBERT STRUCK, EXAMINING ATTORNEY

United States of America

United States Patent and Trademark Office

AUTORADIO

Reg. No. 4,173,393

Registered July 17, 2012

Int. Cls.: 38 and 41

SERVICE MARK

PRINCIPAL REGISTER

AUTORADIO BROADCASTING CORPORATION LTD. (UNITED KINGDOM LIMITED COMPANY)
186 HAMMERSMITH ROAD
LONDON, UNITED KINGDOM W6 7DJ

FOR: TELECOMMUNICATIONS SERVICES, NAMELY, NEWS AGENCIES, NAMELY, THE TRANSMISSION OF NEWS ITEMS TO NEWS REPORTING ORGANIZATIONS; TELECOMMUNICATIONS SERVICES, NAMELY, INFORMATION ABOUT TELECOMMUNICATION; RADIO BROADCASTING; TELEVISION AND CABLE TELEVISION BROADCASTING; INTERNET BROADCASTING SERVICES; CELLULAR TELEPHONE COMMUNICATION; SATELLITE TRANSMISSION, SATELLITE COMMUNICATION SERVICES, SATELLITE BROADCASTING; TELECOMMUNICATION ACCESS SERVICES; PROVIDING ACCESS TO DATABASES; PROVISION OF ACCESS TO A GLOBAL COMPUTER NETWORK; PROVIDING ELECTRONIC TELECOMMUNICATION CONNECTIONS; INTERNET SERVICE PROVIDER SERVICES; PROVIDING MULTIPLE-USER ACCESS TO A GLOBAL COMPUTER INFORMATION NETWORK; PROVIDING CHAT LINES UTILIZING THE INTERNET; COMMUNICATIONS VIA FIBER-OPTIC NETWORKS; COMMUNICATIONS BY COMPUTER TERMINALS; COMPUTER-AIDED TRANSMISSION OF MESSAGES AND IMAGES; RENTAL OF ACCESS TIME TO GLOBAL COMPUTER NETWORKS; RENTAL OF TELECOMMUNICATION EQUIPMENT; RENTAL OF TELEPHONES; TELEPHONE COMMUNICATION SERVICES; VOICE MAIL SERVICES; TELECONFERENCING SERVICES; ELECTRONIC BULLETIN BOARD SERVICES; ELECTRONIC MAIL AND MESSAGING SERVICES; RADIO PAGING SERVICES; TELEPHONE PAGING SERVICES; PROVIDING TELECOMMUNICATION CHANNELS FOR TEleshopping SERVICE; TELECOMMUNICATIONS ROUTING AND JUNCTION SERVICES, IN CLASS 38 (U.S. CLS. 100, 101 AND 104).



David J. Kyffers

Director of the United States Patent and Trademark Office

FOR: ENTERTAINMENT SERVICES, NAMELY, TELEVISION ENTERTAINMENT, NAMELY, ENTERTAINMENT IN THE NATURE OF TELEVISION NEWS SHOWS; RADIO ENTERTAINMENT, NAMELY, ENTERTAINMENT IN THE NATURE OF RADIO PERSONALITY PERFORMANCES; ORGANIZATION OF SHOWS FOR CULTURAL PURPOSES; PRODUCTION OF SHOWS, NAMELY, PRODUCTION OF RADIO AND TELEVISION SHOWS, EDUCATION AND ENTERTAINMENT COMPETITIONS, EXHIBITIONS FOR CULTURAL OR EDUCATIONAL PURPOSES, IMPRESARIO SERVICES, SPORTS COMPETITIONS; PRODUCTION SERVICES, NAMELY, PRODUCTION OF RADIO AND TELEVISION PROGRAMMES, OF SHOWS, OF VIDEOTAPE FILM; PROVIDING OF AMUSEMENT ARCADE SERVICES, KARAOKE SERVICES, ON-LINE ELECTRONIC PUBLICATIONS; PRODUCTION OF RADIO AND TELEVISION PROGRAMS; RENTAL OF RADIO AND TELEVISION SETS; THEATER

Reg. No. 4,173,393 PRODUCTIONS; PRESENTATIONS, NAMELY, PRESENTATIONS OF LIVE PERFORMANCES; MODELLING FOR ARTISTS; TICKET AGENCY SERVICES; CAMP SERVICES, NAMELY, HOLIDAY, SPORT CAMPS; EXHIBITIONS SERVICES, NAMELY, ORGANIZATION OF EXHIBITIONS FOR CULTURAL OR EDUCATIONAL PURPOSES; MUSEUM SERVICES, NAMELY, PROVIDING OF MUSEUMS FACILITIES, PRESENTATION, EXHIBITIONS; SPORT, NAMELY, SPORT CAMP SERVICES, TIMING OF SPORTS EVENTS; TEXTS, NAMELY, PUBLICATION OF TEXT, OTHER THAN PUBLICITY TEXTS, WRITING OF TEXTS, OTHER THAN PUBLICITY TEXTS; VIDEOTAPING SERVICES, NAMELY, VIDEOTAPE FILM PRODUCTION, RENTAL OF VIDEOTAPES, VIDEOTAPING; PROVIDING OF AMUSEMENT ARCADE SERVICES, AMUSEMENT PARKS; BOOKING OF CONCERTS, SEATS FOR SHOWS, BOOKMOBILE SERVICES; PUBLICATION OF BOOKS, MAGAZINES, ELECTRONIC DESKTOP, DIGITAL IMAGING SERVICES; EDUCATION SERVICES, NAMELY, EDUCATION INFORMATION, EXAMINATION, SERVICES; INFORMATION SERVICES ABOUT EDUCATION, ENTERTAINMENT, RECREATION; MUSIC, NAMELY, MUSIC COMPOSITION SERVICES, MUSIC-HALLS; PHOTOGRAPHY, NAMELY, PHOTOGRAPHIC REPORTING; RECORDING, NAMELY, RENTAL OF VIDEO CASSETTE RECORDERS, RECORDING STUDIO SERVICES; RECREATION, NAMELY, PROVIDING OF RECREATION FACILITIES, RECREATION INFORMATION; RENTAL OF AUDIO EQUIPMENT, OF CAMCORDERS, OF CINE-FILMS, OF LIGHTING APPARATUS FOR THEATRICAL SETS OR TELEVISION STUDIOS, OF MOTION PICTURES, OF MOVIE PROJECTORS AND ACCESSORIES, OF RADIO AND TELEVISION SETS, OF SHOW SCENERY, OF SKIN DIVING EQUIPMENT, OF SOUND RECORDINGS, OF SPORTS EQUIPMENT, EXCEPT VEHICLES, OF STADIUM FACILITIES, OF STAGE SCENERY, OF VIDEO CAMERAS, OF VIDEO CASSETTE RECORDERS, OF VIDEOTAPES; PROVIDING OF CASINO FACILITIES, INCLUDING GAMBLING FACILITIES; GAMING, NAMELY, GAME SERVICES PROVIDED ON-LINE FROM A COMPUTER NETWORK, GAMING; OPERATING OF LOTTERIES; RENTAL OF PROJECTORS AND ACCESSORIES, MOVIE STUDIOS, MOVIE THEATER PRESENTATION; ARRANGING AND CONDUCTING OF CONCERTS; NEWS REPORTERS SERVICES, IN CLASS 41 (U.S. CLS. 100, 101 AND 107).

OWNER OF INTERNATIONAL REGISTRATION 1049215 DATED 3-12-2010, EXPIRES 3-12-2020.

SER. NO. 79-086,655, FILED 3-12-2010.

MARLENE BELL, EXAMINING ATTORNEY

United States of America

United States Patent and Trademark Office

BIOMIMETIC SKIN CARE

Reg. No. 4,173,394

Registered July 17, 2012

Int. Cl.: 35

SERVICE MARK

PRINCIPAL REGISTER

DR. SPILLER BIOCOSMETIC GMBH (FED REP GERMANY LIMITED LIABILITY COMPANY)
VOGLINGER STRASSE 11
83313 SIEGSDORF
FED REP GERMANY

FOR: BUSINESS MANAGEMENT SERVICES; BUSINESS ADMINISTRATION AND MANAGEMENT; PROVIDING OFFICE FUNCTIONS; RETAIL STORE AND WHOLESALE STORE SERVICES FEATURING PAPER, CARDBOARD AND GOODS MADE FROM THESE MATERIALS, BOOK BINDING MATERIAL, PHOTOGRAPHS, STATIONERY, PLASTIC MATERIALS FOR PACKAGING, CLOTHING, FOOTWEAR, HEADGEAR, IN CLASS 35 (U.S. CLS. 100, 101 AND 102).

THE MARK CONSISTS OF STANDARD CHARACTERS WITHOUT CLAIM TO ANY PARTICULAR FONT, STYLE, SIZE, OR COLOR.

PRIORITY DATE OF 1-26-2010 IS CLAIMED.

OWNER OF INTERNATIONAL REGISTRATION 1049570 DATED 7-26-2010, EXPIRES 7-26-2020.

SER. NO. 79-086,777, FILED 7-26-2010.

JESSICA FATHY, EXAMINING ATTORNEY



David J. Kybas

Director of the United States Patent and Trademark Office

United States of America

United States Patent and Trademark Office

СТАНДАРТПЛАСТ

STANDARTPLAST

Reg. No. 4,173,395

Registered July 17, 2012

Int. Cls.: 17, 19 and 35

LIMITED LIABILITY COMPANY "AUTOPLASTIC" (RUSSIAN FED. LIMITED LIABILITY COMPANY)
DEREVNJA IVANCEVO
IVANOVSKIJ RAJON; RU-153504 IVANOVSKAJAOBLAST
RUSSIAN FED.

TRADEMARK

SERVICE MARK

PRINCIPAL REGISTER

FOR: INSULATING PAPER FOR ACOUSTIC AND THERMAL INSULATION OF AUTOMOBILES; INSULATING FELT FOR ACOUSTIC AND THERMAL INSULATION OF AUTOMOBILES; POLYURETHANE FOAM INSULATORS FOR ACOUSTIC AND THERMAL INSULATION OF AUTOMOBILES; INSULATING TAPE AND BAND; ADHESIVE BANDS AND TAPES OTHER THAN STATIONERY AND NOT FOR MEDICAL OR HOUSEHOLD PURPOSES; SOUNDPROOFING MATERIALS FOR AUTOMOBILES; INSULATING MATERIALS; INSULATING REFRACTORY MATERIALS; RUBBER MATERIAL FOR RECAPPING TIRES AND TYRES, NAMELY, FOR RESTORING USED TIRES OR TYRES OF A MOTOR VEHICLE TO USABLE CONDITION BY BONDING NEW RUBBER ONTO THE WORN TREAD AND LATERAL SURFACE; NON-CONDUCTING MATERIALS, NAMELY, POLYETHYLENE FOAM, POLYURETHANE FOAM, AND FOAM PLASTIC MEMBRANES FOR RETAINING HEAT; SEALANT COMPOUNDS FOR JOINTS; INSULATING PLASTER; CORDS OF RUBBER; CYLINDER JOININGS; PIPE GASKETS; JOINT PACKINGS FOR AUTOMOBILE PIPES; JOINT PACKINGS AND SEALS, NAMELY, PIPE GASKETS; SUBSTANCES, NAMELY, POLYURETHANE FILM FOR INSULATING BUILDINGS AGAINST MOISTURE; FIBERGLASS FOR INSULATION FOR AUTOMOBILES; INSULATING FABRICS; WATERPROOF PACKINGS, NAMELY, WATER-TIGHT RINGS FOR AUTOMOBILES; FOILS OF METAL FOR AUTOMOBILE INSULATING, IN CLASS 17 (U.S. CLS. 1, 5, 12, 13, 35 AND 50).



David J. Kypas

Director of the United States Patent and Trademark Office

FOR: BITUMEN; BINDING AGENTS IN THE NATURE OF CLAY SOLD IN POWDERED FORM FOR USE IN THE MANUFACTURE OF BRICKS; BINDING MATERIAL IN THE NATURE OF CONCRETE AND ASPHALT FOR ROAD REPAIR; GEOTEXTILES FOR EROSION CONTROL FABRIC, MATS AND SHEETING, NOT OF METAL; NON-METAL CONSTRUCTION MATERIALS, NAMELY, XYLOLITH; REINFORCING MATERIALS, NOT OF METAL, FOR BUILDING; BITUMINOUS PRODUCTS, NAMELY, BITUMEN ASPHALT FOR BUILDING; TAR; BUILDING MATERIALS, NAMELY, CONCRETE, CONCRETE BEAMS AND BLOCKS, BUILDING GLASS, GLASS BRICKS AND PANES, PLASTIC TILES AND FLOORBOARDS, MULTILAYER PANELS OF PLASTIC, DECORATIVE FOAM CORE ARCHITECTURAL ELEMENTS THAT ARE COATED TO RESEMBLE STONE, COMPOSITE SLABS OF CEMENT AND CONCRETE, NOT OF METAL; PITCH; REFRACTORY CONSTRUCTION MATERIALS, NOT OF METAL; COATINGS AS BUILDING MATERIALS, NAMELY,

Reg. No. 4,173,395 ASPHALT ROOF COATINGS; LATHS, NOT OF METAL; WALL LININGS, NAMELY, INSULATING CORK TILES AND TILES OF CORK-BASED CONGLOMERATES, NOT OF METAL, FOR BUILDING; WALL LININGS CONSISTING OF REINFORCED, DRY-STACKED, ENGINEERED CONCRETE BLOCK WITH INSULATING CORE AND COATED WITH SURFACE BOND CEMENT, NOT OF METAL, FOR BUILDING; WAINSCOTTING, NOT OF METAL; PARTITIONS NOT OF METAL, NAMELY, CONSTRUCTION MATERIALS IN THE NATURE OF NONMETAL TOILET PARTITIONS, NON-METAL WALL-MOUNTED PANEL UNITS FOR EXHIBITIONS, DISPLAYS AND PARTITIONING; FLOOR PANELS, NOT OF METAL; CEILING PANELS, NOT OF METAL; CLADDING, NOT OF METAL, FOR BUILDING; INSULATING GLASS FOR WINDOWS FOR BUILDING PURPOSES; FLASHING, NOT OF METAL, FOR BUILDING, IN CLASS 19 (U.S. CLS. 1, 12, 33 AND 50).

FOR: DEMONSTRATION OF PRODUCTS; CONDUCTING MARKETING STUDIES; BUSINESS ORGANIZATION CONSULTANCY; BUSINESS MANAGEMENT CONSULTANCY; PROFESSIONAL BUSINESS CONSULTANCY; BUSINESS MANAGEMENT ASSISTANCE; COMMERCIAL OR INDUSTRIAL MANAGEMENT ASSISTANCE; SALES PROMOTION FOR OTHERS; DISTRIBUTION OF SAMPLES ADVERTISING; PROCUREMENT SERVICES FOR OTHERS, NAMELY, PURCHASING GOODS AND SERVICES, NAMELY, INSULATION MATERIALS AND CONSTRUCTION MATERIALS FOR OTHER BUSINESSES; EFFICIENCY EXPERTS, IN CLASS 35 (U.S. CLS. 100, 101 AND 102).

THE MARK CONSISTS OF CYRILLIC CHARACTERS THAT READ "STANDARTPLAST" IN RUSSIAN, ABOVE THE WORDING "STANDARTPLAST", ALL IN BLUE ON A WHITE BACKGROUND.

OWNER OF INTERNATIONAL REGISTRATION 1050855 DATED 6-16-2010, EXPIRES 6-16-2020.

THE COLOR(S) WHITE AND BLUE IS/ARE CLAIMED AS A FEATURE OF THE MARK.

THE TRANSLITERATION OF THE NON-LATIN CHARACTERS IN THE MARK IS: "STANDARTPLAST".

SER. NO. 79-087,268, FILED 6-16-2010.

ADA HAN, EXAMINING ATTORNEY

United States of America

United States Patent and Trademark Office



MIXING GROUP

Reg. No. 4,173,396

Registered July 17, 2012

Int. Cls.: 7, 9, 37 and 42

HARBURG-FREUDENBERGER MASCHINENBAU GMBH (FED REP GERMANY COMPANY WITH LIMITED LIABILITY)
ASDORFER STR. 60
57258 FREUDENBERG
FED REP GERMANY

TRADEMARK

SERVICE MARK

PRINCIPAL REGISTER

FOR: MACHINERY THE FOR CAOUTCHOUC AND RUBBER PROCESSING INDUSTRY, PARTICULARLY TIRE AND AUTOMOTIVE INDUSTRY, NAMELY, MACHINERY FOR MIXING RUBBER, RUBBER FOR TIRES, RUBBER FOR TECHNICAL GOODS, PLASTIC AND PETROCHEMICAL MATERIALS, INTERNAL BATCH MIXERS, CONTINUOUS MIXERS, MACHINERY FOR CUTTING RUBBER STRIPS AND RUBBER PLATES, AND ROLLING MILLS; ENGINES EXCEPT MOTORS FOR LAND VEHICLES; CLUTCHES AND POWER TRANSMISSION MECHANISMS EXCEPT SUCH FOR LAND VEHICLES; MACHINERY FOR PROCESSING OF PLASTICS EXCEPT INJECTION MOLDING MACHINES; MACHINES FOR PROCESSING OF ELASTOMERS, TIRE MANUFACTURING MACHINES; EXTRUDERS, NAMELY, DUMP EXTRUDERS IN THE NATURE OF PLASTIC AND ELASTOMER EXTRUDERS; MACHINERY FOR EXTRUSION OF SUBSTANCES, NAMELY, RUBBER AND PLASTIC COMPOUNDS, IN CLASS 7 (U.S. CLS. 13, 19, 21, 23, 31, 34 AND 35).

FOR: SCIENTIFIC, NAUTICAL, SURVEYING, PHOTOGRAPHIC, CINEMATOGRAFIC, OPTICAL, WEIGHING, MEASURING, SIGNALING, CONTROLLING, RESCUING AND TEACHING APPARATUS AND INSTRUMENTS, NAMELY, MIXING ROOM CONTROL SYSTEMS FOR MACHINES; SCIENTIFIC, NAUTICAL, SURVEYING, PHOTOGRAPHIC, CINEMATOGRAFIC, OPTICAL, WEIGHING, MEASURING, SIGNALING, CONTROLLING, RESCUING AND TEACHING APPARATUS AND INSTRUMENTS, NAMELY, ELECTRONIC MIXING ROOM CONTROL SYSTEMS FOR MACHINES; APPARATUS AND INSTRUMENTS FOR CONDUCTING, SWITCHING, TRANSFORMING, ACCUMULATING, REGULATING AND CONTROLLING OF ELECTRICITY; ELECTRICAL/ELECTRONIC CONTROL SYSTEMS FOR EXTRUSION MACHINES, ELECTRICAL/ELECTRONIC CONTROL SYSTEMS FOR PRESSES, ELECTRICAL/ELECTRONIC CONTROL SYSTEMS FOR INTERNAL MIXERS, ELECTRIC/ELECTRONIC CONTROL SYSTEMS FOR MACHINERY FOR PROCESSING OF ELASTOMERS; DATA PROCESSING EQUIPMENT AND COMPUTERS, COMPACT DISCS FEATURING SOFTWARE FOR SURVEYING, PHOTOGRAPHY AND SIGNALING, DV DISCS FEATURING SOFTWARE FOR SURVEYING, PHOTOGRAPHY AND SIGNALING; BLANK CD-ROM FOR SOUND OR VIDEO RECORDING, DATA STORAGE MEDIUM, NAMELY, CD, DVD, MASS STORAGE DEVICES WITH SOFTWARE FOR MIXING ROOM CONTROL SYSTEM AND FOR USE IN DATABASE MANAGEMENT; ALL THE AFORESAID GOODS



David J. Kyros

Director of the United States Patent and Trademark Office

Reg. No. 4,173,396 NOT FOR USE IN INJECTION MOLDING MACHINES, IN CLASS 9 (U.S. CLS. 21, 23, 26, 36 AND 38).

FOR: ELECTRIC INSTALLATION SERVICES; INSTALLATION SERVICES OF HEATING, VENTILATION AND AIR CONDITIONING, INDUSTRIAL FACILITIES, COOLING SYSTEMS, MACHINERY, REPAIR OR MAINTENANCE OF PRODUCTS IN ELECTRICAL AND MECHANICAL ENGINEERING, PRECISION ENGINEERING PRODUCTS, HEATING, AIR CONDITIONING, COOLING AND VENTILATION SYSTEMS, THERMOTECHNICAL FACILITIES; INSTALLATION AND REPAIR OF COMPUTERS, IN CLASS 37 (U.S. CLS. 100, 103 AND 106).

FOR: SCIENTIFIC AND TECHNOLOGICAL SERVICES AND RESEARCH AND DESIGN RELATING SERVICES, NAMELY, SCIENTIFIC RESEARCH, TECHNOLOGICAL CONSULTATION IN THE FIELD OF RUBBER AND PLASTICS MIXING TECHNOLOGY, DESIGN FOR OTHERS IN THE FIELD OF RUBBER AND PLASTICS MIXING TECHNOLOGY; INDUSTRIAL ANALYSIS AND RESEARCH SERVICES, IN THE FIELD RUBBER AND PLASTICS MIXING TECHNOLOGY; DESIGN AND DEVELOPMENT OF COMPUTER HARDWARE AND SOFTWARE; SERVICES OF AN ENGINEER RELATED TO RUBBER AND PLASTICS MIXING ROOM TOPICS; COMPUTER PROGRAMMING; ISSUING TECHNICAL EXPERT REPORTS IN THE FIELD OF RUBBER AND PLASTICS MIXING TECHNOLOGY; TECHNICAL CONSULTANCY IN THE FIELD OF RUBBER AND PLASTICS MIXING TECHNOLOGY, SCIENTIFIC RESEARCH FOR OTHERS; INDUSTRIAL RESEARCH FOR OTHERS IN THE FIELD OF RUBBER AND PLASTICS MIXING TECHNOLOGY; RENTAL OF DATA PROCESSING EQUIPMENT; RECORDING DATA FOR OTHERS ON OPTICAL, DIGITAL AND MAGNETIC MEDIA FOR ELECTRONIC STORAGE IN COMPUTER DATABASES, DESIGN OF WEBSITES AND COMPUTER PROGRAMMING; CONSULTING IN GRAPHIC DESIGN AND DESIGN OF WEBSITES; MATERIAL TESTING; ENGINEERING SERVICES DEALING WITH TECHNICAL EVALUATIONS, TECHNICAL STUDIES AND ON THE ISSUE OF TECHNICAL EXPERT REPORTS IN THE FIELD OF SCIENCE AND TECHNOLOGY, IN CLASS 42 (U.S. CLS. 100 AND 101).

OWNER OF U.S. REG. NO. 3,508,780.

PRIORITY DATE OF 12-9-2009 IS CLAIMED.

OWNER OF INTERNATIONAL REGISTRATION 1051504 DATED 5-6-2010, EXPIRES 5-6-2020.

NO CLAIM IS MADE TO THE EXCLUSIVE RIGHT TO USE "MIXING GROUP", APART FROM THE MARK AS SHOWN.

THE MARK CONSISTS OF THE WORDING "HF MIXING GROUP" WITH THE LETTERS "HF" ON A CIRCULAR BACKGROUND WITH CURVED BANDS ABOVE AND BELOW THE LETTERS.

SER. NO. 79-087,510, FILED 5-6-2010.

AISHA SALEM, EXAMINING ATTORNEY

United States of America

United States Patent and Trademark Office

TIBON

Reg. No. 4,173,397

Registered July 17, 2012

Int. Cls.: 2, 6, 11 and 42

TRADEMARK

SERVICE MARK

PRINCIPAL REGISTER

INNOVIC HOLDING APS (DENMARK LIMITED LIABILITY COMPANY)
ANNASVEJ 4A, 3TH.
DK-2900 HELLERUP
DENMARK

FOR: LACQUERS; PAINTS; COATINGS IN THE NATURE OF THERMALLY CONDUCTIVE PAINTS AND FINISHES FOR THE SURFACE TREATMENT OF METAL FOILS, IN CLASS 2 (U.S. CLS. 6, 11 AND 16).

FOR: FOILS OF METAL; ALUMINUM FOIL; GENERAL PURPOSE METAL STORAGE CONTAINERS WITH AND WITHOUT METAL LIDS, IN CLASS 6 (U.S. CLS. 2, 12, 13, 14, 23, 25 AND 50).

FOR: COOKING OVENS, IN CLASS 11 (U.S. CLS. 13, 21, 23, 31 AND 34).

FOR: SCIENTIFIC RESEARCH, SCIENTIFIC AND TECHNOLOGICAL SERVICES, NAMELY, SCIENTIFIC RESEARCH, ANALYSIS AND TESTING IN THE FIELD OF USING COATED METAL FOILS IN THE PREPARATION OF FOOD; INDUSTRIAL DESIGN, IN CLASS 42 (U.S. CLS. 100 AND 101).

THE MARK CONSISTS OF STANDARD CHARACTERS WITHOUT CLAIM TO ANY PARTICULAR FONT, STYLE, SIZE, OR COLOR.

PRIORITY DATE OF 2-10-2010 IS CLAIMED.

OWNER OF INTERNATIONAL REGISTRATION 1051515 DATED 7-16-2010, EXPIRES 7-16-2020.

SER. NO. 79-087,514, FILED 7-16-2010.

ALYSSA STEEL, EXAMINING ATTORNEY



David J. Kyjars

Director of the United States Patent and Trademark Office

United States of America
United States Patent and Trademark Office

Naturalift

Reg. No. 4,173,398

Registered July 17, 2012

Int. Cl.: 3

TRADEMARK

PRINCIPAL REGISTER

MELVITA (FRANCE SOCIÉTÉ PAR ACTIONS SIMPLIFIÉE)
QUARTIER MARQUENOUX -
LA FONTAINE DU CADE; F-07150 LAGORCE
FRANCE

FOR: HAIR LOTIONS, IN CLASS 3 (U.S. CLS. 1, 4, 6, 50, 51 AND 52).

OWNER OF INTERNATIONAL REGISTRATION 1052166 DATED 7-30-2010, EXPIRES 7-30-2020.

SER. NO. 79-087,721, FILED 7-30-2010.

MYRIAH HABEEB, EXAMINING ATTORNEY

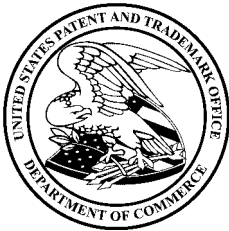

David J. Kybas

Director of the United States Patent and Trademark Office

United States of America

United States Patent and Trademark Office



Reg. No. 4,173,399

Registered July 17, 2012

Int. Cl.: 33

TRADEMARK

PRINCIPAL REGISTER

LAURENT-PERRIER (FRANCE SOCIÉTÉ ANONYME)
32 AVENUE DE CHAMPAGNE
F-51150 TOURS SUR MARNE, FRANCE

FOR: CHAMPAGNE AOC WINES BEING WINES WITH PROTECTED APPELLATION OF ORIGIN, IN CLASS 33 (U.S. CLS. 47 AND 49).

NO CLAIM IS MADE TO THE EXCLUSIVE RIGHT TO USE "CUVÉE ROSÉ", "CHAMPAGNE", "MAISON FONDÉE 1812", AND "BY APPOINTMENT TO H.R.H. THE PRINCE OF WALES PURVEYORS OF CHAMPAGNE", APART FROM THE MARK AS SHOWN.

PRIORITY DATE OF 6-2-2010 IS CLAIMED.

OWNER OF INTERNATIONAL REGISTRATION 1052248 DATED 9-6-2010, EXPIRES 9-6-2020.

THE COLOR(S) BLACK, SALMON PINK, PURPLE AND RED IS/ARE CLAIMED AS A FEATURE OF THE MARK.

THE MARK CONSISTS OF A THREE-DIMENSIONAL CONFIGURATION OF PACKAGING FOR APPLICANT'S GOODS COMPRISED OF A BOX WITH A SALMON PINK BACKGROUND, WITH THE RED STYLIZED WORDING "CUVÉE ROSÉ" ABOVE THE STYLIZED WORDING "CHAMPAGNE" IN PURPLE ABOVE THE BLACK WORDING "LAURENT-PERRIER", WITH A DECORATIVE AND FANCIFUL LINE DESIGN IN PURPLE AROUND "LAURENT-PERRIER", ABOVE THE PURPLE STYLIZED WORDING "MAISON FONDÉE 1812". AT THE BOTTOM OF THE FRONT OF THE BOX IS A FEATHER AND CROWN DESIGN IN BLACK ABOVE THE WORDS IN BLACK "BY APPOINTMENT TO H.R.H. THE PRINCE OF WALES PURVEYORS OF CHAMPAGNE CHAMPAGNE LAURENT-PERRIER". ON THE BACK OF THE BOX APPEARS THE STYLIZED BLACK WORDING "LA CUVÉE ROSÉ EST NÉE EN 1968 DE L'AUDACE ET DU SAVOIR-FAIRE DE LA MAISON LAURENT-PERRIER. AVEC POUR EXIGENCE LA RECHERCHE DE PERFECTION A TOUTES LES ÉTAPES D'ÉLABORATION, LA CUVÉE ROSÉ S'EST VITE IMPOSÉE COMME UNE CRÉATION D'EXCEPTION. DANS SON ÉLÉGANT FLACON D'INSPIRATION HENRI IV, CE CHAMPAGNE ROSÉ SE DISTINGUE PAR SA GRANDE FRAICHEUR ET L'EXPRESSION UNIQUE DE SES AROMES DE FRUITS ROUGES FRAIS." ABOVE A DECORATIVE LINE DESIGN IN BLACK ABOVE THE STYLIZED BLACK WORDING "CUVÉE ROSÉ WAS BORN IN 1968 OF THE BOLD EXPERIMENTATION AND KNOW-HOW OF LAURENT-PERRIER.



David J. Kyjars

Director of the United States Patent and Trademark Office

Reg. No. 4,173,399 DRIVEN BY A CONSTANT SEARCH FOR PERFECTION AT EVERY STEP IN ITS ELABORATION, CUVÉE ROSÉ QUICKLY ESTABLISHED ITS REPUTATION AS A WORK OF ART WITH INIMITABLE STYLE. IN ITS ELEGANT BOTTLE OF LATE 16TH CENTURY INSPIRATION, THIS ROSÉ CHAMPAGNE IS MEMORABLE FOR ITS EXCEPTIONAL FRESHNESS AND UNIQUE AROMAS OF FRESH-PICKED RED BERRIES.". THE BROKEN LINES DEPICTING THE RECTANGULAR SHAPE OF THE PACKAGING INDICATE PLACEMENT OF THE MARK ON THE GOODS AND ARE NOT PART OF THE MARK.

THE ENGLISH TRANSLATION OF "MAISON FONDÉE" AND "LA CUVÉE ROSÉ EST NÉE EN 1968 DE L'AUDACE ET DU SAVOIR-FAIRE DE LA MAISON LAURENT-PERRIER. AVEC POUR EXIGENCE LA RECHERCHE DE PERFECTION A TOUTES LES ÉTAPES D'ÉLABORATION, LA CUVÉE ROSÉ S'EST VITE IMPOSÉE COMME UNE CRÉATION D'EXCEPTION. DANS SON ÉLÉGANT FLACON D'INSPIRATION HENRI IV, CE CHAMPAGNE ROSÉ SE DISTINGUE PAR SA GRANDE FRAICHEUR ET L'EXPRESSION UNIQUE DE SES AROMES DE FRUITS ROUGES FRAIS." IN THE MARK IS "HOUSE FOUNDED" AND "CUVÉE ROSÉ WAS BORN IN 1968 OF THE BOLD EXPERIMENTATION AND KNOW-HOW OF LAURENT-PERRIER. DRIVEN BY A CONSTANT SEARCH FOR PERFECTION AT EVERY STEP IN ITS ELABORATION, CUVÉE ROSÉ QUICKLY ESTABLISHED ITS REPUTATION AS A WORK OF ART WITH INIMITABLE STYLE. IN ITS ELEGANT BOTTLE OF LATE 16TH CENTURY INSPIRATION, THIS ROSÉ CHAMPAGNE IS MEMORABLE FOR ITS EXCEPTIONAL FRESHNESS AND UNIQUE AROMAS OF FRESH-PICKED RED BERRIES".

SER. NO. 79-087,743, FILED 9-6-2010.

KRISTINA MORRIS, EXAMINING ATTORNEY

United States of America

United States Patent and Trademark Office



Reg. No. 4,173,400

Registered July 17, 2012

Int. Cls.: 19 and 42

TRADEMARK

SERVICE MARK

PRINCIPAL REGISTER

FRED & FRED (FRANCE SOCIÉTÉ PAR ACTIONS SIMPLIFIÉE)
27 RUE DU VIEUX FAUBOURG
F-59000 LILLE, FRANCE

FOR: BUILDING MATERIALS, NOT OF METAL, NAMELY, NON-METAL FRAMES AND SEMI-FINISHED SECTIONS FOR USE IN THE FURTHER MANUFACTURE OF WINDOWS, DOORS, FAÇADE GLAZING AND PARTITION WALLS FOR USE AS BUILDING MATERIALS; TRANSPORTABLE BUILDINGS, NOT OF METAL; PORTABLE BUILDINGS, NOT OF METAL; BUILDING GLASS; INSULATING GLASS FOR WINDOWS, WALLS, ROOFS AND CEILINGS FOR BUILDING PURPOSES; GLASS PARTITIONS, NAMELY, NON-METAL TOILET PARTITIONS, JAPANESE STYLE INDOOR SLIDING PARTITIONS (FUSUMA) AND SCREENS, NAMELY, NON-METAL WINDOW SCREENS; MODULAR ELEMENTS OF GLASS, NAMELY, JAPANESE STYLE INDOOR SLIDING PARTITIONS (FUSUMA); OPTICAL GLASS FOR PARTITIONS AND BUILDINGS, NAMELY, OPTICAL GLASS SECTIONS FOR USE IN THE MANUFACTURE OF WINDOWS, DOORS, FAÇADE GLAZING AND PARTITION WALLS, IN CLASS 19 (U.S. CLS. 1, 12, 33 AND 50).

FOR: RESEARCH AND DEVELOPMENT OF NEW PRODUCTS FOR OTHERS; TECHNICAL PROJECT STUDIES IN THE FIELD OF ARCHITECTURE AND INDUSTRIAL DESIGN, NAMELY, OPTICAL STUDY AND OPTICAL DESIGN; ARCHITECTURAL DESIGN OF INTERIOR DÉCOR; DESIGN AND DEVELOPMENT OF NEW MATERIALS FOR BUILDING CONSTRUCTIONS; INDUSTRIAL DESIGN SERVICES, IN CLASS 42 (U.S. CLS. 100 AND 101).

THE MARK CONSISTS OF TWO INWARD FACING STYLIZED "F" DESIGNS COMPOSED OF SQUARES, UNDERNEATH IS THE STYLIZED WORDING "FRED & FRED".

OWNER OF INTERNATIONAL REGISTRATION 1054067 DATED 9-22-2010, EXPIRES 9-22-2020.

SER. NO. 79-088,390, FILED 9-22-2010.

SCOTT BIBB, EXAMINING ATTORNEY



David J. Kybas

Director of the United States Patent and Trademark Office

United States of America

United States Patent and Trademark Office

arrowhead 

Reg. No. 4,173,401

Registered July 17, 2012

Int. Cls.: 36 and 42

KABUSHIKI KAISHA TOKYO SHOKEN TORIHIKISHO (TOKYO STOCK EXCHANGE, INC.) (JAPAN COMPANY LIMITED BY SHARES)
2-1 NIHOMBASHI KABUTOCHO,
CHUO-KU; TOKYO 103-8220
JAPAN

SERVICE MARK

PRINCIPAL REGISTER

FOR: TRADING IN SECURITIES IN THE NATURE OF AGENCIES OR BROKERAGE FOR TRADING OF SECURITIES, SECURITIES INDEX FUTURES, SECURITIES OPTIONS, AND OVERSEAS MARKET SECURITIES FUTURES; TRADING IN SECURITIES IN THE NATURE OF AGENCIES OR BROKERAGE FOR ENTRUSTING AGENTS WITH ON COMMISSION TRADING IN DOMESTIC MARKETS OF SECURITIES, SECURITIES INDEX FUTURES AND SECURITIES OPTIONS; TRADING IN SECURITIES IN THE NATURE OF AGENCIES OR BROKERAGE FOR ENTRUSTING AGENTS WITH ON COMMISSION TRADING IN OVERSEAS MARKETS OF SECURITIES, AND SECURITIES INDEX FUTURES; TRADING IN SECURITIES IN THE NATURE OF AGENCIES OR BROKERAGE FOR FORWARD AGREEMENT OF SECURITIES, FOR FORWARD AGREEMENT OF SECURITIES INDEX FUTURES, FOR FORWARD AGREEMENT OF SECURITIES OPTIONS, SPOT AND FORWARD TRANSACTION OF SECURITIES INDEX FUTURES; PROVIDING STOCK MARKET INFORMATION; RESEARCH AND COMPILING OF STATISTICS OF FINANCIAL INSTRUMENTS MARKETS WHERE TRADING OF SECURITIES OR MARKET TRADING OF DERIVATIVES ARE CONDUCTED, NAMELY, FINANCIAL RESEARCH AND INFORMATION SERVICES; RESEARCH AND COMPILING OF STATISTICS OF MARKETS REGARDING TRADING OF COMMODITY DERIVATIVES OR COMMODITY INDEX DERIVATIVES, NAMELY, FINANCIAL RESEARCH AND INFORMATION SERVICES; RESEARCH AND COMPILING OF STATISTICS OF MARKETS REGARDING EMISSIONS TRADING OR DERIVATIVES TRADING BASED ON THEM, NAMELY, FINANCIAL RESEARCH AND INFORMATION SERVICES; RESEARCH AND COMPILING OF STATISTICS OF MARKETS REGARDING EMISSIONS TRADING IN THE FIELD OF GREENHOUSE GASES OR DERIVATIVES TRADING BASED ON THEM, NAMELY, FINANCIAL RESEARCH AND INFORMATION SERVICES; PROVIDING INFORMATION ON TRADING OF SECURITIES OR MARKET TRADING OF DERIVATIVES, NAMELY, FINANCIAL INFORMATION SERVICES; PROVIDING INFORMATION ON TRADING OF COMMODITY DERIVATIVES OR COMMODITY INDEX DERIVATIVES, NAMELY, FINANCIAL INFORMATION SERVICES; PROVIDING INFORMATION ON EMISSIONS TRADING OR DERIVATIVES TRADING BASED ON THEM, NAMELY, FINANCIAL INFORMATION SERVICES; PROVIDING INFORMATION ON EMISSIONS TRADING IN THE FIELD OF GREENHOUSE GASES OR DERIVATIVES TRADING BASED ON THEM, NAMELY, FINANCIAL INFORMATION



David J. Kappas

Director of the United States Patent and Trademark Office

Reg. No. 4,173,401 SERVICES; PROVIDING INFORMATION ON FINANCIAL INSTRUMENTS MARKETS WHERE TRADING OF SECURITIES OR MARKET TRADING OF DERIVATIVES ARE CONDUCTED, NAMELY, FINANCIAL INFORMATION SERVICES; PROVIDING INFORMATION ON OVERSEAS FINANCIAL INSTRUMENTS MARKETS WHERE TRADING OF SECURITIES OR MARKET TRADING OF DERIVATIVES ARE CONDUCTED, NAMELY, FINANCIAL INFORMATION SERVICES; PROVIDING INFORMATION ON MARKETS REGARDING COMMODITY DERIVATIVES OR COMMODITY INDEX DERIVATIVES, NAMELY, FINANCIAL INFORMATION SERVICES; PROVIDING INFORMATION ON MARKETS REGARDING EMISSIONS TRADING OR DERIVATIVES TRADING BASED ON THEM, NAMELY, FINANCIAL INFORMATION SERVICES; PROVIDING INFORMATION ON MARKETS REGARDING EMISSIONS TRADING IN THE FIELD OF GREENHOUSE GASES OR DERIVATIVES TRADING BASED ON THEM, NAMELY, FINANCIAL INFORMATION SERVICES; PROVIDING INFORMATION REGARDING CREDIT AND FINANCE OF INVESTMENT COMPANIES TO INVESTORS, NAMELY, FINANCIAL INFORMATION SERVICES; TRADING IN SECURITIES IN THE NATURE OF AGENCIES OR BROKERAGE FOR TRADING OF SECURITIES OR MARKET TRADING OF DERIVATIVES; TRADING IN SECURITIES IN THE NATURE OF AGENCIES OR BROKERAGE FOR TRADING OF COMMODITY DERIVATIVES OR COMMODITY INDEX DERIVATIVES; TRADING IN SECURITIES IN THE NATURE OF AGENCIES OR BROKERAGE FOR TRADING OF EMISSIONS TRADING OR DERIVATIVES TRADING BASED ON THEM; TRADING IN SECURITIES IN THE NATURE OF AGENCIES OR BROKERAGE FOR TRADING OF EMISSIONS TRADING IN THE FIELD OF GREENHOUSE GASES OR DERIVATIVES TRADING BASED ON THEM. TRADING IN SECURITIES IN THE NATURE OF ESTABLISHING FINANCIAL INSTRUMENTS MARKETS WHERE TRADING OF SECURITIES OR MARKET TRADING OF DERIVATIVES ARE CONDUCTED, IN CLASS 36 (U.S. CLS. 100, 101 AND 102).

FOR: COMPUTER SOFTWARE DESIGN FOR TRADING OF FINANCIAL INSTRUMENTS, COMPUTER PROGRAMMING FOR TRADING OF FINANCIAL INSTRUMENTS, OR MAINTENANCE OF COMPUTER SOFTWARE FOR TRADING OF FINANCIAL INSTRUMENTS, COMMODITY FEATURES, COMMODITY DERIVATIVES AND COMMODITY INDEX DERIVATIVES; PROVIDING COMPUTER PROGRAMS FOR TRADING OF FINANCIAL INSTRUMENTS, NAMELY, PROVIDING ON-LINE NON-DOWNLOADABLE SOFTWARE FOR THE TRADING OF FINANCIAL INSTRUMENTS, COMMODITY FEATURES, COMMODITY DERIVATIVES AND COMMODITY INDEX DERIVATIVES; RENTAL OF COMPUTER PROGRAMS FOR TRADING OF FINANCIAL INSTRUMENTS, COMMODITY FEATURES, COMMODITY DERIVATIVES AND COMMODITY INDEX DERIVATIVES; RENTAL OF COMPUTERS FOR TRADING OF FINANCIAL INSTRUMENTS, COMMODITY FEATURES, COMMODITY DERIVATIVES AND COMMODITY INDEX DERIVATIVES, IN CLASS 42 (U.S. CLS. 100 AND 101).

THE MARK CONSISTS OF "ARROWHEAD" IN BLACK AND AN ARROW HEAD-SHAPED DESIGN CONSISTING OF TWO ARROW SHAPES POINTING TO THE RIGHT OF THE WORD "ARROWHEAD;" THE LEFT SHAPE IS RED AND THE RIGHT SHAPE IS BLACK.

PRIORITY DATE OF 1-26-2010 IS CLAIMED.

OWNER OF INTERNATIONAL REGISTRATION 1055394 DATED 4-30-2010, EXPIRES 4-30-2020.

THE COLOR(S) BLACK AND RED IS/ARE CLAIMED AS A FEATURE OF THE MARK.

SER. NO. 79-088,893, FILED 4-30-2010.

MICHELE SWAIN, EXAMINING ATTORNEY

United States of America

United States Patent and Trademark Office



Reg. No. 4,173,402

Registered July 17, 2012

Int. Cls.: 35, 39, 41 and 43

SERVICE MARK

PRINCIPAL REGISTER

ITS - SPORT & FUN GESELLSCHAFT M.B.H. (AUSTRIA SOCIÉTÉ À RESPONSABILITÉ LIMITÉE)

MUSEUMSTRASSE 26A
A-6020 INNSBRUCK
AUSTRIA

FOR: SALES PROMOTION SERVICES AND ADVERTISING FOR TOURIST ENTERPRISES, ESPECIALLY ADVERTISING CONCEPTION AND CONCEPTION CONCERNING SALES PROMOTION IN THE FIELDS OF SPORTS AND TRAVEL, BUSINESS MANAGEMENT, CONCERNING SPORTS SCHOOLS AND TOURIST ENTERPRISES, IN CLASS 35 (U.S. CLS. 100, 101 AND 102).

FOR: PASSENGER TRANSPORTATION BY BUS AND TAXI, STORAGE AND TRANSPORT OF SPORTS EQUIPMENT AND TRAVEL LUGGAGE, ESPECIALLY IN SKI STORAGE FACILITIES, TRANSPORT OF PASSENGERS BY SKI-LIFT, TRAVEL AGENCY SERVICES, NAMELY, MAKING RESERVATIONS AND BOOKINGS FOR TRANSPORTATION, ARRANGING OF TOURS, ESCORTING OF TRAVELERS, VEHICLE RENTAL, IN CLASS 39 (U.S. CLS. 100 AND 105).

FOR: EDUCATIONAL SERVICES IN THE NATURE OF SPORTS SCHOOLS AND TOURIST RECREATIONAL INSTALLATIONS, NAMELY, PROVIDING FACILITIES FOR RECREATION ACTIVITIES; SPORTS TRAINING SERVICES, NAMELY, PROVIDING OF TRAINING AND FURTHER TRAINING OF SPORTS TEACHERS AND SUPERVISING PERSONNEL; ENTERTAINMENT, NAMELY, PRODUCTION OF SPORTS AND ANIMATION SHOWS; ENTERTAINMENT, NAMELY, A CONTINUING SPORTS AND ANIMATION SHOW BROADCAST OVER TELEVISION, RADIO, INTERNET; RENTAL OF SPORTS EQUIPMENT, EXCEPT VEHICLES; EDUCATIONAL SERVICES, NAMELY, DEVELOPING TRAINING CURRICULUM FOR OTHERS IN THE FIELD SPORTS AND EXERCISE PROGRAMS FOR CHILDREN AND ADULTS, IN CLASS 41 (U.S. CLS. 100, 101 AND 107).

FOR: TEMPORARY ACCOMMODATION AND PROVIDING FOOD AND DRINK BY HOTELS, BOARDING HOUSES, TOURIST HOMES, ROADHOUSES, AND YOUTH HOSTELS; RESTAURANTS AND CAFES; PROVIDING FOOD AND DRINK, IN CLASS 43 (U.S. CLS. 100 AND 101).

THE MARK CONSISTS OF THE WORDING "KINDER-CLUB" WITH A LIGHT BLUE "K" WITH WHITE CIRCLES, AND "I" WITH A RED BLOCK, YELLOW BLOCK, ANOTHER RED



David J. Kappas

Director of the United States Patent and Trademark Office

Reg. No. 4,173,402 BLOCK, AND AN ORANGE BLOCK, A GREEN SNAKE FOR THE LETTER "N" WITH A RED TONGUE, WHITE AND BLACK EYES, AND BLACK EYELASHES, A RED BALLOON FOR THE LETTER "D", A BLUE LOWER CASE "E" WITH DROPS OF WATER AND A BLUE STAR WITH RAYS, THE R HAS YELLOW SKIS WITH A LIGHT BLUE THAT WITH WHITE ON TOP AND GRAYISH BLUE AT THE BOTTOM, THE HYPHEN IS BLUE WITH BLUE LINES, THE "C" IS A YELLOW BANANA, THE SOCK IS GREEN WITH LIGHT GREEN IN THE HEAL AND TOES AND A LIGHT BLUE PATCH, THE "U" IS A RED AND WHITE CANDY CANE, AND THE "B" IS A WHITE SNOWMAN WITH A GRAY HAT, WHITE AND BLACK EYES, ORANGE NOSE, AND BLACK SMILE.

OWNER OF INTERNATIONAL REGISTRATION 1010243 DATED 3-20-2009, EXPIRES 3-20-2019.

THE COLOR(S) LIGHT BLUE, WHITE, RED, YELLOW, ORANGE, GREEN, BLACK, BLUE, GRAYISH BLUE, GREEN, LIGHT GREEN, AND GRAY IS/ARE CLAIMED AS A FEATURE OF THE MARK.

SER. NO. 79-089,127, FILED 7-14-2010.

RAMONA ORTIGA, EXAMINING ATTORNEY

United States of America

United States Patent and Trademark Office

Créole
Clamy Boccard

Reg. No. 4,173,403

Registered July 17, 2012

Int. Cls.: 18, 25 and 28

TRADEMARK

PRINCIPAL REGISTER

MARIE-JOSÉE CLAMY BOCCARD (SWITZERLAND INDIVIDUAL)
60, RUE DES LATTES
CH-1217 MEYRIN
SWITZERLAND

FOR: LEATHER AND IMITATIONS OF LEATHER AND GOODS MADE OF THESE MATERIALS AND NOT INCLUDED IN OTHER CLASSES, NAMELY, SPORT BAGS, ATHLETIC BAGS, BACKPACKS, BEACHBAGS, SUITBAGS, DUFFEL BAGS, HANDBAGS, SUITCASES; ANIMAL SKINS; TRUNKS AND TRAVELING BAGS; UMBRELLAS, PARASOLS AND WALKING STICKS; WHIPS, HARNESS AND SADDLERY, IN CLASS 18 (U.S. CLS. 1, 2, 3, 22 AND 41).

FOR: CLOTHING, NAMELY, SHIRTS, PANTS, COATS, DRESSES, JACKETS, ATHLETIC UNIFORMS, SPORTS OVER UNIFORMS; FOOTWEAR, HEADGEAR IN THE NATURE OF HATS, CAPS, SCARVES, IN CLASS 25 (U.S. CLS. 22 AND 39).

FOR: GYMNASTIC AND SPORTING ARTICLES INCLUDED IN THIS CLASS, NAMELY, SPORTING GOODS AND EQUIPMENT FOR TENNIS, NAMELY, BALLS AND RACKETS; CHRISTMAS TREE DECORATIONS; PLAYING CARDS, IN CLASS 28 (U.S. CLS. 22, 23, 38 AND 50).

NO CLAIM IS MADE TO THE EXCLUSIVE RIGHT TO USE "CREOLE", APART FROM THE MARK AS SHOWN.

PRIORITY DATE OF 3-26-2010 IS CLAIMED.

OWNER OF INTERNATIONAL REGISTRATION 1056163 DATED 8-30-2010, EXPIRES 8-30-2020.

THE MARK CONSISTS OF THE INTERCONNECTED LETTERS "KB" WHERE THE "K" APPEARS INSIDE THE "B" AND ABOVE THE WORDING "CREOLE CLAMY BOCCARD".

SER. NO. 79-089,159, FILED 8-30-2010.

CHRISTINE COOPER, EXAMINING ATTORNEY



David J. Kyffers

Director of the United States Patent and Trademark Office

United States of America

United States Patent and Trademark Office



EMOTION

BIOLOGICAL SKIN CARE

Reg. No. 4,173,404

Registered July 17, 2012

Int. Cls.: 3, 4, 10 and 44

TRADEMARK

SERVICE MARK

PRINCIPAL REGISTER

NORDBEAUTY S.R.L. (ITALY SOCIÉTÉ À RESPONSABILITÉ LIMITÉE)
VIA BACCHELLI, 6/C,
LOC. MARENGO; I-46045 MARMIROLO (MN)
ITALY

FOR: DETERGENTS FOR COSMETIC USE; FACE, NECK AND BODY LOTIONS; COSMETIC CREAMS; MASSAGE CREAMS FOR PERSONAL COSMETIC TREATMENT; COSMETIC MASKS; COSMETIC SERUMS FOR THE FACE, NECK AND BODY; NON-MEDICATED SKIN CLEANSERS, FACIAL CLEANSERS AND BODY CLEANSERS; HUMECTANTS FOR COSMETIC PURPOSES; COSMETIC SUN-PROTECTING PREPARATIONS FOR THE FACE NECK AND BODY; COSMETIC PREPARATIONS FOR PROTECTING AGAINST WRINKLES FOR THE FACE, NECK AND BODY; MAKE UP PREPARATIONS; SHOWER GEL; SHAMPOOS; COSMETIC BATH PREPARATIONS; SHOWER GEL SHAMPOOS; COSMETIC BATH PREPARATIONS; COSMETIC MASSAGE CREAMS; COSMETIC PREPARATIONS IN THE FORM OF MUDS FOR PERSONAL COSMETIC TREATMENT; NON-MEDICATED BODY MUD; ALGAE FOR COSMETIC USE; MASSAGE WAXES; COSMETIC PREPARATIONS HELD IN PHIALS, IN CLASS 3 (U.S. CLS. 1, 4, 6, 50, 51 AND 52).

FOR: AROMATIC CANDLES, IN CLASS 4 (U.S. CLS. 1, 6 AND 15).

FOR: INSTRUMENTS AND ELECTRIC APPARATUS FOR AESTHETIC TREATMENTS AND WELLBEING, NAMELY, ELECTROPHORESIS APPARATUS; ELECTROMEDICAL APPARATUS FOR MICROMASSAGE BY POSITIVE AND NEGATIVE IONS; WATER BEDS FOR MEDICAL PURPOSES, IN CLASS 10 (U.S. CLS. 26, 39 AND 44).

FOR: AESTHETIC CENTRES, NAMELY, COSMETIC FACE, BODY AND SKIN CARE SERVICES; WELL-BEING CENTRES AND BEAUTY FARMS, NAMELY, BEAUTY SPA AND HEALTH SPA SERVICES FOR HEALTH AND WELLNESS OF THE BODY AND SPIRIT; AESTHETIC AND WELL-BEING TREATMENT CENTRES, NAMELY, PROVIDING MASSAGE, FACIAL AND BODY TREATMENT SERVICES, COSMETIC BODY CARE SERVICES, BODY WRAPS, MUD TREATMENTS, SEAWEED TREATMENTS, HYDROTHERAPY BATHS, AND BODY SCRUBS; GYMNASIA, NAMELY, HEALTH SPA SERVICES FOR HEALTH AND WELLNESS OF THE BODY AND SPIRIT OFFERED AT A HEALTH RESORT; BEAUTY SALONS; FITNESS CENTRES, NAMELY, PROVIDING WEIGHT LOSS PROGRAMS AND COSMETIC BODY CARE SERVICES IN THE NATURE OF NON-SURGICAL BODY CONTOURING, IN CLASS 44 (U.S. CLS. 100 AND 101).



David J. Kyros

Director of the United States Patent and Trademark Office

Reg. No. 4,173,404 NO CLAIM IS MADE TO THE EXCLUSIVE RIGHT TO USE "BIOLOGICAL SKIN CARE" ,
APART FROM THE MARK AS SHOWN.

PRIORITY DATE OF 7-28-2010 IS CLAIMED.

OWNER OF INTERNATIONAL REGISTRATION 1057094 DATED 9-13-2010, EXPIRES 9-13-
2020.

THE MARK CONSISTS OF THE WORD "EMOTION" SUPERIMPOSED ON A LARGE LIGHT-
COLORED LETTER "E" WITH THE WORDING "BIOLOGICAL SKIN CARE" CENTRALLY
LOCATED BELOW THE LETTER "E".

SER. NO. 79-089,542, FILED 9-13-2010.

KATHY DE JONGE, EXAMINING ATTORNEY

United States of America

United States Patent and Trademark Office

SDL

Reg. No. 4,173,405

Registered July 17, 2012

Int. Cls.: 9, 35, 41 and 42

TRADEMARK

SERVICE MARK

PRINCIPAL REGISTER

SDL PLC (UNITED KINGDOM PUBLIC LIMITED COMPANY)
GLOBE HOUSE, CLIVEMONT ROAD
MAIDENHEAD, BERKSHIRE SL6 7DY, UNITED KINGDOM

FOR: COMPUTER FIRMWARE, HARDWARE, PROGRAMS AND SOFTWARE FOR ACCESSING, ANALYZING, ASSEMBLING, AUTHORIZING, CAPTURING, COLLECTING, COMPARING, COMPILING, CONVERTING, CREATING, DECRYPTING, DELIVERING, ENCRYPTING, FILING, FILTERING, GENERATING, INTEGRATING, LINKING, LOGGING, MAINTAINING, MANAGING, PREPARING, PROCESSING, PUBLISHING, RECOVERING, REPRODUCING, RETRIEVING, REVISING, SEARCHING, SECURING, SELECTING, SHARING, STORING, STRUCTURING, SYSTEMATIZING, TRANSCRIBING, TRANSLATING, UPDATING, VERIFYING, AND PROVIDING VERSION CONTROL OF DATA RECORDED IN DIGITAL, ELECTRONIC, OPTICAL AND MAGNETIC FORM; COMPUTER FIRMWARE, HARDWARE, PROGRAMS AND SOFTWARE FOR LANGUAGE LOCALIZATION; COMPUTER FIRMWARE, HARDWARE, PROGRAMS AND SOFTWARE FOR CLASSIFYING DATA INTO A TAXONOMY; ELECTRONIC COMPUTER DATABASES RECORDED ON COMPUTER MEDIA AND IN DOWNLOADABLE FORM CONTAINING SAMPLE DATA FOR USE WITH THE FOREGOING COMPUTER FIRMWARE, HARDWARE, PROGRAMS AND SOFTWARE; AUDIO AND VIDEO RECORDINGS PRERECORDED ON DIGITAL, ELECTRONIC OR MAGNETIC MEDIA AND IN DOWNLOADABLE FORM IN THE NATURE OF TUTORIALS, USER GUIDES, TRAINING GUIDES, AND COURSE MATERIALS RELATING TO THE FOREGOING COMPUTER FIRMWARE, HARDWARE, PROGRAMS AND SOFTWARE; ELECTRONIC INSTRUCTION MANUALS FOR THE FOREGOING COMPUTER FIRMWARE, HARDWARE, PROGRAMS AND SOFTWARE RECORDED ON COMPUTER MEDIA; DOWNLOADABLE ELECTRONIC PUBLICATIONS, NAMELY, INSTRUCTION AND OPERATION MANUALS, TRAINING GUIDES, COURSE MATERIALS, TECHNICAL MANUALS, PRESENTATION MATERIALS, AND WEBINAR MATERIALS RELATING TO THE FOREGOING COMPUTER FIRMWARE, HARDWARE, PROGRAMS AND SOFTWARE, IN CLASS 9 (U.S. CLS. 21, 23, 26, 36 AND 38).

FOR: COLLECTION, COMPILATION, AND SYSTEMATIZATION OF DOCUMENTS, IMAGES, MEDIA, AND INFORMATION INTO COMPUTER DATABASES; COMPUTER DATABASE MANAGEMENT; TRANSCRIPTION OF WRITTEN COMMUNICATIONS AND RECORDINGS; PROVISION OF ADVISORY, CONSULTANCY AND INFORMATION SERVICES RELATED TO THE AFORESAID, IN CLASS 35 (U.S. CLS. 100, 101 AND 102).



David J. Kappas

Director of the United States Patent and Trademark Office

Reg. No. 4,173,405 FOR: LANGUAGE TRANSLATION INCLUDING LANGUAGE TRANSLATION PROVIDED DIGITALLY, ELECTRONICALLY, MAGNETICALLY AND ONLINE; PROVISION OF NON-DOWNLOADABLE ELECTRONIC PUBLICATIONS, NAMELY, INSTRUCTION AND OPERATION MANUALS, TRAINING GUIDES, TRAINING COURSE WORKBOOKS, TECHNICAL MANUALS, PRESENTATION MATERIALS, AND WEBINAR MATERIALS IN THE FIELD OF LANGUAGE TRANSLATION; DESKTOP PUBLISHING FOR OTHERS; AUTHORING AND CREATING DOCUMENTS FOR OTHERS, NAMELY, CUSTOM WRITING SERVICES; AUTHORING AND CREATING MEDIA FOR OTHERS, NAMELY, AUDIO RECORDING AND PRODUCTION, SCRIPT WRITING SERVICES, AND VIDEO PRODUCTION SERVICES; TRAINING IN THE FIELDS OF COMPUTER SOFTWARE, LANGUAGE TRANSLATION, INDUSTRY BEST PRACTICES, BUSINESS COMMUNICATIONS, COLLABORATION AND WORKFLOW; PLANNING, ARRANGING AND CONDUCTING OF SEMINARS IN THE FIELDS OF LANGUAGE TRANSLATION, LANGUAGE LOCALIZATION, INDUSTRY BEST PRACTICES, STRUCTURED CONTENT, MACHINE TRANSLATION, WEB CONTENT MANAGEMENT, DYNAMIC PUBLISHING, SOCIAL MEDIA, AND CLOUD COMPUTING; ALL THE AFORESAID IN RELATION TO ASSEMBLY, AUTHORING, CAPTURE, COLLECTION, COMPARISON, COMPILATION, CONVERSION, CREATION, DECRYPTION, DELIVERY, ENCRYPTION, FILING, FILTERING, GENERATION, GLOBALIZATION, HANDLING, INTEGRATION, LINKING, LOCALIZATION, LOGGING, MAINTENANCE, MANAGEMENT, PREPARATION, PROCESSING, PUBLISHING, RECOVERY, REPRODUCTION, RETRIEVAL, REUSE, REVISION, SEARCHING, SECURITY, SELECTION, SHARING, STORAGE, STRUCTURING, SYSTEMATIZATION, TAXONOMY, TRANSCRIPTION, TRANSLATION, UPDATING, VERIFICATION, VERSION CONTROL OF CONTENT, INFORMATION AND DATA; TRANSLATION OF CONTENT, INFORMATION AND DATA; PROVISION OF ADVISORY, CONSULTANCY AND INFORMATION SERVICES RELATED TO THE AFORESAID, IN CLASS 41 (U.S. CLS. 100, 101 AND 107).

FOR: TRANSLATION OF COMPUTER SOFTWARE; COMPUTER SYSTEM ANALYSIS; COMPUTER CODE CONVERSION FOR OTHERS; COMPUTER SOFTWARE DESIGN, DEVELOPMENT, IMPLEMENTATION, INSTALLATION, AND MAINTENANCE SERVICES; SYSTEM CONFIGURATION OF SETTINGS FOR COMPUTER SOFTWARE, SERVERS, AND NETWORKS; TECHNICAL SUPPORT IN THE NATURE OF TROUBLESHOOTING OF COMPUTER SOFTWARE PROBLEMS; WORKFLOW MODELING, NAMELY, CUSTOMIZING COMPUTER SOFTWARE FOR OTHERS TO IMPLEMENT DESIRED BUSINESS WORKFLOWS; ALL THE AFORESAID IN RELATION TO ASSEMBLY, AUTHORING, CAPTURE, COLLECTION, COMPARISON, COMPILATION, CONVERSION, CREATION, DECRYPTION, DELIVERY, ENCRYPTION, FILING, FILTERING, GENERATION, GLOBALIZATION, HANDLING, INTEGRATION, LINKING, LOCALIZATION, LOGGING, MAINTENANCE, MANAGEMENT, PREPARATION, PROCESSING, PUBLISHING, RECOVERY, REPRODUCTION, RETRIEVAL, REUSE, REVISION, SEARCHING, SECURITY, SELECTION, SHARING, STORAGE, STRUCTURING, SYSTEMATIZATION, TAXONOMY, TRANSCRIPTION, TRANSLATION, UPDATING, VERIFICATION, VERSION CONTROL OF CONTENT, INFORMATION AND DATA; COMPUTER SERVICES, NAMELY, REMOTE AND ON-SITE MANAGEMENT, MONITORING, CONFIGURATION AND TROUBLESHOOTING OF COMPUTER SOFTWARE, SERVERS, AND NETWORKS HOSTED FOR USE BY OTHERS; PROVIDING TEMPORARY USE OF ONLINE NON-DOWNLOADABLE COMPUTER SOFTWARE FOR ACCESSING, ANALYZING, ASSEMBLING, AUTHORING, CAPTURING, COLLECTING, COMPARING, COMPILING, CONVERTING, CREATING, DECRYPTING, DELIVERING, ENCRYPTING, FILING, FILTERING, GENERATING, INTEGRATING, LINKING, LOGGING, MAINTAINING, MANAGING, PREPARING, PROCESSING, PUBLISHING, RECOVERING, REPRODUCING, RETRIEVING, REVISING, SEARCHING, SECURING, SELECTING, SHARING, STORING, STRUCTURING, SYSTEMATIZING, TRANSCRIBING, TRANSLATING, UPDATING, VERIFYING, AND PROVIDING VERSION CONTROL OF CONTENT, INFORMATION AND DATA RECORDED IN DIGITAL, ELECTRONIC, OPTICAL AND MAGNETIC FORM; PROVIDING TEMPORARY USE OF ONLINE NON-DOWNLOADABLE COMPUTER SOFTWARE FOR LANGUAGE LOCALIZATION; PROVIDING TEMPORARY USE OF ONLINE NON-DOWNLOADABLE COMPUTER SOFTWARE FOR CLASSIFYING DATA INTO A TAXONOMY; PROVISION OF ADVISORY, CONSULTANCY AND IN-

Reg. No. 4,173,405 FORMATION SERVICES RELATED TO THE AFORESAID, IN CLASS 42 (U.S. CLS. 100 AND 101).

THE MARK CONSISTS OF STANDARD CHARACTERS WITHOUT CLAIM TO ANY PARTICULAR FONT, STYLE, SIZE, OR COLOR.

OWNER OF INTERNATIONAL REGISTRATION 1058249 DATED 5-17-2010, EXPIRES 5-17-2020.

SER. NO. 79-089,974, FILED 5-17-2010.

TRACY FLETCHER, EXAMINING ATTORNEY

United States of America
United States Patent and Trademark Office

LARRESSINGLE

Reg. No. 4,173,406

Registered July 17, 2012

Int. Cl.: 33

TRADEMARK

PRINCIPAL REGISTER

ETABLISSEMENTS PAPELOREY SOCIÉTÉ PAR ACTIONS SIMPLIFIÉE (FRANCE SOCIÉTÉ
PAR ACTIONS SIMPLIFIÉE)
CHÂTEAU DE LARRESSINGLE
F-32100 LARRESSINGLE, FRANCE

FOR: ARMAGNAC, IN CLASS 33 (U.S. CLS. 47 AND 49).

THE WORDING "LARRESSINGLE" HAS NO MEANING IN A FOREIGN LANGUAGE.

OWNER OF INTERNATIONAL REGISTRATION 0409594 DATED 7-30-1974, EXPIRES 7-30-
2014.

SEC. 2(F).

SER. NO. 79-090,116, FILED 10-8-2010.

CHARISMA HAMPTON, EXAMINING ATTORNEY



David J. Kybas

Director of the United States Patent and Trademark Office

United States of America

United States Patent and Trademark Office

TYCO

Reg. No. 4,173,407

Registered July 17, 2012

**Int. Cls.: 1, 2, 6, 7, 9, 11,
14, 17, 19, 36, 37, 38, 39,
40, 41, 42 and 45**

TYCO INTERNATIONAL SERVICES GMBH (SWITZERLAND SOCIÉTÉ ANONYME)
FREIER PLATZ 10
CH-8200 SCHAFFHAUSEN
SWITZERLAND

FOR: CHEMICALS USED IN INDUSTRY, UNPROCESSED ARTIFICIAL RESINS, UNPROCESSED PLASTICS; FIRE EXTINGUISHING COMPOSITIONS; TEMPERING AND SOLDERING PREPARATIONS; ADHESIVES USED IN INDUSTRY, IN CLASS 1 (U.S. CLS. 1, 5, 6, 10, 26 AND 46).

TRADEMARK

FOR: CORROSION INHIBITORS IN THE NATURE OF CHEMICAL COATINGS; PIPELINE COATINGS FOR RUST PREVENTION, IN CLASS 2 (U.S. CLS. 6, 11 AND 16).

SERVICE MARK

PRINCIPAL REGISTER

FOR: COMMON METALS AND THEIR ALLOYS INCLUDING STAINLESS STEEL; METAL BUILDING MATERIALS, NAMELY, METAL FRAMING, SHEET MEAL, AND FLASHING; TRANSPORTABLE BUILDINGS OF METAL; MATERIALS OF METAL FOR RAILWAY TRACKS; NON-ELECTRIC CABLES AND WIRES OF COMMON METAL; PIPES AND TUBES OF METAL; METAL SAFES; METAL ORES; FLAME ARRESTERS; METAL PIPE JOINTS AND PIPE-JOINT CLAMPS; METAL PIPES AND FLUID CONDUITS AND COUPLINGS AND FITTINGS THEREFOR; NON-MECHANICAL METAL SIGNAGE; METAL FIRE DOORS; METAL FENCE FRAMEWORK AND METAL FENCE FITTINGS; METAL SPRINKLER TUBES AND METAL SPRINKLER TUBE FITTINGS; METAL CABLE TRAY; METAL TUBING; METAL ROLL FORM SHAPES AND ANGLES; BARBED TAPE; STRUCTURAL AND MECHANICAL METAL SUPPORT STRUTS, CHANNELS AND FITTINGS, IN CLASS 6 (U.S. CLS. 2, 12, 13, 14, 23, 25 AND 50).



David J. Kypas

FOR: POWER-OPERATED AND MANUALLY-OPERATED FIRE HOSE REELS; ROTARY, HYDRAULIC AND/OR PNEUMATIC VALVE ACTUATORS FOR OPENING AND CLOSING VALVES AND PARTS AND FITTINGS THEREFOR; VALVE ACTUATOR POSITIONERS; VALVE ACTUATOR CONTROLS; WATER SUPPLY PUMPS FOR MACHINES; PORTABLE CENTRIFUGAL PUMPS AND PUMP ACCESSORIES; FIRE PUMPS; AND PARTS AND FITTINGS FOR ALL THE AFORESAID GOODS; FORCIBLE ENTRY TOOLS FOR FIRE USE COMPRISING HYDRAULIC PUMPS, SPREADERS, WEDGES, LIFTS, AXES, PRY BARS, SLEDGES, BATTERING RAMS, AND BOLT AND CABLE CUTTERS; AIR COMPRESSORS; STEAM TRAPS; AUTOMATICALLY OPERATED ACTUATORS FOR OPENING AND CLOSING VALVES, IN CLASS 7 (U.S. CLS. 13, 19, 21, 23, 31, 34 AND 35).

Reg. No. 4,173,407 FOR: APPARATUS AND INSTRUMENTS FOR CONDUCTING, SWITCHING, TRANSFORMING, ACCUMULATING, REGULATING OR CONTROLLING ELECTRIC CURRENT; APPARATUS FOR RECORDING, TRANSMISSION OR REPRODUCTION OF SOUND OR IMAGES; DATA PROCESSING EQUIPMENT AND COMPUTERS; FIRE-EXTINGUISHING APPARATUS; THERMAL IMAGING CAMERAS; RESCUE APPARATUS AND SELF-CONTAINED BREATHING APPARATUS USED TO PROVIDE RESPIRATORY PROTECTION, NAMELY, BREATHING MASKS, SELF-RESCUE OXYGEN BREATHING UNITS, FILTERS RELATING THERETO, AND AIR PURIFYING RESPIRATORS, NONE OF THE AFOREMENTIONED GOODS BEING MEDICAL DEVICES; COMPUTER HARDWARE AND PARTS, FITTINGS AND ACCESSORIES THEREFOR; COMPUTER SOFTWARE FOR COMPUTER SYSTEM AND APPLICATION DEVELOPMENT, DEPLOYMENT AND MANAGEMENT FOR USE IN RELATION TO FIRE PROTECTION, SECURITY SOLUTIONS, AND FLOW CONTROL; LIGHTING CONTROLS; ELECTRICAL AND ELECTRONIC APPARATUS AND COMPONENTS FOR CONTROLLING AND MONITORING HEATING, AIR-CONDITIONING AND VENTILATION; COMPUTER SOFTWARE FOR ELECTRONIC CONTROL SYSTEMS AND FOR IDENTIFICATION AND LABELING PRODUCTS; SIGNAL TRANSMITTERS, RECEIVERS AND ELECTRIC SWITCHES; ANTENNAS; LASERS FOR WELDING; LASER DIODES AND PUMP LASERS USED IN FIBER OPTIC COMMUNICATIONS; ENVIRONMENTAL MONITORING SYSTEMS COMPRISED OF SENSORS, METERS, AND DETECTORS THAT MEASURE AND ANALYZE WATER QUALITY, WATER SUPPLY, AIR QUALITY, FLUID LEVEL, FLUID AND LIQUID FLOW, AND LIQUID DEPTH; MONITORING AND CONTROL APPARATUS AND INSTRUMENTS, NAMELY, RADIO SIGNAL TRANSMITTERS, RECEIVERS AND ANTENNAS, AND HOME AND OFFICE AUTOMATION SYSTEMS COMPRISING WIRELESS AND WIRED CONTROLLERS, CONTROLLED DEVICES, AND SOFTWARE FOR LIGHTING, HVAC, SECURITY, SAFETY, AND OTHER HOME AND OFFICE MONITORING AND CONTROL APPLICATIONS; FIBER OPTIC CABLE; FIBER OPTIC CONNECTORS; ELECTRICAL AND ELECTRIC CONNECTOR SYSTEMS, NAMELY, CABLE ASSEMBLIES; CABLE ASSEMBLIES, CONSISTING PRIMARILY OF END-TO-END OPTICAL FIBER AND COPPER PREMISES CABLE SYSTEMS; ELECTRIC CABLES; ELECTROMECHANICAL CABLES; ELECTRIC AND ELECTRONIC CONTROL PANELS; ELECTRIC CONNECTIONS; JUNCTION BOXES; CIRCUIT BREAKERS; HOUSE MARK FOR A FULL LINE OF FIRE PROTECTION, ALARM, DETECTION AND EXTINGUISHING SYSTEMS AND THE TELECOMMUNICATIONS AND ELECTRONIC COMPONENTS THEREOF; FIRE ALARMS; FIRE SPRINKLERS AND NOZZLES, FIRE HOSE NOZZLES; ELECTRIC METERS; ELECTRONIC MEASURING, MONITORING, DETECTION, INDICATION, REGULATION AND ANALYZING EQUIPMENT, NAMELY, ENVIRONMENTAL MONITORING SYSTEMS, NAMELY, FLOOD FORECASTING AND WARNING SYSTEMS, HYDRO-METEOROLOGICAL MONITORING SYSTEMS, STORM WATER AND WASTEWATER MONITORING SYSTEMS; WATER QUALITY MONITORING SYSTEMS, WATER INFRASTRUCTURE MANAGEMENT SYSTEMS, OCEAN ENVIRONMENTAL AND GEOLOGICAL MONITORING SYSTEMS, AIR AND GAS EMISSION MONITORING SYSTEMS, IRRIGATION SYSTEMS, DAM AND LAKE MONITORING SYSTEMS; WATER ANALYZERS; WATER QUALITY SENSORS; ENVIRONMENTAL CONDITIONS MONITORING SOFTWARE; SOFTWARE FOR ENVIRONMENTAL DATA COLLECTION, DATA MANAGEMENT, DATA ANALYSIS AND DATA REPORTING, TELEMETRY SYSTEMS TO RECORD AND REPORT ENVIRONMENTAL MONITORING DATA; WATER QUALITY ANALYZING DEVICES; ACCESS CONTROL SYSTEMS AND DEVICES, NAMELY, ACCESS CONTROL PANELS, MONITORS, CIRCUIT BOARDS, SECURITY SYSTEM CONTROLLERS AND INTERNET COMMUNICATION CONTROLLERS, AND PARTS AND ACCESSORIES THEREFOR; ELECTROMAGNETIC LOCKS; ELECTRONIC KEYPADS FOR ACCESS AND SECURITY SYSTEM CONTROL; ELECTRONIC KEY CARDS; ELECTRONIC CARD READERS; READERS FOR RADIO FREQUENCY IDENTIFICATION CREDENTIALS; DATA PROCESSING APPARATUS AND RELATED PERIPHERAL APPARATUS, NAMELY, CCTV, PA, PAGING, WIRELESS COMMUNICATIONS, AND CONGRESS SYSTEMS THAT MANAGE, MONITOR, CONTROL AND PROMOTE TUNNEL SECURITY AND SAFETY BY ASSISTING TRANSPORTATION OPERATORS IN IDENTIFYING TRAFFIC INCIDENTS, INCREASING FLOW CAPACITY AND AVOIDING ACCIDENTS; CLOSED CIRCUIT TELEVISION SYSTEMS COMPRISED OF CAMERAS, SWITCHERS, MONITORS, MICROPHONES, AND RECORDERS, INTERCOMS, AND PUBLIC ADDRESS SYSTEMS

Reg. No. 4,173,407 AND INSTRUMENTS; TRACKING AND MONITORING SYSTEMS COMPRISED PRIMARILY OF SOFTWARE FOR USE IN TRACKING AND MANAGING THE LOCATION OF PERSONNEL AND ARTICLES; POINT OF SALE MONITORING AND SECURITY APPARATUS AND SYSTEMS, NAMELY, COMPUTER-AIDED SURVEILLANCE SYSTEMS COMPRISED OF COMPUTER HARDWARE AND SOFTWARE THAT ANALYZE, COLLATE AND DISPLAY IMAGES AND DATA FROM A VARIETY OF SOURCES; INTRUSION DETECTION APPARATUS AND INSTRUMENTS, NAMELY, INTRUSION ALARMS AND MOTION DETECTORS; ALARM SYSTEM EQUIPMENT, NAMELY, BURGLAR ALARMS AND PARTS AND FITTINGS THEREFORE, NAMELY, GLASS BREAK DETECTORS; SIRENS; SIGNAGE (LUMINOUS OR MECHANICAL); ARTICLES OF SAFETY AND PROTECTIVE CLOTHING FOR WEAR BY FIREFIGHTERS FOR PROTECTION AGAINST ACCIDENT OR INJURY; SAFETY HELMETS; GAS MASKS; FIRE SAFETY EQUIPMENT, NAMELY, FIRE SPRINKLERS; FIRE ALARMS; FIRE EXTINGUISHING AND SUPPRESSION SYSTEMS AND EQUIPMENT FOR FIRE PROTECTION, NAMELY, FIRE SPRINKLERS, AUTOMATIC VALVES, ACCELERATORS, PIPE, PIPE FITTINGS, COUPLINGS AND GASKETS, FLOW SENSORS, FIRE PANELS, ELECTRIC SWITCHES AND ELECTRIC CONTROL PANELS; WIRELESS COMMUNICATION DEVICES FOR VOICE, DATA, OR IMAGE TRANSMISSION; RADIO COMMUNICATION MACHINES AND APPARATUS, NAMELY, RADIOS, RADIO PAGERS, AND WALKIE-TALKIES; TEMPERATURE CONTROL AND SYSTEM MONITORING UNITS FOR HEAT-TRACING SYSTEMS COMPRISED OF HEATING CABLE; THERMOMETERS, THERMOSTATS; COMPUTER HARDWARE AND SOFTWARE, FOR USE WITH MEDICAL PATIENT MONITORING EQUIPMENT, FOR RECEIVING, PROCESSING, TRANSMITTING AND DISPLAYING DATA; ELECTRIC SELF-REGULATING HEATING CABLES FOR THE PURPOSE OF MELTING SNOW; FALL PROTECTION EQUIPMENT FOR FALL RESTRAINT AND FALL ARREST, NAMELY, BARS, ANCHORS, HARNESSSES, LINES, LANYARDS, CARABINERS AND ANCHORAGE CONNECTORS; WIRELESS CONTROLLERS TO MONITOR AND CONTROL THE FUNCTIONING OF OTHER ELECTRONIC DEVICES; WIRELESS INTRUSION SECURITY CONTROL MONITORING AND ALARM SYSTEMS AND PARTS THEREFORE, NAMELY, CONTROL PANELS AND KEYPADS ; PRESSURE REGULATORS AND PARTS AND ACCESSORIES THEREFOR FOR REGULATING THE PRESSURE OF LIQUID, SEMI-LIQUID, AND GASEOUS SUBSTANCES IN INDUSTRIAL PROCESSES; PIPES AND ELECTRICITY CONDUITS AND COUPLINGS AND PARTS AND FITTINGS THEREFOR, IN CLASS 9 (U.S. CLS. 21, 23, 26, 36 AND 38).

FOR: LIGHTING APPARATUS FOR USE IN FIRE PROTECTION AND SECURITY LIGHTING; ENVIRONMENTAL CONTROL APPARATUS AND MACHINES, NAMELY, WATER FILTRATION AND PURIFICATION UNITS FOR DOMESTIC, COMMERCIAL AND INDUSTRIAL USE; WATER SUPPLY INSTALLATIONS, NAMELY, PIPELINES AND PUMPING SYSTEMS; WATER SOFTENING APPARATUS AND INSTALLATIONS; SELF-REGULATING HEATING SYSTEMS PRIMARILY FOR FREEZE PROTECTION AND TEMPERATURE MAINTENANCE CONSISTING OF ELECTRICAL HEATERS, POLYMERIC HEATING STRIPS, AND ELECTRICAL HEATING CABLE; ELECTRIC HEATING APPARATUS, NAMELY, ELECTRICAL HEATING TAPE, HEATING STRIPS, AND HEATING CABLE; AGRICULTURAL IRRIGATION UNITS AND COMPONENTS THEREOF, NAMELY, VALVES, ABS PIPES SYSTEMS, MEASUREMENT AND CONTROL EQUIPMENT, PUMPS AND TANKS ; HOT WATER PRESSURE WATER TANKS AND PARTS THEREFOR; AIR PURIFICATION AND FILTRATION UNITS FOR DOMESTIC, COMMERCIAL AND INDUSTRIAL USE; HYDRANTS (NOT FOR FIRE); FIRE HYDRANTS, IN CLASS 11 (U.S. CLS. 13, 21, 23, 31 AND 34).

FOR: HOROLOGICAL AND CHRONOMETRIC INSTRUMENTS; MECHANICAL-BASED TIME CLOCKS AND MASTER CLOCKS, IN CLASS 14 (U.S. CLS. 2, 27, 28 AND 50).

FOR: RUBBER, GUTTA-PERCHA, GUM, ASBESTOS, MICA AND GOODS MADE FROM THESE MATERIALS AND NOT INCLUDED IN OTHER CLASSES, NAMELY, TUBING PIPES AND HOSES, EXPANSION JOINTS, GASKETS, SHEATHS, SLEEVINGS FOR PROTECTING PARTS OF MACHINES, WRAPPINGS, SHEET (NON-TEXTILE), SEALING PLUGS, SEALANTS AND MASTICS, AND GEL-TYPE TAPE FOR INDUSTRIAL AND COMMERCIAL USE; PLASTICS IN MOLDED AND EXTRUDED FORM FOR USE IN MANUFACTURE; PACKING

Reg. No. 4,173,407 AND INSULATING MATERIALS; FLEXIBLE PIPES, NOT OF METAL; FIRE FIGHTING HOSES; ADHESIVE TAPE FOR INDUSTRIAL AND COMMERCIAL USE, NAMELY, FOR USE IN INSTALLING CABLES AND WIRING; POLYMERIC TAPE FOR INDUSTRIAL AND COMMERCIAL USE, NAMELY, TO PREVENT CORROSION ON PIPES; NON-METAL PIPE JOINTS; NON-METAL FLUID CONDUITS AND COUPLINGS AND FITTINGS THEREFOR; MULTI-PURPOSE THERMOPLASTIC HEAT SHRINKABLE TUBING , IN CLASS 17 (U.S. CLS. 1, 5, 12, 13, 35 AND 50).

FOR: NON-METALLIC RIGID PIPES FOR BUILDING; NON-METALLIC FIRE DOORS; NON-METALLIC CABLE TRAYS; NON-METALLIC CONDUITS FOR BUILDINGS, DRAINAGE AND IRRIGATION, IN CLASS 19 (U.S. CLS. 1, 12, 33 AND 50).

FOR: FINANCIAL SERVICES, NAMELY, ARRANGING OF LOANS AND FINANCIAL LOAN CONSULTATION, IN CLASS 36 (U.S. CLS. 100, 101 AND 102).

FOR: CONSTRUCTION, REPAIR, INSTALLATION AND MAINTENANCE AND INSPECTION RELATING TO FIRE PROTECTION SYSTEMS, ELECTRICAL COMMUNICATIONS SYSTEMS, WATER AND WASTE WATER SYSTEMS, ALARM, SECURITY AND ACCESS CONTROL SYSTEMS, HEATING SYSTEMS, VENTILATING AND AIR CONDITIONING SYSTEMS, PIPELINES, VALVES, VALVE FITTINGS AND ACTUATORS, DUST AND PARTICLE COLLECTION CLEANING EQUIPMENT, ELECTRONIC MONITORING EQUIPMENT AND APPARATUS, TRAFFIC AND TRANSPORT MANAGEMENT SYSTEMS, HEATING, TEMPERATURE SENSING, SNOW MELTING AND DE-ICING SYSTEMS; INSPECTION SERVICES IN THE COURSE OF CONSTRUCTION, REPAIR, INSTALLATION, AND MAINTENANCE SERVICES RELATING TO FIRE PROTECTION SYSTEMS, ELECTRICAL COMMUNICATIONS SYSTEMS, WATER AND WASTE WATER SYSTEMS, ALARM, SECURITY AND ACCESS CONTROL SYSTEMS, HEATING SYSTEMS, VENTILATING AND AIR CONDITIONING SYSTEMS, PIPELINES, VALVES, VALVE FITTINGS AND ACTUATORS, DUST AND PARTICLE COLLECTION CLEANING EQUIPMENT; INSTALLATION AND MAINTENANCE SERVICES RELATING TO ELECTRONIC MONITORING EQUIPMENT AND APPARATUS, TRAFFIC AND TRANSPORT MANAGEMENT SYSTEMS, HEATING SYSTEMS, TEMPERATURE SENSING SYSTEMS, SNOW MELTING AND DE-ICING SYSTEMS; LIVE TAPPING OF PRESSURE AND NON-PRESSURE PIPELINES FOR INDUSTRIAL AND COMMERCIAL PURPOSES; LEASING OF PLANT AND MACHINERY RELATED TO CONSTRUCTION SITES; INSTALLATION, MAINTENANCE AND REPAIR SERVICES RELATING TO FIRE PROTECTION SYSTEMS, FIRE EXTINGUISHING SYSTEMS, SECURITY SYSTEMS AND MONITORING SYSTEMS, AND TO APPARATUS FOR ALL SUCH SYSTEMS, IN CLASS 37 (U.S. CLS. 100, 103 AND 106).

FOR: TELECOMMUNICATIONS SERVICES, NAMELY, TRANSMISSION, RECEPTION AND PROCESSING OF SOUND; PROVIDING TELECOMMUNICATIONS CONNECTIONS TO THE INTERNET OR TO WEBSITES; TELECOMMUNICATIONS GATEWAY SERVICES; PROVIDING ACCESS TO SECURITY AND SURVEILLANCE SYSTEMS VIA TELECOMMUNICATIONS EQUIPMENT; PROVIDING THIRD PARTY USERS WITH REMOTE ACCESS TO SECURITY AND SURVEILLANCE SYSTEMS; ELECTRONIC MAIL AND MESSAGING SERVICES; RENTAL OF APPARATUS AND EQUIPMENT FOR THE FOREGOING, IN CLASS 38 (U.S. CLS. 100, 101 AND 104).

FOR: PACKAGING AND STORAGE OF INDUSTRIAL GOODS AND MACHINERY; WATER DISTRIBUTION AND SUPPLY, IN CLASS 39 (U.S. CLS. 100 AND 105).

FOR: TREATMENT OF MATERIALS, NAMELY, AIR AND WATER TREATMENT SERVICES; PURIFICATION OF AIR, NAMELY, OF EMISSIONS, IN CLASS 40 (U.S. CLS. 100, 103 AND 106).

FOR: EDUCATION SERVICES, NAMELY, CONDUCTING CLASSES, SEMINARS, CONFERENCES, EXHIBITS AND WORKSHOPS IN THE AREAS OF FIRE SAFETY, FIRE PROTECTION, FLOW CONTROL, MECHANICAL PRODUCT USAGE, SECURITY DEVICES AND

Reg. No. 4,173,407 SYSTEMS, SECURITY SOLUTIONS, LABORATORY SAFETY, HUMAN HEALTH, MEDICAL DEVICES, SURGERY, MEDICAL SCIENCE AND MEDICINE; PROVIDING OF TRAINING IN THE FIELDS OF HEALTH AND SAFETY, FIRE PROTECTION, SECURITY, FLOW CONTROL, DIVERSITY, PROJECT MANAGEMENT, INSTALLATION OF MEDIUM VOLTAGE POWER CABLE ACCESSORIES PRODUCTS, MINIMALLY INVASIVE SURGICAL PROCEDURES, VALVES AND CONTROLS FOR SERVICE TECHNICIANS, AND THE SIZING, SELECTION, AND PERFORMANCE OF STEAM TRAPS USED IN STEAM SYSTEMS IN INDUSTRIES SUCH AS CHEMICAL PROCESSING, FOODS, PAPER AND PETROLEUM REFINING, AND STEAM POWER GENERATION; SPORTING AND CULTURAL ACTIVITIES, NAMELY, EXHIBITIONS ON AND EVENTS RELATING TO FIRE PROTECTION, SECURITY SOLUTIONS AND FLOW CONTROL AND RELATED MUSEUM SERVICES; SUPPLYING BACKGROUND MUSIC TO INDUSTRIAL, COMMERCIAL, MERCANTILE, AND OTHER PUBLIC AND PRIVATE ESTABLISHMENTS, IN CLASS 41 (U.S. CLS. 100, 101 AND 107).

FOR: SCIENTIFIC AND TECHNOLOGICAL SERVICES, NAMELY, RESEARCH, DEVELOPMENT AND DESIGN IN THE FIELDS OF WATER, WASTEWATER, ENVIRONMENT, TRANSPORTATION, TELECOMMUNICATIONS INFRASTRUCTURE, FIRE PROTECTION AND EXTINGUISHING SYSTEMS, POWER ELECTRONICS, SECURITY AND MONITORING SYSTEMS, AND FLOW CONTROL SYSTEMS; DESIGN AND DEVELOPMENT OF COMPUTER HARDWARE AND SOFTWARE; ENGINEERING CONSULTING SERVICES; DESIGN SERVICES RELATING TO FIRE PROTECTION AND EXTINGUISHING SYSTEMS AND TO SECURITY AND MONITORING SYSTEMS AND TO APPARATUS FOR SUCH SYSTEMS AND TO COMPUTER SOFTWARE FOR SUCH SYSTEMS AND APPARATUS; COMPUTER SOFTWARE MAINTENANCE SERVICES RELATING TO FIRE PROTECTION AND EXTINGUISHING SYSTEMS AND TO SECURITY AND MONITORING SYSTEMS AND TO APPARATUS FOR SUCH SYSTEMS; DESIGN SERVICES RELATING TO TRAFFIC MANAGEMENT AND TRANSPORTATION SYSTEMS AND TO TELECOMMUNICATIONS SYSTEMS RELATING THERETO; DESIGN AND ENGINEERING OF SYSTEMS FOR HEATING AND COOLING, SENSING SYSTEMS, SEALING AND CORROSION PROTECTION SYSTEMS; TECHNICAL PROJECT STUDIES IN THE FIELDS OF WATER, WASTEWATER, ENVIRONMENT, TRANSPORTATION, TELECOMMUNICATIONS, INFRASTRUCTURE, FIRE PROTECTION AND EXTINGUISHING SYSTEMS, POWER ELECTRONICS, AND SECURITY AND MONITORING SYSTEMS; SYSTEM AND PROCESS DESIGN SERVICES RELATING TO WATER SUPPLY, DRINKING WATER TREATMENT, RAINWATER FACILITIES, WATER SYSTEMS AND HYDRAULIC EQUIPMENT; ENVIRONMENTAL CONSULTING SERVICES IN THE FIELD OF RESEARCH, FEASIBILITY STUDIES, FACILITIES PLANNING, FINAL DESIGN AND CONSTRUCTION SERVICES; ENVIRONMENTAL CONSULTING IN THE AREA OF MONITORING EMISSION QUALITY, IN CLASS 42 (U.S. CLS. 100 AND 101).

FOR: SECURITY SERVICES, NAMELY, PROVIDING ALARM AND SECURITY SYSTEMS FOR THE PROTECTION OF PROPERTY AND INDIVIDUALS; ALARM RESPONSE AND VERIFICATION SERVICES; MONITORING AND MANAGEMENT OF ALARM AND SECURITY SYSTEMS, OF WATER FLOW AND OF HOME AUTOMATION SYSTEMS; MONITORING OF CENTRALIZED BURGLAR AND FIRE ALARM SYSTEMS; CONTROL OF BUILDING ENVIRONMENTAL ACCESS AND SECURITY SYSTEMS, NAMELY, BUILDING ACCESS SYSTEMS, BUILDING ENERGY MANAGEMENT SYSTEMS, AND SECURITY SYSTEMS RELATING TO THE HEATING, VENTILATION, AIR CONDITIONING AND LIGHTING OF BUILDINGS; SECURITY SERVICES IN THE FIELD OF MONITORING AND OF TELEPHONE CALLS FROM SUBSCRIBERS AND NOTIFYING EMERGENCY FACILITIES; THEFT RECOVERY SERVICES, NAMELY, TRACKING, LOCATING AND MONITORING STOLEN PROPERTY VIA A COMPUTER NETWORK; PROVIDING SECURITY CONSULTING AND SECURITY CONSULTING VIA TELEPHONE; CONCIERGE SERVICES FOR OTHERS COMPRISING MAKING REQUESTED PERSONAL ARRANGEMENTS AND RESERVATIONS AND PROVIDING CUSTOMER-SPECIFIC INFORMATION TO MEET INDIVIDUAL NEEDS WITH RESPECT TO ALL THE AFORESAID SERVICES; LEASING OF FIRE FIGHTING EQUIPMENT; MONITORING OF FIRE PROTECTION AND EXTINGUISHING SYSTEMS, SECURITY AND MONITORING SYSTEMS, AND THE COMPONENTS AND SOFTWARE RELATED TO SUCH SYSTEMS, IN CLASS 45 (U.S. CLS. 100 AND 101).

Reg. No. 4,173,407 THE MARK CONSISTS OF STANDARD CHARACTERS WITHOUT CLAIM TO ANY PARTICULAR FONT, STYLE, SIZE, OR COLOR.

PRIORITY DATE OF 6-25-2010 IS CLAIMED.

OWNER OF INTERNATIONAL REGISTRATION 1058764 DATED 9-28-2010, EXPIRES 9-28-2020.

OWNER OF U.S. REG. NOS. 2,931,045, 2,987,658 AND OTHERS.

SER. NO. 79-090,150, FILED 9-28-2010.

DOMINICK J. SALEMI, EXAMINING ATTORNEY

United States of America

United States Patent and Trademark Office

Waka Waka

Reg. No. 4,173,408

Registered July 17, 2012

Int. Cl.: 33

REH KENDERMANN GMBH WEINKELLEREI (FED REP GERMANY GMBH)
AM OCKENHEIMER GRABEN 35
55411 BINGEN
FED REP GERMANY

FOR: WINES, IN CLASS 33 (U.S. CLS. 47 AND 49).

TRADEMARK

THE MARK CONSISTS OF STANDARD CHARACTERS WITHOUT CLAIM TO ANY PARTICULAR FONT, STYLE, SIZE, OR COLOR.

PRINCIPAL REGISTER

PRIORITY DATE OF 6-29-2010 IS CLAIMED.

OWNER OF INTERNATIONAL REGISTRATION 1059066 DATED 10-27-2010, EXPIRES 10-27-2020.

THE ENGLISH TRANSLATION OF "WAKA WAKA" IN THE MARK IS "DO IT".

SER. NO. 79-090,243, FILED 10-27-2010.

JASON BLAIR, EXAMINING ATTORNEY



David J. Kybas

Director of the United States Patent and Trademark Office

United States of America

United States Patent and Trademark Office



Reg. No. 4,173,409

Registered July 17, 2012

Int. Cl.: 25

WINDSOR SMITH PTY LTD (AUSTRALIA AN AUSTRALIAN PROPRIETARY COMPANY,
LIMITED BY SHARES)
189-193 HIGH STREET
PRESTON VIC 3072
AUSTRALIA

TRADEMARK

FOR: FOOTWEAR; HEADGEAR, NAMELY, HATS, CAPS AND VISORS, IN CLASS 25 (U.S.
CLS. 22 AND 39).

PRINCIPAL REGISTER

THE MARK CONSISTS OF THE LETTERS "WS.". THE LETTER "W" FEATURES A SILHOU-
ETTE OF A DOG AND THE LETTER "S" FEATURES A SNAKE WITH A DOT NEAR THE
TAIL.

PRIORITY DATE OF 10-22-2010 IS CLAIMED.

OWNER OF INTERNATIONAL REGISTRATION 1059105 DATED 11-10-2010, EXPIRES 11-
10-2020.

SER. NO. 79-090,251, FILED 11-10-2010.

LOURDES AYALA, EXAMINING ATTORNEY



David J. Kybas

Director of the United States Patent and Trademark Office

United States of America

United States Patent and Trademark Office

GESSMANN

Reg. No. 4,173,410

Registered July 17, 2012

Int. Cl.: 9

TRADEMARK

PRINCIPAL REGISTER

W. GESSMAN GMBH (FED REP GERMANY GMBH)
EPPINGERSTRASSE 221
74211 LEINGARTEN
FED REP GERMANY

FOR: ELECTRIC CONTACTORS, IN CLASS 9 (U.S. CLS. 21, 23, 26, 36 AND 38).

THE WORDING "GESSMANN" HAS NO MEANING IN A FOREIGN LANGUAGE.

OWNER OF INTERNATIONAL REGISTRATION 0850255 DATED 5-25-2005, EXPIRES 5-25-2015.

SEC. 2(F).

SER. NO. 79-090,441, FILED 11-19-2010.

KATHERINE E. HALMEN, EXAMINING ATTORNEY



David J. Kyffers

Director of the United States Patent and Trademark Office

United States of America

United States Patent and Trademark Office

INTERBIO

Reg. No. 4,173,411

Registered July 17, 2012

Int. Cls.: 5, 9 and 10

TRADEMARK

PRINCIPAL REGISTER

INTERSCIENCE SÀRL (FRANCE SOCIÉTÉ À RESPONSABILITÉ LIMITÉE)
30 CHEMIN DU BOIS DES ARPENTS
F-78860 SAINT NOM LA BRETÈCHE, FRANCE

FOR: MICROBIOLOGICAL, PHARMACEUTICAL, VETERINARY AND SANITARY GOOD AND BAGS FOR MICROBIOLOGICAL ANALYSIS, TESTING, SAMPLING AND DIAGNOSIS KITS, NAMELY, MICROBIOCIDES FOR INDUSTRIAL AND INSTITUTIONAL MANUFACTURING PROCESSES AND WASTEWATER APPLICATIONS, VETERINARY VACCINES, SANITARY STERILIZING PREPARATIONS, BUFFERS, AND REAGENTS FOR USE IN DISEASE TESTING AND BAGS SPECIALLY ADAPTED FOR TESTING AND ANALYSIS THEREFORE; FOOD FOR BABIES, ORGANICALLY FARMED OR DERIVED FROM ORGANICALLY FARMED PRODUCTS; DIETETIC SUBSTANCES, NAMELY, BEVERAGE, FOODS, SUGAR SUBSTITUTES, FOOD SUBSTITUTES ADAPTED FOR MEDICAL USE; MEDICAL PLASTERS; MATERIALS FOR DRESSINGS, NAMELY, MEDICAL DRESSING; ALL PURPOSE DISINFECTANTS; ALL PURPOSE DISINFECTANTS FOR INHIBITING MICROBIAL GROWTH; ALL PURPOSE DISINFECTING AND DEODORIZING PREPARATIONS; CONTACT LENS DISINFECTANTS; DISINFECTANT BATHROOM CLEANERS; DISINFECTANT TOILET BOWL CLEANERS; DISINFECTANTS FOR CHEMICAL TOILETS; DISINFECTANTS FOR CONTACT LENSES; DISINFECTANTS FOR HYGIENE PURPOSES; DISINFECTANTS FOR HYGIENIC PURPOSES; DISINFECTANTS FOR MEDICAL INSTRUMENTS; DISINFECTANTS FOR SANITARY PURPOSES; DISINFECTANTS FOR SWIMMING POOLS; DISINFECTING HAND WASH; DISPOSABLE WIPES IMPREGNATED WITH DISINFECTING CHEMICALS OR COMPOUNDS THEREFORE FOR USE IN HOMES, COMMERCIAL BUILDINGS, SCHOOLS, HOTELS, HOSPITALS, CARE FACILITIES, EDUCATIONAL INSTITUTIONS; DISPOSABLE WIPES IMPREGNATED WITH DISINFECTING CHEMICALS OR COMPOUNDS THEREFORE FOR USE ON TRANSPORTATION, PUBLIC FACILITIES, INDUSTRIAL FACILITIES, FARMS, LABORATORIES; KITS COMPRISING SANITIZER GEL, DISINFECTING WIPES, SANITARY MASKS, PLASTIC GLOVES AND HAND CREAM USED FOR GERM PREVENTION; SOIL DISINFECTANTS FOR THE CONTROL OF NEMATODES, SOIL INSECTS AND SOIL FUNGI; PESTICIDES, FUNGICIDES, HERBICIDES, IN CLASS 5 (U.S. CLS. 6, 18, 44, 46, 51 AND 52).



David J. Kypos

Director of the United States Patent and Trademark Office

FOR: SCIENTIFIC, NAUTICAL, SURVEYING, ELECTRIC, PHOTOGRAPHIC, CINEMATOGRAPHIC, OPTICAL, WEIGHING, MEASURING, SIGNALING, CHECKING, EMERGENCY AND TEACHING APPARATUS AND INSTRUMENTS, NAMELY, AUTOMATED LABORATORY EQUIPMENT MAINLY FOR CUTTING SPECIMENS, AND INSTRUMENTS, NAMELY, ELECTRICAL GRINDING MACHINES AND MIXING MACHINES FOR USE AS LABORAT-

Reg. No. 4,173,411 ORY EQUIPMENT, CAMERAS, FLAT PANEL DISPLAY SCREENS; LABORATORY APPARATUS, NAMELY, MICROBIOLOGICAL LAB SAMPLE BLENDER, SCALES, AUTOMATED DILUTORS FOR SOLID SAMPLES, AUTOMATED LABORATORY EQUIPMENT FOR PREPARING CULTURE MEDIA, NAMELY, BACTERIAL COLONY PICKING AND SEEDING MACHINES FOR INOCULATING A SUBSTRATE, MICROBIOLOGICAL LABORATORY SAMPLE BLENDERS, AUTOMATED FILLER FOR PIPETTES AND AUTOMATIC DEVICES FOR PREPARING SAMPLE OR PETRI DISHES, NAMELY, MULTIPURPOSE, MICROPROCESSOR CONTROLLED, AUTOMATIC LIQUID DISPENSER, AUTOMATIC MONO/MULTILAYER UNIT FOR MICROBIOLOGY SAMPLING FOR USE IN LAB SAMPLE GRINDING MACHINE, AUTOMATED SAMPLE PREPARATION UNIT, AUTOMATED MICROPLATE WASHERS, AUTOMATIC MEDIA PREPARATION AUTOMATED MEDIA FILLER, PROGRAMMABLE PERISTALTIC PUMP; APPARATUS FOR RECORDING, TRANSMITTING AND REPRODUCING SOUND OR IMAGES, NAMELY, MAGNETICALLY ENCODED MICRO TAGS OF PLASTIC, METAL AND SILICATE FOR USE IN TRACING SAMPLES; AUTOMATIC VENDING MACHINES AND MECHANISMS FOR COIN-OPERATED APPARATUS; CASH REGISTERS; CALCULATING MACHINES AND DATA PROCESSING EQUIPMENT, NAMELY, TEMPERATURE MONITORS, MICROBIAL COLONY COUNTERS; FIRE EXTINGUISHERS, IN CLASS 9 (U.S. CLS. 21, 23, 26, 36 AND 38).

FOR: SURGICAL, MEDICAL, DENTAL AND VETERINARY APPARATUS FOR USE IN GENERAL SURGERY; ARTIFICIAL LIMBS, EYE AND TEETH; ORTHOPEDIC ARTICLES, NAMELY, POST SURGERY ORTHOPEDIC SUPPORTS; SUTURE MATERIALS; MEDICAL BAGS SOLD AS A UNIT SPECIALLY DESIGNED TO HOLD MEDICAL OR SURGICAL SAMPLINGS FOR BIOPSY, ORGAN RETRIEVALS OR TRANSPLANTATIONS, DNA SAMPLING FOR USE IN MICROBIOLOGY LABORATORY SAMPLE GRINDING MACHINE, IN CLASS 10 (U.S. CLS. 26, 39 AND 44).

THE MARK CONSISTS OF STANDARD CHARACTERS WITHOUT CLAIM TO ANY PARTICULAR FONT, STYLE, SIZE, OR COLOR.

OWNER OF INTERNATIONAL REGISTRATION 1059726 DATED 10-28-2010, EXPIRES 10-28-2020.

THE WORDING "INTERBIO" HAS NO MEANING IN A FOREIGN LANGUAGE.

SER. NO. 79-090,464, FILED 10-28-2010.

TRACY CROSS, EXAMINING ATTORNEY

United States of America

United States Patent and Trademark Office

CARROZZERIA GIUGIARO

Reg. No. 4,173,412

Registered July 17, 2012

Int. Cls.: 12 and 28

TRADEMARK

PRINCIPAL REGISTER

ITALDESIGN-GIUGIARO S.P.A. (ITALY JOINT STOCK COMPANY)
VIA SAN QUINTINO, 28
I-10121 TORINO
ITALY

FOR: LAND VEHICLES, APPARATUS FOR LOCOMOTION BY LAND, WATER, AND AIR, NAMELY, AUTOMOBILES, AIRPLANES, BOATS, BICYCLES, MOTORCYCLES, ROLLING STOCK FOR RAILWAYS, AIRCRAFT, HELICOPTERS, PASSENGER TRAIN CARS FOR UNDERGROUND AND ABOVE-GROUND USE, IN CLASS 12 (U.S. CLS. 19, 21, 23, 31, 35 AND 44).

FOR: GAMES AND PLAYTHINGS, NAMELY, TOY AUTOMOBILES, TOY AIRPLANES, TOY BOATS, TOY BICYCLES, TOY MOTORCYCLES, TOY TRAIN CARS, TOY HELICOPTERS, TOY PASSENGER TRAINS AND SUBWAY CARS, AND PLAY SETS FOR USING TOY VEHICLES ON A ROADWAY, TRAIN TRACK, OR PRINTED SURFACE SIMULATING A ROADWAY, TRAIN PATH, OR AIRPORT COMPRISING TOY AUTOMOBILES, TOY BICYCLES, TOY MOTORCYCLES AND ROAD PLAY MATS, TOY TRAINS, TOY TRAIN TRACKS AND PLAY MATS, TOY AIRPLANES, TOY HELICOPTERS AND AIRPORT PLAY MATS, IN CLASS 28 (U.S. CLS. 22, 23, 38 AND 50).

THE MARK CONSISTS OF STANDARD CHARACTERS WITHOUT CLAIM TO ANY PARTICULAR FONT, STYLE, SIZE, OR COLOR.

PRIORITY DATE OF 11-2-2010 IS CLAIMED.

OWNER OF INTERNATIONAL REGISTRATION 1060938 DATED 11-10-2010, EXPIRES 11-10-2020.

THE NAME AND/OR SIGNATURE SHOWN IN THE MARK IDENTIFIES "GIORGETTO GIUGIARO", WHOSE CONSENT TO REGISTER IS MADE OF RECORD.

THE WORDING "GIUGIARO" HAS NO MEANING IN A FOREIGN LANGUAGE. THE ENGLISH TRANSLATION OF THE WORD "CARROZZERIA" IN THE MARK IS "BODY WORK".

SER. NO. 79-090,929, FILED 11-10-2010.



David J. Kyffers

Director of the United States Patent and Trademark Office

Reg. No. 4,173,412 ANDREA HACK, EXAMINING ATTORNEY

United States of America

United States Patent and Trademark Office

LINEA GIUGIARO

Reg. No. 4,173,413

Registered July 17, 2012

Int. Cls.: 12 and 28

TRADEMARK

PRINCIPAL REGISTER

ITALDESIGN-GIUGIARO S.P.A. (ITALY JOINT STOCK COMPANY)
VIA SAN QUINTINO, 28
I-10121 TORINO
ITALY

FOR: LAND VEHICLES, APPARATUS FOR LOCOMOTION BY LAND, WATER, AND AIR, NAMELY, AUTOMOBILES, AIRPLANES, BOATS, BICYCLES, MOTORCYCLES, ROLLING STOCK FOR RAILWAYS, AIRCRAFT, HELICOPTERS, PASSENGER TRAIN CARS FOR UNDERGROUND AND ABOVE-GROUND USE, IN CLASS 12 (U.S. CLS. 19, 21, 23, 31, 35 AND 44).

FOR: GAMES AND PLAYTHINGS, NAMELY, TOY AUTOMOBILES, TOY AIRPLANES, TOY BOATS, TOY BICYCLES, TOY MOTORCYCLES, TOY TRAIN CARS, TOY HELICOPTERS, TOY PASSENGER TRAINS AND SUBWAY CARS, AND PLAY SETS FOR USING TOY VEHICLES ON A ROADWAY, TRAIN TRACK, OR PRINTED SURFACE SIMULATING A ROADWAY, TRAIN PATH, OR AIRPORT COMPRISING TOY AUTOMOBILES, TOY BICYCLES, TOY MOTORCYCLES AND ROAD PLAY MATS, TOY TRAINS, TOY TRAIN TRACKS AND PLAY MATS, TOY AIRPLANES, TOY HELICOPTERS AND AIRPORT PLAY MATS, IN CLASS 28 (U.S. CLS. 22, 23, 38 AND 50).

THE MARK CONSISTS OF STANDARD CHARACTERS WITHOUT CLAIM TO ANY PARTICULAR FONT, STYLE, SIZE, OR COLOR.

PRIORITY DATE OF 11-2-2010 IS CLAIMED.

OWNER OF INTERNATIONAL REGISTRATION 1060939 DATED 11-10-2010, EXPIRES 11-10-2020.

NO CLAIM IS MADE TO THE EXCLUSIVE RIGHT TO USE "LINEA" , APART FROM THE MARK AS SHOWN.

THE NAME AND/OR SIGNATURE SHOWN IN THE MARK IDENTIFIES "GIORGETTO GIUGIARO", WHOSE CONSENT TO REGISTER IS MADE OF RECORD.

THE WORDING "GIUGIARO" HAS NO MEANING IN A FOREIGN LANGUAGE. THE ENGLISH TRANSLATION OF THE WORD "LINEA" IN THE MARK IS "LINE". "LINEA" IS



David J. Kyjars

Director of the United States Patent and Trademark Office

Reg. No. 4,173,413 ALSO A FEMALE FORM OF A NAME WHICH TRANSLATES INTO ENGLISH AS "LYNN"
OR "THE LIKE".

SER. NO. 79-090,930, FILED 11-10-2010.

ANDREA HACK, EXAMINING ATTORNEY

United States of America
United States Patent and Trademark Office

Log-sa

Reg. No. 4,173,414

Registered July 17, 2012

Int. Cls.: 36 and 39

SERVICE MARK

PRINCIPAL REGISTER

ANTONIO SANCHEZ (FED REP GERMANY INDIVIDUAL)
LANGMAAR 12
41238 MÖNCHENGLADBACH
FED REP GERMANY

FOR: CUSTOMS BROKERAGE, IN CLASS 36 (U.S. CLS. 100, 101 AND 102).

FOR: SUPPLY CHAIN LOGISTIC SERVICES IN THE TRANSPORT SECTOR; TRANSPORTATION AND STORAGE OF GOODS; PACKAGING ARTICLES FOR TRANSPORTATION AND STORAGE OF GOODS; SERVICES OF SHIPPING AND TRANSPORTATION ENTERPRISE AS FAR AS INCLUDED IN THIS CLASS, NAMELY, THE TRANSPORTATION OF GOODS OF ALL KINDS USING MOTOR VEHICLES; RENTING WAREHOUSES AND PLACES OF TRANSSHIPMENT, NAMELY, TRUCK TERMINALS, RAIL TERMINALS, MARINE TERMINALS, AIRPORT TERMINALS, WAREHOUSE CENTERS, DISTRIBUTION CENTERS; RENTING CONTAINERS AND PACKAGING MATERIAL, NAMELY, PACKAGING AND PARCELING OF GOODS FOR TRANSPORT PURPOSES, NAMELY, THE PACKING OF GOODS USING SUSTAINABLE OR BIODEGRADABLE PACKAGING AND SHIPPING MATERIALS; SORTING OF GOODS; PROVIDING TRANSPORTATION INFORMATION IN THE NATURE OF SHIPPING, TRANSPORT, SUPPLY CHAIN LOGISTICS INFORMATION EXCEPT ABOUT CUSTOMS BROKERAGE, IN CLASS 39 (U.S. CLS. 100 AND 105).

THE MARK CONSISTS OF STANDARD CHARACTERS WITHOUT CLAIM TO ANY PARTICULAR FONT, STYLE, SIZE, OR COLOR.

PRIORITY DATE OF 5-3-2010 IS CLAIMED.

OWNER OF INTERNATIONAL REGISTRATION 1060980 DATED 11-2-2010, EXPIRES 11-2-2020.

SER. NO. 79-090,955, FILED 11-2-2010.

WILLIAM ROSSMAN, EXAMINING ATTORNEY



David J. Kyfos

Director of the United States Patent and Trademark Office

United States of America

United States Patent and Trademark Office



Reg. No. 4,173,415

Registered July 17, 2012

Int. Cl.: 32

TRADEMARK

PRINCIPAL REGISTER

POWER HORSE ENERGY DRINKS GMBH (AUSTRIA LIMITED LIABILITY COMPANY)
FIEDLERSTRASSE 10
A-4041 LINZ
AUSTRIA

FOR: NON-ALCOHOLIC DRINKS, NAMELY, SPORTS AND ENERGY DRINKS; PREPARATIONS FOR MAKING BEVERAGES, NAMELY, SPORTS AND ENERGY DRINKS, IN CLASS 32 (U.S. CLS. 45, 46 AND 48).

OWNER OF U.S. REG. NOS. 2,073,791 AND 2,428,647.

OWNER OF INTERNATIONAL REGISTRATION 1037284 DATED 3-22-2010, EXPIRES 3-22-2020.

THE COLOR(S) BLACK AND RED IS/ARE CLAIMED AS A FEATURE OF THE MARK.

THE MARK CONSISTS OF A BLACK HORSE IN BETWEEN TWO RED TRIANGLES AND THE WORDING "POWER HORSE" IN BLACK BELOW.

SER. NO. 79-091,115, FILED 9-15-2010.

TAMARA FRAZIER, EXAMINING ATTORNEY



David J. Kyffers

Director of the United States Patent and Trademark Office

United States of America

United States Patent and Trademark Office

DFG

Reg. No. 4,173,416

Registered July 17, 2012

**Int. Cls.: 35, 38, 41 and
42**

DEUTSCHE FORSCHUNGSGEMEINSCHAFT E.V. (FED REP GERMANY EINGETRAGENER
VEREIN (E.V.))

KENNEDYALLEE 40
53175 BONN

FED REP GERMANY

FOR: PUBLICITY CONSULTATION, IN CLASS 35 (U.S. CLS. 100, 101 AND 102).

SERVICE MARK

FOR: TELECOMMUNICATION SERVICES, NAMELY, TRANSMISSION OF WEBCASTS IN
THE FIELDS OF SCIENCES AND HUMANITIES, IN CLASS 38 (U.S. CLS. 100, 101 AND
104).

PRINCIPAL REGISTER

FOR: TRAINING SERVICES, NAMELY, TRAINING YOUNG RESEARCHERS IN THE FIELD
OF RESEARCH IN THE SCIENCES AND HUMANITIES, IN CLASS 41 (U.S. CLS. 100, 101
AND 107).

FOR: SCIENTIFIC AND TECHNOLOGICAL SERVICES, NAMELY, SCIENTIFIC RESEARCH
AND RESEARCH PROJECTS IN THE FIELDS OF SCIENCES AND HUMANITIES, IN CLASS
42 (U.S. CLS. 100 AND 101).

PRIORITY DATE OF 10-14-2009 IS CLAIMED.

OWNER OF INTERNATIONAL REGISTRATION 1061898 DATED 3-31-2010, EXPIRES 3-31-
2020.

SER. NO. 79-091,336, FILED 3-31-2010.

GEORGE LORENZO, EXAMINING ATTORNEY



David J. Kyjars

Director of the United States Patent and Trademark Office

United States of America

United States Patent and Trademark Office

PROPHYCLEAN

Reg. No. 4,173,417

Registered July 17, 2012

Int. Cl.: 10

TRADEMARK

PRINCIPAL REGISTER

EVE ERNST VETTER GMBH (FED REP GERMANY LIMITED LIABILITY COMPANY)
RASTATTER STRASSE 30
75179 PFORZHEIM
FED REP GERMANY

FOR: ROTATING, GRINDING AND POLISHING INSTRUMENTS FOR SURGICAL, MEDICAL, DENTAL PURPOSES; ROTATING, GRINDING AND POLISHING INSTRUMENTS FOR DENTAL PROPHYLAXIS, IN CLASS 10 (U.S. CLS. 26, 39 AND 44).

THE MARK CONSISTS OF STANDARD CHARACTERS WITHOUT CLAIM TO ANY PARTICULAR FONT, STYLE, SIZE, OR COLOR.

PRIORITY DATE OF 2-11-2010 IS CLAIMED.

OWNER OF INTERNATIONAL REGISTRATION 1062269 DATED 8-11-2010, EXPIRES 8-11-2020.

SER. NO. 79-091,478, FILED 8-11-2010.

FRED CARL, EXAMINING ATTORNEY



David J. Kyfos

Director of the United States Patent and Trademark Office

United States of America

United States Patent and Trademark Office

VANCOGENX

Reg. No. 4,173,418

TECRES S.P.A. (ITALY JOINT STOCK COMPANY)
VIA ANDREA DORIA, 6

Registered July 17, 2012

I-37066 SOMMACAMPAGNA (VR), ITALY

Int. Cls.: 5, 10 and 44

FOR: PHARMACEUTICAL PREPARATIONS FOR THE TREATMENT OF FRACTURES AND DEFORMATION OF BONES; SANITARY PREPARATIONS FOR MEDICAL PURPOSES; ALL PURPOSE DISINFECTANTS; PREPARATIONS FOR DESTROYING VERMIN; FUNGICIDES, HERBICIDES, IN CLASS 5 (U.S. CLS. 6, 18, 44, 46, 51 AND 52).

TRADEMARK

SERVICE MARK

FOR: SURGICAL AND MEDICAL APPARATUS AND INSTRUMENTS FOR USE IN ORTHOPEDIC SURGERY FOR PREPARING, MIXING, EXTRUDING AND APPLYING ACRYLIC RESINS; ARTIFICIAL LIMBS; ORTHOPEDIC ARTICLES, NAMELY, SPACERS FOR JOINTS, HIP PROSTHESES, KNEE PROSTHESES, SHOULDER PROSTHESES, ELBOW PROSTHESES FOR ORTHOPEDIC USE, INTRAMEDULLARY NAILS; SUTURE MATERIALS , IN CLASS 10 (U.S. CLS. 26, 39 AND 44).

PRINCIPAL REGISTER

FOR: MEDICAL SERVICES; VETERINARY SERVICES, IN CLASS 44 (U.S. CLS. 100 AND 101).

THE MARK CONSISTS OF STANDARD CHARACTERS WITHOUT CLAIM TO ANY PARTICULAR FONT, STYLE, SIZE, OR COLOR.

OWNER OF INTERNATIONAL REGISTRATION 1062510 DATED 11-16-2010, EXPIRES 11-16-2020.

SER. NO. 79-091,624, FILED 11-16-2010.

RAMONA ORTIGA, EXAMINING ATTORNEY



David J. Kypos

Director of the United States Patent and Trademark Office

United States of America

United States Patent and Trademark Office

THE COVERT

Reg. No. 4,173,419

Registered July 17, 2012

Int. Cl.: 9

TRADEMARK

PRINCIPAL REGISTER

KONINKLIJKE PHILIPS ELECTRONICS N.V. (NETHERLANDS PUBLIC LIMITED COMPANY)
GROENEWOUDSEWEG 1
NL-5621 BA
EINDHOVEN, NETHERLANDS AND

O'NEIL BRAND S.À R.L. (LUXEMBOURG LIMITED LIABILITY COMPANY)
17 RUE BEAUMONT
L-1219 LUXEMBOURG
LUXEMBOURG

FOR: LOUDSPEAKERS, AUDIO SPEAKERS, HEADPHONES, AND IN EAR HEADPHONES, IN CLASS 9 (U.S. CLS. 21, 23, 26, 36 AND 38).

THE MARK CONSISTS OF STANDARD CHARACTERS WITHOUT CLAIM TO ANY PARTICULAR FONT, STYLE, SIZE, OR COLOR.

PRIORITY DATE OF 5-21-2010 IS CLAIMED.

OWNER OF INTERNATIONAL REGISTRATION 1062716 DATED 11-19-2010, EXPIRES 11-19-2020.

SER. NO. 79-091,703, FILED 11-19-2010.

TOBY BULLOFF, EXAMINING ATTORNEY



David J. Kyffers

Director of the United States Patent and Trademark Office

United States of America

United States Patent and Trademark Office

LD AQUARUNNER

Reg. No. 4,173,420

Registered July 17, 2012

Int. Cl.: 28

TRADEMARK

PRINCIPAL REGISTER

DIPL. HTL ING. GEORG HOF (AUSTRIA INDIVIDUAL)
UFERSTRABE 25/3
A-3011 PURKERSDORF
AUSTRIA

FOR: GAMES AND PLAYTHINGS, NAMELY, AMUSEMENT AQUATIC APPARATUS, NAMELY, AQUATIC TREADMILLS; GYMNAS TIC AND SPORTING ARTICLES NOT INCLUDED IN OTHER CLASSES, NAMELY, UNDERWATER TREADMILLS FOR EXERCISING AND CONDITIONING PURPOSE AND NOT FOR MEDICAL PURPOSES, IN CLASS 28 (U.S. CLS. 22, 23, 38 AND 50).

THE MARK CONSISTS OF STANDARD CHARACTERS WITHOUT CLAIM TO ANY PARTICULAR FONT, STYLE, SIZE, OR COLOR.

PRIORITY DATE OF 10-13-2010 IS CLAIMED.

OWNER OF INTERNATIONAL REGISTRATION 1063206 DATED 10-13-2010, EXPIRES 10-13-2020.

SER. NO. 79-091,864, FILED 10-13-2010.

JACLYN KIDWELL WALKER, EXAMINING ATTORNEY



David J. Kyffers

Director of the United States Patent and Trademark Office

United States of America

United States Patent and Trademark Office

VANDALIST

Reg. No. 4,173,421

Registered July 17, 2012

Int. Cl.: 25

TRADEMARK

PRINCIPAL REGISTER

YANG, HEEMIN (REPUBLIC OF KOREA INDIVIDUAL)
103-903, DONGIL APT. SHINJANG-DONG
HANAM-SI.; GYEONGGI-DO, REPUBLIC OF KOREA 465030

FOR: KENDO CLOTHES, NAMELY, TOPS AND BOTTOMS; CYCLISTS' CLOTHING FOR PROFESSIONAL PLAYER, NAMELY, TOPS AND BOTTOMS; WET SUITS FOR WATER-SKIING FOR PROFESSIONAL PLAYER; JUMP SUITS FOR SPORTS; ANORAKS FOR EXCLUSIVE USE FOR SPORTS; SPORTS WEAR FOR EXCLUSIVE USE FOR SPORTS, NAMELY, TOPS AND BOTTOMS; BREECHES FOR WEAR; CLOTHING FOR HORSEBACK RIDING, NAMELY, TOPS AND BOTTOMS; RIDING COATS; CLOTHING FOR ICE HOCKEY FOR PROFESSIONAL PLAYER, NAMELY, TOPS AND BOTTOMS; BASEBALL CLOTHING, NAMELY, TOPS AND BOTTOMS; AEROBICS SUITS FOR PROFESSIONAL PLAYER; JUDO SUITS; TAEKWONDO SUITS; TENNIS SUITS FOR PROFESSIONAL PLAYER; FENCING CLOTHES, NAMELY, TOPS AND BOTTOMS; HANDBALL SUITS FOR PROFESSIONAL PLAYER; BLAZERS; CLOTHING OF LEATHER, NAMELY, TOPS AND BOTTOMS; TROUSERS OF LEATHER; SUITS OF LEATHER; LEATHER PANTS; MEN'S SUITS; DRESS SUITS; DRESSES; LONG JACKETS; STUFF JACKETS; LADIES' PANTS; LADIES' SUITS; SUEDE JACKETS; SKIRT SUITS; CLOTHING OF IMITATIONS OF LEATHER, NAMELY, TOPS AND BOTTOMS; UNIFORMS FOR WORKING; COVERALLS; COATS; DOWN JACKETS; TRENCH COATS; PANTS; MASQUERADE COSTUMES; SCHOOL UNIFORMS; RAIN COATS; LONG COATS; LIVERIES; MANTLES; SHORTS; HALF-LENGTH COATS; BLOUSONS; SARIS; SAFARIS SUITS; SUITS; SMOCKS; SKIRTS; SLACKS; ANORAKS; CHILDREN'S CLOTHING, NAMELY, TOPS AND BOTTOMS; TROUSERS; CEREMONIAL DRESSES; OVERALLS; OVERCOATS; SUITS JACKETS; INFANTS' CLOTHING, NAMELY, TOPS AND BOTTOMS; EVENING DRESSES; JACKETS; WORK CLOTHES, NAMELY, TOPS AND BOTTOMS; JUMPERS; PAPER CLOTHING, NAMELY, TOPS AND BOTTOMS; CHASUBLES; BLUE JEANS; CAPES; COMBINATIONS; TOP COATS; TUXEDOS; TOGAS; TWO PIECE SUITS; TUNICS; PARKAS; PELISSES; FROCKS; COLLARS FOR KOREAN COATS; KOREAN TRADITIONAL TOPCOATS; KOREAN TRADITIONAL JACKETS WORN OVER UPPER GARMENT; KOREAN TRADITIONAL WOMEN'S WAISTCOATS; KOREAN TRADITIONAL COAT OR JACKET; KOREAN TRADITIONAL TROUSERS; KOREAN TRADITIONAL UNDERWEAR; KOREAN TRADITIONAL SKIRTS; BUTTON-FRONT ALOHA SHIRTS; LONG SLEEVED SHIRTS; SINGLET; KNITWEAR CLOTHING, NAMELY, TOPS AND BOTTOMS; DRESSING GOWNS; RUNNING SHIRTS; SHORT-SLEEVED OR LONG-SLEEVED T-SHIRTS; BOXER SHORTS; SHORT-SLEEVED SHIRTS; BLOUSES; BEACH-WEAR; SHIRTS; SLEEVELESS JERSEYS; SHIRTS FOR SUITS; SWEATERS; SWEAT SHIRTS; SWEAT PANTS; SPORT SHIRTS; SPORTS JERSEYS; SLIPS UNDERGARMENTS. OPEN



David J. Kyros

Director of the United States Patent and Trademark Office

Reg. No. 4,173,421 NECK SHIRTS; DRESS SHIRTS; WOMEN'S UNDERWEAR; COLLARS; SLEEPING GARMENTS; JERSEYS; VESTS; SPORTS SHIRTS WITH SHORT SLEEVES; JERKINS; CARDIGANS; COLLARS; CUFFS; TRAINING WEAR, NAMELY, TOPS AND BOTTOMS; TANK TOPS; TEE-SHIRTS; PANTIES; POLO SHIRTS; PULLOVERS; PIQUET SHIRTS; BEACH CLOTHES, NAMELY, TOPS AND BOTTOMS; MEN'S SOCKS; NECKTIES; LEG WARMERS; HEADBANDS; MUFFS; MUFFLERS; BANDANAS NECKERCHIEFS; ANKLE SOCKS; SHOULDER SCARVES; SCARFS; SILK SCARVES; SUSPENDER BELTS FOR MEN; BELTS; BELTS; WAIST BELTS; LEATHER BELTS; KOREAN TRADITIONAL HATS; NIGHTCAPS; KOREAN TRADITIONAL WINTER CAPS COMMONLY KNOWN AS NANBAWI; KOREAN HEADBANDS MADE OF HORSEHAIR COMMONLY KNOWN AS MANGGON; CAPS HEADWEAR; SUN VISORS; BERETS; MITERS HATS; HOODS; TURBANS; AND TOP HATS, ALL THE AFOREMENTIONED GOODS EXCLUDING THE FIELD OF BASKETBALL OR RELATED TO VINTAGE BASKETBALL TEAMS , IN CLASS 25 (U.S. CLS. 22 AND 39).

THE MARK CONSISTS OF STANDARD CHARACTERS WITHOUT CLAIM TO ANY PARTICULAR FONT, STYLE, SIZE, OR COLOR.

PRIORITY DATE OF 7-7-2010 IS CLAIMED.

OWNER OF INTERNATIONAL REGISTRATION 1063474 DATED 7-13-2010, EXPIRES 7-13-2020.

SER. NO. 79-091,986, FILED 7-13-2010.

SEAN CROWLEY, EXAMINING ATTORNEY

United States of America

United States Patent and Trademark Office

SEEKUENCE

Reg. No. 4,173,422

Registered July 17, 2012

Int. Cl.: 9

TRADEMARK

PRINCIPAL REGISTER

POSICOM AS (NORWAY STOCK COMPANY)
POSTBOKS 787
N-3606 KONGSBERG
NORWAY

FOR: DATA PROCESSING EQUIPMENT AND COMPUTERS, NAMELY, COMPUTER HARDWARE AND PERIPHERALS; PRERECORDED MAGNETIC DATA CARRIERS, NAMELY, COMPUTER SOFTWARE USED TO DOCUMENT, MANAGE, AND ANALYZE MEDICAL AND SURGICAL INFORMATION AND DATA RELATED TO HEALTHCARE, SPORTS PERFORMANCE, SECURITY AND SURVEILLANCE, AND DEFENSE, IN CLASS 9 (U.S. CLS. 21, 23, 26, 36 AND 38).

THE MARK CONSISTS OF STANDARD CHARACTERS WITHOUT CLAIM TO ANY PARTICULAR FONT, STYLE, SIZE, OR COLOR.

PRIORITY DATE OF 5-11-2010 IS CLAIMED.

OWNER OF INTERNATIONAL REGISTRATION 1063746 DATED 10-25-2010, EXPIRES 10-25-2020.

SER. NO. 79-092,069, FILED 10-25-2010.

CHRISTINE MARTIN, EXAMINING ATTORNEY



David J. Kyffers

Director of the United States Patent and Trademark Office

United States of America

United States Patent and Trademark Office

SUAVINEX

Reg. No. 4,173,423

Registered July 17, 2012

Int. Cls.: 3, 5, 10 and 21

TRADEMARK

PRINCIPAL REGISTER

LABORATORIOS SUAVINEX, S.A. (SPAIN SOCIEDAD ANÓNIMA)
DEL MARCO, PARCELA R-88

BUZÓN 20096; POL. INDUSTRIAL LAS ATALAYAS; E-03114 ALICANTE
SPAIN

FOR: BLEACHING PREPARATIONS AND OTHER SUBSTANCES FOR LAUNDRY USE, NAMELY, FABRIC SOFTENERS, DETERGENTS; CLEANING, POLISHING, SCOURING AND ABRASIVE PREPARATIONS; SOAPS, NAMELY, LIQUID SOAPS, BAR SOAPS, BATH SOAPS, SOAPS FOR PERSONAL USE; PERFUMERY, ESSENTIAL OILS, COSMETICS, HAIR LOTIONS AND DENTIFRICES; PERSONAL DEODORANTS, IN CLASS 3 (U.S. CLS. 1, 4, 6, 50, 51 AND 52).

FOR: PHARMACEUTICAL AND VETERINARY PREPARATIONS FOR USE IN THE TREATMENT OF CHILDHOOD DISEASES AND SKIN DISORDERS; SANITARY PREPARATIONS FOR MEDICAL USE AND CHEMICAL PREPARATIONS FOR SANITARY USE IN THE NATURE OF PERSONAL HYGIENE PURPOSES OTHER THAN TOILETRIES; DIETETIC SUBSTANCES ADAPTED FOR MEDICAL USE, NAMELY, FOODS AND BEVERAGES; FOOD FOR BABIES; MEDICAL PLASTERS; MATERIAL FOR STOPPING TEETH; DENTAL WAX; DISINFECTANTS, NAMELY, ALL-PURPOSE DISINFECTANTS, DISINFECTANTS FOR MEDICAL USE; PREPARATIONS FOR DESTROYING VERMIN, FUNGICIDES, HERBICIDES, IN CLASS 5 (U.S. CLS. 6, 18, 44, 46, 51 AND 52).

FOR: MEDICAL AND DENTAL INSTRUMENTS AND APPARATUS, NAMELY, BABIES BOTTLES, RUBBER TEATS FOR FEEDING BOTTLES, BREAST PUMPS, SILICONE NIPPLE SHIELDS, TEETHING RINGS, NOSE ASPIRATORS, CONDOMS, PACIFIERS AND THERMOMETERS FOR MEDICAL USE; ARTIFICIAL LIMBS, EYES AND TEETH; ORTHOPEDIC ARTICLES, NAMELY, MEDICAL INSTRUMENTS AND APPARATUS FOR USE IN ORTHOPEDIC SURGERY; SUTURE MATERIALS, IN CLASS 10 (U.S. CLS. 26, 39 AND 44).

FOR: BRUSHES, NAMELY, HAIR BRUSHES, CLEANING BRUSHES FOR HOUSEHOLD USE, BABY BOTTLE BRUSHES; COMBS; SPONGES FOR HOUSEHOLD PURPOSES, NAMELY, NATURAL SPONGES, LOOP SPONGES, BATH SPONGES, ABSORBENT SPONGES, CLEANING SPONGES; FEEDING BOTTLE CLEANING BRUSHES; CUPS, DRINKING GLASSES AND DISHES IN GENERAL AND AS PARTS OF CHILDREN'S DINNERWARE; DISHES AND CONTAINERS FOR KEEPING FOOD WARM, NAMELY, HEAT-INSULATED VESSELS IN THE NATURE OF THERMO BOXES, THERMO BOWLS, THERMO



David J. Kyjars

Director of the United States Patent and Trademark Office

Reg. No. 4,173,423 CONTAINERS, THERMO DISHES, THERMO BOTTLES, VACUUM FLASKS, THERMO FLASKS, IN CLASS 21 (U.S. CLS. 2, 13, 23, 29, 30, 33, 40 AND 50).

THE MARK CONSISTS OF STANDARD CHARACTERS WITHOUT CLAIM TO ANY PARTICULAR FONT, STYLE, SIZE, OR COLOR.

OWNER OF INTERNATIONAL REGISTRATION 0985930 DATED 5-30-2008, EXPIRES 5-30-2018.

OWNER OF U.S. REG. NOS. 2,901,154 AND 3,052,044.

SER. NO. 79-092,171, FILED 11-25-2010.

SUZANNE BLANE, EXAMINING ATTORNEY

United States of America

United States Patent and Trademark Office

airstatus

Reg. No. 4,173,424

Registered July 17, 2012

Int. Cls.: 7 and 9

TRADEMARK

PRINCIPAL REGISTER

BOGE & CO. MASCHINENHANDELSGESELLSCHAFT GMBH & CO. KG (FED REP GERMANY CORPORATION)
OTTO-BOGE-STR. 1-7
BIELEFELD, FED REP GERMANY 33739

FOR: AIR COMPRESSORS; AIR COMPRESSORS FOR VEHICLES; COMPRESSORS AS PARTS OF MACHINES, MOTORS AND ENGINES; COMPRESSORS FOR AIR CONDITIONERS; COMPRESSORS FOR DEHUMIDIFYING MACHINES; COMPRESSORS FOR MACHINES; ELECTRIC COMPRESSORS; COMPRESSORS AS PARTS FOR COMPRESSED AIR TOOLS; AIR COMPRESSORS FOR WATER AERATION SYSTEMS, IN CLASS 7 (U.S. CLS. 13, 19, 21, 23, 31, 34 AND 35).

FOR: MEASURING, SIGNALING, CHECKING, AND SUPERVISING APPARATUS AND INSTRUMENTS FOR MONITORING COMPRESSORS AND COMPRESSOR INSTALLATIONS, NAMELY, TELECOMMUNICATIONS HARDWARE AND SOFTWARE FOR MONITORING AND ALERTING REMOTE SENSOR STATUS VIA THE INTERNET, VIA WIRED TELEPHONE, VIA WIRELESS CELLULAR AND MOBILE TELEPHONE, VIA FACSIMILE, VIA LOCAL AREA NETWORK (LAN) AND WIRELESS LOCAL AREA NETWORK (WLAN), VIA GSM AND VIA WIRELESS NETWORKS, AND ELECTRIC OR ELECTRONIC SENSORS FOR MONITORING OPERATING PARAMETERS OF COMPRESSORS AND COMPRESSOR INSTALLATIONS; EQUIPMENT FOR ACQUIRING, RECORDING, TRANSMITTING, MONITORING AND REPRODUCING SOUND AND IMAGES, NAMELY, TELECOMMUNICATIONS HARDWARE AND SOFTWARE FOR MONITORING AND ALERTING REMOTE SENSOR STATUS VIA THE INTERNET, VIA WIRED TELEPHONE, VIA WIRELESS CELLULAR AND MOBILE TELEPHONE, VIA FACSIMILE, VIA LOCAL AREA NETWORK (LAN) AND WIRELESS LOCAL AREA NETWORK (WLAN), VIA GSM AND VIA WIRELESS NETWORKS, AND ELECTRIC OR ELECTRONIC SENSORS FOR MONITORING OPERATING PARAMETERS OF COMPRESSORS AND COMPRESSOR INSTALLATIONS; EQUIPMENT FOR ACQUIRING, RECORDING, TRANSMITTING, MONITORING AND REPRODUCING DATA DURING THE MONITORING OF COMPRESSORS AND COMPRESSOR INSTALLATIONS, NAMELY, TELECOMMUNICATIONS HARDWARE AND SOFTWARE FOR MONITORING AND ALERTING REMOTE SENSOR STATUS VIA THE INTERNET, VIA WIRED TELEPHONE, VIA WIRELESS CELLULAR AND MOBILE TELEPHONE, VIA FACSIMILE, VIA LOCAL AREA NETWORK (LAN) AND WIRELESS LOCAL AREA NETWORK (WLAN), VIA GSM AND VIA WIRELESS NETWORKS, AND ELECTRIC OR ELECTRONIC SENSORS FOR MONITORING OPERATING PARAMETERS OF COMPRESSORS AND COMPRESSOR INSTALLATIONS; DATA PROCESSING EQUIPMENT AND COMPUTERS; SOFTWARE FOR



David J. Kybas

Director of the United States Patent and Trademark Office

Reg. No. 4,173,424 MONITORING AND ALERTING REMOTE SENSOR STATUS AND ELECTRIC OR ELECTRONIC SENSORS FOR MONITORING OPERATING PARAMETERS OF COMPRESSORS AND COMPRESSOR INSTALLATIONS, IN CLASS 9 (U.S. CLS. 21, 23, 26, 36 AND 38).

THE MARK CONSISTS OF STANDARD CHARACTERS WITHOUT CLAIM TO ANY PARTICULAR FONT, STYLE, SIZE, OR COLOR.

PRIORITY DATE OF 6-24-2010 IS CLAIMED.

OWNER OF INTERNATIONAL REGISTRATION 1065002 DATED 12-20-2010, EXPIRES 12-20-2020.

SER. NO. 79-092,530, FILED 12-20-2010.

DAWN FELDMAN, EXAMINING ATTORNEY

United States of America

United States Patent and Trademark Office



FIBERTEX PERSONAL CARE

Reg. No. 4,173,425

Registered July 17, 2012

Int. Cl.: 24

TRADEMARK

PRINCIPAL REGISTER

FIBERTEX PERSONAL CARE A/S (DENMARK A/S)
SVENDBORGVEJ 2
DK-9220 AALBORG OST
DENMARK

FOR: NON-WOVEN TEXTILE FABRICS FOR HYGIENE, INDUSTRIAL AND TECHNICAL PURPOSES, NAMELY, FOR USE IN THE PRODUCTION OF DIAPERS, FEMININE HYGIENE AND INCONTINENCE CARE PRODUCTS; NON-WOVEN TEXTILE FABRICS, IMPREGNATED AND/OR LAMINATED FABRICS, FELT AND NEEDLE FELT, WOVEN FABRICS AND NON-WOVEN FABRICS, ALL FOR TEXTILE USE IN THE NATURE OF UPHOLSTERY, MATTRESSES, PILLOWS, RUGS AND COVERINGS; FABRICS FOR TEXTILE USE, NAMELY, NON-WOVEN TEXTILE FABRICS FOR USE IN GARDENING AND LANDSCAPING; FABRICS FOR USE IN MAKING DIAPERS, FEMININE HYGIENE PRODUCTS AND ADULT INCONTINENCE PRODUCTS; NON-WOVEN TEXTILE MATERIALS FOR MEDICAL APPLICATION, NAMELY, NON-WOVEN TEXTILE FABRICS FOR THE MANUFACTURE OF OUTER COVERINGS OF OSTOMY BAGS, IN CLASS 24 (U.S. CLS. 42 AND 50).

NO CLAIM IS MADE TO THE EXCLUSIVE RIGHT TO USE "PERSONAL CARE", APART FROM THE MARK AS SHOWN.

PRIORITY DATE OF 12-2-2010 IS CLAIMED.

OWNER OF INTERNATIONAL REGISTRATION 1065171 DATED 1-10-2011, EXPIRES 1-10-2021.

THE COLOR(S) PINK AND LILAC IS/ARE CLAIMED AS A FEATURE OF THE MARK.

THE MARK CONSISTS OF TWO INTERLOCKED CIRCLES APPEARING IN THE COLORS PINK AND LILAC. TO THE RIGHT IS THE WORDING "FIBERTEX PERSONAL CARE" IN LILAC.

SER. NO. 79-092,593, FILED 1-10-2011.

JESSICA FATHY, EXAMINING ATTORNEY



David J. Kyjars

Director of the United States Patent and Trademark Office

United States of America
United States Patent and Trademark Office

VALEDO

Reg. No. 4,173,426

Registered July 17, 2012

Int. Cls.: 10 and 28

TRADEMARK

PRINCIPAL REGISTER

HOCOMA AG (SWITZERLAND SOCIÉTÉ ANONYME (SA) / JOINT STOCK COMPANY
UNDER THE LAWS OF SWITZERLAND)
INDUSTRIESTRASSE 4B
CH-8604 VOLKETSCHWIL
SWITZERLAND

FOR: MEDICAL APPARATUS FOR PHYSIOTHERAPY AND PHYSICAL EXERCISES,
NAMELY, BACK TRAINERS FOR USE IN THE FIELD OF PHYSIOTHERAPY, ORTHOPEDIC
REHABILITATION, FUNCTIONAL MOVEMENT THERAPY AS WELL AS THE TREATMENT
OF BACK PAIN AND LOWER BACK PAIN, IN CLASS 10 (U.S. CLS. 26, 39 AND 44).

FOR: GYMNASTIC AND SPORTING ARTICLES, NAMELY, BACK TRAINERS, IN CLASS
28 (U.S. CLS. 22, 23, 38 AND 50).

THE MARK CONSISTS OF STANDARD CHARACTERS WITHOUT CLAIM TO ANY PAR-
TICULAR FONT, STYLE, SIZE, OR COLOR.

PRIORITY DATE OF 6-21-2010 IS CLAIMED.

OWNER OF INTERNATIONAL REGISTRATION 1065208 DATED 12-6-2010, EXPIRES 12-
6-2020.

SER. NO. 79-092,598, FILED 12-6-2010.

ALLISON SCHRODY, EXAMINING ATTORNEY



David J. Kybas

Director of the United States Patent and Trademark Office

United States of America

United States Patent and Trademark Office

CeNano

Reg. No. 4,173,427

Registered July 17, 2012

Int. Cls.: 1, 3 and 4

CENANO GMBH & CO. KG (FED REP GERMANY LIMITED PARTNERSHIP WITH A LIABILITY COMPANY AS A GENERAL PARTNER)
PAUL-HUBER-STRABE 5
84405 DORFEN
FED REP GERMANY

TRADEMARK

PRINCIPAL REGISTER

FOR: CHEMICALS USED IN INDUSTRY, AGRICULTURE, HORTICULTURE AND FORESTRY, EXCEPT FUNGICIDES, HERBICIDES, INSECTICIDES AND PARASITICIDES; CHEMICALS FOR SMOOTHING SURFACES USED IN MANUFACTURING MINERAL GLASS, CERAMICS, GLASS-CERAMICS, POLYMETHYLMETHACRYLATE (PMMA), PLASTICS, POLYMER SURFACES, GLASS-FIBRE REINFORCED PLASTIC, PAINT, GEL COAT, STEEL, STAINLESS STEEL, ALUMINIUM, METALS, METALIZED SURFACES, WOOD, FABRICS, LEATHER, SHOES, CLOTHES, OUTDOOR WEAR, SPORTS WEAR, CANVAS BLIND, PARASOL, SAILS, BOAT COVER, CAST, AIR CRAFT COVER, MINERAL SURFACES, MINERAL PAINTS, PLASTERBOARD; CHEMICALS FOR FINISHING SURFACES USED IN MANUFACTURING MINERAL GLASS, CERAMICS, GLASS-CERAMICS, POLYMETHYLMETHACRYLATE (PMMA), PLASTICS, POLYMER SURFACES, GLASS-FIBRE REINFORCED PLASTIC, PAINT, GEL COAT, STEEL, STAINLESS STEEL, ALUMINIUM, METALS, METALIZED SURFACES, WOOD, FABRICS, LEATHER, SHOES, CLOTHES, OUTDOOR WEAR, SPORTS WEAR, CANVAS BLIND, PARASOL, SAILS, BOAT COVER, CAST, AIR CRAFT COVER, MINERAL SURFACES, MINERAL PAINTS, PLASTERBOARD; CHEMICALS FOR SEALING SURFACES USED IN MANUFACTURING MINERAL GLASS, CERAMICS, GLASS-CERAMICS, POLYMETHYLMETHACRYLATE (PMMA), PLASTICS, POLYMER SURFACES, GLASS-FIBRE REINFORCED PLASTIC, PAINT, GEL COAT, STEEL, STAINLESS STEEL, ALUMINIUM, METALS, METALIZED SURFACES, WOOD, FABRICS, LEATHER, SHOES, CLOTHES, OUTDOOR WEAR, SPORTS WEAR, CANVAS BLIND, PARASOL, SAILS, BOAT COVER, CAST, AIR CRAFT COVER, MINERAL SURFACES, MINERAL PAINTS, PLASTERBOARD, IN CLASS 1 (U.S. CLS. 1, 5, 6, 10, 26 AND 46).



David J. Kyffers

Director of the United States Patent and Trademark Office

FOR: CLEANING, POLISHING, SCOURING AND ABRASIVE PREPARATIONS; SOAPS; PREPARATIONS FOR THE CARE, TREATMENT AND BEAUTIFICATION OF MATERIALS, NAMELY, MINERAL GLASS, CERAMICS, GLASS-CERAMICS, POLYMETHYLMETHACRYLATE (PMMA), PLASTICS, POLYMER SURFACES, GLASS-FIBRE REINFORCED PLASTIC, PAINT, GEL COAT, STEEL, STAINLESS STEEL, ALUMINIUM, METALS, METALIZED SURFACES, WOOD, FABRICS, LEATHER, SHOES, CLOTHES, OUTDOOR WEAR, SPORTS WEAR, CANVAS BLIND, PARASOL, SAILS, BOAT COVER, CAST, AIR CRAFT COVER, MINERAL SURFACES, MINERAL PAINTS, PLASTERBOARD, NAMELY,

Reg. No. 4,173,427 CLEANING PREPARATIONS, POLISHING PREPARATIONS, SHINING PREPARATIONS, AND POLYMER AND NANOTECHNOLOGICAL SEALANT FOR CLEANING, SHINING AND PROTECTING AUTOMOBILE SURFACES, IN CLASS 3 (U.S. CLS. 1, 4, 6, 50, 51 AND 52).

FOR: OIL, GREASE AND WATER BASED DUST AND DIRT BINDING AND ABSORBING COMPOSITIONS USED IN MANUFACTURING MINERAL GLASS, CERAMICS, GLASS-CERAMICS, POLYMETHYLMETHACRYLATE (PMMA), PLASTICS, POLYMER SURFACES, GLASS-FIBRE REINFORCED PLASTIC, PAINT, GEL COAT, STEEL, STAINLESS STEEL, ALUMINIUM, METALS, METALIZED SURFACES, WOOD, FABRICS, LEATHER, SHOES, CLOTHES, OUTDOOR WEAR, SPORTS WEAR, CANVAS BLIND, PARASOL, SAILS, BOAT COVER, CAST, AIR CRAFT COVER, MINERAL SURFACES, MINERAL PAINTS, PLASTER-BOARD, IN CLASS 4 (U.S. CLS. 1, 6 AND 15).

THE MARK CONSISTS OF STANDARD CHARACTERS WITHOUT CLAIM TO ANY PARTICULAR FONT, STYLE, SIZE, OR COLOR.

OWNER OF INTERNATIONAL REGISTRATION 1065220 DATED 11-20-2010, EXPIRES 11-20-2020.

SER. NO. 79-092,600, FILED 11-20-2010.

KELLY BOULTON, EXAMINING ATTORNEY

United States of America

United States Patent and Trademark Office

Fibertex Personal Care

Reg. No. 4,173,428

Registered July 17, 2012

Int. Cl.: 24

TRADEMARK

PRINCIPAL REGISTER

FIBERTEX PERSONAL CARE A/S (DENMARK A/S)
SVENDBORGVEJ 2
DK-9220 AALBORG OST
DENMARK

FOR: NON-WOVEN TEXTILE FABRICS FOR HYGIENE, INDUSTRIAL AND TECHNICAL PURPOSES, NAMELY, FOR USE IN THE PRODUCTION OF DIAPERS, FEMININE HYGIENE AND INCONTINENCE CARE PRODUCTS; NON-WOVEN TEXTILE FABRICS, IMPREGNATED AND/OR LAMINATED FABRICS, FELT AND NEEDLE FELT, WOVEN FABRICS AND NON-WOVEN FABRICS, ALL FOR TEXTILE USE IN THE NATURE OF UPHOLSTERY, MATTRESSES, PILLOWS, RUGS AND COVERINGS; FABRICS FOR TEXTILE USE, NAMELY, NON-WOVEN TEXTILE FABRICS FOR USE IN GARDENING AND LANDSCAPING; FABRICS FOR USE IN MAKING DIAPERS, FEMININE HYGIENE PRODUCTS AND ADULT INCONTINENCE PRODUCTS; NON-WOVEN TEXTILE MATERIALS FOR MEDICAL APPLICATION, NAMELY, NON-WOVEN TEXTILE FABRICS FOR THE MANUFACTURE OF OUTER COVERINGS OF OSTOMY BAGS, IN CLASS 24 (U.S. CLS. 42 AND 50).

THE MARK CONSISTS OF STANDARD CHARACTERS WITHOUT CLAIM TO ANY PARTICULAR FONT, STYLE, SIZE, OR COLOR.

PRIORITY DATE OF 12-2-2010 IS CLAIMED.

OWNER OF INTERNATIONAL REGISTRATION 1065392 DATED 1-10-2011, EXPIRES 1-10-2021.

NO CLAIM IS MADE TO THE EXCLUSIVE RIGHT TO USE "PERSONAL CARE", APART FROM THE MARK AS SHOWN.

SER. NO. 79-092,657, FILED 1-10-2011.

JESSICA FATHY, EXAMINING ATTORNEY



David J. Kypos

Director of the United States Patent and Trademark Office

United States of America

United States Patent and Trademark Office

SpinRepair

Reg. No. 4,173,429

AXEL MUNTERMANN (FED REP GERMANY INDIVIDUAL)
KARLSCHMITTER WEG 26 35580 WETZLAR
FED REP GERMANY

Registered July 17, 2012

Int. Cls.: 3, 5 and 10

FOR: PERFUMERY; COSMETIC PREPARATIONS, NAMELY, SKIN AND BODY OILS, SKIN CREAM, BODY LOTION, SKIN PEELS; BODY CARE AND BEAUTY CARE PRODUCTS, NAMELY, COSMETICS, BODY LOTION, SHOWER GEL, CUTICLE CREAM, SHAMPOO, CONDITIONER, NON MEDICATED LIP BALM, SOAP, BODY POLISH, BODY AND FOOT SCRUB AND NON MEDICATED FOOT CREAM; HAIR SHAMPOOS, HAIR LOTIONS, NON MEDICATED HAIR GROWING PREPARATIONS FOR COSMETIC PURPOSES, IN CLASS 3 (U.S. CLS. 1, 4, 6, 50, 51 AND 52).

TRADEMARK

FOR: MEDICAL PREPARATIONS, NAMELY, MEDICATED SKIN CREAMS, MEDICATED BODY LOTIONS AND BODY OILS, MEDICATED HAIR SHAMPOOS, MEDICATED HAIR LOTIONS, IN CLASS 5 (U.S. CLS. 6, 18, 44, 46, 51 AND 52).

PRINCIPAL REGISTER

FOR: MEDICAL APPARATUS AND DEVICES, NAMELY, APPARATUS FOR MAGNET THERAPY AND MAGNETS FOR MEDICAL PURPOSES, IN CLASS 10 (U.S. CLS. 26, 39 AND 44).

THE MARK CONSISTS OF STANDARD CHARACTERS WITHOUT CLAIM TO ANY PARTICULAR FONT, STYLE, SIZE, OR COLOR.

PRIORITY DATE OF 7-1-2010 IS CLAIMED.

OWNER OF INTERNATIONAL REGISTRATION 1065754 DATED 12-22-2010, EXPIRES 12-22-2020.

SER. NO. 79-092,794, FILED 12-22-2010.

MATTHEW MCDOWELL, EXAMINING ATTORNEY



David J. Kyros

Director of the United States Patent and Trademark Office

United States of America

United States Patent and Trademark Office

MORELLINO DI SCANSANO

Reg. No. 4,173,430

Registered July 17, 2012

Int. Cl.: 33

CERTIFICATION MARK

PRINCIPAL REGISTER

CONSORZIO A TUTELA DEL VINO MORELLINO DI SCANSANO (ITALY CONSORTIUM)
VIA MARCONI, 23
I-58054 SCANSANO (GR)
ITALY

FOR: ALCOHOLIC BEVERAGES NOT INCLUDING BEERS, NAMELY, WINE, IN CLASS
33 (U.S. CLS. 47 AND 49).

THE MARK CONSISTS OF STANDARD CHARACTERS WITHOUT CLAIM TO ANY PAR-
TICULAR FONT, STYLE, SIZE, OR COLOR.

PRIORITY DATE OF 12-13-2010 IS CLAIMED.

OWNER OF INTERNATIONAL REGISTRATION 1065893 DATED 12-15-2010, EXPIRES 12-
15-2020.

THE ENGLISH TRANSLATION OF "MORELLINO DI SCANSANO" IN THE MARK IS
"MORELLINO OF SCANSANO".

THE CERTIFICATION MARK, AS USED OR INTENDED TO BE USED BY PERSONS AU-
THORIZED BY THE CERTIFIER, CERTIFIES OR IS INTENDED TO CERTIFY THAT THE
GOODS, NAMELY RED WINES, ARE OBTAINED FROM GRAPES HAVING A MINIMUM
OF 85% OF THE SANGIOVASE VARIETY THAT ARE PRODUCED WITHIN THE ZONE OF
ITALY INCLUDING THE HILLSIDE OF THE PROVINCE OF GROSSETO BETWEEN THE
OMBRONE AND ALBEGNA RIVERS, THAT INCLUDE THE ENTIRE ADMINISTRATIVE
TERRITORY OF THE TOWNSHIP OF SCANSANO AND PART OF THE COMMUNAL TER-
RITORIES OF MANCIANO, MAGLIANO IN TOSCANA, GROSSETO, CAMPAGNATICO,
SAMPRONIANO AND ROCCALBEGNA, IN THE PROVINCE OF GROSSETO, PURSUANT
TO "THE REGULATIONS FOR THE USE OF THE COLLECTIVE TRADEMARK OF THE
CONSORTIUM FOR THE PROTECTION OF "MORELLINO DI SCANSANO WINE".



SER. NO. 79-092,855, FILED 12-15-2010.

JAMES STEIN, EXAMINING ATTORNEY

David J. Kyffers

Director of the United States Patent and Trademark Office

United States of America

United States Patent and Trademark Office

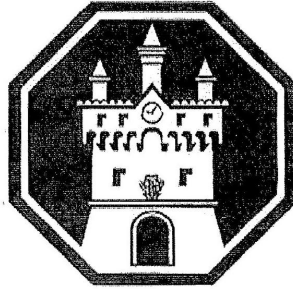

Reg. No. 4,173,431

Registered July 17, 2012

Int. Cl.: 33

CERTIFICATION MARK

PRINCIPAL REGISTER

CONSORZIO A TUTELA DEL VINO MORELLINO DI SCANSANO (ITALY CONSORTIUM)
VIA MARCONI, 23
I-58054 SCANSANO (GR)
ITALY

FOR: ALCOHOLIC BEVERAGES NOT INCLUDING BEERS, NAMELY, WINE, IN CLASS
33 (U.S. CLS. 47 AND 49).

THE MARK CONSISTS OF A STYLIZED CASTLE DESIGN WITH A PENTAGON DESIGN.

PRIORITY DATE OF 12-13-2010 IS CLAIMED.

OWNER OF INTERNATIONAL REGISTRATION 1065894 DATED 12-15-2010, EXPIRES 12-
15-2020.

THE CERTIFICATION MARK, AS USED OR INTENDED TO BE USED BY PERSONS AUTHORIZED BY THE CERTIFIER, CERTIFIES OR IS INTENDED TO CERTIFY THAT THE GOODS, NAMELY RED WINES, ARE OBTAINED FROM GRAPES HAVING A MINIMUM OF 85% OF THE SANGIOVASE VARIETY THAT ARE PRODUCED WITHIN THE ZONE OF ITALY INCLUDING THE HILLSIDE OF THE PROVINCE OF GROSSETO BETWEEN THE OMBRONE AND ALBEGNA RIVERS, THAT INCLUDE THE ENTIRE ADMINISTRATIVE TERRITORY OF THE TOWNSHIP OF SCANSANO AND PART OF THE COMMUNAL TERRITORIES OF MANCIANO, MAGLIANO IN TOSCANA, GROSSETO, CAMPAGNATICO, SAMPRONIANO AND ROCCALBEGNA, IN THE PROVINCE OF GROSSETO, PURSUANT TO "THE REGULATIONS FOR THE USE OF THE COLLECTIVE TRADEMARK OF THE CONSORTIUM FOR THE PROTECTION OF "MORELLINO DI SCANSANO WINE".

SER. NO. 79-092,856, FILED 12-15-2010.

JAMES STEIN, EXAMINING ATTORNEY



David J. Kyffers

Director of the United States Patent and Trademark Office

United States of America

United States Patent and Trademark Office

MACE

Reg. No. 4,173,432

Registered July 17, 2012

**Int. Cls.: 35, 36, 37, 42
and 45**

SERVICE MARK

PRINCIPAL REGISTER

MACE LIMITED (UNITED KINGDOM COMPANY)
ATELIER HOUSE
64 PRATT STREET; LONDON NW1 0LF
UNITED KINGDOM

FOR: ADVERTISING AND ADVERTISEMENT SERVICES; BUSINESS MANAGEMENT; BUSINESS ADMINISTRATION; PROVIDING OFFICE FUNCTIONS; BUSINESS AND MANAGEMENT CONSULTANCY, IN CLASS 35 (U.S. CLS. 100, 101 AND 102).

FOR: INSURANCE SERVICES, NAMELY, UNDERWRITING, ISSUANCE AND ADMINISTRATION OF INSURANCE RELATED TO BUILDING CONSTRUCTION AND REAL ESTATE; FINANCIAL AFFAIRS AND MONETARY AFFAIRS, NAMELY, FINANCIAL INFORMATION, CONSULTANCY, MANAGEMENT AND ANALYSIS; REAL ESTATE AFFAIRS, NAMELY, REAL ESTATE MANAGEMENT AND APPRAISAL, IN CLASS 36 (U.S. CLS. 100, 101 AND 102).

FOR: BUILDING CONSTRUCTION, NAMELY, CONSTRUCTION AND REPAIR OF COMMERCIAL AND PUBLIC BUILDINGS; INSTALLATION OF BUILDING ADDITIONS; CONSTRUCTION PROJECT MANAGEMENT SERVICES IN THE FIELD OF COMMERCIAL AND PUBLIC BUILDINGS, IN CLASS 37 (U.S. CLS. 100, 103 AND 106).

FOR: SCIENTIFIC AND TECHNOLOGICAL SERVICES, NAMELY, RESEARCH AND DESIGN RELATING THERETO IN THE FIELD OF ARCHITECTURAL DESIGN, BUILDING CONSTRUCTION, AND CIVIL ENGINEERING; INDUSTRIAL ANALYSIS AND RESEARCH SERVICES IN THE FIELD OF ARCHITECTURAL DESIGN, BUILDING CONSTRUCTION, AND CIVIL ENGINEERING; DESIGN AND DEVELOPMENT OF COMPUTER HARDWARE AND SOFTWARE; ARCHITECTURAL DESIGN, CIVIL ENGINEERING, IN CLASS 42 (U.S. CLS. 100 AND 101).

FOR: HEALTH AND SAFETY CONSULTATION AND INSPECTION SERVICES, NAMELY, REGULATORY COMPLIANCE CONSULTING IN THE FIELD OF COMMERCIAL AND PUBLIC BUILDING JOB SITES; CONSULTING IN THE FIELD OF WORKPLACE SAFETY; SAFETY CONSULTING SERVICES IN THE FIELDS OF HAZARD ASSESSMENTS AND ABATEMENT PROCEDURES; FIRE PREVENTION CONSULTATION; SAFETY INSPECTION AUDITS TO IMPROVE SAFETY OF CONSTRUCTION WORKERS ON RESIDENTIAL AND COMMERCIAL CONSTRUCTION SITES; SECURITY INSPECTION SERVICES FOR OTHERS, IN CLASS 45 (U.S. CLS. 100 AND 101).



David J. Kyffers

Director of the United States Patent and Trademark Office

Reg. No. 4,173,432 THE MARK CONSISTS OF STANDARD CHARACTERS WITHOUT CLAIM TO ANY PARTICULAR FONT, STYLE, SIZE, OR COLOR.

OWNER OF INTERNATIONAL REGISTRATION 0975727 DATED 4-16-2008, EXPIRES 4-16-2018.

SER. NO. 79-093,117, FILED 12-10-2010.

SCOTT BIBB, EXAMINING ATTORNEY

United States of America
United States Patent and Trademark Office

Ergopad

Reg. No. 4,173,433

Registered July 17, 2012

Int. Cls.: 10 and 25

TRADEMARK

PRINCIPAL REGISTER

BAUERFEIND AG (FED REP GERMANY STOCK CORPORATION)
TRIEBESER STRAÙE 16
07937 ZEULENRODA-TRIEBES
FED REP GERMANY

FOR: ORTHOPAEDIC ARTICLES, NAMELY, ORTHOPAEDIC SUPPORT BANDAGES, MEDICAL COMPRESSION STOCKINGS, ORTHOPAEDIC JOINT PROSTHESES, ORTHOTICS FOR FOOT, ORTHOPAEDIC INSERTS, NAMELY, ORTHOPAEDIC SHOE INSERTS FOR FOOTWEAR, NAMELY, INSERT BLANKS, NAMELY, PRE-FABRICATED INSERT BLANKS, AND SHELL BLANKS, NAMELY, PREFINISHED SHOE INSERTS THAT ASSIST TO CORRECT WALKING; ORTHOPAEDIC DEVICES TO STRETCH, TREAT, RELAX AND EXERCISE THE TOES AND FEET, NAMELY, TOE SPREADERS; ORTHOPAEDIC FOOTWEAR AND PARTS THEREFOR, ORTHOPAEDIC SOLES, IN CLASS 10 (U.S. CLS. 26, 39 AND 44).

FOR: SHOES, PARTS FOR SHOES, NAMELY SOLES, INSOLES, HEELS AND UPPERS , IN CLASS 25 (U.S. CLS. 22 AND 39).

THE MARK CONSISTS OF STANDARD CHARACTERS WITHOUT CLAIM TO ANY PARTICULAR FONT, STYLE, SIZE, OR COLOR.

PRIORITY DATE OF 5-26-2010 IS CLAIMED.

OWNER OF INTERNATIONAL REGISTRATION 1067269 DATED 11-24-2010, EXPIRES 11-24-2020.

SER. NO. 79-093,468, FILED 11-24-2010.

LAKEISHA LEWIS, EXAMINING ATTORNEY



David J. Kybas

Director of the United States Patent and Trademark Office

United States of America

United States Patent and Trademark Office

Sovanta

Reg. No. 4,173,434

Registered July 17, 2012

**Int. Cls.: 9, 16, 35, 38, 41
and 42**

TRADEMARK

SERVICE MARK

PRINCIPAL REGISTER

PROF. DR. CLAUS E. HEINRICH (FED REP GERMANY INDIVIDUAL)
LUDOLF KREHL STRAßE 31
69120 HEIDELBERG
FED REP GERMANY

FOR: COMPUTER PROGRAMS AND SOFTWARE FOR PROVIDING DATA ACCESS AND INFORMATION MANAGEMENT FOR MOBILE BUSINESS APPLICATIONS, IN CLASS 9 (U.S. CLS. 21, 23, 26, 36 AND 38).

FOR: PAPER; CARDBOARD; GOODS MADE FROM PAPER AND CARDBOARD, NAMELY, PAPER BAGS AND PAPER DOILIES, CARDBOARD BOXES, CONTAINERS AND HANGTAGS; PRINTED MATTER, NAMELY, PRINTED GUIDE, JOURNALS AND EDUCATIONAL MATERIALS ALL IN THE FIELD OF DEVELOPING AND DESIGNING SOFTWARE; STATIONERY; INSTRUCTIONAL AND TEACHING MATERIAL, NAMELY, TEACHING TILES AND PRINTED EDUCATIONAL MATERIAL IN THE FIELD OF DEVELOPING AND DESIGNING SOFTWARE; PRINTING BLOCKS; PRINTED MANUALS, CATALOGUES, USER GUIDES AND OPERATING INSTRUCTIONS FOR SOFTWARE AND DATA PROCESSING PROGRAMS, IN CLASS 16 (U.S. CLS. 2, 5, 22, 23, 29, 37, 38 AND 50).

FOR: ADVERTISING; BUSINESS MANAGEMENT; BUSINESS ADMINISTRATION; PROVIDING OFFICE FUNCTIONS; SYSTEMATIZATION OF DATA AND INFORMATION IN COMPUTER DATA BASES ACCESSIBLE ON THE INTERNET, INCLUDING DATA AND INFORMATION RELATING TO THE DEVELOPMENT, CREATION, PROGRAMMING, PRODUCTION, PERFORMANCE, DISTRIBUTION, APPLICATION, USE, MODE OF OPERATION, HANDLING, MODIFICATION, SALE, MAINTENANCE, RENTAL, UPDATING, DESIGN AND OUTSOURCING OF COMPUTER PROGRAMS AND SOFTWARE; BUSINESS RESEARCH; VALUATION OF BUSINESS DATA AND ENTERPRISE DATA, NAMELY, INFORMATION AND DATA COMPILING AND ANALYZING RELATING TO BUSINESS MANAGEMENT AND SYSTEM ANALYSIS; BUSINESS DATA ANALYSIS; BUSINESS MANAGEMENT AND ORGANIZATION CONSULTANCY, BUSINESS MANAGEMENT CONSULTANCY, PROFESSIONAL BUSINESS CONSULTANCY, COMMERCIAL INFORMATION AND ADVICE FOR CONSUMERS, BUSINESS ORGANIZATION CONSULTANCY; CONSULTANCY IN THE FIELD OF DATA PROCESSING, IN CLASS 35 (U.S. CLS. 100, 101 AND 102).



David J. Kyjars

Director of the United States Patent and Trademark Office

FOR: TELECOMMUNICATIONS, INTERNET SERVICES, NAMELY, PROVIDING MULTIPLE USER ACCESS TO DATA AND INFORMATION ON THE INTERNET IN THE FIELD OF

Reg. No. 4,173,434 DEVELOPMENT, CREATION, PROGRAMMING, PRODUCTION, PERFORMANCE, DISTRIBUTION, APPLICATION, USE, MODE OF OPERATION, HANDLING, MODIFICATION, SALE, MAINTENANCE, RENTAL, UPDATING, DESIGN AND OUTSOURCING OF COMPUTER PROGRAMS AND SOFTWARE; PROVIDING INTERNET ACCESS; TELECOMMUNICATIONS CONSULTATION, IN CLASS 38 (U.S. CLS. 100, 101 AND 104).

FOR: EDUCATION, NAMELY, PROVIDING CLASSES AND COURSES OF INSTRUCTION IN THE FIELD OF USE AND APPLICATION OF DATA PROCESSING PROGRAMS AND MOBILE BUSINESS APPLICATIONS; PROVIDING OF TRAINING IN THE FIELD OF USE AND APPLICATION OF DATA PROCESSING PROGRAMS AND MOBILE BUSINESS APPLICATIONS, IN CLASS 41 (U.S. CLS. 100, 101 AND 107).

FOR: SCIENTIFIC RESEARCH; RESEARCH AND DEVELOPMENT OF TECHNOLOGY IN THE FIELD OF DESIGN AND DEVELOPMENT OF COMPUTER PROGRAMS AND SOFTWARE; INDUSTRIAL ANALYSIS SERVICES AND INDUSTRIAL RESEARCH SERVICES IN THE FIELD OF DESIGN AND DEVELOPMENT OF COMPUTER PROGRAMS AND SOFTWARE; DESIGN AND DEVELOPMENT OF COMPUTER HARDWARE AND SOFTWARE, ESPECIALLY CREATION, DEVELOPMENT AND DESIGN OF COMPUTER PROGRAMS AND SOFTWARE FOR USE IN THE FIELD OF FINANCIAL MANAGEMENT, CONTROL MANAGEMENT, PRODUCTION AND MATERIALS MANAGEMENT, QUALITY MANAGEMENT AND PLANT MAINTENANCE, DISTRIBUTION, HUMAN RESOURCES AND PROJECT MANAGEMENT AND ALSO FOR GENERAL OFFICE FUNCTIONS IN THE NATURE OF WORD PROCESSING, ELECTRONIC MAIL AND INFORMATION ARCHIVING ALL OF THE ABOVE IN ASSOCIATION WITH PROGRAMS AND SOFTWARE FOR MOBILE BUSINESS APPLICATIONS; IMPLEMENTATION, UPDATING, RENTAL AND MAINTENANCE OF COMPUTER PROGRAMS AND SOFTWARE; TECHNICAL CONSULTANCY AND ADVICE REGARDING PROGRAMMING, DESIGN, DEVELOPMENT, USE AND APPLICATION OF COMPUTER PROGRAMS AND SOFTWARE FOR MOBILE BUSINESS APPLICATIONS; RESEARCH IN THE FIELD OF COMPUTER PROGRAMS AND SOFTWARE FOR MOBILE BUSINESS APPLICATIONS; CONSULTANCY IN THE FIELD OF ENERGY-SAVING MEASURES TO IMPROVE ENERGY EFFICIENCY, IN CLASS 42 (U.S. CLS. 100 AND 101).

THE MARK CONSISTS OF STANDARD CHARACTERS WITHOUT CLAIM TO ANY PARTICULAR FONT, STYLE, SIZE, OR COLOR.

PRIORITY DATE OF 12-1-2009 IS CLAIMED.

OWNER OF INTERNATIONAL REGISTRATION 1067397 DATED 5-25-2010, EXPIRES 5-25-2020.

THE WORDING "SOVANTA" HAS NO MEANING IN A FOREIGN LANGUAGE.

SER. NO. 79-093,684, FILED 5-25-2010.

ELLEN PERKINS, EXAMINING ATTORNEY

United States of America
United States Patent and Trademark Office

YBRANT

Reg. No. 4,173,435

Registered July 17, 2012

Int. Cl.: 35

SERVICE MARK

PRINCIPAL REGISTER

YBRANT DIGITAL LIMITED (INDIA CORPORATION)
RD#12, PLOT 7A, MLA COLONY
BANJARA HILLS; HYDERABAD-34
INDIA

FOR: DISSEMINATION OF ADVERTISING MATERIAL VIA THE INTERNET, WIRELESS NETWORKS AND OTHER ELECTRONIC AND COMMUNICATIONS NETWORKS; MOBILE MARKETING, NAMELY, DIRECT TARGET MARKETING PROVIDED VIA MOBILE PHONE, SMART PHONES AND PDAS, IN CLASS 35 (U.S. CLS. 100, 101 AND 102).

THE MARK CONSISTS OF STANDARD CHARACTERS WITHOUT CLAIM TO ANY PARTICULAR FONT, STYLE, SIZE, OR COLOR.

PRIORITY DATE OF 12-16-2010 IS CLAIMED.

OWNER OF INTERNATIONAL REGISTRATION 1067418 DATED 12-22-2010, EXPIRES 12-22-2020.

SER. NO. 79-093,693, FILED 12-22-2010.

SUZANNE BLANE, EXAMINING ATTORNEY



David J. Kyfos

Director of the United States Patent and Trademark Office

United States of America

United States Patent and Trademark Office

ZADTA

Reg. No. 4,173,436

Registered July 17, 2012

**Int. Cls.: 3, 5, 9, 19 and
42**

TRADEMARK

SERVICE MARK

PRINCIPAL REGISTER

VADIM GOGICHEV (SWITZERLAND SOCIÉTÉ ANONYME (SA))
C/O PHILIPPE SAINT GER AG
ESCHENRING 12; CH-6300 ZUG
SWITZERLAND

FOR: BODY AND BEAUTY CARE PREPARATIONS, NAMELY, SKIN LOTIONS, IN CLASS 3 (U.S. CLS. 1, 4, 6, 50, 51 AND 52).

FOR: DIETETIC SUBSTANCES FOR MEDICAL USE, NAMELY, FOOD AND BEVERAGES, IN CLASS 5 (U.S. CLS. 6, 18, 44, 46, 51 AND 52).

FOR: MEASURING APPARATUS AND INSTRUMENTS, NAMELY, THERMOMETERS; ELECTROMAGNETS; APPARATUS AND INSTRUMENTS FOR CONDUCTING, TRANSFORMING, ACCUMULATING, GENERATING OR PRODUCING, REGULATING OR CONTROLLING MAGNETIC FIELDS; APPARATUS AND INSTRUMENTS FOR CONDUCTING, TRANSFORMING, ACCUMULATING, GENERATING OR PRODUCING, REGULATING OR CONTROLLING ELECTRICITY, IN CLASS 9 (U.S. CLS. 21, 23, 26, 36 AND 38).

FOR: CONSTRUCTION MATERIALS CONTAINING CELLULOSE OR CELLULOSE FIBERS, NAMELY, FIBERGLASS BOARDS; CONSTRUCTION BOARDS, NON-METALLIC; COMPOUNDS OF NATURAL CELLULOSIC FIBERS FOR SPACKLING; WOOD-PULP BOARD FOR CONSTRUCTION; TARRED PAPER FOR ROOFING; COMPOSITE MATERIALS COMPRISING MINERAL SUBSTANCES OR ROCKS, NAMELY, PANELS COMPOSED PRIMARILY OF NONMETAL MATERIALS FOR USE IN CONSTRUCTION, IN CLASS 19 (U.S. CLS. 1, 12, 33 AND 50).

FOR: SCIENTIFIC AND TECHNOLOGICAL SERVICES AND RESEARCH AND DESIGN RELATING THERETO IN THE FIELD OF THE DESIGN AND DEVELOPMENT OF CONSTRUCTION MATERIALS CONTAINING CELLULOSE OR CELLULOSE FIBERS; INDUSTRIAL ANALYSIS AND RESEARCH SERVICES IN THE FIELD OF THE DESIGN AND DEVELOPMENT OF CONSTRUCTION MATERIALS CONTAINING CELLULOSE OR CELLULOSE FIBERS; TECHNOLOGY CONSULTING IN THE FIELD OF THE DESIGN AND DEVELOPMENT OF CONSTRUCTION MATERIALS CONTAINING CELLULOSE OR CELLULOSE FIBERS; SCIENTIFIC RESEARCH AND DEVELOPMENT RELATING TO THE USE OF MAGNETS; SCIENTIFIC RESEARCH AND DEVELOPMENT RELATING TO ACCUMULATORS AND BATTERIES, IN CLASS 42 (U.S. CLS. 100 AND 101).



David J. Kybas

Director of the United States Patent and Trademark Office

Reg. No. 4,173,436 THE MARK CONSISTS OF STANDARD CHARACTERS WITHOUT CLAIM TO ANY PARTICULAR FONT, STYLE, SIZE, OR COLOR.

PRIORITY DATE OF 7-28-2010 IS CLAIMED.

OWNER OF INTERNATIONAL REGISTRATION 1067963 DATED 1-28-2011, EXPIRES 1-28-2021.

THE WORDING "ZADTA" HAS NO MEANING IN A FOREIGN LANGUAGE.

SER. NO. 79-093,876, FILED 1-28-2011.

DAVID HOFFMAN, EXAMINING ATTORNEY

United States of America

United States Patent and Trademark Office

MMDC

Reg. No. 4,173,437

Registered July 17, 2012

Int. Cl.: 42

SERVICE MARK

PRINCIPAL REGISTER

SIEMENS AKTIENGESELLSCHAFT (FED REP GERMANY AKTIENGESELLSCHAFT)
WITTELSBACHERPLATZ 2
80333 MÜNCHEN
FED REP GERMANY

FOR: TECHNICAL CONSULTANCY IN THE FIELD OF DRIVES FOR INDUSTRIAL MACHINERY, NAMELY, CONSULTATION IN THE DESIGN OF DRIVES FOR INDUSTRIAL MACHINERY; TECHNICAL CONSULTANCY IN THE FIELD OF DRIVE TECHNOLOGY, NAMELY, MECHANICAL ENGINEERING CONSULTING SERVICES RELATING TO DRIVES, IN CLASS 42 (U.S. CLS. 100 AND 101).

THE MARK CONSISTS OF STANDARD CHARACTERS WITHOUT CLAIM TO ANY PARTICULAR FONT, STYLE, SIZE, OR COLOR.

PRIORITY DATE OF 7-21-2010 IS CLAIMED.

OWNER OF INTERNATIONAL REGISTRATION 1068011 DATED 12-23-2010, EXPIRES 12-23-2020.

SER. NO. 79-093,891, FILED 12-23-2010.

VERNA BETH RIRIE, EXAMINING ATTORNEY



David J. Kyfos

Director of the United States Patent and Trademark Office

United States of America

United States Patent and Trademark Office

Aiducation International

Reg. No. 4,173,438

Registered July 17, 2012

Int. Cls.: 9, 36, 41 and 45

TRADEMARK

SERVICE MARK

PRINCIPAL REGISTER

KRISTIN KAPITZA (FED REP GERMANY INDIVIDUAL)
HARDSTRASSE 89
CH-8004 ZÜRICH
SWITZERLAND

FOR: MOTION PICTURE FILMS ABOUT EDUCATION AND PHILANTHROPY; PRERECORDED VIDEO TAPES AND COMPACT DISCS FEATURING EDUCATION AND PHILANTHROPY TOPICS; SOUND RECORDING CARRIERS; ELECTRONICALLY DOWNLOADABLE PRINTED MATTER, NAMELY, DOWNLOADABLE ELECTRONIC NEWSLETTERS IN THE FIELDS OF EDUCATION AND PHILANTHROPY, IN CLASS 9 (U.S. CLS. 21, 23, 26, 36 AND 38).

FOR: CHARITABLE FUNDRAISING; PROVIDING EDUCATIONAL SCHOLARSHIPS TO STUDENTS IN DEVELOPING COUNTRIES, IN CLASS 36 (U.S. CLS. 100, 101 AND 102).

FOR: EDUCATIONAL SERVICES, NAMELY, CONDUCTING CLASSES, SEMINARS AND WORKSHOPS IN THE FIELD OF EDUCATION IN DEVELOPING COUNTRIES, AND DISTRIBUTION OF COURSE MATERIALS IN CONNECTION THEREWITH, AND EDUCATION CONSULTING RELATED THERETO; NON-DOWNLOADABLE ELECTRONIC PUBLICATIONS IN THE NATURE OF NEWSLETTERS IN THE FIELD OF EDUCATION AND PHILANTHROPY; CAREER COUNSELING, NAMELY, PROVIDING ADVICE CONCERNING EDUCATION OPTIONS, SOFT SKILLS TRAINING OPPORTUNITIES, NAMELY, PRESENTATION SKILLS, COMMUNICATION SKILLS, TEAM WORK AND LEADERSHIP SKILLS, AND SELF-MARKETING TO PURSUE CAREER OPPORTUNITIES; COACHING AND ASSISTANCE TO PERSONNEL IN COMPANIES, NAMELY, PROVIDING GROUP COACHING AND LEARNING FORUMS IN THE FIELD OF EDUCATION; INFORMATION ON EVENTS, NAMELY, PROVIDING INFORMATION AND NEWS IN THE FIELD OF EDUCATION; ARRANGING AND CONDUCTING CONFERENCES, COLLOQUIUMS, SEMINARS OR TRAINING WORKSHOPS IN THE FIELD OF EDUCATION; PUBLICATION OF TEXTS; WRITING TEXTS, VIDEOTAPE RECORDING FOR OTHERS, IN CLASS 41 (U.S. CLS. 100, 101 AND 107).

FOR: SOCIAL NETWORKING SERVICES BETWEEN POTENTIAL STUDENT BENEFICIARIES AND POTENTIAL DONORS FOR EDUCATION GRANTS IN DEVELOPING COUNTRIES; SOCIAL NETWORKING SERVICES AIMED AT ESTABLISHING AND MAINTAINING RELATIONSHIPS BETWEEN GRANT DONORS AND STUDENT BENEFICIARIES OF EDUCATIONAL SCHOLARSHIPS, ALL PROVIDED BY MEANS OF THE INTERNET, E-MAIL,



David J. Kybas

Director of the United States Patent and Trademark Office

Reg. No. 4,173,438 VIDEO MESSAGING, PRINTED MEDIA, ORAL PRESENTATIONS, PERSONAL MEETINGS,
AND TELEPHONIC COMMUNICATIONS, IN CLASS 45 (U.S. CLS. 100 AND 101).

NO CLAIM IS MADE TO THE EXCLUSIVE RIGHT TO USE "INTERNATIONAL", APART
FROM THE MARK AS SHOWN.

OWNER OF INTERNATIONAL REGISTRATION 1014962 DATED 5-5-2009, EXPIRES 5-5-
2019.

SER. NO. 79-093,954, FILED 11-25-2010.

JANICE KIM, EXAMINING ATTORNEY

United States of America

United States Patent and Trademark Office

PYXALIS

Reg. No. 4,173,439

Registered July 17, 2012

Int. Cls.: 9 and 42

TRADEMARK

SERVICE MARK

PRINCIPAL REGISTER

PYXALIS (FRANCE SOCIÉTÉ PAR ACTIONS SIMPLIFIÉE)
31 RUE GUSTAVE EIFFEL
GRENOBLE, FRANCE F38000

FOR: MICROPROCESSORS, INTEGRATED CIRCUITS, SEMICONDUCTORS, SEMI-CONDUCTOR DEVICES; ELECTRONIC TRANSISTORS; SEMICONDUCTOR PROCESSORS; PRINTED CIRCUITS; PERIPHERAL DEVICES FOR COMPUTERS; VIDEO PROCESSORS; OPTOELECTRONIC COMPONENTS, NAMELY, IMAGE SENSORS, IN CLASS 9 (U.S. CLS. 21, 23, 26, 36 AND 38).

FOR: DESIGN OF DATA PROCESSING AND COMPUTER EQUIPMENT, MICROPROCESSORS, INTEGRATED CIRCUITS, INTEGRATED CIRCUIT CHIPS, SEMICONDUCTORS, SEMI-CONDUCTOR DEVICES, ELECTRONIC TRANSISTORS, FIRMWARE AND SOFTWARE, SEMICONDUCTOR PROCESSORS, PRINTED CIRCUITS, ELECTRONIC CHIP CARDS, PERIPHERAL DEVICES FOR COMPUTERS, COMPUTER COMPONENTS, VIDEO PROCESSORS, VIDEO GRAPHICS ADAPTERS, MULTIMEDIA ADAPTERS, OPTICAL COMPONENTS, OPTOELECTRONIC COMPONENTS, IMAGING COMPONENTS, IN CLASS 42 (U.S. CLS. 100 AND 101).

THE MARK CONSISTS OF STANDARD CHARACTERS WITHOUT CLAIM TO ANY PARTICULAR FONT, STYLE, SIZE, OR COLOR.

PRIORITY DATE OF 7-30-2010 IS CLAIMED.

OWNER OF INTERNATIONAL REGISTRATION 1068951 DATED 1-28-2011, EXPIRES 1-28-2021.

SER. NO. 79-094,292, FILED 1-28-2011.

DAVID HOFFMAN, EXAMINING ATTORNEY



David J. Kypos

Director of the United States Patent and Trademark Office

United States of America

United States Patent and Trademark Office

ELIOT

Reg. No. 4,173,440

Registered July 17, 2012

Int. Cls.: 17 and 19

TRADEMARK

PRINCIPAL REGISTER

RYB (FRANCE SOCIETE ANONYME)
33 ROUTE DE GRENOBLE LES APPRÊTS
F-38590 SAINT ETIENNE DE ST GEOIRS
FRANCE

FOR: SEMI-PROCESSED PLASTICS FOR USE IN MANUFACTURE AND FOR INDUSTRY, EXCLUDING PLASTIC FOAM INSULATION; SEMI-PROCESSED PLASTICS IN THE FORM OF BARS, BLOCKS, PELLETS, SHAFTS, SHEETS AND TUBES FOR GENERAL MANUFACTURING, EXCLUDING PLASTIC FOAM INSULATION; PLASTICS IN THE FORM OF SHEETS, RODS AND TUBES, EXCLUDING PLASTIC FOAM INSULATION; PLASTICS IN EXTRUDED FORM FOR GENERAL INDUSTRIAL USE, EXCLUDING PLASTIC FOAM INSULATION; PLATES AND RODS OF PLASTICS, EXCLUDING PLASTIC FOAM INSULATION; GOODS MADE OF SEMI-PROCESSED PLASTICS, NAMELY, RODS, PLATES, BARS, AND TUBES, EXCLUDING PLASTIC FOAM INSULATION; SEMI-PROCESSED PLASTICS IN THE FORM OF SHEETS, PANELS, PLATES, EXCLUDING PLASTIC FOAM INSULATION; NON-METALLIC FLEXIBLE PIPES, EXCLUDING PLASTIC FOAM INSULATION; AND PLASTIC ACCESSORIES FOR NON-METALLIC FLEXIBLE PIPES, NAMELY, SLEEVES AND GASKETS, EXCLUDING PLASTIC FOAM INSULATION, IN CLASS 17 (U.S. CLS. 1, 5, 12, 13, 35 AND 50).

FOR: NON-METALLIC BUILDING MATERIALS, NAMELY, PLASTIC PIPE SUPPORTS, NON-METAL PIPE COLLARS, AND NON-METAL PIPE COUPLINGS AND JOINTS; NON-METALLIC BUILDING MATERIALS, NAMELY, RIGID NON-METALLIC PIPES OF PLASTIC, POLYETHYLENE AND COMPOSITE USED IN THE BUILDING OF ROAD AND AGRICULTURAL DRAINAGE, USED FOR CONVEYING LIQUID, GAS AND BIOGAS, USED FOR THE PROTECTION OF ELECTRICAL NETWORKS, USED FOR THE PROTECTION OF OPTICAL FIBER AND CABLES, USED FOR THE PROTECTION OF TUBES MADE OF CROSS-LINKED POLYETHYLENE AND COPPER; NON-METALLIC GUTTER PIPES, WATER PIPES, SEWER PIPES AND RIGID PIPES; NON-METALLIC VENTILATING, AIR CONDITIONING AND HEATING DUCTS; NON-METALLIC TUBES AND FILTERING TUBES USED TO PREVENT STORM WATER RUNOFF POLLUTANTS FROM ENTERING SEWER SYSTEMS; NON-METALLIC POLYETHYLENE PIPES USED IN GEOTHERMAL HEATING AND COOLING SYSTEMS, IN CLASS 19 (U.S. CLS. 1, 12, 33 AND 50).



David J. Kyjars

Director of the United States Patent and Trademark Office

THE MARK CONSISTS OF STANDARD CHARACTERS WITHOUT CLAIM TO ANY PARTICULAR FONT, STYLE, SIZE, OR COLOR.

Reg. No. 4,173,440 PRIORITY DATE OF 11-4-2010 IS CLAIMED.

OWNER OF INTERNATIONAL REGISTRATION 1069250 DATED 11-29-2010, EXPIRES 11-29-2020.

SER. NO. 79-094,387, FILED 11-29-2010.

TRACY FLETCHER, EXAMINING ATTORNEY

United States of America

United States Patent and Trademark Office

LEGAMI

Reg. No. 4,173,441

Registered July 17, 2012

Int. Cls.: 16 and 25

TRADEMARK

PRINCIPAL REGISTER

FASSI, ALBERTO (ITALY INDIVIDUAL)
VIA FARA, 13
I-24129 BERGAMO
ITALY

FOR: PAPER, CARDBOARD AND GOODS MADE FROM THESE MATERIALS, NOT INCLUDED IN OTHER CLASSES, NAMELY, BOXES, GIFT BOXES, GIFT WRAPPING PAPER, PAPER NAPKINS, PAPER TABLECLOTHS, PAPER COASTERS, PAPER PLACE MATS, BOTTLE WRAPPERS OF CARDBOARD OR PAPER, PAPER ENVELOPES, PAPER BAGS, PAPER GIFT BAGS, PAPER GIFT BAGS FOR WINE, BOOK MARKERS, GREETING CARDS AND POSTCARDS; PAPER GIFT CARDS, PAPER GIFT TAGS, WRITING PAPER, NOTE PAPER, NOTEBOOKS, NOTEBOOK COVERS, NOTE PADS, MEMO PADS, WRITING PADS, AGENDAS, ADDRESS BOOKS, DATE BOOKS, DIARIES, PHOTO ALBUMS, SCRAPBOOKS, DAILY PLANNERS; CALENDARS, DESKTOP PLANNERS; BOOKBINDING MATERIAL; PHOTOGRAPHS; STATIONERY; ADHESIVES FOR STATIONERY OR HOUSEHOLD PURPOSES; PAINT BRUSHES; TYPEWRITERS AND OFFICE REQUISITES EXCEPT FURNITURE, NAMELY, PENS, PENCILS, CRAYONS, MARKERS, PEN AND PENCIL HOLDERS, PEN AND PENCIL CASES AND BOXES, STAPLERS, MEMORANDUM BOARDS, ERASERS, PENCIL SHARPENERS, DRAWING RULERS, DESKTOP OR STATIONERY ORGANIZERS, DESK SETS, PERSONAL ORGANIZERS, MAGNETIC BOARDS FOR SCHEDULING ACTIVITIES AND APPOINTMENTS; PLASTIC MATERIALS FOR PACKAGING NOT INCLUDED IN OTHER CLASSES, NAMELY, BAGS, ENVELOPES AND POUCHES OF PLASTIC FOR PACKAGING, PLASTIC SHOPPING BAGS; PRINTERS' TYPE; PRINTING BLOCKS, IN CLASS 16 (U.S. CLS. 2, 5, 22, 23, 29, 37, 38 AND 50).

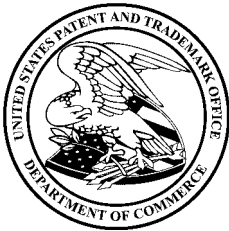

David J. Kyffers

Director of the United States Patent and Trademark Office

FOR: CLOTHING, NAMELY, DRESSES, JACKETS, SPORT JACKETS AND WIND-RESISTANT JACKETS, BLAZERS, COATS, RAIN-COATS, CLOAKS, ANORAKS, SKIRTS, TROUSERS, JEANS, SHORTS, LEGGINGS, CARDIGANS, SWEATERS, SWEAT-SHIRTS, T-SHIRTS, SHIRTS, TANK TOPS, SWEAT SUITS, GYM SUITS, BEACHWEAR, SWIMWEAR, UNDERWEAR, LOUNGEWEAR, NIGHTWEAR, BATHROBES, SOCKS, STOCKINGS, NECKTIES, ASCOTS, GLOVES, MITTENS, FINGERLESS GLOVES, SCARVES, NECKERCHIEFS, SHAWLS, SHOULDER WRAPS, MANTILLAS, FABRIC BELTS; BELTS MADE OF LEATHER OR FROM IMITATION LEATHER; FOOTWEAR; HEADGEAR, NAMELY, HATS, BERETS, CAPS, HOODS, TURBANS AND BANDANAS, IN CLASS 25 (U.S. CLS. 22 AND 39).

THE ENGLISH TRANSLATION OF THE FOREIGN WORD(S) IN THE MARK IS "LINKS".

Reg. No. 4,173,441 OWNER OF INTERNATIONAL REGISTRATION 0901399 DATED 3-8-2006, EXPIRES 3-8-2016.

SER. NO. 79-094,494, FILED 1-21-2011.

MICHELLE DUBOIS, EXAMINING ATTORNEY

United States of America
United States Patent and Trademark Office

Zigma

Reg. No. 4,173,442

Registered July 17, 2012

Int. Cl.: 19

TRADEMARK

PRINCIPAL REGISTER

ZIGMA GROUND SOLUTIONS LTD (ENGLAND PRIVATE COMPANY)
UNIT 11
M11 BUSINESS LINK.; PARSONAGE LANE; STANSTED, ESSEX CM24 8TY
UNITED KINGDOM

FOR: NON-METAL CONSTRUCTION MATERIALS, NAMELY, HEAVY-DUTY MATS MADE PRIMARILY FROM PLASTIC FOR MOVING AND OPERATING EQUIPMENT OVER SOFT OR SENSITIVE GROUND; NON-METAL CONSTRUCTION MATERIALS, NAMELY, HEAVY-DUTY MATS MADE PRIMARILY FROM PLASTIC FOR PROVIDING ACCESS FOR VEHICLES, CONSTRUCTION EQUIPMENT AND PEDESTRIANS FOR PROTECTING THE ENVIRONMENT AND FOR OFFERING SAFE PASSAGE DURING CONSTRUCTION PERIODS; NON-METAL CONSTRUCTION MATERIALS, NAMELY, HEAVY-DUTY MATS MADE PRIMARILY FROM PLASTIC USED TO CREATE TEMPORARY ROADWAYS, SITE ACCESS AND TRAVEL SURFACES FOR VEHICLES AND PEDESTRIANS; NON-METAL FENCING MADE FROM PLASTIC AND OTHER METALLIC MATERIALS, IN CLASS 19 (U.S. CLS. 1, 12, 33 AND 50).

THE MARK CONSISTS OF STANDARD CHARACTERS WITHOUT CLAIM TO ANY PARTICULAR FONT, STYLE, SIZE, OR COLOR.

PRIORITY DATE OF 9-15-2010 IS CLAIMED.

OWNER OF INTERNATIONAL REGISTRATION 1069582 DATED 2-2-2011, EXPIRES 2-2-2021.

SER. NO. 79-094,525, FILED 2-2-2011.

MICHAEL SOUDERS, EXAMINING ATTORNEY



David J. Kyros

Director of the United States Patent and Trademark Office

United States of America
United States Patent and Trademark Office

TuffTrak

Reg. No. 4,173,443

Registered July 17, 2012

Int. Cl.: 19

TRADEMARK

PRINCIPAL REGISTER

ZIGMA GROUND SOLUTIONS LTD (ENGLAND PRIVATE COMPANY)
UNIT 11,
M11 BUSINESS LINK,; PARSONAGE LANE; STANSTED, ESSEX CM24 8TY
UNITED KINGDOM

FOR: NON-METAL CONSTRUCTION MATERIALS, NAMELY, HEAVY-DUTY MATS MADE PRIMARILY FROM PLASTIC FOR MOVING AND OPERATING EQUIPMENT OVER SOFT OR SENSITIVE GROUND; NON-METAL CONSTRUCTION MATERIALS, NAMELY, HEAVY-DUTY MATS MADE PRIMARILY FROM PLASTIC FOR PROVIDING ACCESS FOR VEHICLES, CONSTRUCTION EQUIPMENT AND PEDESTRIANS FOR PROTECTING THE ENVIRONMENT AND FOR OFFERING SAFE PASSAGE DURING CONSTRUCTION PERIODS; NON-METAL CONSTRUCTION MATERIALS, NAMELY, HEAVY-DUTY MATS MADE PRIMARILY FROM PLASTIC USED TO CREATE TEMPORARY ROADWAYS, SITE ACCESS AND TRAVEL SURFACES FOR VEHICLES AND PEDESTRIANS, IN CLASS 19 (U.S. CLS. 1, 12, 33 AND 50).

THE MARK CONSISTS OF STANDARD CHARACTERS WITHOUT CLAIM TO ANY PARTICULAR FONT, STYLE, SIZE, OR COLOR.

OWNER OF INTERNATIONAL REGISTRATION 1069624 DATED 2-2-2011, EXPIRES 2-2-2021.

SER. NO. 79-094,548, FILED 2-2-2011.

MICHAEL SOUDERS, EXAMINING ATTORNEY



David J. Kyffers

Director of the United States Patent and Trademark Office

United States of America

United States Patent and Trademark Office

Blue.net

Reg. No. 4,173,444

Registered July 17, 2012

Int. Cls.: 7 and 12

TRADEMARK

PRINCIPAL REGISTER

HENGST GMBH & CO. KG (FED REP GERMANY KOMMANDITGESELLSCHAFT)
NIENKAMP 55-85
48147 MÜNSTER
FED REP GERMANY

FOR: MOTORS AND ENGINES NOT FOR LAND VEHICLES AND PARTS, NAMELY, DISC SEPARATORS, OIL FILTERS AND FILTER ELEMENTS; MOTOR AND ENGINE PARTS FOR LAND VEHICLES, NAMELY, DISC SEPARATORS, OIL FILTERS AND FILTER ELEMENTS; AND MOTOR AND ENGINE PARTS OF APPARATUS FOR USE IN LOCOMOTION BY LAND, AIR, OR WATER, NAMELY, ENGINE PARTS, NAMELY, DISC SEPARATORS, OIL FILTERS AND FILTER ELEMENTS, IN CLASS 7 (U.S. CLS. 13, 19, 21, 23, 31, 34 AND 35).

FOR: MOTORS AND ENGINES FOR LAND VEHICLES, IN CLASS 12 (U.S. CLS. 19, 21, 23, 31, 35 AND 44).

THE MARK CONSISTS OF STANDARD CHARACTERS WITHOUT CLAIM TO ANY PARTICULAR FONT, STYLE, SIZE, OR COLOR.

PRIORITY DATE OF 4-15-2010 IS CLAIMED.

OWNER OF INTERNATIONAL REGISTRATION 1069759 DATED 10-14-2010, EXPIRES 10-14-2020.

SER. NO. 79-094,596, FILED 10-14-2010.

RONALD DELGIZZI, EXAMINING ATTORNEY



David J. Kypos

Director of the United States Patent and Trademark Office

United States of America

United States Patent and Trademark Office

PUSHFIX

Reg. No. 4,173,445

Registered July 17, 2012

Int. Cls.: 6, 11 and 17

TRADEMARK

PRINCIPAL REGISTER

HERZ ARMATUREN GES.M.B.H. (AUSTRIA PRIVATE LIMITED COMPANY)
RICHARD-STRAUSS-STRASSE 22
A-1232 WIEN
AUSTRIA

FOR: COMMON METALS AND THEIR ALLOYS; IRONMONGERY BEING SMALL ITEMS OF METAL HARDWARE, NAMELY, PIPE CONNECTORS AND PIPE CONNECTOR SEALS; PIPES AND TUBES OF METAL; GOODS OF COMMON METAL, SPECIFICALLY PIPES AND TUBES, JUNCTIONS FOR PIPES AND BRANCHING PIPES OF METAL OR MAINLY OF METAL; SEALING RINGS OF METAL, PIPE MUFFS OF METAL, IN CLASS 6 (U.S. CLS. 2, 12, 13, 14, 23, 25 AND 50).

FOR: HEATING ELEMENTS, RADIATOR CAPS, IN CLASS 11 (U.S. CLS. 13, 21, 23, 31 AND 34).

FOR: RUBBER, GUTTA-PERCHA, GUM BEING RESIN IN EXTRUDED FORM FOR GENERAL INDUSTRIAL USE; ASBESTOS, MICA; PLASTICS IN EXTRUDED FORM FOR USE IN MANUFACTURE; NON-METALLIC FLEXIBLE PIPES AND TUBES; NONMETAL SEALING RINGS FOR USE AS CONNECTION SEALS; NON-METAL FITTINGS FOR FLEXIBLE PIPES, IN CLASS 17 (U.S. CLS. 1, 5, 12, 13, 35 AND 50).

THE MARK CONSISTS OF STANDARD CHARACTERS WITHOUT CLAIM TO ANY PARTICULAR FONT, STYLE, SIZE, OR COLOR.

PRIORITY DATE OF 7-29-2010 IS CLAIMED.

OWNER OF INTERNATIONAL REGISTRATION 1069856 DATED 12-22-2010, EXPIRES 12-22-2020.

SER. NO. 79-094,625, FILED 12-22-2010.

MELISSA VALLILLO, EXAMINING ATTORNEY



David J. Kyffers

Director of the United States Patent and Trademark Office

United States of America

United States Patent and Trademark Office



KOREAN EYE

Reg. No. 4,173,446

Registered July 17, 2012

Int. Cls.: 16, 35 and 41

TRADEMARK

SERVICE MARK

PRINCIPAL REGISTER

CICLITIRA, JOHN DAVID NIKOLAS (UNITED KINGDOM INDIVIDUAL)
2, AVENUE DES CITRONNIERS
MC-98000 MONACO
MONACO

FOR: PAPER, CARDBOARD AND GOODS MADE FROM THESE MATERIALS AND PRINTED MATTER, NAMELY, BOOKS, CATALOGUES, BROCHURES, MAGAZINES, BULLETINS, PRINTED PERIODICALS, POSTCARDS, AND PHOTOGRAPHS ALL IN THE FIELD OF ART; NEWSPAPERS; BOOKBINDING MATERIAL; PHOTOGRAPHS; PAINTINGS; LITHOGRAPHS; ENGRAVINGS; GICLÉE PRINTS; PRINTS; STATIONERY; CALENDARS; POSTERS; BOOKMARKS; NOTEBOOKS; GREETINGS CARDS; ADHESIVES FOR STATIONERY OR HOUSEHOLD PURPOSES; ARTISTS' MATERIALS, NAMELY, ARTISTS' BRUSHES, PASTELS, PAINTS, PALETTES, CANVAS PANELS, MODELING CLAY FOR MAKING SCULPTURES, MODELING CLAY FOR MAKING CERAMICS, AND PHOTOGRAPHIC MATERIALS, NAMELY, PHOTOGRAPHY PAPER, PHOTOGRAPHIC CROPPERS, PHOTOGRAPHIC OR ART MOUNTS, AND PHOTOGRAPHIC OR ART PRINTS; PAINT BRUSHES; TYPEWRITERS; PACKAGING MATERIALS MADE OF PAPER, CANVAS, AND TEXTILES; PRINTERS' TYPE; PRINTING BLOCKS; DISPOSABLE NAPPIES OF PAPER FOR BABIES; PAINT BOXES FOR CHILDREN; CHEQUEBOOK HOLDERS, IN CLASS 16 (U.S. CLS. 2, 5, 22, 23, 29, 37, 38 AND 50).



David J. Kyffers

Director of the United States Patent and Trademark Office

FOR: ADVERTISING; BUSINESS MANAGEMENT; BUSINESS ADMINISTRATION; PROVIDING OFFICE FUNCTIONS; PROVIDING AN ON-LINE COMPUTER DATABASE IN THE FIELD OF ART AND ART WORLD CONTACTS FOR BUSINESS PURPOSES; PROVIDING INCENTIVE AWARD PROGRAMS FOR PURCHASERS OF ARTWORK THROUGH THE ISSUANCE AND PROCESSING OF LOYALTY COUPONS FOR FREQUENT USERS OF PARTICIPATING BUSINESSES; ADVERTISING SERVICES PROVIDED VIA THE INTERNET; PRODUCTION OF TELEVISION AND RADIO ADVERTISEMENTS; ACCOUNTANCY; AUCTIONEERING; ORGANIZATION OF TRADE FAIRS FOR BUSINESS AND PROMOTIONAL PURPOSES IN THE FIELD OF ART AND ART SUPPLIES; CONDUCTING PUBLIC OPINION POLLS; DATA PROCESSING SERVICES; PROVISION OF BUSINESS INFORMATION; ONLINE RETAIL STORE SERVICES FEATURING WORKS OF ART, PAINTINGS, SCULPTURES, PRINTS, PRINTED MATTER, BOOKS, CATALOGUES, AND STATIONERY, IN CLASS 35 (U.S. CLS. 100, 101 AND 102).

FOR: EDUCATION, NAMELY, PROVIDING WORKSHOPS IN THE FIELD OF ART, TEXTILES, AND PHOTOGRAPHY; PROVISION OF TRAINING IN THE FIELD OF ART, TEX-

Reg. No. 4,173,446 TILES, AND PHOTOGRAPHY; ORGANIZING SPORTING AND CULTURAL ACTIVITIES; ORGANIZATION OF EXHIBITIONS FOR ENTERTAINMENT OR EDUCATIONAL PURPOSES FEATURING THE DISPLAY OF ART, TEXTILES, AND PHOTOGRAPHY; ARRANGING COLLOQUIA IN THE FIELD OF ART, TEXTILES, AND PHOTOGRAPHY; ORGANIZATION OF COMPETITIONS IN THE FIELD OF ART, PHOTOGRAPHY, AND THE USAGE OF TEXTILES TO CREATE WORKS OF ART; PUBLICATION OF TEXTS AND IMAGES, NAMELY, PHOTOGRAPHS AND ARTWORKS; ONLINE ELECTRONIC PUBLISHING OF BOOKS, PERIODICALS, CATALOGUES, PHOTOGRAPHS, AND ARTWORKS; PRODUCTION OF FILMS AND OF RADIO AND TELEVISION PROGRAMMES, IN CLASS 41 (U.S. CLS. 100, 101 AND 107).

NO CLAIM IS MADE TO THE EXCLUSIVE RIGHT TO USE "KOREAN", APART FROM THE MARK AS SHOWN.

OWNER OF INTERNATIONAL REGISTRATION 1069943 DATED 11-9-2010, EXPIRES 11-9-2020.

THE COLOR(S) YELLOW, RED, BLUE AND BLACK IS/ARE CLAIMED AS A FEATURE OF THE MARK.

THE MARK CONSISTS OF THE BLACK STYLIZED WORDING "KOREAN EYE" BELOW A GRAPHIC OF THREE CURVED LINES AND THREE CIRCLES, WITH ONE LINE AND ONE CIRCLE EACH APPEARING IN THE COLOR YELLOW, RED, AND BLUE.

SER. NO. 79-094,664, FILED 11-9-2010.

ALYSSA STEEL, EXAMINING ATTORNEY

United States of America

United States Patent and Trademark Office



The Chris O'Brien Lifehouse at RPA

Reg. No. 4,173,447

Registered July 17, 2012

**Int. Cls.: 18, 25, 35, 36,
41, 42 and 44**

TRADEMARK

SERVICE MARK

PRINCIPAL REGISTER

LIFEHOUSE AT RPA (AUSTRALIA COMPANY)

LEVEL 6, GLOUCESTER HOUSE

ROYAL PRINCE ALFRED HOSPITAL.; MISSENDENROAD; CAMPERDOWNROAD
AUSTRALIA

FOR: KEY CASES; WALLETS; PURSES; COIN PURSES; FANNY PACKS; BUSINESS CARD CASES; SHOPPING BAGS; BRIEFCASES; DOCUMENT PORTFOLIOS; SATCHELS; KNAPSACKS; RUCKSACKS; SCHOOL BAGS; BACKPACKS; ALL PURPOSE SPORTS BAGS; ATHLETIC BAGS; BOOK BAGS; GYM BAGS; TOTE BAGS; DUFFEL BAGS; HANDBAGS; BEACH BAGS; SUITCASES; TRUNKS AND TRAVELLING BAGS; ARTICLES OF LUGGAGE; VANITY CASES SOLD EMPTY; TOILET BAGS SOLD EMPTY; ALL THE FOREGOING GOODS MADE OF LEATHER, IMITATION LEATHER, VINYL OR COTTON; UMBRELLAS; PARASOLS; ANIMAL SKINS; ANIMAL HIDES, IN CLASS 18 (U.S. CLS. 1, 2, 3, 22 AND 41).

FOR: FOOTWEAR; CLOTHING, NAMELY, TOPS, SHIRTS, T-SHIRTS, COATS, JACKETS, JUMPERS, SWEATERS, OUTERWEAR IN THE NATURE OF MITTENS, GLOVES, SCARVES, PARKAS, CLOAKS, PONCHOS AND RAINCOATS, PANTS, JEANS, SKIRTS, TRACKSUITS, SPORTSWEAR IN THE NATURE OF TENNIS SHIRTS, TENNIS DRESSES, SHORTS, POLO SHIRTS, SWIMSUITS, RUNNING SHOES, LEGGINGS, SINGLETs, HOODED TOPS AND SWEATSHIRTS, ATHLETIC WEAR IN THE NATURE OF JERSEYS, SWEATBANDS AND WRISTBANDS, DRESSES, NIGHTWEAR, PYJAMAS, UNDERWEAR, LINGERIE; HEADWEAR, NAMELY, HATS, CAPS, HEADBANDS, SCARVES, BANDANNAS; BELTS, IN CLASS 25 (U.S. CLS. 22 AND 39).

FOR: ADMINISTRATION OF CHARITABLE FUNDS AND DONATIONS; PROMOTION AND ADVERTISING SERVICES IN CONNECTION WITH HEALTH FACILITIES AND RESEARCH; PROVIDING A WEBSITE FEATURING INFORMATION IN THE FIELD OF ADVERTISING AND PROMOTIONAL SERVICES FOR HEALTH FACILITIES AND RESEARCH AND PROVIDING INFORMATION IN THE FIELD OF ADMINISTRATION OF CHARITABLE FUNDS AND DONATIONS, IN CLASS 35 (U.S. CLS. 100, 101 AND 102).

FOR: CHARITABLE FUND RAISING; CHARITABLE COLLECTIONS, NAMELY, FUNDRAISING BY MEANS OF COLLECTING NON-CASH ITEMS IN THE NATURE OF HOUSEHOLD GOODS, CULTURAL GIFTS, STOCK SHARES, REAL AND PERSONAL PROPERTY FOR CHARITY; ORGANIZING CHARITABLE COLLECTIONS OF FUNDS AND NON-CASH ITEMS FOR OTHERS; FINANCIAL GRANT SERVICES, NAMELY, PROVIDING GRANTS FOR MEDICAL EDUCATION AND RESEARCH PURPOSES, PATIENT CARE, CAPITAL



David J. Kyjars

Director of the United States Patent and Trademark Office

Reg. No. 4,173,447 WORKS, AND PATIENT OUTREACH; PROVISION OF FUNDING FOR EDUCATIONAL AND MEDICAL RESEARCH PURPOSES, NAMELY, CASH GRANTS FOR FUNDING STAFF AND EQUIPMENT COSTS FOR EDUCATION AND MEDICAL RESEARCH PROJECTS, PROVIDING SCHOLARSHIPS AND RESEARCH PROJECT SCHOLARSHIPS; PROVISION OF FINANCIAL SUPPORT TO PATIENTS AND THEIR FAMILIES TO FACILITATE MEDICAL TREATMENT AND RELATED EXPENSES ASSOCIATED WITH THE DIAGNOSIS AND TREATMENT OF CANCER, IN CLASS 36 (U.S. CLS. 100, 101 AND 102).

FOR: EDUCATIONAL SERVICES, NAMELY, CONDUCTING CLASSES, WORKSHOPS, WEBINARS IN THE FIELD OF HEALTH CARE; ORGANIZING AND CONDUCTING SPORTING AND CULTURAL ACTIVITIES FOR THE PURPOSE OF PROMOTING HEALTH CARE, WELLNESS AND CANCER TREATMENT ISSUES, NAMELY, ORGANIZATION OF CULTURAL SHOWS, ORGANIZATION OF AMATEUR ATHLETIC COMPETITIONS; ORGANIZING AND CONDUCTING SPORTING EVENTS AND CULTURAL ACTIVITIES FOR CHARITABLE PURPOSES, NAMELY, BIKE RACES, WALKS, RUNS, MARATHONS, CAMPING, TREKKING, KAYAKING, CANOEING, SAILING AND CRICKET EVENTS, THEATER, MUSIC, DANCE AND CULTURAL PERFORMANCES; ENTERTAINMENT SERVICES, NAMELY, ARRANGING AND HOSTING ATHLETIC COMPETITIONS AND CULTURAL EVENTS AND PERFORMANCES, THE PROCEEDS OF WHICH ARE DONATED TO CHARITY; ARRANGING AND HOSTING LOTTERIES; ARRANGING AND CONDUCTING EDUCATIONAL WORKSHOPS, CONFERENCES, AND SEMINARS IN THE FIELDS OF HOLISTIC CANCER TREATMENT, RESEARCH, EDUCATION, AND WELLNESS AND SUPPORT FOR CANCER PATIENTS AND FAMILIES; PUBLICATION OF BOOKS, TEXTS AND MAGAZINES; ELECTRONIC PUBLISHING OF BOOKS, PERIODICALS, BROCHURES, PAMPHLETS; DEVELOPING AND CONDUCTING EDUCATIONAL PROGRAMS IN THE FIELDS OF HEALTH, DIET, NUTRITION, CANCER AND CANCER PREVENTION, IN CLASS 41 (U.S. CLS. 100, 101 AND 107).

FOR: SCIENTIFIC AND MEDICAL RESEARCH SERVICES; MANAGING RESEARCH PROGRAMS IN THE FIELDS OF HEALTH, DIET, NUTRITION, CANCER AND CANCER PREVENTION, NAMELY, TECHNICAL CONSULTING IN THE FIELD OF HEALTH, DIET, NUTRITION, CANCER AND CANCER PREVENTION RESEARCH PROGRAMS; PROVIDING INFORMATION ABOUT SCIENTIFIC AND MEDICAL RESEARCH IN THE FIELDS OF HEALTH, DIET, NUTRITION, CANCER AND CANCER PREVENTION, IN CLASS 42 (U.S. CLS. 100 AND 101).

FOR: MEDICAL SERVICES; PROVIDING MEDICAL ADVICE AND INFORMATION RELATING TO THE ALLEVIATION, DIAGNOSIS, PREVENTION AND TREATMENT OF CANCER; HEALTH CARE SERVICES; PROVIDING PERSONAL HEALTH CARE SUPPORT SERVICES, NAMELY, COUNSELING, ADVICE AND CONSULTATION RELATED TO MEDICAL CARE AND CANCER TREATMENT; MEDICAL SPA SERVICES, NAMELY, MINIMALLY AND NON-INVASIVE COSMETIC AND FITNESS THERAPIES FOR HEALTH AND WELLNESS OF THE BODY AND SPIRIT; PROVIDING INFORMATION IN THE FIELDS OF MEDICAL INFORMATION, CANCER DIAGNOSIS AND TREATMENT, AND HOLISTIC MEDICAL TREATMENT, IN CLASS 44 (U.S. CLS. 100 AND 101).

THE NAME(S), PORTRAIT(S), AND/OR SIGNATURE(S) SHOWN IN THE MARK DOES NOT IDENTIFY A PARTICULAR LIVING INDIVIDUAL.

PRIORITY DATE OF 5-19-2010 IS CLAIMED.

OWNER OF INTERNATIONAL REGISTRATION 1070342 DATED 11-19-2010, EXPIRES 11-19-2020.

THE MARK CONSISTS OF A FLOWER COMPRISED OF ARROW SHAPED PETALS AND STAR SHAPED CENTER AND THE WORDING "THE CHRIS O'BRIEN LIFEHOUSE AT RPA".

Reg. No. 4,173,447 SER. NO. 79-094,822, FILED 11-19-2010.

APRIL ROACH, EXAMINING ATTORNEY

United States of America

United States Patent and Trademark Office



Reg. No. 4,173,448

Registered July 17, 2012

Int. Cl.: 9

TRADEMARK

PRINCIPAL REGISTER

SECURE-IC SAS (FRANCE SOCIÉTÉ PAR ACTIONS SIMPLIFIÉE)
47 RUE VILLIERS DE L'ISLE ADAM
F-35000 RENNES
FRANCE

FOR: SCIENTIFIC, PHOTOGRAPHIC, MEASURING, SIGNALING, CHECKING, AND TEACHING APPARATUS AND INSTRUMENTS, NAMELY, COMPUTERS, TELECOMMUNICATION EXCHANGERS, TELECOMMUNICATION SWITCHES, TELECOMMUNICATION TOWERS, TELECOMMUNICATIONS CABLES, TELECOMMUNICATIONS TRANSMITTERS, COMPUTER HARDWARE, APPARATUS FOR RECORDING, TRANSMISSION, PROCESSING AND REPRODUCTION OF SOUND, IMAGES OR DATA, SIGNAL PROCESSORS, TEST MEASUREMENT INSTRUMENTATION USED FOR CHECKING AND TESTING COMPUTER SECURITY, NETWORK SECURITY, DATA SECURITY AND INTEGRATED CIRCUITS SECURITY; APPARATUS AND INSTRUMENTS FOR CONDUCTING, SWITCHING, TRANSFORMING, ACCUMULATING, REGULATING OR CONTROLLING ELECTRICITY, NAMELY, ELECTRICAL TRANSFORMERS, ELECTRIC CURRENT SWITCHES; BLANK OPTICAL DISKS; COMPUTER SOFTWARE, NAMELY, CRYPTOGRAPHY SOFTWARE; COMPUTER SOFTWARE PROVIDING CRYPTOGRAPHIC DATA SECURITY FUNCTIONS; COMPUTER SOFTWARE USED TO INTEGRATE SECURITY SERVICES, NAMELY, DIGITAL CERTIFICATE ISSUANCE, VERIFICATION AND MANAGEMENT; COMPUTER SOFTWARE FOR SECURITY MANAGEMENT FOR COMPUTERS AND COMPUTER NETWORKS; COMPUTER SOFTWARE FOR COMPUTER SECURITY USING CRYPTOGRAPHY, DIGITAL SIGNATURES, SMART CARDS, AND BIOMETRICS; ELECTRIC DETECTORS, NAMELY MOTION DETECTORS; ELECTRIC WIRES; ELECTRIC RELAYS; APPARATUS FOR RECORDING, TRANSMITTING, REPRODUCING, OR PROCESSING SOUND OR IMAGES; AUTOMATIC VENDING MACHINES; CALCULATING MACHINES; DATA PROCESSING EQUIPMENT AND COMPUTERS; COMPUTER GAME PROGRAMS; COMPUTER PERIPHERAL DEVICES; BATTERIES; INTEGRATED CIRCUIT CARDS, IN CLASS 9 (U.S. CLS. 21, 23, 26, 36 AND 38).



NO CLAIM IS MADE TO THE EXCLUSIVE RIGHT TO USE "SECURE" AND "THE TRUSTED COMPUTING COMPANY", APART FROM THE MARK AS SHOWN.

PRIORITY DATE OF 7-27-2010 IS CLAIMED.

OWNER OF INTERNATIONAL REGISTRATION 1070830 DATED 1-27-2011, EXPIRES 1-27-2021.

David J. Kybas

Director of the United States Patent and Trademark Office

Reg. No. 4,173,448 THE COLOR(S) BLACK, RED, GRAY, WHITE AND BLUE IS/ARE CLAIMED AS A FEATURE OF THE MARK.

THE MARK CONSISTS OF THE TERM "SECURE" APPEARS IN BLACK; THE CENTRAL BAR OF THE "E" IN "SECURE" IS RED, THE WORDING "THE TRUSTED COMPUTING COMPANY" APPEARS IN GRAY, THE SHIELD DESIGN APPEARS IN BLUE WITH THE LETTERS "IC" SUPERIMPOSED IN WHITE.

SER. NO. 79-095,008, FILED 1-27-2011.

REBECCA SMITH, EXAMINING ATTORNEY

United States of America

United States Patent and Trademark Office



Building Better Bones

Reg. No. 4,173,449

Registered July 17, 2012

Int. Cls.: 36, 38 and 41

INTERNATIONAL OSTEOPOROSIS FOUNDATION (SWITZERLAND NOT-FOR-PROFIT,
NON-GOVERNMENTAL FOUNDATION)
9, RUE JUSTE-OLIVIER
CH-1260 NYON
SWITZERLAND

SERVICE MARK

FOR: FUNDRAISING, NAMELY, MEDICAL RESEARCH FUNDRAISING, IN CLASS 36 (U.S. CLS. 100, 101 AND 102).

PRINCIPAL REGISTER

FOR: PROVIDING ACCESS TO COMPUTER, ELECTRONIC AND ONLINE DATABASES; TELECOMMUNICATIONS SERVICES, NAMELY, ELECTRONIC TRANSMISSION OF DATA, MESSAGES AND INFORMATION; PROVIDING ONLINE FORUMS FOR COMMUNICATION ON TOPICS OF MEDICINE AND GENERAL INTEREST; PROVIDING ONLINE COMMUNICATIONS LINKS WHICH TRANSFER WEB SITE USERS TO OTHER LOCAL AND GLOBAL WEB PAGES; PROVIDING ACCESS TO THE INTERNET, NAMELY, FACILITATING ACCESS TO THIRD PARTY WEB SITES VIA A UNIVERSAL LOGIN; PROVIDING ONLINE CHAT ROOMS AND ELECTRONIC BULLETIN BOARDS; AUDIO, TEXT AND VIDEO BROADCASTING SERVICES OVER COMPUTER OR OTHER COMMUNICATION NETWORK, NAMELY, INTERNET BROADCASTING; BROADCASTING SERVICES OVER THE INTERNET FEATURING THE UPLOADED, POSTED, DISPLAYED, AND TAGGED VIDEOS OF OTHERS; ELECTRONICALLY TRANSMITTING DATA, INFORMATION, AUDIO AND VIDEO IMAGES, IN CLASS 38 (U.S. CLS. 100, 101 AND 104).



David J. Kyjars

Director of the United States Patent and Trademark Office

FOR: EDUCATION SERVICES, NAMELY, PROVIDING CLASSES, SEMINARS, AND WORKSHOPS IN THE FIELD OF OSTEOPOROSIS AND BONE HEALTH; ARRANGEMENT OF CONFERENCES FOR EDUCATIONAL PURPOSES; ARRANGEMENT OF SEMINARS, WORKSHOPS AND EXHIBITIONS FOR EDUCATIONAL PURPOSES; PUBLICATION OF BOOKS; WRITING OF TEXTS OTHER THAN PUBLICITY TEXTS; EDUCATIONAL SERVICES, NAMELY, CONDUCTING CLASSES, SEMINARS, AND WORKSHOPS IN THE FIELD OF OSTEOPOROSIS AND BONE HEALTH AND THE DISTRIBUTION OF TRAINING MATERIALS IN CONNECTION THEREWITH; EDUCATIONAL SERVICES, NAMELY, PROVIDING ONLINE TRAINING COURSES, ONLINE SEMINARS, AND ONLINE WORKSHOPS IN THE FIELD OF OSTEOPOROSIS AND BONE HEALTH; INSTRUCTIONAL SERVICES IN THE FIELD OF OSTEOPOROSIS AND BONE HEALTH; PROVISION OF ON-LINE NON-DOWNLOADABLE ELECTRONIC PUBLICATIONS IN THE NATURE OF FACT SHEETS, ARTICLES, AND SCIENTIFIC ARTICLES AND VIDEOS, IN THE FIELD OF OSTEOPOROSIS AND BONE HEALTH; PUBLICATION OF EDUCATIONAL MATERIAL IN

Reg. No. 4,173,449 THE NATURE OF SCIENTIFIC JOURNALS, REPORTS, AUDITS, NEWSLETTERS, AND ARTICLES; TECHNOLOGICAL EDUCATION SERVICES, NAMELY, PROVIDING ONLINE CLASSES, WORKSHOPS, AND SEMINARS IN THE FIELD OF OSTEOPOROSIS AND BONE HEALTH; PUBLICATION OF ELECTRONIC JOURNALS AND WEB LOGS FEATURING USER GENERATED OR SPECIFIED CONTENT; ELECTRONIC PUBLISHING OF SCIENTIFIC JOURNALS, SURVEY REPORTS, THEMATIC REPORTS, NEWSLETTERS, AND ARTICLES FOR OTHERS, IN CLASS 41 (U.S. CLS. 100, 101 AND 107).

NO CLAIM IS MADE TO THE EXCLUSIVE RIGHT TO USE "OSTEO" , APART FROM THE MARK AS SHOWN.

PRIORITY DATE OF 8-11-2010 IS CLAIMED.

OWNER OF INTERNATIONAL REGISTRATION 1071331 DATED 2-10-2011, EXPIRES 2-10-2021.

THE COLOR(S) DARK BLUE, LIGHT BLUE AND WHITE IS/ARE CLAIMED AS A FEATURE OF THE MARK.

THE MARK CONSISTS OF A DARK BLUE OBLONG WITH THE WHITE WORD "OSTEO" ON IT, A LIGHT BLUE OBLONG SHAPE WITH THE WHITE WORD "LINK" ON IT, AND THE DARK BLUE WORDING "BUILDING BETTER BONES".

SER. NO. 79-095,166, FILED 2-10-2011.

KRISTIN CARLSON, EXAMINING ATTORNEY

United States of America

United States Patent and Trademark Office

GDX

Reg. No. 4,173,450

Registered July 17, 2012

Int. Cls.: 11 and 17

TRADEMARK

PRINCIPAL REGISTER

NEOPERL INTERNATIONAL AG (SWITZERLAND JOINT STOCK COMPANY)
PFEFFINGERSTRASSE 21
CH-4153 REINACH
SWITZERLAND

FOR: SANITARY HOSES FOR WATER SUPPLY AND WATER DRAIN FOR USE OF SANITARY INSTALLATIONS AS WELL AS COMPONENTS PARTS FOR THE AFORESAID SANITARY HOSES IF INCLUDED IN THIS CLASS; SANITARY FITTINGS NAMELY, FAUCETS, TAPS, AND SHOWER HEADS AS WELL AS COMPONENTS PARTS FOR THE AFORESAID GOODS IF INCLUDED IN THIS CLASS; SANITARY HOSES, PARTICULARLY, SHOWER HOSES FOR SANITARY INSTALLATIONS; CONNECTING HOSES FOR SANITARY INSTALLATIONS, PARTICULARLY, TAPS, FAUCETS, SHOWER HEADS AND SHOWER HOSES FOR SHOWER HEADS; SANITARY CONNECTING HOSES FOR WASHING MACHINES AND DISH WASHERS AS WELL AS COMPONENT PARTS FOR THE AFORESAID SANITARY HOSES IF INCLUDED IN THIS CLASS, IN CLASS 11 (U.S. CLS. 13, 21, 23, 31 AND 34).

FOR: CONNECTING HOSES FOR WASHING MACHINES AND DISH WASHERS AS WELL AS COMPONENT PARTS FOR THE SANITARY HOSES IF INCLUDED IN THIS CLASS, IN CLASS 17 (U.S. CLS. 1, 5, 12, 13, 35 AND 50).

THE MARK CONSISTS OF STANDARD CHARACTERS WITHOUT CLAIM TO ANY PARTICULAR FONT, STYLE, SIZE, OR COLOR.

PRIORITY DATE OF 7-16-2010 IS CLAIMED.

OWNER OF INTERNATIONAL REGISTRATION 1071642 DATED 1-4-2011, EXPIRES 1-4-2021.

SER. NO. 79-095,266, FILED 1-4-2011.

MICHAEL WEBSTER, EXAMINING ATTORNEY



David J. Kybas

Director of the United States Patent and Trademark Office

United States of America

United States Patent and Trademark Office



4 FINGERS
CRISPY CHICKEN

Reg. No. 4,173,451

Registered July 17, 2012

Int. Cl.: 43

SERVICE MARK

PRINCIPAL REGISTER

BENTO HOLDINGS PTE LTD (SINGAPORE COMPANY)
10 WINSTEDT ROAD
#01-08 BLOCK A
SINGAPORE 227977, SINGAPORE

FOR: ARRANGING FOR THE PROVISION OF FOOD AND DRINK, SNACK-BARS, CAFES, RESTAURANTS, BARS; CATERING SERVICES FOR THE PROVISION OF PREPARED, READY-TO-CONSUME AND FRESH FOOD ITEMS AND BEVERAGES FOR CONSUMPTION, IN CLASS 43 (U.S. CLS. 100 AND 101).

NO CLAIM IS MADE TO THE EXCLUSIVE RIGHT TO USE "CRISPY CHICKEN", APART FROM THE MARK AS SHOWN.

PRIORITY DATE OF 1-12-2011 IS CLAIMED.

OWNER OF INTERNATIONAL REGISTRATION 1071722 DATED 1-28-2011, EXPIRES 1-28-2021.

SER. NO. 79-095,282, FILED 1-28-2011.

MATTHEW EINSTEIN, EXAMINING ATTORNEY



David J. Kybas

Director of the United States Patent and Trademark Office

United States of America
United States Patent and Trademark Office

OXITEC

Reg. No. 4,173,452

Registered July 17, 2012

Int. Cl.: 9

TRADEMARK

PRINCIPAL REGISTER

ENOTEC GMBH PROZESS- UND UMWELTMESSTECHNIK (FED REP GERMANY LIMITED LIABILITY COMPANY)
HÖHER BIRKEN 6
51709 MARIENHEIDE, FED REP GERMANY

FOR: APPARATUS AND INSTRUMENTS FOR MEASURING THE PARTIAL PRESSURE OF OXYGEN IN FLUE GASES OF ALL TYPES OF FURNACE INSTALLATIONS AND/OR ANY OTHER TYPE OF COMBUSTION FACILITY; APPARATUS FOR THE RECORDING, STORAGE, TRANSMISSION AND REPRODUCTION OF MEASUREMENT DATA; DATA PROCESSING EQUIPMENT AND COMPUTERS FOR THE EVALUATION OF MEASUREMENT DATA; GAS MEASUREMENT ANALYSIS SYSTEMS COMPRISING MEASURING PROBES AND ZIRCONIUM OXIDE MEASURING CELLS FOR DETERMINING THE O₂ PARTIAL PRESSURE IN THE PPM AND PERCENTAGE RANGE IN NON-COMBUSTIBLE GASES OF ALL KINDS, INCLUDING FLUE GASES FROM FURNACE INSTALLATIONS OF ALL KINDS, IN THE TEMPERATURE RANGE UP TO 1400°C, IN CLASS 9 (U.S. CLS. 21, 23, 26, 36 AND 38).

THE MARK CONSISTS OF STANDARD CHARACTERS WITHOUT CLAIM TO ANY PARTICULAR FONT, STYLE, SIZE, OR COLOR.

OWNER OF INTERNATIONAL REGISTRATION 1024245 DATED 10-27-2009, EXPIRES 10-27-2019.

SER. NO. 79-095,633, FILED 2-17-2011.

SIMON TENG, EXAMINING ATTORNEY



David J. Kyffers

Director of the United States Patent and Trademark Office

United States of America
United States Patent and Trademark Office

FONDITAL

Reg. No. 4,173,453

Registered July 17, 2012

Int. Cl.: 11

TRADEMARK

PRINCIPAL REGISTER

FONDITAL S.P.A. (ITALY ITALIAN JOINT STOCK COMPANY)
VIA CERRETO, 40
VOBARNO (BRESCIA)
ITALY

FOR: PLUMBING APPARATUS, NAMELY, PIPES AND VALVES BEING PARTS OF SANITARY FACILITIES AND RADIATORS; HEATING APPARATUS, NAMELY, HEATING ELEMENTS, HEATING INSTALLATIONS, PAVEMENT HEATING APPARATUS, HEATING SYSTEMS FOR RESIDENTIAL AND COMMERCIAL BUILDINGS COMPRISED OF BIOMASS BURNERS, BOILERS, VALVES, PIPES, MANIFOLDS, SOLAR PANELS, CONTROL PANELS, SWITCHES AND ELECTRICAL WIRE, ALL SOLD AS A UNIT; BOILERS, VALVES, PIPES, MANIFOLDS, CONTROL PANEL SWITCHES, AND ELECTRICAL WIRE, ALL SOLD AS A UNIT; HEATING SYSTEMS FOR RESIDENTIAL AND COMMERCIAL BUILDINGS COMPRISED OF BOILERS, VALVES, PIPES, MANIFOLDS, SOLAR PANELS, CONTROL PANEL, SWITCHES AND ELECTRICAL WIRE, ALL SOLD AS A UNIT; RADIATORS, ELECTRIC RADIATORS, ALUMINUM RADIATORS, BOILERS, NAMELY, BOILERS FOR HEATING INSTALLATIONS, ELECTRICAL BOILERS, GAS BOILERS, HEATING BOILERS; AIR CONDITIONING AND COOLING APPARATUS; SANITARY APPARATUS, NAMELY, TOILETS, WC TOILETS, SHOWERS, BASINS, IN CLASS 11 (U.S. CLS. 13, 21, 23, 31 AND 34).

THE MARK CONSISTS OF STANDARD CHARACTERS WITHOUT CLAIM TO ANY PARTICULAR FONT, STYLE, SIZE, OR COLOR.

PRIORITY DATE OF 8-12-2010 IS CLAIMED.

OWNER OF INTERNATIONAL REGISTRATION 1072946 DATED 1-17-2011, EXPIRES 1-17-2021.

OWNER OF U.S. REG. NO. 3,174,252.

THE WORDING "FONDITAL" HAS NO MEANING IN A FOREIGN LANGUAGE.

SER. NO. 79-095,745, FILED 1-17-2011.

CHARISMA HAMPTON, EXAMINING ATTORNEY



David J. Kyffers

Director of the United States Patent and Trademark Office

United States of America

United States Patent and Trademark Office

SOLQRYST

Reg. No. 4,173,454

Registered July 17, 2012

Int. Cls.: 42 and 45

SERVICE MARK

PRINCIPAL REGISTER

DSM IP ASSETS B.V. (NETHERLANDS BESLOTEN VENNOOTSCHAP)
HET OVERLOON 1
NL-6411 TE HEERLEN
NETHERLANDS

FOR: SCIENTIFIC AND TECHNOLOGICAL SERVICES, NAMELY, ENGINEERING, ENGINEERING DESIGN SERVICES, PRODUCT RESEARCH AND DEVELOPMENT, PROVIDING SCIENTIFIC INFORMATION IN THE FIELDS OF FILTRATION, COATINGS, AND MEDICAL, BIOPHARMACEUTICAL, AND WATER PURIFICATION, RESEARCH AND DEVELOPMENT OF TECHNOLOGY IN THE FIELDS OF FILTRATION, COATINGS, AND MEDICAL, BIOPHARMACEUTICAL, AND WATER PURIFICATION; DESIGN OF NEW PRODUCTS, EQUIPMENT, AND PROCESSES FOR OTHERS IN THE FIELDS OF FILTRATION, COATINGS, AND MEDICAL, BIOPHARMACEUTICAL, AND WATER PURIFICATION, IN CLASS 42 (U.S. CLS. 100 AND 101).

FOR: INTELLECTUAL PROPERTY LICENSING SERVICES, IN CLASS 45 (U.S. CLS. 100 AND 101).

THE MARK CONSISTS OF STANDARD CHARACTERS WITHOUT CLAIM TO ANY PARTICULAR FONT, STYLE, SIZE, OR COLOR.

PRIORITY DATE OF 10-12-2010 IS CLAIMED.

OWNER OF INTERNATIONAL REGISTRATION 1072952 DATED 3-31-2011, EXPIRES 3-31-2021.

SER. NO. 79-095,751, FILED 3-31-2011.

MELISSA VALLILLO, EXAMINING ATTORNEY



David J. Kyffers

Director of the United States Patent and Trademark Office

United States of America

United States Patent and Trademark Office



ITALIAN BEAUTY

Reg. No. 4,173,455

Registered July 17, 2012

**Int. Cls.: 18, 25, 35, 38
and 41**

TRADEMARK

SERVICE MARK

PRINCIPAL REGISTER

ITALIAN BEAUTY S.R.L. (ITALY LIMITED LIABILITY COMPANY)
VIA ENRICO REGINATO, 85/H
I-31100 TREVISO
ITALY

FOR: ARTICLES MADE FROM LEATHER AND FROM ITS IMITATION, NAMELY, BAGS, SATCHELS, TOTE BAGS, SHOULDER BAGS, TOP HANDLE BAGS, CLUTCHES, EVENING BAGS, TRAVEL BAGS, PURSES, WALLETS, BRIEFCASES, TRAVELLING SETS IN THE NATURE OF LUGGAGE, MAKE-UP BAGS AND BEAUTY CASES, ALL SOLD EMPTY; AND UMBRELLAS, IN CLASS 18 (U.S. CLS. 1, 2, 3, 22 AND 41).

FOR: OUTER AND UNDER CLOTHING, NAMELY, JEANS, TROUSERS, SKIRTS, SHIRTS, LONG-SLEEVED T-SHIRTS, JUMPSUITS, WAISTCOATS, DRESSES, T-SHIRTS, TOPS, BLOUSES, SWEATSHIRTS; BRAS, BRIEFS, TEDDIES AND BUSTIERS, SUSPENDER BELTS, TIGHTS AND STOCKINGS, NIGHTSHIRTS, PYJAMAS, DRESSING GOWNS, HEAD SCARVES, SCARVES AND HATS; SHOES, NAMELY, COURT SHOES, BOOTS, PEEP TOES, HIGH HEELED ANKLE BOOTS, ANKLE BOOTS, SANDALS, SNEAKERS, BALLERINA PUMPS, TRAINERS, IN CLASS 25 (U.S. CLS. 22 AND 39).

FOR: ADVERTISING, MARKETING AND PROMOTION SERVICES; SERVICES RELATED TO ADVERTISING, MARKETING AND PROMOTION, NAMELY, ADVERTISING CONSULTATION, IN CLASS 35 (U.S. CLS. 100, 101 AND 102).

FOR: INTERNET BASED TELECOMMUNICATION SERVICES, NAMELY, ELECTRONIC DATA TRANSMISSION, IN CLASS 38 (U.S. CLS. 100, 101 AND 104).

FOR: PROFESSIONAL TRAINING IN THE FIELD OF FASHION, MARKETING AND COMMUNICATION; ARRANGING OF CULTURAL CONFERENCES, IN CLASS 41 (U.S. CLS. 100, 101 AND 107).

NO CLAIM IS MADE TO THE EXCLUSIVE RIGHT TO USE "ITALIAN", APART FROM THE MARK AS SHOWN.

PRIORITY DATE OF 7-12-2010 IS CLAIMED.

OWNER OF INTERNATIONAL REGISTRATION 1073183 DATED 1-11-2011, EXPIRES 1-11-2021.



David J. Kybas

Director of the United States Patent and Trademark Office

Reg. No. 4,173,455 THE MARK CONSISTS OF THE TERM "ITALIANBEAUTY" BENEATH A DESIGN COMPOSED OF FOUR VERTICAL ELLIPSES OF DIFFERENT SIZES; THE THREE LARGER ELLIPSES ARE INTERRUPTED, IN THE UPPER PART, BY A CIRCLE SO AS TO CREATE TWO WINGS ABOVE AN ELLIPSE, INSIDE WHICH ARE THE LETTERS "IB" IN STYLIZED FONT.

SER. NO. 79-095,828, FILED 1-11-2011.

LIEF MARTIN, EXAMINING ATTORNEY

United States of America
United States Patent and Trademark Office

MANTYS

Reg. No. 4,173,456

Registered July 17, 2012

Int. Cl.: 12

TRADEMARK

PRINCIPAL REGISTER

LEEV MOBILITY B.V. (NETHERLANDS LIMITED LIABILITY COMPANY)
KNSM-LAAN 131
NL-1019 LB AMSTERDAM
NETHERLANDS

FOR: ELECTRIC GOLF CARTS, ELECTRIC GOLF CADDIES, IN CLASS 12 (U.S. CLS. 19, 21, 23, 31, 35 AND 44).

THE MARK CONSISTS OF STANDARD CHARACTERS WITHOUT CLAIM TO ANY PARTICULAR FONT, STYLE, SIZE, OR COLOR.

OWNER OF INTERNATIONAL REGISTRATION 1073526 DATED 3-11-2011, EXPIRES 3-11-2021.

SER. NO. 79-095,987, FILED 3-11-2011.

RAUL CORDOVA, EXAMINING ATTORNEY



David J. Kyffers

Director of the United States Patent and Trademark Office

United States of America
United States Patent and Trademark Office

APEX

Reg. No. 4,173,457

Registered July 17, 2012

Int. Cl.: 42

SERVICE MARK

PRINCIPAL REGISTER

PROSYS ENGINEERING PTY LTD (AUSTRALIA COMPANY)
PO BOX 1170
GLENELG SOUTH SA 5045
AUSTRALIA

FOR: DESIGN AND DEVELOPMENT OF COMPUTER SOFTWARE FOR OPTIMIZING PROCESS CONTROL OPERATIONS OF HYDROCARBON AND MINERALS PRODUCTION AND PROCESSING; EVALUATION AND IMPLEMENTATION OF COMPUTER SOFTWARE FOR OTHERS FOR THE PURPOSE OF PROCESS CONTROL AND OPTIMIZATION OF HYDROCARBON AND MINERALS PRODUCTION AND PROCESSING, IN CLASS 42 (U.S. CLS. 100 AND 101).

THE MARK CONSISTS OF STANDARD CHARACTERS WITHOUT CLAIM TO ANY PARTICULAR FONT, STYLE, SIZE, OR COLOR.

PRIORITY DATE OF 8-24-2010 IS CLAIMED.

OWNER OF INTERNATIONAL REGISTRATION 1073578 DATED 2-17-2011, EXPIRES 2-17-2021.

SER. NO. 79-096,007, FILED 2-17-2011.

SIMON TENG, EXAMINING ATTORNEY



David J. Kyros

Director of the United States Patent and Trademark Office

United States of America

United States Patent and Trademark Office



Reg. No. 4,173,458

Registered July 17, 2012

Int. Cls.: 1 and 4

TRADEMARK

PRINCIPAL REGISTER

VROOAM LUBRICANTS HOLDING B.V. (NETHERLANDS BESLOTEN VENNOOTSCHAP)
LICHTENAUERLAAN 102-120
NL-3062 ME ROTTERDAM
NETHERLANDS

FOR: CHEMICALS USED IN INDUSTRY, NAMELY, BRAKE FLUIDS AND TRANSMISSION FLUIDS; CHEMICAL ENGINE ADDITIVES FOR ENHANCING THE PERFORMANCE OF ENGINE OILS, LUBRICATING OILS, GREASES AND INTERNAL COMBUSTION ENGINE FUELS; CHEMICALS PRODUCTS FOR NEUTRALIZING BATTERY ACID; CHEMICALS PRODUCTS FOR USE AS CORROSION AND RUST INHIBITORS; HYDRAULIC FLUIDS ESPECIALLY FOR BRAKING SYSTEMS, TRANSMISSION SYSTEMS, AND AUTOMATIC GEARBOXES; CHEMICAL ADDITIVE FLUIDS FOR THE TREATMENT OF RADIATOR SYSTEMS; ANTIFREEZE FOR RADIATOR COOLING CIRCUITS; ALL THE ABOVE PRODUCTS FOR USE IN OEM (ORIGINAL EQUIPMENT MANUFACTURING) BY THE POWERSPORTS INDUSTRY, RECREATIONAL WATERCRAFT INDUSTRY, GO-KART INDUSTRY, AND AUTOMOTIVE INDUSTRY, IN CLASS 1 (U.S. CLS. 1, 5, 6, 10, 26 AND 46).

FOR: MINERAL OILS, GREASES AND LUBRICANTS FOR INDUSTRIAL PURPOSES AND NOT FOR FUEL, NAMELY, INDUSTRIAL OILS, INDUSTRIAL LUBRICANTS, LUBRICATING OILS, AND LUBRICATING GREASES; ALL PURPOSES LUBRICANTS; LUBRICANTS FOR MOTOR VEHICLES; SILICONE BASED LUBRICANTS FOR MOTOR VEHICLES; GRAPHITE LUBRICANTS; ALL PURPOSE LUBRICANTS IN SPRAY FORM; SOLID FILM DRY LUBRICANTS; LUBRICANTS FOR SPROCKETS CHAINS; NON-MINERAL EMULSION OILS FOR USE AS A COOLING ADDITIVE FOR RADIATOR SYSTEMS; NON-CHEMICAL LUBRICANTS FOR ABSORBING MOISTURE FROM PETROLEUM BASED ENGINE FUELS SUCH AS KEROSENE, DIESEL, BIODIESEL, METHANOL, ETHANOL AND BUTANOL; ENGINE OILS; NON-CHEMICAL MOTOR OIL ADDITIVES; NON-CHEMICAL GASOLINE ADDITIVES; NON-CHEMICAL ADDITIVES FOR FUELS; NON-CHEMICAL ADDITIVES FOR LUBRICANTS, GREASES AND OILS; PETROLEUM BASED DUST ABSORBING COMPOSITIONS FOR USE ON VEHICLE CHAINS, FENDERS AND BODYWORK TO ATTRACT DUST, MUD AND GRIME; NON-CHEMICAL PETROLEUM BASED MOISTURE BINDING COMPOSITIONS FOR USE AS AN ADDITIVE TO ENGINE FUELS AND OTHER ENGINE LUBRICATING AND COOLING LIQUIDS FOR MAINTENANCE OF MOTOR VEHICLES; ALL PURPOSE LUBRICANTS, NAMELY, PENETRATING OILS; ALL THE ABOVE PRODUCTS FOR USE IN OEM (ORIGINAL EQUIPMENT MANUFACTURING) BY THE POWERSPORTS INDUSTRY, RECREATIONAL WATERCRAFT INDUSTRY, GO-KART INDUSTRY, AND AUTOMOTIVE INDUSTRY, IN CLASS 4 (U.S. CLS. 1, 6 AND 15).



David J. Kyjars

Director of the United States Patent and Trademark Office

Reg. No. 4,173,458 THE WORDING "VROOAM" HAS NO MEANING IN A FOREIGN LANGUAGE.

PRIORITY DATE OF 6-18-2010 IS CLAIMED.

OWNER OF INTERNATIONAL REGISTRATION 1074130 DATED 12-15-2010, EXPIRES 12-15-2020.

SER. NO. 79-096,252, FILED 12-15-2010.

RUSS HERMAN, EXAMINING ATTORNEY

United States of America

United States Patent and Trademark Office

EKO-66

Reg. No. 4,173,459

Registered July 17, 2012

Int. Cl.: 7

TRADEMARK

PRINCIPAL REGISTER

EKO ALTMISALTI YAKIT TASARRUF CIHAZLARI SANAYI VE DIS TICARET LIMITED
SIRKETI (TURKEY LIMITED COMPANY)
IHLAMURKUYU MAH.
TURKEY

FOR: FUEL CONVERSION APPARATUS, NAMELY, A MECHANICAL DEVICE FOR INSTALLING INTO INTERNAL COMBUSTION ENGINES TO INCREASE FUEL ECONOMY, IN THE NATURE OF A LIQUID PETROLEUM GAS CONVERSION KIT, IN CLASS 7 (U.S. CLS. 13, 19, 21, 23, 31, 34 AND 35).

THE MARK CONSISTS OF STANDARD CHARACTERS WITHOUT CLAIM TO ANY PARTICULAR FONT, STYLE, SIZE, OR COLOR.

OWNER OF INTERNATIONAL REGISTRATION 1074324 DATED 1-6-2011, EXPIRES 1-6-2021.

SER. NO. 79-096,341, FILED 1-6-2011.

LINDA MICKLEBURGH, EXAMINING ATTORNEY



David J. Kyffers

Director of the United States Patent and Trademark Office

United States of America

United States Patent and Trademark Office

SIGNIQ

Reg. No. 4,173,460

Registered July 17, 2012

Int. Cls.: 9, 42 and 45

TRADEMARK

SERVICE MARK

PRINCIPAL REGISTER

ICONIQ PTY LTD (AUSTRALIA COMPANY)
LEVEL 1
36 PIER STREET; PERTH WA 6000
AUSTRALIA

FOR: COMPUTER SOFTWARE, NAMELY, DISPLAY, PRINT AND MULTI-MEDIA PUBLISHING AND MARKETING SOFTWARE FOR CREATING, COMPOSING, PRINTING, DISPLAYING, MANAGING AND MONITORING DOCUMENTS, FORMS, PROMOTIONS, TICKETS, LABELS, SIGNS, SIGNAGE, CARDS, BADGES, BUSINESS CARDS, AND GREETING CARDS; COMPUTER SOFTWARE, NAMELY, ADD-ON-TEMPLATES FOR USE WITH DISPLAY, PRINT AND MULTI-MEDIA PUBLISHING SOFTWARE, AND ADD-ON-SOFTWARE FOR UPDATING, MAINTAINING, IMPROVING, MANAGING, MONITORING, ANALYZING AND REPORTING ON THE FUNCTIONALITY, THE USE OF, AND THE OUTPUTS OF DISPLAY, PRINT AND MULTI-MEDIA PUBLISHING AND MARKETING SOFTWARE THAT IS USED FOR CREATING, COMPOSING, PRINTING, DISPLAYING, MANAGING AND MONITORING DOCUMENTS, FORMS, PROMOTIONS, TICKETS, LABELS, SIGNS, SIGNAGE, CARDS, BADGES, BUSINESS CARDS AND GREETING CARDS; DATA PROCESSORS AND COMPUTERS PROGRAMMED WITH DISPLAY, PRINT AND MULTI-MEDIA PUBLISHING AND MARKETING SOFTWARE THAT IS USED FOR CREATING, COMPOSING, PRINTING, DISPLAYING, MANAGING AND MONITORING DOCUMENTS, FORMS, PROMOTIONS, TICKETS, LABELS, SIGNS, SIGNAGE, CARDS, BADGES, BUSINESS CARDS, AND GREETING CARDS; SOFTWARE RECORDED ON DATA MEDIA, NAMELY, DISPLAY, PRINT, AND MULTI-MEDIA PUBLISHING AND MARKETING SOFTWARE THAT IS USED FOR CREATING, COMPOSING, PRINTING, DISPLAYING, MANAGING AND MONITORING DOCUMENTS, FORMS, PROMOTIONS, TICKETS, LABELS, SIGNS, SIGNAGE, CARDS, BADGES, BUSINESS CARDS, AND GREETING CARDS; PORTABLE CABINETS AND TROLLEYS ADAPTED TO CONTAIN COMPUTERS AND/OR PRINTERS AND COMMUNICATIONS APPARATUS, PORTABLE CABINETS AND TROLLEYS ADAPTED TO CONTAIN COMPUTERS AND/OR PRINTERS AND COMMUNICATIONS APPARATUS AND CONTAINING POWER SUPPLIES THEREFORE; FIXED CABINETS ADAPTED TO CONTAIN COMPUTERS AND/OR PRINTERS AND COMMUNICATIONS APPARATUS, FIXED CABINETS ADAPTED TO CONTAIN COMPUTERS AND/OR PRINTERS AND COMMUNICATIONS APPARATUS AND CONTAINING POWER SUPPLIES THEREFORE; VIDEO AND MULTI-MEDIA EQUIPMENT, NAMELY, COMPUTER MONITORS, DISPLAY SCREENS, TELEVISIONS AND CAMERAS FOR DISPLAYING AUDIO AND VIDEO SOUNDS AND IMAGES, IN CLASS 9 (U.S. CLS. 21, 23, 26, 36 AND 38).

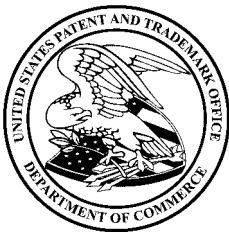

David J. Kyjars

Director of the United States Patent and Trademark Office

Reg. No. 4,173,460 FOR: DESIGN AND DEVELOPMENT OF COMPUTER HARDWARE AND SOFTWARE BEING PRINT AND MULTI-MEDIA PUBLISHING AND MARKETING SOFTWARE FOR COMPOSING, CREATING MANAGING, MONITORING AND PRINTING DOCUMENTS, LABELS, SIGNAGE, SIGNS, FORMS, PROMOTIONS, TICKETS, CARDS, BADGES, BUSINESS CARDS, AND GREETING CARDS; CUSTOMIZATION, IMPLEMENTATION, INSTALLATION, AND MAINTENANCE OF COMPUTER SOFTWARE BEING PRINT AND MULTI-MEDIA PUBLISHING AND MARKETING SOFTWARE FOR COMPOSING, CREATING MANAGING, MONITORING AND PRINTING DOCUMENTS, LABELS, SIGNAGE, SIGNS, FORMS, PROMOTIONS, TICKETS, CARDS, BADGES, BUSINESS CARDS, AND GREETING CARDS; CONSULTING AND TECHNICAL COMPUTER SUPPORT SERVICES, NAMELY, COMPUTER HELP DESK SERVICES AND TROUBLESHOOTING OF COMPUTER SOFTWARE PROBLEMS PROVIDED IN CONNECTION WITH PRINT AND MULTI-MEDIA PUBLISHING AND MARKETING SOFTWARE BEING PRINT AND MULTI-MEDIA PUBLISHING AND MARKETING SOFTWARE FOR COMPOSING, CREATING MANAGING, MONITORING AND PRINTING DOCUMENTS, LABELS, SIGNAGE, SIGNS, FORMS, PROMOTIONS, TICKETS, CARDS, BADGES, BUSINESS CARDS, AND GREETING CARDS; TECHNICAL COMPUTER SUPPORT SERVICES, NAMELY, COMPUTER HELP DESK SERVICES AND TROUBLESHOOTING OF COMPUTER SOFTWARE PROBLEMS FOR COMPUTER SOFTWARE AND INSTALLATIONS CONTAINING COMPUTER SOFTWARE FOR MERCHANDISING, ADVERTISING, AND MARKETING INCLUDING PRINTING LABELS FOR STOCK IN RETAIL AND WHOLESALE STORES AND WAREHOUSES, AND FOR COLLATING INFORMATION ON STOCK CONTROL AND STOCK LEVELS AND PHYSICAL LOCATION OF STOCK; TECHNICAL COMPUTER SUPPORT SERVICES, NAMELY, COMPUTER HELP DESK SERVICES AND TROUBLESHOOTING OF COMPUTER SOFTWARE PROBLEMS FOR COMPUTER SOFTWARE AND INSTALLATIONS CONTAINING COMPUTER SOFTWARE FOR MANAGEMENT OF MERCHANDISING, MARKETING, AND ADVERTISING, AND FOR DATA ACQUISITION AND ANALYSIS IN CONNECTION WITH MERCHANDISING, MARKETING AND PROMOTION, IN CLASS 42 (U.S. CLS. 100 AND 101).

FOR: LICENSING OF COMPUTER SOFTWARE FOR MERCHANDISING, ADVERTISING, AND MARKETING INCLUDING PRINTING LABELS FOR STOCK IN RETAIL AND WHOLESALE STORES AND WAREHOUSES, AND FOR COLLATING INFORMATION ON STOCK CONTROL AND STOCK LEVELS AND PHYSICAL LOCATION OF STOCK; LICENSING OF COMPUTER SOFTWARE FOR MANAGEMENT OF MERCHANDISING, MARKETING, AND ADVERTISING, AND FOR DATA ACQUISITION AND ANALYSIS IN CONNECTION WITH MERCHANDISING, MARKETING AND PROMOTION, IN CLASS 45 (U.S. CLS. 100 AND 101).

THE MARK CONSISTS OF STANDARD CHARACTERS WITHOUT CLAIM TO ANY PARTICULAR FONT, STYLE, SIZE, OR COLOR.

PRIORITY DATE OF 10-12-2010 IS CLAIMED.

OWNER OF INTERNATIONAL REGISTRATION 1074474 DATED 11-4-2010, EXPIRES 11-4-2020.

SER. NO. 79-096,400, FILED 11-4-2010.

KELLEY WELLS, EXAMINING ATTORNEY

United States of America

United States Patent and Trademark Office

TOTARA

Reg. No. 4,173,461

Registered July 17, 2012

Int. Cls.: 9 and 41

TRADEMARK

SERVICE MARK

PRINCIPAL REGISTER

KINEO LIMITED (UNITED KINGDOM PRIVATE LIMITED COMPANY)
100 QUEENS ROAD
BRIGHTON, EAST SUSSEX BN1 3XF
UNITED KINGDOM

FOR: SOFTWARE FOR SKILLS ASSESSMENT, JOB PERFORMANCE ASSESSMENT, AND SKILLS AND BUSINESS TRAINING FOR USE IN CONNECTION WITH E-LEARNING AND ONLINE TRAINING; EDUCATIONAL AND INSTRUCTIONAL CD-ROMS, CDS AND DVDS ALL FOR USE IN CONNECTION WITH E-LEARNING AND ONLINE TRAINING; SOFTWARE FOR SKILLS ASSESSMENT, JOB PERFORMANCE ASSESSMENT, AND SKILLS AND BUSINESS TRAINING FOR USE IN THE FIELD OF IMPROVING THE PERFORMANCE OF ORGANIZATIONS AND INDIVIDUALS WITHIN ORGANIZATIONS THROUGH E-LEARNING, TRAINING AND EDUCATION; EDUCATIONAL AND INSTRUCTIONAL CD-ROMS, CDS AND DVDS, ALL FOR USE IN THE FIELD OF IMPROVING THE PERFORMANCE OF ORGANIZATIONS AND INDIVIDUALS WITHIN ORGANIZATIONS THROUGH E-LEARNING, TRAINING AND EDUCATION; VOCATIONAL AND EDUCATIONAL SOFTWARE FOR SKILLS ASSESSMENT, JOB PERFORMANCE ASSESSMENT, AND SKILLS AND BUSINESS TRAINING FOR IMPROVING THE PERFORMANCE OF ORGANIZATIONS AND INDIVIDUALS WITHIN ORGANIZATIONS THROUGH BUSINESS RELATED E-LEARNING, TRAINING AND EDUCATION IN THE AREAS OF CAREER DEVELOPMENT, LEADERSHIP SKILLS, MANAGEMENT SKILLS, COMPLIANCE SKILLS, SALES AND CUSTOMER SERVICE SKILLS; VOCATIONAL AND EDUCATIONAL CD-ROMS, CDS AND DVDS FEATURING TRAINING AND EDUCATION IN THE AREAS OF CAREER DEVELOPMENT LEADERSHIP SKILLS, MANAGEMENT SKILLS, COMPLIANCE SKILLS, SALES AND CUSTOMER SERVICE SKILLS FOR USE IN IMPROVING THE PERFORMANCE OF ORGANIZATIONS AND INDIVIDUALS WITHIN ORGANIZATIONS, IN CLASS 9 (U.S. CLS. 21, 23, 26, 36 AND 38).



David J. Kyjars

Director of the United States Patent and Trademark Office

FOR: EDUCATION AND TRAINING IN THE FIELDS OF LEADERSHIP SKILLS, MANAGEMENT SKILLS, COMPLIANCE SKILLS, SALES AND CUSTOMER SERVICE SKILLS, NEW EMPLOYEE INITIATION AND ORIENTATION, EMPLOYEE TRAINING, CAREER DEVELOPMENT, BUSINESS POLICIES AND PROCEDURES, BUSINESS MANAGEMENT, BUSINESS IMPROVEMENT, BUSINESS ADMINISTRATION, LEGAL ISSUES PERTAINING TO BUSINESS OPERATION, AND WORKPLACE SAFETY OFFERED THROUGH WORKSHOPS, CLASSES, CORRESPONDENCE COURSES, SEMINARS, CONFERENCES, LECTURES, AND ELECTRONIC TRAINING AND ELECTRONIC LEARNING PROGRAMS; DESIGN AND PROVISION OF TRAINING PROGRAMS IN THE FIELDS OF LEADERSHIP SKILLS, MAN-

Reg. No. 4,173,461 AGEMENT SKILLS, COMPLIANCE SKILLS, SALES AND CUSTOMER SERVICE SKILLS, NEW EMPLOYEE INITIATION AND ORIENTATION, EMPLOYEE TRAINING, CAREER DEVELOPMENT, BUSINESS POLICIES AND PROCEDURES, BUSINESS MANAGEMENT, BUSINESS IMPROVEMENT, BUSINESS ADMINISTRATION, LEGAL ISSUES PERTAINING TO BUSINESS OPERATION, AND WORKPLACE SAFETY; PROVISION OF SELF-DIRECTED WORK-BASED LEARNING PROGRAMS IN THE FIELDS OF LEADERSHIP SKILLS, MANAGEMENT SKILLS, COMPLIANCE SKILLS, SALES AND CUSTOMER SERVICE SKILLS, NEW EMPLOYEE INITIATION AND ORIENTATION, EMPLOYEE TRAINING, CAREER DEVELOPMENT, BUSINESS POLICIES AND PROCEDURES, BUSINESS MANAGEMENT, BUSINESS IMPROVEMENT, BUSINESS ADMINISTRATION, LEGAL ISSUES PERTAINING TO BUSINESS OPERATION, AND WORKPLACE SAFETY; PROVISION OF ON-LINE ELECTRONIC PUBLICATIONS, NAMELY, TEXTBOOKS, COURSE BOOKS, TRAINING MANUALS, LECTURE NOTES AND MATERIALS, PERIODICALS AND NEWSLETTERS IN THE FIELDS OF LEADERSHIP SKILLS, MANAGEMENT SKILLS, COMPLIANCE SKILLS, SALES AND CUSTOMER SERVICE SKILLS, NEW EMPLOYEE INITIATION AND ORIENTATION, EMPLOYEE TRAINING, CAREER DEVELOPMENT, BUSINESS POLICIES AND PROCEDURES, BUSINESS MANAGEMENT, BUSINESS IMPROVEMENT, BUSINESS ADMINISTRATION, LEGAL ISSUES PERTAINING TO BUSINESS OPERATION, AND WORKPLACE SAFETY; ARRANGING, ORGANIZING, CONDUCT AND PROVISION OF WORKSHOPS, SEMINARS, CONFERENCES, COLLOQUIUMS, LECTURES, TEACHING COURSES, TUTORIALS, COURSES, PODCASTS AND COMPUTER AND OTHER ELECTRONIC DEVICE BASED TRAINING IN THE FIELDS OF LEADERSHIP SKILLS, MANAGEMENT SKILLS, COMPLIANCE SKILLS, SALES AND CUSTOMER SERVICE SKILLS, NEW EMPLOYEE INITIATION AND ORIENTATION, EMPLOYEE TRAINING, CAREER DEVELOPMENT, BUSINESS POLICIES AND PROCEDURES, BUSINESS MANAGEMENT, BUSINESS IMPROVEMENT, BUSINESS ADMINISTRATION, LEGAL ISSUES PERTAINING TO BUSINESS OPERATION, AND WORKPLACE SAFETY; E-LEARNING, NAMELY, PROVISION OF EDUCATIONAL AND TRAINING WORKSHOPS, CLASSES, CORRESPONDENCE COURSES, SEMINARS, CONFERENCES, LECTURES, AND ELECTRONIC TRAINING AND ELECTRONIC LEARNING PROGRAMS OFFERED THROUGH AUDIO CONFERENCE, VIDEO CONFERENCE, COMPUTER NETWORKS, COMMUNICATIONS NETWORKS, AND MULTI-MEDIA STORAGE DEVICES IN THE FIELD OF LEADERSHIP SKILLS, MANAGEMENT SKILLS, COMPLIANCE SKILLS, SALES AND CUSTOMER SERVICE SKILLS, NEW EMPLOYEE INITIATION AND ORIENTATION, EMPLOYEE TRAINING, CAREER DEVELOPMENT, BUSINESS POLICIES AND PROCEDURES, BUSINESS MANAGEMENT, BUSINESS IMPROVEMENT, BUSINESS ADMINISTRATION, LEGAL ISSUES PERTAINING TO BUSINESS OPERATION, AND WORKPLACE SAFETY; PROVISION OF ONLINE ELECTRONIC MATERIAL FOR E-LEARNING, NAMELY, NON-DOWNLOADABLE ELECTRONIC PUBLICATIONS IN THE NATURE OF TEXTBOOKS, COURSE BOOKS, TRAINING MANUALS, LECTURE NOTES AND MATERIALS, PERIODICALS IN THE FIELDS OF LEADERSHIP SKILLS, MANAGEMENT SKILLS, COMPLIANCE SKILLS, SALES AND CUSTOMER SERVICE SKILLS, NEW EMPLOYEE INITIATION AND ORIENTATION, EMPLOYEE TRAINING, CAREER DEVELOPMENT, BUSINESS POLICIES AND PROCEDURES, BUSINESS MANAGEMENT, BUSINESS IMPROVEMENT, BUSINESS ADMINISTRATION, LEGAL ISSUES PERTAINING TO BUSINESS OPERATION, AND WORKPLACE SAFETY; DELIVERY OF ONLINE COURSES, NAMELY, PROVIDING A WEB SITE FEATURING ON-LINE COURSES OF INSTRUCTION IN THE FIELDS LEADERSHIP SKILLS, MANAGEMENT SKILLS, COMPLIANCE SKILLS, SALES AND CUSTOMER SERVICE SKILLS, NEW EMPLOYEE INITIATION AND ORIENTATION, EMPLOYEE TRAINING, CAREER DEVELOPMENT, BUSINESS POLICIES AND PROCEDURES, BUSINESS MANAGEMENT, BUSINESS IMPROVEMENT, BUSINESS ADMINISTRATION, LEGAL ISSUES PERTAINING TO BUSINESS OPERATION, AND WORKPLACE SAFETY; DEVELOPMENT OF LEARNING OBJECTS AND MULTIMEDIA CONTENT FOR ONLINE COURSES IN THE FIELD OF LEADERSHIP SKILLS, MANAGEMENT SKILLS, COMPLIANCE SKILLS, SALES AND CUSTOMER SERVICE SKILLS, NEW EMPLOYEE INITIATION AND ORIENTATION, EMPLOYEE TRAINING, CAREER DEVELOPMENT, BUSINESS POLICIES AND PROCEDURES, BUSINESS MANAGEMENT, BUSINESS IMPROVEMENT, BUSINESS ADMINISTRATION, LEGAL ISSUES PERTAINING TO BUSINESS OPERATION, AND WORKPLACE SAFETY; PROVIDING A

Reg. No. 4,173,461 WEBSITE FEATURING RESOURCES, NAMELY, A WEBSITE FEATURING NON-DOWNLOADABLE AUDIO-VISUAL PUBLICATIONS IN THE NATURE OF TEXTBOOKS, COURSE BOOKS, TRAINING MANUALS, LECTURE NOTES AND MATERIALS, PERIODICALS, NON-DOWNLOADABLE SOUND RECORDINGS, NON-DOWNLOADABLE VIDEO RECORDINGS, NON-DOWNLOADABLE INSTRUCTIONAL AND TEACHING MATERIALS IN THE FIELDS OF LEADERSHIP SKILLS, MANAGEMENT SKILLS, COMPLIANCE SKILLS, SALES AND CUSTOMER SERVICE SKILLS, NEW EMPLOYEE INITIATION AND ORIENTATION, EMPLOYEE TRAINING, CAREER DEVELOPMENT, BUSINESS POLICIES AND PROCEDURES, BUSINESS MANAGEMENT, BUSINESS IMPROVEMENT, BUSINESS ADMINISTRATION, LEGAL ISSUES PERTAINING TO BUSINESS OPERATION, AND WORKPLACE SAFETY, ALL ACCESSED VIA A COMMUNICATIONS OR COMPUTER NETWORK; CORRESPONDENCE COURSES IN THE FIELDS OF LEADERSHIP SKILLS, MANAGEMENT SKILLS, COMPLIANCE SKILLS, SALES AND CUSTOMER SERVICE SKILLS, NEW EMPLOYEE INITIATION AND ORIENTATION, EMPLOYEE TRAINING, CAREER DEVELOPMENT, BUSINESS POLICIES AND PROCEDURES, BUSINESS MANAGEMENT, BUSINESS IMPROVEMENT, BUSINESS ADMINISTRATION, LEGAL ISSUES PERTAINING TO BUSINESS OPERATION, AND WORKPLACE SAFETY; ORGANIZATION OF BUSINESS SKILLS COMPETITIONS AND GAME QUIZZES FOR EDUCATIONAL PURPOSES; PROVISION OF EDUCATIONAL SERVICES, NAMELY, ASSESSMENTS, INSTRUCTION AND TRAINING FOR IMPROVING THE PERFORMANCE OF ORGANIZATIONS AND INDIVIDUALS WITHIN ORGANIZATIONS THROUGH E-LEARNING AND KNOWLEDGE TECHNOLOGY, IN CLASS 41 (U.S. CLS. 100, 101 AND 107).

THE MARK CONSISTS OF STANDARD CHARACTERS WITHOUT CLAIM TO ANY PARTICULAR FONT, STYLE, SIZE, OR COLOR.

PRIORITY DATE OF 9-9-2010 IS CLAIMED.

OWNER OF INTERNATIONAL REGISTRATION 1074921 DATED 2-24-2011, EXPIRES 2-24-2021.

SER. NO. 79-096,586, FILED 2-24-2011.

KATHRYN COWARD, EXAMINING ATTORNEY

United States of America

United States Patent and Trademark Office

ZDAR

Reg. No. 4,173,462

Registered July 17, 2012

Int. Cls.: 14, 18 and 25

TRADEMARK

PRINCIPAL REGISTER

FRANK PAPENDIECK (FED REP GERMANY INDIVIDUAL)
ZUM BRÜHL 8
90571 SCHWAIG
FED REP GERMANY AND

PETER SCHMID (FED REP GERMANY INDIVIDUAL)
STADTMÜLLERWEG 2
86956 SCHONGAU
FED REP GERMANY

FOR: JEWELLERY, PRECIOUS STONES; JEWELLERY OF LEATHER AND/OR STONE, NAMELY, AMULETS, CHAINS, RINGS, BRACELETS; HOROLOGICAL AND CHRONOMETRIC INSTRUMENTS, IN CLASS 14 (U.S. CLS. 2, 27, 28 AND 50).

FOR: LEATHER AND IMITATIONS OF LEATHER; ANIMAL SKINS, TRUNKS AND SUITCASES; UMBRELLAS, PARASOLS AND WALKING STICKS; SADDLERY, IN CLASS 18 (U.S. CLS. 1, 2, 3, 22 AND 41).

FOR: CLOTHING, NAMELY, SHIRTS, PANTS, SKIRTS, JACKETS, SCARVES, PULLOVERS, SOCKS, COATS, UNDERWEAR, GLOVES; FOOTWEAR; HEADGEAR, NAMELY, HATS, CAPS, IN CLASS 25 (U.S. CLS. 22 AND 39).

THE MARK CONSISTS OF THE WORDING "ZDAR" WITH A BACKWARD "R" IN STYLIZED FONT.

OWNER OF INTERNATIONAL REGISTRATION 1075227 DATED 2-18-2011, EXPIRES 2-18-2021.

SER. NO. 79-096,709, FILED 2-18-2011.

REGINA DRUMMOND, EXAMINING ATTORNEY



David J. Kyros

Director of the United States Patent and Trademark Office

United States of America

United States Patent and Trademark Office

STRATACELL

Reg. No. 4,173,463

Registered July 17, 2012

Int. Cl.: 19

TRADEMARK

PRINCIPAL REGISTER

BEN GOODEN (AUSTRALIA INDIVIDUAL)
PO BOX 3133
SINGLETON DC, NSW 2330, AUSTRALIA AND

REBECCA GOODEN (AUSTRALIA INDIVIDUAL)
PO BOX 3133
SINGLETON DC, NSW 2330, AUSTRALIA

FOR: STRUCTURAL ELEMENTS OF PLASTIC IN THE FORM OF MODULES AND CELLS FOR PROMOTING PLANT ROOT GROWTH AND HEALTH, AND PROMOTING FLOW OF STORMWATER; STRUCTURAL PLASTIC MODULES FORMING A LOAD BEARING MATRIX FOR SUB-GROUND PROTECTION OF TREES AND VEGETATION, AND STORAGE AND HARVESTING OF GROUNDWATER AND STORMWATER, IN CLASS 19 (U.S. CLS. 1, 12, 33 AND 50).

THE MARK CONSISTS OF STANDARD CHARACTERS WITHOUT CLAIM TO ANY PARTICULAR FONT, STYLE, SIZE, OR COLOR.

OWNER OF INTERNATIONAL REGISTRATION 1075263 DATED 4-7-2011, EXPIRES 4-7-2021.

SER. NO. 79-096,723, FILED 4-7-2011.

ALYSSA STEEL, EXAMINING ATTORNEY



David J. Kybas

Director of the United States Patent and Trademark Office

United States of America

United States Patent and Trademark Office

OXYBUL

Reg. No. 4,173,464

Registered July 17, 2012

**Int. Cls.: 3, 5, 8, 9, 10, 11,
12, 14, 15, 16, 18, 19, 20,
21, 24, 25, 26, 27, 28, 35
and 41**

TRADEMARK

SERVICE MARK

PRINCIPAL REGISTER

ÏD GROUP (FRANCE SOCIÉTÉ ANONYME)
162 BOULEVARD DE FOURMIES
F-59100 ROUBAIX
FRANCE

FOR: BLEACHING AND LAUNDERING PREPARATIONS, NAMELY, LAUNDRY BLEACH; CLEANING PREPARATIONS, NAMELY, LAUNDRY BLEACH; CLEANING, POLISHING, AND ABRASIVE PREPARATIONS; DEGREASING PREPARATIONS FOR USE AS A HOUSEHOLD CLEANER; PERFUMES; EAUX DE TOILETTE; ESSENTIAL OILS; WASHING PREPARATIONS, SOAP; DEODORANTS FOR PERSONAL USE; TOILETRY MILKS AND OILS; TALCUM POWDER FOR TOILETRY USE; ALMOND OIL FOR COSMETIC PURPOSES; ALMOND MILK FOR COSMETIC USE; COSMETIC PRODUCTS AND PREPARATIONS FOR SKINCARE AND FOR THE BATH, NAMELY, COSMETIC SKIN LOTIONS; POMADES FOR COSMETIC USE; SUNSCREEN PREPARATIONS, NAMELY, COSMETIC SUN-TANNING PREPARATIONS; SHAMPOOS; HAIR LOTIONS AND PREPARATIONS FOR HAIR CARE; DENTIFRICES; COTTON WOOL AND COTTON BUDS FOR COSMETIC USE; TISSUES IMPREGNATED WITH COSMETIC LOTIONS; INCENSE; SCENTED WOOD; POTPOURRIS; THE FOREGOING EXCLUDING ALL GOODS FOR PREVENTING AND TREATING ACNE AND SIMILAR SKIN CONDITIONS, IN CLASS 3 (U.S. CLS. 1, 4, 6, 50, 51 AND 52).

FOR: FOODSTUFFS AND LACTEAL FLOUR FOR BABIES; ANTISEPTIC COTTON, NOT IMPREGNATED WITH PREPARATIONS FOR TREATING ACNE OR SIMILAR SKIN CONDITIONS; COTTON WOOL FOR MEDICAL PURPOSES, NOT IMPREGNATED WITH PREPARATIONS FOR TREATING ACNE OR SIMILAR SKIN CONDITIONS; SANITARY PADS, NAPKINS AND PANTIES; BREAST-FEEDING PADS; STERILIZING PREPARATIONS, IN CLASS 5 (U.S. CLS. 6, 18, 44, 46, 51 AND 52).

FOR: HAND OPERATED HAND TOOLS AND IMPLEMENTS, NAMELY, CLAMPS, HAMMERS, CHISELS; NON-ELECTRIC CUTLERY, NAMELY, TABLE FORKS; SPOONS, OTHER THAN FOR FISHING AND FOR MEDICINES; SCISSORS; HAND-OPERATED GARDENING TOOLS, NAMELY, GARDENING TROWELS, WEEDING FORKS, SPADES, HOES; MECHANICAL TOOLS FOR CHOPPING AND CUTTING FOODSTUFFS, NAMELY, HAND OPERATED CHOPPERS; NON ELECTRIC CAN OPENERS; NUTCRACKERS; RAZORS, RAZOR BLADES; NAIL NIPPERS AND FILES, NAIL CLIPPERS; MANICURE AND PEDICURE SETS; ELECTRIC AND NON-ELECTRIC HAIR CLIPPERS FOR PERSONAL USE, NON-ELECTRIC CURLING IRONS, NAMELY, CURLING TONGS; HAIR-REMOVING TWEEZERS, IN CLASS 8 (U.S. CLS. 23, 28 AND 44).



David J. Kypas

Director of the United States Patent and Trademark Office

Reg. No. 4,173,464 FOR: SCIENTIFIC, OTHER THAN MEDICAL, NAUTICAL, SURVEYING, PHOTOGRAPHIC, CINEMATOGRAPHIC, OPTICAL, WEIGHING, MEASURING, SIGNALING, CHECKING AND LIFE-SAVING APPARATUS AND INSTRUMENTS, NAMELY, CAMERAS; TEACHING APPARATUS AND INSTRUMENTS, NAMELY, MEDICAL TEACHING MANNEQUINS; APPARATUS AND INSTRUMENTS FOR CONDUCTING, SWITCHING, TRANSFORMING, ACCUMULATING, REGULATING OR CONTROLLING ELECTRICITY, NAMELY, ELECTRICITY CONDUITS, ELECTRICITY LIMITERS, ADAPTERS; MATERIAL FOR ELECTRICITY MAINS, NAMELY, ELECTRICITY WIRES AND CABLES; ELECTRIC SWITCHES, SOCKETS, PLUGS AND OTHER CONTACTS, NAMELY, SAFETY CONTACT PLUGS, ELECTRICAL CONNECTORS, ELECTRICAL CONNECTIONS; FUSES, ELECTRIC SOCKET; BATTERIES, ELECTRIC; BATTERIES FOR LIGHTING; ELECTRIC IRONS, APPARATUS FOR RECORDING, TRANSMISSION OR REPRODUCTION OF SOUND OR IMAGES; AMPLIFIERS; HEADPHONES; LOUDSPEAKERS; MAGNETIC RECORDING MEDIA, NAMELY, BLANK MAGNETIC DATA CARRIERS; BLANK MAGNETIC DISKS; BLANK MAGNETIC COMPUTER TAPES; BLANK SOUND RECORDING, MAGNETIC AND OPTICAL DISKS, AUDIO AND VIDEO COMPACT DISKS, NAMELY, BLANK MAGNETIC AND OPTICAL DISKS FOR SOUND RECORDING, BLANK MAGNETIC AND OPTICAL DISKS, BLANK AUDIO AND VIDEO COMPACT DISKS; PRERECORDED MAGNETIC AND OPTICAL DISKS FEATURING MUSIC; DIGITAL, VERSATILE, OPTICAL DISK PLAYERS; DVD PLAYERS; CAMCORDERS; VIDEOTAPES, NAMELY, BLANK VIDEOTAPES, PRERECORDED VIDEOTAPES FEATURING MOVIES; FACSIMILE MACHINES; TELEPHONES APPARATUS; ADAPTERS DESIGNED FOR TELEPHONES, BATTERY CHARGERS FOR USE WITH TELEPHONES; BAGS, COVERS AND CASES SPECIALLY ADAPTED FOR MOBILE TELEPHONES AND TELEPHONE EQUIPMENT; ANSWERING MACHINES; HANDS FREE KITS FOR PHONES; TELEVISION APPARATUS, NAMELY, TELEVISIONS, TELEVISION CAMERAS, TELEVISION TRANSMITTERS; ANTENNAS; PHOTOGRAPHIC SLIDES, PROJECTION APPARATUS AND SCREENS, NAMELY, SLIDE AND PHOTOGRAPHIC PROJECTION APPARATUS, TRANSPARENCY PROJECTION APPARATUS, COMPUTER SCREENS, FLAT PANEL DISPLAY SCREENS, PROJECTION SCREENS; PHOTOGRAPH FLASH-BULBS; EXPOSED CAMERA, CINEMATOGRAPHIC, PHOTOGRAPHIC, SLIDE, X-RAY FILMS; CASES ESPECIALLY MADE FOR PHOTOGRAPHIC APPARATUS AND INSTRUMENTS; AUTOMATIC VENDING MACHINES AND MECHANISMS FOR COIN-OPERATED APPARATUS; AUTOMATED TELLER MACHINES; CALCULATING MACHINES; DATA PROCESSING APPARATUS, NAMELY, DATA PROCESSORS, MEMORIES FOR DATA PROCESSING EQUIPMENT, INTERFACE CARDS FOR DATA PROCESSING EQUIPMENT IN THE FORM OF PRINTED CIRCUITS; COMPUTERS; COMPUTER PERIPHERAL DEVICES; DATA PROCESSING EQUIPMENT, NAMELY, FLASH CARD, OPTICAL, SMART CARD READERS; FLOPPY DISKS, NAMELY, BLANK FLOPPY COMPUTER DISKS; MODEMS; ELECTRONIC AGENDAS; GAMES APPARATUS DESIGNED SOLELY TO BE USED WITH TELEVISION SETS, AN EXTERNAL DISPLAY SCREEN OR MONITOR; VIDEO GAME CARTRIDGES; BINOCULARS; OPTICS, NAMELY, SPECTACLES; SPECTACLE CASES; INTEGRATED CIRCUIT CARDS, NAMELY, BLANK INTEGRATED CIRCUIT CARDS; MAGNETICALLY ENCODED DEBIT, CREDIT, KEY, IDENTITY CARDS; CREDIT AND PAYMENT CARDS, NAMELY, MAGNETICALLY ENCODED CREDIT CARDS, MAGNETICALLY ENCODED DEBIT CARDS, ELECTRONIC AND MAGNETIC ID CARDS FOR USE IN CONNECTION WITH PAYMENT FOR SERVICES; MAGNETIC CODED PAYMENT GIFT CARDS; MAGNETICALLY ENCODED IDENTITY CARDS; TELEPHONE CARDS, NAMELY, MAGNETICALLY ENCODED PRE-PAID TELEPHONE CALLING CARDS; DIRECTIONAL COMPASSES; SWIMMING LIFE BELTS AND LIFE JACKETS; DIVING MASKS, NAMELY, FACE MASKS FOR DIVING, SCUBA DIVING MASKS, SKIN DIVING MASKS; WET SUITS; BABY, CALCULATING, WEIGHING SCALES; PROTECTIVE HELMETS; PROTECTION DEVICES FOR PERSONAL USE AGAINST ACCIDENTS, NAMELY, GLOVES FOR PERSONAL USE AGAINST ACCIDENTS, EYE COVERS FOR PROTECTIVE PURPOSES, PROTECTIVE EAR COVERINGS, PROTECTIVE EYEWEAR; NETS FOR PROTECTION AGAINST ACCIDENTS; CLOTHING FOR PROTECTION AGAINST ACCIDENTS, IRRADIATION AND FIRE; BAROMETERS; FIRE EXTINGUISHERS; EGG TIMERS; LOCKS, ELECTRIC; ELECTRIC DOOR BELLS; BURGLAR, FIRE, ELECTRONIC DOOR ALARMS; ANTI-THEFT ALARMS; MAGNETS; DECORATIVE MAGNETS , IN CLASS 9 (U.S. CLS. 21, 23, 26, 36 AND 38).

Reg. No. 4,173,464 FOR: BABY BOTTLES, BABY BOTTLE TEATS; SPOONS FOR ADMINISTERING MEDICINE; DROPPERS FOR MEDICAL USE, SOLD EMPTY; BABY PACIFIERS; BREAST-FEEDING TEATS IN THE NATURE OF NIPPLE PROTECTORS MADE OF LATEX OR SILICONE; TEETHING RINGS; BREAST-FEEDING APPARATUS, NAMELY, BREAST PUMPS; THERMOMETERS FOR MEDICAL USE; MATERNITY BELTS FOR MEDICAL PURPOSES; UMBILICAL BELTS; NASAL ASPIRATOR DEVICES, IN CLASS 10 (U.S. CLS. 26, 39 AND 44).

FOR: APPARATUS FOR LIGHTING, HEATING, STEAM GENERATING, COOKING, REFRIGERATING, DRYING, VENTILATING, AIR-CONDITIONING, DISINFECTING, WATER SUPPLY, NAMELY, REFRIGERATORS, GAS COOKING OVENS, WATER HEATERS; SANITARY INSTALLATIONS IN THE NATURE OF STEAM ROOMS; ELECTRIC APPARATUS FOR AIR DEODORIZING AND PURIFICATION; ELECTRIC FANS FOR PERSONAL USE; WATER PURIFYING APPARATUS; STERILIZERS; FILTERS FOR DRINKING WATER; SOLAR COLLECTORS FOR HEATING; REFRIGERATING CONTAINERS, NAMELY, REFRIGERATED BEVERAGE DISPENSING UNITS; ELECTRICAL PRESSURE COOKERS; ELECTRIC BABY-BOTTLE HEATERS; ELECTRIC KETTLES; ICE BOXES; COOKING INSTALLATIONS, NAMELY, COOKING OVENS, COOKTOPS; REFRIGERATORS; ICE APPARATUS, NAMELY, ICE-MAKING MACHINES; HAIR DRYERS; ELECTRIC LAUNDRY DRYERS; PLATE WARMERS; ELECTRIC LAMPS AND LIGHT BULBS; LAMPS, IN CLASS 11 (U.S. CLS. 13, 21, 23, 31 AND 34).

FOR: VEHICLES, NAMELY, LAND VEHICLES; APPARATUS FOR LOCOMOTION BY LAND, AIR OR WATER, NAMELY, AIR CUSHION VEHICLES; BOATS, CANOES, MOTORCYCLES, BICYCLES, GOODS HANDLING CARTS; SUN-BLINDS FOR AUTOMOBILES; SAFETY HEADRESTS AND SAFETY BELTS FOR VEHICLE SEATS; CHILD SAFETY SEATS FOR VEHICLES; BICYCLE PARTS, NAMELY, KICKSTANDS, FRAMES, BRAKES, HANDLEBARS, SADDLES, PUMPS FOR BICYCLES; NETS IN THE NATURE OF MESH PANNIER BAGS FOR BICYCLES; BABY CARRIAGES; FITTED VEHICLE COVERS, VEHICLE SEAT COVERS; LUGGAGE RACKS FOR MOTOR CARS; BICYCLE RACKS FOR MOTOR CARS; SKI RACKS FOR VEHICLES; BABY STROLLERS; BABY STROLLER COVERS; ANTI-THEFT DEVICES FOR VEHICLES; SHOPPING TROLLEYS, IN CLASS 12 (U.S. CLS. 19, 21, 23, 31, 35 AND 44).

FOR: PRECIOUS METALS AND THEIR ALLOYS OTHER THAN FOR DENTAL USE; JEWELRY ITEMS, NAMELY, RINGS; JEWELRY; PRECIOUS STONES; JEWELRY CASES OF PRECIOUS METAL; JEWELRY CASKETS; HOROLOGICAL AND CHRONOMETRIC INSTRUMENTS; WATCHES AND WATCHBANDS; CUFFLINKS, TIE PINS, ORNAMENTAL PINS, LAPEL PINS BEING JEWELRY; NOVELTY KEY RINGS OF PRECIOUS METAL; SUN DIALS; BOXES OF PRECIOUS METAL; COLLECTIBLE COINS; FIGURINES, NAMELY, STATUETTES OF PRECIOUS METAL; WORKS OF ART OF PRECIOUS METAL OR PRECIOUS STONES; LAPEL PINS, IN CLASS 14 (U.S. CLS. 2, 27, 28 AND 50).

FOR: MUSICAL INSTRUMENTS; COMPONENT PARTS FOR MUSICAL INSTRUMENTS, NAMELY, METAL MOVABLE SUPPORT ARMS FOR PIANO LIDS; MUSIC BOXES; BRIDGES FOR MUSICAL INSTRUMENTS, NAMELY, GUITAR BRIDGES; TUNING FORKS; CASES FOR MUSICAL INSTRUMENTS, IN CLASS 15 (U.S. CLS. 2, 21 AND 36).

FOR: PAPER; UNPROCESSED AND SEMI-PROCESSED CARDBOARD; CARDBOARD FOR STATIONERY USE; CARDBOARD ARTICLES, NAMELY, CARDBOARD BOXES, CARDBOARD CARTONS, CARDBOARD CONTAINERS; PAPER AND PLASTIC PACKAGING BAGS, POUCHES AND SHEETS; PAPER SHEETS, NAMELY, STATIONERY; PRINTED MATTER, NAMELY, PRINTED AWARDS, PRINTED CALENDARS, PRINTED CHARTS; PRINTING TYPE; BOOKBINDING MATERIALS; PHOTOGRAPHS; PRINTING BLOCKS; STATIONERY; ADHESIVE GLUES FOR STATIONERY OR HOUSEHOLD PURPOSES; ARTISTS' MATERIALS, NAMELY, ARTISTS' BRUSHES, ARTISTS' PASTELS, ARTISTS' PENCILS, ARTISTS' PENS; PAINTBRUSHES; ARTICLES FOR USE IN SCHOOL, NAMELY, PAINT BOXES; MODELING PASTE; TYPEWRITERS AND OFFICE REQUISITES EXCEPT FURNITURE, NAMELY, FRANKING MACHINES, PAPER EMBOSSERS, PUNCHES; PRINTED

Reg. No. 4,173,464 INSTRUCTIONAL AND TEACHING MATERIAL IN THE FIELD OF ART; WRITING AND DRAWING MATERIALS, NAMELY, DRAWING BRUSHES, DRAWING INSTRUMENTS, WRITING INSTRUMENTS; SCHOOL SUPPLIES, NAMELY, SCHOOL WRITING BOOKS, PENS, PENCILS; STAPLES FOR OFFICES; THUMB TACKS; PENCIL SHARPENERS; CORRECTING FLUIDS FOR TYPE; PAPER KNIVES; PENCILS; WRITING CHALK; PENCIL LEAD HOLDERS; RUBBER ERASERS; ENVELOPES; CARD, DOCUMENT, LETTER FILES; COIN, EVENTS, PHOTOGRAPHIC ALBUMS; BOOKS AND PRINTED PERIODICALS IN THE FIELD OF MUSIC; COMIC BOOKS; ALMANACS; PAMPHLETS IN THE FIELD OF MUSIC, ADVERTISING; WRITING AND DRAWING BOOKS, NAMELY, SCHOOL WRITING BOOKS, DRAWING PADS, DRAWING TABLETS; CATALOGUES IN THE FIELD OF MUSIC; CALENDARS; LITHOGRAPHS; ENGRAVINGS; PAINTINGS; POSTERS; GEOGRAPHICAL MAPS; NEWSPAPERS; SPOOLS FOR INKING RIBBONS; MAILERS, NAMELY, MAILING LABELS, CARDBOARD MAILING TUBES, PAPER MAIL POUCHES; POSTAGE STAMPS; OFFICE REQUISITES, NAMELY, ADHESIVE TAPE DISPENSERS; TISSUES OF PAPER FOR REMOVING MAKE-UP; BABIES' DIAPERS OF PAPER AND CELLULOSE; PICTURES; DECALCOMANIAS; GARBAGE BAGS OF PAPER AND OF PLASTICS; BAGS FOR MICROWAVE COOKING; SIGNBOARDS OF PAPER AND CARDBOARD; TOILET PAPER; BIBS OF PAPER; TABLE LINEN OF PAPER; TOWELS OF PAPER, HANDKERCHIEFS OF PAPER; GREETING CARDS; POSTCARDS; PATTERNS FOR DRESSMAKING; TERRESTRIAL GLOBES; NON-MAGNETICALLY ENCODED LOYALTY CARDS; NON-MAGNETICALLY ENCODED IDENTITY CARDS, IN CLASS 16 (U.S. CLS. 2, 5, 22, 23, 29, 37, 38 AND 50).

FOR: LEATHER AND IMITATIONS OF LEATHER; ANIMAL SKINS; TRUNKS; SUITCASES; SMALL CASES, NAMELY, ATTACHÉ CASES, CALLING CARD CASES, BUSINESS CARD CASES; UMBRELLAS; PARASOLS; WALKING STICKS; WHIPS; HARNESSES AND SADDLERY; HANDBAGS; BEACH BAGS; BAGS, NAMELY, ATHLETIC BAGS, ALL-PURPOSE CARRYING BAGS; TRAVELING SETS CONSISTING OF TRAVELING BAGS, GARMENT BAGS FOR TRAVEL, GROOMING ORGANIZERS FOR TRAVEL; TRUNKS; VANITY CASES, NOT FITTED; COSMETIC SETS CONSISTING OF COSMETIC BAGS SOLD EMPTY, COSMETIC CASES SOLD EMPTY; SHOPPING NETS AND BAGS, NAMELY, MESH SHOPPING BAGS, STRING BAGS FOR SHOPPING, CANVAS SHOPPING BAGS, LEATHER SHOPPING BAGS; BACKPACKS; SPORTS BAGS EXCEPT THOSE ADAPTED TO THE PRODUCT THAT THEY ARE INTENDED TO CONTAIN; WHEELED SHOPPING BAGS; GARMENT BAGS FOR TRAVEL; SCHOOL BAGS; WALLETS; NOTECASES, NAMELY, NAME, BUSINESS, CALLING CARD CASES; BRIEFCASES; BRIEFCASES; LEATHER KEY CASES; PURSES; TOOL BAGS OF LEATHER SOLD EMPTY; HAT BOXES OF LEATHER; SACHEL BAGS, NAMELY, SACHELS, SCHOOL SACHEL; SLINGS FOR CARRYING INFANT CHILDREN; COLLARS AND CLOTHING FOR ANIMALS, IN CLASS 18 (U.S. CLS. 1, 2, 3, 22 AND 41).

FOR: BUILDING MATERIALS, NOT OF METAL, NAMELY, BUILDING GLASS, SEMI-WORKED WOODS, BUILDING STONE; CEMENT, NAMELY, CEMENT AGGREGATES, CEMENT MIXES, FILLING CEMENT; CONCRETE; COATINGS, NAMELY, ASPHALT ROOF COATINGS, BITUMINOUS ROOF COATINGS, PROTECTIVE SEALING COATINGS SOLD AS AN INTEGRAL COMPONENT OF GRANITE AND STONE; PLASTER; ARTIFICIAL, BUILDING, FOOTING STONE; MARBLE; BUILDING TIMBER; WOOD VENEER; WOOD PANELLING; PLYWOOD; PARQUET FLOOR BOARDS; FIRED, UNFIRED, COMMEMORATIVE, GLASS BRICKS; WINDOW GLASS FOR BUILDING; SURFACINGS FOR BUILDING, NAMELY, NONSTRUCTURAL BUILDING MATERIALS IN THE NATURE OF GRANITE USED IN DECORATIVE SURFACE APPLICATIONS FOR COUNTERTOPS AND VANITY TOPS; TILE FLOORINGS, NOT OF METAL, NAMELY, FLOOR TILES OF WOOD, RUBBER FLOOR TILES, NON-METAL FLOOR TILES; CHIMNEYS, NOT OF METAL; STAIRCASES, NOT OF METAL; WINDOWS AND DOORS, NOT OF METAL; EXTERIOR BLINDS, NOT OF METAL AND NOT OF TEXTILE; NON-METAL SWIMMING POOLS; NON-METALLIC SWIMMING POOLS; CABANAS NOT OF METAL; WATER PIPES, NOT OF METAL; NON-METALLIC TRANSPORTABLE BUILDINGS; NON-TRANSPORTABLE NON-METALLIC BUILDINGS, NAMELY, PREFABRICATED NON-METAL BUILDINGS; AQUARIA STRUCTURES, NAMELY, AQUARIUM GRAVEL, AQUARIUM SAND, DECORATIVE AQUARIUM

Reg. No. 4,173,464 STONES; MONUMENTS, NOT OF METAL; ADVERTISEMENT COLUMNS, NOT OF METAL; DUCKBOARDS, NOT OF METAL, IN CLASS 19 (U.S. CLS. 1, 12, 33 AND 50).

FOR: FURNITURE; DISPLAY STANDS; LOOKING GLASSES, NAMELY, MIRRORS; FRAMES EXCEPT CONSTRUCTION FRAMES, NAMELY, BED FRAMES, PICTURE FRAMES, FURNITURE FRAMES, MIRROR FRAMES; WORKS OF ART MADE OF WOOD, WAX, PLASTER, CORK, REED, CANE, WICKER, HORN, BONE, IVORY, WHALEBONE, SHELL, AMBER, MOTHER-OF-PEARL, MEERSCHAUM AND SUBSTITUTES FOR ALL THESE MATERIALS OR PLASTIC; NON-METALLIC BASKETS AND TRAYS, NAMELY, NON-METALLIC BASKETS FOR TRANSPORTING GOODS FOR COMMERCIAL PURPOSES, NON-METALLIC BAKERS BREAD BASKETS, COMPUTER KEYBOARD TRAYS, PACKAGING MATERIALS IN THE NATURE OF RIGID PLASTIC TRAYS; PACKAGING CONTAINERS OF PLASTIC; DECORATIVE, LETTER BOXES OF WOOD AND PLASTIC; HOUSES FOR HOUSEHOLD PETS, NAMELY, PET CRATES, PLAYHOUSES FOR PETS; BEDS FOR HOUSEHOLD PETS; DISPLAY BOARDS; WORK BENCHES; EMBROIDERY FRAMES; REGISTRATION PLATES IN THE NATURE OF NOVELTY LICENSE PLATES, NOT OF METAL, NON-METAL IDENTITY PLATES, NON-METAL NAME PLATES, NONMETAL NOVELTY LICENSE PLATES; SIGNBOARDS OF WOOD AND PLASTICS; NON-METALLIC AND NON-ELECTRICAL METAL WORK, NAMELY, NON-METAL HOSE HANGERS, NON-METAL CASTORS, NON-METAL BOLTS; NON-METALLIC HINGES AND PEGS; PLAYPENS FOR BABIES; CRADLES; INFANT WALKERS; BEDDING MATERIAL EXCLUDING LINEN, NAMELY, BED FRAMES, BED HEADBOARDS, BED PILLOWS, BED MATTRESSES; BEDS; SLEEPING BAGS FOR CAMPING; CUSHIONS; PILLOWS; BOLSTERS; BEDSPRINGS; MATTRESSES; CLOTHES HANGERS; COVERS, NAMELY, FITTED FABRIC FURNITURE COVERS, PLASTIC TISSUE BOX COVERS, FITTED COVERS FOR HIGH CHAIRS; CURTAIN RINGS, RODS AND HOOKS; DOOR HANDLES, NOT OF METAL; TOWEL DISPENSERS, FIXED, NOT OF METAL; COSTUME DISPLAY STANDS; UMBRELLA STANDS; LADDERS OF WOOD AND PLASTICS; DECORATIONS OF PLASTIC FOR FOODSTUFFS; DRINKING STRAWS; SLATTED INDOOR BLINDS; MANNEQUINS; FANS FOR PERSONAL USE, NON-ELECTRIC, IN CLASS 20 (U.S. CLS. 2, 13, 22, 25, 32 AND 50).

FOR: NON-ELECTRIC UTENSILS FOR HOUSEHOLD OR KITCHEN USE, NAMELY, SPATULAS, STRAINERS, TURNERS, SIEVES; CONTAINERS FOR HOUSEHOLD OR KITCHEN USE; COMBS; BATH, CLEANING, SCOURING SPONGES; BRUSHES, EXCEPT PAINT BRUSHES, NAMELY, BATH BRUSHES, CLEANING BRUSHES FOR HOUSEHOLD USE, COSMETIC BRUSHES; BROOMS; BOWLS; ARTICLES FOR CLEANING PURPOSES, NAMELY, CLEANING CLOTHS, CLEANING SPONGES, CLEANING RAGS; STEEL WOOL; GLOVES FOR HOUSEHOLD PURPOSES; CLEANING CLOTHS; CHAMOIS LEATHER FOR CLEANING; GLASS, UNWORKED OR SEMIWORKED, EXCEPT BUILDING GLASS; UTENSILS FOR KITCHEN AND TABLEWARE USE OF GLASS, PORCELAIN AND EARTHENWARE, NAMELY, BEVERAGE GLASSWARE, GLASS DISHES, FRUIT BOWLS OF GLASS; COOKING POT SETS; THERMALLY INSULATED CONTAINERS FOR FOOD AND BEVERAGES; DRINKING FLASKS FOR TRAVELERS; NON-ELECTRIC PORTABLE COOLERS; TABLEWARE, OTHER THAN KNIVES, FORKS AND SPOONS, NAMELY, PLATES, BOWLS, DRINKING GLASSES; VASES; NON-ELECTRIC CANDELABRA; CANDLE EXTINGUISHERS; PICNIC BASKETS FITTED WITH DISHES; CORKSCREWS; BOTTLE OPENERS; BOXES OF METAL FOR DISPENSING PAPER TOWELS; TOWEL RAILS AND RINGS; SOAP AND TOILET PAPER DISPENSERS; TOILET PAPER HOLDERS; CHAMBER POTS; DRYING RACKS FOR WASHING, NAMELY, CLOTHES DRYING RACKS, DISH DRYING RACKS; CLOTHES PEGS; DUST BINS; IRONING BOARDS AND IRONING BOARD COVERS; ISOTHERMIC BAGS, NAMELY, THERMAL INSULATED BAGS FOR FOOD OR BEVERAGES; INSECT TRAPS; FLOWER POTS; COVERS, NOT OF PAPER, FOR FLOWER POTS; LITTER TRAYS FOR PETS; LITTER TRAYS FOR PETS; CAGES FOR HOUSEHOLD PETS; INDOOR AQUARIA; COMBS FOR ANIMALS; WATERING DEVICES, NAMELY, WATER TROUGHS, WATERING CANS, WATERING POTS; GARDENING GLOVES; TOOTHBRUSHES; FLOSS FOR DENTAL PURPOSES; SOAP BOXES; COSMETIC UTENSILS, NAMELY, MICRODERMABRASION SPONGES FOR COSMETIC USE, NON-WOVEN FABRIC COSMETIC WIPES; TOILET SETS CONSISTING OF TOILET BRUSHES, TOILET

Reg. No. 4,173,464 BRUSH HOLDERS, TOILET SPONGES; PERFUME VAPORIZERS AND ATOMIZERS, SOLD EMPTY; PORTABLE BABY BATHTUBS; SHOE HORNS; PIGGY BANKS, NOT OF METAL; WORKS OF ART OF PORCELAIN, TERRA-COTTA AND GLASS , IN CLASS 21 (U.S. CLS. 2, 13, 23, 29, 30, 33, 40 AND 50).

FOR: FABRIC, NAMELY, FABRIC FOR THE MANUFACTURE OF CLOTHING, FABRIC FOR TEXTILE USE, COTTON FABRIC; ADHESIVE FABRIC FOR APPLICATION BY HEAT; UPHOLSTERY FABRICS; BED AND HOUSEHOLD LINEN; TABLE LINEN, NOT OF PAPER; BED, BATH SHEETS; PILLOWCASES; BED COVERS; BATH LINEN, EXCEPT CLOTHING; TEXTILE FACE CLOTHS AND TOWELS; BILLIARD CLOTH; WALL HANGINGS OF TEXTILE; CURTAINS OF TEXTILE AND PLASTIC; TABLECLOTHS, NOT OF PAPER; OILCLOTH FOR USE AS TABLECLOTHS; SLEEPING BAGS IN THE NATURE OF SHEETING; NAPKINS, OF CLOTH, FOR REMOVING MAKE-UP; MOSQUITO NETS; LABELS OF CLOTH; CANVAS FOR EMBROIDERY; LOOSE COVERS FOR FURNITURE, NAMELY, UNFITTED FURNITURE COVERS NOT OF PAPER; BLINDS OF TEXTILE, NAMELY, FABRIC WINDOW CURTAINS AND DRAPERIES; HANDKERCHIEFS OF TEXTILE, IN CLASS 24 (U.S. CLS. 42 AND 50).

FOR: CLOTHING, NAMELY, SHIRTS, PANTS, JACKETS; KNITWEAR, NAMELY, KNIT BOTTOMS, KNIT DRESSES, KNIT JACKETS; UNDERWEAR; PAJAMAS; DRESSING GOWNS; SWEATERS; SKIRTS; FROCKS; TROUSERS; JACKETS; COATS; WATERPROOF CLOTHING, NAMELY, WATERPROOF JACKETS AND PANTS; SHIRTS; NECKTIES; SCARVES; SASHES FOR WEAR; BELTS; CLOTHING GLOVES; BRACES FOR CLOTHING; HEADGEAR FOR WEAR, NAMELY, HATS, CAPS, BERETS, VISORS; HATS; CAPS; FOOTWEAR; SOCKS; STOCKINGS; TIGHTS; FOOTWEAR EXCLUDING ORTHOPEDIC FOOTWEAR; SLIPPERS, BOOTS; BEACH SHOES, SKI BOOTS; BOOTS FOR SPORTS; BATHING TRUNKS AND COSTUMES; CLOTHING FOR SPORTS EXCLUDING DIVING CLOTHING, NAMELY, SPORTS JERSEYS, SPORTS VESTS, SKI WEAR; LAYETTES; BABIES' DIAPERS OF TEXTILE; BABIES' PANTS, IN CLASS 25 (U.S. CLS. 22 AND 39).

FOR: HABERDASHERY, EXCEPT THREAD, NAMELY, BEADS OTHER THAN FOR MAKING JEWELRY; LACE TRIMMINGS; LACE AND EMBROIDERY; RIBBONS AND BRAID; BUTTONS; HOOKS AND EYES; MARKING, SEWING, SAFETY PINS AND NEEDLES; SNAP FASTENERS; ARTIFICIAL FLOWERS AND FRUITS; HOOKS AND FASTENERS IN THE NATURE OF SNAP FASTENERS, SNAP CLIPS FOR CLOTHING; CLOTHING BUCKLES; ORNAMENTAL NOVELTY BADGES; HAT ORNAMENTS NOT OF PRECIOUS METAL; HAIR ORNAMENTS; HAIR BANDS AND HAIR NETS; HAIR PINS AND GRIPS; BARRETTES; WIGS; ZIP FASTENERS; SHOE LACES; BUCKLES FOR FOOTWEAR; FASTENINGS FOR SUSPENDERS; BELT CLASPS; ELASTIC RIBBONS; LACEWORK, NAMELY, FRILLS FOR ATTACHMENT TO CLOTHING; HABERDASHERY, NAMELY, HEAT ADHESIVE PATCHES FOR DECORATION AND REPAIR OF TEXTILE ARTICLES; SPANGLES FOR CLOTHING; SEWING BOXES, IN CLASS 26 (U.S. CLS. 37, 39, 40, 42 AND 50).

FOR: CARPETS, MATS, RUGS, LINOLEUM FOR COVERING EXISTING FLOORS; FLOOR COVERINGS; NON-TEXTILE WALL HANGINGS; BATH MATS; GYMNASIUM EXERCISE MATS; NON-SLIP MATS FOR BATHS, IN CLASS 27 (U.S. CLS. 19, 20, 37, 42 AND 50).

FOR: GAMES, NAMELY, BOARD GAMES, CARD GAMES, HAND HELD UNITS FOR PLAYING ELECTRONIC GAMES OTHER THAN THOSE ADAPTED FOR USE WITH AN EXTERNAL DISPLAY SCREEN OR MONITOR; TOYS, NAMELY, ACTION FIGURES, ELECTRONIC LEARNING TOYS; GYMNASIUM AND SPORTING ARTICLES EXCEPT FOR SWIMMING ARTICLES, CLOTHING, FOOTWEAR AND MATS, NAMELY, GYMNASIUM APPARATUS, HORIZONTAL BARS, BASKETBALLS, BASEBALL BATS; RACKETS; PARTS OF SPORTS SUITS, NAMELY, PROTECTIVE PADDING FOR PLAYING FOOTBALL, SOCCER, HOCKEY; SHIN GUARDS, NAMELY, SHIN PADS FOR ATHLETIC USE; KNEE GUARDS, NAMELY, KNEE PADS FOR ATHLETIC USE; NETS FOR SPORTS; ARCHERY IMPLEMENTS; CLAY PIGEON TRAPS; TARGETS, DARTS; FENCING WEAPONS; DISCUSSES FOR SPORTS; SKIS; SURF BOARDS; SKATING BOOTS WITH SKATES ATTACHED; ICE SKATES; ROLLER SKATES; SKATEBOARDS; KITES; ORNAMENTS FOR CHRISTMAS

Reg. No. 4,173,464 TREES EXCEPT ILLUMINATION ARTICLES AND CONFECTIONERY; NOVELTIES FOR PARTIES AND DANCES, NAMELY, PAPER AND PLASTIC PARTY HATS, PARTY GAMES, PARTY FAVORS IN THE NATURE OF CRACKERS AND NOISEMAKERS; TOY MASKS; SWINGS; BOWLING BALLS, BOWLING PINS, BOWLING BAGS; PLAY BALLS AND BALLOONS; ROCKING HORSES; SPORTS AND PLAY ARTICLES, NAMELY, PLAY, INFLATABLE SWIMMING POOLS; MARBLES AND COUNTERS FOR GAMES; PLUSH TOYS; DOLLS AND DOLLS' HOUSES; PUPPETS; DOLLS' CLOTHES; TOY FIGURINES, NAMELY, MODELED PLASTIC TOY FIGURINES, ATTACHABLE, WEARABLE, MAGNETIC TOY FIGURINES; PARLOR GAMES; BUILDING GAMES; TOY SPINNING TOPS; TOY MOBILES; TOY VEHICLES; TOY SCOOTERS; KITES; GAMES AND GAME APPLIANCES OTHER THAN THOSE DESIGNED TO BE USED ONLY WITH TELEVISION RECEIVER, AN EXTERNAL DISPLAY SCREEN OR MONITOR, NAMELY, ELECTRONIC GAMES OTHER THAN THOSE ADAPTED FOR USE WITH TELEVISION RECEIVERS ONLY, FLOOR-STANDING UNITS FOR PLAYING ELECTRONIC GAMES OTHER THAN IN CONJUNCTION WITH A TELEVISION OR COMPUTER, HAND HELD UNITS FOR PLAYING ELECTRONIC GAMES OTHER THAN THOSE ADAPTED FOR USE WITH AN EXTERNAL DISPLAY SCREEN OR MONITOR, IN CLASS 28 (U.S. CLS. 22, 23, 38 AND 50).

FOR: ADVERTISING; PUBLICATION OF PUBLICITY TEXTS; DIRECT MAIL ADVERTISING; BILL POSTING, NAMELY, BILL STICKING, BILL PRESENTMENT SERVICES; COMMERCIAL AND INDUSTRIAL MANAGEMENT ASSISTANCE; BUSINESS MANAGEMENT; BUSINESS MANAGEMENT ASSISTANCE; EFFICIENCY EXPERTS; BUSINESS CONSULTING, INFORMATION AND INQUIRIES; ORGANIZATION AND MANAGEMENT OF SHOPPING MALLS, NAMELY, BUSINESS ORGANIZATION CONSULTING FOR SHOPPING MALLS; PROFESSIONAL BUSINESS CONSULTANCY; SECRETARIAL SERVICES; BOOKKEEPING; RENTAL OF OFFICE MACHINES AND APPARATUS EXCLUDING TELECOMMUNICATION APPARATUS AND COMPUTERS; RENTAL OF VENDING MACHINES; ARRANGING NEWSPAPER SUBSCRIPTIONS FOR OTHERS; ELECTRONIC NEWSPAPER SUBSCRIPTION SERVICES; TELEPHONE SUBSCRIPTION SERVICES; SUBSCRIPTION SERVICES FOR SUBSCRIBING TO A WIRELESS TELEPHONY SERVICE AND TO A RADIO-PAGING SERVICE; SUBSCRIPTION SERVICES FOR SUBSCRIBING TO TELECOMMUNICATION SERVICES, NAMELY, ACCESS TO A GLOBAL TELECOMMUNICATION NETWORK IN THE NATURE OF THE INTERNET AND PRIVATE ACCESS NETWORKS IN THE NATURE OF INTRANETS; SUBSCRIPTION SERVICES, NAMELY, ACCESS SERVICE FOR A DATABASE AND MULTIMEDIA SERVER CENTER; SERVICES FOR SUBSCRIBING TO TELEMATIC SERVICES FOR DATA TRANSMISSION SERVICES USING TELEMATIC MEANS; SUBSCRIPTIONS TO A CENTRAL SERVICE PROVIDING ACCESS TO A COMPUTER NETWORK OR DATA COMMUNICATION NETWORK; SUBSCRIPTIONS FOR ACCESS TO COMPUTER DATABASES; GOODS IMPORT-EXPORT AGENCIES; COMMERCIAL INFORMATION AGENCIES; COST PRICE ANALYSIS; MARKET STUDY; MARKET RESEARCH; OPINION POLLING, NAMELY, PUBLIC OPINION POLLING, MARKET OPINION POLLING STUDIES; PRICE COMPARISON SERVICES; COMPILATION OF STATISTICS; PUBLIC RELATIONS; PRESENTATION OF GOODS ON ANY COMMUNICATION MEDIA FOR RETAIL PURPOSES, NAMELY, SALES PROMOTION; COMMERCIAL INFORMATION AND ADVICE FOR CONSUMERS; ADMINISTRATIVE PROCESSING OF PURCHASE ORDERS; ORGANIZATION OF EXHIBITIONS AND TRADE FAIRS FOR COMMERCIAL OR ADVERTISING PURPOSES; COMPUTERIZED FILE MANAGEMENT; COMPILATION AND SYSTEMIZATION OF DATA INTO COMPUTER DATABASES; DOCUMENT REPRODUCTION; BRINGING TOGETHER, FOR THE BENEFIT OF OTHERS, OF A VARIETY OF GOODS, EXCLUDING TRANSPORT, ENABLING CUSTOMERS TO EXAMINE AND CONVENIENTLY VIEW AND PURCHASE THOSE GOODS, AS WELL AS RETAIL STORE SERVICES, WHOLESALE ORDERING SERVICES, ONLINE RETAIL STORE SERVICES, DISTRIBUTORSHIPS, MAIL ORDER SERVICES, INTERNET RETAIL STORE SERVICES, INTERNET WHOLESALE ORDERING SERVICES, AND COMPUTERIZED ONLINE ORDERING SERVICES, ALL FEATURING BLEACHING PREPARATIONS AND OTHER SUBSTANCES FOR LAUNDRY USE, CLEANING, POLISHING, SCOURING AND ABRASIVE PREPARATIONS AND PRODUCTS, STAIN REMOVERS, FABRIC SOFTENERS, LAUNDRY BLUEING, SOAP, PERFUMES, TOILET WATER, PERFUMERY IN THE NATURE OF DE-

Reg. No. 4,173,464 ODORANTS FOR PERSONAL USE, COSMETICS, PREPARATIONS FOR HAIR CARE, HAIR DYES, SHAMPOOS, DENTIFRICES, MOUTH WASHES NOT FOR MEDICAL PURPOSES, DEPILATORIES, MAKE-UP AND MAKE-UP REMOVING PREPARATIONS, SHAVING PREPARATIONS, TOILETRIES, NAIL VARNISH AND PREPARATIONS FOR REMOVING NAIL VARNISH, COSMETIC PREPARATIONS FOR BATHS AND FOR SKIN TANNING, TOILETRY SWABS, COTTON WOOL FOR COSMETIC PURPOSES, TISSUES IMPREGNATED WITH COSMETIC LOTIONS, COSMETIC PREPARATIONS FOR SKIN TANNING IN THE NATURE OF SUNSCREENS, SHAMPOOS FOR PETS, INCENSE, SCENTED WOOD, FRAGRANCES IN THE NATURE OF POTPOURRIS, LIGHTING IN THE NATURE OF CANDLES AND WICKS, TAPERS, PERFUMED CANDLES, GREASE FOR LEATHER, FOODSTUFFS AND LACTEAL FLOUR FOR BABIES, ANTISEPTIC COTTON NOT IMPREGNATED WITH PREPARATIONS FOR TREATING ACNE OR SIMILAR SKIN CONDITIONS, COTTON WOOL NOT IMPREGNATED WITH PREPARATIONS FOR TREATING ACNE OR SIMILAR SKIN CONDITIONS, SANITARY PADS, NAPKINS AND PANTIES, BREAST-NURSING PADS, STERILIZING PREPARATIONS, METAL CONSTRUCTION MATERIALS, LADDERS OF METAL, NON-ELECTRIC CABLES AND WIRES OF COMMON METAL, NONELECTRICAL LOCKSMITHING ARTICLES, HARDWARE OF METAL, CHAINS OF METAL, RINGS OF METAL, HINGES OF METAL, KEYS, PADLOCKS, METAL BOXES, CRATES, BINS, BASKETS AND CONTAINERS, CLOTHES HOOKS OF METAL, WORKS OF ART OF COMMON METAL, HAND-HELD TOOLS NOT MANUALLY DRIVEN, ELECTRO-MECHANICAL APPARATUS FOR THE PREPARATION OF FOODSTUFFS AND BEVERAGES, ELECTRIC MACHINES AND FOOD PROCESSORS, SEWING AND KNITTING MACHINES, HAND-OPERATED HAND TOOLS AND IMPLEMENTS, NON-ELECTRIC CUTLERY, TABLE FORKS, SPOONS OTHER THAN FOR FISHING AND FOR MEDICINES, SCISSORS, HAND-OPERATED HAND TOOLS AND IMPLEMENTS FOR GARDENING, MECHANICAL TOOLS FOR CHOPPING AND CUTTING FOODSTUFFS, NON-ELECTRICAL CAN OPENERS, NUTCRACKERS, RAZORS, RAZOR BLADES, NAIL NIPPERS AND FILES, NAIL CLIPPERS, MANICURE AND PEDICURE SETS, ELECTRIC AND NON-ELECTRIC HAIR CLIPPERS FOR PERSONAL USE, ELECTRIC OR NON-ELECTRIC DEPILATION APPLIANCES, HAIR-REMOVING TWEEZERS, A WIDE VARIETY OF SCIENTIFIC, NAUTICAL, SURVEYING, PHOTOGRAPHIC, CINEMATOGRAPHIC, OPTICAL, WEIGHING, MEASURING, SIGNALING, SUPERVISION CHECKING AND LIFE-SAVING GOODS, NAMELY, CONSUMER GOODS, APPARATUS AND INSTRUMENTS FOR CONDUCTING, SWITCHING, TRANSFORMING, ACCUMULATING, REGULATING OR CONTROLLING ELECTRICITY, MATERIAL FOR ELECTRICITY MAINS IN THE NATURE OF WIRES, CABLES, ELECTRIC SWITCHES, PLUGS, SOCKETS AND OTHER CONTACTS, FUSES, SOCKET COVERS, ELECTRIC BATTERIES, BATTERIES FOR LIGHTING, ELECTRIC FLAT IRONS, APPARATUS FOR RECORDING, TRANSMISSION OR REPRODUCTION OF SOUND OR IMAGES, MAGNETIC RECORDING MEDIA, SOUND RECORDING, MAGNETIC AND OPTICAL DISKS, AUDIO AND VIDEO COMPACT DISKS, VIDEO TAPES, FACSIMILE MACHINES, TELEPHONE APPARATUS, ADAPTORS DESIGNED FOR TELEPHONES, BATTERY CHARGERS FOR TELEPHONES, BAGS, COVERS AND CASES FOR MOBILE TELEPHONES AND TELEPHONE EQUIPMENT, TELEPHONE ANSWERING MACHINES, ANTENNAS, PROJECTION APPARATUS AND SCREENS, PHOTOGRAPHY FLASH-BULBS, EXPOSED FILMS, CASES ESPECIALLY MADE FOR PHOTOGRAPHIC APPARATUS AND INSTRUMENTS, DICTATION MACHINES, CASH REGISTERS, CALCULATING MACHINES, DATA PROCESSING APPARATUS, COMPUTERS, COMPUTER PERIPHERAL DEVICES, COMPUTER SOFTWARE, FLOPPY DISKS, MODEMS, ELECTRONIC AGENDAS, APPARATUS FOR GAMES ADAPTED FOR USE ONLY WITH TELEVISION RECEIVERS, INDEPENDENT DISPLAY SCREENS OR MONITORS, VIDEO GAME CARTRIDGES, BINOCULARS, OPTICS IN THE NATURE OF SPECTACLES, SPECTACLE CASES, INTEGRATED CIRCUIT CARDS IN THE NATURE OF SMART CARDS, MAGNETIC CARDS, TELEPHONE CARDS, DIRECTIONAL COMPASSES, SWIMMING BELTS AND JACKETS, DIVING MASKS AND WET SUITS, WEIGHING SCALES, PROTECTIVE HELMETS, PROTECTION DEVICES FOR PERSONAL USE AGAINST ACCIDENTS, NETS FOR PROTECTION AGAINST ACCIDENTS, CLOTHING FOR PROTECTION AGAINST ACCIDENTS, IRRADIATION AND FIRE, BAROMETERS, FIRE EXTINGUISHERS, EGG-TIMERS, ELECTRIC LOCKS, ELECTRIC DOOR BELLS, ALARMS, ORNAMENTAL MAGNETS, FEEDING BOTTLES, FEEDING BOTTLE TEATS, SPOONS FOR ADMINISTERING

Reg. No. 4,173,464 MEDICINE, DROPPERS FOR MEDICAL PURPOSES, PACIFIERS FOR BABIES, BREAST-FEEDING TEATS MADE OF LATEX OR SILICONE, TEETHING RINGS, NURSING APPLIANCES, BREAST PUMPS, THERMOMETERS FOR MEDICAL PURPOSES, MATERNITY BELTS, UMBILICAL BELTS, NASAL ASPIRATOR DEVICES, APPARATUS FOR LIGHTING, HEATING, STEAM GENERATING, COOKING, REFRIGERATING, DRYING, VENTILATING, DISINFECTING, WATER SUPPLY, APPARATUS FOR AIR DEODORIZING AND PURIFICATION, ELECTRIC FANS FOR PERSONAL USE, WATER PURIFYING APPARATUS, STERILIZERS, ELECTRIC HEATERS FOR FEEDING BOTTLES, ICE CHESTS, HAIR DRYERS, ELECTRIC LAUNDRY DRYERS, LIGHT BULBS AND ELECTRIC LAMPS, VEHICLES, APPARATUS FOR LOCOMOTION BY LAND, AIR AND WATER, BICYCLES, GOODS HANDLING CARTS, VEHICLES IN THE NATURE OF TRAILERS, SUN-BLINDS ADAPTED FOR AUTOMOBILES, WINDSHIELD WIPERS, INNER TUBES AND SPIKES FOR WHEEL TIRES, WHEEL TIRES, HEAD RESTRAINTS AND SAFETY BELTS FOR VEHICLE SEATS, CHILDREN'S SAFETY SEATS FOR VEHICLES, BICYCLE PUMPS, BABY CARRIAGES, SCOOTERS, VEHICLE COVERS, SEAT COVERS FOR VEHICLES, LUGGAGE CARRIERS, BICYCLE RACKS, SKI CARRIERS FOR VEHICLES, STROLLERS, ANTI-THEFT DEVICES FOR VEHICLES, SHOPPING TROLLEYS, FIREWORKS, FIRECRACKERS, JEWELRY PRODUCTS, JEWEL CASES OF PRECIOUS METAL, PRESENTATION CASES, HOROLOGICAL AND CHRONOMETRIC INSTRUMENTS, WATCHES AND WATCH BANDS, CUFF LINKS, TIE PINS, KEY RINGS IN THE NATURE OF TRINKETS AND FOBS, BOXES OF PRECIOUS METAL, STATUETTES OF PRECIOUS METAL, WORKS OF ART OF PRECIOUS METAL AND OF PRECIOUS STONES, MUSICAL INSTRUMENTS AND COMPONENT PARTS OF MUSICAL INSTRUMENTS, MUSICAL BOXES, BRIDGES FOR MUSICAL INSTRUMENTS, TUNING FORKS, CASES FOR MUSICAL INSTRUMENTS, PAPER, UNPROCESSED AND SEMI-PROCESSED CARDBOARD, CARDBOARD FOR STATIONERY USE, CARDBOARD ARTICLES, PAPER AND PLASTIC PACKAGING BAGS, POUCHES AND SHEETS, STATIONERY PAPER SHEETS, PRINTED MATTER, BOOKBINDING ARTICLES, PHOTOGRAPHS, STATIONERY, ADHESIVE GLUES FOR STATIONERY OR HOUSEHOLD PURPOSES, ARTISTS' MATERIALS, PAINTBRUSHES, PAINT BOXES FOR USE IN SCHOOL, TYPEWRITERS AND OFFICE REQUISITES EXCEPT FURNITURE, INSTRUCTIONAL AND TEACHING MATERIAL EXCEPT APPARATUS, SCHOOL SUPPLIES, ENVELOPES, FILES, SCRAPBOOKS, BOOKS, PERIODICALS, ALMANACS, PAMPHLETS, WRITING OR DRAWING BOOKS, CALENDARS, LITHOGRAPHS, ENGRAVINGS, PAINTINGS, POSTERS, GEOGRAPHICAL MAPS, NEWSPAPERS, MAILERS, PAPER TISSUES FOR REMOVING MAKE-UP, BABIES' NAPKIN-PANTS IN THE NATURE OF DIAPER-PANTS OF PAPER AND CELLULOSE, DECALCOMANIAS, GARBAGE BAGS OF PAPER OR OF PLASTICS, BAGS FOR MICROWAVE COOKING, SIGNBOARDS OF PAPER AND CARDBOARD, TOILET PAPER, TABLE LINEN OF PAPER, HAND TOWELS, HANDKERCHIEFS OF PAPER, GREETING CARDS, POSTCARDS, SEWING PATTERNS, TERRESTRIAL GLOBES, SEALING AND INSULATING GASKETS, ELASTIC AND PLASTIC THREADS AND YARNS NOT FOR TEXTILE USE, LEATHER AND IMITATIONS OF LEATHER, ANIMAL SKINS, PELTS AND HIDES, TRUNKS, SUITCASES AND SMALL CASES, SUN UMBRELLAS, UMBRELLAS, PARASOLS AND WALKING STICKS, WHIPS, HARNESSES AND SADDLERY, HANDBAGS, BEACH BAGS, BAGS, TRAVELING SETS AND TRUNKS, VANITY CASES NOT FITTED, COSMETIC SETS, SHOPPING NETS AND BAGS, BACKPACKS, SPORTS BAGS EXCEPT THOSE ADAPTED TO THE PRODUCT THAT THEY ARE INTENDED TO CONTAIN, WHEELED BAGS, GARMENT BAGS FOR TRAVEL, SCHOOL BAGS, WALLETS, CARD CASES IN THE NATURE OF WALLETS, ATTACHÉ CASES, LEATHER KEY CASES, PURSES, EMPTY TOOL SET BAGS, HAT BOXES OF LEATHER, SACHEL BAGS AND SLINGS FOR CARRYING CHILDREN, COLLARS AND CLOTHING FOR ANIMALS, NON-METAL CONSTRUCTION MATERIALS, CEMENT, COATINGS, PLASTER, BUILDING TIMBER, VENEER, BRICKS, SURFACINGS FOR BUILDING, NON-METAL FLOOR TILES, NON-METAL CHIMNEYS, NON-METAL WINDOWS AND DOORS, NON-METAL AND NON-TEXTILE OUTDOOR BLINDS, SWIMMING POOLS, NON-METALLIC TRANSPORTABLE CONSTRUCTIONS, AQUARIA STRUCTURES, FURNITURE, DISPLAY STANDS, LOOKING GLASSES IN THE NATURE OF MIRRORS, FRAMES EXCEPT CONSTRUCTION FRAMES, WORKS OF ART MADE OF WOOD, WAX, PLASTER, CORK, REED, CANE, WICKER, HORN, BONE, IVORY, WHALEBONE, SHELL, AMBER, MOTHER-OF-PEARL, MEERSCHAUM, SUBSTI-

Reg. No. 4,173,464 TUTES FOR ALL THESE MATERIALS AND PLASTIC, NON-METALLIC BASKETS AND TRAYS, PACKAGING CONTAINERS OF PLASTIC, BOXES OF WOOD AND PLASTIC, HOUSES AND BEDS FOR HOUSEHOLD PETS, DISPLAY BOARDS, VISE BENCHES, EMBROIDERY FRAMES, SIGNBOARDS OF WOOD AND PLASTICS, NON-METALLIC AND NON-ELECTRICAL METAL WORK, NON-METALLIC HINGES AND PEGS, PLAYPENS FOR BABIES, BASSINETTES, INFANT WALKERS, NON-METAL DUCKBOARDS, BEDDING MATERIAL EXCLUDING LINEN, SLEEPING BAGS FOR CAMPING, CUSHIONS, PILLOWS, BOLSTERS, BED BASES, MATTRESSES, CLOTHES HANGERS AND COVERS, CURTAIN RINGS, RODS AND HOOKS, NON-METAL DOOR HANDLES, FIXED NON-METAL TOWEL DISPENSERS, BOTTLE RACKS, BOTTLE STOPPERS, NON-METAL BROOM HANDLES, UMBRELLA STANDS, LADDERS OF WOOD AND PLASTICS, DECORATIONS OF PLASTIC FOR FOODSTUFFS, STRAWS FOR DRINKING, SLATTED INDOOR BLINDS, MANNEQUINS, FANS FOR PERSONAL USE, NON-ELECTRIC UTENSILS AND CONTAINERS FOR HOUSEHOLD OR KITCHEN USE, COMBS AND SPONGES, BRUSHES EXCEPT PAINT-BRUSHES, BROOMS, BASINS, MATERIAL FOR BRUSH-MAKING, ARTICLES FOR CLEANING PURPOSES, STEEL WOOL, GLOVES FOR HOUSEHOLD PURPOSES, CLEANING CLOTHS, CHAMOIS LEATHER FOR CLEANING, UTENSILS FOR KITCHEN AND TABLEWARE USE OF GLASS, PORCELAIN AND EARTHENWARE, COOKING POT SETS, DRINKING FLASKS FOR TRAVELLERS, NON-ELECTRIC PORTABLE COOLERS, TABLEWARE OTHER THAN KNIVES, FORKS AND SPOONS, VASES, CANDLE HOLDERS, FITTED PICNIC BASKETS INCLUDING DISHES, BOTTLE OPENERS, SOAP AND TOILET PAPER DISPENSERS, TOILET PAPER ROLL HOLDERS, CHAMBER POTS, DRYING RACKS FOR WASHING, CLOTHESPINS, TRASH CANS, IRONING BOARDS AND IRONING BOARD COVERS, ISOTHERMIC BAGS, INSECT TRAPS, FLOWER POTS, FLOWER-POT COVERS NOT OF PAPER, SPRINKLING DEVICES, GARDENING GLOVES, TOOTHBRUSHES, SOAP BOXES, COSMETIC UTENSILS, TOILET SETS, PERFUME VAPORIZERS AND ATOMIZERS, PORTABLE BATHS FOR BABIES, PIGGY BANKS, NOT OF METAL, WORKS OF ART, OF PORCELAIN, TERRA-COTTA OR GLASS, ROPES NEITHER MADE OF RUBBER, NOR INTENDED AS STRINGS FOR RACKETS OR MUSICAL INSTRUMENTS, STRING, TENTS, TARPAULINS NEITHER AS SAFETY TARPAULINS, NOR AS PUSHCHAIR COVERS, BAGS AND POUCHES FOR PACKAGING MADE OF TEXTILES, PADDING AND STUFFING MATERIALS EXCEPT OF RUBBER AND PLASTICS, HAMMOCKS, NONMETAL THREAD FOR WRAPPING AND BINDING, YARNS AND THREADS FOR TEXTILE USE, SPUN WOOL, ELASTIC AND PLASTIC THREADS AND YARNS FOR TEXTILE USE, FABRICS, BED AND HOUSEHOLD LINEN, TABLE LINEN NOT OF PAPER, BATH LINEN EXCEPT CLOTHING, WALL HANGINGS OF TEXTILE, SHEETING IN THE NATURE OF SLEEPING BAGS, TEXTILE TISSUES FOR REMOVING MAKE-UP, MOSQUITO NETS, HOUSEHOLD LINEN, LABELS OF CLOTH, BLINDS OF TEXTILE, HANDKERCHIEFS OF TEXTILE, CLOTHING, BELTS, CLOTHING GLOVES, SUSPENDERS, HATS, FOOTWEAR, SOCKS, STOCKINGS, TIGHTS, FOOTWEAR EXCLUDING ORTHOPEDIC FOOTWEAR, SLIPPERS, BOOTS, INNER SOLES, BEACH SHOES, SKI BOOTS, SPORTS FOOTWEAR, BONNETS, BATHING SUITS AND TRUNKS, CLOTHING FOR SPORTS EXCLUDING DIVING CLOTHING, SLEEPING MASKS, HABERDASHERY EXCEPT THREAD, LACE TRIMMINGS, LACE AND EMBROIDERY, RIBBONS AND BRAID, BUTTONS, HOOKS AND EYES, PINS AND NEEDLES, ARTIFICIAL FLOWERS AND FRUITS, ORNAMENTAL NOVELTY BADGES, HAT ORNAMENTS NOT OF PRECIOUS METAL, HAIR ORNAMENTS, HAIR BANDS AND HAIR NETS, HAIR PINS AND GRIPS, BARRETTES, WIGS, ZIP FASTENERS, SHOE LACES, HABERDASHERY IN THE NATURE OF HEAT ADHESIVE PATCHES FOR DECORATION OR REPAIR OF TEXTILE ARTICLES, SEWING BOXES, CARPETS, RUGS, MATS AND MATTING, LINOLEUM AND OTHER MATERIALS FOR COVERING FLOORS EXCLUDING FLOOR TILING AND PAINT, NON-TEXTILE WALL HANGINGS, BATH MATS, GYMNAS TIC MATS, NON-SLIP MATS, GAMES, TOYS, PRACTICAL JOKES IN THE NATURE OF NOVELTIES, ORNAMENTS FOR CHRISTMAS TREES EXCEPT ILLUMINATION ARTICLES AND CONFECTIONERY, PARTY FAVORS, TOY MASKS, KITES, PLAYING CARDS, GYMNAS TIC AND SPORTING ARTICLES EXCEPT FOR SWIMMING ARTICLES, CLOTHING, FOOTWEAR AND MATS, RODS FOR FISHING, EXERCISERS AND BODYBUILDING APPARATUS, TOYS FOR DOMESTIC PETS, COIN-OPERATED AMUSEMENT MACHINES, GAMES AND GAMES APPARATUS OTHER THAN THOSE DESIGNED TO BE USED ONLY WITH

Reg. No. 4,173,464 TELEVISION RECEIVERS, SEPARATE DISPLAY SCREENS OR MONITORS, MEAT, FISH, POULTRY AND GAME, PRESERVED, FROZEN, DRIED AND COOKED FRUITS AND VEGETABLES, FRUIT PULP AND SALADS, VEGETABLE SALADS, CANNED MEAT, FISH, VEGETABLES AND FRUIT, JAMS, MARMALADES, STEWED FRUIT, JELLIES FOR FOOD, SOUPS, EGGS, MILK, BUTTER, CREAM, YOGHURTS, CHEESE AND OTHER DAIRY PRODUCTS, EDIBLE OILS AND FATS, COFFEE, TEA, COCOA, CHOCOLATE, CHOCOLATE GOODS, BEVERAGES MADE WITH COFFEE, TEA, COCOA, CHOCOLATE, NON-MEDICINAL INFUSIONS, SUGAR, RICE, PASTA, SEMOLINA, FLOURS AND CEREAL PREPARATIONS, BREAD, PASTRY, CONFECTIONERY, EDIBLE ICES, HONEY, SALT, MUSTARD, VINEGAR, CONDIMENTS IN THE NATURE OF SAUCES, SANDWICHES, PIZZAS, AGRICULTURAL, HORTICULTURAL AND FORESTRY PRODUCTS NEITHER PREPARED NOR TRANSFORMED, SOWING SEEDS, FRESH FRUITS AND VEGETABLES, TREES, SHRUBS, NATURAL PLANTS AND FLOWERS, CHRISTMAS TREES, MINERAL AND AERATED WATERS AND OTHER NON-ALCOHOLIC DRINKS, IN CLASS 35 (U.S. CLS. 100, 101 AND 102).

FOR: PRACTICAL TRAINING, NAMELY, EDUCATIONAL DEMONSTRATIONS; ENTERTAINMENT SERVICES, NAMELY, LIVE PERFORMANCES BY MUSICAL BANDS, PREPARATION OF SPECIAL EFFECTS, CONDUCTING CONTESTS; AMUSEMENT PARKS; SPORTING ACTIVITIES, NAMELY, ORGANIZATION OF SPORTS COMPETITIONS, SPORT CAMP SERVICES, SPORTS INSTRUCTION SERVICES ; PROVIDING SPORTS FACILITIES; ORGANIZATION OF SPORTS COMPETITIONS; ENTERTAINMENT AND EDUCATION SERVICES, NAMELY, COUNTRY CLUBS, FAN CLUB SERVICES; CULTURAL ACTIVITIES, NAMELY, ORGANIZATION OF EXHIBITIONS FOR CULTURAL PURPOSES, ORGANIZING CULTURAL EVENTS; PUBLICATION OF BOOKS AND REVIEWS; PUBLICATION OF TEXTS OTHER THAN ADVERTISING TEXTS; LENDING LIBRARIES; ELECTRONIC DESKTOP PUBLISHING; PUBLICATION OF ELECTRONIC BOOKS AND JOURNALS ON-LINE; GAME SERVICES PROVIDED ON-LINE FROM A COMPUTER NETWORK, NAMELY, PROVIDING ONLINE COMPUTER GAMES, PROVIDING ONLINE VIDEO GAMES, PROVIDING ONLINE ELECTRONIC GAMES; MUSIC COMPOSITION FOR OTHERS; TELEVISION SHOW AND FILM PRODUCTION; RENTAL OF MOTION PICTURE FILMS, VIDEO RECORDERS, TELEVISION SETS, VIDEO TAPES, PHONOGRAPH RECORDINGS, SOUND RECORDINGS, AUDIO EQUIPMENT, VIDEO CAMERAS, VIDEO RECORDERS, RADIO AND TELEVISION SETS, CINEMATOGRAPHIC PROJECTION APPARATUS, CINEMATOGRAPHIC APPARATUS AND ACCESSORIES AND THEATER AND SHOW SETS; RENTAL OF SPORTS EQUIPMENT EXCEPT VEHICLES AND UNDERWATER DIVING EQUIPMENT; ORGANIZATION OF COMPETITIONS IN THE FIELD OF EDUCATION AND ENTERTAINMENT, NAMELY, ATHLETIC COMPETITIONS, CULINARY COMPETITIONS; ORGANIZATION OF EXHIBITIONS FOR CULTURAL OR EDUCATIONAL PURPOSES; BOOKING OF SEATS FOR SHOWS, ENTERTAINMENT, SPORTS AND CULTURAL EVENTS; TICKET AGENCY SERVICES FOR ENTERTAINMENT EVENTS; OPERATING LOTTERIES; PRODUCTION OF RADIO AND TELEVISION PROGRAMS; DIGITAL IMAGING SERVICES; PHOTOGRAPHY; PHOTOGRAPHIC REPORTING; NEWS REPORTERS SERVICES; VIDEOTAPING; VIDEO TAPE EDITING; MICROFILMING FOR OTHERS; TRANSLATION; CONFERENCING SERVICES, NAMELY, ARRANGING AND CONDUCTING EDUCATIONAL CONFERENCES; ENTERTAINMENT SERVICES, NAMELY, PROVIDING DIGITAL NON-DOWNLOADABLE PRERECORDED MUSIC FROM THE INTERNET; ENTERTAINMENT SERVICES, NAMELY, PROVIDING DIGITAL NON-DOWNLOADABLE PRERECORDED MUSIC IN MP3 FORMAT FROM WEBSITES ON THE INTERNET, IN CLASS 41 (U.S. CLS. 100, 101 AND 107).

THE MARK CONSISTS OF STANDARD CHARACTERS WITHOUT CLAIM TO ANY PARTICULAR FONT, STYLE, SIZE, OR COLOR.

PRIORITY DATE OF 10-22-2010 IS CLAIMED.

OWNER OF INTERNATIONAL REGISTRATION 1076039 DATED 10-26-2010, EXPIRES 10-26-2020.

Reg. No. 4,173,464 THE WORDING "OXYBUL" HAS NO MEANING IN A FOREIGN LANGUAGE.

SER. NO. 79-096,995, FILED 10-26-2010.

LIEF MARTIN, EXAMINING ATTORNEY

United States of America

United States Patent and Trademark Office

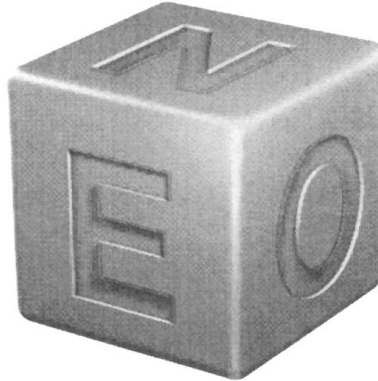

Reg. No. 4,173,465

Registered July 17, 2012

Int. Cls.: 9, 10 and 16

TRADEMARK

PRINCIPAL REGISTER

KARL STORZ GMBH & CO. KG (FED REP GERMANY GMBH & CO. KG)
MITTELSTRASSE 8
78532 TUTTLINGEN
FED REP GERMANY

FOR: APPARATUS FOR RECORDING, TRANSMISSION OR REPRODUCTION OF SOUND OR IMAGES; DATA PROCESSORS AND COMPUTERS; COMPUTER PERIPHERAL DEVICES; COMPUTER HARDWARE; COMPUTER PROGRAMS FOR OPERATING MEDICAL AND SURGICAL APPARATUS FOR GENERAL AND ENDOSCOPIC SURGERY; BLANK MAGNETIC DATA CARRIERS; OPTICAL APPARATUS AND INSTRUMENTS, NAMELY, CHARGE-COUPLED DEVICE CAMERAS; CAMERAS, MICROSCOPES; REMOTE CONTROL APPARATUS FOR MEDICAL AND SURGICAL APPARATUS FOR GENERAL AND ENDOSCOPIC SURGERY; DOWNLOADABLE ELECTRONIC PUBLICATIONS IN THE NATURE OF CATALOGUES, MAGAZINES, JOURNALS, BROCHURES AND INFORMATIONAL FLYERS, LETTERS AND SHEETS IN THE FIELD OF MEDICAL TECHNOLOGY, IN CLASS 9 (U.S. CLS. 21, 23, 26, 36 AND 38).

FOR: SURGICAL AND MEDICAL APPARATUS FOR USE IN GENERAL AND ENDOSCOPIC SURGERY, IN CLASS 10 (U.S. CLS. 26, 39 AND 44).

FOR: PRINTED MATTER, NAMELY, CATALOGUES, MAGAZINES, JOURNALS, BROCHURES AND INFORMATIONAL FLYERS, LETTERS AND SHEETS IN THE FIELD OF MEDICAL TECHNOLOGY; BINDERS; PRINTED TEACHING AND INSTRUCTIONAL MANUALS IN THE FIELD OF MEDICAL TECHNOLOGY; PHOTOGRAPHS, IN CLASS 16 (U.S. CLS. 2, 5, 22, 23, 29, 37, 38 AND 50).

THE MARK CONSISTS OF CUBE WITH THREE VISIBLE SIDES, WITH THE LETTER "N" ON THE TOP, "E" ON THE LEFT SIDE, AND "O" ON THE RIGHT SIDE.

PRIORITY DATE OF 7-30-2010 IS CLAIMED.

OWNER OF INTERNATIONAL REGISTRATION 1077720 DATED 1-25-2011, EXPIRES 1-25-2021.

SER. NO. 79-097,584, FILED 1-25-2011.

ROBIN CHOSID, EXAMINING ATTORNEY

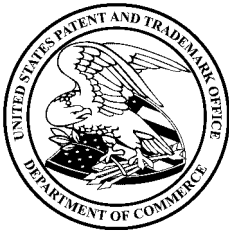

David J. Kyffers

Director of the United States Patent and Trademark Office

United States of America

United States Patent and Trademark Office

HENKOSCIENCE

Reg. No. 4,173,466

Registered July 17, 2012

Int. Cls.: 3, 5 and 24

TRADEMARK

PRINCIPAL REGISTER

VALÉRIE FONTAS (FRANCE INDIVIDUAL)
14 AVENUE VESTA
F-77410 GRESSY
FRANCE

FOR: SOAP FOR PERSONAL USE; PERFUMES, ESSENTIAL OILS, COSMETICS AND COSMETICS INCLUDING CLAY POWDER FOR COSMETIC PURPOSES; HAIR LOTIONS; DENTIFRICES; DEPILATORY PREPARATIONS; MAKE-UP REMOVING PREPARATIONS; LIPSTICKS; BEAUTY MASKS; SHAVING PREPARATIONS, IN CLASS 3 (U.S. CLS. 1, 4, 6, 50, 51 AND 52).

FOR: PHARMACEUTICAL AND VETERINARY PREPARATIONS FOR THE TREATMENT OF PRESSURE ULCERS, ARTHRITIS, MUSCLE ACHES, SPRAINS, WOUNDS, SORES, PARASITES, GALL; SANITARY PREPARATIONS FOR MEDICAL PURPOSES; FOOD FOR BABIES; CLAY BASED MEDICAL PLASTERS, MEDICAL DRESSINGS AND MATERIALS FOR DRESSINGS, NAMELY BANDAGES FOR DRESSINGS, BANDAGES FOR HEALING SCABS, AND BANDAGES FOR DRESSINGS FOR THE TREATMENT OF RHEUMATISM AND TENDINITIS, CLAY POWDER FOR MEDICAL AND HYGIENIC PURPOSES; MATERIAL FOR DENTAL FILLINGS AND DENTAL IMPRESSIONS; DISINFECTANTS FOR HYGIENIC PURPOSES; PESTICIDES; FUNGICIDES, HERBICIDES; BATH PREPARATIONS, MEDICATED; SANITARY PADS, PANTIES OR TOWELS; MEDICINAL HERBS; HERBS TEAS FOR MEDICINAL PURPOSES; PARASITICIDES; ALLOYS OF PRECIOUS METALS FOR DENTAL PURPOSES; CLAY-IMPREGNATED WOVEN OR NON-WOVEN SUPPORTS FOR MEDICAL, VETERINARY OR SANITARY USE FOR THE TREATMENT OF WOUNDS AND SORES AND THE SUPERFICIAL CLEANING OF WOUNDS AND SORES, IN CLASS 5 (U.S. CLS. 6, 18, 44, 46, 51 AND 52).

FOR: CLAY IMPREGNATED AERATED TEXTILE USED AS A SUBSTRATE FOR PRESERVING AND LIMITING THE GROWTH OF BACTERIA OF FOODSTUFF, NAMELY, MEAT, FISH AND FRUIT, IN CLASS 24 (U.S. CLS. 42 AND 50).

THE MARK CONSISTS OF STANDARD CHARACTERS WITHOUT CLAIM TO ANY PARTICULAR FONT, STYLE, SIZE, OR COLOR.

PRIORITY DATE OF 9-8-2010 IS CLAIMED.



David J. Kyffers

Director of the United States Patent and Trademark Office

Reg. No. 4,173,466 OWNER OF INTERNATIONAL REGISTRATION 1077741 DATED 2-18-2011, EXPIRES 2-18-2021.

SER. NO. 79-097,597, FILED 2-18-2011.

KELLY TRUSILO, EXAMINING ATTORNEY

United States of America

United States Patent and Trademark Office

BIGTRAK

Reg. No. 4,173,467

Registered July 17, 2012

Int. Cls.: 7, 9 and 28

TRADEMARK

PRINCIPAL REGISTER

ZEON LIMITED (UNITED KINGDOM LIMITED COMPANY)
39 WATERLOO ROAD
LONDON NW2 7TT
UNITED KINGDOM

FOR: MACHINES AND MACHINE TOOLS, NAMELY, VACUUM CLEANERS AND THEIR COMPONENTS; MOTORS AND ENGINES, NOT FOR LAND VEHICLES; MACHINE COUPLING AND TRANSMISSION COMPONENTS, EXCEPT FOR LAND VEHICLES; COMPONENT AND REPLACEMENT PARTS AND FITTINGS FOR ALL THE AFORESAID GOODS, IN CLASS 7 (U.S. CLS. 13, 19, 21, 23, 31, 34 AND 35).

FOR: SCIENTIFIC, NAUTICAL, SURVEYING, PHOTOGRAPHIC, CINEMATOGRAPHIC, OPTICAL, WEIGHING, MEASURING, SIGNALING, CHECKING, LIFE-SAVING AND TEACHING APPARATUS AND INSTRUMENTS, NAMELY, CAMERAS, DIGITAL CAMERAS, WIRELESS COMMUNICATION DEVICES FOR VOICE, DATA, OR IMAGE TRANSMISSION, WIRELESS CONNECTION MODULES, LIGHTS, NAMELY, LIGHT EMITTING DIODES (LEDS) AND LIGHTS FOR USE ON CAMERAS; ELECTRONIC CONTROL PANELS AND KEYPADS, COMPUTER HARDWARE AND PERIPHERAL DEVICES, PANELS AND KEYPADS FOR PROGRAMMING COMMANDS AND COMPUTER SOFTWARE FOR OPERATING ELECTRONIC TOY VEHICLES; APPARATUS FOR RECORDING, TRANSMISSION OR REPRODUCTION OF SOUND OR IMAGES; PRERECORDED MAGNETIC DATA CARRIERS FEATURING COMPUTER SOFTWARE FOR OPERATING ELECTRONIC TOY VEHICLES; AUTOMATIC VENDING MACHINES AND MECHANISMS FOR COIN-OPERATED APPARATUS; CASH REGISTERS, CALCULATING MACHINES, DATA PROCESSING EQUIPMENT AND COMPUTERS; CAMERAS, DIGITAL CAMERAS, IN CLASS 9 (U.S. CLS. 21, 23, 26, 36 AND 38).

FOR: TOYS, GAMES AND PLAYTHINGS, NAMELY, ELECTRONIC TOY VEHICLES AND ACCESSORIES THEREFOR; PROGRAMMABLE ELECTRONIC TOY VEHICLES AND ACCESSORIES THEREFOR; PROGRAMMABLE ELECTRONIC TOY VEHICLES WHICH RESPOND TO COMMANDS ENTERED BY AN ELECTRONIC KEYPAD; ELECTRONIC TOY VEHICLES INCORPORATING CAMERAS, TOY MISSILE LAUNCHERS, BEVERAGE CAN HOLDERS, TOY GUNS, INFRARED LAMPS, WIRELESS CONNECTION MODULES, AND LIGHTS; PARTS AND FITTINGS FOR ALL THE AFORESAID GOODS, NAMELY, WHEELS FOR TOY VEHICLES, TOY MISSILE LAUNCHERS, AND TOY GUNS, IN CLASS 28 (U.S. CLS. 22, 23, 38 AND 50).



David J. Kyjars

Director of the United States Patent and Trademark Office

Reg. No. 4,173,467 THE MARK CONSISTS OF STANDARD CHARACTERS WITHOUT CLAIM TO ANY PARTICULAR FONT, STYLE, SIZE, OR COLOR.

OWNER OF INTERNATIONAL REGISTRATION 1078148 DATED 12-2-2010, EXPIRES 12-2-2020.

OWNER OF U.S. REG. NO. 3,889,409.

SER. NO. 79-097,711, FILED 12-2-2010.

MATTHEW EINSTEIN, EXAMINING ATTORNEY

United States of America

United States Patent and Trademark Office



Reg. No. 4,173,468

Registered July 17, 2012

Int. Cl.: 33

TRADEMARK

PRINCIPAL REGISTER

LAURENT-PERRIER (FRANCE SOCIÉTÉ ANONYME (SA))
32 AVENUE DE CHAMPAGNE
F-51150 TOURS-SUR-MARNE
FRANCE

FOR: WINES WITH PROTECTED LABEL OF ORIGIN "CHAMPAGNE", BEING AOC WINES FROM FRANCE, IN CLASS 33 (U.S. CLS. 47 AND 49).

OWNER OF U.S. REG. NOS. 718,039, 3,005,606 AND OTHERS.

PRIORITY DATE OF 1-14-2011 IS CLAIMED.

OWNER OF INTERNATIONAL REGISTRATION 1078213 DATED 4-7-2011, EXPIRES 4-7-2021.

THE COLOR(S) BLACK, WHITE, GOLD AND CLARET IS/ARE CLAIMED AS A FEATURE OF THE MARK.

NO CLAIM IS MADE TO THE EXCLUSIVE RIGHT TO USE "CHAMPAGNE", "MAISON FONDEE", "1812", "BRUT", "BY APPOINTMENT TO H.R.H. THE PRINCE OF WALES PURVEYORS OF CHAMPAGNE", AND "TOURS-SUR-MARNE", APART FROM THE MARK AS SHOWN.

THE NAME(S), PORTRAIT(S), AND/OR SIGNATURE(S) SHOWN IN THE MARK DOES NOT IDENTIFY A PARTICULAR LIVING INDIVIDUAL.

THE MARK CONSISTS OF A RIBBON-LIKE BAND IN CLARET AND OUTLINED IN GOLD WITH THE GOLD OUTLINE CONTAINING A FANCIFUL INNER BLACK DESIGN WITH A GOLD SHIELD DESIGN WITH WORDING AND DESIGNS IN BLACK IN THE MIDDLE. THE SHIELD DESIGN CONTAINS WITHIN IT A STYLIZED HELMET AND CROWN DESIGN ABOVE A SMALLER SHIELD CONTAINING AN EAGLE DESIGN WITH TOWER DESIGNS BELOW THE WINGS ON EITHER SIDE, AND AT THE BOTTOM OF THE SHIELD DESIGN THE LATIN WORDS "DE TURII SUPER MATRONAM QUO NON ASCENDAM" APPEARING ON A ROUGHLY U-SHAPED BAND EXTENDING UP TO THE MIDDLE OF THE SMALLER SHIELD ON EITHER SIDE TO ELABORATE SCROLLWORK DESIGNS CONSISTING OF CURVING LINES AND CIRCULAR FIGURES APPEARING TO THE LEFT AND RIGHT AND ABOVE THE SMALLER SHIELD ON EITHER SIDE OF THE STYLIZED HELMET AND



David J. Kybas

Director of the United States Patent and Trademark Office

Reg. No. 4,173,468 CROWN DESIGN. THE WORD "LAURENT" IN GOLD APPEARS TO THE LEFT OF THE SHIELD DESIGN AND THE WORD "PERRIER" IN GOLD APPEARS TO THE RIGHT OF THE SHIELD. AN OVAL IN CLARET OUTLINED IN GOLD APPEARS ON THE FAR LEFT OF THE RIBBON-LIKE BAND, CONTAINING THE STYLIZED LETTERS "LP" IN GOLD. BENEATH THE BAND IS A RECTANGULAR WHITE LABEL CONTAINING THE WORD "CHAMPAGNE" IN BLACK AND ENCASED IN A GOLD FANCIFUL OBLONG BORDER ABOVE THE WORDS "MAISON FONDEE" IN CLARET, WHICH ARE ABOVE "1812" IN CLARET. ON THE LOWER LEFT OF THE LABEL IS THE WORD "BRUT" IN BLACK AND ON THE LOWER RIGHT IS THE STYLIZED WORDING "TOURS-SUR-MARNE" IN BLACK. ON THE UPPER RIGHT OF THE LABEL IS A FEATHER AND CROWN DESIGN IN CLARET ABOVE THE WORDS "BY APPOINTMENT TO H.R.H. THE PRINCE OF WALES PURVEYORS OF CHAMPAGNE CHAMPAGNE LAURENT-PERRIER".

THE ENGLISH TRANSLATION OF "DE TURII SUPER MATRONAM QUO NON ASCENDAM", "MAISON FONDEE", AND "BRUT" IN THE MARK IS "FROM THE TOP OF THESE TOWERS HOW FAR DO I NOT RISE, HOUSE FOUNDED", AND "DRY".

SER. NO. 79-097,729, FILED 4-7-2011.

LAURA KOVALSKY, EXAMINING ATTORNEY

United States of America

United States Patent and Trademark Office

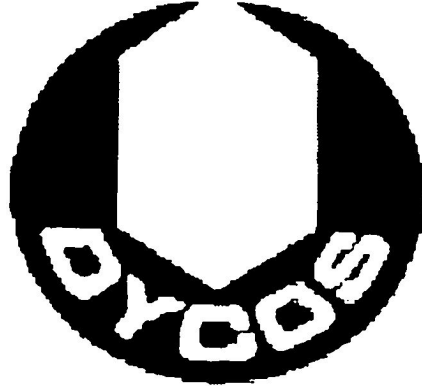

Reg. No. 4,173,469

Registered July 17, 2012

Int. Cls.: 1 and 2

TRADEMARK

PRINCIPAL REGISTER

SINOCHEM CORPORATION (CHINA CORPORATION)
28 FUXINGMENNEI STREET
XICHENG DISTRICT
BEIJING, CHINA

FOR: CHEMICAL AGENTS FOR MANUFACTURING DYESTUFFS, IN CLASS 1 (U.S. CLS. 1, 5, 6, 10, 26 AND 46).

FOR: DYESTUFFS; PIGMENTS; PAINTS; COATINGS USED FOR FURNITURE FINISHING; PRINTING INK, IN CLASS 2 (U.S. CLS. 6, 11 AND 16).

THE MARK CONSISTS OF THE WORDING "DYCOS" ON A DESIGN OF A SHADED POLYGON IN THE SHAPE OF A CIRCLE.

OWNER OF INTERNATIONAL REGISTRATION 1078221 DATED 4-27-2011, EXPIRES 4-27-2021.

THE WORDING "DYCOS" HAS NO MEANING IN A FOREIGN LANGUAGE.

SER. NO. 79-097,731, FILED 4-27-2011.

TAMARA FRAZIER, EXAMINING ATTORNEY



David J. Kybas

Director of the United States Patent and Trademark Office

United States of America

United States Patent and Trademark Office

ALBERT RIELE

Reg. No. 4,173,470

Registered July 17, 2012

Int. Cl.: 14

TRADEMARK

PRINCIPAL REGISTER

ISSY-LA SA (SWITZERLAND SOCIÉTÉ ANONYME (SA))
15, BOULEVARD HELVÉTIQUE
GENÈVE, SWITZERLAND CH1207

FOR: TIMEPIECES AND CHRONOMETRIC INSTRUMENTS; JEWELRY, IN CLASS 14 (U.S. CLS. 2, 27, 28 AND 50).

THE MARK CONSISTS OF STANDARD CHARACTERS WITHOUT CLAIM TO ANY PARTICULAR FONT, STYLE, SIZE, OR COLOR.

OWNER OF INTERNATIONAL REGISTRATION 1078429 DATED 5-2-2011, EXPIRES 5-2-2021.

THE NAME "ALBERT RIELE" DOES NOT IDENTIFY A LIVING INDIVIDUAL.

SER. NO. 79-097,759, FILED 5-2-2011.

MARC LEIPZIG, EXAMINING ATTORNEY



David J. Kyffers

Director of the United States Patent and Trademark Office

United States of America

United States Patent and Trademark Office

LE REVISEUR

Reg. No. 4,173,471

Registered July 17, 2012

Int. Cl.: 33

TRADEMARK

PRINCIPAL REGISTER

SOCIETE DU MAINE DRILHON (FRANCE SOCIÉTÉ EN NOM COLLECTIF)
LE MAINE DRILHON
F-16300 BARRET
FRANCE

FOR: ALCOHOLIC BEVERAGES, EXCEPT BEER; SPIRITS; COGNAC, IN CLASS 33 (U.S. CLS. 47 AND 49).

THE MARK CONSISTS OF STANDARD CHARACTERS WITHOUT CLAIM TO ANY PARTICULAR FONT, STYLE, SIZE, OR COLOR.

PRIORITY DATE OF 1-18-2011 IS CLAIMED.

OWNER OF INTERNATIONAL REGISTRATION 1078451 DATED 4-22-2011, EXPIRES 4-22-2021.

THE ENGLISH TRANSLATION OF "LE REVISEUR" IN THE MARK IS "THE REVISER".

SER. NO. 79-097,778, FILED 4-22-2011.

ALLISON HOLTZ, EXAMINING ATTORNEY



David J. Kybas

Director of the United States Patent and Trademark Office

United States of America

United States Patent and Trademark Office

ARQENC

Reg. No. 4,173,472

Registered July 17, 2012

Int. Cl.: 9

TRADEMARK

PRINCIPAL REGISTER

NTT ELECTRONICS CORPORATION (JAPAN CORPORATION)
1-1-32 SHIN-URASHIMACHO
KANAGAWA-KU; YOKOHAMA-SHI, KANAGAWA 221-0031
JAPAN

FOR: ELECTRONIC DEVICES AND APPARATUS, NAMELY, HDTV LSI ENCODER CHIPS,
IN CLASS 9 (U.S. CLS. 21, 23, 26, 36 AND 38).

THE WORD(S) "ARQENC" HAS NO MEANING IN A FOREIGN LANGUAGE.

PRIORITY DATE OF 11-15-2010 IS CLAIMED.

OWNER OF INTERNATIONAL REGISTRATION 1078761 DATED 5-12-2011, EXPIRES 5-12-2021.

SER. NO. 79-097,912, FILED 5-12-2011.

JANICE KIM, EXAMINING ATTORNEY



David J. Kyffers

Director of the United States Patent and Trademark Office

United States of America

United States Patent and Trademark Office



Reg. No. 4,173,473

Registered July 17, 2012

Int. Cls.: 3, 25, 29 and 33

MM CAPITAL AG (SWITZERLAND SOCIÉTÉ ANONYME (SA))
MÜLIGÄSSLI 3
CH-8598 BOTTIGHOFEN
SWITZERLAND

FOR: FRAGRANCES AND PERFUMERY, IN CLASS 3 (U.S. CLS. 1, 4, 6, 50, 51 AND 52).

TRADEMARK

FOR: CLOTHING, NAMELY, COATS, JACKETS, PANTS, SHIRTS, SKIRTS, SOCKS, SHOES, BELTS, GLOVES, SHORTS, TIES, DRESSES, BLOUSES, PAJAMAS, HOSIERY, HATS, CAPS, SLIPPERS, SWIMWEAR, SWEATERS, UNDERWEAR, BATHROBES, LINGERIE, IN CLASS 25 (U.S. CLS. 22 AND 39).

PRINCIPAL REGISTER

FOR: OLIVE OIL, IN CLASS 29 (U.S. CL. 46).

FOR: WINE, SPIRITS, IN CLASS 33 (U.S. CLS. 47 AND 49).

THE MARK CONSISTS OF THE STYLIZED LETTERING "MM" APPEARING ABOVE THE WORDING "LUXURY LIFESTYLE".

PRIORITY DATE OF 3-30-2011 IS CLAIMED.

OWNER OF INTERNATIONAL REGISTRATION 1078806 DATED 5-2-2011, EXPIRES 5-2-2021.

SER. NO. 79-097,926, FILED 5-2-2011.

MARC LEIPZIG, EXAMINING ATTORNEY



David J. Kyros

Director of the United States Patent and Trademark Office

United States of America

United States Patent and Trademark Office



Reg. No. 4,173,474

Registered July 17, 2012

Int. Cl.: 33

TRADEMARK

PRINCIPAL REGISTER

MARTELL & CO (FRANCE SOCIETE ANONYME)
PLACE EDOUARD MARTELL
F-16100 COGNAC
FRANCE

FOR: ALCOHOLIC BEVERAGES EXCEPT BEER, IN CLASS 33 (U.S. CLS. 47 AND 49).

OWNER OF U.S. REG. NOS. 1,665,193, 1,672,733 AND OTHERS.

PRIORITY DATE OF 11-22-2010 IS CLAIMED.

OWNER OF INTERNATIONAL REGISTRATION 1078817 DATED 5-13-2011, EXPIRES 5-13-2021.

THE MARK CONSISTS OF THE WORDING "MARTELL" WITHIN A RECTANGLE. ABOVE THE RECTANGLE IS A DESIGN OF A FLYING BIRD. THE WORDING, RECTANGLE, AND FLYING BIRD ARE ALL WITHIN A CRESCENT-LIKE "HALF MOON" SHAPE THAT IS TURNED ON ITS SIDE WITH THE POINTS DOWN.

SER. NO. 79-097,927, FILED 5-13-2011.

DAVID HOFFMAN, EXAMINING ATTORNEY



David J. Kyfos

Director of the United States Patent and Trademark Office

United States of America

United States Patent and Trademark Office

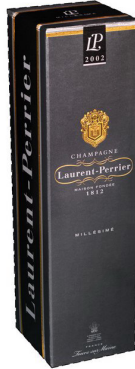

Reg. No. 4,173,475

Registered July 17, 2012

Int. Cl.: 33

TRADEMARK

PRINCIPAL REGISTER

LAURENT-PERRIER (FRANCE SOCIÉTÉ ANONYME (SA))
32 AVENUE DE CHAMPAGNE
F-51150 TOURS-SUR-MARNE
FRANCE

FOR: AOC WINES WITH THE PROTECTED APPELLATION OF ORIGIN CHAMPAGNE, IN CLASS 33 (U.S. CLS. 47 AND 49).

OWNER OF U.S. REG. NOS. 718,039, 3,005,606 AND OTHERS.

PRIORITY DATE OF 1-25-2011 IS CLAIMED.

OWNER OF INTERNATIONAL REGISTRATION 1071767 DATED 1-27-2011, EXPIRES 1-27-2021.

THE COLOR(S) BLACK, WHITE, GOLD AND GRAY IS/ARE CLAIMED AS A FEATURE OF THE MARK.

NO CLAIM IS MADE TO THE EXCLUSIVE RIGHT TO USE "2002", "CHAMPAGNE", "MAISON FONDEE", "1812", "MILLESIME", "BY APPOINTMENT TO H.R.H. THE PRINCE OF WALES PURVEYORS OF CHAMPAGNE", "FRANCE", AND "TOURS-SUR-MARNE", APART FROM THE MARK AS SHOWN.



David J. Kybas

Director of the United States Patent and Trademark Office

THE MARK CONSISTS OF PACKAGING FOR A BOTTLE OF WINE PHOTOGRAPHED IN THREE DIMENSIONS, COMPRISING A RECTANGULAR BOX IN GRAY WITH A THICK BLACK BAND, EDGED BY GOLD STRIPES, ON THE LEFT SIDE OF THE BOX WITH THE WORDING "LAURENT-PERRIER" IN WHITE WITHIN THE BLACK STRIPE. THE TOP OF THE BOX HAS A RECTANGULAR FIGURE IN BLACK EDGED BY GOLD STRIPES WITH THE LETTERING "LP" IN WHITE ABOVE THE WORD "MILLESIME" IN WHITE WITHIN THE RECTANGULAR FIGURE. THE FRONT OF THE BOX HAS A HORIZONTAL GRAY STRIPE ABOVE A HORIZONTAL GOLD STRIPE AT THE TOP, WITH A RECTANGLE DESIGN COLORED BLACK OVERLAPPING THE MIDDLE OF THE STRIPE AND HANGING BELOW, CONTAINING THE STYLIZED LETTERS "LP" IN WHITE ABOVE "2002" IN WHITE, WITH A HORIZONTAL WHITE STRIPE AT THE BOTTOM OF THE BLACK RECTANGLE DESIGN, BELOW WHICH IS A SHIELD DESIGN IN GOLD WITH WORDING AND DESIGNS IN BLACK. THE SHIELD DESIGN CONTAINS WITHIN IT A STYLIZED HELMET AND CROWN DESIGN ABOVE A SMALLER SHIELD CONTAINING AN EAGLE DESIGN WITH

Reg. No. 4,173,475 TOWER DESIGNS BELOW THE WINGS ON EITHER SIDE, AND AT THE BOTTOM OF THE SHIELD DESIGN THE LATIN WORDS "DE TURRI SUPER MATRONAM QUO NON ASCENDAM" APPEAR ON A ROUGHLY U-SHAPED BAND EXTENDING UP TO THE MIDDLE OF THE SMALLER SHIELD ON EITHER SIDE TO ELABORATE SCROLLWORK DESIGNS CONSISTING OF CURVING LINES AND CIRCULAR FIGURES APPEARING TO THE LEFT AND RIGHT AND ABOVE THE SMALLER SHIELD ON EITHER SIDE OF THE STYLIZED HELMET AND CROWN DESIGN. BELOW THE SHIELD DESIGN IS THE WORD "CHAMPAGNE" IN WHITE, WHICH IS ABOVE THE WORDS "LAURENT-PERRIER" IN WHITE INSIDE A GOLD SCROLLWORK DESIGN WHICH IS GENERALLY OBLONG WITH CURVING INTERSECTING DESIGNS. BELOW THE GOLD SCROLLWORK DESIGN ARE THE WORDS "MAISON FONDEE" IN WHITE APPEARING ABOVE "1812" IN WHITE. FURTHER BELOW "1812" IN WHITE APPEARS THE WORD "MILLESIME" IN WHITE. AT THE BOTTOM OF THE BOX IS A CROWN AND FEATHERS DESIGN IN WHITE ABOVE THE WORDS "BY APPOINTMENT TO H.R.H. THE PRINCE OF WALES PURVEYORS OF CHAMPAGNE CHAMPAGNE LAURENT-PERRIER" IN WHITE, WHICH WORDING APPEARS ABOVE THE WORD "FRANCE" IN WHITE, WHICH IN TURN APPEARS ABOVE THE STYLIZED WORDING IN WHITE "TOURS-SUR-MARNE". THE BROKEN LINES DEPICTING THE RECTANGULAR-SHAPED BOX INDICATE PLACEMENT OF THE MARK ON THE GOODS AND ARE NOT PART OF THE MARK.

THE ENGLISH TRANSLATION OF "DE TURRI SUPER MATRONAM QUO NON ASCENDAM", "MAISON FONDEE", AND "MILLESIME" IN THE MARK IS FROM THE TOP OF THESE TOWERS HOW FAR DO I NOT RISE, HOUSE FOUNDED, AND VINTAGE.

SER. NO. 79-098,104, FILED 5-2-2011.

LAURA KOVALSKY, EXAMINING ATTORNEY

United States of America

United States Patent and Trademark Office

BFI OPTILAS

Reg. No. 4,173,476

Registered July 17, 2012

Int. Cls.: 35, 39 and 42

SERVICE MARK

PRINCIPAL REGISTER

ACAL PLC (ENGLAND PUBLIC LIMITED COMPANY (PLC))
2 CHANCELLOR COURT, OCCAM ROAD
SURREY RESEARCH PARK; GUILDFORD, SURREY GU2 7AH
UNITED KINGDOM

FOR: THE BRINGING TOGETHER, FOR THE BENEFIT OF OTHERS OF A VARIETY OF GOODS ENABLING CUSTOMERS TO CONVENIENTLY VIEW AND PURCHASE THOSE GOODS, NAMELY, ELECTRIC, ELECTRONIC, COMMUNICATION, ELECTROMECHANICAL, IMAGING, MAGNETIC AND OPTICAL APPARATUS, EQUIPMENT AND INSTRUMENTS, SENSORS, LASERS, SCANNERS, SEMICONDUCTORS, MICROSYSTEMS AND PHOTONICS GOODS BY WHOLESALE OR IN A RETAIL STORE OR FROM A CATALOGUE BY MAIL ORDER OR BY MEANS OF TELECOMMUNICATIONS OR FROM AN INTERNET WEBSITE; BUSINESS MANAGEMENT SERVICES; BUSINESS ADMINISTRATION SERVICES; OFFICE FUNCTIONS; ADVERTISING AND MARKETING; ADVISORY SERVICES RELATING TO MARKETING; ADVISORY SERVICES FOR BUSINESS MANAGEMENT; PROVIDING INFORMATION ABOUT CONSUMER PRODUCTS AND SERVICES FOR RETAIL SERVICES CONCERNING PRODUCTS AND SERVICES IN PARTICULAR GEOGRAPHIC LOCATIONS, IN CLASS 35 (U.S. CLS. 100, 101 AND 102).

FOR: TRANSPORTATION, STORAGE AND DELIVERY OF GOODS; PACKAGING ARTICLES FOR TRANSPORTATION; TRAVEL ARRANGEMENT SERVICES; WAREHOUSING SERVICES, NAMELY, STORAGE, DISTRIBUTION, AND PACKING FOR SHIPMENT OF DOCUMENTS, PACKAGES, RAW MATERIALS, AND OTHER FREIGHT FOR OTHERS, IN CLASS 39 (U.S. CLS. 100 AND 105).

FOR: SCIENTIFIC AND TECHNOLOGICAL SERVICES, NAMELY, RESEARCH AND DESIGN IN THE FIELD OF COMPUTER NETWORKING HARDWARE; INDUSTRIAL RESEARCH IN THE FIELD OF COMMUNICATIONS NETWORKS, MEDICAL, ELECTRIC, ELECTRONIC, ELECTRO MECHANICAL, IMAGING, MAGNETIC AND OPTICAL APPARATUS EQUIPMENT AND INSTRUMENTS; COMPUTER PROGRAMMING; COMPUTER SOFTWARE DESIGN AND DEVELOPMENT; DESIGN AND DEVELOPMENT OF COMPUTER HARDWARE; ENGINEERING SERVICES; RESEARCH RELATING TO MECHANICAL ENGINEERING; RESEARCH AND DEVELOPMENT RELATING TO MEDICAL, ELECTRIC, ELECTRONIC, COMMUNICATION, ELECTROMECHANICAL, IMAGING, MAGNETIC AND OPTICAL APPARATUS, EQUIPMENT AND INSTRUMENTS; RESEARCH AND DEVELOPMENT RELATING TO MICROSYSTEMS AND PHOTONICS; RESEARCH AND DEVELOPMENT AND CONSULTATION RELATED THERETO IN THE FIELD OF MEDICAL, ELECTRIC, ELEC-

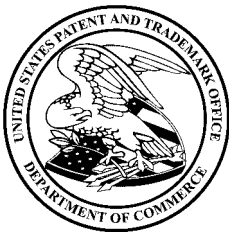

David J. Kyjars

Director of the United States Patent and Trademark Office

Reg. No. 4,173,476 TRONIC, COMMUNICATION, ELECTROMECHANICAL, IMAGING, MAGNETIC AND OPTICAL APPARATUS, EQUIPMENT AND INSTRUMENTS, MICROSYSTEMS AND PHOTONICS; MEDICAL AND SCIENTIFIC RESEARCH INFORMATION IN THE FIELD OF MEDICAL, ELECTRIC, ELECTRONIC, COMMUNICATION, ELECTROMECHANICAL, IMAGING, MAGNETIC AND OPTICAL APPARATUS, EQUIPMENT AND INSTRUMENTS, MICROSYSTEMS AND PHOTONICS; TECHNOLOGICAL CONSULTATION IN THE TECHNOLOGY FIELD OF COMPUTER HARDWARE SYSTEMS; TECHNICAL SUPPORT SERVICES, NAMELY, TROUBLESHOOTING OF COMPUTER SOFTWARE PROBLEMS; TECHNICAL ADVICE RELATING TO OPERATION OF COMPUTERS AND PRODUCT DEVELOPMENT CONSULTATION , IN CLASS 42 (U.S. CLS. 100 AND 101).

THE MARK CONSISTS OF STANDARD CHARACTERS WITHOUT CLAIM TO ANY PARTICULAR FONT, STYLE, SIZE, OR COLOR.

PRIORITY DATE OF 11-19-2010 IS CLAIMED.

OWNER OF INTERNATIONAL REGISTRATION 1079286 DATED 5-12-2011, EXPIRES 5-12-2021.

THE WORDING "OPTILAS" HAS NO MEANING IN A FOREIGN LANGUAGE.

SER. NO. 79-098,111, FILED 5-12-2011.

JANICE KIM, EXAMINING ATTORNEY

United States of America

United States Patent and Trademark Office



Reg. No. 4,173,477

Registered July 17, 2012

Int. Cls.: 6 and 7

TRADEMARK

PRINCIPAL REGISTER

SCHWARZE-ROBITEC GMBH (FED REP GERMANY GMBH)
OLPENER STR. 460-474
51109 KÖLN
FED REP GERMANY

FOR: COMMON METALS AND THEIR ALLOYS; TRANSPORTABLE BUILDINGS OF METAL; NON-ELECTRIC CABLES AND WIRES OF COMMON METAL; PIPES AND TUBES OF METAL, IN CLASS 6 (U.S. CLS. 2, 12, 13, 14, 23, 25 AND 50).

FOR: METAL WORKING MACHINES; METAL WORKING MACHINES, NAMELY, TUBE AND PIPE BENDING MACHINES, IN CLASS 7 (U.S. CLS. 13, 19, 21, 23, 31, 34 AND 35).

THE MARK CONSISTS OF THE WORDING "SR" IN STYLIZED FORM SUPERIMPOSED ON TOP OF A DESIGN OF THE COLOGNE CATHEDRAL. THE WORDING "PERFEKT" APPEARS UNDERNEATH THE DESIGN OF THE COLOGNE CATHEDRAL. THE WORDING "SCHWARZE-ROBITEC" APPEARS UNDER THE WORDING "PERFEKT". A PARTIAL CIRCLE DESIGN APPEARS AROUND THE WORDING "SR PERFEKT" WITH THE DESIGN OF THE COLOGNE CATHEDRAL. THE WORDING "SCHWARZE-ROBITEC" APPEARS AT THE BOTTOM OF THE CIRCLE.

OWNER OF INTERNATIONAL REGISTRATION 1079580 DATED 4-21-2011, EXPIRES 4-21-2021.

THE ENGLISH TRANSLATION OF "PERFEKT" IN THE MARK IS PERFECTLY.

SER. NO. 79-098,223, FILED 4-21-2011.

CHRISTOPHER LAW, EXAMINING ATTORNEY



David J. Kyfos

Director of the United States Patent and Trademark Office

United States of America

United States Patent and Trademark Office

SKANDIA ELEVATOR

Reg. No. 4,173,478

Registered July 17, 2012

Int. Cls.: 7 and 37

TRADEMARK

SERVICE MARK

PRINCIPAL REGISTER

SKANDIA ELEVATOR AB (SWEDEN JOINT STOCK COMPANY)
ARENTORP
SE-534 94 VARA
SWEDEN

FOR: ELEVATORS FOR TRANSMISSION OF GRANULAR PRODUCTS FOR USE IN THE AGRICULTURAL AND FOOD INDUSTRY; CONVEYORS FOR GRANULAR PRODUCTS AND USE IN THE AGRICULTURE AND FOOD INDUSTRY; MACHINES AND MACHINE TOOLS, NAMELY, ELEVATORS AND PARTS OF ELEVATORS FOR GRANULAR PRODUCTS AND FOR USE IN THE AGRICULTURE AND FOOD INDUSTRY, AND AGRICULTURAL MACHINES, NAMELY, ELEVATING AND TRANSPORTING MACHINES FOR GRANULAR PRODUCT AND FOR USE IN THE AGRICULTURAL AND FOOD INDUSTRY; MOTORS AND ENGINES, EXCEPT FOR LAND VEHICLES FOR USE WITH GRANULAR PRODUCTS AND FOR USE IN THE AGRICULTURE AND FOOD INDUSTRY; MACHINE COUPLING AND TRANSMISSION COMPONENTS NOT FOR LAND VEHICLES FOR USE WITH GRANULAR PRODUCTS AND FOR USE IN THE AGRICULTURE AND FOOD INDUSTRY; AGRICULTURAL IMPLEMENTS OTHER THAN HAND-OPERATED, NAMELY, ELEVATORS AND CONVEYORS FOR TRANSPORTING GRANULAR PRODUCTS; NONE OF THE FOREGOING GOODS FOR USE WITH PACKAGING MACHINERY, IN CLASS 7 (U.S. CLS. 13, 19, 21, 23, 31, 34 AND 35).

FOR: BUILDING CONSTRUCTION FOR THE AGRICULTURE AND FOOD INDUSTRY; REPAIR AND INSTALLATION OF MACHINES FOR THE TRANSPORTATION, ELEVATION AND CONVEYING OF GRANULAR PRODUCTS, FOR USE IN THE AGRICULTURE AND FOOD INDUSTRY; NONE OF THE FOREGOING SERVICES FOR USE WITH PACKAGING MACHINERY, IN CLASS 37 (U.S. CLS. 100, 103 AND 106).

THE MARK CONSISTS OF STANDARD CHARACTERS WITHOUT CLAIM TO ANY PARTICULAR FONT, STYLE, SIZE, OR COLOR.

OWNER OF INTERNATIONAL REGISTRATION 1079591 DATED 5-16-2011, EXPIRES 5-16-2021.

NO CLAIM IS MADE TO THE EXCLUSIVE RIGHT TO USE "ELEVATOR", APART FROM THE MARK AS SHOWN.

SER. NO. 79-098,229, FILED 5-16-2011.



David J. Kyffers

Director of the United States Patent and Trademark Office

Reg. No. 4,173,478 LIEF MARTIN, EXAMINING ATTORNEY

United States of America

United States Patent and Trademark Office

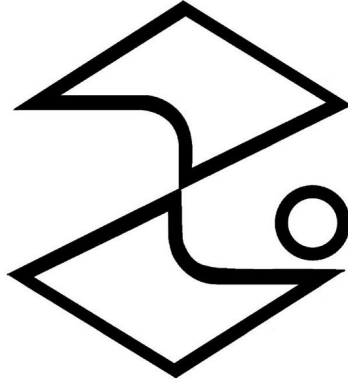

Reg. No. 4,173,479

Registered July 17, 2012

Int. Cl.: 25

TRADEMARK

PRINCIPAL REGISTER

VESTAR INTERNATIONAL S.A. (LUXEMBOURG JOINT STOCK COMPANY)
42-44 AVENUE DE LA GARE
L-1610 LUXEMBOURG
LUXEMBOURG

FOR: PULLOVERS, CARDIGANS, SWEATERS, TROUSERS, SKIRTS, JACKETS, BLOUSES, SHIRTS, JEANS, SWEATPANTS, SHORTS, SWEATSHIRTS, SUITS, DRESSES, OVERCOATS, COATS, RAINCOATS, BELTS, JERSEYS, TIES, SCARVES, TURBANS, HEADBANDS, SOCKS AND STOCKINGS, VESTS, WAISTCOATS, JUMPERS, TRACKSUITS, BLOUSONS, T-SHIRTS, ANORAKS, SUSPENDERS, LOUNGEWEAR, OVERALLS, HATS AND CAPS, GLOVES, SHOES, SANDALS, BOOTS, SLIPPERS, SOLES FOR FOOTWEAR, IN CLASS 25 (U.S. CLS. 22 AND 39).

THE MARK CONSISTS OF TWO IRREGULAR SHAPED SQUARES AND A CIRCLE. THE TOP SQUARE HAS THREE STRAIGHT SIDES AND ONE CURVED LINE. THE LOWER POINT ON THE CURVED LINE TOUCHES THE TOP OF THE CURVE OF THE SECOND IRREGULAR SQUARE WHICH ALSO HAS THREE STRAIGHT SIDES THAT EXTEND IN THE OPPOSITE DIRECTION OF THE TOP SQUARE. A CIRCLE BALANCES ON THE RIGHT HAND POINT OF THE CURVE ON THE LOWER SQUARE.

PRIORITY DATE OF 12-28-2010 IS CLAIMED.

OWNER OF INTERNATIONAL REGISTRATION 1079648 DATED 5-24-2011, EXPIRES 5-24-2021.

SER. NO. 79-098,253, FILED 5-24-2011.

TRACY FLETCHER, EXAMINING ATTORNEY



David J. Kyffers

Director of the United States Patent and Trademark Office

United States of America

United States Patent and Trademark Office



Reg. No. 4,173,480

Registered July 17, 2012

Int. Cls.: 42 and 44

SERVICE MARK

PRINCIPAL REGISTER

CIT (FRANCE SOCIÉTÉ PAR ACTIONS SIMPLIFIÉE)
F-27930 MISEREY, FRANCE

FOR: SCIENTIFIC AND PHYSICS RESEARCH; RESEARCH IN THE FIELD OF CHEMISTRY; RESEARCH IN THE FIELD OF TOXICOLOGY; RESEARCH IN THE FIELD OF BIOTECHNOLOGY; RESEARCH IN THE FIELD OF AGROCHEMISTRY; SERVICES INVOLVING BIOLOGY AND CHEMISTRY, NAMELY, PHARMACOLOGY ANALYSIS AND GENOTOXICITY TESTING, BIOLOGICAL AND CHEMICAL RESEARCH, AND TESTING, ANALYSIS AND ASSESSMENT OF DRUG CANDIDATE TOXICITY AND SAFETY ASSAYS; CONDUCTING CHEMICAL AND BIOLOGICAL ANALYSIS; SCIENTIFIC LABORATORY SERVICES FOR TESTING AND TECHNICAL MEASUREMENTS; BIOLOGICAL RESEARCH; BACTERIOLOGICAL RESEARCH; SCIENTIFIC STUDIES IN THE FIELDS OF PHARMACEUTICALS, CHEMISTRY, BIOLOGY, GENOMICS, IMMUNOLOGY, PHARMACOLOGY AND TOXICOLOGY; SERVICES OF A MEDICAL LABORATORY, IN CLASS 42 (U.S. CLS. 100 AND 101).

FOR: CONDUCTING CLINICAL AND MEDICAL ANALYSES FOR MEDICAL DIAGNOSTIC OR TREATMENT PURPOSES AND DRUG USE TESTING AND EVALUATION PURPOSES; MEDICAL SERVICES IN THE FIELD OF LABORATORY DIAGNOSTICS; RENTAL OF MEDICAL DEVICES, IN CLASS 44 (U.S. CLS. 100 AND 101).

THE MARK CONSISTS OF THE WORDING "LEADSCREEN" ON AN ARROW POINTING TO THE RIGHT AND DESIGNS OF MOLECULES.

PRIORITY DATE OF 2-16-2011 IS CLAIMED.

OWNER OF INTERNATIONAL REGISTRATION 1079725 DATED 4-14-2011, EXPIRES 4-14-2021.

SER. NO. 79-098,290, FILED 4-14-2011.

KRISTIN CARLSON, EXAMINING ATTORNEY



David J. Kybas

Director of the United States Patent and Trademark Office

United States of America

United States Patent and Trademark Office

KOXKA

Reg. No. 4,173,481

Registered July 17, 2012

Int. Cl.: 11

KOXKA TECHNOLOGIES S.L. (SPAIN SOCIEDAD DE RESPONSABILIDAD LIMITADA (SL))
POLÍGONO DE LANDABEN, CALLE A, S/N
E-31012 PAMPLONA (NAVARRA)
SPAIN

TRADEMARK

FOR: REFRIGERATING APPLIANCES AND INSTALLATIONS FOR COMMERCIAL AND INDUSTRIAL USE, IN CLASS 11 (U.S. CLS. 13, 21, 23, 31 AND 34).

PRINCIPAL REGISTER

THE MARK CONSISTS OF THE WORDING "KOXKA" IN GRAY WITH THE LETTER "A" FORMED IN PART BY A RED QUADRILATERAL. THE COLOR WHITE REPRESENTS BACKGROUND AND DOES NOT FORM PART OF THE MARK.

PRIORITY DATE OF 4-12-2011 IS CLAIMED.

OWNER OF INTERNATIONAL REGISTRATION 1079758 DATED 5-24-2011, EXPIRES 5-24-2021.

THE COLOR(S) RED AND GRAY IS/ARE CLAIMED AS A FEATURE OF THE MARK.

THE WORD(S) "KOXKA" HAS NO MEANING IN A FOREIGN LANGUAGE.

SER. NO. 79-098,298, FILED 5-24-2011.

TRACY FLETCHER, EXAMINING ATTORNEY



David J. Kybas

Director of the United States Patent and Trademark Office

United States of America
United States Patent and Trademark Office

Tri-Fender

Reg. No. 4,173,482

Registered July 17, 2012

Int. Cl.: 5

TRADEMARK

PRINCIPAL REGISTER

DELAVAL HOLDING AB (SWEDEN JOINT STOCK COMPANY, EQUIVALENT TO CORPORATION)
GUSTAF DE LAVALS VÄG 15
TUMBA, SWEDEN SE147 21

FOR: ALL PURPOSE DISINFECTANTS, MEDICATED OR SANITARY PREPARATIONS FOR DISINFECTING AND SOFTENING TEATS AND UDDERS, SANITIZING TEAT DIP FOR LIVESTOCK, MEDICATED ANIMAL WASHES, IN CLASS 5 (U.S. CLS. 6, 18, 44, 46, 51 AND 52).

THE MARK CONSISTS OF STANDARD CHARACTERS WITHOUT CLAIM TO ANY PARTICULAR FONT, STYLE, SIZE, OR COLOR.

OWNER OF INTERNATIONAL REGISTRATION 1079772 DATED 5-18-2011, EXPIRES 5-18-2021.

SER. NO. 79-098,305, FILED 5-18-2011.

PATRICIA EVANKO, EXAMINING ATTORNEY



David J. Kyffers

Director of the United States Patent and Trademark Office

United States of America

United States Patent and Trademark Office

coDiagnostiX

Reg. No. 4,173,483

Registered July 17, 2012

Int. Cl.: 9

TRADEMARK

PRINCIPAL REGISTER

STRAUMANN HOLDING AG (SWITZERLAND AG)
PETER MERIAN-WEG 12
CH-4002 BASEL
SWITZERLAND

FOR: CAD/CAM COMPUTER PROGRAMS FOR DENTAL PURPOSES; COMPUTER PROGRAMS FOR MEASURING 3D MEASUREMENTS OF TEETH, JAWS AND BONE STRUCTURE FOR DENTAL PURPOSES; COMPUTER PROGRAMS FOR RECONSTRUCTING 3D DATA FROM 2D PHOTOS FOR DENTAL PURPOSES; COMPUTER PROGRAMS FOR CREATING AND MANAGING X-RAY IMAGES; COMPUTER PROGRAMS FOR CONTROLLING DENTAL APPARATUSES, IN CLASS 9 (U.S. CLS. 21, 23, 26, 36 AND 38).

THE MARK CONSISTS OF STANDARD CHARACTERS WITHOUT CLAIM TO ANY PARTICULAR FONT, STYLE, SIZE, OR COLOR.

PRIORITY DATE OF 11-2-2010 IS CLAIMED.

OWNER OF INTERNATIONAL REGISTRATION 1079775 DATED 4-29-2011, EXPIRES 4-29-2021.

SER. NO. 79-098,308, FILED 4-29-2011.

MARILYN IZZI, EXAMINING ATTORNEY



David J. Kyffers

Director of the United States Patent and Trademark Office

United States of America

United States Patent and Trademark Office

INNER FORCE

Reg. No. 4,173,484

Registered July 17, 2012

Int. Cl.: 3

TRADEMARK

PRINCIPAL REGISTER

GEPARLYS (FRANCE SOCIÉTÉ PAR ACTIONS SIMPLIFIÉE)
422 RUE SAINT HONORÉ
F-75008 PARIS
FRANCE

FOR: PERFUMES, ESSENTIAL OILS, COSMETICS, HAIR LOTIONS, IN CLASS 3 (U.S. CLS. 1, 4, 6, 50, 51 AND 52).

THE MARK CONSISTS OF STANDARD CHARACTERS WITHOUT CLAIM TO ANY PARTICULAR FONT, STYLE, SIZE, OR COLOR.

OWNER OF INTERNATIONAL REGISTRATION 1080063 DATED 5-25-2011, EXPIRES 5-25-2021.

SER. NO. 79-098,430, FILED 5-25-2011.

MAYUR VAGHANI, EXAMINING ATTORNEY



David J. Kybas

Director of the United States Patent and Trademark Office

United States of America

United States Patent and Trademark Office



Reg. No. 4,173,485

Registered July 17, 2012

Int. Cl.: 25

TRADEMARK

PRINCIPAL REGISTER

MA.AL.BI. S.R.L. (ITALY LIMITED LIABILITY COMPANY)
VIA PAPA GIOVANNI XXIII, 8/A
I-13882 CERRIONE (BI)
ITALY

FOR: LEATHER COATS, LEATHER JACKETS, LEATHER TROUSERS, LEATHER SKIRTS, LEATHER TOPS, LEATHER RAINCOATS, LEATHER LONG COATS, LEATHER OVERCOATS, LEATHER BELTS, LEATHER BRACES FOR CLOTHING, BELTS, SUITS, PADDED JACKETS, JACKETS, STUFF JACKETS, JUMPERS, TROUSERS, JEANS, SKIRTS, DRESSES, COATS, OVERCOATS, CLOAKS, RAINCOATS, PARKAS, PULLOVERS, SHIRTS, T-SHIRTS, BLOUSES, SWEATERS, UNDERWEAR, BABY-DOLLS BEING NIGHTWEAR, BATHROBES, BATHING COSTUMES, NEGLIGEE, SWIM SUITS, DRESSING GOWNS, NIGHTGOWNS, ONE-PIECE DRESSES, TWO-PIECE DRESSES, EVENING DRESSES, SHAWLS, SCARVES, TIES, NECKTIES, GENTLEMEN SUITS, DRESS SHIRTS, BUTTON-FRONT ALOHA SHIRTS, SWEAT SHIRTS, UNDER SHIRTS, POLO SHIRTS, BODY SUITS, BLAZERS, SHORTS, SPORT SHIRTS; SHOES, ATHLETIC SHOES, SLIPPERS, OVERSHOES, LOW HEEL SHOES, LEATHER SHOES, RUBBER SHOES, GALOSHES, GOLF SHOES, WOODEN CLOGS, ANGLER SHOES, BASKETBALL SHOES, DRESS SHOES, HEELS, HIKING SHOES, RUGBY SHOES, BOXING SHOES, BASE BALL SHOES, VINYL SHOES, BEACH SHOES, INNER SOLES, SOLES FOR FOOTWEAR, FOOTWEAR UPPER, HEELPIECES FOR SHOES AND BOOTS, NON-SLIPPING PIECES FOR SHOES AND BOOTS, NAMELY, NON-SLIP SOLES FOR FOOTWEAR, TIPS FOR FOOTWEAR, RAIN SHOES, TRACK-RACING SHOES, WORK SHOES, STRAW SHOES, GYMNAS TIC SHOES, BOOTS, SKI BOOTS, HALF BOOTS, ARCTIC BOOTS, FOOTBALL BOOTS, LACED BOOTS, FIELD HOCKEY SHOES, HAND BALL SHOES, ESPARTO SHOES, ESPARTO SANDALS, SANDALS, BATH SANDALS; GLOVES, GLOVES FOR PROTECTION AGAINST COLD, LEATHER GLOVES, MITTENS; HATS AND CAPS, VISORS, LEATHER HATS AND CAPS, IN CLASS 25 (U.S. CLS. 22 AND 39).



NO CLAIM IS MADE TO THE EXCLUSIVE RIGHT TO USE "1947", APART FROM THE MARK AS SHOWN.

PRIORITY DATE OF 4-12-2011 IS CLAIMED.

David J. Kybas

OWNER OF INTERNATIONAL REGISTRATION 1080245 DATED 4-26-2011, EXPIRES 4-26-2021.

Reg. No. 4,173,485 THE MARK CONSISTS OF THE WORDING "MA.AL.BI." SUPERIMPOSED ON A RECTANGULAR ADVERTISING BANNER WHICH IS ON TOP OF THE YEAR "1947" AND UNDERNEATH A DESIGN OF A BEAR SET AGAINST A MOUNTAIN LANDSCAPE ALL CONTAINED INSIDE A MISCELLANEOUS OVAL SHAPE.

SER. NO. 79-098,513, FILED 4-26-2011.

HAI-LY LAM, EXAMINING ATTORNEY

United States of America
United States Patent and Trademark Office

NewGen

Reg. No. 4,173,486

Registered July 17, 2012

Int. Cl.: 9

TRADEMARK

PRINCIPAL REGISTER

GYC (REPUBLIC OF KOREA CORPORATION)
YULCHONJE 1 RURAL INDUSTRIAL
COMPLEX 7 BLOCKFREE TRADE REGION BLOCK
REPUBLIC OF KOREA

FOR: PROTECTIVE GLOVES FOR INDUSTRIAL PURPOSES; GLOVES FOR PROTECTION AGAINST X-RAYS FOR INDUSTRIAL PURPOSES ASBESTOS GLOVES FOR PROTECTION AGAINST ACCIDENTS; GLOVES FOR PROTECTION AGAINST ACCIDENTS, IN CLASS 9 (U.S. CLS. 21, 23, 26, 36 AND 38).

OWNER OF INTERNATIONAL REGISTRATION 1080250 DATED 1-11-2011, EXPIRES 1-11-2021.

SER. NO. 79-098,516, FILED 1-11-2011.

TRACY WHITTAKER-BROWN, EXAMINING ATTORNEY



David J. Kyffers

Director of the United States Patent and Trademark Office

United States of America

United States Patent and Trademark Office



월드웨이주식회사
WORLDWAY CO., LTD.

Reg. No. 4,173,487

Registered July 17, 2012

Int. Cl.: 35

SERVICE MARK

PRINCIPAL REGISTER

WORLDWAY CO., LTD. (REPUBLIC OF KOREA CORPORATION)
618, SINJEONG-RI, JEONUI-MYEON
YEONGI-GUNCHUNGCHEONGNAM-DO
REPUBLIC OF KOREA

FOR: RETAIL STORE SERVICES FEATURING NUTRITIONAL SUPPLEMENTS, SPECIFICALLY EXCLUDING BUSINESS MARKETING AND STRATEGIC PLANNING CONSULTING SERVICE IN THE FIELDS OF PUBLIC HEALTH, NUTRITION AND THE HEALTH FOOD INDUSTRY; ONLINE RETAIL STORE SERVICES FEATURING NUTRITIONAL SUPPLEMENTS, SPECIFICALLY EXCLUDING BUSINESS MARKETING AND STRATEGIC PLANNING CONSULTING SERVICE IN THE FIELDS OF PUBLIC HEALTH, NUTRITION AND THE HEALTH FOOD INDUSTRY; WHOLESALE STORE SERVICES FEATURING NUTRITIONAL SUPPLEMENTS, SPECIFICALLY EXCLUDING BUSINESS MARKETING AND STRATEGIC PLANNING CONSULTING SERVICE IN THE FIELDS OF PUBLIC HEALTH, NUTRITION AND THE HEALTH FOOD INDUSTRY, IN CLASS 35 (U.S. CLS. 100, 101 AND 102).

NO CLAIM IS MADE TO THE EXCLUSIVE RIGHT TO USE "CO., LTD." AND "COMPANY IN KOREAN CHARACTERS.", APART FROM THE MARK AS SHOWN.

PRIORITY DATE OF 10-26-2010 IS CLAIMED.

OWNER OF INTERNATIONAL REGISTRATION 1080265 DATED 4-22-2011, EXPIRES 4-22-2021.

THE transliteration of the non-Latin characters in the mark is: "WORLDWAY JUSIK HOESA".

THE MARK CONSISTS OF ON THE LEFT, A SHADED OVAL WITH FOUR CURVED BANDS ABOVE THE LETTERS "WWC". ON THE RIGHT IS THE WORDING "WORLDWAY STOCK COMPANY" IN KOREAN ABOVE THE WORDING "WORLDWAY CO., LTD."

THE ENGLISH TRANSLATION OF THE FOREIGN WORD(S) IN THE MARK IS: "WORLDWAY STOCK COMPANY".

SER. NO. 79-098,524, FILED 4-22-2011.



David J. Kybas

Director of the United States Patent and Trademark Office

Reg. No. 4,173,487 ALLISON HOLTZ, EXAMINING ATTORNEY

United States of America

United States Patent and Trademark Office

PRECTUS

Reg. No. 4,173,488

Registered July 17, 2012

Int. Cls.: 5, 10 and 25

TRADEMARK

PRINCIPAL REGISTER

UAB "SIMHA" (LITHUANIA CLOSED STOCK COMPANY)
LVOVO G. 89
LT-08104 VILNIUS
LITHUANIA

FOR: PHARMACEUTICAL PREPARATIONS FOR THE TREATMENT OF INFECTIOUS DISEASES; VETERINARY PREPARATIONS FOR THE TREATMENT OF INTESTINAL BACTERIA; SANITARY PREPARATIONS FOR MEDICAL PURPOSES; DIETETIC SUBSTANCES ADAPTED FOR MEDICAL USE, NAMELY, DIETETIC FOODS AND BEVERAGES, DIETETIC SUPPLEMENTS IN THE FORM OF TABLETS OR POWDER ADAPTED FOR MEDICAL USE; VITAMINS, MINERALS AND NUTRITIONAL SUPPLEMENTS; FOOD FOR BABIES; MEDICAL PLASTERS; MATERIALS FOR DRESSINGS, NAMELY, BANDAGES AND GAUZE FOR DRESSING; MATERIAL FOR STOPPING TEETH; DENTAL WAX; ALL PURPOSE DISINFECTANTS; PREPARATIONS FOR DESTROYING VERMIN; FUNGICIDES; HERBICIDES, IN CLASS 5 (U.S. CLS. 6, 18, 44, 46, 51 AND 52).

FOR: SURGICAL INSTRUMENTS AND APPARATUS; MEDICAL APPARATUS AND INSTRUMENTS, NAMELY, APPARATUS AND INSTRUMENTS FOR TREATING CARDIOVASCULAR DISEASE, OSTEOTRAUMATIC INJURIES, DEGENERATIVE BONE DISEASES AND JOINT DISEASES, APPARATUS AND INSTRUMENTS USED IN ORTHOPEDIC SURGERY TO POSITION SURGICAL INSTRUMENTS, IMPLANTS OR PATIENTS' LIMBS, APPARATUS AND INSTRUMENTS FOR USE IN ORTHOPEDIC SURGERY; DENTAL INSTRUMENTS AND APARTMENTS, NAMELY, ORAL IRRIGATORS AND CROWN BRIDGE REMOVERS, DISPOSABLE PROPHY ANGLES, REUSABLE AND RECYCLABLE PROPHY ANGLES, DENTAL ROOT FILES USED IN ROOT CANAL THERAPY PROCEDURES, ROOT CANAL THERAPY INSTRUMENTS USED TO SHAVE THE INSIDE OF A ROOT CANAL, PROPHY ANGLES, HEMOSTATS THAT CLAMP BLOOD VESSELS TO DIMINISH OR HALT BLOOD FLOW; VETERINARY APPARATUS AND INSTRUMENTS, NAMELY, CATHETERS AND ELECTROCARDIOGRAPHS FOR VETERINARY PURPOSES; ARTIFICIAL LIMBS, EYES AND TEETH; ORTHOPEDIC ARTICLES, NAMELY, ORTHOPEDIC BELTS, BRACES AND FOOTWEAR; SUTURE MATERIALS, IN CLASS 10 (U.S. CLS. 26, 39 AND 44).

FOR: CLOTHING, NAMELY, SHIRTS, PANTS, COATS, DRESSES, SOCKS, STOCKINGS, PANTYHOSE, DRESSING-GOWNS, ROBES, ANKLETS (SOCKS), SWEAT SUITS, WARM-UP SUITS, SWEATERS, PAJAMAS, PANTIES, UNDERCLOTHES, UNDERGARMENTS, UNDERPANTS, UNDERWEAR, TROUSERS, POLO SHIRTS, PULLOVERS, BLAZERS, BLOUSES, BLOUSONS, LINGERIE, JOGGING SUITS, JUMPERS, JUMPSUITS, KNEE HIGHS,



David J. Kyjars

Director of the United States Patent and Trademark Office

Reg. No. 4,173,488 LOUNGEWEAR; FOOTWEAR, HEADGEAR, NAMELY, HATS AND CAPS, IN CLASS 25 (U.S. CLS. 22 AND 39).

THE MARK CONSISTS OF STANDARD CHARACTERS WITHOUT CLAIM TO ANY PARTICULAR FONT, STYLE, SIZE, OR COLOR.

OWNER OF INTERNATIONAL REGISTRATION 1080308 DATED 5-19-2011, EXPIRES 5-19-2021.

THE WORDING "PRECTUS" HAS NO MEANING IN A FOREIGN LANGUAGE.

SER. NO. 79-098,536, FILED 5-19-2011.

NATALIE POLZER, EXAMINING ATTORNEY

United States of America
United States Patent and Trademark Office

DODIWAX

Reg. No. 4,173,489

Registered July 17, 2012

Int. Cl.: 1

TRADEMARK

PRINCIPAL REGISTER

CLARIANT AG
ROTHAUSSTRASSE 61
CH-4132 MUTTENZ
SWITZERLAND

FOR: CHEMICALS USED IN INDUSTRY, IN CLASS 1 (U.S. CLS. 1, 5, 6, 10, 26 AND 46).

THE MARK CONSISTS OF STANDARD CHARACTERS WITHOUT CLAIM TO ANY PARTICULAR FONT, STYLE, SIZE, OR COLOR.

OWNER OF INTERNATIONAL REGISTRATION 1080485A DATED 5-18-2011, EXPIRES 5-18-2021.

OWNER OF U.S. REG. NOS. 1,632,801 AND 3,790,394.

SER. NO. 79-098,593, FILED 5-18-2011.

KRISTINA MORRIS, EXAMINING ATTORNEY



David J. Kybas

Director of the United States Patent and Trademark Office

United States of America

United States Patent and Trademark Office

POCHET DU COURVAL

Reg. No. 4,173,490

Registered July 17, 2012

Int. Cl.: 21

TRADEMARK

PRINCIPAL REGISTER

POCHET (FRANCE SOCIÉTÉ PAR ACTIONS SIMPLIFIÉE)
121-127 QUAI DE VALMY
F-75010 PARIS
FRANCE

FOR: GLASSWARE AND BOTTLEWARE FOR DISPLAYING PERFUMERY PRODUCTS, COSMETIC AND BEAUTY PRODUCTS, NAMELY, PERFUME FLASKS AND VAPORIZERS SOLD EMPTY, FLASKS AND BOXES OF GLASS SOLD EMPTY, PERFUME SPRAYERS SOLD EMPTY, IN CLASS 21 (U.S. CLS. 2, 13, 23, 29, 30, 33, 40 AND 50).

THE MARK CONSISTS OF STANDARD CHARACTERS WITHOUT CLAIM TO ANY PARTICULAR FONT, STYLE, SIZE, OR COLOR.

PRIORITY DATE OF 4-15-2011 IS CLAIMED.

OWNER OF INTERNATIONAL REGISTRATION 1080567 DATED 5-5-2011, EXPIRES 5-5-2021.

OWNER OF U.S. REG. NO. 2,275,273.

THE WORDING "POCHET DU COURVAL" HAS NO MEANING IN A FOREIGN LANGUAGE.

SER. NO. 79-098,620, FILED 5-5-2011.

SCOTT BIBB, EXAMINING ATTORNEY



David J. Kyffers

Director of the United States Patent and Trademark Office

United States of America

United States Patent and Trademark Office



Reg. No. 4,173,491

Registered July 17, 2012

Int. Cls.: 9 and 35

TRADEMARK

SERVICE MARK

PRINCIPAL REGISTER

INSIDE SECURE (FRANCE SOCIÉTÉ ANONYME À DIRECTOIRE)
41 PARC DU CLUB DE GOLF
AIX EN PROVENCE, FRANCE F13856

FOR: ELECTRONIC COMPONENTS, NAMELY, COMPUTER CHIPS, INTEGRATED CIRCUITS, MICROCIRCUITS, PRINTED CIRCUITS, PRINTED CIRCUIT BOARDS, SEMI-CONDUCTORS, DATA PROCESSORS, MICROPROCESSORS AND MICROCONTROLLERS, IN CLASS 9 (U.S. CLS. 21, 23, 26, 36 AND 38).

FOR: RETAIL STORE, MAIL ORDER AND ONLINE ORDERING SERVICES AND ONLINE WHOLESALE DISTRIBUTORSHIP SERVICES ALL FEATURING ELECTRONIC COMPONENTS, CHIPS, INTEGRATED CIRCUITS, MICROCIRCUITS, PRINTED CIRCUITS, PRINTED CIRCUIT BOARDS, SEMI-CONDUCTORS, PROCESSORS, MICROPROCESSORS, AND MICROCONTROLLERS, IN CLASS 35 (U.S. CLS. 100, 101 AND 102).

THE MARK CONSISTS OF A STYLIZED BLACK LETTER "C" WITH A YELLOW-ORANGE DOT INSIDE A BLACK CIRCLE AND THE WORDING "AD-X2" IN BLACK. THE COLOR WHITE REPRESENTS BACKGROUND AND DOES NOT FORM PART OF THE MARK.

PRIORITY DATE OF 11-10-2010 IS CLAIMED.

OWNER OF INTERNATIONAL REGISTRATION 1080607 DATED 5-6-2011, EXPIRES 5-6-2021.

THE COLOR(S) BLACK AND ORANGE-YELLOW IS/ARE CLAIMED AS A FEATURE OF THE MARK.

SER. NO. 79-098,629, FILED 5-6-2011.

TRACY FLETCHER, EXAMINING ATTORNEY



David J. Kyros

Director of the United States Patent and Trademark Office

United States of America

United States Patent and Trademark Office

PRIMOS

Reg. No. 4,173,492

Registered July 17, 2012

Int. Cls.: 9 and 42

TRADEMARK

SERVICE MARK

PRINCIPAL REGISTER

SWARCO TRAFFIC SYSTEMS GMBH (FED REP GERMANY GMBH)
KELTERSTR. 67
72669 UNTERENSINGEN
FED REP GERMANY

FOR: ELECTRONIC CONTROL APPARATUS FOR TRAFFIC ENGINEERING SYSTEMS, DATA PROCESSING APPARATUS AND COMPUTERS FOR TRAFFIC ENGINEERING SYSTEMS, COMPUTER SOFTWARE FOR CONTROLLING AND OPERATING TRAFFIC ENGINEERING SYSTEMS, ROAD STATIONS AND CONTROL APPARATUS FOR TRAFFIC MANAGEMENT SYSTEMS, IN CLASS 9 (U.S. CLS. 21, 23, 26, 36 AND 38).

FOR: COMPUTER SOFTWARE DESIGN, MAINTENANCE, INSTALLATION AND UPDATING OF COMPUTER SOFTWARE, IN CLASS 42 (U.S. CLS. 100 AND 101).

THE MARK CONSISTS OF STANDARD CHARACTERS WITHOUT CLAIM TO ANY PARTICULAR FONT, STYLE, SIZE, OR COLOR.

PRIORITY DATE OF 12-9-2010 IS CLAIMED.

OWNER OF INTERNATIONAL REGISTRATION 1080850 DATED 5-19-2011, EXPIRES 5-19-2021.

THE WORDING "PRIMOS" HAS NO MEANING IN A FOREIGN LANGUAGE.

SER. NO. 79-098,698, FILED 5-19-2011.

JESSICA A. POWERS, EXAMINING ATTORNEY



David J. Kyros

Director of the United States Patent and Trademark Office

United States of America
United States Patent and Trademark Office

SealCom

Reg. No. 4,173,493

Registered July 17, 2012

Int. Cl.: 9

HAWO-GERÄTEBAU GMBH & CO. MASCHINENBAU KG (FED REP GERMANY GMBH
& CO. KG)
OBERE AU 2
74847 OBRIGHEIM
FED REP GERMANY

TRADEMARK

PRINCIPAL REGISTER

FOR: ELECTRIC OPERATING UNITS, COMPRISING A DISPLAY AND A TOUCHSCREEN,
USED TO OPERATE HOT SEAL APPARATUS FOR THE PACKAGING OF SEALABLE
POUCHES AND REELS IN HOSPITALS AS WELL AS IN DOCTORS' AND DENTISTS'
SURGERIES, IN CLASS 9 (U.S. CLS. 21, 23, 26, 36 AND 38).

THE MARK CONSISTS OF STANDARD CHARACTERS WITHOUT CLAIM TO ANY PAR-
TICULAR FONT, STYLE, SIZE, OR COLOR.

PRIORITY DATE OF 11-25-2010 IS CLAIMED.

OWNER OF INTERNATIONAL REGISTRATION 1080945 DATED 5-19-2011, EXPIRES 5-19-
2021.

SER. NO. 79-098,742, FILED 5-19-2011.

KIMBERLY PERRY, EXAMINING ATTORNEY



David J. Kyffers

Director of the United States Patent and Trademark Office

United States of America

United States Patent and Trademark Office

NAO

Reg. No. 4,173,494

Registered July 17, 2012

Int. Cls.: 9 and 28

TRADEMARK

PRINCIPAL REGISTER

ALDEBARAN ROBOTICS (FRANCE SOCIÉTÉ ANONYME)
168 BIS - 170 RUE RAYMOND LOSSERAND
PARIS, FRANCE F75014

FOR: COMPUTERS, COMPUTER PROGRAMS FOR OPERATING ROBOTS FOR ENTERTAINMENT PURPOSES, CONTROL APPARATUS, NAMELY, APPARATUS FOR REMOTE CONTROL OF A ROBOT FOR LEISURE PURPOSES, MEMORY CARDS, ALL AFOREMENTIONED GOODS FOR OPERATING ENTERTAINMENT ROBOTS, IN CLASS 9 (U.S. CLS. 21, 23, 26, 36 AND 38).

FOR: TOY ROBOTS; ELECTRONIC LEARNING TOYS; ELECTRONIC ACTION TOYS; ELECTRONIC EDUCATIONAL GAME MACHINES, IN CLASS 28 (U.S. CLS. 22, 23, 38 AND 50).

THE MARK CONSISTS OF STANDARD CHARACTERS WITHOUT CLAIM TO ANY PARTICULAR FONT, STYLE, SIZE, OR COLOR.

PRIORITY DATE OF 11-19-2010 IS CLAIMED.

OWNER OF INTERNATIONAL REGISTRATION 1081012 DATED 5-6-2011, EXPIRES 5-6-2021.

OWNER OF U.S. REG. NO. 3,612,575.

SER. NO. 79-098,770, FILED 5-6-2011.

ANDREA HACK, EXAMINING ATTORNEY



David J. Kypos

Director of the United States Patent and Trademark Office

United States of America

United States Patent and Trademark Office

f. 888

Reg. No. 4,173,495

Registered July 17, 2012

Int. Cls.: 32 and 33

TRADEMARK

PRINCIPAL REGISTER

FASHIONTV.COM GMBH (FED REP GERMANY GMBH (LIMITED LIABILITY COMPANY))
BRIENNER STRASSE 21
80333 MÜNCHEN
FED REP GERMANY

FOR: BEERS; MINERAL AND AERATED WATERS AND OTHER NON-ALCOHOLIC DRINKS, NAMELY, DRINKING WATER; FRUIT DRINKS AND FRUIT JUICES; SYRUPS AND OTHER PREPARATIONS FOR MAKING BEVERAGES, NAMELY, FRUIT DRINKS; MULTIVITAMIN JUICES, NAMELY, FRUIT JUICES WITH VITAMINS, VEGETABLE JUICES WITH VITAMINS; NON-ALCOHOLIC ENERGY DRINKS AND ISOTONIC DRINKS, NON-ALCOHOLIC SOFT DRINKS, IN CLASS 32 (U.S. CLS. 45, 46 AND 48).

FOR: ALCOHOLIC BEVERAGES, EXCEPT BEERS, IN CLASS 33 (U.S. CLS. 47 AND 49).

THE MARK CONSISTS OF THE STYLIZED OUTLINED LOWER-CASE LETTER "F" FOLLOWED BY AN OUTLINED CIRCLE FOLLOWED BY THE STYLIZED OUTLINED NUMBER "88".

PRIORITY DATE OF 11-18-2010 IS CLAIMED.

OWNER OF INTERNATIONAL REGISTRATION 1081185 DATED 5-17-2011, EXPIRES 5-17-2021.

SER. NO. 79-098,834, FILED 5-17-2011.

KRISTINA MORRIS, EXAMINING ATTORNEY



David J. Kybas

Director of the United States Patent and Trademark Office

United States of America

United States Patent and Trademark Office



Reg. No. 4,173,496

Registered July 17, 2012

Int. Cl.: 25

TRADEMARK

PRINCIPAL REGISTER

YVAN MARSAN (FRANCE INDIVIDUAL)
VIA G. BUFFI 2
CH-6900 LUGANO
SWITZERLAND

FOR: CLOTHING, NAMELY, T-SHIRTS AND SWEATERS, IN CLASS 25 (U.S. CLS. 22 AND 39).

THE NAME(S), PORTRAIT(S), AND/OR SIGNATURE(S) SHOWN IN THE MARK DOES NOT IDENTIFY A PARTICULAR LIVING INDIVIDUAL.

OWNER OF INTERNATIONAL REGISTRATION 1081480 DATED 5-24-2011, EXPIRES 5-24-2021.

THE MARK CONSISTS OF THE WORDING "JOHN GALT" WITHIN A SHADED HEART DESIGN.

SER. NO. 79-098,954, FILED 5-24-2011.

RUDY R. SINGLETON, EXAMINING ATTORNEY



David J. Kyffers

Director of the United States Patent and Trademark Office

United States of America

United States Patent and Trademark Office



Reg. No. 4,173,497

Registered July 17, 2012

Int. Cls.: 9, 35 and 38

TRADEMARK

SERVICE MARK

PRINCIPAL REGISTER

ANDREAS REICH (FED REP GERMANY INDIVIDUAL)
KORMORANWEG 1
65201 WIESBADEN
FED REP GERMANY

FOR: APPARATUSES FOR AUDIO-VISUAL RECORDING, TRANSMISSION AND COMMUNICATION TO THE PUBLIC; DATA PROCESSING APPARATUSES AND COMPUTERS, IN CLASS 9 (U.S. CLS. 21, 23, 26, 36 AND 38).

FOR: PROVIDING RADIO ADVERTISING, TELEVISION ADVERTISING AND ADVERTISING ON THE INTERNET; RADIO ADVERTISING, TELEVISION ADVERTISING AND ADVERTISING ON THE INTERNET PROVIDED TO OTHERS, IN CLASS 35 (U.S. CLS. 100, 101 AND 102).

FOR: RADIO BROADCASTING, TELEVISION BROADCASTING AND BROADCASTING OF PROGRAMMES ON THE INTERNET, IN CLASS 38 (U.S. CLS. 100, 101 AND 104).

NO CLAIM IS MADE TO THE EXCLUSIVE RIGHT TO USE "TV", APART FROM THE MARK AS SHOWN.

OWNER OF INTERNATIONAL REGISTRATION 1081554 DATED 5-4-2011, EXPIRES 5-4-2021.

THE MARK CONSISTS OF THE WORDING "KARTINA" ABOVE THE LETTERS "TV", WHICH ARE IN A MUCH LARGER FONT SIZE. THE WORDING APPEARS INSIDE A RECTANGLE WITH ROUNDED CORNERS, WHICH IS INSIDE TILTED RECTANGLE WITH ROUNDED CORNERS. THE ENTIRE MARK IS INSIDE A LARGER RECTANGLE.

SER. NO. 79-098,974, FILED 5-4-2011.

AISHA CLARKE, EXAMINING ATTORNEY



David J. Kybas

Director of the United States Patent and Trademark Office

United States of America

United States Patent and Trademark Office

Little Deviants

Reg. No. 4,173,498

Registered July 17, 2012

Int. Cls.: 9 and 28

TRADEMARK

PRINCIPAL REGISTER

SONY COMPUTER ENTERTAINMENT EUROPE LIMITED (UNITED KINGDOM LIMITED LIABILITY COMPANY)
10 GREAT MARLBOROUGH STREET
LONDON, W1F 7LP
UNITED KINGDOM

FOR: COMPUTER AND VIDEO GAME SOFTWARE; COMPUTER GAMES SOFTWARE; COMPUTER GAME SOFTWARE DOWNLOADABLE FROM THE INTERNET, IN CLASS 9 (U.S. CLS. 21, 23, 26, 36 AND 38).

FOR: TOYS AND PLAYTHINGS, NAMELY, PLUSH TOYS AND PLASTIC TOY FIGURES; ELECTRONIC GAMES FOR THE ENTERTAINMENT OF ADULTS AND CHILDREN, HAND-HELD COMPUTER GAMES EQUIPMENT NOT ADAPTED FOR USE WITH TV RECEIVERS, NAMELY, HAND-HELD UNITS FOR PLAYING ELECTRONIC GAMES OTHER THAN THOSE ADAPTED FOR USE WITH AN EXTERNAL DISPLAY SCREEN OR MONITOR, IN CLASS 28 (U.S. CLS. 22, 23, 38 AND 50).

THE MARK CONSISTS OF STANDARD CHARACTERS WITHOUT CLAIM TO ANY PARTICULAR FONT, STYLE, SIZE, OR COLOR.

PRIORITY DATE OF 12-14-2010 IS CLAIMED.

OWNER OF INTERNATIONAL REGISTRATION 1081888 DATED 6-14-2011, EXPIRES 6-14-2021.

SER. NO. 79-099,082, FILED 6-14-2011.

WILLIAM ROSSMAN, EXAMINING ATTORNEY



David J. Kyffers

Director of the United States Patent and Trademark Office

United States of America
United States Patent and Trademark Office

KANUNNIK

Reg. No. 4,173,499

Registered July 17, 2012

Int. Cl.: 32

GEESTRIJK NV (BELGIUM JOINT STOCK COMPANY)
WILDERENLAAN 8
B-3803 WILDEREN
BELGIUM

FOR: BEERS, NAMELY, ALE, LAGER, STOUT, IN CLASS 32 (U.S. CLS. 45, 46 AND 48).

TRADEMARK

THE MARK CONSISTS OF STANDARD CHARACTERS WITHOUT CLAIM TO ANY PARTICULAR FONT, STYLE, SIZE, OR COLOR.

PRINCIPAL REGISTER

PRIORITY DATE OF 11-25-2010 IS CLAIMED.

OWNER OF INTERNATIONAL REGISTRATION 1081961 DATED 5-13-2011, EXPIRES 5-13-2021.

THE ENGLISH TRANSLATION OF "KANUNNIK" IN THE MARK IS "CANON".

SER. NO. 79-099,110, FILED 5-13-2011.

DAVID HOFFMAN, EXAMINING ATTORNEY



David J. Kyffers

Director of the United States Patent and Trademark Office

United States of America

United States Patent and Trademark Office

Sanalika

Reg. No. 4,173,500

Registered July 17, 2012

Int. Cls.: 35, 41 and 42

OYUN STÜDYOSU İNTERAKTİF TEKNOLOJİLER REKLAM HİZMETLERİ SANAYİ VE
DIS TİCARET LIMITED SİRKETİ (TURKEY LIMITED COMPANY)
TAVUKÇUOĞLU İS MERKEZİ,
SEBNEM SOKAK NO:10/3 BOSTANCI; KADIKÖY -İSTANBUL
TURKEY

SERVICE MARK

PRINCIPAL REGISTER

FOR: ADVERTISING AGENCIES SERVICES; MARKETING AND PUBLICITY BUREAUS SERVICES; ADVERTISEMENT AND PUBLICITY SERVICES BY TELEVISION, RADIO, MAIL; DISSEMINATION OF ADVERTISING MATTER; CUSTOM WRITING SERVICES COMPRISING PUBLIC RELATIONS AND MARKETING MATERIALS FOR THE AUDIO, VIDEO AND TECHNOLOGY INDUSTRIES, COMMERCIAL OR ADVERTISEMENT EXHIBITION AND TRADE FAIR ORGANIZATION SERVICES; ADVERTISING AND ADVERTISEMENT SERVICES; ADVERTISING AGENCIES, NAMELY, PROMOTING THE GOODS AND SERVICES OF OTHERS; PRODUCTION AND DISTRIBUTION OF RADIO AND TELEVISION COMMERCIALS; ARRANGING AND CONDUCTING TRADE SHOWS IN THE FIELD OF FASHION CLOTHING AND TEXTILES, MODELING FOR ADVERTISING OR SALES PROMOTION; CONDUCTING MARKETING STUDIES; PUBLICITY AND SALES PROMOTION SERVICES; WINDOW DRESSING AND DISPLAY ARRANGEMENT SERVICES; PUBLIC OPINION POLLING; PUBLIC RELATIONS; PROVIDING OFFICE FUNCTIONS; BUSINESS MANAGEMENT OF PERFORMING ARTISTS; SECRETARIAL SERVICES; DOCUMENT REPRODUCTION; PHOTOCOPYING; TYPING SERVICES; WORD PROCESSING; COMPILATION OF INFORMATION INTO COMPUTER DATABASES; SYSTEMIZATION OF INFORMATION INTO COMPUTER DATABASES; TELEPHONE ANSWERING SERVICES; ARRANGING NEWSPAPER SUBSCRIPTIONS; RENTAL OF OFFICE MACHINES AND EQUIPMENTS; RENTAL OF VENDING MACHINES; BUSINESS ADMINISTRATION CONSULTANCY; COMMERCIAL OR INDUSTRIAL MANAGEMENT ASSISTANCE; BUSINESS MANAGEMENT AND ORGANIZATION CONSULTANCY; BUSINESS MANAGEMENT OF HOTELS FOR OTHERS; BUSINESS INVESTIGATION; PROVIDING STATISTICAL INFORMATION; PERSONNEL MANAGEMENT CONSULTANCY; PERSONNEL RECRUITMENT; ACCOUNTING; FINANCIAL STATEMENT PREPARATION AND ANALYSIS FOR BUSINESSES; BUSINESS AUDITING; COST PRICE ANALYSIS; ECONOMIC FORECASTING AND ANALYSIS; PAYROLL PREPARATION; TAX PREPARATION; IMPORT AND EXPORT AGENCIES; BUSINESS INVESTIGATIONS, EVALUATIONS, EXPERT APPRAISALS, INFORMATION AND RESEARCH IN THE FIELD OF CLOTHING AND TEXTILES FOR OTHERS; AUCTIONEERING; THE BRINGING TOGETHER, FOR THE BENEFIT OF OTHERS, OF A VARIETY OF GOODS EXCLUDING THE TRANSPORT THEREOF, ENABLING CUSTOMERS TO



David J. Kyros

Director of the United States Patent and Trademark Office

Reg. No. 4,173,500 CONVENIENTLY VIEW AND PURCHASE THOSE GOODS IN THE FIELD OF CLOTHING, IN CLASS 35 (U.S. CLS. 100, 101 AND 102).

FOR: EDUCATIONAL SERVICES, NAMELY, CLASSES AND SEMINARS IN THE FIELD OF METAL TREATING, LEATHER WORKING AND CLOTHING DESIGN; ORGANIZATION OF CONFERENCES, SYMPOSIUMS, SEMINARS AND CONGRESSES IN RELATION TO BUSINESS AND BUSINESS MANAGEMENT, NAMELY, TOURISM; PROVIDING MUSEUM FACILITIES FOR PRESENTATIONS AND EXHIBITIONS IN THE FIELD OF ART EXHIBITS; ARRANGING OF BEAUTY CONTESTS; ORGANIZATION OF ETHNIC DANCE FESTIVALS AND PROFESSIONAL DANCE PERFORMANCES; ORGANIZATION OF DANCE CONTESTS; ON-LINE ACADEMIC LIBRARY SERVICES; SPORT SERVICES, NAMELY, ORGANIZATION OF SPORT ACTIVITIES IN THE FIELD OF SOCCER, FOOTBALL AND TENNIS; ENTERTAINMENT SERVICES; PROVIDING CASINO FACILITIES; PROVIDING CINEMA FACILITIES; PROVIDING THEATRE FACILITIES; ARRANGING AND CONDUCTING CONCERTS BY MUSICAL ORCHESTRAS; ARRANGING OF CONCERTS; BOOKING OF SEATS FOR SHOWS; MODELING FOR ARTISTS; RENTAL OF STAGE AND SHOW SCENERY; PUBLICATIONS OF MAGAZINES, BOOKS AND NEWSPAPERS; PRODUCTION OF RADIO AND TELEVISION PROGRAMS EXCEPT COMMERCIALS; PRODUCTION OF CINE-FILMS; VIDEOTAPE FILM PRODUCTION; RECORDING STUDIO SERVICES; DUBBING; RENTAL OF TELEVISION AND RADIO RECEIVERS; RENTAL OF CINE-FILMS AND MOTION PICTURES; RENTAL OF MOVIE PROJECTORS AND ACCESSORIES; RENTAL OF SOUND RECORDINGS; RENTAL OF VIDEOTAPES; RENTAL OF VIDEOCASSETTES RECORDERS; NEWS REPORTING SERVICES, NAMELY, CURRENT EVENTS, FINANCIAL NEWS, ENTERTAINMENT NEWS; PHOTOGRAPHIC REPORTING SERVICES; PHOTOGRAPHY SERVICES; TRANSLATION SERVICES AND SIGN LANGUAGE TRANSLATION SERVICES, IN CLASS 41 (U.S. CLS. 100, 101 AND 107).

FOR: SCIENTIFIC AND INDUSTRIAL RESEARCH, NAMELY, SCIENTIFIC RESEARCH AND DEVELOPMENT; CHEMICAL RESEARCH SERVICES; GEOLOGICAL RESEARCH; MINING AND MINERAL EXPLORATION SERVICES; GEOLOGICAL RESEARCH SERVICES; EXPLORATION AND SEARCH OF OIL; MATERIAL TESTING AND CONSUMER PRODUCT SAFETY TESTING SERVICES; METEOROLOGICAL SERVICES, NAMELY, METEOROLOGICAL FORECASTING; PROVIDING METEOROLOGICAL INFORMATION; ENGINEERING CONSULTANCY SERVICES; ARCHITECTURAL DESIGN SERVICES; MAPPING SERVICES; LAND SURVEYING; LANDSCAPING SERVICES, NAMELY, LANDSCAPE DESIGN, LANDSCAPE GARDENING; RESEARCH ON BUILDING CONSTRUCTION OR CITY PLANNING; CONSULTANCY SERVICES CONCERNING ENVIRONMENTAL PROTECTION; UNDERWATER EXPLORATION; UNDERWATER STRUCTURAL INSPECTION SERVICES; QUALITY CONTROL SERVICES FOR OTHERS; CONDUCTING RIDE PERFORMANCE EVALUATIONS FOR AUTOMOTIVE COMPANIES; COMPUTER SERVICES, NAMELY, CREATING AND MAINTAINING WEB SITES FOR OTHERS; COMPUTER PROGRAMMING SERVICES; COMPUTER SOFTWARE DESIGN SERVICES FOR OTHERS; COMPUTER SOFTWARE UPDATING SERVICES FOR OTHERS; CONSULTANCY SERVICES IN THE FIELD OF COMPUTER HARDWARE; COMPUTER DATABASE DEVELOPMENT SERVICES; COMPUTER DATA RECOVERY SERVICES; COMPUTER SYSTEMS ANALYSIS SERVICES; COMPUTER CONSULTANCY SERVICES; COMPUTER RENTAL SERVICES; COMPUTER SOFTWARE RENTAL SERVICES; DUPLICATION OF COMPUTER PROGRAMS; INSTALLATION OF COMPUTER SOFTWARE; DESIGN SERVICES, NAMELY, DESIGN FOR OTHERS IN THE FIELD OF CLOTHING; DESIGN AND DEVELOPMENT OF NETWORKS; DESIGN FOR OTHERS IN THE FIELD OF ENGINEERING; GRAPHIC ART DESIGN; AUTHENTICATION IN THE FIELD OF WORKS OF ART, IN CLASS 42 (U.S. CLS. 100 AND 101).

THE MARK CONSISTS OF WORD "SANALIKA" IN HIGHLY STYLIZED UPPER-AND-LOWER CASE LETTERING, EACH LETTER OF WHICH CONTAINS WHITE SPACE OUTLINED IN THREE COLORS: GOLD ON THE BOTTOM, GRAY-BROWN IN THE CENTER AND YELLOW AT THE TOP. THE FIRST AND LAST LETTERS HAVE A GRACEFUL, CURVING STYLIZATION RESEMBLING A FISHTAIL.

Reg. No. 4,173,500 OWNER OF INTERNATIONAL REGISTRATION 1082010 DATED 11-12-2010, EXPIRES 11-12-2020.

THE COLOR(S) YELLOW, GOLD, WHITE, AND BROWN-GREY IS/ARE CLAIMED AS A FEATURE OF THE MARK.

THE OUTER PARTS OF THE LETTER OF THE WORDING "SANALINKA" IS IN COLOR YELLOW; THE INNER PARTS OF THE LETTER ARE MAINLY IN COLOR WHITE AND SOME PARTS OF THE LETTERS ARE SHADED WITH THE COLOR GREY.

SER. NO. 79-099,128, FILED 11-12-2010.

JILL C. ALT, EXAMINING ATTORNEY

United States of America

United States Patent and Trademark Office



Reg. No. 4,173,501

Registered July 17, 2012

Int. Cl.: 25

TRADEMARK

PRINCIPAL REGISTER

VELOCITY APPARELZ CO. (EGYPT JOINT STOCK COMPANY)
PUBLIC FREE ZONE
ISMAILIA
EGYPT

FOR: CLOTHING, NAMELY, SWEATERS, CARDIGANS, WAISTCOATS, SHIRTS, SUITS, TROUSERS, SHORTS, JUMPERS, RAINCOATS, PANTS, JACKETS, DRESSES; HEADGEAR, NAMELY, HATS, CAPS, BERETS, IN CLASS 25 (U.S. CLS. 22 AND 39).

NO CLAIM IS MADE TO THE EXCLUSIVE RIGHT TO USE THE NON-LATIN WORDING THAT MEANS APPARELS, APART FROM THE MARK AS SHOWN.

OWNER OF INTERNATIONAL REGISTRATION 1082103 DATED 5-10-2011, EXPIRES 5-10-2021.

THE TRANSLITERATION OF THE NON-LATIN CHARACTERS IN THE MARK IS "R2 VELOCITY APPARELZ".

THE MARK CONSISTS OF THE WORDING "R2" IN A HAND-WRITTEN, STYLIZED FONT WHERE THE "R" IS BACKWARDS AND THE "2" IS HALF THE HEIGHT OF THE "R", SO THAT THE "R" AND THE "2" FORM A STYLIZED ANKH SYMBOL; THE ARABIC CHARACTERS THAT MEAN R2 ARE CENTERED ABOVE THE WORDING "R2" AND THE ARABIC CHARACTERS THAT MEAN VELOCITY APPARELZ ARE CENTERED BELOW THE WORDING "R2". THE WORDING "R2" AND THE ARABIC CHARACTERS APPEAR CENTERED IN A SINGLE LINE RECTANGULAR BORDER.



SER. NO. 79-099,161, FILED 5-10-2011.

TINA BROWN, EXAMINING ATTORNEY

David J. Kybas

Director of the United States Patent and Trademark Office

United States of America

United States Patent and Trademark Office

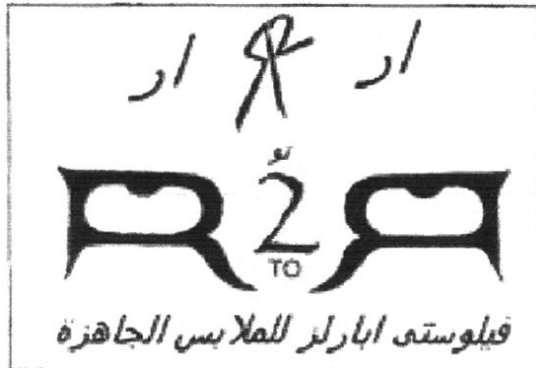

Reg. No. 4,173,502

Registered July 17, 2012

Int. Cl.: 25

TRADEMARK

PRINCIPAL REGISTER

VELOCITY APPARELZ CO. (EGYPT JOINT STOCK COMPANY)
PUBLIC FREE ZONE
ISMAILIA
EGYPT

FOR: CLOTHING, NAMELY, SWEATERS, CARDIGANS, WAISTCOATS, SHIRTS, SUITS, TROUSERS, SHORTS, JUMPERS, RAINCOATS, PANTS, JACKETS, DRESSES, FOOTWEAR; HEADGEAR, NAMELY, HATS, CAPS, BERETS, IN CLASS 25 (U.S. CLS. 22 AND 39).

NO CLAIM IS MADE TO THE EXCLUSIVE RIGHT TO USE THE NON-LATIN WORDING THAT MEANS APPARELS, APART FROM THE MARK AS SHOWN.

OWNER OF INTERNATIONAL REGISTRATION 1082104 DATED 5-10-2011, EXPIRES 5-10-2021.

THE NON-LATIN CHARACTERS CENTERED ABOVE THE WORDING "R2R" TRANSLITERATE TO R2R. THE NON-LATIN CHARACTERS CENTERED BELOW THE WORDING "R2R" TRANSLITERATE TO VELOCITY APPARELZ.

THE MARK CONSISTS OF THE WORDING "R2R" WHERE THE SECOND LETTER "R" IS BACKWARDS WITH THE ARABIC CHARACTERS THAT MEAN "R2R" CENTERED ABOVE THE WORDING "R2R" AND THE ARABIC CHARACTERS THAT MEAN VELOCITY APPARELZ CENTERED BELOW THE WORDING "R2R". THE WORD "TO" IS CENTERED BELOW THE NUMBER "2". THE WORDING "R2R" AND THE ARABIC CHARACTERS APPEAR CENTERED IN A SINGLE LINE RECTANGULAR BORDER.

SER. NO. 79-099,162, FILED 5-10-2011.

TINA BROWN, EXAMINING ATTORNEY



David J. Kybas

Director of the United States Patent and Trademark Office

United States of America
United States Patent and Trademark Office

NERAK

Reg. No. 4,173,503

Registered July 17, 2012

Int. Cl.: 7

NERAK GMBH FÖRDERTECHNIK (FED REP GERMANY GMBH = LIMITED LIABILITY COMPANY UNDER GERMAN FEDERAL LAW)

BRIGITTA 5
29313 HAMBÜHREN
FED REP GERMANY

TRADEMARK

PRINCIPAL REGISTER

FOR: MOTORS AND ENGINES EXCEPT FOR LAND VEHICLES; MACHINE COUPLING AND TRANSMISSION COMPONENTS EXCEPT FOR LAND VEHICLES; BAR GRID AND GRID BELT CONVEYORS; VERTICAL CONVEYORS FOR BOX SHAPED COMPONENTS; MULTI DISCHARGED BUCKET CONVEYORS; CIRCULATING CONVEYORS, BOX LIFTER MACHINES AND UNIT LOAD ELEVATORS, PENDULUM BUCKET ELEVATORS; RUBBER BLOCK CHAINS AND GRID BELTS BEING PARTS OF CONVEYORS AND ELEVATORS; PARTS AND COMPONENTS OF AFOREMENTIONED GOODS, IN CLASS 7 (U.S. CLS. 13, 19, 21, 23, 31, 34 AND 35).

THE MARK CONSISTS OF STANDARD CHARACTERS WITHOUT CLAIM TO ANY PARTICULAR FONT, STYLE, SIZE, OR COLOR.

OWNER OF INTERNATIONAL REGISTRATION 1082177 DATED 5-13-2011, EXPIRES 5-13-2021.

THE WORDING "NERAK" HAS NO MEANING IN A FOREIGN LANGUAGE.

SER. NO. 79-099,190, FILED 5-13-2011.

DAVID HOFFMAN, EXAMINING ATTORNEY



David J. Kyffers

Director of the United States Patent and Trademark Office

United States of America
United States Patent and Trademark Office

LIERAC
P A R I S

Reg. No. 4,173,504

Registered July 17, 2012

Int. Cl.: 3

TRADEMARK

PRINCIPAL REGISTER

LABORATOIRES LIERAC SA (FRANCE SOCIÉTÉ ANONYME)
99 RUE DU FAUBOURG SAINT HONORÉ
F-75008 PARIS
FRANCE

FOR: SOAP, PERFUMES, ESSENTIAL OILS, COSMETICS, NON-MEDICATED PREPARATIONS FOR SKIN CARE; NON-MEDICATED PREPARATIONS FOR SKIN MAINTENANCE AND EMBELLISHMENT, NAMELY, COSMETIC PREPARATIONS; COSMETIC SLIMMING PREPARATIONS, DEODORANTS FOR PERSONAL USE, COSMETIC PRE-SHAVE AND AFTER-SHAVE PREPARATIONS, COSMETIC PREPARATIONS FOR HAIR CARE, MAINTENANCE AND EMBELLISHMENT, SHAMPOOS, COSMETIC SUNCARE AND AFTERSUN PREPARATIONS, BEAUTY MASKS, COSMETIC SHOWER PREPARATIONS, IN CLASS 3 (U.S. CLS. 1, 4, 6, 50, 51 AND 52).

OWNER OF U.S. REG. NOS. 3,148,862, 3,908,357 AND OTHERS.

PRIORITY DATE OF 12-1-2010 IS CLAIMED.

OWNER OF INTERNATIONAL REGISTRATION 1082426 DATED 5-16-2011, EXPIRES 5-16-2021.

NO CLAIM IS MADE TO THE EXCLUSIVE RIGHT TO USE "PARIS", APART FROM THE MARK AS SHOWN.

SER. NO. 79-099,318, FILED 5-16-2011.

LIEF MARTIN, EXAMINING ATTORNEY



David J. Kyffers

Director of the United States Patent and Trademark Office

United States of America
United States Patent and Trademark Office

EXONAUT

Reg. No. 4,173,505

Registered July 17, 2012

Int. Cls.: 9, 35 and 42

TRADEMARK

SERVICE MARK

PRINCIPAL REGISTER

4C STRATEGIES AB (SWEDEN AKTIEBOLAG (AB))
P.O. BOX 7637
SE-103 94 STOCKHOLM
SWEDEN

FOR: COMPUTER PROGRAMMES (PROGRAMS), RECORDED ON DATA MEDIA, WITH SAID PROGRAMS BEING FOR EXERCISE PLANNING AND EVALUATION; COMPUTER SOFTWARE RECORDED ON DATA MEDIA, WITH SAID PROGRAMS BEING FOR EXERCISE PLANNING AND EVALUATION, IN CLASS 9 (U.S. CLS. 21, 23, 26, 36 AND 38).

FOR: PROFESSIONAL BUSINESS CONSULTANCY; PROVIDING BUSINESS INFORMATION, ALSO VIA INTERNET, THE CABLE NETWORK OR OTHER FORMS OF DATA TRANSFER; BUSINESS INVESTIGATIONS; BUSINESS MANAGEMENT AND ORGANIZATION CONSULTANCY; BUSINESS ORGANIZATION CONSULTANCY; COMPILATION OF INFORMATION INTO COMPUTER DATABASES; SYSTEMIZATION OF INFORMATION INTO COMPUTER DATABASES, IN CLASS 35 (U.S. CLS. 100, 101 AND 102).

FOR: RECOVERY OF COMPUTER DATA; COMPUTER PROGRAMMING; COMPUTER SOFTWARE DESIGN; MAINTENANCE OF COMPUTER SOFTWARE; UPDATING OF COMPUTER SOFTWARE; COMPUTER SYSTEMS ANALYSIS; CONSULTANCY IN THE FIELD OF COMPUTER HARDWARE, IN CLASS 42 (U.S. CLS. 100 AND 101).

THE MARK CONSISTS OF STANDARD CHARACTERS WITHOUT CLAIM TO ANY PARTICULAR FONT, STYLE, SIZE, OR COLOR.

OWNER OF INTERNATIONAL REGISTRATION 1082627 DATED 5-26-2011, EXPIRES 5-26-2021.

SER. NO. 79-099,397, FILED 5-26-2011.

KEVIN CORWIN, EXAMINING ATTORNEY



David J. Kyffers

Director of the United States Patent and Trademark Office

United States of America

United States Patent and Trademark Office



Reg. No. 4,173,506

Registered July 17, 2012

Int. Cls.: 6, 7, 9 and 20

TRADEMARK

PRINCIPAL REGISTER

OTTO GANTER GMBH & CO KG. (FED REP GERMANY LIMITED LIABILITY LIMITED PARTNERSHIP)
TRIBERGER STRABE 3
78120 FURTWANGEN, FED REP GERMANY

FOR: GOODS OF COMMON METAL, NAMELY, COMMON METAL DRAWER PULLS AND COMMON METAL PULLS; CONTROL, OPERATING AND CLAMPING ELEMENTS OF METAL, NAMELY, OPERATING HANDLES OF METAL, HANDLES OF METAL, CRANKED HANDLES OF METAL, HAND WHEELS OF METAL, CLAMPING AND OPERATING LEVERS OF METAL, METAL PALM GRIPS AND METAL STAR NOBS, METAL KNOBS, METAL SCREWS, METAL NUTS, HEADLESS PINS OF METAL AND METAL DOOR BOLTS; TOOL HANDLES OF METAL; BOLTS OF METAL, SPRINGS OF METAL; DOOR BOLTS; METAL HINGES; METAL LEVELING MACHINE FEET; METAL HINGES; METAL, PROTECTIVE CAPS FOR THE FEET OF LEVELING MACHINES; HINGED FEET OF METAL, NAMELY, HINGED, METAL, PROTECTIVE CAPS FOR THE FEET OF MACHINES, IN CLASS 6 (U.S. CLS. 2, 12, 13, 14, 23, 25 AND 50).

FOR: METAL AND PLASTIC MACHINE PARTS IN THE NATURE OF DEVICES TO CONTROL MACHINES, OPERATE MACHINE, OR CLAMP MACHINE ELEMENTS TOGETHER, NAMELY, UNIVERSAL JOINTS, BALL JOINTS, FORK JOINTS, TOGGLE CLAMPS, HOOK CLAMPS, BALL LOCK PINS, INDEXING PLUNGERS, SPRING PLUNGERS, CLAMPING BOLTS, SWING BOLTS, GRUB SCREWS, SHOULDER SCREWS, TUBE CLAMP CONNECTORS, LINEAR ACTUATORS, PARTS OF MACHINES, NAMELY, OPERATING HANDLES, HANDLES, BOW-TYPE HANDLES, PIPE HANDLES, CONTROL AND SHUT-OFF CRANKS, CRANK HANDLES, HAND WHEELS, SPOKED HAND WHEELS, DISC-TYPE HAND WHEELS WITH FIXED OR RETRACTABLE HANDLES, CLAMPING AND OPERATING LEVERS, PALM GRIPS AND STAR KNOBS, MACHINE PARTS, NAMELY, KNOBS, SCREWS, NUTS, HEADLESS PINS AND DOOR BOLTS; MACHINE PARTS, NAMELY, CRANKS; MACHINE PADS, NAMELY, HAND WHEELS WITH POSITION INDICATORS; MACHINE PARTS, NAMELY, ANALOG, DIGITAL, MECHANICAL AND ELECTRONIC POSITION DISPLAYS; MACHINE PARTS, NAMELY, CLOSURES OF OPERATING DEVICES, INSPECTION GLASS, CONTROL MODES, ADJUSTMENT DEVICES, DRAWERS, BOARDS, DOORS; MACHINE PARTS, NAMELY, VENTILATING CLOSURES FOR POWER UNITS, ENGINES, COOLING UNITS, IN CLASS 7 (U.S. CLS. 13, 19, 21, 23, 31, 34 AND 35).



David J. Kyffers

Director of the United States Patent and Trademark Office

FOR: WEIGHING, MEASURING, SIGNALING, CHECKING APPARATUS AND INSTRUMENTS, NAMELY, SCALES, POSITION INDICATORS, INSPECTION WINDOWS FOR

Reg. No. 4,173,506 DISPLAYING THE OIL LEVEL IN CONTAINERS FOR LIQUIDS; MAGNETS; HOLDING MAGNETS; ELECTRONIC POSITION INDICATORS; ELECTRONIC LEVEL INDICATORS, COLUMN-TYPE, ELECTRONIC LEVEL INDICATORS; ELECTRIC AND ELECTRONIC CONTROL, OPERATING AND CLAMPING ELEMENTS, NAMELY, CONTROLLERS, VALVES, ADJUSTMENT DEVICES; CONTROL CLOSURES, NAMELY, CLOSURES OF OPERATING DEVICES, INSPECTION GLASS, CONTROL MODES, ADJUSTMENT DEVICES, DRAWERS, BOARDS, DOORS; ELECTRONIC CLOSURES, NAMELY, VALVES WITH MEASURING GAUGES, IN CLASS 9 (U.S. CLS. 21, 23, 26, 36 AND 38).

FOR: PLASTIC FURNITURE PARTS; PLASTIC PARTS TO CONTROL, OPERATE OR TO CLAMP MACHINES, FURNITURE, ASSEMBLY LINES, NAMELY, OPERATING HANDLES, CRANK HANDLES, HAND WHEELS, CLAMPING AND OPERATING LEVERS, PALM GRIPS AND STAR KNOBS, KNOBS, SCREWS, NUTS, HEADLESS PINS; NON-METAL TOOL HANDLES; NON-METAL DOOR LATCHES; NON-METAL LEVELING MACHINE FEET; NON-METAL HINGES, IN CLASS 20 (U.S. CLS. 2, 13, 22, 25, 32 AND 50).

THE MARK CONSISTS OF TWO SQUARES. THE LEFT SQUARE CONTAINS A CURVED DESIGN ELEMENT. THE RIGHT SQUARE CONTAINS THE TERMS "GANTER GRIFF".

PRIORITY DATE OF 6-4-2010 IS CLAIMED.

OWNER OF INTERNATIONAL REGISTRATION 1082815 DATED 12-3-2010, EXPIRES 12-3-2020.

SER. NO. 79-099,446, FILED 12-3-2010.

JANICE L. MCMORROW, EXAMINING ATTORNEY

United States of America

United States Patent and Trademark Office



Reg. No. 4,173,507

Registered July 17, 2012

Int. Cl.: 7

TRADEMARK

PRINCIPAL REGISTER

RODICUT INDUSTRY S.A.U. (SPAIN SOCIEDAD ANÓNIMA UNIPERSONAL)
CTRA. PUXEIROS A MOS, 54
E-36417 TORROSO (MOS)
SPAIN

FOR: DIE-CUTTING MACHINES FOR CORRUGATED CARDBOARD ACCESSORIES AND REPLACEMENTS THEREFOR, NAMELY, ROTATING DIES, STRIPS OF STANDARD POLYURETHANE AND SYSTEM ANVILS, IN CLASS 7 (U.S. CLS. 13, 19, 21, 23, 31, 34 AND 35).

THE MARK CONSISTS OF THE WORDING "RODICUT" APPEARING TO THE LEFT OF A DESIGN REPRESENTING AN ANVIL COVER WITH JIG-SAW JOINT CLOSING. THE LETTERS "R" "O" "C" "U" "T" ARE IN THE COLOR BLACK AND THE LETTERS "D" "I" ARE IN ORANGE. THE LETTERS "DICUT" ARE ON A GRAY BACKGROUND AND THE DESIGN TO THE RIGHT OF THE WORDING IS IN THE COLOR ORANGE.

PRIORITY DATE OF 11-29-2010 IS CLAIMED.

OWNER OF INTERNATIONAL REGISTRATION 1082861 DATED 5-13-2011, EXPIRES 5-13-2021.

THE COLOR(S) BLACK, GRAY AND ORANGE IS/ARE CLAIMED AS A FEATURE OF THE MARK.

SER. NO. 79-099,462, FILED 5-13-2011.

DAVID HOFFMAN, EXAMINING ATTORNEY



David J. Kyffers

Director of the United States Patent and Trademark Office

United States of America

United States Patent and Trademark Office



Reg. No. 4,173,508

Registered July 17, 2012

Int. Cls.: 10 and 42

TRADEMARK

SERVICE MARK

PRINCIPAL REGISTER

PHIBO DENTAL SOLUTIONS, S.L. (SPAIN SOCIEDAD LIMITADA)
GATO PEREZ, 3-9,
POL. IND. MAS D'EN CISA; E-08181 SENTMENAT (BARCELONA)
SPAIN

FOR: SURGICAL APPARATUS AND INSTRUMENTS FOR DENTAL USE; DENTAL PROSTHESES; DENTURES AND ARTIFICIAL TEETH, IN CLASS 10 (U.S. CLS. 26, 39 AND 44).

FOR: RESEARCH SERVICES IN THE MEDICAL, BIOLOGICAL AND PHARMACEUTICAL FIELDS; TECHNICAL PROJECT STUDY, NAMELY, TECHNICAL RESEARCH IN THE MEDICAL FIELD AND SPECIFICALLY IN THE FIELD OF DEONTOLOGY; DESIGN OF COMPUTER SYSTEMS AND SOFTWARE IN THE MEDICAL FIELD AND SPECIFICALLY IN THE FIELD OF DEONTOLOGY, IN CLASS 42 (U.S. CLS. 100 AND 101).

THE MARK CONSISTS OF THE STYLIZED AND INTERTWINED LETTERS "C" AND "P".

PRIORITY DATE OF 11-24-2010 IS CLAIMED.

OWNER OF INTERNATIONAL REGISTRATION 1082887 DATED 5-19-2011, EXPIRES 5-19-2021.

SER. NO. 79-099,480, FILED 5-19-2011.

KIMBERLY PERRY, EXAMINING ATTORNEY



David J. Kyjars

Director of the United States Patent and Trademark Office

United States of America

United States Patent and Trademark Office

USBORNE

Reg. No. 4,173,509

Registered July 17, 2012

Int. Cls.: 9, 16, 28 and 41

TRADEMARK

SERVICE MARK

PRINCIPAL REGISTER

USBORNE PUBLISHING LTD. (UNITED KINGDOM LIMITED COMPANY (LTD.))
USBORNE HOUSE
83-85 SAFFRON HILL; LONDON EC1N 8RT
UNITED KINGDOM

FOR: DOWNLOADABLE ELECTRONIC PUBLICATIONS, NAMELY, EDUCATIONAL BOOKS ON THE SUBJECT OF PARENTING AND CHILDREN'S BOOKS; COMPUTER GAME PROGRAMS DOWNLOADABLE VIA THE INTERNET; DIGITAL MUSIC DOWNLOADABLE FROM THE INTERNET; AUDIO, AUDIOVISUAL AND VIDEO RECORDINGS FOR EDUCATION PURPOSES FEATURING MUSIC, SPOKEN WORD BOOKS FOR CHILDREN AND FILMS FOR CHILDREN; PRE-RECORDED CDS AND DVDS FEATURING MUSIC, SPOKEN WORD BOOKS FOR CHILDREN AND FILMS FOR CHILDREN; COMPUTER SOFTWARE, PROGRAMS AND DATA, NAMELY, EDUCATIONAL SOFTWARE FOR CHILDREN, IN CLASS 9 (U.S. CLS. 21, 23, 26, 36 AND 38).

FOR: BOOKS AND MAGAZINES IN THE FIELD OF EDUCATION AND CHILDREN'S PUBLICATIONS, NAMELY, CHILDREN'S BOOKS AND PARENTING GUIDES; MAPS, POSTERS, STATIONERY, GREETINGS CARDS; PAINT BRUSHES; PAPER; CARDBOARD; ADHESIVE PRINTED STICKERS; PENCILS; PENS; COLOURING BOOKS; CARDBOARD AND PAPER FOR MAKING INTO THREE DIMENSIONAL EDUCATIONAL MODELS FOR CHILDREN; CHILDREN'S ACTIVITY BOOKS; STICKER ACTIVITY BOOKS, NAMELY, STICKER ALBUMS, CHILDREN'S ACTIVITY BOOKS; FLASH CARDS, IN CLASS 16 (U.S. CLS. 2, 5, 22, 23, 29, 37, 38 AND 50).

FOR: TOYS AND GAMES, NAMELY, PUZZLES, CARD GAMES, PLAYING CARDS, JIGSAW PUZZLES, IN CLASS 28 (U.S. CLS. 22, 23, 38 AND 50).

FOR: PUBLISHING SERVICES; PUBLICATION SERVICES, NAMELY, PUBLISHING OF BOOKS AND MEDIA CONTENT IN DIGITAL FORMAT, IN CLASS 41 (U.S. CLS. 100, 101 AND 107).

THE MARK CONSISTS OF STANDARD CHARACTERS WITHOUT CLAIM TO ANY PARTICULAR FONT, STYLE, SIZE, OR COLOR.

PRIORITY DATE OF 12-3-2010 IS CLAIMED.



David J. Kyjars

Director of the United States Patent and Trademark Office

Reg. No. 4,173,509 OWNER OF INTERNATIONAL REGISTRATION 1083120 DATED 5-11-2011, EXPIRES 5-11-2021.

OWNER OF U.S. REG. NO. 2,233,673.

SER. NO. 79-099,585, FILED 5-11-2011.

SAIMA MAKHDOOM, EXAMINING ATTORNEY

United States of America

United States Patent and Trademark Office

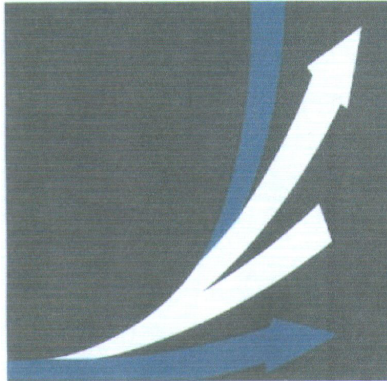

Reg. No. 4,173,510

Registered July 17, 2012

Int. Cls.: 9, 10 and 42

OXFORD NANOPORE TECHNOLOGIES LIMITED (UNITED KINGDOM LIMITED LIABILITY COMPANY)
EDMUND CARTWRIGHT HOUSE
4 ROBERT ROBINSON AVENUE., OXFORD SCIENCE PARK; OXFORD OX4 4GA
UNITED KINGDOM

TRADEMARK

SERVICE MARK

PRINCIPAL REGISTER

FOR: APPARATUS AND INSTRUMENTS FOR BIOLOGICAL, CHEMICAL, BIOCHEMICAL, DNA, RNA, PROTEIN, POLYNUCLEIC ACID SEQUENCING AND MOLECULAR ANALYSIS, NAMELY, AUTOMATED INSTRUMENTS FOR DETECTING THE PRESENCE, PROPERTIES AND IDENTITY OF ANALYTES COMPRISING CARTRIDGES, MICROARRAYS, SILICON CHIP BASED ARRAYS, ASICS (APPLICATION SPECIFIC INTEGRATED CIRCUITS), AND NETWORKED COMPUTER HARDWARE AND SOFTWARE FOR PERFORMING AND CONTROLLING THE ANALYSIS, AND FOR PROCESSING, DISPLAYING AND STORING THE INFORMATION OBTAINED FROM THE ANALYSIS; APPARATUS AND INSTRUMENTS FOR USE IN LABORATORY ANALYSIS, NAMELY, TEST SAMPLE CARTRIDGES; COMPUTER PROGRAMS, COMPUTER HARDWARE AND DATA PROCESSING APPARATUS, ALL OF THE ANALYSIS, PROCESSING AND RECORDING OF SCIENTIFIC DATA AND ANALYTE INFORMATION; SILICON CHIPS; DNA CHIPS; MICROARRAY CHIPS; ANALYTE DETECTOR CHIPS; BIOSENSOR CHIPS; PARTS AND FITTINGS FOR AUTOMATED INSTRUMENTS FOR DETECTING THE PRESENCE, PROPERTIES AND IDENTITY OF ANALYTES, NAMELY, TEST SAMPLE CARTRIDGES, IN CLASS 9 (U.S. CLS. 21, 23, 26, 36 AND 38).



FOR: BLOOD TESTING APPARATUS; TESTING APPARATUS FOR MEDICAL OR VETERINARY PURPOSES, NAMELY, TISSUE TESTING APPARATUS FOR PATHOGENIC, INFECTIOUS, PSYCHIATRIC, ONCOGENIC, METABOLIC, GENETIC, RESPIRATORY, GENITOURINARY, DIGESTIVE, INFLAMMATORY, AUTOIMMUNE, REPRODUCTIVE, HEPATIC, CENTRAL NERVOUS SYSTEM AND CARDIOVASCULAR DISEASES, IN CLASS 10 (U.S. CLS. 26, 39 AND 44).

FOR: SCIENTIFIC AND TECHNOLOGICAL SERVICES AND RESEARCH AND DESIGN RELATING THERETO, NAMELY, CONSULTATION, RESEARCH AND DESIGN SERVICES RELATING TO AUTOMATED SYSTEMS AND INSTRUMENTS FOR DIRECT ELECTRICAL DETECTION AND ANALYSIS OF MOLECULES FOR USE IN THE FIELD OF GENOMICS, PROTEIN ANALYSIS, MOLECULAR ANALYSIS, LIFE SCIENCES, HEALTHCARE, SECURITY AND DEFENCE; INDUSTRIAL ANALYSIS AND RESEARCH SERVICES IN THE FIELD OF GENOMICS, PROTEIN ANALYSIS, MOLECULAR ANALYSIS, LIFE SCIENCES,

David J. Kyjars

Director of the United States Patent and Trademark Office

Reg. No. 4,173,510 HEALTHCARE, SECURITY AND DEFENCE; BIOLOGICAL, CHEMICAL, BIOCHEMICAL, DNA, RNA, PROTEIN, POLYNUCLEIC ACID AND MOLECULAR ANALYSIS SERVICES, NAMELY, DNA AND RNA AND POLYNUCLEIC ACID SEQUENCES SERVICES, PROTEIN SEQUENCING SERVICES, GENOME SEQUENCING SERVICES; DESIGN AND DEVELOPMENT OF INSTRUMENTS AND APPARATUS FOR BIOLOGICAL, CHEMICAL, BIOCHEMICAL, DNA, RNA, PROTEIN AND MOLECULAR ANALYSIS; LABORATORY TESTING SERVICES; DNA AND POLYNUCLEIC ACID TESTING SERVICES; INFORMATION AND ADVICE REGARDING ALL THE AFORESAID SERVICES, IN CLASS 42 (U.S. CLS. 100 AND 101).

THE MARK CONSISTS OF A BLUE ARROW AND LINE AND A WHITE ARROW AND LINE APPEARING ON A GREY SQUARE BACKGROUND.

PRIORITY DATE OF 11-11-2010 IS CLAIMED.

OWNER OF INTERNATIONAL REGISTRATION 1083275 DATED 5-11-2011, EXPIRES 5-11-2021.

THE COLOR(S) GREY, BLUE AND WHITE IS/ARE CLAIMED AS A FEATURE OF THE MARK.

SER. NO. 79-099,636, FILED 5-11-2011.

SAIMA MAKHDOOM, EXAMINING ATTORNEY

United States of America

United States Patent and Trademark Office

GARDEUR

Reg. No. 4,173,511

GARDEUR GMBH (FED REP GERMANY LIMITED LIABILITY COMPANY)
ALSSTRASSE 155

Registered July 17, 2012

MÖNCHENGLADBACH, FED REP GERMANY 41063

Int. Cls.: 3, 18 and 25

FOR: SOAPS; PERFUMERY, ESSENTIAL OILS, COSMETICS, HAIR LOTIONS; DENTIFRICES,
IN CLASS 3 (U.S. CLS. 1, 4, 6, 50, 51 AND 52).

TRADEMARK

FOR: ANIMAL SKINS AND HIDES; TRUNKS AND TRAVELING BAGS; UMBRELLAS,
PARASOLS AND WALKING STICKS; WHIPS, HARNESS AND SADDLERY, IN CLASS 18
(U.S. CLS. 1, 2, 3, 22 AND 41).

PRINCIPAL REGISTER

FOR: CLOTHING FOR MEN AND WOMEN, NAMELY, LOUNGE AND SPORT JACKETS,
COATS, SKIRTS, SHORTS AND KNICKERS, T-SHIRTS, SHIRTS, BLOUSES, SWEATERS,
CARDIGANS; FOOTWEAR AND HEADGEAR IN THE NATURE OF HATS, CAPS AND VI-
SORS; TROUSERS OF ALL KINDS FOR MEN, IN PARTICULAR HIGH-WAISTED TROUSERS,
CUFFED TROUSERS, KNICKERBOCKERS , IN CLASS 25 (U.S. CLS. 22 AND 39).

THE MARK CONSISTS OF STANDARD CHARACTERS WITHOUT CLAIM TO ANY PAR-
TICULAR FONT, STYLE, SIZE, OR COLOR.

OWNER OF INTERNATIONAL REGISTRATION 0938560 DATED 6-15-2007, EXPIRES 6-15-
2017.

OWNER OF U.S. REG. NO. 1,144,263.

THE WORDING "GARDEUR" HAS NO MEANING IN A FOREIGN LANGUAGE.

SER. NO. 79-099,697, FILED 5-23-2011.

SUE LAWRENCE, EXAMINING ATTORNEY



David J. Kyros

Director of the United States Patent and Trademark Office

United States of America

United States Patent and Trademark Office

prajia

步致·璞智

Reg. No. 4,173,512

Registered July 17, 2012

Int. Cl.: 25

TRADEMARK

PRINCIPAL REGISTER

CIMTEX COMPOSITE MFG CO., LTD (CHINA LIMITED COMPANY)

JILING INDUSTRIAL PARK

LIANPING VILLAGE,; DALINGSHAN TOWN; DONGGUAN CITY; GUANGDONG PROVINCE
CHINA

FOR: CLOTHING, NAMELY, TOPS, BOTTOMS, PANTS, SHIRTS, UNDERWEAR, SKIRT,
DRESS, T-SHIRT; TRACK SHOES; SHOES; BOOTS; RAIN SHOES; CAPS; SOCKS; SCARFS;
GLOVES; BELTS, IN CLASS 25 (U.S. CLS. 22 AND 39).

THE ENGLISH TRANSLATION OF PRAJIA BU ZHI PU ZHI IN THE MARK IS WISDOM
ACHIEVING PURE WISDOM.

OWNER OF INTERNATIONAL REGISTRATION 1083323 DATED 5-17-2011, EXPIRES 5-17-
2021.

THE NON-LATIN CHARACTERS IN THE MARK TRANSLITERATE TO BU ZHI PU ZHI.

SER. NO. 79-099,716, FILED 5-17-2011.

DAVID TOOLEY, EXAMINING ATTORNEY



David J. Kypos

Director of the United States Patent and Trademark Office

United States of America

United States Patent and Trademark Office



Reg. No. 4,173,513

Registered July 17, 2012

Int. Cl.: 14

TRADEMARK

PRINCIPAL REGISTER

PAL&C CO., LTD (REPUBLIC OF KOREA CORPORATION)
281, HWI KYUNG-DONG
DONGDAEMUN-GU; SEOUL 130-190
REPUBLIC OF KOREA

FOR: CLOCKS; PARTS FOR WATCHES; GEMSTONES; JEWEL CASES OF PRECIOUS METAL; BOXES OF PRECIOUS METAL; JEWELLERY CASES; KEY RINGS OF PRECIOUS METAL; PRECIOUS METAL KEY RINGS; JEWELLERY; PRECIOUS STONES; COSTUME JEWELRY; PRECIOUS METALS; IMITATIONS OF PRECIOUS METAL; EARRINGS; HAT ORNAMENTS OF PRECIOUS METALS; BADGES OF PRECIOUS METAL; BELT ORNAMENTS OF PRECIOUS METALS; GOLD THREAD JEWELLERY; TIE PINS OF PRECIOUS METAL; NECKLACES JEWELLERY; RINGS JEWELLERY; ORNAMENTS FOR ANKLE JEWELLERY; BROOCHES JEWELLERY; ORNAMENTS JEWELLERY; JEWEL CHAINS; JEWEL PENDANTS; TRINKETS JEWELLERY; SILVER PERSONAL ORNAMENTS; ORNAMENTAL PINS; CHARMS JEWELLERY; TIE CLIPS OF PRECIOUS METAL; BRACELETS JEWELLERY; MEDALS OF PRECIOUS METAL, IN CLASS 14 (U.S. CLS. 2, 27, 28 AND 50).

OWNER OF U.S. REG. NOS. 2,275,308 AND 3,466,584.

PRIORITY DATE OF 4-22-2011 IS CLAIMED.

OWNER OF INTERNATIONAL REGISTRATION 1083408 DATED 4-29-2011, EXPIRES 4-29-2021.

THE COLOR(S) PURPLE IS/ARE CLAIMED AS A FEATURE OF THE MARK.

THE MARK CONSISTS OF A PURPLE STYLIZED HORN DESIGN TO THE LEFT OF THE STYLIZED WORD "NEPA" IN PURPLE.

THE WORDING "NEPA" HAS NO MEANING IN A FOREIGN LANGUAGE.

SER. NO. 79-099,736, FILED 4-29-2011.

REBECCA POVARCHUK, EXAMINING ATTORNEY



David J. Kyffers

Director of the United States Patent and Trademark Office

United States of America

United States Patent and Trademark Office

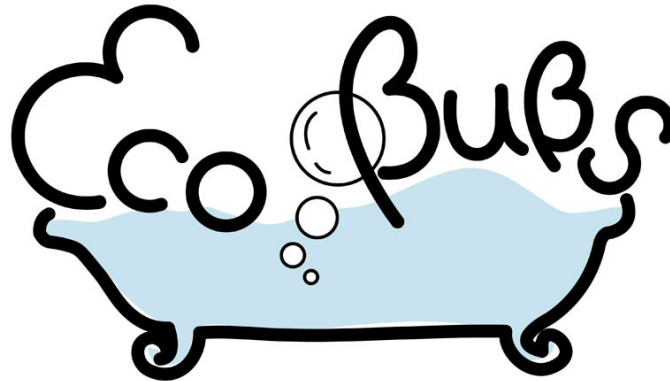

Reg. No. 4,173,514

Registered July 17, 2012

Int. Cl.: 3

TRADEMARK

PRINCIPAL REGISTER

CENCORP KOREA LTD (REPUBLIC OF KOREA CORPORATION)
#402, 38, CHEONGDAM-DONG
GANGNAM-GU; SEOUL
REPUBLIC OF KOREA

FOR: BATH SALTS, NOT FOR MEDICAL PURPOSES; MOUTH WASHES, NOT FOR MEDICAL PURPOSES; TALCUM POWDER, FOR TOILET USE; WASHING SODA, FOR CLEANING; ABRASIVE CLOTH; ABRASIVE PAPER; ROLLS OF ABRASIVE PAPER; ABRASIVE SAND; ABRASIVE SHEETS; COSMETIC ADDITIVES FOR BATHS, BATH BEADS; ADHESIVES FOR AFFIXING FALSE EYELASHES; ADHESIVES FOR AFFIXING FALSE HAIR; ADHESIVES FOR COSMETIC PURPOSES; AFTER SUN CREAMS; AFTER-SHAVE CREAMS; AFTER-SHAVE EMULSIONS; AFTER-SHAVE LOTIONS; ALMOND MILK FOR COSMETIC PURPOSES; ALMOND OIL FOR COSMETIC PURPOSES; ALMOND SOAP; ALUM STONES FOR PERSONAL COSMETIC USE; AMBER PERFUME; AMBERGRIS; AMMONIA FOR CLEANING PURPOSES; ANTIPERSPIRANT SOAP; ANTIPERSPIRANTS; ANTIPERSPIRANTS FOR PERSONAL USE; ANTISTATIC PREPARATIONS FOR HOUSEHOLD PURPOSES; AROMATIC ESSENTIAL OILS FOR HOUSEHOLD PURPOSES; AROMATICS, NAMELY, FRAGRANCES FOR AUTOMOBILES; ASTRINGENTS FOR COSMETIC PURPOSES; AUTOMOBILE POLISHES; BABY HAIR CONDITIONER; BABY OIL; BABY POWDER; BABY SHAMPOO; BADIAN ESSENCE, NAMELY, ESSENTIAL OILS; BASES FOR FLOWER PERFUMES, NAMELY, PERFUME OILS; BATH BEADS; BATH FOAM; BATH GELS; BATH LOTIONS; BATH OIL; BATH OILS FOR HAIR CARE; BATH SALTS; BATH SOAP; BEARD DYES; BEAUTY CREAMS; BEAUTY MASKS; BEAUTY SOAP; BERGAMOT OIL; BLEACHING PREPARATIONS FOR HOUSEHOLD USE; BLEACHING PREPARATIONS FOR COSMETIC PURPOSES; BLEACHING PREPARATIONS FOR LAUNDRY USE; BLEACHING SALTS; BLEACHING SODA; BLUSH PENCILS; BLUSHER; BODY CREAM SOAP; BODY CREAMS; BODY LOTIONS; BODY MILKS; BODY OILS; BOOT CREAM; BREATH FRESHENING SPRAYS; CAKE FLAVORINGS BEING ESSENTIAL OILS; CAKES OF SOAP; CAKES OF TOILET SOAP; CANNED PRESSURIZED AIR FOR CLEANING AND DUSTING PURPOSES; CLEANING PREPARATIONS, NAMELY, CLEANING CHALK; CLEANING PREPARATIONS; CLEANING PREPARATIONS FOR HOUSEHOLD PURPOSES; PREPARATIONS FOR CLEANING AND POLISHING; CLEANSING MILK; CLEANSING MILK FOR TOILET PURPOSES; CLOTHS IMPREGNATED WITH A DETERGENT FOR CLEANING; CLOVE OIL FOR COSMETIC PURPOSES; COBBLERS' WAX; COLD CREAMS; COLD WAVING SOLUTIONS; COLORANTS FOR TOILET PURPOSES, NAMELY, HAIR COLORANTS, COLORING PREPARATIONS FOR COSMETIC PURPOSES; COLOR-REMOVING PREPARATIONS, NAMELY, HAIR COLOR REMOVERS; COLOR-REMOVING PREPAR-



David J. Kyros

Director of the United States Patent and Trademark Office

Reg. No. 4,173,514 ATIONS FOR HAIR, NAMELY, HAIR COLOR REMOVERS; TOILET WATER; COMPLEX PERFUMERY; COMPOUND PERFUMERY; COSMETIC ANTIPERSPIRANTS; COSMETIC BATH OILS; COSMETIC BATH POWDER; COSMETIC BATH SALTS; COSMETIC CLEANSING CREAMS; COSMETIC CREAMS; COSMETIC CREAMS FOR SKIN CARE; COSMETIC DYES, NAMELY, HAIR DYES; COSMETIC FACE CREAMS; COSMETIC FACE POWDER; COSMETIC GELS, NAMELY, BATH GELS; COSMETIC HAIR DRESSING PREPARATIONS; COSMETIC HAND CREAMS; COSMETIC LIQUID FOUNDATIONS; COSMETIC NOURISHING CREAMS; COSMETIC OILS FOR THE EPIDERMIS; COSMETIC PENCILS; COSMETIC PREPARATIONS AGAINST SUNBURN; COSMETIC PREPARATIONS AND PRODUCTS IN THE NATURE OF NON-MEDICATED SKIN CREAMS, SKIN MOISTURIZER FOR DRY SKIN DURING PREGNANCY; COSMETIC PREPARATIONS FOR BATHS; COSMETIC PREPARATIONS FOR EYELASHES; COSMETIC PREPARATIONS FOR SKIN CARE; COSMETIC PREPARATIONS FOR SLIMMING PURPOSES; COSMETIC PRODUCTS FOR THE FACE AND BODY, NAMELY, SKIN LOTION, SUN CREAMS; COSMETIC ROUGES; COSMETIC SKIN FRESHENERS; COSMETIC SOAPS; COSMETIC SUN MILK LOTIONS; COSMETIC SUN OILS; COSMETIC SUN-PROTECTING PREPARATIONS; COSMETIC WHITE FACE POWDER; COSMETICS; COTTON STICKS FOR COSMETIC PURPOSES; COSMETICS FOR ANIMALS; COTTON WOOL FOR COSMETIC PURPOSES; CREAM SOAPS; CREAMS FOR LEATHER; DANDRUFF CREAMS NOT FOR MEDICAL TREATMENT; DANDRUFF LOTIONS NOT FOR MEDICAL TREATMENT; DECORATIVE TRANSFERS FOR COSMETIC PURPOSES; DENTAL BLEACHING GELS; NONMEDICATED DENTAL RINSES; DENTIFRICES; DENTURE POLISHES; DEODORANT SOAP; DEODORANTS FOR PERSONAL USE; DEPILATORIES; DEPILATORY WAX; DETERGENTS FOR AUTOMOBILES; DETERGENTS FOR MACHINE DISHWASHING; DETERGENTS OTHER THAN FOR USE IN MANUFACTURING OPERATIONS AND NOT FOR MEDICAL PURPOSES, NAMELY, DETERGENT SOAP; DETERGENTS PREPARED FROM PETROLEUM; DETERGENTS PREPARED FROM PETROLEUM FOR HOUSEHOLD CLEANING USE; DISH DETERGENT; DISINFECTANT SOAP; DRY-CLEANING PREPARATIONS, DRY CLEANING FLUIDS; EAU DE COLOGNE; EAU DE PARFUM; EAU DE TOILETTE; ELECAMPANE, NAMELY, PERFUMERY; EMERY BOARDS; EMERY CLOTH; EMERY PAPER; ENAMEL FOR NAILS; ESSENTIAL OILS; ESSENTIAL OILS FOR FOOD FLAVORINGS; ESSENTIAL OILS FOR PERSONAL USE; ESSENTIAL OILS OF CEDARWOOD; ESSENTIAL OILS OF CITRON; ESSENTIAL OILS OF LEMON; ETHEREAL ESSENCES; ETHEREAL OILS; EXTRACTS OF FLOWERS FOR USE IN PERFUMES; EYE CREAMS; EYE LOTIONS; EYE MAKE-UP REMOVERS; EYE PENCILS; EYE SHADOWS; EYEBROW COSMETICS; EYEBROW PENCILS; EYELINER; EYELINER PENCILS; FABRIC SOFTENERS FOR LAUNDRY USE; FACE AND BODY CREAMS; FACE AND BODY LOTIONS; FACE AND BODY MILK; FACE MILK AND LOTIONS; FACIAL CLEANSING MILK; FACIAL CREAM; FACIAL LOTIONS; FACIAL WASHES; FALSE EYELASHES; FALSE NAILS; HAIR FIXERS; FLAVORINGS FOR BEVERAGES, NAMELY, ESSENTIAL OILS; FLOOR POLISHES; FLOOR WAX; FLOOR WAX REMOVERS; FOOD FLAVORINGS PREPARED FROM ESSENTIAL OILS; FLOOR WAXES; FOUNDATION CREAMS; FOUNDATIONS; FRAGRANCE FOR HOUSEHOLD PURPOSES; FRAGRANCES FOR PERSONAL USE; FUMIGATION PREPARATIONS, NAMELY, PERFUMES; FURNISHING PREPARATIONS, NAMELY, FURNITURE POLISH; PERFUME OILS, NAMELY, GAULTHERIA OIL AND GERANIOL; GLASS CLEANERS; GLASS CLOTH; GLASS PAPER, NAMELY, ABRASIVE PAPER; GREASES FOR COSMETIC PURPOSES; HAIR BALSAM; HAIR BLEACHES; HAIR CARE CREAMS; HAIR CARE LOTIONS; HAIR COLORANTS; HAIR CONDITIONERS; HAIR CONDITIONING OILS; HAIR CREAMS FOR COSMETIC PURPOSE; HAIR GEL; HAIR GLAZE; HAIR LACQUERS; HAIR LOTIONS; HAIR MASCARA; HAIR MOISTURIZERS; HAIR MOUSSE; HAIR NOURISHERS; HAIR OIL; HAIR POMADES; HAIR POWDERS, NAMELY, HAIRWASHING POWDER; HAIR PRESERVATION TREATMENTS, NAMELY, NON-MEDICATED HAIR TREATMENT PREPARATIONS FOR COSMETIC PURPOSES; HAIR SPRAY; HAIR STYLING GELS; HAIR STYLING SPRAY; HAIR TONIC FOR COSMETIC USE; HAIR WAVING PREPARATIONS; HAND CLEANERS; HAND LOTIONS; PERFUME OILS, NAMELY, HELIOTROPINE; HYDROGEN PEROXIDE FOR COSMETIC PURPOSES; INCENSE; IONONE PERFUMERY; JASMINE OIL FOR PERSONAL USE; JAVELLE WATER BEING PERFUMERY; JEWELLERS' ROUGE; JOSS STICKS; LACQUER-REMOVING PREPARATIONS; LAUNDRY BLUEING;

Reg. No. 4,173,514 LAUNDRY GLAZE; LAUNDRY SOAPS; LAUNDRY STARCH; LAUNDRY WAX; LAVENDER OIL; LAVENDER WATER; LEATHER BLEACHING PREPARATIONS; LEATHER PRESERVATIVES, NAMELY, LEATHER PRESERVING POLISHES; LIP GLOSS; LIP COATINGS, NAMELY, LIP BALM; NON-MEDICATED LIP CONDITIONERS; LIP LINER; LIPSTICKS; LIQUID BATH SOAPS; LIQUID PERFUMES; LIQUID ROUGE; LIQUID SOAP; LIQUID SOAP USED IN FOOT BATH; LOOSE FACE POWDER; LOTIONS FOR BEARDS; LOTIONS FOR COSMETIC PURPOSES; LOTIONS FOR FACE AND BODY CARE; LOTIONS FOR STRENGTHENING THE NAILS; MAKE-UP; MAKE-UP BASES IN THE FORM OF PASTES; MAKE-UP FOUNDATIONS; MAKE-UP POWDER; MAKE-UP REMOVING LOTIONS; MAKE-UP REMOVING MILKS; MAKE-UP REMOVING PREPARATIONS; MASCARA; FACE MASKS; MASSAGE GELS OTHER THAN FOR MEDICAL PURPOSES; MASSAGE OIL; LAUNDRY PREPARATIONS, NAMELY, DETERGENT; POLISHING PREPARATIONS; MEDICATED SOAP; MINT ESSENCE BEING ESSENTIAL OILS; MINT FOR PERFUMERY; MOUSTACHE WAX; MUSK; NAIL CARE PREPARATIONS; NAIL COLORANTS BEING NAIL POLISH; NAIL DECOLORANTS BEING NAIL POLISH REMOVER; NAIL ENAMEL REMOVERS; NAIL POLISH; NAIL POLISHING POWDER; NAIL VARNISH FOR COSMETIC PURPOSES; NATURAL MUSK; NATURAL PERFUMERY; NEUTRALIZERS FOR PERMANENT WAVING BEING HAIR WAVING PREPARATIONS; NON-SLIPPING LIQUIDS FOR FLOORS; NON-SLIPPING WAX FOR FLOORS; OIL OF TURPENTINE FOR DEGREASING FLOORS; OILS FOR CLEANING PURPOSES; OILS FOR COSMETIC PURPOSES; OILS FOR PERFUMES AND SCENTS; PAINT STRIPPING PREPARATIONS; PARQUET FLOOR WAX; ABRASIVE PASTES FOR RAZOR STROPS; PEPPERMINT OIL; PERFUMED CREAMS; PERFUMED OILS FOR COSMETICS; PERFUMED OILS FOR THE MANUFACTURE OF COSMETIC PREPARATIONS; PERFUMED PASTE; PERFUMED SOAPS; PERFUMED TALCUM POWDER; PERFUMED TALCUM POWDER FOR COSMETIC USE; PERFUMERY; PERFUMES; PERFUMING SACHETS; PERMANENT WAVE PREPARATIONS; PERMANENT WAVING LOTIONS; PETROLEUM JELLY FOR COSMETIC PURPOSES; POLISH FOR FURNITURE AND FLOORING; POLISHING CREAMS; POLISHING PAPER; POLISHING ROUGE; POLISHING STONES; POLISHING WAX; POMADES; POMADES FOR COSMETIC PURPOSES; POTASSIUM HYPOCHLORIDE BEING LAUNDRY BLEACH; POTPOURRIS; PREPARATIONS FOR CLEANING DENTURES; PREPARATIONS FOR CLEANING WASTE PIPES; PREPARATIONS FOR SOAKING LAUNDRY, NAMELY, LAUNDRY PRE-SOAK; PREPARATIONS TO MAKE SHINY THE LEAVES OF PLANTS; PRE-SHAVE CREAMS; PRESSED FACE POWDER; NON-MEDICATED PROTECTIVE PREPARATIONS FOR LIPS; PUMICE STONE FOR PERSONAL USE; LAUNDRY DETERGENTS CONTAINING QUILLAIA BARK; ROSE OIL FOR COSMETIC PURPOSES; ROUGES; RUST REMOVING PREPARATIONS; SACHETS FOR PERFUMING LINEN; SAFROL BEING ESSENTIAL OILS; SAND-CLOTH, NAMELY, SANDPAPER; SCALE REMOVING PREPARATIONS FOR HOUSEHOLD PURPOSES; SCENTED WOOD; SCOURING SOLUTIONS; SHAMPOOS; SHAMPOOS FOR PETS; SHARPENING PREPARATIONS, NAMELY, ABRASIVE PASTES; SHAVING CREAMS; SHAVING FOAM; SHAVING GELS; SHAVING LOTIONS; SHAVING MOUSSE; SHAVING PREPARATIONS; SHAVING SOAP; SHAVING STONES, NAMELY, FOOT SMOOTHING STONES AND PUMICE STONES FOR PERSONAL USE; SHOE CREAM; SHOE WAX; SHOWER AND BATH FOAM; SHOWER AND BATH GELS; SHOWER CREAMS; SHOWER GELS; SILICON CARBIDE, NAMELY, ABRASIVE PASTES; SKIN CLEANSERS; SKIN CREAMS; SKIN CREAMS NOT FOR MEDICAL PURPOSES; SKIN LOTIONS; SKIN POLISHING RICE BRAN; SKIN WHITENING CREAMS; SMOOTHING PREPARATIONS, NAMELY, LAUNDRY STARCH; FOOT SMOOTHING STONES; SOAP FOR BRIGHTENING TEXTILE; SOAP POWDER; SOAPS FOR BODY CARE; SOAPS FOR HOUSEHOLD USE; INDUSTRIAL SOAPS; SODA LYE BEING HOUSEHOLD CLEANING PREPARATIONS; SOLID POWDER FOR COMPACTS; STAIN REMOVERS; STARCH GLAZE FOR LAUNDRY PURPOSES; SUN-BLOCK LOTIONS; SUNSCREEN CREAMS FOR COSMETIC USE; SUNSCREEN LOTIONS FOR COSMETIC USE; SUNSCREEN PREPARATIONS; SUNTAN CREAMS; SUNTAN LOTIONS; SUNTANNING PREPARATIONS; SUN-TANNING PREPARATIONS; SYNTHETIC MUSK; SYNTHETIC PERFUMERY; TAILORS' WAX; TALCUM POWDER; TEETH CLEANING LOTIONS; TERPENES BEING ESSENTIAL OILS; TISSUES IMPREGNATED WITH COSMETIC LOTIONS; TOILET BOWL DETERGENTS; TOILET WATER; NON-MEDICATED TOILETRIES; TOOTH CLEANING PREPARATIONS; TOOTH PASTE IN SOFT

Reg. No. 4,173,514 CAKE FORM; TOOTH POWDERS; TRIPOLI STONE FOR POLISHING; VANILLA PERFUMERY; VANISHING CREAMS; VARNISH-REMOVING PREPARATIONS; VOLCANIC ASH FOR CLEANING; WALLPAPER CLEANING PREPARATIONS; WASHING-UP LIQUIDS; POLISHING WAXES FOR LEATHER; COSMETIC WHITE FACE POWDER; WHITING, NAMELY, BLEACHING PREPARATIONS FOR HOUSEHOLD USE; WINDSCREEN CLEANING LIQUIDS; BAY RUMS FOR COSMETIC USE; HAIR RINSES FOR SCRUBBING HAIR; AND SKIN ABRASIVE PREPARATIONS, IN CLASS 3 (U.S. CLS. 1, 4, 6, 50, 51 AND 52).

THE MARK CONSISTS OF A DESIGN OF A CLAWFOOT TUB OUTLINED IN BLACK AND FILLED WITH WATER THAT IS SKY BLUE. FOUR WHITE BUBBLES OUTLINED IN BLACK FLOAT FROM THE TUB AND THE BLACK WORDING "ECO BUBS" APPEAR OVER THE TUB.

OWNER OF INTERNATIONAL REGISTRATION 1083433 DATED 1-14-2011, EXPIRES 1-14-2021.

THE COLOR(S) BLACK, SKY BLUE AND WHITE IS/ARE CLAIMED AS A FEATURE OF THE MARK.

SER. NO. 79-099,744, FILED 1-14-2011.

HAI-LY LAM, EXAMINING ATTORNEY

United States of America

United States Patent and Trademark Office

COSMEPIX

Reg. No. 4,173,515

Registered July 17, 2012

Int. Cls.: 38, 41 and 42

SERVICE MARK

PRINCIPAL REGISTER

ANSTELLOS (FRANCE SOCIÉTÉ À RESPONSABILITÉ LIMITÉE)
11 RUE DE LA RÉPUBLIQUE
F-34670 BAILLARGUES
FRANCE

FOR: ON-LINE SERVICES, NAMELY, PROVISION OF ACCESS TO A BUSINESS PLATFORM OVER THE INTERNET FOR ON-LINE PHOTOGRAPHY STORES AND PHOTOGRAPHIC LABORATORIES OVER THE INTERNET FOR RECEIVING ORDERS ELECTRONICALLY FOR IMAGE PRODUCTS AND FILMS ESPECIALLY FOR THE PURPOSES OF PROCESSING, DEVELOPING REPRODUCING, COLLATING OR DIGITIZING; IMAGE AND INFORMATION TRANSMISSION SERVICES; SERVICES FOR TRANSMITTING DIGITAL PRINTS AND PHOTOGRAPHS OVER THE INTERNET; ELECTRONIC MESSAGING AND INFORMATION TRANSMISSION SERVICES VIA COMPUTER NETWORKS, INCLUDING THE INTERNET, FOR OBTAINING, STORING, PROCESSING, EDITING, REPRODUCING, TRANSMITTING AND PRINTING IMAGES, AS WELL AS FOR TAKING OF ORDERS FOR GOODS IN CONNECTION WITH IMAGES, AUDIOVISUAL AND MULTIMEDIA PROGRAMS, COMPUTER EDITING OF TEXTS AND/OR STILL OR ANIMATED IMAGES, AND/OR MUSICAL OR NON-MUSICAL SOUNDS, FOR INTERACTIVE OR OTHER USE, IN CLASS 38 (U.S. CLS. 100, 101 AND 104).

FOR: INFORMATION AND ADVISORY SERVICES IN CONNECTION WITH PHOTOGRAPHY, IN CLASS 41 (U.S. CLS. 100, 101 AND 107).

FOR: TECHNOLOGICAL CONSULTANCY SERVICES IN CONNECTION WITH COMPUTER-ASSISTED ANALYSIS, STORAGE, EXTRACTION, VIEWING, HANDLING, TRANSMISSION AND PRINTING OF IMAGES AND DATA; DIGITAL IMAGE PROCESSING BY COMPUTER, ELECTRONIC DIGITIZING IMAGES AND DOCUMENTS, MODIFYING DIGITAL IMAGES BY COMPUTER FOR OTHERS, SCANNING OF PHOTOGRAPHS, DOCUMENTS, FILMS AND PHOTOGRAPHIC FILMS, IN CLASS 42 (U.S. CLS. 100 AND 101).

THE WORDING "COSMEPIX" HAS NO MEANING IN A FOREIGN LANGUAGE.

PRIORITY DATE OF 12-3-2010 IS CLAIMED.

OWNER OF INTERNATIONAL REGISTRATION 1083530 DATED 3-10-2011, EXPIRES 3-10-2021.



David J. Kyffers

Director of the United States Patent and Trademark Office

Reg. No. 4,173,515 SER. NO. 79-099,779, FILED 3-10-2011.

BERNICE MIDDLETON, EXAMINING ATTORNEY

United States of America

United States Patent and Trademark Office



Reg. No. 4,173,516

Registered July 17, 2012

Int. Cl.: 28

TRADEMARK

PRINCIPAL REGISTER

GUANGDONG ALPHA ANIMATION AND CULTURE CO., LTD. (CHINA CORPORATION)
AULDEY INDUSTRIAL AREA
WENGUAN RD.,; CHENGHAI; SHANTOU;
GUANGDONG PROVINCE, CHINA

FOR: TOYS, NAMELY, TOY SPACE VEHICLES; TOY MODEL SPACE VEHICLES; SCALE MODEL AIRPLANE AND SPACE VEHICLES, NAMELY, TOY AIRPLANE AND SPACE MOBILES; INTELLIGENT TOYS, NAMELY, ELECTRONIC EDUCATIONAL GAME MACHINES FOR CHILDREN, ELECTRONIC ACTION TOYS, EXCLUDING TOY VEHICLES AND TOY MODEL VEHICLES; ELECTRONIC LEARNING TOYS; SCALE MODEL AIRPLANE AND SPACE VEHICLE BUILDING SETS; GAMES, NAMELY, BOARD GAMES, ARCADE GAMES; TOY AIRPLANE AND SPACE VEHICLES; TOYS STARTED BY LASER, NAMELY, ELECTRONIC ACTION TOYS, EXCLUDING TOY VEHICLES AND TOY MODEL VEHICLES; MACHINES FOR PHYSICAL EXERCISES, IN CLASS 28 (U.S. CLS. 22, 23, 38 AND 50).

THE MARK CONSISTS OF A LIKENESS OF A SPACESHIP WITH WORDING "SKY ROVER" THEREON.

PRIORITY DATE OF 11-17-2010 IS CLAIMED.

OWNER OF INTERNATIONAL REGISTRATION 1083910 DATED 4-27-2011, EXPIRES 4-27-2021.

SER. NO. 79-099,907, FILED 4-27-2011.

TINA BROWN, EXAMINING ATTORNEY



David J. Kybas

Director of the United States Patent and Trademark Office

United States of America

United States Patent and Trademark Office

Reg. No. 4,173,517

Registered July 17, 2012

Int. Cls.: 7, 12 and 17

TRADEMARK

PRINCIPAL REGISTER

TMD FRICTION SERVICES GMBH (FED REP GERMANY GMBH)
SCHLEBUSCHER STR. 99
51381 LEVERKUSEN
FED REP GERMANY

FOR: BRAKE LININGS OF FRICTION MATERIALS FOR MACHINES, REGENERATIVE BRAKE LININGS FOR MACHINES, BEARINGS AS PARTS OF MACHINES, MACHINE BRAKE PARTS, NAMELY, GUIDE PARTS AND VIBRATION ABSORBERS AND MACHINE BRAKE PADS, NAMELY, MECHANICAL SEALS OF SLIDING MATERIALS; EQUIPMENT PARTS FOR BRAKES AND COUPLINGS AS PARTS OF MACHINES, NAMELY BRAKE SEGMENTS, BRAKE BLOCKS, BRAKE DRUMS, BRAKE DISCS, WEAR INDICATORS, SPRINGS, BRAKE LINING AND CLUTCH LINING SUPPORTS, PRESSURE PLATES, BRAKE BANDS, IN CLASS 7 (U.S. CLS. 13, 19, 21, 23, 31, 34 AND 35).

FOR: COUPLING AND BRAKE LININGS OF FRICTION MATERIALS AND REGENERATIVE COUPLING AND BRAKE LININGS FOR LAND VEHICLES, WHEEL BEARINGS FOR LAND VEHICLES, EQUIPMENT PARTS FOR BRAKES AND COUPLINGS, NAMELY, BRAKE SEGMENTS FOR LAND VEHICLES, BRAKE BLOCKS FOR LAND VEHICLES, BRAKE DRUMS, BRAKE DISCS, MECHANICAL BRAKE LINING WEAR INDICATORS FOR LAND VEHICLES, BRAKE LINING AND CLUTCH LINING SUPPORTS FOR LAND VEHICLES, PRESSURE PLATES FOR COUPLINGS OF LAND VEHICLES, BRAKE BANDS FOR LAND VEHICLES, IN CLASS 12 (U.S. CLS. 19, 21, 23, 31, 35 AND 44).

FOR: CLUTCH LININGS OF FRICTION MATERIALS; FRICTION MATERIALS FOR CLUTCH LININGS AND BRAKE LININGS; AND SEMI-WORKED SYNTHETIC RESINS FOR USE AS SLIDING MATERIALS, BONDED ORGANICALLY OR INORGANICALLY, BEING SEMI-FINISHED PRODUCTS IN THE FORM OF BANDS, PIPES, PELLETS, RODS AND SHEETS, REGENERATIVE FRICTION MATERIALS FOR BRAKE LININGS, IN CLASS 17 (U.S. CLS. 1, 5, 12, 13, 35 AND 50).

THE MARK CONSISTS OF THE WORDING "EPAD" WITH A CURVE OVER THE LEFT TOP SIDE OF THE LETTER "E"; THE WORDING AND DESIGN ARE IN BLACK AND THE BACKGROUND IS WHITE

PRIORITY DATE OF 12-8-2010 IS CLAIMED.



David J. Kappas

Director of the United States Patent and Trademark Office

Reg. No. 4,173,517 OWNER OF INTERNATIONAL REGISTRATION 1083995 DATED 5-23-2011, EXPIRES 5-23-2021.

THE COLOR(S) BLACK, WHITE IS/ARE CLAIMED AS A FEATURE OF THE MARK.

THE WORDING "EPAD" HAS NO MEANING IN A FOREIGN LANGUAGE.

SER. NO. 79-099,947, FILED 5-23-2011.

SUE LAWRENCE, EXAMINING ATTORNEY

United States of America

United States Patent and Trademark Office

micro loyalty 

Reg. No. 4,173,518

INSIDE SECURE (FRANCE SOCIÉTÉ ANONYME À DIRECTOIRE)
41 PARC DU CLUB DE GOLF
F-13856 AIX EN PROVENCE, FRANCE

Registered July 17, 2012

Int. Cls.: 9, 35 and 42

FOR: ELECTRONIC COMPONENTS, NAMELY, COMPUTER CHIPS, INTEGRATED CIRCUITS, MICROCIRCUITS, PRINTED CIRCUITS, BOARDS OF PRINTED CIRCUITS, AND SEMICONDUCTORS; APPLETS IN THE NATURE OF SOFTWARE FOR SAFETY OF DATA IN THE FIELD OF PAYMENTS, FINANCE, TELEPHONY, TRANSPORT, ACCESS CONTROL, ELECTRONIC IDENTIFICATION, RETAIL AND GIFT CARD AND MOBILE COMMUNICATION FIELDS; CENTRAL PROCESSING UNITS; MICROPROCESSORS; MICROCONTROLLERS; OPERATING SOFTWARE PLATFORMS FOR MICROPROCESSORS, COMPUTER SOFTWARE PLATFORMS FOR SAFETY OF DATA IN THE FIELD OF PAYMENTS, FINANCE, TELEPHONY, TRANSPORT, ACCESS CONTROL, ELECTRONIC IDENTIFICATION, RETAIL AND GIFT CARD AND MOBILE COMMUNICATION FIELDS, IN CLASS 9 (U.S. CLS. 21, 23, 26, 36 AND 38).

TRADEMARK

SERVICE MARK

PRINCIPAL REGISTER

FOR: RETAIL STORE, MAIL ORDER AND ONLINE ORDERING SERVICES AND ONLINE WHOLESALE DISTRIBUTORSHIP SERVICES ALL FEATURING ELECTRONIC COMPONENTS, CHIPS, INTEGRATED CIRCUITS, MICROCIRCUITS, PRINTED CIRCUITS, PRINTED CIRCUIT BOARDS, SEMI-CONDUCTORS, PROCESSORS, MICROPROCESSORS, MICROCONTROLLERS, PLATFORMS FOR MICROPROCESSORS, COMPUTER PLATFORMS, IN CLASS 35 (U.S. CLS. 100, 101 AND 102).



FOR: DESIGN OF COMPUTER PROGRAMS FOR COMPUTERS AND MICROPROCESSORS FOR OTHERS, COMPUTER SYSTEM DESIGN AND DEVELOPMENT; TECHNICAL DEVELOPMENT AND RESEARCH STUDY FOR DATA EXCHANGE SYSTEMS AND DEVICES, NAMELY, CONDUCTING SCIENTIFIC RESEARCH, CONDUCTING TECHNICAL FEASIBILITY STUDIES AND NEW PRODUCT DEVELOPMENT FOR OTHERS, PERSONALIZED STUDY AND PROGRAMMING SERVICE FOR CHIP CARDS AND ELECTRONIC CARDS, NAMELY, CUSTOMIZATION OF COMPUTER CHIPS CARDS AND ELECTRONIC CARDS WITH INTEGRATED CIRCUITS FOR OTHERS, IN CLASS 42 (U.S. CLS. 100 AND 101).

NO CLAIM IS MADE TO THE EXCLUSIVE RIGHT TO USE "MICRO", APART FROM THE MARK AS SHOWN.

PRIORITY DATE OF 12-3-2010 IS CLAIMED.

David J. Kyjars

Director of the United States Patent and Trademark Office

Reg. No. 4,173,518 OWNER OF INTERNATIONAL REGISTRATION 1084023 DATED 5-30-2011, EXPIRES 5-30-2021.

THE COLOR(S) BLACK AND ORANGE IS/ARE CLAIMED AS A FEATURE OF THE MARK.

THE TRADEMARK CONTAINS THE INVENTED WORD "MICROLOYALTY" IN BLACK AND THE LETTER "M" IN FANCY FONT LOCATED INSIDE A CIRCLE AND PLACED BETWEEN TWO ORANGE DOTS.

THE MARK CONSISTS OF THE WORDING "MICRO LOYALTY" IN BLACK WITH TWO ORANGE DOTS AND THE BLACK LETTER "M" IN A BLACK CIRCLE. THE COLOR WHITE REPRESENTS BACKGROUND AND DOES NOT FORM A PART OF THE MARK.

SER. NO. 79-099,962, FILED 5-30-2011.

TRACY FLETCHER, EXAMINING ATTORNEY

United States of America

United States Patent and Trademark Office

BOLEFLOOR



Reg. No. 4,173,519

Registered July 17, 2012

Int. Cl.: 19

TRADEMARK

PRINCIPAL REGISTER

BOLE OÜ (ESTONIA PRIVATE LIMITED COMPANY)
P. SÜDA 10-8
EE-10118 TALLINN
ESTONIA

FOR: NON-METAL BUILDING MATERIALS, NAMELY, BUILDING TIMBER, SEMI-WORKED WOODS, LOGS, LOGHOUSE LOGS, JOISTS, WOOD AND FLOOR VENEERS, WOOD FOR MAKING HOUSEHOLD UTENSILS, STAVE WOOD, WOODEN BOARDS, FLOORING BOARDS, BARREL BOARDS, HOBBY BOARDS IN THE NATURE OF BOARDS OF WOOD, STAIR TREADS, WOODEN MOULDINGS, PORCHES FOR BUILDING, ARCH ELEMENTS FOR BUILDING PURPOSES, PORTAL ELEMENTS FOR BUILDING PURPOSES, WINDOWSILLS, FLOOR PANELS, WALL PANELS, CEILING PANELS, FACADE PANELS, DOOR PANELS, CLADDING PANELS, FENCE PANELS, SHIPDECK PANELS, WOOD FINGERJOINT PANELS, GLUELAMINATED WOOD PANELS, DECKING PANELS; NON-METAL FLOORS, PARQUET FLOORING; FLOORING SLABS, NAMELY, SLABS OF CONCRETE, GLUELAMINATED SLABS, PARQUET SLABS, WOOD SLABS; NON-METAL FLOOR TRIMS; WOOD PANELS FOR BUILDING CONSTRUCTION, NAMELY, MULTILAYER WOODEN PANELS, SOLID HARDWOOD PANELS, SOLID SOFTWOOD PANELS, SEMI WORKED WOODEN PANELS; REMOVABLE WOOD PARTITION PANELS, NAMELY, SLIDING DOOR PANELS, SLIDING WALL PANELS; NON-METAL WALL SLABS, NON-METAL WAINSCOTTING, NON-METAL GRIDS FOR BUILDING PURPOSES, NON-METAL GRATINGS, IN CLASS 19 (U.S. CLS. 1, 12, 33 AND 50).

THE MARK CONSISTS OF THE STYLIZED WORDING "BOLEFLOOR" NEXT TO A STYLIZED LETTER "B".

PRIORITY DATE OF 1-13-2011 IS CLAIMED.

OWNER OF INTERNATIONAL REGISTRATION 1084027 DATED 6-21-2011, EXPIRES 6-21-2021.

SER. NO. 79-099,964, FILED 6-21-2011.

LEIGH LOWRY, EXAMINING ATTORNEY



David J. Kyffers

Director of the United States Patent and Trademark Office

United States of America

United States Patent and Trademark Office

WEAR & TOSS

Reg. No. 4,173,520

Registered July 17, 2012

**Int. Cls.: 3, 5, 10, 24, 25
and 35**

IDEA BOX SA (SWITZERLAND CORPORATION)
VIA DELLE AIE, 17
CH-6900 LUGANO
SWITZERLAND

FOR: TISSUES IMPREGNATED WITH COSMETIC LOTIONS, IN CLASS 3 (U.S. CLS. 1, 4, 6, 50, 51 AND 52).

TRADEMARK

FOR: SANITARY PREPARATIONS FOR MEDICAL PURPOSES; FOOD FOR BABIES; MEDICAL AND SURGICAL PLASTERS; MATERIALS FOR DRESSINGS, NAMELY, BANDAGES, GAUZE, SELF ADHESIVE DRESSINGS; MATERIAL FOR DENTAL FILLINGS AND DENTAL IMPRESSIONS; PESTICIDES; FUNGICIDES, HERBICIDES, IN CLASS 5 (U.S. CLS. 6, 18, 44, 46, 51 AND 52).

SERVICE MARK

PRINCIPAL REGISTER

FOR: SURGICAL APPARATUS AND INSTRUMENTS; ARTIFICIAL LIMBS, EYES AND TEETH; SUTURE MATERIALS, IN CLASS 10 (U.S. CLS. 26, 39 AND 44).

FOR: FABRICS FOR FURNITURE; TOWELS OF TEXTILE; FACE TOWELS OF TEXTILE; BATH LINEN; LINGERIE FABRIC; HOUSEHOLD LINEN; BED LINEN; BED CLOTHES, NAMELY, BED SHEETS, BED COVERS, BED BLANKETS, BED LINENS, BED SKIRTS, DUVETS, DUVET COVERS, BED SPREADS, MATTRESS COVERS, BED CANOPIES, SHEET SETS, PILLOW CASES, BED SHEETS, FITTED BED SHEETS COVERS, BED FLAT SHEETS, AND PILLOW CASES USED IN THE BEDDING, HEALTH CARE, HOME-HEALTH CARE AND NURSING HOME INDUSTRIES, MADE OF BIODEGRADABLE FILM CREATED FROM RENEWABLE BIOPOLYMER RESOURCES; TABLE LINEN, NOT OF PAPER; TABLE MATS, NOT OF PAPER; OILCLOTH FOR USE AS TABLECLOTHS; BED BLANKETS; HANDKERCHIEFS OF TEXTILE; PILLOWCASES; TEXTILE LININGS, NAMELY, TEXTILE USED AS LINING FOR CLOTHING, LINEN LINING FABRIC FOR SHOES; BED SHEETS; BATH SHEETS; RAYON FABRIC; NAPKINS, OF CLOTH, FOR REMOVING MAKE-UP; NON-WOVEN TEXTILE FABRICS; FABRICS FOR TEXTILE USE; FABRIC, NAMELY, CHENILLE FABRIC, COTTON FABRIC, SILK FABRICS, COTTON BASED MIXED FABRICS, ELASTIC YARN MIXED FABRICS, FELT AND NON-WOVEN TEXTILE FABRICS, GAUZE FABRICS, HAND-TOWELS MADE OF TEXTILE FABRICS, MIXED FIBER FABRICS, NATURAL AND SYNTHETIC FABRICS AND TEXTILES, NAMELY, COTTON, SILK, POLYESTER AND NYLON FABRICS, NON-WOVEN FABRICS AND FELTS, NON-WOVEN TEXTILE FABRICS, POLYESTER FABRICS, POLYLACTIC ACID FABRICS FOR MANUFACTURING CLOTHING,



David J. Kyros

Director of the United States Patent and Trademark Office

Reg. No. 4,173,520 RAYON FABRIC, SYNTHETIC FIBER FABRICS; TABLE NAPKINS OF TEXTILE, IN CLASS 24 (U.S. CLS. 42 AND 50).

FOR: BATH ROBES; CLOTHING APRONS; PAJAMAS; TEE-SHIRTS; TURBANS, IN CLASS 25 (U.S. CLS. 22 AND 39).

FOR: ADVERTISING; BUSINESS MANAGEMENT; BUSINESS ADMINISTRATION; PROVIDING OFFICE FUNCTIONS; WHOLESALE AND RETAIL STORE SERVICES FEATURING TISSUES IMPREGNATED WITH COSMETIC LOTIONS, SANITARY PREPARATIONS FOR MEDICAL PURPOSES, FOOD FOR BABIES, MEDICAL AND SURGICAL PLASTERS, MATERIALS FOR DRESSINGS, NAMELY, BANDAGES, GAUZE, SELF ADHESIVE DRESSINGS, MATERIAL FOR DENTAL FILLINGS AND DENTAL IMPRESSIONS, PESTICIDES, FUNGICIDES, HERBICIDES, SURGICAL APPARATUS AND INSTRUMENTS, ARTIFICIAL LIMBS, EYES AND TEETH, SUTURE MATERIALS, FABRICS FOR FURNITURE, TOWELS OF TEXTILE, FACE TOWELS OF TEXTILE, BATH LINEN, LINGERIE FABRIC, HOUSEHOLD LINEN, BED LINEN, BED CLOTHES, NAMELY, BED SHEETS, BED COVERS, BED BLANKETS, BED LINENS, BED SKIRTS, DUVETS, DUVET COVERS, BED SPREADS, MATTRESS COVERS, BED CANOPIES, SHEET SETS, PILLOW CASES, BED SHEETS, FITTED BED SHEETS COVERS, BED FLAT SHEETS, AND PILLOW CASES USED IN THE BEDDING, HEALTH CARE, HOME-HEALTH CARE AND NURSING HOME INDUSTRIES, MADE OF BIODEGRADABLE FILM CREATED FROM RENEWABLE BIOPOLYMER RESOURCES, TABLE LINEN, NOT OF PAPER, TABLE MATS, NOT OF PAPER, OILCLOTH FOR USE AS TABLECLOTHS, BED BLANKETS, HANDKERCHIEFS OF TEXTILE, PILLOWCASES, TEXTILE LININGS, NAMELY, TEXTILE USED AS LINING FOR CLOTHING, LINEN LINING FABRIC FOR SHOES, BED SHEETS, BATH SHEET, RAYON FABRIC, NAPKINS, OF CLOTH, FOR REMOVING MAKE-UP, NON-WOVEN TEXTILE FABRICS, FABRICS FOR TEXTILE USE, FABRIC, NAMELY, CHENILLE FABRIC, COTTON FABRIC, SILK FABRICS, COTTON BASED MIXED FABRICS, COTTON FABRICS, ELASTIC YARN MIXED FABRICS, FELT AND NON-WOVEN TEXTILE FABRICS, GAUZE FABRICS, HAND-TOWELS MADE OF TEXTILE FABRICS, MIXED FIBER FABRICS, NATURAL AND SYNTHETIC FABRICS AND TEXTILES, NAMELY, COTTON SILK, POLYESTER AND NYLON FABRICS, NON-WOVEN FABRICS AND FELTS, NON WOVEN TEXTILE FABRICS, POLYESTER FABRICS, POLYLACTIC ACID FABRICS FOR MANUFACTURING CLOTHING, RAYON FABRIC, SYNTHETIC FIBER FABRICS AND TABLE NAPKINS OF TEXTILE, IN CLASS 35 (U.S. CLS. 100, 101 AND 102).

THE MARK CONSISTS OF STANDARD CHARACTERS WITHOUT CLAIM TO ANY PARTICULAR FONT, STYLE, SIZE, OR COLOR.

PRIORITY DATE OF 11-25-2010 IS CLAIMED.

OWNER OF INTERNATIONAL REGISTRATION 1084058 DATED 5-10-2011, EXPIRES 5-10-2021.

NO CLAIM IS MADE TO THE EXCLUSIVE RIGHT TO USE "WEAR" FOR CLASS 25, APART FROM THE MARK AS SHOWN.

SER. NO. 79-099,967, FILED 5-10-2011.

TINA BROWN, EXAMINING ATTORNEY

United States of America

United States Patent and Trademark Office

POROPHEN

Reg. No. 4,173,521

Registered July 17, 2012

Int. Cl.: 1

TRADEMARK

PRINCIPAL REGISTER

VYNCOLIT, NAAMLOZE VENNOOTSCHAP (BELGIUM JOINT STOCK COMPANY)
WIEDAUWKAAI 6
GENT, BELGIUM B9000

FOR: CHEMICALS USED IN INDUSTRY AND SCIENCE; CHEMICALS USED IN PHOTOGRAPHY, NAMELY, PHOTOGRAPHIC DEVELOPERS; CHEMICALS USED IN AGRICULTURE, HORTICULTURE AND FORESTRY EXCEPT FUNGICIDES, HERBICIDES, INSECTICIDES AND PARASITICIDES; UNPROCESSED ARTIFICIAL RESINS, UNPROCESSED PLASTICS; MANURES; FIRE EXTINGUISHING COMPOSITIONS; TEMPERING PREPARATIONS AND SOLDERING CHEMICAL PREPARATIONS; CHEMICAL SUBSTANCES FOR PRESERVING FOODSTUFFS; TANNING AGENTS USED IN THE MANUFACTURE OF LEATHER; ADHESIVES USED IN INDUSTRY; REINFORCED POLYMERS USED IN THE MANUFACTURE OF CONFECTIONERY; PLASTIC MOLDING COMPOUNDS FOR USE IN THE MANUFACTURE OF MOLDED PLASTIC ARTICLES , IN CLASS 1 (U.S. CLS. 1, 5, 6, 10, 26 AND 46).

THE MARK CONSISTS OF STANDARD CHARACTERS WITHOUT CLAIM TO ANY PARTICULAR FONT, STYLE, SIZE, OR COLOR.

PRIORITY DATE OF 5-20-2011 IS CLAIMED.

OWNER OF INTERNATIONAL REGISTRATION 1084241 DATED 5-24-2011, EXPIRES 5-24-2021.

SER. NO. 79-100,047, FILED 5-24-2011.

JASON TURNER, EXAMINING ATTORNEY



David J. Kyffers

Director of the United States Patent and Trademark Office

United States of America

United States Patent and Trademark Office

human + kind

skincare with a conscience

Reg. No. 4,173,522

Registered July 17, 2012

Int. Cl.: 3

TRADEMARK

PRINCIPAL REGISTER

HUMAN + KIND LIMITED (IRELAND LIMITED LIABILITY COMPANY)
ARD DOIRE, BARRYSOUTH
CARRIGTWOHILL, CORK
IRELAND

FOR: SKINCARE PREPARATIONS, NAMELY, LOTIONS AND CREAMS FOR FACE AND BODY CARE; BODY LOTIONS; HAIR LOTIONS; BEAUTY PRODUCTS, NAMELY, COSMETICS; PERFUMERY; SOAPS; ESSENTIAL OILS, IN CLASS 3 (U.S. CLS. 1, 4, 6, 50, 51 AND 52).

THE MARK CONSISTS OF THE WORD "HUMAN" ABOVE THE WORD "KIND"- A PLUS SYMBOL WITH A DIAGONAL BREAK APPEARS TO THE LEFT OF THE WORD "KIND". THE PHRASE "SKINCARE WITH A CONSCIENCE" APPEARS AT THE BOTTOM OF THE MARK.

PRIORITY DATE OF 2-11-2011 IS CLAIMED.

OWNER OF INTERNATIONAL REGISTRATION 1084399 DATED 6-30-2011, EXPIRES 6-30-2021.

SER. NO. 79-100,108, FILED 6-30-2011.

DAVID HOFFMAN, EXAMINING ATTORNEY



David J. Kyffers

Director of the United States Patent and Trademark Office

United States of America

United States Patent and Trademark Office



Reg. No. 4,173,523

Registered July 17, 2012

Int. Cls.: 3, 18 and 25

TRADEMARK

PRINCIPAL REGISTER

DSQUARED2 TM S.A. (LUXEMBOURG SOCIÉTÉ ANONYME)
18, RUE DE L'EAU
L-1449 LUXEMBOURG
LUXEMBOURG

FOR: CLOTHS IMPREGNATED WITH A DETERGENT FOR CLEANING; DETERGENTS OTHER THAN FOR USE IN MANUFACTURING OPERATIONS AND FOR MEDICAL PURPOSES, NAMELY, DETERGENT SOAP, DETERGENTS FOR MACHINE DISHWASHING, FOAM DETERGENTS, WASHING UP DETERGENTS; WHITENERS, NAMELY, SKIN WHITENING CREAMS, TEETH WHITENING KITS; FABRIC SOFTENERS FOR LAUNDRY USE; SOAP; BLEACHING PREPARATIONS AND OTHER SUBSTANCES FOR LAUNDRY USE, NAMELY, LAUNDRY DETERGENT, LAUNDRY BLUEING, FABRIC SOFTENER FOR LAUNDRY USE, LAUNDRY WAX, LAUNDRY SIZING, LAUNDRY STARCH, LAUNDRY GLAZE; CLEANING, POLISHING, SCOURING AND ABRASIVE PRODUCTS; COSMETICS, INCLUDING PERFUMES; PERFUMES IN SOLID FORM; DEODORANTS; LIQUID SOAP; CAKES OF TOILET SOAP; BUBBLE BATH; DENTIFRICES; SHAMPOOS; ESSENTIAL OILS; HAIR LOTIONS; PREPARATIONS FOR SETTING AND PERMANENT WAVING OF HAIR; DENTAL BLEACHING GELS; HAIR FIXING GELS; HAIR DYES; FACE CREAMS FOR COSMETIC USE; MASCARA; EYE-LINER; EYESHADOW; MAKE-UP PENCILS; CLAY FOR THE FACE, NAMELY, BEAUTY MASKS, ACNE TREATMENT PREPARATIONS, PIMPLES TREATMENT PREPARATION, WRINKLE REMEDIES, DRY SKIN REMEDIES; LIPSTICKS; FOUNDATION; COSMETIC CREAMS FOR THE BODY; NAIL POLISH; NAIL HARDENERS; TANNING OILS AND CREAMS, IN CLASS 3 (U.S. CLS. 1, 4, 6, 50, 51 AND 52).



David J. Kyjars

Director of the United States Patent and Trademark Office

FOR: LEATHER AND IMITATIONS OF LEATHER; ANIMAL SKINS; RAW SKINS; TRUNKS AND TRAVELING BAGS; UMBRELLAS, PARASOLS AND WALKING STICKS; WHIPS, HARNESS AND SADDLERY; CARD HOLDERS AND CASES, NAMELY, CREDIT CARD HOLDERS, BUSINESS CARD HOLDERS IN THE NATURE OF CARD CASES, WALLETS; KEY CASES OF LEATHER; ATTACHÉ CASES; BRIEFCASES; IMITATION LEATHER MOLESKINS; PARASOLS; PURSES NOT OF PRECIOUS METAL, HANDBAGS, RUCKSACKS, WHEELED SHOPPING BAGS, BAGS FOR CLIMBERS IN THE NATURE OF ALL-PURPOSE CARRYING BAGS, BAGS FOR CAMPERS IN THE NATURE OF ALL-PURPOSE CARRYING BAGS, SHOPPING BAGS, NAMELY, MESH SHOPPING BAGS, REUSABLE SHOPPING BAGS, WHEELED SHOPPING BAGS; BEACH BAGS, TRAVELING BAGS, SCHOOL BAGS; VANITY CASES, NOT FITTED; TRAVELLING SETS MADE OF LEATHER, NAMELY, TRAVEL BAGGAGE; VANITY CASES SOLD EMPTY; MAKE-UP BAGS, NOT FILLED; COLLARS AND CLOTHES FOR ANIMALS; SMALL BAGS AND BAGS, NAMELY, ENVEL-

Reg. No. 4,173,523 OPES, BAGS FOR MERCHANDISE PACKAGING, POUCHES FOR MERCHANDISE PACKAGING, IN CLASS 18 (U.S. CLS. 1, 2, 3, 22 AND 41).

FOR: FOOTWEAR, HEADGEAR, NAMELY, HATS, CAPS, VISORS; SHIRTS; CLOTHING MADE OF LEATHER OR OF IMITATION LEATHER, NAMELY, SHIRTS, PANTS, JACKETS, GLOVES, SKIRTS, BELTS; WOMEN'S UNDERWEAR; HOODS; BELTS AS CLOTHING; GLOVES AS CLOTHING; SASHES FOR WEAR; SCARVES; SHAWLS; NECKTIES; HOSIERY; SOCKS; SHOES; SLIPPERS; CLOTHING FOR SPORTS, SKIING AND THE BEACH, NAMELY, SWIMSUITS, GLOVES, CAPS, SCARVES, JUMPSUITS, WETSUITS, PARKAS, SHORTS, T-SHIRTS, ANTI-PERSPIRANT T-SHIRTS; BABIES' NAPKINS OF TEXTILE, NAMELY, DIAPERS; DIAPERS OF TEXTILE; UNDERWEAR; COATS; OVERALLS; SHORT-SLEEVED SHIRTS; TEE-SHIRTS; TURTLENECKS; SLIPS IN THE NATURE OF UNDERGARMENTS; SUITS; TROUSERS; JACKETS; PULLOVERS; WAISTCOATS; SWEATERS; FROCKS; SHIRT YOKES; SHIRT FRONTS; READY-MADE LININGS BEING PARTS OF CLOTHING; STUFF JACKETS; PELERINES; GABARDINES; WATERPROOF CLOTHING, NAMELY, RAINCOATS, BOOTS, PARKAS, PONCHOS; POCKETS FOR CLOTHING, NAMELY, POCKET KERCHIEFS, ADHESIVE POCKETS THAT MAY BE AFFIXED DIRECTLY TO THE INSIDE OF CLOTHING FOR STORAGE AND SAFEKEEPING OF PERSONAL ITEMS; POCKET SQUARES; JERSEYS; KNITWEAR, NAMELY, SWEATERS, KNIT DRESSES, PULL OVERS; DRESSING GOWNS; PAJAMAS; CAP PEAKS, IN CLASS 25 (U.S. CLS. 22 AND 39).

OWNER OF U.S. REG. NOS. 2,884,711, 3,535,554, AND 3,538,951.

PRIORITY DATE OF 10-8-2010 IS CLAIMED.

OWNER OF INTERNATIONAL REGISTRATION 1084427 DATED 4-7-2011, EXPIRES 4-7-2021.

THE MARK CONSISTS OF THE STYLIZED WORDING "DSQUARED2" WITH A SUPERSCRIPT NUMERAL "2" APPEARING AT THE END OF THE WORD. A LINE BELOW IS THE STYLIZED WORD "POTION". THE ENTIRE MARK APPEARS WITH A FAINT RECTANGULAR BORDER.

SER. NO. 79-100,118, FILED 4-7-2011.

ALLISON SCHRODY, EXAMINING ATTORNEY

United States of America
United States Patent and Trademark Office

VEGESOME

Reg. No. 4,173,524

Registered July 17, 2012

Int. Cls.: 1 and 3

TRADEMARK

PRINCIPAL REGISTER

SEDERMA (FRANCE S.A.S.)
29 RUE DU CHEMIN VERT
F-78610 LE PERRY EN YVELINES
FRANCE

FOR: CHEMICALS USED IN INDUSTRY AND SCIENCE, IN CLASS 1 (U.S. CLS. 1, 5, 6, 10, 26 AND 46).

FOR: COSMETICS, IN CLASS 3 (U.S. CLS. 1, 4, 6, 50, 51 AND 52).

THE MARK CONSISTS OF STANDARD CHARACTERS WITHOUT CLAIM TO ANY PARTICULAR FONT, STYLE, SIZE, OR COLOR.

PRIORITY DATE OF 12-3-2010 IS CLAIMED.

OWNER OF INTERNATIONAL REGISTRATION 1084450 DATED 5-27-2011, EXPIRES 5-27-2021.

THE WORDING "VEGESOME" HAS NO MEANING IN A FOREIGN LANGUAGE.

SER. NO. 79-100,128, FILED 5-27-2011.

MARLENE BELL, EXAMINING ATTORNEY



David J. Kyros

Director of the United States Patent and Trademark Office

United States of America
United States Patent and Trademark Office

EWIPS

Reg. No. 4,173,525

AERAZUR (FRANCE SOCIÉTÉ PAR ACTIONS SIMPLIFIÉES À ASSOCIÉ UNIQUE)
2 RUE MAURICE MALLET
F-92130 ISSY LES MOULINEAUX, FRANCE

Registered July 17, 2012

Int. Cl.: 11

FOR: ELECTRICAL HEATERS FOR PROTECTING FIXED WING OR ROTARY WING AIR-
CRAFT FROM ICING USING JOULE EFFECT, IN CLASS 11 (U.S. CLS. 13, 21, 23, 31 AND
34).

TRADEMARK

THE MARK CONSISTS OF STANDARD CHARACTERS WITHOUT CLAIM TO ANY PAR-
TICULAR FONT, STYLE, SIZE, OR COLOR.

PRINCIPAL REGISTER

PRIORITY DATE OF 1-31-2011 IS CLAIMED.

OWNER OF INTERNATIONAL REGISTRATION 1084496 DATED 5-11-2011, EXPIRES 5-11-
2021.

SER. NO. 79-100,147, FILED 5-11-2011.

SAIMA MAKHDOOM, EXAMINING ATTORNEY



David J. Kyffers

Director of the United States Patent and Trademark Office

United States of America

United States Patent and Trademark Office

M-able

Reg. No. 4,173,526

Registered July 17, 2012

Int. Cls.: 9, 36, 38 and 42

TRADEMARK

SERVICE MARK

PRINCIPAL REGISTER

DEUTSCHE TELEKOM AG
FRIEDRICH-EBERT-ALLEE 140
53113 BONN
FED REP GERMANY

FOR: COMPUTER E-COMMERCE SOFTWARE TO ALLOW USERS TO PERFORM ELECTRONIC BUSINESS TRANSACTIONS VIA A GLOBAL COMPUTER NETWORK; COMPUTER SOFTWARE, NAMELY, ELECTRONIC FINANCIAL PLATFORM THAT ACCOMMODATES MULTIPLE TYPES OF PAYMENT AND DEPT TRANSACTIONS; ELECTRONIC APPARATUS FOR RECORDING, TRANSMITTING AND REPRODUCTION DATA COMPRISING SOUND AND IMAGES; BLANK MAGNETIC DATA CARRIERS; PRERECORDED MAGNETIC DATA CARRIERS FEATURING INFORMATION ABOUT FINANCIAL SERVICE, INSURANCE SERVICES TELECOMMUNICATIONS AND SOFTWARE FOR FINANCIAL SERVICE AND INSURANCE SERVICES; CODED SERVICE CARDS AND PAYMENT CARDS, NAMELY, ELECTRONIC AND MAGNETIC ID CARDS FOR USE IN CONNECTION WITH PAYMENT FOR SERVICES; CREDIT CARDS WITHOUT MAGNETIC CODING; MAGNETICALLY RECORDED CREDIT CARDS; READERS FOR ELECTRONIC DATA MEDIA CARDS, IN CLASS 9 (U.S. CLS. 21, 23, 26, 36 AND 38).

FOR: INSURANCE SERVICES, NAMELY, INSURANCE BROKERAGE, INSURANCE CLAIMS PROCESSING; FINANCIAL SERVICES, NAMELY, CLEARING OF SECURE FINANCIAL TRANSACTIONS THROUGH ONLINE SERVICES; PROVIDING INFORMATION IN THE FIELD OF FINANCE; FINANCIAL TRANSACTION SERVICES, NAMELY, PROVIDING SECURE COMMERCIAL TRANSACTIONS AND PAYMENT OPTIONS; FINANCIAL SERVICES, NAMELY, PROVIDING FINANCIAL TRANSACTION PROCESSING SERVICES AND FINANCIAL INFORMATION BY ELECTRONIC MEANS VIA COMPUTER NETWORKS AND GLOBAL INFORMATION NETWORKS; MONITORING FINANCIAL TRANSACTIONS IN THE FIELD OF ELECTRONIC FUND TRANSFER AND PAYMENT PROCESSING SERVICES; ELECTRONIC FUNDS TRANSFER AND FINANCIAL SERVICES VIA ELECTRONIC COMMUNICATIONS NETWORKS; FINANCIAL TRANSACTION SERVICES, NAMELY, PROVIDING SECURE COMMERCIAL TRANSACTIONS AND PAYMENT OPTIONS VIA A GLOBAL COMPUTER NETWORK; ISSUANCE OF CREDIT CARDS AND CARD-BASED ELECTRONIC MONEY AS WELL AS SOFTWARE-BASED ELECTRONIC MONEY; MONETARY AFFAIRS, NAMELY, TRANSMISSION OF PAYMENTS VIA THE INTERNET AND/OR ELECTRONIC COMMUNICATION NETWORKS; CLAIMS MANAGEMENT, NAMELY, DUNNING, CHARGE BACK, AND DEPT COLLECTING SERVICES; CREDIT ASSESSMENT,



David J. Kyjars

Director of the United States Patent and Trademark Office

Reg. No. 4,173,526 NAMELY, RATING, SCORING, REPORTING SERVICES, IN CLASS 36 (U.S. CLS. 100, 101 AND 102).

FOR: TELECOMMUNICATIONS, NAMELY, PROVIDING ACCESS TO DATABASES, PROVISION OF TELECOMMUNICATION CHANNELS FOR TEleshopping AND INTERNET SHOPPING SERVICES; COMMUNICATION BY MEANS OF FIBRE OPTICAL NETWORKS; COMMUNICATION SERVICES, NAMELY, ELECTRONIC TRANSMISSION OF DATA AND DOCUMENTS BY MEANS OF COMPUTER TERMINALS; COMMUNICATION SERVICES VIA TELEPHONE; PROVIDING ACCESS TO A GLOBAL COMPUTER NETWORK; PROVIDING TELECOMMUNICATION CONNECTIONS TO A GLOBAL COMPUTER NETWORK, IN CLASS 38 (U.S. CLS. 100, 101 AND 104).

FOR: DEVELOPMENT FOR OTHERS AND UPGRADING OF SOFTWARE BASED MICRO AND MACRO-BILLING SYSTEMS FOR USE AND ACCESSED THROUGH THE INTERNET AND THROUGH CELLULAR AND WIRED TELEPHONES; SOFTWARE DEVELOPMENT FOR OTHERS, NAMELY, PROGRAMS FOR THE PROCESSING OF THE BILLING SYSTEMS AND CASH FLOWS IN THE INTERNET; CONSULTING IN THE CREATION OF HOMEPAGES AND INTERNET SITES, IN CLASS 42 (U.S. CLS. 100 AND 101).

THE MARK CONSISTS OF STANDARD CHARACTERS WITHOUT CLAIM TO ANY PARTICULAR FONT, STYLE, SIZE, OR COLOR.

PRIORITY DATE OF 3-2-2010 IS CLAIMED.

OWNER OF INTERNATIONAL REGISTRATION 1084512 DATED 9-2-2010, EXPIRES 9-2-2020.

SER. NO. 79-100,154, FILED 9-2-2010.

JULIE GUTTADAURO, EXAMINING ATTORNEY

United States of America

United States Patent and Trademark Office

TERREDAVINO

Reg. No. 4,173,527

Registered July 17, 2012

Int. Cl.: 33

TRADEMARK

PRINCIPAL REGISTER

TERRE DA VINO S.P.A. (ITALY CORPORATION)
VIA BERGESIA, 6
I-12060 BAROLO (CN)
ITALY

FOR: WINE, IN CLASS 33 (U.S. CLS. 47 AND 49).

OWNER OF U.S. REG. NO. 3,311,957.

OWNER OF INTERNATIONAL REGISTRATION 1084614 DATED 6-17-2011, EXPIRES 6-17-2021.

THE MARK CONSISTS OF THE WORDING "TERREDAVINO" IN STYLIZED FORMAT ENCLOSED IN A RECTANGLE.

THE ENGLISH TRANSLATION OF "TERREDAVINO" IN THE MARK IS LANDS FOR WINE.

SER. NO. 79-100,196, FILED 6-17-2011.

SHANNON TWOHIG, EXAMINING ATTORNEY



David J. Kyffers

Director of the United States Patent and Trademark Office

United States of America

United States Patent and Trademark Office

STARTWEL

Reg. No. 4,173,528

Registered July 17, 2012

Int. Cl.: 9

TRADEMARK

PRINCIPAL REGISTER

RAILTECH INTERNATIONAL (FRANCE SOCIÉTÉ ANONYME)
ZONE INDUSTRIELLE
RUE DU BAS PRÉ
RAISMES, FRANCE F59590

FOR: ELECTRIC IGNITERS FOR WELDING RAILS; ELECTRIC IGNITERS FOR IGNITING REAGENT MIXTURES AND FOR CONTROLLING AND MONITORING REACTIONS , IN CLASS 9 (U.S. CLS. 21, 23, 26, 36 AND 38).

THE MARK CONSISTS OF STANDARD CHARACTERS WITHOUT CLAIM TO ANY PARTICULAR FONT, STYLE, SIZE, OR COLOR.

PRIORITY DATE OF 12-3-2010 IS CLAIMED.

OWNER OF INTERNATIONAL REGISTRATION 1084664 DATED 6-1-2011, EXPIRES 6-1-2021.

SER. NO. 79-100,210, FILED 6-1-2011.

GINA FINK, EXAMINING ATTORNEY



David J. Kyffers

Director of the United States Patent and Trademark Office

United States of America

United States Patent and Trademark Office

ETA plus

Reg. No. 4,173,529

Registered July 17, 2012

Int. Cls.: 11 and 40

TRADEMARK

SERVICE MARK

PRINCIPAL REGISTER

MOTAN HOLDING GMBH (FED REP GERMANY GMBH)
STROMEYERSDORFSTR. 12
78467 KONSTANZ
FED REP GERMANY

FOR: DRYING DEVICES FOR PLASTIC GRANULES FOR ATTACHING TO DRY AIR GENERATORS INCORPORATING STORAGE CONTAINERS FOR THE PLASTIC GRANULES, CONDUITS FOR FEEDING THE DRY AIR TO THE STORAGE CONTAINERS, HEATING DEVICES FOR THE DRY AIR, CONDUITS FOR RETURNING DAMP AIR FROM THE STORAGE CONTAINERS, HEAT EXCHANGERS BETWEEN HEATED DAMP RETURN AIR, UNHEATED DRY FEED AIR AND UNHEATED DRY RETURN AIR; MOTOR-OPERATED CONTROL VALVES FOR AIR VOLUME REGULATION; DRY AIR GENERATORS, IN CLASS 11 (U.S. CLS. 13, 21, 23, 31 AND 34).

FOR: TREATMENT OF MATERIALS, NAMELY, PROVIDING DRYING SERVICES IN THE NATURE OF THE DEHUMIDIFICATION OF THE DRYING AGENTS OF OTHERS, IN CLASS 40 (U.S. CLS. 100, 103 AND 106).

THE MARK CONSISTS OF STANDARD CHARACTERS WITHOUT CLAIM TO ANY PARTICULAR FONT, STYLE, SIZE, OR COLOR.

PRIORITY DATE OF 9-27-2010 IS CLAIMED.

OWNER OF INTERNATIONAL REGISTRATION 1084797 DATED 2-25-2011, EXPIRES 2-25-2021.

SER. NO. 79-100,257, FILED 2-25-2011.

AMY HELLA, EXAMINING ATTORNEY



David J. Kypos

Director of the United States Patent and Trademark Office

United States of America

United States Patent and Trademark Office

TEKAIR

Reg. No. 4,173,530

Registered July 17, 2012

Int. Cl.: 7

TRADEMARK

PRINCIPAL REGISTER

SERVICES COMPANY BELGIUM, AFGEKORT: SECOBEL, NAAMLOZE VENNOOTSCHAP
(BELGIUM JOINT STOCK COMPANY)
WOUDSTRAAT 21
B-3600 GENK, BELGIUM

FOR: AIR COMPRESSORS, NAMELY, POSITIVE DISPLACEMENT COMPRESSORS INCLUDING RECIPROCATING COMPRESSORS AND ROTARY COMPRESSORS SUCH AS PISTON COMPRESSORS, IN-LINE COMPRESSORS, V-SHAPED COMPRESSORS, TANDEM PISTON COMPRESSORS, SINGLE-ACTING COMPRESSORS, DOUBLE-ACTING COMPRESSORS, DIAPHRAGM COMPRESSORS, SCREW COMPRESSORS, VANE TYPE COMPRESSORS, LOBE AND SCROLL COMPRESSORS; AIR COMPRESSORS, NAMELY, ROTODYNAMIC COMPRESSORS SUCH AS CENTRIFUGAL COMPRESSORS, AXIAL FLOW COMPRESSORS, PARTS FOR AIR COMPRESSORS, NAMELY, LUBRICATORS, PRESSURE REDUCERS, VALVES FOR COMPRESSED AIR, AUTOMATIC CONDENSATE DRAINAGE PUMPS, WATER-OIL SEPARATORS FOR PNEUMATIC CONTROLS, ELECTRIC MOTORS, ALL BEING PARTS OF MACHINES, IN CLASS 7 (U.S. CLS. 13, 19, 21, 23, 31, 34 AND 35).

THE MARK CONSISTS OF STANDARD CHARACTERS WITHOUT CLAIM TO ANY PARTICULAR FONT, STYLE, SIZE, OR COLOR.

PRIORITY DATE OF 12-3-2010 IS CLAIMED.

OWNER OF INTERNATIONAL REGISTRATION 1084852 DATED 6-3-2011, EXPIRES 6-3-2021.

SER. NO. 79-100,281, FILED 6-3-2011.

WENDY JUN, EXAMINING ATTORNEY



David J. Kyros

Director of the United States Patent and Trademark Office

United States of America

United States Patent and Trademark Office

INDUCTIVE INTELLIGENCE

Reg. No. 4,173,531

Registered July 17, 2012

Int. Cls.: 9, 35 and 37

TRADEMARK

SERVICE MARK

PRINCIPAL REGISTER

INDUGROEP PARTICIPATIES B.V. (NETHERLANDS BESLOTEN VENNOOTSCHAP)
MERCURIUSWEG 5
NL-9561 AL TER APEL
NETHERLANDS

FOR: APPARATUS AND INSTRUMENTS FOR CONDUCTING, SWITCHING, TRANSFORMING, ACCUMULATING, REGULATING AND CONTROLLING ELECTRICITY, TRANSFORMERS, ELECTRIC COILS, INVERTERS FOR ELECTRICITY, DIRECT CURRENT POWER SUPPLIES, VOICE ELECTRIC COIL ACTUATORS AND HOUSINGS FOR POWER SUPPLIES, IN CLASS 9 (U.S. CLS. 21, 23, 26, 36 AND 38).

FOR: IMPORT AND EXPORT AGENCIES IN THE FIELD OF ELECTRICAL APPARATUS AND INSTRUMENTS FOR CONDUCTING, SWITCHING, TRANSFORMING, ACCUMULATING, REGULATING AND CONTROLLING ELECTRICITY, INCLUDING TRANSFORMERS, COILS, INVERTERS; AND PROCUREMENT SERVICES, NAMELY, PURCHASING GOODS FOR OTHERS IN THE NATURE OF ELECTRICAL APPARATUS AND INSTRUMENTS FOR CONDUCTING, SWITCHING, TRANSFORMING, ACCUMULATING, REGULATING AND CONTROLLING ELECTRICITY, INCLUDING TRANSFORMERS, COILS, INVERTERS, IN CLASS 35 (U.S. CLS. 100, 101 AND 102).

FOR: INSTALLATION, REPAIR AND MAINTENANCE OF ELECTRICAL APPARATUS AND INSTRUMENTS FOR CONDUCTING, SWITCHING, TRANSFORMING, ACCUMULATING, REGULATING AND CONTROLLING ELECTRICITY, INCLUDING TRANSFORMERS, COILS, INVERTERS, IN CLASS 37 (U.S. CLS. 100, 103 AND 106).

THE MARK CONSISTS OF STANDARD CHARACTERS WITHOUT CLAIM TO ANY PARTICULAR FONT, STYLE, SIZE, OR COLOR.

PRIORITY DATE OF 11-24-2010 IS CLAIMED.

OWNER OF INTERNATIONAL REGISTRATION 1084853 DATED 5-23-2011, EXPIRES 5-23-2021.

NO CLAIM IS MADE TO THE EXCLUSIVE RIGHT TO USE "INDUCTIVE", APART FROM THE MARK AS SHOWN.

SER. NO. 79-100,282, FILED 5-23-2011.



David J. Kyjars

Director of the United States Patent and Trademark Office

Reg. No. 4,173,531 SUE LAWRENCE, EXAMINING ATTORNEY

United States of America

United States Patent and Trademark Office

Life Is Not A Straight Line

Reg. No. 4,173,532

Registered July 17, 2012

Int. Cl.: 19

TRADEMARK

PRINCIPAL REGISTER

BOLE OÜ (ESTONIA PRIVATE LIMITED COMPANY)
P. SÜDA 10-8
EE-10118 TALLINN
ESTONIA

FOR: NON-METAL BUILDING MATERIALS, NAMELY, BUILDING TIMBER, SEMI-WORKED WOODS, LOGS, LOGHOUSE LOGS, JOISTS, WOOD AND FLOOR VENEERS, WOOD FOR MAKING HOUSEHOLD UTENSILS, STAVE WOOD, WOODEN BOARDS, FLOORING BOARDS, BARREL BOARDS, HOBBY BOARDS IN THE NATURE OF BOARDS OF WOOD, STAIR TREADS, WOODEN MOULDINGS, PORCHES FOR BUILDING, ARCH ELEMENTS FOR BUILDING PURPOSES, PORTAL ELEMENTS FOR BUILDING PURPOSES, WINDOWSILLS, FLOOR PANELS, WALL PANELS, CEILING PANELS, FACADE PANELS, DOOR PANELS, CLADDING PANELS, FENCE PANELS, SHIPDECK PANELS, WOOD FINGERJOINT PANELS, GLUELAMINATED WOOD PANELS, DECKING PANELS; NON-METAL FLOORS, PARQUET FLOORING; FLOORING SLABS, NAMELY, SLABS OF CONCRETE, GLUELAMINATED SLABS, PARQUET SLABS, WOOD SLABS; NON-METAL FLOOR TRIMS; WOOD PANELS FOR BUILDING CONSTRUCTION, NAMELY, MULTILAYER WOODEN PANELS, SOLID HARDWOOD PANELS, SOLID SOFTWOOD PANELS, SEMI WORKED WOODEN PANELS; REMOVABLE WOOD PARTITION PANELS, NAMELY, SLIDING DOOR PANELS, SLIDING WALL PANELS; NON-METAL WALL SLABS, NON-METAL WAINSCOTTING, NON-METAL GRIDS FOR BUILDING PURPOSES, NON-METAL GRATINGS, IN CLASS 19 (U.S. CLS. 1, 12, 33 AND 50).



THE MARK CONSISTS OF STANDARD CHARACTERS WITHOUT CLAIM TO ANY PARTICULAR FONT, STYLE, SIZE, OR COLOR.

PRIORITY DATE OF 12-21-2010 IS CLAIMED.

OWNER OF INTERNATIONAL REGISTRATION 1084866 DATED 6-21-2011, EXPIRES 6-21-2021.

SER. NO. 79-100,291, FILED 6-21-2011.

LEIGH LOWRY, EXAMINING ATTORNEY

David J. Kyffers

Director of the United States Patent and Trademark Office

United States of America
United States Patent and Trademark Office

SEQUOIA

Reg. No. 4,173,533

Registered July 17, 2012

Int. Cl.: 16

TRADEMARK

PRINCIPAL REGISTER

ARJOWIGGINS PAPIERS COUCHES (FRANCE SOCIÉTÉ PAR ACTIONS SIMPLIFIÉE)
20 RUE ROUGET DE LISLE
F-92130 ISSY LES MOULINEAUX
FRANCE

FOR: UNPROCESSED AND SEMI-PROCESSED PAPER AND CARDBOARD, ALL FOR THE MANUFACTURE BY OTHERS OF GIFT CARDS, LOYALTY CARDS, TELEPHONE CARDS, DOWNLOAD CARDS AND OTHER MAGNETIC CARDS AND SMART CARDS; COATED PAPER, RECYCLED PAPER AND CARDBOARD, ALL FOR THE MANUFACTURE BY OTHERS OF SMART CARDS AND MAGNETIC CARDS, POINT OF SALE DISPLAYS AND CALENDARS, IN CLASS 16 (U.S. CLS. 2, 5, 22, 23, 29, 37, 38 AND 50).

THE MARK CONSISTS OF STANDARD CHARACTERS WITHOUT CLAIM TO ANY PARTICULAR FONT, STYLE, SIZE, OR COLOR.

PRIORITY DATE OF 4-22-2011 IS CLAIMED.

OWNER OF INTERNATIONAL REGISTRATION 1085060 DATED 5-2-2011, EXPIRES 5-2-2021.

SER. NO. 79-100,403, FILED 5-2-2011.

VERNA BETH RIRIE, EXAMINING ATTORNEY



David J. Kyffers

Director of the United States Patent and Trademark Office

United States of America

United States Patent and Trademark Office



Reg. No. 4,173,534

Registered July 17, 2012

Int. Cls.: 18, 25 and 35

TRADEMARK

SERVICE MARK

PRINCIPAL REGISTER

Z-COIL LTD (REPUBLIC OF KOREA CORPORATION)
116-1801 LG METRO CITY
176-30, YONG HO DONG, NAM GU
BUSAN, REPUBLIC OF KOREA 608776

FOR: TOTE BAGS; LEATHER; LEATHER BRIEFCASES; LEATHER SHOULDER BELTS; LEATHER TRAVELLING BAGS; LEATHER PURSES; LEATHER HANDBAGS; WALKING STICKS; GOLF UMBRELLAS; BAGS FOR CLIMBERS IN THE NATURE OF ALL-PURPOSE CARRYING BAGS; RUCKSACKS FOR MOUNTAINEERS; ALPENSTOCKS; FUR PELTS; ANIMAL SKINS; BACKPACKS; BELT BAGS; BOSTON BAGS; BEACH BAGS; BEACH UMBRELLAS; RAW SKINS; RAWHIDES; BRIEFCASES; ATTACHE CASES; SMALL CLUTCH PURSES; ANIMAL HIDES IN THE NATURE OF CATTLE SKINS; MESH SHOPPING BAGS; SHOULDER BAGS; SUITCASES; BAGS FOR SPORTS; LEATHER FOR SHOES; PARASOLS; SUN UMBRELLAS; TRAVELLING TRUNKS; UMBRELLAS; IMITATION LEATHER; SMALL PURSES; PURSES; CANES; BUSINESS CARD CASES; BAGS FOR CAMPERS IN THE NATURE OF ALL-PURPOSE CARRYING BAGS; HIKING BAGS; HIKING RUCKSACKS; SCHOOL SATCHELS; SCHOOL KNAPSACKS; HANDBAGS; HIPSACKS, IN CLASS 18 (U.S. CLS. 1, 2, 3, 22 AND 41).

FOR: GOWNS; LEATHER SHOES; LEATHER HEADWEAR; GOLF SHIRTS; GOLF SKIRTS; GOLF SHOES; SCHOOL UNIFORMS; SHOE SOLES; WOODEN SHOES; NIGHTGOWNS; FISHING VESTS; ANGLERS' SHOES; NECKTIES; BASKETBALL SHIRTS; BASKETBALL SHOES; KNITWEAR, NAMELY, CAPS, SCARVES, SWEATERS, TOPS, DRESSES; SHOES; DECK-SHOES; HEELS; DRESSES; CLIMBING CLOTHES, NAMELY, PANTS, SHIRTS, SHORTS, GLOVES, SHOES; CLIMBING BOOTS; MOUNTAINEERING BOOTS; SWEAT SUITS; RUGBY SHOES; RUNNING SUITS; RAIN COATS; CAPS; HEADWEAR; FUR COATS; SHORTS; WORK HALF-BOOTS; ANKLE SOCKS; WATERPROOF FOOTWEAR; WINTER CLOTHES, NAMELY, JACKETS, JUMPERS, COATS, OVERCOATS, PANTS, HATS; WINTER GLOVES; WINTER BOOTS; VOLLEYBALL SHOES; BOXING SHOES; BOWLING SHOES; BOOTS; UPPERS FOR JAPANESE STYLE SANDALS; BRASSIERES; BLOUSES; BLAZERS; VINYL SHOES; BEACH SHOES; BEACHWEAR; CYCLING SHOES; SANDALS; SHIRTS; SLEEVELESS JERSEYS; SHAWLS; BATHING CAPS; BATHING SUITS; SUITS; SWEATERS; SCARFS; SKIRTS; SKI WEAR; STOCKINGS; SKI BOOTS; SPORTS JERSEYS; SPORTS JACKETS; SPORTS SHOES; SLACKS; SLIPPERS; FOOTWEAR; SOLES FOR FOOTWEAR; HEEL PIECES FOR BOOTS; MEN'S SUITS; SILK SCARVES; CHILDREN'S CLOTHES, NAMELY, SHIRTS, JACKETS, JUMPERS, SUITS, PANTS, CAPS, GLOVES, SHOES; ANKLE BOOTS; BASEBALL CAPS; BASEBALL SHOES; SOCKS; TROUSERS; WOMEN'S SHOES;



David J. Kybas

Director of the United States Patent and Trademark Office

Reg. No. 4,173,534 OVERSHOES; OVERCOATS; ATHLETIC UNIFORMS; ATHLETIC FOOTWEAR; WEDDING DRESSES; INFANT AND TODDLER ONE PIECE CLOTHING; WORK CLOTHES, NAMELY, SHIRTS, JACKETS, JUMPERS, PANTS, CAPS, GLOVES, SOCKS; WORK SHOES AND BOOTS; JUMPERS; JACKETS; JERKINS; CAPS WITH VISORS; BLUE JEANS; GYMNAS TIC SHOES; FOOTBALL BOOTS; CARDIGANS; CORSETS; TOP COATS; TENNIS SHOES; TRAINING WEAR, NAMELY, SHIRTS, JACKETS, PANTS, SHOES; TRENCH COATS; TEE-SHIRTS; PANTS; PANTIES; PANTYHOSE; LACE BOOTS; POLO SHIRTS; FIELD HOCKEY SHOES; WAIST BELTS; HEAVY JACKETS; GOLF CLOTHES, NAMELY, JACKETS, JUMPERS, CAPS, PANTS, SOCKS, IN CLASS 25 (U.S. CLS. 22 AND 39).

FOR: WHOLESALE STORE SERVICES FEATURING FURNITURE; RETAIL AND ONLINE RETAIL STORE SERVICES IN THE FIELD OF BAGS AND WALLETS; RETAIL AND ONLINE RETAIL STORE SERVICES IN THE FIELD OF MINERAL WATER AND WATER; RETAIL AND ONLINE RETAIL STORE SERVICES IN THE FIELD OF FERTILIZERS; RETAIL AND ONLINE RETAIL STORE SERVICES IN THE FIELD OF UNDERWEAR, SWEATERS AND SHIRTS; ADVERTISING AND PROMOTIONAL SERVICES IN THE FIELD OF SPORTS; RETAIL AND ONLINE RETAIL STORE SERVICES IN THE FIELD OF TABLEWARE; RETAIL AND ONLINE RETAIL STORE SERVICES IN THE FIELD OF MEAT; RETAIL AND ONLINE RETAIL STORE SERVICES IN THE FIELD OF FOOTWEAR; RETAIL AND ONLINE RETAIL STORE SERVICES IN THE FIELD OF SPECTACLES; BUSINESS MANAGEMENT OF PERFORMING ARTISTS; PRODUCTION OF FILM ADVERTISING; OUTDOOR ADVERTISING; WHOLESALE STORE SERVICES FEATURING TOYS AND PLAYTHINGS; RETAIL AND ONLINE RETAIL STORE SERVICES IN THE FIELD OF FABRICS; RETAIL AND ONLINE RETAIL STORE SERVICES IN THE FIELD OF BED CLOTHES; SALES PROMOTION SERVICES, IN CLASS 35 (U.S. CLS. 100, 101 AND 102).

THE MARK CONSISTS OF THE LETTERS "RX" AND A DESIGN OF A SPIRAL.

PRIORITY DATE OF 8-20-2010 IS CLAIMED.

OWNER OF INTERNATIONAL REGISTRATION 1085242 DATED 2-19-2011, EXPIRES 2-19-2021.

SER. NO. 79-100,464, FILED 2-19-2011.

SUSAN RICHARDS, EXAMINING ATTORNEY

United States of America

United States Patent and Trademark Office

JAN DE NUL

Reg. No. 4,173,535

Registered July 17, 2012

**Int. Cls.: 12, 35, 37, 39,
40 and 42**

TRADEMARK

SERVICE MARK

PRINCIPAL REGISTER

DREDGING AND MARITIME MANAGEMENT, SOCIÉTÉ ANONYME (LUXEMBOURG SOCIÉTÉ ANONYME)
34-36, PARC D'ACTIVITÉS CAPELLEN
L-8308 CAPELLEN
LUXEMBOURG

FOR: LAND VEHICLES; APPARATUS FOR LOCOMOTION BY LAND, NAMELY, DUMPER TRUCKS AND HAULING TRAILERS FOR TRANSPORTING DREDGED MATERIAL, SLUDGE AND ALL TYPES OF SOIL, ROCK AND QUARRY MATERIAL; APPARATUS FOR LOCOMOTION BY WATER, NAMELY, DREDGING VESSELS, CUTTER SUCTION DREDGERS AND TRAILING SUCTION HOPPER DREDGERS, BOATS AND SHIPS; SHIPS' HULLS, BOAT HOOKS; STEERING GEARS FOR SHIPS; DISENGAGING GEAR FOR BOATS; MASTS FOR BOATS; INCLINED WAYS FOR BOATS; SCREW-PROPELLERS FOR BOATS; OARS; FERRY BOATS; BOATS USED FOR DREDGING; MARINE VESSELS, NAMELY, WORKBOATS, MULTI-CATS, TUGBOATS, CREW VESSELS, SURVEY VESSELS, BARGES, HEAVY LIFT VESSELS, OIL RECOVERY VESSELS, FLOATING AUXILIARY AND ANCILLARY EQUIPMENT; LAND VEHICLES MAINLY USED IN DREDGING OPERATIONS; ENGINES FOR LAND VEHICLES, IN CLASS 12 (U.S. CLS. 19, 21, 23, 31, 35 AND 44).

FOR: ADVERTISING; BUSINESS MANAGEMENT; BUSINESS ADMINISTRATION; OFFICE ADMINISTRATIVE SERVICES; BOOK-KEEPING; DRAWING UP OF STATEMENTS OF ACCOUNTS; DEMONSTRATION OF GOODS; UPDATING OF ADVERTISING MATERIAL; ADMINISTRATIVE MANAGEMENT OF BUILDING COMPANIES AND SALE OF BUILDING MATERIALS; MARKETING CONSULTANCY IN THE FIELDS OF CIVIL ENGINEERING, MARINE CONSTRUCTION, ENVIRONMENTAL REMEDIATION, OFFSHORE OIL AND GAS, BUILDING MATERIALS, LIFTING APPARATUS, CRANES AND CIVIL ENGINEERING EQUIPMENT, VEHICLES, APPARATUS FOR LOCOMOTION BY LAND, AIR OR WATER, OF BOATS, SHIPS' HULLS, BOATHOOKS, STEERING GEAR FOR SHIPS, DISENGAGING GEAR FOR SHIPS, MASTS FOR SHIPS, INCLINED WAYS FOR SHIPS, SCREW-PROPELLERS FOR SHIPS, OARS, FERRY BOATS, SHIPS, DREDGING VESSELS, MARINE VESSELS AND LAND VEHICLES MAINLY USED FOR DREDGING OPERATIONS, DREDGERS; RETAILING SERVICES FOR THE WHOLESALE OF BUILDING MATERIALS, LIFTING APPARATUS, CRANES AND CIVIL ENGINEERING EQUIPMENT, VEHICLES, APPARATUS FOR LOCOMOTION BY LAND, AIR OR WATER, OF BOATS, SHIPS' HULLS, BOATHOOKS, STEERING GEAR FOR SHIPS, DISENGAGING GEAR FOR SHIPS, MASTS FOR SHIPS, INCLINED WAYS FOR SHIPS, SCREW-PROPELLERS FOR SHIPS, OARS, FERRY BOATS, SHIPS, DREDGING VESSELS, MARINE VESSELS AND LAND VEHICLES MAINLY USED FOR



David J. Kybas

Director of the United States Patent and Trademark Office

Reg. No. 4,173,535 DREDGING OPERATIONS, DREDGERS; ADMINISTRATIVE MANAGEMENT OF BUILDING PRODUCTS, NAMELY, ADMINISTRATIVE PROCESSING OF PURCHASE ORDERS, INVOICING AND FINANCIAL STATEMENT ANALYSIS, PRICE COMPARISON SERVICES, COST-PRICE ANALYSIS, MARKETING STUDIES, COMPILATION AND SYSTEMIZATION OF DATA INTO COMPUTER DATABASES; ADMINISTRATIVE SERVICES IN CONNECTION WITH OPERATING INSTALLATIONS INTENDED FOR REMOVING UNDERWATER SEDIMENT; ADMINISTRATIVE PREPARATION OF DREDGING WORKS, NAMELY, OFFICE FUNCTIONS, BUSINESS ASSISTANCE AND PREPARING PRICE OFFERS, IN CLASS 35 (U.S. CLS. 100, 101 AND 102).

FOR: CONSTRUCTION OF FACILITIES, STRUCTURES, UTILITY BUILDINGS, PRODUCTION MODULES AND SUBSEA MODULES IN THE OIL AND GAS INDUSTRY, IN THE FIELD OF CIVIL ENGINEERING, MARINE CONSTRUCTION, ENVIRONMENTAL REMEDIATION, OFFSHORE OIL AND GAS, HYDRAULIC ENGINEERING, MARINE CONSTRUCTION AND PORT DEVELOPMENT; CONSTRUCTION OF DRILLING ISLANDS, BRIDGES, BERTHS, QUAY WALLS AND BREAKWATERS, ROLL-ON/ROLL-OFF FACILITIES; PIPELINE INSTALLATION; INSTALLATION AND REPAIR OF CABLES, WINDMILLS, OFFSHORE AND ONSHORE CONSTRUCTION WORKS, QUAY WALLS AND BREAKWATERS, IN THE FIELD OF CIVIL ENGINEERING, HYDRAULIC ENGINEERING, MARINE CONSTRUCTION AND PORT DEVELOPMENT; DREDGING; BACKFILLING OF EARTH; MAINTENANCE OF OIL CHANGE STATIONS; LAYING OF RAILWAY TRACKS; HOUSE AND BUILDING DEMOLITION, AND DEMOLITION OF UNDERWATER STRUCTURES, BRIDGES, WALLS, QUAY WALLS, BREAKWATERS, WITH THE USE OF EXPLOSIVES OR CRANES; CARRYING OUT BUILDING CONSTRUCTION FOR WATER PIPES; EXTRACTING SAND AND GRAVEL, AS PART OF CLEAN-UP WORK FOR MARINE SOILS AND SUBSOILS; CARRYING OUT AND SUPERVISING THE BUILDING OF ROADS, TUNNELS AND WATER SUPPLY SYSTEMS; FOUNDATION LAYING; CONSTRUCTION, MAINTENANCE AND RENOVATION OF COASTS AND BANKS; BALLASTING SERVICES, NAMELY, BALLASTING OF GRAVITY BASED STRUCTURES FOR THE OFFSHORE INDUSTRY; CONSTRUCTION, REPAIR AND INSTALLATION OF CONSTRUCTIONS AT SEA IN THE NATURE OF BREAKWATERS, PIERS, STRUCTURES AND WINDMILLS, ARTIFICIAL ISLANDS AND LAND RECLAMATIONS; MOVING OF EARTH; SHIPBUILDING AND MAINTENANCE AND REPAIR OF SHIPS AND BOATS; MAINTENANCE AND REPAIR OF DREDGING VESSELS AND EQUIPMENT; PURIFICATION AND DREDGING OF SOILS AND SUBSOILS, IN CLASS 37 (U.S. CLS. 100, 103 AND 106).

FOR: TRANSPORT BY BOATS, BY VESSELS, BY PIPELINES, BY FLOATING PIPELINES OR SINKER PIPELINES; STORAGE OF DREDGED MATERIAL AND OF CONSTRUCTION MATERIAL; BOAT STORAGE; BOAT RENTAL; TRANSPORT BY SHIP; SALVAGE OF SHIPS; TRANSPORT AND STORAGE OF SLUDGE, SAND AND GRAVEL; TRANSPORT OF SLUDGE AND SAND BY PIPELINE; STORAGE OF GOODS; TRANSPORTING GAS AND LIQUIDS, ALSO BY PIPELINE; STORAGE, COLLECTION AND TRANSPORT OF WASTE AND BUILDING MATERIALS, INCLUDING SLUDGE, UNDERGROUND WATER AND WASTE WATER; HAULING IN THE NATURE OF JUNK, TRASH, DEBRIS REMOVAL, DREDGED MATERIAL AND CONSTRUCTION MATERIAL; TRANSPORTATION INFORMATION; VEHICLE RENTAL; RENTAL OF TRUCKS; RENTAL OF VESSELS AND LAND VEHICLES FOR BUILDING MATERIALS, IN CLASS 39 (U.S. CLS. 100 AND 105).

FOR: SUSTAINABLE ON-SITE WATER RECYCLING AND WASTEWATER TREATMENT SERVICES; ENVIRONMENTAL REMEDIATION SERVICES, NAMELY, TREATMENT AND RECYCLING OF SOIL; ENVIRONMENTAL REMEDIATION SERVICES, NAMELY, TREATMENT OF WATER AND SLUDGE; ENVIRONMENTAL REMEDIATION SERVICES, NAMELY, CONVERTING SLUDGE INTO MANURE; DESTRUCTION OF WASTE; MATERIAL TREATMENT INFORMATION; CRUSHING AND RECYCLING OF BUILDING MATERIALS; CUSTOM ASSEMBLING OF DREDGING EQUIPMENT FOR OTHERS; WASTE TREATMENT, NAMELY, UNDERWATER DISPOSAL OF SEDIMENTS; ENVIRONMENTAL REMEDIATION SERVICES, NAMELY, TREATMENT AND PURIFICATION OF SOILS AND

Reg. No. 4,173,535 SUBSOILS; PREPARING REPORTS ON SUBSOILS, IN CLASS 40 (U.S. CLS. 100, 103 AND 106).

FOR: SCIENTIFIC AND TECHNOLOGICAL SERVICES, NAMELY, RESEARCH AND DESIGN IN THE FIELD OF CIVIL ENGINEERING, MARINE CONSTRUCTION, OFFSHORE OIL AND GAS, HYDRAULIC ENGINEERING, MARINE CONSTRUCTION AND PORT DEVELOPMENT, AND IN THE FIELD OF ENVIRONMENTAL REMEDIATION; INDUSTRIAL ANALYSIS AND RESEARCH SERVICES IN THE FIELD OF CIVIL ENGINEERING, MARINE CONSTRUCTION, OFFSHORE OIL AND GAS, HYDRAULIC ENGINEERING, MARINE CONSTRUCTION AND PORT DEVELOPMENT, AND IN THE FIELD OF ENVIRONMENTAL REMEDIATION; ENGINEERING; GEOLOGICAL PROSPECTING; ARCHITECTURAL DESIGN; HYDRAULIC ENGINEERING AND DESIGN; ENGINEERING SERVICES IN THE FIELD OF CIVIL ENGINEERING, HYDRAULIC ENGINEERING, MARINE CONSTRUCTION AND PORT DEVELOPMENT, AND IN THE FIELD OF ENVIRONMENTAL REMEDIATION, NAMELY, PLANNING THE LAYING OF FOUNDATIONS, AND DREDGING, BACKFILLING, COASTAL PROTECTION AND BANK STRENGTHENING WORKS; TECHNICAL RESEARCH IN THE FIELDS OF CIVIL ENGINEERING, HYDRAULIC ENGINEERING, MARINE CONSTRUCTION AND PORT DEVELOPMENT AND IN THE FIELD OF ENVIRONMENTAL REMEDIATION; CONSULTING ON BUILDING CONSTRUCTION; DESIGN AND DEVELOPMENT OF INSTALLATIONS INTENDED FOR ELIMINATING UNDERWATER SEDIMENTS; ENGINEERING SERVICES, NAMELY, DRAWING UP OF STUDIES AND ANALYSES RELATING TO TECHNICAL PROJECTS ON TREATING, CLEANING AND RECYCLING SOIL, ON TREATING, PURIFYING AND DISINFECTING WATER AND SLUDGE, ON TRANSFORMING SLUDGE INTO FERTILIZER AND ON DESTROYING WASTE; MATERIALS TESTING; ENGINEERING SERVICES, NAMELY, TECHNICAL STUDIES AND ANALYSES IN THE FIELDS OF BUILDING CONSTRUCTION AND PURIFYING SOILS AND SUBSOILS, AT SEA OR ON LAND, TO BE USED IN THE DEVELOPMENT OF PROJECTS RELATING TO DREDGING OPERATIONS, IN CLASS 42 (U.S. CLS. 100 AND 101).

THE MARK CONSISTS OF STANDARD CHARACTERS WITHOUT CLAIM TO ANY PARTICULAR FONT, STYLE, SIZE, OR COLOR.

OWNER OF INTERNATIONAL REGISTRATION 1085384 DATED 1-31-2011, EXPIRES 1-31-2021.

THE NAME(S), PORTRAIT(S), AND/OR SIGNATURE(S) SHOWN IN THE MARK DOES NOT IDENTIFY A PARTICULAR LIVING INDIVIDUAL.

SER. NO. 79-100,512, FILED 1-31-2011.

CIMMERIAN COLEMAN, EXAMINING ATTORNEY

United States of America
United States Patent and Trademark Office

ALNOVA

Reg. No. 4,173,536

OC OERLIKON BALZERS AG (LIECHTENSTEIN PUBLIC LIMITED LIABILITY COMPANY)
IRAMALI 18

Registered July 17, 2012

FL-9496 BALZERS, LIECHTENSTEIN

Int. Cl.: 1

FOR: SURFACE COATINGS AND THIN LAYERS FROM CERAMIC MATERIALS AND SUBSTANCES, NAMELY, CHEMICAL COMPOUNDS IN THE NATURE OF ALUMINIUM CHROME NITRIDE VACUUM-APPLIED ON SUBSTRATES FOR TOOLS AND COMPONENTS, IN CLASS 1 (U.S. CLS. 1, 5, 6, 10, 26 AND 46).

TRADEMARK

PRINCIPAL REGISTER

THE MARK CONSISTS OF STANDARD CHARACTERS WITHOUT CLAIM TO ANY PARTICULAR FONT, STYLE, SIZE, OR COLOR.

PRIORITY DATE OF 10-19-2010 IS CLAIMED.

OWNER OF INTERNATIONAL REGISTRATION 1085496 DATED 4-13-2011, EXPIRES 4-13-2021.

SER. NO. 79-100,549, FILED 4-13-2011.

SHANNON TWOHIG, EXAMINING ATTORNEY



David J. Kyffers

Director of the United States Patent and Trademark Office

United States of America

United States Patent and Trademark Office

NOVACOLL

Reg. No. 4,173,537

Registered July 17, 2012

Int. Cl.: 1

TRADEMARK

PRINCIPAL REGISTER

AGRANA STÄRKE GMBH (AUSTRIA LIMITED LIABILITY COMPANY)
DONAU-CITY-STR. 9
A-1220 WIEN
AUSTRIA

FOR: STARCHES FOR USE IN THE MANUFACTURE OF GLUES, IN CLASS 1 (U.S. CLS. 1, 5, 6, 10, 26 AND 46).

THE MARK CONSISTS OF STANDARD CHARACTERS WITHOUT CLAIM TO ANY PARTICULAR FONT, STYLE, SIZE, OR COLOR.

PRIORITY DATE OF 1-27-2011 IS CLAIMED.

OWNER OF INTERNATIONAL REGISTRATION 1085569 DATED 7-25-2011, EXPIRES 7-25-2021.

THE WORDING "NOVACOLL" HAS NO MEANING IN A FOREIGN LANGUAGE.

SER. NO. 79-100,587, FILED 7-25-2011.

MYRIAH HABEEB, EXAMINING ATTORNEY



David J. Kyffers

Director of the United States Patent and Trademark Office

United States of America

United States Patent and Trademark Office



NOVO

moto

Reg. No. 4,173,538

Registered July 17, 2012

**Int. Cls.: 9, 12, 14, 16, 18,
25 and 28**

TRADEMARK

PRINCIPAL REGISTER

FABBRICA ITALIANA AUTOMOBILI MAGGIORA S.R.L. (ITALY LIMITED LIABILITY COMPANY)

VIA DELLE LAVANDAIE S.N.C.

I-08048 TORTOLI (NU)

ITALY

FOR: PROTECTIVE SPORTS HELMETS, NAMELY, HELMETS FOR MOTORCYCLISTS, DRIVERS, SKIERS, MOUNTAINEERS AND CYCLISTS; PROTECTIVE HELMET ACCESSORIES IN THE NATURE OF MOSQUITO-NETS FITTED FOR USE OVER THE HELMET; SPORTS GLASSES, IN CLASS 9 (U.S. CLS. 21, 23, 26, 36 AND 38).

FOR: LAND VEHICLES; APPARATUS FOR LOCOMOTION BY LAND, NAMELY, AUTOMOBILES, BICYCLES AND MOTORBIKES; ENGINES FOR LAND VEHICLES; STRUCTURAL PARTS FOR LAND VEHICLES; ACCESSORIES FOR MOTORCYCLES AND MOPEDS, NAMELY, WINDSCREENS, REAR-VIEW MIRRORS, HANDLEBARS; APPARATUS FOR LOCOMOTION BY AIR OR WATER, NAMELY, AIRPLANES AND BOATS, IN CLASS 12 (U.S. CLS. 19, 21, 23, 31, 35 AND 44).

FOR: JEWELRY, PRECIOUS STONES; HOROLOGICAL AND CHRONOMETRIC INSTRUMENTS, IN CLASS 14 (U.S. CLS. 2, 27, 28 AND 50).

FOR: CAR BUMPER STICKERS; STICKERS FOR HELMETS FOR MOTORCYCLISTS, CAR DRIVERS AND CYCLISTS; STICKERS FOR MOTORCYCLES AND MOPEDS, IN CLASS 16 (U.S. CLS. 2, 5, 22, 23, 29, 37, 38 AND 50).

FOR: SPORT BAGS FOR PROTECTIVE HELMETS, SPORT-TOOLS BAGS, NAMELY, TOOL BAGS SOLD EMPTY, ALL PURPOSE SPORT BAGS, BAGS FOR SPORTS AND HIKING BAGS; LUGGAGE; TRAVEL BAGS; RUCKSACKS, IN CLASS 18 (U.S. CLS. 1, 2, 3, 22 AND 41).

FOR: SPORT CLOTHES FOR CYCLISTS, MOTORCYCLISTS, CAR-DRIVERS AND GO-KART PILOTS, NAMELY, JACKETS FOR DRIVERS, BIKERS AND MOTORCYCLISTS, GLOVES FOR BIKERS AND MOTORCYCLISTS, RAINWEAR, RAIN SUITS, RAIN JACKETS, WIND STOPPERS, WINDCHEATERS, BELTS, NECKWEAR, UNDERGARMENTS, PARKAS, ANORAKS, BODY SUITS, TURTLENECKS, SHORTS, SHIRTS, POLO SHIRTS, PULLOVERS, DENIMS, JEANS, FLEECE VESTS AND OVERALLS; FOOTWEAR; HEADGEAR, NAMELY, HATS, CAPS, BALACLAVAS, HEADBANDS, VISORS, IN CLASS 25 (U.S. CLS. 22 AND 39).



David J. Kybas

Director of the United States Patent and Trademark Office

Reg. No. 4,173,538 FOR: GYMNAS TIC AND SPORTS EQUIPMENT, NAME LY, KNEE GUARDS FOR ATHLETIC AND SPORTS USE, ELBOW GUARDS FOR ATHLETIC AND SPORTS USE, SHIN GUARDS FOR ATHLETIC AND SPORTS USE, WRIST GUARDS FOR ATHLETIC AND SPORTS USE AND WORK-OUT GLOVES, IN CLASS 28 (U.S. CLS. 22, 23, 38 AND 50).

NO CLAIM IS MADE TO THE EXCLUSIVE RIGHT TO USE "MOTO", APART FROM THE MARK AS SHOWN.

PRIORITY DATE OF 2-8-2011 IS CLAIMED.

OWNER OF INTERNATIONAL REGISTRATION 1085757 DATED 3-11-2011, EXPIRES 3-11-2021.

THE MARK CONSISTS OF THE LITERAL ELEMENT "NAVA NAVA MOTO" REPRESENTED IN STYLIZED FONT AND A DESIGN ELEMENT CONSISTING OF TWO SQUARES INSIDE ONE ANOTHER WITH ROUNDED-OFF CORNERS WHEREIN THE INNER SQUARE IS SHADED AND CONTAINS A GRAPHICAL REPRESENTATION OF A STYLIZED WING AND THE TERM "NAVA" AND WHEREIN THE SQUARES ARE LOCATED TO THE LEFT OF THE SECOND TERM "NAVA" WHICH IN TURN IS LOCATED ABOVE THE TERM "MOTO" WHOSE LETTERS APPEAR IN A HORIZONTALLY STRIPED PATTERN. THE LINING SHOWN IN THE DRAWING IS A FEATURE OF THE MARK.

THE ENGLISH TRANSLATION OF THE WORD "MOTO" IN THE MARK IS MOTORBIKE. THE WORDING "NAVA" HAS NO MEANING IN A FOREIGN LANGUAGE.

SER. NO. 79-100,693, FILED 3-11-2011.

RONALD DELGIZZI, EXAMINING ATTORNEY

United States of America

United States Patent and Trademark Office

freedom

FOODS

Reg. No. 4,173,539

Registered July 17, 2012

Int. Cls.: 29 and 30

FREEDOM FOODS PTY LIMITED (AUSTRALIA AUSTRALIAN PROPRIETARY COMPANY,
LIMITED BY SHARES)
80 BOX ROAD
TAREN POINT NSW 2229
AUSTRALIA

TRADEMARK

PRINCIPAL REGISTER

FOR: MEAT, FISH, POULTRY AND GAME; MEAT EXTRACTS; PRESERVED, FROZEN, DRIED AND COOKED FRUITS AND VEGETABLES; JELLIES, JAMS, COMPOTES; EGGS; MILK AND MILK PRODUCTS EXCLUDING ICE CREAM, ICE MILK AND FROZEN YOGHURT; MILK BEVERAGES, NAMELY, BEVERAGES CONSISTING PRINCIPALLY OF MILK; BUTTER, POWDERED MILK, CREAM; CHEESE; YOGHURT; SOYA-BASED DRINKS, NAMELY, BEVERAGES CONSISTING PRINCIPALLY OF SOYA-MILK AND SOYA-BASED FOOD BEVERAGE USED AS A MILK SUBSTITUTE; EDIBLE OILS AND FATS; SNACK FOODS, NAMELY, DEHYDRATED FRUIT SNACKS, FRUIT-BASED SNACK FOOD, SOY-BASED SNACK FOOD AND POTATO-BASED SNACK FOOD; PEANUT BUTTER; PROCESSED NUTS; POTATO CHIPS; SOUPS AND PREPARATIONS FOR MAKING SOUPS; TOFU, IN CLASS 29 (U.S. CL. 46).

FOR: COFFEE, TEA, COCOA, SUGAR; PROCESSED OATS AND PREPARATIONS MADE FROM OATS, NAMELY, ROLLED OATS; OAT MILK IN THE NATURE OF GRAIN-BASED BEVERAGES; RICE AND PREPARATIONS MADE FROM RICE, NAMELY, RICE FLOUR; RICE MILK; SOYA-BASED PREPARATIONS, NAMELY, SOYA FLOUR AND SOYA BEAN PASTE; TAPIOCA, SAGO, ARTIFICIAL COFFEE; FLOUR AND PREPARATIONS MADE FROM CEREALS, NAMELY, BISCUITS, TARTS AND CAKES MADE FROM CEREALS; CEREALS, NAMELY, PROCESSED CEREALS AND PRODUCTS MADE FROM OR CONTAINING CEREALS, NAMELY, CEREAL-BASED SNACK FOODS; BREAKFAST CEREALS; BREAKFAST FOODS, NAMELY, CEREAL-BASED BREAKFAST BARS, PANCAKES; BREAD; BREADCRUMBS; PASTRY; CONFECTIONERIES, NAMELY, CANDY BARS MADE FROM FRUIT IN THE NATURE OF FRUIT JELLY CANDY AND CHOCOLATE BARS; MUESLI BARS, BISCUITS, CAKES, CAKE MIXES, PANCAKE MIXES; PIZZAS; POPCORN, NAMELY, POPPED CORN; QUICHES; CUSTARDS, CUSTARD POWDER FOR MAKING CUSTARD; PUDDINGS; SLICES, NAMELY, FRUIT SLICES IN THE NATURE OF BAKED FRUIT SLICES AND FRUIT SLICES DIPPED IN CHOCOLATE AND MUESLI SLICES IN THE NATURE OF MUESLI BARS; ICE CREAM; SNACK FOODS, NAMELY, CEREAL BASED SNACK FOODS, RICE-BASED SNACK FOODS, CORN-BASED SNACK FOODS AND MULTIGRAIN-BASED SNACK FOODS; ICES, NAMELY, FRUIT ICES; HONEY, TREACLE; YEAST, BAKING-POWDER; PASTA SAUCES; SAUCES BEING CONDIMENTS, NAMELY, PEPPER SAUCE,



David J. Kyjars

Director of the United States Patent and Trademark Office

Reg. No. 4,173,539 OYSTER SAUCE, CHILI SAUCE AND TOMATO SAUCE; SALAD DRESSINGS; SALT, SEASONINGS; MAYONNAISE; MUSTARD; VINEGAR; SUSHI; TABBOULEH; TACOS AND TORTILLAS; TOMATO SAUCE; CHOCOLATE-BASED BEVERAGES; COCOA-BASED BEVERAGES; COFFEE-BASED BEVERAGES; TEA-BASED BEVERAGES; FLAVOURINGS, OTHER THAN ESSENTIAL OILS, FOR BEVERAGES; CHOCOLATE, IN CLASS 30 (U.S. CL. 46).

OWNER OF U.S. REG. NO. 3,564,916.

PRIORITY DATE OF 10-19-2010 IS CLAIMED.

OWNER OF INTERNATIONAL REGISTRATION 1085760 DATED 4-4-2011, EXPIRES 4-4-2021.

NO CLAIM IS MADE TO THE EXCLUSIVE RIGHT TO USE "FOODS" , APART FROM THE MARK AS SHOWN.

THE MARK CONSISTS OF THE WORD "FREEDOM" IN LARGE TEXT WITH THE WORD "FOODS" IN SMALLER TEXT LOCATED WITHIN AN ANGLED BOX AT THE LOWER RIGHT CORNER OF THE WORD "FREEDOM".

SER. NO. 79-100,694, FILED 4-4-2011.

RONALD DELGIZZI, EXAMINING ATTORNEY

United States of America

United States Patent and Trademark Office



Reg. No. 4,173,540

Registered July 17, 2012

Int. Cls.: 16, 35 and 41

TRADEMARK

SERVICE MARK

PRINCIPAL REGISTER

COMEXPOSIUM HOLDING (FRANCE SOCIÉTÉ ANONYME)
70 AVENUE DU GÉNÉRAL DE GAULLE
F-92058 PARIS LA DEFENSE CEDEX
FRANCE

FOR: PRINTED MATTER, NAMELY, NEWSPAPERS, MAGAZINES IN THE FIELD OF TRADE SHOWS, COLLOQUIA, CONFERENCES, CONGRESSES, EXHIBITIONS, TRADE FAIRS, DIGITAL SECURITY, SMART TECHNOLOGIES, PAYMENT MOBILITY, PRINTED PERIODICALS IN THE FIELD OF TRADE SHOWS, COLLOQUIA, CONFERENCES, CONGRESSES, EXHIBITIONS, TRADE FAIRS, DIGITAL SECURITY, SMART TECHNOLOGIES, PAYMENT MOBILITY, INFORMATION BULLETINS CONCERNING TRADE SHOWS, COLLOQUIA, CONFERENCES, CONGRESSES, EXHIBITIONS, TRADE FAIRS, DIGITAL SECURITY, SMART TECHNOLOGIES, PAYMENT MOBILITY, BOOKS IN THE FIELD OF TRADE SHOWS, COLLOQUIA, CONFERENCES, CONGRESSES, EXHIBITIONS, TRADE FAIRS, DIGITAL SECURITY, SMART TECHNOLOGIES, PAYMENT MOBILITY; INDEX CARDS, ALBUMS FOR COINS, PHOTOGRAPHS, STAMPS, CATALOGS IN THE FIELD OF TRADE SHOWS, COLLOQUIA, CONFERENCES, CONGRESSES, EXHIBITIONS, TRADE FAIRS, DIGITAL SECURITY, SMART TECHNOLOGIES, PAYMENT MOBILITY AND PAMPHLETS IN THE FIELD OF TRADE SHOWS, COLLOQUIA, CONFERENCES, CONGRESSES, EXHIBITIONS, TRADE FAIRS, DIGITAL SECURITY, SMART TECHNOLOGIES, PAYMENT MOBILITY AND PAMPHLETS IN THE FIELD OF TRADE SHOWS, COLLOQUIA, CONFERENCES, CONGRESSES, EXHIBITIONS, TRADE FAIRS, DIGITAL SECURITY, SMART TECHNOLOGIES, PAYMENT MOBILITY; POSTERS; WRITING AND DRAWING BOOKS, NAMELY, DRAWING PAPER; CALENDARS; NOTE BOOKS; PUBLICATIONS, NAMELY, BOOKS, HAND-OUTS, WORKBOOKS IN THE FIELD OF TRADE SHOWS, COLLOQUIA, CONFERENCES, CONGRESSES, EXHIBITIONS, TRADE FAIRS, DIGITAL SECURITY, SMART TECHNOLOGIES, PAYMENT MOBILITY; PRINTED BUSINESS PROSPECTUSES; SIGNBOARDS OF PAPER OR CARDBOARD; NON-TEXTILE LABELS, NAMELY, PRINTED PAPER LABELS, ADHESIVE LABELS; STATIONERY, ADHESIVE MATERIALS FOR STATIONERY PURPOSES, STICKERS IN THE NATURE OF STATIONERY; PENCILS; FOUNTAIN PENS; PLASTIC OR PAPER BAGS IN THE NATURE OF ENVELOPES AND POUCHES FOR PACKAGING PURPOSES, IN CLASS 16 (U.S. CLS. 2, 5, 22, 23, 29, 37, 38 AND 50).



David J. Kybas

Director of the United States Patent and Trademark Office

FOR: ORGANIZATION OF EXHIBITIONS, TRADE SHOWS, FAIRS, AND EVENTS FOR COMMERCIAL AND ADVERTISING PURPOSES; ORGANIZATION OF COMPETITIONS FOR PROMOTIONAL PURPOSES WITH OR WITHOUT AWARDING PRIZES OR ALLOCATING REWARDS, ESPECIALLY AS PART OF TRADE SHOWS, COLLOQUIA, CONFERENCES, CONGRESSES, EXHIBITIONS, TRADE FAIRS; ADMINISTRATIVE BUSINESS MANAGEMENT OF EXHIBITIONS SITES; SERVICES FOR ORGANIZING BUSINESS

Reg. No. 4,173,540 MEETINGS IN THE CONTEXT OF TRADE SHOWS, COLLOQUIA, CONFERENCES, CONGRESSES, EXHIBITIONS, AND TRADE FAIRS, NAMELY, PUTTING EXHIBITORS AND VISITORS IN CONTACT WITH EACH OTHER FOR THE PURPOSES OF HOLDING BUSINESS MEETINGS; DISSEMINATION OF ADVERTISING MATERIAL IN THE NATURE OF LEAFLETS, PROSPECTUSES, PRINTED MATTER AND SAMPLES; SALES PROMOTION SERVICES FOR OTHERS; PRESENTATION AND DEMONSTRATION OF GOODS AND SERVICES FOR PROMOTIONAL PURPOSES; STATISTICAL, BUSINESS, COMMERCIAL INFORMATION IN THE FIELD OF EXHIBITIONS AND ESPECIALLY IN CONNECTION WITH ORGANIZING EXHIBITIONS; ADVERTISING BY DIRECT MAIL, RADIO, TELEVISION; ON-LINE ADVERTISING ON A COMPUTER NETWORK; DIRECT MAIL ADVERTISING SERVICES; RENTAL OF ADVERTISING SPACE ON ALL MEANS OF COMMUNICATION; RENTAL OF ADVERTISING SPACE; DISSEMINATION OF ADVERTISEMENTS AND CLASSIFIED ADVERTISEMENTS, ESPECIALLY FOR EMPLOYMENT, INCLUDING VIA THE INTERNET; ORGANIZATION OF PROMOTIONAL ACTIVITIES WITH A VIEW TO DEVELOPING CUSTOMER LOYALTY FOR BUSINESS PURPOSES; ORGANIZING REGIONAL AND NATIONAL PROMOTIONAL CAMPAIGNS FOR BUSINESS; ARRANGING NEWSPAPER SUBSCRIPTION SERVICES FOR OTHERS; ARRANGING SUBSCRIPTION SERVICES FOR OTHERS TO ALL INFORMATION, TEXT, SOUND AND/OR IMAGE MEDIA, AND ESPECIALLY IN THE FORM OF ELECTRONIC AND DIGITAL PUBLICATIONS OF OTHERS; COMPUTER FILE MANAGEMENT SERVICES, IN CLASS 35 (U.S. CLS. 100, 101 AND 102).

FOR: ORGANIZATION OF EXHIBITIONS, TRADE FAIRS NOT FOR COMMERCIAL PURPOSES, NAMELY, FAIRS IN THE NATURE OF EDUCATIONAL SERVICES IN THE FIELD OF TRADE, TRADE SHOWS NOT FOR COMMERCIAL PURPOSES, NAMELY, SHOWS IN THE NATURE OF EDUCATIONAL SERVICES IN THE FIELD OF TRADE, AND EVENTS FOR CULTURAL OR EDUCATIONAL PURPOSES; ARRANGING AND CONDUCTING EDUCATIONAL COLLOQUIA, CONFERENCES, CONVENTIONS, SEMINARS, AND SYMPOSIA IN THE FIELD OF DIGITAL SECURITY, SMART TECHNOLOGIES, AND PAYMENT MOBILITY; HOSTING OF PROFESSIONAL CLUB ACTIVITIES IN THE CONTEXT OF TRADE SHOWS NOT FOR COMMERCIAL PURPOSES, NAMELY, SHOWS IN THE NATURE OF EDUCATIONAL SERVICES IN THE FIELD OF TRADE, COLLOQUIA, CONFERENCES, CONVENTIONS, EXHIBITIONS, AND TRADE FAIRS NOT FOR COMMERCIAL PURPOSES, NAMELY, FAIRS IN THE NATURE OF EDUCATIONAL SERVICES IN THE FIELD OF TRADE, FOR CULTURAL OR EDUCATIONAL PURPOSES; ORGANIZING COMPETITIONS IN THE EDUCATION AND ENTERTAINMENT FIELDS RELATED TO DIGITAL SECURITY, SMART TECHNOLOGIES, AND PAYMENT MOBILITY, WITH OR WITHOUT AWARDED PRIZES OR ATTRIBUTING HONORARY CERTIFICATES, ESPECIALLY IN THE CONTEXT OF TRADE SHOWS NOT FOR COMMERCIAL PURPOSES, NAMELY, SHOWS IN THE NATURE OF EDUCATIONAL SERVICES IN THE FIELD OF TRADE, COLLOQUIA, CONFERENCES, CONGRESSES, EXHIBITIONS, TRADE FAIRS NOT FOR COMMERCIAL PURPOSES, NAMELY, FAIRS IN THE NATURE OF EDUCATIONAL SERVICES IN THE FIELD OF TRADE; MULTIMEDIA PUBLISHING OF PRINTED MATTER OF OTHERS, NAMELY, NEWSPAPERS, MAGAZINES, PERIODICALS, BOOKS, INDEX CARDS, HANDBOOKS, ALBUMS, CATALOGS AND PAMPHLETS, AND POSTERS; PUBLICATION OF TEXTS, NAMELY, TEXTS, BOOKS, MAGAZINES AND OTHER PRINTED MATTER OTHER THAN FOR ADVERTISING PURPOSES ON ALL TYPES OF MEDIA; PARTY-PLANNING AND ARRANGING EVENTS, NAMELY, RECEPTIONS FOR SOCIAL ENTERTAINMENT PURPOSES; OPERATING SERVICES FOR NON-DOWNLOADABLE ELECTRONIC PUBLICATIONS, NAMELY, NON-DOWNLOADABLE ELECTRONIC PUBLICATIONS IN THE NATURE OF MAGAZINES AND PERIODICALS IN THE FIELD OF TRADE SHOWS, EDUCATIONAL COLLOQUIA, EDUCATIONAL CONFERENCES, EDUCATIONAL CONGRESSES, EDUCATIONAL EXHIBITIONS, AND TRADE FAIRS; ENTERTAINMENT SERVICES, NAMELY, PROVIDING INFORMATION ON LEISURE ACTIVITIES; PRODUCTION OF FILMS, SHORT FEATURE FILMS, DOCUMENTARIES, MAGAZINE PROGRAMS FOR RADIO OR TELEVISION; PRODUCTION OF RADIO OR TELEVISION PROGRAMS; SERVICES FOR ORGANIZING AND PRODUCING SHOWS, NAMELY, PRODUCTION OF TELEVISION

Reg. No. 4,173,540 SHOWS, ORGANIZING AND HOSTING OF EVENTS FOR CULTURAL PURPOSES, IN CLASS 41 (U.S. CLS. 100, 101 AND 107).

NO CLAIM IS MADE TO THE EXCLUSIVE RIGHT TO USE "NORTH AMERICA", APART FROM THE MARK AS SHOWN.

PRIORITY DATE OF 2-22-2011 IS CLAIMED.

OWNER OF INTERNATIONAL REGISTRATION 1085816 DATED 4-15-2011, EXPIRES 4-15-2021.

THE COLOR(S) LIGHT ORANGE, DARK ORANGE, LIGHT GRAY, DARK GRAY AND WHITE IS/ARE CLAIMED AS A FEATURE OF THE MARK.

THE MARK CONSISTS OF THE FOLLOWING: A LIGHT GRAY CIRCLE CONTAINING A DARK GRAY REPRESENTATION OF A MAP OF THE NORTH AMERICAN CONTINENT, AND OVER THE MAP, THE WORD "CARTES" IN WHITE, STYLIZED LETTERING DIRECTLY ABOVE THE PHRASE "IN NORTH AMERICA" IN DARK ORANGE, STYLIZED LETTERING AND A LIGHT ORANGE CARD WITH A WHITE REFLECTION APPEARING UNDER THE LETTER "C" IN THE WORD "CARTES".

SER. NO. 79-100,712, FILED 4-15-2011.

RONALD DELGIZZI, EXAMINING ATTORNEY

United States of America

United States Patent and Trademark Office

SILENT SAFARIS

Reg. No. 4,173,541

SILENT PARTY PTY LTD (AUSTRALIA COMPANY)

Registered July 17, 2012

PO BOX 7561
CGMC QLD 9726, AUSTRALIA

Int. Cls.: 9 and 41

FOR: HEADPHONES; PERSONAL HEADPHONES FOR USE WITH SOUND TRANSMITTING SYSTEMS; DIGITAL SIGNAL PROCESSORS; ELECTRONIC AND OPTICAL COMMUNICATIONS INSTRUMENTS AND COMPONENTS, NAMELY, DIGITAL AUDIO TRANSMITTERS; DIGITAL AUDIO PLAYERS; AUDIO AMPLIFIERS; AUDIO MIXERS; AUDIO PROCESSING EQUIPMENT, NAMELY, LIMITERS AND COMPRESSORS; AUDIO SPEAKERS; RECEIVERS FOR AUDIO; AMPLIFIER FOR WIRELESS COMMUNICATIONS; DEVICES FOR WIRELESS RADIO TRANSMISSION, WIRELESS TELEPHONY APPARATUS; APPARATUS FOR WIRELESS TRANSMISSION OF ACOUSTIC INFORMATION; WIRELESS TELEPHONES, IN CLASS 9 (U.S. CLS. 21, 23, 26, 36 AND 38).

TRADEMARK

SERVICE MARK

PRINCIPAL REGISTER

FOR: RENTAL OF WIRELESS HEADPHONES; RENTAL OF AUDIO EQUIPMENT; RENTAL OF AMUSEMENT MACHINES AND APPARATUS; RENTAL OF RADIOS; RENTAL OF SOUND RECORDINGS; AUDIO RECORDING AND PRODUCTION; ENTERTAINMENT IN NATURE OF VISUAL AND AUDIO PERFORMANCES, NAMELY, MUSICAL BAND, ROCK GROUP, AND DANCE PERFORMANCES; ENTERTAINMENT IN THE NATURE OF LASER SHOWS; ENTERTAINMENT IN THE NATURE OF LIGHT SHOWS; ENTERTAINMENT, NAMELY, PREPARATION OF SPECIAL EFFECTS; ENTERTAINMENT SERVICES, NAMELY, PROVIDING AN ON-LINE COMPUTER GAME; ENTERTAINMENT SERVICES, NAMELY, PROVIDING NON-DOWNLOADABLE PRERECORDED MUSIC, INFORMATION IN THE FIELD OF MUSIC, AND COMMENTARY AND ARTICLES ABOUT MUSIC, ALL ON-LINE VIA A GLOBAL COMPUTER NETWORK; ENTERTAINMENT SERVICES IN THE NATURE OF DEVELOPMENT, CREATION, PRODUCTION AND POST-PRODUCTION SERVICES OF MULTIMEDIA ENTERTAINMENT CONTENT; RADIO ENTERTAINMENT PRODUCTION; EDITING OR RECORDING OF SOUNDS AND IMAGES; PRODUCTION OF SOUND AND MUSIC VIDEO RECORDINGS; RENTAL OF PHONOGRAPHIC AND MUSIC RECORDINGS; DANCE EVENTS; ENTERTAINMENT IN THE NATURE OF DANCE PERFORMANCES; NIGHT CLUBS; DISCOTHEQUES; OPERATING OF A DISCOTHEQUE, IN CLASS 41 (U.S. CLS. 100, 101 AND 107).



David J. Kyros

Director of the United States Patent and Trademark Office

THE MARK CONSISTS OF STANDARD CHARACTERS WITHOUT CLAIM TO ANY PARTICULAR FONT, STYLE, SIZE, OR COLOR.

PRIORITY DATE OF 9-30-2010 IS CLAIMED.

Reg. No. 4,173,541 OWNER OF INTERNATIONAL REGISTRATION 1085892 DATED 3-29-2011, EXPIRES 3-29-2021.

SER. NO. 79-100,734, FILED 3-29-2011.

JERI J. FICKES, EXAMINING ATTORNEY

United States of America

United States Patent and Trademark Office

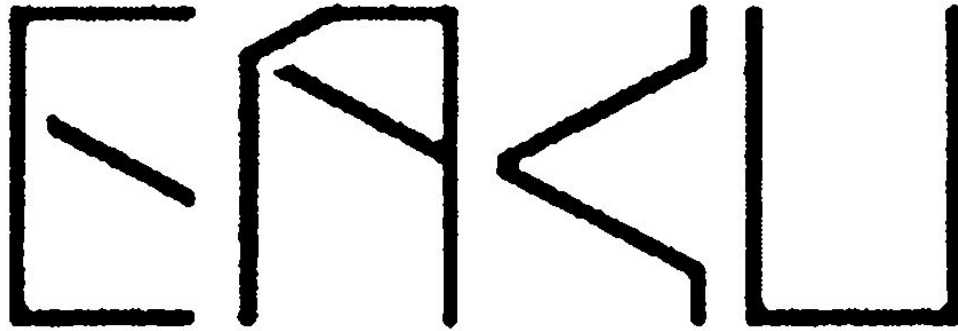

Reg. No. 4,173,542

Registered July 17, 2012

Int. Cl.: 10

TRADEMARK

PRINCIPAL REGISTER

MAANSHAN BOND MEDICAL INSTRUMENTS CO., LTD. (CHINA LIMITED COMPANY)
ECONOMIC AND TECHNOLOGY DEVELOPMENT
MAANSHAN CITY; ANHUI PROVINCE
CHINA

FOR: NEEDLES FOR MEDICAL PURPOSES; SUTURE NEEDLES; LANCETS, NAMELY, FLEAMS FOR USE IN BLOODLETTING; MASSAGE APPARATUS; MEDICAL APPARATUS AND INSTRUMENTS FOR USE IN SURGERY, FOR TREATING OSTEOARTHRITIS, FOR MONITORING VITAL SIGNS; CASES FITTED FOR MEDICAL INSTRUMENTS; CUPPING GLASSES IN THE NATURE OF GLASSES FOR STICKING ONTO SKIN TO DRAW BLOOD TO THE SURFACE FOR MEDICINAL PURPOSES; VETERINARY APPARATUS AND INSTRUMENTS FOR USE IN SURGERY, FOR CASTRATION, FOR MONITORING VITAL SIGNS; PHYSIOTHERAPY APPARATUS, NAMELY, FOAM ROLLERS FOR USE IN PHYSICAL THERAPY, MANUALLY-OPERATED EXERCISE EQUIPMENT FOR PHYSICAL THERAPY PURPOSES, LOW FREQUENCY ELECTRIC THERAPY APPARATUS; ELECTRIC ACUPUNCTURE INSTRUMENTS, IN CLASS 10 (U.S. CLS. 26, 39 AND 44).

THE MARK CONSISTS OF THE STYLIZED LETTERING "EAKU".

OWNER OF INTERNATIONAL REGISTRATION 1085994 DATED 7-22-2011, EXPIRES 7-22-2021.

THE WORDING "EAKU" HAS NO MEANING IN A FOREIGN LANGUAGE.

SER. NO. 79-100,759, FILED 7-22-2011.

KRISTIN CARLSON, EXAMINING ATTORNEY



David J. Kyros

Director of the United States Patent and Trademark Office

United States of America

United States Patent and Trademark Office

iDiner

Reg. No. 4,173,543

Registered July 17, 2012

Int. Cls.: 35 and 42

SERVICE MARK

PRINCIPAL REGISTER

SOFTWAREA GMBH (FED REP GERMANY GMBH)
AUGUSTINERPLATZ 1B
93047 REGENSBURG
FED REP GERMANY

FOR: ONLINE ADVERTISING ON COMPUTER NETWORKS FOR ENTERTAINMENT SERVICES, IN CLASS 35 (U.S. CLS. 100, 101 AND 102).

FOR: DESIGN, DEVELOPMENT AND CUSTOMIZATION OF COMPUTER SOFTWARE AND HARDWARE IN THE FIELDS OF FOOD SERVICES, GASTRONOMY AND ENTERTAINMENT BUSINESSES, IN CLASS 42 (U.S. CLS. 100 AND 101).

THE MARK CONSISTS OF STANDARD CHARACTERS WITHOUT CLAIM TO ANY PARTICULAR FONT, STYLE, SIZE, OR COLOR.

PRIORITY DATE OF 11-23-2010 IS CLAIMED.

OWNER OF INTERNATIONAL REGISTRATION 1086060 DATED 1-29-2011, EXPIRES 1-29-2021.

SER. NO. 79-100,789, FILED 1-29-2011.

HENRY S. ZAK, EXAMINING ATTORNEY



David J. Kyros

Director of the United States Patent and Trademark Office

United States of America

United States Patent and Trademark Office

opto Turn

Reg. No. 4,173,544

Registered July 17, 2012

Int. Cl.: 9

TRADEMARK

PRINCIPAL REGISTER

BAUMER INNOTECH AG (SWITZERLAND JOINT STOCK COMPANY)
HUMMELSTRASSE 17
FRAUENFELD, SWITZERLAND CH8500

FOR: SCIENTIFIC, NAUTICAL, SURVEYING, PHOTOGRAPHIC, CINEMATOGRAPHIC, OPTICAL, WEIGHING, MEASURING, SIGNALING, CHECKING, LIFE-SAVING AND TEACHING APPARATUS AND INSTRUMENTS, IN PARTICULAR, ENCODERS, OPTICAL ENCODERS, MAGNETIC ENCODERS, INCREMENTAL ENCODERS, SINE ENCODERS, ABSOLUTE ENCODERS, END-SHAFT ENCODERS, SHAFT ENCODERS, HOLLOW SHAFT ENCODERS, CONE SHAFT ROTARY ENCODERS, SINGLE-TURN ENCODERS, MULTI-TURN ENCODERS, ENCODERS WITH INTERFACE, FIBRE-OPTIC LIGHT GUIDE CABLES, ENCODERS WITH HIGH SHOCK RESISTANCE, ENCODERS WITH HIGH VIBRATION RESISTANCE, SHAFT ENCODERS WITH CLAMPING FLANGE, SHAFT ENCODERS WITH SYNCHRO FLANGE, ELECTRIC SPEED SWITCHES, ENCODER COMBINATION, IN PARTICULAR ENCODERS WITH TACHOGENERATORS AND SPEED SWITCHES INCORPORATED THEREWITH; ELECTRIC SPEED SWITCHES; ELECTRIC ACCELERATION SENSORS; TACHOMETERS; SPINDLE POSITIONING SYSTEMS, NAMELY, ELECTRIC ACTUATORS, ELECTRIC FORMAT ALIGNMENT SENSORS; MAGNETIC ELECTRONIC SENSORS FOR LINEAR AND ROTARY APPLICATIONS; AUTOMATED PROCESS CONTROL SYSTEM, NAMELY, MICRO-PROCESSOR BASED HARDWARE AND SOFTWARE USED TO MONITOR THE STATUS OF INDUSTRIAL MACHINERY, NAMELY, TACHOGENERATORS, TACHOGENERATORS WITHOUT BEARING, END SHAFT TACHOGENERATORS, SHAFT TACHOGENERATORS, CONE SHAFT TACHOGENERATORS, TACHOGENERATORS WITH HOUSING WITH INTERNAL BEARING, TACHOGENERATORS WITH HIGH SHOCK RESISTANCE, TACHOGENERATORS WITH HIGH VIBRATION RESISTANCE; ELECTRICAL RESOLVER, ELECTRICAL SHAFT RESOLVER, ELECTRICAL HOLLOW SHAFT RESOLVER; ELECTRIC INCLINATION SENSORS, IN CLASS 9 (U.S. CLS. 21, 23, 26, 36 AND 38).



THE MARK CONSISTS OF STANDARD CHARACTERS WITHOUT CLAIM TO ANY PARTICULAR FONT, STYLE, SIZE, OR COLOR.

PRIORITY DATE OF 10-19-2010 IS CLAIMED.

OWNER OF INTERNATIONAL REGISTRATION 1086503 DATED 4-19-2011, EXPIRES 4-19-2021.

SER. NO. 79-100,952, FILED 4-19-2011.

David J. Kybas

Director of the United States Patent and Trademark Office

Reg. No. 4,173,544 JESSICA A. POWERS, EXAMINING ATTORNEY

United States of America

United States Patent and Trademark Office

COMBIBAR

Reg. No. 4,173,545

Registered July 17, 2012

Int. Cls.: 14, 35 and 40

ESG EDELMETALL-SERVICE GMBH & CO. KG (FED REP GERMANY LIMITED PARTNERSHIP)
GEWERBERING 29B
76287 RHEINSTETTEN
FED REP GERMANY

TRADEMARK

SERVICE MARK

PRINCIPAL REGISTER

FOR: PRECIOUS METALS, PLATINUM METALS, GOLD, SILVER AS WELL AS THEIR ALLOYS, UNWROUGHT OR SEMI-WROUGHT PRECIOUS METALS, ALSO IN THE FORM OF SINGLE OR INTERCONNECTED INGOTS OF PRECIOUS METALS OF THE SAME OR OF DIFFERENT DENOMINATIONS, COLLECTIBLE COINS, PRECIOUS METALS, NAMELY, UNCOINED OR COINED SHEETS OR PLATES, FILMS, BANDS, WIRES, MESHES AND NETS, TUBES AND PIPES, STAKES AND RODS, PROFILES, STRIPS OF COINS, BLANKS, PELLETS OF PRECIOUS METALS AND SEMI-FINISHED GOODS OF THIS MATERIAL, IN CLASS 14 (U.S. CLS. 2, 27, 28 AND 50).

FOR: SERVICES OF RETAIL, WHOLESALE, ONLINE STORE OR CATALOGUE SELLING FOR THE GOODS PRECIOUS METALS, PLATINUM METALS, GOLD, SILVER AS WELL AS THEIR ALLOYS IN ANY FORM AND FOR ANY PURPOSES, IN CLASS 35 (U.S. CLS. 100, 101 AND 102).

FOR: TREATMENT OF PRECIOUS METALS, NAMELY, DIE CASTING OR COINING; RECYCLING OF METALS, IN PARTICULAR OF PRECIOUS METALS; REFINING AND SEPARATION OF PRECIOUS METALS AS WELL AS REPROCESSING OF PRECIOUS METAL COMPONENTS AND RESIDUES, IN CLASS 40 (U.S. CLS. 100, 103 AND 106).

THE MARK CONSISTS OF STANDARD CHARACTERS WITHOUT CLAIM TO ANY PARTICULAR FONT, STYLE, SIZE, OR COLOR.

PRIORITY DATE OF 12-23-2010 IS CLAIMED.

OWNER OF INTERNATIONAL REGISTRATION 1086512 DATED 4-28-2011, EXPIRES 4-28-2021.

THE WORDING "COMBIBAR" HAS NO MEANING IN A FOREIGN LANGUAGE.

SER. NO. 79-100,955, FILED 4-28-2011.



David J. Kyros

Director of the United States Patent and Trademark Office

Reg. No. 4,173,545 JESSICA A. POWERS, EXAMINING ATTORNEY

United States of America

United States Patent and Trademark Office

LMT

Reg. No. 4,173,546

Registered July 17, 2012

Int. Cls.: 7, 37 and 42

TRADEMARK

SERVICE MARK

PRINCIPAL REGISTER

LMT GMBH & CO. KG (FED REP GERMANY GMBH & CO. KG)
HEIDENHEIMER STR. 84
73447 OBERKOCHEN
FED REP GERMANY

FOR: MACHINE TOOLS OR TOOLS AS MACHINE PARTS, NAMELY, MILLING CUTTERS, GEAR HOBS, DISK MILLING CUTTERS, MILLING DRILLS, CUTTER HEADS WITH INDEXABLE INSERTS, DRILLS, TAP DRILLS, SPIRAL DRILLS, CENTER DRILLS, CORE DRILLS, STEP DRILLS, MILLING HEADS, GEAR CUTTING TOOLS, SCREW CUTTING TOOLS, THREAD ROLLING HEADS, THREAD ROLLS, CUTTING PLATES, PEELING HEADS, ENGRAVING TOOLS, SHEET CUTTING KNIVES, REAMING TOOLS, REAMERS, ORBITAL TOOLS, CHIPPING TOOLS, CUTTING TOOLS, COUNTERBORES, COUNTER-SINK TOOLS, SAW BLADES, ALL AFOREMENTIONED GOODS AS MACHINE PARTS; MACHINE DRIVEN TOOLS FOR THE METALWORKING AND PLASTICS PROCESSING INDUSTRY, IN CLASS 7 (U.S. CLS. 13, 19, 21, 23, 31, 34 AND 35).

FOR: REPAIR OF TOOLS USED IN THE METALWORKING AND PLASTICS PROCESSING INDUSTRY; INSTALLATION, MAINTENANCE, AND REPAIR OF MACHINE TOOLS USED IN THE METALWORKING AND PLASTICS PROCESSING INDUSTRY; ADJUSTMENT AND BALANCING OF TOOLS AS MAINTENANCE SERVICES OF TOOLS USED IN THE METALWORKING AND PLASTICS PROCESSING INDUSTRY; SHARPENING, REGRINDING, AND RECOATING OF TOOLS BY VAPOR DEPOSITION AS REPAIR SERVICES OF TOOLS USED IN THE METALWORKING AND PLASTICS PROCESSING INDUSTRY, IN CLASS 37 (U.S. CLS. 100, 103 AND 106).

FOR: DESIGN OF TOOLS USED IN THE METALWORKING AND PLASTICS PROCESSING INDUSTRY; TECHNICAL CONSULTING REGARDING THE USE OF TOOLS USED IN THE METALWORKING AND PLASTICS PROCESSING INDUSTRY; ENGINEERING SERVICES; DESIGN AND DEVELOPMENT OF COMPUTER HARDWARE AND SOFTWARE FOR THE APPLICATION OF METALWORKING AND PLASTICS PROCESSING MACHINE TOOLS AND EXCLUDING SOFTWARE FOR PHOTOMETRIC MEASUREMENT, IN CLASS 42 (U.S. CLS. 100 AND 101).

THE MARK CONSISTS OF STANDARD CHARACTERS WITHOUT CLAIM TO ANY PARTICULAR FONT, STYLE, SIZE, OR COLOR.

PRIORITY DATE OF 6-21-2010 IS CLAIMED.



David J. Kyros

Director of the United States Patent and Trademark Office

Reg. No. 4,173,546 OWNER OF INTERNATIONAL REGISTRATION 1086651 DATED 12-21-2010, EXPIRES 12-21-2020.

SER. NO. 79-101,005, FILED 12-21-2010.

CORY BOONE, EXAMINING ATTORNEY

United States of America

United States Patent and Trademark Office

SCULPTOSANE

Reg. No. 4,173,547

BIOTECHMARINE (FRANCE SOCIÉTÉ PAR ACTIONS SIMPLIFIÉE)
ZI DE QUEMPEL GUEZENNEC

Registered July 17, 2012

F-22260 QUEMPEL GUEZENNEC, FRANCE

Int. Cls.: 1 and 3

FOR: BIOLOGICAL PREPARATIONS, NAMELY, ALGAE AND ALGAE BYPRODUCTS,
FOR USE IN THE MANUFACTURING OF COSMETICS, IN CLASS 1 (U.S. CLS. 1, 5, 6, 10,
26 AND 46).

TRADEMARK

FOR: SOAPS; PERFUMERY; ESSENTIAL OILS; COSMETICS; HAIR LOTIONS; DENTI-
FRICES, IN CLASS 3 (U.S. CLS. 1, 4, 6, 50, 51 AND 52).

PRINCIPAL REGISTER

PRIORITY DATE OF 2-25-2011 IS CLAIMED.

OWNER OF INTERNATIONAL REGISTRATION 1086717 DATED 6-21-2011, EXPIRES 6-21-
2021.

SER. NO. 79-101,034, FILED 6-21-2011.

CORY BOONE, EXAMINING ATTORNEY



David J. Kybas

Director of the United States Patent and Trademark Office

United States of America

United States Patent and Trademark Office

LAMINAÏNE MARINE

Reg. No. 4,173,548

BIOTECHMARINE (FRANCE SOCIÉTÉ PAR ACTIONS SIMPLIFIÉE)
ZI QUEMPEL GUEZENNEC
F-22260 PONTRIEUX, FRANCE

Registered July 17, 2012

Int. Cls.: 1 and 3

FOR: BIOLOGICAL PREPARATIONS, NAMELY, ALGAE AND ALGAE BYPRODUCTS FOR USE IN THE MANUFACTURING OF COSMETICS, IN CLASS 1 (U.S. CLS. 1, 5, 6, 10, 26 AND 46).

TRADEMARK

FOR: SOAPS; PERFUMES; ESSENTIAL OILS; COSMETICS; HAIR LOTIONS; DENTIFRICES, IN CLASS 3 (U.S. CLS. 1, 4, 6, 50, 51 AND 52).

PRINCIPAL REGISTER

THE MARK CONSISTS OF STANDARD CHARACTERS WITHOUT CLAIM TO ANY PARTICULAR FONT, STYLE, SIZE, OR COLOR.

OWNER OF INTERNATIONAL REGISTRATION 1086786 DATED 6-21-2011, EXPIRES 6-21-2021.

THE WORDING "LAMINAINE" HAS NO MEANING IN A FOREIGN LANGUAGE.

SER. NO. 79-101,056, FILED 6-21-2011.

CORY BOONE, EXAMINING ATTORNEY



David J. Kyffers

Director of the United States Patent and Trademark Office

United States of America

United States Patent and Trademark Office

MERADISO

Reg. No. 4,173,549

Registered July 17, 2012

**Int. Cls.: 10, 18, 20, 22,
23, 24 and 27**

TRADEMARK

PRINCIPAL REGISTER

LIDL STIFTUNG & CO. KG (FED REP GERMANY KOMMANDITGESELLSCHAFT)
STIFTSBERGSTR. 1
74167 NECKARSULM
FED REP GERMANY

FOR: INCONTINENCE LININGS FOR MATTRESSES; CUSHIONS FOR MEDICAL PURPOSES, IN CLASS 10 (U.S. CLS. 26, 39 AND 44).

FOR: LEATHER AND IMITATIONS OF LEATHER, AND GOODS MADE OF THESE MATERIALS, NAMELY, WALLETS, PURSES, BAGS, KEY CASES, SUITCASES, BRIEFCASES, ALL-PURPOSE CARRYING BAGS AND RUCKSACKS; FURNITURE COVERINGS OF LEATHER, IN CLASS 18 (U.S. CLS. 1, 2, 3, 22 AND 41).

FOR: MATTRESSES, FOLDING MATTRESSES, CHAIRS, NAMELY, SITTING CUBES AND SITTING WEDGES, UPHOLSTERED BEDS, DUCKBOARDS, NOT OF METAL, BEDS, BED PILLOWS, CUSHIONS, NECK-SUPPORTING PILLOWS, BODY PILLOWS, IN CLASS 20 (U.S. CLS. 2, 13, 22, 25, 32 AND 50).

FOR: ROPES, STRING, FISHING NETS, TENTS, AWNINGS, TARPAULINS, SAILS, SACKS AND BAGS FOR THE TRANSPORTATION OR STORAGE OF MATERIALS IN BULK, BAGS FOR COMPOSTING KITCHEN, GARDEN, AND OTHER ORGANIC MATERIAL, MULTI-PURPOSE CLOTH BAGS, LAUNDRY BAGS, BAGS FOR SECURING VALUABLES, PACKAGING BAGS OF TEXTILE MATERIAL, PORTABLE TOY STORAGE BAGS; PADDING AND STUFFING MATERIALS, NOT OF RUBBER, PAPER OR PLASTIC; RAW FIBROUS TEXTILE MATERIALS; ROPE LADDERS, SYNTHETIC TEXTILE FIBRES, WOOD WOOL, WOOL, UPHOLSTERY WOOL; WADDING NOT OF RUBBER, PAPER OR PLASTIC FOR PADDING AND STUFFING UPHOLSTERY, IN CLASS 22 (U.S. CLS. 1, 2, 7, 19, 22, 42 AND 50).

FOR: YARNS AND THREADS, FOR TEXTILE USE; SEWING THREAD, IN CLASS 23 (U.S. CL. 43).

FOR: TEXTILES AND TEXTILE GOODS, NAMELY, WALL HANGINGS OF TEXTILE, HANDKERCHIEFS, FACE TOWELS, HAND TOWELS AND PLACEMATS; BED AND TEXTILE TABLE COVERS; COTTON FABRICS; TEXTILE TABLE RUNNERS; TEXTILE TABLE LINEN; TABLE NAPKINS OF TEXTILE; INDIVIDUAL PLACE MATS MADE OF TEXTILE; CURTAINS MADE FROM TEXTILE MATERIALS; CURTAIN HOLDERS OF TEXTILE MA-



David J. Kyffers

Director of the United States Patent and Trademark Office

Reg. No. 4,173,549 TERIAL; MATTRESS COVERS; MOSQUITO NETS; FURNISHING FABRICS; BED BLANKETS; COVERS FOR DUVETS; SILK FABRICS; BED SHEETS; BED LINEN; BED COVERS; FITTED BED SHEETS; COVERLETS; TAFFETA; FABRICS OF TEXTILES, NAMELY, COTTON FABRICS, LINEN FABRICS, FURNITURE AND UPHOLSTERY FABRICS, KNITTED FABRIC, GAUZE FABRIC, JERSEY FABRIC, FOULARD, FELT AND NON-WOVEN TEXTILE FABRIC, AND LINGERIE FABRIC; OILCLOTH FOR USE AS TABLECLOTHS; FABRICS OF TEXTILES FOR THE MANUFACTURE OF CLOTHING ; WOOLEN FABRIC; PILLOWCASES; CUSHION COVERS; CUSHION COVERS; QUILTS, UNDERBLANKETS, FITTED BED SHEETS AND FITTED BED BLANKETS, IN CLASS 24 (U.S. CLS. 42 AND 50).

FOR: CARPETS, RUGS, FLOOR MATS AND MATTING, LINOLEUM AND OTHER FLOOR COVERINGS FOR EXISTING FLOORS; NON-TEXTILE WALL HANGINGS; BATH MATS, CAR FLOOR MATS, DOOR MATS, LINOLEUM FLOOR MATS, CARPET UNDERLAY, IN CLASS 27 (U.S. CLS. 19, 20, 37, 42 AND 50).

THE MARK CONSISTS OF STANDARD CHARACTERS WITHOUT CLAIM TO ANY PARTICULAR FONT, STYLE, SIZE, OR COLOR.

PRIORITY DATE OF 1-13-2011 IS CLAIMED.

OWNER OF INTERNATIONAL REGISTRATION 1086788 DATED 5-17-2011, EXPIRES 5-17-2021.

THE WORDING "MERADISO" HAS NO MEANING IN A FOREIGN LANGUAGE.

SER. NO. 79-101,058, FILED 5-17-2011.

DAVID TOOLEY, EXAMINING ATTORNEY

United States of America

United States Patent and Trademark Office

DEKSTRIP

Reg. No. 4,173,550

Registered July 17, 2012

Int. Cls.: 17 and 19

TRADEMARK

PRINCIPAL REGISTER

DEKS INDUSTRIES PTY LTD (AUSTRALIA CORPORATION)
5/841 MOUNTAIN HIGHWAY
BAYSWATER VIC 3153
AUSTRALIA

FOR: SEALING DEVICES AND JUNCTIONS, NAMELY, NON-METAL BUILDING FLASHING FOR SEALING ROOF PENETRATIONS AND ROOF-MOUNTED ELEMENTS; NON-METALLIC COVERINGS FOR BUILDING, NAMELY, WATERTIGHT OR HERMETIC COVERS FOR SEALING ROOF PENETRATIONS AND ROOF-MOUNTED ELEMENTS, FLEXIBLE BOOTS FOR SEALING ROOF PENETRATIONS AND ROOF-MOUNTED ELEMENTS; WATERTIGHT CONES OR CLOSURES FOR SEALING ROOF PENETRATIONS AND ROOF-MOUNTED ELEMENTS, IN CLASS 17 (U.S. CLS. 1, 5, 12, 13, 35 AND 50).

FOR: NON-METALLIC BUILDING PRODUCTS AND MATERIALS, NAMELY, NON-METAL BUILDING FLASHING FOR SEALING ROOF PENETRATIONS AND ROOF-MOUNTED ELEMENTS, IN CLASS 19 (U.S. CLS. 1, 12, 33 AND 50).

THE MARK CONSISTS OF STANDARD CHARACTERS WITHOUT CLAIM TO ANY PARTICULAR FONT, STYLE, SIZE, OR COLOR.

OWNER OF INTERNATIONAL REGISTRATION 1086849 DATED 4-27-2011, EXPIRES 4-27-2021.

OWNER OF U.S. REG. NOS. 1,217,573 AND 3,130,072.

SER. NO. 79-101,081, FILED 4-27-2011.

HAI-LY LAM, EXAMINING ATTORNEY



David J. Kyffers

Director of the United States Patent and Trademark Office

United States of America

United States Patent and Trademark Office

THE AIRLINE COOKIE !

Reg. No. 4,173,551

LOTUS BAKERIES, NAAMLOZE VENNOOTSCHAP (BELGIUM JOINT STOCK COMPANY)
GENTSTRAAT 52
B-9971 LEMBEKE, BELGIUM

Registered July 17, 2012

Int. Cl.: 30

FOR: BISCUITS, BAKERY GOODS; PASTRIES, CAKES AND BISCUITS; SPECULOOS, NAMELY, SPICED BISCUITS; SPREADS CONSISTING OF EMULSIFIED BISCUITS OR COOKIES; ICE CREAM, IN CLASS 30 (U.S. CL. 46).

TRADEMARK

THE MARK CONSISTS OF STANDARD CHARACTERS WITHOUT CLAIM TO ANY PARTICULAR FONT, STYLE, SIZE, OR COLOR.

PRINCIPAL REGISTER

PRIORITY DATE OF 3-3-2011 IS CLAIMED.

OWNER OF INTERNATIONAL REGISTRATION 1086899 DATED 6-28-2011, EXPIRES 6-28-2021.

NO CLAIM IS MADE TO THE EXCLUSIVE RIGHT TO USE "COOKIE", APART FROM THE MARK AS SHOWN.

SER. NO. 79-101,096, FILED 6-28-2011.

BERNICE MIDDLETON, EXAMINING ATTORNEY



David J. Kybas

Director of the United States Patent and Trademark Office

United States of America

United States Patent and Trademark Office

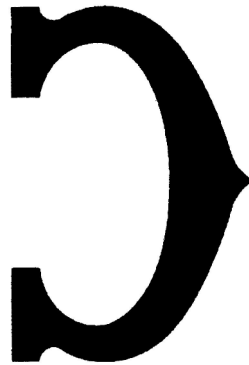

Reg. No. 4,173,552

Registered July 17, 2012

Int. Cl.: 9

TRADEMARK

PRINCIPAL REGISTER

CARTIER INTERNATIONAL AG (SWITZERLAND CORPORATION)
HINTERBERGSTRASSE 22, POSTFACH 61
CH-6312 STEINHAUSEN, SWITZERLAND

FOR: SPECTACLES, SUNGLASSES, SPECTACLE FRAMES, IN CLASS 9 (U.S. CLS. 21, 23, 26, 36 AND 38).

OWNER OF U.S. REG. NOS. 1,110,821, 1,300,379, AND 3,932,980.

OWNER OF INTERNATIONAL REGISTRATION 0520205 DATED 1-8-1988, EXPIRES 1-8-2018.

THE MARK CONSISTS OF A STYLIZED INVERTED LETTER "C".

SER. NO. 79-101,160, FILED 8-2-2010.

WILLIAM VERHOSEK, EXAMINING ATTORNEY



David J. Kybas

Director of the United States Patent and Trademark Office

United States of America

United States Patent and Trademark Office

athé

Reg. No. 4,173,553

Registered July 17, 2012

Int. Cls.: 3, 9, 14 and 18

TRADEMARK

PRINCIPAL REGISTER

BRUNO VANESSA VIRGINIE (FRANCE INDIVIDUAL)
32, RUE D'ARGOUT
F-75002 PARIS
FRANCE

FOR: PERFUMERY PRODUCTS, NAMELY, PERFUMES, EAU DE COLOGNE, PERFUMED WATER; COSMETICS; ESSENTIAL OILS; HAIR LOTIONS; SOAPS; SHAMPOOS; SKIN TANNING CREAMS, IN CLASS 3 (U.S. CLS. 1, 4, 6, 50, 51 AND 52).

FOR: SPECTACLES, NAMELY, FRAMES AND LENSES FOR SPECTACLES; SUNGLASSES, NAMELY, FRAMES AND LENSES FOR SUNGLASSES, IN CLASS 9 (U.S. CLS. 21, 23, 26, 36 AND 38).

FOR: PRECIOUS METALS AND ALLOYS THEREOF OTHER THAN FOR DENTAL USE; JEWELLERY, BIJOUTERIE, PRECIOUS STONES; TIMEPIECES; CHRONOMETRIC INSTRUMENTS, IN CLASS 14 (U.S. CLS. 2, 27, 28 AND 50).

FOR: ANIMAL SKINS, HIDES; TRUNKS AND SUITCASES; UMBRELLAS, PARASOLS AND WALKING STICKS; WHIPS AND SADDLERY; BAGS, BRIEFCASES AND TRAVELLING SETS, NAMELY, BAGS AND CASES MADE OF LEATHER, WALLETS, PURSES NOT OF PRECIOUS METAL, CARD HOLDERS, NAMELY, CREDIT CARD HOLDERS AND BUSINESS CARD HOLDERS; HANDBAGS, BACKPACKS, TRAVELLING BAGS, SCHOOL BAGS, BEACH BAGS, IN CLASS 18 (U.S. CLS. 1, 2, 3, 22 AND 41).

THE WORDING "ATHÉ" HAS NO MEANING IN A FOREIGN LANGUAGE.

OWNER OF INTERNATIONAL REGISTRATION 0808542 DATED 7-8-2003, EXPIRES 7-8-2013.

SER. NO. 79-101,167, FILED 7-21-2010.

NAAKWAMA ANKRAH, EXAMINING ATTORNEY



David J. Kyros

Director of the United States Patent and Trademark Office

United States of America

United States Patent and Trademark Office

Beautifully Yours

Reg. No. 4,173,554

Registered July 17, 2012

Int. Cl.: 3

TRADEMARK

PRINCIPAL REGISTER

JOHN DAHLGREN (SWEDEN INDIVIDUAL)
CLOSEL 13
CH-2074 MARIN-EPAGNIER
SWITZERLAND

FOR: COSMETIC PREPARATIONS FOR SKIN CARE, COSMETIC CREAMS, LIPSTICKS,
SHAMPOOS, IN CLASS 3 (U.S. CLS. 1, 4, 6, 50, 51 AND 52).

OWNER OF INTERNATIONAL REGISTRATION 1016310 DATED 7-8-2009, EXPIRES 7-8-
2019.

SER. NO. 79-101,177, FILED 6-10-2011.

PAUL E. FAHRENKOPF, EXAMINING ATTORNEY

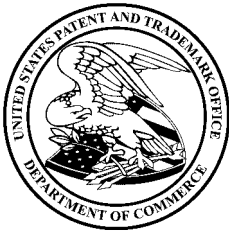

David J. Kybas

Director of the United States Patent and Trademark Office

United States of America

United States Patent and Trademark Office



Reg. No. 4,173,555

Registered July 17, 2012

Int. Cl.: 7

TRADEMARK

PRINCIPAL REGISTER

SICHUAN MIANZHU XINKUN MACHINERY MAKING CO., LTD. (CHINA CORPORATION)
LUOFAN VILLAGE
TUMEN TOWN,; MIANZHU COUNTY,; DEYANG CITY; SICHUAN PROVINCE
CHINA

FOR: STEAM TURBINES; TURBINES, NOT FOR LAND VEHICLES; WIND TURBINES AND ITS FITTINGS; CYLINDERS FOR MOTORS AND ENGINES; ENGINE PISTONS; ENGINE CRANK SHAFTS; CONNECTING RODS FOR MACHINES, MOTORS AND ENGINES; CRANKS FOR MACHINES; FLYWHEELS FOR VEHICLE ENGINES; CAMSHAFTS FOR VEHICLE ENGINES, IN CLASS 7 (U.S. CLS. 13, 19, 21, 23, 31, 34 AND 35).

NO CLAIM IS MADE TO THE EXCLUSIVE RIGHT TO USE "RACING PARTS", APART FROM THE MARK AS SHOWN.

PRIORITY DATE OF 11-25-2010 IS CLAIMED.

OWNER OF INTERNATIONAL REGISTRATION 1087182 DATED 4-11-2011, EXPIRES 4-11-2021.

THE MARK CONSISTS OF THE WORDING "ZRP ZEBU RACING PARTS" INSIDE A SINGLE LINE RECTANGLE, ALL OF WHICH IS OVERLAYING A SHADED BACKGROUND RECTANGLE CARRIER.

SER. NO. 79-101,227, FILED 4-11-2011.

MICHAEL WIENER, EXAMINING ATTORNEY



David J. Kybas

Director of the United States Patent and Trademark Office

United States of America

United States Patent and Trademark Office

CARTIER D'AMOUR

Reg. No. 4,173,556

Registered July 17, 2012

Int. Cl.: 14

TRADEMARK

PRINCIPAL REGISTER

CARTIER INTERNATIONAL AG (SWITZERLAND CORPORATION)
HINTERBERGSTRASSE 22, POSTFACH 61
CH-6312 STEINHAUSEN
SWITZERLAND

FOR: CUFF LINKS, TIE CLIPS, RINGS, BRACELETS, EARRINGS, NECKLACES, BROOCHES, WATCHES, CHRONOMETERS, CLOCKS; WATCH BANDS, BOXES OF PRECIOUS METAL FOR WATCHES AND JEWELRY, IN CLASS 14 (U.S. CLS. 2, 27, 28 AND 50).

THE MARK CONSISTS OF STANDARD CHARACTERS WITHOUT CLAIM TO ANY PARTICULAR FONT, STYLE, SIZE, OR COLOR.

PRIORITY DATE OF 3-29-2011 IS CLAIMED.

OWNER OF INTERNATIONAL REGISTRATION 1087301 DATED 7-29-2011, EXPIRES 7-29-2021.

OWNER OF U.S. REG. NOS. 411,975, 759,202, AND 1,365,478.

THE ENGLISH TRANSLATION OF "D'AMOUR" IN THE MARK IS OF LOVE.

SER. NO. 79-101,269, FILED 7-29-2011.

JOSETTE BEVERLY, EXAMINING ATTORNEY



David J. Kybas

Director of the United States Patent and Trademark Office

United States of America

United States Patent and Trademark Office



Reg. No. 4,173,557

Registered July 17, 2012

Int. Cls.: 7, 37 and 40

TRADEMARK

SERVICE MARK

PRINCIPAL REGISTER

REDUCTION ENGINEERING GMBH (FED REP GERMANY GMBH)
LUDWIGSBURGER STRAÙE 13
70435 STUTTGART
FED REP GERMANY

FOR: MACHINES FOR PLASTIC PROCESSING; PLASTIC STRAND PELLETIZERS; MACHINE PARTS FOR PLASTIC STRAND PELLETIZERS, NAMELY, PELLETIZER KNIVES AND KNIFE DRUMS; PLASTIC STRAND PELLETIZING SYSTEMS COMPRISED OF A MACHINE FOR SIZING, CUTTING, DRYING AND COOLING EXTRUDED MOLTEN PLASTIC MATERIAL, AND PARTS THEREFOR; MACHINE PARTS FOR PLASTIC STRAND PELLETIZING SYSTEMS, NAMELY, COOLING VATS, COOLING TROUGHS, DEWATERING APPARATUSES, WATER RECOOLING SYSTEMS, STRAND DRAW-OFF APPARATUSES, STRAND DIE HEADS, DIE FILTER CHANGING APPARATUSES, AND MELT VALVES, ACCESSORIES AND COMPONENTS WHICH ARE MACHINE PARTS FOR PLASTIC STRAND PELLETIZING SYSTEMS; UNDERWATER PELLETIZERS; MACHINE PARTS FOR UNDERWATER PELLETIZERS, NAMELY, PELLETIZER KNIVES AND KNIFE HEADS; UNDERWATER PELLETIZING SYSTEMS COMPRISED OF A MACHINE FOR SIZING, CUTTING, DRYING AND COOLING EXTRUDED MOLTEN PLASTIC MATERIAL, AND PARTS THEREFOR; MACHINE PARTS FOR UNDERWATER PELLETIZING SYSTEMS, NAMELY, DEWATERING APPARATUSES, WATER RECOOLING SYSTEMS, DIE HEADS, AND MELT VALVES, ACCESSORIES AND COMPONENTS WHICH ARE MACHINE PARTS FOR UNDERWATER PELLETIZING SYSTEMS; PELLET DRYERS, IN CLASS 7 (U.S. CLS. 13, 19, 21, 23, 31, 34 AND 35).

FOR: INSTALLATION, SERVICING AND REPAIR OF MACHINES FOR PLASTIC PROCESSING, PLASTIC STRAND PELLETIZERS, PLASTIC STRAND PELLETIZING SYSTEMS, UNDERWATER PELLETIZERS, UNDERWATER PELLETIZING SYSTEMS, PELLET DRYERS, IN CLASS 37 (U.S. CLS. 100, 103 AND 106).

FOR: GRINDING OF PELLETIZER KNIVES, IN CLASS 40 (U.S. CLS. 100, 103 AND 106).

THE MARK CONSISTS OF A RED BACKGROUND CONTAINING THE LETTERS "SF" INSIDE A CIRCLE AND THE WORDING "SCHEER" BELOW IT. THE COLOR WHITE REPRESENTS SHADING AND IS NOT PART OF THE MARK.

PRIORITY DATE OF 9-9-2010 IS CLAIMED.



David J. Kyjars

Director of the United States Patent and Trademark Office

Reg. No. 4,173,557 OWNER OF INTERNATIONAL REGISTRATION 1087332 DATED 1-19-2011, EXPIRES 1-19-2021.

THE COLOR(S) RED IS/ARE CLAIMED AS A FEATURE OF THE MARK.

SER. NO. 79-101,281, FILED 1-19-2011.

YAT SYE, LEE, EXAMINING ATTORNEY

United States of America

United States Patent and Trademark Office

CLIMALITE

Reg. No. 4,173,558

Registered July 17, 2012

Int. Cls.: 20 and 24

TRADEMARK

PRINCIPAL REGISTER

STUDIO MODERNA SA (SWITZERLAND SOCIÉTÉ ANONYME (SA) / JOINT STOCK COMPANY UNDER THE LAWS OF SWITZERLAND)
VIA FERRUCCIO PELLI 13
CH-6900 LUGANO
SWITZERLAND

FOR: MATTRESSES; BEDS AND PARTS THEREOF; SPIRAL SPRING MATTRESSES; SLATTED MATTRESS BASES AND MATTRESS SUPPORTS FOR BEDS; CUSHIONS; PILLOWS; ANATOMICAL CUSHIONS AND PILLOWS; NON-METAL EDGES IN THE NATURE OF BUMPER GUARDS FOR FURNITURE, IN CLASS 20 (U.S. CLS. 2, 13, 22, 25, 32 AND 50).

FOR: COVERLETS, BED SHEETS, BED COVERS, MATTRESS COVERS, MATTRESS COVERS FOR MATTRESSES WITH LATEX CORES, COVERS FOR UNDERSIDES OF LATEX MATTRESSES; PILLOW COVERS; BED BLANKETS, QUILTED BED BLANKETS, WOOL BASE MIXED FABRICS FOR BED COVERS AND WOOL PRODUCTS, NAMELY, MATTRESS PROTECTORS, MATTRESS COVERS AND MATTRESS DUVETS; BEDDING IN THE NATURE OF BLANKETS OF MERINO WOOL, CASHMERE OR A MIXTURE OF WOOL AND COTTON, IN CLASS 24 (U.S. CLS. 42 AND 50).

THE MARK CONSISTS OF STANDARD CHARACTERS WITHOUT CLAIM TO ANY PARTICULAR FONT, STYLE, SIZE, OR COLOR.

PRIORITY DATE OF 10-5-2010 IS CLAIMED.

OWNER OF INTERNATIONAL REGISTRATION 1087516 DATED 3-28-2011, EXPIRES 3-28-2021.

SER. NO. 79-101,347, FILED 3-28-2011.

KATHLEEN M. VANSTON, EXAMINING ATTORNEY



David J. Kybas

Director of the United States Patent and Trademark Office

United States of America

United States Patent and Trademark Office

ANTI-PANIC MAP

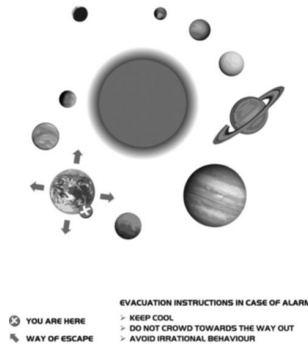

Reg. No. 4,173,559

Registered July 17, 2012

Int. Cls.: 16 and 25

TRADEMARK

PRINCIPAL REGISTER

TADDEI LUCA (ITALY SOLE PROPRIETORSHIP)
VIALE VITTORIO EMANUELLE II, 33
I-53100 SIENA
ITALY

FOR: PEN AND PENCIL CASES, PEN AND PENCIL HOLDERS; PENS, PENCILS AND WRITING INK, FOUNTAIN PENS, MARKERS, RUBBER ERASERS, GLUE FOR STATIONERY OR HOUSEHOLD USE, HIGHLIGHTER PENS, PENCIL SHARPENERS, DRAWING RULERS, LETTER OPENERS, WRITING PADS, DESK PADS, DESKTOP SETS IN THE NATURE OF DESKTOP ORGANIZERS AND DESKTOP PLANNERS, MEMO PADS, WRITING PAPER HOLDERS, SELF-ADHESIVE LABELS, FOLDERS, BOOK COVERS, DIARIES AND AGENDAS COVERS, BOOK ENDS, BOOKMARKS, LEATHER BOOKMARKS, DESK FILE TRAYS, DESK BLOTTER, LETTER RACKS, ENVELOPES, WRITING PAPER, DESK CALENDARS, IN CLASS 16 (U.S. CLS. 2, 5, 22, 23, 29, 37, 38 AND 50).

FOR: ARTICLES OF CLOTHING FOR MEN, WOMEN AND CHILDREN, NAMELY, PULLOVERS, CARDIGANS, SWEATERS, JERSEYS, JUMPERS, JACKETS, SWEATSHIRTS, PARKAS, BATHING SUITS, BLOUSES, SHIRTS, TROUSERS, JEANS, WAISTCOATS, SKIRTS, SHORTS, T-SHIRTS, DRESSES, MEN'S SUITS, COATS, RAINCOATS, OVERCOATS, OVERALLS, UNDERWEAR, VESTS, HOSIERY AND PANTY HOSES, BATHROBES, SHAWLS, SCARVES, NECKTIES, GLOVES FOR CLOTHING, BELTS FOR CLOTHING, SHOES, BOOTS, SANDALS, SLIPPERS, CLOGS, HATS AND CAPS, IN CLASS 25 (U.S. CLS. 22 AND 39).

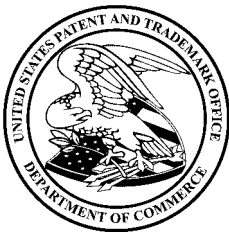

THE MARK CONSISTS OF THE WORDS "ANTI-PANIC" AND "MAP" ON THE TOP OF THE DESIGN; IN THE MIDDLE OF THE DESIGN IS A STYLIZED REPRESENTATION OF THE SUN SURROUNDED BY SEVERAL PLANETS OF THE SOLAR SYSTEM IN WHICH THE EARTH IS MARKED WITH FOUR ARROWS AND A CROSS IN A CIRCLE; IN THE LOWER PART OF THE MARK ON THE LEFT THERE IS THE LEGEND OF THE SYMBOLS SURROUNDING THE PLANET EARTH WITH THE WORDINGS "YOU ARE HERE" AND "WAY OF ESCAPE"; ON THE BOTTOM RIGHT SIDE, THERE ARE THE FOLLOWING WORDINGS ON FOUR DIFFERENT LINES: "EVACUATION INSTRUCTIONS IN CASE OF ALARM": "KEEP COOL", "DO NOT CROWD TOWARDS THE WAY OUT" AND "AVOID IRRATIONAL BEHAVIOUR". THE LAST THREE LINES ARE ALL PRECEDED BY AN ARROW.

David J. Kyffers

PRIORITY DATE OF 11-5-2010 IS CLAIMED.

Reg. No. 4,173,559 OWNER OF INTERNATIONAL REGISTRATION 1087524 DATED 4-28-2011, EXPIRES 4-28-2021.

SER. NO. 79-101,353, FILED 4-28-2011.

MARK SHINER, EXAMINING ATTORNEY

United States of America
United States Patent and Trademark Office

MAGNIDE

Reg. No. 4,173,560

Registered July 17, 2012

Int. Cls.: 10, 24 and 25

TRADEMARK

PRINCIPAL REGISTER

ARION HOLDING B.V. (NETHERLANDS LIMITED LIABILITY COMPANY)
VOUERSWEG 103
NL-6161 AG GELEEN
NETHERLANDS

FOR: MEDICAL APPARATUS AND INSTRUMENTS, NAMELY, MEDICAL DEVICES USED FOR PUTTING ON AND PULLING OFF ELASTIC STOCKINGS, SOCKS AND PANTY HOSE FOR ARMS AND LEGS; MEDICAL DEVICES TO PUT ON A PROSTHESIS; MEDICAL DEVICES TO PUT ON ORTHOPEDIC BRACES, IN CLASS 10 (U.S. CLS. 26, 39 AND 44).

FOR: TEXTILES AND TEXTILE GOODS, NOT INCLUDED IN OTHER CLASSES, NAMELY, A SHEET FABRIC THAT IS PLACED ON THE LEG FOR THE PURPOSE OF DONNING SOCKS AND STOCKINGS, IN CLASS 24 (U.S. CLS. 42 AND 50).

FOR: CLOTHING, NAMELY, WETSUITS WHICH CAN BE PUT ON WITH A DONNING AID; FOOTWEAR, NAMELY, ELASTIC AND NON-ELASTIC STOCKINGS, SOCKS AND PANTY HOSES, IN CLASS 25 (U.S. CLS. 22 AND 39).

THE MARK CONSISTS OF STANDARD CHARACTERS WITHOUT CLAIM TO ANY PARTICULAR FONT, STYLE, SIZE, OR COLOR.

PRIORITY DATE OF 2-23-2011 IS CLAIMED.

OWNER OF INTERNATIONAL REGISTRATION 1087543 DATED 6-27-2011, EXPIRES 6-27-2021.

THE WORDING "MAGNIDE" HAS NO MEANING IN A FOREIGN LANGUAGE.

SER. NO. 79-101,359, FILED 6-27-2011.

KELLY TRUSILO, EXAMINING ATTORNEY



David J. Kyjars

Director of the United States Patent and Trademark Office

United States of America

United States Patent and Trademark Office



Reg. No. 4,173,561

Registered July 17, 2012

Int. Cl.: 1

TRADEMARK

PRINCIPAL REGISTER

S.C. AZOMURES S.A. (ROMANIA JOINT STOCK COMPANY)
STR. GH. DOJA NR. 300
540237 TARGU-MURES, ROMANIA

FOR: FERTILIZERS, NAMELY, CHEMICAL FERTILIZERS INCLUDING AMMONIUM NITRATE FERTILIZERS, CALCIUM NITRATE FERTILIZERS, UREA FERTILIZERS, AMMONIUM CALCIUM SALT FERTILIZERS, COMPLEX FERTILIZERS, NITROGEN, PHOSPHOROUS AND POTASSIUM FERTILIZERS, LIQUID FERTILIZERS, AND UREA AMMONIUM NITRATE FERTILIZERS. CHEMICAL PREPARATIONS FOR INDUSTRIAL USE, INCLUDING MELAMINE, AMMONIA FOR INDUSTRIAL PURPOSES, NITRIC ACID, CARBON DIOXIDE FILLED CYLINDERS AND LIQUID AND GASEOUS NITROGEN, IN CLASS 1 (U.S. CLS. 1, 5, 6, 10, 26 AND 46).

NO CLAIM IS MADE TO THE EXCLUSIVE RIGHT TO USE "AZO" , APART FROM THE MARK AS SHOWN.

OWNER OF INTERNATIONAL REGISTRATION 1087755 DATED 5-12-2011, EXPIRES 5-12-2021.

THE COLOR(S) YELLOW, MEDIUM BLUE, AND DARK BLUE IS/ARE CLAIMED AS A FEATURE OF THE MARK.

THE MARK CONSISTS OF A DESIGN OF A STYLIZED DIAMOND IN MEDIUM BLUE AND DARK BLUE, WITH A YELLOW LEAF LIKE DESIGN CONTAINING A MEDIUM BLUE AND DARK BLUE LEAFY BRANCH AND THE TERM "AZO" IN DARK BLUE.

SER. NO. 79-101,432, FILED 5-12-2011.

SUSAN RICHARDS, EXAMINING ATTORNEY



David J. Kybas

Director of the United States Patent and Trademark Office

United States of America

United States Patent and Trademark Office

colouRem:

Reg. No. 4,173,562

Registered July 17, 2012

**Int. Cls.: 9, 16, 35, 41, 42
and 44**

CCC CORPORATE COACHING COMPANY INTERNATIONAL GMBH (FED REP GERMANY
LIMITED LIABILITY COMPANY)

THEODORSTRASSE 42-90
22761 HAMBURG

FED REP GERMANY

FOR: PRE-RECORDED ELECTRONIC DATA CARRIERS FEATURING CULTURE, EDUCATION, POLITICS, ART, MUSIC, FINANCE, AND BUSINESS, IN CLASS 9 (U.S. CLS. 21, 23, 26, 36 AND 38).

TRADEMARK

SERVICE MARK

FOR: PRINTED MATTER, NAMELY, BROCHURES, MANUALS, BOOKS, BOOKLETS, LEAFLETS, FLYERS, INFORMATIONAL SHEETS AND NEWSLETTERS IN THE FIELD OF CULTURE, EDUCATION, POLITICS, ART, MUSIC, FINANCE, AND BUSINESS, IN CLASS 16 (U.S. CLS. 2, 5, 22, 23, 29, 37, 38 AND 50).

PRINCIPAL REGISTER

FOR: BUSINESS CONSULTANCY, PERSONNEL MANAGEMENT CONSULTANCY, SALES PROMOTION, MARKET RESEARCH STUDIES; ORGANIZATIONAL PROJECT MANAGEMENT FOR OTHERS; MARKET ANALYSIS, IN CLASS 35 (U.S. CLS. 100, 101 AND 102).

FOR: PERSONAL COACHING SERVICES IN THE FIELD OF LEADERSHIP DEVELOPMENT, PERSONALITY DEVELOPMENT, EXECUTIVE TRAINING AND BUSINESS DEVELOPMENT; ARRANGING AND CONDUCTING OF WORKSHOPS IN THE FIELD OF BUSINESS DEVELOPMENT; VOCATIONAL GUIDANCE; PERSONAL FITNESS TRAINING SERVICES AND CONSULTANCY, IN CLASS 41 (U.S. CLS. 100, 101 AND 107).

FOR: PRODUCT RESEARCH AND DEVELOPMENT, IN CLASS 42 (U.S. CLS. 100 AND 101).

FOR: PSYCHOLOGICAL CONSULTATION; PSYCHOLOGICAL COUNSELING; PSYCHOTHERAPY SERVICES, IN CLASS 44 (U.S. CLS. 100 AND 101).



THE MARK CONSISTS OF "COLOUREM": IN STYLIZED LETTERING, AND THE LETTERS "C, O, L, O, U, E" AND "M" ARE IN LOWERCASE, AND THE LETTER "R" IS IN UPPERCASE.

David J. Kypos

OWNER OF INTERNATIONAL REGISTRATION 1087792 DATED 5-24-2011, EXPIRES 5-24-2021.

Director of the United States Patent and Trademark Office

SER. NO. 79-101,466, FILED 5-24-2011.

Reg. No. 4,173,562 PAUL E. FAHRENKOPF, EXAMINING ATTORNEY

United States of America

United States Patent and Trademark Office



Reg. No. 4,173,563

CROPENERGIES AG (FED REP GERMANY AKTIENGESELLSCHAFT (LIMITED COMPANY))
GOTTLIEB-DAIMLER-STR. 12

Registered July 17, 2012

68185 MANNHEIM, FED REP GERMANY

Int. Cls.: 1, 4, 39 and 42

FOR: CHEMICALS USED IN INDUSTRY, SCIENCE AND PHOTOGRAPHY, CHEMICALS USED IN AGRICULTURE, HORTICULTURE AND FORESTRY EXCEPT FUNGICIDES, HERBICIDES, INSECTICIDES AND PARASITICIDES; UNPROCESSED ARTIFICIAL RESINS, UNPROCESSED PLASTICS; MANURES; CHEMICAL ADDITIVES FOR MOTOR FUEL; CHEMICAL ADDITIVES IMPROVING THE PROPERTIES OF LUBRICANTS, INDUSTRIAL OILS AND GREASES, FUEL, IN CLASS 1 (U.S. CLS. 1, 5, 6, 10, 26 AND 46).

TRADEMARK

SERVICE MARK

PRINCIPAL REGISTER

FOR: MOTOR FUEL AND NON-CHEMICAL MOTOR FUEL ADDITIVES, IN PARTICULAR MADE FROM COMPONENTS PRODUCED FROM RENEWABLE PLANT-BASED RAW MATERIALS; FUEL AND NON-CHEMICAL FUEL ADDITIVES, IN PARTICULAR MADE FROM COMPONENTS PRODUCED FROM RENEWABLE PLANT-BASED RAW MATERIALS; INDUSTRIAL OILS AND GREASE, IN PARTICULAR INDUSTRIAL OILS AND GREASES PRODUCED FROM RENEWABLE PLANT-BASED RAW MATERIALS; LUBRICATING GREASE; NON-CHEMICAL ADDITIVES FOR IMPROVING THE PROPERTIES OF LUBRICANTS, INDUSTRIAL OILS AND GREASES, FUEL; SOLID, LIQUID AND GASEOUS FUELS INCLUDING MOTOR SPIRIT; MOISTENING OIL, FUEL OIL, INDUSTRIAL OILS FOR RELEASING FORM WORK IN BUILDING, OIL FOR THE PRESERVATION OF LEATHER, INDUSTRIAL OIL; HEATING OIL; BIOGAS FUEL; BIODIESEL FUEL FROM RAPE SEED OIL BEING RAPE SEED OIL METHYL ESTERS, BIODIESEL FUEL FROM PLANT OILS BEING PLANT OIL METHYL ESTERS, BIODIESEL FUEL FROM USED FATS BEING USED FAT METHYL ESTERS, BIODIESEL FUEL FROM FATS AND OILS; PETROLEUM-BASED DUST ABSORBING, WETTING AND BINDING COMPOSITIONS; CANDLES AND WICKS FOR CANDLES FOR LIGHTING, IN CLASS 4 (U.S. CLS. 1, 6 AND 15).



FOR: SUPPLY, TRANSPORT AND STORAGE OF FUEL, OIL, AND LUBRICANTS; PROVISION OF CHEMICAL ENGINEERING INSTALLATIONS, IN PARTICULAR INSTALLATIONS FOR PROCESSING RENEWABLE RAW MATERIALS, INCLUDING VEGETABLE AND ANIMAL FATS, USED EDIBLE OILS OR WASTE FATS, IN CLASS 39 (U.S. CLS. 100 AND 105).

David J. Kyjars

FOR: QUALITY CONTROL FOR OTHERS AND QUALITY ASSURANCE RELATING TO THE MANUFACTURE, STORAGE, INTERMEDIATE STORAGE, LOADING AND TRANSPORT OF MOTOR FUEL, FUEL, OILS AND GREASES; DEVELOPMENT OF TECHNOLOGIES

Director of the United States Patent and Trademark Office

Reg. No. 4,173,563 FOR PROCESSING RENEWABLE RAW MATERIALS, IN CLASS 42 (U.S. CLS. 100 AND 101).

NO CLAIM IS MADE TO THE EXCLUSIVE RIGHT TO USE "CROP ENERGIES" OR "REGENERATION OF POWER", APART FROM THE MARK AS SHOWN.

OWNER OF INTERNATIONAL REGISTRATION 1087806 DATED 6-16-2011, EXPIRES 6-16-2021.

THE COLOR(S) GREY, RED, AND BLUE IS/ARE CLAIMED AS A FEATURE OF THE MARK.

THE COLOR GREY APPEARS IN THE WORDING "CROP. ENERGIES CREATIVE REGENERATION OF POWER" AND THE COLORS BLUE AND RED APPEAR IN THE CURVED LINE.

SER. NO. 79-101,473, FILED 6-16-2011.

LEIGH LOWRY, EXAMINING ATTORNEY

United States of America

United States Patent and Trademark Office

HDmag

Reg. No. 4,173,564

BAUMER INNOTECH AG (SWITZERLAND JOINT STOCK COMPANY)
HUMMELSTRASSE 17

Registered July 17, 2012

FRAUENFELD, SWITZERLAND CH8500

Int. Cl.: 9

FOR: SCIENTIFIC, NAUTICAL, SURVEYING, PHOTOGRAPHIC, CINEMATOGRAPHIC, OPTICAL, WEIGHING, MEASURING, SIGNALING, CHECKING, LIFE-SAVING AND TEACHING APPARATUS AND INSTRUMENTS, IN PARTICULAR ENCODERS, NAMELY, OPTICAL ENCODERS, MAGNETIC ENCODERS, INCREMENTAL ENCODERS, SINE ENCODERS, ABSOLUTE ENCODERS, END-SHAFT ENCODERS, SHAFT ENCODERS, HOLLOW SHAFT ENCODERS, CONE SHAFT ROTARY ENCODERS, SINGLE-TURN ENCODERS, MULTI-TURN ENCODERS, ENCODERS WITH INTERFACES FOR FIBRE-OPTIC LIGHT GUIDES, ENCODERS WITH HIGH SHOCK RESISTANCE, ENCODERS WITH HIGH VIBRATION RESISTANCE, SHAFT ENCODERS WITH CLAMPING FLANGE, SHAFT ENCODERS WITH SYNCHRO FLANGE, ENCODER COMBINATIONS, IN PARTICULAR ENCODERS WITH TACHOGENERATORS WITH ELECTRIC SPEED SWITCHES INCORPORATED THEREWITH; ELECTRIC SPEED SWITCHES; ACCELERATION SENSORS; TACHOMETERS; SPINDLE POSITIONING SYSTEMS COMPRISED OF ELECTRIC ACTUATORS, ELECTRIC FORMAT ALIGNMENT SENSORS; MAGNETIC ELECTRONIC SENSORS FOR LINEAR AND ROTARY APPLICATIONS; AUTOMATED PROCESS CONTROL SYSTEM, NAMELY, MICRO-PROCESSOR BASED HARDWARE AND SOFTWARE USED TO MONITOR THE STATUS OF INDUSTRIAL MACHINERY, NAMELY, TACHOGENERATORS, TACHOGENERATORS WITHOUT BEARING, END SHAFT TACHOGENERATORS, SHAFT TACHOGENERATORS, CONE SHAFT TACHOGENERATORS, TACHOGENERATORS WITH HOUSING WITH INTERNAL BEARING, TACHOGENERATORS WITH HIGH SHOCK RESISTANCE, AND TACHOGENERATORS WITH HIGH VIBRATION RESISTANCE; ELECTRICAL RESOLVER, ELECTRICAL SHAFT RESOLVER, HOLLOW SHAFT ELECTRICAL RESOLVER; ELECTRIC INCLINATION SENSORS, IN CLASS 9 (U.S. CLS. 21, 23, 26, 36 AND 38).

TRADEMARK

PRINCIPAL REGISTER



THE MARK CONSISTS OF STANDARD CHARACTERS WITHOUT CLAIM TO ANY PARTICULAR FONT, STYLE, SIZE, OR COLOR.

PRIORITY DATE OF 10-19-2010 IS CLAIMED.

David J. Kyffers

OWNER OF INTERNATIONAL REGISTRATION 1087881 DATED 4-19-2011, EXPIRES 4-19-2021.

Director of the United States Patent and Trademark Office

SER. NO. 79-101,493, FILED 4-19-2011.

Reg. No. 4,173,564 NICHOLAS COLEMAN, EXAMINING ATTORNEY

United States of America

United States Patent and Trademark Office

FAST FILL

Reg. No. 4,173,565

Registered July 17, 2012

Int. Cls.: 1, 17 and 19

TRADEMARK

PRINCIPAL REGISTER

A. WEBER (FRANCE SOCIÉTÉ ANONYME)
94, AVENUE DE LA PAIX
F-57520 ROUHLING
FRANCE

FOR: CHEMICAL PRODUCTS FOR GROUND CONSOLIDATION, STRATA SUPPORT AND REINFORCEMENT, GROUND SEALING, CAVITY FILLING FOR USE IN INDUSTRY, MINES AND PUBLIC WORKS; ADHESIVE SUBSTANCES FOR USE IN INDUSTRY AND MINES; FIRE EXTINGUISHING COMPOSITIONS FOR FIGHTING FIRES IN MINES; FIREPROOFING PREPARATIONS; DAMP PROOFING PREPARATIONS, EXCEPT PAINTS, FOR MASONRY; FIREPROOFING PREPARATIONS; UNPROCESSED PLASTICS IN POWDER, LIQUID OR PASTE FORM; CHEMICAL ADDITIVES AS BINDING AGENTS FOR FIXING FISSURED OR POWDERY GEOLOGICAL STRATA; UNPROCESSED ARTIFICIAL AND SYNTHETIC RESINS FOR THE CONSTRUCTION, PUBLIC WORKS AND MINING SECTORS, PARTICULARLY FOR CONSOLIDATION OF LAND, IN CLASS 1 (U.S. CLS. 1, 5, 6, 10, 26 AND 46).

FOR: RESINS AND FOAMS FOR THERMAL INSULATION, AIR AND GAS INSULATION; ARTIFICIAL AND SYNTHETIC RESINS BOTH IN SEMI PROCESSED FORM, FOR USE IN THE CONSTRUCTION, PUBLIC WORKS AND MINING SECTORS, PARTICULARLY FOR CONSOLIDATION OF LAND; PACKING AND INSULATING MATERIALS; STOPPING MATERIALS IN THE NATURE OF SEALING AND INSULATING MATERIALS; INSULATORS FOR CAVITIES AND CRACKS IN GROUND AND STRATA, IN CLASS 17 (U.S. CLS. 1, 5, 12, 13, 35 AND 50).

FOR: BUILDING MATERIALS, NOT OF METAL; REINFORCING MATERIALS, NOT OF METAL, FOR BUILDING, NAMELY, FOR CONSOLIDATION OF FRACTURED AND INSTABLE GROUND AND STRATA SEALING; FIREPROOF CEMENT COATINGS; NON-METALLIC WALL LININGS BEING CONSTRUCTION MATERIALS; CEMENTS, IN CLASS 19 (U.S. CLS. 1, 12, 33 AND 50).

THE MARK CONSISTS OF STANDARD CHARACTERS WITHOUT CLAIM TO ANY PARTICULAR FONT, STYLE, SIZE, OR COLOR.

PRIORITY DATE OF 2-24-2011 IS CLAIMED.

OWNER OF INTERNATIONAL REGISTRATION 1087947 DATED 7-8-2011, EXPIRES 7-8-2021.



David J. Kyros

Director of the United States Patent and Trademark Office

Reg. No. 4,173,565 SER. NO. 79-101,517, FILED 7-8-2011.

JACLYN KIDWELL WALKER, EXAMINING ATTORNEY

United States of America

United States Patent and Trademark Office



Reg. No. 4,173,566

Registered July 17, 2012

Int. Cl.: 1

INDUSTRIELACK AG (SWITZERLAND SOCIÉTÉ ANONYME (SA) / JOINT-STOCK COMPANY)
ALPENBLICKSTRASSE 3-5
POSTFACH 139; CH-8853 LACHEN AM SEE
SWITZERLAND

TRADEMARK

PRINCIPAL REGISTER

FOR: CHEMICAL PRODUCTS, NAMELY, CHEMICALS FOR USE IN INDUSTRY AND SCIENCE; CHEMICAL PRODUCTS, NAMELY, CHEMICALS FOR INDUSTRIAL AND SCIENTIFIC PURPOSES, NAMELY, FUNCTIONAL COATING, PARTICULARLY ANTIADHESIVE COATINGS AND LUBRICATING COATINGS FOR UTENSILS AND PARTS OF ALL KINDS, PARTICULARLY FOR MOLDS, COOKING UTENSILS, FLYING PANS AND FOR OTHER HOUSEHOLD UTENSILS AS WELL AS FOR TOOLS AND TECHNICAL ITEMS; UNPROCESSED ARTIFICIAL RESINS, UNPROCESSED PLASTICS; ADHESIVES FOR INDUSTRIAL PURPOSES, IN CLASS 1 (U.S. CLS. 1, 5, 6, 10, 26 AND 46).

OWNER OF U.S. REG. NO. 3,647,806.

PRIORITY DATE OF 1-7-2011 IS CLAIMED.

OWNER OF INTERNATIONAL REGISTRATION 1088112 DATED 7-7-2011, EXPIRES 7-7-2021.

NO CLAIM IS MADE TO THE EXCLUSIVE RIGHT TO USE "NON STICK TECHNOLOGY", APART FROM THE MARK AS SHOWN.



THE MARK CONSISTS OF THE LETTERS AND WORDS "ILAG" AND "NON STICK TECHNOLOGY" WITHIN A RECTANGULAR BACKGROUND WITH A ROUNDED CORNER WITH AN ARROW FORMING THE BOTTOM BORDER OF THE RECTANGLE AND THE ARROW HEAD CURVING UP ON THE ROUNDED CORNER WITH A DESIGN RESEMBLING A CROSS WITH ROUNDED ANGLES PERFORATED IN THE MIDDLE WITHIN THE HEAD OF THE ARROW.

SER. NO. 79-101,593, FILED 7-7-2011.

CARYN GLASSER, EXAMINING ATTORNEY

David J. Kyros

Director of the United States Patent and Trademark Office

United States of America

United States Patent and Trademark Office



Reg. No. 4,173,567

Registered July 17, 2012

Int. Cl.: 19

TRADEMARK

PRINCIPAL REGISTER

INDUSTRIAS AUXILIARES FAUS, S.L.U. (SPAIN SOCIEDAD LIMITADA UNIPERSONAL)
AVDA. LA VALL D'ALVAIDA, 68
E-46702 GANDÍA (VALENCIA), SPAIN

FOR: LAMINATED FLOORS MADE OF WOOD, IN CLASS 19 (U.S. CLS. 1, 12, 33 AND 50).

OWNER OF U.S. REG. NOS. 2,260,079, 3,524,233 AND OTHERS.

PRIORITY DATE OF 7-8-2011 IS CLAIMED.

OWNER OF INTERNATIONAL REGISTRATION 1088164 DATED 7-14-2011, EXPIRES 7-14-2021.

THE COLOR(S) RED, BLACK AND WHITE IS/ARE CLAIMED AS A FEATURE OF THE MARK.

THE MARK CONSISTS OF THE WORDING "FAUS" IN THE COLOR WHITE. EACH LETTER IS ON A BLACK SQUARE. TO THE LEFT OF THE WORDING IS A RED SQUARE WITH A HIGHLY STYLIZED LETTER "F" IN THE COLORS WHITE AND RED.

THE WORDING "FAUS" HAS NO MEANING IN A FOREIGN LANGUAGE.

SER. NO. 79-101,618, FILED 7-14-2011.

COLLEEN DOMBROW, EXAMINING ATTORNEY



David J. Kyjars

Director of the United States Patent and Trademark Office

United States of America

United States Patent and Trademark Office

GfK MEP

Reg. No. 4,173,568

Registered July 17, 2012

Int. Cl.: 35

SERVICE MARK

PRINCIPAL REGISTER

GfK SE (EUROPEAN UNION CORPORATION)
NORDWESTRING 101
90419 NÜRNBERG
FED REP GERMANY

FOR: DRAWING UP STATISTICS IN THE FIELD OF ECONOMICS, NAMELY, COMPILATION OF ECONOMIC STATISTICS FOR BUSINESS OR COMMERCIAL PURPOSES; MARKETING, MARKET RESEARCH AND MARKET ANALYSIS, BUSINESS CONSULTANCY, CONSULTANCY WITH REGARD TO THE AFFAIRS OF BUSINESS ORGANIZATION, PROFESSIONAL BUSINESS CONSULTANCY, OPINION POLLING IN THE FIELD OF ECONOMICS, IN CLASS 35 (U.S. CLS. 100, 101 AND 102).

THE MARK CONSISTS OF STANDARD CHARACTERS WITHOUT CLAIM TO ANY PARTICULAR FONT, STYLE, SIZE, OR COLOR.

OWNER OF INTERNATIONAL REGISTRATION 1088590 DATED 7-19-2011, EXPIRES 7-19-2021.

OWNER OF U.S. REG. NOS. 2,906,704, 3,964,481 AND OTHERS.

SER. NO. 79-101,767, FILED 7-19-2011.

MICHAEL WIENER, EXAMINING ATTORNEY



David J. Kyffers

Director of the United States Patent and Trademark Office

United States of America

United States Patent and Trademark Office

GRAND PALAIS

Reg. No. 4,173,569

Registered July 17, 2012

Int. Cl.: 33

TRADEMARK

PRINCIPAL REGISTER

YVON MAU (FRANCE SOCIÉTÉ ANONYME (SA))
RUE SAINTE PÉTRONILLE
F-33190 GIRONDE SUR DROPT
FRANCE

FOR: WINE, IN CLASS 33 (U.S. CLS. 47 AND 49).

THE ENGLISH TRANSLATION OF "GRAND PALAIS" IN THE MARK IS "GREAT PALACE".

PRIORITY DATE OF 7-20-2011 IS CLAIMED.

OWNER OF INTERNATIONAL REGISTRATION 1088604 DATED 7-25-2011, EXPIRES 7-25-2021.

SER. NO. 79-101,769, FILED 7-25-2011.

MYRIAH HABEEB, EXAMINING ATTORNEY



David J. Kybas

Director of the United States Patent and Trademark Office

United States of America

United States Patent and Trademark Office

EASY-LOCK by Aplix

Reg. No. 4,173,570

Registered July 17, 2012

Int. Cl.: 20

TRADEMARK

PRINCIPAL REGISTER

APLIX (FRANCE SOCIÉTÉ ANONYME)
19, AVENUE DE MESSINE
F-75008 PARIS
FRANCE

FOR: NON-METALLIC CLOSURES FOR BAGS MADE OF PLASTIC, IN CLASS 20 (U.S. CLS. 2, 13, 22, 25, 32 AND 50).

THE MARK CONSISTS OF STANDARD CHARACTERS WITHOUT CLAIM TO ANY PARTICULAR FONT, STYLE, SIZE, OR COLOR.

PRIORITY DATE OF 2-10-2011 IS CLAIMED.

OWNER OF INTERNATIONAL REGISTRATION 1088874 DATED 7-21-2011, EXPIRES 7-21-2021.

OWNER OF U.S. REG. NO. 1,122,470.

SER. NO. 79-101,873, FILED 7-21-2011.

JOSETTE BEVERLY, EXAMINING ATTORNEY



David J. Kybas

Director of the United States Patent and Trademark Office

United States of America

United States Patent and Trademark Office



Reg. No. 4,173,571

Registered July 17, 2012

Int. Cl.: 9

TRADEMARK

PRINCIPAL REGISTER

RCF S.P.A. (ITALY JOINT STOCK COMPANY)
VIA RAFFAELLO SANZIO, 13
I-42124 REGGIO EMILIA
ITALY

FOR: CABINETS FOR LOUDSPEAKERS, ELECTRIC AND ELECTRONIC APPARATUS AND EQUIPMENT FOR ANALOGOUS, DIGITAL, OPTICAL TRANSMISSIONS; APPARATUS FOR PROCESSING AND CONTROL OR DISTRIBUTION OF ACOUSTIC SIGNALS AND AUDIO-VISUAL EQUIPMENT THEREOF, NAMELY, AUDIO RECEIVERS; HIGH FIDELITY SOUND REPRODUCTION AND HOME CINEMA EQUIPMENT, NAMELY, SOUND AMPLIFIERS, LOUDSPEAKERS; COMPONENTS AND ACCESSORIES FOR ALL THE ITEMS MENTIONED ABOVE, NAMELY, PRE-AMPLIFIERS, SOUND PROCESSORS, ACOUSTIC HORNS, AND ELECTRO ACOUSTIC TRANSDUCERS; STRUCTURAL PARTS FOR THE AFOREMENTIONED GOODS, IN CLASS 9 (U.S. CLS. 21, 23, 26, 36 AND 38).

THE MARK CONSISTS OF THE STYLIZED AND UNDERLINED WORD "ART" WITH A SOLID CIRCLE IN THE LETTER "A".

PRIORITY DATE OF 4-8-2011 IS CLAIMED.

OWNER OF INTERNATIONAL REGISTRATION 1089378 DATED 4-15-2011, EXPIRES 4-15-2021.

SER. NO. 79-102,054, FILED 4-15-2011.

PAUL MORENO, EXAMINING ATTORNEY



David J. Kyros

Director of the United States Patent and Trademark Office

United States of America

United States Patent and Trademark Office

MORGANNE BELLO

PARIS



Reg. No. 4,173,572

Registered July 17, 2012

Int. Cls.: 3, 9, 14 and 25

SOCIÉTÉ MORGANNE BELLO (FRANCE SOCIÉTÉ PAR ACTIONS SIMPLIFIÉE)
3 RUE VOLNEY
F-75002 PARIS
FRANCE

FOR: COSMETICS INCLUDING PERFUMES; PERFUMES IN SOLID FORM; EAU DE TOILETTE AND EAU DE COLOGNE, IN CLASS 3 (U.S. CLS. 1, 4, 6, 50, 51 AND 52).

TRADEMARK

FOR: SPECTACLES, SPECTACLE CASES, EYEGLASS CHAINS; CASES AND COVERS, ESPECIALLY FOR COMPUTERS, PORTABLE DIGITAL APPARATUS AND MOBILE TELEPHONES, NAMELY, COMPUTER CARRYING CASES, CARRYING CASES FOR MOBILE COMPUTERS, CARRYING CASES FOR CELL PHONES, IN CLASS 9 (U.S. CLS. 21, 23, 26, 36 AND 38).

PRINCIPAL REGISTER

FOR: PRECIOUS METALS AND THEIR ALLOYS AND GOODS MADE FROM THESE MATERIALS, NAMELY, RINGS, LOOPS IN THE NATURE OF EARRINGS, EARRINGS, BRILLIANTS IN THE NATURE OF DIAMONDS, BRACELETS, CHARMS, JEWELRY CHAINS, WATCH CHAINS, NECKLACES, PINS BEING JEWELRY, ORNAMENTS OF PRECIOUS METAL IN THE NATURE OF JEWELRY, PENDANTS, EAR STUDS, FASHION PINS BEING JEWELRY, RING WEDDING BANDS; JEWELRY; PRECIOUS STONES; SEMI-PRECIOUS STONES; PEARLS; EARRINGS AND PIERCINGS MADE OF PRECIOUS METAL, NAMELY, BODY-PIERCING RINGS, BODY-PIERCING STUDS, EARRINGS; HAT ORNAMENTS OF PRECIOUS METAL; JEWELRY CASES AND BOXES MADE OF PRECIOUS METAL; CUFF LINKS AND TIE CLIPS; HOROLOGICAL AND CHRONOMETRIC INSTRUMENTS; WATCHES; WATCH STRAPS; WRISTWATCHES; CASES FOR WATCHES; JEWEL BOXES FOR HOLDING JEWELRY; JEWELRY PLATED WITH PRECIOUS METALS; KEY RINGS OF PRECIOUS METAL; STATUES OR FIGURINES OF PRECIOUS METAL; MEDALS, IN CLASS 14 (U.S. CLS. 2, 27, 28 AND 50).



FOR: CLOTHING, NAMELY, SHIRTS, PANTS, DRESSES, SOCKS, SKIRTS, COATS; BELTS; SCARVES, IN CLASS 25 (U.S. CLS. 22 AND 39).

NO CLAIM IS MADE TO THE EXCLUSIVE RIGHT TO USE "PARIS", APART FROM THE MARK AS SHOWN.

PRIORITY DATE OF 4-8-2011 IS CLAIMED.

David J. Kybas

Director of the United States Patent and Trademark Office

Reg. No. 4,173,572 OWNER OF INTERNATIONAL REGISTRATION 1089581 DATED 4-13-2011, EXPIRES 4-13-2021.

THE COLOR(S) BLACK AND GOLD IS/ARE CLAIMED AS A FEATURE OF THE MARK.

THE NAME(S), PORTRAIT(S), AND/OR SIGNATURE(S) SHOWN IN THE MARK IDENTIFIES "MORGANNE BELLO", WHOSE CONSENT(S) TO REGISTER IS MADE OF RECORD.

THE MARK CONSISTS OF THE WORDING "MORGANNE BELLO" IN BLACK OVER THE SMALLER WORDING "PARIS" IN BLACK; TO THE LOWER LEFT OF THE WORDING ARE TWO BUTTERFLIES IN GOLD.

THE ENGLISH TRANSLATION OF "BELLO" IN THE MARK IS "BEAUTIFUL".

SER. NO. 79-102,112, FILED 4-13-2011.

MAYUR VAGHANI, EXAMINING ATTORNEY

United States of America
United States Patent and Trademark Office

INSPIRE

Reg. No. 4,173,573

Registered July 17, 2012

Int. Cl.: 10

TRADEMARK

PRINCIPAL REGISTER

SORIN GROUP ITALIA S.R.L. (ITALY LIMITED LIABILITY COMPANY)
VIA STATALE 12 NORD, 86
I-41037 MIRANDOLA (MO)
ITALY

FOR: MEDICAL DEVICES, NAMELY, BLOOD OXYGENATORS AND HOLLOW FIBER
BLOOD OXYGENATORS, IN CLASS 10 (U.S. CLS. 26, 39 AND 44).

THE MARK CONSISTS OF STANDARD CHARACTERS WITHOUT CLAIM TO ANY PAR-
TICULAR FONT, STYLE, SIZE, OR COLOR.

PRIORITY DATE OF 5-9-2011 IS CLAIMED.

OWNER OF INTERNATIONAL REGISTRATION 1089638 DATED 7-6-2011, EXPIRES 7-6-
2021.

SER. NO. 79-102,131, FILED 7-6-2011.

STEVEN PEREZ, EXAMINING ATTORNEY



David J. Kyros

Director of the United States Patent and Trademark Office

United States of America

United States Patent and Trademark Office

RNA in a Box

Reg. No. 4,173,574

Registered July 17, 2012

Int. Cls.: 1, 5 and 42

TRADEMARK

SERVICE MARK

PRINCIPAL REGISTER

RIBOXX GMBH (FED REP GERMANY LIMITED LIABILITY COMPANY)
MEIßNERSTR. 191
01445 RADEBEUL
FED REP GERMANY

FOR: CHEMICAL, BIOCHEMICAL AND BIOLOGICAL COMPOUNDS FOR INDUSTRIAL AND SCIENTIFIC PURPOSES, NAMELY, FOR DETECTING AND CULTIVATING EUKARYOTIC AND PROKARYOTIC CELLS, VIRUSES AND MICROORGANISMS, NAMELY, BACTERIA, FUNGI AND PARASITES FOR CLINICAL PURPOSES AND NOT FOR PHARMACEUTICAL OR VETERINARY PURPOSES; CHEMICAL, BIOCHEMICAL AND BIOLOGICAL COMPOUNDS FOR SYNTHESIZING AND AMPLIFYING AND LABELING NUCLEIC ACIDS, PROTEINS AND ORGANIC AND INORGANIC COMPOUNDS; CHEMICAL, BIOCHEMICAL AND BIOLOGICAL COMPOUNDS FOR GENETICALLY MODIFYING EUKARYOTIC AND PROKARYOTIC CELLS, VIRUSES AND MICROORGANISMS, NAMELY, BACTERIA, FUNGI AND PARASITES; ALL AFOREMENTIONED GOODS NOT FOR MEDICAL AND VETERINARY PURPOSES, IN CLASS 1 (U.S. CLS. 1, 5, 6, 10, 26 AND 46).

FOR: PHARMACEUTICAL AND VETERINARY PREPARATIONS FOR PREVENTING AND COMBATING VIRAL, MICROBIAL, BACTERIAL, FUNGAL AND PARASITIC, DEGENERATIVE AND PROLIFERATIVE DISEASES, NAMELY, TUMOR DISEASES; REAGENTS FOR MEDICAL AND VETERINARY PURPOSES, NAMELY, FOR DIAGNOSING VIRAL, MICROBIAL, BACTERIAL, FUNGAL, PARASITIC, DEGENERATIVE AND PROLIFERATIVE DISEASES, NAMELY, TUMOR DISEASES, IN CLASS 5 (U.S. CLS. 6, 18, 44, 46, 51 AND 52).

FOR: SCIENTIFIC AND TECHNOLOGICAL SERVICES AND RESEARCH IN THE FIELD OF EUKARYOTIC AND PROKARYOTIC CELLS, VIRUSES AND MICROORGANISMS, NAMELY, BACTERIA, FUNGI AND PARASITES, AND THEIR BIOLOGICAL COMPONENTS; LABORATORY SERVICES FOR CHEMICAL, BIOLOGICAL AND PHYSICAL ANALYSIS AND DETECTION OF VIRUSES AND MICROORGANISMS, NAMELY, BACTERIA, FUNGI AND PARASITES, AND THEIR BIOLOGICAL COMPONENTS; CHEMICAL, BIOCHEMICAL AND BIOLOGICAL RESEARCH AND ANALYSIS, IN CLASS 42 (U.S. CLS. 100 AND 101).

THE MARK CONSISTS OF STANDARD CHARACTERS WITHOUT CLAIM TO ANY PARTICULAR FONT, STYLE, SIZE, OR COLOR.

OWNER OF INTERNATIONAL REGISTRATION 1089676 DATED 4-26-2011, EXPIRES 4-26-2021.



David J. Kyffers

Director of the United States Patent and Trademark Office

Reg. No. 4,173,574 OWNER OF U.S. REG. NO. 3,841,581.

NO CLAIM IS MADE TO THE EXCLUSIVE RIGHT TO USE "RNA", APART FROM THE MARK AS SHOWN.

SER. NO. 79-102,138, FILED 4-26-2011.

JENNIFER DIXON, EXAMINING ATTORNEY

United States of America
United States Patent and Trademark Office

ROXFIT

Reg. No. 4,173,575

Registered July 17, 2012

Int. Cl.: 9

TRADEMARK

PRINCIPAL REGISTER

SMART MOBILE LTD (UNITED KINGDOM LIMITED COMPANY)
1 MORTLAKE TERRACE, KEW
RICHMOND, SURREY TW9 3DT
UNITED KINGDOM

FOR: CONSUMER ELECTRONIC ACCESSORIES, NAMELY, TABLET COMPUTERS, CAMERAS, MOBILE PHONES, SMART PHONES AND REPLACEMENT PARTS THEREFOR, AND ACCESSORIES FOR ALL THE MENTIONED GOODS IN THE NATURE OF USB CABLES AND POWER ADAPTERS; SOFTWARE, NAMELY, COMPUTER OPERATING SOFTWARE, IN CLASS 9 (U.S. CLS. 21, 23, 26, 36 AND 38).

THE MARK CONSISTS OF STANDARD CHARACTERS WITHOUT CLAIM TO ANY PARTICULAR FONT, STYLE, SIZE, OR COLOR.

PRIORITY DATE OF 2-8-2011 IS CLAIMED.

OWNER OF INTERNATIONAL REGISTRATION 1089838 DATED 8-8-2011, EXPIRES 8-8-2021.

SER. NO. 79-102,228, FILED 8-8-2011.

SEAN CROWLEY, EXAMINING ATTORNEY



David J. Kyffers

Director of the United States Patent and Trademark Office

United States of America

United States Patent and Trademark Office

VIROBI

Reg. No. 4,173,576

Registered July 17, 2012

Int. Cls.: 7 and 21

TRADEMARK

PRINCIPAL REGISTER

CARL FREUDENBERG KG (FED REP GERMANY KOMMANDITGESELLSCHAFT)
HÖHNERWEG 2-4
69469 WEINHEIM
FED REP GERMANY

FOR: ELECTRIC MACHINES FOR CLEANING, NAMELY, CLEANING ROBOTS FOR HOUSEHOLD PURPOSES; CLEANING ROBOTS FOR HOUSEHOLD USE, NAMELY, ROBOTIC VACUUM CLEANERS; VACUUM CLEANERS; ELECTRIC ROBOT APPARATUS FOR FLOOR CLEANING, IN CLASS 7 (U.S. CLS. 13, 19, 21, 23, 31, 34 AND 35).

FOR: CLEANING INSTRUMENTS FOR HOUSEHOLD PURPOSES, NAMELY, CLEANING PADS, IN CLASS 21 (U.S. CLS. 2, 13, 23, 29, 30, 33, 40 AND 50).

THE MARK CONSISTS OF STANDARD CHARACTERS WITHOUT CLAIM TO ANY PARTICULAR FONT, STYLE, SIZE, OR COLOR.

PRIORITY DATE OF 2-17-2011 IS CLAIMED.

OWNER OF INTERNATIONAL REGISTRATION 1089841 DATED 8-10-2011, EXPIRES 8-10-2021.

THE WORDING "VIROBI" HAS NO MEANING IN A FOREIGN LANGUAGE.

SER. NO. 79-102,229, FILED 8-10-2011.

MAYUR VAGHANI, EXAMINING ATTORNEY



David J. Kybas

Director of the United States Patent and Trademark Office

United States of America
United States Patent and Trademark Office

SEA SKI

Reg. No. 4,173,577

Registered July 17, 2012

Int. Cl.: 12

TRADEMARK

PRINCIPAL REGISTER

TREVOR WILLIAM PAYNE (AUSTRALIA INDIVIDUAL)
80 CHINDERAH BAY DRIVE
CHINDERAH, AUSTRALIA NSW 2487

FOR: BOATS; LEISURE BOATS; PLEASURE BOATS; POWERBOATS; BOAT HULLS, IN CLASS 12 (U.S. CLS. 19, 21, 23, 31, 35 AND 44).

THE MARK CONSISTS OF STANDARD CHARACTERS WITHOUT CLAIM TO ANY PARTICULAR FONT, STYLE, SIZE, OR COLOR.

PRIORITY DATE OF 10-14-2010 IS CLAIMED.

OWNER OF INTERNATIONAL REGISTRATION 1089924 DATED 4-12-2011, EXPIRES 4-12-2021.

SER. NO. 79-102,255, FILED 4-12-2011.

KIM SAITO, EXAMINING ATTORNEY



David J. Kyffers

Director of the United States Patent and Trademark Office

United States of America

United States Patent and Trademark Office

BETASEED

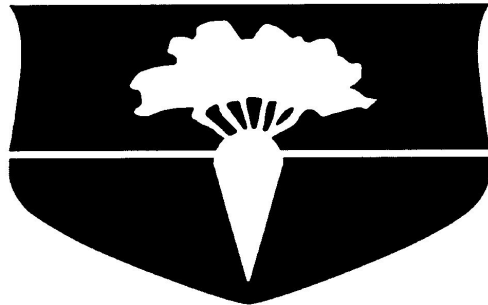

Reg. No. 4,173,578

Registered July 17, 2012

Int. Cls.: 31, 42 and 44

TRADEMARK

SERVICE MARK

PRINCIPAL REGISTER

KWS SAAT AG (FED REP GERMANY AKTIENGESELLSCHAFT)
GRIMSEHLSTRASSE 31
37574 EINBECK, FED REP GERMANY

FOR: AGRICULTURAL, HORTICULTURAL AND FORESTRY PRODUCTS AND SEEDS AS FAR AS INCLUDED IN THIS CLASS, NAMELY, AGRICULTURAL SEEDS, SEEDS FOR HORTICULTURAL PURPOSES; AGRICULTURAL SEEDS AND HORTICULTURAL SEEDS THAT ARE TREATED AND/OR COATED WITH CHEMICAL PRODUCTS; NATURAL PLANTS; FOODSTUFFS FOR ANIMALS, IN CLASS 31 (U.S. CLS. 1 AND 46).

FOR: SCIENTIFIC AND INDUSTRIAL RESEARCH IN THE FIELDS OF HORTICULTURE AND AGRICULTURE; DEVELOPMENT OF COMPUTER SOFTWARE FOR DATA PROCESSING, IN CLASS 42 (U.S. CLS. 100 AND 101).

FOR: AGRICULTURE SERVICES, NAMELY, PLANT BREEDING AND PLANT BREEDING ADVICE FOR OTHERS; HORTICULTURE SERVICES; ADVISORY SERVICES RELATING TO THE CULTIVATION OF PLANTS, ESPECIALLY RELATED TO PLANT CULTIVATION FOR THE PRODUCTION OF BIOGAS AND BIOALCOHOL, IN CLASS 44 (U.S. CLS. 100 AND 101).

OWNER OF U.S. REG. NOS. 935,156, 3,291,166 AND OTHERS.

PRIORITY DATE OF 11-1-2010 IS CLAIMED.

OWNER OF INTERNATIONAL REGISTRATION 1090052 DATED 4-23-2011, EXPIRES 4-23-2021.

THE MARK CONSISTS OF THE WORD "BETASEED" IN STYLIZED FONT WITH A SHIELD CENTERED BELOW THE WORD. THE SHIELD IS MADE UP OF A QUADRILATERAL ABOVE A TRIANGULAR SHAPE WITH THE SILHOUETTE OF A CARROT-SHAPED VEGETABLE IN THE CENTER OF THE SHIELD.

SER. NO. 79-102,312, FILED 4-23-2011.

TINA BROWN, EXAMINING ATTORNEY



David J. Kyffers

Director of the United States Patent and Trademark Office

United States of America

United States Patent and Trademark Office

AZZARO NIGHT TIME

Reg. No. 4,173,579

Registered July 17, 2012

Int. Cl.: 3

TRADEMARK

PRINCIPAL REGISTER

LORIS AZZARO B.V. (NETHERLANDS B.V.)
LAAN VAN WESTENENK 64
NL-7336 AZ APELDOORN
NETHERLANDS

FOR: PERFUMES, TOILET WATER, EAU-DE-COLOGNE, EAU DE PARFUM; DEODORANTS FOR PERSONAL USE; BATH AND SHOWER GELS, IN CLASS 3 (U.S. CLS. 1, 4, 6, 50, 51 AND 52).

THE MARK CONSISTS OF STANDARD CHARACTERS WITHOUT CLAIM TO ANY PARTICULAR FONT, STYLE, SIZE, OR COLOR.

PRIORITY DATE OF 3-11-2011 IS CLAIMED.

OWNER OF INTERNATIONAL REGISTRATION 1090068 DATED 8-2-2011, EXPIRES 8-2-2021.

OWNER OF U.S. REG. NOS. 1,560,359, 2,897,058 AND OTHERS.

NO CLAIM IS MADE TO THE EXCLUSIVE RIGHT TO USE "NIGHT TIME", APART FROM THE MARK AS SHOWN.

SER. NO. 79-102,322, FILED 8-2-2011.

WILLIAM ROSSMAN, EXAMINING ATTORNEY



David J. Kyros

Director of the United States Patent and Trademark Office

United States of America

United States Patent and Trademark Office

SMA | SERVICE

Reg. No. 4,173,580

Registered July 17, 2012

Int. Cls.: 37 and 42

SERVICE MARK

PRINCIPAL REGISTER

SMA SOLAR TECHNOLOGY AG (FED REP GERMANY CORPORATION)
SONNENALLEE 1
34266 NIESTETAL
FED REP GERMANY

FOR: INSTALLATION AND SUPPORT, NAMELY, REPAIR AND MAINTENANCE OF SOLAR, PHOTOVOLTAIC AND ENERGY GENERATING SYSTEMS; INSTALLATION AND SUPPORT, NAMELY, REPAIR AND MAINTENANCE OF SPARE PARTS UNDER WARRANTY FOR SOLAR, PHOTOVOLTAIC AND ENERGY GENERATING SYSTEMS, IN CLASS 37 (U.S. CLS. 100, 103 AND 106).

FOR: MONITORING, NAMELY, INSPECTION (TECHNICAL CHECK) OF SOLAR, PHOTOVOLTAIC AND ENERGY GENERATING SYSTEMS; TECHNICAL ADVICE AND CONSULTATION SERVICES IN CONNECTION WITH THE OPERATION OF SOLAR, PHOTOVOLTAIC AND ENERGY GENERATING SYSTEMS, IN CLASS 42 (U.S. CLS. 100 AND 101).

OWNER OF U.S. REG. NOS. 2,603,918, 3,728,531, AND 3,747,043.

PRIORITY DATE OF 9-24-2010 IS CLAIMED.

OWNER OF INTERNATIONAL REGISTRATION 1090534 DATED 3-17-2011, EXPIRES 3-17-2021.

NO CLAIM IS MADE TO THE EXCLUSIVE RIGHT TO USE "SERVICE", APART FROM THE MARK AS SHOWN.

THE WORDING "SMA" HAS NO MEANING IN A FOREIGN LANGUAGE.

SER. NO. 79-102,462, FILED 3-17-2011.

DARRYL SPRUILL, EXAMINING ATTORNEY



David J. Kyffers

Director of the United States Patent and Trademark Office

United States of America

United States Patent and Trademark Office

DENKER

Reg. No. 4,173,581

Registered July 17, 2012

Int. Cl.: 30

I.T.C.G. INTERNATIONAL TEA COMPANY (GERMANY) GMBH (FED REP GERMANY
LIMITED LIABILITY COMPANY)
OSTSTR. 84
40210 DÜSSELDORF
FED REP GERMANY

TRADEMARK

PRINCIPAL REGISTER

FOR: COFFEE, TEA, COCOA, SUGAR, ARTIFICIAL COFFEE; PREPARATIONS MADE FROM CEREAL, NAMELY, CEREAL-BASED SNACK FOODS AND ENERGY BARS, SEMOLINA, NOODLES AND/OR PASTA, BREAD, PASTRY AND CONFECTIONERY, HONEY, TREACLE, IN CLASS 30 (U.S. CL. 46).

THE MARK CONSISTS OF STANDARD CHARACTERS WITHOUT CLAIM TO ANY PARTICULAR FONT, STYLE, SIZE, OR COLOR.

OWNER OF INTERNATIONAL REGISTRATION 0942613 DATED 10-11-2007, EXPIRES 10-11-2017.

THE ENGLISH TRANSLATION OF THE WORD "DENKER" IN THE MARK IS "THINKER".

SER. NO. 79-102,560, FILED 7-22-2011.

DORITT L. CARROLL, EXAMINING ATTORNEY



David J. Kyffers

Director of the United States Patent and Trademark Office

United States of America

United States Patent and Trademark Office

ANNYER

Reg. No. 4,173,582

Registered July 17, 2012

Int. Cls.: 3, 5 and 25

TRADEMARK

PRINCIPAL REGISTER

WACHEM D.O.O. (CROATIA DRUSTVO S OGRANICENOM ODGOVORNOSCU (D.O.O.))
BRANIMIROVA 24-26
HR-42202 TRNOVEC
CROATIA

FOR: BLEACHING PREPARATIONS AND OTHER SUBSTANCES FOR LAUNDRY USE, NAMELY, DETERGENTS FOR HOUSEHOLD USE; CLEANING, POLISHING, SCOURING AND ABRASIVE PREPARATIONS; SOAPS; PERFUMERY, ESSENTIAL OILS, COSMETICS, HAIR LOTIONS; DENTIFRICE, IN CLASS 3 (U.S. CLS. 1, 4, 6, 50, 51 AND 52).

FOR: PHARMACEUTICAL PREPARATIONS, NAMELY, ANTI-AGING AND REGENERATIVE MEDICATED SKIN CARE PREPARATIONS; PHARMACEUTICAL PREPARATIONS, NAMELY, ANTIFUNGAL PREPARATIONS, MEDICATED DERMATOLOGICAL PREPARATIONS; PHARMACEUTICAL PREPARATIONS, NAMELY, MEDICATED OINTMENTS FOR TREATING DERMATOLOGICAL CONDITIONS AS AN AIDE IN HEALING SIMPLE CUTS, BURNS, BRUISES AND SPRAINS, PHARMACEUTICAL AND SANITARY PREPARATIONS, NAMELY, MEDICATED ORAL CARE PREPARATIONS AND MEDICATED MOUTHWASH CONCENTRATE; FOOD FOR BABIES; MEDICAL PLASTERS, WOUND DRESSINGS; ACNE TREATMENT PREPARATIONS; MEDICATED SKIN CARE PREPARATIONS ALL IN THE NATURE OF ANTI-INFLAMMATORY CREAMS, FACIAL MASQUES FOR ACNE TREATMENT, AND FACIAL PEELS FOR ACNE TREATMENT, IN CLASS 5 (U.S. CLS. 6, 18, 44, 46, 51 AND 52).

FOR: CLOTHING, NAMELY, SHIRTS, T-SHIRTS, SWEATSHIRTS, HOODED SWEATSHIRTS, JACKETS, HOODED JACKETS, COATS, HEADBANDS, SPORTS JERSEYS, NIGHT SHIRTS, PAJAMAS, PANTS, RAIN COATS, RAIN WEAR, ROBES, SCARVES, SHORTS, SOCKS, SWEATERS, SWEAT PANTS, UNDERWEAR, WARM-UP SUITS, WRISTBANDS, SWEATBANDS, BELTS; FOOTWEAR, NAMELY, SHOES, SLIPPERS, SANDALS, ATHLETIC FOOTWEAR, SNEAKERS; HEADWEAR, NAMELY, CAPS, HATS, VISORS, BANDANAS, IN CLASS 25 (U.S. CLS. 22 AND 39).

THE MARK CONSISTS OF STANDARD CHARACTERS WITHOUT CLAIM TO ANY PARTICULAR FONT, STYLE, SIZE, OR COLOR.

OWNER OF INTERNATIONAL REGISTRATION 1090987 DATED 5-24-2011, EXPIRES 5-24-2021.



David J. Kyffers

Director of the United States Patent and Trademark Office

Reg. No. 4,173,582 SER. NO. 79-102,670, FILED 5-24-2011.

JESSICA A. POWERS, EXAMINING ATTORNEY

United States of America

United States Patent and Trademark Office

BMC

Reg. No. 4,173,583

Registered July 17, 2012

Int. Cls.: 12 and 25

TRADEMARK

PRINCIPAL REGISTER

ISH INTERNATIONAL SPORT HOLDING AG (SWITZERLAND SOCIÉTÉ ANONYME)
SPORTSTRASSE 49
GRENCHEM, SWITZERLAND CH2540

FOR: BICYCLES AND THEIR PARTS; BICYCLE FRAMES; BICYCLE SADDLES; HANDLE BARS FOR BICYCLES; BICYCLE RIMS; WHEELS FOR BICYCLES, IN CLASS 12 (U.S. CLS. 19, 21, 23, 31, 35 AND 44).

FOR: CLOTHING, NAMELY, CYCLISTS' CLOTHING, PARTICULARLY SHIRTS, TEE-SHIRTS, TROUSERS, SOCKS, GLOVES, FOOTWEAR AND HEADWEAR, IN CLASS 25 (U.S. CLS. 22 AND 39).

OWNER OF U.S. REG. NO. 2,909,468.

PRIORITY DATE OF 4-15-2011 IS CLAIMED.

OWNER OF INTERNATIONAL REGISTRATION 1091140 DATED 8-15-2011, EXPIRES 8-15-2021.

SER. NO. 79-102,720, FILED 8-15-2011.

JOHN WILKE, EXAMINING ATTORNEY



David J. Kybas

Director of the United States Patent and Trademark Office

United States of America

United States Patent and Trademark Office

WOLF-EYES

Reg. No. 4,173,584

Registered July 17, 2012

Int. Cl.: 11

TRADEMARK

PRINCIPAL REGISTER

CO-PHOTOEL TECH CO., LTD. (CHINA CORPORATION)
ROOM 501

5/F, JINDA SCIENCE & TECHNOLOGY CENTER, 8 KEFENG ROAD, HIGH-TECH
INDUSTRIAL PARK, NANSHAN DISTRICT
SHENZHEN CITY, CHINA

FOR: ELECTRIC POCKET TORCHES FOR LIGHTING; POCKET SEARCH LIGHTS; ELECTRIC
TORCHES FOR LIGHTING; FLASHLIGHTS; BURNERS FOR LAMPS; LAMPS, IN CLASS
11 (U.S. CLS. 13, 21, 23, 31 AND 34).

THE MARK CONSISTS OF STANDARD CHARACTERS WITHOUT CLAIM TO ANY PAR-
TICULAR FONT, STYLE, SIZE, OR COLOR.

OWNER OF INTERNATIONAL REGISTRATION 1091226 DATED 8-16-2011, EXPIRES 8-16-
2021.

SER. NO. 79-102,739, FILED 8-16-2011.

JAMES MACFARLANE, EXAMINING ATTORNEY



David J. Kyffers

Director of the United States Patent and Trademark Office

United States of America

United States Patent and Trademark Office

htlInternational

Reg. No. 4,173,585

Registered July 17, 2012

Int. Cl.: 20

TRADEMARK

PRINCIPAL REGISTER

HTL INTERNATIONAL HOLDINGS LIMITED (SINGAPORE LIMITED COMPANY)
11, GUL CIRCLE
SINGAPORE 629567
SINGAPORE

FOR: SOFAS; FURNITURE, IN CLASS 20 (U.S. CLS. 2, 13, 22, 25, 32 AND 50).

OWNER OF U.S. REG. NO. 3,130,047.

OWNER OF INTERNATIONAL REGISTRATION 1091289 DATED 8-16-2011, EXPIRES 8-16-2021.

SER. NO. 79-102,764, FILED 8-16-2011.

JAMES MACFARLANE, EXAMINING ATTORNEY



David J. Kybas

Director of the United States Patent and Trademark Office

United States of America

United States Patent and Trademark Office

nonvert

Reg. No. 4,173,586

Registered July 17, 2012

Int. Cl.: 35

SERVICE MARK

PRINCIPAL REGISTER

HARMONY INTERNET LTD (UNITED KINGDOM CORPORATION)
3 THE GRANARY BUILDINGS
DUNTON
BEDFORDSHIRE SG18 8RH, UNITED KINGDOM

FOR: ADVERTISING; ADVERTISING SERVICES PROVIDED VIA THE INTERNET, IN CLASS 35 (U.S. CLS. 100, 101 AND 102).

THE MARK CONSISTS OF STANDARD CHARACTERS WITHOUT CLAIM TO ANY PARTICULAR FONT, STYLE, SIZE, OR COLOR.

OWNER OF INTERNATIONAL REGISTRATION 1091297 DATED 8-20-2011, EXPIRES 8-20-2021.

THE WORDING "NONVERT" HAS NO MEANING IN A FOREIGN LANGUAGE.

SER. NO. 79-102,767, FILED 8-20-2011.

KATHY DE JONGE, EXAMINING ATTORNEY



David J. Kyffers

Director of the United States Patent and Trademark Office

United States of America
United States Patent and Trademark Office

MOSARE

Reg. No. 4,173,587

Registered July 17, 2012

Int. Cls.: 9 and 42

TRADEMARK

SERVICE MARK

PRINCIPAL REGISTER

VEOLIA EAU-COMPAGNIE GENERALE DES EAUX (FRANCE SOCIÉTÉ EN COMMANDITE
PAR ACTIONS (SCA))
52 RUE D'ANJOU
PARIS, FRANCE F75008

FOR: RECORDED COMPUTER SOFTWARE FOR PLANNING THE REHABILITATION,
MAINTENANCE AND REPAIR OF THE COMPONENT PARTS OF WATER AND HEAT
SUPPLY SYSTEMS, NAMELY, PIPEWORKS, CONNECTIONS, AND EQUIPMENT, FOR
PURPOSES OF IMPROVING THE PERFORMANCE OF THESE SYSTEMS BY MANAGING
RELATED COSTS AND RISKS, IN CLASS 9 (U.S. CLS. 21, 23, 26, 36 AND 38).

FOR: DEVELOPMENT, DESIGN, INSTALLATION, MAINTENANCE, UPDATING AND
RENTAL OF RECORDED COMPUTER SOFTWARE FOR PLANNING THE REHABILITATION,
MAINTENANCE AND REPAIR OF WATER AND HEAT SUPPLY SYSTEMS FOR PURPOSES
OF IMPROVING THE PERFORMANCE OF THESE SYSTEMS BY MANAGING RELATED
COSTS AND RISKS, IN CLASS 42 (U.S. CLS. 100 AND 101).

THE MARK CONSISTS OF STANDARD CHARACTERS WITHOUT CLAIM TO ANY PAR-
TICULAR FONT, STYLE, SIZE, OR COLOR.

PRIORITY DATE OF 2-18-2011 IS CLAIMED.

OWNER OF INTERNATIONAL REGISTRATION 1091376 DATED 8-2-2011, EXPIRES 8-2-
2021.

SER. NO. 79-102,790, FILED 8-2-2011.

MARC LEIPZIG, EXAMINING ATTORNEY



David J. Kypos

Director of the United States Patent and Trademark Office

United States of America
United States Patent and Trademark Office

Lubesnow

Reg. No. 4,173,588

BUCHER AG LANGENTHAL (SWITZERLAND AKTIENGESELLSCHAFT)
BERN-ZÜRICH-STRASSE 31
CH-4900 LANGENTHAL, SWITZERLAND

Registered July 17, 2012

Int. Cl.: 4

FOR: LUBRICANTS FOR INDUSTRIAL MACHINERY IN THE NATURE OF SYNTHETIC LUBRICATING FOAM FOR MECHANICAL PARTS IN MOTION, IN CLASS 4 (U.S. CLS. 1, 6 AND 15).

TRADEMARK

THE MARK CONSISTS OF STANDARD CHARACTERS WITHOUT CLAIM TO ANY PARTICULAR FONT, STYLE, SIZE, OR COLOR.

PRINCIPAL REGISTER

PRIORITY DATE OF 4-19-2011 IS CLAIMED.

OWNER OF INTERNATIONAL REGISTRATION 1091434 DATED 8-30-2011, EXPIRES 8-30-2021.

THE WORD "LUBESNOW" HAS NO MEANING IN A FOREIGN LANGUAGE.

SER. NO. 79-102,812, FILED 8-30-2011.

COLLEEN KEARNEY, EXAMINING ATTORNEY



David J. Kyffers

Director of the United States Patent and Trademark Office

United States of America

United States Patent and Trademark Office



Reg. No. 4,173,589

Registered July 17, 2012

Int. Cl.: 7

DEMIR OTOPARK VE STOK SISTEMLERİ MÜHENDİSLİK MAKİNE LTD. STİ. (TURKEY LIMITED COMPANY)
DEMETGÜL MAHALLESİ 95. SOKAK 46/A
YENİMAHALLE - ANKARA
TURKEY

TRADEMARK

PRINCIPAL REGISTER

FOR: PARKING DEVICES, PARKING INSTALLATIONS AND PARKING SYSTEMS FOR MOTOR VEHICLES, THAT CONSIST OF PLATFORMS, CABINS OR DRIVE WAYS MANUFACTURED FROM STEEL COMPONENTS AND PAINTED OR GALVANIZED FOR PROTECTION, LIFTED BY ELECTRICAL MOTORS OR HYDRAULIC PISTONS WHICH ARE MAINLY OPERATED BY ELECTRICITY, HAS A CARRYING CAPACITY OF 1, 2 OR MORE CARS AT ONE TIME, PROVIDING TO INCREASE THE PARKING SPACE TO 2 OR MORE TIMES BY MOVING CARS IN THE VERTICAL AND HORIZONTAL DIRECTION BY MEANS OF POWER-OPERATED LIFTS TO PARK, STORE AND MOVE THE CARS, HAVING SOME LOCKING SYSTEMS TO KEEP THE CARS SAFELY AT THEIR PARKED POSITIONS AND UNLOCKED BY MANUALLY OR AUTOMATICALLY BY THE SYSTEM ITSELF BY A UNLOCKING ROTOR; MACHINE OPERATED PLATFORMS CAPABLE OF STORING THE CARS ABOVE OR BELOW THE GROUND LEVEL TO CREATE MORE PARKING SPACE BY THE HYDRAULIC SYSTEMS CONSISTING OF HYDRAULIC CYLINDERS, HYDRAULIC PUMPS, PUMP OPERATING MOTORS, VALVES, HYDRAULIC OIL, PARKING CARS SEMI-AUTOMATICALLY (USER INTERFERENCE) OR FULLY-AUTOMATICALLY, IN CLASS 7 (U.S. CLS. 13, 19, 21, 23, 31, 34 AND 35).

NO CLAIM IS MADE TO THE EXCLUSIVE RIGHT TO USE "PARK", APART FROM THE MARK AS SHOWN.

PRIORITY DATE OF 6-13-2011 IS CLAIMED.

OWNER OF INTERNATIONAL REGISTRATION 1091446 DATED 7-4-2011, EXPIRES 7-4-2021.

THE COLOR(S) BLACK, WHITE AND ORANGE IS/ARE CLAIMED AS A FEATURE OF THE MARK.

THE MARK CONSISTS OF THE WORDS "PARK", "ON" AND "PARK". TWO "PARK" WORDS ARE IN WHITE AND "ON" IS IN BLACK. ALL THREE WORDS ARE IN SMALL LETTERS. "ON" IS CENTERED IN THE WHOLE SQUARE COVERING ALL WORDS INSIDE AND



David J. Kyros

Director of the United States Patent and Trademark Office

Reg. No. 4,173,589 TWO "PARK" WORDS ARE LOCATED ABOVE AND BELOW "ON". THE LETTERS "P" AND "K" ARE LOCATED SLIGHTLY BELOW THE "AR" FOR THE FIRST "PARK", AND THE LETTERS "P" AND "K" ARE LOCATED SLIGHTLY ABOVE THE "AR" FOR THE SECOND "PARK". THE SQUARE COLOR IS ORANGE. THE COLORS ARE WHITE, BLACK AND ORANGE. ORANGE COLOR` S CMYK CODES ARE "C : 0 / M : 30 / Y : 100 / K : 0".

SER. NO. 79-102,814, FILED 7-4-2011.

DAVID I, EXAMINING ATTORNEY

United States of America

United States Patent and Trademark Office



Reg. No. 4,173,590

Registered July 17, 2012

Int. Cls.: 29 and 30

TRADEMARK

PRINCIPAL REGISTER

GRANDI SALUMIFICI ITALIANI S.P.A. (ITALY JOINT STOCK COMPANY)
STRADA GHERBELLA, 320
I-41126 MODENA (MO)
ITALY

FOR: MEAT, FISH, POULTRY AND GAME; PREPARATIONS FOR STUFFING PASTA MADE FROM MEAT, FISH, POULTRY, GAME; MEAT EXTRACTS; COOKED, SEASONED, SMOKED CHARCUTERIE OF ALL KIND OF MEAT; SAUSAGES IN THE NATURE OF WURSTEL; SPREADABLE PATE OF ANY KIND AND OF ANY FLAVOR, PATE MADE FROM MEAT, FISH, POULTRY, GAME, VEGETARIAN PATE, MEAT PRODUCTS; PRESERVED, FROZEN, DRIED AND COOKED, FRUITS AND VEGETABLES; FRUIT PRESERVES, JELLIES, JAMS, COMPOTES; BROTH, EGGS, MILK AND MILK PRODUCTS EXCLUDING ICE CREAM, ICE MILK AND FROZEN YOGURT; CHEESE, CHEESE PRODUCTS, NAMELY, CREAM CHEESE, EDIBLE OILS AND EDIBLE FATS, IN CLASS 29 (U.S. CL. 46).

FOR: COFFEE, TEA, COCOA, SUGAR, RICE, TAPIOCA, SAGO, ARTIFICIAL COFFEE; FLOUR AND PREPARATIONS MADE FROM CEREALS, NAMELY, BREAKFAST CEREAL, BREAD, PASTRY AND CONFECTIONERY CHIPS FOR BAKING, ICES; HONEY, TREACLE; YEAST, BAKING-POWDER; SALT, MUSTARD; VINEGAR, SAUCES; SPICES; ICE, IN CLASS 30 (U.S. CL. 46).

NO CLAIM IS MADE TO THE EXCLUSIVE RIGHT TO USE "PARMIGIANI" AND "SALUMERIA", APART FROM THE MARK AS SHOWN.

PRIORITY DATE OF 7-15-2011 IS CLAIMED.

OWNER OF INTERNATIONAL REGISTRATION 1091540 DATED 7-22-2011, EXPIRES 7-22-2021.

THE MARK CONSISTS OF THE STYLIZED WORDING "FRATELLI PARMIGIANI" PLACED ON TWO LINES WHERE THE WRITING "PARMIGIANI" IS BIGGER THAN "FRATELLI"; UNDER SAID WORDINGS, THERE IS A RIBBON INSIDE WHICH THE WRITING "ALTA SALUMERIA" IS REPRODUCED; THE MARK MAY BE REPRODUCED IN EVERY COLOUR AND IN EVERY COMBINATION OF COLOURS.

THE ENGLISH TRANSLATION OF "FRATELLI PARMIGIANI ALTA SALUMERIA" IN THE MARK IS "BROTHERS PARMESAN HIGH DELICATESSEN".



David J. Kappas

Director of the United States Patent and Trademark Office

Reg. No. 4,173,590 SER. NO. 79-102,881, FILED 7-22-2011.

SEAN CROWLEY, EXAMINING ATTORNEY

United States of America

United States Patent and Trademark Office

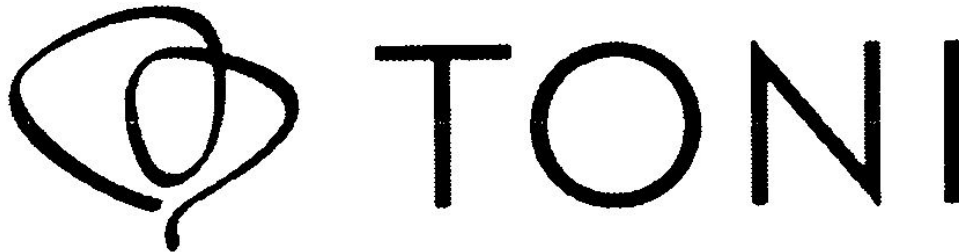

Reg. No. 4,173,591

Registered July 17, 2012

Int. Cl.: 25

TRADEMARK

PRINCIPAL REGISTER

WEBER & OTT AG (FED REP GERMANY AG)
KONRAD-OTT-STR. 1
91301 FORCHHEIM
FED REP GERMANY

FOR: CLOTHING, NAMELY, LADIES' SLACKS, PANTS, SHORTS, JEANS, JACKETS, TOPS,
ALL GOODS BEING LADIES' CLOTHING, IN CLASS 25 (U.S. CLS. 22 AND 39).

OWNER OF U.S. REG. NO. 3,679,853.

PRIORITY DATE OF 6-9-2011 IS CLAIMED.

OWNER OF INTERNATIONAL REGISTRATION 1091736 DATED 8-12-2011, EXPIRES 8-12-2021.

THE MARK CONSISTS OF THE WORDING "TONI" WITH A CURVE WAVE DESIGN.

SER. NO. 79-102,941, FILED 8-12-2011.

JOSETTE BEVERLY, EXAMINING ATTORNEY



David J. Kyffers

Director of the United States Patent and Trademark Office

United States of America
United States Patent and Trademark Office

SUGAR

Reg. No. 4,173,592

Registered July 17, 2012

Int. Cl.: 2

TRADEMARK

PRINCIPAL REGISTER

RAMSEYCORP PTY LTD AS TRUSTEE FOR THE HEATH RAMSEY FAMILY TRUST
(AUSTRALIA AUSTRALIAN PROPRIETARY LIMITED COMPANY)
4/7 INDIA STREET
CAPALABA QLD, AUSTRALIA 4157 AND

RAMSEYGATE PTY LTD AS TRUSTEE FOR THE LEVI RAMSEY FAMILY TRUST
(AUSTRALIA AUSTRALIAN PROPRIETARY LIMITED COMPANY)
4/7 INDIA STREET
CAPALABA QLD, AUSTRALIA 4157

FOR: PAINTS; PAINTS FOR THE PREVENTION OF RUST; PAINTS FOR USE IN PREVENTING MOULD; SEALANTS IN THE NATURE OF PAINTS; ENAMEL PAINTS; VARNISHES; FIXATIVES IN SPRAY FORM FOR INDUSTRIAL USE IN THE NATURE OF AN ACRYLIC PROTECTIVE COATING; MORDANT DYES; LACQUERS; LACQUERS IN THE NATURE OF PAINTS; PAINTS FOR USE AS CEMENT PRESERVATIVES; PAINTS FOR USE AS MASONRY PRESERVATIVES; PAINTS FOR USE AS METAL PRESERVATIVES; PRESERVATIVES AGAINST RUST IN THE NATURE OF A COATING; WOOD PRESERVATIVES; PAINTS FOR USE AS WEATHERING PRESERVATIVES; COLORANTS, IN CLASS 2 (U.S. CLS. 6, 11 AND 16).

THE MARK CONSISTS OF STANDARD CHARACTERS WITHOUT CLAIM TO ANY PARTICULAR FONT, STYLE, SIZE, OR COLOR.

PRIORITY DATE OF 8-4-2011 IS CLAIMED.

OWNER OF INTERNATIONAL REGISTRATION 1091822 DATED 8-26-2011, EXPIRES 8-26-2021.

SER. NO. 79-102,974, FILED 8-26-2011.

KELLY TRUSILO, EXAMINING ATTORNEY



David J. Kyffers

Director of the United States Patent and Trademark Office

United States of America

United States Patent and Trademark Office

Act. Connect. Perfect.

Reg. No. 4,173,593

Registered July 17, 2012

Int. Cls.: 9 and 17

ERNI ELECTRONICS GMBH (FED REP GERMANY GESELLSCHAFT MIT BESCHRANKTER
HAFTUNG (GHBH))
SEESTRASSE 9
73099 ADELBERG
FED REP GERMANY

TRADEMARK

PRINCIPAL REGISTER

FOR: ELECTRICAL AND ELECTRONIC DEVICES, NAMELY, ELECTRICAL CONTACTS, ELECTRICAL CONTACT PINS, ELECTRICAL CONTACT SPRINGS, ELECTRICAL CONTACT SCREENING PLATES; PLUG CONNECTORS, PLUG CONNECTORS AND ELECTRICAL FITTINGS AND FASTENERS FOR BACKPLANES, NAMELY, PLUGS, ELECTRIC CONTACT PINS, HOUSING FOR BACKPLANES; ELECTRICAL WIRES, ELECTRIC CABLES, IN CLASS 9 (U.S. CLS. 21, 23, 26, 36 AND 38).

FOR: INSULATING PARTS MADE OF PLASTIC FOR ELECTRICAL WIRES, ELECTRICAL SWITCHES, PLUG CONNECTORS, IN CLASS 17 (U.S. CLS. 1, 5, 12, 13, 35 AND 50).

THE MARK CONSISTS OF STANDARD CHARACTERS WITHOUT CLAIM TO ANY PARTICULAR FONT, STYLE, SIZE, OR COLOR.

PRIORITY DATE OF 4-5-2011 IS CLAIMED.

OWNER OF INTERNATIONAL REGISTRATION 1092027 DATED 7-21-2011, EXPIRES 7-21-2021.

SER. NO. 79-103,047, FILED 7-21-2011.

CAROLINE WOOD, EXAMINING ATTORNEY



David J. Kyffers

Director of the United States Patent and Trademark Office

United States of America

United States Patent and Trademark Office

KaVo EXPERTgrip

Reg. No. 4,173,594

Registered July 17, 2012

Int. Cl.: 10

KALTENBACH & VOIGT GMBH (FED REP GERMANY GMBH (LIMITED LIABILITY COMPANY))
BISMARCKRING 39
88400 BIBERACH
FED REP GERMANY

TRADEMARK

FOR: DENTAL INSTRUMENTS, APPARATUS AND DEVICES, NAMELY, HAND AND ANGLE PIECES, IN CLASS 10 (U.S. CLS. 26, 39 AND 44).

PRINCIPAL REGISTER

THE MARK CONSISTS OF STANDARD CHARACTERS WITHOUT CLAIM TO ANY PARTICULAR FONT, STYLE, SIZE, OR COLOR.

PRIORITY DATE OF 2-10-2011 IS CLAIMED.

OWNER OF INTERNATIONAL REGISTRATION 1092093 DATED 8-3-2011, EXPIRES 8-3-2021.

OWNER OF U.S. REG. NOS. 597,438, 3,187,528 AND OTHERS.

SER. NO. 79-103,067, FILED 8-3-2011.

KATINA MISTER, EXAMINING ATTORNEY



David J. Kyffers

Director of the United States Patent and Trademark Office

United States of America

United States Patent and Trademark Office



Reg. No. 4,173,595

FREDDY S.P.A. (ITALY CORPORATION)
VIA GESÙ, 11
I-20121 MILANO, ITALY

Registered July 17, 2012

Int. Cl.: 28

FOR: GYMNASTICS AND SPORTS ARTICLES, NAMELY, BASKETBALL BASKETS COMPRISED OF BASKETBALL HOOPS AND NETS, BASEBALL NETS, NAMELY, PITCHING SCREENS, BEACH VOLLEYBALL NETS, HANDBALLS, ANKLE PROTECTORS, NAMELY, ANKLE PADS FOR ATHLETIC USE; RUNNING MATS, NAMELY, PERSONAL EXERCISE MATS, IN CLASS 28 (U.S. CLS. 22, 23, 38 AND 50).

TRADEMARK

PRINCIPAL REGISTER

OWNER OF U.S. REG. NOS. 2,963,491, 3,256,743 AND OTHERS.

OWNER OF INTERNATIONAL REGISTRATION 0653358 DATED 3-19-1996, EXPIRES 3-19-2016.

THE MARK CONSISTS OF A STYLIZED DEPICTION OF A DANCING FIGURE COMPRISED OF AN OVAL, CURVED BAND AND A RECTANGULAR SHAPE WITH IRREGULAR EDGES.

SER. NO. 79-103,176, FILED 3-30-2010.

MARY CRAWFORD, EXAMINING ATTORNEY



David J. Kyffers

Director of the United States Patent and Trademark Office

United States of America

United States Patent and Trademark Office

COFILAC

Reg. No. 4,173,596

Registered July 17, 2012

Int. Cls.: 5 and 30

TRADEMARK

PRINCIPAL REGISTER

FEEDBACK TRAYER, S.L. (SPAIN SOCIEDAD LIMITADA)
C.C. MONTECLARO, LOCAL 16
E-28223 POZUELO DE ALARCON (MADRID), SPAIN

FOR: DIETETIC SUBSTANCES ADAPTED FOR MEDICAL USE, NAMELY, DIETARY SUPPLEMENTS; DIETARY SUPPLEMENTS TO IMPROVE AND PROMOTE INTESTINAL TRANSIT, DIETARY SUPPLEMENTS TO PROMOTE ABSORPTION OF MINERALS LIKE CALCIUM, AND DIETARY SUPPLEMENTS TO PROMOTE PREBIOTIC SUPPLEMENTATION; VITAMIN PREPARATIONS TO PROMOTE THE ABSORPTION OF CALCIUM AND TO IMPROVE INTESTINAL TRANSIT, IN CLASS 5 (U.S. CLS. 6, 18, 44, 46, 51 AND 52).

FOR: COFFEE AND ARTIFICIAL COFFEE, IN CLASS 30 (U.S. CL. 46).

THE MARK CONSISTS OF THE WORD "COFILAC" IN STYLIZED LETTERING; THE LETTER "O" IN THE WORD IS REPRESENTED AS A FILLED COFFEE CUP, VIEWED FROM ABOVE.

PRIORITY DATE OF 6-9-2011 IS CLAIMED.

OWNER OF INTERNATIONAL REGISTRATION 1092432 DATED 7-19-2011, EXPIRES 7-19-2021.

SER. NO. 79-103,206, FILED 7-19-2011.

HENRY S. ZAK, EXAMINING ATTORNEY



David J. Kybas

Director of the United States Patent and Trademark Office

United States of America

United States Patent and Trademark Office

FLOW FOCUSING

Reg. No. 4,173,597

Registered July 17, 2012

Int. Cls.: 9 and 42

TRADEMARK

SERVICE MARK

PRINCIPAL REGISTER

INGENIATRICS TECNOLOGIAS, S.L. (SPAIN SOCIEDAD LIMITADA)
AVENIDA AMÉRICO VESPUCIO, 5-E,
1ª PL., MÓD. 12; PARQUE CIENTÍFICO Y TECNOLÓGICO CARTUJA 93; E-41092 SEVILLA
SPAIN

FOR: SCIENTIFIC APPARATUS AND INSTRUMENTS, PARTICULARLY FOR HANDLING FLUIDS ON A MICROMETRIC AND NANOMETRIC SCALE AND DEVICES ENABLING CONTROL IN THE GENERATION OF MICROJETS, SIMPLE AND COMPLEX MICRO-PARTICLES, MICROFIBERS AND MICROBUBBLES, IN CLASS 9 (U.S. CLS. 21, 23, 26, 36 AND 38).

FOR: SCIENTIFIC AND TECHNOLOGICAL SERVICES, NAMELY, RESEARCH AND DESIGN IN THE FIELD OF GENETIC TESTING; ANALYSIS SERVICES, ENGINEERING SERVICES AND SCIENTIFIC AND INDUSTRIAL RESEARCH SERVICES APPLIED TO THE FIELD OF MEDICINE, PHARMACOLOGY AND HEALTH SCIENCES; BIOLOGICAL, CHEMICAL AND BACTERIOLOGICAL RESEARCH AND ANALYSIS; GENETIC TESTING FOR SCIENTIFIC RESEARCH PURPOSES, IN CLASS 42 (U.S. CLS. 100 AND 101).

THE MARK CONSISTS OF STANDARD CHARACTERS WITHOUT CLAIM TO ANY PARTICULAR FONT, STYLE, SIZE, OR COLOR.

OWNER OF INTERNATIONAL REGISTRATION 1092640 DATED 7-22-2011, EXPIRES 7-22-2021.

SER. NO. 79-103,280, FILED 7-22-2011.

NAKIA HENRY, EXAMINING ATTORNEY



David J. Kypos

Director of the United States Patent and Trademark Office

United States of America

United States Patent and Trademark Office



Reg. No. 4,173,598

Registered July 17, 2012

Int. Cl.: 19

TRADEMARK

PRINCIPAL REGISTER

UNICOM S.R.L. (ITALY LIMITED LIABILITY COMPANY)
VIA FLUMENDOSA, 7
I-41042 SPEZZANO DI FIORANO (MO)
ITALY

FOR: CERAMIC MATERIAL, NAMELY, CERAMIC TILES FOR FLOORS AND COVERINGS,
IN CLASS 19 (U.S. CLS. 1, 12, 33 AND 50).

OWNER OF U.S. REG. NO. 3,882,761.

PRIORITY DATE OF 7-28-2011 IS CLAIMED.

OWNER OF INTERNATIONAL REGISTRATION 1092671 DATED 7-29-2011, EXPIRES 7-29-2021.

THE MARK CONSISTS OF THE WRITING "UNICOMSTARKER" IN FANCY LOWER-CASE.
TO THE LEFT SIDE OF SAID WRITING THERE IS A FANCY STYLIZED FIGURE COMPOSED
OF SPHERICAL DOTS OF DIFFERENT SIZE.

SER. NO. 79-103,293, FILED 7-29-2011.

JAMES STEIN, EXAMINING ATTORNEY



David J. Kybas

Director of the United States Patent and Trademark Office

United States of America

United States Patent and Trademark Office

SAELOX

Reg. No. 4,173,599

Registered July 17, 2012

Int. Cls.: 6 and 20

SÄLZER SICHERHEITSTECHNIK GMBH (FED REP GERMANY LIMITED LIABILITY COMPANY)
DIETRICH-BONHOEFFER-STRABE 1-3
35037 MARBURG
FED REP GERMANY

TRADEMARK

PRINCIPAL REGISTER

FOR: METAL SITTINGS FOR WINDOWS, DOORS, GATES, FACADES, ESPECIALLY NON-ELECTRICAL METAL LOCKS, METAL STRIPES IN THE NATURE OF HINGES THAT ARE USED TO PIVOTALLY CONNECT WINDOWS, DOORS OR GATES TO A SUPPORT, METAL ANCHORAGE CONNECTORS, METAL LOCKING DEVICES, METAL T-SHAPED AND CORNER CONNECTIONS, AND TURN, SWING, TILT, CLICK AND TURN AND TILT METAL FITTINGS, ALL AFOREMENTIONED GOODS INCLUDED IN THIS CLASS, IN CLASS 6 (U.S. CLS. 2, 12, 13, 14, 23, 25 AND 50).

FOR: NON-METAL SITTINGS FOR WINDOWS, DOORS, GATES, FACADES, ESPECIALLY NON-ELECTRICAL NON-METAL LOCKS NON-METAL STRIPES IN THE NATURE OF HINGES THAT ARE USED TO PIVOTALLY CONNECT WINDOWS, DOORS OR GATES TO A SUPPORT, NON-METAL ANCHORAGE CONNECTORS NON-METAL LOCKING DEVICES, NON-METAL T-SHAPED AND CORNER CONNECTIONS, AND TURN, SWING, TILT, CLICK AND TURN AND TILT NON-METAL FITTINGS, ALL AFOREMENTIONED GOODS INCLUDED IN THIS CLASS, IN CLASS 20 (U.S. CLS. 2, 13, 22, 25, 32 AND 50).

THE MARK CONSISTS OF STANDARD CHARACTERS WITHOUT CLAIM TO ANY PARTICULAR FONT, STYLE, SIZE, OR COLOR.

PRIORITY DATE OF 4-13-2011 IS CLAIMED.

OWNER OF INTERNATIONAL REGISTRATION 1092726 DATED 7-26-2011, EXPIRES 7-26-2021.

SER. NO. 79-103,312, FILED 7-26-2011.

JOHN DWYER, EXAMINING ATTORNEY



David J. Kyros

Director of the United States Patent and Trademark Office

United States of America

United States Patent and Trademark Office

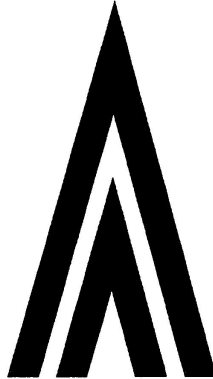

Reg. No. 4,173,600

Registered July 17, 2012

Int. Cl.: 11

TRADEMARK

PRINCIPAL REGISTER

ECLAIRAGE ROGER PRADIER (FRANCE SOCIÉTÉ ANONYME)
46 AV. D'OCCITANIE, CAP SUD
F-36250 ST MAUR
FRANCE

FOR: LIGHTING APPARATUS AND INSTALLATIONS, NAMELY, WALL LAMPS, LAMP POSTS, SUSPENSION LAMPS, TABLE LAMPS, PORTABLE LAMPS, CEILING LIGHTS, LAMPS AND LIGHT BULBS, IN CLASS 11 (U.S. CLS. 13, 21, 23, 31 AND 34).

THE MARK CONSISTS OF A STYLIZED LETTER "A".

PRIORITY DATE OF 6-1-2011 IS CLAIMED.

OWNER OF INTERNATIONAL REGISTRATION 1092914 DATED 9-5-2011, EXPIRES 9-5-2021.

SER. NO. 79-103,371, FILED 9-5-2011.

HEATHER BIDDULPH, EXAMINING ATTORNEY



David J. Kybas

Director of the United States Patent and Trademark Office

United States of America

United States Patent and Trademark Office

泰 瑞

TAI RUI

Reg. No. 4,173,601

Registered July 17, 2012

Int. Cl.: 5

TRADEMARK

PRINCIPAL REGISTER

NINGXIA TAIRUI PHARMACEUTICAL CO., LTD. (CHINA CORPORATION)
WANGYUAN ECONOMIC ZONE
YONGNING COUNTY, YINCHUAN
NINGXIA, CHINA

FOR: VETERINARY PREPARATIONS FOR PAIN RELIEF; VETERINARY PREPARATIONS FOR TREATMENT OF INTESTINAL BACTERIA; ENZYMES FOR VETERINARY PURPOSES; CATTLE WASHES, NAMELY, ANTISEPTIC WASHES; BIOLOGICAL PREPARATIONS FOR VETERINARY PURPOSES FOR PAIN RELIEF; BIOLOGICAL PREPARATIONS FOR VETERINARY PURPOSES FOR TREATMENT OF INTESTINAL BACTERIA; CHEMICAL PREPARATIONS FOR VETERINARY PURPOSES FOR PAIN RELIEF; CHEMICAL PREPARATIONS FOR TREATMENT OF INTESTINAL BACTERIA; ADDITIVES TO FODDER FOR MEDICAL PURPOSES, IN CLASS 5 (U.S. CLS. 6, 18, 44, 46, 51 AND 52).

THE MARK CONSISTS OF THE WORDING "TAI RUI" IN STYLIZED FONT BELOW TWO CHINESE CHARACTERS.

OWNER OF INTERNATIONAL REGISTRATION 1093054 DATED 9-5-2011, EXPIRES 9-5-2021.

THE ENGLISH TRANSLATION OF THE FOREIGN WORDS IN THE MARK IS: "TAI" MEANS SAFE; "RUI" MEANS LUCKY. THE CREATED COMBINATION, WHEN READ TOGETHER, CONVEYS NO SPECIAL MEANING.

SER. NO. 79-103,433, FILED 9-5-2011.

HEATHER BIDDULPH, EXAMINING ATTORNEY



David J. Kyros

Director of the United States Patent and Trademark Office

United States of America

United States Patent and Trademark Office

dot2

Reg. No. 4,173,602

Registered July 17, 2012

Int. Cls.: 9 and 11

MA LIGHTING TECHNOLOGY GMBH (FED REP GERMANY LIMITED LIABILITY COMPANY)
DACHDECKERSTRASSE 16
97297 WALDBÜTTELBRUNN
FED REP GERMANY

TRADEMARK

PRINCIPAL REGISTER

FOR: SCIENTIFIC, NAUTICAL, SURVEYING, PHOTOGRAPHIC, CINEMATOGRAPHIC, OPTICAL, WEIGHING, MEASURING, REGULATING, SIGNALING, CHECKING APPARATUS AND INSTRUMENTS, NAMELY, LIGHTING CONSOLES, INTEGRATED MEDIA SERVERS AND SIGNAL PROCESSING UNITS TO CONTROL SHOW, STUDIO AND STAGE LIGHTING; APPARATUS AND INSTRUMENTS FOR CONDUCTING, SWITCHING, TRANSFORMING, ACCUMULATING, REGULATING OR CONTROLLING ELECTRICITY, NAMELY, ELECTRIC CIRCUIT SWITCHES; AUTOMATIC VENDING MACHINES AND MECHANISMS FOR COIN OPERATED APPARATUS; CASH REGISTERS, CALCULATING MACHINES, FIRE EXTINGUISHING APPARATUS; STAGE LIGHTING REGULATORS; ELECTRICITY POWER SUPPLY UNITS; ELECTRICITY POWER DISTRIBUTION UNITS; LIGHTING BALLASTS; ELECTRIFIED RAILS FOR MOUNTING SPOT LIGHTS, IN CLASS 9 (U.S. CLS. 21, 23, 26, 36 AND 38).

FOR: APPARATUS FOR LIGHTING, HEATING, STEAM GENERATING, COOKING, REFRIGERATING, DRYING, VENTILATING, WATER SUPPLY AND SANITARY PURPOSES, NAMELY, SPOT LIGHTS; LIGHTING APPARATUS AND INSTALLATIONS, NAMELY, SPOT LIGHTS AND LAMPS; LIGHTING SYSTEMS COMPRISED PRIMARILY OF SPOT LIGHTS FOR LIGHTING STAGES, SPOT LIGHTS INTENDED FOR THEATERS, STUDIOS, FAIRS, EXHIBITIONS AND STAGES; LAMPS; COLOUR-CHANGING DEVICES FOR LIGHTING APPARATUS AND LIGHTING INSTALLATIONS, NAMELY, COLOR FILTERS FOR USE IN LIGHTING INSTRUMENTS; PROTECTION DEVICES FOR LIGHTS, NAMELY, FITTED COVERS FOR SPOT LIGHTS, IN CLASS 11 (U.S. CLS. 13, 21, 23, 31 AND 34).

THE MARK CONSISTS OF STANDARD CHARACTERS WITHOUT CLAIM TO ANY PARTICULAR FONT, STYLE, SIZE, OR COLOR.

PRIORITY DATE OF 2-8-2011 IS CLAIMED.

OWNER OF INTERNATIONAL REGISTRATION 1093203 DATED 8-4-2011, EXPIRES 8-4-2021.



David J. Kappas

Director of the United States Patent and Trademark Office

Reg. No. 4,173,602 SER. NO. 79-103,528, FILED 8-4-2011.

SEAN CROWLEY, EXAMINING ATTORNEY

United States of America

United States Patent and Trademark Office



Reg. No. 4,173,603

Registered July 17, 2012

Int. Cl.: 26

TRADEMARK

PRINCIPAL REGISTER

JIANGXI STYLER INDUSTRIAL CO., LTD. (CHINA CORPORATION)
INDUSTRIAL AVEA
ECONOMIC DEVELOPMENT ZONE,; YICHUN; JIANGXI
CHINA

FOR: EXPANDING BANDS FOR HOLDING SLEEVES; HAIR ORNAMENTS; BUTTONS;
FALSE HAIR; NEEDLES; ARTIFICIAL FLOWERS; COLLAR STAYS; HEAT ADHESIVE
PATCHES FOR REPAIRING TEXTILE ARTICLES; MARKING PINS; TEA COSIES, IN CLASS
26 (U.S. CLS. 37, 39, 40, 42 AND 50).

THE MARK CONSISTS OF THE WORDING "STYLER" IN STYLIZED FONT AND A STYL-
IZED BUTTERFLY.

OWNER OF INTERNATIONAL REGISTRATION 1093298 DATED 9-5-2011, EXPIRES 9-5-
2021.

SER. NO. 79-103,563, FILED 9-5-2011.

HEATHER BIDDULPH, EXAMINING ATTORNEY



David J. Kyffers

Director of the United States Patent and Trademark Office

United States of America

United States Patent and Trademark Office

VingCard Elsafe

Reg. No. 4,173,604

VINGCARD ELSAFE AS (NORWAY AS)

Registered July 17, 2012

SOPHUS LIES VEI
MOSS, NORWAY N1523

Int. Cls.: 6, 9 and 45

FOR: LOCKS OF METAL; MECHANICAL LOCKS, NAMELY, METAL LOCKING MECHANISMS; KEYCARD OPERATED LOCKS OF METAL, OTHER THAN ELECTRIC; METAL KEYS FOR LOCKS AND SAFES; METAL SAFES; ELECTRONIC SAFES; SAFETY DEPOSIT BOXES; STRUCTURAL PARTS AND EQUIPMENT FOR ALL THE AFOREMENTIONED GOODS, IN CLASS 6 (U.S. CLS. 2, 12, 13, 14, 23, 25 AND 50).

TRADEMARK

SERVICE MARK

PRINCIPAL REGISTER

FOR: ELECTRIC AND ELECTRONIC LOCKS; ELECTRIC AND ELECTRONIC KEYCARD OPERATED LOCKS; MICROPROCESSORS FOR OPERATING LOCKING MECHANISMS; SECURITY SYSTEMS COMPRISED OF COMPUTER PROGRAMS, KEYCARDS, KEYPADS, ENCODERS AND ACCESS CONTROL DEVICES FOR HOTELS, HOMES AND COMPANIES/ENTERPRISES; MAGNETIC CARDS FOR OPERATING SAFES, LOCKS, LIGHTS AND HEATING AND AIR CONDITIONING UNITS; ENCODED SMART CARDS AND RFID CARDS (RADIO FREQUENCY IDENTIFICATION) FOR SAFES AND LOCKS; SOFTWARE FOR OPERATING, MANAGING AND MAINTENANCE OF SAFES AND LOCKS; HANDHELD COMPUTERS AND DEVICES FOR OPERATING, MANAGING AND MAINTENANCE OF SAFES AND LOCKS; COMPUTER KEYPADS AND KEYPADS FOR PROGRAMMABLE LOCKS AND SAFES; ELECTRONIC CARD READERS; ELECTRIC AND ELECTRONIC ACCESS CONTROLS FOR ACCESSING SECURE AREAS AND FOR ACCESSING AND OPERATING LOCKS, DOORS AND ELEVATORS; STRUCTURAL PARTS FOR ALL THE AFOREMENTIONED GOODS; OPERATIONAL COMPUTER PROGRAMS AND ELECTRONIC KEY CARDS FOR ALL THE AFOREMENTIONED GOODS, IN CLASS 9 (U.S. CLS. 21, 23, 26, 36 AND 38).



FOR: GUARD- AND SECURITY SERVICES FOR HOTELS, HOMES AND COMPANIES/ENTERPRISES; SECURITY CONSULTANCY IN THE FIELD OF PHYSICAL SECURITY SYSTEMS, LOCKS, LOCKING SYSTEMS AND SAFES, IN CLASS 45 (U.S. CLS. 100 AND 101).

THE MARK CONSISTS OF STANDARD CHARACTERS WITHOUT CLAIM TO ANY PARTICULAR FONT, STYLE, SIZE, OR COLOR.

David J. Kyffers

PRIORITY DATE OF 1-10-2011 IS CLAIMED.

Reg. No. 4,173,604 OWNER OF INTERNATIONAL REGISTRATION 1093721 DATED 6-17-2011, EXPIRES 6-17-2021.

OWNER OF U.S. REG. NOS. 1,310,856, 3,272,596 AND OTHERS.

SER. NO. 79-103,722, FILED 6-17-2011.

MARGERY A. TIERNEY, EXAMINING ATTORNEY

United States of America

United States Patent and Trademark Office

FLOW BLURRING

Reg. No. 4,173,605

Registered July 17, 2012

Int. Cls.: 9, 11 and 42

TRADEMARK

SERVICE MARK

PRINCIPAL REGISTER

INGENIATRICS TECNOLOGIAS, S.L. (SPAIN SOCIEDAD LIMITADA)
AVENIDA AMÉRICO VESPUCIO, 5-E,
1ª PL., MÓD. 12; PARQUE CIENTÍFICO Y TECNOLÓGICO CARTUJA 93; E-41092 SEVILLA
SPAIN

FOR: SCIENTIFIC APPARATUS AND INSTRUMENTS, PARTICULARLY FOR HANDLING FLUIDS AT A MICRO AND NANOMETRIC SCALE AND DEVICES FOR CONTROLLING THE PRODUCTION OF MICROJETS, SIMPLE AND COMPLEX MICRODROPS, SIMPLE AND COMPLEX MICROPARTICLES, MICROEMULSIONS, MICROFIBERS AND MICRO-BUBBLES, IN CLASS 9 (U.S. CLS. 21, 23, 26, 36 AND 38).

FOR: APPARATUS FOR HEATING, STEAM GENERATING, REFRIGERATING, DRYING, VENTILATING, WATER SUPPLY AND SANITARY INSTALLATIONS FOR EVAPORATIVE REFRIGERATION SYSTEMS, IN CLASS 11 (U.S. CLS. 13, 21, 23, 31 AND 34).

FOR: SCIENTIFIC AND TECHNOLOGICAL SERVICES, NAMELY, RESEARCH AND DESIGN IN THE FIELD OF GENETIC TESTING, AND PRODUCT DEVELOPMENT OF GENETIC TESTS; ANALYSIS SERVICES, SPECIFICALLY BIOLOGICAL, GENETIC MAPPING FOR SCIENTIFIC PURPOSES, BIO-PHYSIOLOGICAL, CHEMICAL AND BACTERIOLOGICAL ANALYSIS SERVICES; INDUSTRIAL AND SCIENTIFIC RESEARCH AND ENGINEERING SERVICES APPLIED TO THE FIELD OF MEDICINE, BIOTECHNOLOGY, PHARMACOLOGY, SCIENCE IN CONNECTION WITH HEALTH, PLANTS, COSMETICS, VETERINARY AND HUMAN CONSUMPTION AND INDUSTRIAL RESEARCH APPLIED TO TEXTILES; GENETIC TESTING FOR SCIENTIFIC RESEARCH PURPOSES, IN CLASS 42 (U.S. CLS. 100 AND 101).

THE MARK CONSISTS OF STANDARD CHARACTERS WITHOUT CLAIM TO ANY PARTICULAR FONT, STYLE, SIZE, OR COLOR.

OWNER OF INTERNATIONAL REGISTRATION 1093905 DATED 7-22-2011, EXPIRES 7-22-2021.

SER. NO. 79-103,810, FILED 7-22-2011.

NAKIA HENRY, EXAMINING ATTORNEY



David J. Kyros

Director of the United States Patent and Trademark Office

United States of America

United States Patent and Trademark Office



geomecon
GmbH

Reg. No. 4,173,606

DR. TOBIAS BACKERS (FED REP GERMANY INDIVIDUAL)

Registered July 17, 2012

BAHRFELDTSTR. 39A
BERLIN, FED REP GERMANY

Int. Cls.: 35 and 42

FOR: COLLECTION, SYSTEMATIZATION AND COMPILATION OF GEOMECHANICAL, GEOHYDRAULIC, GEOTHERMAL, GEOPHYSICAL, STRUCTURAL GEOLOGICAL AND TECTONIC DATA STORED IN COMPUTER DATABASES; COMPILATION AND SYSTEMATIZATION OF INFORMATION IN COMPUTER DATABANKS, IN CLASS 35 (U.S. CLS. 100, 101 AND 102).

SERVICE MARK

PRINCIPAL REGISTER

FOR: MATERIAL TESTING, NAMELY, THE DETERMINATION OF GEOMECHANICAL, GEOHYDRAULIC, GEOTHERMAL, GEOPHYSICAL, STRUCTURAL GEOLOGICAL AND TECTONIC PARAMETERS; GEOLOGICAL RESEARCH, NAMELY, GEOMECHANICAL, GEOHYDRAULIC, GEOTHERMAL, GEOPHYSICAL, STRUCTURAL GEOLOGICAL AND TECTONIC RESEARCH; GEOLOGICAL SERVICES, NAMELY, GEOMECHANICAL, GEOHYDRAULIC, GEOTHERMAL, GEOPHYSICAL, STRUCTURAL GEOLOGICAL AND TECTONIC ADVISORY SERVICES; GEOLOGICAL ANALYTICAL SERVICES, NAMELY, GEOMECHANICAL, GEOHYDRAULIC, GEOTHERMAL, GEOPHYSICAL, STRUCTURAL GEOLOGICAL AND TECTONIC ANALYSES; DESIGN AND DEVELOPMENT OF COMPUTER SOFTWARE, NAMELY, SOFTWARE FOR THE SIMULATION OF GEOMECHANICAL, GEOHYDRAULIC AND GEOPHYSICAL PROCESSES, AS WELL AS THOSE RELATING TO RUPTURE MECHANICS; INSTALLATION AND MAINTENANCE OF COMPUTER SOFTWARE, IN CLASS 42 (U.S. CLS. 100 AND 101).



NO CLAIM IS MADE TO THE EXCLUSIVE RIGHT TO USE "GMBH", APART FROM THE MARK AS SHOWN.

PRIORITY DATE OF 12-14-2010 IS CLAIMED.

OWNER OF INTERNATIONAL REGISTRATION 1094092 DATED 6-14-2011, EXPIRES 6-14-2021.

THE COLOR(S) RED, BLUE AND GREY IS/ARE CLAIMED AS A FEATURE OF THE MARK.

David J. Kyffers

THE MARK CONSISTS OF : THE TERM "GEO" IS RED, THE TERM "MECON" IS BLUE, THE LETTERS "GMBH" ARE GREY, AND THERE IS A GREY LINE BEGINNING AT THE

Reg. No. 4,173,606 BOTTOM OF THE LETTER G, CURVING UPWARDS THROUGH THE M AND THEN CURVING OVER THE TERM "MECON" ENDING AT THE "N".

SER. NO. 79-103,870, FILED 6-14-2011.

MARK T. MULLEN, EXAMINING ATTORNEY

United States of America

United States Patent and Trademark Office

HOLIDAY

INTERNATIONAL MEN'S APPAREL REVUE

Reg. No. 4,173,607

Registered July 17, 2012

Int. Cls.: 16 and 41

TRADEMARK

SERVICE MARK

PRINCIPAL REGISTER

DURAND FRANCK (FRANCE INDIVIDUAL)
15 VILLA CLAUDE LORRAIN
F-75016 PARIS
FRANCE

FOR: JOURNALS, MAGAZINES, NEWSPAPERS, BOOKS, ALL THE AFOREMENTIONED GOODS RELATING TO FASHION, IN CLASS 16 (U.S. CLS. 2, 5, 22, 23, 29, 37, 38 AND 50).

FOR: PUBLICATION OF BOOKS, JOURNALS, MAGAZINES, NEWSPAPERS, ELECTRONIC DESKTOP PUBLISHING, ALL THE AFOREMENTIONED SERVICES RELATING TO FASHION, IN CLASS 41 (U.S. CLS. 100, 101 AND 107).

NO CLAIM IS MADE TO THE EXCLUSIVE RIGHT TO USE "INTERNATIONAL MEN'S APPAREL REVUE", APART FROM THE MARK AS SHOWN.

PRIORITY DATE OF 5-24-2011 IS CLAIMED.

OWNER OF INTERNATIONAL REGISTRATION 1094174 DATED 7-26-2011, EXPIRES 7-26-2021.

THE MARK CONSISTS OF THE STYLIZED WORDING "HOLIDAY" ON TOP OF THE STYLIZED WORDING "INTERNATIONAL MEN'S APPAREL REVUE".

SER. NO. 79-103,904, FILED 7-26-2011.

JENNIFER VASQUEZ, EXAMINING ATTORNEY



David J. Kyffers

Director of the United States Patent and Trademark Office

United States of America

United States Patent and Trademark Office



Reg. No. 4,173,608

Registered July 17, 2012

Int. Cl.: 20

TRADEMARK

PRINCIPAL REGISTER

CHUANG FENG CRAFTS FACTORY XIANJU (CHINA CORPORATION)
SOUTH TOWN INDUSTRY DISTRICT
XIANJU COUNTY; 317300 ZHEJIANG PROVINCE
CHINA

FOR: DESKS; OFFICE FURNITURE; FURNITURE; TABLES; BEDS; FURNITURE OF METAL,
SCREENS; PICTURE FRAMES; BAMBOO AND WOOD WORKS OF ART, IN CLASS 20 (U.S.
CLS. 2, 13, 22, 25, 32 AND 50).

OWNER OF INTERNATIONAL REGISTRATION 1094386 DATED 7-22-2011, EXPIRES 7-22-
2021.

THE NON-LATIN CHARACTERS IN THE MARK TRANSLITERATE TO "XIANFENG" AND
THIS HAS NO MEANING IN A FOREIGN LANGUAGE.

SER. NO. 79-103,976, FILED 7-22-2011.

NAKIA HENRY, EXAMINING ATTORNEY



David J. Kybas

Director of the United States Patent and Trademark Office

United States of America

United States Patent and Trademark Office

TOS

Reg. No. 4,173,609

Registered July 17, 2012

Int. Cls.: 37, 38 and 42

SERVICE MARK

PRINCIPAL REGISTER

MAPAL FABRIK FÜR PRÄZISIONSWERKZEUGE DR. KRESS KG (FED REP GERMANY LIMITED PARTNERSHIP)
OBERE BAHNSTRASSE 13
73431 AALEN, FED REP GERMANY

FOR: INSTALLING AND SETTING OF MACHINE-TOOLS FOR MACHINING METAL AND OTHER MATERIALS; INSTALLING, SETTING, ADJUSTING, TESTING, REPAIR, MAINTENANCE AND WORKING UP OF MEASURING AND TESTING INSTRUMENTS AS WELL AS OF CHUCKING IMPLEMENTS AND TOOLS, IN CLASS 37 (U.S. CLS. 100, 103 AND 106).

FOR: INTERNET ACCESS PROVIDER SERVICES, ESPECIALLY TO ALLOW USERS TO MAKE RETAIL TRANSACTIONS ONLINE; ON-LINE TRANSMISSION OF INFORMATION, TEXTS, DRAWINGS, TABLES AND IMAGES, AND INCLUDING THE GATHERING AND PROVISION OF THE AFOREMENTIONED, IN CLASS 38 (U.S. CLS. 100, 101 AND 104).

FOR: ENGINEERING SERVICES; SERVICES OF AN INFORMATION SCIENTIST, NAMELY, CONSULTING IN THE FIELD OF INFORMATION TECHNOLOGY; ENGINEERING SERVICES, NAMELY, TECHNICAL PROJECT PLANNING AND CONSTRUCTION PLANNING; ADVICE ON PROBLEMS OF PRODUCTION TECHNOLOGY, ESPECIALLY PLANNING AND ORGANIZATION OF PRODUCTION FLOWS, PLANNING OF WORKING STOCK, PRODUCTION PREPARATION, OPTIMIZING OF TECHNICAL PROCESSES AS WELL AS SELECTION OF PROPER TOOLS; RESEARCH AND DEVELOPMENT IN THE FIELD OF MACHINE-TOOLS MANUFACTURE; DRAWING UP OF OPERATION PLANS; ON-SITE AND REMOTE DIAGNOSIS OF WORKING PROCESSES IN MECHANICAL PRODUCTION; TECHNICAL SUPPORT TO PUTTING INTO OPERATION AND PROCESS OPTIMIZING OF PRODUCTION PLANTS; ANALYSIS, DESIGN AND OPTIMIZING OF PROCESS FLOWS IN MECHANICAL PRODUCTION; PROVIDING INFORMATION ON THE INTERNET ESPECIALLY IN THE FORM OF DESIGN AIDS, SELECTION CRITERIA AND POSSIBILITIES OF USE OF CHUCKING IMPLEMENT AND TOOLS, IN CLASS 42 (U.S. CLS. 100 AND 101).

THE MARK CONSISTS OF STANDARD CHARACTERS WITHOUT CLAIM TO ANY PARTICULAR FONT, STYLE, SIZE, OR COLOR.

OWNER OF INTERNATIONAL REGISTRATION 0765181 DATED 5-14-2001, EXPIRES 5-14-2021.

SER. NO. 79-104,089, FILED 5-17-2011.



David J. Kappas

Director of the United States Patent and Trademark Office

Reg. No. 4,173,609 KEVIN DINALLO, EXAMINING ATTORNEY

United States of America

United States Patent and Trademark Office

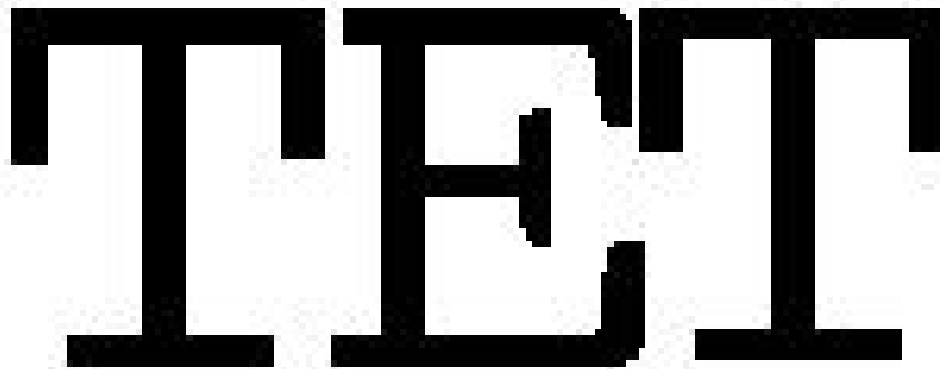

Reg. No. 4,173,610

Registered July 17, 2012

Int. Cls.: 37, 38 and 42

SERVICE MARK

PRINCIPAL REGISTER

MAPAL FABRIK FÜR PRÄZISIONSWERKZEUGE DR. KRESS KG (FED REP GERMANY LIMITED PARTNERSHIP)
OBERE BAHNSTRASSE 13
73431 AALEN, FED REP GERMANY

FOR: INSTALLING AND SETTING OF MACHINE-TOOLS FOR MACHINING METAL AND OTHER MATERIALS; INSTALLING, SETTING, ADJUSTING, TESTING, REPAIR, MAINTENANCE AND WORKING UP OF MEASURING AND TESTING INSTRUMENTS AS WELL AS OF CHUCKING IMPLEMENTS AND TOOLS, IN CLASS 37 (U.S. CLS. 100, 103 AND 106).

FOR: INTERNET ACCESS PROVIDER SERVICES, ESPECIALLY TO ALLOW USERS TO MAKE RETAIL TRANSACTIONS ONLINE; ON-LINE TRANSMISSION OF INFORMATION, TEXTS, DRAWINGS, TABLES AND IMAGES, AND INCLUDING THE GATHERING AND PROVISION OF THE AFOREMENTIONED, IN CLASS 38 (U.S. CLS. 100, 101 AND 104).

FOR: ENGINEERING SERVICES; SERVICES OF AN INFORMATION SCIENTIST, NAMELY, CONSULTING IN THE FIELD OF INFORMATION TECHNOLOGY; ENGINEERING SERVICES, NAMELY, TECHNICAL PROJECT PLANNING AND CONSTRUCTION PLANNING; ADVICE ON PROBLEMS OF PRODUCTION TECHNOLOGY, ESPECIALLY PLANNING AND ORGANIZATION OF PRODUCTION FLOWS, PLANNING OF WORKING STOCK, PRODUCTION PREPARATION, OPTIMIZING OF TECHNICAL PROCESSES AS WELL AS SELECTION OF PROPER TOOLS; RESEARCH AND DEVELOPMENT IN THE FIELD OF MACHINE-TOOLS MANUFACTURE; DRAWING UP OF OPERATION PLANS; ON-SITE AND REMOTE DIAGNOSIS OF WORKING PROCESSES IN MECHANICAL PRODUCTION; TECHNICAL SUPPORT TO PUTTING INTO OPERATION AND PROCESS OPTIMIZING OF PRODUCTION PLANTS; ANALYSIS, DESIGN AND OPTIMIZING OF PROCESS FLOWS IN MECHANICAL PRODUCTION; PROVIDING INFORMATION ON THE INTERNET ESPECIALLY IN THE FORM OF DESIGN AIDS, SELECTION CRITERIA AND POSSIBILITIES OF USE OF CHUCKING IMPLEMENT AND TOOLS, IN CLASS 42 (U.S. CLS. 100 AND 101).

THE MARK CONSISTS OF STANDARD CHARACTERS WITHOUT CLAIM TO ANY PARTICULAR FONT, STYLE, SIZE, OR COLOR.

OWNER OF INTERNATIONAL REGISTRATION 0765184 DATED 5-15-2001, EXPIRES 5-15-2021.

SER. NO. 79-104,091, FILED 5-17-2011.



David J. Kyjars

Director of the United States Patent and Trademark Office

Reg. No. 4,173,610 KEVIN DINALLO, EXAMINING ATTORNEY

United States of America

United States Patent and Trademark Office

Team Corporate

Reg. No. 4,173,611

Registered July 17, 2012

Int. Cls.: 9, 35, 38 and 42

TRADEMARK

SERVICE MARK

PRINCIPAL REGISTER

MOOD MEDIA (FRANCE SOCIÉTÉ PAR ACTIONS SIMPLIFIÉE (SAS))
ROUTE DÉPARTEMENTALE 307
F-78810 FEUCHEROLLES, FRANCE

FOR: CINEMATOGRAPHIC APPARATUS AND INSTRUMENTS; APPARATUS FOR RECORDING, TRANSMITTING AND REPRODUCING SOUND OR IMAGES, BLANK VIDEO-CASSETTES; PRERECORDED VIDEOCASSETTES FEATURING IMAGES, FILMS, SOUND AND MUSIC; MONITORS AND VIDEO CASSETTE PLAYERS, SOFTWARE FOR TRANSMITTING AND DISTRIBUTING IMAGES, SOUNDS AND MESSAGES VIA THE INTERNET, SOFTWARE FOR CREATING MULTIMEDIA PRODUCTS, IN CLASS 9 (U.S. CLS. 21, 23, 26, 36 AND 38).

FOR: ADVERTISING SERVICES BY MEANS OF DISTRIBUTING ADVERTISING RECORDED MESSAGES AND IMAGES, IN CLASS 35 (U.S. CLS. 100, 101 AND 102).

FOR: TRANSMISSION AND DISTRIBUTION SERVICES FOR IMAGES, SOUND AND MESSAGES VIA THE INTERNET, IN CLASS 38 (U.S. CLS. 100, 101 AND 104).

FOR: INTERIOR DECORATING SERVICES FOR VIDEOCASSETTE PROJECTION ROOMS; SOFTWARE DEVELOPMENT, UPDATING AND MAINTENANCE FOR TRANSMISSION AND DISTRIBUTION OF IMAGES, SOUNDS AND MESSAGES VIA THE INTERNET; SOFTWARE DEVELOPMENT, UPDATING AND MAINTENANCE FOR DATA ENCRYPTION; SOFTWARE DEVELOPMENT, UPDATING AND MAINTENANCE FOR CREATING MULTIMEDIA PRODUCTS, IN CLASS 42 (U.S. CLS. 100 AND 101).

NO CLAIM IS MADE TO THE EXCLUSIVE RIGHT TO USE "CORPORATE", APART FROM THE MARK AS SHOWN.

OWNER OF INTERNATIONAL REGISTRATION 0772025 DATED 10-17-2001, EXPIRES 10-17-2011.

SER. NO. 79-104,092, FILED 11-16-2010.

SEAN CROWLEY, EXAMINING ATTORNEY



David J. Kyffers

Director of the United States Patent and Trademark Office

United States of America
United States Patent and Trademark Office

VINoceros

Reg. No. 4,173,612

Registered July 17, 2012

Int. Cl.: 33

TRADEMARK

PRINCIPAL REGISTER

WAUTERS STEFAAN (BELGIUM INDIVIDUAL)
WAAIENBERG 87
B-1745 OPWIJK
BELGIUM

FOR: SPARKLING WINES; WINES; WINES WITH AN ELEVATED ALCOHOL DEGREE, IN CLASS 33 (U.S. CLS. 47 AND 49).

THE MARK CONSISTS OF STANDARD CHARACTERS WITHOUT CLAIM TO ANY PARTICULAR FONT, STYLE, SIZE, OR COLOR.

PRIORITY DATE OF 3-7-2011 IS CLAIMED.

OWNER OF INTERNATIONAL REGISTRATION 1094870 DATED 9-5-2011, EXPIRES 9-5-2021.

SER. NO. 79-104,192, FILED 9-5-2011.

PAUL E. FAHRENKOPF, EXAMINING ATTORNEY



David J. Kyffers

Director of the United States Patent and Trademark Office

United States of America

United States Patent and Trademark Office

NATURALMARK

Reg. No. 4,173,613

Registered July 17, 2012

Int. Cls.: 14 and 35

TRADEMARK

SERVICE MARK

PRINCIPAL REGISTER

BHP BILLITON CANADA INC (CANADA CORPORATION)
2900-550 BURRARD STREET
VANCOUVER BC V6C 0A3, CANADA

FOR: DIAMONDS, PRECIOUS GEMS AND GEMSTONES, AND SEMI-PRECIOUS GEMS AND GEMSTONES; JEWELLERY; JEWELLERY CONTAINING DIAMONDS, PRECIOUS GEMS AND GEMSTONES, AND SEMI-PRECIOUS GEMS AND GEMSTONES INCLUDING BRACELETS, RINGS, NECKLACES, PENDANTS, CHAINS, ANKLETS, EARRINGS, BROOCHES, TIE PINS, TIE CLIPS, CUFFLINKS, PENDANTS, AND RINGS; WATCHES AND CLOCKS; TIMEPIECES CONTAINING DIAMONDS, PRECIOUS GEMS AND GEMSTONES, AND SEMI-PRECIOUS GEMS AND GEMSTONES INCLUDING WATCHES, STOP WATCHES, CHRONOMETERS, AND CLOCKS, IN CLASS 14 (U.S. CLS. 2, 27, 28 AND 50).

FOR: RETAIL STORE SERVICES, ONLINE RETAIL STORE SERVICES, WHOLESALE DISTRIBUTORSHIP SERVICES AND ONLINE WHOLESALE DISTRIBUTORSHIP SERVICES FEATURING DIAMONDS, GEMS, GEMSTONES, SEMI-PRECIOUS GEMS OR GEMSTONES, JEWELLERY, JEWELLERY CONTAINING DIAMONDS, GEMS, GEMSTONES, SEMI-PRECIOUS GEMS OR GEMSTONES, WATCHES, CLOCKS AND TIMEPIECES CONTAINING DIAMONDS, GEMS, GEMSTONES, SEMI-PRECIOUS GEMS OR GEMSTONES; MARKETING, PROMOTING AND ADVERTISING OF DIAMONDS, PRECIOUS GEMS, GEMSTONES, SEMI-PRECIOUS GEMS AND GEMSTONES, AND JEWELLERY ON BEHALF OF OTHERS, IN CLASS 35 (U.S. CLS. 100, 101 AND 102).

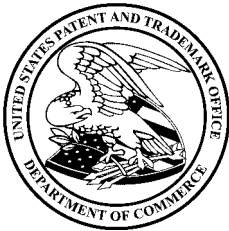

THE MARK CONSISTS OF STANDARD CHARACTERS WITHOUT CLAIM TO ANY PARTICULAR FONT, STYLE, SIZE, OR COLOR.

PRIORITY DATE OF 6-14-2011 IS CLAIMED.

OWNER OF INTERNATIONAL REGISTRATION 1094931 DATED 6-22-2011, EXPIRES 6-22-2021.

SER. NO. 79-104,214, FILED 6-22-2011.

AISHA CLARKE, EXAMINING ATTORNEY

David J. Kyjars

Director of the United States Patent and Trademark Office

United States of America

United States Patent and Trademark Office

INSPIRED BY ICELAND

Reg. No. 4,173,614

Registered July 17, 2012

Int. Cls.: 16, 35 and 39

TRADEMARK

SERVICE MARK

PRINCIPAL REGISTER

ISLANDSSTOFA (PROMOTE ICELAND) (ICELAND CORPORATION)
BORGARTUN 35
IS-105 REYKJAVIK
ICELAND

FOR: PAPER, CARDBOARD AND GOODS MADE FROM THESE MATERIALS, NAMELY, CARDBOARD BOXES AND CARTONS, PAPER BAGS AND SACKS, PAPER GIFT WRAP, PAPER PARTY FAVORS, PAPER RIBBONS, PLACE MATS OF PAPER, POSTERS MADE OF PAPER; PRINTED MATTER, NAMELY, PRINTED CALENDARS, PRINTED FORMS, PRINTED GRAPHS, PRINTED PAPER SIGNS; BOOKBINDING MATERIALS; PHOTOGRAPHS, STATIONERY, ADHESIVES FOR STATIONERY OR HOUSEHOLD PURPOSES, ARTISTS' MATERIALS, NAMELY, MOLDS FOR MODELING CLAYS, ARTISTS' BRUSHES, ARTISTS' PASTELS, ARTISTS' PENS AND PENCILS; PAINT BRUSHES, TYPEWRITERS AND OFFICE REQUISITES, NAMELY, STAPLERS, PAPER HOLE PUNCHES; INSTRUCTIONAL AND TEACHING MATERIAL, NAMELY, PRINTED INSTRUCTIONAL, EDUCATIONAL, AND TEACHING MATERIALS IN THE FIELD OF MATH AND SPELLING; PLASTIC MATERIALS FOR PACKAGING, NAMELY, PLASTIC BAGS FOR PACKAGING, PLASTIC BUBBLE PACKS FOR PACKAGING; PRINTERS' TYPE, PRINTING BLOCK, IN CLASS 16 (U.S. CLS. 2, 5, 22, 23, 29, 37, 38 AND 50).

FOR: ADVERTISING SERVICES; BUSINESS ADMINISTRATION AND MANAGEMENT; PROVIDING OFFICE FUNCTIONS, IN CLASS 35 (U.S. CLS. 100, 101 AND 102).

FOR: TRAVEL ARRANGEMENT IN THE NATURE OF TRAVEL, EXCURSION AND CRUISE ARRANGEMENT, IN CLASS 39 (U.S. CLS. 100 AND 105).

NO CLAIM IS MADE TO THE EXCLUSIVE RIGHT TO USE "ICELAND", APART FROM THE MARK AS SHOWN.

PRIORITY DATE OF 2-3-2011 IS CLAIMED.

OWNER OF INTERNATIONAL REGISTRATION 1094966 DATED 7-5-2011, EXPIRES 7-5-2021.

THE MARK CONSISTS OF THE STYLIZED WORDING "INSPIRED BY ICELAND", WITH SHORT HORIZONTAL LINES OVER AND UNDER "BY", WHICH IS WRITTEN IN SMALLER LETTERS.



David J. Kyjars

Director of the United States Patent and Trademark Office

Reg. No. 4,173,614 SER. NO. 79-104,234, FILED 7-5-2011.

ROBIN MITTLER, EXAMINING ATTORNEY

United States of America

United States Patent and Trademark Office



Reg. No. 4,173,615

Registered July 17, 2012

Int. Cl.: 28

TRADEMARK

PRINCIPAL REGISTER

SHIMANO INC. (JAPAN CORPORATION)
3-77 OIMATSU-CHO
SAKAI-KU.; SAKAI CITY; OSAKA 590-8577
JAPAN

FOR: FISHING FLOATS; FISHING SINKERS; LANDING NETS FOR ANGLERS; FISHING LINES; FISHING REELS; FISHING RODS; CASES FOR FISHING RODS; FISHING HOOKS; LURES FOR FISHING, IN CLASS 28 (U.S. CLS. 22, 23, 38 AND 50).

THE MARK CONSISTS OF TWO STYLIZED LETTERS "M".

OWNER OF INTERNATIONAL REGISTRATION 1095114 DATED 10-6-2011, EXPIRES 10-6-2021.

SER. NO. 79-104,273, FILED 10-6-2011.

LEIGH LOWRY, EXAMINING ATTORNEY



David J. Kyffers

Director of the United States Patent and Trademark Office

United States of America

United States Patent and Trademark Office



Reg. No. 4,173,616

Registered July 17, 2012

Int. Cls.: 9, 11, 35 and 42

MA LIGHTING TECHNOLOGY GMBH (FED REP GERMANY LIMITED LIABILITY COMPANY)

DACHDECKERSTRASSE 16
97297 WALDBÜTTELBRUNN

FED REP GERMANY

TRADEMARK

SERVICE MARK

PRINCIPAL REGISTER

FOR: SCIENTIFIC, NAUTICAL, SURVEYING, PHOTOGRAPHIC, CINEMATOGRAPHIC, OPTICAL, WEIGHING, MEASURING, CONTROLLING, SIGNALLING, CHECKING APPARATUS AND INSTRUMENTS, NAMELY, LIGHTING CONSOLES, INTEGRATED MEDIA SERVERS AND SIGNAL PROCESSING UNITS TO CONTROL SHOW STUDIO AND STAGE LIGHTING; APPARATUS AND INSTRUMENTS FOR CONDUCTING, SWITCHING, TRANSFORMING, ACCUMULATING, REGULATING AND CONTROLLING ELECTRICITY, NAMELY, ELECTRICITY CONDUITS; AUTOMATIC VENDING MACHINES AND MECHANISMS FOR COIN-OPERATED APPARATUS; CASH REGISTERS, CALCULATING MACHINES; FIRE-EXTINGUISHING APPARATUS; APPARATUS FOR RECORDING, PROCESSING, TRANSMISSION AND REPRODUCTION OF SOUND, IMAGE, DATA AND LIGHT EFFECTS; ELECTRICAL AND ELECTRONIC APPARATUS AND SYSTEMS FOR CONTROLLING LIGHT SIGNALS, LIGHT EFFECTS AND LIGHT SHOWS, NAMELY, COMPUTERS; ELECTRICAL AND ELECTRONIC CONTROLS AND CONTROL MECHANISMS FOR LIGHTING INSTALLATIONS, SPOT LIGHTS, LIGHTS AND DIMMERS; LIGHTING CONTROL DESKS AND CONSOLES, NAMELY, ELECTRIC DISTRIBUTION CONSOLES; DIGITAL DIMMERS FOR LIGHT; ELECTRICAL AND ELECTRONIC APPARATUS AND SYSTEMS FOR PROCESSING, AMPLIFYING, REPRODUCING, MIXING, CONVERSION AND TRANSMISSION OF CONTROL DATA AND CONTROL SIGNALS, NAMELY, AMPLIFIERS; STAGE LIGHTING REGULATORS; ELECTRICAL POWER SUPPLY UNITS; ELECTRICAL POWER DISTRIBUTION UNITS; LIGHTING BALLASTS; ELECTRIFIED RAILS FOR MOUNTING SPOT LIGHTS; DATA PROCESSING EQUIPMENT AND COMPUTERS; RECORDED COMPUTER SOFTWARE FOR CONTROLLING LIGHT SIGNALS, LIGHT EFFECTS AND LIGHT SHOWS; RECORDED COMPUTER SOFTWARE FOR VISUALISING STAGE SHOWS AND FOR DESIGNING THREE-DIMENSIONAL STAGE LAYOUTS, IN CLASS 9 (U.S. CLS. 21, 23, 26, 36 AND 38).



David J. Kybas

Director of the United States Patent and Trademark Office

FOR: APPARATUS FOR LIGHTING, HEATING, STEAM GENERATING, COOKING, REFRIGERATING, DRYING, VENTILATING, WATER SUPPLY AND SANITARY PURPOSES, NAMELY, SPOT LIGHTS; LIGHTING APPARATUS AND INSTALLATIONS, NAMELY, SPOT LIGHTS; LIGHTING SYSTEMS FOR LIGHTING STAGES, NAMELY, SPOT LIGHTS, SPOT LIGHTS INTENDED FOR THEATERS, STUDIOS, FAIRS, EXHIBITIONS AND STAGES;

Reg. No. 4,173,616 LAMPS; COLOUR-CHANGING DEVICES FOR LIGHTING APPARATUS AND LIGHTING INSTALLATIONS, NAMELY, COLOR FILTERS FOR USE IN LIGHTING INSTRUMENTS; PROTECTION DEVICES FOR LIGHTS, NAMELY, FITTED COVERS FOR SPOT LIGHTS, IN CLASS 11 (U.S. CLS. 13, 21, 23, 31 AND 34).

FOR: ADVERTISING; BUSINESS MANAGEMENT; BUSINESS ADMINISTRATION; OFFICE FUNCTIONS; ONLINE MARKETING AND ADVERTISING SERVICES IN THE FIELD OF ELECTRICAL GOODS AND ELECTRONIC GOODS, SOUND CARRIERS AND DATA CARRIERS, MACHINES, HOBBY EQUIPMENT, LIGHTING TECHNOLOGY, SWITCHING TECHNOLOGY; PRESENTATION OF COMPANIES ON THE INTERNET, NAMELY, PROVIDING ADVERTISING SERVICES FOR OTHERS; PRESENTATION OF GOODS IN COMMUNICATION MEDIA FOR RETAIL TRADE, NAMELY, PROVIDING TELEVISION HOME SHOPPING SERVICES IN THE FIELD OF GENERAL CONSUMER MERCHANDISE; RETAIL STORE SERVICES VIA THE INTERNET IN THE FIELDS OF CHEMICAL PRODUCTS, PAINTS, DRUGSTORE ARTICLES, COSMETIC PRODUCTS AND HOUSEHOLD ARTICLES, FUELS AND COMBUSTIBLES, GOODS OF THE HEALTH SECTOR, MACHINES, TOOLS AND METALWARE, BUILDING MATERIAL, HOME WORKER ARTICLES AND GARDEN ARTICLES, HOBBY EQUIPMENT AND HANDICRAFT SUPPLIES, ELECTRICAL GOODS AND ELECTRONIC GOODS, SOUND CARRIERS AND DATA CARRIERS, SANITARY INSTALLATIONS, VEHICLES AND BICYCLE EQUIPMENT, FIREWORKS, CLOCKS AND JEWELLERY, MUSICAL INSTRUMENTS, PRINTED MATTER, STATIONERY, OFFICE ARTICLES, LEATHER ARTICLES AND SADDLERY, FURNITURE AND DECORATION ARTICLES, TENTS, TARPAULINS, ARTICLES OF CLOTHING, FOOTWEAR AND TEXTILE GOODS, TOYS, SPORTSWEAR, FOODSTUFFS AND BEVERAGES, AGRICULTURAL PRODUCTS, HORTICULTURAL PRODUCTS AND FORESTRY PRODUCTS, TOBACCO PRODUCTS AND OTHER SEMI-LUXURY FOODSTUFFS, IN CLASS 35 (U.S. CLS. 100, 101 AND 102).

FOR: SCIENTIFIC AND TECHNOLOGICAL SERVICES AND RESEARCH AND DESIGN RELATING THERETO, NAMELY, ENGINEERING SERVICES; INDUSTRIAL ANALYSIS AND RESEARCH SERVICES, NAMELY, ENGINEERING SERVICES; DESIGN DEVELOPMENT AND UPDATING OF COMPUTER SOFTWARE; DESIGN AND DEVELOPMENT OF COMPUTER HARDWARE; HARDWARE AND SOFTWARE CONSULTANCY; IMPLEMENTATION OF EDP PROGRAMS IN NETWORKS; COMPUTER NETWORK CONFIGURATION USING SOFTWARE, IN CLASS 42 (U.S. CLS. 100 AND 101).

THE MARK CONSISTS OF THE WORDING "DOT" IN A CIRCLE FOLLOWED BY THE NUMBER "2".

PRIORITY DATE OF 2-14-2011 IS CLAIMED.

OWNER OF INTERNATIONAL REGISTRATION 1095128 DATED 6-24-2011, EXPIRES 6-24-2021.

SER. NO. 79-104,277, FILED 6-24-2011.

SEAN CROWLEY, EXAMINING ATTORNEY

United States of America

United States Patent and Trademark Office

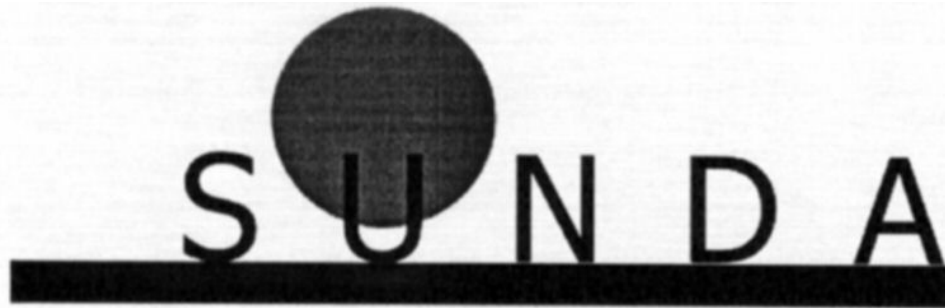

Reg. No. 4,173,617

Registered July 17, 2012

Int. Cl.: 11

TRADEMARK

PRINCIPAL REGISTER

BEIJING SUNDA SOLAR ENERGY TECHNOLOGY CO. LTD (CHINA CORPORATION)
NO. 3 HUA YUAN ROAD
HAIDIAN DISTRICT
BEIJING, CHINA

FOR: SOLAR COLLECTORS FOR HEATING, IN CLASS 11 (U.S. CLS. 13, 21, 23, 31 AND 34).

THE MARK CONSISTS OF THE WORD "SUNDA" RESTING ON A HORIZONTAL BAR WITH A SHADED CIRCLE BEHIND THE UPPER PORTION OF THE LETTER "U".

OWNER OF INTERNATIONAL REGISTRATION 1095238 DATED 10-4-2011, EXPIRES 10-4-2021.

SER. NO. 79-104,325, FILED 10-4-2011.

ALLISON HOLTZ, EXAMINING ATTORNEY



David J. Kyros

Director of the United States Patent and Trademark Office

United States of America

United States Patent and Trademark Office

promend

Reg. No. 4,173,618

Registered July 17, 2012

Int. Cl.: 12

TRADEMARK

PRINCIPAL REGISTER

XU JUAN (CHINA INDIVIDUAL)
GROUP 7

XINXI VILLAGE,; ZHANGGOU TOWN,; XIANTAOCITY; HUBEI PROVINCE
CHINA

FOR: BICYCLES; BICYCLE STANDS, BEING KICKSTANDS; RIMS FOR BICYCLE WHEELS;
MOTORCYCLES; BABY CARRIAGES, IN CLASS 12 (U.S. CLS. 19, 21, 23, 31, 35 AND 44).

THE MARK CONSISTS OF THE WORD "PROMEND" IN STYLIZED FORM.

OWNER OF INTERNATIONAL REGISTRATION 1095303 DATED 10-4-2011, EXPIRES 10-4-2021.

SER. NO. 79-104,354, FILED 10-4-2011.

ALLISON HOLTZ, EXAMINING ATTORNEY



David J. Kybas

Director of the United States Patent and Trademark Office

United States of America

United States Patent and Trademark Office

MAGNUS

Reg. No. 4,173,619

Registered July 17, 2012

Int. Cls.: 9 and 13

TRADEMARK

PRINCIPAL REGISTER

LEICA CAMERA AG (FED REP GERMANY JOINT STOCK CORPORATION)
OSKAR-BARNACK-STRASSE 11
35606 SOLMS
FED REP GERMANY

FOR: PHOTOGRAPHIC, CINEMATOGRAPHIC, OPTICAL, MEASURING APPARATUS AND INSTRUMENTS, NAMELY, ANALOGUE AND DIGITAL CAMERAS; APPARATUS FOR RECORDING, TRANSMISSION OR REPRODUCTION OF SOUND OR IMAGES; TELEOPTICAL APPARATUS AND DEVICES, NAMELY, MONOCULAR AND BINOCULAR TELESCOPES, BINOCULARS, FIELD GLASSES, TELESCOPES, TELEPHOTO LENS SIGHTS, TARGET GUN SCOPES, OPTOELECTRONIC RANGEFINDERS, IN CLASS 9 (U.S. CLS. 21, 23, 26, 36 AND 38).

FOR: SIGHTING DEVICE FOR HAND-HELD WEAPONS, NAMELY, FIREARM SIGHTS, NON-TELESCOPIC GUN SIGHTS FOR FIREARMS, SIGHT PROTECTORS FOR FIREARMS, OPEN SIGHTS FOR USE ON FIREARMS (NON-OPTICAL OR NON-TELESCOPIC), IN CLASS 13 (U.S. CLS. 2 AND 9).

THE MARK CONSISTS OF STANDARD CHARACTERS WITHOUT CLAIM TO ANY PARTICULAR FONT, STYLE, SIZE, OR COLOR.

PRIORITY DATE OF 12-24-2010 IS CLAIMED.

OWNER OF INTERNATIONAL REGISTRATION 1095360 DATED 6-17-2011, EXPIRES 6-17-2021.

SER. NO. 79-104,391, FILED 6-17-2011.

SUZANNE BLANE, EXAMINING ATTORNEY



David J. Kyffers

Director of the United States Patent and Trademark Office

United States of America

United States Patent and Trademark Office



Reg. No. 4,173,620

Registered July 17, 2012

Int. Cls.: 6 and 11

ANTEL ARITMA TESISLERI INSAAT SANAYI VE TICARET ANONIM SIRKETI (TURKEY JOINT-STOCK CORPORATION)
INÖNÜ CAD. TURABOGLU SK. SÜMKO SITESI
M3-A BLOK D:15-16; KOZYATAGI KADIKOY; ISTANBUL
TURKEY

TRADEMARK

FOR: METAL MESHES AND SIEVES, NAMELY, WIRE MESH, WEDGE WIRES, FOR SIEVING, FILTERING AND SIMILAR PURPOSES, IN CLASS 6 (U.S. CLS. 2, 12, 13, 14, 23, 25 AND 50).

PRINCIPAL REGISTER

FOR: WATER SOFTENING DEVICES, NAMELY, WATER SOFTENING FILTRATION UNITS; WATER TREATMENT DEVICES AND WATER TREATMENT EQUIPMENT, NAMELY, WATER FILTRATION UNITS, REVERSE OSMOSIS FILTRATION UNITS; WASTE TREATMENT EQUIPMENT, NAMELY, WASTE WATER PURIFICATION UNITS; WATER FILTERS USED IN HOUSES; WATER FILTERS FOR INDUSTRIAL EQUIPMENT; FILTERS FOR DRINKING WATER; WATER FILTERS FOR COOLING WATER, WATER FILTERS FOR COOLING TOWERS FULL FLOW AND SIDE STREAM FILTRATION, WATER FILTERS FOR NOZZLE PROTECTION, FILTERS FOR SEA WATER FILTRATION, FILTERS FOR WELL WATER, FILTERS FOR SURFACE WATER, FILTERS FOR BALLAST WATER FILTRATION, FILTERS FOR IRRIGATION WATER FILTRATION, WATER FILTERS FOR PRESSURIZED IRRIGATION SYSTEM, IN CLASS 11 (U.S. CLS. 13, 21, 23, 31 AND 34).



THE MARK CONSISTS OF THE WORD "FILTERNOX" WITH THE LETTER "O" RESEMBLING A DRAIN SIEVE. THE COLORS BLUE AND GREEN APPEAR IN THE WORD "FILTERNOX" WITH THE COLOR GREEN APPEARING IN THE BOTTOM PORTION OF THE LETTERS AND BLUE BEING THE TOP PORTION OF THE LETTERS, AND IN THE REVERSE WITH RESPECT TO THE DESIGN OF THE DRAIN.

OWNER OF INTERNATIONAL REGISTRATION 1095361 DATED 8-9-2011, EXPIRES 8-9-2021.

THE COLOR(S) BLUE AND GREEN IS/ARE CLAIMED AS A FEATURE OF THE MARK.

SER. NO. 79-104,392, FILED 8-9-2011.

CARYN GLASSER, EXAMINING ATTORNEY

David J. Kyros

Director of the United States Patent and Trademark Office

United States of America
United States Patent and Trademark Office

BLESS

Reg. No. 4,173,621

Registered July 17, 2012

Int. Cls.: 9 and 41

TRADEMARK

SERVICE MARK

PRINCIPAL REGISTER

NEOWIZ GAMES CO., LTD. (REPUBLIC OF KOREA CORPORATION)
NEOWIZ TOWER, 192-2, GUMI-DONG
BUNDANG-GU, SEONGNAM-SI.; GYEONGGI-DO, 463-500
REPUBLIC OF KOREA

FOR: RECORDED COMPUTER GAME PROGRAMS; DOWNLOADABLE COMPUTER GAME PROGRAMS; DOWNLOADABLE COMPUTER GAME SOFTWARE, IN CLASS 9 (U.S. CLS. 21, 23, 26, 36 AND 38).

FOR: ENTERTAINMENT SERVICES, NAMELY, PROVIDING ONLINE COMPUTER GAMES; ENTERTAINMENT SERVICES, NAMELY, PROVIDING ONLINE ELECTRONIC GAMES, IN CLASS 41 (U.S. CLS. 100, 101 AND 107).

THE MARK CONSISTS OF STANDARD CHARACTERS WITHOUT CLAIM TO ANY PARTICULAR FONT, STYLE, SIZE, OR COLOR.

PRIORITY DATE OF 7-26-2011 IS CLAIMED.

OWNER OF INTERNATIONAL REGISTRATION 1095427 DATED 9-21-2011, EXPIRES 9-21-2021.

SER. NO. 79-104,410, FILED 9-21-2011.

BILL DAWE, EXAMINING ATTORNEY



David J. Kyffers

Director of the United States Patent and Trademark Office

United States of America

United States Patent and Trademark Office

DEB ✈ RA

Reg. No. 4,173,622

RHEINMETALL ITALIA S.P.A. (ITALY JOINT STOCK COMPANY)
VIA AFFILE, 102

Registered July 17, 2012

I-00131 ROMA (RM), ITALY

Int. Cl.: 9

FOR: AIRPORT RADAR FOR CIVIL AND MILITARY APPLICATIONS, RADAR TO DETECT OBSTACLES ON AIRPORT RUNWAYS, ALARM SYSTEMS FOR MONITORING WHEN A RUNWAY IS BLOCKED, DEBRIS ELECTRIC SENSOR, IN CLASS 9 (U.S. CLS. 21, 23, 26, 36 AND 38).

TRADEMARK

PRINCIPAL REGISTER

THE MARK CONSISTS OF THE STYLIZED WORD, "DEBRA", WITH A LANDING STRIP AND AN AIRPLANE IN BETWEEN THE LETTERS "B" AND "R".

PRIORITY DATE OF 3-25-2011 IS CLAIMED.

OWNER OF INTERNATIONAL REGISTRATION 1095475 DATED 8-5-2011, EXPIRES 8-5-2021.

SER. NO. 79-104,434, FILED 8-5-2011.

LANA PHAM, EXAMINING ATTORNEY



David J. Kyffers

Director of the United States Patent and Trademark Office

United States of America

United States Patent and Trademark Office

TANAGEN

Reg. No. 4,173,623

Registered July 17, 2012

Int. Cl.: 3

TRADEMARK

PRINCIPAL REGISTER

GREEN MOUNTAIN BIOTECH CO., LTD. (CHINA CORPORATION)
NO. 109, JINJIANG STREET
JHONGJHENG DISTRICT; TAIPEI
TAIWAN, CHINA

FOR: HAIR LOTIONS; CLEANSING MILK FOR TOILET PURPOSES; SOFT HAIR LOTION;
HAIR CARE CREAMS; BEAUTY MASKS; COSMETICS; ANTI-WRINKLE CREAMS; SKIN
WHITENING CREAMS; SPOT REMOVER; BLACK HAIR GREASE; HAIR TONIC, IN CLASS
3 (U.S. CLS. 1, 4, 6, 50, 51 AND 52).

OWNER OF INTERNATIONAL REGISTRATION 1095612 DATED 9-27-2011, EXPIRES 9-27-
2021.

THE TRANSLITERATION OF THE NON-LATIN CHARACTERS IN THE MARK IS:
"TANAGEN", THIS MARK HAS NO FOREIGN EQUIVALENT MEANING OR SIGNIFICANCE
NOR IDENTIFIES ANY GEOGRAPHIC PLACE AND IT IS NOT A SURNAME.

SER. NO. 79-104,498, FILED 9-27-2011.

FRANK LATTUCA, EXAMINING ATTORNEY



David J. Kyfos

Director of the United States Patent and Trademark Office

United States of America
United States Patent and Trademark Office

CRISCA

Reg. No. 4,173,624

Registered July 17, 2012

Int. Cl.: 3

TRADEMARK

PRINCIPAL REGISTER

BIBA GMBH (FED REP GERMANY LIMITED LIABILITY COMPANY)
DAIMLERSTRASSE 3
47167 DUISBURG
FED REP GERMANY

FOR: PERFUMERY, COSMETICS, ESSENTIAL OILS, IN CLASS 3 (U.S. CLS. 1, 4, 6, 50, 51 AND 52).

OWNER OF U.S. REG. NOS. 1,478,770 AND 3,570,143.

OWNER OF INTERNATIONAL REGISTRATION 0498614 DATED 11-21-1985, EXPIRES 11-21-2015.

SER. NO. 79-104,684, FILED 4-15-2011.

HEATHER BIDDULPH, EXAMINING ATTORNEY



David J. Kyffers

Director of the United States Patent and Trademark Office

United States of America
United States Patent and Trademark Office

COMPAC

Reg. No. 4,173,625

Registered July 17, 2012

Int. Cl.: 19

TRADEMARK

PRINCIPAL REGISTER

MMAG. DR. MARKUS FELLNER (FED REP GERMANY INDIVIDUAL)
SCHOTTENRING 12
A-1010 WIEN
AUSTRIA

FOR: REFRACTORY PRODUCTS AS MASSES, NAMELY, NON-METAL REFRACTORY MIXES; NON-METAL REFRACTORY PRODUCTS AS LININGS, MORTARS, BRICKS, CONCRETES, MASTICS AND AS REFRACTORY SHAPES, IN CLASS 19 (U.S. CLS. 1, 12, 33 AND 50).

OWNER OF INTERNATIONAL REGISTRATION 0562486 DATED 10-18-1990, EXPIRES 10-18-2020.

SER. NO. 79-104,689, FILED 6-22-2011.

HEATHER BIDDULPH, EXAMINING ATTORNEY



David J. Kyffers

Director of the United States Patent and Trademark Office

United States of America
United States Patent and Trademark Office

floktu

Reg. No. 4,173,626

Registered July 17, 2012

Int. Cls.: 35 and 42

SERVICE MARK

PRINCIPAL REGISTER

FLOKTU PTY LTD (AUSTRALIA AUSTRALIAN PROPRIETARY COMPANY, LIMITED BY SHARES)
SUITE 145,
NATIONAL INNOVATION CENTRE,; 4 CORNWALLIS STREET,; AUSTRALIAN
TECHNOLOGY PARK; EVELEIGH
AUSTRALIA

FOR: EVENT MANAGEMENT SERVICES, NAMELY, ORGANIZATION OF EXHIBITIONS OR TRADE FAIRS FOR COMMERCIAL OR ADVERTISING PURPOSES; CORPORATE EVENT MANAGEMENT SERVICES; EVENT PLANNING AND MANAGEMENT FOR MARKETING, BRANDING, PROMOTING OR ADVERTISING THE GOODS AND SERVICES OF OTHERS; BUSINESS MANAGEMENT OF BOOKING AND DELIVERY OF TICKETS; PROVIDING MARKETING AND PROMOTION OF EVENTS FOR OTHERS USING DIGITAL MEDIUM, IN CLASS 35 (U.S. CLS. 100, 101 AND 102).

FOR: PROVIDING ONLINE, NON-DOWNLOADABLE, INTERNET-BASED SOFTWARE APPLICATION THAT AUTOMATES AND ENABLES MARKETING OF EVENTS; DESIGN, INSTALLATION, MAINTENANCE, REPAIR AND UPDATING OF COMPUTER SOFTWARE; PROVIDING A WEBSITE FEATURING TECHNOLOGY THAT ENABLES USERS TO AUTOMATE MANAGING OF EVENTS, IN CLASS 42 (U.S. CLS. 100 AND 101).

THE MARK CONSISTS OF STANDARD CHARACTERS WITHOUT CLAIM TO ANY PARTICULAR FONT, STYLE, SIZE, OR COLOR.

PRIORITY DATE OF 2-15-2011 IS CLAIMED.

OWNER OF INTERNATIONAL REGISTRATION 1096154 DATED 8-10-2011, EXPIRES 8-10-2021.

THE WORDING "FLOKTU" HAS NO MEANING IN A FOREIGN LANGUAGE.

SER. NO. 79-104,787, FILED 8-10-2011.

WENDY JUN, EXAMINING ATTORNEY



David J. Kyros

Director of the United States Patent and Trademark Office

United States of America

United States Patent and Trademark Office

CIRCLEFLEX

Reg. No. 4,173,627

Registered July 17, 2012

Int. Cl.: 9

TRADEMARK

PRINCIPAL REGISTER

SENNHEISER COMMUNICATIONS A/S (DENMARK AKTIESELSKAB)
LANGAGER 6
DK-2680 SOLRØD STRAND
DENMARK

FOR: COMMUNICATIONS HEADSETS FOR USE WITH COMMUNICATION RADIOS, INTERCOM SYSTEMS, OR OTHER COMMUNICATIONS NETWORK TRANSCEIVERS; EARPHONES AND HEADPHONES; GAMING HEADSETS FOR USE IN PLAYING VIDEO GAMES; HEADSETS FOR CELLULAR OR MOBILE PHONES; HEADSETS FOR USE WITH COMPUTERS; MUSIC HEADPHONES; STEREO HEADPHONES, IN CLASS 9 (U.S. CLS. 21, 23, 26, 36 AND 38).

THE MARK CONSISTS OF STANDARD CHARACTERS WITHOUT CLAIM TO ANY PARTICULAR FONT, STYLE, SIZE, OR COLOR.

PRIORITY DATE OF 5-27-2011 IS CLAIMED.

OWNER OF INTERNATIONAL REGISTRATION 1096333 DATED 10-26-2011, EXPIRES 10-26-2021.

SER. NO. 79-104,862, FILED 10-26-2011.

MARC LEIPZIG, EXAMINING ATTORNEY



David J. Kyffers

Director of the United States Patent and Trademark Office

United States of America

United States Patent and Trademark Office



Reg. No. 4,173,628

Registered July 17, 2012

Int. Cls.: 18 and 25

TRADEMARK

PRINCIPAL REGISTER

KILL NO ELEPHANTS AB (SWEDEN PRIVATE LIMITED COMPANY)
STORA VÄGEN 81
SE-297 72 SE-297 72 EVERÖD
SWEDEN

FOR: LEATHER AND IMITATION LEATHER BAGS, IN CLASS 18 (U.S. CLS. 1, 2, 3, 22 AND 41).

FOR: JACKETS, SHOES AND BOOTS, IN CLASS 25 (U.S. CLS. 22 AND 39).

NO CLAIM IS MADE TO THE EXCLUSIVE RIGHT TO USE "1986", APART FROM THE MARK AS SHOWN.

OWNER OF INTERNATIONAL REGISTRATION 1096339 DATED 10-14-2011, EXPIRES 10-14-2021.

THE NAME(S), PORTRAIT(S), AND/OR SIGNATURE(S) SHOWN IN THE MARK DOES NOT IDENTIFY A PARTICULAR LIVING INDIVIDUAL.

THE MARK CONSISTS OF A RECTANGULAR BOX CONTAINING THE WORDING "AVEDON COLBY AC 1986", WITH A LION ABOVE "AVEDON", A GLOBE BEHIND "AC", AND A JAGUAR ABOVE "COLBY". THE WORDING "AVEDON" AND "COLBY" HAVE HORIZONTAL LINES ABOVE AND BELOW.

SER. NO. 79-104,863, FILED 10-14-2011.

TOBY BULLOFF, EXAMINING ATTORNEY



David J. Kyffers

Director of the United States Patent and Trademark Office

United States of America

United States Patent and Trademark Office

paw
PureAnimalWellbeing

Reg. No. 4,173,629

Registered July 17, 2012

Int. Cls.: 3 and 5

TRADEMARK

PRINCIPAL REGISTER

BLACKMORES LIMITED; AUSTRALIAN COMPANY NUMBER 009 713 437 (AUSTRALIA
AUSTRALIAN PUBLIC COMPANY, LIMITED BY SHARES)
20 JUBILEE AVENUE
WARRIEWOOD NSW 2102, AUSTRALIA

FOR: ANIMAL SHAMPOOS, CONDITIONERS AND CLEANING PRODUCTS, NAMELY, NON-MEDICATED SKIN CARE PREPARATIONS IN THE NATURE OF BODY MISTS AND BODY SPRAYS FOR GROOMING ANIMALS; NON-MEDICATED AND NON-VETERINARY SKINCARE PREPARATIONS FOR ANIMALS; NON-MEDICATED TOILETRIES FOR ANIMALS, IN CLASS 3 (U.S. CLS. 1, 4, 6, 50, 51 AND 52).

FOR: VITAMINS; FOOD SUPPLEMENTS; VETERINARY PREPARATIONS FOR TOPICAL APPLICATION, NAMELY, PHARMACEUTICAL PRODUCTS FOR ANIMAL SKINCARE; VETERINARY PREPARATIONS, NAMELY, MEDICATED SHAMPOO FOR THE TREATMENT OF SKIN INFECTIONS AND MEDICATED EAR CLEANING DROPS, IN CLASS 5 (U.S. CLS. 6, 18, 44, 46, 51 AND 52).

OWNER OF U.S. REG. NO. 3,655,062.

OWNER OF INTERNATIONAL REGISTRATION 1096444 DATED 9-20-2011, EXPIRES 9-20-2021.

THE MARK CONSISTS OF THE WORD "PAW" IN STYLIZED FONT AND A PAW PRINT DESIGN ALL ABOVE THE WORDS "PUREANIMALWELLBEING".

SER. NO. 79-104,912, FILED 9-20-2011.

DAVID YONTEF, EXAMINING ATTORNEY



David J. Kybas

Director of the United States Patent and Trademark Office

United States of America

United States Patent and Trademark Office



Reg. No. 4,173,630

Registered July 17, 2012

Int. Cl.: 3

TRADEMARK

PRINCIPAL REGISTER

RECIPE FOR MEN AB (SWEDEN LIMITED LIABILITY COMPANY)
BOX 24102
SE-104 51 STOCKHOLM
SWEDEN

FOR: SOAPS; PERFUMERY; ESSENTIAL OILS; COSMETICS; HAIR CARE PREPARATIONS;
COSMETIC CREAMS; COSMETIC PREPARATIONS FOR SKIN CARE; LIP BALM; LIP-
STICKS, IN CLASS 3 (U.S. CLS. 1, 4, 6, 50, 51 AND 52).

NO CLAIM IS MADE TO THE EXCLUSIVE RIGHT TO USE "FRUIT" AND "LIPBALM",
APART FROM THE MARK AS SHOWN.

PRIORITY DATE OF 3-9-2011 IS CLAIMED.

OWNER OF INTERNATIONAL REGISTRATION 1096683 DATED 7-1-2011, EXPIRES 7-1-
2021.

THE MARK CONSISTS OF THE STYLIZED WORDING "FRUIT" AND "GORILLA &
FRIENDS" AROUND THE EDGES OF A CIRCLE EMBLEM. IN THE CENTER OF THE EM-
BLEM IS A GORILLA DESIGN. ABOVE AND BELOW THE GORILLA IS THE WORDING
"THE CARING LIPBALM".

SER. NO. 79-104,998, FILED 7-1-2011.

ALLISON SCHRODY, EXAMINING ATTORNEY



David J. Kybas

Director of the United States Patent and Trademark Office

United States of America

United States Patent and Trademark Office

DEGAROUTE

Reg. No. 4,173,631

Registered July 17, 2012

Int. Cls.: 1, 2 and 19

TRADEMARK

PRINCIPAL REGISTER

EVONIK RÖHM GMBH (FED REP GERMANY LIMITED LIABILITY COMPANY)
KIRSCHENALLEE
DARMSTADT, FED REP GERMANY 64293

FOR: UNPROCESSED PLASTICS IN THE FORM OF POWDERS, PASTES, LIQUIDS, EMULSIONS, DISPERSIONS AND GRANULES; ARTIFICIAL RESINS IN LIQUID FORM FOR COATING AND/OR MARKING OF FLOORS, WALLS, FACADES, STREETS, BRIDGES, VEHICLES, MACHINES AND METAL CONSTRUCTIONS; CASTING MASSES, NAMELY, INDUSTRIAL CHEMICALS FOR USE IN THE FURTHER MANUFACTURE OF COATINGS AND/OR MARKINGS OF FLOORS, WALLS, FACADES, STREETS, BRIDGES, VEHICLES, MACHINES AND METAL CONSTRUCTIONS, IN CLASS 1 (U.S. CLS. 1, 5, 6, 10, 26 AND 46).

FOR: LACQUERS, PAINTS, IN CLASS 2 (U.S. CLS. 6, 11 AND 16).

FOR: BUILDING MATERIALS, NAMELY, PLASTIC BASED ROAD MARKING FOR ROAD SURFACES AND PLASTIC BASED WALL COATING; WALL COVERINGS BASED ON PLASTICS AND OR PLASTIC INTERMEDIATES; BUILDING MATERIALS, NAMELY, PLASTIC BASED BOUNDARY ROAD MARKING FOR ROAD SURFACES; SYNTHETIC WALL CLADDINGS AND SYNTHETIC WALL COVERINGS BASED ON PLASTICS AND OR PLASTIC INTERMEDIATES, IN CLASS 19 (U.S. CLS. 1, 12, 33 AND 50).

THE MARK CONSISTS OF STANDARD CHARACTERS WITHOUT CLAIM TO ANY PARTICULAR FONT, STYLE, SIZE, OR COLOR.

OWNER OF INTERNATIONAL REGISTRATION 0807983 DATED 4-3-2003, EXPIRES 4-3-2013.

SER. NO. 79-105,056, FILED 9-15-2011.

JANICE KIM, EXAMINING ATTORNEY



David J. Kyjars

Director of the United States Patent and Trademark Office

United States of America

United States Patent and Trademark Office

PELVIVA

Reg. No. 4,173,632

Registered July 17, 2012

Int. Cls.: 5 and 10

TRADEMARK

PRINCIPAL REGISTER

FEMEDA LIMITED (UNITED KINGDOM LIMITED COMPANY)
WELLINGTON HOUSE

WESTMINSTER BUSINESS CENTRE, WYNYARD AVENUE WYNYARD; BILLINGHAM
CLEVELAND, UNITED KINGDOM TS22 5BT

FOR: PHARMACEUTICAL PREPARATIONS FOR THE TREATMENT OF INCONTINENCE AND URINARY TRACT INFECTIONS; FEMININE HYGIENE PRODUCTS, NAMELY, PADS FOR THE TREATMENT OF INCONTINENCE; SANITARY PADS; PANTY LINERS, SANITARY NAPKINS, TAMPONS, SANITARY BRIEFS, INTERLABIAL FEMININE HYGIENE PADS; SANITARY PREPARATIONS FOR MEDICAL PURPOSES; MEDICATED TOILETRIES; INCONTINENCE PADS AND DIAPERS; INCONTINENCE LINERS, INCONTINENCE NAPKINS, INCONTINENCE PANTS; CLEANING PREPARATIONS FOR FEMININE HYGIENE, NAMELY, MEDICATED FEMININE HYGIENE WASH; PRE-MOISTENED MEDICATED WIPES FOR EXTERNAL VAGINAL AND PERINEAL CLEANSING; PADS FOR FEMININE PROTECTION, IN CLASS 5 (U.S. CLS. 6, 18, 44, 46, 51 AND 52).

FOR: SURGICAL AND MEDICAL APPARATUS AND INSTRUMENTS FOR THE TREATMENT OF FEMININE INCONTINENCE; MEDICAL APPLIANCES FOR USE BY PERSONS SUFFERING FROM INCONTINENCE; ELECTRONIC APPARATUS FOR THE PREVENTION OF INCONTINENCE, NAMELY, ELECTRONIC STIMULATOR FOR NERVES OF THE PELVIC FLOOR; FEMALE URINARY INCONTINENCE DEVICES, NAMELY, INCONTINENCE SHEETS; PELVIC FLOOR EXERCISERS FOR STRENGTHENING MUSCLES OF THE PELVIC FLOOR; MEDICAL APPARATUS FOR TESTING MUSCLES OF THE PELVIC FLOOR; PELVIC MUSCLE EXERCISERS FOR MEDICAL PURPOSES, NAMELY, TO STRENGTHEN WEAK PELVIC FLOOR MUSCLES FOR THE TREATMENT OF URGE INCONTINENCE, STRESS INCONTINENCE AND MIXED INCONTINENCE IN WOMEN; VAGINAL EXERCISER TO STIMULATE THE PELVIC MUSCLES FOR MEDICAL PURPOSES, NAMELY, TO STRENGTHEN WEAK PELVIC FLOOR MUSCLES FOR THE TREATMENT OF URGE INCONTINENCE, STRESS INCONTINENCE AND MIXED INCONTINENCE IN WOMEN; APPARATUS AND INSTRUMENTS, ALL FOR USE IN THE CONTROL OF INCONTINENCE IN HUMAN BEINGS, NAMELY, CATHETERS, URETHRAL INSERTS, PESSARIES; PELVIC FLOOR EXERCISE WEIGHT KITS CONTAINING CONES FOR USE IN THE CONTROL OF INCONTINENCE IN HUMAN BEINGS; URINE DRAINAGE BAGS FOR MEDICAL PURPOSES; CATHETERS; MASSAGE APPARATUS, NAMELY, BODY MASSAGERS; PARTS AND FITTINGS FOR ALL THE AFORESAID GOODS, IN CLASS 10 (U.S. CLS. 26, 39 AND 44).



David J. Kyjars

Director of the United States Patent and Trademark Office

Reg. No. 4,173,632 THE MARK CONSISTS OF STANDARD CHARACTERS WITHOUT CLAIM TO ANY PARTICULAR FONT, STYLE, SIZE, OR COLOR.

PRIORITY DATE OF 2-2-2011 IS CLAIMED.

OWNER OF INTERNATIONAL REGISTRATION 1096856 DATED 6-17-2011, EXPIRES 6-17-2021.

SER. NO. 79-105,093, FILED 6-17-2011.

SHANNON TWOHIG, EXAMINING ATTORNEY

United States of America

United States Patent and Trademark Office

TENSIOTIN

Reg. No. 4,173,633

Registered July 17, 2012

Int. Cls.: 5 and 29

TRADEMARK

PRINCIPAL REGISTER

MAREALIS AS (NORWAY PRIVATE COMPANY LIMITED BY SHARES)
PO BOX 6458
N-9294 TROMSØ
NORWAY

FOR: NUTRITIONAL AND DIETARY SUPPLEMENTS, AMINO ACIDS FOR MEDICAL OR VETERINARY USE, AMINO ACIDS FOR NUTRITIONAL PURPOSES; SYNTHETIC PEPTIDES FOR THE TREATMENT FOR HYPERTENSION OR HIGH NORMAL BLOOD PRESSURE, IN CLASS 5 (U.S. CLS. 6, 18, 44, 46, 51 AND 52).

FOR: SHRIMPS, NOT LIVE; PROTEINS BEING FOODSTUFFS FOR HUMAN CONSUMPTION, IN CLASS 29 (U.S. CL. 46).

THE MARK CONSISTS OF STANDARD CHARACTERS WITHOUT CLAIM TO ANY PARTICULAR FONT, STYLE, SIZE, OR COLOR.

OWNER OF INTERNATIONAL REGISTRATION 1097015 DATED 6-6-2011, EXPIRES 6-6-2021.

THE WORDING "TENSIOTIN" HAS NO MEANING IN A FOREIGN LANGUAGE.

SER. NO. 79-105,152, FILED 6-6-2011.

JESSICA FATHY, EXAMINING ATTORNEY



David J. Kyros

Director of the United States Patent and Trademark Office

United States of America

United States Patent and Trademark Office

엑시옴

XIOM

Reg. No. 4,173,634

Registered July 17, 2012

Int. Cls.: 18, 25 and 28

TRADEMARK

PRINCIPAL REGISTER

J ASSOCIATES CO., LTD (REPUBLIC OF KOREA CORPORATION)
681 BAKDAL-DONG
MANAN-GU.; ANYANG-SI; GYEONGGI-DO
REPUBLIC OF KOREA

FOR: BAGS, NAMELY, HANDBAGS; BACKPACKS; BOSTON BAGS; BAGS FOR SPORTS; LEATHER AND IMITATION LEATHER BAGS; BAGS FOR CLIMBERS IN THE NATURE OF ALL-PURPOSE CARRYING BAGS; RUCKSACKS FOR MOUNTAINEERS; WHEELED SHOPPING BAGS; TRAVELLING BAGS; TRAVELLING TRUNKS, IN CLASS 18 (U.S. CLS. 1, 2, 3, 22 AND 41).

FOR: ATHLETIC FOOTWEAR; SPORTS SHOES; SPORTS CLOTHING, NAMELY, TRAINING SUITS AND ATHLETIC UNIFORMS; CAPS; CLOTHING, NAMELY, SHIRTS, PANTS; SOCKS, IN CLASS 25 (U.S. CLS. 22 AND 39).

FOR: TABLE TENNIS BALLS; TABLE TENNIS NETS; TABLES FOR TABLE TENNIS; TABLE TENNIS RACKETS; RACKET CASES FOR TABLE TENNIS; BASKETBALLS, IN CLASS 28 (U.S. CLS. 22, 23, 38 AND 50).

THE MARK CONSISTS OF THE NON-LATIN CHARACTERS THAT TRANSLITERATE TO "XIOM" AND THE ENGLISH WORD "XIOM" LOCATED DIRECTLY BELOW.

PRIORITY DATE OF 7-20-2011 IS CLAIMED.

OWNER OF INTERNATIONAL REGISTRATION 1097403 DATED 10-10-2011, EXPIRES 10-10-2021.

THE NON-LATIN CHARACTERS IN THE MARK TRANSLITERATE TO "XIOM" AND THIS HAS NO MEANING IN A FOREIGN LANGUAGE.

THE WORDING "XIOM" HAS NO MEANING IN A FOREIGN LANGUAGE.

SER. NO. 79-105,293, FILED 10-10-2011.

LANA PHAM, EXAMINING ATTORNEY



David J. Kyffers

Director of the United States Patent and Trademark Office

United States of America

United States Patent and Trademark Office

AS TIME GOES BY

Reg. No. 4,173,635

Registered July 17, 2012

Int. Cl.: 35

SERVICE MARK

PRINCIPAL REGISTER

OFFICINE PANERAI A.G. (SWITZERLAND CORPORATION)
HINTERBERGSTRASSE 22, POSTFACH 61
CH-6312 STEINHAUSEN
SWITZERLAND

FOR: ADVERTISING; OUTDOOR ADVERTISING; PUBLICITY PREPARATION, NAMELY, DESIGN AND WRITING OF PUBLICITY MATERIALS; DIRECT MAIL ADVERTISING; ON-LINE ADVERTISEMENT ON A COMPUTER NETWORK; ORGANIZATION OF EXHIBITIONS FOR COMMERCIAL OR ADVERTISING PURPOSE; ARRANGEMENT OF COMMERCIAL SHOWCASES, NAMELY, COMMERCIAL EXHIBITIONS IN THE FIELD OF JEWELRY AND HOROLOGICAL INSTRUMENTS; BUSINESS MANAGEMENT CONSULTANCY IN CONNECTION WITH, IN PARTICULAR, THE RETAIL SALE OF JEWELRY, HOROLOGICAL INSTRUMENTS, IN CLASS 35 (U.S. CLS. 100, 101 AND 102).

THE MARK CONSISTS OF STANDARD CHARACTERS WITHOUT CLAIM TO ANY PARTICULAR FONT, STYLE, SIZE, OR COLOR.

PRIORITY DATE OF 6-23-2011 IS CLAIMED.

OWNER OF INTERNATIONAL REGISTRATION 1097755 DATED 10-26-2011, EXPIRES 10-26-2021.

SER. NO. 79-105,563, FILED 10-26-2011.

APRIL ROACH, EXAMINING ATTORNEY



David J. Kyffers

Director of the United States Patent and Trademark Office

United States of America

United States Patent and Trademark Office

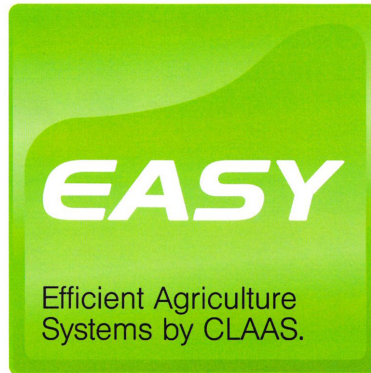

Reg. No. 4,173,636

Registered July 17, 2012

Int. Cls.: 7, 9, 12 and 35

TRADEMARK

SERVICE MARK

PRINCIPAL REGISTER

CLAAS KGAA MBH (FED REP GERMANY KGAA MBH)
MÜNSTERSTRASSE 33
33428 HARSEWINKEL
FED REP GERMANY

FOR: AGRICULTURAL MACHINERY AND EQUIPMENT OTHER THAN MANUALLY OPERATED, NAMELY, COMBINE HARVESTERS, FORAGE HARVESTERS, BAILERS, MOWERS, TURNERS AND SWATHERS; CULTIVATING MACHINERY AND EQUIPMENT, NAMELY, SOWING MACHINES; EQUIPMENT FOR THE APPLICATION OF FERTILIZERS AND PESTICIDES, NAMELY, TRACTOR-TOWED FERTILIZER AND PESTICIDE APPLICATORS AND SPREADERS, AND THEIR PARTS AND COMPONENTS, NAMELY, POWER OPERATED SPRAYERS AND AUTOMATIC NOZZLES, IN CLASS 7 (U.S. CLS. 13, 19, 21, 23, 31, 34 AND 35).

FOR: APPARATUS FOR RECORDING, TRANSMITTING AND REPRODUCING DATA, SOUNDS AND IMAGES; TELECOMMUNICATION EQUIPMENT, NAMELY, ELECTRONIC TRANSMITTERS AND RECEIVERS FOR USE IN AGRICULTURAL MACHINERY, AERIALS, MODEMS; MAGNETIC RECORDING MEDIA, NAMELY, BLANK MAGNETIC TAPES FOR TAPE RECORDERS; CALCULATORS, DATA PROCESSORS; COMPUTERS; DATA READING DEVICES, NAMELY, MAGNETIC CODED CARD READERS; DATA STORAGE DEVICES, NAMELY, COMPUTER DISC DRIVES; PRINTERS; COMPUTER MONITORS; SCANNERS; BLANK MAGNETIC DATA CARRIERS, NAMELY, COMPUTER DISKETTES, CD-ROMS AND DVDS; PRE-RECORDED MAGNETIC DATA CARRIERS, NAMELY, COMPUTER DISKETTES, CD-ROMS AND DVDS FEATURING PROGRAMS ALGORITHMS AND DATA RECORDS IN THE FIELD OF AGRICULTURE; COMPUTER SOFTWARE, VIDEO TAPES AND MAGNETIC OPTICAL DATA CARRIERS FOR USE IN OPERATING AGRICULTURAL MACHINERY; DATA PROCESSING EQUIPMENT, NAMELY, COMPUTERS; FUSES; ELECTRICAL SOCKETS; ELECTRIC PLUGS; THERMOSTATS; CONTROL BOXES CONSISTING OF ELECTRICAL AND ELECTRONIC CONTROL ELEMENTS, NAMELY, ELECTRICAL DISTRIBUTION BOXES; COMPUTER PROGRAMS AND COMPUTER SOFTWARE FOR USE IN THE FIELD OF AGRICULTURAL MANAGEMENT, ELECTRONIC DATA PROCESSORS FOR OPTIMIZING THE MODE OF OPERATION OF AGRICULTURAL MACHINES, IN CLASS 9 (U.S. CLS. 21, 23, 26, 36 AND 38).



David J. Kybas

FOR: LAND VEHICLES, APPARATUSES FOR TRAVEL ON LAND, NAMELY, TRACTORS AND FARM TRACTORS, IN CLASS 12 (U.S. CLS. 19, 21, 23, 31, 35 AND 44).

Reg. No. 4,173,636 FOR: DEVELOPMENT OF MARKETING STRATEGIES AND CONCEPTS, NAMELY, DEVELOPING MARKETING CONCEPTS FOR AGRICULTURAL SERVICE SUPPLY AGENCIES AND INTERFARM USE OF MACHINERY, AND DEVELOPING MARKETING CONCEPTS FOR COMPARING THE EFFICIENCY OF AGRICULTURAL MACHINES ORGANIZATIONAL SERVICES FOR BUSINESS PURPOSES, NAMELY, CONSULTING FOR PLANNING AND MANAGING AGRICULTURAL OPERATIONS AND SERVICE SUPPLY AGENCIES; BUSINESS MANAGEMENT CONSULTING SERVICES OF THE PURPOSE OF OPTIMIZING AGRICULTURAL MACHINE-SYSTEM TRANSPORT CHAINS AND FOR THE PURPOSE OF OPTIMIZING LOGISTICS PROCESSES, IN CLASS 35 (U.S. CLS. 100, 101 AND 102).

OWNER OF U.S. REG. NOS. 768,532, 3,910,306 AND OTHERS.

PRIORITY DATE OF 12-8-2010 IS CLAIMED.

OWNER OF INTERNATIONAL REGISTRATION 1097758 DATED 3-22-2011, EXPIRES 3-22-2021.

THE COLOR(S) GREEN, BLACK, AND WHITE IS/ARE CLAIMED AS A FEATURE OF THE MARK.

NO CLAIM IS MADE TO THE EXCLUSIVE RIGHT TO USE "EFFICIENT AGRICULTURE SYSTEMS", APART FROM THE MARK AS SHOWN.

THE MARK CONSISTS OF THE WORD "EASY" APPEARING IN WHITE STYLIZED FONT IN THE CENTER OF A GREEN RECTANGLE WITH A WHITE BORDER; THE WORDING "EFFICIENT AGRICULTURE SYSTEMS BY CLAAS" APPEARS IN BLACK STYLIZED FONT IN THE LOWER PORTION OF THE RECTANGLE.

SER. NO. 79-105,566, FILED 3-22-2011.

DAVID ELTON, EXAMINING ATTORNEY

United States of America

United States Patent and Trademark Office

TPBV TENNIS MASTERS

Reg. No. 4,173,637

Registered July 17, 2012

Int. Cls.: 38 and 41

SERVICE MARK

PRINCIPAL REGISTER

TENNIS PROPERTIES B.V. (NETHERLANDS CORPORATION)
COOLWIJKSEWEG 1A
NL-3218 VC HEENVLIET
NETHERLANDS

FOR: TELEVISION TRANSMISSION SERVICES OF REAL-TIME, DELAYED OR RECORDED SPORTING EVENTS; RADIO AND TELEVISION BROADCASTING; COMPUTER AIDED TRANSMISSIONS OF TEXT, SOUND, IMAGES AND AUDIO-VISUAL ITEMS; PROVIDING ACCESS TO DATABASES; BROADCASTING OF TENNIS AND OTHER SPORTS EVENTS, IN CLASS 38 (U.S. CLS. 100, 101 AND 104).

FOR: ORGANIZATION OF SPORTS COMPETITIONS; ORGANIZATION OF EVENTS FOR CULTURAL PURPOSES; ENTERTAINMENT IN THE NATURE OF TENNIS TOURNAMENTS; TENNIS INSTRUCTION AND EDUCATIONAL SERVICES, NAMELY, CONDUCTING CLASSES IN THE FIELD OF TENNIS; ENTERTAINMENT SERVICES IN THE NATURE OF TENNIS TOURNAMENTS AND TENNIS-RELATED EVENTS; PROVIDING INFORMATION ON THE SPORT OF TENNIS VIA THE INTERNET; PROVIDING TENNIS INFORMATION VIA AN ONLINE WEBSITE; PUBLICATION OF TEXT AND GRAPHIC WORKS OF OTHERS ONLINE FEATURING TENNIS AND OTHER SPORTING EVENTS; BETTING SERVICES; ONLINE GAMING SERVICES; GAMBLING AND LOTTERY SERVICES; ORGANIZATION AND PRESENTATION OF COMPETITIONS, GAMES, QUIZZES, FUN EVENTS AND AUDIENCE PARTICIPATING EVENTS IN THE FIELD OF TENNIS AND OTHER SPORTS, IN CLASS 41 (U.S. CLS. 100, 101 AND 107).



THE MARK CONSISTS OF STANDARD CHARACTERS WITHOUT CLAIM TO ANY PARTICULAR FONT, STYLE, SIZE, OR COLOR.

OWNER OF INTERNATIONAL REGISTRATION 1098208 DATED 2-8-2011, EXPIRES 2-8-2021.

OWNER OF U.S. REG. NOS. 2,963,884 AND 4,051,694.

NO CLAIM IS MADE TO THE EXCLUSIVE RIGHT TO USE "TENNIS", APART FROM THE MARK AS SHOWN.

SER. NO. 79-105,715, FILED 2-8-2011.

David J. Kyffers

Director of the United States Patent and Trademark Office

Reg. No. 4,173,637 JENNIFER MARTIN, EXAMINING ATTORNEY

United States of America

United States Patent and Trademark Office

MT-BIOMETHAN

Reg. No. 4,173,638

Registered July 17, 2012

Int. Cls.: 1, 9 and 11

TRADEMARK

PRINCIPAL REGISTER

MT-BIOMETHAN GMBH (FED REP GERMANY LIMITED LIABILITY COMPANY)
LUDWIG-ELSBETT-STR. 1
27404 ZEVEN
FED REP GERMANY

FOR: METHANE; CARBON DIOXIDE, EITHER GASEOUS, LIQUID OR SOLID, NAMELY, DRY ICE; THE AFOREMENTIONED GASES IN PARTICULAR FROM BIOGAS, IN CLASS 1 (U.S. CLS. 1, 5, 6, 10, 26 AND 46).

FOR: MEASURING GLASSES AND MEASURING INSTRUMENTS, NAMELY, GAS SENSORS FOR MEASURING GAS CONCENTRATION AND MEASURING APPARATUS FOR TEMPERATURE AND HUMIDITY LEVELS IN GASES AND SOLID SUBSTANCES, ALL OF THE FOREGOING FOR PROCESS MEASURING AND PROCESSING CONTROL SYSTEMS IN BIOGAS INSTALLATIONS AND BLOCK-TYPE COGENERATION INSTALLATIONS; INSTALLATIONS AND APPARATUS FOR REMOTE DATA TRANSMISSION AND REMOTE CONTROL OF BIOGAS INSTALLATIONS AND BLOCK-TYPE COGENERATION INSTALLATIONS, NAMELY, REMOTE CONTROL TELEMETERING MACHINES AND APPARATUS, WIRELESS REMOTE TEMPERATURE AND HUMIDITY MONITORS FOR BUILDING MAINTENANCE, DEVICES FOR WIRELESS RADIO TRANSMISSION, WIRELESS CONTROLLER TO MONITOR AND CONTROL THE FUNCTIONING OF OTHER ELECTRONIC DEVICES; APPARATUS AND INSTRUMENTS FOR MEASURING EXCESS PRESSURE OR NEGATIVE PRESSURE IN BIOGAS INSTALLATIONS AND BLOCK-TYPE COGENERATION INSTALLATIONS, NAMELY, AUTOMATIC PRESSURE CONTROL MACHINES AND INSTRUMENTS, PRESSURE GAUGES, PRESSURE INDICATING PLUGS FOR VALVES, PRESSURE SENSORS; INDUSTRIAL PROCESS CONTROL SOFTWARE FOR BIOGAS INSTALLATIONS AND BLOCK-TYPE COGENERATION INSTALLATIONS, IN CLASS 9 (U.S. CLS. 21, 23, 26, 36 AND 38).

FOR: GAS PURIFICATION DEVICES IN THE NATURE OF GAS PURIFICATION WASHERS, IN PARTICULAR FOR SEPARATING UNDESIRABLE COMPONENTS FROM BIOGAS, FOR EXAMPLE, CARBON DIOXIDE AND/OR HYDROGEN SULPHIDE AND/OR NITROGEN, IN CLASS 11 (U.S. CLS. 13, 21, 23, 31 AND 34).

THE MARK CONSISTS OF STANDARD CHARACTERS WITHOUT CLAIM TO ANY PARTICULAR FONT, STYLE, SIZE, OR COLOR.



David J. Kyjars

Director of the United States Patent and Trademark Office

Reg. No. 4,173,638 OWNER OF INTERNATIONAL REGISTRATION 1098398 DATED 7-28-2011, EXPIRES 7-28-2021.

SER. NO. 79-105,766, FILED 7-28-2011.

SHAILA SETTLES, EXAMINING ATTORNEY

United States of America

United States Patent and Trademark Office



CHRISTIAN GAUTIER

Reg. No. 4,173,639

Registered July 17, 2012

Int. Cl.: 3

TRADEMARK

PRINCIPAL REGISTER

D'PERFUMENET CREATIONS (SINGAPORE SOLE PROPRIETORSHIP)
P.O. BOX 237 KATONG POST OFFICE
SINGAPORE 914308
SINGAPORE

FOR: PERFUME, PERFUME OILS, EAU DE TOILETTE, EAU DE PARFUM; FRAGRANCES AND PERFUMES; DEODORANT, NAMELY, DEODORANTS FOR PERSONAL USE; AFTER SHAVE LOTIONS, ANTI-PERSPIRANTS; COSMETICS, IN CLASS 3 (U.S. CLS. 1, 4, 6, 50, 51 AND 52).

THE NAME(S), PORTRAIT(S), AND/OR SIGNATURE(S) SHOWN IN THE MARK DOES NOT IDENTIFY A PARTICULAR LIVING INDIVIDUAL.

PRIORITY DATE OF 8-12-2011 IS CLAIMED.

OWNER OF INTERNATIONAL REGISTRATION 1098489 DATED 10-7-2011, EXPIRES 10-7-2021.

THE MARK CONSISTS OF THE WORDING "CG CHRISTIAN GAUTIER" AND A DESIGN ELEMENT COMPRISING TWO KNIGHT CHESS PIECES IN THE SHAPE OF A HORSE'S HEAD.

SER. NO. 79-105,792, FILED 10-7-2011.

LAURIE KAUFMAN, EXAMINING ATTORNEY



David J. Kybas

Director of the United States Patent and Trademark Office

United States of America

United States Patent and Trademark Office

SAMSON

Reg. No. 4,173,640

Registered July 17, 2012

Int. Cls.: 7 and 9

TRADEMARK

PRINCIPAL REGISTER

SAMSON AG (FED REP GERMANY SA)
3, WEISMÜLLERSTRASSE,
60314 FRANKFURT
FED REP GERMANY

FOR: LATHES; SLIDING LATHES WITH ONE OR SEVERAL SHAFTS OR TOOL CARRIERS; TURRET LATHES; DRILLING MACHINES, MILLING MACHINES, SHARPENING AND POLISHING MACHINES FOR USE IN GRINDING AND POLISHING METAL, WOOD, CERAMICS AND PLASTICS; SEMI-AUTOMATIC AND AUTOMATIC LATHES, SEMI-AUTOMATIC AND AUTOMATIC DRILLING, MILLING AND SHARPENING MACHINES; MACHINE TOOL HOLDERS, CHUCKS FOR POWER DRILLS AND CLAMPING APPARATUS FOR MACHINES FOR USE IN THE PRECISION CLAMPING OF WORK PIECES; GEAR SYSTEMS, COUNTER GEARS, REDUCTION GEARS, REVOLVING HEADS, LEAD SCREWS, STUD BOLTS, SLIDING BRACKETS AND SLIDE RESTS, ALL FOR MACHINES, IN CLASS 7 (U.S. CLS. 13, 19, 21, 23, 31, 34 AND 35).

FOR: SEMI-AUTOMATIC AND AUTOMATIC ELECTRONIC MEASURING AND COUNTING DEVICES FOR MEASURING AND COUNTING WORK PIECES OF MACHINE TOOLS, LATHES, DRILLING MACHINES AND MACHINES FOR MILLING AND REPRODUCING BY MEANS OF MILLWORKING, IN CLASS 9 (U.S. CLS. 21, 23, 26, 36 AND 38).

THE MARK CONSISTS OF STANDARD CHARACTERS WITHOUT CLAIM TO ANY PARTICULAR FONT, STYLE, SIZE, OR COLOR.

OWNER OF INTERNATIONAL REGISTRATION 0382584 DATED 7-29-1971, EXPIRES 7-29-2021.

OWNER OF U.S. REG. NO. 1,387,225.

SER. NO. 79-105,799, FILED 7-30-2011.

SHAILA SETTLES, EXAMINING ATTORNEY



David J. Kyffers

Director of the United States Patent and Trademark Office

United States of America

United States Patent and Trademark Office



Reg. No. 4,173,641

Registered July 17, 2012

Int. Cls.: 35, 39, 40 and 42

SERVICE MARK

PRINCIPAL REGISTER

NORMA GROUP AG (FED REP GERMANY JOINT STOCK COMPANY)
EDISONSTRASSE 4
63477 MAINTAL
FED REP GERMANY

FOR: ADVERTISING, DISSEMINATION AND RENTAL OF ADVERTISING MATTER, PROVIDING OFFICE FUNCTIONS, COST-PRICE ANALYSIS, RECEIVING AND ADMINISTRATIVE PROCESSING OF ORDERS AND DELIVERIES, COMPUTERIZED FILE MANAGEMENT, COMPILATION OF STATISTICS, BUSINESS CONSULTING AND INFORMATION SERVICES FOR BUSINESS PARTNERS, COMMERCIAL ADMINISTRATION OF THE LICENSING OF GOODS AND SERVICES, FOR OTHERS, ARRANGING AND CONCLUDING OF COMMERCIAL TRANSACTIONS, FOR OTHERS, INVOICE MANAGEMENT SERVICES, NAMELY, BILLING, BUSINESS ORGANIZATION ADVICE, BUSINESS MANAGEMENT, WHOLESALE DISTRIBUTORSHIP SERVICES FOR GOODS IN THE FIELDS OF METAL GOODS, PLASTIC GOODS, AND RELATED GOODS THERETO; ALL THE AFORESAID SERVICES FOR GOODS IN THE FIELDS OF METAL GOODS, PLASTIC GOODS, AND RELATED GOODS THERETO, IN CLASS 35 (U.S. CLS. 100, 101 AND 102).

FOR: STORAGE, PACKAGING ARTICLES FOR TRANSPORTATION AND DELIVERY OF GOODS, IN PARTICULAR FOR GOODS IN THE FIELDS OF METAL GOODS, PLASTIC GOODS, AND RELATED GOODS THERETO, IN CLASS 39 (U.S. CLS. 100 AND 105).

FOR: PROCESSING OF METAL AND PLASTIC, NAMELY, GALVANIZING, FORGING OF METAL GOODS TO THE ORDER AND SPECIFICATION OF OTHERS, ENGRAVING, HARDENING OF METAL PRODUCTS, AND PLATINIZING IN THE NATURE OF METAL PLATING, IN RELATION TO GOODS IN THE FIELDS OF METAL GOODS, PLASTIC GOODS, AND RELATED GOODS THERETO, IN CLASS 40 (U.S. CLS. 100, 103 AND 106).

FOR: TECHNICAL RESEARCH IN THE FIELD OF PROCESSING METALS AND PLASTICS, MECHANICAL RESEARCH, CONSTRUCTION DRAFTING, MATERIALS TESTING, RESEARCH AND DEVELOPMENT IN THE FIELD OF PROCESSING OF METALS AND PLASTICS; DEVELOPMENT OF NEW GOODS OF METAL AND PLASTICS; ALL THE AFORESAID SERVICES FOR GOODS IN THE FIELDS OF METAL GOODS, PLASTIC GOODS, AND RELATED GOODS THERETO, IN CLASS 42 (U.S. CLS. 100 AND 101).

NO CLAIM IS MADE TO THE EXCLUSIVE RIGHT TO USE "GROUP", APART FROM THE MARK AS SHOWN.



David J. Kyjars

Director of the United States Patent and Trademark Office

Reg. No. 4,173,641 OWNER OF INTERNATIONAL REGISTRATION 1098565 DATED 6-20-2011, EXPIRES 6-20-2021.

THE MARK CONSISTS OF THE WORD "NORMA" OVER THE WORD "GROUP" WITH A CURVED LINE WITH A SHADED CIRCLE IN THE MIDDLE OF THE LINE TO THE LEFT OF AND OVER THE WORDING.

SER. NO. 79-105,943, FILED 6-20-2011.

AMY HELLA, EXAMINING ATTORNEY

United States of America

United States Patent and Trademark Office

WAVE
GARDEN →

Reg. No. 4,173,642

INSTANT SPORT, S.L. (SPAIN SOCIEDAD LIMITADA)
CALLE JOSÉ MARÍA SOROA, 25 BAJO
E-20013 SAN SEBASTIAN - GUIPÚZCOA, SPAIN

Registered July 17, 2012

Int. Cl.: 7

FOR: WAVE GENERATING MACHINES FOR GENERATING WAVES FOR SURFING, IN CLASS 7 (U.S. CLS. 13, 19, 21, 23, 31, 34 AND 35).

TRADEMARK

NO CLAIM IS MADE TO THE EXCLUSIVE RIGHT TO USE "WAVE", APART FROM THE MARK AS SHOWN.

PRINCIPAL REGISTER

OWNER OF INTERNATIONAL REGISTRATION 1098672 DATED 10-13-2011, EXPIRES 10-13-2021.

SER. NO. 79-105,979, FILED 10-13-2011.

ESTHER BELENKER, EXAMINING ATTORNEY



David J. Kybas

Director of the United States Patent and Trademark Office

United States of America

United States Patent and Trademark Office

UEFA EURO 2016

Reg. No. 4,173,643

Registered July 17, 2012

**Int. Cls.: 16, 25, 28, 32,
36, 38, 41 and 43**

TRADEMARK

SERVICE MARK

PRINCIPAL REGISTER

UNION DES ASSOCIATIONS EUROPÉENNES; DE FOOTBALL (UEFA) (SWITZERLAND ASSOCIATION)
ROUTE DE GENÈVE 46
CH-1260 NYON
SWITZERLAND

FOR: COLORING AND DRAWING BOOKS; CHILDREN'S ACTIVITY BOOKS; MAGAZINES; NEWSPAPERS; BOOKS AND PRINTED REVIEWS, ALL IN THE FIELD OF SPORTS PERSONALITIES AND SPORTS EVENTS; BOOKMARKERS; PRINTED TEACHING MATERIAL IN THE FIELD OF SPORTS; SCORE SHEETS; EVENT PROGRAMS; EVENT ALBUMS; PHOTOGRAPH ALBUMS; AUTOGRAPH BOOKS; PRINTED TIMETABLES; PAMPHLETS IN THE FIELD OF SPORTS PERSONALITIES AND SPORTS EVENTS; COLLECTIBLE PHOTOGRAPHS OF SPORTS PLAYERS; BUMPER STICKERS; STICKERS; ALBUMS, NAMELY, PHOTO ALBUMS AND EVENT ALBUMS; STICKER ALBUMS; POSTERS; PHOTOGRAPHS; TABLECLOTHS OF PAPER; TOWELS OF PAPER; PAPER BAGS; INVITATION CARDS; GREETING CARDS; GIFT WRAPPING PAPER; PAPER COASTERS AND PLACE MATS; GARBAGE BAGS OF PAPER AND OF PLASTICS; FOOD WRAPPING PAPER; SACHETS FOR PRESERVING FOODSTUFFS IN THE NATURE OF PLASTIC BAGS FOR PACKING FOODSTUFFS; FILTER PAPER; LABELS, NOT OF TEXTILE, NAMELY, PAPER LABELS, ADDRESS LABELS AND SHIPPING LABELS; WET DISPOSABLE WIPES NOT IMPREGNATED WITH CHEMICALS OR COMPOUNDS; TOILET PAPER; NAPKINS OF PAPER FOR REMOVING MAKE-UP; BOXES OF PAPER AND CARDBOARD FOR HANDKERCHIEF STORAGE; BABIES' DIAPERS OF PAPER; STATIONERY AND PRINTED INSTRUCTIONAL AND TEACHING MATERIAL IN THE FIELD OF SPORTS; TYPEWRITER PAPER; COPYING PAPER; ENVELOPES; NOTEPADS; PAPER FOLDERS; TISSUE PAPER; SCHOOL WRITING BOOKS; PAPER SHEETS FOR NOTE TAKING; WRITING PAPER; PAPER FOR NOTEBOOK BINDERS; WASTE PAPER BASKETS; FILES, NAMELY, CARD FILES, DOCUMENT FILES, LETTER FILES AND PAPER EXPANDING FILES; BOOK COVER PAPER; LUMINOUS PAPER; SELF-ADHESIVE PAPER FOR NOTES; PAPERWEIGHTS; CREPE PAPER; CLOTH PAPER IN THE NATURE OF FIBER PAPER; PAPER BADGES AND PAPER INSIGNIA IN THE NATURE OF EMBLEMS; FLAGS OF PAPER; SPORTS TEAMS FLAGS OF PAPER; WRITING INSTRUMENTS; FOUNTAIN PENS; PENCILS; BALLPOINT PENS; BALL-POINT PEN AND PENCIL SETS; FELT-TIP PENS; FIBER-TIP PENS FOR COLORING; FELT-TIP WRITING PENS; MARKING PENS, NAMELY, MARKERS; WRITING INK, INKING PADS, RUBBER STAMPS; ELECTRIC AND NON-ELECTRIC TYPEWRITERS; LITHOGRAPHS, LITHOGRAPHIC WORKS OF ART; FRAMED AND UNFRAMED PAINTINGS AND PICTURES; PAINT BOXES; ARTS AND CRAFTS PAINT KITS; COLORING PENCILS;

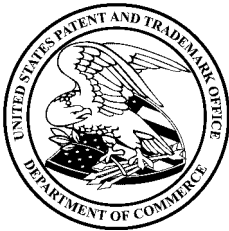

David J. Kybas

Director of the United States Patent and Trademark Office

Reg. No. 4,173,643 CHALKS; PENCIL ORNAMENTS; BLOCKS FOR PRINTING; ADDRESS BOOKS; DIARIES; PERSONAL ORGANIZERS OF PAPER; ROAD MAPS; PRINTED TICKETS; PRINTED ADMISSION TICKETS, LOTTERY TICKETS; SCRATCH CARDS; BANK CHECKS; COMIC BOOKS; CALENDARS; POSTCARDS; PRINTED ADVERTISING BOARDS OF PAPER OR CARDBOARD; PAPER BANNERS; DECALCOMANIAS; ADHESIVE LABELS; OFFICE REQUISITES, NAMELY, CORRECTION FLUIDS FOR DOCUMENTS, RUBBER ERASERS, PENCIL SHARPENERS, HOLDERS FOR PENS, PENCILS, AND INK, AND DESK STANDS AND CONTAINERS FOR OFFICE ARTICLES IN THE NATURE OF CORRUGATED BOARD AND PAPER CONTAINERS FOR OFFICE ARTICLES; STANDS AND CONTAINERS FOR OFFICE ARTICLES, NAMELY, CALENDAR STANDS, STANDS FOR WRITING IMPLEMENTS, STAMP STANDS, DESKTOP DOCUMENT STANDS, STORAGE CONTAINERS MADE OF PAPER OR CARDBOARD; PAPER CLIPS; THUMB TACKS; RULERS, NAMELY, DRAFTING RULERS, DRAWING RULERS AND UNGRADUATED RULERS; ADHESIVE TAPES FOR STATIONERY, ADHESIVE TAPE DISPENSERS; STAPLES; MARKING TEMPLATES; BINDER CLIPS; HOLDERS FOR NOTEPADS; CASES FOR VISITING CARDS; BOOK ENDS; BOOK SUPPORTS IN THE NATURE OF BOOK HOLDERS; STAMPS, NAMELY, RUBBER STAMPS, SEALING STAMPS, INK STAMPS AND POSTAGE STAMPS; CREDIT CARDS WITHOUT MAGNETIC CODING, TELEPHONE CALLING CARDS, NOT MAGNETICALLY ENCODED; CASH CARDS IN THE NATURE OF DEBIT CARDS, NOT MAGNETICALLY CODED, NON-MAGNETICALLY ENCODED TRAVEL CARDS MADE OF PAPER OR CARDBOARD; NON-MAGNETICALLY ENCODED DISCOUNT CARDS FOR SHOWS MADE OF PAPER OR CARDBOARD; NON-MAGNETICALLY ENCODED CHECK GUARANTEE CARDS AND DEBIT CARDS MADE OF PAPER OR CARDBOARD; BABIES' DISPOSABLE DIAPER-PANTS OF PAPER OR CELLULOSE; BAGGAGE TAGS OF PAPER; PASSPORT CASES; TRAVELERS' BANK CHECKS; HOLDERS FOR CHECKBOOKS; METAL NOTE CLIPS IN THE NATURE OF MONEY CLIPS; SUITCASE TAGS; IDENTITY CARD HOLDERS IN THE NATURE OF DRIVER'S LICENSE HOLDERS, IN CLASS 16 (U.S. CLS. 2, 5, 22, 23, 29, 37, 38 AND 50).

FOR: CLOTHING, NAMELY, SHIRTS, POLO SHIRTS, SLIPOVERS, PULLOVERS, SLEEVELESS PULLOVERS, BLOUSES, TEE-SHIRTS, WAISTCOATS, SINGLETs, SLEEVELESS JERSEYS, FROCKs, DRESSES, SKIRTS, SHORTS, TROUSERS; UNDERWEAR, SWEATSHIRTS, BLAZERS, JACKETS, SPORTS JACKETS, STADIUM VESTS; BATHING SUITS; SWIMWEAR; BATH-ROBES; SWEATERS; SASHES FOR WEAR; SCARVES; SHAWLS; TRACKSUITS; KNITWEAR, NAMELY, KNIT BOTTOMS, KNIT DRESSES, KNIT JACKETS, KNIT SHIRTS, KNIT SKIRTS, KNITTED CAPS, KNITTED GLOVES AND KNITTED UNDERWEAR; WATERPROOF CLOTHING, NAMELY, WATERPROOF JACKETS, PANTS AND FOOTWEAR; COATS; UNIFORMS; NECKTIES; WRIST BANDS; HEADBANDS; GLOVES; APRONS; BIBS NOT OF PAPER; PAJAMAS; PLAY SUITS FOR INFANTS AND CHILDREN; SHOES AND FOOTWEAR; SOCKS AND STOCKINGS; HEADWEAR; KNITTED CAPS; CAPS; HATS; CAPS WITH VISORS; GARTERS; BELTS; BRACES FOR CLOTHING, IN CLASS 25 (U.S. CLS. 22 AND 39).

FOR: GAMES AND PLAYTHINGS, NAMELY, SPORTS BALLS, PLAY BALLOONS, BALLOONS; BOARD GAMES; GAME TABLES FOR INDOOR FOOTBALL; DOLLS AND PLUSH TOYS; TOY VEHICLES; JIGSAW PUZZLES; BALLS FOR GAMES; INFLATABLE TOYS; DISC TOSS TOYS; PLAYING CARDS; CONFETTI; GYMNAS TIC AND SPORTING ARTICLES, NAMELY, GYMNAS TIC APPARATUS, SPORTING BOARDS AND NETS FOR SPORTING PURPOSES; SOCCER EQUIPMENT, NAMELY, SOCCER BALLS, GLOVES, KNEE GUARDS, ELBOW GUARDS, SHOULDER PROTECTORS IN THE NATURE OF PROTECTIVE SUPPORTS FOR SHOULDERS, SHIN GUARDS; SOCCER GOALS; SPORT BAGS AND CONTAINERS SPECIALLY ADAPTED FOR SPORTS EQUIPMENT FOR CARRYING SPORTS ARTICLES; PAPER AND PLASTIC PARTY HATS; ELECTRONIC GAMES OTHER THAN THOSE ADAPTED FOR USE ONLY WITH A TELEVISION SET; TOY FOAM AND RUBBER NOVELTY ITEMS, NAMELY, HANDS MADE OF RUBBER AND OF FOAM; TOY ROBOTS FOR AMUSEMENT; KITES; ROLLER SKATES; TOY SCOOTERS; SKATEBOARDS, IN CLASS 28 (U.S. CLS. 22, 23, 38 AND 50).

Reg. No. 4,173,643 FOR: NON-ALCOHOLIC BEVERAGES, NAMELY, SODA POP, SOFT DRINKS, LOW CALORIES SOFT DRINKS, DIET SOFT DRINKS, DRINKING WATER, WATER BEVERAGES, FLAVORED WATERS, ENERGY DRINKS, FRUIT DRINKS, VEGETABLE DRINKS, FRUIT JUICES AND VEGETABLE JUICES, LEMONADES AND ORANGE JUICE; SYRUPS AND POWDERS FOR MAKING NON-ALCOHOLIC BEVERAGES; MINERAL AND AERATED WATERS; ISOTONIC BEVERAGES; FRUIT AND VEGETABLE DRINKS; FRUIT AND VEGETABLE JUICES; ICED FRUIT BEVERAGES; BEER; STRONG DARK BEERS; LAGERS AND ALES; ALCOHOL-FREE OR LOW-ALCOHOL BEERS, IN CLASS 32 (U.S. CLS. 45, 46 AND 48).

FOR: ISSUING OF CREDIT CARDS AND TRAVELERS' CHECKS; FINANCIAL SERVICES, NAMELY, FINANCING SERVICES AND CREDIT RISK MANAGEMENT; BANKING SERVICES; CREDIT CARD SERVICES; FUNDS INVESTMENT; INSURANCE UNDERWRITING FOR ALL TYPES OF INSURANCE; HIRE-PURCHASE FINANCING; HIRE-PURCHASE SERVICES, NAMELY, BROKERAGE FOR HIRE-PURCHASE; FINANCIAL SPONSORSHIP OF SPORTS MEETINGS; INFORMATION SERVICES CONCERNING FINANCE AND INSURANCE, PROVIDED FROM A COMPUTER DATABASE OR VIA THE INTERNET OR ON ANY WIRELESS ELECTRONIC COMMUNICATION NETWORK; HOME BANKING SERVICES; BANKING SERVICES VIA THE INTERNET OR ON ANY WIRELESS ELECTRONIC COMMUNICATION NETWORK; PAYMENT SERVICES VIA MOBILE TELEPHONE, NAMELY, PROVIDING SECURE COMMERCIAL TRANSACTION PAYMENT OPTIONS USING A MOBILE DEVICE AT A POINT OF SALE; PAYMENT SERVICES VIA MOBILE TELEPHONE, NAMELY, ELECTRONIC PROCESSING AND TRANSMISSION OF BILL PAYMENT DATA FOR PAYMENTS; BILL PAYMENT SERVICES VIA MOBILE TELEPHONE; SAFE DEPOSIT BOX SERVICES, IN CLASS 36 (U.S. CLS. 100, 101 AND 102).

FOR: TELECOMMUNICATIONS, NAMELY, COMMUNICATIONS BY MOBILE TELEPHONES, TELEPHONE AND TELETXT SERVICES, PROVIDING ACCESS TO DATABASES AND TELECOMMUNICATION NETWORKS; COMMUNICATIONS VIA ELECTRONIC COMPUTER TERMINALS LINKED TO TELECOMMUNICATION NETWORKS, DATA BANKS AND THE INTERNET AND VIA WIRELESS ELECTRONIC COMMUNICATION DEVICES; COMMUNICATION BY TELEGRAPH; COMMUNICATION BY TELEPHONE; COMMUNICATION BY FACSIMILE; PAGING SERVICES; PROVIDING TELEPHONE AND VIDEO CONFERENCING SERVICES; TELEVISION BROADCASTING; CABLE TELEVISION PROGRAM BROADCASTING; RADIO BROADCASTING; RADIO AND TELEVISION BROADCASTING OF SPORTS AND SPORTS EVENTS; NEWS AGENCY SERVICES FOR ELECTRONIC TRANSMISSION; OTHER MESSAGE TRANSMISSION SERVICES, NAMELY, TRANSMISSION OF MESSAGES; RENTAL OF TELEPHONES, FACSIMILE MACHINES AND OTHER TELECOMMUNICATION DEVICES; ELECTRONIC TRANSMISSION OF DATA, NAMELY, OF COMMERCIAL INTERNET PAGES ONLINE OR VIA WIRELESS ELECTRONIC COMMUNICATION DEVICES; TRANSMISSION OF TELEVISION AND RADIO PROGRAMS VIA THE INTERNET AND VIA WIRELESS ELECTRONIC COMMUNICATION NETWORKS; ELECTRONIC MESSAGE TRANSMISSION; PROVIDING ACCESS TO DATABASES ON DATA COMMUNICATION SERVERS AND TO INTERNET REAL-TIME CHAT FORUMS; COMPUTER AIDED TRANSMISSION OF MESSAGES AND IMAGES; TELECOMMUNICATION VIA A FIBER-OPTIC NETWORK; PROVIDING ACCESS TO GLOBAL COMPUTER NETWORKS AND INTERACTIVE COMMUNICATIONS NETWORKS FOR ACCESS TO PRIVATE AND COMMERCIAL PURCHASING AND ORDERING SERVICES; TELECOMMUNICATION OF COMPUTER INFORMATION AND OTHER DATA, NAMELY, TELEMATIC SENDING OF INFORMATION AND DATA; TRANSMISSION OF INFORMATION VIA NATIONAL AND INTERNATIONAL NETWORKS; ELECTRONIC TRANSMISSION OF DATA IN THE NATURE OF COMPUTER PROGRAMS AND OTHER DATA; ELECTRONIC MAIL; INTERNET SERVICE PROVIDER SERVICES VIA THE GLOBAL COMMUNICATIONS NETWORKS AND VIA WIRELESS ELECTRONIC COMMUNICATION NETWORKS; PROVIDING ELECTRONIC TELECOMMUNICATION CONNECTIONS FOR TELECOMMUNICATIONS WITH A GLOBAL COMPUTER NETWORK AND WITH DATA BANKS; PROVIDING ACCESS TO DATABASES ON WEBSITES OFFERING DIGITAL MUSIC ON THE INTERNET VIA A GLOBAL COMPUTER NETWORK AND VIA WIRELESS ELECTRON-

Reg. No. 4,173,643 IC COMMUNICATION DEVICES; PROVIDING TEMPORARY ACCESS TO DATABASES, NAMELY, RENTAL OF ACCESS TIME TO MP3 WEBSITES ON THE INTERNET VIA A GLOBAL COMPUTER NETWORK AND VIA WIRELESS ELECTRONIC COMMUNICATION DEVICES; PROVIDING TEMPORARY ACCESS TO DATABASES, NAMELY, RENTAL OF ACCESS TIME TO A DATABASE SERVER CENTER; PROVIDING TEMPORARY ACCESS TO DATABASES, NAMELY, RENTAL OF ACCESS TIME TO A COMPUTER DATABASE; ELECTRONIC TRANSMISSION OF DIGITAL MUSIC VIA TELECOMMUNICATIONS; ELECTRONIC ON-LINE TRANSMISSION OF DATA, NAMELY, TRANSMISSION OF ELECTRONIC PUBLICATIONS; ELECTRONIC TRANSMISSION OF DIGITAL MUSIC VIA THE INTERNET AND VIA WIRELESS ELECTRONIC COMMUNICATION NETWORKS; ELECTRONIC TRANSMISSION OF DIGITAL MUSIC VIA MP3 WEBSITES; SIMULCASTING BROADCAST TELEVISION FEATURING FILM RECORDINGS AND SOUND AND VIDEO RECORDINGS OVER GLOBAL COMMUNICATION NETWORKS, THE INTERNET AND WIRELESS NETWORKS; SIMULCASTING BROADCAST TELEVISION FEATURING INTERACTIVE EDUCATIONAL INFORMATION AND ENTERTAINMENT PRODUCT INFORMATION OVER GLOBAL COMMUNICATION NETWORKS, THE INTERNET AND WIRELESS NETWORKS; SIMULTANEOUS TRANSMISSION, DELIVERY, AND MANAGEMENT OF INTERACTIVE ELECTRONIC FILES CONTAINING EDUCATIONAL AND ENTERTAINMENT INFORMATION VIA GLOBAL COMPUTER NETWORKS; PROVIDING USER ACCESS TO COMPUTER GAME PROGRAMS IN DATA NETWORKS; PROVIDING ACCESS TO BLACKBOARDS, NAMELY, ELECTRONIC BULLETIN BOARD SERVICES; PROVIDING CHAT ROOMS, NAMELY, PROVIDING ON-LINE FACILITIES FOR REAL-TIME INTERACTION WITH OTHER COMPUTER USERS CONCERNING TOPICS OF GENERAL INTEREST OR TRANSMISSION OF MESSAGES VIA A GLOBAL COMPUTER NETWORK; PROVIDING TEMPORARY ACCESS TO BLACKBOARDS, NAMELY, ELECTRONIC BULLETIN BOARD SERVICES; PROVIDING INTERNET CHATROOMS; COMMUNICATIONS VIA MULTINATIONAL TELECOMMUNICATION NETWORKS DEDICATED TO RETAIL SALES BY MEANS OF INTERACTIVE COMMUNICATIONS WITH CUSTOMERS; MULTIMEDIA TELECOMMUNICATION SERVICES, NAMELY, PROVIDING TELECOMMUNICATION CONNECTIVITY SERVICES FOR TRANSFER OF MULTIMEDIA WORKS AND TRANSMISSION OF SOUND AND VISION VIA INTERACTIVE MULTIMEDIA NETWORKS; VIDEOTEXT AND TELETEXT TRANSMISSION SERVICES; SATELLITE TRANSMISSION OF INFORMATION; MICROWAVE TRANSMISSION OF INFORMATION, NAMELY, RADIO COMMUNICATION; ELECTRONIC, DIGITAL AND ELECTRONIC ANALOG TRANSMISSION OF INFORMATION; TRANSMISSION OF DIGITAL INFORMATION BY CABLE, WIRE AND FIBER ACROSS ELECTRONIC COMMUNICATIONS NETWORKS; TRANSMISSION OF INFORMATION VIA MOBILE TELEPHONE, TELEPHONE, FACSIMILE MACHINE AND TELETYPEWRITER ACROSS NATIONAL AND INTERNATIONAL NETWORKS; TELECOMMUNICATION SERVICES, NAMELY, RECEIVING AND ELECTRONICALLY EXCHANGING INFORMATION, MESSAGES, IMAGES AND DATA STORED IN DATABASES ACCESSIBLE VIA TELECOMMUNICATION NETWORKS, IN CLASS 38 (U.S. CLS. 100, 101 AND 104).

FOR: EDUCATION, NAMELY, PROVIDING CLASSES, SEMINARS, WORKSHOPS AND TRAINING COURSES IN THE FIELDS OF SOCCER, SOCCER COACHING AND SOCCER OFFICIATING; PROVIDING OF TRAINING, NAMELY, ATHLETIC TRAINING SERVICES; ENTERTAINMENT IN THE NATURE OF SOCCER GAMES, MATCHES AND TOURNAMENTS; OPERATING LOTTERIES AND LOTTERY PRIZE DRAWS AND ARRANGING OF CONTESTS; BETTING SERVICES AND CASINO GAMING SERVICES RELATED TO SPORTS; HOSPITALITY SERVICES, NAMELY, CUSTOMER RECEPTION SERVICES IN THE NATURE OF ARRANGING, ORGANIZING, CONDUCTING AND HOSTING PARTIES AND SOCIAL ENTERTAINMENT EVENTS IN CONJUNCTION WITH SPORTING EVENTS; ENTERTAINMENT SERVICES IN CONNECTION WITH SPORTS EVENTS, NAMELY, ENTERTAINMENT IN THE NATURE OF LASER SHOWS, LIGHT SHOWS, AUDIO AND VISUAL PERFORMANCES, LIVE PERFORMANCES BY A MUSICAL BAND, PREPARATION OF SPECIAL EFFECTS, AND FIREWORKS DISPLAYS; SPORTING AND CULTURAL ACTIVITIES, NAMELY, ORGANIZATION OF EXHIBITIONS FOR CULTURAL OR EDUCATIONAL PURPOSES; ORGANIZATION OF SPORTING AND CULTURAL EVENTS AND ACTIVITIES; ORGANIZATION OF SPORTS COMPETITIONS; ORGANIZATION OF EVENTS RELATING

Reg. No. 4,173,643 TO SOCCER, NAMELY, ORGANIZATION OF COMPETITIONS AND TOURNAMENTS IN THE FIELD OF SOCCER; PROVIDING SPORTS FACILITIES; RENTAL OF VIDEO AND AUDIOVISUAL EQUIPMENT; FILM AND VIDEO TAPE PRODUCTION, DISPLAYING A SERIES OF FILMS, FILM DISTRIBUTION, AND RENTAL OF FILM RECORDINGS AND SOUND AND VIDEO TAPES; COVERAGE OF SPORTS EVENTS BROADCAST ON RADIO OR TELEVISION, NAMELY, RADIO AND TELEVISION BROADCASTING IN THE FIELD OF SPORTS EVENTS; PRODUCTION OF PROGRAMS FOR RADIO, TELEVISION AND VIDEOTAPE; ENTERTAINMENT SERVICES, NAMELY, ARRANGING FOR TICKET RESERVATIONS FOR SHOWS AND OTHER ENTERTAINMENT EVENTS; AND ENTERTAINMENT INFORMATION SERVICES IN THE FIELD OF SPORTS EVENTS AND OTHER ENTERTAINMENT INFORMATION; AND ENTERTAINMENT TICKET AGENCY SERVICES FOR SPORTS EVENTS AND ENTERTAINMENT; TIMING DURING OF SPORTS EVENTS; ARRANGING OF BEAUTY CONTESTS; INTERACTIVE ENTERTAINMENT, NAMELY, PROVIDING OF AN ONLINE QUIZ GAME IN THE FIELD OF SOCCER; INTERACTIVE ENTERTAINMENT IN THE NATURE OF FANTASY SPORTS LEAGUES; BETTING AND CASINO GAMING SERVICES ON-LINE ON THE INTERNET AND ON ANY WIRELESS ELECTRONIC COMMUNICATION NETWORK; ENTERTAINMENT INFORMATION IN THE FIELD OF SPORTS, PROVIDED ON-LINE FROM A COMPUTER DATABASE OR VIA THE INTERNET OR VIA WIRELESS ELECTRONIC COMMUNICATION NETWORK; SERVICES OF ELECTRONIC GAMES TRANSMITTED VIA THE INTERNET OR ON MOBILE TELEPHONES, NAMELY, PROVIDING ONLINE COMPUTER GAMES VIA THE INTERNET AND MOBILE TELEPHONES; PUBLICATION OF BOOKS; PUBLICATION OF BOOKS AND ELECTRONIC JOURNALS ON-LINE; AUDIO AND VIDEO RECORDING SERVICES; ANIMATION PRODUCTION SERVICES, NAMELY, PRODUCTION OF ANIMATED CARTOONS FOR THE CINEMA, AND PRODUCTION OF ANIMATED CARTOONS FOR TELEVISION; RENTAL OF SOUND AND MOTION PICTURE RECORDINGS FOR ENTERTAINMENT PURPOSES; EDUCATION INFORMATION PROVIDED ON-LINE FROM A COMPUTER DATABASE OR VIA THE INTERNET OR VIA WIRELESS ELECTRONIC COMMUNICATION NETWORK; OPERATING OF DISCUSSION GROUPS, NAMELY, CONDUCTING EDUCATIONAL PANEL DISCUSSIONS IN THE FIELD OF SPORTS ON THE INTERNET OR ON WIRELESS ELECTRONIC COMMUNICATION NETWORKS; TRANSLATION; PHOTOGRAPHY SERVICES; PROVISION OF ENTERTAINMENT INFRASTRUCTURES, NAMELY, PROVIDING AMUSEMENT FACILITIES; PROVISION OF ENTERTAINMENT INFRASTRUCTURES, NAMELY, PROVIDING FACILITIES FOR RECREATION ACTIVITIES; PROVISION OF ENTERTAINMENT INFRASTRUCTURES, NAMELY, PROVIDING VARIOUS FACILITIES FOR AN ARRAY OF SPORTING EVENTS, SPORTS AND ATHLETIC COMPETITIONS AND AWARDS PROGRAMS; PROVISION OF ENTERTAINMENT INFRASTRUCTURES, NAMELY, PROVIDING FACILITIES FOR SPORTS TOURNAMENTS; PROVISION OF ENTERTAINMENT INFRASTRUCTURES, NAMELY, PROVISION OF PLAY FACILITIES FOR CHILDREN; PROVISION OF ENTERTAINMENT INFRASTRUCTURES, NAMELY, RENTAL OF STADIUM FACILITIES, IN CLASS 41 (U.S. CLS. 100, 101 AND 107).

FOR: PROVIDING OF FOOD AND DRINK, SNACK-BARS; RECEPTION SERVICES, NAMELY, PROVIDING FOOD AND DRINK; FOOD AND DRINK CATERING; HOTELS; PROVIDING FOOD, DRINK AND TEMPORARY HOUSING ACCOMMODATIONS; MAKING HOTELS RESERVATIONS AND TEMPORARY ACCOMMODATION RESERVATIONS FOR OTHERS; HOSPITALITY SERVICES, NAMELY, PROVIDING FOOD AND DRINK AT SPORTS AND ENTERTAINMENT EVENTS, IN CLASS 43 (U.S. CLS. 100 AND 101).

THE MARK CONSISTS OF STANDARD CHARACTERS WITHOUT CLAIM TO ANY PARTICULAR FONT, STYLE, SIZE, OR COLOR.

PRIORITY DATE OF 3-23-2011 IS CLAIMED.

OWNER OF INTERNATIONAL REGISTRATION 1099152 DATED 8-22-2011, EXPIRES 8-22-2021.

OWNER OF U.S. REG. NOS. 3,181,196, 3,537,198 AND OTHERS.

Reg. No. 4,173,643 SER. NO. 79-106,117, FILED 8-22-2011.

ANDREA K. NADELMAN, EXAMINING ATTORNEY

United States of America

United States Patent and Trademark Office



Reg. No. 4,173,644

Registered July 17, 2012

Int. Cl.: 28

TRADEMARK

PRINCIPAL REGISTER

SHIMANO INC. (JAPAN CORPORATION)
3-77, OIMATSU-CHO
SAKAI-KU, SAKAI CITY; OSAKA 590-8577
JAPAN

FOR: FISHING FLOATS; FISHING SINKERS; LANDING NETS FOR ANGLERS; FISHING LINES, FISHING REELS; FISHING RODS; CASES FOR FISHING RODS; FISHING HOOKS, LURES FOR FISHING, IN CLASS 28 (U.S. CLS. 22, 23, 38 AND 50).

THE MARK CONSISTS OF THE WORDING "SVS" WITH A CURVED BAND ABOVE THE WORDING AND A CURVED BAND BELOW THE WORDING.

PRIORITY DATE OF 10-21-2011 IS CLAIMED.

OWNER OF INTERNATIONAL REGISTRATION 1099232 DATED 10-27-2011, EXPIRES 10-27-2021.

SER. NO. 79-106,151, FILED 10-27-2011.

LEIGH LOWRY, EXAMINING ATTORNEY



David J. Kyffers

Director of the United States Patent and Trademark Office

United States of America

United States Patent and Trademark Office

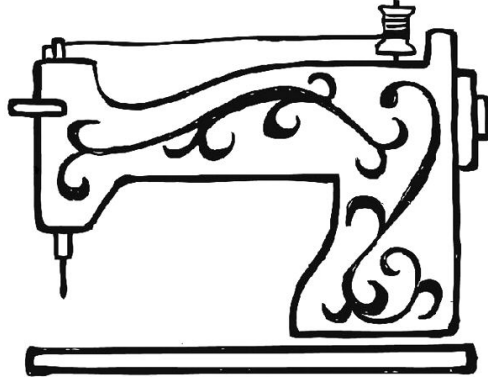

Reg. No. 4,173,645

Registered July 17, 2012

Int. Cl.: 14

TRADEMARK

PRINCIPAL REGISTER

SCOTCH & SODA B.V. (NETHERLANDS PRIVATE LIMITED LIABILITY COMPANY)
JACOBUS SPIJKERDREEF 20-24
NL-2132 PZ HOOFDORP
NETHERLANDS

FOR: PRECIOUS METALS AND THEIR ALLOYS AND GOODS IN PRECIOUS METALS AND COATED THEREWITH, NAMELY BRACELETS, JEWELLERY, CLOCKS, FIGURINES, KEY CHAINS, ORNAMENTAL PINS, WATCHES; JEWELLERY, PRECIOUS STONES; HOROLOGICAL AND CHRONOMETRIC INSTRUMENTS, IN CLASS 14 (U.S. CLS. 2, 27, 28 AND 50).

OWNER OF U.S. REG. NO. 3,623,232.

OWNER OF INTERNATIONAL REGISTRATION 1028903 DATED 1-13-2010, EXPIRES 1-13-2020.

THE MARK CONSISTS OF A SEWING MACHINE.

SER. NO. 79-106,354, FILED 10-7-2011.

RAMONA ORTIGA, EXAMINING ATTORNEY



David J. Kyffers

Director of the United States Patent and Trademark Office

United States of America
United States Patent and Trademark Office

XINHUASEN

Reg. No. 4,173,646

Registered July 17, 2012

Int. Cl.: 7

ZHEJIANG HUASEN; RADIATOR MANUFACTURING CO., LTD. (CHINA LIMITED LIABILITY COMPANY)
ECONOMICAL DEVELOPMENT ZONE
RUIAN CITY; 325200 ZHEJIANG PROVINCE
CHINA

TRADEMARK

PRINCIPAL REGISTER

FOR: EXPANSION TANKS BEING PARTS OF MACHINES; VALVES BEING PARTS OF MACHINES; PULLEYS BEING PARTS OF MACHINES; STARTERS FOR MOTORS AND ENGINES; COOLING RADIATORS FOR MOTORS AND ENGINES; TAPS BEING PARTS OF MACHINES, ENGINES OR MOTORS, OTHER THAN FOR LAND VEHICLES; SHOCK ABSORBERS FOR MACHINES; LAND VEHICLE OIL PUMPS; LAND VEHICLE WATER PUMPS; WATER HEATERS BEING PARTS OF MACHINES, IN CLASS 7 (U.S. CLS. 13, 19, 21, 23, 31, 34 AND 35).

THE WORDING "XINHUASEN" HAS NO MEANING IN A FOREIGN LANGUAGE.

OWNER OF INTERNATIONAL REGISTRATION 1099748 DATED 8-15-2011, EXPIRES 8-15-2021.

SER. NO. 79-106,424, FILED 8-15-2011.

DAVID HOFFMAN, EXAMINING ATTORNEY



David J. Kyffers

Director of the United States Patent and Trademark Office

United States of America

United States Patent and Trademark Office

FLOWLOGIC

Reg. No. 4,173,647

Registered July 17, 2012

Int. Cl.: 9

TRADEMARK

PRINCIPAL REGISTER

INIVAI TECHNOLOGIES PTY LTD (AUSTRALIA CORPORATION)
136 BALCOMBE ROAD
MENTONE VIC 3194
AUSTRALIA

FOR: COMPUTER SOFTWARE FOR MEASURING PHYSICAL AND CHEMICAL CHARACTERISTICS OF CELLS OR OTHER PARTICLES; COMPUTER SOFTWARE FOR GATHERING, ANALYSING, ORGANISING AND DISPLAYING DATA IN THE FIELD OF CELL ANALYSIS; RECORDED MATERIALS, NAMELY, DISCS, TAPES AND OTHER RECORDINGS FEATURING THE AFORESAID SOFTWARE, SOLD TOGETHER AS PART OF A UNIT, IN CLASS 9 (U.S. CLS. 21, 23, 26, 36 AND 38).

THE MARK CONSISTS OF STANDARD CHARACTERS WITHOUT CLAIM TO ANY PARTICULAR FONT, STYLE, SIZE, OR COLOR.

PRIORITY DATE OF 5-2-2011 IS CLAIMED.

OWNER OF INTERNATIONAL REGISTRATION 1100015 DATED 10-31-2011, EXPIRES 10-31-2021.

SER. NO. 79-106,501, FILED 10-31-2011.

DAVID HOFFMAN, EXAMINING ATTORNEY



David J. Kyffers

Director of the United States Patent and Trademark Office

United States of America

United States Patent and Trademark Office

PASSE-GUIDE

Reg. No. 4,173,648

Registered July 17, 2012

Int. Cl.: 18

TRADEMARK

PRINCIPAL REGISTER

HERMES INTERNATIONAL (FRANCE SOCIÉTÉ EN COMMANDITE PAR ACTIONS)
24 RUE DU FAUBOURG SAINT-HONORÉ
F-75008 PARIS
FRANCE

FOR: GOODS MADE OF LEATHER AND IMITATIONS OF LEATHER, NAMELY, HANDBAGS, TRAVELING BAGS, BACKPACKS, SACHELS, SCHOOL BAGS, BEACH BAGS, SHOPPING BAGS, GARMENT BAGS FOR TRAVEL, SPORTS BAGS, EXCLUDING THOSE ADAPTED TO PRODUCTS WHICH THEY ARE INTENDED TO HOLD, WHEELED BAGS, BAGS IN THE NATURE OF ENVELOPES AND POUCHES MADE OF LEATHER FOR PACKAGING, WALLETS, PURSES, BUSINESS CARD CASES, BRIEFCASES, ATTACHÉ CASES, LEATHER KEY CASES, TRUNKS, SUITCASES, TOILETRY BAGS SOLD EMPTY, VANITY CASES SOLD EMPTY, CLUTCH BAGS, NAMELY, EVENING HANDBAGS, IN CLASS 18 (U.S. CLS. 1, 2, 3, 22 AND 41).

THE MARK CONSISTS OF STANDARD CHARACTERS WITHOUT CLAIM TO ANY PARTICULAR FONT, STYLE, SIZE, OR COLOR.

PRIORITY DATE OF 4-14-2011 IS CLAIMED.

OWNER OF INTERNATIONAL REGISTRATION 1100446 DATED 10-5-2011, EXPIRES 10-5-2021.

SER. NO. 79-106,672, FILED 10-5-2011.

BRIAN CALLAGHAN, EXAMINING ATTORNEY



David J. Kyffers

Director of the United States Patent and Trademark Office

United States of America

United States Patent and Trademark Office

KIRSCHVERLANGEN

Reg. No. 4,173,649

Registered July 17, 2012

Int. Cl.: 30

TRADEMARK

PRINCIPAL REGISTER

GUSTAV BERNING GMBH & CO. KG (FED REP GERMANY LIMITED PARTNERSHIP)
ALTE HEERSTRASSE 1
49124 GEORGSMARIENHÜTTE
FED REP GERMANY

FOR: PASTRY AND CONFECTIONERY MADE OF SUGAR; SWEETMEATS AND FRUIT JELLY CANDY; CHOCOLATE PRODUCTS, NAMELY, CHOCOLATE CONFECTIONS, CHOCOLATE COVERED FRUIT; CHOCOLATE BARS WITH CHOCOLATE GLAZES OR FAT GLAZES; CONFECTIONERY MADE OF SUGAR, NAMELY, COMFITS, FILLED CHOCOLATES AND TRUFFLES, CANDY, EDIBLE ICES, IN CLASS 30 (U.S. CL. 46).

THE MARK CONSISTS OF STANDARD CHARACTERS WITHOUT CLAIM TO ANY PARTICULAR FONT, STYLE, SIZE, OR COLOR.

PRIORITY DATE OF 9-20-2011 IS CLAIMED.

OWNER OF INTERNATIONAL REGISTRATION 1100491 DATED 10-27-2011, EXPIRES 10-27-2021.

THE ENGLISH TRANSLATION OF "KIRSCHVERLANGEN" IN THE MARK IS "CHERRY DESIRE".

SER. NO. 79-106,691, FILED 10-27-2011.

DEIRDRE ROBERTSON, EXAMINING ATTORNEY



David J. Kyjars

Director of the United States Patent and Trademark Office

United States of America

United States Patent and Trademark Office

S-PEARL

Reg. No. 4,173,650

Registered July 17, 2012

Int. Cls.: 17 and 19

TRADEMARK

PRINCIPAL REGISTER

FIBRECEM HOLDING AG (SWITZERLAND AKTIENGESELLSCHAFT (JOINT STOCK COMPANY))
ETERNITSTRASSE 3
CH-8867 NIEDERURNEN
SWITZERLAND

FOR: INSULATING AND SOUNDPROOFING BOARDS FOR BUILDING, IN CLASS 17 (U.S. CLS. 1, 5, 12, 13, 35 AND 50).

FOR: PREFABRICATED CONSTRUCTION ELEMENTS NOT MADE OF METAL, NAMELY, PANELS, PLATES, SLABS, BOARDS, SHEATHINGS WITH INTEGRATED HEAT AND SOUND INSULATION BOARDS; NON-METAL CONSTRUCTION MATERIALS, NAMELY, PANELS, PLATES, SLABS, BOARDS, SHEATHINGS MOLDED IN FIBROCEMENT OR OTHER RAW MATERIALS OF MINERAL ORIGIN COMBINED WITH BINDING AGENTS SUCH AS CEMENT, GYPSUM OR SYNTHETIC MATERIALS FOR THE CONSTRUCTION OF CLADDINGS, PARTICULARLY FOR WALLS, PARTITIONS, CEILINGS, PIPES, FACADES AND FOR THE CONSTRUCTION OF PREFABRICATED HOUSES, BUILDINGS AND STORAGE SHEDS; SELF-SUPPORTING WALL BOARDS AND NON-METAL FAÇADE PANELS FOR CONSTRUCTION PURPOSES, IN CLASS 19 (U.S. CLS. 1, 12, 33 AND 50).

THE MARK CONSISTS OF STANDARD CHARACTERS WITHOUT CLAIM TO ANY PARTICULAR FONT, STYLE, SIZE, OR COLOR.

PRIORITY DATE OF 5-3-2011 IS CLAIMED.

OWNER OF INTERNATIONAL REGISTRATION 1100736 DATED 9-29-2011, EXPIRES 9-29-2021.

SER. NO. 79-106,794, FILED 9-29-2011.

GEOFFREY FOSDICK, EXAMINING ATTORNEY



David J. Kypos

Director of the United States Patent and Trademark Office

United States of America

United States Patent and Trademark Office

POWERPRESS

Reg. No. 4,173,651

Registered July 17, 2012

Int. Cl.: 12

TRADEMARK

PRINCIPAL REGISTER

FAUN UMWELTECHNIK GMBH & CO. KG (FED REP GERMANY LIMITED PARTNERSHIP)
FELDHORST 4
27711 OSTERHOLZ-SCHARMBECK, FED REP GERMANY

FOR: MOTORISED LAND VEHICLES FOR MUNICIPAL PURPOSES, IN PARTICULAR VEHICLES FOR CLEANING SEWERS, STREET SPRINKLER VEHICLES, WASTE COLLECTION AND TRANSPORT VEHICLES; CONTAINER-TYPE CLOSED WASTE DISPOSAL SUPERSTRUCTURES FOR WASTE COLLECTION AND TRANSPORT VEHICLES WITH AT LEAST ONE OPENING FOR WASTE MATERIALS AND SECONDARY RAW MATERIALS, AS STRUCTURAL PARTS OF VEHICLES, IN CLASS 12 (U.S. CLS. 19, 21, 23, 31, 35 AND 44).

THE MARK CONSISTS OF STANDARD CHARACTERS WITHOUT CLAIM TO ANY PARTICULAR FONT, STYLE, SIZE, OR COLOR.

OWNER OF INTERNATIONAL REGISTRATION 1037436 DATED 2-24-2010, EXPIRES 2-24-2020.

SER. NO. 79-106,851, FILED 8-12-2011.

KRISTINA MORRIS, EXAMINING ATTORNEY



David J. Kybas

Director of the United States Patent and Trademark Office

United States of America

United States Patent and Trademark Office



Reg. No. 4,173,652

Registered July 17, 2012

Int. Cls.: 35 and 42

SERVICE MARK

PRINCIPAL REGISTER

FLOKTU PTY LTD (AUSTRALIA AUSTRALIAN PROPRIETARY COMPANY, LIMITED BY SHARES)
SUITE 145, NATIONAL INNOVATION CENTRE
4 CORNWALLIS STREET, AUSTRALIAN TECHNOLOGY PARK;
EVELEIGH, AUSTRALIA

FOR: EVENT MANAGEMENT SERVICES, NAMELY, ORGANIZATION OF EXHIBITIONS OR TRADE FAIRS FOR COMMERCIAL OR ADVERTISING PURPOSES; CORPORATE EVENT MANAGEMENT SERVICES; EVENT PLANNING AND MANAGEMENT FOR MARKETING, BRANDING, PROMOTING OR ADVERTISING THE GOODS AND SERVICES OF OTHERS; BUSINESS MANAGEMENT OF BOOKING AND DELIVERY OF TICKETS; PROVIDING MARKETING AND PROMOTION OF EVENTS FOR OTHERS USING DIGITAL MEDIUM, IN CLASS 35 (U.S. CLS. 100, 101 AND 102).

FOR: PROVIDING ONLINE, NON-DOWNLOADABLE, INTERNET-BASED SOFTWARE APPLICATION THAT AUTOMATES AND ENABLES MARKETING OF EVENTS; DESIGN, INSTALLATION, MAINTENANCE, REPAIR AND UPDATING OF COMPUTER SOFTWARE; PROVIDING A WEBSITE FEATURING TECHNOLOGY THAT ENABLES USERS TO AUTOMATE MANAGING OF EVENTS, IN CLASS 42 (U.S. CLS. 100 AND 101).

THE MARK CONSISTS OF THE STYLIZED WORDING "FLOKTU" WITH A BIRD INSIDE THE "O" AND TWO BIRDS FLYING ABOVE THE WORDING.

PRIORITY DATE OF 2-15-2011 IS CLAIMED.

OWNER OF INTERNATIONAL REGISTRATION 1100878 DATED 8-10-2011, EXPIRES 8-10-2021.

SER. NO. 79-106,889, FILED 8-10-2011.

TOBY BULLOFF, EXAMINING ATTORNEY



David J. Kyffers

Director of the United States Patent and Trademark Office

United States of America

United States Patent and Trademark Office



Reg. No. 4,173,653

Registered July 17, 2012

Int. Cls.: 17 and 18

TRADEMARK

PRINCIPAL REGISTER

GRAND IPEARL; ELECTRONIC & TECHNOLOGY CO., LTD. (CHINA LTD.)
YINSONG ROAD
YINKENG INDUSTRIAL PARK.; QINGXI TOWN; DONGGUAN; GUANGDONG
CHINA

FOR: FIRE HOSE; COMPOSITIONS TO PREVENT THE RADIATION OF HEAT, NAMELY, CONDUCTIVE TAPE FOR ELECTROMAGNETIC RADIATION SHIELDING IN ELECTRONIC PRODUCTS; INSULATORS FOR ELECTRIC MAINS, IN CLASS 17 (U.S. CLS. 1, 5, 12, 13, 35 AND 50).

FOR: VALISES AND BACKPACKS FOR TRAVEL; BOXES OF LEATHER OR LEATHER BOARD; UMBRELLAS; ALPENSTOCKS; COVERS FOR ANIMALS, NAMELY, PET CLOTHING, IN CLASS 18 (U.S. CLS. 1, 2, 3, 22 AND 41).

THE MARK CONSISTS OF TWO INTERSECTING CONCENTRIC CIRCLES PRECEDING THE WORDING "IPEARL" IN STYLIZED LETTERING

PRIORITY DATE OF 3-3-2011 IS CLAIMED.

OWNER OF INTERNATIONAL REGISTRATION 1100905 DATED 8-17-2011, EXPIRES 8-17-2021.

SER. NO. 79-106,897, FILED 8-17-2011.

ANDREA HACK, EXAMINING ATTORNEY



David J. Kybas

Director of the United States Patent and Trademark Office

United States of America

United States Patent and Trademark Office

RICHEL

Reg. No. 4,173,654

Registered July 17, 2012

Int. Cl.: 6

TRADEMARK

PRINCIPAL REGISTER

RICHEL SERRES DE FRANCE (FRANCE SOCIÉTÉ ANONYME)
QUARTIER DE LA GARE
EYGALIERES, FRANCE F13810

FOR: GREENHOUSES OF METAL; TRANSPORTABLE GREENHOUSES OF METAL; CHASSIS FOR GREENHOUSES OF METAL; FRAMEWORK OF METAL FOR BUILDING; REINFORCING MATERIALS OF METAL FOR BUILDING PURPOSES; TRANSPORTABLE BUILDINGS OF METAL; BUILDINGS OF METAL, NAMELY, MODULAR METALLIC BUILDINGS; SILOS OF METAL; METAL STORAGE SHELTERS, NAMELY, BUILDINGS OF METAL INTENDED FOR STORING GRAINS OR FOODSTUFFS FOR LIVESTOCK, IN CLASS 6 (U.S. CLS. 2, 12, 13, 14, 23, 25 AND 50).

THE MARK CONSISTS OF STANDARD CHARACTERS WITHOUT CLAIM TO ANY PARTICULAR FONT, STYLE, SIZE, OR COLOR.

PRIORITY DATE OF 3-31-2011 IS CLAIMED.

OWNER OF INTERNATIONAL REGISTRATION 1100955 DATED 9-15-2011, EXPIRES 9-15-2021.

THE WORDING "RICHEL" HAS NO MEANING IN A FOREIGN LANGUAGE.

SER. NO. 79-106,916, FILED 9-15-2011.

JAY BESCH, EXAMINING ATTORNEY



David J. Kypos

Director of the United States Patent and Trademark Office

United States of America

United States Patent and Trademark Office



Reg. No. 4,173,655

Registered July 17, 2012

Int. Cl.: 11

TRADEMARK

PRINCIPAL REGISTER

BLUPURA SRL (ITALY LIMITED LIABILITY COMPANY)
VIA ALDO MORO, SNC
I-60022 CASTELFIDARDO (AN)
ITALY

FOR: BEVERAGES COOLING APPARATUS; COOLING DOMES; COOLING EVAPORATORS; FILTERS FOR DRINKING WATER; INDUSTRIAL WATER PURIFYING APPARATUS; REGULATING ACCESSORIES FOR WATER OR GAS APPARATUS AND PIPES; TAP WATER FAUCETS; TAP WATER PURIFYING APPARATUS; WATER FILTERING APPARATUS; WATER PURIFICATION AND FILTRATION APPARATUS; WATER PURIFICATION INSTALLATIONS; WATER PURIFICATION MACHINES; WATER PURIFYING APPARATUS; WATER SOFTENING APPARATUS AND INSTALLATIONS; WATER STERILIZERS, IN CLASS 11 (U.S. CLS. 13, 21, 23, 31 AND 34).

THE MARK CONSISTS OF A DESIGN OF A WATER DROP IN LIGHT BLUE ABOVE THE WORD "BLUPURA" WHERE "BLU" IS IN AQUA GREEN STYLIZED FONT AND "PURA" IS IN LIGHT BLUE STYLIZED FONT. THE COLOR WHITE IS INTENDED AS BACKGROUND, OUTLINING, SHADING AND/OR TRANSPARENT AREAS AND IS NOT PART OF THE MARK.

OWNER OF INTERNATIONAL REGISTRATION 1101385 DATED 10-13-2011, EXPIRES 10-13-2021.

THE COLOR(S) AQUA GREEN AND LIGHT BLUE IS/ARE CLAIMED AS A FEATURE OF THE MARK.

THE ENGLISH TRANSLATION OF THE FOREIGN WORD(S) IN THE MARK IS: "BLUE" "PURE".

SER. NO. 79-107,070, FILED 10-13-2011.

ERNEST SHOSHO, EXAMINING ATTORNEY



David J. Kybas

Director of the United States Patent and Trademark Office

United States of America
United States Patent and Trademark Office

HYBRID
HYBRID
core

Reg. No. 4,173,656

Registered July 17, 2012

Int. Cl.: 6

TRADEMARK

PRINCIPAL REGISTER

REDAELLI TECNA S.P.A. (ITALY JOINT STOCK COMPANY)
PIAZZALE LIBIA, 2
I-20135 MILANO
ITALY

FOR: NON ELECTRICAL CABLES AND WIRES OF COMMON METALS, METAL ROPES, STEEL CORDS, NAMELY, TO BE USED FOR TIRES, METAL COMPONENTS TO BE USED FOR HOOKING, INSTALLATION AND CONTROL OF CABLES AND WIRE ROPES, NAMELY, STEEL CARABINERS, PRETENSIONERS, SPRINGS, HOOKS, BOLT SNAPS OF METAL, ANCHORS, IN CLASS 6 (U.S. CLS. 2, 12, 13, 14, 23, 25 AND 50).

THE MARK CONSISTS IN THE WORDING "HYBRID CORE" IN STYLIZED FONT.

PRIORITY DATE OF 9-29-2011 IS CLAIMED.

OWNER OF INTERNATIONAL REGISTRATION 1101780 DATED 10-13-2011, EXPIRES 10-13-2021.

SER. NO. 79-107,224, FILED 10-13-2011.

ERNEST SHOSHO, EXAMINING ATTORNEY



David J. Kypos

Director of the United States Patent and Trademark Office

United States of America

United States Patent and Trademark Office

MITIZAX

Reg. No. 4,173,657

Registered July 17, 2012

Int. Cls.: 5 and 44

TRADEMARK

SERVICE MARK

PRINCIPAL REGISTER

ALK-ABELLÓ A/S (DENMARK CORPORATION)
BØGE ALLÉ 6-8
DK-2970 HØRSBOLM
DENMARK

FOR: PHARMACEUTICAL PREPARATIONS, NAMELY, PREPARATIONS FOR IMMUNOTHERAPEUTIC PURPOSES AND PREPARATIONS FOR DIAGNOSIS, PREVENTION AND TREATMENT OF ALLERGIES, ALLERGIC RHINITIS AND ASTHMA, INCLUDING ALLERGIC ASTHMA, IN CLASS 5 (U.S. CLS. 6, 18, 44, 46, 51 AND 52).

FOR: MEDICAL SERVICES AND MEDICAL CONSULTING SERVICES, INCLUDING COUNSELLING AND INFORMATION REGARDING IMMUNOTHERAPY, ALLERGY, ALLERGIC ASTHMA, ALLERGIC RHINITIS AND ASTHMA; PROVIDING PATIENT SUPPORT RELATING TO IMMUNOTHERAPY AS WELL AS TO PREVENTION AND TREATMENT OF ALLERGY, ALLERGIC ASTHMA, ALLERGIC RHINITIS AND ASTHMA THROUGH A WEBSITE; PROVIDING INFORMATION TO MEDICAL PROFESSIONALS RELATING TO IMMUNOTHERAPY AS WELL AS PREVENTION AND TREATMENT OF ALLERGY, ALLERGIC ASTHMA, ALLERGIC RHINITIS AND ASTHMA THROUGH A WEBSITE, IN CLASS 44 (U.S. CLS. 100 AND 101).

THE MARK CONSISTS OF STANDARD CHARACTERS WITHOUT CLAIM TO ANY PARTICULAR FONT, STYLE, SIZE, OR COLOR.

OWNER OF INTERNATIONAL REGISTRATION 1101820 DATED 10-17-2011, EXPIRES 10-17-2021.

OWNER OF U.S. REG. NO. 3,148,902.

THE WORDING "MITIZAX" HAS NO MEANING IN A FOREIGN LANGUAGE.

SER. NO. 79-107,241, FILED 10-17-2011.

DAVID TOOLEY, EXAMINING ATTORNEY



David J. Kyffers

Director of the United States Patent and Trademark Office

United States of America

United States Patent and Trademark Office

ITALIAN WINE EXPERIENCE

Reg. No. 4,173,658

IL MIO CASTELLO SPA (ITALY JOINT STOCK COMPANY)

Registered July 17, 2012

VIA FELTRE, 28/6
I-20132 MILANO (MI), ITALY

Int. Cls.: 35 and 41

FOR: SERVICES FOR ORGANIZING TRADE FAIRS AND EXHIBITIONS FOR COMMERCIAL OR ADVERTISING PURPOSES, IN CLASS 35 (U.S. CLS. 100, 101 AND 102).

SERVICE MARK

FOR: ENTERTAINMENT SERVICES, NAMELY, CONDUCTING FAIRS FOR CULTURAL AND EDUCATIONAL PURPOSES, IN CLASS 41 (U.S. CLS. 100, 101 AND 107).

PRINCIPAL REGISTER

NO CLAIM IS MADE TO THE EXCLUSIVE RIGHT TO USE "ITALIAN WINE", APART FROM THE MARK AS SHOWN.

PRIORITY DATE OF 10-14-2011 IS CLAIMED.

OWNER OF INTERNATIONAL REGISTRATION 1102001 DATED 10-17-2011, EXPIRES 10-17-2021.

THE COLOR(S) PANTONE RED AND GREEN IS/ARE CLAIMED AS A FEATURE OF THE MARK.

THE TRADEMARK IS MADE UP OF THE WORDS "ITALIAN WINE EXPERIENCE" IN UPPER CASE IN PANTONE RED; THIS VERBAL ELEMENT APPEARS BETWEEN TWO GREEN PARALLEL LINES.

SER. NO. 79-107,310, FILED 10-17-2011.

ALEXANDER L. POWERS, EXAMINING ATTORNEY



David J. Kybas

Director of the United States Patent and Trademark Office

United States of America

United States Patent and Trademark Office

GRAZAX

Reg. No. 4,173,659

Registered July 17, 2012

Int. Cls.: 5 and 44

TRADEMARK

SERVICE MARK

PRINCIPAL REGISTER

ALK-ABELLÓ A/S (DENMARK CORPORATION)
BØGE ALLÉ 6-8
DK-2970 HØRSBOLM
DENMARK

FOR: PHARMACEUTICAL PREPARATIONS, NAMELY, PREPARATIONS FOR IMMUNOTHERAPEUTIC PURPOSES AND PREPARATIONS FOR DIAGNOSIS, PREVENTION AND TREATMENT OF ALLERGIES, ALLERGIC RHINITIS AND ASTHMA, INCLUDING ALLERGIC ASTHMA, IN CLASS 5 (U.S. CLS. 6, 18, 44, 46, 51 AND 52).

FOR: MEDICAL SERVICES AND MEDICAL CONSULTING SERVICES, INCLUDING COUNSELLING AND INFORMATION REGARDING IMMUNOTHERAPY, ALLERGY, ALLERGIC ASTHMA, ALLERGIC RHINITIS AND ASTHMA; PROVIDING PATIENT SUPPORT RELATING TO IMMUNOTHERAPY AS WELL AS TO PREVENTION AND TREATMENT OF ALLERGY, ALLERGIC ASTHMA, ALLERGIC RHINITIS AND ASTHMA THROUGH A WEBSITE; PROVIDING INFORMATION TO MEDICAL PROFESSIONALS RELATING TO IMMUNOTHERAPY AS WELL AS PREVENTION AND TREATMENT OF ALLERGY, ALLERGIC ASTHMA, ALLERGIC RHINITIS AND ASTHMA THROUGH A WEBSITE, IN CLASS 44 (U.S. CLS. 100 AND 101).

THE MARK CONSISTS OF STANDARD CHARACTERS WITHOUT CLAIM TO ANY PARTICULAR FONT, STYLE, SIZE, OR COLOR.

OWNER OF INTERNATIONAL REGISTRATION 1102119 DATED 10-17-2011, EXPIRES 10-17-2021.

OWNER OF U.S. REG. NOS. 3,154,293 AND 3,154,294.

THE WORDING "GRAZAX" HAS NO MEANING IN A FOREIGN LANGUAGE.

SER. NO. 79-107,341, FILED 10-17-2011.

DAVID TOOLEY, EXAMINING ATTORNEY



David J. Kyffers

Director of the United States Patent and Trademark Office

United States of America

United States Patent and Trademark Office



Reg. No. 4,173,660

Registered July 17, 2012

Int. Cls.: 5 and 44

TRADEMARK

SERVICE MARK

PRINCIPAL REGISTER

ALK-ABELLÓ A/S (DENMARK CORPORATION)
BØGE ALLÉ 6-8
DK-2970 HØRSBOLM
DENMARK

FOR: PHARMACEUTICAL PREPARATIONS, NAMELY, PREPARATIONS FOR IMMUNOTHERAPEUTIC PURPOSES AND PREPARATIONS FOR DIAGNOSIS, PREVENTION AND TREATMENT OF ALLERGIES, ALLERGIC RHINITIS AND ASTHMA, INCLUDING ALLERGIC ASTHMA, IN CLASS 5 (U.S. CLS. 6, 18, 44, 46, 51 AND 52).

FOR: MEDICAL SERVICES AND MEDICAL CONSULTING SERVICES, INCLUDING COUNSELLING AND INFORMATION REGARDING IMMUNOTHERAPY, ALLERGY, ALLERGIC ASTHMA, ALLERGIC RHINITIS AND ASTHMA; PROVIDING PATIENT SUPPORT RELATING TO IMMUNOTHERAPY AS WELL AS TO PREVENTION AND TREATMENT OF ALLERGY, ALLERGIC ASTHMA, ALLERGIC RHINITIS AND ASTHMA THROUGH A WEBSITE; PROVIDING INFORMATION TO MEDICAL PROFESSIONALS RELATING TO IMMUNOTHERAPY AS WELL AS PREVENTION AND TREATMENT OF ALLERGY, ALLERGIC ASTHMA, ALLERGIC RHINITIS AND ASTHMA THROUGH A WEBSITE, IN CLASS 44 (U.S. CLS. 100 AND 101).

OWNER OF U.S. REG. NOS. 3,154,293 AND 3,154,294.

OWNER OF INTERNATIONAL REGISTRATION 1102120 DATED 10-17-2011, EXPIRES 10-17-2021.

THE MARK CONSISTS OF THE STYLIZED WORD "GRAZAX" WITHIN A SQUARE WITH TWO SETS OF TWO LINES INTERSECTING AT THE BOTTOM LEFT CORNER OF THE SQUARE AND EXTENDING UPWARDS AND RIGHTWARDS RESPECTIVELY.

THE WORDING "GRAZAX" HAS NO MEANING IN A FOREIGN LANGUAGE.

SER. NO. 79-107,342, FILED 10-17-2011.

DAVID TOOLEY, EXAMINING ATTORNEY



David J. Kyros

Director of the United States Patent and Trademark Office

United States of America

United States Patent and Trademark Office

SUN-SWATTER

Reg. No. 4,173,661

Registered July 17, 2012

Int. Cls.: 9 and 11

TRADEMARK

PRINCIPAL REGISTER

WOLFGANG-PETER GELLER (FED REP GERMANY INDIVIDUAL)
SIEMS TWIETEN 4
21376 GARLSTORF, FED REP GERMANY

FOR: SOLAR CANOPIES AND LIGHT CANOPIES FOR CHANGING LIGHT CHARACTERISTICS, NAMELY, OPTICAL REFLECTORS AND OPTICAL FILTERS; DIFFUSERS AND FILTERS FOR LIGHT, AS MEANS FOR ASSISTING IN ILLUMINATION, IN PARTICULAR OF CINEMATOGRAPHIC SCENES, PHOTOGRAPHIC SCENES, THEATRE AND OTHER STAGES, NAMELY, COLLAPSIBLE LIGHT DIRECTORS AND DIFFUSERS FOR USE WITH PHOTOGRAPHIC LIGHTING EQUIPMENT FOR PROFESSIONAL AND HIGH-END PHOTOGRAPHY, IN CLASS 9 (U.S. CLS. 21, 23, 26, 36 AND 38).

FOR: LIGHTING APPARATUS, IN PARTICULAR FOR ILLUMINATING CINEMATOGRAPHIC SCENES, PHOTOGRAPHIC SCENES, THEATRE AND OTHER STAGES, NAMELY, LIGHTING INSTALLATIONS; LAMP ATTACHMENTS FOR ILLUMINATION PURPOSES, IN PARTICULAR FOR ILLUMINATING CINEMATOGRAPHIC SCENES, PHOTOGRAPHIC SCENES, THEATRE AND OTHER STAGES, NAMELY, LAMPSHADE HOLDERS, IN CLASS 11 (U.S. CLS. 13, 21, 23, 31 AND 34).

THE MARK CONSISTS OF STANDARD CHARACTERS WITHOUT CLAIM TO ANY PARTICULAR FONT, STYLE, SIZE, OR COLOR.

PRIORITY DATE OF 4-14-2011 IS CLAIMED.

OWNER OF INTERNATIONAL REGISTRATION 1102803 DATED 10-12-2011, EXPIRES 10-12-2021.

SER. NO. 79-107,623, FILED 10-12-2011.

JAMES STEIN, EXAMINING ATTORNEY



David J. Kypos

Director of the United States Patent and Trademark Office

United States of America

United States Patent and Trademark Office

ECOMIZER

Reg. No. 4,173,662

Registered July 17, 2012

Int. Cls.: 7 and 11

TRADEMARK

PRINCIPAL REGISTER

HENNLICH INDUSTRIE TECHNIK SPOL. S R.O. (CZECH REPUBLIC LTD.)
CESKOLIPSKÁ 9
CZ-412 01 LITOMERICE
CZECH REPUBLIC

FOR: HEAT EXCHANGERS BEING PARTS OF MACHINES, IN CLASS 7 (U.S. CLS. 13, 19, 21, 23, 31, 34 AND 35).

FOR: HEAT EXCHANGERS , IN CLASS 11 (U.S. CLS. 13, 21, 23, 31 AND 34).

THE MARK CONSISTS OF STANDARD CHARACTERS WITHOUT CLAIM TO ANY PARTICULAR FONT, STYLE, SIZE, OR COLOR.

PRIORITY DATE OF 9-6-2011 IS CLAIMED.

OWNER OF INTERNATIONAL REGISTRATION 1103713 DATED 9-7-2011, EXPIRES 9-7-2021.

SER. NO. 79-107,942, FILED 9-7-2011.

BRIAN CALLAGHAN, EXAMINING ATTORNEY



David J. Kyfos

Director of the United States Patent and Trademark Office

United States of America

United States Patent and Trademark Office



Reg. No. 4,173,663

LUIS ALFONSO MASTRAL LÓPEZ DE HEREDIA (SPAIN INDIVIDUAL)
C/ DONANTES, 19, 3º A
E-31500 TUDELA (NAVARRA), SPAIN

Registered July 17, 2012

Int. Cl.: 33

FOR: ALCOHOLIC BEVERAGES, EXCEPT BEER, IN CLASS 33 (U.S. CLS. 47 AND 49).

TRADEMARK

THE MARK CONSISTS OF THE WORDING "MLH LAFIESTA" IN CURSIVE LETTERING WITHIN A RECTANGLE IN BLACK THAT CONTAINS SOME ETCHING AND BACKGROUND IN WHITE.

PRINCIPAL REGISTER

OWNER OF INTERNATIONAL REGISTRATION 1103886 DATED 10-24-2011, EXPIRES 10-24-2021.

THE COLOR(S) WHITE AND BLACK IS/ARE CLAIMED AS A FEATURE OF THE MARK.

THE ENGLISH TRANSLATION OF "LAFIESTA" IN THE MARK IS "THE PARTY".

SER. NO. 79-108,007, FILED 10-24-2011.

GINA FINK, EXAMINING ATTORNEY



David J. Kybas

Director of the United States Patent and Trademark Office

United States of America

United States Patent and Trademark Office

T²RECS

Reg. No. 4,173,664

Registered July 17, 2012

Int. Cls.: 7 and 12

TRADEMARK

PRINCIPAL REGISTER

RENK AKTIENGESELLSCHAFT (FED REP GERMANY STOCK CORPORATION)
GÖGGINGER STRASSE 73
86159 AUGSBURG
FED REP GERMANY

FOR: GEARS FOR MACHINES, IN CLASS 7 (U.S. CLS. 13, 19, 21, 23, 31, 34 AND 35).

FOR: STEERING GEARS FOR SHIPS , IN CLASS 12 (U.S. CLS. 19, 21, 23, 31, 35 AND 44).

THE MARK CONSISTS OF THE WORDING "T²RECS" WHERE THE NUMERAL "2" IS SUPERSCRIPT.

PRIORITY DATE OF 3-4-2011 IS CLAIMED.

OWNER OF INTERNATIONAL REGISTRATION 1104102 DATED 9-2-2011, EXPIRES 9-2-2021.

SER. NO. 79-108,100, FILED 9-2-2011.

LINDA LAVACHE, EXAMINING ATTORNEY



David J. Kyffers

Director of the United States Patent and Trademark Office

United States of America

United States Patent and Trademark Office

ONSET

Reg. No. 4,173,665

Registered July 17, 2012

**Int. Cls.: 9, 16, 41, 42
and 44**

TRADEMARK

SERVICE MARK

PRINCIPAL REGISTER

NOVO NORDISK A/S (DENMARK LIMITED LIABILITY COMPANY)
NOVO ALLÉ
DK-2880 BAGSVAERD
DENMARK

FOR: ELECTRONIC PUBLICATIONS, NAMELY, DOWNLOADABLE LEAFLETS, BOOKS, BOOKLETS, MAGAZINES AS WELL AS INSTRUCTIONAL AND TEACHING MATERIAL IN THE FIELD OF PREVENTION AND TREATMENT OF DIABETES; DOWNLOADABLE ELECTRONIC REPORTS FEATURING RESULTS FROM CLINICAL TRIALS AND STUDIES IN THE FIELD OF PREVENTION AND TREATMENT OF DIABETES, IN CLASS 9 (U.S. CLS. 21, 23, 26, 36 AND 38).

FOR: PUBLICATIONS, NAMELY, LEAFLETS, BOOKS, BOOKLETS, MAGAZINES AS WELL AS INSTRUCTIONAL AND TEACHING MATERIAL IN THE FIELD OF PREVENTION AND TREATMENT OF DIABETES; PRINTED REPORTS FEATURING RESULTS FROM CLINICAL TRIALS AND STUDIES IN THE FIELD OF PREVENTION AND TREATMENT OF DIABETES, IN CLASS 16 (U.S. CLS. 2, 5, 22, 23, 29, 37, 38 AND 50).

FOR: EDUCATIONAL SERVICES, NAMELY, CONDUCTING LECTURES, WEBCASTS, SEMINARS, WORKSHOPS, CONFERENCES, CONGRESSES AND SYMPOSIA IN THE FIELD OF DIABETES; ARRANGING AND CONDUCTING AWARENESS-RAISING CAMPAIGNS FOR THE GENERAL PUBLIC AIMED AT PREVENTING AND TREATING DIABETES, IN CLASS 41 (U.S. CLS. 100, 101 AND 107).

FOR: MEDICAL AND SCIENTIFIC RESEARCH, NAMELY, CONDUCTING CLINICAL TRIALS AND STUDIES IN THE FIELD OF PHARMACEUTICAL PREPARATIONS RELATED TO THE TREATMENT OF DIABETES; PROVIDING SCIENTIFIC INFORMATION ON PHARMACEUTICAL PREPARATIONS FOR THE PREVENTION AND TREATMENT OF DIABETES, IN CLASS 42 (U.S. CLS. 100 AND 101).

FOR: PROVIDING MEDICAL INFORMATION ON PHARMACEUTICAL PREPARATIONS FOR THE TREATMENT OF DIABETES, IN CLASS 44 (U.S. CLS. 100 AND 101).

THE MARK CONSISTS OF STANDARD CHARACTERS WITHOUT CLAIM TO ANY PARTICULAR FONT, STYLE, SIZE, OR COLOR.



David J. Kyjars

Director of the United States Patent and Trademark Office

Reg. No. 4,173,665 OWNER OF INTERNATIONAL REGISTRATION 1105190 DATED 10-31-2011, EXPIRES 10-31-2021.

SER. NO. 79-108,554, FILED 10-31-2011.

DAWN FELDMAN, EXAMINING ATTORNEY

United States of America

United States Patent and Trademark Office

RF3

Reg. No. 4,173,666

WYNLIFE HEALTHCARE, INC. (DELAWARE CORPORATION)
12707 HIGH BLUFF DRIVE, SUITE 200
SAN DIEGO, CA 92130

Registered July 17, 2012

Int. Cl.: 5

FOR: DIETARY AND NUTRITIONAL SUPPLEMENTS FOR NON-MEDICAL PURPOSES, NAMELY, FISH OIL, FISH OIL SUPPLEMENT, DEEP SEA FISH OIL, COD LIVER OIL; FISH-FREE DIETARY SUPPLEMENT; VITAMIN PREPARATIONS; NUTRITIONAL SUPPLEMENT, VITAMIN AND MINERAL SUPPLEMENT; VITAMIN PREPARATION; VITAMIN SUPPLEMENT; VITAMINS AND DIETARY FOOD SUPPLEMENTS; DIETARY SUPPLEMENTS FOR HUMAN CONSUMPTION DERIVED FROM EDIBLE FISH OILS AND FATS; BLENDED LIQUID NUTRITIONAL SUPPLEMENTS; FOOD SUPPLEMENT IN TABLET OR CAPSULAR SHAPE FOR PEOPLE WITH SPECIAL DIETETIC NEEDS; FOOD SUPPLEMENT IN TABLET OR CAPSULAR SHAPE MAINLY CONSISTING OF VITAMINS; FOOD SUPPLEMENT IN TABLET OR CAPSULAR SHAPE CONSISTING OF VITAMINS AND MINERALS, FOOD SUPPLEMENT IN TABLET OR CAPSULAR SHAPE CONSISTING OF VITAMINS AND MINERALS, POLYUNSATURATED FATTY ACIDS, MINERALS, ANTIOXIDANTS AND CARBONIC HYDRATES; DIETARY SUPPLEMENTS FOR HUMAN CONSUMPTION; NUTRITIONAL SUPPLEMENTS; DIETARY FIBER AS AN ADDITIVE FOR FOOD PRODUCTS; FOOD SUPPLEMENTS, NAMELY, ANTI-OXIDANTS; GROUND FLAXSEED FIBER FOR USE AS A DIETARY SUPPLEMENT; HERBAL SUPPLEMENTS; MINERAL FOOD SUPPLEMENTS; MINERAL NUTRITIONAL SUPPLEMENTS; MINERAL SUPPLEMENTS; PROTEIN SUPPLEMENTS, IN CLASS 5 (U.S. CLS. 6, 18, 44, 46, 51 AND 52).

TRADEMARK

PRINCIPAL REGISTER

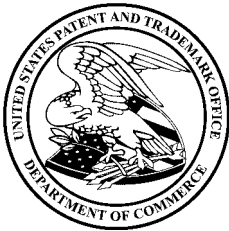

FIRST USE 8-29-2008; IN COMMERCE 8-29-2008.

THE MARK CONSISTS OF STANDARD CHARACTERS WITHOUT CLAIM TO ANY PARTICULAR FONT, STYLE, SIZE, OR COLOR.

SER. NO. 85-005,531, FILED 4-2-2010.

NATALIE POLZER, EXAMINING ATTORNEY

David J. Kybas

Director of the United States Patent and Trademark Office

United States of America

United States Patent and Trademark Office



Reg. No. 4,173,667

Registered July 17, 2012

Int. Cl.: 5

TRADEMARK

PRINCIPAL REGISTER

ZAMY, ANTOINE (UNITED STATES INDIVIDUAL), DBA AUTOBREEZ, INC
500 SOUTH MAIN ST
RANDOLPH, MA 02368

FOR: AIR FRESHENERS, IN CLASS 5 (U.S. CLS. 6, 18, 44, 46, 51 AND 52).

FIRST USE 2-5-2010; IN COMMERCE 2-23-2010.

NO CLAIM IS MADE TO THE EXCLUSIVE RIGHT TO USE "TRINIDAD", THE GEOGRAPHICALLY DESCRIPTIVE DESIGN OF THE MAP OF "TRINIDAD" AND "INC.", APART FROM THE MARK AS SHOWN.

THE COLOR(S) RED, YELLOW, WHITE AND BLACK IS/ARE CLAIMED AS A FEATURE OF THE MARK.

THE MARK CONSISTS OF A CIRCULAR DESIGN OF THE RAY OF THE SUN IN BRIGHT YELLOW, WHICH A MAP OF "TRINIDAD" INSIDE THE CIRCLE. THE MAP IS COLORED IN RED AT THE BOTTOM SMALL PORTION IN WHITE, MIDDLE IN BLACK AND WHITE AND RED AT THE TOP END OF THE MAP. THE WORD "TRINIDAD" IS STYLIZED IN RED AND BLACK, EACH LETTER IS WRITTEN IN BLACK AND HAS RED HIGHLIGHTS "TRINIDAD" IS LOCATED DIRECTLY UNDER THE MAP. THE WORD "AUTOBREEZ, INC" IS STYLIZED IN BLACK AND IS LOCATED DIRECTLY UNDER THE WORD "TRINIDAD". THE WHITE BEHIND THE MARK AND THE WHITE AND BLACK SURROUNDING THE MARK IS NOT CLAIMED AS PART OF THE MARK AND IS SHOWN FOR BACKGROUND PURPOSES.

SER. NO. 85-005,721, FILED 4-3-2010.

DEZMONA MIZELLE, EXAMINING ATTORNEY



David J. Kybas

Director of the United States Patent and Trademark Office

United States of America

United States Patent and Trademark Office



Reg. No. 4,173,668

Registered July 17, 2012

Int. Cl.: 5

TRADEMARK

PRINCIPAL REGISTER

ZAMY, ANTOINE (UNITED STATES INDIVIDUAL), DBA AUTOBREEZ, INC
500 SOUTH MAIN ST
RANDOLPH, MA 02368

FOR: AIR FRESHENERS, IN CLASS 5 (U.S. CLS. 6, 18, 44, 46, 51 AND 52).

FIRST USE 2-5-2010; IN COMMERCE 2-23-2010.

NO CLAIM IS MADE TO THE EXCLUSIVE RIGHT TO USE "JAMAICA", THE GEOGRAPHICALLY DESCRIPTIVE DESIGN OF THE MAP OF "JAMAICA" AND "INC.", APART FROM THE MARK AS SHOWN.

THE COLOR(S) YELLOW, GREEN AND BLACK IS/ARE CLAIMED AS A FEATURE OF THE MARK.

THE MARK HAS A CIRCULAR DESIGN OF THE RAY OF THE SUN IN BRIGHT YELLOW, WITH A MAP OF "JAMAICA" INSIDE THE CIRCLE. THE MAP IS COLORED IN BLACK ON THE TWO SIDES OF THE MAP, WITH A YELLOW CROSS LINE IN THE MIDDLE AND GREEN AT TOP AND BOTTOM. THE WORD "JAMAICA" IS STYLIZED WITH EACH LETTER WRITTEN IN BLACK WITH GREEN HIGHLIGHTS AND IS LOCATED DIRECTLY UNDER THE MAP. THE WORD "BY AUTOBREEZ, INC" IS STYLIZED IN BLACK AND IS LOCATED DIRECTLY UNDER THE WORD "JAMAICA". THE WHITE AND BLACK SURROUNDING THE MARK IS NOT CLAIMED AS PART OF THE MARK AND IS SHOWN FOR BACKGROUND PURPOSES.

SER. NO. 85-005,738, FILED 4-3-2010.

DEZMONA MIZELLE, EXAMINING ATTORNEY



David J. Kybas

Director of the United States Patent and Trademark Office

United States of America

United States Patent and Trademark Office

COOL VEGE

Reg. No. 4,173,669

RISWOOD CO. LTD. (JAPAN CORPORATION)

Registered July 17, 2012

AOYAMADAI 3-37-3
SUITA CITY, JAPAN

Int. Cls.: 29, 30 and 31

FOR: MEAT, FISH, POULTRY AND GAME; MEAT EXTRACTS; PRESERVED, FROZEN, DRIED AND COOKED FRUITS AND VEGETABLES; JELLIES, JAMS, COMPOTES; EGGS, MILK AND MILK PRODUCTS EXCLUDING ICE CREAM, ICE MILK AND FROZEN YOGURT; EDIBLE OILS AND FATS; PROCESSED MUSHROOM, IN CLASS 29 (U.S. CL. 46).

TRADEMARK

PRINCIPAL REGISTER

FOR: COFFEE, TEA, COCOA, SUGAR, RICE, TAPIOCA, SAGO, ARTIFICIAL COFFEE; FLOUR AND PREPARATIONS MADE FROM CEREALS, NAMELY, CEREAL BASED SNACK FOOD AND READY-TO-EAT CEREALS, BREAD, PASTRY AND CONFECTIONARY, NAMELY, BAKERY GOODS, CANDIES AND CHOCOLATE, ICES; HONEY, TREACLE, YEAST, BAKING-POWDER; SALT, MUSTARD; VINEGAR, SAUCES (CONDIMENTS); SPICES; ICE; MALT FOR FOOD PURPOSES, IN CLASS 30 (U.S. CL. 46).

FOR: AGRICULTURAL, HORTICULTURAL AND FORESTRY PRODUCTS AND GRAINS NOT INCLUDED IN OTHER CLASSES, NAMELY, FRESH NUTS, FRESH HERBS, FRESH OLIVES, LIVE SHELLFISH, LIVE POULTRY, SUGARCANE, TREES, NATURAL TURF, UNPROCESSED TIMBER, FRESH MUSHROOMS; UNPROCESSED GRAINS FOR EATING; LIVE ANIMALS; FRESH FRUITS AND VEGETABLES; SEEDS FOR AGRICULTURAL PURPOSES, NATURAL PLANTS AND FLOWERS; FOODSTUFFS FOR ANIMALS; MALT FOR BREWING AND DISTILLING, IN CLASS 31 (U.S. CLS. 1 AND 46).



THE MARK CONSISTS OF STANDARD CHARACTERS WITHOUT CLAIM TO ANY PARTICULAR FONT, STYLE, SIZE, OR COLOR.

OWNER OF REPUBLIC OF KOREA REG. NO. 40-0848218, DATED 10-18-2010, EXPIRES 10-18-2020.

OWNER OF HONG KONG REG. NO. 301398574, DATED 4-8-2009, EXPIRES 3-8-2019.

SER. NO. 85-006,404, FILED 4-5-2010.

WON TEAK OH, EXAMINING ATTORNEY

David J. Kyffers

Director of the United States Patent and Trademark Office

United States of America

United States Patent and Trademark Office



Reg. No. 4,173,670

MONKEY WORLD LIMITED (UNITED KINGDOM CORPORATION)
LONGTHORNS

Registered July 17, 2012

WAREHAM, DORSET, UNITED KINGDOM BH206HH

**Int. Cls.: 6, 9, 16, 20, 21,
24, 25, 26, 28 and 41**

FOR: METAL NAME BADGES; KEY RINGS OF COMMON METAL; METAL SIGN POSTS, IN CLASS 6 (U.S. CLS. 2, 12, 13, 14, 23, 25 AND 50).

TRADEMARK

SERVICE MARK

PRINCIPAL REGISTER

FOR: COMPUTER PROGRAM TO TRACK THE RESCUE OF NON-HUMAN PRIMATES, TO ASSIST WITH TRAINING OF INDIVIDUALS TO PROVIDE ASSISTANCE FOR THE RESCUE AND ADOPTION OF NON-HUMAN PRIMATES AND TO FACILITATE THE CARE OF THE RESCUED NON-HUMAN PRIMATES; COMPUTER SOFTWARE AND HARDWARE TO TRACK THE RESCUE OF NON-HUMAN PRIMATES, TO ASSIST WITH TRAINING OF INDIVIDUALS TO PROVIDE ASSISTANCE FOR THE RESCUE AND ADOPTION OF NON-HUMAN PRIMATES AND TO FACILITATE THE CARE OF THE RESCUED NON-HUMAN PRIMATES; PRE-RECORDED AND BLANK COMPACT DISCS, CD ROMS, VIDEO CASSETTES, AUDIO TAPES, AUDIOVISUAL TAPES, LASER DISCS, DVDS AND ALL OF THE AFOREMENTIONED FEATURING NON-HUMAN PRIMATES; DOWNLOADABLE DIGITAL VIDEO, AUDIO AND AUDIOVISUAL RECORDINGS FEATURING NON-HUMAN PRIMATES; FIXED AND MOBILE TELEPHONES; COMPUTER SCREEN SAVER SOFTWARE; SUNGLASSES; APPARATUS FOR RECORDING OF SOUND AND IMAGES; COMPUTER GAME DISCS, CARTRIDGES, AND CASSETTES; COMPUTER GAME SOFTWARE; COMPUTER GAME CONSOLES FOR USE WITH AN EXTERNAL DISPLAY SCREEN OR MONITOR; CURRENCY COUNTING MACHINES, COIN COUNTING OR SORTING MACHINES; ELECTRONIC DATA LOGGERS; SPEEDOMETERS; CALCULATORS; ELECTRONIC SCOREBOARDS; ELECTRONIC TIMERS; RADIOS; ILLUMINATED, LUMINOUS AND MECHANICAL SIGNS AND SIGNPOSTS; ENCODED MAGNETIC CARDS; BATTERIES; SATELLITES; AUDIO AND VIDEO RECEIVERS; DIGITAL APPARATUS, NAMELY, DIGITAL CLOCKS AND CLOCK RADIOS; TELEVISIONS; MAGNETS; BINOCULARS; PROTECTIVE CLOTHING AND HEADGEAR, PROTECTIVE HELMETS, SUPPORT BELTS FOR WORKERS, SAFETY GOGGLES, GLOVES FOR PROTECTION AGAINST ACCIDENTS; REPLACEMENT PARTS AND FITTINGS FOR THE AFOREMENTIONED GOODS, IN CLASS 9 (U.S. CLS. 21, 23, 26, 36 AND 38).



David J. Kypos

Director of the United States Patent and Trademark Office

FOR: METAL BOOKMARKS; CARDBOARD ADVERTISING SIGNBOARDS; BOOKS, PERIODICALS, NEWSLETTERS, BROCHURES, PAMPHLETS, NEWSPAPERS, MAGAZINES, JOURNALS, BOOKLETS, ALL IN THE FIELD OF NON-HUMAN PRIMATES; PHOTOGRAPHS; POSTERS; STATIONERY GOODS, NAMELY, NOTE PADS, ADDRESS BOOKS, PENCILS,

Reg. No. 4,173,670 PENS, CRAYONS, UNGRADUATED RULERS, RUBBER ERASERS, PENCIL CASES, PENCIL SHARPENERS, POSTCARDS, FELT TIP MARKERS, GREETING CARDS, NOTELETS, CARDBOARD BOOKMARKS, ROLLER PENS, FELT PENS, FOUNTAIN PENS, PAPER TABLE NAPKINS, PAPER TABLECLOTHS, COASTERS AND TABLE MATS MADE OF PAPER, PAPER BADGES, BALL POINT PENS, WRITING PAPER, ENVELOPES, LOOSE LEAF BINDERS, BLOTTERS, WRAPPING PAPER, FOLDERS FOR PAPERS, INK AND PENCIL HOLDERS; ADHESIVES FOR STATIONERY AND HOUSEHOLD PURPOSES; ARTISTS' MATERIALS, NAMELY, DRAWING BOOKS, PENCILS, CHARCOAL PENCILS, CRAYONS, PASTELS, PAINTING PALETTES, CANVAS FOR PAINTING, CHALK, COMPASSES FOR DRAWING, DRAWING PADS, DRAWING PENS, PAINTERS' EASELS, MODELLING CLAY, MODELLING MATERIALS, NAMELY, MODELLING COMPOUNDS, MODELLING WAX NOT FOR DENTAL PURPOSES, PAINT BRUSHES, PAINT BOXES, AND STENCILS; DIARIES, CALENDARS, STICKERS; PRINTED INSTRUCTIONAL AND TEACHING MATERIAL IN THE FIELD OF NON-HUMAN PRIMATES; PAPER GIFT BAGS FOR BOTTLES, IN CLASS 16 (U.S. CLS. 2, 5, 22, 23, 29, 37, 38 AND 50).

FOR: NON-ELECTRIC, PLASTIC SCOREBOARDS FOR SPORTS; PLASTIC ADVERTISING SIGNBOARDS; GOODS MADE OF WOOD, CORK, REED, CANE, WICKER, HORN, BONE, IVORY, WHALEBONE, SHELL, AMBER, MOTHER-OF-PEARL, MEERSCHAUM AND SUBSTITUTES FOR ALL THESE MATERIALS, NAMELY, PICTURE FRAMES, ORNAMENTS, FIGURINES, PLASTIC NAME BADGES AND PLASTIC KEY RINGS, IN CLASS 20 (U.S. CLS. 2, 13, 22, 25, 32 AND 50).

FOR: BEVERAGE GLASSWARE, PORCELAIN FIGURINES AND ORNAMENTS, EARTHENWARE BASINS, MUGS, FIGURINES AND SCULPTURES AND CHINA PLAQUES, STATUETTES, AND BUSTS; ORNAMENTS AND FIGURINES MADE OF CHINA, CRYSTAL, EARTHENWARE, TERRA COTTA, GLASS, OR PORCELAIN, IN CLASS 21 (U.S. CLS. 2, 13, 23, 29, 30, 33, 40 AND 50).

FOR: TEXTILES AND TEXTILE GOODS, NAMELY, TEXTILE COASTERS, UPHOLSTERY FABRICS, TEXTILE FABRICS FOR MANUFACTURING INTO CLOTHING; TEXTILE FABRICS FOR CURTAINS, TEXTILE FLAGS, TEXTILE HANDKERCHIEFS, TEXTILE PIECE GOODS FOR MAKING CUSHION COVERS, TEXTILE TABLE MATS; BED AND TABLE LINEN; TOWELS, IN CLASS 24 (U.S. CLS. 42 AND 50).

FOR: SUN VISORS; CLOTHING, NAMELY, PYJAMAS, RAINCOATS, T-SHIRTS, SWEAT-SHIRTS, SWEATERS, APRONS AS ARTICLES OF CLOTHING, BATHROBES, GLOVES, PULLOVERS, SCARVES, SHIRTS, POLO SHIRTS, RUGBY SHIRTS, SHORTS, AND SOCKS; FOOTWEAR, HEADGEAR, NAMELY, HATS AND CAPS, IN CLASS 25 (U.S. CLS. 22 AND 39).

FOR: ORNAMENTAL NOVELTY BADGES, IN CLASS 26 (U.S. CLS. 37, 39, 40, 42 AND 50).

FOR: COIN OPERATED AMUSEMENT MACHINES, PLAYING CARDS; GAMES, TOYS AND PLAYTHINGS, NAMELY, SOFT TOYS, BOARD GAMES, CARD GAMES, DOMINOES, PUZZLES, PARLOUR GAMES, AND HAND-HELD VIDEO GAMES; CHRISTMAS TREE DECORATIONS, IN CLASS 28 (U.S. CLS. 22, 23, 38 AND 50).

FOR: EDUCATION SERVICES IN THE NATURE OF SEMINARS, CONFERENCES, SYMPOSIUMS, CLASSES, WORKSHOPS, LECTURES, AND ON-GOING TELEVISION PROGRAMS RELATING TO NON-HUMAN PRIMATES AND RESCUE AND REHABILITATION OF NON-HUMAN PRIMATES AND DISTRIBUTING COURSE MATERIAL IN CONNECTION THEREWITH; PRODUCTION OF VIDEOS AND FILMS RELATING TO NON-HUMAN PRIMATES AND RESCUE AND REHABILITATION OF NON-HUMAN PRIMATES; PROVIDING OF TRAINING SERVICES IN THE FIELD OF NON-HUMAN PRIMATES; ORGANIZING CULTURAL EVENTS; ENTERTAINMENT SERVICES, NAMELY, PROVIDING ON-LINE COMPUTER GAMES; PROVIDING ON-LINE PUBLICATIONS RELATING TO NON-HUMAN PRIMATES AND RESCUE AND REHABILITATION OF NON-HUMAN

Reg. No. 4,173,670 PRIMATES, NAMELY, BULLETINS, NEWSLETTERS AND MAGAZINES IN THE FIELD OF NON-HUMAN PRIMATES; THE PROVISION OF ON-LINE ELECTRONIC INFORMATION ON THE INTERNET RELATING TO ANIMAL TRAINING AND ANIMAL EXHIBITIONS FOR EDUCATIONAL OR ENTERTAINMENT PURPOSES; PRODUCTION OF TELEVISION PROGRAMMES AND FILMS RELATING TO ANIMALS; TEACHING SERVICES IN THE FIELD OF NON-HUMAN PRIMATES; TRAINING SERVICES IN THE FIELD OF NON-HUMAN PRIMATES; PROVIDING TRAINING COURSES IN THE FIELD OF NON-HUMAN PRIMATES; ON-LINE COMPUTER-BASED TRAINING SERVICES IN THE FIELD OF NON-HUMAN PRIMATES; PUBLISHING OF BOOKS, E-BOOKS, AUDIO BOOKS, MUSIC AND ILLUSTRATION; PUBLICATION OF BOOKS; PUBLICATION OF NEWSPAPERS, MAGAZINES, PERIODICALS AND JOURNALS; PRODUCTION OF RADIO AND TELEVISION PROGRAMMES; MULTIMEDIA PUBLISHING OF BOOKS, MAGAZINES, JOURNALS, SOFTWARE, GAMES, MUSIC, AND ELECTRONIC PUBLICATIONS; ELECTRONIC PUBLISHING SERVICES, NAMELY, PUBLICATION OF TEXT AND GRAPHIC WORKS OF OTHERS ON CD, DVD OR ON-LINE FEATURING NON-HUMAN PRIMATES; ENTERTAINMENT IN THE NATURE OF ON-GOING TELEVISION PROGRAMS IN THE FIELD OF NON-HUMAN PRIMATES; ENTERTAINMENT SERVICES, NAMELY, PROVIDING AN ON-GOING RADIO PROGRAM IN THE FIELD OF NON-HUMAN PRIMATES; PRODUCTION OF MOTION PICTURES; PRODUCTION AND RENTAL OF VIDEOS AND VIDEO TAPES; AMUSEMENT PARKS; PROVISION OF AMUSEMENT PARK RIDES; PROVIDING THEME PARK SERVICES; ENTERTAINMENT IN THE NATURE OF LASER LIGHT SHOWS; ZOOLOGICAL PARK SERVICES; ZOOLOGICAL GARDEN SERVICES; PARKS AND GARDENS FOR PUBLIC ADMISSION FOR RECREATIONAL PURPOSES; MUSEUM SERVICES; PROVISION OF RECREATION FACILITIES; PROVIDING, ORGANIZING, PLANNING, ARRANGING, CONDUCTING AND HOLDING OF SHOWS, CONCERTS, LECTURES, CONFERENCES, DISPLAYS IN THE FIELD OF NON-HUMAN PRIMATES, EXHIBITIONS IN THE FIELD OF NON-HUMAN PRIMATES AND SEMINARS IN THE FIELD OF NON-HUMAN PRIMATES; ENTERTAINMENT IN THE NATURE OF TELEVISION SERIES AND VIDEOTAPING RELATING TO NON-HUMAN PRIMATES; PHOTOGRAPHY AND RELATED ADVISORY SERVICES, IN CLASS 41 (U.S. CLS. 100, 101 AND 107).

OWNER OF ERPN CMNTY TM OFC REG. NO. 008994261, DATED 10-26-2010, EXPIRES 3-30-2020.

THE COLOR(S) RED, GREEN, BLUE AND YELLOW IS/ARE CLAIMED AS A FEATURE OF THE MARK.

OWNER OF U.S. REG. NO. 2,671,805.

NO CLAIM IS MADE TO THE EXCLUSIVE RIGHT TO USE "MONKEY" AND "APE RESCUE CENTRE", APART FROM THE MARK AS SHOWN.

THE MARK CONSISTS OF THREE RED PRIMATES IN SILHOUETTE IN FRONT OF A FLATTENED BLUE AND YELLOW GLOBE ABOVE THE WORDING "MONKEY WORLD" IN GREEN ABOVE THE WORDING "APE RESCUE CENTRE" IN RED.

SER. NO. 85-019,102, FILED 4-21-2010.

TRACY CROSS, EXAMINING ATTORNEY

United States of America

United States Patent and Trademark Office

PLED Plasma Evolution Display

Reg. No. 4,173,671

LG ELECTRONICS INC. (REPUBLIC OF KOREA CORPORATION)
20, YEOUIDO-DONG, YEONGDEUNGPO-GU
SEOUL, REPUBLIC OF KOREA 150-721

Registered July 17, 2012

Int. Cl.: 9

FOR: TELEVISION RECEIVERS, IN CLASS 9 (U.S. CLS. 21, 23, 26, 36 AND 38).

TRADEMARK

THE MARK CONSISTS OF STANDARD CHARACTERS WITHOUT CLAIM TO ANY PARTICULAR FONT, STYLE, SIZE, OR COLOR.

PRINCIPAL REGISTER

PRIORITY CLAIMED UNDER SEC. 44(D) ON REPUBLIC OF KOREA APPLICATION NO. 40-2010-0021, FILED 4-21-2010, REG. NO. 009056748, DATED 11-6-2010, EXPIRES 4-26-2020.

NO CLAIM IS MADE TO THE EXCLUSIVE RIGHT TO USE "PLED", "PLASMA" OR "DISPLAY", APART FROM THE MARK AS SHOWN.

SER. NO. 85-023,082, FILED 4-26-2010.

ANDREW RHIM, EXAMINING ATTORNEY



David J. Kyffers

Director of the United States Patent and Trademark Office

United States of America

United States Patent and Trademark Office



TONY'S FINER FOODS

Reg. No. 4,173,672

Registered July 17, 2012

Int. Cl.: 35

SERVICE MARK

PRINCIPAL REGISTER

TONY'S FINER FOODS ENTERPRISES, INC. (ILLINOIS CORPORATION)
1200 BRYN MAWR AVENUE
ITASCA, IL 60143

FOR: RETAIL GROCERY STORES, IN CLASS 35 (U.S. CLS. 100, 101 AND 102).

FIRST USE 4-18-1984; IN COMMERCE 5-1-1984.

NO CLAIM IS MADE TO THE EXCLUSIVE RIGHT TO USE "FINER FOODS", APART FROM THE MARK AS SHOWN.

THE COLOR(S) MAROON IS/ARE CLAIMED AS A FEATURE OF THE MARK.

THE MARK CONSISTS OF THE STYLIZED LETTERS "TFF" IN A CIRCLE TO THE LEFT OF THE WORDING "TONY'S". TO THE RIGHT OF THE WORD "TONY'S" APPEARS THE WORD "FINER" ABOVE THE WORD "FOODS". ALL THE DESCRIBED ELEMENTS OF THE MARK APPEAR IN MAROON. THE BACKGROUND OF THE MARK IS TRANSPARENT.

SER. NO. 85-030,495, FILED 5-5-2010.

ANDREA HACK, EXAMINING ATTORNEY



David J. Kyffers

Director of the United States Patent and Trademark Office

United States of America

United States Patent and Trademark Office

RAINER WERNER FASSBINDER

Reg. No. 4,173,673

Registered July 17, 2012

Int. Cl.: 45

RAINER WERNER FASSBINDER FOUNDATION, GEMEINNUTZIGE NACHLASSSTIFTUNG
GMBH (FED REP GERMANY GESELLSCHAFT MIT BESCHRÄNKTER HAFTUNG
(GMBH))
7 TIMES SQUARE, C/O PRYOR CASHMAN LLP
NEW YORK, NY 10036

SERVICE MARK

FOR: TRADE IN AND EXPLOITATION OF FILM, TELEVISION AND VIDEO LICENSES,
NAMELY, LICENSING OF FILMS, TELEVISION SHOWS, AND VIDEOS; COPYRIGHT
MANAGEMENT, IN CLASS 45 (U.S. CLS. 100 AND 101).

PRINCIPAL REGISTER

THE MARK CONSISTS OF STANDARD CHARACTERS WITHOUT CLAIM TO ANY PAR-
TICULAR FONT, STYLE, SIZE, OR COLOR.

OWNER OF FED REP GERMANY REG. NO. 30121055, DATED 11-11-2005, EXPIRES 3-31-
2021.

THE NAME "RAINER WERNER FASSBINDER" DOES NOT IDENTIFY A PARTICULAR
LIVING INDIVIDUAL.

SER. NO. 85-035,710, FILED 5-11-2010.

SARA BENJAMIN, EXAMINING ATTORNEY



David J. Kybas

Director of the United States Patent and Trademark Office

United States of America

United States Patent and Trademark Office

IC-Engine

Reg. No. 4,173,674

LG ELECTRONICS INC. (REPUBLIC OF KOREA CORPORATION)
20, YEOUIDO-DONG, YEONGDEUNGPO-GU
SEOUL, REPUBLIC OF KOREA 150-721

Registered July 17, 2012

Int. Cl.: 9

FOR: COMPUTER MONITORS; COMPUTER APPLICATION SOFTWARE FOR COMPUTER MONITORS FOR IMPROVEMENT OF IMAGE QUALITY; INTEGRATED CIRCUIT CHIPS FOR IMPROVING IMAGES ON COMPUTER MONITORS, IN CLASS 9 (U.S. CLS. 21, 23, 26, 36 AND 38).

TRADEMARK

PRINCIPAL REGISTER

THE MARK CONSISTS OF STANDARD CHARACTERS WITHOUT CLAIM TO ANY PARTICULAR FONT, STYLE, SIZE, OR COLOR.

PRIORITY CLAIMED UNDER SEC. 44(D) ON REPUBLIC OF KOREA APPLICATION NO. 40-2010-0006, FILED 2-3-2010, REG. NO. 0864178, DATED 5-11-2011, EXPIRES 5-11-2021.

SER. NO. 85-043,352, FILED 5-20-2010.

DOUGLAS LEE, EXAMINING ATTORNEY



David J. Kyffers

Director of the United States Patent and Trademark Office

United States of America

United States Patent and Trademark Office

CHATTEREXCHANGE

Reg. No. 4,173,675

SALESFORCE.COM, INC. (DELAWARE CORPORATION)
THE LANDMARK @ ONE MARKET ST., SUITE 300
SAN FRANCISCO, CA 94105

Registered July 17, 2012

Int. Cls.: 35 and 42

FOR: OPERATING ONLINE MARKETPLACES FOR BUYING AND SELLING COMPUTER SOFTWARE AND ON-DEMAND APPLICATIONS, IN CLASS 35 (U.S. CLS. 100, 101 AND 102).

SERVICE MARK

FIRST USE 4-8-2010; IN COMMERCE 4-8-2010.

PRINCIPAL REGISTER

FOR: FILE SHARING SERVICES, NAMELY, PROVIDING A WEBSITE FEATURING TECHNOLOGY ENABLING USERS TO UPLOAD AND DOWNLOAD ELECTRONIC FILES IN THE NATURE OF COMPUTER SOFTWARE AND ON-DEMAND APPLICATIONS; PROVIDING TEMPORARY USE OF ON-LINE NON-DOWNLOADABLE SOFTWARE TO STORE, MANAGE, TRACK, ANALYZE, AND REPORT DATA IN THE FIELD OF MARKETING, PROMOTION, SALES, CUSTOMER INFORMATION, CUSTOMER RELATIONSHIP MANAGEMENT, SALES SUPPORT AND EMPLOYEE EFFICIENCY; PROVIDING TEMPORARY USE OF ON-LINE NON-DOWNLOADABLE SOFTWARE TO FACILITATE COMMUNICATING AMONG PEER PROFESSIONALS IN THE ADVERTISING, MARKETING AND BUSINESS SERVICES FIELDS, AND FOR CUSTOMIZING COMPUTER APPLICATION USER INTERFACES; COMPUTER SERVICES, NAMELY, DESIGNING, DEVELOPING, AND MAINTAINING COMPUTER SOFTWARE APPLICATIONS FOR OTHERS AND CONSULTING SERVICES RELATED THERETO; PROVIDING TEMPORARY USE OF ONLINE NON-DOWNLOADABLE COMPUTER SOFTWARE APPLICATION DEVELOPMENT TOOLS AND PROGRAMMING LANGUAGE FOR USE IN DEVELOPING, ANALYZING, CODING, CHECKING, AND CONTROLLING OTHER COMPUTER SOFTWARE; PROVIDING TEMPORARY USE OF ONLINE NON-DOWNLOADABLE COMPUTER SOFTWARE THAT IMPLEMENTS A PROCEDURAL AND OBJECT-ORIENTED PROGRAMMING LANGUAGE; ONLINE HOSTED COMPUTER SERVICES, NAMELY, DESIGNING, DEVELOPING, CUSTOMIZING, AND MAINTAINING COMPUTER SOFTWARE APPLICATIONS FOR OTHERS AND CONSULTING SERVICES RELATED THERETO, IN CLASS 42 (U.S. CLS. 100 AND 101).



David J. Kyffers

Director of the United States Patent and Trademark Office

FIRST USE 4-8-2010; IN COMMERCE 4-8-2010.

THE MARK CONSISTS OF STANDARD CHARACTERS WITHOUT CLAIM TO ANY PARTICULAR FONT, STYLE, SIZE, OR COLOR.

Reg. No. 4,173,675 SER. NO. 85-044,905, FILED 5-21-2010.

GRETTA YAO, EXAMINING ATTORNEY

United States of America

United States Patent and Trademark Office

PROJECT PLANET

Reg. No. 4,173,676

STANLEY, JOHN (UNITED STATES INDIVIDUAL)
120 PEACHTREE CIRCLE/CARRIAGE HOUSE
ATLANTA, GA 30309

Registered July 17, 2012

Int. Cl.: 35

FOR: ENVIRONMENTAL CONSULTING SERVICES IN THE FIELDS OF ENERGY AND WATER CONSUMPTION AND USAGE CONSERVATION TO IMPROVE ENERGY AND WATER USAGE EFFICIENCY, IN CLASS 35 (U.S. CLS. 100, 101 AND 102).

SERVICE MARK

FIRST USE 11-1-1997; IN COMMERCE 11-1-1997.

PRINCIPAL REGISTER

THE MARK CONSISTS OF STANDARD CHARACTERS WITHOUT CLAIM TO ANY PARTICULAR FONT, STYLE, SIZE, OR COLOR.

SER. NO. 85-045,620, FILED 5-22-2010.

KELLEY WELLS, EXAMINING ATTORNEY



David J. Kybas

Director of the United States Patent and Trademark Office

United States of America

United States Patent and Trademark Office

COLON-AID

Reg. No. 4,173,677

DIRECT ACCESS NETWORK, INC. (FLORIDA CORPORATION)
600 N WESTSHORE BLVD SUITE 800
TAMPA, FL 33609

Registered July 17, 2012

Int. Cl.: 5

FOR: HERBAL AND NUTRITIONAL SUPPLEMENTS FOR COLON CLEANSING, IN CLASS 5 (U.S. CLS. 6, 18, 44, 46, 51 AND 52).

TRADEMARK

FIRST USE 12-31-1996; IN COMMERCE 12-31-1996.

PRINCIPAL REGISTER

THE MARK CONSISTS OF STANDARD CHARACTERS WITHOUT CLAIM TO ANY PARTICULAR FONT, STYLE, SIZE, OR COLOR.

SER. NO. 85-050,592, FILED 5-28-2010.

SUZANNE BLANE, EXAMINING ATTORNEY



David J. Kyffers

Director of the United States Patent and Trademark Office

United States of America

United States Patent and Trademark Office

CHUBBY BUDDYS

Reg. No. 4,173,678

Registered July 17, 2012

Int. Cl.: 44

SERVICE MARK

PRINCIPAL REGISTER

ORGANIC LIAISON, LLC. (FLORIDA LIMITED LIABILITY COMPANY)
1515 UNIVERSITY BLVD., SUITE 222
CORAL SPRINGS, FL 33071

FOR: CONSULTING TO INDIVIDUALS AND COMMUNITIES ENGAGED IN GROUP WEIGHT LOSS PROGRAMS; PROVIDING A WEBSITE FEATURING INFORMATION AND ADVICE IN THE FIELDS OF DIET, WEIGHT LOSS, DIET PLANNING AND LIFESTYLE WELLNESS; PROVIDING INFORMATION ON MAINTAINING A HEALTHY LIFESTYLE AND LOSING WEIGHT; PROVIDING WEIGHT LOSS PROGRAM SERVICES; WEIGHT MANAGEMENT SERVICES, NAMELY, PROVIDING WEIGHT LOSS AND/OR WEIGHT MAINTENANCE PROGRAMS; WEIGHT REDUCTION DIET PLANNING AND SUPERVISION, IN CLASS 44 (U.S. CLS. 100 AND 101).

FIRST USE 8-31-2009; IN COMMERCE 2-25-2010.

THE MARK CONSISTS OF STANDARD CHARACTERS WITHOUT CLAIM TO ANY PARTICULAR FONT, STYLE, SIZE, OR COLOR.

SER. NO. 85-052,144, FILED 6-1-2010.

REGINA DRUMMOND, EXAMINING ATTORNEY



David J. Kyjars

Director of the United States Patent and Trademark Office

United States of America

United States Patent and Trademark Office

GURRA GURRA CREEK

Reg. No. 4,173,679

OENOFOROS AB (SWEDEN AKTIEBOLAG (AB))
P.O. BOX 24005

Registered July 17, 2012

STOCKHOLM, SWEDEN 10450

Int. Cl.: 33

FOR: WINE, IN CLASS 33 (U.S. CLS. 47 AND 49).

TRADEMARK

THE MARK CONSISTS OF STANDARD CHARACTERS WITHOUT CLAIM TO ANY PARTICULAR FONT, STYLE, SIZE, OR COLOR.

PRINCIPAL REGISTER

PRIORITY CLAIMED UNDER SEC. 44(D) ON ERPN CMNTY TM OFC APPLICATION NO. 008817868, FILED 1-19-2010, REG. NO. 008817868, DATED 8-12-2011, EXPIRES 1-19-2020.

SER. NO. 85-052,786, FILED 6-2-2010.

NATALIE POLZER, EXAMINING ATTORNEY



David J. Kyffers

Director of the United States Patent and Trademark Office

United States of America

United States Patent and Trademark Office

URBAN FARM

Reg. No. 4,173,680

Registered July 17, 2012

**Int. Cls.: 16, 35, 38, 41,
43 and 44**

TRADEMARK

SERVICE MARK

PRINCIPAL REGISTER

BOWTIE, INC. (CALIFORNIA CORPORATION)
3 BURROUGHS
IRVINE, CA 926182804

FOR: MAGAZINES IN THE FIELD OF AGRICULTURE, HORTICULTURE, FOOD, COOKING, FOOD PREPARATION AND PRESERVATION, HEALTH, NUTRITION, RECYCLING, COMMUNITY BUILDING AND GREEN LIVING, IN CLASS 16 (U.S. CLS. 2, 5, 22, 23, 29, 37, 38 AND 50).

FIRST USE 7-0-2009; IN COMMERCE 7-0-2009.

FOR: PROVIDING ONLINE BUSINESS DIRECTORIES FEATURING PROVIDERS OF PRODUCTS AND SERVICES IN THE FIELDS OF AGRICULTURE, HORTICULTURE, COOKING, FOOD PREPARATION, AND FOOD PRESERVATION; PROMOTING THE GOODS AND SERVICES OF OTHERS THROUGH ONLINE ADVERTISEMENTS; PROVIDING ONLINE CLASSIFIED ADVERTISING SPACE; PROVIDING AN ONLINE SEARCHABLE DATABASE FEATURING INFORMATION ABOUT CONSUMER PRODUCTS AND SERVICES IN THE FIELDS OF AGRICULTURE, HORTICULTURE, COOKING, FOOD PREPARATION, FOOD PRESERVATION, AND RECYCLING, IN CLASS 35 (U.S. CLS. 100, 101 AND 102).

FIRST USE 5-0-2010; IN COMMERCE 5-0-2010.

FOR: PROVIDING ON-LINE FORUMS FOR TRANSMISSION OF MESSAGES AMONG COMPUTER USERS CONCERNING AGRICULTURE, HORTICULTURE, COOKING, FOOD PREPARATION, FOOD PRESERVATION, RECYCLING AND TOPICS OF GENERAL INTEREST; PROVIDING ON-LINE ELECTRONIC BULLETIN BOARDS FOR TRANSMISSION OF MESSAGES AMONG COMPUTER USERS CONCERNING AGRICULTURE, HORTICULTURE, COOKING, FOOD PREPARATION, FOOD PRESERVATION, RECYCLING AND TOPICS OF GENERAL INTEREST; TRANSMISSION OF SOUND, VIDEO AND INFORMATION, IN CLASS 38 (U.S. CLS. 100, 101 AND 104).

FIRST USE 5-0-2010; IN COMMERCE 5-0-2010.

FOR: ON-LINE JOURNALS, NAMELY, BLOGS FEATURING AGRICULTURE, HORTICULTURE, FOOD, COOKING, FOOD PREPARATION AND PRESERVATION, HEALTH, NUTRITION, RECYCLING AND TOPICS OF GENERAL INTEREST; PROVIDING ONLINE NON-DOWNLOADABLE PUBLICATIONS IN THE NATURE OF ARTICLES IN THE FIELD OF A



David J. Kyjars

Director of the United States Patent and Trademark Office

Reg. No. 4,173,680 AGRICULTURE, HORTICULTURE, FOOD, COOKING, FOOD PREPARATION AND PRESERVATION, HEALTH, NUTRITION, RECYCLING AND TOPICS OF GENERAL INTEREST; ENTERTAINMENT SERVICES, NAMELY, CONDUCTING CONTESTS, IN CLASS 41 (U.S. CLS. 100, 101 AND 107).

FIRST USE 5-0-2010; IN COMMERCE 5-0-2010.

FOR: PROVIDING ONLINE INFORMATION REGARDING COOKING, AND FOOD PREPARATION; PROVIDING A WEBSITE FEATURING ONLINE NON-DOWNLOADABLE VIDEOS FEATURING INFORMATION ON COOKING AND FOOD PREPARATION, IN CLASS 43 (U.S. CLS. 100 AND 101).

FIRST USE 5-0-2010; IN COMMERCE 5-0-2010.

FOR: PROVIDING ONLINE INFORMATION REGARDING AGRICULTURE, HORTICULTURE, HEALTH, NUTRITION AND GARDENING; PROVIDING A WEBSITE FEATURING ONLINE NON-DOWNLOADABLE VIDEOS FEATURING INFORMATION ON AGRICULTURE, HORTICULTURE, HEALTH, NUTRITION, IN CLASS 44 (U.S. CLS. 100 AND 101).

FIRST USE 8-0-2009; IN COMMERCE 8-0-2009.

THE MARK CONSISTS OF STANDARD CHARACTERS WITHOUT CLAIM TO ANY PARTICULAR FONT, STYLE, SIZE, OR COLOR.

OWNER OF U.S. REG. NO. 3,690,781.

SEC. 2(F).

SER. NO. 85-055,373, FILED 6-4-2010.

WENDY GOODMAN, EXAMINING ATTORNEY

United States of America

United States Patent and Trademark Office

Relationship Architecture

Reg. No. 4,173,681

Registered July 17, 2012

Int. Cl.: 41

SERVICE MARK

PRINCIPAL REGISTER

IMBRIANO, LOUIS A (UNITED STATES INDIVIDUAL)
11 RUSTIC ROAD
STONEHAM, MA 02180

FOR: EDUCATIONAL SERVICES, NAMELY, PROVIDING WORKSHOPS IN THE FIELD OF A PHILOSOPHICAL APPROACH TO MARKETING THAT EMPHASIZES THE VALUE IN FORMING UNBREAKABLE RELATIONSHIPS BY DESIGN, PRACTICAL METHODS TO FACILITATE BUILDING CUSTOMER RELATIONSHIPS, BUSINESS TO BUSINESS MANAGEMENT STRATEGY, ORGANIZATIONAL STRUCTURE AND IMPLEMENTATION, CUSTOMER LOYALTY MARKETING, NEGOTIATION TACTICS AND RELATIONSHIP DEVELOPMENT FOR SPORTS TEAMS AND VENUES, ENTERTAINMENT ENTITIES, MEDIA ORGANIZATIONS, ATHLETES, PERSONALITIES, CHARITABLE ORGANIZATIONS AND COMPANIES, IN CLASS 41 (U.S. CLS. 100, 101 AND 107).

FIRST USE 4-1-2001; IN COMMERCE 7-1-2009.

THE MARK CONSISTS OF STANDARD CHARACTERS WITHOUT CLAIM TO ANY PARTICULAR FONT, STYLE, SIZE, OR COLOR.

NO CLAIM IS MADE TO THE EXCLUSIVE RIGHT TO USE "RELATIONSHIP", APART FROM THE MARK AS SHOWN.

SER. NO. 85-055,959, FILED 6-7-2010.

ASMAT KHAN, EXAMINING ATTORNEY



David J. Kyffers

Director of the United States Patent and Trademark Office

United States of America

United States Patent and Trademark Office



OfficePOD

Reg. No. 4,173,682

Registered July 17, 2012

Int. Cl.: 19

TRADEMARK

PRINCIPAL REGISTER

OFFICEPOD LIMITED (UNITED KINGDOM LIMITED COMPANY (LTD.))
W1W 5BB
131-151 GREAT TITCHFIELD STREET
LONDON, UNITED KINGDOM

FOR: PORTABLE AND RELOCATABLE BUILDINGS AND CABINS MADE WHOLLY OR PRINCIPALLY OF NON-METALLIC MATERIALS; PARTS AND FITTINGS, NAMELY, NON-METAL WINDOWS AND DOORS, COMPOSITE BUILDING PANELS COMPOSED PRIMARILY OF NON-METAL MATERIALS, GLASS BUILDING PANELS, FOR PORTABLE AND RELOCATABLE BUILDINGS AND CABINS MADE WHOLLY OR PRINCIPALLY OF NON-METALLIC MATERIALS, IN CLASS 19 (U.S. CLS. 1, 12, 33 AND 50).

OWNER OF UNITED KINGDOM REG. NO. 2462028, DATED 7-21-2007, EXPIRES 7-21-2017.

THE MARK CONSISTS OF AN ABSTRACT, SQUARE-SHAPED DESIGN ELEMENT WITH ROUNDED CORNERS ON THE UPPER LEFT AND LOWER RIGHT PORTIONS OF THE SHAPE. A LEAF-SHAPED DESIGN IS LOCATED INSIDE THE SQUARE AT THE BOTTOM LEFT QUADRANT OF THE SQUARE. THE TERM "OFFICEPOD" APPEARS BENEATH THE DESIGN IN STYLIZED LETTERING.

SER. NO. 85-056,561, FILED 6-7-2010.

KATHERINE CHANG, EXAMINING ATTORNEY



David J. Kyffers

Director of the United States Patent and Trademark Office

United States of America

United States Patent and Trademark Office



Reg. No. 4,173,683

Registered July 17, 2012

Int. Cl.: 41

SERVICE MARK

PRINCIPAL REGISTER

PERRY, ANN OLESON (UNITED STATES INDIVIDUAL), DBA THE YOGA SPOT
3467 PASEO FLAMENCO
SAN CLEMENTE, CA 92672

FOR: YOGA INSTRUCTION, IN CLASS 41 (U.S. CLS. 100, 101 AND 107).

FIRST USE 2-0-2000; IN COMMERCE 2-0-2000.

THE MARK CONSISTS OF A CIRCLE FADING FROM BLUE TO PURPLE, TO THE LEFT OF THE BLACK WORDS "THE YOGA SPOT".

THE COLOR(S) BLUE, PURPLE AND BLACK IS/ARE CLAIMED AS A FEATURE OF THE MARK.

SEC. 2(F) AS TO "YOGA".

SER. NO. 85-059,771, FILED 6-10-2010.

ESTHER BELENKER, EXAMINING ATTORNEY



David J. Kyros

Director of the United States Patent and Trademark Office

United States of America

United States Patent and Trademark Office

SMOOTH & HEALTHY

Reg. No. 4,173,684

Registered July 17, 2012

Int. Cl.: 3

TRADEMARK

PRINCIPAL REGISTER

GHC SYSTEMS INC. (CANADA CORPORATION)
SASKATOON
2-501 CARTWRIGHT STREET
SASKATCHEWAN, CANADA S7T1E1

FOR: HAIRCARE PRODUCTS FOR USE BY LICENSED HAIR SALONS AND COSMETOLOGISTS, NAMELY, CURL REDUCTION HAIR CARE PREPARATIONS, FRIZZ REDUCTION HAIR CARE PREPARATIONS, HAIR STRAIGHTENING PRODUCTS, NAMELY, HAIR STRAIGHTENING TOOLS AND PREPARATIONS, NAMELY, HAIR STRAIGHTENING AND RELAXING PREPARATIONS, IN CLASS 3 (U.S. CLS. 1, 4, 6, 50, 51 AND 52).

THE MARK CONSISTS OF STANDARD CHARACTERS WITHOUT CLAIM TO ANY PARTICULAR FONT, STYLE, SIZE, OR COLOR.

PRIORITY CLAIMED UNDER SEC. 44(D) ON CANADA APPLICATION NO. 1464205, FILED 12-24-2009, REG. NO. TMA816492, DATED 1-31-2012, EXPIRES 1-31-2027.

SER. NO. 85-068,933, FILED 6-22-2010.

MATTHEW EINSTEIN, EXAMINING ATTORNEY



David J. Kyffers

Director of the United States Patent and Trademark Office

United States of America

United States Patent and Trademark Office

COLOR VITACOMPLEX

Reg. No. 4,173,685

Registered July 17, 2012

Int. Cl.: 3

TRADEMARK

PRINCIPAL REGISTER

GHC SYSTEMS INC. (CANADA CORPORATION)
SASKATOON
2-501 CARTWRIGHT STREET
SASKATCHEWAN, CANADA S7T1E1

FOR: HAIR CARE PRODUCTS FOR USE BY LICENSED HAIR SALONS AND COSMETOLOGISTS, NAMELY, HAIR REPAIR TREATMENTS TO STRENGTHEN HAIR, REPAIR DAMAGE AND PROTECT HAIR, NAMELY, STRENGTHENING SHAMPOOS AND CONDITIONERS, PROTEIN HAIR REPAIR TONICS, HAIR SHINE AND GLOSS DROPS; HAIR SPRAY, HAIR SMOOTHING CREAM, HAIR STYLING GELS, OIL FOR HAIR, HAIR PASTES, WAXES, POMADES AND CREAMS, MOUSSE FOR HAIRSTYLING, LOTIONS FOR HAIR, HAIR CURLING AND STRAIGHTENING CHEMICALS, CURL REDUCTION HAIR CARE PREPARATIONS, FRIZZ REDUCTION HAIR CARE PREPARATIONS, HAIR STRAIGHTENING PREPARATIONS, NAMELY, RELAXING PREPARATIONS, IN CLASS 3 (U.S. CLS. 1, 4, 6, 50, 51 AND 52).

THE MARK CONSISTS OF STANDARD CHARACTERS WITHOUT CLAIM TO ANY PARTICULAR FONT, STYLE, SIZE, OR COLOR.

PRIORITY CLAIMED UNDER SEC. 44(D) ON CANADA APPLICATION NO. 1464718, FILED 1-1-2010, REG. NO. TMA816612, DATED 2-1-2012, EXPIRES 2-1-2027.

NO CLAIM IS MADE TO THE EXCLUSIVE RIGHT TO USE "COLOR", APART FROM THE MARK AS SHOWN.

SER. NO. 85-068,955, FILED 6-22-2010.

MATTHEW EINSTEIN, EXAMINING ATTORNEY



David J. Kyros

Director of the United States Patent and Trademark Office

United States of America

United States Patent and Trademark Office



Reg. No. 4,173,686

Registered July 17, 2012

Int. Cl.: 26

TRADEMARK

PRINCIPAL REGISTER

MITCHELL, TYRA K. (DELAWARE CORPORATION), DBA BEAUTY FOR ASHES
213 BEAVER CREEK DRIVE
COLUMBIA, SC 29223

FOR: CHRISTIAN THEMED NOVELTY BUTTONS CONTAINING ELECTRONIC MEANS TO PRODUCE VOICES, SOUNDS, AND MUSIC, IN CLASS 26 (U.S. CLS. 37, 39, 40, 42 AND 50).

FIRST USE 9-11-2009; IN COMMERCE 9-11-2009.

THE MARK CONSISTS OF THE WORDPHRASE "BEAUTY FOR ASHES", THE LETTER "B" HAS A CURVED RIBBON ATTACHED WITH THE APPEARANCE OF BLACK ASHES SHOOTING OUT OF IT. THE WORD FOR APPEARS ON THE LEFT SIDE OF THE LETTER "A", THE "A" IN THE WORD ASHES HAS A RIBBON ATTACHED IN THE SHAPE OF AN "S", THE "S" IN "ASHES" HAS THE APPEARANCE OF ASHES POURING OUT OF IT.

SER. NO. 85-069,144, FILED 6-22-2010.

TRACY CROSS, EXAMINING ATTORNEY



David J. Kyros

Director of the United States Patent and Trademark Office

United States of America

United States Patent and Trademark Office



Reg. No. 4,173,687

Registered July 17, 2012

Int. Cl.: 41

SERVICE MARK

PRINCIPAL REGISTER

THE YOUNG PEOPLE'S CHORUS OF NEW YORK CITY, INC. (NEW YORK CORPORATION)
1995 BROADWAY
NEW YORK, NY 10023

FOR: ENTERTAINMENT SERVICES, NAMELY, PROVIDING LIVE PERFORMANCES IN THE NATURE OF CONCERTS BY A CHILDREN'S CHORUS, IN CLASS 41 (U.S. CLS. 100, 101 AND 107).

FIRST USE 12-9-1996; IN COMMERCE 12-9-1996.

NO CLAIM IS MADE TO THE EXCLUSIVE RIGHT TO USE "CHORUS", APART FROM THE MARK AS SHOWN.

THE MARK CONSISTS OF THE WORDS "YOUNG PEOPLE'S CHORUS" OVER A DESIGN OF MUSICAL NOTES WHICH ARE OVER A DESIGN OF THE NEW YORK CITY SKYLINE.

SEC. 2(F) AS TO "YOUNG PEOPLE'S CHORUS OF NEW YORK CITY".

SER. NO. 85-070,964, FILED 6-24-2010.

BARNEY CHARLON, EXAMINING ATTORNEY



David J. Kyffers

Director of the United States Patent and Trademark Office

United States of America

United States Patent and Trademark Office

SOCK IT TO ME

Reg. No. 4,173,688

Registered July 17, 2012

Int. Cl.: 25

TRADEMARK

PRINCIPAL REGISTER

SOCK IT TO ME, INC. (OREGON CORPORATION)
6624 SE 45TH
PORTLAND, OR 97206

FOR: SOCKS AND STOCKINGS, IN CLASS 25 (U.S. CLS. 22 AND 39).

FIRST USE 10-1-2004; IN COMMERCE 10-1-2004.

THE MARK CONSISTS OF STANDARD CHARACTERS WITHOUT CLAIM TO ANY PARTICULAR FONT, STYLE, SIZE, OR COLOR.

NO CLAIM IS MADE TO THE EXCLUSIVE RIGHT TO USE "SOCK", APART FROM THE MARK AS SHOWN.

SER. NO. 85-071,062, FILED 6-24-2010.

CARYN GLASSER, EXAMINING ATTORNEY



David J. Kyffers

Director of the United States Patent and Trademark Office

United States of America

United States Patent and Trademark Office



Reg. No. 4,173,689

Registered July 17, 2012

Int. Cls.: 7, 9, 12 and 35

TRADEMARK

SERVICE MARK

PRINCIPAL REGISTER

CLAAS KGAA MBH (FED REP GERMANY LIMITED LIABILITY COMPANY)
MUENSTERSTRASSE 33
HARSEWINKEL, FED REP GERMANY 33428

FOR: AGRICULTURAL MACHINERY, NAMELY, COMBINE HARVESTERS, FORAGE HARVESTERS, BAILING PRESSES, MOWERS, AND SWATHERS; TEDDERS AND PARTS AND COMPONENTS OF THE ABOVE, IN CLASS 7 (U.S. CLS. 13, 19, 21, 23, 31, 34 AND 35).

FOR: SCIENTIFIC-SURVEYING, ELECTRIC PHOTOGRAPHIC, OPTICAL WEIGHTING, MEASURING, SIGNALING, CONTROL APPARATUSES AND INSTRUMENTS, NAMELY, LASERS, SENSORS, SCALES AND CAMERAS; APPARATUS FOR RECORDING, TRANSMISSION AND REPRODUCTION OF SOUND AND IMAGES, NAMELY, SPEAKERS, RADIOS, RECEIVERS AND TRANSCEIVERS; CABLES, NAMELY, COAXIAL CABLES AND ELECTRICAL CABLES SWITCHES, NAMELY, ELECTRIC SWITCHES, AND ANTENNAS; MAGNETIC DATA CARRIERS, NAMELY, BLANK MAGNETIC DATA CARRIERS AND PRE-RECORDED MAGNETIC DATA CARRIERS FEATURING MAPS, AGRICULTURAL DATA AND AGRICULTURAL MACHINE INFORMATION; COMPUTING MACHINES AND PROCESSING DEVICES, NAMELY, COMPUTERS AND COMPUTER PROGRAMS FOR GLOBAL POSITIONING FOR USE IN HARVESTING, FOR USE IN MACHINE SERVING MANAGEMENT, LINKS, NAMELY, FUSIBLE LINKS, ELECTRICAL FUSES, AND TAPE MEASURES, IN CLASS 9 (U.S. CLS. 21, 23, 26, 36 AND 38).

FOR: VEHICLES AND APPARATUS FOR TRANSPORT BY LAND, NAMELY, TRACTORS, TRAILERS FOR HAULING, HARVESTING PLANT MATERIAL, WAGONS, SELF-LOADING FORAGE WAGONS, SELF-LOADING FORAGE WAGONS FOR THE TRANSPORT OF HARVESTER PLAN MATERIALS; BRAKE LINES FOR VEHICLES, DRIVE GEARS, CLUTCHES FOR LAND VEHICLES, BRAKES FOR LAND VEHICLES, IN CLASS 12 (U.S. CLS. 19, 21, 23, 31, 35 AND 44).

FOR: RENDERING OF SERVICES IN THE AGRICULTURAL, GARDENING AND FORESTRY INDUSTRIES, NAMELY, CREATION OF MARKETING CONCEPTS FOR CONTRACTORS AND THE USE OF MACHINERY FOR MULTIPLE OPERATIONS; CREATION OF MARKETING CONCEPTS FOR COMPARING THE EFFICIENCY OF AGRICULTURAL MACHINERY; BUSINESS CONSULTATION RELATING TO METHODS AND SYSTEMS FOR PLANNING, ORGANIZING, LEADING AND CONTROLLING AGRICULTURAL OPERATIONS AND CONTRACTORS; BUSINESS CONSULTING RELATING TO THE OPTIMIZATION OF AG-



David J. Kybas

Director of the United States Patent and Trademark Office

Reg. No. 4,173,689 AGRICULTURAL MACHINE SYSTEMS AND TRANSPORT CHAINS FOR THE PURPOSE OF OPTIMIZING LOGISTICAL PROCESSES, IN CLASS 35 (U.S. CLS. 100, 101 AND 102).

PRIORITY CLAIMED UNDER SEC. 44(D) ON ERPN CMNTY TM OFC APPLICATION NO. 009211657, FILED 6-14-2010, REG. NO. 009211657, DATED 12-13-2011, EXPIRES 6-14-2020.

THE MARK CONSISTS OF A SQUARE WITHIN WHICH THE WORD "EASY" APPEARS. AT THE TOP OF THE SQUARE THE WORDING "GO ON. GO EASY" APPEARS.

SER. NO. 85-073,955, FILED 6-29-2010.

CHERYL CLAYTON, EXAMINING ATTORNEY

United States of America

United States Patent and Trademark Office

JX25

Reg. No. 4,173,690

Registered July 17, 2012

Int. Cl.: 12

TRADEMARK

PRINCIPAL REGISTER

NISSAN JIDOSHA KABUSHIKI KAISHA (JAPAN CORPORATION), DBA NISSAN MOTOR CO., LTD.
NO. 2 TAKARACHO, KANAGAWA-KU
YOKOHAMA-SHI, KANAGAWA, JAPAN 2208623

FOR: AUTOMOBILES; VANS; MOTORBUSES; SPORTS CARS; RACING CARS; FORK LIFT TRUCKS; REFRIGERATED VEHICLES; SNOWMOBILES; DUMP TRUCKS; SPRINKLING TRUCKS; AMPHIBIOUS VEHICLES; PASSENGER CARS; AMBULANCES; CAMPING CARS; TRAILERS; GARBAGE HAULING TRAILERS; AIR BAGS; WINDSCREEN WIPERS; HOODS FOR AUTOMOBILE ENGINES; HORNS FOR AUTOMOBILES; AIR PUMPS FOR AUTOMOBILES; LUGGAGE RACKS FOR MOTOR CARS; DOORS FOR AUTOMOBILE; DIRECTION SIGNALS FOR AUTOMOBILES; MIRRORS FOR VEHICLES; BUMPERS FOR AUTOMOBILES; AUTOMOBILE BODIES; AUTOMOBILE CHASSIS; SKI CARRIERS FOR CARS; AUTOMOBILE WINDOWS; CAR SAFETY SEATS FOR CHILDREN; STEERING WHEELS FOR AUTOMOBILES; AUTOMOBILES SEATS; AUTOMOBILE WHEELS; WINDSCREENS FOR AUTOMOBILES; AUTOMOBILE HOODS; REVERSING ALARMS FOR AUTOMOBILES; HEAD RESTS FOR SEATS FOR MOTOR CARS; SAFETY BELTS FOR AUTOMOBILE SEATS; BALANCES WEIGHTS FOR AUTOMOBILE WHEELS; RIMS FOR AUTOMOBILE WHEELS; AUTOMOBILE WHEEL SPOKES; SPOKE CLIPS FOR WHEELS FOR BICYCLES; BANDS FOR WHEEL HUBS; MUDGUARDS FOR TRUCKS; VEHICLE WHEEL TIRES; SEAT COVERS FOR AUTOMOBILES; CLUTCHES FOR LAND VEHICLES, IN CLASS 12 (U.S. CLS. 19, 21, 23, 31, 35 AND 44).

THE MARK CONSISTS OF STANDARD CHARACTERS WITHOUT CLAIM TO ANY PARTICULAR FONT, STYLE, SIZE, OR COLOR.

PRIORITY CLAIMED UNDER SEC. 44(D) ON REPUBLIC OF KOREA APPLICATION NO. 40-2010-7011, FILED 2-8-2010, REG. NO. 40-0885900, DATED 10-18-2011, EXPIRES 10-18-2021.

SER. NO. 85-080,157, FILED 7-8-2010.

DAVID TOOLEY, EXAMINING ATTORNEY



David J. Kyffers

Director of the United States Patent and Trademark Office

United States of America

United States Patent and Trademark Office



Reg. No. 4,173,691

Registered July 17, 2012

Int. Cls.: 29 and 43

TRADEMARK

SERVICE MARK

PRINCIPAL REGISTER

LUCCA ENTERPRISES, INC. (CALIFORNIA CORPORATION)
160 UNITY CIRCLE
SACRAMENTO, CA 95833

FOR: BEEF, IN CLASS 29 (U.S. CL. 46).

FIRST USE 12-1-2006; IN COMMERCE 12-1-2006.

FOR: RESTAURANT AND CAFE SERVICES, IN CLASS 43 (U.S. CLS. 100 AND 101).

FIRST USE 12-1-2006; IN COMMERCE 12-1-2006.

NO CLAIM IS MADE TO THE EXCLUSIVE RIGHT TO USE "ALL NATURAL BEEF" OR "RANCH" OR "DIXON, CA", APART FROM THE MARK AS SHOWN.

THE COLOR(S) BLACK AND TAN IS/ARE CLAIMED AS A FEATURE OF THE MARK.

THE MARK CONSISTS OF A BLACK OVAL WHICH INCLUDES THE BLACK SILHOUETTE OF A COW AND A DOG AGAINST A TAN BACKGROUND WITH THE WORDS "ALL NATURAL BEEF" IN TAN ABOVE THE ANIMALS AND THE STYLIZED WORDING "LUCKY DOG" IN BLACK AND TAN AND "RANCH DIXON, CA" IN TAN BELOW THE ANIMALS.

SER. NO. 85-080,308, FILED 7-8-2010.

KYLE PEETE, EXAMINING ATTORNEY



David J. Kybas

Director of the United States Patent and Trademark Office

United States of America

United States Patent and Trademark Office



Reg. No. 4,173,692

Registered July 17, 2012

**Int. Cls.: 1, 3, 4, 5, 11, 16,
19, 31, 37, 40 and 44**

RECKITT BENCKISER S.À.R.L. (LUXEMBOURG CORPORATION)
L-1840
39 BOULEVARD JOSEPH II
LUXEMBOURG, LUXEMBOURG

FOR: WATER SOFTENING CHEMICALS; DESCALING PREPARATIONS FOR INDUSTRIAL PURPOSES, IN CLASS 1 (U.S. CLS. 1, 5, 6, 10, 26 AND 46).

TRADEMARK

SERVICE MARK

PRINCIPAL REGISTER

FOR: LAUNDRY BLEACH; LAUNDRY BLUEING; LAUNDRY DETERGENT; LAUNDRY PRE-SOAK; LAUNDRY SOAP; LAUNDRY STARCH; CARPET CLEANERS; FABRIC SOFTENERS; STAIN REMOVERS; SHAMPOOS; SCOURING POWDERS AND LIQUIDS; GENERAL PURPOSE CLEANING, POLISHING, AND ABRASIVE LIQUIDS, POWDERS, GELS AND CREAMS; PRE-MOISTENED TOWELETTS IMPREGNATED WITH DISHWASHING DETERGENT; DISPOSABLE WIPES IMPREGNATED WITH CLEANING CHEMICALS OR COMPOUNDS FOR HOUSEHOLD USE; DENTIFRICES; TOOTHPASTES; NON-MEDICATED MOUTH WASHES; DENTURE CLEANING PREPARATIONS; COSMETICS; BODY AND BEAUTY CARE COSMETICS; COSMETIC CREAMS AND LOTIONS; SKIN CREAMS; SKIN MOISTURIZING CREAMS, LOTIONS AND GELS; EXFOLIANTS FOR SKIN; SOAPS FOR BODY CARE; SOAPS FOR PERSONAL USE; BLEACHING PREPARATIONS FOR COSMETIC PURPOSES; SHAVING PREPARATIONS; DEPILATORIES, IN CLASS 3 (U.S. CLS. 1, 4, 6, 50, 51 AND 52).

FOR: CANDLES, IN CLASS 4 (U.S. CLS. 1, 6 AND 15).



David J. Kyros

Director of the United States Patent and Trademark Office

FOR: INSECTICIDES; INSECT REPELLENTS; PESTICIDES; RODENTICIDES; MITICIDES FOR DOMESTIC USE; PREPARATIONS FOR DESTROYING VERMIN; ALLERGY RELIEF MEDICATIONS; GERMICIDES; FUNGICIDES; HERBICIDES; PREPARATIONS FOR KILLING WEEDS; PREPARATIONS FOR KILLING VERMIN; PHARMACEUTICAL PREPARATIONS FOR THE TREATMENT OF CHEMICAL ADDICTIONS; PHARMACEUTICAL, VETERINARY AND SANITARY PREPARATIONS, NAMELY, ANTISEPTIC PREPARATIONS FOR TREATMENT OF CUTS, GRAZES, BITES AND STINGS AND SKIN AND SCALP CONDITIONS; PHARMACEUTICAL PREPARATIONS FOR THE TREATMENT OF NAUSEA, VOMITING, MIGRAINE AND VERTIGO; PHARMACEUTICAL PREPARATIONS AND SUBSTANCES FOR THE RELIEF OF COLDS, COUGHS, INFLUENZA AND SORE THROATS; MEDICATED BEVERAGES AND POWDERS FOR USE IN MAKING MEDICATED BEVERAGES FOR THE TREATMENT OF COLDS, COUGHS, INFLUENZA AND SORE THROATS; MEDICAL PLASTERS; WOUND AND BURN DRESSINGS; MATERIAL FOR STOPPING

Reg. No. 4,173,692 TEETH; DENTAL WAX; ALL PURPOSE DISINFECTANTS; ANTISEPTICS AND MEDICAL PREPARATIONS FOR USE IN ORAL HYGIENE; PREPARATIONS FOR THE DISINFECTION OF DENTURES, NAMELY, DENTURE FIXATIVES; DENTURE ADHESIVES; MEDICATED MOUTH WASHES; VITAMIN PREPARATIONS; MINERAL SUPPLEMENTS; HERBAL SUPPLEMENTS; PADS OR PATCHES IMPREGNATED WITH OR CONTAINING SUBSTANCES FOR THE RELIEF OF SYMPTOMS OF COLDS AND INFLUENZA; DECONGESTANTS, IN CLASS 5 (U.S. CLS. 6, 18, 44, 46, 51 AND 52).

FOR: AIR PURIFYING UNITS FOR DOMESTIC USE; WATER FILTERS; WATER SOFTENING UNITS; WATER FILTER CARTRIDGES; WATER TREATMENT EQUIPMENT, NAMELY, CARTRIDGE FILTRATION UNITS, IN CLASS 11 (U.S. CLS. 13, 21, 23, 31 AND 34).

FOR: PAPER GOODS, NAMELY, FACIAL TISSUES, TOILET TISSUES, PAPER NAPKINS, AND PAPER TOWELS; AND PRINTED PAMPHLETS AND BROCHURES IN THE FIELD OF PRESERVATION, IN CLASS 16 (U.S. CLS. 2, 5, 22, 23, 29, 37, 38 AND 50).

FOR: TIMBER, IN CLASS 19 (U.S. CLS. 1, 12, 33 AND 50).

FOR: FORESTRY PRODUCTS, NAMELY, LIVING TREES; LIVING TREES; RAW TIMBER; WOOD CHIPS FOR USE AS ANIMAL BEDDING AND LITTER, IN CLASS 31 (U.S. CLS. 1 AND 46).

FOR: WOOD TREATMENT, NAMELY, APPLYING PROTECTIVE COATINGS TO WOOD; TREATMENT FOR TIMBER, NAMELY, APPLYING PROTECTIVE COATINGS TO TIMBER, IN CLASS 37 (U.S. CLS. 100, 103 AND 106).

FOR: WOODWORKING; WOOD PRESERVATION; WOOD PRESERVATION SERVICES; TIMBER PRESERVATION, IN CLASS 40 (U.S. CLS. 100, 103 AND 106).

FOR: PLANTING OF TREES; TREE SURGERY, IN CLASS 44 (U.S. CLS. 100 AND 101).

OWNER OF ERPN CMNTY TM OFC REG. NO. 005169693, DATED 9-6-2007, EXPIRES 6-29-2016.

OWNER OF U.S. REG. NO. 3,839,408.

THE MARK CONSISTS OF STYLIZED DEPICTION OF SEVERAL TREES.

SER. NO. 85-085,207, FILED 7-15-2010.

COLLEEN DOMBROW, EXAMINING ATTORNEY

United States of America

United States Patent and Trademark Office

VIBERG

Reg. No. 4,173,693

Registered July 17, 2012

Int. Cls.: 25 and 35

TRADEMARK

SERVICE MARK

PRINCIPAL REGISTER

VIBERG BOOT MFG. LTD. (CANADA CORPORATION)
662 HERALD STREET
VICTORIA, B.C., CANADA V8W1S7

FOR: FOOTWEAR, NAMELY, BOOTS AND SHOES; CLOTHING, NAMELY, T-SHIRTS AND JACKETS; HEADWEAR, NAMELY, HATS, CAPS, TOQUES AND SUN VISORS; BOOT AND SHOE CARE ACCESSORIES, NAMELY, INSOLES, IN CLASS 25 (U.S. CLS. 22 AND 39).

FOR: RETAIL STORE AND WHOLESALE DISTRIBUTORSHIPS FEATURING FOOTWEAR; RETAIL STORE AND WHOLESALE DISTRIBUTORSHIPS FEATURING CLOTHING, HEADWEAR AND BOOT AND SHOE CARE ACCESSORIES, IN CLASS 35 (U.S. CLS. 100, 101 AND 102).

THE MARK CONSISTS OF STANDARD CHARACTERS WITHOUT CLAIM TO ANY PARTICULAR FONT, STYLE, SIZE, OR COLOR.

PRIORITY CLAIMED UNDER SEC. 44(D) ON CANADA APPLICATION NO. 1,485,602, FILED 6-17-2010, REG. NO. TMA807,111, DATED 9-21-2011, EXPIRES 9-21-2026.

SER. NO. 85-087,557, FILED 7-19-2010.

WON TEAK OH, EXAMINING ATTORNEY



David J. Kyfos

Director of the United States Patent and Trademark Office

United States of America

United States Patent and Trademark Office



Reg. No. 4,173,694

DIRTEE APPAREL INC (UTAH CORPORATION)
1767 N 4850 W
PLAIN CITY, UT 84404

Registered July 17, 2012

Int. Cl.: 25

FOR: CLOTHING PRODUCTS FOR CONSUMERS OF ALL AGES, NAMELY, T SHIRTS, LONG SLEEVE SHIRTS, CAPRIS, SHORTS, SLEEVELESS TEE SHIRTS, GOLF SHIRTS, NOVELTY CLOTHING IN THE NATURE OF ADULT NOVELTY GAG CLOTHING ITEM, NAMELY, SOCKS, AND LOUNGE PANTS, IN CLASS 25 (U.S. CLS. 22 AND 39).

TRADEMARK

PRINCIPAL REGISTER

FIRST USE 3-1-2010; IN COMMERCE 5-1-2010.

OWNER OF U.S. REG. NO. 4,001,132.

COLOR IS NOT CLAIMED AS A FEATURE OF THE MARK.

NO CLAIM IS MADE TO THE EXCLUSIVE RIGHT TO USE "AUTHENTIC EARTH DYED APPAREL", APART FROM THE MARK AS SHOWN.

THE MARK CONSISTS OF AN IMAGE OF PLANET EARTH. THE WORDS "AUTHENTIC EARTH DYED APPAREL" ARE ARCHED BELOW THE EARTH AND THE WORD "DIRTEE" IS ARCHED ABOVE THE EARTH WHERE THE LETTER "T" IS SHAPED LIKE A T-SHIRT.

SER. NO. 85-090,178, FILED 7-22-2010.

RICHARD WHITE, EXAMINING ATTORNEY



David J. Kyffers

Director of the United States Patent and Trademark Office

United States of America

United States Patent and Trademark Office

IBIS Integrative BodyMind Information System

Reg. No. 4,173,695

MITCHELL BEBEL STARGROVE (UNITED STATES INDIVIDUAL)
4750 SW WATSON AVE.
BEAVERTON, OR 97005 AND

Registered July 17, 2012

Int. Cl.: 9

LORI BETH STARGROVE (UNITED STATES INDIVIDUAL)
4750 SW WATSON AVE.
BEAVERTON, OR 97005

TRADEMARK

PRINCIPAL REGISTER

FOR: DOWNLOADABLE COMPUTER SOFTWARE FOR ACCESSING MEDICAL AND SCIENTIFIC INFORMATION ABOUT DIAGNOSIS AND TREATMENT OPTIONS FROM THE RANGE OF MEDICAL THERAPIES AND HEALTHCARE APPROACHES WHICH ALSO CONTAINS USER-CUSTOMIZABLE COMMENTS FEATURES, NOTEBOOK FEATURES FOR STORING USER NOTES AND PATIENT AND VISITS OUTCOMES TRACKING TOOLS, FOR USE BY HEALTHCARE PROFESSIONALS, MEDICAL STUDENTS, HEALTHCARE-RELATED INSTITUTIONS, ORGANIZATIONS AND BUSINESSES; COMPUTER SOFTWARE RECORDED ON CD-ROM FOR ACCESSING MEDICAL AND SCIENTIFIC INFORMATION ABOUT DIAGNOSIS AND TREATMENT OPTIONS FROM THE RANGE OF MEDICAL THERAPIES AND HEALTHCARE APPROACHES WHICH ALSO CONTAINS USER-CUSTOMIZABLE COMMENTS FEATURES, NOTEBOOK FEATURES FOR STORING USER NOTES AND PATIENT AND VISITS OUTCOMES TRACKING TOOLS, FOR USE BY HEALTHCARE PROFESSIONALS, MEDICAL STUDENTS, HEALTHCARE-RELATED INSTITUTIONS, ORGANIZATIONS AND BUSINESSES, IN CLASS 9 (U.S. CLS. 21, 23, 26, 36 AND 38).

FIRST USE 8-15-1989; IN COMMERCE 12-15-1999.

THE MARK CONSISTS OF STANDARD CHARACTERS WITHOUT CLAIM TO ANY PARTICULAR FONT, STYLE, SIZE, OR COLOR.

NO CLAIM IS MADE TO THE EXCLUSIVE RIGHT TO USE "INTEGRATIVE BODYMIND INFORMATION SYSTEM", APART FROM THE MARK AS SHOWN.

SER. NO. 85-100,475, FILED 8-4-2010.

COLLEEN KEARNEY, EXAMINING ATTORNEY



David J. Kyros

Director of the United States Patent and Trademark Office

United States of America

United States Patent and Trademark Office

LUMINOTAG

Reg. No. 4,173,696

U-NICA INTERNATIONAL AG (SWITZERLAND AKTIENGESELLSCHAFT)
INDUSTRIESTRASSE 4

Registered July 17, 2012

7208 MALANS, SWITZERLAND

Int. Cls.: 2, 9, 40, 42 and 45

FOR: BIOLOGICAL PIGMENTS FOR INDUSTRIAL USE IN SAFETY TECHNOLOGY; OIL COLORS, IN CLASS 2 (U.S. CLS. 6, 11 AND 16).

TRADEMARK

FOR: OPTICAL READERS, DATA PROCESSING EQUIPMENT; INFRARED AND VISIBLE LIGHT DETECTORS; ROUTE CONTROL DEVICES, NAMELY, NETWORK ROUTERS; SOFTWARE IN THE FIELD OF PRODUCT AND DOCUMENT AUTHENTICATION AND BRAND MONITORING AND PROTECTION, TO PROTECT AGAINST COUNTERFEITING, TAMPERING, AND DIVERSION, AND TO ENSURE THE INTEGRITY OF GENUINE PRODUCTS AND DOCUMENTS, NOT FOR MEDICAL USE, IN CLASS 9 (U.S. CLS. 21, 23, 26, 36 AND 38).

SERVICE MARK

PRINCIPAL REGISTER

FOR: TREATMENT OF MATERIALS, NAMELY, LASER SCRIBING AND CHEMICAL MARKING OR TREATMENT OF MATERIALS, NAMELY, CERAMIC, OIL COLORS, GLASS, FABRIC, PAPER, PLASTIC, PRECIOUS AND NON-PRECIOUS METALS BY SURFACE FORMING TOOLS TO PRINT, VARNISH, COAT, EMBOSS, GRIND, TREATMENT OF MATERIAL BY COLD AND WARM DEFORMATION, MACHINING, ABLATING AND MOLDING OF SPARE PARTS, MACHINES, LUXURY GOODS, PHARMACEUTICALS, FOOD, CONSUMER GOODS, CONSUMABLES, TEXTILES, CERAMICS, POLYMERS AND COMPOSITES TO PROTECT AGAINST COUNTERFEITING, TAMPERING, AND DIVERSION, AND TO ENSURE THE INTEGRITY OF GENUINE PRODUCTS AND DOCUMENTS, IN CLASS 40 (U.S. CLS. 100, 103 AND 106).



FOR: SCIENTIFIC AND TECHNOLOGY SERVICES, IN PARTICULAR ENGINEERING FOR THE PLANNING AND DEVELOPMENT OF PRODUCT IDENTIFICATION SYSTEMS, SECURITY SYSTEMS AND PRODUCT TRACKING SYSTEMS, IN CLASS 42 (U.S. CLS. 100 AND 101).

David J. Kybas

FOR: CONSULTATION IN THE FIELD OF SECURITY FOR THE PROTECTION OF PROPERTY, IN PARTICULAR FOR THE PROTECTION AND PROOF OF AUTHENTICITY OF ALL KINDS OF GOODS BEARING TRADEMARKS, IN PARTICULAR GOODS OF METAL AND THEIR PARTS, NAMELY, PRODUCT AND DOCUMENT AUTHENTICATION AND TRACKING, AND BRAND MONITORING AND PROTECTION, TO PROTECT AGAINST

Reg. No. 4,173,696 COUNTERFEITING, TAMPERING, AND DIVERSION, AND TO ENSURE THE INTEGRITY OF GENUINE PRODUCTS AND DOCUMENTS, IN CLASS 45 (U.S. CLS. 100 AND 101).

THE MARK CONSISTS OF STANDARD CHARACTERS WITHOUT CLAIM TO ANY PARTICULAR FONT, STYLE, SIZE, OR COLOR.

PRIORITY CLAIMED UNDER SEC. 44(D) ON SWITZERLAND APPLICATION NO. 51926/2010, FILED 2-25-2010, REG. NO. 601422, DATED 6-9-2010, EXPIRES 2-25-2020.

SER. NO. 85-102,871, FILED 8-9-2010.

NAKIA HENRY, EXAMINING ATTORNEY

United States of America

United States Patent and Trademark Office

REDSTONE REWARDS

Reg. No. 4,173,697

Registered July 17, 2012

Int. Cls.: 35 and 36

SERVICE MARK

PRINCIPAL REGISTER

REDSTONE FEDERAL CREDIT UNION (ALABAMA FEDERALLY CHARTERED CREDIT UNION)
220 WYNN DRIVE
HUNTSVILLE, AL 35893

FOR: REWARDS PROGRAMS FOR DEBIT CARD USE; PROMOTING THE GOODS AND SERVICES OF OTHERS BY AWARDING PURCHASE POINTS FOR DEBIT CARD USE , IN CLASS 35 (U.S. CLS. 100, 101 AND 102).

FIRST USE 9-8-2010; IN COMMERCE 9-8-2010.

FOR: DEBIT CARD SERVICES FEATURING A COMPUTER READABLE CARD, AND FEATURING AN INCENTIVE PROGRAM WHEREBY PARTICIPANTS ACCUMULATE POINTS FROM PURCHASES WHICH THEY CAN REDEEM FOR MERCHANDISE OR TRAVEL REWARDS, IN CLASS 36 (U.S. CLS. 100, 101 AND 102).

FIRST USE 9-8-2010; IN COMMERCE 9-8-2010.

THE MARK CONSISTS OF STANDARD CHARACTERS WITHOUT CLAIM TO ANY PARTICULAR FONT, STYLE, SIZE, OR COLOR.

NO CLAIM IS MADE TO THE EXCLUSIVE RIGHT TO USE "REWARDS", APART FROM THE MARK AS SHOWN.

SER. NO. 85-105,918, FILED 8-12-2010.

DAVID TAYLOR, EXAMINING ATTORNEY



David J. Kyfos

Director of the United States Patent and Trademark Office

United States of America

United States Patent and Trademark Office

KANDEE JOHNSON

Reg. No. 4,173,698

JOHNSON, KANDEE (UNITED STATES INDIVIDUAL)

Registered July 17, 2012

P.O. BOX 700
MINDEN, NV 89423

Int. Cl.: 41

FOR: EDUCATION SERVICES, NAMELY, PROVIDING SEMINARS AND MOTIVATIONAL SPEAKING SERVICES IN THE FIELDS OF MAKE-UP AND SELF-ESTEEM; ENTERTAINMENT, NAMELY, A CONTINUING MOTIVATIONAL SHOW IN THE FIELD OF MAKE-UP AND SELF-ESTEEM OVER INTERNET AND TELEVISION, IN CLASS 41 (U.S. CLS. 100, 101 AND 107).

SERVICE MARK

PRINCIPAL REGISTER

FIRST USE 7-9-1978; IN COMMERCE 6-19-2009.

THE MARK CONSISTS OF STANDARD CHARACTERS WITHOUT CLAIM TO ANY PARTICULAR FONT, STYLE, SIZE, OR COLOR.

THE NAME "KANDEE JOHNSON" IDENTIFIES A LIVING INDIVIDUAL WHOSE CONSENT IS OF RECORD.

SER. NO. 85-106,652, FILED 8-12-2010.

CHARLES L. JENKINS, EXAMINING ATTORNEY



David J. Kyffers

Director of the United States Patent and Trademark Office

United States of America

United States Patent and Trademark Office



Reg. No. 4,173,699

Registered July 17, 2012

Int. Cls.: 35 and 36

SERVICE MARK

PRINCIPAL REGISTER

REDSTONE FEDERAL CREDIT UNION (ALABAMA FEDERALLY CHARTERED CREDIT UNION)
220 WYNN DRIVE
HUNTSVILLE, AL 35893

FOR: REWARDS PROGRAMS FOR DEBIT CARD USE; PROMOTING THE GOODS AND SERVICES OF OTHERS BY AWARDING PURCHASE POINTS FOR DEBIT CARD USE, IN CLASS 35 (U.S. CLS. 100, 101 AND 102).

FIRST USE 9-8-2010; IN COMMERCE 9-8-2010.

FOR: DEBIT CARD SERVICES FEATURING A COMPUTER READABLE CARD, AND FEATURING AN INCENTIVE PROGRAM WHEREBY PARTICIPANTS ACCUMULATE POINTS FROM PURCHASES WHICH THEY CAN REDEEM FOR MERCHANDISE OR TRAVEL REWARDS, IN CLASS 36 (U.S. CLS. 100, 101 AND 102).

FIRST USE 9-8-2010; IN COMMERCE 9-8-2010.

NO CLAIM IS MADE TO THE EXCLUSIVE RIGHT TO USE "REWARDS", APART FROM THE MARK AS SHOWN.

THE COLOR(S) BLUE AND ORANGE IS/ARE CLAIMED AS A FEATURE OF THE MARK.

THE MARK CONSISTS OF THE WORD "REDSTONE" IN ALL CAPS, WITH THE STYLIZED WORD "REWARDS!" BELOW, BOTH IN BLUE, WITH A LEFT-POINTING, CURVED ARROW ABOVE THE WORD, "REDSTONE", AND A RIGHT-POINTING, CURVED ARROW BELOW BOTH WORDS, BOTH ARROWS BEING ORANGE.

SER. NO. 85-114,429, FILED 8-24-2010.

DAVID TAYLOR, EXAMINING ATTORNEY



David J. Kyffers

Director of the United States Patent and Trademark Office

United States of America

United States Patent and Trademark Office

TECHNOLOGY THERAPY

Reg. No. 4,173,700

Registered July 17, 2012

Int. Cls.: 35 and 42

SERVICE MARK

PRINCIPAL REGISTER

THE TECHNOLOGY THERAPY GROUP LLC (NEWYORK LIMITED LIABILITY COMPANY)
235 MAIN STREET
WHITE PLAINS, NY 10601

FOR: SOCIAL MEDIA CAMPAIGNS, NAMELY, DEVELOPING PROMOTIONAL CAMPAIGNS FOR OTHERS IN THE FIELD OF SOCIAL MEDIA, SOCIAL MEDIA STRATEGY AND MARKETING CONSULTANCY FOCUSING ON HELPING CLIENTS CREATE AND EXTEND THEIR PRODUCT AND BRAND STRATEGIES BY BUILDING VIRALLY ENGAGING MARKETING SOLUTIONS, IN CLASS 35 (U.S. CLS. 100, 101 AND 102).

FIRST USE 7-1-2002; IN COMMERCE 7-3-2004.

FOR: WEBSITE SERVICES, NAMELY, DESIGN AND CREATION OF CUSTOM WEBSITES FOR OTHERS; COMPUTER CONSULTATION SERVICES IN THE FIELD OF SEARCH ENGINE OPTIMIZATION, IN CLASS 42 (U.S. CLS. 100 AND 101).

FIRST USE 7-1-2002; IN COMMERCE 7-1-2002.

THE MARK CONSISTS OF STANDARD CHARACTERS WITHOUT CLAIM TO ANY PARTICULAR FONT, STYLE, SIZE, OR COLOR.

NO CLAIM IS MADE TO THE EXCLUSIVE RIGHT TO USE "TECHNOLOGY", APART FROM THE MARK AS SHOWN.

SER. NO. 85-116,391, FILED 8-26-2010.

MYRIAH HABEEB, EXAMINING ATTORNEY



David J. Kyjars

Director of the United States Patent and Trademark Office

United States of America

United States Patent and Trademark Office

O2BLOCK

Reg. No. 4,173,701

Registered July 17, 2012

Int. Cl.: 1

NANOBIOMATTERS INDUSTRIES S.L. (SPAIN SOCIEDAD DE RESPONSABILIDAD
LIMITADA (SL))
PARQUE TECNOLOGICO C/ LUIS PASTEUR
11 NAVE 5
46980 PATERNA-VALENCIA, SPAIN

TRADEMARK

PRINCIPAL REGISTER

FOR: CHEMICALS FOR USE IN INDUSTRY; SPECIALTY CHEMICALS, NAMELY,
CHEMICAL ADDITIVES FOR GENERAL INDUSTRIAL USE IN THE MANUFACTURE OF
A WIDE VARIETY OF GOODS, IN CLASS 1 (U.S. CLS. 1, 5, 6, 10, 26 AND 46).

FIRST USE 2-28-2011; IN COMMERCE 2-28-2011.

THE MARK CONSISTS OF STANDARD CHARACTERS WITHOUT CLAIM TO ANY PAR-
TICULAR FONT, STYLE, SIZE, OR COLOR.

SER. NO. 85-117,299, FILED 8-27-2010.

JASON BLAIR, EXAMINING ATTORNEY



David J. Kyffers

Director of the United States Patent and Trademark Office

United States of America

United States Patent and Trademark Office

GEARED UP

Reg. No. 4,173,702

Registered July 17, 2012

Int. Cls.: 9, 11 and 12

TRADEMARK

PRINCIPAL REGISTER

HOT HEADZ INTERNATIONAL, INC. (PENNSYLVANIA CORPORATION), AKA HOT HEADZ
1890 WOODHAVEN ROAD
PHILADELPHIA, PA 19116

FOR: ELECTRICALLY HEATED MUGS; ELECTRICALLY HEATED AUTOMOBILE SEAT CUSHIONS, IN CLASS 9 (U.S. CLS. 21, 23, 26, 36 AND 38).

FIRST USE 11-10-2010; IN COMMERCE 11-10-2010.

FOR: LED LIGHTS FOR LIGHTING PURPOSES INCORPORATED INTO KEY CHAINS, IN CLASS 11 (U.S. CLS. 13, 21, 23, 31 AND 34).

FIRST USE 1-10-2011; IN COMMERCE 1-10-2011.

FOR: ORGANIZERS SPECIALLY ADAPTED TO REST INSIDE AUTOMOBILE CUP HOLDERS, FOR HOLDING CELL PHONES, WALLETS, MONEY, CREDIT CARDS, NOTEPADS, PENS, SUNGLASSES, AND OTHER PERSONAL ITEMS, IN CLASS 12 (U.S. CLS. 19, 21, 23, 31, 35 AND 44).

FIRST USE 1-10-2011; IN COMMERCE 1-10-2011.

THE MARK CONSISTS OF STANDARD CHARACTERS WITHOUT CLAIM TO ANY PARTICULAR FONT, STYLE, SIZE, OR COLOR.

SER. NO. 85-121,524, FILED 9-2-2010.

KIMBERLY FRYE, EXAMINING ATTORNEY



David J. Kyjars

Director of the United States Patent and Trademark Office

United States of America

United States Patent and Trademark Office

Delcube

Reg. No. 4,173,703

Registered July 17, 2012

Int. Cl.: 29

TRADEMARK

PRINCIPAL REGISTER

DONGWON F&B CO., LTD. (REPUBLIC OF KOREA LIMITED COMPANY)
68 MABANG-RO SEOCHO-GU
(YANGJAE-DONG, DONGWON INDUSTRY)
SEOUL, REPUBLIC OF KOREA

FOR: PROCESSED MEAT; FERMENTED VEGETABLES; TOASTED LAVER; TUNA FISH; SALMON; CANNED FISH; BOTTLED FISH; FOOD PRODUCTS MADE FROM FISH, SPECIFICALLY, PICKLED FISH AND FISH STOCK; PRESERVED FISH; PROCESSED VEGETABLE PRODUCTS; SALTED FISH; SMOKED FISH AND SHELLFISH, IN CLASS 29 (U.S. CL. 46).

THE MARK CONSISTS OF STANDARD CHARACTERS WITHOUT CLAIM TO ANY PARTICULAR FONT, STYLE, SIZE, OR COLOR.

PRIORITY CLAIMED UNDER SEC. 44(D) ON REPUBLIC OF KOREA APPLICATION NO. 40-2010-0047, FILED 9-8-2010, REG. NO. 885123, DATED 10-14-2011, EXPIRES 10-14-2021.

SER. NO. 85-125,612, FILED 9-9-2010.

JUDITH HELFMAN, EXAMINING ATTORNEY



David J. Kyffers

Director of the United States Patent and Trademark Office

United States of America

United States Patent and Trademark Office

HOT ITALIAN

Reg. No. 4,173,704

Registered July 17, 2012

Int. Cls.: 18 and 25

TRADEMARK

PRINCIPAL REGISTER

HOT ITALIAN, LLC (CALIFORNIA LIMITED LIABILITY COMPANY)
1627 16TH STREET
SACRAMENTO, CA 95814

FOR: SPORTS BAGS, IN CLASS 18 (U.S. CLS. 1, 2, 3, 22 AND 41).

FIRST USE 9-0-2007; IN COMMERCE 9-0-2007.

FOR: CLOTHING AND ACCESSORIES, NAMELY, T-SHIRTS, HATS, SHORTS, PANTS, BI-CYCLING GLOVES, MOTORCYCLING GLOVES, MOTORCYCLE JACKETS, MOTORCYCLE RAIN SUITS, CYCLISTS JERSEYS, IN CLASS 25 (U.S. CLS. 22 AND 39).

FIRST USE 9-0-2007; IN COMMERCE 9-0-2007.

THE MARK CONSISTS OF STANDARD CHARACTERS WITHOUT CLAIM TO ANY PARTICULAR FONT, STYLE, SIZE, OR COLOR.

NO CLAIM IS MADE TO THE EXCLUSIVE RIGHT TO USE "ITALIAN", APART FROM THE MARK AS SHOWN.

SER. NO. 85-126,908, FILED 9-10-2010.

STEVEN PEREZ, EXAMINING ATTORNEY



David J. Kyros

Director of the United States Patent and Trademark Office

United States of America
United States Patent and Trademark Office

Advanto

Reg. No. 4,173,705

SUPRAMEDICAL, LLC (FLORIDA LIMITED LIABILITY COMPANY)
8805 NW 35 LN
DORAL, FL 33172

Registered July 17, 2012

Int. Cl.: 10

FOR: LASERS FOR SURGICAL AND MEDICAL USE; ELECTRICAL MEDICAL APPARATUS AND INSTRUMENTS FOR USE IN SURGERY; ELECTRICAL SURGICAL APPARATUS AND INSTRUMENTS FOR MEDICAL, DENTAL OR VETERINARY USE, IN CLASS 10 (U.S. CLS. 26, 39 AND 44).

TRADEMARK

PRINCIPAL REGISTER

FIRST USE 8-15-2010, THE MARK WAS FIRST USED ANYWHERE IN A DIFFERENT FORM OTHER THAN THAT SOUGHT TO BE REGISTERED AT LEAST AS EARLY AS 08/15/2010.; IN COMMERCE 8-15-2010, THE MARK WAS FIRST USED IN COMMERCE IN A DIFFERENT FORM OTHER THAN THAT SOUGHT TO BE REGISTERED AT LEAST AS EARLY AS 08/15/2010..

THE MARK CONSISTS OF THE WORD "ADVANTO" IN A STYLIZED FORM WHEREBY THE LETTER "A", IN BLUE, IS CAPITALIZED AND THE HORIZONTAL BAR HAS BEEN REPLACED BY A RHOMBUS, IN LIGHT BLUE, AND IT IS FOLLOWED BY THE LETTERS "D" AND "V", BOTH IN BLUE, IN SMALL CAPS, WHICH ARE IN CONTACT AT THE UPPER LEFT CORNER OF THE LETTER "V" AND THE VERTICAL PORTION OF THE LETTER "D"; FOLLOWED BY A STYLIZED LETTER "A" IN SMALL CAPS, HAVING A SPACE SEPARATING THE UPPER CURL, IN LIGHT BLUE, FROM THE BODY OF THE LETTER "A", IN BLUE, FOLLOWED BY THE LETTERS "N" AND "T", IN BLUE, FOLLOWED BY THE STYLIZED LETTER "O", IN BLUE, BEARING AN OPENING ON THE UPPER RIGHT CORNER.

THE COLOR(S) BLUE AND LIGHT BLUE IS/ARE CLAIMED AS A FEATURE OF THE MARK.

THE WORDING "ADVANTO" HAS NO MEANING IN A FOREIGN LANGUAGE.

SER. NO. 85-127,218, FILED 9-10-2010.

LINDA M. KING, EXAMINING ATTORNEY



David J. Kyffers

Director of the United States Patent and Trademark Office

United States of America

United States Patent and Trademark Office

Life-Tamers

Reg. No. 4,173,706

KEITH M. CUMMING (CANADA INDIVIDUAL)
125 HAGAR STREET
WELLAND, ON, CANADA L3B5V9

Registered July 17, 2012

Int. Cls.: 8, 20 and 21

FOR: MANUALLY OPERATED SHARPENERS FOR WIPERS; HAND-OPERATED TOOL FOR HANGING SIGNS, PICTURES AND MOBILES, NAMELY, A MULTIPURPOSE COMBINATION TOOL CONSISTING OF A MAGNETIC TACK HOLDER AND PUNCH, A CENTERING STRING LINE, A LEVEL AND TACK STORAGE COMPARTMENT, IN CLASS 8 (U.S. CLS. 23, 28 AND 44).

TRADEMARK

PRINCIPAL REGISTER

FIRST USE 2-4-2010; IN COMMERCE 3-14-2010.

FOR: SHELVES AND SHELVING; MINI-MIRROR, IN CLASS 20 (U.S. CLS. 2, 13, 22, 25, 32 AND 50).

FIRST USE 2-4-2010; IN COMMERCE 3-14-2010.

FOR: CONTAINERS FOR HOUSEHOLD USE; HOUSEHOLD UTENSILS, NAMELY, CONVENIENCE PRODUCTS, NAMELY, BOWLS, CUPS, CONTAINERS; COOKING UTENSILS, NAMELY, WIRE BASKETS; TRAYS FOR DOMESTIC PURPOSES, FOR ORGANIZATION AND STORAGE OF GOODS AND COOKING OF FOODS, IN CLASS 21 (U.S. CLS. 2, 13, 23, 29, 30, 33, 40 AND 50).

FIRST USE 2-4-2010; IN COMMERCE 3-14-2010.

THE MARK CONSISTS OF STANDARD CHARACTERS WITHOUT CLAIM TO ANY PARTICULAR FONT, STYLE, SIZE, OR COLOR.

SER. NO. 85-129,506, FILED 9-14-2010.

ANNE E. GUSTASON, EXAMINING ATTORNEY



David J. Kyros

Director of the United States Patent and Trademark Office

United States of America

United States Patent and Trademark Office

TRACER

Reg. No. 4,173,707

Registered July 17, 2012

Int. Cl.: 41

SERVICE MARK

PRINCIPAL REGISTER

STEARNS, CONRAD AND SCHMIDT, CONSULTING ENGINEERS, INC. (VIRGINIA CORPORATION)
3900 KILROY AIRPORT WAY, SUITE 100
LONG BEACH, CA 908066816

FOR: TRAINING SERVICES, NAMELY, PROVIDING TRAINING IN THE FIELDS OF SECURITY, RISK ASSESSMENT AND COUNTER-TERRORISM IN THE FIELDS OF ACCIDENTAL OR OTHER RELEASE OF HAZARDOUS CHEMICAL AND BIOLOGICAL MATERIAL IN COMMERCIAL FACILITIES, URBAN AREAS, AND MILITARY FACILITIES, IN CLASS 41 (U.S. CLS. 100, 101 AND 107).

FIRST USE 2-1-1999; IN COMMERCE 2-1-1999.

THE MARK CONSISTS OF STANDARD CHARACTERS WITHOUT CLAIM TO ANY PARTICULAR FONT, STYLE, SIZE, OR COLOR.

OWNER OF U.S. REG. NOS. 4,008,643 AND 4,008,644.

SER. NO. 85-131,539, FILED 9-16-2010.

JEAN IM, EXAMINING ATTORNEY



David J. Kyffers

Director of the United States Patent and Trademark Office

United States of America

United States Patent and Trademark Office

TEXT ACCELERATOR

Reg. No. 4,173,708

Registered July 17, 2012

**Int. Cls.: 9, 16, 35, 41
and 45**

TRADEMARK

SERVICE MARK

PRINCIPAL REGISTER

THE STRATEGIC COACH INC. (CANADA CORPORATION)
33 FRASER AVENUE, SUITE #201
TORONTO, ONTARIO, CANADA M6K3J9

FOR: PRERECORDED DVDS AND PRE-RECORDED COMPACT DISCS CONTAINING INSTRUCTIONAL GUIDES FOR USE WITH PROFESSIONAL AND PERSONAL DEVELOPMENT TRAINING PROGRAMS, SEMINARS AND WORKSHOPS; EDUCATIONAL SOFTWARE FOR PROFESSIONAL AND PERSONAL DEVELOPMENT TRAINING PROGRAMS, IN CLASS 9 (U.S. CLS. 21, 23, 26, 36 AND 38).

FOR: BOOKS, MANUALS AND NEWSLETTERS IN THE FIELD OF PROFESSIONAL AND PERSONAL DEVELOPMENT; PERSONAL PLANNING DIARIES, IN CLASS 16 (U.S. CLS. 2, 5, 22, 23, 29, 37, 38 AND 50).

FOR: CONSULTING SERVICES IN THE FIELDS OF BUSINESS, MANAGEMENT AND HUMAN RESOURCES RELATED TO PROFESSIONAL AND PERSONAL DEVELOPMENT, IN CLASS 35 (U.S. CLS. 100, 101 AND 102).

FOR: OPERATION OF SEMINARS, WORKSHOPS AND PRIVATE STUDY PROGRAMS RELATED TO PROFESSIONAL AND PERSONAL DEVELOPMENT, IN CLASS 41 (U.S. CLS. 100, 101 AND 107).

FOR: PROVIDING CONSULTING IN THE FIELD OF PERSONAL DEVELOPMENT, NAMELY, SELF-IMPROVEMENT, SELF-FULFILLMENT, AND INTERPERSONAL COMMUNICATIONS, IN CLASS 45 (U.S. CLS. 100 AND 101).

THE MARK CONSISTS OF STANDARD CHARACTERS WITHOUT CLAIM TO ANY PARTICULAR FONT, STYLE, SIZE, OR COLOR.

PRIORITY CLAIMED UNDER SEC. 44(D) ON CANADA APPLICATION NO. 1490571, FILED 7-29-2010, REG. NO. TMA815,475, DATED 1-12-2012, EXPIRES 1-12-2027.

NO CLAIM IS MADE TO THE EXCLUSIVE RIGHT TO USE "TEXT", APART FROM THE MARK AS SHOWN.

SER. NO. 85-132,429, FILED 9-17-2010.



David J. Kybas

Director of the United States Patent and Trademark Office

Reg. No. 4,173,708 RON FAIRBANKS, EXAMINING ATTORNEY

United States of America

United States Patent and Trademark Office

I-BLING

Reg. No. 4,173,709

Registered July 17, 2012

Int. Cls.: 9 and 16

TRADEMARK

PRINCIPAL REGISTER

MULTICRAFT IMPORTS INC. (CANADA CORPORATION)
101 INNES PARK WAY #180
OTTAWA, ONTARIO, CANADA K1B1E3

FOR: ACCESSORIES FOR ELECTRONIC DEVICES, NAMELY, OVERLAYS FOR PERSONALIZING AND PROTECTING DEVICES, NAMELY, PERSONAL DIGITAL ASSISTANTS, CELLULAR TELEPHONES, DIGITAL CAMERAS, AUDIO DEVICES, NAMELY, SMART PHONES, MP3 PLAYERS, AND PORTABLE TABLETS, GAMING CONSOLES, AND COMPUTERS; ADHESIVE, DECORATIVE PLASTIC GEMS FOR APPLICATION TO PERSONAL ELECTRONICS, EXCLUDING STICKERS, IN CLASS 9 (U.S. CLS. 21, 23, 26, 36 AND 38).

FOR: STICKERS, IN CLASS 16 (U.S. CLS. 2, 5, 22, 23, 29, 37, 38 AND 50).

THE MARK CONSISTS OF STANDARD CHARACTERS WITHOUT CLAIM TO ANY PARTICULAR FONT, STYLE, SIZE, OR COLOR.

PRIORITY CLAIMED UNDER SEC. 44(D) ON CANADA APPLICATION NO. 1489996, FILED 7-26-2010, REG. NO. TMA808009, DATED 9-29-2011, EXPIRES 9-29-2026.

SER. NO. 85-133,625, FILED 9-20-2010.

CHRISTOPHER BUONGIORNO, EXAMINING ATTORNEY



David J. Kyros

Director of the United States Patent and Trademark Office

United States of America

United States Patent and Trademark Office



Reg. No. 4,173,710

Registered July 17, 2012

**Int. Cls.: 4, 35, 36, 37
and 39**

PIEDMONT NATURAL GAS COMPANY, INC. (NORTH CAROLINA CORPORATION)
4720 PIEDMONT ROW DRIVE
CHARLOTTE, NC 28210

FOR: NATURAL GAS, IN CLASS 4 (U.S. CLS. 1, 6 AND 15).

FIRST USE 9-20-2010; IN COMMERCE 9-20-2010.

TRADEMARK

SERVICE MARK

PRINCIPAL REGISTER

FOR: RETAIL AND ONLINE STORE SERVICES FEATURING NATURAL GAS APPLIANCES AND EQUIPMENT; RETAIL AND ONLINE STORE SERVICES IN THE FIELD OF ENERGY CONSERVATION AND ENERGY MANAGEMENT PRODUCTS; ENERGY CONSERVATION AND ENERGY MANAGEMENT SERVICES; HOME ENERGY ASSESSMENT SERVICES FOR THE PURPOSE OF DETERMINING ENERGY EFFICIENCY OR USAGE MANAGEMENT; CONSULTING SERVICES IN THE FIELDS OF ENERGY CONSUMPTION AND USAGE CONSERVATION TO IMPROVE ENERGY EFFICIENCY; CONSULTING SERVICES IN THE FIELD OF ENERGY USAGE MANAGEMENT AND ENERGY EFFICIENCY; ENERGY USAGE MANAGEMENT; ENERGY USAGE MANAGEMENT INFORMATION SERVICES; ENERGY MANAGEMENT SERVICES, NAMELY, PROVIDING A SERVICE THAT ALLOWS CUSTOMERS TO PURCHASE ENERGY, NAMELY, NATURAL GAS, AT A FIXED PRICE; PROMOTING PUBLIC AWARENESS OF THE NEED FOR NATURAL RESOURCE CONSERVATION AND ENERGY CONSERVATION AND SAFETY, THE NEED FOR APPLIANCES, EQUIPMENT AND OTHER PRODUCTS THAT ASSIST IN ACHIEVING ENERGY CONSERVATION AND COST SAVINGS, AND NATURAL GAS SAFETY; PROMOTING THE INTERESTS OF NATURAL RESOURCE CONSERVATION, ENERGY CONSERVATION AND ENERGY MANAGEMENT VIA THE PROVISION OF INFORMATION AND ECONOMIC INCENTIVES TO NATURAL GAS USERS, IN CLASS 35 (U.S. CLS. 100, 101 AND 102).

FIRST USE 9-20-2010; IN COMMERCE 9-20-2010.

FOR: PROVIDING EXTENDED WARRANTIES ON NATURAL GAS APPLIANCES AND INTERIOR NATURAL GAS PIPING; EXTENDED WARRANTY SERVICES, NAMELY, SERVICE CONTRACTS, IN CLASS 36 (U.S. CLS. 100, 101 AND 102).

FIRST USE 9-20-2010; IN COMMERCE 9-20-2010.



David J. Kyjars

Director of the United States Patent and Trademark Office

Reg. No. 4,173,710 FOR: INSTALLATION, MAINTENANCE AND REPAIR OF NATURAL GAS APPLIANCES AND EQUIPMENT; INSTALLATION, MAINTENANCE AND REPAIR OF NATURAL GAS PIPELINES, IN CLASS 37 (U.S. CLS. 100, 103 AND 106).

FIRST USE 9-20-2010; IN COMMERCE 9-20-2010.

FOR: PUBLIC UTILITY SERVICES IN THE NATURE OF NATURAL GAS DISTRIBUTION; TRANSPORT BY PIPELINE OF NATURAL GAS; STORAGE OF NATURAL GAS; TRANSPORTATION OF NATURAL GAS LIQUIDS, IN CLASS 39 (U.S. CLS. 100 AND 105).

FIRST USE 9-20-2010; IN COMMERCE 9-20-2010.

OWNER OF U.S. REG. NOS. 2,014,834, 2,499,678, AND 2,573,768.

THE COLOR(S) BLUE, GREEN, BLACK AND WHITE IS/ARE CLAIMED AS A FEATURE OF THE MARK.

NO CLAIM IS MADE TO THE EXCLUSIVE RIGHT TO USE "NATURAL GAS", APART FROM THE MARK AS SHOWN.

THE MARK CONSISTS OF THE FOLLOWING: THE WORD "PIEDMONT" STACKED OVER THE WORDS "NATURAL GAS" ALL IN BLACK, TO THE RIGHT OF A DESIGN COMPRISED OF A STYLIZED FLAME IN WHITE ON A BLUE BACKGROUND IN THE SHAPE OF AN ANGLED PARALLELOGRAM WITH CURVED CORNERS ON ITS LEFT SIDE WITH A DETACHED BASE TO THE RIGHT OF THE PARALLELOGRAM IN GREEN WITH CURVED CORNERS ON ITS RIGHT SIDE.

SER. NO. 85-134,284, FILED 9-21-2010.

CAROLYN CATALDO, EXAMINING ATTORNEY

United States of America

United States Patent and Trademark Office



Reg. No. 4,173,711

Registered July 17, 2012

**Int. Cls.: 4, 35, 36, 37
and 39**

PIEDMONT NATURAL GAS COMPANY, INC. (NORTH CAROLINA CORPORATION)
4720 PIEDMONT ROW DRIVE
CHARLOTTE, NC 28210

FOR: NATURAL GAS, IN CLASS 4 (U.S. CLS. 1, 6 AND 15).

FIRST USE 9-20-2010; IN COMMERCE 9-20-2010.

TRADEMARK

SERVICE MARK

PRINCIPAL REGISTER

FOR: RETAIL AND ONLINE STORE SERVICES FEATURING NATURAL GAS APPLIANCES AND EQUIPMENT; RETAIL AND ONLINE STORE SERVICES IN THE FIELD OF ENERGY CONSERVATION AND ENERGY MANAGEMENT PRODUCTS; ENERGY CONSERVATION AND ENERGY MANAGEMENT SERVICES; HOME ENERGY ASSESSMENT SERVICES FOR THE PURPOSE OF DETERMINING ENERGY EFFICIENCY OR USAGE MANAGEMENT; CONSULTING SERVICES IN THE FIELDS OF ENERGY CONSUMPTION AND USAGE CONSERVATION TO IMPROVE ENERGY EFFICIENCY; CONSULTING SERVICES IN THE FIELD OF ENERGY USAGE MANAGEMENT AND ENERGY EFFICIENCY; ENERGY USAGE MANAGEMENT; ENERGY USAGE MANAGEMENT INFORMATION SERVICES; ENERGY MANAGEMENT SERVICES, NAMELY, PROVIDING A SERVICE THAT ALLOWS CUSTOMERS TO PURCHASE ENERGY, NAMELY, NATURAL GAS, AT A FIXED PRICE; PROMOTING PUBLIC AWARENESS OF THE NEED FOR NATURAL RESOURCE CONSERVATION AND ENERGY CONSERVATION AND SAFETY, THE NEED FOR APPLIANCES, EQUIPMENT AND OTHER PRODUCTS THAT ASSIST IN ACHIEVING ENERGY CONSERVATION AND COST SAVINGS, AND NATURAL GAS SAFETY; PROMOTING THE INTERESTS OF NATURAL RESOURCE CONSERVATION, ENERGY CONSERVATION AND ENERGY MANAGEMENT VIA THE PROVISION OF INFORMATION AND ECONOMIC INCENTIVES TO NATURAL GAS USERS, IN CLASS 35 (U.S. CLS. 100, 101 AND 102).

FIRST USE 9-20-2010; IN COMMERCE 9-20-2010.

FOR: PROVIDING EXTENDED WARRANTIES ON NATURAL GAS APPLIANCES AND INTERIOR NATURAL GAS PIPING; EXTENDED WARRANTY SERVICES, NAMELY, SERVICE CONTRACTS, IN CLASS 36 (U.S. CLS. 100, 101 AND 102).

FIRST USE 9-20-2010; IN COMMERCE 9-20-2010.



David J. Kyffers

Director of the United States Patent and Trademark Office

Reg. No. 4,173,711 FOR: INSTALLATION, MAINTENANCE AND REPAIR OF NATURAL GAS APPLIANCES AND EQUIPMENT; INSTALLATION, MAINTENANCE AND REPAIR OF NATURAL GAS PIPELINES, IN CLASS 37 (U.S. CLS. 100, 103 AND 106).

FIRST USE 9-20-2010; IN COMMERCE 9-20-2010.

FOR: PUBLIC UTILITY SERVICES IN THE NATURE OF NATURAL GAS DISTRIBUTION; TRANSPORT BY PIPELINE OF NATURAL GAS; STORAGE OF NATURAL GAS; TRANSPORTATION OF NATURAL GAS LIQUIDS, IN CLASS 39 (U.S. CLS. 100 AND 105).

FIRST USE 9-20-2010; IN COMMERCE 9-20-2010.

OWNER OF U.S. REG. NOS. 2,014,834, 2,499,678, AND 2,573,768.

NO CLAIM IS MADE TO THE EXCLUSIVE RIGHT TO USE "NATURAL GAS", APART FROM THE MARK AS SHOWN.

THE MARK CONSISTS OF THE WORD "PIEDMONT" STACKED OVER THE WORDS "NATURAL GAS" TO THE RIGHT OF A DESIGN COMPRISED OF A STYLIZED FLAME IN THE SHAPE OF AN ANGLED PARALLELOGRAM WITH CURVED CORNERS ON ITS LEFT SIDE WITH A DETACHED BASE TO THE RIGHT OF THE PARALLELOGRAM WITH CURVED CORNERS ON ITS RIGHT SIDE.

SER. NO. 85-134,288, FILED 9-21-2010.

CAROLYN CATALDO, EXAMINING ATTORNEY

United States of America

United States Patent and Trademark Office

Blaster Bouncer

Reg. No. 4,173,712

WRIGHT, JEREMY D (UNITED STATES INDIVIDUAL)
8259 S. SAULSBURY WAY
LITTLETON, CO 80128

Registered July 17, 2012

Int. Cls.: 28 and 41

FOR: AMUSEMENT DEVICES, NAMELY, BOUNCE HOUSES IN THE NATURE OF AN AIR INFLATED CUSHION IN AN AIR INFLATED STRUCTURE, IN CLASS 28 (U.S. CLS. 22, 23, 38 AND 50).

TRADEMARK

FIRST USE 9-1-2004; IN COMMERCE 9-1-2004.

SERVICE MARK

FOR: ENTERTAINMENT SERVICES, NAMELY, CONDUCTING CARNIVALS; ENTERTAINMENT SERVICES, NAMELY, CONDUCTING PARTIES, IN CLASS 41 (U.S. CLS. 100, 101 AND 107).

PRINCIPAL REGISTER

FIRST USE 9-1-2004; IN COMMERCE 9-1-2004.

THE MARK CONSISTS OF STANDARD CHARACTERS WITHOUT CLAIM TO ANY PARTICULAR FONT, STYLE, SIZE, OR COLOR.

NO CLAIM IS MADE TO THE EXCLUSIVE RIGHT TO USE "BOUNCER", APART FROM THE MARK AS SHOWN.

SER. NO. 85-135,459, FILED 9-22-2010.

DARRYL SPRUILL, EXAMINING ATTORNEY



David J. Kybas

Director of the United States Patent and Trademark Office

United States of America

United States Patent and Trademark Office

WebGreeter

Reg. No. 4,173,713

LIVEADMINS LLC (ILLINOIS LIMITED LIABILITY COMPANY)
500 N. MICHIGAN AVE, SUITE 300
CHICAGO, IL 60611

Registered July 17, 2012

Int. Cl.: 35

FOR: ADVERTISING AND COMMERCIAL INFORMATION SERVICES, VIA THE INTERNET,
IN CLASS 35 (U.S. CLS. 100, 101 AND 102).

SERVICE MARK

FIRST USE 1-1-2003; IN COMMERCE 1-1-2003.

PRINCIPAL REGISTER

THE MARK CONSISTS OF STANDARD CHARACTERS WITHOUT CLAIM TO ANY PARTICULAR FONT, STYLE, SIZE, OR COLOR.

SER. NO. 85-136,005, FILED 9-22-2010.

CHRISTOPHER LAW, EXAMINING ATTORNEY



David J. Kybas

Director of the United States Patent and Trademark Office

United States of America

United States Patent and Trademark Office

WATCHMAN MONITORING

Reg. No. 4,173,714

Registered July 17, 2012

Int. Cls.: 9 and 42

TRADEMARK

SERVICE MARK

PRINCIPAL REGISTER

MAC CONSULTING GROUP, INC. (LOUISIANA CORPORATION)
STE. B
8568 GOODWOOD BLVD.
BATON ROUGE, LA 708067910

FOR: COMPUTER PROGRAMS FOR SEARCHING REMOTELY FOR CONTENT ON COMPUTERS AND COMPUTER NETWORKS , IN CLASS 9 (U.S. CLS. 21, 23, 26, 36 AND 38).

FIRST USE 9-24-2010; IN COMMERCE 9-24-2010.

FOR: COMPUTER MONITORING SERVICE WHICH TRACKS HARDWARE PERFORMANCE AND PROCESSES AND SENDS OUT HISTORICAL REPORTS AND ALERTS, IN CLASS 42 (U.S. CLS. 100 AND 101).

FIRST USE 9-24-2010; IN COMMERCE 9-24-2010.

THE MARK CONSISTS OF STANDARD CHARACTERS WITHOUT CLAIM TO ANY PARTICULAR FONT, STYLE, SIZE, OR COLOR.

NO CLAIM IS MADE TO THE EXCLUSIVE RIGHT TO USE "MONITORING" , APART FROM THE MARK AS SHOWN.

SER. NO. 85-136,738, FILED 9-23-2010.

STEPHANIE ALI, EXAMINING ATTORNEY



David J. Kyjars

Director of the United States Patent and Trademark Office

United States of America

United States Patent and Trademark Office

Om Organic

Reg. No. 4,173,715

HEALTHY LIVING MEDIA, LLC (TEXAS LIMITED LIABILITY COMPANY)
6247 PROSPECT AVENUE
DALLAS, TX 75214

Registered July 17, 2012

Int. Cl.: 25

FOR: ORGANIC CLOTHING, NAMELY, SHIRTS, T-SHIRTS, SWEATSHIRTS, JACKETS, COATS, PANTS, SHORTS, SWEATPANTS, HATS AND SOCKS, IN CLASS 25 (U.S. CLS. 22 AND 39).

TRADEMARK

FIRST USE 9-10-2010; IN COMMERCE 9-22-2010.

PRINCIPAL REGISTER

THE MARK CONSISTS OF STANDARD CHARACTERS WITHOUT CLAIM TO ANY PARTICULAR FONT, STYLE, SIZE, OR COLOR.

NO CLAIM IS MADE TO THE EXCLUSIVE RIGHT TO USE "ORGANIC", APART FROM THE MARK AS SHOWN.

SEC. 2(F).

SER. NO. 85-136,860, FILED 9-23-2010.

CHRISTINE MARTIN, EXAMINING ATTORNEY



David J. Kyffers

Director of the United States Patent and Trademark Office

United States of America

United States Patent and Trademark Office

BEE ABOUT IT

Reg. No. 4,173,716

TERRELL, JACQUELINE S. (UNITED STATES INDIVIDUAL), DBA BEE ABOUT IT
2810 EDGEWICK ELM ST.
FRESNO, TX 77545

Registered July 17, 2012

Int. Cl.: 41

FOR: ENTERTAINMENT SERVICES, NAMELY, ARRANGING AND CONDUCTING OF
COMPETITIONS FOR SPELLING BEES, IN CLASS 41 (U.S. CLS. 100, 101 AND 107).

SERVICE MARK

FIRST USE 1-0-2010; IN COMMERCE 9-9-2010.

PRINCIPAL REGISTER

THE MARK CONSISTS OF STANDARD CHARACTERS WITHOUT CLAIM TO ANY PAR-
TICULAR FONT, STYLE, SIZE, OR COLOR.

SER. NO. 85-136,973, FILED 9-23-2010.

ARETHA SOMERVILLE, EXAMINING ATTORNEY



David J. Kybas

Director of the United States Patent and Trademark Office

United States of America

United States Patent and Trademark Office

POLYGOBS

Reg. No. 4,173,717

Registered July 17, 2012

Int. Cls.: 16, 41 and 45

TRADEMARK

SERVICE MARK

PRINCIPAL REGISTER

OCHS, KIMBERLY (UNITED STATES INDIVIDUAL)
2701 CHERRYWOOD ROAD
MINNETONKA, MN 55305

FOR: A SERIES OF BOOKS IN THE FIELD OF TEACHER PROFESSIONAL DEVELOPMENT; A SERIES OF BOOKS IN THE FIELD OF PARENTING; A SERIES OF BOOKS IN THE FIELD OF CHILD DEVELOPMENT; A SERIES OF BOOKS IN THE FIELD OF EARLY LEARNING; A SERIES OF BOOKS IN THE FIELD OF LANGUAGE LEARNING; A SERIES OF BOOKS IN THE FIELD OF PUPPETRY; BOOKLETS IN THE FIELD OF TEACHER PROFESSIONAL DEVELOPMENT; BOOKLETS IN THE FIELD OF PARENTING; BOOKLETS IN THE FIELD OF CHILD DEVELOPMENT; BOOKLETS IN THE FIELD OF EARLY LEARNING; BOOKLETS IN THE FIELD OF LANGUAGE LEARNING; BOOKLETS IN THE FIELD OF PUPPETRY; BOOKLETS IN THE FIELD OF EDUCATION; BOOKS IN THE FIELD OF TEACHER PROFESSIONAL DEVELOPMENT; BOOKS IN THE FIELD OF PARENTING; BOOKS IN THE FIELD OF CHILD DEVELOPMENT; BOOKS IN THE FIELD OF EARLY LEARNING; BOOKS IN THE FIELD OF LANGUAGE LEARNING; BOOKS IN THE FIELD OF PUPPETRY; BOOKS IN THE FIELD OF EDUCATION; BOOKS IN THE FIELD OF MEMORY TRAINING ACTIVITIES SOLD AS A UNIT WITH TWO AND THREE DIMENSIONAL POSITIONABLE FIGURES; CHILDREN'S ACTIVITY BOOKS; CHILDREN'S BOOKS; CHILDREN'S INTERACTIVE EDUCATIONAL BOOKS; CHILDREN'S STORYBOOKS; COMPUTER GAME INSTRUCTION MANUALS; EDUCATIONAL AND LEARNING PUBLICATIONS, NAMELY, BOOKLETS AND FLASH CARDS ON A VARIETY OF EDUCATIONAL DISCIPLINES IN PRE-SCHOOL THROUGH EIGHTH GRADE; EDUCATIONAL BOOKS FEATURING LANGUAGE LEARNING; EDUCATIONAL PUBLICATIONS, NAMELY, TRAINING MANUALS IN THE FIELD OF LANGUAGE LEARNING; EDUCATIONAL PUBLICATIONS, NAMELY, TRAINING MANUALS IN THE FIELD OF EARLY CHILDHOOD EDUCATION; EDUCATIONAL PUBLICATIONS, NAMELY, TRAINING MANUALS IN THE FIELD OF TEACHER TRAINING/PROFESSIONAL DEVELOPMENT; EDUCATIONAL PUBLICATIONS, NAMELY, TRAINING MANUALS IN THE FIELD OF INTERNATIONAL EDUCATION; EDUCATIONAL PUBLICATIONS, NAMELY, TRAINING MANUALS IN THE FIELD OF PARENTING; EDUCATIONAL PUBLICATIONS, NAMELY, TRAINING MANUALS IN THE FIELD OF CHILD DEVELOPMENT; EDUCATIONAL PUBLICATIONS, NAMELY, EDUCATIONAL WORKBOOKS, TEXTBOOKS, ACTIVITY BOOKS, STORY BOOKS, PUZZLE BOOKS, TEACHER GUIDES, MANUALS, AND EDUCATIONAL BOOKLETS IN THE FIELD OF LANGUAGE LEARNING; EDUCATIONAL PUBLICATIONS, NAMELY, BOOKS AND WORKBOOKS IN THE FIELDS OF LANGUAGE LEARNING, CHILD DEVELOPMENT AND RELATED TEACHER TRAINING; EDUCATIONAL PUBLICATIONS, NAMELY, BOOKS AND WORKBOOKS IN THE FIELD



David J. Kyjars

Director of the United States Patent and Trademark Office

Reg. No. 4,173,717 OF RIGHT-BRAIN FITNESS; MANUALS IN THE FIELD OF TEACHING; MANUALS IN THE FIELD OF MULTICULTURAL AND MULTILINGUAL EDUCATION; MANUALS IN THE FIELD OF EARLY LEARNING; MANUALS IN THE FIELD OF PARENTING; MANUALS IN THE FIELD OF CHILD DEVELOPMENT; PACKAGED KITS COMPRISING PRINTED INSTRUCTIONAL, EDUCATIONAL, AND TEACHING MATERIALS FOR EDUCATIONAL ACTIVITIES IN THE FIELD OF LANGUAGE LEARNING; PRINTED MATTER, NAMELY, BOOKS AND MANUALS IN THE FIELD OF TEACHER PROFESSIONAL DEVELOPMENT, PARENTING, CHILD DEVELOPMENT, LANGUAGE LEARNING OR PUPPETRY; PRINTED MUSIC BOOKS; PRINTED MANUALS, BOOKS AND BOOKLETS IN THE FIELD OF TEACHER PROFESSIONAL DEVELOPMENT, PARENTING, CHILD DEVELOPMENT, EARLY LEARNING, LANGUAGE LEARNING OR PUPPETRY; PUBLICATIONS, NAMELY, BOOKLETS IN THE FIELD OF TEACHER PROFESSIONAL DEVELOPMENT, PARENTING, CHILD DEVELOPMENT, EARLY LEARNING, LANGUAGE LEARNING, INTERNATIONAL EDUCATION OR PUPPETRY; PUBLICATIONS, NAMELY, BOOKS AND WORKBOOKS IN THE FIELDS OF TEACHER PROFESSIONAL DEVELOPMENT, PARENTING, CHILD DEVELOPMENT, EARLY LEARNING, LANGUAGE LEARNING, INTERNATIONAL EDUCATION OR PUPPETRY; QUICK REFERENCE POCKET GUIDES IN THE FIELD OF TEACHER PROFESSIONAL DEVELOPMENT, PARENTING, CHILD DEVELOPMENT, EARLY LEARNING, LANGUAGE LEARNING, INTERNATIONAL EDUCATION OR PUPPETRY; RECIPE BOOKS; REFERENCE BOOKS IN THE FIELD OF TEACHER PROFESSIONAL DEVELOPMENT, PARENTING, CHILD DEVELOPMENT, EARLY LEARNING, LANGUAGE LEARNING, INTERNATIONAL EDUCATION OR PUPPETRY; RELIGIOUS BOOKS; RESOURCE BOOKS IN THE FIELD OF TEACHER PROFESSIONAL DEVELOPMENT, PARENTING, CHILD DEVELOPMENT, EARLY LEARNING, LANGUAGE LEARNING, INTERNATIONAL EDUCATION OR PUPPETRY; SCHOLARLY BOOKS ON VARIOUS TOPICS, NAMELY, TEACHER PROFESSIONAL DEVELOPMENT, PARENTING, CHILD DEVELOPMENT, EARLY LEARNING, LANGUAGE LEARNING, INTERNATIONAL EDUCATION OR PUPPETRY; SERIES OF NON-FICTION BOOKS IN THE FIELD OF TEACHER PROFESSIONAL DEVELOPMENT, PARENTING, CHILD DEVELOPMENT, EARLY LEARNING, LANGUAGE LEARNING, INTERNATIONAL EDUCATION OR PUPPETRY; TALKING CHILDREN'S BOOKS; TEXTBOOKS IN THE FIELD OF TEACHER PROFESSIONAL DEVELOPMENT, PARENTING, CHILD DEVELOPMENT, EARLY LEARNING, LANGUAGE LEARNING OR PUPPETRY, IN CLASS 16 (U.S. CLS. 2, 5, 22, 23, 29, 37, 38 AND 50).

FIRST USE 10-26-2009; IN COMMERCE 9-15-2010.

FOR: DEVELOPING EDUCATIONAL MANUALS FOR OTHERS IN THE FIELD OF EARLY CHILDHOOD EDUCATION; DEVELOPMENT AND DISSEMINATION OF EDUCATIONAL MATERIALS OF OTHERS IN THE FIELD OF EARLY CHILDHOOD EDUCATION; EDUCATION AND ENTERTAINMENT SERVICES, NAMELY, ONGOING TELEVISION PUBLIC SERVICE ANNOUNCEMENTS AND ONGOING TELEVISION PROGRAMS IN THE FIELD OF EARLY CHILDHOOD EDUCATION; EDUCATION AND ENTERTAINMENT SERVICES, NAMELY, PRODUCTION AND DISTRIBUTION OF ONGOING TELEVISION PROGRAMS IN THE FIELD OF FAMILY MANAGEMENT AND RELATIONSHIPS; EDUCATION SERVICES IN THE NATURE OF EARLY CHILDHOOD INSTRUCTION; EDUCATION SERVICES, NAMELY, A PROGRAM TO PROMOTE THE USE OF PROPER PUNCTUATION TO SCHOOL AGE CHILDREN; EDUCATION SERVICES, NAMELY, PRE-KINDERGARTEN THROUGH 12TH GRADE CLASSROOM INSTRUCTION, VOCATIONAL INSTRUCTION, MENTORING, TUTORING, CLASSES, SEMINARS AND WORKSHOPS FOR INDIVIDUALS WITH AUTISM AND OTHER DEVELOPMENTAL DISORDERS; EDUCATION SERVICES, NAMELY, PROVIDING LIVE AND ON-LINE BOOKS, GAMES, VIDEOS, RECIPES IN THE FIELD OF EARLY CHILDHOOD EDUCATION; EDUCATION SERVICES, NAMELY, PROVIDING MENTORING, TUTORING, CLASSES, SEMINARS AND WORKSHOPS IN THE FIELD OF EARLY CHILDHOOD EDUCATION; EDUCATION SERVICES, NAMELY, PROVIDING ON-LINE BOOKS, GAMES, VIDEOS, RECIPES IN THE FIELD OF PUPPETRY; EDUCATION SERVICES, NAMELY, PROVIDING TUTORIAL SESSIONS IN THE FIELD(S) OF EARLY CHILDHOOD EDUCATION; EDUCATION SERVICES, NAMELY, PROVIDING TUTORIAL SESSIONS IN THE FIELDS OF LANGUAGE LEARNING; EDUCATION SERVICES, NAMELY,

Reg. No. 4,173,717 PROVIDING TUTORING IN THE FIELD OF EARLY CHILDHOOD LANGUAGE LEARNING; EDUCATION SERVICES, NAMELY, PROVIDING TUTORING IN THE FIELDS OF PUPPETRY; EDUCATION SERVICES, NAMELY, PROVIDING A SOCIAL NETWORK FOR INTERACTIVE EDUCATION IN THE FIELD OF EARLY CHILDHOOD LANGUAGE LEARNING; EDUCATION SERVICES, NAMELY, PROVIDING ONLINE BOOKS, GAMES, VIDEOS, RECIPES IN THE FIELDS OF PUPPETRY; EDUCATION SERVICES, NAMELY, TRAINING EDUCATORS TO TEACH THROUGH SERVICE LEARNING AND CIVIC ENGAGEMENT AND PROVIDING CURRICULA IN CONNECTION THEREWITH; EDUCATIONAL AND ENTERTAINMENT SERVICES FOR CHILDREN, NAMELY, PROVIDING INTERACTIVE PLAY AREAS, INSTRUCTIONAL CLASSES IN THE FIELD OF EARLY CHILDHOOD LANGUAGE LEARNING AND SOCIAL GATHERINGS FOR CHILDREN; EDUCATIONAL AND ENTERTAINMENT SERVICES, NAMELY, A CONTINUING PROGRAM ABOUT EARLY CHILDHOOD LANGUAGE LEARNING ACCESSIBLE BY RADIO, TELEVISION, SATELLITE, AUDIO, VIDEO AND COMPUTER NETWORKS; EDUCATIONAL AND ENTERTAINMENT SERVICES, NAMELY, PROVIDING MOTIVATIONAL SPEAKING SERVICES IN THE FIELD OF EARLY CHILDHOOD LANGUAGE LEARNING; EDUCATIONAL AND ENTERTAINMENT SERVICES, NAMELY, PROVIDING ON-LINE INTERACTIVE CHILDREN'S STORIES; EDUCATIONAL PROGRAMS, NAMELY, PRE-SCHOOLS; EDUCATIONAL RESEARCH; EDUCATIONAL RESEARCH SERVICES VIA INTERNET; EDUCATIONAL SERVICES, NAMELY, DEVELOPING CURRICULUM FOR EDUCATORS; EDUCATIONAL SERVICES, NAMELY, DEVELOPING CURRICULUM FOR OTHERS IN THE FIELD OF EARLY CHILDHOOD LANGUAGE LEARNING; EDUCATIONAL SERVICES, NAMELY, DEVELOPING CURRICULUM FOR TEACHERS; EDUCATIONAL SERVICES, NAMELY, PROVIDING DOLLS AND TOYS DESIGNED TO TEACH ABOUT AND PROMOTE DENTAL HEALTH; EDUCATIONAL SERVICES, NAMELY, PROVIDING ON-LINE BOOKS, GAMES, VIDEOS, RECIPES IN THE FIELD OF EARLY CHILDHOOD EDUCATION; EDUCATIONAL SERVICES, NAMELY, PROVIDING GAMES, VIDEOS, RECIPES IN THE FIELDS OF PARENTING; EDUCATIONAL SERVICES, NAMELY, TEACHER TRAINING IN THE FIELD OF EARLY CHILDHOOD LANGUAGE LEARNING PROVIDED ON A REAL-TIME BASIS DURING CLASSROOM INSTRUCTION; ENTERTAINMENT AND EDUCATION SERVICES IN THE NATURE OF A SERIES OF SHORT SHOWS FEATURING PUPPETS COMMUNICATING IN MULTIPLE LANGUAGES DISTRIBUTED TO MOBILE HANDSETS, WHICH MAY INCLUDE VIDEO, TEXT, PHOTOS, ILLUSTRATIONS OR HYPERTEXT; ENTERTAINMENT AND EDUCATION SERVICES IN THE NATURE OF LIVE DANCE AND MUSICAL PERFORMANCES; ENTERTAINMENT AND EDUCATIONAL SERVICES IN THE NATURE OF ON-LINE COMPETITIONS IN THE FIELD OF ENTERTAINMENT, EDUCATION, CULTURE, SPORTS, AND OTHER NON-BUSINESS AND NON-COMMERCIAL FIELDS; ENTERTAINMENT AND EDUCATIONAL SERVICES, NAMELY, PROVIDING A WEBSITE THAT DISPLAYS VARIOUS REQUESTS, REVIEWS, RECOMMENDATIONS, RANKINGS, TRACKING, VOTES, AND INFORMATION RELATING TO UNCREATED, UNRELEASED, NEW, SPECIAL, POPULAR, AND RARE PRODUCTS, SERVICES, AND EVENTS IN THE FIELDS OF POP CULTURE, ENTERTAINMENT, EDUCATION, AND SPORTS, ALL EXCLUSIVELY FOR NON-BUSINESS AND NON-COMMERCIAL TRANSACTIONS AND PURPOSES; ENTERTAINMENT AND EDUCATIONAL SERVICES, NAMELY, PROVIDING ADVICE AND INFORMATION FOR MUSIC, VIDEO AND FILM CONCEPT AND SCRIPT DEVELOPMENT; ENTERTAINMENT AND EDUCATIONAL SERVICES, NAMELY, THE PRESENTATION OF SEMINARS, LECTURES, WORKSHOPS AND PANEL DISCUSSIONS, AND ONGOING TELEVISION AND RADIO TALK SHOWS ALL IN THE FIELD OF PUBLIC INTEREST CONCERNING EARLY CHILDHOOD LANGUAGE LEARNING; INFORMATION ABOUT EDUCATION; INFORMATION IN THE FIELD OF PARENTING CONCERNING EDUCATION OF CHILDREN; INFORMATION ON EDUCATION; INFORMATION RELATING TO ENTERTAINMENT AND EDUCATION, PROVIDED ON-LINE FROM A COMPUTER DATABASE OR THE INTERNET; INTERACTIVE EDUCATIONAL AND ENTERTAINMENT SERVICES, NAMELY, PROVIDING A WEB-BASED VIRTUAL EDUCATIONAL THEME-PARK FEATURING PUPPETS AND ANIMATED CHARACTERS IN A MULTI-LINGUAL ENVIRONMENT; ON-LINE EDUCATIONAL PARENTAL TRAINING CLASSES; ORGANIZATION OF EXHIBITIONS FOR CULTURAL OR EDUCATIONAL PURPOSES; ORGANIZATION OF EXHIBITIONS FOR CULTURAL OR EDUCATIONAL PURPOSES; ORGANIZING ON-LINE EXHIBITIONS AND

Reg. No. 4,173,717 CONFERENCES IN THE FIELDS OF EDUCATION, CULTURE, SPORTS AND ENTERTAINMENT FOR NON-BUSINESS AND NON-COMMERCIAL PURPOSES; PROVIDING A WEB SITE WHERE USERS CAN POST RATINGS, REVIEWS AND RECOMMENDATIONS ON EVENTS AND ACTIVITIES IN THE FIELD OF ENTERTAINMENT AND EDUCATION; PROVIDING A WEBSITE FEATURING INFORMATION IN THE FIELDS OF EDUCATION AND ENTERTAINMENT FOR CHILDREN; PROVIDING AN EDUCATIONAL WEBSITE IN THE FIELDS OF MUSIC AND ENTERTAINMENT; PROVIDING FACILITIES FOR MOVIES, SHOWS, PLAYS, MUSIC OR EDUCATIONAL TRAINING; PROVIDING INFORMATION AND NEWS IN THE FIELD OF TEACHING METHODOLOGY AND EDUCATION; PROVIDING INFORMATION IN THE FIELD OF LITERACY, READING, SIGN LANGUAGE, EDUCATION, TRAINING, EARLY CHILDHOOD INSTRUCTION AND TUTORING RELATED TO HEARING AND SPEECH DISABILITIES VIA THE INTERNET; PROVIDING INFORMATION ON TEACHING METHODOLOGY AND EDUCATION ISSUES TO MUSIC EDUCATORS; PROVIDING INFORMATION ON-LINE RELATING TO EDUCATIONAL OPPORTUNITIES; PROVIDING ON-LINE RESOURCE GUIDES FOR RELATIVES CONCERNING CHILDREN IN THE FIELDS OF EDUCATION, RECREATION, AND ENTERTAINMENT; PROVISION OF INFORMATION IN THE FIELD OF CHILDREN'S EDUCATION; PROVISION OF INFORMATION RELATING TO EDUCATION SERVICES FOR CHILDREN; PROVISION OF INFORMATION RELATING TO EDUCATIONAL AND ENTERTAINMENT ACTIVITIES AND EVENTS FOR CHILDREN; PROVISION OF INFORMATION RELATING TO EDUCATIONAL SERVICES, IN CLASS 41 (U.S. CLS. 100, 101 AND 107).

FIRST USE 10-26-2009; IN COMMERCE 9-15-2010.

FOR: ORGANIZING AND CONDUCTING SUPPORT GROUPS IN THE FIELD OF PARENTING; PROVIDING INFORMATION IN THE FIELD OF SELF-IMPROVEMENT; PROVIDING INFORMATION RELATING TO DIVERSE HUMAN CULTURES, BELIEFS, AND LIFESTYLES; PROVIDING INFORMATION IN THE FIELD OF CHILD SAFETY; PROVIDING ON-LINE INFORMATION IN THE FIELD OF SPIRITUALITY, SELF-HELP, AND PERSONAL EMPOWERMENT SUBJECT MATTERS, IN CLASS 45 (U.S. CLS. 100 AND 101).

FIRST USE 10-26-2009; IN COMMERCE 9-15-2010.

THE MARK CONSISTS OF STANDARD CHARACTERS WITHOUT CLAIM TO ANY PARTICULAR FONT, STYLE, SIZE, OR COLOR.

SER. NO. 85-137,000, FILED 9-23-2010.

ALAIN LAPTEK, EXAMINING ATTORNEY

United States of America

United States Patent and Trademark Office

LOADISC

Reg. No. 4,173,718

Registered July 17, 2012

Int. Cls.: 6 and 7

TRADEMARK

PRINCIPAL REGISTER

UNEX CORPORATION (NEW JERSEY CORPORATION)
333 ROUTE 17 NORTH
MAHWAH, NJ 07430

FOR: METALLIC FASTENERS FOR INDUSTRIAL USE, NAMELY, BOLTS, EXPANSION BOLTS, SINGLE- AND MULTI-PART NUTS, CLAMPS AND CLAMP CONNECTORS, AND WASHERS FOR SUCH FASTENERS; METALLIC BOLTING PRODUCTS, ACCESSORIES AND ASSEMBLIES FOR USE WITH SUCH FASTENERS, NAMELY, SOCKETS, REACTION FIXTURES, ADAPTERS, REDUCERS, RINGS, CONNECTORS, EXTENDERS, OFF-SET LINKS AND SILENCERS; AND ASSOCIATED STRUCTURAL AND REPLACEMENT PARTS THEREOF, NAMELY, HOUSINGS, HANDLES, PAWLS, SHIFTERS, GEARS, SPACERS, BUSHINGS, CAPS, FORCE TRANSMITTERS, PLUGS, COVERS, SCREWS, SPRINGS, PINS, BUTTONS, SLEEVES, DRIVES, PLUNGERS, RATCHETS, DRIVE PLATES, DRIVE SEGMENTS, O-RINGS, RINGS, SEALS, PISTON RODS, GLANDS, SHROUDS, SWIVELS, COUPLERS, RETAINERS, CLIPS, DRIVES, BEARINGS, VALVES, HOSES, CONTROLLERS, TRANSDUCERS AND CLUTCHES, IN CLASS 6 (U.S. CLS. 2, 12, 13, 14, 23, 25 AND 50).

FIRST USE 1-1-2003; IN COMMERCE 1-1-2003.

FOR: WORKING MACHINES AND TOOLS FOR INDUSTRIAL USE, NAMELY, HYDRAULIC, PNEUMATIC, ELECTRIC AND FLUID OPERATED TORQUE WRENCHES, NUT DRIVERS, TENSIONERS, TORQUE CONVERTERS, RATCHETS, AND NUT SPANNERS; PUMPS AND POWER UNITS FOR USE WITH SUCH MACHINES AND TOOLS, NAMELY, HYDRAULIC, PNEUMATIC AND FLUID OPERATED PUMPS AND POWER UNITS; BOLTING MACHINES AND BOLTING MACHINE PARTS FOR USE WITH BOLTING MACHINES, TOOLS, PUMPS AND POWER UNITS, NAMELY, SOCKETS, REACTION FIXTURES, ADAPTERS, REDUCERS, RINGS, CONNECTORS, EXTENDERS, OFF-SET LINKS AND SILENCERS; AND ASSOCIATED STRUCTURAL AND REPLACEMENT PARTS THEREOF, NAMELY, HOUSINGS, HANDLES, PAWLS, SHIFTERS, GEARS, SPACERS, BUSHINGS, CAPS, FORCE TRANSMITTERS, PLUGS, COVERS, SCREWS, SPRINGS, PINS, BUTTONS, SLEEVES, DRIVES, PLUNGERS, RATCHETS, DRIVE PLATES, DRIVE SEGMENTS, O-RINGS, RINGS, SEALS, PISTON RODS, GLANDS, SHROUDS, SWIVELS, COUPLERS, RETAINERS, CLIPS, DRIVES, BEARINGS, VALVES, HOSES, CONTROLLERS, TRANSDUCERS, CLUTCHES AND WASHERS, IN CLASS 7 (U.S. CLS. 13, 19, 21, 23, 31, 34 AND 35).

FIRST USE 1-1-2003; IN COMMERCE 1-1-2003.



David J. Kyjars

Director of the United States Patent and Trademark Office

Reg. No. 4,173,718 THE MARK CONSISTS OF STANDARD CHARACTERS WITHOUT CLAIM TO ANY PARTICULAR FONT, STYLE, SIZE, OR COLOR.

SER. NO. 85-137,053, FILED 9-23-2010.

TRACY CROSS, EXAMINING ATTORNEY

United States of America

United States Patent and Trademark Office

MANAGE SECURE DOCUMENT RETRIEVALS SMARTER

Reg. No. 4,173,719

TSG THE SIERRA GROUP, INC (TEXAS CORPORATION)
PO BOX 180791
ARLINGTON, TX 76096

Registered July 17, 2012

Int. Cl.: 42

FOR: DOCUMENT MANAGEMENT SERVICES, NAMELY, PROVIDING ONLINE NON-DOWNLOADABLE SOFTWARE FOR ACCESSING AND RETRIEVING ARCHIVED DOCUMENTS, IN CLASS 42 (U.S. CLS. 100 AND 101).

SERVICE MARK

FIRST USE 2-26-2005; IN COMMERCE 2-26-2005.

PRINCIPAL REGISTER

THE MARK CONSISTS OF STANDARD CHARACTERS WITHOUT CLAIM TO ANY PARTICULAR FONT, STYLE, SIZE, OR COLOR.

SER. NO. 85-137,853, FILED 9-24-2010.

REBECCA EISINGER, EXAMINING ATTORNEY



David J. Kyjars

Director of the United States Patent and Trademark Office

United States of America

United States Patent and Trademark Office

UUVOL

Reg. No. 4,173,720

CAMBRIDGE AUDIO LIMITED (UNITED KINGDOM COMPANY)
GALLERY COURT, HANKEY PLACE
LONDON, UNITED KINGDOM SE14BB

Registered July 17, 2012

Int. Cls.: 9, 35, 38 and 41

FOR: APPARATUS FOR RECORDING, TRANSMISSION OR REPRODUCTION OF SOUND OR IMAGES; AMPLIFIERS, RADIO SIGNAL TUNERS, DIGITAL TO ANALOGUE CONVERTERS, DIGITAL MEDIA PLAYER DEVICES FOR ACCESSING AND PLAYING MUSIC OVER AN IP NETWORK, DIGITAL MEDIA PLAYERS, PORTABLE MEDIA PLAYERS AND ACCESSORIES THEREFOR, NON-PORTABLE MEDIA PLAYERS AND ACCESSORIES THEREFOR, HEADPHONES, GRAMOPHONE PICKUPS, LOUDSPEAKERS, HI-FIDELITY AUDIO RECORDING AND REPRODUCING EQUIPMENT, NAMELY, SOUND RECORDING APPARATUS; RECORD PLAYERS, IP VIDEO SERVERS, DIGITAL AUDIO AND VIDEO PLAYERS, DIGITAL MUSIC STREAMING DEVICES, COMPACT DISC PLAYERS, DIGITAL VIDEO DISC PLAYERS, OPTICAL DISC PLAYERS, PORTABLE MEDIA PLAYER DOCKING SYSTEMS CONSISTING OF ELECTRONIC DOCKING STATIONS, PERSONAL COMPUTER MUSIC SYSTEMS CONSISTING OF COMPUTER-CONNECTED DIGITAL ELECTRONIC DEVICES FOR RECORDING, ORGANIZING, TRANSMITTING, MANIPULATING AND REVIEWING AUDIO FILES, RADIOS, MICROPHONES; CONNECTION CABLES AND ASSOCIATED CABLE CONNECTORS, ELECTRIC CABLES, TELEVISIONS AND VIDEO RECORDERS; DIGITAL MUSIC DOWNLOADABLE FROM THE INTERNET; COMPUTER SOFTWARE AND COMPUTER HARDWARE FOR USE IN DOWNLOADING AND STREAMING AUDIO AND VIDEO CONTENT VIA A GLOBAL COMPUTER NETWORK; AND PARTS AND FITTINGS FOR ALL THE AFOREMENTIONED GOODS, IN CLASS 9 (U.S. CLS. 21, 23, 26, 36 AND 38).

TRADEMARK

SERVICE MARK

PRINCIPAL REGISTER



David J. Kybas

Director of the United States Patent and Trademark Office

FOR: ADVERTISING SERVICES; BUSINESS MANAGEMENT; PROVIDING OFFICE FUNCTIONS; PROVISION OF ADVERTISING SPACE ON INTERNET WEBSITES; ADVERTISING SERVICES, NAMELY, PROMOTING A VARIETY OF MUSIC AND VIDEO-RELATED GOODS OF OTHERS VIA TELECOMMUNICATIONS NETWORKS AND VIA AN INTERNET WEB SITE; MAIL ORDER SERVICES FEATURING A VARIETY OF MUSIC AND VIDEO-RELATED GOODS; RETAIL OUTLETS FEATURING A VARIETY OF MUSIC AND VIDEO-RELATED GOODS; MAIL ORDER SERVICES FEATURING APPARATUS FOR RECORDING, TRANSMISSION OR REPRODUCTION OF SOUND OR IMAGES, AMPLIFIERS, RADIO TUNERS, TURNTABLES, DIGITAL TO ANALOGUE CONVERTERS, NETWORK MUSIC PLAYERS, NETWORK MEDIA PLAYERS, PORTABLE MEDIA PLAYERS AND ACCESSORIES, NON-PORTABLE MEDIA PLAYERS AND ACCESSORIES, HEADPHONES, TONE ARMS, GRAMOPHONE PICKUPS, LOUDSPEAKERS, HI-FIDELITY AUDIO RECORDING

Reg. No. 4,173,720 AND REPRODUCING EQUIPMENT, RECORD PLAYERS, MEDIA RENDERERS, AUDIO SERVERS, VIDEO SERVERS, MUSIC PLAYBACK DEVICES, NETWORK MUSIC PLAYBACK DEVICES, AUDIO CLIENT PLAYBACK DEVICES, VIDEO CLIENT PLAYBACK DEVICES, DIGITAL MUSIC PLAYBACK DEVICES, STREAMING MUSIC DEVICES, COMPACT DISC PLAYERS, DIGITAL VIDEO DISC PLAYERS, OPTICAL DISC PLAYERS, PORTABLE MEDIA PLAYER DOCKING SYSTEMS, PERSONAL COMPUTER MUSIC SYSTEMS, RADIOS, MICROPHONES, INTERCONNECTOR CABLES AND ASSOCIATED CONNECTORS, ELECTRIC CABLES, TELEVISIONS AND VIDEO RECORDERS, DIGITAL MUSIC AND VIDEO, DOWNLOADABLE OR STREAMABLE CONTENT FROM THE INTERNET OR VIA OTHER COMMUNICATIONS NETWORKS, SOFTWARE AND HARDWARE FOR USE IN CONNECTION WITH WEBSITES FOR DOWNLOADABLE OR STREAMABLE CONTENT, AND PARTS AND FITTINGS FOR ALL THE AFOREMENTIONED GOODS, IN CLASS 35 (U.S. CLS. 100, 101 AND 102).

FOR: STREAMING OF AUDIO, VIDEO AND TEXT MATERIAL ON THE INTERNET; TELECOMMUNICATIONS, NAMELY, TELECOMMUNICATIONS GATEWAY SERVICES; DELIVERY OF DIGITAL MUSIC AND VIDEO BY ELECTRONIC TRANSMISSION OVER TELECOMMUNICATION NETWORKS; MUSIC AND VIDEO BROADCASTING; TELECOMMUNICATIONS GATEWAY SERVICES RELATING TO ENTERTAINMENT, IN CLASS 38 (U.S. CLS. 100, 101 AND 104).

FOR: EDUCATIONAL SERVICES, NAMELY, TRAINING SERVICES IN THE FIELD OF THE PROVISION OF DOWNLOADABLE CONTENT; PRODUCTION OF AUDIO AND VIDEO RECORDINGS; EDUCATIONAL AND ENTERTAINMENT SERVICES, NAMELY, PROVIDING TRAINING IN THE FIELD OF THE USE AND MAINTENANCE OF APPARATUS FOR RECORDING, TRANSMISSION OR REPRODUCTION OF SOUND OR IMAGES VIA NON-DOWNLOADABLE DIGITAL AUDIO AND VIDEO RECORDINGS, IN CLASS 41 (U.S. CLS. 100, 101 AND 107).

THE MARK CONSISTS OF STANDARD CHARACTERS WITHOUT CLAIM TO ANY PARTICULAR FONT, STYLE, SIZE, OR COLOR.

PRIORITY CLAIMED UNDER SEC. 44(D) ON ERPN CMNTY TM OFC APPLICATION NO. 009212382, FILED 6-30-2010, REG. NO. 009212382, DATED 1-4-2011, EXPIRES 6-30-2020.

THE WORD(S) "UUVOL" HAS NO MEANING IN A FOREIGN LANGUAGE.

SER. NO. 85-138,605, FILED 9-27-2010.

ANDREW RHIM, EXAMINING ATTORNEY

United States of America

United States Patent and Trademark Office

ALINT

Reg. No. 4,173,721

Registered July 17, 2012

Int. Cl.: 9

TRADEMARK

PRINCIPAL REGISTER

ALDEC, INC. (NEVADA CORPORATION)
SUITE 490
2260 CORPORATE CIRCLE
HENDERSON, NV 89074

FOR: DOWNLOADABLE COMPUTER-AIDED ENGINEERING SOFTWARE FOR USE IN THE DEVELOPMENT OF SILICON HARDWARE, IN CLASS 9 (U.S. CLS. 21, 23, 26, 36 AND 38).

FIRST USE 1-9-2008; IN COMMERCE 1-9-2008.

THE MARK CONSISTS OF STANDARD CHARACTERS WITHOUT CLAIM TO ANY PARTICULAR FONT, STYLE, SIZE, OR COLOR.

SER. NO. 85-140,098, FILED 9-28-2010.

MARGARET POWER, EXAMINING ATTORNEY



David J. Kybas

Director of the United States Patent and Trademark Office

United States of America

United States Patent and Trademark Office

LEARNING ENCOUNTERS

Reg. No. 4,173,722

Registered July 17, 2012

Int. Cl.: 16

TRADEMARK

PRINCIPAL REGISTER

LEARNING ENCOUNTERS, LLC (WISCONSIN LIMITED LIABILITY COMPANY)
1833 OAKDALE AVENUE
RACINE, WI 53406

FOR: TEACHING AIDES, NAMELY, THREE-DIMENSIONAL MODELS; BOOKS; PRINTED EDUCATIONAL MATERIALS; MAGAZINES; NEWSLETTERS; TEACHING KITS COMPRISED OF ONE OR MORE OF THREE-DIMENSIONAL MODELS, BOOKS, PRINTED EDUCATIONAL MATERIALS, MAGAZINES, AND/OR NEWSLETTERS; EXPERIMENT KITS COMPRISED OF ONE OR MORE OF THREE-DIMENSIONAL MODELS FOR EDUCATIONAL PURPOSES, BOOKS, PRINTED EDUCATIONAL MATERIALS, MAGAZINES, AND/OR NEWSLETTERS; ALL OF THE AFOREMENTIONED GOODS IN THE EDUCATIONAL FIELD OF SCIENCE, IN CLASS 16 (U.S. CLS. 2, 5, 22, 23, 29, 37, 38 AND 50).

FIRST USE 11-3-2009; IN COMMERCE 11-3-2009.

THE MARK CONSISTS OF STANDARD CHARACTERS WITHOUT CLAIM TO ANY PARTICULAR FONT, STYLE, SIZE, OR COLOR.

NO CLAIM IS MADE TO THE EXCLUSIVE RIGHT TO USE "LEARNING", APART FROM THE MARK AS SHOWN.

SER. NO. 85-141,039, FILED 9-29-2010.

ELI HELLMAN, EXAMINING ATTORNEY



David J. Kybas

Director of the United States Patent and Trademark Office

United States of America

United States Patent and Trademark Office

The logo for DATAPIPE, featuring the word "DATAPIPE" in a bold, italicized, sans-serif font. The letters are black with a white outline, and the entire word is set against a light gray rectangular background. A dark shadow is cast beneath the text, giving it a three-dimensional appearance.

Reg. No. 4,173,723

Registered July 17, 2012

Int. Cls.: 39 and 42

SERVICE MARK

PRINCIPAL REGISTER

DATAPIPE, INC. (DELAWARE CORPORATION)
10 EXCHANGE PLACE
JERSEY CITY, NJ 07302

FOR: ELECTRONIC DATA STORAGE SERVICES, NAMELY, STORING ELECTRONIC DATA AT DATA CENTERS; ELECTRONIC DATA STORAGE, IN CLASS 39 (U.S. CLS. 100 AND 105).

FIRST USE 12-16-2009; IN COMMERCE 12-16-2009.

FOR: COMPUTER SERVICES IN THE NATURE OF PROVIDING AN INTEGRATED SUITE OF DATA AND COMPUTER RELATED SERVICES, NAMELY, PROVIDING COMPUTER SECURITY CONSULTING IN THE AREA OF DATA STORAGE, ONLINE SECURITY AND INFORMATION SECURITY VULNERABILITY; PROVIDING A SECURE AND SAFE ENVIRONMENT FOR THE INFORMATION TECHNOLOGY SYSTEMS OF OTHERS, NAMELY, PROVIDING COMPUTER CO-LOCATION SERVICES IN THE NATURE OF PROVIDING FACILITIES FOR THE LOCATION OF COMPUTER SERVERS AND EQUIPMENT OF OTHERS; COMPUTER SERVICES IN THE NATURE OF MONITORING AND MANAGING COMPUTER NETWORK SYSTEMS; NETWORK SECURITY SERVICES IN THE NATURE OF COMPUTER NETWORK SECURITY SERVICES, NAMELY, RESTRICTING ACCESS TO AND BY COMPUTER NETWORKS TO AND OF UNDESIREED WEB SITES, MEDIA AND INDIVIDUALS AND FACILITIES; SECURITY MANAGEMENT SERVICES, NAMELY, COMPUTER CONSULTATION IN THE FIELD OF COMPUTER SECURITY; DISASTER RECOVERY SERVICES, NAMELY, COMPUTER DISASTER RECOVERY PLANNING AND RECOVERY OF COMPUTER DATA; SERVER MANAGEMENT SERVICES, NAMELY, HOSTING THE WEB SITES OF OTHERS ON A COMPUTER SERVER FOR A GLOBAL COMPUTER NETWORK; DATA BACKUP SERVICES, NAMELY, BACK-UP SERVICES FOR COMPUTER HARD DRIVE DATA; WEB SITE HOSTING SERVICES; COMPUTER SERVICES, NAMELY, REMOTE AND ON-SITE MANAGEMENT OF THE INFORMATION TECHNOLOGY CLOUD COMPUTING SYSTEMS OF OTHERS; TECHNICAL SUPPORT SERVICES, NAMELY, REMOTE AND ON-SITE INFRASTRUCTURE MANAGEMENT SERVICES FOR MONITORING, ADMINISTRATION AND MANAGEMENT OF PUBLIC AND PRIVATE CLOUD COMPUTING AND APPLICATION SYSTEMS; CONSULTING SERVICES IN THE FIELD OF CLOUD COMPUTING, NAMELY, CONSULTING IN CONNECTION WITH CLOUD COMPUTING APPLICATIONS AND NETWORKS; TECHNICAL CONSULTING SERVICES IN THE FIELDS OF PUBLIC AND PRIVATE CLOUD COMPUTING, NAMELY, CONSULTING SERVICES IN THE FIELD OF DESIGN, SELECTION, IMPLEMENTATION AND USE OF



David J. Kyffers

Director of the United States Patent and Trademark Office

Reg. No. 4,173,723 COMPUTER HARDWARE AND SOFTWARE SYSTEMS FOR OTHERS; TECHNICAL SUPPORT SERVICES, NAMELY, MONITORING OF NETWORK SYSTEMS, SERVERS AND WEB AND DATABASE APPLICATIONS AND NOTIFICATION OF RELATED EVENTS AND ALERTS; PROVIDING ON-DEMAND RESOURCE ALLOCATION FOR COMPUTER SYSTEMS, NAMELY, PROVIDING NON-DOWNLOADABLE COMPUTER SOFTWARE FOR USE IN ACCESSING VIRTUAL SERVERS AND VIRTUAL MACHINES; HOSTING THE SOFTWARE AND OTHER COMPUTER APPLICATIONS OF OTHERS ON A VIRTUAL PRIVATE AND PUBLIC SERVER; TECHNICAL SUPPORT SERVICES FOR HARDWARE, SOFTWARE AND OPERATING SYSTEMS IN THE NATURE OF MONITORING, DIAGNOSING AND PROBLEM RESOLUTION RELATED TO SOFTWARE APPLICATIONS; COMPUTER SERVICES, NAMELY, REMOTE AND ON-SITE MANAGEMENT OF ELECTRONIC MESSAGING SYSTEMS OF OTHERS INCLUDING TROUBLESHOOTING, OPTIMIZING, PATCHING, HARDENING, STORAGE MANAGEMENT, MAILBOX MOVEMENT, INSTALLATION AND CONFIGURATION AND MIGRATION OF ELECTRONIC MESSAGES AND MESSAGE SYSTEMS, SUCH AS E-MAIL, IN CLASS 42 (U.S. CLS. 100 AND 101).

FIRST USE 12-16-2009; IN COMMERCE 12-16-2009.

OWNER OF U.S. REG. NOS. 3,404,027, 3,826,385 AND OTHERS.

THE MARK CONSISTS OF THE WORD "DATAPIPE" ABOVE AN INVERTED PEDESTAL DESIGN. THE CROSSES THROUGH THE LETTERS A IN "DATAPIPE" PROJECT OUT TO THE RIGHT OF THE LETTERS.

SEC. 2(F) AS TO "DATAPIPE".

SER. NO. 85-141,042, FILED 9-29-2010.

KAELIE KUNG, EXAMINING ATTORNEY

United States of America

United States Patent and Trademark Office

MICRO SKIN

Reg. No. 4,173,724

NKEM, INC. (CALIFORNIA CORPORATION)
1440C FOURTH STREET
BERKELEY, CA 94710

Registered July 17, 2012

Int. Cl.: 10

FOR: OSTOMY POUCHES, IN CLASS 10 (U.S. CLS. 26, 39 AND 44).

TRADEMARK

FIRST USE 2-5-1988; IN COMMERCE 2-5-1988.

PRINCIPAL REGISTER

THE MARK CONSISTS OF STANDARD CHARACTERS WITHOUT CLAIM TO ANY PARTICULAR FONT, STYLE, SIZE, OR COLOR.

SER. NO. 85-141,448, FILED 9-29-2010.

ERIN FALK, EXAMINING ATTORNEY



David J. Kyffers

Director of the United States Patent and Trademark Office

United States of America

United States Patent and Trademark Office

NICKA K NEW YORK

Reg. No. 4,173,725

PROXIMA, INC. (NEW YORK CORPORATION), DBA NICKA K. COSMETICS
109-15 178TH STREET
JAMAICA, NY 11433

Registered July 17, 2012

Int. Cl.: 3

FOR: COSMETICS; HAND AND FOOT CARE PRODUCTS, NAMELY, NON-MEDICATED FOOT CREAMS, NON-MEDICATED FOOT LOTION, FOOT SMOOTHING STONES, HAND CREAMS, HAND LOTIONS, SCRUBS, NAMELY, BODY SCRUBS, FACIAL SCRUBS, FOOT SCRUBS, HAND SCRUBS, IN CLASS 3 (U.S. CLS. 1, 4, 6, 50, 51 AND 52).

TRADEMARK

PRINCIPAL REGISTER

FIRST USE 6-1-2009; IN COMMERCE 6-1-2009.

THE MARK CONSISTS OF STANDARD CHARACTERS WITHOUT CLAIM TO ANY PARTICULAR FONT, STYLE, SIZE, OR COLOR.

OWNER OF U.S. REG. NO. 2,255,251.

NO CLAIM IS MADE TO THE EXCLUSIVE RIGHT TO USE "NEW YORK", APART FROM THE MARK AS SHOWN.

THE NAME(S), PORTRAIT(S), AND/OR SIGNATURE(S) SHOWN IN THE MARK IDENTIFIES BERNICKA KIM, WHOSE CONSENT(S) TO REGISTER IS MADE OF RECORD.

SER. NO. 85-142,141, FILED 9-30-2010.

RICHARD WHITE, EXAMINING ATTORNEY



David J. Kybas

Director of the United States Patent and Trademark Office

United States of America

United States Patent and Trademark Office

REFLEXE SOLAIRE

Reg. No. 4,173,726

Registered July 17, 2012

Int. Cls.: 3 and 5

TRADEMARK

PRINCIPAL REGISTER

PIERRE FABRE DERMO-COSMETIQUE (FRANCE SOCIÉTÉ PAR ACTIONS SIMPLIFIÉE (SAS))
45, PLACE ABEL GANCE
BOULOGNE, FRANCE 92100

FOR: COSMETICS FOR SUN PROTECTION, IN CLASS 3 (U.S. CLS. 1, 4, 6, 50, 51 AND 52).

FOR: DERMATOLOGICAL PHARMACEUTICAL PREPARATIONS FOR SUN PROTECTION;
MEDICATED DERMO-COSMETIC PREPARATIONS FOR SUN PROTECTION, IN CLASS 5
(U.S. CLS. 6, 18, 44, 46, 51 AND 52).

THE MARK CONSISTS OF STANDARD CHARACTERS WITHOUT CLAIM TO ANY PARTICULAR FONT, STYLE, SIZE, OR COLOR.

OWNER OF FRANCE REG. NO. 103729027, DATED 4-12-2010, EXPIRES 4-12-2020.

NO CLAIM IS MADE TO THE EXCLUSIVE RIGHT TO USE "SOLAIRE", APART FROM THE MARK AS SHOWN.

THE ENGLISH TRANSLATION OF "REFLEXE SOLAIRE" IN THE MARK IS "REFLEX SOLAR".

SER. NO. 85-144,189, FILED 10-4-2010.

GENE MACIOL, EXAMINING ATTORNEY



David J. Kybas

Director of the United States Patent and Trademark Office

United States of America

United States Patent and Trademark Office

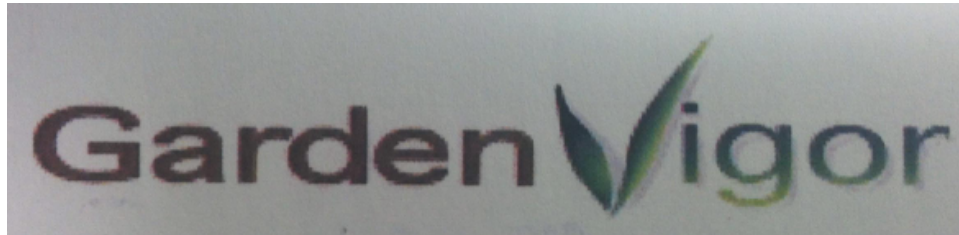

Reg. No. 4,173,727

GARDEN VIGOR, INC. (INDIANA CORPORATION)
12834 COLUMA BAY
FORT WAYNE, IN 46845

Registered July 17, 2012

Int. Cl.: 1

FOR: PLANT NUTRITION PREPARATIONS, IN CLASS 1 (U.S. CLS. 1, 5, 6, 10, 26 AND 46).

FIRST USE 1-23-2010; IN COMMERCE 2-25-2010.

TRADEMARK

NO CLAIM IS MADE TO THE EXCLUSIVE RIGHT TO USE "GARDEN", APART FROM THE MARK AS SHOWN.

PRINCIPAL REGISTER

THE COLOR(S) BROWN, GREEN, BLACK AND GRAY IS/ARE CLAIMED AS A FEATURE OF THE MARK.

THE MARK CONSISTS OF THE WORD "GARDEN" IN BROWN; TWO IMAGES OF LEAVES FORM THE APPEARANCE OF A CAPITAL "V" THE FIRST LEAF IS BLACK AT THE TOP, FADING DOWNWARD TO GRAY, AND THEN TO GREEN; THE SECOND LEAF IS MOSTLY GREEN WITH A BIT GRAY ON THE LEFT SIDE AND A BLACK EDGE; THE LETTERS "IGOR" ARE GREEN ON THE LOWER HALF AND FADING UPWARD TO GRAY; THE DOT FOR THE LETTER "I" IS BLACK. THE COLOR WHITE REPRESENTS BACKGROUND AND IS NOT PART OF THE MARK.

SER. NO. 85-144,987, FILED 10-5-2010.

LINDA ESTRADA, EXAMINING ATTORNEY



David J. Kyffers

Director of the United States Patent and Trademark Office

United States of America

United States Patent and Trademark Office

The Greener Good

Reg. No. 4,173,728

GREEN BRANDS, LLC (TEXAS LIMITED LIABILITY COMPANY)
1320 SOUTH UNIVERSITY DR., SUITE 806
FORT WORTH, TX 76107

Registered July 17, 2012

Int. Cl.: 35

FOR: ON-LINE RETAIL STORE SERVICES FEATURING HOME, LAWN AND GARDEN, HOME IMPROVEMENT, CLEANING, APPAREL, BODY, BABY, OFFICE, AND PET PRODUCTS; RETAIL SHOPS FEATURING HOME, LAWN AND GARDEN, HOME IMPROVEMENT, CLEANING, APPAREL, BODY, BABY, OFFICE, AND PET PRODUCTS, IN CLASS 35 (U.S. CLS. 100, 101 AND 102).

SERVICE MARK

PRINCIPAL REGISTER

FIRST USE 6-1-2009; IN COMMERCE 6-1-2009.

THE MARK CONSISTS OF STANDARD CHARACTERS WITHOUT CLAIM TO ANY PARTICULAR FONT, STYLE, SIZE, OR COLOR.

SER. NO. 85-146,768, FILED 10-6-2010.

PATRICIA EVANKO, EXAMINING ATTORNEY



David J. Kyjars

Director of the United States Patent and Trademark Office

United States of America

United States Patent and Trademark Office



Reg. No. 4,173,729

GREEN BRANDS, LLC (TEXAS LIMITED LIABILITY COMPANY)
1320 SOUTH UNIVERSITY DR., SUITE 806
FORT WORTH, TX 76107

Registered July 17, 2012

Int. Cl.: 35

FOR: ON-LINE RETAIL STORE SERVICES FEATURING HOME, LAWN AND GARDEN, HOME IMPROVEMENT, CLEANING, APPAREL, BODY, BABY, OFFICE, AND PET PRODUCTS; RETAIL SHOPS FEATURING HOME, LAWN AND GARDEN, HOME IMPROVEMENT, CLEANING, APPAREL, BODY, BABY, OFFICE, AND PET PRODUCTS, IN CLASS 35 (U.S. CLS. 100, 101 AND 102).

SERVICE MARK

PRINCIPAL REGISTER

FIRST USE 6-1-2009; IN COMMERCE 6-1-2009.

THE MARK CONSISTS OF THE WORDING "THEGREENERGOOD IT'S ALL GOOD!" IN GREEN, A STYLIZED INITIAL "G" IN WHITE ON A GRAY CIRCULAR BACKGROUND OUTLINED IN WHITE AND GREEN, WITH A GREEN LEAF AT THE TIP OF THE LETTER "G".

THE COLOR(S) GREEN, WHITE AND GRAY IS/ARE CLAIMED AS A FEATURE OF THE MARK.

SER. NO. 85-146,770, FILED 10-6-2010.

PATRICIA EVANKO, EXAMINING ATTORNEY



David J. Kybas

Director of the United States Patent and Trademark Office

United States of America

United States Patent and Trademark Office

ROYAL SOVEREIGN

Reg. No. 4,173,730

ROYAL SOVEREIGN INTERNATIONAL INC. (NEW JERSEY CORPORATION)
2 VOLVO DRIVE

Registered July 17, 2012

ROCKLEIGH, NJ 07647

Int. Cls.: 7, 9, 11, 16 and 17

FOR: ELECTRIC VACUUM SEALERS FOR FOOD STORAGE, CLOTHES WASHING MACHINES; LAMINATING MACHINES FOR HOME AND OFFICE USE; ROLL LAMINATING MACHINES FOR INDUSTRIAL USE, IN CLASS 7 (U.S. CLS. 13, 19, 21, 23, 31, 34 AND 35).

TRADEMARK

FIRST USE 2-1-2002; IN COMMERCE 9-1-2002.

PRINCIPAL REGISTER

FOR: BILL COUNTING MACHINE, COIN SORTING MACHINE, COIN COUNTING MACHINE, COUNTERFEIT CURRENCY DETECTORS, CASH REGISTERS, IN CLASS 9 (U.S. CLS. 21, 23, 26, 36 AND 38).

FIRST USE 2-1-2002; IN COMMERCE 9-1-2002.

FOR: AIR CONDITIONERS, DEHUMIDIFIERS, HUMIDIFIERS, AIR PURIFIERS, PORTABLE ELECTRIC HEATERS, PORTABLE OIL HEATERS, ELECTRIC FANS, REFRIGERATORS, FREEZERS, APPLIANCE FOR DOMESTIC USE, NAMELY, TEMPERATURE CONTROLLED WINE CELLARS, CLOTHES DRYERS, IN CLASS 11 (U.S. CLS. 13, 21, 23, 31 AND 34).

FIRST USE 2-1-2002; IN COMMERCE 9-1-2002.

FOR: LAMINATING MACHINES FOR HOME AND OFFICE USE, LAMINATING SUPPLIES, NAMELY, LAMINATING POUCHES FOR HOME AND OFFICE USE, PAPER SHREDDERS, PAPER BINDING MACHINES FOR HOME OR OFFICE USE, PAPER BINDING SUPPLIES, NAMELY, BINDING MATERIALS FOR BOOKS AND PAPERS, ROLL LAMINATING MACHINES FOR HOME AND OFFICE USE, STANDS FOR PAPER BANNERS; COIN WRAPPING PAPER, IN CLASS 16 (U.S. CLS. 2, 5, 22, 23, 29, 37, 38 AND 50).

FIRST USE 2-1-2002; IN COMMERCE 9-1-2002.

FOR: ROLL LAMINATING FILM, NAMELY, PLASTIC FILM FOR USE IN PROTECTING, PRESERVING, AND ENHANCING PAPER AND VINYL MATERIALS, IN CLASS 17 (U.S. CLS. 1, 5, 12, 13, 35 AND 50).

FIRST USE 2-1-2002; IN COMMERCE 9-1-2002.



David J. Kyros

Director of the United States Patent and Trademark Office

Reg. No. 4,173,730 THE MARK CONSISTS OF STANDARD CHARACTERS WITHOUT CLAIM TO ANY PARTICULAR FONT, STYLE, SIZE, OR COLOR.

SER. NO. 85-146,897, FILED 10-7-2010.

JENNY PARK, EXAMINING ATTORNEY

United States of America

United States Patent and Trademark Office

HELIA

Reg. No. 4,173,731

Registered July 17, 2012

Int. Cl.: 7

TRADEMARK

PRINCIPAL REGISTER

EARLEX LIMITED (GREAT BRITAIN LIMITED COMPANY (LTD.))
OPUS PARK, MOORFIELD ROAD, GUILDFORD
SURREY GU1 1SZ, GREAT BRITAIN

FOR: SPRAYING APPARATUS AND DEVICES, NAMELY, POWER OPERATED SPRAYORS, NOZZLES AND CONNECTING HOSES; APPARATUS AND DEVICES, NAMELY, POWER OPERATED SPRAYERS, NOZZLES AND CONNECTING HOSES FOR SPRAYING SUN TANNING PREPARATIONS AND SOLUTIONS; HIGH VOLUME LOW PRESSURE POWER-OPERATED SPRAYING SYSTEMS, NAMELY, SPRAY GUNS AND BLOWERS; PARTS AND FITTINGS FOR ALL THE AFOREMENTIONED GOODS, IN CLASS 7 (U.S. CLS. 13, 19, 21, 23, 31, 34 AND 35).

THE MARK CONSISTS OF STANDARD CHARACTERS WITHOUT CLAIM TO ANY PARTICULAR FONT, STYLE, SIZE, OR COLOR.

OWNER OF ERPN CMNTY TM OFC REG. NO. 9424888, DATED 11-12-2010, EXPIRES 11-12-2020.

SER. NO. 85-148,626, FILED 10-8-2010.

SUSAN STIGLITZ, EXAMINING ATTORNEY



David J. Kybas

Director of the United States Patent and Trademark Office

United States of America

United States Patent and Trademark Office

Realhound

Reg. No. 4,173,732

Registered July 17, 2012

Int. Cl.: 9

TRADEMARK

PRINCIPAL REGISTER

REALHOUND.COM (CALIFORNIA CORPORATION)
1001 AVENIDA PICO STE C518
1001 AVENIDA PICO STE C514
SAN CLEMENTE, CA 92673

FOR: COMPUTER APPLICATION SOFTWARE FOR REAL ESTATE PROFESSIONALS, NAMELY, SOFTWARE FOR ORGANIZING CLIENT AND PROPERTY INFORMATION , IN CLASS 9 (U.S. CLS. 21, 23, 26, 36 AND 38).

FIRST USE 1-1-2000; IN COMMERCE 1-1-2000.

THE MARK CONSISTS OF STANDARD CHARACTERS WITHOUT CLAIM TO ANY PARTICULAR FONT, STYLE, SIZE, OR COLOR.

SER. NO. 85-149,192, FILED 10-10-2010.

BRENDAN REGAN, EXAMINING ATTORNEY



David J. Kyffers

Director of the United States Patent and Trademark Office

United States of America

United States Patent and Trademark Office

RenDx

Reg. No. 4,173,733

Registered July 17, 2012

Int. Cls.: 9, 10 and 42

TRADEMARK

SERVICE MARK

PRINCIPAL REGISTER

RENISHAW DIAGNOSTICS LTD (SCOTLAND COMPANY)
NOVA TECHNOLOGY PARK, 5 ROBROYSTON OVAL
GLASGOW, UNITED KINGDOM G331AP

FOR: MEASURING APPARATUS AND INSTRUMENTS OTHER THAN FOR MEDICAL USE, NAMELY, SPECTROPHOTOMETERS AND CHEMICAL HANDLING ROBOTS USED TO DETECT THE PRESENCE OR ABSENCE OF NUCLEIC ACIDS ASSOCIATED WITH PRE-DEFINED BIOLOGICAL TARGETS; SCANNING APPARATUS, INSTRUMENTS AND MACHINES, OTHER THAN FOR MEDICAL USE, NAMELY, SPECTROPHOTOMETERS AND CHEMICAL HANDLING ROBOTS USED TO DETECT THE PRESENCE OR ABSENCE OF NUCLEIC ACIDS ASSOCIATED WITH PREDEFINED BIOLOGICAL TARGETS; RAMAN MICROSCOPES; SPECTROPHOTOMETERS FOR SCIENTIFIC AND MEDICAL RESEARCH AND SCIENTIFIC, HUMAN DIAGNOSTIC PURPOSES, NAMELY, SPECTROPHOTOMETERS USED TO DETECT THE PRESENCE OR ABSENCE OF NUCLEIC ACIDS ASSOCIATED WITH PATHOGENS CAUSING DISEASE; SPECTROPHOTOMETERS, NAMELY, SPECTROPHOTOMETERS THAT UTILIZE RAMAN SPECTROSCOPY TO DETECT THE PRESENCE OR ABSENCE OF NUCLEIC ACIDS ASSOCIATED WITH PREDEFINED BIOLOGICAL TARGETS; SPECTROPHOTOMETERS, NAMELY, SPECTROPHOTOMETERS THAT UTILIZE SURFACE ENHANCED RESONANCE RAMAN SCATTERING (SERRS) SPECTROSCOPY FOR RESEARCH APPLICATIONS AND NON-MEDICAL MOLECULAR HUMAN DIAGNOSTIC PURPOSES; IN-VITRO HUMAN DIAGNOSTIC TESTING APPARATUS INCORPORATING CHEMICAL REAGENTS OTHER THAN FOR MEDICAL USE, NAMELY, SPECTROPHOTOMETERS AND CHEMICAL HANDLING ROBOTS USED TO DETECT THE PRESENCE OR ABSENCE OF NUCLEIC ACIDS ASSOCIATED WITH PREDEFINED BIOLOGICAL TARGETS; SPECTROSCOPY SYSTEMS FOR SCIENTIFIC RESEARCH AND SCIENTIFIC, HUMAN DIAGNOSTIC PURPOSES, NAMELY, SPECTROPHOTOMETERS USED TO DETECT RESONANT DYES AT A MOLECULAR LEVEL WHICH ARE ASSOCIATED WITH PREDEFINED NUCLEIC ACID TARGETS; SPECTROSCOPY SYSTEMS FOR SCIENTIFIC RESEARCH AND SCIENTIFIC, HUMAN DIAGNOSTIC PURPOSES, NAMELY, SPECTROPHOTOMETERS THAT UTILIZE SURFACE ENHANCED RESONANCE RAMAN SCATTERING TECHNOLOGY TO DETECT RESONANT DYES AT A MOLECULAR LEVEL WHICH ARE ASSOCIATED WITH PREDEFINED NUCLEIC ACID TARGETS; SPECTROSCOPY INSTRUMENTS, NAMELY, LABORATORY EQUIPMENT IN THE NATURE OF SPECTROPHOTOMETERS; LASERS FOR NON-MEDICAL PURPOSES; MICROSCOPE STAGES; CHEMICAL HANDLING ROBOTS FOR NON-MEDICAL USE; DOWNLOADABLE ELECTRONIC PUBLICATIONS, NAMELY, INSTRUCTIONAL AND SERVICE MANUALS FOR SCIENTIFIC APPARATUS AND MATERIALS, NAMELY, SPECTROPHOTOMETERS, RAMAN MICROSCOPES, MICRO-



David J. Kyjars

Director of the United States Patent and Trademark Office

Reg. No. 4,173,733 SCOPE STAGES, CHEMICAL HANDLING ROBOTS FOR NON-MEDICAL USE, LASERS FOR NON-MEDICAL PURPOSES, RESONANT DYES THAT ATTACH TO NUCLEIC ACIDS FOR USE IN DETECTION OF MOLECULES BY SPECTROSCOPY INSTRUMENTS, AND COMPUTER PROGRAMS FOR CONTROLLING ROBOT HANDLING MACHINES; COMPUTER PROGRAMS FOR CONTROLLING ROBOT HANDLING MACHINES, IN CLASS 9 (U.S. CLS. 21, 23, 26, 36 AND 38).

FOR: SPECTROPHOTOMETERS FOR MEDICAL DIAGNOSTIC PURPOSES FOR HUMANS, NAMELY, SPECTROPHOTOMETERS USED TO DETECT THE PRESENCE OR ABSENCE OF NUCLEIC ACIDS ASSOCIATED WITH PATHOGENS CAUSING DISEASE, IN CLASS 10 (U.S. CLS. 26, 39 AND 44).

FOR: TECHNICAL SUPPORT SERVICES, NAMELY, PROVIDING TECHNICAL ADVICE REGARDING OPERATION OF SCIENTIFIC EQUIPMENT IN THE FIELD OF HUMAN DISEASE RESEARCH AND DIAGNOSTICS; SCIENTIFIC RESEARCH AND DEVELOPMENT IN THE FIELD OF HUMAN DISEASE RESEARCH AND DIAGNOSTICS; INDUSTRIAL ANALYSIS AND RESEARCH SERVICES IN THE FIELD OF HUMAN DISEASE RESEARCH AND DIAGNOSTICS; CALIBRATION OF INDUSTRIAL AND TECHNICAL APPARATUS AND INSTRUMENTS IN THE FIELD OF HUMAN DISEASE RESEARCH AND DIAGNOSTICS, IN CLASS 42 (U.S. CLS. 100 AND 101).

THE MARK CONSISTS OF STANDARD CHARACTERS WITHOUT CLAIM TO ANY PARTICULAR FONT, STYLE, SIZE, OR COLOR.

PRIORITY CLAIMED UNDER SEC. 44(D) ON ERPN CMNTY TM OFC APPLICATION NO. 9434226, FILED 10-8-2010, REG. NO. 009434226, DATED 5-16-2011, EXPIRES 10-8-2020.

SER. NO. 85-150,863, FILED 10-12-2010.

SARA BENJAMIN, EXAMINING ATTORNEY

United States of America

United States Patent and Trademark Office

MINNESOTA LETTERS

Reg. No. 4,173,734

GEMINI, INC. (MINNESOTA CORPORATION)
103 MENSING WAY
CANNON FALLS, MN 55009

Registered July 17, 2012

Int. Cl.: 16

FOR: PRE-CAST PLASTIC LETTERS OR CHARACTERS FOR DISPLAY ON SIGN BOARDS,
IN CLASS 16 (U.S. CLS. 2, 5, 22, 23, 29, 37, 38 AND 50).

TRADEMARK

FIRST USE 0-0-1984; IN COMMERCE 0-0-1984.

PRINCIPAL REGISTER

THE MARK CONSISTS OF STANDARD CHARACTERS WITHOUT CLAIM TO ANY PARTICULAR FONT, STYLE, SIZE, OR COLOR.

NO CLAIM IS MADE TO THE EXCLUSIVE RIGHT TO USE "LETTERS", APART FROM THE MARK AS SHOWN.

SEC. 2(F).

SER. NO. 85-155,897, FILED 10-19-2010.

JASON BLAIR, EXAMINING ATTORNEY



David J. Kybas

Director of the United States Patent and Trademark Office

United States of America

United States Patent and Trademark Office



Reg. No. 4,173,735

CERTEK HEAT MACHINES INC. (CANADA CORPORATION)
BOX 87

Registered July 17, 2012

GRANDE PRAIRIE ALBERTA, CANADA T8V3A1

Int. Cl.: 40

FOR: RENTAL OF PROPYLENE GLYCOL HEATERS FOR INDUSTRIAL AND COMMERCIAL USE, CUSTOM MANUFACTURE OF PROPYLENE GLYCOL HEATERS FOR INDUSTRIAL AND COMMERCIAL USE, IN CLASS 40 (U.S. CLS. 100, 103 AND 106).

SERVICE MARK

FIRST USE 12-31-2000; IN COMMERCE 12-31-2004.

PRINCIPAL REGISTER

NO CLAIM IS MADE TO THE EXCLUSIVE RIGHT TO USE "HEAT MACHINE", APART FROM THE MARK AS SHOWN.

THE MARK CONSISTS OF FLAME IN THE FOREGROUND OF A CIRCLE AND ENCASED IN A ROUNDED SQUARE POSITIONED TO THE RIGHT OF THE PHRASE "CERTEK HEAT MACHINE" IN A RECTANGLE DESIGN WHERE THERE ARE TWO PARALLEL LINES OVER AND UNDER THE WORDING AND DESIGN.

SER. NO. 85-157,269, FILED 10-20-2010.

LINDA ORNDORFF, EXAMINING ATTORNEY



David J. Kyffers

Director of the United States Patent and Trademark Office

United States of America

United States Patent and Trademark Office

BIRTEE PRO

Reg. No. 4,173,736

Registered July 17, 2012

Int. Cl.: 28

CAYA, MARIO (CANADA INDIVIDUAL)
317 CHERIE HILL ROAD, RR5
PERTH
ONTARIO, CANADA K7H3C7

FOR: GOLF TEES, IN CLASS 28 (U.S. CLS. 22, 23, 38 AND 50).

TRADEMARK

THE MARK CONSISTS OF STANDARD CHARACTERS WITHOUT CLAIM TO ANY PARTICULAR FONT, STYLE, SIZE, OR COLOR.

PRINCIPAL REGISTER

PRIORITY CLAIMED UNDER SEC. 44(D) ON CANADA APPLICATION NO. 1478312, FILED 4-23-2010, REG. NO. TMA818,601, DATED 2-28-2012, EXPIRES 2-28-2027.

OWNER OF U.S. REG. NO. 3,601,108.

NO CLAIM IS MADE TO THE EXCLUSIVE RIGHT TO USE "PRO", APART FROM THE MARK AS SHOWN.

SER. NO. 85-158,886, FILED 10-22-2010.

BERNICE MIDDLETON, EXAMINING ATTORNEY



David J. Kyros

Director of the United States Patent and Trademark Office

United States of America

United States Patent and Trademark Office

LI-DAT

Reg. No. 4,173,737

ESPERTI PETERSON AND CAHOONE, LLC (WYOMING LIMITED LIABILITY COMPANY)
1605 MAIN STREET, SUITE 900
SARASOTA, FL 34236

Registered July 17, 2012

Int. Cl.: 36

FOR: FINANCIAL ADMINISTRATION OF INSURANCE SERVICES, NAMELY, SERVICES RENDERED BY AGENTS AND BROKERS ENGAGED IN INSURANCE, SERVICES RENDERED TO INSURED, AND INSURANCE UNDERWRITING SERVICES, IN CLASS 36 (U.S. CLS. 100, 101 AND 102).

SERVICE MARK

PRINCIPAL REGISTER

FIRST USE 10-11-2010; IN COMMERCE 10-11-2010.

THE MARK CONSISTS OF STANDARD CHARACTERS WITHOUT CLAIM TO ANY PARTICULAR FONT, STYLE, SIZE, OR COLOR.

SER. NO. 85-159,096, FILED 10-22-2010.

TIMOTHY FINNEGAN, EXAMINING ATTORNEY



David J. Kyffers

Director of the United States Patent and Trademark Office

United States of America

United States Patent and Trademark Office



Reg. No. 4,173,738

Registered July 17, 2012

Int. Cl.: 1

TRADEMARK

PRINCIPAL REGISTER

LIANYUNGANG LIANLIAN CHEMICALS CO., LTD (CHINA CORPORATION)
LINGANG INDUSTRY ZONE, GUANYUN TOWN
WEI NO. 7 RD. SOUTH, JING NO. 4 RD. WEST
LIANYUNGANG CITY, CHINA JIANGSUPR

FOR: VULCANIZATION ACCELERATORS; ACCELERATORS, NAMELY, CHEMICAL PREPARATIONS USED IN RUBBER MANUFACTURING; ANTIOXIDANT, NAMELY, RUBBER ANTIOXIDANTS USED IN THE RUBBER MANUFACTURING PROCESS, TO RESIST OZONE AGING AND CRACKING, AND IMPROVE WEATHERABILITY OF COSMETICS, BEVERAGES, FOOD PRODUCTS AND FOOD SUPPLEMENTS; AGRICULTURAL CHEMICALS, EXCEPT FUNGICIDES, WEED KILLERS, HERBICIDES, INSECTICIDES AND PARASITICIDES; CHEMICAL REAGENTS FOR NON-MEDICAL OR VETERINARY PURPOSES; PLASTICIZERS; ADHESIVE FOR INDUSTRIAL PURPOSES, IN CLASS 1 (U.S. CLS. 1, 5, 6, 10, 26 AND 46).

OWNER OF CHINA REG. NO. 4739171, DATED 12-14-2008, EXPIRES 12-13-2018.

THE MARK CONSISTS OF A TWO CURVE LINES THAT LOOKS LIKE A BEAKER AND THE WORD "LIANLIAN" IS UNDERNEATH THE DESIGN.

THE ENGLISH TRANSLATION OF "LIAN" IN THE MARK IS "CONNECTION". THE WORDING "LIANLIAN" HAS NO MEANING IN A FOREIGN LANGUAGE.

SER. NO. 85-160,932, FILED 10-26-2010.

PAULA MAHONEY, EXAMINING ATTORNEY



David J. Kybas

Director of the United States Patent and Trademark Office

United States of America

United States Patent and Trademark Office

PRIVACY BOARD

Reg. No. 4,173,739

Registered July 17, 2012

Int. Cl.: 17

TRADEMARK

PRINCIPAL REGISTER

WILREP LTD. (CANADA CORPORATION)
C10
1515 MATHESON BLVD EAST
MISSISSAUGA, ONTARIO, CANADA L4W2P5

FOR: PRE-ENGINEERED ACOUSTICAL INSULATION BARRIER SYSTEM COMPRISING MINERAL FIBER BOARD PANELS AND AIR DISTRIBUTION SOUND ATTENUATION SILENCER UNITS FOR USE BETWEEN OFFICE AREAS FROM THE TOP OF THE PARTITION WALLS TO THE UNDERSIDE OF THE CEILING DECK ABOVE, IN CLASS 17 (U.S. CLS. 1, 5, 12, 13, 35 AND 50).

THE MARK CONSISTS OF STANDARD CHARACTERS WITHOUT CLAIM TO ANY PARTICULAR FONT, STYLE, SIZE, OR COLOR.

PRIORITY CLAIMED UNDER SEC. 44(D) ON CANADA APPLICATION NO. 1491498, FILED 8-6-2010, REG. NO. TMA804444, DATED 8-15-2011, EXPIRES 8-15-2026.

NO CLAIM IS MADE TO THE EXCLUSIVE RIGHT TO USE "BOARD", APART FROM THE MARK AS SHOWN.

SER. NO. 85-161,231, FILED 10-26-2010.

MICHAEL WIENER, EXAMINING ATTORNEY



David J. Kybas

Director of the United States Patent and Trademark Office

United States of America

United States Patent and Trademark Office



Reg. No. 4,173,740

Registered July 17, 2012

Int. Cl.: 9

TRADEMARK

PRINCIPAL REGISTER

COMPUTER PROCESS CONTROLS, INC. (GEORGIA CORPORATION)
1640 AIRPORT ROAD, SUITE 104
KENNESAW, GA 30144

FOR: CONTROLLERS, NAMELY, VARIABLE AIR VOLUME (VAV) SYSTEM CONTROLLERS, PROGRAMMABLE LOGIC CONTROLLERS (PLCS), ELECTRICAL CONTROLLERS, POWER CONTROLLERS, TEMPERATURE CONTROLLERS FOR DISPLAY CASES AND REFRIGERATED CABINETS; ELECTRONIC CONTROLLERS FOR LIGHTING, HVAC UNITS, COMPRESSORS, CONDENSERS, DISPLAY FIXTURES, REFRIGERANT LEAK DETECTION SYSTEMS, REMOTE MONITORING AND ALARMING SYSTEMS, CURRENT TRANSFORMERS AND REFRIGERATED DISPLAY CASES; ELECTRIC CONTROL PANELS FOR LIGHTING, HVAC UNITS, COMPRESSORS, CONDENSERS, DISPLAY FIXTURES, REFRIGERANT LEAK DETECTION SYSTEMS, REMOTE MONITORING AND ALARMING SYSTEMS, CURRENT TRANSFORMERS AND REFRIGERATED DISPLAY CASES; ELECTRONIC CONTROLLERS FOR REFRIGERATED DISPLAY CASES; ELECTRIC CONTROL PANELS FOR REFRIGERATED DISPLAY CASES; MODEM BOARDS; I/O BOARDS, NAMELY, COMPUTER INTERFACE BOARDS, DATA COMMUNICATION HARDWARE, MICROCONTROLLERS, CIRCUIT BOARDS; COMPUTER TERMINALS; SOFTWARE FOR MONITORING CONTROLLERS AND CONTROLS, ELECTRICAL DISTRIBUTION SYSTEMS, NAMELY, POWER DISTRIBUTION PANELS; POWER MONITORING EQUIPMENT, NAMELY, COMPUTERS, COMPUTER HARDWARE, ELECTRIC METERS, POWER CONTROLLERS, IN CLASS 9 (U.S. CLS. 21, 23, 26, 36 AND 38).

FIRST USE 1-31-1995; IN COMMERCE 1-31-1995.

NO CLAIM IS MADE TO THE EXCLUSIVE RIGHT TO USE "CONTROLS", APART FROM THE MARK AS SHOWN.

THE MARK CONSISTS OF THE TERM "COMPUTER PROCESS CONTROLS" BENEATH THE LETTERS "CPC" AND A REPRESENTATION OF A FACE AND A KEYPAD.

SEC. 2(F) AS TO "COMPUTER PROCESS CONTROLS".

SER. NO. 85-161,449, FILED 10-26-2010.

KATHERINE CONNOLLY, EXAMINING ATTORNEY



David J. Kyffers

Director of the United States Patent and Trademark Office

United States of America

United States Patent and Trademark Office

TRAINING WHEY

Reg. No. 4,173,741

Registered July 17, 2012

Int. Cl.: 5

TRADEMARK

PRINCIPAL REGISTER

WEIDER GLOBAL NUTRITION, LLC (NEVADA LIMITED LIABILITY COMPANY)
2002 SOUTH 5070 WEST
SALT LAKE CITY, UT 84104

FOR: DIETARY SUPPLEMENTS CONTAINING WHEY; DIETARY SUPPLEMENTS FOR HUMAN CONSUMPTION CONTAINING WHEY; POWDERED NUTRITIONAL SUPPLEMENT DRINK MIX CONTAINING WHEY, IN CLASS 5 (U.S. CLS. 6, 18, 44, 46, 51 AND 52).

FIRST USE 10-4-2011; IN COMMERCE 10-4-2011.

THE MARK CONSISTS OF STANDARD CHARACTERS WITHOUT CLAIM TO ANY PARTICULAR FONT, STYLE, SIZE, OR COLOR.

NO CLAIM IS MADE TO THE EXCLUSIVE RIGHT TO USE "WHEY", APART FROM THE MARK AS SHOWN.

SER. NO. 85-161,934, FILED 10-26-2010.

THEODORE MCBRIDE, EXAMINING ATTORNEY



David J. Kyros

Director of the United States Patent and Trademark Office

United States of America

United States Patent and Trademark Office

Envy

Reg. No. 4,173,742

CHADE FASHIONS, INC. (ILLINOIS CORPORATION)
6400 W. GROSS POINT RD.
NILES, IL 60714

Registered July 17, 2012

Int. Cl.: 26

FOR: HAIRWARE, NAMELY, WIGS, HAIRPIECES, AND ADD-IN AND ADD-ON HAIR ACCESSORIES CONSTRUCTED PRIMARILY OF SYNTHETIC AND/OR HUMAN HAIR; WIG CAPS; TAPE FOR FIXING WIGS, IN CLASS 26 (U.S. CLS. 37, 39, 40, 42 AND 50).

TRADEMARK

FIRST USE 9-10-1999; IN COMMERCE 9-10-1999.

PRINCIPAL REGISTER

THE MARK CONSISTS OF STANDARD CHARACTERS WITHOUT CLAIM TO ANY PARTICULAR FONT, STYLE, SIZE, OR COLOR.

SER. NO. 85-162,313, FILED 10-27-2010.

JIM RINGLE, EXAMINING ATTORNEY



David J. Kyffers

Director of the United States Patent and Trademark Office

United States of America

United States Patent and Trademark Office



Reg. No. 4,173,743

Registered July 17, 2012

Int. Cls.: 37, 41 and 42

SERVICE MARK

PRINCIPAL REGISTER

SHERMCO INDUSTRIES, INC. (TEXAS CORPORATION)
2425 EAST PIONEER DRIVE
IRVING, TX 75061

FOR: PROVIDING CLEAN-UP, COMMISSIONING, INSTALLATION, MAINTENANCE, MODIFICATION, REMANUFACTURE, REPAIR, RESTORATION, CONVERSION AND RETROFITTING, AND SYSTEM STARTUP, IN THE FIELD OF ELECTRICAL POWER SYSTEMS, THE SYSTEMS INCLUDING APPARATUS FOR ELECTRICAL GENERATION, DISTRIBUTION, SUPPLY, CONTROL, AND ROTATING ELECTRICAL APPARATUS, IN CLASS 37 (U.S. CLS. 100, 103 AND 106).

FIRST USE 5-1-1974; IN COMMERCE 5-1-1974.

FOR: EDUCATIONAL AND TRAINING SERVICES, NAMELY, CONDUCTING CLASSES, COURSES, PROGRAMS, AND PRESENTATIONS, IN THE FIELD OF ELECTRICAL POWER SYSTEMS, THE SYSTEMS INCLUDING APPARATUS FOR ELECTRICAL GENERATION, DISTRIBUTION, SUPPLY, CONTROL, AND ROTATING ELECTRICAL, IN CLASS 41 (U.S. CLS. 100, 101 AND 107).

FIRST USE 3-1-2001; IN COMMERCE 3-1-2001.

FOR: PROVIDING TECHNICAL ANALYSIS, TESTING, EVALUATION, CONSULTING, DESIGN, TECHNICAL WRITING, ENGINEERING STUDIES, FORENSIC SCIENCE SERVICES, DATA-ACQUISITION, INSPECTION, RESEARCH, AND TECHNICAL SUPPORT IN THE NATURE OF DIAGNOSING AND TROUBLESHOOTING PROBLEMS, ALL RELATING TO THE FIELD OF ELECTRICAL POWER SYSTEMS, THE SYSTEMS INCLUDING APPARATUS FOR ELECTRICAL GENERATION, DISTRIBUTION, SUPPLY, CONTROL, AND ROTATING ELECTRICAL APPARATUS EXCLUDING COMPUTER SOFTWARE AND COMPUTER SYSTEM CONSULTATION, COMPUTER SOFTWARE AND COMPUTER SYSTEM DESIGN, COMPUTER SOFTWARE AND COMPUTER SYSTEM SELECTION, COMPUTER SOFTWARE AND COMPUTER SYSTEM IMPLEMENTATION, COMPUTER SOFTWARE AND COMPUTER SYSTEM MAINTENANCE, COMPUTER SOFTWARE AND COMPUTER SYSTEM TECHNICAL SUPPORT AND COMPUTER SOFTWARE AND COMPUTER SYSTEM PROGRAMMING SERVICES, IN CLASS 42 (U.S. CLS. 100 AND 101).

FIRST USE 5-1-1974; IN COMMERCE 5-1-1974.



David J. Kybas

Director of the United States Patent and Trademark Office

Reg. No. 4,173,743 THE MARK CONSISTS OF AN UPPERCASE LETTER "S" FOLLOWED IMMEDIATELY BY A LOWERCASE LETTER "I", WHERE THE "I" IS DOTTED BY A REPRESENTATION OF A GEAR WITH A SINE WAVE EXTENDING HORIZONTALLY ACROSS THE GEAR.

SER. NO. 85-163,579, FILED 10-28-2010.

JORDAN BAKER, EXAMINING ATTORNEY

United States of America

United States Patent and Trademark Office

DIVASOLUTIONS

Reg. No. 4,173,744

Registered July 17, 2012

Int. Cl.: 42

SERVICE MARK

PRINCIPAL REGISTER

FRONT PORCH DIGITAL, INC. (DELAWARE CORPORATION)
SUITE 204
2011 CHERRY STREET
LOUISVILLE, CO 80027

FOR: COMPUTER SERVICES, NAMELY, DIGITAL FORMATTING OF VIDEOTAPE IMAGES INTO DIGITAL VIDEO FILES; DATA MIGRATION SERVICES; COMPUTER SERVICES, NAMELY, DISTRIBUTING DIGITAL VIDEO CONTENT ACROSS PRIVATE AND PUBLIC CLOUD COMPUTING ENVIRONMENTS; COMPUTER SERVICES, NAMELY, PROVIDING AN INTERACTIVE WEB SITE FEATURING TECHNOLOGY THAT ALLOWS USERS TO COLLECT, STORE, MANAGE, DELIVER AND SHOWCASE ELECTRONIC VIDEO CONTENT, IN CLASS 42 (U.S. CLS. 100 AND 101).

FIRST USE 10-9-2010; IN COMMERCE 10-9-2010.

THE MARK CONSISTS OF STANDARD CHARACTERS WITHOUT CLAIM TO ANY PARTICULAR FONT, STYLE, SIZE, OR COLOR.

OWNER OF U.S. REG. NOS. 2,864,097, 3,626,187, AND 3,865,183.

SER. NO. 85-166,887, FILED 11-2-2010.

ANN E. SAPPENFIELD, EXAMINING ATTORNEY



David J. Kyffers

Director of the United States Patent and Trademark Office

United States of America

United States Patent and Trademark Office

SURVIVOR OUTREACH SERVICES

Reg. No. 4,173,745

Registered July 17, 2012

Int. Cl.: 45

SERVICE MARK

PRINCIPAL REGISTER

SURVIVOR OUTREACH SERVICES, LLC (TEXAS LIMITED LIABILITY COMPANY)
6800 BISHOP ROAD, SUITE 220
PLANO, TX 75024

FOR: CONCIERGE SERVICES FOR OTHERS COMPRISING ASSISTING OWNERS AND BENEFICIARIES OF INSURANCE POLICIES THROUGH THE INSURANCE CLAIMS PROCESS, ASSISTING WITH FUNERAL ASSIGNMENTS AND NOTIFYING FINANCIAL INSTITUTIONS, GOVERNMENT AND CREDIT REPORTING AGENCIES OF DEATHS, IN CLASS 45 (U.S. CLS. 100 AND 101).

FIRST USE 5-0-2007; IN COMMERCE 5-0-2007.

THE MARK CONSISTS OF STANDARD CHARACTERS WITHOUT CLAIM TO ANY PARTICULAR FONT, STYLE, SIZE, OR COLOR.

NO CLAIM IS MADE TO THE EXCLUSIVE RIGHT TO USE "OUTREACH SERVICES", APART FROM THE MARK AS SHOWN.

SEC. 2(F).

SER. NO. 85-167,356, FILED 11-2-2010.

MICHAEL KEATING, EXAMINING ATTORNEY



David J. Kybas

Director of the United States Patent and Trademark Office

United States of America

United States Patent and Trademark Office

Apiste

Reg. No. 4,173,746

Registered July 17, 2012

Int. Cls.: 9 and 11

TRADEMARK

PRINCIPAL REGISTER

APISTE CORPORATION (JAPAN CORPORATION)
1-4-16 DOJIMA, KITA-KU
OSAKA, JAPAN

FOR: MEASURING APPARATUS FOR TEMPERATURE; THERMAL INSPECTION SYSTEMS, NOT FOR MEDICAL USE, COMPRISED OF INFRARED CAMERAS; THERMOGRAPHY APPARATUS FOR MONITORING HEAT DISTRIBUTION; DIGITAL THERMOGRAPHIC MICROSCOPES; SOFTWARE PROGRAMS FOR PROCESSING AND ANALYZING THERMOGRAPHIC INFORMATION GAINED FROM INFRARED CAMERAS; COOLING APPARATUS FOR COMPUTERS, NAMELY, INTERNAL COOLING FANS FOR COMPUTERS; COOLING APPARATUS FOR POWER DISTRIBUTION OR CONTROL MACHINES AND APPARATUS, NAMELY, INTERNAL COOLERS FOR ELECTRIC CONTROL PANELS; ELECTRICAL POWER METERS; ELECTRIC MONITORS AND MONITOR MODULES FOR MONITORING ELECTRIC ENERGY, ELECTRIC POWER, ELECTRIC PRESSURE AND ELECTRIC CURRENT USAGE; DATA COLLECTING APPARATUS IN THE NATURE OF A SYSTEM COMPRISING A COMPUTER AND ELECTRIC FLOW METER USING TELECOMMUNICATION FOR MONITORING ELECTRIC ENERGY, ELECTRIC POWER, ELECTRIC PRESSURE AND ELECTRIC CURRENT USAGE; COMPUTER PROGRAMS FOR USE WITH DATA COLLECTING APPARATUS FOR USE IN DATABASE MANAGEMENT; DEFECTIVE INSULATION DETECTORS, NAMELY, ELECTRICAL INSULATION MONITORS; ELECTRONIC DOOR OPENING AND CLOSING STATUS SWITCHES; THERMOSTATS; CONTROLLING APPARATUS FOR TEMPERATURE AND HUMIDITY, NAMELY, TEMPERATURE AND HUMIDITY CONTROLLERS FOR AIR IN ELECTRIC CONTROL PANELS; WIND SPEED SENSORS, TEMPERATURE SENSORS AND HUMIDITY SENSORS; ELECTRICAL POWER SUPPLIES, IN CLASS 9 (U.S. CLS. 21, 23, 26, 36 AND 38).

FIRST USE 12-1-1992; IN COMMERCE 3-21-2007.

FOR: AIR COOLING APPARATUS; LIQUID COOLING APPARATUS, NAMELY, WATER-COOLED PROCESS CHILLERS USING CIRCULATING WATER COOLANTS THAT PROVIDE TEMPERATURE CONTROLLED FLUID TO VARIOUS APPLICATIONS IN THE ANALYTICAL, SEMICONDUCTOR, LASER, PLASTICS AND PACKAGING MARKETS; COOLING APPLIANCES AND INSTALLATIONS, NAMELY, AIR-CONDITIONERS; AIR-CONDITIONING, AIR COOLING AND VENTILATION APPARATUS AND INSTRUMENTS; AIR CONDITIONING APPARATUS; FILTERS FOR AIR CONDITIONING; LIQUID TEMPERATURE CONDITIONING APPARATUS, NAMELY, WATER-COOLED AND WATER-HEATED CHILLER UNITS THAT COOL DOWN CIRCULATING WATER AND CONTROL THE WATER



David J. Kybas

Director of the United States Patent and Trademark Office

Reg. No. 4,173,746 TEMPERATURE FOR INDUSTRIAL USE; AIR COOLING APPARATUS HAVING HUMIDIFIERS; HUMIDIFIERS; AIR COOLING APPARATUS HAVING TEMPERATURE AND HUMIDITY CONTROLLERS; FAN FILTER UNIT FOR FILTERING AIR; MACHINES THAT GENERATE PURIFIED WATER FROM THE ATMOSPHERE AND SIMULTANEOUSLY PURIFY THE AIR; CLEAN ROOMS; OIL TEMPERATURE CONDITIONING APPARATUS, NAMELY, OIL-COOLED AND OIL-HEATED OIL CHILLERS THAT COOL DOWN OIL IN MACHINE TOOLS AND CONTROL THE OIL TEMPERATURE FOR INDUSTRIAL USE; OIL COOLING APPARATUS, NAMELY, OIL CHILLERS THAT COOL DOWN OIL IN MACHINE TOOLS BY CIRCULATING OIL COOLANTS FOR INDUSTRIAL USE; HEAT EXCHANGERS, NOT BEING PARTS OF MACHINES; EVAPORATORS; ELECTRIC FANS; DEHUMIDIFIERS; ELECTRIC HEATERS FOR COMMERCIAL USE, IN CLASS 11 (U.S. CLS. 13, 21, 23, 31 AND 34).

FIRST USE 12-1-1992; IN COMMERCE 3-21-2007.

THE MARK CONSISTS OF THE WORDING "APISTE" IN STYLIZED FONT.

SER. NO. 85-169,511, FILED 11-4-2010.

JERI J. FICKES, EXAMINING ATTORNEY

United States of America

United States Patent and Trademark Office

MANDEL METALS

Reg. No. 4,173,747

Registered July 17, 2012

Int. Cls.: 6, 35 and 40

TRADEMARK

SERVICE MARK

PRINCIPAL REGISTER

MANDEL METALS, INC. (ILLINOIS CORPORATION)
11400 W. ADDISON STREET
FRANKLIN PARK, IL 60131

FOR: UNFINISHED ALUMINUM AND STAINLESS STEEL FOR FURTHER MANUFACTURE, NAMELY, SHEETS, PLATES, AND COILS, IN CLASS 6 (U.S. CLS. 2, 12, 13, 14, 23, 25 AND 50).

FIRST USE 9-5-1968; IN COMMERCE 9-5-1968.

FOR: DISTRIBUTORSHIP SERVICES IN THE FIELD OF ALUMINUM AND STAINLESS STEEL PRODUCTS, NAMELY, COILS, SHEETS, PLATES, BARS, RODS, TUBES, SHAPES AND SIGN BLANKS, IN CLASS 35 (U.S. CLS. 100, 101 AND 102).

FIRST USE 9-5-1968; IN COMMERCE 9-5-1968.

FOR: MANUFACTURING SERVICES FOR OTHERS IN THE FIELD OF ALUMINUM AND STAINLESS STEEL, NAMELY, CUTTING, LEVELING, SLITTING, SHEARING, BAR CUTTING, PLATE SAWING, PUNCHING, AND CONVERSION COATING, IN CLASS 40 (U.S. CLS. 100, 103 AND 106).

FIRST USE 9-5-1968; IN COMMERCE 9-5-1968.

THE MARK CONSISTS OF STANDARD CHARACTERS WITHOUT CLAIM TO ANY PARTICULAR FONT, STYLE, SIZE, OR COLOR.

NO CLAIM IS MADE TO THE EXCLUSIVE RIGHT TO USE "METALS", APART FROM THE MARK AS SHOWN.

SEC. 2(F).

SER. NO. 85-169,661, FILED 11-4-2010.

CORY BOONE, EXAMINING ATTORNEY



David J. Kyros

Director of the United States Patent and Trademark Office

United States of America
United States Patent and Trademark Office

BRONXCARE

Reg. No. 4,173,748

BRONX-LEBANON HOSPITAL CENTER (NEW YORK NON-PROFIT CORPORATION)
1276 FULTON AVENUE
BRONX, NY 10456

Registered July 17, 2012

Int. Cl.: 44

FOR: HEALTH CARE, NAMELY, COMMUNITY BASED PRIMARY HEALTH CARE AND HOSPITAL SERVICES, IN CLASS 44 (U.S. CLS. 100 AND 101).

SERVICE MARK

FIRST USE 2-0-1997; IN COMMERCE 2-0-1997.

PRINCIPAL REGISTER

THE MARK CONSISTS OF STANDARD CHARACTERS WITHOUT CLAIM TO ANY PARTICULAR FONT, STYLE, SIZE, OR COLOR.

SEC. 2(F).

SER. NO. 85-170,458, FILED 11-5-2010.

JOHN WILKE, EXAMINING ATTORNEY



David J. Kyffers

Director of the United States Patent and Trademark Office

United States of America
United States Patent and Trademark Office

BRONXcare

Reg. No. 4,173,749

BRONX-LEBANON HOSPITAL CENTER (NEW YORK NON-PROFIT CORPORATION)
1276 FULTON AVENUE
BRONX, NY 10456

Registered July 17, 2012

Int. Cl.: 44

FOR: HEALTH CARE, NAMELY, COMMUNITY BASED PRIMARY HEALTH CARE AND HOSPITAL SERVICES, IN CLASS 44 (U.S. CLS. 100 AND 101).

SERVICE MARK

FIRST USE 2-0-1997; IN COMMERCE 2-0-1997.

PRINCIPAL REGISTER

THE MARK CONSISTS OF THE TERM "BRONXCARE" WITH A HEART DESIGN FORMING THE LETTER "B", THE LETTERS "RONX" IN A STYLIZED FONT AND THE LETTERS "CARE" IN A DIFFERENT STYLIZED FONT.

SEC. 2(F).

SER. NO. 85-170,468, FILED 11-5-2010.

JOHN WILKE, EXAMINING ATTORNEY



David J. Kyffers

Director of the United States Patent and Trademark Office

United States of America

United States Patent and Trademark Office

GridDNA

Reg. No. 4,173,750

Registered July 17, 2012

Int. Cl.: 9

TRADEMARK

PRINCIPAL REGISTER

VERDEECO (GEORGIA CORPORATION)
#209-232
4850 SUGARLOAF PARKWAY
LAWRENCEVILLE, GA 30046

FOR: COMPUTER SOFTWARE FOR INFORMATION ANALYTICS FOR ELECTRIC, GAS, AND MOTOR UTILITIES, IN CLASS 9 (U.S. CLS. 21, 23, 26, 36 AND 38).

FIRST USE 6-1-2008; IN COMMERCE 6-1-2008.

THE MARK CONSISTS OF STANDARD CHARACTERS WITHOUT CLAIM TO ANY PARTICULAR FONT, STYLE, SIZE, OR COLOR.

SER. NO. 85-171,461, FILED 11-8-2010.

MARC LEIPZIG, EXAMINING ATTORNEY



David J. Kybas

Director of the United States Patent and Trademark Office

United States of America

United States Patent and Trademark Office

360MOUTHGUARDS.COM

Reg. No. 4,173,751

MOHL, REUVEN (UNITED STATES INDIVIDUAL)
215 WEST 90TH STREET, SUITE 1C
NEW YORK, NY 10024

Registered July 17, 2012

Int. Cl.: 28

FOR: ATHLETIC EQUIPMENT, NAMELY, MOUTH GUARDS; MOUTH GUARDS FOR ATHLETIC USE; SPORTS EQUIPMENT FOR BOXING AND MARTIAL ARTS, NAMELY, BOXING GLOVES, BOXING BAGS, PUNCHING MITTS, BELLY PROTECTORS, GROIN PROTECTORS AND SHIN GUARDS, IN CLASS 28 (U.S. CLS. 22, 23, 38 AND 50).

TRADEMARK

PRINCIPAL REGISTER

FIRST USE 10-1-2010; IN COMMERCE 10-1-2010.

THE MARK CONSISTS OF STANDARD CHARACTERS WITHOUT CLAIM TO ANY PARTICULAR FONT, STYLE, SIZE, OR COLOR.

SER. NO. 85-172,955, FILED 11-9-2010.

WON TEAK OH, EXAMINING ATTORNEY



David J. Kyffers

Director of the United States Patent and Trademark Office

United States of America

United States Patent and Trademark Office

AtheroNova

Reg. No. 4,173,752

Registered July 17, 2012

Int. Cls.: 5 and 42

TRADEMARK

SERVICE MARK

PRINCIPAL REGISTER

ATHERONOVA INC. (DELAWARE CORPORATION)
SUITE 525
2301 DUPONT DRIVE
IRVINE, CA 92612

FOR: PHARMACEUTICAL PREPARATIONS FOR THE TREATMENT AND PREVENTION OF CARDIOVASCULAR DISEASES, ATHEROSCLEROSIS, OBESITY, AND OBESITY RELATED DISORDERS ; VITAMINS FOR THE TREATMENT AND PREVENTION OF CARDIOVASCULAR DISEASES, ATHEROSCLEROSIS, OBESITY, AND OBESITY RELATED DISORDERS ; NUTRACEUTICALS AND NUTRITIONAL SUPPLEMENTS FOR THE TREATMENT AND PREVENTION OF CARDIOVASCULAR DISEASES, ATHEROSCLEROSIS, OBESITY, AND OBESITY RELATED DISORDERS, IN CLASS 5 (U.S. CLS. 6, 18, 44, 46, 51 AND 52).

FIRST USE 8-1-2010; IN COMMERCE 9-21-2010.

FOR: SCIENTIFIC AND MEDICAL RESEARCH SERVICES IN THE FIELD OF TREATMENT AND PREVENTION OF CARDIOVASCULAR DISEASES, ATHEROSCLEROSIS, OBESITY, AND OBESITY RELATED DISORDERS, IN CLASS 42 (U.S. CLS. 100 AND 101).

FIRST USE 8-1-2010; IN COMMERCE 9-21-2010.

THE MARK CONSISTS OF STANDARD CHARACTERS WITHOUT CLAIM TO ANY PARTICULAR FONT, STYLE, SIZE, OR COLOR.

THE ENGLISH TRANSLATION OF "ATHERO" IN THE MARK IS "SOFT GRUEL-LIKE DEPOSIT"; "ATHEROMA".

SER. NO. 85-173,025, FILED 11-9-2010.

SUE LAWRENCE, EXAMINING ATTORNEY



David J. Kyjars

Director of the United States Patent and Trademark Office

United States of America

United States Patent and Trademark Office



Reg. No. 4,173,753

POWERFUL MIND COACHING, LLC (COLORADO LIMITED LIABILITY COMPANY)
4595 WEST LAKE CIRCLE
LITTLETON, CO 80123

Registered July 17, 2012

Int. Cl.: 14

FOR: JEWELRY DESIGNED TO ASSIST IN BALANCED EATING, DIET, AND A CLEAN EATING LIFESTYLE, IN CLASS 14 (U.S. CLS. 2, 27, 28 AND 50).

TRADEMARK

FIRST USE 9-29-2010; IN COMMERCE 9-29-2010.

PRINCIPAL REGISTER

THE MARK CONSISTS OF THE WORDS "POLSA PURA" IN RED BELOW A RED ARCHED LINE REPRESENTING THE TOP PORTION OF AN APPLE, WITH A GREEN LEAF APPEARING ABOVE THE RED LINE IN THE APPROXIMATE LOCATION OF THE STEM.

THE COLOR(S) RED AND GREEN IS/ARE CLAIMED AS A FEATURE OF THE MARK.

THE ENGLISH TRANSLATION OF "PURA" IN THE MARK IS PURE. THE WORDING "POLSA" HAS NO MEANING IN A FOREIGN LANGUAGE.

SER. NO. 85-173,869, FILED 11-10-2010.

NAPOLEON SHARMA, EXAMINING ATTORNEY



David J. Kyffers

Director of the United States Patent and Trademark Office

United States of America

United States Patent and Trademark Office

ASK AICA

Reg. No. 4,173,754

ACCIDENT INJURY CENTERS OF ATLANTA, INC. (GEORGIA CORPORATION)
1132 HIGHTOWER TRAIL, SUITE C
SANDY SPRINGS, GA 30350

Registered July 17, 2012

Int. Cl.: 44

FOR: HEALTH CARE SERVICES, NAMELY, MEDICAL, CHIROPRACTIC, PHYSICAL THERAPY, DIAGNOSTIC TESTING AND IMAGING SERVICES, IN CLASS 44 (U.S. CLS. 100 AND 101).

SERVICE MARK

FIRST USE 9-0-2007; IN COMMERCE 9-0-2007.

PRINCIPAL REGISTER

THE MARK CONSISTS OF STANDARD CHARACTERS WITHOUT CLAIM TO ANY PARTICULAR FONT, STYLE, SIZE, OR COLOR.

SER. NO. 85-174,767, FILED 11-11-2010.

SARA BENJAMIN, EXAMINING ATTORNEY



David J. Kybas

Director of the United States Patent and Trademark Office

United States of America

United States Patent and Trademark Office

CROA

Reg. No. 4,173,755

Registered July 17, 2012

Int. Cl.: 35

SERVICE MARK

PRINCIPAL REGISTER

SHAREDXPRTISE MEDIA, LLC (PENNSYLVANIA LIMITED LIABILITY COMPANY)
343 THORNALL STREET
EDISON, NJ 08837

FOR: ASSOCIATION SERVICES, NAMELY, PROMOTING THE INTERESTS AND CONCERNS OF BUSINESS PROFESSIONALS IN THE FIELDS OF CORPORATE MANAGEMENT, GOVERNANCE, RISK, COMPLIANCE, SUSTAINABILITY, SOCIAL RESPONSIBILITY, CITIZENSHIP, INVESTOR RELATIONS, HUMAN RELATIONS, PHILANTHROPY AND CORPORATE RESPONSIBILITY; PROVIDING INFORMATION TO BUSINESS PROFESSIONALS IN THE FIELDS OF CORPORATE MANAGEMENT, CORPORATE GOVERNANCE, BUSINESS RISK MANAGEMENT, SUSTAINABLE BUSINESS SOLUTIONS, SOCIALLY RESPONSIBLE BUSINESS PRACTICES, GOOD CORPORATE CITIZENSHIP, INVESTOR RELATIONS, HUMAN RESOURCES AND CORPORATE RESPONSIBILITY, IN CLASS 35 (U.S. CLS. 100, 101 AND 102).

FIRST USE 10-31-2007; IN COMMERCE 10-31-2007.

THE MARK CONSISTS OF STANDARD CHARACTERS WITHOUT CLAIM TO ANY PARTICULAR FONT, STYLE, SIZE, OR COLOR.

SER. NO. 85-174,782, FILED 11-11-2010.

JAMES A. RAUEN, EXAMINING ATTORNEY



David J. Kybas

Director of the United States Patent and Trademark Office

United States of America

United States Patent and Trademark Office

NANCY CHIPPENDALE

Reg. No. 4,173,756

NANCY CHIPPENDALE'S DANCE STUDIOS, INC. (MASSACHUSETTS CORPORATION)
110 SUTTON STREET, LOWER LEVEL
NORTH ANDOVER, MA 01845

Registered July 17, 2012

Int. Cl.: 41

FOR: DANCE STUDIOS; EDUCATIONAL SERVICES, NAMELY, PROVIDING CLASSES AND INSTRUCTION TO CHILDREN IN THE FIELD OF DANCE, IN CLASS 41 (U.S. CLS. 100, 101 AND 107).

SERVICE MARK

FIRST USE 0-0-1978; IN COMMERCE 0-0-1979.

PRINCIPAL REGISTER

THE MARK CONSISTS OF STANDARD CHARACTERS WITHOUT CLAIM TO ANY PARTICULAR FONT, STYLE, SIZE, OR COLOR.

THE NAME(S), PORTRAIT(S), AND/OR SIGNATURE(S) SHOWN IN THE MARK IDENTIFIES "NANCY CHIPPENDALE", WHOSE CONSENT(S) TO REGISTER IS MADE OF RECORD.

SER. NO. 85-175,674, FILED 11-12-2010.

LAURA KOVALSKY, EXAMINING ATTORNEY



David J. Kybas

Director of the United States Patent and Trademark Office

United States of America

United States Patent and Trademark Office

CALIGIORE

Reg. No. 4,173,757

LLIHUÉ S.A. (ARGENTINA CORPORATION)
VIDELA CORREAS, 381

Registered July 17, 2012

MENDOZA, ARGENTINA 5500

Int. Cl.: 33

FOR: LIQUOR; SPARKLING WINES; WINES, IN CLASS 33 (U.S. CLS. 47 AND 49).

TRADEMARK

THE MARK CONSISTS OF STANDARD CHARACTERS WITHOUT CLAIM TO ANY PARTICULAR FONT, STYLE, SIZE, OR COLOR.

PRINCIPAL REGISTER

OWNER OF ARGENTINA REG. NO. 2048802, DATED 10-26-2005, EXPIRES 10-26-2015.

THE WORDING "CALIGIORE" HAS NO MEANING IN A FOREIGN LANGUAGE.

SER. NO. 85-181,078, FILED 11-19-2010.

JOHN WILKE, EXAMINING ATTORNEY



David J. Kyffers

Director of the United States Patent and Trademark Office

United States of America

United States Patent and Trademark Office

aerometric

Geospatial Solutions

Reg. No. 4,173,758

Registered July 17, 2012

Int. Cls.: 35 and 42

SERVICE MARK

PRINCIPAL REGISTER

AERO-METRIC, INC. (WISCONSIN CORPORATION)
4020 TECHNOLOGY PARKWAY
SHEBOYGAN, WI 53083

FOR: (BASED ON USE IN COMMERCE) BUSINESS AND PROJECT MANAGEMENT AND BUSINESS PLANNING IN THE FIELD OF GEOGRAPHIC INFORMATION SYSTEMS, IN CLASS 35 (U.S. CLS. 100, 101 AND 102).

FIRST USE 11-15-2010; IN COMMERCE 11-15-2010.

FOR: (BASED ON USE IN COMMERCE) RESEARCH AND CONSULTING SERVICES IN THE FIELDS OF GEOGRAPHIC INFORMATION SYSTEMS, THE ENVIRONMENT, ENVIRONMENTAL REGULATORY REQUIREMENTS; GEOGRAPHIC INFORMATION SYSTEMS SOFTWARE DEVELOPMENT SERVICES; GEOGRAPHIC INFORMATION SYSTEMS DATABASE DESIGN; CARTOGRAPHY AND MAPPING; MARINE, AERIAL AND LAND SURVEYING, IN CLASS 42 (U.S. CLS. 100 AND 101).

FIRST USE 11-15-2010; IN COMMERCE 11-15-2010.

OWNER OF U.S. REG. NO. 3,344,199.

NO CLAIM IS MADE TO THE EXCLUSIVE RIGHT TO USE "GEOSPATIAL SOLUTIONS", APART FROM THE MARK AS SHOWN.

THE MARK CONSISTS OF THE WORD "AEROMETRIC" IN DISTINCTIVE FONT WITH OPEN SIDED BOX IN BACKGROUND AND THE WORDS "GEOSPATIAL SOLUTIONS" IN DISTINCTIVE FONT TO THE RIGHT, RUNNING FROM BOTTOM TO TOP OF MARK.

SER. NO. 85-181,919, FILED 11-21-2010.

SUE LAWRENCE, EXAMINING ATTORNEY



David J. Kybas

Director of the United States Patent and Trademark Office

United States of America

United States Patent and Trademark Office

Jenkins Orphanage

Reg. No. 4,173,759

ORPHAN AID SOCIETY, INC. (SOUTH CAROLINA CORPORATION)
3923 AZAELA DRIVE
CHARLESTON, SC 29405

Registered July 17, 2012

Int. Cl.: 43

FOR: CHILD WELFARE SERVICES, NAMELY, PROVIDING RESIDENTIAL HOMES AND HOUSING FOR AT-RISK CHILDREN AND YOUTH, IN CLASS 43 (U.S. CLS. 100 AND 101).

SERVICE MARK

FIRST USE 7-17-1891; IN COMMERCE 7-17-1891.

PRINCIPAL REGISTER

THE MARK CONSISTS OF STANDARD CHARACTERS WITHOUT CLAIM TO ANY PARTICULAR FONT, STYLE, SIZE, OR COLOR.

NO CLAIM IS MADE TO THE EXCLUSIVE RIGHT TO USE "ORPHANAGE", APART FROM THE MARK AS SHOWN.

SEC. 2(F).

SER. NO. 85-182,697, FILED 11-22-2010.

TINA L. SNAPP, EXAMINING ATTORNEY



David J. Kybas

Director of the United States Patent and Trademark Office

United States of America

United States Patent and Trademark Office

D'FRUTA

Reg. No. 4,173,760

TRIGO CORPORATION (PUERTO RICO CORPORATION)
P.O. BOX 2369

Registered July 17, 2012

TOA BAJA, PUERTO RICO 007592661

Int. Cl.: 33

FOR: FRUIT WINE; WINE, IN CLASS 33 (U.S. CLS. 47 AND 49).

TRADEMARK

FIRST USE 11-15-2010; IN COMMERCE 11-15-2010.

PRINCIPAL REGISTER

THE MARK CONSISTS OF STANDARD CHARACTERS WITHOUT CLAIM TO ANY PARTICULAR FONT, STYLE, SIZE, OR COLOR.

THE WORDING D'FRUTA HAS NO MEANING IN A FOREIGN LANGUAGE.

SER. NO. 85-183,512, FILED 11-23-2010.

KEVON CHISOLM, EXAMINING ATTORNEY



David J. Kyffers

Director of the United States Patent and Trademark Office

United States of America

United States Patent and Trademark Office

NOX TWILIGHT

Reg. No. 4,173,761

Registered July 17, 2012

Int. Cl.: 3

TRADEMARK

PRINCIPAL REGISTER

SUMMIT ENTERTAINMENT, LLC (DELAWARE LIMITED LIABILITY COMPANY)
1630 STEWART STREET, SUITE 120
SANTA MONICA, CA 90404

FOR: NAIL POLISH, IN CLASS 3 (U.S. CLS. 1, 4, 6, 50, 51 AND 52).

FIRST USE 6-0-2010; IN COMMERCE 6-0-2010.

THE MARK CONSISTS OF STANDARD CHARACTERS WITHOUT CLAIM TO ANY PARTICULAR FONT, STYLE, SIZE, OR COLOR.

OWNER OF U.S. REG. NOS. 3,756,560, 3,867,985 AND OTHERS.

SER. NO. 85-185,130, FILED 11-24-2010.

ERNEST SHOSHO, EXAMINING ATTORNEY



David J. Kyffers

Director of the United States Patent and Trademark Office

United States of America

United States Patent and Trademark Office



Reg. No. 4,173,762

Registered July 17, 2012

Int. Cl.: 25

TRADEMARK

PRINCIPAL REGISTER

CHARNIS INC. (CALIFORNIA CORPORATION), DBA WHITE PICKET FENCE
325 S. SWALL DR. # 202
LOS ANGELES, CA 90048

FOR: BLAZERS; CAPS; COATS; DENIMS; DRESS PANTS; DRESS SHIRTS; FLEECE SHORTS; JEANS; JERSEYS; JOGGING SUITS; MEN'S AND WOMEN'S JACKETS, COATS, TROUSERS, VESTS; PARKAS; POLO SHIRTS; SHORTS; SWEATPANTS; SWEATSHIRTS; SWIMMING TRUNKS; T-SHIRTS; TANK TOPS; TOPS; UNDERWEAR; WARM-UP SUITS; WEARABLE GARMENTS AND CLOTHING, NAMELY, SHIRTS, IN CLASS 25 (U.S. CLS. 22 AND 39).

FIRST USE 3-1-2010; IN COMMERCE 10-1-2010.

THE MARK CONSISTS OF A STYLIZED PICKET FENCE CONSISTING OF SEVEN BOARDS JOINED BY TWO HORIZONTAL LINES. THE MIDDLE, OR FOURTH, BOARD IS TILTED TO THE RIGHT. THE COLOR WHITE REPRESENTS TRANSPARENT AREAS OF THE FENCE DESIGN, AND THE COLOR BLACK REPRESENTS BACKGROUND, AND NEITHER THE WHITE NOR THE BLACK IS CLAIMED AS A FEATURE OF THE MARK.

SER. NO. 85-187,329, FILED 11-30-2010.

NANCY CLARKE, EXAMINING ATTORNEY



David J. Kyffers

Director of the United States Patent and Trademark Office

United States of America

United States Patent and Trademark Office

bio3 Health

Reg. No. 4,173,763

Registered July 17, 2012

Int. Cls.: 5 and 30

TRADEMARK

PRINCIPAL REGISTER

BIODES, S.L. (SPAIN LIMITED LIABILITY COMPANY)
BURDEOS, 8- POL. IND. BIERZO
24400 PONFERRADA, LEON, SPAIN

FOR: NUTRITIONAL SUPPLEMENTS; NUTRITIONAL SUPPLEMENTS MADE OF HERBS AND/OR OTHER BIOLOGICAL ACTIVE INGREDIENTS, FOR DIETETIC AND/OR MEDICAL USE; DIETETIC FOODS ADAPTED FOR MEDICAL USE, PREPARATIONS FOR DIETETIC AND/OR MEDICAL USE, NAMELY, DIETARY FOOD SUPPLEMENTS, DIETARY SUPPLEMENTS, NUTRITIONAL ADDITIVES FOR MEDICAL USE FOR USE IN FOODS AND DIETARY SUPPLEMENTS FOR HUMAN CONSUMPTION; MEDICINAL TEAS AND MEDICINAL INFUSIONS; HERBAL TEAS FOR MEDICINAL PURPOSES; SLIMMING TEAS FOR MEDICAL USE; HERBS, PREPARATIONS OF MEDICINAL HERBS AND/OR PLANTS FOR DIETETIC AND/OR MEDICAL USE; PARTS OF PLANTS AND EXTRACTS OF PLANTS, ALSO IN COMPOSITION WITH OTHER INGREDIENTS, FOR THE PREPARATION OF MEDICINAL INFUSIONS AND MEDICINAL INFUSIONS IN THE NATURE OF MEDICAL AND/OR DIETETIC DRINKS; DIETETIC PRODUCTS AND SUBSTANCES FOR MEDICAL USE, NAMELY, FOOD SUPPLEMENTS, DIETETIC FOODS, DIETETIC BEVERAGES, DIETETIC SUGAR, DIETETIC SUGAR SUBSTITUTES; NUTRITIONAL COMPLEMENTS IN THE NATURE OF FOOD SUPPLEMENTS FOR HUMANS; MEDICINAL PREPARATIONS TO LOSE WEIGHT, IN CLASS 5 (U.S. CLS. 6, 18, 44, 46, 51 AND 52).

FOR: TEA AND TEA-TYPE PRODUCTS, NAMELY, TEA LEAVES AND TEA SUBSTITUTES, HERBAL TEAS; FRUIT TEAS INCLUDING VITAMIN-ENRICHED, AND/OR FLAVORED AND/OR IN INSTANT FORM AND/OR WITH ADDED MINERALS NOT FOR MEDICINAL PURPOSES; ICED TEA; BEVERAGES WITH TEA BASE, HERBAL TEA BASE AND FRUIT TEA BASE; TEA EXTRACTS; POWDERED DRINKS, NAMELY, COFFEE, TEA, COCOA; PREPARED DRINKS NOT INCLUDED IN OTHER CLASSES, SPECIFICALLY MADE OF TEA, EXTRACTS OF TEA, COFFEE, NAMELY, COFFEE-BASED BEVERAGES, TEA-BASED BEVERAGES; EXTRACTS OF COFFEE; COFFEE SUBSTITUTES; EXTRACTS OF COFFEE SUBSTITUTES, COCOA, MALT FOR FOOD PURPOSES, SUGAR, SUBSTITUTES OF SUGAR, CHICORY AND/OR OTHER INGREDIENTS FOR FLAVOR PURPOSES, INDIVIDUALLY AND/OR IN COMBINATION WITH EACH OTHER; NON-MEDICINAL TEAS, HERBAL TEAS OR DRINK PREPARATIONS MADE OF HERBS, AS WELL AS FLAVORS FOR DRINKS, EXCEPT ETHEREAL OILS; HERBAL PREPARATIONS FOR NON-MEDICINAL DRINKS; PARTS OF PLANTS AND EXTRACTS OF PLANTS, ALSO IN COMPOSITION WITH OTHER INGREDIENTS, FOR THE PREPARATION OF NON-MEDICINAL INFUSIONS, IN CLASS 30 (U.S. CL. 46).



David J. Kyjars

Director of the United States Patent and Trademark Office

Reg. No. 4,173,763 OWNER OF SPAIN REG. NO. 2956896, DATED 5-26-2011, EXPIRES 11-23-2020.

THE COLOR(S) GREEN AND BLUE IS/ARE CLAIMED AS A FEATURE OF THE MARK.

OWNER OF U.S. REG. NO. 2,059,644.

NO CLAIM IS MADE TO THE EXCLUSIVE RIGHT TO USE "HEALTH", APART FROM THE MARK AS SHOWN.

THE MARK CONSISTS OF WORDS AND A NUMBER.

SER. NO. 85-187,382, FILED 11-30-2010.

PRISCILLA MILTON, EXAMINING ATTORNEY

United States of America

United States Patent and Trademark Office

30 Minute Meals with Rachael Ray

Reg. No. 4,173,764

RAY MARKS CO. LLC (NEW YORK LIMITED LIABILITY COMPANY)
900 BROADWAY, SUITE 1001
NEW YORK, NY 10003

Registered July 17, 2012

Int. Cl.: 41

FOR: ENTERTAINMENT SERVICES IN THE NATURE OF ON-GOING TELEVISION PROGRAMS IN THE FIELD OF FOOD AND COOKING, IN CLASS 41 (U.S. CLS. 100, 101 AND 107).

SERVICE MARK

FIRST USE 12-31-2001; IN COMMERCE 12-31-2001.

PRINCIPAL REGISTER

THE MARK CONSISTS OF STANDARD CHARACTERS WITHOUT CLAIM TO ANY PARTICULAR FONT, STYLE, SIZE, OR COLOR.

OWNER OF U.S. REG. NO. 3,263,247.

THE NAME(S), PORTRAIT(S), AND/OR SIGNATURE(S) SHOWN IN THE MARK IDENTIFIES "RACHAEL RAY", WHOSE CONSENT(S) TO REGISTER IS MADE OF RECORD.

SEC. 2(F) AS TO "30 MINUTE MEALS".

SER. NO. 85-191,514, FILED 12-6-2010.

ALYSSA STEEL, EXAMINING ATTORNEY



David J. Kybas

Director of the United States Patent and Trademark Office

United States of America

United States Patent and Trademark Office

BIZFLOW PLUS

Reg. No. 4,173,765

HANDYSOFT GLOBAL CORPORATION (VIRGINIA CORPORATION)
3141 FAIRVIEW PARK DRIVE, SUITE 850
FALLS CHURCH, VA 22042

Registered July 17, 2012

Int. Cl.: 9

FOR: COMPUTER SOFTWARE DEALING WITH ELECTRONIC BUSINESS FORM DESIGN, DIGITIZATION OF ELECTRONIC BUSINESS FORMS, ELECTRONIC INFORMATION TRANSFER, ELECTRONIC DOCUMENT MANAGEMENT, AND ELECTRONIC PERFORMANCE MONITORING, IN CLASS 9 (U.S. CLS. 21, 23, 26, 36 AND 38).

TRADEMARK

PRINCIPAL REGISTER

FIRST USE 3-31-2010; IN COMMERCE 3-31-2010.

THE MARK CONSISTS OF STANDARD CHARACTERS WITHOUT CLAIM TO ANY PARTICULAR FONT, STYLE, SIZE, OR COLOR.

OWNER OF U.S. REG. NOS. 2,466,594, 2,780,391, AND 2,816,487.

SER. NO. 85-192,550, FILED 12-7-2010.

GRETTA YAO, EXAMINING ATTORNEY



David J. Kyffers

Director of the United States Patent and Trademark Office

United States of America

United States Patent and Trademark Office

OPTI-VISOR

Reg. No. 4,173,766

Registered July 17, 2012

Int. Cl.: 9

TRADEMARK

PRINCIPAL REGISTER

S. A. ARMSTRONG LIMITED (CANADA CORPORATION)
23 BERTRAND AVENUE
SCARBOROUGH, ONTARIO, CANADA M1L2P3

FOR: ELECTRIC CONTROL PANELS, NAMELY, ELECTRIC CONTROL PANELS FOR CHILLER PLANT OPTIMIZATION THAT OPERATE WITH EXISTING BUILDING AUTOMATION SYSTEMS TO INSTRUCT THE CHILLER PLANT AS TO THE MOST ENERGY EFFICIENT SETTINGS FOR THE VARIABLE SPEED PLANT EQUIPMENT, IN CLASS 9 (U.S. CLS. 21, 23, 26, 36 AND 38).

THE MARK CONSISTS OF STANDARD CHARACTERS WITHOUT CLAIM TO ANY PARTICULAR FONT, STYLE, SIZE, OR COLOR.

PRIORITY CLAIMED UNDER SEC. 44(D) ON CANADA APPLICATION NO. 1486311, FILED 6-23-2010, REG. NO. TMA814,314, DATED 12-20-2011, EXPIRES 12-20-2026.

SER. NO. 85-193,017, FILED 12-8-2010.

SUSAN RICHARDS, EXAMINING ATTORNEY



David J. Kyffers

Director of the United States Patent and Trademark Office

United States of America

United States Patent and Trademark Office



Reg. No. 4,173,767

DEXCEL PHARMA TECHNOLOGIES LTD. (ISRAEL COMPANY)
P.O. BOX 50

Registered July 17, 2012

AKIVA, ISRAEL 30650

Int. Cl.: 5

FOR: PHARMACEUTICAL PREPARATIONS FOR USE IN DENTISTRY; PHARMACEUTICAL COMPOSITIONS FOR THE TREATMENT OF GINGIVITIS, PERIODONTITIS AND OTHER ORAL LESIONS; PHARMACEUTICAL COMPOSITIONS FOR DENTAL USE OR FOR THE TREATMENT OF THE MOUTH AND ORAL CAVITY; PHARMACEUTICAL PREPARATIONS FOR TREATING PERIODONTAL DISEASES; PHARMACEUTICAL PREPARATION IN A BIODEGRADABLE, SUSTAINED RELEASE, POLYMER DEVICE FOR THE TREATMENT OF PERIODONTITIS, IN CLASS 5 (U.S. CLS. 6, 18, 44, 46, 51 AND 52).

TRADEMARK

PRINCIPAL REGISTER

PRIORITY CLAIMED UNDER SEC. 44(D) ON ISRAEL APPLICATION NO. 233138, FILED 10-14-2010, REG. NO. 233138, DATED 2-2-2012, EXPIRES 2-2-2022.

THE COLOR(S) ORANGE, BROWN, GRAY, AND WHITE IS/ARE CLAIMED AS A FEATURE OF THE MARK.

OWNER OF U.S. REG. NO. 2,200,024.

THE MARK CONSISTS OF AN ORANGE RECTANGLE WITH THE WORD "PERIOCHIP" IN WHITE IN THE UPPER LEFT CORNER. THE RIGHT SIDE OF THE RECTANGLE IS IN A DARK SHADE OF BROWN. THE ORANGE AND DARK BROWN RECTANGLES ARE DIVIDED BY A GRAY LINE. INSIDE THE DARK BROWN RECTANGLE IS ANOTHER RECTANGULAR SHAPED DEVICE WHICH CONSISTS OF FOUR LINES AND FIVE COLUMNS OF NINETEEN GEOMETRICALLY SHAPED DEVICES IN GRAY, WITH AN ORANGE GEOMETRICALLY SHAPED DEVICE THE THIRD COLUMN OF THE SECOND LINE.



SER. NO. 85-194,376, FILED 12-9-2010.

JAMES STEIN, EXAMINING ATTORNEY

David J. Kypos

Director of the United States Patent and Trademark Office

United States of America

United States Patent and Trademark Office



Reg. No. 4,173,768

Registered July 17, 2012

Int. Cl.: 30

TRADEMARK

PRINCIPAL REGISTER

MISTY ANGELINI (UNITED STATES INDIVIDUAL)
104 WOODLAND DRIVE
BARRE, VT 05641

FOR: COFFEE, IN CLASS 30 (U.S. CL. 46).

FIRST USE 1-30-2010; IN COMMERCE 1-30-2010.

OWNER OF U.S. REG. NO. 3,929,230.

NO CLAIM IS MADE TO THE EXCLUSIVE RIGHT TO USE "COFFEE" AND "EXCEPTIONAL ROASTED BLENDS", APART FROM THE MARK AS SHOWN.

THE MARK CONSISTS OF THE WORDS "MOUNTAIN GROVE COFFEE" WITH THE STYLIZED PHRASE "EXCEPTIONAL DARK ROAST BLENDS" UNDERNEATH AND ALL LITERAL ELEMENTS SURROUNDED BY A SHAPE RESEMBLING A PLACARD WITH CURVED TOP COMING TO A POINT IN THE CENTER, TOP AND BOTTOM OF THE PLACARD ARE MIRRORED HORIZONTALLY WITH A SOLID LINE OFFSET FROM OUTER EDGE.

SER. NO. 85-194,979, FILED 12-10-2010.

BENJAMIN OKEKE, EXAMINING ATTORNEY



David J. Kyffers

Director of the United States Patent and Trademark Office

United States of America

United States Patent and Trademark Office



Reg. No. 4,173,769

Registered July 17, 2012

Int. Cl.: 30

TRADEMARK

PRINCIPAL REGISTER

L. SHUMAN AND SONS, LLC (VIRGINIA LIMITED LIABILITY COMPANY)
POST OFFICE BOX 26066
ALEXANDRIA, VA 22313

FOR: BAKERY GOODS, IN CLASS 30 (U.S. CL. 46).

FIRST USE 11-4-2010; IN COMMERCE 11-4-2010.

NO CLAIM IS MADE TO THE EXCLUSIVE RIGHT TO USE "ALEXANDRIA, VIRGINIA", "BAKERY" AND "EST. 1876", APART FROM THE MARK AS SHOWN.

THE MARK CONSISTS OF THE WORDING "SHUMAN'S BAKERY EST. 1876 ALEXANDRIA, VIRGINIA" WITH THE WORD "SHUMAN'S" IN STYLIZED LETTERING BELOW THE WORDS "ALEXANDRIA, VIRGINIA" AND ABOVE TWO HORIZONTAL LINES OF DIFFERENT WIDTHS AND ENDING WITH CURVES ON THE RIGHT ENDS BELOW WHICH APPEARS THE WORD "BAKERY" ABOVE "EST. 1876" WHICH, IN TURN, IS ABOVE TWO HORIZONTAL LINES OF DIFFERENT WIDTHS AND WITH CURVES ON BOTH ENDS AND ABOVE A DESIGN CONSISTING OF A CIRCLE, SEMICIRCLES, CURVING LINES AND A MODIFIED FLEUR-DE-LIS DESIGN.

SER. NO. 85-195,057, FILED 12-10-2010.

COLLEEN DOMBROW, EXAMINING ATTORNEY



David J. Kybas

Director of the United States Patent and Trademark Office

United States of America

United States Patent and Trademark Office

VARAN-BUS

Reg. No. 4,173,770

SIGMATEK GMBH & CO KG (AUSTRIA CORPORATION)
SIGMATEKSTRASSE 1

Registered July 17, 2012

LAMPRECHTSHAUSEN, AUSTRIA A-5112

Int. Cls.: 7, 9 and 42

FOR: MACHINES FOR INJECTION MOLDING; MACHINE TOOLS, NAMELY, LATHES, DRILLING MACHINES, MILLING MACHINES, POWER-OPERATED GRINDERS, HONING MACHINES; MOTORS AND ENGINES EXCEPT FOR LAND VEHICLES; DRIVES FOR MACHINES, IN CLASS 7 (U.S. CLS. 13, 19, 21, 23, 31, 34 AND 35).

TRADEMARK

SERVICE MARK

PRINCIPAL REGISTER

FOR: UNIVERSAL SERIAL BUS HARDWARE AND OPERATING SOFTWARE FOR EQUIPMENT AND APPARATUS FOR REAL-TIME DATA COMMUNICATION BETWEEN ELECTRONIC AND ELECTRIC APPARATUSES; SURVEYING INSTRUMENTS, WEIGHING APPARATUS AND INSTRUMENTS; SIGNAL CONDITIONING AND COMMUNICATION DEVICES FOR INDUSTRIAL PROCESS CONTROL; APPARATUS AND INSTRUMENTS FOR CONDUCTING, SWITCHING, TRANSFORMING, ACCUMULATING, REGULATING OR CONTROLLING ELECTRICITY; DATA-PROCESSING EQUIPMENT AND COMPUTERS; ETHERNET SWITCHES AND ROUTERS, AND SOFTWARE SOLD BOTH AS COMPONENTS THEREOF AND SEPARATELY, NAMELY, SOFTWARE ADAPTED AND ARRANGED FOR OPERATING, INSTALLING, TESTING, DIAGNOSING AND MANAGING THE FORGOING TELECOMMUNICATION EQUIPMENT; ALL THE AFORESAID GOODS OTHER THAN IN THE FIELD OF OPTICS, IN PARTICULAR LENSES AND FITTINGS IN THE FIELDS OF PHOTO-OPTICS, CLASSICAL CINEMA PROJECTION, INDUSTRIAL OPTICS, INCLUDING MECHANICAL AND ELECTRIC ASSEMBLIES, AND LENSES FOR DIGITAL RECORDING AND DIGITAL PROJECTION, OPHTHALMIC OPTIC PRODUCTS, OPTICAL FILTERS FOR PHOTOGRAPHIC AND INDUSTRIAL APPLICATIONS, IN CLASS 9 (U.S. CLS. 21, 23, 26, 36 AND 38).



David J. Kyffers

FOR: DEVELOPMENT OF PROGRAMS FOR ELECTRIC AND ELECTRONIC AUTOMATION AND CONTROL INSTALLATIONS, AND FOR DATA PROCESSING, IN PARTICULAR REAL-TIME DATA BUS SYSTEMS, AND CONSULTANCY WITH REGARD TO THE APPLICATION THEREOF; DESIGN AND DEVELOPMENT OF COMPUTER HARDWARE AND SOFTWARE FOR DATA TRANSMISSION; ALL THE AFORESAID SERVICES OTHER THAN IN THE FIELD OF OPTICS, IN PARTICULAR CALCULATING LENSES, OPTICAL RECORDING, TRANSMISSION OR REPRODUCTION SYSTEMS FOR USERS, IN CLASS 42 (U.S. CLS. 100 AND 101).

Reg. No. 4,173,770 THE MARK CONSISTS OF STANDARD CHARACTERS WITHOUT CLAIM TO ANY PARTICULAR FONT, STYLE, SIZE, OR COLOR.

OWNER OF ERPN CMNTY TM OFC REG. NO. 004875837, DATED 12-20-2007, EXPIRES 2-2-2016.

THE WORDING "VARAN-BUS" HAS NO MEANING IN A FOREIGN LANGUAGE.

SER. NO. 85-198,119, FILED 12-15-2010.

ALEXANDER L. POWERS, EXAMINING ATTORNEY

United States of America

United States Patent and Trademark Office

ESPRESSO ITALIANO

Reg. No. 4,173,771

C.O.R.E.X. S.P.A. S.S. (ITALY CORPORATION)

Registered July 17, 2012

19 3/5 BATTIPAGLIA
SALERNO, ITALY

Int. Cl.: 30

FOR: PASTA SAUCE, PESTO, PASTA AND BALSAMIC VINEGAR, IN CLASS 30 (U.S. CL. 46).

TRADEMARK

FIRST USE 1-1-2005; IN COMMERCE 1-1-2005.

PRINCIPAL REGISTER

THE MARK CONSISTS OF STANDARD CHARACTERS WITHOUT CLAIM TO ANY PARTICULAR FONT, STYLE, SIZE, OR COLOR.

NO CLAIM IS MADE TO THE EXCLUSIVE RIGHT TO USE "ITALIANO", APART FROM THE MARK AS SHOWN.

THE ENGLISH TRANSLATION OF THE WORDS "ESPRESSO ITALIANO" IN THE MARK IS "ITALIAN EXPRESS".

SER. NO. 85-199,111, FILED 12-16-2010.

DOMINICK J. SALEMI, EXAMINING ATTORNEY



David J. Kybas

Director of the United States Patent and Trademark Office

United States of America

United States Patent and Trademark Office

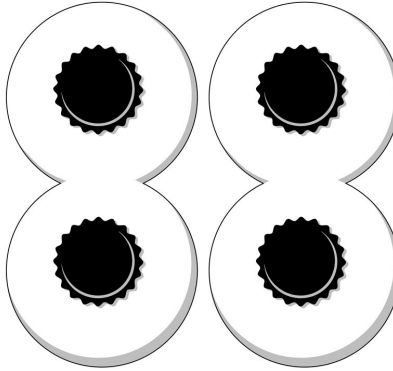

Reg. No. 4,173,772

Registered July 17, 2012

Int. Cl.: 32

TRADEMARK

PRINCIPAL REGISTER

LAKEFRONT BREWERY, INC. (WISCONSIN CORPORATION)
1872 N. COMMERCE
MILWAUKEE, WI 53212

FOR: BEER, IN CLASS 32 (U.S. CLS. 45, 46 AND 48).

FIRST USE 12-14-2010; IN COMMERCE 12-14-2010.

THE MARK CONSISTS OF THE NUMBER "88" IN A STYLIZED FORM.

SER. NO. 85-199,681, FILED 12-16-2010.

BRIAN NEVILLE, EXAMINING ATTORNEY



David J. Kyffers

Director of the United States Patent and Trademark Office

United States of America

United States Patent and Trademark Office

e4Legal

Reg. No. 4,173,773

Registered July 17, 2012

Int. Cl.: 9

TRADEMARK

PRINCIPAL REGISTER

TOGIAC ENTERPRISES, LLC (OHIO LIMITED LIABILITY COMPANY)
9146 CINCINNATI-COLUMBUS RD
WEST CHESTER, OH 45069

FOR: COMPUTER SOFTWARE FOR USE IN CUSTOMER RELATIONSHIP MANAGEMENT (CRM); COMPUTER SOFTWARE PLATFORMS FOR FILE MANAGEMENT, DOCUMENT MANAGEMENT, BUSINESS LOGIC, AND AUTOMATION OF THE PRACTICE OF LAW, IN CLASS 9 (U.S. CLS. 21, 23, 26, 36 AND 38).

FIRST USE 12-3-2010; IN COMMERCE 12-3-2010.

THE MARK CONSISTS OF STANDARD CHARACTERS WITHOUT CLAIM TO ANY PARTICULAR FONT, STYLE, SIZE, OR COLOR.

SER. NO. 85-203,004, FILED 12-21-2010.

KIM MONINGHOFF, EXAMINING ATTORNEY



David J. Kyffers

Director of the United States Patent and Trademark Office

United States of America

United States Patent and Trademark Office

FASCOPIY

Reg. No. 4,173,774

GOULD PAPER COMPANY, INC. (NEW YORK CORPORATION)
11 MADISON AVENUE
NEW YORK, NY 10010

Registered July 17, 2012

Int. Cl.: 16

FOR: COPYING PAPER; PAPER; PRINTING PAPER, IN CLASS 16 (U.S. CLS. 2, 5, 22, 23, 29, 37, 38 AND 50).

TRADEMARK

FIRST USE 1-0-1999; IN COMMERCE 1-0-1999.

PRINCIPAL REGISTER

THE MARK CONSISTS OF STANDARD CHARACTERS WITHOUT CLAIM TO ANY PARTICULAR FONT, STYLE, SIZE, OR COLOR.

SER. NO. 85-203,945, FILED 12-22-2010.

COURTNEY ALVAREZ, EXAMINING ATTORNEY



David J. Kybas

Director of the United States Patent and Trademark Office

United States of America

United States Patent and Trademark Office

CP SCORE

Reg. No. 4,173,775

SERVICE QUALITY MEASUREMENT GROUP INC. (CANADA CORPORATION)
4609 23D STREET

Registered July 17, 2012

VERNON, CANADA V1T4K7C

Int. Cl.: 35

SERVICE MARK

PRINCIPAL REGISTER

FOR: BUSINESS CONSULTATION SERVICES IN THE NATURE OF PERFORMING QUALITY ASSURANCE EVALUATIONS OF THE PERFORMANCE OF CALL AND CONTACT CENTERS TO DETERMINE SERVICE QUALITY AND PROVIDING BUSINESS ANALYSES, REPORTS AND RECOMMENDATIONS BASED ON THE RESULTS THEREOF, EVALUATING THE COMPARATIVE PERFORMANCE OF CALL AND CONTACT CENTERS OPERATING COSTS, CUSTOMER SATISFACTION AND ABILITY TO HELP RETAIN CUSTOMERS FOR THE ORGANIZATION; PROVIDING INCENTIVE AWARD PROGRAMS RECOGNIZING QUALITY ASSURANCE EXCELLENCE IN SELECTED AREAS OF CALL AND CONTACT CENTER SERVICE AND PERFORMANCE; PERFORMING BUSINESS STUDIES IN THE NATURE OF CALL AND CONTACT CENTER QUALITY ASSURANCE BENCHMARKING STUDIES FOR THE MEASUREMENT OF QUALITY ASSURANCE PERFORMANCE AND PROVIDING BUSINESS ANALYSES, REPORTS AND RECOMMENDATIONS BASED ON THE RESULTS THEREOF, INCLUDING COMPARISONS TO OTHER CALL AND CONTACT CENTERS THAT HAVE UNDERGONE SIMILAR QUALITY ASSURANCE BENCHMARKING STUDIES; CONDUCTING BUSINESS AND CONSUMER SURVEYS AMONG THE CUSTOMERS OF CALL AND CONTACT CENTERS TO ASSESS QUALITY ASSURANCE LEVELS AND PROVIDING BUSINESS REPORTS ON THE RESULTS THEREOF INCLUDING OUTCOMES, DATA ANALYSIS AND RECOMMENDATIONS; PERFORMING BUSINESS AND CONSUMER STUDIES AND SURVEYS TO DETERMINE THE RATE AT WHICH CALL AND CONTACT CENTERS RESOLVE CUSTOMER INQUIRIES ON THE FIRST CALL, AND PROVIDING BUSINESS REPORTS ON THE RESULTS THEREOF INCLUDING OUTCOMES, DATA ANALYSIS AND RECOMMENDATIONS; PERFORMING BUSINESS STUDIES IN THE NATURE OF CALL AND CONTACT CENTER CUSTOMER TRACKING STUDIES FOR MEASURING QUALITY ASSURANCE LEVELS OVER PREDETERMINED AMOUNTS OF TIME AND PROVIDING BUSINESS REPORTS BASED ON THE RESULTS THEREOF; PERFORMING BUSINESS STUDIES IN THE NATURE OF BENCHMARKING STUDIES TO EVALUATE QUALITY ASSURANCE LEVELS WITH CALL AND CONTACT CENTER WEBSITES AND PROVIDING BUSINESS REPORTS ON THE RESULTS THEREOF, AND BENCHMARKING STUDIES TO EVALUATE QUALITY ASSURANCE LEVELS WITH CALL AND CONTACT CENTER INTERACTIVE VOICE RESPONSE CHANNELS AND PROVIDING BUSINESS REPORTS ON THE RESULTS; PERFORMING BUSINESS EVALUATIONS AND ANALYSIS BASED ON DATA METRICS FOR CUSTOMER CALL RESOLUTION, CUSTOMER SATISFACTION WITH A CALL CENTER AND ITS CUSTOMER SERVICE REPRESENTAT-



David J. Kybas

Director of the United States Patent and Trademark Office

Reg. No. 4,173,775 IVES AND CUSTOMER RETENTION FOLLOWING A CALL AND PROVIDING BUSINESS REPORTS ON THE RESULTS THEREOF INCLUDING NUMERICAL RATINGS, IN CLASS 35 (U.S. CLS. 100, 101 AND 102).

THE MARK CONSISTS OF STANDARD CHARACTERS WITHOUT CLAIM TO ANY PARTICULAR FONT, STYLE, SIZE, OR COLOR.

PRIORITY CLAIMED UNDER SEC. 44(D) ON CANADA APPLICATION NO. 1508573, FILED 12-20-2010, REG. NO. TMA817415, DATED 2-10-2012, EXPIRES 2-10-2027.

NO CLAIM IS MADE TO THE EXCLUSIVE RIGHT TO USE "SCORE", APART FROM THE MARK AS SHOWN.

SER. NO. 85-204,267, FILED 12-22-2010.

TOBY BULLOFF, EXAMINING ATTORNEY

United States of America

United States Patent and Trademark Office



memostars

Reg. No. 4,173,776

Registered July 17, 2012

Int. Cl.: 35

SERVICE MARK

PRINCIPAL REGISTER

MEMOSTARS INC. (CANADA CORPORATION)
891 BOUL CHAREST OUEST
SUITE 200
QUEBEC, QC, CANADA G1N 2C9

FOR: ADVERTISING; BUSINESS MANAGEMENT; BUSINESS ADMINISTRATION; CONDUCTING BUSINESS SURVEYS; PROMOTING THE GOODS AND SERVICES OF OTHERS BY MEANS OF INCENTIVE REWARD PROGRAMS BASED ON THE USERS' MEMORY AND MEMORIZATION ABILITIES, IN CLASS 35 (U.S. CLS. 100, 101 AND 102).

FIRST USE 12-23-2010; IN COMMERCE 12-23-2010.

THE MARK CONSISTS OF THE WORD "MEMOSTARS" WITH A DRAWING REPRESENTING A HUMAN SHAPE WITH A STAR ON THE FACE.

SER. NO. 85-205,001, FILED 12-23-2010.

ANN E. SAPPENFIELD, EXAMINING ATTORNEY



David J. Kyffers

Director of the United States Patent and Trademark Office

United States of America

United States Patent and Trademark Office



Reg. No. 4,173,777

Registered July 17, 2012

Int. Cl.: 29

TRADEMARK

PRINCIPAL REGISTER

INDUSTRIA LECHERA DE PUERTO RICO, INC. (PUERTO RICO CORPORATION)
URB INDUSTRIAL TRES MONJITAS
198 CHARDON AVENUE
SAN JUAN, PUERTO RICO 00918

FOR: MILK, IN CLASS 29 (U.S. CL. 46).

FIRST USE 5-20-1984; IN COMMERCE 5-20-1984.

THE MARK CONSISTS OF THE WORD "INDULAC" STYLIZED IN BLUE OVER A GLASS OF WHITE MILK BEING POURED, ALL OVER A BLUE BACKGROUND CONTAINING WHITE SWIRLS.

THE COLOR(S) BLUE AND WHITE IS/ARE CLAIMED AS A FEATURE OF THE MARK.

SER. NO. 85-205,843, FILED 12-27-2010.

ANN E. SAPPENFIELD, EXAMINING ATTORNEY



David J. Kyffers

Director of the United States Patent and Trademark Office

United States of America

United States Patent and Trademark Office

RHIA

Reg. No. 4,173,778

Registered July 17, 2012

CERTIFICATION MARK

PRINCIPAL REGISTER

AMERICAN HEALTH INFORMATION MANAGEMENT ASSOCIATION (ILLINOIS CORPORATION)
233 N. MICHIGAN AVE., STE. 2150
CHICAGO, IL 606015519

FOR: ADMINISTRATOR SERVICES FOR PATIENT HEALTH INFORMATION AND MEDICAL RECORDS, IN CLASS B (U.S. CL. B).

FIRST USE 0-0-1932; IN COMMERCE 0-0-1932.

THE MARK CONSISTS OF STANDARD CHARACTERS WITHOUT CLAIM TO ANY PARTICULAR FONT, STYLE, SIZE, OR COLOR.

THE CERTIFICATION MARK, AS USED BY AUTHORIZED PERSONS, CERTIFIES THAT THE SERVICES ARE PROVIDED BY PROFESSIONALS WHO HAVE OBTAINED CREDENTIALS BASED ON A COMBINATION OF EDUCATION, EXPERIENCE AND PERFORMANCE-BASED EXAMS ESTABLISHED BY AMERICAN HEALTH INFORMATION MANAGEMENT ASSOCIATION.

SER. NO. 85-207,041, FILED 12-29-2010.

AMEEN IMAM, EXAMINING ATTORNEY



David J. Kyjars

Director of the United States Patent and Trademark Office

United States of America

United States Patent and Trademark Office

RHIT

Reg. No. 4,173,779

Registered July 17, 2012

CERTIFICATION MARK

PRINCIPAL REGISTER

AMERICAN HEALTH INFORMATION MANAGEMENT ASSOCIATION (ILLINOIS CORPORATION)
233 N. MICHIGAN AVE., STE. 2150
CHICAGO, IL 606015519

FOR: TECHNICIAN SERVICES FOR PATIENT HEALTH INFORMATION AND MEDICAL RECORDS, IN CLASS B (U.S. CL. B).

FIRST USE 0-0-1953; IN COMMERCE 0-0-1953.

THE MARK CONSISTS OF STANDARD CHARACTERS WITHOUT CLAIM TO ANY PARTICULAR FONT, STYLE, SIZE, OR COLOR.

THE CERTIFICATION MARK, AS USED BY AUTHORIZED PERSONS, CERTIFIES THAT THE SERVICES ARE PROVIDED BY PROFESSIONALS WHO HAVE OBTAINED CREDENTIALS BASED ON A COMBINATION OF EDUCATION, EXPERIENCE AND PERFORMANCE-BASED EXAMS ESTABLISHED BY AMERICAN HEALTH INFORMATION MANAGEMENT ASSOCIATION.

SER. NO. 85-207,053, FILED 12-29-2010.

AMEEN IMAM, EXAMINING ATTORNEY



David J. Kyjars

Director of the United States Patent and Trademark Office

United States of America

United States Patent and Trademark Office

CCS-P

Reg. No. 4,173,780

Registered July 17, 2012

CERTIFICATION MARK

PRINCIPAL REGISTER

AMERICAN HEALTH INFORMATION MANAGEMENT ASSOCIATION (ILLINOIS CORPORATION)
233 N. MICHIGAN AVE., STE. 2150
CHICAGO, IL 606015519

FOR: PHYSICIAN-BASED CODING SPECIALIST SERVICES FOR PATIENT DIAGNOSES AND PROCEDURES, IN CLASS B (U.S. CL. B).

FIRST USE 0-0-1997; IN COMMERCE 0-0-1997.

THE MARK CONSISTS OF STANDARD CHARACTERS WITHOUT CLAIM TO ANY PARTICULAR FONT, STYLE, SIZE, OR COLOR.

THE CERTIFICATION MARK, AS USED BY AUTHORIZED PERSONS, CERTIFIES THAT THE SERVICES ARE PROVIDED BY PROFESSIONALS WHO HAVE OBTAINED CREDENTIALS BASED ON A COMBINATION OF EDUCATION, EXPERIENCE AND PERFORMANCE-BASED EXAMS ESTABLISHED BY AMERICAN HEALTH INFORMATION MANAGEMENT ASSOCIATION.

SER. NO. 85-207,057, FILED 12-29-2010.

AMEEN IMAM, EXAMINING ATTORNEY



David J. Kyjars

Director of the United States Patent and Trademark Office

United States of America

United States Patent and Trademark Office

CCS

Reg. No. 4,173,781

Registered July 17, 2012

CERTIFICATION MARK

PRINCIPAL REGISTER

AMERICAN HEALTH INFORMATION MANAGEMENT ASSOCIATION (ILLINOIS CORPORATION)
233 N. MICHIGAN AVE., STE. 2150
CHICAGO, IL 606015519

FOR: CODING SPECIALIST SERVICES FOR CLASSIFYING MEDICAL DATA FROM PATIENT RECORDS, IN CLASS B (U.S. CL. B).

FIRST USE 0-0-1992; IN COMMERCE 0-0-1992.

THE MARK CONSISTS OF STANDARD CHARACTERS WITHOUT CLAIM TO ANY PARTICULAR FONT, STYLE, SIZE, OR COLOR.

THE CERTIFICATION MARK, AS USED BY AUTHORIZED PERSONS, CERTIFIES THAT THE SERVICES ARE PROVIDED BY PROFESSIONALS WHO HAVE OBTAINED CREDENTIALS BASED ON A COMBINATION OF EDUCATION, EXPERIENCE AND PERFORMANCE-BASED EXAMS ESTABLISHED BY AMERICAN HEALTH INFORMATION MANAGEMENT ASSOCIATION.

SER. NO. 85-207,062, FILED 12-29-2010.

AMEEN IMAM, EXAMINING ATTORNEY



David J. Kyjars

Director of the United States Patent and Trademark Office

United States of America

United States Patent and Trademark Office

CCA

Reg. No. 4,173,782

Registered July 17, 2012

CERTIFICATION MARK

PRINCIPAL REGISTER

AMERICAN HEALTH INFORMATION MANAGEMENT ASSOCIATION (ILLINOIS CORPORATION)
233 N. MICHIGAN AVE., STE. 2150
CHICAGO, IL 606015519

FOR: CODING ASSOCIATE SERVICES FOR CLASSIFYING MEDICAL DATA FROM PATIENT RECORDS IN HOSPITAL AND PHYSICIAN-BASED PRACTICES, IN CLASS B (U.S. CL. B).

FIRST USE 0-0-2002; IN COMMERCE 0-0-2002.

THE MARK CONSISTS OF STANDARD CHARACTERS WITHOUT CLAIM TO ANY PARTICULAR FONT, STYLE, SIZE, OR COLOR.

THE CERTIFICATION MARK, AS USED BY AUTHORIZED PERSONS, CERTIFIES THAT THE SERVICES ARE PROVIDED BY PROFESSIONALS WHO HAVE OBTAINED CREDENTIALS BASED ON A COMBINATION OF EDUCATION, EXPERIENCE AND PERFORMANCE-BASED EXAMS ESTABLISHED BY AMERICAN HEALTH INFORMATION MANAGEMENT ASSOCIATION.

SER. NO. 85-207,072, FILED 12-29-2010.

AMEEN IMAM, EXAMINING ATTORNEY



David J. Kyjars

Director of the United States Patent and Trademark Office

United States of America

United States Patent and Trademark Office

FLEXTRACKER

Reg. No. 4,173,783

DISPLAY INDUSTRIES, LLC (GEORGIA LIMITED LIABILITY COMPANY)
5850 PEACHTREE INDUSTRIAL DRIVE
NORCROSS, GA 30071

Registered July 17, 2012

Int. Cl.: 20

FOR: DISPLAY RACKS AND SHELVES, NAMELY, SINGLE AND MULTIPLE TRACK MEMBER INSERTS FOR DISPLAY RACKS AND SHELVES, IN CLASS 20 (U.S. CLS. 2, 13, 22, 25, 32 AND 50).

TRADEMARK

FIRST USE 11-30-2001; IN COMMERCE 11-30-2001.

PRINCIPAL REGISTER

THE MARK CONSISTS OF STANDARD CHARACTERS WITHOUT CLAIM TO ANY PARTICULAR FONT, STYLE, SIZE, OR COLOR.

SER. NO. 85-207,265, FILED 12-29-2010.

ANGELA DUONG, EXAMINING ATTORNEY



David J. Kyffers

Director of the United States Patent and Trademark Office

United States of America

United States Patent and Trademark Office

JAY B

Reg. No. 4,173,784

BORZINI, JARROD J (UNITED STATES INDIVIDUAL)
1252 GREENLEAF LOOP
GREENFIELD, CA 93927

Registered July 17, 2012

Int. Cl.: 41

FOR: ENTERTAINMENT SERVICES IN THE NATURE OF PRESENTING LIVE MUSICAL PERFORMANCES, IN CLASS 41 (U.S. CLS. 100, 101 AND 107).

SERVICE MARK

FIRST USE 0-0-2009; IN COMMERCE 0-0-2009.

PRINCIPAL REGISTER

THE MARK CONSISTS OF STANDARD CHARACTERS WITHOUT CLAIM TO ANY PARTICULAR FONT, STYLE, SIZE, OR COLOR.

THE NAME(S), PORTRAIT(S), AND/OR SIGNATURE(S) SHOWN IN THE MARK IDENTIFIES JARROD J BORZINI, WHOSE CONSENT(S) TO REGISTER IS MADE OF RECORD.

SER. NO. 85-211,394, FILED 1-5-2011.

JORDAN BAKER, EXAMINING ATTORNEY



David J. Kyffers

Director of the United States Patent and Trademark Office

United States of America

United States Patent and Trademark Office

HARDCORE CHRISTIANITY

Reg. No. 4,173,785

Registered July 17, 2012

Int. Cl.: 35

HARDCORE CHRISTIANITY INCORPORATED (ARIZONA CORPORATION), DBA
HARDCORE CHRISTIANITY INCORPORATED
1095 E. INDIAN SCHOOL ROAD
SUITE #302
PHOENIX, AZ 85014

SERVICE MARK

FOR: PROMOTING PUBLIC AWARENESS ONLINE OF THE NEED FOR AN ACCURATE REPRESENTATION OF CHRISTIANITY , IN CLASS 35 (U.S. CLS. 100, 101 AND 102).

PRINCIPAL REGISTER

FIRST USE 1-1-2004; IN COMMERCE 9-28-2006.

THE MARK CONSISTS OF STANDARD CHARACTERS WITHOUT CLAIM TO ANY PARTICULAR FONT, STYLE, SIZE, OR COLOR.

NO CLAIM IS MADE TO THE EXCLUSIVE RIGHT TO USE "CHRISTIANITY", APART FROM THE MARK AS SHOWN.

SER. NO. 85-212,959, FILED 1-7-2011.

WENDY JUN, EXAMINING ATTORNEY



David J. Kyffers

Director of the United States Patent and Trademark Office

United States of America

United States Patent and Trademark Office



Reg. No. 4,173,786

Registered July 17, 2012

Int. Cl.: 33

TRADEMARK

PRINCIPAL REGISTER

PAZ-OSORIO FEDERICO (MEXICO INDIVIDUAL)
VENUSTIANO CARRANZA NO. 25
TONAYAN, MEXICO 48761

FOR: APERITIFS WITH A DISTILLED ALCOHOLIC LIQUOR BASE; EXTRACTS OF SPIRITUOUS LIQUORS; LIQUOR, IN CLASS 33 (U.S. CLS. 47 AND 49).

OWNER OF MEXICO REG. NO. 141151, DATED 5-11-1967, RENEWED AS REG. NO. 141151, DATED 5-11-2012, EXPIRES 5-11-2022.

NO CLAIM IS MADE TO THE EXCLUSIVE RIGHT TO USE "TONAYAN", APART FROM THE MARK AS SHOWN.

THE MARK CONSISTS OF THE WORDMARK "TONAYAN", WRITTEN IN CURLY TYPES ON THE SKY OF A LANDSCAPE, SHOWING A BULL PULLED WAGON AND A FARMER, WORKING ON AN AGAVE FIELD.

THE ENGLISH TRANSLATION OF "TONAYAN" IN THE MARK IS NAME GIVEN TO "PEOPLE FROM TONAYA".

SER. NO. 85-214,570, FILED 1-11-2011.

ALICE BENMAMAN, EXAMINING ATTORNEY



David J. Kybas

Director of the United States Patent and Trademark Office

United States of America

United States Patent and Trademark Office

EARTHLINK BUSINESS

Reg. No. 4,173,787

EARTHLINK, INC. (DELAWARE CORPORATION)
1375 PEACHTREET STREET
ATLANTA, GA 30309

Registered July 17, 2012

Int. Cl.: 42

FOR: NETWORK MIGRATION AND INTEGRATION SERVICES; NETWORK DESIGN AND DEVELOPMENT SERVICES; NETWORK MANAGEMENT; SYSTEM EQUIPMENT SERVICES, NAMELY, EQUIPMENT DESIGN; INSTALLATION, MAINTENANCE AND REPAIR OF COMPUTER SOFTWARE; COMPUTER SECURITY SERVICE, NAMELY, RESTRICTING ACCESS TO AND BY COMPUTER NETWORKS TO AND OF UNDESIRE WEB SITES, MEDIA AND INDIVIDUALS AND FACILITIES; COMPUTER SECURITY CONSULTANCY; COMPUTER SERVICES, NAMELY, INTEGRATION OF PRIVATE AND PUBLIC CLOUD COMPUTING ENVIRONMENTS; COMPUTER SERVICES, NAMELY, CLOUD HOSTING PROVIDER SERVICES, IN CLASS 42 (U.S. CLS. 100 AND 101).

SERVICE MARK

PRINCIPAL REGISTER

FIRST USE 12-8-2010; IN COMMERCE 12-8-2010.

THE MARK CONSISTS OF STANDARD CHARACTERS WITHOUT CLAIM TO ANY PARTICULAR FONT, STYLE, SIZE, OR COLOR.

OWNER OF U.S. REG. NOS. 2,372,117, 3,438,160 AND OTHERS.

NO CLAIM IS MADE TO THE EXCLUSIVE RIGHT TO USE "BUSINESS", APART FROM THE MARK AS SHOWN.

SER. NO. 85-215,722, FILED 1-12-2011.

BARBARA BROWN, EXAMINING ATTORNEY



David J. Kyjars

Director of the United States Patent and Trademark Office

United States of America

United States Patent and Trademark Office

R.T.(CT)(ARRT)

Reg. No. 4,173,788

Registered July 17, 2012

CERTIFICATION MARK

PRINCIPAL REGISTER

THE AMERICAN REGISTRY OF RADIOLOGIC TECHNOLOGISTS (MINNESOTA
NON-PROFIT CORPORATION)
1255 NORTHLAND DRIVE
ST. PAUL, MN 551201155

FOR: DIAGNOSTIC MEDICAL IMAGING, INTERVENTIONAL MEDICAL PROCEDURES,
THERAPEUTIC TREATMENT AND RADIATION THERAPY, IN CLASS B (U.S. CL. B).

FIRST USE 3-16-1995; IN COMMERCE 3-16-1995.

THE MARK CONSISTS OF STANDARD CHARACTERS WITHOUT CLAIM TO ANY PAR-
TICULAR FONT, STYLE, SIZE, OR COLOR.

OWNER OF U.S. REG. NOS. 2,758,500, 3,244,563 AND OTHERS.

NO CLAIM IS MADE TO THE EXCLUSIVE RIGHT TO USE "CT", APART FROM THE MARK
AS SHOWN.

THE CERTIFICATION MARK, AS USED BY AUTHORIZED PERSONS, CERTIFIES THAT
PERSONS PERFORMING COMPUTED TOMOGRAPHY SERVICES HAVE MET THE
STANDARDS, QUALIFICATIONS, AND TESTING REQUIREMENTS ESTABLISHED BY
THE CERTIFIER.

SER. NO. 85-217,930, FILED 1-14-2011.

LINDA E. BLOHM, EXAMINING ATTORNEY



David J. Kyjars

Director of the United States Patent and Trademark Office

United States of America

United States Patent and Trademark Office

R.T.(VI)(ARRT)

Reg. No. 4,173,789

Registered July 17, 2012

CERTIFICATION MARK

PRINCIPAL REGISTER

THE AMERICAN REGISTRY OF RADIOLOGIC TECHNOLOGISTS (MINNESOTA
NON-PROFIT CORPORATION)
1255 NORTHLAND DRIVE
ST. PAUL, MN 551201155

FOR: DIAGNOSTIC MEDICAL IMAGING, INTERVENTIONAL MEDICAL PROCEDURES,
THERAPEUTIC TREATMENT, AND RADIATION THERAPY, IN CLASS B (U.S. CL. B).

FIRST USE 2-27-2003; IN COMMERCE 2-27-2003.

THE MARK CONSISTS OF STANDARD CHARACTERS WITHOUT CLAIM TO ANY PAR-
TICULAR FONT, STYLE, SIZE, OR COLOR.

OWNER OF U.S. REG. NOS. 2,758,500, 3,244,563 AND OTHERS.

THE CERTIFICATION MARK, AS USED BY AUTHORIZED PERSONS, CERTIFIES THAT
PERSONS PERFORMING VASCULAR- INTERVENTIONAL RADIOGRAPHY SERVICES
HAVE MET THE STANDARDS, QUALIFICATIONS, AND TESTING REQUIREMENTS ES-
TABLISHED BY THE CERTIFIER.

SER. NO. 85-218,135, FILED 1-14-2011.

LINDA E. BLOHM, EXAMINING ATTORNEY



David J. Kyjars

Director of the United States Patent and Trademark Office

United States of America

United States Patent and Trademark Office

R.T.(VS)(ARRT)

Reg. No. 4,173,790

Registered July 17, 2012

CERTIFICATION MARK

PRINCIPAL REGISTER

THE AMERICAN REGISTRY OF RADIOLOGIC TECHNOLOGISTS (MINNESOTA
NON-PROFIT CORPORATION)
1255 NORTHLAND DRIVE
ST. PAUL, MN 551201155

FOR: DIAGNOSTIC MEDICAL IMAGING, INTERVENTIONAL MEDICAL PROCEDURES,
THERAPEUTIC TREATMENT, AND RADIATION THERAPY, IN CLASS B (U.S. CL. B).

FIRST USE 6-28-2001; IN COMMERCE 6-28-2001.

THE MARK CONSISTS OF STANDARD CHARACTERS WITHOUT CLAIM TO ANY PAR-
TICULAR FONT, STYLE, SIZE, OR COLOR.

OWNER OF U.S. REG. NOS. 2,758,500, 3,244,563 AND OTHERS.

THE CERTIFICATION MARK, AS USED BY AUTHORIZED PERSONS, CERTIFIES THAT
PERSONS PERFORMING VASCULAR SONOGRAPHY SERVICES HAVE MET THE
STANDARDS, QUALIFICATIONS, AND TESTING REQUIREMENTS ESTABLISHED BY
THE CERTIFIER.

SER. NO. 85-218,171, FILED 1-14-2011.

LINDA E. BLOHM, EXAMINING ATTORNEY



David J. Kyros

Director of the United States Patent and Trademark Office

United States of America

United States Patent and Trademark Office

R.T.(QM)(ARRT)

Reg. No. 4,173,791

Registered July 17, 2012

CERTIFICATION MARK

PRINCIPAL REGISTER

THE AMERICAN REGISTRY OF RADIOLOGIC TECHNOLOGISTS (MINNESOTA
NON-PROFIT CORPORATION)
1255 NORTHLAND DRIVE
ST. PAUL, MN 551201155

FOR: DIAGNOSTIC MEDICAL IMAGING, INTERVENTIONAL MEDICAL PROCEDURES,
THERAPEUTIC TREATMENT AND RADIATION THERAPY, IN CLASS B (U.S. CL. B).

FIRST USE 3-20-1997; IN COMMERCE 3-20-1997.

THE MARK CONSISTS OF STANDARD CHARACTERS WITHOUT CLAIM TO ANY PAR-
TICULAR FONT, STYLE, SIZE, OR COLOR.

OWNER OF U.S. REG. NOS. 2,785,800, 3,244,563 AND OTHERS.

NO CLAIM IS MADE TO THE EXCLUSIVE RIGHT TO USE "QM", APART FROM THE
MARK AS SHOWN.

THE CERTIFICATION MARK, AS USED BY AUTHORIZED PERSONS, CERTIFIES THAT
PERSONS PERFORMING QUALITY MANAGEMENT SERVICES HAVE MET THE
STANDARDS, QUALIFICATIONS, AND TESTING REQUIREMENTS ESTABLISHED BY
THE CERTIFIER.

SER. NO. 85-218,181, FILED 1-14-2011.

LINDA E. BLOHM, EXAMINING ATTORNEY



David J. Kyjars

Director of the United States Patent and Trademark Office

United States of America

United States Patent and Trademark Office

R.T.(CV)(ARRT)

Reg. No. 4,173,792

Registered July 17, 2012

CERTIFICATION MARK

PRINCIPAL REGISTER

THE AMERICAN REGISTRY OF RADIOLOGIC TECHNOLOGISTS (MINNESOTA
NON-PROFIT CORPORATION)
1255 NORTHLAND DRIVE
ST. PAUL, MN 551201155

FOR: DIAGNOSTIC MEDICAL IMAGING, INTERVENTIONAL MEDICAL PROCEDURES,
THERAPEUTIC TREATMENT AND RADIATION THERAPY, IN CLASS B (U.S. CL. B).

FIRST USE 7-16-1991; IN COMMERCE 7-16-1991.

THE MARK CONSISTS OF STANDARD CHARACTERS WITHOUT CLAIM TO ANY PAR-
TICULAR FONT, STYLE, SIZE, OR COLOR.

OWNER OF U.S. REG. NOS. 2,758,500, 3,244,563 AND OTHERS.

NO CLAIM IS MADE TO THE EXCLUSIVE RIGHT TO USE "CV", APART FROM THE MARK
AS SHOWN.

THE CERTIFICATION MARK, AS USED BY AUTHORIZED PERSONS, CERTIFIES THAT
PERSONS PERFORMING CARDIOVASCULAR- INTERVENTIONAL RADIOGRAPHY
SERVICES HAVE MET THE STANDARDS, QUALIFICATIONS, AND TESTING REQUIRE-
MENTS ESTABLISHED BY THE CERTIFIER.

SER. NO. 85-218,217, FILED 1-14-2011.

LINDA E. BLOHM, EXAMINING ATTORNEY



David J. Kyjars

Director of the United States Patent and Trademark Office

United States of America

United States Patent and Trademark Office

BIGJIGS

Reg. No. 4,173,793

Registered July 17, 2012

Int. Cl.: 28

TRADEMARK

PRINCIPAL REGISTER

BIGJIGS TOYS LTD (GREAT BRITAIN CORPORATION)
UNIT B, KINGSMEAD
WEST PARK FARM INDUSTRIAL ESTATE
FOLKESTONE, KENT, GREAT BRITAIN CT195EU

FOR: GAMES AND PLAYTHINGS, NAMELY, WOODEN TRAIN OR CAR SETS COMPOSED OF RAIL OR VEHICLE TRACKS AND TRAIN CARRIAGES OR CARS, TOY WRITING BOARDS, TOY SORTING GAMES, BOARD GAMES, CARD GAMES, DOMINOS, TOY TABLE TOP THEATRES, TOY PUPPET THEATRES, TOY GOLF SETS, PUSH-ALONG TOYS, WOODEN MOBILES, TOY BOOK ENDS, TOY BABY GYMS, TOY MONEY BOXES, TOYS FOR CLIPPING-ON, NAMELY SMALL TOYS DANGLING FROM A CLIP THAT CAN BE ATTACHED TO A STROLLER; BABY TOY RINGS AND RATTLES, DRESSING UP OUTFITS, TOY WEAPONS, NAMELY, SWORDS, DAGGERS, SHIELDS; TOY FOOD AND TOY COOKING UTENSILS, TOY IRONING SETS, TOY CLEANING SETS, TOY COOKING AND TOY HOUSEHOLD APPLIANCES, TOY MUSIC BOXES, TOY GARDENING TOOLS, TOY RIDE-ON VEHICLES, TOY PUSHCHAIRS; GYMNASTIC AND SPORTING ARTICLES, NAMELY, SWINGS, ROPE LADDERS, CROQUET MALLETS, CROQUET BALLS, CROQUET HOOPS, SKIPPING ROPES, BOWLING PINS, DECORATIONS FOR CHRISTMAS TREES; RATTLES; JIGSAWS AND PUZZLES; DOLLS, DOLLS' CLOTHING AND ACCESSORIES; DOLLS' FURNITURE; TOY JEWELRY; TOY MUSICAL INSTRUMENTS; DICE; PUPPETS; TOY ACTION FIGURES; TOY VEHICLES; RIDE-ON TOYS; TOY BUILDING STRUCTURES AND TOY VEHICLE TRACKS; PLAY SETS, NAMELY, DOLL HOUSE PLAY SET COMPOSED OF A DOLL HOUSE AND DOLL HOUSE FURNITURE AND FIGURINES, TOY FARM PLAY SETS COMPLETE WITH DOLLS AND ANIMALS, CASTLE WITH FURNITURE AND FIGURINES, PLAY SET COMPOSED OF A TOY GARAGE COMPLETE WITH CARS; TOY COSMETIC SETS, HOBBY CRAFT SETS COMPRISING BEADS FOR MAKING JEWELRY, PLAY PICNIC SET WITH BASKET, PLATES, BOWLS, AND CUPS, JUNIOR TOY TOOL BOX AND TOY TOOLS, ACTION FIGURE PLAY SETS; CHILDREN SWINGS AND CLIMBING LADDERS, IN CLASS 28 (U.S. CLS. 22, 23, 38 AND 50).



THE MARK CONSISTS OF STANDARD CHARACTERS WITHOUT CLAIM TO ANY PARTICULAR FONT, STYLE, SIZE, OR COLOR.

David J. Kyffers

OWNER OF ERPN CMNTY TM OFC REG. NO. 006679229, DATED 1-22-2009, EXPIRES 2-18-2018.

SER. NO. 85-219,022, FILED 1-17-2011.

Director of the United States Patent and Trademark Office

Reg. No. 4,173,793 PRISCILLA MILTON, EXAMINING ATTORNEY

United States of America

United States Patent and Trademark Office

PLATINUM LOGISTICS

Reg. No. 4,173,794

WOBBROCK, JEFF (UNITED STATES INDIVIDUAL)

Registered July 17, 2012

1367 LORING STREET
SAN DIEGO, CA 92109

Int. Cl.: 35

FOR: TRANSPORTATION LOGISTICS SERVICES, NAMELY, ARRANGING THE TRANSPORTATION OF GOODS FOR OTHERS, IN CLASS 35 (U.S. CLS. 100, 101 AND 102).

SERVICE MARK

FIRST USE 4-30-2002; IN COMMERCE 4-30-2002.

PRINCIPAL REGISTER

THE MARK CONSISTS OF STANDARD CHARACTERS WITHOUT CLAIM TO ANY PARTICULAR FONT, STYLE, SIZE, OR COLOR.

NO CLAIM IS MADE TO THE EXCLUSIVE RIGHT TO USE "LOGISTICS", APART FROM THE MARK AS SHOWN.

SER. NO. 85-221,074, FILED 1-19-2011.

KAPIL BHANOT, EXAMINING ATTORNEY



David J. Kybas

Director of the United States Patent and Trademark Office

United States of America

United States Patent and Trademark Office

Domino  *Tille*

Reg. No. 4,173,795

Registered July 17, 2012

Int. Cl.: 25

TRADEMARK

PRINCIPAL REGISTER

JENKS, NICHOLAS (UNITED STATES INDIVIDUAL), AKA DETROIT BRAND
51879 ADLER PARK DRIVE EAST
CHESTERFIELD, MI 48051

FOR: BELTS; BELTS MADE OUT OF CLOTH; BOTTOMS; DUSTERS; EYESHADES; FABRIC SOLD AS AN INTEGRAL COMPONENT OF FINISHED CLOTHING ITEMS, NAMELY, HOODED SWEATSHIRTS, HATS, T-SHIRTS, BOARD SHORTS, BATHING SUITS, SKIRTS; HEADBANDS FOR CLOTHING; HOODS; JACKETS; JERSEYS; LEATHER BELTS; PARTS OF CLOTHING, NAMELY, GUSSETS FOR TIGHTS, GUSSETS FOR STOCKINGS, GUSSETS FOR BATHING SUITS, GUSSETS FOR UNDERWEAR, GUSSETS FOR LEOTARDS AND GUSSETS FOR FOOTLETS; POCKET SQUARES; TOPS; WEARABLE GARMENTS AND CLOTHING, NAMELY, SHIRTS; WRAPS, IN CLASS 25 (U.S. CLS. 22 AND 39).

FIRST USE 12-13-2010; IN COMMERCE 12-28-2010.

THE NAME "DOMINO TILLE" DOES NOT IDENTIFY A LIVING INDIVIDUAL.

THE MARK CONSISTS OF THE STYLIZED WORDS "DOMINO TILLE" WITH THE STYLIZED LETTERS "DT" APPEARING IN A CIRCLE BETWEEN "DOMINO" AND "TILLE".

SER. NO. 85-221,764, FILED 1-20-2011.

TRICIA SONNEBORN, EXAMINING ATTORNEY



David J. Kyros

Director of the United States Patent and Trademark Office

United States of America

United States Patent and Trademark Office

SIMPLETREAD

Reg. No. 4,173,796

Registered July 17, 2012

Int. Cl.: 19

TRADEMARK

PRINCIPAL REGISTER

MOULURE ALEXANDRIA MOULDING INC. (CANADA CORPORATION)
95 LOCHIEL STREET EAST
ALEXANDRIA, ONTARIO, CANADA K0C1A0

FOR: NON-METAL STAIR COMPONENTS, NAMELY, SOLID TREADS, VENEER TREADS, SOLID RISERS, VENEER RISERS AND WOOD RETURNS, IN CLASS 19 (U.S. CLS. 1, 12, 33 AND 50).

THE MARK CONSISTS OF STANDARD CHARACTERS WITHOUT CLAIM TO ANY PARTICULAR FONT, STYLE, SIZE, OR COLOR.

PRIORITY CLAIMED UNDER SEC. 44(D) ON CANADA APPLICATION NO. 1510918, FILED 1-12-2011, REG. NO. TMA817,421, DATED 2-10-2012, EXPIRES 2-10-2027.

SER. NO. 85-221,798, FILED 1-20-2011.

REBECCA POVARCHUK, EXAMINING ATTORNEY



David J. Kybas

Director of the United States Patent and Trademark Office

United States of America

United States Patent and Trademark Office

MACKADENICE

Reg. No. 4,173,797

VENEY, DANA (UNITED STATES INDIVIDUAL)
510 POCHAHONTAS PLACE
HAMPTON, VA 23661

Registered July 17, 2012

Int. Cls.: 9 and 41

FOR: AUDIO AND VIDEO MUSICAL RECORDINGS FEATURING PERFORMANCES BY A SINGER, IN CLASS 9 (U.S. CLS. 21, 23, 26, 36 AND 38).

TRADEMARK

FIRST USE 9-2-2009; IN COMMERCE 12-3-2009.

SERVICE MARK

FOR: ENTERTAINMENT SERVICES, NAMELY, MUSICAL PERFORMANCES BY A SINGER, IN CLASS 41 (U.S. CLS. 100, 101 AND 107).

PRINCIPAL REGISTER

FIRST USE 9-2-2009; IN COMMERCE 12-3-2009.

THE MARK CONSISTS OF STANDARD CHARACTERS WITHOUT CLAIM TO ANY PARTICULAR FONT, STYLE, SIZE, OR COLOR.

SER. NO. 85-225,073, FILED 1-25-2011.

DAVID H. STINE, EXAMINING ATTORNEY



David J. Kyffers

Director of the United States Patent and Trademark Office

United States of America

United States Patent and Trademark Office

Words Of Wisdom The Game

Reg. No. 4,173,798

REEDER, STEPHEN W (UNITED STATES INDIVIDUAL)
23293 VENTURA BLVD.

Registered July 17, 2012

WOODLAND HILLS, CA 91364

Int. Cl.: 28

FOR: BOARD GAMES; CARD GAMES; EDUCATIONAL CARD GAMES, IN CLASS 28 (U.S. CLS. 22, 23, 38 AND 50).

TRADEMARK

FIRST USE 9-5-2011; IN COMMERCE 9-5-2011.

PRINCIPAL REGISTER

THE MARK CONSISTS OF STANDARD CHARACTERS WITHOUT CLAIM TO ANY PARTICULAR FONT, STYLE, SIZE, OR COLOR.

NO CLAIM IS MADE TO THE EXCLUSIVE RIGHT TO USE "GAME", APART FROM THE MARK AS SHOWN.

SER. NO. 85-226,764, FILED 1-26-2011.

STEVEN PEREZ, EXAMINING ATTORNEY



David J. Kyffers

Director of the United States Patent and Trademark Office

United States of America

United States Patent and Trademark Office

Frugal - The New F Word

Reg. No. 4,173,799

Registered July 17, 2012

Int. Cl.: 41

SERVICE MARK

PRINCIPAL REGISTER

TERESA STONE (ILLINOIS SOLE PROPRIETORSHIP), DBA FRUGAL - THE NEW F WORD
1009 IROQUOIS AVE
NAPERVILLE, IL 60563

FOR: ONLINE BLOG AND COLUMN AVAILABLE TO ONLINE AND EREADERS IN THE
FIELD OF MONEY MANAGEMENT AND BARGAIN SHOPPING FOR PUBLIC CONSUMERS
, IN CLASS 41 (U.S. CLS. 100, 101 AND 107).

FIRST USE 1-15-2011; IN COMMERCE 1-15-2011.

THE MARK CONSISTS OF STANDARD CHARACTERS WITHOUT CLAIM TO ANY PAR-
TICULAR FONT, STYLE, SIZE, OR COLOR.

NO CLAIM IS MADE TO THE EXCLUSIVE RIGHT TO USE "FRUGAL", APART FROM THE
MARK AS SHOWN.

SER. NO. 85-227,116, FILED S.R. 1-26-2011 AM. P.R. 3-22-2012.

DAVID HOFFMAN, EXAMINING ATTORNEY



David J. Kyffers

Director of the United States Patent and Trademark Office

United States of America

United States Patent and Trademark Office

GO HEALTHY

Reg. No. 4,173,800

NBC UNIVERSAL MEDIA, LLC (DELAWARE LIMITED LIABILITY COMPANY)
30 ROCKEFELLER PLAZA
NEW YORK, NY 10112

Registered July 17, 2012

Int. Cl.: 41

FOR: ENTERTAINMENT SERVICES, NAMELY, ONGOING TELEVISION PROGRAMS CONCERNING HEALTH ISSUES; ENTERTAINMENT SERVICES, NAMELY, PROVIDING A WEBSITE FEATURING ENTERTAINMENT-RELATED INFORMATION AND ONGOING TELEVISION ENTERTAINMENT PROGRAMS ABOUT HEALTH ISSUES; AMUSEMENT PARK SERVICES; PROVIDING A WEBPAGE FEATURING ONGOING ENTERTAINMENT PROGRAMS IN THE NATURE OF NEWS, REALITY, COMEDY, OR DRAMA PROGRAMS RELATED TO HEALTH ISSUES; ENTERTAINMENT AND EDUCATIONAL SERVICES, NAMELY, CONDUCTING EDUCATIONAL HEALTH FAIRS, WORKSHOPS, DEMONSTRATIONS, LECTURES, PRESENTATIONS, AND FITNESS CLASSES IN THE FIELD OF HEALTH, NOT FOR COMMERCIAL PURPOSES, IN CLASS 41 (U.S. CLS. 100, 101 AND 107).

SERVICE MARK

PRINCIPAL REGISTER

FIRST USE 6-14-2010; IN COMMERCE 6-14-2010.

THE MARK CONSISTS OF STANDARD CHARACTERS WITHOUT CLAIM TO ANY PARTICULAR FONT, STYLE, SIZE, OR COLOR.

NO CLAIM IS MADE TO THE EXCLUSIVE RIGHT TO USE "HEALTHY", APART FROM THE MARK AS SHOWN.

SER. NO. 85-227,206, FILED 1-26-2011.

CORY BOONE, EXAMINING ATTORNEY



David J. Kyffers

Director of the United States Patent and Trademark Office

United States of America

United States Patent and Trademark Office



Reg. No. 4,173,801

Registered July 17, 2012

Int. Cl.: 29

TRADEMARK

PRINCIPAL REGISTER

ATLANTIC CAPES FISHERIES, INC. (NEW JERSEY CORPORATION)
985 OCEAN DRIVE
CAPE MAY, NJ 08204

FOR: FROZEN APPETIZERS CONSISTING PRIMARILY OF CHICKEN OR SEAFOOD; FROZEN PRE-PACKAGED ENTREES CONSISTING PRIMARILY OF SEAFOOD; MARINATED SEAFOOD AND SHELLFISH; PRE-PACKAGED DINNERS CONSISTING OF SEAFOOD AND SHELLFISH; PREPARED ENTREES CONSISTING PRIMARILY OF SEAFOOD; PREPARED FOOD KITS COMPOSED OF MEAT, POULTRY, FISH, SEAFOOD, AND/OR VEGETABLES AND ALSO INCLUDING SAUCES OR SEASONINGS, READY FOR COOKING AND ASSEMBLY AS A MEAL; PROCESSED SEAFOOD, NAMELY, FISH; SEAFOOD; SEAFOOD, NAMELY, SCALLOPS, CRAWFISH AND SHELLFISH; SEAFOODS BOILED DOWN IN SOY SAUCE (TSUKUDANI); SEASONED SEAFOOD AND SHELLFISH; SHELLFISH; SHELLFISH FOR HUMAN CONSUMPTION; SHELLFISH, NOT LIVE; TINNED SEAFOOD, IN CLASS 29 (U.S. CL. 46).

FIRST USE 2-1-2003; IN COMMERCE 3-1-2003.

NO CLAIM IS MADE TO THE EXCLUSIVE RIGHT TO USE "ATLANTIC" AND "FISHERIES", APART FROM THE MARK AS SHOWN.

THE COLOR(S) BLUE, LIGHT BLUE, YELLOW AND WHITE IS/ARE CLAIMED AS A FEATURE OF THE MARK.

THE MARK CONSISTS OF THE WORDING "ATLANTIC CAPES FISHERIES" IN WHITE, ENCLOSED WITHIN A BLUE RECTANGLE WITH A YELLOW OUTLINE; AN OVAL SHAPE WITH A YELLOW OUTLINE IS OVER THE TOP PORTION OF THE RECTANGLE AND CONTAINS A WHITE SCALLOP BOAT OUTLINED IN BLUE IN AN OCEAN WITH WAVES OUTLINED IN BLUE AND THAT FADES FROM WHITE AT THE TOP TOWARDS BLUE ON THE BOTTOM, AND A FADING LIGHT BLUE SKY WITH BLUE SEAGULLS FLYING ABOVE THE BOAT.

SER. NO. 85-227,818, FILED 1-27-2011.

TARA PATE, EXAMINING ATTORNEY



David J. Kyros

Director of the United States Patent and Trademark Office

United States of America

United States Patent and Trademark Office

ROUNDUP PERFORMANCE PACT

Reg. No. 4,173,802

MONSANTO TECHNOLOGY LLC (DELAWARE LIMITED LIABILITY COMPANY)
800 NORTH LINDBERGH BLVD., E2NA
ST. LOUIS, MO 63167

Registered July 17, 2012

Int. Cl.: 36

FOR: INCENTIVE WEED MANAGEMENT PROGRAM, NAMELY, PROVIDING PERFORMANCE WARRANTIES OF AGRICULTURAL HERBICIDES TO FARMERS, IN CLASS 36 (U.S. CLS. 100, 101 AND 102).

SERVICE MARK

FIRST USE 12-1-2010; IN COMMERCE 12-1-2010.

PRINCIPAL REGISTER

THE MARK CONSISTS OF STANDARD CHARACTERS WITHOUT CLAIM TO ANY PARTICULAR FONT, STYLE, SIZE, OR COLOR.

OWNER OF U.S. REG. NOS. 2,775,857, 3,076,137 AND OTHERS.

NO CLAIM IS MADE TO THE EXCLUSIVE RIGHT TO USE "PERFORMANCE PACT", APART FROM THE MARK AS SHOWN.

SER. NO. 85-227,934, FILED 1-27-2011.

KAPIL BHANOT, EXAMINING ATTORNEY



David J. Kyjars

Director of the United States Patent and Trademark Office

United States of America

United States Patent and Trademark Office



grapevine

Reg. No. 4,173,803

Registered July 17, 2012

Int. Cls.: 35 and 43

SERVICE MARK

PRINCIPAL REGISTER

THE GRAPEVINE OF FORT MILL, INC. (SOUTH CAROLINA CORPORATION)
1012 MARKET STREET
SUITE 105
FORT MILL, SC 29708

FOR: RETAIL STORE SERVICES FEATURING WINE, BEER AND CIGARS, IN CLASS 35
(U.S. CLS. 100, 101 AND 102).

FIRST USE 7-0-2007; IN COMMERCE 7-0-2007.

FOR: BAR SERVICES FEATURING WINE, BEER AND CIGARS, IN CLASS 43 (U.S. CLS.
100 AND 101).

FIRST USE 7-0-2007; IN COMMERCE 7-0-2007.

THE MARK CONSISTS OF A STYLIZED DEPICTION OF A BUNCH OF GRAPES WITH THE
WORD "GRAPEVINE" APPEARING BENEATH IT.

SER. NO. 85-230,934, FILED 2-1-2011.

LINDA MICKLEBURGH, EXAMINING ATTORNEY



David J. Kybas

Director of the United States Patent and Trademark Office

United States of America

United States Patent and Trademark Office

Pre-Prohibition Style

Reg. No. 4,173,804

Registered July 17, 2012

Int. Cl.: 32

TRADEMARK

PRINCIPAL REGISTER

THE BROOKLYN BREWERY CORPORATION (NEW YORK CORPORATION)
79 NORTH 11TH STREET
BROOKLYN, NY 11211

FOR: MALT BEER, IN CLASS 32 (U.S. CLS. 45, 46 AND 48).

FIRST USE 9-1-2008; IN COMMERCE 9-1-2008.

THE MARK CONSISTS OF STANDARD CHARACTERS WITHOUT CLAIM TO ANY PARTICULAR FONT, STYLE, SIZE, OR COLOR.

OWNER OF U.S. REG. NO. 2,420,487.

SER. NO. 85-232,293, FILED 2-2-2011.

MICHELE SWAIN, EXAMINING ATTORNEY



David J. Kyffers

Director of the United States Patent and Trademark Office

United States of America

United States Patent and Trademark Office



Reg. No. 4,173,805

Registered July 17, 2012

Int. Cls.: 29 and 30

TRADEMARK

PRINCIPAL REGISTER

FLEURY MICHON S.A. (FRANCE CORPORATION)
ROUTE DE LA GARE
POUZAUGES, FRANCE 85700

FOR: PREPARED MEALS CONSISTING OF VEGETABLE AND GARDEN SALADS, IN CLASS 29 (U.S. CL. 46).

FOR: PREPARED MEALS CONSISTING OF PASTA, RICE AND NOODLES, IN CLASS 30 (U.S. CL. 46).

PRIORITY CLAIMED UNDER SEC. 44(D) ON CANADA APPLICATION NO. 1490969, FILED 8-3-2010, REG. NO. TMA818033, DATED 2-21-2012, EXPIRES 2-21-2027.

THE NAME(S), PORTRAIT(S), AND/OR SIGNATURE(S) SHOWN IN THE MARK DOES NOT IDENTIFY A PARTICULAR LIVING INDIVIDUAL.

THE MARK CONSISTS OF THE DESIGN OF A TRAPEZOID DIVIDED INTO FOUR (4) AREAS DIVIDED BY (3) HORIZONTAL LINES. THE DISTANCE BETWEEN THE TOP (3) LINES IS EQUAL MAKING THREE AREAS OF ROUGHLY EQUAL SIZE. WITHIN THE TOP AREA IS THE DESIGN OF PEOPLES' LEGS, WITHIN THE SECOND AREA IS THE LITERAL ELEMENT "OLIDA" REVERSED OUT OF A SHADED BACKGROUND AND WITHIN THE THIRD AREA IS SHADING. THE DOTTED LINE IS NOT A FEATURE OF THE MARK BUT IS TO INDICATE THE BORDER OF THE DESIGN.

THE WORDING "OLIDA" HAS NO MEANING IN A FOREIGN LANGUAGE.

SER. NO. 85-232,400, FILED 2-2-2011.

STEVEN JACKSON, EXAMINING ATTORNEY



David J. Kybas

Director of the United States Patent and Trademark Office

United States of America

United States Patent and Trademark Office

HUG LIFE

Reg. No. 4,173,806

Registered July 17, 2012

Int. Cl.: 25

TRADEMARK

PRINCIPAL REGISTER

HUG LIFE, INC. (CALIFORNIA CORPORATION)
#103
1251 ARMACOST AVE.
LOS ANGELES, CA 90025

FOR: DRESSES; HOODED SWEATSHIRTS; JACKETS; LEGGINGS; ONE PIECE GARMENT FOR INFANTS AND TODDLERS; PANTS; SWEATSHIRTS; TEE SHIRTS; YOGA PANTS; YOGA SHIRTS, IN CLASS 25 (U.S. CLS. 22 AND 39).

FIRST USE 5-13-2007; IN COMMERCE 4-21-2010.

THE MARK CONSISTS OF STANDARD CHARACTERS WITHOUT CLAIM TO ANY PARTICULAR FONT, STYLE, SIZE, OR COLOR.

OWNER OF U.S. REG. NO. 3,946,467.

SER. NO. 85-233,200, FILED 2-3-2011.

KATHRYN COWARD, EXAMINING ATTORNEY



David J. Kyffers

Director of the United States Patent and Trademark Office

United States of America

United States Patent and Trademark Office



Reg. No. 4,173,807

Registered July 17, 2012

Int. Cl.: 39

SERVICE MARK

PRINCIPAL REGISTER

GRUPO AEROMEXICO, S.A. DE C.V. (MEXICO CORPORATION)
PISO 9
PASEO DE LA REFORMA NO. 445
COL. CUAUHTEMOC, D.F., MEXICO 06500

FOR: TRANSPORTATION SERVICES, NAMELY, AIRLINE PASSENGER SERVICES FEATURING A FREQUENT FLYER BONUS PROGRAM, TRANSPORTATION OF PASSENGERS, FREIGHT, GOODS AND MAIL BY AIR, LAND AND SEA; STORAGE OF GOODS OF ALL KINDS IN WAREHOUSES AND SHIPPING CONTAINERS; CRATING OF GOODS, NAMELY, PACKING OF GOODS FOR TRANSPORTATION BY AIR, TRUCK, TRAIN, AND SHIP, PARCEL DELIVERY BY AIR, TRUCK CAR, TRAIN, AND SHIP, IN CLASS 39 (U.S. CLS. 100 AND 105).

PRIORITY CLAIMED UNDER SEC. 44(D) ON MEXICO APPLICATION NO. 1149845, FILED 1-25-2011, REG. NO. 1257617, DATED 1-25-2011, EXPIRES 1-25-2021.

THE COLOR(S) BLUE AND RED IS/ARE CLAIMED AS A FEATURE OF THE MARK.

OWNER OF U.S. REG. NOS. 1,938,267, 2,293,104 AND OTHERS.

NO CLAIM IS MADE TO THE EXCLUSIVE RIGHT TO USE "CARGO", APART FROM THE MARK AS SHOWN.

THE MARK CONSISTS OF AN EAGLE HEAD IN THE COLOR BLUE TO THE LEFT OF THE WORD "AEROMEXICO" IN THE COLOR BLUE. A RED VERTICAL LINE IS BETWEEN THE WORD "AEROMEXICO" AND THE WORD "CARGO" IN THE COLOR BLUE.

SER. NO. 85-235,624, FILED 2-7-2011.

DANNEAN HETZEL, EXAMINING ATTORNEY



David J. Kypos

Director of the United States Patent and Trademark Office

United States of America

United States Patent and Trademark Office

Got Respect

Reg. No. 4,173,808

Registered July 17, 2012

Int. Cl.: 25

TRADEMARK

PRINCIPAL REGISTER

STARK, DANIEL G (UNITED STATES INDIVIDUAL)
1150 EVERGREEN RD #7 1150 EVERGREEN RD #
7;
REDWAY, CA 95560

FOR: SCIENTIFIC AND TECHNOLOGICAL APPAREL, NAMELY, SHIRTS, PANTS, JACKETS,
FOOTWEAR, HATS AND CAPS, UNIFORMS, IN CLASS 25 (U.S. CLS. 22 AND 39).

FIRST USE 2-1-2011; IN COMMERCE 2-1-2011.

THE MARK CONSISTS OF STANDARD CHARACTERS WITHOUT CLAIM TO ANY PAR-
TICULAR FONT, STYLE, SIZE, OR COLOR.

SER. NO. 85-236,832, FILED 2-8-2011.

PAM WILLIS, EXAMINING ATTORNEY



David J. Kyffers

Director of the United States Patent and Trademark Office

United States of America

United States Patent and Trademark Office

MATORTHO

Reg. No. 4,173,809

Registered July 17, 2012

Int. Cl.: 10

TRADEMARK

PRINCIPAL REGISTER

MATORTHO LIMITED (UNITED KINGDOM LIMITED COMPANY (LTD.))
21 WARWICKS BENCH, LANGTON
GUILDFORD, SURREY, UNITED KINGDOM GU13TF

FOR: ORTHOPAEDIC ARTICLES, NAMELY, JOINT PROSTHESIS, HIP PROSTHESIS, ARTIFICIAL KNEE IMPLANTS, ARTIFICIAL ANKLE IMPLANTS, ARTIFICIAL FINGER IMPLANTS; ORTHOPAEDIC JOINT PROSTHESIS AND IMPLANTS; SURGICAL OPERATIVE INSTRUMENTS, ALL FOR USE IN ORTHOPAEDIC SURGERY, IN CLASS 10 (U.S. CLS. 26, 39 AND 44).

THE MARK CONSISTS OF STANDARD CHARACTERS WITHOUT CLAIM TO ANY PARTICULAR FONT, STYLE, SIZE, OR COLOR.

PRIORITY CLAIMED UNDER SEC. 44(D) ON UNITED KINGDOM APPLICATION NO. 2565908, FILED 11-30-2010, REG. NO. 2565908, DATED 11-30-2010, EXPIRES 11-30-2020.

SER. NO. 85-238,854, FILED 2-10-2011.

Alice Benmaman, Examining Attorney



David J. Kyffers

Director of the United States Patent and Trademark Office

United States of America

United States Patent and Trademark Office

PAZO SEÑORANS

Reg. No. 4,173,810

PAZO DE SEÑORANS, S.L.U. (SPAIN LIMITED LIABILITY COMPANY)
VILANOVIÑA, S/N
PONTEVEDRA, SPAIN

Registered July 17, 2012

Int. Cl.: 33

FOR: ALCOHOLIC BEVERAGES EXCEPT BEERS, IN CLASS 33 (U.S. CLS. 47 AND 49).

TRADEMARK

FIRST USE 1-1-1989; IN COMMERCE 1-1-1989.

PRINCIPAL REGISTER

THE MARK CONSISTS OF STANDARD CHARACTERS WITHOUT CLAIM TO ANY PARTICULAR FONT, STYLE, SIZE, OR COLOR.

THE ENGLISH TRANSLATION OF "PAZO SEÑORANS" IN THE MARK IS "SEÑORANZ COUNTRY HOUSE". THE WORDING SEÑORANZ HAS NO MEANING IN A FOREIGN LANGUAGE.

SER. NO. 85-241,130, FILED 2-14-2011.

DANNEAN HETZEL, EXAMINING ATTORNEY



David J. Kyffers

Director of the United States Patent and Trademark Office

United States of America

United States Patent and Trademark Office

FLASH VALET

Reg. No. 4,173,811

Registered July 17, 2012

Int. Cls.: 35, 38 and 42

SERVICE MARK

PRINCIPAL REGISTER

KLEVER LOGIC INC (DELAWARE CORPORATION)
SUITE 1400
700 LAVACA STREET, STE 1400
AUSTIN, TX 78701

FOR: ADVERTISING SERVICES AND BUSINESS CONSULTATION SERVICES, ALL RELATING TO VALET PARKING SERVICES, AUTOMOTIVE PARKING SERVICES, AND OR MOBILE PAYMENTS FOR AUTOMOTIVE PARKING SERVICES, IN CLASS 35 (U.S. CLS. 100, 101 AND 102).

FIRST USE 12-15-2010; IN COMMERCE 1-7-2011.

FOR: COMMUNICATION SERVICES, NAMELY, TRANSMISSION OF INFORMATION VIA TELECOMMUNICATIONS NETWORKS, WIRELESS COMMUNICATION NETWORKS, THE INTERNET, INFORMATION SERVICES NETWORKS AND DATA NETWORKS TO VALUE PARKING COMPANIES AND OPERATIONS WHICH ALLOWS THEM TO COMMUNICATE WITH THEIR END-CUSTOMERS, ALL OF THE FOREGOING RELATING TO VALET PARKING SERVICES, AUTOMOTIVE PARKING SERVICES, AND OR MOBILE PAYMENTS FOR AUTOMOTIVE PARKING SERVICES, IN CLASS 38 (U.S. CLS. 100, 101 AND 104).

FIRST USE 12-15-2010; IN COMMERCE 1-7-2011.

FOR: CONSULTANCY IN THE FIELD OF COMPUTER HARDWARE; INSTALLATION OF COMPUTER SOFTWARE; COMPUTER SOFTWARE CONSULTANCY; COMPUTER PROGRAMMING; UPDATING OF COMPUTER SOFTWARE; COMPUTER SOFTWARE DESIGN; DUPLICATION OF COMPUTER PROGRAMS; COMPUTER SOFTWARE DEVELOPMENT IN THE FIELD OF MOBILE APPLICATIONS; ALL OF THE FOREGOING RELATING TO VALET PARKING SERVICES, AUTOMOTIVE PARKING SERVICES, AND OR MOBILE PAYMENTS FOR AUTOMOTIVE PARKING SERVICES, IN CLASS 42 (U.S. CLS. 100 AND 101).

FIRST USE 12-15-2010; IN COMMERCE 1-7-2011.

THE MARK CONSISTS OF STANDARD CHARACTERS WITHOUT CLAIM TO ANY PARTICULAR FONT, STYLE, SIZE, OR COLOR.



David J. Kyros

Director of the United States Patent and Trademark Office

Reg. No. 4,173,811 NO CLAIM IS MADE TO THE EXCLUSIVE RIGHT TO USE "VALET", APART FROM THE MARK AS SHOWN.

SER. NO. 85-241,182, FILED 2-14-2011.

GEOFFREY FOSDICK, EXAMINING ATTORNEY

United States of America

United States Patent and Trademark Office

ROCKY

Reg. No. 4,173,812

Registered July 17, 2012

Int. Cl.: 25

TRADEMARK

PRINCIPAL REGISTER

ROCKY BRANDS, INC. (OHIO CORPORATION)
39 EAST CANAL STREET
NELSONVILLE, OH 45764

FOR: CLOTHING, NAMELY, PANTS, JACKETS, BIB OVERALLS, PARKAS, WADING PANTS, HEADWEAR, HATS, SOCKS, SWEATSHIRTS, SWEATPANTS, COMPRESSION PANTS, THERMAL UNDERWEAR, LONG UNDERWEAR, HOODED SHIRTS, SHIRTS, T-SHIRTS, VESTS, GLOVES, IN CLASS 25 (U.S. CLS. 22 AND 39).

FIRST USE 0-0-1998; IN COMMERCE 0-0-1998.

THE MARK CONSISTS OF STANDARD CHARACTERS WITHOUT CLAIM TO ANY PARTICULAR FONT, STYLE, SIZE, OR COLOR.

SER. NO. 85-243,873, FILED 2-16-2011.

C. DIONNE CLYBURN, EXAMINING ATTORNEY



David J. Kyffers

Director of the United States Patent and Trademark Office

United States of America

United States Patent and Trademark Office

Biscotti Goddess

Reg. No. 4,173,813

Registered July 17, 2012

Int. Cl.: 30

TRADEMARK

PRINCIPAL REGISTER

EAGLESNEST LLC (VIRGINIA LIMITED LIABILITY COMPANY), DBA BISCOTTI GODDESS
12500 EAGLES NEST ROAD
CHARLES CITY, VA 23030

FOR: BISCOTTI, IN CLASS 30 (U.S. CL. 46).

FIRST USE 3-1-2010; IN COMMERCE 3-1-2010.

THE MARK CONSISTS OF STANDARD CHARACTERS WITHOUT CLAIM TO ANY PARTICULAR FONT, STYLE, SIZE, OR COLOR.

NO CLAIM IS MADE TO THE EXCLUSIVE RIGHT TO USE "BISCOTTI", APART FROM THE MARK AS SHOWN.

SER. NO. 85-245,209, FILED 2-17-2011.

DAVID ELTON, EXAMINING ATTORNEY



David J. Kyffers

Director of the United States Patent and Trademark Office

United States of America

United States Patent and Trademark Office



Reg. No. 4,173,814

CRC BROADCASTING COMPANY, INC. (ARIZONA CORPORATION), DBA MONEY RADIO
1510

Registered July 17, 2012

4800 N. CENTRAL AVE.
PHOENIX, AZ 85012

Int. Cl.: 41

FOR: ENTERTAINMENT SERVICES, NAMELY, AN ON-GOING SERIES FEATURING FINANCIAL RELATED PROGRAMMING PROVIDED THROUGH RADIO, SATELLITE, AND INTERNET BROADCAST, IN CLASS 41 (U.S. CLS. 100, 101 AND 107).

SERVICE MARK

PRINCIPAL REGISTER

FIRST USE 2-17-2011; IN COMMERCE 2-17-2011.

NO CLAIM IS MADE TO THE EXCLUSIVE RIGHT TO USE "RADIO 1510 AM", APART FROM THE MARK AS SHOWN.

THE COLOR(S) DARK GREEN, LIGHT GREEN, BEIGE AND WHITE IS/ARE CLAIMED AS A FEATURE OF THE MARK.

THE MARK CONSISTS OF A BEIGE OVAL DISK WITH ACCENT MARKS AROUND THE BORDER, WITH A LIGHT GREEN THREE-DIMENSIONAL DOLLAR SIGN TO THE LEFT, WITH THE WORDS "MONEY" AND "RADIO" IN THE CENTER IN A DARK-GREEN TO LIGHT-GREEN GRADIENT, FOLLOWED BY "1510 AM" IN WHITE TO THE RIGHT OF CENTER ON THE OVAL.

SER. NO. 85-246,419, FILED 2-18-2011.

AISHA CLARKE, EXAMINING ATTORNEY



David J. Kybas

Director of the United States Patent and Trademark Office

United States of America

United States Patent and Trademark Office

A-TACS

Reg. No. 4,173,815

Registered July 17, 2012

Int. Cl.: 25

TRADEMARK

PRINCIPAL REGISTER

DIGITAL CONCEALMENT SYSTEMS, LLC (GEORGIA LIMITED LIABILITY COMPANY)
618 - 10TH PLACE
PHENIX CITY, AL 36867

FOR: TACTICAL AND ASSAULT CLOTHING, NAMELY, CAMOUFLAGE SHIRTS, CAMOUFLAGE JACKETS, CAMOUFLAGE T-SHIRTS, CAMOUFLAGE TOPS, CAMOUFLAGE PANTS, CAMOUFLAGE CAPS, CAMOUFLAGE HATS, ALL OF WHICH EXCLUDE SPORTSWEAR AND ALL FOR USE IN THE FIELDS OF MILITARY, LAW ENFORCEMENT, PARAMILITARY, RESCUE AND PUBLIC SAFETY APPLICATIONS AND ALL OF WHICH ARE SOLD EXCLUSIVELY THROUGH RETAIL STORES, CATALOGS AND INTERNET STORES DEVOTED TO THE SALE OF GOODS IN THE FIELDS OF MILITARY, LAW ENFORCEMENT, PARAMILITARY, RESCUE AND PUBLIC SAFETY; TACTICAL ASSAULT VESTS, NAMELY, CAMOUFLAGE VESTS, ALL OF WHICH EXCLUDE SPORTSWEAR AND ALL FOR USE IN THE FIELDS OF MILITARY, LAW ENFORCEMENT, PARAMILITARY, RESCUE AND PUBLIC SAFETY APPLICATIONS AND ALL OF WHICH ARE SOLD EXCLUSIVELY THROUGH RETAIL STORES, CATALOGS AND INTERNET STORES DEVOTED TO THE SALE OF GOODS IN THE FIELDS OF MILITARY, LAW ENFORCEMENT, PARAMILITARY, RESCUE AND PUBLIC SAFETY, IN CLASS 25 (U.S. CLS. 22 AND 39).

FIRST USE 10-14-2009; IN COMMERCE 6-1-2010.

THE MARK CONSISTS OF STANDARD CHARACTERS WITHOUT CLAIM TO ANY PARTICULAR FONT, STYLE, SIZE, OR COLOR.

OWNER OF U.S. REG. NO. 3,815,288.

SER. NO. 85-248,017, FILED 2-22-2011.

RUDY R. SINGLETON, EXAMINING ATTORNEY



David J. Kyros

Director of the United States Patent and Trademark Office

United States of America

United States Patent and Trademark Office

MillRock

Reg. No. 4,173,816

CEPHAS LLC (VIRGINIA LIMITED LIABILITY COMPANY)
4660 EARLY RD
MT. CRAWFORD, VA 22841

Registered July 17, 2012

Int. Cl.: 20

FOR: BATHROOM VANITIES; CABINETS; CABINETS FOR DISPLAY PURPOSES; DESKS;
FILING CABINETS; KITCHEN CABINETS, IN CLASS 20 (U.S. CLS. 2, 13, 22, 25, 32 AND
50).

TRADEMARK

FIRST USE 12-31-1979; IN COMMERCE 12-31-1979.

PRINCIPAL REGISTER

THE MARK CONSISTS OF STANDARD CHARACTERS WITHOUT CLAIM TO ANY PAR-
TICULAR FONT, STYLE, SIZE, OR COLOR.

SER. NO. 85-250,443, FILED 2-24-2011.

COLLEEN DOMBROW, EXAMINING ATTORNEY



David J. Kyffers

Director of the United States Patent and Trademark Office

United States of America

United States Patent and Trademark Office

DIAMOND DRAW POKER

Reg. No. 4,173,817

Registered July 17, 2012

Int. Cl.: 9

TRADEMARK

PRINCIPAL REGISTER

SPIELO INTERNATIONAL CANADA ULC (CANADA CORPORATION)
328 URQUHART AVENUE
MONCTON, NEW BRUNSWICK, CANADA E1H 2R6

FOR: RECONFIGURABLE CASINO AND LOTTERY GAMING EQUIPMENT, NAMELY, VIDEO POKER MACHINES, AND OPERATIONAL COMPUTER GAME SOFTWARE THEREFOR, IN CLASS 9 (U.S. CLS. 21, 23, 26, 36 AND 38).

FIRST USE 5-31-2009; IN COMMERCE 5-31-2009.

THE MARK CONSISTS OF STANDARD CHARACTERS WITHOUT CLAIM TO ANY PARTICULAR FONT, STYLE, SIZE, OR COLOR.

NO CLAIM IS MADE TO THE EXCLUSIVE RIGHT TO USE "DRAW POKER", APART FROM THE MARK AS SHOWN.

SER. NO. 85-251,415, FILED 2-25-2011.

MARGARET POWER, EXAMINING ATTORNEY



David J. Kybas

Director of the United States Patent and Trademark Office

United States of America

United States Patent and Trademark Office

WATERFOWLER INNOVATIONS

Reg. No. 4,173,818

Registered July 17, 2012

Int. Cls.: 28 and 35

TRADEMARK

SERVICE MARK

PRINCIPAL REGISTER

WATERFOWLER INNOVATIONS, LLC (KENTUCKY LIMITED LIABILITY COMPANY)
521 SOUTH MAIN STREET
BEAVER DAM, KY 423200167

FOR: WATERFOWL HUNTING DECOYS, IN CLASS 28 (U.S. CLS. 22, 23, 38 AND 50).

FIRST USE 9-22-2011; IN COMMERCE 9-22-2011.

FOR: ON-LINE RETAIL STORE SERVICES FEATURING HUNTING SUPPLIES, DECOYS
AND ACCESSORIES, IN CLASS 35 (U.S. CLS. 100, 101 AND 102).

FIRST USE 9-22-2011; IN COMMERCE 9-22-2011.

THE MARK CONSISTS OF STANDARD CHARACTERS WITHOUT CLAIM TO ANY PAR-
TICULAR FONT, STYLE, SIZE, OR COLOR.

NO CLAIM IS MADE TO THE EXCLUSIVE RIGHT TO USE "WATERFOWLER", APART
FROM THE MARK AS SHOWN.

SER. NO. 85-253,128, FILED 2-28-2011.

TASNEEM HUSSAIN, EXAMINING ATTORNEY



David J. Kybas

Director of the United States Patent and Trademark Office

United States of America

United States Patent and Trademark Office



Reg. No. 4,173,819

Registered July 17, 2012

Int. Cl.: 5

TRADEMARK

PRINCIPAL REGISTER

NORLAND PRODUCTS INC. (NEW JERSEY CORPORATION)
SUITE 100
2540 ROUTE 130
CRANBURY, NJ 08512

FOR: DIETARY AND NUTRITIONAL SUPPLEMENTS, IN CLASS 5 (U.S. CLS. 6, 18, 44, 46, 51 AND 52).

FIRST USE 9-30-2010; IN COMMERCE 9-30-2010.

NO CLAIM IS MADE TO THE EXCLUSIVE RIGHT TO USE "COLLAGEN", APART FROM THE MARK AS SHOWN.

THE MARK CONSISTS OF NESTING WAVES THAT EVOKE THE SHAPE OF THE LETTER "S", TO THE LEFT OF THE WORDS "SEA SOURCE" ABOVE THE WORD "COLLAGEN", WITH A HORIZONTAL LINE SEPARATING THE WORDS "SEA SOURCE" AND "COLLAGEN".

SER. NO. 85-253,659, FILED 2-28-2011.

DAVID COLLIER, EXAMINING ATTORNEY



David J. Kyros

Director of the United States Patent and Trademark Office

United States of America

United States Patent and Trademark Office

Mutt 'N Jeff 's Classics

Reg. No. 4,173,820

Registered July 17, 2012

Int. Cl.: 37

SERVICE MARK

PRINCIPAL REGISTER

FLAMINGO CONSTRUCTION LLC (NEVADA LIMITED LIABILITY COMPANY), DBA
MUTT 'N JEFF 'S CLASSICS
3588 S. VALLEY VIEW BLVD
LAS VEGAS, NV 89103

FOR: AUTOMOBILE BODY REPAIR AND FINISHING FOR OTHERS; AUTOMOBILE CLEANING; AUTOMOBILE CLEANING AND CAR WASHING; AUTOMOBILE CUSTOMIZATION SERVICES; AUTOMOBILE DETAILING; AUTOMOBILE GREASING; AUTOMOBILE LUBRICATION; AUTOMOBILE PAINTING; AUTOMOBILE PINSTRIPING; AUTOMOBILE POLISHING; AUTOMOBILE RECONDITIONING SERVICES; AUTOMOBILE REPAIR AND MAINTENANCE; AUTOMOBILE SERVICE STATION SERVICES; AUTOMOBILE UNDERCOATING SERVICES; AUTOMOBILE WASHING; CUSTOM INSTALLATION OF AUTOMOBILE INTERIORS; GARAGE SERVICES, NAMELY, REPAIR OF AUTOMOBILES; INSTALLATION AND MAINTENANCE OF CLASSIC CARS; INSTALLATION, MAINTENANCE AND REPAIR OF CLASSIC CARS; MAINTENANCE AND/OR REPAIR OF CLASSIC CARS; PROVIDING A WEB SITE FEATURING INFORMATION FOR AUTOMOBILE DEALERSHIPS AND CUSTOMERS ABOUT AUTOMOBILE EXTERIOR AND INTERIOR COATINGS AND PROTECTANTS; PROVIDING INFORMATION RELATED TO THE INSTALLATION, MAINTENANCE AND REPAIR OF CLASSIC CARS; REBUILDING OF CLASSIC CARS ENGINES; REPAIR OF AUTOMOBILES; REPAIR OF AUTOMOBILES, NAMELY, CLASSIC CARS; REPAIR OF CLASSIC CARS; REPAIR OR MAINTENANCE OF AUTOMOBILES, IN CLASS 37 (U.S. CLS. 100, 103 AND 106).

FIRST USE 1-1-2009; IN COMMERCE 1-1-2009.

THE MARK CONSISTS OF STANDARD CHARACTERS WITHOUT CLAIM TO ANY PARTICULAR FONT, STYLE, SIZE, OR COLOR.

NO CLAIM IS MADE TO THE EXCLUSIVE RIGHT TO USE "CLASSICS", APART FROM THE MARK AS SHOWN.

THE NAME "MUTT" DOES NOT IDENTIFY A LIVING INDIVIDUAL.

SER. NO. 85-253,947, FILED 2-28-2011.

TIMOTHY FINNEGAN, EXAMINING ATTORNEY



David J. Kyffers

Director of the United States Patent and Trademark Office

United States of America

United States Patent and Trademark Office

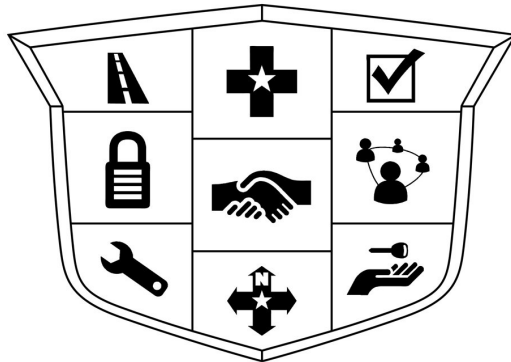

Reg. No. 4,173,821

Registered July 17, 2012

**Int. Cls.: 36, 37, 38, 39
and 45**

GENERAL MOTORS LLC (DELAWARE LIMITED LIABILITY COMPANY)
300 RENAISSANCE CENTER
DETROIT, MI 482653000

FOR: PROVIDING EXTENDED WARRANTIES FOR AUTOMOBILES, IN CLASS 36 (U.S. CLS. 100, 101 AND 102).

FIRST USE 2-11-2011; IN COMMERCE 2-11-2011.

SERVICE MARK

PRINCIPAL REGISTER

FOR: EMERGENCY ROADSIDE ASSISTANCE SERVICES, NAMELY, RESPONDING TO CALLS FOR ROADSIDE ASSISTANCE, FLAT TIRE CHANGING, EMERGENCY FUEL SUPPLYING AND BATTERY JUMP STARTING; MOTOR VEHICLE MAINTENANCE AND REPAIR SERVICES, IN CLASS 37 (U.S. CLS. 100, 103 AND 106).

FIRST USE 2-11-2011; IN COMMERCE 2-11-2011.

FOR: TELECOMMUNICATION SERVICES, NAMELY, WIRELESS, HANDS FREE TRANSMISSION OF VOICE, MESSAGES AND DATA; TELEMATIC TRANSMISSION OF INFORMATION FOR THE DEPLOYMENT OF EMERGENCY ASSISTANCE SERVICES, THE AUTOMATIC NOTIFICATION OF AIR BAG DEPLOYMENT, STOLEN VEHICLE TRACKING, REMOTE VEHICLE DIAGNOSTICS, REMOTE VEHICLE DOOR LOCK AND UNLOCK, REMOTE VEHICLE HORN AND LIGHT ACTIVATION, LOCATION AND NAVIGATION ASSISTANCE PROVIDING ROUTE SUPPORT AND DIRECTIONS, IN CLASS 38 (U.S. CLS. 100, 101 AND 104).

FIRST USE 2-11-2011; IN COMMERCE 2-11-2011.

FOR: EMERGENCY ROADSIDE ASSISTANCE SERVICES, NAMELY, TOWING SERVICES, IN CLASS 39 (U.S. CLS. 100 AND 105).

FIRST USE 2-11-2011; IN COMMERCE 2-11-2011.

FOR: SECURITY SERVICES FOR MOTOR LAND VEHICLE THEFT RECOVERY, NAMELY, PROVIDING REMOTE VEHICLE DECELERATION BY SIGNALING AN ON-BOARD ELECTRONIC DEVICE, IN CLASS 45 (U.S. CLS. 100 AND 101).

FIRST USE 2-11-2011; IN COMMERCE 2-11-2011.



David J. Kyros

Director of the United States Patent and Trademark Office

Reg. No. 4,173,821 THE MARK CONSISTS OF A SHIELD DESIGN WITH NINE COMPARTMENTS CONTAINING A ROAD DESIGN, A CROSS DESIGN WITH A STAR IN THE CENTER, A BOX WITH A CHECK MARK, A LOCK DESIGN, TWO HANDS ENGAGED IN A HANDSHAKE, THE UPPERBODY OF FOUR PERSONS CONNECTED BY A LINE, A WRENCH, A CROSS DESIGN WITH A STAR IN THE CENTER AND AN "N" IN THE TOP ARROW, AND A HAND UNDER A KEY.

SER. NO. 85-254,581, FILED 3-1-2011.

HOWARD SMIGA, EXAMINING ATTORNEY

United States of America

United States Patent and Trademark Office

CADILLAC SHIELD

Reg. No. 4,173,822

Registered July 17, 2012

**Int. Cls.: 36, 37, 38, 39
and 45**

SERVICE MARK

PRINCIPAL REGISTER

GENERAL MOTORS LLC (DELAWARE LIMITED LIABILITY COMPANY)
300 RENAISSANCE CENTER
DETROIT, MI 482653000

FOR: PROVIDING EXTENDED WARRANTIES FOR AUTOMOBILES, IN CLASS 36 (U.S. CLS. 100, 101 AND 102).

FIRST USE 2-11-2011; IN COMMERCE 2-11-2011.

FOR: EMERGENCY ROADSIDE ASSISTANCE SERVICES, NAMELY, RESPONDING TO CALLS FOR ROADSIDE ASSISTANCE, FLAT TIRE CHANGING, EMERGENCY FUEL SUPPLYING AND BATTERY JUMP STARTING; MOTOR VEHICLE MAINTENANCE AND REPAIR SERVICES, IN CLASS 37 (U.S. CLS. 100, 103 AND 106).

FIRST USE 2-11-2011; IN COMMERCE 2-11-2011.

FOR: TELECOMMUNICATION SERVICES, NAMELY, WIRELESS, HANDS FREE TRANSMISSION OF VOICE, MESSAGES AND DATA; TELEMATIC TRANSMISSION OF INFORMATION FOR THE DEPLOYMENT OF EMERGENCY ASSISTANCE SERVICES, THE AUTOMATIC NOTIFICATION OF AIR BAG DEPLOYMENT, STOLEN VEHICLE TRACKING, REMOTE VEHICLE DIAGNOSTICS, REMOTE VEHICLE DOOR LOCK AND UNLOCK, REMOTE VEHICLE HORN AND LIGHT ACTIVATION, LOCATION AND NAVIGATION ASSISTANCE PROVIDING ROUTE SUPPORT AND DIRECTIONS, IN CLASS 38 (U.S. CLS. 100, 101 AND 104).

FIRST USE 2-11-2011; IN COMMERCE 2-11-2011.

FOR: PROVIDING A COURTESY MOTOR VEHICLE TO CONSUMERS WHILE THEIR VEHICLE IS BEING REPAIRED: EMERGENCY ROADSIDE ASSISTANCE SERVICES, NAMELY, TOWING SERVICES, IN CLASS 39 (U.S. CLS. 100 AND 105).

FIRST USE 2-11-2011; IN COMMERCE 2-11-2011.

FOR: SECURITY SERVICES FOR MOTOR LAND VEHICLE THEFT RECOVERY, NAMELY, PROVIDING REMOTE VEHICLE DECELERATION BY SIGNALING AN ON-BOARD ELECTRONIC DEVICE, IN CLASS 45 (U.S. CLS. 100 AND 101).



David J. Kyros

Director of the United States Patent and Trademark Office

Reg. No. 4,173,822 FIRST USE 2-11-2011; IN COMMERCE 2-11-2011.

THE MARK CONSISTS OF STANDARD CHARACTERS WITHOUT CLAIM TO ANY PARTICULAR FONT, STYLE, SIZE, OR COLOR.

SER. NO. 85-255,350, FILED 3-2-2011.

HOWARD SMIGA, EXAMINING ATTORNEY

United States of America

United States Patent and Trademark Office

FEAR NO FOOD

Reg. No. 4,173,823

BOHAGER HOLDINGS, LLC (FLORIDA LIMITED LIABILITY COMPANY)
1341 RAZORBILL LANE
PUNTA GORDA, FL 33983

Registered July 17, 2012

Int. Cls.: 5 and 44

FOR: NUTRITIONAL SUPPLEMENTS; ENZYMES FOR MEDICAL PURPOSES; ENZYME FOOD SUPPLEMENTS, IN CLASS 5 (U.S. CLS. 6, 18, 44, 46, 51 AND 52).

TRADEMARK

FIRST USE 3-1-2011; IN COMMERCE 3-1-2011.

SERVICE MARK

FOR: PROVIDING A WEBSITE FEATURING INFORMATION, NON-DOWNLOADABLE VIDEOS, ONLINE INTERACTIVE NUTRITIONAL QUIZZES AND TESTS, AND ARTICLES ABOUT NUTRITION AND DIET, NAMELY, IN THE FIELDS OF NUTRITIONAL AND FOOD SUPPLEMENTS, ENZYMES, AND DIETARY INFORMATION, IN CLASS 44 (U.S. CLS. 100 AND 101).

PRINCIPAL REGISTER

FIRST USE 3-1-2011; IN COMMERCE 3-1-2011.

THE MARK CONSISTS OF STANDARD CHARACTERS WITHOUT CLAIM TO ANY PARTICULAR FONT, STYLE, SIZE, OR COLOR.

SER. NO. 85-258,098, FILED 3-4-2011.

REBECCA EISINGER, EXAMINING ATTORNEY



David J. Kyros

Director of the United States Patent and Trademark Office

United States of America

United States Patent and Trademark Office

LIVE TO SNACK

Reg. No. 4,173,824

Registered July 17, 2012

Int. Cl.: 30

TRADEMARK

PRINCIPAL REGISTER

CANDYWAREHOUSE.COM, INC. (CALIFORNIA CORPORATION)
215 S. DOUGLAS STREET
EL SEGUNDO, CA 90245

FOR: CANDY, IN CLASS 30 (U.S. CL. 46).

FIRST USE 2-22-2011; IN COMMERCE 2-22-2011.

THE MARK CONSISTS OF STANDARD CHARACTERS WITHOUT CLAIM TO ANY PARTICULAR FONT, STYLE, SIZE, OR COLOR.

SER. NO. 85-258,916, FILED 3-5-2011.

KAREN K. BUSH, EXAMINING ATTORNEY



David J. Kyffers

Director of the United States Patent and Trademark Office

United States of America

United States Patent and Trademark Office



Reg. No. 4,173,825

Registered July 17, 2012

Int. Cl.: 30

TRADEMARK

PRINCIPAL REGISTER

ONCE AGAIN NUT BUTTER COLLECTIVE, INC. (NEW YORK CORPORATION)
12 SOUTH STATE ST.
NUNDA, NY 14517

FOR: HONEY, IN CLASS 30 (U.S. CL. 46).

FIRST USE 11-1-2010; IN COMMERCE 1-1-2011.

OWNER OF U.S. REG. NO. 1,727,892.

THE MARK CONSISTS OF A RACCOON USING A KNIFE TO SPREAD A PIECE OF BREAD WITH SPREAD FROM A JAR SITTING ATOP A BORDER WITH AN OVERALL RECTANGULAR SHAPE THAT CONTAINS THE WORDS "ONCE AGAIN". THE WORDS "DAWES HILL" APPEAR BENEATH THE BORDER. THE LABEL ON THE JAR OF SPREAD CONTAINS THE WORDS "ONCE AGAIN WE SPREAD INTEGRITY" AND THE DESIGN OF A RACCOON USING A KNIFE TO SPREAD A PIECE OF BREAD WITH SPREAD.

SER. NO. 85-260,110, FILED 3-7-2011.

LINDA LAVACHE, EXAMINING ATTORNEY



David J. Kyffers

Director of the United States Patent and Trademark Office

United States of America

United States Patent and Trademark Office

Cowboy Homecoming

Reg. No. 4,173,826

Registered July 17, 2012

Int. Cl.: 41

SERVICE MARK

PRINCIPAL REGISTER

PLEASANTON CHAMBER OF COMMERCE (TEXAS NON-PROFIT CORPORATION)
605 2ND STREET
PLEASANTON, TX 78064

FOR: ORGANIZING COMMUNITY FESTIVALS FEATURING PRIMARILY LIVE DANCE AND MUSICAL PERFORMANCES, SPORTING EVENTS, AMUSEMENT PARK RIDE, RODEO, VOLLEYBALL GAMES, AND ART EXHIBITIONS, AND ALSO PROVIDING FOOD, ARTS, AND CRAFTS VENDORS, PARADE, AND BEAUTY AND COOKING CONTESTS, IN CLASS 41 (U.S. CLS. 100, 101 AND 107).

FIRST USE 0-0-1965; IN COMMERCE 0-0-1965.

THE MARK CONSISTS OF STANDARD CHARACTERS WITHOUT CLAIM TO ANY PARTICULAR FONT, STYLE, SIZE, OR COLOR.

NO CLAIM IS MADE TO THE EXCLUSIVE RIGHT TO USE "COWBOY", APART FROM THE MARK AS SHOWN.

SER. NO. 85-260,922, FILED 3-8-2011.

B. PARADEWELAI, EXAMINING ATTORNEY



David J. Kyffers

Director of the United States Patent and Trademark Office

United States of America

United States Patent and Trademark Office

uRapidFlow

Reg. No. 4,173,827

UNIRGY LLC (OREGON LIMITED LIABILITY COMPANY)
PO BOX 90304

Registered July 17, 2012

PORTLAND, OR 97290

Int. Cl.: 9

FOR: COMPUTER E-COMMERCE SOFTWARE TO ALLOW USERS TO PERFORM ELECTRONIC BUSINESS TRANSACTIONS VIA A GLOBAL COMPUTER NETWORK, IN CLASS 9 (U.S. CLS. 21, 23, 26, 36 AND 38).

TRADEMARK

FIRST USE 8-7-2009; IN COMMERCE 2-14-2010.

PRINCIPAL REGISTER

THE MARK CONSISTS OF STANDARD CHARACTERS WITHOUT CLAIM TO ANY PARTICULAR FONT, STYLE, SIZE, OR COLOR.

SER. NO. 85-260,958, FILED 3-8-2011.

DEZMONA MIZELLE, EXAMINING ATTORNEY



David J. Kybas

Director of the United States Patent and Trademark Office

United States of America

United States Patent and Trademark Office

uDropship

Reg. No. 4,173,828

UNIRGY LLC (OREGON LIMITED LIABILITY COMPANY)
PO BOX 90304
PORTLAND, OR 97290

Registered July 17, 2012

Int. Cl.: 9

FOR: COMPUTER E-COMMERCE SOFTWARE TO ALLOW USERS TO PERFORM ELECTRONIC BUSINESS TRANSACTIONS VIA A GLOBAL COMPUTER NETWORK, IN CLASS 9 (U.S. CLS. 21, 23, 26, 36 AND 38).

TRADEMARK

FIRST USE 4-4-2009; IN COMMERCE 4-23-2009.

PRINCIPAL REGISTER

THE MARK CONSISTS OF STANDARD CHARACTERS WITHOUT CLAIM TO ANY PARTICULAR FONT, STYLE, SIZE, OR COLOR.

SER. NO. 85-260,967, FILED 3-8-2011.

DEZMONA MIZELLE, EXAMINING ATTORNEY



David J. Kyffers

Director of the United States Patent and Trademark Office

United States of America

United States Patent and Trademark Office

PSIBER

Reg. No. 4,173,829

PSIBER DATA SYSTEMS, INC (CALIFORNIA CORPORATION)
4011 CAMINO ALLEGRE
LA MESA, CA 91941

Registered July 17, 2012

Int. Cl.: 9

FOR: ELECTRONIC HAND-HELD APPARATUS FOR TESTING AND MONITORING COMPUTER NETWORKS, IN CLASS 9 (U.S. CLS. 21, 23, 26, 36 AND 38).

TRADEMARK

FIRST USE 9-1-1994; IN COMMERCE 9-1-1994.

PRINCIPAL REGISTER

THE MARK CONSISTS OF STANDARD CHARACTERS WITHOUT CLAIM TO ANY PARTICULAR FONT, STYLE, SIZE, OR COLOR.

SER. NO. 85-263,609, FILED 3-10-2011.

JERI J. FICKES, EXAMINING ATTORNEY



David J. Kyffers

Director of the United States Patent and Trademark Office

United States of America

United States Patent and Trademark Office

ACO

Reg. No. 4,173,830

Registered July 17, 2012

Int. Cl.: 35

SERVICE MARK

PRINCIPAL REGISTER

MENTOR ENTERPRISES, INC. (ALABAMA CORPORATION)
121 CASTLE DRIVE, SUITE F
MADISON, AL 35758

FOR: PROVIDING A WEBSITE USED TO PLACE ON-LINE COMMERCIAL ORDERS FOR COUNSELING AND ADMINISTRATIVE SOFTWARE PACKAGES FOR MILITARY PERSONNEL, IN CLASS 35 (U.S. CLS. 100, 101 AND 102).

FIRST USE 9-1-2005; IN COMMERCE 9-1-2005.

THE MARK CONSISTS OF STANDARD CHARACTERS WITHOUT CLAIM TO ANY PARTICULAR FONT, STYLE, SIZE, OR COLOR.

SER. NO. 85-263,766, FILED 3-10-2011.

JILL C. ALT, EXAMINING ATTORNEY



David J. Kyffers

Director of the United States Patent and Trademark Office

United States of America

United States Patent and Trademark Office

RESPONSIBLE DEBT RELIEF

Reg. No. 4,173,831

Registered July 17, 2012

Int. Cls.: 36 and 42

SERVICE MARK

PRINCIPAL REGISTER

RESPONSIBLE DEBT RELIEF INSTITUTE (DELAWARE CORPORATION), AKA RDR
INSTITUTE
1100 UNIVERSITY AVENUE, SUITE 209
ROCHESTER, NY 14607

FOR: CONSULTING SERVICES FOR CONSUMERS AND CREDITORS TO ACHIEVE SUCCESSFUL DEBTOR-CREDITOR RELATIONSHIPS THROUGH DEBT CAPACITY ASSESSMENTS AND FOR USE OF THOSE ASSESSMENTS FOR IMPROVING CREDIT SCORING, LOAN UNDERWRITING JUDGMENTS, AND ANALYSES OF INVESTMENT POOLS, IN CLASS 36 (U.S. CLS. 100, 101 AND 102).

FIRST USE 12-2-2008; IN COMMERCE 12-2-2008.

FOR: INTERNET ACCESSIBLE, NON-DOWNLOADABLE INFORMATION MANAGEMENT COMPUTER SOFTWARE FOR USE BY CONSUMERS AND ORGANIZATIONS IN EVALUATING THE FINANCIAL CAPABILITY OF INDIVIDUALS AND HOUSEHOLDS THROUGH THE CALCULATION OF CREDIT CAPACITY SCORES, IN CLASS 42 (U.S. CLS. 100 AND 101).

FIRST USE 12-2-2008; IN COMMERCE 12-2-2008.

THE MARK CONSISTS OF STANDARD CHARACTERS WITHOUT CLAIM TO ANY PARTICULAR FONT, STYLE, SIZE, OR COLOR.

NO CLAIM IS MADE TO THE EXCLUSIVE RIGHT TO USE "DEBT RELIEF", APART FROM THE MARK AS SHOWN.

SER. NO. 85-265,006, FILED 3-11-2011.

DAVID TAYLOR, EXAMINING ATTORNEY



David J. Kypos

Director of the United States Patent and Trademark Office

United States of America

United States Patent and Trademark Office

RDR

Reg. No. 4,173,832

Registered July 17, 2012

Int. Cls.: 36 and 42

SERVICE MARK

PRINCIPAL REGISTER

RESPONSIBLE DEBT RELIEF INSTITUTE (DELAWARE CORPORATION), AKA RDR
INSTITUTE
1100 UNIVERSITY AVENUE, SUITE 209
ROCHESTER, NY 14607

FOR: CONSULTING SERVICES FOR CONSUMERS AND CREDITORS TO ACHIEVE SUCCESSFUL DEBTOR-CREDITOR RELATIONSHIPS THROUGH DEBT CAPACITY ASSESSMENTS AND FOR USE OF THOSE ASSESSMENTS FOR IMPROVING CREDIT SCORING, LOAN UNDERWRITING JUDGMENTS, AND ANALYSES OF INVESTMENT POOLS, IN CLASS 36 (U.S. CLS. 100, 101 AND 102).

FIRST USE 12-2-2008; IN COMMERCE 12-2-2008.

FOR: INTERNET ACCESSIBLE, NON-DOWNLOADABLE INFORMATION MANAGEMENT COMPUTER SOFTWARE FOR USE BY CONSUMERS AND ORGANIZATIONS IN EVALUATING THE FINANCIAL CAPABILITY OF INDIVIDUALS AND HOUSEHOLDS THROUGH THE CALCULATION OF CREDIT CAPACITY SCORES, IN CLASS 42 (U.S. CLS. 100 AND 101).

FIRST USE 12-2-2008; IN COMMERCE 12-2-2008.

THE MARK CONSISTS OF STANDARD CHARACTERS WITHOUT CLAIM TO ANY PARTICULAR FONT, STYLE, SIZE, OR COLOR.

SER. NO. 85-265,075, FILED 3-11-2011.

DAVID TAYLOR, EXAMINING ATTORNEY



David J. Kypos

Director of the United States Patent and Trademark Office

United States of America

United States Patent and Trademark Office

Brain-Friendly Communication

Reg. No. 4,173,833

ERIC OLIVER (MICHIGAN LIMITED PARTNERSHIP), DBA ERIC OLIVER
42015 FORD ROAD, #224
CANTON, MI 48187

Registered July 17, 2012

Int. Cl.: 45

FOR: JURY CONSULTANCY; LITIGATION CONSULTANCY; LITIGATION SUPPORT SERVICES, IN CLASS 45 (U.S. CLS. 100 AND 101).

SERVICE MARK

FIRST USE 5-1-2010; IN COMMERCE 5-1-2010.

PRINCIPAL REGISTER

THE MARK CONSISTS OF STANDARD CHARACTERS WITHOUT CLAIM TO ANY PARTICULAR FONT, STYLE, SIZE, OR COLOR.

NO CLAIM IS MADE TO THE EXCLUSIVE RIGHT TO USE "COMMUNICATION", APART FROM THE MARK AS SHOWN.

SER. NO. 85-266,035, FILED 3-14-2011.

C. DIONNE CLYBURN, EXAMINING ATTORNEY



David J. Kybas

Director of the United States Patent and Trademark Office

United States of America

United States Patent and Trademark Office

Indigenous Tease

Reg. No. 4,173,834

Registered July 17, 2012

Int. Cl.: 25

TRADEMARK

PRINCIPAL REGISTER

GOLDSBY, JOEL V (UNITED STATES INDIVIDUAL)
P.O. BOX 2128
386 OAK AVENUE
SANTA ROSA BEACH, FL 32459

FOR: A-SHIRTS; SHIRTS; SHORT-SLEEVED OR LONG-SLEEVED T-SHIRTS; T-SHIRTS;
WOMEN'S CLOTHING, NAMELY, SHIRTS, DRESSES, SKIRTS, BLOUSES, IN CLASS 25
(U.S. CLS. 22 AND 39).

FIRST USE 1-1-2010; IN COMMERCE 1-1-2010.

THE MARK CONSISTS OF STANDARD CHARACTERS WITHOUT CLAIM TO ANY PAR-
TICULAR FONT, STYLE, SIZE, OR COLOR.

SER. NO. 85-268,480, FILED S.R. 3-16-2011 AM. P.R. 3-26-2012.

RAUL CORDOVA, EXAMINING ATTORNEY



David J. Kyffers

Director of the United States Patent and Trademark Office

United States of America

United States Patent and Trademark Office



Reg. No. 4,173,835

Registered July 17, 2012

Int. Cl.: 42

SERVICE MARK

PRINCIPAL REGISTER

PHARCOM SOLUTIONS CORP. (PUERTO RICO CORPORATION)
COSTA NORTE 122, CALLE PALMAS
HATILLO, PUERTO RICO 00659

FOR: SCIENTIFIC RESEARCH CONSULTING IN THE FIELDS OF BIOTECHNOLOGY, PHARMACEUTICALS, COSMETICS, VETERINARY FOOD AND MEDICAL DEVICES; ENGINEERING SERVICES IN THE FIELD OF CONSTRUCTION; RESEARCH ON BUILDING CONSTRUCTION; PROVIDING QUALITY ASSURANCE SERVICES IN THE FIELDS OF BIOTECHNOLOGY, PHARMACEUTICALS, COSMETICS, VETERINARY FOOD AND MEDICAL DEVICES; DESIGN AND DEVELOPMENT OF INTEGRATED DATA COLLECTION AND WIRELESS TRANSMISSION HARDWARE SYSTEMS FOR EQUIPMENT AND FOR SOFTWARE APPLICATIONS ASSOCIATED WITH THAT EQUIPMENT AT CONSTRUCTION, AND INDUSTRIAL SITES; DEVELOPMENT AND ESTABLISHMENT OF TESTING SPECIFICATIONS AND PROCEDURES FOR THE BIOTECHNOLOGY, PHARMACEUTICAL, COSMETICS, VETERINARY FOOD AND MEDICAL DEVICES INDUSTRIES; TECHNICAL VERIFICATION AND VALIDATION OF INSTRUMENTATION RADAR SYSTEMS; TESTING, ANALYSIS AND EVALUATION OF METAL TOOLS, MACHINERY AND FABRICATION EQUIPMENT; WORKPLACE CERTIFICATION SERVICES, NAMELY, CONDUCTING SURVEYS AND TESTING FOR WORKPLACE EXCELLENCE; TESTING, ANALYSIS AND EVALUATION OF THE RESEARCH AND DEVELOPMENT AND MANUFACTURING FACILITIES, EQUIPMENT, UTILITIES AND SYSTEMS OF BIOTECHNOLOGY, PHARMACEUTICALS, COSMETICS, VETERINARY FOOD AND MEDICAL DEVICES PRODUCING COMPANIES FOR THE PURPOSE OF CERTIFICATION; TECHNOLOGY CONSULTATION IN THE FIELDS OF BIOTECHNOLOGY, PHARMACEUTICALS, COSMETICS, VETERINARY FOOD AND MEDICAL DEVICES DESIGN AND MANUFACTURING; DESIGN OF PRODUCTION FACILITIES; PLANNING AND DESIGN OF PHARMACEUTICALS, COSMETICS, VETERINARY FOOD, MEDICAL DEVICES AND BIOTECHNOLOGY, RESEARCH AND DEVELOPMENT; PLANNING AND DESIGN OF MANUFACTURING PLANTS AND FACILITIES OF PHARMACEUTICALS, COSMETICS, VETERINARY FOOD AND MEDICAL DEVICES; ELECTRONIC AND ELECTRICAL SYSTEMS DESIGN SERVICES, IN CLASS 42 (U.S. CLS. 100 AND 101).



David J. Kyjars

Director of the United States Patent and Trademark Office

FIRST USE 12-18-2009; IN COMMERCE 1-4-2010.

NO CLAIM IS MADE TO THE EXCLUSIVE RIGHT TO USE "SOLUTIONS CORP.", APART FROM THE MARK AS SHOWN.

Reg. No. 4,173,835 THE MARK CONSISTS OF AN ABSTRACT DESIGN CONSISTING OF TWO CURVED LINES FOLLOWED BY THE WORDING "PHARCOM SOLUTIONS CORP." IN STYLIZED LETTERS.

THE WORDING "PHARCOM" HAS NO MEANING IN A FOREIGN LANGUAGE.

SER. NO. 85-268,983, FILED 3-16-2011.

TAMARA FRAZIER, EXAMINING ATTORNEY

United States of America

United States Patent and Trademark Office



Reg. No. 4,173,836

Registered July 17, 2012

Int. Cl.: 41

SERVICE MARK

PRINCIPAL REGISTER

U.S. EDUCATION DELIVERY INSTITUTE, INC. (D.C. CORPORATION)
1250 H STREET, NW, SUITE 880
WASHINGTON, DC 20005

FOR: CONSULTING SERVICES IN THE FIELD OF K-12 STATE EDUCATION SYSTEMS AND HIGHER EDUCATION SYSTEMS, NAMELY, CONSULTING IN THE IMPLEMENTATION OF REFORM AGENDAS AND ASSISTANCE IN DELIVERING ADVANCED EDUCATIONAL OUTCOMES; EDUCATIONAL SERVICES, NAMELY, PROVIDING CLASSES, SEMINARS, AND WORKSHOPS TO STATE EDUCATION LEADERS IN THE FIELD OF THE DELIVERY APPROACH TO EDUCATION REFORM FOR THE PURPOSE OF TURNING SYSTEM PLANS INTO STUDENT OUTCOMES, IN CLASS 41 (U.S. CLS. 100, 101 AND 107).

FIRST USE 9-0-2010; IN COMMERCE 9-0-2010.

NO CLAIM IS MADE TO THE EXCLUSIVE RIGHT TO USE "U.S. EDUCATION DELIVERY INSTITUTE", APART FROM THE MARK AS SHOWN.

THE COLOR(S) DARK GREY, RED, GREEN, AND YELLOW IS/ARE CLAIMED AS A FEATURE OF THE MARK.

THE MARK CONSISTS OF RED, YELLOW, AND GREEN VERTICAL BARS OF INCREASING HEIGHT NEXT TO THE DARK GREY TERM EDI, ALL APPEARING ABOVE THE DARK GREY TERM U.S. EDUCATION DELIVERY INSTITUTE.

SER. NO. 85-269,365, FILED 3-17-2011.

MARK SPARACINO, EXAMINING ATTORNEY



David J. Kyffers

Director of the United States Patent and Trademark Office

United States of America

United States Patent and Trademark Office

ROUTESHOUT

Reg. No. 4,173,837

ROUTEMATCH SOFTWARE, INC. (GEORGIA CORPORATION)
1180 W. PEACHTREE ST. SUITE 1130
ATLANTA, GA 30327

Registered July 17, 2012

Int. Cl.: 9

FOR: COMPUTER APPLICATION SOFTWARE WHICH ENABLES USERS TO VIEW, TRACK AND SELECT BUS ROUTES AND TO OBTAIN REAL TIME TRAVELER INFORMATION FOR USE WITH MOBILE PHONES, MOBILE DATA COMPUTERS, TABLETS AND COMPUTERS, IN CLASS 9 (U.S. CLS. 21, 23, 26, 36 AND 38).

TRADEMARK

PRINCIPAL REGISTER

FIRST USE 12-15-2010; IN COMMERCE 12-15-2010.

THE MARK CONSISTS OF STANDARD CHARACTERS WITHOUT CLAIM TO ANY PARTICULAR FONT, STYLE, SIZE, OR COLOR.

SER. NO. 85-269,717, FILED 3-17-2011.

ROSELLE HERRERA, EXAMINING ATTORNEY



David J. Kyjars

Director of the United States Patent and Trademark Office

United States of America

United States Patent and Trademark Office

EVO

Reg. No. 4,173,838

CARL ZEISS NTS GMBH (FED REP GERMANY LIMITED LIABILITY COMPANY)
CARL-ZEISS-STRASSE 56
OBERKOCHEN, FED REP GERMANY 73447

Registered July 17, 2012

Int. Cl.: 9

FOR: ELECTRON MICROSCOPES AND PARTS THEREOF, IN CLASS 9 (U.S. CLS. 21, 23, 26, 36 AND 38).

TRADEMARK

FIRST USE 12-31-2005; IN COMMERCE 12-31-2005.

PRINCIPAL REGISTER

THE MARK CONSISTS OF STANDARD CHARACTERS WITHOUT CLAIM TO ANY PARTICULAR FONT, STYLE, SIZE, OR COLOR.

SER. NO. 85-271,073, FILED 3-18-2011.

TRACY CROSS, EXAMINING ATTORNEY



David J. Kybas

Director of the United States Patent and Trademark Office

United States of America

United States Patent and Trademark Office

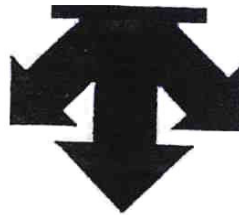

Reg. No. 4,173,839

Registered July 17, 2012

Int. Cls.: 18 and 25

TRADEMARK

PRINCIPAL REGISTER

DESCENTE, LTD. (JAPAN CORPORATION)
11-3, DOGASHIBA 1-CHOME, TENNOJI-KU
OSAKA, JAPAN

FOR: TRAVELING BAGS; SHOES BAGS FOR TRAVEL; BOOT BAGS FOR TRAVEL, IN CLASS 18 (U.S. CLS. 1, 2, 3, 22 AND 41).

FIRST USE 4-0-1981; IN COMMERCE 4-0-1981.

FOR: RUNNING WEAR, NAMELY, RUNNING SHIRTS, RUNNING PANTS AND SOCKS; BICYCLING WEAR, NAMELY, SHIRTS, PANTS, SWEAT SHIRTS, SWEAT PANTS, SPORTS JERSEY, POLO SHIRTS, ONE-PIECE SUITS AND SOCKS; BICYCLING GLOVES, IN CLASS 25 (U.S. CLS. 22 AND 39).

FIRST USE 4-0-1981; IN COMMERCE 4-0-1981.

OWNER OF U.S. REG. NO. 1,129,589.

THE MARK CONSISTS OF A HORIZONTAL LINE WITH THREE DOWNWARD POINTING ARROWS, ONE FACING DOWNWARD LEFT, THE LARGE MIDDLE ARROW FACING STRAIGHT DOWN, AND THE RIGHT ARROW FACING DOWNWARD RIGHT.

SER. NO. 85-272,111, FILED 3-21-2011.

SCOTT BIBB, EXAMINING ATTORNEY



David J. Kybas

Director of the United States Patent and Trademark Office

United States of America

United States Patent and Trademark Office

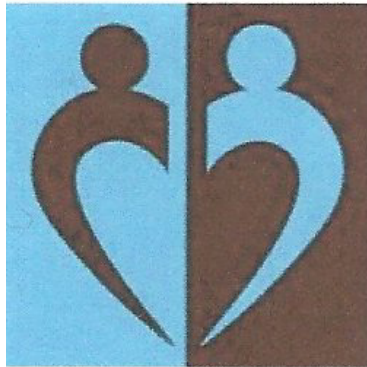

Reg. No. 4,173,840

Registered July 17, 2012

Int. Cl.: 41

SERVICE MARK

PRINCIPAL REGISTER

LAST FIRST DATE, LLC (CONNECTICUT LIMITED LIABILITY COMPANY)
91 APPLE TREE DRIVE
STAMFORD, CT 06906

FOR: LIFE COACHING SERVICES IN THE FIELD OF DATING, IN CLASS 41 (U.S. CLS. 100, 101 AND 107).

FIRST USE 3-28-2010; IN COMMERCE 3-28-2010.

THE MARK CONSISTS OF TWO CONNECTED RECTANGLES EACH CONTAIN A STYLIZED HUMAN FIGURE THAT TOGETHER FORM A STYLIZED DESIGN OF A HEART THAT IS SEPARATED DOWN THE MIDDLE; THE LEFT BLUE RECTANGLE CONTAINS A BROWN HUMAN FIGURE; THE RIGHT BROWN RECTANGLE CONTAINS A BLUE HUMAN FIGURE.

THE COLOR(S) BROWN AND BLUE IS/ARE CLAIMED AS A FEATURE OF THE MARK.

SER. NO. 85-272,863, FILED 3-21-2011.

ANTHONY RINKER, EXAMINING ATTORNEY



David J. Kyffers

Director of the United States Patent and Trademark Office

United States of America

United States Patent and Trademark Office

pole2pole

Reg. No. 4,173,841

AUDI AG (FED REP GERMANY CORPORATION)
85045

Registered July 17, 2012

INGOLSTADT, FED REP GERMANY

**Int. Cls.: 9, 12, 16, 25, 28,
39 and 41**

FOR: APPARATUS FOR RECORDING, TRANSMISSION OR REPRODUCTION OF SOUND OR IMAGES; PRE-RECORDED MAGNETIC DATA CARRIERS, NAMELY, VIDEO TAPES AND AUDIO TAPES, CDS, VIDEO DISCS, DVDS, ALL CONTAINING INFORMATION ON THE TOPIC OF TRAVEL EXPEDITIONS AND MOTOR VEHICLES; USB STICKS; FLASH MEMORY CARDS; DOWNLOADABLE ELECTRONIC PUBLICATIONS IN THE NATURE OF BOOKS, MAGAZINES AND NEWSLETTERS IN THE FIELD OF MOTOR VEHICLES AND ON THE TOPIC OF TRAVEL EXPEDITIONS; VIDEO GAME CARTRIDGES, AND DVDS FEATURING VIDEO GAMES, IN CLASS 9 (U.S. CLS. 21, 23, 26, 36 AND 38).

TRADEMARK

SERVICE MARK

PRINCIPAL REGISTER

FOR: VEHICLES, NAMELY, AUTOMOBILES, MOTORCYCLES AND THEIR STRUCTURAL PARTS, IN CLASS 12 (U.S. CLS. 19, 21, 23, 31, 35 AND 44).

FOR: CARDBOARD AND GOODS MADE FROM THESE MATERIALS, NAMELY, CALENDARS, ENVELOPES, BOXES, CIRCULARS IN THE FIELD OF AUTOMOBILES AND TRAVEL EXPEDITIONS, DIARIES, LEAFLETS ABOUT AUTOMOBILES AND TRAVEL EXPEDITIONS, CARTONS, MAILING TUBES, BLOC NOTES CARDS, ADHESIVE NOTE PAPER; PRINTED MATTER, NAMELY, BOOKS, MAGAZINES, BROCHURES, PAMPHLETS, ALL IN THE FIELD OF AUTOMOBILES AND TRAVEL EXPEDITIONS; PHOTOGRAPHS; STATIONERY, NAMELY, PAPER LABELS, NOTE PADS, PERSONAL ORGANIZERS, PENS, PENCILS; ADHESIVES FOR STATIONERY OR HOUSEHOLD PURPOSES; PRINTED INSTRUCTIONAL AND TEACHING MATERIAL, NAMELY, BOOKS, JOURNALS ALL CONTAINING INFORMATION ON THE TOPIC OF TRAVEL EXPEDITIONS AND MOTOR VEHICLES; PLASTIC MATERIALS FOR PACKAGING, NAMELY, BAGS, POUCHES, SACKS, ENVELOPES, IN CLASS 16 (U.S. CLS. 2, 5, 22, 23, 29, 37, 38 AND 50).



FOR: CLOTHING, NAMELY, BEACHWEAR, MEN'S AND WOMEN'S SUITS, TUXEDOS, DRESSES, JACKETS, COATS, RAINWEAR, SKIWEAR, SPORTS CLOTHING, NAMELY, TANK TOPS, SHORTS AND SHIRTS; FOOTWEAR; HEADGEAR, NAMELY, BERETS, EARMUFFS, HATS, TOQUES, CAPS, IN CLASS 25 (U.S. CLS. 22 AND 39).

David J. Kyjars

FOR: GAMES AND PLAYTHINGS, NAMELY, PLAYING CARDS, PADDLE BALL GAMES, CONSTRUCTION TOYS; MODEL CARS; GYMNAS TIC AND SPORTING ARTICLES,

Reg. No. 4,173,841 NAMELY, WINTER AND WATER SKIS, ICE SKATES, IN CLASS 28 (U.S. CLS. 22, 23, 38 AND 50).

FOR: ARRANGING AND ORGANIZING TRAVEL EXPEDITIONS TO TRAVERSE THE GLOBE FROM ONE POLE TO ANOTHER, IN CLASS 39 (U.S. CLS. 100 AND 105).

FOR: EDUCATIONAL SERVICES, NAMELY, WORKSHOPS IN THE FIELD OF TRAVEL EXPEDITIONS, TRAVEL PLANNING AND ORGANIZATION; PROVIDING ONLINE TRAINING ON THE TOPIC OF TRAVEL EXPEDITIONS; EDUCATIONAL SERVICES, NAMELY, PROVISION OF LECTURES BY AN ADVENTURER ABOUT TRAVEL EXPERIENCES, TELEVISION SHOWS AND ONLINE BROADCASTS FEATURING A TRAVEL EXPEDITION; ORGANIZING SPORTING AND CULTURAL EVENTS; PROVIDING NON-DOWNLOADABLE ON-LINE ELECTRONIC PUBLICATIONS IN THE NATURE OF BOOKS, MAGAZINES, AND NEWSLETTERS IN THE FIELD OF TRAVEL EXPEDITIONS, IN CLASS 41 (U.S. CLS. 100, 101 AND 107).

THE MARK CONSISTS OF STANDARD CHARACTERS WITHOUT CLAIM TO ANY PARTICULAR FONT, STYLE, SIZE, OR COLOR.

OWNER OF FED REP GERMANY REG. NO. 302011015704, DATED 3-30-2011, EXPIRES 3-31-2021.

SER. NO. 85-275,669, FILED 3-24-2011.

ALICE BENMAMAN, EXAMINING ATTORNEY

United States of America

United States Patent and Trademark Office

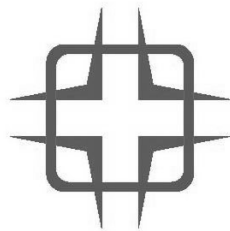

Reg. No. 4,173,842

HEALTHCARE RESOURCES ONLINE (NEW JERSEY LIMITED LIABILITY COMPANY)
27 WESLEY ROAD
HILLSBOROUGH, NJ 08844

Registered July 17, 2012

Int. Cl.: 35

FOR: PROMOTING THE EXCHANGE OF INFORMATION AND RESOURCES AMONG
HEALTHCARE PROFESSIONALS AND MEDICAL COMMUNITIES TO ACHIEVE AD-
VANCES IN THE FIELD OF HEALTHCARE, IN CLASS 35 (U.S. CLS. 100, 101 AND 102).

SERVICE MARK

FIRST USE 1-1-2009; IN COMMERCE 4-1-2009.

PRINCIPAL REGISTER

THE MARK CONSISTS OF A CROSS SHAPE DESIGN SUPERIMPOSED OVER A SQUARE.

SER. NO. 85-275,967, FILED 3-24-2011.

CHERYL CLAYTON, EXAMINING ATTORNEY



David J. Kybas

Director of the United States Patent and Trademark Office

United States of America

United States Patent and Trademark Office

MULBERRY PROJECT

Reg. No. 4,173,843

NICHOLAS BOCCIO (UNITED STATES INDIVIDUAL)
115 EAST 72ND STREET, APT. 4B
NEW YORK, NY 10021

Registered July 17, 2012

Int. Cl.: 43

FOR: BAR AND COCKTAIL LOUNGE SERVICES; BAR AND RESTAURANT SERVICES;
COCKTAIL PARLOR SERVICES, IN CLASS 43 (U.S. CLS. 100 AND 101).

SERVICE MARK

FIRST USE 12-1-2010; IN COMMERCE 12-31-2010.

PRINCIPAL REGISTER

THE MARK CONSISTS OF STANDARD CHARACTERS WITHOUT CLAIM TO ANY PARTICULAR FONT, STYLE, SIZE, OR COLOR.

SER. NO. 85-276,262, FILED 3-24-2011.

IRA J. GOODSaid, EXAMINING ATTORNEY



David J. Kybas

Director of the United States Patent and Trademark Office

United States of America

United States Patent and Trademark Office

Photocrati

Reg. No. 4,173,844

Registered July 17, 2012

Int. Cl.: 42

SERVICE MARK

PRINCIPAL REGISTER

PHOTOCRATI MEDIA LLC (COLORADO LIMITED LIABILITY COMPANY)
4800 BASELINE ROAD, SUITE E104
BOULDER, CO 80303

FOR: (BASED ON USE IN COMMERCE) CREATION, DESIGN, DEVELOPMENT AND MAINTENANCE OF WEB SITES FOR THIRD PARTIES, IN CLASS 42 (U.S. CLS. 100 AND 101).

FIRST USE 2-3-2009; IN COMMERCE 7-27-2009.

THE MARK CONSISTS OF STANDARD CHARACTERS WITHOUT CLAIM TO ANY PARTICULAR FONT, STYLE, SIZE, OR COLOR.

THE WORDING "PHOTOCRATI" HAS NO MEANING IN A FOREIGN LANGUAGE.

SER. NO. 85-277,102, FILED 3-25-2011.

JERI J. FICKES, EXAMINING ATTORNEY



David J. Kyffers

Director of the United States Patent and Trademark Office

United States of America

United States Patent and Trademark Office

FACTS

Reg. No. 4,173,845

Registered July 17, 2012

Int. Cl.: 36

SERVICE MARK

PRINCIPAL REGISTER

NEXT DECADE, INC. (NEW JERSEY CORPORATION)
39 OLD FARMSTEAD ROAD
CHESTER, NJ 07930

FOR: FINANCIAL INVESTMENT SERVICES IN THE FIELD OF SECURITIES AND BONDS,
IN CLASS 36 (U.S. CLS. 100, 101 AND 102).

FIRST USE 1-1-2010; IN COMMERCE 1-1-2010.

THE MARK CONSISTS OF STANDARD CHARACTERS WITHOUT CLAIM TO ANY PAR-
TICULAR FONT, STYLE, SIZE, OR COLOR.

SER. NO. 85-279,518, FILED 3-29-2011.

ELLEN PERKINS, EXAMINING ATTORNEY



David J. Kybas

Director of the United States Patent and Trademark Office

United States of America

United States Patent and Trademark Office

DELTA SIX

Reg. No. 4,173,846

THE BUS DEPOT, INC. (PENNSYLVANIA CORPORATION)
3703 WILHELM ROAD
HELLERTOWN, PA 18055 AND

Registered July 17, 2012

Int. Cls.: 12 and 35

GFAB MANUFACTURING LTD (CANADA LIMITED COMPANY (LTD.))
PO BOX 631
GIBSONS, BC, CANADA V0N1V0

TRADEMARK

FOR: STRUCTURAL REPLACEMENT PARTS FOR RECREATIONAL VEHICLES AND CAMPER VANS, IN CLASS 12 (U.S. CLS. 19, 21, 23, 31, 35 AND 44).

SERVICE MARK

PRINCIPAL REGISTER

FIRST USE 1-1-1975; IN COMMERCE 1-1-1975.

FOR: WHOLESALE AND RETAIL STORE SERVICES AND ON-LINE RETAIL AND WHOLESALE STORE SERVICES FEATURING STRUCTURAL PARTS, REPLACEMENT PARTS AND ACCESSORIES FOR CAMPER VANS AND SIMILAR RECREATIONAL VEHICLES, IN CLASS 35 (U.S. CLS. 100, 101 AND 102).

FIRST USE 1-1-1975; IN COMMERCE 1-1-1975.

THE MARK CONSISTS OF STANDARD CHARACTERS WITHOUT CLAIM TO ANY PARTICULAR FONT, STYLE, SIZE, OR COLOR.

SER. NO. 85-279,969, FILED 3-29-2011.

NORA BUCHANAN WILL, EXAMINING ATTORNEY



David J. Kyffers

Director of the United States Patent and Trademark Office

United States of America

United States Patent and Trademark Office

EXITO

Reg. No. 4,173,847

Registered July 17, 2012

Int. Cl.: 32

TRADEMARK

PRINCIPAL REGISTER

CHONG,PETER (UNITED STATES INDIVIDUAL), DBA EXITO COMPANY
242 N. WESTERN AVE #612
LOS ANGELES, CA 90004

FOR: PREPARED ENTREES CONSISTING OF FRUIT DRINKS AND FRUIT JUICES, FRUIT-BASED BEVERAGES, NON-ALCOHOLIC BEVERAGES CONTAINING FRUIT JUICES, NON-ALCOHOLIC FRUIT EXTRACTS USED IN THE PREPARATION OF BEVERAGES, NON-ALCOHOLIC FRUIT JUICE BEVERAGES, VEGETABLE JUICES, VEGETABLE-FRUIT JUICES AND SMOOTHIES, IN CLASS 32 (U.S. CLS. 45, 46 AND 48).

FIRST USE 1-1-2011; IN COMMERCE 1-1-2011.

THE MARK CONSISTS OF STANDARD CHARACTERS WITHOUT CLAIM TO ANY PARTICULAR FONT, STYLE, SIZE, OR COLOR.

THE ENGLISH TRANSLATION OF "EXITO" IN THE MARK IS "SUCCESS".

SER. NO. 85-280,218, FILED 3-29-2011.

TRACY CROSS, EXAMINING ATTORNEY



David J. Kyffers

Director of the United States Patent and Trademark Office

United States of America

United States Patent and Trademark Office

fitfresh
DUAL TOOL
UTENSIL SET

Reg. No. 4,173,848

MEDPORT LLC (RHODE ISLAND LIMITED LIABILITY COMPANY)
23 ACORN STREET
PROVIDENCE, RI 02903

Registered July 17, 2012

Int. Cl.: 8

FOR: UTENSILS FOR EATING, NAMELY, FORK AND SPOON COMBINATIONS, IN CLASS 8 (U.S. CLS. 23, 28 AND 44).

TRADEMARK

FIRST USE 7-0-2011; IN COMMERCE 7-0-2011.

PRINCIPAL REGISTER

OWNER OF U.S. REG. NOS. 3,587,967, 3,679,620 AND OTHERS.

NO CLAIM IS MADE TO THE EXCLUSIVE RIGHT TO USE "DUAL TOOL UTENSIL SET", APART FROM THE MARK AS SHOWN.

THE MARK CONSISTS OF THE WORDS "FIT" AND "FRESH" SEPARATED BY AN INCOMPLETE CIRCLE COMPRISED OF TWO RAINDROP-LIKE GEOMETRIC DESIGN ELEMENTS. THE STACKED TERMS "DUAL TOOL" AND "UTENSIL SET" APPEAR BELOW THE TERM "FRESH".

SER. NO. 85-281,312, FILED 3-30-2011.

PAULA MAHONEY, EXAMINING ATTORNEY



David J. Kyfos

Director of the United States Patent and Trademark Office

United States of America

United States Patent and Trademark Office

DEBUG

Reg. No. 4,173,849

Registered July 17, 2012

Int. Cl.: 5

TRADEMARK

PRINCIPAL REGISTER

AGRO LOGISTIC SYSTEMS INC. (DELAWARE CORPORATION)
P.O. BOX 5799
DIAMOND BAR, CA 91765

FOR: NATURAL PLANT ORIGIN PESTICIDES FOR AGRICULTURAL, HORTICULTURAL, GREENHOUSE, LAWNS, PARKS, GOLF COURSES AND HOME GARDEN USE, IN CLASS 5 (U.S. CLS. 6, 18, 44, 46, 51 AND 52).

FIRST USE 3-21-2005; IN COMMERCE 4-21-2005.

THE MARK CONSISTS OF STANDARD CHARACTERS WITHOUT CLAIM TO ANY PARTICULAR FONT, STYLE, SIZE, OR COLOR.

OWNER OF U.S. REG. NO. 3,074,975.

SEC. 2(F).

SER. NO. 85-281,674, FILED 3-30-2011.

STEVEN PEREZ, EXAMINING ATTORNEY



David J. Kyffers

Director of the United States Patent and Trademark Office

United States of America

United States Patent and Trademark Office

p53/p21

Reg. No. 4,173,850

PNC, INC. (WASHINGTON CORPORATION), DBA PHYTRX
17819 NE 156TH ST
WOODINVILLE, WA 98072

Registered July 17, 2012

Int. Cl.: 5

FOR: DIETARY AND NUTRITIONAL SUPPLEMENTS, IN CLASS 5 (U.S. CLS. 6, 18, 44, 46, 51 AND 52).

TRADEMARK

FIRST USE 3-31-2011; IN COMMERCE 3-31-2011.

PRINCIPAL REGISTER

THE MARK CONSISTS OF STANDARD CHARACTERS WITHOUT CLAIM TO ANY PARTICULAR FONT, STYLE, SIZE, OR COLOR.

SER. NO. 85-283,296, FILED 4-1-2011.

TINA BROWN, EXAMINING ATTORNEY



David J. Kyffers

Director of the United States Patent and Trademark Office

United States of America

United States Patent and Trademark Office



Reg. No. 4,173,851

Registered July 17, 2012

Int. Cl.: 9

TRADEMARK

PRINCIPAL REGISTER

LAND, TONI (UNITED STATES INDIVIDUAL)
113 SEACLIFF TERRACE
BROOKINGS, OR 97415

FOR: MUSIC AUDIO RECORDINGS; MUSICAL WORKS, NAMELY, PRE-RECORDED CDS FEATURING MUSIC; MUSICAL AUDIOVISUAL RECORDINGS; AUDIOVISUAL WORKS, NAMELY, PRE-RECORDED DVDS FEATURING MUSIC, IN CLASS 9 (U.S. CLS. 21, 23, 26, 36 AND 38).

FIRST USE 1-1-2011; IN COMMERCE 1-1-2011.

OWNER OF U.S. REG. NO. 2,512,665.

THE MARK CONSISTS OF THE WORD "STAGEWORK" WITH A MICROPHONE INCLUDED IN THE LETTER "K" AND A RECTANGLE AROUND "WORK".

SER. NO. 85-285,028, FILED 4-4-2011.

MAYUR VAGHANI, EXAMINING ATTORNEY



David J. Kybas

Director of the United States Patent and Trademark Office

United States of America

United States Patent and Trademark Office

Optic Blue

Reg. No. 4,173,852

Registered July 17, 2012

Int. Cl.: 42

BLUE OPTICS, LLC (TEXAS LIMITED LIABILITY COMPANY)
3809 22ND STREET
SUITE 2A
LUBBOCK, TX 79410

FOR: OPTICAL LABORATORIES, IN CLASS 42 (U.S. CLS. 100 AND 101).

SERVICE MARK

FIRST USE 8-1-2006; IN COMMERCE 8-1-2006.

PRINCIPAL REGISTER

THE MARK CONSISTS OF STANDARD CHARACTERS WITHOUT CLAIM TO ANY PARTICULAR FONT, STYLE, SIZE, OR COLOR.

NO CLAIM IS MADE TO THE EXCLUSIVE RIGHT TO USE "OPTIC", APART FROM THE MARK AS SHOWN.

SER. NO. 85-285,079, FILED 4-4-2011.

JOHN KELLY, EXAMINING ATTORNEY



David J. Kyros

Director of the United States Patent and Trademark Office

United States of America

United States Patent and Trademark Office



optic blue
PRECISION LENS LABORATORY

Reg. No. 4,173,853

Registered July 17, 2012

Int. Cl.: 42

BLUE OPTICS, LLC (TEXAS LIMITED LIABILITY COMPANY)
3809 22ND STREET
SUITE 2A
LUBBOCK, TX 79410

FOR: OPTICAL LABORATORIES, IN CLASS 42 (U.S. CLS. 100 AND 101).

SERVICE MARK

FIRST USE 8-1-2006; IN COMMERCE 8-1-2006.

PRINCIPAL REGISTER

NO CLAIM IS MADE TO THE EXCLUSIVE RIGHT TO USE "OPTIC" OR "LENS LABORATORY", APART FROM THE MARK AS SHOWN.

THE MARK CONSISTS OF A DESIGN OF A SOLID CIRCLE CONTAINING A STARBURST DESIGN IN THE CENTER OF THE CIRCLE; THE DESIGN IS LOCATED IN THE UPPER LEFT-HAND CORNER OF THE MARK; UNDERNEATH THE DESIGN ARE THE WORDS "OPTIC BLUE" IN LARGE STYLIZED LOWER-CASE LETTERS; POSITIONED BENEATH THE WORDS "OPTIC BLUE" AND IN THE LOWER RIGHT-HAND CORNER ARE THE WORDS "PRECISION LENS LABORATORY" IN SMALL STYLIZED UPPER-CASE LETTERS.

SER. NO. 85-285,357, FILED 4-4-2011.

JOHN KELLY, EXAMINING ATTORNEY



David J. Kyros

Director of the United States Patent and Trademark Office

United States of America

United States Patent and Trademark Office

PAG

Reg. No. 4,173,854

Registered July 17, 2012

Int. Cl.: 35

SERVICE MARK

PRINCIPAL REGISTER

PAG IPR HOLDINGS LIMITED (HONG KONG LIMITED LIABILITY COMPANY)
2503 BANK OF AMERICA TOWER
12 HARCOURT ROAD
CENTRAL, HONG KONG

FOR: ADVERTISING; BUSINESS MANAGEMENT; BUSINESS ADMINISTRATION; PUBLIC RELATIONS; PUBLICITY, IN CLASS 35 (U.S. CLS. 100, 101 AND 102).

THE MARK CONSISTS OF STANDARD CHARACTERS WITHOUT CLAIM TO ANY PARTICULAR FONT, STYLE, SIZE, OR COLOR.

OWNER OF HONG KONG REG. NO. 301866952, DATED 3-23-2011, EXPIRES 3-23-2021.

THE WORD(S) "PAG" HAS NO MEANING IN A FOREIGN LANGUAGE.

SER. NO. 85-285,430, FILED 4-4-2011.

PAULA MAHONEY, EXAMINING ATTORNEY



David J. Kybas

Director of the United States Patent and Trademark Office

United States of America

United States Patent and Trademark Office



Reg. No. 4,173,855

Registered July 17, 2012

Int. Cl.: 42

SERVICE MARK

PRINCIPAL REGISTER

EC INNOVATIONS (USA), INC. (DELAWARE CORPORATION)
STE 105
501 SILVERSIDE ROAD
WILMINGTON, DE 19809

FOR: SOFTWARE AS A SERVICE (SAAS) SERVICES FEATURING SOFTWARE FOR BUSINESSES OR USERS TO MANAGE THEIR TRANSLATION AND LOCALIZATION WORKFLOW, IN CLASS 42 (U.S. CLS. 100 AND 101).

FIRST USE 3-17-2011; IN COMMERCE 3-17-2011.

NO CLAIM IS MADE TO THE EXCLUSIVE RIGHT TO USE "TRANSLATION BUSINESS MANAGEMENT SYSTEM", APART FROM THE MARK AS SHOWN.

THE MARK CONSISTS OF SIX RINGS IN A THREE-D LOOK FLOATING OVER THE "M" IN "TBMS". BELOW THERE IS THE STYLIZED TEXT "TRANSLATION BUSINESS MANAGEMENT SYSTEM".

SER. NO. 85-286,735, FILED 4-5-2011.

REGINA DRUMMOND, EXAMINING ATTORNEY



David J. Kyffers

Director of the United States Patent and Trademark Office

United States of America

United States Patent and Trademark Office

LABBARRA

Reg. No. 4,173,856

Registered July 17, 2012

Int. Cls.: 18, 25 and 35

TRADEMARK

SERVICE MARK

PRINCIPAL REGISTER

LABBARRA LIMITED (UNITED KINGDOM LIMITED COMPANY (LTD.))
1 NORTHUMBERLAND AVENUE TRAFALGAR SQUARE
LONDON, UNITED KINGDOM WC2N5BW

FOR: LEATHER AND IMITATIONS OF LEATHER, AND GOODS MADE OF THESE MATERIALS AND NOT INCLUDED IN OTHER CLASSES, NAMELY, SUITCASES, HANDBAGS, WALLETS, PURSES, TRUNKS AND TRAVELLING BAGS, BAGS, CASES, BEACH BAGS, HANDBAGS, TOTE BAGS, SHOULDER BAGS, SHOPPING BAGS, COSMETICS BAGS SOLD EMPTY, LUGGAGE, HOLDALLS, SUITCASES; HANDBAGS; WALLETS; PURSES; TRUNKS AND TRAVELLING BAGS; BAGS MADE OF GENUINE AND IMITATION SNAKE SKIN, ANIMAL SKIN, CROCODILE AND ALLIGATOR SKIN, CANVAS, FABRIC, TEXTILE, SUEDE, AND ACRYLIC; ATTACHE CASES; BRIEFCASES; CARRYING CASES; COSMETIC CARRYING CASES SOLD EMPTY; OVERNIGHT CASES; TOILETRY CASES SOLD EMPTY; TRAVEL CASES; UNFITTED VANITY CASES; BEACH BAGS; HANDBAGS; TOTE BAGS; SHOULDER BAGS; SHOPPING BAGS MADE OF GENUINE AND IMITATION SNAKE SKIN, ANIMAL SKIN, CROCODILE AND ALLIGATOR SKIN, CANVAS, FABRIC, TEXTILE, SUEDE, AND ACRYLIC; COSMETICS BAGS SOLD EMPTY; LUGGAGE; HOLDALLS, IN CLASS 18 (U.S. CLS. 1, 2, 3, 22 AND 41).

FOR: DRESSES; SKIRTS; TOPS; BELTS; HEADSCARVES; FOOTWEAR, IN CLASS 25 (U.S. CLS. 22 AND 39).

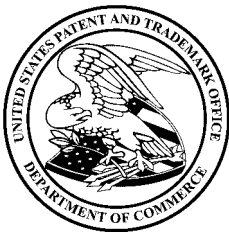

David J. Kybas

Director of the United States Patent and Trademark Office

FOR: THE BRINGING TOGETHER, FOR THE BENEFIT OF OTHERS, OF A VARIETY OF GOODS, NAMELY, LEATHER AND IMITATIONS OF LEATHER AND GOODS MADE OF THESE MATERIALS, BRIEFCASES, CARD CASES, SUITCASES, HANDBAGS, WALLETS, PURSES, CREDIT CARD HOLDERS, DIARY CASES, HAT BOXES, KEY FOBs, KEY CASES, STRAPS, LUGGAGE LABELS, NOTEPAD HOLDERS, SPORT BAGS, TRUNKS AND TRAVELLING BAGS, BAGS, BELTS, CASES, SATCHELS, POUCHES, RUCKSACKS, BEACH BAGS, HANDBAGS, UMBRELLAS, PARASOLS, WALKING STICKS, BACK PACKS, JEWELLERY ROLLS, TOTE BAGS, SHOULDER BAGS, SHOPPING BAGS, COSMETICS BAGS, LUGGAGE, LUGGAGE STRAPS, LUGGAGE TAGS, HOLDALLS, CASES FOR HAND-HELD MULTIMEDIA DEVICES, CASES AND BAGS FOR PORTABLE COMPUTERS, CLOTHING, FOOTWEAR, HEADGEAR, ENABLING CUSTOMERS TO CONVENIENTLY VIEW AND PURCHASE THOSE GOODS FROM A CATALOGUE BY MAIL ORDER, OR BY MEANS OF TELECOMMUNICATIONS, OR FROM AN INTERNET WEBSITE; RETAIL STORE SERVICES FEATURING LEATHER AND IMITATIONS OF LEATHER AND GOODS MADE OF THESE MATERIALS, BRIEFCASES, CARD CASES, SUITCASES, HANDBAGS, WALLETS, PURSES,

Reg. No. 4,173,856 CREDIT CARD HOLDERS, DIARY CASES, HAT BOXES, KEY FOBs, KEY CASES, STRAPS, LUGGAGE LABELS, NOTEPAD HOLDERS, SPORT BAGS, TRUNKS AND TRAVELLING BAGS, BAGS, BELTS, CASES, SATCHELS, POUCHES, RUCKSACKS, BEACH BAGS, HANDBAGS, UMBRELLAS, PARASOLS, WALKING STICKS, BACK PACKS, JEWELLERY ROLLS, TOTE BAGS, SHOULDER BAGS, SHOPPING BAGS, COSMETICS BAGS, LUGGAGE, LUGGAGE STRAPS, LUGGAGE TAGS, HOLDALLS, CASES FOR HAND-HELD MULTIMEDIA DEVICES, CASES AND BAGS FOR PORTABLE COMPUTERS, CLOTHING, FOOTWEAR, HEADGEAR. ONLINE RETAIL STORE SERVICES FEATURING LEATHER AND IMITATIONS OF LEATHER AND GOODS MADE OF THESE MATERIALS, BRIEFCASES, CARD CASES, SUITCASES, HANDBAGS, WALLETS, PURSES, CREDIT CARD HOLDERS, DIARY CASES, HAT BOXES, KEY FOBs, KEY CASES, STRAPS, LUGGAGE LABELS, NOTEPAD HOLDERS, SPORT BAGS, TRUNKS AND TRAVELLING BAGS, BAGS, BELTS, CASES, SATCHELS, POUCHES, RUCKSACKS, BEACH BAGS, HANDBAGS, UMBRELLAS, PARASOLS, WALKING STICKS, BACK PACKS, JEWELLERY ROLLS, TOTE BAGS, SHOULDER BAGS, SHOPPING BAGS, COSMETICS BAGS, LUGGAGE, LUGGAGE STRAPS, LUGGAGE TAGS, HOLDALLS, CASES FOR HAND-HELD MULTIMEDIA DEVICES, CASES AND BAGS FOR PORTABLE COMPUTERS, CLOTHING, FOOTWEAR, HEADGEAR, IN CLASS 35 (U.S. CLS. 100, 101 AND 102).

THE MARK CONSISTS OF STANDARD CHARACTERS WITHOUT CLAIM TO ANY PARTICULAR FONT, STYLE, SIZE, OR COLOR.

PRIORITY CLAIMED UNDER SEC. 44(D) ON ERPN CMNTY TM OFC APPLICATION NO. 009442757, FILED 10-13-2010, REG. NO. 009442757, DATED 3-25-2011, EXPIRES 10-13-2020.

THE WORDING "LABBARRA" HAS NO MEANING IN A FOREIGN LANGUAGE.

SER. NO. 85-286,758, FILED 4-5-2011.

C. DIONNE CLYBURN, EXAMINING ATTORNEY

United States of America

United States Patent and Trademark Office

Hometown 401k

Reg. No. 4,173,857

Registered July 17, 2012

Int. Cl.: 36

SERVICE MARK

PRINCIPAL REGISTER

EMERALD WEALTH MANAGEMENT (GEORGIA LIMITED LIABILITY COMPANY)
SUITE 1245
900 CIRCLE 75 PARKWAY
ATLANTA, GA 30339

FOR: FINANCIAL ADMINISTRATION OF RETIREMENT PLANS; FINANCIAL CONSULTING;
FINANCIAL PLANNING FOR RETIREMENT; INVESTMENT CONSULTATION; INVEST-
MENT MANAGEMENT, IN CLASS 36 (U.S. CLS. 100, 101 AND 102).

FIRST USE 1-1-2011; IN COMMERCE 1-1-2011.

THE MARK CONSISTS OF STANDARD CHARACTERS WITHOUT CLAIM TO ANY PAR-
TICULAR FONT, STYLE, SIZE, OR COLOR.

NO CLAIM IS MADE TO THE EXCLUSIVE RIGHT TO USE "401K", APART FROM THE
MARK AS SHOWN.

SER. NO. 85-287,169, FILED 4-5-2011.

REGINA DRUMMOND, EXAMINING ATTORNEY



David J. Kyffers

Director of the United States Patent and Trademark Office

United States of America

United States Patent and Trademark Office

ONLY JACKIE'S TAN TRUE

Reg. No. 4,173,858

Registered July 17, 2012

Int. Cl.: 25

TRADEMARK

PRINCIPAL REGISTER

JACQUELINE HUTCHERSON (UNITED STATES INDIVIDUAL)
UNIT A
154 174TH TERRACE DRIVE
REDINGTON SHORES, FL 33708

FOR: APPAREL, NAMELY, SWIMSUIT COVER-UPS, SWIMWEAR, SHORTS, SKIRTS,
HATS, TANK-TOPS, AND SWEATERS, IN CLASS 25 (U.S. CLS. 22 AND 39).

FIRST USE 3-31-2011; IN COMMERCE 3-31-2011.

THE MARK CONSISTS OF STANDARD CHARACTERS WITHOUT CLAIM TO ANY PAR-
TICULAR FONT, STYLE, SIZE, OR COLOR.

SER. NO. 85-287,580, FILED 4-6-2011.

JENNY PARK, EXAMINING ATTORNEY



David J. Kyffers

Director of the United States Patent and Trademark Office

United States of America

United States Patent and Trademark Office

ELEMENT XR

Reg. No. 4,173,859

EASTERN APPLIED RESEARCH, INC. (PENNSYLVANIA CORPORATION)

Registered July 17, 2012

P.O. BOX 1558
SEAFORD, DE 19973

Int. Cl.: 9

FOR: SCIENTIFIC INSTRUMENTS, NAMELY, X-RAY FLUORESCENCE INSTRUMENTS USED TO MEASURE COATING THICKNESSES, IN CLASS 9 (U.S. CLS. 21, 23, 26, 36 AND 38).

TRADEMARK

FIRST USE 3-14-2011; IN COMMERCE 3-14-2011.

PRINCIPAL REGISTER

THE MARK CONSISTS OF STANDARD CHARACTERS WITHOUT CLAIM TO ANY PARTICULAR FONT, STYLE, SIZE, OR COLOR.

NO CLAIM IS MADE TO THE EXCLUSIVE RIGHT TO USE "XR", APART FROM THE MARK AS SHOWN.

SER. NO. 85-287,957, FILED 4-6-2011.

MARK T. MULLEN, EXAMINING ATTORNEY



David J. Kybas

Director of the United States Patent and Trademark Office

United States of America

United States Patent and Trademark Office

MELAMED

Reg. No. 4,173,860

Registered July 17, 2012

Int. Cls.: 14, 15 and 25

TRADEMARK

PRINCIPAL REGISTER

MELAMED, MOJGAN M (UNITED STATES INDIVIDUAL)
9015 NORMA PLACE
C/O MELAMED INTERNATIONAL, INC.
WEST HOLLYWOOD, CA 90069 AND

MELAMED, KATHY K (UNITED STATES INDIVIDUAL)
9015 NORMA PLACE
C/O MELAMED INTERNATIONAL, INC.
WEST HOLLYWOOD, CA 90069

FOR: JEWELRY, IN CLASS 14 (U.S. CLS. 2, 27, 28 AND 50).

FIRST USE 12-31-1990; IN COMMERCE 12-31-2000.

FOR: GUITAR STRAPS, IN CLASS 15 (U.S. CLS. 2, 21 AND 36).

FIRST USE 12-31-1990; IN COMMERCE 12-31-2008.

FOR: BELTS, IN CLASS 25 (U.S. CLS. 22 AND 39).

FIRST USE 12-31-1990; IN COMMERCE 12-31-2000.

THE MARK CONSISTS OF STANDARD CHARACTERS WITHOUT CLAIM TO ANY PARTICULAR FONT, STYLE, SIZE, OR COLOR.

THE ENGLISH TRANSLATION OF "MELAMED" IN THE MARK IS "TEACHER".

SEC. 2(F).

SER. NO. 85-289,553, FILED 4-7-2011.

MICHAEL KEATING, EXAMINING ATTORNEY



David J. Kyffers

Director of the United States Patent and Trademark Office

United States of America

United States Patent and Trademark Office

ID

Reg. No. 4,173,861

INTELLIGENT DECISIONS, INC. (VIRGINIA CORPORATION)
21445 BEAUMEADE CIRCLE
ASHBURN, VA 20147

Registered July 17, 2012

Int. Cls.: 35, 37 and 42

FOR: ONLINE RETAIL AND WHOLESALE STORE SERVICES FEATURING INFORMATION TECHNOLOGY AND COMPUTER HARDWARE, IN CLASS 35 (U.S. CLS. 100, 101 AND 102).

SERVICE MARK

FIRST USE 12-31-1988; IN COMMERCE 10-20-2008.

PRINCIPAL REGISTER

FOR: INSTALLATION OF SECURITY SYSTEMS; REPAIR AND MAINTENANCE OF SECURITY SYSTEMS, IN CLASS 37 (U.S. CLS. 100, 103 AND 106).

FIRST USE 12-31-1988; IN COMMERCE 10-20-2008.

FOR: COMPUTER NETWORK PROJECT MANAGEMENT SERVICES; TECHNICAL ADVICE CONCERNING THE REPAIR OF INFORMATION TECHNOLOGY AND COMPUTER HARDWARE AND SOFTWARE; TECHNICAL ADVICE CONCERNING THE MAINTENANCE OF INFORMATION TECHNOLOGY AND COMPUTER HARDWARE AND SOFTWARE; PROVIDING CONSULTING, PLANNING AND ENGINEERING SERVICES IN THE FIELD OF INFORMATION AND COMMUNICATIONS NETWORKS; DESIGN AND DEVELOPMENT OF ELECTRONIC DATA SECURITY SYSTEMS; DATABASE DEVELOPMENT SERVICES AND MAINTENANCE OF ONLINE DATABASES FOR OTHERS; CONSULTING IN THE FIELD OF CONFIGURATION MANAGEMENT FOR COMPUTER HARDWARE AND SOFTWARE; DEVELOPMENT OF SECURITY SYSTEMS AND CONTINGENCY PLANNING FOR INFORMATION SYSTEMS, IN CLASS 42 (U.S. CLS. 100 AND 101).

FIRST USE 12-31-1988; IN COMMERCE 10-20-2008.

THE MARK CONSISTS OF STANDARD CHARACTERS WITHOUT CLAIM TO ANY PARTICULAR FONT, STYLE, SIZE, OR COLOR.

OWNER OF U.S. REG. NOS. 2,818,611 AND 2,868,198.

SER. NO. 85-290,057, FILED 4-8-2011.

JANICE KIM, EXAMINING ATTORNEY



David J. Kyros

Director of the United States Patent and Trademark Office

United States of America

United States Patent and Trademark Office

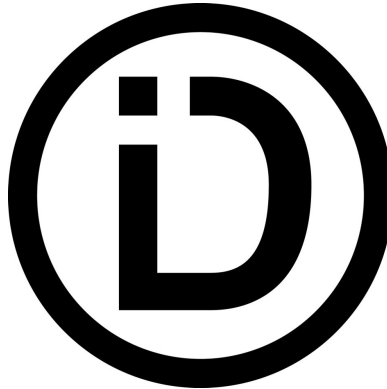

Reg. No. 4,173,862

INTELLIGENT DECISIONS, INC. (VIRGINIA CORPORATION)
21445 BEAUMEADE CIRCLE
ASHBURN, VA 20147

Registered July 17, 2012

Int. Cls.: 35, 37 and 42

FOR: ONLINE RETAIL AND WHOLESALE STORE SERVICES FEATURING INFORMATION TECHNOLOGY AND COMPUTER HARDWARE, IN CLASS 35 (U.S. CLS. 100, 101 AND 102).

SERVICE MARK

FIRST USE 10-20-2008; IN COMMERCE 10-20-2008.

PRINCIPAL REGISTER

FOR: INSTALLATION OF SECURITY SYSTEMS; REPAIR AND MAINTENANCE OF SECURITY SYSTEMS, IN CLASS 37 (U.S. CLS. 100, 103 AND 106).

FIRST USE 10-20-2008; IN COMMERCE 10-20-2008.

FOR: COMPUTER NETWORK PROJECT MANAGEMENT SERVICES; TECHNICAL ADVICE CONCERNING THE REPAIR OF INFORMATION TECHNOLOGY AND COMPUTER HARDWARE AND SOFTWARE; TECHNICAL ADVICE CONCERNING THE MAINTENANCE OF INFORMATION TECHNOLOGY AND COMPUTER HARDWARE AND SOFTWARE; PROVIDING CONSULTING, PLANNING AND ENGINEERING SERVICES IN THE FIELD OF INFORMATION AND COMMUNICATIONS NETWORKS; DESIGN AND DEVELOPMENT OF ELECTRONIC DATA SECURITY SYSTEMS; DATABASE DEVELOPMENT SERVICES AND MAINTENANCE OF ONLINE DATABASES FOR OTHERS; CONSULTING IN THE FIELD OF CONFIGURATION MANAGEMENT FOR COMPUTER HARDWARE AND SOFTWARE; DEVELOPMENT OF SECURITY SYSTEMS AND CONTINGENCY PLANNING FOR INFORMATION SYSTEMS, IN CLASS 42 (U.S. CLS. 100 AND 101).

FIRST USE 10-20-2008; IN COMMERCE 10-20-2008.

OWNER OF U.S. REG. NOS. 2,818,611 AND 2,868,198.

THE MARK CONSISTS OF THE STYLIZED LETTERS "ID". THERE IS A CIRCLE AROUND THE STYLIZED LETTERS.

SER. NO. 85-290,092, FILED 4-8-2011.

JANICE KIM, EXAMINING ATTORNEY



David J. Kyros

Director of the United States Patent and Trademark Office

United States of America

United States Patent and Trademark Office



Reg. No. 4,173,863

TECNOLOGICA DE ALIMENTOS S.A. (PERU SOCIEDAD ANONIMA (SA))
LAS BEGONIAS NO. 441, OF. 352
SAN ISIDRO, LIMA, PERU

Registered July 17, 2012

Int. Cl.: 29

FOR: COMPOTES; DAIRY PRODUCTS EXCLUDING ICE CREAM, ICE MILK AND FROZEN YOGURT; EDIBLE OILS AND FATS; EGGS; FROZEN FRUITS; FROZEN VEGETABLES; JELLIES AND JAMS; MEAT EXTRACTS; MEAT, FISH, POULTRY AND GAME; PRESERVED, DRIED AND COOKED FRUIT AND VEGETABLES, IN CLASS 29 (U.S. CL. 46).

TRADEMARK

PRINCIPAL REGISTER

PRIORITY CLAIMED UNDER SEC. 44(D) ON PERU APPLICATION NO. 451944-2011, FILED 4-7-2011, REG. NO. 178262, DATED 8-9-2011, EXPIRES 8-9-2021.

THE COLOR(S) GREEN, BLUE, AND SKY BLUE IS/ARE CLAIMED AS A FEATURE OF THE MARK.

THE MARK CONSISTS OF AN ABSTRACT DRAWING OF ONE GREEN, ONE BLUE, AND ONE SKY BLUE IRREGULAR SHAPED FIGURE FORMING A STYLIZED TRIANGLE AND THE WORD "OMEGATRACE" APPEARING TO THE RIGHT OF THE TRIANGLE DESIGN, WITH THE WORD "OMEGA" APPEARING IN GREEN AND THE WORD "TRACE" APPEARING IN BLUE. THE COLOR WHITE APPEARING IN THE BACKGROUND OF THE MARK REPRESENTS TRANSPARENT AREAS AND THEREFORE IS NOT PART OF THE MARK.

SER. NO. 85-290,102, FILED 4-8-2011.

LINDA M. KING, EXAMINING ATTORNEY



David J. Kybas

Director of the United States Patent and Trademark Office

United States of America

United States Patent and Trademark Office

EXCELLENCE IN MOTION

Reg. No. 4,173,864

Registered July 17, 2012

Int. Cl.: 16

TRADEMARK

PRINCIPAL REGISTER

SANLUIS CORPORACIÓN, S.A.B DE C.V. (MEXICO CORPORATION)
MONTE PELVOUX NO. 220
8TH FLOOR LOMAS DE CHAPULTEPEC
MEXICO, D.F., MEXICO 11000

FOR: PAPER, CARDBOARD AND GOODS MADE FROM THESE MATERIALS, NAMELY, BOXES, SIGNBOARDS, AND ADVERTISING SIGNS; PRINTED MATTER, NAMELY, NEWSPAPERS, PHOTOGRAPHS, MAGAZINES, BOOKS, PRINTED PERIODICALS, NEWSLETTERS, MANUALS, AND BROCHURES ALL IN THE FIELD OF DESIGN, MANUFACTURE AND SALE OF VEHICLES' PARTS; BOOKBINDING MATERIAL; PHOTOGRAPHS; STATIONERY; ADHESIVES FOR STATIONERY OR HOUSEHOLD PURPOSES; ARTISTS' MATERIALS, NAMELY, MOULDS FOR MODELING CLAYS, GESSO, NAMELY, PLASTERS; PAINT BRUSHES; TYPEWRITERS AND OFFICE REQUISITES, NAMELY, STAPLERS, ADHESIVE TAPE DISPENSERS, CORRECTING FLUID FOR TYPE, ELECTRIC PAPER HOLE PUNCHES, ENVELOPE SEALING MACHINES, RUBBER BANDS, PUNCHES, PAPER FOLDING MACHINES AND PAPER TRIMMERS; PRINTED INSTRUCTIONAL AND TEACHING MATERIAL IN THE FIELD OF DESIGN, MANUFACTURE AND SALE OF VEHICLES' PARTS; PLASTIC BAGS FOR PACKAGING; PRINTERS' TYPE; PRINTING CLICHÉS, IN CLASS 16 (U.S. CLS. 2, 5, 22, 23, 29, 37, 38 AND 50).

THE MARK CONSISTS OF STANDARD CHARACTERS WITHOUT CLAIM TO ANY PARTICULAR FONT, STYLE, SIZE, OR COLOR.

OWNER OF MEXICO REG. NO. 19183, DATED 3-31-2000, EXPIRES 2-28-2020.

SER. NO. 85-290,201, FILED 4-8-2011.

PAM WILLIS, EXAMINING ATTORNEY



David J. Kyffers

Director of the United States Patent and Trademark Office

United States of America

United States Patent and Trademark Office

EXCELENCIA EN MOVIMIENTO

Reg. No. 4,173,865

Registered July 17, 2012

Int. Cl.: 16

TRADEMARK

PRINCIPAL REGISTER

SANLUIS CORPORACIÓN, S.A.B DE C.V. (MEXICO CORPORATION)
MONTE PELVOUX NO. 220
8TH FLOOR LOMAS DE CHAPULTEPEC
MEXICO, D.F., MEXICO 11000

FOR: PAPER, CARDBOARD AND GOODS MADE FROM THESE MATERIALS, NAMELY, BOXES, SIGNBOARDS, AND ADVERTISING SIGNS; PRINTED MATTER, NAMELY, NEWSPAPERS, PHOTOGRAPHS, MAGAZINES, BOOKS, PRINTED PERIODICALS, NEWSLETTERS, MANUALS, AND BROCHURES ALL IN THE FIELD OF DESIGN, MANUFACTURE AND SALE OF VEHICLES' PARTS; BOOKBINDING MATERIAL; PHOTOGRAPHS; STATIONERY; ADHESIVES FOR STATIONERY OR HOUSEHOLD PURPOSES; ARTISTS' MATERIALS, NAMELY, MOULDS FOR MODELING CLAYS, GESSO, NAMELY, PLASTERS; PAINT BRUSHES; TYPEWRITERS AND OFFICE REQUISITES, NAMELY, STAPLERS, ADHESIVE TAPE DISPENSERS, CORRECTING FLUID FOR TYPE, ELECTRIC PAPER HOLE PUNCHES, ENVELOPE SEALING MACHINES, RUBBER BANDS, PUNCHES, PAPER FOLDING MACHINES AND PAPER TRIMMERS; PRINTED INSTRUCTIONAL AND TEACHING MATERIAL IN THE FIELD OF DESIGN, MANUFACTURE AND SALE OF VEHICLES' PARTS; PLASTIC BAGS FOR PACKAGING; PRINTERS' TYPE; PRINTING CLICHÉS, IN CLASS 16 (U.S. CLS. 2, 5, 22, 23, 29, 37, 38 AND 50).

THE MARK CONSISTS OF STANDARD CHARACTERS WITHOUT CLAIM TO ANY PARTICULAR FONT, STYLE, SIZE, OR COLOR.

OWNER OF MEXICO REG. NO. 19189, DATED 3-31-2000, EXPIRES 2-28-2020.

THE ENGLISH TRANSLATION OF "EXCELENCIA EN MOVIMIENTO" IN THE MARK IS EXCELLENCE IN MOTION.

SER. NO. 85-290,435, FILED 4-8-2011.

PAM WILLIS, EXAMINING ATTORNEY



David J. Kyffers

Director of the United States Patent and Trademark Office

United States of America

United States Patent and Trademark Office

LIQUID SOIL SUPREME

Reg. No. 4,173,866

ORGANIC SOIL BUILDERS, INC (CALIFORNIA CORPORATION)

Registered July 17, 2012

P.O. BOX 466
KINGSBURG, CA 93631

Int. Cl.: 1

FOR: A NATURAL ORGANIC SOIL AMENDMENT, IN LIQUID FORM, THAT SUPPLIES ORGANIC MATTER TO THE SOIL/ROOT ZONE AND ENCOURAGES VIGOROUS GROWTH, IN CLASS 1 (U.S. CLS. 1, 5, 6, 10, 26 AND 46).

TRADEMARK

FIRST USE 1-1-2011; IN COMMERCE 1-1-2011.

PRINCIPAL REGISTER

THE MARK CONSISTS OF STANDARD CHARACTERS WITHOUT CLAIM TO ANY PARTICULAR FONT, STYLE, SIZE, OR COLOR.

NO CLAIM IS MADE TO THE EXCLUSIVE RIGHT TO USE "LIQUID SOIL", APART FROM THE MARK AS SHOWN.

SER. NO. 85-290,927, FILED 4-9-2011.

RON FAIRBANKS, EXAMINING ATTORNEY



David J. Kyfos

Director of the United States Patent and Trademark Office

United States of America

United States Patent and Trademark Office

The logo for MedData, featuring a stylized cross icon inside a square on the left, followed by the word "MedData" in a large, bold, sans-serif font.

Reg. No. 4,173,867

MEDDATA, INC. (WASHINGTON CORPORATION)
1407 116TH AVE N.E., SUITE E-104
BELLEVUE, WA 98004

Registered July 17, 2012

Int. Cl.: 35

FOR: BUSINESS SERVICES, NAMELY, CUSTOMIZED BILLING, ACCOUNTING, MEDICAL CLAIMS PROCESSING AND DATA MANAGEMENT SERVICES, NAMELY, DATA VERIFICATION SERVICES FOR USE IN VERIFICATION OF PATIENT DEMOGRAPHIC DATA, DATA MANAGEMENT SERVICES FOR USE IN REPORTING DEBT COLLECTION ACCOUNTS TO A COLLECTION AGENCY, AND CLASSIFICATION AND CODING OF MEDICAL SERVICES FOR INSURANCE REIMBURSEMENT, ALL FOR EMERGENCY AND OTHER MEDICAL PROVIDERS, HOSPITALS, PHYSICIANS, AND MEDICAL ADMINISTRATORS, AND CONSULTATION IN RELATION THERETO, IN CLASS 35 (U.S. CLS. 100, 101 AND 102).

SERVICE MARK

PRINCIPAL REGISTER

FIRST USE 4-0-2011; IN COMMERCE 4-0-2011.

OWNER OF U.S. REG. NO. 2,718,626.

THE MARK CONSISTS OF THE WORD "MEDDATA" TO THE RIGHT OF A CROSS DESIGN INSIDE A RECTANGLE.

SER. NO. 85-294,564, FILED 4-13-2011.

SHANNON TWOHIG, EXAMINING ATTORNEY



David J. Kyffers

Director of the United States Patent and Trademark Office

United States of America

United States Patent and Trademark Office

THE MARGINAL PROPHET

Reg. No. 4,173,868

LEE W. GEIGER (UNITED STATES INDIVIDUAL)
203 PASEO DEL RIO
MORAGA, CA 94556

Registered July 17, 2012

Int. Cl.: 41

FOR: PROVIDING INFORMATION, NEWS AND COMMENTARY IN THE AREA OF CURRENT EVENTS IN THE FIELD OF BUSINESS, THE ECONOMY, POLITICS AND POPULAR CULTURE, IN CLASS 41 (U.S. CLS. 100, 101 AND 107).

SERVICE MARK

FIRST USE 9-7-2010; IN COMMERCE 1-24-2011.

PRINCIPAL REGISTER

THE MARK CONSISTS OF STANDARD CHARACTERS WITHOUT CLAIM TO ANY PARTICULAR FONT, STYLE, SIZE, OR COLOR.

SER. NO. 85-295,119, FILED 4-14-2011.

KAREN BRACEY, EXAMINING ATTORNEY



David J. Kyffers

Director of the United States Patent and Trademark Office

United States of America

United States Patent and Trademark Office



Reg. No. 4,173,869

NETSOL TECHNOLOGIES, INC. (NEVADA CORPORATION)
23901 CALABASAS ROAD, SUITE 2072
CALABASAS, CA 91302

Registered July 17, 2012

Int. Cl.: 42

FOR: SOFTWARE AS A SERVICE (SAAS) SERVICES FEATURING COMPUTER PROGRAMS FOR SEARCHING REMOTELY FOR CONTENT ON COMPUTERS AND COMPUTER NETWORKS, COMPUTER SEARCH ENGINE SOFTWARE, AND COMPUTER SOFTWARE THAT PROVIDES WEB-BASED ACCESS TO APPLICATIONS AND SERVICES THROUGH A WEB OPERATING SYSTEM OR PORTAL INTERFACE, IN CLASS 42 (U.S. CLS. 100 AND 101).

SERVICE MARK

PRINCIPAL REGISTER

FIRST USE 4-1-2011; IN COMMERCE 4-1-2011.

NO CLAIM IS MADE TO THE EXCLUSIVE RIGHT TO USE "SMART OCI", APART FROM THE MARK AS SHOWN.

THE COLOR(S) BLACK, WHITE AND YELLOW IS/ARE CLAIMED AS A FEATURE OF THE MARK.

THE MARK CONSISTS OF BLACK RECTANGLE WITH THE WORD "SMART" WRITTEN IN WHITE LETTERS AND THE LETTERS "OCI" WRITTEN IN YELLOW. THERE IS AN IMAGE OF AN OWL HEAD WITH POINTY EARS IN BLACK AND FEATURES THE LETTERS "O" AND "C" AS ITS EYES.

SER. NO. 85-298,145, FILED 4-18-2011.

BARBARA GAYNOR, EXAMINING ATTORNEY



David J. Kybas

Director of the United States Patent and Trademark Office

United States of America

United States Patent and Trademark Office

iCONiC BASEBALL

Reg. No. 4,173,870

AINSWORTH, JEFF (UNITED STATES INDIVIDUAL)
106 FEDERAL STREET
GREENFIELD, MA 01301

Registered July 17, 2012

Int. Cl.: 9

FOR: COMPUTER GAME PROGRAMS, IN CLASS 9 (U.S. CLS. 21, 23, 26, 36 AND 38).

TRADEMARK

FIRST USE 4-1-2011; IN COMMERCE 4-1-2011.

PRINCIPAL REGISTER

THE MARK CONSISTS OF STANDARD CHARACTERS WITHOUT CLAIM TO ANY PARTICULAR FONT, STYLE, SIZE, OR COLOR.

NO CLAIM IS MADE TO THE EXCLUSIVE RIGHT TO USE "BASEBALL", APART FROM THE MARK AS SHOWN.

SER. NO. 85-299,560, FILED 4-20-2011.

SCOTT BIBB, EXAMINING ATTORNEY



David J. Kyffers

Director of the United States Patent and Trademark Office

United States of America

United States Patent and Trademark Office

All Day IPA

Reg. No. 4,173,871

CANAL STREET BREWING COMPANY, LLC (MICHIGAN LIMITED LIABILITY COMPANY)
235 GRANDVILLE AVE SW
GRAND RAPIDS, MI 49503

Registered July 17, 2012

Int. Cl.: 32

FOR: BEER, IN CLASS 32 (U.S. CLS. 45, 46 AND 48).

TRADEMARK

FIRST USE 6-13-2011; IN COMMERCE 6-13-2011.

PRINCIPAL REGISTER

THE MARK CONSISTS OF STANDARD CHARACTERS WITHOUT CLAIM TO ANY PARTICULAR FONT, STYLE, SIZE, OR COLOR.

NO CLAIM IS MADE TO THE EXCLUSIVE RIGHT TO USE "IPA", APART FROM THE MARK AS SHOWN.

SER. NO. 85-300,755, FILED 4-21-2011.

BARBARA A. GOLD, EXAMINING ATTORNEY



David J. Kyffers

Director of the United States Patent and Trademark Office

United States of America

United States Patent and Trademark Office

PUDDLE

Reg. No. 4,173,872

Registered July 17, 2012

Int. Cl.: 9

TRADEMARK

PRINCIPAL REGISTER

NEKO ENTERTAINMENT (FRANCE LIMITED LIABILITY COMPANY)
IMMEUBLE LE MAJOR, 38 RUE DE LA REPUB.
93100 MONTREUIL, FRANCE

FOR: RECORDED COMPUTER GAME SOFTWARE; COMPUTER GAME PROGRAMS; VIDEO GAME PROGRAMS FOR VIDEO GAME APPARATUS; CD-ROMS AND DVD-ROMS STORING VIDEO GAME PROGRAMS FOR VIDEO GAME APPARATUS, STORAGE MEDIA IN THE NATURE OF DEMATERIALIZED STORAGE MEDIA, DVDS, VIDEO GAME ROM CARTRIDGES, SMART CARDS, AND HARD DISCS FOR COMPUTERS, ALL STORING VIDEO GAME PROGRAMS FOR VIDEO GAME APPARATUS; VIDEO GAME PROGRAMS FOR HANDHELD GAME APPARATUS WITH LIQUID CRYSTAL DISPLAYS; CD-ROMS AND DVD-ROMS STORING VIDEO GAME PROGRAMS FOR HANDHELD GAME APPARATUS WITH LIQUID CRYSTAL DISPLAYS; STORAGE MEDIA IN THE NATURE OF DEMATERIALIZED STORAGE MEDIA, DVDS, VIDEO GAME ROM CARTRIDGES, SMART CARDS, AND HARD DISCS FOR COMPUTERS, ALL STORING VIDEO GAME PROGRAMS FOR HANDHELD GAME APPARATUS WITH LIQUID CRYSTAL DISPLAYS; VIDEO GAME PROGRAMS FOR ARCADE VIDEO GAME MACHINES; CD-ROMS AND DVD-ROMS STORING VIDEO GAME PROGRAMS FOR ARCADE VIDEO GAME MACHINES; STORAGE MEDIA IN THE NATURE OF DEMATERIALIZED STORAGE MEDIA, DVDS, VIDEO GAME ROM CARTRIDGES, SMART CARDS, AND HARD DISCS FOR COMPUTERS, ALL STORING VIDEO GAME PROGRAMS FOR ARCADE VIDEO GAME MACHINES, IN CLASS 9 (U.S. CLS. 21, 23, 26, 36 AND 38).



THE MARK CONSISTS OF STANDARD CHARACTERS WITHOUT CLAIM TO ANY PARTICULAR FONT, STYLE, SIZE, OR COLOR.

PRIORITY CLAIMED UNDER SEC. 44(D) ON ERPN CMNTY TM OFC APPLICATION NO. 009904376, FILED 4-19-2011, REG. NO. 009904376, DATED 4-19-2011, EXPIRES 4-19-2021.

SER. NO. 85-300,778, FILED 4-21-2011.

KALIE KUNG, EXAMINING ATTORNEY

David J. Kyros

Director of the United States Patent and Trademark Office

United States of America

United States Patent and Trademark Office

small
hands
big art



A CHILDREN'S
ART STUDIO

life is short.
use more glitter.

704.246.8271

Reg. No. 4,173,873

BRYANT, JENNIFER L (UNITED STATES INDIVIDUAL)
7722 RATHLIN CT.
CHARLOTTE, NC 28270

Registered July 17, 2012

Int. Cl.: 41

FOR: EDUCATIONAL SERVICES IN THE NATURE OF CHILDREN'S FINE ART INSTRUCTION SCHOOLS, IN CLASS 41 (U.S. CLS. 100, 101 AND 107).

SERVICE MARK

FIRST USE 9-1-2009; IN COMMERCE 9-1-2009.

PRINCIPAL REGISTER

NO CLAIM IS MADE TO THE EXCLUSIVE RIGHT TO USE "ART" "A CHILDREN'S ART STUDIO" "704.246.8271", APART FROM THE MARK AS SHOWN.

THE COLOR(S) ORANGE, BROWN, LIGHT BLUE, PINK, TURQUOISE, YELLOW, WHITE AND GREEN IS/ARE CLAIMED AS A FEATURE OF THE MARK.

THE MARK CONSISTS OF A BROWN RIGHT-FACING BIRD IN THE SHAPE OF AN ARTIST PALETTE, WITH WHITE, YELLOW, PINK, TURQUOISE AND ORANGE CIRCLES OF "PAINT" ALONG THE BELLY OF THE BIRD AND A BROWN DOT IN A WHITE CIRCLE TO FORM THE EYE. UNDER THE BIRD IN TURQUOISE CAPITAL LETTERS ARE THE WORDS "A CHILDREN'S ART STUDIO". THE BIRD APPEARS UNDER AN ORANGE CALL OUT BOX WITH THE LOWER CASE WORDS "SMALL HANDS BIG ART" IN WHITE FUTURA FONT. THE CALL OUT BOX APPEARS ABOVE THE BIRD. THE PHRASE "LIFE IS SHORT. USE MORE GLITTER" APPEARS IN GREEN, BELOW THE DESIGN AND THE TELEPHONE NUMBER 704.246.8271 APPEARS IN ORANGE BELOW THE WORDING.

SER. NO. 85-301,863, FILED 4-22-2011.

ALLISON HOLTZ, EXAMINING ATTORNEY



David J. Kybas

Director of the United States Patent and Trademark Office

United States of America

United States Patent and Trademark Office

Apexcare

Reg. No. 4,173,874

Registered July 17, 2012

Int. Cl.: 10

TRADEMARK

PRINCIPAL REGISTER

APEX HEALTH CARE MFG. INC. (TAIWAN CORPORATION)
1-1, HU WEI LIAO
JHEN BEI VILLAGE, MIN SYONG TOWNSHIP
CHIA YI COUNTY, TAIWAN

FOR: OPERATING TABLES; BEDS, SPECIALLY MADE FOR MEDICAL PURPOSES; INVALIDS' HOISTS; BED CUSHIONS FOR MEDICAL PURPOSES; BED PANS; CRUTCHES; SPHYGMOMANOMETERS; STETHOSCOPES; WHEELED STRETCHERS; MASSAGE APPARATUS; COMMODE CHAIRS FOR MEDICAL PURPOSES; MEDICAL EXAMINATION TABLES; STAND FOR INFUSION APPARATUS, IN CLASS 10 (U.S. CLS. 26, 39 AND 44).

FIRST USE 1-10-2011; IN COMMERCE 1-10-2011.

THE MARK CONSISTS OF THE WORD "APEXCARE" WITH THE LETTERS "A" AND "X" IN A STYLIZED FONT.

SER. NO. 85-302,162, FILED 4-22-2011.

JOHN DWYER, EXAMINING ATTORNEY



David J. Kybas

Director of the United States Patent and Trademark Office

United States of America

United States Patent and Trademark Office

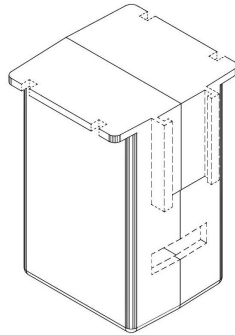

Reg. No. 4,173,875

Registered July 17, 2012

Int. Cl.: 28

TRADEMARK

PRINCIPAL REGISTER

CIRCUITRON, INC. (ILLINOIS CORPORATION)
211 ROCBAAR DRIVE
ROMEDEVILLE, IL 604461163

FOR: MODEL RAILROAD SET ACCESSORIES, NAMELY, MODEL RAILROAD SWITCH MACHINE, IN CLASS 28 (U.S. CLS. 22, 23, 38 AND 50).

FIRST USE 12-31-1985; IN COMMERCE 12-31-1985.

THE MARK CONSISTS OF A THREE-DIMENSIONAL CONFIGURATION OF A MODEL RAILROAD SWITCH MACHINE HAVING A HOUSING FORMED BY SIX RECTANGULAR FACES WHICH DEFINE A HEIGHT, WIDTH AND DEPTH WITH THE HEIGHT BEING ABOUT 50% GREATER THAN THE WIDTH OR DEPTH. A FLANGE EXTENDS HORIZONTALLY FROM THE INTERSECTION OF THE TOP FACE AND EACH SIDE FACE. THE INTERSECTIONS OF THE FACES SHOWS RADIUS CORNERS. THE FOREGOING FEATURES ARE CLAIMED AS PART OF THE MARK. THE MATTER SHOWN IN BROKEN LINES IS NOT PART OF THE MARK AND ONLY SERVES TO SHOW THE POSITION OR PLACEMENT OF THE MARK. THE FRONT FACE HAS TWO VERTICALLY-EXTENDING ANGLE PIECES, AND AN OPENING SLOT, WHICH ARE NOT PART OF THE MARK. THE FLANGES EACH HAVE TWO SPACED-APART INDENTATIONS WHICH ARE NOT PART OF THE MARK.

SEC. 2(F).

SER. NO. 85-302,302, FILED 4-22-2011.

JAY BESCH, EXAMINING ATTORNEY



David J. Kybas

Director of the United States Patent and Trademark Office

United States of America

United States Patent and Trademark Office

dj flaco

Reg. No. 4,173,876

RENTAS, CLARK (UNITED STATES INDIVIDUAL)
3883 GREGUS AVE
LORAIN, OH 44055

Registered July 17, 2012

Int. Cl.: 41

FOR: DISC JOCKEYS FOR PARTIES AND SPECIAL EVENTS, IN CLASS 41 (U.S. CLS. 100, 101 AND 107).

SERVICE MARK

FIRST USE 4-10-2010; IN COMMERCE 4-10-2010.

PRINCIPAL REGISTER

THE MARK CONSISTS OF STANDARD CHARACTERS WITHOUT CLAIM TO ANY PARTICULAR FONT, STYLE, SIZE, OR COLOR.

NO CLAIM IS MADE TO THE EXCLUSIVE RIGHT TO USE "DJ", APART FROM THE MARK AS SHOWN.

THE NAME(S), PORTRAIT(S), AND/OR SIGNATURE(S) SHOWN IN THE MARK IDENTIFIES "CLARK RENTAS", WHOSE CONSENT(S) TO REGISTER IS MADE OF RECORD.

THE WORDING "FLACO" HAS NO MEANING IN A FOREIGN LANGUAGE.

SER. NO. 85-302,964, FILED 4-23-2011.

LAKEISHA LEWIS, EXAMINING ATTORNEY



David J. Kybas

Director of the United States Patent and Trademark Office

United States of America

United States Patent and Trademark Office



Reg. No. 4,173,877

Registered July 17, 2012

Int. Cl.: 9

TRADEMARK

PRINCIPAL REGISTER

HOSANNA (NEW MEXICO CORPORATION), DBA FAITH COMES BY HEARING
2421 AZTEC ROAD NE
ALBUQUERQUE, NM 87107

FOR: COMPUTER APPLICATION SOFTWARE FOR DISTRIBUTION OF DIGITAL CONTENT VIA INTERNET NETWORKS, NAMELY, SOFTWARE FOR AUDIO AND TEXT; COMPUTER APPLICATION SOFTWARE FOR DISTRIBUTION OF DIGITAL CONTENT, NAMELY, RELIGIOUS MATERIAL; COMPUTER APPLICATION SOFTWARE FOR DISTRIBUTION OF DIGITAL CONTENT, NAMELY, HUMANITARIAN AND EDUCATIONAL INFORMATION PROVIDED VIA MOBILE PHONES AND A GLOBAL COMMUNICATION NETWORK, IN CLASS 9 (U.S. CLS. 21, 23, 26, 36 AND 38).

FIRST USE 4-11-2011; IN COMMERCE 4-11-2011.

OWNER OF U.S. REG. NO. 3,940,366.

THE COLOR(S) RED AND WHITE IS/ARE CLAIMED AS A FEATURE OF THE MARK.

THE NON-LATIN CHARACTERS IN THE MARK TRANSLITERATE TO ALKITAB ALMUQADDAS AND THIS MEANS THE HOLY BIBLE IN ENGLISH.

THE MARK CONSISTS OF NON-LATIN ARABIC CHARACTERS JOINED WITH THE WORDING ".IS" IN WHITE ON A RED SQUARE BACKGROUND WITH ROUNDED CORNERS.

THE ENGLISH TRANSLATION OF THE ARABIC CHARACTERS IN THE MARK IS THE HOLY BIBLE.

SER. NO. 85-303,459, FILED 4-25-2011.

CHRISTINE COOPER, EXAMINING ATTORNEY



David J. Kybas

Director of the United States Patent and Trademark Office

United States of America

United States Patent and Trademark Office



Reg. No. 4,173,878

Registered July 17, 2012

Int. Cl.: 36

SERVICE MARK

PRINCIPAL REGISTER

NATIONAL CLAIMS SERVICE, INC. (ILLINOIS CORPORATION)
1225 GARDNER ROAD
BROADVIEW, IL 60155

FOR: THIRD PARTY CLAIMS SETTLEMENT SERVICES, NAMELY, SETTLEMENT OF CLAIMS AGAINST OTHERS FOR LOSS AND/OR DAMAGE TO SHIPMENTS OF MILITARY HOUSEHOLD GOODS, IN CLASS 36 (U.S. CLS. 100, 101 AND 102).

FIRST USE 7-0-1992; IN COMMERCE 7-0-1992.

NO CLAIM IS MADE TO THE EXCLUSIVE RIGHT TO USE "CLAIM SERVICES, INC." AND THE REPRESENTATION OF THE MAP OF THE UNITED STATES, APART FROM THE MARK AS SHOWN.

THE MARK CONSISTS OF A DESIGN OF THE UNITED STATES, FOLLOWED BY THE TEXT "NCS" WITH A WHITE ARROW POINTING TO THE LEFT TRAVELING THROUGH THE IMAGE, WITH A SOLID BLOCK LOCATED BENEATH, WITH THE TEXT "NATIONAL CLAIMS SERVICES, INC." SUPERIMPOSED INSIDE THE BLOCK.

SEC. 2(F) AS TO "NATIONAL".

SER. NO. 85-303,742, FILED 4-25-2011.

CHARLES L. JENKINS, EXAMINING ATTORNEY



David J. Kyffers

Director of the United States Patent and Trademark Office

United States of America

United States Patent and Trademark Office

TONY PACKO'S CAFE

Reg. No. 4,173,879

TONY PACKO'S INC. (OHIO CORPORATION)
1902 FRONT STREET
TOLEDO, OH 43605

Registered July 17, 2012

Int. Cl.: 43

FOR: RESTAURANT SERVICES, IN CLASS 43 (U.S. CLS. 100 AND 101).

SERVICE MARK

FIRST USE 1-0-1933; IN COMMERCE 1-0-1933.

PRINCIPAL REGISTER

THE MARK CONSISTS OF STANDARD CHARACTERS WITHOUT CLAIM TO ANY PARTICULAR FONT, STYLE, SIZE, OR COLOR.

OWNER OF U.S. REG. NOS. 3,004,156 AND 3,191,194.

NO CLAIM IS MADE TO THE EXCLUSIVE RIGHT TO USE "CAFE", APART FROM THE MARK AS SHOWN.

THE NAME(S), PORTRAIT(S), AND/OR SIGNATURE(S) SHOWN IN THE MARK DOES NOT IDENTIFY A PARTICULAR LIVING INDIVIDUAL.

SER. NO. 85-303,847, FILED 4-25-2011.

STEVEN R. FINE, EXAMINING ATTORNEY



David J. Kyffers

Director of the United States Patent and Trademark Office

United States of America

United States Patent and Trademark Office



GLOBAL ENERGY INNOVATIONS

Reg. No. 4,173,880

Registered July 17, 2012

Int. Cl.: 9

TRADEMARK

PRINCIPAL REGISTER

GLOBAL ENERGY INNOVATIONS, LLC (CALIFORNIA LIMITED LIABILITY COMPANY)
254 EAST GISH ROAD
SAN JOSE, CA 95112

FOR: ELECTRONIC BATTERY TESTERS, NAMELY, AUTOMATED APPLIANCES THAT EMPLOY INTEGRATED CIRCUITS AND FREQUENCY RESPONSE ANALYSIS TO MONITOR IMPORTANT CHARACTERISTICS OF A BATTERY SUCH AS THE STATE OF CHARGE, A MEASURE OF HOW MUCH ENERGY IT CAN DELIVER, AND THE STATE OF HEALTH, A MEASURE OF HOW LONG IT WILL CONTINUE TO FUNCTION PROPERLY; ELECTRONIC BATTERY CONDITIONERS, NAMELY, AUTOMATED APPLIANCES USED TO RESTORE THE HEALTH OF BATTERIES THAT HAVE CEASED TO FUNCTION PROPERLY; ASSOCIATED FIRMWARE AND SOFTWARE, NAMELY, COMPUTER PROGRAMS USED TO CONTROL THE AUTOMATED FUNCTIONS OF DATA ANALYSIS, REPORT GENERATION, TASK MANAGEMENT, AND EVENT HANDLING , IN CLASS 9 (U.S. CLS. 21, 23, 26, 36 AND 38).

FIRST USE 1-3-2011; IN COMMERCE 1-3-2011.

NO CLAIM IS MADE TO THE EXCLUSIVE RIGHT TO USE "GLOBAL ENERGY", APART FROM THE MARK AS SHOWN.

THE COLOR(S) LIGHT GREEN, GRAY, AND DARK GREEN IS/ARE CLAIMED AS A FEATURE OF THE MARK.

THE MARK CONSISTS OF A STYLIZED CAPITAL LETTER "G" OF LIGHT GREEN COLOR, A STYLIZED CAPITAL LETTER "E" OF GRAY COLOR, A STYLIZED CAPITAL LETTER "I" OF LIGHT GREEN COLOR, AND THE WORDS "GLOBAL ENERGY INNOVATIONS" IN CAPITAL LETTERS OF THE COLOR DARK GREEN BELOW THE LETTERS "GEI".

SER. NO. 85-304,066, FILED 4-25-2011.

GINA HAYES, EXAMINING ATTORNEY



David J. Kybas

Director of the United States Patent and Trademark Office

United States of America

United States Patent and Trademark Office

ULLA-MAIJA Couture

Reg. No. 4,173,881

Registered July 17, 2012

Int. Cl.: 25

ULLA-MAIJA, INC. (NEW YORK CORPORATION), AKA ANNA MAIER ~ ULLA-MAIJA
COUTURE
32 WEST 39TH STREET
NEW YORK, NY 10018

FOR: WEDDING GOWNS, IN CLASS 25 (U.S. CLS. 22 AND 39).

TRADEMARK

PRINCIPAL REGISTER

FIRST USE 3-24-1993, THE MARK WAS FIRST USED ANYWHERE IN A DIFFERENT FORM OTHER THAN THAT SOUGHT TO BE REGISTERED AT LEAST AS EARLY AS 03/24/1993; IN COMMERCE 3-24-1993, THE MARK WAS FIRST USED IN COMMERCE IN A DIFFERENT FORM OTHER THAN THAT SOUGHT TO BE REGISTERED AT LEAST AS EARLY AS 03/24/1993.

THE MARK CONSISTS OF STANDARD CHARACTERS WITHOUT CLAIM TO ANY PARTICULAR FONT, STYLE, SIZE, OR COLOR.

NO CLAIM IS MADE TO THE EXCLUSIVE RIGHT TO USE "COUTURE", APART FROM THE MARK AS SHOWN.

SER. NO. 85-304,068, FILED 4-25-2011.

GINA HAYES, EXAMINING ATTORNEY



David J. Kyffers

Director of the United States Patent and Trademark Office

United States of America

United States Patent and Trademark Office

Dr. Penny

Reg. No. 4,173,882

PUBLIC SERVICE CREDIT UNION (COLORADO CREDIT UNION)
7055 E EVANS
DENVER, CO 80224

Registered July 17, 2012

Int. Cl.: 36

FOR: BANKING, IN CLASS 36 (U.S. CLS. 100, 101 AND 102).

SERVICE MARK

FIRST USE 2-1-2011; IN COMMERCE 4-1-2011.

PRINCIPAL REGISTER

THE MARK CONSISTS OF STANDARD CHARACTERS WITHOUT CLAIM TO ANY PARTICULAR FONT, STYLE, SIZE, OR COLOR.

SER. NO. 85-304,320, FILED 4-25-2011.

KEVIN DINALLO, EXAMINING ATTORNEY



David J. Kybas

Director of the United States Patent and Trademark Office

United States of America

United States Patent and Trademark Office

SOUL ORGANS

Reg. No. 4,173,883

Registered July 17, 2012

Int. Cl.: 42

SERVICE MARK

PRINCIPAL REGISTER

DE LA CRUZ, MICHAEL (UNITED STATES INDIVIDUAL)
75 CONGRESS STREET
PORTSMOUTH, NH 03801

FOR: ARCHEOLOGICAL EXPLORATION AND RESEARCH; BIOLOGICAL RESEARCH; BIOMEDICAL RESEARCH SERVICES; MEDICAL AND SCIENTIFIC RESEARCH IN THE FIELD OF MEDICAL IMAGING; MEDICAL AND SCIENTIFIC RESEARCH IN THE FIELD OF BIOPHYSICS AND BIOMEDICINE; MEDICAL RESEARCH; PHARMACEUTICAL RESEARCH AND DEVELOPMENT; PHYSICS RESEARCH; PRODUCT RESEARCH AND DEVELOPMENT; PROVIDING MEDICAL AND SCIENTIFIC RESEARCH INFORMATION IN THE FIELD OF PHARMACEUTICALS; RESEARCH AND ANALYSIS IN THE FIELD OF MEDICINE; RESEARCH AND DEVELOPMENT AND CONSULTATION RELATED THERETO IN THE FIELD OF BIOPHYSICS AND BIOMEDICINE; RESEARCH AND DEVELOPMENT OF ADVANCED LEARNING TECHNOLOGIES AND TEACHING METHODS; RESEARCH AND DEVELOPMENT OF COMPUTER SOFTWARE; RESEARCH AND DEVELOPMENT OF NEW PRODUCTS; RESEARCH AND DEVELOPMENT OF 3D CONTENT, 3D TECHNOLOGY AND PROCESSES, STEREOSCOPIC 3D PROJECTION, 3D ANIMATION TECHNOLOGY, 3D PROCESSING POWER, 3D TECHNIQUES, AND FLEXIBLE FORWARD PROJECTION; RESEARCH IN THE PHARMACEUTICAL AND BIOTECHNOLOGY FIELDS; RESEARCH AND DEVELOPMENT IN THE FIELD OF PSYCHOLOGY, PHYSIOLOGY, ANATOMY, ACUPUNCTURE; RESEARCH IN THE FIELD OF CHEMISTRY; RESEARCH IN THE FIELD OF PHYSICS; SCIENTIFIC AND TECHNOLOGICAL SERVICES, NAMELY, RESEARCH AND DESIGN IN THE FIELD OF INTEGRATED SYSTEM ARCHITECTURE THAT ALLOWS FOR THE RAPID DEVELOPMENT OF HIGHLY INTERACTIVE AND CUSTOMIZABLE LEARNING APPLICATIONS; ZOOLOGICAL RESEARCH AND CONSULTATION; SCIENTIFIC STUDY AND RESEARCH IN THE FIELDS OF MEDICINE, THE PREVENTION, TREATMENT AND MANAGEMENT OF ILLNESS, HEALTH CARE DELIVERY AND THE SCIENTIFIC ASPECTS OF HEALTH CARE POLICY, HEALTH CARE COST MANAGEMENT AND FINANCING AS THESE FIELDS IMPACT ON QUALITY OF HEALTH CARE; SCIENTIFIC RESEARCH AND DEVELOPMENT; SCIENTIFIC RESEARCH IN THE FIELDS OF QIGONG AND OTHER PERSONAL ENERGETIC DEVELOPMENT SYSTEMS; SCIENTIFIC RESEARCH SERVICES FOR OTHERS IN THE FIELD OF SENSORY PERCEPTIONS, IN CLASS 42 (U.S. CLS. 100 AND 101).



David J. Kybas

FIRST USE 4-11-2011; IN COMMERCE 4-11-2011.

Reg. No. 4,173,883 THE MARK CONSISTS OF STANDARD CHARACTERS WITHOUT CLAIM TO ANY PARTICULAR FONT, STYLE, SIZE, OR COLOR.

SER. NO. 85-306,334, FILED 4-27-2011.

CHARLOTTE CORWIN, EXAMINING ATTORNEY

United States of America

United States Patent and Trademark Office

SOUL ORGAN SYSTEMS

Reg. No. 4,173,884

Registered July 17, 2012

Int. Cl.: 42

SERVICE MARK

PRINCIPAL REGISTER

DE LA CRUZ, MICHAEL (UNITED STATES INDIVIDUAL)
75 CONGRESS STREET
PORTSMOUTH, NH 03801

FOR: ARCHEOLOGICAL EXPLORATION AND RESEARCH; BIOLOGICAL RESEARCH; BIOMEDICAL RESEARCH SERVICES; MEDICAL AND SCIENTIFIC RESEARCH IN THE FIELD OF MEDICAL IMAGING; MEDICAL AND SCIENTIFIC RESEARCH IN THE FIELD OF BIOPHYSICS AND BIOMEDICINE; MEDICAL RESEARCH; PHARMACEUTICAL RESEARCH AND DEVELOPMENT; PHYSICS RESEARCH; PRODUCT RESEARCH AND DEVELOPMENT; PROVIDING MEDICAL AND SCIENTIFIC RESEARCH INFORMATION IN THE FIELD OF PHARMACEUTICALS; RESEARCH AND ANALYSIS IN THE FIELD OF MEDICINE; RESEARCH AND DEVELOPMENT AND CONSULTATION RELATED THERETO IN THE FIELD OF BIOPHYSICS AND BIOMEDICINE; RESEARCH AND DEVELOPMENT OF ADVANCED LEARNING TECHNOLOGIES AND TEACHING METHODS; RESEARCH AND DEVELOPMENT OF COMPUTER SOFTWARE; RESEARCH AND DEVELOPMENT OF NEW PRODUCTS; RESEARCH AND DEVELOPMENT OF 3D CONTENT, 3D TECHNOLOGY AND PROCESSES, STEREOSCOPIC 3D PROJECTION, 3D ANIMATION TECHNOLOGY, 3D PROCESSING POWER, 3D TECHNIQUES, AND FLEXIBLE FORWARD PROJECTION; RESEARCH IN THE PHARMACEUTICAL AND BIOTECHNOLOGY FIELDS; RESEARCH AND DEVELOPMENT IN THE FIELD OF PSYCHOLOGY, PHYSIOLOGY, ANATOMY, ACUPUNCTURE; RESEARCH IN THE FIELD OF CHEMISTRY; RESEARCH IN THE FIELD OF PHYSICS; SCIENTIFIC AND TECHNOLOGICAL SERVICES, NAMELY, RESEARCH AND DESIGN IN THE FIELD OF INTEGRATED SYSTEM ARCHITECTURE THAT ALLOWS FOR THE RAPID DEVELOPMENT OF HIGHLY INTERACTIVE AND CUSTOMIZABLE LEARNING APPLICATIONS; ZOOLOGICAL RESEARCH AND CONSULTATION; SCIENTIFIC STUDY AND RESEARCH IN THE FIELDS OF MEDICINE, THE PREVENTION, TREATMENT AND MANAGEMENT OF ILLNESS, HEALTH CARE DELIVERY AND THE SCIENTIFIC ASPECTS OF HEALTH CARE POLICY, HEALTH CARE COST MANAGEMENT AND FINANCING AS THESE FIELDS IMPACT ON QUALITY OF HEALTH CARE; SCIENTIFIC RESEARCH AND DEVELOPMENT; SCIENTIFIC RESEARCH IN THE FIELDS OF QIGONG AND OTHER PERSONAL ENERGETIC DEVELOPMENT SYSTEMS; SCIENTIFIC RESEARCH SERVICES FOR OTHERS IN THE FIELD OF SENSORY PERCEPTIONS, IN CLASS 42 (U.S. CLS. 100 AND 101).



David J. Kyjars

FIRST USE 4-11-2011; IN COMMERCE 4-11-2011.

Reg. No. 4,173,884 THE MARK CONSISTS OF STANDARD CHARACTERS WITHOUT CLAIM TO ANY PARTICULAR FONT, STYLE, SIZE, OR COLOR.

SER. NO. 85-306,344, FILED 4-27-2011.

CHARLOTTE CORWIN, EXAMINING ATTORNEY

United States of America

United States Patent and Trademark Office



Reg. No. 4,173,885

Registered July 17, 2012

Int. Cl.: 11

TRADEMARK

PRINCIPAL REGISTER

GRANG FAIR INDUSTRIAL CO., LTD. (TAIWAN CORPORATION)
NO. 21, LANE 22
SUNG PAI STREET, PAN CHIAO DISTRICT
NEW TAIPEI CITY 22044, TAIWAN

FOR: LIGHTS FOR VEHICLES, NAMELY, TAIL LIGHTS, VEHICLE TURN-SIGNAL LIGHT BULBS, ROOM LAMPS, LICENSE PLATE LAMPS, DOME LAMPS, FENDER LAMPS, NAMELY, FRONT AND REAR LIGHTS, BACKUP LIGHTS, SIDE LAMPS, FOG LIGHTS, HEADLIGHTS, STOP LAMPS, NAMELY, BRAKE LIGHTS, DRIVING LAMPS, NAMELY, HEADLIGHTS, DIRECTION SIGNAL LIGHTS, HIGH INTENSITY SEARCH LIGHTS AND LAMP REFLECTORS, IN CLASS 11 (U.S. CLS. 13, 21, 23, 31 AND 34).

FIRST USE 11-15-2010; IN COMMERCE 1-15-2011.

THE MARK CONSISTS OF THE STYLIZED LETTERS "RELIABLE" WITH THE LOWER LEG OF THE "R" FORMING A TRIANGULAR CONTOUR AND THE "A" FORMED WITH A DOT IN A LOWER SECTION, ALL ABOVE A BAR LINE AND HAVING A BAR THROUGH A LOWER SECTION OF EACH OF THE LETTERS, WITH ALL LETTERS ADJACENT A CUSP LIKE CONTOUR ON ONE SIDE OF THE "R" AND WHICH EXTENDS OVER THE LETTERS "REL".

SER. NO. 85-306,536, FILED 4-27-2011.

MARLENE BELL, EXAMINING ATTORNEY



David J. Kybas

Director of the United States Patent and Trademark Office

United States of America

United States Patent and Trademark Office

Private-Share

Reg. No. 4,173,886

THIRD FOUNDATION (CALIFORNIA CORPORATION)
3723 HAVEN AVE.

Registered July 17, 2012

MENLO PARK, CA 94025

Int. Cl.: 35

FOR: ONLINE BUSINESS MANAGEMENT SERVICES RELATING TO MARKETING, SALES, PERSONNEL RECRUITING INFORMATION, FINANCIAL INFORMATION, AND PERSONAL CONTACT INFORMATION, THAT ALLOWS USERS TO SECURELY SHARE SUCH INFORMATION, IN CLASS 35 (U.S. CLS. 100, 101 AND 102).

SERVICE MARK

PRINCIPAL REGISTER

FIRST USE 4-19-2011; IN COMMERCE 4-19-2011.

THE MARK CONSISTS OF STANDARD CHARACTERS WITHOUT CLAIM TO ANY PARTICULAR FONT, STYLE, SIZE, OR COLOR.

SER. NO. 85-306,736, FILED 4-28-2011.

JOHN E. MICHOS, EXAMINING ATTORNEY



David J. Kybas

Director of the United States Patent and Trademark Office

United States of America

United States Patent and Trademark Office

AADS

Reg. No. 4,173,887

Registered July 17, 2012

Int. Cl.: 9

TRADEMARK

PRINCIPAL REGISTER

4 S TECHNOLOGIES, LLC (NEW JERSEY LIMITED LIABILITY COMPANY)
SUITE 101
200 SHEFFIELD STREET
MOUNTAINSIDE, NJ 07092

FOR: COMPUTER PROGRAMS AND SOFTWARE FOR THE AUTOMATED GATHERING, RECOGNITION, FORMATTING AND TRANSMISSION OF DATA AND INFORMATION TO AND FROM COMPUTERS, WEB PORTALS, OR COMPUTER NETWORKS, IN CLASS 9 (U.S. CLS. 21, 23, 26, 36 AND 38).

FIRST USE 8-6-2010; IN COMMERCE 8-6-2010.

THE MARK CONSISTS OF STANDARD CHARACTERS WITHOUT CLAIM TO ANY PARTICULAR FONT, STYLE, SIZE, OR COLOR.

OWNER OF U.S. REG. NO. 3,971,554.

SER. NO. 85-306,832, FILED 4-28-2011.

NICHOLAS COLEMAN, EXAMINING ATTORNEY



David J. Kybas

Director of the United States Patent and Trademark Office

United States of America

United States Patent and Trademark Office



Reg. No. 4,173,888

Registered July 17, 2012

Int. Cls.: 10 and 25

TRADEMARK

PRINCIPAL REGISTER

SYNERGY MEDICAL SUPPLY COMPANY, INC. (NEVADA CORPORATION)
1329 HIGHWAY 398 N., SUITE 10, BOX 803B
GARDNERVILLE, NV 89140

FOR: ORTHOPEDIC BRACES; BRACES FOR LIMBS AND JOINTS FOR MEDICAL USE; SUPPORTS FOR LIMBS AND JOINTS FOR MEDICAL USE; ORTHOPEDIC SUPPORTS; THERAPEUTIC SUPPORT GLOVES; THERAPEUTIC HIP PROTECTORS; POST-OPERATIVE SHOES AND SLIPPERS FOR MEDICAL USE, IN CLASS 10 (U.S. CLS. 26, 39 AND 44).

FIRST USE 3-1-2010; IN COMMERCE 3-1-2010.

FOR: SLIPPERS, IN CLASS 25 (U.S. CLS. 22 AND 39).

FIRST USE 3-1-2010; IN COMMERCE 3-1-2010.

THE MARK CONSISTS OF THE WORD "SYNERGY" AND TWO DROPS APPEARING TO THE LEFT OF "SYNERGY".

SER. NO. 85-306,871, FILED 4-28-2011.

EDWARD NELSON, EXAMINING ATTORNEY



David J. Kyffers

Director of the United States Patent and Trademark Office

United States of America

United States Patent and Trademark Office

myidwear

Reg. No. 4,173,889

Registered July 17, 2012

Int. Cls.: 16 and 40

TRADEMARK

SERVICE MARK

PRINCIPAL REGISTER

F&M EXPRESSIONS UNLIMITED, INC. (NEW JERSEY CORPORATION)
211 ISLAND ROAD
MAHWAH, NJ 07430

FOR: IRON-ON OR HEAT-APPLIED TRANSFERS, IN CLASS 16 (U.S. CLS. 2, 5, 22, 23, 29, 37, 38 AND 50).

FIRST USE 1-1-2009; IN COMMERCE 1-1-2009.

FOR: APPLYING FINISHES TO CLOTHING, CLOTH, FABRICS, AND OTHER TEXTILES THROUGH CUSTOM-MANUFACTURED HEAT APPLIED IMAGE TRANSFERS; CUSTOM IMPRINTING OF CLOTHING, CLOTH, FABRICS, AND OTHER TEXTILES WITH HEAT-APPLIED TRANSFERS WITH DECORATIVE DESIGNS, IN CLASS 40 (U.S. CLS. 100, 103 AND 106).

FIRST USE 1-1-2009; IN COMMERCE 1-1-2009.

THE MARK CONSISTS OF THE WORD "MYIDWEAR" IN LOWER CASE LETTERS IN A SPECIALIZED FONT.

SER. NO. 85-306,889, FILED 4-28-2011.

VIVIAN MICZNIK FIRST, EXAMINING ATTORNEY



David J. Kyros

Director of the United States Patent and Trademark Office

United States of America

United States Patent and Trademark Office



Reg. No. 4,173,890

Registered July 17, 2012

Int. Cl.: 9

TRADEMARK

PRINCIPAL REGISTER

HOSANNA (NEW MEXICO CORPORATION), DBA FAITH COMES BY HEARING
2421 AZTEC ROAD NE
ALBUQUERQUE, NM 87107

FOR: COMPUTER APPLICATION SOFTWARE FOR DISTRIBUTION OF DIGITAL CONTENT VIA INTERNET NETWORKS, NAMELY, SOFTWARE FOR AUDIO AND TEXT; COMPUTER APPLICATION SOFTWARE FOR DISTRIBUTION OF DIGITAL CONTENT, NAMELY, RELIGIOUS MATERIAL; COMPUTER APPLICATION SOFTWARE FOR DISTRIBUTION OF DIGITAL CONTENT, NAMELY, HUMANITARIAN AND EDUCATIONAL INFORMATION PROVIDED VIA MOBILE PHONES AND A GLOBAL COMMUNICATION NETWORK, IN CLASS 9 (U.S. CLS. 21, 23, 26, 36 AND 38).

FIRST USE 2-21-2011; IN COMMERCE 2-21-2011.

OWNER OF U.S. REG. NO. 3,940,366.

THE COLOR(S) RED AND WHITE IS/ARE CLAIMED AS A FEATURE OF THE MARK.

THE MARK CONSISTS OF THE WORDING "BIBLIA.IS" IN WHITE ON A RED SQUARE BACKGROUND WITH ROUNDED CORNERS.

THE ENGLISH TRANSLATION OF "BIBLIA" IN THE MARK IS "BIBLE".

SER. NO. 85-306,961, FILED 4-28-2011.

CHRISTINE COOPER, EXAMINING ATTORNEY



David J. Kybas

Director of the United States Patent and Trademark Office

United States of America

United States Patent and Trademark Office



Reg. No. 4,173,891

Registered July 17, 2012

Int. Cls.: 16 and 41

TRADEMARK

SERVICE MARK

PRINCIPAL REGISTER

NORTHERN CALIFORNIA URBAN DEVELOPMENT (CALIFORNIA NON-PROFIT CORPORATION)
1836 BAY ROAD
EAST PALO ALTO, CA 94303

FOR: PRINTED EDUCATIONAL MATERIALS AND CURRICULUM IN THE FIELD OF PERSONAL FINANCE, IN CLASS 16 (U.S. CLS. 2, 5, 22, 23, 29, 37, 38 AND 50).

FIRST USE 7-30-2009; IN COMMERCE 7-30-2009.

FOR: EDUCATIONAL SERVICES, NAMELY, CONDUCTING CLASSES, SEMINARS, WORKSHOPS IN THE FIELD OF PERSONAL FINANCE; PROVIDING A WEB SITE FEATURING BLOGS IN THE FIELD OF PERSONAL FINANCE; PROVIDING A WEB SITE FEATURING EDUCATIONAL ONLINE NON-DOWNLOADABLE CONFERENCES, SEMINARS AND WEBINARS IN THE FIELD OF PERSONAL FINANCE; PROVIDING A WEB SITE FEATURING ONLINE NON-DOWNLOADABLE EDUCATIONAL MATERIALS AND CURRICULUM IN THE FIELD OF PERSONAL FINANCE, IN CLASS 41 (U.S. CLS. 100, 101 AND 107).

FIRST USE 7-30-2009; IN COMMERCE 7-30-2009.

THE MARK CONSISTS OF THE LOWERCASE LETTERS "FP" WITHIN A BOX NEXT TO THE WORD "FUTUREPROFITS".

SER. NO. 85-307,052, FILED 4-28-2011.

LEIGH LOWRY, EXAMINING ATTORNEY



David J. Kyjars

Director of the United States Patent and Trademark Office

United States of America

United States Patent and Trademark Office

WIND WEIGHTED

Reg. No. 4,173,892

AER-FLO CANVAS PRODUCTS, INC. (FLORIDA CORPORATION)
P.O. BOX 1356
ONECO, FL 34264

Registered July 17, 2012

Int. Cl.: 22

FOR: PROTECTIVE TARPULINS FOR THE GROUND, EQUIPMENT, WOODPILES, AND THE LIKE, IN CLASS 22 (U.S. CLS. 1, 2, 7, 19, 22, 42 AND 50).

TRADEMARK

FIRST USE 10-30-2002; IN COMMERCE 11-3-2002.

PRINCIPAL REGISTER

THE MARK CONSISTS OF STANDARD CHARACTERS WITHOUT CLAIM TO ANY PARTICULAR FONT, STYLE, SIZE, OR COLOR.

OWNER OF U.S. REG. NO. 2,956,060.

SEC. 2(F).

SER. NO. 85-307,126, FILED 4-28-2011.

ROBIN MITTLER, EXAMINING ATTORNEY



David J. Kybas

Director of the United States Patent and Trademark Office

United States of America

United States Patent and Trademark Office



Reg. No. 4,173,893

Registered July 17, 2012

Int. Cls.: 35 and 42

SERVICE MARK

PRINCIPAL REGISTER

UBER OPERATIONS LLC (FLORIDA LIMITED LIABILITY COMPANY)
400 CAPITAL CIRCLE SE, STE 18299
TALLAHASSEE, FL 323013839

FOR: PROJECT MANAGEMENT SERVICES FOR OTHERS IN THE FIELDS OF DATA INTEGRATION AND INFORMATION EXCHANGE, IN CLASS 35 (U.S. CLS. 100, 101 AND 102).

FIRST USE 12-1-2004; IN COMMERCE 12-1-2004.

FOR: ADVISORY SERVICES IN THE FIELD OF PRODUCT DEVELOPMENT AND QUALITY IMPROVEMENT OF SOFTWARE RELATED TO DATA INTEGRATION; COMPUTER PROGRAMMING AND SOFTWARE DESIGN; COMPUTER PROJECT MANAGEMENT SERVICES FOR DATA INTEGRATION AND INFORMATION EXCHANGE; COMPUTER SERVICES, NAMELY, DESIGN AND DEVELOPMENT OF COMPUTER HARDWARE AND SOFTWARE FOR BIDIRECTIONAL SECURE TRANSMISSION OF DATA BETWEEN ORGANIZATIONS AND/OR SOFTWARE AND DATA APPLICATIONS FOR OTHERS; COMPUTER SERVICES, NAMELY, PROVIDING A SYSTEM FOR CUSTOMERS TO MANAGE, ADMINISTER, MODIFY AND CONTROL THEIR END USER COMPUTER DEVICES, DATA, AND SOFTWARE APPLICATIONS; CONSULTING IN THE FIELDS OF IT PROJECT MANAGEMENT AND OF COMPUTER SOFTWARE AND SYSTEMS RELATING TO DATA INTEGRATION AND INFORMATION EXCHANGE; DESIGN, DEVELOPMENT AND CONSULTING SERVICES IN THE FIELD OF COMPUTER HARDWARE AND SOFTWARE FOR DATA INTEGRATION AND INFORMATION EXCHANGE; INFORMATION TECHNOLOGY CONSULTATION AND INTEGRATION SERVICES; RESEARCH SERVICES IN THE FIELD OF DATA INTEGRATION AND INFORMATION EXCHANGE, IN CLASS 42 (U.S. CLS. 100 AND 101).

FIRST USE 12-1-2004; IN COMMERCE 12-1-2004.

THE MARK CONSISTS OF THE LETTERS "Ü" AND "O", WITH THE "O" APPEARING TO HANG FROM THE BOTTOM CURVE OF THE "Ü".

SER. NO. 85-307,312, FILED 4-28-2011.

JAY FLOWERS, EXAMINING ATTORNEY



David J. Kyros

Director of the United States Patent and Trademark Office

United States of America

United States Patent and Trademark Office

CASCADE VR

Reg. No. 4,173,894

Registered July 17, 2012

Int. Cls.: 7 and 9

TRADEMARK

PRINCIPAL REGISTER

WEIR VALVES & CONTROLS UK LIMITED (UNITED KINGDOM COMPANY)
BRITANNIA HOUSE HUDDERSFIELD ROAD ELLAND
HALIFAX WEST YORKSHIRE, UNITED KINGDOM HX59JR

FOR: MACHINE PARTS, NAMELY, FLUID CONTROL VALVES; FLUID FLOW CONTROL APPARATUS, NAMELY, CAGE TRIM VALVES, CHOKE VALVES; TRIM STACKS AND TRIM CAGES AND STRUCTURAL PARTS FOR GENERAL INDUSTRIAL AND COMMERCIAL USE, IN CLASS 7 (U.S. CLS. 13, 19, 21, 23, 31, 34 AND 35).

FOR: FLUID PRESSURE CONTROL VALVES, IN CLASS 9 (U.S. CLS. 21, 23, 26, 36 AND 38).

THE MARK CONSISTS OF STANDARD CHARACTERS WITHOUT CLAIM TO ANY PARTICULAR FONT, STYLE, SIZE, OR COLOR.

PRIORITY CLAIMED UNDER SEC. 44(D) ON ERPN CMNTY TM OFC APPLICATION NO. 009495359, FILED 11-4-2010, REG. NO. 009495359, DATED 4-19-2011, EXPIRES 11-4-2020.

SER. NO. 85-307,324, FILED 4-28-2011.

MATTHEW KLINE, EXAMINING ATTORNEY



David J. Kypas

Director of the United States Patent and Trademark Office

United States of America

United States Patent and Trademark Office

Über Operations

Reg. No. 4,173,895

Registered July 17, 2012

Int. Cls.: 35 and 42

SERVICE MARK

PRINCIPAL REGISTER

UBER OPERATIONS LLC (FLORIDA LIMITED LIABILITY COMPANY)
400 CAPITAL CIRCLE SE, STE 18299
TALLAHASSEE, FL 323013839

FOR: PROJECT MANAGEMENT SERVICES FOR OTHERS IN THE FIELDS OF DATA INTEGRATION AND INFORMATION EXCHANGE, IN CLASS 35 (U.S. CLS. 100, 101 AND 102).

FIRST USE 12-1-2004; IN COMMERCE 12-1-2004.

FOR: ADVISORY SERVICES IN THE FIELD OF PRODUCT DEVELOPMENT AND QUALITY IMPROVEMENT OF SOFTWARE RELATED TO DATA INTEGRATION; COMPUTER PROGRAMMING AND SOFTWARE DESIGN; COMPUTER PROJECT MANAGEMENT SERVICES FOR DATA INTEGRATION AND INFORMATION EXCHANGE; COMPUTER SERVICES, NAMELY, DESIGN AND DEVELOPMENT OF COMPUTER HARDWARE AND SOFTWARE FOR BIDIRECTIONAL SECURE TRANSMISSION OF DATA BETWEEN ORGANIZATIONS AND/OR SOFTWARE AND DATA APPLICATIONS FOR OTHERS; COMPUTER SERVICES, NAMELY, PROVIDING A SYSTEM FOR CUSTOMERS TO MANAGE, ADMINISTER, MODIFY AND CONTROL THEIR END USER COMPUTER DEVICES, DATA, AND SOFTWARE APPLICATIONS; CONSULTING IN THE FIELDS OF IT PROJECT MANAGEMENT AND OF COMPUTER SOFTWARE AND SYSTEMS RELATING TO DATA INTEGRATION AND INFORMATION EXCHANGE; DESIGN, DEVELOPMENT AND CONSULTING SERVICES IN THE FIELD OF COMPUTER HARDWARE AND SOFTWARE FOR DATA INTEGRATION AND INFORMATION EXCHANGE; INFORMATION TECHNOLOGY CONSULTATION AND INTEGRATION SERVICES; RESEARCH SERVICES IN THE FIELD OF DATA INTEGRATION AND INFORMATION EXCHANGE, IN CLASS 42 (U.S. CLS. 100 AND 101).

FIRST USE 12-1-2004; IN COMMERCE 12-1-2004.

THE MARK CONSISTS OF STANDARD CHARACTERS WITHOUT CLAIM TO ANY PARTICULAR FONT, STYLE, SIZE, OR COLOR.

NO CLAIM IS MADE TO THE EXCLUSIVE RIGHT TO USE "OPERATIONS", APART FROM THE MARK AS SHOWN.

SER. NO. 85-307,335, FILED 4-28-2011.



David J. Kybas

Director of the United States Patent and Trademark Office

Reg. No. 4,173,895 JAY FLOWERS, EXAMINING ATTORNEY

United States of America

United States Patent and Trademark Office

FLEX NET

Reg. No. 4,173,896

JAYPRO SPORTS, LLC (CONNECTICUT LIMITED LIABILITY COMPANY)
976 HARTFORD TURNPIKE
WATERFORD, CT 06385

Registered July 17, 2012

Int. Cl.: 28

FOR: VOLLEYBALL GAME PLAYING EQUIPMENT, IN CLASS 28 (U.S. CLS. 22, 23, 38 AND 50).

TRADEMARK

FIRST USE 12-31-1995; IN COMMERCE 12-31-1995.

PRINCIPAL REGISTER

THE MARK CONSISTS OF STANDARD CHARACTERS WITHOUT CLAIM TO ANY PARTICULAR FONT, STYLE, SIZE, OR COLOR.

NO CLAIM IS MADE TO THE EXCLUSIVE RIGHT TO USE "NET", APART FROM THE MARK AS SHOWN.

SEC. 2(F).

SER. NO. 85-307,455, FILED 4-28-2011.

RAUL CORDOVA, EXAMINING ATTORNEY



David J. Kybas

Director of the United States Patent and Trademark Office

United States of America

United States Patent and Trademark Office



Reg. No. 4,173,897

Registered July 17, 2012

Int. Cl.: 9

TRADEMARK

PRINCIPAL REGISTER

SHOHERO TECHNOLOGIES LIMITED (BR. VIRGIN ISLANDS CORPORATION)
PO BOX 116
SEA MEADOW HOUSE BLACKBURNE HIGHWAY
ROAD TOWN, TORTOLA, BR. VIRGIN ISLANDS

FOR: CIRCUIT BREAKERS; CIRCUIT OVERLOAD PROTECTOR DEVICES; ELECTRIC CONDUCTORS; ELECTRIC PLUGS; ELECTRIC SOCKETS; ELECTRICAL CONDUCTORS; ELECTRICAL OUTLETS; ELECTRICAL POWER DISTRIBUTION UNITS; ELECTRICAL POWER EXTENSION CORDS; ELECTRICAL RECEPTACLES; ELECTRICAL SOCKETS; EXTENSION CORDS; FUSES; INSULATED COPPER ELECTRICAL WIRE; VOLTAGE STABILIZING POWER SUPPLY; VOLTAGE SURGE PROTECTORS, IN CLASS 9 (U.S. CLS. 21, 23, 26, 36 AND 38).

FIRST USE 6-20-2010; IN COMMERCE 6-20-2010.

THE MARK CONSISTS OF THE STYLIZED DEPICTION OF AN ELECTRICAL SOCKET IN A WATER-DROP-SHAPED CONTOUR.

SER. NO. 85-307,648, FILED 4-28-2011.

TRICIA SONNEBORN, EXAMINING ATTORNEY



David J. Kyffers

Director of the United States Patent and Trademark Office

United States of America

United States Patent and Trademark Office



Reg. No. 4,173,898

Registered July 17, 2012

Int. Cls.: 1 and 5

TRADEMARK

PRINCIPAL REGISTER

EXCENTIALS IP, BESLOTEN VENNOOTSCHAP (CURACAO LIMITED LIABILITY COMPANY)
BERG ARRARAT 1
CURACAO, CURACAO

FOR: CHEMICAL ADDITIVES FOR USE IN THE MANUFACTURE OF ANIMAL FEED; CHEMICAL ADDITIVES FOR PRESERVING FOODSTUFFS; ARTIFICIAL SWEETENERS; ENZYMES FOR USE IN THE MANUFACTURE OF ANIMAL FEED; EMULSIFIERS FOR USE IN THE MANUFACTURE OF ANIMAL FEED; ANTI-OXIDANTS FOR USE IN THE MANUFACTURE OF ANIMAL FEED; MINERAL ACIDS FOR USE IN THE MANUFACTURE OF ANIMAL FEED; ANIMAL FEED SUPPLEMENT INGREDIENTS, NAMELY, PLANT COMPOUNDS, NAMELY, AMINO ACIDS, ANTI-OXIDANTS, CARBOHYDRATES AND DERIVATIVES OF ALL OF THE FOREGOING, PEPTIDES, FATS AND FATTY ACIDS AND THEIR DERIVATIVES EXTRACTED FROM PLANTS FOR USE IN THE MANUFACTURE OF MEDICINE, IN CLASS 1 (U.S. CLS. 1, 5, 6, 10, 26 AND 46).

FOR: ANIMAL FEED SUPPLEMENTS; ENZYME PREPARATIONS FOR VETERINARY PURPOSES FOR USE AS A DIGESTIVE AND NUTRITIONAL AID; VITAMINS AND VITAMIN SUPPLEMENTS; MINERAL SUPPLEMENTS; ANIMAL FEED SUPPLEMENT INGREDIENTS FOR MEDICAL PURPOSES, NAMELY, PLANT COMPOUNDS, NAMELY, AMINO ACIDS, ANTI-OXIDANTS, CARBOHYDRATES AND DERIVATIVES OF ALL OF THE FOREGOING, PEPTIDES, FATS AND FATTY ACIDS AND THEIR DERIVATIVES EXTRACTED FROM PLANTS FOR PHYSIOLOGICAL PURPOSES, NAMELY, FOR USE AS A DIGESTIVE AND NUTRITIONAL SUPPLEMENT; SUGAR REPLACEMENT FOR VETERINARY PURPOSES; AMINO ACIDS FOR VETERINARY PURPOSES, IN CLASS 5 (U.S. CLS. 6, 18, 44, 46, 51 AND 52).

PRIORITY CLAIMED UNDER SEC. 44(D) ON BENELUX APPLICATION NO. 1212977, FILED 11-2-2010, REG. NO. 0890759, DATED 2-10-2011, EXPIRES 11-2-2020.

THE COLOR(S) GREEN, BLUE AND WHITE IS/ARE CLAIMED AS A FEATURE OF THE MARK.

THE MARK CONSISTS OF "EXCENTIALS" WRITTEN IN GREEN LETTERS TO THE RIGHT OF WHICH IS THE DESIGN OF A PLANT WITH A BLUE STEM AND GREEN LEAVES WHICH HAVE WHITE MARKINGS ON THEM.



David J. Kyjars

Director of the United States Patent and Trademark Office

Reg. No. 4,173,898 THE WORDING "EXCENTIALS" HAS NO MEANING IN A FOREIGN LANGUAGE.

SER. NO. 85-308,001, FILED 4-29-2011.

BARNEY CHARLON, EXAMINING ATTORNEY

United States of America

United States Patent and Trademark Office

SAFETY MADE EASY

Reg. No. 4,173,899

Registered July 17, 2012

**Int. Cls.: 35, 41, 42, 44
and 45**

SERVICE MARK

PRINCIPAL REGISTER

PREPAREFIRST, INC. (GEORGIA CORPORATION)
P. O. BOX 20155
ATLANTA, GA 30325

FOR: REFERRALS IN THE FIELDS OF HEALTH, SAFETY, MEDICINE, DISASTER PREPAREDNESS AND SECURITY; PHYSICIAN AND MEDICAL REFERRALS; BUSINESS SERVICES, NAMELY, PROVIDING COMPUTER DATABASES REGARDING THE PURCHASE AND SALE OF A WIDE VARIETY OF PRODUCTS AND SERVICES OF OTHERS; ON-LINE ORDERING SERVICES VIA COMPUTER FEATURING PRODUCTS IN THE FIELDS OF HEALTH, SAFETY, SECURITY, DISASTER PREPAREDNESS AND MEDICINE; PROVIDING CONSUMER INFORMATION ABOUT THE HEALTH, SAFETY, SECURITY, DISASTER PREPAREDNESS AND MEDICAL GOODS AND SERVICES OF OTHERS VIA THE GLOBAL COMPUTER NETWORK; COMPUTERIZED ON-LINE RETAIL STORE SERVICES IN THE FIELDS OF HEALTH, SAFETY, SECURITY, DISASTER PREPAREDNESS AND MEDICAL PRODUCTS; ON-LINE RETAIL STORE SERVICES FEATURING HEALTH, SAFETY, SECURITY, DISASTER PREPAREDNESS AND MEDICAL PRODUCTS; RETAIL SERVICES BY DIRECT SOLICITATION BY SALES AGENTS IN THE FIELDS OF HEALTH, SAFETY, SECURITY, DISASTER PREPAREDNESS AND MEDICAL PRODUCTS CONDUCTED ON-LINE AND IN-PERSON; DISTRIBUTORSHIPS IN THE FIELDS OF HEALTH, SAFETY, SECURITY, DISASTER PREPAREDNESS AND MEDICAL PRODUCTS, IN CLASS 35 (U.S. CLS. 100, 101 AND 102).

FIRST USE 9-30-2008; IN COMMERCE 9-30-2008.



FOR: EDUCATIONAL SERVICES NAMELY, CONDUCTING PROGRAMS IN THE FIELDS OF HEALTH, SAFETY, SECURITY, DISASTER PREPAREDNESS AND MEDICINE; TRAINING SERVICES IN THE FIELDS OF HEALTH, SAFETY, SECURITY, DISASTER PREPAREDNESS AND MEDICINE; INSTRUCTION IN THE FIELD OF HEALTH, SAFETY, SECURITY, DISASTER PREPAREDNESS AND MEDICINE, IN CLASS 41 (U.S. CLS. 100, 101 AND 107).

FIRST USE 9-30-2008; IN COMMERCE 9-30-2008.

David J. Kyjars

Director of the United States Patent and Trademark Office

FOR: CONSUMER PRODUCT SAFETY TESTING AND CONSULTATION; PROVIDING INFORMATION AT THE SPECIFIC REQUEST OF END-USERS AND CUSTOMERS BY MEANS OF GLOBAL COMPUTER NETWORKS; TECHNOLOGY SUPERVISION AND INSPECTION IN THE FIELDS OF HEALTH, SAFETY, SECURITY, DISASTER PREPAREDNESS AND

Reg. No. 4,173,899 MEDICINE; TECHNICAL SUPERVISION, CONSULTATION AND INSPECTION IN THE FIELDS OF HEALTH, SAFETY, SECURITY, DISASTER PREPAREDNESS AND MEDICINE; PROVIDING TEMPORARY USE OF ON-LINE NON-DOWNLOADABLE SOFTWARE FOR RETRIEVAL OF INFORMATION IN THE FIELDS OF HEALTH, SAFETY, SECURITY, DISASTER PREPAREDNESS AND MEDICINE; PROVIDING TEMPORARY USE OF ON-LINE NON-DOWNLOADABLE SOFTWARE FOR PURCHASING PRODUCTS IN THE FIELDS OF HEALTH, SAFETY, SECURITY, DISASTER PREPAREDNESS AND MEDICINE; PROVIDING TEMPORARY USE OF ON-LINE NON-DOWNLOADABLE SOFTWARE FOR INPUTTING AND ACCESSING INFORMATION AND DATA, MANAGING DATA, TRACKING THE EXPIRATION DATES OF MEDICATIONS AND OTHER PRODUCTS AND FOR ANALYZING, EVALUATING AND ASSESSING RISKS, PROBLEMS AND REMEDIAL MEASURES, ALL IN THE FIELDS OF HEALTH, SAFETY, SECURITY, DISASTER PREPAREDNESS AND MEDICINE, IN CLASS 42 (U.S. CLS. 100 AND 101).

FIRST USE 9-30-2008; IN COMMERCE 9-30-2008.

FOR: COUNSELING IN THE FIELDS OF HEALTH AND MEDICINE; PROVIDING HEALTH AND MEDICAL INFORMATION; MEDICAL AND HEALTH CARE SERVICES; HOME HEALTH CARE SERVICES; PROVIDING INFORMATION IN THE FIELDS OF HEALTH AND MEDICINE VIA THE INTERNET; FOOD NUTRITION CONSULTATION; PROVIDING AN ON-LINE COMPUTER DATABASE IN THE FIELDS OF HEALTH AND MEDICINE; PROVIDING INFORMATION IN THE FIELDS OF HEALTH AND MEDICINE, IN CLASS 44 (U.S. CLS. 100 AND 101).

FIRST USE 9-30-2008; IN COMMERCE 9-30-2008.

FOR: FIRE PREVENTION CONSULTATION; COUNSELING, PROVIDING INFORMATION, PROVIDING INFORMATION VIA THE INTERNET, AND PROVIDING ON-LINE COMPUTER DATABASE, ALL IN THE FIELDS OF PERSONAL SECURITY, HOMELAND SECURITY, PUBLIC SAFETY, AND NATURAL DISASTER PREPAREDNESS, IN CLASS 45 (U.S. CLS. 100 AND 101).

FIRST USE 9-30-2008; IN COMMERCE 9-30-2008.

THE MARK CONSISTS OF STANDARD CHARACTERS WITHOUT CLAIM TO ANY PARTICULAR FONT, STYLE, SIZE, OR COLOR.

SER. NO. 85-308,498, FILED 4-29-2011.

BRENDAN MCCAULEY, EXAMINING ATTORNEY

United States of America

United States Patent and Trademark Office



Reg. No. 4,173,900

Registered July 17, 2012

Int. Cl.: 44

SERVICE MARK

PRINCIPAL REGISTER

MD REVOLUTION, INC. (DELAWARE CORPORATION)
2711 CENTERVILLE ROAD, SUITE 400
WILMINGTON, DE 19808

FOR: HEALTHCARE SERVICES, IN CLASS 44 (U.S. CLS. 100 AND 101).

FIRST USE 5-6-2011; IN COMMERCE 5-6-2011.

NO CLAIM IS MADE TO THE EXCLUSIVE RIGHT TO USE THE CADUCEUS SYMBOL AND THE PRESCRIPTION SYMBOL, APART FROM THE MARK AS SHOWN.

THE MARK CONSISTS OF FOUR ICONS IN A STACKED MANNER. THE FIRST ICON CONTAINS A CADUCEUS DESIGN ENCLOSED WITHIN A CIRCLE, THE SECOND ICON CONTAINS A DNA STRAND ENCLOSED WITHIN A CIRCLE, THE THIRD ICON CONTAINS A PRESCRIPTION SYMBOL WITHIN A CELLULAR PHONE ENCLOSED WITHIN A CIRCLE, AND THE FOURTH ICON CONTAINS AN APPLE ENCLOSED WITHIN A CIRCLE.

SER. NO. 85-308,626, FILED 4-29-2011.

BRENDAN MCCAULEY, EXAMINING ATTORNEY



David J. Kyffers

Director of the United States Patent and Trademark Office

United States of America

United States Patent and Trademark Office

SHOWBIZ SOFTWARE

Reg. No. 4,173,901

Registered July 17, 2012

Int. Cls.: 9, 16 and 35

TRADEMARK

SERVICE MARK

PRINCIPAL REGISTER

OBERMAN, TIVOLI & PICKERT, INC. (CALIFORNIA CORPORATION)
500 S. SEPULVEDA BOULEVARD, 4TH FLOOR
LOS ANGELES, CA 90049

FOR: SOFTWARE FOR ACCOUNTING, BUDGETING, TIMEKEEPING AND SCHEDULING, TRACKING PURCHASE ORDERS, PETTY CASH, AND PAYROLL IN THE FIELD OF TELEVISION AND MOVIE PRODUCTION, IN CLASS 9 (U.S. CLS. 21, 23, 26, 36 AND 38).

FIRST USE 11-5-2008; IN COMMERCE 11-5-2008.

FOR: NEWSLETTERS IN THE FIELD OF BUSINESS MANAGEMENT AND ADMINISTRATIVE SERVICES FOR THE ENTERTAINMENT INDUSTRY, IN CLASS 16 (U.S. CLS. 2, 5, 22, 23, 29, 37, 38 AND 50).

FIRST USE 11-5-2008; IN COMMERCE 11-5-2008.

FOR: ONLINE AND RETAIL STORE SERVICES FEATURING SOFTWARE, HARDWARE AND BOOKS IN THE FIELD OF TELEVISION AND MOVIE PRODUCTION; PROVIDING AN ON-LINE DIRECTORY INFORMATION SERVICE FEATURING INFORMATION REGARDING TELEVISION AND MOVIE PRODUCTION AND RELATED SERVICES, IN CLASS 35 (U.S. CLS. 100, 101 AND 102).

FIRST USE 11-5-2008; IN COMMERCE 11-5-2008.

THE MARK CONSISTS OF STANDARD CHARACTERS WITHOUT CLAIM TO ANY PARTICULAR FONT, STYLE, SIZE, OR COLOR.

OWNER OF U.S. REG. NOS. 2,962,105 AND 2,970,175.

NO CLAIM IS MADE TO THE EXCLUSIVE RIGHT TO USE "SOFTWARE" , APART FROM THE MARK AS SHOWN.

SEC. 2(F).

SER. NO. 85-309,194, FILED 4-30-2011.

HANNO RITTNER, EXAMINING ATTORNEY



David J. Kyffers

Director of the United States Patent and Trademark Office

United States of America

United States Patent and Trademark Office

SHOWBIZ

Reg. No. 4,173,902

OBERMAN, TIVOLI & PICKERT, INC. (CALIFORNIA CORPORATION)
500 S. SEPULVEDA BOULEVARD, 4TH FLOOR
LOS ANGELES, CA 90049

Registered July 17, 2012

Int. Cl.: 16

FOR: BOOKS, DIRECTORIES AND GUIDES IN THE FIELD OF TELEVISION AND MOVIE PRODUCTION, IN CLASS 16 (U.S. CLS. 2, 5, 22, 23, 29, 37, 38 AND 50).

TRADEMARK

FIRST USE 0-0-2003; IN COMMERCE 0-0-2003.

PRINCIPAL REGISTER

THE MARK CONSISTS OF STANDARD CHARACTERS WITHOUT CLAIM TO ANY PARTICULAR FONT, STYLE, SIZE, OR COLOR.

OWNER OF U.S. REG. NOS. 2,962,105 AND 2,970,175.

SEC. 2(F).

SER. NO. 85-309,196, FILED 4-30-2011.

HANNO RITTNER, EXAMINING ATTORNEY



David J. Kyffers

Director of the United States Patent and Trademark Office

United States of America

United States Patent and Trademark Office

Talismans Of Power

Reg. No. 4,173,903

HUTTON WILKINSON (UNITED STATES INDIVIDUAL)

Registered July 17, 2012

P.O. BOX 69858
WEST HOLLYWOOD, CA 90069

Int. Cl.: 14

FOR: DESIGNER FASHION JEWELRY, IN CLASS 14 (U.S. CLS. 2, 27, 28 AND 50).

TRADEMARK

FIRST USE 7-1-1989; IN COMMERCE 7-1-1989.

PRINCIPAL REGISTER

THE MARK CONSISTS OF STANDARD CHARACTERS WITHOUT CLAIM TO ANY PARTICULAR FONT, STYLE, SIZE, OR COLOR.

NO CLAIM IS MADE TO THE EXCLUSIVE RIGHT TO USE "TALISMANS", APART FROM THE MARK AS SHOWN.

SER. NO. 85-309,221, FILED 4-30-2011.

HEATHER BIDDULPH, EXAMINING ATTORNEY



David J. Kyffers

Director of the United States Patent and Trademark Office

United States of America

United States Patent and Trademark Office



Reg. No. 4,173,904

Registered July 17, 2012

Int. Cl.: 35

SERVICE MARK

PRINCIPAL REGISTER

LOCALIZE IT ONLINE, LLC (COLORADO LIMITED LIABILITY COMPANY)
3488 W. HAYWORD PL
DENVER, CO 80211

FOR: ADVERTISING AND MARKETING SERVICES PROVIDED BY MEANS OF INDIRECT METHODS OF MARKETING COMMUNICATIONS, NAMELY, SEARCH ENGINE MARKETING FEATURING PLACEMENT OF LOCAL SEARCH RESULT LISTINGS, IN CLASS 35 (U.S. CLS. 100, 101 AND 102).

FIRST USE 3-30-2009; IN COMMERCE 3-30-2009.

THE MARK CONSISTS OF THE TERM "LOCALIZEIT" WITH THE LETTERS "L" AND "CALIZE" IN LARGE GREY FONT WITH A GREY SHADOW, THE "IT" APPEARS IN LARGE ORANGE FONT WITH AN GREY SHADOW, AN ORANGE AND WHITE TARGET APPEARS FOR THE LETTER "O", WHICH HAS A WHITE ARROW WITH A PINK OUTLINE POINTING TO THE CENTER OF THE TARGET, THE TERMS "TARGETING TOMORROW'S ONLINE LEADS, TODAY!" APPEAR BELOW "LOCALIZIT" IN A SMALLER GREY FONT WITH A GREY SHADOW, EXCEPT "ONLINE" WHICH IS ORANGE WITH AN ORANGE SHADOW.

THE COLOR(S) GREY, ORANGE, PINK AND WHITE IS/ARE CLAIMED AS A FEATURE OF THE MARK.

SER. NO. 85-309,289, FILED 5-1-2011.

ANTHONY RINKER, EXAMINING ATTORNEY



David J. Kyffers

Director of the United States Patent and Trademark Office

United States of America

United States Patent and Trademark Office

REGIONS ADVANTAGE ANNUITY

Reg. No. 4,173,905

REGIONS ASSET COMPANY (DELAWARE CORPORATION)
3501 SILVERSIDE ROAD; SUITE 209
WILMINGTON, DE 19810

Registered July 17, 2012

Int. Cl.: 36

FOR: ANNUITY SERVICES, NAMELY, ACCOUNT AND INVESTMENT ADMINISTRATION,
IN CLASS 36 (U.S. CLS. 100, 101 AND 102).

SERVICE MARK

FIRST USE 6-0-2008; IN COMMERCE 6-0-2008.

PRINCIPAL REGISTER

THE MARK CONSISTS OF STANDARD CHARACTERS WITHOUT CLAIM TO ANY PAR-
TICULAR FONT, STYLE, SIZE, OR COLOR.

OWNER OF U.S. REG. NOS. 1,881,600, 3,505,814 AND OTHERS.

NO CLAIM IS MADE TO THE EXCLUSIVE RIGHT TO USE "ANNUITY", APART FROM
THE MARK AS SHOWN.

SER. NO. 85-309,627, FILED 5-2-2011.

PAUL E. FAHRENKOPF, EXAMINING ATTORNEY



David J. Kyffers

Director of the United States Patent and Trademark Office

United States of America

United States Patent and Trademark Office

FIBER WALA

Reg. No. 4,173,906

Registered July 17, 2012

Int. Cl.: 30

TRADEMARK

PRINCIPAL REGISTER

BRAR NATURAL FLOUR MILLING INC. (CANADA CORPORATION)
101 PLYMOUTH STREET
WINNIPEG, MANITOBA, CANADA R2X2V5

FOR: FLOUR, IN CLASS 30 (U.S. CL. 46).

FIRST USE 10-0-2010; IN COMMERCE 10-0-2010.

THE MARK CONSISTS OF STANDARD CHARACTERS WITHOUT CLAIM TO ANY PARTICULAR FONT, STYLE, SIZE, OR COLOR.

NO CLAIM IS MADE TO THE EXCLUSIVE RIGHT TO USE "FIBER", APART FROM THE MARK AS SHOWN.

THE WORDING "WALA" HAS NO MEANING IN A FOREIGN LANGUAGE.

SER. NO. 85-310,263, FILED 5-2-2011.

RONALD DELGIZZI, EXAMINING ATTORNEY



David J. Kyffers

Director of the United States Patent and Trademark Office

United States of America

United States Patent and Trademark Office

PX

Reg. No. 4,173,907

SHANYAO LEE (UNITED STATES INDIVIDUAL)
2961 W MACARTHUR BLVD. UNIT#119
SANTA ANA, CA 92704

Registered July 17, 2012

Int. Cl.: 13

FOR: CASE COVERS FOR FIREARMS; FIREARM ATTACHMENTS, NAMELY, MODULAR EXTERNAL RAIL SYSTEMS FOR ATTACHING ACCESSORIES TO FIREARMS; FIREARM ATTACHMENTS, NAMELY, MODULAR EXTERNAL RAIL SYSTEMS FOR FIREARMS; FIREARM ATTACHMENTS, NAMELY, MOUNTS FOR ATTACHING ACCESSORIES TO A FIREARM; FIREARM ATTACHMENTS, NAMELY, MOUNTS FOR ATTACHING ANCILLARY EQUIPMENT TO A FIREARM; FIREARM ATTACHMENTS, NAMELY, MOUNTS FOR ATTACHING GRIPS TO A FIREARM; FIREARM ATTACHMENTS, NAMELY, MOUNTS FOR ATTACHING GUN SIGHTS TO A FIREARM; FIREARM ATTACHMENTS, NAMELY, MOUNTS FOR ATTACHING LASER POINTING DEVICES TO A FIREARM; FIREARM ATTACHMENTS, NAMELY, MOUNTS FOR ATTACHING LIGHTS TO A FIREARM; FIREARM ATTACHMENTS, NAMELY, MOUNTS FOR ATTACHING TELESCOPIC SIGHTS TO A FIREARM; FIREARM HAND GUARDS; FIREARM SLINGS; FORESIGHTS FOR FIREARMS; GUNSIGHTS FOR FIREARMS; NON-TELESCOPIC GUN SIGHTS FOR FIREARMS; SIGHTS, NAMELY, OPEN SIGHTS FOR USE ON FIREARMS; SLING STRAPS FOR FIREARMS; WEAPON CASES FOR FIREARMS, IN CLASS 13 (U.S. CLS. 2 AND 9).

TRADEMARK

PRINCIPAL REGISTER

FIRST USE 1-1-2011; IN COMMERCE 1-1-2011.

THE MARK CONSISTS OF STANDARD CHARACTERS WITHOUT CLAIM TO ANY PARTICULAR FONT, STYLE, SIZE, OR COLOR.

SER. NO. 85-310,406, FILED 5-2-2011.

TRACY CROSS, EXAMINING ATTORNEY



David J. Kyffers

Director of the United States Patent and Trademark Office

United States of America

United States Patent and Trademark Office

BENDING THE AGING CURVE

Reg. No. 4,173,908

SIGNORILE FITNESS, INC. (FLORIDA CORPORATION)

Registered July 17, 2012

5880 SW 81 STREET
SOUTH MIAMI, FL 33143

Int. Cl.: 41

FOR: CONSULTING SERVICES IN THE FIELDS OF PHYSICAL FITNESS, PERSONAL FITNESS TRAINING AND EXERCISE, IN CLASS 41 (U.S. CLS. 100, 101 AND 107).

SERVICE MARK

FIRST USE 7-19-2002; IN COMMERCE 7-19-2002.

PRINCIPAL REGISTER

THE MARK CONSISTS OF STANDARD CHARACTERS WITHOUT CLAIM TO ANY PARTICULAR FONT, STYLE, SIZE, OR COLOR.

SER. NO. 85-310,604, FILED 5-3-2011.

EDWARD NELSON, EXAMINING ATTORNEY



David J. Kyffers

Director of the United States Patent and Trademark Office

United States of America

United States Patent and Trademark Office

PATIENT PORTION PROJECTOR

Reg. No. 4,173,909

Registered July 17, 2012

Int. Cl.: 42

SERVICE MARK

PRINCIPAL REGISTER

COVENANT TECHNOLOGY GROUP LLC (GEORGIA LIMITED LIABILITY COMPANY)
SUITE 602
413 WEST MONTGOMERY CROSS ROAD
SAVANNAH, GA 31406

FOR: PROVIDING ONLINE NON-DOWNLOADABLE COMPUTER SOFTWARE FOR DETERMINING PATIENT FINANCIAL RESPONSIBILITY IN A MEDICAL OR HEALTHCARE SETTING, IN CLASS 42 (U.S. CLS. 100 AND 101).

FIRST USE 5-1-2010; IN COMMERCE 5-1-2010.

THE MARK CONSISTS OF STANDARD CHARACTERS WITHOUT CLAIM TO ANY PARTICULAR FONT, STYLE, SIZE, OR COLOR.

NO CLAIM IS MADE TO THE EXCLUSIVE RIGHT TO USE "PATIENT PORTION", APART FROM THE MARK AS SHOWN.

SER. NO. 85-310,774, FILED 5-3-2011.

MICHELLE DUBOIS, EXAMINING ATTORNEY



David J. Kyffers

Director of the United States Patent and Trademark Office

United States of America

United States Patent and Trademark Office

Simplicity

by STRASSER WOODENWORKS

GOOD QUALITY. GOOD PRICE. U.S. MADE.

Reg. No. 4,173,910

Registered July 17, 2012

Int. Cl.: 20

TRADEMARK

PRINCIPAL REGISTER

STRASSER WOODENWORKS, INC. (WASHINGTON CORPORATION)
P.O. BOX 446
WOODINVILLE, WA 980720446

FOR: BATH FURNITURE AND FIXTURES, NAMELY, VANITIES, CABINETS, VANITY BASES, AND MIRRORS, IN CLASS 20 (U.S. CLS. 2, 13, 22, 25, 32 AND 50).

FIRST USE 4-1-2011; IN COMMERCE 4-1-2011.

OWNER OF U.S. REG. NO. 3,205,642.

NO CLAIM IS MADE TO THE EXCLUSIVE RIGHT TO USE "WOODENWORKS" AND "GOOD QUALITY. GOOD PRICE. U.S. MADE", APART FROM THE MARK AS SHOWN.

THE MARK CONSISTS OF THE WORDING "GOOD QUALITY. GOOD PRICE. U.S. MADE." IN WHITE UPPER AND LOWER CASE LETTERING, CENTERED ON A THICK BLACK HORIZONTAL BAR HAVING A 45 DEGREE ANGLE ON THE RIGHT END; ABOVE THE BAR AND CENTERED TO THE RIGHT IS THE WORDING "BY STRASSER WOODENWORKS" IN BLACK; AND ABOVE ALL IN BLACK UPPER AND LOWER CASE LETTERING IS THE WORD "SIMPLICITY".

SER. NO. 85-310,928, FILED 5-3-2011.

VERNA BETH RIRIE, EXAMINING ATTORNEY



David J. Kyffers

Director of the United States Patent and Trademark Office

United States of America

United States Patent and Trademark Office

MOVE 'N STORE

Reg. No. 4,173,911

PIONEER PACKAGING, INC. (ARIZONA CORPORATION)
730 E. UNIVERSITY DR.
PHOENIX, AZ 85034

Registered July 17, 2012

Int. Cl.: 16

FOR: MOVING AND PACKAGING SUPPLIES FOR MOVING AND STORAGE OF PERSONAL PROPERTY, NAMELY, CORRUGATED CARDBOARD BOXES, WRAPPING PAPER, PAPER ADHESIVE TAPE, AND PAPER PACKING MATERIALS, NAMELY, DISHPACKS, PADS, AND CELL-KITS, IN CLASS 16 (U.S. CLS. 2, 5, 22, 23, 29, 37, 38 AND 50).

TRADEMARK

PRINCIPAL REGISTER

FIRST USE 7-4-2003; IN COMMERCE 7-4-2003.

THE MARK CONSISTS OF STANDARD CHARACTERS WITHOUT CLAIM TO ANY PARTICULAR FONT, STYLE, SIZE, OR COLOR.

SEC. 2(F).

SER. NO. 85-310,992, FILED 5-3-2011.

JILL C. ALT, EXAMINING ATTORNEY



David J. Kybas

Director of the United States Patent and Trademark Office

United States of America

United States Patent and Trademark Office

SHEETZ FEEL THE LOVE

Reg. No. 4,173,912

Registered July 17, 2012

Int. Cls.: 35 and 43

SERVICE MARK

PRINCIPAL REGISTER

SHEETZ OF DELAWARE, INC. (DELAWARE CORPORATION)
501 SILVERSIDE DRIVE
SUITE 67
WILMINGTON, DE 19809

FOR: RETAIL CONVENIENCE STORE SERVICES; RETAIL GASOLINE STORE SERVICES,
IN CLASS 35 (U.S. CLS. 100, 101 AND 102).

FIRST USE 5-13-2009; IN COMMERCE 5-13-2009.

FOR: FOOD PREPARATION SERVICES; RESTAURANT SERVICES, IN CLASS 43 (U.S. CLS.
100 AND 101).

FIRST USE 5-13-2009; IN COMMERCE 5-13-2009.

THE MARK CONSISTS OF STANDARD CHARACTERS WITHOUT CLAIM TO ANY PAR-
TICULAR FONT, STYLE, SIZE, OR COLOR.

OWNER OF U.S. REG. NOS. 1,274,635, 2,650,622 AND OTHERS.

SER. NO. 85-311,162, FILED 5-3-2011.

DAVID COLLIER, EXAMINING ATTORNEY



David J. Kyros

Director of the United States Patent and Trademark Office

United States of America

United States Patent and Trademark Office

JAVLOR

Reg. No. 4,173,913

PIERRE FABRE MEDICAMENT (FRANCE SOCIÉTÉ PAR ACTIONS SIMPLIFIÉE (SAS))
45 PLACE ABEL GANCE

Registered July 17, 2012

BOULOGNE BILLANCOURT, FRANCE 92100

Int. Cl.: 5

FOR: ANTICANCER PREPARATIONS, IN CLASS 5 (U.S. CLS. 6, 18, 44, 46, 51 AND 52).

TRADEMARK

THE MARK CONSISTS OF STANDARD CHARACTERS WITHOUT CLAIM TO ANY PARTICULAR FONT, STYLE, SIZE, OR COLOR.

PRINCIPAL REGISTER

OWNER OF FRANCE REG. NO. 99/805576, DATED 7-21-1999, EXPIRES 7-21-2019.

SER. NO. 85-311,167, FILED 5-3-2011.

DAVID COLLIER, EXAMINING ATTORNEY



David J. Kyros

Director of the United States Patent and Trademark Office

United States of America

United States Patent and Trademark Office

CAFE LOVERS

Reg. No. 4,173,914

Registered July 17, 2012

Int. Cl.: 30

TRADEMARK

PRINCIPAL REGISTER

WISSAM AMOUDI (UNITED STATES INDIVIDUAL)
2101 NW 84TH AVENUE
MIAMI, FL 33122

FOR: ARTIFICIAL COFFEE; BEVERAGES MADE OF COFFEE; CAFFEINE-FREE COFFEE; COFFEE AND ARTIFICIAL COFFEE; COFFEE BASED BEVERAGES; COFFEE BEVERAGES WITH MILK; COFFEE ESSENCES; COFFEE EXTRACTS; COFFEE FLAVORED SYRUP USED IN MAKING FOOD BEVERAGES; COFFEE-BASED BEVERAGE CONTAINING MILK; COFFEE-BASED BEVERAGES, IN CLASS 30 (U.S. CL. 46).

FIRST USE 10-1-2008; IN COMMERCE 10-1-2008.

THE MARK CONSISTS OF STANDARD CHARACTERS WITHOUT CLAIM TO ANY PARTICULAR FONT, STYLE, SIZE, OR COLOR.

OWNER OF U.S. REG. NO. 3,954,079.

NO CLAIM IS MADE TO THE EXCLUSIVE RIGHT TO USE "CAFE", APART FROM THE MARK AS SHOWN.

THE ENGLISH TRANSLATION OF "CAFE" IN THE MARK IS "COFFEE".

SER. NO. 85-311,790, FILED 5-4-2011.

SEAN CROWLEY, EXAMINING ATTORNEY



David J. Kybas

Director of the United States Patent and Trademark Office

United States of America

United States Patent and Trademark Office

COFFEE LOVERS

Reg. No. 4,173,915

WISSAM AMOUDI (UNITED STATES INDIVIDUAL)
2101 NW 84TH AVENUE
MIAMI, FL 33122

Registered July 17, 2012

Int. Cl.: 29

FOR: MILK-BASED BEVERAGE CONTAINING COFFEE; NON-DAIRY CREAMER, IN CLASS 29 (U.S. CL. 46).

TRADEMARK

FIRST USE 10-1-2008; IN COMMERCE 10-1-2008.

PRINCIPAL REGISTER

THE MARK CONSISTS OF STANDARD CHARACTERS WITHOUT CLAIM TO ANY PARTICULAR FONT, STYLE, SIZE, OR COLOR.

OWNER OF U.S. REG. NO. 3,954,079.

NO CLAIM IS MADE TO THE EXCLUSIVE RIGHT TO USE "COFFEE", APART FROM THE MARK AS SHOWN.

SER. NO. 85-311,902, FILED 5-4-2011.

SEAN CROWLEY, EXAMINING ATTORNEY



David J. Kyffers

Director of the United States Patent and Trademark Office

United States of America

United States Patent and Trademark Office



Reg. No. 4,173,916

Registered July 17, 2012

Int. Cl.: 36

SERVICE MARK

PRINCIPAL REGISTER

SEACOMM FEDERAL CREDIT UNION (UNITED STATES FEDERALLY CHARTERED CREDIT UNION)
30 STEARNS STREET
MASSENA, NY 13662

FOR: ADVISORY SERVICES RELATING TO CREDIT AND DEBIT CONTROL, INVESTMENT, GRANTS AND FINANCING OF LOANS; ARRANGING AND PROVISION OF CREDIT, LOANS, INSURANCE, CURRENCY EXCHANGE AND TRAVELLERS CHEQUES; ARRANGING OF LOANS; ATM BANKING SERVICES; BANKING AND FINANCING SERVICES; BANKING SERVICES; BANKING SERVICES FEATURING THE PROVISION OF CERTIFICATES OF DEPOSIT; CHECKING ACCOUNT SERVICES; CREDIT AND DEBIT CARD SERVICES; CREDIT AND LOAN SERVICES; CREDIT CARD AND DEBIT CARD SERVICES; FINANCING AND LOAN SERVICES; FINANCING OF LOANS; HOME EQUITY LOANS; INDIVIDUAL RETIREMENT ACCOUNT SERVICES; LOAN FINANCING; MORTGAGE BANKING; MORTGAGE BANKING SERVICES, NAMELY, ORIGINATION, ACQUISITION, SERVICING, SECURITIZATION AND BROKERAGE OF MORTGAGE LOANS; MORTGAGE LENDING; ON-LINE CASH ACCOUNT SERVICES; PROVIDING LOANS SECURED BY COMMERCIAL PAPER; PROVIDING STUDENT LOANS; PROVIDING TEMPORARY LOANS; SAVINGS ACCOUNT SERVICES; SAVINGS AND LOAN SERVICES; STUDENT LOAN SERVICES; TEMPORARY LOANS, IN CLASS 36 (U.S. CLS. 100, 101 AND 102).

FIRST USE 11-2-2001; IN COMMERCE 11-2-2001.

OWNER OF U.S. REG. NOS. 2,504,386 AND 2,527,276.

THE COLOR(S) BLUE, LIGHT BLUE AND GREY IS/ARE CLAIMED AS A FEATURE OF THE MARK.

NO CLAIM IS MADE TO THE EXCLUSIVE RIGHT TO USE "FEDERAL CREDIT UNION", APART FROM THE MARK AS SHOWN.

THE MARK CONSISTS OF THE FOLLOWING: THE WORD "SEACOMM", IN BLUE APPEARING IN THE FOREGROUND, WITH THE LITERAL ELEMENT "SEA" RAISED ABOVE AND THE LEFT OF THE LITERAL ELEMENT "COMM" AND THREE SETS OF LIGHT BLUE AND GRAY WAVES WITH CRESTS AND TROUGHS APPEARING IN THE BACKGROUND OF THE LITERAL MARK, AND THE WORDS "FEDERAL CREDIT UNION" IN BLUE AP-



David J. Kybas

Director of the United States Patent and Trademark Office

Reg. No. 4,173,916 PEARING TO THE RIGHT OF THE LITERAL ELEMENT "SEA" AND DIRECTLY ABOVE
THE LITERAL ELEMENT "COMM".

SER. NO. 85-312,293, FILED 5-4-2011.

SCOTT BIBB, EXAMINING ATTORNEY

United States of America

United States Patent and Trademark Office

Net Element PRODUCTIONS

Reg. No. 4,173,917

Registered July 17, 2012

Int. Cls.: 35 and 38

SERVICE MARK

PRINCIPAL REGISTER

NET ELEMENT, INC. (FLORIDA CORPORATION)
1450 S MIAMI AVENUE
MIAMI, FL 33031

FOR: BUSINESS SERVICES, NAMELY, PROVIDING AN ONLINE MARKETPLACE FOR BUYERS AND SELLERS OF SERVICES ON A GLOBAL COMPUTER NETWORK, IN CLASS 35 (U.S. CLS. 100, 101 AND 102).

FIRST USE 2-16-2011; IN COMMERCE 2-16-2011.

FOR: TELECOMMUNICATION SERVICES, NAMELY, PROVIDING INTERNET PLATFORMS FOR REAL TIME INTERACTION AMONG COMPUTER USERS IN RELATION TO ENTERTAINMENT AND INFORMATION REGARDING MOVIE, PHOTO AND MUSIC INTERESTS, IN CLASS 38 (U.S. CLS. 100, 101 AND 104).

FIRST USE 2-16-2011; IN COMMERCE 2-16-2011.

NO CLAIM IS MADE TO THE EXCLUSIVE RIGHT TO USE "NET" AND "PRODUCTIONS", APART FROM THE MARK AS SHOWN.

THE MARK CONSISTS OF A RECTANGLE WITH THE WORDING "NET ELEMENT" AND A BROKEN LINE INSIDE AND THE WORDING "PRODUCTIONS" NEXT TO THE RECTANGLE.

SER. NO. 85-312,343, FILED 5-4-2011.

PRISCILLA MILTON, EXAMINING ATTORNEY



David J. Kyros

Director of the United States Patent and Trademark Office

United States of America

United States Patent and Trademark Office

NET ELEMENT PRODUCTIONS

Reg. No. 4,173,918

NET ELEMENT, INC. (FLORIDA CORPORATION)
1450 S MIAMI AVENUE
MIAMI, FL 33031

Registered July 17, 2012

Int. Cls.: 35 and 38

FOR: BUSINESS SERVICES, NAMELY, PROVIDING AN ONLINE MARKETPLACE FOR BUYERS AND SELLERS OF SERVICES ON A GLOBAL COMPUTER NETWORK, IN CLASS 35 (U.S. CLS. 100, 101 AND 102).

SERVICE MARK

FIRST USE 2-16-2011; IN COMMERCE 2-16-2011.

PRINCIPAL REGISTER

FOR: TELECOMMUNICATION SERVICES, NAMELY, PROVIDING INTERNET PLATFORMS FOR REAL TIME INTERACTION AMONG COMPUTER USERS IN RELATION TO ENTERTAINMENT AND INFORMATION REGARDING MOVIE, PHOTO AND MUSIC INTERESTS, IN CLASS 38 (U.S. CLS. 100, 101 AND 104).

FIRST USE 2-16-2011; IN COMMERCE 2-16-2011.

THE MARK CONSISTS OF STANDARD CHARACTERS WITHOUT CLAIM TO ANY PARTICULAR FONT, STYLE, SIZE, OR COLOR.

NO CLAIM IS MADE TO THE EXCLUSIVE RIGHT TO USE "NET" AND "PRODUCTIONS", APART FROM THE MARK AS SHOWN.

SER. NO. 85-312,363, FILED 5-4-2011.

PRISCILLA MILTON, EXAMINING ATTORNEY



David J. Kybas

Director of the United States Patent and Trademark Office

United States of America

United States Patent and Trademark Office



Reg. No. 4,173,919

Registered July 17, 2012

Int. Cls.: 33 and 44

TRADEMARK

SERVICE MARK

PRINCIPAL REGISTER

HALECKY, DEREK ALAN (UNITED STATES INDIVIDUAL), DBA HUNTERS OAK
VINEYARD
18101 E. STAMPEDE RD.
LODI, CA 95240

FOR: WINE, IN CLASS 33 (U.S. CLS. 47 AND 49).

FIRST USE 12-5-2011; IN COMMERCE 12-5-2011.

FOR: VITICULTURE SERVICES, NAMELY, WINE GRAPE GROWING AND CULTIVATION
OF GRAPES FOR OTHERS, IN CLASS 44 (U.S. CLS. 100 AND 101).

FIRST USE 10-5-2011; IN COMMERCE 10-5-2011.

THE MARK CONSISTS OF OLD WORLD ENGLISH TYPE FONT STYLE, EMBRACED BY
LEAF DESIGN AND STAG SILHOUETTE.

SER. NO. 85-313,179, FILED 5-5-2011.

PAM WILLIS, EXAMINING ATTORNEY



David J. Kyros

Director of the United States Patent and Trademark Office

United States of America

United States Patent and Trademark Office

ChillMed

Reg. No. 4,173,920

Registered July 17, 2012

Int. Cl.: 21

TRADEMARK

PRINCIPAL REGISTER

GROUP MEDICAL SUPPLY (MINNESOTA LIMITED LIABILITY COMPANY)
3850 ANNAPOLIS LN N. STE 140
PLYMOUTH, MN 55447

FOR: MEDICATION CASES FOR CARRYING MEDICATION, NAMELY, MEDICATION CONTAINERS FOR PERSONAL USE, IN CLASS 21 (U.S. CLS. 2, 13, 23, 29, 30, 33, 40 AND 50).

FIRST USE 12-5-2011; IN COMMERCE 12-5-2011.

THE MARK CONSISTS OF STANDARD CHARACTERS WITHOUT CLAIM TO ANY PARTICULAR FONT, STYLE, SIZE, OR COLOR.

SER. NO. 85-313,213, FILED 5-5-2011.

GEORGE LORENZO, EXAMINING ATTORNEY



David J. Kyffers

Director of the United States Patent and Trademark Office

United States of America

United States Patent and Trademark Office



Reg. No. 4,173,921

SMALL BUSINESS BEANSTALK, LLC (OHIO LIMITED LIABILITY COMPANY)
1655 OLD LEONARD AVE
COLUMBUS, OH 43219

Registered July 17, 2012

Int. Cl.: 35

FOR: PROMOTING THE SERVICES OF OTHERS BY DISTRIBUTING DISCOUNT CARDS TO ENCOURAGE RESIDENTS TO SHOP AT LOCAL BUSINESSES, IN CLASS 35 (U.S. CLS. 100, 101 AND 102).

SERVICE MARK

FIRST USE 2-7-2012; IN COMMERCE 2-7-2012.

PRINCIPAL REGISTER

THE MARK CONSISTS OF SIX LIGHT GREEN LEAVES, NOT ATTACHED TO BRANCHES, STACKED ON TOP OF EACH OTHER, BECOMING SMALLER AS THE LEAVES INCREASE IN HEIGHT, WITH THE LETTERS "SBB" IN LOWER CASE TO THE RIGHT OF THE LEAVES.

THE COLOR(S) LIGHT GREEN IS/ARE CLAIMED AS A FEATURE OF THE MARK.

SER. NO. 85-313,394, FILED 5-5-2011.

JULIE VEPPUMTHARA, EXAMINING ATTORNEY



David J. Kyffers

Director of the United States Patent and Trademark Office

United States of America

United States Patent and Trademark Office

SUSTAINABLETRIP.ORG

Reg. No. 4,173,922

RAINFOREST ALLIANCE, INC. (NEW YORK NON-PROFIT CORPORATION)
665 BROADWAY, SUITE 500
NEW YORK, NY 10012

Registered July 17, 2012

Int. Cls.: 39 and 43

FOR: PROVIDING AN ONLINE SEARCHABLE DATABASE FEATURING TOUR OPERATORS THAT IMPLEMENT BEST MANAGEMENT PRACTICES FOR SUSTAINABLE TOURISM, CONSERVE NATURAL RESOURCES, PROTECT PLANTS AND WILDLIFE AND CONTRIBUTE TO THE WELL-BEING OF LOCAL COMMUNITIES, IN CLASS 39 (U.S. CLS. 100 AND 105).

SERVICE MARK

PRINCIPAL REGISTER

FIRST USE 7-1-2010; IN COMMERCE 7-1-2010.

FOR: PROVIDING AN ONLINE SEARCHABLE DATABASE FEATURING TEMPORARY HOUSING ACCOMMODATIONS AND RESTAURANTS THAT IMPLEMENT BEST MANAGEMENT PRACTICES FOR SUSTAINABLE TOURISM, CONSERVE NATURAL RESOURCES, PROTECT PLANTS AND WILDLIFE, AND CONTRIBUTE TO THE WELL-BEING OF LOCAL COMMUNITIES, IN CLASS 43 (U.S. CLS. 100 AND 101).

FIRST USE 7-1-2010; IN COMMERCE 7-1-2010.

THE MARK CONSISTS OF STANDARD CHARACTERS WITHOUT CLAIM TO ANY PARTICULAR FONT, STYLE, SIZE, OR COLOR.

SER. NO. 85-313,433, FILED 5-5-2011.

ROSELLE HERRERA, EXAMINING ATTORNEY



David J. Kyffers

Director of the United States Patent and Trademark Office

United States of America

United States Patent and Trademark Office

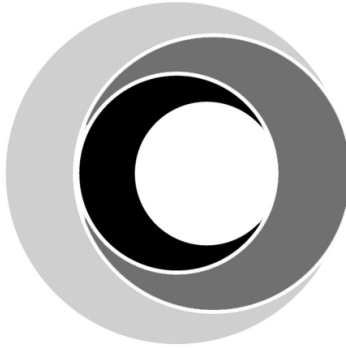

Reg. No. 4,173,923

Registered July 17, 2012

Int. Cl.: 44

SERVICE MARK

PRINCIPAL REGISTER

QUALITY PARTNERS OF RHODE ISLAND (RHODE ISLAND CORPORATION)
235 PROMENADE STREET, SUITE 500 BOX 18
PROVIDENCE, RI 02908

FOR: CONSULTING SERVICES IN THE FIELD OF HEALTH, IN CLASS 44 (U.S. CLS. 100 AND 101).

FIRST USE 5-1-2011; IN COMMERCE 5-1-2011.

THE MARK CONSISTS OF THREE CONCENTRIC OFFSET CIRCLES STARTING WITH A SMALLER CIRCLE IN THE CENTER AND GETTING PROGRESSIVE LARGER.

SER. NO. 85-313,502, FILED 5-5-2011.

THOMAS MANOR, EXAMINING ATTORNEY



David J. Kyfos

Director of the United States Patent and Trademark Office

United States of America

United States Patent and Trademark Office

SAFEROUTE

Reg. No. 4,173,924

Registered July 17, 2012

Int. Cl.: 9

TRADEMARK

PRINCIPAL REGISTER

AVIATION COMMUNICATION & SURVEILLANCE SYSTEMS LLC (DELAWARE LIMITED LIABILITY COMPANY)
19810 N. 7TH AVENUE
PHOENIX, AZ 850274400

FOR: AIRCRAFT AVIONICS FOR ALERTING PILOTS TO POTENTIAL HAZARDS, NAMELY, COMPUTERS, TRANSPONDERS, TRANSMITTERS, RECEIVERS, RADARS, DISPLAYS, ANNUNCIATORS, ANTENNAS, SENSORS, CONTROL PANELS, POWER SUPPLIES, DATA LOADERS, CABLE ASSEMBLIES, PROGRAMMABLE INTEGRATED CIRCUITS, CIRCUIT CARDS, SMART CARDS, MAGNETIC AND OPTICAL MEDIA, ALL FOR THE STORAGE AND TRANSPORT OF DATA AND SOFTWARE USED WITH AVIONICS; AND SOFTWARE FOR INITIALIZING, TESTING AND OPERATING AVIONICS, IN CLASS 9 (U.S. CLS. 21, 23, 26, 36 AND 38).

FIRST USE 6-15-2005; IN COMMERCE 6-15-2005.

THE MARK CONSISTS OF STANDARD CHARACTERS WITHOUT CLAIM TO ANY PARTICULAR FONT, STYLE, SIZE, OR COLOR.

SER. NO. 85-313,726, FILED 5-5-2011.

JANICE L. MCMORROW, EXAMINING ATTORNEY



David J. Kybas

Director of the United States Patent and Trademark Office

United States of America

United States Patent and Trademark Office

probinaca

Reg. No. 4,173,925

Registered July 17, 2012

Int. Cl.: 21

TRADEMARK

PRINCIPAL REGISTER

DEAN SPIRIT LTD. (BR.VIRGIN ISLANDS LIMITED COMPANY)
OMC CHAMBERS, WICKHAMS CAY 1, ROAD TOWN
TORTOLA, BR.VIRGIN ISLANDS

FOR: COMPACTS CONTAINING DENTAL FLOSS AND ALSO INCLUDING LIP GLOSS;
DENTAL CARE KIT COMPRISING TOOTHBRUSHES AND FLOSS; DENTAL FLOSS;
DENTAL FLOSS; DENTAL FLOSS DISPENSERS; ELECTRIC TOOTHBRUSHES; ELECTRIC-
AL TOOTHBRUSHES; HOME DENTAL CARE PRODUCTS FOR DOGS AND CATS, NAMELY,
TOOTHBRUSH; MANUAL TOOTHBRUSHES; ORAL CARE KIT COMPRISING TOOTH-
BRUSHES AND FLOSS; TOOTHBRUSH CASES; TOOTHBRUSH HOLDERS; TOOTH-
BRUSHES; TOOTHBRUSHES; TOOTHBRUSHES, IN CLASS 21 (U.S. CLS. 2, 13, 23, 29, 30,
33, 40 AND 50).

FIRST USE 3-16-2010; IN COMMERCE 3-16-2010.

THE MARK CONSISTS OF STANDARD CHARACTERS WITHOUT CLAIM TO ANY PAR-
TICULAR FONT, STYLE, SIZE, OR COLOR.

OWNER OF U.S. REG. NOS. 3,698,889, 3,884,822 AND OTHERS.

SER. NO. 85-314,454, FILED 5-6-2011.

TARA PATE, EXAMINING ATTORNEY



David J. Kyros

Director of the United States Patent and Trademark Office

United States of America

United States Patent and Trademark Office

LORENA GARCIA COCINA

Reg. No. 4,173,926

Registered July 17, 2012

Int. Cls.: 29 and 43

TRADEMARK

SERVICE MARK

PRINCIPAL REGISTER

LG LICENSING, LLC (FLORIDA LIMITED LIABILITY COMPANY)
201 S. BISCAYNE BOULEVARD
SUITE 800
MIAMI, FL 33131

FOR: PREPARED ENTREES CONSISTING PRIMARILY OF MEAT, FISH, POULTRY OR VEGETABLES; COMBINATION MEAL CONSISTING PRIMARILY OF A MEAT OR VEGETABLE-BASED ENTRÉE AND A SOUP OR SALAD FOR CONSUMPTION ON OR OFF PREMISES; FRUIT SALADS; VEGETABLE SALADS, IN CLASS 29 (U.S. CL. 46).

FIRST USE 4-13-2011; IN COMMERCE 4-13-2011.

FOR: BAR AND RESTAURANT SERVICES; TAKE-OUT RESTAURANT SERVICES, IN CLASS 43 (U.S. CLS. 100 AND 101).

FIRST USE 4-13-2011; IN COMMERCE 4-13-2011.

THE MARK CONSISTS OF STANDARD CHARACTERS WITHOUT CLAIM TO ANY PARTICULAR FONT, STYLE, SIZE, OR COLOR.

NO CLAIM IS MADE TO THE EXCLUSIVE RIGHT TO USE "COCINA", APART FROM THE MARK AS SHOWN.

THE NAME(S), PORTRAIT(S), AND/OR SIGNATURE(S) SHOWN IN THE MARK IDENTIFIES LORENA GARCIA, WHOSE CONSENT(S) TO REGISTER IS MADE OF RECORD.

THE ENGLISH TRANSLATION OF "COCINA" IN THE MARK IS "KITCHEN".

SER. NO. 85-314,523, FILED 5-6-2011.

STEVEN R. FINE, EXAMINING ATTORNEY



David J. Kypos

Director of the United States Patent and Trademark Office

United States of America

United States Patent and Trademark Office

SWEB

Reg. No. 4,173,927

SKIDATA AG (AUSTRIA CORPORATION)
UNTERSBERGSTR. 40
GROEDIG, AUSTRIA A-5083

Registered July 17, 2012

Int. Cls.: 9, 35, 41 and 42

TRADEMARK

SERVICE MARK

PRINCIPAL REGISTER

FOR: ELECTRIC AND ELECTRONIC APPARATUS, NAMELY, COMPUTER TERMINALS FOR PROCESSING, RECORDING, STORING, TRANSMITTING, RECEIVING, MONITORING AND PRINTING OUT DATA; COMPUTER NETWORK SERVER AND PRERECORDED MAGNETIC DATA CARRIERS FEATURING SOFTWARE FOR THE RESERVING, BOOKING, SELLING AND ADVANCE SELLING OF TICKET RESERVATIONS FOR SKI AREAS, PARKING PLACES, HOTEL ACCOMMODATIONS, TRADE FAIRS, ENTERTAINMENT EVENTS, AND SPORTS EQUIPMENT FOR ATHLETES, TRAVELERS, VISITORS, AND SUPERVISORS; AUTOMATIC TURNSTILES; AUTOMATIC PARKING BARRIERS; CASH REGISTERS; VEHICLE IDENTIFICATION ELECTRONIC TOLL COLLECTION DEVICE FOR TOLL BOOTHS AND MULTI-STORY CAR PARKS; MOBILE TELEPHONES; SOFTWARE FOR RESERVING, BOOKING, SELLING AND ADVANCE SELLING OF TICKET RESERVATIONS FOR PARKING PLACES, SKI AREAS, SPORTS AND LEISURE FACILITIES, TRADE FAIRS, SEATING AND PARKING PLACE RESERVATIONS FOR ENTERTAINMENT EVENTS; SOFTWARE FOR RESERVING AND BOOKING OF HOTEL ACCOMMODATIONS AND SPORTS EQUIPMENT FOR LEISURE ACTIVITIES, IN CLASS 9 (U.S. CLS. 21, 23, 26, 36 AND 38).

FOR: OPERATING ON-LINE MARKETPLACES FOR BUYING, SELLING AND EXCHANGING SOFTWARE AND ON-DEMAND SOFTWARE APPLICATIONS FOR RESERVING, BOOKING, SELLING AND ADVANCE SELLING OF TICKET RESERVATIONS TO PARKING PLACES, SKI AREAS, SPORTS AND LEISURE FACILITIES, TRADE FAIRS, SEATING AND PARKING PLACE RESERVATION FOR ENTERTAINMENT EVENTS, AND FOR RESERVING AND BOOKING OF HOTEL ACCOMMODATIONS AND SPORTS EQUIPMENT FOR LEISURE ACTIVITIES, IN CLASS 35 (U.S. CLS. 100, 101 AND 102).

FOR: ENTERTAINMENT SERVICES, NAMELY, TICKET RESERVATION AND BOOKING SERVICES FOR ENTERTAINMENT SPORT, LEISURE, AND TRADE FAIR EVENTS, IN CLASS 41 (U.S. CLS. 100, 101 AND 107).

FOR: DESIGN AND DEVELOPMENT OF SOFTWARE FOR RESERVING, BOOKING, SELLING AND ADVANCE SELLING OF TICKET RESERVATIONS FOR PARKING PLACES, SKI AREAS, SPORTS AND LEISURE FACILITIES, TRADE FAIRS, AND SEATING AND PARKING PLACE RESERVATION FOR ENTERTAINMENT EVENTS; DESIGN AND DEVELOPMENT



David J. Kybas

Director of the United States Patent and Trademark Office

Reg. No. 4,173,927 OF SOFTWARE FOR RESERVING AND BOOKING OF HOTEL ACCOMMODATION, ATHLETIC EQUIPMENT AND PHYSICAL TRAINING SERVICES IN THE FIELD OF SPORTS AND LEISURE; DESIGN AND DEVELOPMENT OF SOFTWARE FOR RESERVING TICKETS FOR TRADE FAIRS AND ENTERTAINMENT EVENTS FOR TRAVELERS AND VISITORS, IN CLASS 42 (U.S. CLS. 100 AND 101).

THE MARK CONSISTS OF STANDARD CHARACTERS WITHOUT CLAIM TO ANY PARTICULAR FONT, STYLE, SIZE, OR COLOR.

PRIORITY CLAIMED UNDER SEC. 44(D) ON ERPN CMNTY TM OFC APPLICATION NO. 009895293, FILED 4-14-2011, REG. NO. 009895293, DATED 9-19-2011, EXPIRES 4-14-2021.

SER. NO. 85-314,593, FILED 5-6-2011.

SIMON TENG, EXAMINING ATTORNEY

United States of America

United States Patent and Trademark Office

PRODUCTS TO PROFITS

Reg. No. 4,173,928

Registered July 17, 2012

Int. Cls.: 35 and 42

SERVICE MARK

PRINCIPAL REGISTER

WENSLow, AMY (UNITED STATES INDIVIDUAL)
SUITE 439
530 S. LAKE AVE.
PASADENA, CA 91101

FOR: BUSINESS SERVICES, NAMELY, MARKETING AND PROMOTION SERVICES FOR CONSUMER GOODS, IN CLASS 35 (U.S. CLS. 100, 101 AND 102).

FIRST USE 7-14-2008; IN COMMERCE 7-17-2008.

FOR: PRODUCT DEVELOPMENT OF CONSUMER GOODS, IN CLASS 42 (U.S. CLS. 100 AND 101).

FIRST USE 7-14-2008; IN COMMERCE 7-14-2008.

THE MARK CONSISTS OF STANDARD CHARACTERS WITHOUT CLAIM TO ANY PARTICULAR FONT, STYLE, SIZE, OR COLOR.

SER. NO. 85-314,980, FILED 5-6-2011.

ROBIN MITTLER, EXAMINING ATTORNEY



David J. Kybas

Director of the United States Patent and Trademark Office

United States of America

United States Patent and Trademark Office



GREENLITSCRIPTS

Reg. No. 4,173,929

Registered July 17, 2012

Int. Cl.: 41

SERVICE MARK

PRINCIPAL REGISTER

MARION, JAMES P. (UNITED STATES INDIVIDUAL)
UNIT A
1051 BERYL STREET
SAN DIEGO, CA 92109

FOR: ENTERTAINMENT SERVICES IN THE NATURE OF DEVELOPMENT, CREATION, PRODUCTION AND POST-PRODUCTION SERVICES OF MULTIMEDIA ENTERTAINMENT CONTENT, IN CLASS 41 (U.S. CLS. 100, 101 AND 107).

FIRST USE 3-1-2009; IN COMMERCE 3-1-2009.

THE MARK CONSISTS OF A HYBRID DESIGN OF A MOVIE PROJECTOR AND AN OLD-FASHIONED TYPEWRITER IN BLACK AND WHITE, PROJECTING A GREEN TRIANGULAR LIGHT TO THE RIGHT SIDE. BELOW THE IMAGE IS THE STYLIZED WORD "GREENLITSCRIPTS" WITH "GREENLIT" IN GREEN AND "SCRIPTS" IN BLACK.

THE COLOR(S) GREEN, BLACK, AND WHITE IS/ARE CLAIMED AS A FEATURE OF THE MARK.

SER. NO. 85-314,986, FILED 5-6-2011.

JULIE GUTTADAURO, EXAMINING ATTORNEY



David J. Kybas

Director of the United States Patent and Trademark Office

United States of America

United States Patent and Trademark Office

THE LAZY GOAT

Reg. No. 4,173,930

RIVERPLACE RESTAURANTS, LLC (SOUTH CAROLINA LIMITED LIABILITY COMPANY)
170 RIVER PLACE
GREENVILLE, SC 29601

Registered July 17, 2012

Int. Cl.: 43

FOR: RESTAURANT, BAR AND CATERING SERVICES, IN CLASS 43 (U.S. CLS. 100 AND 101).

SERVICE MARK

FIRST USE 6-30-2007; IN COMMERCE 6-30-2007.

PRINCIPAL REGISTER

THE MARK CONSISTS OF STANDARD CHARACTERS WITHOUT CLAIM TO ANY PARTICULAR FONT, STYLE, SIZE, OR COLOR.

SER. NO. 85-315,162, FILED 5-7-2011.

KATHLEEN M. VANSTON, EXAMINING ATTORNEY



David J. Kybas

Director of the United States Patent and Trademark Office

United States of America

United States Patent and Trademark Office

TIME WELL WASTED

Reg. No. 4,173,931 RIVERPLACE RESTAURANTS, LLC (SOUTH CAROLINA LIMITED LIABILITY COMPANY)
170 RIVER PLACE
Registered July 17, 2012 GREENVILLE, SC 29601

Int. Cl.: 43 FOR: RESTAURANT, BAR AND CATERING SERVICES, IN CLASS 43 (U.S. CLS. 100 AND 101).

SERVICE MARK FIRST USE 6-30-2007; IN COMMERCE 6-30-2007.

PRINCIPAL REGISTER THE MARK CONSISTS OF STANDARD CHARACTERS WITHOUT CLAIM TO ANY PARTICULAR FONT, STYLE, SIZE, OR COLOR.

SER. NO. 85-315,163, FILED 5-7-2011.

KATHLEEN M. VANSTON, EXAMINING ATTORNEY



David J. Kybas

Director of the United States Patent and Trademark Office

United States of America

United States Patent and Trademark Office

TRI-COMPAX

Reg. No. 4,173,932

Registered July 17, 2012

Int. Cl.: 14

TRADEMARK

PRINCIPAL REGISTER

UNIVERSAL GENEVE S.A. (SWITZERLAND SOCIÉTÉ ANONYME (SA))
38 CHEMIN DU GRAND PUIITS
CASE POSTALE 128 1217 MEYRIN 2
GENEVE, SWITZERLAND

FOR: CLOCKS AND WATCHES AND PARTS THEREFOR, IN CLASS 14 (U.S. CLS. 2, 27, 28 AND 50).

THE MARK CONSISTS OF STANDARD CHARACTERS WITHOUT CLAIM TO ANY PARTICULAR FONT, STYLE, SIZE, OR COLOR.

OWNER OF SWITZERLAND REG. NO. 379882, DATED 9-10-1990, EXPIRES 9-10-2020.

SER. NO. 85-315,408, FILED 5-9-2011.

STEVEN PEREZ, EXAMINING ATTORNEY



David J. Kybas

Director of the United States Patent and Trademark Office

United States of America

United States Patent and Trademark Office



Reg. No. 4,173,933

LET'S SPOON FROZEN YOGURT (INDIANA LIMITED LIABILITY COMPANY)
1635 EDISON RD
SOUTH BEND, IN 46637

Registered July 17, 2012

Int. Cl.: 43

FOR: RESTAURANT SERVICES FEATURING FROZEN CONFECTIONS, IN CLASS 43 (U.S. CLS. 100 AND 101).

SERVICE MARK

FIRST USE 4-14-2010; IN COMMERCE 4-14-2010.

PRINCIPAL REGISTER

NO CLAIM IS MADE TO THE EXCLUSIVE RIGHT TO USE "FROZEN YOGURT", APART FROM THE MARK AS SHOWN.

THE COLOR(S) PINK, LIME GREEN, BLACK, AND WHITE IS/ARE CLAIMED AS A FEATURE OF THE MARK.

THE MARK CONSISTS OF THE WORDS "LET'S SPOON, FROZEN YOGURT AND CREATE IT, WEIGH IT, SPOON IT". THE LETTERS IN "LET'S SPOON" ARE OUTLINED IN BLACK. THE LETTERS IN "FROZEN YOGURT" ARE WHITE AND ARE OUTLINED IN LIME GREEN. THE LETTERS IN "CREATE IT, WEIGH IT, SPOON IT!" ARE WHITE AND ARE OUTLINED IN PINK AND THIS INCLUDES THE COMMAS AND THE EXCLAMATION POINT WHICH ARE ALSO WHITE AND OUTLINED IN PINK. THE MARK CONSISTS OF A RECTANGLE WITH FOUR WAVELIKE DESIGNS CONTAINED THEREIN. THE FIRST WAVELIKE DESIGN IS AT THE TOP OF THE RECTANGLE AND IS IN PINK. UNDERNEATH THIS IS THE SECOND WAVELIKE DESIGN IN WHITE, A THIRD WAVELIKE DESIGN UNDERNEATH THAT IN LIME GREEN AND A DARKER LIME GREEN DESIGN AT THE BOTTOM OF THE RECTANGLE. THE WORDS "LET'S SPOON" APPEAR AT THE TOP LEFT OF THE RECTANGLE. THE WORDS "FROZEN YOGURT" APPEAR UNDERNEATH "LET'S SPOON" IN A CIRCLE AT THE END OF A SPOON. AT THE BOTTOM RIGHT OF THE RECTANGLE, THERE APPEAR THE WORDS WITH PUNCTUATION "CREATE IT, WEIGH IT, SPOON IT!" THE SPOON RUNS FROM THE MIDDLE OF THE RECTANGLE TO THE LEFT OF SAID RECTANGLE AND IS WHITE WITH BLACK OUTLINES. THE CIRCLE HANGING ON THE END OF THE SPOON IS PINK AND PARTIALLY OUTLINED IN BLACK AND CONTAINS THE WORDS "FROZEN YOGURT" THEREIN, SAID LETTERS BEING WHITE WITH A LIME GREEN OUTLINE. IN THE RECTANGLE ARE FIVE CIRCLES OF VARIOUS SIZES AND ONE PARTIALLY OBSCURED LIME GREEN CIRCLE. THE OTHER FIVE CIRCLES ARE EITHER LIME GREEN OR PINK.



David J. Kyjars

Director of the United States Patent and Trademark Office

Reg. No. 4,173,933 SER. NO. 85-315,866, FILED 5-9-2011.

DOMINICK J. SALEMI, EXAMINING ATTORNEY

United States of America

United States Patent and Trademark Office

CIVIC MIRROR

Reg. No. 4,173,934

Registered July 17, 2012

Int. Cls.: 9 and 41

TRADEMARK

SERVICE MARK

PRINCIPAL REGISTER

ROSS, REGAN (CANADA INDIVIDUAL)
1038 HABGOOD STREET
WHITEROCK, BC, CANADA V4B4W8

FOR: CHILDREN'S EDUCATIONAL SOFTWARE; COMPUTER GAME DISCS; COMPUTER GAME PROGRAMMES DOWNLOADABLE VIA THE INTERNET; EDUCATIONAL SOFTWARE FEATURING INSTRUCTION IN GOVERNMENT, ECONOMICS, LAW AND CITIZENSHIP; INTERACTIVE MULTIMEDIA COMPUTER GAME PROGRAM, IN CLASS 9 (U.S. CLS. 21, 23, 26, 36 AND 38).

FIRST USE 12-31-2007; IN COMMERCE 12-31-2007.

FOR: CONDUCTING WORKSHOPS AND SEMINARS IN GOVERNMENT, ECONOMICS, LAW AND CITIZENSHIP; EDUCATION SERVICES, NAMELY, PROVIDING MENTORING, TUTORING, CLASSES, SEMINARS AND WORKSHOPS IN THE FIELD OF GOVERNMENT, ECONOMICS, LAW AND CITIZENSHIP, IN CLASS 41 (U.S. CLS. 100, 101 AND 107).

FIRST USE 12-31-2007; IN COMMERCE 12-31-2007.

THE MARK CONSISTS OF STANDARD CHARACTERS WITHOUT CLAIM TO ANY PARTICULAR FONT, STYLE, SIZE, OR COLOR.

NO CLAIM IS MADE TO THE EXCLUSIVE RIGHT TO USE "CIVIC", APART FROM THE MARK AS SHOWN.

SER. NO. 85-316,023, FILED 5-9-2011.

ELISSA GARBER KON, EXAMINING ATTORNEY



David J. Kyffers

Director of the United States Patent and Trademark Office

United States of America

United States Patent and Trademark Office

NX Rail

Reg. No. 4,173,935

Registered July 17, 2012

Int. Cl.: 19

TRADEMARK

PRINCIPAL REGISTER

MID ATLANTIC VINYL PRODUCTS, INC. (VIRGINIA CORPORATION)
5109 COMMONWEALTH DRIVE
FREDERISCKSBURG, VA 22404

FOR: PVC/VINYL RAILING, IN CLASS 19 (U.S. CLS. 1, 12, 33 AND 50).

FIRST USE 6-0-2008; IN COMMERCE 6-0-2008.

NO CLAIM IS MADE TO THE EXCLUSIVE RIGHT TO USE "RAIL", APART FROM THE MARK AS SHOWN.

THE MARK CONSISTS OF THE LETTERS "NX" AND THE WORD RAIL IN SCRIPT WITH A STYLIZED "NX" SEPARATING THE LETTERS FROM THE WORD.

SER. NO. 85-316,082, FILED 5-9-2011.

CARYN GLASSER, EXAMINING ATTORNEY



David J. Kyffers

Director of the United States Patent and Trademark Office

United States of America

United States Patent and Trademark Office

LIVE IN IT

Reg. No. 4,173,936

FREE COUNTRY LTD. (DELAWARE CORPORATION)

Registered July 17, 2012

1071 AVENUE OF THE AMERICAS
NEW YORK, NY 10018

Int. Cl.: 25

FOR: CASUAL CLOTHING FOR CHILDREN AND ADULTS, NAMELY, JACKETS, COATS, HATS, SHIRTS, PANTS, SHORTS, TOPS, SOCKS, SHOES, ATHLETIC SHOES, SNEAKERS, DRESSES, SWEATSHIRTS, SWEATPANTS, SPORT JACKETS, SKIRTS, AND SWIMWEAR, IN CLASS 25 (U.S. CLS. 22 AND 39).

TRADEMARK

PRINCIPAL REGISTER

FIRST USE 11-30-2006; IN COMMERCE 11-30-2006.

THE MARK CONSISTS OF STANDARD CHARACTERS WITHOUT CLAIM TO ANY PARTICULAR FONT, STYLE, SIZE, OR COLOR.

SER. NO. 85-316,083, FILED 5-9-2011.

ALLISON HOLTZ, EXAMINING ATTORNEY



David J. Kybas

Director of the United States Patent and Trademark Office

United States of America

United States Patent and Trademark Office



Reg. No. 4,173,937

NRG LOGISTICS, LLC (ILLINOIS LIMITED LIABILITY COMPANY)
4497 HAMELTON CT.

Registered July 17, 2012

LONG GROVE, IL 60047

Int. Cl.: 42

FOR: RESEARCH AND DEVELOPMENT OF ENVIRONMENTALLY FRIENDLY FORMS OF ENERGY AND POWER, NAMELY, IMPROVING FUEL EFFICIENCY IN INDUSTRIAL AND COMMERCIAL APPLICATIONS, AND EXCLUDING SOLAR POWER GENERATION, WIND POWER GENERATION, BIO MASS GENERATION AND ELECTRIC VEHICLE CHARGING STATIONS, IN CLASS 42 (U.S. CLS. 100 AND 101).

SERVICE MARK

PRINCIPAL REGISTER

FIRST USE 7-21-2010; IN COMMERCE 7-21-2010.

NO CLAIM IS MADE TO THE EXCLUSIVE RIGHT TO USE "LOGISTICS INTERNATIONAL PROVIDER OF ENERGY SOLUTIONS", APART FROM THE MARK AS SHOWN.

THE COLOR(S) GREEN, BLUE, WHITE AND BLACK IS/ARE CLAIMED AS A FEATURE OF THE MARK.

THE MARK CONSISTS OF A BLUE CIRCULAR SHAPE MEETING AT A SMALLER GREEN CIRCLE, ENCLOSED IN THE BLUE CIRCULAR SHAPE IS A BLACK SHADED SEMICIRCLE TO LEFT, IN THE MIDDLE IS A WHITE AND BLACK ROAD AND TO THE RIGHT OF THE ROAD IS GREEN GRASS WITH A WHITE PATH IN THE MIDDLE. THE BLACK SHADED SEMICIRCLE, WHITE AND BLACK ROAD AND GREEN GRASS WITH WHITE PATH ALL FORM A CIRCLE. TO THE RIGHT OF THE CIRCULAR LOGO ARE THE STYLIZED WORDS "NRG LOGISTICS INTERNATIONAL PROVIDER OF ENERGY SOLUTIONS" IN BLACK. THE FIRST LETTER "I" IN LOGISTICS IS PUNCTUATED WITH A BLUE DOT AND THE SECOND "I" IS PUNCTUATED WITH A GREEN DOT.

SER. NO. 85-316,106, FILED 5-9-2011.

ALYSSA STEEL, EXAMINING ATTORNEY



David J. Kybas

Director of the United States Patent and Trademark Office

United States of America

United States Patent and Trademark Office

KING ABDULLAH PETROLEUM STUDIES AND RESEARCH CENTER

Reg. No. 4,173,938

Registered July 17, 2012

Int. Cls.: 9, 16, 41 and 42

SAUDI ARABIAN OIL COMPANY (SAUDI ARABIA A COMPANY OF LIMITED LIABILITY
CREATED BY ROYAL DECREE ACCORDING TO THE LAWS OF THE KINGDOM OF
SAUDI ARABIA)
1 EASTERN AVENUE
DHAHRAN, SAUDI ARABIA 31311

TRADEMARK

SERVICE MARK

PRINCIPAL REGISTER

FOR: INTERACTIVE MULTIMEDIA COMPUTER PROGRAMS AND SOFTWARE USED FOR ACCESSING COMPUTER DATABASES AND COMPUTER NAVIGATION SYSTEMS IN THE FIELD OF HISTORY, SCIENCE, GEOGRAPHY, BIOGRAPHY, CULTURE, ART, ENERGY, TECHNOLOGY OF AND RELATING TO THE KINGDOM OF SAUDI ARABIA; ELECTRONIC INTERACTIVE GAME PROGRAMS; INTERACTIVE VIDEO GAME PROGRAMS; AUDIO AND VIDEO ANALOG AND DIGITAL RECORDINGS ON VIDEO TAPES, RECORDS, COMPACT DISC, DVD'S, CD'S, CASSETTE TAPES, AND COMPUTER HARD DISCS ALL FEATURING A WIDE VARIETY OF TOPICS, NAMELY, THE ENERGY AND PETROLEUM INDUSTRIES, HISTORY, SCIENCE, GEOGRAPHY, CULTURE, ART, TECHNOLOGY, CURRENT EVENTS, BUSINESS, FINANCE, AND THE KINGDOM OF SAUDI ARABIA; MOTION PICTURE FILMS FEATURING A WIDE VARIETY OF TOPICS, NAMELY, DOCUMENTARIES, COMEDIES, DRAMAS AND FILMS FEATURING TOPICS RELATING TO THE ENERGY AND PETROLEUM INDUSTRIES, HISTORY, SCIENCE, GEOGRAPHY, CULTURE, ART, TECHNOLOGY, CURRENT EVENTS, BUSINESS, FINANCE AND THE KINGDOM OF SAUDI ARABIA; RECORDED AND DOWNLOADABLE COMPUTER SOFTWARE USED TO DEVELOP INTERACTIVE COMPUTER PROGRAMS; COMPUTER GAME CONSOLES FOR USE ON AN EXTERNAL MONITOR; APPARATUS FOR RECORDING, PRODUCING, REPRODUCING AND TRANSMITTING SOUND, VIDEO, DATA AND IMAGES; CD PLAYERS AND DVD PLAYERS; TERRESTRIAL AND SATELLITE RADIOS, TELEVISIONS; COMPUTERS, COMPUTER MEMORY CARDS, CD-ROM DRIVES AND DIGITAL DISC DRIVES; CAMERAS, EXPOSED CAMERA FILM; DIGITAL CAMERAS AND MEMORY CARDS; TELEPHONES, MOBILE TELEPHONES; PERSONAL DIGITAL ASSISTANT PDA; ELECTRONIC DIARIES; ELECTRONIC BOOKS RECORDED ON ELECTRONIC MEDIA FEATURING A WIDE VARIETY OF TOPICS, NAMELY, THE ENERGY AND PETROLEUM INDUSTRIES, HISTORY, SCIENCE, GEOGRAPHY, CULTURE, ART, TECHNOLOGY, CURRENT EVENTS, BUSINESS, FINANCE AND THE KINGDOM OF SAUDI ARABIA; COMPUTER AND VIDEO GAME PROGRAMS AND SOFTWARE; COMPUTER GAME EQUIPMENT, NAMELY, CONSOLES FOR USE WITH EXTERNAL MONITOR, CONTAINING MEMORY DEVICES, NAMELY, COMPUTER GAME DISCS, SOLD AS A UNIT FOR PLAYING A PARLOR-TYPE COMPUTER GAME; CALCULATORS; MOUSE PADS; OPTICAL INSTRUMENTS, NAMELY, BINOCULARS, TELESCOPES, PERISCOPES, MICROSCOPES, MAGNI-



David J. Kybas

Director of the United States Patent and Trademark Office

Reg. No. 4,173,938 FLYING LENSES AND GLASSES, PRISMS, SUNGLASSES AND EYEGLASSES; APPARATUS FOR MEASURING, SIGNALING, MONITORING, ANALYZING, RECORDING LIGHT, SOUND, LENGTH, HEIGHT, SPEED, FLUID FLOW, TEMPERATURE, HUMIDITY, PRESSURE, WEIGHT, VOLUME, DEPTH, MAGNETISM, ELECTRICITY, SURFACE CHARACTERISTICS, DATA, AND IMAGE, NAMELY, GRADUATED RULERS, THERMOMETERS, BAROMETERS, AND CALCULATING SCALES; COMPASSES; DECORATIVE MAGNETS; MAGNETS; BATTERIES; MAGNETICALLY ENCODED IDENTITY CARDS; COMPUTER PROGRAMS, NAMELY, SOFTWARE LINKING DIGITIZED VIDEO AND AUDIO MEDIA TO A GLOBAL COMPUTER INFORMATION NETWORK; IDENTIFICATION AND SECURITY CARDS, NAMELY, MAGNETIC IDENTIFYING CARDS; CONSUMER ELECTRONICS, NAMELY, ALL TYPES OF COMPUTER HARDWARE AND COMPUTER PERIPHERALS, AUDIO AND VIDEO RECORDERS, PLAYERS, AND TRANSMITTERS AND MOBILE COMMUNICATION DEVICES FOR RECORDING, PRODUCING, EDITING, REPRODUCING AND TRANSMITTING SOUND, VIDEO, DATA AND IMAGES, NAMELY, MOBILE DATA RECEIVERS, MOBILE PHONES, MOBILE RADIOS, HEADSETS FOR MOBILE PHONES, AND KEYBOARDS FOR MOBILE PHONES; AND STRUCTURAL PARTS AND ACCESSORIES OF THESE GOODS, NAMELY, HEADPHONES AND HANDS FREE HEADSETS, IN CLASS 9 (U.S. CLS. 21, 23, 26, 36 AND 38).

FOR: PAPER AND PAPER ARTICLES, NAMELY, PRINTED PUBLICATIONS IN THE NATURE OF BOOKS, MAGAZINES, NEWSPAPERS, NEWSLETTERS, CATALOGS, MANUALS, ALL IN PRINTED FORM FEATURING A WIDE VARIETY OF TOPICS, NAMELY, THE ENERGY AND PETROLEUM INDUSTRIES, HISTORY, SCIENCE, GEOGRAPHY, CULTURE, ART, TECHNOLOGY, CURRENT EVENTS, BUSINESS, FINANCE AND THE KINGDOM OF SAUDI ARABIA; DIRECTORIES, NAMELY, PRINTED BUSINESS, CLASSIFIED, TELEPHONE AND INFORMATIONAL DIRECTORIES RELATING TO THE ENERGY AND PETROLEUM INDUSTRIES AND UNIVERSITY FACILITIES AND PERSONNEL; POSTERS; ETCHINGS; LITHOGRAPHS; PHOTOGRAPHS; MAPS; ALMANACS; CALENDARS; STATIONERY; MEMO PADS; NOTEBOOKS; BOOK COVERS; APPOINTMENT BOOKS; LETTER AND ENVELOPE SETS; POSTCARDS; GIFT CARDS; PLACE CARDS; GREETING CARDS; ANNOUNCEMENT CARDS; NOTE PADS; UNGRADUATED RULERS; PHOTOGRAPH ALBUMS, ADDRESS BOOKS; BOOK AND LOOSE LEAF PAPER BINDERS; AUTOGRAPH BOOKS; DIARIES; DATE BOOKS; INFORMATION BULLETINS CONCERNING THE NEWS; PICTURE BOOKS; MEMORANDUM BOARDS; DESK ACCESSORIES, NAMELY, LETTER OPENERS, DESK PADS, COLORING BOOKS, CHILDREN'S ACTIVITY BOOKS; SKETCH BOOKS, STICKER ALBUMS, MODELING CLAY; STAPLERS, ERASERS, PENCIL SHARPENERS, PENS, PENCILS, MARKERS, CRAYONS, HIGHLIGHTER PENS, CHALK; PENCIL CASES; PAPERWEIGHTS; OFFICE SUPPLIES, NAMELY, BOOK AND PAPER BINDERS, FOLDERS, ASSIGNMENT BOOKS, NOTE BOOKS, NOTE PADS, BOOK COVERS, BOOK MARKERS; PRINTED EDUCATIONAL AND INSTRUCTIONAL MATERIALS FEATURING A WIDE VARIETY OF TOPICS, NAMELY, THE ENERGY AND PETROLEUM INDUSTRIES, HISTORY, SCIENCE, GEOGRAPHY, CULTURE, ART, TECHNOLOGY, CURRENT EVENTS, BUSINESS, FINANCE AND THE KINGDOM OF SAUDI ARABIA; STICKERS, DECALS, APPLIQUÉS IN THE FORM OF DECAL, TRADING CARDS; PAPER IDENTIFICATION TAGS; PAPER NAPKINS; PAPER PARTY BAGS; PAPER GIFT WRAP; PAPER GIFT WRAP BOWS, PAPER TABLECLOTHS, PAPER TABLEMATS; BOOKENDS; PASSPORT CASES, FLAGS OF PAPER, BANNERS AND PENNANTS MADE OF PAPER; PAPER AND PLASTIC SHEETS FOR WRITING, PRINTING AND MARKING, PAPER SACKS AND BAGS FOR WRAPPING AND PACKAGING, IN CLASS 16 (U.S. CLS. 2, 5, 22, 23, 29, 37, 38 AND 50).

FOR: MUSEUM SERVICES; ART EXHIBITIONS; EDUCATIONAL SERVICES, NAMELY, ARRANGING AND CONDUCTING EXHIBITIONS, WORKSHOPS, SEMINARS, TRAINING COURSES, LECTURES, EDUCATIONAL CONFERENCES, FILM AND VIDEO PRESENTATIONS IN THE FIELDS OF HISTORY, ARCHEOLOGY, GEOGRAPHY, BIOGRAPHY, CULTURE, ART, SCIENCE, ENERGY, ECONOMY, TECHNOLOGY, PETROLEUM, RELIGION; GUIDED TOURS OF A MUSEUM AND HISTORICAL SITE; CHILDREN'S EDUCATIONAL SERVICES, NAMELY, PROVIDING CLASSES AND WORKSHOPS IN THE FIELD OF ENERGY AND PETROLEUM INDUSTRIES, HISTORY, SCIENCE, GEOGRAPHY, CULTURE,

Reg. No. 4,173,938 ART, TECHNOLOGY, CURRENT EVENTS, BUSINESS, FINANCE, AND THE KINGDOM OF SAUDI ARABIA; CHILDREN'S ENTERTAINMENT AND AMUSEMENT CENTERS, NAMELY, INTERACTIVE PLAY FACILITIES; EDUCATIONAL DEMONSTRATIONS; ARRANGING AND CONDUCTING EDUCATIONAL EXHIBITIONS AND DISPLAYS AND INTERACTIVE EXHIBITIONS IN THE FIELD OF SCIENCE, HISTORY, CULTURE AND REGARDING THE KINGDOM OF SAUDI ARABIA; LIBRARY SERVICES, NAMELY, LENDING LIBRARIES AND ON-LINE ACADEMIC LIBRARY SERVICES; BOOK, CD, DVD, FILM LOANING AND RENTAL SERVICES; REFERENCE LIBRARIES OF LITERATURE AND DOCUMENTARY RECORDS; PUBLISHING SERVICES, NAMELY, PUBLISHING OF NON-DOWNLOADABLE EDUCATIONAL MATERIAL IN THE NATURE OF BOOKS, MAGAZINES, AND ELECTRONIC PUBLICATIONS ON A WIDE VARIETY OF TOPICS, NAMELY, THE ENERGY AND PETROLEUM INDUSTRIES, HISTORY, SCIENCE, GEOGRAPHY, CULTURE, ART, TECHNOLOGY, CURRENT EVENTS, BUSINESS, FINANCE, AND THE KINGDOM OF SAUDI ARABIA; PROVIDING ONLINE NON-DOWNLOADABLE ELECTRONIC PUBLICATIONS IN THE NATURE OF ARTICLES, NEWSLETTERS AND BOOKS FEATURING A WIDE VARIETY OF TOPICS, NAMELY, THE ENERGY AND PETROLEUM INDUSTRIES, HISTORY, SCIENCE, GEOGRAPHY, CULTURE, ART, TECHNOLOGY, CURRENT EVENTS, BUSINESS, FINANCE, AND THE KINGDOM OF SAUDI ARABIA; PUBLICATION OF ELECTRONIC BOOKS AND JOURNALS ONLINE, ELECTRONIC PUBLISHING OF TEXT AND GRAPHIC WORKS OF OTHERS ON CD, DVD AND ONLINE FORMAT FEATURING A WIDE VARIETY OF TOPICS, NAMELY, THE ENERGY AND PETROLEUM INDUSTRIES, HISTORY, SCIENCE, GEOGRAPHY, CULTURE, ART, TECHNOLOGY, CURRENT EVENTS, BUSINESS, FINANCE, AND THE KINGDOM OF SAUDI ARABIA; ONLINE REVIEW OF BOOKS; ENTERTAINMENT SERVICES, NAMELY, MOVIE THEATERS; PRODUCTION AND DISTRIBUTION OF PROGRAMS FOR TELEVISION, CABLE TELEVISION, DIGITAL TELEVISION, SATELLITE TELEVISION, THE GLOBAL COMPUTER NETWORK, AND TERRESTRIAL AND SATELLITE RADIO; MOTION PICTURE FILM PRODUCTIONS; PROVISION OF ON-LINE NON-DOWNLOADABLE COMPUTER GAMES VIA A WORLD-WIDE WEB; PROVIDING ONLINE NON-DOWNLOADABLE MAGAZINES FEATURING A WIDE VARIETY OF TOPICS, NAMELY, IN THE FIELD OF THE ENERGY AND PETROLEUM INDUSTRIES, HISTORY, SCIENCE, GEOGRAPHY, CULTURE, ART, TECHNOLOGY, CURRENT EVENTS, BUSINESS, FINANCE, AND THE KINGDOM OF SAUDI ARABIA; PROVIDING ON-LINE UNIVERSITY INFORMATION SERVICES, NAMELY, INFORMATION AND COMMENTARY IN THE FIELD OF EDUCATION AND ENTERTAINMENT RELATING TO A WIDE VARIETY OF TOPICS, NAMELY, THE ENERGY AND PETROLEUM INDUSTRIES, HISTORY, SCIENCE, GEOGRAPHY, CULTURE, ART, TECHNOLOGY, CURRENT EVENTS, BUSINESS, FINANCE, AND THE KINGDOM OF SAUDI ARABIA VIA THE INTERNET; PROVIDING AN ON-LINE WEBSITE FEATURING INFORMATION CONCERNING COURSES AT THE UNIVERSITY LEVEL, IN CLASS 41 (U.S. CLS. 100, 101 AND 107).

FOR: SCIENTIFIC AND TECHNOLOGICAL SERVICES, NAMELY, SCIENTIFIC RESEARCH, ANALYSIS AND TESTING IN THE FIELD OF INFORMATION AND TELECOMMUNICATIONS TECHNOLOGY, AND RESEARCH AND DESIGN SERVICES IN THE FIELD OF ENERGY AND PETROLEUM; ENGINEERING SERVICES FOR BUILDING AND PROPERTY CONDITION ASSESSMENT, FACILITY MANAGEMENT, REPAIR AND RESTORATION; TECHNICAL CONSULTING IN THE FIELD OF ENVIRONMENTAL ASSESSMENT; COMPUTER SERVICES, NAMELY, CREATING AN ON-LINE COMMUNITY FOR REGISTERED USERS TO PARTICIPATE IN ONLINE MEETINGS, AND DISCUSSIONS WITH THEIR PEERS IN THE FIELD OF EDUCATION, LEARNING, TRAINING AND STUDYING; INTEGRATION AND DESIGN OF A COMPUTER SYSTEM; MAINTENANCE OF SOFTWARE FOR COMPUTER SYSTEMS; SCIENTIFIC RESEARCH SERVICES, IN CLASS 42 (U.S. CLS. 100 AND 101).

THE MARK CONSISTS OF STANDARD CHARACTERS WITHOUT CLAIM TO ANY PARTICULAR FONT, STYLE, SIZE, OR COLOR.

OWNER OF SAUDI ARABIA REG. NO. 1221/88, DATED 1-10-2011, EXPIRES 8-10-2020.

Reg. No. 4,173,938 OWNER OF SAUDI ARABIA REG. NO. 1219/62, DATED 1-3-2011, EXPIRES 9-3-2020.

OWNER OF SAUDI ARABIA REG. NO. 1219/61, DATED 1-3-2011, EXPIRES 9-3-2020.

OWNER OF SAUDI ARABIA REG. NO. 1219/60, DATED 1-3-2011, EXPIRES 9-3-2020.

NO CLAIM IS MADE TO THE EXCLUSIVE RIGHT TO USE "PETROLEUM STUDIES AND RESEARCH CENTER", APART FROM THE MARK AS SHOWN.

THE NAME(S), PORTRAIT(S), AND/OR SIGNATURE(S) SHOWN IN THE MARK IDENTIFIES "KING ABDULLAH", WHOSE CONSENT(S) TO REGISTER IS MADE OF RECORD.

SER. NO. 85-316,109, FILED 5-9-2011.

COURTNEY ALVAREZ, EXAMINING ATTORNEY

United States of America

United States Patent and Trademark Office

CardioChek Connect

Reg. No. 4,173,939

Registered July 17, 2012

Int. Cl.: 9

TRADEMARK

PRINCIPAL REGISTER

POLYMER TECHNOLOGY SYSTEMS, INC. (INDIANA CORPORATION)
7736 ZIONSVILLE ROAD
INDIANAPOLIS, IN 46268

FOR: COMPUTER SYSTEMS, COMPRISED OF SOFTWARE, HARDWARE AND INTERFACES FOR PROVIDING THE RECORDING OF TEST RESULTS, HEALTH RISK ASSESSMENTS, AND ENTERPRISE SOLUTIONS FOR AGGREGATING DATA, IN CLASS 9 (U.S. CLS. 21, 23, 26, 36 AND 38).

FIRST USE 11-15-2010; IN COMMERCE 11-15-2010.

THE MARK CONSISTS OF STANDARD CHARACTERS WITHOUT CLAIM TO ANY PARTICULAR FONT, STYLE, SIZE, OR COLOR.

OWNER OF U.S. REG. NOS. 3,085,202 AND 3,681,134.

NO CLAIM IS MADE TO THE EXCLUSIVE RIGHT TO USE "CONNECT", APART FROM THE MARK AS SHOWN.

SER. NO. 85-316,216, FILED 5-9-2011.

CARRIE GENOVESE, EXAMINING ATTORNEY



David J. Kybas

Director of the United States Patent and Trademark Office

United States of America

United States Patent and Trademark Office

GOMEZ

Reg. No. 4,173,940

Registered July 17, 2012

Int. Cl.: 42

SERVICE MARK

PRINCIPAL REGISTER

COMPUWARE CORPORATION (MICHIGAN CORPORATION)
ONE CAMPUS MARTIUS
DETROIT, MI 48226

FOR: COMPUTER SERVICES, NAMELY, MONITORING AND MANAGING WEB BROWSER AND COMPUTER APPLICATION PERFORMANCE, TESTING LOAD PERFORMANCE, TESTING WEBSITE PERFORMANCE; CONSULTING SERVICES IN THE FIELD OF COMPUTER APPLICATION AND WEB PERFORMANCE, IN CLASS 42 (U.S. CLS. 100 AND 101).

FIRST USE 6-1-1997; IN COMMERCE 6-1-1997.

THE MARK CONSISTS OF STANDARD CHARACTERS WITHOUT CLAIM TO ANY PARTICULAR FONT, STYLE, SIZE, OR COLOR.

OWNER OF U.S. REG. NO. 2,508,613.

SEC. 2(F).

SER. NO. 85-316,880, FILED 5-10-2011.

BRENDAN MCCAULEY, EXAMINING ATTORNEY



David J. Kyros

Director of the United States Patent and Trademark Office

United States of America

United States Patent and Trademark Office

ÚNASE A LOS MILLONES

Reg. No. 4,173,941

AMERICAN DIABETES ASSOCIATION, INC. (OHIO CORPORATION)
1701 N BEAUREGARD STREET
ALEXANDRIA, VA 22311

Registered July 17, 2012

Int. Cls.: 35 and 36

FOR: PROMOTING PUBLIC AWARENESS OF DIABETES, DIABETES PREVENTION AND DIABETES CONTROL, IN CLASS 35 (U.S. CLS. 100, 101 AND 102).

SERVICE MARK

FIRST USE 2-2-2011; IN COMMERCE 2-2-2011.

PRINCIPAL REGISTER

FOR: CHARITABLE FUNDRAISING SERVICES, IN CLASS 36 (U.S. CLS. 100, 101 AND 102).

FIRST USE 2-2-2011; IN COMMERCE 2-2-2011.

THE MARK CONSISTS OF STANDARD CHARACTERS WITHOUT CLAIM TO ANY PARTICULAR FONT, STYLE, SIZE, OR COLOR.

THE ENGLISH TRANSLATION OF "ÚNASE A LOS MILLONES" IN THE MARK IS "JOIN THE MILLIONS".

SER. NO. 85-316,920, FILED 5-10-2011.

JOSETTE BEVERLY, EXAMINING ATTORNEY



David J. Kybas

Director of the United States Patent and Trademark Office

United States of America

United States Patent and Trademark Office

AUDREY NAPOLEON

Reg. No. 4,173,942

RESTIVO, ASHLEY E. (UNITED STATES INDIVIDUAL), AKA AUDREY NAPOLEON
PO BOX 48132

Registered July 17, 2012

LOS ANGELES, CA 900480132

Int. Cls.: 9, 25 and 41

FOR: AUDIO RECORDINGS FEATURING MUSIC, IN CLASS 9 (U.S. CLS. 21, 23, 26, 36 AND 38).

TRADEMARK

FIRST USE 11-1-2010; IN COMMERCE 11-1-2010.

SERVICE MARK

FOR: CLOTHING, NAMELY, BODY SUITS, BRAS, LEGGINGS, TANK TOPS, AND T-SHIRTS, IN CLASS 25 (U.S. CLS. 22 AND 39).

PRINCIPAL REGISTER

FIRST USE 5-1-2010; IN COMMERCE 5-1-2010.

FOR: DISC JOCKEY SERVICES, IN CLASS 41 (U.S. CLS. 100, 101 AND 107).

FIRST USE 5-1-2008; IN COMMERCE 5-1-2008.

THE MARK CONSISTS OF STANDARD CHARACTERS WITHOUT CLAIM TO ANY PARTICULAR FONT, STYLE, SIZE, OR COLOR.

THE NAME "AUDREY NAPOLEON" IDENTIFIES A LIVING INDIVIDUAL WHOSE CONSENT IS OF RECORD.

SER. NO. 85-316,981, FILED 5-10-2011.

SUNG IN, EXAMINING ATTORNEY



David J. Kypos

Director of the United States Patent and Trademark Office

United States of America

United States Patent and Trademark Office

DREAMFIT

Reg. No. 4,173,943

HOMTEX, INC. (ALABAMA CORPORATION)
15295 ALABAMA HIGHWAY 157
VINEMONT, AL 35179

Registered July 17, 2012

Int. Cl.: 20

FOR: BED PILLOWS; PILLOWS, IN CLASS 20 (U.S. CLS. 2, 13, 22, 25, 32 AND 50).

TRADEMARK

FIRST USE 6-7-1993; IN COMMERCE 6-7-1993.

PRINCIPAL REGISTER

THE MARK CONSISTS OF STANDARD CHARACTERS WITHOUT CLAIM TO ANY PARTICULAR FONT, STYLE, SIZE, OR COLOR.

OWNER OF U.S. REG. NO. 1,862,560.

SER. NO. 85-317,068, FILED 5-10-2011.

SIMON TENG, EXAMINING ATTORNEY



David J. Kyffers

Director of the United States Patent and Trademark Office

United States of America

United States Patent and Trademark Office

DROPLET MEASUREMENT TECHNOLOGIES

Reg. No. 4,173,944

Registered July 17, 2012

Int. Cl.: 9

TRADEMARK

PRINCIPAL REGISTER

DROPLET MEASUREMENT TECHNOLOGIES, INC. (COLORADO CORPORATION)
2545 CENTRAL AVE.
BOULDER, CO 80301

FOR: SCIENTIFIC APPARATUS AND INSTRUMENTS FOR MEASURING AIRBORNE PARTICLES, NAMELY, TEST EQUIPMENT, PROBES, INSTRUMENTS AND DATA COLLECTION AND ANALYSIS SYSTEMS COMPRISED OF ANALYTICAL SPECTROMETERS, DATA PROCESSORS AND SOFTWARE, ALL FOR COLLECTING AND ANALYZING AIRBORNE PARTICLES FOR DETERMINATION OF PARTICLE SIZE, CONCENTRATION, SHAPE, DENSITY AND TYPE IN AIR, IN CLASS 9 (U.S. CLS. 21, 23, 26, 36 AND 38).

FIRST USE 8-2-1995; IN COMMERCE 8-2-1995.

THE MARK CONSISTS OF STANDARD CHARACTERS WITHOUT CLAIM TO ANY PARTICULAR FONT, STYLE, SIZE, OR COLOR.

SEC. 2(F).

SER. NO. 85-318,034, FILED 5-11-2011.

SKYE YOUNG, EXAMINING ATTORNEY



David J. Kybas

Director of the United States Patent and Trademark Office

United States of America

United States Patent and Trademark Office

LIGHTHOUSE

Reg. No. 4,173,945

DOMTAR PAPER COMPANY, LLC (DELAWARE LIMITED LIABILITY COMPANY)
100 KINGSLEY PARK DRIVE
FORT MILL, SC 29175

Registered July 17, 2012

Int. Cl.: 1

FOR: GROUNDWOOD PULP; PAPER PULP; PAPER PULP FOR MANUFACTURING PURPOSES, IN CLASS 1 (U.S. CLS. 1, 5, 6, 10, 26 AND 46).

TRADEMARK

FIRST USE 8-15-2011; IN COMMERCE 8-15-2011.

PRINCIPAL REGISTER

THE MARK CONSISTS OF STANDARD CHARACTERS WITHOUT CLAIM TO ANY PARTICULAR FONT, STYLE, SIZE, OR COLOR.

SER. NO. 85-318,070, FILED 5-11-2011.

MATTHEW MCDOWELL, EXAMINING ATTORNEY



David J. Kyffers

Director of the United States Patent and Trademark Office

United States of America

United States Patent and Trademark Office

Do it, Wear it

Reg. No. 4,173,946

DIVEGEAR, LLC (GEORGIA LIMITED LIABILITY COMPANY)
209 HUDSON TRACE
AUGUSTA, GA 30907

Registered July 17, 2012

Int. Cl.: 25

FOR: ATHLETIC APPAREL, NAMELY, SHIRTS, PANTS, JACKETS, FOOTWEAR, HATS AND CAPS, ATHLETIC UNIFORMS, IN CLASS 25 (U.S. CLS. 22 AND 39).

TRADEMARK

FIRST USE 2-2-2011; IN COMMERCE 2-2-2011.

PRINCIPAL REGISTER

THE MARK CONSISTS OF STANDARD CHARACTERS WITHOUT CLAIM TO ANY PARTICULAR FONT, STYLE, SIZE, OR COLOR.

SER. NO. 85-318,304, FILED 5-11-2011.

EDWARD NELSON, EXAMINING ATTORNEY



David J. Kyffers

Director of the United States Patent and Trademark Office

United States of America

United States Patent and Trademark Office

PrayerCords

Reg. No. 4,173,947

Registered July 17, 2012

Int. Cl.: 45

SERVICE MARK

PRINCIPAL REGISTER

STRATEGIC PRAYER INITIATIVE, INC. (ILLINOIS CORPORATION)
1C
84 PINE AVE.
RIVERSIDE, IL 60546

FOR: CHARITABLE OUTREACH SERVICES, NAMELY, PROVIDING COUNSELING SERVICES IN THE FIELD OF RELIGION; CHRISTIAN MINISTRY SERVICES; CONDUCTING RELIGIOUS PRAYER SERVICES; COUNSELING SERVICES IN THE FIELD OF CHRISTIAN CONDUCT IN PERSONAL RELATIONSHIPS; MINISTERIAL SERVICES, NAMELY, HOLDING SPIRITUAL RETREATS TO ASSIST RELIGIOUS LEADERS, BOTH CLERGY AND LAY, TO DEVELOP AND ENHANCE THEIR SPIRITUAL LIVES; ORGANIZING AND CONDUCTING SUPPORT GROUPS IN THE FIELD OF RELIGION; PROVIDING A WEB SITE FEATURING INFORMATION ABOUT RELIGION; PROVIDING A WEBSITE FEATURING INFORMATION ABOUT RELIGIOUS BELIEF SYSTEMS; PROVIDING A WEBSITE FEATURING INFORMATION FOR LOCAL CHURCH LEADERS IN THE FIELD OF CHRISTIAN GROWTH; RELIGIOUS AND SPIRITUAL SERVICES, NAMELY, CONDUCTING RELIGIOUS WORSHIP, MARRIAGE CEREMONIES, BAPTISMAL CEREMONIES, BABY DEDICATIONS, BEREAVEMENT CEREMONIES, AND RELIGIOUS COUNSELING; RELIGIOUS AND SPIRITUAL SERVICES, NAMELY, PROVIDING GATHERINGS AND RETREATS TO DEVELOP AND ENHANCE THE SPIRITUAL LIVES OF INDIVIDUALS; RELIGIOUS SERVICES, NAMELY, PRAYER MEETINGS, IN CLASS 45 (U.S. CLS. 100 AND 101).

FIRST USE 3-1-2004; IN COMMERCE 3-1-2004.

THE MARK CONSISTS OF STANDARD CHARACTERS WITHOUT CLAIM TO ANY PARTICULAR FONT, STYLE, SIZE, OR COLOR.

SER. NO. 85-318,418, FILED 5-11-2011.

DEIRDRE ROBERTSON, EXAMINING ATTORNEY



David J. Kyjars

Director of the United States Patent and Trademark Office

United States of America

United States Patent and Trademark Office

INCLUSION FIRST

Reg. No. 4,173,948

Registered July 17, 2012

Int. Cl.: 35

SERVICE MARK

PRINCIPAL REGISTER

JEFF CARMICHAEL (CANADA INDIVIDUAL)
17 PARRAVANO COURT
TORONTO, ONTARIO, CANADA M2R3S8

FOR: ASSOCIATION SERVICES, NAMELY, PROMOTING THE PUBLIC INTEREST OF THE BENEFITS OF INCLUSIVITY IN SOCIETY; PROMOTING PUBLIC AWARENESS OF THE BENEFITS OF INCLUSIVITY IN SOCIETY, AND PARTICULARLY AMONG YOUTH, THROUGH THE SUPPORT OF HUMAN RIGHTS AND THE RIGHTS OF ALL INDIVIDUALS, IN CLASS 35 (U.S. CLS. 100, 101 AND 102).

FIRST USE 7-19-2011; IN COMMERCE 7-19-2011.

THE MARK CONSISTS OF STANDARD CHARACTERS WITHOUT CLAIM TO ANY PARTICULAR FONT, STYLE, SIZE, OR COLOR.

NO CLAIM IS MADE TO THE EXCLUSIVE RIGHT TO USE "INCLUSION", APART FROM THE MARK AS SHOWN.

SER. NO. 85-318,520, FILED 5-11-2011.

RAUL CORDOVA, EXAMINING ATTORNEY



David J. Kyffers

Director of the United States Patent and Trademark Office

United States of America

United States Patent and Trademark Office

SPI

Reg. No. 4,173,949

Registered July 17, 2012

Int. Cl.: 45

SERVICE MARK

PRINCIPAL REGISTER

STRATEGIC PRAYER INITIATIVE, INC. (ILLINOIS CORPORATION)
1C
84 PINE AVE.
RIVERSIDE, IL 60546

FOR: CHARITABLE OUTREACH SERVICES, NAMELY, PROVIDING COUNSELING SERVICES IN THE FIELD OF RELIGION; CHRISTIAN MINISTRY SERVICES; CONDUCTING RELIGIOUS PRAYER SERVICES; COUNSELING SERVICES IN THE FIELD OF CHRISTIAN CONDUCT IN PERSONAL RELATIONSHIPS; MINISTERIAL SERVICES, NAMELY, HOLDING SPIRITUAL RETREATS TO ASSIST RELIGIOUS LEADERS, BOTH CLERGY AND LAY, TO DEVELOP AND ENHANCE THEIR SPIRITUAL LIVES; ORGANIZING AND CONDUCTING SUPPORT GROUPS IN THE FIELD OF RELIGION; PROVIDING A WEB SITE FEATURING INFORMATION ABOUT RELIGION; PROVIDING A WEBSITE FEATURING INFORMATION ABOUT RELIGIOUS BELIEF SYSTEMS; PROVIDING A WEBSITE FEATURING INFORMATION FOR LOCAL CHURCH LEADERS IN THE FIELD OF CHRISTIAN GROWTH; RELIGIOUS AND SPIRITUAL SERVICES, NAMELY, CONDUCTING RELIGIOUS WORSHIP, MARRIAGE CEREMONIES, BAPTISMAL CEREMONIES, BABY DEDICATIONS, BEREAVEMENT CEREMONIES, AND RELIGIOUS COUNSELING; RELIGIOUS AND SPIRITUAL SERVICES, NAMELY, PROVIDING GATHERINGS AND RETREATS TO DEVELOP AND ENHANCE THE SPIRITUAL LIVES OF INDIVIDUALS; RELIGIOUS SERVICES, NAMELY, PRAYER MEETINGS, IN CLASS 45 (U.S. CLS. 100 AND 101).

FIRST USE 3-1-2004; IN COMMERCE 10-1-2004.

THE MARK CONSISTS OF STANDARD CHARACTERS WITHOUT CLAIM TO ANY PARTICULAR FONT, STYLE, SIZE, OR COLOR.

SER. NO. 85-318,551, FILED 5-11-2011.

DEIRDRE ROBERTSON, EXAMINING ATTORNEY



David J. Kybas

Director of the United States Patent and Trademark Office

United States of America

United States Patent and Trademark Office

MARS HILL GRADUATE SCHOOL

Reg. No. 4,173,950

Registered July 17, 2012

Int. Cl.: 41

SERVICE MARK

PRINCIPAL REGISTER

THE SEATTLE SCHOOL OF THEOLOGY AND PSYCHOLOGY (WASHINGTON CORPORATION)
2501 ELLIOTT AVENUE
SEATTLE, WA 98121

FOR: ALUMNI SERVICES, NAMELY, PROVIDING COURSES OF CONTINUING EDUCATION AT THE COLLEGE LEVEL TO ALUMNI AND OTHERS IN THE FIELDS OF RELIGION AND COUNSELING PSYCHOLOGY, IN CLASS 41 (U.S. CLS. 100, 101 AND 107).

FIRST USE 1-1-1999; IN COMMERCE 1-1-1999.

THE MARK CONSISTS OF STANDARD CHARACTERS WITHOUT CLAIM TO ANY PARTICULAR FONT, STYLE, SIZE, OR COLOR.

NO CLAIM IS MADE TO THE EXCLUSIVE RIGHT TO USE "GRADUATE SCHOOL", APART FROM THE MARK AS SHOWN.

SER. NO. 85-318,557, FILED 5-11-2011.

KIM SAITO, EXAMINING ATTORNEY



David J. Kyffers

Director of the United States Patent and Trademark Office

United States of America

United States Patent and Trademark Office

OLD SOUTH CHIC'N'RIBS ROTISSERIE

Reg. No. 4,173,951

Registered July 17, 2012

Int. Cl.: 43

OLD SOUTH CHIC'N'RIBS ROTISSERIE INC. (DELAWARE CORPORATION), DBA OLD
SOUTH CHIC'N'RIBS
2500 WINDING CREEK
#G207
CLEARWATER, FL 33761

SERVICE MARK

FOR: RESTAURANT SERVICES, IN CLASS 43 (U.S. CLS. 100 AND 101).

PRINCIPAL REGISTER

FIRST USE 5-1-2010; IN COMMERCE 7-30-2010.

THE MARK CONSISTS OF STANDARD CHARACTERS WITHOUT CLAIM TO ANY PARTICULAR FONT, STYLE, SIZE, OR COLOR.

NO CLAIM IS MADE TO THE EXCLUSIVE RIGHT TO USE "ROTISSERIE", APART FROM THE MARK AS SHOWN.

SER. NO. 85-318,762, FILED 5-12-2011.

KYLE PEETE, EXAMINING ATTORNEY



David J. Kyffers

Director of the United States Patent and Trademark Office

United States of America

United States Patent and Trademark Office



Better Schools

Reg. No. 4,173,952

Registered July 17, 2012

**Int. Cls.: 35, 36, 37 and
42**

SERVICE MARK

PRINCIPAL REGISTER

AMERESCO CANADA, INC. (CANADA CORPORATION)
90 SHEPPARD AVENUE EAST,
TORONTO, ONTARIO, CANADA M2N6X3

FOR: BUSINESS SERVICES, NAMELY, OPERATING ENERGY GENERATING PLANTS AND PLANTS THAT CONVERT ONE FORM OF ENERGY TO ANOTHER ON BEHALF OF OTHERS; PROCURING OF CONTRACTS FOR THE PURCHASE AND SALE OF ENERGY ON BEHALF OF OTHERS, BUSINESS RISK MANAGEMENT AS IT RELATES TO ENERGY PROCUREMENT, COLLECTING AND ANALYZING DATA AND REPORTING TO ENABLE CONSUMERS AND BUSINESSES TO EVALUATE THEIR ENERGY USAGE AND CONSUMPTION, IN CLASS 35 (U.S. CLS. 100, 101 AND 102).

FOR: FINANCING OF INSTITUTIONAL, GOVERNMENT AND COMMERCIAL BUILDING PROJECTS THAT IMPROVE THE EFFICIENT USE OF ENERGY; FINANCIAL RISK MANAGEMENT AS IT RELATES TO ENERGY PROCUREMENT, IN CLASS 36 (U.S. CLS. 100, 101 AND 102).

FOR: CONSTRUCTION OF INSTITUTIONAL, GOVERNMENT AND COMMERCIAL BUILDING PROJECTS THAT IMPROVE THE EFFICIENT USE OF ENERGY, IN CLASS 37 (U.S. CLS. 100, 103 AND 106).

FOR: DESIGN OF INSTITUTIONAL, GOVERNMENT AND COMMERCIAL BUILDING PROJECTS THAT IMPROVE THE EFFICIENT USE OF ENERGY, IN CLASS 42 (U.S. CLS. 100 AND 101).

OWNER OF CANADA REG. NO. TMA720,153, DATED 8-1-2008, EXPIRES 8-1-2023.

NO CLAIM IS MADE TO THE EXCLUSIVE RIGHT TO USE "BETTER SCHOOLS", APART FROM THE MARK AS SHOWN.

THE MARK CONSISTS OF THE WORDS "BETTER SCHOOLS" AND A RECTANGLE RESEMBLING A WINDOW WITH FOUR (4) OUTSTRETCHED ARMS AND HANDS THEREIN.

SER. NO. 85-318,945, FILED 5-12-2011.

BARBARA RUTLAND, EXAMINING ATTORNEY



David J. Kyffers

Director of the United States Patent and Trademark Office

United States of America

United States Patent and Trademark Office

The Examination Station

Reg. No. 4,173,953

THOMPSON, JIMMIE (UNITED STATES INDIVIDUAL)
497 HUNTER AVENUE
TWIN FALLS, ID 83301

Registered July 17, 2012

Int. Cl.: 44

FOR: MEDICAL CLINICS, IN CLASS 44 (U.S. CLS. 100 AND 101).

SERVICE MARK

FIRST USE 3-3-2006; IN COMMERCE 3-15-2006.

PRINCIPAL REGISTER

THE MARK CONSISTS OF STANDARD CHARACTERS WITHOUT CLAIM TO ANY PARTICULAR FONT, STYLE, SIZE, OR COLOR.

NO CLAIM IS MADE TO THE EXCLUSIVE RIGHT TO USE "EXAMINATION", APART FROM THE MARK AS SHOWN.

SEC. 2(F).

SER. NO. 85-319,015, FILED 5-12-2011.

DAVID YONTEF, EXAMINING ATTORNEY



David J. Kyffers

Director of the United States Patent and Trademark Office

United States of America

United States Patent and Trademark Office

PERSONAL FACTORY

Reg. No. 4,173,954

PONOKO LIMITED (NEW ZEALAND LIMITED COMPANY (LTD.))
LEVEL 27, 88 SHORTLAND STREET
AUCKLAND, NEW ZEALAND

Registered July 17, 2012

Int. Cls.: 35, 40 and 42

FOR: BUSINESS MANAGEMENT AND ADVICE; BUSINESS FACILITATION, NAMELY, FACILITATING OF COMMUNICATION BETWEEN AND AMONG CONSUMERS, PRODUCT DESIGNERS, SOFTWARE APPLICATION DEVELOPERS AND PRODUCT MANUFACTURERS FOR THE PROCUREMENT OF CONTRACTS FOR OTHERS FOR THE DESIGN, CUSTOMIZATION AND MANUFACTURE OF PRODUCTS; ADVERTISING; INFORMATION SERVICES RELATING TO THE ABOVE, IN CLASS 35 (U.S. CLS. 100, 101 AND 102).

SERVICE MARK

PRINCIPAL REGISTER

FOR: TREATMENT OF MATERIALS BY LASER BEAM, WATER JETTING, 3D PRINTING AND COMPUTER NUMERICAL CONTROL (CNC) ROUTING; TREATMENT OF MATERIALS, NAMELY, ARTICLES OF STONE, METAL, WOOD, PLASTIC, FABRIC, LEATHER, CARDBOARD, PAPER, RUBBER AND GLASS OR SOME COMBINATION OF SUCH MATERIALS; CUSTOM MANUFACTURING OF PRODUCTS MADE OF STONE, METAL, WOOD, PLASTIC, FABRIC, LEATHER, CARDBOARD, PAPER, RUBBER AND GLASS OR SOME COMBINATION OF SUCH MATERIALS; ASSEMBLY OF PRODUCTS FOR OTHERS; INFORMATION SERVICES RELATING TO THE ABOVE, IN CLASS 40 (U.S. CLS. 100, 103 AND 106).

FOR: PRODUCT DESIGN AND DEVELOPMENT SERVICES; DESIGN AND DEVELOPMENT OF COMPUTER HARDWARE AND SOFTWARE; INFORMATION SERVICES RELATING TO THE ABOVE, IN CLASS 42 (U.S. CLS. 100 AND 101).



THE MARK CONSISTS OF STANDARD CHARACTERS WITHOUT CLAIM TO ANY PARTICULAR FONT, STYLE, SIZE, OR COLOR.

PRIORITY CLAIMED UNDER SEC. 44(D) ON NEW ZEALAND APPLICATION NO. 833450, FILED 11-17-2010, REG. NO. 833450, DATED 11-17-2010, EXPIRES 11-17-2020.

NO CLAIM IS MADE TO THE EXCLUSIVE RIGHT TO USE "FACTORY", APART FROM THE MARK AS SHOWN.

SER. NO. 85-319,094, FILED 5-12-2011.

MICHAEL ENGEL, EXAMINING ATTORNEY

David J. Kyffers

Director of the United States Patent and Trademark Office

United States of America

United States Patent and Trademark Office

CUSTOM BUILDER

Reg. No. 4,173,955

Registered July 17, 2012

Int. Cls.: 9, 16 and 41

TRADEMARK

SERVICE MARK

PRINCIPAL REGISTER

SGC HORIZON, LLC (ILLINOIS LIMITED LIABILITY COMPANY)
SUITE 201
3030 W. SALT CREEK LANE
ARLINGTON HEIGHTS, IL 60005

FOR: DOWNLOADABLE ELECTRONIC PUBLICATIONS IN THE NATURE OF MAGAZINES IN THE FIELD OF THE BUILDING, DESIGN AND CONSTRUCTION INDUSTRY AND BUILDING, DESIGN AND CONSTRUCTION; DOWNLOADABLE ELECTRONIC NEWSLETTERS DELIVERED BY E-MAIL IN THE FIELD OF THE BUILDING, DESIGN AND CONSTRUCTION INDUSTRY AND BUILDING, DESIGN AND CONSTRUCTION, IN CLASS 9 (U.S. CLS. 21, 23, 26, 36 AND 38).

FIRST USE 1-31-2005; IN COMMERCE 1-31-2005.

FOR: PRINTED PUBLICATIONS, NAMELY, MAGAZINES AND MAGAZINE SUPPLEMENTS FEATURING NEWS AND INFORMATION RELATING TO THE BUILDING, DESIGN AND CONSTRUCTION INDUSTRY AND BUILDING, DESIGN AND CONSTRUCTION, IN CLASS 16 (U.S. CLS. 2, 5, 22, 23, 29, 37, 38 AND 50).

FIRST USE 1-31-2005; IN COMMERCE 1-31-2005.

FOR: PROVIDING A WEBSITE FEATURING RESOURCES, NAMELY, NON-DOWNLOADABLE PUBLICATIONS IN THE NATURE OF MAGAZINES IN THE FIELD OF THE BUILDING, DESIGN AND CONSTRUCTION INDUSTRY AND BUILDING, DESIGN AND CONSTRUCTION, IN CLASS 41 (U.S. CLS. 100, 101 AND 107).

FIRST USE 1-31-2005; IN COMMERCE 1-31-2005.

THE MARK CONSISTS OF STANDARD CHARACTERS WITHOUT CLAIM TO ANY PARTICULAR FONT, STYLE, SIZE, OR COLOR.

OWNER OF U.S. REG. NO. 2,950,574.

SEC. 2(F).

SER. NO. 85-319,116, FILED 5-12-2011.



David J. Kyffers

Director of the United States Patent and Trademark Office

Reg. No. 4,173,955 THEODORE MCBRIDE, EXAMINING ATTORNEY

United States of America

United States Patent and Trademark Office



Reg. No. 4,173,956

MARVEL CHARACTERS, INC. (DELAWARE CORPORATION)
1600 ROSECRANS AVENUE
MANHATTAN BEACH, CA 90266

Registered July 17, 2012

Int. Cl.: 16

TRADEMARK

PRINCIPAL REGISTER

FOR: ALBUMS FOR STICKERS; BOOK COVERS; BOOK MARKS; CALENDARS; CARDS, NAMELY, VALENTINE CARDS FOR EXCHANGE; CHILDREN'S ACTIVITY BOOKS; COLORING BOOKS; COMIC BOOKS; COMIC STRIPS; DECALS; DIARIES; FOLDERS; GREETING CARDS; LUNCH BAGS MADE OF TEXTILE; MAGAZINES FEATURING PRINTED STORIES IN ILLUSTRATED FORM AND COMIC BOOK STORIES AND ARTWORK; PAPER NAPKINS; PAPER PARTY DECORATIONS; PAPER PARTY FAVORS; PAPER TABLECLOTHS; PARTY GOODIE BAGS OF PAPER OR PLASTIC; POSTERS; PRINTED INVITATIONS; PRINTED PERIODICALS IN THE FIELD OF COMIC BOOK STORIES AND ARTWORK; PRINTED VISUALS IN THE NATURE OF COMIC BOOK STORIES AND ARTWORK; SERIES OF FICTION BOOKS; STICKERS; TEMPORARY TATTOOS; TRADING CARDS, IN CLASS 16 (U.S. CLS. 2, 5, 22, 23, 29, 37, 38 AND 50).

FIRST USE 9-1-2001; IN COMMERCE 9-1-2001.

OWNER OF U.S. REG. NOS. 870,506, 3,116,241 AND OTHERS.

THE COLOR(S) RED AND WHITE IS/ARE CLAIMED AS A FEATURE OF THE MARK.

THE MARK CONSISTS OF THE WORD "MARVEL" IN WHITE LETTERS IN A RED RECTANGLE.

SER. NO. 85-319,220, FILED 5-12-2011.

MARC LEIPZIG, EXAMINING ATTORNEY



David J. Kyffers

Director of the United States Patent and Trademark Office

United States of America

United States Patent and Trademark Office

PRECISION ANIMAL AGRICULTURE

Reg. No. 4,173,957

ENVIRO-AG ENGINEERING, INC. (TEXAS CORPORATION)
3404 AIRWAY BLVD.

Registered July 17, 2012

AMARILLO, TX 79118

Int. Cl.: 35

FOR: DATA MANAGEMENT SERVICES FOR USE BY CONCENTRATED ANIMAL FEEDING OPERATIONS IN THE FIELDS OF ENVIRONMENTAL AND WASTE MANAGEMENT AND NOT PERTAINING TO NUTRIENT LEVELS IN FEED, IN CLASS 35 (U.S. CLS. 100, 101 AND 102).

SERVICE MARK

PRINCIPAL REGISTER

FIRST USE 2-23-2011; IN COMMERCE 2-23-2011.

THE MARK CONSISTS OF STANDARD CHARACTERS WITHOUT CLAIM TO ANY PARTICULAR FONT, STYLE, SIZE, OR COLOR.

NO CLAIM IS MADE TO THE EXCLUSIVE RIGHT TO USE "ANIMAL AGRICULTURE", APART FROM THE MARK AS SHOWN.

SER. NO. 85-319,242, FILED 5-12-2011.

ELISSA GARBER KON, EXAMINING ATTORNEY



David J. Kyffers

Director of the United States Patent and Trademark Office

United States of America

United States Patent and Trademark Office



Better Campuses

Reg. No. 4,173,958

Registered July 17, 2012

**Int. Cls.: 35, 36, 37 and
42**

SERVICE MARK

PRINCIPAL REGISTER

AMERESCO CANADA, INC. (CANADA CORPORATION)
90 SHEPPARD AVENUE EAST,
TORONTO, ONTARIO, CANADA M2N6X3

FOR: BUSINESS SERVICES, NAMELY, OPERATING ENERGY GENERATING PLANTS AND PLANTS THAT CONVERT ONE FORM OF ENERGY TO ANOTHER ON BEHALF OF OTHERS; PROCURING OF CONTRACTS FOR THE PURCHASE AND SALE OF ENERGY ON BEHALF OF OTHERS, BUSINESS RISK MANAGEMENT AS IT RELATES TO ENERGY PROCUREMENT, COLLECTING AND ANALYZING DATA AND REPORTING TO ENABLE CONSUMERS AND BUSINESSES TO EVALUATE THEIR ENERGY USAGE AND CONSUMPTION, IN CLASS 35 (U.S. CLS. 100, 101 AND 102).

FOR: FINANCING OF INSTITUTIONAL, GOVERNMENT AND COMMERCIAL BUILDING PROJECTS THAT IMPROVE THE EFFICIENT USE OF ENERGY; FINANCIAL RISK MANAGEMENT AS IT RELATES TO ENERGY PROCUREMENT, IN CLASS 36 (U.S. CLS. 100, 101 AND 102).

FOR: CONSTRUCTION OF INSTITUTIONAL, GOVERNMENT AND COMMERCIAL BUILDING PROJECTS THAT IMPROVE THE EFFICIENT USE OF ENERGY, IN CLASS 37 (U.S. CLS. 100, 103 AND 106).

FOR: DESIGN OF INSTITUTIONAL, GOVERNMENT AND COMMERCIAL BUILDING PROJECTS THAT IMPROVE THE EFFICIENT USE OF ENERGY, IN CLASS 42 (U.S. CLS. 100 AND 101).

OWNER OF CANADA REG. NO. TMA719501, DATED 7-28-2008, EXPIRES 7-28-2023.

NO CLAIM IS MADE TO THE EXCLUSIVE RIGHT TO USE "BETTER CAMPUSES", APART FROM THE MARK AS SHOWN.

THE MARK CONSISTS OF THE WORDS "BETTER CAMPUSES" AND A RECTANGLE WITH A MORTARBOARD AND TASSEL THEREIN.

SER. NO. 85-319,273, FILED 5-12-2011.

BARBARA RUTLAND, EXAMINING ATTORNEY



David J. Kyjars

Director of the United States Patent and Trademark Office

United States of America

United States Patent and Trademark Office



Better Housing

Reg. No. 4,173,959

Registered July 17, 2012

**Int. Cls.: 35, 36, 37 and
42**

SERVICE MARK

PRINCIPAL REGISTER

AMERESCO CANADA, INC. (CANADA CORPORATION)
90 SHEPPARD AVENUE EAST,
TORONTO, ONTARIO, CANADA M2N6X3

FOR: BUSINESS SERVICES, NAMELY, OPERATING ENERGY GENERATING PLANTS AND PLANTS THAT CONVERT ONE FORM OF ENERGY TO ANOTHER ON BEHALF OF OTHERS; PROCURING OF CONTRACTS FOR THE PURCHASE AND SALE OF ENERGY ON BEHALF OF OTHERS, BUSINESS RISK MANAGEMENT AS IT RELATES TO ENERGY PROCUREMENT, COLLECTING AND ANALYZING DATA AND REPORTING TO ENABLE CONSUMERS AND BUSINESSES TO EVALUATE THEIR ENERGY USAGE AND CONSUMPTION, IN CLASS 35 (U.S. CLS. 100, 101 AND 102).

FOR: FINANCING OF INSTITUTIONAL, GOVERNMENT AND COMMERCIAL BUILDING PROJECTS THAT IMPROVE THE EFFICIENT USE OF ENERGY; FINANCIAL RISK MANAGEMENT AS IT RELATES TO ENERGY PROCUREMENT, IN CLASS 36 (U.S. CLS. 100, 101 AND 102).

FOR: CONSTRUCTION OF INSTITUTIONAL, GOVERNMENT AND COMMERCIAL BUILDING PROJECTS THAT IMPROVE THE EFFICIENT USE OF ENERGY, IN CLASS 37 (U.S. CLS. 100, 103 AND 106).

FOR: DESIGN OF INSTITUTIONAL, GOVERNMENT AND COMMERCIAL BUILDING PROJECTS THAT IMPROVE THE EFFICIENT USE OF ENERGY, IN CLASS 42 (U.S. CLS. 100 AND 101).

OWNER OF CANADA REG. NO. TMA719502, DATED 7-28-2008, EXPIRES 7-28-2023.

NO CLAIM IS MADE TO THE EXCLUSIVE RIGHT TO USE "BETTER HOUSING", APART FROM THE MARK AS SHOWN.

THE MARK CONSISTS OF THE WORDS "BETTER HOUSING" AND A RECTANGLE RESEMBLING A WINDOW WITH A POTTED PLANT THEREIN.

SER. NO. 85-319,390, FILED 5-12-2011.

BARBARA RUTLAND, EXAMINING ATTORNEY



David J. Kyffers

Director of the United States Patent and Trademark Office

United States of America

United States Patent and Trademark Office



Better Municipalities

Reg. No. 4,173,960

Registered July 17, 2012

**Int. Cls.: 35, 36, 37 and
42**

SERVICE MARK

PRINCIPAL REGISTER

AMERESCO CANADA, INC. (CANADA CORPORATION)
90 SHEPPARD AVENUE EAST,
TORONTO, ONTARIO, CANADA M2N6X3

FOR: BUSINESS SERVICES, NAMELY, OPERATING ENERGY GENERATING PLANTS AND PLANTS THAT CONVERT ONE FORM OF ENERGY TO ANOTHER ON BEHALF OF OTHERS; PROCURING OF CONTRACTS FOR THE PURCHASE AND SALE OF ENERGY ON BEHALF OF OTHERS, BUSINESS RISK MANAGEMENT AS IT RELATES TO ENERGY PROCUREMENT, COLLECTING AND ANALYZING DATA AND REPORTING TO ENABLE CONSUMERS AND BUSINESSES TO EVALUATE THEIR ENERGY USAGE AND CONSUMPTION, IN CLASS 35 (U.S. CLS. 100, 101 AND 102).

FOR: FINANCING OF INSTITUTIONAL, GOVERNMENT AND COMMERCIAL BUILDING PROJECTS THAT IMPROVE THE EFFICIENT USE OF ENERGY; FINANCIAL RISK MANAGEMENT AS IT RELATES TO ENERGY PROCUREMENT, IN CLASS 36 (U.S. CLS. 100, 101 AND 102).

FOR: CONSTRUCTION OF INSTITUTIONAL, GOVERNMENT AND COMMERCIAL BUILDING PROJECTS THAT IMPROVE THE EFFICIENT USE OF ENERGY, IN CLASS 37 (U.S. CLS. 100, 103 AND 106).

FOR: DESIGN OF INSTITUTIONAL, GOVERNMENT AND COMMERCIAL BUILDING PROJECTS THAT IMPROVE THE EFFICIENT USE OF ENERGY, IN CLASS 42 (U.S. CLS. 100 AND 101).

OWNER OF CANADA REG. NO. TMA720146, DATED 8-1-2008, EXPIRES 8-1-2023.

NO CLAIM IS MADE TO THE EXCLUSIVE RIGHT TO USE "BETTER MUNICIPALITIES", APART FROM THE MARK AS SHOWN.

THE MARK CONSISTS OF THE WORDS "BETTER MUNICIPALITIES" AND A RECTANGLE DEPICTING A CLOCK TOWER, WITH FLAG ATOP, THEREIN.

SER. NO. 85-319,487, FILED 5-12-2011.

BARBARA RUTLAND, EXAMINING ATTORNEY



David J. Kyjars

Director of the United States Patent and Trademark Office

United States of America

United States Patent and Trademark Office

WAX

Reg. No. 4,173,961

Registered July 17, 2012

Int. Cl.: 9

TRADEMARK

PRINCIPAL REGISTER

SCRUBLIFE, INC. (CALIFORNIA CORPORATION)
C/O FOX ROTHSCHILD LLP
P.O. BOX 5231
PRINCETON, NJ 085435231

FOR: DOWNLOADABLE MUSICAL SOUND RECORDINGS; MUSICAL SOUND RECORDINGS, IN CLASS 9 (U.S. CLS. 21, 23, 26, 36 AND 38).

FIRST USE 12-13-2006; IN COMMERCE 12-13-2006.

THE MARK CONSISTS OF STANDARD CHARACTERS WITHOUT CLAIM TO ANY PARTICULAR FONT, STYLE, SIZE, OR COLOR.

SER. NO. 85-319,536, FILED 5-12-2011.

NORA BUCHANAN WILL, EXAMINING ATTORNEY



David J. Kyffers

Director of the United States Patent and Trademark Office

United States of America

United States Patent and Trademark Office



Better Healthcare

Reg. No. 4,173,962

Registered July 17, 2012

**Int. Cls.: 35, 36, 37 and
42**

SERVICE MARK

PRINCIPAL REGISTER

AMERESCO CANADA, INC. (CANADA CORPORATION)
90 SHEPPARD AVENUE EAST,
TORONTO, ONTARIO, CANADA M2N6X3

FOR: BUSINESS SERVICES, NAMELY, OPERATING ENERGY GENERATING PLANTS AND PLANTS THAT CONVERT ONE FORM OF ENERGY TO ANOTHER ON BEHALF OF OTHERS; PROCURING OF CONTRACTS FOR THE PURCHASE AND SALE OF ENERGY ON BEHALF OF OTHERS, BUSINESS RISK MANAGEMENT AS IT RELATES TO ENERGY PROCUREMENT, COLLECTING AND ANALYZING DATA AND REPORTING TO ENABLE CONSUMERS AND BUSINESSES TO EVALUATE THEIR ENERGY USAGE AND CONSUMPTION, IN CLASS 35 (U.S. CLS. 100, 101 AND 102).

FOR: FINANCING OF INSTITUTIONAL, GOVERNMENT AND COMMERCIAL BUILDING PROJECTS THAT IMPROVE THE EFFICIENT USE OF ENERGY; FINANCIAL RISK MANAGEMENT AS IT RELATES TO ENERGY PROCUREMENT, IN CLASS 36 (U.S. CLS. 100, 101 AND 102).

FOR: CONSTRUCTION OF INSTITUTIONAL, GOVERNMENT AND COMMERCIAL BUILDING PROJECTS THAT IMPROVE THE EFFICIENT USE OF ENERGY, IN CLASS 37 (U.S. CLS. 100, 103 AND 106).

FOR: DESIGN OF INSTITUTIONAL, GOVERNMENT AND COMMERCIAL BUILDING PROJECTS THAT IMPROVE THE EFFICIENT USE OF ENERGY, IN CLASS 42 (U.S. CLS. 100 AND 101).

OWNER OF CANADA REG. NO. TMA720145, DATED 8-1-2008, EXPIRES 8-1-2023.

NO CLAIM IS MADE TO THE EXCLUSIVE RIGHT TO USE "BETTER HEALTHCARE", APART FROM THE MARK AS SHOWN.

THE MARK CONSISTS OF THE WORDS "BETTER HEALTHCARE" AND A RECTANGLE WITH A STETHOSCOPE THEREIN.

SER. NO. 85-319,606, FILED 5-12-2011.

BARBARA RUTLAND, EXAMINING ATTORNEY



David J. Kyffers

Director of the United States Patent and Trademark Office

United States of America

United States Patent and Trademark Office

BETTY DAIN SIGNATURE

Reg. No. 4,173,963

Registered July 17, 2012

Int. Cls.: 21 and 25

TRADEMARK

PRINCIPAL REGISTER

BETTY DAIN CREATIONS, LLC. (FLORIDA LIMITED LIABILITY COMPANY)
9701 NW 112 AVENUE, SUITE 10
MIAMI, FL 33178

FOR: HAIR BRUSHES, IN CLASS 21 (U.S. CLS. 2, 13, 23, 29, 30, 33, 40 AND 50).

FIRST USE 5-0-2010; IN COMMERCE 7-0-2010.

FOR: CAPES, APRONS, GOWNS, ROBES, WRAPS, VESTS AND JACKETS FOR USE IN SALONS AND BARBER SHOPS, IN CLASS 25 (U.S. CLS. 22 AND 39).

FIRST USE 5-0-2010; IN COMMERCE 7-0-2010.

THE MARK CONSISTS OF STANDARD CHARACTERS WITHOUT CLAIM TO ANY PARTICULAR FONT, STYLE, SIZE, OR COLOR.

THE NAME(S), PORTRAIT(S), AND/OR SIGNATURE(S) SHOWN IN THE MARK DOES NOT IDENTIFY A PARTICULAR LIVING INDIVIDUAL.

SER. NO. 85-319,631, FILED 5-12-2011.

KAELIE KUNG, EXAMINING ATTORNEY



David J. Kyffers

Director of the United States Patent and Trademark Office

United States of America

United States Patent and Trademark Office

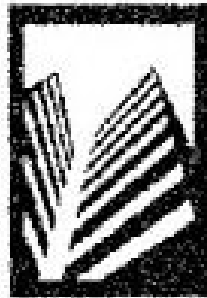

Better Facilities

Reg. No. 4,173,964

Registered July 17, 2012

**Int. Cls.: 35, 36, 37 and
42**

SERVICE MARK

PRINCIPAL REGISTER

AMERESCO CANADA, INC. (CANADA CORPORATION)
90 SHEPPARD AVENUE EAST,
TORONTO, ONTARIO, CANADA M2N6X3

FOR: BUSINESS SERVICES, NAMELY, OPERATING ENERGY GENERATING PLANTS AND PLANTS THAT CONVERT ONE FORM OF ENERGY TO ANOTHER ON BEHALF OF OTHERS; PROCURING OF CONTRACTS FOR THE PURCHASE AND SALE OF ENERGY ON BEHALF OF OTHERS, BUSINESS RISK MANAGEMENT AS IT RELATES TO ENERGY PROCUREMENT, COLLECTING AND ANALYZING DATA AND REPORTING TO ENABLE CONSUMERS AND BUSINESSES TO EVALUATE THEIR ENERGY USAGE AND CONSUMPTION, IN CLASS 35 (U.S. CLS. 100, 101 AND 102).

FOR: FINANCING OF INSTITUTIONAL, GOVERNMENT AND COMMERCIAL BUILDING PROJECTS THAT IMPROVE THE EFFICIENT USE OF ENERGY; FINANCIAL RISK MANAGEMENT AS IT RELATES TO ENERGY PROCUREMENT, IN CLASS 36 (U.S. CLS. 100, 101 AND 102).

FOR: CONSTRUCTION OF INSTITUTIONAL, GOVERNMENT AND COMMERCIAL BUILDING PROJECTS THAT IMPROVE THE EFFICIENT USE OF ENERGY, IN CLASS 37 (U.S. CLS. 100, 103 AND 106).

FOR: DESIGN OF INSTITUTIONAL, GOVERNMENT AND COMMERCIAL BUILDING PROJECTS THAT IMPROVE THE EFFICIENT USE OF ENERGY, IN CLASS 42 (U.S. CLS. 100 AND 101).

OWNER OF CANADA REG. NO. TMA720147, DATED 8-1-2008, EXPIRES 8-1-2023.

NO CLAIM IS MADE TO THE EXCLUSIVE RIGHT TO USE "BETTER FACILITIES", APART FROM THE MARK AS SHOWN.

THE MARK CONSISTS OF THE WORDS "BETTER FACILITIES" AND A RECTANGLE DEPICTING TWO (2) BUILDINGS THEREIN.

SER. NO. 85-319,633, FILED 5-12-2011.

BARBARA RUTLAND, EXAMINING ATTORNEY



David J. Kyffers

Director of the United States Patent and Trademark Office

United States of America

United States Patent and Trademark Office



Reg. No. 4,173,965

Registered July 17, 2012

Int. Cl.: 41

SERVICE MARK

PRINCIPAL REGISTER

APEX TIGERS MARTIAL ARTS, LLC (NEW JERSEY LIMITED LIABILITY COMPANY)
182 RIDGEDALE AVENUE
UNIT #7
FLORHAM PARK, NJ 07932

FOR: MARTIAL ARTS INSTRUCTION, IN CLASS 41 (U.S. CLS. 100, 101 AND 107).

FIRST USE 0-0-2009; IN COMMERCE 0-0-2009.

THE MARK CONSISTS OF A SERIES OF SWIRLING LINES SURROUNDED BY THREE CURVED BANDS. THE FIRST BAND ON THE LEFT IS RED, THE SECOND BAND ON THE RIGHT IS BLUE AND THE THIRD BAND IS BLACK UNDERNEATH APPEARS THE WORDS "APEX TIGERS".

THE COLOR(S) RED, BLUE AND BLACK IS/ARE CLAIMED AS A FEATURE OF THE MARK.

SER. NO. 85-319,855, FILED 5-12-2011.

CAROLYN CATALDO, EXAMINING ATTORNEY



David J. Kybas

Director of the United States Patent and Trademark Office

United States of America

United States Patent and Trademark Office

SIRCON

Reg. No. 4,173,966

Registered July 17, 2012

Int. Cls.: 36, 42 and 45

SERVICE MARK

PRINCIPAL REGISTER

SIRCON CORPORATION (DELAWARE CORPORATION)
2112 UNIVERSITY PARK DRIVE
OKEMOS, MI 48864

FOR: PROVIDING ON-LINE DATABASES AND REFERENCE INFORMATION IN THE FIELD OF INSURANCE, ALL FOR USE BY INSURANCE REGULATORY AGENCIES AND INSURANCE CARRIERS, AGENCIES, BROKERS, AND PRODUCERS, IN CLASS 36 (U.S. CLS. 100, 101 AND 102).

FIRST USE 10-4-2004; IN COMMERCE 10-4-2004.

FOR: PROVIDING ONLINE NON-DOWNLOADABLE SOFTWARE FOR USE IN ELECTRONICALLY MANAGING, PROCESSING, AND TRACKING INFORMATION IN THE FIELD OF INSURANCE; PROVIDING ONLINE NON-DOWNLOADABLE SOFTWARE THAT ENABLES USERS TO TRANSACT BUSINESS WITH INSURANCE REGULATORY AGENCIES IN THE FIELD OF INSURANCE, IN CLASS 42 (U.S. CLS. 100 AND 101).

FIRST USE 10-4-2004; IN COMMERCE 10-4-2004.

FOR: PROVIDING ON-LINE DATABASES AND REFERENCE INFORMATION IN THE FIELD OF REGULATORY COMPLIANCE IN THE INSURANCE INDUSTRY, ALL FOR USE BY INSURANCE REGULATORY AGENCIES AND INSURANCE CARRIERS, AGENCIES, BROKERS, AND PRODUCERS, IN CLASS 45 (U.S. CLS. 100 AND 101).

FIRST USE 10-4-2004; IN COMMERCE 10-4-2004.

THE MARK CONSISTS OF STANDARD CHARACTERS WITHOUT CLAIM TO ANY PARTICULAR FONT, STYLE, SIZE, OR COLOR.

OWNER OF U.S. REG. NOS. 2,397,583 AND 3,471,270.

SER. NO. 85-320,015, FILED 5-13-2011.

DAVID H. STINE, EXAMINING ATTORNEY



David J. Kyffers

Director of the United States Patent and Trademark Office

United States of America

United States Patent and Trademark Office

WAX

Reg. No. 4,173,967

Registered July 17, 2012

Int. Cl.: 9

TRADEMARK

PRINCIPAL REGISTER

SCRUBLIFE, INC. (CALIFORNIA CORPORATION)
C/O FOX ROTHSCHILD LLP
P.O. BOX 5231
PRINCETON, NJ 085435231

FOR: DOWNLOADABLE MUSICAL SOUND RECORDINGS; MUSICAL SOUND RECORDINGS, IN CLASS 9 (U.S. CLS. 21, 23, 26, 36 AND 38).

FIRST USE 12-13-2006; IN COMMERCE 12-13-2006.

THE MARK CONSISTS OF THE WORD "WAX" IN STYLIZED FORM WITH THE LETTER "A" LARGER THAN THE OTHER LETTERS.

SER. NO. 85-320,058, FILED 5-13-2011.

NORA BUCHANAN WILL, EXAMINING ATTORNEY



David J. Kyffers

Director of the United States Patent and Trademark Office

United States of America

United States Patent and Trademark Office

DENGUINA

Reg. No. 4,173,968

Registered July 17, 2012

Int. Cl.: 5

LABORATORIOS LOPEZ, S.A. DE C.V. (EL SALVADOR SOCIEDAD ANONIMA (SA DE CV)))

KILOMETRO 5 1/2

BOULEVARD DEL EJERCITO NACIONAL

SOYAPANGO, SAN SALVADOR, EL SALVADOR

TRADEMARK

PRINCIPAL REGISTER

FOR: CHEMICAL PRODUCTS, PHARMACEUTICALS AND DRUGS, NAMELY, ANALGESICS, ANTIPYRETIC ANALGESICS, AND ANTIPYRETIC PREPARATIONS, IN CLASS 5 (U.S. CLS. 6, 18, 44, 46, 51 AND 52).

THE MARK CONSISTS OF STANDARD CHARACTERS WITHOUT CLAIM TO ANY PARTICULAR FONT, STYLE, SIZE, OR COLOR.

OWNER OF EL SALVADOR REG. NO. 00129, DATED 2-7-1986, EXPIRES 2-7-2016.

THE WORDING "DENQUINA" HAS NO MEANING IN A FOREIGN LANGUAGE.

SER. NO. 85-320,085, FILED 5-13-2011.

EVELYN BRADLEY, EXAMINING ATTORNEY



David J. Kyffers

Director of the United States Patent and Trademark Office

United States of America

United States Patent and Trademark Office

INSPECTORPRO

Reg. No. 4,173,969

CITADEL INSURANCE SERVICES (UTAH LIMITED LIABILITY COMPANY)
826 EAST STATE ROAD, SUITE 100
AMERICAN FORK, UT 84003

Registered July 17, 2012

Int. Cl.: 36

FOR: INSURANCE BROKERAGE IN THE FIELD OF HOME INSPECTION INSURANCE;
PROGRAM MANAGEMENT, NAMELY, INSURANCE ADMINISTRATION IN THE FIELD
OF HOME INSPECTOR INSURANCE, IN CLASS 36 (U.S. CLS. 100, 101 AND 102).

SERVICE MARK

FIRST USE 5-31-2010; IN COMMERCE 5-31-2010.

PRINCIPAL REGISTER

THE MARK CONSISTS OF STANDARD CHARACTERS WITHOUT CLAIM TO ANY PAR-
TICULAR FONT, STYLE, SIZE, OR COLOR.

SER. NO. 85-320,418, FILED 5-13-2011.

CARRIE GENOVESE, EXAMINING ATTORNEY



David J. Kybas

Director of the United States Patent and Trademark Office

United States of America

United States Patent and Trademark Office

STINK BLASTERS

Reg. No. 4,173,970

Registered July 17, 2012

Int. Cl.: 28

ME, LLC (CALIFORNIA LIMITED LIABILITY COMPANY)
2101 ROSECRANS AVENUE
SUITE 5260
EL SEGUNDO, CA 90245

FOR: TOY FIGURES, IN CLASS 28 (U.S. CLS. 22, 23, 38 AND 50).

TRADEMARK

FIRST USE 11-25-2002; IN COMMERCE 12-5-2002.

PRINCIPAL REGISTER

THE MARK CONSISTS OF STANDARD CHARACTERS WITHOUT CLAIM TO ANY PARTICULAR FONT, STYLE, SIZE, OR COLOR.

NO CLAIM IS MADE TO THE EXCLUSIVE RIGHT TO USE "STINK", APART FROM THE MARK AS SHOWN.

SER. NO. 85-320,515, FILED 5-13-2011.

ZACHARY BELLO, EXAMINING ATTORNEY



David J. Kyffers

Director of the United States Patent and Trademark Office

United States of America

United States Patent and Trademark Office

Feel The Euphoria

Reg. No. 4,173,971

Registered July 17, 2012

Int. Cl.: 33

TRADEMARK

PRINCIPAL REGISTER

XV EXCLUSIVES, INC. (NEW YORK CORPORATION)
133 MIDLAND AVENUE
MONTCLAIR, NJ 07042

FOR: WINE, IN CLASS 33 (U.S. CLS. 47 AND 49).

FIRST USE 4-8-2011; IN COMMERCE 4-8-2011.

THE MARK CONSISTS OF STANDARD CHARACTERS WITHOUT CLAIM TO ANY PARTICULAR FONT, STYLE, SIZE, OR COLOR.

OWNER OF U.S. REG. NO. 4,053,088.

SER. NO. 85-320,612, FILED 5-13-2011.

JEFF DEFORD, EXAMINING ATTORNEY



David J. Kyffers

Director of the United States Patent and Trademark Office

United States of America

United States Patent and Trademark Office

WARING COMMERCIAL XTREME

Reg. No. 4,173,972

CONAIR CORPORATION (DELAWARE CORPORATION)
ONE CUMMINGS POINT ROAD
STAMFORD, CT 06902

Registered July 17, 2012

Int. Cl.: 7

FOR: ELECTRIC FOOD BLENDERS, IN CLASS 7 (U.S. CLS. 13, 19, 21, 23, 31, 34 AND 35).

FIRST USE 6-0-2006; IN COMMERCE 6-0-2006.

TRADEMARK

THE MARK CONSISTS OF STANDARD CHARACTERS WITHOUT CLAIM TO ANY PARTICULAR FONT, STYLE, SIZE, OR COLOR.

PRINCIPAL REGISTER

OWNER OF U.S. REG. NOS. 2,843,844, 3,607,179 AND OTHERS.

NO CLAIM IS MADE TO THE EXCLUSIVE RIGHT TO USE "COMMERCIAL", APART FROM THE MARK AS SHOWN.

SER. NO. 85-320,627, FILED 5-13-2011.

JENNIFER MARTIN, EXAMINING ATTORNEY



David J. Kyffers

Director of the United States Patent and Trademark Office

United States of America

United States Patent and Trademark Office

UPCR

Reg. No. 4,173,973

Registered July 17, 2012

Int. Cl.: 9

TRADEMARK

PRINCIPAL REGISTER

INTER-INDUSTRY CONFERENCE ON AUTO COLLISION REPAIR (ILLINOIS NON-PROFIT CORPORATION)
5125 TRILLIUM BLVD.
HOFFMAN ESTATES, IL 60192

FOR: DOWNLOADABLE INSTRUCTIONAL MATERIALS AND INFORMATIONAL SHEETS IN THE FIELD OF AUTO BODY REPAIR, IN CLASS 9 (U.S. CLS. 21, 23, 26, 36 AND 38).

FIRST USE 1-0-2002; IN COMMERCE 1-0-2002.

THE MARK CONSISTS OF STANDARD CHARACTERS WITHOUT CLAIM TO ANY PARTICULAR FONT, STYLE, SIZE, OR COLOR.

SER. NO. 85-320,899, FILED 5-13-2011.

SEAN CROWLEY, EXAMINING ATTORNEY



David J. Kybas

Director of the United States Patent and Trademark Office

United States of America

United States Patent and Trademark Office

TOWNSEND
THERAPY
SOLUTIONS
GREAT
THERAPISTS
MAKE THE
DIFFERENCE!

Reg. No. 4,173,974

Registered July 17, 2012

Int. Cl.: 44

SERVICE MARK

PRINCIPAL REGISTER

TOWNSEND THERAPY SOLUTIONS (MARYLAND SOLE PROPRIETORSHIP)
1200 EAST WEST HWY, APT 304
SILVER SPRING, MD 20910

FOR: SPEECH PATHOLOGY THERAPY SERVICES, IN CLASS 44 (U.S. CLS. 100 AND 101).

FIRST USE 5-11-2011; IN COMMERCE 5-11-2011.

THE MARK CONSISTS OF STANDARD CHARACTERS WITHOUT CLAIM TO ANY PARTICULAR FONT, STYLE, SIZE, OR COLOR.

NO CLAIM IS MADE TO THE EXCLUSIVE RIGHT TO USE "THERAPY SOLUTIONS", APART FROM THE MARK AS SHOWN.

SER. NO. 85-321,094, FILED 5-14-2011.

DOMINICK J. SALEMI, EXAMINING ATTORNEY



David J. Kyffers

Director of the United States Patent and Trademark Office

United States of America

United States Patent and Trademark Office

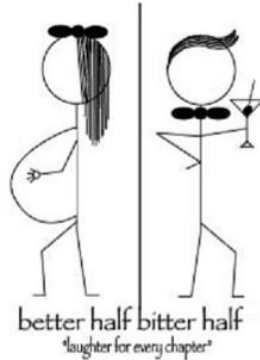

Reg. No. 4,173,975

Registered July 17, 2012

Int. Cl.: 16

TRADEMARK

PRINCIPAL REGISTER

BETTER HALF BITTER HALF, LLC (NEW JERSEY LIMITED LIABILITY COMPANY)
3 BROOK RD
ALLENTOWN, NJ 08501

FOR: CARDS, NAMELY, GREETING CARDS, IN CLASS 16 (U.S. CLS. 2, 5, 22, 23, 29, 37, 38 AND 50).

FIRST USE 5-1-2011; IN COMMERCE 5-13-2011.

THE MARK CONSISTS OF TWO STICK FIGURES WITH A VERTICAL LINE BETWEEN WHERE THE LEFT FIGURE DEPICTS A PREGNANT WOMAN WITH A HAIR BOW AND THE RIGHT FIGURE DEPICTS A MAN WEARING A BOWTIE AND HOLDING A MARTINI GLASS WITH AN OLIVE INSIDE; BELOW THE DESIGN ARE THE WORDS "BETTER HALF BITTER HALF" WITH THE QUOTE "LAUGHTER FOR EVERY CHAPTER" AT THE BOTTOM IN SMALLER FONT.

SER. NO. 85-321,215, FILED S.R. 5-14-2011 AM. P.R. 3-8-2012.

CHARLOTTE CORWIN, EXAMINING ATTORNEY



David J. Kybas

Director of the United States Patent and Trademark Office

United States of America

United States Patent and Trademark Office

FilterFab

Reg. No. 4,173,976

FILTERFAB MANUFACTURING CORPORATION (PENNSYLVANIA CORPORATION)
3709 GREENGARDEN ROAD
ALIQUIPPA, PA 15001

Registered July 17, 2012

Int. Cl.: 11

FOR: FILTERING UNITS TO REMOVE DRY AND WET PARTICULATE CONTAMINANTS FROM NATURAL GAS PIPING, PIPELINES, OR FUEL LINES, IN CLASS 11 (U.S. CLS. 13, 21, 23, 31 AND 34).

TRADEMARK

FIRST USE 9-12-1986; IN COMMERCE 9-12-1986.

PRINCIPAL REGISTER

THE MARK CONSISTS OF STANDARD CHARACTERS WITHOUT CLAIM TO ANY PARTICULAR FONT, STYLE, SIZE, OR COLOR.

SER. NO. 85-321,500, FILED 5-16-2011.

NICHOLAS COLEMAN, EXAMINING ATTORNEY



David J. Kyffers

Director of the United States Patent and Trademark Office

United States of America

United States Patent and Trademark Office



Reg. No. 4,173,977

Registered July 17, 2012

Int. Cl.: 36

SERVICE MARK

PRINCIPAL REGISTER

COMPUCREDIT INTELLECTUAL PROPERTY HOLDINGS CORP. II (NEVADA CORPORATION)
101 CONVENTION CENTER DRIVE, STE 850-15C
LAS VEGAS, NV 89109

FOR: FINANCING RELATING TO AUTOMOBILES, IN CLASS 36 (U.S. CLS. 100, 101 AND 102).

FIRST USE 4-1-2005; IN COMMERCE 4-1-2005.

OWNER OF U.S. REG. NO. 3,116,541.

NO CLAIM IS MADE TO THE EXCLUSIVE RIGHT TO USE "CAR FINANCIAL SERVICES, INC.", APART FROM THE MARK AS SHOWN.

THE MARK CONSISTS OF THE WORDS "CAR FINANCIAL SERVICES, INC." ENCLOSED IN A CRESCENT ABOVE THE WORDS "DEALER SOLUTIONS".

SEC. 2(F).

SER. NO. 85-321,649, FILED 5-16-2011.

WILLIAM P. SHANAHAN, EXAMINING ATTORNEY



David J. Kyffers

Director of the United States Patent and Trademark Office

United States of America

United States Patent and Trademark Office

MAX TORQUE

Reg. No. 4,173,978

Registered July 17, 2012

Int. Cl.: 37

SERVICE MARK

PRINCIPAL REGISTER

MAX TORQUE INDUSTRIAL, LLC (TEXAS LIMITED LIABILITY COMPANY)
10000 MANCHESTER STREET, SUITE H
HOUSTON, TX 77012

FOR: SCRAP METAL AND DEBRIS CLEAN UP SERVICES; REMANUFACTURING SERVICES, NAMELY, REMANUFACTURE OF MACHINERY AND SCRAP METAL TO THE ORDER AND/OR SPECIFICATIONS OF OTHERS; BUILDING DEMOLITION SERVICES; CONSULTING SERVICES RELATED TO THE FOREGOING, IN CLASS 37 (U.S. CLS. 100, 103 AND 106).

FIRST USE 4-29-2010; IN COMMERCE 4-29-2010.

THE MARK CONSISTS OF STANDARD CHARACTERS WITHOUT CLAIM TO ANY PARTICULAR FONT, STYLE, SIZE, OR COLOR.

SER. NO. 85-321,681, FILED 5-16-2011.

ANDREW LEASER, EXAMINING ATTORNEY



David J. Kyffers

Director of the United States Patent and Trademark Office

United States of America

United States Patent and Trademark Office

MAX TORQUE INDUSTRIAL

Reg. No. 4,173,979

Registered July 17, 2012

Int. Cl.: 37

SERVICE MARK

PRINCIPAL REGISTER

MAX TORQUE INDUSTRIAL, LLC (TEXAS LIMITED LIABILITY COMPANY)
10000 MANCHESTER STREET, SUITE H
HOUSTON, TX 77012

FOR: SCRAP METAL AND DEBRIS CLEAN UP SERVICES; REMANUFACTURING SERVICES, NAMELY, REMANUFACTURE OF MACHINERY AND SCRAP METAL TO THE ORDER AND/OR SPECIFICATIONS OF OTHERS; BUILDING DEMOLITION SERVICES; CONSULTING SERVICES RELATED TO THE FOREGOING, IN CLASS 37 (U.S. CLS. 100, 103 AND 106).

FIRST USE 4-29-2010; IN COMMERCE 4-29-2010.

THE MARK CONSISTS OF STANDARD CHARACTERS WITHOUT CLAIM TO ANY PARTICULAR FONT, STYLE, SIZE, OR COLOR.

NO CLAIM IS MADE TO THE EXCLUSIVE RIGHT TO USE "INDUSTRIAL", APART FROM THE MARK AS SHOWN.

SER. NO. 85-321,700, FILED 5-16-2011.

ANDREW LEASER, EXAMINING ATTORNEY



David J. Kypos

Director of the United States Patent and Trademark Office

United States of America

United States Patent and Trademark Office



Inspector Pro

Reg. No. 4,173,980

CITADEL INSURANCE SERVICES (UTAH LIMITED LIABILITY COMPANY)
826 EAST STATE ROAD, SUITE 100
AMERICAN FORK, UT 84003

Registered July 17, 2012

Int. Cl.: 36

FOR: INSURANCE BROKERAGE IN THE FIELD OF HOME INSPECTION INSURANCE;
PROGRAM MANAGEMENT, NAMELY, INSURANCE ADMINISTRATION IN THE FIELD
OF HOME INSPECTOR INSURANCE, IN CLASS 36 (U.S. CLS. 100, 101 AND 102).

SERVICE MARK

FIRST USE 5-31-2010; IN COMMERCE 5-31-2010.

PRINCIPAL REGISTER

THE MARK CONSISTS OF A DRAWING OF A CHARACTER HOLDING A MAGNIFYING
GLASS STANDING IN FRONT OF AN OUTLINE OF A HOUSE WITH THE WORDING "IN-
SPECTORPRO" APPEARING BENEATH THE DESIGN.

SER. NO. 85-321,706, FILED 5-16-2011.

CARRIE GENOVESE, EXAMINING ATTORNEY



David J. Kybas

Director of the United States Patent and Trademark Office

United States of America

United States Patent and Trademark Office

ULTRA SURFACE

Reg. No. 4,173,981

CONCRETE SOLUTIONS, INC. (CALIFORNIA CORPORATION)
3904 RILEY STREET
SAN DIEGO, CA 92110

Registered July 17, 2012

Int. Cl.: 1

FOR: EPOXY, ACRYLIC AND VINYL ACETATE POLYMER ADDITIVES FOR CEMENTITIOUS MIXTURES; EPOXY, ACRYLIC AND URETHANE CHEMICAL MIXTURES FOR USE IN REPAIRING AND RE-SURFACING CONCRETE, ASPHALT, WOOD, METAL, TILE, STONE AND FOAM, IN CLASS 1 (U.S. CLS. 1, 5, 6, 10, 26 AND 46).

TRADEMARK

PRINCIPAL REGISTER

FIRST USE 8-19-1999; IN COMMERCE 6-28-2000.

THE MARK CONSISTS OF STANDARD CHARACTERS WITHOUT CLAIM TO ANY PARTICULAR FONT, STYLE, SIZE, OR COLOR.

SER. NO. 85-321,714, FILED 5-16-2011.

HEATHER BIDDULPH, EXAMINING ATTORNEY



David J. Kyffers

Director of the United States Patent and Trademark Office

United States of America

United States Patent and Trademark Office

THE KING OF THE INDUSTRIAL JUNGLE

Reg. No. 4,173,982

Registered July 17, 2012

Int. Cl.: 37

SERVICE MARK

PRINCIPAL REGISTER

MAX TORQUE INDUSTRIAL, LLC (TEXAS LIMITED LIABILITY COMPANY)
10000 MANCHESTER STREET, SUITE H
HOUSTON, TX 77012

FOR: SCRAP METAL AND DEBRIS CLEAN UP SERVICES; REMANUFACTURING SERVICES, NAMELY, REMANUFACTURE OF MACHINERY AND SCRAP METAL TO THE ORDER AND/OR SPECIFICATIONS OF OTHERS; BUILDING DEMOLITION SERVICES; CONSULTING SERVICES RELATED TO THE FOREGOING, IN CLASS 37 (U.S. CLS. 100, 103 AND 106).

FIRST USE 2-10-2011; IN COMMERCE 2-10-2011.

THE MARK CONSISTS OF STANDARD CHARACTERS WITHOUT CLAIM TO ANY PARTICULAR FONT, STYLE, SIZE, OR COLOR.

SER. NO. 85-321,716, FILED 5-16-2011.

ANDREW LEASER, EXAMINING ATTORNEY



David J. Kyffers

Director of the United States Patent and Trademark Office

United States of America

United States Patent and Trademark Office



Reg. No. 4,173,983

Registered July 17, 2012

Int. Cl.: 37

SERVICE MARK

PRINCIPAL REGISTER

MAX TORQUE INDUSTRIAL, LLC (TEXAS LIMITED LIABILITY COMPANY)
10000 MANCHESTER STREET, SUITE H
HOUSTON, TX 77012

FOR: SCRAP METAL AND DEBRIS CLEAN UP SERVICES; REMANUFACTURING SERVICES, NAMELY, REMANUFACTURE OF MACHINERY AND SCRAP METAL TO THE ORDER AND/OR SPECIFICATIONS OF OTHERS; BUILDING DEMOLITION SERVICES; CONSULTING SERVICES RELATED TO THE FOREGOING, IN CLASS 37 (U.S. CLS. 100, 103 AND 106).

FIRST USE 2-10-2011; IN COMMERCE 2-10-2011.

NO CLAIM IS MADE TO THE EXCLUSIVE RIGHT TO USE "INDUSTRIAL", APART FROM THE MARK AS SHOWN.

THE MARK CONSISTS OF THE DESIGN OF A LION ABOVE THE STYLIZED WORDING "MAX TORQUE" THAT IS ABOVE TWO RECTANGLES, WITH THE LEFT RECTANGLE HAVING A POINTED RIGHT END, AND THE RIGHT RECTANGLE HAVING A POINTED LEFT END, AND BELOW THIS IS THE WORD "INDUSTRIAL".

SER. NO. 85-321,737, FILED 5-16-2011.

ANDREW LEASER, EXAMINING ATTORNEY



David J. Kyffers

Director of the United States Patent and Trademark Office

United States of America

United States Patent and Trademark Office



STANY

The Security Traders Association of New York, Inc.

Reg. No. 4,173,984

Registered July 17, 2012

Int. Cls.: 35 and 41

THE SECURITY TRADERS ASSOCIATION OF NEW YORK, INC. (NEW YORK CORPORATION), AKA STANY

APT. 2K
71 BROADWAY
NEW YORK, NY 10006

SERVICE MARK

PRINCIPAL REGISTER

FOR: ASSOCIATION SERVICES, NAMELY, PROMOTING THE INTERESTS AND OBJECTIVES OF ITS MEMBERS WHICH ARE INDIVIDUALS WHO TRADE, INVEST AND/OR FACILITATE THE TRADING OF AND INVESTING IN EQUITY, DEBT AND DERIVATIVE SECURITIES; ARRANGING AND CONDUCTING SPECIAL EVENTS FOR BUSINESS PURPOSES; BUSINESS NETWORKING; ORGANIZATION OF EXHIBITIONS AND TRADE FAIRS FOR BUSINESS AND PROMOTIONAL PURPOSES, IN CLASS 35 (U.S. CLS. 100, 101 AND 102).

FIRST USE 3-16-2011; IN COMMERCE 3-16-2011.

FOR: EDUCATIONAL SERVICES, NAMELY, ARRANGING AND CONDUCTING CONFERENCES IN THE FIELD OF SECURITIES AND FINANCIAL MARKETS; EDUCATIONAL SERVICES, NAMELY, ARRANGING AND CONDUCTING CLASSES, SEMINARS, CONFERENCES, WORKSHOPS AND ONLINE EXHIBITIONS, DISPLAYS AND INTERACTIVE EXHIBITS IN THE FIELD OF FINANCE, INVESTMENTS, LOANS, SECURITIES, BONDS, STOCKS, MUTUAL FUNDS, AND FINANCIAL MARKETS AND DISTRIBUTION OF COURSE MATERIALS IN CONNECTION THEREWITH; ARRANGING AND CONDUCTING SPECIAL EVENTS FOR SOCIAL ENTERTAINMENT PURPOSES, IN CLASS 41 (U.S. CLS. 100, 101 AND 107).

FIRST USE 3-16-2011; IN COMMERCE 3-16-2011.

NO CLAIM IS MADE TO THE EXCLUSIVE RIGHT TO USE "THE SECURITY TRADERS ASSOCIATION OF NEW YORK, INC.", APART FROM THE MARK AS SHOWN.

THE COLOR(S) ORANGE,BLUE AND WHITE IS/ARE CLAIMED AS A FEATURE OF THE MARK.

THE MARK CONSISTS OF A SHADED OR PARTIALLY SHADED INCOMPLETE SQUARE BISECTED BY ZIG ZAG LINES IN BLUE AND WHITE, WHEREBY THE TOP, ORANGE PORTION OF THE FIGURE IS LARGER THAN THE BOTTOM BLUE PORTION AND IN-



David J. Kyjars

Director of the United States Patent and Trademark Office

Reg. No. 4,173,984 CLUDING THE NAME "STANY" APPEARING IN THE COLOR BLUE TO THE RIGHT OF THE FIGURE AND THE WORDS "THE SECURITY TRADERS ASSOCIATION OF NEW YORK, INC." APPEARING IN THE COLOR BLUE.

SER. NO. 85-321,769, FILED 5-16-2011.

MICHAEL SOUDERS, EXAMINING ATTORNEY

United States of America

United States Patent and Trademark Office

Technology Spa

Reg. No. 4,173,985

Registered July 17, 2012

Int. Cls.: 35 and 42

SERVICE MARK

PRINCIPAL REGISTER

TECHNOLOGY SPA (TEXAS LIMITED LIABILITY COMPANY)
SUITE 400
12404 PARK CENTRAL DRIVE
DALLAS, TX 75251

FOR: BUSINESS CONSULTATION IN THE FIELD OF CUSTOMER-CENTRIC INTERACTIVE AND DIGITAL ACTIVITIES; BUSINESS STRATEGY DEVELOPMENT SERVICES; LOGISTICS MANAGEMENT IN THE FIELD OF CUSTOMER-CENTRIC INTERACTIVE AND DIGITAL ACTIVITIES, IN CLASS 35 (U.S. CLS. 100, 101 AND 102).

FIRST USE 4-18-2011; IN COMMERCE 4-18-2011.

FOR: APPLICATION SERVICE PROVIDER, NAMELY, HOSTING, MANAGING, DEVELOPING, ANALYZING, AND MAINTAINING APPLICATIONS, SOFTWARE, AND WEB SITES, OF OTHERS IN THE FIELDS OF ADVERTISING AND MARKETING; COMPUTER CONSULTATION IN THE FIELD OF COMPUTER SECURITY; COMPUTER SOFTWARE DEVELOPMENT IN THE FIELD OF MOBILE APPLICATIONS; DEVELOPING AND HOSTING A SERVER ON A GLOBAL COMPUTER NETWORK FOR THE PURPOSE OF FACILITATING E-COMMERCE VIA SUCH A SERVER; HOSTING INTERNET SITES FOR OTHERS, IN CLASS 42 (U.S. CLS. 100 AND 101).

FIRST USE 4-18-2011; IN COMMERCE 4-18-2011.

THE MARK CONSISTS OF STANDARD CHARACTERS WITHOUT CLAIM TO ANY PARTICULAR FONT, STYLE, SIZE, OR COLOR.

NO CLAIM IS MADE TO THE EXCLUSIVE RIGHT TO USE "TECHNOLOGY", APART FROM THE MARK AS SHOWN.

SER. NO. 85-321,966, FILED 5-16-2011.

KATHLEEN LORENZO, EXAMINING ATTORNEY



David J. Kyjars

Director of the United States Patent and Trademark Office

United States of America

United States Patent and Trademark Office

GLOBAL PDR SOLUTIONS

Reg. No. 4,173,986

GLOBAL PDR SOLUTIONS LLC (DELAWARE LIMITED LIABILITY COMPANY)

Registered July 17, 2012

5505 W. KELLOGG
WICHITA, KS 67209

Int. Cl.: 37

FOR: REPAIR SERVICES FOR MOTOR VEHICLES, NAMELY, PAINTLESS DENT REPAIR,
IN CLASS 37 (U.S. CLS. 100, 103 AND 106).

SERVICE MARK

FIRST USE 4-1-2004; IN COMMERCE 4-1-2004.

PRINCIPAL REGISTER

THE MARK CONSISTS OF STANDARD CHARACTERS WITHOUT CLAIM TO ANY PAR-
TICULAR FONT, STYLE, SIZE, OR COLOR.

SEC. 2(F).

SER. NO. 85-322,029, FILED 5-16-2011.

KRISTIN DAHLING, EXAMINING ATTORNEY



David J. Kybas

Director of the United States Patent and Trademark Office

United States of America

United States Patent and Trademark Office

VERYVERYCHIC

Reg. No. 4,173,987

SEWARD, N. JAYNE (UNITED STATES INDIVIDUAL)

Registered July 17, 2012

P.O. BOX 291908
LOS ANGELES, CA 90029

Int. Cls.: 38, 41 and 45

FOR: PROVIDING ON-LINE ELECTRONIC BULLETIN BOARDS FOR TRANSMISSION OF MESSAGES AMONG COMPUTER USERS CONCERNING FASHION, BEAUTY, ART, PHOTOGRAPHY, APPAREL, ACCESSORIES, TRENDS, TRAVEL, SHOPPING, STYLE, CELEBRITIES, ENTERTAINMENT AND POPULAR CULTURE, IN CLASS 38 (U.S. CLS. 100, 101 AND 104).

SERVICE MARK

PRINCIPAL REGISTER

FIRST USE 4-0-2011; IN COMMERCE 4-0-2011.

FOR: PROVIDING INTERACTIVE WEB JOURNALS, NAMELY, BLOGS, FEATURING FASHION, BEAUTY, ART, PHOTOGRAPHY, APPAREL, ACCESSORIES, TRENDS, TRAVEL, SHOPPING, STYLE, CELEBRITIES, ENTERTAINMENT AND POPULAR CULTURE; PROVIDING INFORMATION ABOUT PHOTOGRAPHY, CELEBRITIES, ENTERTAINMENT AND POPULAR CULTURE, IN CLASS 41 (U.S. CLS. 100, 101 AND 107).

FIRST USE 5-19-2008; IN COMMERCE 9-1-2008.

FOR: PROVIDING A WEBSITE FEATURING INFORMATION IN THE FIELDS OF FASHION, FASHION TRENDS, PERSONAL AND ONLINE SHOPPING, AND STYLE PERTAINING TO BEAUTY, FASHION AND INTERIORS; PROVIDING INFORMATION IN THE FIELDS OF FASHION, FASHION TRENDS, PERSONAL AND ONLINE SHOPPING, AND STYLE PERTAINING TO BEAUTY, FASHION AND INTERIORS, IN CLASS 45 (U.S. CLS. 100 AND 101).

FIRST USE 5-19-2008; IN COMMERCE 9-1-2008.

THE MARK CONSISTS OF STANDARD CHARACTERS WITHOUT CLAIM TO ANY PARTICULAR FONT, STYLE, SIZE, OR COLOR.

SER. NO. 85-322,046, FILED 5-16-2011.

BRENDAN MCCAULEY, EXAMINING ATTORNEY



David J. Kyffers

Director of the United States Patent and Trademark Office

United States of America

United States Patent and Trademark Office

SOCIAL LEVERAGE

Reg. No. 4,173,988

Registered July 17, 2012

Int. Cls.: 36 and 41

SERVICE MARK

PRINCIPAL REGISTER

HOW TO, LLC (ARIZONA LIMITED LIABILITY COMPANY)
5110 NORTH 40TH STREET
SUITE 108
PHOENIX, AZ 85108

FOR: VENTURE CAPITAL FINANCING, IN CLASS 36 (U.S. CLS. 100, 101 AND 102).

FIRST USE 1-1-2010; IN COMMERCE 1-1-2010.

FOR: PROVIDING A WEBSITE FEATURING BLOGS IN THE FIELD OF FINANCIAL INVESTMENTS OF BUSINESSES AND NEW TECHNOLOGY, IN CLASS 41 (U.S. CLS. 100, 101 AND 107).

FIRST USE 1-1-2010; IN COMMERCE 1-1-2010.

THE MARK CONSISTS OF STANDARD CHARACTERS WITHOUT CLAIM TO ANY PARTICULAR FONT, STYLE, SIZE, OR COLOR.

NO CLAIM IS MADE TO THE EXCLUSIVE RIGHT TO USE "LEVERAGE", APART FROM THE MARK AS SHOWN.

SER. NO. 85-322,206, FILED 5-16-2011.

SIMON TENG, EXAMINING ATTORNEY



David J. Kybas

Director of the United States Patent and Trademark Office

United States of America

United States Patent and Trademark Office

ICE WAND

Reg. No. 4,173,989

STREAMLINE CAPITAL (GEORGIA CORPORATION), DBA STREAMLINE CAPITAL
3342 INTERNATIONAL PARK DRIVE
ATLANTA, GA 30316

Registered July 17, 2012

Int. Cls.: 1 and 11

FOR: MOLD AND SLIME INHIBITOR FOR PREVENTING GROWTH OF MOLD AND SLIME
IN ICE MAKING MACHINES , IN CLASS 1 (U.S. CLS. 1, 5, 6, 10, 26 AND 46).

TRADEMARK

FIRST USE 2-22-2002; IN COMMERCE 2-22-2002.

PRINCIPAL REGISTER

FOR: ICE FILTRATION UNIT COMPRISED OF COPPER, SILVER AND ALUMINUM COM-
PONENTS USED TO CONTROL SLIME AND MOLD GROWTH IN ICE MAKING MACHINES,
IN CLASS 11 (U.S. CLS. 13, 21, 23, 31 AND 34).

FIRST USE 2-22-2002; IN COMMERCE 2-22-2002.

THE MARK CONSISTS OF STANDARD CHARACTERS WITHOUT CLAIM TO ANY PAR-
TICULAR FONT, STYLE, SIZE, OR COLOR.

NO CLAIM IS MADE TO THE EXCLUSIVE RIGHT TO USE "ICE" , APART FROM THE
MARK AS SHOWN.

SER. NO. 85-322,333, FILED 5-16-2011.

SALLY SHIH, EXAMINING ATTORNEY



David J. Kybas

Director of the United States Patent and Trademark Office

United States of America

United States Patent and Trademark Office

Little Saigon Chamber of Commerce

Reg. No. 4,173,990

Registered July 17, 2012

Int. Cl.: 35

SERVICE MARK

PRINCIPAL REGISTER

TU, HOANG HUY (UNITED STATES INDIVIDUAL), DBA LITTLE SAIGON CHAMBER OF
COMMERCE
16185 BROOKHURST STREET
FOUNTAIN VALLEY, CA 92708

FOR: CHAMBER OF COMMERCE SERVICES, NAMELY, PROMOTING BUSINESS AND
TOURISM IN THE CALIFORNIA AREA; ELECTRONIC COMMERCE SERVICES, NAMELY,
PROVIDING INFORMATION ABOUT PRODUCTS VIA TELECOMMUNICATION NETWORKS
FOR ADVERTISING AND SALES PURPOSES; PROVIDING A WEB-BASED SYSTEM AND
ONLINE PORTALS IN THE FIELD OF CONSUMER-TO-BUSINESS COMMERCE FOR
CONSUMERS TO ENTER, MANAGE AND MODIFY THEIR CONSUMER PREFERENCE
INFORMATION FOR USE BY MERCHANTS TO CREATE AND MANAGE OFFERS FOR
DELIVERY TO CONSUMERS; PROVIDING COMMERCIAL INFORMATION UPDATES
ONLINE AND OVER A GLOBAL COMPUTER NETWORK IN THE FIELDS OF BUSINESS,
COMMERCE, AND INDUSTRY , IN CLASS 35 (U.S. CLS. 100, 101 AND 102).

FIRST USE 11-15-2010; IN COMMERCE 11-15-2010.

THE MARK CONSISTS OF STANDARD CHARACTERS WITHOUT CLAIM TO ANY PAR-
TICULAR FONT, STYLE, SIZE, OR COLOR.

NO CLAIM IS MADE TO THE EXCLUSIVE RIGHT TO USE "CHAMBER OF COMMERCE",
APART FROM THE MARK AS SHOWN.

SEC. 2(F).

SER. NO. 85-322,350, FILED 5-16-2011.

PATRICIA EVANKO, EXAMINING ATTORNEY



David J. Kyjars

Director of the United States Patent and Trademark Office

United States of America

United States Patent and Trademark Office

C. T. Y.

Reg. No. 4,173,991

Registered July 17, 2012

Int. Cls.: 17 and 19

TRADEMARK

PRINCIPAL REGISTER

CHEN, WEN-CHANG (TAIWAN INDIVIDUAL)
NO. 14, LANE 32
WUQING 3RD RD., LINGYA DIST.,
KAOHSIUNG CITY, TAIWAN

FOR: OIL RING SEALS MADE OF PLASTICS FOR USE AS CONNECTION SEALS; OIL RING SEALS MADE OF RUBBER FOR USE AS CONNECTION SEALS; GASKETS MADE OF PLASTICS FOR USE IN PLUMBING; GASKETS MADE OF RUBBER FOR USE IN PLUMBING; SEALING RINGS MADE OF PLASTICS FOR USE AS CONNECTION SEALS; SEALING RINGS MADE OF RUBBER FOR USE AS CONNECTION SEALS; OIL CONTROL RINGS MADE OF PLASTICS FOR USE AS CONNECTION SEALS; OIL CONTROL RINGS MADE OF RUBBER FOR USE AS CONNECTION SEALS; LINERS MADE OF RUBBER FOR USE IN THE REPAIR OF ELECTRICAL, TELECOMMUNICATION AND NATURAL GAS UTILITY CONDUITS AND PIPES; LINERS MADE OF PLASTICS FOR USE IN THE REPAIR OF ELECTRICAL, TELECOMMUNICATION AND NATURAL GAS UTILITY CONDUITS AND PIPES, IN CLASS 17 (U.S. CLS. 1, 5, 12, 13, 35 AND 50).

FIRST USE 4-16-2001; IN COMMERCE 4-1-2003.

FOR: SPACERS MADE OF PLASTICS, NAMELY, PLASTIC TILE SPACING INSERTS; SPACERS MADE OF RUBBER, NAMELY, RUBBER TILE SPACING INSERTS, IN CLASS 19 (U.S. CLS. 1, 12, 33 AND 50).

FIRST USE 4-16-2001; IN COMMERCE 4-1-2003.

THE MARK CONSISTS OF STANDARD CHARACTERS WITHOUT CLAIM TO ANY PARTICULAR FONT, STYLE, SIZE, OR COLOR.

SER. NO. 85-322,456, FILED 5-17-2011.

MARLENE BELL, EXAMINING ATTORNEY



David J. Kybas

Director of the United States Patent and Trademark Office

United States of America

United States Patent and Trademark Office



Reg. No. 4,173,992

Registered July 17, 2012

Int. Cl.: 21

TRADEMARK

PRINCIPAL REGISTER

ALLER, JARED (UNITED STATES INDIVIDUAL)
#101
924 FULTON STREET
SAN FRANCISCO, CA 94117

FOR: POTS, NAMELY, MAGNETIC ECO-PLASTIC POTS FOR FLOWERS AND PLANTS; HOUSEHOLD CONTAINERS, NAMELY, MAGNETIC WALL ORGANIZATIONAL STORAGE CONTAINERS, IN CLASS 21 (U.S. CLS. 2, 13, 23, 29, 30, 33, 40 AND 50).

FIRST USE 3-31-2011; IN COMMERCE 3-31-2011.

NO CLAIM IS MADE TO THE EXCLUSIVE RIGHT TO USE "URBAN VERTICAL GARDEN", APART FROM THE MARK AS SHOWN.

THE COLOR(S) BLACK AND GREEN IS/ARE CLAIMED AS A FEATURE OF THE MARK.

THE MARK CONSISTS OF THE WORDS "URBAN VERTICAL GARDEN" WRITTEN IN BLACK COLOR BELOW THE WORD "URBIO" IN BLACK COLOR WHEREIN THE UPPER LEFT PORTION OF THE LETTER "U" DEPICTS A LEAF IN GREEN COLOR AS SHOWN IN THE MARK.

THE WORDING "URBIO" HAS NO MEANING IN A FOREIGN LANGUAGE.

SER. NO. 85-322,472, FILED 5-17-2011.

NAKIA HENRY, EXAMINING ATTORNEY



David J. Kybas

Director of the United States Patent and Trademark Office

United States of America

United States Patent and Trademark Office

OneCodec

Reg. No. 4,173,993

ONECODEC LTD. (SCOTLAND LIMITED LIABILITY COMPANY)
44 WAVERLEY STREET
BELMONT, MA 02478

Registered July 17, 2012

Int. Cl.: 42

FOR: DESIGN, DEVELOPMENT AND IMPLEMENTATION OF SOFTWARE FOR MULTIMEDIA COMPRESSION/DECOMPRESSION AND PLAYBACK, AND EXCLUDING THE FIELD OF CANCER DISEASES AND ONCOLOGY, IN CLASS 42 (U.S. CLS. 100 AND 101).

SERVICE MARK

FIRST USE 12-2-2009; IN COMMERCE 9-10-2010.

PRINCIPAL REGISTER

THE MARK CONSISTS OF STANDARD CHARACTERS WITHOUT CLAIM TO ANY PARTICULAR FONT, STYLE, SIZE, OR COLOR.

SER. NO. 85-322,730, FILED 5-17-2011.

IRA J. GOODSaid, EXAMINING ATTORNEY



David J. Kyros

Director of the United States Patent and Trademark Office

United States of America

United States Patent and Trademark Office

Poronomics

Reg. No. 4,173,994

Registered July 17, 2012

Int. Cl.: 1

TRADEMARK

PRINCIPAL REGISTER

JSR CORPORATION (JAPAN CORPORATION)
9-2, HIGASHI-SHINBASHI 1-CHOME
MINATO-KU, TOKYO, JAPAN

FOR: CHEMICALS FOR USE IN INDUSTRY; CHEMICALS FOR USE IN THE MANUFACTURE OF CHROMATOGRAPHY MEDIA; CHROMATOGRAPHY MEDIA; POLYMER PARTICLES, NAMELY, UNPROCESSED SYNTHETIC RESINS IN THE FORM OF PARTICLES FOR USE IN THE MANUFACTURE OF CHROMATOGRAPHY MEDIA; UNPROCESSED ARTIFICIAL RESINS AS RAW MATERIALS IN THE FORM OF POWDERS, IN CLASS 1 (U.S. CLS. 1, 5, 6, 10, 26 AND 46).

THE MARK CONSISTS OF STANDARD CHARACTERS WITHOUT CLAIM TO ANY PARTICULAR FONT, STYLE, SIZE, OR COLOR.

PRIORITY CLAIMED UNDER SEC. 44(D) ON JAPAN APPLICATION NO. 2011-032701, FILED 5-13-2011, REG. NO. 5465635, DATED 1-27-2012, EXPIRES 1-27-2022.

SER. NO. 85-322,795, FILED 5-17-2011.

STEVEN JACKSON, EXAMINING ATTORNEY



David J. Kyffers

Director of the United States Patent and Trademark Office

United States of America

United States Patent and Trademark Office



The logo features the words "MILITARY" and "AUTHORITY" in a bold, serif font. "MILITARY" is on the top line and "AUTHORITY" is on the bottom line. Each word is flanked by three horizontal lines, and a five-pointed star is positioned above each set of lines.

Reg. No. 4,173,995

Registered July 17, 2012

Int. Cl.: 41

SERVICE MARK

PRINCIPAL REGISTER

GRANTHAM EDUCATION CORPORATION (DELAWARE CORPORATION)
2101 WILSON BOULEVARD
SUITE 110
ARLINGTON, VA 22201

FOR: EDUCATIONAL SERVICES, NAMELY, PROVIDING ACCREDITED AND CERTIFIED COURSES OF INSTRUCTION AT THE POST-SECONDARY AND COLLEGE LEVEL; ELECTRONIC PUBLISHING SERVICES, NAMELY, PUBLISHING OF ONLINE TEXT AND GRAPHIC WORKS OF OTHERS FEATURING USER-CREATED CONTENT; PROVIDING ON-LINE JOURNALS, NAMELY, BLOGS AND INTERACTIVE ONLINE WEB JOURNALS FEATURING USER-CREATED CONTENT; ONLINE JOURNALS, NAMELY, BLOGS FEATURING INFORMATION REGARDING EDUCATION, HEALTH CARE, FINANCE, INSURANCE AND MILITARY LIFE, IN CLASS 41 (U.S. CLS. 100, 101 AND 107).

FIRST USE 3-15-2011; IN COMMERCE 3-15-2011.

NO CLAIM IS MADE TO THE EXCLUSIVE RIGHT TO USE "MILITARY" , APART FROM THE MARK AS SHOWN.

THE MARK CONSISTS OF CONSISTS OF A LINE OF A SET OF TWO STARS ON A FIELD OF THREE HORIZONTAL LINES FRAMING THE WORD "MILITARY" AND BROADLY BENEATH, A SECOND LINE CONTAINING THE WORD "AUTHORITY".

SER. NO. 85-322,886, FILED 5-17-2011.

NATALIE POLZER, EXAMINING ATTORNEY



David J. Kyffers

Director of the United States Patent and Trademark Office

United States of America

United States Patent and Trademark Office



The logo features the word "MILITARY" in a bold, serif font, centered between two five-pointed stars. Each star is flanked by three horizontal lines. Below "MILITARY" is the word "AUTHORITY" in a larger, bold, serif font, also centered between two five-pointed stars, each flanked by three horizontal lines.

Reg. No. 4,173,996

Registered July 17, 2012

Int. Cl.: 38

SERVICE MARK

PRINCIPAL REGISTER

GRANTHAM EDUCATION CORPORATION (DELAWARE CORPORATION)
2101 WILSON BOULEVARD
SUITE 110
ARLINGTON, VA 22201

FOR: PROVIDING ONLINE CHAT ROOMS AND ELECTRONIC BULLETIN BOARDS FOR TRANSMISSION OF MESSAGES REGARDING, AND IN THE NATURE OF, SOCIAL NETWORKING, VIRTUAL COMMUNITY, PHOTOGRAPHIC IMAGE SHARING, ADVERTISING AND CLASSIFIEDS; PROVISION OF ON-LINE FORUMS FOR COMMUNICATIONS IN THE NATURE OF, SOCIAL NETWORKING, VIRTUAL COMMUNITY, PHOTOGRAPHIC IMAGE SHARING, ADVERTISING AND CLASSIFIEDS, IN CLASS 38 (U.S. CLS. 100, 101 AND 104).

FIRST USE 3-15-2011; IN COMMERCE 3-15-2011.

NO CLAIM IS MADE TO THE EXCLUSIVE RIGHT TO USE "MILITARY", APART FROM THE MARK AS SHOWN.

THE MARK CONSISTS OF CONSISTS OF A LINE OF A SET OF TWO STARS ON A FIELD OF THREE HORIZONTAL LINES FRAMING THE WORD "MILITARY" AND BROADLY BENEATH, A SECOND LINE CONTAINING THE WORD "AUTHORITY".

SER. NO. 85-322,903, FILED 5-17-2011.

NATALIE POLZER, EXAMINING ATTORNEY



David J. Kybas

Director of the United States Patent and Trademark Office

United States of America

United States Patent and Trademark Office

 **MILITARY**
AUTHORITY

Reg. No. 4,173,997

Registered July 17, 2012

Int. Cls.: 35 and 45

SERVICE MARK

PRINCIPAL REGISTER

GRANTHAM EDUCATION CORPORATION (DELAWARE CORPORATION)
2101 WILSON BOULEVARD
SUITE 110
ARLINGTON, VA 22201

FOR: AN ONLINE DIRECTORY INFORMATION SERVICE FEATURING INFORMATION REGARDING SCHOOLS AND JOBS; CLASSIFIED ADVERTISING SERVICES; ADVERTISING AND INFORMATION DISTRIBUTION SERVICES, NAMELY, PROVIDING CLASSIFIED ADVERTISING SPACE VIA THE INTERNET AND GLOBAL COMPUTER NETWORKS; PROMOTING THE GOODS AND SERVICES OF OTHERS VIA THE INTERNET AND GLOBAL COMPUTER NETWORKS; PROMOTING THE GOODS AND SERVICES OF OTHERS BY PROVIDING LINKS TO THE WEB SITES OF OTHERS; PROVIDING ON-LINE COMPUTER DATABASE AND ON-LINE SEARCHABLE DATABASES IN THE FIELD OF ADVERTISING AND CLASSIFIED; BUSINESS NETWORKING; PROVIDING INFORMATION REGARDING CHARITABLE SERVICES IN THE NATURE OF ORGANIZING AND CONDUCTING VOLUNTEER PROGRAMS AND COMMUNITY SERVICE PROJECTS, IN CLASS 35 (U.S. CLS. 100, 101 AND 102).

FIRST USE 3-15-2011; IN COMMERCE 3-15-2011.

FOR: ON-LINE SOCIAL NETWORKING SERVICES; INTERNET-BASED AND GLOBAL COMPUTER NETWORK BASED SOCIAL INTRODUCTION AND SOCIAL NETWORKING SERVICES; PROVIDING ON-LINE COMPUTER DATABASES AND ON-LINE SEARCHABLE DATABASES IN THE FIELD OF SOCIAL NETWORKING; SOCIAL INTRODUCTION SERVICES; PROVIDING INFORMATION IN THE FIELD OF PERSONAL DEVELOPMENT, NAMELY, SELF-IMPROVEMENT AND SELF-FULFILLMENT; PROVIDING AN ONLINE COMPUTER DATABASE IN THE FIELD OF SOCIAL NETWORKING; PROVIDING INFORMATION CONCERNING CHARITABLE CAUSES AND HUMANITARIAN EFFORTS IN THE FIELD OF SOCIAL JUSTICE, IN CLASS 45 (U.S. CLS. 100 AND 101).

FIRST USE 3-15-2011; IN COMMERCE 3-15-2011.

NO CLAIM IS MADE TO THE EXCLUSIVE RIGHT TO USE "MILITARY", APART FROM THE MARK AS SHOWN.



David J. Kyjars

Director of the United States Patent and Trademark Office

Reg. No. 4,173,997 THE MARK CONSISTS OF CONSISTS OF A LINE OF A SET OF TWO STARS ON A FIELD OF THREE HORIZONTAL LINES FRAMING THE WORD "MILITARY" AND BROADLY BENEATH, A SECOND LINE CONTAINING THE WORD "AUTHORITY".

SER. NO. 85-322,911, FILED 5-17-2011.

NATALIE POLZER, EXAMINING ATTORNEY

United States of America

United States Patent and Trademark Office

 **MILITARY**
AUTHORITY

Reg. No. 4,173,998

Registered July 17, 2012

Int. Cl.: 42

SERVICE MARK

PRINCIPAL REGISTER

GRANTHAM EDUCATION CORPORATION (DELAWARE CORPORATION)
2101 WILSON BOULEVARD
SUITE 110
ARLINGTON, VA 22201

FOR: COMPUTER SERVICES, NAMELY, HOSTING ONLINE WEB FACILITIES FOR OTHERS FOR ORGANIZING AND CONDUCTING ONLINE MEETINGS, GATHERINGS, AND INTERACTIVE DISCUSSIONS; COMPUTER SERVICES IN THE NATURE OF CUSTOMIZED WEB PAGES FEATURING USER-DEFINED INFORMATION, PERSONAL PROFILES AND INFORMATION; COMPUTER SERVICES, NAMELY, CREATING AN ON-LINE COMMUNITY FOR REGISTERED USERS TO PARTICIPATE IN DISCUSSION, GET FEEDBACK FROM THEIR PEERS, FORM VIRTUAL COMMUNITIES, AND ENGAGE IN SOCIAL NETWORKING; PEER-TO-BROWSER PHOTO SHARING SERVICES NAMELY, PROVIDING A WEBSITE FEATURING TECHNOLOGY ENABLING USERS TO UPLOAD, VIEW AND DOWNLOAD DIGITAL PHOTOS; PROVIDING TEMPORARY USE OF NON-DOWNLOADABLE SOFTWARE APPLICATIONS FOR CLASSIFIEDS, VIRTUAL COMMUNITY, SOCIAL NETWORKING, PHOTO SHARING, AND TRANSMISSION OF PHOTOGRAPHIC IMAGES; COMPUTER SERVICES, NAMELY, CREATING VIRTUAL COMMUNITIES FOR REGISTERED USERS TO ORGANIZE GROUPS AND EVENTS, PARTICIPATE IN DISCUSSIONS, AND ENGAGE IN SOCIAL, BUSINESS AND COMMUNITY NETWORKING; COMPUTER SERVICES, NAMELY, HOSTING ONLINE FACILITIES FOR OTHERS FOR ORGANIZING AND CONDUCTING MEETINGS, EVENTS AND INTERACTIVE DISCUSSIONS VIA COMMUNICATION NETWORKS; APPLICATION SERVICE PROVIDER (ASP) SERVICES, NAMELY, HOSTING COMPUTER SOFTWARE APPLICATIONS OF OTHERS; APPLICATION SERVICE PROVIDER (ASP) FEATURING SOFTWARE TO ENABLE OR FACILITATE THE UPLOADING, DOWNLOADING, STREAMING, POSTING, DISPLAYING, BLOGGING, LINKING, SHARING OR OTHERWISE PROVIDING ELECTRONIC MEDIA OR INFORMATION OVER COMMUNICATION NETWORKS; PROVIDING AN ONLINE NETWORK SERVICE THAT ENABLES USERS TO TRANSFER PERSONAL IDENTITY DATA TO AND SHARE PERSONAL IDENTIFY DATA WITH AND AMONG MULTIPLE WEBSITES; PROVIDING A WEB SITE FEATURING TECHNOLOGY THAT ENABLES ONLINE USERS TO CREATE PERSONAL PROFILES FEATURING SOCIAL NETWORKING INFORMATION AND TO TRANSFER AND SHARE SUCH INFORMATION AMONG MULTIPLE WEBSITES; PROVIDING TEMPORARY USE OF NON-DOWNLOADABLE SOFTWARE APPLICATIONS FOR SOCIAL NETWORKING, CREATING A VIRTUAL COMMUNITY, AND TRANSMISSION OF AUDIO, VIDEO, PHOTOGRAPHIC IMAGES, TEXT, GRAPHICS AND DATA; COMPUTER SERVICES IN THE NATURE OF CUSTOMIZED WEB PAGES FEATURING USER-DEFINED OR SPE-



David J. Kyjars

Director of the United States Patent and Trademark Office

Reg. No. 4,173,998 CIFIED INFORMATION, PERSONAL PROFILES, AUDIO, VIDEO, PHOTOGRAPHIC IMAGES, TEXT, GRAPHICS AND DATA, IN CLASS 42 (U.S. CLS. 100 AND 101).

FIRST USE 3-15-2011; IN COMMERCE 3-15-2011.

NO CLAIM IS MADE TO THE EXCLUSIVE RIGHT TO USE "MILITARY", APART FROM THE MARK AS SHOWN.

THE MARK CONSISTS OF CONSISTS OF A LINE OF A SET OF TWO STARS ON A FIELD OF THREE HORIZONTAL LINES FRAMING THE WORD "MILITARY" AND BROADLY BENEATH, A SECOND LINE CONTAINING THE WORD "AUTHORITY".

SER. NO. 85-322,917, FILED 5-17-2011.

NATALIE POLZER, EXAMINING ATTORNEY

United States of America

United States Patent and Trademark Office

UmbreLight

Reg. No. 4,173,999

Registered July 17, 2012

Int. Cl.: 18

TRADEMARK

PRINCIPAL REGISTER

PRINCIPI, VALERIE (UNITED STATES INDIVIDUAL)
12 SCHOOLHOUSE HILL ROAD
NEWTOWN, CT 06470

FOR: UMBRELLAS, IN CLASS 18 (U.S. CLS. 1, 2, 3, 22 AND 41).

FIRST USE 12-22-2011; IN COMMERCE 2-17-2012.

THE MARK CONSISTS OF STANDARD CHARACTERS WITHOUT CLAIM TO ANY PARTICULAR FONT, STYLE, SIZE, OR COLOR.

SER. NO. 85-322,933, FILED S.R. 5-17-2011 AM. P.R. 3-1-2012.

TOBY BULLOFF, EXAMINING ATTORNEY



David J. Kyffers

Director of the United States Patent and Trademark Office

United States of America

United States Patent and Trademark Office



Reg. No. 4,174,000

Registered July 17, 2012

Int. Cl.: 42

SERVICE MARK

PRINCIPAL REGISTER

CHAMPLIN RESOURCES, LLC (OKLAHOMA LIMITED LIABILITY COMPANY)
PO BOX 1066
ENID, OK 73702

FOR: EXPLORATION AND SEARCHING OF OIL AND GAS, IN CLASS 42 (U.S. CLS. 100 AND 101).

FIRST USE 1-1-2009; IN COMMERCE 1-1-2009.

THE MARK CONSISTS OF RED MALTESE CROSS BACKGROUND WITH CIRCULAR WHITE "C" AND A BLUE BANNER WITH WHITE BORDER WITH THE WORD "CHAMPLIN" IN WHITE ACROSS THE BANNER.

THE COLOR(S) RED, WHITE AND BLUE IS/ARE CLAIMED AS A FEATURE OF THE MARK.

SER. NO. 85-322,958, FILED 5-17-2011.

JOHN DWYER, EXAMINING ATTORNEY



David J. Kyffers

Director of the United States Patent and Trademark Office

United States of America

United States Patent and Trademark Office

MILITARY AUTHORITY

Reg. No. 4,174,001

Registered July 17, 2012

Int. Cl.: 41

SERVICE MARK

PRINCIPAL REGISTER

GRANTHAM EDUCATION CORPORATION (DELAWARE CORPORATION)
2101 WILSON BOULEVARD
SUITE 110
ARLINGTON, VA 22201

FOR: EDUCATIONAL SERVICES, NAMELY, PROVIDING ACCREDITED AND CERTIFIED COURSES OF INSTRUCTION AT THE POST-SECONDARY AND COLLEGE LEVEL; ELECTRONIC PUBLISHING SERVICES, NAMELY, PUBLISHING OF ONLINE TEXT AND GRAPHIC WORKS OF OTHERS FEATURING USER-CREATED CONTENT; PROVIDING ON-LINE JOURNALS, NAMELY, BLOGS AND INTERACTIVE ONLINE WEB JOURNALS FEATURING USER-CREATED CONTENT; ONLINE JOURNALS, NAMELY, BLOGS FEATURING INFORMATION REGARDING EDUCATION, HEALTH CARE, FINANCE, INSURANCE AND MILITARY LIFE, IN CLASS 41 (U.S. CLS. 100, 101 AND 107).

FIRST USE 3-15-2011; IN COMMERCE 3-15-2011.

THE MARK CONSISTS OF STANDARD CHARACTERS WITHOUT CLAIM TO ANY PARTICULAR FONT, STYLE, SIZE, OR COLOR.

NO CLAIM IS MADE TO THE EXCLUSIVE RIGHT TO USE "MILITARY", APART FROM THE MARK AS SHOWN.

SER. NO. 85-323,014, FILED 5-17-2011.

NATALIE POLZER, EXAMINING ATTORNEY



David J. Kybas

Director of the United States Patent and Trademark Office

United States of America

United States Patent and Trademark Office

MILITARY AUTHORITY

Reg. No. 4,174,002

Registered July 17, 2012

Int. Cl.: 38

SERVICE MARK

PRINCIPAL REGISTER

GRANTHAM EDUCATION CORPORATION (DELAWARE CORPORATION)
2101 WILSON BOULEVARD
SUITE 110
ARLINGTON, VA 22201

FOR: PROVIDING ONLINE CHAT ROOMS AND ELECTRONIC BULLETIN BOARDS FOR TRANSMISSION OF MESSAGES REGARDING, AND IN THE NATURE OF, SOCIAL NETWORKING, VIRTUAL COMMUNITY, PHOTOGRAPHIC IMAGE SHARING, ADVERTISING AND CLASSIFIEDS; PROVISION OF ON-LINE FORUMS FOR COMMUNICATIONS IN THE NATURE OF, SOCIAL NETWORKING, VIRTUAL COMMUNITY, PHOTOGRAPHIC IMAGE SHARING, ADVERTISING AND CLASSIFIEDS, IN CLASS 38 (U.S. CLS. 100, 101 AND 104).

FIRST USE 3-15-2011; IN COMMERCE 3-15-2011.

THE MARK CONSISTS OF STANDARD CHARACTERS WITHOUT CLAIM TO ANY PARTICULAR FONT, STYLE, SIZE, OR COLOR.

NO CLAIM IS MADE TO THE EXCLUSIVE RIGHT TO USE "MILITARY" , APART FROM THE MARK AS SHOWN.

SER. NO. 85-323,030, FILED 5-17-2011.

NATALIE POLZER, EXAMINING ATTORNEY



David J. Kyffers

Director of the United States Patent and Trademark Office

United States of America

United States Patent and Trademark Office

Cross Of A Storm

Reg. No. 4,174,003

GUIDRY II, HAROLD J. (UNITED STATES INDIVIDUAL)

Registered July 17, 2012

511 HARRELL DRIVE
LAFAYETTE, LA 70503

Int. Cl.: 14

FOR: JEWELRY, NAMELY, CROSSES, IN CLASS 14 (U.S. CLS. 2, 27, 28 AND 50).

TRADEMARK

FIRST USE 10-21-2005; IN COMMERCE 10-21-2005.

PRINCIPAL REGISTER

THE MARK CONSISTS OF STANDARD CHARACTERS WITHOUT CLAIM TO ANY PARTICULAR FONT, STYLE, SIZE, OR COLOR.

NO CLAIM IS MADE TO THE EXCLUSIVE RIGHT TO USE "CROSS", APART FROM THE MARK AS SHOWN.

SER. NO. 85-323,035, FILED 5-17-2011.

ROBIN MITTLER, EXAMINING ATTORNEY



David J. Kyffers

Director of the United States Patent and Trademark Office

United States of America

United States Patent and Trademark Office

MILITARY AUTHORITY

Reg. No. 4,174,004

Registered July 17, 2012

Int. Cls.: 35 and 45

SERVICE MARK

PRINCIPAL REGISTER

GRANTHAM EDUCATION CORPORATION (DELAWARE CORPORATION)
2101 WILSON BOULEVARD
SUITE 110
ARLINGTON, VA 22201

FOR: AN ONLINE DIRECTORY INFORMATION SERVICE FEATURING INFORMATION REGARDING SCHOOLS AND JOBS; CLASSIFIED ADVERTISING SERVICES; ADVERTISING AND INFORMATION DISTRIBUTION SERVICES, NAMELY, PROVIDING CLASSIFIED ADVERTISING SPACE VIA THE INTERNET AND GLOBAL COMPUTER NETWORKS; PROMOTING THE GOODS AND SERVICES OF OTHERS VIA THE INTERNET AND GLOBAL COMPUTER NETWORKS; PROMOTING THE GOODS AND SERVICES OF OTHERS BY PROVIDING LINKS TO THE WEB SITES OF OTHERS; PROVIDING ON-LINE COMPUTER DATABASE AND ON-LINE SEARCHABLE DATABASES IN THE FIELD OF ADVERTISING AND CLASSIFIED; BUSINESS NETWORKING; PROVIDING INFORMATION REGARDING CHARITABLE SERVICES IN THE NATURE OF ORGANIZING AND CONDUCTING VOLUNTEER PROGRAMS AND COMMUNITY SERVICE PROJECTS, IN CLASS 35 (U.S. CLS. 100, 101 AND 102).

FIRST USE 3-15-2011; IN COMMERCE 3-15-2011.

FOR: ON-LINE SOCIAL NETWORKING SERVICES; INTERNET-BASED AND GLOBAL COMPUTER NETWORK BASED SOCIAL INTRODUCTION AND SOCIAL NETWORKING SERVICES; PROVIDING ON-LINE COMPUTER DATABASES AND ON-LINE SEARCHABLE DATABASES IN THE FIELD OF SOCIAL NETWORKING; SOCIAL INTRODUCTION SERVICES; PROVIDING INFORMATION IN THE FIELD OF PERSONAL DEVELOPMENT, NAMELY, SELF-IMPROVEMENT AND SELF-FULFILLMENT; PROVIDING AN ONLINE COMPUTER DATABASE IN THE FIELD OF SOCIAL NETWORKING; PROVIDING INFORMATION CONCERNING CHARITABLE CAUSES AND HUMANITARIAN EFFORTS IN THE FIELD OF SOCIAL JUSTICE, IN CLASS 45 (U.S. CLS. 100 AND 101).

FIRST USE 3-15-2011; IN COMMERCE 3-15-2011.

THE MARK CONSISTS OF STANDARD CHARACTERS WITHOUT CLAIM TO ANY PARTICULAR FONT, STYLE, SIZE, OR COLOR.

NO CLAIM IS MADE TO THE EXCLUSIVE RIGHT TO USE "MILITARY" , APART FROM THE MARK AS SHOWN.



David J. Kyffers

Director of the United States Patent and Trademark Office

Reg. No. 4,174,004 SER. NO. 85-323,038, FILED 5-17-2011.

NATALIE POLZER, EXAMINING ATTORNEY

United States of America

United States Patent and Trademark Office

MILITARY AUTHORITY

Reg. No. 4,174,005

Registered July 17, 2012

Int. Cl.: 42

SERVICE MARK

PRINCIPAL REGISTER

GRANTHAM EDUCATION CORPORATION (DELAWARE CORPORATION)
2101 WILSON BOULEVARD
SUITE 110
ARLINGTON, VA 22201

FOR: COMPUTER SERVICES, NAMELY, HOSTING ONLINE WEB FACILITIES FOR OTHERS FOR ORGANIZING AND CONDUCTING ONLINE MEETINGS, GATHERINGS, AND INTERACTIVE DISCUSSIONS; COMPUTER SERVICES IN THE NATURE OF CUSTOMIZED WEB PAGES FEATURING USER-DEFINED INFORMATION, PERSONAL PROFILES AND INFORMATION; COMPUTER SERVICES, NAMELY, CREATING AN ON-LINE COMMUNITY FOR REGISTERED USERS TO PARTICIPATE IN DISCUSSION, GET FEEDBACK FROM THEIR PEERS, FORM VIRTUAL COMMUNITIES, AND ENGAGE IN SOCIAL NETWORKING; PEER-TO-BROWSER PHOTO SHARING SERVICES, NAMELY, PROVIDING A WEBSITE FEATURING TECHNOLOGY ENABLING USERS TO UPLOAD, VIEW AND DOWNLOAD DIGITAL PHOTOS; PROVIDING TEMPORARY USE OF NON-DOWNLOADABLE SOFTWARE APPLICATIONS FOR CLASSIFIEDS, VIRTUAL COMMUNITY, SOCIAL NETWORKING, PHOTO SHARING, AND TRANSMISSION OF PHOTOGRAPHIC IMAGES; COMPUTER SERVICES, NAMELY, CREATING VIRTUAL COMMUNITIES FOR REGISTERED USERS TO ORGANIZE GROUPS AND EVENTS, PARTICIPATE IN DISCUSSIONS, AND ENGAGE IN SOCIAL, BUSINESS AND COMMUNITY NETWORKING; COMPUTER SERVICES, NAMELY, HOSTING ONLINE FACILITIES FOR OTHERS FOR ORGANIZING AND CONDUCTING MEETINGS, EVENTS AND INTERACTIVE DISCUSSIONS VIA COMMUNICATION NETWORKS; APPLICATION SERVICE PROVIDER (ASP) SERVICES, NAMELY, HOSTING COMPUTER SOFTWARE APPLICATIONS OF OTHERS; APPLICATION SERVICE PROVIDER (ASP) FEATURING SOFTWARE TO ENABLE OR FACILITATE THE UPLOADING, DOWNLOADING, STREAMING, POSTING, DISPLAYING, BLOGGING, LINKING, SHARING OR OTHERWISE PROVIDING ELECTRONIC MEDIA OR INFORMATION OVER COMMUNICATION NETWORKS; PROVIDING AN ONLINE NETWORK SERVICE THAT ENABLES USERS TO TRANSFER PERSONAL IDENTITY DATA TO AND SHARE PERSONAL IDENTIFY DATA WITH AND AMONG MULTIPLE WEBSITES; PROVIDING A WEB SITE FEATURING TECHNOLOGY THAT ENABLES ONLINE USERS TO CREATE PERSONAL PROFILES FEATURING SOCIAL NETWORKING INFORMATION AND TO TRANSFER AND SHARE SUCH INFORMATION AMONG MULTIPLE WEBSITES; PROVIDING TEMPORARY USE OF NON-DOWNLOADABLE SOFTWARE APPLICATIONS FOR SOCIAL NETWORKING, CREATING A VIRTUAL COMMUNITY, AND TRANSMISSION OF AUDIO, VIDEO, PHOTOGRAPHIC IMAGES, TEXT, GRAPHICS AND DATA; COMPUTER SERVICES IN THE NATURE OF CUSTOMIZED WEB PAGES FEATURING USER-DEFINED OR SPE-



David J. Kybas

Director of the United States Patent and Trademark Office

Reg. No. 4,174,005 CIFIED INFORMATION, PERSONAL PROFILES, AUDIO, VIDEO, PHOTOGRAPHIC IMAGES, TEXT, GRAPHICS AND DATA, IN CLASS 42 (U.S. CLS. 100 AND 101).

FIRST USE 3-15-2011; IN COMMERCE 3-15-2011.

THE MARK CONSISTS OF STANDARD CHARACTERS WITHOUT CLAIM TO ANY PARTICULAR FONT, STYLE, SIZE, OR COLOR.

NO CLAIM IS MADE TO THE EXCLUSIVE RIGHT TO USE "MILITARY", APART FROM THE MARK AS SHOWN.

SER. NO. 85-323,046, FILED 5-17-2011.

NATALIE POLZER, EXAMINING ATTORNEY

United States of America

United States Patent and Trademark Office



Gay & Lesbian Event Web

Reg. No. 4,174,006

Registered July 17, 2012

Int. Cl.: 42

SERVICE MARK

PRINCIPAL REGISTER

DICINQUE, PAULA (UNITED STATES INDIVIDUAL)
193 DEVON DRIVE
WEST DEPTFORD, NJ 08096

FOR: COMPUTER SERVICES, NAMELY, CREATING AN ON-LINE COMMUNITY FOR REGISTERED USERS TO PARTICIPATE IN DISCUSSIONS, GET FEEDBACK FROM THEIR PEERS, FORM VIRTUAL COMMUNITIES, AND ENGAGE IN SOCIAL NETWORKING IN THE FIELD OF INFORMATION ON LOCAL GAY, LESBIAN, BISEXUAL, TRANSGENDER VENUES AND SOCIAL GATHERINGS AS WELL AS BEING A PREMIER GAY, LESBIAN, BISEXUAL, TRANSGENDER PERSONAL, PROFESSIONAL, AND SOCIAL NETWORKING SITE, IN CLASS 42 (U.S. CLS. 100 AND 101).

FIRST USE 9-11-2009; IN COMMERCE 9-11-2009.

NO CLAIM IS MADE TO THE EXCLUSIVE RIGHT TO USE "GAY & LESBIAN EVENT WEB", APART FROM THE MARK AS SHOWN.

THE MARK CONSISTS OF A HALF-MOON SHAPED RAINBOW WITH A CARTOON COMPUTER SCREEN SUPERIMPOSED THEREUPON, BELOW WHICH APPEARS THE WORDING "SWEETGLUE.COM" AND BELOW WHICH APPEARS THE WORDING "GAY & LESBIAN EVENT WEB".

SER. NO. 85-323,302, FILED 5-17-2011.

ERIN FALK, EXAMINING ATTORNEY



David J. Kybas

Director of the United States Patent and Trademark Office

United States of America

United States Patent and Trademark Office

HOME OF THE FREE DENTAL IMPLANTS

Reg. No. 4,174,007

WERDER, LORI (UNITED STATES INDIVIDUAL)
771 LATINA CT
HENDERSON, NV 89012

Registered July 17, 2012

Int. Cl.: 44

FOR: DENTISTRY, IN CLASS 44 (U.S. CLS. 100 AND 101).

SERVICE MARK

FIRST USE 1-1-2010; IN COMMERCE 1-5-2010.

PRINCIPAL REGISTER

THE MARK CONSISTS OF STANDARD CHARACTERS WITHOUT CLAIM TO ANY PARTICULAR FONT, STYLE, SIZE, OR COLOR.

NO CLAIM IS MADE TO THE EXCLUSIVE RIGHT TO USE "FREE DENTAL IMPLANTS", APART FROM THE MARK AS SHOWN.

SER. NO. 85-323,480, FILED 5-18-2011.

TINA BROWN, EXAMINING ATTORNEY



David J. Kyffers

Director of the United States Patent and Trademark Office

United States of America

United States Patent and Trademark Office

1 BEER 2 BEER 3 BEER FREE
BEER

Reg. No. 4,174,008

CAMPAGNO, MICHAEL (UNITED STATES INDIVIDUAL)
2850 E. TROPICANA AVENUE
LAS VEGAS, NV 89120

Registered July 17, 2012

Int. Cl.: 43

FOR: BAR SERVICES, IN CLASS 43 (U.S. CLS. 100 AND 101).

SERVICE MARK

FIRST USE 5-11-2011; IN COMMERCE 5-11-2011.

PRINCIPAL REGISTER

THE MARK CONSISTS OF STANDARD CHARACTERS WITHOUT CLAIM TO ANY PARTICULAR FONT, STYLE, SIZE, OR COLOR.

SER. NO. 85-323,482, FILED 5-18-2011.

MATTHEW EINSTEIN, EXAMINING ATTORNEY



David J. Kybas

Director of the United States Patent and Trademark Office

United States of America

United States Patent and Trademark Office

Productive
Affection
—
Constructive
Kindness



Reg. No. 4,174,009

Registered July 17, 2012

Int. Cl.: 41

SERVICE MARK

PRINCIPAL REGISTER

TUNCSIPER, ERDEM (UNITED STATES INDIVIDUAL)
700 N. LARRABEE STREET
CHICAGO, IL 60654

FOR: DOG TRAINING, IN CLASS 41 (U.S. CLS. 100, 101 AND 107).

FIRST USE 6-0-2010; IN COMMERCE 7-0-2010.

THE MARK CONSISTS OF "PRODUCTIVE" "AFFECTION" "CONSTRUCTIVE" AND "KINDNESS" STACKED WITH A LINE BETWEEN "CONSTRUCTIVE" AND "KINDNESS" AND DISPLAYED NEAR A DOG SILHOUETTE; EACH OF THE WORDS HAVING EACH FIRST LETTER IN BOLD THUS REVEALING THE ACRONYM "P.A.C.K.", TO THE RIGHT THERE IS A DOG SILHOUETTE STYLIZED OUT OF THE LETTERS "PACK", THE P IS STYLIZED INTO A HEAD, THE A IS THE FRONT OF THE BODY WITH TWO LEGS, THE C IS THE MAIN BODY PORTION, THE K IS THE REAR WITH TWO MORE LEGS AND THE TOP RIGHT OF THE K STYLIZED INTO A DOG TAIL, WHICH HAS SHADOW MARKS ON EITHER SIDE REPRESENTING A DOG'S TAIL WAGGING; PORTIONS OF THE LETTERS ARE FILLED IN TO DENOTE THE DOG'S BODY, AND THERE IS A COLLAR BETWEEN P AND THE A.

SER. NO. 85-323,640, FILED 5-18-2011.

CHERYL CLAYTON, EXAMINING ATTORNEY



David J. Kyjars

Director of the United States Patent and Trademark Office

United States of America

United States Patent and Trademark Office

Reflect H2O

Reg. No. 4,174,010

REFLECT SPORTS (CALIFORNIA CORPORATION)
7 CHANTILLY LANE

Registered July 17, 2012

LADERA RANCH, CA 92694

Int. Cl.: 3

FOR: GEL FOR SUN PROTECTION; HAIR SHAMPOOS AND CONDITIONERS, IN CLASS 3 (U.S. CLS. 1, 4, 6, 50, 51 AND 52).

TRADEMARK

FIRST USE 3-1-2009; IN COMMERCE 7-23-2009.

PRINCIPAL REGISTER

THE MARK CONSISTS OF STANDARD CHARACTERS WITHOUT CLAIM TO ANY PARTICULAR FONT, STYLE, SIZE, OR COLOR.

SER. NO. 85-323,657, FILED 5-18-2011.

SKYE YOUNG, EXAMINING ATTORNEY



David J. Kyros

Director of the United States Patent and Trademark Office

United States of America

United States Patent and Trademark Office

SUPER DUST

Reg. No. 4,174,011

L'OREAL (FRANCE SOCIÉTÉ ANONYME (SA))

Registered July 17, 2012

14 RUE ROYALE
PARIS, FRANCE 75008

Int. Cl.: 3

FOR: SHAMPOOS; NON-MEDICATED HAIR STYLING AND HAIR CARE PREPARATIONS, NAMELY, GELS, MOUSSES, BALMS, CREAM, WAX, SERUMS, LOTIONS AND MASKS; HAIR LACQUERS; HAIR COLORING AND HAIR DECOLORANT PREPARATIONS; PROTECTIVE COLORING PREPARATIONS FOR TREATED HAIR; PERMANENT WAVING AND CURLING PREPARATIONS FOR HAIR; ESSENTIAL OILS FOR PERSONAL USE, IN CLASS 3 (U.S. CLS. 1, 4, 6, 50, 51 AND 52).

TRADEMARK

PRINCIPAL REGISTER

THE MARK CONSISTS OF STANDARD CHARACTERS WITHOUT CLAIM TO ANY PARTICULAR FONT, STYLE, SIZE, OR COLOR.

PRIORITY CLAIMED UNDER SEC. 44(D) ON FRANCE APPLICATION NO. 103790774, FILED 12-15-2010, REG. NO. 103790774, DATED 12-15-2010, EXPIRES 12-15-2020.

SER. NO. 85-323,670, FILED 5-18-2011.

HEATHER THOMPSON, EXAMINING ATTORNEY



David J. Kyffers

Director of the United States Patent and Trademark Office

United States of America

United States Patent and Trademark Office

POPPY CAT

Reg. No. 4,174,012

Registered July 17, 2012

**Int. Cls.: 3, 9, 11, 14, 16,
18, 20, 21, 24, 25, 26, 27,
28, 29, 30, 32, 38 and 41**

TRADEMARK

SERVICE MARK

PRINCIPAL REGISTER

COOLABI PRODUCTIONS LIMITED (UNITED KINGDOM LIMITED COMPANY (LTD.))
1ST FLOOR, WATERGATE HOUSE,
13-15 YORK BUILDINGS
LONDON WC2N 6JU, UNITED KINGDOM

FOR: COSMETICS AND FRAGRANCES; COSMETIC KITS COMPRISING NAIL POLISH, COSMETIC PENCILS, LIP BALM, LIP STICKS, LIP GLOSS, BATH OIL, BUBBLE BATH; PERFUMERY; ESSENTIAL OILS; CREAMS, LOTIONS AND POWDERS FOR THE COSMETIC TREATMENT AND CARE OF THE SKIN, HANDS, FACE, BODY, EYES, HAIR AND NAILS; SKIN MOISTURIZERS; HAND CREAM; TALCUM POWDER; LIP BALM; NON-MEDICATED PREPARATIONS FOR THE HAIR, SHAMPOO, HAIR CONDITIONER, MOUSSE, STYLING GEL; ANTI-PERSPIRANTS AND DEODORANTS FOR PERSONAL USE; SHOWER GEL, BODY WASH, SOAP; SUN SCREEN; BATH OIL, BUBBLE BATH; TOOTHPASTE; BABY WIPES; WIPES IMPREGNATED WITH COSMETIC LOTIONS AND CLEANING AGENTS; COTTON WOOL, COTTON BALLS AND COTTON BUDS FOR COSMETIC AND PERSONAL USE, IN CLASS 3 (U.S. CLS. 1, 4, 6, 50, 51 AND 52).

FOR: COMPUTER GAMES; COMPUTER GAME SOFTWARE; VIDEO GAME PROGRAMMES; INTERACTIVE ENTERTAINMENT SOFTWARE; ELECTRONIC GAMES; VIDEO GAME CARTRIDGES; COMPUTER AND VIDEO GAME SOFTWARE DOWNLOADED FROM THE INTERNET OR OTHER COMPUTER NETWORKS; PUBLICATIONS, NAMELY, MAGAZINES, COMICS, PERIODICALS, ARTWORK PUBLICATIONS, NEWSLETTERS AND NEWSPAPERS, ALL RECORDED ON COMPUTER READABLE MEDIA; DOWNLOADABLE ANIMATED CARTOONS AND FILMS; SOUND, VIDEO, FILM AND PICTURE RECORDINGS FEATURING ANIMATED CARTOONS AND CHILDREN'S ENTERTAINMENT; PRE-RECORDED MEDIA IN THE FORM OF COMPACT DISCS, CD ROMS, DVDS, COMPUTER DISCS, VIDEO CASSETTES, VIDEO TAPES FEATURING SOUND, VIDEO, FILM AND PICTURE RECORDINGS IN THE FIELD OF CHILDREN'S ENTERTAINMENT; ANIMATED CARTOONS AND ANIMATED FILMS RECORDED ON DVDS; SOUND RECORDINGS FEATURING MUSIC AND DIALOGUE IN THE FIELD OF CHILDREN'S ENTERTAINMENT, BUT NOT INCLUDING AUDIO BOOKS; COMPUTER SOFTWARE RELATING TO CHILDREN'S EDUCATION AND ENTERTAINMENT; AUTOMATIC VENDING MACHINES AND MECHANISMS FOR COIN OPERATED APPARATUS; APPARATUS AND INSTRUMENTS FOR RECORDING AND/OR REPRODUCING SOUND AND/OR VIDEO AND/OR DATA AND/OR INFORMATION, NAMELY, DIGITAL CAMERAS, DIGITAL AUDIO RECORDERS AND PLAYERS, DVD PLAYERS, PERSONAL DIGITAL ASSISTANTS; TELECOMMUNICATIONS DEVICES AND ACCESSORIES, NAMELY, TELEPHONES, MOBILE TELEPHONES, WALKIE-TALKIES;



David J. Kappas

Director of the United States Patent and Trademark Office

Reg. No. 4,174,012 ELECTRONIC AUDIO EQUIPMENT, NAMELY, COMPACT DISC PLAYERS, MP3 PLAYERS, AUDIO HEADPHONES AND EARPHONES, LOUDSPEAKERS, MICROPHONES; PORTABLE AUDIO AND VIDEO PLAYERS; RADIOS, CLOCK RADIOS; TELEVISIONS; COMPUTER GAMES CONSOLES FOR USE WITH AN EXTERNAL DISPLAY SCREEN OR MONITOR; CAMERAS; VIDEO CAMERAS, MATS FOR USE WITH A COMPUTER MOUSE; DECORATIVE MAGNETS; SUNGLASSES AND SPECTACLE FRAMES; SPECTACLE CASES; COMPASSES; BINOCULARS; TELESCOPES; MICROSCOPES; MICROPHONES; CALCULATORS; BICYCLE HELMETS, PROTECTIVE HELMETS; PROTECTIVE HOLDERS AND COVERS FOR NOTEBOOK COMPUTERS, COMPACT DISC PLAYERS, MP3 PLAYERS, DVD PLAYERS, PERSONAL DIGITAL ASSISTANTS, DIGITAL CAMERAS, VIDEO CAMERAS, MOBILE TELEPHONES; PARTS FOR ALL THE AFORESAID GOODS, IN CLASS 9 (U.S. CLS. 21, 23, 26, 36 AND 38).

FOR: NIGHT LIGHTS; SEASONAL LIGHTS; LAMPS; HANGING LAMPS; CHANDELIERS; LAMP SHADES; STRING LIGHTS; DECORATIVE ELECTRIC LIGHTING SETS; LIGHT WANDS; FLASHLIGHTS; BICYCLE REFLECTORS; BICYCLE LIGHTS; TOILET TRAINER SEATS, NAMELY, SMALLER TRAINING SEATS FOR ATTACHMENT TO FULL-SIZE TOILETS AND TOILET SEATS FOR TRAINING PURPOSES, IN CLASS 11 (U.S. CLS. 13, 21, 23, 31 AND 34).

FOR: JEWELLERY; IMITATION AND PLASTIC JEWELLERY; JEWELLERY BOXES; JEWELLERY CASES; JEWELLERY STANDS; WATCHES AND CLOCKS; WATCH STRAPS; KEY RINGS OF PRECIOUS METAL; TIE-PINS; CUFFLINKS; PARTS FOR ALL THE AFORESAID GOODS, IN CLASS 14 (U.S. CLS. 2, 27, 28 AND 50).

FOR: GREETINGS CARDS; POSTCARDS; TRADING CARDS; GIFT WRAP; GIFT BAGS; GIFT TAGS; WRAPPING AND PACKAGING MATERIAL NAMELY, WRAPPING PAPER; BADGES MADE OF CARDBOARD OR PAPER; STICKERS OTHER THAN FOR USE WITH STICKER BOOKS, TRANSFERS AND DECALS; DECORATIVE WALL DECALS; FRAMED OR UNFRAMED PICTURES, PHOTOGRAPHS, PRINTS; POSTERS; STATIONERY; PENS, PENCILS, COLOURED PENCILS, FELT-TIPPED PENS, MARKERS AND CRAYONS; CASES AND CONTAINERS FOR PENS, PENCILS, COLOURED PENCILS, FELT-TIPPED PENS, MARKERS AND CRAYONS; ERASERS, RULERS, STENCILS, PENCIL SHARPENERS, PENCIL AND PEN HOLDERS; ADHESIVES AND GLUES FOR HOUSEHOLD PURPOSES; MODELLING CLAY; PRINTING STAMPS AND INK PADS; CHALK AND CHALK BOARDS; NOTEBOOKS, NOTEPADS, BLANK JOURNALS; FOLDERS, BINDERS, DOCUMENT FILES; BOXES FOR STATIONERY AND PAPERS; BOXES MADE OF PAPER OR CARDBOARD; WRITING PADS AND PAPER; BLANK DRAWING BOOKS, COLOURING BOOKS; JOINTHE-DOT BOOKS; ART AND CRAFTS ART PAINT SETS; PAINT BOXES; PAINT BRUSHES, PASTELS; RUBBER STAMPS, PRINTING BLOCKS; INK PADS FOR STAMPS; CALENDARS; DIARIES; ADDRESS BOOKS; SCRAP BOOKS; AUTOGRAPH BOOKS; MAGAZINES FEATURING STORIES AND ENTERTAINMENT FOR CHILDREN, COMICS, PRINTED PERIODICALS FEATURING STORIES AND ENTERTAINMENT FOR CHILDREN; NEWSLETTERS AND NEWSPAPERS IN THE FIELD OF CHILDREN'S ENTERTAINMENT; SHEET MUSIC; BOOKMARKS; BOOKENDS; HEIGHT CHARTS; PARTY FAVORS MADE OF PAPER OR CARDBOARD; PARTY INVITATIONS; PARTY DECORATIONS AND BANNERS MADE OF PAPER OR CARDBOARD; COASTERS MADE OF PAPER OR CARDBOARD; PAPER TABLE COVERINGS; TABLE MATS; PAPER TABLE NAPKINS; PAPER HANDKERCHIEFS AND TISSUES; PRINTED PATTERNS FOR COSTUMES; LAP DESKS, NOTEBOOK COVERS; DOCUMENT HOLDERS, DRY ERASE WRITING BOARDS, WHITE BOARDS, IN CLASS 16 (U.S. CLS. 2, 5, 22, 23, 29, 37, 38 AND 50).

FOR: ARTICLES MADE OF LEATHER OR IMITATIONS OF LEATHER, NAMELY, BAGS OF LEATHER OR IMITATIONS OF LEATHER, BACK PACKS, RUCKSACKS, SCHOOL BAGS AND SACHELS, BOOK BAGS, WAIST PACKS, DUFFLE BAGS, LUNCH BAGS, GYM BAGS, SPORTS BAGS, TOTE BAGS, MESSENGER BAGS, BEACH BAGS, DIAPER BAGS; TOILETRY CASES AND BAGS SOLD EMPTY; KEY CASES; SUITCASES, TRAVEL CASES, LUGGAGE, HOLDALLS, HANDBAGS, SHOULDER BAGS; UMBRELLAS, PARA-

Reg. No. 4,174,012 SOLS, WALKING STICKS; WALLET, PURSES, COIN PURSES; DOCUMENT CASES, IN CLASS 18 (U.S. CLS. 1, 2, 3, 22 AND 41).

FOR: FURNITURE; MIRRORS; PICTURE FRAMES, PHOTO FRAMES; BEDS; CHAIRS; HIGH CHAIRS FOR BABIES; BOOK SHELVES; MAGAZINE RACKS, OTTOMANS; STOOLS; TABLES; TRAY TABLES; NOVELTY CHAIRS, INFLATABLE CHAIRS; BEAN BAG CHAIRS; ROCKING CHAIRS; MEDIA STORAGE FURNITURE; INDOOR BLINDS; FIGURINES MADE OF WOOD, WAX, PLASTER, RESIN OR PLASTIC; SLEEPING BAGS, SLEEPING MATS; DRINKING STRAWS; PILLOWS AND CUSHIONS; NOVELTY PILLOWS; CLOTHES HANGERS; NON-METAL CLOTHES HOOKS; FABRIC HANGING ORGANIZERS; PREFABRICATED CLOSET ORGANIZATION SYSTEMS MADE OF WOOD OR METAL; DECORATIVE MOBILES; PLASTIC CAKE DECORATIONS; CORK NOTICE BOARDS AND PIN BOARDS; MEMO BOARDS; WALL DECORATIONS OF WOOD; NON-METAL AND NON-PAPER CONTAINERS FOR STORAGE; WOODEN KNOBS, PLASTIC KNOBS, WOOD AND PLASTIC DRAWER PULLS; NON-METAL NAME PLATES; NON-METAL KEY-RINGS, IN CLASS 20 (U.S. CLS. 2, 13, 22, 25, 32 AND 50).

FOR: GLASS BEVERAGE WARE; PORCELAIN DISHES AND PLATES; BOXES MADE OF GLASS, PORCELAIN, CERAMIC OR EARTHENWARE; CUPS, MUGS, PLATES, DISHES, BOWLS AND POTS; CUPS MADE OF PAPER OR PLASTIC; PLATES MADE OF PAPER OR PLASTIC; DISPOSABLE TABLEWARE, NAMELY, PLATES, BOWLS AND CUPS; BOTTLES, SOLD EMPTY; WATER CANTEENS; DRINKING BOTTLES, SOLD EMPTY; DRINKING GLASSES; LUNCH BOXES; HOUSEHOLD CONTAINERS FOR FOOD OR BEVERAGES; SOAP BOXES, SOAP DISHES, SOAP DISPENSERS; TOOTHBRUSHES; ELECTRIC TOOTHBRUSHES; TOOTHBRUSH HOLDERS AND CONTAINERS; COMBS, HAIR BRUSHES; CLEANING SPONGES; POTTIES FOR CHILDREN; GENERAL PURPOSE HOUSEHOLD BINS FOR STORAGE; WASTE PAPER BINS AND WASTE BASKETS FOR DOMESTIC USE; NON-METAL MONEY BOXES; COOKIE CUTTERS; ARTICLES FOR USE IN CAKE DECORATING, NAMELY, CAKE DECORATING SETS COMPRISED PRIMARILY OF DECORATING TUBES, COUPLERS, TIPS, SOLD AS A UNIT; CLOTHING PEGS WHICH ARE CLOTHES PINS; GLASS DRAWER PULLS, IN CLASS 21 (U.S. CLS. 2, 13, 23, 29, 30, 33, 40 AND 50).

FOR: HOUSEHOLD LINEN; KITCHEN TOWELS, TOWELS; BEACH TOWELS; HANDKERCHIEFS; FABRIC NAPKINS; OVEN MITTS; DISHCLOTHS; FLANNELS; WASHING MITTS; TABLE LINEN; TABLE CLOTHS; PLACE MATS NOT OF PAPER, TABLE MATS NOT OF PAPER, COASTERS OF TEXTILE; BED LINEN; BABY BLANKETS; INFANT BEDDING SETS COMPRISING CRIB BLANKET, CRIB SHEET AND CRIB BUMPER; BED SHEETS; DUVETS; DUVET COVERS; BLANKETS FOR BEDS; BEDSPREADS; BED COVERS; PILLOW CASES; FABRIC VALANCES; TEXTILE WALL HANGINGS; CURTAINS; SHOWER CURTAINS; FABRIC FLAGS; PLASTIC TABLE COVERS, IN CLASS 24 (U.S. CLS. 42 AND 50).

FOR: CLOTHING, NAMELY, SHIRTS, SHORTS, TROUSERS, T-SHIRTS, POLO SHIRTS, SWEATSHIRTS, SWEATERS, DRESSES, SKIRTS; BOXER SHORTS, LINGERIE, SOCKS, HOSIERY, UNDERWEAR; COATS, JACKETS; SLEEPWEAR; SCARVES, GLOVES; SWIMWEAR; BEACHWEAR; BATHROBES, DRESSING GOWNS; INFANT WEAR; FOOTWEAR, HEADWEAR; SLIPPERS; HATS, CAPS, VISORS; EARMUFFS; BELTS; FANCY DRESS, MASQUERADE AND HALLOWEEN COSTUMES, IN CLASS 25 (U.S. CLS. 22 AND 39).

FOR: ORNAMENTAL NOVELTY BADGES; ORNAMENTAL CLOTH PATCHES; BUTTONS, RIBBON AND BRAID; HAIR BANDS AND SLIDES; BELT CLASPS; HAIRGRIPS; HAIR AND SHOE ORNAMENTS NOT OF PRECIOUS METAL; HAT ORNAMENTS NOT OF PRECIOUS METAL; SHOE LACES; BROOCHES BEING CLOTHING ACCESSORIES, HAIR AND SHOE BUCKLES, IN CLASS 26 (U.S. CLS. 37, 39, 40, 42 AND 50).

FOR: CARPETS, RUGS, MATS AND MATTING, LINOLEUMS FOR COVERING EXISTING FLOORS; NON-TEXTILE WALL HANGINGS; WALL BORDERS BEING DECORATIONS IN THE NATURE OF WALL COVERINGS; WALLPAPER; DOOR MATS; BATH MATS, IN CLASS 27 (U.S. CLS. 19, 20, 37, 42 AND 50).

Reg. No. 4,174,012 FOR: TOYS, NAMELY, CHILDREN'S MULTIPLE ACTIVITY TOYS, COLLECTABLE TOY FIGURES, STUFFED FIGURES, TOY ACTION FIGURES, DOLLS, PLUSH DOLLS, RAG DOLLS; DOLLS AND ACCESSORIES AND CLOTHES THEREFOR; PLUSH TOYS; SOFT TOYS; SOFT SCULPTED TOY FIGURES AND DOLLS; PUPPETS; GAMES, NAMELY, BOARD GAMES, ACTION SKILL GAMES, PLAYING CARDS, CARD GAMES; PLAYTHINGS, NAMELY, PUPPET THEATRES; GYMNAS TIC AND SPORTING ARTICLES NAMELY, BALLS OF ALL KINDS; FANCY DRESS, MASQUERADE AND HALLOWEEN MASKS; JIGSAW PUZZLES; HOBBY CRAFT SETS AND ACTIVITY SETS IN THE FORM OF SCRAPBOOK MAKING KITS, DIARY MAKING KITS, GREETINGS CARD MAKING KITS, STAMP MAKING KITS, JEWELLERY MAKING KITS, JEWELLERY BOX MAKING KITS, CLOTHES DESIGN KITS, BAG MAKING KITS, COSMETICS MAKING KITS, LANTERN MAKING KITS, FASHION ACCESSORY MAKING AND DESIGN KITS, BADGE MAKING SETS, TOY MODELLING DOUGH ACTIVITY SETS, PHOTOFRAME PAINTING KITS, COLOURING ACTIVITY SETS; TOY WATCHES; BALLOONS; MOBILES FOR CHILDREN; POOL RINGS, NAMELY, SWIM FLOATS, WATER WINGS; INFLATABLE SWIMMING POOLS; BATH TOYS; POOL TOYS; KITES; SOAP BUBBLES; NOVELTIES FOR PARTIES, NAMELY, PARTY PAPER HATS AND PARTY FAVORS IN THE NATURE OF SMALL TOYS; ROLLER SKATES, IN-LINE SKATES, SKATEBOARDS; JUMP ROPES; PARTY HATS; DECORATIONS FOR CHRISTMAS TREES; AMUSEMENT APPARATUS INCORPORATING A TELEVISION SCREEN AND ELECTRONIC ARCADE GAMES; PROTECTIVE ELBOW AND KNEE PADS FOR ATHLETIC USE; SWIMMING AIDS, NAMELY, FLOATS, ARM FLOATS, POOL RINGS, SWIMMING BELTS, ALL FOR RECREATIONAL USE; CRIB MOBILES; TOY CONFECTIONERY DISPENSERS, IN CLASS 28 (U.S. CLS. 22, 23, 38 AND 50).

FOR: MEAT, FISH, POULTRY AND GAME; PREPARATIONS MADE FROM MEAT, FISH, SEAFOOD, POULTRY AND GAME, NAMELY, PATÉS, HAMS, SAUSAGES, MEATBALLS, STOCKS, PROCESSED MEATS; MEAT EXTRACTS; SOUPS; PRESERVED, DRIED AND COOKED FRUITS AND VEGETABLES; JELLIES, JAMS, FRUIT SAUCES; DAIRY PRODUCTS EXCLUDING ICE CREAM, ICE MILK AND FROZEN YOGHURT; EGGS, MILK AND MILK PRODUCTS EXCLUDING ICE CREAM, ICE MILK AND FROZEN YOGHURT; EDIBLE OILS AND FATS; NUTS; SNACK FOODS NAMELY, FRUIT-BASED SNACK FOODS, NUT-BASED SNACK FOODS, POTATO-BASED SNACK FOODS; POTATO CHIPS; DESSERTS AND FILLINGS THEREFOR, NAMELY, DESSERTS CONSISTING PRIMARILY OF FRUITS; DESSERTS CONSISTING PRIMARILY OF YOGHURTS OR MILK PRODUCTS EXCLUDING ICE CREAM, ICE MILK AND FROZEN YOGHURT; PREPARED ENTREES CONSISTING PRIMARILY OF MEAT, OR FISH, OR SEAFOOD, OR POULTRY; PREPARED SALADS EXCEPT RICE, PASTA, MACARONI; FRUIT SALADS, IN CLASS 29 (U.S. CL. 46).

FOR: CONFECTIONERY MADE OF SUGAR; CHOCOLATE; ICES, ICE CREAM, FROZEN CONFECTIONS; COFFEE, TEA, COCOA, SUGAR, RICE, FLOUR AND PREPARATIONS MADE FROM CEREALS, NAMELY, PORRIDGE, MUESLI, BREAKFAST CEREALS, PROCESSED CEREALS; BREAD, CAKES, PASTRY; CAKE MIXES; HONEY, TREACLE; SAUCES; CUSTARD; SPICES; BREAKFAST CEREALS; BISCUITS, COOKIES; PANCAKES; PIZZAS; POPCORN; COCOA AND CHOCOLATE BASED BEVERAGES WITH MILK; EDIBLE CAKE DECORATIONS; CEREAL-BASED SNACK FOODS, CORN-BASED SNACK FOODS, IN CLASS 30 (U.S. CL. 46).

FOR: MINERAL AND AERATED WATERS AND OTHER NON-ALCOHOLIC DRINKS, NAMELY, SOFT DRINKS, SODAS AND SMOOTHIES; FRUIT DRINKS AND FRUIT JUICES; SYRUPS AND OTHER PREPARATIONS FOR MAKING BEVERAGES IN THE NATURE OF FRUIT FLAVOURED SOFT DRINKS, TEA FLAVOURED BEVERAGES, COFFEE FLAVOURED BEVERAGES, IN CLASS 32 (U.S. CLS. 45, 46 AND 48).

FOR: BROADCASTING SERVICES; TELEVISION AND RADIO BROADCASTING SERVICES; STREAMING OF AUDIO AND VIDEO MATERIAL ON THE INTERNET, IN CLASS 38 (U.S. CLS. 100, 101 AND 104).

Reg. No. 4,174,012 FOR: FILM, VIDEO, AND TELEVISION ENTERTAINMENT IN THE NATURE OF A SERIES OF CINEMATIC FILMS, VIDEO FILMS AND TELEVISION PROGRAMMES CONTAINING ANIMATED CARTOONS AND FILMS FOR CHILDREN AND CHILDREN'S ENTERTAINMENT FEATURES BROADCAST OVER TELEVISION AND VIDEO MEDIA; PROVIDING RADIO ENTERTAINMENT PROGRAMMES FOR CHILDREN; PRODUCTION AND DISTRIBUTION OF TELEVISION PROGRAMMES AND FILMS; PRODUCTION OF VIDEOTAPES; ENTERTAINMENT SERVICES PROVIDED VIA THE INTERNET, NAMELY, THE PROVISION OF AN INTERACTIVE ONLINE WEBSITE FOR CHILDREN FEATURING GAMES, PUZZLES, ENTERTAINMENT INFORMATION, STREAMING VIDEO CLIPS CONTAINING ANIMATED CARTOONS; VIDEOTAPE, FILM, CD-ROM, DVD AND CASSETTE PRODUCTION; VIDEO AND VIDEOTAPE EDITING; ORGANIZATION OF GAMES AND COMPETITIONS FOR CHILDREN IN THE NATURE OF QUIZZES, PUZZLES OR REQUIRING THE SUBMISSION OF ARTWORK AND OTHER MATERIALS TO WIN PRIZES; PROVISION OF PLAY FACILITIES FOR CHILDREN; MUSIC WRITING SERVICES; AMUSEMENT ARCADE SERVICES; INFORMATIONAL, ADVISORY AND CONSULTANCY SERVICES RELATING TO THE AFORESAID SERVICES, IN CLASS 41 (U.S. CLS. 100, 101 AND 107).

THE MARK CONSISTS OF STANDARD CHARACTERS WITHOUT CLAIM TO ANY PARTICULAR FONT, STYLE, SIZE, OR COLOR.

OWNER OF UNITED KINGDOM REG. NO. 2580066, DATED 9-2-2011, EXPIRES 5-3-2021.

SER. NO. 85-323,710, FILED 5-18-2011.

ANNE MADDEN, EXAMINING ATTORNEY

United States of America

United States Patent and Trademark Office



Reg. No. 4,174,013

Registered July 17, 2012

**Int. Cls.: 3, 9, 11, 14, 16,
18, 20, 21, 24, 25, 26, 27,
28, 29, 30, 32, 38 and 41**

TRADEMARK

SERVICE MARK

PRINCIPAL REGISTER

COOLABI PRODUCTIONS LIMITED (UNITED KINGDOM LIMITED COMPANY (LTD.))
1ST FLOOR, WATERGATE HOUSE,
13-15 YORK BUILDINGS
LONDON WC2N 6JU, UNITED KINGDOM

FOR: COSMETICS AND FRAGRANCES; COSMETIC KITS COMPRISING NAIL POLISH, COSMETIC PENCILS, LIP BALM, LIP STICKS, LIP GLOSS, BATH OIL, BUBBLE BATH; PERFUMERY; ESSENTIAL OILS; CREAMS, LOTIONS AND POWDERS FOR THE COSMETIC TREATMENT AND CARE OF THE SKIN, HANDS, FACE, BODY, EYES, HAIR AND NAILS; SKIN MOISTURIZERS; HAND CREAM; TALCUM POWDER; LIP BALM; NON-MEDICATED PREPARATIONS FOR THE HAIR, SHAMPOO, HAIR CONDITIONER, MOUSSE, STYLING GEL; ANTI-PERSPIRANTS AND DEODORANTS FOR PERSONAL USE; SHOWER GEL, BODY WASH, SOAP; SUN SCREEN; BATH OIL, BUBBLE BATH; TOOTHPASTE; BABY WIPES; WIPES IMPREGNATED WITH COSMETIC LOTIONS AND CLEANING AGENTS; COTTON WOOL, COTTON BALLS AND COTTON BUDS FOR COSMETIC AND PERSONAL USE, IN CLASS 3 (U.S. CLS. 1, 4, 6, 50, 51 AND 52).

FOR: COMPUTER GAMES; COMPUTER GAME SOFTWARE; VIDEO GAME PROGRAMMES; INTERACTIVE ENTERTAINMENT SOFTWARE; ELECTRONIC GAMES; VIDEO GAME CARTRIDGES; COMPUTER AND VIDEO GAME SOFTWARE DOWNLOADED FROM THE INTERNET OR OTHER COMPUTER NETWORKS; PUBLICATIONS, NAMELY, MAGAZINES, COMICS, PERIODICALS, ARTWORK PUBLICATIONS, NEWSLETTERS AND NEWSPAPERS, ALL RECORDED ON COMPUTER READABLE MEDIA; DOWNLOADABLE ANIMATED CARTOONS AND FILMS; SOUND, VIDEO, FILM AND PICTURE RECORDINGS FEATURING ANIMATED CARTOONS AND CHILDREN'S ENTERTAINMENT; PRE-RECORDED MEDIA IN THE FORM OF COMPACT DISCS, CD ROMS, DVDS, COMPUTER DISCS, VIDEO CASSETTES, VIDEO TAPES FEATURING SOUND, VIDEO, FILM AND PICTURE RECORDINGS IN THE FIELD OF CHILDREN'S ENTERTAINMENT; ANIMATED CARTOONS AND ANIMATED FILMS RECORDED ON DVDS; SOUND RECORDINGS FEATURING MUSIC AND DIALOGUE IN THE FIELD OF CHILDREN'S ENTERTAINMENT, BUT NOT INCLUDING AUDIO BOOKS; COMPUTER SOFTWARE RELATING TO CHILDREN'S EDUCATION AND ENTERTAINMENT; AUTOMATIC VENDING MACHINES AND MECHANISMS FOR COIN OPERATED APPARATUS; APPARATUS AND INSTRUMENTS FOR RECORDING AND/OR REPRODUCING SOUND AND/OR VIDEO AND/OR DATA AND/OR INFORMATION, NAMELY, DIGITAL CAMERAS, DIGITAL AUDIO RECORDERS AND PLAYERS, DVD PLAYERS, PERSONAL DIGITAL ASSISTANTS; TELECOMMUNICATIONS DEVICES AND ACCESSORIES, NAMELY, TELEPHONES, MOBILE TELEPHONES, WALKIE-TALKIES;



David J. Kappas

Director of the United States Patent and Trademark Office

Reg. No. 4,174,013 ELECTRONIC AUDIO EQUIPMENT, NAMELY, COMPACT DISC PLAYERS, MP3 PLAYERS, AUDIO HEADPHONES AND EARPHONES, LOUDSPEAKERS, MICROPHONES; PORTABLE AUDIO AND VIDEO PLAYERS; RADIOS, CLOCK RADIOS; TELEVISIONS; COMPUTER GAMES CONSOLES FOR USE WITH AN EXTERNAL DISPLAY SCREEN OR MONITOR; CAMERAS; VIDEO CAMERAS, MATS FOR USE WITH A COMPUTER MOUSE; DECORATIVE MAGNETS; SUNGLASSES AND SPECTACLE FRAMES; SPECTACLE CASES; COMPASSES; BINOCULARS; TELESCOPES; MICROSCOPES; MICROPHONES; CALCULATORS; BICYCLE HELMETS, PROTECTIVE HELMETS; PROTECTIVE HOLDERS AND COVERS FOR NOTEBOOK COMPUTERS, COMPACT DISC PLAYERS, MP3 PLAYERS, DVD PLAYERS, PERSONAL DIGITAL ASSISTANTS, DIGITAL CAMERAS, VIDEO CAMERAS, MOBILE TELEPHONES; PARTS FOR ALL THE AFORESAID GOODS, IN CLASS 9 (U.S. CLS. 21, 23, 26, 36 AND 38).

FOR: NIGHT LIGHTS; SEASONAL LIGHTS; LAMPS; HANGING LAMPS; CHANDELIERS; LAMP SHADES; STRING LIGHTS; DECORATIVE ELECTRIC LIGHTING SETS; LIGHT WANDS; FLASHLIGHTS; BICYCLE REFLECTORS; BICYCLE LIGHTS; TOILET TRAINER SEATS, NAMELY, SMALLER TRAINING SEATS FOR ATTACHMENT TO FULL-SIZE TOILETS AND TOILET SEATS FOR TRAINING PURPOSES, IN CLASS 11 (U.S. CLS. 13, 21, 23, 31 AND 34).

FOR: JEWELLERY; IMITATION AND PLASTIC JEWELLERY; JEWELLERY BOXES; JEWELLERY CASES; JEWELLERY STANDS; WATCHES AND CLOCKS; WATCH STRAPS; KEY RINGS OF PRECIOUS METAL; TIE-PINS; CUFFLINKS; PARTS FOR ALL THE AFORESAID GOODS, IN CLASS 14 (U.S. CLS. 2, 27, 28 AND 50).

FOR: GREETINGS CARDS; POSTCARDS; TRADING CARDS; GIFT WRAP; GIFT BAGS; GIFT TAGS; WRAPPING AND PACKAGING MATERIAL, NAMELY, WRAPPING PAPER; BADGES MADE OF CARDBOARD OR PAPER; STICKERS OTHER THAN FOR USE WITH STICKER BOOKS, TRANSFERS AND DECALS; DECORATIVE WALL DECALS; FRAMED OR UNFRAMED PICTURES, PHOTOGRAPHS, PRINTS; POSTERS; STATIONERY; PENS, PENCILS, COLOURED PENCILS, FELT-TIPPED PENS, MARKERS AND CRAYONS; CASES AND CONTAINERS FOR PENS, PENCILS, COLOURED PENCILS, FELT-TIPPED PENS, MARKERS AND CRAYONS; ERASERS, RULERS, STENCILS, PENCIL SHARPENERS, PENCIL AND PEN HOLDERS; ADHESIVES AND GLUES FOR HOUSEHOLD PURPOSES; MODELLING CLAY; PRINTING STAMPS AND INK PADS; CHALK AND CHALK BOARDS; NOTEBOOKS, NOTEPADS, BLANK JOURNALS; FOLDERS, BINDERS, DOCUMENT FILES; BOXES FOR STATIONERY AND PAPERS; BOXES MADE OF PAPER OR CARDBOARD; WRITING PADS AND PAPER; BLANK DRAWING BOOKS, COLOURING BOOKS; JOINTHE-DOT BOOKS; ART AND CRAFTS ART PAINT SETS; PAINT BOXES; PAINT BRUSHES, PASTELS; RUBBER STAMPS, PRINTING BLOCKS; INK PADS FOR STAMPS; CALENDARS; DIARIES; ADDRESS BOOKS; SCRAP BOOKS; AUTOGRAPH BOOKS; MAGAZINES FEATURING STORIES AND ENTERTAINMENT FOR CHILDREN, COMICS, PRINTED PERIODICALS FEATURING STORIES AND ENTERTAINMENT FOR CHILDREN; NEWSLETTERS AND NEWSPAPERS IN THE FIELD OF CHILDREN'S ENTERTAINMENT; SHEET MUSIC; BOOKMARKS; BOOKENDS; HEIGHT CHARTS; PARTY FAVORS MADE OF PAPER OR CARDBOARD; PARTY INVITATIONS; PARTY DECORATIONS AND BANNERS MADE OF PAPER OR CARDBOARD; COASTERS MADE OF PAPER OR CARDBOARD; PAPER TABLE COVERINGS; TABLE MATS; PAPER TABLE NAPKINS; PAPER HANDKERCHIEFS AND TISSUES; PRINTED PATTERNS FOR COSTUMES; LAP DESKS, NOTEBOOK COVERS; DOCUMENT HOLDERS, DRY ERASE WRITING BOARDS, WHITE BOARDS, IN CLASS 16 (U.S. CLS. 2, 5, 22, 23, 29, 37, 38 AND 50).

FOR: ARTICLES MADE OF LEATHER OR IMITATIONS OF LEATHER, NAMELY, BAGS OF LEATHER OR IMITATIONS OF LEATHER, BACK PACKS, RUCKSACKS, SCHOOL BAGS AND SACHELS, BOOK BAGS, WAIST PACKS, DUFFLE BAGS, LUNCH BAGS, GYM BAGS, SPORTS BAGS, TOTE BAGS, MESSENGER BAGS, BEACH BAGS, DIAPER BAGS; TOILETRY CASES AND BAGS SOLD EMPTY; KEY CASES; SUITCASES, TRAVEL CASES, LUGGAGE, HOLDALLS, HANDBAGS, SHOULDER BAGS; UMBRELLAS, PARA-

Reg. No. 4,174,013 SOLS, WALKING STICKS; WALLETTS, PURSES, COIN PURSES; DOCUMENT CASES, IN CLASS 18 (U.S. CLS. 1, 2, 3, 22 AND 41).

FOR: FURNITURE; MIRRORS; PICTURE FRAMES, PHOTO FRAMES; BEDS; CHAIRS; HIGH CHAIRS FOR BABIES; BOOK SHELVES; MAGAZINE RACKS, OTTOMANS; STOOLS; TABLES; TRAY TABLES; NOVELTY CHAIRS, INFLATABLE CHAIRS; BEAN BAG CHAIRS; ROCKING CHAIRS; MEDIA STORAGE FURNITURE; INDOOR BLINDS; FIGURINES MADE OF WOOD, WAX, PLASTER, RESIN OR PLASTIC; SLEEPING BAGS, SLEEPING MATS; DRINKING STRAWS; PILLOWS AND CUSHIONS; NOVELTY PILLOWS; CLOTHES HANGERS; NON-METAL CLOTHES HOOKS; FABRIC HANGING ORGANIZERS; PREFABRICATED CLOSET ORGANIZATION SYSTEMS MADE OF WOOD OR METAL; DECORATIVE MOBILES; PLASTIC CAKE DECORATIONS; CORK NOTICE BOARDS AND PIN BOARDS; MEMO BOARDS; WALL DECORATIONS OF WOOD; NON-METAL AND NON-PAPER CONTAINERS FOR STORAGE; WOODEN KNOBS, PLASTIC KNOBS, WOOD AND PLASTIC DRAWER PULLS; NON-METAL NAME PLATES; NON-METAL KEY-RINGS, IN CLASS 20 (U.S. CLS. 2, 13, 22, 25, 32 AND 50).

FOR: GLASS BEVERAGE WARE; PORCELAIN DISHES AND PLATES; BOXES MADE OF GLASS, PORCELAIN, CERAMIC OR EARTHENWARE; CUPS, MUGS, PLATES, DISHES, BOWLS AND POTS; CUPS MADE OF PAPER OR PLASTIC; PLATES MADE OF PAPER OR PLASTIC; DISPOSABLE TABLEWARE, NAMELY, PLATES, BOWLS AND CUPS; BOTTLES, SOLD EMPTY; WATER CANTEENS; DRINKING BOTTLES, SOLD EMPTY; DRINKING GLASSES; LUNCH BOXES; HOUSEHOLD CONTAINERS FOR FOOD OR BEVERAGES; SOAP BOXES, SOAP DISHES, SOAP DISPENSERS; TOOTHBRUSHES; ELECTRIC TOOTHBRUSHES; TOOTHBRUSH HOLDERS AND CONTAINERS; COMBS, HAIR BRUSHES; CLEANING SPONGES; POTTIES FOR CHILDREN; GENERAL PURPOSE HOUSEHOLD BINS FOR STORAGE; WASTE PAPER BINS AND WASTE BASKETS FOR DOMESTIC USE; NON-METAL MONEY BOXES; COOKIE CUTTERS; ARTICLES FOR USE IN CAKE DECORATING, NAMELY, CAKE DECORATING SETS COMPRISED PRIMARILY OF DECORATING TUBES, COUPLERS, TIPS, SOLD AS A UNIT; CLOTHING PEGS WHICH ARE CLOTHES PINS; GLASS DRAWER PULLS, IN CLASS 21 (U.S. CLS. 2, 13, 23, 29, 30, 33, 40 AND 50).

FOR: HOUSEHOLD LINEN; KITCHEN TOWELS, TOWELS; BEACH TOWELS; HANDKERCHIEFS; FABRIC NAPKINS; OVEN MITTS; DISHCLOTHS; FLANNELS; WASHING MITTS; TABLE LINEN; TABLE CLOTHS; PLACE MATS NOT OF PAPER, TABLE MATS NOT OF PAPER, COASTERS OF TEXTILE; BED LINEN; BABY BLANKETS; INFANT BEDDING SETS COMPRISING CRIB BLANKET, CRIB SHEET AND CRIB BUMPER; BED SHEETS; DUVETS; DUVET COVERS; BLANKETS FOR BEDS; BEDSPREADS; BED COVERS; PILLOW CASES; FABRIC VALANCES; TEXTILE WALL HANGINGS; CURTAINS; SHOWER CURTAINS; FABRIC FLAGS; PLASTIC TABLE COVERS, IN CLASS 24 (U.S. CLS. 42 AND 50).

FOR: CLOTHING, NAMELY, SHIRTS, SHORTS, TROUSERS, T-SHIRTS, POLO SHIRTS, SWEATSHIRTS, SWEATERS, DRESSES, SKIRTS; BOXER SHORTS, LINGERIE, SOCKS, HOSIERY, UNDERWEAR; COATS, JACKETS; SLEEPWEAR; SCARVES, GLOVES; SWIMWEAR; BEACHWEAR; BATHROBES, DRESSING GOWNS; INFANT WEAR; FOOTWEAR, HEADWEAR; SLIPPERS; HATS, CAPS, VISORS; EARMUFFS; BELTS; FANCY DRESS, MASQUERADE AND HALLOWEEN COSTUMES, IN CLASS 25 (U.S. CLS. 22 AND 39).

FOR: ORNAMENTAL NOVELTY BADGES; ORNAMENTAL CLOTH PATCHES; BUTTONS, RIBBON AND BRAID; HAIR BANDS AND SLIDES; BELT CLASPS; HAIRGRIPS; HAIR AND SHOE ORNAMENTS NOT OF PRECIOUS METAL; HAT ORNAMENTS NOT OF PRECIOUS METAL; SHOE LACES; BROOCHES BEING CLOTHING ACCESSORIES, HAIR AND SHOE BUCKLES, IN CLASS 26 (U.S. CLS. 37, 39, 40, 42 AND 50).

FOR: CARPETS, RUGS, MATS AND MATTING, LINOLEUMS FOR COVERING EXISTING FLOORS; NON-TEXTILE WALL HANGINGS; WALL BORDERS BEING DECORATIONS IN THE NATURE OF WALL COVERINGS; WALLPAPER; DOOR MATS; BATH MATS, IN CLASS 27 (U.S. CLS. 19, 20, 37, 42 AND 50).

Reg. No. 4,174,013 FOR: TOYS, NAMELY, CHILDREN'S MULTIPLE ACTIVITY TOYS, COLLECTABLE TOY FIGURES, STUFFED FIGURES, TOY ACTION FIGURES, DOLLS, PLUSH DOLLS, RAG DOLLS; DOLLS AND ACCESSORIES AND CLOTHES THEREFOR; PLUSH TOYS; SOFT TOYS; SOFT SCULPTED TOY FIGURES AND DOLLS; PUPPETS; GAMES, NAMELY, BOARD GAMES, ACTION SKILL GAMES, PLAYING CARDS, CARD GAMES; PLAYTHINGS, NAMELY, PUPPET THEATRES; GYMNAS TIC AND SPORTING ARTICLES, NAMELY, BALLS OF ALL KINDS; FANCY DRESS, MASQUERADE AND HALLOWEEN MASKS; JIGSAW PUZZLES; HOBBY CRAFT SETS AND ACTIVITY SETS IN THE FORM OF SCRAPBOOK MAKING KITS, DIARY MAKING KITS, GREETINGS CARD MAKING KITS, STAMP MAKING KITS, JEWELLERY MAKING KITS, JEWELLERY BOX MAKING KITS, CLOTHES DESIGN KITS, BAG MAKING KITS, COSMETICS MAKING KITS, LANTERN MAKING KITS, FASHION ACCESSORY MAKING AND DESIGN KITS, BADGE MAKING SETS, TOY MODELLING DOUGH ACTIVITY SETS, PHOTOFRAME PAINTING KITS, COLOURING ACTIVITY SETS; TOY WATCHES; BALLOONS; MOBILES FOR CHILDREN; POOL RINGS, NAMELY, SWIM FLOATS, WATER WINGS; INFLATABLE SWIMMING POOLS; BATH TOYS; POOL TOYS; KITES; SOAP BUBBLES; NOVELTIES FOR PARTIES, NAMELY, PARTY PAPER HATS AND PARTY FAVORS IN THE NATURE OF SMALL TOYS; ROLLER SKATES, IN-LINE SKATES, SKATEBOARDS; JUMP ROPES; PARTY HATS; DECORATIONS FOR CHRISTMAS TREES; AMUSEMENT APPARATUS INCORPORATING A TELEVISION SCREEN AND ELECTRONIC ARCADE GAMES; PROTECTIVE ELBOW AND KNEE PADS FOR ATHLETIC USE; SWIMMING AIDS, NAMELY, FLOATS, ARM FLOATS, POOL RINGS, SWIMMING BELTS, ALL FOR RECREATIONAL USE; CRIB MOBILES; TOY CONFECTIONERY DISPENSERS, IN CLASS 28 (U.S. CLS. 22, 23, 38 AND 50).

FOR: MEAT, FISH, POULTRY AND GAME; PREPARATIONS MADE FROM MEAT, FISH, SEAFOOD, POULTRY AND GAME, NAMELY, PATÉS, HAMS, SAUSAGES, MEATBALLS, STOCKS, PROCESSED MEATS; MEAT EXTRACTS; SOUPS; PRESERVED, DRIED AND COOKED FRUITS AND VEGETABLES; JELLIES, JAMS, FRUIT SAUCES; DAIRY PRODUCTS EXCLUDING ICE CREAM, ICE MILK AND FROZEN YOGHURT; EGGS, MILK AND MILK PRODUCTS EXCLUDING ICE CREAM, ICE MILK AND FROZEN YOGHURT; EDIBLE OILS AND FATS; NUTS; SNACK FOODS NAMELY, FRUIT-BASED SNACK FOODS, NUT-BASED SNACK FOODS, POTATO-BASED SNACK FOODS; POTATO CHIPS; DESSERTS AND FILLINGS THEREFOR, NAMELY, DESSERTS CONSISTING PRIMARILY OF FRUITS; DESSERTS CONSISTING PRIMARILY OF YOGHURTS OR MILK PRODUCTS EXCLUDING ICE CREAM, ICE MILK AND FROZEN YOGHURT; PREPARED ENTREES CONSISTING PRIMARILY OF MEAT, OR FISH, OR SEAFOOD, OR POULTRY; PREPARED SALADS EXCEPT RICE, PASTA, MACARONI; FRUIT SALADS, IN CLASS 29 (U.S. CL. 46).

FOR: CONFECTIONERY MADE OF SUGAR; CHOCOLATE; ICES, ICE CREAM, FROZEN CONFECTIONS; COFFEE, TEA, COCOA, SUGAR, RICE, FLOUR AND PREPARATIONS MADE FROM CEREALS, NAMELY, PORRIDGE, MUESLI, BREAKFAST CEREALS, PROCESSED CEREALS; BREAD, CAKES, PASTRY; CAKE MIXES; HONEY, TREACLE; SAUCES; CUSTARD; SPICES; BREAKFAST CEREALS; BISCUITS, COOKIES; PANCAKES; PIZZAS; POPCORN; COCOA AND CHOCOLATE BASED BEVERAGES WITH MILK; EDIBLE CAKE DECORATIONS; CEREAL-BASED SNACK FOODS, CORN-BASED SNACK FOODS, IN CLASS 30 (U.S. CL. 46).

FOR: MINERAL AND AERATED WATERS AND OTHER NON-ALCOHOLIC DRINKS, NAMELY, SOFT DRINKS, SODAS AND SMOOTHIES; FRUIT DRINKS AND FRUIT JUICES; SYRUPS AND OTHER PREPARATIONS FOR MAKING BEVERAGES IN THE NATURE OF FRUIT FLAVOURED SOFT DRINKS, TEA FLAVOURED BEVERAGES, COFFEE FLAVOURED BEVERAGES, IN CLASS 32 (U.S. CLS. 45, 46 AND 48).

FOR: BROADCASTING SERVICES; TELEVISION AND RADIO BROADCASTING SERVICES; STREAMING OF AUDIO AND VIDEO MATERIAL ON THE INTERNET, IN CLASS 38 (U.S. CLS. 100, 101 AND 104).

Reg. No. 4,174,013 FOR: FILM, VIDEO, AND TELEVISION ENTERTAINMENT IN THE NATURE OF A SERIES OF CINEMATIC FILMS, VIDEO FILMS AND TELEVISION PROGRAMMES CONTAINING ANIMATED CARTOONS AND FILMS FOR CHILDREN AND CHILDREN'S ENTERTAINMENT FEATURES BROADCAST OVER TELEVISION AND VIDEO MEDIA; PROVIDING RADIO ENTERTAINMENT PROGRAMMES FOR CHILDREN; PRODUCTION AND DISTRIBUTION OF TELEVISION PROGRAMMES AND FILMS; PRODUCTION OF VIDEOTAPES; ENTERTAINMENT SERVICES PROVIDED VIA THE INTERNET, NAMELY, THE PROVISION OF AN INTERACTIVE ONLINE WEBSITE FOR CHILDREN FEATURING GAMES, PUZZLES, ENTERTAINMENT INFORMATION, STREAMING VIDEO CLIPS CONTAINING ANIMATED CARTOONS; VIDEOTAPE, FILM, CD-ROM, DVD AND CASSETTE PRODUCTION; VIDEO AND VIDEOTAPE EDITING; ORGANIZATION OF GAMES AND COMPETITIONS FOR CHILDREN IN THE NATURE OF QUIZZES, PUZZLES OR REQUIRING THE SUBMISSION OF ARTWORK AND OTHER MATERIALS TO WIN PRIZES; PROVISION OF PLAY FACILITIES FOR CHILDREN; MUSIC WRITING SERVICES; AMUSEMENT ARCADE SERVICES; INFORMATIONAL, ADVISORY AND CONSULTANCY SERVICES RELATING TO THE AFORESAID SERVICES, IN CLASS 41 (U.S. CLS. 100, 101 AND 107).

OWNER OF UNITED KINGDOM REG. NO. 2579937, DATED 8-19-2011, EXPIRES 5-4-2021.

THE MARK CONSISTS OF THE WORD "POPPY" OVER THE WORD "CAT" ALL WITHIN AN OUTLINE OF THE SHAPE OF A CAT'S HEAD.

SER. NO. 85-323,714, FILED 5-18-2011.

ANNE MADDEN, EXAMINING ATTORNEY

United States of America

United States Patent and Trademark Office

INYAN

Reg. No. 4,174,014

HAMODIA CORP. (NEW YORK CORPORATION)
207 FOSTER AVENUE
BROOKLYN, NY 11230

Registered July 17, 2012

Int. Cl.: 16

FOR: GENERAL FEATURES MAGAZINES, IN CLASS 16 (U.S. CLS. 2, 5, 22, 23, 29, 37, 38 AND 50).

TRADEMARK

FIRST USE 1-19-2011; IN COMMERCE 1-19-2011.

PRINCIPAL REGISTER

THE MARK CONSISTS OF STANDARD CHARACTERS WITHOUT CLAIM TO ANY PARTICULAR FONT, STYLE, SIZE, OR COLOR.

THE ENGLISH TRANSLATION OF "INYAN" IN THE MARK IS MATTER, ISSUE, PROBLEM, CONCERN, INTEREST OR BUSINESS.

SER. NO. 85-323,740, FILED 5-18-2011.

JEFFREY LOOK, EXAMINING ATTORNEY



David J. Kyffers

Director of the United States Patent and Trademark Office

United States of America

United States Patent and Trademark Office

THE PEOPLE WHO ENTERTAIN AND INFORM AMERICA

Reg. No. 4,174,015

Registered July 17, 2012

Int. Cls.: 16 and 35

TRADEMARK

SERVICE MARK

PRINCIPAL REGISTER

AMERICAN FEDERATION OF TELEVISION AND RADIO ARTISTS (NEW YORK
UNINCORPORATED LABOR ASSOCIATION)
260 MADISON AVE., 7TH FLOOR
NEW YORK, NY 10016

FOR: PUBLICATIONS, NAMELY, MAGAZINES, BROCHURES, PRESS RELEASES OR
ANNOUNCEMENTS, PAMPHLETS, AND NEWSLETTERS FOR PERFORMERS, JOURNAL-
ISTS, AND OTHER ARTISTS IN THE FIELDS OF TELEVISION, RADIO, SOUND RECORD-
INGS, AND NON-BROADCAST, INDUSTRIAL, INTERNET AND DIGITAL PROGRAMMING,
IN CLASS 16 (U.S. CLS. 2, 5, 22, 23, 29, 37, 38 AND 50).

FIRST USE 11-16-2006; IN COMMERCE 11-16-2006.

FOR: ASSOCIATION SERVICES, NAMELY, PROMOTING THE INTERESTS OF PER-
FORMERS, JOURNALISTS AND OTHER ARTISTS IN THE FIELDS OF TELEVISION, RADIO,
SOUND RECORDINGS, AND NON-BROADCAST, INDUSTRIAL, INTERNET AND DIGITAL
PROGRAMMING, IN CLASS 35 (U.S. CLS. 100, 101 AND 102).

FIRST USE 11-16-2006; IN COMMERCE 11-16-2006.

THE MARK CONSISTS OF STANDARD CHARACTERS WITHOUT CLAIM TO ANY PAR-
TICULAR FONT, STYLE, SIZE, OR COLOR.

SER. NO. 85-323,769, FILED 5-18-2011.

HOWARD SMIGA, EXAMINING ATTORNEY



David J. Kybas

Director of the United States Patent and Trademark Office

United States of America

United States Patent and Trademark Office

NITE DAWG

Reg. No. 4,174,016

Registered July 17, 2012

Int. Cl.: 18

TRADEMARK

PRINCIPAL REGISTER

NITE IZE, INC. (COLORADO CORPORATION)
5660 CENTRAL AVENUE
BOULDER, CO 80301

FOR: COLLARS FOR ANIMALS, IN CLASS 18 (U.S. CLS. 1, 2, 3, 22 AND 41).

FIRST USE 12-1-2003; IN COMMERCE 12-1-2003.

THE MARK CONSISTS OF STANDARD CHARACTERS WITHOUT CLAIM TO ANY PARTICULAR FONT, STYLE, SIZE, OR COLOR.

NO CLAIM IS MADE TO THE EXCLUSIVE RIGHT TO USE "DOG", APART FROM THE MARK AS SHOWN.

SER. NO. 85-324,042, FILED 5-18-2011.

HEATHER THOMPSON, EXAMINING ATTORNEY



David J. Kyffers

Director of the United States Patent and Trademark Office

United States of America

United States Patent and Trademark Office



Reg. No. 4,174,017

SIDNEY B. GRANT (UNITED STATES INDIVIDUAL)
178 E. 117TH STREET, SUITE 1B
NEW YORK, NY 10035

Registered July 17, 2012

Int. Cl.: 41

FOR: PHYSICAL FITNESS INSTRUCTION, IN CLASS 41 (U.S. CLS. 100, 101 AND 107).

SERVICE MARK

FIRST USE 10-0-2010; IN COMMERCE 10-0-2010.

PRINCIPAL REGISTER

NO CLAIM IS MADE TO THE EXCLUSIVE RIGHT TO USE "BALLROOM BASICS", APART FROM THE MARK AS SHOWN.

THE COLOR(S) BLUE, BLACK AND WHITE IS/ARE CLAIMED AS A FEATURE OF THE MARK.

THE MARK CONSISTS OF STYLIZED WORDING "BALLROOM BASIX" IN WHITE LETTERS WITH "BALLROOM" IN CURSIVE FONT, FIRST TWO LETTERS (BA) OF "BASIX" IN CURSIVE FONT, LAST THREE LETTERS (SIX) OF BASIX IN NON-CURSIVE FONT, LETTER "I" OF "BASIX" SHOWN WITH A BLACK FOOTPRINT DESIGN, ALL ON A BLUE RECTANGULAR BACKGROUND.

SER. NO. 85-324,066, FILED 5-18-2011.

PATRICIA EVANKO, EXAMINING ATTORNEY



David J. Kyjars

Director of the United States Patent and Trademark Office

United States of America

United States Patent and Trademark Office

TEZ

Reg. No. 4,174,018

Registered July 17, 2012

Int. Cl.: 29

TRADEMARK

PRINCIPAL REGISTER

RECON OIL INDUSTRIES LIMITED (INDIA CORPORATION)
KONDIVITTA RD.
5, CHUNAWALA EST.
MUMBAI, INDIA 400059

FOR: MEAT, FISH, POULTRY AND GAME; MEAT EXTRACTS; PRESERVED, DRIED AND COOKED FRUITS AND VEGETABLES; JELLIES, JAMS; CRANBERRY SAUCE AND APPLESAUCE; EGGS, MILK AND DAIRY PRODUCTS EXCLUDING ICE CREAM, ICE MILK AND FROZEN YOGURT; EDIBLE OILS AND FATS, IN CLASS 29 (U.S. CL. 46).

FIRST USE 2-18-1993; IN COMMERCE 2-18-1993.

THE MARK CONSISTS OF STANDARD CHARACTERS WITHOUT CLAIM TO ANY PARTICULAR FONT, STYLE, SIZE, OR COLOR.

THE ENGLISH TRANSLATION OF "TEZ" IN THE MARK IS "FAST"/"VERY FAST"/"SHARP"/"STRONG"/"SPEED".

SER. NO. 85-324,114, FILED 5-18-2011.

MARC LEIPZIG, EXAMINING ATTORNEY



David J. Kyffers

Director of the United States Patent and Trademark Office

United States of America

United States Patent and Trademark Office

ROGER TORY PETERSON

Reg. No. 4,174,019

Registered July 17, 2012

Int. Cl.: 41

SERVICE MARK

PRINCIPAL REGISTER

MARITAL TRUST B U/W ROGER TORY PETERSON (CONNECTICUT TRUST)
200 WEST 57TH ST STE 904
C/O SCOTT MEREDITH LITERARY AGENCY
NEW YORK, NY 10019

FOR: EDUCATION AND ENTERTAINMENT SERVICES IN THE NATURE OF THE EXHIBITION OF ANIMALS, FILMS, ARTWORK, FLORA, AND FAUNA , IN CLASS 41 (U.S. CLS. 100, 101 AND 107).

FIRST USE 0-0-1953; IN COMMERCE 0-0-1953.

THE MARK CONSISTS OF STANDARD CHARACTERS WITHOUT CLAIM TO ANY PARTICULAR FONT, STYLE, SIZE, OR COLOR.

THE NAME AND/OR SIGNATURE "ROGER TORY PETERSON" SHOWN IN THE MARK DOES NOT IDENTIFY A PARTICULAR LIVING INDIVIDUAL.

SER. NO. 85-324,166, FILED 5-18-2011.

PRISCILLA MILTON, EXAMINING ATTORNEY



David J. Kyffers

Director of the United States Patent and Trademark Office

United States of America

United States Patent and Trademark Office

KRAL

Reg. No. 4,174,020

Registered July 17, 2012

Int. Cl.: 7

TRADEMARK

PRINCIPAL REGISTER

KRAL AG (AUSTRIA CORPORATION)
BILDGASSE 40
A-6893 LUSTENAU, AUSTRIA

FOR: MACHINE PUMPS, IN CLASS 7 (U.S. CLS. 13, 19, 21, 23, 31, 34 AND 35).

FIRST USE 0-0-2001; IN COMMERCE 0-0-2001.

THE MARK CONSISTS OF STANDARD CHARACTERS WITHOUT CLAIM TO ANY PARTICULAR FONT, STYLE, SIZE, OR COLOR.

SER. NO. 85-324,184, FILED 5-18-2011.

SUNG IN, EXAMINING ATTORNEY



David J. Kyffers

Director of the United States Patent and Trademark Office

United States of America

United States Patent and Trademark Office

MUSE GALLERY

Reg. No. 4,174,021

A MUSE GALLERY (OHIO SOLE PROPRIETORSHIP)
188 E. WHITTIER ST.
COLUMBUS, OH 43206

Registered July 17, 2012

Int. Cl.: 35

FOR: ART GALLERIES, IN CLASS 35 (U.S. CLS. 100, 101 AND 102).

SERVICE MARK

FIRST USE 3-1-2011; IN COMMERCE 3-1-2011.

PRINCIPAL REGISTER

THE MARK CONSISTS OF STANDARD CHARACTERS WITHOUT CLAIM TO ANY PARTICULAR FONT, STYLE, SIZE, OR COLOR.

OWNER OF U.S. REG. NO. 2,471,368.

NO CLAIM IS MADE TO THE EXCLUSIVE RIGHT TO USE "GALLERY", APART FROM THE MARK AS SHOWN.

SER. NO. 85-324,267, FILED 5-18-2011.

JULIE GUTTADAURO, EXAMINING ATTORNEY



David J. Kyffers

Director of the United States Patent and Trademark Office

United States of America

United States Patent and Trademark Office

Speakal

Reg. No. 4,174,022

Registered July 17, 2012

Int. Cl.: 9

TRADEMARK

PRINCIPAL REGISTER

EGY HANDLE USA, INC. (CALIFORNIA CORPORATION), DBA SPEAKAL
5555 INGLEWOOD BLVD.
CULVER CITY, CA 90230

FOR: DOCKING STATIONS FOR PORTABLE MUSIC PLAYERS, DOCKING STATIONS FOR PORTABLE MEDIA PLAYERS, DOCKING STATIONS FOR MOBILE PHONES, DOCKING STATIONS FOR WIRELESS INTERNET DEVICES; DOCKING STATION SPEAKER SYSTEMS COMPRISED OF AUDIO SPEAKERS; PORTABLE AMPLIFIED SPEAKER SYSTEMS COMPRISED OF AUDIO AMPLIFIERS AND AUDIO SPEAKERS; AMPLIFIERS, AUDIO SPEAKERS, DIGITAL AUDIO PLAYERS, SPEAKER PHONES, TELEPHONES, RADIOS, SHOWER RADIOS, BOOM BOXES, DIGITAL RADIO AND SPEAKER PHONES, TELEPHONES, TELEPHONE SETS, MEDIA PLAYERS, MP3 PLAYERS, CAMERAS; REMOTE CONTROLS FOR RADIOS, SPEAKERS, AND TELEPHONES; AUTOMOTIVE ADAPTORS, NAMELY, AUDIO CABLES AND POWER SUPPLY CONNECTORS AND ADAPTORS FOR USE WITH FOR USE WITH MEDIA PLAYERS, SPEAKERS, AND TELEPHONES; STORAGE PRODUCTS FOR MUSIC OR AUDIO-VISUAL MEDIA, NAMELY, CD CASES AND DVD CASES; PROTECTIVE CARRYING CASES FOR PORTABLE MEDIA PLAYERS, IN CLASS 9 (U.S. CLS. 21, 23, 26, 36 AND 38).

FIRST USE 8-1-2009; IN COMMERCE 8-1-2009.

THE MARK CONSISTS OF STANDARD CHARACTERS WITHOUT CLAIM TO ANY PARTICULAR FONT, STYLE, SIZE, OR COLOR.

SER. NO. 85-324,366, FILED 5-18-2011.

JOHN KELLY, EXAMINING ATTORNEY



David J. Kyffers

Director of the United States Patent and Trademark Office

United States of America

United States Patent and Trademark Office

netanova

Reg. No. 4,174,023

Registered July 17, 2012

Int. Cl.: 42

SERVICE MARK

PRINCIPAL REGISTER

NETANOVA, INC. (CALIFORNIA CORPORATION)
24307 MAGIC MOUNTAIN PKWY
SUITE 440
VALENCIA, CA 91355

FOR: PROVIDING A WEBSITE FEATURING TEMPORARY USE OF ONLINE NON-DOWNLOADABLE SOFTWARE FEATURING AN ONLINE OPEN APPLICATION PROGRAM INTERFACE AND SUITE OF ONLINE MARKETING AND ADVERTISING MANAGEMENT AND ANALYSIS TOOLS ALL FOR THE MANAGEMENT AND ANALYSIS OF MARKETING AND ADVERTISING CAMPAIGNS, IN CLASS 42 (U.S. CLS. 100 AND 101).

FIRST USE 10-15-2010; IN COMMERCE 10-15-2010.

THE MARK CONSISTS OF STANDARD CHARACTERS WITHOUT CLAIM TO ANY PARTICULAR FONT, STYLE, SIZE, OR COLOR.

SER. NO. 85-324,493, FILED 5-19-2011.

LOURDES AYALA, EXAMINING ATTORNEY



David J. Kybas

Director of the United States Patent and Trademark Office

United States of America

United States Patent and Trademark Office

MYSKRIBLE

Reg. No. 4,174,024

Registered July 17, 2012

Int. Cls.: 16, 25 and 28

TRADEMARK

PRINCIPAL REGISTER

AIDAN MICHAEL UTTINGER (NEW ZEALAND INDIVIDUAL)
65 VERMONT STREET PONSONBY
AUCKLAND, NEW ZEALAND 1051

FOR: NON-PERMANENT MARKER PENS; ART SUPPLIES, NAMELY, ART PAPER, ART CANVAS, ARTS AND CRAFT PAINT KITS; CHILDREN'S COLOURING SETS COMPRISED OF COLOURING PAGES, STENCILS AND MARKERS; AND PENCIL CASES, IN CLASS 16 (U.S. CLS. 2, 5, 22, 23, 29, 37, 38 AND 50).

FOR: CLOTHING, NAMELY, T-SHIRTS, HATS AND CAPS, IN CLASS 25 (U.S. CLS. 22 AND 39).

FOR: TOYS AND PLAYTHINGS, NAMELY, CHILDREN'S EDUCATIONAL TOYS FOR DEVELOPING ARTISTIC AND CREATIVE SKILLS AND CHILDREN'S ART ACTIVITY AND DRAWING TOYS, IN CLASS 28 (U.S. CLS. 22, 23, 38 AND 50).

THE MARK CONSISTS OF STANDARD CHARACTERS WITHOUT CLAIM TO ANY PARTICULAR FONT, STYLE, SIZE, OR COLOR.

PRIORITY CLAIMED UNDER SEC. 44(D) ON NEW ZEALAND APPLICATION NO. 834287, FILED 12-3-2010, REG. NO. 834287, DATED 12-3-2010, EXPIRES 12-3-2020.

SER. NO. 85-324,913, FILED 5-19-2011.

PAM WILLIS, EXAMINING ATTORNEY



David J. Kyjars

Director of the United States Patent and Trademark Office

United States of America

United States Patent and Trademark Office

URBAN EFFECTS MEDSPA

Reg. No. 4,174,025

Registered July 17, 2012

Int. Cl.: 44

SERVICE MARK

PRINCIPAL REGISTER

URBAN EFFECTS MEDSPA, INC. (IOWA CORPORATION)
2480 BERKSHIRE PARKWAY
SUITE B
CLIVE, IA 50325

FOR: MEDICAL CLINIC AND SPA SERVICES PROVIDING SKIN EVALUATIONS, TREATMENTS AND MEDICAL AESTHETIC PROCEDURES INCLUDING INJECTABLE FILLER TREATMENTS, LASER PEELS, BOTULINUM TOXIN TREATMENTS, MICRODERMABRASION AND VEIN THERAPY SERVICES; FACIAL TREATMENT SERVICES INCLUDING ANTI-AGING, REJUVENATION, ROSACEA, ACTINIC AND CUSTOM FACIALS, PERMANENT HAIR REMOVAL AND REDUCTION SERVICES; MASSAGE THERAPY SERVICES, AIRBRUSH SKIN TANNING SERVICES FOR HUMANS FOR COSMETIC PURPOSES; AND NUTRITIONAL COUNSELING; WEIGHT LOSS SOLUTIONS, NAMELY, WEIGHT LOSS PROGRAMS; WEIGHT LOSS SERVICES, NAMELY, WEIGHT LOSS PROGRAMS, IN CLASS 44 (U.S. CLS. 100 AND 101).

FIRST USE 3-28-2011; IN COMMERCE 3-28-2011.

THE MARK CONSISTS OF STANDARD CHARACTERS WITHOUT CLAIM TO ANY PARTICULAR FONT, STYLE, SIZE, OR COLOR.

NO CLAIM IS MADE TO THE EXCLUSIVE RIGHT TO USE "MEDSPA", APART FROM THE MARK AS SHOWN.

SER. NO. 85-325,048, FILED 5-19-2011.

ELLEN BURNS, EXAMINING ATTORNEY



David J. Kyffers

Director of the United States Patent and Trademark Office

United States of America

United States Patent and Trademark Office

YORK TECHNICAL INSTITUTE

Reg. No. 4,174,026

Registered July 17, 2012

Int. Cl.: 41

SERVICE MARK

PRINCIPAL REGISTER

YORK TECHNICAL INSTITUTE LLC (DELAWARE LIMITED LIABILITY COMPANY)
1400 WILLIAMS ROAD
YORK, PA 17402

FOR: EDUCATIONAL SERVICES, NAMELY, SEMINARS AND COURSES OF INSTRUCTION IN THE FIELDS OF BUSINESS, COMPUTERS, ELECTRONICS, AUTOMATION, CULINARY ARTS AND FOOD SERVICES, MECHANICS, PUBLIC SAFETY, SECURITY, BUILDING AND REFRIGERATION SYSTEMS, DRAFTING AND DESIGN, TRAVEL, TOURISM AND HOSPITALITY, TECHNOLOGY, AND MEDICAL AND HEALTH, IN CLASS 41 (U.S. CLS. 100, 101 AND 107).

FIRST USE 6-30-1967; IN COMMERCE 6-30-1967.

THE MARK CONSISTS OF STANDARD CHARACTERS WITHOUT CLAIM TO ANY PARTICULAR FONT, STYLE, SIZE, OR COLOR.

OWNER OF U.S. REG. NOS. 3,575,876 AND 3,579,660.

NO CLAIM IS MADE TO THE EXCLUSIVE RIGHT TO USE "TECHNICAL INSTITUTE", APART FROM THE MARK AS SHOWN.

SEC. 2(F).

SER. NO. 85-325,070, FILED 5-19-2011.

KELLEY WELLS, EXAMINING ATTORNEY



David J. Kyffers

Director of the United States Patent and Trademark Office

United States of America

United States Patent and Trademark Office

CYBER-ANATOMY

Reg. No. 4,174,027

CYBER ANATOMY CORPORATION (IOWA CORPORATION)
1910 S. GILBERT

Registered July 17, 2012

IOWA CITY, IA 52240

Int. Cl.: 9

FOR: COMPUTER HARDWARE AND EDUCATIONAL SOFTWARE FOR INSTRUCTION IN SCIENCE, TECHNOLOGY AND MATH EDUCATION; INTERACTIVE MULTIMEDIA COMPUTER PROGRAM FEATURING EDUCATIONAL INSTRUCTION IN SCIENCE, TECHNOLOGY AND MATH EDUCATION, IN CLASS 9 (U.S. CLS. 21, 23, 26, 36 AND 38).

TRADEMARK

PRINCIPAL REGISTER

FIRST USE 9-0-2005; IN COMMERCE 9-0-2005.

THE MARK CONSISTS OF STANDARD CHARACTERS WITHOUT CLAIM TO ANY PARTICULAR FONT, STYLE, SIZE, OR COLOR.

SEC. 2(F).

SER. NO. 85-325,203, FILED 5-19-2011.

JENNIFER DIXON, EXAMINING ATTORNEY



David J. Kyffers

Director of the United States Patent and Trademark Office

United States of America

United States Patent and Trademark Office



CertificateVault

Reg. No. 4,174,028

SHARE AGENT, LLC (COLORADO LIMITED LIABILITY COMPANY)
4626 SOUTH BROADWAY
ENGLEWOOD, CO 80113

Registered July 17, 2012

Int. Cl.: 45

FOR: LEGAL SERVICES, IN CLASS 45 (U.S. CLS. 100 AND 101).

SERVICE MARK

FIRST USE 12-13-2010; IN COMMERCE 2-1-2011.

PRINCIPAL REGISTER

THE MARK CONSISTS OF A STYLIZED DESIGN CONSISTING OF A 5-SPOKE SAFE SPINNER HANDLE CENTERED IN THE MIDDLE OF A BLACK SQUARE SURROUNDED BY A THIN WHITE BORDER AND AN 8 LINED SCROLLING FRAMEWORK NEXT TO THE WORD "CERTIFICATEVAULT".

SER. NO. 85-325,238, FILED 5-19-2011.

JULIE WATSON, EXAMINING ATTORNEY



David J. Kybas

Director of the United States Patent and Trademark Office

United States of America

United States Patent and Trademark Office



Reg. No. 4,174,029

SHARE AGENT, LLC (COLORADO LIMITED LIABILITY COMPANY)
4626 SOUTH BROADWAY
ENGLEWOOD, CO 80113

Registered July 17, 2012

Int. Cl.: 45

FOR: LEGAL SERVICES, IN CLASS 45 (U.S. CLS. 100 AND 101).

SERVICE MARK

FIRST USE 12-13-2010; IN COMMERCE 2-1-2011.

PRINCIPAL REGISTER

NO CLAIM IS MADE TO THE EXCLUSIVE RIGHT TO USE "AGENT" AND "SHAREHOLDER'S", APART FROM THE MARK AS SHOWN.

THE MARK CONSISTS OF A STYLIZED DESIGN WITH TWO TRIANGLES CREATING A DIAMOND SHAPE WITH AN OFFSET LETTER "S" IN THE MIDDLE NEXT TO THE WORDS "SHAREAGENT" IN ALL CAPS OVER THE WORDS "THE SHARHOLDERS'S CONCIERGE".

SER. NO. 85-325,244, FILED 5-19-2011.

JULIE WATSON, EXAMINING ATTORNEY



David J. Kyffers

Director of the United States Patent and Trademark Office

United States of America

United States Patent and Trademark Office



Fossil Creek
LIQUOR

Reg. No. 4,174,030

Registered July 17, 2012

Int. Cl.: 35

SERVICE MARK

PRINCIPAL REGISTER

GTF INVESTMENTS, LTD. (TEXAS LIMITED PARTNERSHIP), DBA FOSSIL CREEK LIQUOR
1900 WESTERN CENTER BOULEVARD
FORT WORTH, TX 761312201

FOR: RETAIL AND WHOLESALE STORE SERVICES FEATURING BEER, WINE AND SPIRITS; RETAIL AND WHOLESALE LIQUOR STORE SERVICES, IN CLASS 35 (U.S. CLS. 100, 101 AND 102).

FIRST USE 4-6-2001; IN COMMERCE 4-6-2001.

NO CLAIM IS MADE TO THE EXCLUSIVE RIGHT TO USE "LIQUOR", APART FROM THE MARK AS SHOWN.

THE COLOR(S) GREEN, PURPLE, YELLOW, AND WHITE IS/ARE CLAIMED AS A FEATURE OF THE MARK.

THE MARK CONSISTS OF THE TERM "FOSSIL CREEK" IN PURPLE OVER A GREEN HORIZONTAL LINE; BENEATH THE LINE APPEARS THE TERM "LIQUOR" IN YELLOW AND OUTLINED IN PURPLE; TO THE LEFT APPEARS A STYLIZED DEPICTION OF A WHITE CREEK RUNNING THROUGH A GREEN RECTANGLE; THE BACKGROUND OF THE ENTIRE MARK IS WHITE.

SER. NO. 85-325,287, FILED 5-19-2011.

JIM RINGLE, EXAMINING ATTORNEY



David J. Kyffers

Director of the United States Patent and Trademark Office

United States of America

United States Patent and Trademark Office

S'MORES INDOORS

Reg. No. 4,174,031

Registered July 17, 2012

Int. Cl.: 30

TRADEMARK

PRINCIPAL REGISTER

GOLDEN WEST FOOD GROUP (CALIFORNIA CORPORATION)
3420 E. VERNON AVE.
VERNON, CA 90058

FOR: PIZZA COMBINATIONS CONSISTING OF MARSHMALLOWS, CHOCOLATE, GRAHAM CRACKER OR CANDY SPRINKLE COATINGS, DESSERT AND BREAKFAST COMBINATIONS CONSISTING OF MARSHMALLOWS, CHOCOLATE, GRAHAM CRACKER OR CANDY SPRINKLE COATINGS, INCLUDING, AND BAKERY DESSERTS; PASTRIES; CAKES; BROWNIES; COOKIES; CANDY AND CHOCOLATES, NAMELY, CREAMS AND NOUGATS; INDIVIDUAL DESSERT AND SPECIALTY CAKES; CHOCOLATES, NAMELY, CHOCOLATE NOVELTIES; SPECIALTY COFFEES; CROISSANTS; MUFFINS; DANISHES; CAPPUCCINOS; BISCOTTI; BREADSTICKS, IN CLASS 30 (U.S. CL. 46).

FIRST USE 5-12-2011; IN COMMERCE 5-12-2011.

THE MARK CONSISTS OF STANDARD CHARACTERS WITHOUT CLAIM TO ANY PARTICULAR FONT, STYLE, SIZE, OR COLOR.

NO CLAIM IS MADE TO THE EXCLUSIVE RIGHT TO USE "S'MORES", APART FROM THE MARK AS SHOWN.

SER. NO. 85-325,393, FILED 5-19-2011.

MATTHEW KLINE, EXAMINING ATTORNEY



David J. Kyffers

Director of the United States Patent and Trademark Office

United States of America

United States Patent and Trademark Office

Consultant's Table

Reg. No. 4,174,032

Registered July 17, 2012

Int. Cl.: 35

SERVICE MARK

PRINCIPAL REGISTER

BACKWARDS COMPATIBLE ENTERTAINMENT, LLC (GEORGIA LIMITED LIABILITY COMPANY), DBA CONSULTANT'S TABLE
4692 CHIEF JOSEPH CIRCLE
DOUGLASVILLE, GA 30135

FOR: ADVERTISING AND MARKETING CONSULTANCY, IN CLASS 35 (U.S. CLS. 100, 101 AND 102).

FIRST USE 5-17-2011; IN COMMERCE 5-17-2011.

THE MARK CONSISTS OF STANDARD CHARACTERS WITHOUT CLAIM TO ANY PARTICULAR FONT, STYLE, SIZE, OR COLOR.

SER. NO. 85-325,873, FILED 5-20-2011.

HENRY S. ZAK, EXAMINING ATTORNEY



David J. Kyffers

Director of the United States Patent and Trademark Office

United States of America

United States Patent and Trademark Office

SUGARLIME

Reg. No. 4,174,033

Registered July 17, 2012

Int. Cls.: 14 and 35

TRADEMARK

SERVICE MARK

PRINCIPAL REGISTER

SUGARLIME DESIGN INC. (CANADA CORPORATION)
611 - 402 WEST PENDER STREET
VANCOUVER, BC, CANADA V6B1T6

FOR: JEWELRY, IN CLASS 14 (U.S. CLS. 2, 27, 28 AND 50).

FIRST USE 11-14-2004; IN COMMERCE 6-1-2005.

FOR: WHOLESALE DISTRIBUTORSHIP FEATURING JEWELRY AND JEWELRY CLEANING CLOTHS; ONLINE RETAIL STORE SERVICES FEATURING JEWELRY AND JEWELRY CLEANING CLOTHS, IN CLASS 35 (U.S. CLS. 100, 101 AND 102).

FIRST USE 11-14-2004; IN COMMERCE 0-0-2006.

THE MARK CONSISTS OF STANDARD CHARACTERS WITHOUT CLAIM TO ANY PARTICULAR FONT, STYLE, SIZE, OR COLOR.

SER. NO. 85-326,023, FILED 5-20-2011.

BARNEY CHARLON, EXAMINING ATTORNEY



David J. Kyfos

Director of the United States Patent and Trademark Office

United States of America

United States Patent and Trademark Office

INSPECT>UNDERSTAND>PLAN>EXECUTE

Reg. No. 4,174,034

Registered July 17, 2012

Int. Cls.: 9 and 42

TRADEMARK

SERVICE MARK

PRINCIPAL REGISTER

REDZONE ROBOTICS, INC. (PENNSYLVANIA CORPORATION)
91 43RD STREET
SUITE 250
PITTSBURGH, PA 15201

FOR: PROVIDING DOWNLOADABLE SOFTWARE FOR USE IN PIPE INSPECTION ASSET MANAGEMENT, IN CLASS 9 (U.S. CLS. 21, 23, 26, 36 AND 38).

FIRST USE 10-12-2009; IN COMMERCE 10-12-2009.

FOR: PIPELINE INSPECTION SERVICES, IN CLASS 42 (U.S. CLS. 100 AND 101).

FIRST USE 10-12-2009; IN COMMERCE 10-12-2009.

THE MARK CONSISTS OF STANDARD CHARACTERS WITHOUT CLAIM TO ANY PARTICULAR FONT, STYLE, SIZE, OR COLOR.

SER. NO. 85-326,042, FILED 5-20-2011.

CHARLES L. JENKINS, EXAMINING ATTORNEY



David J. Kyros

Director of the United States Patent and Trademark Office

United States of America

United States Patent and Trademark Office

MACH-1

Reg. No. 4,174,035

Registered July 17, 2012

Int. Cl.: 9

TRADEMARK

PRINCIPAL REGISTER

BIOMOMENTUM INC. (CANADA CORPORATION)
SUITE 200
970 MICHELIN
LAVAL, QUEBEC, CANADA H7L5C1

FOR: MECHANICAL TESTERS TO MEASURE WITH PRECISION THE MECHANICAL PROPERTIES OF BIOLOGICAL, CHEMICAL, AND PHARMACEUTICAL SAMPLES, NAMELY, STIFFNESS, VISCOSITY, POROELASTICITY, STRENGTH, SWELLING, ADHESION AND PLASTICITY, IN CLASS 9 (U.S. CLS. 21, 23, 26, 36 AND 38).

FIRST USE 10-19-1998; IN COMMERCE 11-15-1998.

THE MARK CONSISTS OF STANDARD CHARACTERS WITHOUT CLAIM TO ANY PARTICULAR FONT, STYLE, SIZE, OR COLOR.

SER. NO. 85-326,096, FILED 5-20-2011.

JAMES A. RAUEN, EXAMINING ATTORNEY



David J. Kyffers

Director of the United States Patent and Trademark Office

United States of America

United States Patent and Trademark Office

Loving Lengths

Reg. No. 4,174,036

Registered July 17, 2012

Int. Cl.: 26

TRADEMARK

PRINCIPAL REGISTER

MARIE BERNARD HAIR CONCEPTS LLC (FLORIDA LIMITED LIABILITY COMPANY),
DBA LOVING LENGTHS
6001 PARK OF COMMERCE BLVD
BOCA RATON, FL 33487

FOR: HAIR EXTENSIONS, IN CLASS 26 (U.S. CLS. 37, 39, 40, 42 AND 50).

FIRST USE 3-1-2011; IN COMMERCE 3-1-2011.

THE MARK CONSISTS OF STANDARD CHARACTERS WITHOUT CLAIM TO ANY PARTICULAR FONT, STYLE, SIZE, OR COLOR.

NO CLAIM IS MADE TO THE EXCLUSIVE RIGHT TO USE "LENGTHS", APART FROM THE MARK AS SHOWN.

SER. NO. 85-326,117, FILED 5-20-2011.

GISELLE AGOSTO, EXAMINING ATTORNEY



David J. Kyffers

Director of the United States Patent and Trademark Office

United States of America

United States Patent and Trademark Office



Reg. No. 4,174,037

Registered July 17, 2012

Int. Cl.: 9

TRADEMARK

PRINCIPAL REGISTER

DUNAMIS TECHNOLOGY INC. (CALIFORNIA CORPORATION)
841 BLOSSOM HILL ROAD SUITE 205
SAN JOSE, CA 95123

FOR: DOWNLOADABLE COMPUTER SOFTWARE FOR MECHANICAL ENGINEERING FOR CALCULATION TOOL SUITES FOR ENGINEERING ANALYSIS AND DESIGN , IN CLASS 9 (U.S. CLS. 21, 23, 26, 36 AND 38).

FIRST USE 1-0-2009; IN COMMERCE 1-0-2009.

THE MARK CONSISTS OF THE STYLIZED TERMS "LUXEA" THE "X" IS IN ORANGE. THE LETTERS "L", "U", "E" AND "A" ARE IN WHITE. THERE IS A SMALL SUN THAT IS WHITE AND IS RISING ABOVE THE "X". ALL TERMS ARE ON A BLACK BACKGROUND.

THE COLOR(S) ORANGE, BLACK AND WHITE IS/ARE CLAIMED AS A FEATURE OF THE MARK.

THE WORDING "LUXEA" HAS NO MEANING IN A FOREIGN LANGUAGE.

SER. NO. 85-326,251, FILED 5-20-2011.

JULIE WATSON, EXAMINING ATTORNEY



David J. Kyffers

Director of the United States Patent and Trademark Office

United States of America

United States Patent and Trademark Office

TRAM ELECTRIC, INC.

Reg. No. 4,174,038

Registered July 17, 2012

Int. Cl.: 37

SERVICE MARK

PRINCIPAL REGISTER

TRAM ELECTRIC, INC. (UTAH CORPORATION)
1750 WEST 360 NORTH
PRICE, UT 84501

FOR: REPAIR OF MOTORS, MACHINERY, AND ELECTRICAL AND MECHANICAL EQUIPMENT, NAMELY, ELECTRIC MOTORS, PUMPS, CONTROL PANELS, TRANSFORMERS, SWITCH GEAR, GEAR BOXES, AND GENERATORS IN THE FIELDS OF MINING, INDUSTRIAL, AND COMMERCIAL MACHINES, NOT IN THE FIELD OF TRANSPORTATION VEHICLES; REMANUFACTURE OF ELECTRIC MOTORS TO THE ORDER AND/OR SPECIFICATION OF OTHERS IN THE FIELDS OF MINING, INDUSTRIAL, AND COMMERCIAL MACHINES, NOT IN THE FIELD OF TRANSPORTATION VEHICLES, IN CLASS 37 (U.S. CLS. 100, 103 AND 106).

FIRST USE 5-10-2011; IN COMMERCE 5-10-2011.

THE MARK CONSISTS OF STANDARD CHARACTERS WITHOUT CLAIM TO ANY PARTICULAR FONT, STYLE, SIZE, OR COLOR.

NO CLAIM IS MADE TO THE EXCLUSIVE RIGHT TO USE "ELECTRIC, INC.", APART FROM THE MARK AS SHOWN.

SER. NO. 85-326,267, FILED 5-20-2011.

CORY BOONE, EXAMINING ATTORNEY



David J. Kyffers

Director of the United States Patent and Trademark Office

United States of America

United States Patent and Trademark Office

3SIXTY

Reg. No. 4,174,039

MIMI IBARRA PRODUCTIONS, INC. (NEW YORK CORPORATION)
8520 55 AVE. ELMHURST
QUEENS, NY 11373

Registered July 17, 2012

Int. Cl.: 41

FOR: ENTERTAINMENT IN THE NATURE OF VISUAL AND AUDIO PERFORMANCES BY A MUSICAL GROUP, IN CLASS 41 (U.S. CLS. 100, 101 AND 107).

SERVICE MARK

FIRST USE 2-9-2011; IN COMMERCE 2-9-2011.

PRINCIPAL REGISTER

THE MARK CONSISTS OF STANDARD CHARACTERS WITHOUT CLAIM TO ANY PARTICULAR FONT, STYLE, SIZE, OR COLOR.

SER. NO. 85-326,375, FILED 5-20-2011.

JOHN WILKE, EXAMINING ATTORNEY



David J. Kyffers

Director of the United States Patent and Trademark Office

United States of America

United States Patent and Trademark Office

360°

Reg. No. 4,174,040

MIMI IBARRA PRODUCTIONS, INC. (NEW YORK CORPORATION)
8520 55 AVE. ELMHURST
QUEENS, NY 11373

Registered July 17, 2012

Int. Cl.: 41

FOR: ENTERTAINMENT IN THE NATURE OF VISUAL AND AUDIO PERFORMANCES BY A MUSICAL GROUP, IN CLASS 41 (U.S. CLS. 100, 101 AND 107).

SERVICE MARK

FIRST USE 2-9-2011; IN COMMERCE 2-9-2011.

PRINCIPAL REGISTER

THE MARK CONSISTS OF STANDARD CHARACTERS WITHOUT CLAIM TO ANY PARTICULAR FONT, STYLE, SIZE, OR COLOR.

SER. NO. 85-326,381, FILED 5-20-2011.

JOHN WILKE, EXAMINING ATTORNEY



David J. Kyffers

Director of the United States Patent and Trademark Office

United States of America

United States Patent and Trademark Office

DDB UNLIMITED

Reg. No. 4,174,041

Registered July 17, 2012

Int. Cl.: 20

TRADEMARK

PRINCIPAL REGISTER

DDB UNLIMITED, INC. (OKLAHOMA CORPORATION)
ROUTE 1, BOX 15C
WYNNEWOOD, OK 73098

FOR: METAL STORAGE CABINETS, NAMELY, CABINETS AND ENCLOSURES MADE PRIMARILY FROM ALUMINUM AND STAINLESS STEEL FOR THE TELECOMMUNICATIONS AND RAILROAD INDUSTRIES, IN CLASS 20 (U.S. CLS. 2, 13, 22, 25, 32 AND 50).

FIRST USE 2-19-1997; IN COMMERCE 2-19-1997.

THE MARK CONSISTS OF STANDARD CHARACTERS WITHOUT CLAIM TO ANY PARTICULAR FONT, STYLE, SIZE, OR COLOR.

NO CLAIM IS MADE TO THE EXCLUSIVE RIGHT TO USE "UNLIMITED", APART FROM THE MARK AS SHOWN.

SER. NO. 85-326,693, FILED 5-21-2011.

DAVID C. REIHNER, EXAMINING ATTORNEY



David J. Kyros

Director of the United States Patent and Trademark Office

United States of America

United States Patent and Trademark Office



Reg. No. 4,174,042

Registered July 17, 2012

Int. Cl.: 9

TRADEMARK

PRINCIPAL REGISTER

WILLIAMS, MICHAEL BRANDON (COLORADO LIMITED LIABILITY COMPANY), DBA
IRON EDISON BATTERY COMPANY
10171 W. 9TH DR.
LAKEWOOD, CO 80215

FOR: GALVANIC BATTERIES, IN CLASS 9 (U.S. CLS. 21, 23, 26, 36 AND 38).

FIRST USE 1-1-2011; IN COMMERCE 1-1-2011.

NO CLAIM IS MADE TO THE EXCLUSIVE RIGHT TO USE "IRON EDISON", APART FROM
THE MARK AS SHOWN.

THE MARK CONSISTS OF THE WORDS "IRON EDISON" WITHIN AN OUTLINE THAT IS
SHAPED LIKE A BATTERY WITH TWO TERMINAL POSTS AT THE TOP. THE LOGO IN-
CLUDES A HORIZONTAL BOLT THAT FORMS PART OF THE OUTLINE.

SER. NO. 85-326,926, FILED 5-22-2011.

PATRICIA EVANKO, EXAMINING ATTORNEY



David J. Kyffers

Director of the United States Patent and Trademark Office

United States of America

United States Patent and Trademark Office

MARIAN'S RESERVE

Reg. No. 4,174,043

PINE RIDGE WINERY, LLC (DELAWARE LIMITED LIABILITY COMPANY)
5901 SILVERADO TRAIL
NAPA, CA 94558

Registered July 17, 2012

Int. Cl.: 33

FOR: ALCOHOLIC BEVERAGES EXCEPT BEERS, IN CLASS 33 (U.S. CLS. 47 AND 49).

TRADEMARK

FIRST USE 12-31-2006; IN COMMERCE 12-31-2006.

PRINCIPAL REGISTER

THE MARK CONSISTS OF STANDARD CHARACTERS WITHOUT CLAIM TO ANY PARTICULAR FONT, STYLE, SIZE, OR COLOR.

NO CLAIM IS MADE TO THE EXCLUSIVE RIGHT TO USE "RESERVE", APART FROM THE MARK AS SHOWN.

SER. NO. 85-326,932, FILED 5-22-2011.

DOMINICK J. SALEMI, EXAMINING ATTORNEY



David J. Kyffers

Director of the United States Patent and Trademark Office

United States of America

United States Patent and Trademark Office



Reg. No. 4,174,044

MCMAHAN, MIKE (UNITED STATES INDIVIDUAL)
5210 HOVIS RD.
CHARLOTTE, NC 28208

Registered July 17, 2012

Int. Cl.: 1

FOR: CHEMICALS FOR INDUSTRIAL PURPOSES, IN CLASS 1 (U.S. CLS. 1, 5, 6, 10, 26 AND 46).

TRADEMARK

FIRST USE 12-1-2006; IN COMMERCE 12-1-2006.

PRINCIPAL REGISTER

NO CLAIM IS MADE TO THE EXCLUSIVE RIGHT TO USE "TECHNOLOGIES", APART FROM THE MARK AS SHOWN.

THE MARK CONSISTS OF THE WORD "MCTRON" IN BOLD LETTERING RESTING ON TOP OF THE WORD "TECHNOLOGIES" APPROXIMATELY 1/5TH OF HEIGHT OF "MCTRON" BUT THE SAME LENGTH. ABOVE THE WORD "MCTRON" ARE TWO ASYMMETRICAL ARROWHEAD SHAPES, ONE RESTING WITHIN THE OTHER, EXTENDING THE LENGTH OF THE WORD. THE ARROWS POINT TOWARD THE FAR LEFT SIDE OF THE MARK WITH THE TIP OF THE OUTER ARROW ALIGNED WITH THE LEFT SIDE OF THE "M" IN "MCTRON". THE BOTTOM SIDE OF THE ARROWS FADE OUT AS THEY REACH THE FAR RIGHT SIDE OF THE MARK REPRESENTED BY THE RIGHT SIDE OF THE "N" IN "MCTRON". BELOW THE WORD "TECHNOLOGIES", ARE TWO ASYMMETRICAL ARROWHEAD SHAPES, ONE RESTING WITHIN THE OTHER, EXTENDING THE LENGTH OF THE WORD. THE ARROWS POINT TOWARD THE FAR RIGHT OF THE MARK WITH THE TIP OF THE OUTER ARROW ALIGNED WITH THE RIGHT SIDE OF THE "S" IN "TECHNOLOGIES". THE TOP SIDE OF THE ARROWS FADE OUT AS THEY REACH THE FAR LEFT SIDE OF THE MARK REPRESENTED BY THE LEFT SIDE OF THE "T" IN "TECHNOLOGIES".



SER. NO. 85-326,991, FILED 5-23-2011.

ALICE BENMAMAN, EXAMINING ATTORNEY

David J. Kyjars

Director of the United States Patent and Trademark Office

United States of America

United States Patent and Trademark Office

Nutrition Nanny

Reg. No. 4,174,045

PIZZOFERRATO, DEIRDRE (UNITED STATES INDIVIDUAL)
1 SAW MILL ROAD

Registered July 17, 2012

SOUTH GLASTONBURY, CT 06073

Int. Cl.: 44

FOR: COUNSELING SERVICES IN THE FIELDS OF HEALTH, NUTRITION AND LIFESTYLE WELLNESS; DIETARY AND NUTRITIONAL GUIDANCE; FOOD NUTRITION CONSULTATION; NUTRITION COUNSELING; NUTRITIONAL THERAPY SERVICES; PROVIDING A WEB SITE FEATURING INFORMATION ON HEALTH AND NUTRITION; PROVIDING A WEB SITE THAT FEATURES INFORMATION ON CHILDREN'S NUTRITION; PROVIDING A WEBSITE FEATURING INFORMATION ABOUT HEALTH, WELLNESS AND NUTRITION; PROVIDING ASSISTANCE, FITNESS EVALUATION AND CONSULTATION TO INDIVIDUALS TO HELP THEM MAKE HEALTH, WELLNESS AND NUTRITIONAL CHANGES IN THEIR DAILY LIVING TO IMPROVE HEALTH; PROVIDING HEALTHY LIFESTYLE AND NUTRITION SERVICES, NAMELY, PERSONAL ASSESSMENTS, PERSONALIZED ROUTINES, MAINTENANCE SCHEDULES, AND COUNSELING; PROVIDING INFORMATION, NEWS AND COMMENTARY IN THE FIELD OF NUTRITION, HEALTH AND WELLNESS, IN CLASS 44 (U.S. CLS. 100 AND 101).

SERVICE MARK

PRINCIPAL REGISTER

FIRST USE 1-1-2011; IN COMMERCE 1-31-2011.

THE MARK CONSISTS OF STANDARD CHARACTERS WITHOUT CLAIM TO ANY PARTICULAR FONT, STYLE, SIZE, OR COLOR.

NO CLAIM IS MADE TO THE EXCLUSIVE RIGHT TO USE "NUTRITION", APART FROM THE MARK AS SHOWN.

SER. NO. 85-327,007, FILED 5-23-2011.

NELSON SNYDER, EXAMINING ATTORNEY



David J. Kypos

Director of the United States Patent and Trademark Office

United States of America

United States Patent and Trademark Office

KOHERE

Reg. No. 4,174,046

MCMAHAN, MIKE (UNITED STATES INDIVIDUAL)
5210 HOVIS RD.
CHARLOTTE, NC 28208

Registered July 17, 2012

Int. Cl.: 1

FOR: CHEMICALS PREPARATIONS FOR USE IN INDUSTRY IN THE FIELD OF ASPHALT TECHNOLOGIES, IN CLASS 1 (U.S. CLS. 1, 5, 6, 10, 26 AND 46).

TRADEMARK

FIRST USE 1-1-2010; IN COMMERCE 1-1-2010.

PRINCIPAL REGISTER

THE MARK CONSISTS OF STANDARD CHARACTERS WITHOUT CLAIM TO ANY PARTICULAR FONT, STYLE, SIZE, OR COLOR.

SER. NO. 85-327,013, FILED 5-23-2011.

ALICE BENMAMAN, EXAMINING ATTORNEY



David J. Kyffers

Director of the United States Patent and Trademark Office

United States of America

United States Patent and Trademark Office

RYSE

Reg. No. 4,174,047

CRYTEK GMBH (FED REP GERMANY LIMITED LIABILITY COMPANY)
HANAUER LANDSTRASSE 523

Registered July 17, 2012

FRANKFURT AM MAIN, FED REP GERMANY 60386

Int. Cls.: 9, 16, 28 and 41

FOR: COMPUTER SOFTWARE FOR THE MANAGEMENT, TRANSMISSION, STORAGE AND SHARED USE OF COMPUTER GAME PROGRAMS AND OF ELECTRONICALLY STORED INFORMATION VIA COMPUTER NETWORKS FOR USERS; GAME SOFTWARE AND ELECTRONIC GAME PROGRAMS, NAMELY, SOFTWARE GAMES RECORDED ON CD-ROM AND DIGITAL VIDEO DISCS FOR COMPUTERS; SOFTWARE GAMES RECORDED ON CD-ROMS, DIGITAL VIDEO DISCS, AND CARTRIDGES FOR CONSOLE AND INDIVIDUAL, PORTABLE GAMING SYSTEMS; SOFTWARE GAMES THAT ARE DOWNLOADABLE FROM A REMOTE COMPUTER SITE AND ELECTRONIC GAME SOFTWARE FOR MOBILE PHONES, PERSONAL DIGITAL ASSISTANTS, AND HANDHELD COMPUTERS; VIDEO TAPES FEATURING COMEDY, DRAMA, ACTION, ADVENTURE AND/OR ANIMATION; INTEGRATED CIRCUITS CONTAINING RECORDED SOFTWARE FOR USE WITH COMPUTER GAMING CONSOLES AND VIDEO GAME CONSOLES FOR USE WITH AN EXTERNAL DISPLAY SCREEN OR MONITOR; AND MANUALS SOLD TOGETHER AS A UNIT OR PROVIDED VIA DOWNLOAD OR ONLINE WITH AND RELATING TO ANY OF THE FOREGOING, IN CLASS 9 (U.S. CLS. 21, 23, 26, 36 AND 38).

TRADEMARK

SERVICE MARK

PRINCIPAL REGISTER

FOR: BOOKS AND BOOKLETS FEATURING COMEDY, DRAMA, ACTION, ADVENTURE, ANIMATION AND MUSIC; PUBLICATIONS, NAMELY, BROCHURES, BOOKLETS, MANUALS AND TEACHING MATERIALS IN THE FIELD OF COMPUTER AND VIDEO GAMES, IN CLASS 16 (U.S. CLS. 2, 5, 22, 23, 29, 37, 38 AND 50).



FOR: TOYS AND PLAYTHINGS, NAMELY, DOLLS, TOY ACTION FIGURES, PLUSH TOYS AND ACCESSORIES THEREOF, PLAYSETS FOR DOLLS AND TOY ACTION FIGURES, TOY VEHICLES, TOY MODEL HOBBY CRAFT KITS, AND HAND HELD UNITS FOR ELECTRONIC GAMES OTHER THAN THOSE ADAPTED FOR USE WITH AN EXTERNAL DISPLAY SCREEN OR MONITOR, IN CLASS 28 (U.S. CLS. 22, 23, 38 AND 50).

FOR: ENTERTAINMENT SERVICES, NAMELY, PROVIDING AN ON-LINE COMPUTER GAME FOR OTHERS OVER GLOBAL AND LOCAL AREA COMPUTER NETWORKS AND PROVIDING INFORMATION ON-LINE RELATING TO COMPUTER GAMES, VIDEO GAMES AND COMPUTER AND VIDEO GAMES RELATED PRODUCTS; MULTIMEDIA PUBLISHING OF BOOKS, MAGAZINES, JOURNALS, SOFTWARE, GAMES, MUSIC AND ELECTRONIC PUBLICATIONS, IN CLASS 41 (U.S. CLS. 100, 101 AND 107).

David J. Kyjars

Director of the United States Patent and Trademark Office

Reg. No. 4,174,047 THE MARK CONSISTS OF STANDARD CHARACTERS WITHOUT CLAIM TO ANY PARTICULAR FONT, STYLE, SIZE, OR COLOR.

OWNER OF ERPN CMNTY TM OFC REG. NO. 009979089, DATED 9-28-2011, EXPIRES 5-19-2021.

SER. NO. 85-327,063, FILED 5-23-2011.

SHARON MEIER, EXAMINING ATTORNEY

United States of America

United States Patent and Trademark Office

Texicun Gormay Pickuls

Reg. No. 4,174,048

Registered July 17, 2012

Int. Cl.: 29

TRADEMARK

PRINCIPAL REGISTER

TRANS PAK INC. (KANSAS CORPORATION), DBA CONSCIOUS CHOICE FOODS
1015 S. HARWOOD ST.
WWW.CONSCIOUSCHOICEFOODS.COM
DALLAS, TX 75201

FOR: PICKLED CUCUMBERS; SPICY PICKLES, IN CLASS 29 (U.S. CL. 46).

FIRST USE 12-17-2010; IN COMMERCE 12-17-2010.

THE MARK CONSISTS OF STANDARD CHARACTERS WITHOUT CLAIM TO ANY PARTICULAR FONT, STYLE, SIZE, OR COLOR.

NO CLAIM IS MADE TO THE EXCLUSIVE RIGHT TO USE "GOURMET PICKLES", APART FROM THE MARK AS SHOWN.

SER. NO. 85-327,069, FILED 5-23-2011.

SHARON MEIER, EXAMINING ATTORNEY



David J. Kyffers

Director of the United States Patent and Trademark Office

United States of America

United States Patent and Trademark Office



Reg. No. 4,174,049

MEDIA PLUMBING & HEATING (PENNSYLVANIA CORPORATION), DBA KINETIX
43 DOUGHERTY BLVD.
GLEN MILLS, PA 19342

Registered July 17, 2012

Int. Cl.: 37

FOR: INSTALLATION AND MAINTENANCE OF FIRE ALARM, DETECTION AND SUPPRESSION SYSTEMS, IN CLASS 37 (U.S. CLS. 100, 103 AND 106).

SERVICE MARK

FIRST USE 5-1-1993; IN COMMERCE 1-16-2003.

PRINCIPAL REGISTER

THE MARK CONSISTS OF THE WORD "KINETIX" WITH A CIRCLE DESIGNED AROUND THE LETTER "K".

SER. NO. 85-327,117, FILED 5-23-2011.

ASMAT KHAN, EXAMINING ATTORNEY



David J. Kyffers

Director of the United States Patent and Trademark Office

United States of America

United States Patent and Trademark Office

DIRECTOR

Reg. No. 4,174,050

Registered July 17, 2012

Int. Cl.: 6

TRADEMARK

PRINCIPAL REGISTER

THOMAS & BETTS INTERNATIONAL, INC. (DELAWARE CORPORATION)
SUITE 67
501 SILVERSIDE ROAD
WILMINGTON, DE 19809

FOR: METAL HARDWARE, NAMELY, METAL CABLE FITTINGS FOR ARMORED ELECTRICAL CABLE FOR USE IN INDUSTRIAL, RESIDENTIAL OR COMMERCIAL ENVIRONMENTS, IN CLASS 6 (U.S. CLS. 2, 12, 13, 14, 23, 25 AND 50).

FIRST USE 2-28-2011; IN COMMERCE 2-28-2011.

THE MARK CONSISTS OF STANDARD CHARACTERS WITHOUT CLAIM TO ANY PARTICULAR FONT, STYLE, SIZE, OR COLOR.

SER. NO. 85-327,224, FILED 5-23-2011.

ALICIA COLLINS, EXAMINING ATTORNEY



David J. Kyffers

Director of the United States Patent and Trademark Office

United States of America

United States Patent and Trademark Office

STED

Reg. No. 4,174,051

Registered July 17, 2012

Int. Cl.: 9

TRADEMARK

PRINCIPAL REGISTER

THOMAS & BETTS INTERNATIONAL, INC. (DELAWARE CORPORATION)
SUITE 67
501 SILVERSIDE ROAD
WILMINGTON, DE 19809

FOR: METAL HARDWARE, NAMELY, METAL CABLE FITTINGS FOR ARMORED ELECTRICAL CABLE FOR USE IN INDUSTRIAL, RESIDENTIAL OR COMMERCIAL ENVIRONMENTS, IN CLASS 9 (U.S. CLS. 21, 23, 26, 36 AND 38).

FIRST USE 2-28-2011; IN COMMERCE 2-28-2011.

THE MARK CONSISTS OF STANDARD CHARACTERS WITHOUT CLAIM TO ANY PARTICULAR FONT, STYLE, SIZE, OR COLOR.

SER. NO. 85-327,242, FILED 5-23-2011.

ALICIA COLLINS, EXAMINING ATTORNEY



David J. Kybas

Director of the United States Patent and Trademark Office

United States of America

United States Patent and Trademark Office

REVERENCE

Reg. No. 4,174,052

HOLLAND, BRYAN (UNITED STATES INDIVIDUAL)
P.O. BOX 113
OTSEGO, MI 49078

Registered July 17, 2012

Int. Cls.: 9 and 41

FOR: SOUND RECORDINGS FEATURING MUSIC, IN CLASS 9 (U.S. CLS. 21, 23, 26, 36 AND 38).

TRADEMARK

FIRST USE 1-1-2010; IN COMMERCE 1-1-2010.

SERVICE MARK

FOR: ENTERTAINMENT, NAMELY, LIVE PERFORMANCES BY A MUSICAL BAND, IN CLASS 41 (U.S. CLS. 100, 101 AND 107).

PRINCIPAL REGISTER

FIRST USE 1-1-2010; IN COMMERCE 1-1-2010.

THE MARK CONSISTS OF THE STYLIZED TEXT "REVERENCE".

SER. NO. 85-327,312, FILED 5-23-2011.

DAVID H. STINE, EXAMINING ATTORNEY



David J. Kyffers

Director of the United States Patent and Trademark Office

United States of America

United States Patent and Trademark Office

MYSHIPRUSH

Reg. No. 4,174,053

Z-FIRM LLC (CALIFORNIA LIMITED LIABILITY COMPANY)
120 LAKESIDE AVENUE
SEATTLE, WA 98122

Registered July 17, 2012

Int. Cls.: 9 and 42

FOR: SOFTWARE FOR READING, MANAGING AND UPDATING INFORMATION RELATED TO THE SHIPMENT OF LETTERS, PARCELS AND FREIGHT IN CONNECTION WITH SYSTEMS INVOLVED IN ECOMMERCE, ORDER PROCESSING, ACCOUNTING AND WAREHOUSE MANAGEMENT, IN CLASS 9 (U.S. CLS. 21, 23, 26, 36 AND 38).

TRADEMARK

SERVICE MARK

FIRST USE 5-0-2009; IN COMMERCE 5-0-2009.

PRINCIPAL REGISTER

FOR: APPLICATION SERVICE PROVIDER (ASP) FEATURING SOFTWARE FOR THE AUTOMATED PROCESSING AND SHIPPING OF LETTERS, PARCELS, AND FREIGHT WITH THE U.S. POSTAL SERVICE AND PRIVATE SHIPPING CARRIERS; APPLICATION SERVICE PROVIDER (ASP) FEATURING SOFTWARE FOR A SYSTEM FOR OTHERS TO AGGREGATE AND MANAGE INFORMATION RELATED TO SHIPPING OF LETTERS, PARCELS AND FREIGHT WITH THE U.S. POSTAL SERVICE AND PRIVATE SHIPPING CARRIERS, IN CLASS 42 (U.S. CLS. 100 AND 101).

FIRST USE 8-0-2009; IN COMMERCE 8-0-2009.

THE MARK CONSISTS OF STANDARD CHARACTERS WITHOUT CLAIM TO ANY PARTICULAR FONT, STYLE, SIZE, OR COLOR.

OWNER OF U.S. REG. NO. 2,486,108.

SER. NO. 85-327,327, FILED 5-23-2011.

JESSICA A. POWERS, EXAMINING ATTORNEY



David J. Kypos

Director of the United States Patent and Trademark Office

United States of America

United States Patent and Trademark Office



Reg. No. 4,174,054

Registered July 17, 2012

Int. Cl.: 9

TRADEMARK

PRINCIPAL REGISTER

ELESOUND ELECTRONICS TECHNOLOGY CO., LIMITED (HONG KONG CORPORATION)
23/F SEAVIEW COMM BLDG
21-24 CONNAUGHT RD WEST
SHEUNG WAN, HONG KONG

FOR: CABINETS FOR LOUDSPEAKERS; CAMCORDERS; COMPUTER MOUSE; COMPUTER PERIPHERAL DEVICES; DATA PROCESSORS; EAR PHONES; EAR PLUGS NOT FOR MEDICAL PURPOSES; KEYBOARDS; LAPTOP COMPUTERS; MICROPHONES; PERSONAL COMPUTERS, IN CLASS 9 (U.S. CLS. 21, 23, 26, 36 AND 38).

FIRST USE 3-17-2008; IN COMMERCE 3-17-2008.

THE MARK CONSISTS OF STYLIZED LETTER "E" AND THE STYLIZED WORD "ELESOUND". THE LETTER "E" IS CONTAINED IN A CIRCLE WHICH IS IN FRONT OF THE STYLIZED WORD "ELESOUND". A LINE APPEARS BELOW THE LETTER "E" AND BELOW THE WORD "ELESOUND".

SER. NO. 85-328,187, FILED 5-24-2011.

JESSICA FATHY, EXAMINING ATTORNEY



David J. Kyjars

Director of the United States Patent and Trademark Office

United States of America

United States Patent and Trademark Office

I Wasn't Here

Reg. No. 4,174,055

NAVALTEES, LLC (MARYLAND LIMITED LIABILITY COMPANY)
PO BOX 230

Registered July 17, 2012

LEONARDTOWN, MD 20650

Int. Cl.: 25

FOR: WEARABLE GARMENTS AND CLOTHING, NAMELY, SHIRTS, IN CLASS 25 (U.S. CLS. 22 AND 39).

TRADEMARK

FIRST USE 12-1-2010; IN COMMERCE 12-1-2010.

PRINCIPAL REGISTER

THE MARK CONSISTS OF STANDARD CHARACTERS WITHOUT CLAIM TO ANY PARTICULAR FONT, STYLE, SIZE, OR COLOR.

SER. NO. 85-328,502, FILED 5-24-2011.

JOHN SCHUYLER YARD, EXAMINING ATTORNEY



David J. Kyffers

Director of the United States Patent and Trademark Office

United States of America

United States Patent and Trademark Office



Reg. No. 4,174,056

Registered July 17, 2012

Int. Cl.: 35

SERVICE MARK

PRINCIPAL REGISTER

FLORIDA TRUCKING ASSOCIATION (FLORIDA CORPORATION)
350 EAST COLLEGE AVENUE
TALLAHASSEE, FL 323011565

FOR: ASSOCIATION SERVICES, NAMELY, PROMOTING THE INTERESTS OF THE TRUCKING INDUSTRY AND PERSONS ENGAGED IN IT AND ALLIED INDUSTRIES, IN CLASS 35 (U.S. CLS. 100, 101 AND 102).

FIRST USE 2-0-2007; IN COMMERCE 2-0-2007.

NO CLAIM IS MADE TO THE EXCLUSIVE RIGHT TO USE "FLORIDA TRUCKING ASSOCIATION", APART FROM THE MARK AS SHOWN.

THE MARK CONSISTS OF THE WORDING "FLORIDA TRUCKING ASSOCIATION" IN AN OVAL SURROUNDING AN INNER OVAL CONTAINING STYLIZED REPRESENTATIONS OF THE OUTLINE OF THE STATE OF FLORIDA AND A TRUCK.

SER. NO. 85-328,658, FILED 5-24-2011.

PRISCILLA MILTON, EXAMINING ATTORNEY



David J. Kybas

Director of the United States Patent and Trademark Office

United States of America

United States Patent and Trademark Office



Reg. No. 4,174,057

Registered July 17, 2012

**COLLECTIVE
MEMBERSHIP**

PRINCIPAL REGISTER

FLORIDA TRUCKING ASSOCIATION (FLORIDA CORPORATION)
350 EAST COLLEGE AVENUE
TALLAHASSEE, FL 323011565

FOR: INDICATING MEMBERSHIP IN A TRUCKING INDUSTRY ASSOCIATION, IN CLASS
200 (U.S. CL. 200).

FIRST USE 0-0-1961; IN COMMERCE 0-0-1961.

NO CLAIM IS MADE TO THE EXCLUSIVE RIGHT TO USE "TRUCKING ASSOCIATION"
AND "MEMBER", APART FROM THE MARK AS SHOWN.

THE MARK CONSISTS OF THE WORDING "FLORIDA TRUCKING ASSOCIATION MEM-
BER" IN AN OVAL SURROUNDING AN INNER OVAL CONTAINING STYLIZED REPRESENTATIONS OF THE OUTLINE OF THE STATE OF FLORIDA AND A TRUCK.

SEC. 2(F) AS TO "FLORIDA TRUCKING ASSOCIATION MEMBER".

SER. NO. 85-328,702, FILED 5-24-2011.

PRISCILLA MILTON, EXAMINING ATTORNEY



David J. Kyffers

Director of the United States Patent and Trademark Office

United States of America

United States Patent and Trademark Office

CABLES INDUSTRY ANALYST

Reg. No. 4,174,058

Registered July 17, 2012

Int. Cl.: 16

TRADEMARK

PRINCIPAL REGISTER

CRU INTERNATIONAL, LIMITED (UNITED KINGDOM CORPORATION)
31 MOUNT PLEASANT
LONDON, UNITED KINGDOM WC1X0AD

FOR: NEWSLETTER FEATURING INTERNATIONAL AND DOMESTIC NEWS ABOUT THE CABLE INDUSTRY AND RELATED TOPICS, IN CLASS 16 (U.S. CLS. 2, 5, 22, 23, 29, 37, 38 AND 50).

FIRST USE 8-29-2002; IN COMMERCE 8-29-2002.

THE MARK CONSISTS OF STANDARD CHARACTERS WITHOUT CLAIM TO ANY PARTICULAR FONT, STYLE, SIZE, OR COLOR.

OWNER OF U.S. REG. NO. 3,009,719.

NO CLAIM IS MADE TO THE EXCLUSIVE RIGHT TO USE "CABLES INDUSTRY", APART FROM THE MARK AS SHOWN.

SEC. 2(F).

SER. NO. 85-328,764, FILED 5-24-2011.

MICHAEL WEBSTER, EXAMINING ATTORNEY



David J. Kyffers

Director of the United States Patent and Trademark Office

United States of America

United States Patent and Trademark Office

Guidelook

Reg. No. 4,174,059

ROCHA MIGUEL (TEXAS INDIVIDUAL), DBA PROGRAMAX, LLC
1618 CALEDONIA TRAIL
SUGAR LAND, TX 77479

Registered July 17, 2012

Int. Cl.: 35

FOR: ADVERTISING AND DIRECTORY SERVICES, NAMELY, PROMOTING THE SERVICES OF OTHERS BY PROVIDING A WEBPAGE FEATURING LINKS TO THE WEBSITES OF OTHERS, IN CLASS 35 (U.S. CLS. 100, 101 AND 102).

SERVICE MARK

FIRST USE 1-1-2011; IN COMMERCE 1-1-2011.

PRINCIPAL REGISTER

THE MARK CONSISTS OF STANDARD CHARACTERS WITHOUT CLAIM TO ANY PARTICULAR FONT, STYLE, SIZE, OR COLOR.

SER. NO. 85-328,806, FILED 5-24-2011.

HOWARD SMIGA, EXAMINING ATTORNEY



David J. Kybas

Director of the United States Patent and Trademark Office

United States of America

United States Patent and Trademark Office

PUPPY KISSES

Reg. No. 4,174,060

PUPPY KISSES LLC (NEW JERSEY LIMITED LIABILITY COMPANY)
6 JASON WOODS ROAD
CLOSTER, NJ 07624

Registered July 17, 2012

Int. Cls.: 18 and 35

FOR: PET HAIR ORNAMENTS, IN CLASS 18 (U.S. CLS. 1, 2, 3, 22 AND 41).

TRADEMARK

FIRST USE 8-0-1999; IN COMMERCE 8-0-1999.

SERVICE MARK

FOR: ONLINE RETAIL STORE SERVICES FEATURING PET CLOTHING, PET ACCESSORIES,
AND PET SUPPLIES, IN CLASS 35 (U.S. CLS. 100, 101 AND 102).

PRINCIPAL REGISTER

FIRST USE 7-0-1999; IN COMMERCE 7-0-1999.

THE MARK CONSISTS OF STANDARD CHARACTERS WITHOUT CLAIM TO ANY PARTICULAR FONT, STYLE, SIZE, OR COLOR.

SER. NO. 85-328,915, FILED 5-24-2011.

PAUL MORENO, EXAMINING ATTORNEY



David J. Kybas

Director of the United States Patent and Trademark Office

United States of America

United States Patent and Trademark Office

ERIC KAYSER

Reg. No. 4,174,061

T.A.L.E.K. S.A.S. (FRANCE CORPORATION)

Registered July 17, 2012

19-21 RUE VALETTE
PARIS, FRANCE 75005

Int. Cl.: 30

FOR: COFFEE, TEA, COCOA, SUGAR, RICE, TAPIOCA, SAGO, ARTIFICIAL COFFEE; FLOUR AND PREPARATIONS MADE FROM CEREALS, NAMELY, CEREAL BASED ENERGY BARS, GRANOLA, READY-TO-EAT CEREALS, CEREAL-BASED SNACK FOODS, BISCUITS, TARTS, CAKES, DANISH PASTRIES MADE WITH CEREALS; BREAD, BAKERY GOODS, PASTRY AND CONFECTIONERY MADE OF SUGAR, EDIBLE ICES; HONEY, TREACLE; YEAST, BAKING-POWDER; SALT, MUSTARD; VINEGAR, CONDIMENT SAUCES; SPICES; ICE, IN CLASS 30 (U.S. CL. 46).

TRADEMARK

PRINCIPAL REGISTER

THE MARK CONSISTS OF STANDARD CHARACTERS WITHOUT CLAIM TO ANY PARTICULAR FONT, STYLE, SIZE, OR COLOR.

OWNER OF ERPN CMNTY TM OFC REG. NO. 4861233, DATED 3-2-2007, EXPIRES 1-26-2016.

THE NAME(S), PORTRAIT(S), AND/OR SIGNATURE(S) SHOWN IN THE MARK IDENTIFIES "ERIC KAYSER", WHOSE CONSENT(S) TO REGISTER IS MADE OF RECORD.

SER. NO. 85-328,942, FILED 5-24-2011.

THEODORE MCBRIDE, EXAMINING ATTORNEY



David J. Kyros

Director of the United States Patent and Trademark Office

United States of America

United States Patent and Trademark Office



Reg. No. 4,174,062

BOGUS, DORRIS L. (UNITED STATES INDIVIDUAL), DBA AMIT APPAREL
3105 SAN SIMEON WAY
PLANO, TX 75023

Registered July 17, 2012

Int. Cl.: 25

FOR: ATHLETIC APPAREL, NAMELY, SHIRTS, PANTS, JACKETS, HATS AND CAPS,
ATHLETIC UNIFORMS, IN CLASS 25 (U.S. CLS. 22 AND 39).

TRADEMARK

FIRST USE 5-21-2001; IN COMMERCE 3-15-2002.

PRINCIPAL REGISTER

THE MARK CONSISTS OF THE WORDING "KAMIT" WITH THE LETTERS "KA" IN A
CAPITALIZED BRUSH SCRIPT FONT AND LETTERS "MIT" IN A CAPITALIZED FONT
WITH AN ARCHED SHAPE; ABOVE THE WORDING IS A SINGLE 8-POINT STAR.

THE WORDING "KAMIT" HAS NO MEANING IN A FOREIGN LANGUAGE.

SER. NO. 85-329,382, FILED 5-24-2011.

SHAILA SETTLES, EXAMINING ATTORNEY



David J. Kyffers

Director of the United States Patent and Trademark Office

United States of America

United States Patent and Trademark Office

TRIMSCIENCE

Reg. No. 4,174,063

Registered July 17, 2012

Int. Cl.: 5

TRADEMARK

PRINCIPAL REGISTER

TRIM SCIENCE LLC (FLORIDA LIMITED LIABILITY COMPANY)
2776 UNIVERSITY DRIVE
CORAL SPRINGS, FL 33065

FOR: DIETARY AND NUTRITIONAL SUPPLEMENTS; DIETARY FOOD SUPPLEMENTS; DIETARY SUPPLEMENTAL DRINKS; DIETARY SUPPLEMENTS; DIETARY SUPPLEMENTS FOR HUMAN CONSUMPTION; MINERAL SUPPLEMENTS; NUTRACEUTICALS FOR USE AS A DIETARY SUPPLEMENT; NUTRITIONAL ADDITIVES FOR MEDICAL PURPOSES USED IN FOODS AND DIETARY SUPPLEMENTS FOR HUMAN CONSUMPTION; NUTRITIONAL SUPPLEMENTS; NUTRITIONAL SUPPLEMENTS IN LOTION FORM SOLD AS A COMPONENT OF NUTRITIONAL SKIN CARE PRODUCTS; POWDERED NUTRITIONAL SUPPLEMENT DRINK MIX; VITAMIN AND MINERAL SUPPLEMENTS; VITAMIN SUPPLEMENT IN TABLET FORM FOR USE IN MAKING AN EFFERVESCENT BEVERAGE WHEN ADDED TO WATER; VITAMIN SUPPLEMENTS; DIET CAPSULES; DIET PILLS, IN CLASS 5 (U.S. CLS. 6, 18, 44, 46, 51 AND 52).

FIRST USE 5-19-2011; IN COMMERCE 5-19-2011.

THE MARK CONSISTS OF STANDARD CHARACTERS WITHOUT CLAIM TO ANY PARTICULAR FONT, STYLE, SIZE, OR COLOR.

SER. NO. 85-329,455, FILED 5-25-2011.

HAI-LY LAM, EXAMINING ATTORNEY



David J. Kyros

Director of the United States Patent and Trademark Office

United States of America

United States Patent and Trademark Office

Penetrator

Reg. No. 4,174,064

Registered July 17, 2012

Int. Cl.: 11

TRADEMARK

PRINCIPAL REGISTER

HGL TECHNOLOGIES LLC (NEVADA LIMITED LIABILITY COMPANY)
200 S. VIRGINIA
8TH FLOOR
RENO, NV 89501

FOR: AQUARIUM LIGHTS; LED (LIGHT EMITTING DIODE) UNDERWATER LIGHTS; LED (LIGHT EMITTING DIODE) PLANT GROW LIGHTS; AND NONE OF THESE GOODS BEING FOR THE AUTOMOTIVE INDUSTRY, IN CLASS 11 (U.S. CLS. 13, 21, 23, 31 AND 34).

FIRST USE 7-1-2009; IN COMMERCE 7-1-2009.

THE MARK CONSISTS OF STANDARD CHARACTERS WITHOUT CLAIM TO ANY PARTICULAR FONT, STYLE, SIZE, OR COLOR.

SER. NO. 85-329,798, FILED 5-25-2011.

NAPOLEON SHARMA, EXAMINING ATTORNEY



David J. Kyffers

Director of the United States Patent and Trademark Office

United States of America

United States Patent and Trademark Office

MID-STATE AEROSPACE, INC.

Reg. No. 4,174,065

Registered July 17, 2012

Int. Cls.: 35 and 40

SERVICE MARK

PRINCIPAL REGISTER

MID-STATE AEROSPACE, INC. (KANSAS CORPORATION)
710 N. LINDENWOOD DRIVE
OLATHE, KS 66062

FOR: DISTRIBUTORSHIP SERVICES IN THE FIELD OF AEROSPACE HARDWARE, HOSE ASSEMBLIES AND SPECIALIZED INDUSTRIAL AND MARINE EQUIPMENT , IN CLASS 35 (U.S. CLS. 100, 101 AND 102).

FIRST USE 6-0-1983; IN COMMERCE 6-0-1983.

FOR: CUSTOM FABRICATION AND PRODUCTION OF AEROSPACE HARDWARE AND HOSE ASSEMBLIES; ASSEMBLY OF HOSE, FIELD-ATTACHABLE AND CRIMP FITTINGS AND HOSE ASSEMBLIES FOR OTHERS, IN CLASS 40 (U.S. CLS. 100, 103 AND 106).

FIRST USE 6-0-1983; IN COMMERCE 6-0-1983.

THE MARK CONSISTS OF STANDARD CHARACTERS WITHOUT CLAIM TO ANY PARTICULAR FONT, STYLE, SIZE, OR COLOR.

NO CLAIM IS MADE TO THE EXCLUSIVE RIGHT TO USE "AEROSPACE, INC.", APART FROM THE MARK AS SHOWN.

SER. NO. 85-329,896, FILED 5-25-2011.

ZACHARY BELLO, EXAMINING ATTORNEY



David J. Kybas

Director of the United States Patent and Trademark Office

United States of America

United States Patent and Trademark Office



MID-STATE
AEROSPACE, INC.

Reg. No. 4,174,066

Registered July 17, 2012

Int. Cls.: 35 and 40

SERVICE MARK

PRINCIPAL REGISTER

MID-STATE AEROSPACE, INC. (KANSAS CORPORATION)
710 N. LINDENWOOD DRIVE
OLATHE, KS 66062

FOR: DISTRIBUTORSHIP SERVICES IN THE FIELD OF AEROSPACE HARDWARE, HOSE ASSEMBLIES AND SPECIALIZED INDUSTRIAL AND MARINE EQUIPMENT, IN CLASS 35 (U.S. CLS. 100, 101 AND 102).

FIRST USE 6-0-1983; IN COMMERCE 6-0-1983.

FOR: CUSTOM FABRICATION AND PRODUCTION OF AEROSPACE HARDWARE AND HOSE ASSEMBLIES; ASSEMBLY OF HOSE, FIELD-ATTACHABLE AND CRIMP FITTINGS AND HOSE ASSEMBLIES FOR OTHERS, IN CLASS 40 (U.S. CLS. 100, 103 AND 106).

FIRST USE 6-0-1983; IN COMMERCE 6-0-1983.

NO CLAIM IS MADE TO THE EXCLUSIVE RIGHT TO USE "AEROSPACE, INC.", APART FROM THE MARK AS SHOWN.

THE MARK CONSISTS OF THE WORDS "MID-STATE AEROSPACE, INC." TO THE RIGHT OF A SCREW DESIGN WITH THREE LINES IN THE BACKGROUND.

SER. NO. 85-329,902, FILED 5-25-2011.

ZACHARY BELLO, EXAMINING ATTORNEY



David J. Kyros

Director of the United States Patent and Trademark Office

United States of America

United States Patent and Trademark Office

TCAR

Reg. No. 4,174,067

THE LAURELWOOD GROUP, INC. (OREGON CORPORATION)
31772 SW CALLAHAN RD.
SCAPPOOSE, OR 97056

Registered July 17, 2012

Int. Cls.: 16 and 41

FOR: EDUCATIONAL PUBLICATIONS, NAMELY, TRAINING MANUALS IN THE FIELD OF HEALTHCARE AND NURSING PROFESSIONAL TRAINING , IN CLASS 16 (U.S. CLS. 2, 5, 22, 23, 29, 37, 38 AND 50).

TRADEMARK

FIRST USE 11-15-2009; IN COMMERCE 11-15-2009.

SERVICE MARK

FOR: PROVIDING CONTINUING NURSING EDUCATION COURSES, IN CLASS 41 (U.S. CLS. 100, 101 AND 107).

PRINCIPAL REGISTER

FIRST USE 11-15-2009; IN COMMERCE 11-15-2009.

THE MARK CONSISTS OF STANDARD CHARACTERS WITHOUT CLAIM TO ANY PARTICULAR FONT, STYLE, SIZE, OR COLOR.

SER. NO. 85-330,405, FILED 5-25-2011.

HOWARD B. LEVINE, EXAMINING ATTORNEY



David J. Kyros

Director of the United States Patent and Trademark Office

United States of America

United States Patent and Trademark Office

THE WHY STORE

Reg. No. 4,174,068

CHRIS SHAFFER (UNITED STATES INDIVIDUAL)

Registered July 17, 2012

6380 S 725 W
MANILLA, IN 46150

Int. Cls.: 9 and 41

FOR: PRE-RECORDED CDS FEATURING MUSICAL PERFORMANCES; PRE-RECORDED DIGITAL MEDIA FEATURING MUSICAL PERFORMANCES, IN CLASS 9 (U.S. CLS. 21, 23, 26, 36 AND 38).

TRADEMARK

FIRST USE 8-27-2007; IN COMMERCE 8-27-2007.

SERVICE MARK

FOR: ENTERTAINMENT SERVICES IN THE NATURE OF LIVE MUSICAL PERFORMANCES, IN CLASS 41 (U.S. CLS. 100, 101 AND 107).

PRINCIPAL REGISTER

FIRST USE 8-27-2007; IN COMMERCE 8-27-2007.

THE MARK CONSISTS OF STANDARD CHARACTERS WITHOUT CLAIM TO ANY PARTICULAR FONT, STYLE, SIZE, OR COLOR.

SER. NO. 85-330,734, FILED 5-26-2011.

JOHN KELLY, EXAMINING ATTORNEY



David J. Kyfos

Director of the United States Patent and Trademark Office

United States of America

United States Patent and Trademark Office

PROSAR

Reg. No. 4,174,069

PRODUCT SAFETY RESOURCES, INC. (MINNESOTA CORPORATION)
2635 UNIVERSITY AVENUE WEST
ST. PAUL, MN 55114

Registered July 17, 2012

Int. Cls.: 42 and 45

FOR: PHARMACOVIGILANCE SERVICES, NAMELY, MONITORING THE QUALITY AND EFFICACY OF PHARMACEUTICAL PREPARATIONS; MONITORING THE QUALITY AND EFFICACY OF MEDICAL DEVICES AND BIOLOGICAL COMPOUNDS USED FOR MEDICAL PURPOSES, IN CLASS 42 (U.S. CLS. 100 AND 101).

SERVICE MARK

PRINCIPAL REGISTER

FIRST USE 10-1-2004; IN COMMERCE 10-1-2004.

FOR: PHARMACOVIGILANCE SERVICES, NAMELY, MONITORING THE SAFETY OF PHARMACEUTICAL PREPARATIONS; MONITORING THE SAFETY OF MEDICAL DEVICES AND BIOLOGICAL COMPOUNDS USED FOR MEDICAL PURPOSES, IN CLASS 45 (U.S. CLS. 100 AND 101).

FIRST USE 10-1-2004; IN COMMERCE 10-1-2004.

THE MARK CONSISTS OF STANDARD CHARACTERS WITHOUT CLAIM TO ANY PARTICULAR FONT, STYLE, SIZE, OR COLOR.

OWNER OF U.S. REG. NO. 2,472,742.

SER. NO. 85-331,039, FILED 5-26-2011.

EVELYN BRADLEY, EXAMINING ATTORNEY



David J. Kyjars

Director of the United States Patent and Trademark Office

United States of America

United States Patent and Trademark Office



Reg. No. 4,174,070

Registered July 17, 2012

Int. Cl.: 41

SERVICE MARK

PRINCIPAL REGISTER

ALIOTTI, SHELLEY (UNITED STATES INDIVIDUAL)
15 SOUTHBANK ROAD
CARMEL VALLEY, CA 93924

FOR: PROVIDING A WEBSITE FOR EDUCATION AND ENTERTAINMENT PURPOSES THAT IS SAFE FOR CHILDREN AND WHERE USERS CAN USE A SEARCHABLE ON-LINE LIBRARY, PLAY ON-LINE CHILDREN'S GAMES AND ACTIVITIES AND VIEW AND POST PHOTOS, VIDEO AND TEXT FEATURING SUBJECT MATTER OF INTEREST TO CHILDREN, IN CLASS 41 (U.S. CLS. 100, 101 AND 107).

FIRST USE 1-15-2011; IN COMMERCE 3-9-2011.

NO CLAIM IS MADE TO THE EXCLUSIVE RIGHT TO USE "PEN PAL KIDS CLUB", APART FROM THE MARK AS SHOWN.

THE COLOR(S) RED, ORANGE, YELLOW, BLUE, GREEN, PURPLE, BLACK, GRAY, BROWN, BEIGE, CHARTREUSE, AND WHITE IS/ARE CLAIMED AS A FEATURE OF THE MARK.

THE MARK CONSISTS OF THE FOLLOWING: THE STYLIZED WORDS "PEN PAL KIDS CLUB" IN THE COLORS GREEN, PURPLE, ORANGE, BLUE, RED, CHARTREUSE, AND BLACK ON A WHITE BACKGROUND, WITH AN IMAGE OF A GLOBE IN THE COLORS BLUE AND GREEN WITH A WHITE BORDER, AND THREE CHILDREN BEHIND THE WORDS "PEN PAL KIDS CLUB". ONE FEMALE CHILD IN THE COLORS BLUE, YELLOW AND LIGHT BEIGE IS LOOKING THROUGH BINOCULARS IN THE COLOR GRAY, THE OTHER FEMALE CHILD IN THE COLORS PURPLE, LIGHT PURPLE, MEDIUM BEIGE, AND GREEN IS HOLDING A POSTCARD IN THE COLORS WHITE WITH A RED AND YELLOW MARK AND THE MALE CHILD IN THE COLORS BROWN, ORANGE, AND YELLOW IS HOLDING A VIDEO GAME CONTROLLER IN THE COLOR BLACK.

SER. NO. 85-331,089, FILED 5-26-2011.

STEVEN JACKSON, EXAMINING ATTORNEY



David J. Kyffers

Director of the United States Patent and Trademark Office

United States of America

United States Patent and Trademark Office

SAM

Reg. No. 4,174,071

SEATTLE ART MUSEUM (WASHINGTON NON-PROFIT CORPORATION)
1300 FIRST AVENUE
SEATTLE, WA 98101

Registered July 17, 2012

Int. Cl.: 41

FOR: MUSEUM SERVICES; MUSEUMS; RUNNING OF MUSEUMS, IN CLASS 41 (U.S. CLS. 100, 101 AND 107).

SERVICE MARK

FIRST USE 12-31-2003; IN COMMERCE 12-31-2003.

PRINCIPAL REGISTER

THE MARK CONSISTS OF STANDARD CHARACTERS WITHOUT CLAIM TO ANY PARTICULAR FONT, STYLE, SIZE, OR COLOR.

SER. NO. 85-331,736, FILED 5-26-2011.

JULIE GUTTADAURO, EXAMINING ATTORNEY



David J. Kyffers

Director of the United States Patent and Trademark Office

United States of America

United States Patent and Trademark Office

RVMS

Reg. No. 4,174,072

Registered July 17, 2012

CERTIFICATION MARK

PRINCIPAL REGISTER

AMERICAN ASSOCIATION OF VETERINARY RADIOLOGISTS (CALIFORNIA CORPORATION)
7522 CLAIREMONT MESA BLVD.
SAN DIEGO, CA 92111

FOR: VETERINARY SPECIALTY SERVICES PROVIDING ADVANCED MEDICAL, DIAGNOSTIC OR SURGICAL SERVICES FOR ANIMALS, IN CLASS B (U.S. CL. B).

FIRST USE 5-1-2008; IN COMMERCE 10-1-2009.

THE MARK CONSISTS OF STANDARD CHARACTERS WITHOUT CLAIM TO ANY PARTICULAR FONT, STYLE, SIZE, OR COLOR.

THE CERTIFICATION MARK, AS USED BY AUTHORIZED PERSONS, CERTIFIES "RVMS" IS AN ACRONYM FOR REGISTERED VETERINARY MEDICAL SONOGRAPHER. THIS TERM IS USED BY THE AVVR OR AMERICAN ASSOCIATION OF VETERINARY RADIOLOGISTS TO DENOTE A SONOGRAPHER WHO IS REGISTERED WITH THE AAVR, A CURRENT MEMBER OF THE AAVR WHO IS IN GOOD STANDING WITH THE AAVR AND HAS SUCCESSFULLY COMPLETED AN AAVR APPROVED VETERINARY SONOGRAPHER TRAINING, PASSED THE VETERINARY SONOGRAPHER QUALIFYING EXAMINATION ADMINISTERED BY THE AMERICAN ASSOCIATION OF VETERINARY RADIOLOGISTS AND RETAINS A CONSTANT PROFESSIONAL RELATIONSHIP WITH A BOARD CERTIFIED VETERINARY RADIOLOGIST OR BOARD CERTIFIED VETERINARY RADIOLOGIST.

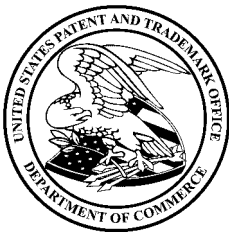

SER. NO. 85-331,802, FILED 5-26-2011.

AMY HELLA, EXAMINING ATTORNEY

David J. Kyjars

Director of the United States Patent and Trademark Office

United States of America

United States Patent and Trademark Office

Exclusive

Reg. No. 4,174,073

ZEE PORTAL LLC (NEVADA LIMITED LIABILITY COMPANY)
14 BAYBROOK LANE
OAK BROOK, IL 60523

Registered July 17, 2012

Int. Cl.: 35

FOR: PROMOTING THE GOODS AND SERVICES OF OTHERS BY PROVIDING A WEBSITE FEATURING DISCOUNT INFORMATION, IN CLASS 35 (U.S. CLS. 100, 101 AND 102).

SERVICE MARK

FIRST USE 5-1-2011; IN COMMERCE 5-1-2011.

PRINCIPAL REGISTER

THE MARK CONSISTS OF STANDARD CHARACTERS WITHOUT CLAIM TO ANY PARTICULAR FONT, STYLE, SIZE, OR COLOR.

SER. NO. 85-332,183, FILED 5-27-2011.

PATRICIA EVANKO, EXAMINING ATTORNEY



David J. Kybas

Director of the United States Patent and Trademark Office

United States of America

United States Patent and Trademark Office



Reg. No. 4,174,074

Registered July 17, 2012

Int. Cl.: 37

SERVICE MARK

PRINCIPAL REGISTER

TRAM ELECTRIC, INC. (UTAH CORPORATION)
1750 WEST 360 NORTH
PRICE, UT 84501

FOR: REPAIR OF MOTORS, MACHINERY, AND ELECTRICAL AND MECHANICAL EQUIPMENT, NAMELY, ELECTRIC MOTORS, PUMPS, CONTROL PANELS, TRANSFORMERS, SWITCH GEAR, GEAR BOXES, AND GENERATORS IN THE FIELDS OF MINING, INDUSTRIAL, AND COMMERCIAL MACHINES, NOT IN THE FIELD OF TRANSPORTATION VEHICLES; REMANUFACTURE OF ELECTRIC MOTORS TO THE ORDER AND/OR SPECIFICATION OF OTHERS IN THE FIELDS OF MINING, INDUSTRIAL, AND COMMERCIAL MACHINES, NOT IN THE FIELD OF TRANSPORTATION VEHICLES, IN CLASS 37 (U.S. CLS. 100, 103 AND 106).

FIRST USE 5-10-2011; IN COMMERCE 5-10-2011.

NO CLAIM IS MADE TO THE EXCLUSIVE RIGHT TO USE "ELECTRIC, INC. PRICE, UTAH", APART FROM THE MARK AS SHOWN.

THE MARK CONSISTS OF WORDING AND DESIGNS WITHIN A DARK OVAL BORDER. INSIDE THE BORDER, THERE IS LIGHT SPACE AND ANOTHER, SMALLER DARK OVAL AT THE CENTER. THE WORD "TRAM" APPEARS ABOVE THE CENTRAL OVAL, AND THE WORDING "ELECTRIC INC. PRICE, UTAH" APPEARS BELOW IT. THE CENTRAL OVAL CONTAINS A STYLIZED DESIGN OF A HORSE.

SER. NO. 85-332,303, FILED 5-27-2011.

CORY BOONE, EXAMINING ATTORNEY



David J. Kyffers

Director of the United States Patent and Trademark Office

United States of America

United States Patent and Trademark Office

You Call—We Haul

Reg. No. 4,174,075

Registered July 17, 2012

Int. Cl.: 37

SERVICE MARK

PRINCIPAL REGISTER

TRAM ELECTRIC, INC. (UTAH CORPORATION)
1750 WEST 360 NORTH
PRICE, UT 84501

FOR: REPAIR OF MOTORS, MACHINERY, AND ELECTRICAL AND MECHANICAL EQUIPMENT, NAMELY, ELECTRIC MOTORS AND PUMPS; REPAIR OF MOTORS, MACHINERY, AND ELECTRICAL AND MECHANICAL EQUIPMENT, NAMELY, CONTROL PANELS, TRANSFORMERS, SWITCH GEAR, GEAR BOXES, AND GENERATORS IN THE FIELDS OF MINING, INDUSTRIAL, AND COMMERCIAL MACHINES; REMANUFACTURE OF ELECTRIC MOTORS TO THE ORDER AND/OR SPECIFICATION OF OTHERS, IN CLASS 37 (U.S. CLS. 100, 103 AND 106).

FIRST USE 5-10-2011; IN COMMERCE 5-10-2011.

THE MARK CONSISTS OF STANDARD CHARACTERS WITHOUT CLAIM TO ANY PARTICULAR FONT, STYLE, SIZE, OR COLOR.

SER. NO. 85-332,529, FILED 5-27-2011.

CORY BOONE, EXAMINING ATTORNEY



David J. Kyffers

Director of the United States Patent and Trademark Office

United States of America

United States Patent and Trademark Office



Reg. No. 4,174,076

PEREL, DAVID (UNITED STATES INDIVIDUAL)

Registered July 17, 2012

#608
701 W. LAKESIDE AVE.
CLEVELAND, OH 44113

Int. Cl.: 16

FOR: PRINTED MATERIAL, NAMELY, SURVEYS AND ASSESSMENTS IN THE FIELD OF EDUCATOR TRAINING AND PERFORMANCE, IN CLASS 16 (U.S. CLS. 2, 5, 22, 23, 29, 37, 38 AND 50).

TRADEMARK

PRINCIPAL REGISTER

FIRST USE 3-1-2011; IN COMMERCE 5-1-2011.

NO CLAIM IS MADE TO THE EXCLUSIVE RIGHT TO USE "TALENT ASSESSMENT", APART FROM THE MARK AS SHOWN.

THE COLOR(S) BURGUNDY , GOLD, AND BLACK IS/ARE CLAIMED AS A FEATURE OF THE MARK.

THE MARK CONSISTS OF THE WORDING "ACES TALENT ASSESSMENT", WITH THE WORD "ACES" IN BURGUNDY ON THE LEFT, AND FADING TO GOLD ON THE RIGHT. A GOLD CHECK MARK PASSES THROUGH THE "A", FORMING THE CROSSBAR. UNDER THE LENGTH OF THE WORD "ACES" IS THE STYLIZED TEXT "TALENT ASSESSMENT" IN BLACK.

SER. NO. 85-332,689, FILED 5-27-2011.

JASON BLAIR, EXAMINING ATTORNEY



David J. Kyffers

Director of the United States Patent and Trademark Office

United States of America

United States Patent and Trademark Office



Reg. No. 4,174,077

Registered July 17, 2012

Int. Cls.: 25 and 43

TRADEMARK

SERVICE MARK

PRINCIPAL REGISTER

SINH DARELLA, INC. (CALIFORNIA CORPORATION)
14241 EUCLID STREET, SUITE C-116
GARDEN GROVE, CA 928434959

FOR: SHIRTS; SWEAT SHIRTS; T-SHIRTS, IN CLASS 25 (U.S. CLS. 22 AND 39).

FIRST USE 3-1-2011; IN COMMERCE 3-1-2011.

FOR: RESTAURANT SERVICES, IN CLASS 43 (U.S. CLS. 100 AND 101).

FIRST USE 6-13-2003; IN COMMERCE 9-11-2003.

OWNER OF U.S. REG. NO. 3,256,219.

NO CLAIM IS MADE TO THE EXCLUSIVE RIGHT TO USE THE WORD "CRAB" OR THE PICTORIAL REPRESENTATION OF A CRAB, APART FROM THE MARK AS SHOWN.

THE MARK CONSISTS OF THE WORDS "THE BOILING CRAB" AROUND THE GRAPHIC DEPICTION OF A CRAB.

SER. NO. 85-332,952, FILED 5-27-2011.

RONALD MCMORROW, EXAMINING ATTORNEY



David J. Kyffers

Director of the United States Patent and Trademark Office

United States of America

United States Patent and Trademark Office

TIGHTS AND TIARAS

Reg. No. 4,174,078

Registered July 17, 2012

Int. Cl.: 25

TRADEMARK

PRINCIPAL REGISTER

LAMARK, HENRIK (NORWAY INDIVIDUAL)
2163 NEWCASTLE AVENUE, SUITE 200
CARDIFF BY THE SEA, CA 92007

FOR: CLOTHING, FOOTWEAR, AND HEADWEAR, NAMELY, LEOTARDS, TIGHTS, TUTUS, UNITARDS, LEG WARMERS, LEGGINGS, DANCE PANTS, DANCE SHORTS, DANCE FOOTWEAR, BALLET SHOES, TOE SHOES, TAP SHOES, JAZZ SHOES, BOOTS, SANDALS, ATHLETIC FOOTWEAR, SNEAKERS, BATH SLIPPERS, GYM SUITS, SWEAT PANTS, T-SHIRTS, SHIRTS, UNDERGARMENTS, CAMISOLES, BALLET BELTS AND HEADWEAR, IN CLASS 25 (U.S. CLS. 22 AND 39).

FIRST USE 1-16-2010; IN COMMERCE 4-26-2011.

THE MARK CONSISTS OF STANDARD CHARACTERS WITHOUT CLAIM TO ANY PARTICULAR FONT, STYLE, SIZE, OR COLOR.

NO CLAIM IS MADE TO THE EXCLUSIVE RIGHT TO USE "TIGHTS", APART FROM THE MARK AS SHOWN.

SER. NO. 85-333,000, FILED 5-27-2011.

MARCIE MILONE, EXAMINING ATTORNEY



David J. Kybas

Director of the United States Patent and Trademark Office

United States of America

United States Patent and Trademark Office



Reg. No. 4,174,079

HELLER JR., WILLIAM (UNITED STATES INDIVIDUAL)
100 JOFFRE AVENUE

Registered July 17, 2012

CAPE MAY COURT HOUSE, NJ 08210

Int. Cl.: 41

FOR: ARRANGING, ORGANIZING, CONDUCTING, AND HOSTING SOCIAL ENTERTAINMENT EVENTS; ENTERTAINMENT SERVICES, NAMELY, WRESTLING EXHIBITS AND PERFORMANCES BY A PROFESSIONAL WRESTLER AND ENTERTAINER, IN CLASS 41 (U.S. CLS. 100, 101 AND 107).

SERVICE MARK

PRINCIPAL REGISTER

FIRST USE 6-1-1983; IN COMMERCE 6-1-1983.

THE MARK CONSISTS OF A SKELETAL MASK WITH LONG ROBE AND CAPE. THE SKELETON FIGURE IS HOLDING A SELF MADE ONE OF A KIND SCYTHE MADE WITH SKULL HEAD AND BACK BONE. THE BASE OF THE SCYTHE IS A METAL BARB. IN THE BACKGROUND IS A TREE AND GRAVESTONES. THERE IS A CIRCLE AROUND THE FIGURE AND THE WORDS "THE REAL" APPEAR ON THE TOP OF PERIMETER OF THE CIRCLE AND THE WORDS "GRIM REAPER" ARE AROUND THE BOTTOM PERIMETER OF THE CIRCLE.

SER. NO. 85-333,080, FILED 5-28-2011.

ANNE FARRELL, EXAMINING ATTORNEY



David J. Kyfos

Director of the United States Patent and Trademark Office

United States of America

United States Patent and Trademark Office

Spit and Spite

Reg. No. 4,174,080

SALAZAR, ABEL (UNITED STATES INDIVIDUAL)
3647 CALLE JOAQUIN
CALABASAS, CA 91302

Registered July 17, 2012

Int. Cl.: 41

FOR: ENTERTAINMENT SERVICES IN THE NATURE OF DEVELOPMENT, CREATION, PRODUCTION AND POST-PRODUCTION SERVICES OF MULTIMEDIA ENTERTAINMENT CONTENT, IN CLASS 41 (U.S. CLS. 100, 101 AND 107).

SERVICE MARK

FIRST USE 1-1-2004; IN COMMERCE 1-1-2006.

PRINCIPAL REGISTER

THE MARK CONSISTS OF STANDARD CHARACTERS WITHOUT CLAIM TO ANY PARTICULAR FONT, STYLE, SIZE, OR COLOR.

SER. NO. 85-333,448, FILED 5-30-2011.

PAM WILLIS, EXAMINING ATTORNEY



David J. Kyffers

Director of the United States Patent and Trademark Office

United States of America

United States Patent and Trademark Office



Reg. No. 4,174,081

Registered July 17, 2012

Int. Cls.: 7, 19 and 37

TRADEMARK

SERVICE MARK

PRINCIPAL REGISTER

ECOVENTIA S.L.U. (SPAIN CORPORATION)
Pº DE LA CASTELLANA 259D, PLANTA 6
MADRID, SPAIN 28046

FOR: MACHINES AND APPARATUS FOR GENERATING ELECTRICITY FROM RENEWABLE SOURCES, IN PARTICULAR, WIND POWER, NAMELY, WIND TURBINES AND WIND POWERED ELECTRICITY GENERATORS, IN CLASS 7 (U.S. CLS. 13, 19, 21, 23, 31, 34 AND 35).

FOR: TOWERS FOR WIND ENERGY INSTALLATIONS, NAMELY, PORTABLE NON-METAL BUILDINGS IN THE NATURE OF TOWERS INTENDED FOR USE IN WIND ENERGY INSTALLATIONS, IN CLASS 19 (U.S. CLS. 1, 12, 33 AND 50).

FOR: INSTALLATION, MAINTENANCE AND REPAIR OF WIND TOWERS, IN CLASS 37 (U.S. CLS. 100, 103 AND 106).

PRIORITY CLAIMED UNDER SEC. 44(D) ON ERPN CMNTY TM OFC APPLICATION NO. 9606872, FILED 12-17-2010, REG. NO. 9606872, DATED 5-27-2011, EXPIRES 12-17-2020.

THE COLOR(S) LIGHT GREEN AND DARK GREEN IS/ARE CLAIMED AS A FEATURE OF THE MARK.

NO CLAIM IS MADE TO THE EXCLUSIVE RIGHT TO USE "WIND TOWERS", APART FROM THE MARK AS SHOWN.

THE MARK CONSISTS OF THE WORD "ECOVENTIA" IN STYLIZED LETTERS BELOW OF WHICH APPEARS A SQUARE INSIDE OF WHICH APPEARS THE DRAWING OF A PARTIAL VIEW OF A WINDMILL. BELOW THE SQUARE APPEARS THE WORDING "WIND TOWERS". THE LIGHT GREEN COLOR APPEARS IN THE "ECO" PORTION OF THE WORD "ECOVENTIA", IN THE OUTER BORDER OF THE SQUARE AND IN THE WINDMILL. THE COLOR DARK GREEN APPEARS IN THE "VENTIA" PORTION OF THE WORD "ECOVENTIA" AND IN THE WORDING "WIND TOWERS".

THE WORDING "ECOVENTIA" HAS NO MEANING IN A FOREIGN LANGUAGE.

SER. NO. 85-333,555, FILED 5-31-2011.



David J. Kybas

Director of the United States Patent and Trademark Office

Reg. No. 4,174,081 SEAN CROWLEY, EXAMINING ATTORNEY

United States of America

United States Patent and Trademark Office

TEMCARE PRO LT

Reg. No. 4,174,082

TEMCARE MEDICAL DESIGN AND MANUFACTURING, INC. (FLORIDA CORPORATION)
3111 SW 10TH STREET
POMPANO BEACH, FL 33069

Registered July 17, 2012

Int. Cl.: 10

FOR: BACK SUPPORTS FOR MEDICAL PURPOSES, IN CLASS 10 (U.S. CLS. 26, 39 AND 44).

TRADEMARK

FIRST USE 8-10-2011; IN COMMERCE 1-24-2012.

PRINCIPAL REGISTER

THE MARK CONSISTS OF STANDARD CHARACTERS WITHOUT CLAIM TO ANY PARTICULAR FONT, STYLE, SIZE, OR COLOR.

OWNER OF U.S. REG. NOS. 3,881,235, 3,993,037, AND 3,993,324.

NO CLAIM IS MADE TO THE EXCLUSIVE RIGHT TO USE "PRO LT", APART FROM THE MARK AS SHOWN.

SER. NO. 85-333,737, FILED 5-31-2011.

ESTHER BELENKER, EXAMINING ATTORNEY



David J. Kybas

Director of the United States Patent and Trademark Office

United States of America

United States Patent and Trademark Office

UNITED

—ARTIST NETWORK—

Reg. No. 4,174,083

KJM ENTERPRISES INC. (CALIFORNIA CORPORATION)
9590 DISTRIBUTION AVE.
SAN DIEGO, CA 92121

Registered July 17, 2012

Int. Cl.: 25

FOR: TOPS; WEARABLE GARMENTS AND CLOTHING, NAMELY, SHIRTS, IN CLASS 25 (U.S. CLS. 22 AND 39).

TRADEMARK

FIRST USE 5-31-2011; IN COMMERCE 5-31-2011.

PRINCIPAL REGISTER

NO CLAIM IS MADE TO THE EXCLUSIVE RIGHT TO USE "ARTIST NETWORK", APART FROM THE MARK AS SHOWN.

THE MARK CONSISTS OF ALL CAPS WORD "UNITED" WITH SMALLER "ARTIST NETWORK" POSITIONED UNDERNEATH.

SER. NO. 85-334,236, FILED 5-31-2011.

DOMINICK J. SALEMI, EXAMINING ATTORNEY



David J. Kyffers

Director of the United States Patent and Trademark Office

United States of America

United States Patent and Trademark Office

FAST HEAT

Reg. No. 4,174,084

X3 LABS INC. (CANADA CORPORATION)
35 RAGLAN AVE., STE 106
TORONTO, ONTARIO, CANADA M6C2K7

Registered July 17, 2012

Int. Cl.: 5

FOR: TOPICAL PREPARATIONS FOR THE RELIEF OF PAIN, IN CLASS 5 (U.S. CLS. 6, 18, 44, 46, 51 AND 52).

TRADEMARK

FIRST USE 1-12-2011; IN COMMERCE 1-12-2011.

PRINCIPAL REGISTER

THE MARK CONSISTS OF STANDARD CHARACTERS WITHOUT CLAIM TO ANY PARTICULAR FONT, STYLE, SIZE, OR COLOR.

PRIORITY CLAIMED UNDER SEC. 44(D) ON CANADA APPLICATION NO. 1511081, FILED 1-13-2011, REG. NO. TMA818751, DATED 2-29-2012, EXPIRES 2-28-2027.

NO CLAIM IS MADE TO THE EXCLUSIVE RIGHT TO USE "HEAT", APART FROM THE MARK AS SHOWN.

SER. NO. 85-334,355, FILED 5-31-2011.

DOMINICK J. SALEMI, EXAMINING ATTORNEY



David J. Kyros

Director of the United States Patent and Trademark Office

United States of America

United States Patent and Trademark Office

RTS

Reg. No. 4,174,085

BARRY W. DUECK (UNITED STATES INDIVIDUAL), DBA DUECK DEFENSE
P.O. BOX 1312
SUNSET BEACH, CA 90742

Registered July 17, 2012

Int. Cl.: 13

FOR: FIREARM ATTACHMENTS, NAMELY, FIREARM SIGHTS, IN CLASS 13 (U.S. CLS. 2 AND 9).

TRADEMARK

FIRST USE 2-12-2010; IN COMMERCE 2-12-2010.

PRINCIPAL REGISTER

THE MARK CONSISTS OF STANDARD CHARACTERS WITHOUT CLAIM TO ANY PARTICULAR FONT, STYLE, SIZE, OR COLOR.

SER. NO. 85-334,376, FILED 5-31-2011.

B. PARADEWELAI, EXAMINING ATTORNEY



David J. Kybas

Director of the United States Patent and Trademark Office

United States of America

United States Patent and Trademark Office

Kyla & Carlos

Reg. No. 4,174,086

Registered July 17, 2012

Int. Cl.: 3

MERCURY RETAIL SERVICES LLC (TEXAS LIMITED LIABILITY COMPANY)
BUILDING 19
5130 COMMERCE PARKWAY
SAN ANTONIO, TX 78218

FOR: LIP BALM, IN CLASS 3 (U.S. CLS. 1, 4, 6, 50, 51 AND 52).

TRADEMARK

FIRST USE 6-3-2011; IN COMMERCE 6-3-2011.

PRINCIPAL REGISTER

THE NAME(S), PORTRAIT(S), AND/OR SIGNATURE(S) SHOWN IN THE MARK IDENTIFIES KYLA HOLDER, MINOR DAUGHTER OF LOUIE LEE HOLDER III, WHOSE CONSENT(S) TO REGISTER IS MADE OF RECORD.

THE MARK CONSISTS OF THE STYLIZED WORDS "KYLA & CARLOS" HAVING A FLOWER IN THE "A" OF "KYLA" AND A HAT ON THE "A" OF "CARLOS". EACH OF THE WORDS IS SEPARATELY OUTLINED.

SER. NO. 85-334,790, FILED 6-1-2011.

FLORENTINA BLANDU, EXAMINING ATTORNEY



David J. Kyffers

Director of the United States Patent and Trademark Office

United States of America

United States Patent and Trademark Office

KYLA & CARLOS

Reg. No. 4,174,087

Registered July 17, 2012

Int. Cl.: 14

TRADEMARK

PRINCIPAL REGISTER

MERCURY RETAIL SERVICES LLC (TEXAS LIMITED LIABILITY COMPANY)
BUILDING 19
5130 COMMERCE PARKWAY
SAN ANTONIO, TX 78218

FOR: BRACELETS, IN CLASS 14 (U.S. CLS. 2, 27, 28 AND 50).

FIRST USE 5-27-2011; IN COMMERCE 7-12-2011.

THE MARK CONSISTS OF STANDARD CHARACTERS WITHOUT CLAIM TO ANY PARTICULAR FONT, STYLE, SIZE, OR COLOR.

THE NAME(S), PORTRAIT(S), AND/OR SIGNATURE(S) SHOWN IN THE MARK IDENTIFIES KYLA HOLDER, MINOR DAUGHTER OF LOUIE LEE HOLDER III, WHOSE CONSENT(S) TO REGISTER IS MADE OF RECORD.

SER. NO. 85-334,801, FILED 6-1-2011.

FLORENTINA BLANDU, EXAMINING ATTORNEY



David J. Kyffers

Director of the United States Patent and Trademark Office

United States of America

United States Patent and Trademark Office

Kyla & Carlos

Reg. No. 4,174,088

Registered July 17, 2012

Int. Cl.: 14

MERCURY RETAIL SERVICES LLC (TEXAS LIMITED LIABILITY COMPANY)
BUILDING 19
5130 COMMERCE PARKWAY
SAN ANTONIO, TX 78218

FOR: BRACELETS, IN CLASS 14 (U.S. CLS. 2, 27, 28 AND 50).

TRADEMARK

FIRST USE 5-27-2011; IN COMMERCE 7-12-2011.

PRINCIPAL REGISTER

THE NAME(S), PORTRAIT(S), AND/OR SIGNATURE(S) SHOWN IN THE MARK IDENTIFIES KYLA HOLDER, MINOR DAUGHTER OF LOUIE LEE HOLDER III, WHOSE CONSENT(S) TO REGISTER IS MADE OF RECORD.

THE MARK CONSISTS OF THE STYLIZED WORDS "KYLA & CARLOS" HAVING A FLOWER IN THE "A" OF "KYLA" AND A HAT ON THE "A" OF "CARLOS". EACH OF THE WORDS IS SEPARATELY OUTLINED.

SER. NO. 85-334,807, FILED 6-1-2011.

FLORENTINA BLANDU, EXAMINING ATTORNEY



David J. Kyffers

Director of the United States Patent and Trademark Office

United States of America

United States Patent and Trademark Office

Kyla & Carlos

Reg. No. 4,174,089

Registered July 17, 2012

Int. Cl.: 16

TRADEMARK

PRINCIPAL REGISTER

MERCURY RETAIL SERVICES LLC (TEXAS LIMITED LIABILITY COMPANY)
BUILDING 19
5130 COMMERCE PARKWAY
SAN ANTONIO, TX 78218

FOR: BOOKMARKS; CHILDREN'S BOOKS; COLORING BOOKS; CRAYONS, IN CLASS 16
(U.S. CLS. 2, 5, 22, 23, 29, 37, 38 AND 50).

FIRST USE 6-3-2011; IN COMMERCE 7-12-2011.

THE NAME(S), PORTRAIT(S), AND/OR SIGNATURE(S) SHOWN IN THE MARK IDENTIFIES KYLA HOLDER, MINOR DAUGHTER OF LOUIE LEE HOLDER III, WHOSE CONSENT(S) TO REGISTER IS MADE OF RECORD.

THE MARK CONSISTS OF THE STYLIZED WORDS "KYLA & CARLOS" HAVING A FLOWER IN THE "A" OF "KYLA" AND A HAT ON THE "A" OF "CARLOS". EACH OF THE WORDS IS SEPARATELY OUTLINED.

SER. NO. 85-334,825, FILED 6-1-2011.

FLORENTINA BLANDU, EXAMINING ATTORNEY



David J. Kyffers

Director of the United States Patent and Trademark Office

United States of America

United States Patent and Trademark Office

ENDURO-TECH

Reg. No. 4,174,090

Registered July 17, 2012

Int. Cl.: 1

TRADEMARK

PRINCIPAL REGISTER

ENERGY & ENVIRONMENTAL SERVICES, INC. (OKLAHOMA CORPORATION)
PO BOX 14726
C/O ERNIE SELL
OKLAHOMA CITY, OK 73113

FOR: INDUSTRIAL CHEMICALS FOR USE AS CORROSION INHIBITORS, DEMULSIFIERS AND SCALE INHIBITORS IN INDUSTRIAL METAL PIPES AND FITTINGS , IN CLASS 1 (U.S. CLS. 1, 5, 6, 10, 26 AND 46).

FIRST USE 11-6-2010; IN COMMERCE 1-1-2011.

THE MARK CONSISTS OF STANDARD CHARACTERS WITHOUT CLAIM TO ANY PARTICULAR FONT, STYLE, SIZE, OR COLOR.

SER. NO. 85-334,974, FILED 6-1-2011.

TRACY FLETCHER, EXAMINING ATTORNEY



David J. Kyffers

Director of the United States Patent and Trademark Office

United States of America

United States Patent and Trademark Office

QUICKBOOKS CONNECT

Reg. No. 4,174,091

Registered July 17, 2012

Int. Cls.: 9 and 42

TRADEMARK

SERVICE MARK

PRINCIPAL REGISTER

INTUIT INC. (DELAWARE CORPORATION)
2535 GARCIA AVENUE
MOUNTAIN VIEW, CA 94043

FOR: COMPUTER APPLICATION SOFTWARE FOR MOBILE PHONES FOR CUSTOMER RELATIONSHIP MANAGEMENT; COMPUTER APPLICATION SOFTWARE FOR MOBILE PHONES FOR CREATING AND MANAGING INVOICES, RECORDING PAYMENTS, AND ISSUING RECEIPTS; COMPUTER APPLICATION SOFTWARE FOR MOBILE PHONES FOR ACCOUNTING; COMPUTER SOFTWARE FOR USE IN ORGANIZING, SERVICING AND TRACKING SALES, COLLECTIONS AND RECEIVABLES DATA, ALL IN THE FIELD OF ACCOUNTING; COMPUTER SOFTWARE FOR ACCOUNTING; COMPUTER SOFTWARE FOR CREATING AND MANAGING INVOICES, RECORDING PAYMENTS, AND ISSUING RECEIPTS; COMPUTER SOFTWARE FOR CUSTOMER RELATIONSHIP MANAGEMENT; COMPUTER SOFTWARE FOR SYNCHRONIZING DATA AMONG COMPUTERS AND MOBILE DEVICES, IN CLASS 9 (U.S. CLS. 21, 23, 26, 36 AND 38).

FIRST USE 9-27-2010; IN COMMERCE 9-27-2010.

FOR: PROVIDING TEMPORARY USE OF ONLINE NON-DOWNLOADABLE SOFTWARE FOR USE IN ORGANIZING, SERVICING AND TRACKING SALES, COLLECTIONS AND RECEIVABLES DATA, ALL IN THE FIELD OF ACCOUNTING; PROVIDING TEMPORARY USE OF ONLINE NON-DOWNLOADABLE SOFTWARE FOR ACCOUNTING; PROVIDING TEMPORARY USE OF ONLINE NON-DOWNLOADABLE SOFTWARE FOR CREATING AND MANAGING INVOICES, RECORDING PAYMENTS, AND ISSUING RECEIPTS; SOFTWARE AS A SERVICES (SAAS) SERVICES FEATURING SOFTWARE FOR USE IN ORGANIZING, SERVICING AND TRACKING SALES, COLLECTIONS AND RECEIVABLES DATA, ALL IN THE FIELD OF ACCOUNTING; SOFTWARE AS A SERVICES (SAAS) SERVICES FEATURING SOFTWARE FOR ACCOUNTING; SOFTWARE AS A SERVICE (SAAS) SERVICES FEATURING SOFTWARE FOR CREATING AND MANAGING INVOICES, RECORDING PAYMENTS, AND ISSUING RECEIPTS; PROVIDING TEMPORARY USE OF ONLINE NON-DOWNLOADABLE SOFTWARE FOR CUSTOMER RELATIONSHIP MANAGEMENT; SOFTWARE AS A SERVICE (SAAS) SERVICES FEATURING SOFTWARE FOR CUSTOMER RELATIONSHIP MANAGEMENT; TECHNICAL SUPPORT SERVICES, NAMELY, TROUBLESHOOTING OF COMPUTER SOFTWARE PROBLEMS, WEB AND ONLINE APPLICATION PROBLEMS, MOBILE APPLICATION PROBLEMS, AND NETWORK PROBLEMS; PROVIDING TEMPORARY USE OF ONLINE NON-DOWNLOADABLE SOFTWARE FOR SYNCHRONIZING DATA AMONG COMPUTERS AND MOBILE DEVICES; SOFTWARE



David J. Kyjars

Director of the United States Patent and Trademark Office

Reg. No. 4,174,091 AS A SERVICE (SAAS) SERVICES FEATURING SOFTWARE FOR SYNCHRONIZING DATA AMONG COMPUTERS AND MOBILE DEVICES; COMPUTER SERVICES, NAMELY, SYNCHRONIZING DATA AMONG COMPUTERS AND MOBILE DEVICES, IN CLASS 42 (U.S. CLS. 100 AND 101).

FIRST USE 9-27-2010; IN COMMERCE 9-27-2010.

THE MARK CONSISTS OF STANDARD CHARACTERS WITHOUT CLAIM TO ANY PARTICULAR FONT, STYLE, SIZE, OR COLOR.

OWNER OF U.S. REG. NOS. 1,719,357, 2,905,457 AND OTHERS.

NO CLAIM IS MADE TO THE EXCLUSIVE RIGHT TO USE "CONNECT", APART FROM THE MARK AS SHOWN.

SER. NO. 85-335,023, FILED 6-1-2011.

PAM WILLIS, EXAMINING ATTORNEY

United States of America

United States Patent and Trademark Office

JEREMIAH'S TAVERN

Reg. No. 4,174,092

Registered July 17, 2012

Int. Cl.: 43

SERVICE MARK

PRINCIPAL REGISTER

JEREMIAH'S TAVERN INC. (NEW YORK CORPORATION)
SUITE 185
620 PARK AVENUE
ROCHESTER, NY 14607

FOR: RESTAURANT AND BAR SERVICES, IN CLASS 43 (U.S. CLS. 100 AND 101).

FIRST USE 5-1-1978; IN COMMERCE 12-31-1978.

THE MARK CONSISTS OF STANDARD CHARACTERS WITHOUT CLAIM TO ANY PARTICULAR FONT, STYLE, SIZE, OR COLOR.

NO CLAIM IS MADE TO THE EXCLUSIVE RIGHT TO USE "TAVERN", APART FROM THE MARK AS SHOWN.

SER. NO. 85-335,046, FILED 6-1-2011.

KATHY DE JONGE, EXAMINING ATTORNEY



David J. Kybas

Director of the United States Patent and Trademark Office

United States of America

United States Patent and Trademark Office



Reg. No. 4,174,093

Registered July 17, 2012

Int. Cl.: 29

TRADEMARK

PRINCIPAL REGISTER

BELOVO S.A. (BELGIUM CORPORATION)
RUE DE LA FAGNE D'HI 43
B - 6600 BASTOGNE, BELGIUM

FOR: FRESH EGGS, IN CLASS 29 (U.S. CL. 46).

FIRST USE 5-25-2011; IN COMMERCE 5-25-2011.

NO CLAIM IS MADE TO THE EXCLUSIVE RIGHT TO USE "ALL NATURAL EGGS", APART FROM THE MARK AS SHOWN.

THE MARK CONSISTS OF THE STYLIZED WORDS "CHRISTOPHER" ABOVE A LINE WITH THE WORDS "ALL NATURAL EGGS" UNDERNEATH. THE WORDS ARE IN A RECTANGLE STYLED BOX.

SER. NO. 85-335,340, FILED 6-1-2011.

BRIAN NEVILLE, EXAMINING ATTORNEY



David J. Kybas

Director of the United States Patent and Trademark Office

United States of America

United States Patent and Trademark Office

Patriot Academy

Reg. No. 4,174,094

TORCH OF FREEDOM FOUNDATION (TEXAS NON-PROFIT CORPORATION)
P.O. BOX 586

Registered July 17, 2012

DRIPPING SPRINGS, TX 78620

Int. Cl.: 41

FOR: EDUCATIONAL SERVICES, NAMELY, CONDUCTING SEMINARS, CONFERENCES, AND WORKSHOPS IN THE FIELDS OF LEADERSHIP, PUBLIC POLICY, COMMUNICATION, AND CONSTITUTIONAL STUDIES AND DISTRIBUTION OF TRAINING MATERIALS IN CONNECTION THEREWITH, IN CLASS 41 (U.S. CLS. 100, 101 AND 107).

SERVICE MARK

PRINCIPAL REGISTER

FIRST USE 8-1-2000; IN COMMERCE 8-16-2001.

THE MARK CONSISTS OF STANDARD CHARACTERS WITHOUT CLAIM TO ANY PARTICULAR FONT, STYLE, SIZE, OR COLOR.

NO CLAIM IS MADE TO THE EXCLUSIVE RIGHT TO USE "ACADEMY", APART FROM THE MARK AS SHOWN.

SEC. 2(F).

SER. NO. 85-335,809, FILED 6-1-2011.

ELLEN PERKINS, EXAMINING ATTORNEY



David J. Kyffers

Director of the United States Patent and Trademark Office

United States of America

United States Patent and Trademark Office



TOUR STRIKER

Reg. No. 4,174,095

CHUCK, MARTIN J. (CANADA INDIVIDUAL)
20361 PENHOLLOW LANE
BEND, OR 97702 AND

Registered July 17, 2012

Int. Cl.: 28

CHUCK, STACEY R. (UNITED STATES INDIVIDUAL)
20361 PENHOLLOW LANE
BEND, OR 97702

TRADEMARK

FOR: GOLF BAGS; GOLF CLUBS, IN CLASS 28 (U.S. CLS. 22, 23, 38 AND 50).

PRINCIPAL REGISTER

FIRST USE 12-0-2008; IN COMMERCE 12-0-2008.

THE MARK CONSISTS OF THE WORDING "TOUR STRIKER" AND THE DESIGN OF A CRESCENT.

SER. NO. 85-336,783, FILED 6-2-2011.

PRISCILLA MILTON, EXAMINING ATTORNEY



David J. Kybas

Director of the United States Patent and Trademark Office

United States of America

United States Patent and Trademark Office



Reg. No. 4,174,096

Registered July 17, 2012

Int. Cl.: 30

TRADEMARK

PRINCIPAL REGISTER

BRAR NATURAL FLOUR MILLING INC. (CANADA CORPORATION)
101 PLYMOUTH STREET
WINNIPEG, MANITOBA, CANADA R2X2V5

FOR: FLOUR FEATURING NATURAL INGREDIENTS, IN CLASS 30 (U.S. CL. 46).

FIRST USE 12-0-2005; IN COMMERCE 12-0-2005.

NO CLAIM IS MADE TO THE EXCLUSIVE RIGHT TO USE "NATURAL FLOUR MILLING INC.", APART FROM THE MARK AS SHOWN.

THE MARK CONSISTS OF THE LITERAL ELEMENT "BRAR NATURAL FLOUR MILLING (INC.)" AND A DESIGN CONSISTING OF A GRAPHIC REPRESENTATION OF A LION STANDING ATOP TWO RECTANGULAR BORDERS WITH ROUNDED CORNERS, ONE RECTANGLE CONTAINED WITHIN THE OTHER, AND TWO BUNDLES OF STALKS OF WHEAT GRAIN, WHEREIN THE BORDERS SURROUND THE LITERAL ELEMENT, AND THE STALKS ARE LOCATED BELOW THE LITERAL ELEMENT AND ARE SUPERIMPOSED UPON A LOWER PORTION OF THE RECTANGULAR BORDERS.

SER. NO. 85-336,820, FILED 6-2-2011.

RONALD DELGIZZI, EXAMINING ATTORNEY



David J. Kyffers

Director of the United States Patent and Trademark Office

United States of America

United States Patent and Trademark Office

Vegas Hot!

Reg. No. 4,174,097

Registered July 17, 2012

Int. Cl.: 41

SERVICE MARK

PRINCIPAL REGISTER

ROLLINS, RONALD (UNITED STATES INDIVIDUAL)
#206
5875 SOUTH RAINBOW BLVD
LAS VEGAS, NV 89118

FOR: PROVIDING FITNESS AND EXERCISE FACILITIES FEATURING INSTRUCTION IN THE FIELD OF YOGA, PILATES, AND SPIN CLASSES, IN CLASS 41 (U.S. CLS. 100, 101 AND 107).

FIRST USE 3-20-2010; IN COMMERCE 3-20-2010.

THE MARK CONSISTS OF STANDARD CHARACTERS WITHOUT CLAIM TO ANY PARTICULAR FONT, STYLE, SIZE, OR COLOR.

NO CLAIM IS MADE TO THE EXCLUSIVE RIGHT TO USE "VEGAS", APART FROM THE MARK AS SHOWN.

SER. NO. 85-336,870, FILED 6-2-2011.

RICHARD WHITE, EXAMINING ATTORNEY



David J. Kyffers

Director of the United States Patent and Trademark Office

United States of America

United States Patent and Trademark Office



Reg. No. 4,174,098

Registered July 17, 2012

Int. Cls.: 2, 18 and 26

TRADEMARK

PRINCIPAL REGISTER

ELAIR, LARA NAOMI (SWEDEN INDIVIDUAL)
CALLE DE MAR 20-22
TORREVIEJA (ALICANTE), SPAIN 03182

FOR: PAINTS, VARNISHES, LACQUERS; RUST PRESERVATIVES IN THE NATURE OF A COATING AND WOOD PRESERVATIVES; COLORANTS; MORDANTS DYES; RAW NATURAL RESINS; METALS IN FOIL AND POWDER FORM FOR PAINTERS, DECORATORS, PRINTERS AND ARTISTS, IN CLASS 2 (U.S. CLS. 6, 11 AND 16).

FOR: LEATHER AND IMITATIONS OF LEATHER; ANIMAL SKINS AND HIDES; TRUNKS AND TRAVELLING BAGS; UMBRELLAS, PARASOLS AND WALKING STICKS; WHIPS, HARNESS AND SADDLERY, IN CLASS 18 (U.S. CLS. 1, 2, 3, 22 AND 41).

FOR: LACE AND EMBROIDERY, RIBBONS AND BRAID; BUTTONS, HOOK AND EYES, BOBBY PINS AND HAIR PINS, AND NEEDLES; ARTIFICIAL FLOWERS , IN CLASS 26 (U.S. CLS. 37, 39, 40, 42 AND 50).

OWNER OF ERPN CMNTY TM OFC REG. NO. 009420241, DATED 2-18-2011, EXPIRES 10-4-2020.

OWNER OF U.S. REG. NO. 3,936,838.

THE MARK CONSISTS OF A PROFILE OF A MAN WITH FOREHEAD, EYE, NOSE, MOUTH AND CHIN AND FACE OF A WOMAN SHOWN FROM THE FRONT BY A NOSE, TWO EYES AND MOUTH.

SER. NO. 85-336,873, FILED 6-2-2011.

STEPHANIE ALI, EXAMINING ATTORNEY



David J. Kyros

Director of the United States Patent and Trademark Office

United States of America

United States Patent and Trademark Office



Reg. No. 4,174,099

AGRI COMPLIANCE (NORTH CAROLINA CORPORATION)
523 SALEM ROAD
OXFORD, CA 27565

Registered July 17, 2012

Int. Cl.: 45

FOR: REGULATORY COMPLIANCE CONSULTING IN THE FIELD OF FOOD SAFETY FOR THE FOOD AND BEVERAGE INDUSTRIES, IN CLASS 45 (U.S. CLS. 100 AND 101).

SERVICE MARK

FIRST USE 11-15-2006; IN COMMERCE 11-15-2006.

PRINCIPAL REGISTER

NO CLAIM IS MADE TO THE EXCLUSIVE RIGHT TO USE "COMPLIANCE", APART FROM THE MARK AS SHOWN.

THE MARK CONSISTS OF THE STYLIZED TEXT "AGRI COMPLIANCE" WITH A PLANT WITH LEAVES GROWING UP THROUGH THE TEXT.

SER. NO. 85-336,945, FILED 6-2-2011.

CIMMERIAN COLEMAN, EXAMINING ATTORNEY



David J. Kyffers

Director of the United States Patent and Trademark Office

United States of America

United States Patent and Trademark Office

ORGASM ARTS

Reg. No. 4,174,100

CK GLOBAL MEDIA, LLC (CALIFORNIA LIMITED LIABILITY COMPANY)
7770 REGENTS ROAD STE 113 #567
SAN DIEGO, CA 92122

Registered July 17, 2012

Int. Cl.: 9

FOR: DIGITAL MATERIALS, NAMELY, DOWNLOADABLE AUDIO AND VIDEO RECORDINGS, CDS, DVDS, AND HIGH DEFINITION DIGITAL DISCS FEATURING EDUCATIONAL AND INFORMATIONAL MATERIAL RELATED TO HUMAN SEXUALITY, IN CLASS 9 (U.S. CLS. 21, 23, 26, 36 AND 38).

TRADEMARK

PRINCIPAL REGISTER

FIRST USE 10-17-2008; IN COMMERCE 10-17-2008.

THE MARK CONSISTS OF STANDARD CHARACTERS WITHOUT CLAIM TO ANY PARTICULAR FONT, STYLE, SIZE, OR COLOR.

NO CLAIM IS MADE TO THE EXCLUSIVE RIGHT TO USE "ORGASM", APART FROM THE MARK AS SHOWN.

SER. NO. 85-337,008, FILED 6-3-2011.

CHARLOTTE CORWIN, EXAMINING ATTORNEY



David J. Kyffers

Director of the United States Patent and Trademark Office

United States of America

United States Patent and Trademark Office

YOURWAY BURGERS & WINGS

Reg. No. 4,174,101

Registered July 17, 2012

Int. Cl.: 35

SERVICE MARK

PRINCIPAL REGISTER

YOURWAY FRANCHISE, LLC (TEXAS LIMITED LIABILITY COMPANY), DBA YOURWAY BURGERS & WINGS
13605 MIDWAY STE. 120
FARMERS BRANCH, TX 75244 AND

YOURWAY FRANCHISE, LLC (TEXAS LIMITED LIABILITY COMPANY), DBA YOURWAY BURGERS 'N WINGS
13605 MIDWAY STE. 120
FARMERS BRANCH, TX 75244

FOR: RESTAURANT FRANCHISING, NAMELY, OFFERING BUSINESS MANAGEMENT ASSISTANCE IN THE ESTABLISHMENT AND/OR OPERATION OF RESTAURANTS, IN CLASS 35 (U.S. CLS. 100, 101 AND 102).

FIRST USE 12-1-2009; IN COMMERCE 12-1-2009.

THE MARK CONSISTS OF STANDARD CHARACTERS WITHOUT CLAIM TO ANY PARTICULAR FONT, STYLE, SIZE, OR COLOR.

NO CLAIM IS MADE TO THE EXCLUSIVE RIGHT TO USE "BURGERS AND WINGS", APART FROM THE MARK AS SHOWN.

SER. NO. 85-337,045, FILED 6-3-2011.

JOHN SCHUYLER YARD, EXAMINING ATTORNEY



David J. Kybas

Director of the United States Patent and Trademark Office

United States of America

United States Patent and Trademark Office



Reg. No. 4,174,102

Registered July 17, 2012

Int. Cl.: 41

SERVICE MARK

PRINCIPAL REGISTER

WHOLEREN, LLC (PENNSYLVANIA LIMITED LIABILITY COMPANY)
1706 SAW GRASS COURT
PITTSBURGH, PA 17108

FOR: EDUCATION SERVICES, NAMELY, PROVIDING COURSES IN ENGLISH AS A SECOND LANGUAGE, ADMISSION CONSULTING SERVICES, NAMELY, CONSULTING IN THE FIELD OF COLLEGE ADMISSIONS, AND PREPARATION FOR COLLEGE ADMISSION INTERVIEWS, IN CLASS 41 (U.S. CLS. 100, 101 AND 107).

FIRST USE 4-26-2010; IN COMMERCE 4-26-2010.

THE MARK CONSISTS OF A CIRCLE WITH THE WORD "WHOLEREN" IN IT. ABOVE THE WORD "WHOLEREN" IS A HORIZONTAL LINE. ABOVE THE LINE IS A DESIGN OF A TREE. BELOW THE WORD "WHOLEREN" IS A HORIZONTAL LINE. BELOW THE LINE IS A SYMMETRICAL PAIR OF DESIGNS FORMED BY A PLURALITY OF RADIANT ARCS.

THE ENGLISH TRANSLATION OF "REN" IN THE MARK IS "PERSON".

SER. NO. 85-337,588, FILED 6-3-2011.

EDWARD FENNESSY, EXAMINING ATTORNEY



David J. Kyffers

Director of the United States Patent and Trademark Office

United States of America

United States Patent and Trademark Office

TEN LIL' IMPRINTS

Reg. No. 4,174,103

Registered July 17, 2012

Int. Cl.: 16

TRADEMARK

PRINCIPAL REGISTER

DACTEK INTERNATIONAL CORPORATION (CALIFORNIA CORPORATION)
17150 NEW HOPE STREET, SUITE 301
FOUNTAIN VALLEY, CA 92708

FOR: PRINTS; FINGERPRINT, HANDPRINT AND FOOTPRINT KITS; PRINTED KEEPSAKE BIRTH CERTIFICATES; KEEPSAKE HOSPITAL BIRTH RECORDS NOT BEING BUSINESS RECORDS, NAMELY PRINTED COPIES OF BIRTH CERTIFICATES; PRINTED CHILD IDENTIFICATION CARDS, NOT MAGNETICALLY ENCODED; GREETING CARDS, INCLUDING, BIRTH ANNOUNCEMENT CARDS, MOTHER'S DAY CARDS, FATHER'S DAY CARDS AND HOLIDAY CARDS; INVITATION CARDS; NOTE CARDS; SCRAPBOOKS; EVENT ALBUMS; MEMORY ALBUMS, IN CLASS 16 (U.S. CLS. 2, 5, 22, 23, 29, 37, 38 AND 50).

FIRST USE 8-12-2011; IN COMMERCE 8-12-2011.

THE MARK CONSISTS OF STANDARD CHARACTERS WITHOUT CLAIM TO ANY PARTICULAR FONT, STYLE, SIZE, OR COLOR.

SER. NO. 85-337,839, FILED 6-3-2011.

BRENDAN MCCAULEY, EXAMINING ATTORNEY



David J. Kyros

Director of the United States Patent and Trademark Office

United States of America

United States Patent and Trademark Office

West Texas Safety Training Center

Reg. No. 4,174,104

WEST TEXAS SAFETY TRAINING CENTER (TEXAS NON-PROFIT ORGANIZATION)
11900 W. I-20 E.

Registered July 17, 2012

ODESSA, TX 79765

Int. Cl.: 41

FOR: TRAINING SERVICES IN THE FIELD OF MAINTAINING WORKPLACE SAFETY, IN CLASS 41 (U.S. CLS. 100, 101 AND 107).

SERVICE MARK

FIRST USE 5-1-1994; IN COMMERCE 5-1-1994.

PRINCIPAL REGISTER

THE MARK CONSISTS OF STANDARD CHARACTERS WITHOUT CLAIM TO ANY PARTICULAR FONT, STYLE, SIZE, OR COLOR.

NO CLAIM IS MADE TO THE EXCLUSIVE RIGHT TO USE "TRAINING CENTER", APART FROM THE MARK AS SHOWN.

SEC. 2(F).

SER. NO. 85-338,175, FILED 6-4-2011.

WILLIAM ROSSMAN, EXAMINING ATTORNEY



David J. Kyfos

Director of the United States Patent and Trademark Office

United States of America

United States Patent and Trademark Office

AgilityDocs

Reg. No. 4,174,105

ENGRAPHIX IMAGING SYSTEM, INC (TEXAS CORPORATION), DBA AGILITYDOCS
28420 HARDY TOLL RD, SUITE 175
SPRING, TX 77373

Registered July 17, 2012

Int. Cls.: 9 and 35

FOR: COMPUTER APPLICATION SOFTWARE FOR DOCUMENT MANAGEMENT, NAMELY, SOFTWARE FOR BUSINESS PROCESS AUTOMATION; COMPUTER PROGRAMMES FOR DOCUMENT MANAGEMENT, IN CLASS 9 (U.S. CLS. 21, 23, 26, 36 AND 38).

TRADEMARK

FIRST USE 7-1-2010; IN COMMERCE 7-1-2010.

SERVICE MARK

FOR: BUSINESS CONSULTATION SERVICES, IN CLASS 35 (U.S. CLS. 100, 101 AND 102).

PRINCIPAL REGISTER

FIRST USE 7-1-2010; IN COMMERCE 7-1-2010.

THE MARK CONSISTS OF STANDARD CHARACTERS WITHOUT CLAIM TO ANY PARTICULAR FONT, STYLE, SIZE, OR COLOR.

SER. NO. 85-338,327, FILED 6-5-2011.

DAVID C. REIHNER, EXAMINING ATTORNEY



David J. Kyffers

Director of the United States Patent and Trademark Office

United States of America

United States Patent and Trademark Office

HEADDIES

Reg. No. 4,174,106

Registered July 17, 2012

Int. Cls.: 25 and 34

TRADEMARK

PRINCIPAL REGISTER

FAUST MARKETING GROUP, LLC (PENNSYLVANIA LIMITED LIABILITY COMPANY)
512 NORTHAMPTON STREET
KINGSTON, PA 18704

FOR: CLOTHING, NAMELY, TEE SHIRTS, SHIRTS, SWEATSHIRTS, SWEATPANTS, PANTS, SOCKS, JACKETS, SHORTS, SKIRTS, DRESSES, HATS, HEADBANDS AND CAPS , IN CLASS 25 (U.S. CLS. 22 AND 39).

FIRST USE 1-14-2008; IN COMMERCE 5-1-2010.

FOR: TOBACCO AND CIGARETTE PRODUCTS, NAMELY, ROLLING PAPERS, GRINDERS, PIPES, WATER PIPES, CIGARETTE BOXES, CIGARETTE TINS, LIGHTERS AND PIPE POUCHES, IN CLASS 34 (U.S. CLS. 2, 8, 9 AND 17).

FIRST USE 1-14-2008; IN COMMERCE 5-1-2010.

THE MARK CONSISTS OF STANDARD CHARACTERS WITHOUT CLAIM TO ANY PARTICULAR FONT, STYLE, SIZE, OR COLOR.

OWNER OF U.S. REG. NO. 3,699,947.

SER. NO. 85-338,464, FILED 6-6-2011.

ROBERT STRUCK, EXAMINING ATTORNEY



David J. Kybas

Director of the United States Patent and Trademark Office

United States of America

United States Patent and Trademark Office



Reg. No. 4,174,107

Registered July 17, 2012

Int. Cls.: 3, 5 and 30

TRADEMARK

PRINCIPAL REGISTER

GLOBAL FINANCIAL SYSTEMS INC (FLORIDA CORPORATION)
10137 FISHBOWL DRIVE
HOMOSASA, FL 34448

FOR: ANTI-BACTERIAL SOAP; DISHWASHER DETERGENTS; FABRIC SOFTENERS; GLASS CLEANERS; LAUNDRY BLEACH; LAUNDRY DETERGENT; LIQUID SOAP; OVEN CLEANERS, IN CLASS 3 (U.S. CLS. 1, 4, 6, 50, 51 AND 52).

FIRST USE 9-1-2006; IN COMMERCE 9-1-2006.

FOR: AIR FRESHENERS; ANTIBACTERIAL ALCOHOL SKIN SANITIZER GEL; DISINFECTANT BATHROOM CLEANERS; DISINFECTANT TOILET BOWL CLEANERS, IN CLASS 5 (U.S. CLS. 6, 18, 44, 46, 51 AND 52).

FIRST USE 9-1-2006; IN COMMERCE 9-1-2006.

FOR: BREAKFAST CEREALS, IN CLASS 30 (U.S. CL. 46).

FIRST USE 9-1-2006; IN COMMERCE 9-1-2006.

NO CLAIM IS MADE TO THE EXCLUSIVE RIGHT TO USE "BRANDS", APART FROM THE MARK AS SHOWN.

THE MARK CONSISTS OF THE IMAGE OF A GOAT FROM THE SHOULDERS UP. THE GOAT IS HOLDING HIS RIGHT HAND TO HIS CHIN, AND THERE IS A BOXING GLOVE ON HIS HAND. ARCHING ABOVE THE GOAT IS THE STYLIZED TEXT "MIGHTY GOAT BRANDS". A THIN BORDER AND A BOLD BORDER OUTLINE THE TEXT AND THE GOAT'S HEAD AND NECK.

SER. NO. 85-338,765, FILED 6-6-2011.

DOMINIC FATHY, EXAMINING ATTORNEY



David J. Kybas

Director of the United States Patent and Trademark Office

United States of America

United States Patent and Trademark Office

THE BOSS BRUSH

Reg. No. 4,174,108

Registered July 17, 2012

Int. Cl.: 16

TRADEMARK

PRINCIPAL REGISTER

HAUG, WILLIAM B. (MINNESOTA CORPORATION), DBA BOSS HAUG ENTERPRISES,
INC.
6713 HAUGEN LANE
DULUTH, MN 55803

FOR: ARTISTS' BRUSHES; DECORATORS' PAINTBRUSHES; DRAWING BRUSHES; PAINT
APPLICATOR ROLLERS; PAINT APPLICATORS; PAINT BOXES AND BRUSHES; PAINT
BRUSHES; PAINT ROLLER HANDLES; PAINT ROLLERS; PAINTBRUSHES; PAINTING
PALETTES; PALETTES FOR PAINTING, IN CLASS 16 (U.S. CLS. 2, 5, 22, 23, 29, 37, 38 AND
50).

FIRST USE 12-20-2010; IN COMMERCE 12-20-2010.

THE MARK CONSISTS OF STANDARD CHARACTERS WITHOUT CLAIM TO ANY PAR-
TICULAR FONT, STYLE, SIZE, OR COLOR.

NO CLAIM IS MADE TO THE EXCLUSIVE RIGHT TO USE "BRUSH", APART FROM THE
MARK AS SHOWN.

SER. NO. 85-338,779, FILED 6-6-2011.

KEVON CHISOLM, EXAMINING ATTORNEY



David J. Kyffers

Director of the United States Patent and Trademark Office

United States of America

United States Patent and Trademark Office

RING OF THE DRAGONS

Reg. No. 4,174,109

Registered July 17, 2012

Int. Cl.: 9

TRADEMARK

PRINCIPAL REGISTER

ARISTOCRAT TECHNOLOGIES AUSTRALIA PTY LTD. (AUSTRALIA CORPORATION)
BUILDING A, PINNACLE OFFICE PARK
85 EPPING ROAD
NORTH RYDE, NSW, AUSTRALIA 2113

FOR: ELECTRONIC GAMING MACHINES, NAMELY, DEVICES WHICH ACCEPT A WAGER,
IN CLASS 9 (U.S. CLS. 21, 23, 26, 36 AND 38).

THE MARK CONSISTS OF STANDARD CHARACTERS WITHOUT CLAIM TO ANY PAR-
TICULAR FONT, STYLE, SIZE, OR COLOR.

PRIORITY CLAIMED UNDER SEC. 44(D) ON AUSTRALIA APPLICATION NO. 1428475,
FILED 6-6-2011, REG. NO. 1428475, DATED 6-6-2011, EXPIRES 6-6-2021.

SER. NO. 85-339,805, FILED 6-7-2011.

SUNG IN, EXAMINING ATTORNEY



David J. Kyffers

Director of the United States Patent and Trademark Office

United States of America

United States Patent and Trademark Office

PTSD Coach

Reg. No. 4,174,110

Registered July 17, 2012

Int. Cl.: 9

TRADEMARK

PRINCIPAL REGISTER

DEPARTMENT OF VETERANS AFFAIRS (UNITED STATES AGENCY OF THE UNITED STATES GOVERNMENT)
810 VERMONT AVE
WASHINGTON, DC 20420

FOR: COMPUTER APPLICATION SOFTWARE FOR SMARTPHONES, NAMELY, SOFTWARE PROVIDING INFORMATION RELATING TO POST-TRAUMATIC STRESS DISORDER, SELF-ASSESSMENT TOOLS, SELF-TREATMENT TOOLS, REFERRALS TO HEALTH CARE PROFESSIONALS, AND REFERRALS TO SELF-DESIGNATED INDIVIDUALS FOR SUPPORT, IN CLASS 9 (U.S. CLS. 21, 23, 26, 36 AND 38).

FIRST USE 2-16-2011; IN COMMERCE 4-7-2011.

THE MARK CONSISTS OF STANDARD CHARACTERS WITHOUT CLAIM TO ANY PARTICULAR FONT, STYLE, SIZE, OR COLOR.

NO CLAIM IS MADE TO THE EXCLUSIVE RIGHT TO USE "PTSD", APART FROM THE MARK AS SHOWN.

SER. NO. 85-339,810, FILED 6-7-2011.

DAVID C. REIHNER, EXAMINING ATTORNEY



David J. Kybas

Director of the United States Patent and Trademark Office

United States of America

United States Patent and Trademark Office

HEALTHY NEIGHBORS

Reg. No. 4,174,111

BAYCARE HEALTH SYSTEM, INC. (FLORIDA CORPORATION)
16255 BAY VISTA DRIVE
CLEARWATER, FL 33760

Registered July 17, 2012

Int. Cl.: 16

FOR: MAGAZINES FEATURING HEALTH TIPS, COMMUNITY STORIES AND HEALTH INFORMATION, IN CLASS 16 (U.S. CLS. 2, 5, 22, 23, 29, 37, 38 AND 50).

TRADEMARK

FIRST USE 4-24-2011; IN COMMERCE 4-24-2011.

PRINCIPAL REGISTER

THE MARK CONSISTS OF STANDARD CHARACTERS WITHOUT CLAIM TO ANY PARTICULAR FONT, STYLE, SIZE, OR COLOR.

NO CLAIM IS MADE TO THE EXCLUSIVE RIGHT TO USE "HEALTHY", APART FROM THE MARK AS SHOWN.

SER. NO. 85-339,901, FILED 6-7-2011.

HENRY S. ZAK, EXAMINING ATTORNEY



David J. Kyffers

Director of the United States Patent and Trademark Office

United States of America

United States Patent and Trademark Office

F.O. LICHT

Reg. No. 4,174,112

Registered July 17, 2012

**Int. Cls.: 9, 16, 35, 36, 41
and 42**

TRADEMARK

SERVICE MARK

PRINCIPAL REGISTER

INFORMA UK LIMITED (UNITED KINGDOM CORPORATION)
MORTIMER HOUSE
37-41 MORTIMER STREET
LONDON, UNITED KINGDOM W1T3JH

FOR: DOWNLOADABLE ELECTRONIC PUBLICATIONS, NAMELY, NEWSLETTERS AND REPORTS IN THE FIELDS OF COMMODITIES, AGRICULTURE, COFFEE, SUGAR, SWEETENERS, GRAIN, ETHANOL, BIOFUELS, BIODIESEL, BIOMASS, COGENERATION, MOLASSES, FEED INGREDIENTS, RENEWABLE ENERGY, IN CLASS 9 (U.S. CLS. 21, 23, 26, 36 AND 38).

FIRST USE 0-0-2001; IN COMMERCE 0-0-2001.

FOR: PRINTED PUBLICATIONS, NAMELY, NEWSLETTERS AND REPORTS IN THE FIELDS OF COMMODITIES, AGRICULTURE, COFFEE, SUGAR, SWEETENERS, GRAIN, ETHANOL, BIOFUELS, BIODIESEL, BIOMASS, COGENERATION, MOLASSES, FEED INGREDIENTS, RENEWABLE ENERGY, IN CLASS 16 (U.S. CLS. 2, 5, 22, 23, 29, 37, 38 AND 50).

FIRST USE 0-0-1867; IN COMMERCE 0-0-1867.

FOR: PROVIDING AN ON-LINE COMPUTER DATABASE IN THE FIELD OF LOCATING PRODUCTS, DESCRIBING PRODUCTS, RATING PRODUCTS, PRICING PRODUCTS, COMPARING PRICES OF PRODUCTS AND FEATURING TRADE INFORMATION IN THE FIELDS OF COMMODITIES, AGRICULTURE, COFFEE, SUGAR, SWEETENERS, GRAIN, ETHANOL, BIOFUELS, BIODIESEL AND RENEWABLE ENERGY, IN CLASS 35 (U.S. CLS. 100, 101 AND 102).

FIRST USE 0-0-2003; IN COMMERCE 0-0-2003.

FOR: PROVIDING AN INFORMATIONAL WEBSITE IN THE FIELD OF COMMODITY AND ENERGY BROKERAGE INCLUDING COFFEE, SUGAR, SWEETENERS, GRAIN, ETHANOL, BIOFUELS, BIODIESEL, BIOMASS, COGENERATION, MOLASSES, FEED INGREDIENTS, RENEWABLE ENERGY, IN CLASS 36 (U.S. CLS. 100, 101 AND 102).

FIRST USE 0-0-2007; IN COMMERCE 0-0-2007.



David J. Kyjars

Director of the United States Patent and Trademark Office

Reg. No. 4,174,112 FOR: ARRANGING AND CONDUCTING EDUCATIONAL CONFERENCES IN THE FIELDS OF COMMODITIES, AGRICULTURE, COFFEE, SUGAR, SWEETENERS, GRAIN, ETHANOL, BIOFUELS, BIODIESEL AND RENEWABLE ENERGY, IN CLASS 41 (U.S. CLS. 100, 101 AND 107).

FIRST USE 0-0-2007; IN COMMERCE 0-0-2007.

FOR: INDUSTRIAL RESEARCH IN THE FIELDS OF COMMODITIES, AGRICULTURE, COFFEE, SUGAR, SWEETENERS, GRAIN, ETHANOL, BIOFUELS, BIODIESEL, BIOMASS, COGENERATION, MOLASSES, FEED INGREDIENTS, RENEWABLE ENERGY, IN CLASS 42 (U.S. CLS. 100 AND 101).

FIRST USE 0-0-2003; IN COMMERCE 0-0-2003.

THE MARK CONSISTS OF STANDARD CHARACTERS WITHOUT CLAIM TO ANY PARTICULAR FONT, STYLE, SIZE, OR COLOR.

THE WORDING "F.O. LICHT" HAS NO MEANING IN A FOREIGN LANGUAGE.

SER. NO. 85-340,425, FILED 6-7-2011.

KYLE PEETE, EXAMINING ATTORNEY

United States of America

United States Patent and Trademark Office

NeurOnLine

fire together wire together

Reg. No. 4,174,113

Registered July 17, 2012

Int. Cls.: 38 and 42

SERVICE MARK

PRINCIPAL REGISTER

SOCIETY FOR NEUROSCIENCE (D.C. CORPORATION)
1121 14TH STREET, NW SUITE 1010
WASHINGTON, DC 20005

FOR: PROVIDING AN ONLINE NETWORK SERVICE THAT ENABLES USERS TO DISCUSS THE FIELD OF NEUROSCIENCE, INCLUDING SCIENCE AND METHODS, CAREER DEVELOPMENT AND PUBLIC OUTREACH, NAMELY, PROVIDING ON-LINE CHAT ROOMS AND ELECTRONIC BULLETIN BOARDS FOR TRANSMISSION OF MESSAGES AMONG USERS IN THE AFOREMENTIONED FIELD, IN CLASS 38 (U.S. CLS. 100, 101 AND 104).

FIRST USE 4-15-2011; IN COMMERCE 4-15-2011.

FOR: PROVIDING AN ONLINE NETWORK SERVICE THAT ENABLES USERS TO DISCUSS THE FIELD OF NEUROSCIENCE, INCLUDING SCIENCE AND METHODS, CAREER DEVELOPMENT AND PUBLIC OUTREACH, NAMELY, PROVIDING AN ONLINE NETWORK SERVICE THAT ENABLES USERS TO SHARE DATA IN THE AFOREMENTIONED FIELD, IN CLASS 42 (U.S. CLS. 100 AND 101).

FIRST USE 4-15-2011; IN COMMERCE 4-15-2011.

THE MARK CONSISTS OF THE STYLIZED WORDING "NEURONLINE", WITH ONE THIN HORIZONTAL LINE APPEARING BENEATH THE "NEUR" AND ANOTHER BENEATH "NLINE"; THE STYLIZED WORDING "FIRE TOGETHER WIRE TOGETHER" IN ALL LOWER-CASE APPEARS BELOW THE AFOREMENTIONED WORDING AND DESIGN ELEMENTS.

SER. NO. 85-340,706, FILED 6-8-2011.

KEVIN CORWIN, EXAMINING ATTORNEY



David J. Kyjars

Director of the United States Patent and Trademark Office

United States of America

United States Patent and Trademark Office

NEURONLINE

Reg. No. 4,174,114

Registered July 17, 2012

Int. Cls.: 38 and 42

SERVICE MARK

PRINCIPAL REGISTER

SOCIETY FOR NEUROSCIENCE (D.C. CORPORATION)
1121 14TH STREET, NW SUITE 1010
WASHINGTON, DC 20005

FOR: PROVIDING AN ONLINE NETWORK SERVICE THAT ENABLES USERS TO DISCUSS THE FIELD OF NEUROSCIENCE, INCLUDING SCIENCE AND METHODS, CAREER DEVELOPMENT AND PUBLIC OUTREACH, NAMELY, PROVIDING ON-LINE CHAT ROOMS AND ELECTRONIC BULLETIN BOARDS FOR TRANSMISSION OF MESSAGES AMOUNT USERS IN THE AFOREMENTIONED FIELD, IN CLASS 38 (U.S. CLS. 100, 101 AND 104).

FIRST USE 4-15-2011; IN COMMERCE 4-15-2011.

FOR: PROVIDING AN ONLINE NETWORK SERVICE THAT ENABLES USERS TO DISCUSS THE FIELD OF NEUROSCIENCE, INCLUDING SCIENCE AND METHODS, CAREER DEVELOPMENT AND PUBLIC OUTREACH, NAMELY, PROVIDING AN ONLINE NETWORK SERVICE THAT ENABLES USERS TO SHARE DATA IN THE AFOREMENTIONED FIELD, IN CLASS 42 (U.S. CLS. 100 AND 101).

FIRST USE 4-15-2011; IN COMMERCE 4-15-2011.

THE MARK CONSISTS OF STANDARD CHARACTERS WITHOUT CLAIM TO ANY PARTICULAR FONT, STYLE, SIZE, OR COLOR.

SER. NO. 85-340,725, FILED 6-8-2011.

KEVIN CORWIN, EXAMINING ATTORNEY



David J. Kybas

Director of the United States Patent and Trademark Office

United States of America

United States Patent and Trademark Office

TONALEAN

Reg. No. 4,174,115

Registered July 17, 2012

Int. Cl.: 5

TRADEMARK

PRINCIPAL REGISTER

HEALTHY DIRECTIONS, LLC (DELAWARE LIMITED LIABILITY COMPANY)
7811 MONTROSE ROAD
POTOMAC, MD 20854

FOR: NUTRITIONAL SUPPLEMENTS, IN CLASS 5 (U.S. CLS. 6, 18, 44, 46, 51 AND 52).

FIRST USE 7-0-2009; IN COMMERCE 7-0-2009.

THE MARK CONSISTS OF STANDARD CHARACTERS WITHOUT CLAIM TO ANY PARTICULAR FONT, STYLE, SIZE, OR COLOR.

OWNER OF U.S. REG. NO. 3,755,924.

SER. NO. 85-340,762, FILED 6-8-2011.

LOURDES AYALA, EXAMINING ATTORNEY



David J. Kyffers

Director of the United States Patent and Trademark Office

United States of America
United States Patent and Trademark Office

PROGRILLE

Reg. No. 4,174,116

Registered July 17, 2012

Int. Cl.: 11

TRADEMARK

PRINCIPAL REGISTER

PRO PRODUCTS, INC. (TEXAS CORPORATION)
ATTN: CHARLIE PARHAM
8920 ROYAL LANE
IRVING, TX 75063

FOR: VENTILATION GRILLS AND REGISTERS FOR USE IN HEATING AND AIR-CONDITIONING SYSTEMS, IN CLASS 11 (U.S. CLS. 13, 21, 23, 31 AND 34).

FIRST USE 12-31-2001; IN COMMERCE 12-31-2001.

THE MARK CONSISTS OF STANDARD CHARACTERS WITHOUT CLAIM TO ANY PARTICULAR FONT, STYLE, SIZE, OR COLOR.

SEC. 2(F).

SER. NO. 85-340,876, FILED 6-8-2011.

CHARLOTTE CORWIN, EXAMINING ATTORNEY



David J. Kybas

Director of the United States Patent and Trademark Office

United States of America

United States Patent and Trademark Office

COMPASSION EDUCATION

Reg. No. 4,174,117

HEALING SPECIES, INC. (SOUTH CAROLINA NON-PROFIT CORPORATION)
P.O. BOX 1202

Registered July 17, 2012

ORANGEBURG, SC 291161202

Int. Cls.: 16 and 41

FOR: PRINTED INSTRUCTION MANUAL FOR TEACHING YOUTH POSITIVE CHARACTER TRAITS, IN CLASS 16 (U.S. CLS. 2, 5, 22, 23, 29, 37, 38 AND 50).

TRADEMARK

FIRST USE 2-28-2001; IN COMMERCE 2-28-2001.

SERVICE MARK

FOR: EDUCATIONAL SERVICES, NAMELY, DEVELOPING AND PRESENTING CURRICULUM BASED PROGRAMS FOR TEACHING YOUTH POSITIVE CHARACTER TRAITS, IN CLASS 41 (U.S. CLS. 100, 101 AND 107).

PRINCIPAL REGISTER

FIRST USE 1-31-2000; IN COMMERCE 1-31-2000.

THE MARK CONSISTS OF STANDARD CHARACTERS WITHOUT CLAIM TO ANY PARTICULAR FONT, STYLE, SIZE, OR COLOR.

SEC. 2(F).

SER. NO. 85-340,912, FILED 6-8-2011.

KIMBERLY PERRY, EXAMINING ATTORNEY



David J. Kybas

Director of the United States Patent and Trademark Office

United States of America

United States Patent and Trademark Office



Reg. No. 4,174,118

Registered July 17, 2012

Int. Cl.: 6

TRADEMARK

PRINCIPAL REGISTER

VIRGO ENGINEERS, INC (DELAWARE CORPORATION)
10225 MULA ROAD, SUITE 130
STAFFORD, TX 77477

FOR: VALVES, NAMELY, METAL VALVES NOT BEING PARTS OF MACHINES, IN CLASS 6 (U.S. CLS. 2, 12, 13, 14, 23, 25 AND 50).

FIRST USE 6-30-2009; IN COMMERCE 6-30-2009.

NO CLAIM IS MADE TO THE EXCLUSIVE RIGHT TO USE "SEVERE SERVICE BALL VALVES", APART FROM THE MARK AS SHOWN.

THE MARK CONSISTS OF A LOWER CASE "E" FOLLOWED BY THE LETTERS "VS" WITH A HORIZONTAL LINE RUNNING THROUGH THE "E" AND ABOVE THE "VS". THE WORDING "SEVERE SERVICE BALL VALVES" IS BELOW THE LETTERS "EVS".

SER. NO. 85-341,039, FILED 6-8-2011.

RAMONA ORTIGA, EXAMINING ATTORNEY



David J. Kyffers

Director of the United States Patent and Trademark Office

United States of America

United States Patent and Trademark Office

MORNING GLORY PRODUCTS, INC.

Reg. No. 4,174,119

Registered July 17, 2012

Int. Cl.: 3

TRADEMARK

PRINCIPAL REGISTER

MORNING GLORY PRODUCTS, INC. (NORTH CAROLINA CORPORATION)
C/O ALLMARK TRADEMARK
4041 SUGAR MAPLE DRIVE
DANVILLE, CA 94506

FOR: HAIR CARE PRODUCTS, NAMELY, NON-MEDICATED HAIR GROWTH SERUMS,
HAIR GLOSSERS, AND HAIR SPRITZ PREPARATIONS, IN CLASS 3 (U.S. CLS. 1, 4, 6, 50,
51 AND 52).

FIRST USE 9-15-2007; IN COMMERCE 9-15-2007.

THE MARK CONSISTS OF STANDARD CHARACTERS WITHOUT CLAIM TO ANY PAR-
TICULAR FONT, STYLE, SIZE, OR COLOR.

NO CLAIM IS MADE TO THE EXCLUSIVE RIGHT TO USE "PRODUCTS, INC.", APART
FROM THE MARK AS SHOWN.

SER. NO. 85-341,324, FILED 6-8-2011.

ZACHARY BELLO, EXAMINING ATTORNEY



David J. Kyffers

Director of the United States Patent and Trademark Office

United States of America

United States Patent and Trademark Office

ELLA'S KITCHEN BABY BREKKIE

Reg. No. 4,174,120

Registered July 17, 2012

Int. Cls.: 5, 29 and 30

TRADEMARK

PRINCIPAL REGISTER

ELLA'S KITCHEN (IP) LIMITED (UNITED KINGDOM COMPANY)
C/O 2020 CHARTERED ACCOUNTANTS
1 ST. ANDREW'S HILL
LONDON, UNITED KINGDOM EC4V5BY

FOR: FOOD FOR BABIES; CEREALS FOR BABIES, IN CLASS 5 (U.S. CLS. 6, 18, 44, 46, 51 AND 52).

FOR: PRESERVED, FROZEN, DRIED AND COOKED FRUITS AND VEGETABLES; FRUIT PUREES; VEGETABLE PUREES; MILK AND MILK PRODUCTS EXCLUDING ICE CREAM, ICE MILK AND FROZEN YOGURT; PREPARED MEALS CONSISTING PRIMARILY OF VEGETABLES AND SNACKS, NAMELY, VEGETABLE-BASED AND FRUIT-BASED SNACK FOODS, IN CLASS 29 (U.S. CL. 46).

FOR: PREPARATIONS MADE FROM RICE, NAMELY, RICE-BASED SNACK FOODS AND PACKAGED MEAL MIXES CONSISTING PRIMARILY OF RICE; RICE FLOUR; BREAKFAST CEREALS; CEREAL BASED FOODS, NAMELY, CEREAL-BASED SNACK FOODS AND PROCESSED CEREAL-BASED FOOD TO BE USED AS A BREAKFAST FOOD, SNACK FOOD OR INGREDIENT FOR MAKING OTHER FOODS; BREAKFAST CEREAL CONTAINING FRUIT; MAIZE, CORN AND RICE SNACKS, NAMELY, MAIZE-BASED SNACK FOODS, CORN-BASED SNACK FOODS AND RICE-BASED SNACK FOODS; PREPARED MEALS AND SNACKS CONSISTING PRIMARILY OF PASTA, RICE OR CORN, IN CLASS 30 (U.S. CL. 46).

THE MARK CONSISTS OF STANDARD CHARACTERS WITHOUT CLAIM TO ANY PARTICULAR FONT, STYLE, SIZE, OR COLOR.

PRIORITY CLAIMED UNDER SEC. 44(D) ON ERPN CMNTY TM OFC APPLICATION NO. 009589805, FILED 12-10-2010, REG. NO. 009589805, DATED 5-20-2011, EXPIRES 12-10-2020.

OWNER OF U.S. REG. NOS. 3,784,824 AND 4,014,812.

NO CLAIM IS MADE TO THE EXCLUSIVE RIGHT TO USE "KITCHEN BABY", APART FROM THE MARK AS SHOWN.

SER. NO. 85-342,122, FILED 6-9-2011.



David J. Kyros

Director of the United States Patent and Trademark Office

Reg. No. 4,174,120 JENNIFER DIXON, EXAMINING ATTORNEY

United States of America

United States Patent and Trademark Office

ALGENESS

Reg. No. 4,174,121

Registered July 17, 2012

Int. Cl.: 5

TRADEMARK

PRINCIPAL REGISTER

GHIMAS S.P.A. (ITALY JOINT STOCK COMPANY)
VIA DOMENICO CIMAROSA 85
40033 CASALECCHIO DI RENO
(BO), ITALY

FOR: INJECTABLE DERMAL FILLER, IN CLASS 5 (U.S. CLS. 6, 18, 44, 46, 51 AND 52).

THE MARK CONSISTS OF STANDARD CHARACTERS WITHOUT CLAIM TO ANY PARTICULAR FONT, STYLE, SIZE, OR COLOR.

PRIORITY CLAIMED UNDER SEC. 44(D) ON ERPN CMNTY TM OFC APPLICATION NO. 010028397, FILED 6-8-2011, REG. NO. 010028397, DATED 1-28-2012, EXPIRES 6-8-2021.

SER. NO. 85-342,177, FILED 6-9-2011.

JOHN DWYER, EXAMINING ATTORNEY



David J. Kybas

Director of the United States Patent and Trademark Office

United States of America

United States Patent and Trademark Office

SPEEDI-SLEEVE

Reg. No. 4,174,122

Registered July 17, 2012

Int. Cl.: 7

TRADEMARK

PRINCIPAL REGISTER

SKF USA INC. (DELAWARE CORPORATION)
CORPORATE HEADQUARTERS, N.A.
890 FORTY FOOT ROAD, PO BOX 352
LANSDALE, PA 19446

FOR: MECHANICAL SEALS FOR USE IN LAND VEHICLE ENGINES AND MACHINERY,
NAMELY, SHAFT SLEEVES FOR REPAIRING ROTATING SHAFTS, IN CLASS 7 (U.S. CLS.
13, 19, 21, 23, 31, 34 AND 35).

FIRST USE 7-15-1967; IN COMMERCE 10-1-1967.

THE MARK CONSISTS OF STANDARD CHARACTERS WITHOUT CLAIM TO ANY PAR-
TICULAR FONT, STYLE, SIZE, OR COLOR.

SER. NO. 85-342,414, FILED 6-9-2011.

WENDY JUN, EXAMINING ATTORNEY



David J. Kyffers

Director of the United States Patent and Trademark Office

United States of America

United States Patent and Trademark Office



cap

Reg. No. 4,174,123

Registered July 17, 2012

**Int. Cls.: 16, 35, 41, 42
and 44**

COLLEGE OF AMERICAN PATHOLOGISTS (ILLINOIS NON-PROFIT CORPORATION)
325 WAUKEGAN ROAD
NORTHFIELD, IL 60093

FOR: PRINTED NEWSPAPERS, NEWSLETTERS AND PERIODICALS IN THE FIELD OF PATHOLOGY AND LABORATORY MEDICINE, IN CLASS 16 (U.S. CLS. 2, 5, 22, 23, 29, 37, 38 AND 50).

TRADEMARK

FIRST USE 6-0-2010; IN COMMERCE 6-0-2010.

SERVICE MARK

FOR: ASSOCIATION SERVICES, NAMELY, PROMOTING THE INTERESTS OF AND ADVOCATING FOR PATHOLOGISTS AND HEALTH CARE WORKERS IN THE FIELDS OF PATHOLOGY AND LABORATORY SERVICES; LOBBYING SERVICES, NAMELY, PROMOTING THE INTERESTS OF PATHOLOGISTS AND HEALTH CARE WORKERS IN THE FIELDS OF LEGISLATION AND REGULATION; PROVIDING INFORMATION IN THE FIELD OF PATHOLOGY CAREERS VIA THE INTERNET; PROVIDING INFORMATION IN THE FIELD OF PATHOLOGY PRACTICE MANAGEMENT; PROMOTING PUBLIC AWARENESS OF THE ROLE OF PATHOLOGISTS IN HEALTH CARE, IN CLASS 35 (U.S. CLS. 100, 101 AND 102).

PRINCIPAL REGISTER

FIRST USE 6-0-2010; IN COMMERCE 6-0-2010.



FOR: EDUCATIONAL SERVICES, NAMELY, DEVELOPING, ARRANGING, AND CONDUCTING EDUCATIONAL CONFERENCES AND PROGRAMS AND PROVIDING COURSES OF INSTRUCTION IN THE FIELD OF PATHOLOGY; PROVIDING ON-LINE NON-DOWNLOADABLE PUBLICATIONS IN THE NATURE OF NEWSLETTERS AND PERIODICALS IN THE FIELD OF PATHOLOGY AND LABORATORY MEDICINE, IN CLASS 41 (U.S. CLS. 100, 101 AND 107).

FIRST USE 6-0-2010; IN COMMERCE 6-0-2010.

FOR: ACCREDITATION SERVICES, NAMELY, DEVELOPING, EVALUATING, AND TESTING STANDARDS FOR MEDICAL LABORATORY SERVICES AND FACILITIES FOR THE PURPOSE OF ACCREDITATION, IN CLASS 42 (U.S. CLS. 100 AND 101).

FIRST USE 6-0-2010; IN COMMERCE 6-0-2010.

David J. Kyjars

Director of the United States Patent and Trademark Office

Reg. No. 4,174,123 FOR: CONSULTING SERVICES IN THE FIELD OF HEALTH CARE, NAMELY, CONSULTING SERVICES IN THE FIELD OF CLINICAL TERMINOLOGY AND HEALTH CARE STANDARDS AND THE USE AND IMPLEMENTATION THEREOF, IN CLASS 44 (U.S. CLS. 100 AND 101).

FIRST USE 6-0-2010; IN COMMERCE 6-0-2010.

OWNER OF U.S. REG. NOS. 1,664,117, 3,819,547 AND OTHERS.

THE MARK CONSISTS OF CONCENTRIC CIRCLES ADJACENT THE STYLIZED WORD "CAP" WITH THE WORDS "COLLEGE OF AMERICAN PATHOLOGISTS" WITHIN THE OUTER CIRCLE AND WITHIN THE INNER CIRCLE A STYLIZED TRIANGLE ATOP A FLAT SPHERE WITH A SMALLER CIRCLE CONTAINED THEREIN.

SEC. 2(F) AS TO "COLLEGE OF AMERICAN PATHOLOGISTS".

SER. NO. 85-342,478, FILED 6-9-2011.

ERIN FALK, EXAMINING ATTORNEY

United States of America

United States Patent and Trademark Office



Reg. No. 4,174,124

Registered July 17, 2012

Int. Cl.: 43

SERVICE MARK

PRINCIPAL REGISTER

LAMONICA, JOHN (UNITED STATES INDIVIDUAL), DBA LAMONICA'S NY-PIZZA
1066 GAYLEY AVENUE
LOS ANGELES, CA 90024

FOR: RESTAURANT SERVICES, IN CLASS 43 (U.S. CLS. 100 AND 101).

FIRST USE 10-0-1980; IN COMMERCE 10-0-1980.

NO CLAIM IS MADE TO THE EXCLUSIVE RIGHT TO USE "NY-PIZZA", APART FROM THE MARK AS SHOWN.

THE COLOR(S) BLUE AND YELLOW IS/ARE CLAIMED AS A FEATURE OF THE MARK.

THE MARK CONSISTS OF A LICENSE PLATE UPON WHICH THE WORDING "LAMONICAS" APPEARS OVER "NY-PIZZA" AND THE "L" IN "LAMONICA'S" IS OVER THE "Y" IN "NY". THERE ARE FOUR DOTS, ONE TO LEFT OF THE "L", ONE TO THE RIGHT OF THE "S", ONE BETWEEN THE "N" AND "Y" IN "NY" AND ONE BELOW THE "A" IN "PIZZA".

SER. NO. 85-342,649, FILED 6-9-2011.

ANGELA M. MICHELI, EXAMINING ATTORNEY



David J. Kybas

Director of the United States Patent and Trademark Office

United States of America

United States Patent and Trademark Office

Dolorox

Reg. No. 4,174,125

BIOTANIKA USA (FLORIDA LIMITED LIABILITY COMPANY)
3300 NE 14TH COURT

Registered July 17, 2012

FT. LAUDERDALE, FL 33304

Int. Cl.: 5

FOR: DIETARY AND NUTRITIONAL SUPPLEMENT FOR HUMAN USE ONLY THAT IS A BLEND OF BOTANICAL EXTRACTS, IN CLASS 5 (U.S. CLS. 6, 18, 44, 46, 51 AND 52).

TRADEMARK

FIRST USE 4-9-2010; IN COMMERCE 4-9-2010.

PRINCIPAL REGISTER

THE MARK CONSISTS OF STANDARD CHARACTERS WITHOUT CLAIM TO ANY PARTICULAR FONT, STYLE, SIZE, OR COLOR.

SER. NO. 85-343,215, FILED 6-10-2011.

KYLE PEETE, EXAMINING ATTORNEY



David J. Kybas

Director of the United States Patent and Trademark Office

United States of America

United States Patent and Trademark Office

Coaching Into Care

Reg. No. 4,174,126

DEPARTMENT OF VETERANS AFFAIRS (UNITED STATES FEDERAL AGENCY)
810 VERMONT AVENUE
WASHINGTON, DC 20420

Registered July 17, 2012

Int. Cl.: 44

FOR: PROVIDING HEALTH CARE INFORMATION BY TELEPHONE TO FAMILY MEMBERS AND FRIENDS OF VETERANS IN ORDER THAT THEY MAY ENCOURAGE THE VETERANS TO SEEK HEALTH CARE SERVICES THROUGH THE DEPARTMENT OF VETERANS AFFAIRS, IN CLASS 44 (U.S. CLS. 100 AND 101).

SERVICE MARK

PRINCIPAL REGISTER

FIRST USE 5-25-2011; IN COMMERCE 6-2-2011.

THE MARK CONSISTS OF STANDARD CHARACTERS WITHOUT CLAIM TO ANY PARTICULAR FONT, STYLE, SIZE, OR COLOR.

SER. NO. 85-343,243, FILED 6-10-2011.

DAVID C. REIHNER, EXAMINING ATTORNEY



David J. Kybas

Director of the United States Patent and Trademark Office

United States of America

United States Patent and Trademark Office

Angel eCare

Iowa's eHealth Care Provider

Reg. No. 4,174,127

ERIN FITZSIMMONS (IOWA LIMITED LIABILITY COMPANY), DBA ANGEL ECARE LLC
2261 CROSSPARK ROAD, SUITE 108
CORALVILLE, IA 52241

Registered July 17, 2012

Int. Cl.: 9

FOR: COMPUTER SOFTWARE FOR CONTROLLING AND MANAGING PATIENT MEDICAL INFORMATION, IN CLASS 9 (U.S. CLS. 21, 23, 26, 36 AND 38).

TRADEMARK

FIRST USE 3-10-2011; IN COMMERCE 3-10-2011.

PRINCIPAL REGISTER

NO CLAIM IS MADE TO THE EXCLUSIVE RIGHT TO USE "ECARE" AND "IOWA'S EHEALTH CARE PROVIDER", APART FROM THE MARK AS SHOWN.

THE MARK CONSISTS OF THE WORDS "ANGEL ECARE" IN STYLIZED FONT WITH AN ANGEL'S HALO POSITIONED OVER THE SMALL "E" IN "ECARE". BENEATH IS THE PHRASE "IOWA'S EHEALTH CARE PROVIDER" IN STYLIZED FONT.

SER. NO. 85-343,650, FILED 6-10-2011.

STEVEN PEREZ, EXAMINING ATTORNEY



David J. Kyffers

Director of the United States Patent and Trademark Office

United States of America

United States Patent and Trademark Office



Reg. No. 4,174,128

Registered July 17, 2012

Int. Cls.: 7 and 8

TRADEMARK

PRINCIPAL REGISTER

KARAT INDUSTRIAL CORPORATION (TAIWAN CORPORATION)
NO. 54, WUCYUAN 7TH RD., WUGU DIST.
NEW TAIPEI CITY, TAIWAN 248

FOR: POWER OPERATED TOOLS, NAMELY, RIVETING TOOLS, RIVET NUT TOOLS, RIVET BOLT TOOLS, FASTENER SETTING TOOLS, DRILLING TOOLS, PUNCHING TOOLS; AIR-OPERATED POWER TOOLS, NAMELY, RIVETING TOOLS, RIVET NUT TOOLS, RIVET BOLT TOOLS, FASTENER SETTING TOOLS, DRILLING TOOLS, PUNCHING TOOLS; HAND-HELD AIR ACTUATED HYDRAULIC POWER TOOLS, NAMELY, RIVETING TOOLS, RIVET NUT TOOLS, RIVET BOLT TOOLS, FASTENER SETTING TOOLS, DRILLING TOOLS, PUNCHING TOOLS; AIR ACTUATED HYDRAULIC POWER TOOLS, NAMELY, RIVETING TOOLS, RIVET NUT TOOLS, RIVET BOLT TOOLS, FASTENER SETTING TOOLS, DRILLING TOOLS, PUNCHING TOOLS; HAND-HELD ELECTRONICALLY AND POWER OPERATED TOOLS, NAMELY, RIVETING TOOLS, RIVET NUT TOOLS, RIVET BOLT TOOLS, FASTENER SETTING TOOLS, DRILLING TOOLS, PUNCHING TOOLS; ELECTRONICALLY AND POWER OPERATED TOOLS, NAMELY, RIVETING TOOLS, RIVET NUT TOOLS, RIVET BOLT TOOLS, FASTENER SETTING TOOLS, DRILLING TOOLS, PUNCHING TOOLS; HAND-HELD BATTERY OPERATED POWER TOOLS, NAMELY, RIVETING TOOLS, RIVET NUT TOOLS, RIVET BOLT TOOLS, FASTENER SETTING TOOLS, DRILLING TOOLS, PUNCHING TOOLS; BATTERY OPERATED POWER TOOLS, NAMELY, RIVETING TOOLS, RIVET NUT TOOLS, RIVET BOLT TOOLS, FASTENER SETTING TOOLS, DRILLING TOOLS, PUNCHING TOOLS, IN CLASS 7 (U.S. CLS. 13, 19, 21, 23, 31, 34 AND 35).

FIRST USE 10-11-2005; IN COMMERCE 10-11-2005.

FOR: HAND TOOLS, NAMELY, RIVETERS, RIVETING TOOLS, RIVET NUT TOOLS, RIVET BOLT TOOLS, FASTENER SETTING TOOLS, DRILLING TOOLS, PUNCHING TOOLS, IN CLASS 8 (U.S. CLS. 23, 28 AND 44).

FIRST USE 10-11-2005; IN COMMERCE 10-11-2005.

THE MARK CONSISTS OF THE WORD "KARAT" WITH THE "K" SET IN A DIAMOND SHAPED OUTLINE.

SER. NO. 85-343,740, FILED 6-10-2011.

ERIN FALK, EXAMINING ATTORNEY



David J. Kypos

Director of the United States Patent and Trademark Office

United States of America

United States Patent and Trademark Office

Hawk Rocks

Reg. No. 4,174,129

Registered July 17, 2012

Int. Cl.: 14

TRADEMARK

PRINCIPAL REGISTER

JAGGEDFASHION (WASHINGTON LIMITED LIABILITY COMPANY)
P.O. BOX 4383
EVERETT, WA 98204

FOR: NECKLACES MADE WITH ROCKS, IN CLASS 14 (U.S. CLS. 2, 27, 28 AND 50).

FIRST USE 10-1-2010; IN COMMERCE 10-1-2010.

THE MARK CONSISTS OF STANDARD CHARACTERS WITHOUT CLAIM TO ANY PARTICULAR FONT, STYLE, SIZE, OR COLOR.

NO CLAIM IS MADE TO THE EXCLUSIVE RIGHT TO USE "ROCKS", APART FROM THE MARK AS SHOWN.

SER. NO. 85-343,807, FILED S.R. 6-10-2011 AM. P.R. 3-13-2012.

JULIE VEPPUMTHARA, EXAMINING ATTORNEY



David J. Kyffers

Director of the United States Patent and Trademark Office

United States of America

United States Patent and Trademark Office

ME Addiction

Reg. No. 4,174,130

Registered July 17, 2012

Int. Cl.: 41

SERVICE MARK

PRINCIPAL REGISTER

SHOESTRING MINISTRIES, INC., A CALIFORNIA NON-PROFIT CORPORATION
(CALIFORNIA CORPORATION)
PO BOX 4579
MODESTO, CA 953524579

FOR: ENTERTAINMENT, NAMELY, A CONTINUING ON AIR TALK SHOW BROADCAST OVER THE MEDIUM OF RADIO, INTERNET, TELEVISION, AND COMPUTER NETWORKS , IN CLASS 41 (U.S. CLS. 100, 101 AND 107).

FIRST USE 1-10-2011; IN COMMERCE 1-10-2011.

THE MARK CONSISTS OF STANDARD CHARACTERS WITHOUT CLAIM TO ANY PARTICULAR FONT, STYLE, SIZE, OR COLOR.

OWNER OF U.S. REG. NO. 3,221,418.

NO CLAIM IS MADE TO THE EXCLUSIVE RIGHT TO USE "ADDICTION", APART FROM THE MARK AS SHOWN.

SER. NO. 85-345,000, FILED 6-13-2011.

SHAUNIA CARLYLE, EXAMINING ATTORNEY



David J. Kyffers

Director of the United States Patent and Trademark Office

United States of America
United States Patent and Trademark Office

RICEBLISS

Reg. No. 4,174,131

RICEBLISS, LLC (CALIFORNIA LIMITED LIABILITY COMPANY)
2132 EL ROBLE LANE
BEVERLY HILLS, CA 90210

Registered July 17, 2012

Int. Cl.: 30

FOR: READY-TO-EAT PORRIDGE AND PRE-PACKAGED FOODS, NAMELY, RICE PORRIDGE, RICE PUDDING, AND RICE CEREAL, IN CLASS 30 (U.S. CL. 46).

TRADEMARK

FIRST USE 2-0-2012; IN COMMERCE 2-0-2012.

PRINCIPAL REGISTER

THE MARK CONSISTS OF STANDARD CHARACTERS WITHOUT CLAIM TO ANY PARTICULAR FONT, STYLE, SIZE, OR COLOR.

SER. NO. 85-345,019, FILED 6-13-2011.

MARTHA SANTOMARTINO, EXAMINING ATTORNEY



David J. Kybas

Director of the United States Patent and Trademark Office

United States of America

United States Patent and Trademark Office

ECOME

Reg. No. 4,174,132

Registered July 17, 2012

Int. Cls.: 24 and 25

TRADEMARK

PRINCIPAL REGISTER

DESIGNER TEXTILES INTERNATIONAL LIMITED (NEW ZEALAND LIMITED LIABILITY COMPANY)
11 LOVEGROVE CRESCENT
OTARA, NEW ZEALAND

FOR: FABRIC, NAMELY, MERINO WOOL AND MERINO WOOL BLENDED FABRICS; VISCOSE RAYON AND VISCOSE RAYON BLENDED FABRICS; POLYESTER AND POLYESTER BLENDED FABRICS; FABRICS FOR TEXTILE USE; TEXTILE FABRICS FOR THE MANUFACTURING OF CLOTHING; NON-WOVEN TEXTILE FABRICS, IN CLASS 24 (U.S. CLS. 42 AND 50).

FOR: CLOTHING, NAMELY, TANK TOPS, T-SHIRTS, SHIRTS, SPORT SHIRTS, DRESS SHIRTS, POLO SHIRTS, UNDERSHIRTS, UNDERPANTS, SWEATSHIRTS, SWEATERS, PULLOVERS, BLOUSES, JACKETS, RAINCOATS, OVERCOATS, TOPCOATS, TROUSERS, PANTS, JOGGING SUITS, EXERCISE PANTS, EXERCISE SUITS, SWEATPANTS, IN CLASS 25 (U.S. CLS. 22 AND 39).

THE MARK CONSISTS OF STANDARD CHARACTERS WITHOUT CLAIM TO ANY PARTICULAR FONT, STYLE, SIZE, OR COLOR.

OWNER OF NEW ZEALAND REG. NO. 843778, DATED 6-13-2011, EXPIRES 6-13-2021.

SER. NO. 85-345,256, FILED 6-14-2011.

ANDREA HACK, EXAMINING ATTORNEY



David J. Kypos

Director of the United States Patent and Trademark Office

United States of America

United States Patent and Trademark Office



Reg. No. 4,174,133

Registered July 17, 2012

Int. Cl.: 10

TRADEMARK

PRINCIPAL REGISTER

ECHO THERAPEUTICS, INC. (DELAWARE CORPORATION)
8 PENN CENTER, 1628 JFK BOULEVARD
PHILADELPHIA, PA 19103

FOR: TRANSDERMAL CONTINUOUS GLUCOSE MONITORING SYSTEM CONSISTING OF A MECHANICAL SKIN ABLATOR, A BIOSENSOR, A HYDROGEL, AND A TRANSCEIVER WITH WIRELESS CONNECTIVITY CAPABILITIES; MECHANICAL SKIN ABLATOR FOR MEDICAL AND COSMECEUTICAL PURPOSES, IN CLASS 10 (U.S. CLS. 26, 39 AND 44).

FIRST USE 5-1-2010; IN COMMERCE 5-1-2010.

THE MARK CONSISTS OF THE LETTER "E" ENCLOSED WITHIN CONCENTRIC, INCOMPLETE OVALS.

SER. NO. 85-345,516, FILED 6-14-2011.

JULIE VEPPUMTHARA, EXAMINING ATTORNEY



David J. Kyffers

Director of the United States Patent and Trademark Office

United States of America

United States Patent and Trademark Office



Reg. No. 4,174,134

ISIB LABS (DELAWARE LIMITED LIABILITY COMPANY), DBA BISIMOTO ENGINEERING
1916 S. LYNX PLACE
ONTARIO, CA 91761

Registered July 17, 2012

Int. Cl.: 40

FOR: MANUFACTURING SERVICES FOR OTHERS IN THE FIELD OF AUTOMOTIVE PARTS AND ACCESSORIES, IN CLASS 40 (U.S. CLS. 100, 103 AND 106).

SERVICE MARK

FIRST USE 1-6-1996; IN COMMERCE 1-1-2004.

PRINCIPAL REGISTER

NO CLAIM IS MADE TO THE EXCLUSIVE RIGHT TO USE "ENGINEERING", APART FROM THE MARK AS SHOWN.

THE MARK CONSISTS OF A BETA SYMBOL WITH A SINGLE ELECTRON ORBIT GOING AROUND IT. TO THE RIGHT THERE IS THE STYLIZED TEXT "BISIMOTO ENGINEERING".

SER. NO. 85-346,255, FILED 6-14-2011.

MARTHA SANTOMARTINO, EXAMINING ATTORNEY



David J. Kyffers

Director of the United States Patent and Trademark Office

United States of America

United States Patent and Trademark Office

Bay Products

Reg. No. 4,174,135

ENDURO COMPOSITES, INC. (DELAWARE CORPORATION)
16602 CENTRAL GREEN BLVD.
HOUSTON, TX 77032

Registered July 17, 2012

Int. Cl.: 11

FOR: AIR REMEDIATION SYSTEMS IN THE NATURE OF ENVIRONMENTAL CONTROL APPARATUS, NAMELY, PARTICLE ACTIVATORS, ABSORBERS, AND BIOLOGICAL FILTERS, ALL FOR USE IN AIR TREATMENT AND ODOR REMOVAL FROM AIR; AIR REMEDIATION SYSTEMS, NAMELY, GAS SCRUBBERS, IN CLASS 11 (U.S. CLS. 13, 21, 23, 31 AND 34).

TRADEMARK

PRINCIPAL REGISTER

FIRST USE 3-1-1996; IN COMMERCE 3-1-1996.

THE MARK CONSISTS OF STANDARD CHARACTERS WITHOUT CLAIM TO ANY PARTICULAR FONT, STYLE, SIZE, OR COLOR.

NO CLAIM IS MADE TO THE EXCLUSIVE RIGHT TO USE "PRODUCTS", APART FROM THE MARK AS SHOWN.

SER. NO. 85-346,366, FILED 6-15-2011.

MATTHEW MCDOWELL, EXAMINING ATTORNEY



David J. Kyfos

Director of the United States Patent and Trademark Office

United States of America

United States Patent and Trademark Office

NETWORK

Reg. No. 4,174,136

Registered July 17, 2012

Int. Cl.: 35

SERVICE MARK

PRINCIPAL REGISTER

NETWORK ASSOCIATES, INC. (DELAWARE CORPORATION)
SUITE 200
1100 E. WOODFIELD ROAD
SCHAUMBURG, IL 60173

FOR: BUSINESS MANAGEMENT CONSULTING SERVICES RELATING TO PRODUCT DISTRIBUTION, OPERATIONS MANAGEMENT SERVICES, COST AND PRODUCTIVITY MANAGEMENT SERVICES, LOGISTICS, REVERSE LOGISTICS, SUPPLY CHAIN, PRODUCTION SYSTEMS, BRAND SELECTION AND SUPPLY AND DEMAND FORECASTING, IN CLASS 35 (U.S. CLS. 100, 101 AND 102).

FIRST USE 1-1-1973; IN COMMERCE 1-1-1974.

THE MARK CONSISTS OF STANDARD CHARACTERS WITHOUT CLAIM TO ANY PARTICULAR FONT, STYLE, SIZE, OR COLOR.

OWNER OF U.S. REG. NOS. 1,618,244 AND 1,854,358.

SEC. 2(F).

SER. NO. 85-347,065, FILED 6-15-2011.

IRA J. GOODSaid, EXAMINING ATTORNEY



David J. Kyffers

Director of the United States Patent and Trademark Office

United States of America

United States Patent and Trademark Office



PATRIOT SUPPORT PROGRAMS of UHS

Reg. No. 4,174,137

Registered July 17, 2012

Int. Cl.: 44

SERVICE MARK

PRINCIPAL REGISTER

UHS OF DELAWARE, INC. (DELAWARE CORPORATION)
367 SOUTH GULPH ROAD
KING OF PRUSSIA, PA 194060958

FOR: HEALTHCARE; MEDICAL COUNSELING; MEDICAL SERVICES, IN CLASS 44 (U.S. CLS. 100 AND 101).

FIRST USE 5-30-2011; IN COMMERCE 5-30-2011.

OWNER OF U.S. REG. NOS. 1,696,433, 2,741,663 AND OTHERS.

NO CLAIM IS MADE TO THE EXCLUSIVE RIGHT TO USE "SUPPORT PROGRAMS", APART FROM THE MARK AS SHOWN.

THE MARK CONSISTS OF A DESIGN ELEMENT ON THE LEFT PORTION OF THE MARK THAT IS FRAMED ON THE RIGHT SIDE BY THE WORDS "PATRIOT SUPPORT PROGRAMS OF UHS" IN STYLIZED FONT. THE DESIGN PORTION INCLUDES AN ELEMENT IN THE SHAPE OF A SHIELD. THE SHIELD HAS THREE POINTS AT THE TOP AND IS TAPERED TO A POINT AT THE BOTTOM, WITH A SERIES OF STRIPES AND A STAR CENTERED AT THE TOP.

SER. NO. 85-347,193, FILED 6-15-2011.

MARGARET POWER, EXAMINING ATTORNEY



David J. Kyffers

Director of the United States Patent and Trademark Office

United States of America

United States Patent and Trademark Office

NO GUESSWORK... JUST
ANSWERS

Reg. No. 4,174,138

CHUDKOWSKI, STEPHEN P (UNITED STATES INDIVIDUAL)
960 ROUTE 9

Registered July 17, 2012

SOUTH AMBOY, NJ 08879

Int. Cl.: 44

FOR: CHIROPRACTIC SERVICES, IN CLASS 44 (U.S. CLS. 100 AND 101).

SERVICE MARK

FIRST USE 1-1-2008; IN COMMERCE 1-1-2008.

PRINCIPAL REGISTER

THE MARK CONSISTS OF STANDARD CHARACTERS WITHOUT CLAIM TO ANY PARTICULAR FONT, STYLE, SIZE, OR COLOR.

SER. NO. 85-347,315, FILED 6-15-2011.

JOHN DWYER, EXAMINING ATTORNEY



David J. Kyffers

Director of the United States Patent and Trademark Office

United States of America

United States Patent and Trademark Office

TUXEDO TOTS

Reg. No. 4,174,139

Registered July 17, 2012

Int. Cl.: 25

TRADEMARK

PRINCIPAL REGISTER

GILBERT, RUTH (UNITED STATES INDIVIDUAL), DBA TUXEDO TOTS
C/O BUCHALTER NEMER
1000 WILSHIRE BLVD., SUITE 1500
LOS ANGELES, CA 90017

FOR: BOTTOMS; INFANT AND TODDLER ONE PIECE CLOTHING; TOPS, IN CLASS 25
(U.S. CLS. 22 AND 39).

FIRST USE 0-0-2005; IN COMMERCE 0-0-2005.

THE MARK CONSISTS OF STANDARD CHARACTERS WITHOUT CLAIM TO ANY PARTICULAR FONT, STYLE, SIZE, OR COLOR.

SEC. 2(F).

SER. NO. 85-347,831, FILED 6-16-2011.

DAWN HAN, EXAMINING ATTORNEY



David J. Kyffers

Director of the United States Patent and Trademark Office

United States of America

United States Patent and Trademark Office

EXPLORING MY AMERICA

Reg. No. 4,174,140

Registered July 17, 2012

Int. Cl.: 41

SERVICE MARK

PRINCIPAL REGISTER

SEARS BRANDS, LLC (ILLINOIS LIMITED LIABILITY COMPANY)
3333 BEVERLY DRIVE
HOFFMAN ESTATES, IL 60179

FOR: ENTERTAINMENT SERVICES, NAMELY, CONDUCTING A CONTEST IN WHICH PARTICIPANTS SUBMIT VIDEOS TO COMPETE FOR PRIZES; ENTERTAINMENT SERVICES, NAMELY, CONDUCTING CONTESTS; ENTERTAINMENT SERVICES IN THE NATURE OF AN ON-GOING REALITY BASED WEBISODE SERIES; PROVIDING A WEBSITE FOR ENTERTAINMENT PURPOSES WHERE USERS CAN VIEW AND VOTE FOR VIDEOS SUBMITTED BY CONTEST PARTICIPANTS, IN CLASS 41 (U.S. CLS. 100, 101 AND 107).

FIRST USE 6-0-2010; IN COMMERCE 6-0-2010.

THE MARK CONSISTS OF STANDARD CHARACTERS WITHOUT CLAIM TO ANY PARTICULAR FONT, STYLE, SIZE, OR COLOR.

NO CLAIM IS MADE TO THE EXCLUSIVE RIGHT TO USE "AMERICA", APART FROM THE MARK AS SHOWN.

SER. NO. 85-348,235, FILED 6-16-2011.

JANICE KIM, EXAMINING ATTORNEY



David J. Kyros

Director of the United States Patent and Trademark Office

United States of America

United States Patent and Trademark Office



Q U I N T E S S
B E Y O N D

Reg. No. 4,174,141

Registered July 17, 2012

Int. Cl.: 39

SERVICE MARK

PRINCIPAL REGISTER

CLUB HOLDINGS, LLC (DELAWARE LIMITED LIABILITY COMPANY)
SUITE 300
11101 WEST 120TH AVENUE
BROOMFIELD, CO 80021

FOR: MEMBERSHIP CLUB SERVICES, NAMELY, ORGANIZATION OF THEME-BASED EXCURSIONS, SIGHTSEEING TOURS, HOLIDAYS, TOURS AND TRAVEL AS PART OF CLUB MEMBERSHIPS THAT OFFER TEMPORARY LODGING ACCOMMODATIONS IN CLUB OWNED, LEASED, LICENSED, OPERATED OR SPONSORED VACATION RESIDENCES OR DESTINATION PROPERTIES; PROVIDING INFORMATION OVER THE INTERNET ABOUT THEME-BASED EXCURSIONS, SIGHTSEEING TOURS, HOLIDAYS, TOURS AND TRAVEL AS PART OF CLUB MEMBERSHIPS THAT OFFER TEMPORARY LODGING ACCOMMODATIONS IN CLUB OWNED, LEASED, LICENSED, OPERATED OR SPONSORED VACATION RESIDENCES OR DESTINATION PROPERTIES, IN CLASS 39 (U.S. CLS. 100 AND 105).

FIRST USE 6-9-2011; IN COMMERCE 6-9-2011.

OWNER OF U.S. REG. NOS. 3,122,187 AND 3,972,038.

THE MARK CONSISTS OF A STYLIZED LETTER "Q" WHICH IS ABOVE THE WORD "QUINTESS", WHICH IN TURN IS ABOVE A HORIZONTAL LINE, WHICH IN TURN IS ABOVE THE WORD "BEYOND".

THE WORDING "QUINTESS" HAS NO MEANING IN A FOREIGN LANGUAGE.

SER. NO. 85-348,319, FILED 6-16-2011.

BRIAN PINO, EXAMINING ATTORNEY



David J. Kyffers

Director of the United States Patent and Trademark Office

United States of America

United States Patent and Trademark Office



Reg. No. 4,174,142

Registered July 17, 2012

Int. Cls.: 42 and 45

SERVICE MARK

PRINCIPAL REGISTER

10SPORTAL, LLC (TEXAS LIMITED LIABILITY COMPANY)
#1733
4825 DAVIS LANE
AUSTIN, TX 78749

FOR: SOFTWARE AS A SERVICE (SAAS) SERVICES FEATURING SOFTWARE FOR TENNIS CLUB MANAGEMENT AND FREELANCE TENNIS PROS, FOR SUCH INDIVIDUALS TO MANAGE MEMBERS/STUDENTS MEMBERSHIP, SCHEDULING, TEACHING FEES AND BILLING, IN CLASS 42 (U.S. CLS. 100 AND 101).

FIRST USE 1-1-2008; IN COMMERCE 1-1-2008.

FOR: ON-LINE SOCIAL NETWORKING SERVICES, IN CLASS 45 (U.S. CLS. 100 AND 101).

FIRST USE 1-1-2008; IN COMMERCE 1-1-2008.

NO CLAIM IS MADE TO THE EXCLUSIVE RIGHT TO USE "TENNISPORTAL.COM", APART FROM THE MARK AS SHOWN.

THE MARK CONSISTS OF A DESIGN OF THREE TENNIS BALLS ARRANGED IN TRIANGLE LIKE FORMATION WITH THE WORD "10SPORTAL.COM".

SER. NO. 85-348,495, FILED 6-16-2011.

HENRY S. ZAK, EXAMINING ATTORNEY



David J. Kybas

Director of the United States Patent and Trademark Office

United States of America

United States Patent and Trademark Office

Cartridge Mate

Reg. No. 4,174,143

Registered July 17, 2012

Int. Cl.: 2

TRADEMARK

PRINCIPAL REGISTER

ECO WORLD, INC. (CALIFORNIA CORPORATION), DBA PRINTPAYLESS
136 GREENBRIAR LN.,
LA PUTENTE, CA 91744

FOR: COLORANTS FOR USE IN THE MANUFACTURE OF PRINTING INK; COPYING INKS; DRY INKS; ENGRAVING INK; FILLED INK CARTRIDGES; INK CARTRIDGES FOR PRINTERS; INK FOR MULTIFUNCTION ELECTRONIC DEVICES FOR USE IN COPYING, PRINTING, SCANNING, VIDEO CAPTURE OR TRANSMITTING DOCUMENTS AND IMAGES; INK JET CARTRIDGES; INK JET PRINTER INK; INK-DRYING PREPARATIONS SOLD AS A COMPONENT OF INKS; INKS, TONERS AND DYES FOR USE WITH OR ON TEXTILES AND FABRICS; INTAGLIO INK; METALLIC INKS, IN CLASS 2 (U.S. CLS. 6, 11 AND 16).

FIRST USE 6-6-2010; IN COMMERCE 6-6-2010.

THE MARK CONSISTS OF STANDARD CHARACTERS WITHOUT CLAIM TO ANY PARTICULAR FONT, STYLE, SIZE, OR COLOR.

NO CLAIM IS MADE TO THE EXCLUSIVE RIGHT TO USE "CARTRIDGE", APART FROM THE MARK AS SHOWN.

SER. NO. 85-349,208, FILED 6-17-2011.

LINDA POWELL, EXAMINING ATTORNEY



David J. Kyffers

Director of the United States Patent and Trademark Office

United States of America

United States Patent and Trademark Office

OUTSMART WASTE

Reg. No. 4,174,144

Registered July 17, 2012

Int. Cls.: 16, 35 and 40

TRADEMARK

SERVICE MARK

PRINCIPAL REGISTER

TERRACYCLE, INC. (DELAWARE CORPORATION)
121 NEW YORK AVENUE
TRENTON, NJ 08638

FOR: PLASTIC SHOPPING BAGS MADE OF RECYCLED PLASTIC AND PACKAGING, NOTEPADS, CLIP BOARDS, AND PENCIL CASES, ALL MADE OF RECYCLED PLASTIC AND PACKAGING, IN CLASS 16 (U.S. CLS. 2, 5, 22, 23, 29, 37, 38 AND 50).

FIRST USE 6-30-2007; IN COMMERCE 6-30-2007.

FOR: PROMOTING PUBLIC AWARENESS IN THE FIELD OF RECYCLING, UPCYCLING, RE-USE AND RESPONSIBLE USE OF CONSUMER PACKAGING AND OTHER MATERIALS; PROMOTING PUBLIC AWARENESS OF CORPORATE EFFORTS IN THE AREA OF RECYCLING, UPCYCLING, RE-USE AND RESPONSIBLE USE, IN CLASS 35 (U.S. CLS. 100, 101 AND 102).

FIRST USE 9-0-2007; IN COMMERCE 9-0-2007.

FOR: RECYCLING SERVICES FEATURING A REUSE PROGRAM FOR UPCYCLING AND REUSE; PROVIDING A WEBSITE FEATURING INFORMATION ON RECYCLING AND RECYCLING IN THE NATURE OF UPCYCLING OF PACKAGING AND CONSUMER PRODUCT WASTE, IN CLASS 40 (U.S. CLS. 100, 103 AND 106).

FIRST USE 9-0-2007; IN COMMERCE 9-0-2007.

THE MARK CONSISTS OF STANDARD CHARACTERS WITHOUT CLAIM TO ANY PARTICULAR FONT, STYLE, SIZE, OR COLOR.

NO CLAIM IS MADE TO THE EXCLUSIVE RIGHT TO USE "WASTE", APART FROM THE MARK AS SHOWN.

SER. NO. 85-349,214, FILED 6-17-2011.

JEAN IM, EXAMINING ATTORNEY



David J. Kyffers

Director of the United States Patent and Trademark Office

United States of America

United States Patent and Trademark Office

MMC

Reg. No. 4,174,145

SWEET PEOPLE APPAREL INC. (CALIFORNIA CORPORATION)
4715 S. ALAMEDA STREET
LOS ANGELES, CA 90058

Registered July 17, 2012

Int. Cls.: 6 and 25

FOR: METAL KEY RINGS, IN CLASS 6 (U.S. CLS. 2, 12, 13, 14, 23, 25 AND 50).

TRADEMARK

FIRST USE 5-6-2011; IN COMMERCE 5-6-2011.

PRINCIPAL REGISTER

FOR: APPAREL, NAMELY, BLOUSES, CARDIGANS, VESTS, SHIRTS, SWEATERS, T-SHIRTS, TANK TOPS, SWEATSHIRTS, PULLOVERS, JACKETS, DRESSES, SHORTS, AND PANTS, IN CLASS 25 (U.S. CLS. 22 AND 39).

FIRST USE 3-24-2011; IN COMMERCE 3-24-2011.

THE MARK CONSISTS OF STANDARD CHARACTERS WITHOUT CLAIM TO ANY PARTICULAR FONT, STYLE, SIZE, OR COLOR.

SER. NO. 85-349,474, FILED 6-17-2011.

THEODORE MCBRIDE, EXAMINING ATTORNEY



David J. Kybas

Director of the United States Patent and Trademark Office

United States of America

United States Patent and Trademark Office

WHITE LOTUS

Reg. No. 4,174,146

Registered July 17, 2012

Int. Cls.: 9 and 41

TRADEMARK

SERVICE MARK

PRINCIPAL REGISTER

WHITE LOTUS FOUNDATION (CALIFORNIA CORPORATION)
C/O KOENIG & ASSOCIATES
920 GARDEN STREET, SUITE A
SANTA BARBARA, CA 93101

FOR: DIGITAL MEDIA, NAMELY, PRE-RECORDED DVDS, DOWNLOADABLE AUDIO AND VIDEO RECORDINGS, AND CDS FEATURING AND PROMOTING MUSIC AND ARTISTIC PERFORMANCES, YOGA, RELIGION, HEALTH, HEALING, RELIGIOUS UNITY, WORLD PEACE, SPIRITUAL DEVELOPMENT, SPIRITUAL GROWTH, PERSONAL SPIRITUAL EXPLORATION, SPIRITUAL STUDIES, HOLISTIC HEALTH, NUTRITION, FITNESS, EXERCISE, BEAUTY, PAINTING, WRITING, AND DANCING; AUDIO AND VIDEO RECORDINGS FEATURING MUSIC AND ARTISTIC PERFORMANCES; PRE-RECORDED DIGITAL VIDEO DISCS, DVDS, HIGH DEFINITION DIGITAL DISKS, AUDIO RECORDINGS, MUSICAL AND VOICE SOUND RECORDINGS, AND COMPACT DISCS FEATURING YOGA, RELIGION, HEALTH, HEALING, RELIGIOUS UNITY, WORLD PEACE, SPIRITUAL DEVELOPMENT, SPIRITUAL GROWTH, PERSONAL SPIRITUAL EXPLORATION, SPIRITUAL STUDIES, HOLISTIC HEALTH, NUTRITION, FITNESS, EXERCISE, BEAUTY, PAINTING, WRITING, AND DANCING; DOWNLOADABLE AUDIO FILES, MULTIMEDIA FILES, WRITTEN DOCUMENTS, AUDIO MATERIAL, AND VIDEO MATERIAL FEATURING INFORMATION IN THE FORM OF DOWNLOADABLE EDUCATIONAL/TRAINING COMMUNICATIONS IN THE FIELD OF YOGA, YOGA INSTRUCTION AND TRAINING, PHYSICAL FITNESS INSTRUCTION, PSYCHOLOGICAL DEVELOPMENT, RELIGION, HEALTH, HEALING, RELIGIOUS UNITY, WORLD PEACE, SPIRITUAL DEVELOPMENT, SPIRITUAL GROWTH, PERSONAL SPIRITUAL EXPLORATION, SPIRITUAL STUDIES, HOLISTIC HEALTH, NUTRITION, FITNESS, EXERCISE, BEAUTY, PAINTING, WRITING, DANCING, AND CERTIFICATION OF TEACHERS AND CONTINUING EDUCATION IN YOGA INSTRUCTION, IN CLASS 9 (U.S. CLS. 21, 23, 26, 36 AND 38).

FIRST USE 3-1-1987; IN COMMERCE 3-1-1987.

FOR: YOGA INSTRUCTION; PROVIDING FITNESS AND EXERCISE STUDIO SERVICES, NAMELY, YOGA INSTRUCTION AND TRAINING; PHYSICAL FITNESS INSTRUCTION; HEALTH AND EDUCATIONAL SERVICES, NAMELY, CONDUCTING WORKSHOPS AND COURSES IN YOGA AND MEDITATION; EDUCATIONAL SERVICES, NAMELY, CONDUCTING SPIRITUAL LEARNING RETREATS AND SEMINARS; INSTRUCTIONAL SERVICES IN THE FIELD OF YOGA IN THE NATURE OF CLASSES, RETREATS, LECTURES, WORKSHOPS AND SEMINARS; EDUCATIONAL SERVICES, NAMELY, CONDUCTING



David J. Kappas

Director of the United States Patent and Trademark Office

Reg. No. 4,174,146 CONFERENCES, WORKSHOPS, PROFESSIONAL TRAININGS AND SPIRITUAL RETREATS IN THE FIELDS OF HOLISTIC HEALTH, PSYCHOLOGICAL DEVELOPMENT, SPIRITUAL PRACTICE AND RELATED PRACTICES; EDUCATIONAL SERVICES, NAMELY, THE OFFERING OF TRAINING FOR CERTIFICATION OF TEACHERS AND CONTINUING EDUCATION FOR TEACHERS IN YOGA INSTRUCTION; PROVIDING A WEB SITE FEATURING NON-DOWNLOADABLE VIDEOS IN THE FIELD OF YOGA INSTRUCTION AND TRAINING, PHYSICAL FITNESS INSTRUCTION, YOGA, RELIGION, HEALTH, HEALING, RELIGIOUS UNITY, WORLD PEACE, SPIRITUAL DEVELOPMENT, SPIRITUAL GROWTH, PERSONAL SPIRITUAL EXPLORATION, SPIRITUAL STUDIES, HOLISTIC HEALTH, NUTRITION, FITNESS, EXERCISE, BEAUTY, PAINTING, WRITING, AND DANCING, AND CERTIFICATION OF TEACHERS AND CONTINUING EDUCATION FOR TEACHERS IN YOGA INSTRUCTION; EDUCATIONAL SERVICES, NAMELY, PROVIDING INSTRUCTION, CLASSES, AND SEMINARS IN THE FIELD OF YOGA AND YOGA INSTRUCTION AND TRAINING, IN CLASS 41 (U.S. CLS. 100, 101 AND 107).

FIRST USE 8-1-1976; IN COMMERCE 9-1-1976.

THE MARK CONSISTS OF STANDARD CHARACTERS WITHOUT CLAIM TO ANY PARTICULAR FONT, STYLE, SIZE, OR COLOR.

OWNER OF U.S. REG. NOS. 1,477,138, 2,766,923, AND 2,775,878.

SER. NO. 85-349,492, FILED 6-17-2011.

PAM WILLIS, EXAMINING ATTORNEY

United States of America

United States Patent and Trademark Office

JUAN CARLOS CAMARENA

Reg. No. 4,174,147

Registered July 17, 2012

Int. Cl.: 33

TRADEMARK

PRINCIPAL REGISTER

TEQUILA SUPREMO, S.A. DE C.V. (MEXICO SOCIEDAD ANONIMA (SA DE CV))
CARRETERA A LA BASE AÉREA # 3460-4
COL. BASE AÉREA II C.P. 45200 ZAPOPAN
JALISCO, MEXICO

FOR: ALCOHOLIC BEVERAGES, EXCEPT BEERS, IN CLASS 33 (U.S. CLS. 47 AND 49).

THE MARK CONSISTS OF STANDARD CHARACTERS WITHOUT CLAIM TO ANY PARTICULAR FONT, STYLE, SIZE, OR COLOR.

OWNER OF MEXICO REG. NO. 1214247, DATED 4-28-2011, EXPIRES 12-1-2020.

OWNER OF U.S. REG. NOS. 3,574,282 AND 3,945,075.

THE NAME(S), PORTRAIT(S), AND/OR SIGNATURE(S) SHOWN IN THE MARK IDENTIFIES "JUAN CARLOS CAMARENA", WHOSE CONSENT(S) TO REGISTER IS MADE OF RECORD.

SER. NO. 85-349,837, FILED 6-18-2011.

DARRYL SPRUILL, EXAMINING ATTORNEY



David J. Kyffers

Director of the United States Patent and Trademark Office

United States of America

United States Patent and Trademark Office

MAURICIO CAMARENA

Reg. No. 4,174,148

Registered July 17, 2012

Int. Cl.: 33

TRADEMARK

PRINCIPAL REGISTER

TEQUILA SUPREMO, S.A. DE C.V. (MEXICO SOCIEDAD ANONIMA (SA DE CV))
CARRETERA A LA BASE AÉREA # 3460-4
COL. BASE AÉREA II C.P. 45200 ZAPOPAN
JALISCO, MEXICO

FOR: ALCOHOLIC BEVERAGES, EXCEPT BEERS, IN CLASS 33 (U.S. CLS. 47 AND 49).

THE MARK CONSISTS OF STANDARD CHARACTERS WITHOUT CLAIM TO ANY PARTICULAR FONT, STYLE, SIZE, OR COLOR.

OWNER OF MEXICO REG. NO. 1214246, DATED 4-28-2011, EXPIRES 12-1-2020.

OWNER OF U.S. REG. NOS. 3,574,282 AND 3,945,075.

THE NAME(S), PORTRAIT(S), AND/OR SIGNATURE(S) SHOWN IN THE MARK IDENTIFIES "MAURICIO CAMARENA", WHOSE CONSENT(S) TO REGISTER IS MADE OF RECORD.

SER. NO. 85-349,839, FILED 6-18-2011.

DARRYL SPRUILL, EXAMINING ATTORNEY



David J. Kyffers

Director of the United States Patent and Trademark Office

United States of America

United States Patent and Trademark Office



Reg. No. 4,174,149

Registered July 17, 2012

Int. Cl.: 9

TRADEMARK

PRINCIPAL REGISTER

HOSANNA (NEW MEXICO CORPORATION), DBA FAITH COMES BY HEARING
2421 AZTEC ROAD NE
ALBUQUERQUE, NM 87107

FOR: COMPUTER APPLICATION SOFTWARE FOR DISTRIBUTION OF DIGITAL CONTENT VIA INTERNET NETWORKS, NAMELY, SOFTWARE FOR AUDIO AND TEXT; COMPUTER APPLICATION SOFTWARE FOR DISTRIBUTION OF DIGITAL CONTENT, NAMELY, RELIGIOUS MATERIAL; COMPUTER APPLICATION SOFTWARE FOR DISTRIBUTION OF DIGITAL CONTENT, NAMELY, HUMANITARIAN AND EDUCATIONAL INFORMATION PROVIDED VIA MOBILE PHONES AND A GLOBAL COMMUNICATION NETWORK, IN CLASS 9 (U.S. CLS. 21, 23, 26, 36 AND 38).

FIRST USE 5-31-2011; IN COMMERCE 5-31-2011.

OWNER OF U.S. REG. NO. 3,940,366.

THE COLOR(S) RED AND WHITE IS/ARE CLAIMED AS A FEATURE OF THE MARK.

THE NON-LATIN CHARACTERS IN THE MARK TRANSLITERATE TO "SHÈNG JING" AND THIS MEANS "BIBLE" IN ENGLISH.

THE MARK CONSISTS OF CHINESE CHARACTERS JOINED WITH THE WORDING ".IS" IN WHITE ON A RED SQUARE BACKGROUND WITH ROUNDED CORNERS.

THE ENGLISH TRANSLATION OF CHINESE CHARACTERS IN THE MARK IS "BIBLE".

SER. NO. 85-350,249, FILED 6-20-2011.

CHRISTINE COOPER, EXAMINING ATTORNEY



David J. Kybas

Director of the United States Patent and Trademark Office

United States of America

United States Patent and Trademark Office

GREENFIT

Reg. No. 4,174,150

FUNCTIONAL FOODS INC. (CALIFORNIA CORPORATION)
35 LA VERNE AVENUE
LONG BEACH, CA 90803

Registered July 17, 2012

Int. Cl.: 5

FOR: NUTRITIONAL FOOD BARS FOR USE AS A MEAL REPLACEMENT; NUTRITIONALLY FORTIFIED BEVERAGES; POWDERED NUTRITIONAL SUPPLEMENT DRINK MIX, IN CLASS 5 (U.S. CLS. 6, 18, 44, 46, 51 AND 52).

TRADEMARK

FIRST USE 6-1-2010; IN COMMERCE 1-14-2011.

PRINCIPAL REGISTER

THE MARK CONSISTS OF STANDARD CHARACTERS WITHOUT CLAIM TO ANY PARTICULAR FONT, STYLE, SIZE, OR COLOR.

OWNER OF U.S. REG. NO. 4,068,330.

SER. NO. 85-350,270, FILED 6-20-2011.

JANICE L. MCMORROW, EXAMINING ATTORNEY



David J. Kyros

Director of the United States Patent and Trademark Office

United States of America

United States Patent and Trademark Office

ENERGIE DE VIE

Reg. No. 4,174,151

Registered July 17, 2012

Int. Cl.: 3

TRADEMARK

PRINCIPAL REGISTER

LANCOME PARFUMS ET BEAUTE & CIE (FRANCE SOCIÉTÉ EN NOM COLLECTIF (SENC))
29, RUE DU FAUBOURG SAINT-HONORE
PARIS, FRANCE 75008

FOR: PERFUME; EAU DE TOILETTE; BATH AND SHOWER GELS AND SALTS NOT FOR MEDICAL PURPOSE; TOILET SOAPS; BODY DEODORANTS; COSMETICS, NAMELY, CREAMS, MILKS, LOTIONS, GELS AND POWDERS FOR THE FACE, BODY AND HANDS; NON-MEDICATED SUN CARE PREPARATIONS; MAKEUP PREPARATIONS; SHAMPOOS; HAIR GELS, SPRAYS AND MOUSSES; HAIR LACQUERS; HAIR COLOURING AND DE-COLORANT PREPARATIONS; PERMANENT WAVE AND HAIR CURLING PREPARATIONS; ESSENTIAL OILS FOR PERSONAL USE, IN CLASS 3 (U.S. CLS. 1, 4, 6, 50, 51 AND 52).

THE MARK CONSISTS OF STANDARD CHARACTERS WITHOUT CLAIM TO ANY PARTICULAR FONT, STYLE, SIZE, OR COLOR.

PRIORITY CLAIMED UNDER SEC. 44(D) ON FRANCE APPLICATION NO. 11/3828645, FILED 5-3-2011, REG. NO. 113828645, DATED 5-4-2011, EXPIRES 5-4-2021.

THE ENGLISH TRANSLATION OF "ENERGIE DE VIE" IN THE MARK IS ENERGY OF LIFE.

SER. NO. 85-351,460, FILED 6-21-2011.

KATHRYN COWARD, EXAMINING ATTORNEY



David J. Kyjars

Director of the United States Patent and Trademark Office

United States of America

United States Patent and Trademark Office



Reg. No. 4,174,152

Registered July 17, 2012

Int. Cl.: 35

SERVICE MARK

PRINCIPAL REGISTER

J. BYRNE AGENCY, INC. (NEW JERSEY CORPORATION)
P.O. BOX 1409
5200 NEW JERSEY AVENUE
WILDWOOD, NJ 08260

FOR: PROVIDING INSURANCE AGENT REFERRALS IN THE FIELD OF MARINE INSURANCE POLICIES, IN CLASS 35 (U.S. CLS. 100, 101 AND 102).

FIRST USE 11-1-2008; IN COMMERCE 11-1-2008.

NO CLAIM IS MADE TO THE EXCLUSIVE RIGHT TO USE "MARINE INSURANCE", APART FROM THE MARK AS SHOWN.

THE NAME "J. BYRNE" DOES NOT IDENTIFY A PARTICULAR LIVING INDIVIDUAL.

THE MARK CONSISTS OF THE DESIGN OF THE FRONT OF A BOAT THAT CONTAINS AT ITS BOTTOM THE STYLIZED WORDING "J. BYRNE MARINE INSURANCE".

SER. NO. 85-351,564, FILED 6-21-2011.

DAWN HAN, EXAMINING ATTORNEY



David J. Kybas

Director of the United States Patent and Trademark Office

United States of America

United States Patent and Trademark Office

Donor Insight Gateway

Reg. No. 4,174,153

Registered July 17, 2012

Int. Cl.: 35

SERVICE MARK

PRINCIPAL REGISTER

DRAKES BAY FUNDRAISING, INC. (CALIFORNIA CORPORATION)
SUITE 280
1100 LARKSPUR LANDING CIRCLE
LARKSPUR, CA 94939

FOR: STATISTICAL ANALYSIS AND REPORTING SERVICES FOR BUSINESS PURPOSES,
IN CLASS 35 (U.S. CLS. 100, 101 AND 102).

FIRST USE 1-11-2011; IN COMMERCE 1-11-2011.

THE MARK CONSISTS OF STANDARD CHARACTERS WITHOUT CLAIM TO ANY PAR-
TICULAR FONT, STYLE, SIZE, OR COLOR.

NO CLAIM IS MADE TO THE EXCLUSIVE RIGHT TO USE "DONOR", APART FROM THE
MARK AS SHOWN.

SER. NO. 85-351,876, FILED 6-21-2011.

ANTHONY RINKER, EXAMINING ATTORNEY



David J. Kybas

Director of the United States Patent and Trademark Office

United States of America

United States Patent and Trademark Office

BRAIN-TARGETED TEACHING

Reg. No. 4,174,154

MARIALE HARDIMAN (UNITED STATES INDIVIDUAL)
5804 KIPLING COURT
BALTIMORE, MD 21212

Registered July 17, 2012

Int. Cls.: 16 and 41

FOR: BOOKS, WRITTEN ARTICLES, HANDOUTS, AND WORKSHEETS IN THE FIELD OF EDUCATION, IN CLASS 16 (U.S. CLS. 2, 5, 22, 23, 29, 37, 38 AND 50).

TRADEMARK

FIRST USE 5-23-2011; IN COMMERCE 5-23-2011.

SERVICE MARK

FOR: RESEARCH IN THE FIELD OF EDUCATION; EDUCATION SERVICES, NAMELY, PROVIDING SEMINARS AND WORKSHOPS FOR TEACHERS IN THE FIELD OF EDUCATION, IN CLASS 41 (U.S. CLS. 100, 101 AND 107).

PRINCIPAL REGISTER

FIRST USE 5-23-2011; IN COMMERCE 5-23-2011.

THE MARK CONSISTS OF STANDARD CHARACTERS WITHOUT CLAIM TO ANY PARTICULAR FONT, STYLE, SIZE, OR COLOR.

NO CLAIM IS MADE TO THE EXCLUSIVE RIGHT TO USE "TEACHING", APART FROM THE MARK AS SHOWN.

SER. NO. 85-352,774, FILED 6-22-2011.

MICHELLE DUBOIS, EXAMINING ATTORNEY



David J. Kyjars

Director of the United States Patent and Trademark Office

United States of America

United States Patent and Trademark Office

ETHIOPIAN SUPER NATURAL

Reg. No. 4,174,155

Registered July 17, 2012

Int. Cl.: 30

TRADEMARK

PRINCIPAL REGISTER

PEET'S TRADEMARK COMPANY (WASHINGTON CORPORATION)
1400 PARK AVENUE
EMERYVILLE, CA 94608

FOR: COFFEE, IN CLASS 30 (U.S. CL. 46).

FIRST USE 9-0-2006; IN COMMERCE 9-0-2006.

THE MARK CONSISTS OF STANDARD CHARACTERS WITHOUT CLAIM TO ANY PARTICULAR FONT, STYLE, SIZE, OR COLOR.

NO CLAIM IS MADE TO THE EXCLUSIVE RIGHT TO USE "ETHIOPIAN", APART FROM THE MARK AS SHOWN.

SER. NO. 85-353,479, FILED 6-22-2011.

LOURDES AYALA, EXAMINING ATTORNEY



David J. Kyffers

Director of the United States Patent and Trademark Office

United States of America

United States Patent and Trademark Office



Reg. No. 4,174,156

Registered July 17, 2012

Int. Cl.: 35

SERVICE MARK

PRINCIPAL REGISTER

CAPANTZZI, LLC (NEW JERSEY LIMITED LIABILITY COMPANY)
121 STRYKER LANE, BLDG. 30, UNIT 8
HILLSBOROUGH, NJ 08844

FOR: ONLINE RETAIL APPAREL STORES, IN CLASS 35 (U.S. CLS. 100, 101 AND 102).

FIRST USE 5-12-2011; IN COMMERCE 6-12-2011.

THE MARK CONSISTS OF THE LETTER "C" WHICH APPEARS AS A STYLIZED BRUSH-STROKE, UNDERNEATH WHICH APPEARS THE WORDING "CAPANTZZI COLOR YOUR LIFE".

SER. NO. 85-353,728, FILED 6-23-2011.

EMILY CARLSEN, EXAMINING ATTORNEY



David J. Kybas

Director of the United States Patent and Trademark Office

United States of America

United States Patent and Trademark Office

eUgot
entertainment
Network

Reg. No. 4,174,157

Registered July 17, 2012

Int. Cls.: 38 and 41

SERVICE MARK

PRINCIPAL REGISTER

VASQUEZ, JUAN C. (UNITED STATES INDIVIDUAL)
7546 BRUSHWOOD DR.
HOUSTON, TX 77055

FOR: STREAMING OF AUDIO, VISUAL AND AUDIOVISUAL MATERIAL VIA A GLOBAL COMPUTER NETWORK; PROVIDING AN ON-LINE FORUM FOR DISCUSSION OF VIDEOS, FILMS, AND ENTERTAINMENT TOPICS, IN CLASS 38 (U.S. CLS. 100, 101 AND 104).

FIRST USE 9-11-2010; IN COMMERCE 3-12-2011.

FOR: ENTERTAINMENT SERVICES, NAMELY, PROVIDING NON-DOWNLOADABLE IMAGES, GRAPHICS, VIDEO, AND PHOTOGRAPHS IN THE FIELD OF ENTERTAINMENT VIA A GLOBAL COMPUTER NETWORK, IN CLASS 41 (U.S. CLS. 100, 101 AND 107).

FIRST USE 9-11-2010; IN COMMERCE 3-12-2011.

NO CLAIM IS MADE TO THE EXCLUSIVE RIGHT TO USE "ENTERTAINMENT NETWORK", APART FROM THE MARK AS SHOWN.

THE MARK CONSISTS OF THE TEXT "EUGOT ENTERTAINMENT NETWORK" IN A STACKED FORMATION, WITH AN OVAL, ABOVE THE "G" AND "O" IN "EUGOT" IS A CIRCLE, AND THE "U" IN "EUGOT" AND THE "N" IN "NETWORK" ARE CAPITALIZED.

SER. NO. 85-354,679, FILED 6-23-2011.

ROBERT C. CLARK JR., EXAMINING ATTORNEY



David J. Kybas

Director of the United States Patent and Trademark Office

United States of America

United States Patent and Trademark Office

20 Mondì

Reg. No. 4,174,158

LOOS MICHAEL (UNITED STATES INDIVIDUAL)
VIA BENEDETTO MARCELLO 4
MILANO, ITALY

Registered July 17, 2012

**Int. Cls.: 33, 38, 41 and
43**

FOR: WINE, IN CLASS 33 (U.S. CLS. 47 AND 49).

FOR: PROVIDING INTERNET CHAT ROOMS; PROVISION OF ACCESS TO ELECTRONIC SITES, IN CLASS 38 (U.S. CLS. 100, 101 AND 104).

TRADEMARK

FOR: ORGANIZATION OF EVENTS FOR CULTURAL PURPOSES; ORGANIZATION OF EXHIBITIONS FOR CULTURAL OR EDUCATIONAL PURPOSES; ORGANIZING AND HOSTING OF EVENTS FOR CULTURAL PURPOSES; ORGANIZING CULTURAL AND ARTS EVENTS; PROVIDING AN INTERNET WEBSITE PORTAL IN THE FIELD OF ENTERTAINMENT, CULTURAL AND SPORTING EVENTS; PROVISION OF INFORMATION RELATING TO THE ORGANIZING OF EDUCATIONAL, CULTURAL, SPORTING, OR ENTERTAINMENT EXHIBITIONS, IN CLASS 41 (U.S. CLS. 100, 101 AND 107).

SERVICE MARK

PRINCIPAL REGISTER

FOR: BAR AND RESTAURANT SERVICES, IN CLASS 43 (U.S. CLS. 100 AND 101).

THE MARK CONSISTS OF STANDARD CHARACTERS WITHOUT CLAIM TO ANY PARTICULAR FONT, STYLE, SIZE, OR COLOR.

PRIORITY CLAIMED UNDER SEC. 44(D) ON ERPN CMNTY TM OFC APPLICATION NO. 010074326, FILED 6-24-2011, REG. NO. 010074326, DATED 2-11-2012, EXPIRES 6-24-2021.

THE ENGLISH TRANSLATION OF "MONDI" IN THE MARK IS "WORLDS".

SER. NO. 85-355,015, FILED 6-24-2011.

JULIE WATSON, EXAMINING ATTORNEY



David J. Kypos

Director of the United States Patent and Trademark Office

United States of America

United States Patent and Trademark Office

PRINOVA

Reg. No. 4,174,159

Registered July 17, 2012

Int. Cls.: 9 and 42

TRADEMARK

SERVICE MARK

PRINCIPAL REGISTER

PRINOVA, INC. (CANADA CORPORATION)
155 UNIVERSITY AVENUE, SUITE 207
TORONTO, CANADA M5H3B7

FOR: COMPUTER SOFTWARE, NAMELY, COMPUTER SOFTWARE FOR MANAGING AND MEASURING MARKETING MESSAGES ACROSS CUSTOMER TOUCH POINTS; COMPUTER SOFTWARE FOR MANAGING AND MEASURING PAPER-BASED MARKETING MESSAGES; COMPUTER SOFTWARE FOR MANAGING AND MEASURING ELECTRONIC DOCUMENT MARKETING MESSAGES; COMPUTER SOFTWARE FOR MANAGING AND MEASURING E-MAIL MARKETING MESSAGES; COMPUTER SOFTWARE FOR MANAGING AND MEASURING WEB-BASED MESSAGES; COMPUTER SOFTWARE FOR MANAGING AND MEASURING VOICE MESSAGES, SUCH AS VOICE MESSAGES ORIGINATING FROM CALL CENTERS; ELECTRONIC PUBLICATIONS, NAMELY, ELECTRONIC PAMPHLETS, BROCHURES AND MANUALS FEATURING COMPUTER SOFTWARE FOR MANAGING AND MEASURING MARKETING MESSAGES ACROSS CUSTOMER TOUCH POINTS, PAPER-BASED MARKETING MESSAGES, ELECTRONIC DOCUMENT MARKETING MESSAGES, E-MAIL MARKETING MESSAGES, WEB-BASED MESSAGES, AND VOICE MESSAGES, SUCH AS VOICE MESSAGES ORIGINATING FROM CALL CENTERS ALL FOR USE WITH THE AFOREMENTIONED GOODS PROVIDED ON ELECTRONIC MEDIA ENCLOSED WITH THE WARES, IN CLASS 9 (U.S. CLS. 21, 23, 26, 36 AND 38).

FIRST USE 12-7-2007; IN COMMERCE 12-7-2007.



FOR: COMPUTER, CONSULTING, SUPPORT AND PROGRAMMING SERVICES, NAMELY, SOFTWARE PROGRAMMING AND CUSTOMIZATION, ARCHITECTURE, DESIGN, ENGINEERING, PROGRAMMING, QUALITY ASSURANCE, TESTING AND SUPPORT OF IMPLEMENTED MESSAGING SOFTWARE AND RELATED SOFTWARE APPLICATIONS; COMPUTER CONSULTATION SERVICES IN THE FIELD OF MESSAGING ARCHITECTURE, DESIGN, INSTALLATION, IMPLEMENTATION, CONFIGURATION, INTEGRATION AND OPERATION, IN CLASS 42 (U.S. CLS. 100 AND 101).

FIRST USE 10-1-1998; IN COMMERCE 10-1-1998.

David J. Kypos

THE MARK CONSISTS OF STANDARD CHARACTERS WITHOUT CLAIM TO ANY PARTICULAR FONT, STYLE, SIZE, OR COLOR.

SER. NO. 85-355,407, FILED 6-24-2011.

Reg. No. 4,174,159 KIMBERLY PERRY, EXAMINING ATTORNEY

United States of America

United States Patent and Trademark Office

SALUD PARA TODOS

Reg. No. 4,174,160

Registered July 17, 2012

Int. Cl.: 5

TRADEMARK

PRINCIPAL REGISTER

SALUD PARA TODOS INC. (NEW YORK CORPORATION)
3773 103 ST
CORONA, NY 11368

FOR: DIETARY SUPPLEMENTS; HEALTH FOOD SUPPLEMENTS; HOMEOPATHIC SUPPLEMENTS; NATURAL HERBAL SUPPLEMENTS; NUTRITIONAL SUPPLEMENTS; VITAMIN SUPPLEMENTS DIETARY AND NUTRITIONAL SUPPLEMENTS, IN CLASS 5 (U.S. CLS. 6, 18, 44, 46, 51 AND 52).

FIRST USE 5-2-1989; IN COMMERCE 4-26-2001.

THE MARK CONSISTS OF STANDARD CHARACTERS WITHOUT CLAIM TO ANY PARTICULAR FONT, STYLE, SIZE, OR COLOR.

NO CLAIM IS MADE TO THE EXCLUSIVE RIGHT TO USE "SALUD", APART FROM THE MARK AS SHOWN.

THE ENGLISH TRANSLATION OF "SALUD PARA TODOS" IN THE MARK IS HEALTH FOR ALL.

SER. NO. 85-355,597, FILED 6-24-2011.

STEVEN R. FINE, EXAMINING ATTORNEY



David J. Kybas

Director of the United States Patent and Trademark Office

United States of America

United States Patent and Trademark Office

FORWARD THINKING. FORWARD
MOTION. FORWARD SYSTEMS.

Reg. No. 4,174,161

FORWARD SYSTEMS GROUP, INC. (FLORIDA CORPORATION)
1915 NW 79TH AVENUE
DORAL, FL 33126

Registered July 17, 2012

Int. Cl.: 39

FOR: FREIGHT FORWARDING SERVICES; SUPPLY CHAIN LOGISTICS AND REVERSE LOGISTICS SERVICES, NAMELY, STORAGE, TRANSPORTATION AND DELIVERY OF DOCUMENTS, PACKAGES, RAW MATERIALS, AND OTHER FREIGHT FOR OTHER BY AIR, RAIL, SHIP OR TRUCK, IN CLASS 39 (U.S. CLS. 100 AND 105).

SERVICE MARK

PRINCIPAL REGISTER

FIRST USE 3-1-2011; IN COMMERCE 3-1-2011.

THE MARK CONSISTS OF STANDARD CHARACTERS WITHOUT CLAIM TO ANY PARTICULAR FONT, STYLE, SIZE, OR COLOR.

SER. NO. 85-355,674, FILED 6-24-2011.

TARAH HARDY, EXAMINING ATTORNEY



David J. Kybas

Director of the United States Patent and Trademark Office

United States of America

United States Patent and Trademark Office



JUSTICE FOR VETS

Reg. No. 4,174,162

Registered July 17, 2012

Int. Cl.: 35

NATIONAL ASSOCIATION OF DRUG COURT PROFESSIONALS (VIRGINIA CORPORATION)
SUITE 201
1029 N. ROYAL STREET
ALEXANDRIA, VA 22314

SERVICE MARK

PRINCIPAL REGISTER

FOR: PROMOTING PUBLIC AWARENESS OF VETERANS TREATMENT COURTS; INFORMATION CLEARING HOUSE IN THE FIELD OF VETERANS TREATMENT COURTS, IN CLASS 35 (U.S. CLS. 100, 101 AND 102).

FIRST USE 10-0-2010; IN COMMERCE 10-0-2010.

NO CLAIM IS MADE TO THE EXCLUSIVE RIGHT TO USE "VETS", APART FROM THE MARK AS SHOWN.

THE MARK CONSISTS OF FIVE STARS AND THE REPRESENTATION OF SCALES IN A CIRCULAR FIELD TO THE LEFT OF THE LITERAL ELEMENT "JUSTICE" ALL STACKED ABOVE THE LITERAL ELEMENT "FOR VETS".

SER. NO. 85-355,808, FILED 6-24-2011.

FLORENTINA BLANDU, EXAMINING ATTORNEY



David J. Kyjars

Director of the United States Patent and Trademark Office

United States of America

United States Patent and Trademark Office

JUSTICE FOR VETS

Reg. No. 4,174,163

Registered July 17, 2012

Int. Cl.: 35

NATIONAL ASSOCIATION OF DRUG COURT PROFESSIONALS (VIRGINIA CORPORATION)
SUITE 201
1029 N. ROYAL STREET
ALEXANDRIA, VA 22314

SERVICE MARK

PRINCIPAL REGISTER

FOR: PROMOTING PUBLIC AWARENESS OF VETERANS TREATMENT COURTS; INFORMATION CLEARING HOUSE IN THE FIELD OF VETERANS TREATMENT COURTS, IN CLASS 35 (U.S. CLS. 100, 101 AND 102).

FIRST USE 5-0-2010; IN COMMERCE 5-0-2010.

THE MARK CONSISTS OF STANDARD CHARACTERS WITHOUT CLAIM TO ANY PARTICULAR FONT, STYLE, SIZE, OR COLOR.

NO CLAIM IS MADE TO THE EXCLUSIVE RIGHT TO USE "VETS", APART FROM THE MARK AS SHOWN.

SER. NO. 85-355,831, FILED 6-24-2011.

FLORENTINA BLANDU, EXAMINING ATTORNEY



David J. Kyffers

Director of the United States Patent and Trademark Office

United States of America

United States Patent and Trademark Office

CENTURYTEL CENTER

Reg. No. 4,174,164

CENTURYLINK, INC. (LOUISIANA CORPORATION)
100 CENTURYLINK DR.
MONROE, LA 71203

Registered July 17, 2012

Int. Cl.: 41

FOR: PRODUCTION OF BUSINESS, SPORTS AND ENTERTAINMENT EVENTS FOR PUBLIC EXHIBITION AND TELEVISION AND RADIO BROADCAST, IN CLASS 41 (U.S. CLS. 100, 101 AND 107).

SERVICE MARK

FIRST USE 10-28-2000; IN COMMERCE 10-28-2000.

PRINCIPAL REGISTER

THE MARK CONSISTS OF STANDARD CHARACTERS WITHOUT CLAIM TO ANY PARTICULAR FONT, STYLE, SIZE, OR COLOR.

NO CLAIM IS MADE TO THE EXCLUSIVE RIGHT TO USE "CENTER", APART FROM THE MARK AS SHOWN.

SER. NO. 85-355,835, FILED 6-24-2011.

JAMES A. RAUEN, EXAMINING ATTORNEY



David J. Kyffers

Director of the United States Patent and Trademark Office

United States of America

United States Patent and Trademark Office

CASCADE
WATER SERVICES

Reg. No. 4,174,165

CASCADE WATER SERVICES, INC. (NEW YORK CORPORATION)
113 BLOOMINGDALE ROAD
HICKSVILLE, NY 11801

Registered July 17, 2012

Int. Cls.: 1, 40 and 42

FOR: CHEMICALS, NAMELY, USED FOR TREATING WATER CONTAINED IN WATER RECIRCULATION SYSTEMS INCLUDING BOILER AND COOLING SYSTEMS, AND FOR TREATING WATER USED IN MANUFACTURING PROCESS SYSTEMS AND IN DOMESTIC WATER SYSTEMS, IN CLASS 1 (U.S. CLS. 1, 5, 6, 10, 26 AND 46).

TRADEMARK

SERVICE MARK

FIRST USE 10-15-1981; IN COMMERCE 10-15-1981.

PRINCIPAL REGISTER

FOR: WATER SYSTEM TREATMENT SERVICES, NAMELY, WATER TREATMENT AND CONDITIONING SERVICES OF WATER WITHIN OPEN AND CLOSED WATER SYSTEMS INCLUDING DOMESTIC WATER SYSTEMS, MANUFACTURING PROCESS SYSTEMS, BOILER SYSTEMS AND HEATING AND COOLING SYSTEMS; AIR TREATMENT SERVICES, NAMELY, AIR DEODORIZING, FRESHENING, AND PURIFICATION OF AIR WITHIN AIR VENTILATION AND RECIRCULATION SYSTEMS, IN CLASS 40 (U.S. CLS. 100, 103 AND 106).

FIRST USE 10-15-1981; IN COMMERCE 10-15-1981.

FOR: WATER SYSTEM ANALYSIS SERVICES, NAMELY, TESTING OF WATER QUALITY WITHIN OPEN AND CLOSED WATER SYSTEMS INCLUDING DOMESTIC WATER SYSTEMS, MANUFACTURING PROCESS SYSTEMS, BOILER SYSTEMS AND HEATING AND COOLING SYSTEMS; INTEGRITY TESTING SERVICES, NAMELY, NON-DESTRUCTIVE TESTING OF PIPES AND OTHER CONDUITS USED IN OPEN AND CLOSED WATER SYSTEMS INCLUDING DOMESTIC WATER SYSTEMS, MANUFACTURING PROCESS SYSTEMS, BOILER SYSTEMS AND HEATING AND COOLING SYSTEMS; AIR QUALITY TESTING OF AIR WITHIN AIR VENTILATION AND RECIRCULATION SYSTEMS; TECHNICAL ANALYSIS OF PROCEDURES AND PROCESSES USED IN THE MAINTENANCE AND REPAIR OF AIR AND WATER HEATING AND COOLING SYSTEMS AND CONSULTATION IN CONNECTION THEREWITH; TECHNICAL WRITING FOR OTHERS, NAMELY, SPECIFICATION WRITING SERVICES REGARDING SPECIFICATIONS AND PROCEDURES FOR MAINTAINING AIR AND WATER HEATING AND COOLING SYSTEMS, IN CLASS 42 (U.S. CLS. 100 AND 101).



David J. Kypos

Director of the United States Patent and Trademark Office

FIRST USE 10-15-1981; IN COMMERCE 10-15-1981.

Reg. No. 4,174,165 NO CLAIM IS MADE TO THE EXCLUSIVE RIGHT TO USE "WATER SERVICES", APART FROM THE MARK AS SHOWN.

SER. NO. 85-356,584, FILED 6-27-2011.

MARY CRAWFORD, EXAMINING ATTORNEY

United States of America

United States Patent and Trademark Office

CASCADE WATER SERVICES

Reg. No. 4,174,166

CASCADE WATER SERVICES, INC. (NEW YORK CORPORATION)
113 BLOOMINGDALE ROAD
HICKSVILLE, NY 11801

Registered July 17, 2012

Int. Cls.: 1, 40 and 42

FOR: CHEMICALS, NAMELY, USED FOR TREATING WATER CONTAINED IN WATER RECIRCULATION SYSTEMS INCLUDING BOILER AND COOLING SYSTEMS, AND FOR TREATING WATER USED IN MANUFACTURING PROCESS SYSTEMS AND IN DOMESTIC WATER SYSTEMS, IN CLASS 1 (U.S. CLS. 1, 5, 6, 10, 26 AND 46).

TRADEMARK

SERVICE MARK

FIRST USE 10-15-1981; IN COMMERCE 10-15-1981.

PRINCIPAL REGISTER

FOR: WATER SYSTEM TREATMENT SERVICES, NAMELY, WATER TREATMENT AND CONDITIONING SERVICES OF WATER WITHIN OPEN AND CLOSED WATER SYSTEMS INCLUDING DOMESTIC WATER SYSTEMS, MANUFACTURING PROCESS SYSTEMS, BOILER SYSTEMS AND HEATING AND COOLING SYSTEMS; AIR TREATMENT SERVICES, NAMELY, AIR DEODORIZING, FRESHENING, AND PURIFICATION OF AIR WITHIN AIR VENTILATION AND RECIRCULATION SYSTEMS, IN CLASS 40 (U.S. CLS. 100, 103 AND 106).

FIRST USE 10-15-1981; IN COMMERCE 10-15-1981.



David J. Kyjars

Director of the United States Patent and Trademark Office

FOR: WATER SYSTEM ANALYSIS SERVICES, NAMELY, TESTING OF WATER QUALITY WITHIN OPEN AND CLOSED WATER SYSTEMS INCLUDING DOMESTIC WATER SYSTEMS, MANUFACTURING PROCESS SYSTEMS, BOILER SYSTEMS AND HEATING AND COOLING SYSTEMS; INTEGRITY TESTING SERVICES, NAMELY, NON-DESTRUCTIVE TESTING OF PIPES AND OTHER CONDUITS USED IN OPEN AND CLOSED WATER SYSTEMS INCLUDING DOMESTIC WATER SYSTEMS, MANUFACTURING PROCESS SYSTEMS, BOILER SYSTEMS AND HEATING AND COOLING SYSTEMS; AIR QUALITY TESTING SERVICES OF AIR WITHIN AIR VENTILATION AND RECIRCULATION SYSTEMS; TECHNICAL ANALYSIS OF PROCEDURES AND PROCESSES USED IN THE MAINTENANCE AND REPAIR OF AIR AND WATER HEATING AND COOLING SYSTEMS AND CONSULTATION IN CONNECTION THEREWITH; TECHNICAL WRITING FOR OTHERS, NAMELY, SPECIFICATION WRITING SERVICES REGARDING SPECIFICATIONS AND PROCEDURES FOR MAINTAINING AIR AND WATER HEATING AND COOLING SYSTEMS, IN CLASS 42 (U.S. CLS. 100 AND 101).

FIRST USE 10-15-1981; IN COMMERCE 10-15-1981.

Reg. No. 4,174,166 THE MARK CONSISTS OF STANDARD CHARACTERS WITHOUT CLAIM TO ANY PARTICULAR FONT, STYLE, SIZE, OR COLOR.

NO CLAIM IS MADE TO THE EXCLUSIVE RIGHT TO USE "WATER SERVICES", APART FROM THE MARK AS SHOWN.

SER. NO. 85-356,594, FILED 6-27-2011.

MARY CRAWFORD, EXAMINING ATTORNEY

United States of America

United States Patent and Trademark Office

GREEN MACHINE

Reg. No. 4,174,167

HUFFY CORPORATION (OHIO CORPORATION)
6551 CENTERVILLE BUSINESS PARKWAY
CENTERVILLE, OH 45459

Registered July 17, 2012

Int. Cl.: 12

FOR: THREE-WHEELED BICYCLES OR VEHICLES, WITH OR WITHOUT A MOTOR, IN CLASS 12 (U.S. CLS. 19, 21, 23, 31, 35 AND 44).

TRADEMARK

FIRST USE 12-9-2002; IN COMMERCE 12-9-2002.

PRINCIPAL REGISTER

THE MARK CONSISTS OF STANDARD CHARACTERS WITHOUT CLAIM TO ANY PARTICULAR FONT, STYLE, SIZE, OR COLOR.

OWNER OF U.S. REG. NO. 2,748,984.

SEC. 2(F).

SER. NO. 85-356,729, FILED 6-27-2011.

TINA L. SNAPP, EXAMINING ATTORNEY



David J. Kybas

Director of the United States Patent and Trademark Office

United States of America

United States Patent and Trademark Office

Independent Living Experience

Reg. No. 4,174,168

Registered July 17, 2012

Int. Cl.: 41

COLLEGE LIVING EXPERIENCE, LLC (DELAWARE LIMITED LIABILITY COMPANY),
DBA COLLEGE LIVING EXPERIENCE, LLC
SUITE J
7150 COLUMBIA GATEWAY DRIVE
COLUMBIA, MD 21046

SERVICE MARK

PRINCIPAL REGISTER

FOR: EDUCATION SERVICES, NAMELY, PROVIDING A NON-THERAPEUTIC POST-SECONDARY SUPPORT PROGRAM IN THE NATURE OF CLASSES, TUTORING AND WORKSHOPS DESIGNED TO PROVIDE ASSISTANCE TO YOUNG ADULTS WITH VARYING EXCEPTIONALITIES TO ACHIEVE INDEPENDENCE IN THE FIELDS OF INDEPENDENT LIVING SUPPORT AND SOCIAL SUPPORT, AS WELL AS SUPPORT IN TRANSITIONING INTO THE WORKFORCE, IN CLASS 41 (U.S. CLS. 100, 101 AND 107).

FIRST USE 6-23-2011; IN COMMERCE 6-23-2011.

THE MARK CONSISTS OF STANDARD CHARACTERS WITHOUT CLAIM TO ANY PARTICULAR FONT, STYLE, SIZE, OR COLOR.

NO CLAIM IS MADE TO THE EXCLUSIVE RIGHT TO USE "INDEPENDENT LIVING", APART FROM THE MARK AS SHOWN.

SER. NO. 85-356,951, FILED 6-27-2011.

MARLENE BELL, EXAMINING ATTORNEY



David J. Kyffers

Director of the United States Patent and Trademark Office

United States of America

United States Patent and Trademark Office

HELPING YOU SECURE YOUR FINANCIAL FUTURE TODAY

Reg. No. 4,174,169

Registered July 17, 2012

Int. Cl.: 36

SERVICE MARK

PRINCIPAL REGISTER

METROPOLITAN LIFE INSURANCE COMPANY (NEW YORK CORPORATION)
1095 AVENUE OF THE AMERICAS
NEW YORK, NY 10036

FOR: INSURANCE, BANKING AND FINANCIAL SERVICES, NAMELY, UNDERWRITING AND ADMINISTRATION OF LONG TERM CARE, DISABILITY, DENTAL, PROPERTY AND CASUALTY AND LIFE INSURANCE; FINANCIAL ADMINISTRATION OF RETIREMENT PLANS, NAMELY, TAX-DEFERRED RETIREMENT PLANS; ADMINISTRATION OF ANNUITIES, NAMELY, DISTRIBUTED ANNUITIES; ADMINISTRATION OF EMPLOYEE BENEFITS PLANS CONCERNING INSURANCE AND FINANCE; ADMINISTRATION OF LEGAL SERVICES INSURANCE PLANS, NAMELY, UNDERWRITING INSURANCE FOR PREPAID LEGAL SERVICES AS AN EMPLOYEE BENEFIT, IN CLASS 36 (U.S. CLS. 100, 101 AND 102).

FIRST USE 12-1-2008; IN COMMERCE 12-1-2008.

THE MARK CONSISTS OF STANDARD CHARACTERS WITHOUT CLAIM TO ANY PARTICULAR FONT, STYLE, SIZE, OR COLOR.

SER. NO. 85-357,550, FILED 6-27-2011.

KATHLEEN LORENZO, EXAMINING ATTORNEY



David J. Kyjars

Director of the United States Patent and Trademark Office

United States of America

United States Patent and Trademark Office

Buchi

Reg. No. 4,174,170

Registered July 17, 2012

Int. Cl.: 30

TRADEMARK

PRINCIPAL REGISTER

ASHEVILLE KOMBUCHA MAMAS, LLC (NORTH CAROLINA LIMITED LIABILITY COMPANY), AKA BUCHI
12 LOCUST COVE ROAD
WEAVERVILLE, NC 28787

FOR: BEVERAGES MADE OF TEA; KOMBUCHA TEA, IN CLASS 30 (U.S. CL. 46).

FIRST USE 7-5-2010; IN COMMERCE 7-5-2010.

THE MARK CONSISTS OF STANDARD CHARACTERS WITHOUT CLAIM TO ANY PARTICULAR FONT, STYLE, SIZE, OR COLOR.

THE WORDING "BUCHI" HAS NO MEANING IN A FOREIGN LANGUAGE.

SER. NO. 85-358,425, FILED 6-28-2011.

HAI-LY LAM, EXAMINING ATTORNEY



David J. Kybas

Director of the United States Patent and Trademark Office

United States of America

United States Patent and Trademark Office



Reg. No. 4,174,171

MILLER, JEFFREY (UNITED STATES INDIVIDUAL)
421 HAMPSHIRE DRIVE
BROOMALL, PA 19008

Registered July 17, 2012

Int. Cl.: 38

FOR: PROVIDING ON-LINE FORUMS AND ELECTRONIC BULLETIN BOARDS FOR TRANSMISSION OF MESSAGES AMONG USERS IN THE FIELDS OF CURRENT EVENTS, GENERAL INTERESTS, POLITICS, TECHNOLOGY, LITERATURE, COMPUTER GAMING, IN CLASS 38 (U.S. CLS. 100, 101 AND 104).

SERVICE MARK

PRINCIPAL REGISTER

FIRST USE 4-1-1987; IN COMMERCE 4-1-1987.

THE MARK CONSISTS OF THE WORD "ONIX" IN BLUE, STYLIZED CAPITAL LETTERS, SHOWN AGAINST A LIGHT BLUE BACKGROUND, EXCEPT FOR THE AREA BEHIND AND TO THE RIGHT OF THE LETTER "X", WHICH IS WHITE, WITH GRAY SHADOWS OF THE LETTERS APPEARING IN THE BACKGROUND, WITH A HORIZONTAL BLACK LINE ABOVE AND BELOW THE WORD "ONIX", AND WITH A WHITE HORIZONTAL BAND ABOVE AND BELOW THE HORIZONTAL BLACK LINES.

THE COLOR(S) BLUE, LIGHT BLUE, GRAY, BLACK AND WHITE IS/ARE CLAIMED AS A FEATURE OF THE MARK.

SER. NO. 85-359,206, FILED 6-29-2011.

ESTHER BELENKER, EXAMINING ATTORNEY



David J. Kyjars

Director of the United States Patent and Trademark Office

United States of America

United States Patent and Trademark Office



Reg. No. 4,174,172

Registered July 17, 2012

Int. Cl.: 37

SERVICE MARK

PRINCIPAL REGISTER

IMC COMPANIES, LLC (NEVADA LIMITED LIABILITY COMPANY)
SUITE 312
3150 LENOX PARK BLVD.
MEMPHIS, TN 38115

FOR: REPAIR AND MAINTENANCE OF MOTOR VEHICLES; REPAIR AND MAINTENANCE OF TRUCKS, TRAILERS, AND SHIPPING CONTAINERS, IN CLASS 37 (U.S. CLS. 100, 103 AND 106).

FIRST USE 4-0-2011; IN COMMERCE 4-0-2011.

NO CLAIM IS MADE TO THE EXCLUSIVE RIGHT TO USE "CO" AND "RIVER CITY" AND "MAINTENANCE AND REPAIR", APART FROM THE MARK AS SHOWN.

THE MARK CONSISTS OF A SHIELD SHAPE CONTAINING FIVE STARS ABOVE A DEPICTION OF A GLOBE CONTAINING THE WORDS "AN IMC CO." TO THE RIGHT OF THE SHIELD ARE THE LETTERS "RCMR" IN ALL CAPS WITH THE WORDS "RIVER CITY MAINTENANCE AND REPAIR" APPEARING IN SMALLER FONT UNDERNEATH.

SER. NO. 85-359,247, FILED 6-29-2011.

CAROLYN CATALDO, EXAMINING ATTORNEY



David J. Kyffers

Director of the United States Patent and Trademark Office

United States of America

United States Patent and Trademark Office



Reg. No. 4,174,173

Registered July 17, 2012

Int. Cl.: 39

SERVICE MARK

PRINCIPAL REGISTER

IMC COMPANIES, LLC (NEVADA LIMITED LIABILITY COMPANY)
SUITE 312
3150 LENOX PARK BLVD.
MEMPHIS, TN 38115

FOR: FREIGHT AND TRANSPORT BROKERAGE; FREIGHT FORWARDING SERVICES; FREIGHT LOADING SERVICES; FREIGHT TRANSPORTATION BY TRUCK, TRAIN, AND INTERMODAL TRANSPORTATION; DRAYAGE AND CARTAGE SERVICES; STORAGE AND DELIVERY OF GOODS, IN CLASS 39 (U.S. CLS. 100 AND 105).

FIRST USE 4-0-2011; IN COMMERCE 4-0-2011.

NO CLAIM IS MADE TO THE EXCLUSIVE RIGHT TO USE "CO" AND "ATLANTIC INTERMODAL SERVICES", APART FROM THE MARK AS SHOWN.

THE MARK CONSISTS OF A SHIELD SHAPE CONTAINING FIVE STARS ABOVE A DEPICTION OF A GLOBE CONTAINING THE WORDS "AN IMC CO." TO THE RIGHT OF THE SHIELD ARE THE LETTERS "AIS" IN ALL CAPS WITH THE WORDS "ATLANTIC INTERMODAL SERVICES" APPEARING IN SMALLER FONT UNDERNEATH.

SER. NO. 85-359,493, FILED 6-29-2011.

CAROLYN CATALDO, EXAMINING ATTORNEY



David J. Kyffers

Director of the United States Patent and Trademark Office

United States of America

United States Patent and Trademark Office



Reg. No. 4,174,174

Registered July 17, 2012

Int. Cl.: 39

SERVICE MARK

PRINCIPAL REGISTER

IMC COMPANIES, LLC (NEVADA LIMITED LIABILITY COMPANY)
SUITE 312
3150 LENOX PARK BLVD.
MEMPHIS, TN 38115

FOR: FREIGHT AND TRANSPORT BROKERAGE; FREIGHT FORWARDING SERVICES; FREIGHT LOADING SERVICES; FREIGHT TRANSPORTATION BY TRUCK, TRAIN, AND INTERMODAL TRANSPORTATION; WAREHOUSING SERVICES, NAMELY, STORAGE, DISTRIBUTION, PICK-UP, AND PACKING FOR SHIPMENT OF DOCUMENTS, PACKAGES, RAW MATERIALS, AND OTHER FREIGHT FOR OTHERS; DRAYAGE AND CARTAGE SERVICES; STORAGE AND DELIVERY OF GOODS, IN CLASS 39 (U.S. CLS. 100 AND 105).

FIRST USE 4-0-2011; IN COMMERCE 4-0-2011.

NO CLAIM IS MADE TO THE EXCLUSIVE RIGHT TO USE "CO" AND "INTERMODAL SERVICES", APART FROM THE MARK AS SHOWN.

THE MARK CONSISTS OF A SHIELD SHAPE CONTAINING FIVE STARS ABOVE A DEPICTION OF A GLOBE CONTAINING THE WORDS "AN IMC CO." TO THE RIGHT OF THE SHIELD ARE THE LETTERS "DNJ" IN ALL CAPS WITH THE WORDS "DNJ INTERMODAL SERVICES" APPEARING IN SMALLER FONT UNDERNEATH.

SER. NO. 85-359,550, FILED 6-29-2011.

CAROLYN CATALDO, EXAMINING ATTORNEY



David J. Kyffers

Director of the United States Patent and Trademark Office

United States of America

United States Patent and Trademark Office



Reg. No. 4,174,175

Registered July 17, 2012

Int. Cl.: 39

SERVICE MARK

PRINCIPAL REGISTER

IMC COMPANIES, LLC (NEVADA LIMITED LIABILITY COMPANY)
SUITE 312
3150 LENOX PARK BLVD.
MEMPHIS, TN 38115

FOR: FREIGHT AND TRANSPORT BROKERAGE; FREIGHT FORWARDING SERVICES; FREIGHT LOADING SERVICES; FREIGHT TRANSPORTATION BY TRUCK, TRAIN, AND INTERMODAL TRANSPORTATION; WAREHOUSING SERVICES, NAMELY, STORAGE, DISTRIBUTION, PICK-UP, AND PACKING FOR SHIPMENT OF DOCUMENTS, PACKAGES, RAW MATERIALS, AND OTHER FREIGHT FOR OTHERS; DRAYAGE AND CARTAGE SERVICES; STORAGE AND DELIVERY OF GOODS, IN CLASS 39 (U.S. CLS. 100 AND 105).

FIRST USE 6-8-2011; IN COMMERCE 6-8-2011.

NO CLAIM IS MADE TO THE EXCLUSIVE RIGHT TO USE "CO" AND "GULF INTERMODAL SERVICES", APART FROM THE MARK AS SHOWN.

THE MARK CONSISTS OF A SHIELD SHAPE CONTAINING FIVE STARS ABOVE A DEPICTION OF A GLOBE CONTAINING THE WORDS "AN IMC CO." TO THE RIGHT OF THE SHIELD ARE THE LETTERS "GIS" IN ALL CAPS WITH THE WORDS "GULF INTERMODAL SERVICES" APPEARING IN SMALLER FONT UNDERNEATH.

SER. NO. 85-359,582, FILED 6-29-2011.

CAROLYN CATALDO, EXAMINING ATTORNEY



David J. Kyffers

Director of the United States Patent and Trademark Office

United States of America

United States Patent and Trademark Office

STOP ICE

Reg. No. 4,174,176

KISSNER MILLING CO. LTD. (CANADA CORPORATION)
32 CHERRY BLOSSOM ROAD
CAMBRIDGE, ONTARIO, CANADA N3H4R7

Registered July 17, 2012

Int. Cl.: 1

FOR: CHEMICAL PREPARATIONS FOR MELTING SNOW AND ICE, IN CLASS 1 (U.S. CLS. 1, 5, 6, 10, 26 AND 46).

TRADEMARK

FIRST USE 11-7-2011; IN COMMERCE 11-7-2011.

PRINCIPAL REGISTER

THE MARK CONSISTS OF STANDARD CHARACTERS WITHOUT CLAIM TO ANY PARTICULAR FONT, STYLE, SIZE, OR COLOR.

NO CLAIM IS MADE TO THE EXCLUSIVE RIGHT TO USE "ICE", APART FROM THE MARK AS SHOWN.

SER. NO. 85-359,595, FILED 6-29-2011.

JEFF DEFORD, EXAMINING ATTORNEY



David J. Kyffers

Director of the United States Patent and Trademark Office

United States of America

United States Patent and Trademark Office



Reg. No. 4,174,177

Registered July 17, 2012

Int. Cls.: 37 and 39

SERVICE MARK

PRINCIPAL REGISTER

IMC COMPANIES, LLC (NEVADA LIMITED LIABILITY COMPANY)
SUITE 312
3150 LENOX PARK BLVD.
MEMPHIS, TN 38115

FOR: REPAIR AND MAINTENANCE OF MOTOR VEHICLES; REPAIR AND MAINTENANCE OF TRUCKS, TRAILERS, AND SHIPPING CONTAINERS, IN CLASS 37 (U.S. CLS. 100, 103 AND 106).

FIRST USE 1-0-2011; IN COMMERCE 1-0-2011.

FOR: FREIGHT AND TRANSPORT BROKERAGE; FREIGHT FORWARDING SERVICES; FREIGHT LOADING SERVICES; FREIGHT TRANSPORTATION BY TRUCK, TRAIN, AND INTERMODAL TRANSPORTATION; WAREHOUSING SERVICES, NAMELY, STORAGE, DISTRIBUTION, PICK-UP, AND PACKING FOR SHIPMENT OF DOCUMENTS, PACKAGES, RAW MATERIALS, AND OTHER FREIGHT FOR OTHERS; DRAYAGE AND CARTAGE SERVICES; STORAGE AND DELIVERY OF GOODS, IN CLASS 39 (U.S. CLS. 100 AND 105).

FIRST USE 1-0-2011; IN COMMERCE 1-0-2011.

NO CLAIM IS MADE TO THE EXCLUSIVE RIGHT TO USE "COMPANIES", APART FROM THE MARK AS SHOWN.

THE MARK CONSISTS OF A SHIELD SHAPE CONTAINING FIVE STARS ABOVE A DEPICTION OF A GLOBE WITH A ROAD RUNNING HORIZONTALLY ACROSS IT. THE SHIELD IS SET ABOVE THE LETTERS "IMC" IN ALL CAPS WITH "IMC" COMPANIES APPEARING IN SMALLER FONT UNDERNEATH.

SER. NO. 85-359,614, FILED 6-29-2011.

CAROLYN CATALDO, EXAMINING ATTORNEY



David J. Kybas

Director of the United States Patent and Trademark Office

United States of America

United States Patent and Trademark Office



Reg. No. 4,174,178

Registered July 17, 2012

Int. Cl.: 39

SERVICE MARK

PRINCIPAL REGISTER

IMC COMPANIES, LLC (NEVADA LIMITED LIABILITY COMPANY)
SUITE 312
3150 LENOX PARK BLVD.
MEMPHIS, TN 38115

FOR: FREIGHT AND TRANSPORT BROKERAGE; FREIGHT FORWARDING SERVICES; FREIGHT LOADING SERVICES; FREIGHT TRANSPORTATION BY TRUCK, TRAIN, AND INTERMODAL TRANSPORTATION; WAREHOUSING SERVICES, NAMELY, STORAGE, DISTRIBUTION, PICK-UP, AND PACKING FOR SHIPMENT OF DOCUMENTS, PACKAGES, RAW MATERIALS, AND OTHER FREIGHT FOR OTHERS; DRAYAGE AND CARTAGE SERVICES; STORAGE AND DELIVERY OF GOODS, IN CLASS 39 (U.S. CLS. 100 AND 105).

FIRST USE 4-0-2011; IN COMMERCE 4-0-2011.

NO CLAIM IS MADE TO THE EXCLUSIVE RIGHT TO USE "CO AND COMPANY", APART FROM THE MARK AS SHOWN.

THE MARK CONSISTS OF A SHIELD SHAPE CONTAINING FIVE STARS ABOVE A DEPICTION OF A GLOBE CONTAINING THE WORDS "AN IMC CO." TO THE RIGHT OF THE SHIELD ARE THE LETTERS "IMCG" IN ALL CAPS WITH THE WORDS "INTERMODAL CARTAGE COMPANY" APPEARING IN SMALLER FONT UNDERNEATH.

SEC. 2(F) AS TO "INTERMODAL CARTAGE" HAS BECOME DISTINCTIVE OF THE GOODS/SERVICES THROUGH THE APPLICANT'S SUBSTANTIALLY EXCLUSIVE AND CONTINUOUS USE IN COMMERCE THAT THE U.S. CONGRESS MAY LAWFULLY REGULATE FOR AT LEAST THE FIVE YEARS IMMEDIATELY BEFORE THE DATE OF THIS STATEMENT.

SER. NO. 85-359,642, FILED 6-29-2011.

CAROLYN CATALDO, EXAMINING ATTORNEY



David J. Kyffers

Director of the United States Patent and Trademark Office

United States of America

United States Patent and Trademark Office



Reg. No. 4,174,179

Registered July 17, 2012

Int. Cl.: 39

SERVICE MARK

PRINCIPAL REGISTER

IMC COMPANIES, LLC (NEVADA LIMITED LIABILITY COMPANY)
SUITE 312
3150 LENOX PARK BLVD.
MEMPHIS, TN 38115

FOR: FREIGHT AND TRANSPORT BROKERAGE; FREIGHT FORWARDING SERVICES; FREIGHT LOADING SERVICES; FREIGHT TRANSPORTATION BY TRUCK, TRAIN, AND INTERMODAL TRANSPORTATION; WAREHOUSING SERVICES, NAMELY, STORAGE, DISTRIBUTION, PICK-UP, AND PACKING FOR SHIPMENT OF DOCUMENTS, PACKAGES, RAW MATERIALS, AND OTHER FREIGHT FOR OTHERS; DRAYAGE AND CARTAGE SERVICES; STORAGE AND DELIVERY OF GOODS, IN CLASS 39 (U.S. CLS. 100 AND 105).

FIRST USE 4-0-2011; IN COMMERCE 4-0-2011.

NO CLAIM IS MADE TO THE EXCLUSIVE RIGHT TO USE "CO" AND "NATIONAL DRAYAGE SERVICES", APART FROM THE MARK AS SHOWN.

THE MARK CONSISTS OF A SHIELD SHAPE CONTAINING FIVE STARS ABOVE A DEPICTION OF A GLOBE CONTAINING THE WORDS "AN IMC CO." TO THE RIGHT OF THE SHIELD ARE THE LETTERS "NDS" IN ALL CAPS WITH THE WORDS "NATIONAL DRAYAGE SERVICES" APPEARING IN SMALLER FONT UNDERNEATH.

SER. NO. 85-359,665, FILED 6-29-2011.

CAROLYN CATALDO, EXAMINING ATTORNEY



David J. Kyffers

Director of the United States Patent and Trademark Office

United States of America

United States Patent and Trademark Office

TUNNEL RADIO LINK

Reg. No. 4,174,180

Registered July 17, 2012

Int. Cl.: 9

TRADEMARK

PRINCIPAL REGISTER

TUNNEL RADIO OF AMERICA, INC. (OREGON CORPORATION)
6435 NE HYSLOP RD.
CORVALLIS, OR 97330

FOR: WIRELESS EXTENSION SYSTEMS FOR TUNNELS, NAMELY, DISTRIBUTED ANTENNA SYSTEMS COMPRISING BASE INTERFACE UNITS TO CONNECT TO BASE RADIOS, IN-TUNNEL NETWORK BOOSTERS, IN-TUNNEL CABLING AND TUNNEL NETWORK ANTENNAS; DISTRIBUTED ANTENNA SYSTEMS COMPRISING INTERFACE UNITS TO CONNECT TO BASE RADIOS, NETWORK BOOSTERS, REPEATERS, AND SIGNAL ANTENNAS SPECIFICALLY FOR RAILROAD AND MASS TRANSIT, THAT EXTENDS TWO WAY WIRELESS DATA AND VOICE SIGNALS IN ZONES THAT ARE NORMALLY SHIELDED FROM COVERAGE BY CONVENTIONAL WIRELESS SYSTEMS, IN CLASS 9 (U.S. CLS. 21, 23, 26, 36 AND 38).

FIRST USE 9-5-2001; IN COMMERCE 9-28-2001.

THE MARK CONSISTS OF STANDARD CHARACTERS WITHOUT CLAIM TO ANY PARTICULAR FONT, STYLE, SIZE, OR COLOR.

NO CLAIM IS MADE TO THE EXCLUSIVE RIGHT TO USE "RADIO LINK", APART FROM THE MARK AS SHOWN.

SER. NO. 85-362,208, FILED 7-1-2011.

KEVON CHISOLM, EXAMINING ATTORNEY



David J. Kybas

Director of the United States Patent and Trademark Office

United States of America

United States Patent and Trademark Office

DORIS GOTHARD'S CEJO (CAN NOT EAT JUST ONE!) ORIGINAL RECIPE GOURMET COOKIES

Reg. No. 4,174,181

Registered July 17, 2012

Int. Cl.: 30

TRADEMARK

PRINCIPAL REGISTER

GOTHARD, DORIS M. (MICHIGAN SOLE PROPRIETORSHIP), DBA DORIS GOTHARD'S CEJO COOKIE (CAN'T EAT JUST ONE!) ORIGINAL RECIPE GOURMET COOKIES.
PO BOX 796
WASHINGTON, MI 48094

FOR: COOKIES, IN CLASS 30 (U.S. CL. 46).

FIRST USE 5-1-2011; IN COMMERCE 5-1-2011.

THE MARK CONSISTS OF STANDARD CHARACTERS WITHOUT CLAIM TO ANY PARTICULAR FONT, STYLE, SIZE, OR COLOR.

NO CLAIM IS MADE TO THE EXCLUSIVE RIGHT TO USE "ORIGINAL RECIPE GOURMET COOKIES", APART FROM THE MARK AS SHOWN.

THE NAME "DORIS GOTHARD" IDENTIFIES A LIVING INDIVIDUAL WHOSE CONSENT IS OF RECORD.

SER. NO. 85-362,411, FILED 7-2-2011.

NAAKWAMA ANKRAH, EXAMINING ATTORNEY



David J. Kyffers

Director of the United States Patent and Trademark Office

United States of America

United States Patent and Trademark Office

SGROUPLES

Reg. No. 4,174,182

Registered July 17, 2012

Int. Cl.: 42

SERVICE MARK

PRINCIPAL REGISTER

SGROUPLES, INC. (DELAWARE CORPORATION)
440 N. WOLFE RD. MS 117
SUNNYVALE, CA 94085

FOR: COMPUTER SERVICES, NAMELY, COMPUTER SOFTWARE DEVELOPMENT OF WEB APPLICATIONS FOR INTERNET USERS; PROVIDING TEMPORARY USE OF ON-LINE NON-DOWNLOADABLE SOFTWARE FOR ASSISTING IN WEBSITE DEVELOPMENT; PROVIDING USE OF ONLINE NON-DOWNLOADABLE SOFTWARE FOR INTERNET PUBLISHING; COMPUTER SERVICES, NAMELY, CREATING ON-LINE VIRTUAL COMMUNITIES FOR REGISTERED USERS TO ORGANIZE GROUPS AND EVENTS, PARTICIPATE IN DISCUSSIONS, AND ENGAGE IN SOCIAL, PERSONAL, BUSINESS AND COMMUNITY NETWORKING; COMPUTER SERVICES, NAMELY, HOSTING ON-LINE WEB FACILITIES FOR OTHERS FOR ORGANIZING GROUPS AND CONDUCTING MEETINGS, EVENTS AND INTERACTIVE DISCUSSIONS VIA COMMUNICATION NETWORKS; APPLICATION SERVICE PROVIDER SERVICES, NAMELY, HOSTING COMPUTER SOFTWARE APPLICATIONS OF OTHERS; APPLICATION SERVICE PROVIDER FEATURING SOFTWARE TO ENABLE OR FACILITATE THE UPLOADING, DOWNLOADING, STREAMING, POSTING, DISPLAYING, BLOGGING, LINKING, SHARING OR OTHERWISE PROVIDING ELECTRONIC MEDIA OR INFORMATION OVER COMMUNICATION NETWORKS; PROVIDING AN ONLINE NETWORK SERVICE THAT ENABLES USERS TO TRANSFER PERSONAL IDENTITY DATA TO AND SHARE PERSONAL IDENTITY DATA WITH AND AMONG MULTIPLE WEBSITES; PROVIDING A WEB SITE FEATURING TECHNOLOGY THAT ENABLES ON-LINE USERS TO CREATE PERSONAL PROFILES FEATURING SOCIAL NETWORKING INFORMATION AND TO TRANSFER AND SHARE SUCH INFORMATION AMONG INDIVIDUALS AND MULTIPLE WEBSITES; PROVIDING TEMPORARY USE OF NON-DOWNLOADABLE SOFTWARE APPLICATIONS FOR SOCIAL NETWORKING, CREATING A VIRTUAL COMMUNITY, AND TRANSMISSION OF AUDIO, VIDEO, PHOTOGRAPHIC IMAGES, TEXT, GRAPHICS AND DATA; COMPUTER SERVICES IN THE NATURE OF CUSTOMIZED WEB PAGES FEATURING USER-DEFINED OR SPECIFIED INFORMATION, PERSONAL PROFILES, AUDIO, VIDEO, PHOTOGRAPHIC IMAGES, TEXT, GRAPHICS AND DATA; PEER TO BROWSER PHOTO SHARING SERVICES, NAMELY, PROVIDING A WEBSITE FEATURING TECHNOLOGY ENABLING USERS TO UPLOAD, VIEW, AND DOWNLOAD DIGITAL PHOTOS; PROVIDING A WEB SITE FEATURING TECHNOLOGY THAT ENABLES USERS TO UPLOAD AND SHARE VIDEO, PHOTOS, TEXT, GRAPHICS AND DATA; DESIGNING, DEVELOPING AND MANAGING A SOFTWARE PROGRAM FOR USE IN MANAGING MULTIPLE SOCIAL NETWORKING SERVICE ACCOUNTS, TRACKING LINK STATISTICS AND MONITORING KEYWORD MENTIONS MADE ON SOCIAL NET-



David J. Kyjars

Director of the United States Patent and Trademark Office

Reg. No. 4,174,182 WORKING WEBSITES; PROVIDING ONLINE NON-DOWNLOADABLE SOFTWARE FOR UPLOADING, SHARING AND TRANSFERRING FILES, IN CLASS 42 (U.S. CLS. 100 AND 101).

FIRST USE 7-2-2011; IN COMMERCE 7-2-2011.

THE MARK CONSISTS OF STANDARD CHARACTERS WITHOUT CLAIM TO ANY PARTICULAR FONT, STYLE, SIZE, OR COLOR.

SER. NO. 85-362,469, FILED 7-2-2011.

CHARLES L. JENKINS, EXAMINING ATTORNEY

United States of America

United States Patent and Trademark Office

TILT ENTERTAINMENT

Reg. No. 4,174,183

Registered July 17, 2012

Int. Cl.: 41

SERVICE MARK

PRINCIPAL REGISTER

PISCIOTTA, JOHN N. (UNITED STATES INDIVIDUAL)
166 TRINITY PLACE
WEST HEMPSTEAD, NY 11552

FOR: ANIMATION PRODUCTION SERVICES; AUDIO PRODUCTION SERVICES, NAMELY, CREATING AND PRODUCING AMBIENT SOUNDSCAPES, AND SOUND STORIES FOR MUSEUMS, GALLERIES, ATTRACTIONS, PODCASTS, BROADCASTS, WEBSITES AND GAMES; AUDIO RECORDING AND PRODUCTION; CABLE TELEVISION PROGRAMMING; CREATING AND DEVELOPING CONCEPTS FOR TELEVISION PROGRAMS; DIRECTION OF MAKING RADIO OR TELEVISION PROGRAMS; DISTRIBUTION OF MOTION PICTURE FILMS; DISTRIBUTION OF RADIO PROGRAMS FOR OTHERS; DISTRIBUTION OF TELEVISION PROGRAMMING TO CABLE TELEVISION SYSTEMS; DISTRIBUTION OF TELEVISION PROGRAMS FOR OTHERS; EDITING OF RADIO AND TELEVISION PROGRAMMES; ENTERTAINMENT IN THE NATURE OF LIVE RADIO PERSONALITY PERFORMANCES; ENTERTAINMENT IN THE NATURE OF THEATER PRODUCTIONS; ENTERTAINMENT MEDIA PRODUCTION SERVICES FOR MOTION PICTURES, TELEVISION AND INTERNET; ENTERTAINMENT SERVICES BY A MUSICAL ARTIST AND PRODUCER, NAMELY, MUSICAL COMPOSITION FOR OTHERS AND PRODUCTION OF MUSICAL SOUND RECORDINGS; ENTERTAINMENT SERVICES IN THE NATURE OF A NON-FICTION TELEVISION PROGRAMMING SERIES ON TOPICS RELATING TO FAMILY STORIES TOLD BY FAMILY MEMBERS TO PRESERVE THEIR HERITAGE; ENTERTAINMENT SERVICES IN THE NATURE OF AN ON-GOING REALITY BASED TELEVISION PROGRAM; ENTERTAINMENT SERVICES IN THE NATURE OF AN ONGOING IPTV (INTERNET PROTOCOL TELEVISION), TELEVISION PROGRAMMING SEGMENTS IN THE FIELD OF POSITIVE PSYCHOLOGY, PERSONAL RELATIONSHIPS, THE ART AND SCIENCE OF HAPPINESS; ENTERTAINMENT SERVICES IN THE NATURE OF DEVELOPMENT, CREATION, PRODUCTION AND POST-PRODUCTION SERVICES OF MULTIMEDIA ENTERTAINMENT CONTENT; ENTERTAINMENT SERVICES IN THE NATURE OF ON-GOING TELEVISION PROGRAMS IN THE FIELD OF CHILDREN'S ENTERTAINMENT; ENTERTAINMENT SERVICES IN THE NATURE OF RECORDING, PRODUCTION AND POST-PRODUCTION SERVICES IN THE FIELD OF MUSIC; ENTERTAINMENT SERVICES, NAMELY, AN ONGOING TELEVISION GAME SHOW AND GAMES OF CHANCE TO BE PLAYED AT A CASINO; ENTERTAINMENT SERVICES, NAMELY, DISPLAYING A SERIES OF FILMS; ENTERTAINMENT SERVICES, NAMELY, LIVE, TELEVISED AND MOVIE APPEARANCES BY A PROFESSIONAL ENTERTAINER; ENTERTAINMENT SERVICES, NAMELY, MULTIMEDIA PRODUCTION SERVICES; ENTERTAINMENT SERVICES, NAMELY, PLANNING AND CONDUCTING A SERIES OF FILM FESTIVALS; ENTERTAINMENT SERVICES,



David J. Kybas

Director of the United States Patent and Trademark Office

Reg. No. 4,174,183 NAMELY, PRODUCTION AND DISTRIBUTION OF A GAME SHOW; ENTERTAINMENT SERVICES, NAMELY, THE PRESENTATION OF LIVE CHRISTMAS MUSICAL PRODUCTIONS; FILM AND VIDEO FILM PRODUCTION; FILM AND VIDEO PRODUCTION; FILM AND VIDEO PRODUCTION CONSULTING SERVICES; FILM AND VIDEO TAPE FILM PRODUCTION; FILM DISTRIBUTION; FILM EDITING; FILM MASTERING SERVICES; FILM PRODUCTION; FILM RENTAL; FILM STUDIOS; MEDIA PRODUCTION LOCATION SCOUTING SERVICES FOR ENTERTAINMENT PURPOSES; MEDIA PRODUCTION SERVICES, NAMELY, VIDEO AND FILM PRODUCTION; MOTION PICTURE FILM PRODUCTION; MOTION PICTURE SONG PRODUCTION; MOVIE STUDIOS; MULTIMEDIA ENTERTAINMENT SERVICES IN THE NATURE OF DEVELOPMENT, PRODUCTION AND POST-PRODUCTION SERVICES IN THE FIELDS OF VIDEO AND FILMS; MULTIMEDIA ENTERTAINMENT SERVICES IN THE NATURE OF RECORDING, PRODUCTION AND POST-PRODUCTION SERVICES IN THE FIELDS OF MUSIC, VIDEO, AND FILMS; MULTIMEDIA ENTERTAINMENT SOFTWARE PRODUCTION SERVICES; MUSIC PRODUCTION SERVICES; MUSIC SELECTION SERVICES FOR USE IN TELEVISION, FILM, RADIO AND VIDEO GAMES; MUSIC VIDEO PRODUCTION; OPERATING OF FILM STUDIOS; PLANNING ARRANGEMENT OF SHOWING MOVIES, SHOWS, PLAYS OR MUSICAL PERFORMANCES; POST-PRODUCTION EDITING SERVICES IN THE FIELD OF MUSIC, VIDEOS AND FILM; PREPARING SUBTITLES FOR MOVIES; PRODUCTION AND DISTRIBUTION OF INDEPENDENT MOTION PICTURES; PRODUCTION AND DISTRIBUTION OF MOTION PICTURES; PRODUCTION AND DISTRIBUTION OF RADIO PROGRAMMES; PRODUCTION AND DISTRIBUTION OF RADIO PROGRAMS; PRODUCTION AND DISTRIBUTION OF TELEVISION SHOWS AND MOVIES; PRODUCTION OF AUDIO RECORDING; PRODUCTION OF CABLE TELEVISION PROGRAMS; PRODUCTION OF FILM STUDIES; PRODUCTION OF FILMS; PRODUCTION OF HUMOROUS VIDEOS FOR THE INTERNET; PRODUCTION OF MUSICAL SOUND RECORDING; PRODUCTION OF MUSICAL VIDEOS; PRODUCTION OF RADIO AND TELEVISION PROGRAMMES; PRODUCTION OF RADIO AND TELEVISION PROGRAMS; PRODUCTION OF RADIO OR TELEVISION PROGRAMS; PRODUCTION OF RADIO PROGRAMMES; PRODUCTION OF RADIO PROGRAMS; PRODUCTION OF SOUND AND IMAGE RECORDINGS ON SOUND AND IMAGE CARRIERS; PRODUCTION OF SOUND AND MUSIC VIDEO RECORDINGS; PRODUCTION OF SOUND RECORDINGS; PRODUCTION OF TELEVISION AND RADIO PROGRAMMES; PRODUCTION OF TELEVISION PROGRAMS; PRODUCTION OF VIDEO CASSETTES; PRODUCTION OF VIDEO DISCS FOR OTHERS; PRODUCTION OF VISUAL EFFECTS FOR VIDEOS, DVDS, TELEVISION AND FOR INTERNET WEB SITES; PROVIDING A WEB SITE FEATURING A SEARCHABLE DATABASE OF INFORMATION RELATED TO RADIO CONTROLLED MODEL VEHICLES; PROVIDING FACILITIES FOR MOVIES, SHOWS, PLAYS, MUSIC OR EDUCATIONAL TRAINING; PROVIDING ON-LINE ENTERTAINMENT INFORMATION, NAMELY, INFORMATION ABOUT TELEVISION PROGRAMMING; RADIO ENTERTAINMENT PRODUCTION; RADIO PROGRAM SYNDICATION; RECORD MASTER PRODUCTION; RECORD PRODUCTION; RENTAL AND COMPUTERIZED ON-LINE RENTAL SERVICES FEATURING INTERACTIVE SOFTWARE AND HARDWARE HOME ENTERTAINMENT AND CONSUMER ELECTRONICS IN THE NATURE OF MOTION PICTURES, FILMS, MOVIES, PRERECORDED DIGITAL VERSATILE DISCS (OR DVDS), PRERECORDED VIDEOTAPE CASSETTES, AUDIO, AUDIO RECORDINGS IN A VARIETY OF GENRES; TELEVISION AND RADIO PROGRAMMING; TELEVISION PROGRAM SYNDICATION; TELEVISION PROGRAMMING; TELEVISION SCHEDULING; TELEVISION SHOW PRODUCTION; TELEVISION, VIDEO AND MOVIE FILMING SERVICES; VIDEO PRODUCTION SERVICES; VIDEO TAPE FILM PRODUCTION, IN CLASS 41 (U.S. CLS. 100, 101 AND 107).

FIRST USE 12-1-2003; IN COMMERCE 12-1-2003.

THE MARK CONSISTS OF STANDARD CHARACTERS WITHOUT CLAIM TO ANY PARTICULAR FONT, STYLE, SIZE, OR COLOR.

NO CLAIM IS MADE TO THE EXCLUSIVE RIGHT TO USE "ENTERTAINMENT", APART FROM THE MARK AS SHOWN.

Reg. No. 4,174,183 SER. NO. 85-362,693, FILED 7-4-2011.

DOUGLAS LEE, EXAMINING ATTORNEY

United States of America

United States Patent and Trademark Office

TOTAL BENEFITS SOLUTION

Reg. No. 4,174,184

Registered July 17, 2012

Int. Cl.: 35

SERVICE MARK

PRINCIPAL REGISTER

KELLY & ASSOCIATES INSURANCE GROUP, INC. (MARYLAND CORPORATION)
301 INTERNATIONAL CIRCLE
HUNT VALLEY, MN 21030

FOR: BUSINESS ADMINISTRATION SERVICES, NAMELY, ADMINISTRATION OF INSURANCE BILLING AND CUSTOMER SERVICE IN THE FIELD OF INSURANCE BENEFITS; PROVIDING ADMINISTRATIVE INFORMATION FOR OTHERS IN THE FIELD OF HUMAN RESOURCES VIA A GLOBAL COMPUTER NETWORK, IN CLASS 35 (U.S. CLS. 100, 101 AND 102).

FIRST USE 10-5-2001; IN COMMERCE 10-5-2001.

THE MARK CONSISTS OF STANDARD CHARACTERS WITHOUT CLAIM TO ANY PARTICULAR FONT, STYLE, SIZE, OR COLOR.

OWNER OF U.S. REG. NOS. 2,660,290 AND 3,260,261.

SEC. 2(F).

SER. NO. 85-362,788, FILED 7-5-2011.

NAAKWAMA ANKRAH, EXAMINING ATTORNEY



David J. Kyffers

Director of the United States Patent and Trademark Office

United States of America

United States Patent and Trademark Office



Reg. No. 4,174,185

Registered July 17, 2012

Int. Cls.: 16 and 25

TRADEMARK

PRINCIPAL REGISTER

LITTLE, CRAIG (UNITED STATES INDIVIDUAL)
#102C
14021 MARQUESAS WAY
MARINA DEL REY, CA 90292

FOR: DECALS, IN CLASS 16 (U.S. CLS. 2, 5, 22, 23, 29, 37, 38 AND 50).

FIRST USE 1-26-2010; IN COMMERCE 1-26-2010.

FOR: HATS; JACKETS; PANTS; SHIRTS; SHOES; SHORTS; SWIM WEAR, IN CLASS 25 (U.S. CLS. 22 AND 39).

FIRST USE 1-26-2010; IN COMMERCE 1-26-2010.

OWNER OF U.S. REG. NO. 3,823,133.

THE STIPPLING IS FOR SHADING PURPOSES ONLY.

THE MARK CONSISTS OF THE STYLIZED TEXT "NOICE!" OVERLAPPING AN OVAL. UNDER "NOICE!" IS THE STYLIZED TEXT "BETTER THAN NICE". ALONG THE LEFT BORDER OF THE OVAL IS A WAVE THAT IS A STYLIZED LETTER "N".

SER. NO. 85-362,839, FILED 7-5-2011.

KAPIL BHANOT, EXAMINING ATTORNEY



David J. Kyffers

Director of the United States Patent and Trademark Office

United States of America

United States Patent and Trademark Office

PAINT YOUR PAIN AWAY

Reg. No. 4,174,186

COMISSO, GRACE (UNITED STATES INDIVIDUAL)
7137 PARKSIDE PLACE

Registered July 17, 2012

RANCHO CUCAMONGA, CA 91701

Int. Cl.: 41

FOR: EDUCATIONAL SERVICES, NAMELY, CONDUCTING COURSES OF INSTRUCTION
IN THE FIELD OF PAINTING, IN CLASS 41 (U.S. CLS. 100, 101 AND 107).

SERVICE MARK

FIRST USE 3-21-2007; IN COMMERCE 3-21-2007.

PRINCIPAL REGISTER

THE MARK CONSISTS OF STANDARD CHARACTERS WITHOUT CLAIM TO ANY PAR-
TICULAR FONT, STYLE, SIZE, OR COLOR.

SER. NO. 85-363,021, FILED 7-5-2011.

REBECCA SMITH, EXAMINING ATTORNEY



David J. Kyffers

Director of the United States Patent and Trademark Office

United States of America

United States Patent and Trademark Office

MACKILLOP'S CHOICE

Reg. No. 4,174,187

ANGUS DUNDEE DISTILLERS PLC (UNITED KINGDOM CORPORATION)
20-21 CATO STREET

Registered July 17, 2012

LONDON, UNITED KINGDOM W1H5JQ

Int. Cl.: 33

FOR: SCOTCH WHISKY, IN CLASS 33 (U.S. CLS. 47 AND 49).

TRADEMARK

THE MARK CONSISTS OF STANDARD CHARACTERS WITHOUT CLAIM TO ANY PARTICULAR FONT, STYLE, SIZE, OR COLOR.

PRINCIPAL REGISTER

OWNER OF ERPN CMNTY TM OFC REG. NO. 1,139,211, DATED 6-29-2000, EXPIRES 4-8-2019.

SER. NO. 85-364,029, FILED 7-6-2011.

DEIRDRE ROBERTSON, EXAMINING ATTORNEY



David J. Kyffers

Director of the United States Patent and Trademark Office

United States of America

United States Patent and Trademark Office

Comerica Sensible Stimulus Package

Reg. No. 4,174,188

Registered July 17, 2012

Int. Cl.: 36

SERVICE MARK

PRINCIPAL REGISTER

COMERICA INCORPORATED (DELAWARE CORPORATION)
MC 3391
411 LAFAYETTE ST
DETROIT, MI 48226

FOR: PROVIDING CASH AND OTHER REBATES FOR CHECKING ACCOUNT USE AS PART OF A CUSTOMER LOYALTY PROGRAM, IN CLASS 36 (U.S. CLS. 100, 101 AND 102).

FIRST USE 6-1-2009; IN COMMERCE 6-1-2009.

THE MARK CONSISTS OF STANDARD CHARACTERS WITHOUT CLAIM TO ANY PARTICULAR FONT, STYLE, SIZE, OR COLOR.

OWNER OF U.S. REG. NOS. 1,251,846, 1,776,041, AND 2,708,722.

NO CLAIM IS MADE TO THE EXCLUSIVE RIGHT TO USE "PACKAGE", APART FROM THE MARK AS SHOWN.

SER. NO. 85-364,315, FILED 7-6-2011.

HELENE LIWINSKI, EXAMINING ATTORNEY



David J. Kyffers

Director of the United States Patent and Trademark Office

United States of America

United States Patent and Trademark Office

Sensible Stimulus Package

Reg. No. 4,174,189

Registered July 17, 2012

Int. Cl.: 36

SERVICE MARK

PRINCIPAL REGISTER

COMERICA INCORPORATED (DELAWARE CORPORATION)
MC 3391
411 LAFAYETTE
DETROIT, MI 48226

FOR: PROVIDING CASH AND OTHER REBATES FOR CHECKING ACCOUNT USE AS PART OF A CUSTOMER LOYALTY PROGRAM, IN CLASS 36 (U.S. CLS. 100, 101 AND 102).

FIRST USE 6-1-2009; IN COMMERCE 6-1-2009.

THE MARK CONSISTS OF STANDARD CHARACTERS WITHOUT CLAIM TO ANY PARTICULAR FONT, STYLE, SIZE, OR COLOR.

NO CLAIM IS MADE TO THE EXCLUSIVE RIGHT TO USE "PACKAGE", APART FROM THE MARK AS SHOWN.

SER. NO. 85-364,324, FILED 7-6-2011.

HELENE LIWINSKI, EXAMINING ATTORNEY



David J. Kyffers

Director of the United States Patent and Trademark Office

United States of America
United States Patent and Trademark Office

BOTSKIS

Reg. No. 4,174,190

MUELLER, AARON D. (UNITED STATES INDIVIDUAL)
3608 E. ROBIN LANE
PHOENIX, AZ 85050

Registered July 17, 2012

Int. Cl.: 24

FOR: PARTY DECORATIONS MADE OF CLOTH, NAMELY, NECKTIE SHAPED DECORATIONS FOR BOTTLES AND BOTTLENECK SHAPED GOODS, IN CLASS 24 (U.S. CLS. 42 AND 50).

TRADEMARK

FIRST USE 7-1-2011; IN COMMERCE 7-1-2011.

PRINCIPAL REGISTER

THE MARK CONSISTS OF STANDARD CHARACTERS WITHOUT CLAIM TO ANY PARTICULAR FONT, STYLE, SIZE, OR COLOR.

SER. NO. 85-364,615, FILED 7-6-2011.

DAVID MURRAY, EXAMINING ATTORNEY



David J. Kyffers

Director of the United States Patent and Trademark Office

United States of America

United States Patent and Trademark Office

Executive Lease Your Listing

Reg. No. 4,174,191

Registered July 17, 2012

Int. Cl.: 36

SERVICE MARK

PRINCIPAL REGISTER

EXECUTIVE HOME RENTALS PROPERTY MANAGEMENT, LLC (COLORADO LIMITED LIABILITY COMPANY)
603 PARK POINT DRIVE, SUITE 224
GOLDEN, CO 80401

FOR: REAL ESTATE SERVICES, NAMELY, PROPERTY MANAGEMENT OF RESIDENTIAL RENTAL PROPERTIES, AND VACATION RENTAL PROPERTY MANAGEMENT SERVICES; REAL ESTATE BROKERAGE REPRESENTATION SERVICES FOR OWNERS, INVESTORS, SELLERS, BUYERS, LESSORS, TENANTS AND OTHERS ENGAGED IN RESIDENTIAL REAL ESTATE SALES, LEASING AND LEASE-SALE TRANSACTIONS, IN CLASS 36 (U.S. CLS. 100, 101 AND 102).

FIRST USE 6-30-2011; IN COMMERCE 6-30-2011.

THE MARK CONSISTS OF STANDARD CHARACTERS WITHOUT CLAIM TO ANY PARTICULAR FONT, STYLE, SIZE, OR COLOR.

NO CLAIM IS MADE TO THE EXCLUSIVE RIGHT TO USE "LEASE YOUR LISTING", APART FROM THE MARK AS SHOWN.

SER. NO. 85-364,681, FILED 7-6-2011.

RUSS HERMAN, EXAMINING ATTORNEY



David J. Kypos

Director of the United States Patent and Trademark Office

United States of America

United States Patent and Trademark Office

Executive Home Rentals Property Management

Reg. No. 4,174,192

Registered July 17, 2012

Int. Cl.: 36

SERVICE MARK

PRINCIPAL REGISTER

EXECUTIVE HOME RENTALS PROPERTY MANAGEMENT, LLC (COLORADO LIMITED LIABILITY COMPANY)
603 PARK POINT DRIVE, SUITE 224
GOLDEN, CO 80401

FOR: REAL ESTATE SERVICES, NAMELY, PROPERTY MANAGEMENT OF RESIDENTIAL RENTAL PROPERTIES, AND VACATION RENTAL PROPERTY MANAGEMENT SERVICES; REAL ESTATE BROKERAGE REPRESENTATION SERVICES FOR OWNERS, INVESTORS, SELLERS, BUYERS, LESSORS, TENANTS AND OTHERS ENGAGED IN RESIDENTIAL REAL ESTATE SALES, LEASING AND LEASE-SALE TRANSACTIONS, IN CLASS 36 (U.S. CLS. 100, 101 AND 102).

FIRST USE 6-30-2011; IN COMMERCE 6-30-2011.

THE MARK CONSISTS OF STANDARD CHARACTERS WITHOUT CLAIM TO ANY PARTICULAR FONT, STYLE, SIZE, OR COLOR.

NO CLAIM IS MADE TO THE EXCLUSIVE RIGHT TO USE "HOME RENTALS PROPERTY MANAGEMENT", APART FROM THE MARK AS SHOWN.

SER. NO. 85-364,684, FILED 7-6-2011.

RUSS HERMAN, EXAMINING ATTORNEY



David J. Kyros

Director of the United States Patent and Trademark Office

United States of America

United States Patent and Trademark Office

SORRY FOR PARTYING

Reg. No. 4,174,193

Registered July 17, 2012

Int. Cl.: 42

SERVICE MARK

PRINCIPAL REGISTER

SORRY FOR PARTYING LLC (MASSACHUSETTS LIMITED LIABILITY COMPANY)
12 5TH STREET
CAMBRIDGE, MA 02141

FOR: PROVIDING A WEBSITE THAT GIVES COMPUTER USERS THE ABILITY TO UPLOAD AND SHARE USER-GENERATED VIDEOS, PHOTOS, ESSAYS AND ARTICLES ON A WIDE VARIETY OF TOPICS; COMPUTER SERVICES, NAMELY, CREATING AN ON-LINE COMMUNITY FOR REGISTERED USERS TO PARTICIPATE IN DISCUSSIONS, GET FEEDBACK FROM THEIR PEERS, ENGAGE IN SOCIAL NETWORKING, IN CLASS 42 (U.S. CLS. 100 AND 101).

FIRST USE 6-15-2011; IN COMMERCE 6-15-2011.

THE MARK CONSISTS OF STANDARD CHARACTERS WITHOUT CLAIM TO ANY PARTICULAR FONT, STYLE, SIZE, OR COLOR.

SER. NO. 85-364,776, FILED 7-6-2011.

MARTHA FROMM, EXAMINING ATTORNEY



David J. Kyffers

Director of the United States Patent and Trademark Office

United States of America

United States Patent and Trademark Office

VPIX

Reg. No. 4,174,194

Registered July 17, 2012

Int. Cl.: 42

SERVICE MARK

PRINCIPAL REGISTER

WILSON, BART (UNITED STATES INDIVIDUAL)
7 AVENIDA VISTA GRANDE, B-7 #428
SANTA FE, NM 87508

FOR: PROVIDING ON-LINE NON-DOWNLOADABLE SOFTWARE FOR CREATING THREE DIMENSIONAL VIEWS OF ANY PHOTOGRAPHIC SCENE FOR MOBILE DEVICES AND COMPUTERS, IN CLASS 42 (U.S. CLS. 100 AND 101).

FIRST USE 0-0-2001; IN COMMERCE 0-0-2001.

THE MARK CONSISTS OF STANDARD CHARACTERS WITHOUT CLAIM TO ANY PARTICULAR FONT, STYLE, SIZE, OR COLOR.

SER. NO. 85-365,173, FILED 7-7-2011.

EMILY CARLSEN, EXAMINING ATTORNEY



David J. Kyffers

Director of the United States Patent and Trademark Office

United States of America

United States Patent and Trademark Office

TV OUR WAY

Reg. No. 4,174,195

Registered July 17, 2012

Int. Cl.: 41

SERVICE MARK

PRINCIPAL REGISTER

BOUNCE HOLDINGS, LLC (GEORGIA LIMITED LIABILITY COMPANY)
600 GALLERIA PARKWAY
SUITE 1900
ATLANTA, GA 30339

FOR: ENTERTAINMENT SERVICES IN THE NATURE OF CREATING AND DEVELOPING CONCEPTS FOR TELEVISION PROGRAMS, PRODUCTION, AND DISTRIBUTION OF MOVIES, ON-GOING TELEVISION PROGRAMS, ON-GOING TELEVISION SERIES AND ON-GOING INTERSTITIAL TELEVISION PROGRAM SEGMENTS FEATURING MOVIES IN THE FIELD OF COMEDY, DRAMA, SPORTS, ACTION, OR ADVENTURE, PROVIDED THROUGH BROADCAST AND CABLE TELEVISION AND VIA GLOBAL COMPUTER NETWORKS; TELEVISION SHOW PRODUCTION SERVICES; DISTRIBUTION OF TELEVISION PROGRAMMING; PROVIDING ON-LINE INFORMATION IN THE FIELD OF ENTERTAINMENT, IN CLASS 41 (U.S. CLS. 100, 101 AND 107).

FIRST USE 9-26-2011; IN COMMERCE 9-26-2011.

THE MARK CONSISTS OF STANDARD CHARACTERS WITHOUT CLAIM TO ANY PARTICULAR FONT, STYLE, SIZE, OR COLOR.

NO CLAIM IS MADE TO THE EXCLUSIVE RIGHT TO USE "TV", APART FROM THE MARK AS SHOWN.

SER. NO. 85-366,018, FILED 7-7-2011.

ANDREA HACK, EXAMINING ATTORNEY



David J. Kybas

Director of the United States Patent and Trademark Office

United States of America

United States Patent and Trademark Office

STRONG IS THE NEW SKINNY

Reg. No. 4,174,196

MARSHA TIEKEN CHRISTENSEN (UNITED STATES INDIVIDUAL)

Registered July 17, 2012

4204 CALLOWAY DRIVE
MANSFIELD, TX 76063

Int. Cl.: 25

FOR: CLOTHING, NAMELY, T-SHIRTS AND TANK TOPS, IN CLASS 25 (U.S. CLS. 22 AND 39).

TRADEMARK

FIRST USE 9-3-2010; IN COMMERCE 9-7-2010.

PRINCIPAL REGISTER

THE MARK CONSISTS OF STANDARD CHARACTERS WITHOUT CLAIM TO ANY PARTICULAR FONT, STYLE, SIZE, OR COLOR.

SER. NO. 85-367,041, FILED 7-8-2011.

VIVIAN MICZNIK FIRST, EXAMINING ATTORNEY



David J. Kybas

Director of the United States Patent and Trademark Office

United States of America

United States Patent and Trademark Office



Reg. No. 4,174,197

Registered July 17, 2012

Int. Cl.: 9

TRADEMARK

PRINCIPAL REGISTER

DEPARTMENT OF VETERANS AFFAIRS (UNITED STATES AGENCY OF THE UNITED STATES GOVERNMENT)
810 VERMONT AVE
WASHINGTON, DC 20420

FOR: COMPUTER APPLICATION SOFTWARE FOR SMARTPHONES, NAMELY, SOFTWARE FOR HELPING INDIVIDUALS WITH POST-TRAUMATIC STRESS DISORDER BY PROVIDING INFORMATION RELATING TO POST-TRAUMATIC STRESS DISORDER, SELF-ASSESSMENT TOOLS, SELF-TREATMENT TOOLS, REFERRALS TO TREATMENT PROFESSIONALS AND REFERRALS TO SELF-DESIGNATED SUPPORT INDIVIDUALS, IN CLASS 9 (U.S. CLS. 21, 23, 26, 36 AND 38).

FIRST USE 2-16-2011; IN COMMERCE 4-7-2011.

NO CLAIM IS MADE TO THE EXCLUSIVE RIGHT TO USE "PTSD", APART FROM THE MARK AS SHOWN.

THE MARK CONSISTS OF THE WORDING "PTSD" IN UPPERCASE LETTERS, THE WORDING "COACH" IN SMALLER UPPERCASE LETTERS AND BELOW THE WORDING "PTSD", A CRESCENT SURROUNDING THE WORDING AND TO THE RIGHT OF THE WORDING, AND A STAR BELOW THE WORDING "COACH" AND AT THE LOWER END OF THE CRESCENT.

SER. NO. 85-367,063, FILED 7-8-2011.

DAVID C. REIHNER, EXAMINING ATTORNEY



David J. Kyjars

Director of the United States Patent and Trademark Office

United States of America

United States Patent and Trademark Office



Reg. No. 4,174,198

DASGALOS INTERACTIVE SOLUTIONS, INC. (CALIFORNIA CORPORATION)
7754 VIA CATALINA
BURBANK, CA 91504

Registered July 17, 2012

Int. Cl.: 42

FOR: COMPUTER SERVICES, NAMELY, CREATING AN ON-LINE COMMUNITY FOR REGISTERED USERS TO STATE A CLAIM OR OPINION REGARDING ANY TOPIC, DEBATE THE TOPIC, GET FEEDBACK FROM THEIR PEERS REGARDING THE CLAIM, FORM VIRTUAL COMMUNITIES, AND ENGAGE IN SOCIAL NETWORKING, IN CLASS 42 (U.S. CLS. 100 AND 101).

SERVICE MARK

PRINCIPAL REGISTER

FIRST USE 3-1-2011; IN COMMERCE 4-1-2011.

THE MARK CONSISTS OF THE WORD "KLAIM" WITH THE LETTER "K" IN AN UPSIDE DOWN CALLOUT OR CONVERSATION BUBBLE ; NEXT TO THE "K" APPEAR THE LETTERS "LA" IN STANDARD BOLD FONT; NEXT TO THAT APPEARS THE LETTER "I" IN THE SHAPE OF A PERSON OR STICK FIGURE. NEXT TO THAT APPEARS THE LETTER "M" IN STANDARD BOLD FONT.

SER. NO. 85-367,242, FILED 7-9-2011.

LINDA MICKLEBURGH, EXAMINING ATTORNEY



David J. Kyros

Director of the United States Patent and Trademark Office

United States of America

United States Patent and Trademark Office



Reg. No. 4,174,199

Registered July 17, 2012

Int. Cl.: 9

TRADEMARK

PRINCIPAL REGISTER

COFFMAN, MATT J (UNITED STATES INDIVIDUAL)
625 CODY COURT
LAKEWOOD, CO 80215

FOR: AMUSEMENT APPARATUS AND GAMES ADAPTED FOR USE WITH TELEVISION RECEIVERS OR WITH VIDEO OR COMPUTER MONITORS; BIOS (BASIC INPUT OUTPUT SYSTEM) COMPUTER PROGRAMS; BIOS (BASIC INPUT/OUTPUT SYSTEM) COMPUTER PROGRAM; COMPUTER GAME EQUIPMENT, NAMELY, DISCS; COMPUTER GAME PROGRAMS; COMPUTER GAME SOFTWARE, IN CLASS 9 (U.S. CLS. 21, 23, 26, 36 AND 38).

FIRST USE 6-1-2011; IN COMMERCE 7-7-2011.

THE MARK CONSISTS OF "SWORD OF THE SPIRIT". THE "SWORD" WORD IS BEVELED AND THE "OF THE SPIRIT" IS BELOW THE "SWORD" WORD.

SER. NO. 85-367,267, FILED S.R. 7-9-2011 AM. P.R. 3-9-2012.

MARC LEIPZIG, EXAMINING ATTORNEY



David J. Kyffers

Director of the United States Patent and Trademark Office

United States of America

United States Patent and Trademark Office



CAPITAL
MANAGEMENT

Reg. No. 4,174,200

Registered July 17, 2012

Int. Cl.: 36

SERVICE MARK

PRINCIPAL REGISTER

MIDAMERICA FINANCIAL CORPORATION (IOWA CORPORATION)
665 LOCUST STREET
DES MOINES, IA 50309

FOR: FINANCIAL SERVICES, NAMELY, ASSISTING OTHERS WITH INVESTMENT MANAGEMENT, INVESTMENT ADVISORY AND CONSULTING SERVICES, IN CLASS 36 (U.S. CLS. 100, 101 AND 102).

FIRST USE 1-1-2011; IN COMMERCE 1-1-2011.

OWNER OF U.S. REG. NOS. 3,210,458 AND 3,855,958.

NO CLAIM IS MADE TO THE EXCLUSIVE RIGHT TO USE "CAPITAL MANAGEMENT", APART FROM THE MARK AS SHOWN.

THE MARK CONSISTS OF A SHIELD WITH THE LETTERS "BTC" AND THE WORDS "CAPITAL MANAGEMENT" TO THE RIGHT OF THE SHIELD.

SER. NO. 85-368,025, FILED 7-11-2011.

LINDA ORNDORFF, EXAMINING ATTORNEY



David J. Kyffers

Director of the United States Patent and Trademark Office

United States of America

United States Patent and Trademark Office



Reg. No. 4,174,201

Registered July 17, 2012

Int. Cl.: 36

SERVICE MARK

PRINCIPAL REGISTER

KIDS MATTER INTERNATIONAL (TEXAS CORPORATION), AKA KIDS MATTER
401 N. CARROLL AVE., STE. 153
SOUTHLAKE, TX 760926407

FOR: CHARITABLE FUNDRAISING SERVICES, IN CLASS 36 (U.S. CLS. 100, 101 AND 102).

FIRST USE 9-15-2008; IN COMMERCE 9-15-2008.

NO CLAIM IS MADE TO THE EXCLUSIVE RIGHT TO USE "KIDS", APART FROM THE MARK AS SHOWN.

THE COLOR(S) YELLOW, BLUE, GREEN, RED AND BLACK IS/ARE CLAIMED AS A FEATURE OF THE MARK.

THE STIPPLING IS FOR SHADING PURPOSES ONLY.

THE MARK CONSISTS OF THE WORDS "KIDS" WITH: A YELLOW "K"; A BLUE "I" DOTTED WITH A STIPPLED BLUE LEFT HAND PRINT; A GREEN "D"; AND, A RED "S" ALL OUTLINED IN BLACK.

SEC. 2(F).

SER. NO. 85-368,323, FILED 7-11-2011.

STEPHANIE ALI, EXAMINING ATTORNEY



David J. Kyffers

Director of the United States Patent and Trademark Office

United States of America

United States Patent and Trademark Office

GRIPOLE

Reg. No. 4,174,202

MONTONE, PAUL (UNITED STATES INDIVIDUAL)
523 TRACE CIRCLE #205
DEERFIELD BEACH, FL 33441

Registered July 17, 2012

Int. Cls.: 14 and 22

FOR: JEWELRY, NAMELY, WRIST BANDS AND BRACELETS, IN CLASS 14 (U.S. CLS. 2, 27, 28 AND 50).

TRADEMARK

FIRST USE 4-20-2011; IN COMMERCE 4-20-2011.

PRINCIPAL REGISTER

FOR: ARTICLES OF GENERAL USE, NAMELY, MULTI-PURPOSE ASSEMBLY IN THE NATURE OF A PLASTIC, VINYL, AND RUBBER STRAP WITH MAGNETS AT EITHER END OF THE STRAP USED FOR HANGING, ATTACHING, STRAPPING, HOLDING, BANDING, TYING, FASTENING, SECURING, RETAINING, WRAPPING, BINDING, SUPPORTING, AND/OR BUNDLING OF VARIOUS OBJECTS, IN CLASS 22 (U.S. CLS. 1, 2, 7, 19, 22, 42 AND 50).

FIRST USE 4-20-2011; IN COMMERCE 4-20-2011.

THE MARK CONSISTS OF STANDARD CHARACTERS WITHOUT CLAIM TO ANY PARTICULAR FONT, STYLE, SIZE, OR COLOR.

SER. NO. 85-368,326, FILED 7-11-2011.

BRENDAN MCCAULEY, EXAMINING ATTORNEY



David J. Kybas

Director of the United States Patent and Trademark Office

United States of America

United States Patent and Trademark Office



Reg. No. 4,174,203

Registered July 17, 2012

Int. Cls.: 14 and 22

TRADEMARK

PRINCIPAL REGISTER

MONTONE, PAUL (UNITED STATES INDIVIDUAL)
523 TRACE CIRCLE #205
DEERFIELD BEACH, FL 33441

FOR: JEWELRY, NAMELY, WRIST BANDS AND BRACELETS, IN CLASS 14 (U.S. CLS. 2, 27, 28 AND 50).

FIRST USE 4-20-2011; IN COMMERCE 4-20-2011.

FOR: ARTICLES OF GENERAL USE, NAMELY, MULTI-PURPOSE ASSEMBLY IN THE NATURE OF A PLASTIC, VINYL, AND RUBBER STRAP WITH MAGNETS AT EITHER END OF THE STRAP USED FOR HANGING, ATTACHING, STRAPPING, HOLDING, BANDING, TYING, FASTENING, SECURING, RETAINING, WRAPPING, BINDING, SUPPORTING, AND/OR BUNDLING OF VARIOUS OBJECTS, IN CLASS 22 (U.S. CLS. 1, 2, 7, 19, 22, 42 AND 50).

FIRST USE 4-20-2011; IN COMMERCE 4-20-2011.

THE MARK CONSISTS OF DESIGN OF A FROG.

SER. NO. 85-368,334, FILED 7-11-2011.

BRENDAN MCCAULEY, EXAMINING ATTORNEY



David J. Kybas

Director of the United States Patent and Trademark Office

United States of America
United States Patent and Trademark Office

OmniStar

Reg. No. 4,174,204

AETHER SYSTEMS INC. (TAIWAN CORPORATION)
407, 10TH FLOOR, RUEY-KWANG RD.

Registered July 17, 2012

NEI-HU, TAIPEI, TAIWAN

Int. Cl.: 9

FOR: PRISMS FOR OPTICS PURPOSES; OPTICAL LENSES; OPTICAL LENS BLANKS, NAMELY, CONTACT LENS BLANKS AND SPECTACLE LENS BLANKS; OPTICAL CORRECTIVE LENSES; MICROSCOPE CONDENSER LENSES; OPTICAL GLASSES, IN CLASS 9 (U.S. CLS. 21, 23, 26, 36 AND 38).

TRADEMARK

PRINCIPAL REGISTER

OWNER OF TAIWAN REG. NO. 01502249, DATED 2-1-2012, EXPIRES 1-31-2022.

THE MARK CONSISTS OF THE STYLIZED UPPER-CASE LETTER "O" FOLLOWED BY STYLIZED LOWER CASE LETTERS "M", "N", "I"; THE STYLIZED UPPER-CASE LETTER "S" FOLLOWED BY STYLIZED LOWER CASE LETTERS "T", "A", "R". THERE ARE NO SPACES BETWEEN THE LETTERS.

SER. NO. 85-368,337, FILED 7-11-2011.

BRENDAN MCCAULEY, EXAMINING ATTORNEY



David J. Kyros

Director of the United States Patent and Trademark Office

United States of America

United States Patent and Trademark Office

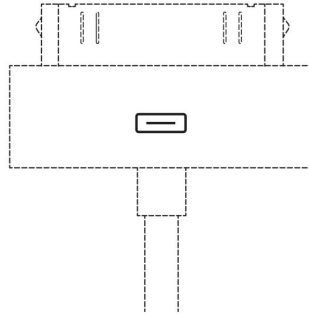

Reg. No. 4,174,205

Registered July 17, 2012

Int. Cl.: 9

TRADEMARK

PRINCIPAL REGISTER

APPLE INC. (CALIFORNIA CORPORATION)
1 INFINITE LOOP
CUPERTINO, CA 95014

FOR: ELECTRICAL CONNECTORS, WIRES, CABLES, CHARGERS, AND ADAPTERS, ALL FOR USE WITH COMPUTERS, COMPUTER PERIPHERALS, CONSUMER ELECTRONICS, PORTABLE AND HANDHELD DIGITAL ELECTRONIC DEVICES, DIGITAL MEDIA PLAYERS, HANDHELD COMPUTERS, TABLET COMPUTERS, MOBILE PHONES, ELECTRONIC BOOK READERS, ELECTRONIC PERSONAL ORGANIZER, PERSONAL DIGITAL ASSISTANT, ELECTRONIC CALENDAR, AND GLOBAL POSITIONING SYSTEM (GPS) DEVICES, IN CLASS 9 (U.S. CLS. 21, 23, 26, 36 AND 38).

FIRST USE 4-28-2003; IN COMMERCE 4-28-2003.

THE MARK CONSISTS OF A HORIZONTAL LINE SURROUNDED BY A RECTANGLE WITH ROUNDED CORNERS. THE BROKEN LINES ARE NOT A PART OF THE MARK AND SERVE ONLY TO SHOW THE POSITION OF THE MARK.

SER. NO. 85-368,339, FILED 7-11-2011.

KAPIL BHANOT, EXAMINING ATTORNEY



David J. Kyjars

Director of the United States Patent and Trademark Office

United States of America

United States Patent and Trademark Office

SunSil

Reg. No. 4,174,206

Registered July 17, 2012

Int. Cl.: 35

SERVICE MARK

PRINCIPAL REGISTER

SUNSIL INC. (CALIFORNIA CORPORATION)
3174 DANVILLE BLVD. #1
ALAMO, CA 94507

FOR: PROMOTING THE GOODS AND SERVICES OF OTHERS BY PROVIDING MARKETING SERVICES AND ADVERTISING SERVICES OVER A WEBSITE, PRINTED MATERIALS, OR VIA PERSONAL COMMUNICATIONS IN THE FIELD OF SEMICONDUCTORS, WAFER FABRICATION, COMPONENT ASSEMBLY OF INTEGRATED CIRCUITS, INTEGRATED CIRCUIT PROBE AND FINAL TEST PROCESS AND REQUIREMENTS, AND PROVIDING MERGER AND ACQUISITION ACTIVITIES RELATING TO SEMICONDUCTOR MANUFACTURING, IN CLASS 35 (U.S. CLS. 100, 101 AND 102).

FIRST USE 9-20-1999; IN COMMERCE 9-20-1999.

THE MARK CONSISTS OF STYLIZED WORDING "SUNSIL" IN WHICH THE LETTERS ARE IN BLUE WITH NO COLOR OUTLINING THEM AND SLIGHTLY ITALICIZED OR TILTED TO THE RIGHT AS THE READER LOOKS AT THE MARK AND THE SECOND "S" IN THE MARK IS CAPITALIZED.

THE COLOR(S) BLUE IS/ARE CLAIMED AS A FEATURE OF THE MARK.

SER. NO. 85-368,349, FILED 7-11-2011.

KATINA MISTER, EXAMINING ATTORNEY



David J. Kyffers

Director of the United States Patent and Trademark Office

United States of America

United States Patent and Trademark Office

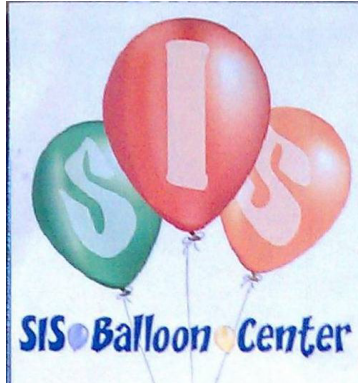

Reg. No. 4,174,207

Registered July 17, 2012

Int. Cl.: 20

TRADEMARK

PRINCIPAL REGISTER

SELF INFLATION STATION, LLC (MICHIGAN LIMITED LIABILITY COMPANY)
1151 MADISON AVE SE
GRAND RAPIDS, MI 49507

FOR: DISPLAY CASES IN THE NATURE OF THE HELIUM BALLOON DISPLAY AND INFLATION KIOSK, IN CLASS 20 (U.S. CLS. 2, 13, 22, 25, 32 AND 50).

FIRST USE 8-27-2008; IN COMMERCE 2-1-2009.

NO CLAIM IS MADE TO THE EXCLUSIVE RIGHT TO USE "BALLOON" AND "CENTER", APART FROM THE MARK AS SHOWN.

THE COLOR(S) GREEN, RED, ORANGE, BLUE, AND WHITE IS/ARE CLAIMED AS A FEATURE OF THE MARK.

THE MARK CONSISTS OF THREE BALLOONS WITH STRINGS ATTACHED AND WITH THE WHITE LETTER "S" IN THE FIRST BALLOON WHICH IS GREEN, THE WHITE LETTER "I" ON THE MIDDLE BALLOON THAT IS RED, AND THE WHITE LETTER "S" ON THE LAST BALLOON WHICH IS ORANGE. THE CENTER BALLOON IS IN THE FOREFRONT AND POSITIONED SLIGHTLY HIGHER THAN THE OTHER TWO BALLOONS. BELOW THE BALLOONS ARE THE WORDS "SIS BALLOON CENTER" IN BLUE WITH A SMALL TRANSPARENT BLUE BALLOON APPEARING BETWEEN THE WORDS "SIS" AND "BALLOON" AND A SMALL TRANSPARENT ORANGE BALLOON APPEARING BETWEEN THE WORDS "BALLOON" AND "CENTER".

SER. NO. 85-368,766, FILED 7-12-2011.

NAKIA HENRY, EXAMINING ATTORNEY



David J. Kyjars

Director of the United States Patent and Trademark Office

United States of America

United States Patent and Trademark Office

Elvis Orbison

Reg. No. 4,174,208

Registered July 17, 2012

Int. Cl.: 41

SERVICE MARK

PRINCIPAL REGISTER

LYDA, BRETT (UNITED STATES INDIVIDUAL)
K
801 MERIDIAN AVE
SOUTH PASADENA, CA 91030

FOR: ENTERTAINMENT, NAMELY, LIVE PERFORMANCES BY A MUSICAL BAND, IN CLASS 41 (U.S. CLS. 100, 101 AND 107).

FIRST USE 4-1-2011; IN COMMERCE 4-1-2011.

THE MARK CONSISTS OF STANDARD CHARACTERS WITHOUT CLAIM TO ANY PARTICULAR FONT, STYLE, SIZE, OR COLOR.

THE NAME(S), PORTRAIT(S), AND/OR SIGNATURE(S) SHOWN IN THE MARK DOES NOT IDENTIFY A PARTICULAR LIVING INDIVIDUAL.

SER. NO. 85-368,973, FILED 7-12-2011.

SUSAN STIGLITZ, EXAMINING ATTORNEY



David J. Kyffers

Director of the United States Patent and Trademark Office

United States of America

United States Patent and Trademark Office



Reg. No. 4,174,209

Registered July 17, 2012

Int. Cl.: 36

SERVICE MARK

PRINCIPAL REGISTER

KIDS MATTER INTERNATIONAL (TEXAS CORPORATION), AKA KIDS MATTER
401 N. CARROLL AVE., STE. 153
SOUTHLAKE, TX 760926407

FOR: CHARITABLE FUNDRAISING SERVICES, IN CLASS 36 (U.S. CLS. 100, 101 AND 102).

FIRST USE 12-15-2007; IN COMMERCE 12-15-2007.

NO CLAIM IS MADE TO THE EXCLUSIVE RIGHT TO USE "KIDS", APART FROM THE MARK AS SHOWN.

THE COLOR(S) YELLOW, BLUE, GREEN, RED AND BLACK IS/ARE CLAIMED AS A FEATURE OF THE MARK.

THE STIPPLING IS FOR SHADING PURPOSES ONLY.

THE MARK CONSISTS OF THE WORD "KIDS" WITH: A YELLOW "K"; A BLUE "I" DOTTED WITH A STIPPLED BLUE LEFT HAND PRINT; A GREEN "D"; AND A RED "S" ALL OUTLINED IN BLACK FOLLOWED BY THE WORD "MATTER" IN BLUE LETTERS OUTLINED IN GREEN.

SER. NO. 85-369,231, FILED 7-12-2011.

STEPHANIE ALI, EXAMINING ATTORNEY



David J. Kybas

Director of the United States Patent and Trademark Office

United States of America

United States Patent and Trademark Office



Reg. No. 4,174,210

KIDS MATTER INTERNATIONAL (TEXAS CORPORATION), AKA KIDS MATTER
401 N. CARROLL AVE., STE. 153
SOUTHLAKE, TX 760926407

Registered July 17, 2012

Int. Cl.: 36

FOR: CHARITABLE FUNDRAISING SERVICES, IN CLASS 36 (U.S. CLS. 100, 101 AND 102).

SERVICE MARK

FIRST USE 12-15-2007; IN COMMERCE 12-15-2007.

PRINCIPAL REGISTER

NO CLAIM IS MADE TO THE EXCLUSIVE RIGHT TO USE "KIDS" AND "INTERNATIONAL",
APART FROM THE MARK AS SHOWN.

THE COLOR(S) YELLOW, BLUE, GREEN, RED AND BLACK IS/ARE CLAIMED AS A
FEATURE OF THE MARK.

THE STIPPLING IS FOR SHADING PURPOSES ONLY.

THE MARK CONSISTS OF THE WORD "KIDS" WITH: A YELLOW "K"; A BLUE "I" DOTTED
WITH A STIPPLED LEFT HAND PRINT; A GREEN "D"; AND A RED "S" ALL OUTLINED
IN BLACK FOLLOWED BY THE WORD "MATTER" IN BLUE LETTERS OUTLINED IN
GREEN ALL OVER THE WORD "INTERNATIONAL" IN BLUE WITH A SPACE BETWEEN
EACH LETTER.

SER. NO. 85-369,380, FILED 7-12-2011.

STEPHANIE ALI, EXAMINING ATTORNEY



David J. Kyjars

Director of the United States Patent and Trademark Office

United States of America

United States Patent and Trademark Office

EMOTIONAL LIFEGUARD

Reg. No. 4,174,211

MARTIN, MOYA (AUSTRALIA INDIVIDUAL)
14 KING STREET

Registered July 17, 2012

BALMAIN NSW 2041, AUSTRALIA

Int. Cls.: 9, 16, 41 and 44

FOR: PRERECORDED CDS, DISCS BEARING VIDEO RECORDINGS, PRE-RECORDED MOTION PICTURE VIDEOS, PRE-RECORDED MOTION PICTURE VIDEOS, PRE-RECORDED VIDEO DISCS, PRE-RECORDED VIDEO RECORDINGS, PRE-RECORDED VIDEOS ON OPTICAL DISK STORAGE MEDIA, COMPACT DISKS AND DVDS, PRERECORDED VIDEO COMPACT DISCS, PRERECORDED VIDEO RECORDING DISCS, VIDEO RECORDINGS, RECORDINGS INCORPORATING SOUND TRACK, AUDIO RECORDINGS, AND PRERECORDED COMPACT DISCS WITH AUDIO-VIDEO, ALL FEATURING INFORMATION PERTAINING TO HEALTH, PSYCHOLOGY, EMOTIONAL WELL-BEING, AND PSYCHOLOGICAL AND EMOTIONAL COUNSELING; PRERECORDED CDS, DISCS BEARING VIDEO RECORDINGS, PRE-RECORDED MOTION PICTURE VIDEOS, PRE-RECORDED VIDEO DISCS, PRE-RECORDED VIDEO RECORDINGS, PRE-RECORDED VIDEOS ON OPTICAL DISK STORAGE MEDIA, COMPACT DISKS, DVDS, PRE-RECORDED VIDEO COMPACT DISCS, PRERECORDED VIDEO RECORDING DISCS, VIDEO RECORDINGS, VIDEO RECORDINGS INCORPORATING SOUND TRACK, AUDIO RECORDINGS, PRERECORDED COMPACT DISCS WITH AUDIO-VIDEO, ALL FOR TEACHING AND INSTRUCTIONAL PURPOSES AND FEATURING INFORMATION PERTAINING TO HEALTH, PSYCHOLOGY, EMOTIONAL WELL-BEING, AND PSYCHOLOGICAL AND EMOTIONAL COUNSELING, IN CLASS 9 (U.S. CLS. 21, 23, 26, 36 AND 38).

TRADEMARK

SERVICE MARK

PRINCIPAL REGISTER

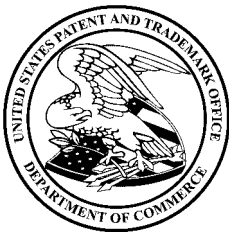

David J. Kyros

Director of the United States Patent and Trademark Office

FOR: EDUCATIONAL MATERIALS FOR USE IN TEACHING, NAMELY, WRITTEN AND PRINTED BOOKS, NEWSLETTERS, BROCHURES AND PAMPHLETS, ALL FEATURING INFORMATION PERTAINING TO HEALTH, PSYCHOLOGY, EMOTIONAL WELL-BEING, AND PSYCHOLOGICAL AND EMOTIONAL COUNSELING; EDUCATIONAL MATERIALS IN PRINTED FORM FEATURING INFORMATION PERTAINING TO HEALTH, PSYCHOLOGY, EMOTIONAL WELL-BEING, AND PSYCHOLOGICAL AND EMOTIONAL COUNSELING; PRINTED EDUCATIONAL MATERIALS IN WRITTEN FORM FEATURING INFORMATION PERTAINING TO HEALTH, PSYCHOLOGY, EMOTIONAL WELLBEING, PSYCHOLOGICAL AND EMOTIONAL COUNSELING; TEACHING MATERIALS FOR EDUCATION, NAMELY, BOOKS, NEWSLETTERS, BROCHURES AND PAMPHLETS FEATURING INFORMATION PERTAINING TO HEALTH, PSYCHOLOGY, EMOTIONAL WELL-BEING, PSYCHOLOGICAL AND EMOTIONAL COUNSELING; INSTRUCTION MANUALS AND HANDBOOKS IN THE FORM OF BOOKS, NEWSLETTERS, BROCHURES AND PAMPHLETS, ALL FEATURING INFORMATION PERTAINING TO HEALTH, PSYCHOLOGY,

Reg. No. 4,174,211 EMOTIONAL WELL-BEING, AND PSYCHOLOGICAL AND EMOTIONAL COUNSELING; MANUALS IN THE FIELD OF INSTRUCTIONAL COUNSELING; MANUALS IN THE FIELD OF TRAINING SEMINARS RELATING TO INFORMATION PERTAINING TO HEALTH, PSYCHOLOGY, EMOTIONAL WELL-BEING, AND PSYCHOLOGICAL AND EMOTIONAL COUNSELING; PRINTED QUESTIONNAIRES ON PERSONAL PSYCHOLOGICAL ASSESSMENT; IN THE FIELD OF INSTRUCTIONAL MEDICAL HEALTH; PRINTED PERIODICALS IN THE FIELD OF HEALTH CARE; PRINTED MATTER, NAMELY, BOOKS, NEWSLETTERS, BROCHURES AND PAMPHLETS IN THE FIELD OF HEALTH EDUCATION, IN CLASS 16 (U.S. CLS. 2, 5, 22, 23, 29, 37, 38 AND 50).

FOR: BOOK PUBLISHING; ADULT EDUCATION, NAMELY, PERSONAL SESSIONS, CLASSES, WORKSHOPS, SEMINARS AND ONLINE FORUMS AND SESSIONS IN THE FIELD OF HEALTH, PSYCHOLOGY, EMOTIONAL WELL-BEING, AND PSYCHOLOGICAL AND EMOTIONAL COUNSELING; PROVIDING TRAINING TO MEMBERS OF AN ASSOCIATION, NAMELY, PERSONAL SESSIONS, CLASSES, WORKSHOPS, SEMINARS AND ONLINE FORUMS AND SESSIONS IN THE FIELD OF HEALTH, PSYCHOLOGY, EMOTIONAL WELL-BEING, AND PSYCHOLOGICAL AND EMOTIONAL COUNSELING; ARRANGING AND CONDUCTING EDUCATIONAL CONFERENCES; CONDUCTING OF EDUCATIONAL COURSES IN THE FIELD OF HEALTH, PSYCHOLOGY, EMOTIONAL WELL-BEING, AND PSYCHOLOGICAL AND EMOTIONAL COUNSELING; DEVELOPMENT AND DISSEMINATION OF EDUCATIONAL MATERIAL OF OTHERS IN THE FIELD OF HEALTH, PSYCHOLOGY, EMOTIONAL WELL-BEING, AND PSYCHOLOGICAL AND EMOTIONAL COUNSELING; EDUCATIONAL INSTRUCTION, NAMELY, PERSONAL SESSIONS, CLASSES, WORKSHOPS, SEMINARS AND ONLINE FORUMS AND SESSIONS IN THE FIELD OF HEALTH, PSYCHOLOGY, EMOTIONAL WELL-BEING, AND PSYCHOLOGICAL AND EMOTIONAL COUNSELING; HEALTH EDUCATION, NAMELY, PERSONAL SESSIONS, CLASSES, WORKSHOPS, SEMINARS AND ONLINE FORUMS AND SESSIONS; LIFE COACHING SERVICES IN THE FIELD OF HEALTH, PSYCHOLOGY, AND EMOTIONAL WELL-BEING; MENTORING IN THE FIELD OF HEALTH, PSYCHOLOGY, EMOTIONAL WELL-BEING; PROVISION OF EDUCATION COURSES IN THE FIELD OF HEALTH, PSYCHOLOGY, AND EMOTIONAL WELLBEING; PROVISION OF EDUCATION SERVICES VIA AN ONLINE FORUM IN THE FIELD OF HEALTH, PSYCHOLOGY, EMOTIONAL WELL-BEING, AND PSYCHOLOGICAL AND EMOTIONAL COUNSELING; PROVIDING INFORMATION ABOUT EDUCATION; PUBLICATION OF EDUCATIONAL TEXTS, NAMELY, BOOKS, NEWSLETTERS, BROCHURES AND PAMPHLETS IN THE FIELD OF HEALTH, PSYCHOLOGY, EMOTIONAL WELL-BEING, AND PSYCHOLOGICAL AND EMOTIONAL COUNSELING; PERSONAL SESSIONS, CLASSES, WORKSHOPS, SEMINARS AND ONLINE FORUMS OR SESSIONS IN THE FIELD OF HEALTH EDUCATION , IN CLASS 41 (U.S. CLS. 100, 101 AND 107).

FOR: PSYCHOLOGICAL COUNSELING; PROVISION OF INFORMATION RELATING TO PSYCHOLOGY; ADVISORY SERVICES RELATING TO HEALTH; ADVISORY SERVICES RELATING TO MEDICAL PROBLEMS; CONSULTANCY AND ADVISORY SERVICES IN RELATION TO MEDICAL SERVICES; PSYCHOTHERAPY SERVICES; LIFESTYLE COUNSELING IN THE NATURE OF MEDICAL ADVICE; LIFESTYLE COUNSELING IN THE NATURE OF PSYCHOLOGICAL ADVICE; PROVISION OF INFORMATION RELATING TO PSYCHOLOGY; PREPARATION OF PSYCHOLOGICAL PROFILES FOR MEDICAL PURPOSES; PREPARING PSYCHOLOGICAL PROFILES; PSYCHIATRIC SERVICES; PSYCHIATRY; PSYCHOLOGICAL COUNSELING; PSYCHOLOGICAL EXAMINATION; PSYCHIATRIC COUNSELING; CONSULTANCY RELATING TO HEALTH CARE; HEALTH CARE; HEALTH CARE CONSULTANCY SERVICES; HEALTH CLINIC SERVICES; HEALTHCARE; INFORMATION SERVICES RELATING TO HEALTH CARE; MEDICAL HEALTH ASSESSMENT SERVICES; MEDICAL NURSING; HYGIENIC AND BEAUTY CARE, IN CLASS 44 (U.S. CLS. 100 AND 101).

THE MARK CONSISTS OF STANDARD CHARACTERS WITHOUT CLAIM TO ANY PARTICULAR FONT, STYLE, SIZE, OR COLOR.

Reg. No. 4,174,211 OWNER OF AUSTRALIA REG. NO. 1302317, DATED 1-28-2010, EXPIRES 6-3-2019.

SER. NO. 85-369,595, FILED 7-12-2011.

MARGERY A. TIERNEY, EXAMINING ATTORNEY

United States of America

United States Patent and Trademark Office

Sleep When You're Dead

Reg. No. 4,174,212

SWYD, LLC (WEST VIRGINIA LIMITED LIABILITY COMPANY)
406 N. RED HILL ROAD
MARTINSBURG, WV 25401

Registered July 17, 2012

Int. Cl.: 25

FOR: ATHLETIC APPAREL, NAMELY, SHIRTS, PANTS, JACKETS, FOOTWEAR, HATS AND CAPS, ATHLETIC UNIFORMS, IN CLASS 25 (U.S. CLS. 22 AND 39).

TRADEMARK

FIRST USE 7-7-2011; IN COMMERCE 7-7-2011.

PRINCIPAL REGISTER

THE MARK CONSISTS OF THE STYLIZED WORDING "SLEEP WHEN YOU'RE DEAD".

SER. NO. 85-370,127, FILED 7-13-2011.

SUE LAWRENCE, EXAMINING ATTORNEY



David J. Kybas

Director of the United States Patent and Trademark Office

United States of America

United States Patent and Trademark Office

APT212

Reg. No. 4,174,213

APT212 INC. (NEW YORK CORPORATION)
303 PARK AVENUE SOUTH, SUITE 1450
NEW YORK, NY 10010

Registered July 17, 2012

Int. Cl.: 36

FOR: REAL ESTATE MANAGEMENT OF FURNISHED RESIDENTIAL REAL ESTATE, IN CLASS 36 (U.S. CLS. 100, 101 AND 102).

SERVICE MARK

FIRST USE 5-27-2010; IN COMMERCE 5-27-2010.

PRINCIPAL REGISTER

THE MARK CONSISTS OF STANDARD CHARACTERS WITHOUT CLAIM TO ANY PARTICULAR FONT, STYLE, SIZE, OR COLOR.

SER. NO. 85-370,134, FILED 7-13-2011.

JENNY PARK, EXAMINING ATTORNEY



David J. Kyffers

Director of the United States Patent and Trademark Office

United States of America

United States Patent and Trademark Office

EXCENTIAL

Reg. No. 4,174,214

Registered July 17, 2012

Int. Cls.: 1 and 5

TRADEMARK

PRINCIPAL REGISTER

EXCENTIALS IP, BESLOTEN VENNOOTSCHAP (CURACAO LIMITED LIABILITY COMPANY)
BERG ARRARAT 1
CURACAO, CURACAO

FOR: CHEMICAL ADDITIVES FOR USE IN THE MANUFACTURE OF ANIMAL FEED; CHEMICAL ADDITIVES FOR PRESERVING FOODSTUFFS; ARTIFICIAL SWEETENERS; ENZYMES FOR USE IN THE MANUFACTURE OF ANIMAL FEED; EMULSIFIERS FOR USE IN THE MANUFACTURE OF ANIMAL FEED; ANTI-OXIDANTS FOR USE IN THE MANUFACTURE OF ANIMAL FEED; MINERAL ACIDS FOR USE IN THE MANUFACTURE OF ANIMAL FEED; ANIMAL FEED SUPPLEMENT INGREDIENTS, NAMELY, PLANT COMPOUNDS, NAMELY, AMINO ACIDS, ANTI-OXIDANTS, CARBOHYDRATES AND DERIVATIVES OF ALL OF THE FOREGOING, PEPTIDES, FATS AND FATTY ACIDS AND THEIR DERIVATIVES EXTRACTED FROM PLANTS FOR USE IN THE MANUFACTURE OF MEDICINE, IN CLASS 1 (U.S. CLS. 1, 5, 6, 10, 26 AND 46).

FOR: ANIMAL FEED SUPPLEMENTS; ENZYME PREPARATIONS FOR VETERINARY PURPOSES FOR USE AS A DIGESTIVE AND NUTRITIONAL AID; VITAMINS AND VITAMIN SUPPLEMENTS; MINERAL SUPPLEMENTS; ANIMAL FEED SUPPLEMENT INGREDIENTS FOR MEDICAL PURPOSES, NAMELY, PLANT COMPOUNDS, NAMELY, AMINO ACIDS, ANTI-OXIDANTS, CARBOHYDRATES AND DERIVATIVES OF ALL OF THE FOREGOING, PEPTIDES, FATS AND FATTY ACIDS AND THEIR DERIVATIVES EXTRACTED FROM PLANTS FOR PHYSIOLOGICAL PURPOSES, NAMELY, FOR USE AS A DIGESTIVE AND NUTRITIONAL SUPPLEMENT; SUGAR REPLACEMENT FOR VETERINARY PURPOSES; AMINO ACIDS FOR VETERINARY PURPOSES, IN CLASS 5 (U.S. CLS. 6, 18, 44, 46, 51 AND 52).

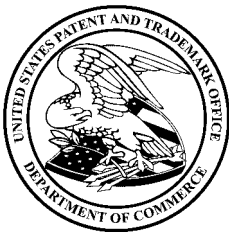

THE MARK CONSISTS OF STANDARD CHARACTERS WITHOUT CLAIM TO ANY PARTICULAR FONT, STYLE, SIZE, OR COLOR.

OWNER OF BENELUX REG. NO. 867121, DATED 10-12-2009, EXPIRES 7-15-2019.

THE WORDING "EXCENTIAL" HAS NO MEANING IN A FOREIGN LANGUAGE.

SER. NO. 85-370,422, FILED 7-13-2011.

BARNEY CHARLON, EXAMINING ATTORNEY

David J. Kypos

Director of the United States Patent and Trademark Office

United States of America

United States Patent and Trademark Office



Reg. No. 4,174,215

OAKBROOK SOLUTIONS, INC (NORTH CAROLINA CORPORATION)
301 N. MAIN STREET, SUITE 2424
WINSTON-SALEM, NC 27101

Registered July 17, 2012

Int. Cl.: 35

FOR: BUSINESS PROCESS RE-ENGINEERING SERVICES; CONSULTING SERVICES IN THE AREA OF SUSTAINABLE BUSINESS SOLUTIONS; INFORMATION AND DATA COMPILING AND ANALYZING RELATING TO BUSINESS MANAGEMENT, IN CLASS 35 (U.S. CLS. 100, 101 AND 102).

SERVICE MARK

PRINCIPAL REGISTER

FIRST USE 10-10-2007; IN COMMERCE 11-12-2007.

NO CLAIM IS MADE TO THE EXCLUSIVE RIGHT TO USE "THE BPM SOLUTION FOR WEALTH MANAGEMENT", APART FROM THE MARK AS SHOWN.

THE COLOR(S) BLUE AND GRAY IS/ARE CLAIMED AS A FEATURE OF THE MARK.

THE MARK CONSISTS OF LITERAL ELEMENTS "WEALTHWORX THE BPM SOLUTION FOR WEALTH MANAGEMENT" IN SHADES OF BLUE AND GRAY WHEREIN AN IMAGE CONSISTING OF A STYLIZED LETTER "W" IN SHADES OF BLUE AND GRAY SITS TO THE LEFT OF THE OTHER LITERAL ELEMENTS, AND WHEREIN THE WORD "WEALTHWORX" IS UNDERLINED WITH A DIAMOND IMAGE AT THE CENTER, ALL IN LIGHT BLUE.

SER. NO. 85-370,847, FILED 7-13-2011.

TINA MAI, EXAMINING ATTORNEY



David J. Kybas

Director of the United States Patent and Trademark Office

United States of America

United States Patent and Trademark Office

EuroclearReach

Reg. No. 4,174,216

EUROCLEAR PLC (UNITED KINGDOM COMPANY)

Registered July 17, 2012

BAARERMATTE
CH-6340 BAAR, SWITZERLAND

**Int. Cls.: 9, 35, 36, 38
and 42**

FOR: SOFTWARE FOR ELECTRONIC DATA PROCESSING AND ELECTRONIC TRANSMISSION OF FUNDS, DATA AND DOCUMENTS RELATING TO FINANCIAL SERVICES, IN CLASS 9 (U.S. CLS. 21, 23, 26, 36 AND 38).

TRADEMARK

FOR: MANAGEMENT AND COMPILATION OF COMPUTERIZED DATABASES FEATURING FINANCIAL INFORMATION FOR THE BUYING, SELLING, TRADING, CUSTODY AND ADMINISTRATION OF SECURITIES, IN CLASS 35 (U.S. CLS. 100, 101 AND 102).

SERVICE MARK

PRINCIPAL REGISTER

FOR: PROVIDING AN ONLINE COMPUTERIZED DATABASE IN THE FIELD OF FINANCIAL INFORMATION FOR THE BUYING, SELLING, TRADING, CUSTODY AND ADMINISTRATION OF SECURITIES; BANKING AND FINANCIAL SERVICES, NAMELY, ELECTRONIC FINANCIAL TRADING SERVICES; FINANCIAL AFFAIRS AND MONETARY AFFAIRS, NAMELY, FINANCIAL INFORMATION, MANAGEMENT AND ANALYSIS SERVICES; FINANCIAL SERVICES, NAMELY, INVESTMENT FUND TRANSFER AND TRANSACTION SERVICES; FINANCIAL SERVICES, NAMELY, ASSISTING OTHERS WITH THE COMPLETION OF FINANCIAL TRANSACTIONS FOR STOCKS, BONDS, SECURITIES AND EQUITIES; FINANCIAL TRANSACTION SERVICES, NAMELY, PROVIDING SECURE COMMERCIAL TRANSACTIONS AND PAYMENT OPTIONS, IN CLASS 36 (U.S. CLS. 100, 101 AND 102).



FOR: ELECTRONIC TRANSMISSION OF FINANCIAL DATA AND DOCUMENTS VIA A GLOBAL COMPUTER NETWORK, IN CLASS 38 (U.S. CLS. 100, 101 AND 104).

FOR: DATABASE DEVELOPMENT SERVICES IN THE FIELD OF FINANCIAL INFORMATION FOR THE BUYING, SELLING, TRADING, CUSTODY AND ADMINISTRATION OF SECURITIES, IN CLASS 42 (U.S. CLS. 100 AND 101).

THE MARK CONSISTS OF STANDARD CHARACTERS WITHOUT CLAIM TO ANY PARTICULAR FONT, STYLE, SIZE, OR COLOR.

David J. Kyffers

PRIORITY CLAIMED UNDER SEC. 44(D) ON ERPN CMNTY TM OFC APPLICATION NO. 010124915, FILED 7-14-2011, REG. NO. 010124915, DATED 2-23-2012, EXPIRES 7-14-2021.

Reg. No. 4,174,216 OWNER OF U.S. REG. NOS. 874,461, 3,576,251 AND OTHERS.

SER. NO. 85-372,242, FILED 7-15-2011.

AMY ALFIERI, EXAMINING ATTORNEY

United States of America

United States Patent and Trademark Office



Post-trade made easy

Reg. No. 4,174,217

Registered July 17, 2012

**Int. Cls.: 9, 35, 36, 38
and 42**

TRADEMARK

SERVICE MARK

PRINCIPAL REGISTER

EUROCLEAR PLC (UNITED KINGDOM COMPANY)
BAARERMATTE
CH 6340, BAAR, SWITZERLAND

FOR: SOFTWARE FOR ELECTRONIC DATA PROCESSING AND ELECTRONIC TRANSMISSION OF FUNDS, DATA AND DOCUMENTS RELATING TO FINANCIAL SERVICES, IN CLASS 9 (U.S. CLS. 21, 23, 26, 36 AND 38).

FOR: MANAGEMENT AND COMPILATION OF COMPUTERIZED DATABASES FEATURING FINANCIAL INFORMATION FOR THE BUYING, SELLING, TRADING, CUSTODY AND ADMINISTRATION OF SECURITIES, IN CLASS 35 (U.S. CLS. 100, 101 AND 102).

FOR: PROVIDING AN ONLINE COMPUTERIZED DATABASE IN THE FIELD OF FINANCIAL INFORMATION FOR THE BUYING, SELLING, TRADING, CUSTODY AND ADMINISTRATION OF SECURITIES; BANKING AND FINANCIAL SERVICES, NAMELY, ELECTRONIC FINANCIAL TRADING SERVICES; FINANCIAL AFFAIRS AND MONETARY AFFAIRS, NAMELY, FINANCIAL INFORMATION, MANAGEMENT AND ANALYSIS SERVICES; FINANCIAL SERVICES, NAMELY, INVESTMENT FUND TRANSFER AND TRANSACTION SERVICES; FINANCIAL SERVICES, NAMELY, ASSISTING OTHERS WITH THE COMPLETION OF FINANCIAL TRANSACTIONS FOR STOCKS, BONDS, SECURITIES AND EQUITIES; FINANCIAL TRANSACTION SERVICES, NAMELY, PROVIDING SECURE COMMERCIAL TRANSACTIONS AND PAYMENT OPTIONS, IN CLASS 36 (U.S. CLS. 100, 101 AND 102).

FOR: ELECTRONIC TRANSMISSION OF FINANCIAL DATA AND DOCUMENTS VIA A GLOBAL COMPUTER NETWORK, IN CLASS 38 (U.S. CLS. 100, 101 AND 104).

FOR: DATABASE DEVELOPMENT SERVICES IN THE FIELD OF FINANCIAL INFORMATION FOR THE BUYING, SELLING, TRADING, CUSTODY AND ADMINISTRATION OF SECURITIES, IN CLASS 42 (U.S. CLS. 100 AND 101).

PRIORITY CLAIMED UNDER SEC. 44(D) ON ERPN CMNTY TM OFC APPLICATION NO. 010124923, FILED 7-14-2011, REG. NO. 010124923, DATED 2-23-2012, EXPIRES 7-14-2021.

OWNER OF U.S. REG. NOS. 874,461, 2,940,449 AND OTHERS.



David J. Kyjars

Director of the United States Patent and Trademark Office

Reg. No. 4,174,217 NO CLAIM IS MADE TO THE EXCLUSIVE RIGHT TO USE "POST-TRADE", APART FROM THE MARK AS SHOWN.

THE MARK CONSISTS OF BROKEN SWIRLS INSIDE A SQUARE WITH ROUNDED CORNERS. THE WORD "EUROCLEAR" APPEARS BELOW THE BROKEN SWIRLS AND THE WORDS "POST-TRADE MADE EASY" APPEAR BELOW THE SQUARE WITH ROUNDED CORNERS.

SER. NO. 85-372,580, FILED 7-15-2011.

AMY ALFIERI, EXAMINING ATTORNEY

United States of America

United States Patent and Trademark Office



Reg. No. 4,174,218

Registered July 17, 2012

Int. Cl.: 35

SERVICE MARK

PRINCIPAL REGISTER

CALIFORNIA FAMILY HEALTH COUNCIL, INC. (CALIFORNIA CORPORATION)
3600 WILSHIRE BOULEVARD, SUITE 600
LOS ANGELES, CA 90010

FOR: PROMOTING PUBLIC AWARENESS OF THE NEED FOR FAMILY PLANNING AND RELATED REPRODUCTIVE HEALTH CARE ISSUES; PROMOTING PUBLIC AWARENESS OF THE ACCESSIBILITY OF EFFECTIVE MEANS OF VOLUNTARY FERTILITY CONTROL, CONTRACEPTION, FAMILY PLANNING AND RELATED REPRODUCTIVE HEALTH CARE; PROMOTING PUBLIC AWARENESS OF THE NEED FOR FAMILY PLANNING AND RELATED REPRODUCTIVE HEALTH CARE SERVICES TO HEALTH PROFESSIONALS AND POLICY MAKERS; PROMOTING PUBLIC AWARENESS OF THE NEED FOR FAMILY PLANNING AND RELATED REPRODUCTIVE HEALTH CARE SERVICES; PROMOTING PUBLIC AWARENESS OF THE NEED FOR EFFECTIVE PUBLIC POLICY DECISIONS THAT ENSURE AND EXPAND ACCESS TO HIGH QUALITY FAMILY PLANNING AND RELATED REPRODUCTIVE HEALTH CARE SERVICES; CAREER PLACEMENT, NAMELY, FIELD PLACEMENT FOR GRADUATE STUDENTS IN REPRODUCTIVE HEALTH CARE AND FAMILY PLANNING AGENCIES AND ORGANIZATIONS; BUSINESS PLANNING FOR HEALTH CARE PROVIDERS, NAMELY, COORDINATING AND SUPPORTING THE DELIVERY OF FAMILY PLANNING AND RELATED REPRODUCTIVE HEALTH CARE SERVICES IN COMMUNITY-BASED ORGANIZATIONS THROUGHOUT CALIFORNIA, IN CLASS 35 (U.S. CLS. 100, 101 AND 102).

FIRST USE 7-11-1997; IN COMMERCE 7-11-1997.

OWNER OF U.S. REG. NO. 2,909,664.

THE MARK CONSISTS OF A SHADED RECTANGLE WHICH HAS WITHIN IT FROM LEFT TO RIGHT THE LETTER "C" SLIGHTLY ELEVATED ABOVE AND TOUCHING THE LETTER "F", FOLLOWED BY THE LETTER "H" SLIGHTLY ELEVATED ABOVE THE LETTER "F", AND FOLLOWED BY THE LETTER "C" BELOW AND TOUCHING THE LETTER "H".

SER. NO. 85-373,012, FILED 7-15-2011.

MICHAEL WIENER, EXAMINING ATTORNEY



David J. Kyjars

Director of the United States Patent and Trademark Office

United States of America

United States Patent and Trademark Office

MABOROSHI

Reg. No. 4,174,219

Registered July 17, 2012

Int. Cl.: 33

TRADEMARK

PRINCIPAL REGISTER

NAKAO SAKE BREWERY CO., LTD. (JAPAN JOINT STOCK COMPANY)
5-9-14 CHUOU, TAKEHARA-SHI
HIROSHIMA, JAPAN 725-0026

FOR: SAKE, IN CLASS 33 (U.S. CLS. 47 AND 49).

FIRST USE 10-14-2010; IN COMMERCE 10-14-2010.

THE MARK CONSISTS OF STANDARD CHARACTERS WITHOUT CLAIM TO ANY PARTICULAR FONT, STYLE, SIZE, OR COLOR.

OWNER OF U.S. REG. NO. 3,734,469.

THE ENGLISH TRANSLATION OF THE WORD "MABOROSHI" IN THE MARK IS "MYSTERY".

SER. NO. 85-373,484, FILED 7-18-2011.

HOWARD B. LEVINE, EXAMINING ATTORNEY



David J. Kyros

Director of the United States Patent and Trademark Office

United States of America

United States Patent and Trademark Office

Drop the Rope

Reg. No. 4,174,220

ASLAN TRAINING & DEVELOPMENT, LLC (GEORGIA LIMITED LIABILITY COMPANY)
680 VILLAGE TRACE, SE, SUITE E
MARIETTA, GA 30067

Registered July 17, 2012

Int. Cl.: 41

FOR: EDUCATIONAL SERVICES, NAMELY, PROVIDING CLASSES, SEMINARS, WEBINARS, WORKSHOPS, PODCAST, TRAINING AND PERSONAL AND GROUP COACHING IN SALES, CUSTOMER SERVICE, CONSULTING, MARKETING AND DISTRIBUTION OF TRAINING MATERIAL IN CONNECTION THEREWITH, IN CLASS 41 (U.S. CLS. 100, 101 AND 107).

SERVICE MARK

PRINCIPAL REGISTER

FIRST USE 2-28-2000; IN COMMERCE 2-28-2000.

THE MARK CONSISTS OF STANDARD CHARACTERS WITHOUT CLAIM TO ANY PARTICULAR FONT, STYLE, SIZE, OR COLOR.

SER. NO. 85-373,512, FILED 7-18-2011.

CHERYL CLAYTON, EXAMINING ATTORNEY



David J. Kyffers

Director of the United States Patent and Trademark Office

United States of America

United States Patent and Trademark Office



Reg. No. 4,174,221

Registered July 17, 2012

Int. Cl.: 33

TRADEMARK

PRINCIPAL REGISTER

NAKAO SAKE BREWERY CO., LTD. (JAPAN JOINT STOCK COMPANY)
5-9-14 CHUOU, TAKEHARA-SHI
HIROSHIMA, JAPAN 725-0026

FOR: SAKE, IN CLASS 33 (U.S. CLS. 47 AND 49).

FIRST USE 10-14-2010; IN COMMERCE 10-14-2010.

THE MARK CONSISTS OF STYLIZED JAPANESE CHARACTERS.

THE NON-LATIN CHARACTERS IN THE MARK TRANSLITERATE TO "SEIKYO" AND THIS MEANS "MIRROR OF TRUTH" IN ENGLISH.

SER. NO. 85-373,520, FILED 7-18-2011.

HOWARD B. LEVINE, EXAMINING ATTORNEY



David J. Kybas

Director of the United States Patent and Trademark Office

United States of America

United States Patent and Trademark Office



Reg. No. 4,174,222

Registered July 17, 2012

Int. Cls.: 35, 36 and 42

SERVICE MARK

PRINCIPAL REGISTER

INFINITE POTENTIAL MANAGEMENT LP (CANADA LIMITED PARTNERSHIP)
485 WES GRAHAM WAY
WATERLOO, ONTARIO, CANADA N2L0A7

FOR: BUSINESS CONSULTING AND BUSINESS MANAGEMENT SERVICES FOR OTHERS IN THE FIELDS OF ENERGY SOURCES AND ENERGY EFFICIENCY; ORGANIZATIONAL, EMPLOYMENT STAFFING, AND BUSINESS RISK MANAGEMENT SERVICES FOR BUSINESSES; BUSINESS RESEARCH SERVICES IN THE FIELD OF ENERGY EFFICIENCY, IN CLASS 35 (U.S. CLS. 100, 101 AND 102).

FOR: FUNDRAISING SERVICES; FINANCIAL RISK MANAGEMENT, IN CLASS 36 (U.S. CLS. 100, 101 AND 102).

FOR: SCIENTIFIC AND TECHNICAL RESEARCH SERVICES IN THE FIELD OF ENERGY EFFICIENCY, IN CLASS 42 (U.S. CLS. 100 AND 101).

PRIORITY CLAIMED UNDER SEC. 44(D) ON CANADA APPLICATION NO. 1512184, FILED 1-21-2011, REG. NO. TMA813,239, DATED 12-2-2011, EXPIRES 12-2-2026.

THE MARK CONSISTS OF AN INFINITY SIGN WITH A PLUS SIGN AS PART OF THE RIGHT-HAND SIDE, AND A PARTIAL REFLECTION OF THE INFINITY AND PLUS SIGNS UNDERNEATH.

SER. NO. 85-373,753, FILED 7-18-2011.

DAVID ELTON, EXAMINING ATTORNEY



David J. Kyros

Director of the United States Patent and Trademark Office

United States of America

United States Patent and Trademark Office

Video Butler Network

Reg. No. 4,174,223

Registered July 17, 2012

Int. Cls.: 9 and 42

TRADEMARK

SERVICE MARK

PRINCIPAL REGISTER

HORTON & ASSOCIATES, INC. (ARIZONA CORPORATION)
2432 W. PEORIA AVE. SUITE 1189
PHOENIX, AZ 85029

FOR: COMPUTER APPLICATION SOFTWARE FOR STANDALONE COMPUTERS MOUNTED TO A DESK, RACK, OR KIOSK, NAMELY, SOFTWARE FOR SCHEDULING THE PLAYBACK TIMING OF PRE-RECORDED AUDIO, VIDEO, GRAPHICS AND IMAGES, COMPUTER HARDWARE AND COMPUTER SOFTWARE PROGRAMS FOR THE INTEGRATION OF TEXT, AUDIO, GRAPHICS, STILL IMAGES AND MOVING PICTURES INTO AN INTERACTIVE DELIVERY FOR MULTIMEDIA APPLICATIONS, COMPUTER HARDWARE AND SOFTWARE SYSTEMS FOR REMOTELY CONTROLLING DISPLAY OF PRE-RECORDED AUDIO, VIDEO, GRAPHICS, AND IMAGES, COMPUTER PROGRAMS FOR SCHEDULED PLAYBACK OF PRE-RECORDED AUDIO, VIDEO, GRAPHICS AND IMAGES IN THE HOSPITALITY AND MEDICAL FIELDS, COMPUTER WORKSTATIONS COMPRISING OF COMPUTER, MOUSE, KEYBOARD, MONITOR, DESK, KIOSK, RACK, SERVER, DIGITAL STORAGE AND DIGITAL TRANSMITTERS, ELECTRONIC COMMUNICATIONS SYSTEMS COMPRISED OF COMPUTER HARDWARE AND SOFTWARE FOR THE TRANSMISSION OF DATA BETWEEN TWO POINTS, IN CLASS 9 (U.S. CLS. 21, 23, 26, 36 AND 38).

FIRST USE 9-27-2005; IN COMMERCE 1-15-2006.



FOR: COMPUTER SOFTWARE DESIGN FOR THE DISPLAY OF PRE-RECORDED AUDIO, VIDEO, GRAPHICS AND IMAGES, COMPUTER PROGRAMMING AND SOFTWARE DESIGN. COMPUTER PROGRAMMING SERVICES FOR THE DISPLAY OF PRE-RECORDED AUDIO, VIDEO, GRAPHICS AND IMAGES. SOFTWARE SYSTEMS FOR OTHERS, CUSTOM DESIGN AND DEVELOPMENT OF COMPUTER SOFTWARE FOR THE DISPLAY OF PRE-RECORDED AUDIO, VIDEO, GRAPHICS AND IMAGES. DESIGN AND DEVELOPMENT OF COMPUTER SOFTWARE FOR THE DISPLAY OF PRE-RECORDED AUDIO, VIDEO, GRAPHICS AND IMAGES, DEVELOPING AND UPDATING COMPUTER SOFTWARE, IN CLASS 42 (U.S. CLS. 100 AND 101).

FIRST USE 9-27-2005; IN COMMERCE 1-15-2006.

David J. Kyffers

THE MARK CONSISTS OF STANDARD CHARACTERS WITHOUT CLAIM TO ANY PARTICULAR FONT, STYLE, SIZE, OR COLOR.

Reg. No. 4,174,223 NO CLAIM IS MADE TO THE EXCLUSIVE RIGHT TO USE "VIDEO" AND "NETWORK",
APART FROM THE MARK AS SHOWN.

SER. NO. 85-374,162, FILED 7-18-2011.

DEZMONA MIZELLE, EXAMINING ATTORNEY

United States of America

United States Patent and Trademark Office

TRUE CAJUN

Reg. No. 4,174,224

Registered July 17, 2012

Int. Cl.: 30

TRADEMARK

PRINCIPAL REGISTER

BROUSSARD, THEODORE, A, (UNITED STATES INDIVIDUAL), AKA TRUE CAJUN, INC.,
TRUE CAJUN, TRUE CAJUN BAYOU BLEND, TRUE CAJUN SEASONING, TRUE
CAJUN.COM, BROUSSARDS TRUE CAJUN SEASONING, BROUSSARDS, CAJUN TRUE
633 MERMENTAU RIVER ROAD
GRAND CHENIER, LA 70643

FOR: DRY SEASONING MIXES FOR FOOD SEASONINGS, IN CLASS 30 (U.S. CL. 46).

FIRST USE 2-15-1996; IN COMMERCE 4-9-1997.

THE MARK CONSISTS OF STANDARD CHARACTERS WITHOUT CLAIM TO ANY PARTICULAR FONT, STYLE, SIZE, OR COLOR.

NO CLAIM IS MADE TO THE EXCLUSIVE RIGHT TO USE "CAJUN", APART FROM THE MARK AS SHOWN.

SER. NO. 85-374,313, FILED 7-18-2011.

DEZMONA MIZELLE, EXAMINING ATTORNEY



David J. Kyffers

Director of the United States Patent and Trademark Office

United States of America
United States Patent and Trademark Office

BOOBZIE

Reg. No. 4,174,225

PIN USA (CALIFORNIA CORPORATION)
626 JUSTIN AVENUE
GLENDALE, CA 91201

Registered July 17, 2012

Int. Cl.: 21

FOR: BEVERAGE CAN COVERS, NAMELY, INSULATING SLEEVE HOLDERS FOR BEVERAGE CANS, IN CLASS 21 (U.S. CLS. 2, 13, 23, 29, 30, 33, 40 AND 50).

TRADEMARK

FIRST USE 12-16-2011; IN COMMERCE 12-16-2011.

PRINCIPAL REGISTER

THE MARK CONSISTS OF STANDARD CHARACTERS WITHOUT CLAIM TO ANY PARTICULAR FONT, STYLE, SIZE, OR COLOR.

SER. NO. 85-374,394, FILED 7-18-2011.

KIM MONINGHOFF, EXAMINING ATTORNEY



David J. Kyffers

Director of the United States Patent and Trademark Office

United States of America

United States Patent and Trademark Office

DISCLOSURE ASSIST

Reg. No. 4,174,226

Registered July 17, 2012

Int. Cl.: 42

SERVICE MARK

PRINCIPAL REGISTER

TEACHERS INSURANCE AND ANNUITY ASSOCIATION OF AMERICA (NEW YORK CORPORATION)
730 THIRD AVENUE
NEW YORK, NY 10017

FOR: PROVIDING A SECURE WEBSITE FEATURING AN ONLINE NON-DOWNLOADABLE SOFTWARE TOOL THAT ENABLES PLAN SPONSORS TO ACCESS, AMEND, AND PROCESS THEIR DISCLOSURES, IN CLASS 42 (U.S. CLS. 100 AND 101).

FIRST USE 10-20-2011; IN COMMERCE 10-20-2011.

THE MARK CONSISTS OF STANDARD CHARACTERS WITHOUT CLAIM TO ANY PARTICULAR FONT, STYLE, SIZE, OR COLOR.

NO CLAIM IS MADE TO THE EXCLUSIVE RIGHT TO USE "DISCLOSURE", APART FROM THE MARK AS SHOWN.

SER. NO. 85-374,548, FILED 7-19-2011.

MICHELE SWAIN, EXAMINING ATTORNEY



David J. Kyffers

Director of the United States Patent and Trademark Office

United States of America

United States Patent and Trademark Office

MARLBORO SPECIAL BLEND

Reg. No. 4,174,227

PHILIP MORRIS USA INC. (VIRGINIA CORPORATION)
6601 WEST BROAD STREET
RICHMOND, VA 23230

Registered July 17, 2012

Int. Cl.: 34

FOR: TOBACCO PRODUCTS, NAMELY, CIGARETTES, IN CLASS 34 (U.S. CLS. 2, 8, 9 AND 17).

TRADEMARK

FIRST USE 1-6-2010; IN COMMERCE 1-6-2010.

PRINCIPAL REGISTER

THE MARK CONSISTS OF STANDARD CHARACTERS WITHOUT CLAIM TO ANY PARTICULAR FONT, STYLE, SIZE, OR COLOR.

OWNER OF U.S. REG. NOS. 68,502, 938,510 AND OTHERS.

NO CLAIM IS MADE TO THE EXCLUSIVE RIGHT TO USE "SPECIAL BLEND", APART FROM THE MARK AS SHOWN.

SER. NO. 85-374,616, FILED 7-19-2011.

PATRICIA EVANKO, EXAMINING ATTORNEY



David J. Kybas

Director of the United States Patent and Trademark Office

United States of America

United States Patent and Trademark Office



Reg. No. 4,174,228

RETREAT & REFRESH STROKE CAMP (ILLINOIS CORPORATION)
425 W. GILES LN.
PEORIA, IL 61614

Registered July 17, 2012

Int. Cl.: 41

FOR: CHARITABLE SERVICES, NAMELY, PROVIDING CAMPS FOR STROKE SURVIVORS AND CAREGIVERS, IN CLASS 41 (U.S. CLS. 100, 101 AND 107).

SERVICE MARK

FIRST USE 6-1-2004; IN COMMERCE 9-17-2004.

PRINCIPAL REGISTER

NO CLAIM IS MADE TO THE EXCLUSIVE RIGHT TO USE "STROKE CAMP", APART FROM THE MARK AS SHOWN.

THE COLOR(S) YELLOW, ORANGE, GREEN, BLUE, BLACK IS/ARE CLAIMED AS A FEATURE OF THE MARK.

THE MARK CONSISTS OF THE WORDS "RETREAT & REFRESH STROKE CAMP" "RE-TREAT & REFRESH" BEING ITALICIZED AND POSITIONED ABOVE "STROKE CAMP" BEGINNING WITH CAPITAL LETTERS AND THE REMAINDER OF BOTH WORDS IN SMALL CASE; AND "STROKE CAMP" BEING IN CAPITAL LETTERS; ALL WORDS BEING IN BLACK; ENCLOSED IN A CIRCULAR GRAPHIC OF AN ORANGE SUN WITH A YELLOW CENTER POSITIONED TO THE RIGHT AND SETTING OVER A GREEN FOREST AND GREEN FIELD AND BLUE RIVER LOCATED UNDER THE SUN; WITH A SKY WHICH IS MOST YELLOW AT THE TOP OF THE IMAGE AND FADING TO AN ORANGISH-YELLOW TOWARDS THE CENTER; THE ENTIRE IMAGE BEING SLIGHTLY CURVED TO APPEAL TO THE EARTH'S HORIZON; AND THE ENTIRE IMAGE ENCLOSED BY A BOLD BLACK CIRCLE.



SER. NO. 85-374,986, FILED 7-19-2011.

BARBARA RUTLAND, EXAMINING ATTORNEY

David J. Kybas

Director of the United States Patent and Trademark Office

United States of America

United States Patent and Trademark Office

INDEMAND BANDS

Reg. No. 4,174,229

INDEMAND BANDS, LLC (COLORADO LIMITED LIABILITY COMPANY)
3845 SOUTH JERSEY STREET
DENVER, CO 80237

Registered July 17, 2012

Int. Cl.: 35

FOR: PROVIDING AN ON-LINE SEARCHABLE DATABASE OF MUSICIANS FOR PEOPLE TO HIRE, IN CLASS 35 (U.S. CLS. 100, 101 AND 102).

SERVICE MARK

FIRST USE 1-1-2011; IN COMMERCE 1-1-2011.

PRINCIPAL REGISTER

THE MARK CONSISTS OF STANDARD CHARACTERS WITHOUT CLAIM TO ANY PARTICULAR FONT, STYLE, SIZE, OR COLOR.

NO CLAIM IS MADE TO THE EXCLUSIVE RIGHT TO USE "BANDS", APART FROM THE MARK AS SHOWN.

SER. NO. 85-375,679, FILED 7-20-2011.

JAY FLOWERS, EXAMINING ATTORNEY



David J. Kyffers

Director of the United States Patent and Trademark Office

United States of America

United States Patent and Trademark Office



Reg. No. 4,174,230

Registered July 17, 2012

Int. Cl.: 41

SERVICE MARK

PRINCIPAL REGISTER

MIMI IBARRA PRODUCTIONS, INC. (NEW YORK CORPORATION)
8520 55 AVE. ELMHURST
QUEENS, NY 11373

FOR: ENTERTAINMENT IN THE NATURE OF VISUAL AND AUDIO PERFORMANCES BY
A MUSICAL GROUP, IN CLASS 41 (U.S. CLS. 100, 101 AND 107).

FIRST USE 7-0-2011; IN COMMERCE 7-0-2011.

THE MARK CONSISTS OF A STYLIZED NUMBER "3" ON A SHADED CIRCLE BESIDE
THE WORD "SIXTY" WITH A DOT ABOVE THE LETTER "Y" AND BELOW ARE THE
WORDS "THE HIGHEST LEVEL".

SER. NO. 85-375,878, FILED 7-20-2011.

JOHN WILKE, EXAMINING ATTORNEY



David J. Kybas

Director of the United States Patent and Trademark Office

United States of America

United States Patent and Trademark Office

ADD-A-RIB

Reg. No. 4,174,231

MURRAY R. BRAUN (UNITED STATES INDIVIDUAL)
1688 CHURCH STREET
HOLBROOK, NY 11741

Registered July 17, 2012

Int. Cl.: 13

FOR: ADD ON RIBS FOR FIREARMS, IN CLASS 13 (U.S. CLS. 2 AND 9).

TRADEMARK

FIRST USE 3-1-2011; IN COMMERCE 3-1-2011.

PRINCIPAL REGISTER

THE MARK CONSISTS OF STANDARD CHARACTERS WITHOUT CLAIM TO ANY PARTICULAR FONT, STYLE, SIZE, OR COLOR.

SER. NO. 85-375,914, FILED S.R. 7-20-2011 AM. P.R. 3-14-2012.

ZACHARY BELLO, EXAMINING ATTORNEY



David J. Kyffers

Director of the United States Patent and Trademark Office

United States of America

United States Patent and Trademark Office



Reg. No. 4,174,232

Registered July 17, 2012

Int. Cl.: 42

SERVICE MARK

PRINCIPAL REGISTER

ENI S.P.A. (ITALY CORPORATION)
PIAZZALE ENRICO MATTEI 1
ROME, ITALY 00144

FOR: METEOROLOGICAL INFORMATION SERVICES; SCIENTIFIC AND TECHNOLOGICAL SERVICES AND RESEARCH AND DESIGN RELATING TO METEOROLOGY; INDUSTRIAL ANALYSIS AND RESEARCH SERVICES IN THE FIELD OF METEOROLOGY; DESIGN AND DEVELOPMENT OF COMPUTER HARDWARE AND SOFTWARE, IN CLASS 42 (U.S. CLS. 100 AND 101).

PRIORITY CLAIMED UNDER SEC. 44(D) ON ERPN CMNTY TM OFC APPLICATION NO. 10129021, FILED 7-18-2011, REG. NO. 010129021, DATED 11-29-2011, EXPIRES 7-18-2021.

THE COLOR(S) BLACK, RED AND YELLOW IS/ARE CLAIMED AS A FEATURE OF THE MARK.

NO CLAIM IS MADE TO THE EXCLUSIVE RIGHT TO USE "METEO FORECAST", APART FROM THE MARK AS SHOWN.

THE MARK CONSISTS OF YELLOW SQUARE WITH THE LETTERING "E-KMF" APPEARING IN THE LOWER PORTION OF THE SQUARE, IN BLACK AND A BLACK SIX LEGGED FIRE BREATHING DOG WITH THE FIRE BEING SHOWN IN THE COLOR RED . TO THE RIGHT OF THE SQUARE IS AN OUTLINE OF A SQUARE IN BLACK WITH THE WORDING "ENI KASSANDRA METEO FORECAST" APPEARING IN BLACK.

THE ENGLISH TRANSLATION OF "METEO" IN THE MARK IS "WEATHER". THE WORDING "ENI KASSANDRA" HAS NO MEANING IN A FOREIGN LANGUAGE.

SER. NO. 85-376,235, FILED 7-20-2011.

JULIE WATSON, EXAMINING ATTORNEY



David J. Kyjars

Director of the United States Patent and Trademark Office

United States of America
United States Patent and Trademark Office

BABU'S

Reg. No. 4,174,233

DEEP FOODS, INC. (NEW JERSEY CORPORATION)
1090 SPRINGFIELD ROAD
UNION, NJ 07083

Registered July 17, 2012

Int. Cl.: 30

FOR: PREPARED FOODS, NAMELY, FROZEN POCKET SANDWICHES WITH VEGETABLE AND/OR MEAT FILLING, IN CLASS 30 (U.S. CL. 46).

TRADEMARK

FIRST USE 10-6-2008; IN COMMERCE 10-6-2008.

PRINCIPAL REGISTER

THE MARK CONSISTS OF STANDARD CHARACTERS WITHOUT CLAIM TO ANY PARTICULAR FONT, STYLE, SIZE, OR COLOR.

OWNER OF U.S. REG. NO. 3,703,153.

SER. NO. 85-376,253, FILED 7-20-2011.

KATHY DE JONGE, EXAMINING ATTORNEY



David J. Kyffers

Director of the United States Patent and Trademark Office

United States of America

United States Patent and Trademark Office

BOOK OF SHADOWS

Reg. No. 4,174,234

URBAN DECAY COSMETICS LLC (DELAWARE LIMITED LIABILITY COMPANY)
833 WEST 16TH STREET
NEWPORT BEACH, CA 92663

Registered July 17, 2012

Int. Cl.: 3

FOR: COLORING PREPARATIONS FOR COSMETIC PURPOSES; COSMETICS; MAKE-UP;
KITS CONSISTING OF COLORING PREPARATIONS FOR COSMETIC PURPOSES, COSMETICS AND MAKE-UP, IN CLASS 3 (U.S. CLS. 1, 4, 6, 50, 51 AND 52).

TRADEMARK

FIRST USE 8-1-2008; IN COMMERCE 8-1-2008.

PRINCIPAL REGISTER

THE MARK CONSISTS OF STANDARD CHARACTERS WITHOUT CLAIM TO ANY PARTICULAR FONT, STYLE, SIZE, OR COLOR.

OWNER OF U.S. REG. NO. 3,693,586.

SER. NO. 85-376,492, FILED 7-20-2011.

TASNEEM HUSSAIN, EXAMINING ATTORNEY



David J. Kybas

Director of the United States Patent and Trademark Office

United States of America

United States Patent and Trademark Office

GRILLING'S JUICY LITTLE SECRET

Reg. No. 4,174,235

Registered July 17, 2012

Int. Cl.: 11

TRADEMARK

PRINCIPAL REGISTER

W.C. BRADLEY CO. (GEORGIA CORPORATION)
1017 FRONT AVENUE
COLUMBUS, GA 31904

FOR: BARBECUE GRILLS, IN CLASS 11 (U.S. CLS. 13, 21, 23, 31 AND 34).

FIRST USE 8-31-2009; IN COMMERCE 8-31-2009.

THE MARK CONSISTS OF STANDARD CHARACTERS WITHOUT CLAIM TO ANY PARTICULAR FONT, STYLE, SIZE, OR COLOR.

NO CLAIM IS MADE TO THE EXCLUSIVE RIGHT TO USE "GRILLING'S", APART FROM THE MARK AS SHOWN.

SER. NO. 85-376,978, FILED 7-21-2011.

CHRIS WELLS, EXAMINING ATTORNEY



David J. Kyffers

Director of the United States Patent and Trademark Office

United States of America

United States Patent and Trademark Office

MICRO-TECH

ENTERPRISES

Reg. No. 4,174,236

Registered July 17, 2012

Int. Cl.: 9

TRADEMARK

PRINCIPAL REGISTER

STANLEY LOGISTICS L.L.C. (DELAWARE LIMITED LIABILITY COMPANY)
1000 STANLEY DRIVE
NEW BRITAIN, CT 06053

FOR: ELECTRIC WEIGHT, MOTION, AND POSITION DETECTORS FOR PROVIDING AN INDICATION TO A NURSE OR CARETAKER WHEN A PATIENT LEAVES A CHAIR OR BED, IN CLASS 9 (U.S. CLS. 21, 23, 26, 36 AND 38).

FIRST USE 12-31-2007; IN COMMERCE 12-31-2007.

NO CLAIM IS MADE TO THE EXCLUSIVE RIGHT TO USE "ENTERPRISES", APART FROM THE MARK AS SHOWN.

THE MARK CONSISTS OF FANCIFUL BLOCK LETTERING WITH THE WORDS "MICRO-TECH" ABOVE THE WORD "ENTERPRISES", WITH TWO LINES, THE TOP LINE THINNER THAN THE BOTTOM LINE, ON EACH SIDE OF THE WORD "ENTERPRISES".

SER. NO. 85-376,991, FILED 7-21-2011.

JESSICA A. POWERS, EXAMINING ATTORNEY



David J. Kyffers

Director of the United States Patent and Trademark Office

United States of America

United States Patent and Trademark Office

MICRO-TECH ENTERPRISES

Reg. No. 4,174,237

Registered July 17, 2012

Int. Cl.: 9

TRADEMARK

PRINCIPAL REGISTER

STANLEY LOGISTICS L.L.C. (DELAWARE LIMITED LIABILITY COMPANY)
1000 STANLEY DRIVE
NEW BRITAIN, CT 06053

FOR: ELECTRIC WEIGHT, MOTION, AND POSITION DETECTORS FOR PROVIDING AN INDICATION TO A NURSE OR CARETAKER WHEN A PATIENT LEAVES A CHAIR OR BED, IN CLASS 9 (U.S. CLS. 21, 23, 26, 36 AND 38).

FIRST USE 12-31-1999; IN COMMERCE 12-31-1999.

THE MARK CONSISTS OF STANDARD CHARACTERS WITHOUT CLAIM TO ANY PARTICULAR FONT, STYLE, SIZE, OR COLOR.

NO CLAIM IS MADE TO THE EXCLUSIVE RIGHT TO USE "ENTERPRISES", APART FROM THE MARK AS SHOWN.

SER. NO. 85-377,000, FILED 7-21-2011.

JESSICA A. POWERS, EXAMINING ATTORNEY



David J. Kyffers

Director of the United States Patent and Trademark Office

United States of America

United States Patent and Trademark Office



Reg. No. 4,174,238

Registered July 17, 2012

Int. Cl.: 43

SERVICE MARK

PRINCIPAL REGISTER

VOTANO, PAOLO (ITALY INDIVIDUAL)
24 PRINCE STREET
NEW YORK, NY 10012 AND

BUSATO, MAURIZIO (ITALY INDIVIDUAL)
24 PRINCE STREET
NEW YORK, NY 10012

FOR: BAR AND RESTAURANT SERVICES, IN CLASS 43 (U.S. CLS. 100 AND 101).

FIRST USE 10-0-2010; IN COMMERCE 10-0-2010.

THE MARK CONSISTS OF A STYLIZED VERSION OF THE LETTERS "OLA", WITH THE CROSS-MEMBER OF THE LETTER "A" REPRESENTED BY A RED STAR; THE LETTER "O" IS LIGHT BLUE, THE LETTER "L" IS DARK BLUE AND THE LETTER "A" IS RED.

THE COLOR(S) LIGHT BLUE, DARK BLUE AND RED IS/ARE CLAIMED AS A FEATURE OF THE MARK.

THE ENGLISH TRANSLATION OF "OLA" IN THE MARK IS WAVE.

SER. NO. 85-377,189, FILED 7-21-2011.

MARGARET POWER, EXAMINING ATTORNEY



David J. Kyjars

Director of the United States Patent and Trademark Office

United States of America

United States Patent and Trademark Office

A LOT TO LIFT? WE'LL SUPPORT YOU!

Reg. No. 4,174,239

PATRICIA M. BYRNES (UNITED STATES INDIVIDUAL)
1410 BROADWAY, SUITE 2903
NEW YORK, NY 10017

Registered July 17, 2012

Int. Cl.: 25

FOR: SWIMWEAR, NAMELY, SWIMSUITS AND COVERUPS; SHAPEWEAR, NAMELY, BRAS; ACTIVEWEAR, NAMELY, CASUAL DRESSES, PANTS AND TOPS, IN CLASS 25 (U.S. CLS. 22 AND 39).

TRADEMARK

FIRST USE 11-15-2011; IN COMMERCE 11-15-2011.

PRINCIPAL REGISTER

THE MARK CONSISTS OF STANDARD CHARACTERS WITHOUT CLAIM TO ANY PARTICULAR FONT, STYLE, SIZE, OR COLOR.

SER. NO. 85-377,459, FILED 7-21-2011.

REBECCA GILBERT, EXAMINING ATTORNEY



David J. Kyffers

Director of the United States Patent and Trademark Office

United States of America

United States Patent and Trademark Office

MULTIGOAL

Reg. No. 4,174,240

GENMOVE USA, LLC (SOUTH CAROLINA LIMITED LIABILITY COMPANY)
672 MARINA DRIVE, SUITE 106
CHARLESTON, SC 29492

Registered July 17, 2012

Int. Cl.: 28

FOR: SPORTS FIELD EQUIPMENT, NAMELY, SPORT BALLS AND GOALS COMPOSED OF NYLON NETTING SUSPENDED BETWEEN TWO CONNECTED PLASTIC HOOPS THAT ARE INTENDED TO BE PLACED ON THE GROUND, IN CLASS 28 (U.S. CLS. 22, 23, 38 AND 50).

TRADEMARK

PRINCIPAL REGISTER

FIRST USE 6-1-2011; IN COMMERCE 6-1-2011.

THE MARK CONSISTS OF STANDARD CHARACTERS WITHOUT CLAIM TO ANY PARTICULAR FONT, STYLE, SIZE, OR COLOR.

SER. NO. 85-377,568, FILED 7-21-2011.

TIMOTHY FINNEGAN, EXAMINING ATTORNEY



David J. Kybas

Director of the United States Patent and Trademark Office

United States of America

United States Patent and Trademark Office

NEED SOME ELEVATION? WE'LL
TAKE U TO NEW HEIGHTS!

Reg. No. 4,174,241

PATRICIA M. BYRNES (UNITED STATES INDIVIDUAL)
1410 BROADWAY, SUITE 2903
NEW YORK, NY 10017

Registered July 17, 2012

Int. Cl.: 25

FOR: SWIMWEAR, NAMELY, SWIMSUITS AND COVERUPS; SHAPEWEAR, NAMELY, BRAS; ACTIVEWEAR, NAMELY, CASUAL DRESSES, PANTS AND TOPS, IN CLASS 25 (U.S. CLS. 22 AND 39).

TRADEMARK

FIRST USE 11-15-2011; IN COMMERCE 11-15-2011.

PRINCIPAL REGISTER

THE MARK CONSISTS OF STANDARD CHARACTERS WITHOUT CLAIM TO ANY PARTICULAR FONT, STYLE, SIZE, OR COLOR.

SER. NO. 85-378,134, FILED 7-22-2011.

ROBIN CHOSID, EXAMINING ATTORNEY



David J. Kyffers

Director of the United States Patent and Trademark Office

United States of America

United States Patent and Trademark Office

AVAST!

Reg. No. 4,174,242

Registered July 17, 2012

Int. Cl.: 9

TRADEMARK

PRINCIPAL REGISTER

AVAST SOFTWARE A.S. (CZECH REPUBLIC JOINT STOCK COMPANY)
MICHLE, BUDEJOVICKA 1518/76
PRAGUE 4, CZECH REPUBLIC 140 00

FOR: COMPUTER PROGRAMS, NAMELY, INTRUSION DETECTION, INTRUSION PREVENTION AND VIRUS PROTECTION SOFTWARE FOR SCANNING INCOMING AND OUTGOING E-MAIL MESSAGES FOR COMPUTER VIRUSES AND MALWARE; COMPUTER SOFTWARE FOR SCANNING AND MONITORING COMPUTER NETWORK CONNECTIONS FOR SIGNS OF UNAUTHORIZED ENTRY, FOR CREATING AND MAINTAINING FIREWALLS AND FOR SCANNING COMPUTER DATA STORAGE DEVICES FOR COMPUTER VIRUSES AND OTHER MALWARE FOR USE IN PRIVATE COMPUTER NETWORKS AND CORPORATE COMPUTER NETWORKS, IN CLASS 9 (U.S. CLS. 21, 23, 26, 36 AND 38).

FIRST USE 6-30-2000; IN COMMERCE 6-30-2000.

THE MARK CONSISTS OF STANDARD CHARACTERS WITHOUT CLAIM TO ANY PARTICULAR FONT, STYLE, SIZE, OR COLOR.

OWNER OF U.S. REG. NO. 3,082,991.

SER. NO. 85-378,515, FILED 7-22-2011.

DANIEL CAPSHAW, EXAMINING ATTORNEY



David J. Kypos

Director of the United States Patent and Trademark Office

United States of America

United States Patent and Trademark Office

SOCKINGS

Reg. No. 4,174,243

STEVIE DELLAMARTA (AUSTRALIA INDIVIDUAL)
LEVEL 1, 157 VICTORIA PARADE
COLLINGWOOD, VICTORIA, AUSTRALIA 3065

Registered July 17, 2012

Int. Cl.: 25

FOR: LEGGINGS; SOCKS; STOCKINGS, IN CLASS 25 (U.S. CLS. 22 AND 39).

TRADEMARK

THE MARK CONSISTS OF STANDARD CHARACTERS WITHOUT CLAIM TO ANY PARTICULAR FONT, STYLE, SIZE, OR COLOR.

PRINCIPAL REGISTER

PRIORITY CLAIMED UNDER SEC. 44(D) ON AUSTRALIA APPLICATION NO. 1420814, FILED 4-18-2011, REG. NO. 1420814, DATED 2-13-2012, EXPIRES 4-18-2021.

SER. NO. 85-378,549, FILED 7-22-2011.

TINA MAI, EXAMINING ATTORNEY



David J. Kyffers

Director of the United States Patent and Trademark Office

United States of America

United States Patent and Trademark Office



Reg. No. 4,174,244

VS MEDIA, INC. (CALIFORNIA CORPORATION)

Registered July 17, 2012

26672 AGOURA ROAD
CALABASAS, CA 91302

Int. Cl.: 45

FOR: PROVIDING A WEBSITE FOR ENTERTAINMENT PURPOSES FEATURING PSYCHIC READINGS; PROVIDING LIVE INTERACTIVE PSYCHIC READINGS; PSYCHIC READING SERVICES, IN CLASS 45 (U.S. CLS. 100 AND 101).

SERVICE MARK

FIRST USE 7-6-2011; IN COMMERCE 7-6-2011.

PRINCIPAL REGISTER

NO CLAIM IS MADE TO THE EXCLUSIVE RIGHT TO USE "PSYCHICS LIVE", APART FROM THE MARK AS SHOWN.

THE MARK CONSISTS OF THE DESIGN OF A STYLIZED EYE BEING HELD BY A PAIR OF HANDS, TO THE LEFT OF THAT IS THE WORDING "PSYCHICS LIVE".

SER. NO. 85-378,858, FILED 7-22-2011.

SUE LAWRENCE, EXAMINING ATTORNEY



David J. Kyros

Director of the United States Patent and Trademark Office

United States of America

United States Patent and Trademark Office



Reg. No. 4,174,245

BEENE, LANDON (UNITED STATES INDIVIDUAL)
269 LAKE MEADOW DR
GRAY, TN 37615

Registered July 17, 2012

Int. Cl.: 39

FOR: ARRANGING OF CRUISES, IN CLASS 39 (U.S. CLS. 100 AND 105).

SERVICE MARK

FIRST USE 6-1-2009; IN COMMERCE 8-1-2009.

PRINCIPAL REGISTER

NO CLAIM IS MADE TO THE EXCLUSIVE RIGHT TO USE "GOSPEL MUSIC CELEBRATION", APART FROM THE MARK AS SHOWN.

THE COLOR(S) BLUE, GREEN AND WHITE IS/ARE CLAIMED AS A FEATURE OF THE MARK.

THE MARK CONSISTS OF THE WORDS "GOSPELMUSIC CELEBRATION!" WHEREIN THE WORD "GOSPELMUSIC" IS WRITTEN IN BLUE COLOR AND THE WORD "CELEBRATION!" IS WRITTEN IN GREEN COLOR BELOW THE WORD "GOSPELMUSIC" HAVING AN EXCLAMATION MARK AND THE LETTER "M" CONTAINS THE IMAGE OF A COCONUT TREE IN WHITE COLOR AS SHOWN IN THE MARK.

SER. NO. 85-379,510, FILED 7-25-2011.

EDWARD FENNESSY, EXAMINING ATTORNEY



David J. Kybas

Director of the United States Patent and Trademark Office

United States of America

United States Patent and Trademark Office



Reg. No. 4,174,246

Registered July 17, 2012

Int. Cls.: 30 and 35

TRADEMARK

SERVICE MARK

PRINCIPAL REGISTER

SIMPLY NUT FREE CHOCOLATES (VIRGINIA LIMITED LIABILITY COMPANY)
21304 HIDDEN POND PLACE
ASHBURN, VA 20148

FOR: NUT FREE CHOCOLATE; NUT FREE CHOCOLATE CANDIES; NUT FREE CANDIES; NUT FREE FUDGE; NUT FREE COCOA POWDER; NUT FREE BAKING CHOCOLATE; NUT FREE CHOCOLATE WAFERS FOR BAKING, IN CLASS 30 (U.S. CL. 46).

FIRST USE 2-18-2011; IN COMMERCE 2-18-2011.

FOR: RETAIL STORE SERVICES FEATURING NUT FREE CHOCOLATES AND NUT FREE CANDIES; ONLINE RETAIL STORE SERVICES FEATURING NUT FREE CHOCOLATES AND NUT FREE CANDIES; WHOLESALE STORE SERVICES FEATURING NUT FREE CHOCOLATES AND NUT FREE CANDIES; ONLINE ORDERING SERVICES FEATURING NUT FREE CHOCOLATES AND NUT FREE CANDIES, IN CLASS 35 (U.S. CLS. 100, 101 AND 102).

FIRST USE 2-18-2011; IN COMMERCE 2-18-2011.

NO CLAIM IS MADE TO THE EXCLUSIVE RIGHT TO USE "NUT FREE CHOCOLATES", APART FROM THE MARK AS SHOWN.

THE MARK CONSISTS OF THE STYLIZED LETTERS "SNFC" SURROUNDED BY A SQUARE BORDER, WITH THE WORDS "SIMPLY NUT FREE" ABOVE "CHOCOLATES" IN AN ATTACHED TEXT BOX BELOW THE "SNFC" BOX, MAKING THE MARK WITH TEXT A RECTANGLE.

SER. NO. 85-379,653, FILED 7-25-2011.

DEBORAH LOBO, EXAMINING ATTORNEY



David J. Kybas

Director of the United States Patent and Trademark Office

United States of America

United States Patent and Trademark Office

TECTA^{•••••}pure

Reg. No. 4,174,247

O'MAHONY, PATRICK (IRELAND INDIVIDUAL)
GREENVILLE, SOUTH CIRCULAR ROAD
LIMERICK, CO LIMERICK, IRELAND

Registered July 17, 2012

Int. Cl.: 3

FOR: DISPOSABLE WIPES IMPREGNATED WITH CLEANING CHEMICALS OR COMPOUNDS FOR INDUSTRIAL AND COMMERCIAL USE; DISPOSABLE WIPES IMPREGNATED WITH CLEANSING CHEMICALS OR COMPOUNDS FOR PERSONAL HYGIENE AND HOUSEHOLD USE; CLEAN ROOM WIPES, NAMELY, DISPOSABLE WIPES IMPREGNATED WITH CLEANSING CHEMICALS OR COMPOUNDS FOR INDUSTRIAL AND COMMERCIAL USE; CLEANING PREPARATIONS; DISINFECTANT SOAP, IN CLASS 3 (U.S. CLS. 1, 4, 6, 50, 51 AND 52).

TRADEMARK

PRINCIPAL REGISTER

OWNER OF ERPN CMNTY TM OFC REG. NO. 005398342, DATED 1-4-2008, EXPIRES 10-18-2016.

THE MARK CONSISTS OF THE STYLIZED WORD "TECTAPURE" WITH A SERIES OF SIX SMALL CIRCLES FORMING A LINE ABOVE THE LETTERS "PURE".

SER. NO. 85-379,861, FILED 7-25-2011.

GEOFFREY FOSDICK, EXAMINING ATTORNEY



David J. Kyros

Director of the United States Patent and Trademark Office

United States of America

United States Patent and Trademark Office



irish titan
Business First. Online Second.

Reg. No. 4,174,248

Registered July 17, 2012

Int. Cls.: 35 and 42

SERVICE MARK

PRINCIPAL REGISTER

DARIN LYNCH (UNITED STATES INDIVIDUAL)
8243 VINCENT AVENUE SOUTH
BLOOMINGTON, MN 55437

FOR: ADVERTISING AND MARKETING SERVICES PROVIDED BY MEANS OF INDIRECT METHODS OF MARKETING COMMUNICATIONS, NAMELY, SOCIAL MEDIA, SEARCH ENGINE MARKETING, INQUIRY MARKETING, INTERNET MARKETING, MOBILE MARKETING, BLOGGING AND OTHER FORMS OF PASSIVE, SHARABLE OR VIRAL COMMUNICATIONS CHANNELS; BRANDING SERVICES, NAMELY, CONSULTING, DEVELOPMENT, MANAGEMENT AND MARKETING OF BRANDS FOR BUSINESSES; COMMERCIAL ASSISTANCE RELATING TO SYSTEM IMPLEMENTATION AND SYSTEM INTEGRATION; PLANNING, DESIGN, DEVELOPMENT, MAINTENANCE, TRACKING AND REPORTING OF ONLINE MARKETING ACTIVITIES FOR THIRD PARTIES; PROMOTING, ADVERTISING AND MARKETING OF THE BRANDS, PRODUCTS, SERVICES AND ONLINE WEBSITES OF INDIVIDUALS, BUSINESSES AND NONPROFIT ORGANIZATIONS, IN CLASS 35 (U.S. CLS. 100, 101 AND 102).

FIRST USE 4-5-2004; IN COMMERCE 4-5-2004.

FOR: APPLICATION SERVICE PROVIDER, NAMELY, HOSTING, MANAGING, DEVELOPING, AND MAINTAINING APPLICATIONS, SOFTWARE, AND WEB SITES, IN THE FIELDS OF PERSONAL PRODUCTIVITY, WIRELESS COMMUNICATION, MOBILE INFORMATION ACCESS, AND REMOTE DATA MANAGEMENT FOR WIRELESS DELIVERY OF CONTENT TO HANDHELD COMPUTERS, LAPTOPS AND MOBILE ELECTRONIC DEVICES; COMPUTER SERVICES, NAMELY, SEARCH ENGINE OPTIMIZATION; COMPUTER SOFTWARE DEVELOPMENT IN THE FIELD OF MOBILE APPLICATIONS; PLANNING, DESIGN, DEVELOPMENT, MAINTENANCE AND OPTIMIZATION OF ONLINE WEBSITES FOR THIRD PARTIES, IN CLASS 42 (U.S. CLS. 100 AND 101).

FIRST USE 4-5-2004; IN COMMERCE 4-5-2004.

THE MARK CONSISTS OF A BLACK STYLIZED WARRIOR HELMET WITH A ROUNDED FRONT AND JAGGED BACK WITH A GRAY AND WHITE OUTLINE AND INTERNAL DESIGN, IN FRONT OF THE WORD "IRISH" APPEARING IN GREEN, LOWER-CASE PRINT, IN FRONT OF THE WORD "TITAN" APPEARING IN BLACK AND GRAY, LOWER-CASE PRINT, ALL OF WHICH APPEARS OVER THE WORDS "BUSINESS FIRST. ONLINE SECOND." IN GRAY ITALICIZED PRINT.



David J. Kybas

Director of the United States Patent and Trademark Office

Reg. No. 4,174,248 THE COLOR(S) BLACK, GRAY, WHITE AND GREEN IS/ARE CLAIMED AS A FEATURE OF THE MARK.

SER. NO. 85-380,032, FILED 7-25-2011.

JOHN DALIER, EXAMINING ATTORNEY

United States of America

United States Patent and Trademark Office

THE MOST POINTS. THE MOST
PLACES.

Reg. No. 4,174,249

Registered July 17, 2012

Int. Cl.: 35

SERVICE MARK

PRINCIPAL REGISTER

WORLD FUEL SERVICES, INC. (TEXAS CORPORATION)
9800 NW 41ST STREET, SUITE 400
MIAMI, FL 33178

FOR: CUSTOMER LOYALTY SERVICES RELATED TO AVIATION FOR COMMERCIAL, PROMOTIONAL AND ADVERTISING PURPOSES FEATURING REWARDS ON AVIATION FUEL; PROVIDING INCENTIVE AWARD PROGRAMS FOR CUSTOMERS THROUGH ISSUANCE AND PROCESSING OF LOYALTY POINTS FOR ON-LINE PURCHASE OF COMPANY'S GOODS AND SERVICES VIA A REWARDS PROGRAM FOR INTERNATIONAL TRIP PLANNING SERVICES AND CHARGES MADE ON A PROPRIETARY AVIATION CHARGE CARD, IN CLASS 35 (U.S. CLS. 100, 101 AND 102).

FIRST USE 3-0-2011; IN COMMERCE 3-0-2011.

THE MARK CONSISTS OF STANDARD CHARACTERS WITHOUT CLAIM TO ANY PARTICULAR FONT, STYLE, SIZE, OR COLOR.

SER. NO. 85-380,060, FILED 7-25-2011.

TASNEEM HUSSAIN, EXAMINING ATTORNEY



David J. Kyffers

Director of the United States Patent and Trademark Office

United States of America

United States Patent and Trademark Office

East Coast Badboyz 4 Life Motorcycle Club

Reg. No. 4,174,250

Registered July 17, 2012

Int. Cl.: 25

TRADEMARK

PRINCIPAL REGISTER

JOHNSON, DAVID (UNITED STATES INDIVIDUAL)
254 CLARK STREET
HILLSIDE, NJ 07205

FOR: APPAREL FOR DANCERS, NAMELY, TEE SHIRTS, SWEATSHIRTS, PANTS, LEGGINGS, SHORTS AND JACKETS; ATHLETIC APPAREL, NAMELY, SHIRTS, PANTS, JACKETS, FOOTWEAR, HATS AND CAPS, ATHLETIC UNIFORMS; BUTTON DOWN SHIRTS; DRESS SHIRTS; LEATHER VESTS; MEN'S AND WOMEN'S JACKETS, COATS, TROUSERS, VESTS; SHIRTS; SHIRTS AND SHORT-SLEEVED SHIRTS; SHORT-SLEEVED OR LONG-SLEEVED T-SHIRTS; T-SHIRTS FOR MEN WOMEN; TEE SHIRTS, IN CLASS 25 (U.S. CLS. 22 AND 39).

FIRST USE 7-2-2000; IN COMMERCE 7-2-2000.

THE MARK CONSISTS OF STANDARD CHARACTERS WITHOUT CLAIM TO ANY PARTICULAR FONT, STYLE, SIZE, OR COLOR.

NO CLAIM IS MADE TO THE EXCLUSIVE RIGHT TO USE "EAST COAST", APART FROM THE MARK AS SHOWN.

SER. NO. 85-380,490, FILED 7-25-2011.

THEODORE MCBRIDE, EXAMINING ATTORNEY



David J. Kyffers

Director of the United States Patent and Trademark Office

United States of America

United States Patent and Trademark Office

Fasteners · Tools

Maintenance & Shop Supplies

Reg. No. 4,174,251

TACOMA SCREW PRODUCTS, INC. (WASHINGTON CORPORATION)
2001 CENTER STREET
TACOMA, WA 98409

Registered July 17, 2012

Int. Cl.: 6

FOR: METAL HARDWARE, NAMELY, SCREWS, NAILS, NUTS, BOLTS AND WASHERS, IN CLASS 6 (U.S. CLS. 2, 12, 13, 14, 23, 25 AND 50).

TRADEMARK

FIRST USE 1-1-1946; IN COMMERCE 1-1-1946.

PRINCIPAL REGISTER

NO CLAIM IS MADE TO THE EXCLUSIVE RIGHT TO USE "FASTENERS" OR "TOOLS", APART FROM THE MARK AS SHOWN.

THE MARK CONSISTS OF THE WORD "FASTENERS" FOLLOWED BY A SINGLE SPACE, A LENTHWISE CENTERED DOT FOLLOWED BY A SINGLE SPACE, THE WORD "TOOLS"; A SECOND BLANK LINE, A THIRD LINE WITH THE WORD "MAINTENANCE" FOLLOWED BY A SINGLE SPACE, AN AMPERSAND FOLLOWED BY A SINGLE SPACE, THE WORDS "SHOP SUPPLIES"; WITH THE FIRST AND THIRD LINES BEING CENTERED RELATIVE TO EACH OTHER.

SEC. 2(F).

SER. NO. 85-380,911, FILED 7-26-2011.

ALYSSA STEEL, EXAMINING ATTORNEY



David J. Kybas

Director of the United States Patent and Trademark Office

United States of America

United States Patent and Trademark Office

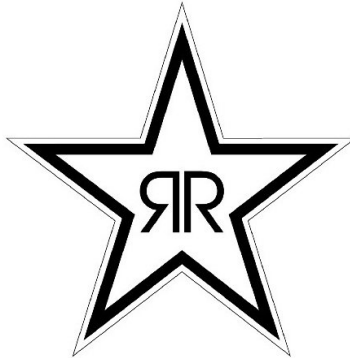

Reg. No. 4,174,252

Registered July 17, 2012

Int. Cl.: 25

TRADEMARK

PRINCIPAL REGISTER

WEINER, RUSSELL G. (UNITED STATES INDIVIDUAL)
P.O. BOX 27740
101 CONVENTION CENTER DRIVE, SUITE 777
LAS VEGAS, NV 89126

FOR: BATHING SUITS; BEANIES; BELTS; BIKINIS; BOARD SHORTS; CAPS; CAPS WITH VISORS; FLEECE BOTTOMS; FLEECE SHORTS; FLEECE TOPS; GYM PANTS; GYM SHORTS; HATS; HOODED SWEATSHIRTS; JACKETS; JERSEYS; PANTS; SHIRTS; SHORTS; SOCKS; SPORTS SHIRTS; SWEAT PANTS; SWEAT SHIRTS; SWEAT SHORTS; SWIM SUITS; T-SHIRTS; TANK TOPS; TOPS; VISORS, IN CLASS 25 (U.S. CLS. 22 AND 39).

FIRST USE 1-1-2007; IN COMMERCE 1-1-2007.

OWNER OF U.S. REG. NOS. 2,736,521 AND 2,895,083.

THE MARK CONSISTS OF THE STYLIZED LETTERS "RR" WITHIN THE TWO CONCENTRIC OUTLINES OF A FIVE-POINT STAR, WHERE THE STYLIZED LETTERS "RR" ARE MIRROR IMAGED.

SER. NO. 85-380,947, FILED 7-26-2011.

JAY BESCH, EXAMINING ATTORNEY



David J. Kyffers

Director of the United States Patent and Trademark Office

United States of America

United States Patent and Trademark Office

badass auger

Reg. No. 4,174,253

KUDOPARTNERS I, LTD. (TEXAS LIMITED PARTNERSHIP), DBA GREATMARK
1250 N.E. LOOP 410, SUITE 800
SAN ANTONIO, TX 78209

Registered July 17, 2012

Int. Cl.: 7

FOR: FILLING MACHINES AND PARTS THEREOF; MECHANIZED FEEDERS FOR WILD-LIFE, IN CLASS 7 (U.S. CLS. 13, 19, 21, 23, 31, 34 AND 35).

TRADEMARK

FIRST USE 7-1-2011; IN COMMERCE 7-15-2011.

PRINCIPAL REGISTER

THE MARK CONSISTS OF STANDARD CHARACTERS WITHOUT CLAIM TO ANY PARTICULAR FONT, STYLE, SIZE, OR COLOR.

NO CLAIM IS MADE TO THE EXCLUSIVE RIGHT TO USE "AUGER", APART FROM THE MARK AS SHOWN.

SER. NO. 85-380,982, FILED 7-26-2011.

MARK SPARACINO, EXAMINING ATTORNEY



David J. Kyffers

Director of the United States Patent and Trademark Office

United States of America

United States Patent and Trademark Office

Grands produits tout simples Grand products simply done

Reg. No. 4,174,254

Registered July 17, 2012

Int. Cl.: 30

TRADEMARK

PRINCIPAL REGISTER

MAISON LEGRAND (CANADA CORPORATION)
935, CHEMIN PRINCIPAL
ST-JOSEPH-DU-LAC, CANADA J0N1M0

FOR: PESTO; SAUCES, IN CLASS 30 (U.S. CL. 46).

FIRST USE 6-1-2011; IN COMMERCE 6-1-2011.

THE MARK CONSISTS OF STANDARD CHARACTERS WITHOUT CLAIM TO ANY PARTICULAR FONT, STYLE, SIZE, OR COLOR.

THE ENGLISH TRANSLATION OF "GRANDS PRODUITS TOUT SIMPLES" IN THE MARK IS "GRAND PRODUCTS SIMPLY DONE".

SER. NO. 85-381,058, FILED 7-26-2011.

KAREN K. BUSH, EXAMINING ATTORNEY



David J. Kyffers

Director of the United States Patent and Trademark Office

United States of America

United States Patent and Trademark Office



Reg. No. 4,174,255

WAUN, DOUGLAS (UNITED STATES INDIVIDUAL)
101 N. 85TH STREET
SEATTLE, WA 98103

Registered July 17, 2012

Int. Cls.: 35 and 44

FOR: APPOINTMENT SCHEDULING SERVICES FOR OTHERS, IN CLASS 35 (U.S. CLS. 100, 101 AND 102).

SERVICE MARK

FIRST USE 11-1-2010; IN COMMERCE 11-1-2010.

PRINCIPAL REGISTER

FOR: MEDICAL SERVICES , IN CLASS 44 (U.S. CLS. 100 AND 101).

FIRST USE 11-1-2010; IN COMMERCE 11-1-2010.

NO CLAIM IS MADE TO THE EXCLUSIVE RIGHT TO USE "WELLNESS", APART FROM THE MARK AS SHOWN.

THE MARK CONSISTS OF THE STYLIZED WORDS "GREEN WELLNESS". AN IMAGE OF A CROSS TO THE LEFT OF THE TEXT.

SER. NO. 85-381,583, FILED 7-26-2011.

DAVID MURRAY, EXAMINING ATTORNEY



David J. Kyffers

Director of the United States Patent and Trademark Office

United States of America

United States Patent and Trademark Office

lovelife

Reg. No. 4,174,256

Registered July 17, 2012

Int. Cl.: 41

SERVICE MARK

PRINCIPAL REGISTER

THE LOVE CLEANSE, LLC (TEXAS LIMITED LIABILITY COMPANY)
SUITE 101
1107 GARNER
AUSTIN, TX 78704

FOR: PROFESSIONAL COACHING SERVICES IN THE FIELDS OF HEALTH, NUTRITION,
FITNESS AND LIFESTYLE WELLNESS, IN CLASS 41 (U.S. CLS. 100, 101 AND 107).

FIRST USE 7-1-2011; IN COMMERCE 7-1-2011.

THE MARK CONSISTS OF STANDARD CHARACTERS WITHOUT CLAIM TO ANY PAR-
TICULAR FONT, STYLE, SIZE, OR COLOR.

SER. NO. 85-381,707, FILED 7-26-2011.

SKYE YOUNG, EXAMINING ATTORNEY



David J. Kybas

Director of the United States Patent and Trademark Office

United States of America

United States Patent and Trademark Office

Joy The Sock Puppet

Reg. No. 4,174,257

COSTELLO JR, TOM (UNITED STATES INDIVIDUAL)
580 LINDSEY DR.
RADNOR, PA 19087

Registered July 17, 2012

Int. Cl.: 28

FOR: PUPPETS, IN CLASS 28 (U.S. CLS. 22, 23, 38 AND 50).

TRADEMARK

FIRST USE 3-24-2011; IN COMMERCE 3-24-2011.

PRINCIPAL REGISTER

THE MARK CONSISTS OF STANDARD CHARACTERS WITHOUT CLAIM TO ANY PARTICULAR FONT, STYLE, SIZE, OR COLOR.

NO CLAIM IS MADE TO THE EXCLUSIVE RIGHT TO USE "THE SOCK PUPPET", APART FROM THE MARK AS SHOWN.

SER. NO. 85-382,466, FILED 7-27-2011.

DAVID TOOLEY, EXAMINING ATTORNEY



David J. Kybas

Director of the United States Patent and Trademark Office

United States of America

United States Patent and Trademark Office

Rhythm & Light

Reg. No. 4,174,258

Registered July 17, 2012

Int. Cl.: 41

SERVICE MARK

PRINCIPAL REGISTER

ORDOWER PRODUCTIONS, INC. (ILLINOIS CORPORATION), DBA RHYTHM & LIGHT
1452 N. ARTESIAN AVE.
CHICAGO, IL 606221703

FOR: FILM AND VIDEO PRODUCTION SERVICES; MULTIMEDIA PRODUCTION SERVICES; DOCUMENTARY, MOVIE, MUSIC VIDEO PRODUCTION SERVICES; PRODUCTION OF DVDS IN THE FIELD OF MUSICAL PERFORMANCES, DRAMATIC PERFORMANCES, DOCUMENTARIES AND EDUCATIONAL PROGRAMS; DISTRIBUTION SERVICES, NAMELY, DISTRIBUTION OF MOVIES, FILMS, TELEVISION AND RADIO PROGRAMS, IN CLASS 41 (U.S. CLS. 100, 101 AND 107).

FIRST USE 9-24-2001; IN COMMERCE 9-24-2001.

THE MARK CONSISTS OF STANDARD CHARACTERS WITHOUT CLAIM TO ANY PARTICULAR FONT, STYLE, SIZE, OR COLOR.

SER. NO. 85-382,603, FILED 7-27-2011.

JEFFREY LOOK, EXAMINING ATTORNEY



David J. Kyffers

Director of the United States Patent and Trademark Office

United States of America

United States Patent and Trademark Office

SPRAYSHIELD

Reg. No. 4,174,259

CONFLUENT SURGICAL, INC. (DELAWARE CORPORATION)

Registered July 17, 2012

15 CROSBY DRIVE
BEDFORD, MA 01730

Int. Cls.: 5 and 10

FOR: ANTI-ADHESION SURGICAL PREPARATIONS, IN CLASS 5 (U.S. CLS. 6, 18, 44, 46, 51 AND 52).

TRADEMARK

FIRST USE 8-31-2008; IN COMMERCE 8-31-2008.

PRINCIPAL REGISTER

FOR: MEDICAL PREPARATION DELIVERY SYSTEMS; AND SPRAY APPLICATOR AND AIR PUMP FOR APPLYING ANTI-ADHESION SURGICAL PREPARATIONS, IN CLASS 10 (U.S. CLS. 26, 39 AND 44).

FIRST USE 8-31-2008; IN COMMERCE 8-31-2008.

THE MARK CONSISTS OF STANDARD CHARACTERS WITHOUT CLAIM TO ANY PARTICULAR FONT, STYLE, SIZE, OR COLOR.

SER. NO. 85-383,061, FILED 7-28-2011.

ANN E. SAPPENFIELD, EXAMINING ATTORNEY



David J. Kypos

Director of the United States Patent and Trademark Office

United States of America

United States Patent and Trademark Office

Diamond Red

Reg. No. 4,174,260

Registered July 17, 2012

Int. Cl.: 30

TRADEMARK

PRINCIPAL REGISTER

PERK-UP INC. (NEW YORK CORPORATION)
SUITE 309
399 KNOLLWOOD ROAD
WHITE PLAINS, NY 10603

FOR: FOOD CONDIMENT CONSISTING PRIMARILY OF KETCHUP AND SALSA; HOT SAUCE, IN CLASS 30 (U.S. CL. 46).

FIRST USE 3-13-1997; IN COMMERCE 3-13-1997.

THE MARK CONSISTS OF STANDARD CHARACTERS WITHOUT CLAIM TO ANY PARTICULAR FONT, STYLE, SIZE, OR COLOR.

OWNER OF U.S. REG. NO. 2,262,119.

NO CLAIM IS MADE TO THE EXCLUSIVE RIGHT TO USE "RED", APART FROM THE MARK AS SHOWN.

SER. NO. 85-383,805, FILED 7-28-2011.

KATHY DE JONGE, EXAMINING ATTORNEY



David J. Kyffers

Director of the United States Patent and Trademark Office

United States of America

United States Patent and Trademark Office

MiaDallas

Reg. No. 4,174,261

Registered July 17, 2012

Int. Cl.: 35

SERVICE MARK

PRINCIPAL REGISTER

WALTERS MIA MAREE (UNITED STATES INDIVIDUAL)
#1156
2707 N. FITZHUGH AVENUE
DALLAS, TX 75204

FOR: ADVERTISING AND MARKETING SERVICES PROVIDED BY MEANS OF INDIRECT METHODS OF MARKETING COMMUNICATIONS, NAMELY, SOCIAL MEDIA, SEARCH ENGINE MARKETING, INQUIRY MARKETING, INTERNET MARKETING, MOBILE MARKETING, BLOGGING AND OTHER FORMS OF PASSIVE, SHARABLE OR VIRAL COMMUNICATIONS CHANNELS, IN CLASS 35 (U.S. CLS. 100, 101 AND 102).

FIRST USE 6-14-2011; IN COMMERCE 6-14-2011.

THE MARK CONSISTS OF STANDARD CHARACTERS WITHOUT CLAIM TO ANY PARTICULAR FONT, STYLE, SIZE, OR COLOR.

THE WORDING "MIADALLAS" HAS NO MEANING IN A FOREIGN LANGUAGE.

SER. NO. 85-383,972, FILED 7-28-2011.

LINDA MICKLEBURGH, EXAMINING ATTORNEY



David J. Kyros

Director of the United States Patent and Trademark Office

United States of America

United States Patent and Trademark Office

PLASTIFLOOR

Reg. No. 4,174,262

PLASTI CHEMIE NORTH AMERICA LLC. (FLORIDA LIMITED LIABILITY COMPANY)
3665 BONITA BEACH RD
BONITA SPRINGS, FL 34134

Registered July 17, 2012

Int. Cl.: 2

FOR: COATINGS FOR FLOORS, CEILINGS OR WALLS; RESIN-BASED COATINGS FOR USE ON ROOFS, WALLS AND FLOORS, IN CLASS 2 (U.S. CLS. 6, 11 AND 16).

TRADEMARK

FIRST USE 1-1-1995; IN COMMERCE 1-1-1995.

PRINCIPAL REGISTER

THE MARK CONSISTS OF STANDARD CHARACTERS WITHOUT CLAIM TO ANY PARTICULAR FONT, STYLE, SIZE, OR COLOR.

SER. NO. 85-384,047, FILED 7-28-2011.

FLORENTINA BLANDU, EXAMINING ATTORNEY



David J. Kybas

Director of the United States Patent and Trademark Office

United States of America

United States Patent and Trademark Office

THE PLANT LADY

Reg. No. 4,174,263

KASSMAN, INGRID (UNITED STATES INDIVIDUAL)
101 PARKCREST
NEWPORT BEACH, CA 92657

Registered July 17, 2012

Int. Cls.: 35, 39 and 44

FOR: WHOLESALE AND RETAIL STORE SERVICES FEATURING PLANTS, FLOWERS,
AND PLANT AND FLOWER CONTAINERS, IN CLASS 35 (U.S. CLS. 100, 101 AND 102).

SERVICE MARK

FIRST USE 10-31-1972; IN COMMERCE 10-31-1972.

PRINCIPAL REGISTER

FOR: PLANT AND FLOWER DELIVERY, IN CLASS 39 (U.S. CLS. 100 AND 105).

FIRST USE 10-31-1972; IN COMMERCE 10-31-1972.

FOR: PLANTING OF PLANT AND FLOWERS; PLANTS AND FLOWERS CARE SERVICES,
IN CLASS 44 (U.S. CLS. 100 AND 101).

FIRST USE 10-31-1972; IN COMMERCE 10-31-1972.

THE MARK CONSISTS OF STANDARD CHARACTERS WITHOUT CLAIM TO ANY PAR-
TICULAR FONT, STYLE, SIZE, OR COLOR.

NO CLAIM IS MADE TO THE EXCLUSIVE RIGHT TO USE "PLANT" , APART FROM THE
MARK AS SHOWN.

SER. NO. 85-384,073, FILED 7-28-2011.

FLORENTINA BLANDU, EXAMINING ATTORNEY



David J. Kyffers

Director of the United States Patent and Trademark Office

United States of America

United States Patent and Trademark Office



Reg. No. 4,174,264

Registered July 17, 2012

Int. Cl.: 37

SERVICE MARK

PRINCIPAL REGISTER

TIRE PROS FRANCORP (CALIFORNIA CORPORATION)
12200 HERBERT WAYNE COURT
SUITE 150
HUNTERSVILLE, NC 280703145

FOR: MAINTENANCE AND REPAIR OF VEHICLE TIRES AND WHEELS, IN CLASS 37
(U.S. CLS. 100, 103 AND 106).

FIRST USE 6-1-2006; IN COMMERCE 6-1-2006.

OWNER OF U.S. REG. NOS. 1,592,463, 3,064,740 AND OTHERS.

NO CLAIM IS MADE TO THE EXCLUSIVE RIGHT TO USE "TIRE", APART FROM THE
MARK AS SHOWN.

THE MARK CONSISTS OF THE WORDS "TIRE PROS" IN STYLIZED FONT DISPLAYED
ABOVE A DEPICTION OF TIRE TREAD. THE BOTTOM OF THE "T" AND "P" EXTEND
DOWN AND ARE SUPERIMPOSED OVER THE TIRE TREAD. THE WORDS "INSTALLING
PEACE OF MIND" ARE PRESENTED IN STYLIZED FONT AND ARE DISPLAYED BELOW
THE TIRE TREAD.

SER. NO. 85-384,364, FILED 7-29-2011.

GRETCHEN ULRICH, EXAMINING ATTORNEY



David J. Kyros

Director of the United States Patent and Trademark Office

United States of America

United States Patent and Trademark Office

Rock-A-Hula

Reg. No. 4,174,265

ON STAGE ENTERTAINMENT, INC. (NEVADA CORPORATION)
333 ORVILLE WRIGHT COURT

Registered July 17, 2012

LAS VEGAS, NV 89119

Int. Cl.: 41

FOR: ENTERTAINMENT SERVICES, NAMELY, LIVE MUSICAL ENTERTAINMENT STAGE PERFORMANCES, IN CLASS 41 (U.S. CLS. 100, 101 AND 107).

SERVICE MARK

FIRST USE 7-28-2011; IN COMMERCE 7-28-2011.

PRINCIPAL REGISTER

THE MARK CONSISTS OF STANDARD CHARACTERS WITHOUT CLAIM TO ANY PARTICULAR FONT, STYLE, SIZE, OR COLOR.

SER. NO. 85-385,000, FILED 7-29-2011.

KATHLEEN M. VANSTON, EXAMINING ATTORNEY



David J. Kybas

Director of the United States Patent and Trademark Office

United States of America

United States Patent and Trademark Office

Nationwide © CONVEYOR SPECIALISTS LLC ©

Reg. No. 4,174,266

Registered July 17, 2012

Int. Cl.: 37

SERVICE MARK

PRINCIPAL REGISTER

NATIONWIDE CONVEYOR SPECIALISTS LLC (CONNECTICUT LIMITED LIABILITY COMPANY)
340 MAPLE AVE
BRISTOL, CT 06010

FOR: INSTALLATION AND REPAIR OF CONVEYOR SYSTEMS, IN CLASS 37 (U.S. CLS. 100, 103 AND 106).

FIRST USE 3-31-2007; IN COMMERCE 4-11-2007.

NO CLAIM IS MADE TO THE EXCLUSIVE RIGHT TO USE "NATIONWIDE CONVEYOR SPECIALISTS LLC", APART FROM THE MARK AS SHOWN.

THE MARK CONSISTS OF THE STYLIZED WORDING "NATIONWIDE CONVEYOR SPECIALISTS LLC" WITH A STRAIGHT LINE INCORPORATING TWO ROUND DESIGNS THAT SEPARATE THE WORDS "NATIONWIDE" AND "CONVEYOR SPECIALISTS LLC".

SER. NO. 85-385,779, FILED 8-1-2011.

DAWN HAN, EXAMINING ATTORNEY



David J. Kyffers

Director of the United States Patent and Trademark Office

United States of America

United States Patent and Trademark Office



Reg. No. 4,174,267

Registered July 17, 2012

Int. Cl.: 9

TRADEMARK

PRINCIPAL REGISTER

WHEATON INDUSTRIES, INC. (DELAWARE CORPORATION)
1501 N. 10TH STREET
MILLVILLE, NJ 08332

FOR: LABORATORY EQUIPMENT AND SUPPLIES, NAMELY, LABORATORY BOTTLES, VIALS, TEST TUBES, PETRI DISHES, GLASS TUBING FOR SCIENTIFIC PURPOSES, DISPENSER SYRINGES FOR LABORATORY USE, PIPETTES, PIPETTE TIPS; LABORATORY EQUIPMENT, NAMELY, PLASTIC, RUBBER AND ELASTOMER CLOSURES, SEALS AND STOPPERS FOR LABORATORY BOTTLES AND VIALS; LABORATORY GLASSWARE; CONDENSERS; LABORATORY GLASSWARE RACKS; PIPETTE RACKS; LABORATORY INCUBATORS, IN CLASS 9 (U.S. CLS. 21, 23, 26, 36 AND 38).

FIRST USE 3-2-1972; IN COMMERCE 3-2-1972.

OWNER OF U.S. REG. NO. 1,016,028.

THE MARK CONSISTS OF THE STYLIZED LETTER "W" WITH AN EXTENDED MIDDLE POINT REPRESENTING AN "I".

SER. NO. 85-385,993, FILED 8-1-2011.

LUCY ARANT, EXAMINING ATTORNEY



David J. Kyffers

Director of the United States Patent and Trademark Office

United States of America

United States Patent and Trademark Office



RCG
GLOBAL SERVICES

Reg. No. 4,174,268

Registered July 17, 2012

Int. Cls.: 35, 41 and 42

SERVICE MARK

PRINCIPAL REGISTER

RCG GLOBAL SERVICES, INC. (NEW JERSEY CORPORATION)
379 THORNALL STREET
EDISON, NJ 08837

FOR: BUSINESS MANAGEMENT CONSULTING AND ADVISORY SERVICES, IN CLASS 35 (U.S. CLS. 100, 101 AND 102).

FIRST USE 4-14-2011; IN COMMERCE 4-14-2011.

FOR: TEACHING AND TRAINING IN BUSINESS, INDUSTRY AND INFORMATION TECHNOLOGY, IN CLASS 41 (U.S. CLS. 100, 101 AND 107).

FIRST USE 4-14-2011; IN COMMERCE 4-14-2011.

FOR: CONSULTING IN THE FIELD OF INFORMATION TECHNOLOGY; PLANNING, DESIGN AND MANAGEMENT OF INFORMATION TECHNOLOGY SYSTEMS, IN CLASS 42 (U.S. CLS. 100 AND 101).

FIRST USE 4-14-2011; IN COMMERCE 4-14-2011.

OWNER OF U.S. REG. NO. 2,564,314.

NO CLAIM IS MADE TO THE EXCLUSIVE RIGHT TO USE "GLOBAL SERVICES" , APART FROM THE MARK AS SHOWN.

THE MARK CONSISTS OF THE LETTERS "RCG" IN STYLIZED FORM ABOVE THE WORDS "RCG GLOBAL SERVICES".

SER. NO. 85-386,226, FILED 8-1-2011.

BRENDAN MCCAULEY, EXAMINING ATTORNEY



David J. Kybas

Director of the United States Patent and Trademark Office

United States of America

United States Patent and Trademark Office



Reg. No. 4,174,269

Registered July 17, 2012

Int. Cl.: 43

SERVICE MARK

PRINCIPAL REGISTER

NEWPORT RESTAURANT VENTURE, LLC (CALIFORNIA LIMITED LIABILITY COMPANY)
19700 FAIRCHILD RD., STE 130
IRVINE, CA 92612

FOR: BAR AND RESTAURANT SERVICES, IN CLASS 43 (U.S. CLS. 100 AND 101).

FIRST USE 7-15-2011; IN COMMERCE 7-15-2011.

NO CLAIM IS MADE TO THE EXCLUSIVE RIGHT TO USE "LIBATIONS AND SEASONAL PLATES", APART FROM THE MARK AS SHOWN.

THE MARK CONSISTS OF A CIRCLE CONTAINING AN IMAGE OF A MAPLE TREE SUPERIMPOSED BY THE WORDS "GREAT MAPLE" ABOVE THE WORDS "LIBATIONS AND SEASONAL PLATES".

SER. NO. 85-386,237, FILED 8-1-2011.

BRENDAN MCCAULEY, EXAMINING ATTORNEY



David J. Kybas

Director of the United States Patent and Trademark Office

United States of America

United States Patent and Trademark Office

SEE SAY CREATE

Reg. No. 4,174,270

Registered July 17, 2012

Int. Cl.: 16

TRADEMARK

PRINCIPAL REGISTER

SCHUE, LORI (UNITED STATES INDIVIDUAL)
40377 STONEBROOK HAMLET PL
WATERFORD, VA 20197

FOR: CHILDREN'S STORY BOOKS THAT EACH INCLUDE A STORY, DESCRIPTIVE CREATIVE VOCABULARY LIST AND ART ACTIVITIES PERTAINING SPECIFICALLY TO THE PLOT OF THE STORY , IN CLASS 16 (U.S. CLS. 2, 5, 22, 23, 29, 37, 38 AND 50).

FIRST USE 5-1-2009; IN COMMERCE 5-1-2009.

THE MARK CONSISTS OF STANDARD CHARACTERS WITHOUT CLAIM TO ANY PARTICULAR FONT, STYLE, SIZE, OR COLOR.

SER. NO. 85-386,446, FILED 8-1-2011.

JEFFERY COWARD, EXAMINING ATTORNEY



David J. Kyffers

Director of the United States Patent and Trademark Office

United States of America

United States Patent and Trademark Office

Products to Enhance Our Water Resources

Reg. No. 4,174,271

CYGNET ENTERPRISES, INC. (MICHIGAN CORPORATION)
1860 BAGWELL STREET
FLUSHING, MI 48503

Registered July 17, 2012

Int. Cl.: 5

FOR: AQUATIC HERBICIDES, IN CLASS 5 (U.S. CLS. 6, 18, 44, 46, 51 AND 52).

TRADEMARK

FIRST USE 6-1-1974; IN COMMERCE 10-1-1998.

PRINCIPAL REGISTER

THE MARK CONSISTS OF STANDARD CHARACTERS WITHOUT CLAIM TO ANY PARTICULAR FONT, STYLE, SIZE, OR COLOR.

SER. NO. 85-387,140, FILED 8-2-2011.

SANI KHOURI, EXAMINING ATTORNEY



David J. Kyffers

Director of the United States Patent and Trademark Office

United States of America

United States Patent and Trademark Office

DistanceDesign

Reg. No. 4,174,272

Registered July 17, 2012

Int. Cl.: 42

SERVICE MARK

PRINCIPAL REGISTER

SMITH LAROCK ARCHITECTURE PC (COLORADO CORPORATION)
210
800 GRANT STREET
DENVER, CO 80203

FOR: ARCHITECTURAL DESIGN, IN CLASS 42 (U.S. CLS. 100 AND 101).

FIRST USE 5-1-2004; IN COMMERCE 5-1-2004.

THE MARK CONSISTS OF STANDARD CHARACTERS WITHOUT CLAIM TO ANY PARTICULAR FONT, STYLE, SIZE, OR COLOR.

SER. NO. 85-388,687, FILED 8-3-2011.

TIMOTHY FINNEGAN, EXAMINING ATTORNEY



David J. Kybas

Director of the United States Patent and Trademark Office

United States of America

United States Patent and Trademark Office

USRADIO SURGERY

Reg. No. 4,174,273

Registered July 17, 2012

Int. Cl.: 35

SERVICE MARK

PRINCIPAL REGISTER

USR HOLDINGS, LLC (DELAWARE LIMITED LIABILITY COMPANY)
40 BURTON HILLS BOULEVARD, SUITE 220
NASHVILLE, TN 37215

FOR: BUSINESS ADMINISTRATION AND MANAGEMENT SERVICES FOR RADIOSURGERY FACILITIES; BUSINESS DEVELOPMENT SERVICES, NAMELY, PROVIDING START-UP SUPPORT FOR BUSINESSES OF OTHERS IN THE FIELD OF RADIOSURGERY; OFFERING TECHNICAL AND BUSINESS MANAGEMENT ASSISTANCE IN THE ESTABLISHMENT AND OPERATION OF RADIOSURGERY FACILITIES, IN CLASS 35 (U.S. CLS. 100, 101 AND 102).

FIRST USE 5-1-2011; IN COMMERCE 6-10-2011.

OWNER OF U.S. REG. NO. 3,282,864.

NO CLAIM IS MADE TO THE EXCLUSIVE RIGHT TO USE "USRADIO SURGERY", APART FROM THE MARK AS SHOWN.

THE MARK CONSISTS OF THE WORDING "US RADIOSURGERY" WITH THE LETTER "O" INCORPORATING A DESIGN WITH A SPHERE SURROUNDED BY TWO OPEN-ENDED SEMI-CIRCLES WITH EXTENDED LINES.

SER. NO. 85-388,961, FILED 8-3-2011.

ANNE MADDEN, EXAMINING ATTORNEY



David J. Kybas

Director of the United States Patent and Trademark Office

United States of America

United States Patent and Trademark Office

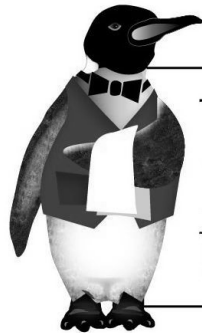

Ralphie's
Room Service

Reg. No. 4,174,274

Registered July 17, 2012

Int. Cl.: 35

SERVICE MARK

PRINCIPAL REGISTER

UNIVERSITY DELIVERY SERVICES LLC (COLORADO LIMITED LIABILITY COMPANY),
DBA UNIVERSITY STUDENT SERVICES; RALPHIE'S ROOM SERVICE
2704-02(A)
3800 BARR COURT, , CO
BOULDER, CO 80305

FOR: ON-LINE RETAIL STORE SERVICES FEATURING GIFT BASKETS AND CARE
PACKAGES WITH SELECTED ITEMS REGARDING A PARTICULAR THEME OR OCCASION,
IN CLASS 35 (U.S. CLS. 100, 101 AND 102).

FIRST USE 1-25-2011; IN COMMERCE 1-25-2011.

THE MARK CONSISTS OF A STYLIZED PENGUIN WEARING A BOW TIE AND VEST AND
WITH A TOWEL DRAPED OVER THE FOLDED LEFT WING WITH THE VEST AND WITH
THE WORDS "RALPHIE'S ROOM SERVICE" DEPICTED TO THE RIGHT OF THE STYLIZED
PENGUIN WITH THE WORD "RALPHIE'S" OVER THE WORDS "ROOM SERVICE" SEPAR-
ATED BY A LINE AND BOXED BY THREE LINES-ONE ABOVE, ONE BELOW AND ONE
TO THE RIGHT OF THE WORDS.

SER. NO. 85-389,521, FILED 8-4-2011.

LAURIE MAYES, EXAMINING ATTORNEY



David J. Kybas

Director of the United States Patent and Trademark Office

United States of America

United States Patent and Trademark Office

NEWSOUL

Reg. No. 4,174,275

ONE OFF INTERNATIONAL AB (SWEDEN CORPORATION)
HAMMARGATAN 6-8
ANGELHOLM, SWEDEN 262 71

Registered July 17, 2012

Int. Cls.: 25 and 28

FOR: CLOTHING, NAMELY, T-SHIRTS, HATS AND CAPS, AND SOCKS, IN CLASS 25 (U.S. CLS. 22 AND 39).

TRADEMARK

FIRST USE 10-0-2009; IN COMMERCE 5-0-2011.

PRINCIPAL REGISTER

FOR: SKATEBOARDS AND PARTS AND ACCESSORIES THEREFOR, IN CLASS 28 (U.S. CLS. 22, 23, 38 AND 50).

FIRST USE 10-0-2009; IN COMMERCE 5-0-2011.

THE MARK CONSISTS OF STANDARD CHARACTERS WITHOUT CLAIM TO ANY PARTICULAR FONT, STYLE, SIZE, OR COLOR.

SER. NO. 85-390,727, FILED 8-5-2011.

WILLIAM BRECKENFELD, EXAMINING ATTORNEY



David J. Kyffers

Director of the United States Patent and Trademark Office

United States of America

United States Patent and Trademark Office

Dutch Valley Food Distributors Inc.

Reg. No. 4,174,276

DUTCH VALLEY FOOD DISTRIBUTORS INC. (PENNSYLVANIA CORPORATION)
7615 LANCASTER AVENUE, P.O. BOX 465
MYERSTOWN, PA 17067

Registered July 17, 2012

Int. Cl.: 35

FOR: WHOLESALE FOOD DISTRIBUTORSHIP SERVICES, IN CLASS 35 (U.S. CLS. 100, 101 AND 102).

SERVICE MARK

FIRST USE 8-1-1990; IN COMMERCE 8-1-1990.

PRINCIPAL REGISTER

THE MARK CONSISTS OF STANDARD CHARACTERS WITHOUT CLAIM TO ANY PARTICULAR FONT, STYLE, SIZE, OR COLOR.

OWNER OF U.S. REG. NOS. 2,993,861, 3,844,549 AND OTHERS.

NO CLAIM IS MADE TO THE EXCLUSIVE RIGHT TO USE "FOOD DISTRIBUTORS INC.", APART FROM THE MARK AS SHOWN.

SER. NO. 85-390,741, FILED 8-5-2011.

SANDRA BUJA, EXAMINING ATTORNEY



David J. Kyffers

Director of the United States Patent and Trademark Office

United States of America

United States Patent and Trademark Office



AVU Registrations, Inc.

Reg. No. 4,174,277

Registered July 17, 2012

Int. Cl.: 42

SERVICE MARK

PRINCIPAL REGISTER

AVU INC. (MICHIGAN CORPORATION)
5279 NORTH ISABELLA ROAD
ROSEBUSH, MI 48878

FOR: TESTING, ANALYSIS AND EVALUATION OF THE GOODS AND SERVICES OF OTHERS FOR THE PURPOSE OF CERTIFICATION, IN CLASS 42 (U.S. CLS. 100 AND 101).

FIRST USE 9-28-2010; IN COMMERCE 9-28-2010.

NO CLAIM IS MADE TO THE EXCLUSIVE RIGHT TO USE "REGISTRATIONS, INC.", APART FROM THE MARK AS SHOWN.

THE MARK CONSISTS OF A GRAPHICAL REPRESENTATION OF THE UNDERLINED TEXT "AVU", AND THE TEXT "AVU REGISTRATIONS, INC." WRITTEN BELOW THE GRAPHICAL REPRESENTATION.

THE ENGLISH TRANSLATION OF "AVU" IN THE MARK IS ADVANTAGE, QUALITY, VIRTUE, ASSET, MERIT.

SER. NO. 85-390,920, FILED 8-5-2011.

DANNEAN HETZEL, EXAMINING ATTORNEY



David J. Kyffers

Director of the United States Patent and Trademark Office

United States of America

United States Patent and Trademark Office



Reg. No. 4,174,278

Registered July 17, 2012

Int. Cl.: 30

TRADEMARK

PRINCIPAL REGISTER

ORGANIC TEAS UNITED LLC (WASHINGTON LIMITED LIABILITY COMPANY), DBA
KOFFIETTI GOURMET BEVERAGE
606 E. HARRISON STREET
TACOMA, WA 98404

FOR: BEVERAGES MADE OF TEA; BEVERAGES WITH A COFFEE BASE; BEVERAGES WITH A TEA BASE; COFFEE AND TEA; COFFEE BASED BEVERAGES; COFFEE-BASED BEVERAGES; TEA FOR INFUSIONS; TEA-BASED BEVERAGES; TEA-BASED BEVERAGES WITH FRUIT FLAVORING, IN CLASS 30 (U.S. CL. 46).

FIRST USE 8-1-2011; IN COMMERCE 8-1-2011.

NO CLAIM IS MADE TO THE EXCLUSIVE RIGHT TO USE "GOURMET BEVERAGE, REAL COFFEE, AND REAL TEA", APART FROM THE MARK AS SHOWN.

THE MARK CONSISTS OF A BROWN COFFEE POT ON THE LEFT AND A GREEN TEA POT ON THE RIGHT, TILTED INWARD TOWARD EACH OTHER, WITH A RED TEACUP BELOW, FORMING A CIRCULAR PATTERN, WITH THE WORD "KOFFIETTI" IN BLACK FORMING THE TOP OF THE CIRCLE BETWEEN THE TOPS OF THE POTS, THE WORD "GOURMET" IN BLACK ON THE LOWER LEFT OF THE CIRCLE (AT ABOUT 7 O'CLOCK POSITION), AND THE WORD "BEVERAGE" IN BLACK ON THE LOWER RIGHT OF THE CIRCLE (AT ABOUT 5 O'CLOCK POSITION), ALL LETTERS WITH THEIR TOPS OUTWARD SO THE WORD "KOFFIETTI" READS CLOCKWISE, AND THE WORDS "GOURMET BEVERAGE" READ COUNTER-CLOCKWISE. FROM THE SPOUT OF THE BROWN COFFEE POT, BROWN COFFEE BEANS ARE POURING INTO THE RED CUP. FROM THE SPOUT OF THE GREEN TEA POT, GREEN TEA LEAVES ARE POURING INTO THE RED CUP. BENEATH THE RED CUP, THERE IS A FADED MIRROR IMAGE OR REFLECTION OF THE RED CUP, AND OF THE LAST 5 LETTERS OF THE WORD "GOURMET", AND THE FIRST 5 LETTERS OF THE WORD "BEVERAGE", ALL FACING DOWNWARD IN BLACK. BENEATH ALL OF THE ABOVE ARE TWO STRAIGHT LINES OF TEXT: "THE JOY OF REAL COFFEE" IN BROWN AND "THE BENEFITS OF REAL TEA" IN GREEN. THE LETTERING "KOFFIETTI GOURMET BEVERAGE" IS BLACK, THE FIRST PHRASE BELOW ("THE JOY OF REAL COFFEE") IS BROWN, AND THE SECOND PHRASE BELOW ("THE BENEFITS OF REAL TEA") IS GREEN. THE WORDS "KOFFIETTI GOURMET BEVERAGE" ARE IN SLIGHTLY DISTORTED BLOCK LETTERS; THE OTHER WORDS ARE IN A FANCY SCRIPT.



David J. Kappas

Director of the United States Patent and Trademark Office

SER. NO. 85-391,032, FILED 8-5-2011.

Reg. No. 4,174,278 WILLIAM BRECKENFELD, EXAMINING ATTORNEY

United States of America

United States Patent and Trademark Office

White Widow

Reg. No. 4,174,279

Registered July 17, 2012

Int. Cl.: 9

TRADEMARK

PRINCIPAL REGISTER

CARLA PATULLO (UNITED STATES INDIVIDUAL)
3507 ROBINSON
AUSTIN, TX 78722

FOR: AUDIO AND VIDEO RECORDINGS FEATURING MUSIC AND ARTISTIC PERFORMANCES; COMPACT DISCS FEATURING MUSIC; DOWNLOADABLE MP3 FILES, MP3 RECORDINGS, ON-LINE DISCUSSION BOARDS, WEBCASTS, WEBINARS AND PODCASTS FEATURING MUSIC, AUDIO BOOKS IN THE FIELD OF MUSIC, AND NEWS BROADCASTS; DOWNLOADABLE MUSICAL SOUND RECORDINGS; DOWNLOADABLE RING TONES, GRAPHICS AND MUSIC VIA A GLOBAL COMPUTER NETWORK AND WIRELESS DEVICES; DOWNLOADABLE MUSIC AND VIDEO VIA THE INTERNET AND WIRELESS DEVICES; MUSICAL SOUND RECORDINGS; MUSICAL VIDEO RECORDINGS; VISUAL RECORDINGS AND AUDIOVISUAL RECORDINGS FEATURING MUSIC AND ANIMATION, IN CLASS 9 (U.S. CLS. 21, 23, 26, 36 AND 38).

FIRST USE 4-1-2004; IN COMMERCE 10-1-2004.

THE MARK CONSISTS OF STANDARD CHARACTERS WITHOUT CLAIM TO ANY PARTICULAR FONT, STYLE, SIZE, OR COLOR.

SER. NO. 85-391,339, FILED 8-5-2011.

LAKEISHA LEWIS, EXAMINING ATTORNEY



David J. Kyros

Director of the United States Patent and Trademark Office

United States of America

United States Patent and Trademark Office

TruJoin

Reg. No. 4,174,280

JENKINS, JOSHUA L (UNITED STATES INDIVIDUAL)
972 EDWIN DR
VIRGINIA BEACH, VA 23464

Registered July 17, 2012

Int. Cl.: 36

FOR: FINANCIAL ADMINISTRATION OF COMMERCIAL AND RESIDENTIAL RENTAL PROPERTY, IN CLASS 36 (U.S. CLS. 100, 101 AND 102).

SERVICE MARK

FIRST USE 5-15-2011; IN COMMERCE 6-1-2011.

PRINCIPAL REGISTER

THE MARK CONSISTS OF STANDARD CHARACTERS WITHOUT CLAIM TO ANY PARTICULAR FONT, STYLE, SIZE, OR COLOR.

SER. NO. 85-391,611, FILED 8-7-2011.

JASON TURNER, EXAMINING ATTORNEY



David J. Kybas

Director of the United States Patent and Trademark Office

United States of America

United States Patent and Trademark Office

Karen Kilimnik

Reg. No. 4,174,281

KILIMNIK, KAREN (UNITED STATES INDIVIDUAL)
247 RIGHTERS FERRY ROAD
BALA CYNWYD, PA 19004

Registered July 17, 2012

Int. Cl.: 16

FOR: WORKS OF ART IN THE NATURE OF PAINTING, DRAWINGS, AND PHOTOGRAPHS,
IN CLASS 16 (U.S. CLS. 2, 5, 22, 23, 29, 37, 38 AND 50).

TRADEMARK

FIRST USE 7-13-1990; IN COMMERCE 7-13-1990.

PRINCIPAL REGISTER

THE MARK CONSISTS OF STANDARD CHARACTERS WITHOUT CLAIM TO ANY PARTICULAR FONT, STYLE, SIZE, OR COLOR.

THE NAME(S), PORTRAIT(S), AND/OR SIGNATURE(S) SHOWN IN THE MARK IDENTIFIES "KAREN KILIMNIK", WHOSE CONSENT(S) TO REGISTER IS MADE OF RECORD.

SER. NO. 85-391,669, FILED 8-7-2011.

WENDY GOODMAN, EXAMINING ATTORNEY



David J. Kybas

Director of the United States Patent and Trademark Office

United States of America

United States Patent and Trademark Office

SUMMERSON.COM

Reg. No. 4,174,282

SUMMERSON, PHILIP D. (UNITED STATES INDIVIDUAL)
8101 COLLEGE BLVD. SUITE 100
OVERLAND PARK, KS 66210

Registered July 17, 2012

Int. Cl.: 36

FOR: RESIDENTIAL REAL ESTATE AGENCY SERVICES, IN CLASS 36 (U.S. CLS. 100, 101 AND 102).

SERVICE MARK

FIRST USE 8-0-1975; IN COMMERCE 8-0-1975.

PRINCIPAL REGISTER

THE MARK CONSISTS OF STANDARD CHARACTERS WITHOUT CLAIM TO ANY PARTICULAR FONT, STYLE, SIZE, OR COLOR.

SEC. 2(F).

SER. NO. 85-392,036, FILED 8-8-2011.

TARA PATE, EXAMINING ATTORNEY



David J. Kyffers

Director of the United States Patent and Trademark Office

United States of America

United States Patent and Trademark Office

I PROMISE TO LIVE BEAUTIFULLY

Reg. No. 4,174,283

TRUE PROMISE BEAUTY, INC. (CALIFORNIA CORPORATION)
638 LINDERO CANYON ROAD, #316
OAK PARK, CA 91377

Registered July 17, 2012

Int. Cl.: 3

FOR: NON-MEDICATED SKIN CARE PREPARATIONS, IN CLASS 3 (U.S. CLS. 1, 4, 6, 50, 51 AND 52).

TRADEMARK

FIRST USE 7-0-2009; IN COMMERCE 7-0-2009.

PRINCIPAL REGISTER

THE MARK CONSISTS OF STANDARD CHARACTERS WITHOUT CLAIM TO ANY PARTICULAR FONT, STYLE, SIZE, OR COLOR.

SER. NO. 85-392,701, FILED 8-8-2011.

RONALD AIKENS, EXAMINING ATTORNEY



David J. Kyffers

Director of the United States Patent and Trademark Office

United States of America

United States Patent and Trademark Office



Reg. No. 4,174,284

Registered July 17, 2012

Int. Cl.: 35

SERVICE MARK

PRINCIPAL REGISTER

TISSELL, JENNIFER (UNITED STATES INDIVIDUAL)
18276 HWY 20
WINTHROP, WA 98862

FOR: RETAIL STORE AND ON-LINE RETAIL STORE SERVICES FEATURING EQUESTRIAN RELATED CLOTHING AND EQUESTRIAN RELATED ACCESSORIES, IN CLASS 35 (U.S. CLS. 100, 101 AND 102).

FIRST USE 4-14-2004; IN COMMERCE 4-14-2004.

NO CLAIM IS MADE TO THE EXCLUSIVE RIGHT TO USE "RETRO", APART FROM THE MARK AS SHOWN.

THE MARK CONSISTS OF A FLORAL FRAME WITH A BANNER AT THE TOP AND A HEAD OF A HORSE AT THE BOTTOM OF THE FRAME AND WITH THE STYLIZED TEXT "RETRO PONY" INSIDE THE FRAME.

SER. NO. 85-392,736, FILED 8-8-2011.

Laurie Mayes, Examining Attorney



David J. Kyfos

Director of the United States Patent and Trademark Office

United States of America

United States Patent and Trademark Office

The Mansion on O Street

Reg. No. 4,174,285

2020 O STREET CORPORATION INC. (D.C. CORPORATION)

Registered July 17, 2012

2020 O STREET N.W.
WASHINGTON, DC 20036

Int. Cl.: 43

FOR: EXTENDED-STAY HOTELS; HOTEL ACCOMMODATION SERVICES; HOTEL SERVICES; HOTEL, BAR AND RESTAURANT SERVICES; HOTELS; PRIVATE RESIDENCE CLUB SERVICES, NAMELY, PROVISION TO CLUB MEMBERS OF TEMPORARY ACCOMMODATIONS IN COMPANY OWNED OR LEASED PRIVATE RESIDENCES, IN CLASS 43 (U.S. CLS. 100 AND 101).

SERVICE MARK

PRINCIPAL REGISTER

FIRST USE 2-14-1980; IN COMMERCE 2-14-1980.

THE MARK CONSISTS OF STANDARD CHARACTERS WITHOUT CLAIM TO ANY PARTICULAR FONT, STYLE, SIZE, OR COLOR.

NO CLAIM IS MADE TO THE EXCLUSIVE RIGHT TO USE "O STREET", APART FROM THE MARK AS SHOWN.

SER. NO. 85-393,457, FILED 8-9-2011.

HANNO RITTNER, EXAMINING ATTORNEY



David J. Kyffers

Director of the United States Patent and Trademark Office

United States of America

United States Patent and Trademark Office

WE CERTIFY

Reg. No. 4,174,286

Registered July 17, 2012

Int. Cls.: 42 and 45

SERVICE MARK

PRINCIPAL REGISTER

HEALTH RESEARCH, INC. (NEW YORK CORPORATION)
RIVERVIEW CENTER
150 BROADWAY, SUITE 150
MENANDS, NY 122042719

FOR: WEB-BASED SERVICES FEATURING TECHNOLOGY THAT ASSIST NONPROFIT BUSINESSES IN COMPLYING WITH FEDERAL REGULATIONS FOR USE OF FEDERAL FUNDING , IN CLASS 42 (U.S. CLS. 100 AND 101).

FIRST USE 9-17-2010; IN COMMERCE 9-17-2010.

FOR: CONSULTING SERVICES IN THE FIELD OF FEDERAL REGULATORY COMPLIANCE REQUIREMENTS FOR USE OF FEDERAL MONEY, IN CLASS 45 (U.S. CLS. 100 AND 101).

FIRST USE 9-17-2010; IN COMMERCE 9-17-2010.

THE MARK CONSISTS OF STANDARD CHARACTERS WITHOUT CLAIM TO ANY PARTICULAR FONT, STYLE, SIZE, OR COLOR.

NO CLAIM IS MADE TO THE EXCLUSIVE RIGHT TO USE "CERTIFY", APART FROM THE MARK AS SHOWN.

SER. NO. 85-393,462, FILED 8-9-2011.

FLORENTINA BLANDU, EXAMINING ATTORNEY



David J. Kybas

Director of the United States Patent and Trademark Office

United States of America

United States Patent and Trademark Office

JOHN R. STARR, INC.

Reg. No. 4,174,287

Registered July 17, 2012

Int. Cl.: 16

TRADEMARK

PRINCIPAL REGISTER

JOHN R. STARR, INC. (MASSACHUSETTS CORPORATION)
SUITE 201
1112 GOODLETTE ROAD NORTH
NAPLES, FL 34102

FOR: PUBLICATIONS, NAMELY, PERIODIC REPORTS ON DIFFERENT SEGMENTS OF THE NONWOVEN FABRICS AND HYGIENE ABSORBENT PRODUCTS BUSINESSES AND TECHNOLOGIES AND ALSO ON THE BUSINESSES AND TECHNOLOGIES THAT PROVIDE THE KEY RAW MATERIALS FOR NONWOVEN FABRICS AND HYGIENE ABSORBENT PRODUCTS, IN CLASS 16 (U.S. CLS. 2, 5, 22, 23, 29, 37, 38 AND 50).

FIRST USE 3-31-1985; IN COMMERCE 3-31-1985.

THE MARK CONSISTS OF STANDARD CHARACTERS WITHOUT CLAIM TO ANY PARTICULAR FONT, STYLE, SIZE, OR COLOR.

NO CLAIM IS MADE TO THE EXCLUSIVE RIGHT TO USE "INC.", APART FROM THE MARK AS SHOWN.

THE NAME(S), PORTRAIT(S), AND/OR SIGNATURE(S) SHOWN IN THE MARK IDENTIFIES "JOHN R. STARR", WHOSE CONSENT(S) TO REGISTER IS MADE OF RECORD.

SER. NO. 85-393,530, FILED 8-9-2011.

LINDSEY RUBIN, EXAMINING ATTORNEY



David J. Kybas

Director of the United States Patent and Trademark Office

United States of America

United States Patent and Trademark Office

UniChrom

Reg. No. 4,174,288

Registered July 17, 2012

Int. Cls.: 9 and 42

TRADEMARK

SERVICE MARK

PRINCIPAL REGISTER

PSS POLYMER STANDARDS SERVICE GMBH (FED REP GERMANY LIMITED LIABILITY COMPANY)
IN DER DALHEIMER WIESE 5
MAINZ, FED REP GERMANY 55120

FOR: COMPUTER SOFTWARE FOR THE CHARACTERIZATION AND ANALYSIS OF SYNTHETIC AND NATURAL POLYMERS, MACROMOLECULES AND PROTEINS IN THE FIELD OF CHROMATOGRAPHY, IN CLASS 9 (U.S. CLS. 21, 23, 26, 36 AND 38).

FOR: DESIGN AND DEVELOPMENT OF COMPUTER SOFTWARE, IN CLASS 42 (U.S. CLS. 100 AND 101).

THE MARK CONSISTS OF STANDARD CHARACTERS WITHOUT CLAIM TO ANY PARTICULAR FONT, STYLE, SIZE, OR COLOR.

OWNER OF ERPN CMNTY TM OFC REG. NO. 010190213, DATED 1-10-2012, EXPIRES 2-16-2021.

SER. NO. 85-393,980, FILED 8-10-2011.

SUSAN RICHARDS, EXAMINING ATTORNEY



David J. Kyjars

Director of the United States Patent and Trademark Office

United States of America

United States Patent and Trademark Office

Multimedia Plus

Reg. No. 4,174,289

HAROUCHE, DAVID (UNITED STATES INDIVIDUAL)
29 PINE HILL ROAD

Registered July 17, 2012 LAKE SUCCESS, NY 11020

Int. Cl.: 9

FOR: COMPUTER SOFTWARE THAT ALLOWS FOR CREATION OF ON-LINE CUSTOMER SERVICE TRAINING, WEB-BASED TRAINING UPDATES, OR FULL SCALE MULTIMEDIA TRAINING COURSE, PRE-RECORDED COMPACT DISCS, CD-ROMS, DVD-ROMS, OR OTHER ELECTRONICALLY DISTRIBUTED INTERACTIVE MULTIMEDIA TECHNOLOGY, NAMELY, AUDIO, VIDEO AND GRAPHICAL RECORDINGS AND ELEMENTS, ELECTRONICALLY DISTRIBUTED INTERACTIVE MULTIMEDIA TECHNOLOGIES, NAMELY, DOWNLOADABLE MULTIMEDIA FILES CONTAINING ARTWORK, TEXT, AUDIO, VIDEO, TESTS, AND INTERNET WEB LINKS FEATURING TRAINING INFORMATION, NAMELY, PLANNING TOOLS FOR TRAINING, AUTHORING DEVELOPMENT, TEMPLATES AND OTHER CLIP MEDIA ELEMENTS TO HELP TRAINERS CREATE INTERACTIVE TRADE SHOW PRESENTATIONS, INFORMATION KIOSKS, ON-LINE CUSTOMER SERVICE TRAINING, WEB-BASED TRAINING UPDATES FOR AN INTERNATIONAL SALES FORCE, OR FULL SCALE MULTIMEDIA TRAINING COURSE, IN CLASS 9 (U.S. CLS. 21, 23, 26, 36 AND 38).

TRADEMARK

PRINCIPAL REGISTER

FIRST USE 1-1-1997; IN COMMERCE 1-1-1997.

THE MARK CONSISTS OF STANDARD CHARACTERS WITHOUT CLAIM TO ANY PARTICULAR FONT, STYLE, SIZE, OR COLOR.

OWNER OF U.S. REG. NO. 2,746,401.

NO CLAIM IS MADE TO THE EXCLUSIVE RIGHT TO USE "MULTIMEDIA", APART FROM THE MARK AS SHOWN.

SER. NO. 85-394,165, FILED 8-10-2011.

MATTHEW EINSTEIN, EXAMINING ATTORNEY



David J. Kyros

Director of the United States Patent and Trademark Office

United States of America

United States Patent and Trademark Office



FINANCIAL WINGS

Reg. No. 4,174,290

Registered July 17, 2012

Int. Cl.: 45

SERVICE MARK

PRINCIPAL REGISTER

MITCHELL, KARLENE, E. (CONNECTICUT LIMITED LIABILITY COMPANY)
128 EAST AVENUE
NORWALK, CT 06851

FOR: DIVORCE MEDIATION SERVICES; MEDIATION OF DISPUTES REGARDING ELDERS, THEIR FAMILIES, CAREGIVERS AND STAKEHOLDERS; PERSONAL SERVICES, NAMELY, CONSULTATION IN THE FIELD OF DIVORCE, IN CLASS 45 (U.S. CLS. 100 AND 101).

FIRST USE 7-19-2002; IN COMMERCE 7-19-2002.

NO CLAIM IS MADE TO THE EXCLUSIVE RIGHT TO USE "FINANCIAL", APART FROM THE MARK AS SHOWN.

THE MARK CONSISTS OF PAIR OF BLACK OUTLINE STYLIZED WINGS WITH BLACK OVAL DOT BELOW AND LEFT OF CENTER AND BLACK COMPANY NAME "FINANCIAL WINGS" CENTERED BENEATH THE GRAPHIC.

SER. NO. 85-394,209, FILED 8-10-2011.

CHRISIE B. KING, EXAMINING ATTORNEY



David J. Kyffers

Director of the United States Patent and Trademark Office

United States of America

United States Patent and Trademark Office

JUNGLE LARRY

Reg. No. 4,174,291

JUNGLE LARRY'S SAFARI LAND, INC. (FLORIDA CORPORATION)
5841 SPANISH OAKS LANE
NAPLES, FL 34119

Registered July 17, 2012

Int. Cl.: 41

FOR: PROVIDING EXHIBITS, SHOWS, AND DISPLAYS RELATING TO OR INVOLVING WILD ANIMALS, IN CLASS 41 (U.S. CLS. 100, 101 AND 107).

SERVICE MARK

FIRST USE 8-12-1957; IN COMMERCE 8-12-1957.

PRINCIPAL REGISTER

THE MARK CONSISTS OF STANDARD CHARACTERS WITHOUT CLAIM TO ANY PARTICULAR FONT, STYLE, SIZE, OR COLOR.

SER. NO. 85-394,347, FILED 8-10-2011.

KATHLEEN LORENZO, EXAMINING ATTORNEY



David J. Kybas

Director of the United States Patent and Trademark Office

United States of America

United States Patent and Trademark Office

ZEE STAND

Reg. No. 4,174,292

STREET SMART RENTAL, INC. (DELAWARE CORPORATION)
7526 4TH AVENUE

Registered July 17, 2012

LINO LAKES, MN 55014

Int. Cl.: 6

FOR: METAL SIGN STANDS FOR DISPLAYING TRAFFIC SIGNS, IN CLASS 6 (U.S. CLS. 2, 12, 13, 14, 23, 25 AND 50).

TRADEMARK

FIRST USE 6-18-2007; IN COMMERCE 6-18-2007.

PRINCIPAL REGISTER

THE MARK CONSISTS OF STANDARD CHARACTERS WITHOUT CLAIM TO ANY PARTICULAR FONT, STYLE, SIZE, OR COLOR.

NO CLAIM IS MADE TO THE EXCLUSIVE RIGHT TO USE "STAND", APART FROM THE MARK AS SHOWN.

SER. NO. 85-394,460, FILED 8-10-2011.

COLLEEN DOMBROW, EXAMINING ATTORNEY



David J. Kyffers

Director of the United States Patent and Trademark Office

United States of America

United States Patent and Trademark Office

TCI

Reg. No. 4,174,293

Registered July 17, 2012

Int. Cl.: 36

SERVICE MARK

PRINCIPAL REGISTER

EDMUNDS.COM, INC. (NEW YORK CORPORATION)
SUITE 400 SOUTH
1620 26TH STREET
SANTA MONICA, CA 90404

FOR: PROVIDING ONLINE INFORMATION IN THE NATURE OF AN ANALYSIS OF THE AVERAGE COST PER UNIT OF AUTOMOBILE MANUFACTURER INCENTIVES PROGRAMS FOR PASSENGER VEHICLES , IN CLASS 36 (U.S. CLS. 100, 101 AND 102).

FIRST USE 3-3-2003; IN COMMERCE 3-3-2003.

THE MARK CONSISTS OF STANDARD CHARACTERS WITHOUT CLAIM TO ANY PARTICULAR FONT, STYLE, SIZE, OR COLOR.

SER. NO. 85-394,919, FILED 8-10-2011.

ANNE FARRELL, EXAMINING ATTORNEY



David J. Kyffers

Director of the United States Patent and Trademark Office

United States of America

United States Patent and Trademark Office

FFI FOSSFORWARD INNOVATIONS

Reg. No. 4,174,294

Registered July 17, 2012

Int. Cl.: 9

TRADEMARK

PRINCIPAL REGISTER

FOSSFORWARD INNOVATIONS LLC (MICHIGAN LIMITED LIABILITY COMPANY)
3769 PIUTE DRIVE SW
GRANDVILLE, MI 494181950

FOR: AMPERAGE TESTERS, IN CLASS 9 (U.S. CLS. 21, 23, 26, 36 AND 38).

FIRST USE 11-19-2010; IN COMMERCE 11-19-2010.

THE MARK CONSISTS OF STANDARD CHARACTERS WITHOUT CLAIM TO ANY PARTICULAR FONT, STYLE, SIZE, OR COLOR.

SER. NO. 85-395,179, FILED 8-11-2011.

JESSICA FATHY, EXAMINING ATTORNEY



David J. Kyffers

Director of the United States Patent and Trademark Office

United States of America

United States Patent and Trademark Office

GMYLE

Reg. No. 4,174,295

Registered July 17, 2012

Int. Cl.: 9

TRADEMARK

PRINCIPAL REGISTER

NETWORK PARTNER LTD. (HONG KONG CORPORATION)
1292 KIFER ROAD, #802
SUNNYVALE, CA 94086

FOR: ELECTRONIC APPARATUS AND DEVICES, NAMELY, COMPUTERS AND COMPUTER PERIPHERALS; ACCESSORIES FOR THE ELECTRONIC DEVICES, NAMELY, CAMERA CASE AND SUPPORT, CELLULAR PHONE CASE AND STAND, TABLET CASE AND STAND, NOTEBOOK COMPUTER CARRYING CASES, BACKPACKS ESPECIALLY ADAPTED FOR HOLDING LAPTOPS AND NOTEBOOK COMPUTERS, NOTEBOOK COMPUTER COOLING PADS, AND EARPHONE ACCESSORIES, NAMELY, EARPHONE CUSHIONS, EARPHONE PADS, CORD MANAGEMENT SYSTEMS, EARPHONE CASES, AND EARPHONE EXTENSION CORDS; ELECTRONIC CABLES; ELECTRONIC CALCULATORS; ELECTRONIC CARD READERS; ELECTRONIC CARDS FOR PROCESSING IMAGES; ELECTRONIC CIRCUITS; ELECTRONIC COMPONENTS FOR COMPUTERS; ELECTRONIC COMPUTERS; ELECTRONIC CONTROLLERS FOR CONSUMER ELECTRONIC DEVICES, NAMELY, TV, ELECTRONIC MOBILE DEVICES, PERSONAL ASSISTANT DEVICES; ELECTRONIC DAY PLANNERS, IN CLASS 9 (U.S. CLS. 21, 23, 26, 36 AND 38).

FIRST USE 6-13-2011; IN COMMERCE 6-13-2011.

THE MARK CONSISTS OF STANDARD CHARACTERS WITHOUT CLAIM TO ANY PARTICULAR FONT, STYLE, SIZE, OR COLOR.

SER. NO. 85-396,028, FILED 8-11-2011.

JACQUELINE A. LAVINE, EXAMINING ATTORNEY



David J. Kyffers

Director of the United States Patent and Trademark Office

United States of America

United States Patent and Trademark Office

GLANCE

Reg. No. 4,174,296

Registered July 17, 2012

Int. Cls.: 11 and 21

TRADEMARK

PRINCIPAL REGISTER

AS IP HOLDCO, LLC (DELAWARE LIMITED LIABILITY COMPANY)
1 CENTENNIAL AVENUE
PISCATAWAY, NJ 08855

FOR: PLUMBING FITTINGS, NAMELY, FITTINGS FOR BATHTUBS, BIDET AND SHOWER, NAMELY, SHOWER VALVES, FLUSH VALVES, AND BATH SPOUTS; FAUCETS; TUB PARTS, NAMELY, FILLERS; SHOWER HEAD SPRAYERS; HAND-HELD SHOWERS; PLUMBING FITTINGS, NAMELY, VALVES, NAMELY, MIXING, WALL AND DIVERTER VALVES, IN CLASS 11 (U.S. CLS. 13, 21, 23, 31 AND 34).

FIRST USE 9-1-2003; IN COMMERCE 9-1-2003.

FOR: TOWEL BARS, TOILET AND FACIAL TISSUE HOLDER, SOLD EMPTY; TUMBLER HOLDERS, HOUSEHOLD SKIN LOTION DISPENSERS, SOLD EMPTY; SOAP DISHES, ALL MADE OF METAL, IN CLASS 21 (U.S. CLS. 2, 13, 23, 29, 30, 33, 40 AND 50).

FIRST USE 9-1-2003; IN COMMERCE 9-1-2003.

THE MARK CONSISTS OF STANDARD CHARACTERS WITHOUT CLAIM TO ANY PARTICULAR FONT, STYLE, SIZE, OR COLOR.

SER. NO. 85-396,370, FILED 8-12-2011.

KHANH LE, EXAMINING ATTORNEY



David J. Kybas

Director of the United States Patent and Trademark Office

United States of America

United States Patent and Trademark Office



Reg. No. 4,174,297

Registered July 17, 2012

Int. Cl.: 36

SERVICE MARK

PRINCIPAL REGISTER

BOWLING FOR BEARS, A NEW JERSEY NONPROFIT CORPORATION (NEW JERSEY NON-PROFIT CORPORATION)
5 PARNELL DRIVE
CHERRY HILL, NJ 08003

FOR: CHARITABLE SERVICES, NAMELY, RAISING MONEY TO PROVIDE TOYS TO NEEDY CHILDREN, IN CLASS 36 (U.S. CLS. 100, 101 AND 102).

FIRST USE 11-0-2008; IN COMMERCE 11-0-2008.

NO CLAIM IS MADE TO THE EXCLUSIVE RIGHT TO USE "BOWLING", APART FROM THE MARK AS SHOWN.

THE COLOR(S) BLACK, RED, YELLOW, GRAY, WHITE, AND CREAM IS/ARE CLAIMED AS A FEATURE OF THE MARK.

THE MARK CONSISTS OF THE BLACK WORDING "BOWLING FOR BEARS" SHADOWED IN LIGHT RED AND CONTAINING EIGHT YELLOW STARS ABOVE SOME OF THE LETTERS. THERE IS A STYLIZED CREAM OBLONG SHAPE OUTLINED IN GREY BEHIND PART OF "BOWLING." UNDERNEATH THE WORDING THERE IS A STYLIZED YELLOW AND BLACK-STRIPED BOWLING LANE WITH RED AND BLACK SHADING AND OUTLINING. THERE ARE BLACK AND RED STARS, A LARGE WHITE AND CREAM BOWLING PIN WITH TWO RED STRIPS AND OUTLINED IN BLACK, AND TEN SMALLER WHITE BOWLING PINS WITH TWO RED STRIPS AND OUTLINED IN BLACK BEING HIT BY A BLACK AND WHITE BOWLING BALL. THERE IS A YELLOW AND CREAM TEDDY BEAR WITH BLACK OUTLINING AND BLACK FACIAL FEATURES LEANING AGAINST THE LARGE BOWLING PIN.

SER. NO. 85-396,816, FILED 8-12-2011.

TOBY BULLOFF, EXAMINING ATTORNEY



David J. Kyffers

Director of the United States Patent and Trademark Office

United States of America

United States Patent and Trademark Office

Gig Connector

Reg. No. 4,174,298

Registered July 17, 2012

Int. Cl.: 42

SERVICE MARK

PRINCIPAL REGISTER

OURSTAGE, INC. (DELAWARE CORPORATION)
321 BILLERICA ROAD, SUITE 202
CHELMSFORD, MA 01824

FOR: PROVIDING A WEBSITE FEATURING ONLINE NON-DOWNLOADABLE SOFTWARE TOOLS FOR REQUESTING, SCHEDULING, AND MANAGING EVENT PERFORMANCES BY MUSIC ARTISTS, IN CLASS 42 (U.S. CLS. 100 AND 101).

FIRST USE 5-6-2011; IN COMMERCE 5-6-2011.

THE MARK CONSISTS OF STANDARD CHARACTERS WITHOUT CLAIM TO ANY PARTICULAR FONT, STYLE, SIZE, OR COLOR.

NO CLAIM IS MADE TO THE EXCLUSIVE RIGHT TO USE "GIG", APART FROM THE MARK AS SHOWN.

SER. NO. 85-396,983, FILED 8-12-2011.

MICHELLE DUBOIS, EXAMINING ATTORNEY



David J. Kyffers

Director of the United States Patent and Trademark Office

United States of America

United States Patent and Trademark Office

byroot

Reg. No. 4,174,299

Registered July 17, 2012

Int. Cl.: 42

SERVICE MARK

PRINCIPAL REGISTER

BYROOT LLC (MICHIGAN LIMITED LIABILITY COMPANY), DBA BYROOT
TECHNOLOGIES
220 E HURON ST. SUITE 225
ANN ARBOR, MI 48104

FOR: COMPUTER SERVICES, NAMELY, ON-SITE MANAGEMENT OF INFORMATION TECHNOLOGY (IT) SYSTEMS; COMPUTER SERVICES, NAMELY, REMOTE MANAGEMENT OF THE INFORMATION TECHNOLOGY (IT) SYSTEMS OF OTHERS; CONSULTING IN THE FIELD OF INFORMATION TECHNOLOGY; CONSULTING IN THE FIELD OF TELECOMMUNICATIONS TECHNOLOGY; CONSULTING IN THE FIELD OF VIRTUALIZATION TECHNOLOGIES FOR ENTERPRISES AND BUSINESSES; PLANNING, DESIGN AND IMPLEMENTATION OF COMPUTER TECHNOLOGIES FOR OTHERS; PLANNING, DESIGN AND MANAGEMENT OF INFORMATION TECHNOLOGY SYSTEMS, IN CLASS 42 (U.S. CLS. 100 AND 101).

FIRST USE 6-30-2010; IN COMMERCE 6-30-2010.

THE MARK CONSISTS OF STANDARD CHARACTERS WITHOUT CLAIM TO ANY PARTICULAR FONT, STYLE, SIZE, OR COLOR.

SER. NO. 85-397,404, FILED 8-13-2011.

TRACY FLETCHER, EXAMINING ATTORNEY



David J. Kybas

Director of the United States Patent and Trademark Office

United States of America

United States Patent and Trademark Office

THE MUDDY ROSES

Reg. No. 4,174,300

Registered July 17, 2012

Int. Cl.: 41

SERVICE MARK

PRINCIPAL REGISTER

JOHN LOGIUDICI (UNITED STATES INDIVIDUAL), DBA MUDDY ROSES
1117 NOE STREET
SAN FRANCISCO, CA 94114

FOR: ENTERTAINMENT IN THE NATURE OF VISUAL AND AUDIO PERFORMANCES, NAMELY, MUSICAL BAND, ROCK GROUP, GYMNASTIC, DANCE, AND BALLET PERFORMANCES; ENTERTAINMENT IN THE NATURE OF PERFORMANCES BY A MUSICAL GROUP; ENTERTAINMENT SERVICES IN THE NATURE OF LIVE MUSICAL PERFORMANCES; ENTERTAINMENT SERVICES IN THE NATURE OF RECORDING, PRODUCTION AND POST-PRODUCTION SERVICES IN THE FIELD OF MUSIC; ENTERTAINMENT, NAMELY, LIVE PERFORMANCES BY A MUSICAL BAND; LIVE PERFORMANCES BY A MUSICAL GROUP, IN CLASS 41 (U.S. CLS. 100, 101 AND 107).

FIRST USE 1-1-2010; IN COMMERCE 5-1-2010.

THE MARK CONSISTS OF STANDARD CHARACTERS WITHOUT CLAIM TO ANY PARTICULAR FONT, STYLE, SIZE, OR COLOR.

SER. NO. 85-398,438, FILED 8-15-2011.

KAELIE KUNG, EXAMINING ATTORNEY



David J. Kyffers

Director of the United States Patent and Trademark Office

United States of America

United States Patent and Trademark Office



Reg. No. 4,174,301

Registered July 17, 2012

Int. Cl.: 43

SERVICE MARK

PRINCIPAL REGISTER

COCO DOLCE L.L.C. (NEVADA LIMITED LIABILITY COMPANY)
1910 COLLEGE PARKWAY
SUITE 130
CARSON CITY, NV 89706

FOR: BAR AND RESTAURANT SERVICES; CAFE AND RESTAURANT SERVICES; CAFE-RESTAURANTS; CARRY-OUT RESTAURANTS; DELICATESSENS; RESTAURANT; RESTAURANT AND BAR SERVICES; RESTAURANT AND CAFE SERVICES; RESTAURANT SERVICES; RESTAURANTS, IN CLASS 43 (U.S. CLS. 100 AND 101).

FIRST USE 12-16-2010; IN COMMERCE 12-16-2010.

THE MARK CONSISTS OF THE WORDS "COCO DOLCE" IN ALL CAPITAL LETTERS; THE WORDS ARE IN BROWN FONT AND THE "O'S" IN "COCO" ARE SOLID BROWN WITH A WHITE LINE THAT FOLLOWS A SWITCH BACK PATTERN; THE SWITCH BACK PATTERN ON THE FIRST "O" OF "COCO" BEGINS IN THE TOP LEFT CORNER OF THE "O" IN A WIDE SWITCH BACK AND MOVES TO THE BOTTOM RIGHT BECOMING MORE NARROW AS IT MOVES DOWN AND TO THE RIGHT UNTIL IT CURLS AT THE END; THE SWITCH BACK PATTERN ON THE SECOND "O" OF "COCO" BEGINS IN THE BOTTOM RIGHT CORNER OF THE "O" IN A WIDE SWITCH BACK AND MOVES TO THE UP AND TO THE LEFT BECOMING MORE NARROW AS IT MOVES UP AND TO THE LEFT UNTIL IT CURLS AT THE END.

THE COLOR(S) BROWN AND WHITE IS/ARE CLAIMED AS A FEATURE OF THE MARK.

SER. NO. 85-398,832, FILED 8-16-2011.

BRENDAN MCCAULEY, EXAMINING ATTORNEY



David J. Kyffers

Director of the United States Patent and Trademark Office

United States of America

United States Patent and Trademark Office

Madie Jane

Reg. No. 4,174,302

Registered July 17, 2012

Int. Cl.: 25

TRADEMARK

PRINCIPAL REGISTER

MADIE JANE LLC (TEXAS LIMITED LIABILITY COMPANY)
3613 STONINGTON DRIVE
PLANO
TEXAS, TX 75093

FOR: SHOES AND APPAREL, NAMELY, HATS, HEAD BANDS, SCARVES, BELTS, SOCKS, SHIRTS, BLOUSES, PANTS AND DRESSES, IN CLASS 25 (U.S. CLS. 22 AND 39).

FIRST USE 6-23-2011; IN COMMERCE 8-12-2011.

THE MARK CONSISTS OF STANDARD CHARACTERS WITHOUT CLAIM TO ANY PARTICULAR FONT, STYLE, SIZE, OR COLOR.

THE NAME(S), PORTRAIT(S), AND/OR SIGNATURE(S) SHOWN IN THE MARK DOES NOT IDENTIFY A PARTICULAR LIVING INDIVIDUAL.

SER. NO. 85-398,942, FILED 8-16-2011.

HOWARD B. LEVINE, EXAMINING ATTORNEY



David J. Kyffers

Director of the United States Patent and Trademark Office

United States of America

United States Patent and Trademark Office

Duramold-2 Super Slab

Reg. No. 4,174,303

VISTA METALS CORP. (CALIFORNIA CORPORATION)
13425 WHITTRAM AVE.
FONTANA, CA 92335

Registered July 17, 2012

Int. Cl.: 6

FOR: CASTINGS, FOILS, POWDER, AND ROLLED, DRAWN OR EXTRUDED SEMI-FINISHED ARTICLES OF ALUMINIUM OR ITS ALLOYS, IN CLASS 6 (U.S. CLS. 2, 12, 13, 14, 23, 25 AND 50).

TRADEMARK

FIRST USE 3-15-2011; IN COMMERCE 3-15-2011.

PRINCIPAL REGISTER

THE MARK CONSISTS OF STANDARD CHARACTERS WITHOUT CLAIM TO ANY PARTICULAR FONT, STYLE, SIZE, OR COLOR.

OWNER OF U.S. REG. NOS. 3,189,337, 3,246,982 AND OTHERS.

NO CLAIM IS MADE TO THE EXCLUSIVE RIGHT TO USE "SUPER SLAB", APART FROM THE MARK AS SHOWN.

SER. NO. 85-398,986, FILED 8-16-2011.

KATHRYN COWARD, EXAMINING ATTORNEY



David J. Kyffers

Director of the United States Patent and Trademark Office

United States of America

United States Patent and Trademark Office

Duramold-5 Super Slab

Reg. No. 4,174,304

VISTA METALS CORP. (CALIFORNIA CORPORATION)
13425 WHITTRAM AVE.
FONTANA, CA 92335

Registered July 17, 2012

Int. Cl.: 6

FOR: CASTINGS, FOILS, POWDER, AND ROLLED, DRAWN OR EXTRUDED SEMI-FINISHED ARTICLES OF ALUMINIUM OR ITS ALLOYS, IN CLASS 6 (U.S. CLS. 2, 12, 13, 14, 23, 25 AND 50).

TRADEMARK

FIRST USE 3-15-2011; IN COMMERCE 3-15-2011.

PRINCIPAL REGISTER

THE MARK CONSISTS OF STANDARD CHARACTERS WITHOUT CLAIM TO ANY PARTICULAR FONT, STYLE, SIZE, OR COLOR.

OWNER OF U.S. REG. NOS. 3,189,343, 3,246,982 AND OTHERS.

NO CLAIM IS MADE TO THE EXCLUSIVE RIGHT TO USE "SUPER SLAB", APART FROM THE MARK AS SHOWN.

SER. NO. 85-399,002, FILED 8-16-2011.

KATHRYN COWARD, EXAMINING ATTORNEY



David J. Kyffers

Director of the United States Patent and Trademark Office

United States of America

United States Patent and Trademark Office



Reg. No. 4,174,305

Registered July 17, 2012

Int. Cl.: 25

TRADEMARK

PRINCIPAL REGISTER

HUNZIKER DESIGN LLC (NEVADA LIMITED LIABILITY COMPANY), DBA HUNZIKER APPAREL
11700 W CHARLESTON BLVD 170-191
LAS VEGAS, NV 89135

FOR: ATHLETIC APPAREL, NAMELY, SHIRTS, PANTS, JACKETS, FOOTWEAR, HATS AND CAPS, ATHLETIC UNIFORMS, IN CLASS 25 (U.S. CLS. 22 AND 39).

FIRST USE 8-16-2011; IN COMMERCE 8-16-2011.

NO CLAIM IS MADE TO THE EXCLUSIVE RIGHT TO USE "APPAREL", APART FROM THE MARK AS SHOWN.

THE MARK CONSISTS OF RALLY PLAQUE WITH AN OUTLINE. THE FOLLOWING ELEMENTS ARE LOCATED WITHIN: WHITE SPACE WITH "HUNZIKER" SIGNATURE. THE WORDS "HUNZIKER APPAREL" AND THE WORD "NICOLASHUNZIKER.COM" BELOW.

SER. NO. 85-399,403, FILED 8-16-2011.

JILL PRATER, EXAMINING ATTORNEY



David J. Kybas

Director of the United States Patent and Trademark Office

United States of America

United States Patent and Trademark Office



*Stowe
Ice Cream*

Reg. No. 4,174,306

Registered July 17, 2012

Int. Cls.: 30 and 43

TRADEMARK

SERVICE MARK

PRINCIPAL REGISTER

STOWE ICE CREAM LLC (VERMONT LIMITED LIABILITY COMPANY), DBA STOWE ICE CREAM
112 MAIN STREET
STOWE, VT 05672

FOR: ICE CREAM, IN CLASS 30 (U.S. CL. 46).

FIRST USE 12-12-2009; IN COMMERCE 12-12-2009.

FOR: ICE CREAM PARLORS , IN CLASS 43 (U.S. CLS. 100 AND 101).

FIRST USE 12-12-2009; IN COMMERCE 12-12-2009.

NO CLAIM IS MADE TO THE EXCLUSIVE RIGHT TO USE "STOWE ICE CREAM", APART FROM THE MARK AS SHOWN.

THE COLOR(S) RED, BLUE, BLACK, GRAY, WHITE, AND PINK IS/ARE CLAIMED AS A FEATURE OF THE MARK.

THE MARK CONSISTS OF THE STYLIZED WORDING "STOWE ICE CREAM" IN RED; A COW WITH A BLACK AND WHITE BODY, WITH BLACK AND GRAY BOOTS, PINK UDDERS, ON A DARK RED SNOWBOARD, WITH A BLUE, BLACK, AND WHITE BACKGROUND ENCIRCLED BY A RED BORDER.

SER. NO. 85-399,452, FILED 8-16-2011.

JACQUELINE A. LAVINE, EXAMINING ATTORNEY

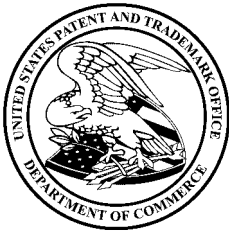

David J. Kybas

Director of the United States Patent and Trademark Office

United States of America

United States Patent and Trademark Office

CONCACAF

Reg. No. 4,174,307

Registered July 17, 2012

Int. Cl.: 41

SERVICE MARK

PRINCIPAL REGISTER

THE CONFEDERATION OF NORTH, CENTRAL AMERICAN AND CARIBBEAN
ASSOCIATION FOOTBALL (CONCACAF) (BAHAMAS COMPANY)
SASSOON HOUSE, P.O. BOX 272
NASSAU, BAHAMAS

FOR: ORGANIZING SPORTING EVENTS, NAMELY, SOCCER MATCHES AND SOCCER TOURNAMENTS; PRODUCTION OF RADIO AND TELEVISION PROGRAMS; PRODUCTION OF CDS AND DVDS FEATURING INFORMATION AND ENTERTAINMENT IN THE FIELD OF SOCCER; PRODUCTION OF FILMS; PROGRAMMING AND PRODUCTION OF TELEVISION, RADIO AND INTERNET PROGRAMS ON A GLOBAL COMPUTER NETWORK; PROVIDING A WEB SITE FEATURING INFORMATION ABOUT SOCCER AND SOCCER TOURNAMENTS; PUBLICATION OF PRINTED MATTER; TICKET RESERVATION AND BOOKING SERVICES FOR SOCCER MATCHES AND SOCCER TOURNAMENTS, IN CLASS 41 (U.S. CLS. 100, 101 AND 107).

FIRST USE 9-18-1961; IN COMMERCE 9-18-1961.

THE MARK CONSISTS OF STANDARD CHARACTERS WITHOUT CLAIM TO ANY PARTICULAR FONT, STYLE, SIZE, OR COLOR.

OWNER OF U.S. REG. NOS. 2,108,128, 3,628,073 AND OTHERS.

SER. NO. 85-399,513, FILED 8-16-2011.

TINA BROWN, EXAMINING ATTORNEY



David J. Kyros

Director of the United States Patent and Trademark Office

United States of America

United States Patent and Trademark Office



Reg. No. 4,174,308

Registered July 17, 2012

Int. Cl.: 38

SERVICE MARK

PRINCIPAL REGISTER

THE CONFEDERATION OF NORTH, CENTRAL AMERICAN AND CARIBBEAN
ASSOCIATION FOOTBALL (CONCACAF) (BAHAMAS COMPANY)
SASSOON HOUSE, P.O. BOX 272
NASSAU, BAHAMAS

FOR: BROADCASTING OF TELEVISION AND RADIO PROGRAMS; BROADCASTING SERVICES AND PROVISION OF TELECOMMUNICATION ACCESS TO VIDEO AND AUDIO CONTENT PROVIDED VIA A GLOBAL COMPUTER NETWORK, IN CLASS 38 (U.S. CLS. 100, 101 AND 104).

FIRST USE 5-0-2004; IN COMMERCE 5-0-2004.

NO CLAIM IS MADE TO THE EXCLUSIVE RIGHT TO USE THE DESIGN OF A SOCCER BALL, APART FROM THE MARK AS SHOWN.

THE MARK CONSISTS OF A SOCCER BALL IN THE CENTER OF A PENTAGON-SHAPED PINWHEEL.

SER. NO. 85-399,527, FILED 8-16-2011.

TINA BROWN, EXAMINING ATTORNEY



David J. Kyffers

Director of the United States Patent and Trademark Office

United States of America

United States Patent and Trademark Office



Reg. No. 4,174,309

Registered July 17, 2012

Int. Cl.: 41

SERVICE MARK

PRINCIPAL REGISTER

THE CONFEDERATION OF NORTH, CENTRAL AMERICAN AND CARIBBEAN
ASSOCIATION FOOTBALL (CONCACAF) (BAHAMAS COMPANY)
SASSOON HOUSE, P.O. BOX 272
NASSAU, BAHAMAS

FOR: ORGANIZING SPORTING EVENTS, NAMELY, SOCCER MATCHES AND SOCCER TOURNAMENTS; PRODUCTION OF RADIO AND TELEVISION PROGRAMS; PRODUCTION OF CDS AND DVDS FEATURING INFORMATION AND ENTERTAINMENT IN THE FIELD OF SOCCER; PRODUCTION OF FILMS; PROGRAMMING AND PRODUCTION OF TELEVISION, RADIO AND INTERNET PROGRAMS ON A GLOBAL COMPUTER NETWORK; PROVIDING A WEB SITE FEATURING INFORMATION ABOUT SOCCER AND SOCCER TOURNAMENTS; PUBLICATION OF PRINTED MATTER; TICKET RESERVATION AND BOOKING SERVICES FOR SOCCER MATCHES AND SOCCER TOURNAMENTS, IN CLASS 41 (U.S. CLS. 100, 101 AND 107).

FIRST USE 5-0-2004; IN COMMERCE 5-0-2004.

NO CLAIM IS MADE TO THE EXCLUSIVE RIGHT TO USE THE DESIGN OF A SOCCER BALL, APART FROM THE MARK AS SHOWN.

THE MARK CONSISTS OF A SOCCER BALL IN THE CENTER OF A PENTAGON-SHAPED PINWHEEL.

SER. NO. 85-399,534, FILED 8-16-2011.

TINA BROWN, EXAMINING ATTORNEY



David J. Kybas

Director of the United States Patent and Trademark Office

United States of America

United States Patent and Trademark Office



Reg. No. 4,174,310

Registered July 17, 2012

Int. Cl.: 35

SERVICE MARK

PRINCIPAL REGISTER

UNITED NATIONS FOUNDATION, INC. (NEW YORK CORPORATION)
SUITE 400
1800 MASSACHUSETTS AVE, NW
WASHINGTON, DC 20036

FOR: CHARITABLE SERVICES, NAMELY, PROMOTING PUBLIC INTEREST IN AND AWARENESS OF THE NEED FOR THE DEVELOPMENT OF SUSTAINABLE SOLUTIONS TO THE CHALLENGES OF CLIMATE CHANGE, FOOD SECURITY, ECONOMIC DEVELOPMENT AND BIODIVERSITY CONSERVATION, IN CLASS 35 (U.S. CLS. 100, 101 AND 102).

FIRST USE 12-14-2010; IN COMMERCE 12-14-2010.

NO CLAIM IS MADE TO THE EXCLUSIVE RIGHT TO USE "SOLUTIONS FROM THE LAND", APART FROM THE MARK AS SHOWN.

THE MARK CONSISTS OF THE WORDS "SOLUTIONS FROM THE LAND" WITH A CURVED LINE SEPARATING THE WORD "SOLUTIONS" FROM THE WORDS "FROM THE LAND", WITH THE CURVED LINE CURVING BELOW THE WORD "SOLUTIONS" AND BELOW THE WORDS "FROM THE LAND", RESEMBLING LAND. TWO LEAVES EXTEND FROM A STEM THAT HAS FORMED ROOTS AROUND THE LETTER "O" WITHIN THE WORD "SOLUTIONS" AND EXTENDS VERTICALLY THROUGH THE CURVED LINE.

SER. NO. 85-400,148, FILED 8-17-2011.

LAKEISHA LEWIS, EXAMINING ATTORNEY



David J. Kyjars

Director of the United States Patent and Trademark Office

United States of America

United States Patent and Trademark Office



Reg. No. 4,174,311

Registered July 17, 2012

Int. Cl.: 20

TRADEMARK

PRINCIPAL REGISTER

COUNTY OF LOS ANGELES SHERIFF'S DEPARTMENT (CALIFORNIA GOVERNMENT AGENCY)
4700 RAMONA BOULEVARD
MONTEREY PARK, CA 91754

FOR: LAW ENFORCEMENT BADGES, IN CLASS 20 (U.S. CLS. 2, 13, 22, 25, 32 AND 50).

FIRST USE 12-0-2000; IN COMMERCE 12-0-2000.

OWNER OF U.S. REG. NOS. 2,967,828, 2,972,038 AND OTHERS.

NO CLAIM IS MADE TO THE EXCLUSIVE RIGHT TO USE "EST. 1850 DEPUTY SHERIFF", APART FROM THE MARK AS SHOWN.

THE MARK CONSISTS OF A THREE-DIMENSIONAL CONFIGURATION OF A BADGE WITH "LA COUNTY EST. 1850 DEPUTY" ABOVE A DESIGN OF A BEAR WITH THE WORD "SHERIFF" BELOW THE DESIGN. THE BROKEN LINES DEPICTING THE BADGE INDICATE PLACEMENT OF THE MARK ON THE GOODS AND ARE NOT PART OF THE MARK.

SEC. 2(F).

SER. NO. 85-400,274, FILED 8-17-2011.

VIVIAN MICZNIK FIRST, EXAMINING ATTORNEY



David J. Kybas

Director of the United States Patent and Trademark Office

United States of America

United States Patent and Trademark Office

HOT MAX TORCHES

Reg. No. 4,174,312

NIEDERS, RANDAL JAMES (UNITED STATES INDIVIDUAL)
1307 WESTCHESTER MANOR LANE
CHESTERFIELD, MO 63005

Registered July 17, 2012

Int. Cl.: 7

FOR: GAS-OPERATED BLOW TORCHES, IN CLASS 7 (U.S. CLS. 13, 19, 21, 23, 31, 34 AND 35).

TRADEMARK

FIRST USE 12-24-2002; IN COMMERCE 5-1-2003.

PRINCIPAL REGISTER

THE MARK CONSISTS OF STANDARD CHARACTERS WITHOUT CLAIM TO ANY PARTICULAR FONT, STYLE, SIZE, OR COLOR.

NO CLAIM IS MADE TO THE EXCLUSIVE RIGHT TO USE "HOT" AND "TORCHES", APART FROM THE MARK AS SHOWN.

SER. NO. 85-400,315, FILED 8-17-2011.

TARA PATE, EXAMINING ATTORNEY



David J. Kyffers

Director of the United States Patent and Trademark Office

United States of America

United States Patent and Trademark Office



Reg. No. 4,174,313

Registered July 17, 2012

Int. Cls.: 15 and 16

TRADEMARK

PRINCIPAL REGISTER

ANGEL MUSICAL INSTRUMENT CO., LTD. (REPUBLIC OF KOREA CORPORATION)
135-139, SONGSAN-DONG
HWASEONG-CITY, REPUBLIC OF KOREA 445-370

FOR: PIANO PART, NAMELY, INTENSITY REGULATORS FOR MECHANICAL PIANOS; TUNING APPARATUS FOR MUSICAL INSTRUMENTS; KOREAN ZITHER ALSO KNOWN AS A GAYAGEUM; BAMBOO FLUTES; DOUBLE BASSES; DRUMS; DRUMHEADS; DRUMSTICKS; REEDS; LYRES; MANDOLINS; XYLOPHONES; MUSIC SYNTHESIZERS; MUSICAL BOXES; VIOLINS; CHIN RESTS FOR VIOLINS; CONCERTINA ALSO KNOWN AS BANDONIONS; BARREL ORGANS; BAGPIPES; BUCCIN TROMBONES; BASSES, NAMELY, ELECTRIC BASSES; BASS DRUM STICKS; DRUMS; DRUMSTICKS; VIOLAS; CHINESE PIPA; SAXOPHONES; SHENG; TUNING FORKS; SUONA KNOWN AS CHINESE TRUMPETS; CYMBALS; MUSICAL INSTRUMENTS FOR COURT MUSIC; ACCORDIONS; MUSICAL INSTRUMENTS; KEYBOARDS FOR MUSICAL INSTRUMENTS; MOUTHPIECES FOR MUSICAL INSTRUMENTS; STANDS FOR MUSICAL INSTRUMENTS; VALVES FOR MUSICAL INSTRUMENTS; BRIDGES FOR MUSICAL INSTRUMENTS; BELLOWS FOR MUSICAL INSTRUMENTS; DAMPERS FOR MUSICAL INSTRUMENTS; CATGUT FOR MUSICAL INSTRUMENTS; CASES FOR MUSICAL INSTRUMENTS; KEYS FOR MUSICAL INSTRUMENTS; PEDALS FOR MUSICAL INSTRUMENTS; PICKS FOR STRINGED INSTRUMENTS; STRINGS FOR MUSICAL INSTRUMENTS; PEGS FOR MUSICAL INSTRUMENTS; BOWS FOR MUSICAL INSTRUMENTS; BOW NUTS FOR MUSICAL INSTRUMENTS; STICKS FOR BOWS FOR MUSICAL INSTRUMENTS; SHEET MUSIC STANDS; TURNING APPARATUS FOR SHEET MUSIC; ORGANS; WIND PIPES FOR ORGANS; OBOES; OCARINAS; JANGGU; KOREAN FLUTE; ELECTRIC GUITARS; ELECTRIC ORGANS; ELECTRONIC MUSICAL INSTRUMENTS; ELECTRONIC ORGANS; GONGS; CHIMES; GLOCKENSPIELS; CELLOS; ZITHERS; CARILLONS; CASTANETS; KETTLEDRUMS; KETTLEDRUM FRAMES; CORNETS; CONCERTINAS; CONTRABASS; CHROMAHARPS; CLARINETS; CLARIONS; TOM-TOM DRUMS; TAMBOURINES; TRIANGLES; TROMBONES; TRUMPETS; TIMPANI; BASSOON; PLECTRUMS; FLUTES; PIANOS; PIANO KEYBOARDS; MUSIC ROLLS, NAMELY, PERFORATED MUSIC ROLLS FOR USE IN PLAYER PIANOS; PIANO KEYS; PIANO STRINGS; HARMONIUMS; HARMONICAS; HARPS; HARP STRINGS; HANDBELLS; STRINGED MUSICAL INSTRUMENTS; HORSEHAIR FOR BOWS FOR MUSICAL INSTRUMENTS; CHINESE FIDDLES; HORNS; HUQIN, IN CLASS 15 (U.S. CLS. 2, 21 AND 36).



David J. Kybas

Director of the United States Patent and Trademark Office

FOR: CIGAR BANDS; ADHESIVES FOR HOUSEHOLD PURPOSES; ADHESIVE TAPES FOR HOUSEHOLD PURPOSES; GARBAGE BAGS OF PAPER; GARBAGE BAGS OF PLASTICS; ALUMINUM FOILS FOR COLLECTING GAS RANGE DIRT; BAGS FOR MICROWAVE

Reg. No. 4,174,313 COOKING; FOILS FOR KITCHENS; LABELS NOT OF TEXTILE, NAMELY, PAPER LABELS; SIGNBOARDS OF PAPER OR CARDBOARD; PLACARDS OF PAPER OR CARDBOARD; FLAGS OF PAPER; PAPER PENNANTS; COVERS OF PAPER FOR FLOWER POTS; FITTED TOILET LID COVERS OF PAPER; STEATITE; EMBROIDERY DESIGN PATTERNS PRINTED ON PAPER; PATTERNS FOR KNITTING; PAPER ROLLS FOR CALCULATING MACHINES; CORRUGATED BOARD; PAPER NAPKINS; ROOFING PAPERBOARD; INKING RIBBON FOR DOCUMENT REPRODUCING MACHINES; WHITE PAPERBOARD; PAPER CONTAINING MICA; OILPAPER FOR FLOOR; PAPERS; PAPER TAPES; PAPER COFFEE FILTERS; BLANK PAPER TAPES AND CARDS FOR THE RECORDING OF COMPUTER PROGRAMS; CARDBOARD; WOOD PULP BOARD; MILLBOARD; PAPIER MACHE; STRAWBOARD; HANDKERCHIEFS OF PAPER; TOWELS OF PAPER; TISSUES OF PAPER; TOILET PAPER; TAGS FOR INDEX CARDS; RUBBER STAMPS; MOISTENERS IN THE NATURE OF HAND HELD DEVICES FOR WETTING GUMMED PAPER SURFACES; NOTEBOOKS; PAINT BOXES; ERASING PRODUCTS, NAMELY, ERASERS; DESK FILE TRAY FOR SORTING AND COUNTING MONEY; PEN NIBS OF GOLD; RECORD CARDS; LEDGER BOOKS; INK PASTE USED FOR SEALS; STENCILS; STENCIL CASES; STENCIL PLATES; MARKERS; INK STICKS; MEMO BLOCKS; HOLDERS FOR NOTEPADS; MEMO PADS; STATIONERY; DOCUMENT FILES FOR STATIONERY; SEALING COMPOUNDS, NAMELY, SEALING WAX FOR STATIONERY PURPOSES; ENVELOPES; ISINGLASS FOR STATIONERY; INDEX CARDS; STICKERS; PENCIL ORNAMENTS; SEALS; GUMMED CLOTH FOR STATIONERY PURPOSES, NAMELY, BOOKBINDING CLOTH; GUMMED TAPE FOR STATIONERY OR HOUSEHOLD USE; ADHESIVE FOR STATIONERY PURPOSES; ADHESIVE TAPES FOR STATIONERY; ADHESIVE FOILS STATIONERY; BOOK COVERS; CASES FOR STATIONERY; NOTE PADS; FOLDERS; PAPERWEIGHTS; INK STONES; REFILLS FOR BALLPOINT PENS; BALLS FOR BALL-POINT PENS; TIPS FOR BALLPOINT PENS; SEALING STAMPS; BOOKENDS; PROTRACTORS; CHALK STICKS; CHALK HOLDERS; WRITING BRUSHES; STAPLERS; NON-ELECTRONIC CHART POINTERS; ELASTIC BANDS FOR OFFICES; FINGER-STALLS; FINGER MOISTENERS; DESKTOP CABINETS FOR STATIONERY; BINDERS AS OFFICE SUPPLIES; CORRECTING FLUIDS FOR TYPE; SEALS FOR OFFICES; PAPER SHEETS; PAPER CUTTERS; STAPLES FOR OFFICES; CLIPS FOR OFFICES; FILES; PAPER HOLE PUNCHES; PENS; GLUE FOR THE OFFICE; PHOTOGRAPH STANDS; APPARATUS FOR MOUNTING PHOTOGRAPHS, NAMELY, PHOTO MOUNTING CORNERS; PHOTOGRAPHIC ALBUMS; PHOTOGRAPH CORNERS; PAPER FILE JACKETS; LETTER TRAYS; CORRECTION FLUIDS FOR DOCUMENTS; DOCUMENT HOLDERS; STAPLING PRESSES; DOCUMENT PORTFOLIOS; LITHOGRAPHIC STONES; CHALK FOR LITHOGRAPHY; CHECKBOOK HOLDERS; SKETCHBOOKS; SCRAPBOOKS; STAMP STANDS; STAMP PADS; CASES FOR STAMPS; HOLDERS FOR STAMPS; STAPLER HOLDERS; ALBUMS FOR STICKERS; BLOTTERS; THUMB TACKS; ALBUMS FOR STAMPS; BULLDOG CLIPS; ETCHING NEEDLES; PENCILS; PENCIL SHARPENERS ELECTRIC OR NON-ELECTRIC; PENCIL LEADS; PENCIL POINT PROTECTORS; PENCIL LEAD HOLDERS; DECORATIONS FOR PENCILS; PENCIL HOLDERS; PAPER PARCEL TAGS; FRENCH CURVES; EVENT ALBUMS; SEALS; DATE STAMPS; WRITING INK; SPOOLS FOR INKING RIBBONS; INKWELLS; INKSTANDS; INKING PADS; MAGNETIC STAMPS; MAGNETIC BOARDS; PERFORATED CARDS FOR JACQUARD LOOMS; ACCOUNT BOOKS; BOOK-MARKERS; ACCOUNT SLIP PADS; ADHESIVE NOTE PADS; ADHESIVE NOTE PAPER; THUMB TACKS FOR DRAWING; DRAWING RULERS; DRAWING SQUARES; COMPASSES FOR DRAWING; TRACING NEEDLES FOR DRAWING PURPOSES; DRAWING PADS; DRAWING PINS; DRAWING T-SQUARES; DRAWING MATERIALS FOR BLACKBOARDS; BOOKBINDING CORDS; ENGRAVING PLATES; PAPER RIBBONS; PAPER PICTURE MOUNTS; BOWS OF PAPER; DRAWER LINERS OF PAPER PERFUMED OR NOT; PAPER-CLIPS; TERRESTRIAL GLOBES; SQUARE RULERS; PRINTED CHARTS; SHEETS OF PLASTICS PLACED UNDER A SHEET OF PAPER WHEN WRITING; BLACKBOARDS; BLACKBOARD ERASERS; PUSH PINS; CARBON PAPER FOR STATIONERY; CANVAS FOR PAINTING; CRAYONS; CLIPBOARDS; ANNOUNCEMENT CARDS; PAPER OR PLASTIC TRANSPARENCIES; PRINTED TRACING PATTERNS; TRACING PAPER; PASTELS; PAPER KNIVES; PEN RESTS; STANDS FOR PENS AND PENCILS; PENS; PENHOLDERS; BOXES FOR PENS; PEN CASES; PEN CLIPS; CORRESPONDENCE RACKS; PAPER CLIPS FOR LETTERS; WRITING PADS; MARKING CHALK; WRITING-BRUSH RACK, NAMELY,

Reg. No. 4,174,313 PRINTERS' GALLEY RACKS; WRITING INSTRUMENTS; STANDS FOR WRITING IMPLEMENTS; POUCHES FOR WRITING INSTRUMENTS; WRISTBANDS FOR THE RETENTION OF WRITING INSTRUMENTS; WRITING CHALK; WRITING SLATES; WRITING PAPER HOLDERS; NOTEBOARDS; PENCIL OR PEN BOXES; WRITING BOARDS, NAMELY, MEMORANDUM BOARDS; SPONGES AS PAINT APPLICATORS; PAINTBRUSHES; PALETTES FOR PAINTERS; POCKET MEMORANDUM BOOKS; FOOD WRAPPING PLASTIC FILM FOR HOUSEHOLD USE; MONEY CLIPS; PASSPORT HOLDERS; STORAGE CONTAINERS OF PAPER; CARTONS MADE FROM CORRUGATED FIBRE BOARD; COLLAPSIBLE BOXES OF PAPER; BOXES OF PAPER OR CARDBOARD; PACKAGING CONTAINERS COMPRISED OF STARCH-BASED MATERIALS IN THE NATURE OF A PAPER SUBSTITUTE FOR FOOD, BEVERAGES AND CONSUMER PRODUCTS; BAGS AND SACKS OF PAPER; BOTTLE WRAPPERS OF CARDBOARD OR PAPER; CARDBOARD TUBES; BAGS OF PAPER OR PLASTICS FOR PACKAGING; PAPER SACKS FOR WRAPPING; SACKS OF PLASTICS FOR PACKAGING; PLASTIC BUBBLE PACKS FOR WRAPPING OR PACKAGING; GRAINING COMBS; DECORATORS' PAINTBRUSHES; PAINT BRUSHES; DUPLICATORS, NAMELY, DUPLICATING MACHINES; MIMEOGRAPHS AND MIMEOGRAPH MACHINES; PAPER SHREDDING MACHINES; NUMBERING STAMPS; IMPRINTERS FOR OFFICE USE; ENVELOPE SEALING MACHINES FOR OFFICES; DOCUMENT LAMINATORS FOR OFFICE USE; ELECTRIC STAPLERS FOR OFFICES; ADHESIVE TAPE DISPENSERS; PAPER FOLDING MACHINES AS OFFICE REQUISITES; OBLITERATING STAMPS; HAND LABELING APPLIANCES, NAMELY, HANDHELD LABELING DEVICES; RUBBER STAMP PRINTERS; FRANKING MACHINES; INKING RIBBONS; ELECTRIC AND ELECTRONIC FRANKING MACHINES; OFFICE PERFORATORS; DRAWING INSTRUMENTS; DRAWING BOARDS; HECTOGRAPHS; ADDRESS STAMPS; ADDRESSING MACHINES; ADDRESS PLATES FOR ADDRESSING MACHINES; PANTOGRAPHS; CARTRIDGE RIBBONS AND CARTRIDGE TAPES FOR PRINTERS; TYPEWRITERS ELECTRIC OR NON-ELECTRIC; TYPEWRITER KEYS; ROLLERS FOR TYPEWRITERS; TYPEWRITER RIBBONS; LETTER-OPENERS; LETTER SEALERS; STEEL LETTER OPENERS; PHOTO-ENGRAVINGS; NUMBERS IN THE NATURE OF VINYL NUMBERS FOR USE IN MAKING SIGNS AND POSTERS; PRINTERS GALLEY RACKS; PRINTING TYPE; ELECTROTYPES; BINDING STRIPS; BOOKBINDING MATERIAL; PRINT WHEELS; PRINT BLOCKS; CORRECTION FLUIDS FOR PRINTING BLOCKS; SEALING WAX; DIAPERS OF CELLULOSE; PAPER DIAPERS; BIBS OF PAPER; CHAPLETS; ADVERTISING PAMPHLETS; GRAPHIC PRINTS; PICTURE POSTCARDS; CALENDARS; ROAD MAPS; MUSICAL GREETING CARDS; BUSINESS CARDS; SUBWAY PASSENGER TICKETS; TELEPHONE CALLING CARDS, NOT MAGNETICALLY ENCODED; CREDIT CARDS, WITHOUT MAGNETIC CODING; PRINTED PLANS; CHECK BOOKS; PASSENGER TICKETS; DAILY PLANNERS; PATTERNS FOR MAKING CLOTHES; GREETING CARDS; POSTCARDS; PRINTED PATTERNS; POSTAGE STAMPS; PRINTED CALENDARS; FORMS PRINTED; PRINTED TIMETABLES; DIARIES; ENTRY TICKETS; POSTERS MADE OF PAPER; GEOGRAPHICAL MAPS; ATLASES; INVITATION CARDS; OCCASION CARDS; PRINTED TICKETS; POSTERS; TEAR-OFF CALENDARS; GRAPHIC REPRODUCTIONS; GRAPHIC REPRESENTATIONS; ART PICTURES; CHROMOLITHOGRAPHS; DECALCOMANIAS; ETCHINGS; PAINTINGS AND CALLIGRAPHIC WORKS OF ART; LITHOGRAPHIC WORKS OF ART; LITHOGRAPHS; AQUARELLES; ART PICTURES; OLEOGRAPHS; TRANSFERS IN THE NATURE OF STICKERS; PORTRAITS; PRINT ENGRAVINGS; PAINTINGS FRAMED OR UNFRAMED; PAINTINGS; PHOTOGRAPHS; BLUEPRINTS; MODELING WAX NOT FOR DENTAL PURPOSES; MODELING MATERIALS, NAMELY, MODELING CLAY AND MODELING PASTE; PLASTICS AS A COMPOUND FOR MODELING; TEACHING MATERIALS, NAMELY, PICTURE BOOKS; LITURGICAL BOOKS; SONG BOOKS; COMIC BOOKS; SCORE-BOOKS; WRITING OR DRAWING BOOKS, NAMELY, DRAWING PADS, BLANK WRITING JOURNALS; COPY BOOKS; PRINTED PROSPECTUSES; NEWSPAPERS; COMPOSITION BOOKS; ALMANACS; CARTOON STRIPS; BOOKS FOR USE IN THE TEACHING OF MUSIC, NAMELY, PRINTED MUSIC BOOKS; GENERAL FEATURE MAGAZINES; TELEPHONE DIRECTORIES; ADDRESS BOOKS; SCHOOL WRITING BOOKS, IN CLASS 16 (U.S. CLS. 2, 5, 22, 23, 29, 37, 38 AND 50).

Reg. No. 4,174,313 OWNER OF REPUBLIC OF KOREA REG. NO. 40-0890606, DATED 11-18-2011, EXPIRES 11-18-2021.

OWNER OF REPUBLIC OF KOREA REG. NO. 40-0889631, DATED 11-11-2011, EXPIRES 11-11-2021.

THE MARK CONSISTS OF A MONOGRAM FORM COMPRISED OF THE STYLIZED LETTERS "A" AND "G" OVER THE WORD "ANGEL". THE LETTER "G" IN "ANGEL" IS IN STYLIZED FORM, AND ABOVE IS THE DESIGN OF A BIRD'S WING.

SER. NO. 85-400,353, FILED 8-17-2011.

CARYN GLASSER, EXAMINING ATTORNEY

United States of America

United States Patent and Trademark Office



badger
mountain
SOUTH

Reg. No. 4,174,314

Registered July 17, 2012

Int. Cl.: 37

SERVICE MARK

PRINCIPAL REGISTER

NOR AM INVESTMENT LLC (WASHINGTON LIMITED LIABILITY COMPANY)
3600 PORT OF TACOMA ROAD, SUITE 311
TACOMA, WA 98424

FOR: REAL ESTATE DEVELOPMENT, NAMELY, THE PLANNING AND DEVELOPMENT OF A MASTER PLANNED COMMUNITY INCLUDING HOUSES, TOWNHOUSES, CONDOMINIUMS, APARTMENTS AND COMMERCIAL PROPERTIES, INCLUDING OFFICES, MIXED USE AND RETAIL SPACE, IN CLASS 37 (U.S. CLS. 100, 103 AND 106).

FIRST USE 5-4-2011; IN COMMERCE 5-4-2011.

NO CLAIM IS MADE TO THE EXCLUSIVE RIGHT TO USE "BADGER MOUNTAIN SOUTH", APART FROM THE MARK AS SHOWN.

THE COLOR(S) BLUE, WHITE, BROWN, BRIGHT GREEN, GRASS GREEN, LIGHT GRAY AND DARK GRAY IS/ARE CLAIMED AS A FEATURE OF THE MARK.

THE MARK CONSISTS OF AN IRREGULAR-SHAPED RECTANGLE MADE UP OF FOUR PAINTERLY COLOR BANDS: BLUE, BROWN, BRIGHT GREEN AND GRASS GREEN EACH SEPARATED BY WHITE LINES, THAT IS CENTERED ABOVE THE OFF-CENTERED AND STACKED WORDS "BADGER" AND "MOUNTAIN", BOTH IN LOWER CASE, SANS SERIF LIGHT GRAY TYPE, AND LASTLY, THE WORD "SOUTH" WHICH IS FEATURED IN A SANS SERIF, DARK GRAY CAPITALIZED FONT.

SER. NO. 85-400,667, FILED S.R. 8-17-2011 AM. P.R. 2-28-2012.

MELISSA VALLILLO, EXAMINING ATTORNEY



David J. Kybas

Director of the United States Patent and Trademark Office

United States of America

United States Patent and Trademark Office

STRAT LAND EXPLORATION COMPANY

Reg. No. 4,174,315

Registered July 17, 2012

Int. Cls.: 40 and 42

SERVICE MARK

PRINCIPAL REGISTER

STRAT LAND EXPLORATION COMPANY (OKLAHOMA CORPORATION)
15 EAST 5TH STREET, SUITE 2020
TULSA, OK 741034318

FOR: OIL AND GAS PRODUCTION SERVICES, IN CLASS 40 (U.S. CLS. 100, 103 AND 106).

FIRST USE 3-5-1980; IN COMMERCE 3-5-1980.

FOR: OIL AND GAS EXPLORATION SERVICES, IN CLASS 42 (U.S. CLS. 100 AND 101).

FIRST USE 3-5-1980; IN COMMERCE 3-5-1980.

THE MARK CONSISTS OF STANDARD CHARACTERS WITHOUT CLAIM TO ANY PARTICULAR FONT, STYLE, SIZE, OR COLOR.

NO CLAIM IS MADE TO THE EXCLUSIVE RIGHT TO USE "LAND EXPLORATION COMPANY", APART FROM THE MARK AS SHOWN.

SER. NO. 85-401,081, FILED 8-18-2011.

TARA PATE, EXAMINING ATTORNEY



David J. Kyffers

Director of the United States Patent and Trademark Office

United States of America

United States Patent and Trademark Office

YOULAB

Reg. No. 4,174,316

VOLVO CAR CORPORATION (SWEDEN CORPORATION)
S-405 31

Registered July 17, 2012

GOTEBORG, SWEDEN

Int. Cl.: 35

FOR: PROMOTING THE SALE OF GOODS AND SERVICES OF OTHERS IN THE AUTOMOTIVE INDUSTRY BY DISSEMINATION OF PROMOTIONAL MATERIALS AND PRODUCT INFORMATION THROUGH AN ONLINE GLOBAL COMPUTER NETWORK, THROUGH THE DISTRIBUTION OF PRINTED MATERIAL, AUDIO AND VIDEO RECORDINGS, TELEVISION AND RADIO ADVERTISING, ONLINE ADVERTISING, AND INTERNET WEB SITES, IN CLASS 35 (U.S. CLS. 100, 101 AND 102).

SERVICE MARK

PRINCIPAL REGISTER

THE MARK CONSISTS OF STANDARD CHARACTERS WITHOUT CLAIM TO ANY PARTICULAR FONT, STYLE, SIZE, OR COLOR.

PRIORITY CLAIMED UNDER SEC. 44(D) ON ERPN CMNTY TM OFC APPLICATION NO. 010195121, FILED 8-12-2011, REG. NO. 010195121, DATED 1-12-2012, EXPIRES 8-12-2021.

SER. NO. 85-401,364, FILED 8-18-2011.

KATHLEEN LORENZO, EXAMINING ATTORNEY



David J. Kyffers

Director of the United States Patent and Trademark Office

United States of America

United States Patent and Trademark Office

ATP-5 Super Slab

Reg. No. 4,174,317

VISTA METALS CORP. (CALIFORNIA CORPORATION)
13425 WHITTRAM AVE.
FONTANA, CA 92335

Registered July 17, 2012

Int. Cl.: 6

FOR: CASTINGS, FOILS, POWDER, AND ROLLED, DRAWN OR EXTRUDED SEMI-FINISHED ARTICLES OF ALUMINIUM OR ITS ALLOYS, IN CLASS 6 (U.S. CLS. 2, 12, 13, 14, 23, 25 AND 50).

TRADEMARK

FIRST USE 3-15-2011; IN COMMERCE 3-15-2011.

PRINCIPAL REGISTER

THE MARK CONSISTS OF STANDARD CHARACTERS WITHOUT CLAIM TO ANY PARTICULAR FONT, STYLE, SIZE, OR COLOR.

OWNER OF U.S. REG. NO. 3,189,345.

NO CLAIM IS MADE TO THE EXCLUSIVE RIGHT TO USE "SUPER SLAB", APART FROM THE MARK AS SHOWN.

SER. NO. 85-401,787, FILED 8-18-2011.

KATHRYN COWARD, EXAMINING ATTORNEY



David J. Kyros

Director of the United States Patent and Trademark Office

United States of America

United States Patent and Trademark Office

dessert spa

Reg. No. 4,174,318

Registered July 17, 2012

Int. Cls.: 30 and 35

TRADEMARK

SERVICE MARK

PRINCIPAL REGISTER

VAINORIUS, MONIKA (UNITED STATES INDIVIDUAL), DBA DESSERT SPA
200 MILLICENT WAY
MORRISVILLE, NC 27560

FOR: BAKERY DESSERTS; BAKERY GOODS AND DESSERT ITEMS, NAMELY, CHEESECAKES FOR RETAIL AND WHOLESALE DISTRIBUTION AND CONSUMPTION ON OR OFF THE PREMISES; DESSERT MOUSSE; DESSERT PUDDINGS; DESSERT SOUFFLES; DOUGH-ENROBED FOODS CONSISTING OF A DOUGH-BASED WRAPPER WITH FILLINGS CONSISTING PRIMARILY OF ICE CREAM AND OTHER DAIRY-BASED DESSERTS; FLAVORED, SWEETENED GELATIN DESSERTS; FROZEN CASHEW-BASED DESSERTS; FROZEN DESSERT CONSISTING OF FRUIT AND CREAM OR CREAM SUBSTITUTES; FROZEN DESSERTS CONSISTING OF FLAVORED ICE BLOCKS WITH TOPPINGS; FROZEN SOY-BASED DESSERTS; ICE CREAM DESSERTS; INSTANT DESSERT PUDDINGS; MAIZE-BASED PUDDING DESSERT (MAZAMORRA MORADA); NON-FAT, LOW-CARBOHYDRATE, HIGH-PROTEIN DAIRY-BASED MIX FOR MAKING DESSERTS, NAMELY, CACKES, PASTRY, BREAD; PUDDINGS; PUDDINGS FOR USE AS DESSERTS; RICE-BASED PUDDING DESSERT; RICE-BASED PUDDING DESSERT (ARROZ CON LECHE), IN CLASS 30 (U.S. CL. 46).

FIRST USE 12-10-2006; IN COMMERCE 12-10-2006.

FOR: DESSERT SHOPS; PASTRY AND DESSERT SHOPS, IN CLASS 35 (U.S. CLS. 100, 101 AND 102).

FIRST USE 12-10-2006; IN COMMERCE 12-10-2006.

THE MARK CONSISTS OF STANDARD CHARACTERS WITHOUT CLAIM TO ANY PARTICULAR FONT, STYLE, SIZE, OR COLOR.

NO CLAIM IS MADE TO THE EXCLUSIVE RIGHT TO USE "DESSERT", APART FROM THE MARK AS SHOWN.

SER. NO. 85-401,849, FILED 8-18-2011.

STEPHANIE ALI, EXAMINING ATTORNEY



David J. Kyros

Director of the United States Patent and Trademark Office

United States of America

United States Patent and Trademark Office

THERAPEUTIC PROCESS EMOTIONAL EVOLUTION

Reg. No. 4,174,319

Registered July 17, 2012

Int. Cl.: 44

SERVICE MARK

PRINCIPAL REGISTER

LABONTE, DAVID (UNITED STATES INDIVIDUAL)
1935 SHERINGTON PLACE
F 111
NEWPORT BEACH, CA 92663

FOR: PSYCHOLOGICAL ASSESSMENT SERVICES; PSYCHOLOGICAL COUNSELING, IN CLASS 44 (U.S. CLS. 100 AND 101).

FIRST USE 8-12-2010; IN COMMERCE 8-12-2010.

THE MARK CONSISTS OF STANDARD CHARACTERS WITHOUT CLAIM TO ANY PARTICULAR FONT, STYLE, SIZE, OR COLOR.

SER. NO. 85-401,857, FILED 8-18-2011.

BERNICE MIDDLETON, EXAMINING ATTORNEY



David J. Kyffers

Director of the United States Patent and Trademark Office

United States of America

United States Patent and Trademark Office

ALLARD

Reg. No. 4,174,320

ALLARD, LLOYD (UNITED KINGDOM INDIVIDUAL)
CAE PEN HOUSE

Registered July 17, 2012

MONMOUTH, UNITED KINGDOM

Int. Cl.: 12

FOR: CARS; RACING CARS; SPORTS CARS; MOTOR CAR SEATS; AUTOMOBILE CHASSIS; BODY AND DOOR PANELS FOR AUTOMOBILES; FUEL LINES FOR VEHICLES; AUTOMOTIVE STRUCTURAL PARTS, NAMELY, TANKS FOR FUEL STORAGE, COOLANT STORAGE, OIL STORAGE, AND/OR WATER STORAGE; AUTOMOBILE STRUCTURAL PARTS FOR RACING PURPOSES, NAMELY, FUEL STORAGE SYSTEMS AND COMPONENT PARTS; AUTOMOBILE ENGINES; AUTOMOTIVE ENGINE MOUNTS; ENGINES FOR LAND VEHICLES; LAND VEHICLE TRANSMISSIONS AND REPLACEMENT PARTS THEREOF; TRANSMISSION MOUNTING PLATES FOR LAND VEHICLES; VEHICLE PARTS, NAMELY, STEERING WHEELS, WHEELS, WINDSHIELDS, DIFFERENTIALS, DRIVE BELTS, AXLES, FENDERS, RUNNING BOARDS, SHOCK ABSORBERS, SUSPENSION STRUTS, REARVIEW MIRRORS; VEHICLE WHEEL RIMS AND STRUCTURAL PARTS THEREFOR; LAND VEHICLES AND STRUCTURAL PARTS THEREFOR, IN CLASS 12 (U.S. CLS. 19, 21, 23, 31, 35 AND 44).

TRADEMARK

PRINCIPAL REGISTER

FIRST USE 1-1-1980; IN COMMERCE 1-1-1980.

THE MARK CONSISTS OF STANDARD CHARACTERS WITHOUT CLAIM TO ANY PARTICULAR FONT, STYLE, SIZE, OR COLOR.

SEC. 2(F).

SER. NO. 85-402,384, FILED 8-19-2011.

ALAIN LAPTEY, EXAMINING ATTORNEY



David J. Kyros

Director of the United States Patent and Trademark Office

United States of America

United States Patent and Trademark Office

LP MARKETER

Reg. No. 4,174,321

LIVEPERSON, INC. (DELAWARE CORPORATION)

Registered July 17, 2012

475 10TH AVENUE, 5TH FLOOR
NEW YORK, NY 10018

Int. Cl.: 42

SERVICE MARK

PRINCIPAL REGISTER

FOR: APPLICATION SERVICE PROVIDER (ASP) FEATURING SOFTWARE FOR USE BY BUSINESSES TO ENABLE REAL-TIME COMMUNICATIONS WITH ONLINE CUSTOMERS THROUGH THE USE OF COUPONS, ADS, OFFERS, VIDEO AND OTHER TYPES OF ONLINE CONTENT BASED ON BUSINESS RULES AND ANALYTICS ABOUT THE VISITORS' ON-LINE BEHAVIOR; COMPUTER SERVICES, NAMELY, HOSTING ON-LINE WEB FACILITIES FOR OTHERS FOR ORGANIZING, SERVING AND CONDUCTING ONLINE INTERACTIVE PROMOTIONS, NAMELY, COUPONS, ADS, OFFERS, VIDEO AND OTHER TYPES OF ON-LINE CONTENT; PROVIDING TEMPORARY USE OF ONLINE NON-DOWNLOADABLE SOFTWARE FOR DISSEMINATING OF TARGETED ADVERTISING CONTENT, DATA AND INFORMATION AND FOR DISSEMINATING IMMEDIATE AND RELEVANT SHOPPING INFORMATION TO CONSUMERS ON THE INTERNET; PROVIDING TEMPORARY USE OF ONLINE NON-DOWNLOADABLE SOFTWARE FOR SENDING CUSTOMIZED MESSAGES AND PROMOTIONS TO ONLINE CUSTOMERS AND POTENTIAL CUSTOMERS BASED ON THEIR LANGUAGE, LOCATION, AND HISTORY OF PURCHASES", IN CLASS 42 (U.S. CLS. 100 AND 101).

FIRST USE 6-0-2011; IN COMMERCE 6-0-2011.

THE MARK CONSISTS OF STANDARD CHARACTERS WITHOUT CLAIM TO ANY PARTICULAR FONT, STYLE, SIZE, OR COLOR.

NO CLAIM IS MADE TO THE EXCLUSIVE RIGHT TO USE "MARKETER", APART FROM THE MARK AS SHOWN.

SER. NO. 85-402,791, FILED 8-19-2011.

DEBORAH LOBO, EXAMINING ATTORNEY



David J. Kyros

Director of the United States Patent and Trademark Office

United States of America

United States Patent and Trademark Office

EPITEC

Reg. No. 4,174,322

Registered July 17, 2012

Int. Cls.: 35 and 42

SERVICE MARK

PRINCIPAL REGISTER

THE EPITEC GROUP, INC. (MICHIGAN CORPORATION)
SUITE 150
24800 DENSO DRIVE
SOUTHFIELD, MI 48033

FOR: EMPLOYMENT AGENCY SERVICES, NAMELY, FILLING THE TEMPORARY AND PERMANENT STAFFING NEEDS OF BUSINESSES; EMPLOYMENT HIRING, RECRUITING, PLACEMENT, STAFFING AND CAREER NETWORKING SERVICES; EMPLOYMENT STAFFING CONSULTATION SERVICES; EMPLOYMENT STAFFING IN THE FIELD OF INFORMATION TECHNOLOGY; PROFESSIONAL STAFFING AND RECRUITING SERVICES, IN CLASS 35 (U.S. CLS. 100, 101 AND 102).

FIRST USE 1-1-2000; IN COMMERCE 1-1-2000.

FOR: BUSINESS TECHNOLOGY SOFTWARE CONSULTATION SERVICES; COMPUTER CONSULTATION; COMPUTER DIAGNOSTIC SERVICES; COMPUTER DISASTER RECOVERY PLANNING; COMPUTER GRAPHICS SERVICES; COMPUTER HARDWARE AND SOFTWARE CONSULTING SERVICES; COMPUTER PROGRAMMING; COMPUTER PROGRAMMING AND SOFTWARE DESIGN; COMPUTER PROJECT MANAGEMENT SERVICES; COMPUTER SOFTWARE CONSULTING; CONSULTING IN THE FIELD OF INFORMATION TECHNOLOGY; CONSULTING IN THE FIELD OF IT PROJECT MANAGEMENT, IN CLASS 42 (U.S. CLS. 100 AND 101).

FIRST USE 1-1-2000; IN COMMERCE 1-1-2000.

THE MARK CONSISTS OF STANDARD CHARACTERS WITHOUT CLAIM TO ANY PARTICULAR FONT, STYLE, SIZE, OR COLOR.

SER. NO. 85-403,375, FILED 8-22-2011.

BERYL GARDNER, EXAMINING ATTORNEY



David J. Kyffers

Director of the United States Patent and Trademark Office

United States of America

United States Patent and Trademark Office

DIVISIONS MAINTENANCE GROUP

Reg. No. 4,174,323

Registered July 17, 2012

Int. Cl.: 37

SERVICE MARK

PRINCIPAL REGISTER

DIVISIONS, INC. (KENTUCKY CORPORATION)
300 DAVE COWENS DRIVE
SUITE 500
NEWPORT, KY 41071

FOR: FACILITY MAINTENANCE SERVICES, NAMELY, SNOW AND ICE REMOVAL, GENERAL CONSTRUCTION CONTRACTING, PLUMBING REPAIRS, ELECTRICAL REPAIRS AND THE CLEANING AND REPAIR OF BUILDINGS, IN CLASS 37 (U.S. CLS. 100, 103 AND 106).

FIRST USE 5-0-1999; IN COMMERCE 5-0-1999.

THE MARK CONSISTS OF STANDARD CHARACTERS WITHOUT CLAIM TO ANY PARTICULAR FONT, STYLE, SIZE, OR COLOR.

NO CLAIM IS MADE TO THE EXCLUSIVE RIGHT TO USE "MAINTENANCE GROUP", APART FROM THE MARK AS SHOWN.

SER. NO. 85-403,380, FILED 8-22-2011.

BERYL GARDNER, EXAMINING ATTORNEY



David J. Kyffers

Director of the United States Patent and Trademark Office

United States of America

United States Patent and Trademark Office

The Snead

Reg. No. 4,174,324

Registered July 17, 2012

Int. Cl.: 41

SERVICE MARK

PRINCIPAL REGISTER

THE GREENBRIER SPORTING CLUB DEVELOPMENT COMPANY, INC. (DELAWARE CORPORATION)
5 KATE'S MOUNTAIN ROAD
WHITE SULPHUR SPRINGS, WV 24986

FOR: GOLF COURSES, IN CLASS 41 (U.S. CLS. 100, 101 AND 107).

FIRST USE 5-1-2004; IN COMMERCE 5-1-2004.

THE MARK CONSISTS OF STANDARD CHARACTERS WITHOUT CLAIM TO ANY PARTICULAR FONT, STYLE, SIZE, OR COLOR.

SER. NO. 85-403,633, FILED 8-22-2011.

KAPIL BHANOT, EXAMINING ATTORNEY



David J. Kybas

Director of the United States Patent and Trademark Office

United States of America

United States Patent and Trademark Office



Reg. No. 4,174,325

DEANDA DESIGN ENT. INC (CALIFORNIA CORPORATION)
717 WALA DRIVE
OCEANSIDE, CA 92058

Registered July 17, 2012

Int. Cl.: 25

FOR: BELTS; BOTTOMS; HATS; JACKETS; PANTS; SHIRTS; SHORTS; SKIRTS; SWIM-WEAR; T-SHIRTS; TOPS, IN CLASS 25 (U.S. CLS. 22 AND 39).

TRADEMARK

FIRST USE 5-8-2011; IN COMMERCE 5-8-2011.

PRINCIPAL REGISTER

THE MARK CONSISTS OF THE STYLIZED WORDS "ALOHA SUNDAY" DISPLAYED WITHIN A CIRCULAR SHAPED REPRESENTATION OF A LIFE PRESERVER.

SER. NO. 85-404,043, FILED 8-22-2011.

PRISCILLA MILTON, EXAMINING ATTORNEY



David J. Kyffers

Director of the United States Patent and Trademark Office

United States of America

United States Patent and Trademark Office

planet ⊕

Reg. No. 4,174,326

Registered July 17, 2012

Int. Cls.: 16 and 21

ASEAN TRADING AND SHIPPING, INC. (OREGON CORPORATION), DBA ASEAN CORPORATION
16540 SW 72ND AVENUE
BUILDING 7
PORTLAND, OR 97224

TRADEMARK

FOR: COMPOSTABLE SOUP AND PREPARED TAKE-OUT FOOD CONTAINERS MADE PRIMARILY OF PAPER WITH BIODEGRADABLE WATERPROOF FILM LINING AND LIDS THEREFOR, IN CLASS 16 (U.S. CLS. 2, 5, 22, 23, 29, 37, 38 AND 50).

PRINCIPAL REGISTER

FIRST USE 1-9-2008; IN COMMERCE 1-9-2008.

FOR: COMPOSTABLE HOT AND COLD BEVERAGE CUPS MADE PRIMARILY OF PAPER WITH BIODEGRADABLE WATERPROOF FILM LINING AND LIDS THEREFOR; COMPOSTABLE INSULATING SLEEVE HOLDER FOR BEVERAGE CUPS, IN CLASS 21 (U.S. CLS. 2, 13, 23, 29, 30, 33, 40 AND 50).

FIRST USE 1-9-2008; IN COMMERCE 1-9-2008.

OWNER OF U.S. REG. NO. 3,488,014.

THE MARK CONSISTS OF THE WORD "PLANET" IN STYLIZED LOWER CASE FONT WITH THE "+" SIGN IN A CIRCLE.

SER. NO. 85-404,049, FILED 8-22-2011.

WENDY GOODMAN, EXAMINING ATTORNEY



David J. Kybas

Director of the United States Patent and Trademark Office

United States of America

United States Patent and Trademark Office

PRECISION TATTOO SUPPLY

Reg. No. 4,174,327

DWYER, DENNIS (UNITED STATES INDIVIDUAL)
2108 S. ALVERNON WAY
TUCSON, AZ 85711

Registered July 17, 2012

Int. Cl.: 35

FOR: RETAIL AND WHOLESALE STORE SERVICES FEATURING TATTOO SUPPLIES AND EQUIPMENT, IN CLASS 35 (U.S. CLS. 100, 101 AND 102).

SERVICE MARK

FIRST USE 1-1-1990; IN COMMERCE 1-1-1990.

PRINCIPAL REGISTER

THE MARK CONSISTS OF STANDARD CHARACTERS WITHOUT CLAIM TO ANY PARTICULAR FONT, STYLE, SIZE, OR COLOR.

NO CLAIM IS MADE TO THE EXCLUSIVE RIGHT TO USE "TATTOO SUPPLY", APART FROM THE MARK AS SHOWN.

SER. NO. 85-404,315, FILED 8-23-2011.

LINDA ORNDORFF, EXAMINING ATTORNEY



David J. Kyffers

Director of the United States Patent and Trademark Office

United States of America

United States Patent and Trademark Office



a **GE** Group Company

Reg. No. 4,174,328

BI INCORPORATED (COLORADO CORPORATION)
6400 LOOKOUT ROAD
BOULDER, CO 80301

Registered July 17, 2012

Int. Cls.: 44 and 45

FOR: BEHAVIORAL HEALTH SERVICES IN THE NATURE OF RECIDIVISM REDUCTION PROGRAMS FOR JUVENILES, PRISONERS AND DETAINEES; BEHAVIORAL HEALTH TREATMENT PROGRAMS FOR COMMUNITY-BASED PAROLEES, PROBATIONERS, AND PRE-TRIAL DEFENDANTS, IN CLASS 44 (U.S. CLS. 100 AND 101).

SERVICE MARK

PRINCIPAL REGISTER

FIRST USE 3-1-2011; IN COMMERCE 3-1-2011.

FOR: PROVIDING NATIONAL MONITORING SERVICES OF COMMUNITY-BASED PAROLEES, PROBATIONERS, AND PRE-TRIAL DEFENDANTS THROUGH THE USE OF GPS TRACKING DEVICES, ELECTRONIC MONITORING PROGRAMS AND DEVICES, WEB-BASED SOFTWARE APPLICATIONS, AND VOICE RECOGNITION EQUIPMENT; SUPERVISION PROGRAMS IN THE NATURE OF CASE MANAGEMENT SERVICES, NAMELY, COORDINATION OF COMPLIANCE WITH CONDITIONS OF RELEASE AND MONITORING SERVICES FOR COMMUNITY-BASED PAROLEES, PROBATIONERS, AND PRE-TRIAL DEFENDANTS, IN CLASS 45 (U.S. CLS. 100 AND 101).

FIRST USE 3-1-2011; IN COMMERCE 3-1-2011.

OWNER OF U.S. REG. NOS. 1,788,412, 2,697,736 AND OTHERS.

NO CLAIM IS MADE TO THE EXCLUSIVE RIGHT TO USE "GROUP COMPANY" AND THE DESIGN OF THE WORLD MAP, APART FROM THE MARK AS SHOWN.

THE MARK CONSISTS OF THE LETTERS "BI" CONTAINED WITHIN RECTANGLES THAT RESEMBLE A BAR CODE. THE PHRASE "A GEO GROUP COMPANY" APPEARS BENEATH. A REPRESENTATION OF THE CONTINENTS APPEAR WITHIN THE LETTER "O" OF THE WORD "GEO".

SER. NO. 85-404,475, FILED 8-23-2011.

MARGARET POWER, EXAMINING ATTORNEY



David J. Kyros

Director of the United States Patent and Trademark Office

United States of America

United States Patent and Trademark Office



Reg. No. 4,174,329

Registered July 17, 2012

Int. Cls.: 35 and 37

SERVICE MARK

PRINCIPAL REGISTER

LOS PINOS FINCA AGRICOLA, S.L. (SPAIN SOCIEDAD DE RESPONSABILIDAD LIMITADA (SL))
PINTOR AGRASOT, 9 03313
TORREMENDO (ALICANTE), SPAIN

FOR: ADVERTISING AND PUBLICITY SERVICES; BUSINESS ADMINISTRATION AND MANAGEMENT; WHOLESALE AND RETAIL STORE SERVICES AND ON-LINE RETAIL AND WHOLESALE STORE SERVICES FEATURING MACHINERY AND MACHINE TOOLS USED FOR STACKING, FORMING, COMPACTING, GROUPING AND/OR GLUING CARDBOARD BOXES; WHOLESALE AND RETAIL STORE SERVICES AND ON-LINE RETAIL AND WHOLESALE STORE SERVICES FEATURING MACHINERY AND MACHINE TOOLS USED FOR WINDING, FORMING AND/OR COMPACTING ALUMINIUM; EXPORT AND IMPORT AGENCIES; FRANCHISING, NAMELY, CONSULTATION AND ASSISTANCE IN BUSINESS MANAGEMENT, ORGANIZATION AND PROMOTION, IN CLASS 35 (U.S. CLS. 100, 101 AND 102).

FOR: MACHINERY INSTALLATION, MAINTENANCE AND REPAIR; RENTAL OF MACHINERY AND MACHINE TOOLS USED FOR STACKING, FORMING, COMPACTING, GROUPING AND/OR GLUING CARDBOARD BOXES AND ALUMINIUM, IN CLASS 37 (U.S. CLS. 100, 103 AND 106).

PRIORITY CLAIMED UNDER SEC. 44(D) ON ERPN CMNTY TM OFC APPLICATION NO. 9856311, FILED 3-31-2011, REG. NO. 009856311, DATED 9-5-2011, EXPIRES 3-31-2021.

OWNER OF U.S. REG. NO. 1,769,714.

THE MARK CONSISTS OF THE STYLIZED WORD "BOIX" APPEARING TO THE LEFT OF AND WITHIN A SEMI-CIRCULAR DESIGN REPRESENTING A MACHINE GEAR.

SER. NO. 85-405,053, FILED 8-23-2011.

TASHIA BUNCH, EXAMINING ATTORNEY



David J. Kypos

Director of the United States Patent and Trademark Office

United States of America

United States Patent and Trademark Office

CWEB Hosting

Reg. No. 4,174,330

Registered July 17, 2012

Int. Cl.: 42

SERVICE MARK

PRINCIPAL REGISTER

CWEB, INC (NEVADA CORPORATION)
10624 S EASTERN AVE A-978
HENDERSON, NV 89052

FOR: APPLICATION SERVICE PROVIDER, NAMELY, HOSTING, MANAGING, DEVELOPING, ANALYZING, AND MAINTAINING APPLICATIONS, SOFTWARE, AND WEB SITES, OF OTHERS IN THE FIELDS OF ADVERTISING AND MARKETING; APPLICATION SERVICE PROVIDER, NAMELY, HOSTING, MANAGING, DEVELOPING, AND MAINTAINING APPLICATIONS, SOFTWARE, AND WEB SITES, IN THE FIELDS OF PERSONAL PRODUCTIVITY, WIRELESS COMMUNICATION, MOBILE INFORMATION ACCESS, AND REMOTE DATA MANAGEMENT FOR WIRELESS DELIVERY OF CONTENT TO HANDHELD COMPUTERS, LAPTOPS AND MOBILE ELECTRONIC DEVICES; APPLICATION SERVICE PROVIDER, NAMELY, HOSTING, MANAGING, DEVELOPING, ANALYZING, AND MAINTAINING APPLICATIONS, SOFTWARE AND WEB SITES OF OTHERS IN THE FIELDS OF DOMAIN REGISTRATION, WEB HOSTING SERVICES; COMPUTER SERVICES, NAMELY, ACTING AS AN APPLICATION SERVICE PROVIDER IN THE FIELD OF INFORMATION MANAGEMENT TO HOST COMPUTER APPLICATION SOFTWARE FOR THE PURPOSE OF DOMAIN REGISTRATION, WEB HOSTING SERVICES; COMPUTER SERVICES, NAMELY, ACTING AS AN APPLICATION SERVICE PROVIDER IN THE FIELD OF KNOWLEDGE MANAGEMENT TO HOST COMPUTER APPLICATION SOFTWARE FOR THE PURPOSE OF DOMAIN REGISTRATION, WEB HOSTING SERVICES; COMPUTER SERVICES, NAMELY, CLOUD HOSTING PROVIDER SERVICES; COMPUTER SERVICES, NAMELY, DOMAIN FORWARDING SERVICES; COMPUTER SERVICES, NAMELY, HOSTING AND MAINTAINING AN ON-LINE WEB SITE FOR OTHERS FOR DOMAIN REGISTRATION, WEB HOSTING SERVICES; COMPUTER SERVICES, NAMELY, INTERACTIVE HOSTING SERVICES WHICH ALLOW THE USER TO PUBLISH AND SHARE THEIR OWN CONTENT AND IMAGES ON-LINE; CONSULTING SERVICES IN THE FIELD OF HOSTING COMPUTER SOFTWARE APPLICATIONS; DESIGN, CREATION, HOSTING AND MAINTENANCE OF INTERNET SITES FOR THIRD PARTIES; DESIGN, CREATION, HOSTING, MAINTENANCE OF WEBSITES FOR OTHERS; DESIGNING, CREATING, MAINTAINING, AND HOSTING DOMAIN REGISTRATION, WEB HOSTING SERVICES WEBSITES FOR OTHERS; HOSTING INTERNET SITES FOR OTHERS; HOSTING OF DIGITAL CONTENT ON THE INTERNET; HOSTING OF WEB SITES, IN CLASS 42 (U.S. CLS. 100 AND 101).



David J. Kyjars

FIRST USE 1-1-2002; IN COMMERCE 1-1-2002.

Reg. No. 4,174,330 THE MARK CONSISTS OF STANDARD CHARACTERS WITHOUT CLAIM TO ANY PARTICULAR FONT, STYLE, SIZE, OR COLOR.

OWNER OF U.S. REG. NOS. 2,791,645, 3,823,686 AND OTHERS.

NO CLAIM IS MADE TO THE EXCLUSIVE RIGHT TO USE "HOSTING", APART FROM THE MARK AS SHOWN.

SEC. 2(F).

SER. NO. 85-405,317, FILED 8-23-2011.

INGA ERVIN, EXAMINING ATTORNEY

United States of America

United States Patent and Trademark Office

My Goal Board

Reg. No. 4,174,331

Registered July 17, 2012

Int. Cl.: 20

TRADEMARK

PRINCIPAL REGISTER

BORDENAVE, SHAWANNAH (UNITED STATES INDIVIDUAL)
256 S. ROBERTSON BLVD.
#7596
BEVERLY HILLS, CA 90211

FOR: WALL PLAQUES MADE OF HARD PLASTIC, IN CLASS 20 (U.S. CLS. 2, 13, 22, 25, 32 AND 50).

FIRST USE 12-21-2007; IN COMMERCE 12-21-2007.

THE MARK CONSISTS OF STANDARD CHARACTERS WITHOUT CLAIM TO ANY PARTICULAR FONT, STYLE, SIZE, OR COLOR.

NO CLAIM IS MADE TO THE EXCLUSIVE RIGHT TO USE "GOAL BOARD", APART FROM THE MARK AS SHOWN.

SER. NO. 85-406,428, FILED 8-24-2011.

ELIZABETH HUGHITT, EXAMINING ATTORNEY



David J. Kyffers

Director of the United States Patent and Trademark Office

United States of America

United States Patent and Trademark Office



Reg. No. 4,174,332

Registered July 17, 2012

Int. Cl.: 36

SERVICE MARK

PRINCIPAL REGISTER

UNITED NATIONS FOUNDATION, INC. (NEW YORK CORPORATION)
SUITE 400
1800 MASSACHUSETTS AVE, NW
WASHINGTON, DC 20036

FOR: FACILITATING AND ARRANGING FOR THE FINANCING OF CHARITABLE DONATIONS FOR THE PURPOSES OF STREAMLINING THE PROCUREMENT AND DISTRIBUTION OF GLOBAL HEALTH SUPPLIES, IN CLASS 36 (U.S. CLS. 100, 101 AND 102).

FIRST USE 5-1-2010; IN COMMERCE 5-1-2010.

NO CLAIM IS MADE TO THE EXCLUSIVE RIGHT TO USE "PLEDGE GUARANTEE FOR HEALTH", APART FROM THE MARK AS SHOWN.

THE MARK CONSISTS OF THE CAPITAL LETTERS "PGH" AND THE WORDS "PLEDGE GUARANTEE FOR HEALTH" ENCLOSED IN A RECTANGULAR BORDER.

SER. NO. 85-406,791, FILED 8-25-2011.

LAKEISHA LEWIS, EXAMINING ATTORNEY



David J. Kybas

Director of the United States Patent and Trademark Office

United States of America

United States Patent and Trademark Office

Pink Tweed

Reg. No. 4,174,333

Registered July 17, 2012

Int. Cls.: 35 and 42

SERVICE MARK

PRINCIPAL REGISTER

PINK TWEED, INC. (OKLAHOMA CORPORATION), DBA PINK TWEED
11422 S. KINGSTON AVE.
TULSA, OK 74137

FOR: ADVICE IN THE FIELD OF BUSINESS MANAGEMENT AND MARKETING; ANALYSIS OF MARKET RESEARCH DATA AND STATISTICS; BRANDING SERVICES, NAMELY, CONSULTING, DEVELOPMENT, MANAGEMENT AND MARKETING OF BRANDS FOR BUSINESSES; BUSINESS ADVICE AND ANALYSIS OF MARKETS; BUSINESS CONSULTATION AND MANAGEMENT REGARDING MARKETING ACTIVITIES AND LAUNCHING OF NEW PRODUCTS; BUSINESS MANAGEMENT CONSULTING WITH RELATION TO STRATEGY, MARKETING, PRODUCTION, PERSONNEL AND RETAIL SALE MATTERS; BUSINESS MANAGEMENT CONSULTING WITH RELATION TO STRATEGY, MARKETING, SALES, OPERATION, PRODUCT DESIGN PARTICULARLY SPECIALIZING IN THE USE OF ANALYTIC AND STATISTIC MODELS FOR THE UNDERSTANDING AND PREDICTING OF CONSUMERS, BUSINESSES, AND MARKET TRENDS AND ACTIONS; BUSINESS RESEARCH; BUSINESS RESEARCH AND SURVEYS; BUSINESS RESEARCH CONSULTATION; BUSINESS RESEARCH USING FOCUS GROUPS; COLLECTION OF MARKET RESEARCH INFORMATION; COMPUTERIZED MARKET RESEARCH SERVICES; CONDUCTING BUSINESS AND MARKET RESEARCH SURVEYS; CONDUCTING BUSINESS RESEARCH AND SURVEYS; CONDUCTING EMPLOYEE SURVEYS FOR OTHERS FOR PURPOSES OF IMPROVING EMPLOYEE PERFORMANCE AND MORALE; CONDUCTING MARKET SURVEYS; CONDUCTING MARKETING STUDIES; CONDUCTING ON-LINE BUSINESS MANAGEMENT RESEARCH SURVEYS; CONSULTATION SERVICES, NAMELY, CREATIVE AND STRATEGIC CONSULTATION REGARDING DEVELOPMENT AND PRODUCTION OF MARKETING CAMPAIGNS FOR OTHERS; CONSUMER MARKETING RESEARCH AND CONSULTING RELATED THERETO; CONSUMER RESEARCH; CONSUMER SURVEY SERVICES; DEVELOPMENT OF MARKETING STRATEGIES AND CONCEPTS; DEVELOPMENT OF MARKETING STRATEGIES, CONCEPTS AND TACTICS, NAMELY, AUDIENCE DEVELOPMENT, BRAND AWARENESS, ONLINE COMMUNITY BUILDING AND DIGITAL WORD OF MOUTH COMMUNICATIONS; MARKET ANALYSIS; MARKET ANALYSIS AND RESEARCH SERVICES; MARKET ASSESSMENT SERVICES; MARKET MANIPULATION RESEARCH AND ANALYSIS, WHETHER OR NOT VIA THE INTERNET; MARKET OPINION POLLING STUDIES; MARKET REPORTS AND STUDIES; MARKET RESEARCH; MARKET RESEARCH AND BUSINESS ANALYSES; MARKET RESEARCH AND MARKET INTELLIGENCE SERVICES; MARKET RESEARCH BY MEANS OF A COMPUTER DATABASE; MARKET RESEARCH CONSULTATION; MARKET RESEARCH SERVICES; MARKET RESEARCH STUDIES; MARKET SEGMENTATION CONSULTATION; MARKET STUDY AND



David J. Kyffers

Director of the United States Patent and Trademark Office

Reg. No. 4,174,333 ANALYSIS OF MARKET STUDIES; MARKETING ANALYSIS SERVICES; MARKETING AND BRANDING SERVICES, NAMELY, PROVIDING CUSTOMIZED COMMUNICATION PROGRAMS TO OBTAIN CONSUMER INSIGHTS AND DEVELOP BRANDING STRATEGIES; MARKETING CONSULTING; MARKETING RESEARCH SERVICES; MARKETING SERVICES, NAMELY, CONDUCTING CONSUMER TRACKING BEHAVIOR RESEARCH AND CONSUMER TREND ANALYSIS; MARKETING SERVICES, NAMELY, CONSUMER MARKETING RESEARCH; ONLINE BUSINESS RESEARCH SERVICES THAT ALLOW USERS TO SHARE OPINIONS WITH A MARKETING RESEARCH COMPANY RELATED TO EVERYDAY CONSUMER PRODUCTS AND SERVICES; PROVIDING BUSINESS MARKETING INFORMATION; PROVISION OF MARKET RESEARCH INFORMATION; PUBLIC OPINION SURVEYS; PUBLIC POLICY RESEARCH SERVICES; SHOPPING BY RESEARCHERS WHO POSE AS CUSTOMERS TO EVALUATE THE QUALITY OF SERVICE DELIVERED, IN CLASS 35 (U.S. CLS. 100, 101 AND 102).

FIRST USE 7-15-2011; IN COMMERCE 8-8-2011.

FOR: SURVEY DESIGN AND RESEARCH; WEBSITE USABILITY TESTING SERVICES, IN CLASS 42 (U.S. CLS. 100 AND 101).

FIRST USE 7-15-2011; IN COMMERCE 8-8-2011.

THE MARK CONSISTS OF STANDARD CHARACTERS WITHOUT CLAIM TO ANY PARTICULAR FONT, STYLE, SIZE, OR COLOR.

SER. NO. 85-407,168, FILED 8-25-2011.

DAVID H. STINE, EXAMINING ATTORNEY

United States of America

United States Patent and Trademark Office



Reg. No. 4,174,334

Registered July 17, 2012

Int. Cl.: 28

TRADEMARK

PRINCIPAL REGISTER

J.E.M. CONCEPT INTERNATIONAL, INC. (CANADA CORPORATION)
404 DORSET STREET
MASCOUCHE, QUEBEC, CANADA J7L3V8

FOR: EXERCISE EQUIPMENT, NAMELY, EXERCISE BICYCLES, STATIONARY EXERCISE BICYCLES, ABDOMINAL BENCHES, ABDOMINAL CRUNCH BENCHES, IN CLASS 28 (U.S. CLS. 22, 23, 38 AND 50).

FIRST USE 1-0-1998; IN COMMERCE 1-0-1998.

THE MARK CONSISTS OF A LINE REPRESENTATION OF A RUNNING MAN IN MID-STRIDE WITH A SWOOSH CURVING FROM THE UPPER REAR TO THE BOTTOM FRONT.

SER. NO. 85-407,436, FILED 8-25-2011.

LAURIE KAUFMAN, EXAMINING ATTORNEY



David J. Kybas

Director of the United States Patent and Trademark Office

United States of America

United States Patent and Trademark Office



Reg. No. 4,174,335

Registered July 17, 2012

Int. Cls.: 2 and 3

TRADEMARK

PRINCIPAL REGISTER

W.M. BARR & COMPANY, INC. (TENNESSEE CORPORATION)
8000 CENTERVIEW PARKWAY, SUITE 400
MEMPHIS, TN 38018

FOR: ADHESION-PROMOTING COATINGS, IN CLASS 2 (U.S. CLS. 6, 11 AND 16).

FIRST USE 6-30-2008; IN COMMERCE 6-30-2008.

FOR: CLEANERS FOR USE ON VEHICLE SURFACES INCLUDING VEHICLE BODIES, VEHICLE BEDS, AUTOMOTIVE SURFACES, FRAMES, SUSPENSION PARTS, BOATS, TRAILERS, AND BOAT, TRUCK, CAR AND MOTORCYCLE ENGINES, IN CLASS 3 (U.S. CLS. 1, 4, 6, 50, 51 AND 52).

FIRST USE 6-30-2008; IN COMMERCE 6-30-2008.

OWNER OF U.S. REG. NOS. 760,145, 3,053,118 AND OTHERS.

THE MARK CONSISTS OF THE WORD "BULLDOG" UNDER A SEMI-CIRCLE BACKGROUND CONTAINING THE IMAGE OF A DOG'S HEAD WEARING A SPIKED COLLAR.

SER. NO. 85-407,496, FILED 8-25-2011.

KAREN SEVERSON, EXAMINING ATTORNEY



David J. Kybas

Director of the United States Patent and Trademark Office

United States of America

United States Patent and Trademark Office



Reg. No. 4,174,336

W.M. BARR & COMPANY, INC. (TENNESSEE CORPORATION)
8000 CENTERVIEW PARKWAY, SUITE 400
MEMPHIS, TN 38018

Registered July 17, 2012

Int. Cl.: 3

FOR: CLEANERS AND COATING STRIPPERS FOR USE ON METALS, PLASTICS AND WOOD, SPECIFICALLY EXCLUDING STRIPPERS FOR AIRCRAFT METAL COATINGS , IN CLASS 3 (U.S. CLS. 1, 4, 6, 50, 51 AND 52).

TRADEMARK

FIRST USE 6-30-2008; IN COMMERCE 6-30-2008.

PRINCIPAL REGISTER

OWNER OF U.S. REG. NO. 3,526,540.

THE MARK CONSISTS OF THE WORD "AIRCRAFT" UNDER A SEMI-CIRCLE AND THE IMAGE OF AN AIRPLANE.

SER. NO. 85-407,539, FILED 8-25-2011.

KAREN SEVERSON, EXAMINING ATTORNEY



David J. Kybas

Director of the United States Patent and Trademark Office

United States of America

United States Patent and Trademark Office



Reg. No. 4,174,337

W.M. BARR & COMPANY, INC. (TENNESSEE CORPORATION)
8000 CENTERVIEW PARKWAY, SUITE 400
MEMPHIS, TN 38018

Registered July 17, 2012

Int. Cl.: 3

FOR: CHEMICAL CLEANERS FOR EQUIPMENT USED IN APPLYING PAINT AND OTHER COATINGS, IN CLASS 3 (U.S. CLS. 1, 4, 6, 50, 51 AND 52).

TRADEMARK

FIRST USE 6-30-2008; IN COMMERCE 6-30-2008.

PRINCIPAL REGISTER

OWNER OF U.S. REG. NO. 3,448,661.

NO CLAIM IS MADE TO THE EXCLUSIVE RIGHT TO USE THE PICTORIAL REPRESENTATION OF A SPRAY GUN, APART FROM THE MARK AS SHOWN.

THE MARK CONSISTS OF THE WORDS "NAKED GUN" UNDER THE IMAGE OF A PAINT SPRAY GUN.

SER. NO. 85-407,544, FILED 8-25-2011.

KAREN SEVERSON, EXAMINING ATTORNEY



David J. Kyffers

Director of the United States Patent and Trademark Office

United States of America

United States Patent and Trademark Office

DOMINION VOTING

Reg. No. 4,174,338

Registered July 17, 2012

**Int. Cls.: 9, 35, 37, 40
and 41**

DOMINION VOTING SYSTEMS, INC. (DELAWARE CORPORATION)
1201 18TH STREET, SUITE 210
DENVER, CO 80202

FOR: VOTING MACHINES, IN CLASS 9 (U.S. CLS. 21, 23, 26, 36 AND 38).

FIRST USE 1-0-2007; IN COMMERCE 1-0-2007.

TRADEMARK

FOR: MANAGING AND ADMINISTERING POLITICAL ELECTIONS FOR OTHERS; CONDUCTING THE POLITICAL VOTING PROCESS FOR THE CASTING OF VOTES FOR OTHERS; RENTAL OF ELECTRONIC VOTING SYSTEMS AND PROVIDING OPERATORS THEREFOR; ORGANIZING VOTER REGISTRATION DRIVES; PROJECT MANAGEMENT SERVICES FOR OTHERS IN THE FIELD OF VOTER ELECTIONS; TECHNICAL CONSULTATION IN THE FIELD OF VOTER POLITICAL ELECTIONS, NAMELY, POST ELECTION REVIEW, ANALYSIS AND AUDITS TO IMPROVE EFFECTIVENESS, EFFICIENCY AND TO CONTROL COST, IN CLASS 35 (U.S. CLS. 100, 101 AND 102).

SERVICE MARK

FIRST USE 1-0-2003; IN COMMERCE 1-0-2003.

PRINCIPAL REGISTER

FOR: TECHNICAL SUPPORT SERVICES, NAMELY, TROUBLESHOOTING AND HELP DESK SERVICES IN THE NATURE OF REPAIR OF VOTING MACHINES AND RELATED HARDWARE AND INSTALLATION ADVICE FOR VOTING MACHINES AND RELATED HARDWARE, IN CLASS 37 (U.S. CLS. 100, 103 AND 106).

FIRST USE 1-0-2003; IN COMMERCE 1-0-2003.

FOR: PRINTING SERVICES, IN CLASS 40 (U.S. CLS. 100, 103 AND 106).

FIRST USE 1-0-2003; IN COMMERCE 1-0-2003.

FOR: TRAINING IN THE USE AND OPERATION OF VOTING MACHINES AND RELATED COMPUTER HARDWARE AND OPERATING SOFTWARE; TRAINING COURSES IN THE FIELD OF ORGANIZING, MANAGING, AND ADMINISTERING POLITICAL ELECTIONS; VOTER EDUCATION SERVICES, NAMELY, CONDUCTING CLASSES AND WORKSHOPS IN THE FIELD OF POLITICS, POLITICAL ELECTIONS, POLITICAL CANDIDATES, AND USING VOTING MACHINES, IN CLASS 41 (U.S. CLS. 100, 101 AND 107).



David J. Kyffers

Director of the United States Patent and Trademark Office

Reg. No. 4,174,338 FIRST USE 1-0-2003; IN COMMERCE 1-0-2003.

THE MARK CONSISTS OF STANDARD CHARACTERS WITHOUT CLAIM TO ANY PARTICULAR FONT, STYLE, SIZE, OR COLOR.

NO CLAIM IS MADE TO THE EXCLUSIVE RIGHT TO USE "VOTING", APART FROM THE MARK AS SHOWN.

SER. NO. 85-407,870, FILED 8-25-2011.

MARY CRAWFORD, EXAMINING ATTORNEY

United States of America

United States Patent and Trademark Office



Reg. No. 4,174,339

Registered July 17, 2012

Int. Cls.: 35, 37, 40 and 41

SERVICE MARK

PRINCIPAL REGISTER

DOMINION VOTING SYSTEMS, INC. (DELAWARE CORPORATION)
1201 18TH STREET, SUITE 210
DENVER, CO 80202

FOR: MANAGING AND ADMINISTERING POLITICAL ELECTIONS FOR OTHERS; CONDUCTING THE POLITICAL VOTING PROCESS FOR THE CASTING OF VOTES FOR OTHERS; RENTAL OF ELECTRONIC VOTING SYSTEMS AND PROVIDING OPERATORS THEREFOR; ORGANIZING VOTER REGISTRATION DRIVES; PROJECT MANAGEMENT SERVICES FOR OTHERS IN THE FIELD OF VOTER ELECTIONS; TECHNICAL CONSULTATION IN THE FIELD OF VOTER POLITICAL ELECTIONS, NAMELY, POST ELECTION REVIEW, ANALYSIS AND AUDITS TO IMPROVE EFFECTIVENESS, EFFICIENCY AND TO CONTROL COST, IN CLASS 35 (U.S. CLS. 100, 101 AND 102).

FIRST USE 6-0-2011; IN COMMERCE 6-0-2011.

FOR: TECHNICAL SUPPORT SERVICES, NAMELY, TROUBLESHOOTING AND HELP DESK SERVICES IN THE NATURE OF REPAIR OF VOTING MACHINES AND RELATED HARDWARE AND INSTALLATION ADVICE FOR VOTING MACHINES AND RELATED HARDWARE, IN CLASS 37 (U.S. CLS. 100, 103 AND 106).

FIRST USE 6-0-2011; IN COMMERCE 6-0-2011.

FOR: PRINTING SERVICES, IN CLASS 40 (U.S. CLS. 100, 103 AND 106).

FIRST USE 6-0-2011; IN COMMERCE 6-0-2011.

FOR: TRAINING IN THE USE AND OPERATION OF VOTING MACHINES AND RELATED COMPUTER HARDWARE AND OPERATING SOFTWARE; TRAINING COURSES IN THE FIELD OF ORGANIZING, MANAGING, AND ADMINISTERING POLITICAL ELECTIONS; VOTER EDUCATION SERVICES, NAMELY, CONDUCTING CLASSES AND WORKSHOPS IN THE FIELD OF POLITICS, POLITICAL ELECTIONS, POLITICAL CANDIDATES, AND USING VOTING MACHINES, IN CLASS 41 (U.S. CLS. 100, 101 AND 107).

FIRST USE 6-0-2011; IN COMMERCE 6-0-2011.

THE MARK CONSISTS OF THE STYLIZED DESIGN OF A BALLOT GOING INTO A BALLOT BOX.



David J. Kybas

Director of the United States Patent and Trademark Office

Reg. No. 4,174,339 SER. NO. 85-407,877, FILED 8-25-2011.

MARY CRAWFORD, EXAMINING ATTORNEY

United States of America

United States Patent and Trademark Office

LINE OF FIRE

Reg. No. 4,174,340

AUTOMOTIVE MANUFACTURING GROUP, INC. (FLORIDA CORPORATION)

Registered July 17, 2012

20479 VIA MARISA
BOCA RATON, FL 33498

Int. Cl.: 11

FOR: LED LIGHT FIXTURES; LED LIGHT BULBS; LIGHT BARS FOR VEHICLES, NAMELY, LAND VEHICLES; LIGHTING APPARATUS FOR VEHICLES; LIGHTING TUBES; LIGHTS FOR VEHICLES; LED LAMPS, LED LAMP CLUSTERS, BLINKING LED LAMPS, LED LIGHT PIPES, LED DOWNLIGHTS, TAILGATE LIGHT BARS FOR VEHICLES, NAMELY, LAND VEHICLES, TAILGATE RUNNING LIGHTS FOR LAND VEHICLES, TAILGATE BRAKE LIGHTS, TAILGATE VEHICLE TURN SIGNALS LIGHT BULBS, IN CLASS 11 (U.S. CLS. 13, 21, 23, 31 AND 34).

TRADEMARK

PRINCIPAL REGISTER

FIRST USE 11-1-2003; IN COMMERCE 11-1-2003.

THE MARK CONSISTS OF STANDARD CHARACTERS WITHOUT CLAIM TO ANY PARTICULAR FONT, STYLE, SIZE, OR COLOR.

SER. NO. 85-408,329, FILED 8-26-2011.

Alice Benmaman, Examining Attorney



David J. Kyffers

Director of the United States Patent and Trademark Office

United States of America

United States Patent and Trademark Office

THE HEALING SPECIES

Reg. No. 4,174,341

HEALING SPECIES, INC. (SOUTH CAROLINA CORPORATION)
P.O. BOX 1202
ORANGEBURG, SC 291161202

Registered July 17, 2012

Int. Cls.: 16, 35, 41 and 45

FOR: INSTRUCTION MANUAL FOR TEACHING YOUTH POSITIVE CHARACTER TRAITS, IN CLASS 16 (U.S. CLS. 2, 5, 22, 23, 29, 37, 38 AND 50).

FIRST USE 2-28-2001; IN COMMERCE 2-28-2001.

TRADEMARK

FOR: PROMOTING PUBLIC AWARENESS OF ISSUES RELATED TO PET ADOPTION, APPROPRIATE CARE OF PETS, ANIMAL CRUELTY AND LIMITING USE OF ANIMALS IN SCIENTIFIC RESEARCH, IN CLASS 35 (U.S. CLS. 100, 101 AND 102).

SERVICE MARK

PRINCIPAL REGISTER

FIRST USE 1-31-2000; IN COMMERCE 1-31-2000.

FOR: EDUCATION SERVICES, NAMELY, CURRICULUM-BASED PROGRAM FOR TEACHING YOUTH POSITIVE CHARACTER TRAITS, IN CLASS 41 (U.S. CLS. 100, 101 AND 107).

FIRST USE 1-31-2000; IN COMMERCE 1-31-2000.

FOR: ANIMAL ADOPTION SERVICES, NAMELY, ARRANGING FOR DOGS FROM VARIOUS SHELTERS TO BE PLACED IN HOMES, IN CLASS 45 (U.S. CLS. 100 AND 101).

FIRST USE 1-31-2000; IN COMMERCE 1-31-2000.

THE MARK CONSISTS OF STANDARD CHARACTERS WITHOUT CLAIM TO ANY PARTICULAR FONT, STYLE, SIZE, OR COLOR.

SER. NO. 85-408,448, FILED 8-26-2011.

KELLEY WELLS, EXAMINING ATTORNEY



David J. Kybas

Director of the United States Patent and Trademark Office

United States of America

United States Patent and Trademark Office



Reg. No. 4,174,342

Registered July 17, 2012

Int. Cl.: 11

TRADEMARK

PRINCIPAL REGISTER

NORTHSTAR SYSTEMS CORP. (TAIWAN CORPORATION)
5F., NO. 200, KANG-CHIEN ROAD
TAIPEI, TAIWAN 114

FOR: LED LIGHT BULBS, MINERS' LAMPS, DOWNLIGHTERS, FLASHLIGHTS, LED UNDERWATER LIGHTS, PROJECTOR LAMPS, CEILING LIGHTS, SOLAR LIGHT FIXTURES, NAMELY, INDOOR AND OUTDOOR SOLAR POWERED LIGHTING UNITS AND FIXTURES, SAFETY LAMPS, LAMPS, SEARCHLIGHT, THEATRICAL STAGE LIGHTING APPARATUS, SPOTLIGHTS, SPOT LIGHTS, LIGHTS FOR VEHICLES, FLARES, ELECTRIC LIGHTING FIXTURES, NAMELY, POWER FAILURE BACKUP SAFETY LIGHTING, AQUARIUM LIGHTS, DIVING LIGHTS, IN CLASS 11 (U.S. CLS. 13, 21, 23, 31 AND 34).

OWNER OF TAIWAN REG. NO. 01387469, DATED 12-1-2009, EXPIRES 11-30-2019.

THE MARK CONSISTS OF A STYLIZED LETTER "N" APPEARING WITHIN A SQUARE BACKGROUND WITH TWO CURVED LINES FORMING AN INCOMPLETE CIRCLE AROUND THE "N".

SER. NO. 85-408,521, FILED 8-26-2011.

AMY KERTGATE, EXAMINING ATTORNEY



David J. Kyffers

Director of the United States Patent and Trademark Office

United States of America

United States Patent and Trademark Office

Multi-Mount

Reg. No. 4,174,343

Registered July 17, 2012

Int. Cl.: 9

AKCES MEDIA LLC (CONNECTICUT LIMITED LIABILITY COMPANY), DBA ALZO
DIGITAL
SUITE E
32 STONY HILL ROAD
BETHEL, CT 06801

TRADEMARK

FOR: MOUNTING DEVICES FOR CAMERAS AND MONITORS, IN CLASS 9 (U.S. CLS. 21, 23, 26, 36 AND 38).

PRINCIPAL REGISTER

FIRST USE 8-1-2011; IN COMMERCE 8-1-2011.

THE MARK CONSISTS OF STANDARD CHARACTERS WITHOUT CLAIM TO ANY PARTICULAR FONT, STYLE, SIZE, OR COLOR.

SER. NO. 85-408,540, FILED 8-26-2011.

STEVEN JACKSON, EXAMINING ATTORNEY



David J. Kybas

Director of the United States Patent and Trademark Office

United States of America

United States Patent and Trademark Office

Kyla & Carlos

Reg. No. 4,174,344

Registered July 17, 2012

Int. Cl.: 9

MERCURY RETAIL SERVICES LLC (TEXAS LIMITED LIABILITY COMPANY)
BUILDING 19
5130 COMMERCE PARKWAY
SAN ANTONIO, TX 78218

FOR: SUNGLASSES, IN CLASS 9 (U.S. CLS. 21, 23, 26, 36 AND 38).

TRADEMARK

FIRST USE 6-30-2011; IN COMMERCE 6-30-2011.

PRINCIPAL REGISTER

THE NAME(S), PORTRAIT(S), AND/OR SIGNATURE(S) SHOWN IN THE MARK IDENTIFIES KYLA HOLDER, MINOR DAUGHTER OF LOUIE LEE HOLDER III, WHOSE CONSENT(S) TO REGISTER IS MADE OF RECORD.

THE MARK CONSISTS OF THE STYLIZED WORDS "KYLA & CARLOS" HAVING A FLOWER IN THE "A" OF "KYLA" AND A HAT ON THE "A" OF "CARLOS". EACH OF THE WORDS IS SEPARATELY OUTLINED.

SER. NO. 85-408,790, FILED 8-26-2011.

FLORENTINA BLANDU, EXAMINING ATTORNEY



David J. Kyffers

Director of the United States Patent and Trademark Office

United States of America

United States Patent and Trademark Office

DUSTY KLEPTO KITTY

Reg. No. 4,174,345

JEAN CHU (UNITED STATES INDIVIDUAL)
422 WEST 25TH AVENUE
SAN MATEO, CA 94403

Registered July 17, 2012

Int. Cl.: 41

FOR: ENTERTAINMENT SERVICES, NAMELY, PROVIDING IMAGES AND TEXT FEATURING ANIMAL STORIES AND PICTURES ON-LINE AND IN MOBILE WIRELESS FORM; ENTERTAINMENT SERVICES, NAMELY, PROVIDING IMAGES AND TEXT FEATURING ANIMAL STORIES THROUGH MONTHLY LETTERS SENT THROUGH THE MAIL; FAN CLUBS; RENTAL OF TRAINED ANIMALS FOR USE IN MOTION PICTURES AND THE ENTERTAINMENT INDUSTRY, IN CLASS 41 (U.S. CLS. 100, 101 AND 107).

SERVICE MARK

PRINCIPAL REGISTER

FIRST USE 3-1-2011; IN COMMERCE 3-1-2011.

THE MARK CONSISTS OF STANDARD CHARACTERS WITHOUT CLAIM TO ANY PARTICULAR FONT, STYLE, SIZE, OR COLOR.

NO CLAIM IS MADE TO THE EXCLUSIVE RIGHT TO USE "KITTY", APART FROM THE MARK AS SHOWN.

SER. NO. 85-408,841, FILED 8-26-2011.

SOPHIA S. KIM, EXAMINING ATTORNEY



David J. Kybas

Director of the United States Patent and Trademark Office

United States of America

United States Patent and Trademark Office

White Glove Standard

Reg. No. 4,174,346

Registered July 17, 2012

Int. Cl.: 37

SERVICE MARK

PRINCIPAL REGISTER

DUAL SERVICE CONTRACTORS, INC. (MINNESOTA CORPORATION), AKA DUAL SERVICES, INC.
636 39TH AVE NE
MINNEAPOLIS, MN 55421

FOR: REAL ESTATE PROPERTY CLEANING SERVICES, IN CLASS 37 (U.S. CLS. 100, 103 AND 106).

FIRST USE 5-15-2011; IN COMMERCE 6-1-2011.

THE MARK CONSISTS OF STANDARD CHARACTERS WITHOUT CLAIM TO ANY PARTICULAR FONT, STYLE, SIZE, OR COLOR.

SER. NO. 85-409,005, FILED 8-27-2011.

TRACY CROSS, EXAMINING ATTORNEY



David J. Kyffers

Director of the United States Patent and Trademark Office

United States of America

United States Patent and Trademark Office

A REASON FOR SPELLING

Reg. No. 4,174,347

Registered July 17, 2012

Int. Cl.: 16

TRADEMARK

PRINCIPAL REGISTER

THE CONCERNED GROUP, INC (ARKANSAS CORPORATION), FORMERLY CONCERNED COMMUNICATIONS
PO BOX 1000
SILOAM SPRINGS, AR 72761

FOR: EDUCATIONAL PUBLICATIONS, NAMELY, ELEMENTARY SCHOOL SPELLING CURRICULUM CONSISTING OF STUDENT WORKBOOKS AND A TEACHER GUIDEBOOK, FOR CHRISTIAN AND PAROCHIAL SCHOOLS, THAT USES A SCRIPTURE VERSE IN EACH WEEKLY LESSON IN THE FIELDS OF SPELLING, IN CLASS 16 (U.S. CLS. 2, 5, 22, 23, 29, 37, 38 AND 50).

FIRST USE 12-0-1997; IN COMMERCE 4-16-1998.

THE MARK CONSISTS OF STANDARD CHARACTERS WITHOUT CLAIM TO ANY PARTICULAR FONT, STYLE, SIZE, OR COLOR.

OWNER OF U.S. REG. NOS. 1,913,310, 3,078,305 AND OTHERS.

NO CLAIM IS MADE TO THE EXCLUSIVE RIGHT TO USE "SPELLING", APART FROM THE MARK AS SHOWN.

SER. NO. 85-409,120, FILED 8-28-2011.

TARA PATE, EXAMINING ATTORNEY



David J. Kybas

Director of the United States Patent and Trademark Office

United States of America

United States Patent and Trademark Office



Reg. No. 4,174,348

Registered July 17, 2012

Int. Cls.: 16, 35, 41 and 45

HEALING SPECIES, INC. (SOUTH CAROLINA NON-PROFIT CORPORATION)
P.O. BOX 1202
ORANGEBURG, SC 291161202

FOR: INSTRUCTION MANUAL FOR TEACHING YOUTH POSITIVE CHARACTER TRAITS, IN CLASS 16 (U.S. CLS. 2, 5, 22, 23, 29, 37, 38 AND 50).

FIRST USE 2-28-2001; IN COMMERCE 2-28-2001.

TRADEMARK

SERVICE MARK

PRINCIPAL REGISTER

FOR: PROMOTING PUBLIC AWARENESS OF ISSUES RELATED TO PET ADOPTION, APPROPRIATE CARE OF PETS, ANIMAL CRUELTY AND LIMITING USE OF ANIMALS IN SCIENTIFIC RESEARCH, IN CLASS 35 (U.S. CLS. 100, 101 AND 102).

FIRST USE 1-31-2000; IN COMMERCE 1-31-2000.

FOR: EDUCATION SERVICES, NAMELY, CURRICULUM-BASED PROGRAM FOR TEACHING YOUTH POSITIVE CHARACTER TRAITS, IN CLASS 41 (U.S. CLS. 100, 101 AND 107).

FIRST USE 1-31-2000; IN COMMERCE 1-31-2000.

FOR: ANIMAL ADOPTION SERVICES, NAMELY, ARRANGING FOR DOGS FROM VARIOUS SHELTERS TO BE PLACED IN HOMES, IN CLASS 45 (U.S. CLS. 100 AND 101).

FIRST USE 1-31-2000; IN COMMERCE 1-31-2000.

THE MARK CONSISTS OF THE SILHOUETTE OF A CHILD'S HEAD FACING THE SILHOUETTE OF A DOGS HEAD INSIDE AN OVAL OUTLINE.

SER. NO. 85-409,297, FILED 8-29-2011.

KELLEY WELLS, EXAMINING ATTORNEY



David J. Kybas

Director of the United States Patent and Trademark Office

United States of America

United States Patent and Trademark Office



Reg. No. 4,174,349

DINE ON DEMAND LLC (TEXAS LIMITED LIABILITY COMPANY)
8500 SHOAL CREEK BLVD
AUSTIN, TX 78757

Registered July 17, 2012

Int. Cl.: 35

FOR: ON-LINE ORDERING SERVICES IN THE FIELD OF RESTAURANT TAKE-OUT AND DELIVERY, IN CLASS 35 (U.S. CLS. 100, 101 AND 102).

SERVICE MARK

FIRST USE 6-1-2006; IN COMMERCE 6-1-2006.

PRINCIPAL REGISTER

NO CLAIM IS MADE TO THE EXCLUSIVE RIGHT TO USE "PREMIER RESTAURANT DELIVERY SERVICE", APART FROM THE MARK AS SHOWN.

THE COLOR(S) RED, BLACK, YELLOW, WHITE, AND SILVER IS/ARE CLAIMED AS A FEATURE OF THE MARK.

THE MARK CONSISTS OF A DESIGN OF A BLACK AND SILVER FORK AGAINST A PLATE WITH A YELLOW CENTER OUTLINED IN BLACK AND RED OUTER RING WITH A YELLOW EDGE OUTLINED IN BLACK; ON THE BLACK HANDLE OF THE FORK APPEAR THE WORDS "PREMIER RESTAURANT DELIVERY SERVICE" IN WHITE AND ON THE OUTER RING OF THE PLATE APPEAR THE WORDS "DINE ON DEMAND" IN WHITE. THERE ARE THREE SMALL OBLONG SOLIDS IN BLACK, TO THE LEFT OF THE FORK.

SER. NO. 85-409,393, FILED 8-29-2011.

CHRISTOPHER BUONGIORNO, EXAMINING ATTORNEY



David J. Kybas

Director of the United States Patent and Trademark Office

United States of America

United States Patent and Trademark Office

Quick and Easy Coupons

Reg. No. 4,174,350

Registered July 17, 2012

Int. Cl.: 35

SERVICE MARK

PRINCIPAL REGISTER

QUICK AND EASY PRODUCTS, LLC (RHODE ISLAND LIMITED LIABILITY COMPANY),
DBA QUICK AND EASY COUPONS
PO BOX 141
WAKEFIELD, RI 02880

FOR: PROMOTING THE SALE OF GOODS AND SERVICES OF OTHERS BY MEANS OF
PROVIDING COUPONS BY ELECTRONIC DELIVERY TO COMPUTERS OR MOBILE
DEVICES, IN CLASS 35 (U.S. CLS. 100, 101 AND 102).

FIRST USE 8-22-2011; IN COMMERCE 8-22-2011.

THE MARK CONSISTS OF STANDARD CHARACTERS WITHOUT CLAIM TO ANY PAR-
TICULAR FONT, STYLE, SIZE, OR COLOR.

NO CLAIM IS MADE TO THE EXCLUSIVE RIGHT TO USE "COUPONS", APART FROM
THE MARK AS SHOWN.

SER. NO. 85-409,628, FILED 8-29-2011.

CHRIS WELLS, EXAMINING ATTORNEY



David J. Kyffers

Director of the United States Patent and Trademark Office

United States of America

United States Patent and Trademark Office

WELCOME TO FABULOUS

Reg. No. 4,174,351

Registered July 17, 2012

Int. Cls.: 35 and 44

SERVICE MARK

PRINCIPAL REGISTER

ULTA SALON, COSMETICS & FRAGRANCE, INC. (DELAWARE CORPORATION)
1000 REMINGTON BOULEVARD., STE 120
BOLINGBROOK, IL 60440

FOR: ONLINE RETAIL STORE SERVICES FEATURING HEALTH AND BEAUTY AIDS, PERFUMES, JEWELRY, WATCHES AND PHARMACEUTICALS, IN CLASS 35 (U.S. CLS. 100, 101 AND 102).

FIRST USE 10-26-2011; IN COMMERCE 10-26-2011.

FOR: BEAUTY SALON SERVICES, NAMELY, HAIR CUTTING, HAIRDRESSING, FACIALS, SKIN CARE, NAIL CARE, MANICURES AND PEDICURES, IN CLASS 44 (U.S. CLS. 100 AND 101).

FIRST USE 10-26-2011; IN COMMERCE 10-26-2011.

THE MARK CONSISTS OF STANDARD CHARACTERS WITHOUT CLAIM TO ANY PARTICULAR FONT, STYLE, SIZE, OR COLOR.

SER. NO. 85-409,739, FILED 8-29-2011.

COLLEEN DOMBROW, EXAMINING ATTORNEY



David J. Kybas

Director of the United States Patent and Trademark Office

United States of America

United States Patent and Trademark Office

ONE WITH NATURE

Reg. No. 4,174,352

MADAEN NATURAL PRODUCTS (DELAWARE CORPORATION), DBA ONE WITH NATURE
23811 CHAGRIN BLVD SUITE 110
BEACHWOOD, OH 44122

Registered July 17, 2012

Int. Cl.: 3

FOR: BAR SOAP; BATH SALTS; BATH SOAPS; BATH SOAPS IN LIQUID, SOLID OR GEL FORM; BEAUTY SOAP; HAND SOAPS; LIQUID BATH SOAPS; LIQUID SOAP; LIQUID SOAPS FOR HANDS, FACE AND BODY; SOAPS FOR PERSONAL USE, IN CLASS 3 (U.S. CLS. 1, 4, 6, 50, 51 AND 52).

TRADEMARK

PRINCIPAL REGISTER

FIRST USE 1-1-2004; IN COMMERCE 1-1-2004.

THE MARK CONSISTS OF STANDARD CHARACTERS WITHOUT CLAIM TO ANY PARTICULAR FONT, STYLE, SIZE, OR COLOR.

OWNER OF U.S. REG. NO. 3,668,391.

SER. NO. 85-409,763, FILED 8-29-2011.

FLORENTINA BLANDU, EXAMINING ATTORNEY



David J. Kyffers

Director of the United States Patent and Trademark Office

United States of America

United States Patent and Trademark Office

SENTRYPAL

Reg. No. 4,174,353

Registered July 17, 2012

Int. Cl.: 9

TRADEMARK

PRINCIPAL REGISTER

LOGICMARK, LLC (DELAWARE LIMITED LIABILITY COMPANY)
1359 BARCLAY BLVD.
BUFFALO GROVE, IL 60654

FOR: ELECTRONIC PERSONAL EMERGENCY RESPONSE SYSTEM CONSISTING OF A DEVICE COMPRISED OF PENDANT CARRIED OR WORN ON THE BODY WITH A BUTTON THAT USERS PUSH IN AN EMERGENCY TO NOTIFY OTHERS USING GPS TRACKING AND CELLULAR COMMUNICATIONS IN THE EVENT OF AN EMERGENCY, IN CLASS 9 (U.S. CLS. 21, 23, 26, 36 AND 38).

FIRST USE 6-30-2010; IN COMMERCE 6-30-2010.

THE MARK CONSISTS OF STANDARD CHARACTERS WITHOUT CLAIM TO ANY PARTICULAR FONT, STYLE, SIZE, OR COLOR.

SER. NO. 85-410,182, FILED 8-30-2011.

EUGENIA MARTIN, EXAMINING ATTORNEY



David J. Kyffers

Director of the United States Patent and Trademark Office

United States of America

United States Patent and Trademark Office

HURST REVIEW

Reg. No. 4,174,354

Registered July 17, 2012

Int. Cl.: 41

SERVICE MARK

PRINCIPAL REGISTER

HURST REVIEW SERVICES, INC. (MISSISSIPPI CORPORATION)
111 SOUTH RAILROAD AVENUE
BROOKHAVEN, MS 39601

FOR: EDUCATION SERVICES, NAMELY, PROVIDING LIVE AND ON-LINE CLASSES, SEMINARS AND WORKSHOPS IN THE FIELD OF NURSING EXAM PREPARATION , IN CLASS 41 (U.S. CLS. 100, 101 AND 107).

FIRST USE 1-1-1988; IN COMMERCE 1-1-1988.

THE MARK CONSISTS OF STANDARD CHARACTERS WITHOUT CLAIM TO ANY PARTICULAR FONT, STYLE, SIZE, OR COLOR.

NO CLAIM IS MADE TO THE EXCLUSIVE RIGHT TO USE "REVIEW", APART FROM THE MARK AS SHOWN.

SEC. 2(F).

SER. NO. 85-410,258, FILED 8-30-2011.

MARTHA SANTOMARTINO, EXAMINING ATTORNEY



David J. Kyffers

Director of the United States Patent and Trademark Office

United States of America

United States Patent and Trademark Office



Reg. No. 4,174,355

Registered July 17, 2012

Int. Cl.: 41

SERVICE MARK

PRINCIPAL REGISTER

HURST REVIEW SERVICES, INC. (MISSISSIPPI CORPORATION)
111 SOUTH RAILROAD AVENUE
BROOKHAVEN, MS 39601

FOR: EDUCATION SERVICES, NAMELY, PROVIDING LIVE AND ON-LINE CLASSES, SEMINARS AND WORKSHOPS IN THE FIELD OF NURSING EXAM PREPARATION , IN CLASS 41 (U.S. CLS. 100, 101 AND 107).

FIRST USE 1-1-2004; IN COMMERCE 1-1-2004.

NO CLAIM IS MADE TO THE EXCLUSIVE RIGHT TO USE "REVIEW SERVICES", APART FROM THE MARK AS SHOWN.

THE COLOR(S) RED AND BLACK IS/ARE CLAIMED AS A FEATURE OF THE MARK.

THE MARK CONSISTS OF A STYLIZED IMAGE OF AN EKG FOLLOWED BY THE WORD "HURST" IN RED WITH THE WORDS "REVIEW SERVICES" IN SMALLER BLACK FONT BELOW.

SER. NO. 85-410,315, FILED 8-30-2011.

MARTHA SANTOMARTINO, EXAMINING ATTORNEY



David J. Kyffers

Director of the United States Patent and Trademark Office

United States of America

United States Patent and Trademark Office

Ziblio

Reg. No. 4,174,356

ZIBLIO, LLC (NEVADA LIMITED LIABILITY COMPANY)
801 SOUTH PLEASANT GROVE BLVD.
PLEASANT GROVE, UT 84062

Registered July 17, 2012

Int. Cl.: 16

FOR: BRAG BOOKS; MEMORY BOOKS, IN CLASS 16 (U.S. CLS. 2, 5, 22, 23, 29, 37, 38 AND 50).

TRADEMARK

FIRST USE 2-7-2009; IN COMMERCE 3-24-2009.

PRINCIPAL REGISTER

THE MARK CONSISTS OF STANDARD CHARACTERS WITHOUT CLAIM TO ANY PARTICULAR FONT, STYLE, SIZE, OR COLOR.

THE WORDING "ZIBLIO" HAS NO MEANING IN A FOREIGN LANGUAGE.

SER. NO. 85-410,555, FILED 8-30-2011.

RUDY R. SINGLETON, EXAMINING ATTORNEY



David J. Kybas

Director of the United States Patent and Trademark Office

United States of America

United States Patent and Trademark Office



Reg. No. 4,174,357

Registered July 17, 2012

Int. Cl.: 36

SERVICE MARK

PRINCIPAL REGISTER

LYONS, DAVID E (UNITED STATES INDIVIDUAL)
32483 TEMECULA PARKWAY SUITE E112 #90
TEMECULA, CA 92592

FOR: CHARITABLE FUNDRAISING SERVICES BY MEANS OF BODY BUILDING EVENT,
IN CLASS 36 (U.S. CLS. 100, 101 AND 102).

FIRST USE 2-20-2008; IN COMMERCE 3-19-2008.

NO CLAIM IS MADE TO THE EXCLUSIVE RIGHT TO USE "MS" "BODYBUILDING
CHALLENGE" "WWW." AND ".COM", APART FROM THE MARK AS SHOWN.

THE COLOR(S) PURPLE, BLACK IS/ARE CLAIMED AS A FEATURE OF THE MARK.

THE MARK CONSISTS OF THE STYLIZED WORDING MS IN PURPLE BEING CRUSHED
BY MUSCULAR ARMS OUTLINES IN BLACK. THE WORDING "THE" APPEARS ABOVE
IT IN BLACK. THE WORDING BODYBUILDING CHALLENGE APPEARS BELOW IN
BLACK. AT THE BOTTOM OF THE MARK IS THE WORDING "WWW.THEMSBODYBUILD-
INGCHALLENGE.COM" IN BLACK.

SER. NO. 85-411,037, FILED 8-30-2011.

BERNICE MIDDLETON, EXAMINING ATTORNEY



David J. Kybas

Director of the United States Patent and Trademark Office

United States of America

United States Patent and Trademark Office

GLUTEN FREE BY BEVERLY

Reg. No. 4,174,358

SCOTT, BEVERLY (UNITED STATES INDIVIDUAL)
5525 PALMER CROSSING CIRCLE
SARASOTA, FL 34233

Registered July 17, 2012

Int. Cl.: 5

FOR: GLUTEN-FREE FOOD TO ACCOMMODATE SPECIAL MEDICAL AND HEALTH CONDITIONS, IN CLASS 5 (U.S. CLS. 6, 18, 44, 46, 51 AND 52).

TRADEMARK

FIRST USE 3-1-2011; IN COMMERCE 3-1-2011.

PRINCIPAL REGISTER

THE MARK CONSISTS OF STANDARD CHARACTERS WITHOUT CLAIM TO ANY PARTICULAR FONT, STYLE, SIZE, OR COLOR.

NO CLAIM IS MADE TO THE EXCLUSIVE RIGHT TO USE "GLUTEN FREE", APART FROM THE MARK AS SHOWN.

THE NAME(S), PORTRAIT(S), AND/OR SIGNATURE(S) SHOWN IN THE MARK IDENTIFIES "BEVERLY" SCOTT, WHOSE CONSENT(S) TO REGISTER IS MADE OF RECORD.

SER. NO. 85-411,189, FILED 8-30-2011.

LEIGH CAROLINE CASE, EXAMINING ATTORNEY



David J. Kyffers

Director of the United States Patent and Trademark Office

United States of America

United States Patent and Trademark Office

PET BASICS

Reg. No. 4,174,359

PET BASICS, LLC (SOUTH CAROLINA LIMITED LIABILITY COMPANY), DBA PET BASICS
5818 OLD LEESBURG ROAD
HOPKINS, SC 29061

Registered July 17, 2012

Int. Cl.: 35

FOR: WHOLESALE AND RETAIL STORE SERVICES AND ON-LINE RETAIL AND WHOLESALE STORE SERVICES FEATURING PET SUPPLIES, IN CLASS 35 (U.S. CLS. 100, 101 AND 102).

SERVICE MARK

FIRST USE 8-8-2010; IN COMMERCE 3-1-2011.

PRINCIPAL REGISTER

THE MARK CONSISTS OF STANDARD CHARACTERS WITHOUT CLAIM TO ANY PARTICULAR FONT, STYLE, SIZE, OR COLOR.

NO CLAIM IS MADE TO THE EXCLUSIVE RIGHT TO USE "PET", APART FROM THE MARK AS SHOWN.

SER. NO. 85-411,441, FILED 8-31-2011.

AMY ALFIERI, EXAMINING ATTORNEY



David J. Kybas

Director of the United States Patent and Trademark Office

United States of America

United States Patent and Trademark Office

Bink's Outfitters

Reg. No. 4,174,360

Registered July 17, 2012

Int. Cl.: 35

SERVICE MARK

PRINCIPAL REGISTER

BINKLEY, BRANDON DOUGLAS (UNITED STATES INDIVIDUAL)
1606 CHAMPIONSHIP BOULEVARD
FRANKLIN, TN 37064

FOR: RETAIL APPAREL STORES; RETAIL CLOTHING BOUTIQUES; RETAIL CLOTHING STORES; RETAIL GIFT SHOPS; RETAIL STORE AND ON-LINE RETAIL STORE SERVICES FEATURING CLOTHING, FOOTWEAR, CAMPING AND OUTDOOR SUPPLIES; RETAIL STORE SERVICES FEATURING CLOTHING, FOOTWEAR, CAMPING AND OUTDOOR SUPPLIES ACCESSIBLE ON-LINE AND BY TELEPHONE, FACSIMILE AND MAIL ORDER, IN CLASS 35 (U.S. CLS. 100, 101 AND 102).

FIRST USE 11-1-2004; IN COMMERCE 11-1-2004.

THE MARK CONSISTS OF STANDARD CHARACTERS WITHOUT CLAIM TO ANY PARTICULAR FONT, STYLE, SIZE, OR COLOR.

NO CLAIM IS MADE TO THE EXCLUSIVE RIGHT TO USE "OUTFITTERS", APART FROM THE MARK AS SHOWN.

SEC. 2(F).

SER. NO. 85-411,499, FILED 8-31-2011.

CHRISTINA SOBRAL, EXAMINING ATTORNEY



David J. Kybas

Director of the United States Patent and Trademark Office

United States of America

United States Patent and Trademark Office



Reg. No. 4,174,361

Registered July 17, 2012

Int. Cl.: 40

SERVICE MARK

PRINCIPAL REGISTER

RTI INTERNATIONAL METALS, INC. (OHIO CORPORATION)
1000 WARREN AVENUE
NILES, OH 444461168

FOR: FLAT FINISHING AND FORMING OF TITANIUM SHEETS, NAMELY, SUPER PLASTIC FORMING OF TITANIUM SHEETS INTO FORMED PRODUCT FOR OTHERS, IN CLASS 40 (U.S. CLS. 100, 103 AND 106).

FIRST USE 12-30-1983; IN COMMERCE 12-30-1983.

OWNER OF U.S. REG. NOS. 2,462,589, 2,464,398, AND 2,470,335.

THE MARK CONSISTS OF A STYLIZED WORLD GLOBE TO THE LEFT OF THE STYLIZED LETTERS "RTI" AND WORD "TRADCO" WITH A VERTICAL LINE SEPARATING "RTI" AND "TRADCO".

SER. NO. 85-411,561, FILED 8-31-2011.

BARBARA BROWN, EXAMINING ATTORNEY



David J. Kyffers

Director of the United States Patent and Trademark Office

United States of America

United States Patent and Trademark Office

Colle Salon & Spa

Reg. No. 4,174,362

COLLE SALON & SPA (MARYLAND CORPORATION)
7002 REISTERSTOWN RD.
PIKESVILLE, MD 21208

Registered July 17, 2012

Int. Cl.: 44

FOR: BEAUTY ANALYSIS TO DETERMINE COSMETICS THAT ARE BEST SUITED TO PARTICULAR INDIVIDUALS; BEAUTY CONSULTATION SERVICES; BEAUTY SALON SERVICES; HYGIENIC AND BEAUTY CARE; MEDSPA SERVICES FOR HEALTH AND BEAUTY OF THE BODY AND SPIRIT; PROVIDING NEWS AND INFORMATION IN THE FIELD OF PERSONAL BEAUTY, IN CLASS 44 (U.S. CLS. 100 AND 101).

SERVICE MARK

PRINCIPAL REGISTER

FIRST USE 2-1-2011; IN COMMERCE 2-1-2011.

THE MARK CONSISTS OF STANDARD CHARACTERS WITHOUT CLAIM TO ANY PARTICULAR FONT, STYLE, SIZE, OR COLOR.

NO CLAIM IS MADE TO THE EXCLUSIVE RIGHT TO USE "SALON AND SPA", APART FROM THE MARK AS SHOWN.

SER. NO. 85-411,681, FILED 8-31-2011.

JOHN E. MICHOS, EXAMINING ATTORNEY



David J. Kyffers

Director of the United States Patent and Trademark Office

United States of America

United States Patent and Trademark Office

MOJOPHONIC

Reg. No. 4,174,363

Registered July 17, 2012

Int. Cls.: 16, 25 and 41

TRADEMARK

SERVICE MARK

PRINCIPAL REGISTER

BROOKS, STEVEN JOE (CANADA INDIVIDUAL)
APT. #206
956 PALM AVENUE
WEST HOLLYWOOD, CA 90069

FOR: PRINTED MATTER, NAMELY, POSTERS, CALENDARS, CONCERT PROGRAMS, BUMPER STICKERS, DECALS, PAPER BADGES, POSTCARDS, NOTEPADS, PHOTOGRAPHS, AND NOTE BOOKS, IN CLASS 16 (U.S. CLS. 2, 5, 22, 23, 29, 37, 38 AND 50).

FIRST USE 4-1-2003; IN COMMERCE 4-1-2003.

FOR: CLOTHING, NAMELY, T-SHIRTS, JACKETS, TANK TOPS, SWEATSHIRTS, BOXERS AND UNDERWEAR; BELTS; HATS, CAPS, VISORS AND HEADWEAR; FOOTWEAR, IN CLASS 25 (U.S. CLS. 22 AND 39).

FIRST USE 3-1-2009; IN COMMERCE 3-1-2009.

FOR: ENTERTAINMENT SERVICES IN THE NATURE OF LIVE MUSICAL PERFORMANCES; PROVIDING A WEBSITE FEATURING NON-DOWNLOADABLE MUSICAL PERFORMANCES AND VIDEOS OF SAME, RELATED VIDEO CLIPS AND OTHER RELATED MUSICAL MULTI-MEDIA MATERIALS, INFORMATION ON A MUSICAL PERFORMER AND SCHEDULED LIVE MUSICAL PERFORMANCES; ONGOING SHORT PROGRAMS FEATURING VARIETY ENTERTAINMENT AND MUSICAL PERFORMANCES THAT ARE BROADCAST AND STREAMED OVER THE INTERNET, CABLE, SATELLITE AND TELEVISION, IN CLASS 41 (U.S. CLS. 100, 101 AND 107).

FIRST USE 10-1-2000; IN COMMERCE 11-7-2000.

THE MARK CONSISTS OF STANDARD CHARACTERS WITHOUT CLAIM TO ANY PARTICULAR FONT, STYLE, SIZE, OR COLOR.

SER. NO. 85-411,839, FILED 8-31-2011.

DORITT L. CARROLL, EXAMINING ATTORNEY



David J. Kyffers

Director of the United States Patent and Trademark Office

United States of America

United States Patent and Trademark Office

Investment Tools for a Changing Economy

Reg. No. 4,174,364

C4CAST.COM, INC. (DELAWARE CORPORATION)
750 E. WALNUT ST.

Registered July 17, 2012

PASADENA, CA 91101

Int. Cl.: 36

FOR: FINANCIAL FORECASTING, FINANCIAL RESEARCH, PROVIDING FINANCIAL INFORMATION BY ELECTRONIC MEANS, FINANCIAL ANALYSIS AND CONSULTATION, AND INVESTMENT PLANNING ADVICE; PROVIDING INFORMATION AND DATABASES FEATURING FINANCIAL AND ECONOMIC FORECASTING NEWS, RESEARCH, ANALYSIS, DATA COMPILATION, STATISTICAL AND MATHEMATICAL ALGORITHMS AND COMPILATION VIA A GLOBAL NETWORK, IN CLASS 36 (U.S. CLS. 100, 101 AND 102).

SERVICE MARK

PRINCIPAL REGISTER

FIRST USE 12-10-2009; IN COMMERCE 5-1-2010.

THE MARK CONSISTS OF STANDARD CHARACTERS WITHOUT CLAIM TO ANY PARTICULAR FONT, STYLE, SIZE, OR COLOR.

SER. NO. 85-412,228, FILED 8-31-2011.

ANGELA M. MICHELI, EXAMINING ATTORNEY



David J. Kyffers

Director of the United States Patent and Trademark Office

United States of America

United States Patent and Trademark Office



Reg. No. 4,174,365

Registered July 17, 2012

Int. Cl.: 35

SERVICE MARK

PRINCIPAL REGISTER

FOUR HUNDRED LIFE, LLC (FLORIDA LIMITED LIABILITY COMPANY), AKA THE 400 LIFE
555 WASHINGTON AVE #240
MIAMI BEACH, FL 33139

FOR: ADVERTISING AND MARKETING SERVICES PROVIDED BY MEANS OF INDIRECT METHODS OF MARKETING COMMUNICATIONS, NAMELY, SOCIAL MEDIA, SEARCH ENGINE MARKETING, INQUIRY MARKETING, INTERNET MARKETING, MOBILE MARKETING, BLOGGING AND OTHER FORMS OF PASSIVE, SHARABLE OR VIRAL COMMUNICATIONS CHANNELS; ADVERTISING AND MARKETING SERVICES, NAMELY, PROMOTING THE GOODS AND SERVICES OF OTHERS; ADVERTISING SERVICES, NAMELY, PROMOTING AND MARKETING THE GOODS AND SERVICES OF OTHERS IN THE FIELD OF ENTERTAINMENT VIA PRINT AND ELECTRONIC MEDIA; ADVERTISING, MARKETING AND PROMOTION SERVICES; ADVERTISING, PROMOTION AND MARKETING SERVICES IN THE NATURE OF E-MAIL BLAST CAMPAIGNS FOR OTHERS, IN CLASS 35 (U.S. CLS. 100, 101 AND 102).

FIRST USE 10-0-2008; IN COMMERCE 1-1-2009.

THE MARK CONSISTS OF "THE 400 LIFE" LOGO IS A SHIELD IN 3D WITH A CHROME EFFECT.

SER. NO. 85-413,013, FILED 9-1-2011.

ANN E. SAPPENFIELD, EXAMINING ATTORNEY



David J. Kyjars

Director of the United States Patent and Trademark Office

United States of America

United States Patent and Trademark Office



Reg. No. 4,174,366

Registered July 17, 2012

Int. Cl.: 41

SERVICE MARK

PRINCIPAL REGISTER

KIDVENTURE, INC. (TEXAS CORPORATION)
SUITE 100
6633 PORTWEST DRIVE
HOUSTON, TX 77024

FOR: SUMMER CAMPS, CHILDREN'S CAMP PROGRAMS IN THE NATURE OF FIELD TRIPS, SCIENCE EXPERIMENTS, ENVIRONMENTAL LEARNING, ATHLETICS, ART PROJECTS, DRAMA AND TALENT SHOWS, AND SPECIAL EVENTS IN THE NATURE OF ORGANIZING GUEST SPEAKERS, IN CLASS 41 (U.S. CLS. 100, 101 AND 107).

FIRST USE 3-1-1994; IN COMMERCE 3-1-1994.

THE MARK CONSISTS OF THE LETTERS "K" AND "V" ENCLOSED IN A SQUARE.

SER. NO. 85-413,222, FILED 9-1-2011.

C. DIONNE CLYBURN, EXAMINING ATTORNEY



David J. Kyffers

Director of the United States Patent and Trademark Office

United States of America

United States Patent and Trademark Office

TRAVELERS CLUB

Reg. No. 4,174,367

Registered July 17, 2012

Int. Cl.: 33

TRADEMARK

PRINCIPAL REGISTER

SAZERAC COMPANY, INC. (LOUISIANA CORPORATION)
3850 N. CAUSEWAY BLVD.
SUITE 1695
METAIRIE, LA 70002

FOR: GIN AND VODKA, IN CLASS 33 (U.S. CLS. 47 AND 49).

FIRST USE 4-0-2010; IN COMMERCE 4-0-2010.

THE MARK CONSISTS OF STANDARD CHARACTERS WITHOUT CLAIM TO ANY PARTICULAR FONT, STYLE, SIZE, OR COLOR.

OWNER OF U.S. REG. NO. 852,889.

SER. NO. 85-413,234, FILED 9-1-2011.

JENNY PARK, EXAMINING ATTORNEY



David J. Kybas

Director of the United States Patent and Trademark Office

United States of America

United States Patent and Trademark Office



Reg. No. 4,174,368

Registered July 17, 2012

Int. Cl.: 41

SERVICE MARK

PRINCIPAL REGISTER

TOY STUDIO MEDIA CORPORATION (DELAWARE CORPORATION)
SUITE 201
1550 N. DAMEN
CHICAGO, IL 60622

FOR: ENTERTAINMENT SERVICES, NAMELY, PROVIDING ON-LINE COMPUTER GAMES;
ON-LINE JOURNALS, NAMELY, BLOGS FEATURING INFORMATION ON ONLINE GAMES
, IN CLASS 41 (U.S. CLS. 100, 101 AND 107).

FIRST USE 12-2-2009; IN COMMERCE 12-2-2009.

NO CLAIM IS MADE TO THE EXCLUSIVE RIGHT TO USE "STUDIO", APART FROM THE
MARK AS SHOWN.

THE MARK CONSISTS OF THE STYLIZED WORDS "TOY STUDIO" WITH THE "O" IN
"TOY" DEPICTING A FOUR-HOLE BUTTON.

SER. NO. 85-413,672, FILED 9-2-2011.

SHARON MEIER, EXAMINING ATTORNEY



David J. Kyffers

Director of the United States Patent and Trademark Office

United States of America

United States Patent and Trademark Office

Home Solutions

Reg. No. 4,174,369

Registered July 17, 2012

Int. Cl.: 11

TRADEMARK

PRINCIPAL REGISTER

MURRAY FEISS IMPORT LLC (DELAWARE LIMITED LIABILITY COMPANY)
125 ROSE FEISS BOULEVARD
BRONX, NY 10454

FOR: ELECTRIC LIGHTING FIXTURES, IN CLASS 11 (U.S. CLS. 13, 21, 23, 31 AND 34).

FIRST USE 1-1-2006; IN COMMERCE 1-1-2006.

THE MARK CONSISTS OF STANDARD CHARACTERS WITHOUT CLAIM TO ANY PARTICULAR FONT, STYLE, SIZE, OR COLOR.

NO CLAIM IS MADE TO THE EXCLUSIVE RIGHT TO USE "HOME", APART FROM THE MARK AS SHOWN.

SER. NO. 85-413,814, FILED 9-2-2011.

DORITT L. CARROLL, EXAMINING ATTORNEY



David J. Kyffers

Director of the United States Patent and Trademark Office

United States of America

United States Patent and Trademark Office

NSBANK

Reg. No. 4,174,370

Registered July 17, 2012

Int. Cls.: 9 and 42

TRADEMARK

SERVICE MARK

PRINCIPAL REGISTER

ZIONS BANCORPORATION (UTAH CORPORATION)
ONE SOUTH MAIN STREET, SUITE 700
SALT LAKE CITY, UT 84111

FOR: APPLICATION SOFTWARE AND DOWNLOADABLE SOFTWARE FOR PERSONAL COMPUTERS, MOBILE DEVICES, AND TABLET DEVICES, NAMELY, SOFTWARE TO ALLOW CUSTOMERS TO ACCESS BANK ACCOUNT INFORMATION, TRANSACT BANK BUSINESS, AND ENGAGE IN CONSUMER TRANSACTIONS, IN CLASS 9 (U.S. CLS. 21, 23, 26, 36 AND 38).

FIRST USE 7-26-2011; IN COMMERCE 7-26-2011.

FOR: PROVIDING ONLINE NON-DOWNLOADABLE SOFTWARE TO ALLOW USERS OF PERSONAL COMPUTERS, MOBILE DEVICES, AND TABLET DEVICES TO ACCESS BANK ACCOUNT INFORMATION, TRANSACT BANK BUSINESS, AND ENGAGE IN CONSUMER TRANSACTIONS, IN CLASS 42 (U.S. CLS. 100 AND 101).

FIRST USE 7-26-2011; IN COMMERCE 7-26-2011.

THE MARK CONSISTS OF STANDARD CHARACTERS WITHOUT CLAIM TO ANY PARTICULAR FONT, STYLE, SIZE, OR COLOR.

SER. NO. 85-414,148, FILED 9-2-2011.

JOHN DWYER, EXAMINING ATTORNEY



David J. Kyffers

Director of the United States Patent and Trademark Office

United States of America

United States Patent and Trademark Office

KUSTUM COWBOY

Reg. No. 4,174,371

KUSTUM COWBOY CLOTHING (CALIFORNIA PARTNERSHIP)
900 ROANOKE DR. #42
MARTINEZ, CA 94553

Registered July 17, 2012

Int. Cl.: 25

FOR: CLOTHING, NAMELY, SWEATSHIRTS; HEADWEAR, NAMELY, BASEBALL CAPS;
SWIMSUITS, IN CLASS 25 (U.S. CLS. 22 AND 39).

TRADEMARK

FIRST USE 10-1-2011; IN COMMERCE 10-1-2011.

PRINCIPAL REGISTER

THE MARK CONSISTS OF STANDARD CHARACTERS WITHOUT CLAIM TO ANY PARTICULAR FONT, STYLE, SIZE, OR COLOR.

SER. NO. 85-414,218, FILED 9-2-2011.

REBECCA POVARCHUK, EXAMINING ATTORNEY



David J. Kybas

Director of the United States Patent and Trademark Office

United States of America

United States Patent and Trademark Office

THE ART & ADVENTURE OF NATURE PHOTOGRAPHY

Reg. No. 4,174,372

Registered July 17, 2012

Int. Cl.: 39

SERVICE MARK

PRINCIPAL REGISTER

BLUE, JAMES (UNITED STATES INDIVIDUAL)
200 EAST 57TH ST
APT 18A
NEW YORK, NY 10022

FOR: ARRANGING AND CONDUCTING JUNGLE AND SAFARI EXPEDITIONS FOR THE PURPOSE OF PHOTOGRAPHY, IN CLASS 39 (U.S. CLS. 100 AND 105).

FIRST USE 2-1-2011; IN COMMERCE 6-1-2011.

THE MARK CONSISTS OF STANDARD CHARACTERS WITHOUT CLAIM TO ANY PARTICULAR FONT, STYLE, SIZE, OR COLOR.

NO CLAIM IS MADE TO THE EXCLUSIVE RIGHT TO USE "NATURE PHOTOGRAPHY", APART FROM THE MARK AS SHOWN.

SER. NO. 85-414,539, FILED 9-2-2011.

VIVIAN MICZNIK FIRST, EXAMINING ATTORNEY



David J. Kyffers

Director of the United States Patent and Trademark Office

United States of America

United States Patent and Trademark Office



Reg. No. 4,174,373

Registered July 17, 2012

Int. Cl.: 35

SERVICE MARK

PRINCIPAL REGISTER

PALAZZOLA, JOSEPH (UNITED STATES INDIVIDUAL)
18312 EDDY STREET
18312 EDDY STREET, NORTHRIDGE, CA 91325
NORTHRIDGE, CA 91325

FOR: SELF-CHECKOUT RETAIL CONVENIENCE STORES, IN CLASS 35 (U.S. CLS. 100, 101 AND 102).

FIRST USE 6-15-2011; IN COMMERCE 7-25-2011.

NO CLAIM IS MADE TO THE EXCLUSIVE RIGHT TO USE "SHOP" AND "24 7" AND "SELF" AND "CONVENIENCE", APART FROM THE MARK AS SHOWN.

THE MARK CONSISTS OF THE STYLIZED TEXT "SHOP" ABOVE THE STYLIZED TEXT "SMART". UNDER THIS IS THE STYLIZED TEXT "SELF CONVENIENCE 2 U" WITH A CHECK MARK BETWEEN "SELF" AND "CONVENIENCE". TO THE RIGHT OF "SHOP SMART" IS A PARTIAL IMAGE OF A LARGE POCKET WATCH THAT BEGINS AT THE TOP OF THE "P" AND EXTENDS TO THE BOTTOM OF THE "T". THE "T" IS EXTENDED UP AS AN HOUR HAND TO THE 12TH HOUR. TO THE LEFT OF THE HOUR HAND AND CENTERED IS A STYLIZED NUMBER "24" AND TO THE RIGHT AND CENTERED IS A STYLIZED NUMBER "7".

SER. NO. 85-414,615, FILED 9-2-2011.

DAWN FELDMAN, EXAMINING ATTORNEY



David J. Kyros

Director of the United States Patent and Trademark Office

United States of America

United States Patent and Trademark Office

OX HIDE

Reg. No. 4,174,374

SEYLER, BROCK A (UNITED STATES INDIVIDUAL)
8504 INTERLOCHEN DR
NIXA, MO 65714

Registered July 17, 2012

Int. Cl.: 25

FOR: BUTTON DOWN SHIRTS; DENIMS; COTTON CAPS; T-SHIRTS, IN CLASS 25 (U.S. CLS. 22 AND 39).

TRADEMARK

FIRST USE 5-16-2011; IN COMMERCE 9-3-2011.

PRINCIPAL REGISTER

THE MARK CONSISTS OF STANDARD CHARACTERS WITHOUT CLAIM TO ANY PARTICULAR FONT, STYLE, SIZE, OR COLOR.

SER. NO. 85-414,933, FILED S.R. 9-4-2011 AM. P.R. 3-27-2012.

CHRIS WELLS, EXAMINING ATTORNEY



David J. Kyffers

Director of the United States Patent and Trademark Office

United States of America

United States Patent and Trademark Office

THE NEW MYSTICS

Reg. No. 4,174,375

SONS OF THUNDER MINISTRIES AND PUBLICATIONS, INC. (ALASKA CORPORATION)
P.O. BOX 3591

Registered July 17, 2012

SANTA CRUZ, CA 95063

Int. Cls.: 9, 16, 41 and 45

FOR: AUDIO AND VIDEO RECORDINGS FEATURING RELIGION AND RELIGIOUS MINISTRY; PRE-RECORDED CDS, VIDEO TAPES, LASER DISKS AND DVDS FEATURING RELIGION AND RELIGIOUS MINISTRY; DIGITAL MATERIALS, NAMELY, DOWNLOADABLE AUDIO AND VIDEO RECORDINGS FEATURING RELIGION AND RELIGIOUS MINISTRY, IN CLASS 9 (U.S. CLS. 21, 23, 26, 36 AND 38).

TRADEMARK

SERVICE MARK

PRINCIPAL REGISTER

FIRST USE 8-1-2005; IN COMMERCE 8-1-2005.

FOR: A SERIES OF BOOKS AND WRITTEN ARTICLES IN THE FIELD OF RELIGION AND RELIGIOUS MINISTRY; STUDY GUIDES; INSTRUCTIONAL MANUALS IN THE FIELD OF RELIGION AND RELIGIOUS MINISTRY; PAMPHLETS IN THE FIELD OF RELIGION AND RELIGIOUS MINISTRY; BROCHURES ABOUT RELIGION AND RELIGIOUS MINISTRY; MAGAZINES IN THE FIELD OF RELIGION AND RELIGIOUS MINISTRY; RELIGIOUS CIRCULAR LETTERS; RELIGIOUS BOOKS, IN CLASS 16 (U.S. CLS. 2, 5, 22, 23, 29, 37, 38 AND 50).

FIRST USE 8-1-2005; IN COMMERCE 8-1-2005.

FOR: EDUCATIONAL SERVICES, NAMELY, CONDUCTING CLASSES, SEMINARS, CONFERENCES AND WORKSHOPS IN THE FIELD OF RELIGION AND RELIGIOUS MINISTRY AND DISTRIBUTION OF COURSE MATERIAL IN CONNECTION THEREWITH; RELIGIOUS INSTRUCTION SERVICES; PROVIDING ON-LINE RELIGIOUS INSTRUCTION PROMOTING CHRISTIAN AND FAMILY VALUES, IN CLASS 41 (U.S. CLS. 100, 101 AND 107).

FIRST USE 8-1-2005; IN COMMERCE 8-1-2005.

FOR: CONDUCTING RELIGIOUS PRAYER SERVICES; MINISTERIAL SERVICES, NAMELY, HOLDING SPIRITUAL RETREATS TO ASSIST RELIGIOUS LEADERS, BOTH CLERGY AND LAY, TO DEVELOP AND ENHANCE THEIR SPIRITUAL LIVES; PROVIDING A WEBSITE FEATURING INFORMATION ABOUT RELIGIOUS BELIEF SYSTEMS; RELIGIOUS AND SPIRITUAL SERVICES, NAMELY, PROVIDING GATHERINGS AND RETREATS TO DEVELOP AND ENHANCE THE SPIRITUAL LIVES OF INDIVIDUALS; RELIGIOUS SERVICES, NAMELY, PRAYER MEETINGS, IN CLASS 45 (U.S. CLS. 100 AND 101).



David J. Kybas

Director of the United States Patent and Trademark Office

Reg. No. 4,174,375 FIRST USE 8-1-2005; IN COMMERCE 8-1-2005.

THE MARK CONSISTS OF STANDARD CHARACTERS WITHOUT CLAIM TO ANY PARTICULAR FONT, STYLE, SIZE, OR COLOR.

SER. NO. 85-414,966, FILED 9-5-2011.

KEVIN DINALLO, EXAMINING ATTORNEY

United States of America

United States Patent and Trademark Office

E-Z FORCE

Reg. No. 4,174,376

Registered July 17, 2012

Int. Cl.: 8

TRADEMARK

PRINCIPAL REGISTER

EZ FORCE INDUSTRIAL CO., LTD. (TAIWAN CORPORATION)
12F.-2, NO.324, SEC. 1, WENXIN RD.,
TAICHUNG CITY, TAIWAN 40866

FOR: HAND TOOLS, NAMELY, WRENCHES, SCREWDRIVERS, HAMMERS, HAND-POWERED STAPLE GUNS, LOCKING HAND OPERATED TOOLS, NAMELY, WRENCHES AND PLIERS, SETS OF SOCKET SPANNERS, FILES, METAL AND WOOD BORERS, SLEEVES IN THE NATURE OF CASES ESPECIALLY ADAPTED FOR HAND WRENCHES, CLAMPS, FILES, SCISSORS, PUNCHES, SHEARS, SAW BLADES FOR HAND SAWS, SCREW-THREAD CUTTERS IN THE NATURE OF METAL AND WOOD REAMERS, SLEEVES IN THE NATURE OF CASES ESPECIALLY ADAPTED FOR HAND DRILLS AND GOUGES, IN CLASS 8 (U.S. CLS. 23, 28 AND 44).

FIRST USE 8-6-2010; IN COMMERCE 5-6-2011.

THE MARK CONSISTS OF STYLIZED WORDS "E-Z FORCE".

SER. NO. 85-415,152, FILED S.R. 9-6-2011 AM. P.R. 2-28-2012.

MARCIE MILONE, EXAMINING ATTORNEY



David J. Kyffers

Director of the United States Patent and Trademark Office

United States of America

United States Patent and Trademark Office

SUBSURFER

Reg. No. 4,174,377

SUBSURFER LLC (CALIFORNIA LIMITED LIABILITY COMPANY)
1100 SEACOAST DR, #6

Registered July 17, 2012

IMPERIAL BEACH, CA 91932

Int. Cl.: 41

FOR: ENTERTAINMENT SERVICES, MAINLY LIVE PERFORMANCES BY A MUSICAL GROUP, IN CLASS 41 (U.S. CLS. 100, 101 AND 107).

SERVICE MARK

FIRST USE 1-1-2011; IN COMMERCE 1-1-2011.

PRINCIPAL REGISTER

THE MARK CONSISTS OF STANDARD CHARACTERS WITHOUT CLAIM TO ANY PARTICULAR FONT, STYLE, SIZE, OR COLOR.

SER. NO. 85-415,237, FILED 9-6-2011.

KAREN BRACEY, EXAMINING ATTORNEY



David J. Kybas

Director of the United States Patent and Trademark Office

United States of America

United States Patent and Trademark Office

E-Z FORCE

Reg. No. 4,174,378

EZ FORCE INDUSTRIAL CO., LTD. (TAIWAN CORPORATION)
12F.-2, NO.324, SEC. 1, WENXIN RD.,
TAICHUNG CITY, TAIWAN 40866

Registered July 17, 2012

Int. Cl.: 9

FOR: ELECTRIC BATTERIES; ELECTRIC BATTERIES FOR VEHICLES; BATTERIES FOR LIGHTING; BATTERY CHARGERS; BATTERY CHARGERS FOR CELL PHONES, IN CLASS 9 (U.S. CLS. 21, 23, 26, 36 AND 38).

TRADEMARK

FIRST USE 3-7-2011; IN COMMERCE 6-7-2011.

PRINCIPAL REGISTER

THE MARK CONSISTS OF STYLIZED WORD "E-Z FORCE".

SER. NO. 85-416,126, FILED S.R. 9-6-2011 AM. P.R. 2-28-2012.

MARCIE MILONE, EXAMINING ATTORNEY



David J. Kyffers

Director of the United States Patent and Trademark Office

United States of America

United States Patent and Trademark Office



Reg. No. 4,174,379

Registered July 17, 2012

Int. Cl.: 28

TRADEMARK

PRINCIPAL REGISTER

CUPID, CARL L (UNITED STATES INDIVIDUAL)
PO BOX 1054
WILKESBORO, NC 28697

FOR: CHILDREN'S MULTIPLE ACTIVITY TOYS; CHILDREN'S MULTIPLE ACTIVITY TOYS SOLD AS A UNIT WITH PRINTED BOOKS; CRIB TOYS; PLUSH DOLLS; PLUSH TOYS; STUFFED TOY ANIMALS; STUFFED TOY BEARS; STUFFED TOYS, IN CLASS 28 (U.S. CLS. 22, 23, 38 AND 50).

FIRST USE 11-1-2010; IN COMMERCE 3-12-2011.

THE MARK CONSISTS OF AN ENLARGED "C" THAT ACTS AS THE ABSTRACT TUMMY OF A TEDDY BEAR WITH AN ORANGE BLANKET EXTENDED OUT OF IT. THIS "C" ALSO ACTS AS A SLEEPER FOR A CHILD CHARACTER WITH YELLOW HAIR AND A PINK FACE. THE LETTERS "COZY TYME CUDDLERS" IN THE LOGO ARE BLACK WITH BOLD FONT. BEHIND THE LETTER "C" IN THE LOGO THERE IS A PORTION OF A TEDDY BEAR'S FACE, THIS TEDDY BEAR IS BROWN WITH BLACK FACIAL FEATURES. THE PUPILS OF THE BEAR'S EYES AND THE BACKGROUND ARE WHITE.

THE COLOR(S) BLACK, WHITE, YELLOW, BROWN, ORANGE, AND PINK IS/ARE CLAIMED AS A FEATURE OF THE MARK.

SER. NO. 85-416,165, FILED 9-6-2011.

DORITT L. CARROLL, EXAMINING ATTORNEY



David J. Kyffers

Director of the United States Patent and Trademark Office

United States of America

United States Patent and Trademark Office



Reg. No. 4,174,380

PRIME MEDICAL RESOURCES INC. (CALIFORNIA CORPORATION)
1317 NORTH SAN FERNANDO BLVD, UNIT 315
BURBANK, CA 91504

Registered July 17, 2012

Int. Cl.: 35

FOR: WHOLESALE DISTRIBUTORSHIP OF MEDICAL EQUIPMENT, IN CLASS 35 (U.S. CLS. 100, 101 AND 102).

SERVICE MARK

FIRST USE 1-0-2010; IN COMMERCE 1-0-2010.

PRINCIPAL REGISTER

NO CLAIM IS MADE TO THE EXCLUSIVE RIGHT TO USE "MEDICAL RESOURCES", APART FROM THE MARK AS SHOWN.

THE COLOR(S) RED AND WHITE IS/ARE CLAIMED AS A FEATURE OF THE MARK.

THE MARK CONSISTS OF A RED BOX ON THE LEFT SIDE WITH A LARGE "P" AND "M" IN WHITE WHERE THE "M" IS PLACED IN A WAY WHERE THE "P" CAN ALSO BE AN "R" AND ON THE RIGHT HAND SIDE, THE WORDS "PRIME MEDICAL RESOURCES" IN RED IN DESCENDING FONT SIZE WITH A WHITE BACKGROUND.

SER. NO. 85-416,268, FILED 9-7-2011.

KELLY TRUSILO, EXAMINING ATTORNEY



David J. Kybas

Director of the United States Patent and Trademark Office

United States of America

United States Patent and Trademark Office



Reg. No. 4,174,381

Registered July 17, 2012

Int. Cl.: 35

SERVICE MARK

PRINCIPAL REGISTER

SUMMIT CHURCH OF CENTRAL FLORIDA (FLORIDA CORPORATION)
735 HERNDON AVE
ORLANDO, FL 32803

FOR: CHARITABLE SERVICES, NAMELY, ORGANIZING AND CONDUCTING VOLUNTEER PROGRAMS AND COMMUNITY SERVICE PROJECTS; CHARITABLE SERVICES, NAMELY, PROVIDING A FREE ONLINE RESOURCE IN THE NATURE OF A WEBSITE FOR CONNECTING PEOPLE WHO HAVE SERVICE NEEDS WITH PEOPLE WHO ARE WILLING TO PROVIDE VOLUNTEER SERVICES; DEVELOPING AND COORDINATING VOLUNTEER PROJECTS FOR CHARITABLE ORGANIZATIONS, IN CLASS 35 (U.S. CLS. 100, 101 AND 102).

FIRST USE 1-1-2003; IN COMMERCE 1-1-2003.

THE MARK CONSISTS OF A GREEN CIRCLE CONTAINING A WHITE, THREE LEAF PLANT, WITH THE WORD "NICESERVE" STRETCHED ALONG THE OUTSIDE, LOWER RIGHT HAND SIDE OF THE CIRCLE IN GREEN LETTER.

THE COLOR(S) GREEN AND WHITE IS/ARE CLAIMED AS A FEATURE OF THE MARK.

SER. NO. 85-416,528, FILED 9-7-2011.

CHARLOTTE CORWIN, EXAMINING ATTORNEY



David J. Kyffers

Director of the United States Patent and Trademark Office

United States of America

United States Patent and Trademark Office

SOAPBOX

Reg. No. 4,174,382

RESTAURANT INTELLIGENCE AGENCY, LLC (ILLINOIS LIMITED LIABILITY COMPANY)
5006 N. CENTRAL PARK AVE.
CHICAGO, IL 60625

Registered July 17, 2012

Int. Cl.: 41

FOR: PROVIDING NON-DOWNLOADABLE ON-LINE DIGITAL MAGAZINES ABOUT RESTAURANTS, IN CLASS 41 (U.S. CLS. 100, 101 AND 107).

SERVICE MARK

FIRST USE 11-10-2010; IN COMMERCE 11-10-2010.

PRINCIPAL REGISTER

THE MARK CONSISTS OF STANDARD CHARACTERS WITHOUT CLAIM TO ANY PARTICULAR FONT, STYLE, SIZE, OR COLOR.

SER. NO. 85-416,831, FILED 9-7-2011.

WENDY GOODMAN, EXAMINING ATTORNEY



David J. Kybas

Director of the United States Patent and Trademark Office

United States of America

United States Patent and Trademark Office



Reg. No. 4,174,383

Registered July 17, 2012

Int. Cls.: 9, 12 and 35

TRADEMARK

SERVICE MARK

PRINCIPAL REGISTER

BOMBARDIER RECREATIONAL PRODUCTS INC. (CANADA CORPORATION)
726 ST-JOSEPH STREET
VALCOURT, QUEBEC, CANADA J0E2L0

FOR: ARTICLES OF PROTECTIVE CLOTHING, NAMELY, GLOVES AND BOOTS FOR WEAR BY WATERCRAFT RIDERS FOR PROTECTION AGAINST ACCIDENT OR INJURY; SIGNAL AND SPORT WHISTLES; PROGRAMMABLE LOCKING SYSTEMS CONSISTING OF ELECTRONIC CYLINDRICAL LOCKSETS AND KEYPADS; LIFE VESTS IN THE NATURE OF LIFE JACKETS; SCUBA EQUIPMENT, NAMELY, SCUBA DIVING MASKS, SCUBA GOGGLES, SNORKELS, AIR TANKS AND REGULATORS FOR USE IN SCUBA DIVING; SAFETY KITS FOR WATERCRAFT COMPRISED PRIMARILY OF WHISTLES, ROPES, PINS AND INFLATABLE FLOATATION DEVICES; MARINE DEPTH FINDERS; CELL PHONE HOLDER FOR USE IN CONNECTING CELL PHONES TO BOATS AUDIO SPEAKERS; WET SUITS, IN CLASS 9 (U.S. CLS. 21, 23, 26, 36 AND 38).

FIRST USE 9-30-2000; IN COMMERCE 9-30-2000.

FOR: PERSONAL WATERCRAFT, NAMELY, SINGLE AND MULTIPLE PASSENGER RECREATIONAL JET BOATS AND STRUCTURAL PARTS THEREFOR; BOATS; PERSONAL MARINE PROPULSION VEHICLE WITH MOTORIZED PROPELLER USED TO PULL SWIMMERS, DIVERS AND/OR SNORKELERS; FITTED AND SEMI-FITTED WATERCRAFT AND BOAT COVERS; BOAT FENDERS; HANDLE BAR GRIPS FOR PERSONAL WATERCRAFT; VEHICLE PARTS, NAMELY, REARVIEW MIRRORS; VEHICLE PARTS, NAMELY, SIDE VIEW MIRRORS; SHOCK TUBES FOR BOATS AND PERSONAL WATERCRAFT; BOAT HOOKS; RACKS FOR BOATS FOR WAKEBOARD; CUP HOLDERS FOR USE IN BOATS, IN CLASS 12 (U.S. CLS. 19, 21, 23, 31, 35 AND 44).

FIRST USE 9-30-2000; IN COMMERCE 9-30-2000.

FOR: ONLINE RETAIL STORE SERVICES FOR PERSONAL WATERCRAFT AND BOATS; ADVERTISING SERVICES, COOPERATIVE ADVERTISING OF PERSONAL WATERCRAFT AND BOATS FOR OTHERS BY MEANS OF AIRING TELEVISION ADVERTISEMENTS, RADIO ADVERTISEMENTS, PLACING NEWS PAPER ADVERTISEMENTS, CIRCULATING BROCHURES, POSTERS, BANNERS AND PROVIDING ADVERTISING INFORMATION IN THE AREA OF PERSONAL WATERCRAFT AND BOATS VIA THE INTERNET; PROMOTING THE SALE OF PERSONAL WATERCRAFT AND BOATS FOR OTHERS BY MEANS OF AIRING TELEVISION ADVERTISEMENTS, RADIO ADVERTISEMENTS, PLACING NEWS



David J. Kyffers

Director of the United States Patent and Trademark Office

Reg. No. 4,174,383 PAPER ADVERTISEMENTS, CIRCULATING BROCHURES, POSTERS, BANNERS AND PROVIDING ADVERTISING INFORMATION IN THE AREA OF PERSONAL WATERCRAFT AND BOATS VIA THE INTERNET , IN CLASS 35 (U.S. CLS. 100, 101 AND 102).

FIRST USE 9-30-2000; IN COMMERCE 9-30-2000.

OWNER OF U.S. REG. NOS. 1,532,911, 1,876,288 AND OTHERS.

THE MARK CONSISTS OF THE WORDING "SEA" AND "DOO" SEPARATED BY A SHADED CIRCLE WITH A SHADED DOLPHIN JUMPING OVER THE SHADED CIRCLE.

SER. NO. 85-417,149, FILED 9-7-2011.

DOMINIC FATHY, EXAMINING ATTORNEY

United States of America

United States Patent and Trademark Office

Think Outside the House

Reg. No. 4,174,384

Registered July 17, 2012

Int. Cl.: 36

SERVICE MARK

PRINCIPAL REGISTER

THE DAILEY GROUP, LLC (MARYLAND LIMITED LIABILITY COMPANY)
8911 RICKY TREVOR ROAD
PERRY HALL, MD 21128

FOR: APPRAISAL AND EVALUATION OF REAL ESTATE; APPRAISAL OF REAL ESTATE; ASSESSMENT AND MANAGEMENT OF REAL ESTATE; CLASSIFIED REAL ESTATE LISTINGS OF APARTMENT RENTALS AND HOUSING RENTALS; COMMERCIAL AND RESIDENTIAL REAL ESTATE AGENCY SERVICES; EVALUATION OF REAL PROPERTY; HOUSING SERVICES, NAMELY, REAL PROPERTY ACQUISITION AND CONSUMER FINANCING TO FACILITATE HOME OWNERSHIP; LEASE OF REAL ESTATE; LEASING OF REAL ESTATE; LEASING OF REAL PROPERTY; PROVIDING A DATABASE OF INFORMATION ABOUT RESIDENTIAL REAL ESTATE LISTINGS IN DIFFERENT NEIGHBORHOODS AND COMMUNITIES; PROVIDING A DATABASE OF RESIDENTIAL REAL ESTATE LISTINGS WITHIN NEIGHBORHOODS AND COMMUNITIES SPECIFICALLY IDENTIFIED BY USERS; PROVIDING AN INTERNET WEBSITE PORTAL OFFERING INFORMATION IN THE FIELDS OF REAL ESTATE CONCERNING THE PURCHASE AND SALE OF NEW AND RESALE HOMES AND CONDOS; PROVIDING INFORMATION IN THE FIELD OF REAL ESTATE BY MEANS OF LINKING THE WEB SITE TO OTHER WEB SITES FEATURING REAL ESTATE INFORMATION; PROVIDING INFORMATION IN THE FIELD OF REAL ESTATE VIA THE INTERNET; PROVIDING REAL ESTATE LISTINGS AND REAL ESTATE INFORMATION VIA THE INTERNET; PROVIDING REAL ESTATE LISTINGS VIA THE INTERNET; REAL ESTATE ACQUISITION SERVICES; REAL ESTATE AGENCIES; REAL ESTATE APPRAISAL; REAL ESTATE APPRAISAL AND VALUATION; REAL ESTATE BROKERAGE; REAL ESTATE CONSULTANCY; REAL ESTATE CONSULTATION; REAL ESTATE ESCROW SERVICES; REAL ESTATE FINANCING SERVICES; REAL ESTATE LISTING; REAL ESTATE LISTING SERVICES FOR HOUSING RENTALS AND APARTMENT RENTALS; REAL ESTATE MANAGEMENT CONSULTATION; REAL ESTATE MULTIPLE LISTING SERVICES; REAL ESTATE PROCUREMENT FOR OTHERS; REAL ESTATE RENTAL SERVICES, NAMELY, RENTAL OF RESIDENTIAL HOUSING; REAL ESTATE SERVICE, NAMELY, RENTAL PROPERTY MANAGEMENT; RESIDENTIAL REAL ESTATE AGENCY SERVICES, IN CLASS 36 (U.S. CLS. 100, 101 AND 102).



David J. Kybas

Director of the United States Patent and Trademark Office

FIRST USE 8-1-2009; IN COMMERCE 8-1-2009.

THE MARK CONSISTS OF STANDARD CHARACTERS WITHOUT CLAIM TO ANY PARTICULAR FONT, STYLE, SIZE, OR COLOR.

Reg. No. 4,174,384 SER. NO. 85-417,254, FILED 9-7-2011.

DAWN FELDMAN, EXAMINING ATTORNEY

United States of America

United States Patent and Trademark Office

Farm Strong

Reg. No. 4,174,385

Registered July 17, 2012

Int. Cl.: 35

SERVICE MARK

PRINCIPAL REGISTER

IOWA FARM BUREAU FEDERATION (IOWA NON-PROFIT CORPORATION)
5400 UNIVERSITY AVENUE
WEST DES MOINES, IA 50266

FOR: PROMOTING THE BUSINESS, ECONOMIC, SOCIAL, EDUCATIONAL, AGRICULTURAL AND OTHER INTERESTS OF FARMERS AND RANCHERS, IN CLASS 35 (U.S. CLS. 100, 101 AND 102).

FIRST USE 8-11-2011; IN COMMERCE 8-11-2011.

THE MARK CONSISTS OF STANDARD CHARACTERS WITHOUT CLAIM TO ANY PARTICULAR FONT, STYLE, SIZE, OR COLOR.

NO CLAIM IS MADE TO THE EXCLUSIVE RIGHT TO USE "FARM", APART FROM THE MARK AS SHOWN.

SER. NO. 85-417,910, FILED 9-8-2011.

TINA MAI, EXAMINING ATTORNEY



David J. Kyffers

Director of the United States Patent and Trademark Office

United States of America

United States Patent and Trademark Office

PI DELTA PSI

Reg. No. 4,174,386

PI DELTA PSI FRATERNITY, INC. (NEW YORK CORPORATION)

Registered July 17, 2012

P.O. BOX 520269
FLUSHING, NY 11352

Int. Cls.: 14, 25 and 35

FOR: JEWELRY, NECKLACES, WATCHES, WATCH STRAPS AND BRACELETS; CLOCKS, IN CLASS 14 (U.S. CLS. 2, 27, 28 AND 50).

TRADEMARK

FIRST USE 2-20-1994; IN COMMERCE 2-20-1994.

SERVICE MARK

FOR: T-SHIRTS, SHORTS, COATS, JACKETS, VESTS, SWEATSHIRTS, SWEATPANTS, JERSEYS, SPORTSWEAR, NAMELY, WARM-UP SUITS, PULLOVERS, HATS, CAPS, POLO SHIRTS, TANKTOPS, SWEATERS, RAINCOATS, SWIMWEAR, ROBES AND PAJAMAS, NECKWEAR, NECKTIES, SCARVES, GLOVES, MITTENS, IN CLASS 25 (U.S. CLS. 22 AND 39).

PRINCIPAL REGISTER

FIRST USE 2-20-1994; IN COMMERCE 2-20-1994.

FOR: ASSOCIATION SERVICES, NAMELY, ORGANIZING CHAPTERS OF A FRATERNITY AND PROMOTING THE INTERESTS OF THE MEMBERS THEREOF, IN CLASS 35 (U.S. CLS. 100, 101 AND 102).

FIRST USE 2-20-1994; IN COMMERCE 2-20-1994.

THE MARK CONSISTS OF STANDARD CHARACTERS WITHOUT CLAIM TO ANY PARTICULAR FONT, STYLE, SIZE, OR COLOR.

SER. NO. 85-417,955, FILED 9-8-2011.

CHERYL CLAYTON, EXAMINING ATTORNEY



David J. Kyros

Director of the United States Patent and Trademark Office

United States of America

United States Patent and Trademark Office



NAHC

NATIONAL ASSOCIATION OF HOUSING COOPERATIVES

Reg. No. 4,174,387

Registered July 17, 2012

Int. Cl.: 35

SERVICE MARK

PRINCIPAL REGISTER

NATIONAL ASSOCIATION OF HOUSING COOPERATIVES (DELAWARE CORPORATION)
SUITE 700
1444 I STREET NW
WASHINGTON, DC 200056542

FOR: ASSOCIATION SERVICES, NAMELY, PROMOTING THE INTERESTS OF HOUSING COOPERATIVES, COOPERATIVE HOUSING ASSOCIATIONS, AND PROFESSIONALS IN THE FIELD OF COOPERATIVE HOUSING, IN CLASS 35 (U.S. CLS. 100, 101 AND 102).

FIRST USE 12-0-2008; IN COMMERCE 12-0-2008.

OWNER OF U.S. REG. NOS. 3,108,512 AND 3,149,306.

NO CLAIM IS MADE TO THE EXCLUSIVE RIGHT TO USE "ASSOCIATION", APART FROM THE MARK AS SHOWN.

THE MARK CONSISTS OF AN ARCH DESIGN STACKED ON TOP OF THE LITERAL PORTION "NAHC" WHICH IS IN TURN STACKED ABOVE THE LITERAL PORTION "NATIONAL ASSOCIATION OF HOUSING COOPERATIVES" WHICH IS BORDERED ABOVE AND BELOW BY PARALLEL LINES.

SEC. 2(F) AS TO "NATIONAL ASSOCIATION OF HOUSING COOPERATIVES".

SER. NO. 85-418,038, FILED 9-8-2011.

DAVID ELTON, EXAMINING ATTORNEY



David J. Kybas

Director of the United States Patent and Trademark Office

United States of America

United States Patent and Trademark Office



NAHC

NATIONAL ASSOCIATION OF HOUSING COOPERATIVES

Reg. No. 4,174,388

Registered July 17, 2012

Int. Cl.: 41

SERVICE MARK

PRINCIPAL REGISTER

NATIONAL ASSOCIATION OF HOUSING COOPERATIVES (DELAWARE CORPORATION)
SUITE 700
1444 I STREET NW
WASHINGTON, DC 200056542

FOR: EDUCATIONAL SERVICES, NAMELY, ARRANGING AND CONDUCTING EDUCATIONAL CONFERENCES, SEMINARS, WORKSHOPS, CLASSES AND SYMPOSIA IN THE FIELDS OF COOPERATIVE HOUSING AND COOPERATIVE HOUSING MANAGEMENT, IN CLASS 41 (U.S. CLS. 100, 101 AND 107).

FIRST USE 12-0-2008; IN COMMERCE 12-0-2008.

OWNER OF U.S. REG. NOS. 3,108,512 AND 3,149,306.

THE MARK CONSISTS OF AN ARCH DESIGN STACKED ON TOP OF THE LITERAL PORTION "NAHC" WHICH IS IN TURN STACKED ABOVE THE LITERAL PORTION "NATIONAL ASSOCIATION OF HOUSING COOPERATIVES" WHICH IS BORDERED ABOVE AND BELOW BY PARALLEL LINES.

SEC. 2(F) AS TO "NATIONAL ASSOCIATION OF HOUSING COOPERATIVES".

SER. NO. 85-418,074, FILED 9-8-2011.

DAVID ELTON, EXAMINING ATTORNEY



David J. Kyffers

Director of the United States Patent and Trademark Office

United States of America

United States Patent and Trademark Office

SPARK E*

Reg. No. 4,174,389

WORLD WIDE IMPORTS, LLC (NEW JERSEY LIMITED LIABILITY COMPANY)
215 GODWIN AVENUE

Registered July 17, 2012

MIDLAND PARK, NJ 07432

Int. Cl.: 11

FOR: SPARK IGNITERS FOR GAS APPLIANCES, IN CLASS 11 (U.S. CLS. 13, 21, 23, 31 AND 34).

TRADEMARK

FIRST USE 10-1-2010; IN COMMERCE 10-1-2010.

PRINCIPAL REGISTER

NO CLAIM IS MADE TO THE EXCLUSIVE RIGHT TO USE "SPARK", APART FROM THE MARK AS SHOWN.

THE MARK CONSISTS OF ALL CAPITAL LETTERS, A SINGLE SPACING BETWEEN THE LETTER "K" AND "E" WITH AN ASTERISK IMMEDIATELY FOLLOWING.

SER. NO. 85-418,088, FILED 9-8-2011.

ZACHARY BELLO, EXAMINING ATTORNEY



David J. Kybas

Director of the United States Patent and Trademark Office

United States of America

United States Patent and Trademark Office



Reg. No. 4,174,390

Registered July 17, 2012

Int. Cl.: 15

TRADEMARK

PRINCIPAL REGISTER

FLETCHER SCOTT M. (UNITED STATES INDIVIDUAL), DBA HOBO KING GUITAR CO.
28 MONTAGUE ST.
BINGHAMTON, NY 13901

FOR: ELECTRIC GUITARS, IN CLASS 15 (U.S. CLS. 2, 21 AND 36).

FIRST USE 1-1-2011; IN COMMERCE 1-1-2011.

NO CLAIM IS MADE TO THE EXCLUSIVE RIGHT TO USE "GUITAR CO.", APART FROM THE MARK AS SHOWN.

THE MARK CONSISTS OF A HERALDIC COAT OF ARMS WITH THE WORDS "HOBO KING GUITAR CO." IN BANNERS ACROSS THE BOTTOM OF THE COAT OF ARMS. THE TOP OF THE COAT OF ARMS CONTAINS A CROWN WITH A "P" IN THE CENTER OF THE CROWN. THERE IS A SMOKE STACK WITH SMOKE TO THE TOP RIGHT SIDE OF THE COAT OF ARMS AND PINECONES ON THE LEFT SIDE OF THE TOP OF THE COAT OF ARMS. IN THE CENTER OF THE COAT OF ARMS IS A BOXCAR UNDER A STARRY SKY ON RAILROAD TRACKS WITH "OXO" UNDER THE BOXCAR. ORNATE LEAF DESIGNS SURROUND THE COAT OF ARMS.

SER. NO. 85-418,807, FILED 9-9-2011.

DAWN FELDMAN, EXAMINING ATTORNEY



David J. Kybas

Director of the United States Patent and Trademark Office

United States of America

United States Patent and Trademark Office

OLD SCHOOL MALIBU

Reg. No. 4,174,391

ROMY DETRIXHE (UNITED STATES INDIVIDUAL), DBA OLD SCHOOL MALIBU
21221 PACIFIC COAST HWY
MALIBU, CA 90265

Registered July 17, 2012

Int. Cl.: 25

FOR: HOODED SWEATSHIRTS; JACKETS; SHORTS; SWEATERS; SWEATPANTS;
SWEATSHIRTS; T-SHIRTS; TOPS, IN CLASS 25 (U.S. CLS. 22 AND 39).

TRADEMARK

FIRST USE 1-1-2009; IN COMMERCE 1-1-2009.

PRINCIPAL REGISTER

OWNER OF U.S. REG. NO. 4,066,771.

NO CLAIM IS MADE TO THE EXCLUSIVE RIGHT TO USE "MALIBU", APART FROM THE
MARK AS SHOWN.

THE MARK CONSISTS OF "OLD SCHOOL MALIBU" STYLIZED.

SER. NO. 85-419,057, FILED 9-9-2011.

JANICE KIM, EXAMINING ATTORNEY



David J. Kyffers

Director of the United States Patent and Trademark Office

United States of America

United States Patent and Trademark Office



Reg. No. 4,174,392

Registered July 17, 2012

Int. Cl.: 37

SERVICE MARK

PRINCIPAL REGISTER

POWERHOUSE PARTNERS, L.L.C. (IOWA LIMITED LIABILITY COMPANY)
13044 NE 14TH STREET
ALLEMAN, IA 50007

FOR: CONSTRUCTION MANAGEMENT, INCLUDING THE COORDINATION AND DEPLOYMENT OF RESOURCES AND CONTRACTORS, TECHNICIANS AND SPECIALISTS, AND BUILDING CONSTRUCTION CONSULTING SERVICES, BOTH INVOLVING THE CONSTRUCTION AND REMODELING OF RETAIL LOCATIONS AND KIOSKS, THE INSTALLATION OF LIGHTING AND FIXTURES, AND THE INSTALLATION OF SIGNAGE, IN CLASS 37 (U.S. CLS. 100, 103 AND 106).

FIRST USE 1-1-2011; IN COMMERCE 1-1-2011.

NO CLAIM IS MADE TO THE EXCLUSIVE RIGHT TO USE "RETAIL SERVICES", APART FROM THE MARK AS SHOWN.

THE MARK CONSISTS OF A STYLIZED EXCLAMATION MARK PLACED WITHIN A CIRCLE AND THE WORDS "POWERHOUSE RETAIL SERVICES" APPEARING IN A STYLIZED FONT.

SER. NO. 85-419,133, FILED 9-9-2011.

BARNEY CHARLON, EXAMINING ATTORNEY



David J. Kyffers

Director of the United States Patent and Trademark Office

United States of America

United States Patent and Trademark Office

MONSAC

Reg. No. 4,174,393

MONSAC INTERNATIONAL LLC (DELAWARE LIMITED LIABILITY COMPANY)
75 OXFORD DRIVE
MOONACHIE, NJ 07074

Registered July 17, 2012

Int. Cl.: 18

FOR: HANDBAGS, WALLETS; SMALL LEATHER GOODS, NAMELY, PURSES, AND CREDIT CARD CASES, IN CLASS 18 (U.S. CLS. 1, 2, 3, 22 AND 41).

TRADEMARK

FIRST USE 12-1-1998; IN COMMERCE 12-1-1998.

PRINCIPAL REGISTER

THE MARK CONSISTS OF STANDARD CHARACTERS WITHOUT CLAIM TO ANY PARTICULAR FONT, STYLE, SIZE, OR COLOR.

THE ENGLISH TRANSLATION OF "MONSAC" IS "MY BAG".

SER. NO. 85-419,240, FILED 9-9-2011.

GISELLE AGOSTO, EXAMINING ATTORNEY



David J. Kyffers

Director of the United States Patent and Trademark Office

United States of America

United States Patent and Trademark Office



Reg. No. 4,174,394

Registered July 17, 2012

Int. Cls.: 25 and 35

TRADEMARK

SERVICE MARK

PRINCIPAL REGISTER

VELVET SERIES SDN. BHD. (MALAYSIA CORPORATION)
11-1, JALAN 3/62A
BANDAR MENJALARA
KEPONG, KUALA LUMPUR, MALAYSIA 52100

FOR: READY-MADE CLOTHING, NAMELY, DRESSES, FROCKS, CARDIGANS, COATS, CULOTTES, RAINCOATS, JACKETS, SUITS, SWIMWEAR, BIKINIS, ENSEMBLES CONSISTING OF TOPS AND BOTTOMS, COMBINATIONS, PULLOVERS, JUMPERS, SHIRTS, SKIRTS, TROUSERS, SLACKS, JEANS, SHORTS, BLOUSES AND BELTS; KNITTED ARTICLES OF CLOTHING, NAMELY, SWEATERS, JERSEYS AND POLO SHIRTS; MASQUERADE COSTUMES; HEADWEAR, NAMELY, HATS AND CAPS; ARTICLES OF SPORTS CLOTHING, NAMELY, SHIRTS, TOPS, PANTS, HATS AND FOOTWEAR; ARTICLES OF CLOTHING MADE FROM WOVEN MATERIALS, NAMELY, SHIRTS HATS, SWEATERS AND PANTS; FOOTWEAR, NAMELY, BOOTS, SHOES AND SLIPPERS; HEADWEAR FOR GIRLS, NAMELY, HATS AND CAPS, IN CLASS 25 (U.S. CLS. 22 AND 39).

FOR: RETAIL STORE SERVICES, WHOLESALE STORE SERVICES, AND MARKETING SERVICES, ALL FEATURING CLOTHING, FOOTWEAR, HEADWEAR, PRECIOUS METALS AND THEIR ALLOYS, JEWELRY, IMITATION AND COSTUME JEWELRY, PRECIOUS STONES, LEATHER AND IMITATION LEATHER, HANDBAGS, UMBRELLAS, PARASOLS, WALKING STICKS, AND LEATHER AND IMITATION LEATHER TRUNKS AND TRAVELING BAGS; MAIL ORDER SERVICES, TELEPHONE ORDERING SERVICES, AND ONLINE RETAIL STORE SERVICES, ALL FEATURING CLOTHING; DIRECT MAIL ADVERTISING SERVICES; BUSINESS MANAGEMENT AND ADVICE; ADVERTISING AND PUBLICITY SERVICES; BUSINESS MERCHANDISING DISPLAY SERVICES; ADVERTISING, MARKETING AND PROMOTING THE GOODS AND SERVICES OF OTHERS VIA BILLBOARDS AND PROMOTIONAL EXHIBITIONS; MARKET ANALYSIS AND RESEARCH; EXPORT AND IMPORT AGENCIES; PROCUREMENT SERVICES, NAMELY, PURCHASING CLOTHING FOR OTHERS; WINDOW DRESSING AND DISPLAY ARRANGEMENT SERVICES; ADVISORY AND CONSULTANCY SERVICES RELATING TO RETAIL STORE SERVICES, WHOLESALE STORE SERVICES, ONLINE RETAIL STORE SERVICES, ADVERTISING SERVICES, PUBLICITY SERVICES AND PROMOTIONAL SERVICES, IN CLASS 35 (U.S. CLS. 100, 101 AND 102).

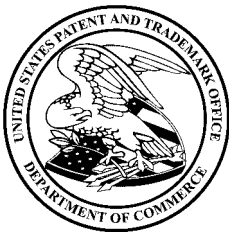

David J. Kyffers

Director of the United States Patent and Trademark Office

OWNER OF MALAYSIA REG. NO. 03007667, DATED 6-25-2003, EXPIRES 6-25-2013.

OWNER OF MALAYSIA REG. NO. 03007666, DATED 6-25-2003, EXPIRES 6-25-2013.

Reg. No. 4,174,394 NO CLAIM IS MADE TO THE EXCLUSIVE RIGHT TO USE "GIRLS", APART FROM THE MARK AS SHOWN.

THE MARK CONSISTS OF THE WORDING, "GIRLS GIRLS", WITH ONE "GIRLS" ABOVE AND THE OTHER "GIRLS" BELOW THE DESIGN OF A LARGE HEART COMPRISED OF CONCENTRIC SHADED HEARTS, WITH SEVEN SMALL HEARTS ON EITHER SIDE OF THE LARGE HEART DESIGN

SER. NO. 85-419,492, FILED 9-9-2011.

BARBARA A. GOLD, EXAMINING ATTORNEY

United States of America

United States Patent and Trademark Office

Gigafy

Reg. No. 4,174,395

Registered July 17, 2012

Int. Cl.: 42

SERVICE MARK

PRINCIPAL REGISTER

MEGUERDI INC. (CALIFORNIA CORPORATION)
17239 VENTURA BLVD.
ENCINO, CA 91316

FOR: COMPUTER SERVICES, NAMELY, CREATING AN ON-LINE COMMUNITY FOR REGISTERED USERS TO PARTICIPATE IN DISCUSSIONS, GET FEEDBACK FROM THEIR PEERS, FORM VIRTUAL COMMUNITIES, AND ENGAGE IN SOCIAL NETWORKING SERVICES IN THE FIELD OF MUSIC; PROVIDING A WEBSITE THAT GIVES USERS THE ABILITY TO VOTE FOR THEIR FAVORITE MUSICAL ARTISTS TO GO SEE THEM PERFORM A SHOW OR GIG, IN CLASS 42 (U.S. CLS. 100 AND 101).

FIRST USE 5-12-2011; IN COMMERCE 5-12-2011.

THE MARK CONSISTS OF STANDARD CHARACTERS WITHOUT CLAIM TO ANY PARTICULAR FONT, STYLE, SIZE, OR COLOR.

SER. NO. 85-419,642, FILED 9-10-2011.

ASMAT KHAN, EXAMINING ATTORNEY



David J. Kybas

Director of the United States Patent and Trademark Office

United States of America

United States Patent and Trademark Office

CREATIVE CREATURES

Reg. No. 4,174,396

Registered July 17, 2012

Int. Cls.: 35 and 41

SERVICE MARK

PRINCIPAL REGISTER

SIMMONDS, MARK (UNITED KINGDOM INDIVIDUAL)
MEADOW LODGE
ORCHARD LANE STEWKLEY
BEDS, UNITED KINGDOM LU70HS AND

HANNE, KRISTIANSEN (DENMARK INDIVIDUAL)
CALLE FREIXURES 10
BARCELONA, SPAIN 5E-08003

FOR: ADVERTISING, MARKETING AND PROMOTION SERVICES; BUSINESS ADMINISTRATION AND MANAGEMENT; BUSINESS MANAGEMENT, NAMELY, BUSINESS INFORMATION MANAGEMENT; BUSINESS MANAGEMENT CONSULTANCY SERVICES, NAMELY, PROVIDING PSYCHOMETRIC TESTING FOR EFFECTIVE EXECUTIVE AND STAFF RECRUITMENT AND SELECTION, ADVISING AND CONSULTING IN RELATION TO EFFECTIVE EXECUTIVE AND STAFF RECRUITMENT, MAXIMIZING EXECUTIVE AND STAFF CAPABILITY, AND DEVELOPMENT OF INNOVATION AND CREATIVITY AMONG EXECUTIVES AND STAFF; CONDUCTING BUSINESS AND MARKET RESEARCH SURVEYS; CONDUCTING EMPLOYEE SURVEYS FOR OTHERS FOR PURPOSES OF IMPROVING EMPLOYEE PERFORMANCE AND MORALE; BUSINESS OPERATION, BUSINESS ADMINISTRATION AND OFFICE FUNCTIONS; HUMAN RESOURCES SERVICES, NAMELY, OFFERING OF ASSESSMENTS AND PSYCHOMETRIC SURVEYS IN THE FIELD OF INNOVATION AND CREATIVITY FOR THE PURPOSE OF EFFECTIVE EXECUTIVE AND STAFF RECRUITMENT AND SELECTION, IN CLASS 35 (U.S. CLS. 100, 101 AND 102).

FOR: BUSINESS EDUCATION AND TRAINING SERVICES, NAMELY, DEVELOPING AND PROVIDING CUSTOMIZED TRAINING PROGRAMS AND WORKSHOPS RELATING TO MANAGEMENT AND DEVELOPMENT OF INNOVATION AND CREATIVITY AMONG EXECUTIVES AND STAFF, PROVIDING TRAINING AND PROFESSIONAL, PERSONAL AND PEER TO PEER COACHING IN EMPLOYMENT SKILLS AND IN RELATION TO CAREER OPPORTUNITIES; EDUCATIONAL AND ENTERTAINMENT SERVICES, NAMELY, PROVIDING EVENTS RELATING TO INNOVATION AND CREATION OF NEW IDEAS FOR SOCIAL ENTERTAINMENT AND EDUCATIONAL PURPOSES; PROVISION OF INFORMATION RELATING TO ORGANIZING COMMUNITY SPORTING AND CULTURAL ACTIVITIES, CONTESTS AND GAMES, IN CLASS 41 (U.S. CLS. 100, 101 AND 107).



David J. Kyjars

Director of the United States Patent and Trademark Office

THE MARK CONSISTS OF STANDARD CHARACTERS WITHOUT CLAIM TO ANY PARTICULAR FONT, STYLE, SIZE, OR COLOR.

Reg. No. 4,174,396 OWNER OF ERPN CMNTY TM OFC REG. NO. 008285181, DATED 12-1-2009, EXPIRES 5-7-2019.

NO CLAIM IS MADE TO THE EXCLUSIVE RIGHT TO USE "CREATIVE", APART FROM THE MARK AS SHOWN.

SER. NO. 85-419,709, FILED 9-11-2011.

TINA BROWN, EXAMINING ATTORNEY

United States of America

United States Patent and Trademark Office

UKORA

Reg. No. 4,174,397

KUIS, BAS (NETHERLANDS INDIVIDUAL)
2552 N WEIL ST
MILWAUKEE, WI 53212

Registered July 17, 2012

Int. Cl.: 9

FOR: DOWNLOADABLE SOFTWARE FOR DEVELOPING AND MANAGING DYNAMIC WEBSITES, IN CLASS 9 (U.S. CLS. 21, 23, 26, 36 AND 38).

TRADEMARK

FIRST USE 5-11-2011; IN COMMERCE 8-6-2011.

PRINCIPAL REGISTER

THE MARK CONSISTS OF STANDARD CHARACTERS WITHOUT CLAIM TO ANY PARTICULAR FONT, STYLE, SIZE, OR COLOR.

THE WORDING "UKORA" HAS NO MEANING IN A FOREIGN LANGUAGE.

SER. NO. 85-420,139, FILED 9-12-2011.

MAUREEN DALL, EXAMINING ATTORNEY



David J. Kyffers

Director of the United States Patent and Trademark Office

United States of America

United States Patent and Trademark Office

Infinity By Powerhouse

Reg. No. 4,174,398

POWERHOUSE PARTNERS, L.L.C. (IOWA LIMITED LIABILITY COMPANY)
13044 NE 14TH STREET
ALLEMAN, IA 50007

Registered July 17, 2012

Int. Cl.: 42

FOR: PROVIDING AN INTERACTIVE WEB SITE THAT ENABLES USERS TO ENTER, ACCESS, TRACK, MANAGE, MONITOR, AND GENERATE INFORMATION AND REPORTS REGARDING THEIR RETAIL AND COMMERCIAL BUILDING CONSTRUCTION PROJECTS, IN CLASS 42 (U.S. CLS. 100 AND 101).

SERVICE MARK

PRINCIPAL REGISTER

FIRST USE 7-1-2011; IN COMMERCE 7-1-2011.

THE MARK CONSISTS OF STANDARD CHARACTERS WITHOUT CLAIM TO ANY PARTICULAR FONT, STYLE, SIZE, OR COLOR.

SER. NO. 85-420,212, FILED 9-12-2011.

BARNEY CHARLON, EXAMINING ATTORNEY



David J. Kyffers

Director of the United States Patent and Trademark Office

United States of America

United States Patent and Trademark Office

RETAX
FUNDING 

Reg. No. 4,174,399

RETAX FUNDING, LLC (TEXAS LIMITED LIABILITY COMPANY)
14785 PRESTON RD., SUITE 495
DALLAS, TX 75254

Registered July 17, 2012

Int. Cl.: 36

FOR: FINANCIAL AND INVESTMENT SERVICES, NAMELY, ASSET AND INVESTMENT ACQUISITION, CONSULTATION, ADVISORY AND DEVELOPMENT; FINANCING SERVICES, IN CLASS 36 (U.S. CLS. 100, 101 AND 102).

SERVICE MARK

FIRST USE 7-15-2005; IN COMMERCE 6-27-2006.

PRINCIPAL REGISTER

NO CLAIM IS MADE TO THE EXCLUSIVE RIGHT TO USE "FUNDING", APART FROM THE MARK AS SHOWN.

THE MARK CONSISTS OF THE STYLIZED WORD "RETAX" APPEARING OVER THE STYLIZED WORD "FUNDING". TO THE RIGHT OF THE WORDING IS A SHADED, VERTICAL RECTANGLE.

SER. NO. 85-420,363, FILED 9-12-2011.

ROBIN CHOSID, EXAMINING ATTORNEY



David J. Kyffers

Director of the United States Patent and Trademark Office

United States of America

United States Patent and Trademark Office

JobHabitat

Reg. No. 4,174,400

Registered July 17, 2012

Int. Cl.: 35

SERVICE MARK

PRINCIPAL REGISTER

JOB HABITAT, INC. (CALIFORNIA CORPORATION)
2030 MAIN ST.
IRVINE, CA 92614

FOR: PROVIDING ON-LINE INFORMATION IN THE FIELDS OF EMPLOYMENT, RECRUITMENT, CAREERS, PERSONAL ISSUES RELATED TO CAREERS AND WORK LIFE, JOB RESOURCES, JOB LISTINGS AND RESUMES; PROVIDING ON-LINE INTERACTIVE EMPLOYMENT COUNSELING AND RECRUITMENT SERVICES; PROVIDING ON-LINE EMPLOYMENT PLACEMENT SERVICES, NAMELY, RESUME MATCHING SERVICES VIA A GLOBAL COMPUTER NETWORK, IN CLASS 35 (U.S. CLS. 100, 101 AND 102).

FIRST USE 5-1-2011; IN COMMERCE 6-15-2011.

THE MARK CONSISTS OF STANDARD CHARACTERS WITHOUT CLAIM TO ANY PARTICULAR FONT, STYLE, SIZE, OR COLOR.

SER. NO. 85-420,427, FILED 9-12-2011.

HOWARD B. LEVINE, EXAMINING ATTORNEY



David J. Kyffers

Director of the United States Patent and Trademark Office

United States of America

United States Patent and Trademark Office

ATHLETES TOUCH

Reg. No. 4,174,401

Registered July 17, 2012

Int. Cl.: 35

SERVICE MARK

PRINCIPAL REGISTER

ATHLETES TOUCH, LLC (CALIFORNIA LIMITED LIABILITY COMPANY)
8730 WILSHIRE BLVD. SUITE 400
BEVERLY HILLS, CA 90211

FOR: BUSINESS NETWORKING SERVICES, NAMELY, BUSINESS NETWORKING SERVICES FOR FORMER PROFESSIONAL AND COLLEGE ATHLETES THROUGH LIVE MEETINGS AND FUNCTIONS, IN CLASS 35 (U.S. CLS. 100, 101 AND 102).

FIRST USE 4-1-2009; IN COMMERCE 4-1-2009.

THE MARK CONSISTS OF STANDARD CHARACTERS WITHOUT CLAIM TO ANY PARTICULAR FONT, STYLE, SIZE, OR COLOR.

SER. NO. 85-420,628, FILED 9-12-2011.

DORITT L. CARROLL, EXAMINING ATTORNEY



David J. Kyffers

Director of the United States Patent and Trademark Office

United States of America

United States Patent and Trademark Office

JACK HENRY BANKING

Reg. No. 4,174,402

Registered July 17, 2012

Int. Cl.: 9

TRADEMARK

PRINCIPAL REGISTER

JACK HENRY SOFTWARE/COMMLINK, L.P. (TEXAS LIMITED PARTNERSHIP)
663 W. HWY. 60
P.O. BOX 807
MONETT, MO 65708

FOR: COMPUTER PROGRAMS FOR FINANCIAL MANAGEMENT APPLICATIONS USED BY BANKS, NAMELY, CUSTOMER ACCOUNTING SOFTWARE AND ADD-ON MODULES DESIGNED TO SUPPLEMENT THAT ACCOUNTING SOFTWARE, IN CLASS 9 (U.S. CLS. 21, 23, 26, 36 AND 38).

FIRST USE 7-31-2007; IN COMMERCE 7-31-2007.

THE MARK CONSISTS OF STANDARD CHARACTERS WITHOUT CLAIM TO ANY PARTICULAR FONT, STYLE, SIZE, OR COLOR.

OWNER OF U.S. REG. NO. 3,186,295.

NO CLAIM IS MADE TO THE EXCLUSIVE RIGHT TO USE "BANKING", APART FROM THE MARK AS SHOWN.

"JACK HENRY" DOES NOT IDENTIFY A LIVING INDIVIDUAL.

SER. NO. 85-420,631, FILED 9-12-2011.

DEZMONA MIZELLE, EXAMINING ATTORNEY



David J. Kyffers

Director of the United States Patent and Trademark Office

United States of America

United States Patent and Trademark Office



Reg. No. 4,174,403

Registered July 17, 2012

Int. Cl.: 41

SERVICE MARK

PRINCIPAL REGISTER

ACQUISITION MEDIA, LLC (ARIZONA LIMITED LIABILITY COMPANY)
SUITE 300
7144 E. STETSON DRIVE
SCOTTSDALE, AZ 85251

FOR: PROVIDING A WEBSITE FEATURING ON-LINE DOCUMENTS AND APPLICATIONS
PERTAINING TO PAYDAY LOANS, IN CLASS 41 (U.S. CLS. 100, 101 AND 107).

FIRST USE 12-1-2010; IN COMMERCE 12-1-2010.

THE MARK CONSISTS OF A RECTANGULAR CARRIER IN BLUE, CONTAINING A SILVER,
WHITE AND RED STOPWATCH AT APPROXIMATELY 48 SECONDS ON THE LEFT, THE
WORDS "SUPERSONICPAYDAY" IN WHITE AND LIGHT BLUE AND "WHEN YOU NEED
A PAYDAY LOAN" IN LIGHT BLUE.

THE COLOR(S) BLUE, WHITE, SILVER, RED AND LIGHT BLUE IS/ARE CLAIMED AS A
FEATURE OF THE MARK.

SER. NO. 85-420,737, FILED S.R. 9-12-2011 AM. P.R. 1-4-2012.

REGINA DRUMMOND, EXAMINING ATTORNEY



David J. Kyffers

Director of the United States Patent and Trademark Office

United States of America

United States Patent and Trademark Office

Planning Seattle's Sweetest Weddings

Reg. No. 4,174,404

KELSEY EADS (UNITED STATES INDIVIDUAL)
3213 W. WHEELER ST, #187
SEATTLE, WA 98199

Registered July 17, 2012

Int. Cl.: 41

FOR: WEDDING AND PARTY PLANNING, COORDINATION AND CONSULTATION SERVICES, IN CLASS 41 (U.S. CLS. 100, 101 AND 107).

SERVICE MARK

FIRST USE 10-26-2010; IN COMMERCE 1-6-2011.

PRINCIPAL REGISTER

THE MARK CONSISTS OF STANDARD CHARACTERS WITHOUT CLAIM TO ANY PARTICULAR FONT, STYLE, SIZE, OR COLOR.

SER. NO. 85-420,956, FILED S.R. 9-13-2011 AM. P.R. 3-3-2012.

AMY C. KEAN, EXAMINING ATTORNEY



David J. Kybas

Director of the United States Patent and Trademark Office

United States of America

United States Patent and Trademark Office

WE USA

Reg. No. 4,174,405

CHANG, EVIKE (UNITED STATES INDIVIDUAL)
136 S. SAN GABRIEL BLVD.
SAN GABRIEL, CA 91776

Registered July 17, 2012

Int. Cl.: 28

FOR: AIRSOFT GUNS FOR RECREATIONAL PURPOSES, IN CLASS 28 (U.S. CLS. 22, 23, 38 AND 50).

TRADEMARK

FIRST USE 1-1-2011; IN COMMERCE 1-1-2011.

PRINCIPAL REGISTER

THE MARK CONSISTS OF STANDARD CHARACTERS WITHOUT CLAIM TO ANY PARTICULAR FONT, STYLE, SIZE, OR COLOR.

NO CLAIM IS MADE TO THE EXCLUSIVE RIGHT TO USE "USA", APART FROM THE MARK AS SHOWN.

SER. NO. 85-421,498, FILED 9-13-2011.

DANNEAN HETZEL, EXAMINING ATTORNEY



David J. Kyffers

Director of the United States Patent and Trademark Office

United States of America

United States Patent and Trademark Office

PERSONEER

Reg. No. 4,174,406

COLUMBUS GROUP, LLC (INDIANA LIMITED LIABILITY COMPANY)
817 PAYNE STREET
TELL CITY, IN 47586

Registered July 17, 2012

Int. Cl.: 35

FOR: EMPLOYMENT COUNSELING, RECRUITING, PLACEMENT, STAFFING AND CAREER NETWORKING SERVICES, IN CLASS 35 (U.S. CLS. 100, 101 AND 102).

SERVICE MARK

FIRST USE 10-1-1998; IN COMMERCE 10-1-1998.

PRINCIPAL REGISTER

THE MARK CONSISTS OF STANDARD CHARACTERS WITHOUT CLAIM TO ANY PARTICULAR FONT, STYLE, SIZE, OR COLOR.

SER. NO. 85-422,163, FILED 9-14-2011.

JOHN KELLY, EXAMINING ATTORNEY



David J. Kyffers

Director of the United States Patent and Trademark Office

United States of America

United States Patent and Trademark Office



Reg. No. 4,174,407

Registered July 17, 2012

Int. Cls.: 35, 41 and 45

SERVICE MARK

PRINCIPAL REGISTER

REMARRIAGE LLC (MARYLAND LIMITED LIABILITY COMPANY)
P.O. BOX 1
WEST FRIENDSHIP, MD 21794

FOR: ADVERTISING AND DIRECTORY SERVICES, NAMELY, PROMOTING THE SERVICES OF OTHERS BY PROVIDING A WEB PAGE FEATURING LINKS TO THE WEBSITES OF OTHERS; ORGANIZATION OF EVENTS, EXHIBITIONS, FAIRS AND SHOWS FOR COMMERCIAL, PROMOTIONAL AND ADVERTISING PURPOSES; ORGANIZATION OF FAIRS AND EXHIBITIONS FOR COMMERCIAL AND ADVERTISING PURPOSES; ORGANIZING EXHIBITIONS FOR WEDDINGS FOR SECOND MARRIAGES AND STEPFAMILIES, SHOWCASING FLOWERS, FASHION, WEDDING CAKES, JEWELRY, AND PHOTOGRAPHY; PROMOTING THE SALE OF GOODS AND SERVICES OF OTHERS BY ORGANIZING SHOWCASE EVENTS FOR SECOND MARRIAGES AND STEPFAMILIES, SHOWCASING FLOWERS, FASHION, WEDDING CAKES, JEWELRY, AND PHOTOGRAPHY; PROMOTING, ADVERTISING AND MARKETING ON-LINE WEB SITES OF OTHERS; PROVIDING A WEB SITE FEATURING CONSUMER INFORMATION ON VARIOUS PUBLICATIONS AND PROVIDING HYPERLINKS TO ON-LINE RETAILERS THAT SELL THE PUBLICATIONS; PROVIDING A WEBSITE FOR CONNECTING SELLERS WITH BUYERS; PROVIDING CONSUMER INFORMATION AND RELATED NEWS IN THE FIELD OF SECOND MARRIAGES AND STEPFAMILIES, SHOWCASING FLOWERS, FASHION, WEDDING CAKES, JEWELRY, AND PHOTOGRAPHY, IN CLASS 35 (U.S. CLS. 100, 101 AND 102).

FIRST USE 3-3-2011; IN COMMERCE 3-3-2011.



David J. Kybas

Director of the United States Patent and Trademark Office

FOR: PARTY AND WEDDING PLANNING, COORDINATION AND CONSULTATION SERVICES; PROVIDING A WEBSITE FEATURING NONDOWNLOADABLE PUBLICATIONS IN THE NATURE OF MAGAZINES, BOOKS AND ARTICLES PROVIDING ADVICE, INFORMATION AND PLANNING IN THE FIELD OF MARRIAGE, FAMILY RELATIONSHIPS, WEDDING PLANNING; PROVIDING A WEBSITE FEATURING RESOURCES, NAMELY, NON-DOWNLOADABLE PUBLICATIONS IN THE NATURE OF MAGAZINES, BOOKS AND ARTICLES PROVIDING ADVICE, INFORMATION AND PLANNING IN THE FIELD OF MARRIAGE, FAMILY RELATIONSHIPS, WEDDING PLANNING; PROVIDING INFORMATION REGARDING WEDDING PLANNING FOR WEDDING PARTIES; WEDDING PLANNING AND COORDINATION SERVICES; ORGANIZING EXHIBITIONS FOR EDUCATIONAL AND ENTERTAINMENT PURPOSES FEATURING SPEAKERS THAT GIVE EDUCATIONAL DISCUSSIONS IN THE FIELDS OF ESTATE PLANNING, MEDIATION, FAMILY LAW, STEP FAMILY COUNSELING, FINANCIAL ADVICE AND MORTGAGE CREDIT INFORMATION;

Reg. No. 4,174,407 EDUCATIONAL AND ENTERTAINMENT SERVICES, NAMELY, PROVIDING EDUCATIONAL SPEAKERS IN THE FIELDS OF ESTATE PLANNING, MEDIATION, FAMILY LAW, STEP FAMILY COUNSELING, FINANCIAL ADVICE AND MORTGAGE CREDIT INFORMATION, IN CLASS 41 (U.S. CLS. 100, 101 AND 107).

FIRST USE 4-15-2011; IN COMMERCE 4-15-2011.

FOR: CONSULTING IN THE FIELD OF PERSONAL RELATIONSHIPS; INFORMATION IN THE FIELD OF PARENTING CONCERNING INTRAFAMILY RELATIONSHIPS; ONLINE INFORMATION SERVICES IN THE FIELD OF INTRAFAMILY RELATIONSHIPS AS THEY RELATE TO DIVORCE; PROVIDING A WEB SITE FEATURING INFORMATION AND CONTENT IN THE FIELDS OF PERSONAL RELATIONSHIPS, DATING AND FASHION; PROVIDING A WEB SITE FEATURING INFORMATION AND CONTENT IN THE FIELDS OF PERSONAL RELATIONSHIPS, PERSONAL GROWTH AND MOTIVATION, AND SELF-FULFILLMENT; PROVIDING A WEB SITE FEATURING INFORMATION ON LOVE, ROMANCE AND INTERPERSONAL RELATIONSHIPS, IN CLASS 45 (U.S. CLS. 100 AND 101).

FIRST USE 3-3-2011; IN COMMERCE 3-3-2011.

NO CLAIM IS MADE TO THE EXCLUSIVE RIGHT TO USE "REMARRIAGE SHOWCASE" AND "BRIDES" , APART FROM THE MARK AS SHOWN.

THE MARK CONSISTS OF A FANCIFUL DESIGN WITH A LEFT-HAND CURLY VINE AND A RIGHT-HAND CURLY VINE WITH THE WORDS, "REMARRIAGE SHOWCASE FOR ENCORE BRIDES" BELOW THE VINE DESIGN.

SER. NO. 85-422,183, FILED 9-14-2011.

LEIGH LOWRY, EXAMINING ATTORNEY

United States of America

United States Patent and Trademark Office

REMARRIAGE SHOWCASE FOR ENCORE BRIDES

Reg. No. 4,174,408

Registered July 17, 2012

Int. Cls.: 35, 41 and 45

SERVICE MARK

PRINCIPAL REGISTER

REMARRIAGE LLC (MARYLAND LIMITED LIABILITY COMPANY)
P.O. BOX 1
WEST FRIENDSHIP, MD 21794

FOR: ADVERTISING AND DIRECTORY SERVICES, NAMELY, PROMOTING THE SERVICES OF OTHERS BY PROVIDING A WEB PAGE FEATURING LINKS TO THE WEBSITES OF OTHERS; ORGANIZATION OF EVENTS, EXHIBITIONS, FAIRS AND SHOWS FOR COMMERCIAL, PROMOTIONAL AND ADVERTISING PURPOSES; ORGANIZATION OF FAIRS AND EXHIBITIONS FOR COMMERCIAL AND ADVERTISING PURPOSES; ORGANIZING EXHIBITIONS FOR WEDDINGS FOR SECOND MARRIAGES AND STEPFAMILIES, SHOWCASING FLOWERS, FASHION, WEDDING CAKES, JEWELRY, AND PHOTOGRAPHY; PROMOTING THE SALE OF GOODS AND SERVICES OF OTHERS BY ORGANIZING SHOWCASE EVENTS FOR SECOND MARRIAGES AND STEPFAMILIES, SHOWCASING FLOWERS, FASHION, WEDDING CAKES, JEWELRY, AND PHOTOGRAPHY; PROMOTING, ADVERTISING AND MARKETING ON-LINE WEB SITES OF OTHERS; PROVIDING A WEB SITE FEATURING CONSUMER INFORMATION ON VARIOUS PUBLICATIONS AND PROVIDING HYPERLINKS TO ON-LINE RETAILERS THAT SELL THE PUBLICATIONS; PROVIDING A WEBSITE FOR CONNECTING SELLERS WITH BUYERS; PROVIDING CONSUMER INFORMATION AND RELATED NEWS IN THE FIELD OF SECOND MARRIAGES AND STEPFAMILIES, SHOWCASING FLOWERS, FASHION, WEDDING CAKES, JEWELRY, AND PHOTOGRAPHY, IN CLASS 35 (U.S. CLS. 100, 101 AND 102).

FIRST USE 3-3-2011; IN COMMERCE 3-3-2011.



David J. Kybas

Director of the United States Patent and Trademark Office

FOR: PARTY AND WEDDING PLANNING, COORDINATION AND CONSULTATION SERVICES; PROVIDING A WEBSITE FEATURING NONDOWNLOADABLE PUBLICATIONS IN THE NATURE OF MAGAZINES, BOOKS AND ARTICLES PROVIDING ADVICE, INFORMATION AND PLANNING IN THE FIELD OF MARRIAGE, FAMILY RELATIONSHIPS, WEDDING PLANNING; PROVIDING A WEBSITE FEATURING RESOURCES, NAMELY, NON-DOWNLOADABLE PUBLICATIONS IN THE NATURE OF MAGAZINES, BOOKS AND ARTICLES PROVIDING ADVICE, INFORMATION AND PLANNING IN THE FIELD OF MARRIAGE, FAMILY RELATIONSHIPS, WEDDING PLANNING; PROVIDING INFORMATION REGARDING WEDDING PLANNING FOR WEDDING PARTIES; WEDDING PLANNING AND COORDINATION SERVICES; ORGANIZING EXHIBITIONS FOR EDUCATIONAL AND ENTERTAINMENT PURPOSES FEATURING SPEAKERS THAT GIVE EDUCATIONAL DISCUSSIONS IN THE FIELDS OF ESTATE PLANNING, MEDIATION, FAMILY LAW, STEP FAMILY COUNSELING, FINANCIAL ADVICE AND MORTGAGE CREDIT INFORMATION;

Reg. No. 4,174,408 EDUCATIONAL AND ENTERTAINMENT SERVICES, NAMELY, PROVIDING EDUCATIONAL SPEAKERS IN THE FIELDS OF ESTATE PLANNING, MEDIATION, FAMILY LAW, STEP FAMILY COUNSELING, FINANCIAL ADVICE AND MORTGAGE CREDIT INFORMATION, IN CLASS 41 (U.S. CLS. 100, 101 AND 107).

FIRST USE 4-15-2011; IN COMMERCE 4-15-2011.

FOR: CONSULTING IN THE FIELD OF PERSONAL RELATIONSHIPS; INFORMATION IN THE FIELD OF PARENTING CONCERNING INTRAFAMILY RELATIONSHIPS; ONLINE INFORMATION SERVICES IN THE FIELD OF INTRAFAMILY RELATIONSHIPS AS THEY RELATE TO DIVORCE; PROVIDING A WEB SITE FEATURING INFORMATION AND CONTENT IN THE FIELDS OF PERSONAL RELATIONSHIPS, DATING AND FASHION; PROVIDING A WEB SITE FEATURING INFORMATION AND CONTENT IN THE FIELDS OF PERSONAL RELATIONSHIPS, PERSONAL GROWTH AND MOTIVATION, AND SELF-FULFILLMENT; PROVIDING A WEB SITE FEATURING INFORMATION ON LOVE, ROMANCE AND INTERPERSONAL RELATIONSHIPS, IN CLASS 45 (U.S. CLS. 100 AND 101).

FIRST USE 3-3-2011; IN COMMERCE 3-3-2011.

THE MARK CONSISTS OF STANDARD CHARACTERS WITHOUT CLAIM TO ANY PARTICULAR FONT, STYLE, SIZE, OR COLOR.

NO CLAIM IS MADE TO THE EXCLUSIVE RIGHT TO USE "REMARRIAGE SHOWCASE" AND "BRIDES", APART FROM THE MARK AS SHOWN.

SER. NO. 85-422,214, FILED 9-14-2011.

LEIGH LOWRY, EXAMINING ATTORNEY

United States of America

United States Patent and Trademark Office

BOOM!
BY CINDY JOSEPH

Reg. No. 4,174,409

CINDY JOSEPH (UNITED STATES INDIVIDUAL)
147 SHONNARD TERRACE
YONKERS, NY 10701

Registered July 17, 2012

Int. Cl.: 3

FOR: COSMETICS; NON-MEDICATED SKIN CARE PREPARATIONS, IN CLASS 3 (U.S. CLS. 1, 4, 6, 50, 51 AND 52).

TRADEMARK

FIRST USE 4-28-2010, THE MARK WAS FIRST USED ANYWHERE IN A DIFFERENT FORM OTHER THAN THAT SOUGHT TO BE REGISTERED AT LEAST AS EARLY AS 09/02/2009.; IN COMMERCE 4-28-2010, THE MARK WAS FIRST USED IN COMMERCE IN A DIFFERENT FORM OTHER THAN THAT SOUGHT TO BE REGISTERED AT LEAST AS EARLY AS 09/02/2009..

PRINCIPAL REGISTER

OWNER OF U.S. REG. NO. 3,710,613.

THE COLOR(S) RED, PINK AND BLACK IS/ARE CLAIMED AS A FEATURE OF THE MARK.

THE NAME(S), PORTRAIT(S), AND/OR SIGNATURE(S) SHOWN IN THE MARK IDENTIFIES A LIVING INDIVIDUAL, WHOSE CONSENT(S) TO REGISTER IS MADE OF RECORD.

THE MARK CONSISTS OF THE FOLLOWING THE WORDING "BOOM!" WITH THE FIRST "O" SUBSTITUTED BY A RED CIRCLE AND THE SECOND "O" SUBSTITUTED BY A PINK CIRCLE. THE LETTERS "B" AND "M", AND THE EXCLAMATION POINT ARE IN BLACK. THE WORDING "BY CINDY JOSEPH" IS UNDERNEATH THE WORDING "BOOM!" ALSO IN BLACK.



SER. NO. 85-422,580, FILED 9-14-2011.

JANET LEE, EXAMINING ATTORNEY

David J. Kybas

Director of the United States Patent and Trademark Office

United States of America

United States Patent and Trademark Office



Reg. No. 4,174,410

Registered July 17, 2012

Int. Cl.: 35

SERVICE MARK

PRINCIPAL REGISTER

NEW CITY CONNECTION ENT.; INC (NEW YORK CORPORATION)
146
79 PINE STREET
NEW YORK, NY 11226

FOR: MANAGEMENT OF PERFORMING AND RECORDING ARTISTS, IN CLASS 35 (U.S. CLS. 100, 101 AND 102).

FIRST USE 1-1-1996; IN COMMERCE 1-1-1996.

THE MARK CONSISTS OF A BIG APPLE WITH A FLEUR DE LIS SYMBOL EMBEDDED IN THE MIDDLE OF IT. AROUND THE APPLE IS THE STYLIZED TEXT "NEW CITY CONNECTION", ALSO WITH A G-NOTE SYMBOL ON EACH SIDE OF THE APPLE.

SER. NO. 85-422,603, FILED 9-14-2011.

BARNEY CHARLON, EXAMINING ATTORNEY



David J. Kybas

Director of the United States Patent and Trademark Office

United States of America

United States Patent and Trademark Office



Reg. No. 4,174,411

POWERHOUSE PARTNERS, L.L.C. (IOWA LIMITED LIABILITY COMPANY)
13044 NE 14TH STREET
ALLEMAN, IA 50007

Registered July 17, 2012

Int. Cl.: 42

FOR: PROVIDING AN INTERACTIVE WEB SITE THAT ENABLES USERS TO ENTER, ACCESS, TRACK, MANAGE, MONITOR, AND GENERATE INFORMATION AND REPORTS REGARDING THEIR RETAIL AND COMMERCIAL BUILDING CONSTRUCTION PROJECTS, IN CLASS 42 (U.S. CLS. 100 AND 101).

SERVICE MARK

PRINCIPAL REGISTER

FIRST USE 7-1-2011; IN COMMERCE 7-1-2011.

THE MARK CONSISTS OF THE WORDS "INFINITY BY POWERHOUSE" IN STYLIZED LETTERING WITH THE FIRST "I" IN THE WORD "INFINITY" APPEARING AS A STYLIZED EXCLAMATION MARK. A CIRCLE APPEARS OVER THE FIRST THREE LETTERS OF THE WORD "INFINITY".

SER. NO. 85-422,632, FILED 9-14-2011.

BARNEY CHARLON, EXAMINING ATTORNEY



David J. Kyjars

Director of the United States Patent and Trademark Office

United States of America

United States Patent and Trademark Office

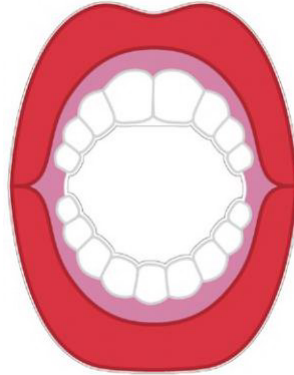

Reg. No. 4,174,412

Registered July 17, 2012

Int. Cl.: 9

TRADEMARK

PRINCIPAL REGISTER

ROBERTSON, TIM (UNITED KINGDOM INDIVIDUAL)
1 COTTAGE CLOSE
RUISLIP, MIDDLESEX, UNITED KINGDOM HA47JE

FOR: TIMERS; WATER TIMERS; SHOWER TIMERS; TIMERS FOR USE WHILE BRUSHING TEETH, IN CLASS 9 (U.S. CLS. 21, 23, 26, 36 AND 38).

PRIORITY CLAIMED UNDER SEC. 44(D) ON UNITED KINGDOM APPLICATION NO. 2589983, FILED 8-26-2011, REG. NO. 2589983, DATED 11-4-2011, EXPIRES 8-3-2021.

THE COLOR(S) RED, PINK, AND WHITE IS/ARE CLAIMED AS A FEATURE OF THE MARK.

THE MARK CONSISTS OF THE IMAGE OF AN OPEN HUMAN MOUTH WITH RED LIPS PINK GUMS AND WHITE TEETH.

SER. NO. 85-422,768, FILED 9-14-2011.

LAURIE KAUFMAN, EXAMINING ATTORNEY



David J. Kybas

Director of the United States Patent and Trademark Office

United States of America

United States Patent and Trademark Office

PETUNIA

Reg. No. 4,174,413

Registered July 17, 2012

Int. Cls.: 9 and 18

TRADEMARK

PRINCIPAL REGISTER

PETUNIA PICKLE BOTTOM CORPORATION (CALIFORNIA CORPORATION)
6320 CANOGA AVENUE
SUITE 1650
WOODLAND HILLS, CA 91367

FOR: CELL PHONE CASES; TELEPHONE CASES; COMPUTER CASES; LAPTOP BAGS; TABLET COMPUTER CASES; COMPUTER BAGS; EYE GLASS CASES; LAPTOP SLEEVES; AND TECHNOLOGY CASES, NAMELY, CELL PHONE CASES, TELEPHONE CASES, COMPUTER CASES, TABLET COMPUTER CASES, AND CASES FOR MP3 PLAYERS, IN CLASS 9 (U.S. CLS. 21, 23, 26, 36 AND 38).

FIRST USE 3-22-2006; IN COMMERCE 3-22-2006.

FOR: LUGGAGE; TRAVEL BAGS; GARMENT BAGS FOR TRAVEL; ALL PURPOSE SPORTS BAGS; OVERNIGHT BAGS; BACK PACKS; DUFFLE BAGS; SUITCASES; SHOULDER BAGS; TOTE BAGS; FABRIC TOTE BAGS; SCHOOL BAGS; COSMETIC BAGS SOLD EMPTY; HAND BAGS; BABY BACK PACKS; BABY CARRYING BAGS; DIAPER BAGS; FABRIC DIAPER BAGS; DIAPER BAGS INCORPORATING AN ATTACHED FLAP THAT MAY BE USED AS CHANGING PAD; DIAPER BAGS COMBINED WITH BACK PACKS; DIAPER BAGS INCORPORATING COMPARTMENTS FOR HOLDING BABY BOTTLES AND POCKET COMPARTMENTS; FRONT BABY CARRIERS WORN ON THE BODY AND ACCESSORIES THEREFOR, NAMELY, STRAPS, POCKETS, AND LINERS; BACK BABY SLING BAGS AND ACCESSORIES THEREFOR, NAMELY, STRAPS, POCKETS, AND LINERS; PURSES; WALLETS; POCKET BAGS IN THE NATURE OF POCKET WALLETS; POWDER ROOM BAGS IN THE NATURE OF COSMETIC BAGS SOLD EMPTY; CASES FOR BABY WIPES SOLD EMPTY; SATCHELS; TRAIN CASES IN THE NATURE OF TRUNKS; HAT BAGS IN THE NATURE OF HAT BOXES; OVERSIZED CRESCENT SHAPED SHOULDER BAGS; CLUTCHES; COIN PURSES; WRISTLET BAGS; BEACH TOTE BAGS; CROSS BODY BAGS IN THE NATURE OF SLING BAGS; SLING BAGS; MESSENGER BAGS; REUSABLE SHOPPING TOTE BAGS; SHOULDER BAGS; CARRYALLS; HIP BAGS; AND ROLLER LUGGAGE, IN CLASS 18 (U.S. CLS. 1, 2, 3, 22 AND 41).

FIRST USE 3-22-2006; IN COMMERCE 3-22-2006.

THE MARK CONSISTS OF STANDARD CHARACTERS WITHOUT CLAIM TO ANY PARTICULAR FONT, STYLE, SIZE, OR COLOR.



David J. Kybas

Director of the United States Patent and Trademark Office

Reg. No. 4,174,413 OWNER OF U.S. REG. NOS. 2,590,549, 3,289,096 AND OTHERS.

SER. NO. 85-422,970, FILED 9-14-2011.

NICHOLAS COLEMAN, EXAMINING ATTORNEY

United States of America

United States Patent and Trademark Office



Reg. No. 4,174,414

Registered July 17, 2012

Int. Cls.: 41 and 43

SERVICE MARK

PRINCIPAL REGISTER

PACIFIC INSTITUTE OF CULINARY ARTS INC. (CANADA CORPORATION)
101 - 1505 WEST 2ND AVENUE
VANCOUVER, BC, CANADA V6H3Y4

FOR: EDUCATIONAL SERVICES, NAMELY, CONDUCTING COURSES OF INSTRUCTION, SEMINARS AND DEMONSTRATIONS IN THE FIELD OF CULINARY ARTS AND THE MANAGEMENT AND OPERATION OF RESTAURANTS, IN CLASS 41 (U.S. CLS. 100, 101 AND 107).

FOR: PROVIDING ON-LINE INFORMATION RELATING TO FOOD, BEVERAGE, COOKING, BAKING AND RECIPES, IN CLASS 43 (U.S. CLS. 100 AND 101).

OWNER OF CANADA REG. NO. TMA483,766, DATED 10-8-1997, EXPIRES 10-8-2012.

OWNER OF U.S. REG. NO. 3,130,796.

NO CLAIM IS MADE TO THE EXCLUSIVE RIGHT TO USE "INSTITUTE OF CULINARY ARTS", APART FROM THE MARK AS SHOWN.

THE MARK CONSISTS OF THE WORDS "PACIFIC INSTITUTE" DISPLAYED ABOVE THE WORD "OF" WHICH IS DISPLAYED ABOVE "CULINARY ARTS".

SER. NO. 85-423,009, FILED 9-14-2011.

REGINA DRUMMOND, EXAMINING ATTORNEY



David J. Kybas

Director of the United States Patent and Trademark Office

United States of America

United States Patent and Trademark Office

WATER SLOG

Reg. No. 4,174,415

COMPETITIVE ACTION SPORTS, L.L.C. (OKLAHOMA LIMITED LIABILITY COMPANY)
6000 OAK TREE DRIVE
EDMOND, OK 73003

Registered July 17, 2012

Int. Cl.: 28

FOR: EXERCISE EQUIPMENT, NAMELY, RESISTIVE EXERCISE APPARATUS FOR STRENGTHENING AND CONDITIONING INDIVIDUALS, IN CLASS 28 (U.S. CLS. 22, 23, 38 AND 50).

TRADEMARK

FIRST USE 5-5-2011; IN COMMERCE 5-5-2011.

PRINCIPAL REGISTER

THE MARK CONSISTS OF STANDARD CHARACTERS WITHOUT CLAIM TO ANY PARTICULAR FONT, STYLE, SIZE, OR COLOR.

NO CLAIM IS MADE TO THE EXCLUSIVE RIGHT TO USE "WATER", APART FROM THE MARK AS SHOWN.

SER. NO. 85-423,776, FILED S.R. 9-15-2011 AM. P.R. 9-19-2011.

REGINA DRUMMOND, EXAMINING ATTORNEY



David J. Kyffers

Director of the United States Patent and Trademark Office

United States of America

United States Patent and Trademark Office

n1 Health

Reg. No. 4,174,416

Registered July 17, 2012

Int. Cl.: 35

SERVICE MARK

PRINCIPAL REGISTER

N1 HEALTH LLC (VIRGINIA LIMITED LIABILITY COMPANY)
6641 W. BROAD STREET, SUITE 250
RICHMOND, VA 23230

FOR: MARKETING AND BUSINESS MANAGEMENT CONSULTANCY, IN CLASS 35 (U.S. CLS. 100, 101 AND 102).

FIRST USE 6-3-2011; IN COMMERCE 6-3-2011.

THE MARK CONSISTS OF STANDARD CHARACTERS WITHOUT CLAIM TO ANY PARTICULAR FONT, STYLE, SIZE, OR COLOR.

NO CLAIM IS MADE TO THE EXCLUSIVE RIGHT TO USE "HEALTH", APART FROM THE MARK AS SHOWN.

SER. NO. 85-424,423, FILED 9-16-2011.

HENRY S. ZAK, EXAMINING ATTORNEY



David J. Kyffers

Director of the United States Patent and Trademark Office

United States of America

United States Patent and Trademark Office



Reg. No. 4,174,417

GOURMET PIZZA COMPANY, L.L.C. (ARIZONA LIMITED LIABILITY COMPANY)
4001 NORTH 87TH STREET
SCOTTSDALE, AZ 85251

Registered July 17, 2012

Int. Cl.: 43

FOR: RESTAURANT SERVICES; TAKE-OUT RESTAURANT SERVICES, IN CLASS 43 (U.S. CLS. 100 AND 101).

SERVICE MARK

FIRST USE 3-0-2001; IN COMMERCE 3-0-2001.

PRINCIPAL REGISTER

NO CLAIM IS MADE TO THE EXCLUSIVE RIGHT TO USE "PIZZA JOINT" OR "SLICES", APART FROM THE MARK AS SHOWN.

THE MARK CONSISTS OF THE WORDS "A UNIQUE STYLE PIZZA JOINT" CURVED ACROSS THE TOP EDGE OF A DRAWING OF A SLICE OF PIZZA OVER WHICH THE WAVY AND STYLIZED WORD "SLICES" IS SUPERIMPOSED, WITH A WAVY SHADOWED LINE DIRECTLY ABOVE AND BELOW THE WORD "SLICES".

SER. NO. 85-424,457, FILED 9-16-2011.

ANDREW LEASER, EXAMINING ATTORNEY



David J. Kyffers

Director of the United States Patent and Trademark Office

United States of America

United States Patent and Trademark Office

PIGLET PLUNGE

Reg. No. 4,174,418

SPRINGBOK GROUP (UTAH LIMITED LIABILITY COMPANY)
380 WEST 200 SOUTH, #303
SALT LAKE CITY, UT 84101

Registered July 17, 2012

Int. Cl.: 41

FOR: ORGANIZING SPORTING AND ATHLETIC EVENTS, NAMELY, MUD RUN OR WALK AND OBSTACLE RACE, IN CLASS 41 (U.S. CLS. 100, 101 AND 107).

SERVICE MARK

FIRST USE 5-1-2010; IN COMMERCE 6-1-2010.

PRINCIPAL REGISTER

THE MARK CONSISTS OF STANDARD CHARACTERS WITHOUT CLAIM TO ANY PARTICULAR FONT, STYLE, SIZE, OR COLOR.

SER. NO. 85-424,566, FILED 9-16-2011.

CARRIE GENOVESE, EXAMINING ATTORNEY



David J. Kyffers

Director of the United States Patent and Trademark Office

United States of America

United States Patent and Trademark Office



Reg. No. 4,174,419

Registered July 17, 2012

Int. Cl.: 41

SERVICE MARK

PRINCIPAL REGISTER

CALIFORNIA INTERSCHOLASTIC FEDERATION (CALIFORNIA NON-PROFIT ORGANIZATION)
4658 DUCKHORN DRIVE
SACRAMENTO, CA 95834

FOR: ENCOURAGING PARTICIPATION IN HIGH SCHOOL SPORTS COMPETITIONS AND EVENTS BY ESTABLISHING RULES AND PROVIDING GOVERNANCE FOR THE COMPETITIONS AND EVENTS; PROVIDING A WEBSITE FEATURING INFORMATION RELATING TO HIGH SCHOOL SPORTS; AND PROVIDING ON-LINE NEWSLETTERS IN THE FIELD OF HIGH SCHOOL SPORTS, IN CLASS 41 (U.S. CLS. 100, 101 AND 107).

FIRST USE 0-0-1950; IN COMMERCE 0-0-1950.

OWNER OF U.S. REG. NO. 1,691,152.

THE MARK CONSISTS OF THE STYLIZED WORDING "CIF".

SER. NO. 85-424,619, FILED 9-16-2011.

DAWN HAN, EXAMINING ATTORNEY



David J. Kyffers

Director of the United States Patent and Trademark Office

United States of America

United States Patent and Trademark Office

Quick and Easy Products

Reg. No. 4,174,420

Registered July 17, 2012

Int. Cl.: 35

SERVICE MARK

PRINCIPAL REGISTER

QUICK AND EASY PRODUCTS, LLC (RHODE ISLAND LIMITED LIABILITY COMPANY),
DBA QUICK AND EASY PRODUCTS
PO BOX 141
WAKEFIELD, RI 02880

FOR: PROMOTING THE SALE OF GOODS AND SERVICES OF OTHERS BY MEANS OF
IN-STORE PLACEMENT AND INTERNET SALES AND/OR PROVIDING COUPONS BY
ELECTRONIC DELIVERY TO COMPUTERS OR MOBILE DEVICES, IN CLASS 35 (U.S.
CLS. 100, 101 AND 102).

FIRST USE 8-22-2011; IN COMMERCE 8-22-2011.

THE MARK CONSISTS OF STANDARD CHARACTERS WITHOUT CLAIM TO ANY PAR-
TICULAR FONT, STYLE, SIZE, OR COLOR.

NO CLAIM IS MADE TO THE EXCLUSIVE RIGHT TO USE "PRODUCTS", APART FROM
THE MARK AS SHOWN.

SER. NO. 85-424,884, FILED 9-16-2011.

CHRIS WELLS, EXAMINING ATTORNEY



David J. Kyffers

Director of the United States Patent and Trademark Office

United States of America

United States Patent and Trademark Office



Reg. No. 4,174,421

Registered July 17, 2012

Int. Cl.: 35

SERVICE MARK

PRINCIPAL REGISTER

ALZHEIMER'S IMPACT MOVEMENT (ILLINOIS NON-PROFIT CORPORATION)
SUITE 1700
225 N. MICHIGAN AVENUE
CHICAGO, IL 606017633

FOR: POLITICAL ACTION COMMITTEE SERVICES, NAMELY, PROMOTING IN THE FIELD OF POLITICS THE INTERESTS OF THOSE AFFECTED BY NEURODEGENERATIVE DISORDERS, IN CLASS 35 (U.S. CLS. 100, 101 AND 102).

FIRST USE 8-2-2010; IN COMMERCE 8-2-2010.

NO CLAIM IS MADE TO THE EXCLUSIVE RIGHT TO USE "ALZHEIMER'S" AND "PAC", APART FROM THE MARK AS SHOWN.

THE MARK CONSISTS OF THE TERM "AIM PAC", THE WORDS "ALZHEIMER'S IMPACT MOVEMENT" AND A DESIGN COMPOSED OF FIVE POINTED STARS IN A CIRCLE.

SER. NO. 85-424,940, FILED 9-16-2011.

NAKIA HENRY, EXAMINING ATTORNEY



David J. Kyffers

Director of the United States Patent and Trademark Office

United States of America

United States Patent and Trademark Office



Reg. No. 4,174,422

Registered July 17, 2012

Int. Cl.: 35

SERVICE MARK

PRINCIPAL REGISTER

ALZHEIMER'S IMPACT MOVEMENT (ILLINOIS NON-PROFIT CORPORATION)
SUITE 1700
225 N. MICHIGAN AVENUE
CHICAGO, IL 606017633

FOR: LOBBYING SERVICES, NAMELY, PROMOTING THE INTERESTS OF THOSE WITH NEURODEGENERATIVE DISORDERS IN THE FIELDS OF LEGISLATION AND REGULATION, IN CLASS 35 (U.S. CLS. 100, 101 AND 102).

FIRST USE 8-2-2010; IN COMMERCE 8-2-2010.

NO CLAIM IS MADE TO THE EXCLUSIVE RIGHT TO USE "ALZHEIMER'S", APART FROM THE MARK AS SHOWN.

THE MARK CONSISTS OF THE WORDING "AIM" IN CAPITAL LETTERS WITH THE WORDS "ALZHEIMER'S IMPACT MOVEMENT" IN LOWERCASE LETTERS POSITIONED UNDERNEATH "AIM". A STAR IS INSERTED IN THE UPPER TRIANGULAR PORTION OF THE LETTER "A" IN THE WORD "AIM".

SER. NO. 85-424,991, FILED 9-16-2011.

NAKIA HENRY, EXAMINING ATTORNEY



David J. Kyffers

Director of the United States Patent and Trademark Office

United States of America

United States Patent and Trademark Office



oneteam. onefocus. onevision.

Reg. No. 4,174,423

1VIZN, L.L.C. (UTAH LIMITED LIABILITY COMPANY)
169 S. 950 E.

Registered July 17, 2012

PLEASANT GROVE, UT 84062

Int. Cl.: 5

FOR: DIETARY AND NUTRITIONAL SUPPLEMENTS; NUTRITIONAL SUPPLEMENTS FOR BOOSTING ENERGY, IN CLASS 5 (U.S. CLS. 6, 18, 44, 46, 51 AND 52).

TRADEMARK

FIRST USE 3-15-2011; IN COMMERCE 3-15-2011.

PRINCIPAL REGISTER

THE MARK CONSISTS OF THE WORDING "1VIZN" IN BLUE. IN BETWEEN THE "1" AND "V" IN "1VIZN" ARE THREE VERTICAL YELLOW SQUARES. BELOW "1VIZN", IN SMALLER, BLUE TEXT, IS THE WORDING, "ONETEAM. ONEFOCUS. ONEVISION.".

THE COLOR(S) BLUE AND YELLOW IS/ARE CLAIMED AS A FEATURE OF THE MARK.

THE WORDING "VIZN" HAS NO MEANING IN A FOREIGN LANGUAGE.

SER. NO. 85-425,516, FILED 9-18-2011.

BILL DAWE, EXAMINING ATTORNEY



David J. Kyffers

Director of the United States Patent and Trademark Office

United States of America

United States Patent and Trademark Office



Reg. No. 4,174,424

Registered July 17, 2012

Int. Cl.: 41

SERVICE MARK

PRINCIPAL REGISTER

CASHMAN MEDIA, LLC (MASSACHUSETTS LIMITED LIABILITY COMPANY)
549 SOUTH STREET
QUINCY, MA 02169

FOR: PROVIDING INFORMATION, NEWS AND COMMENTARY IN THE FIELD OF CURRENT EVENTS RELATING TO POLITICS, THE MEDIA, ENTERTAINMENT, SPORTS, BUSINESS, HEALTHY LIVING AND LIFESTYLE, WELLNESS, FASHION, ENVIRONMENTALLY CONSCIOUS AND GREEN ISSUES, FOOD, TECHNOLOGY, TRAVEL, EDUCATION, BOOKS, FINE ARTS, AND PERFORMING ARTS, IN CLASS 41 (U.S. CLS. 100, 101 AND 107).

FIRST USE 8-17-2011; IN COMMERCE 8-17-2011.

NO CLAIM IS MADE TO THE EXCLUSIVE RIGHT TO USE "NE", APART FROM THE MARK AS SHOWN.

THE COLOR(S) GREEN, AND BLACK IS/ARE CLAIMED AS A FEATURE OF THE MARK.

THE MARK CONSISTS OF LETTERS "N E" APPEARING ABOVE THE WORD "POST", IN GREEN, SURROUNDED BY A BLACK BORDER IN THE SHAPE OF A SQUARE.

SER. NO. 85-425,543, FILED 9-18-2011.

ALLISON HOLTZ, EXAMINING ATTORNEY



David J. Kybas

Director of the United States Patent and Trademark Office

United States of America

United States Patent and Trademark Office

NEW ENGLAND POST

Reg. No. 4,174,425

Registered July 17, 2012

Int. Cl.: 41

SERVICE MARK

PRINCIPAL REGISTER

CASHMAN MEDIA, LLC (MASSACHUSETTS LIMITED LIABILITY COMPANY)
549 SOUTH STREET
QUINCY, MA 02169

FOR: PROVIDING INFORMATION, NEWS AND COMMENTARY IN THE FIELD OF CURRENT EVENTS RELATING TO POLITICS, THE MEDIA, ENTERTAINMENT, SPORTS, BUSINESS, HEALTHY LIVING AND LIFESTYLE, WELLNESS, FASHION, ENVIRONMENTALLY CONSCIOUS AND GREEN ISSUES, FOOD, TECHNOLOGY, TRAVEL, EDUCATION, BOOKS, FINE ARTS, AND PERFORMING ARTS, IN CLASS 41 (U.S. CLS. 100, 101 AND 107).

FIRST USE 8-17-2011; IN COMMERCE 8-17-2011.

NO CLAIM IS MADE TO THE EXCLUSIVE RIGHT TO USE "NEW ENGLAND", APART FROM THE MARK AS SHOWN.

THE COLOR(S) GREEN IS/ARE CLAIMED AS A FEATURE OF THE MARK.

THE MARK CONSISTS OF "NEW ENGLAND POST", IN GREEN LETTERING.

SER. NO. 85-425,544, FILED 9-18-2011.

ALLISON HOLTZ, EXAMINING ATTORNEY



David J. Kyffers

Director of the United States Patent and Trademark Office

United States of America

United States Patent and Trademark Office

916

Reg. No. 4,174,426

CRUZ, MIGUEL IVÁN (MEXICO INDIVIDUAL)
2833 PEDRO MARIA ANAYA
GUADALAJARA, JALISCO, MEXICO

Registered July 17, 2012

Int. Cl.: 33

FOR: TEQUILA, IN CLASS 33 (U.S. CLS. 47 AND 49).

TRADEMARK

THE MARK CONSISTS OF STANDARD CHARACTERS WITHOUT CLAIM TO ANY PARTICULAR FONT, STYLE, SIZE, OR COLOR.

PRINCIPAL REGISTER

OWNER OF MEXICO REG. NO. 972660, DATED 2-16-2007, EXPIRES 2-16-2017.

SER. NO. 85-425,851, FILED 9-19-2011.

CHRISTOPHER LAW, EXAMINING ATTORNEY



David J. Kybas

Director of the United States Patent and Trademark Office

United States of America

United States Patent and Trademark Office



Reg. No. 4,174,427

Registered July 17, 2012

Int. Cl.: 41

SERVICE MARK

PRINCIPAL REGISTER

SOLMINOD (IOWA LIMITED LIABILITY COMPANY)
9235 COWDEN DR
JOHNSTON, IA 50131

FOR: ENTERTAINMENT SERVICES, NAMELY, PROVIDING WEBCASTS IN THE FIELD OF CONDUCTING AND HOSTING INTERVIEWS OF HEALTHCARE PROFESSIONALS, RELIGIOUS PROFESSIONALS, CELEBRITIES, ENTREPRENEURS AND PHILANTHROPISTS; ENTERTAINMENT SERVICES, NAMELY, AN ON-GOING SERIES FEATURING OVERALL HEALTH AND WELLNESS AS IT RELATES TO SPIRITUAL GROWTH PROVIDED THROUGH CABLE TELEVISION, WEBCASTS, RADIO BROADCASTS ; PROFESSIONAL COACHING SERVICES IN THE FIELD OF INTERPERSONAL, SOCIAL AND HEALTHY CHOICES ; SPECIAL EVENT PLANNING FOR SOCIAL ENTERTAINMENT PURPOSES ; EDUCATION SERVICES, NAMELY, PROVIDING CLASSES, CONFERENCES, TEACHING, AND PUBLIC SPEAKING IN THE FIELDS OF HUMAN POTENTIAL AND MATURITY, IN CLASS 41 (U.S. CLS. 100, 101 AND 107).

FIRST USE 7-7-2010; IN COMMERCE 11-15-2010.

THE STIPPLING IS FOR SHADING PURPOSES ONLY.

THE MARK CONSISTS OF A WAVE IN LAYERS, FLOWING HORIZONTALLY, WITH TWO RIBBONS FLOWING THROUGH IT. ON THE TOP THERE IS THE STYLIZED TEXT "SOLMINOD", WHILE AT THE BOTTOM THERE IS THE STYLIZED TEXT "INHALING LOVE EXHALING COMPASSION."

SER. NO. 85-426,290, FILED 9-19-2011.

SALLY SHIH, EXAMINING ATTORNEY



David J. Kyros

Director of the United States Patent and Trademark Office

United States of America

United States Patent and Trademark Office



Reg. No. 4,174,428

Registered July 17, 2012

Int. Cl.: 36

SERVICE MARK

PRINCIPAL REGISTER

MAFER INTERNATIONAL HOLDINGS LIMITED (BR.VIRGIN ISLANDS CORPORATION)
PALM CHAMBERS
197 MAIN STREET, ROAD TOWN
TORTOLA, BR.VIRGIN ISLANDS

FOR: REAL ESTATE MANAGEMENT SERVICES; REAL ESTATE BROKERAGE; RENTING
OF APARTMENTS, IN CLASS 36 (U.S. CLS. 100, 101 AND 102).

OWNER OF PERU REG. NO. 00062681, DATED 6-22-2010, EXPIRES 6-22-2020.

THE COLOR(S) BLUE, BLACK, AND RED IS/ARE CLAIMED AS A FEATURE OF THE
MARK.

NO CLAIM IS MADE TO THE EXCLUSIVE RIGHT TO USE "REAL ESTATE", APART FROM
THE MARK AS SHOWN.

THE MARK CONSISTS OF A BLUE BALL TO THE LEFT OF THE WORD "MAFER" IN RED
WITH A BLUE SLASH BENEATH IT THAT IS SEPARATED BY THE LETTER "A" IN
"MAFER". BELOW THE BLUE SLASH ARE THE WORDS "REAL ESTATE" IN BLACK.

SER. NO. 85-426,314, FILED 9-19-2011.

SIMON TENG, EXAMINING ATTORNEY



David J. Kybas

Director of the United States Patent and Trademark Office

United States of America

United States Patent and Trademark Office



Reg. No. 4,174,429

Registered July 17, 2012

Int. Cl.: 43

SERVICE MARK

PRINCIPAL REGISTER

ARGO ASSOCIATES, INC. (NORTH CAROLINA CORPORATION), DBA THE ARGO GROUP
10729 FRED GUTT DR.
CHARLOTTE, NC 28270

FOR: CONSULTING SERVICES IN THE FIELD OF HOSPITALITY, IN CLASS 43 (U.S. CLS. 100 AND 101).

FIRST USE 3-25-2011; IN COMMERCE 3-25-2011.

NO CLAIM IS MADE TO THE EXCLUSIVE RIGHT TO USE "GROUP" OR "SERVING THE HOSPITALITY INDUSTRY", APART FROM THE MARK AS SHOWN.

THE COLOR(S) BLACK, WHITE, BLUE, GREEN, BROWN AND RED IS/ARE CLAIMED AS A FEATURE OF THE MARK.

THE STIPLING IS FOR SHADING PURPOSES ONLY.

THE MARK CONSISTS OF THE WORD "TAG" COMPRISED OF A WHITE OUTLINE AND UNDERLINED IN WHITE. BELOW THAT IS THE WORDING "THE ARGO GROUP" COMPRISED OF A WHITE OUTLINE, AND BELOW THAT IS THE WORDING "SERVING THE HOSPITALITY INDUSTRY" IN WHITE. BELOW THE RIGHT-MOST PORTION OF THE WORDING IS AN IMAGE OF THE EARTH IN BLUE, WHITE, BROWN AND GREEN. THE WORDING "PROVIDING A GLOBAL VIEW" APPEARS IN RED BELOW THE IMAGE OF THE EARTH. A FAINT WHITE TRAIL APPEARS TO THE LEFT OF THE RED WORDING. ALL OF THE FOREGOING APPEARS ON A BLACK BACKGROUND.

SER. NO. 85-426,395, FILED 9-19-2011.

KATHERINE CHANG, EXAMINING ATTORNEY



David J. Kybas

Director of the United States Patent and Trademark Office

United States of America

United States Patent and Trademark Office



Reg. No. 4,174,430

SISTERS 4 SURVIVORS, INC. (OREGON CORPORATION)
5624 NW 164TH AVE
PORTLAND, OR 97229

Registered July 17, 2012

Int. Cls.: 35 and 36

FOR: CHARITABLE SERVICES, NAMELY, SUPPORTING AND EMPOWERING BREAST CANCER PATIENTS AND SURVIVORS BY PROVIDING SCHEDULING ASSISTANCE FOR PATIENTS NEEDING PERSONAL IMAGE AND ALTERNATIVE HEALTH SERVICES, AND ORGANIZING AND DEVELOPING PROGRAMS THAT AIM TO IMPROVE THE LIVES OF THOSE FACING BREAST CANCER, IN CLASS 35 (U.S. CLS. 100, 101 AND 102).

SERVICE MARK

PRINCIPAL REGISTER

FIRST USE 9-1-2011; IN COMMERCE 9-1-2011.

FOR: CHARITABLE FUNDRAISING SERVICES, AND CHARITABLE SERVICES, NAMELY, SUPPORTING AND EMPOWERING BREAST CANCER PATIENTS AND SURVIVORS BY PROVIDING FINANCIAL ASSISTANCE FOR PATIENTS NEEDING PERSONAL IMAGE AND ALTERNATIVE HEALTH SERVICES, IN CLASS 36 (U.S. CLS. 100, 101 AND 102).

FIRST USE 9-1-2011; IN COMMERCE 9-1-2011.

THE MARK CONSISTS OF THE WORDS "SISTERS" AND "SURVIVORS" IN WHITE SCRIPT JOINED BY A STYLIZED PINK "4" RESEMBLING A RIBBON. THE GREY RECTANGLE SHOWN IN THE DRAWING IS NOT A FEATURE OF THE MARK BUT IS USED TO SHOW BACKGROUND AND CONTRAST ONLY.

THE COLOR(S) WHITE AND PINK IS/ARE CLAIMED AS A FEATURE OF THE MARK.

SER. NO. 85-426,490, FILED 9-19-2011.

JERI J. FICKES, EXAMINING ATTORNEY



David J. Kyjars

Director of the United States Patent and Trademark Office

United States of America

United States Patent and Trademark Office



Shield Pack

Reg. No. 4,174,431

Registered July 17, 2012

Int. Cl.: 22

TRADEMARK

PRINCIPAL REGISTER

SHIELD PACK, LLC (DELAWARE LIMITED LIABILITY COMPANY)
411 DOWNING PINES ROAD
WEST MONROE, LA 71292

FOR: DISPOSABLE BULK CONTAINER LINERS SOLD ON SPECIAL ORDER OF A CUSTOMER TO THE CUSTOMER'S SPECIFICATIONS, IN CLASS 22 (U.S. CLS. 1, 2, 7, 19, 22, 42 AND 50).

FIRST USE 11-8-1979; IN COMMERCE 11-8-1979.

NO CLAIM IS MADE TO THE EXCLUSIVE RIGHT TO USE "PACK", APART FROM THE MARK AS SHOWN.

THE MARK CONSISTS OF THE RIGHT SIDE PROFILE OF AN EAGLE'S FACE; THE SIDE PROFILE INCLUDES THE SILHOUETTE OF THE EAGLE'S BEAK, EYE AND HEAD; BELOW THE EAGLE'S HEAD IN BLOCK PRINT ARE THE TERMS "SHIELD PACK".

SER. NO. 85-427,074, FILED 9-20-2011.

ROBIN MITTLER, EXAMINING ATTORNEY



David J. Kybas

Director of the United States Patent and Trademark Office

United States of America
United States Patent and Trademark Office

KISSINO

Reg. No. 4,174,432

KISSINO PASTA SAUCE INC. (NEVADA CORPORATION)
P.O. BOX 3222
INCLINE VILLAGE, NV 89451

Registered July 17, 2012

Int. Cl.: 30

FOR: SPAGHETTI SAUCE, IN CLASS 30 (U.S. CL. 46).

TRADEMARK

FIRST USE 1-1-2007; IN COMMERCE 1-1-2007.

PRINCIPAL REGISTER

THE MARK CONSISTS OF STANDARD CHARACTERS WITHOUT CLAIM TO ANY PARTICULAR FONT, STYLE, SIZE, OR COLOR.

THE WORDING "KISSINO" HAS NO MEANING IN A FOREIGN LANGUAGE.

SER. NO. 85-427,580, FILED 9-20-2011.

CHRISTOPHER SIDOTI, EXAMINING ATTORNEY



David J. Kybas

Director of the United States Patent and Trademark Office

United States of America

United States Patent and Trademark Office



Reg. No. 4,174,433

Registered July 17, 2012

Int. Cl.: 30

TRADEMARK

PRINCIPAL REGISTER

KISSINO PASTA SAUCE INC. (NEVADA CORPORATION)
P.O. BOX 3222
INCLINE VILLAGE, NV 89451

FOR: SPAGHETTI SAUCE, IN CLASS 30 (U.S. CL. 46).

FIRST USE 1-1-2007; IN COMMERCE 1-1-2007.

NO CLAIM IS MADE TO THE EXCLUSIVE RIGHT TO USE "ITALIAN SPAGHETTI SAUCE",
APART FROM THE MARK AS SHOWN.

THE NAME(S), PORTRAIT(S), AND/OR SIGNATURE(S) SHOWN IN THE MARK DOES NOT
IDENTIFY A PARTICULAR LIVING INDIVIDUAL.

THE MARK CONSISTS OF A PHOTOGRAPH OF ROCCO CASINO, DECEASED, WITH THE
CAPITALIZED WORDS, "KILLER ITALIAN SPAGHETTI SAUCE, IT'S NUMBER ONE!",
SURROUNDING THE PHOTOGRAPH, STARTING FROM THE LEFT SIDE AROUND TO
THE RIGHT SIDE OF THE PHOTOGRAPH. COLOR IS NOT CLAIMED AS A FEATURE OF
THE MARK.

THE WORDING "KISSINO" HAS NO MEANING IN A FOREIGN LANGUAGE.

SER. NO. 85-427,648, FILED 9-20-2011.

CHRISTOPHER SIDOTI, EXAMINING ATTORNEY



David J. Kyffers

Director of the United States Patent and Trademark Office

United States of America

United States Patent and Trademark Office

LTR

Reg. No. 4,174,434

Registered July 17, 2012

Int. Cls.: 28 and 41

TRADEMARK

SERVICE MARK

PRINCIPAL REGISTER

THE BURTON CORPORATION (VERMONT CORPORATION)
80 INDUSTRIAL PARKWAY
BURLINGTON, VT 05401

FOR: SNOWBOARDS, IN CLASS 28 (U.S. CLS. 22, 23, 38 AND 50).

FIRST USE 1-20-2000; IN COMMERCE 1-20-2000.

FOR: INSTRUCTION IN THE FIELD OF SNOWBOARDING; EDUCATIONAL SERVICES, NAMELY, CONDUCTING SEMINARS, CONDUCTING CLASSES FOR OTHERS IN THE SPORT OF SNOWBOARDING; SPORTS CAMPS; RENTAL OF SPORTS EQUIPMENT, IN CLASS 41 (U.S. CLS. 100, 101 AND 107).

FIRST USE 1-20-2000; IN COMMERCE 1-20-2000.

THE MARK CONSISTS OF STANDARD CHARACTERS WITHOUT CLAIM TO ANY PARTICULAR FONT, STYLE, SIZE, OR COLOR.

SER. NO. 85-427,850, FILED 9-21-2011.

DANNEAN HETZEL, EXAMINING ATTORNEY



David J. Kypos

Director of the United States Patent and Trademark Office

United States of America

United States Patent and Trademark Office

DEHEN

Reg. No. 4,174,435

Registered July 17, 2012

Int. Cls.: 18 and 25

TRADEMARK

PRINCIPAL REGISTER

DEHEN JACKETS, INC. (OREGON CORPORATION)
SUITE 3
1040 NE 44TH AVE
PORTLAND, OR 97213

FOR: DUFFEL BAGS; GYM BAGS; SHOULDER BAGS; TOTE BAGS, IN CLASS 18 (U.S. CLS. 1, 2, 3, 22 AND 41).

FIRST USE 7-0-1994; IN COMMERCE 7-0-1994.

FOR: JACKETS; SWEATERS; T-SHIRTS, IN CLASS 25 (U.S. CLS. 22 AND 39).

FIRST USE 12-31-2006; IN COMMERCE 12-31-2006.

THE MARK CONSISTS OF STANDARD CHARACTERS WITHOUT CLAIM TO ANY PARTICULAR FONT, STYLE, SIZE, OR COLOR.

SER. NO. 85-428,604, FILED 9-21-2011.

THEODORE MCBRIDE, EXAMINING ATTORNEY



David J. Kyffers

Director of the United States Patent and Trademark Office

United States of America

United States Patent and Trademark Office

Diavoli Rossi

Reg. No. 4,174,436

BRICKER HOLDINGS LLC (COLORADO LIMITED LIABILITY COMPANY)
PO BOX 460307
DENVER, CO 80246

Registered July 17, 2012

Int. Cls.: 25 and 41

FOR: ATHLETIC APPAREL, NAMELY, SHIRTS, PANTS, JACKETS, FOOTWEAR, HATS AND CAPS, ATHLETIC UNIFORMS, IN CLASS 25 (U.S. CLS. 22 AND 39).

TRADEMARK

FIRST USE 5-22-2011; IN COMMERCE 5-22-2011.

SERVICE MARK

FOR: ENTERTAINMENT IN THE NATURE OF POLO GAMES; ENTERTAINMENT SERVICES, NAMELY, PARTICIPATION IN THE SPORT OF POLO, IN CLASS 41 (U.S. CLS. 100, 101 AND 107).

PRINCIPAL REGISTER

FIRST USE 5-15-2011; IN COMMERCE 5-15-2011.

THE MARK CONSISTS OF STANDARD CHARACTERS WITHOUT CLAIM TO ANY PARTICULAR FONT, STYLE, SIZE, OR COLOR.

THE NAME "DIAVOLI ROSSI" DOES NOT IDENTIFY A LIVING INDIVIDUAL.

SER. NO. 85-428,988, FILED 9-22-2011.

JACLYN KIDWELL WALKER, EXAMINING ATTORNEY



David J. Kyros

Director of the United States Patent and Trademark Office

United States of America

United States Patent and Trademark Office

¡Estamos con Usted!

Reg. No. 4,174,437

DIRECT GENERAL CORPORATION (TENNESSEE CORPORATION)
1281 MURFREESBORO ROAD
NASHVILLE, TN 37217

Registered July 17, 2012

Int. Cls.: 36 and 37

FOR: CONSUMER LENDING SERVICES; DEBIT CARD SERVICES; INSURANCE ADMINISTRATION IN THE FIELD OF AUTOMOBILE LIABILITY, PROPERTY, CASUALTY, PHYSICAL DAMAGE, LIFE INSURANCE AND ADJUSTING, IN CLASS 36 (U.S. CLS. 100, 101 AND 102).

SERVICE MARK

PRINCIPAL REGISTER

FIRST USE 9-1-2011; IN COMMERCE 9-1-2011.

FOR: EMERGENCY ROADSIDE ASSISTANCE SERVICES, NAMELY, RESPONDING TO CALLS FOR ROADSIDE ASSISTANCE, FLAT TIRE CHANGING, EMERGENCY FUEL SUPPLYING, AND BATTERY JUMP STARTING, IN CLASS 37 (U.S. CLS. 100, 103 AND 106).

FIRST USE 9-22-2011; IN COMMERCE 9-22-2011.

THE MARK CONSISTS OF STANDARD CHARACTERS WITHOUT CLAIM TO ANY PARTICULAR FONT, STYLE, SIZE, OR COLOR.

THE ENGLISH TRANSLATION OF THE WORDS "ESTAMOS CONUSTED" IN THE MARK IS WE ARE WITH YOU.

SER. NO. 85-429,014, FILED 9-22-2011.

DOMINICK J. SALEMI, EXAMINING ATTORNEY



David J. Kyffers

Director of the United States Patent and Trademark Office

United States of America

United States Patent and Trademark Office

MIDWEST URBAN TREE CARE FORUM - MUTCF

Reg. No. 4,174,438

ILLINOIS ARBORIST ASSOCIATION (ILLINOIS NON-PROFIT ASSOCIATION)
P.O. BOX 860

Registered July 17, 2012

ANTIOCH, IL 60002

Int. Cl.: 41

FOR: ORGANIZING EXHIBITIONS FOR EDUCATIONAL PURPOSES FEATURING THE MANY FACETS OF URBAN FORESTRY AND HOW IT RELATES TO PROFESSIONAL TREE CARE, IN CLASS 41 (U.S. CLS. 100, 101 AND 107).

SERVICE MARK

FIRST USE 4-3-2003; IN COMMERCE 4-3-2003.

PRINCIPAL REGISTER

THE MARK CONSISTS OF STANDARD CHARACTERS WITHOUT CLAIM TO ANY PARTICULAR FONT, STYLE, SIZE, OR COLOR.

NO CLAIM IS MADE TO THE EXCLUSIVE RIGHT TO USE "MIDWEST URBAN TREE CARE FORUM", APART FROM THE MARK AS SHOWN.

SER. NO. 85-429,047, FILED 9-22-2011.

DAWN HAN, EXAMINING ATTORNEY



David J. Kyffers

Director of the United States Patent and Trademark Office

United States of America

United States Patent and Trademark Office

BOMBON

Reg. No. 4,174,439

IDT TELECOM, INC. (DELAWARE CORPORATION)
550 BROAD STREET
NEWARK, NJ 07102

Registered July 17, 2012

Int. Cls.: 16, 36 and 38

FOR: PREPAID TELEPHONE CALLING CARDS, NOT MAGNETICALLY ENCODED, IN CLASS 16 (U.S. CLS. 2, 5, 22, 23, 29, 37, 38 AND 50).

TRADEMARK

FIRST USE 9-2-2011; IN COMMERCE 9-2-2011.

SERVICE MARK

FOR: PREPAID TELEPHONE CALLING CARD AND TELEPHONE DEBIT CARD SERVICES, IN CLASS 36 (U.S. CLS. 100, 101 AND 102).

PRINCIPAL REGISTER

FIRST USE 9-2-2011; IN COMMERCE 9-2-2011.

FOR: TELEPHONE TELECOMMUNICATIONS SERVICES PROVIDED VIA PREPAID TELEPHONE CALLING CARDS, IN CLASS 38 (U.S. CLS. 100, 101 AND 104).

FIRST USE 9-2-2011; IN COMMERCE 9-2-2011.

THE MARK CONSISTS OF STANDARD CHARACTERS WITHOUT CLAIM TO ANY PARTICULAR FONT, STYLE, SIZE, OR COLOR.

THE ENGLISH TRANSLATION OF "BOMBON" IN THE MARK IS "SWEETIE".

SER. NO. 85-429,132, FILED 9-22-2011.

EDWARD FENNESSY, EXAMINING ATTORNEY



David J. Kyros

Director of the United States Patent and Trademark Office

United States of America

United States Patent and Trademark Office

FIFTH THIRD BANK DUO CARD

Reg. No. 4,174,440

FIFTH THIRD BANCORP (OHIO CORPORATION)
38 FOUNTAIN SQUARE PLAZA
CINCINNATI, OH 45263

Registered July 17, 2012

Int. Cl.: 36

FOR: BANKING SERVICES, NAMELY, CREDIT AND DEBIT CARD SERVICES, IN CLASS 36 (U.S. CLS. 100, 101 AND 102).

SERVICE MARK

FIRST USE 8-24-2011; IN COMMERCE 8-24-2011.

PRINCIPAL REGISTER

THE MARK CONSISTS OF STANDARD CHARACTERS WITHOUT CLAIM TO ANY PARTICULAR FONT, STYLE, SIZE, OR COLOR.

OWNER OF U.S. REG. NOS. 1,645,502, 3,857,726 AND OTHERS.

NO CLAIM IS MADE TO THE EXCLUSIVE RIGHT TO USE "BANK" AND "CARD", APART FROM THE MARK AS SHOWN.

SER. NO. 85-429,185, FILED 9-22-2011.

KELLEY WELLS, EXAMINING ATTORNEY



David J. Kybas

Director of the United States Patent and Trademark Office

United States of America

United States Patent and Trademark Office



Reg. No. 4,174,441

Registered July 17, 2012

Int. Cl.: 1

TRADEMARK

PRINCIPAL REGISTER

NATURALAWN OF AMERICA, INC. (MARYLAND CORPORATION)
P.O. BOX 116, 1 EAST CHURCH STREET
FREDERICK, MD 21701

FOR: CHEMICAL PREPARATIONS FOR MELTING SNOW AND ICE; CHEMICALS USED FOR THE TREATMENT OF CONCRETE AND ASPHALT SURFACES; CHEMICALS FOR USE IN AGRICULTURE, EXCEPT FUNGICIDES, HERBICIDES, INSECTICIDES AND PARASITICIDES; HORTICULTURE CHEMICALS, EXCEPT FUNGICIDES, HERBICIDES, INSECTICIDES AND PARASITICIDES, ALL THE FOREGOING FEATURING NATURAL INGREDIENTS, IN CLASS 1 (U.S. CLS. 1, 5, 6, 10, 26 AND 46).

FIRST USE 11-1-2010; IN COMMERCE 11-1-2010.

OWNER OF U.S. REG. NOS. 2,511,749, 2,548,940, AND 3,522,172.

THE MARK CONSISTS OF THE WORDS "NATURAL ALTERNATIVE" ABOVE THE WORDING "IT'S AN EASY CHOICE.", AND THREE CRESCENT DESIGNS POSITIONED TO THE LOWER LEFT OF THE WORDING.

SER. NO. 85-429,237, FILED 9-22-2011.

JEFF DEFORD, EXAMINING ATTORNEY



David J. Kyffers

Director of the United States Patent and Trademark Office

United States of America

United States Patent and Trademark Office

I*PMIS

Reg. No. 4,174,442

DE NEUL, THOMAS (UNITED STATES INDIVIDUAL)
16828 IVYWOOD COURT
LAKEVILLE, MN 55044

Registered July 17, 2012

Int. Cl.: 9

FOR: COMPUTER SOFTWARE FOR USE IN THE IDENTIFICATION, DEFINITION, PLANNING, ASSIGNING, SCHEDULING, AND MANAGEMENT OF THE EXECUTION OF PROJECTS AND TASKS IN THE FIELD OF PROJECT MANAGEMENT, IN CLASS 9 (U.S. CLS. 21, 23, 26, 36 AND 38).

TRADEMARK

PRINCIPAL REGISTER

FIRST USE 6-17-2011; IN COMMERCE 6-17-2011.

THE MARK CONSISTS OF STANDARD CHARACTERS WITHOUT CLAIM TO ANY PARTICULAR FONT, STYLE, SIZE, OR COLOR.

NO CLAIM IS MADE TO THE EXCLUSIVE RIGHT TO USE "PMIS", APART FROM THE MARK AS SHOWN.

SER. NO. 85-429,755, FILED 9-22-2011.

ANDREA K. NADELMAN, EXAMINING ATTORNEY



David J. Kyffers

Director of the United States Patent and Trademark Office

United States of America

United States Patent and Trademark Office

SCOWMON 4.0

Reg. No. 4,174,443

RAYMOND E. BERGERON (UNITED STATES INDIVIDUAL)
3452 W. JEFFERSON
TRENTON, MI 48183

Registered July 17, 2012

Int. Cl.: 9

FOR: ELECTRONIC IMAGING APPARATUS USED FOR TRACKING MOVEMENT, MATERIAL LOCATION AND MATERIAL REMOVAL FOR UNDERWATER DREDGING, IN CLASS 9 (U.S. CLS. 21, 23, 26, 36 AND 38).

TRADEMARK

FIRST USE 1-0-2007; IN COMMERCE 1-0-2007.

PRINCIPAL REGISTER

THE MARK CONSISTS OF STANDARD CHARACTERS WITHOUT CLAIM TO ANY PARTICULAR FONT, STYLE, SIZE, OR COLOR.

SER. NO. 85-430,106, FILED 9-23-2011.

LINDA M. KING, EXAMINING ATTORNEY



David J. Kybas

Director of the United States Patent and Trademark Office

United States of America

United States Patent and Trademark Office

F.i.T. Food in Transit

Reg. No. 4,174,444

BETH DRAYER (CALIFORNIA LIMITED LIABILITY COMPANY), DBA BD BAKES LLC
PO BOX 6
REDONDO BEACH, CA 90277

Registered July 17, 2012

Int. Cl.: 5

FOR: FOODS AND SNACKS WHICH ARE FREE OF WHEAT, DAIRY, SOY AND GMO TO ACCOMMODATE SPECIAL MEDICAL AND HEALTH CONDITIONS; NUTRITIONAL FOOD BARS FOR USE AS A MEAL REPLACEMENT, IN CLASS 5 (U.S. CLS. 6, 18, 44, 46, 51 AND 52).

TRADEMARK

PRINCIPAL REGISTER

FIRST USE 1-4-2012; IN COMMERCE 1-30-2012.

THE MARK CONSISTS OF STANDARD CHARACTERS WITHOUT CLAIM TO ANY PARTICULAR FONT, STYLE, SIZE, OR COLOR.

NO CLAIM IS MADE TO THE EXCLUSIVE RIGHT TO USE "FOOD", APART FROM THE MARK AS SHOWN.

SER. NO. 85-430,699, FILED 9-23-2011.

RICHARD WHITE, EXAMINING ATTORNEY



David J. Kyffers

Director of the United States Patent and Trademark Office

United States of America

United States Patent and Trademark Office

MAXPERFORMANCE

Reg. No. 4,174,445

Registered July 17, 2012

Int. Cl.: 11

TRADEMARK

PRINCIPAL REGISTER

LAVELLE INDUSTRIES, INC. (DELAWARE CORPORATION)
665 MCHENRY STREET
BURLINGTON, WI 53105

FOR: TOILET TANK FILL VALVES, IN CLASS 11 (U.S. CLS. 13, 21, 23, 31 AND 34).

FIRST USE 1-0-2011; IN COMMERCE 3-0-2011.

THE MARK CONSISTS OF STANDARD CHARACTERS WITHOUT CLAIM TO ANY PARTICULAR FONT, STYLE, SIZE, OR COLOR.

SER. NO. 85-430,931, FILED 9-23-2011.

DEZMONA MIZELLE, EXAMINING ATTORNEY



David J. Kyffers

Director of the United States Patent and Trademark Office

United States of America

United States Patent and Trademark Office

East-West

Integrative Medicine Clinic

Reg. No. 4,174,446

Registered July 17, 2012

Int. Cl.: 44

SERVICE MARK

PRINCIPAL REGISTER

MARNIE MCCURDY (CALIFORNIA SOLE PROPRIETORSHIP), DBA EAST-WEST
INTEGRATIVE MEDICINE CLINIC
SUITE C
605 CHENERY STREET
SAN FRANCISCO, CA 94131

FOR: ACUPUNCTURE; MASSAGES, IN CLASS 44 (U.S. CLS. 100 AND 101).

FIRST USE 3-15-2003; IN COMMERCE 3-15-2003.

NO CLAIM IS MADE TO THE EXCLUSIVE RIGHT TO USE "INTEGRATIVE MEDICINE CLINIC", APART FROM THE MARK AS SHOWN.

THE MARK CONSISTS OF "EAST-WEST" IN STYLIZED TEXT WITH "INTEGRATIVE MEDICINE CLINIC" BELOW "EAST-WEST".

SER. NO. 85-431,009, FILED 9-23-2011.

ANDREA K. NADELMAN, EXAMINING ATTORNEY



David J. Kybas

Director of the United States Patent and Trademark Office

United States of America

United States Patent and Trademark Office



DRUMMERS
AND
DREAMERS

Reg. No. 4,174,447

Registered July 17, 2012

Int. Cl.: 33

TRADEMARK

PRINCIPAL REGISTER

BURK, DOUGLAS F (UNITED STATES INDIVIDUAL), DBA DRUMMERS AND DREAMERS
LLC
608 WEST DIVISION AVE
EPHRATA, WA 98823

FOR: WINES DERIVED FROM GRAPES GROWN IN THE WAHLUKE SLOPE REGION OF WASHINGTON, LABELED AND ADVERTISED IN COMPLIANCE WITH ALCOHOL AND TOBACCO TAX AND TRADE BUREAU AND DEPARTMENT OF TREASURY LAWS FOR GEOGRAPHIC ORIGIN OF THE GOODS, IN CLASS 33 (U.S. CLS. 47 AND 49).

FIRST USE 6-1-2009; IN COMMERCE 5-17-2011.

THE MARK CONSISTS OF THE STYLIZED WORDING "DRUMMERS AND DREAMERS" WITH A HORIZONTAL LINE SET ON EACH SIDE OF THE TERM "AND" ALL SET BELOW A DESIGN ELEMENT COMPRISED OF A STYLIZED DEPICTION OF A BIRD AND TWO FEATHERS SET INSIDE A CIRCLE.

SER. NO. 85-431,066, FILED 9-23-2011.

MICHAEL GAAFAR, EXAMINING ATTORNEY



David J. Kyffers

Director of the United States Patent and Trademark Office

United States of America

United States Patent and Trademark Office



Reg. No. 4,174,448

Registered July 17, 2012

Int. Cl.: 44

SERVICE MARK

PRINCIPAL REGISTER

SILVERSTEIN, PENELOPE (UNITED STATES INDIVIDUAL)
31 HIGH STREET
EASTHAMPTON, MA 01027

FOR: COSMETIC BODY ART SERVICES, NAMELY, BODY MODIFICATION IN THE NATURE OF PROVIDING PERMANENT BODY ART CONSISTING OF HAND DRAWN DESIGNS APPLIED TO THE BODY, SCARIFICATION, AND BRANDING OF HUMANS, AS WELL AS THE TEMPORARY BODY ART OF PIERCING WHICH CONSISTS OF PLACING IMPLANT GRADE JEWELRY THROUGH THE SKIN OF HUMANS, IN CLASS 44 (U.S. CLS. 100 AND 101).

FIRST USE 1-1-2000; IN COMMERCE 1-1-2000.

NO CLAIM IS MADE TO THE EXCLUSIVE RIGHT TO USE "BODY ARTS", APART FROM THE MARK AS SHOWN.

THE MARK CONSISTS OF A DESIGN WHICH RESEMBLES THE LETTER "T" WITH ONE EXTRA HORIZONTAL BAR AT THE TOP. THE BOTTOM OF THE "T" HAS AN INFINITY SYMBOL HORIZONTALLY ALIGNED WITH THE RIGHT LOOP BEING MADE TO LOOK LIKE THE HEAD OF A SNAKE. THE WORD "HAVEN" APPEARS TO THE RIGHT OF THE DESIGN ABOVE THE WORDING "BODY ARTS".

SER. NO. 85-431,231, FILED 9-24-2011.

SHAILA SETTLES, EXAMINING ATTORNEY



David J. Kyros

Director of the United States Patent and Trademark Office

United States of America

United States Patent and Trademark Office

LogiCover

Reg. No. 4,174,449

EMNET, LLC (INDIANA LIMITED LIABILITY COMPANY)
520 E. LASALLE AVE.

Registered July 17, 2012

SOUTH BEND, IN 46617

Int. Cl.: 6

FOR: METAL MANHOLE COVERS FEATURING AN ELECTRONIC TELEMETRY SYSTEM USED TO MONITOR AND COMMUNICATE UNDERGROUND ENVIRONMENTAL PARAMETERS, IN CLASS 6 (U.S. CLS. 2, 12, 13, 14, 23, 25 AND 50).

TRADEMARK

FIRST USE 1-1-2008; IN COMMERCE 1-1-2008.

PRINCIPAL REGISTER

THE MARK CONSISTS OF STANDARD CHARACTERS WITHOUT CLAIM TO ANY PARTICULAR FONT, STYLE, SIZE, OR COLOR.

SER. NO. 85-431,322, FILED 9-24-2011.

MICHAEL GAAFAR, EXAMINING ATTORNEY



David J. Kyffers

Director of the United States Patent and Trademark Office

United States of America
United States Patent and Trademark Office

naturegrind

Reg. No. 4,174,450

PIA INGREDIENTS CORP. (CALIFORNIA CORPORATION)
2420 INDUSTRY STREET
OCEANSIDE, CA 92054

Registered July 17, 2012

Int. Cl.: 29

FOR: FRUIT AND VEGETABLE GRANULES FOR USE IN PREPARED MEALS OR FOOD,
IN CLASS 29 (U.S. CL. 46).

TRADEMARK

FIRST USE 8-1-2011; IN COMMERCE 9-1-2011.

PRINCIPAL REGISTER

THE MARK CONSISTS OF THE STYLIZED WORDING "NATUREGRIND".

SER. NO. 85-431,739, FILED 9-26-2011.

DOMINIC FATHY, EXAMINING ATTORNEY



David J. Kyffers

Director of the United States Patent and Trademark Office

United States of America

United States Patent and Trademark Office

Billy and the Essentials

Reg. No. 4,174,451

Registered July 17, 2012

Int. Cl.: 9

TRADEMARK

PRINCIPAL REGISTER

CARLUCCI, WILLIAM V. (UNITED STATES INDIVIDUAL), DBA BILLY AND THE ESSENTIALS
911 PALMERS MILL RD.
MEDIA, PA 19063

FOR: AUDIO AND VIDEO RECORDINGS FEATURING MUSIC AND ARTISTIC PERFORMANCES; AUDIO AND VIDEO RECORDINGS FEATURING MUSIC; AUDIO RECORDINGS FEATURING MUSIC; COMPACT DISCS FEATURING MUSIC; COMPACT DISCS FEATURING MUSIC AND SPOKEN WORD IN THE FORM OF POETRY; COMPACT DISCS FEATURING MUSIC; DIGITAL MEDIA, NAMELY, PRE-RECORDED DVDS, DOWNLOADABLE AUDIO AND VIDEO RECORDINGS, AND CDS FEATURING AND PROMOTING MUSIC; DIGITAL MEDIA, NAMELY, PRE-RECORDED VIDEO CASSETTES, DIGITAL VIDEO DISCS, DIGITAL VERSATILE DISCS, DOWNLOADABLE AUDIO AND VIDEO RECORDINGS, DVDS, AND HIGH DEFINITION DIGITAL DISCS FEATURING MUSIC; DOWNLOADABLE MP3 FILES AND MP3 RECORDINGS FEATURING MUSIC; DOWNLOADABLE MP3 FILES, MP3 RECORDINGS, ON-LINE DISCUSSION BOARDS, WEBCASTS, WEBINARS AND PODCASTS FEATURING MUSIC, AUDIO BOOKS IN THE FIELD OF MUSIC, AND NEWS BROADCASTS; DOWNLOADABLE MUSICAL SOUND RECORDINGS; DOWNLOADABLE VIDEO RECORDINGS FEATURING MUSIC; ELECTRONIC DATABASE IN THE FIELD OF MUSIC RECORDED ON COMPUTER MEDIA; ELECTRONIC PUBLICATIONS, NAMELY, ARTICLES FEATURING MUSIC RECORDED ON COMPUTER MEDIA; MULTIMEDIA SOFTWARE RECORDED ON CD-ROM FEATURING MUSIC; MUSICAL RECORDINGS; MUSICAL SOUND RECORDINGS; MUSICAL VIDEO RECORDINGS; OPTICAL COMPACT DISCS FEATURING MUSIC; OPTICAL DISCS FEATURING MUSIC; PHONOGRAPH RECORDS FEATURING MUSIC; PHONOGRAPH RECORDS FEATURING MUSIC; PRE-RECORDED CDS FEATURING MUSIC; PRE-RECORDED CDS, VIDEO TAPES, LASER DISKS AND DVDS FEATURING MUSIC; PRE-RECORDED DIGITAL MEDIA FEATURING MUSIC; PRE-RECORDED DIGITAL VIDEO DISCS FEATURING MUSIC; PRE-RECORDED DVDS FEATURING MUSIC; PRE-RECORDED ELECTRONIC AND DIGITAL MEDIA FEATURING MUSIC; PRE-RECORDED ELECTRONIC MEDIA FEATURING MUSIC; PRE-RECORDED FLASH DRIVES FEATURING MUSIC; PRE-RECORDED VIDEO DISCS, VIDEO RECORDING AND VIDEO TAPES FEATURING MUSIC; SERIES OF MUSICAL SOUND RECORDINGS; SOUND RECORDED MAGNETIC CARDS, SHEETS AND TAPES; SOUND RECORDINGS FEATURING MUSIC; VIDEO DISCS FEATURING MUSIC; VIDEO RECORDINGS FEATURING MUSIC; VISUAL AND AUDIO RECORDINGS FEATURING MUSIC, IN CLASS 9 (U.S. CLS. 21, 23, 26, 36 AND 38).



David J. Kyffers

Director of the United States Patent and Trademark Office

FIRST USE 1-1-1959; IN COMMERCE 1-1-1960.

Reg. No. 4,174,451 THE MARK CONSISTS OF STANDARD CHARACTERS WITHOUT CLAIM TO ANY PARTICULAR FONT, STYLE, SIZE, OR COLOR.

OWNER OF U.S. REG. NO. 4,062,708.

SER. NO. 85-432,375, FILED 9-26-2011.

LINDA MICKLEBURGH, EXAMINING ATTORNEY

United States of America

United States Patent and Trademark Office

SafeTHome

Reg. No. 4,174,452

Registered July 17, 2012

Int. Cl.: 6

TRADEMARK

PRINCIPAL REGISTER

SUKUP MANUFACTURING CO. (IOWA CORPORATION)
P.O. BOX 677
1555 - 255TH STREET
SHEFFIELD, IA 504750677

FOR: PREFABRICATED STEEL SHELTER STRUCTURE KITS COMPRISING A PREFABRICATED STEEL BUILDING AND WATER COLLECTION SYSTEM, AFORESAID WITH AN ANCHORING SYSTEM RESISTANT TO SEISMIC ACTIVITY AND ENGINEERED TO WITHSTAND STRONG WINDS, IN CLASS 6 (U.S. CLS. 2, 12, 13, 14, 23, 25 AND 50).

FIRST USE 1-15-2011; IN COMMERCE 1-15-2011.

THE MARK CONSISTS OF STANDARD CHARACTERS WITHOUT CLAIM TO ANY PARTICULAR FONT, STYLE, SIZE, OR COLOR.

SER. NO. 85-432,676, FILED 9-27-2011.

LEIGH LOWRY, EXAMINING ATTORNEY



David J. Kybas

Director of the United States Patent and Trademark Office

United States of America

United States Patent and Trademark Office

EMSCOOL

Reg. No. 4,174,453

Registered July 17, 2012

Int. Cls.: 9, 11, 37 and 42

EMSCO, INC. (DELAWARE CORPORATION)
NOVA TECHNOLOGY PARK
1000 NAVE ROAD, S.E.
MASSILLON, OH 44646

FOR: ELECTRIC CONTROLLERS FOR FLUID COOLING UNITS, FLUID PUMPING UNITS AND FLUID FILTRATION UNITS, IN CLASS 9 (U.S. CLS. 21, 23, 26, 36 AND 38).

FIRST USE 3-31-2010; IN COMMERCE 3-31-2010.

TRADEMARK

SERVICE MARK

PRINCIPAL REGISTER

FOR: LIQUID COOLING EQUIPMENT, NAMELY, FLUID COOLING UNITS, FLUID PUMPING UNITS, FLUID FILTRATION UNITS AND COOLING SYSTEMS COMPRISED OF FLUID COOLING, PUMPING AND FILTRATION UNITS, FLUID COOLING AND PUMPING CONTROLLERS, FLUID-TO-FLUID HEAT EXCHANGERS, PIPING, HOSES, FITTINGS AND VALVES FOR INDUSTRIAL PROCESS EQUIPMENT, INCLUDING INDUCTION FURNACES, THAT REQUIRE REMOVAL OF PROCESS HEAT BY CIRCULATING COOLING LIQUID, IN CLASS 11 (U.S. CLS. 13, 21, 23, 31 AND 34).

FIRST USE 3-31-2010; IN COMMERCE 3-31-2010.

FOR: INSTALLATION AND SERVICING OF LIQUID COOLING EQUIPMENT AND COOLING SYSTEMS USED FOR INDUSTRIAL PROCESS EQUIPMENT, INCLUDING INDUCTION FURNACES, THAT REQUIRE REMOVAL OF PROCESS HEAT BY CIRCULATING COOLING LIQUID, IN CLASS 37 (U.S. CLS. 100, 103 AND 106).

FIRST USE 4-30-2010; IN COMMERCE 4-30-2010.

FOR: DESIGN SERVICES FOR LIQUID COOLING EQUIPMENT AND COOLING SYSTEMS USED FOR INDUSTRIAL PROCESS EQUIPMENT, INCLUDING INDUCTION FURNACES, THAT REQUIRE REMOVAL OF PROCESS HEAT BY CIRCULATING COOLING LIQUID, IN CLASS 42 (U.S. CLS. 100 AND 101).

FIRST USE 4-30-2010; IN COMMERCE 4-30-2010.

THE MARK CONSISTS OF STANDARD CHARACTERS WITHOUT CLAIM TO ANY PARTICULAR FONT, STYLE, SIZE, OR COLOR.



David J. Kyros

Director of the United States Patent and Trademark Office

Reg. No. 4,174,453 OWNER OF U.S. REG. NO. 3,180,682.

SER. NO. 85-432,887, FILED 9-27-2011.

BRIAN NEVILLE, EXAMINING ATTORNEY

United States of America

United States Patent and Trademark Office

UP
N

Reg. No. 4,174,454

Registered July 17, 2012

Int. Cl.: 35

SERVICE MARK

PRINCIPAL REGISTER

UNIVERSITY PHYSICIANS NETWORK, LLC (NEW YORK CORPORATION)
9TH FLOOR
14 WALL STREET
NEW YORK, NY 10005

FOR: BUSINESS MANAGEMENT SERVICES FOR PHYSICIANS, NAMELY, NEGOTIATING MANAGED CARE CONTRACTS, COOPERATIVE MARKETING SERVICES AND PHYSICIAN PRACTICE MANAGEMENT SERVICES; BUSINESS CONSULTATION SERVICES FOR PHYSICIANS IN THE FIELD OF MEDICAL PRACTICE AND COOPERATIVE MEDICAL PRACTICE MARKETING, IN CLASS 35 (U.S. CLS. 100, 101 AND 102).

FIRST USE 7-9-1996; IN COMMERCE 7-9-1996.

THE MARK CONSISTS OF THE CAPITAL LETTERS "U" AND "P" BUTTED TOGETHER WITH THE CAPITAL LETTER "N" AFFIXED BENEATH.

SER. NO. 85-433,046, FILED 9-27-2011.

PAUL MORENO, EXAMINING ATTORNEY



David J. Kyffers

Director of the United States Patent and Trademark Office

United States of America

United States Patent and Trademark Office

My French Café

Reg. No. 4,174,455

MY FRENCH CAFE, INC. (FLORIDA CORPORATION)
499 N. STATE ROAD 434, SUITE 2063
ALTAMONTE SPRINGS, FL 32714

Registered July 17, 2012

Int. Cl.: 43

FOR: PROVIDING OF FOOD AND DRINK, IN CLASS 43 (U.S. CLS. 100 AND 101).

SERVICE MARK

FIRST USE 5-31-2011; IN COMMERCE 5-31-2011.

PRINCIPAL REGISTER

THE MARK CONSISTS OF STANDARD CHARACTERS WITHOUT CLAIM TO ANY PARTICULAR FONT, STYLE, SIZE, OR COLOR.

NO CLAIM IS MADE TO THE EXCLUSIVE RIGHT TO USE "FRENCH CAFE", APART FROM THE MARK AS SHOWN.

SER. NO. 85-433,100, FILED 9-27-2011.

JANICE KIM, EXAMINING ATTORNEY



David J. Kyffers

Director of the United States Patent and Trademark Office

United States of America

United States Patent and Trademark Office



Reg. No. 4,174,456

Registered July 17, 2012

Int. Cl.: 25

TRADEMARK

PRINCIPAL REGISTER

CATAWBA COLLEGE (NORTH CAROLINA COLLEGE)
2300 WEST INNES STREET
SALISBURY, NC 28144

FOR: HATS; UNIFORMS, IN CLASS 25 (U.S. CLS. 22 AND 39).

FIRST USE 8-15-1984; IN COMMERCE 8-15-1984.

THE MARK CONSISTS OF A STYLIZED LETTER "C" WITH A DESIGN OF THREE FEATHERS.

SER. NO. 85-433,308, FILED 9-27-2011.

RICHARD WHITE, EXAMINING ATTORNEY



David J. Kyffers

Director of the United States Patent and Trademark Office

United States of America

United States Patent and Trademark Office

NEMAT INTERNATIONAL

Reg. No. 4,174,457

Registered July 17, 2012

Int. Cl.: 3

TRADEMARK

PRINCIPAL REGISTER

NEMAT INTERNATIONAL INC. (CALIFORNIA CORPORATION)
3070 OSGOOD COURT
FREMONT, CA 94539

FOR: AROMATIC ESSENTIAL OILS; AROMATIC OILS; BEAUTY LOTIONS; BODY LOTION; BODY LOTIONS; COLOGNE; COSMETIC OILS; COSMETIC OILS FOR THE EPIDERMIS; EAU DE COLOGNES; EAU DE PARFUM; EAU DE PERFUME; EAU DE TOILETTE; EAU DE TOILETTE AND EAU DE COLOGNE; EAU-DE-COLOGNE; EAU-DE-TOILETTE; EAUX DE COLOGNE; EAUX DE TOILETTE; ESSENTIAL OILS; ESSENTIAL OILS FOR AROMATHERAPY USE; ESSENTIAL OILS FOR FOOD FLAVORINGS; ESSENTIAL OILS FOR PERSONAL USE; ESSENTIAL OILS FOR USE IN AROMATHERAPY; ESSENTIAL OILS FOR USE IN MANUFACTURING OF SOAPS, CANDLES, INCENSE, POTPOURRI, INCENSE STICKS, REED DIFFUSERS, DIFFUSER FRAGRANCES, AND DIFFUSER OILS; ESSENTIAL OILS FOR USE IN THE MANUFACTURE OF SCENTED PRODUCTS; ETHEREAL ESSENCES; ETHEREAL OILS; FACE AND BODY LOTIONS; FRAGRANCE EMITTING WICKS FOR ROOM FRAGRANCE; FRAGRANCES; FRAGRANCES AND PERFUMERY; FRAGRANCES FOR PERSONAL USE; HAND LOTIONS; INCENSE; INCENSE STICKS; LIQUID PERFUMES; LOTIONS FOR COSMETIC PURPOSES; MASSAGE LOTIONS; MASSAGE OIL; MASSAGE OILS; NATURAL ESSENTIAL OILS; OILS FOR PERFUMES AND SCENTS; PERFUME; PERFUME OILS; PERFUME OILS FOR THE MANUFACTURE OF COSMETIC PREPARATIONS; PERFUMED CREAMS; PERFUMES; PERFUMES AND COLOGNES; PERFUMES IN SOLID FORM; REEDS AND SCENTED OILS SOLD AS A UNIT FOR USE IN ROOM SCENT DIFFUSERS; ROOM FRAGRANCE REFILLS FOR NON-ELECTRIC ROOM FRAGRANCE DISPENSERS; ROOM FRAGRANCES; ROOM FRAGRANCING PREPARATIONS; ROSE OIL FOR COSMETIC PURPOSES; SCENTED BODY LOTIONS AND CREAMS; SCENTED BODY SPRAY; SCENTED LINEN SPRAYS; SCENTED OILS; SCENTED OILS USED TO PRODUCE AROMAS WHEN HEATED; SCENTED ROOM SPRAYS; SCENTED STICKS FOR ADDING SCENT TO A FLOWER BOUQUET OR FLOWERING POT PLANT; SCENTED WOOD; SKIN LOTION; SKIN LOTIONS; SYNTHETIC PERFUMERY, IN CLASS 3 (U.S. CLS. 1, 4, 6, 50, 51 AND 52).



FIRST USE 11-1-1989; IN COMMERCE 11-1-1989.

David J. Kybas

THE MARK CONSISTS OF STANDARD CHARACTERS WITHOUT CLAIM TO ANY PARTICULAR FONT, STYLE, SIZE, OR COLOR.

Reg. No. 4,174,457 NO CLAIM IS MADE TO THE EXCLUSIVE RIGHT TO USE "INTERNATIONAL", APART FROM THE MARK AS SHOWN.

SER. NO. 85-433,313, FILED 9-27-2011.

LINDA ESTRADA, EXAMINING ATTORNEY

United States of America

United States Patent and Trademark Office

Adapt Courseware

Reg. No. 4,174,458

Registered July 17, 2012

Int. Cl.: 41

SERVICE MARK

PRINCIPAL REGISTER

ADAPT COURSEWARE, INC. (NEW YORK CORPORATION)
SUITE 315
3300 MONROE AVENUE
ROCHESTER, NY 14618

FOR: EDUCATIONAL SERVICES, NAMELY, PROVIDING ONLINE LECTURES OF COLLEGE COURSES IN THE FIELD OF GENERAL EDUCATION AND DISTRIBUTION OF COURSE MATERIALS IN CONNECTION THEREWITH, IN CLASS 41 (U.S. CLS. 100, 101 AND 107).

FIRST USE 9-1-2010; IN COMMERCE 9-1-2010.

THE MARK CONSISTS OF STANDARD CHARACTERS WITHOUT CLAIM TO ANY PARTICULAR FONT, STYLE, SIZE, OR COLOR.

NO CLAIM IS MADE TO THE EXCLUSIVE RIGHT TO USE "COURSEWARE", APART FROM THE MARK AS SHOWN.

SER. NO. 85-433,412, FILED 9-27-2011.

DEZMONA MIZELLE, EXAMINING ATTORNEY



David J. Kyffers

Director of the United States Patent and Trademark Office

United States of America

United States Patent and Trademark Office

OSCAR ROBERTSON SOLUTIONS

Reg. No. 4,174,459

Registered July 17, 2012

Int. Cls.: 35, 38 and 42

SERVICE MARK

PRINCIPAL REGISTER

ROBERTSON, OSCAR (UNITED STATES INDIVIDUAL)
10999 REED HARTMAN HIGHWAY
SUITE 206
CINCINNATI, OH 45242

FOR: BUSINESS SERVICES, NAMELY, FACILITIES MANAGEMENT SERVICES IN THE NATURE OF MANAGEMENT OF TECHNICAL OPERATIONS; BUSINESS RECORDS MANAGEMENT SERVICES; PROVIDING CONSULTING FACILITATING COMMERCIAL PLANNING AND BUYING OF PRINT SERVICES FOR OTHERS; DIRECT MAIL ADVERTISING SERVICES; ORDER FULFILLMENT SERVICES; ADVERTISING AND MARKETING SERVICES, NAMELY, PROMOTING THE GOODS AND SERVICES OF OTHERS; DOCUMENT IMAGING, NAMELY, DOCUMENT COPYING; MAIL CENTER AND COURIER BUSINESS MANAGEMENT SERVICES, NAMELY, CONSULTING REGARDING THE MANAGEMENT OF RECEIVING, PROCESSING, AND SENDING INTERNATIONAL AND DOMESTIC MAIL AND PACKAGES, IN CLASS 35 (U.S. CLS. 100, 101 AND 102).

FIRST USE 0-0-2000; IN COMMERCE 0-0-2000.

FOR: ON-LINE DOCUMENT DELIVERY VIA A GLOBAL COMPUTER NETWORK, IN CLASS 38 (U.S. CLS. 100, 101 AND 104).

FIRST USE 0-0-2000; IN COMMERCE 0-0-2000.

FOR: PLANNING, DESIGN AND MANAGEMENT OF INFORMATION TECHNOLOGY SYSTEMS OF OTHERS; DOCUMENT IMAGING, NAMELY, DIGITIZATION OF DOCUMENTS, IN CLASS 42 (U.S. CLS. 100 AND 101).

FIRST USE 0-0-2000; IN COMMERCE 0-0-2000.

THE MARK CONSISTS OF STANDARD CHARACTERS WITHOUT CLAIM TO ANY PARTICULAR FONT, STYLE, SIZE, OR COLOR.

NO CLAIM IS MADE TO THE EXCLUSIVE RIGHT TO USE "SOLUTIONS", APART FROM THE MARK AS SHOWN.

THE NAME(S), PORTRAIT(S), AND/OR SIGNATURE(S) SHOWN IN THE MARK IDENTIFIES "OSCAR ROBERTSON", WHOSE CONSENT(S) TO REGISTER IS MADE OF RECORD.



David J. Kybas

Director of the United States Patent and Trademark Office

Reg. No. 4,174,459 SER. NO. 85-433,520, FILED 9-27-2011.

LINDA POWELL, EXAMINING ATTORNEY

United States of America

United States Patent and Trademark Office

Jokage

Reg. No. 4,174,460

Registered July 17, 2012

Int. Cl.: 28

TRADEMARK

PRINCIPAL REGISTER

WESMAH LLC (WASHINGTON LIMITED LIABILITY COMPANY), TA JOKAGE
18639 175TH AVE SE
RENTON, WA 98058

FOR: BINGO CARDS; CARD GAME FOR BUSINESS TRAINING; CARD GAMES; EDUCATIONAL CARD GAMES; EQUIPMENT SOLD AS A UNIT FOR PLAYING CARD GAMES; GAME CARDS; GAME EQUIPMENT SET SOLD AS A UNIT COMPRISED PRIMARILY OF A PLAYING BOARD AND PLAYING CARDS AND ALSO INCLUDING RULES OF PLAY, DRY ERASE BOARDS AND ERASERS, MARKERS, A TIMER AND T-SHIRTS; GAMING EQUIPMENT, NAMELY, PLAYING CARDS, CHIPS, GAMING TABLES AND GAMING CLOTHS; JAPANESE PLAYING CARDS (HANAFUDA); KARUTA PLAYING CARDS (JAPANESE CARD GAME); KENO CARDS; LOTTERY CARDS; ORDINARY PLAYING CARDS; PLAYING CARD CASES; PLAYING CARD GAME ACCESSORIES, NAMELY, PLAYING CARD CASES, PLAYING CARD HOLDERS, MATS FOR USE IN CONNECTION WITH PLAYING CARD GAMES, PLAYING CARD SHUFFLING DEVICES AND DICE; PLAYING CARD SHUFFLING DEVICE; PLAYING CARD SHUFFLING MACHINES; PLAYING CARDS; PLAYING CARDS AND CARD GAMES; POKER CARD GUARDS; PROMOTIONAL GAME CARDS; SCRATCH CARDS FOR PLAYING LOTTERY GAMES; TRADING CARD GAMES; TRIVIA GAME PLAYED WITH CARDS AND GAME COMPONENTS, IN CLASS 28 (U.S. CLS. 22, 23, 38 AND 50).

FIRST USE 3-18-2010; IN COMMERCE 9-25-2011.

THE MARK CONSISTS OF STANDARD CHARACTERS WITHOUT CLAIM TO ANY PARTICULAR FONT, STYLE, SIZE, OR COLOR.

SER. NO. 85-433,627, FILED S.R. 9-28-2011 AM. P.R. 2-29-2012.

BARBARA RUTLAND, EXAMINING ATTORNEY



David J. Kyffers

Director of the United States Patent and Trademark Office

United States of America

United States Patent and Trademark Office

Twin Farms

Reg. No. 4,174,461

TWIN FARMS MANAGEMENT COMPANY (VERMONT CORPORATION)
452 ROYALTON TURNPIKE
BARNARD, VT 05031

Registered July 17, 2012

Int. Cl.: 43

FOR: RESORT HOTEL SERVICES, IN CLASS 43 (U.S. CLS. 100 AND 101).

SERVICE MARK

FIRST USE 8-1-1993; IN COMMERCE 8-1-1993.

PRINCIPAL REGISTER

THE MARK CONSISTS OF STANDARD CHARACTERS WITHOUT CLAIM TO ANY PARTICULAR FONT, STYLE, SIZE, OR COLOR.

SER. NO. 85-433,686, FILED 9-28-2011.

NAPOLEON SHARMA, EXAMINING ATTORNEY



David J. Kybas

Director of the United States Patent and Trademark Office

United States of America

United States Patent and Trademark Office



Reg. No. 4,174,462

Registered July 17, 2012

Int. Cl.: 20

TRADEMARK

PRINCIPAL REGISTER

DREAMWELL, LTD. (NEVADA LIMITED LIABILITY COMPANY)
SUITE 12
2215-B RENAISSANCE DRIVE
LAS VEGAS, NV 89119

FOR: MATTRESSES; MATTRESS FOUNDATIONS; BOX SPRINGS, IN CLASS 20 (U.S. CLS. 2, 13, 22, 25, 32 AND 50).

FIRST USE 1-29-2012; IN COMMERCE 1-29-2012.

THE NAME(S), PORTRAIT(S), AND/OR SIGNATURE(S) SHOWN IN THE MARK IDENTIFIES TATYANA ZAYKA, WHOSE CONSENT(S) TO REGISTER IS MADE OF RECORD.

THE MARK CONSISTS OF A SLEEPING WOMAN WITH HER HEAD ON A PILLOW, INSIDE A RECTANGULAR BACKGROUND, OUTLINED WITH A STYLIZED SHAPE OF A BATTERY.

SER. NO. 85-433,712, FILED 9-28-2011.

ELISSA GARBER KON, EXAMINING ATTORNEY



David J. Kybas

Director of the United States Patent and Trademark Office

United States of America

United States Patent and Trademark Office

DON'T STOP THE BEAT

Reg. No. 4,174,463

Registered July 17, 2012

Int. Cl.: 35

SERVICE MARK

PRINCIPAL REGISTER

RITCHIE, DAVID (UNITED STATES INDIVIDUAL)
3072 GLEN OAK AVE N.
CLEARWATER, FL 33759

FOR: PROMOTING PUBLIC AWARENESS IN SUPPORT OF PRO-LIFE BELIEFS; ON-LINE RETAIL STORE SERVICES FEATURING T-SHIRTS, HATS, RUBBER BRACELETS, SILICON BRACELETS, BRACELETS, BELTS, VINYL DECALS, STICKERS, HOODED SWEATSHIRTS, BAGS, JACKETS, FOOTWEAR, HEADWEAR, TOPS, BOTTOMS, SHIRTS, AND PANTS, IN CLASS 35 (U.S. CLS. 100, 101 AND 102).

FIRST USE 8-18-2011; IN COMMERCE 8-22-2011.

THE MARK CONSISTS OF STANDARD CHARACTERS WITHOUT CLAIM TO ANY PARTICULAR FONT, STYLE, SIZE, OR COLOR.

SER. NO. 85-434,399, FILED 9-28-2011.

JESSICA A. POWERS, EXAMINING ATTORNEY



David J. Kybas

Director of the United States Patent and Trademark Office

United States of America

United States Patent and Trademark Office

Ray Charles Easy Shine

Reg. No. 4,174,464

Registered July 17, 2012

Int. Cl.: 7

TRADEMARK

PRINCIPAL REGISTER

PATTERSON, RAY CHARLES (UNITED STATES INDIVIDUAL)
#716
13428 MAXELLA AVE.
MARINA DEL REY, CA 90292

FOR: HAND HELD ELECTRIC SHOE POLISHER, IN CLASS 7 (U.S. CLS. 13, 19, 21, 23, 31, 34 AND 35).

FIRST USE 4-1-2011; IN COMMERCE 6-1-2011.

THE MARK CONSISTS OF STANDARD CHARACTERS WITHOUT CLAIM TO ANY PARTICULAR FONT, STYLE, SIZE, OR COLOR.

NO CLAIM IS MADE TO THE EXCLUSIVE RIGHT TO USE "SHINE", APART FROM THE MARK AS SHOWN.

THE NAME "RAY CHARLES" IDENTIFIES A LIVING INDIVIDUAL WHOSE CONSENT IS OF RECORD.

SER. NO. 85-434,549, FILED 9-28-2011.

ANNE MADDEN, EXAMINING ATTORNEY



David J. Kyjars

Director of the United States Patent and Trademark Office

United States of America

United States Patent and Trademark Office

CLEAN EARTH CARD

Reg. No. 4,174,465

Registered July 17, 2012

Int. Cl.: 17

TRADEMARK

PRINCIPAL REGISTER

SWIECICKI, MICHAEL (UNITED STATES INDIVIDUAL)
9708 TURQUOISE LANE
BRENTWOOD, TN 37027

FOR: ENVIRONMENTALLY FRIENDLY PLASTIC IN THE NATURE OF PVC IN PRE-CUT AND SHEET FORM USED TO MANUFACTURE DRIVER'S LICENSES, ACCESS CONTROL CARDS, CARDS FOR SEVERE-SERVICE AND EXTENDED LIFE APPLICATIONS, CREDIT CARDS, GOVERNMENT CARDS, IDENTIFICATION CARDS, MILITARY CARDS, SECURITY CARDS, AND SMART CARDS, IN CLASS 17 (U.S. CLS. 1, 5, 12, 13, 35 AND 50).

FIRST USE 9-1-2009; IN COMMERCE 9-14-2009.

THE MARK CONSISTS OF STANDARD CHARACTERS WITHOUT CLAIM TO ANY PARTICULAR FONT, STYLE, SIZE, OR COLOR.

OWNER OF U.S. REG. NO. 4,095,520.

NO CLAIM IS MADE TO THE EXCLUSIVE RIGHT TO USE "CARD", APART FROM THE MARK AS SHOWN.

SER. NO. 85-434,661, FILED 9-28-2011.

MARTHA FROMM, EXAMINING ATTORNEY



David J. Kyffers

Director of the United States Patent and Trademark Office

United States of America
United States Patent and Trademark Office

apmTV

Reg. No. 4,174,466

MERIDIUM, INC. (VIRGINIA CORPORATION)
207 BULLITT AVENUE SE
ROANOKE, VA 24013

Registered July 17, 2012

Int. Cl.: 35

FOR: PROVIDING A WEB SITE FEATURING NONDOWNLOADABLE AUDIO AND VIDEO PRESENTATIONS IN THE FIELD OF BUSINESS INFORMATION, IN CLASS 35 (U.S. CLS. 100, 101 AND 102).

SERVICE MARK

FIRST USE 8-26-2011; IN COMMERCE 8-26-2011.

PRINCIPAL REGISTER

NO CLAIM IS MADE TO THE EXCLUSIVE RIGHT TO USE "APM", APART FROM THE MARK AS SHOWN.

THE MARK CONSISTS OF LOWERCASE LETTERS "APM", FOLLOWED BY THE UPPER-CASE LETTERS "TV" IN A BOX WITH ROUNDED CORNERS.

SER. NO. 85-434,933, FILED 9-29-2011.

BRENDAN MCCAULEY, EXAMINING ATTORNEY



David J. Kyffers

Director of the United States Patent and Trademark Office

United States of America

United States Patent and Trademark Office



Reg. No. 4,174,467

Registered July 17, 2012

Int. Cl.: 37

SERVICE MARK

PRINCIPAL REGISTER

PANNELL MECHANICAL, INC. (TENNESSEE CORPORATION)
PO BOX 15082
CHATTANOOGA, TN 37415

FOR: INSTALLATION, MAINTENANCE AND REPAIR OF HVAC, REFRIGERATION AND FOODSERVICE EQUIPMENT, IN CLASS 37 (U.S. CLS. 100, 103 AND 106).

FIRST USE 10-0-2007, THE MARK WAS FIRST USED ANYWHERE IN A DIFFERENT FORM OTHER THAN THAT SOUGHT TO BE REGISTERED AT LEAST AS EARLY AS 00/00/1991.; IN COMMERCE 10-0-2007, THE MARK WAS FIRST USED IN COMMERCE IN A DIFFERENT FORM OTHER THAN THAT SOUGHT TO BE REGISTERED AT LEAST AS EARLY AS 00/00/1991..

THE MARK CONSISTS OF THE WORD "PANNELL" NEXT TO INTERLOCKING HALF CIRCLES.

SER. NO. 85-435,290, FILED 9-29-2011.

JOHN DALIER, EXAMINING ATTORNEY



David J. Kyffers

Director of the United States Patent and Trademark Office

United States of America

United States Patent and Trademark Office

Ramaura

Reg. No. 4,174,468

Registered July 17, 2012

Int. Cl.: 14

TRADEMARK

PRINCIPAL REGISTER

OSMER, JUDITH A. (CALIFORNIA CORPORATION)
111 VIA LA CIRCULA
REDONDO BEACH, CA 90277

FOR: GEMS, IN CLASS 14 (U.S. CLS. 2, 27, 28 AND 50).

FIRST USE 1-1-1987; IN COMMERCE 1-1-1987.

THE MARK CONSISTS OF STANDARD CHARACTERS WITHOUT CLAIM TO ANY PARTICULAR FONT, STYLE, SIZE, OR COLOR.

THE WORDING "RAMAURA" HAS NO MEANING IN A FOREIGN LANGUAGE.

SER. NO. 85-435,828, FILED 9-29-2011.

LUCY ARANT, EXAMINING ATTORNEY



David J. Kyffers

Director of the United States Patent and Trademark Office

United States of America

United States Patent and Trademark Office

live to the beat.

Reg. No. 4,174,469

Registered July 17, 2012

Int. Cl.: 25

TRADEMARK

PRINCIPAL REGISTER

IMPUHLS, INC. (COLORADO CORPORATION)
9211 SOUTH ROCKPORT LANE
HIGHLANDS RANCH, CO 80126

FOR: T-SHIRTS, IN CLASS 25 (U.S. CLS. 22 AND 39).

FIRST USE 9-29-2011; IN COMMERCE 9-29-2011.

THE MARK CONSISTS OF STANDARD CHARACTERS WITHOUT CLAIM TO ANY PARTICULAR FONT, STYLE, SIZE, OR COLOR.

SER. NO. 85-435,894, FILED 9-29-2011.

ADA HAN, EXAMINING ATTORNEY



David J. Kyffers

Director of the United States Patent and Trademark Office

United States of America

United States Patent and Trademark Office

GEAR MIRROR



GEAR AT A GLANCE

Reg. No. 4,174,470

FINN, HARVEY (UNITED STATES INDIVIDUAL)
0340 CABALLO STREET
CARBONDALE, CO 81623

Registered July 17, 2012

Int. Cl.: 12

FOR: BICYCLE ACCESSORIES, NAMELY, BICYCLE MIRRORS FOR USE IN MONITORING THE REAR CASSETTE ON MULTI-SPEED ROADS AND MOUNTAIN BICYCLES, IN CLASS 12 (U.S. CLS. 19, 21, 23, 31, 35 AND 44).

TRADEMARK

FIRST USE 4-10-2010; IN COMMERCE 9-13-2010.

PRINCIPAL REGISTER

NO CLAIM IS MADE TO THE EXCLUSIVE RIGHT TO USE "GEAR MIRROR", APART FROM THE MARK AS SHOWN.

THE MARK CONSISTS OF AN EYE WITH A GEAR IN THE CENTER OF THE EYE AND THE STYLIZED TEXT "GEAR MIRROR GEAR AT A GLANCE".

SER. NO. 85-435,908, FILED 9-29-2011.

MARIA-VICTORIA SUAREZ, EXAMINING ATTORNEY



David J. Kyffers

Director of the United States Patent and Trademark Office

United States of America

United States Patent and Trademark Office

DIABETESTEPS RX

Reg. No. 4,174,471

HEALTHSTEPS RX, INC. (TEXAS CORPORATION)
103 SWEETLEAF GROVE LANE
CONROE, TX 77384

Registered July 17, 2012

Int. Cls.: 41 and 44

FOR: EDUCATIONAL AND ENTERTAINMENT SERVICES, NAMELY, CONDUCTING CLASSES, SEMINARS, CONFERENCES, WORKSHOPS, RETREATS, CAMPS AND FIELD TRIPS IN THE FIELDS OF NUTRITION, HEALTH AND WELLNESS AND DISTRIBUTION OF TRAINING MATERIAL IN CONNECTION THEREWITH; PROVIDING A WEBSITE FEATURING INFORMATION ABOUT NUTRITION, HEALTH AND WELLNESS, INCLUDING NON-DOWNLOADABLE PUBLICATIONS IN THE NATURE OF AN E-ZINE, NEWSLETTER AND ONLINE ARTICLES, IN CLASS 41 (U.S. CLS. 100, 101 AND 107).

SERVICE MARK

PRINCIPAL REGISTER

FIRST USE 4-9-2010; IN COMMERCE 4-9-2010.

FOR: PROVISION OF HEALTH CARE AND MEDICAL SERVICES BY HEALTH CARE PROFESSIONALS VIA THE INTERNET, TELECOMMUNICATION NETWORKS, AND IN PERSON AT HEALTH CLINICS IN THE FIELDS OF NUTRITION, HEALTH AND WELLNESS; PROVIDING A WEBSITE FEATURING INFORMATION, NEWS AND COMMENTARY ABOUT NUTRITION, HEALTH AND WELLNESS, IN CLASS 44 (U.S. CLS. 100 AND 101).

FIRST USE 4-9-2010; IN COMMERCE 4-9-2010.

THE MARK CONSISTS OF STANDARD CHARACTERS WITHOUT CLAIM TO ANY PARTICULAR FONT, STYLE, SIZE, OR COLOR.

NO CLAIM IS MADE TO THE EXCLUSIVE RIGHT TO USE "RX", APART FROM THE MARK AS SHOWN.

SER. NO. 85-436,132, FILED 9-30-2011.

MATTHEW KLINE, EXAMINING ATTORNEY



David J. Kappas

Director of the United States Patent and Trademark Office

United States of America

United States Patent and Trademark Office

ENERGYSTEPS RX

Reg. No. 4,174,472

Registered July 17, 2012

Int. Cls.: 35 and 41

SERVICE MARK

PRINCIPAL REGISTER

HEALTHSTEPS RX, INC. (TEXAS CORPORATION)
103 SWEETLEAF GROVE LANE
CONROE, TX 77384

FOR: BUSINESS MANAGEMENT CONSULTING SERVICES IN THE FIELD OF ENERGY AND NATURAL GAS USAGE; PROVIDING AN ON-LINE COMPUTER DATABASE AND ORDERING SERVICES IN THE FIELD OF LOCATING, DESCRIBING, RATING, PRICING AND COMPARING PRICES OF RESIDENTIAL UTILITY PRODUCTS, IN CLASS 35 (U.S. CLS. 100, 101 AND 102).

FIRST USE 9-20-2010; IN COMMERCE 9-20-2010.

FOR: EDUCATIONAL SERVICES, NAMELY, CONDUCTING CLASSES, SEMINARS, CONFERENCES, WORKSHOPS, RETREATS, CAMPS AND FIELD TRIPS IN THE FIELD OF ENERGY AND NATURAL GAS USAGE, CONSUMPTION, PROCUREMENT, CONTRACTING, EFFICIENCY, MANAGEMENT, CONSERVATION, MEASUREMENT, AND REMEDIES AND DISTRIBUTION OF TRAINING MATERIAL IN CONNECTION THEREWITH; PROVIDING A WEBSITE FEATURING BLOGS AND NON-DOWNLOADABLE PUBLICATIONS IN THE NATURE OF ARTICLES, BOOKLETS, BROCHURES, MANUALS AND WORKBOOKS ABOUT THE ENERGY AND NATURAL GAS INDUSTRIES, IN CLASS 41 (U.S. CLS. 100, 101 AND 107).

FIRST USE 9-20-2010; IN COMMERCE 9-20-2010.

THE MARK CONSISTS OF STANDARD CHARACTERS WITHOUT CLAIM TO ANY PARTICULAR FONT, STYLE, SIZE, OR COLOR.

SER. NO. 85-436,144, FILED 9-30-2011.

MATTHEW KLINE, EXAMINING ATTORNEY



David J. Kybas

Director of the United States Patent and Trademark Office

United States of America

United States Patent and Trademark Office



Reg. No. 4,174,473

Registered July 17, 2012

Int. Cls.: 33, 35 and 43

TRADEMARK

SERVICE MARK

PRINCIPAL REGISTER

VITICOLTORI D'ITALIA S.R.L. (ITALY LIMITED LIABILITY COMPANY)
VIA PACINOTTI, 9
37135 VERONA, ITALY

FOR: WINES, IN CLASS 33 (U.S. CLS. 47 AND 49).

FOR: PUBLICITY BUREAU SERVICES; DISSEMINATION OF ADVERTISING MATTER; DIRECT MAIL ADVERTISING SERVICES; ADVERTISING SERVICES; BUSINESS PLANNING; ASSISTANCE WITH BUSINESS MANAGEMENT AND PLANNING; PRESENTATION OF GOODS ON COMMUNICATION MEDIA FOR RETAIL PURPOSES, IN CLASS 35 (U.S. CLS. 100, 101 AND 102).

FOR: RESTAURANT SERVICES AND CARRY-OUT RESTAURANT SERVICES, IN CLASS 43 (U.S. CLS. 100 AND 101).

OWNER OF ERPN CMNTY TM OFC REG. NO. 9904459, DATED 9-13-2011, EXPIRES 4-19-2021.

THE COLOR(S) BLACK, RED, GREY AND YELLOW IS/ARE CLAIMED AS A FEATURE OF THE MARK.

NO CLAIM IS MADE TO THE EXCLUSIVE RIGHT TO USE "ITALIANS", "VITICOLTORI SINGOLARI AL PLURALE" AND "PLURALITY OF SINGULAR VINTNERS", APART FROM THE MARK AS SHOWN.

THE MARK CONSISTS OF THE WORD "ITALIANS" IN UPPER CASE CHARACTERS BELOW WHICH ARE THE LOWER CASE WORDS "VITICOLTORI SINGOLARI AL PLURALE" STACKED ON THREE LEVELS ON THE LEFT AND THE LOWER CASE WORDS "PLURALITY OF SINGULAR VINTNERS" STACKED ON THREE LEVELS ON THE RIGHT, ALL SURROUNDED BY A STYLIZED RECTANGULAR FRAME MADE OF SPAGHETTI. THE WORD "ITALIAN" APPEARS IN THE COLOR BLACK; THE LETTER "S" IN THE WORD "ITALIANS" APPEARS IN THE COLOR RED; THE WORDS "VITICOLTORI SINGOLARI AL PLURALE" APPEAR IN THE COLOR BLACK; THE WORDS "PLURALITY OF SINGULAR VINTNERS" APPEAR IN THE COLOR GREY; AND THE SPAGHETTI FRAME APPEARS IN THE COLOR YELLOW.



David J. Kybas

Director of the United States Patent and Trademark Office

Reg. No. 4,174,473 THE ENGLISH TRANSLATION OF VITICOLTORI SINGOLARIAL PLURALE IN THE MARK
IS PLURALITY OF SINGULAR VINTNERS.

SER. NO. 85-436,294, FILED 9-30-2011.

JENNIFER WILLISTON, EXAMINING ATTORNEY

United States of America

United States Patent and Trademark Office

UNIVISION STUDIOS

Reg. No. 4,174,474

UNIVISION COMMUNICATIONS INC. (DELAWARE CORPORATION)
5999 CENTER DRIVE
LOS ANGELES, CA 90045

Registered July 17, 2012

Int. Cl.: 41

FOR: ENTERTAINMENT SERVICES, NAMELY, PRODUCTION AND DISTRIBUTION OF TELEVISION PROGRAMS, IN CLASS 41 (U.S. CLS. 100, 101 AND 107).

SERVICE MARK

FIRST USE 12-7-2009; IN COMMERCE 12-7-2009.

PRINCIPAL REGISTER

THE MARK CONSISTS OF STANDARD CHARACTERS WITHOUT CLAIM TO ANY PARTICULAR FONT, STYLE, SIZE, OR COLOR.

OWNER OF U.S. REG. NOS. 3,568,848, 4,012,168 AND OTHERS.

NO CLAIM IS MADE TO THE EXCLUSIVE RIGHT TO USE "STUDIOS", APART FROM THE MARK AS SHOWN.

SER. NO. 85-436,362, FILED 9-30-2011.

HEATHER BIDDULPH, EXAMINING ATTORNEY



David J. Kybas

Director of the United States Patent and Trademark Office

United States of America

United States Patent and Trademark Office



Reg. No. 4,174,475

Registered July 17, 2012

Int. Cl.: 35

LONE WOLFS MOTORCYCLE CORPORATION (NEVADA CORPORATION), DBA IRON
EAGLE
8174 S LAS VEGAS BLVD
STE 109-15
LAS VEGAS, NV 89123

SERVICE MARK

PRINCIPAL REGISTER

FOR: CHARITABLE SERVICES, NAMELY, COORDINATION OF NON-MONETARY CONTRIBUTIONS TO CHARITIES AND NON-PROFITS; PROMOTING THE CHARITABLE SERVICES OF OTHERS, NAMELY, PROVIDING INDIVIDUALS WITH INFORMATION ABOUT VARIOUS CHARITIES FOR THE PURPOSE OF MAKING DONATIONS TO CHARITIES; PROMOTIONAL SERVICES, NAMELY, PROMOTING THE CHARITIES OF OTHERS, IN CLASS 35 (U.S. CLS. 100, 101 AND 102).

FIRST USE 5-1-2011; IN COMMERCE 6-7-2011.

NO CLAIM IS MADE TO THE EXCLUSIVE RIGHT TO USE "DIABETES", APART FROM THE MARK AS SHOWN.

THE COLOR(S) BLUE AND RED IS/ARE CLAIMED AS A FEATURE OF THE MARK.

THE MARK CONSISTS OF A RED AND BLUE EAGLE ON A SHIELD HOLDING AN OLIVE BRANCH AND THREE ARROWS, AND INCLUDING THE WORDS "MOBILIZING TO DEFEAT DIABETES" ON A SCROLL; THE WORDS "IRON EAGLE" APPEAR BELOW THE EAGLE DESIGN; AND THE LINING SHOWN IN THE DRAWING IS FOR SHADING PURPOSES.

SER. NO. 85-436,510, FILED 9-30-2011.

ALEXANDER L. POWERS, EXAMINING ATTORNEY



David J. Kyffers

Director of the United States Patent and Trademark Office

United States of America

United States Patent and Trademark Office

ITG

Reg. No. 4,174,476

Registered July 17, 2012

Int. Cls.: 9, 35, 36 and 38

TRADEMARK

SERVICE MARK

PRINCIPAL REGISTER

ITG SOFTWARE SOLUTIONS, INC. (DELAWARE CORPORATION)
6TH FL.
400 CORPORATE POINTE
CULVER CITY, CA 90230

FOR: DOWNLOADABLE COMPUTER APPLICATIONS OFFERED VIA THE GLOBAL COMPUTER NETWORK FOR USE IN FORECASTING OF FINANCIAL COSTS; COMPUTER PROGRAMS THAT COLLECT AND ANALYZE SECURITIES TRADING DATA AND EXECUTE AUTOMATED SECURITIES TRADES FOR INSTITUTIONAL INVESTORS, MONEY MANAGERS, PENSION FUND MANAGERS, BROKER DEALERS AND INSTITUTIONS; DOWNLOADABLE COMPUTER PROGRAMS FOR USE BY PROFESSIONAL TRADERS, NAMELY, COMPUTER PROGRAMS THAT PROVIDE REAL-TIME AND HISTORICAL COST ANALYSIS OF THE TRADING PERFORMANCE OF SECURITIES BY COMPARING TRADING PRICES TO USER DEFINED INFORMATION, IN CLASS 9 (U.S. CLS. 21, 23, 26, 36 AND 38).

FIRST USE 0-0-1998; IN COMMERCE 0-0-1998.

FOR: MARKET RESEARCH SERVICES, IN CLASS 35 (U.S. CLS. 100, 101 AND 102).

FIRST USE 0-0-1998; IN COMMERCE 0-0-1998.



FOR: FINANCIAL INVESTMENT SERVICES IN THE FIELD OF COMMODITIES, SECURITIES, STOCKS, BONDS, DERIVATIVES, INVESTMENT RESEARCH, AND MARKET RESEARCH RENDERED VIA A GLOBAL COMPUTER NETWORK; FINANCIAL SERVICES IN THE NATURE OF PROVIDING ELECTRONIC TRADING SERVICES FOR THE PURPOSE OF TRADING COMMODITIES, STOCKS, BONDS, DERIVATIVES AND SECURITIES, PROVIDING INVESTMENT RESEARCH SERVICES; PROVIDING AND MANAGING SECURITIES TRADING AND TRADING STRATEGIES; INVESTMENT AND FINANCIAL MANAGEMENT CONSULTING SERVICES; COMPUTERIZED STOCK BROKERAGE SERVICES; FINANCIAL SERVICES, NAMELY, MANAGING FINANCIAL PORTFOLIO TRADES; TRADING SERVICES, NAMELY, ELECTRONIC TRADING IN EQUITIES, STOCKS, BONDS, OPTIONS, AND MUTUAL FUNDS FOR OTHERS, AND BROKERAGE SERVICES, NAMELY, INSURANCE BROKERAGE, INVESTMENT BROKERAGE, MUTUAL FUND BROKERAGE, SECURITY BROKERAGE, IN CLASS 36 (U.S. CLS. 100, 101 AND 102).

FIRST USE 0-0-1998; IN COMMERCE 0-0-1998.

David J. Kyjars

Director of the United States Patent and Trademark Office

Reg. No. 4,174,476 FOR: TELECOMMUNICATIONS SERVICES FOR THE SECURITIES INDUSTRY, NAMELY, ROUTING, IN CLASS 38 (U.S. CLS. 100, 101 AND 104).

FIRST USE 0-0-1998; IN COMMERCE 0-0-1998.

THE MARK CONSISTS OF STANDARD CHARACTERS WITHOUT CLAIM TO ANY PARTICULAR FONT, STYLE, SIZE, OR COLOR.

OWNER OF U.S. REG. NOS. 3,039,653, 3,581,050 AND OTHERS.

SER. NO. 85-436,736, FILED 9-30-2011.

JENNIFER VASQUEZ, EXAMINING ATTORNEY

United States of America

United States Patent and Trademark Office



Reg. No. 4,174,477

Registered July 17, 2012

Int. Cls.: 35, 38 and 42

SERVICE MARK

PRINCIPAL REGISTER

ROBERTSON, OSCAR (UNITED STATES INDIVIDUAL)
SUITE 206
10999 REED HARTMAN HIGHWAY
CINCINNATI, OH 45242

FOR: BUSINESS SERVICES, NAMELY, FACILITIES MANAGEMENT SERVICES IN THE NATURE OF MANAGEMENT OF TECHNICAL OPERATIONS; BUSINESS RECORDS MANAGEMENT SERVICES; PROVIDING CONSULTING FACILITATING COMMERCIAL PLANNING AND BUYING OF PRINT SERVICES FOR OTHERS; DIRECT MAIL ADVERTISING SERVICES; ORDER FULFILLMENT SERVICES; ADVERTISING AND MARKETING SERVICES, NAMELY, PROMOTING THE GOODS AND SERVICES OF OTHERS; DOCUMENT IMAGING, NAMELY, DOCUMENT COPYING; MAIL CENTER AND COURIER BUSINESS MANAGEMENT SERVICES, NAMELY, CONSULTING REGARDING THE MANAGEMENT OF RECEIVING, PROCESSING, AND SENDING INTERNATIONAL AND DOMESTIC MAIL AND PACKAGES, IN CLASS 35 (U.S. CLS. 100, 101 AND 102).

FIRST USE 0-0-2000; IN COMMERCE 0-0-2000.

FOR: ON-LINE DOCUMENT DELIVERY VIA A GLOBAL COMPUTER NETWORK, IN CLASS 38 (U.S. CLS. 100, 101 AND 104).

FIRST USE 0-0-2000; IN COMMERCE 0-0-2000.

FOR: PLANNING, DESIGN AND MANAGEMENT OF INFORMATION TECHNOLOGY SYSTEMS OF OTHERS; DOCUMENT IMAGING, NAMELY, DIGITIZATION OF DOCUMENTS, IN CLASS 42 (U.S. CLS. 100 AND 101).

FIRST USE 0-0-2000; IN COMMERCE 0-0-2000.

NO CLAIM IS MADE TO THE EXCLUSIVE RIGHT TO USE "SOLUTIONS", APART FROM THE MARK AS SHOWN.

THE NAME(S), PORTRAIT(S), AND/OR SIGNATURE(S) SHOWN IN THE MARK IDENTIFIES "OSCAR ROBERTSON", WHOSE CONSENT(S) TO REGISTER IS MADE OF RECORD.

THE MARK CONSISTS OF THE WORDS "OSCAR ROBERTSON SOLUTIONS" IN A SUB-DIVIDED RECTANGLE WITH AN "O" DESIGN.



David J. Kyjars

Director of the United States Patent and Trademark Office

Reg. No. 4,174,477 SER. NO. 85-436,904, FILED 9-30-2011.

LINDA POWELL, EXAMINING ATTORNEY

United States of America

United States Patent and Trademark Office

Goldmine Girl

Reg. No. 4,174,478

CALVITTI, RAYMOND (UNITED STATES INDIVIDUAL)
10 BUGLE LANE
BLUE BELL, PA 19422

Registered July 17, 2012

Int. Cl.: 25

FOR: BRAS; CAMISOLES; HOODED SWEAT SHIRTS; JEANS; PANTIES; PANTS; SHIRTS;
SHOES; SHORTS; SNEAKERS; SOCKS; SWEAT PANTS; SWEAT SHIRTS; T-SHIRTS; YOGA
PANTS, IN CLASS 25 (U.S. CLS. 22 AND 39).

TRADEMARK

FIRST USE 8-1-2011; IN COMMERCE 8-1-2011.

PRINCIPAL REGISTER

THE MARK CONSISTS OF STANDARD CHARACTERS WITHOUT CLAIM TO ANY PAR-
TICULAR FONT, STYLE, SIZE, OR COLOR.

NO CLAIM IS MADE TO THE EXCLUSIVE RIGHT TO USE "GIRL", APART FROM THE
MARK AS SHOWN.

SER. NO. 85-436,923, FILED 9-30-2011.

KEVIN DINALLO, EXAMINING ATTORNEY



David J. Kyffers

Director of the United States Patent and Trademark Office

United States of America

United States Patent and Trademark Office

RELIQE

Reg. No. 4,174,479

Registered July 17, 2012

Int. Cl.: 21

TRADEMARK

PRINCIPAL REGISTER

RELIQE LTD (NEW YORK CORPORATION)
PO BOX 32
NEW YORK, NY 10013

FOR: BASINS; BOWLS; BUTTER DISHES; BUTTER-DISH AND CHEESE-DISH COVERS; CANDLE EXTINGUISHERS AND CANDLESTICKS NOT OF PRECIOUS METAL; CANDLE EXTINGUISHERS AND CANDLESTICKS OF PRECIOUS METAL; CANDLE EXTINGUISHERS, NOT OF PRECIOUS METAL; CANDLE HOLDERS; CANDLE HOLDERS NOT OF PRECIOUS METAL; CANDLE HOLDERS OF PRECIOUS METAL; CANDLE RINGS NOT OF PRECIOUS METAL; CANDLE RINGS OF PRECIOUS METAL; CANDLE SNUFFER AND TRAY COMBINATION; CANDLE SNUFFER AND TRAY COMBINATION MADE IN WHOLE OR IN PART OF PRECIOUS METAL; CANDLE SNUFFERS; CANDLE SNUFFERS NOT OF PRECIOUS METAL; CANDLE SNUFFERS OF PRECIOUS METAL; CASSEROLES; CERAMIC SCULPTURES, VASES, VESSELS, BOWLS, PLATES AND POTS; CROCKERY, NAMELY, POTS, DISHES, DRINKING CUPS AND SAUCERS, BOWLS, SERVING BOWLS AND TRAYS; DISH COVERS; DISH STANDS; DISHES; DISHES AND PLATES; FINGER BOWLS; FLOOR VASES; FLOWER BOWLS; FLOWER BOWLS OF PRECIOUS METAL; FLOWER VASES; FLOWER VASES AND BOWLS; FLOWER VASES AND BOWLS OF PRECIOUS METAL; FRUIT BOWLS; FRUIT BOWLS OF GLASS; GLASS BOWLS; GLASS DISHES; GLASS FLOOR VASES; HAND BASINS; MIXING BOWLS; NON-ELECTRIC CANDELABRAS; NON-ELECTRIC CANDELABRAS MADE OF PRECIOUS METAL; NON-ELECTRIC CANDELABRAS, NOT OF PRECIOUS METAL; NON-ELECTRIC WALL SCONCES; PILLAR CANDLE PLATE MADE IN WHOLE OR IN PART OF PRECIOUS METAL; PILLAR CANDLE PLATES; POTPOURRI DISHES; POTPOURRI DISHES MADE IN WHOLE OR IN PART OF PRECIOUS METAL; SALAD BOWLS; SALAD BOWLS; SERVING DISHES; SHALLOW BOWLS; SHAVING DISHES; SOAP DISHES; STANDS FOR DISHES; STONE FLOOR VASES; SUGAR BOWLS; VASES; VASES OF PRECIOUS METAL; WALL SOAP DISHES, IN CLASS 21 (U.S. CLS. 2, 13, 23, 29, 30, 33, 40 AND 50).



FIRST USE 6-5-2011; IN COMMERCE 6-5-2011.

THE MARK CONSISTS OF STANDARD CHARACTERS WITHOUT CLAIM TO ANY PARTICULAR FONT, STYLE, SIZE, OR COLOR.

SER. NO. 85-437,049, FILED 9-30-2011.

Alice Benmaman, Examining Attorney

David J. Kyffers

Director of the United States Patent and Trademark Office

United States of America

United States Patent and Trademark Office

**STAY
PHIT**
OnSite. OnLine.

Reg. No. 4,174,480

JOSEPH LEMON (UNITED STATES INDIVIDUAL)
1077 ROWANSHYRE CIRCLE
MCDONOUGH, GA 30253

Registered July 17, 2012

Int. Cl.: 41

FOR: PERSONAL FITNESS TRAINING SERVICES, IN CLASS 41 (U.S. CLS. 100, 101 AND 107).

SERVICE MARK

FIRST USE 12-31-2010; IN COMMERCE 12-31-2010.

PRINCIPAL REGISTER

NO CLAIM IS MADE TO THE EXCLUSIVE RIGHT TO USE "ONSITE. ONLINE.", APART FROM THE MARK AS SHOWN.

THE MARK CONSISTS OF THE WORD "STAY" WITH A CIRCLE ABOVE THE LETTER "Y", POSITIONED ABOVE THE WORD "PHIT", ALL ABOVE THE WORDS "ONSITE. ON-LINE."

SER. NO. 85-437,124, FILED 10-1-2011.

DANNEAN HETZEL, EXAMINING ATTORNEY



David J. Kybas

Director of the United States Patent and Trademark Office

United States of America

United States Patent and Trademark Office

Fino Consulting

Reg. No. 4,174,481

Registered July 17, 2012

Int. Cls.: 35 and 42

SERVICE MARK

PRINCIPAL REGISTER

FINO CONSULTING LLC (NEW YORK LIMITED LIABILITY COMPANY)
20TH FLOOR
271 MADISON AVENUE
NEW YORK, NY 10016

FOR: BUSINESS CONSULTING AND INFORMATION SERVICES, IN CLASS 35 (U.S. CLS. 100, 101 AND 102).

FIRST USE 3-1-2006; IN COMMERCE 3-1-2006.

FOR: BUSINESS TECHNOLOGY SOFTWARE CONSULTATION SERVICES; CONSULTING IN THE FIELD OF INFORMATION TECHNOLOGY; INFORMATION TECHNOLOGY CONSULTATION, IN CLASS 42 (U.S. CLS. 100 AND 101).

FIRST USE 3-1-2006; IN COMMERCE 3-1-2006.

THE MARK CONSISTS OF STANDARD CHARACTERS WITHOUT CLAIM TO ANY PARTICULAR FONT, STYLE, SIZE, OR COLOR.

NO CLAIM IS MADE TO THE EXCLUSIVE RIGHT TO USE "CONSULTING", APART FROM THE MARK AS SHOWN.

THE ENGLISH TRANSLATION OF "FINO" IN THE MARK IS "FINE".

SER. NO. 85-437,446, FILED 10-3-2011.

MICHELE SWAIN, EXAMINING ATTORNEY



David J. Kyros

Director of the United States Patent and Trademark Office

United States of America

United States Patent and Trademark Office

Baja Classic

Reg. No. 4,174,482

Registered July 17, 2012

Int. Cl.: 31

ANDREW WILLIAMSON SALES COMPANY (CALIFORNIA CORPORATION), AKA
ANDREW WILLIAMSON FRESH PRODUCE
9940 MARCONI DRIVE, SAN DIEGO, CA 92154
9940 MARCONI DRIVE
SAN DIEGO, CA 92154

TRADEMARK

FOR: FRESH FRUIT; FRESH FRUIT AND VEGETABLES; FRESH GRAPE TOMATOES;
FRESH STRAWBERRIES; FRESH TOMATOES; FRESH VEGETABLES, IN CLASS 31 (U.S.
CLS. 1 AND 46).

PRINCIPAL REGISTER

FIRST USE 1-1-2000; IN COMMERCE 1-6-2007.

THE MARK CONSISTS OF STANDARD CHARACTERS WITHOUT CLAIM TO ANY PAR-
TICULAR FONT, STYLE, SIZE, OR COLOR.

NO CLAIM IS MADE TO THE EXCLUSIVE RIGHT TO USE "BAJA", APART FROM THE
MARK AS SHOWN.

SER. NO. 85-437,683, FILED 10-3-2011.

ZHALEH DELANEY, EXAMINING ATTORNEY



David J. Kyros

Director of the United States Patent and Trademark Office

United States of America

United States Patent and Trademark Office

QCSA DIRECT

Reg. No. 4,174,483

Registered July 17, 2012

Int. Cl.: 35

SERVICE MARK

PRINCIPAL REGISTER

QCSA HOLDINGS, INC. (DELAWARE CORPORATION)
7300 NORTH BRADY STREET
DAVENPORT, IA 52806

FOR: ARRANGING AND CONDUCTING AUCTIONS; AUCTION MANAGEMENT SERVICES PROVIDED TO OTHERS OVER AN ON-LINE WEB SITE ACCESSED THROUGH A GLOBAL COMPUTER NETWORK; AUCTION SERVICES; ON-LINE AUCTION SERVICES, IN CLASS 35 (U.S. CLS. 100, 101 AND 102).

FIRST USE 10-3-2011; IN COMMERCE 10-3-2011.

THE MARK CONSISTS OF STANDARD CHARACTERS WITHOUT CLAIM TO ANY PARTICULAR FONT, STYLE, SIZE, OR COLOR.

NO CLAIM IS MADE TO THE EXCLUSIVE RIGHT TO USE "DIRECT", APART FROM THE MARK AS SHOWN.

SER. NO. 85-438,227, FILED 10-3-2011.

INGA ERVIN, EXAMINING ATTORNEY



David J. Kyffers

Director of the United States Patent and Trademark Office

United States of America

United States Patent and Trademark Office

EMK3

Reg. No. 4,174,484

Registered July 17, 2012

Int. Cls.: 9 and 42

TRADEMARK

SERVICE MARK

PRINCIPAL REGISTER

EMK3 LLC (TEXAS LIMITED LIABILITY COMPANY)
917 QUARRY OAKS
FAIRVIEW, TX 750691992

FOR: DOWNLOADABLE COMPUTER SOFTWARE THAT MANAGES ALL UPSTREAM MARKETING, GATHERING AND TRANSPORTATION ACTIVITY FROM THE WELL TO THE SALES POINTS FOR OIL AND GAS PRODUCERS, MARKETERS AND FIRST-PURCHASERS, IN CLASS 9 (U.S. CLS. 21, 23, 26, 36 AND 38).

FIRST USE 2-1-2000; IN COMMERCE 2-1-2000.

FOR: PROVIDING INFORMATION TECHNOLOGY SOLUTIONS THAT ARE DESIGNED SPECIFICALLY FOR OIL AND GAS PRODUCERS, MARKETERS AND FIRST-PURCHASERS, IN CLASS 42 (U.S. CLS. 100 AND 101).

FIRST USE 2-1-2000; IN COMMERCE 2-1-2000.

THE MARK CONSISTS OF STANDARD CHARACTERS WITHOUT CLAIM TO ANY PARTICULAR FONT, STYLE, SIZE, OR COLOR.

SER. NO. 85-438,436, FILED 10-4-2011.

NAKIA HENRY, EXAMINING ATTORNEY



David J. Kybas

Director of the United States Patent and Trademark Office

United States of America

United States Patent and Trademark Office

GRANTSAFE

Reg. No. 4,174,485

Registered July 17, 2012

Int. Cl.: 45

SERVICE MARK

PRINCIPAL REGISTER

FOUNDATION SOURCE PHILANTHROPIC SERVICE, INC. (DELAWARE CORPORATION)
55 WALLS DRIVE, SUITE 302
FAIRFIELD, CT 06824

FOR: PROVIDING AN ONLINE SEARCHABLE DATABASE FOR USE BY PRIVATE FOUNDATIONS BEFORE FUNDING GRANTS IN ORDER TO DETERMINE IF AN ORGANIZATION HAS PUBLIC CHARITY TAX STATUS UNDER INTERNAL REVENUE CODE SECTIONS 509(A)(1), (A)(2), OR (A)(3), PER THE LATEST VERSION OF THE BUSINESS MASTER FILE EXTRACT RELEASED BY THE INTERNAL REVENUE SERVICE, IN CLASS 45 (U.S. CLS. 100 AND 101).

FIRST USE 9-23-2011; IN COMMERCE 9-23-2011.

THE MARK CONSISTS OF STANDARD CHARACTERS WITHOUT CLAIM TO ANY PARTICULAR FONT, STYLE, SIZE, OR COLOR.

SER. NO. 85-438,987, FILED 10-4-2011.

ROBIN CHOSID, EXAMINING ATTORNEY



David J. Kyjars

Director of the United States Patent and Trademark Office

United States of America

United States Patent and Trademark Office

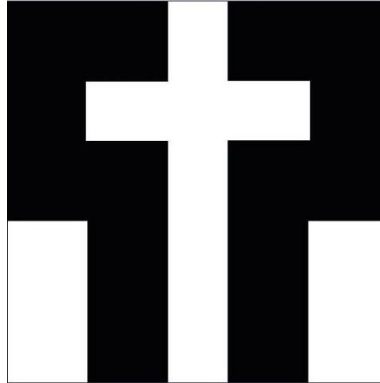

Reg. No. 4,174,486

Registered July 17, 2012

Int. Cl.: 25

TRADEMARK

PRINCIPAL REGISTER

MANTE, RYAN (UNITED STATES INDIVIDUAL)
2197 HOGAN DRIVE
SANTA CLARA, CA 95054

FOR: CLOTHING, NAMELY, FOOTWEAR, HEADWEAR, TOPS, BOTTOMS, SHIRTS, T-SHIRTS, PANTS, AND DRESSES, IN CLASS 25 (U.S. CLS. 22 AND 39).

FIRST USE 6-12-2011; IN COMMERCE 7-4-2011.

THE MARK CONSISTS OF A CROSS INSIDE A STYLIZED VESTMENT DESIGN.

SER. NO. 85-439,062, FILED 10-4-2011.

KATHLEEN KOLACZ, EXAMINING ATTORNEY



David J. Kybas

Director of the United States Patent and Trademark Office

United States of America

United States Patent and Trademark Office

International Congress on Hematologic Malignancies

Reg. No. 4,174,487

Registered July 17, 2012

Int. Cl.: 41

SERVICE MARK

PRINCIPAL REGISTER

ARC MESA EDUCATORS, LLC (NEW JERSEY LIMITED LIABILITY COMPANY)
SUITE 356
666 PLAINSBORO ROAD
PLAINSBORO, NJ 08536

FOR: EDUCATION SERVICES, NAMELY, PROVIDING ANNUAL MEDICAL CONFERENCE, LECTURES, INTERACTIVE DISCUSSIONS, POSTER SESSIONS, HANDS-ON WORKSHOPS, AND BROADCAST SYMPOSIA FOR ONCOLOGISTS AND SURGEONS IN THE FIELD OF ONCOLOGY, IN CLASS 41 (U.S. CLS. 100, 101 AND 107).

FIRST USE 2-0-1997; IN COMMERCE 2-0-1997.

THE MARK CONSISTS OF STANDARD CHARACTERS WITHOUT CLAIM TO ANY PARTICULAR FONT, STYLE, SIZE, OR COLOR.

NO CLAIM IS MADE TO THE EXCLUSIVE RIGHT TO USE "CONGRESS", APART FROM THE MARK AS SHOWN.

SEC. 2(F).

SER. NO. 85-439,390, FILED 10-5-2011.

BERNICE MIDDLETON, EXAMINING ATTORNEY



David J. Kyffers

Director of the United States Patent and Trademark Office

United States of America

United States Patent and Trademark Office

International Congress on the Future of Breast Cancer

Reg. No. 4,174,488

Registered July 17, 2012

Int. Cl.: 41

SERVICE MARK

PRINCIPAL REGISTER

ARC MESA EDUCATORS, LLC (NEW JERSEY LIMITED LIABILITY COMPANY)
SUITE 356
666 PLAINSBORO ROAD
PLAINSBORO, NJ 08536

FOR: EDUCATION SERVICES, NAMELY, PROVIDING ANNUAL MEDICAL CONFERENCE, LECTURES, INTERACTIVE DISCUSSIONS, POSTER SESSIONS, HANDS-ON WORKSHOPS, AND BROADCAST SYMPOSIA FOR ONCOLOGISTS AND SURGEONS IN THE FIELD OF ONCOLOGY, IN CLASS 41 (U.S. CLS. 100, 101 AND 107).

FIRST USE 7-0-2002; IN COMMERCE 7-0-2002.

THE MARK CONSISTS OF STANDARD CHARACTERS WITHOUT CLAIM TO ANY PARTICULAR FONT, STYLE, SIZE, OR COLOR.

NO CLAIM IS MADE TO THE EXCLUSIVE RIGHT TO USE "CONGRESS", APART FROM THE MARK AS SHOWN.

SEC. 2(F).

SER. NO. 85-439,410, FILED 10-5-2011.

BERNICE MIDDLETON, EXAMINING ATTORNEY



David J. Kybas

Director of the United States Patent and Trademark Office

United States of America

United States Patent and Trademark Office

ALPHASEAL

Reg. No. 4,174,489

Registered July 17, 2012

Int. Cls.: 35 and 41

SERVICE MARK

PRINCIPAL REGISTER

MARK MY MEDIA, LLC (DELAWARE LIMITED LIABILITY COMPANY)
4TH FLOOR
6 LANDMARK SQUARE
STAMFORD, CT 06901

FOR: ADVERTISING, MARKETING AND PROMOTIONAL SERVICES RELATED TO ALL INDUSTRIES FOR THE PURPOSE OF FACILITATING NETWORKING AND SOCIALIZING OPPORTUNITIES FOR BUSINESS PURPOSES, IN CLASS 35 (U.S. CLS. 100, 101 AND 102).

FIRST USE 5-1-2011; IN COMMERCE 7-14-2011.

FOR: PROVIDING EDUCATIONAL MENTORING SERVICES AND PROGRAMS IN THE FIELD OF FINANCIAL SERVICES, IN CLASS 41 (U.S. CLS. 100, 101 AND 107).

FIRST USE 5-1-2011; IN COMMERCE 7-14-2011.

THE MARK CONSISTS OF STANDARD CHARACTERS WITHOUT CLAIM TO ANY PARTICULAR FONT, STYLE, SIZE, OR COLOR.

SEC. 2(F).

SER. NO. 85-439,735, FILED 10-5-2011.

KIMBERLY PERRY, EXAMINING ATTORNEY



David J. Kybas

Director of the United States Patent and Trademark Office

United States of America

United States Patent and Trademark Office

MFR

Reg. No. 4,174,490

Registered July 17, 2012

Int. Cl.: 4

TRADEMARK

PRINCIPAL REGISTER

A.B.C. COMPOUNDING COMPANY, INC. (GEORGIA CORPORATION)
6970 JONESBORO ROAD
MORROW, GA 30260

FOR: ALL PURPOSE LUBRICANT, IN CLASS 4 (U.S. CLS. 1, 6 AND 15).

FIRST USE 0-0-1993; IN COMMERCE 0-0-1994.

THE MARK CONSISTS OF STANDARD CHARACTERS WITHOUT CLAIM TO ANY PARTICULAR FONT, STYLE, SIZE, OR COLOR.

SER. NO. 85-439,840, FILED 10-5-2011.

SUSAN LESLIE DUBOIS, EXAMINING ATTORNEY



David J. Kyffers

Director of the United States Patent and Trademark Office

United States of America

United States Patent and Trademark Office

HONEYWELL

Reg. No. 4,174,491

Registered July 17, 2012

Int. Cl.: 38

SERVICE MARK

PRINCIPAL REGISTER

HONEYWELL INTERNATIONAL INC. (DELAWARE CORPORATION)
101 COLUMBIA ROAD
MORRISTOWN, NJ 07962

FOR: ELECTRONIC TRANSMISSION OF SIGNALS INCLUDING MESSAGES, VIDEO AND DATA RELATED TO THE MONITORING AND MANAGEMENT OF HOME AND BUSINESS ELECTRONIC SYSTEMS, HOME AND BUSINESS SECURITY SYSTEMS AND HOME AND BUSINESS AUTOMATION SYSTEMS BY MEANS OF WIRELESS SERVICES, WIRELINE SERVICES AND THROUGH A GLOBAL COMPUTER NETWORK, IN CLASS 38 (U.S. CLS. 100, 101 AND 104).

FIRST USE 12-31-1957; IN COMMERCE 12-31-1957.

THE MARK CONSISTS OF STANDARD CHARACTERS WITHOUT CLAIM TO ANY PARTICULAR FONT, STYLE, SIZE, OR COLOR.

OWNER OF U.S. REG. NOS. 520,350, 3,256,975 AND OTHERS.

SER. NO. 85-439,861, FILED 10-5-2011.

SEAN CROWLEY, EXAMINING ATTORNEY



David J. Kyros

Director of the United States Patent and Trademark Office

United States of America

United States Patent and Trademark Office

PG2000

Reg. No. 4,174,492

Registered July 17, 2012

Int. Cl.: 4

TRADEMARK

PRINCIPAL REGISTER

A.B.C. COMPOUNDING COMPANY, INC. (GEORGIA CORPORATION)
6970 JONESBORO ROAD
MORROW, GA 30260

FOR: ALL PURPOSE LUBRICANT, IN CLASS 4 (U.S. CLS. 1, 6 AND 15).

FIRST USE 0-0-1995; IN COMMERCE 0-0-1995.

THE MARK CONSISTS OF STANDARD CHARACTERS WITHOUT CLAIM TO ANY PARTICULAR FONT, STYLE, SIZE, OR COLOR.

SER. NO. 85-440,011, FILED 10-5-2011.

SUSAN LESLIE DUBOIS, EXAMINING ATTORNEY



David J. Kyffers

Director of the United States Patent and Trademark Office

United States of America

United States Patent and Trademark Office



Reg. No. 4,174,493

SEARS BRANDS, LLC (ILLINOIS LIMITED LIABILITY COMPANY)
3333 BEVERLY DRIVE
HOFFMAN ESTATES, IL 60179

Registered July 17, 2012

Int. Cl.: 7

FOR: CLOTHES WASHER FEATURE, NAMELY, A COMPONENT FEATURE OF CLOTHES WASHING MACHINES THAT ALLOWS USERS TO CREATE UNIQUE CYCLES AND SETTINGS FOR WASHING CLOTHES, SOLD AS AN INTEGRAL PART OF CLOTHES WASHING MACHINES, IN CLASS 7 (U.S. CLS. 13, 19, 21, 23, 31, 34 AND 35).

TRADEMARK

PRINCIPAL REGISTER

FIRST USE 1-0-2011; IN COMMERCE 1-0-2011.

THE MARK CONSISTS OF A STYLIZED CLOCK WITH TWO ARCS WITHIN THE CLOCK, ONE OF WHICH HAS AN ARROW AT ITS END.

SER. NO. 85-440,015, FILED 10-5-2011.

JOHN WILKE, EXAMINING ATTORNEY



David J. Kyffers

Director of the United States Patent and Trademark Office

United States of America

United States Patent and Trademark Office

YVES VEGGIE CUISINE

Reg. No. 4,174,494

Registered July 17, 2012

Int. Cl.: 29

TRADEMARK

PRINCIPAL REGISTER

HAIN-CELESTIAL CANADA, ULC (CANADA CORPORATION)
1683 DERWENT WAY
DELTA, CANADA V3M6R9

FOR: MEAT SUBSTITUTES; POULTRY SUBSTITUTES; SEAFOOD SUBSTITUTES; SOY BASED MEAT SUBSTITUTES; SOY BASED POULTRY SUBSTITUTES; SOY BASED SEAFOOD SUBSTITUTES; MEAT SUBSTITUTES MADE FROM TEXTURIZED VEGETABLE PROTEIN; POULTRY SUBSTITUTES MADE FROM TEXTURIZED VEGETABLE PROTEIN; SEAFOOD SUBSTITUTES MADE FROM TEXTURIZED VEGETABLE PROTEIN; VEGETABLE BASED MEAT SUBSTITUTES; VEGETABLE BASED POULTRY SUBSTITUTES; VEGETABLE BASED SEAFOOD SUBSTITUTES; REFRIGERATED AND FROZEN PREPARED ENTREES CONSISTING PRIMARILY OF VEGETABLES; REFRIGERATED AND FROZEN PREPARED ENTREES CONSISTING PRIMARILY OF MEAT SUBSTITUTES; REFRIGERATED AND FROZEN PREPARED ENTREES CONSISTING PRIMARILY OF POULTRY SUBSTITUTES; REFRIGERATED AND FROZEN PREPARED ENTREES CONSISTING PRIMARILY OF SEAFOOD SUBSTITUTES, IN CLASS 29 (U.S. CL. 46).

FIRST USE 11-0-1998; IN COMMERCE 11-0-1998.

THE MARK CONSISTS OF STANDARD CHARACTERS WITHOUT CLAIM TO ANY PARTICULAR FONT, STYLE, SIZE, OR COLOR.

NO CLAIM IS MADE TO THE EXCLUSIVE RIGHT TO USE "VEGGIE CUISINE", APART FROM THE MARK AS SHOWN.

SER. NO. 85-440,096, FILED 10-5-2011.

ROBERT C. CLARK JR., EXAMINING ATTORNEY



David J. Kypos

Director of the United States Patent and Trademark Office

United States of America

United States Patent and Trademark Office



Reg. No. 4,174,495

Registered July 17, 2012

Int. Cl.: 29

TRADEMARK

PRINCIPAL REGISTER

HAIN-CELESTIAL CANADA, ULC (CANADA CORPORATION)
1683 DERWENT WAY
DELTA, CANADA V3M6R9

FOR: MEAT SUBSTITUTES; POULTRY SUBSTITUTES; SEAFOOD SUBSTITUTES; SOY BASED MEAT SUBSTITUTES; SOY BASED POULTRY SUBSTITUTES; SOY BASED SEAFOOD SUBSTITUTES; MEAT SUBSTITUTES MADE FROM TEXTURIZED VEGETABLE PROTEIN; POULTRY SUBSTITUTES MADE FROM TEXTURIZED VEGETABLE PROTEIN; SEAFOOD SUBSTITUTES MADE FROM TEXTURIZED VEGETABLE PROTEIN; VEGETABLE BASED MEAT SUBSTITUTES; VEGETABLE BASED POULTRY SUBSTITUTES; VEGETABLE BASED SEAFOOD SUBSTITUTES; REFRIGERATED AND FROZEN PREPARED ENTREES CONSISTING PRIMARILY OF VEGETABLES; REFRIGERATED AND FROZEN PREPARED ENTREES CONSISTING PRIMARILY OF MEAT SUBSTITUTES; REFRIGERATED AND FROZEN PREPARED ENTREES CONSISTING PRIMARILY OF POULTRY SUBSTITUTES; REFRIGERATED AND FROZEN PREPARED ENTREES CONSISTING PRIMARILY OF SEAFOOD SUBSTITUTES, IN CLASS 29 (U.S. CL. 46).

FIRST USE 1-0-2009; IN COMMERCE 1-0-2009.

NO CLAIM IS MADE TO THE EXCLUSIVE RIGHT TO USE "VEGGIE CUISINE", APART FROM THE MARK AS SHOWN.

THE MARK CONSISTS OF THE STYLIZED TERMS "YVES VEGGIE CUISINE" WITHIN A CURVED RECTANGULAR BORDER, ALONGSIDE A STYLIZED DRAWING OF A CHEF HOLDING A BOWL OF VEGETABLES.

SER. NO. 85-440,143, FILED 10-5-2011.

ROBERT C. CLARK JR., EXAMINING ATTORNEY



David J. Kybas

Director of the United States Patent and Trademark Office

United States of America

United States Patent and Trademark Office

IMPACTWEAR

Reg. No. 4,174,496

Registered July 17, 2012

Int. Cl.: 9

TRADEMARK

PRINCIPAL REGISTER

IMPACTWEAR HIP PROTECTORS LIMITED (NEW ZEALAND CORPORATION), DBA
IMPACTWEAR HIP PROTECTORS LIMITED
92 TENDER ROAD
DAIRY FLAT ALBANY, NEW ZEALAND

FOR: PROTECTIVE PADDED CLOTHING FOR PROTECTION AGAINST BODILY HARM
AND BLUNT FORCE TRAUMA , IN CLASS 9 (U.S. CLS. 21, 23, 26, 36 AND 38).

OWNER OF NEW ZEALAND REG. NO. 806549, DATED 5-18-2009, EXPIRES 5-18-2019.

THE MARK CONSISTS OF THE WORD "IMPACTWEAR" IN A STYLIZED FONT.

SER. NO. 85-440,307, FILED 10-5-2011.

GIANCARLO CASTRO, EXAMINING ATTORNEY



David J. Kyffers

Director of the United States Patent and Trademark Office

United States of America

United States Patent and Trademark Office

Opgrade

Reg. No. 4,174,497

BARBER & BARBER ASSOCIATES, INC. (TEXAS CORPORATION)
4737 COLLEGE PARK, #105
SAN ANTONIO, TX 78249

Registered July 17, 2012

Int. Cl.: 35

FOR: BUSINESS CONSULTATION SERVICES THAT PROVIDE INFORMATION IN THE FIELD OF OPERATING AND MANAGING PHYSICAL CAPITAL, IN CLASS 35 (U.S. CLS. 100, 101 AND 102).

SERVICE MARK

FIRST USE 7-1-2009; IN COMMERCE 7-1-2010.

PRINCIPAL REGISTER

THE MARK CONSISTS OF THE STYLIZED WORDS "OPGRADE". THE TAIL OF THE LETTER "G" CONNECTS TO THE TAIL ON THE LETTER "P".

SER. NO. 85-440,542, FILED 10-6-2011.

SHANNON TWOHIG, EXAMINING ATTORNEY



David J. Kyffers

Director of the United States Patent and Trademark Office

United States of America

United States Patent and Trademark Office

KEENELAND SELECT

Reg. No. 4,174,498

KEENELAND ASSOCIATION, INC. (KENTUCKY CORPORATION)
4201 VERSAILLES ROAD
LEXINGTON, KY 40510

Registered July 17, 2012

Int. Cl.: 41

FOR: WAGERING SERVICES; ONLINE ADVANCE DEPOSIT AND PREPAID ACCOUNT WAGERING SERVICES; PROVIDING AN ONLINE WEBSITE FEATURING NEWS AND INFORMATION IN THE FIELD OF HORSE RACING, IN CLASS 41 (U.S. CLS. 100, 101 AND 107).

SERVICE MARK

PRINCIPAL REGISTER

FIRST USE 8-15-2011; IN COMMERCE 8-15-2011.

THE MARK CONSISTS OF STANDARD CHARACTERS WITHOUT CLAIM TO ANY PARTICULAR FONT, STYLE, SIZE, OR COLOR.

OWNER OF U.S. REG. NOS. 2,674,309, 2,781,193 AND OTHERS.

NO CLAIM IS MADE TO THE EXCLUSIVE RIGHT TO USE "SELECT", APART FROM THE MARK AS SHOWN.

SER. NO. 85-440,572, FILED 10-6-2011.

ANDREA K. NADELMAN, EXAMINING ATTORNEY



David J. Kyjars

Director of the United States Patent and Trademark Office

United States of America

United States Patent and Trademark Office

KEENELAND SELECT

Reg. No. 4,174,499

KEENELAND ASSOCIATION, INC. (KENTUCKY CORPORATION)
4201 VERSAILLES ROAD
LEXINGTON, KY 40510

Registered July 17, 2012

Int. Cl.: 38

FOR: STREAMING OF AUDIO, VISUAL AND AUDIOVISUAL MATERIAL VIA A GLOBAL COMPUTER NETWORK, IN CLASS 38 (U.S. CLS. 100, 101 AND 104).

SERVICE MARK

FIRST USE 8-15-2011; IN COMMERCE 8-15-2011.

PRINCIPAL REGISTER

THE MARK CONSISTS OF STANDARD CHARACTERS WITHOUT CLAIM TO ANY PARTICULAR FONT, STYLE, SIZE, OR COLOR.

OWNER OF U.S. REG. NOS. 2,674,309, 2,781,193 AND OTHERS.

NO CLAIM IS MADE TO THE EXCLUSIVE RIGHT TO USE "SELECT", APART FROM THE MARK AS SHOWN.

SER. NO. 85-440,575, FILED 10-6-2011.

ANDREA K. NADELMAN, EXAMINING ATTORNEY



David J. Kyffers

Director of the United States Patent and Trademark Office

United States of America

United States Patent and Trademark Office

McElveen

Reg. No. 4,174,500

MCELVEEN BUICK GMC INC. (SOUTH CAROLINA CORPORATION)
PO BOX 160
SUMMERVILLE, SC 29484

Registered July 17, 2012

Int. Cl.: 35

FOR: AUTOMOBILE DEALERSHIP SERVICES, NAMELY, ENGAGED IN THE SALE OF NEW AND USED CARS, TRUCKS, AND COMMERCIAL TRUCKS; WHOLESALE AND RETAIL STORE SERVICES FEATURING AUTOMOBILE AND TRUCK PARTS AND ACCESSORIES, IN CLASS 35 (U.S. CLS. 100, 101 AND 102).

SERVICE MARK

PRINCIPAL REGISTER

FIRST USE 0-0-1970; IN COMMERCE 0-0-1970.

THE MARK CONSISTS OF STANDARD CHARACTERS WITHOUT CLAIM TO ANY PARTICULAR FONT, STYLE, SIZE, OR COLOR.

SEC. 2(F).

SER. NO. 85-440,709, FILED 10-6-2011.

SUSAN LESLIE DUBOIS, EXAMINING ATTORNEY



David J. Kybas

Director of the United States Patent and Trademark Office

United States of America

United States Patent and Trademark Office



Reg. No. 4,174,501

Registered July 17, 2012

Int. Cls.: 9 and 42

TRADEMARK

SERVICE MARK

PRINCIPAL REGISTER

BLUE WOLF ENTERPRISES, INC (IDAHO CORPORATION), DBA BLUE WOLF
9179 W. STATE ST.
GARDEN CITY, ID 83714

FOR: ROBOTS FOR PERSONAL OR HOBBY USE; ROBOTS FOR PERSONAL, EDUCATIONAL AND HOBBY USE AND STRUCTURAL PARTS THEREFOR, IN CLASS 9 (U.S. CLS. 21, 23, 26, 36 AND 38).

FIRST USE 2-11-2011; IN COMMERCE 2-11-2011.

FOR: CONSULTING SERVICES IN THE FIELD OF DESIGN AND DEVELOPMENT OF ENGINEERING PROCESSES; CONSULTING SERVICES IN THE FIELD OF THE DESIGN OF PRODUCT DEVELOPMENT PROTOTYPES; DESIGN, DEVELOPMENT, AND CONSULTING SERVICES RELATED THERETO IN THE FIELD OF MANUFACTURING EQUIPMENT, IN CLASS 42 (U.S. CLS. 100 AND 101).

FIRST USE 2-21-2002; IN COMMERCE 2-21-2002.

THE MARK CONSISTS OF THE WORDS "BLUE WOLF" IN MIDNIGHT BLUE. IN BETWEEN THESE WORDS IS THE DESIGN OF A WOLF HOWLING, ALSO IN MIDNIGHT BLUE AND CONTAINING HUES OF WHITE. THE OUTLINE OF THE WOLF'S BODY FORMS A CIRCULAR DESIGN WITH JAGGED EDGES AND IS ALSO IN MIDNIGHT BLUE AND CONTAINS HUES OF WHITE. THERE IS A MOON YELLOW SEMI-CIRCLE NEXT TO THIS DESIGN. THE ENTIRE MARK IS PLACED OVER A TRANSPARENT BACKGROUND.

THE COLOR(S) MIDNIGHT BLUE, MOON YELLOW, AND WHITE IS/ARE CLAIMED AS A FEATURE OF THE MARK.

SER. NO. 85-441,050, FILED 10-6-2011.

AHSEN KHAN, EXAMINING ATTORNEY



David J. Kyjars

Director of the United States Patent and Trademark Office

United States of America

United States Patent and Trademark Office

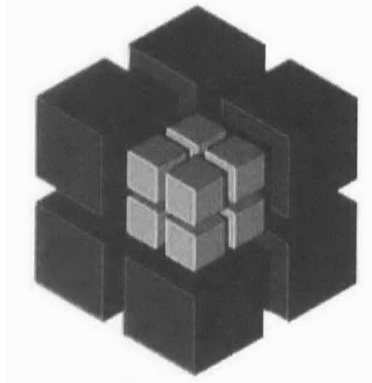

Reg. No. 4,174,502

Registered July 17, 2012

Int. Cl.: 9

TRADEMARK

PRINCIPAL REGISTER

SECTOR 42 TECHNOLOGIES INC. (CANADA CORPORATION)
15, GAMELIN STREET, SUITE 506, GATINEAU
QUEBEC, CANADA J8Y6N5

FOR: COMPUTER PROGRAMS FOR PROVIDING A MULTI-POINT DATA BROADCASTING NETWORK FOR INTERACTIVE ELECTRONIC DELIVERY OF TEXTUAL AND GRAPHICAL INFORMATION USING A DIGITAL COMMUNICATION PLATFORM IN THE FIELDS OF DATABASE MANAGEMENT, BROADCASTING AND COMMUNICATIONS AND INSTRUCTION MANUALS SOLD AS A UNIT, IN CLASS 9 (U.S. CLS. 21, 23, 26, 36 AND 38).

FIRST USE 5-0-1998; IN COMMERCE 5-0-1998.

THE MARK CONSISTS OF A SERIES OF SEVEN (7) CUBES FORMING A SQUARE PARTIALLY SURROUNDED BY A SERIES OF SIX (6) LARGER CUBES.

SER. NO. 85-441,089, FILED 10-6-2011.

ANDREA BUTLER, EXAMINING ATTORNEY



David J. Kyffers

Director of the United States Patent and Trademark Office

United States of America

United States Patent and Trademark Office

TRIOMPHE

Reg. No. 4,174,503

THOMAS HINE & CO. (FRANCE SOCIÉTÉ PAR ACTIONS SIMPLIFIÉE (SAS))
16 QUAI DE L'ORANGERIE
JARNAC, FRANCE 16200

Registered July 17, 2012

Int. Cl.: 33

FOR: WINES AND SPIRITS, NAMELY, BRANDIES AND COGNACS, IN CLASS 33 (U.S. CLS. 47 AND 49).

TRADEMARK

FIRST USE 2-0-1977; IN COMMERCE 2-0-1977.

PRINCIPAL REGISTER

THE MARK CONSISTS OF STANDARD CHARACTERS WITHOUT CLAIM TO ANY PARTICULAR FONT, STYLE, SIZE, OR COLOR.

OWNER OF FRANCE REG. NO. 1622366, DATED 10-19-1990, RENEWED AS REG. NO. 1622366, DATED 9-17-2020, EXPIRES 9-17-2030.

OWNER OF U.S. REG. NO. 1,663,589.

THE ENGLISH TRANSLATION OF "TRIOMPHE" IN THE MARK IS "TRIUMPH".

SER. NO. 85-441,279, FILED 10-6-2011.

ANNE E. GUSTASON, EXAMINING ATTORNEY



David J. Kybas

Director of the United States Patent and Trademark Office

United States of America

United States Patent and Trademark Office

CELLAN

Reg. No. 4,174,504

Registered July 17, 2012

Int. Cl.: 5

TRADEMARK

PRINCIPAL REGISTER

ENGAGE BDR, INC. (CALIFORNIA CORPORATION)
9000 WEST SUNSET BLVD., SUITE 525
WEST HOLLYWOOD, CA 90069

FOR: WEIGHT LOSS NUTRACEUTICAL, IN CLASS 5 (U.S. CLS. 6, 18, 44, 46, 51 AND 52).

FIRST USE 10-4-2011; IN COMMERCE 10-4-2011.

THE MARK CONSISTS OF STANDARD CHARACTERS WITHOUT CLAIM TO ANY PARTICULAR FONT, STYLE, SIZE, OR COLOR.

SER. NO. 85-441,475, FILED 10-6-2011.

JORDAN BAKER, EXAMINING ATTORNEY



David J. Kyffers

Director of the United States Patent and Trademark Office

United States of America

United States Patent and Trademark Office



Reg. No. 4,174,505

CLOUD CAPITAL PARTNERS LLC (DELAWARE LIMITED LIABILITY COMPANY)
64 OLD HILL ROAD
WESTPORT, CT 06880

Registered July 17, 2012

Int. Cl.: 36

FOR: VENTURE CAPITAL FUND MANAGEMENT SERVICES, IN CLASS 36 (U.S. CLS. 100, 101 AND 102).

SERVICE MARK

FIRST USE 10-15-2010; IN COMMERCE 10-15-2010.

PRINCIPAL REGISTER

OWNER OF U.S. REG. NO. 4,075,491.

NO CLAIM IS MADE TO THE EXCLUSIVE RIGHT TO USE "CLOUD" AND "CAPITAL PARTNERS", APART FROM THE MARK AS SHOWN.

THE MARK CONSISTS OF AN IMAGE OF A CLOUD WITHIN A SQUARE AND THE WORD "CLOUD" WITHIN THE CLOUD AND THE WORDS "CAPITAL PARTNERS" IN SMALLER FONT UNDER THE CLOUD IMAGE.

SER. NO. 85-441,883, FILED 10-7-2011.

MICHAEL LITZAU, EXAMINING ATTORNEY



David J. Kyffers

Director of the United States Patent and Trademark Office

United States of America

United States Patent and Trademark Office

JACK PUCK

Reg. No. 4,174,506

4522958 CANADA INC. (CANADA CORPORATION)
9 D'ÉDIMBOURG STREET
CANDIAC, QUEBEC, CANADA J5R6M8

Registered July 17, 2012

Int. Cl.: 7

FOR: HYDRAULIC PRESS USED TO TRANSFORM PLANT'S EXTRACT INTO A COMPACT PASTE, IN CLASS 7 (U.S. CLS. 13, 19, 21, 23, 31, 34 AND 35).

TRADEMARK

FIRST USE 3-21-2005; IN COMMERCE 8-23-2005.

PRINCIPAL REGISTER

THE MARK CONSISTS OF STANDARD CHARACTERS WITHOUT CLAIM TO ANY PARTICULAR FONT, STYLE, SIZE, OR COLOR.

PRIORITY CLAIMED UNDER SEC. 44(D) ON CANADA APPLICATION NO. 1546300, FILED 9-28-2011.

NO CLAIM IS MADE TO THE EXCLUSIVE RIGHT TO USE "JACK", APART FROM THE MARK AS SHOWN.

THE NAME(S), PORTRAIT(S), AND/OR SIGNATURE(S) SHOWN IN THE MARK DOES NOT IDENTIFY A PARTICULAR LIVING INDIVIDUAL.

SER. NO. 85-442,207, FILED 10-7-2011.

LAURIE KAUFMAN, EXAMINING ATTORNEY



David J. Kybas

Director of the United States Patent and Trademark Office

United States of America

United States Patent and Trademark Office

THE BARNS

Reg. No. 4,174,507

Registered July 17, 2012

Int. Cl.: 41

SERVICE MARK

PRINCIPAL REGISTER

WOLF TRAP FOUNDATION FOR THE PERFORMING ARTS (D.C. NON-PROFIT CORPORATION)
1645 TRAP ROAD
VIENNA, VA 22182

FOR: ENTERTAINMENT SERVICES, NAMELY, THE OPERATION OF A THEATRE FOR PRESENTING ENTERTAINMENT EVENTS FOR THE PUBLIC, IN CLASS 41 (U.S. CLS. 100, 101 AND 107).

FIRST USE 10-0-1981; IN COMMERCE 10-0-1981.

THE MARK CONSISTS OF STANDARD CHARACTERS WITHOUT CLAIM TO ANY PARTICULAR FONT, STYLE, SIZE, OR COLOR.

OWNER OF U.S. REG. NO. 2,499,351.

SER. NO. 85-442,316, FILED 10-7-2011.

DAVID COLLIER, EXAMINING ATTORNEY



David J. Kyffers

Director of the United States Patent and Trademark Office

United States of America

United States Patent and Trademark Office

SHIPSHAPE IT

Reg. No. 4,174,508

Registered July 17, 2012

Int. Cls.: 37 and 42

SERVICE MARK

PRINCIPAL REGISTER

SHIPSHAPE IT, LLC (VIRGINIA LIMITED LIABILITY COMPANY)
18783 THOMAS LEE WAY
LANDSDOWNE, VA 20176

FOR: COMPUTER HARDWARE INSTALLATION AND REPAIR, INCLUDING MOBILE PERFORMANCE OF SUCH SERVICES ON CUSTOMER PREMISES, IN CLASS 37 (U.S. CLS. 100, 103 AND 106).

FIRST USE 6-8-2010; IN COMMERCE 7-27-2010.

FOR: CONSULTATION SERVICES IN THE FIELDS OF SELECTION, IMPLEMENTATION AND USE OF COMPUTER HARDWARE AND SOFTWARE SYSTEMS FOR OTHERS; CONSULTING IN THE FIELD OF INFORMATION TECHNOLOGY; DESIGN, CREATION, HOSTING, MAINTENANCE OF WEBSITES FOR OTHERS; INFORMATION TECHNOLOGY CONSULTATION; MAINTENANCE OF WEBSITES AND HOSTING ON-LINE WEB FACILITIES FOR OTHERS; PLANNING, DESIGN AND MANAGEMENT OF INFORMATION TECHNOLOGY SYSTEMS; REMOTE ONLINE BACKUP OF COMPUTER DATA, IN CLASS 42 (U.S. CLS. 100 AND 101).

FIRST USE 6-8-2010; IN COMMERCE 7-27-2010.

THE MARK CONSISTS OF STANDARD CHARACTERS WITHOUT CLAIM TO ANY PARTICULAR FONT, STYLE, SIZE, OR COLOR.

NO CLAIM IS MADE TO THE EXCLUSIVE RIGHT TO USE "IT", APART FROM THE MARK AS SHOWN.

SER. NO. 85-442,417, FILED 10-7-2011.

BRENDAN REGAN, EXAMINING ATTORNEY



David J. Kyjars

Director of the United States Patent and Trademark Office

United States of America

United States Patent and Trademark Office



Reg. No. 4,174,509

Registered July 17, 2012

Int. Cl.: 5

TRADEMARK

PRINCIPAL REGISTER

ROCKY MOUNTAIN TISSUE BANK (COLORADO NON-PROFIT CORPORATION)
SUITE 390
2993 S PEORIA ST.
AURORA, CO 80014

FOR: HUMAN ALLOGRAFT TISSUE, IN CLASS 5 (U.S. CLS. 6, 18, 44, 46, 51 AND 52).

FIRST USE 6-11-2009; IN COMMERCE 6-11-2009.

NO CLAIM IS MADE TO THE EXCLUSIVE RIGHT TO USE "ROCKY MOUNTAIN TISSUE BANK" OR THE CADUCEUS SYMBOL, APART FROM THE MARK AS SHOWN.

THE MARK CONSISTS OF THE LETTERS "R M T B" OVER A LINE, WITH A RIBBON AROUND THE LETTERS WITH TWO MEN AT THE ENDS OF THE RIBBON, FIVE SPHERES AT BOTH ENDS OF THE RIBBON, A CADUCEUS REPRESENTATIVE OF THE LETTER "T" IN "RMTB" AND A LETTER "D" EMBEDDED IN THE CADUCEUS, WHICH IS ALL OVER THE WORDS "ROCKY MOUNTAIN TISSUE BANK".

SER. NO. 85-442,694, FILED 10-7-2011.

SANJEEV VOHRA, EXAMINING ATTORNEY



David J. Kyffers

Director of the United States Patent and Trademark Office

United States of America

United States Patent and Trademark Office

International Symposium on Ovarian Cancer and Gynecologic Malignancies

Reg. No. 4,174,510

Registered July 17, 2012

Int. Cl.: 41

SERVICE MARK

PRINCIPAL REGISTER

ARC MESA EDUCATORS, LLC (NEW JERSEY LIMITED LIABILITY COMPANY)
BUILDING 356
666 PLAINSBORO ROAD
PLAINSBORO, NJ 08536

FOR: EDUCATION SERVICES, NAMELY, PROVIDING ANNUAL MEDICAL CONFERENCE, LECTURES, INTERACTIVE DISCUSSIONS, POSTER SESSIONS, HANDS-ON WORKSHOPS, AND BROADCAST SYMPOSIA FOR ONCOLOGISTS AND SURGEONS IN THE FIELD OF ONCOLOGY, IN CLASS 41 (U.S. CLS. 100, 101 AND 107).

FIRST USE 3-0-2004; IN COMMERCE 3-0-2004.

THE MARK CONSISTS OF STANDARD CHARACTERS WITHOUT CLAIM TO ANY PARTICULAR FONT, STYLE, SIZE, OR COLOR.

NO CLAIM IS MADE TO THE EXCLUSIVE RIGHT TO USE "SYMPOSIUM", APART FROM THE MARK AS SHOWN.

SEC. 2(F).

SER. NO. 85-442,795, FILED 10-8-2011.

BERNICE MIDDLETON, EXAMINING ATTORNEY



David J. Kybas

Director of the United States Patent and Trademark Office

United States of America

United States Patent and Trademark Office

Divanil

Reg. No. 4,174,511

Registered July 17, 2012

Int. Cl.: 5

TRADEMARK

PRINCIPAL REGISTER

DRIVEN SPORTS, INC. (NEW YORK CORPORATION)
SUITE 329
672 DOGWOOD AVE.
FRANKLIN SQUARE, NY 11010

FOR: DIETARY AND NUTRITIONAL SUPPLEMENTS, IN CLASS 5 (U.S. CLS. 6, 18, 44, 46, 51 AND 52).

FIRST USE 1-1-2009; IN COMMERCE 1-1-2009.

THE MARK CONSISTS OF STANDARD CHARACTERS WITHOUT CLAIM TO ANY PARTICULAR FONT, STYLE, SIZE, OR COLOR.

SER. NO. 85-442,969, FILED S.R. 10-9-2011 AM. P.R. 2-29-2012.

NAPOLEON SHARMA, EXAMINING ATTORNEY



David J. Kyffers

Director of the United States Patent and Trademark Office

United States of America

United States Patent and Trademark Office

CoreTest

Reg. No. 4,174,512

Registered July 17, 2012

Int. Cl.: 5

TRADEMARK

PRINCIPAL REGISTER

DRIVEN SPORTS, INC. (NEW YORK CORPORATION)
SUITE 329
672 DOGWOOD AVE.
FRANKLIN SQUARE, NY 11010

FOR: DIETARY AND NUTRITIONAL SUPPLEMENTS, IN CLASS 5 (U.S. CLS. 6, 18, 44, 46, 51 AND 52).

FIRST USE 9-1-2010; IN COMMERCE 9-1-2010.

THE MARK CONSISTS OF STANDARD CHARACTERS WITHOUT CLAIM TO ANY PARTICULAR FONT, STYLE, SIZE, OR COLOR.

SER. NO. 85-442,970, FILED S.R. 10-9-2011 AM. P.R. 2-29-2012.

NAPOLEON SHARMA, EXAMINING ATTORNEY



David J. Kyffers

Director of the United States Patent and Trademark Office

United States of America

United States Patent and Trademark Office



Reg. No. 4,174,513

Registered July 17, 2012

Int. Cl.: 41

SERVICE MARK

PRINCIPAL REGISTER

K&SJ INVESTMENTS, INC. (CALIFORNIA CORPORATION), DBA VISUAL EDGE
PHOTOGRAPHY
3503 SILVA LANE
ALAMEDA, CA 94502

FOR: PHOTOGRAPHY SERVICES, IN CLASS 41 (U.S. CLS. 100, 101 AND 107).

FIRST USE 8-1-2011; IN COMMERCE 8-1-2011.

NO CLAIM IS MADE TO THE EXCLUSIVE RIGHT TO USE "VISUAL" AND "PHOTOGRAPHY", APART FROM THE MARK AS SHOWN.

THE MARK CONSISTS OF A SILHOUETTE OF A NUDE FEMALE FIGURE INTERTWINED WITH A LEAF DESIGN ELEMENT ABOVE THE WORDING "VISUAL EDGE PHOTOGRAPHY".

SER. NO. 85-443,194, FILED 10-10-2011.

NAPOLEON SHARMA, EXAMINING ATTORNEY



David J. Kybas

Director of the United States Patent and Trademark Office

United States of America

United States Patent and Trademark Office

EDIBLE MICHIANA

Reg. No. 4,174,514

EDIBLE COMMUNITIES, INC. (MONTANA CORPORATION)
629 STATE STREET, SUITE 203
SANTA BARBARA, CA 93101

Registered July 17, 2012

Int. Cl.: 16

FOR: MAGAZINES FEATURING TOURISM, CULINARY AND AGRICULTURE INDUSTRIES AND PUBLICATIONS, NAMELY, MAGAZINES AND NEWSLETTERS DEALING WITH CONNECTING CONSUMERS WITH LOCAL GROWERS, FOOD RETAILERS, CHEFS AND FOOD ARTISANS, IN CLASS 16 (U.S. CLS. 2, 5, 22, 23, 29, 37, 38 AND 50).

TRADEMARK

PRINCIPAL REGISTER

FIRST USE 2-24-2011; IN COMMERCE 2-24-2011.

THE MARK CONSISTS OF STANDARD CHARACTERS WITHOUT CLAIM TO ANY PARTICULAR FONT, STYLE, SIZE, OR COLOR.

OWNER OF U.S. REG. NOS. 3,599,996, 3,664,700, AND 3,839,047.

NO CLAIM IS MADE TO THE EXCLUSIVE RIGHT TO USE "MICHIANA", APART FROM THE MARK AS SHOWN.

SER. NO. 85-443,259, FILED 10-10-2011.

MARILYN IZZI, EXAMINING ATTORNEY



David J. Kyffers

Director of the United States Patent and Trademark Office

United States of America

United States Patent and Trademark Office

BEAR
DATA SOLUTIONS

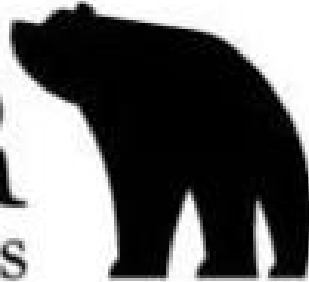

Reg. No. 4,174,515

BEAR DATA SOLUTIONS (CALIFORNIA CORPORATION)

Registered July 17, 2012

1000 BRANNAN ST., SUITE 200
SAN FRANCISCO, CA 94103

Int. Cls.: 35, 37 and 42

FOR: PLACEMENT OF STAFF; PROVIDING COMPUTER SUPPORT STAFF SERVICES; MANAGING THE ORDERING AND HIRING OF ADDITIONAL STAFF FOR OTHERS; VALUE-ADDED RESELLER SERVICES, NAMELY, DISTRIBUTORSHIP SERVICES FEATURING COMPUTERS; OPERATION AND ADMINISTRATION OF TELECOMMUNICATION SYSTEMS FOR OTHERS, IN CLASS 35 (U.S. CLS. 100, 101 AND 102).

SERVICE MARK

PRINCIPAL REGISTER

FIRST USE 10-0-2004; IN COMMERCE 10-0-2004.

FOR: CUSTOM COMPUTER TELECOMMUNICATIONS SYSTEM INSTALLATION AND REPAIR; TECHNICAL ADVICE CONCERNING THE INSTALLATION AND REPAIR OF COMPUTER AND TELECOMMUNICATIONS SYSTEMS; INSTALLATION OF TELECOMMUNICATIONS COMPUTER SYSTEMS, IN CLASS 37 (U.S. CLS. 100, 103 AND 106).

FIRST USE 10-0-2004; IN COMMERCE 10-0-2004.

FOR: DESIGN OF TELECOMMUNICATIONS SYSTEMS; CONSULTING SERVICES IN THE FIELD OF DESIGN, SELECTION, IMPLEMENTATION AND USE OF ENTERPRISE COMPUTER HARDWARE AND SOFTWARE SYSTEMS FOR OTHERS; DESIGN OF CUSTOM COMPUTER AND TELECOMMUNICATIONS SYSTEMS, IN CLASS 42 (U.S. CLS. 100 AND 101).

FIRST USE 10-0-2004; IN COMMERCE 10-0-2004.

NO CLAIM IS MADE TO THE EXCLUSIVE RIGHT TO USE "DATA SOLUTIONS", APART FROM THE MARK AS SHOWN.

THE MARK CONSISTS OF THE WORDING "BEAR DATA SOLUTIONS" WITH A DESIGN OF A BEAR TO THE RIGHT OF THE WORDING.

SER. NO. 85-443,371, FILED 10-10-2011.

AISHA SALEM, EXAMINING ATTORNEY



David J. Kyjars

Director of the United States Patent and Trademark Office

United States of America

United States Patent and Trademark Office



Reg. No. 4,174,516

FMR LLC (DELAWARE LIMITED LIABILITY COMPANY)
82 DEVONSHIRE STREET
BOSTON, MA 02109

Registered July 17, 2012

Int. Cl.: 35

FOR: ARRANGING AND MANAGING WORKPLACE FACILITIES TO PROVIDE FLEXIBLE USE OF WORKSPACE AND TECHNOLOGY, NAMELY, COMPUTERS, TELEPHONES, PRINTERS, FACSIMILES AND COPY MACHINES, ALL FOR USE BY MOBILE EMPLOYEES, IN CLASS 35 (U.S. CLS. 100, 101 AND 102).

SERVICE MARK

PRINCIPAL REGISTER

FIRST USE 6-22-2010; IN COMMERCE 6-22-2010.

OWNER OF U.S. REG. NO. 4,029,638.

NO CLAIM IS MADE TO THE EXCLUSIVE RIGHT TO USE "CENTERS", APART FROM THE MARK AS SHOWN.

THE MARK CONSISTS OF AN OFFICE CHAIR, A CLOCK AND A COMPUTER MOUSE ABOVE THE WORDS "GOWORK CENTERS".

SER. NO. 85-443,451, FILED 10-10-2011.

MARIA-VICTORIA SUAREZ, EXAMINING ATTORNEY



David J. Kyjars

Director of the United States Patent and Trademark Office

United States of America

United States Patent and Trademark Office

hedgehog

Reg. No. 4,174,517

Registered July 17, 2012

Int. Cl.: 33

TRADEMARK

PRINCIPAL REGISTER

SCHINDLER WEISSMAN CO., LLC (CALIFORNIA LIMITED LIABILITY COMPANY), DBA
WINEMONGER
164 SLEEPY HOLLOW DRIVE
SAN ANSELMO, CA 94960

FOR: WINE, IN CLASS 33 (U.S. CLS. 47 AND 49).

FIRST USE 8-5-2011; IN COMMERCE 10-7-2011.

THE MARK CONSISTS OF STANDARD CHARACTERS WITHOUT CLAIM TO ANY PARTICULAR FONT, STYLE, SIZE, OR COLOR.

SER. NO. 85-443,516, FILED 10-10-2011.

CHARISMA HAMPTON, EXAMINING ATTORNEY



David J. Kybas

Director of the United States Patent and Trademark Office

United States of America

United States Patent and Trademark Office

BEAUTYCODE

Reg. No. 4,174,518

COSSWISS AG (SWITZERLAND AKTIENGESELLSCHAFT)
SEESTRASSE 59

Registered July 17, 2012

ERLENBACH, SWITZERLAND 8703

Int. Cl.: 25

FOR: BODY SHAPERS; BODY SUITS; BRAS; CAMISOLES; DRESSES; HOSIERY; PANTIES;
PANTS; SHAPEWEAR, NAMELY, HIP AND THIGH SHAPERS, HIGH WASTE SHAPERS,
ANTI-CELLULITE SHAPERS FULL BODY SHAPERS.; SHIRTS; SKIRTS; SLIPS; TIGHTS,
IN CLASS 25 (U.S. CLS. 22 AND 39).

TRADEMARK

PRINCIPAL REGISTER

THE MARK CONSISTS OF STANDARD CHARACTERS WITHOUT CLAIM TO ANY PAR-
TICULAR FONT, STYLE, SIZE, OR COLOR.

OWNER OF SWITZERLAND REG. NO. 512970, DATED 7-24-2003, EXPIRES 2-18-2013.

OWNER OF U.S. REG. NO. 3,004,523.

SER. NO. 85-443,523, FILED 10-10-2011.

SHAILA SETTLES, EXAMINING ATTORNEY



David J. Kyfos

Director of the United States Patent and Trademark Office

United States of America

United States Patent and Trademark Office

ROUTERVAC

Reg. No. 4,174,519

KMT ROBOTIC SOLUTIONS, INC. (MICHIGAN CORPORATION)
1255 HARMON ROAD
AUBURN HILLS, MI 48326

Registered July 17, 2012

Int. Cl.: 7

FOR: INDUSTRIAL VACUUMS FOR HOLDING PARTS ONTO A FIXTURE AND FOR REMOVING SOLID WASTE, IN CLASS 7 (U.S. CLS. 13, 19, 21, 23, 31, 34 AND 35).

TRADEMARK

FIRST USE 8-0-2005; IN COMMERCE 8-0-2005.

PRINCIPAL REGISTER

THE MARK CONSISTS OF STANDARD CHARACTERS WITHOUT CLAIM TO ANY PARTICULAR FONT, STYLE, SIZE, OR COLOR.

OWNER OF U.S. REG. NOS. 2,532,447 AND 3,053,736.

SEC. 2(F).

SER. NO. 85-443,540, FILED 10-10-2011.

BRIAN NEVILLE, EXAMINING ATTORNEY



David J. Kybas

Director of the United States Patent and Trademark Office

United States of America

United States Patent and Trademark Office



Reg. No. 4,174,520

Registered July 17, 2012

**COLLECTIVE
MEMBERSHIP**

PRINCIPAL REGISTER

TENNESSEE PEACEMAKERS MOTORCYCLE CLUB, INC. (VIRGINIA CORPORATION)
801 BOOZY CREEK ROAD
BLOUNTVILLE, TN 37617

FOR: INDICATING MEMBERSHIP IN A SOCIAL CLUB OF MOTORCYCLE ENTHUSIASTS,
IN CLASS 200 (U.S. CL. 200).

FIRST USE 1-1-1990; IN COMMERCE 1-1-1990.

NO CLAIM IS MADE TO THE EXCLUSIVE RIGHT TO USE "TENNESSEE" AND "M.C.",
APART FROM THE MARK AS SHOWN.

THE COLOR(S) RED, WHITE AND BLACK IS/ARE CLAIMED AS A FEATURE OF THE
MARK.

THE MARK CONSISTS OF THE WORDS "PEACEMAKERS" AND "TENNESSEE" AND THE
LETTERS "M.C." ARE RED IN COLOR ON A WHITE BACKGROUND. THE DESIGN IS AN
OUTLINE PROFILE IN BLACK OF A SKULL WITH CROSSED BONES WITH A BLACK
GRAPHIC DESIGN OF A MOTORCYCLE HELMET ON THE SKULL'S HEAD, ON A WHITE
BACKGROUND. THE LETTERS "M.C." APPEAR TO THE RIGHT OF THE SKULL DESIGN
ENCLOSED IN A BLACK SQUARE BORDER. THE WORDS "PEACEMAKERS" AND
"TENNESSEE" ARE EACH SURROUNDED BY A BLACK BORDER.

SER. NO. 85-444,415, FILED 10-11-2011.

ANDREA BUTLER, EXAMINING ATTORNEY



David J. Kyjars

Director of the United States Patent and Trademark Office

United States of America

United States Patent and Trademark Office

123 CERTIFICATES

Reg. No. 4,174,521

MES, INC. (JAPAN CORPORATION)

Registered July 17, 2012

7820-3 KYOWA
SAKU, NAGANO, JAPAN

Int. Cl.: 42

FOR: PROVIDING AN INTERACTIVE WEBSITE FEATURING TECHNOLOGY THAT ENABLES USERS TO CUSTOMIZE PRINTABLE CERTIFICATES AND OTHER PRINTED ITEMS; PROVIDING A WEBSITE FEATURING NON-DOWNLOADABLE SOFTWARE THAT ENABLES USERS TO CUSTOMIZE PRINTABLE CERTIFICATES AND OTHER PRINTED ITEMS, IN CLASS 42 (U.S. CLS. 100 AND 101).

SERVICE MARK

PRINCIPAL REGISTER

FIRST USE 11-13-2006; IN COMMERCE 11-13-2006.

THE MARK CONSISTS OF STANDARD CHARACTERS WITHOUT CLAIM TO ANY PARTICULAR FONT, STYLE, SIZE, OR COLOR.

NO CLAIM IS MADE TO THE EXCLUSIVE RIGHT TO USE "CERTIFICATES", APART FROM THE MARK AS SHOWN.

SER. NO. 85-444,459, FILED 10-11-2011.

APRIL ROACH, EXAMINING ATTORNEY



David J. Kypos

Director of the United States Patent and Trademark Office

United States of America

United States Patent and Trademark Office

MES CARDS

Reg. No. 4,174,522

MES, INC. (JAPAN CORPORATION)

Registered July 17, 2012

7820-3 KYOWA
SAKU, NAGANO, JAPAN

Int. Cl.: 42

FOR: PROVIDING AN INTERACTIVE WEBSITE FEATURING TECHNOLOGY THAT ENABLES USERS TO CUSTOMIZE PRINTABLE CERTIFICATES AND OTHER PRINTED ITEMS; PROVIDING A WEBSITE FEATURING NON-DOWNLOADABLE SOFTWARE THAT ENABLES USERS TO CUSTOMIZE PRINTABLE CERTIFICATES AND OTHER PRINTED ITEMS, IN CLASS 42 (U.S. CLS. 100 AND 101).

SERVICE MARK

PRINCIPAL REGISTER

FIRST USE 6-21-2011; IN COMMERCE 6-21-2011.

THE MARK CONSISTS OF STANDARD CHARACTERS WITHOUT CLAIM TO ANY PARTICULAR FONT, STYLE, SIZE, OR COLOR.

NO CLAIM IS MADE TO THE EXCLUSIVE RIGHT TO USE "CARDS", APART FROM THE MARK AS SHOWN.

SER. NO. 85-444,475, FILED 10-11-2011.

APRIL ROACH, EXAMINING ATTORNEY



David J. Kypos

Director of the United States Patent and Trademark Office

United States of America

United States Patent and Trademark Office

PRINT WITH MY PIC

Reg. No. 4,174,523

MES, INC. (JAPAN CORPORATION)

Registered July 17, 2012

7820-3 KYOWA
SAKU, NAGANO, JAPAN

Int. Cl.: 42

FOR: PROVIDING AN INTERACTIVE WEBSITE FEATURING TECHNOLOGY THAT EN-
ABLES USERS TO CUSTOMIZE PRINTABLE CERTIFICATES AND OTHER PRINTED
ITEMS; PROVIDING A WEBSITE FEATURING NON-DOWNLOADABLE SOFTWARE THAT
ENABLES USERS TO CUSTOMIZE PRINTABLE CERTIFICATES AND OTHER PRINTED
ITEMS, IN CLASS 42 (U.S. CLS. 100 AND 101).

SERVICE MARK

PRINCIPAL REGISTER

FIRST USE 1-20-2010; IN COMMERCE 1-20-2010.

THE MARK CONSISTS OF STANDARD CHARACTERS WITHOUT CLAIM TO ANY PAR-
TICULAR FONT, STYLE, SIZE, OR COLOR.

SER. NO. 85-444,491, FILED 10-11-2011.

APRIL ROACH, EXAMINING ATTORNEY



David J. Kyffers

Director of the United States Patent and Trademark Office

United States of America

United States Patent and Trademark Office



Reg. No. 4,174,524

Registered July 17, 2012

Int. Cl.: 33

TRADEMARK

PRINCIPAL REGISTER

BODEGAS COPA DE ORO S.A. DE C.V. (MEXICO CORPORATION)
904
3 SUR COLONIA CENTRO
SAN PEDRO CHOLULA, PUE, MEXICO

FOR: ALCOHOLIC BEVERAGES, EXCEPT BEER, IN CLASS 33 (U.S. CLS. 47 AND 49).

OWNER OF MEXICO REG. NO. 1171921, DATED 7-30-2010, EXPIRES 5-27-2020.

NO CLAIM IS MADE TO THE EXCLUSIVE RIGHT TO USE "BLUE PEACH", APART FROM THE MARK AS SHOWN.

THE MARK CONSISTS OF A CIRCLE RESEMBLING A FLARING STAR WITH WAVY LINES BELOW AND THE TEXT "CARACAYA BLUE PEACH" ALL WITHIN AN IRREGULAR-SHAPED RECTANGULAR BACKGROUND.

SER. NO. 85-444,514, FILED 10-11-2011.

CARYN GLASSER, EXAMINING ATTORNEY



David J. Kybas

Director of the United States Patent and Trademark Office

United States of America

United States Patent and Trademark Office



Reg. No. 4,174,525

Registered July 17, 2012

Int. Cl.: 33

TRADEMARK

PRINCIPAL REGISTER

BODEGAS COPA DE ORO S.A. DE C.V. (MEXICO CORPORATION)
904
3 SUR COLONIA CENTRO
SAN PEDRO CHOLULA, PUE, MEXICO

FOR: ALCOHOLIC BEVERAGES, EXCEPT BEER, IN CLASS 33 (U.S. CLS. 47 AND 49).

OWNER OF MEXICO REG. NO. 1171922, DATED 7-30-2010, EXPIRES 5-27-2020.

NO CLAIM IS MADE TO THE EXCLUSIVE RIGHT TO USE "CHOLULA", APART FROM THE MARK AS SHOWN.

THE MARK CONSISTS OF A CIRCLE RESEMBLING A FLARING STAR WITH WAVY LINES BELOW AND THE TEXT "CARACAYA CHOLULA ON FIRE" ALL WITHIN AN IRREGULAR-SHAPED RECTANGULAR BACKGROUND.

SER. NO. 85-444,545, FILED 10-11-2011.

CARYN GLASSER, EXAMINING ATTORNEY



David J. Kyffers

Director of the United States Patent and Trademark Office

United States of America

United States Patent and Trademark Office



Reg. No. 4,174,526

Registered July 17, 2012

Int. Cl.: 33

TRADEMARK

PRINCIPAL REGISTER

BODEGAS COPA DE ORO S.A. DE C.V. (MEXICO CORPORATION)
904
3 SUR COLONIA CENTRO
SAN PEDRO CHOLULA, PUE, MEXICO

FOR: ALCOHOLIC BEVERAGES, EXCEPT BEER, IN CLASS 33 (U.S. CLS. 47 AND 49).

OWNER OF MEXICO REG. NO. 1171923, DATED 7-30-2010, EXPIRES 5-27-2020.

THE MARK CONSISTS OF A CIRCLE RESEMBLING A FLARING STAR WITH WAVY LINES BELOW AND THE TEXT "CARACAYA DELIRIUM BLOOD" ALL WITHIN AN IRREGULAR-SHAPED RECTANGULAR BACKGROUND.

SER. NO. 85-444,553, FILED 10-11-2011.

CARYN GLASSER, EXAMINING ATTORNEY



David J. Kyffers

Director of the United States Patent and Trademark Office

United States of America

United States Patent and Trademark Office



Reg. No. 4,174,527

Registered July 17, 2012

Int. Cl.: 33

TRADEMARK

PRINCIPAL REGISTER

BODEGAS COPA DE ORO S.A. DE C.V. (MEXICO CORPORATION)
904
3 SUR COLONIA CENTRO
SAN PEDRO CHOLULA, PUE, MEXICO

FOR: ALCOHOLIC BEVERAGES, EXCEPT BEER, IN CLASS 33 (U.S. CLS. 47 AND 49).

OWNER OF MEXICO REG. NO. 1171920, DATED 7-30-2010, EXPIRES 5-27-2020.

NO CLAIM IS MADE TO THE EXCLUSIVE RIGHT TO USE "TROPICAL", APART FROM THE MARK AS SHOWN.

THE MARK CONSISTS OF A CIRCLE RESEMBLING A FLARING STAR WITH WAVY LINES BELOW AND THE TEXT "CARACAYA TROPICAL BEAT" ALL WITHIN AN IRREGULAR-SHAPED RECTANGULAR BACKGROUND.

SER. NO. 85-444,571, FILED 10-11-2011.

CARYN GLASSER, EXAMINING ATTORNEY



David J. Kyros

Director of the United States Patent and Trademark Office

United States of America

United States Patent and Trademark Office

ConvergeTrack

Reg. No. 4,174,528

Registered July 17, 2012

Int. Cls.: 35 and 42

SERVICE MARK

PRINCIPAL REGISTER

CONVERGEDIRECT LLC (NEW YORK LIMITED LIABILITY COMPANY)
100 SOUTH BEDFORD ROAD, SUITE 320
MOUNT KISCO, NY 10549

FOR: ADVERTISING AND COMMERCIAL INFORMATION SERVICES, VIA THE INTERNET; PROVIDING BOTH ON-LINE DIGITAL AND OFF-LINE NON-DIGITAL ADVERTISING, AND MARKETING INFORMATION FOR CAMPAIGN PLANNING, TRACKING, ATTRIBUTION, REPORTING, ANALYSIS, AND BIDDING, IN CLASS 35 (U.S. CLS. 100, 101 AND 102).

FIRST USE 1-1-2009; IN COMMERCE 1-1-2009.

FOR: COMPUTER SERVICES, NAMELY, HOSTING, MANAGING, DEVELOPING AND MAINTAINING APPLICATIONS, DATABASES, SOFTWARE, AND WEB SITES FOR OTHERS FOR USE IN ADVERTISING AND MARKETING CAMPAIGN PLANNING, TRACKING, ATTRIBUTION, REPORTING, ANALYSIS, AND BIDDING, IN CLASS 42 (U.S. CLS. 100 AND 101).

FIRST USE 1-1-2009; IN COMMERCE 1-1-2009.

THE MARK CONSISTS OF STANDARD CHARACTERS WITHOUT CLAIM TO ANY PARTICULAR FONT, STYLE, SIZE, OR COLOR.

SER. NO. 85-444,813, FILED 10-11-2011.

LINDA MICKLEBURGH, EXAMINING ATTORNEY



David J. Kyros

Director of the United States Patent and Trademark Office

United States of America

United States Patent and Trademark Office

VANQUEST

Reg. No. 4,174,529

Registered July 17, 2012

Int. Cls.: 9, 13 and 18

TRADEMARK

PRINCIPAL REGISTER

VANQUEST GEAR, INC. (CALIFORNIA CORPORATION)
PO BOX 16322
IRVINE, CA 92623

FOR: PROTECTIVE CASES, POUCHES, AND BAGS DESIGNED FOR CARRYING RADIOS, CELL PHONES, GLOBAL POSITIONING SYSTEMS, NIGHT VISION GOGGLES, AND BINOCULARS; CARRYING CASES, BACKPACKS, LUGGAGE WITH AND WITHOUT ROLLING WHEELS, WAIST PACKS, BAGS, AND POUCHES DESIGNED AND SPECIALLY ADAPTED FOR CARRYING CAMERAS, PHOTOGRAPHY EQUIPMENT, AND VIDEOGRAPHY EQUIPMENT; TACTICAL VESTS, RESCUE VESTS, LOAD-BEARING VESTS, HARNESSSES, SLINGS, AND STRAPS ALL DESIGNED AND SPECIALLY ADAPTED FOR CARRYING, AND KEEPING ELECTRONIC DEVICES, RADIOS, CELL PHONES, GLOBAL POSITIONING SYSTEMS, NIGHT VISION GOGGLES, CAMERAS, AND PHOTOGRAPHY EQUIPMENT IN PLACE, IN CLASS 9 (U.S. CLS. 21, 23, 26, 36 AND 38).

FIRST USE 1-1-2004; IN COMMERCE 6-1-2009.

FOR: HOLSTER BELTS; DUTY BELTS, NAMELY, GUN BELTS; PISTOL HOLSTERS; SHOULDER HOLSTER HARNESSSES, NAMELY, HOLSTERS ; LEG-MOUNTED HOLSTERS; SLINGS AND SLING STRAPS FOR FIREARMS; CARTRIDGE POUCHES, PACKS, CASES, AND CARRIERS, NAMELY, BAGS SPECIALLY ADAPTED TO HOLD GUN CARTRIDGES; MAGAZINE POUCHES, PACKS, CASES, AND CARRIERS, NAMELY, BAGS SPECIALLY ADAPTED TO HOLD GUN MAGAZINES; PROTECTIVE CASES AND PROTECTIVE BAGS SPECIALLY ADAPTED FOR FIREARMS; POUCHES, PACKS, CASES, AND CARRIERS ALL SPECIALLY ADAPTED FOR HOLDING FIREARMS FOR ATTACHMENT TO BACKPACKS, BELTS, AND VESTS, IN CLASS 13 (U.S. CLS. 2 AND 9).

FIRST USE 1-1-2004; IN COMMERCE 1-1-2004.

FOR: SPORT BAGS; TRAVEL BAGS; BACKPACKS; LUGGAGE; WAIST PACKS; SLING BAGS; SHOULDER PACKS; HARNESSSES; HIKING BAGS; HUNTING BAGS; WALLETS; MESSENGER BAGS; BRIEFCASES; ATTACHE CASES; DUFFEL BAGS; ALL-PURPOSE CARRYING BAGS, SPORTS PACKS, CARRYING CASES, AND FABRIC POUCHES ALL SOLD EMPTY FOR ATTACHMENT TO LUGGAGE, BACKPACKS, VESTS, AND BELTS, IN CLASS 18 (U.S. CLS. 1, 2, 3, 22 AND 41).

FIRST USE 1-1-2004; IN COMMERCE 6-1-2009.



David J. Kyjars

Director of the United States Patent and Trademark Office

Reg. No. 4,174,529 THE MARK CONSISTS OF STANDARD CHARACTERS WITHOUT CLAIM TO ANY PARTICULAR FONT, STYLE, SIZE, OR COLOR.

THE WORD(S) "VANQUEST" HAS NO MEANING IN A FOREIGN LANGUAGE.

SER. NO. 85-444,887, FILED 10-11-2011.

JENNIFER WILLISTON, EXAMINING ATTORNEY

United States of America

United States Patent and Trademark Office

Pop-Gram

Reg. No. 4,174,530

Registered July 17, 2012

Int. Cl.: 35

SERVICE MARK

PRINCIPAL REGISTER

POP-GRAM LLC (CALIFORNIA LIMITED LIABILITY COMPANY), FORMERLY
SCHWARZMAN, ELANA B.
7151 HAWTHORN AVE.
LOS ANGELES, CA 90046

FOR: RETAIL STORE AND ON-LINE RETAIL STORE SERVICES FEATURING POPCORN,
KETTLE CORN, NUTS, CARAMEL APPLES, CANDY, PRETZELS, CHURROS, TOYS, AND
GIFT BASKETS, IN CLASS 35 (U.S. CLS. 100, 101 AND 102).

FIRST USE 8-1-2009; IN COMMERCE 8-1-2009.

THE MARK CONSISTS OF STANDARD CHARACTERS WITHOUT CLAIM TO ANY PAR-
TICULAR FONT, STYLE, SIZE, OR COLOR.

OWNER OF U.S. REG. NO. 3,767,397.

SER. NO. 85-444,975, FILED 10-11-2011.

KATHLEEN KOLACZ, EXAMINING ATTORNEY



David J. Kyffers

Director of the United States Patent and Trademark Office

United States of America

United States Patent and Trademark Office

WRS REAL ESTATE

Reg. No. 4,174,531

Registered July 17, 2012

Int. Cl.: 36

SERVICE MARK

PRINCIPAL REGISTER

WRS REAL ESTATE GROUP INC. (FLORIDA CORPORATION)
SUITE L5418
4281 EXPRESS LN
SARASOTA, FL 34238

FOR: REAL ESTATE ACQUISITION SERVICES; REAL ESTATE BROKERAGE; REAL ESTATE CONSULTANCY; REAL ESTATE CONSULTATION; REAL ESTATE FINANCING SERVICES; REAL ESTATE FUNDS INVESTMENT SERVICES; REAL ESTATE INVESTMENT SERVICES; REAL ESTATE INVESTMENT TRUST ADVISORY SERVICES; REAL ESTATE INVESTMENT TRUST MANAGEMENT SERVICES; REAL ESTATE INVESTMENT TRUST SERVICES, IN CLASS 36 (U.S. CLS. 100, 101 AND 102).

FIRST USE 1-1-2011; IN COMMERCE 1-1-2011.

THE MARK CONSISTS OF STANDARD CHARACTERS WITHOUT CLAIM TO ANY PARTICULAR FONT, STYLE, SIZE, OR COLOR.

NO CLAIM IS MADE TO THE EXCLUSIVE RIGHT TO USE "REAL ESTATE", APART FROM THE MARK AS SHOWN.

SER. NO. 85-445,027, FILED 10-12-2011.

LINDA M. KING, EXAMINING ATTORNEY



David J. Kyffers

Director of the United States Patent and Trademark Office

United States of America

United States Patent and Trademark Office

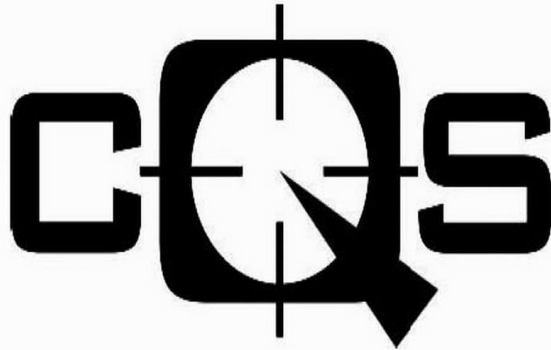

Reg. No. 4,174,532

Registered July 17, 2012

Int. Cl.: 12

TRADEMARK

PRINCIPAL REGISTER

C.Q.S. TECHNOLOGIES INC. (TAIWAN CORPORATION)
10F., NO. 2, BAOSHENG RD., YONGHE DIST.,
NEW TAIPEI CITY, TAIWAN 234

FOR: WHEEL RIMS FOR VEHICLES, IN CLASS 12 (U.S. CLS. 19, 21, 23, 31, 35 AND 44).

FIRST USE 5-14-1998; IN COMMERCE 10-12-2011.

OWNER OF U.S. REG. NO. 3,025,538.

THE MARK CONSISTS OF THE LETTERS "CQS", WHERE THE LETTER "Q" IS STYLIZED WITH A DESIGN OF A GUN SIGHT.

SER. NO. 85-445,035, FILED 10-12-2011.

RAUL CORDOVA, EXAMINING ATTORNEY



David J. Kybas

Director of the United States Patent and Trademark Office

United States of America

United States Patent and Trademark Office

All Things Marcellus

Reg. No. 4,174,533

Registered July 17, 2012

Int. Cl.: 45

CLARK, DOUGLAS A. (UNITED STATES INDIVIDUAL), DBA THE CLARK LAW FIRM,
PC
1563 MAIN STREET
1563 MAIN STREET
PECKVILLE, PA 18452

SERVICE MARK

PRINCIPAL REGISTER

FOR: LEGAL SERVICES, NAMELY, PROVIDING CUSTOMIZED DOCUMENTATION, INFORMATION, COUNSELING, ADVICE AND CONSULTATION SERVICES IN ALL AREAS OF OIL AND GAS LAW, IN CLASS 45 (U.S. CLS. 100 AND 101).

FIRST USE 8-15-2010; IN COMMERCE 8-15-2010.

THE MARK CONSISTS OF STANDARD CHARACTERS WITHOUT CLAIM TO ANY PARTICULAR FONT, STYLE, SIZE, OR COLOR.

NO CLAIM IS MADE TO THE EXCLUSIVE RIGHT TO USE "MARCELLUS", APART FROM THE MARK AS SHOWN.

SER. NO. 85-445,064, FILED 10-12-2011.

JULIE VEPPUMTHARA, EXAMINING ATTORNEY



David J. Kyffers

Director of the United States Patent and Trademark Office

United States of America

United States Patent and Trademark Office

KRONO FIT

Reg. No. 4,174,534

KRONOFIT, LLC (GEORGIA LIMITED LIABILITY COMPANY)
1140 HAVENBROOK COURT
SUWANEE, GA 30024

Registered July 17, 2012

Int. Cl.: 28

FOR: PERSONAL FITNESS KIT COMPRISED OF EXERCISE EQUIPMENT, NAMELY, RESISTANCE BANDS, STRAPS USED FOR SUPPORT AND RESISTANCE WHILE PERFORMING EXERCISES, JUMP ROPE, HANDLE GRIPS FOR SPORTING EQUIPMENT, BAG FITTED FOR EXERCISE EQUIPMENT AND PACKAGED WITH ACCOMPANYING BOOKLET IN THE FIELDS OF FITNESS AND EXERCISE EQUIPMENT, IN CLASS 28 (U.S. CLS. 22, 23, 38 AND 50).

TRADEMARK

PRINCIPAL REGISTER

FIRST USE 6-30-2010; IN COMMERCE 6-30-2010.

THE MARK CONSISTS OF THE WORDING "KRONOFIT" WITH THE SECOND "O" IN THE TERM APPEARING AS A STOPWATCH.

SER. NO. 85-445,209, FILED 10-12-2011.

JOHN DALIER, EXAMINING ATTORNEY



David J. Kyffers

Director of the United States Patent and Trademark Office

United States of America

United States Patent and Trademark Office



Reg. No. 4,174,535

WARREN H. CAREY (UNITED STATES INDIVIDUAL)
75779 HERITAGE
PALM DESERT, CA 92211

Registered July 17, 2012

Int. Cl.: 20

FOR: PLASTIC SHIPPING AND STORAGE BOXES USED TO SHIP GOLF CLUBS AND GOLF BAGS, IN CLASS 20 (U.S. CLS. 2, 13, 22, 25, 32 AND 50).

TRADEMARK

FIRST USE 6-22-2004; IN COMMERCE 9-14-2004.

PRINCIPAL REGISTER

NO CLAIM IS MADE TO THE EXCLUSIVE RIGHT TO USE "GOLF BOX", APART FROM THE MARK AS SHOWN.

THE MARK CONSISTS OF "GOLF BOX", WITH A CURVED ARROW BEGINNING OVER THE "O" IN "GOLF" AND CURVING TO THE RIGHT AROUND THE LETTERS WITH THE ARROW POINT ENDING IN THE REAR OF THE "X" IN "BOX", THE WORD, "XPRESS", UNDERNEATH THE WORDS, "GOLF BOX", WITH A CURVED ARROW BEGINNING UNDERNEATH THE FIRST "S" IN "XPRESS" AND CURVING TO THE LEFT AROUND THE LETTERS WITH THE ARROW POINT ENDING IN THE FRONT OF THE "X" IN "XPRESS".

SER. NO. 85-445,348, FILED 10-12-2011.

KIMBERLY PERRY, EXAMINING ATTORNEY



David J. Kyffers

Director of the United States Patent and Trademark Office

United States of America

United States Patent and Trademark Office

ST. JAMES TEAROOM

Reg. No. 4,174,536

THE ST. JAMES TEAROOM, INC. (NEW MEXICO CORPORATION)
320 OSUNA N.E.

Registered July 17, 2012

ALBUQUERQUE, NM 87107

Int. Cl.: 43

FOR: RESTAURANT AND BAR SERVICES, IN CLASS 43 (U.S. CLS. 100 AND 101).

SERVICE MARK

FIRST USE 5-6-1999; IN COMMERCE 5-6-1999.

PRINCIPAL REGISTER

THE MARK CONSISTS OF STANDARD CHARACTERS WITHOUT CLAIM TO ANY PARTICULAR FONT, STYLE, SIZE, OR COLOR.

NO CLAIM IS MADE TO THE EXCLUSIVE RIGHT TO USE "TEAROOM", APART FROM THE MARK AS SHOWN.

SER. NO. 85-445,918, FILED 10-12-2011.

SEAN CROWLEY, EXAMINING ATTORNEY



David J. Kyffers

Director of the United States Patent and Trademark Office

United States of America

United States Patent and Trademark Office

ST. JAMES TEAROOM

Reg. No. 4,174,537

ST. JAMES TEAROOM, INC., THE (NEW MEXICO CORPORATION)
320 OSUNA N.E.

Registered July 17, 2012

ALBUQUERQUE, NM 87107

Int. Cl.: 35

FOR: RETAIL AND ON-LINE RETAIL GIFT SHOP, IN CLASS 35 (U.S. CLS. 100, 101 AND 102).

SERVICE MARK

FIRST USE 5-6-1999; IN COMMERCE 5-6-1999.

PRINCIPAL REGISTER

THE MARK CONSISTS OF STANDARD CHARACTERS WITHOUT CLAIM TO ANY PARTICULAR FONT, STYLE, SIZE, OR COLOR.

NO CLAIM IS MADE TO THE EXCLUSIVE RIGHT TO USE "TEAROOM", APART FROM THE MARK AS SHOWN.

SER. NO. 85-445,953, FILED 10-12-2011.

SEAN CROWLEY, EXAMINING ATTORNEY



David J. Kyffers

Director of the United States Patent and Trademark Office

United States of America

United States Patent and Trademark Office

Knowledge at the Point of Execution

Reg. No. 4,174,538

Registered July 17, 2012

Int. Cl.: 35

SERVICE MARK

PRINCIPAL REGISTER

WORKING KNOWLEDGECSP LLC (VIRGINIA LIMITED LIABILITY COMPANY), DBA
WORKING KNOWLEDGECSP LLC
11107 COROBON LANE
GREAT FALLS, VA 22066

FOR: ADVISORY SERVICES RELATING TO BUSINESS MANAGEMENT AND BUSINESS OPERATIONS; BUSINESS CONSULTING SERVICES IN THE FIELD OF BUSINESS KNOWLEDGE TRANSFER THROUGH AUDIO TOOLS, NAMELY, RECORDING INTERVIEWS WITH SUBJECT MATTER EXPERTS FOR AN ORGANIZATION'S CAPTURE AND FUTURE USE; BUSINESS CONSULTING SERVICES IN THE FIELD OF ORGANIZATIONAL CHANGE MANAGEMENT; BUSINESS KNOWLEDGE MANAGEMENT SERVICES; BUSINESS MANAGEMENT AND CONSULTATION; BUSINESS MANAGEMENT CONSULTANCY AND ADVISORY SERVICES; BUSINESS MANAGEMENT CONSULTANCY SERVICES; BUSINESS MANAGEMENT CONSULTATION; BUSINESS MANAGEMENT CONSULTING; BUSINESS MANAGEMENT CONSULTING AND ADVISORY SERVICES; BUSINESS ORGANIZATION AND MANAGEMENT CONSULTING SERVICES, IN CLASS 35 (U.S. CLS. 100, 101 AND 102).

FIRST USE 10-18-2010; IN COMMERCE 10-18-2010.

THE MARK CONSISTS OF STANDARD CHARACTERS WITHOUT CLAIM TO ANY PARTICULAR FONT, STYLE, SIZE, OR COLOR.

SER. NO. 85-446,001, FILED 10-12-2011.

AMY ALFIERI, EXAMINING ATTORNEY



David J. Kybas

Director of the United States Patent and Trademark Office

United States of America

United States Patent and Trademark Office

DECKRIDER

Reg. No. 4,174,539

Registered July 17, 2012

Int. Cl.: 7

TRADEMARK

PRINCIPAL REGISTER

NIFTYLIFT LIMITED (UNITED KINGDOM PRIVATE LIMITED COMPANY)
FINGLE DRIVE
STONEBRIDGE, MILTON KEYNES
BUCKS, UNITED KINGDOM MK130ER

FOR: MACHINES, NAMELY, LIFTING AND HOISTING PLATFORMS; ELEVATING WORK PLATFORMS, HYDRAULIC LIFT PLATFORMS; CRANES; MANLIFTS AND CHERRY-PICKERS; MACHINE TOOLS FOR GAINING ACCESS TO TALL STRUCTURES AND BUILDINGS; MOTORS AND ENGINES OTHER THAN FOR LAND VEHICLES; MACHINE COUPLING AND TRANSMISSION COMPONENTS, EXCEPT FOR LAND VEHICLES, IN CLASS 7 (U.S. CLS. 13, 19, 21, 23, 31, 34 AND 35).

THE MARK CONSISTS OF STANDARD CHARACTERS WITHOUT CLAIM TO ANY PARTICULAR FONT, STYLE, SIZE, OR COLOR.

PRIORITY CLAIMED UNDER SEC. 44(D) ON ERPN CMNTY TM OFC APPLICATION NO. 009897794, FILED 4-15-2011, REG. NO. 009897794, DATED 7-29-2011, EXPIRES 4-15-2021.

SER. NO. 85-446,035, FILED 10-12-2011.

GEOFFREY FOSDICK, EXAMINING ATTORNEY



David J. Kyffers

Director of the United States Patent and Trademark Office

United States of America

United States Patent and Trademark Office

International Lung Cancer Congress

Reg. No. 4,174,540

ARC MESA EDUCATORS, LLC (NEW JERSEY LIMITED LIABILITY COMPANY)
666 PLAINSBORO ROAD
PLAINSBORO, NJ 08536

Registered July 17, 2012

Int. Cl.: 41

FOR: EDUCATION SERVICES, NAMELY, PROVIDING ANNUAL MEDICAL CONFERENCE, LECTURES, INTERACTIVE DISCUSSIONS, POSTER SESSIONS, HANDS-ON WORKSHOPS, AND BROADCAST SYMPOSIA FOR ONCOLOGISTS AND SURGEONS IN THE FIELD OF ONCOLOGY, IN CLASS 41 (U.S. CLS. 100, 101 AND 107).

SERVICE MARK

PRINCIPAL REGISTER

FIRST USE 7-0-2000; IN COMMERCE 7-0-2000.

THE MARK CONSISTS OF STANDARD CHARACTERS WITHOUT CLAIM TO ANY PARTICULAR FONT, STYLE, SIZE, OR COLOR.

NO CLAIM IS MADE TO THE EXCLUSIVE RIGHT TO USE "CONGRESS", APART FROM THE MARK AS SHOWN.

SEC. 2(F).

SER. NO. 85-446,090, FILED 10-12-2011.

BERNICE MIDDLETON, EXAMINING ATTORNEY



David J. Kyjars

Director of the United States Patent and Trademark Office

United States of America

United States Patent and Trademark Office

International Symposium on Melanoma and Other Cutaneous Malignancies

Reg. No. 4,174,541

ARC MESA EDUCATORS, LLC (NEW JERSEY LIMITED LIABILITY COMPANY)
666 PLAINSBORO ROAD

Registered July 17, 2012

PLAINSBORO, NJ 08536

Int. Cl.: 41

FOR: EDUCATION SERVICES, NAMELY, PROVIDING ANNUAL MEDICAL CONFERENCE, LECTURES, INTERACTIVE DISCUSSIONS, POSTER SESSIONS, HANDS-ON WORKSHOPS, AND BROADCAST SYMPOSIA FOR ONCOLOGISTS AND SURGEONS IN THE FIELD OF ONCOLOGY, IN CLASS 41 (U.S. CLS. 100, 101 AND 107).

SERVICE MARK

PRINCIPAL REGISTER

FIRST USE 9-0-2004; IN COMMERCE 9-0-2004.

THE MARK CONSISTS OF STANDARD CHARACTERS WITHOUT CLAIM TO ANY PARTICULAR FONT, STYLE, SIZE, OR COLOR.

NO CLAIM IS MADE TO THE EXCLUSIVE RIGHT TO USE "SYMPOSIUM", APART FROM THE MARK AS SHOWN.

SEC. 2(F).

SER. NO. 85-446,097, FILED 10-12-2011.

BERNICE MIDDLETON, EXAMINING ATTORNEY



David J. Kyffers

Director of the United States Patent and Trademark Office

United States of America

United States Patent and Trademark Office



Reg. No. 4,174,542

Registered July 17, 2012

Int. Cls.: 9, 18, 25 and 28

TRADEMARK

PRINCIPAL REGISTER

IIC-INTERSPORT INTERNATIONAL CORPORATION GMBH (SWITZERLAND CORPORATION)
WÖFLISTRASSE 2
3006 BERN, SWITZERLAND

FOR: PEDOMETERS ; INDIVIDUAL REFLECTIVE DISCS, BANDS AND EQUIPMENT FOR THE PREVENTION OF TRAFFIC ACCIDENTS, IN PARTICULAR FOR JOGGING, WALKING AND TRAINING; SPORT WHISTLES, PROTECTIVE HELMETS FOR SPORT, SPORT GLASSES, SUNGLASSES, IN CLASS 9 (U.S. CLS. 21, 23, 26, 36 AND 38).

FOR: ALL-PURPOSE SPORTS BAGS, BUMBAGS, NAMELY, BUMBAGS FOR THE PRACTICE OF RUNNING; NORDIC WALKING STICKS; RUCKSACKS FOR SPORTS, IN CLASS 18 (U.S. CLS. 1, 2, 3, 22 AND 41).

FOR: CLOTHING AND FOOTWEAR ADAPTED TO THE PRACTICE OF INDOOR AND OUTDOOR COLLECTIVE SPORTS, AS WELL AS FOR TRAINING, NAMELY, SPORTS UNIFORMS, OVERALLS, JOGGING AND TRAINING SUITS, SPORT SHIRTS, SPORT SHORTS, SPORT UNDERWEAR, SOCKS, SWEATSHIRTS, CLUB JACKETS AND CAPS; SOCCER SHOES, BASKETBALL SHOES, HANDBALL SHOES, VOLLEYBALL SHOES, HOCKEY SHOES, FOOTBALL SHOES, BASEBALL SHOES, CROSS-TRAINING SHOES, LEISURE SHOES, FITNESS SHOES, AEROBIC SHOES, GYMNAS TIC SHOES, RUNNING SHOES, TENNIS SHOES, SQUASH SHOES, JOGGING SHOES, SPORT SANDALS AND SLIPPERS, IN CLASS 25 (U.S. CLS. 22 AND 39).

FOR: GYMNAS TIC AND SPORTING ARTICLES DESIGNED FOR THE PRACTICE OF INDOOR AND OUTDOOR COLLECTIVE SPORTS, NAMELY, KNEE PADS USED WHILE PLAYING SOCCER, ELBOW SUPPORTS AND PADS, SHIN GUARDS, WAIST PADS TO BE WORN AROUND THE BODY FOR THE PREVENTION OF SPORTING ACCIDENT, AND HEAD, ARMS AND LEG PROTECTORS ALL FOR ATHLETIC USE; GOALKEEPER GLOVES; PARTITIONED BAGS SPECIALLY ADAPTED FOR SPORTS EQUIPMENT; SPORT TRAINING MATERIAL, NAMELY, CONES, HURDLES, POLES AND GOALS, FLOORBALL STICKS, FIELD HOCKEY STICKS, WEIGHT LIFTING BELTS FOR SPORT, SWIMMING BELTS FOR SPORT , IN CLASS 28 (U.S. CLS. 22, 23, 38 AND 50).

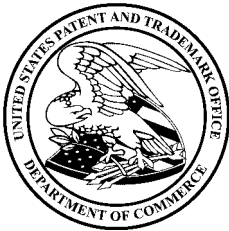

David J. Kybas

Director of the United States Patent and Trademark Office

OWNER OF SWITZERLAND REG. NO. 611181, DATED 2-2-2011, EXPIRES 10-1-2020.

THE COLOR(S) BLACK AND RED IS/ARE CLAIMED AS A FEATURE OF THE MARK.

Reg. No. 4,174,542 OWNER OF U.S. REG. NO. 3,195,497.

NO CLAIM IS MADE TO THE EXCLUSIVE RIGHT TO USE "PRO", APART FROM THE MARK AS SHOWN.

THE MARK CONSISTS OF A STYLIZED "P" FORMED BY TWO IDENTICAL OPPOSING GEOMETRIC SHAPES, ONE IN RED AND THE OTHER IN BLACK, BELOW WHICH APPEAR THE WORDS "PRO TOUCH" IN BLACK.

SER. NO. 85-446,292, FILED 10-13-2011.

JAMES GRIFFIN, EXAMINING ATTORNEY

United States of America

United States Patent and Trademark Office

HIGHTECH REHAB SOLUTIONS

Reg. No. 4,174,543

Registered July 17, 2012

Int. Cl.: 44

SERVICE MARK

PRINCIPAL REGISTER

NEU TECHNOLOGY INNOVATIONS, LLC (TEXAS LIMITED LIABILITY COMPANY), DBA
HIGHTECH REHAB SOLUTIONS
109 ENTERPRISE PKWY, STE. 205
BOERNE, TX 78006

FOR: LEASING OR RENTAL OF MEDICAL EQUIPMENT; MEDICAL EVALUATION SERVICES, NAMELY, FUNCTIONAL ASSESSMENT PROGRAMS FOR PATIENTS RECEIVING MEDICAL REHABILITATION SERVICES FOR THE PURPOSES OF GUIDING TREATMENT AND ASSESSING PROGRAM EFFECTIVENESS, IN CLASS 44 (U.S. CLS. 100 AND 101).

FIRST USE 6-1-2001; IN COMMERCE 6-1-2001.

THE MARK CONSISTS OF STANDARD CHARACTERS WITHOUT CLAIM TO ANY PARTICULAR FONT, STYLE, SIZE, OR COLOR.

NO CLAIM IS MADE TO THE EXCLUSIVE RIGHT TO USE "REHAB SOLUTIONS", APART FROM THE MARK AS SHOWN.

SEC. 2(F).

SER. NO. 85-446,502, FILED 10-13-2011.

LAKEISHA LEWIS, EXAMINING ATTORNEY



David J. Kyffers

Director of the United States Patent and Trademark Office

United States of America

United States Patent and Trademark Office



scrub up!
save lives

Reg. No. 4,174,544

Registered July 17, 2012

Int. Cl.: 44

SERVICE MARK

PRINCIPAL REGISTER

OHIO HOSPITAL ASSOCIATION (OHIO NON-PROFIT CORPORATION)
FLOOR 15
155 EAST BROAD STREET
COLUMBUS, OH 43215

FOR: PROVIDING HEALTH INFORMATION, IN CLASS 44 (U.S. CLS. 100 AND 101).

FIRST USE 10-12-2011; IN COMMERCE 10-12-2011.

THE MARK CONSISTS OF THE WORDS "SCRUB UP! SAVE LIVES" UNDER A DESIGN OF A HAND HOLDING BUBBLES.

SER. NO. 85-446,624, FILED 10-13-2011.

DAVID MURRAY, EXAMINING ATTORNEY



David J. Kyffers

Director of the United States Patent and Trademark Office

United States of America

United States Patent and Trademark Office



Reg. No. 4,174,545

Registered July 17, 2012

Int. Cl.: 25

TRADEMARK

PRINCIPAL REGISTER

N & J FASHION, INC. (CALIFORNIA CORPORATION)
207
6228 FULTON AVE
VAN NUYS, CA 91401

FOR: CAPRI PANTS; COATS FOR MEN AND WOMEN; DRESS PANTS; FOOTWEAR FOR MEN AND WOMEN; JACKETS; MEN'S AND WOMEN'S JACKETS, COATS, TROUSERS, VESTS; MEN'S DRESS SOCKS; MEN'S SOCKS; MEN'S SUITS; MEN'S SUITS, WOMEN'S SUITS; MEN'S UNDERWEAR; PANTS; SWEATSHIRTS FOR WOMEN; T-SHIRTS FOR MEN AND WOMEN; WEARABLE GARMENTS AND CLOTHING, NAMELY, SHIRTS; WOMEN'S CLOTHING, NAMELY, SHIRTS, DRESSES, SKIRTS, BLOUSES; WOMEN'S HATS AND HOODS; WOMEN'S SHOES; WOMEN'S TOPS, NAMELY, CAMIS; WOMEN'S UNDERWEAR, IN CLASS 25 (U.S. CLS. 22 AND 39).

FIRST USE 2-8-2008; IN COMMERCE 2-8-2008.

NO CLAIM IS MADE TO THE EXCLUSIVE RIGHT TO USE "PARIS", "FRENCH DESIGN", AND "DESIGN MADE IN FRANCE", APART FROM THE MARK AS SHOWN.

THE MARK CONSISTS OF THE STYLIZED WORDING "N & J", "PARIS", "FRENCH DESIGN", "DESIGN MADE IN FRANCE" AND "ROMANS 10:9". THE MARK SHOWS THE LETTER "N" IN BOLDFACE WITH A FOUR-POINTED CROWN ON THE LETTER'S LEFT SIDE. NEXT TO THE "N" IS AN AMPERSAND, SLIGHTLY ELEVATED AND SITTING BETWEEN THE LETTERS "N" AND "J". FINALLY, FOLLOWING THE AMPERSAND IS A LETTER "J", ALSO PORTRAYED WITH A FOUR-POINTED CROWN ON TOP. BELOW IS THE WORD "PARIS" IN CURSIVE SCRIPT, WITH THE "A" REPRESENTED AS A SIMPLISTIC SHAPE OF THE EIFFEL TOWER. UNDER THE "N & J" AND "PARIS", THERE IS AN INSCRIPTION THAT READS "FRENCH DESIGN" ON THE FIRST LINE. THE LINE BELOW IT READS "DESIGN MADE IN FRANCE", ALL LETTERS CAPITALIZED, AND ON THE THIRD LINE IT READS "ROMANS 10:9", ALSO ALL CAPITALIZED.



SER. NO. 85-446,779, FILED 10-13-2011.

ELLEN B. AWRICH, EXAMINING ATTORNEY

David J. Kyros

Director of the United States Patent and Trademark Office

United States of America

United States Patent and Trademark Office

Kennedy Self Storage

Reg. No. 4,174,546

RPV LIMITED PARTNERSHIP (PENNSYLVANIA LIMITED PARTNERSHIP)
35 FAIRHAVEN ROAD
MCKEES ROCKS, PA 15136

Registered July 17, 2012

Int. Cl.: 39

FOR: PROVIDING SELF-STORAGE FACILITIES FOR OTHERS; STORAGE OF GOODS, IN CLASS 39 (U.S. CLS. 100 AND 105).

SERVICE MARK

FIRST USE 5-1-2000; IN COMMERCE 5-1-2000.

PRINCIPAL REGISTER

THE MARK CONSISTS OF STANDARD CHARACTERS WITHOUT CLAIM TO ANY PARTICULAR FONT, STYLE, SIZE, OR COLOR.

NO CLAIM IS MADE TO THE EXCLUSIVE RIGHT TO USE "SELF STORAGE", APART FROM THE MARK AS SHOWN.

SEC. 2(F).

SER. NO. 85-447,363, FILED 10-14-2011.

KAREN K. BUSH, EXAMINING ATTORNEY



David J. Kybas

Director of the United States Patent and Trademark Office

United States of America

United States Patent and Trademark Office

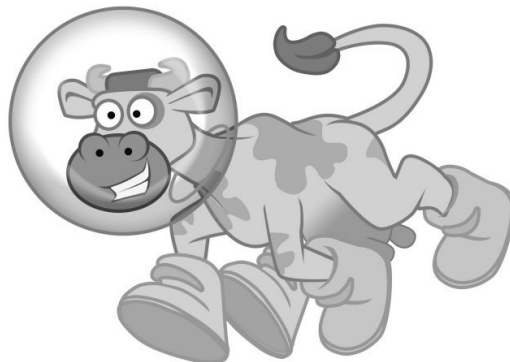

Reg. No. 4,174,547

Registered July 17, 2012

Int. Cl.: 16

TRADEMARK

PRINCIPAL REGISTER

CARRA L. RILEY, P.C. (ARIZONA CORPORATION), DBA CARRA RILEY, INC.
1111 S. TORREY PINES DR.
WILLIAMS, AZ 86046

FOR: A SERIES OF BOOKS, WRITTEN ARTICLES, HANDOUTS AND WORKSHEETS IN THE FIELD OF STRESS MANAGEMENT AND INSPIRATION, IN CLASS 16 (U.S. CLS. 2, 5, 22, 23, 29, 37, 38 AND 50).

FIRST USE 1-28-2009; IN COMMERCE 1-28-2009.

THE MARK CONSISTS OF A DRAWING OF A SPOTTED COW WITH TWO HORNS, TWO BIG EYES, AND TEETH SHOWING THROUGH A SMILE. THE COW IS WEARING BOOTS ON EACH OF ITS FOUR LEGS, AND HAS AN OLD SPHERICAL ASTRONAUT HELMET ON ITS HEAD.

SER. NO. 85-447,567, FILED 10-14-2011.

LINDA E. BLOHM, EXAMINING ATTORNEY



David J. Kybas

Director of the United States Patent and Trademark Office

United States of America

United States Patent and Trademark Office

LOCK SHOTS

Reg. No. 4,174,548

Registered July 17, 2012

Int. Cl.: 5

TRADEMARK

PRINCIPAL REGISTER

MITZI HALE (UNITED STATES INDIVIDUAL)
2123 REYNOLDS STREET
FALLS CHURCH, VA 22043

FOR: LIQUID VITAMIN SUPPLEMENTS, IN CLASS 5 (U.S. CLS. 6, 18, 44, 46, 51 AND 52).

FIRST USE 8-31-2011; IN COMMERCE 8-31-2011.

THE MARK CONSISTS OF STANDARD CHARACTERS WITHOUT CLAIM TO ANY PARTICULAR FONT, STYLE, SIZE, OR COLOR.

NO CLAIM IS MADE TO THE EXCLUSIVE RIGHT TO USE "SHOTS", APART FROM THE MARK AS SHOWN.

SER. NO. 85-447,619, FILED 10-14-2011.

CHRISTINA SOBRAL, EXAMINING ATTORNEY



David J. Kyffers

Director of the United States Patent and Trademark Office

United States of America

United States Patent and Trademark Office

DR. EVERMOR

Reg. No. 4,174,549

EVERY, THOMAS OWEN (UNITED STATES INDIVIDUAL), DBA META HAPPENINGS
P.O. BOX 103
PRAIRIE DU SAC, WI 53578 AND

Registered July 17, 2012

Int. Cl.: 41

EVERY, ELEANOR (UNITED STATES INDIVIDUAL), DBA META HAPPENINGS
P.O. BOX 103
PRAIRIE DU SAC, WI 53578

SERVICE MARK

FOR: PROVIDING THEME PARK SERVICES , IN CLASS 41 (U.S. CLS. 100, 101 AND 107).

PRINCIPAL REGISTER

FIRST USE 8-0-1988; IN COMMERCE 8-0-1988.

THE MARK CONSISTS OF STANDARD CHARACTERS WITHOUT CLAIM TO ANY PARTICULAR FONT, STYLE, SIZE, OR COLOR.

THE NAME(S), PORTRAIT(S), AND/OR SIGNATURE(S) SHOWN IN THE MARK IDENTIFIES THE PSEUDONYM OF THOMAS OWEN EVERY, A LIVING INDIVIDUAL, WHOSE CONSENT(S) TO REGISTER IS MADE OF RECORD.

SER. NO. 85-447,625, FILED 10-14-2011.

BERYL GARDNER, EXAMINING ATTORNEY



David J. Kyros

Director of the United States Patent and Trademark Office

United States of America

United States Patent and Trademark Office

Beauty Bender

Reg. No. 4,174,550

BEAUTY BENDER, LLC (CALIFORNIA LIMITED LIABILITY COMPANY)
11908 DARLINGTON AVE, #201
LOS ANGELES, CA 90049

Registered July 17, 2012

Int. Cl.: 44

FOR: PROVIDING NEWS AND INFORMATION IN THE FIELD OF PERSONAL BEAUTY,
IN CLASS 44 (U.S. CLS. 100 AND 101).

SERVICE MARK

FIRST USE 5-18-2010; IN COMMERCE 10-5-2011.

PRINCIPAL REGISTER

THE MARK CONSISTS OF STANDARD CHARACTERS WITHOUT CLAIM TO ANY PAR-
TICULAR FONT, STYLE, SIZE, OR COLOR.

NO CLAIM IS MADE TO THE EXCLUSIVE RIGHT TO USE "BEAUTY", APART FROM THE
MARK AS SHOWN.

SER. NO. 85-447,783, FILED 10-14-2011.

DAVID HOFFMAN, EXAMINING ATTORNEY



David J. Kyffers

Director of the United States Patent and Trademark Office

United States of America

United States Patent and Trademark Office

Christian Genes

Reg. No. 4,174,551

CHRISTIE, PHELLIP (UNITED STATES INDIVIDUAL)
2189 E 81ST ST
CLEVELAND, OH 44103

Registered July 17, 2012

Int. Cl.: 25

FOR: SHIRTS, JACKETS, SWEAT PANTS, SOCKS, SHOES, SANDALS, CAPS, HATS, IN CLASS 25 (U.S. CLS. 22 AND 39).

TRADEMARK

FIRST USE 5-15-2007; IN COMMERCE 5-15-2007.

PRINCIPAL REGISTER

THE MARK CONSISTS OF STANDARD CHARACTERS WITHOUT CLAIM TO ANY PARTICULAR FONT, STYLE, SIZE, OR COLOR.

SER. NO. 85-448,262, FILED 10-14-2011.

BRIDGETT SMITH, EXAMINING ATTORNEY



David J. Kyffers

Director of the United States Patent and Trademark Office

United States of America

United States Patent and Trademark Office

International Congress on Genitourinary Malignancies

Reg. No. 4,174,552

ARC MESA EDUCATORS, LLC (NEW JERSEY LIMITED LIABILITY COMPANY)
666 PLAINSBORO ROAD

Registered July 17, 2012

PLAINSBORO, NJ 08536

Int. Cl.: 41

FOR: EDUCATION SERVICES, NAMELY, PROVIDING ANNUAL MEDICAL CONFERENCE, LECTURES, INTERACTIVE DISCUSSIONS, POSTER SESSIONS, HANDS-ON WORKSHOPS, AND BROADCAST SYMPOSIA FOR ONCOLOGISTS AND SURGEONS IN THE FIELD OF ONCOLOGY, IN CLASS 41 (U.S. CLS. 100, 101 AND 107).

SERVICE MARK

PRINCIPAL REGISTER

FIRST USE 8-0-2002; IN COMMERCE 8-0-2002.

THE MARK CONSISTS OF STANDARD CHARACTERS WITHOUT CLAIM TO ANY PARTICULAR FONT, STYLE, SIZE, OR COLOR.

NO CLAIM IS MADE TO THE EXCLUSIVE RIGHT TO USE "CONGRESS", APART FROM THE MARK AS SHOWN.

SEC. 2(F).

SER. NO. 85-448,274, FILED 10-14-2011.

BERNICE MIDDLETON, EXAMINING ATTORNEY



David J. Kyjars

Director of the United States Patent and Trademark Office

United States of America

United States Patent and Trademark Office

Annual Multidisciplinary Symposium on Head and Neck Cancer

Reg. No. 4,174,553

ARC MESA EDUCATORS, LLC (NEW JERSEY LIMITED LIABILITY COMPANY)
666 PLAINSBORO ROAD
PLAINSBORO, NJ 08536

Registered July 17, 2012

Int. Cl.: 41

FOR: EDUCATION SERVICES, NAMELY, PROVIDING ANNUAL MEDICAL CONFERENCE, LECTURES, INTERACTIVE DISCUSSIONS, POSTER SESSIONS, HANDS-ON WORKSHOPS, AND BROADCAST SYMPOSIA FOR ONCOLOGISTS AND SURGEONS IN THE FIELD OF ONCOLOGY, IN CLASS 41 (U.S. CLS. 100, 101 AND 107).

SERVICE MARK

PRINCIPAL REGISTER

FIRST USE 11-0-2005; IN COMMERCE 11-0-2005.

THE MARK CONSISTS OF STANDARD CHARACTERS WITHOUT CLAIM TO ANY PARTICULAR FONT, STYLE, SIZE, OR COLOR.

NO CLAIM IS MADE TO THE EXCLUSIVE RIGHT TO USE "SYMPOSIUM", APART FROM THE MARK AS SHOWN.

SEC. 2(F).

SER. NO. 85-448,278, FILED 10-15-2011.

BERNICE MIDDLETON, EXAMINING ATTORNEY



David J. Kyjars

Director of the United States Patent and Trademark Office

United States of America

United States Patent and Trademark Office

PLUS FASHION WEEK

Reg. No. 4,174,554

MYISHA HILL (UNITED STATES INDIVIDUAL)
760 N 14TH ST #A
DEKALB, IL 60115

Registered July 17, 2012

Int. Cl.: 41

FOR: ENTERTAINMENT IN THE NATURE OF PLUS SIZE FASHION SHOWS, NAMELY, CONDUCTING FAIRS FOR PLUS SIZE INDIVIDUALS; ENTERTAINMENT IN THE NATURE OF EXHIBITIONS OF PLUS SIZE FASHION FESTIVALS; ENTERTAINMENT IN THE NATURE OF FASHION EXPOS; EDUCATION SERVICES, NAMELY, PROVIDING SEMINARS AND WORKSHOPS IN THE FIELDS OF PLUS SIZE FASHION DESIGN, PLUS SIZE WARDROBE DESIGN, NUTRITION, WELLNESS, BEAUTY, HEALTH AND SPA SERVICES, SPORTS, FITNESS AND FASHION TECHNOLOGIES; PRODUCTION OF RADIO, TELEVISION AND FILM PROGRAMS, IN CLASS 41 (U.S. CLS. 100, 101 AND 107).

SERVICE MARK

PRINCIPAL REGISTER

FIRST USE 1-1-2011; IN COMMERCE 1-1-2011.

THE MARK CONSISTS OF STANDARD CHARACTERS WITHOUT CLAIM TO ANY PARTICULAR FONT, STYLE, SIZE, OR COLOR.

NO CLAIM IS MADE TO THE EXCLUSIVE RIGHT TO USE "FASHION WEEK", APART FROM THE MARK AS SHOWN.

SER. NO. 85-448,303, FILED 10-15-2011.

HEATHER BIDDULPH, EXAMINING ATTORNEY



David J. Kyffers

Director of the United States Patent and Trademark Office

United States of America

United States Patent and Trademark Office

JOBELYN

Reg. No. 4,174,555

Registered July 17, 2012

Int. Cl.: 5

TRADEMARK

PRINCIPAL REGISTER

HEALTH FOREVER PRODUCT LTD (NIGERIA LIMITED LIABILITY COMPANY)
7 DIPEOLU ST., OFF OBAFEMI AWOLOWO WAY
IKEJA, NIGERIA

FOR: DIETARY AND NUTRITIONAL SUPPLEMENTS; HERBAL SUPPLEMENTS, IN CLASS
5 (U.S. CLS. 6, 18, 44, 46, 51 AND 52).

FIRST USE 1-1-2000; IN COMMERCE 10-18-2002.

THE MARK CONSISTS OF STANDARD CHARACTERS WITHOUT CLAIM TO ANY PAR-
TICULAR FONT, STYLE, SIZE, OR COLOR.

OWNER OF U.S. REG. NOS. 2,777,967 AND 4,022,344.

SER. NO. 85-448,304, FILED 10-15-2011.

DANIEL CAPSHAW, EXAMINING ATTORNEY



David J. Kyffers

Director of the United States Patent and Trademark Office

United States of America

United States Patent and Trademark Office

Pink Biker Chic

Reg. No. 4,174,556

Registered July 17, 2012

Int. Cl.: 25

TRADEMARK

PRINCIPAL REGISTER

DYNAMIC VISION INTERNATIONAL, INC. (CALIFORNIA CORPORATION)
#8-302
800 S. PACIFIC COAST HIGHWAY
REDONDO BEACH, CA 90277

FOR: HOODED SWEAT SHIRTS; LEATHER SHIRTS; T-SHIRTS, IN CLASS 25 (U.S. CLS. 22 AND 39).

FIRST USE 10-1-2008; IN COMMERCE 10-1-2008.

THE MARK CONSISTS OF STANDARD CHARACTERS WITHOUT CLAIM TO ANY PARTICULAR FONT, STYLE, SIZE, OR COLOR.

NO CLAIM IS MADE TO THE EXCLUSIVE RIGHT TO USE "CHIC", APART FROM THE MARK AS SHOWN.

SER. NO. 85-448,322, FILED 10-15-2011.

ERIN FALK, EXAMINING ATTORNEY



David J. Kyffers

Director of the United States Patent and Trademark Office

United States of America

United States Patent and Trademark Office



Reg. No. 4,174,557

OLD CAROLINA BARBECUE CO., LLC (OHIO LIMITED LIABILITY COMPANY)
5757 MAYFAIR ROAD

Registered July 17, 2012

NORTH CANTON, OH 44720

Int. Cl.: 25

FOR: CLOTHING, NAMELY, SHIRTS, T-SHIRTS, POLO SHIRTS, HATS, SWEATSHIRTS,
IN CLASS 25 (U.S. CLS. 22 AND 39).

TRADEMARK

FIRST USE 5-31-2006; IN COMMERCE 5-31-2006.

PRINCIPAL REGISTER

NO CLAIM IS MADE TO THE EXCLUSIVE RIGHT TO USE "COMPANY", APART FROM
THE MARK AS SHOWN.

THE MARK CONSISTS OF THE WORDS "OLD CAROLINA" REVERSE IMAGED OVER A
DARK RECTANGULAR BOX WITH MOTTLING, ALL ABOVE THE WORDS "BARBECUE
COMPANY" WITH A TILDE BEFORE "BARBECUE" AND AFTER "COMPANY".

SER. NO. 85-448,519, FILED 10-17-2011.

ELISSA GARBER KON, EXAMINING ATTORNEY



David J. Kyjars

Director of the United States Patent and Trademark Office

United States of America

United States Patent and Trademark Office



Reg. No. 4,174,558

Registered July 17, 2012

Int. Cl.: 31

TRADEMARK

PRINCIPAL REGISTER

DIVINE RIPE, LLC (TEXAS LIMITED LIABILITY COMPANY)
SUITE A
9901 S. JACKSON ROAD
PHARR, TX 78577

FOR: FRESH TOMATOES, IN CLASS 31 (U.S. CLS. 1 AND 46).

FIRST USE 6-28-2007; IN COMMERCE 6-28-2007.

NO CLAIM IS MADE TO THE EXCLUSIVE RIGHT TO USE THE DESIGN OF THE TOMATO,
APART FROM THE MARK AS SHOWN.

THE MARK CONSISTS OF A HAND HOLDING A TOMATO.

SER. NO. 85-448,544, FILED 10-17-2011.

WILLIAM BRECKENFELD, EXAMINING ATTORNEY



David J. Kybas

Director of the United States Patent and Trademark Office

United States of America

United States Patent and Trademark Office

Making Business Intelligent

Reg. No. 4,174,559

Registered July 17, 2012

Int. Cl.: 42

SERVICE MARK

PRINCIPAL REGISTER

PRAGMATIC WORKS SOFTWARE (FLORIDA CORPORATION)
SUITE 216
400 COLLEGE DR
MIDDLEBURG, FL 32068

FOR: COMPUTER CONSULTATION, IN CLASS 42 (U.S. CLS. 100 AND 101).

FIRST USE 6-1-2011; IN COMMERCE 6-1-2011.

THE MARK CONSISTS OF STANDARD CHARACTERS WITHOUT CLAIM TO ANY PARTICULAR FONT, STYLE, SIZE, OR COLOR.

SER. NO. 85-448,783, FILED 10-17-2011.

JAMES LOVELACE, EXAMINING ATTORNEY



David J. Kyros

Director of the United States Patent and Trademark Office

United States of America
United States Patent and Trademark Office

Kalipso

Reg. No. 4,174,560

WESTPORT RESEARCH ASSOCIATES, INC. (MISSOURI CORPORATION)
7001 BLUE RIDGE BOULEVARD
RAYTOWN, MO 64113

Registered July 17, 2012

Int. Cl.: 9

FOR: DIGITAL MUSIC DEVICE FOR THE DELIVERY AND PLAYBACK OF AUDIO CONTENT, IN CLASS 9 (U.S. CLS. 21, 23, 26, 36 AND 38).

TRADEMARK

FIRST USE 11-19-2010; IN COMMERCE 11-19-2010.

PRINCIPAL REGISTER

THE MARK CONSISTS OF THE WORD "KALIPSO" IN A STYLIZED FORMAT.

SER. NO. 85-449,156, FILED 10-17-2011.

JORDAN BAKER, EXAMINING ATTORNEY



David J. Kyffers

Director of the United States Patent and Trademark Office

United States of America

United States Patent and Trademark Office



Reg. No. 4,174,561

LANCO MANUFACTURING CO. (PUERTO RICO CORPORATION)
URB. APONTE #5

Registered July 17, 2012

SAN LORENZO, PUERTO RICO 00754

Int. Cl.: 2

FOR: HOUSE PAINT; INTERIOR PAINT; PAINTS; PAINTS FOR FLAT INTERIOR, IN CLASS 2 (U.S. CLS. 6, 11 AND 16).

TRADEMARK

FIRST USE 9-8-2011; IN COMMERCE 9-8-2011.

PRINCIPAL REGISTER

NO CLAIM IS MADE TO THE EXCLUSIVE RIGHT TO USE "ACRYLIC LATEX PAINT", APART FROM THE MARK AS SHOWN.

THE MARK CONSISTS OF THE WORDS "SIM" AND "PLUS" SEPARATED BY A COLON. UNDER THE WORDS THERE ARE THE WORDS "ACRYLIC LATEX PAINT".

THE WORDING "SIM" HAS NO MEANING IN A FOREIGN LANGUAGE.

SER. NO. 85-449,817, FILED 10-18-2011.

KATHRYN COWARD, EXAMINING ATTORNEY



David J. Kybas

Director of the United States Patent and Trademark Office

United States of America

United States Patent and Trademark Office

SITU

Reg. No. 4,174,562

Registered July 17, 2012

Int. Cls.: 11 and 20

TRADEMARK

PRINCIPAL REGISTER

TAKTL, LLC (DELAWARE LIMITED LIABILITY COMPANY)
30 PINE STREET
PITTSBURGH, PA 15223

FOR: LIGHTING FIXTURES, IN CLASS 11 (U.S. CLS. 13, 21, 23, 31 AND 34).

FIRST USE 10-17-2011; IN COMMERCE 10-17-2011.

FOR: FURNITURE PRIMARILY MADE OF ULTRA-HIGH PERFORMANCE CONCRETE (UHPC), IN CLASS 20 (U.S. CLS. 2, 13, 22, 25, 32 AND 50).

FIRST USE 4-0-2010; IN COMMERCE 4-0-2010.

THE MARK CONSISTS OF STANDARD CHARACTERS WITHOUT CLAIM TO ANY PARTICULAR FONT, STYLE, SIZE, OR COLOR.

SER. NO. 85-450,038, FILED 10-18-2011.

ANDREA K. NADELMAN, EXAMINING ATTORNEY



David J. Kybas

Director of the United States Patent and Trademark Office

United States of America

United States Patent and Trademark Office

CASHCALL MORTGAGE DIVISION

Reg. No. 4,174,563

CASHCALL, INC. (CALIFORNIA CORPORATION)
1600 S. DOUGLASS RD.
ANAHEIM, CA 92806

Registered July 17, 2012

Int. Cl.: 36

FOR: MORTGAGE LENDING, IN CLASS 36 (U.S. CLS. 100, 101 AND 102).

SERVICE MARK

FIRST USE 2-1-2009; IN COMMERCE 2-1-2009.

PRINCIPAL REGISTER

THE MARK CONSISTS OF STANDARD CHARACTERS WITHOUT CLAIM TO ANY PARTICULAR FONT, STYLE, SIZE, OR COLOR.

NO CLAIM IS MADE TO THE EXCLUSIVE RIGHT TO USE "MORTGAGE DIVISION", APART FROM THE MARK AS SHOWN.

SER. NO. 85-450,325, FILED 10-18-2011.

JESSICA FATHY, EXAMINING ATTORNEY



David J. Kybas

Director of the United States Patent and Trademark Office

United States of America

United States Patent and Trademark Office

Plura Financial

Reg. No. 4,174,564

Registered July 17, 2012

Int. Cl.: 35

SERVICE MARK

PRINCIPAL REGISTER

IOS FINANCIAL, LLC (DELAWARE LIMITED LIABILITY COMPANY)
#3A
454 WEST WRIGHTWOOD
CHICAGO, IL 60614

FOR: MATCHING BORROWERS WITH POTENTIAL LENDERS IN THE FIELD OF COMMERCIAL LOANS, IN CLASS 35 (U.S. CLS. 100, 101 AND 102).

FIRST USE 3-22-2011; IN COMMERCE 3-22-2011.

THE MARK CONSISTS OF STANDARD CHARACTERS WITHOUT CLAIM TO ANY PARTICULAR FONT, STYLE, SIZE, OR COLOR.

NO CLAIM IS MADE TO THE EXCLUSIVE RIGHT TO USE "FINANCIAL", APART FROM THE MARK AS SHOWN.

SER. NO. 85-450,504, FILED 10-19-2011.

EMILY CARLSEN, EXAMINING ATTORNEY



David J. Kybas

Director of the United States Patent and Trademark Office

United States of America

United States Patent and Trademark Office

3D-Flex

Reg. No. 4,174,565

MADIE JANE LLC (TEXAS LIMITED LIABILITY COMPANY)
3613 STONINGTON DRIVE
PLANO, TX 75093

Registered July 17, 2012

Int. Cl.: 25

FOR: SHOES AND APPAREL, NAMELY, HATS, HEAD BANDS, SCARVES, BELTS, SOCKS, SHIRTS, BLOUSES, PANTS AND DRESSES, IN CLASS 25 (U.S. CLS. 22 AND 39).

TRADEMARK

FIRST USE 6-23-2011; IN COMMERCE 8-12-2011.

PRINCIPAL REGISTER

THE MARK CONSISTS OF STANDARD CHARACTERS WITHOUT CLAIM TO ANY PARTICULAR FONT, STYLE, SIZE, OR COLOR.

SER. NO. 85-450,751, FILED 10-19-2011.

HOWARD B. LEVINE, EXAMINING ATTORNEY



David J. Kybas

Director of the United States Patent and Trademark Office

United States of America

United States Patent and Trademark Office

MLSLI 

Reg. No. 4,174,566

MULTIPLE LISTING SERVICE OF LONG ISLAND, INC. (NEW YORK CORPORATION)
300 SUNRISE HIGHWAY
WEST BABYLON, NY 11704

Registered July 17, 2012

Int. Cl.: 36

FOR: REAL ESTATE MULTIPLE LISTING SERVICES, IN CLASS 36 (U.S. CLS. 100, 101 AND 102).

SERVICE MARK

FIRST USE 1-1-2011; IN COMMERCE 1-1-2011.

PRINCIPAL REGISTER

NO CLAIM IS MADE TO THE EXCLUSIVE RIGHT TO USE "MLS LI", APART FROM THE MARK AS SHOWN.

THE MARK CONSISTS OF A LITERAL ELEMENT "MLSLI" WHERE THE "LI" IS BOLD. UNDERNEATH THE LITERAL ELEMENT THERE IS A DESIGN ELEMENT CONSISTING OF A HORIZONTAL LINE THAT HAS A OUTLINE OF A HOUSE ON THE RIGHT SIDE.

SER. NO. 85-450,879, FILED 10-19-2011.

MICHAEL WEBSTER, EXAMINING ATTORNEY



David J. Kyffers

Director of the United States Patent and Trademark Office

United States of America

United States Patent and Trademark Office



Reg. No. 4,174,567

LABEL WORKS, LLC (CALIFORNIA LIMITED LIABILITY COMPANY)
1180 SOUTH BEVERLY DRIVE, SUITE 509
LOS ANGELES, CA 90035

Registered July 17, 2012

Int. Cl.: 29

FOR: PROCESSED FOODS, NAMELY, CANNED VEGETABLES, CANNED FISH, AND FRUITS, IN CLASS 29 (U.S. CL. 46).

TRADEMARK

FIRST USE 8-31-2004; IN COMMERCE 10-0-2004.

PRINCIPAL REGISTER

OWNER OF U.S. REG. NOS. 3,130,722 AND 3,229,858.

THE MARK CONSISTS OF THE WORD "STELLA" IN ALL-CAPS ON AN OVAL BACKGROUND WITH STARS OVER THE LETTER "A".

SER. NO. 85-451,024, FILED 10-19-2011.

STEVEN R. FINE, EXAMINING ATTORNEY



David J. Kyffers

Director of the United States Patent and Trademark Office

United States of America

United States Patent and Trademark Office

Stella

Reg. No. 4,174,568

LABEL WORKS, LLC (CALIFORNIA LIMITED LIABILITY COMPANY)
1180 SOUTH BEVERLY DRIVE, SUITE 509
LOS ANGELES, CA 90035

Registered July 17, 2012

Int. Cl.: 29

FOR: PROCESSED FOODS, NAMELY, CANNED VEGETABLES, CANNED FISH, AND FRUITS, IN CLASS 29 (U.S. CL. 46).

TRADEMARK

FIRST USE 8-31-2004; IN COMMERCE 10-0-2004.

PRINCIPAL REGISTER

OWNER OF U.S. REG. NOS. 3,130,722 AND 3,229,858.

THE MARK CONSISTS OF THE WORD "STELLA" IN SHADOWED SCRIPT WITH STARS OVER THE LETTER "A".

SER. NO. 85-451,042, FILED 10-19-2011.

STEVEN R. FINE, EXAMINING ATTORNEY



David J. Kyffers

Director of the United States Patent and Trademark Office

United States of America

United States Patent and Trademark Office

Cirque des Voix

Reg. No. 4,174,569

KEY CHORALE, INC. (FLORIDA CORPORATION)

Registered July 17, 2012

PO BOX 20613
SARASOTA, FL 34276

Int. Cl.: 41

FOR: ENTERTAINMENT SERVICES IN THE NATURE OF CIRCUS PERFORMANCES; ENTERTAINMENT IN THE NATURE OF LIVE VOCAL PERFORMANCES IN A CIRCUS, IN CLASS 41 (U.S. CLS. 100, 101 AND 107).

SERVICE MARK

FIRST USE 12-15-2010; IN COMMERCE 12-15-2010.

PRINCIPAL REGISTER

THE MARK CONSISTS OF STANDARD CHARACTERS WITHOUT CLAIM TO ANY PARTICULAR FONT, STYLE, SIZE, OR COLOR.

NO CLAIM IS MADE TO THE EXCLUSIVE RIGHT TO USE "CIRQUE", APART FROM THE MARK AS SHOWN.

THE ENGLISH TRANSLATION OF "CIRQUE DES VOIX" IN THE MARK IS "CIRCUS OF THE VOICES".

SER. NO. 85-451,681, FILED 10-20-2011.

MICHAEL WIENER, EXAMINING ATTORNEY



David J. Kypos

Director of the United States Patent and Trademark Office

United States of America

United States Patent and Trademark Office

MEDPRO

Reg. No. 4,174,570

MEDPRO SAFETY PRODUCTS, INC. (NEVADA CORPORATION)
145 ROSE STREET
LEXINGTON, KY 40507

Registered July 17, 2012

Int. Cl.: 42

FOR: PRODUCT DEVELOPMENT IN THE FIELD OF MEDICAL DEVICES, IN CLASS 42
(U.S. CLS. 100 AND 101).

SERVICE MARK

FIRST USE 1-1-1994; IN COMMERCE 1-1-1994.

PRINCIPAL REGISTER

THE MARK CONSISTS OF STANDARD CHARACTERS WITHOUT CLAIM TO ANY PARTICULAR FONT, STYLE, SIZE, OR COLOR.

SER. NO. 85-451,820, FILED 10-20-2011.

DAWN FELDMAN, EXAMINING ATTORNEY



David J. Kybas

Director of the United States Patent and Trademark Office

United States of America

United States Patent and Trademark Office

ZIRNORITE

Reg. No. 4,174,571

Registered July 17, 2012

Int. Cl.: 19

TRADEMARK

PRINCIPAL REGISTER

SAINT-GOBAIN CERAMICS & PLASTICS, INC. (DELAWARE CORPORATION)
ONE NEW BOND STREET
WORCESTER, MA 01615

FOR: SHAPED REFRACTORY BRICKS, BATTS, PLATES, SETTERS, TUBES AND SPECIALTY SHAPES OF ZIRCONIA FOR USE IN ALL KINDS OF FURNACES AND KILNS, IN CLASS 19 (U.S. CLS. 1, 12, 33 AND 50).

FIRST USE 7-0-1975; IN COMMERCE 7-0-1975.

THE MARK CONSISTS OF STANDARD CHARACTERS WITHOUT CLAIM TO ANY PARTICULAR FONT, STYLE, SIZE, OR COLOR.

OWNER OF U.S. REG. NO. 4,010,547.

SER. NO. 85-451,938, FILED 10-20-2011.

LINDA M. KING, EXAMINING ATTORNEY



David J. Kyffers

Director of the United States Patent and Trademark Office

United States of America

United States Patent and Trademark Office

BOWLER'S ED

Reg. No. 4,174,572

Registered July 17, 2012

Int. Cl.: 41

SERVICE MARK

PRINCIPAL REGISTER

BOWLING PROPRIETORS' ASSOCIATION OF AMERICA, INC. (ILLINOIS NON-PROFIT CORPORATION)
621 SIX FLAGS DRIVE
ARLINGTON, TX 76011

FOR: CONDUCTING CLASSES AND INSTRUCTIONAL PROGRAMS ON BOWLING, IN CLASS 41 (U.S. CLS. 100, 101 AND 107).

FIRST USE 4-12-2000; IN COMMERCE 4-12-2000.

THE MARK CONSISTS OF STANDARD CHARACTERS WITHOUT CLAIM TO ANY PARTICULAR FONT, STYLE, SIZE, OR COLOR.

OWNER OF U.S. REG. NOS. 2,501,900 AND 2,614,119.

SEC. 2(F).

SER. NO. 85-451,946, FILED 10-20-2011.

LINDA MICKLEBURGH, EXAMINING ATTORNEY



David J. Kybas

Director of the United States Patent and Trademark Office

United States of America

United States Patent and Trademark Office

Help Earth Foundation

Reg. No. 4,174,573

Registered July 17, 2012

Int. Cl.: 35

SERVICE MARK

PRINCIPAL REGISTER

HELP EARTH FOUNDATION (D.C. CORPORATION), AKA HELP EARTH
4324 YUMA ST. NW
4324 YUMA ST. NW
WASHINGTON, DC 20016

FOR: PROMOTING, ADVERTISING AND MARKETING OF THE BRANDS, PRODUCTS, SERVICES AND ONLINE WEBSITES OF INDIVIDUALS, BUSINESSES AND NONPROFIT ORGANIZATIONS, IN CLASS 35 (U.S. CLS. 100, 101 AND 102).

FIRST USE 2-2-1996; IN COMMERCE 3-26-1999.

THE MARK CONSISTS OF STANDARD CHARACTERS WITHOUT CLAIM TO ANY PARTICULAR FONT, STYLE, SIZE, OR COLOR.

NO CLAIM IS MADE TO THE EXCLUSIVE RIGHT TO USE "FOUNDATION", APART FROM THE MARK AS SHOWN.

SER. NO. 85-451,971, FILED 10-20-2011.

MICHELE SWAIN, EXAMINING ATTORNEY



David J. Kyjars

Director of the United States Patent and Trademark Office

United States of America

United States Patent and Trademark Office

AGAVE DENIMSMITH

Reg. No. 4,174,574

SURF COWBOY, INC. (CALIFORNIA CORPORATION)
6210 S 11TH STREET
RIDGEFIELD, WA 98642

Registered July 17, 2012

Int. Cl.: 25

FOR: CLOTHING, NAMELY, DENIM SHIRTS, DENIM JACKETS, DENIM JEANS, DENIM SHORTS AND DENIM HEADWEAR, IN CLASS 25 (U.S. CLS. 22 AND 39).

TRADEMARK

FIRST USE 0-0-2002; IN COMMERCE 0-0-2002.

PRINCIPAL REGISTER

THE MARK CONSISTS OF STANDARD CHARACTERS WITHOUT CLAIM TO ANY PARTICULAR FONT, STYLE, SIZE, OR COLOR.

OWNER OF U.S. REG. NOS. 2,832,699, 3,556,156 AND OTHERS.

SER. NO. 85-452,110, FILED 10-20-2011.

JOHN WILKE, EXAMINING ATTORNEY



David J. Kyffers

Director of the United States Patent and Trademark Office

United States of America

United States Patent and Trademark Office

SEASONAL BLENDS

Reg. No. 4,174,575

HEATH OUTDOOR PRODUCTS (MICHIGAN CORPORATION)
140 MILL STREET
COOPERSVILLE, MI 49404

Registered July 17, 2012

Int. Cl.: 31

FOR: BIRD FEED CONTAINING SUET, IN CLASS 31 (U.S. CLS. 1 AND 46).

TRADEMARK

FIRST USE 9-29-2011; IN COMMERCE 9-29-2011.

PRINCIPAL REGISTER

NO CLAIM IS MADE TO THE EXCLUSIVE RIGHT TO USE "BLENDS", APART FROM THE MARK AS SHOWN.

THE MARK CONSISTS OF THE LETTERS "SEASONAL BLENDS" ALIGNED HORIZONTALLY ALONG THEIR TOP EDGE, THE BOTTOM EDGES OF LETTERS "SEASONAL BLENDS" FORMING AN ARCH SHAPE IN WHICH THE TWO LETTERS "S" AT THE ENDS OF THE MARK ARE LARGEST IN SIZE AND THE LETTERS GRADUALLY DECREASE IN SIZE FROM THE ENDS TO THE MIDDLE OF THE MARK, AND EACH OF THE LETTERS ARE OUTLINED BY MULTIPLE LAYERS WHERE COMMON LAYERS OF ADJACENT LETTERS JOIN TO FORM CONTINUOUS LAYER ABOUT EACH OF THE WORDS "SEASONAL" AND "BLENDS".

SER. NO. 85-452,260, FILED 10-20-2011.

ELLEN PERKINS, EXAMINING ATTORNEY



David J. Kyffers

Director of the United States Patent and Trademark Office

United States of America

United States Patent and Trademark Office

DISTILLED SPIRITS UNIVERSITY

Reg. No. 4,174,576

DISTILLED SPIRITS EPICENTER, LLC (KENTUCKY LIMITED LIABILITY COMPANY)
801 S. 8TH STREET
LOUISVILLE, KY 40203

Registered July 17, 2012

Int. Cl.: 41

FOR: EDUCATION SERVICES FOR THE DISTILLED SPIRITS INDUSTRY, NAMELY, PROVIDING CLASSES, SEMINARS, WORKSHOPS, AND TRAINING IN THE FIELD OF DISTILLED SPIRITS, IN CLASS 41 (U.S. CLS. 100, 101 AND 107).

SERVICE MARK

FIRST USE 10-12-2011; IN COMMERCE 10-12-2011.

PRINCIPAL REGISTER

THE MARK CONSISTS OF STANDARD CHARACTERS WITHOUT CLAIM TO ANY PARTICULAR FONT, STYLE, SIZE, OR COLOR.

NO CLAIM IS MADE TO THE EXCLUSIVE RIGHT TO USE "DISTILLED SPIRITS", APART FROM THE MARK AS SHOWN.

SER. NO. 85-453,028, FILED 10-21-2011.

KRISTIN DAHLING, EXAMINING ATTORNEY



David J. Kyjars

Director of the United States Patent and Trademark Office

United States of America

United States Patent and Trademark Office



Reg. No. 4,174,577

ALCHEMIST PUBLISHING, LLC (NEVADA LIMITED LIABILITY COMPANY)
PO BOX 91926
HENDERSON, NV 89009

Registered July 17, 2012

Int. Cl.: 35

FOR: ONLINE RETAIL STORE AND MAIL ORDER SERVICES FEATURING TAROT CARDS, BOOKS, PRINTS, TOYS, GAMES, IN CLASS 35 (U.S. CLS. 100, 101 AND 102).

SERVICE MARK

FIRST USE 1-1-1998; IN COMMERCE 1-0-2008.

PRINCIPAL REGISTER

NO CLAIM IS MADE TO THE EXCLUSIVE RIGHT TO USE "PUBLISHING", APART FROM THE MARK AS SHOWN.

THE MARK CONSISTS OF THE WORDING "ALCHEMIST PUBLISHING" IN ALL CAPS TO THE RIGHT OF A DESIGN COMPRISING AN ORNATE MEDIEVAL STYLE LETTER "A" WITH TWO HORIZONTAL BARS AT TOP, AN OPEN CIRCULAR CURVE IN THE LOWER MIDDLE PORTION AND AN ORNATE V SHAPED DECORATION BELOW THAT.

SER. NO. 85-453,349, FILED 10-21-2011.

HAI-LY LAM, EXAMINING ATTORNEY



David J. Kybas

Director of the United States Patent and Trademark Office

United States of America

United States Patent and Trademark Office



Reg. No. 4,174,578

HEALTHY HEART DOC LLC (TENNESSEE LIMITED LIABILITY COMPANY)
2205 GREY CLIFF DRIVE
FRANKLIN, TN 37064

Registered July 17, 2012

Int. Cl.: 43

FOR: FROZEN YOGURT SHOP SERVICES IN THE NATURE OF A RESTAURANT, IN CLASS 43 (U.S. CLS. 100 AND 101).

SERVICE MARK

FIRST USE 10-20-2011; IN COMMERCE 10-20-2011.

PRINCIPAL REGISTER

NO CLAIM IS MADE TO THE EXCLUSIVE RIGHT TO USE "TREATS", APART FROM THE MARK AS SHOWN.

THE MARK CONSISTS OF THE WORD "SWIRLY" WITH THE WORD "TREATS" UNDERNEATH, WITH THE DESIGN OF A BOWL OF A FROZEN TREAT ABOVE THE WORD "SWIRLY"; THE BOWL DESIGN APPEARS IN A SMALLER CIRCLE AT THE TOP OF THE MARK; THE WORD "SWIRLY" APPEARS IN A LARGE, SHADED OVAL IN THE CENTER OF THE MARK; THE WORD "TREATS" APPEARS IN A SMALLER, SHADED RECTANGLE AT THE BOTTOM OF THE MARK; ARABESQUES APPEAR AT THE TOP AND BOTTOM ENDS OF THE MARK; THE COLOR GRAY REPRESENTS SHADING AND/OR TRANSPARENT AREAS AND IS NOT PART OF THE MARK.

SER. NO. 85-453,576, FILED 10-21-2011.

GILBERT SWIFT, EXAMINING ATTORNEY



David J. Kyffers

Director of the United States Patent and Trademark Office

United States of America

United States Patent and Trademark Office



Reg. No. 4,174,579

Registered July 17, 2012

Int. Cl.: 30

TRADEMARK

PRINCIPAL REGISTER

NOM NOM'S CUPCAKE FACTORY, CORP. (MICHIGAN CORPORATION)
5975 N WAYNE ROAD
WESTLAND, MI 48185

FOR: CUP CAKES, IN CLASS 30 (U.S. CL. 46).

FIRST USE 3-4-2011; IN COMMERCE 3-4-2011.

NO CLAIM IS MADE TO THE EXCLUSIVE RIGHT TO USE "CUPCAKE" AND "SWEETS SHOPPE", APART FROM THE MARK AS SHOWN.

THE NAME(S), PORTRAIT(S), AND/OR SIGNATURE(S) SHOWN IN THE MARK DOES NOT IDENTIFY A PARTICULAR LIVING INDIVIDUAL.

THE MARK CONSISTS OF THE STYLIZED TEXT "NOM NOM'S" WITH A CHERRY FOR THE "O" IN THE SECOND "NOM'S" AND A CUPCAKE ABOVE THE WORDING. THERE IS A VINE DESIGN ABOVE AND AROUND THE WORDING. BELOW THIS TEXT IS A BANNER CONTAINING THE STYLIZED TEXT "CUPCAKE FACTORY" ABOVE AN OVAL CONTAINING THE STYLIZED TEXT "& SWEETS SHOPPE".

THE WORDING "NOM NOM'S" HAS NO MEANING IN A FOREIGN LANGUAGE.

SER. NO. 85-453,630, FILED 10-21-2011.

BILL DAWE, EXAMINING ATTORNEY



David J. Kybas

Director of the United States Patent and Trademark Office

United States of America

United States Patent and Trademark Office

FORCE & FORM

Reg. No. 4,174,580

Registered July 17, 2012

Int. Cls.: 35 and 42

SERVICE MARK

PRINCIPAL REGISTER

FORCE & FORM LLC (CALIFORNIA LIMITED LIABILITY COMPANY)
1211 PINE STREET
OAKLAND, CA 94607

FOR: BRANDING SERVICES, NAMELY, CONSULTING, DEVELOPMENT, MANAGEMENT AND MARKETING OF BRANDS FOR BUSINESSES, IN CLASS 35 (U.S. CLS. 100, 101 AND 102).

FIRST USE 1-1-2007; IN COMMERCE 1-1-2007.

FOR: GRAPHIC DESIGN SERVICES; PACKAGING DESIGN SERVICES; VISUAL DESIGN SERVICES IN THE NATURE OF DESIGNING VISUAL ELEMENTS FOR ON-LINE, BROADCAST, PRINT, OUTDOOR AND OTHER COMMUNICATION MEDIA, IN CLASS 42 (U.S. CLS. 100 AND 101).

FIRST USE 1-1-2007; IN COMMERCE 1-1-2007.

THE MARK CONSISTS OF STANDARD CHARACTERS WITHOUT CLAIM TO ANY PARTICULAR FONT, STYLE, SIZE, OR COLOR.

SER. NO. 85-453,660, FILED 10-21-2011.

BARBARA RUTLAND, EXAMINING ATTORNEY



David J. Kybas

Director of the United States Patent and Trademark Office

United States of America

United States Patent and Trademark Office

Murlonio Productions

Reg. No. 4,174,581

MURLONIO PRODUCTIONS, LLC (DELAWARE LIMITED LIABILITY COMPANY)
4641 OMAHA DRIVE
PENSACOLA, FL 32507

Registered July 17, 2012

Int. Cl.: 41

FOR: PRODUCTION OF RADIO AND TELEVISION PROGRAMMES, IN CLASS 41 (U.S. CLS. 100, 101 AND 107).

SERVICE MARK

FIRST USE 10-13-2011; IN COMMERCE 2-29-2012.

PRINCIPAL REGISTER

THE MARK CONSISTS OF STANDARD CHARACTERS WITHOUT CLAIM TO ANY PARTICULAR FONT, STYLE, SIZE, OR COLOR.

NO CLAIM IS MADE TO THE EXCLUSIVE RIGHT TO USE "PRODUCTIONS", APART FROM THE MARK AS SHOWN.

THE WORDING "MURLONIO" HAS NO MEANING IN A FOREIGN LANGUAGE.

SER. NO. 85-453,898, FILED 10-22-2011.

NELSON SNYDER, EXAMINING ATTORNEY



David J. Kybas

Director of the United States Patent and Trademark Office

United States of America

United States Patent and Trademark Office

littlbug enterprises

RUGGED SIMPLICITY in OUTDOOR GEAR

Reg. No. 4,174,582

LITTLBUG ENTERPRISES, INC. (MINNESOTA CORPORATION)

Registered July 17, 2012

P.O. BOX 1154
BEMIDJI, MN 566191154

Int. Cl.: 11

FOR: PORTABLE STOVES; SOLID FUEL BURNING STOVES; WOOD BURNING STOVES,
IN CLASS 11 (U.S. CLS. 13, 21, 23, 31 AND 34).

TRADEMARK

FIRST USE 0-0-1999; IN COMMERCE 3-19-2003.

PRINCIPAL REGISTER

NO CLAIM IS MADE TO THE EXCLUSIVE RIGHT TO USE "ENTERPRISES" OR "OUTDOOR
GEAR", APART FROM THE MARK AS SHOWN.

THE MARK CONSISTS OF AN IMAGE OF THE FACE OF A BUG EMBEDDED IN THE
NAME OF THE COMPANY (BETWEEN THE WORDS "LITTLBUG" AND "ENTERPRISES").
BENEATH THE COMPANY NAME IS THE PHRASE "RUGGED SIMPLICITY IN OUTDOOR
GEAR".

SER. NO. 85-454,014, FILED 10-23-2011.

LINDA MICKLEBURGH, EXAMINING ATTORNEY



David J. Kybas

Director of the United States Patent and Trademark Office

United States of America

United States Patent and Trademark Office

Robert A. Guida MD

Reg. No. 4,174,583

ROBERT A. GUIDA, M.D., P.C. (NEW YORK CORPORATION)
1175 PARK AVE 1B

Registered July 17, 2012

NEW YORK, NY 10128

Int. Cl.: 44

FOR: COSMETIC AND PLASTIC SURGERY, IN CLASS 44 (U.S. CLS. 100 AND 101).

SERVICE MARK

FIRST USE 10-1-2000; IN COMMERCE 10-1-2000.

PRINCIPAL REGISTER

THE MARK CONSISTS OF STANDARD CHARACTERS WITHOUT CLAIM TO ANY PARTICULAR FONT, STYLE, SIZE, OR COLOR.

NO CLAIM IS MADE TO THE EXCLUSIVE RIGHT TO USE "MD", APART FROM THE MARK AS SHOWN.

THE NAME "ROBERT A. GUIDA" IDENTIFIES A LIVING INDIVIDUAL WHOSE CONSENT IS OF RECORD.

SER. NO. 85-454,124, FILED 10-24-2011.

GRETТА YAO, EXAMINING ATTORNEY



David J. Kyffers

Director of the United States Patent and Trademark Office

United States of America

United States Patent and Trademark Office

i | epbs
intermedix

Reg. No. 4,174,584

Registered July 17, 2012

Int. Cls.: 35 and 36

SERVICE MARK

PRINCIPAL REGISTER

INTERMEDIX CORPORATION (DELAWARE CORPORATION)
6451 NORTH FEDERAL HIGHWAY, SUITE 1002
FT. LAUDERDALE, FL 33308

FOR: BILLING SERVICES; BILLING CONSULTING SERVICES; BILLING PRACTICE MANAGEMENT FOR OTHERS; MEDICAL CLAIMS MANAGEMENT SERVICES, NAMELY, RECEIVING, DATA ENTERING, AND RE-PRICING OF TRANSACTIONS THAT ARE ORIGINATED BY PHYSICIANS, HOSPITALS, AND ANCILLARY MEDICAL CARE PROVIDERS; PREPARATION OF BUSINESS AND FINANCIAL REPORTS FOR OTHERS RELATING TO PRACTICE MANAGEMENT, ACCOUNTS RECEIVABLE MANAGEMENT, BUSINESS AND FINANCIAL RISK MANAGEMENT, QUALITY ASSURANCE, MARKET ANALYSIS, AND PAYER DENIAL; ACCOUNTS MANAGEMENT SERVICES, NAMELY, ADMINISTRATION, BILLING AND RECONCILIATION OF ACCOUNTS ON BEHALF OF OTHERS; BUSINESS INFORMATION REPORTING SERVICES FOR HOSPITALS, NAMELY, PROVIDING HOSPITAL SPECIFIC REPORTS FOR THE PURPOSE OF ANALYZING GOVERNMENT REIMBURSEMENT DATA AND DRIVE BUSINESS DECISION MAKING; PROVIDING REIMBURSEMENT BENCHMARKING INFORMATION AND OTHER MARKET INTELLIGENCE TO HEALTHCARE ORGANIZATIONS; ACCOUNTING SERVICES; PAYROLL SERVICES, NAMELY, PAYROLL ADMINISTRATION AND MANAGEMENT SERVICES, IN CLASS 35 (U.S. CLS. 100, 101 AND 102).

FIRST USE 3-0-2009; IN COMMERCE 3-0-2009.

FOR: FINANCIAL ANALYSIS; FINANCIAL ADVICE, NAMELY, BUDGET PLANNING, IN CLASS 36 (U.S. CLS. 100, 101 AND 102).

FIRST USE 3-0-2009; IN COMMERCE 3-0-2009.

OWNER OF U.S. REG. NO. 1,597,793.

THE MARK CONSISTS OF "I", A VERTICAL LINE, "EPBS" AND "INTERMEDIX".

SER. NO. 85-454,135, FILED 10-24-2011.

BARBARA GAYNOR, EXAMINING ATTORNEY



David J. Kyffers

Director of the United States Patent and Trademark Office

United States of America

United States Patent and Trademark Office

Where Your Cargo Connects

Reg. No. 4,174,585

AMERIPORT, LLC (TEXAS LIMITED LIABILITY COMPANY)
3331 S. SAM HOUSTON PKWY E.
HOUSTON, TX 77047

Registered July 17, 2012

Int. Cls.: 36 and 37

FOR: REAL ESTATE SERVICES, NAMELY, RENTAL, BROKERAGE, LEASING AND MANAGEMENT OF COMMERCIAL PROPERTY, INDUSTRIAL PROPERTY, RETAIL PROPERTY, OFFICE SPACE PROPERTY, AND RAIL-SERVED LOGISTICS PARK PROPERTY, IN CLASS 36 (U.S. CLS. 100, 101 AND 102).

SERVICE MARK

PRINCIPAL REGISTER

FIRST USE 9-1-2011; IN COMMERCE 9-1-2011.

FOR: REAL ESTATE DEVELOPMENT OF RAIL-SERVED LOGISTICS PARK PROPERTY, IN CLASS 37 (U.S. CLS. 100, 103 AND 106).

FIRST USE 9-1-2011; IN COMMERCE 9-1-2011.

THE MARK CONSISTS OF STANDARD CHARACTERS WITHOUT CLAIM TO ANY PARTICULAR FONT, STYLE, SIZE, OR COLOR.

SER. NO. 85-454,331, FILED 10-24-2011.

PAULA MAHONEY, EXAMINING ATTORNEY



David J. Kybas

Director of the United States Patent and Trademark Office

United States of America

United States Patent and Trademark Office

IF YOUR SPACE ISN'T
BECOMING TO YOU, YOU
SHOULD BE COMING TO ME!

Reg. No. 4,174,586

COC ENTERPRISES LLC (NEW JERSEY LIMITED LIABILITY COMPANY)
80 MATHEWS AVE
RIVERDALE, NJ 07457

Registered July 17, 2012

Int. Cl.: 35

FOR: PROVIDING ORGANIZING SERVICES FOR BELONGINGS AND SPACES IN A RES-
IDENCE OR OFFICE SUCH AS PAPERS AND TIME; PROVIDING ORGANIZING SERVICES
FOR INDIVIDUALS AT HOME, IN HOME OFFICES AND IN BUSINESS OFFICES, THAT
PROVIDES HELP WITH TIME AND PAPER MANAGEMENT, IN CLASS 35 (U.S. CLS. 100,
101 AND 102).

SERVICE MARK

PRINCIPAL REGISTER

FIRST USE 11-1-2009; IN COMMERCE 11-1-2009.

THE MARK CONSISTS OF STANDARD CHARACTERS WITHOUT CLAIM TO ANY PAR-
TICULAR FONT, STYLE, SIZE, OR COLOR.

SER. NO. 85-454,451, FILED 10-24-2011.

PRISCILLA MILTON, EXAMINING ATTORNEY



David J. Kybas

Director of the United States Patent and Trademark Office

United States of America

United States Patent and Trademark Office

SHADE BRIGHT

Reg. No. 4,174,587

RICKETSON, BRENT (UNITED STATES INDIVIDUAL)
13276 297TH STREET
LINDSTROM, MN 55045

Registered July 17, 2012

Int. Cl.: 7

FOR: VACUUM CLEANER ACCESSORY, NAMELY, A SUCTION NOZZLE, IN CLASS 7
(U.S. CLS. 13, 19, 21, 23, 31, 34 AND 35).

TRADEMARK

FIRST USE 10-11-2011; IN COMMERCE 10-11-2011.

PRINCIPAL REGISTER

THE MARK CONSISTS OF STANDARD CHARACTERS WITHOUT CLAIM TO ANY PARTICULAR FONT, STYLE, SIZE, OR COLOR.

NO CLAIM IS MADE TO THE EXCLUSIVE RIGHT TO USE "SHADE", APART FROM THE MARK AS SHOWN.

SER. NO. 85-454,574, FILED 10-24-2011.

DAVID I, EXAMINING ATTORNEY



David J. Kyfos

Director of the United States Patent and Trademark Office

United States of America

United States Patent and Trademark Office

ENDOSCOPE REPROCESSING THE WAY IT SHOULD BE

Reg. No. 4,174,588

MINNTECH CORPORATION (MINNESOTA CORPORATION)
14605 28TH AVENUE NORTH
MINNEAPOLIS, MN 55447

Registered July 17, 2012

Int. Cl.: 5

FOR: STERILIZING AND DISINFECTING SOLUTION FOR MEDICAL PURPOSES, IN CLASS
5 (U.S. CLS. 6, 18, 44, 46, 51 AND 52).

TRADEMARK

FIRST USE 5-7-2010; IN COMMERCE 5-7-2010.

PRINCIPAL REGISTER

THE MARK CONSISTS OF STANDARD CHARACTERS WITHOUT CLAIM TO ANY PAR-
TICULAR FONT, STYLE, SIZE, OR COLOR.

SER. NO. 85-455,138, FILED 10-25-2011.

APRIL ROACH, EXAMINING ATTORNEY



David J. Kyffers

Director of the United States Patent and Trademark Office

United States of America

United States Patent and Trademark Office

HAWG WILD LURE CO. MORE BITE FOR YOUR BUCK!

Reg. No. 4,174,589

HAWG WILD LURE CO., LLC (MAINE LIMITED LIABILITY COMPANY)
482 MAIN ROAD S
HAMPDEN, ME 04444

Registered July 17, 2012

Int. Cl.: 28

FOR: FISH ATTRACTANTS; FISH HOOKS; FISHING LINES; FISHING LURES; FISHING REELS; FISHING RODS, IN CLASS 28 (U.S. CLS. 22, 23, 38 AND 50).

TRADEMARK

FIRST USE 10-15-2009; IN COMMERCE 10-15-2009.

PRINCIPAL REGISTER

THE MARK CONSISTS OF STANDARD CHARACTERS WITHOUT CLAIM TO ANY PARTICULAR FONT, STYLE, SIZE, OR COLOR.

NO CLAIM IS MADE TO THE EXCLUSIVE RIGHT TO USE "LURE CO.", APART FROM THE MARK AS SHOWN.

SER. NO. 85-455,261, FILED 10-25-2011.

KARANENDRA S. CHHINA, EXAMINING ATTORNEY



David J. Kybas

Director of the United States Patent and Trademark Office

United States of America

United States Patent and Trademark Office

Healthy Soles School of Reflexology

Reg. No. 4,174,590

Registered July 17, 2012

Int. Cl.: 44

SERVICE MARK

PRINCIPAL REGISTER

HEALTHY SOLES SCHOOL OF REFLEXOLOGY, LLC (ILLINOIS LIMITED LIABILITY COMPANY)
605 FULTON AVE.
ROCKFORD, IL 61103

FOR: REFLEXOLOGY SERVICES, IN CLASS 44 (U.S. CLS. 100 AND 101).

FIRST USE 6-6-2008; IN COMMERCE 6-6-2008.

THE MARK CONSISTS OF STANDARD CHARACTERS WITHOUT CLAIM TO ANY PARTICULAR FONT, STYLE, SIZE, OR COLOR.

NO CLAIM IS MADE TO THE EXCLUSIVE RIGHT TO USE "SCHOOL OF REFLEXOLOGY", APART FROM THE MARK AS SHOWN.

SER. NO. 85-455,518, FILED 10-25-2011.

PAUL E. FAHRENKOPF, EXAMINING ATTORNEY



David J. Kyffers

Director of the United States Patent and Trademark Office

United States of America

United States Patent and Trademark Office

MICROSCAN WALKAWAY 40 PLUS

Reg. No. 4,174,591

SIEMENS HEALTHCARE DIAGNOSTICS INC. (CALIFORNIA CORPORATION)
1717 DEERFIELD ROAD
DEERFIELD, IL 60015

Registered July 17, 2012

Int. Cl.: 9

FOR: COMPUTERIZED APPARATUS FOR USE IN THE CLINICAL LABORATORY IN THE FIELD OF MICROBIOLOGY FOR DETERMINING THE IDENTIFICATION OF BACTERIA AND THE MINIMUM INHIBITORY CONCENTRATION OF AN ANTIBIOTIC NEEDED TO INHIBIT BACTERIA, IN CLASS 9 (U.S. CLS. 21, 23, 26, 36 AND 38).

TRADEMARK

PRINCIPAL REGISTER

FIRST USE 6-1-2008; IN COMMERCE 6-1-2008.

THE MARK CONSISTS OF STANDARD CHARACTERS WITHOUT CLAIM TO ANY PARTICULAR FONT, STYLE, SIZE, OR COLOR.

OWNER OF U.S. REG. NOS. 1,454,910, 1,814,777, AND 2,533,967.

SER. NO. 85-455,707, FILED 10-25-2011.

KATINA MISTER, EXAMINING ATTORNEY



David J. Kybas

Director of the United States Patent and Trademark Office

United States of America

United States Patent and Trademark Office

SAFEPACE

Reg. No. 4,174,592

GNR TECHNOLOGIES INC. (CANADA CORPORATION)
990 UPTON

Registered July 17, 2012

LASALLE, QUEBEC, CANADA H8R2T9

Int. Cl.: 9

FOR: ELECTRIC, BATTERY-OPERATED OR SOLAR POWERED SIGNS FOR MONITORING AND DISPLAYING VEHICLE SPEED DETECTED USING RADAR, IN CLASS 9 (U.S. CLS. 21, 23, 26, 36 AND 38).

TRADEMARK

FIRST USE 8-9-2010; IN COMMERCE 8-9-2010.

PRINCIPAL REGISTER

THE MARK CONSISTS OF STANDARD CHARACTERS WITHOUT CLAIM TO ANY PARTICULAR FONT, STYLE, SIZE, OR COLOR.

PRIORITY CLAIMED UNDER SEC. 44(D) ON CANADA APPLICATION NO. 1541914, FILED 8-31-2011.

SER. NO. 85-455,834, FILED 10-25-2011.

EDWARD FENNESSY, EXAMINING ATTORNEY



David J. Kyffers

Director of the United States Patent and Trademark Office

United States of America

United States Patent and Trademark Office

AJ CRIMSON
M A K E U P

Reg. No. 4,174,593

Registered July 17, 2012

Int. Cl.: 3

TRADEMARK

PRINCIPAL REGISTER

AJ CRIMSON MAKEUP, LLC (DELAWARE LIMITED LIABILITY COMPANY)
C/O KRADITOR & HABER, 5TH FL.
75 NINTH AVE.
NEW YORK, NY 10011

FOR: COSMETICS AND MAKE-UP, IN CLASS 3 (U.S. CLS. 1, 4, 6, 50, 51 AND 52).

FIRST USE 6-30-2010; IN COMMERCE 6-30-2010.

NO CLAIM IS MADE TO THE EXCLUSIVE RIGHT TO USE "MAKEUP", APART FROM THE MARK AS SHOWN.

THE NAME(S), PORTRAIT(S), AND/OR SIGNATURE(S) SHOWN IN THE MARK DOES NOT IDENTIFY A PARTICULAR LIVING INDIVIDUAL.

THE MARK CONSISTS OF THE STYLIZED WORDS "AJ CRIMSON MAKEUP".

SER. NO. 85-455,875, FILED 10-25-2011.

KATHLEEN LORENZO, EXAMINING ATTORNEY



David J. Kybas

Director of the United States Patent and Trademark Office

United States of America

United States Patent and Trademark Office

ROYAL FINE

Reg. No. 4,174,594

INTERNATIONAL MODERN INVESTMENT INC. (MICHIGAN CORPORATION)
21535 HOOVER ROAD
WARREN, MI 48089

Registered July 17, 2012

Int. Cls.: 29 and 30

FOR: LEMON JUICE FOR COOKING PURPOSES, OLIVE OIL, CORN OIL, PROCESSED CHICKPEAS, TAHINI, IN CLASS 29 (U.S. CL. 46).

TRADEMARK

FIRST USE 2-18-2011; IN COMMERCE 2-18-2011.

PRINCIPAL REGISTER

FOR: EDIBLE SALT, IN CLASS 30 (U.S. CL. 46).

FIRST USE 2-18-2011; IN COMMERCE 2-18-2011.

THE MARK CONSISTS OF STANDARD CHARACTERS WITHOUT CLAIM TO ANY PARTICULAR FONT, STYLE, SIZE, OR COLOR.

NO CLAIM IS MADE TO THE EXCLUSIVE RIGHT TO USE "FINE", APART FROM THE MARK AS SHOWN.

SER. NO. 85-456,121, FILED 10-25-2011.

AMY KELLY, EXAMINING ATTORNEY



David J. Kypos

Director of the United States Patent and Trademark Office

United States of America
United States Patent and Trademark Office

.love

Reg. No. 4,174,595

PHIL'S FRESH FOODS, LLC (DELAWARE LIMITED LIABILITY COMPANY)
100 ARAPAHOE AVENUE, SUITE 10
BOULDER, CO 80304

Registered July 17, 2012

Int. Cl.: 30

FOR: BURRITOS, IN CLASS 30 (U.S. CL. 46).

TRADEMARK

FIRST USE 4-5-2011; IN COMMERCE 4-5-2011.

PRINCIPAL REGISTER

OWNER OF U.S. REG. NO. 3,791,440.

THE MARK CONSISTS OF THE WORD "LOVE" WITH A PERIOD IN FRONT OF IT.

SER. NO. 85-456,202, FILED 10-26-2011.

MYRIAH HABEEB, EXAMINING ATTORNEY



David J. Kyffers

Director of the United States Patent and Trademark Office

United States of America

United States Patent and Trademark Office

BRING COMFORT TO YOUR COMMUNITY

Reg. No. 4,174,596

BOXERCRAFT, INC. (GEORGIA CORPORATION)

Registered July 17, 2012

P.O. BOX 20016
ATLANTA, GA 30325

Int. Cl.: 45

FOR: CHARITABLE SERVICES, NAMELY, PROVIDING CLOTHING AND EMOTIONAL SUPPORT AND ENCOURAGEMENT TO ORGANIZATIONS AND GROUPS OFFERING CHARITABLE SERVICES TO OTHERS, IN CLASS 45 (U.S. CLS. 100 AND 101).

SERVICE MARK

FIRST USE 3-18-2010; IN COMMERCE 3-18-2010.

PRINCIPAL REGISTER

THE MARK CONSISTS OF STANDARD CHARACTERS WITHOUT CLAIM TO ANY PARTICULAR FONT, STYLE, SIZE, OR COLOR.

SER. NO. 85-456,235, FILED 10-26-2011.

KIMBERLY PERRY, EXAMINING ATTORNEY



David J. Kybas

Director of the United States Patent and Trademark Office

United States of America

United States Patent and Trademark Office

EYE-FI

Reg. No. 4,174,597

Registered July 17, 2012

Int. Cls.: 9 and 42

TRADEMARK

SERVICE MARK

PRINCIPAL REGISTER

EYE-FI, INC. (CALIFORNIA CORPORATION)
305 W. EVELYN AVENUE
MOUNTAIN VIEW, CA 94041

FOR: DOWNLOADABLE SOFTWARE THAT ENABLES USERS TO ELECTRONICALLY UPLOAD, DOWNLOAD, TRANSFER, DISPLAY AND STORE DIGITAL PHOTOGRAPHS AND VIDEO COMPRISING PHOTOGRAPHS, IN CLASS 9 (U.S. CLS. 21, 23, 26, 36 AND 38).

FIRST USE 4-25-2006; IN COMMERCE 10-15-2007.

FOR: COMPUTER SERVICES, NAMELY, PROVIDING A WEB-BASED SERVICE FEATURING TECHNOLOGY THAT ENABLES USERS TO ELECTRONICALLY UPLOAD, DOWNLOAD, TRANSFER, DISPLAY AND STORE DIGITAL PHOTOGRAPHS AND VIDEO COMPRISING PHOTOGRAPHS, IN CLASS 42 (U.S. CLS. 100 AND 101).

FIRST USE 4-25-2006; IN COMMERCE 10-15-2007.

THE MARK CONSISTS OF STANDARD CHARACTERS WITHOUT CLAIM TO ANY PARTICULAR FONT, STYLE, SIZE, OR COLOR.

OWNER OF U.S. REG. NOS. 3,840,431 AND 3,934,326.

SER. NO. 85-456,367, FILED 10-26-2011.

ZHALEH DELANEY, EXAMINING ATTORNEY



David J. Kyros

Director of the United States Patent and Trademark Office

United States of America
United States Patent and Trademark Office

yootheme

Reg. No. 4,174,598

Registered July 17, 2012

Int. Cls.: 9 and 42

TRADEMARK

SERVICE MARK

PRINCIPAL REGISTER

SASCHA DUBE (FED REP GERMANY INDIVIDUAL)
FELIX-DAHN-STRASSE 2
HAMBURG, FED REP GERMANY 20357 AND

STEFFAN SCHIEWE (FED REP GERMANY INDIVIDUAL)
CHRISTEL-SCHMIDT-ALLEE 17
AHRENSBURG, FED REP GERMANY 22926

FOR: DOWNLOADABLE SOFTWARE FOR THE CREATION, DESIGN AND DEVELOPMENT OF WEBSITES AND FOR MANAGING THEIR CONTENT, IN CLASS 9 (U.S. CLS. 21, 23, 26, 36 AND 38).

FIRST USE 2-12-2007; IN COMMERCE 2-12-2007.

FOR: DESIGN AND DEVELOPMENT OF WEBSITES, WEB APPLICATIONS AND SOFTWARE FOR OTHERS; DESIGNING ARTWORK FOR OTHERS, NAMELY, GRAPHIC ART DESIGN, IN CLASS 42 (U.S. CLS. 100 AND 101).

FIRST USE 2-12-2007; IN COMMERCE 2-12-2007.

THE MARK CONSISTS OF THE WORD "YOOTHEME", WITH THE FIRST THREE CHARACTERS IN LARGER, BOLD FONT AND THE LAST FIVE CHARACTERS IN STANDARD BOLD FONT.

SER. NO. 85-456,450, FILED 10-26-2011.

ELLEN PERKINS, EXAMINING ATTORNEY



David J. Kyros

Director of the United States Patent and Trademark Office

United States of America

United States Patent and Trademark Office



Reg. No. 4,174,599

Registered July 17, 2012

Int. Cl.: 25

TRADEMARK

PRINCIPAL REGISTER

SHOOKHTIM, RAMIN (UNITED STATES INDIVIDUAL)
SUITE #A467
110 E. 9TH ST.
LOS ANGELES, CA 90079

FOR: MEN'S, WOMEN'S, AND CHILDREN'S CLOTHING, NAMELY, SHIRTS, BLOUSES, JACKETS, PANTS, SHOES, SOCKS, UNDERWEAR, SLEEPWEAR, AND MATCHING SETS CONTAINING ANY OF THE AFOREMENTIONED CLOTHING, IN CLASS 25 (U.S. CLS. 22 AND 39).

FIRST USE 8-6-2008; IN COMMERCE 9-1-2008.

NO CLAIM IS MADE TO THE EXCLUSIVE RIGHT TO USE "FASHION", APART FROM THE MARK AS SHOWN.

THE STIPLING IS FOR SHADING PURPOSES ONLY.

THE MARK CONSISTS OF CIRCLE WITH A COAT OF ARMS INSIDE, THE COAT OF ARMS CONSISTS OF A SHIELD WITH AND NEEDLE AND THREAD ACROSS THE CENTER WITH A FLEUR DE LE ABOVE AND A RAMPANT LION BELOW, ABOVE THE SHIELD IS A THREAD BOBBIN WITH A CROWN ON TOP AND ANOTHER RAMPANT LION ABOVE THE CROWN; BELOW THE SHIELD IS THE BOTTOM OF A THREAD BOBBIN; TO THE LEFT AND RIGHT OF THE SHIELD APPEARS THE PROTECTIVE COVERINGS FOR THE SHIELD; BELOW THE CIRCLE APPEARS A SCROLL BANNER WITH THE TEXT "MINISTRY OF FASHION".

SER. NO. 85-456,460, FILED 10-26-2011.

JEFF DEFORD, EXAMINING ATTORNEY



David J. Kyros

Director of the United States Patent and Trademark Office

United States of America

United States Patent and Trademark Office



Reg. No. 4,174,600

Registered July 17, 2012

Int. Cl.: 41

SERVICE MARK

PRINCIPAL REGISTER

LIL' SPORTS, INC. (PENNSYLVANIA CORPORATION)
C/O 360 W MAIN STREET
TRAPE, PA 19426

FOR: AMATEUR YOUTH SPORTS SERVICES, NAMELY, ORGANIZING AND PROVIDING YOUTH SPORTS ACTIVITIES, IN CLASS 41 (U.S. CLS. 100, 101 AND 107).

FIRST USE 10-1-2011; IN COMMERCE 10-1-2011.

NO CLAIM IS MADE TO THE EXCLUSIVE RIGHT TO USE "PROGRAMS", APART FROM THE MARK AS SHOWN.

THE COLOR(S) WHITE, YELLOW, AND BLUE IS/ARE CLAIMED AS A FEATURE OF THE MARK.

THE MARK CONSISTS OF A YELLOW OVAL WITH A BLUE BORDER, THE OVAL CONTAINS FIVE SILHOUETTES OF PEOPLE IN BLUE AND OUTLINED IN WHITE, FOUR CHILDREN INVOLVED IN SPORT ACTIVITIES, NAMELY, KARATE, BALLET, YOGA, AND RUNNING AFTER A BLUE BALL, AND ONE ADULT RUNNING IN THE CENTER, ELEMENTS OF ALL THE PEOPLE EXTEND OUTSIDE THE TOP HALF OF THE OVAL, THE WORDING "LIL' PROGRAMS" APPEARS IN LARGE WHITE LETTERS WITH BLUE BORDERS UNDER THE PEOPLE AND EXTENDS OUTSIDE OF THE OVAL, THE WORDING "BY LIL' SPORTS" APPEARS IN SMALLER WHITE LETTERS WITH BLUE BORDERS BELOW THE LARGER WORDING.

SER. NO. 85-456,474, FILED 10-26-2011.

JEFF DEFORD, EXAMINING ATTORNEY



David J. Kypos

Director of the United States Patent and Trademark Office

United States of America

United States Patent and Trademark Office



Reg. No. 4,174,601

Registered July 17, 2012

Int. Cls.: 14 and 35

TRADEMARK

SERVICE MARK

PRINCIPAL REGISTER

ROSY BLUE, INC. (NEW YORK CORPORATION)
529 FIFTH AVENUE, 12TH FLOOR
NEW YORK, NY 10017

FOR: DIAMONDS; PRECIOUS STONES; JEWELRY, IN CLASS 14 (U.S. CLS. 2, 27, 28 AND 50).

FIRST USE 12-0-2001; IN COMMERCE 5-0-2009.

FOR: WHOLESALE DISTRIBUTORSHIP SERVICES IN THE FIELD OF DIAMONDS, PRECIOUS STONES AND JEWELRY, IN CLASS 35 (U.S. CLS. 100, 101 AND 102).

FIRST USE 12-0-2001; IN COMMERCE 12-0-2001.

OWNER OF U.S. REG. NO. 2,141,053.

THE COLOR(S) BLUE, LIGHT BLUE, RED AND PINK IS/ARE CLAIMED AS A FEATURE OF THE MARK.

THE MARK CONSISTS OF THE WORDING "ROSYBLUE" IN BLUE WITH THE WORDING "MORE THAN DIAMONDS" IN LIGHT BLUE APPEARING BENEATH AND SLIGHTLY TO THE RIGHT, WITH THE STYLIZED DESIGN OF A DIAMOND IN PINK, RED, BLUE AND LIGHT BLUE TO THE RIGHT OF THE WORDING "ROSYBLUE" AND ABOVE THE WORDING "MORE THAN DIAMONDS".

SER. NO. 85-456,477, FILED 10-26-2011.

JEFF DEFORD, EXAMINING ATTORNEY



David J. Kybas

Director of the United States Patent and Trademark Office

United States of America
United States Patent and Trademark Office

VISIQUITY

Reg. No. 4,174,602

NOVAQUEST LLC (NORTH CAROLINA LIMITED LIABILITY COMPANY)
9115 HARRIS CORNERS PARKWAY, SUITE 310
CHARLOTTE, NC 28269

Registered July 17, 2012

Int. Cl.: 9

FOR: COMPUTER SEARCH ENGINE SOFTWARE, IN CLASS 9 (U.S. CLS. 21, 23, 26, 36 AND 38).

TRADEMARK

FIRST USE 10-25-2011; IN COMMERCE 10-25-2011.

PRINCIPAL REGISTER

THE MARK CONSISTS OF STANDARD CHARACTERS WITHOUT CLAIM TO ANY PARTICULAR FONT, STYLE, SIZE, OR COLOR.

SER. NO. 85-456,595, FILED 10-26-2011.

KATHERINE CONNOLLY, EXAMINING ATTORNEY



David J. Kybas

Director of the United States Patent and Trademark Office

United States of America

United States Patent and Trademark Office

PARTSMAX

Reg. No. 4,174,603

PARTSMAX, INC. (FLORIDA CORPORATION)
3401 N.W. 73RD ST
MIAMI, FL 33147

Registered July 17, 2012

Int. Cl.: 35

FOR: RETAIL AUTOMOBILE PARTS AND ACCESSORIES STORES, IN CLASS 35 (U.S. CLS. 100, 101 AND 102).

SERVICE MARK

FIRST USE 1-22-2003; IN COMMERCE 1-22-2003.

PRINCIPAL REGISTER

THE MARK CONSISTS OF STANDARD CHARACTERS WITHOUT CLAIM TO ANY PARTICULAR FONT, STYLE, SIZE, OR COLOR.

OWNER OF U.S. REG. NO. 2,743,483.

SER. NO. 85-456,651, FILED 10-26-2011.

MARK SPARACINO, EXAMINING ATTORNEY



David J. Kyffers

Director of the United States Patent and Trademark Office

United States of America

United States Patent and Trademark Office

PAPERLINE

Reg. No. 4,174,604

Registered July 17, 2012

Int. Cl.: 16

TRADEMARK

PRINCIPAL REGISTER

PT. PURINUSA EKAPERSADA (INDONESIA CORPORATION)
PLAZA BII TOWER 2, 33RD FLOOR
JL. M. H. THAMRIN NO. 51
JAKARTA, INDONESIA AND

PT INDAH KIAT PULP AND PAPER TBK (INDONESIA CORPORATION)
PLAZA BII TOWER 2, 7TH FLOOR
JL. M.H. THAMRIN KAV 22, NO. 51
JAKARTA, INDONESIA 10350

FOR: PAPER, CARDBOARD AND GOODS MADE FROM THESE MATERIALS, NAMELY, UNCOATED COLOR PAPER, FINE PAPER, NAMELY, WOOD-FREE PAPER, OFFSET PAPER, PRINTING PAPER, COLOR PHOTOCOPY PAPER AND WRITING PAPER, IN CLASS 16 (U.S. CLS. 2, 5, 22, 23, 29, 37, 38 AND 50).

FIRST USE 11-0-1990; IN COMMERCE 11-0-1990.

THE MARK CONSISTS OF STANDARD CHARACTERS WITHOUT CLAIM TO ANY PARTICULAR FONT, STYLE, SIZE, OR COLOR.

OWNER OF U.S. REG. NO. 1,735,855.

SEC. 2(F).

SER. NO. 85-456,764, FILED 10-26-2011.

LAKEISHA LEWIS, EXAMINING ATTORNEY



David J. Kyffers

Director of the United States Patent and Trademark Office

United States of America

United States Patent and Trademark Office

MORENA BACCARIN

Reg. No. 4,174,605

Registered July 17, 2012

Int. Cl.: 41

SERVICE MARK

PRINCIPAL REGISTER

BACCARIN, MORENA (UNITED STATES INDIVIDUAL)
GARDEN LEVEL
8906 W. OLYMPIC BOULEVARD
BEVERLY HILLS, CA 90211

FOR: ENTERTAINMENT SERVICES, NAMELY, LIVE, TELEVISED AND MOVIE APPEARANCES BY A PROFESSIONAL ENTERTAINER, IN CLASS 41 (U.S. CLS. 100, 101 AND 107).

FIRST USE 12-31-2002; IN COMMERCE 12-31-2002.

THE MARK CONSISTS OF STANDARD CHARACTERS WITHOUT CLAIM TO ANY PARTICULAR FONT, STYLE, SIZE, OR COLOR.

THE NAME(S), PORTRAIT(S), AND/OR SIGNATURE(S) SHOWN IN THE MARK IDENTIFIES "MORENA BACCARIN", WHOSE CONSENT(S) TO REGISTER IS MADE OF RECORD.

SER. NO. 85-457,205, FILED 10-26-2011.

CHARLES L. JENKINS, EXAMINING ATTORNEY



David J. Kybas

Director of the United States Patent and Trademark Office

United States of America

United States Patent and Trademark Office

CandidMarkets

Prosperity Powered by Openness

Reg. No. 4,174,606

CANDIDMARKETS, INC. (DELAWARE CORPORATION)
2711 CENTERVILLE ROAD, SUITE 400
WILMINGTON, DE 19808

Registered July 17, 2012

Int. Cls.: 41 and 42

FOR: PROVIDING RECOGNITION AND INCENTIVES BY THE WAY OF AWARDS TO DEMONSTRATE EXCELLENCE IN THE FIELDS OF INVESTMENT MARKETS, STOCKS, BONDS, REAL ESTATE AND NATIONAL ECONOMIC CONDITIONS, IN CLASS 41 (U.S. CLS. 100, 101 AND 107).

SERVICE MARK

PRINCIPAL REGISTER

FIRST USE 9-19-2011; IN COMMERCE 9-19-2011.

FOR: APPLICATION SERVICE PROVIDER, NAMELY, HOSTING, MANAGING, DEVELOPING, AND MAINTAINING APPLICATIONS, SOFTWARE, AND WEB SITES, IN THE FIELDS OF INVESTMENT MARKETS, STOCKS, BONDS, REAL ESTATE AND NATIONAL ECONOMIC CONDITIONS; COMPUTER SERVICES, NAMELY, HOSTING AND MAINTAINING AN ON-LINE WEB SITE FOR USERS TO NETWORK AND TO EXCHANGE THEIR ANALYSIS OF INVESTMENT MARKETS, STOCKS, BONDS, REAL ESTATE AND NATIONAL ECONOMIC CONDITIONS, IN CLASS 42 (U.S. CLS. 100 AND 101).

FIRST USE 9-19-2011; IN COMMERCE 9-19-2011.

THE MARK CONSISTS OF THE WORD "CANDIDMARKETS" OVER THE WORDS "PROSPERITY POWERED BY OPENNESS" WITH THE LETTER "M" DEPICTED HAVING A TRIANGLE IN THE CENTER OF THE "M" AND AT THE TOP OF THE RIGHT HALF OF THE "M".

SER. NO. 85-457,560, FILED 10-27-2011.

REGINA DRUMMOND, EXAMINING ATTORNEY



David J. Kyjars

Director of the United States Patent and Trademark Office

United States of America

United States Patent and Trademark Office

RARE BIRD

Reg. No. 4,174,607

Registered July 17, 2012

Int. Cl.: 29

TRADEMARK

PRINCIPAL REGISTER

RARE BIRD PRESERVES, INCORPORATED (ILLINOIS CORPORATION)
511 EDGEWOOD PLACE
RIVER FOREST, IL 60305

FOR: FRUIT PRESERVES, IN CLASS 29 (U.S. CL. 46).

FIRST USE 6-30-2007; IN COMMERCE 9-6-2008.

THE MARK CONSISTS OF STANDARD CHARACTERS WITHOUT CLAIM TO ANY PARTICULAR FONT, STYLE, SIZE, OR COLOR.

SER. NO. 85-457,573, FILED 10-27-2011.

REGINA DRUMMOND, EXAMINING ATTORNEY



David J. Kyffers

Director of the United States Patent and Trademark Office

United States of America

United States Patent and Trademark Office

bleu sur bleu

Reg. No. 4,174,608

ALI, LUTFAR R. (UNITED STATES INDIVIDUAL)
1190 3RD AVENUE
NEW YORK, NY 10021

Registered July 17, 2012

Int. Cl.: 44

FOR: BEAUTY SALON SERVICES; HAIR SALON SERVICES, IN CLASS 44 (U.S. CLS. 100 AND 101).

SERVICE MARK

FIRST USE 1-1-2008; IN COMMERCE 1-1-2008.

PRINCIPAL REGISTER

THE MARK CONSISTS OF STANDARD CHARACTERS WITHOUT CLAIM TO ANY PARTICULAR FONT, STYLE, SIZE, OR COLOR.

THE ENGLISH TRANSLATION OF "BLEU SUR BLEU" IN THE MARK IS "BLUE ON BLUE".

SER. NO. 85-457,953, FILED 10-27-2011.

ELLEN B. AWRICH, EXAMINING ATTORNEY



David J. Kyffers

Director of the United States Patent and Trademark Office

United States of America

United States Patent and Trademark Office

nersess

Reg. No. 4,174,609

ABEDIYAN, ROMIK (UNITED STATES INDIVIDUAL)
6524 SAN FERNANDO RD.
GLENDALE, CA 91201

Registered July 17, 2012

Int. Cl.: 43

FOR: RESTAURANT SERVICES FEATURING PERSIAN FOOD, IN CLASS 43 (U.S. CLS. 100 AND 101).

SERVICE MARK

FIRST USE 10-18-2004; IN COMMERCE 10-18-2004.

PRINCIPAL REGISTER

THE MARK CONSISTS OF STANDARD CHARACTERS WITHOUT CLAIM TO ANY PARTICULAR FONT, STYLE, SIZE, OR COLOR.

THE WORDING "NERSESS" HAS NO MEANING IN A FOREIGN LANGUAGE.

SER. NO. 85-458,344, FILED 10-27-2011.

CHRISTINA SOBRAL, EXAMINING ATTORNEY



David J. Kybas

Director of the United States Patent and Trademark Office

United States of America

United States Patent and Trademark Office

ROCKIN' FOR THE HOMELESS

Reg. No. 4,174,610

BRADLEY D. SCHWARTZ (UNITED STATES INDIVIDUAL)
500 SOUTH GRAND AVENUE, SUITE 2050
LOS ANGELES, CA 90071

Registered July 17, 2012

Int. Cl.: 36

FOR: CHARITABLE FUNDRAISING SERVICES, IN CLASS 36 (U.S. CLS. 100, 101 AND 102).

SERVICE MARK

FIRST USE 10-16-2010; IN COMMERCE 10-16-2010.

PRINCIPAL REGISTER

THE MARK CONSISTS OF STANDARD CHARACTERS WITHOUT CLAIM TO ANY PARTICULAR FONT, STYLE, SIZE, OR COLOR.

NO CLAIM IS MADE TO THE EXCLUSIVE RIGHT TO USE "HOMELESS", APART FROM THE MARK AS SHOWN.

SER. NO. 85-458,455, FILED 10-27-2011.

CHARLES L. JENKINS, EXAMINING ATTORNEY



David J. Kybas

Director of the United States Patent and Trademark Office

United States of America

United States Patent and Trademark Office



2012 INTERNATIONAL YEAR OF SUSTAINABLE ENERGY FOR ALL

Reg. No. 4,174,611

Registered July 17, 2012

Int. Cl.: 35

SERVICE MARK

PRINCIPAL REGISTER

UNITED NATIONS FOUNDATION, INC. (NEW YORK CORPORATION)
SUITE 400
1800 MASSACHUSETTS AVE, NW
WASHINGTON, DC 20036

FOR: PROMOTING PUBLIC INTEREST IN AND AWARENESS OF THE IMPORTANCE OF UNIVERSAL ACCESS TO ENERGY, IMPROVED ENERGY EFFICIENCY AND ENHANCED DEPLOYMENT OF RENEWABLE SOURCES, IN CLASS 35 (U.S. CLS. 100, 101 AND 102).

FIRST USE 4-7-2011; IN COMMERCE 4-7-2011.

NO CLAIM IS MADE TO THE EXCLUSIVE RIGHT TO USE "2012 INTERNATIONAL YEAR OF SUSTAINABLE ENERGY FOR ALL", APART FROM THE MARK AS SHOWN.

THE MARK CONSISTS OF FOUR CURVED BANDS WRAPPED AROUND THE LEFT SIDE OF THE WORDS "2012 INTERNATIONAL YEAR OF SUSTAINABLE ENERGY FOR ALL".

SER. NO. 85-458,509, FILED 10-27-2011.

LAKEISHA LEWIS, EXAMINING ATTORNEY



David J. Kybas

Director of the United States Patent and Trademark Office

United States of America

United States Patent and Trademark Office



Reg. No. 4,174,612

MOUNTAIN STATES HEALTH ALLIANCE (TENNESSEE NON-PROFIT CORPORATION)
400 NORTH STATE OF FRANKLIN RD.
JOHNSON CITY, TN 37604

Registered July 17, 2012

Int. Cl.: 44

FOR: HOSPITAL AND HEALTH CARE SERVICES, IN CLASS 44 (U.S. CLS. 100 AND 101).

SERVICE MARK

FIRST USE 2-1-1999; IN COMMERCE 2-1-1999.

PRINCIPAL REGISTER

THE MARK CONSISTS OF A RECTANGLE WITH A STYLIZED FIVE-POINT STAR ON ITS UPPER LEFT CORNER ABOVE THREE STYLIZED MOUNTAINS

SER. NO. 85-458,630, FILED 10-28-2011.

DAWN FELDMAN, EXAMINING ATTORNEY



David J. Kyffers

Director of the United States Patent and Trademark Office

United States of America

United States Patent and Trademark Office

VENTURE STUDIO

Reg. No. 4,174,613

Registered July 17, 2012

Int. Cl.: 41

SERVICE MARK

PRINCIPAL REGISTER

VENTURE STUDIO, LLC (NEW YORK LIMITED LIABILITY COMPANY)
ATTN: DAVID LERNER
468 RIVERSIDE DRIVE, #83
NEW YORK, NY 10027

FOR: PROVIDING ONLINE INTERVIEWS FEATURING ENTREPRENEURS, INVESTORS, WRITERS AND PERSONALITIES IN THE FIELD OF ENTREPRENEURSHIP FOR ENTERTAINMENT PURPOSES, IN CLASS 41 (U.S. CLS. 100, 101 AND 107).

FIRST USE 2-28-2011; IN COMMERCE 2-28-2011.

THE MARK CONSISTS OF STANDARD CHARACTERS WITHOUT CLAIM TO ANY PARTICULAR FONT, STYLE, SIZE, OR COLOR.

NO CLAIM IS MADE TO THE EXCLUSIVE RIGHT TO USE "STUDIO", APART FROM THE MARK AS SHOWN.

SER. NO. 85-458,643, FILED 10-28-2011.

ZACHARY BELLO, EXAMINING ATTORNEY



David J. Kyffers

Director of the United States Patent and Trademark Office

United States of America

United States Patent and Trademark Office

My Dead Pet

Reg. No. 4,174,614

COSTANZO, PAUL A (UNITED STATES INDIVIDUAL)
9 DEERFIELD TRACE
BURLINGTON, CT 06013

Registered July 17, 2012

Int. Cl.: 25

FOR: JACKETS; JERSEYS; PERSPIRATION ABSORBENT UNDERWEAR CLOTHING; TOPS; WEARABLE GARMENTS AND CLOTHING, NAMELY, SHIRTS; WOMEN'S CLOTHING, NAMELY, SHIRTS, DRESSES, SKIRTS, BLOUSES, IN CLASS 25 (U.S. CLS. 22 AND 39).

TRADEMARK

FIRST USE 3-31-2011; IN COMMERCE 3-31-2011.

PRINCIPAL REGISTER

THE MARK CONSISTS OF STANDARD CHARACTERS WITHOUT CLAIM TO ANY PARTICULAR FONT, STYLE, SIZE, OR COLOR.

SER. NO. 85-458,663, FILED 10-28-2011.

JULIE VEPPUMTHARA, EXAMINING ATTORNEY



David J. Kyffers

Director of the United States Patent and Trademark Office

United States of America

United States Patent and Trademark Office



Reg. No. 4,174,615

Registered July 17, 2012

Int. Cl.: 45

SERVICE MARK

PRINCIPAL REGISTER

LEWIS, MICHAEL K. (UNITED STATES INDIVIDUAL)
#2A
400 HALL STREET
ELIZABETHTOWN, NC 283379551

FOR: CHRISTIAN MINISTRY SERVICES, IN CLASS 45 (U.S. CLS. 100 AND 101).

FIRST USE 5-1-2002; IN COMMERCE 5-1-2002.

NO CLAIM IS MADE TO THE EXCLUSIVE RIGHT TO USE "SEISHIN-DO KARATE KIRISUTO KYOTO-HA", APART FROM THE MARK AS SHOWN.

THE MARK CONSISTS OF A CIRCLE CONTAINING A JAPANESE TORRI WITH A CROSS OVERLAPPING IT AT THE TOP. ANOTHER CIRCLE SURROUNDS THE FIRST CIRCLE. IN THE SPACE BETWEEN THE CIRCLES AT THE TOP IS THE STYLIZED TEXT "SEISHIN-DO KARATE". AND IN THE SPACE BETWEEN THE CIRCLES AT THE BOTTOM IS A PARTIAL WREATH ABOVE THE STYLIZED TEXT "KIRISUTO KYOTO-HA · SHU HA RI-SHITO-RYU".

THE ENGLISH TRANSLATION OF "SEISHIN-DO KARATE KIRISUTO KYOTO-HA · SHU HA RI-SHITO-RYU" IN THE MARK IS "HOLY SPIRIT PATH KARATE CHRISTIAN INTERPRETATION ·LEARN FROM, BREAK FROM, TRANSCEND TRADITION ·WAY OF THE APOSTLES".

SER. NO. 85-458,679, FILED 10-28-2011.

LINDA ORNDORFF, EXAMINING ATTORNEY



David J. Kyros

Director of the United States Patent and Trademark Office

United States of America

United States Patent and Trademark Office

PROT3IN ZVP

Reg. No. 4,174,616

Registered July 17, 2012

Int. Cl.: 32

HSGN COMPANY, S. DE R.L. DE C.V. (MEXICO SOCIEDAD DE RESPONSABILIDAD
LIMITADA DE CAPITAL VARIABLE)
SANTA MARIA NUEVO LEÓN
BLVD. ANTONIO L. RODRIGUEZ #3058, 201-B
MONTERREY, MEXICO

TRADEMARK

FOR: FRUIT DRINKS AND FRUIT JUICES; ISOTONIC BEVERAGES; MINERAL AND
AERATED WATERS; NON-ALCOHOLIC BEVERAGES, NAMELY, CARBONATED
BEVERAGES, IN CLASS 32 (U.S. CLS. 45, 46 AND 48).

PRINCIPAL REGISTER

THE MARK CONSISTS OF STANDARD CHARACTERS WITHOUT CLAIM TO ANY PAR-
TICULAR FONT, STYLE, SIZE, OR COLOR.

OWNER OF MEXICO REG. NO. 1111481, DATED 7-22-2009, EXPIRES 3-10-2019.

NO CLAIM IS MADE TO THE EXCLUSIVE RIGHT TO USE "PROTEIN", APART FROM THE
MARK AS SHOWN.

SER. NO. 85-458,746, FILED 10-28-2011.

GIANCARLO CASTRO, EXAMINING ATTORNEY



David J. Kyffers

Director of the United States Patent and Trademark Office

United States of America

United States Patent and Trademark Office

EPX

Reg. No. 4,174,617

Registered July 17, 2012

Int. Cl.: 4

TRADEMARK

PRINCIPAL REGISTER

A.B.C. COMPOUNDING COMPANY, INC. (GEORGIA CORPORATION)
6970 JONESBORO ROAD
MORROW, GA 30260

FOR: GENERAL PURPOSE GREASE, IN CLASS 4 (U.S. CLS. 1, 6 AND 15).

FIRST USE 0-0-1993; IN COMMERCE 0-0-1994.

THE MARK CONSISTS OF STANDARD CHARACTERS WITHOUT CLAIM TO ANY PARTICULAR FONT, STYLE, SIZE, OR COLOR.

SER. NO. 85-459,087, FILED 10-28-2011.

SUSAN LESLIE DUBOIS, EXAMINING ATTORNEY



David J. Kyffers

Director of the United States Patent and Trademark Office

United States of America

United States Patent and Trademark Office

STUDY HOTELS

Reg. No. 4,174,618

Registered July 17, 2012

Int. Cl.: 43

SERVICE MARK

PRINCIPAL REGISTER

HOSPITALITY 3, LLC (CONNECTICUT LIMITED LIABILITY COMPANY)
1032 CHAPEL STREET, SUITE 3A
NEW HAVEN, CT 06510

FOR: HOTEL SERVICES, IN CLASS 43 (U.S. CLS. 100 AND 101).

FIRST USE 9-29-2008; IN COMMERCE 9-29-2008.

THE MARK CONSISTS OF STANDARD CHARACTERS WITHOUT CLAIM TO ANY PARTICULAR FONT, STYLE, SIZE, OR COLOR.

OWNER OF U.S. REG. NO. 3,594,738.

NO CLAIM IS MADE TO THE EXCLUSIVE RIGHT TO USE "HOTELS", APART FROM THE MARK AS SHOWN.

SER. NO. 85-459,112, FILED 10-28-2011.

HEATHER BIDDULPH, EXAMINING ATTORNEY



David J. Kyffers

Director of the United States Patent and Trademark Office

United States of America

United States Patent and Trademark Office



Reg. No. 4,174,619

Registered July 17, 2012

Int. Cl.: 28

TRADEMARK

PRINCIPAL REGISTER

KHIRO SKATEBOARD PRODUCTS LLC (CALIFORNIA LIMITED LIABILITY COMPANY)
5
747 NORTH TWIN OAKS VALLEY ROAD
SAN MARCOS, CA 92069

FOR: SKATEBOARDING ACCESSORIES, NAMELY, BUSHINGS, BOLTS, LOCK NUTS, BALL BEARINGS, SKATEBOARD RAILS, SKATEBOARD RISERS, SKATEBOARD TRUCKS, SKATEBOARD WHEELS, SKATEBOARD WAX, SKATEBOARD SHOCK PADS, IN CLASS 28 (U.S. CLS. 22, 23, 38 AND 50).

FIRST USE 1-0-2010; IN COMMERCE 1-0-2010.

OWNER OF U.S. REG. NOS. 3,162,005 AND 3,162,006.

NO CLAIM IS MADE TO THE EXCLUSIVE RIGHT TO USE "SKATEBOARD PRODUCTS", APART FROM THE MARK AS SHOWN.

THE MARK CONSISTS OF A BLACK SHIELD CONTAINING A WHITE OUTLINE WITHIN THE INNER EDGE OF THE SHIELD, THE WORD "KHIRO" APPEARS IN WHITE LETTERS IN THE CENTER OF THE SHIELD, THE WORDS "SKATEBOARD PRODUCTS" IN WHITE, EXCEPT FOR THE LETTER "D" IN BLACK, BELOW, A BLACK AND WHITE BANNER CONTAINING THE WORD "HONOR" IN WHITE, THE LETTER "K" IN WHITE BELOW THE BANNER, THE THREE WHITE SWORDS EXTEND THROUGH THE WORDS "SKATEBOARD PRODUCTS" AND "HONOR", AND BISECTED BY THE LETTER "K" AT THE TIP, A WHITE CIRCLE SURROUNDS THE HANDLE OF THE CENTER SWORD. THE COLORS BLACK AND WHITE REPRESENT BACKGROUND, OUTLINING, SHADING AND ARE NOT PART OF THE MARK.

SER. NO. 85-459,118, FILED 10-28-2011.

TIMOTHY FINNEGAN, EXAMINING ATTORNEY



David J. Kybas

Director of the United States Patent and Trademark Office

United States of America

United States Patent and Trademark Office

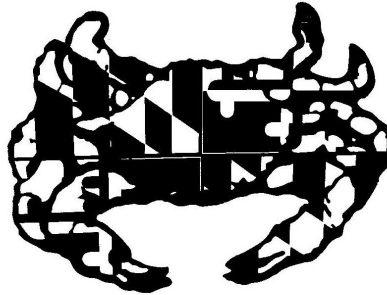

Reg. No. 4,174,620

ANDERSON, RICHARD (UNITED STATES INDIVIDUAL)
2176 SCHUSTER ROAD
JARRETTSVILLE, MD 21084

Registered July 17, 2012

Int. Cl.: 43

FOR: RESTAURANT SERVICES, IN CLASS 43 (U.S. CLS. 100 AND 101).

SERVICE MARK

FIRST USE 8-10-2010; IN COMMERCE 8-10-2010.

PRINCIPAL REGISTER

THE MARK CONSISTS OF AN ATLANTIC BLUE CRAB FACING DOWN. INFUSED INTO THE CRAB IS THE DESIGN OF MARYLAND'S CRESTS: CHECKERED IN THE UPPER-LEFT AND LOWER- RIGHT CORNERS AND CROSSES IN THE UPPER-RIGHT AND LOWER-LEFT CORNERS.

SER. NO. 85-459,149, FILED 10-28-2011.

ANGELA DUONG, EXAMINING ATTORNEY



David J. Kyjars

Director of the United States Patent and Trademark Office

United States of America
United States Patent and Trademark Office

study
HOTELS

Reg. No. 4,174,621

HOSPITALITY 3, LLC (CONNECTICUT LIMITED LIABILITY COMPANY)
1032 CHAPEL STREET, SUITE 3A
NEW HAVEN, CT 06510

Registered July 17, 2012

Int. Cl.: 43

FOR: HOTEL SERVICES, IN CLASS 43 (U.S. CLS. 100 AND 101).

SERVICE MARK

FIRST USE 9-29-2008; IN COMMERCE 9-29-2008.

PRINCIPAL REGISTER

OWNER OF U.S. REG. NO. 3,594,738.

NO CLAIM IS MADE TO THE EXCLUSIVE RIGHT TO USE "HOTELS", APART FROM THE MARK AS SHOWN.

THE MARK CONSISTS OF THE WORD "STUDY" IN LOWER CASE LETTERS WITH THE WORD "HOTELS" IN UPPER CASE LETTERS AND POSITIONED BELOW THE "U" AND "D" OF THE WORD "STUDY". THE WORD "HOTELS" IS ALSO SHOWN IN A SMALLER SIZED FONT THAN THAT USED FOR THE WORD "STUDY".

SER. NO. 85-459,207, FILED 10-28-2011.

HEATHER BIDDULPH, EXAMINING ATTORNEY



David J. Kyffers

Director of the United States Patent and Trademark Office

United States of America

United States Patent and Trademark Office

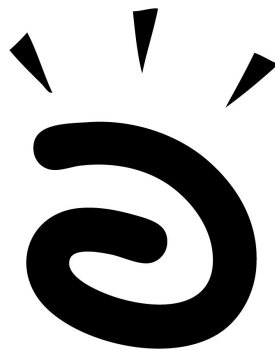

Reg. No. 4,174,622

SNAPDRAGON FASHIONS, LLC (PENNSYLVANIA LIMITED LIABILITY COMPANY)
201 BERWIND ROAD
WAYNE, PA 19087

Registered July 17, 2012

Int. Cl.: 25

FOR: JEANS, JACKETS, FABRIC CUFFS, AND SNAP-ON ACCESSORIES FOR CLOTHING,
NAMELY, FABRIC CUFFS AND FABRIC COLLARS, IN CLASS 25 (U.S. CLS. 22 AND 39).

TRADEMARK

FIRST USE 5-0-2011; IN COMMERCE 5-0-2011.

PRINCIPAL REGISTER

THE MARK CONSISTS OF A REVERSED UPPER CASE "G" HAVING THREE RADIALLY
ORIENTED TRIANGLES ABOVE IT.

SER. NO. 85-459,283, FILED 10-28-2011.

ZHALEH DELANEY, EXAMINING ATTORNEY



David J. Kybas

Director of the United States Patent and Trademark Office

United States of America

United States Patent and Trademark Office



Reg. No. 4,174,623

ACCETTA, ANTHONY (UNITED STATES INDIVIDUAL)
15 MIRALESTE PLAZA

Registered July 17, 2012

RANCHO PALOS VERDES, CA 90275

Int. Cl.: 43

FOR: RESTAURANT SERVICES FEATURING SANDWICHES; SANDWICH SHOP SERVICES; TAKE-OUT FOOD SERVICES; FAST-FOOD RESTAURANT SERVICES FOR CONSUMPTION ON AND OFF THE PREMISES; CATERING SERVICES, IN CLASS 43 (U.S. CLS. 100 AND 101).

SERVICE MARK

PRINCIPAL REGISTER

FIRST USE 2-11-2008; IN COMMERCE 10-1-2011.

NO CLAIM IS MADE TO THE EXCLUSIVE RIGHT TO USE "GOURMET" AND "SANDWICH CO.", APART FROM THE MARK AS SHOWN.

THE MARK CONSISTS OF THE STYLIZED WORDS "CAPICOLA'S GOURMET SANDWICH CO." DISPLAYED WITHIN A CONCENTRIC CIRCULAR SHAPED DESIGN. THE INNER CIRCLE CONTAINS TWO SEMI-CIRCLES.

SER. NO. 85-459,379, FILED 10-28-2011.

KAREN BRACEY, EXAMINING ATTORNEY



David J. Kybas

Director of the United States Patent and Trademark Office

United States of America

United States Patent and Trademark Office

GOLD STANDARD BLOCKER

Reg. No. 4,174,624

GOLDEN WEST BIOLOGICALS, INC. (CALIFORNIA CORPORATION)
27625 COMMERCE CENTER DRIVE
TEMECULA, CA 92590

Registered July 17, 2012

Int. Cl.: 1

FOR: BIOCHEMICALS, NAMELY, MONOCLONAL ANTIBODIES FOR IN VITRO SCIENTIFIC OR RESEARCH USE; BIOCHEMICALS, NAMELY, MONOCLONAL ANTIBODIES FOR SCIENTIFIC OR RESEARCH USE AS IMMUNOASSAY BLOCKING AGENTS, IN CLASS 1 (U.S. CLS. 1, 5, 6, 10, 26 AND 46).

TRADEMARK

PRINCIPAL REGISTER

FIRST USE 9-21-2010; IN COMMERCE 9-21-2010.

THE MARK CONSISTS OF STANDARD CHARACTERS WITHOUT CLAIM TO ANY PARTICULAR FONT, STYLE, SIZE, OR COLOR.

NO CLAIM IS MADE TO THE EXCLUSIVE RIGHT TO USE "BLOCKER", APART FROM THE MARK AS SHOWN.

SER. NO. 85-459,506, FILED 10-28-2011.

AHSEN KHAN, EXAMINING ATTORNEY



David J. Kybas

Director of the United States Patent and Trademark Office

United States of America

United States Patent and Trademark Office

We dish out the good stuff.

Reg. No. 4,174,625

Registered July 17, 2012

Int. Cl.: 35

SERVICE MARK

PRINCIPAL REGISTER

PET PANTRY SUPER DISCOUNT STORES (CONNECTICUT LIMITED LIABILITY COMPANY)
290 RAILROAD AVE
GREENWICH, CT 06830

FOR: RETAIL PET STORES, IN CLASS 35 (U.S. CLS. 100, 101 AND 102).

FIRST USE 9-0-2009; IN COMMERCE 9-0-2009.

THE MARK CONSISTS OF THE STYLIZED TEXT "WE DISH OUT THE GOOD STUFF".

SER. NO. 85-459,541, FILED 10-28-2011.

CHRISTINA SOBRAL, EXAMINING ATTORNEY



David J. Kybas

Director of the United States Patent and Trademark Office

United States of America

United States Patent and Trademark Office

Samy's Camera

Reg. No. 4,174,626

Registered July 17, 2012

**Int. Cls.: 9, 35, 37, 40
and 41**

TRADEMARK

SERVICE MARK

PRINCIPAL REGISTER

SAMY'S CAMERA, INC. (CALIFORNIA CORPORATION)
SAMY'S CAMERA, INC.
12636 BEATRICE STREET
LOS ANGELES, CA 90066

FOR: PHOTOGRAPHIC EQUIPMENT, HARDWARE AND ACCESSORIES, NAMELY, CAMERAS, LENSES, FILTERS, TRIPODS, CAMERA BAGS, LIGHTING, NAMELY, ELECTRONIC FLASH EQUIPMENT, CONSTANT LIGHT EQUIPMENT, COLLAPSIBLE LIGHT DIRECTORS AND DIFFUSERS FOR USE WITH PHOTOGRAPHIC LIGHTING EQUIPMENT FOR PROFESSIONAL AND HIGH-END PHOTOGRAPHY, PHOTO ENLARGERS, PHOTOGRAPHIC FILM; DIGITAL IMAGING EQUIPMENT, NAMELY, COMPUTERS, DIGITAL CAMERAS, PRINTERS, SCANNERS AND COMPUTER SOFTWARE (FOR USE IN PROCESSING AND MANIPULATING DIGITAL IMAGES IN THE FIELD OF PHOTOGRAPHY); AUDIO/VIDEO EQUIPMENT, NAMELY, CONSUMER-GRADE VIDEO CAMERAS, PROFESSIONAL-GRADE VIDEO CAMERAS, CAMCORDERS, MICROPHONES, DIGITAL RECORDERS, TAPE RECORDERS, HEADPHONES, AND AUDIO MIXERS, IN CLASS 9 (U.S. CLS. 21, 23, 26, 36 AND 38).

FIRST USE 9-10-1976; IN COMMERCE 9-10-1976.

FOR: RETAIL STORE SERVICES AND ONLINE RETAIL STORE SERVICES FEATURING PHOTOGRAPHIC EQUIPMENT, DIGITAL IMAGING EQUIPMENT, COMPUTER EQUIPMENT AND AUDIO/VIDEO EQUIPMENT, IN CLASS 35 (U.S. CLS. 100, 101 AND 102).

FIRST USE 9-10-1976; IN COMMERCE 10-14-2002.

FOR: CAMERA AND COMPUTER REPAIR, IN CLASS 37 (U.S. CLS. 100, 103 AND 106).

FIRST USE 9-10-1976; IN COMMERCE 9-10-1976.

FOR: FILM PROCESSING AND PHOTOFINISHING; DIGITAL PHOTO PRINTING SERVICES, NAMELY, PHOTO-BOOK PRINTING AND PHOTOGRAPHIC PRINTING, IN CLASS 40 (U.S. CLS. 100, 103 AND 106).

FIRST USE 9-10-1976; IN COMMERCE 10-14-2002.



David J. Kyjars

Director of the United States Patent and Trademark Office

Reg. No. 4,174,626 FOR: EDUCATION SERVICES, NAMELY, PROVIDING CLASSES, SEMINARS, WORKSHOPS IN THE FIELD OF PHOTOGRAPHY, VIDEO-MAKING, PRODUCT TRAINING, PHOTOGRAPHIC BOOKMAKING AND SOFTWARE; RENTAL OF PHOTOGRAPHIC EQUIPMENT, DIGITAL IMAGING EQUIPMENT, COMPUTERS AND AUDIO/VIDEO EQUIPMENT, IN CLASS 41 (U.S. CLS. 100, 101 AND 107).

FIRST USE 1-3-1977; IN COMMERCE 1-3-1977.

THE MARK CONSISTS OF STANDARD CHARACTERS WITHOUT CLAIM TO ANY PARTICULAR FONT, STYLE, SIZE, OR COLOR.

NO CLAIM IS MADE TO THE EXCLUSIVE RIGHT TO USE "CAMERA", APART FROM THE MARK AS SHOWN.

SER. NO. 85-459,546, FILED 10-28-2011.

JESSICA FATHY, EXAMINING ATTORNEY

United States of America

United States Patent and Trademark Office

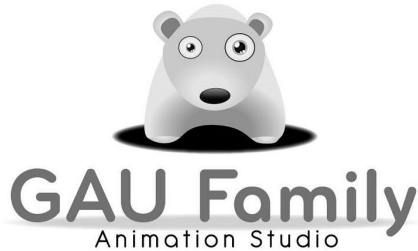

Reg. No. 4,174,627

Registered July 17, 2012

Int. Cl.: 42

SERVICE MARK

PRINCIPAL REGISTER

BUI, DANG H. (VIETNAM INDIVIDUAL)
5031 TIMBERWOOD COURT
WEST DES MOINES, IA 50265

FOR: ANIMATION AND SPECIAL-EFFECTS DESIGN FOR OTHERS; ANIMATION DESIGN FOR OTHERS; COMPUTER GRAPHICS DESIGN SERVICES, NAMELY, CREATING OF 3D MODELLING, GRAPHIC DESIGN, OIL PAINTING, COMIC, SCI-FI ART, DIGITAL ART, CONCEPT ART, AS THAT RELATES TO ART, IN CLASS 42 (U.S. CLS. 100 AND 101).

FIRST USE 5-5-2011; IN COMMERCE 5-5-2011.

NO CLAIM IS MADE TO THE EXCLUSIVE RIGHT TO USE "ANIMATION STUDIO", APART FROM THE MARK AS SHOWN.

THE LIKENESS (OR, "PORTRAIT") IN THE MARK DOES NOT IDENTIFY A LIVING INDIVIDUAL.

THE MARK CONSISTS OF A POLAR BEAR WITH LARGER SIZED LEFT EYE STANDING ON A CIRCLE, CENTERED BELOW THAT ARE THE WORDS "GAU FAMILY" AND THEN BELOW THAT "ANIMATION STUDIO".

SER. NO. 85-459,597, FILED 10-28-2011.

KEVON CHISOLM, EXAMINING ATTORNEY



David J. Kybas

Director of the United States Patent and Trademark Office

United States of America

United States Patent and Trademark Office



MADISON35

P R O D U C T I O N S

Reg. No. 4,174,628

BORUCHOWITZ, DAN (FED REP GERMANY INDIVIDUAL)
7 E. 35TH STREET #1F
NEW YORK, NY 10016 AND

Registered July 17, 2012

Int. Cl.: 41

ZAIDERMAN, GENA (UNITED STATES INDIVIDUAL)
7 E. 35TH STREET, #1F
NEW YORK, NY 10016

SERVICE MARK

PRINCIPAL REGISTER

FOR: ENTERTAINMENT IN THE NATURE OF LIVE PERFORMANCES BY MUSICAL BANDS, MUSICIANS, SINGERS AND DANCERS FOR WEDDINGS, PRIVATE PARTIES, SIMCHAS AND OTHER EVENTS. DISC JOCKEY SERVICES FOR WEDDINGS, PRIVATE PARTIES, SIMCHAS AND OTHER EVENTS; THEATRICAL PERFORMANCES PROVIDED AT PUBLIC AND PRIVATE VENUES, IN CLASS 41 (U.S. CLS. 100, 101 AND 107).

FIRST USE 1-1-2010; IN COMMERCE 11-11-2010.

NO CLAIM IS MADE TO THE EXCLUSIVE RIGHT TO USE "PRODUCTIONS", APART FROM THE MARK AS SHOWN.

THE MARK CONSISTS OF THE WORDS "MADISON35" AND "PRODUCTIONS". A SOLID DARK HORIZONTAL LINE SEPARATES THESE WORDS. A FANCIFUL URBAN SKYLINE APPEARS BEHIND THE WORDS "MADISON 35".

SER. NO. 85-459,766, FILED 10-29-2011.

HENRY S. ZAK, EXAMINING ATTORNEY



David J. Kybas

Director of the United States Patent and Trademark Office

United States of America

United States Patent and Trademark Office

Ready2Go Marketing Solutions

Reg. No. 4,174,629

READY2GO MARKETING SOLUTIONS, INC. (COLORADO CORPORATION)

Registered July 17, 2012

3860 RED DEER TRAIL
BROOMFIELD, CO 80020

Int. Cl.: 41

FOR: PROVIDING TRAINING AND EDUCATION TO BUSINESSES IN THE FIELD OF MARKETING THROUGH THE CREATION AND DISTRIBUTION OF PREPACKAGED TELESEMINARS, WORKSHOPS AND AUDIO MATERIALS, AND PROVIDING ONE-ON-ONE COACHING AND LIVE WORKSHOP TRAINING IN CONNECTION THEREWITH, IN CLASS 41 (U.S. CLS. 100, 101 AND 107).

SERVICE MARK

PRINCIPAL REGISTER

FIRST USE 9-1-2008; IN COMMERCE 12-1-2008.

THE MARK CONSISTS OF STANDARD CHARACTERS WITHOUT CLAIM TO ANY PARTICULAR FONT, STYLE, SIZE, OR COLOR.

NO CLAIM IS MADE TO THE EXCLUSIVE RIGHT TO USE "MARKETING SOLUTIONS", APART FROM THE MARK AS SHOWN.

SER. NO. 85-459,973, FILED 10-31-2011.

JACQUELINE A. LAVINE, EXAMINING ATTORNEY



David J. Kybas

Director of the United States Patent and Trademark Office

United States of America

United States Patent and Trademark Office

Greenhorn Connect

Reg. No. 4,174,630

Registered July 17, 2012

Int. Cls.: 35 and 42

SERVICE MARK

PRINCIPAL REGISTER

GREENHORN CONNECT, LLC (MASSACHUSETTS LIMITED LIABILITY COMPANY)
28 MONMOUTH STREET
SOMERVILLE, MA 02143

FOR: ARRANGING AND CONDUCTING SPECIAL EVENTS FOR BUSINESS PURPOSES, NAMELY, FOR ENTREPRENEURS, START-UPS AND STUDENTS; ARRANGING AND CONDUCTING MARKETING PROMOTIONAL EVENTS FOR OTHERS, NAMELY, ENTREPRENEURS AND COMMUNITY ORGANIZATIONS; MEDIA MONITORING SERVICES, NAMELY, MONITORING PRINT MEDIA, TELEVISION, RADIO, AND OTHER MEDIA FOR CUSTOMER-SPECIFIED TOPICS, GATHERING RELEVANT CONTENT ON THOSE TOPICS, AND PROVIDING DOCUMENTATION AND ANALYSIS OF THAT MEDIA CONTENT TO OTHERS FOR BUSINESS PURPOSES; MEDIA PLANNING, NAMELY, ADVISING THE CLIENT ON THE CORRECT TIMES AND STATIONS TO ADVERTISE BASED ON MEDIAL ANALYSIS OF THE MARKET FOR THAT MEDIA; ENDORSEMENT SERVICES, NAMELY, PROMOTING THE GOODS AND SERVICES OF OTHERS; ADVERTISING AND MARKETING SERVICES, NAMELY, PROMOTING THE GOODS AND SERVICES OF OTHERS; PROVIDING MARKETING AND PROMOTION OF SPECIAL EVENTS, IN CLASS 35 (U.S. CLS. 100, 101 AND 102).

FIRST USE 10-7-2009; IN COMMERCE 10-7-2009.

FOR: PROVIDING A WEBSITE FEATURING A MEDIA AGGREGATOR AND SEARCH ENGINE FOR INTERNET CONTENT FOR ENTREPRENEURS AND START-UP BUSINESSES, IN CLASS 42 (U.S. CLS. 100 AND 101).

FIRST USE 10-7-2009; IN COMMERCE 10-7-2009.

THE MARK CONSISTS OF STANDARD CHARACTERS WITHOUT CLAIM TO ANY PARTICULAR FONT, STYLE, SIZE, OR COLOR.

NO CLAIM IS MADE TO THE EXCLUSIVE RIGHT TO USE "CONNECT", APART FROM THE MARK AS SHOWN.

SER. NO. 85-459,995, FILED 10-31-2011.

LOURDES AYALA, EXAMINING ATTORNEY



David J. Kyros

Director of the United States Patent and Trademark Office

United States of America

United States Patent and Trademark Office

U-Gro Learning Centres

Reg. No. 4,174,631

U-GRO LEARNING CENTRES, INC. (PENNSYLVANIA CORPORATION)
3880 TECPORT DRIVE
HARRISBURG, PA 17111

Registered July 17, 2012

Int. Cls.: 41 and 43

FOR: EARLY CHILDHOOD EDUCATION AND PRE-SCHOOL SERVICES, IN CLASS 41 (U.S. CLS. 100, 101 AND 107).

SERVICE MARK

FIRST USE 7-31-1986; IN COMMERCE 7-31-1986.

PRINCIPAL REGISTER

FOR: DAY CARE SERVICES, IN CLASS 43 (U.S. CLS. 100 AND 101).

FIRST USE 7-31-1986; IN COMMERCE 7-31-1986.

THE MARK CONSISTS OF STANDARD CHARACTERS WITHOUT CLAIM TO ANY PARTICULAR FONT, STYLE, SIZE, OR COLOR.

NO CLAIM IS MADE TO THE EXCLUSIVE RIGHT TO USE "LEARNING CENTRES", APART FROM THE MARK AS SHOWN.

SER. NO. 85-460,077, FILED 10-31-2011.

AISHA SALEM, EXAMINING ATTORNEY



David J. Kybas

Director of the United States Patent and Trademark Office

United States of America

United States Patent and Trademark Office



SUSTAINABLE
ENERGY FOR ALL

Reg. No. 4,174,632

Registered July 17, 2012

Int. Cl.: 35

SERVICE MARK

PRINCIPAL REGISTER

UNITED NATIONS FOUNDATION, INC. (NEW YORK CORPORATION)
SUITE 400
1800 MASSACHUSETTS AVE, NW
WASHINGTON, DC 20036

FOR: PROMOTING PUBLIC INTEREST IN AND AWARENESS OF THE IMPORTANCE OF UNIVERSAL ACCESS TO ENERGY, IMPROVED ENERGY EFFICIENCY AND ENHANCED DEPLOYMENT OF RENEWABLE SOURCES, IN CLASS 35 (U.S. CLS. 100, 101 AND 102).

FIRST USE 4-7-2011; IN COMMERCE 4-7-2011.

NO CLAIM IS MADE TO THE EXCLUSIVE RIGHT TO USE "SUSTAINABLE ENERGY FOR ALL", APART FROM THE MARK AS SHOWN.

THE MARK CONSISTS OF FOUR CURVED BANDS WRAPPED AROUND THE LEFT SIDE OF THE WORDS "SUSTAINABLE ENERGY FOR ALL".

SER. NO. 85-460,082, FILED 10-31-2011.

LAKEISHA LEWIS, EXAMINING ATTORNEY



David J. Kyjars

Director of the United States Patent and Trademark Office

United States of America

United States Patent and Trademark Office

ORTHO MD

Reg. No. 4,174,633

Registered July 17, 2012

Int. Cl.: 44

SERVICE MARK

PRINCIPAL REGISTER

ORTHOPAEDIC SPECIALTY CENTER (MARYLAND CORPORATION)
2700 QUARRY LAKE DRIVE, SUITE 300
BALTIMORE, MD 21209

FOR: MEDICAL SERVICES, IN CLASS 44 (U.S. CLS. 100 AND 101).

FIRST USE 1-1-2005; IN COMMERCE 1-1-2005.

THE MARK CONSISTS OF STANDARD CHARACTERS WITHOUT CLAIM TO ANY PARTICULAR FONT, STYLE, SIZE, OR COLOR.

NO CLAIM IS MADE TO THE EXCLUSIVE RIGHT TO USE "MD", APART FROM THE MARK AS SHOWN.

SEC. 2(F).

SER. NO. 85-460,248, FILED 10-31-2011.

TASNEEM HUSSAIN, EXAMINING ATTORNEY



David J. Kyros

Director of the United States Patent and Trademark Office

United States of America

United States Patent and Trademark Office

Fresh Look

Reg. No. 4,174,634

FRESH LOOK CONSULTING, LLC (MINNESOTA LIMITED LIABILITY COMPANY)
6517 WILLOW WOOD ROAD
EDINA, MN 55436

Registered July 17, 2012

Int. Cl.: 35

FOR: PROVIDING BUSINESS ADVISORY AND CONSULTING SERVICES IN THE FIELDS OF STRATEGIC ASSESSMENT, BUSINESS OPPORTUNITY, ACQUISITION, DIVESTITURE AND TURNAROUNDS, AND BRAND REMARKETING AND REPOSITIONING, ON BEHALF OF INDIVIDUALS AND BUSINESSES, INCLUDING FOR-PROFIT AND NON-PROFIT ENTITIES, IN CLASS 35 (U.S. CLS. 100, 101 AND 102).

SERVICE MARK

PRINCIPAL REGISTER

FIRST USE 10-4-2011; IN COMMERCE 10-13-2011.

THE MARK CONSISTS OF STANDARD CHARACTERS WITHOUT CLAIM TO ANY PARTICULAR FONT, STYLE, SIZE, OR COLOR.

SER. NO. 85-460,324, FILED 10-31-2011.

AMY HELLA, EXAMINING ATTORNEY



David J. Kyffers

Director of the United States Patent and Trademark Office

United States of America

United States Patent and Trademark Office

SEAPURE

Reg. No. 4,174,635

LONZA ROCKLAND, INC. (DELAWARE CORPORATION)
191 THOMASTON STREET
ROCKLAND, ME 048412994

Registered July 17, 2012

Int. Cl.: 1

FOR: AGAROSE POWDER FOR USE AS GELLING AGENTS AND STABILIZERS IN MANUFACTURING PROCESSES, IN CLASS 1 (U.S. CLS. 1, 5, 6, 10, 26 AND 46).

TRADEMARK

FIRST USE 3-0-2007; IN COMMERCE 3-0-2007.

PRINCIPAL REGISTER

THE MARK CONSISTS OF STANDARD CHARACTERS WITHOUT CLAIM TO ANY PARTICULAR FONT, STYLE, SIZE, OR COLOR.

SER. NO. 85-460,334, FILED 10-31-2011.

RONALD MCMORROW, EXAMINING ATTORNEY



David J. Kybas

Director of the United States Patent and Trademark Office

United States of America

United States Patent and Trademark Office



LEARNING CENTRES

Reg. No. 4,174,636

Registered July 17, 2012

Int. Cls.: 41 and 43

SERVICE MARK

PRINCIPAL REGISTER

U-GRO LEARNING CENTRES, INC. (PENNSYLVANIA CORPORATION)
3880 TECPORT DRIVE
HARRISBURG, PA 17111

FOR: EARLY CHILDHOOD EDUCATION AND PRE-SCHOOL SERVICES, IN CLASS 41 (U.S. CLS. 100, 101 AND 107).

FIRST USE 6-30-2010; IN COMMERCE 6-30-2010.

FOR: DAY CARE SERVICES, IN CLASS 43 (U.S. CLS. 100 AND 101).

FIRST USE 6-30-2010; IN COMMERCE 6-30-2010.

NO CLAIM IS MADE TO THE EXCLUSIVE RIGHT TO USE "LEARNING CENTRES", APART FROM THE MARK AS SHOWN.

THE MARK CONSISTS OF THE STYLIZED WORDING "U-GRO" SURROUNDED BY AN OBLONG BORDER WITH THE WORDING "LEARNING CENTRES" UNDERNEATH.

SER. NO. 85-460,376, FILED 10-31-2011.

AISHA SALEM, EXAMINING ATTORNEY

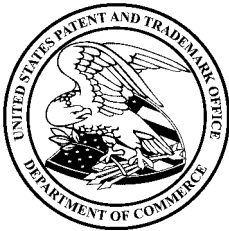

David J. Kybas

Director of the United States Patent and Trademark Office

United States of America

United States Patent and Trademark Office

THE LEVO LEAGUE

Reg. No. 4,174,637

Registered July 17, 2012

Int. Cl.: 35

SERVICE MARK

PRINCIPAL REGISTER

THE LEVO LEAGUE LLC (DELAWARE LIMITED LIABILITY COMPANY)
122 GREENWICH AVENUE, # 2B
NEW YORK, NY 10011

FOR: INFORMATION SERVICES, NAMELY, DISSEMINATION OVER THE INTERNET OF INFORMATION FOR YOUNG PROFESSIONAL WOMEN IN THE FIELDS OF CAREER ADVICE AND EMPLOYMENT ADVICE, IN CLASS 35 (U.S. CLS. 100, 101 AND 102).

FIRST USE 7-6-2011; IN COMMERCE 7-6-2011.

THE MARK CONSISTS OF STANDARD CHARACTERS WITHOUT CLAIM TO ANY PARTICULAR FONT, STYLE, SIZE, OR COLOR.

NO CLAIM IS MADE TO THE EXCLUSIVE RIGHT TO USE "LEAGUE", APART FROM THE MARK AS SHOWN.

SER. NO. 85-460,479, FILED 10-31-2011.

JACLYN KIDWELL WALKER, EXAMINING ATTORNEY



David J. Kyffers

Director of the United States Patent and Trademark Office

United States of America

United States Patent and Trademark Office



Reg. No. 4,174,638

Registered July 17, 2012

Int. Cls.: 6, 8 and 22

TRADEMARK

PRINCIPAL REGISTER

LANDMANN WIRE ROPE PRODUCTS, INC. (CALIFORNIA CORPORATION)
SUITE 148
1818 GILBRETH ROAD
BURLINGAME, CA 94010

FOR: WIRE ROPES; WIRE ROPE USED FOR LIFTING AND RIGGING; WIRE ROPE SLING; STEEL WIRE ROPE; WIRE ROPE FITTINGS OF METAL, NAMELY, SWAGED, IMPACT SWAGED, AND COMPACTED SOCKETS, THREADED STUDS, BUTTONS, AND LOOP; CHAIN BLOCK USED FOR LIFTING AND RIGGING; CHAIN HOIST USED FOR LIFTING AND RIGGING; METAL RIGGING CHAIN; METAL SHACKLES AND HOOKS FOR LIFTING; METAL HARDWARE, NAMELY, SWIVELS, EYE BOLTS, EYE NUTS, CHAIN, BINDER CHAINS, QUICK LINKS, SNAP LINKS, SWAGE SLEEVES, DOUBLE-END SWIVELS, WIRE ROPE CLIPS, THIMBLES, ANCHOR SHACKLES, CHAIN SHACKLES, MASTER LINKS, PEAR LINKS, ROUND RINGS AND HOIST HOOKS; METAL TURNBUCKLES; METAL LOAD BINDERS, IN CLASS 6 (U.S. CLS. 2, 12, 13, 14, 23, 25 AND 50).

FIRST USE 6-1-1998; IN COMMERCE 6-1-1998.

FOR: HAND TOOLS, NAMELY, WIRE ROPE CUTTERS AND SWAGERS; RATCHET ASSEMBLIES, NAMELY, HAND OPERATED RATCHET WRENCHES; MANUALLY OPERATED METAL WINCH BARS USED TO TURN WINCH SPOOLS AND TIGHTEN WINCH STRAPS, IN CLASS 8 (U.S. CLS. 23, 28 AND 44).

FIRST USE 6-1-1998; IN COMMERCE 6-1-1998.

FOR: CARGO CONTROL EQUIPMENT FOR VEHICLES, NAMELY, RATCHET AND QUICK RELEASE TIE DOWN STRAPS; NON-METAL STRAPPING IN THE NATURE OF WINCH STRAPS, IN CLASS 22 (U.S. CLS. 1, 2, 7, 19, 22, 42 AND 50).

FIRST USE 6-1-1998; IN COMMERCE 6-1-1998.

THE MARK CONSISTS OF THE STANDARD CHARACTER "LANDMANN" BELOW A PARTIAL TOP PLANAR VIEW OF AN ANCHOR SHACKLE.

SER. NO. 85-460,790, FILED 10-31-2011.

COLLEEN DOMBROW, EXAMINING ATTORNEY



David J. Kyros

Director of the United States Patent and Trademark Office

United States of America

United States Patent and Trademark Office

FAKE IT 2 MAKE IT

Reg. No. 4,174,639

FAKEIT2MAKEIT, LLC (FLORIDA LIMITED LIABILITY COMPANY)

Registered July 17, 2012

P.O. BOX 954027
LAKE MARY, FL 32795

Int. Cl.: 42

FOR: PROVIDING A WEBSITE FEATURING TECHNOLOGY THAT ALLOWS USERS TO PUBLISH PERSONAL CONTENT THAT WILL BE VOTED ON, SHARED AND COMMENTED ON; COMPUTER SERVICES, NAMELY, CREATING AN ON-LINE COMMUNITY FOR REGISTERED USERS TO PARTICIPATE IN DISCUSSIONS, GET FEEDBACK FROM THEIR PEERS, FORM VIRTUAL COMMUNITIES, AND ENGAGE IN SOCIAL NETWORKING; PROVIDING A WEBSITE THAT GIVES USERS THE ABILITY TO REVIEW VARIOUS PRINT, PHOTOGRAPHIC, GRAPHIC IMAGE, AND AUDIO AND VIDEO CONTENT AND UTILIZE A CUSTOM TEMPLATE TO PROVIDE INPUT, LIKES, DISLIKES, EDITS, CHANGES, MODIFICATIONS, OPINIONS, SUGGESTIONS, AND COMMENTS AND ENGAGE IN SOCIAL, BUSINESS AND COMMUNITY NETWORKING; PROVIDING NON-DOWNLOADABLE ON-LINE COMPUTER DATABASE SOFTWARE THAT PROVIDES USERS UP TO DATE NOTIFICATIONS ON USERS' RECENT ACTIVITY, IN CLASS 42 (U.S. CLS. 100 AND 101).

SERVICE MARK

PRINCIPAL REGISTER

FIRST USE 1-31-2010; IN COMMERCE 10-19-2011.

THE MARK CONSISTS OF STANDARD CHARACTERS WITHOUT CLAIM TO ANY PARTICULAR FONT, STYLE, SIZE, OR COLOR.

SER. NO. 85-460,807, FILED 10-31-2011.

JASON BLAIR, EXAMINING ATTORNEY



David J. Kyffers

Director of the United States Patent and Trademark Office

United States of America

United States Patent and Trademark Office

Cloud Path

Reg. No. 4,174,640

Registered July 17, 2012

Int. Cl.: 42

SERVICE MARK

PRINCIPAL REGISTER

RACEMI, INC. (DELAWARE CORPORATION)
#360
360 INTERSTATE NORTH PARKWAY SE
ATLANTA, GA 30339

FOR: SOFTWARE AS A SERVICE (SAAS) SERVICES FEATURING A HOSTED COMPUTER SOFTWARE APPLICATION FOR MIGRATING COMPUTER OPERATING SYSTEMS, APPLICATIONS, AND DATA BETWEEN CUSTOMER DATA CENTERS AND PUBLIC CLOUD PROVIDERS, IN CLASS 42 (U.S. CLS. 100 AND 101).

FIRST USE 8-23-2011; IN COMMERCE 8-23-2011.

THE MARK CONSISTS OF STANDARD CHARACTERS WITHOUT CLAIM TO ANY PARTICULAR FONT, STYLE, SIZE, OR COLOR.

NO CLAIM IS MADE TO THE EXCLUSIVE RIGHT TO USE "CLOUD", APART FROM THE MARK AS SHOWN.

SER. NO. 85-460,848, FILED 10-31-2011.

ALAIN LAPTER, EXAMINING ATTORNEY



David J. Kyffers

Director of the United States Patent and Trademark Office

United States of America
United States Patent and Trademark Office

FORTRESS
f u n d i n g

Reg. No. 4,174,641

Registered July 17, 2012

Int. Cl.: 36

SERVICE MARK

PRINCIPAL REGISTER

FORTRESS FUNDING, LLC (FLORIDA LIMITED LIABILITY COMPANY)
SUITE 100
7777 GLADES ROAD
BOCA RATON, FL 33434

FOR: FINANCIAL SERVICES IN THE FIELD OF STRUCTURED SETTLEMENTS, NAMELY, THE ACQUISITION AND TRANSFER OF STRUCTURED SETTLEMENTS FOR OTHERS , IN CLASS 36 (U.S. CLS. 100, 101 AND 102).

FIRST USE 9-1-2011; IN COMMERCE 9-1-2011.

NO CLAIM IS MADE TO THE EXCLUSIVE RIGHT TO USE "FUNDING", APART FROM THE MARK AS SHOWN.

THE COLOR(S) BLUE AND BLACK IS/ARE CLAIMED AS A FEATURE OF THE MARK.

THE MARK CONSISTS OF THE WORD "FORTRESS" IN BLUE WITH BLACK SHADING AND OUTLINING WITH "\$\$" AS THE TWO ENDING LETTERS ABOVE A BLACK LINE WITH THE WORD "FUNDING" IN BLACK. THE COLOR WHITE REPRESENTS BACKGROUND AND IS NOT PART OF THE MARK.

SER. NO. 85-460,973, FILED 10-31-2011.

DOUGLAS LEE, EXAMINING ATTORNEY



David J. Kyros

Director of the United States Patent and Trademark Office

United States of America

United States Patent and Trademark Office

LIPO ILLUSION

Reg. No. 4,174,642

DREAM BODIES CORPORATION (CALIFORNIA CORPORATION)
817 BOWSPRIT ROAD
CHULA VISTA, CA 91914

Registered July 17, 2012

Int. Cl.: 25

FOR: BODY SHAPERS; UNDERGARMENTS; SHAPEWEAR, NAMELY, GIRDLES AND PANTS WITH ABDOMINAL CONTROL; CORSETS; PANTIES; UNDERCLOTHES AND APPAREL, NAMELY, PANTS AND SHIRTS, IN CLASS 25 (U.S. CLS. 22 AND 39).

TRADEMARK

FIRST USE 4-23-2007; IN COMMERCE 4-23-2007.

PRINCIPAL REGISTER

THE MARK CONSISTS OF STANDARD CHARACTERS WITHOUT CLAIM TO ANY PARTICULAR FONT, STYLE, SIZE, OR COLOR.

SER. NO. 85-460,993, FILED 10-31-2011.

ERIN FALK, EXAMINING ATTORNEY



David J. Kyffers

Director of the United States Patent and Trademark Office

United States of America

United States Patent and Trademark Office



Reg. No. 4,174,643

Registered July 17, 2012

Int. Cl.: 37

SERVICE MARK

PRINCIPAL REGISTER

CLEAN CLUBS LTD (GREAT BRITAIN LIMITED LIABILITY COMPANY), TA CLUB-CLEAN
3 PORTAL BUSINESS PARK
EATON LANE
TARPORLEY, CHESHIRE, GREAT BRITAIN CW69DL

FOR: ULTRASONIC GOLF CLUB CLEANING SERVICES, NAMELY, ULTRASONIC
CLEANING OF GOLF CLUBS , IN CLASS 37 (U.S. CLS. 100, 103 AND 106).

OWNER OF GREAT BRITAIN REG. NO. 2459426, DATED 6-25-2007, EXPIRES 6-25-2017.

THE COLOR(S) PURPLE, WHITE, BLACK AND SILVER IS/ARE CLAIMED AS A FEATURE
OF THE MARK.

NO CLAIM IS MADE TO THE EXCLUSIVE RIGHT TO USE "DIGITAL ULTRASONIC GOLF
CLUB", APART FROM THE MARK AS SHOWN.

THE MARK CONSISTS OF "CLUB-CLEAN" IN 3D FORMAT IN BLACK, SILVER FIVE
POINTED STAR OVER PURPLE TRIANGLE, "DIGITAL ULTRASONIC GOLF CLUB VALET"
IN BLACK UNDER 3D TEXT, ALL ON A WHITE BACKGROUND.

SER. NO. 85-461,050, FILED 11-1-2011.

KAELIE KUNG, EXAMINING ATTORNEY



David J. Kyjars

Director of the United States Patent and Trademark Office

United States of America

United States Patent and Trademark Office

STICK IT TO THE BUG

Reg. No. 4,174,644

KEIM, DONALD E. (UNITED STATES INDIVIDUAL)
713 JAKE LANDIS ROAD
LITITZ, PA 17543

Registered July 17, 2012

Int. Cl.: 21

FOR: ADHESIVE DEVICES FOR ACTIVELY CAPTURING INSECTS, IN CLASS 21 (U.S. CLS. 2, 13, 23, 29, 30, 33, 40 AND 50).

TRADEMARK

FIRST USE 9-30-2011; IN COMMERCE 9-30-2011.

PRINCIPAL REGISTER

THE MARK CONSISTS OF STANDARD CHARACTERS WITHOUT CLAIM TO ANY PARTICULAR FONT, STYLE, SIZE, OR COLOR.

SER. NO. 85-461,055, FILED 11-1-2011.

KAELIE KUNG, EXAMINING ATTORNEY



David J. Kybas

Director of the United States Patent and Trademark Office

United States of America

United States Patent and Trademark Office

networkingworks!

Building Relationships • Building Business

Reg. No. 4,174,645

SANDLER SYSTEMS, INC. (MARYLAND CORPORATION), DBA SANDLER TRAINING
300 RED BROOK BOULEVARD, SUITE 400
OWINGS MILLS, MD 21117

Registered July 17, 2012

Int. Cl.: 41

FOR: EDUCATIONAL SERVICES, NAMELY, CONDUCTING TRAINING THROUGH SEMINARS, MEETINGS, WORKSHOPS AND ON-LINE PRESENTATIONS IN THE FIELD OF INCREASING THE EFFECTIVENESS OF PERSONS WHOSE GOAL IS TO EFFECTUATE PURCHASES OF PRODUCTS OR SERVICES AND DISTRIBUTION OF EDUCATIONAL MATERIALS IN CONNECTION THEREWITH, IN CLASS 41 (U.S. CLS. 100, 101 AND 107).

SERVICE MARK

PRINCIPAL REGISTER

FIRST USE 6-16-2011; IN COMMERCE 6-16-2011.

THE MARK CONSISTS OF THE WORDING "NETWORKINGWORKS! BUILDING RELATIONSHIPS BUILDING BUSINESS" IN STYLIZED FORM.

SER. NO. 85-461,094, FILED 11-1-2011.

JOHN E. MICHOS, EXAMINING ATTORNEY



David J. Kyffers

Director of the United States Patent and Trademark Office

United States of America

United States Patent and Trademark Office

Sallie Mae 529 Rewards

Reg. No. 4,174,646

SALLIE MAE, INC. (DELAWARE CORPORATION)
2001 EDMUND HALLEY DRIVE
RESTON, VA 20191

Registered July 17, 2012

Int. Cl.: 36

FOR: CREDIT CARD SERVICES FEATURING A REWARD PROGRAM TO HELP SAVE FOR HIGHER EDUCATION, IN CLASS 36 (U.S. CLS. 100, 101 AND 102).

SERVICE MARK

FIRST USE 10-31-2011; IN COMMERCE 10-31-2011.

PRINCIPAL REGISTER

THE MARK CONSISTS OF STANDARD CHARACTERS WITHOUT CLAIM TO ANY PARTICULAR FONT, STYLE, SIZE, OR COLOR.

OWNER OF U.S. REG. NOS. 1,337,128, 3,144,398 AND OTHERS.

NO CLAIM IS MADE TO THE EXCLUSIVE RIGHT TO USE "529 REWARDS", APART FROM THE MARK AS SHOWN.

SER. NO. 85-461,106, FILED 11-1-2011.

MICHAEL GAAFAR, EXAMINING ATTORNEY



David J. Kyffers

Director of the United States Patent and Trademark Office

United States of America

United States Patent and Trademark Office



Reg. No. 4,174,647

Registered July 17, 2012

Int. Cl.: 28

TRADEMARK

PRINCIPAL REGISTER

CARO, RICHARD (UNITED STATES INDIVIDUAL)
710 TUPPER ST.
SANTA ROSA, CA 95404

FOR: FISHING LURES, IN CLASS 28 (U.S. CLS. 22, 23, 38 AND 50).

FIRST USE 4-1-2010; IN COMMERCE 4-1-2010.

NO CLAIM IS MADE TO THE EXCLUSIVE RIGHT TO USE "BAIT CO." , APART FROM THE MARK AS SHOWN.

THE MARK CONSISTS OF AN OUTLINE OF AN INDIVIDUAL FISHING IN A BOAT ON WATER WITH THE STYLIZED TEXT "CATCHEMCARO BAIT CO." BELOW THE WATER AND A FISHING LURE BELOW THE TEXT, ALL CONTAINED A STYLIZED BACKGROUND WITH A STRAIGHT LINE ON TOP AND A CURVED LINE PASSING BELOW THE FISHING LURE AND CONNECTING THE TWO ENDS OF THE STRAIGHT LINE.

SER. NO. 85-461,272, FILED 11-1-2011.

NICHOLAS COLEMAN, EXAMINING ATTORNEY



David J. Kyffers

Director of the United States Patent and Trademark Office

United States of America

United States Patent and Trademark Office

THE RELAXING TRANSITION TO RETIREMENT PROGRAM

Reg. No. 4,174,648

Registered July 17, 2012

Int. Cl.: 36

SERVICE MARK

PRINCIPAL REGISTER

STRATEGIC PLANNING GROUP, INC. (MASSACHUSETTS CORPORATION)
SUITE 306
57 RIVER STREET
WELLESLEY, MA 02481

FOR: FINANCIAL PLANNING FOR RETIREMENT, IN CLASS 36 (U.S. CLS. 100, 101 AND 102).

FIRST USE 10-1-2001; IN COMMERCE 10-1-2001.

THE MARK CONSISTS OF STANDARD CHARACTERS WITHOUT CLAIM TO ANY PARTICULAR FONT, STYLE, SIZE, OR COLOR.

NO CLAIM IS MADE TO THE EXCLUSIVE RIGHT TO USE "PROGRAM", APART FROM THE MARK AS SHOWN.

SER. NO. 85-461,310, FILED 11-1-2011.

JULIE GUTTADAURO, EXAMINING ATTORNEY



David J. Kyffers

Director of the United States Patent and Trademark Office

United States of America

United States Patent and Trademark Office

PS

Reg. No. 4,174,649

Registered July 17, 2012

Int. Cls.: 3 and 5

TRADEMARK

PRINCIPAL REGISTER

RIEMANN TRADING APS (DENMARK PRIVATE LIMITED COMPANY)
KRAKASVEJ 8
HILLEROD, DENMARK DK-3400

FOR: COSMETIC PREPARATIONS, NAMELY, SUN TANNING AND AFTER SUN SKIN CARE PREPARATIONS, IN CLASS 3 (U.S. CLS. 1, 4, 6, 50, 51 AND 52).

FOR: MEDICATED SKIN CARE PREPARATIONS FOR THE TREATMENT OF SUNBURN AND PREVENTING SUNBURN, IN CLASS 5 (U.S. CLS. 6, 18, 44, 46, 51 AND 52).

OWNER OF DENMARK REG. NO. VR03.7851989, DATED 6-23-1989, EXPIRES 6-23-2019.

OWNER OF U.S. REG. NO. 3,005,628.

THE MARK CONSISTS OF THE LETTERS "P" AND "S" WITH THE LETTER "S" POSITIONED IN A SUBSCRIPT LOCATION TO THE RIGHT OF THE LETTER "P". THE LETTER "P" IS SHOWN IN A SOLID TYPEFACE AND THE LETTER "S" IS SHOWN IN A THINNER TYPEFACE.

SER. NO. 85-461,344, FILED 11-1-2011.

ZHALEH DELANEY, EXAMINING ATTORNEY



David J. Kyjars

Director of the United States Patent and Trademark Office

United States of America

United States Patent and Trademark Office

T-HUB

Reg. No. 4,174,650

ATANDRA LLC. (NEW JERSEY LIMITED LIABILITY COMPANY)
300 MILLBURN AVENUE, 653
MILLBURN, NJ 07041

Registered July 17, 2012

Int. Cl.: 9

FOR: COMPUTER SOFTWARE FOR USE IN MANAGING INTERNET RETAIL STORES, IN CLASS 9 (U.S. CLS. 21, 23, 26, 36 AND 38).

TRADEMARK

FIRST USE 8-16-2006; IN COMMERCE 8-16-2006.

PRINCIPAL REGISTER

THE MARK CONSISTS OF STANDARD CHARACTERS WITHOUT CLAIM TO ANY PARTICULAR FONT, STYLE, SIZE, OR COLOR.

SER. NO. 85-461,368, FILED 11-1-2011.

PAUL MORENO, EXAMINING ATTORNEY



David J. Kybas

Director of the United States Patent and Trademark Office

United States of America

United States Patent and Trademark Office

Sun Touch Plus

Reg. No. 4,174,651

Registered July 17, 2012

Int. Cl.: 10

TRADEMARK

PRINCIPAL REGISTER

NATURE BRIGHT COMPANY (CALIFORNIA CORPORATION), DBA NATURE BRIGHT
COMPANY
19200 VON KARMAN AVE SUITE 600
IRVINE, CA 92612

FOR: THERAPEUTIC LAMP CONSISTING OF 10,000 LUX WHICH EMIT LIGHT AND IONS
FOR USE IN TREATMENT OF SEASONAL AFFECTIVE DISORDER AND DEPRESSIVE
DISORDERS, IN CLASS 10 (U.S. CLS. 26, 39 AND 44).

FIRST USE 2-25-2002; IN COMMERCE 2-25-2002.

THE MARK CONSISTS OF STANDARD CHARACTERS WITHOUT CLAIM TO ANY PAR-
TICULAR FONT, STYLE, SIZE, OR COLOR.

SER. NO. 85-461,491, FILED 11-1-2011.

KELLEY WELLS, EXAMINING ATTORNEY



David J. Kyffers

Director of the United States Patent and Trademark Office

United States of America

United States Patent and Trademark Office



We Are Where Corporate Travel is Going

Reg. No. 4,174,652

Registered July 17, 2012

Int. Cl.: 39

SERVICE MARK

PRINCIPAL REGISTER

DONALD MORELAND INCORPORATED (DELAWARE CORPORATION)
C/O FOSTER PEPPER PLLC SUITE 3400
1111 3RD AVENUE
SEATTLE, WA 98101

FOR: TRANSPORTATION CONSULTING SERVICES IN THE FIELD OF TRAVEL SERVICES,
IN CLASS 39 (U.S. CLS. 100 AND 105).

FIRST USE 8-20-2011; IN COMMERCE 8-20-2011.

NO CLAIM IS MADE TO THE EXCLUSIVE RIGHT TO USE "INCORPORATED", APART
FROM THE MARK AS SHOWN.

THE NAME(S), PORTRAIT(S), AND/OR SIGNATURE(S) SHOWN IN THE MARK DOES NOT
IDENTIFY A PARTICULAR LIVING INDIVIDUAL.

THE MARK CONSISTS OF THE LETTERS "D", "M" WITH A DESIGN OF AN AIRPLANE
ON THE LEFT SIDE OF THE "M", FOLLOWED BY A VERTICAL LINE WITH THE WORDS
"DONALD MORELAND INCORPORATED" IN CAPITAL LETTERS STACKED ONE WORD
ON TOP OF THE OTHER. THE TAGLINE "WE ARE WHERE CORPORATE TRAVEL IS
GOING" IS UNDERNEATH.

SER. NO. 85-461,545, FILED 11-1-2011.

ELI HELLMAN, EXAMINING ATTORNEY



David J. Kybas

Director of the United States Patent and Trademark Office

United States of America

United States Patent and Trademark Office

CAMPUS SQUARE

Reg. No. 4,174,653

Registered July 17, 2012

Int. Cl.: 36

SERVICE MARK

PRINCIPAL REGISTER

1760 REALTY OWNER LLC (DELAWARE LIMITED LIABILITY COMPANY)
15TH FLOOR
512 7TH AVENUE
NEW YORK, NY 10018

FOR: REAL ESTATE SERVICES, NAMELY, RENTAL AND MANAGEMENT OF STUDENT HOUSING RESIDENTIAL ACCOMMODATIONS IN UNIVERSITY DORMITORY-STYLE APARTMENT BUILDINGS HAVING UNIVERSITY DORMITORY AMENITIES SUCH AS FURNISHED ROOMS, LAUNDRY FACILITIES, COMPUTER ACCESS, GYM FACILITIES AND OTHER RESIDENTIAL SERVICES TYPICALLY USED BY UNIVERSITY STUDENTS, IN CLASS 36 (U.S. CLS. 100, 101 AND 102).

FIRST USE 8-10-2011; IN COMMERCE 8-10-2011.

THE MARK CONSISTS OF STANDARD CHARACTERS WITHOUT CLAIM TO ANY PARTICULAR FONT, STYLE, SIZE, OR COLOR.

NO CLAIM IS MADE TO THE EXCLUSIVE RIGHT TO USE "CAMPUS", APART FROM THE MARK AS SHOWN.

SER. NO. 85-461,568, FILED 11-1-2011.

AISHA SALEM, EXAMINING ATTORNEY



David J. Kyros

Director of the United States Patent and Trademark Office

United States of America

United States Patent and Trademark Office

THE JOURNAL OF PRIVATE EQUITY

Reg. No. 4,174,654

INSTITUTIONAL INVESTOR, INC. (DELAWARE CORPORATION)
225 PARK AVENUE SOUTH
NEW YORK, NY 10003

Registered July 17, 2012

Int. Cl.: 41

FOR: ON-LINE FINANCIAL JOURNALS PROVIDED ELECTRONICALLY BY MEANS OF
THE INTERNET, IN CLASS 41 (U.S. CLS. 100, 101 AND 107).

SERVICE MARK

FIRST USE 11-0-1999; IN COMMERCE 11-0-1999.

PRINCIPAL REGISTER

THE MARK CONSISTS OF STANDARD CHARACTERS WITHOUT CLAIM TO ANY PAR-
TICULAR FONT, STYLE, SIZE, OR COLOR.

OWNER OF U.S. REG. NO. 2,143,745.

NO CLAIM IS MADE TO THE EXCLUSIVE RIGHT TO USE "JOURNAL", APART FROM
THE MARK AS SHOWN.

SEC. 2(F).

SER. NO. 85-461,642, FILED 11-1-2011.

CHARLOTTE CORWIN, EXAMINING ATTORNEY



David J. Kybas

Director of the United States Patent and Trademark Office

United States of America

United States Patent and Trademark Office

TEN FOUR PAPER

Reg. No. 4,174,655

TEN FOUR PAPER, LLC (MISSOURI LIMITED LIABILITY COMPANY)

Registered July 17, 2012

1612 REDBIRD COVE
BRENTWOOD, MO 63144

Int. Cl.: 16

FOR: PAPER GOODS, NAMELY, CUSTOM PRINTED INVITATIONS, STATIONERY, NOTE CARDS, ANNOUNCEMENT CARDS, GREETING CARDS, ENVELOPES, EVENT PROGRAMS, MENU CARDS, PLACE CARDS, PAPER GIFT TAGS, IN CLASS 16 (U.S. CLS. 2, 5, 22, 23, 29, 37, 38 AND 50).

TRADEMARK

PRINCIPAL REGISTER

FIRST USE 1-19-2011; IN COMMERCE 6-15-2011.

THE MARK CONSISTS OF STANDARD CHARACTERS WITHOUT CLAIM TO ANY PARTICULAR FONT, STYLE, SIZE, OR COLOR.

NO CLAIM IS MADE TO THE EXCLUSIVE RIGHT TO USE "PAPER", APART FROM THE MARK AS SHOWN.

SER. NO. 85-461,668, FILED 11-1-2011.

GIANCARLO CASTRO, EXAMINING ATTORNEY



David J. Kyffers

Director of the United States Patent and Trademark Office

United States of America

United States Patent and Trademark Office

THE JOURNAL OF ALTERNATIVE INVESTMENTS

Reg. No. 4,174,656

INSTITUTIONAL INVESTOR, INC. (DELAWARE CORPORATION)
225 PARK AVENUE SOUTH
NEW YORK, NY 10003

Registered July 17, 2012

Int. Cl.: 41

FOR: ON-LINE FINANCIAL JOURNALS PROVIDED ELECTRONICALLY BY MEANS OF
THE INTERNET, IN CLASS 41 (U.S. CLS. 100, 101 AND 107).

SERVICE MARK

FIRST USE 11-0-1999; IN COMMERCE 11-0-1999.

PRINCIPAL REGISTER

THE MARK CONSISTS OF STANDARD CHARACTERS WITHOUT CLAIM TO ANY PAR-
TICULAR FONT, STYLE, SIZE, OR COLOR.

OWNER OF U.S. REG. NO. 2,344,160.

NO CLAIM IS MADE TO THE EXCLUSIVE RIGHT TO USE "JOURNAL", APART FROM
THE MARK AS SHOWN.

SEC. 2(F).

SER. NO. 85-461,677, FILED 11-1-2011.

CHARLOTTE CORWIN, EXAMINING ATTORNEY



David J. Kybas

Director of the United States Patent and Trademark Office

United States of America

United States Patent and Trademark Office

TED'S BAR-B-Q

Reg. No. 4,174,657

BJF MANAGEMENT, LLC (ALABAMA LIMITED LIABILITY COMPANY)
2105 DRAKE AVENUE
HUNTSVILLE, AL 35805

Registered July 17, 2012

Int. Cl.: 43

FOR: RESTAURANT SERVICES; AND, TAKE-OUT RESTAURANT SERVICES, IN CLASS 43 (U.S. CLS. 100 AND 101).

SERVICE MARK

FIRST USE 9-7-2011; IN COMMERCE 9-7-2011.

PRINCIPAL REGISTER

THE MARK CONSISTS OF STANDARD CHARACTERS WITHOUT CLAIM TO ANY PARTICULAR FONT, STYLE, SIZE, OR COLOR.

NO CLAIM IS MADE TO THE EXCLUSIVE RIGHT TO USE "BAR-B-Q", APART FROM THE MARK AS SHOWN.

SER. NO. 85-461,687, FILED 11-1-2011.

WARREN L. OLANDRIA, EXAMINING ATTORNEY



David J. Kyffers

Director of the United States Patent and Trademark Office

United States of America

United States Patent and Trademark Office

Mandala Messages

Reg. No. 4,174,658

ALIGNMENT MEDIA (CALIFORNIA LIMITED LIABILITY COMPANY)
561 MORRO HILLS RD.
FALLBROOK, CA 92028

Registered July 17, 2012

Int. Cl.: 45

FOR: PROVIDING A SUBSCRIPTION BASED WEBSITE FEATURING INSPIRATIONAL MESSAGES, IN CLASS 45 (U.S. CLS. 100 AND 101).

SERVICE MARK

FIRST USE 7-16-2011; IN COMMERCE 7-16-2011.

PRINCIPAL REGISTER

THE MARK CONSISTS OF STANDARD CHARACTERS WITHOUT CLAIM TO ANY PARTICULAR FONT, STYLE, SIZE, OR COLOR.

NO CLAIM IS MADE TO THE EXCLUSIVE RIGHT TO USE "MESSAGES", APART FROM THE MARK AS SHOWN.

SER. NO. 85-461,693, FILED 11-1-2011.

LEIGH CAROLINE CASE, EXAMINING ATTORNEY



David J. Kyffers

Director of the United States Patent and Trademark Office

United States of America

United States Patent and Trademark Office

COUNTRIGHT

Reg. No. 4,174,659

ELECTION SYSTEMS & SOFTWARE, LLC (DELAWARE LIMITED LIABILITY COMPANY)
11208 JOHN GALT BLVD

Registered July 17, 2012

OMAHA, NE 68137

Int. Cl.: 16

FOR: CUSTOM MANUFACTURED PAPER STOCK FOR OPTICALLY SCANNED BALLOTS,
IN CLASS 16 (U.S. CLS. 2, 5, 22, 23, 29, 37, 38 AND 50).

TRADEMARK

FIRST USE 3-31-2010; IN COMMERCE 6-30-2010.

PRINCIPAL REGISTER

THE MARK CONSISTS OF STANDARD CHARACTERS WITHOUT CLAIM TO ANY PAR-
TICULAR FONT, STYLE, SIZE, OR COLOR.

SER. NO. 85-461,702, FILED 11-1-2011.

NAAKWAMA ANKRAH, EXAMINING ATTORNEY



David J. Kyffers

Director of the United States Patent and Trademark Office

United States of America

United States Patent and Trademark Office



Reg. No. 4,174,660

Registered July 17, 2012

Int. Cls.: 35 and 36

SERVICE MARK

PRINCIPAL REGISTER

PLYMOUTH ROCK ENERGY LLC (NEW YORK LIMITED LIABILITY COMPANY)
1074 BROADWAY
WOODMERE, NY 11598

FOR: ENERGY MANAGEMENT SERVICES, NAMELY, PROVIDING A SERVICE THAT
ALLOWS CUSTOMERS TO PURCHASE ENERGY, NAMELY, ELECTRICITY AND NATURAL
GAS, IN CLASS 35 (U.S. CLS. 100, 101 AND 102).

FIRST USE 5-1-2011; IN COMMERCE 5-1-2011.

FOR: BROKERAGE OF ENERGY, NAMELY, NATURAL GAS AND ELECTRICITY, IN CLASS
36 (U.S. CLS. 100, 101 AND 102).

FIRST USE 5-1-2011; IN COMMERCE 5-1-2011.

NO CLAIM IS MADE TO THE EXCLUSIVE RIGHT TO USE "ENERGY", APART FROM THE
MARK AS SHOWN.

THE MARK CONSISTS OF A CIRCULAR DESIGN TO THE LEFT OF THE WORDING
"PLYMOUTH ROCK"; THE WORD "ENERGY" IS IN CAPITAL LETTERS UNDERNEATH
THE WORD "ROCK".

SER. NO. 85-461,738, FILED 11-1-2011.

MATTHEW PAPPAS, EXAMINING ATTORNEY



David J. Kyffers

Director of the United States Patent and Trademark Office

United States of America

United States Patent and Trademark Office



Reg. No. 4,174,661

Registered July 17, 2012

Int. Cl.: 1

TRADEMARK

PRINCIPAL REGISTER

PHARMGRADE, INC. (IDAHO CORPORATION)
P.O. BOX 1801
IDAHO FALLS, ID 83401

FOR: FERTILIZERS; FERTILIZERS FOR AGRICULTURAL USE; FERTILIZERS FOR DOMESTIC USE; NATURAL FERTILIZERS; SOIL AMENDMENTS, IN CLASS 1 (U.S. CLS. 1, 5, 6, 10, 26 AND 46).

FIRST USE 5-1-2011; IN COMMERCE 5-1-2011.

NO CLAIM IS MADE TO THE EXCLUSIVE RIGHT TO USE "PHARMGRADE", APART FROM THE MARK AS SHOWN.

THE COLOR(S) GREEN, BROWN, WHITE IS/ARE CLAIMED AS A FEATURE OF THE MARK.

THE MARK CONSISTS OF THE WORDING "PHARMGRADE" IS CAPITALIZED IN TWO SHADES OF GREEN ("PHARM" IN DARK GREEN, "GRADE" IN LIGHT GREEN) SET ON A WHITE BANNER OUTLINED IN GREEN; THE BANNER IS BENEATH TWO MULTITONED GREEN SHADED LEAVES WITH THREE DROPS OF DEW ON EACH LEAF, SET ON A SQUARE-SHAPED BACKGROUND THAT IS WHITE WITH TONES OF LIGHT BROWN; A TWO-TONE GREEN STRIPE AND A BROWN STRIPE OUTLINE THE SQUARE AND THE BANNER BUT NOT THE LEAVES.

SER. NO. 85-461,845, FILED 11-1-2011.

SUE LAWRENCE, EXAMINING ATTORNEY



David J. Kyjars

Director of the United States Patent and Trademark Office

United States of America

United States Patent and Trademark Office

ERIC D-LUX

Reg. No. 4,174,662

DE LA TORRE, ERIC (UNITED STATES INDIVIDUAL)
15250 VENTURA BOULEVARD, #710
SHERMAN OAKS, CA 91403

Registered July 17, 2012

Int. Cl.: 41

FOR: ENTERTAINMENT SERVICES, NAMELY, PRODUCTION AND REMIXING OF MUSICAL AUDIO RECORDINGS, CONCERT BOOKINGS, PERFORMANCES AS A DISC JOCKEY (DJ) FOR PARTIES, NIGHTCLUBS, CONCERTS AND SPECIAL EVENTS; RADIO ENTERTAINMENT SERVICES, NAMELY, RADIO PROGRAMS FEATURING PERFORMANCES BY A RADIO PERSONALITY; ENTERTAINMENT SERVICES BY A MUSICAL ARTIST AND PRODUCER, NAMELY, MUSICAL COMPOSITION FOR OTHERS AND PRODUCTION OF MUSICAL SOUND RECORDINGS, IN CLASS 41 (U.S. CLS. 100, 101 AND 107).

SERVICE MARK

PRINCIPAL REGISTER

FIRST USE 12-15-2000; IN COMMERCE 11-13-2004.

THE MARK CONSISTS OF STANDARD CHARACTERS WITHOUT CLAIM TO ANY PARTICULAR FONT, STYLE, SIZE, OR COLOR.

THE NAME(S), PORTRAIT(S), AND/OR SIGNATURE(S) SHOWN IN THE MARK IDENTIFIES THE STAGE NAME OF "ERIC" DE LA TORRE, A LIVING INDIVIDUAL, WHOSE CONSENT(S) TO REGISTER IS MADE OF RECORD.

SER. NO. 85-461,928, FILED 11-1-2011.

COLLEEN KEARNEY, EXAMINING ATTORNEY



David J. Kyros

Director of the United States Patent and Trademark Office

United States of America

United States Patent and Trademark Office



Reg. No. 4,174,663

FIRST RELIANCE BANK (SOUTH CAROLINA CORPORATION)
2107 WEST PALMETTO STREET
FLORENCE, SC 29501

Registered July 17, 2012

Int. Cl.: 36

FOR: BANKING AND FINANCING SERVICES, IN CLASS 36 (U.S. CLS. 100, 101 AND 102).

SERVICE MARK

FIRST USE 11-1-2011; IN COMMERCE 11-1-2011.

PRINCIPAL REGISTER

NO CLAIM IS MADE TO THE EXCLUSIVE RIGHT TO USE "PROGRAM", APART FROM THE MARK AS SHOWN.

THE MARK CONSISTS OF THE WORDS "BETTER LIFE PROGRAM". THE WORD "BETTER" HAS THREE ARCHES IN THE MIDDLE OF THE T'S. THE WORD "LIFE" HAS A STYLIZED I IN THE FORM OF A PERSON. EACH WORD IS CENTERED OVER EACH OTHER.

SER. NO. 85-462,033, FILED 11-2-2011.

BARNEY CHARLON, EXAMINING ATTORNEY



David J. Kyffers

Director of the United States Patent and Trademark Office

United States of America

United States Patent and Trademark Office

SIGBOP

Reg. No. 4,174,664

Registered July 17, 2012

Int. Cl.: 42

SERVICE MARK

PRINCIPAL REGISTER

SIGBOP, LLC (DELAWARE LIMITED LIABILITY COMPANY)
3535 STATE ROUTE 66
SUITE 7
NEPTUNE, NJ 07753

FOR: PROVIDING TEMPORARY USE OF A WEB-BASED SOFTWARE APPLICATION FOR USERS TO CREATE ELECTRONIC MAIL SIGNATURES, IN CLASS 42 (U.S. CLS. 100 AND 101).

FIRST USE 10-11-2011; IN COMMERCE 10-11-2011.

THE MARK CONSISTS OF STANDARD CHARACTERS WITHOUT CLAIM TO ANY PARTICULAR FONT, STYLE, SIZE, OR COLOR.

THE WORDING "SIGBOP" HAS NO MEANING IN A FOREIGN LANGUAGE.

SER. NO. 85-462,077, FILED 11-2-2011.

BRIAN PINO, EXAMINING ATTORNEY



David J. Kyffers

Director of the United States Patent and Trademark Office

United States of America

United States Patent and Trademark Office



Reg. No. 4,174,665

LAWDOCSXPRESS, INC. (GEORGIA CORPORATION)
1266 WEST PACES FERRY ROAD, #611
ATLANTA, GA 30327

Registered July 17, 2012

Int. Cl.: 35

FOR: SECRETARIAL AND CLERICAL SERVICES, IN CLASS 35 (U.S. CLS. 100, 101 AND 102).

SERVICE MARK

FIRST USE 10-20-2011; IN COMMERCE 10-20-2011.

PRINCIPAL REGISTER

OWNER OF U.S. REG. NOS. 3,102,536 AND 4,088,895.

THE MARK CONSISTS OF THE WORD "LAWDOCS" BENEATH A SWOOP DESIGN COMPRISED OF BOXES OF VARYING SIZES SHOWN AT VARYING ANGLES.

SER. NO. 85-462,079, FILED 11-2-2011.

LINDA LAVACHE, EXAMINING ATTORNEY



David J. Kyffers

Director of the United States Patent and Trademark Office

United States of America

United States Patent and Trademark Office

RESEARCHER SOURCEBOOK

Reg. No. 4,174,666

QUIRK ENTERPRISES, INC. (MINNESOTA CORPORATION)

Registered July 17, 2012

4662 SLATER RD
EAGAN, MN 55122

Int. Cl.: 16

FOR: DIRECTORIES OF MARKET RESEARCH COMPANIES, IN CLASS 16 (U.S. CLS. 2, 5, 22, 23, 29, 37, 38 AND 50).

TRADEMARK

FIRST USE 8-31-1990; IN COMMERCE 8-31-1990.

PRINCIPAL REGISTER

THE MARK CONSISTS OF STANDARD CHARACTERS WITHOUT CLAIM TO ANY PARTICULAR FONT, STYLE, SIZE, OR COLOR.

NO CLAIM IS MADE TO THE EXCLUSIVE RIGHT TO USE "SOURCEBOOK", APART FROM THE MARK AS SHOWN.

SEC. 2(F).

SER. NO. 85-462,353, FILED 11-2-2011.

JAMES GRIFFIN, EXAMINING ATTORNEY



David J. Kyffers

Director of the United States Patent and Trademark Office

United States of America

United States Patent and Trademark Office

GAYLICIOUS

Reg. No. 4,174,667

Registered July 17, 2012

Int. Cl.: 45

SERVICE MARK

PRINCIPAL REGISTER

FIESTA CATERING INTERNATIONAL, INC. (ANGUILLA CORPORATION)
BABROW BUILDING
P.O. BOX 371
THE VALLEY, ANGUILLA

FOR: DATING SERVICES; AND INTERNET BASED SOCIAL NETWORKING AND INTRODUCTION SERVICES, IN CLASS 45 (U.S. CLS. 100 AND 101).

FIRST USE 8-22-2011; IN COMMERCE 8-22-2011.

THE MARK CONSISTS OF STANDARD CHARACTERS WITHOUT CLAIM TO ANY PARTICULAR FONT, STYLE, SIZE, OR COLOR.

SER. NO. 85-462,377, FILED 11-2-2011.

MICHELE SWAIN, EXAMINING ATTORNEY



David J. Kyjars

Director of the United States Patent and Trademark Office

United States of America

United States Patent and Trademark Office

Nail Fitness

Reg. No. 4,174,668

DEREK BERG (UNITED STATES INDIVIDUAL), DBA NAIL FITNESS
1004 ROCKFELLOW DR
MT SHASTA, CA 96067 AND

Registered July 17, 2012

Int. Cl.: 3

WENDY BERG (UNITED STATES INDIVIDUAL), DBA NAIL FITNESS
1004 ROCKFELLOW DR
MT SHASTA, CA 96067

TRADEMARK

FOR: NAIL ENAMEL, IN CLASS 3 (U.S. CLS. 1, 4, 6, 50, 51 AND 52).

PRINCIPAL REGISTER

FIRST USE 1-1-1999; IN COMMERCE 1-1-1999.

THE MARK CONSISTS OF STANDARD CHARACTERS WITHOUT CLAIM TO ANY PARTICULAR FONT, STYLE, SIZE, OR COLOR.

NO CLAIM IS MADE TO THE EXCLUSIVE RIGHT TO USE "NAIL", APART FROM THE MARK AS SHOWN.

SER. NO. 85-462,427, FILED 11-2-2011.

SARA BENJAMIN, EXAMINING ATTORNEY



David J. Kyros

Director of the United States Patent and Trademark Office

United States of America

United States Patent and Trademark Office

THE COOK'S ATELIER

Reg. No. 4,174,669

MARJORIE LEE TAYLOR (UNITED STATES INDIVIDUAL)
21 RUE MAUFOUX
BEAUNE, FRANCE 21200

Registered July 17, 2012

Int. Cl.: 41

FOR: EDUCATIONAL SERVICES IN THE NATURE OF A COOKING SCHOOL AND PROVIDING AN ONLINE COLUMN IN THE FIELD OF COOKING, FOOD AND WINE, IN CLASS 41 (U.S. CLS. 100, 101 AND 107).

SERVICE MARK

FIRST USE 9-15-2008; IN COMMERCE 9-15-2008.

PRINCIPAL REGISTER

THE MARK CONSISTS OF STANDARD CHARACTERS WITHOUT CLAIM TO ANY PARTICULAR FONT, STYLE, SIZE, OR COLOR.

NO CLAIM IS MADE TO THE EXCLUSIVE RIGHT TO USE "COOK'S", APART FROM THE MARK AS SHOWN.

SER. NO. 85-462,438, FILED 11-2-2011.

SIMON TENG, EXAMINING ATTORNEY



David J. Kybas

Director of the United States Patent and Trademark Office

United States of America

United States Patent and Trademark Office

Country Dollar

Reg. No. 4,174,670

COUNTRY DOLLAR, INC (FLORIDA CORPORATION)
11844 GRAZING BUCK LANE
TALLAHASSEE, FL 32317

Registered July 17, 2012

Int. Cl.: 35

FOR: RETAIL STORE SERVICES FEATURING FASHION JEWELRY AND FASHION ACCESSORIES, IN CLASS 35 (U.S. CLS. 100, 101 AND 102).

SERVICE MARK

FIRST USE 5-8-2004; IN COMMERCE 5-8-2004.

PRINCIPAL REGISTER

THE MARK CONSISTS OF STANDARD CHARACTERS WITHOUT CLAIM TO ANY PARTICULAR FONT, STYLE, SIZE, OR COLOR.

NO CLAIM IS MADE TO THE EXCLUSIVE RIGHT TO USE "DOLLAR", APART FROM THE MARK AS SHOWN.

SEC. 2(F).

SER. NO. 85-462,463, FILED 11-2-2011.

SIMON TENG, EXAMINING ATTORNEY



David J. Kybas

Director of the United States Patent and Trademark Office

United States of America

United States Patent and Trademark Office

TRANSIM

Reg. No. 4,174,671

Registered July 17, 2012

Int. Cl.: 42

SERVICE MARK

PRINCIPAL REGISTER

TRANSIM TECHNOLOGY CORPORATION (CALIFORNIA CORPORATION)
433 NW 4TH AVENUE, SUITE 200
PORTLAND, OR 97209

FOR: CLOUD-COMPUTING BASED CONSULTATION SERVICES, NAMELY, SIMULATION, VERIFICATION, AND LAYOUT OF ELECTRONIC CIRCUIT DESIGN PROVIDED VIA THE GLOBAL COMPUTER NETWORK; ELECTRONIC CIRCUIT DESIGN AND SELECTION SIMULATION ANALYSIS PROVIDED VIA CLOUD- BASED GLOBAL COMPUTER NETWORK; CLOUD-COMPUTING FEATURING SOFTWARE FOR USE IN COMPUTER-AIDED DESIGN OF ELECTRONIC CIRCUITRY AND SELECTION SIMULATION ANALYSIS; CLOUD-COMPUTING FEATURING SOFTWARE THAT PROVIDES WEB-BASED ACCESS TO APPLICATIONS AND SERVICES THROUGH A WEB OPERATING SYSTEM OR PORTAL INTERFACE; SOFTWARE AS A SERVICE (SAAS) SERVICES FEATURING SOFTWARE FOR ELECTRONIC CIRCUITRY AND SELECTION SIMULATION ANALYSIS; APPLICATION SERVICE PROVIDER (ASP) FEATURING SOFTWARE FOR USE IN ELECTRONIC CIRCUIT DESIGN AND SELECTION SIMULATION ANALYSIS, IN CLASS 42 (U.S. CLS. 100 AND 101).

FIRST USE 10-0-1999; IN COMMERCE 10-0-1999.

THE MARK CONSISTS OF STANDARD CHARACTERS WITHOUT CLAIM TO ANY PARTICULAR FONT, STYLE, SIZE, OR COLOR.

OWNER OF U.S. REG. NOS. 2,513,285 AND 2,568,008.

SER. NO. 85-462,586, FILED 11-2-2011.

EMILY CHUO, EXAMINING ATTORNEY



David J. Kybas

Director of the United States Patent and Trademark Office

United States of America

United States Patent and Trademark Office



Reg. No. 4,174,672

Registered July 17, 2012

Int. Cl.: 9

TRADEMARK

PRINCIPAL REGISTER

QR WINNER, INC. (CALIFORNIA CORPORATION)
24655 PARK MIRAMAR
CALABASAS, CA 91302

FOR: COMPUTER APPLICATION SOFTWARE FOR MOBILE PHONES, NAMELY, SOFTWARE FOR GENERATING ADVERTISING WITH THE USE OF QUICK RESPONSE CODES, IN CLASS 9 (U.S. CLS. 21, 23, 26, 36 AND 38).

FIRST USE 10-10-2011; IN COMMERCE 10-10-2011.

THE MARK CONSISTS OF A SQUARE WITH ROUNDED CORNERS, AND A BOW SHAPE ON TOP, MADE OF LETTERS "Q" AND "R".

SER. NO. 85-462,620, FILED 11-2-2011.

COLLEEN KEARNEY, EXAMINING ATTORNEY



David J. Kyffers

Director of the United States Patent and Trademark Office

United States of America

United States Patent and Trademark Office



Reg. No. 4,174,673

Registered July 17, 2012

Int. Cl.: 43

SERVICE MARK

PRINCIPAL REGISTER

BUFFALO CHIP CAMPGROUND, LLC (SOUTH DAKOTA LIMITED LIABILITY COMPANY)
20622 131ST AVENUE
STURGIS, SD 57785

FOR: PROVIDING CAMPGROUND FACILITIES, IN CLASS 43 (U.S. CLS. 100 AND 101).

FIRST USE 7-1-2010; IN COMMERCE 7-1-2010.

OWNER OF U.S. REG. NOS. 3,825,985, 4,007,124 AND OTHERS.

NO CLAIM IS MADE TO THE EXCLUSIVE RIGHT TO USE "STURGIS", APART FROM THE MARK AS SHOWN.

THE MARK CONSISTS OF A BUFFALO SKULL WITH A STAR ON THE RIGHT SIDE OF THE BUFFALO SKULL AND A STAR ON THE LEFT SIDE OF THE BUFFALO SKULL; THE WORD "STURGIS" IN A STYLIZED FONT IN A SEMI-CIRCLE PATTERN ABOVE A BUFFALO SKULL AND THE WORDS "BUFFALO CHIP" IN A SEMI-CIRCLE PATTERN IN A STYLIZED FONT BELOW THE BUFFALO SKULL.

SER. NO. 85-462,629, FILED 11-2-2011.

BRIAN NEVILLE, EXAMINING ATTORNEY



David J. Kybas

Director of the United States Patent and Trademark Office

United States of America

United States Patent and Trademark Office

SINARSPECTRA PREMIUM COLOURED PAPERS

Reg. No. 4,174,674

Registered July 17, 2012

Int. Cl.: 16

TRADEMARK

PRINCIPAL REGISTER

PT. PURINUSA EKAPERSADA (INDONESIA CORPORATION)
PLAZA BII TOWER 2, 7TH FLOOR
JL. M. H. THAMRIN NO. 51
JAKARTA, INDONESIA AND

PT. INDAH KIAT PULP AND PAPER TBK (INDONESIA CORPORATION)
PLAZA BII MENARA 2 LT. 7
JL. M.H. THAMRIN NO. 51
JAKARTA, INDONESIA 10350

FOR: PAPER, CARDBOARD AND GOODS MADE FROM THESE MATERIALS, NAMELY, UNCOATED COLOR PAPER, FINE PAPER, NAMELY, WOOD-FREE PAPER, OFFSET PAPER, PRINTING PAPER, COLOR PHOTOCOPY PAPER AND WRITING PAPER, IN CLASS 16 (U.S. CLS. 2, 5, 22, 23, 29, 37, 38 AND 50).

FIRST USE 0-0-2000; IN COMMERCE 0-0-2000.

THE MARK CONSISTS OF STANDARD CHARACTERS WITHOUT CLAIM TO ANY PARTICULAR FONT, STYLE, SIZE, OR COLOR.

NO CLAIM IS MADE TO THE EXCLUSIVE RIGHT TO USE "PREMIUM COLORED PAPERS", APART FROM THE MARK AS SHOWN.

SER. NO. 85-462,710, FILED 11-2-2011.

LAKEISHA LEWIS, EXAMINING ATTORNEY



David J. Kybas

Director of the United States Patent and Trademark Office

United States of America

United States Patent and Trademark Office

Hotel Pigeon Forge

Reg. No. 4,174,675

HOTEL PIGEON FORGE LLC. (TENNESSEE LIMITED LIABILITY COMPANY)
2179 PARKWAY

Registered July 17, 2012

PIGEON FORGE, TN 37863

Int. Cl.: 43

FOR: HOTEL ACCOMMODATION SERVICES, IN CLASS 43 (U.S. CLS. 100 AND 101).

SERVICE MARK

FIRST USE 4-14-2008; IN COMMERCE 5-23-2008.

PRINCIPAL REGISTER

THE MARK CONSISTS OF STANDARD CHARACTERS WITHOUT CLAIM TO ANY PARTICULAR FONT, STYLE, SIZE, OR COLOR.

NO CLAIM IS MADE TO THE EXCLUSIVE RIGHT TO USE "HOTEL", APART FROM THE MARK AS SHOWN.

SER. NO. 85-462,765, FILED 11-2-2011.

NAAKWAMA ANKRAH, EXAMINING ATTORNEY



David J. Kyffers

Director of the United States Patent and Trademark Office

United States of America

United States Patent and Trademark Office



Reg. No. 4,174,676

Registered July 17, 2012

Int. Cl.: 44

SERVICE MARK

PRINCIPAL REGISTER

TROY A. CASEY GREEN ENTREPRENEUR (CALIFORNIA LIMITED LIABILITY COMPANY),
AKA THE CERTIFIED HEALTH NUT
220 SAN VICENTE BOULEVARD, PENTHOUSE 107
SANTA MONICA, CA 90402

FOR: BEHAVIORAL HEALTH SERVICES; CONSULTING IN THE FIELD OF HEALTH AND WELLNESS TO BRING ABOUT PERSONAL HAPPINESS; CONSULTING SERVICES IN THE FIELD OF HEALTH; CONSULTING SERVICES IN THE FIELD OF MENTAL HEALTH AND WELLNESS; CONSULTING SERVICES IN THE FIELDS OF HEALTH AND NUTRITION; COUNSELING SERVICES IN THE FIELDS OF HEALTH, HERBALISM, AND LIFESTYLE WELLNESS; COUNSELING SERVICES IN THE FIELDS OF HEALTH, NUTRITION AND LIFESTYLE WELLNESS; DIETARY AND NUTRITIONAL GUIDANCE; FOOD NUTRITION CONSULTATION; HEALTH CARE SERVICES, NAMELY, WELLNESS PROGRAMS; HOLISTIC HEALTH SERVICES; HOLISTIC HEALTH SERVICES FEATURING HERBAL MEDICINE; INTERNET-BASED HEALTH CARE INFORMATION SERVICES; NUTRITION COUNSELING; NUTRITIONAL THERAPY SERVICES; PROVIDING A INTERACTIVE HOLISTIC WEB SITE FEATURING HEALTH INFORMATION AND PATIENT INITIATED, PATIENT AUTHORIZED, FEE-FOR-SERVICE, HOLISTIC APPROACH DISTANCE HEALING SESSIONS BASED ON THE PATIENT'S SPECIFIC SET OF SYMPTOMS, MEDICAL PROFILE AND MEDICAL RECORD ANALYSIS AND PATIENT BENEFIT INFORMATION CONCERNING ORGANIC AND HOLISTIC PRODUCTS AND SERVICES; PROVIDING A WEB SITE FEATURING EDUCATIONAL INFORMATION REGARDING NUTRITION AND GENETICS; PROVIDING A WEB SITE FEATURING INFORMATION IN THE FIELD OF MENTAL HEALTH AND PHYSICAL HEALTH, INCLUDING LIVING A HEALTHY AND DISEASE FREE LIFE; PROVIDING A WEB SITE FEATURING INFORMATION IN THE FIELD OF MENTAL HEALTH AND WELLNESS; PROVIDING A WEB SITE FEATURING INFORMATION ON HEALTH AND NUTRITION; PROVIDING A WEBSITE FEATURING INFORMATION ABOUT HEALTH AND WELLNESS, NAMELY, ALTERNATIVE MEDICINE; PROVIDING A WEBSITE FEATURING INFORMATION CONCERNING ALTERNATIVE HEALTH AND HEALING; PROVIDING HEALTH INFORMATION; PROVIDING HEALTHY LIFESTYLE AND NUTRITION SERVICES, NAMELY, PERSONAL ASSESSMENTS, PERSONALIZED ROUTINES, MAINTENANCE SCHEDULES, AND COUNSELING; PROVIDING IN-PERSON HOLISTIC HEALTH CARE SERVICES; PROVIDING INFORMATION, NEWS AND COMMENTARY IN THE FIELD OF NUTRITION, HEALTH AND WELLNESS; WELLNESS AND HEALTH-RELATED CONSULTING SERVICES, IN CLASS 44 (U.S. CLS. 100 AND 101).



David J. Kappas

Director of the United States Patent and Trademark Office

FIRST USE 1-1-2003; IN COMMERCE 1-1-2003.

Reg. No. 4,174,676 NO CLAIM IS MADE TO THE EXCLUSIVE RIGHT TO USE "CERTIFIED" OR "HEALTH", APART FROM THE MARK AS SHOWN.

THE COLOR(S) WHITE, GREEN, BROWN, TAN AND BLUE IS/ARE CLAIMED AS A FEATURE OF THE MARK.

THE MARK CONSISTS OF A CIRCLE OUTLINED IN BROWN AND DIVIDED IN HALF WITH WHITE ON THE UPPER HALF AND GREEN ON THE BOTTOM HALF. THE WORD "THE" APPEARS IN GREEN IN THE WHITE-SHADED UPPER HALF AND THE WORD "CERTIFIED" APPEARS IN WHITE IN THE LOWER GREEN-SHADED HALF OF THE CIRCLE. THE WORDS "HEALTH NUT" APPEAR TO THE RIGHT OF THE CIRCLE IN SOLID BROWN TYPE; FOLLOWED BY THE IMAGE OF A BROWN AND TAN ACORN. THE WORDING "HOW TO THRIVE IN THE CONCRETE JUNGLE" APPEARS AT THE BOTTOM IN BLACK. THE BACKGROUND APPEARS AS A BLUE AND WHITE SKY.

SER. NO. 85-462,780, FILED 11-2-2011.

TAMARA FRAZIER, EXAMINING ATTORNEY

United States of America

United States Patent and Trademark Office

EVERY DAY IS BANK TRANSFER DAY

Reg. No. 4,174,677

CREDIT UNION NATIONAL ASSOCIATION, INC. (WISCONSIN CORPORATION)
5710 MINERAL POINT ROAD

Registered July 17, 2012

MADISON, WI 53705

Int. Cl.: 36

FOR: FINANCIAL SERVICES, NAMELY, CREDIT UNION AND BANKING SERVICES FEATURING DEPOSIT AND INVESTMENT ACCOUNT SERVICES, LOAN SERVICES, CREDIT CARD SERVICES, DEBIT CHECK CARD SERVICES, AUTOMATED TELLER MACHINE SERVICES, PROVIDING BANK ACCOUNT INFORMATION BY TELEPHONE AND ONLINE BANKING SERVICES, IN CLASS 36 (U.S. CLS. 100, 101 AND 102).

SERVICE MARK

PRINCIPAL REGISTER

FIRST USE 11-4-2011; IN COMMERCE 11-4-2011.

THE MARK CONSISTS OF STANDARD CHARACTERS WITHOUT CLAIM TO ANY PARTICULAR FONT, STYLE, SIZE, OR COLOR.

SER. NO. 85-462,855, FILED 11-2-2011.

ASMAT KHAN, EXAMINING ATTORNEY



David J. Kyffers

Director of the United States Patent and Trademark Office

United States of America
United States Patent and Trademark Office

FTI

Reg. No. 4,174,678

Registered July 17, 2012

Int. Cl.: 26

TRADEMARK

PRINCIPAL REGISTER

FOREST INDUSTRIAL COMPANY LIMITED (HONG KONG LIMITED LIABILITY COMPANY)
RM02, 5/F, HUNG TAT INDUSTRIAL BUILDING
NO.43, HUNG TO RD.
KWUN TONG, HONG KONG

FOR: BUTTONS; ZIPPERS, IN CLASS 26 (U.S. CLS. 37, 39, 40, 42 AND 50).

OWNER OF HONG KONG REG. NO. 301908865, DATED 5-6-2011, EXPIRES 5-5-2021.

THE MARK CONSISTS OF STYLIZED TEXT FOR "FTI".

SER. NO. 85-462,877, FILED 11-2-2011.

COLLEEN DOMBROW, EXAMINING ATTORNEY



David J. Kybas

Director of the United States Patent and Trademark Office

United States of America

United States Patent and Trademark Office



Reg. No. 4,174,679

HEP41 ENTERPRISES, INC. (ILLINOIS CORPORATION)
4549 PRIME PARKWAY
MCHENRY, IL 60050

Registered July 17, 2012

Int. Cl.: 35

FOR: BUSINESS MANAGEMENT ADVISORY SERVICES RELATING TO FRANCHISING; FRANCHISING, NAMELY, OFFERING BUSINESS MANAGEMENT ASSISTANCE IN THE ESTABLISHMENT AND/OR OPERATION OF VENDING MACHINES CONTAINING SNACKS AND BEVERAGES WITH NATURAL INGREDIENTS, IN CLASS 35 (U.S. CLS. 100, 101 AND 102).

SERVICE MARK

PRINCIPAL REGISTER

FIRST USE 5-27-2009; IN COMMERCE 5-27-2009.

NO CLAIM IS MADE TO THE EXCLUSIVE RIGHT TO USE "HEALTHY" AND "SNACKS", APART FROM THE MARK AS SHOWN.

THE COLOR(S) BLUE AND YELLOW IS/ARE CLAIMED AS A FEATURE OF THE MARK.

THE MARK CONSISTS OF A RISING SUN IN THE COLOR YELLOW SLANTED TO THE RIGHT AND ABOVE THE LETTERS "HEALTHY U" IN BLUE COLOR. DIRECTLY BELOW THE LETTER "U" IS THE WORD "SNACKS" IN YELLOW AND IN CAPITAL LETTERS.

SER. NO. 85-463,097, FILED 11-3-2011.

BRIDGETT SMITH, EXAMINING ATTORNEY



David J. Kybas

Director of the United States Patent and Trademark Office

United States of America

United States Patent and Trademark Office

Game-o-Meter

Reg. No. 4,174,680

FUTUREMARK OY (FINLAND LIMITED LIABILITY COMPANY)
KAPPELITIE 6 C
ESPOO, FINLAND

Registered July 17, 2012

Int. Cl.: 42

FOR: TESTING OF COMPUTER HARDWARE AND SOFTWARE TO DETERMINE COMPATIBILITY IN THE FIELD OF GAMING, IN CLASS 42 (U.S. CLS. 100 AND 101).

SERVICE MARK

FIRST USE 3-31-2007; IN COMMERCE 3-31-2007.

PRINCIPAL REGISTER

THE MARK CONSISTS OF STANDARD CHARACTERS WITHOUT CLAIM TO ANY PARTICULAR FONT, STYLE, SIZE, OR COLOR.

SER. NO. 85-463,143, FILED 11-3-2011.

WILLIAM BRECKENFELD, EXAMINING ATTORNEY



David J. Kyffers

Director of the United States Patent and Trademark Office

United States of America

United States Patent and Trademark Office



Reg. No. 4,174,681

SHELTON, JOHN (UNITED STATES INDIVIDUAL)
8834 NORWALK RD.

Registered July 17, 2012

LITCHFIELD, OH 44253

Int. Cl.: 40

FOR: MOLDING AND FABRICATING ROLLING CHASSIS, UNFINISHED CARS, AND COMPLETE TURNKEY CARS, NAMELY, CUSTOM MANUFACTURING OF REPLICA GASSER ERA CARS AND THEIR PARTS; MOLDING AND FABRICATING AUTO RELATED ITEMS, NAMELY, MANUFACTURING OF CARS TO THE ORDER AND/OR SPECIFICATION OF OTHERS; CUSTOM BUILDING OF ROLLING CHASSIS, UNFINISHED CARS, AND COMPLETE TURNKEY CARS, IN CLASS 40 (U.S. CLS. 100, 103 AND 106).

SERVICE MARK

PRINCIPAL REGISTER

FIRST USE 7-1-2008; IN COMMERCE 7-1-2008.

NO CLAIM IS MADE TO THE EXCLUSIVE RIGHT TO USE "AMERICAN GASSER", APART FROM THE MARK AS SHOWN.

THE COLOR(S) GREEN, BLACK, RED, AND ORANGE IS/ARE CLAIMED AS A FEATURE OF THE MARK.

THE MARK CONSISTS OF THE WORD "AMERICAN" IN BLACK WITH A LIGHT GREEN OUTLINE AND A GREEN BORDER, THE WORD "GASSER" IS IN LIGHT GREEN WITH A BLACK BORDER OVER A GREEN BACKGROUND BRACKETED BY TWO BLACK OUTLINED DIAMONDS. THERE ARE RED AND ORANGE FLAMES OUTLINED IN GREEN COMING OUT OF THE LETTER "A" WHICH RESEMBLES AN EXHAUST PIPE.



SER. NO. 85-463,150, FILED 11-3-2011.

MARK SHINER, EXAMINING ATTORNEY

David J. Kybas

Director of the United States Patent and Trademark Office

United States of America

United States Patent and Trademark Office

THE JOURNAL OF PORTFOLIO MANAGEMENT

Reg. No. 4,174,682

INSTITUTIONAL INVESTOR, INC. (DELAWARE CORPORATION)
225 PARK AVENUE SOUTH
NEW YORK, NY 10003

Registered July 17, 2012

Int. Cl.: 41

FOR: ON-LINE FINANCIAL JOURNALS PROVIDED ELECTRONICALLY BY MEANS OF
THE INTERNET, IN CLASS 41 (U.S. CLS. 100, 101 AND 107).

SERVICE MARK

FIRST USE 11-0-1999; IN COMMERCE 11-0-1999.

PRINCIPAL REGISTER

THE MARK CONSISTS OF STANDARD CHARACTERS WITHOUT CLAIM TO ANY PAR-
TICULAR FONT, STYLE, SIZE, OR COLOR.

OWNER OF U.S. REG. NO. 1,756,784.

NO CLAIM IS MADE TO THE EXCLUSIVE RIGHT TO USE "JOURNAL", APART FROM
THE MARK AS SHOWN.

SEC. 2(F).

SER. NO. 85-463,190, FILED 11-3-2011.

CHARLOTTE CORWIN, EXAMINING ATTORNEY



David J. Kybas

Director of the United States Patent and Trademark Office

United States of America

United States Patent and Trademark Office

THE JOURNAL OF FIXED INCOME

Reg. No. 4,174,683

INSTITUTIONAL INVESTOR, INC. (DELAWARE CORPORATION)
225 PARK AVENUE SOUTH
NEW YORK, NY 10003

Registered July 17, 2012

Int. Cl.: 41

FOR: ON-LINE FINANCIAL JOURNALS PROVIDED ELECTRONICALLY BY MEANS OF THE INTERNET, IN CLASS 41 (U.S. CLS. 100, 101 AND 107).

SERVICE MARK

FIRST USE 11-0-1999; IN COMMERCE 11-0-1999.

PRINCIPAL REGISTER

THE MARK CONSISTS OF STANDARD CHARACTERS WITHOUT CLAIM TO ANY PARTICULAR FONT, STYLE, SIZE, OR COLOR.

OWNER OF U.S. REG. NO. 1,814,582.

NO CLAIM IS MADE TO THE EXCLUSIVE RIGHT TO USE "JOURNAL", APART FROM THE MARK AS SHOWN.

SEC. 2(F).

SER. NO. 85-463,250, FILED 11-3-2011.

CHARLOTTE CORWIN, EXAMINING ATTORNEY



David J. Kyffers

Director of the United States Patent and Trademark Office

United States of America

United States Patent and Trademark Office

ADHESIVES SPECIALISTS INC.

Reg. No. 4,174,684

ADHESIVES SPECIALISTS, INC. (NEW JERSEY CORPORATION)
739 ROBLE ROAD
ALLENTOWN, PA 18109

Registered July 17, 2012

Int. Cl.: 1

FOR: ADHESIVES AND GLUES FOR INDUSTRIAL AND COMMERCIAL USE, IN CLASS 1 (U.S. CLS. 1, 5, 6, 10, 26 AND 46).

TRADEMARK

FIRST USE 0-0-1983; IN COMMERCE 0-0-1983.

PRINCIPAL REGISTER

THE MARK CONSISTS OF STANDARD CHARACTERS WITHOUT CLAIM TO ANY PARTICULAR FONT, STYLE, SIZE, OR COLOR.

NO CLAIM IS MADE TO THE EXCLUSIVE RIGHT TO USE "ADHESIVES" AND "INC.", APART FROM THE MARK AS SHOWN.

SEC. 2(F).

SER. NO. 85-463,252, FILED 11-3-2011.

AMY ALFIERI, EXAMINING ATTORNEY



David J. Kybas

Director of the United States Patent and Trademark Office

United States of America

United States Patent and Trademark Office

THE JOURNAL OF WEALTH MANAGEMENT

Reg. No. 4,174,685

INSTITUTIONAL INVESTOR, INC. (DELAWARE CORPORATION)
225 PARK AVENUE SOUTH
NEW YORK, NY 10003

Registered July 17, 2012

Int. Cl.: 41

FOR: ON-LINE FINANCIAL JOURNALS PROVIDED ELECTRONICALLY BY MEANS OF
THE INTERNET, IN CLASS 41 (U.S. CLS. 100, 101 AND 107).

SERVICE MARK

FIRST USE 11-0-1999; IN COMMERCE 11-0-1999.

PRINCIPAL REGISTER

THE MARK CONSISTS OF STANDARD CHARACTERS WITHOUT CLAIM TO ANY PAR-
TICULAR FONT, STYLE, SIZE, OR COLOR.

OWNER OF U.S. REG. NO. 2,493,693.

NO CLAIM IS MADE TO THE EXCLUSIVE RIGHT TO USE "JOURNAL", APART FROM
THE MARK AS SHOWN.

SEC. 2(F).

SER. NO. 85-463,278, FILED 11-3-2011.

CHARLOTTE CORWIN, EXAMINING ATTORNEY



David J. Kybas

Director of the United States Patent and Trademark Office

United States of America

United States Patent and Trademark Office

THE JOURNAL OF DERIVATIVES

Reg. No. 4,174,686

INSTITUTIONAL INVESTOR, INC. (DELAWARE CORPORATION)
225 PARK AVENUE SOUTH
NEW YORK, NY 10003

Registered July 17, 2012

Int. Cl.: 41

FOR: ON-LINE FINANCIAL JOURNALS PROVIDED ELECTRONICALLY BY MEANS OF THE INTERNET, IN CLASS 41 (U.S. CLS. 100, 101 AND 107).

SERVICE MARK

FIRST USE 11-0-1999; IN COMMERCE 11-0-1999.

PRINCIPAL REGISTER

THE MARK CONSISTS OF STANDARD CHARACTERS WITHOUT CLAIM TO ANY PARTICULAR FONT, STYLE, SIZE, OR COLOR.

OWNER OF U.S. REG. NO. 1,805,622.

NO CLAIM IS MADE TO THE EXCLUSIVE RIGHT TO USE "JOURNAL", APART FROM THE MARK AS SHOWN.

SEC. 2(F).

SER. NO. 85-463,296, FILED 11-3-2011.

CHARLOTTE CORWIN, EXAMINING ATTORNEY



David J. Kyffers

Director of the United States Patent and Trademark Office

United States of America

United States Patent and Trademark Office

THE JOURNAL OF INVESTING

Reg. No. 4,174,687

INSTITUTIONAL INVESTOR, INC. (DELAWARE CORPORATION)
225 PARK AVENUE SOUTH
NEW YORK, NY 10003

Registered July 17, 2012

Int. Cl.: 41

FOR: ON-LINE FINANCIAL JOURNALS PROVIDED ELECTRONICALLY BY MEANS OF THE INTERNET, IN CLASS 41 (U.S. CLS. 100, 101 AND 107).

SERVICE MARK

FIRST USE 11-0-1999; IN COMMERCE 11-0-1999.

PRINCIPAL REGISTER

THE MARK CONSISTS OF STANDARD CHARACTERS WITHOUT CLAIM TO ANY PARTICULAR FONT, STYLE, SIZE, OR COLOR.

OWNER OF U.S. REG. NO. 1,760,824.

NO CLAIM IS MADE TO THE EXCLUSIVE RIGHT TO USE "JOURNAL", APART FROM THE MARK AS SHOWN.

SEC. 2(F).

SER. NO. 85-463,323, FILED 11-3-2011.

CHARLOTTE CORWIN, EXAMINING ATTORNEY



David J. Kybas

Director of the United States Patent and Trademark Office

United States of America

United States Patent and Trademark Office



Reg. No. 4,174,688

Registered July 17, 2012

Int. Cl.: 28

TRADEMARK

PRINCIPAL REGISTER

KIN PAL, LLC (TENNESSEE LIMITED LIABILITY COMPANY)
SUITE B
7535 BARTLETT CORPORATE DRIVE
BARTLETT, TN 38133

FOR: STUFFED AND PLUSH TOYS, IN CLASS 28 (U.S. CLS. 22, 23, 38 AND 50).

FIRST USE 7-27-2011; IN COMMERCE 7-27-2011.

THE MARK CONSISTS OF A ROUNDED IRREGULAR SHAPED OUTLINED CARRIER CONTAINING THE WORDS "KIN PAL" IN STYLIZED FONT. THE "A" IN "PAL" IS FORMED TO APPEAR AS THE FACE OF A DOG.

SER. NO. 85-463,411, FILED 11-3-2011.

PAM WILLIS, EXAMINING ATTORNEY



David J. Kyffers

Director of the United States Patent and Trademark Office

United States of America

United States Patent and Trademark Office



Reg. No. 4,174,689

Registered July 17, 2012

Int. Cl.: 30

TRADEMARK

PRINCIPAL REGISTER

GREAT GARLIC FOODS INC. (NEW JERSEY CORPORATION)
709 FIFTH AVENUE
BRADLEY BEACH, NJ 07720

FOR: ADOBO; MINCED GARLIC; PESTO SAUCE; PROCESSED GARLIC FOR USE AS SEASONING; PROCESSED SHALLOTS FOR USE AS SEASONING, IN CLASS 30 (U.S. CL. 46).

FIRST USE 2-1-1979; IN COMMERCE 2-1-1979.

NO CLAIM IS MADE TO THE EXCLUSIVE RIGHT TO USE "GARLIC" AND THE REPRESENTATIONS OF THE GARLIC BULB, THE GARLIC CLOVES AND THE BASIL LEAVES, APART FROM THE MARK AS SHOWN.

THE MARK CONSISTS OF AN OVAL OUTLINE WITH THE STYLIZED REPRESENTATIONS OF A HEAD OF GARLIC AND THREE GARLIC CLOVES AT THE RIGHT HAND SIDE OF THE OVAL, AND THE STYLIZED REPRESENTATION OF BASIL LEAVES AT THE LOWER LEFT SIDE OF THE OVAL, ALL SURROUNDING THE WORDS "GREAT GARLIC" WHICH APPEAR IN THE CENTER OF THE OVAL.

SER. NO. 85-463,468, FILED 11-3-2011.

ESTHER BELENKER, EXAMINING ATTORNEY



David J. Kyjars

Director of the United States Patent and Trademark Office

United States of America

United States Patent and Trademark Office

reddit

Reg. No. 4,174,690

Registered July 17, 2012

Int. Cl.: 16

TRADEMARK

PRINCIPAL REGISTER

REDDIT, INC. (DELAWARE CORPORATION)
FOUR TIMES SQUARE
NEW YORK, NY 10036

FOR: STICKERS, IN CLASS 16 (U.S. CLS. 2, 5, 22, 23, 29, 37, 38 AND 50).

FIRST USE 10-26-2011; IN COMMERCE 10-26-2011.

THE MARK CONSISTS OF STANDARD CHARACTERS WITHOUT CLAIM TO ANY PARTICULAR FONT, STYLE, SIZE, OR COLOR.

OWNER OF U.S. REG. NOS. 3,474,493, 3,786,519, AND 4,087,966.

SER. NO. 85-463,492, FILED 11-3-2011.

RUDY R. SINGLETON, EXAMINING ATTORNEY



David J. Kybas

Director of the United States Patent and Trademark Office

United States of America

United States Patent and Trademark Office

FASHION THAT SAVES LIVES

Reg. No. 4,174,691

HILARY ROWLAND (CANADA INDIVIDUAL), DBA PROJECT MIGRATION INC.
4753-B MASTWOODS RD.

Registered July 17, 2012

PORT HOPE ONTARIO, CANADA L1A3V5

Int. Cls.: 14, 18 and 25

FOR: BRACELETS; NECKLACES, IN CLASS 14 (U.S. CLS. 2, 27, 28 AND 50).

FIRST USE 8-10-2009; IN COMMERCE 9-25-2010.

TRADEMARK

FOR: FASHION HANDBAGS, IN CLASS 18 (U.S. CLS. 1, 2, 3, 22 AND 41).

PRINCIPAL REGISTER

FIRST USE 8-10-2009; IN COMMERCE 10-3-2011.

FOR: ATHLETIC APPAREL, NAMELY, SHIRTS, PANTS, JACKETS, FOOTWEAR, HATS AND CAPS, ATHLETIC UNIFORMS; SHIRTS; T-SHIRTS; TEE SHIRTS, IN CLASS 25 (U.S. CLS. 22 AND 39).

FIRST USE 8-10-2009; IN COMMERCE 10-21-2009.

THE MARK CONSISTS OF STANDARD CHARACTERS WITHOUT CLAIM TO ANY PARTICULAR FONT, STYLE, SIZE, OR COLOR.

SER. NO. 85-463,519, FILED 11-3-2011.

ALEX KEAM, EXAMINING ATTORNEY



David J. Kybas

Director of the United States Patent and Trademark Office

United States of America

United States Patent and Trademark Office



Reg. No. 4,174,692

Registered July 17, 2012

Int. Cl.: 35

SERVICE MARK

PRINCIPAL REGISTER

MENLO PRODUCTS, INC. (CALIFORNIA CORPORATION)
7300 CENTRAL AVENUE, SUITE C
NEWARK, CA 94560

FOR: DISTRIBUTORSHIP SERVICES FEATURING NETWORKING CABINETS, EQUIPMENT MOUNTING RACKS, ELECTRONIC RACKMOUNTABLE PRODUCTS, RACKMOUNT ACCESSORIES, WIRE AND CABLE MANAGERS, NETWORK WIRE AND CABLE MANAGEMENT SYSTEMS AND ACCESSORIES, WIRE AND CABLE PATHWAY SYSTEMS AND ACCESSORIES, ELECTRICAL BONDING AND GROUNDING PRODUCTS, SEISMIC BRACING PRODUCTS, VARIETY OF PRODUCTS THAT COVER, STORE AND SECURE VARIETY OF TECHNOLOGY AND TELECOMMUNICATION HARDWARE PRODUCTS FROM DAMAGE, IN CLASS 35 (U.S. CLS. 100, 101 AND 102).

FIRST USE 0-0-2009; IN COMMERCE 0-0-2009.

NO CLAIM IS MADE TO THE EXCLUSIVE RIGHT TO USE "PRODUCTS", APART FROM THE MARK AS SHOWN.

THE MARK CONSISTS OF THREE VERTICAL LINES TO THE LEFT OF THE MARK "MENLO PRODUCTS"; THE MIDDLE LINE BEING SHORTER THAN THE SIDE LINES.

SER. NO. 85-463,551, FILED 11-3-2011.

LAURIE KAUFMAN, EXAMINING ATTORNEY



David J. Kyffers

Director of the United States Patent and Trademark Office

United States of America

United States Patent and Trademark Office



Reg. No. 4,174,693

ROYAL PETROLEUM CO. (CALIFORNIA CORPORATION)
365 TODD ROAD
SANTA ROSA, CA 95407

Registered July 17, 2012

Int. Cl.: 4

FOR: FUEL FOR MOTOR VEHICLES, NAMELY, GASOLINE AND PETROLEUM PRODUCTS,
IN CLASS 4 (U.S. CLS. 1, 6 AND 15).

TRADEMARK

FIRST USE 7-15-2010; IN COMMERCE 7-15-2010.

PRINCIPAL REGISTER

NO CLAIM IS MADE TO THE EXCLUSIVE RIGHT TO USE "GASOLINE", APART FROM
THE MARK AS SHOWN.

THE COLOR(S) RED, WHITE, BLUE IS/ARE CLAIMED AS A FEATURE OF THE MARK.

THE MARK CONSIST OF A STYLIZED LETTER "A" WITH WINGS IN WHITE OUTLINED
IN BLUE. ABOVE IS THE WORD "FLYING" IN WHITE AND UNDERNEATH THE WORD
"GASOLINE" IN WHITE ALL ON A RED BACKGROUND.

SER. NO. 85-463,769, FILED 11-3-2011.

STEPHANIE ALI, EXAMINING ATTORNEY



David J. Kyffers

Director of the United States Patent and Trademark Office

United States of America

United States Patent and Trademark Office



david | peck

Reg. No. 4,174,694

Registered July 17, 2012

Int. Cl.: 25

TRADEMARK

PRINCIPAL REGISTER

DAVID PECK COLLECTION, LLC (TEXAS LIMITED LIABILITY COMPANY)
202 WEST DREW
HOUSTON, TX 77006

FOR: BLOUSES; COATS; DRESSES; GOWNS; PANTS; SHIRTS; SKIRTS; SWEATERS, IN CLASS 25 (U.S. CLS. 22 AND 39).

FIRST USE 5-0-2006; IN COMMERCE 5-0-2006.

THE NAME "DAVID PECK" IDENTIFIES A LIVING INDIVIDUAL WHOSE CONSENT IS OF RECORD.

THE MARK CONSISTS OF THE STYLIZED LETTERS "D","P" ABOVE THE STYLIZED WORDING "DAVID PECK".

SER. NO. 85-463,811, FILED 11-3-2011.

MARLENE BELL, EXAMINING ATTORNEY



David J. Kyffers

Director of the United States Patent and Trademark Office

United States of America

United States Patent and Trademark Office



Reg. No. 4,174,695

Registered July 17, 2012

Int. Cl.: 43

SERVICE MARK

PRINCIPAL REGISTER

JTC15 MADISON HOTEL, L.P. (DELAWARE LIMITED PARTNERSHIP)
ONE OVERTON PARK, 12TH FLOOR
3625 CUMBERLAND BLVD.
ATLANTA, GA 30339

FOR: RESTAURANT SERVICES, IN CLASS 43 (U.S. CLS. 100 AND 101).

FIRST USE 10-28-2011; IN COMMERCE 10-28-2011.

NO CLAIM IS MADE TO THE EXCLUSIVE RIGHT TO USE "WASHINGTON, D.C.", APART FROM THE MARK AS SHOWN.

THE COLOR(S) RED IS/ARE CLAIMED AS A FEATURE OF THE MARK.

THE MARK CONSISTS OF THE WORDING "THE FEDERALIST WASHINGTON, D.C." IN RED, INSIDE OF THREE RED CONCENTRIC DIAMONDS. A RED ARROW APPEARS BEFORE AND AFTER THE WORD "THE". BELOW THE TERM "THE" IS THE WORD "FEDERALIST" WHICH IS ABOVE THE WORDING "WASHINGTON, D.C.".

SER. NO. 85-463,820, FILED 11-3-2011.

MARLENE BELL, EXAMINING ATTORNEY



David J. Kyffers

Director of the United States Patent and Trademark Office

United States of America

United States Patent and Trademark Office

THE LEVO LEAGUE

Reg. No. 4,174,696

Registered July 17, 2012

Int. Cl.: 35

SERVICE MARK

PRINCIPAL REGISTER

THE LEVO LEAGUE LLC (DELAWARE LIMITED LIABILITY COMPANY)
122 GREENWICH AVENUE, #2B
NEW YORK, NY 10011

FOR: INFORMATION SERVICES, NAMELY, DISSEMINATION OVER THE INTERNET OF INFORMATION FOR YOUNG PROFESSIONAL WOMEN IN THE FIELDS OF CAREER ADVICE AND EMPLOYMENT ADVICE, IN CLASS 35 (U.S. CLS. 100, 101 AND 102).

FIRST USE 10-31-2011; IN COMMERCE 10-31-2011.

NO CLAIM IS MADE TO THE EXCLUSIVE RIGHT TO USE "LEAGUE", APART FROM THE MARK AS SHOWN.

THE MARK CONSISTS OF THE STYLIZED WORDING "THE LEVO LEAGUE" WITH A DESIGN STANDING IN FOR THE LETTER "A" CONSISTING OF A CONCENTRIC CIRCLE AND A SINGLE TRIANGLE WITH A CURVED BOTTOM.

SER. NO. 85-463,853, FILED 11-3-2011.

JACLYN KIDWELL WALKER, EXAMINING ATTORNEY



David J. Kyjars

Director of the United States Patent and Trademark Office

United States of America

United States Patent and Trademark Office

CHAPELLE ST. THEODORIC

Reg. No. 4,174,697

Registered July 17, 2012

Int. Cl.: 33

TRADEMARK

PRINCIPAL REGISTER

WEYGANDT-METZLER IMPORTING, LTD. (PENNSYLVANIA CORPORATION), DBA
WEYGANDT-METZLER
2226 HILLTOP VIEW ROAD
COATESVILLE, PA 19320

FOR: GRAPE WINE; RED WINE; RED WINES; ROSE WINE; STILL WINES; TABLE WINES;
WINE; WINES; WINES AND FORTIFIED WINES; WINES AND LIQUEURS; WINES DERIVED
FROM GRAPES GROWN IN FRANCE, LABELED AND ADVERTISED IN COMPLIANCE
WITH US LAWS FOR WINE LABELING, IN CLASS 33 (U.S. CLS. 47 AND 49).

FIRST USE 9-21-2011; IN COMMERCE 9-21-2011.

THE MARK CONSISTS OF STANDARD CHARACTERS WITHOUT CLAIM TO ANY PAR-
TICULAR FONT, STYLE, SIZE, OR COLOR.

THE ENGLISH TRANSLATION OF THE MARK IS "ST. THEODORE CHAPEL".

SER. NO. 85-463,884, FILED 11-3-2011.

KATHERINE STOIDES, EXAMINING ATTORNEY



David J. Kyffers

Director of the United States Patent and Trademark Office

United States of America

United States Patent and Trademark Office

YORzyme

Reg. No. 4,174,698

Registered July 17, 2012

Int. Cl.: 5

TRADEMARK

PRINCIPAL REGISTER

PERFICIO NETWORKS, INC. (CALIFORNIA CORPORATION), DBA YOR HEALTH
SUITE 150
2802 KELVIN AVE.
IRVINE, CA 92614

FOR: DIETARY AND NUTRITIONAL SUPPLEMENTS; DIETARY AND NUTRITIONAL SUPPLEMENTS CONTAINING THE DIGESTIVE ENZYME PROTEASE AND CELLULASE FOR HUMAN CONSUMPTION; NUTRITIONAL SUPPLEMENTS FOR HELPING WITH DIGESTION BY BREAKING DOWN FOOD AND PROMOTING A HEALTHY DIGESTION; ALL OF THE FOREGOING SOLD AS A COMPONENT PART OF NUTRITIONAL SUPPLEMENTS IN THE FORM OF POWDER, CAPSULES OR TABLETS, IN CLASS 5 (U.S. CLS. 6, 18, 44, 46, 51 AND 52).

FIRST USE 2-1-2011; IN COMMERCE 2-1-2011.

THE MARK CONSISTS OF STANDARD CHARACTERS WITHOUT CLAIM TO ANY PARTICULAR FONT, STYLE, SIZE, OR COLOR.

OWNER OF U.S. REG. NOS. 3,546,597, 3,698,081 AND OTHERS.

SER. NO. 85-464,058, FILED 11-3-2011.

HELENE LIWINSKI, EXAMINING ATTORNEY



David J. Kyros

Director of the United States Patent and Trademark Office

United States of America
United States Patent and Trademark Office

KYO-RED

Reg. No. 4,174,699

WAKUNAGA OF AMERICA CO., LTD. (CALIFORNIA CORPORATION)
23501 MADERO
MISSION VIEJO, CA 926912744

Registered July 17, 2012

Int. Cl.: 5

FOR: DIETARY SUPPLEMENTS, IN CLASS 5 (U.S. CLS. 6, 18, 44, 46, 51 AND 52).

TRADEMARK

FIRST USE 5-26-2010; IN COMMERCE 5-26-2010.

PRINCIPAL REGISTER

THE MARK CONSISTS OF STANDARD CHARACTERS WITHOUT CLAIM TO ANY PARTICULAR FONT, STYLE, SIZE, OR COLOR.

OWNER OF U.S. REG. NOS. 1,853,473, 2,135,895 AND OTHERS.

THE WORDING "KYO-RED" HAS NO MEANING IN A FOREIGN LANGUAGE.

SER. NO. 85-464,111, FILED 11-3-2011.

BARNEY CHARLON, EXAMINING ATTORNEY



David J. Kyffers

Director of the United States Patent and Trademark Office

United States of America

United States Patent and Trademark Office



Reg. No. 4,174,700

TOLS, LLC (FLORIDA LIMITED LIABILITY COMPANY)
247 SW 8TH ST, # 243
MIAMI, FL 33130

Registered July 17, 2012

Int. Cl.: 35

FOR: ASSOCIATION SERVICES, NAMELY, PROMOTING THE INTERESTS OF LEGAL PROFESSIONALS, IN CLASS 35 (U.S. CLS. 100, 101 AND 102).

SERVICE MARK

FIRST USE 2-0-2011; IN COMMERCE 2-0-2011.

PRINCIPAL REGISTER

NO CLAIM IS MADE TO THE EXCLUSIVE RIGHT TO USE "THE ONLINE BAR", APART FROM THE MARK AS SHOWN.

THE COLOR(S) YELLOW, BLUE, AND PINK IS/ARE CLAIMED AS A FEATURE OF THE MARK.

THE MARK CONSISTS OF FOUR INCOMPLETE RINGS COLORED, FROM LEFT TO RIGHT, YELLOW, BLUE, PINK AND BLUE, NEXT TO WHICH IS THE WORDING "THE ONLINE BAR" IN BLUE.

SER. NO. 85-464,151, FILED 11-3-2011.

FRED CARL, EXAMINING ATTORNEY



David J. Kybas

Director of the United States Patent and Trademark Office

United States of America

United States Patent and Trademark Office

Got Wipes

Reg. No. 4,174,701

X2, INC. (DELAWARE CORPORATION)
9663 SANTA MONICA BLVD, # 593
BEVERLY HILLS, CA 90210

Registered July 17, 2012

Int. Cl.: 3

FOR: DISPOSABLE WIPES IMPREGNATED WITH CLEANING CHEMICALS OR COMPOUNDS FOR INDUSTRIAL AND COMMERCIAL USE; DISPOSABLE WIPES IMPREGNATED WITH CLEANSING CHEMICALS OR COMPOUNDS FOR HOUSEHOLD USE, IN CLASS 3 (U.S. CLS. 1, 4, 6, 50, 51 AND 52).

TRADEMARK

PRINCIPAL REGISTER

FIRST USE 9-13-2004; IN COMMERCE 12-4-2004.

NO CLAIM IS MADE TO THE EXCLUSIVE RIGHT TO USE "WIPES", APART FROM THE MARK AS SHOWN.

THE MARK CONSISTS OF "GOT WIPES".

SER. NO. 85-464,263, FILED 11-4-2011.

MARTHA FROMM, EXAMINING ATTORNEY



David J. Kybas

Director of the United States Patent and Trademark Office

United States of America
United States Patent and Trademark Office



Reg. No. 4,174,702

CENTENE CORPORATION (DELAWARE CORPORATION)
7700 FORSYTH BOULEVARD
ST. LOUIS, MO 63105

Registered July 17, 2012

Int. Cl.: 44

FOR: MANAGED HEALTHCARE SERVICES, IN CLASS 44 (U.S. CLS. 100 AND 101).

SERVICE MARK

FIRST USE 1-28-2004; IN COMMERCE 1-28-2004.

PRINCIPAL REGISTER

OWNER OF U.S. REG. NO. 2,404,033.

NO CLAIM IS MADE TO THE EXCLUSIVE RIGHT TO USE "HEALTH", APART FROM THE MARK AS SHOWN.

THE MARK CONSISTS OF A STYLIZED STAR WITHIN A SQUARE TO THE LEFT OF THE WORDS "NOVASYS" ALL PLACED ABOVE THE TERM "HEALTH".

SER. NO. 85-464,307, FILED 11-4-2011.

RAUL CORDOVA, EXAMINING ATTORNEY



David J. Kyffers

Director of the United States Patent and Trademark Office

United States of America

United States Patent and Trademark Office

RAY WILLIAM JOHNSON

Reg. No. 4,174,703

Registered July 17, 2012

Int. Cl.: 41

SERVICE MARK

PRINCIPAL REGISTER

RAY WILLIAM JOHNSON (UNITED STATES INDIVIDUAL)
#525
13428 MAXELLA AVE
MARINA DEL REY, CA 90292

FOR: ENTERTAINMENT SERVICES, NAMELY, PROVIDING ON-GOING WEBISODES FEATURING CARTOONS VIA A GLOBAL COMPUTER NETWORK; ENTERTAINMENT SERVICES, NAMELY, PROVIDING A WEBSITE FEATURING NON-DOWNLOADABLE MUSIC VIDEOS AND NON-DOWNLOADABLE COMEDIC VIDEOS; ON-LINE JOURNALS, NAMELY, VIDEO BLOGS FEATURING COMMENTARY ON VIDEOS PRODUCED BY OTHERS, IN CLASS 41 (U.S. CLS. 100, 101 AND 107).

FIRST USE 0-0-2007; IN COMMERCE 0-0-2007.

THE MARK CONSISTS OF STANDARD CHARACTERS WITHOUT CLAIM TO ANY PARTICULAR FONT, STYLE, SIZE, OR COLOR.

THE NAME "RAY WILLIAM JOHNSON" IDENTIFIES A LIVING INDIVIDUAL WHOSE CONSENT IS OF RECORD.

SER. NO. 85-464,331, FILED 11-4-2011.

KAPIL BHANOT, EXAMINING ATTORNEY



David J. Kyffers

Director of the United States Patent and Trademark Office

United States of America

United States Patent and Trademark Office



Reg. No. 4,174,704

Registered July 17, 2012

Int. Cl.: 41

SERVICE MARK

PRINCIPAL REGISTER

RAY WILLIAM JOHNSON (UNITED STATES INDIVIDUAL)
#525
13428 MAXELLA AVE
MARINA DEL REY, CA 90292

FOR: ENTERTAINMENT SERVICES, NAMELY, PROVIDING ON-GOING WEBISODES FEATURING CARTOONS VIA A GLOBAL COMPUTER NETWORK; ENTERTAINMENT SERVICES, NAMELY, PROVIDING A WEBSITE FEATURING NON-DOWNLOADABLE MUSIC VIDEOS AND NON-DOWNLOADABLE COMEDIC VIDEOS; ON-LINE JOURNALS, NAMELY, VIDEO BLOGS FEATURING COMMENTARY ON VIDEOS PRODUCED BY OTHERS, IN CLASS 41 (U.S. CLS. 100, 101 AND 107).

FIRST USE 0-0-2007; IN COMMERCE 0-0-2007.

THE MARK CONSISTS OF A STYLIZED EQUALS SIGN "=" ADJACENT TO THE STYLIZED NUMBER "3".

SER. NO. 85-464,334, FILED 11-4-2011.

KAPIL BHANOT, EXAMINING ATTORNEY



David J. Kyffers

Director of the United States Patent and Trademark Office

United States of America

United States Patent and Trademark Office

STREAM ON DEMAND BY CLEARLEAP

Reg. No. 4,174,705

Registered July 17, 2012

Int. Cls.: 38, 41 and 42

SERVICE MARK

PRINCIPAL REGISTER

CLEARLEAP, INC. (GEORGIA CORPORATION)
3090 PREMIERE PKWY, STE 400
DULUTH, GA 30097

FOR: AUDIO AND VIDEO STREAMING SERVICES VIA INTERNET, INTERNET PROTOCOL TELEVISION (IPTV), CABLE, OR SATELLITE, NAMELY, TRANSMISSION OF AUDIO AND VIDEO CONTENT TO OTHERS VIA A GLOBAL COMMUNICATIONS NETWORK; VIDEO ON DEMAND TRANSMISSION SERVICES; TELECOMMUNICATIONS SERVICES, NAMELY, TRANSMISSION OF VIDEO IMAGES COMPATIBLE WITH OPEN NETWORK COMMUNICATION FORMATS VIA A GLOBAL COMMUNICATIONS NETWORK; ON-DEMAND DELIVERY OF MOVIES, TELEVISION PROGRAMMING, AND OTHER VIDEO CONTENT VIA IP-BASED (INTERNET PROTOCOL-BASED) NETWORK DELIVERY, IN CLASS 38 (U.S. CLS. 100, 101 AND 104).

FIRST USE 11-11-2010; IN COMMERCE 11-11-2010.

FOR: CABLE TELEVISION PROGRAMMING; SYNDICATION OF MOVIES, TELEVISION PROGRAMMING, AND OTHER VIDEO CONTENT FOR OTHERS VIA IP-BASED NETWORK DELIVERY, IN CLASS 41 (U.S. CLS. 100, 101 AND 107).

FIRST USE 11-11-2010; IN COMMERCE 11-11-2010.



FOR: COMPUTER NETWORK MANAGEMENT SERVICES, NAMELY, ADMINISTRATION OF A COMPUTER NETWORK DESIGNED TO FACILITATE THE CAPTURE, TRANSMISSION, EDITING, MANAGEMENT AND/OR BROADCAST OF DIGITAL IMAGES, AUDIO AND VIDEO CONTENT; ADMINISTRATION OF A COMPUTER NETWORK DESIGNED TO MONITOR AND MEASURE NETWORK BANDWIDTH DEMANDS, TO ALLOCATE APPROPRIATE POOLS OF BANDWIDTH TO SATISFY NETWORK REQUIREMENTS, AND TO COORDINATE DIGITAL MEDIA CONTENT TRANSMISSION TO AND FROM INDIVIDUAL AND MULTIPLE SITES; TRANSCODING, SEND-FOR-REVIEW, REVIEW-AND-APPROVAL, MARKING AVAILABLE INVENTORY, AND FILE ATTACHMENT OF DIGITAL ADVERTISING ASSETS; ELECTRONIC ENCODING AND TRANSCODING OF VIDEO/AUDIO DATA, IN CLASS 42 (U.S. CLS. 100 AND 101).

FIRST USE 11-11-2010; IN COMMERCE 11-11-2010.

David J. Kyffers

Director of the United States Patent and Trademark Office

Reg. No. 4,174,705 THE MARK CONSISTS OF STANDARD CHARACTERS WITHOUT CLAIM TO ANY PARTICULAR FONT, STYLE, SIZE, OR COLOR.

OWNER OF U.S. REG. NO. 3,717,849.

NO CLAIM IS MADE TO THE EXCLUSIVE RIGHT TO USE "STREAM ON DEMAND", APART FROM THE MARK AS SHOWN.

SER. NO. 85-464,416, FILED 11-4-2011.

KAELIE KUNG, EXAMINING ATTORNEY

United States of America

United States Patent and Trademark Office

ACUVUE ADVANCE

Reg. No. 4,174,706

JOHNSON & JOHNSON (NEW JERSEY CORPORATION)
ONE JOHNSON & JOHNSON PLAZA
NEW BRUNSWICK, NJ 089337001

Registered July 17, 2012

Int. Cl.: 9

FOR: CONTACT LENSES, IN CLASS 9 (U.S. CLS. 21, 23, 26, 36 AND 38).

TRADEMARK

FIRST USE 6-0-2004; IN COMMERCE 6-0-2004.

PRINCIPAL REGISTER

THE MARK CONSISTS OF STANDARD CHARACTERS WITHOUT CLAIM TO ANY PARTICULAR FONT, STYLE, SIZE, OR COLOR.

OWNER OF U.S. REG. NOS. 1,458,177, 3,014,623 AND OTHERS.

SER. NO. 85-464,477, FILED 11-4-2011.

THEODORE MCBRIDE, EXAMINING ATTORNEY



David J. Kyffers

Director of the United States Patent and Trademark Office

United States of America

United States Patent and Trademark Office

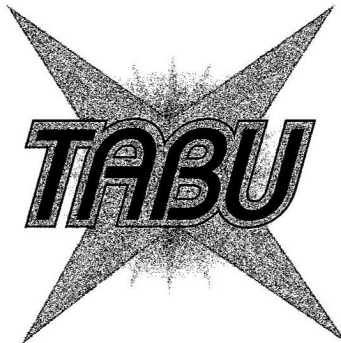

Reg. No. 4,174,707

Registered July 17, 2012

Int. Cl.: 42

SERVICE MARK

PRINCIPAL REGISTER

COOKS, KELVIN (UNITED STATES INDIVIDUAL)
109 JACOB MCKIE RD
TRENTON, SC 29847

FOR: PROVIDING A WEBSITE THAT GIVES COMPUTER USERS THE ABILITY TO GENERATE PRINT-READY FILES IN THE NATURE OF INFORMATIONAL POST-CARDS AND BUSINESS CARDS REGARDING CHARITABLE FUNDRAISING EFFORTS AND OUTREACH EFFORTS, UTILIZING THE INFORMATION SUBMITTED BY THE USER, IN CLASS 42 (U.S. CLS. 100 AND 101).

FIRST USE 8-1-2010; IN COMMERCE 8-11-2011.

THE STIPPLING IS FOR SHADING PURPOSES ONLY.

THE MARK CONSISTS OF A 4-POINT STAR WITH RAYS AND THE STYLIZED TEXT "TABU".

SER. NO. 85-464,657, FILED 11-4-2011.

AMY HELLA, EXAMINING ATTORNEY



David J. Kyffers

Director of the United States Patent and Trademark Office

United States of America

United States Patent and Trademark Office

SCHOOLPRIDE

Reg. No. 4,174,708

Registered July 17, 2012

Int. Cls.: 9 and 16

TRADEMARK

PRINCIPAL REGISTER

SCHOOL PRIDE, LTD. (OHIO CORPORATION)
3511 JOHNNY APPLESEED CT.
COLUMBUS, OH 43231

FOR: DECORATIVE MAGNETS; DECORATIVE REFRIGERATOR MAGNETS; MAGNETIC DOOR COVERS WITH A PRINTED IMAGE THEREON FOR AFFIXING TO METAL DOORS; MAGNETS; REFRIGERATOR MAGNETS, IN CLASS 9 (U.S. CLS. 21, 23, 26, 36 AND 38).

FIRST USE 12-22-2000; IN COMMERCE 12-22-2000.

FOR: 3D DECALS FOR USE ON ANY SURFACE; APPLIQUES IN THE FORM OF DECALS; BUMPER STICKERS; DECALS; DECORATIVE DECALS FOR VEHICLE WINDOWS; DECORATIVE STICKERS FOR HELMETS; MAGNETIC BUMPER STICKERS; PRESSURE SENSITIVE GRAPHICS FOR APPLICATION TO AUTOMOBILES; STICKERS; STICKERS AND TRANSFERS; STATIC CLING WINDOW TRANSFERS, IN CLASS 16 (U.S. CLS. 2, 5, 22, 23, 29, 37, 38 AND 50).

FIRST USE 12-22-2000; IN COMMERCE 12-22-2000.

THE MARK CONSISTS OF STANDARD CHARACTERS WITHOUT CLAIM TO ANY PARTICULAR FONT, STYLE, SIZE, OR COLOR.

OWNER OF U.S. REG. NO. 3,031,412.

SER. NO. 85-464,775, FILED 11-4-2011.

IRA J. GOODSaid, EXAMINING ATTORNEY



David J. Kyfos

Director of the United States Patent and Trademark Office

United States of America

United States Patent and Trademark Office



Reg. No. 4,174,709

Registered July 17, 2012

Int. Cl.: 9

TRADEMARK

PRINCIPAL REGISTER

ELECTRONIC TELE-COMMUNICATIONS, INC. (WISCONSIN CORPORATION)
1915 MCARTHUR ROAD
WAUKESHA, WI 53188

FOR: SIGNAL ACTUATED ELECTRICAL SOUND RECORDING AND REPRODUCING APPARATUS USEFUL FOR PERIODIC MESSAGE ANNOUNCEMENT ASSOCIATED WITH A TELEPHONE SYSTEM; TELEPHONE INTERCEPT SYSTEM HAVING AN INTERCEPT AUDIO RECORDER AND ELECTRONIC ANNOUNCER, A MEMORY EXPANSION CARD AND ACCESSORY CIRCUITS FOR CONNECTION TO CENTRAL OFFICE TELEPHONE FACILITIES, IN CLASS 9 (U.S. CLS. 21, 23, 26, 36 AND 38).

FIRST USE 7-14-1980; IN COMMERCE 10-15-1980.

THE MARK CONSISTS OF "ETC" ON A LOGO DESIGN SOMEWHAT SIMILAR TO A ROLL OF CANDY.

SER. NO. 85-464,806, FILED 11-4-2011.

JULIE WATSON, EXAMINING ATTORNEY



David J. Kyjars

Director of the United States Patent and Trademark Office

United States of America

United States Patent and Trademark Office

MILLENIUM DESIGNER

Reg. No. 4,174,710

MCLIN, THOMAS (UNITED STATES INDIVIDUAL)
1706 E. BROWN STREET
LUBBOCK, TX 79403

Registered July 17, 2012

Int. Cl.: 25

FOR: BELTS MADE OF LEATHER; BOOTS; VESTS, IN CLASS 25 (U.S. CLS. 22 AND 39).

TRADEMARK

FIRST USE 1-1-2007; IN COMMERCE 1-1-2007.

PRINCIPAL REGISTER

THE MARK CONSISTS OF STANDARD CHARACTERS WITHOUT CLAIM TO ANY PARTICULAR FONT, STYLE, SIZE, OR COLOR.

NO CLAIM IS MADE TO THE EXCLUSIVE RIGHT TO USE "DESIGNER", APART FROM THE MARK AS SHOWN.

SER. NO. 85-464,870, FILED 11-4-2011.

KEVIN DINALLO, EXAMINING ATTORNEY



David J. Kyffers

Director of the United States Patent and Trademark Office

United States of America

United States Patent and Trademark Office

Factoring Made Easy.

Reg. No. 4,174,711

NATIONAL BANKERS TRUST CORPORATION (TENNESSEE CORPORATION)
8245 TOURNAMENT DRIVE, SUITE 120
MEMPHIS, TN 38125

Registered July 17, 2012

Int. Cl.: 36

FOR: FACTORING AGENCIES, IN CLASS 36 (U.S. CLS. 100, 101 AND 102).

SERVICE MARK

FIRST USE 3-23-2011; IN COMMERCE 3-23-2011.

PRINCIPAL REGISTER

THE MARK CONSISTS OF STANDARD CHARACTERS WITHOUT CLAIM TO ANY PARTICULAR FONT, STYLE, SIZE, OR COLOR.

NO CLAIM IS MADE TO THE EXCLUSIVE RIGHT TO USE "FACTORING", APART FROM THE MARK AS SHOWN.

SER. NO. 85-464,898, FILED 11-4-2011.

STEVEN PEREZ, EXAMINING ATTORNEY



David J. Kyffers

Director of the United States Patent and Trademark Office

United States of America

United States Patent and Trademark Office

AMERITUS

Reg. No. 4,174,712

KENTEC MEDICAL, INC. (CALIFORNIA CORPORATION)
17871 FITCH AVENUE
IRVINE, CA 92614

Registered July 17, 2012

Int. Cl.: 10

FOR: MEDICAL DEVICES, NAMELY, FETAL TRANSDUCERS IN THE NATURE OF MEDICAL ULTRASOUND APPARATUS, THERMISTOR PROBES IN THE NATURE OF THERMOMETERS FOR MEDICAL PURPOSES AND COVERS THEREFOR, ENTERAL SYRINGES, ENTERAL FEEDING TUBES, ENTERAL EXTENSION SETS COMPRISED PRIMARILY OF ENTERAL EXTENSION TUBES, ENTERAL FEEDING TUBES, ENTERAL SYRINGES AND ORAL SYRINGES, PERIPHERALLY INSERTED CENTRAL CATHETER (PICC) PROCEDURAL TRAYS COMPRISING CATHETERS AND PARTS AND FITTINGS THEREFOR, COMPONENTS OF INCUBATORS FOR BABIES, NAMELY, INCUBATOR SLEEVES, INCUBATOR CUFFS, AND INCUBATOR AIR FILTERS, IN CLASS 10 (U.S. CLS. 26, 39 AND 44).

TRADEMARK

PRINCIPAL REGISTER

FIRST USE 4-0-2007; IN COMMERCE 4-0-2007.

THE MARK CONSISTS OF STANDARD CHARACTERS WITHOUT CLAIM TO ANY PARTICULAR FONT, STYLE, SIZE, OR COLOR.

OWNER OF U.S. REG. NO. 3,018,292.

SER. NO. 85-465,073, FILED 11-4-2011.

STEVEN PEREZ, EXAMINING ATTORNEY



David J. Kyffers

Director of the United States Patent and Trademark Office

United States of America

United States Patent and Trademark Office

Buggs Baggs

Reg. No. 4,174,713

JENSEN, CAROL (UNITED STATES INDIVIDUAL)
N4659 MOSS RD.

Registered July 17, 2012

IRON RIDGE, WI 53035

Int. Cl.: 18

FOR: PURSES, IN CLASS 18 (U.S. CLS. 1, 2, 3, 22 AND 41).

TRADEMARK

FIRST USE 6-10-2010; IN COMMERCE 8-21-2010.

PRINCIPAL REGISTER

THE MARK CONSISTS OF STANDARD CHARACTERS WITHOUT CLAIM TO ANY PARTICULAR FONT, STYLE, SIZE, OR COLOR.

NO CLAIM IS MADE TO THE EXCLUSIVE RIGHT TO USE "BAGS", APART FROM THE MARK AS SHOWN.

SER. NO. 85-465,163, FILED 11-4-2011.

REBECCA GILBERT, EXAMINING ATTORNEY



David J. Kyffers

Director of the United States Patent and Trademark Office

United States of America

United States Patent and Trademark Office

Discover Mystery

Reg. No. 4,174,714

POISONED PEN PRESS (DELAWARE CORPORATION)
6962 E. 1ST AVE, SUITE 103
SCOTTSDALE, AZ 85251

Registered July 17, 2012

Int. Cl.: 16

FOR: SERIES OF FICTION AND NON-FICTION BOOKS ON A VARIETY OF TOPICS, IN CLASS 16 (U.S. CLS. 2, 5, 22, 23, 29, 37, 38 AND 50).

TRADEMARK

FIRST USE 3-1-2012; IN COMMERCE 3-1-2012.

PRINCIPAL REGISTER

THE MARK CONSISTS OF STANDARD CHARACTERS WITHOUT CLAIM TO ANY PARTICULAR FONT, STYLE, SIZE, OR COLOR.

SER. NO. 85-465,229, FILED 11-4-2011.

JANET LEE, EXAMINING ATTORNEY



David J. Kybas

Director of the United States Patent and Trademark Office

United States of America

United States Patent and Trademark Office



Reg. No. 4,174,715

HEALTHPLUS OF MICHIGAN, INC. (MICHIGAN NON-PROFIT CORPORATION)
2050 S. LINDEN ROAD
FLINT, MI 48532

Registered July 17, 2012

Int. Cls.: 35, 36 and 44

FOR: ADMINISTRATION OF A PROGRAM FOR ENABLING PARTICIPANTS TO OBTAIN DISCOUNTS ON PRODUCTS AND SERVICES, IN CLASS 35 (U.S. CLS. 100, 101 AND 102).

SERVICE MARK

FIRST USE 4-0-2006; IN COMMERCE 4-0-2006.

PRINCIPAL REGISTER

FOR: HEALTH CARE INSURANCE SERVICES, NAMELY, UNDERWRITING AND ADMINISTRATION OF HEALTH CARE PLANS; ADMINISTRATION, FINANCIAL MANAGEMENT AND MAINTENANCE OF HEALTH SAVINGS ACCOUNTS, MEDICAL SAVINGS ACCOUNTS, HEALTH REIMBURSEMENT ARRANGEMENTS AND FLEXIBLE SPENDING ACCOUNTS; INSURANCE CLAIMS PROCESSING AND ADMINISTRATION; PHARMACY BENEFIT MANAGEMENT SERVICES, IN CLASS 36 (U.S. CLS. 100, 101 AND 102).

FIRST USE 4-0-2006; IN COMMERCE 4-0-2006.

FOR: HEALTH CARE SERVICES PROVIDED THROUGH PREFERRED PROVIDER OR EXCLUSIVE PROVIDER NETWORKS, HEALTH MAINTENANCE ORGANIZATIONS AND POINT OF SERVICE PLANS; COMPREHENSIVE HEALTH CARE BENEFIT PROGRAMS, RENDERED THROUGH PREFERRED PROVIDER OR EXCLUSIVE PROVIDER NETWORKS, HEALTH MAINTENANCE ORGANIZATIONS AND POINT OF SERVICE PLANS; PROVIDING HEALTH CARE INFORMATION IN THE FIELD OF HEALTH AND WELLNESS, BEHAVIORAL HEALTH, DISABILITY MANAGEMENT AND DISEASE MANAGEMENT; MANAGED HEALTH CARE SERVICES, NAMELY, HEALTH AND WELLNESS COUNSELING; MEDICAL, BEHAVIORAL HEALTH, AND DISABILITY CARE MANAGEMENT SERVICES; DISEASE CARE MANAGEMENT SERVICES, IN CLASS 44 (U.S. CLS. 100 AND 101).

FIRST USE 4-0-2006; IN COMMERCE 4-0-2006.

NO CLAIM IS MADE TO THE EXCLUSIVE RIGHT TO USE "RX" AND THE PICTORIAL REPRESENTATION OF A MORTAR AND PESTLE, APART FROM THE MARK AS SHOWN.

THE MARK CONSISTS OF THE LETTERING "ASK FOR 90" ABOVE A MORTAR AND PESTLE CONTAINING THE LETTERS "RX".



David J. Kybas

Director of the United States Patent and Trademark Office

Reg. No. 4,174,715 SER. NO. 85-465,251, FILED 11-4-2011.

SHARON MEIER, EXAMINING ATTORNEY

United States of America

United States Patent and Trademark Office



Reg. No. 4,174,716

YKS ACCEPTANCE, INC. (COLORADO CORPORATION)
2699 47TH AVE.
GREELEY, CO 80027

Registered July 17, 2012

Int. Cl.: 36

FOR: FINANCING SERVICES, IN CLASS 36 (U.S. CLS. 100, 101 AND 102).

SERVICE MARK

FIRST USE 10-28-2011; IN COMMERCE 10-28-2011.

PRINCIPAL REGISTER

NO CLAIM IS MADE TO THE EXCLUSIVE RIGHT TO USE "ACCEPTANCE INC" , APART FROM THE MARK AS SHOWN.

THE MARK CONSISTS OF A DESIGN MARK SETTING FORTH THE LETTERS "YKS" NEXT TO A BLACK AND WHITE, SIX-SIDED DESIGN ELEMENT SUGGESTIVE OF STRENGTH, RELIABILITY AND SOLIDITY, WITH THE WORDS "ACCEPTANCE INC" WRITTEN IN SMALL TYPE BENEATH THE LETTERS "KS".

SER. NO. 85-465,285, FILED 11-4-2011.

ANNE E. GUSTASON, EXAMINING ATTORNEY



David J. Kyffers

Director of the United States Patent and Trademark Office

United States of America

United States Patent and Trademark Office

D.E.Solution

Reg. No. 4,174,717

SHULMAN, ELENA (UNITED STATES INDIVIDUAL)
4226 20TH STREET
SAN FRANCISCO, CA 94114 AND

Registered July 17, 2012

Int. Cl.: 42

MASSART, DAVID A. (BELGIUM INDIVIDUAL)
AVENUE DU CONGO 14/33
BRUSSELS, BELGIUM 1000

SERVICE MARK

PRINCIPAL REGISTER

FOR: CONSULTING IN THE FIELD OF INFORMATION TECHNOLOGY , IN CLASS 42 (U.S. CLS. 100 AND 101).

FIRST USE 10-15-2011; IN COMMERCE 10-15-2011.

THE MARK CONSISTS OF STANDARD CHARACTERS WITHOUT CLAIM TO ANY PARTICULAR FONT, STYLE, SIZE, OR COLOR.

SER. NO. 85-465,345, FILED 11-5-2011.

BRENDAN MCCAULEY, EXAMINING ATTORNEY



David J. Kyffers

Director of the United States Patent and Trademark Office

United States of America

United States Patent and Trademark Office

BADGER CHILDHOOD CANCER NETWORK

Reg. No. 4,174,718

Registered July 17, 2012

Int. Cl.: 36

BADGER CHILDHOOD CANCER NETWORK, INC. (WISCONSIN CORPORATION),
FORMERLY CAPITAL CANDLELIGHTERS, INC.

SUITE 100
517 N SEGOE ROAD
MADISON, WI 53705

SERVICE MARK

PRINCIPAL REGISTER

FOR: CHARITABLE SERVICES, NAMELY, PROVIDING FINANCIAL SUPPORT AND FINANCIAL ASSISTANCE TO FAMILIES OF CHILDREN WITH CANCER FOR THE PURPOSE OF ENSURING THAT THE FAMILIES ARE ABLE TO COVER BASIC LIVING EXPENSES AND TRANSPORTATION TO MEDICAL APPOINTMENTS, IN CLASS 36 (U.S. CLS. 100, 101 AND 102).

FIRST USE 9-6-2010; IN COMMERCE 9-6-2010.

THE MARK CONSISTS OF STANDARD CHARACTERS WITHOUT CLAIM TO ANY PARTICULAR FONT, STYLE, SIZE, OR COLOR.

NO CLAIM IS MADE TO THE EXCLUSIVE RIGHT TO USE "CHILDHOOD CANCER NETWORK", APART FROM THE MARK AS SHOWN.

SER. NO. 85-465,396, FILED 11-5-2011.

MAUREEN DALL, EXAMINING ATTORNEY



David J. Kyffers

Director of the United States Patent and Trademark Office

United States of America

United States Patent and Trademark Office

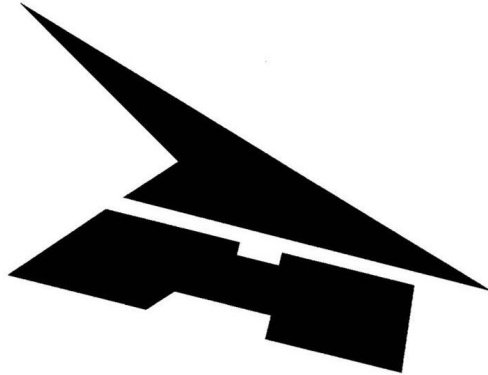

Reg. No. 4,174,719

AXO SPORT S.P.A. (ITALY SOCIETÀ PER AZIONI (SPA))
VIA FABIO FILZI, 66
ISTRANA (TREVISO), ITALY

Registered July 17, 2012

Int. Cls.: 9, 18, 25 and 28

FOR: ARTICLES OF PROTECTIVE CLOTHING FOR PROTECTION AGAINST ACCIDENT OR INJURY FOR USE IN MOTORCYCLING, SKATEBOARDING AND SKIING; ARTICLES OF PROTECTIVE CLOTHING FOR WEAR BY MOTORCYCLISTS FOR PROTECTION AGAINST ACCIDENT OR INJURY; BICYCLE HELMETS; CASES FOR SPECTACLES AND SUNGLASSES; CRASH HELMETS; GLOVES FOR PROTECTION AGAINST ACCIDENTS; GOGGLES FOR SPORTS; HELMETS FOR MOTORCYCLISTS; MOTORCYCLE GOGGLES; MOTORCYCLE HELMETS; PROTECTIVE FACE-SHIELDS FOR PROTECTIVE HELMETS; PROTECTIVE SPECTACLES; PROTECTIVE SPORTS HELMET ACCESSORIES THAT ATTACH TO THE HELMETS, NAMELY, MOUTH GUARDS, EAR PADS, THROAT PROTECTORS, CHIN STRAPS, FACE MASKS, JAW PADS AND EYE SHIELDS; SPECTACLE LENSES; SPORT GOGGLES FOR USE IN MOTORCYCLING, SKATEBOARDING AND SKIING, IN CLASS 9 (U.S. CLS. 21, 23, 26, 36 AND 38).

TRADEMARK

PRINCIPAL REGISTER

FIRST USE 10-1-2011; IN COMMERCE 10-1-2011.

FOR: ALL PURPOSE SPORT BAGS; BEACH BAGS; BELT BAGS; CLUTCH BAGS; CREDIT CARD CASES AND HOLDERS; DOCUMENT CASES; KEY CASES; KNAPSACKS; LEATHER BAGS, SUITCASES AND WALLETS; RUCKSACKS; SCHOOLBAGS; SHOULDER BAGS; SHOULDER STRAPS; TOTE BAGS; TRAVEL BAGS; UMBRELLAS AND PARASOLS , IN CLASS 18 (U.S. CLS. 1, 2, 3, 22 AND 41).

FIRST USE 10-1-2011; IN COMMERCE 10-1-2011.

FOR: ANKLE SOCKS; ANORAK; BICYCLING GLOVES; BOOTS FOR MOTORCYCLING; CARDIGANS; GLOVES AS CLOTHING; HEADGEAR, NAMELY, HATS AND CAPS; JACKETS AND SOCKS; KNEE HIGHS; MOTORCYCLE GLOVES; MOTORCYCLE JACKETS; MOTORCYCLE RAIN SUITS; MOTORCYCLIST BOOTS; SCARFS; SHOULDER SCARVES; SNOWBOARD BOOTS; SNOWBOARD GLOVES; SNOWBOARD JACKETS; SNOWBOARD TROUSERS; T-SHIRTS, IN CLASS 25 (U.S. CLS. 22 AND 39).



David J. Kyjars

FIRST USE 10-1-2011; IN COMMERCE 10-1-2011.

Reg. No. 4,174,719 FOR: CHEST PROTECTORS FOR SPORTS; KNEE PADS FOR ATHLETIC USE; PROTECTIVE PADDING FOR SKATEBOARDING; PROTECTIVE PADDING FOR SNOWBOARDING; PROTECTIVE SUPPORTS FOR SHOULDERS AND ELBOWS; SAFETY PADDING FOR USE ON WALLS OF STADIUMS AND FIELD ENCLOSURES TO PREVENT INJURY DURING SPORTS EVENTS; THROAT PROTECTORS FOR ATHLETIC USE, IN CLASS 28 (U.S. CLS. 22, 23, 38 AND 50).

FIRST USE 10-1-2011; IN COMMERCE 10-1-2011.

OWNER OF U.S. REG. NOS. 2,495,746 AND 2,703,998.

THE MARK CONSISTS OF A STYLIZED LETTER "A".

SER. NO. 85-465,431, FILED 11-5-2011.

LAKEISHA LEWIS, EXAMINING ATTORNEY

United States of America

United States Patent and Trademark Office

RACEHORSE

Reg. No. 4,174,720

Registered July 17, 2012

Int. Cl.: 9

TRADEMARK

PRINCIPAL REGISTER

FULHAM COMPANY LTD (HONG KONG A COMPANY LIMITED BY SHARES)
12D FORD GLORY PLAZA
37-39 WING HONG STREET
CHEUNG SHAWAN, KOWLOON, HONG KONG

FOR: ELECTRICAL AND ELECTRONIC LIGHTING BALLASTS, IN CLASS 9 (U.S. CLS. 21, 23, 26, 36 AND 38).

FIRST USE 9-14-2011; IN COMMERCE 9-14-2011.

THE MARK CONSISTS OF STANDARD CHARACTERS WITHOUT CLAIM TO ANY PARTICULAR FONT, STYLE, SIZE, OR COLOR.

SER. NO. 85-465,450, FILED 11-5-2011.

ROBERT C. CLARK JR., EXAMINING ATTORNEY



David J. Kybas

Director of the United States Patent and Trademark Office

United States of America

United States Patent and Trademark Office



Reg. No. 4,174,721

Registered July 17, 2012

Int. Cl.: 36

SERVICE MARK

PRINCIPAL REGISTER

RBP SOLAR FINICIAL (CALIFORNIA LIMITED LIABILITY COMPANY)
SUITE 956
1220 ROSECRANS ST.
SAN DIEGO, CA 92106

FOR: FINANCING SERVICES, IN CLASS 36 (U.S. CLS. 100, 101 AND 102).

FIRST USE 7-0-2011; IN COMMERCE 7-0-2011.

NO CLAIM IS MADE TO THE EXCLUSIVE RIGHT TO USE "SOLAR FINANCIAL", APART FROM THE MARK AS SHOWN.

THE MARK CONSISTS OF A CIRCULAR IMAGE OF A SUN WITH TRIANGULAR RAYS SURROUNDING IT. INSIDE THE SUN IS THE STYLIZED TEXT "RBP" WITH A DOLLAR SIGN (\$) DIRECTLY BELOW IT. DIRECTLY TO THE RIGHT OF THE DOLLAR SIGN IS THE STYLIZED TEXT "OLAR FINANCIAL".

SER. NO. 85-465,774, FILED 11-7-2011.

MARY ROSSMAN, EXAMINING ATTORNEY



David J. Kyros

Director of the United States Patent and Trademark Office

United States of America

United States Patent and Trademark Office

THE AUTOMOTIVE ARCHEOLOGISTS, LTD.

Reg. No. 4,174,722

THE AUTOMOTIVE ARCHEOLOGISTS, LTD. (MISSOURI CORPORATION)
6303 S. FARM ROAD 189
ROGERSVILLE, MO 65742

Registered July 17, 2012

Int. Cl.: 37

FOR: RESTORATION IN THE FIELD OF ANTIQUE CARS, IN CLASS 37 (U.S. CLS. 100, 103 AND 106).

SERVICE MARK

FIRST USE 11-24-1989; IN COMMERCE 11-24-1989.

PRINCIPAL REGISTER

THE MARK CONSISTS OF STANDARD CHARACTERS WITHOUT CLAIM TO ANY PARTICULAR FONT, STYLE, SIZE, OR COLOR.

NO CLAIM IS MADE TO THE EXCLUSIVE RIGHT TO USE "AUTOMOTIVE" AND "LTD.", APART FROM THE MARK AS SHOWN.

SER. NO. 85-466,049, FILED 11-7-2011.

JAMES STEIN, EXAMINING ATTORNEY



David J. Kyffers

Director of the United States Patent and Trademark Office

United States of America

United States Patent and Trademark Office

STREPTOCOCCUS UBERIS KJ2

Reg. No. 4,174,723

ORAGENICS, INC. (FLORIDA CORPORATION)
13700 PROGRESS BOULEVARD
ALACHUA, FL 32615

Registered July 17, 2012

Int. Cl.: 3

FOR: PROBIOTIC BACTERIA AS AN INTEGRAL INGREDIENT OF NON-MEDICATED PROBIOTIC PREPARATIONS FOR THE CARE OF MOUTH AND TEETH, IN CLASS 3 (U.S. CLS. 1, 4, 6, 50, 51 AND 52).

TRADEMARK

FIRST USE 9-30-2009; IN COMMERCE 9-30-2009.

PRINCIPAL REGISTER

THE MARK CONSISTS OF STANDARD CHARACTERS WITHOUT CLAIM TO ANY PARTICULAR FONT, STYLE, SIZE, OR COLOR.

NO CLAIM IS MADE TO THE EXCLUSIVE RIGHT TO USE "STREPTOCOCCUS UBERIS", APART FROM THE MARK AS SHOWN.

SER. NO. 85-466,139, FILED 11-7-2011.

APRIL HESIK, EXAMINING ATTORNEY



David J. Kyros

Director of the United States Patent and Trademark Office

United States of America

United States Patent and Trademark Office

STREPTOCOCCUS RATTUS JH145

Reg. No. 4,174,724

ORAGENICS, INC. (FLORIDA CORPORATION)
13700 PROGRESS BOULEVARD
ALACHUA, FL 32615

Registered July 17, 2012

Int. Cl.: 3

FOR: PROBIOTIC BACTERIA AS AN INTEGRAL INGREDIENT OF NON-MEDICATED PROBIOTIC PREPARATIONS FOR THE CARE OF MOUTH AND TEETH, IN CLASS 3 (U.S. CLS. 1, 4, 6, 50, 51 AND 52).

TRADEMARK

FIRST USE 9-30-2009; IN COMMERCE 9-30-2009.

PRINCIPAL REGISTER

THE MARK CONSISTS OF STANDARD CHARACTERS WITHOUT CLAIM TO ANY PARTICULAR FONT, STYLE, SIZE, OR COLOR.

NO CLAIM IS MADE TO THE EXCLUSIVE RIGHT TO USE "STREPTOCOCCUS RATTUS", APART FROM THE MARK AS SHOWN.

SER. NO. 85-466,150, FILED 11-7-2011.

APRIL HESIK, EXAMINING ATTORNEY



David J. Kyros

Director of the United States Patent and Trademark Office

United States of America

United States Patent and Trademark Office

STREPTOCOCCUS ORALIS KJ3

Reg. No. 4,174,725

Registered July 17, 2012

Int. Cl.: 3

TRADEMARK

PRINCIPAL REGISTER

ORAGENICS, INC. (FLORIDA CORPORATION)
13700 PROGRESS BOULEVARD
ALACHUA, FL 32615

FOR: PROBIOTIC BACTERIA AS AN INTEGRAL INGREDIENT OF NON-MEDICATED PROBIOTIC PREPARATIONS FOR THE CARE OF MOUTH AND TEETH, IN CLASS 3 (U.S. CLS. 1, 4, 6, 50, 51 AND 52).

FIRST USE 9-30-2009; IN COMMERCE 9-30-2009.

THE MARK CONSISTS OF STANDARD CHARACTERS WITHOUT CLAIM TO ANY PARTICULAR FONT, STYLE, SIZE, OR COLOR.

NO CLAIM IS MADE TO THE EXCLUSIVE RIGHT TO USE "STREPTOCOCCUS ORALIS", APART FROM THE MARK AS SHOWN.

SER. NO. 85-466,154, FILED 11-7-2011.

APRIL HESIK, EXAMINING ATTORNEY



David J. Kyfos

Director of the United States Patent and Trademark Office

United States of America

United States Patent and Trademark Office



Reg. No. 4,174,726

Registered July 17, 2012

Int. Cl.: 38

SERVICE MARK

PRINCIPAL REGISTER

WFCR FOUNDATION, INC. (MASSACHUSETTS CORPORATION)
HAMPSHIRE HOUSE, UNIV. OF MASSACHUSETTS
131 COUNTRY CIRCLE
AMHERST, MA 010039259

FOR: RADIO BROADCASTING; STREAMING OF AUDIO MATERIAL ON THE INTERNET,
IN CLASS 38 (U.S. CLS. 100, 101 AND 104).

FIRST USE 5-11-2011; IN COMMERCE 5-11-2011.

NO CLAIM IS MADE TO THE EXCLUSIVE RIGHT TO USE "NEW ENGLAND PUBLIC
RADIO", APART FROM THE MARK AS SHOWN.

THE MARK CONSISTS OF "NEW ENGLAND PUBLIC RADIO" & STYLIZED BAR DESIGN.

SER. NO. 85-466,216, FILED 11-7-2011.

ANNE E. GUSTASON, EXAMINING ATTORNEY



David J. Kybas

Director of the United States Patent and Trademark Office

United States of America

United States Patent and Trademark Office

Premier Turbo

Reg. No. 4,174,727

R&D DYNAMICS CORPORATION (CONNECTICUT CORPORATION)
49 WEST DUDLEY TOWN ROAD
BLOOMFIELD, CT 06002

Registered July 17, 2012

Int. Cl.: 7

FOR: TURBOMACHINES, NAMELY, POWER-OPERATED BLOWERS, IN CLASS 7 (U.S. CLS. 13, 19, 21, 23, 31, 34 AND 35).

TRADEMARK

FIRST USE 10-17-2011; IN COMMERCE 10-17-2011.

PRINCIPAL REGISTER

THE MARK CONSISTS OF STANDARD CHARACTERS WITHOUT CLAIM TO ANY PARTICULAR FONT, STYLE, SIZE, OR COLOR.

SER. NO. 85-466,230, FILED 11-7-2011.

MARY ROSSMAN, EXAMINING ATTORNEY



David J. Kyffers

Director of the United States Patent and Trademark Office

United States of America

United States Patent and Trademark Office



Reg. No. 4,174,728

Registered July 17, 2012

Int. Cls.: 41 and 44

SERVICE MARK

PRINCIPAL REGISTER

HAND SURGERY ASSOCIATES OF INDIANA, INC. (INDIANA CORPORATION)
P.O. BOX 80434
8501 HARCOURT ROAD
INDIANAPOLIS, IN 46280

FOR: EDUCATIONAL SERVICES, NAMELY, CONDUCTING COURSES OF INSTRUCTION, SEMINARS, TRAINING PROGRAMS AND LECTURES RELATED TO MEDICAL TREATMENTS AND TRAUMA AFFECTING THE HANDS AND EXTREMITIES, IN CLASS 41 (U.S. CLS. 100, 101 AND 107).

FIRST USE 1-1-2010; IN COMMERCE 1-1-2010.

FOR: DIAGNOSTIC, EVALUATION AND TESTING SERVICES FOR SURGICAL, THERAPEUTIC AND REHABILITATION SERVICES RELATING TO TRAUMA AFFECTING THE HANDS AND THE UPPER EXTREMITIES, IN CLASS 44 (U.S. CLS. 100 AND 101).

FIRST USE 1-1-2010; IN COMMERCE 1-1-2010.

NO CLAIM IS MADE TO THE EXCLUSIVE RIGHT TO USE "INDIANA HAND TO SHOULDER CENTER", APART FROM THE MARK AS SHOWN.

THE MARK CONSISTS OF THE DESIGN OF A STYLIZED CIRCLE AND ARC COMBINED TO FORM THE IMPRESSION OF A HEAD AND ARMS POSITIONED TO THE RIGHT OF THE WORD "INDIANA" AND ABOVE THE WORDS "HAND TO SHOULDER". THE WORD "CENTER" IS POSITIONED BELOW THE MARK JUSTIFIED TO THE RIGHT.

SER. NO. 85-466,249, FILED 11-7-2011.

MARK T. MULLEN, EXAMINING ATTORNEY



David J. Kybas

Director of the United States Patent and Trademark Office

United States of America

United States Patent and Trademark Office

CafeCountertops

Reg. No. 4,174,729

Registered July 17, 2012

Int. Cl.: 19

TRADEMARK

PRINCIPAL REGISTER

SAMUEL ROCHAT (TENNESSEE SOLE PROPRIETORSHIP), DBA TERRASSA NORTH AMERICA
2811 JOHN DEERE DR.
KNOXVILLE, TN 37917

FOR: BUILDING MATERIALS, NAMELY, NON-METAL COUNTERTOPS FOR FURTHER INSTALLATION, IN CLASS 19 (U.S. CLS. 1, 12, 33 AND 50).

FIRST USE 12-1-2005; IN COMMERCE 12-1-2005.

THE MARK CONSISTS OF STANDARD CHARACTERS WITHOUT CLAIM TO ANY PARTICULAR FONT, STYLE, SIZE, OR COLOR.

SER. NO. 85-466,287, FILED 11-7-2011.

HENRY S. ZAK, EXAMINING ATTORNEY



David J. Kybas

Director of the United States Patent and Trademark Office

United States of America

United States Patent and Trademark Office



Reg. No. 4,174,730

DRIVERS TRAINING CENTER LLC4 (TENNESSEE LIMITED LIABILITY COMPANY)
119 E.L. MORGAN DRIVE
JACKSON, TN 38305

Registered July 17, 2012

Int. Cl.: 41

FOR: TRACTOR-TRAILER DRIVING INSTRUCTION, IN CLASS 41 (U.S. CLS. 100, 101 AND 107).

SERVICE MARK

FIRST USE 6-0-1995; IN COMMERCE 6-0-1995.

PRINCIPAL REGISTER

NO CLAIM IS MADE TO THE EXCLUSIVE RIGHT TO USE "TRAINING AND PROFESSIONAL DRIVERS AND THE DESIGN OF A TRACTOR TRAILER TRUCK WITH THE WORDS STUDENT DRIVER", APART FROM THE MARK AS SHOWN.

THE MARK CONSISTS OF A SEMI-TRUCK WITH THE TRAILER AND THE STYLIZED TEXT "STUDENT DRIVER" ON THE SIDE OF THE TRAILER. BELOW THERE IS A BANNER WITH THE STYLIZED TEXT "DRIVE-TRAIN TRAINING TOMORROW'S PROFESSIONAL DRIVERS".

SER. NO. 85-466,300, FILED 11-7-2011.

HENRY S. ZAK, EXAMINING ATTORNEY



David J. Kybas

Director of the United States Patent and Trademark Office

United States of America

United States Patent and Trademark Office

OSCAR ROBERTSON TROPHY

Reg. No. 4,174,731

Registered July 17, 2012

Int. Cl.: 41

SERVICE MARK

PRINCIPAL REGISTER

ROBERTSON, OSCAR (UNITED STATES INDIVIDUAL)
SUITE 206
10999 REED HARTMAN HIGHWAY
CINCINNATI, OH 45242

FOR: PROVIDING RECOGNITION AND INCENTIVES BY WAY OF AWARDS TO DEMONSTRATE EXCELLENCE IN THE FIELD OF COLLEGE BASKETBALL, IN CLASS 41 (U.S. CLS. 100, 101 AND 107).

FIRST USE 0-0-1998; IN COMMERCE 0-0-1998.

THE MARK CONSISTS OF STANDARD CHARACTERS WITHOUT CLAIM TO ANY PARTICULAR FONT, STYLE, SIZE, OR COLOR.

NO CLAIM IS MADE TO THE EXCLUSIVE RIGHT TO USE "TROPHY", APART FROM THE MARK AS SHOWN.

THE NAME(S), PORTRAIT(S), AND/OR SIGNATURE(S) SHOWN IN THE MARK IDENTIFIES "OSCAR ROBERTSON", WHOSE CONSENT(S) TO REGISTER IS MADE OF RECORD.

SER. NO. 85-466,334, FILED 11-7-2011.

LINDA POWELL, EXAMINING ATTORNEY



David J. Kyffers

Director of the United States Patent and Trademark Office

United States of America

United States Patent and Trademark Office

Desperado Choppers

Reg. No. 4,174,732

MORTIMER, KENTON D. (UNITED STATES INDIVIDUAL)
3140 N. ARGYLE AVE. #104
FRESNO, CA 93727

Registered July 17, 2012

Int. Cl.: 25

FOR: T-SHIRTS, IN CLASS 25 (U.S. CLS. 22 AND 39).

TRADEMARK

FIRST USE 5-18-2006; IN COMMERCE 5-18-2006.

PRINCIPAL REGISTER

THE MARK CONSISTS OF STANDARD CHARACTERS WITHOUT CLAIM TO ANY PARTICULAR FONT, STYLE, SIZE, OR COLOR.

SER. NO. 85-466,452, FILED 11-7-2011.

IRA J. GOODSaid, EXAMINING ATTORNEY



David J. Kyffers

Director of the United States Patent and Trademark Office

United States of America

United States Patent and Trademark Office



Reg. No. 4,174,733

RACHEL DELABRUERE (UNITED STATES INDIVIDUAL), DBA BEACH BABE SWIMWEAR
42560 MORAGA RD # 205
TEMECULA, CA 92591

Registered July 17, 2012

Int. Cl.: 25

FOR: BEACH COVERUPS; BEACHWEAR; COVERUPS; SWIMWEAR, IN CLASS 25 (U.S. CLS. 22 AND 39).

TRADEMARK

FIRST USE 8-1-2011; IN COMMERCE 9-12-2011.

PRINCIPAL REGISTER

NO CLAIM IS MADE TO THE EXCLUSIVE RIGHT TO USE "SWIMWEAR", APART FROM THE MARK AS SHOWN.

THE COLOR(S) BLACK, PURPLE, PINK, BROWN, WHITE, AND YELLOW IS/ARE CLAIMED AS A FEATURE OF THE MARK.

THE MARK CONSISTS OF MERMAID WITH PURPLE TAIL, PURPLE AND PINK BRA, PINK WAIST BELT AND YELLOW AND BROWN HAIR, WHITE BODY OUT-LINED WITH BLACK, AND "BEACH BABE SWIMWEAR" IN ITALIC LETTERING IN BLACK TO THE RIGHT OF THE MERMAID.

SER. NO. 85-466,458, FILED 11-7-2011.

GRETTA YAO, EXAMINING ATTORNEY



David J. Kyros

Director of the United States Patent and Trademark Office

United States of America

United States Patent and Trademark Office

Yeast

Reg. No. 4,174,734

Registered July 17, 2012

Int. Cl.: 42

SERVICE MARK

PRINCIPAL REGISTER

YOAST BV (NETHERLANDS CORPORATION)
ABERSLAND 2955
WIJCHEN, NETHERLANDS 6605PD

FOR: CONSULTATION SERVICES IN THE FIELD OF SEARCH ENGINE OPTIMIZATION; CONSULTATION SERVICES IN THE FIELD OF DESIGNING WEBSITES TO BE MORE EFFICIENT WITH SEARCH ENGINES; WEB DEVELOPMENT, NAMELY, DESIGNING AND DEVELOPING WEB PAGES FOR THE INTERNET; WEB SITE DEVELOPMENT FOR OTHERS; WEBSITE DEVELOPMENT SERVICES; WEB DESIGN AND DEVELOPMENT, NAMELY, PROVIDING CUSTOMIZED WEB PAGES AND CUSTOMIZED INTERNET APPLICATIONS; WEB SITE DESIGN; CONSULTATION AND DEVELOPMENT SERVICES IN THE FIELD OF SEARCH ENGINE OPTIMIZATION AND INTERNET CONTENT MANAGEMENT SYSTEMS IN THE NATURE OF COMPUTER SOFTWARE ALLOWING PUBLISHING, EDITING, AND MODIFYING OF WEB SITE CONTENT, IN CLASS 42 (U.S. CLS. 100 AND 101).

FIRST USE 6-8-2008; IN COMMERCE 6-8-2008.

THE MARK CONSISTS OF STANDARD CHARACTERS WITHOUT CLAIM TO ANY PARTICULAR FONT, STYLE, SIZE, OR COLOR.

SER. NO. 85-466,680, FILED 11-8-2011.

JACLYN KIDWELL WALKER, EXAMINING ATTORNEY



David J. Kyjars

Director of the United States Patent and Trademark Office

United States of America

United States Patent and Trademark Office



Reg. No. 4,174,735

Registered July 17, 2012

Int. Cl.: 28

TRADEMARK

PRINCIPAL REGISTER

JG WORKS LIMITED (HONG KONG LIMITED COMPANY (LTD.))
UNIT 2503, 141 DES VOEUX ROAD CENTRAL
HONG KONG, HONG KONG

FOR: ACTION SKILL GAMES; ACTION TARGET GAMES; ACTION-TYPE TARGET GAMES; AIRSOFT GUNS FOR RECREATIONAL PURPOSES; AMUSEMENT GAME MACHINES; ARCADE CRANE GAME MACHINES; ARCADE GAME MACHINES; ARCADE GAMES; ARCADE-TYPE ELECTRONIC VIDEO GAMES; BACKGAMMON GAME SETS; BADMINTON GAME PLAYING EQUIPMENT; BALLS FOR GAMES; BATS FOR GAMES; BATTERY OPERATED ACTION TOYS; BOARD GAMES; CAPS FOR TOY PISTOLS; CARD GAMES; CHESS GAMES; CHEST PROTECTORS; CHRISTMAS TREE ORNAMENTS AND DECORATIONS; COIN-OPERATED VIDEO GAMES; DART BOARDS; DART GAMES; DICE GAMES; EDUCATIONAL CARD GAMES; ELECTRIC ACTION TOYS; ELECTRONIC ACTION TOYS; ELECTRONIC DART GAMES; ELECTRONIC GAME EQUIPMENT WITH A WATCH FUNCTION; ELECTRONIC GAMES FOR THE TEACHING OF CHILDREN; ELECTRONIC GAMES OTHER THAN THOSE ADAPTED FOR USE WITH TELEVISION RECEIVERS ONLY; ELECTRONIC TOY VEHICLES; ELECTRONICALLY OPERATED TOY MOTOR VEHICLES; FIELD HOCKEY BALLS; FIELD HOCKEY GLOVES; FIELD HOCKEY GOALIE PADS; FIELD HOCKEY STICK BAGS; FIELD HOCKEY STICKS; FLUTTER BOARDS; GAME APPARATUS, NAMELY, BASES, BATS, AND BALLS FOR PLAYING INDOOR AND OUTDOOR GAMES; GAME CARDS; GO GAMES; GYMNASTIC APPARATUS; GYMNASTIC HORIZONTAL BARS; GYMNASTIC PARALLEL BARS; GYMNASTIC TRAINING STOOLS; GYMNASTIC VAULTING HORSES; HAND HELD UNITS FOR PLAYING VIDEO GAMES OTHER THAN THOSE ADAPTED FOR USE WITH AN EXTERNAL DISPLAY SCREEN OR MONITOR; HAND-HELD GAMES WITH LIQUID CRYSTAL DISPLAYS; HOCKEY GLOVES; HOCKEY GOALS; HOCKEY PUCKS; HOCKEY STICK BLADES; HOCKEY STICK SHAFTS; HOCKEY STICKS; HORIZONTAL BARS; ICE HOCKEY GOALIE PADS; ICE HOCKEY STICKS; NETS FOR BALL GAMES; PADDLE BALL GAMES; PADDLES FOR USE IN PADDLE BALL GAMES; PAINTBALL GUNS; PAINTBALLS; PARALLEL BARS; POMMEL HORSES; RADIO CONTROLLED TOY VEHICLES; SPRINGBOARDS; TARGET GAMES; TENNIS RACQUETS, BASEBALL BATS, CRICKET BATS, GOLF CLUBS AND HOCKEY STICKS; TOY GUNS; TOY, NAMELY, BATTERY-POWERED COMPUTER GAME WITH LCD SCREEN WHICH FEATURES ANIMATION AND SOUND EFFECTS; VOLLEYBALL GAME PLAYING EQUIPMENT, IN CLASS 28 (U.S. CLS. 22, 23, 38 AND 50).



David J. Kybas

Director of the United States Patent and Trademark Office

OWNER OF HONG KONG REG. NO. 300896897, DATED 11-27-2007, EXPIRES 11-27-2017.

Reg. No. 4,174,735 THE NON-LATIN CHARACTERS IN THE MARK TRANSLITERATE TO "JIN GONG" AND THIS MEANS "GOLDEN BOW" IN ENGLISH.

THE MARK CONSISTS OF A STYLISTIC CIRCLE, SPLIT HORIZONTALLY INTO 2 HEMISPHERES BY A THICK LINE FORMING AN ARROW HEAD ON THE LEFT SIDE OF THE SPHERE; WITH THE NORTHERN HEMISPHERE CONTAINING A STYLISTIC REPRESENTATION OF THE SUN WITH RADIANCE LINES AND AN INTERNAL DARK CIRCLE; WITH THE SOUTHERN HEMISPHERE HAVING A STYLISTIC REPRESENTATION OF THE OCEAN, WITH 2 BUBBLES AND WAVE LINES; ALL TO THE LEFT OF LARGE CHINESE CHARACTERS THAT TRANSLITERATE TO "JIN GONG" AND THIS MEANS "GOLDEN BOW" IN ENGLISH. BELOW THE CHINESE CHARACTERS APPEARS THE WORDING "J.G. WORKS" IN A SMALLER ITALICIZED FONT.

SER. NO. 85-466,685, FILED 11-8-2011.

JACLYN KIDWELL WALKER, EXAMINING ATTORNEY

United States of America

United States Patent and Trademark Office

american
CAMP
association

Reg. No. 4,174,736

AMERICAN CAMPING ASSOCIATION, INC. (INDIANA CORPORATION)
5000 STATE ROAD 67 NORTH
MARTINSVILLE, IN 46151

Registered July 17, 2012

Int. Cl.: 35

FOR: ASSOCIATION SERVICES, NAMELY, PROMOTING THE INTERESTS OF PERSONS INTERESTED IN ORGANIZED CAMPING AND RELATED CONFERENCE AND RETREAT CENTERS FOR YOUTH AND ADULTS, IN CLASS 35 (U.S. CLS. 100, 101 AND 102).

SERVICE MARK

FIRST USE 4-0-2004; IN COMMERCE 4-0-2004.

PRINCIPAL REGISTER

OWNER OF U.S. REG. NOS. 3,043,665 AND 3,058,496.

NO CLAIM IS MADE TO THE EXCLUSIVE RIGHT TO USE "CAMP ASSOCIATION", APART FROM THE MARK AS SHOWN.

THE MARK CONSISTS OF THE WORD "AMERICAN" VERTICALLY STACKED ABOVE THE STYLIZED WORD "CAMP," AND THE STYLIZED WORD "CAMP" VERTICALLY STACKED ABOVE THE WORD "ASSOCIATION".

SEC. 2(F).

SER. NO. 85-466,747, FILED 11-8-2011.

BRIAN CALLAGHAN, EXAMINING ATTORNEY



David J. Kyjars

Director of the United States Patent and Trademark Office

United States of America

United States Patent and Trademark Office

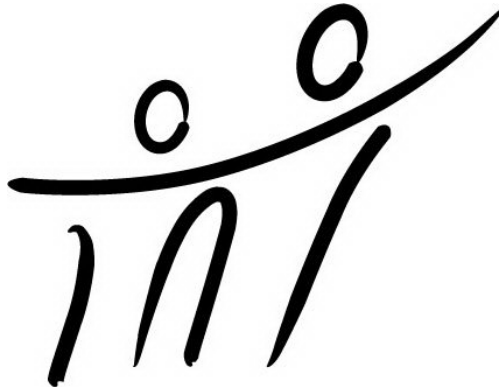

Reg. No. 4,174,737

AMERICAN CAMPING ASSOCIATION, INC. (INDIANA CORPORATION)
5000 STATE ROAD 67 NORTH
MARTINSVILLE, IN 46151

Registered July 17, 2012

Int. Cl.: 35

FOR: ASSOCIATION SERVICES, NAMELY, PROMOTING THE INTERESTS OF PERSONS INTERESTED IN ORGANIZED CAMPING AND RELATED CONFERENCE AND RETREAT CENTERS FOR YOUTH AND ADULTS, IN CLASS 35 (U.S. CLS. 100, 101 AND 102).

SERVICE MARK

FIRST USE 4-0-2004; IN COMMERCE 4-0-2004.

PRINCIPAL REGISTER

OWNER OF U.S. REG. NOS. 3,043,665 AND 3,169,229.

THE MARK CONSISTS OF A SET OF LINES, INCLUDING CURVED LINES AND CIRCULAR LINES, THAT FORM TWO STICK FIGURES WITH ONE LARGER THAN THE OTHER, AND ARE STYLISTICALLY RENDERED TO SUGGEST A BRIDGE.

SER. NO. 85-466,753, FILED 11-8-2011.

BRIAN CALLAGHAN, EXAMINING ATTORNEY



David J. Kyffers

Director of the United States Patent and Trademark Office

United States of America

United States Patent and Trademark Office



Reg. No. 4,174,738

Registered July 17, 2012

Int. Cl.: 44

SERVICE MARK

PRINCIPAL REGISTER

SUBURBAN GASTROENTEROLOGY, LTD. (ILLINOIS CORPORATION)
1243 RICKERT DRIVE
NAPERVILLE, IL 60540

FOR: MEDICAL CLINICS; MEDICAL SCREENING SERVICES IN THE FIELD OF ENDOSCOPY, COLONOSCOPY, HEARTBURN TREATMENT, GERD TREATMENT, IBD TREATMENT, COLON CANCER TREATMENT AND COLITIS TREATMENT; MEDICAL SERVICES; MEDICAL SERVICES, NAMELY, ENDOSCOPY, COLONOSCOPY, HEARTBURN TREATMENT, GERD TREATMENT, IBD TREATMENT, COLON CANCER TREATMENT AND COLITIS TREATMENT; MEDICAL TESTING FOR DIAGNOSTIC OR TREATMENT PURPOSES, IN CLASS 44 (U.S. CLS. 100 AND 101).

FIRST USE 8-1-2010; IN COMMERCE 8-1-2010.

THE MARK CONSISTS OF A BLUE SQUARE DISPLAYING THE WHITE LETTERS "S" AND "G".

THE COLOR(S) BLUE AND WHITE IS/ARE CLAIMED AS A FEATURE OF THE MARK.

SER. NO. 85-466,848, FILED 11-8-2011.

ROBIN CHOSID, EXAMINING ATTORNEY



David J. Kybas

Director of the United States Patent and Trademark Office

United States of America

United States Patent and Trademark Office

AMERICAN HOMEPRIDE

Reg. No. 4,174,739

Registered July 17, 2012

Int. Cl.: 37

SERVICE MARK

PRINCIPAL REGISTER

AMERICAN HOMEPRIDE, INC. (SOUTH CAROLINA CORPORATION)
284 ROCKY CREEK ROAD
GREENVILLE, SC 29615

FOR: GENERAL CONTRACTOR SERVICES, NAMELY, PLUMBING, HEATING AND AIR CONDITIONING, CARPENTRY, DRYWALL, PAINTING, ELECTRICAL, BUILDING AND FRAMING CONTRACTOR SERVICES; BUILDING CONSTRUCTION, REMODELING AND REPAIR; CONSTRUCTION CONSULTATION AND PLANNING; CONSTRUCTION, MAINTENANCE AND RENOVATION OF PROPERTY; CUSTOM CONSTRUCTION AND BUILDING RENOVATION; GENERAL CONSTRUCTION CONTRACTING; HOUSING SERVICES, NAMELY, DEVELOPMENT OF REAL PROPERTY, NAMELY, REPAIR, IMPROVEMENT, AND NEW CONSTRUCTION; RESIDENTIAL AND COMMERCIAL BUILDING CONSTRUCTION; INSTALLING SIDING; GENERAL CONTRACTING SERVICES IN THE FIELD OF FLOORING; ELECTRICAL REPAIRS, MAINTENANCE, AND INSTALLATION OF ELECTRICAL WIRING, OUTLETS, LIGHT FIXTURES, AND ELECTRICAL PANELS; INSTALLATION OF CABINETS AND COUNTERTOPS, IN CLASS 37 (U.S. CLS. 100, 103 AND 106).

FIRST USE 10-1-2011; IN COMMERCE 10-1-2011.

THE MARK CONSISTS OF STANDARD CHARACTERS WITHOUT CLAIM TO ANY PARTICULAR FONT, STYLE, SIZE, OR COLOR.

NO CLAIM IS MADE TO THE EXCLUSIVE RIGHT TO USE "AMERICAN", APART FROM THE MARK AS SHOWN.

SER. NO. 85-466,854, FILED 11-8-2011.

CARRIE GENOVESE, EXAMINING ATTORNEY



David J. Kyffers

Director of the United States Patent and Trademark Office

United States of America

United States Patent and Trademark Office

COWBOY JOE'S GOOD MEDICINE SHOW

Reg. No. 4,174,740

JOSEPH T. BABCOCK (UNITED STATES INDIVIDUAL)
108 KINGSGATE LANE
FRANKLIN, TN 37064

Registered July 17, 2012

Int. Cl.: 41

FOR: ENTERTAINMENT IN THE NATURE OF LIVE PERFORMANCES BY A MUSICAL GROUP, IN CLASS 41 (U.S. CLS. 100, 101 AND 107).

SERVICE MARK

FIRST USE 7-16-2004; IN COMMERCE 7-16-2004.

PRINCIPAL REGISTER

THE MARK CONSISTS OF STANDARD CHARACTERS WITHOUT CLAIM TO ANY PARTICULAR FONT, STYLE, SIZE, OR COLOR.

OWNER OF U.S. REG. NO. 2,034,889.

NO CLAIM IS MADE TO THE EXCLUSIVE RIGHT TO USE "SHOW", APART FROM THE MARK AS SHOWN.

THE NAME(S), PORTRAIT(S), AND/OR SIGNATURE(S) SHOWN IN THE MARK DOES NOT IDENTIFY A PARTICULAR LIVING INDIVIDUAL.

SER. NO. 85-466,856, FILED 11-8-2011.

CARRIE GENOVESE, EXAMINING ATTORNEY



David J. Kybas

Director of the United States Patent and Trademark Office

United States of America

United States Patent and Trademark Office



Reg. No. 4,174,741

LEE, MELISSA (UNITED STATES INDIVIDUAL)
259 MELVIN AVE. SOUTH
MORRISVILLE, PA 19061

Registered July 17, 2012

Int. Cl.: 25

FOR: T-SHIRTS, IN CLASS 25 (U.S. CLS. 22 AND 39).

TRADEMARK

FIRST USE 9-16-2011; IN COMMERCE 10-21-2011.

PRINCIPAL REGISTER

NO CLAIM IS MADE TO THE EXCLUSIVE RIGHT TO USE "GIFTS" , APART FROM THE MARK AS SHOWN.

THE MARK CONSISTS OF A GIRL WITH TWO PIG TAILS WITH A BOW IN IT. TO THE RIGHT THERE IS THE STYLIZED TEXT "BROWN GIRL GIFTS".

SER. NO. 85-466,912, FILED 11-8-2011.

STEVEN PEREZ, EXAMINING ATTORNEY



David J. Kybas

Director of the United States Patent and Trademark Office

United States of America

United States Patent and Trademark Office

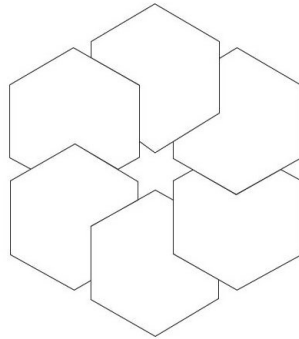

Reg. No. 4,174,742

Registered July 17, 2012

Int. Cl.: 42

SERVICE MARK

PRINCIPAL REGISTER

ELCOM TECHNOLOGY INC. (DELAWARE CORPORATION)
154 GRAND STREET
NEW YORK, NY 10013

FOR: APPLICATION SERVICE PROVIDER (ASP) FEATURING SOFTWARE FOR USE IN MANAGING, DEVELOPING AND MAINTAINING THE PERFORMANCE OF WEBSITES, PORTALS, INTRANETS, EXTRANETS, ELECTRONIC COMMERCE, ONLINE TRAINING AND ONLINE ORIENTATION PROGRAMS OF OTHERS, IN CLASS 42 (U.S. CLS. 100 AND 101).

FIRST USE 11-30-2007; IN COMMERCE 11-30-2007.

THE MARK CONSISTS OF A CIRCULAR ARRANGEMENT OF INTERSECTING CUBES FORMING A STAR IN THE CENTER.

SER. NO. 85-466,920, FILED 11-8-2011.

ASMAT KHAN, EXAMINING ATTORNEY



David J. Kybas

Director of the United States Patent and Trademark Office

United States of America

United States Patent and Trademark Office

NOTABLI

Reg. No. 4,174,743

CONSTANTLY CURIOUS, LLC (VERMONT LIMITED LIABILITY COMPANY)
209 COLLEGE STREET, 3W
BURLINGTON, VT 05401

Registered July 17, 2012

Int. Cl.: 42

FOR: A SECURE, WEB-BASED SERVICE ENABLING PARENTS TO STORE AND SHARE DIGITAL MEDIA THAT CAPTURE IMPORTANT MOMENTS IN THEIR CHILDREN'S LIVES, IN CLASS 42 (U.S. CLS. 100 AND 101).

SERVICE MARK

FIRST USE 9-15-2011; IN COMMERCE 9-15-2011.

PRINCIPAL REGISTER

THE MARK CONSISTS OF STANDARD CHARACTERS WITHOUT CLAIM TO ANY PARTICULAR FONT, STYLE, SIZE, OR COLOR.

SER. NO. 85-466,925, FILED 11-8-2011.

ASMAT KHAN, EXAMINING ATTORNEY



David J. Kyffers

Director of the United States Patent and Trademark Office

United States of America

United States Patent and Trademark Office

Conexion

Reg. No. 4,174,744

CONEXION, INC. (MASSACHUSETTS CORPORATION)
151 COOLIDGE AVE. #609
WATERTOWN, MA 02472

Registered July 17, 2012

Int. Cl.: 41

FOR: ARRANGING AND CONDUCTING EDUCATIONAL CONFERENCES AND EDUCATION SERVICES, NAMELY, MENTORING IN THE FIELD OF LEADERSHIP DEVELOPMENT IN BUSINESS, ACADEMIA, NON-PROFITS AND GOVERNMENT, IN CLASS 41 (U.S. CLS. 100, 101 AND 107).

SERVICE MARK

PRINCIPAL REGISTER

FIRST USE 12-18-2006; IN COMMERCE 1-1-2007.

THE MARK CONSISTS OF STANDARD CHARACTERS WITHOUT CLAIM TO ANY PARTICULAR FONT, STYLE, SIZE, OR COLOR.

THE ENGLISH TRANSLATION OF "CONEXION" IN THE MARK IS "CONNECTION".

SER. NO. 85-466,977, FILED 11-8-2011.

TRACY FLETCHER, EXAMINING ATTORNEY



David J. Kyfos

Director of the United States Patent and Trademark Office

United States of America

United States Patent and Trademark Office

TUNEUPS

Reg. No. 4,174,745

BELL SPORTS, INC. (CALIFORNIA CORPORATION)
5550 SCOTTS VALLEY DRIVE
SCOTTS VALLEY, CA 95066

Registered July 17, 2012

Int. Cl.: 9

FOR: AUDIO EQUIPMENT FOR USE IN CONNECTION WITH HELMETS, NAMELY, A DEVICE FOR TRANSMITTING AND RECEIVING VOICE, MUSIC AND OTHER SOUNDS WHILE WEARING A HELMET, NAMELY, SPEAKERS AND MICROPHONES THAT DROP OR SNAP INTO THE EARFLAPS OF HELMETS, IN CLASS 9 (U.S. CLS. 21, 23, 26, 36 AND 38).

TRADEMARK

PRINCIPAL REGISTER

FIRST USE 1-31-2004; IN COMMERCE 1-31-2004.

THE MARK CONSISTS OF STANDARD CHARACTERS WITHOUT CLAIM TO ANY PARTICULAR FONT, STYLE, SIZE, OR COLOR.

SER. NO. 85-467,074, FILED 11-8-2011.

MATTHEW KLINE, EXAMINING ATTORNEY



David J. Kybas

Director of the United States Patent and Trademark Office

United States of America

United States Patent and Trademark Office



Reg. No. 4,174,746

MEMBER ONE FEDERAL CREDIT UNION (UNITED STATES CREDIT UNION)
202 FOURTH STREET
ROANOKE, VA 24016

Registered July 17, 2012

Int. Cl.: 36

FOR: BANKING AND FINANCING SERVICES; CHECKING ACCOUNT SERVICES; CREDIT AND DEBIT CARD SERVICES; FINANCIAL SERVICES, NAMELY, SAVINGS PROGRAMS FOR YOUTHS; ON-LINE BANKING SERVICES; SAVINGS ACCOUNT SERVICES, IN CLASS 36 (U.S. CLS. 100, 101 AND 102).

SERVICE MARK

PRINCIPAL REGISTER

FIRST USE 1-1-2009; IN COMMERCE 1-1-2009.

NO CLAIM IS MADE TO THE EXCLUSIVE RIGHT TO USE "FEDERAL CREDIT UNION", APART FROM THE MARK AS SHOWN.

THE COLOR(S) GRAY AND PURPLE IS/ARE CLAIMED AS A FEATURE OF THE MARK.

THE MARK CONSISTS OF THE GRAY WORD "MEMBER" UNDERLINED AND PURPLE WORD "ONE" WITH A STYLIZED "O" AND THE WORDS "FEDERAL CREDIT UNION" UNDER THE WORD "MEMBER".

SER. NO. 85-467,134, FILED 11-8-2011.

REGINA DRUMMOND, EXAMINING ATTORNEY



David J. Kybas

Director of the United States Patent and Trademark Office

United States of America

United States Patent and Trademark Office

LUCI'S

Reg. No. 4,174,747

Registered July 17, 2012

Int. Cls.: 35 and 43

SERVICE MARK

PRINCIPAL REGISTER

HEALTHY CONCEPTS, L.L.C. (CALIFORNIA LIMITED LIABILITY COMPANY), DBA
LUCI'S HEALTHY MARKETPLACE
1590 E. BETHANY HOME ROAD
PHOENIX, AZ 85014

FOR: RETAIL MARKETS FEATURING GROCERIES; RETAIL STORE SERVICES FEATURING GROCERIES, IN CLASS 35 (U.S. CLS. 100, 101 AND 102).

FIRST USE 3-22-2009; IN COMMERCE 3-22-2009.

FOR: BAR SERVICES; CAFE SERVICES; COFFEE BARS; JUICE BAR SERVICES; RESTAURANT AND CAFE SERVICES; SALAD BARS; SNACK BAR SERVICES; TEA BARS; WINE BARS, IN CLASS 43 (U.S. CLS. 100 AND 101).

FIRST USE 3-22-2009; IN COMMERCE 3-22-2009.

THE MARK CONSISTS OF STANDARD CHARACTERS WITHOUT CLAIM TO ANY PARTICULAR FONT, STYLE, SIZE, OR COLOR.

THE NAME(S), PORTRAIT(S), AND/OR SIGNATURE(S) SHOWN IN THE MARK IDENTIFIES LUCIA V. SCHNITZER, WHOSE CONSENT(S) TO REGISTER IS MADE OF RECORD.

SER. NO. 85-467,168, FILED 11-8-2011.

NAKIA HENRY, EXAMINING ATTORNEY



David J. Kybas

Director of the United States Patent and Trademark Office

United States of America

United States Patent and Trademark Office

Cuptakes

Reg. No. 4,174,748

Registered July 17, 2012

Int. Cl.: 9

TRADEMARK

PRINCIPAL REGISTER

FINELY INTOUCH (TEXAS LIMITED LIABILITY COMPANY)
PO BOX 90673
AUSTIN, TX 78709

FOR: DOWNLOADABLE SOFTWARE FOR MOBILE DEVICES, PERSONAL COMPUTERS, CONSOLES, TABLETS, NAMELY, APPLICATION SOFTWARE FOR PROCESSING IMAGES, GRAPHICS AND TEXT, FOR CREATING CUSTOM COMPUTER AND MOBILE PHONE WALLPAPERS AND CALENDARS, AND FOR ORGANIZING AND VIEWING DIGITAL PHOTOGRAPHS FOR USE IN THE FIELDS OF GRAPHICS, GRAPHIC DESIGN, LIFESTYLE, ENTERTAINMENT AND PHOTOGRAPHY; PROTECTIVE CARRYING CASES SPECIALLY ADAPTED FOR PHONES AND HANDHELD COMPUTERS, IN CLASS 9 (U.S. CLS. 21, 23, 26, 36 AND 38).

FIRST USE 11-11-2010; IN COMMERCE 12-8-2010.

THE MARK CONSISTS OF STANDARD CHARACTERS WITHOUT CLAIM TO ANY PARTICULAR FONT, STYLE, SIZE, OR COLOR.

SER. NO. 85-467,297, FILED 11-8-2011.

BRENDAN MCCAULEY, EXAMINING ATTORNEY



David J. Kybas

Director of the United States Patent and Trademark Office

United States of America

United States Patent and Trademark Office

silverback

Reg. No. 4,174,749

Registered July 17, 2012

Int. Cl.: 28

TRADEMARK

PRINCIPAL REGISTER

SILVERBACK HOCKEY, LLC (MASSACHUSETTS LIMITED LIABILITY COMPANY)
190 HAVERHILL STREET #123
METHUEN, MA 01844

FOR: HOCKEY EQUIPMENT FOR BOTH ICE AND ROLLER HOCKEY, INCLUDING SKATES, STICKS, HELMETS, FACE MASKS, CAGES, VISORS, GLOVES, SHOULDER PADS, ELBOW PADS, JOCKS, SHIN GUARDS, STICK EXTENSIONS, TAPE, MOUTH GUARDS, NECK GUARDS, SKATE GUARDS, HOCKEY PUCKS, SLASH GUARDS, GOALIE HELMETS, GOALIE CHEST PROTECTORS, GOALIE GLOVES AND BLOCKERS, GOALIE LEG PADS, WHEELS, AND HOCKEY BAGS, IN CLASS 28 (U.S. CLS. 22, 23, 38 AND 50).

FIRST USE 5-1-2011; IN COMMERCE 5-1-2011.

THE MARK CONSISTS OF THE WORD "SILVERBACK" WRITTEN IN A STYLIZED FONT

SER. NO. 85-467,359, FILED 11-8-2011.

RICHARD WHITE, EXAMINING ATTORNEY



David J. Kybas

Director of the United States Patent and Trademark Office

United States of America

United States Patent and Trademark Office

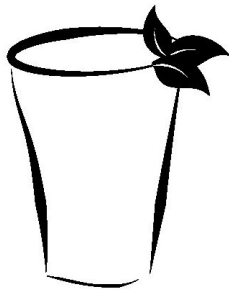

STAINLESS
CUPS

Reg. No. 4,174,750

Registered July 17, 2012

Int. Cl.: 21

TRADEMARK

PRINCIPAL REGISTER

STAINLESS CUPS (ILLINOIS CORPORATION)
PO BOX 87703
CAROL STREAM, IL 60188

FOR: CUPS; DRINKING CUPS FOR BABIES AND CHILDREN AND PARTS AND FITTINGS THEREFOR, NAMELY, CUPS FOR BABIES AND CHILDREN SOLD AS A UNIT WITH VALVES AND LIDS; HOUSEHOLD CONTAINERS FOR FOODS; REUSABLE STAINLESS STEEL WATER BOTTLES SOLD EMPTY, IN CLASS 21 (U.S. CLS. 2, 13, 23, 29, 30, 33, 40 AND 50).

FIRST USE 11-2-2008; IN COMMERCE 11-2-2008.

NO CLAIM IS MADE TO THE EXCLUSIVE RIGHT TO USE "STAINLESS CUPS", APART FROM THE MARK AS SHOWN.

THE MARK CONSISTS OF AN IMAGE OF A CUP WITH A GROUP OF THREE LEAVES ON THE RIGHT SIDE OF THE RIM. TO THE RIGHT OF THE CUP IS THE STYLIZED TEXT "STAINLESS" ABOVE THE STYLIZED TEXT "CUPS".

SER. NO. 85-467,424, FILED 11-8-2011.

MARY CRAWFORD, EXAMINING ATTORNEY



David J. Kybas

Director of the United States Patent and Trademark Office

United States of America

United States Patent and Trademark Office

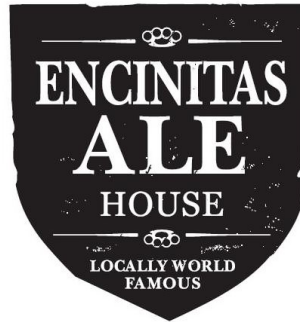

Reg. No. 4,174,751

Registered July 17, 2012

Int. Cl.: 43

SERVICE MARK

PRINCIPAL REGISTER

COASTAL PUBLIC & ALE HOUSES, INC. (CALIFORNIA CORPORATION)
SUITE 305
875 PROSPECT
LA JOLLA, CA 92037

FOR: BAR AND RESTAURANT SERVICES, IN CLASS 43 (U.S. CLS. 100 AND 101).

FIRST USE 11-3-2009; IN COMMERCE 11-3-2009.

NO CLAIM IS MADE TO THE EXCLUSIVE RIGHT TO USE "ENCINITAS" OR "ALE HOUSE", APART FROM THE MARK AS SHOWN.

THE MARK CONSISTS OF A TATTERED SHIELD WITH THE LITERAL ELEMENT "ENCINITAS ALE HOUSE" BETWEEN UPPER AND LOWER BRASS KNUCKLES, A TAPERING LINE EXTENDING FROM BOTH SIDES OF BOTH BRASS KNUCKLES, AND THE LITERAL ELEMENT "LOCALLY WORLD FAMOUS" BENEATH THE LOWER BRASS KNUCKLE.

SER. NO. 85-467,579, FILED 11-8-2011.

KATHRYN COWARD, EXAMINING ATTORNEY



David J. Kybas

Director of the United States Patent and Trademark Office

United States of America

United States Patent and Trademark Office



Reg. No. 4,174,752

Registered July 17, 2012

Int. Cl.: 43

SERVICE MARK

PRINCIPAL REGISTER

COASTAL PUBLIC & ALE HOUSES, INC. (CALIFORNIA CORPORATION)
SUITE 305
875 PROSPECT
LA JOLLA, CA 92037

FOR: BAR AND RESTAURANT SERVICES, IN CLASS 43 (U.S. CLS. 100 AND 101).

FIRST USE 1-1-2011; IN COMMERCE 1-19-2011.

NO CLAIM IS MADE TO THE EXCLUSIVE RIGHT TO USE "PUBLIC HOUSE" OR "LA JOLLA", APART FROM THE MARK AS SHOWN.

THE MARK CONSISTS OF A TATTERED SHIELD WITH THE LITERAL ELEMENT "THE PUBLIC HOUSE LA JOLLA" BETWEEN UPPER AND LOWER BRASS KNUCKLES, A TAPERING LINE EXTENDING FROM BOTH SIDES OF BOTH BRASS KNUCKLES, AND THE LITERAL ELEMENT "LOCALLY WORLD FAMOUS" BENEATH THE LOWER BRASS KNUCKLE.

SER. NO. 85-467,585, FILED 11-8-2011.

KATHRYN COWARD, EXAMINING ATTORNEY



David J. Kyffers

Director of the United States Patent and Trademark Office

United States of America

United States Patent and Trademark Office

Yama's Herbs

Reg. No. 4,174,753

Registered July 17, 2012

Int. Cl.: 5

TRADEMARK

PRINCIPAL REGISTER

YAMAGUCHI, YOSHIHIRO (UNITED STATES INDIVIDUAL)
SUITE 21
161 WEST 54TH STREET
NEW YORK, NY 10019

FOR: NATURAL HERBAL SUPPLEMENTS, IN CLASS 5 (U.S. CLS. 6, 18, 44, 46, 51 AND 52).

FIRST USE 7-24-2009; IN COMMERCE 7-24-2009.

THE MARK CONSISTS OF STANDARD CHARACTERS WITHOUT CLAIM TO ANY PARTICULAR FONT, STYLE, SIZE, OR COLOR.

NO CLAIM IS MADE TO THE EXCLUSIVE RIGHT TO USE "HERBS", APART FROM THE MARK AS SHOWN.

THE ENGLISH TRANSLATION OF THE WORD "YAMA" IN THE MARK IS "MOUNTAIN".

SER. NO. 85-467,614, FILED 11-8-2011.

ANGELA M. MICHELI, EXAMINING ATTORNEY



David J. Kybas

Director of the United States Patent and Trademark Office

United States of America
United States Patent and Trademark Office

PULSEONE

Reg. No. 4,174,754

NIKOMED USA, INC. (PENNSYLVANIA CORPORATION)
2000 PIONEER ROAD
HUNTINGTON VALLEY, PA 19006

Registered July 17, 2012

Int. Cl.: 10

FOR: CARDIAC DEFIBRILLATION ELECTRODES; CARDIAC ELECTRODES, IN CLASS 10 (U.S. CLS. 26, 39 AND 44).

TRADEMARK

FIRST USE 10-15-2011; IN COMMERCE 10-15-2011.

PRINCIPAL REGISTER

THE MARK CONSISTS OF STANDARD CHARACTERS WITHOUT CLAIM TO ANY PARTICULAR FONT, STYLE, SIZE, OR COLOR.

SER. NO. 85-467,697, FILED 11-8-2011.

MICHAEL KEATING, EXAMINING ATTORNEY



David J. Kybas

Director of the United States Patent and Trademark Office

United States of America

United States Patent and Trademark Office

BLOWLUX

Reg. No. 4,174,755

BE HAIRCARE, LLC (NEVADA LIMITED LIABILITY COMPANY)
6655 SAHARA AVE, SUITE B200

Registered July 17, 2012

LAS VEGAS, NV 89146

Int. Cl.: 44

FOR: BEAUTY SALON SERVICES; BEAUTY SALONS; HAIR SALON SERVICES;
HAIRDRESSING SALONS; PROVIDING ON-SITE BEAUTY SERVICES, NAMELY, HAIR
STYLING, NAIL CARE AND MAKE-UP APPLICATION SERVICES, IN CLASS 44 (U.S. CLS.
100 AND 101).

SERVICE MARK

PRINCIPAL REGISTER

FIRST USE 9-20-2011; IN COMMERCE 9-20-2011.

THE MARK CONSISTS OF STANDARD CHARACTERS WITHOUT CLAIM TO ANY PAR-
TICULAR FONT, STYLE, SIZE, OR COLOR.

SER. NO. 85-467,725, FILED 11-8-2011.

IRA J. GOODSaid, EXAMINING ATTORNEY



David J. Kyffers

Director of the United States Patent and Trademark Office

United States of America

United States Patent and Trademark Office



Reg. No. 4,174,756

Registered July 17, 2012

Int. Cl.: 35

NATIONAL REVERSE MORTGAGE LENDERS ASSOCIATION (D.C. UNINCORPORATED ASSOCIATION)
SUITE 420
1400 16TH STREET NW
WASHINGTON, DC 20036

SERVICE MARK

FOR: ASSOCIATION SERVICES, NAMELY, PROMOTING THE INTERESTS OF THE REVERSE MORTGAGE INDUSTRY, IN CLASS 35 (U.S. CLS. 100, 101 AND 102).

PRINCIPAL REGISTER

FIRST USE 10-24-2011; IN COMMERCE 10-24-2011.

OWNER OF U.S. REG. NOS. 3,435,195, 3,515,074 AND OTHERS.

NO CLAIM IS MADE TO THE EXCLUSIVE RIGHT TO USE "SINCE 1997", APART FROM THE MARK AS SHOWN.

THE MARK CONSISTS OF A SMALL CIRCLE WITHIN A LARGER CIRCLE WITH THE WORDS "BORROW WITH CONFIDENCE" IN BETWEEN THE CIRCLES ON THE TOP AND A BANNER IN THE MIDDLE WITH THE LETTERS "NRMLA" AND THE WORDS "SINCE 1997" IN BETWEEN THE CIRCLES ON THE BOTTOM, AN IMAGE REPRESENTING THE SIDE OF A BUILDING IS IN THE CENTER OF THE CIRCLES.

SER. NO. 85-467,994, FILED 11-9-2011.

SANJEEV VOHRA, EXAMINING ATTORNEY



David J. Kybas

Director of the United States Patent and Trademark Office

United States of America

United States Patent and Trademark Office

Tuscantan

Reg. No. 4,174,757

Registered July 17, 2012

Int. Cl.: 3

TRADEMARK

PRINCIPAL REGISTER

TUSCAN TAN PTY LTD (AUSTRALIA CORPORATION)
SUITE 7, BOLTE BUSINESS PARK
9 WOOLBOARD ROAD
PORT MELBOURNE, AUSTRALIA 3207

FOR: SUN-TANNING PREPARATIONS, NAMELY, OILS, LOTIONS, GELS, CREAMS, WASHES AND MOISTURIZERS; COSMETIC PREPARATIONS FOR SKIN CARE, NAMELY, SCRUBS, LOTIONS, GELS, MASKS, MILKS, CREAMS, WASHES, MOISTURIZERS AND OILS; SUN SCREEN; NON-MEDICATED SKIN CARE PREPARATIONS, NAMELY, BEAUTY SCRUBS, LOTIONS, GELS, MASKS, MILKS, CREAMS, WASHES, MOISTURIZERS, AND OILS; AROMATIC OILS; AFTER SUN CREAMS, LOTIONS AND GELS; SUN CARE CREAMS, LOTIONS AND GELS, IN CLASS 3 (U.S. CLS. 1, 4, 6, 50, 51 AND 52).

THE MARK CONSISTS OF STANDARD CHARACTERS WITHOUT CLAIM TO ANY PARTICULAR FONT, STYLE, SIZE, OR COLOR.

OWNER OF AUSTRALIA REG. NO. 942455, DATED 9-26-2003, EXPIRES 2-5-2013.

SER. NO. 85-468,095, FILED 11-9-2011.

CHRISTINA SOBRAL, EXAMINING ATTORNEY



David J. Kypos

Director of the United States Patent and Trademark Office

United States of America

United States Patent and Trademark Office

UNION PLUS

Reg. No. 4,174,758

Registered July 17, 2012

Int. Cls.: 9 and 36

TRADEMARK

SERVICE MARK

PRINCIPAL REGISTER

UNION PRIVILEGE, INC. (D.C. CORPORATION)
SUITE 300
1125 15TH STREET, NW
WASHINGTON, DC 20005

FOR: MAGNETICALLY ENCODED DEBIT CARDS, IN CLASS 9 (U.S. CLS. 21, 23, 26, 36 AND 38).

FIRST USE 9-19-2011; IN COMMERCE 9-19-2011.

FOR: ISSUING PREPAID DEBIT CARDS, IN CLASS 36 (U.S. CLS. 100, 101 AND 102).

FIRST USE 9-19-2011; IN COMMERCE 9-19-2011.

THE MARK CONSISTS OF STANDARD CHARACTERS WITHOUT CLAIM TO ANY PARTICULAR FONT, STYLE, SIZE, OR COLOR.

OWNER OF U.S. REG. NOS. 2,180,858, 3,123,641 AND OTHERS.

SEC. 2(F) AS TO "UNION".

SER. NO. 85-468,255, FILED 11-9-2011.

MATTHEW KLINE, EXAMINING ATTORNEY



David J. Kybas

Director of the United States Patent and Trademark Office

United States of America

United States Patent and Trademark Office

RYL Wireless

Reg. No. 4,174,759

Registered July 17, 2012

Int. Cl.: 9

TRADEMARK

PRINCIPAL REGISTER

LIM, INDRIYANI (UNITED STATES INDIVIDUAL)
G. 11
3351 QUARTZ LN.
FULLERTON, CA 92831

FOR: CARRYING CASES FOR CELL PHONES; CARRYING CASES FOR ELECTRONIC EQUIPMENT, NAMELY, TABLETS, COMPUTERS, AND CELL PHONES; CELL PHONE BATTERY CHARGERS; CELL PHONE BATTERY CHARGERS FOR USE IN VEHICLES; CELL PHONE CASES; CELL PHONE COVERS; CELL PHONE FACEPLATES; CELL PHONE STRAPS; DISPLAY PROTECTOR TO PROVIDE SHADE AND PRIVACY FOR ELECTRONIC DEVICES HAVING SCREENS; HEAD-CLIP CELL PHONE HOLDERS; PROTECTIVE COVERS AND CASES FOR CELL PHONES, LAPTOPS AND PORTABLE MEDIA PLAYERS; VINYL COVERS SPECIALLY ADAPTED FOR CELL PHONES, MP3 PLAYERS, LAPTOPS, COMPUTERS, PORTABLE SATELLITE RADIOS, PERSONAL DIGITAL ASSISTANTS, REMOTE CONTROLS, AND TELEVISION SATELLITE RECORDERS , IN CLASS 9 (U.S. CLS. 21, 23, 26, 36 AND 38).

FIRST USE 10-15-2010; IN COMMERCE 10-15-2010.

THE MARK CONSISTS OF STANDARD CHARACTERS WITHOUT CLAIM TO ANY PARTICULAR FONT, STYLE, SIZE, OR COLOR.

NO CLAIM IS MADE TO THE EXCLUSIVE RIGHT TO USE "WIRELESS", APART FROM THE MARK AS SHOWN.

SER. NO. 85-468,342, FILED 11-9-2011.

DAVID I, EXAMINING ATTORNEY



David J. Kyfos

Director of the United States Patent and Trademark Office

United States of America

United States Patent and Trademark Office

REPUBLIC WIRELESS

Reg. No. 4,174,760

Registered July 17, 2012

Int. Cl.: 38

SERVICE MARK

PRINCIPAL REGISTER

BANDWIDTH.COM, INC. (DELAWARE CORPORATION)
4001 WESTON PARKWAY, SUITE 100
CARY, NC 27513

FOR: PROVIDING UNIFIED COMMUNICATIONS SERVICES VIA COMPUTER AND TELECOMMUNICATIONS NETWORKS; INTERNET TELEPHONY SERVICES; VOICE OVER INTERNET PROTOCOL (VOIP) SERVICES, IN CLASS 38 (U.S. CLS. 100, 101 AND 104).

FIRST USE 11-8-2011; IN COMMERCE 11-8-2011.

THE MARK CONSISTS OF STANDARD CHARACTERS WITHOUT CLAIM TO ANY PARTICULAR FONT, STYLE, SIZE, OR COLOR.

NO CLAIM IS MADE TO THE EXCLUSIVE RIGHT TO USE "WIRELESS", APART FROM THE MARK AS SHOWN.

SER. NO. 85-468,489, FILED 11-9-2011.

JULIE VEPPUMTHARA, EXAMINING ATTORNEY



David J. Kyffers

Director of the United States Patent and Trademark Office

United States of America

United States Patent and Trademark Office

TOWEL DEPOT

Reg. No. 4,174,761

Registered July 17, 2012

Int. Cl.: 24

TRADEMARK

PRINCIPAL REGISTER

TOWEL DEPOT INC (NEW YORK CORPORATION)
PO BOX 22965
ROCHESTER, NY 14692

FOR: TOWELS; TOWELS OF TEXTILE, IN CLASS 24 (U.S. CLS. 42 AND 50).

FIRST USE 7-11-2000; IN COMMERCE 3-24-2004.

THE MARK CONSISTS OF STANDARD CHARACTERS WITHOUT CLAIM TO ANY PARTICULAR FONT, STYLE, SIZE, OR COLOR.

NO CLAIM IS MADE TO THE EXCLUSIVE RIGHT TO USE "TOWEL", APART FROM THE MARK AS SHOWN.

SEC. 2(F).

SER. NO. 85-468,502, FILED 11-9-2011.

DAVID I, EXAMINING ATTORNEY



David J. Kyffers

Director of the United States Patent and Trademark Office

United States of America

United States Patent and Trademark Office

GESTUREWORKS

Reg. No. 4,174,762

IDEUM, INC. (NEW MEXICO CORPORATION)
2469 CORRALES RD., BLDG. C
CORRALES, NM 87048

Registered July 17, 2012

Int. Cl.: 9

FOR: COMPUTER SOFTWARE FOR USE IN CREATING MULTITOUCH COMPUTER APPLICATIONS, IN CLASS 9 (U.S. CLS. 21, 23, 26, 36 AND 38).

TRADEMARK

FIRST USE 6-1-2009; IN COMMERCE 6-1-2009.

PRINCIPAL REGISTER

THE MARK CONSISTS OF STANDARD CHARACTERS WITHOUT CLAIM TO ANY PARTICULAR FONT, STYLE, SIZE, OR COLOR.

SER. NO. 85-468,635, FILED 11-9-2011.

DORITT L. CARROLL, EXAMINING ATTORNEY



David J. Kybas

Director of the United States Patent and Trademark Office

United States of America

United States Patent and Trademark Office



Reg. No. 4,174,763

IDEUM, INC. (NEW MEXICO CORPORATION)
2469 CORRALES ROAD, BLDG. C
CORRALES, NM 87048

Registered July 17, 2012

Int. Cl.: 9

FOR: COMPUTER SOFTWARE FOR USE IN CREATING MULTITOUCH COMPUTER AP-
PLICATIONS, IN CLASS 9 (U.S. CLS. 21, 23, 26, 36 AND 38).

TRADEMARK

FIRST USE 6-1-2009; IN COMMERCE 6-1-2009.

PRINCIPAL REGISTER

THE MARK CONSISTS OF A WHITE LOWERCASE "G" IN THE MIDDLE OF A RED SQUARE.

THE COLOR(S) RED, WHITE IS/ARE CLAIMED AS A FEATURE OF THE MARK.

SER. NO. 85-468,711, FILED 11-9-2011.

DORITT L. CARROLL, EXAMINING ATTORNEY



David J. Kybas

Director of the United States Patent and Trademark Office

United States of America

United States Patent and Trademark Office

site producer

Reg. No. 4,174,764

Registered July 17, 2012

Int. Cl.: 42

SERVICE MARK

PRINCIPAL REGISTER

SITEPRODUCER, INC (CALIFORNIA CORPORATION)
1100
600 ANTON BLVD
COSTA MESA, CA 92626

FOR: WEB SITE DEVELOPMENT FOR OTHERS AND COMPUTER SOFTWARE DEVELOPMENT IN THE FIELD OF MOBILE APPLICATIONS, IN CLASS 42 (U.S. CLS. 100 AND 101).

FIRST USE 4-5-2011; IN COMMERCE 5-1-2011.

NO CLAIM IS MADE TO THE EXCLUSIVE RIGHT TO USE "SITE PRODUCER", APART FROM THE MARK AS SHOWN.

THE MARK CONSISTS OF A RECTANGULAR SHAPE WITH THE STYLIZED TEXT "SITE PRODUCER". THE RECTANGLE ONLY COVERS THE TEXT "SITE".

SER. NO. 85-468,853, FILED 11-9-2011.

RONALD MCMORROW, EXAMINING ATTORNEY



David J. Kyffers

Director of the United States Patent and Trademark Office

United States of America

United States Patent and Trademark Office



Reg. No. 4,174,765

Registered July 17, 2012

Int. Cl.: 44

SERVICE MARK

PRINCIPAL REGISTER

INNOVATIVE THERAPY SOLUTIONS LLC (NEW YORK LIMITED LIABILITY COMPANY)
#61
1330 5TH AVENUE
NEW YORK, NY 100263917

FOR: SPEECH THERAPY SERVICES, AND EVALUATION AND CONSULTATION SERVICES RELATED THERETO, IN CLASS 44 (U.S. CLS. 100 AND 101).

FIRST USE 8-1-2011; IN COMMERCE 8-1-2011.

NO CLAIM IS MADE TO THE EXCLUSIVE RIGHT TO USE "INNOVATIVE THERAPY SOLUTIONS PEDIATRIC SPEECH THERAPY", APART FROM THE MARK AS SHOWN.

THE MARK CONSISTS OF A SPEECH BUBBLE WITH SILHOUETTES OF A BOY AND A GIRL INSIDE IT. BELOW THE SPEECH BUBBLE ARE THE FOLLOWING STYLIZED PHRASES WITH EACH PHRASE ABOVE THE NEXT: "INNOVATIVE", "THERAPY SOLUTIONS", AND "PEDIATRIC SPEECH THERAPY".

SER. NO. 85-468,881, FILED 11-9-2011.

NICHOLAS ALTREE, EXAMINING ATTORNEY



David J. Kyffers

Director of the United States Patent and Trademark Office

United States of America

United States Patent and Trademark Office



Reg. No. 4,174,766

DAN-FOAM APS (DENMARK CORPORATION)
HOLMELUND 43

Registered July 17, 2012

AARUP, DENMARK DK-5560

Int. Cl.: 25

FOR: FOOTWEAR, IN CLASS 25 (U.S. CLS. 22 AND 39).

TRADEMARK

FIRST USE 12-31-2007; IN COMMERCE 12-31-2007.

PRINCIPAL REGISTER

OWNER OF U.S. REG. NOS. 1,853,088 AND 3,900,919.

THE MARK CONSISTS OF A FEMALE FIGURE ON A PILLOW RECLINING ON TOP OF A CROSS AND THE WORDS "TEMPUR-PEDIC". THE PORTION OF THE MARK COMPRISED OF A CROSS DESIGN IS NOT DISPLAYED IN THE COLOR RED OR A COLORABLE IMITATION THEREOF; AND IS NOT USED AND WILL NOT BE USED IN THE COLOR RED OR A COLORABLE IMITATION THEREOF.

SER. NO. 85-469,070, FILED 11-10-2011.

MIDGE BUTLER, EXAMINING ATTORNEY



David J. Kybas

Director of the United States Patent and Trademark Office

United States of America

United States Patent and Trademark Office



VolPro Portfolios

Your Volatility Shield

Reg. No. 4,174,767

Registered July 17, 2012

Int. Cl.: 36

SERVICE MARK

PRINCIPAL REGISTER

THE ELEMENTS FINANCIAL GROUP, LLC (CALIFORNIA LIMITED LIABILITY COMPANY)
#800
19200 VON KARMAN AVE.
IRVINE, CA 92612

FOR: FINANCIAL PLANNING AND INVESTMENT ADVISORY SERVICES, IN CLASS 36
(U.S. CLS. 100, 101 AND 102).

FIRST USE 9-28-2011; IN COMMERCE 9-28-2011.

NO CLAIM IS MADE TO THE EXCLUSIVE RIGHT TO USE "PORTFOLIOS", APART FROM
THE MARK AS SHOWN.

THE MARK CONSISTS OF THE STYLIZED TEXT "VOLPRO PORTFOLIOS" ABOVE THE
STYLIZED TEXT "YOUR VOLATILITY SHIELD". THE LETTER "V" IN "VOLPRO" IS EN-
CLOSED IN A SHIELD.

SER. NO. 85-469,075, FILED 11-10-2011.

KATHY DE JONGE, EXAMINING ATTORNEY



David J. Kyjars

Director of the United States Patent and Trademark Office

United States of America

United States Patent and Trademark Office

ROYAL BOOKS

Reg. No. 4,174,768

ROYAL BOOKS, INC. (MARYLAND CORPORATION)
32 WEST 25TH STREET
BALTIMORE, MD 21218

Registered July 17, 2012

Int. Cl.: 35

FOR: RETAIL AND ONLINE RETAIL STORE SERVICES FEATURING BOOKS; MAIL ORDER CATALOG SERVICES FEATURING BOOKS, IN CLASS 35 (U.S. CLS. 100, 101 AND 102).

SERVICE MARK

FIRST USE 3-1-1997; IN COMMERCE 3-1-1997.

PRINCIPAL REGISTER

THE MARK CONSISTS OF STANDARD CHARACTERS WITHOUT CLAIM TO ANY PARTICULAR FONT, STYLE, SIZE, OR COLOR.

NO CLAIM IS MADE TO THE EXCLUSIVE RIGHT TO USE "BOOKS", APART FROM THE MARK AS SHOWN.

SER. NO. 85-469,104, FILED 11-10-2011.

TINA MAI, EXAMINING ATTORNEY



David J. Kyffers

Director of the United States Patent and Trademark Office

United States of America

United States Patent and Trademark Office



Reg. No. 4,174,769

US FOODS, INC. (DELAWARE CORPORATION)
9399 WEST HIGGINS ROAD
ROSEMONT, IL 60618

Registered July 17, 2012

Int. Cl.: 35

FOR: BUSINESS MANAGEMENT CONSULTING SERVICES, NAMELY, PROVIDING COST MANAGEMENT PROGRAMS FOR THE INSTITUTIONAL HEALTHCARE FOODSERVICE INDUSTRY, IN CLASS 35 (U.S. CLS. 100, 101 AND 102).

SERVICE MARK

FIRST USE 12-0-2008; IN COMMERCE 12-0-2008.

PRINCIPAL REGISTER

THE MARK CONSISTS OF THE WORDS "LEGACY" AND "A HERITAGE OF SOLUTIONS" DIVIDED BY A LINE WITHIN A RECTANGULAR BOX WHICH IS ON A FRINGED SCARF.

SER. NO. 85-469,137, FILED 11-10-2011.

YAT SYE, LEE, EXAMINING ATTORNEY



David J. Kybas

Director of the United States Patent and Trademark Office

United States of America

United States Patent and Trademark Office

187 DEGREES

Reg. No. 4,174,770

NOFAL JR, THEODORE A (UNITED STATES INDIVIDUAL)
571 HWY 78

Registered July 17, 2012

RAMONA, CA 92065

Int. Cl.: 35

FOR: PROMOTING THE GOODS AND SERVICES OF OTHERS BY PROVIDING A WEBSITE FEATURING COUPONS, REBATES, PRE-PAID CREDITS, PRE-PAID COMPLIMENTARY CREDITS, COMPLIMENTARY CREDITS, PRICE-COMPARISON INFORMATION, PRODUCT REVIEWS, SERVICE REVIEWS, LINKS TO THE RETAIL WEBSITES OF OTHERS, AND DISCOUNT INFORMATION, IN CLASS 35 (U.S. CLS. 100, 101 AND 102).

SERVICE MARK

PRINCIPAL REGISTER

FIRST USE 1-1-2011; IN COMMERCE 1-1-2011.

THE MARK CONSISTS OF STANDARD CHARACTERS WITHOUT CLAIM TO ANY PARTICULAR FONT, STYLE, SIZE, OR COLOR.

SER. NO. 85-469,155, FILED 11-10-2011.

CHRISTINA SOBRAL, EXAMINING ATTORNEY



David J. Kyffers

Director of the United States Patent and Trademark Office

United States of America

United States Patent and Trademark Office



Reg. No. 4,174,771

ROYAL BOOKS, INC. (MARYLAND CORPORATION)
32 WEST 25TH STREET
BALTIMORE, MD 21218

Registered July 17, 2012

Int. Cl.: 35

FOR: RETAIL AND ONLINE RETAIL STORE SERVICES FEATURING BOOKS; MAIL ORDER CATALOG SERVICES FEATURING BOOKS, IN CLASS 35 (U.S. CLS. 100, 101 AND 102).

SERVICE MARK

FIRST USE 2-1-2009; IN COMMERCE 2-1-2009.

PRINCIPAL REGISTER

THE MARK CONSISTS OF A STYLIZED CROWN AGAINST A SQUARE BACKGROUND.

SER. NO. 85-469,198, FILED 11-10-2011.

TINA MAI, EXAMINING ATTORNEY



David J. Kybas

Director of the United States Patent and Trademark Office

United States of America

United States Patent and Trademark Office

Hypnosis Today

Reg. No. 4,174,772

Registered July 17, 2012

Int. Cl.: 16

TRADEMARK

PRINCIPAL REGISTER

ADVANCED STUDIES CONSULTANTS (NEW HAMPSHIRE UNINCORPORATED ASSOCIATION)
3 LESA DR
MERRIMACK, NH 03054

FOR: GENERAL FEATURE MAGAZINE IN THE FIELD OF HYPNOTISM, IN CLASS 16 (U.S. CLS. 2, 5, 22, 23, 29, 37, 38 AND 50).

FIRST USE 8-10-1998; IN COMMERCE 4-23-1999.

THE MARK CONSISTS OF STANDARD CHARACTERS WITHOUT CLAIM TO ANY PARTICULAR FONT, STYLE, SIZE, OR COLOR.

NO CLAIM IS MADE TO THE EXCLUSIVE RIGHT TO USE "HYPNOSIS", APART FROM THE MARK AS SHOWN.

SER. NO. 85-469,231, FILED 11-10-2011.

KIM SAITO, EXAMINING ATTORNEY



David J. Kybas

Director of the United States Patent and Trademark Office

United States of America

United States Patent and Trademark Office

SINGING FLOWER STUDIO

Reg. No. 4,174,773

SINGING FLOWER STUDIO, LLC (MINNESOTA LIMITED LIABILITY COMPANY)
1925 GLUEK LN S

Registered July 17, 2012

ROSEVILLE, MN 55113

Int. Cl.: 3

FOR: FACE AND BODY LOTIONS; HAND LOTIONS; LIP BALM; NATURAL SOAP BARS;
SOAPS FOR BODY CARE, IN CLASS 3 (U.S. CLS. 1, 4, 6, 50, 51 AND 52).

TRADEMARK

FIRST USE 7-2-2011; IN COMMERCE 7-11-2011.

PRINCIPAL REGISTER

THE MARK CONSISTS OF STANDARD CHARACTERS WITHOUT CLAIM TO ANY PAR-
TICULAR FONT, STYLE, SIZE, OR COLOR.

SER. NO. 85-469,261, FILED 11-10-2011.

SARA BENJAMIN, EXAMINING ATTORNEY



David J. Kyffers

Director of the United States Patent and Trademark Office

United States of America

United States Patent and Trademark Office

LAMP LOOKUP

Reg. No. 4,174,774

Registered July 17, 2012

Int. Cl.: 9

LASALLE SYSTEMS LEASING, INC. (ILLINOIS CORPORATION), DBA LASALLE SOLUTIONS
SUITE 200
6111 N RIVER ROAD
ROSEMONT, IL 60018

TRADEMARK

PRINCIPAL REGISTER

FOR: COMPUTER APPLICATION SOFTWARE FOR MOBILE PHONES, LAPTOPS, TABLET COMPUTERS, AND HANDHELD COMPUTERS, NAMELY, SOFTWARE FOR ALLOWING USERS TO SCAN OR INPUT A SERIAL NUMBER FOR AN ITEM AND FIND INFORMATION ABOUT THE PART; COMPUTER SOFTWARE FOR ALLOWING USERS TO SCAN OR INPUT A SERIAL NUMBER FOR AN ITEM AND FIND INFORMATION ABOUT THE PART, IN CLASS 9 (U.S. CLS. 21, 23, 26, 36 AND 38).

FIRST USE 4-1-2011; IN COMMERCE 6-30-2011.

THE MARK CONSISTS OF STANDARD CHARACTERS WITHOUT CLAIM TO ANY PARTICULAR FONT, STYLE, SIZE, OR COLOR.

OWNER OF U.S. REG. NO. 3,334,494.

NO CLAIM IS MADE TO THE EXCLUSIVE RIGHT TO USE "LOOKUP", APART FROM THE MARK AS SHOWN.

SER. NO. 85-469,283, FILED 11-10-2011.

LOURDES AYALA, EXAMINING ATTORNEY



David J. Kyffers

Director of the United States Patent and Trademark Office

United States of America

United States Patent and Trademark Office

OSHKOSH B'GOSH THE GENUINE ARTICLE

Reg. No. 4,174,775

Registered July 17, 2012

Int. Cl.: 25

TRADEMARK

PRINCIPAL REGISTER

OSHKOSH B'GOSH, INC. (DELAWARE CORPORATION)
1170 PEACHTREE ST.
SUITE 900
ATLANTA, GA 30309

FOR: CLOTHING, NAMELY, BIB OVERALLS, BIB SHORTALLS, JUMPERS, DRESSES, SKIRTS, JEANS, PANTS, DUNGAREES, SHORTS, SHIRTS, TOPS, JUMPSUITS, WARM UP OUTFITS, SWEATERS, JACKETS AND SNOWSUITS, SWIMWEAR, CAPS, SHOES, AND HEADWEAR, IN CLASS 25 (U.S. CLS. 22 AND 39).

FIRST USE 11-30-1979; IN COMMERCE 11-30-1979.

THE MARK CONSISTS OF STANDARD CHARACTERS WITHOUT CLAIM TO ANY PARTICULAR FONT, STYLE, SIZE, OR COLOR.

OWNER OF U.S. REG. NOS. 1,232,852, 1,498,723, AND 1,561,067.

SER. NO. 85-469,297, FILED 11-10-2011.

JULIE VEPPUMTHARA, EXAMINING ATTORNEY



David J. Kyffers

Director of the United States Patent and Trademark Office

United States of America

United States Patent and Trademark Office

HEALTHY BABIES ARE WORTH THE WAIT

Reg. No. 4,174,776

Registered July 17, 2012

Int. Cl.: 35

SERVICE MARK

PRINCIPAL REGISTER

MARCH OF DIMES FOUNDATION (NEW YORK NOT-FOR-PROFIT CORPORATION)
1275 MAMARONECK AVENUE
WHITE PLAINS, NY 10605

FOR: PROMOTING PUBLIC AWARENESS OF PRETERM BIRTH PREVENTION AND THE IMPORTANCE OF MAINTAINING A HEALTHY PREGNANCY FOR AT LEAST 39 WEEKS , IN CLASS 35 (U.S. CLS. 100, 101 AND 102).

FIRST USE 8-17-2011; IN COMMERCE 8-17-2011.

THE MARK CONSISTS OF STANDARD CHARACTERS WITHOUT CLAIM TO ANY PARTICULAR FONT, STYLE, SIZE, OR COLOR.

OWNER OF U.S. REG. NO. 3,402,652.

SER. NO. 85-469,360, FILED 11-10-2011.

JUSTINE D. PARKER, EXAMINING ATTORNEY



David J. Kybas

Director of the United States Patent and Trademark Office

United States of America

United States Patent and Trademark Office

FOOTPRINTER

Reg. No. 4,174,777

Registered July 17, 2012

Int. Cl.: 42

SERVICE MARK

PRINCIPAL REGISTER

FOOTPRINTER INC. (DELAWARE CORPORATION)
135 COMMONWEALTH DRIVE
MENLO PARK, CA 94025

FOR: SOFTWARE AS A SERVICE (SAAS) SERVICES, NAMELY, PROVIDING WEB-BASED, INTERACTIVE SOFTWARE THAT ALLOWS USERS TO GATHER, BUILD, MANIPULATE, VISUALIZE AND SHARE ENVIRONMENTAL DATA INSIDE AN ORGANIZATION AND EXTERNALLY WITH CUSTOMERS AND THE SUPPLY CHAIN IN ORDER TO ASSESS SPECIFIC AREAS OF ENVIRONMENTAL IMPACT OF A USER AND TO COLLABORATE ON REDUCING ENVIRONMENTAL IMPACTS, IN CLASS 42 (U.S. CLS. 100 AND 101).

FIRST USE 9-0-2008; IN COMMERCE 9-0-2008.

THE MARK CONSISTS OF STANDARD CHARACTERS WITHOUT CLAIM TO ANY PARTICULAR FONT, STYLE, SIZE, OR COLOR.

SER. NO. 85-469,390, FILED 11-10-2011.

JIM RINGLE, EXAMINING ATTORNEY



David J. Kyffers

Director of the United States Patent and Trademark Office

United States of America

United States Patent and Trademark Office

BenePhoto

Reg. No. 4,174,778

PRINTMANAGEMENT, LLC (OHIO LIMITED LIABILITY COMPANY)
3950 VIRGINIA AVENUE
CINCINNATI, OH 45227

Registered July 17, 2012

Int. Cl.: 40

FOR: PRINTING OF PHOTOGRAPHIC IMAGES FROM DIGITAL MEDIA, IN CLASS 40 (U.S. CLS. 100, 103 AND 106).

SERVICE MARK

FIRST USE 6-1-2011; IN COMMERCE 7-1-2011.

PRINCIPAL REGISTER

THE MARK CONSISTS OF STANDARD CHARACTERS WITHOUT CLAIM TO ANY PARTICULAR FONT, STYLE, SIZE, OR COLOR.

SER. NO. 85-469,431, FILED 11-10-2011.

CHRISTINA SOBRAL, EXAMINING ATTORNEY



David J. Kybas

Director of the United States Patent and Trademark Office

United States of America

United States Patent and Trademark Office

HYPNO-GRAM

Reg. No. 4,174,779

NATIONAL GUILD OF HYPNOTISTS, INC. (NEW HAMPSHIRE CORPORATION)
3 LESA DR
MERRIMACK, NH 03054

Registered July 17, 2012

Int. Cl.: 16

FOR: INFORMATIONAL FLYERS FEATURING HYPNOTISM; INFORMATIONAL LETTERS CONCERNING HYPNOTISM; NEWSLETTERS IN THE FIELD OF HYPNOTISM, IN CLASS 16 (U.S. CLS. 2, 5, 22, 23, 29, 37, 38 AND 50).

TRADEMARK

FIRST USE 1-1-1987; IN COMMERCE 1-1-1987.

PRINCIPAL REGISTER

THE MARK CONSISTS OF THE STYLIZED WORDING "HYPNO-GRAM".

SER. NO. 85-469,590, FILED 11-10-2011.

KIM SAITO, EXAMINING ATTORNEY



David J. Kybas

Director of the United States Patent and Trademark Office

United States of America

United States Patent and Trademark Office



Reg. No. 4,174,780

Registered July 17, 2012

Int. Cls.: 9 and 42

TRADEMARK

SERVICE MARK

PRINCIPAL REGISTER

INNOVMETRIC SOFTWARE INC. (CANADA CORPORATION)
2014, CYRILLE-DUQUET, SUITE 310
QUÉBEC, QUÉBEC, CANADA G1N4N6

FOR: SOFTWARE PROGRAMS USED FOR PROCESSING 3-D DIGITIZER DATA FOR MODELING AND INSPECTION APPLICATIONS, IN CLASS 9 (U.S. CLS. 21, 23, 26, 36 AND 38).

FIRST USE 1-19-2001; IN COMMERCE 1-19-2001.

FOR: TECHNICAL SUPPORT SERVICES, NAMELY, TROUBLESHOOTING SUPPORT SERVICES FOR SOFTWARE PROGRAMS USED FOR PROCESSING 3-D DIGITIZER DATA FOR MODELING AND INSPECTION APPLICATIONS, IN CLASS 42 (U.S. CLS. 100 AND 101).

FIRST USE 11-1-2006; IN COMMERCE 11-1-2006.

THE MARK CONSISTS OF THE UPPER HALF OF A WRENCH INSIDE THE DESIGN OF TWO CONCENTRIC CIRCLES COMPRISED OF A LARGER SHADED CIRCLE WITH A SMALLER SINGLE LINE CIRCLE INSIDE.

SER. NO. 85-469,614, FILED 11-10-2011.

MARY I. SPARROW, EXAMINING ATTORNEY



David J. Kybas

Director of the United States Patent and Trademark Office

United States of America

United States Patent and Trademark Office

WITH THE WIND AT YOUR BACK
AND ROLLING LIKE THUNDER,
MAKE IT RAIN

Reg. No. 4,174,781

Registered July 17, 2012

Int. Cl.: 41

SERVICE MARK

PRINCIPAL REGISTER

BODY BY X SKILL DEVELOPMENT & TRAINING CENTER, LLC (CALIFORNIA LIMITED LIABILITY COMPANY)
5768 PARADISE DRIVE, SUITE J
CORTE MADERA, CA 94925

FOR: OPERATION OF A FITNESS CENTER FOR DEVELOPMENT OF PHYSICAL SKILLS AND STRENGTHS, SPORTS TRAINING , IN CLASS 41 (U.S. CLS. 100, 101 AND 107).

FIRST USE 6-1-2010; IN COMMERCE 6-1-2010.

THE MARK CONSISTS OF STANDARD CHARACTERS WITHOUT CLAIM TO ANY PARTICULAR FONT, STYLE, SIZE, OR COLOR.

SER. NO. 85-469,619, FILED 11-10-2011.

BARBARA A. GOLD, EXAMINING ATTORNEY



David J. Kyros

Director of the United States Patent and Trademark Office

United States of America

United States Patent and Trademark Office

RAVEN ALERT

Reg. No. 4,174,782

Registered July 17, 2012

Int. Cl.: 9

TRADEMARK

PRINCIPAL REGISTER

AMERICAN MESSAGING SERVICES, LLC (DELAWARE LIMITED LIABILITY COMPANY)
1720 LAKEPOINTE DRIVE
SUITE 100
LEWISVILLE, TX 75057

FOR: ELECTRONIC ALERT DEVICES, NAMELY, FLASH DRIVES THAT PROVIDE SIMULTANEOUS EMERGENCY ALERTS BY MEANS OF RADIO-BASED PAGING SERVICES , IN CLASS 9 (U.S. CLS. 21, 23, 26, 36 AND 38).

FIRST USE 4-15-2009; IN COMMERCE 4-15-2009.

THE MARK CONSISTS OF STANDARD CHARACTERS WITHOUT CLAIM TO ANY PARTICULAR FONT, STYLE, SIZE, OR COLOR.

NO CLAIM IS MADE TO THE EXCLUSIVE RIGHT TO USE "ALERT", APART FROM THE MARK AS SHOWN.

SER. NO. 85-469,656, FILED 11-10-2011.

KELLY BOULTON, EXAMINING ATTORNEY



David J. Kyffers

Director of the United States Patent and Trademark Office

United States of America

United States Patent and Trademark Office



Reg. No. 4,174,783

ATLANTIC INTERNATIONAL DISTRIBUTORS, INC. (FLORIDA CORPORATION)
2905 DANESE STREET
JACKSONVILLE, FL 32206

Registered July 17, 2012

Int. Cl.: 7

FOR: HEAVY-DUTY TRACTOR OIL AND FUEL FILTERS FOR INDUSTRIAL USE, IN CLASS 7 (U.S. CLS. 13, 19, 21, 23, 31, 34 AND 35).

TRADEMARK

FIRST USE 7-13-2011; IN COMMERCE 7-13-2011.

PRINCIPAL REGISTER

NO CLAIM IS MADE TO THE EXCLUSIVE RIGHT TO USE "HEAVY-DUTY FILTERS", APART FROM THE MARK AS SHOWN.

THE COLOR(S) BLACK AND BURNT ORANGE IS/ARE CLAIMED AS A FEATURE OF THE MARK.

THE MARK CONSISTS OF IN ALL CAPITAL BOLD BLACK LETTERS THE WORD "TRAC" CENTERED, WITH BURNT ORANGE STIPPLING TIRE TREAD RUNNING DIAGONALLY FROM BENEATH THE LETTER "C" AND ABOVE THE LETTER "C", WITH THE WORDING IN BURNT ORANGE "HEAVY-DUTY FILTERS" CENTERED BENEATH THE WORD "TRAC".

SER. NO. 85-469,660, FILED 11-10-2011.

FRANK LATTUCA, EXAMINING ATTORNEY



David J. Kyros

Director of the United States Patent and Trademark Office

United States of America

United States Patent and Trademark Office

INTELLIGUARD

Reg. No. 4,174,784

Registered July 17, 2012

Int. Cl.: 38

SERVICE MARK

PRINCIPAL REGISTER

AMERICAN MESSAGING SERVICES, LLC (DELAWARE LIMITED LIABILITY COMPANY)
1720 LAKEPOINTE DRIVE
SUITE 100
LEWISVILLE, TX 75057

FOR: WIRELESS COMMUNICATIONS SERVICES, NAMELY, PROVIDING SIMULTANEOUS EMERGENCY ALERTS VIA RADIO-PAGING AND TEXT MESSAGING SERVICES , IN CLASS 38 (U.S. CLS. 100, 101 AND 104).

FIRST USE 12-31-2009; IN COMMERCE 12-31-2009.

THE MARK CONSISTS OF STANDARD CHARACTERS WITHOUT CLAIM TO ANY PARTICULAR FONT, STYLE, SIZE, OR COLOR.

SER. NO. 85-469,666, FILED 11-10-2011.

KELLY BOULTON, EXAMINING ATTORNEY



David J. Kyffers

Director of the United States Patent and Trademark Office

United States of America

United States Patent and Trademark Office

INTELLIGUARD SYSTEMS

Reg. No. 4,174,785

Registered July 17, 2012

Int. Cl.: 38

SERVICE MARK

PRINCIPAL REGISTER

AMERICAN MESSAGING SERVICES, LLC (DELAWARE LIMITED LIABILITY COMPANY)
1720 LAKEPOINTE DRIVE
SUITE 100
LEWISVILLE, TX 75057

FOR: WIRELESS COMMUNICATIONS SERVICES, NAMELY, PROVIDING SIMULTANEOUS EMERGENCY ALERTS VIA RADIO-PAGING AND TEXT MESSAGING SERVICES, IN CLASS 38 (U.S. CLS. 100, 101 AND 104).

FIRST USE 12-31-2009; IN COMMERCE 12-31-2009.

THE MARK CONSISTS OF STANDARD CHARACTERS WITHOUT CLAIM TO ANY PARTICULAR FONT, STYLE, SIZE, OR COLOR.

NO CLAIM IS MADE TO THE EXCLUSIVE RIGHT TO USE "SYSTEMS", APART FROM THE MARK AS SHOWN.

SER. NO. 85-469,671, FILED 11-10-2011.

KELLY BOULTON, EXAMINING ATTORNEY



David J. Kyffers

Director of the United States Patent and Trademark Office

United States of America

United States Patent and Trademark Office

HIGHFIVE YOUR LIFE FROZEN YOGURT

Reg. No. 4,174,786

Registered July 17, 2012

Int. Cls.: 30 and 43

TRADEMARK

SERVICE MARK

PRINCIPAL REGISTER

HIGHFIVE IP HOLDINGS, LLC (FLORIDA LIMITED LIABILITY COMPANY)
3730 GRISSOM LANE
KISSIMMEE, FL 34741

FOR: FROZEN YOGURT, IN CLASS 30 (U.S. CL. 46).

FIRST USE 8-28-2010; IN COMMERCE 8-28-2010.

FOR: RESTAURANT SERVICES, IN CLASS 43 (U.S. CLS. 100 AND 101).

FIRST USE 8-28-2010; IN COMMERCE 8-28-2010.

THE MARK CONSISTS OF STANDARD CHARACTERS WITHOUT CLAIM TO ANY PARTICULAR FONT, STYLE, SIZE, OR COLOR.

OWNER OF U.S. REG. NO. 3,891,069.

NO CLAIM IS MADE TO THE EXCLUSIVE RIGHT TO USE "FROZEN YOGURT", APART FROM THE MARK AS SHOWN.

SER. NO. 85-470,119, FILED 11-11-2011.

JAMES A. RAUEN, EXAMINING ATTORNEY



David J. Kyffers

Director of the United States Patent and Trademark Office

United States of America

United States Patent and Trademark Office

QSTART

Reg. No. 4,174,787

ADS LLC (DELAWARE LIMITED LIABILITY COMPANY)
4940 RESEARCH DRIVE
HUNTSVILLE, AL 35805

Registered July 17, 2012

Int. Cl.: 9

FOR: SOFTWARE FOR MONITORING WATER FLOW METERS IN MUNICIPAL WASTEWATER SYSTEMS, IN CLASS 9 (U.S. CLS. 21, 23, 26, 36 AND 38).

TRADEMARK

FIRST USE 10-4-2011; IN COMMERCE 10-4-2011.

PRINCIPAL REGISTER

THE MARK CONSISTS OF STANDARD CHARACTERS WITHOUT CLAIM TO ANY PARTICULAR FONT, STYLE, SIZE, OR COLOR.

SER. NO. 85-470,131, FILED 11-11-2011.

TIMOTHY FINNEGAN, EXAMINING ATTORNEY



David J. Kybas

Director of the United States Patent and Trademark Office

United States of America

United States Patent and Trademark Office



Reg. No. 4,174,788

Registered July 17, 2012

Int. Cl.: 41

SERVICE MARK

PRINCIPAL REGISTER

CENTRAL PIEDMONT COMMUNITY COLLEGE (NORTH CAROLINA NON-PROFIT CORPORATION)
P.O. BOX 35009
CHARLOTTE, NC 282355009

FOR: EDUCATION SERVICES, NAMELY, PROVIDING COURSES OF INSTRUCTION AT THE COMMUNITY COLLEGE LEVEL, IN CLASS 41 (U.S. CLS. 100, 101 AND 107).

FIRST USE 0-0-1963; IN COMMERCE 0-0-1963.

NO CLAIM IS MADE TO THE EXCLUSIVE RIGHT TO USE "COMMUNITY COLLEGE", APART FROM THE MARK AS SHOWN.

THE MARK CONSISTS OF THE STYLIZED WORDS "CENTRAL PIEDMONT COMMUNITY COLLEGE" INSIDE AN OUTER CIRCLE WITH A SMALL SHADED CIRCLE APPEARING AT THE BOTTOM AND CENTER THEREOF, THE STYLIZED WORDS "CHARLOTTE NORTH CAROLINA" INSIDE A MIDDLE CIRCLE WITH A SMALL SHADED CIRCLE APPEARING AT THE BOTTOM AND CENTER THEREOF, AND THE DESIGN OF A TREE INSIDE THE INNER CIRCLE.

SEC. 2(F) AS TO "CENTRAL PIEDMONT COMMUNITY COLLEGE CHARLOTTE NORTH CAROLINA".

SER. NO. 85-470,151, FILED 11-11-2011.

BRIAN CALLAGHAN, EXAMINING ATTORNEY



David J. Kyffers

Director of the United States Patent and Trademark Office

United States of America

United States Patent and Trademark Office

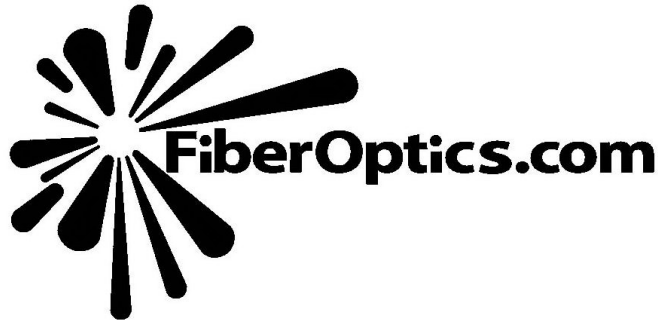

Reg. No. 4,174,789

FIBEROPTICS.COM, INC. (PENNSYLVANIA CORPORATION)
1919 SYCAMORE DR.
QUAKERTOWN, PA 18951

Registered July 17, 2012

Int. Cl.: 9

FOR: ELECTRONIC TEST AND MEASUREMENT DEVICES FOR USE IN THE FIELDS OF NETWORKS AND TELECOMMUNICATIONS, NAMELY, INSTRUMENTATION USED TO TEST AND CERTIFY NEW AND EXISTING DATA AND VOICE COMMUNICATION CABLE AND COAXIAL CABLE, IN CLASS 9 (U.S. CLS. 21, 23, 26, 36 AND 38).

TRADEMARK

PRINCIPAL REGISTER

FIRST USE 6-12-2007; IN COMMERCE 6-12-2007.

NO CLAIM IS MADE TO THE EXCLUSIVE RIGHT TO USE "FIBEROPTICS.COM", APART FROM THE MARK AS SHOWN.

THE MARK CONSISTS OF AN ABSTRACT DESIGN ON THE LEFT, AND ON THE RIGHT ARE THE WORDS "FIBER" AND "OPTICS" PLACED NEXT TO EACH OTHER AND USED IN THE FORM OF AN INTERNET ADDRESS BY FURTHER ADDING THE ".COM" EXTENSION TO MAKE "FIBEROPTICS.COM" WITH A CAPITAL "F" IN "FIBER" AND CAPITAL "O" IN "OPTICS".

SER. NO. 85-470,152, FILED 11-11-2011.

CHRIS WELLS, EXAMINING ATTORNEY



David J. Kyffers

Director of the United States Patent and Trademark Office

United States of America

United States Patent and Trademark Office

SYNNATE

Reg. No. 4,174,790

Registered July 17, 2012

Int. Cl.: 5

TRADEMARK

PRINCIPAL REGISTER

BAYER AKTIENGESELLSCHAFT (FED REP GERMANY AKTIENGESELLSCHAFT)
KAISER-WILHELM-ALLEE
51373 LEVERKUSEN, FED REP GERMANY

FOR: VETERINARY PREPARATIONS FOR USE IN ANIMALS BY INJECTION OR OTHER MEANS OF ADMINISTRATION TO STIMULATE IMMUNITY, IN CLASS 5 (U.S. CLS. 6, 18, 44, 46, 51 AND 52).

THE MARK CONSISTS OF STANDARD CHARACTERS WITHOUT CLAIM TO ANY PARTICULAR FONT, STYLE, SIZE, OR COLOR.

PRIORITY CLAIMED UNDER SEC. 44(D) ON FED REP GERMANY APPLICATION NO. 302011050507, FILED 9-13-2011, REG. NO. 302011050507, DATED 10-5-2011, EXPIRES 9-30-2021.

THE WORD(S) "SYNNATE" HAS NO MEANING IN A FOREIGN LANGUAGE.

SER. NO. 85-470,161, FILED 11-11-2011.

ERIN FALK, EXAMINING ATTORNEY



David J. Kyjars

Director of the United States Patent and Trademark Office

United States of America

United States Patent and Trademark Office

You Work For Them

Reg. No. 4,174,791

Registered July 17, 2012

Int. Cl.: 9

TRADEMARK

PRINCIPAL REGISTER

YOUWORKFORTHEM, INC (ALABAMA CORPORATION)
624 RIVERWOOD LODGE ROAD
QUINTON, AL 35130

FOR: DOWNLOADABLE COMPUTER SOFTWARE FOR USE IN DISPLAYING AND PRINTING FONTS AND DOWNLOADABLE MULTIMEDIA FILES CONTAINING STOCK ARTWORK, STOCK PHOTOS, AND STOCK MUSIC RECORDINGS FOR USE BY GRAPHIC DESIGNERS, IN CLASS 9 (U.S. CLS. 21, 23, 26, 36 AND 38).

FIRST USE 1-1-2002; IN COMMERCE 1-1-2002.

THE MARK CONSISTS OF STANDARD CHARACTERS WITHOUT CLAIM TO ANY PARTICULAR FONT, STYLE, SIZE, OR COLOR.

SER. NO. 85-470,163, FILED 11-11-2011.

LANA PHAM, EXAMINING ATTORNEY



David J. Kybas

Director of the United States Patent and Trademark Office

United States of America

United States Patent and Trademark Office



Reg. No. 4,174,792

Registered July 17, 2012

Int. Cl.: 45

SERVICE MARK

PRINCIPAL REGISTER

ATHLETES CHEF LLC (ARIZONA LIMITED LIABILITY COMPANY)
STE. 23-123
4802 E. RAY RD.
PHOENIX, AZ 85044

FOR: PERSONAL CHEF SERVICES, IN CLASS 45 (U.S. CLS. 100 AND 101).

FIRST USE 8-27-2011; IN COMMERCE 8-27-2011.

NO CLAIM IS MADE TO THE EXCLUSIVE RIGHT TO USE "ATHLETE'S CHEF", APART FROM THE MARK AS SHOWN.

THE MARK CONSISTS OF THE WORD "ATHLETES", THEN A MAN (WITH HIS HANDS HELD HIGH WHILE RUNNING), FOLLOWED BY THE WORD "CHEF", AND TWO LEAFS COMING OFF THE "F" IN "CHEF".

SER. NO. 85-470,167, FILED 11-11-2011.

REBECCA SMITH, EXAMINING ATTORNEY



David J. Kybas

Director of the United States Patent and Trademark Office

United States of America

United States Patent and Trademark Office



Reg. No. 4,174,793

WALTON, CARLOS (UNITED STATES INDIVIDUAL)
7947 B SHOALS DR.
ORLANDO, FL 32817

Registered July 17, 2012

Int. Cl.: 45

FOR: ONLINE SOCIAL NETWORKING SERVICES IN THE FIELD OF MUSIC ENGINEERING,
IN CLASS 45 (U.S. CLS. 100 AND 101).

SERVICE MARK

FIRST USE 10-19-2011; IN COMMERCE 10-19-2011.

PRINCIPAL REGISTER

NO CLAIM IS MADE TO THE EXCLUSIVE RIGHT TO USE ".COM", APART FROM THE
MARK AS SHOWN.

THE MARK CONSISTS OF A THREE STRAND VERTICAL TWIST WITH A CIRCLE IN THE
CENTER CONTAINING THREE SIMPLISTIC HUMAN FIGURES. TO THE LEFT IS A CIRCLE
CONTAINING A BEAMED PAIR OF EIGHTH NOTES. TO THE RIGHT OF THE TWIST IS
A CIRCLE CONTAINING A TRIANGLE THAT REPRESENTS A PLAY BUTTON. TO THE
RIGHT OF ALL THESE IMAGES IS THE STYLIZED TEXT "COLLABAVE". UNDER THE
LETTERS "VE" IN "COLLABAVE" IS THE STYLIZED TEXT ".COM".

SER. NO. 85-470,193, FILED 11-11-2011.

MEGHAN REINHART, EXAMINING ATTORNEY



David J. Kybas

Director of the United States Patent and Trademark Office

United States of America

United States Patent and Trademark Office



Reg. No. 4,174,794

Registered July 17, 2012

Int. Cl.: 41

SERVICE MARK

PRINCIPAL REGISTER

CENTRAL PIEDMONT COMMUNITY COLLEGE (NORTH CAROLINA NON-PROFIT CORPORATION)
PO BOX 35009
CHARLOTTE, NC 282355009

FOR: EDUCATION SERVICES, NAMELY, PROVIDING COURSES OF INSTRUCTION AT THE COMMUNITY COLLEGE LEVEL, IN CLASS 41 (U.S. CLS. 100, 101 AND 107).

FIRST USE 0-0-1980; IN COMMERCE 0-0-1980.

NO CLAIM IS MADE TO THE EXCLUSIVE RIGHT TO USE "COMMUNITY COLLEGE", APART FROM THE MARK AS SHOWN.

THE MARK CONSISTS OF STYLIZED LETTERS "C", "P", "C", "C" POSITIONED DIAGONALLY WITHIN THE SQUARE AND THE STYLIZED WORDS "CENTRAL PIEDMONT" BESIDE THE SQUARE AND ABOVE THE STYLIZED WORDS "COMMUNITY COLLEGE".

SEC. 2(F) AS TO "CENTRAL PIEDMONT COMMUNITY COLLEGE".

SER. NO. 85-470,195, FILED 11-11-2011.

BRIAN CALLAGHAN, EXAMINING ATTORNEY



David J. Kybas

Director of the United States Patent and Trademark Office

United States of America

United States Patent and Trademark Office



Reg. No. 4,174,795

Registered July 17, 2012

Int. Cl.: 12

TRADEMARK

PRINCIPAL REGISTER

SAKAE ENGINEERING INC. (JAPAN CORPORATION)
CHIBA-KEN KASIWASI
CHUOU 1-2-25
YAHANE BIRU 501, JAPAN

FOR: BICYCLES AND STRUCTURAL PARTS THEREOF, IN CLASS 12 (U.S. CLS. 19, 21, 23, 31, 35 AND 44).

FIRST USE 2-0-2008; IN COMMERCE 2-0-2008.

THE MARK CONSISTS OF THE TERM "WERX" AND A DESIGN MADE OF A HORIZONTAL LINE WITH THREE VERTICAL LINES OF VARYING SIZES EXTENDING UP FROM IT AND THE SMALLEST OF THE VERTICAL LINES BEING SEPARATED FROM THE HORIZONTAL LINE BY A SMALL SPACE.

SER. NO. 85-470,201, FILED 11-11-2011.

MEGHAN REINHART, EXAMINING ATTORNEY



David J. Kybas

Director of the United States Patent and Trademark Office

United States of America

United States Patent and Trademark Office

Lot 2 Restaurant · Wine Bar

Reg. No. 4,174,796

MARR LLC (NEBRASKA LIMITED LIABILITY COMPANY)
6205 1/2 MAPLE ST
OMAHA, NE 68104

Registered July 17, 2012

Int. Cl.: 43

FOR: RESTAURANT SERVICES; WINE BARS, IN CLASS 43 (U.S. CLS. 100 AND 101).

SERVICE MARK

FIRST USE 10-15-2011; IN COMMERCE 10-15-2011.

PRINCIPAL REGISTER

THE MARK CONSISTS OF STANDARD CHARACTERS WITHOUT CLAIM TO ANY PARTICULAR FONT, STYLE, SIZE, OR COLOR.

NO CLAIM IS MADE TO THE EXCLUSIVE RIGHT TO USE "RESTAURANT" AND "WINE BAR", APART FROM THE MARK AS SHOWN.

SER. NO. 85-470,203, FILED 11-11-2011.

MEGHAN REINHART, EXAMINING ATTORNEY



David J. Kyffers

Director of the United States Patent and Trademark Office

United States of America

United States Patent and Trademark Office

CENTRAL PIEDMONT COMMUNITY COLLEGE

Reg. No. 4,174,797

Registered July 17, 2012

Int. Cl.: 41

SERVICE MARK

PRINCIPAL REGISTER

CENTRAL PIEDMONT COMMUNITY COLLEGE (NORTH CAROLINA NON-PROFIT CORPORATION)
P.O. BOX 35009
CHARLOTTE, NC 282355009

FOR: EDUCATION SERVICES, NAMELY, PROVIDING COURSES OF INSTRUCTION AT THE COMMUNITY COLLEGE LEVEL, IN CLASS 41 (U.S. CLS. 100, 101 AND 107).

FIRST USE 0-0-1963; IN COMMERCE 0-0-1963.

THE MARK CONSISTS OF STANDARD CHARACTERS WITHOUT CLAIM TO ANY PARTICULAR FONT, STYLE, SIZE, OR COLOR.

NO CLAIM IS MADE TO THE EXCLUSIVE RIGHT TO USE "COMMUNITY COLLEGE", APART FROM THE MARK AS SHOWN.

SEC. 2(F).

SER. NO. 85-470,212, FILED 11-11-2011.

BRIAN CALLAGHAN, EXAMINING ATTORNEY



David J. Kyffers

Director of the United States Patent and Trademark Office

United States of America

United States Patent and Trademark Office

Tea
Xotics

Reg. No. 4,174,798

EL DORADO ROASTING CO. LLC (CALIFORNIA LIMITED LIABILITY COMPANY)
4661 GOLDENFOOTHILL PARKWAY STE 103
EL DORADO HILLS, CA 95762

Registered July 17, 2012

Int. Cl.: 30

FOR: TEA, IN CLASS 30 (U.S. CL. 46).

TRADEMARK

FIRST USE 4-1-2011; IN COMMERCE 4-1-2011.

PRINCIPAL REGISTER

NO CLAIM IS MADE TO THE EXCLUSIVE RIGHT TO USE "TEA" , APART FROM THE MARK AS SHOWN.

THE MARK CONSISTS OF THE STYLIZED TEXT "TEA XOTICS" WITH TWO LEAVES AT THE BEGINNING AND AT THE END OF THE TEXT.

SER. NO. 85-470,214, FILED 11-11-2011.

BRIAN PINO, EXAMINING ATTORNEY



David J. Kyffers

Director of the United States Patent and Trademark Office

United States of America

United States Patent and Trademark Office

AG LOAN FUND

Reg. No. 4,174,799

Registered July 17, 2012

Int. Cl.: 36

SERVICE MARK

PRINCIPAL REGISTER

ASSEMBLIES OF GOD LOAN FUND (MISSOURI NON-PROFIT CORPORATION)
1661 NORTH BOONVILLE AVENUE
SPRINGFIELD, MO 65803

FOR: SAVINGS AND LOAN SERVICES AND LOAN FINANCING SERVICES, NAMELY, LOAN ORIGATION, LOAN UNDERWRITING, LOAN SERVICING, ISSUING PROMISSORY NOTES OR LOAN CERTIFICATES TO INVESTORS, PROVIDING SHORT-TERM AND PERMANENT FINANCING, PROVIDING REFINANCING OF EXISTING LOANS, PROVIDING FORECLOSURE SERVICES, AND PROVIDING LOAN CONSULTING SERVICES; FINANCIAL ANALYSIS AND CONSULTATION SERVICES; REAL ESTATE CONSULTANCY AND REAL ESTATE MANAGEMENT SERVICES, IN CLASS 36 (U.S. CLS. 100, 101 AND 102).

FIRST USE 1-1-1995; IN COMMERCE 1-1-1995.

THE MARK CONSISTS OF STANDARD CHARACTERS WITHOUT CLAIM TO ANY PARTICULAR FONT, STYLE, SIZE, OR COLOR.

OWNER OF U.S. REG. NO. 3,020,265.

NO CLAIM IS MADE TO THE EXCLUSIVE RIGHT TO USE "LOAN FUND", APART FROM THE MARK AS SHOWN.

SER. NO. 85-470,276, FILED 11-11-2011.

DAVID COLLIER, EXAMINING ATTORNEY



David J. Kyffers

Director of the United States Patent and Trademark Office

United States of America

United States Patent and Trademark Office

PASSALACQUA WINERY

Reg. No. 4,174,800

JASON PASSALACQUA (UNITED STATES INDIVIDUAL)
3805 LAMBERT BRIDGE ROAD
HEALDSBURG, CA 95448

Registered July 17, 2012

Int. Cl.: 33

FOR: WINE, IN CLASS 33 (U.S. CLS. 47 AND 49).

TRADEMARK

FIRST USE 3-5-2004; IN COMMERCE 3-5-2004.

PRINCIPAL REGISTER

THE MARK CONSISTS OF STANDARD CHARACTERS WITHOUT CLAIM TO ANY PARTICULAR FONT, STYLE, SIZE, OR COLOR.

OWNER OF U.S. REG. NO. 3,022,168.

NO CLAIM IS MADE TO THE EXCLUSIVE RIGHT TO USE "WINERY", APART FROM THE MARK AS SHOWN.

SEC. 2(F).

SER. NO. 85-470,294, FILED 11-11-2011.

DAVID COLLIER, EXAMINING ATTORNEY



David J. Kyffers

Director of the United States Patent and Trademark Office

United States of America

United States Patent and Trademark Office

BLUEBIRD PRODUCTIONS

Reg. No. 4,174,801

BLUEBIRD ASPEN, LLC (COLORADO LIMITED LIABILITY COMPANY)
163 STALLION CIRCLE
SNOWMASS VILLAGE, CO 81615

Registered July 17, 2012

Int. Cls.: 35 and 41

FOR: SOCIAL MEDIA STRATEGY AND MARKETING CONSULTANCY FOCUSING ON HELPING CLIENTS CREATE AND EXTEND THEIR PRODUCT AND BRAND STRATEGIES BY BUILDING VIRALLY ENGAGING MARKETING SOLUTIONS; SPECIAL EVENT PLANNING FOR BUSINESS PURPOSES, IN CLASS 35 (U.S. CLS. 100, 101 AND 102).

SERVICE MARK

PRINCIPAL REGISTER

FIRST USE 3-3-2011; IN COMMERCE 11-1-2011.

FOR: PARTY AND WEDDING PLANNING, COORDINATION AND CONSULTATION SERVICES, IN CLASS 41 (U.S. CLS. 100, 101 AND 107).

FIRST USE 1-29-2011; IN COMMERCE 2-22-2011.

THE MARK CONSISTS OF STANDARD CHARACTERS WITHOUT CLAIM TO ANY PARTICULAR FONT, STYLE, SIZE, OR COLOR.

NO CLAIM IS MADE TO THE EXCLUSIVE RIGHT TO USE "PRODUCTIONS", APART FROM THE MARK AS SHOWN.

SER. NO. 85-470,347, FILED 11-11-2011.

SIMON TENG, EXAMINING ATTORNEY



David J. Kybas

Director of the United States Patent and Trademark Office

United States of America

United States Patent and Trademark Office

COUNTDOWN

Reg. No. 4,174,802

Registered July 17, 2012

Int. Cl.: 41

SERVICE MARK

PRINCIPAL REGISTER

JUVENILE DIABETES RESEARCH FOUNDATION INTERNATIONAL (PENNSYLVANIA CORPORATION)
26 BROADWAY, 14TH FLOOR
NEW YORK, NY 10004

FOR: PROVIDING ON-LINE MAGAZINES IN THE FIELD OF DIABETES RESEARCH, FUNDING AND EDUCATION, IN CLASS 41 (U.S. CLS. 100, 101 AND 107).

FIRST USE 12-3-2010; IN COMMERCE 12-3-2010.

THE MARK CONSISTS OF STANDARD CHARACTERS WITHOUT CLAIM TO ANY PARTICULAR FONT, STYLE, SIZE, OR COLOR.

OWNER OF U.S. REG. NO. 1,661,660.

SER. NO. 85-470,354, FILED 11-11-2011.

SIMON TENG, EXAMINING ATTORNEY



David J. Kyffers

Director of the United States Patent and Trademark Office

United States of America

United States Patent and Trademark Office

FeatherStone

Reg. No. 4,174,803

WEST FLORIDA DISTRIBUTORS, INC. (FLORIDA CORPORATION)
4500 CARMICHAEL AVENUE
SARASOTA, FL 34234

Registered July 17, 2012

Int. Cl.: 19

FOR: GRANITE PANELS FOR USE AS COUNTERTOPS AND INTERIOR SURFACE TOPS
IN HOMES, ELEVATORS, YACHTS, PLANES AND BUILDINGS, IN CLASS 19 (U.S. CLS.
1, 12, 33 AND 50).

TRADEMARK

FIRST USE 1-1-2006; IN COMMERCE 1-1-2006.

PRINCIPAL REGISTER

NO CLAIM IS MADE TO THE EXCLUSIVE RIGHT TO USE "STONE", APART FROM THE
MARK AS SHOWN.

THE MARK CONSISTS OF THE WORD "FEATHERSTONE" WITH A FEATHER PLACED
BETWEEN THE WORD "FEATHER" AND THE WORD "STONE".

SER. NO. 85-470,367, FILED 11-11-2011.

DAVID C. REIHNER, EXAMINING ATTORNEY



David J. Kyffers

Director of the United States Patent and Trademark Office

United States of America

United States Patent and Trademark Office



Reg. No. 4,174,804

Registered July 17, 2012

Int. Cl.: 35

SERVICE MARK

PRINCIPAL REGISTER

PIXELFISH INC. (CALIFORNIA CORPORATION)
21250 HAWTHORNE BLVD., SUITE 770
TORRANCE, CA 90503

FOR: PROVIDING ONLINE BUSINESS DIRECTORIES FEATURING DESCRIPTIONS OF GOODS AND SERVICES OF A WIDE VARIETY OF BUSINESSES, LISTINGS OF DEALS AND PRICES OF SUCH GOODS AND SERVICES, STREAMING VIDEOS OF BUSINESSES AND SERVICES, AND DIRECTORY LISTINGS OF ADDRESSES, PHONE NUMBERS, WEBSITE ADDRESSES AND EMAIL ADDRESSES OF LOCAL BUSINESSES; PROVIDING A WEB SITE WHICH FEATURES ADVERTISEMENTS FOR THE GOODS AND SERVICES OF OTHERS ON A GLOBAL COMPUTER NETWORK; ADVERTISING AND COMMERCIAL INFORMATION SERVICES, VIA THE INTERNET; SHOPPERS' GUIDE INFORMATION; PROVIDING ONLINE INFORMATION IN THE FIELD OF GOVERNMENT AFFAIRS; PROVIDING CUSTOMER INFORMATION SERVICES AND MAKING REFERRALS IN THE FIELD OF ENTERTAINMENT SERVICES FOR PRODUCTS, SERVICES, EVENTS, ACTIVITIES, FACILITIES AND LOCATIONS, IN CLASS 35 (U.S. CLS. 100, 101 AND 102).

FIRST USE 11-7-2011; IN COMMERCE 11-7-2011.

THE MARK CONSISTS OF AN UPSIDE-DOWN TEAR DROP, SLANTED SLIGHTLY TO THE LEFT.

SER. NO. 85-470,406, FILED 11-11-2011.

MICHAEL WIENER, EXAMINING ATTORNEY



David J. Kyffers

Director of the United States Patent and Trademark Office

United States of America

United States Patent and Trademark Office



Reg. No. 4,174,805

SNAR LODGING, INC. (TEXAS CORPORATION)
930 INTERSTATE 35E
LANCASTER, TX 75146

Registered July 17, 2012

Int. Cl.: 43

FOR: HOTEL SERVICES; MOTEL SERVICES, IN CLASS 43 (U.S. CLS. 100 AND 101).

SERVICE MARK

FIRST USE 10-14-2011; IN COMMERCE 10-14-2011.

PRINCIPAL REGISTER

NO CLAIM IS MADE TO THE EXCLUSIVE RIGHT TO USE "INN & SUITES", APART FROM THE MARK AS SHOWN.

THE COLOR(S) BLUE, ORANGE, WHITE, YELLOW AND RED IS/ARE CLAIMED AS A FEATURE OF THE MARK.

THE MARK CONSISTS OF A BLUE SHIELD WITH AN ORANGE SPHERE WITH WHITE WAVY LINES AT THE TOP AND BELOW IT THE WORD "HWY" IN WHITE AND BELOW IT THE WORD "EXPRESS" IN YELLOW WITH ORANGE, RED, AND YELLOW PARALLEL HORIZONTAL LINES AT THE BOTTOM OF THE "P" IN "EXPRESS" AND BELOW THAT THE WORDS "INN & SUITES" IN WHITE.

SER. NO. 85-470,446, FILED 11-11-2011.

DOMINIC J. FERRAIUOLO, EXAMINING ATTORNEY



David J. Kyffers

Director of the United States Patent and Trademark Office

United States of America

United States Patent and Trademark Office



Reg. No. 4,174,806

ISRAEL, HEPHIZBAH (UNITED STATES INDIVIDUAL)
463 MOUNTAIN TOP CT

Registered July 17, 2012

LAKE HOPATCONG, NJ 07849

Int. Cl.: 41

FOR: ON-LINE JOURNALS, NAMELY, BLOGS FEATURING BIBLE STUDY, IN CLASS 41
(U.S. CLS. 100, 101 AND 107).

SERVICE MARK

FIRST USE 9-2-2010; IN COMMERCE 9-2-2010.

PRINCIPAL REGISTER

THE MARK CONSISTS OF A STEAMING COFFEE CUP SITTING ON A SAUCER, ALL RENDERED IN INCOMPLETE BLACK LINES SAVE FOR THE ONE DEFINING THE LEVEL OF THE BROWN COFFEE IN THE CUP, ALL OF THE FOREGOING BEING TO THE LEFT OF STYLIZED BROWN TEXT THAT READS "COFFEE WITH JESUS".

THE COLOR(S) BLACK AND BROWN IS/ARE CLAIMED AS A FEATURE OF THE MARK.

SER. NO. 85-470,547, FILED 11-11-2011.

BRENDAN REGAN, EXAMINING ATTORNEY



David J. Kybas

Director of the United States Patent and Trademark Office

United States of America

United States Patent and Trademark Office



Reg. No. 4,174,807

Registered July 17, 2012

Int. Cl.: 33

TRADEMARK

PRINCIPAL REGISTER

MANUCCI WINERY, INC. (CALIFORNIA CORPORATION), DBA WILD COYOTE WINERY
3775 ADELAIDA RD.
PASO ROBLES, CA 93446

FOR: RED WINE; WINE; WINES, IN CLASS 33 (U.S. CLS. 47 AND 49).

FIRST USE 1-15-2010; IN COMMERCE 1-15-2010.

THE MARK CONSISTS OF STYLIZED "WILD COYOTE" NAME AND THE COYOTE IMAGE
TIPPING HIS HAT AS A SALUTATION.

SER. NO. 85-470,606, FILED 11-11-2011.

JOHN DALIER, EXAMINING ATTORNEY



David J. Kyffers

Director of the United States Patent and Trademark Office

United States of America

United States Patent and Trademark Office

THE RENEGADE LEADER

Reg. No. 4,174,808

Registered July 17, 2012

Int. Cl.: 41

SERVICE MARK

PRINCIPAL REGISTER

MCLAUGHLIN, DEBORA (UNITED STATES INDIVIDUAL)
SUITE 110
120 MAIN STREET
NASHUA, NH 03060

FOR: BUSINESS TRAINING IN THE FIELD OF EXECUTIVE LEADERSHIP COACHING,
TRAINING AND DEVELOPMENT SERVICES, IN CLASS 41 (U.S. CLS. 100, 101 AND 107).

FIRST USE 7-1-2011; IN COMMERCE 7-1-2011.

THE MARK CONSISTS OF STANDARD CHARACTERS WITHOUT CLAIM TO ANY PAR-
TICULAR FONT, STYLE, SIZE, OR COLOR.

NO CLAIM IS MADE TO THE EXCLUSIVE RIGHT TO USE "LEADER", APART FROM THE
MARK AS SHOWN.

SER. NO. 85-470,651, FILED 11-11-2011.

BENJAMIN OKEKE, EXAMINING ATTORNEY



David J. Kyffers

Director of the United States Patent and Trademark Office

United States of America

United States Patent and Trademark Office

OPEN ARTISTS

Reg. No. 4,174,809

Registered July 17, 2012

Int. Cl.: 35

SERVICE MARK

PRINCIPAL REGISTER

SHAW, CHONG YEA (UNITED STATES INDIVIDUAL), DBA CHAIN SEARCH
TECHNOLOGY
42653 QUEENS PARK COURT
FREMONT, CA 94538

FOR: AD SERVING, NAMELY, PLACING ADVERTISEMENTS ON WEBSITES FOR OTHERS
USING SPECIALIZED COMPUTER SOFTWARE, IN CLASS 35 (U.S. CLS. 100, 101 AND
102).

FIRST USE 10-10-2011; IN COMMERCE 11-1-2011.

THE MARK CONSISTS OF STANDARD CHARACTERS WITHOUT CLAIM TO ANY PAR-
TICULAR FONT, STYLE, SIZE, OR COLOR.

SER. NO. 85-470,705, FILED 11-11-2011.

SUNG IN, EXAMINING ATTORNEY



David J. Kyffers

Director of the United States Patent and Trademark Office

United States of America

United States Patent and Trademark Office

TANGO'S TACO SHOP

Reg. No. 4,174,810

TANGO DEVELOPMENT, LLC (TEXAS LIMITED LIABILITY COMPANY)
4026 TREY DR.
HOUSTON, TX 77084

Registered July 17, 2012

Int. Cl.: 43

FOR: RESTAURANT SERVICES, IN CLASS 43 (U.S. CLS. 100 AND 101).

SERVICE MARK

FIRST USE 9-26-2011; IN COMMERCE 9-26-2011.

PRINCIPAL REGISTER

THE MARK CONSISTS OF STANDARD CHARACTERS WITHOUT CLAIM TO ANY PARTICULAR FONT, STYLE, SIZE, OR COLOR.

NO CLAIM IS MADE TO THE EXCLUSIVE RIGHT TO USE "TACO SHOP", APART FROM THE MARK AS SHOWN.

SER. NO. 85-470,753, FILED 11-11-2011.

GISELLE AGOSTO, EXAMINING ATTORNEY



David J. Kyffers

Director of the United States Patent and Trademark Office

United States of America

United States Patent and Trademark Office

APPLIED STAFFING SOLUTIONS

Reg. No. 4,174,811

Registered July 17, 2012

Int. Cl.: 35

SERVICE MARK

PRINCIPAL REGISTER

APPLIED STAFFING SOLUTIONS, LLC (NEVADA LIMITED LIABILITY COMPANY)
890 PATRIOT BLVD., SUITE E
RENO, NV 89511

FOR: EMPLOYMENT AGENCY SERVICES, NAMELY, FILLING THE TEMPORARY AND PERMANENT STAFFING NEEDS OF BUSINESSES, IN CLASS 35 (U.S. CLS. 100, 101 AND 102).

FIRST USE 9-1-2002; IN COMMERCE 9-1-2002.

THE MARK CONSISTS OF STANDARD CHARACTERS WITHOUT CLAIM TO ANY PARTICULAR FONT, STYLE, SIZE, OR COLOR.

NO CLAIM IS MADE TO THE EXCLUSIVE RIGHT TO USE "STAFFING SOLUTIONS", APART FROM THE MARK AS SHOWN.

SER. NO. 85-470,804, FILED 11-11-2011.

JOHN WILKE, EXAMINING ATTORNEY



David J. Kyffers

Director of the United States Patent and Trademark Office

United States of America

United States Patent and Trademark Office

Inside West Coast Customs

Reg. No. 4,174,812

Registered July 17, 2012

Int. Cl.: 41

SERVICE MARK

PRINCIPAL REGISTER

RYAN FRIEDLINGHAUS (UNITED STATES INDIVIDUAL)
SUITE 1400
C/O MWZB 2200 CLARENDON BLVD
ARLINGTON, VA 22201

FOR: ENTERTAINMENT IN THE NATURE OF ON-GOING TELEVISION PROGRAMS IN THE FIELD OF VEHICLE MODIFICATIONS; ENTERTAINMENT SERVICES IN THE NATURE OF AN ON-GOING REALITY BASED TELEVISION PROGRAM, IN CLASS 41 (U.S. CLS. 100, 101 AND 107).

FIRST USE 1-30-2011; IN COMMERCE 1-30-2011.

THE MARK CONSISTS OF STANDARD CHARACTERS WITHOUT CLAIM TO ANY PARTICULAR FONT, STYLE, SIZE, OR COLOR.

OWNER OF U.S. REG. NOS. 3,086,237, 3,273,220, AND 3,656,212.

NO CLAIM IS MADE TO THE EXCLUSIVE RIGHT TO USE "WEST COAST", APART FROM THE MARK AS SHOWN.

SER. NO. 85-470,812, FILED 11-11-2011.

JEFF DEFORD, EXAMINING ATTORNEY



David J. Kyffers

Director of the United States Patent and Trademark Office

United States of America

United States Patent and Trademark Office

THE HUNTLEY BOOKSTORE OF THE CLAREMONT COLLEGES

Reg. No. 4,174,813

Registered July 17, 2012

Int. Cl.: 35

SERVICE MARK

PRINCIPAL REGISTER

CLAREMONT UNIVERSITY CONSORTIUM (CALIFORNIA NONPROFIT PUBLIC BENEFIT CORPORATION)
101 SOUTH MILLS AVENUE
CLAREMONT, CA 91711

FOR: RETAIL BOOK STORE SERVICES; RETAIL COLLEGE STUDENT BOOKSTORE; RETAIL STORE AND ON-LINE RETAIL STORE SERVICES FEATURING BOOKS, APPAREL, TEXTBOOKS AND COURSE MATERIALS, COMPUTER PRODUCTS, GIFT CARDS, ART SUPPLIES, SCHOOL SUPPLIES, PRINTED MATERIALS AND A WIDE VARIETY OF CONSUMER GOODS OF OTHERS, IN CLASS 35 (U.S. CLS. 100, 101 AND 102).

FIRST USE 11-6-1969; IN COMMERCE 11-6-1969.

THE MARK CONSISTS OF STANDARD CHARACTERS WITHOUT CLAIM TO ANY PARTICULAR FONT, STYLE, SIZE, OR COLOR.

OWNER OF U.S. REG. NOS. 3,830,707, 4,008,335 AND OTHERS.

NO CLAIM IS MADE TO THE EXCLUSIVE RIGHT TO USE "BOOKSTORE", APART FROM THE MARK AS SHOWN.

SEC. 2(F) AS TO "CLAREMONT COLLEGES".

SER. NO. 85-470,829, FILED 11-11-2011.

JOHN WILKE, EXAMINING ATTORNEY



David J. Kybas

Director of the United States Patent and Trademark Office

United States of America

United States Patent and Trademark Office

COFFEE STAIN STUDIOS

Reg. No. 4,174,814

COFFEE STAIN STUDIOS AB (SWEDEN AKTIEBOLAG (AB))
KANIKEGRÄND 3

Registered July 17, 2012

541 23 SKÖVDE, SWEDEN

Int. Cls.: 41 and 42

FOR: PRODUCTION OF VIDEO AND COMPUTER GAME SOFTWARE, IN CLASS 41 (U.S. CLS. 100, 101 AND 107).

SERVICE MARK

FIRST USE 4-15-2011; IN COMMERCE 4-15-2011.

PRINCIPAL REGISTER

FOR: VIDEO GAME DEVELOPMENT SERVICES, IN CLASS 42 (U.S. CLS. 100 AND 101).

FIRST USE 11-4-2010; IN COMMERCE 11-4-2010.

THE MARK CONSISTS OF STANDARD CHARACTERS WITHOUT CLAIM TO ANY PARTICULAR FONT, STYLE, SIZE, OR COLOR.

NO CLAIM IS MADE TO THE EXCLUSIVE RIGHT TO USE "STUDIOS", APART FROM THE MARK AS SHOWN.

SER. NO. 85-470,862, FILED 11-11-2011.

ANGELA DUONG, EXAMINING ATTORNEY



David J. Kybas

Director of the United States Patent and Trademark Office

United States of America

United States Patent and Trademark Office

{UN}THINK CHURCH

Reg. No. 4,174,815

Registered July 17, 2012

Int. Cl.: 45

SERVICE MARK

PRINCIPAL REGISTER

GRACE INTERNATIONAL CHURCH (MARYLAND CORPORATION)
950 W LOMBARD ST
BALTIMORE, MD 21223

FOR: CHRISTIAN MINISTRY SERVICES; CONDUCTING RELIGIOUS PRAYER SERVICES; EVANGELISTIC AND MINISTERIAL SERVICES; MINISTERIAL SERVICES; RELIGIOUS AND SPIRITUAL SERVICES, NAMELY, CONDUCTING RELIGIOUS WORSHIP, MARRIAGE CEREMONIES, BAPTISMAL CEREMONIES, BABY DEDICATIONS, BEREAVEMENT CEREMONIES, AND RELIGIOUS COUNSELING; RELIGIOUS AND SPIRITUAL SERVICES, NAMELY, PROVIDING GATHERINGS AND RETREATS TO DEVELOP AND ENHANCE THE SPIRITUAL LIVES OF INDIVIDUALS; RELIGIOUS SERVICES, NAMELY, PRAYER MEETINGS, IN CLASS 45 (U.S. CLS. 100 AND 101).

FIRST USE 0-0-2008; IN COMMERCE 0-0-2008.

THE MARK CONSISTS OF STANDARD CHARACTERS WITHOUT CLAIM TO ANY PARTICULAR FONT, STYLE, SIZE, OR COLOR.

NO CLAIM IS MADE TO THE EXCLUSIVE RIGHT TO USE "CHURCH", APART FROM THE MARK AS SHOWN.

SER. NO. 85-470,980, FILED 11-11-2011.

CHRISTOPHER SIDOTI, EXAMINING ATTORNEY



David J. Kyffers

Director of the United States Patent and Trademark Office

United States of America

United States Patent and Trademark Office

DREAMY

Reg. No. 4,174,816

ZADEH, SAHBA E (UNITED STATES INDIVIDUAL)
PO BOX 340
CENTREVILLE, VA 20122

Registered July 17, 2012

Int. Cl.: 41

FOR: ENTERTAINMENT SERVICES, NAMELY, AN ON-GOING SERIES FEATURING AWARDS PROGRAMS, CELEBRITY ENTERTAINMENT NEWS, SPORTS AND POP CULTURE PROGRAMS PROVIDED THROUGH WEBCASTS AND WIRELESS COMMUNICATIONS; ON-LINE JOURNALS, NAMELY, BLOGS FEATURING AWARDS, SPORTS AND POPULAR CULTURE TOPICS; ORGANIZING ON-LINE EXHIBITIONS AND CONFERENCES IN THE FIELDS OF EDUCATION, CULTURE, SPORTS AND ENTERTAINMENT FOR NON-BUSINESS AND NON-COMMERCIAL PURPOSES, IN CLASS 41 (U.S. CLS. 100, 101 AND 107).

SERVICE MARK

PRINCIPAL REGISTER

FIRST USE 1-22-2008; IN COMMERCE 10-25-2011.

THE MARK CONSISTS OF STANDARD CHARACTERS WITHOUT CLAIM TO ANY PARTICULAR FONT, STYLE, SIZE, OR COLOR.

SER. NO. 85-471,008, FILED 11-11-2011.

LAURA KOVALSKY, EXAMINING ATTORNEY



David J. Kypos

Director of the United States Patent and Trademark Office

United States of America

United States Patent and Trademark Office

Educated Patient

Reg. No. 4,174,817

Registered July 17, 2012

Int. Cls.: 9 and 41

TRADEMARK

SERVICE MARK

PRINCIPAL REGISTER

INTELLISPHERE, LLC (DELAWARE LIMITED LIABILITY COMPANY)
BUILDING 300
666 PLAINSBORO ROAD
PLAINSBORO, NJ 08536

FOR: DOWNLOADABLE ELECTRONIC PUBLICATIONS IN THE NATURE OF ARTICLES AND PAMPHLETS IN THE FIELD OF HEALTHCARE, IN CLASS 9 (U.S. CLS. 21, 23, 26, 36 AND 38).

FIRST USE 2-0-2007; IN COMMERCE 2-0-2007.

FOR: PROVIDING A WEBSITE FEATURING NON-DOWNLOADABLE PUBLICATIONS IN THE NATURE OF ARTICLES AND PAMPHLETS IN THE FIELD OF HEALTHCARE, IN CLASS 41 (U.S. CLS. 100, 101 AND 107).

FIRST USE 2-0-2007; IN COMMERCE 2-0-2007.

THE MARK CONSISTS OF STANDARD CHARACTERS WITHOUT CLAIM TO ANY PARTICULAR FONT, STYLE, SIZE, OR COLOR.

OWNER OF U.S. REG. NO. 2,476,034.

NO CLAIM IS MADE TO THE EXCLUSIVE RIGHT TO USE "PATIENT", APART FROM THE MARK AS SHOWN.

SER. NO. 85-471,056, FILED 11-12-2011.

CHRISTOPHER SIDOTI, EXAMINING ATTORNEY



David J. Kybas

Director of the United States Patent and Trademark Office

United States of America

United States Patent and Trademark Office

Get your apps talking

Reg. No. 4,174,818

DBSYNC LLC (TENNESSEE LIMITED LIABILITY COMPANY)
7807 PASEO SANTA CRUZ
PLEASANTON, CA 94566

Registered July 17, 2012

Int. Cl.: 9

FOR: COMPUTER SOFTWARE, NAMELY, DOWNLOADABLE COMPUTER SOFTWARE FOR INTEGRATING DATA FROM MULTIPLE ONLINE AND OFFLINE SOURCES, AND USER MANUALS SOLD AS A UNIT, IN CLASS 9 (U.S. CLS. 21, 23, 26, 36 AND 38).

TRADEMARK

FIRST USE 1-5-2007; IN COMMERCE 1-5-2007.

PRINCIPAL REGISTER

THE MARK CONSISTS OF STANDARD CHARACTERS WITHOUT CLAIM TO ANY PARTICULAR FONT, STYLE, SIZE, OR COLOR.

SER. NO. 85-471,072, FILED 11-12-2011.

AISHA CLARKE, EXAMINING ATTORNEY



David J. Kyjars

Director of the United States Patent and Trademark Office

United States of America

United States Patent and Trademark Office

FLO-MOTION

Reg. No. 4,174,819

Registered July 17, 2012

Int. Cl.: 41

SERVICE MARK

PRINCIPAL REGISTER

OWENS, JIMMIE (UNITED STATES INDIVIDUAL)
#11
16803 IMPERIAL VALLEY DR.
HOUSTON, TX 77060

FOR: DANCE INSTRUCTION, IN CLASS 41 (U.S. CLS. 100, 101 AND 107).

FIRST USE 7-10-2009; IN COMMERCE 7-11-2009.

THE MARK CONSISTS OF STANDARD CHARACTERS WITHOUT CLAIM TO ANY PARTICULAR FONT, STYLE, SIZE, OR COLOR.

SER. NO. 85-471,081, FILED 11-12-2011.

DAVID COLLIER, EXAMINING ATTORNEY



David J. Kyffers

Director of the United States Patent and Trademark Office

United States of America

United States Patent and Trademark Office



Reg. No. 4,174,820

Registered July 17, 2012

Int. Cl.: 25

TRADEMARK

PRINCIPAL REGISTER

GARZA, RAYNALDO (UNITED STATES INDIVIDUAL)
2245 NORTH GREEN VALLEY PARKWAY, # 282
HENDERSON, NV 89014

FOR: MEN'S, WOMEN'S, CHILDREN'S AND BABY APPAREL, NAMELY, T-SHIRTS, POLO SHIRTS, TANK TOPS, SWEAT SHIRTS, ATHLETIC SHIRTS, COLLARED SHIRTS, JEANS, SWEAT PANTS, SWEAT JACKETS, HOODED SWEATSHIRTS, LEATHER JACKETS, ATHLETIC JACKETS, SHORTS, UNDERGARMENTS, LINGERIE, PAJAMAS, TENNIS SHIRTS, SKIRTS, DRESSES, WRIST BANDS, BELTS, BANDANAS, SWEATERS, NECKTIES; FOOTWEAR, NAMELY, ATHLETIC SHOES, SNEAKERS, SANDALS, FLIP FLOP SHOES, BOOTS, STOCKINGS, SOCKS; HEADWEAR, NAMELY, HATS, CAPS, VISORS, COWBOY HATS, TENNIS HATS, BASEBALL HATS, HEAD BANDS, IN CLASS 25 (U.S. CLS. 22 AND 39).

FIRST USE 11-2-2004; IN COMMERCE 1-25-2005.

OWNER OF U.S. REG. NOS. 3,311,287 AND 3,741,517.

THE COLOR(S) RED AND BLACK IS/ARE CLAIMED AS A FEATURE OF THE MARK.

NO CLAIM IS MADE TO THE EXCLUSIVE RIGHT TO USE "LV", APART FROM THE MARK AS SHOWN.

THE MARK CONSISTS OF THE LETTERS "I" AND "LV" IN THE COLOR BLACK WITH A RED HEART BETWEEN THE LETTERS.

SER. NO. 85-471,159, FILED 11-12-2011.

CARRIE GENOVESE, EXAMINING ATTORNEY



David J. Kybas

Director of the United States Patent and Trademark Office

United States of America

United States Patent and Trademark Office

social networking just got social

Reg. No. 4,174,821

Registered July 17, 2012

Int. Cl.: 45

SERVICE MARK

PRINCIPAL REGISTER

BLENDR LLC (CALIFORNIA LIMITED LIABILITY COMPANY)
6725 SUNSET BLVD, SUITE 430
6725 SUNSET BLVD, SUITE 430
LOS ANGELES, CA 90028

FOR: INTERNET-BASED DATING, SOCIAL INTRODUCTION AND SOCIAL NETWORKING SERVICES, IN CLASS 45 (U.S. CLS. 100 AND 101).

FIRST USE 9-9-2011; IN COMMERCE 9-9-2011.

THE MARK CONSISTS OF STANDARD CHARACTERS WITHOUT CLAIM TO ANY PARTICULAR FONT, STYLE, SIZE, OR COLOR.

SER. NO. 85-471,176, FILED 11-12-2011.

SARA BENJAMIN, EXAMINING ATTORNEY



David J. Kyffers

Director of the United States Patent and Trademark Office

United States of America

United States Patent and Trademark Office

GRINDR FOR EQUALITY

Reg. No. 4,174,822

Registered July 17, 2012

Int. Cl.: 35

SERVICE MARK

PRINCIPAL REGISTER

GRINDR LLC (CALIFORNIA LIMITED LIABILITY COMPANY)
8710 HOLLYWOOD HILLS ROAD
6725 SUNSET BLVD, SUITE 430
LOS ANGELES, CA 90028

FOR: POLITICAL ACTION COMMITTEE SERVICES, NAMELY, PROMOTING THE INTERESTS AND RIGHTS FOR LESBIAN, GAY, BI-SEXUAL AND TRANSGENDERED INDIVIDUALS AND SAME-SEX COUPLES IN THE FIELD OF POLITICS; LOBBYING SERVICES, NAMELY, PROMOTING THE INTERESTS AND RIGHTS FOR LESBIAN, GAY, BI-SEXUAL AND TRANSGENDERED INDIVIDUALS AND SAME-SEX COUPLES IN THE FIELDS OF LEGISLATION AND REGULATION; ASSOCIATION SERVICES, NAMELY, PROMOTING THE INTERESTS AND RIGHTS OF LESBIAN, GAY, BI-SEXUAL AND TRANSGENDERED INDIVIDUALS AND SAME-SEX COUPLES; PROMOTING PUBLIC AWARENESS ABOUT THE NEED FOR CIVIL RIGHTS AND EQUAL PROTECTION UNDER THE LAW FOR LESBIAN, GAY, BI-SEXUAL AND TRANSGENDERED INDIVIDUALS AND SAME-SEX COUPLES, IN CLASS 35 (U.S. CLS. 100, 101 AND 102).

FIRST USE 10-1-2011; IN COMMERCE 10-1-2011.

THE MARK CONSISTS OF STANDARD CHARACTERS WITHOUT CLAIM TO ANY PARTICULAR FONT, STYLE, SIZE, OR COLOR.

SER. NO. 85-471,178, FILED 11-12-2011.

MARCIE MILONE, EXAMINING ATTORNEY



David J. Kyffers

Director of the United States Patent and Trademark Office

United States of America

United States Patent and Trademark Office

DRAWN

Reg. No. 4,174,823

Registered July 17, 2012

Int. Cl.: 25

TRADEMARK

PRINCIPAL REGISTER

DRAWN INC. (CALIFORNIA CORPORATION)
311 MANHATTAN AVE.
HERMOSA BEACH, CA 90254

FOR: SHORT-SLEEVED OR LONG-SLEEVED T-SHIRTS, IN CLASS 25 (U.S. CLS. 22 AND 39).

FIRST USE 3-1-2010; IN COMMERCE 5-1-2010.

THE MARK CONSISTS OF STANDARD CHARACTERS WITHOUT CLAIM TO ANY PARTICULAR FONT, STYLE, SIZE, OR COLOR.

SER. NO. 85-471,181, FILED 11-12-2011.

LEIGH LOWRY, EXAMINING ATTORNEY



David J. Kyffers

Director of the United States Patent and Trademark Office

United States of America

United States Patent and Trademark Office

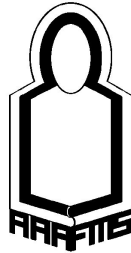

Reg. No. 4,174,824

Registered July 17, 2012

Int. Cl.: 44

SERVICE MARK

PRINCIPAL REGISTER

THE ALLIANCE AGAINST ALL FIBROMYALGIAS LLC (NEW JERSEY LIMITED LIABILITY COMPANY)
P.O. BOX 10255
NEW BRUNSWICK, NJ 08906

FOR: PROVIDING A WEBSITE FEATURING INFORMATION ABOUT HEALTH AND WELLNESS, NAMELY, FIBROMYALGIA, IN CLASS 44 (U.S. CLS. 100 AND 101).

FIRST USE 12-14-2010; IN COMMERCE 9-27-2011.

THE MARK CONSISTS OF A DESIGN MADE UP OF THREE ABSTRACT FORWARD-FACING SILHOUETTES OVERLAPPING EACH OTHER OVER THE STYLIZED TEXT "AAAFMS".

SER. NO. 85-471,218, FILED 11-13-2011.

ELIZABETH HUGHITT, EXAMINING ATTORNEY



David J. Kyjars

Director of the United States Patent and Trademark Office

United States of America

United States Patent and Trademark Office



Reg. No. 4,174,825

Registered July 17, 2012

Int. Cl.: 42

SERVICE MARK

PRINCIPAL REGISTER

NICHOLSON, GREGORY ALLAN (UNITED STATES INDIVIDUAL), DBA COURT VISUAL EXPERT
11832 OLD EUREKA WAY
GOLD RIVER, CA 956708361

FOR: DESIGN OF INFORMATION GRAPHICS AND DATA VISUALIZATION MATERIALS, IN CLASS 42 (U.S. CLS. 100 AND 101).

FIRST USE 2-23-2011; IN COMMERCE 2-23-2011.

NO CLAIM IS MADE TO THE EXCLUSIVE RIGHT TO USE "COURT VISUAL EXPERT", APART FROM THE MARK AS SHOWN.

THE COLOR(S) YELLOW, RED, AND BLACK IS/ARE CLAIMED AS A FEATURE OF THE MARK.

THE MARK CONSISTS OF A YELLOW VERTICAL RECTANGLE WITH ROUNDED CORNERS AS THE BACKGROUND, A BLACK OUTLINE OF AN EYE WITH A SOLID BLACK PUPIL WITH A CONE-SHAPED PORTION IN YELLOW IN THE UPPER RIGHT QUADRANT, AND THE WORDS "COURT" AND "EXPERT" IN BLACK, THE FONT IS MINION PRO AND THE WORD VISUAL IN RED, THE FONT IS MYRIAD PRO.

SER. NO. 85-471,267, FILED 11-13-2011.

DAVID H. STINE, EXAMINING ATTORNEY



David J. Kybas

Director of the United States Patent and Trademark Office

United States of America

United States Patent and Trademark Office

Tom's Tiny Kitchen

Reg. No. 4,174,826

FLOURNOY, THOMAS J. (UNITED STATES INDIVIDUAL), DBA TOM'S TINY KITCHEN
154 MARY ANN DR
MEMPHIS, TN 38117

Registered July 17, 2012

Int. Cl.: 29

FOR: DAIRY-BASED SNACK FOODS EXCLUDING ICE CREAM, ICE MILK AND FROZEN YOGURT, IN CLASS 29 (U.S. CL. 46).

TRADEMARK

FIRST USE 12-4-2010; IN COMMERCE 7-14-2011.

PRINCIPAL REGISTER

THE MARK CONSISTS OF STANDARD CHARACTERS WITHOUT CLAIM TO ANY PARTICULAR FONT, STYLE, SIZE, OR COLOR.

NO CLAIM IS MADE TO THE EXCLUSIVE RIGHT TO USE "KITCHEN", APART FROM THE MARK AS SHOWN.

SER. NO. 85-471,268, FILED 11-13-2011.

DAVID H. STINE, EXAMINING ATTORNEY



David J. Kyffers

Director of the United States Patent and Trademark Office

United States of America

United States Patent and Trademark Office

GOWEY PROTOCOL

Reg. No. 4,174,827

DR. BRANDIE E. GOWEY, NMD (UNITED STATES INDIVIDUAL)
2532 N 4TH ST, #537

Registered July 17, 2012

FLAGSTAFF, AZ 86004

Int. Cl.: 1

FOR: PLANT EXTRACTS MADE FROM SARRACENIA PURPUREA AND OTHER CARNIVOROUS PLANTS, USED IN THE MANUFACTURE OF TOPICAL GELS AND CREAMS FOR ANTI-MICROBIAL AND ANTI-VIRAL THERAPEUTIC USES, IN CLASS 1 (U.S. CLS. 1, 5, 6, 10, 26 AND 46).

TRADEMARK

PRINCIPAL REGISTER

FIRST USE 12-1-2009; IN COMMERCE 11-13-2011.

THE MARK CONSISTS OF STANDARD CHARACTERS WITHOUT CLAIM TO ANY PARTICULAR FONT, STYLE, SIZE, OR COLOR.

SER. NO. 85-471,325, FILED 11-13-2011.

JEFFREY LOOK, EXAMINING ATTORNEY



David J. Kybas

Director of the United States Patent and Trademark Office

United States of America

United States Patent and Trademark Office

GETLOST

Reg. No. 4,174,828

GETLOST LTD (OHIO LIMITED LIABILITY COMPANY)
24 WHITEHEAD STREET
WESTERVILLE, OH 43081

Registered July 17, 2012

Int. Cl.: 25

FOR: ATHLETIC APPAREL, NAMELY, SHIRTS, PANTS, JACKETS, FOOTWEAR, HATS AND CAPS, ATHLETIC UNIFORMS, IN CLASS 25 (U.S. CLS. 22 AND 39).

TRADEMARK

FIRST USE 7-1-2011; IN COMMERCE 9-1-2011.

PRINCIPAL REGISTER

THE MARK CONSISTS OF "GETLOST" TYPE IN ITALICIZED FONT WITH A SINGLE HORIZONTAL LINE ABOVE AND BELOW AND A SLASH THROUGH THE LETTERS.

SER. NO. 85-471,371, FILED 11-14-2011.

JULIE WATSON, EXAMINING ATTORNEY



David J. Kyffers

Director of the United States Patent and Trademark Office

United States of America

United States Patent and Trademark Office

SALON *Luba*

Reg. No. 4,174,829

Registered July 17, 2012

Int. Cl.: 44

SERVICE MARK

PRINCIPAL REGISTER

SALON LUBA, LLC (NEW JERSEY LIMITED LIABILITY COMPANY)
1 RIVERSIDE SQ.
HACKENSACK, NJ 07601

FOR: BODY WAXING SERVICES FOR HAIR REMOVAL IN HUMANS; COSMETIC SERVICES, NAMELY, NON-PERMANENT HAIR REMOVAL; HAIR COLOR SALON SERVICES; HAIR COLOURING SERVICES; HAIR CUTTING SERVICES; HAIR SALON SERVICES; HAIR SALON SERVICES, NAMELY, HAIR CUTTING, STYLING, COLORING, AND HAIR EXTENSION SERVICES; HAIR SALON SERVICES, NAMELY, TREATMENTS TO PROTECT HAIR FROM EFFECTS OF EXPOSURE TO SUNLIGHT, HEAT, HUMIDITY AND CHLORINATED WATER; HAIR STYLING; PERSONAL HAIR REMOVAL SERVICES; PROVIDING INFORMATION IN THE FIELD OF HAIR STYLING; PROVIDING ON-SITE BEAUTY SERVICES, NAMELY, HAIR STYLING AND MAKE-UP APPLICATION SERVICES, IN CLASS 44 (U.S. CLS. 100 AND 101).

FIRST USE 1-13-2008; IN COMMERCE 1-13-2008.

NO CLAIM IS MADE TO THE EXCLUSIVE RIGHT TO USE "SALON", APART FROM THE MARK AS SHOWN.

THE COLOR(S) BLACK AND GREY IS/ARE CLAIMED AS A FEATURE OF THE MARK.

THE MARK CONSISTS OF THE WORD "SALON" IN ALL BLACK CAPITALIZED LETTERING FOLLOWED BY THE WORD "LUBA" WRITTEN IN BOTH UP AND LOWER CASE CURSIVE AND STYLIZED GREY LETTERING.

SER. NO. 85-471,405, FILED 11-14-2011.

EMILY CARLSEN, EXAMINING ATTORNEY



David J. Kybas

Director of the United States Patent and Trademark Office

United States of America

United States Patent and Trademark Office

HEADWATERS SEAT COVERS

Reg. No. 4,174,830

HEADWATERS SEAT COVERS LLC (MONTANA LIMITED LIABILITY COMPANY)
PO BOX 1205

Registered July 17, 2012

THREE FORKS, MT 59752

Int. Cl.: 12

FOR: VEHICLE SEAT COVERS, IN CLASS 12 (U.S. CLS. 19, 21, 23, 31, 35 AND 44).

TRADEMARK

FIRST USE 1-29-2008; IN COMMERCE 1-29-2008.

PRINCIPAL REGISTER

THE MARK CONSISTS OF STANDARD CHARACTERS WITHOUT CLAIM TO ANY PARTICULAR FONT, STYLE, SIZE, OR COLOR.

NO CLAIM IS MADE TO THE EXCLUSIVE RIGHT TO USE "SEAT COVERS", APART FROM THE MARK AS SHOWN.

SER. NO. 85-471,407, FILED 11-14-2011.

EMILY CARLSEN, EXAMINING ATTORNEY



David J. Kyffers

Director of the United States Patent and Trademark Office

United States of America

United States Patent and Trademark Office

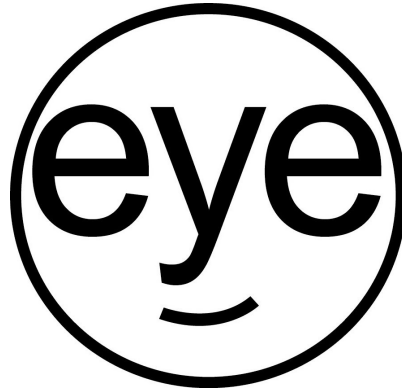

Reg. No. 4,174,831

Registered July 17, 2012

Int. Cl.: 9

TRADEMARK

PRINCIPAL REGISTER

GRINBATH, LLC (TEXAS LIMITED LIABILITY COMPANY)
SUITE F
2321 50TH STREET
LUBBOCK, TX 79412

FOR: SOFTWARE FOR USED FOR EYE TRACKING; OPTICAL HEADSETS USED FOR EYE TRACKING, IN CLASS 9 (U.S. CLS. 21, 23, 26, 36 AND 38).

FIRST USE 10-17-2011; IN COMMERCE 10-17-2011.

NO CLAIM IS MADE TO THE EXCLUSIVE RIGHT TO USE "EYE", APART FROM THE MARK AS SHOWN.

THE MARK CONSISTS OF THE WORD "EYE" INSIDE OF A CIRCLE POSITIONED IN SUCH A WAY TO CREATE A FACE. THE LETTERS "E" AND "E" REPRESENT THE TWO EYES AND THE LETTER "Y" REPRESENTS THE NOSE. BENEATH THE "Y" IS A HALF SMILE REPRESENTING THE MOUTH.

SER. NO. 85-471,414, FILED 11-14-2011.

MARGERY A. TIERNEY, EXAMINING ATTORNEY



David J. Kybas

Director of the United States Patent and Trademark Office

United States of America

United States Patent and Trademark Office



Reg. No. 4,174,832

Registered July 17, 2012

Int. Cl.: 43

SERVICE MARK

PRINCIPAL REGISTER

IK RETAIL GROUP, INC. (D.C. CORPORATION)
3238 PROSPECT STREET, N.W.
WASHINGTON, DC 20007

FOR: RESTAURANT AND BAR SERVICES, IN CLASS 43 (U.S. CLS. 100 AND 101).

FIRST USE 9-0-2006; IN COMMERCE 9-0-2006.

NO CLAIM IS MADE TO THE EXCLUSIVE RIGHT TO USE "CAFE BAR", APART FROM THE MARK AS SHOWN.

THE COLOR(S) BLUE-GRAY AND BLACK IS/ARE CLAIMED AS A FEATURE OF THE MARK.

THE MARK CONSISTS OF A BLUE-GRAY STYLIZED CAPITAL LETTER "M". TO THE RIGHT OF THE LETTER "M" ARE THE VERTICAL WORDS "CAFE BAR" IN BLACK STYLIZED SCRIPT LOWER CASE LETTERS. THE COLOR WHITE IS EMPLOYED MERELY AS BACKGROUND.

SER. NO. 85-471,427, FILED 11-14-2011.

DOMINICK J. SALEMI, EXAMINING ATTORNEY



David J. Kyros

Director of the United States Patent and Trademark Office

United States of America

United States Patent and Trademark Office



Reg. No. 4,174,833

IK RETAIL GROUP, INC. (D.C. CORPORATION)
3238 PROSPECT STREET, N.W.
WASHINGTON, DC 20007

Registered July 17, 2012

Int. Cl.: 35

FOR: RETAIL STORES FEATURING MEN'S AND WOMEN'S CLOTHING AND ACCESSORIES, IN CLASS 35 (U.S. CLS. 100, 101 AND 102).

SERVICE MARK

FIRST USE 3-0-2008; IN COMMERCE 3-0-2008.

PRINCIPAL REGISTER

THE MARK CONSISTS OF STYLIZED CAPITAL LETTERS "DNA" WITH THE NUMBER "2050" TO THE RIGHT OF THE LETTERS "DNA" IN A SMALLER FONT.

SER. NO. 85-471,451, FILED 11-14-2011.

DOMINICK J. SALEMI, EXAMINING ATTORNEY



David J. Kyffers

Director of the United States Patent and Trademark Office

United States of America

United States Patent and Trademark Office

MATTOX X

Reg. No. 4,174,834

Registered July 17, 2012

Int. Cl.: 25

TRADEMARK

PRINCIPAL REGISTER

ADRIANNA PAPELL, L.L.C. (NEW YORK LIMITED LIABILITY COMPANY)
8TH FLOOR
512 SEVENTH AVENUE
NEW YORK, NY 10018

FOR: WOMEN'S WEARING APPAREL, NAMELY, DRESSES, IN CLASS 25 (U.S. CLS. 22 AND 39).

FIRST USE 10-31-2011; IN COMMERCE 10-31-2011.

THE MARK CONSISTS OF STANDARD CHARACTERS WITHOUT CLAIM TO ANY PARTICULAR FONT, STYLE, SIZE, OR COLOR.

OWNER OF U.S. REG. NO. 3,493,486.

SER. NO. 85-471,459, FILED 11-14-2011.

ALICE BENMAMAN, EXAMINING ATTORNEY



David J. Kybas

Director of the United States Patent and Trademark Office

United States of America

United States Patent and Trademark Office

A SMARTER WAY TO ENJOY SODA

Reg. No. 4,174,835

Registered July 17, 2012

Int. Cl.: 7

SODA-CLUB (CO2) ATLANTIC GMBH (SWITZERLAND GESELLSCHAFT MIT
BESCHRÄNKTER HAFTUNG (GMBH))
C/O TAX EXPERT INTERNATIONAL AG
BAARERSTRASSE 20
ZUG, SWITZERLAND 6300

TRADEMARK

FOR: MACHINES FOR THE PRODUCTION OF SODA WATER AND SPARKLING BEVER-
AGES, IN CLASS 7 (U.S. CLS. 13, 19, 21, 23, 31, 34 AND 35).

PRINCIPAL REGISTER

FIRST USE 12-22-2010; IN COMMERCE 12-22-2010.

THE MARK CONSISTS OF STANDARD CHARACTERS WITHOUT CLAIM TO ANY PAR-
TICULAR FONT, STYLE, SIZE, OR COLOR.

SER. NO. 85-471,467, FILED 11-14-2011.

DOMINICK J. SALEMI, EXAMINING ATTORNEY



David J. Kybas

Director of the United States Patent and Trademark Office

United States of America
United States Patent and Trademark Office

LYONROSS

Reg. No. 4,174,836

Registered July 17, 2012

Int. Cl.: 36

SERVICE MARK

PRINCIPAL REGISTER

LYONROSS CAPITAL MANAGEMENT LLC (DELAWARE LIMITED LIABILITY COMPANY)
26TH FLOOR
150 ESAT 52ND STREET
NEW YORK, NY 10022

FOR: FINANCIAL SERVICES, NAMELY, INVESTMENT MANAGEMENT SERVICES, INVESTMENT ADVISORY SERVICES AND ASSET MANAGEMENT SERVICES, IN CLASS 36 (U.S. CLS. 100, 101 AND 102).

FIRST USE 10-11-2006; IN COMMERCE 10-11-2006.

THE MARK CONSISTS OF STANDARD CHARACTERS WITHOUT CLAIM TO ANY PARTICULAR FONT, STYLE, SIZE, OR COLOR.

SER. NO. 85-471,469, FILED 11-14-2011.

DOMINICK J. SALEMI, EXAMINING ATTORNEY



David J. Kyffers

Director of the United States Patent and Trademark Office

United States of America

United States Patent and Trademark Office

ALWAYS-ON TIP TRACKED

Reg. No. 4,174,837

VERAN MEDICAL TECHNOLOGIES, INC. (DELAWARE CORPORATION)

Registered July 17, 2012

5743 W. PARK AVENUE
ST. LOUIS, MO 63110

Int. Cl.: 10

FOR: MEDICAL DEVICES, NAMELY, FORCEPS, ASPIRATION NEEDLES, BRUSHES, SHEATHS, AND STEERABLE CURETTES THAT ARE USED FOR BRONCHOSCOPIC PROCEDURES; ENDOBRONCHIAL NAVIGATION INSTRUMENTS, NAMELY, ENDOBRONCHIAL NAVIGATION INSTRUMENTS THAT EMPLOY ELECTROMAGNETIC LOCALIZERS FOR VIRTUAL FLY-THROUGHS AND NAVIGATION ON THREE-DIMENSIONAL AND FOUR-DIMENSIONAL DATASETS, WHICH ARE USED TO DIAGNOSE AND TREAT LUNG CANCER AND DISEASES, IN CLASS 10 (U.S. CLS. 26, 39 AND 44).

TRADEMARK

PRINCIPAL REGISTER

FIRST USE 4-23-2010; IN COMMERCE 4-23-2010.

THE MARK CONSISTS OF STANDARD CHARACTERS WITHOUT CLAIM TO ANY PARTICULAR FONT, STYLE, SIZE, OR COLOR.

SER. NO. 85-471,506, FILED 11-14-2011.

KATHERINE CHANG, EXAMINING ATTORNEY



David J. Kybas

Director of the United States Patent and Trademark Office

United States of America

United States Patent and Trademark Office

fuelculture

Reg. No. 4,174,838

Registered July 17, 2012

Int. Cl.: 35

SERVICE MARK

PRINCIPAL REGISTER

FUEL CULTURE MEDIA (DELAWARE LIMITED LIABILITY COMPANY)
3440 BLUE SPRINGS ROAD, SUITE 403
KENNESAW, GA 30144

FOR: PROVIDING A WEB SITE FEATURING PRODUCT RATINGS OF THE CONSUMER GOODS OF OTHERS IN THE FIELD OF AUTO PARTS AND ACCESSORIES , IN CLASS 35 (U.S. CLS. 100, 101 AND 102).

FIRST USE 11-30-2010; IN COMMERCE 11-30-2010.

THE MARK CONSISTS OF STANDARD CHARACTERS WITHOUT CLAIM TO ANY PARTICULAR FONT, STYLE, SIZE, OR COLOR.

SER. NO. 85-471,526, FILED 11-14-2011.

LINDA E. BLOHM, EXAMINING ATTORNEY



David J. Kyffers

Director of the United States Patent and Trademark Office

United States of America

United States Patent and Trademark Office

Killa's Garage

Reg. No. 4,174,839

BARRILLEAUX, MARK F. (UNITED STATES INDIVIDUAL)
19610 AUBURN MEADOWS DR
HOUSTON, TX 77094

Registered July 17, 2012

Int. Cl.: 37

FOR: REPAIR OF BICYCLES, IN CLASS 37 (U.S. CLS. 100, 103 AND 106).

SERVICE MARK

FIRST USE 1-16-2008; IN COMMERCE 1-16-2008.

PRINCIPAL REGISTER

THE MARK CONSISTS OF STANDARD CHARACTERS WITHOUT CLAIM TO ANY PARTICULAR FONT, STYLE, SIZE, OR COLOR.

NO CLAIM IS MADE TO THE EXCLUSIVE RIGHT TO USE "GARAGE", APART FROM THE MARK AS SHOWN.

SER. NO. 85-471,528, FILED 11-14-2011.

ALAIN LAPTER, EXAMINING ATTORNEY



David J. Kyffers

Director of the United States Patent and Trademark Office

United States of America

United States Patent and Trademark Office

Coach Fresh

Reg. No. 4,174,840

SOUNDING BOARD INK, LLC (MARYLAND LIMITED LIABILITY COMPANY)
9024 MOUNTAINBERRY CIRCLE
FREDERICK, MD 21702

Registered July 17, 2012

Int. Cl.: 16

FOR: GRAPHIC PRINTS AND REPRESENTATIONS, AND PRINTED INSTRUCTIONAL MATERIALS FOR USE BY TEACHERS, FACILITATORS, THERAPISTS, AND LIFE COACHES, IN THE FIELDS OF PROFESSIONAL AND PERSONAL EDUCATION AND COACHING, IN CLASS 16 (U.S. CLS. 2, 5, 22, 23, 29, 37, 38 AND 50).

TRADEMARK

PRINCIPAL REGISTER

FIRST USE 7-12-2011; IN COMMERCE 10-11-2011.

THE MARK CONSISTS OF STANDARD CHARACTERS WITHOUT CLAIM TO ANY PARTICULAR FONT, STYLE, SIZE, OR COLOR.

NO CLAIM IS MADE TO THE EXCLUSIVE RIGHT TO USE "COACH", APART FROM THE MARK AS SHOWN.

SER. NO. 85-471,564, FILED 11-14-2011.

JULIE GUTTADAURO, EXAMINING ATTORNEY



David J. Kyjars

Director of the United States Patent and Trademark Office

United States of America

United States Patent and Trademark Office



Reg. No. 4,174,841

Registered July 17, 2012

Int. Cl.: 16

TRADEMARK

PRINCIPAL REGISTER

CLARENCE J. VENNE, LLC (DELAWARE LIMITED LIABILITY COMPANY)
7900 NORTH RADCLIFFE STREET
BRISTOL, PA 19006

FOR: ARTS AND CRAFT PAINT KITS, IN CLASS 16 (U.S. CLS. 2, 5, 22, 23, 29, 37, 38 AND 50).

FIRST USE 6-30-2004; IN COMMERCE 6-30-2004.

NO CLAIM IS MADE TO THE EXCLUSIVE RIGHT TO USE "KIDS PAINT", APART FROM THE MARK AS SHOWN.

THE MARK CONSISTS OF AN IMAGE OF A PAINT PALLET WITH THE WORDS "CRAFTY DAB" ABOVE THE PAINT PALLET AND THE WORDS "KIDS PAINT" ON TOP OF THE PAINT PALLET.

SER. NO. 85-471,599, FILED 11-14-2011.

KATHLEEN LORENZO, EXAMINING ATTORNEY



David J. Kybas

Director of the United States Patent and Trademark Office

United States of America

United States Patent and Trademark Office



Reg. No. 4,174,842

Registered July 17, 2012

Int. Cl.: 16

TRADEMARK

PRINCIPAL REGISTER

CLARENCE J. VENNE, LLC (DELAWARE LIMITED LIABILITY COMPANY)
7900 NORTH RADCLIFFE STREET
BRISTOL, PA 19006

FOR: ARTS AND CRAFT PAINT KITS, IN CLASS 16 (U.S. CLS. 2, 5, 22, 23, 29, 37, 38 AND 50).

FIRST USE 6-30-2004; IN COMMERCE 6-30-2004.

NO CLAIM IS MADE TO THE EXCLUSIVE RIGHT TO USE "KIDS PAINT", APART FROM THE MARK AS SHOWN.

THE MARK CONSISTS OF AN IMAGE OF A PAINT PALLET WITH THE WORDS "CRAFTY DAB" ABOVE THE PAINT PALLET AND THE WORDS "SHIMMER KIDS PAINT" ON TOP OF THE PAINT PALLET.

SER. NO. 85-471,601, FILED 11-14-2011.

KATHLEEN LORENZO, EXAMINING ATTORNEY



David J. Kybas

Director of the United States Patent and Trademark Office

United States of America

United States Patent and Trademark Office



Reg. No. 4,174,843

Registered July 17, 2012

Int. Cl.: 29

TRADEMARK

PRINCIPAL REGISTER

MIMS MEAT COMPANY, LLC (TEXAS LIMITED LIABILITY COMPANY)
11303 ANTOINE DRIVE
HOUSTON, TX 77066

FOR: MEAT, POULTRY AND GAME, IN CLASS 29 (U.S. CL. 46).

FIRST USE 9-0-2011; IN COMMERCE 9-0-2011.

NO CLAIM IS MADE TO THE EXCLUSIVE RIGHT TO USE "MEAT" AND "QUALITY MEATS SINCE 1945", APART FROM THE MARK AS SHOWN.

THE MARK CONSISTS OF THE WORDS "MIMS MEAT" BETWEEN TWO HORIZONTAL LINES, WITH A STYLIZED STEER HEAD CENTERED ABOVE UPPER HORIZONTAL LINE AND WITH THE WORDS "QUALITY MEATS SINCE 1945" IN AN ARC CENTERED BELOW THE LOWER HORIZONTAL LINE, ALL OF WHICH IS SUPERIMPOSED OVER A STAR-BURST DESIGN, AND ALL OF WHICH IS CONTAINED WITH A SHIELD DEVICE WITH RIVETS AT THE FAR LEFT AND FAR RIGHT POSITIONS.

SER. NO. 85-471,604, FILED 11-14-2011.

KATHLEEN LORENZO, EXAMINING ATTORNEY



David J. Kybas

Director of the United States Patent and Trademark Office

United States of America

United States Patent and Trademark Office

FALL FOR KC

Reg. No. 4,174,844

Registered July 17, 2012

Int. Cl.: 35

SERVICE MARK

PRINCIPAL REGISTER

CONVENTION AND VISITORS BUREAU OF GREATER KANSAS CITY (MISSOURI
NON-PROFIT CORPORATION), DBA KANSAS CITY CONVENTION & VISITORS
ASSOCIATION

1100 MAIN STREET, SUITE 2200
KANSAS CITY, MO 64105

FOR: ADVERTISING AND MARKETING SERVICES; PROMOTION OF TRADE, TRAVEL,
TOURISM AND CONVENTION BUSINESS IN AND AROUND THE CITIES OF KANSAS
CITY, MISSOURI AND KANSAS CITY, KANSAS, IN CLASS 35 (U.S. CLS. 100, 101 AND
102).

FIRST USE 7-1-2007; IN COMMERCE 8-15-2007.

THE MARK CONSISTS OF STANDARD CHARACTERS WITHOUT CLAIM TO ANY PAR-
TICULAR FONT, STYLE, SIZE, OR COLOR.

NO CLAIM IS MADE TO THE EXCLUSIVE RIGHT TO USE "KC", APART FROM THE MARK
AS SHOWN.

SER. NO. 85-471,612, FILED 11-14-2011.

MICHAEL GAAFAR, EXAMINING ATTORNEY



David J. Kyffers

Director of the United States Patent and Trademark Office

United States of America

United States Patent and Trademark Office

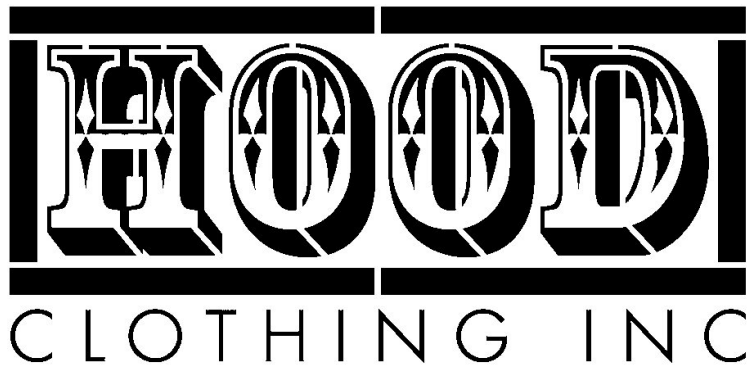

Reg. No. 4,174,845

GAGNON, RENE (UNITED STATES INDIVIDUAL)
1158 ELSBREE STREET
FALL RIVER, MA 02720

Registered July 17, 2012

Int. Cl.: 25

FOR: HATS; JEANS; SWEAT SHIRTS; T-SHIRTS, IN CLASS 25 (U.S. CLS. 22 AND 39).

FIRST USE 2-14-2009; IN COMMERCE 6-28-2009.

TRADEMARK

NO CLAIM IS MADE TO THE EXCLUSIVE RIGHT TO USE "CLOTHING INC.", APART FROM THE MARK AS SHOWN.

PRINCIPAL REGISTER

THE MARK CONSISTS OF THE STYLIZED TEXT "HOOD" SURROUNDED BY RECTANGULAR SHAPES/LINES ALONG WITH THE STYLIZED TEXT "CLOTHING INC.".

SER. NO. 85-471,632, FILED 11-14-2011.

KATHRYN COWARD, EXAMINING ATTORNEY



David J. Kyffers

Director of the United States Patent and Trademark Office

United States of America

United States Patent and Trademark Office

ColorCore

Reg. No. 4,174,846

THE TIFFEN COMPANY, LLC (DELAWARE LIMITED LIABILITY COMPANY)
90 OSER AVENUE
HAUPPAUGE, NY 11788

Registered July 17, 2012

Int. Cl.: 9

FOR: PHOTOGRAPHIC FILTERS, IN CLASS 9 (U.S. CLS. 21, 23, 26, 36 AND 38).

TRADEMARK

FIRST USE 9-15-1999; IN COMMERCE 9-15-1999.

PRINCIPAL REGISTER

THE MARK CONSISTS OF STANDARD CHARACTERS WITHOUT CLAIM TO ANY PARTICULAR FONT, STYLE, SIZE, OR COLOR.

SER. NO. 85-471,637, FILED 11-14-2011.

PAUL MORENO, EXAMINING ATTORNEY



David J. Kyffers

Director of the United States Patent and Trademark Office

United States of America

United States Patent and Trademark Office



Reg. No. 4,174,847

Registered July 17, 2012

Int. Cl.: 35

SERVICE MARK

PRINCIPAL REGISTER

HART WEALTH LLC (FLORIDA LIMITED LIABILITY COMPANY)
1502 NEWHAVEN POINT LANE
WEST PALM BEACH, FL 33411

FOR: REAL ESTATE MARKETING SERVICES IN THE FIELD OF CONDOMINIUMS, APARTMENTS, LUXURY APARTMENTS, HOMES, IN CLASS 35 (U.S. CLS. 100, 101 AND 102).

FIRST USE 10-17-2011; IN COMMERCE 10-17-2011.

NO CLAIM IS MADE TO THE EXCLUSIVE RIGHT TO USE "WEALTH", APART FROM THE MARK AS SHOWN.

THE MARK CONSISTS OF THE LETTERS "H" AND "W" TOGETHER MAKING A HOME. THE "H" HAS A ROOF OVER IT AND THE "W" HAS A CHIMNEY STACK WITH SMOKE. BELOW THERE IS THE STYLIZED TEXT "HART WEALTH".

SER. NO. 85-471,642, FILED 11-14-2011.

BRIAN PINO, EXAMINING ATTORNEY



David J. Kyffers

Director of the United States Patent and Trademark Office

United States of America

United States Patent and Trademark Office

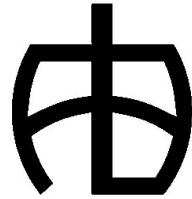

P A R K E R B R A N D
C R E A T I V E S E R V I C E S

Reg. No. 4,174,848

Registered July 17, 2012

Int. Cl.: 42

SERVICE MARK

PRINCIPAL REGISTER

PARKER, ORAN (UNITED STATES INDIVIDUAL)
199 TARA DRIVE
SULPHUR, LA 70665

FOR: GRAPHIC DESIGN; GRAPHIC DESIGN SERVICES FOR CORPORATE LOGOS; GRAPHIC ILLUSTRATION SERVICES FOR OTHERS; VISUAL DESIGN SERVICES IN THE NATURE OF DESIGNING VISUAL ELEMENTS FOR ON-LINE, BROADCAST, PRINT, OUTDOOR AND OTHER COMMUNICATION MEDIA; WEB SITE DESIGN, IN CLASS 42 (U.S. CLS. 100 AND 101).

FIRST USE 11-10-2010; IN COMMERCE 12-1-2010.

NO CLAIM IS MADE TO THE EXCLUSIVE RIGHT TO USE "BRAND" AND "CREATIVE SERVICES", APART FROM THE MARK AS SHOWN.

THE MARK CONSISTS OF A SYMBOL OF A CUSTOM GLYPH-STYLE MARK WITH A VERTICAL BAR INTERSECTING WITH A HORIZONTAL BAR NEARLY TWO-THIRDS UP. THE LEFT SIDE OF THE SYMBOL EXTENDS DOWN FROM THE HORIZONTAL CROSS-BAR FORMING AN ARCH THAT ENDS NEAR THE BOTTOM PARALLEL TO THE VERTICAL CROSS-BAR. THE RIGHT SIDE OF THE SYMBOL EXTENDS DOWN FROM THE HORIZONTAL CROSS-BAR FORMING AN ARCH THAT ENDS NEAR THE BOTTOM PARALLEL TO THE VERTICAL CROSS-BAR. ANOTHER HORIZONTAL BAR CONNECTS THE RIGHT ARCH TO THE CENTER VERTICAL BAR. BELOW THERE IS THE STYLIZED TEXT "PARKER BRAND CREATIVE SERVICES".

SER. NO. 85-471,648, FILED 11-14-2011.

MICHELE SWAIN, EXAMINING ATTORNEY



David J. Kyffers

Director of the United States Patent and Trademark Office

United States of America

United States Patent and Trademark Office

CommunityOn

Reg. No. 4,174,849

Registered July 17, 2012

Int. Cl.: 35

SERVICE MARK

PRINCIPAL REGISTER

FELDSTEIN, TINA (UNITED STATES INDIVIDUAL)
P.O. BOX 6410
CHICAGO, IL 60680

FOR: DEVELOPMENT OF MARKETING STRATEGIES, CONCEPTS AND TACTICS, NAMELY, AUDIENCE DEVELOPMENT, BRAND AWARENESS, ONLINE COMMUNITY BUILDING AND DIGITAL WORD OF MOUTH COMMUNICATIONS; MARKETING CONSULTING; MARKETING CONSULTING SERVICES RELATING TO LONG-TERM BUSINESS STRATEGY DEVELOPMENT FOR NON-PROFIT ORGANIZATIONS; SPECIAL EVENT PLANNING FOR BUSINESS PURPOSES, IN CLASS 35 (U.S. CLS. 100, 101 AND 102).

FIRST USE 5-29-2011; IN COMMERCE 5-29-2011.

THE MARK CONSISTS OF STANDARD CHARACTERS WITHOUT CLAIM TO ANY PARTICULAR FONT, STYLE, SIZE, OR COLOR.

SER. NO. 85-471,662, FILED 11-14-2011.

BRIAN PINO, EXAMINING ATTORNEY



David J. Kyffers

Director of the United States Patent and Trademark Office

United States of America

United States Patent and Trademark Office

StrategyB4Tactics

Reg. No. 4,174,850

NEXTSTEP MARKETING LLC (NORTH CAROLINA LIMITED LIABILITY COMPANY)
506 ABBOTSFORD COURT
CHARLOTTE, NC 28270

Registered July 17, 2012

Int. Cl.: 41

FOR: EDUCATION SERVICES, NAMELY, PROVIDING WORKSHOPS IN THE FIELD OF BUSINESS MARKETING, IN CLASS 41 (U.S. CLS. 100, 101 AND 107).

SERVICE MARK

FIRST USE 8-1-2011; IN COMMERCE 8-1-2011.

PRINCIPAL REGISTER

THE MARK CONSISTS OF STANDARD CHARACTERS WITHOUT CLAIM TO ANY PARTICULAR FONT, STYLE, SIZE, OR COLOR.

SER. NO. 85-471,666, FILED 11-14-2011.

ROBERT C. CLARK JR., EXAMINING ATTORNEY



David J. Kybas

Director of the United States Patent and Trademark Office

United States of America
United States Patent and Trademark Office

AIRSTACK

Reg. No. 4,174,851

MULTISTACK LLC (MINNESOTA LIMITED LIABILITY COMPANY)
1065 SPARTA AVE.
SPARTA, WI 54656

Registered July 17, 2012

Int. Cl.: 11

FOR: AIR CONDITIONING MODULAR REFRIGERATION UNITS, IN CLASS 11 (U.S. CLS. 13, 21, 23, 31 AND 34).

TRADEMARK

FIRST USE 10-9-2000; IN COMMERCE 3-15-2001.

PRINCIPAL REGISTER

THE MARK CONSISTS OF STANDARD CHARACTERS WITHOUT CLAIM TO ANY PARTICULAR FONT, STYLE, SIZE, OR COLOR.

OWNER OF U.S. REG. NO. 2,588,107.

SER. NO. 85-471,706, FILED 11-14-2011.

TARAH HARDY, EXAMINING ATTORNEY



David J. Kyffers

Director of the United States Patent and Trademark Office

United States of America

United States Patent and Trademark Office

AMERICAN MEDICAL INDUSTRIES

Reg. No. 4,174,852

AMERICAN MEDICAL INDUSTRIES, INC. (ILLINOIS CORPORATION)
28045 NORTH ASHLEY CIRCLE, SUITE 106
LIBERTYVILLE, IL 60048

Registered July 17, 2012

Int. Cl.: 35

FOR: WHOLESALE AND RETAIL STORE SERVICES AND ON-LINE RETAIL AND WHOLESALE STORE SERVICES FEATURING HOME HEALTH CARE PRODUCTS, IN CLASS 35 (U.S. CLS. 100, 101 AND 102).

SERVICE MARK

FIRST USE 8-29-1988; IN COMMERCE 8-29-1988.

PRINCIPAL REGISTER

THE MARK CONSISTS OF STANDARD CHARACTERS WITHOUT CLAIM TO ANY PARTICULAR FONT, STYLE, SIZE, OR COLOR.

NO CLAIM IS MADE TO THE EXCLUSIVE RIGHT TO USE "INDUSTRIES", APART FROM THE MARK AS SHOWN.

SEC. 2(F).

SER. NO. 85-471,755, FILED 11-14-2011.

CHARLES L. JENKINS, EXAMINING ATTORNEY



David J. Kyffers

Director of the United States Patent and Trademark Office

United States of America

United States Patent and Trademark Office

WE WANT WINGS!

Reg. No. 4,174,853

Registered July 17, 2012

Int. Cl.: 43

SERVICE MARK

PRINCIPAL REGISTER

GLORY DAYS, INC. (VIRGINIA CORPORATION), DBA GLORY DAYS GRILL
9426 STEWARTOWN ROAD
GAITHERSBURG, MD 20879

FOR: RESTAURANT SERVICES, IN CLASS 43 (U.S. CLS. 100 AND 101).

FIRST USE 1-31-2009; IN COMMERCE 1-31-2009.

THE MARK CONSISTS OF STANDARD CHARACTERS WITHOUT CLAIM TO ANY PARTICULAR FONT, STYLE, SIZE, OR COLOR.

NO CLAIM IS MADE TO THE EXCLUSIVE RIGHT TO USE "WINGS", APART FROM THE MARK AS SHOWN.

SER. NO. 85-471,757, FILED 11-14-2011.

CHARLES L. JENKINS, EXAMINING ATTORNEY



David J. Kyffers

Director of the United States Patent and Trademark Office

United States of America

United States Patent and Trademark Office

FAITH MIRACLE TEMPLE

Reg. No. 4,174,854

Registered July 17, 2012

Int. Cl.: 45

SERVICE MARK

PRINCIPAL REGISTER

FAITH MIRACLE TEMPLE CHURCH OF GOD APOSTOLIC, INC. (MISSOURI CORPORATION)
5320 NORTH HIGHWAY 67
FLORISSANT, MO 63034

FOR: RELIGIOUS AND SPIRITUAL SERVICES, NAMELY, CONDUCTING RELIGIOUS WORSHIP, MARRIAGE CEREMONIES, BAPTISMAL CEREMONIES, BABY DEDICATIONS, BEREAVEMENT CEREMONIES, RELIGIOUS COUNSELING AND OUTREACH MINISTRIES, IN CLASS 45 (U.S. CLS. 100 AND 101).

FIRST USE 0-0-1970; IN COMMERCE 0-0-1970.

THE MARK CONSISTS OF STANDARD CHARACTERS WITHOUT CLAIM TO ANY PARTICULAR FONT, STYLE, SIZE, OR COLOR.

NO CLAIM IS MADE TO THE EXCLUSIVE RIGHT TO USE "FAITH" AND "TEMPLE", APART FROM THE MARK AS SHOWN.

SER. NO. 85-471,779, FILED 11-14-2011.

MEGHAN REINHART, EXAMINING ATTORNEY



David J. Kybas

Director of the United States Patent and Trademark Office

United States of America

United States Patent and Trademark Office

REDNECKS AT PLAY

Reg. No. 4,174,855

O'NEIL, RANAE (UNITED STATES INDIVIDUAL)
P.O. BOX 13
HARRISVILLE, NH 03450 AND

Registered July 17, 2012

Int. Cl.: 25

O'NEIL, DAVID (UNITED STATES INDIVIDUAL)
P.O. BOX 13
HARRISVILLE, NH 03450

TRADEMARK

PRINCIPAL REGISTER

FOR: APPAREL, NAMELY, SHIRTS, HATS, PANTS, SWEATSHIRTS, SHORTS, UNDERGARMENTS AND SWIMWEAR FOR ADULTS; CHILDREN'S APPAREL, NAMELY, SHIRTS, SWEATSHIRTS AND ROMPERS, IN CLASS 25 (U.S. CLS. 22 AND 39).

FIRST USE 10-31-2006; IN COMMERCE 10-31-2006.

THE MARK CONSISTS OF STANDARD CHARACTERS WITHOUT CLAIM TO ANY PARTICULAR FONT, STYLE, SIZE, OR COLOR.

SER. NO. 85-471,844, FILED 11-14-2011.

DAWN HAN, EXAMINING ATTORNEY



David J. Kyros

Director of the United States Patent and Trademark Office

United States of America

United States Patent and Trademark Office

Not Your Father's

Reg. No. 4,174,856

CHEN, CANDACE (UNITED STATES INDIVIDUAL)
3710 AVALON BLVD

Registered July 17, 2012

LOS ANGELES, CA 90011

Int. Cl.: 3

FOR: FACIAL CLEANSERS; SHAVE CREAMS; SKIN CREAM; SUNSCREEN CREAM, IN CLASS 3 (U.S. CLS. 1, 4, 6, 50, 51 AND 52).

TRADEMARK

FIRST USE 2-3-2012; IN COMMERCE 2-3-2012.

PRINCIPAL REGISTER

THE MARK CONSISTS OF STANDARD CHARACTERS WITHOUT CLAIM TO ANY PARTICULAR FONT, STYLE, SIZE, OR COLOR.

SER. NO. 85-471,845, FILED 11-14-2011.

DAWN HAN, EXAMINING ATTORNEY



David J. Kyffers

Director of the United States Patent and Trademark Office

United States of America

United States Patent and Trademark Office

RustSeal

Reg. No. 4,174,857

Registered July 17, 2012

Int. Cl.: 2

TRADEMARK

PRINCIPAL REGISTER

ADVANCED PROTECTIVE TECHNOLOGIES LLC (INDIANA LIMITED LIABILITY COMPANY), AKA KBS COATINGS
SALES@KBS-COATINGS.COM
1101 CUMBERLAND CROSSING #180
VALPARAISO, IN 46383

FOR: ANTICORROSIVE PAINTS FOR AUTOMOTIVE AND INDUSTRIAL APPLICATIONS,
IN CLASS 2 (U.S. CLS. 6, 11 AND 16).

FIRST USE 7-1-2006; IN COMMERCE 8-15-2006.

THE MARK CONSISTS OF STANDARD CHARACTERS WITHOUT CLAIM TO ANY PARTICULAR FONT, STYLE, SIZE, OR COLOR.

SER. NO. 85-471,854, FILED 11-14-2011.

RONALD MCMORROW, EXAMINING ATTORNEY



David J. Kyffers

Director of the United States Patent and Trademark Office

United States of America

United States Patent and Trademark Office

PETOVERFEST

Reg. No. 4,174,858

Registered July 17, 2012

Int. Cl.: 36

SERVICE MARK

PRINCIPAL REGISTER

SPRING OAKS ANIMAL HOSPITAL, INC. (FLORIDA CORPORATION), DBA SPRING OAKS
ANIMAL CARE CENTER
152 MCGREGOR ROAD
DELAND, FL 32720

FOR: CHARITABLE SERVICES, NAMELY, FUNDRAISING EVENTS FOR ANIMALS, IN
CLASS 36 (U.S. CLS. 100, 101 AND 102).

FIRST USE 10-7-2011; IN COMMERCE 10-7-2011.

THE MARK CONSISTS OF STANDARD CHARACTERS WITHOUT CLAIM TO ANY PAR-
TICULAR FONT, STYLE, SIZE, OR COLOR.

SER. NO. 85-471,875, FILED 11-14-2011.

NORA BUCHANAN WILL, EXAMINING ATTORNEY



David J. Kybas

Director of the United States Patent and Trademark Office

United States of America

United States Patent and Trademark Office

MoxyBox

Reg. No. 4,174,859

Registered July 17, 2012

Int. Cl.: 42

SERVICE MARK

PRINCIPAL REGISTER

MOXY BOX CLOUD COMPUTING, LLC (NEW MEXICO LIMITED LIABILITY COMPANY)
SUITE A-103
5801 OSUNA RD NE
ALBUQUERQUE, NM 87109

FOR: CLOUD COMPUTING FEATURING SOFTWARE FOR USE AS DESKTOP AS A SERVICE; COMPUTER SERVICES, NAMELY, CLOUD HOSTING PROVIDER SERVICES , IN CLASS 42 (U.S. CLS. 100 AND 101).

FIRST USE 11-4-2011; IN COMMERCE 11-4-2011.

THE MARK CONSISTS OF STANDARD CHARACTERS WITHOUT CLAIM TO ANY PARTICULAR FONT, STYLE, SIZE, OR COLOR.

SER. NO. 85-471,892, FILED 11-14-2011.

PRISCILLA MILTON, EXAMINING ATTORNEY



David J. Kyros

Director of the United States Patent and Trademark Office

United States of America

United States Patent and Trademark Office

Workhaus

Reg. No. 4,174,860

WORKHAUS LODGE LLC (TEXAS LIMITED LIABILITY COMPANY)
9514 CRESTEDGE DR
DALLAS, TX 75238

Registered July 17, 2012

Int. Cl.: 36

FOR: RENTAL OF OFFICE SPACE TO FREELANCERS, START-UPS, EXISTING BUSINESSES
AND NON-PROFITS, IN CLASS 36 (U.S. CLS. 100, 101 AND 102).

SERVICE MARK

FIRST USE 5-1-2010; IN COMMERCE 5-1-2010.

PRINCIPAL REGISTER

THE MARK CONSISTS OF STANDARD CHARACTERS WITHOUT CLAIM TO ANY PAR-
TICULAR FONT, STYLE, SIZE, OR COLOR.

SER. NO. 85-471,895, FILED 11-14-2011.

MARY ROSSMAN, EXAMINING ATTORNEY



David J. Kyffers

Director of the United States Patent and Trademark Office

United States of America

United States Patent and Trademark Office

Voxy

Reg. No. 4,174,861

Registered July 17, 2012

Int. Cl.: 9

TRADEMARK

PRINCIPAL REGISTER

VOXY, INC. (DELAWARE CORPORATION), DBA VOXY, INC.
85 EAST 10TH ST., SUITE 5M
NEW YORK, NY 10003

FOR: COMPUTER APPLICATION SOFTWARE FOR MOBILE PHONES, TABLETS AND PERSONAL COMPUTERS, NAMELY, SOFTWARE FOR EDUCATION, ENTERTAINMENT AND NEWS , IN CLASS 9 (U.S. CLS. 21, 23, 26, 36 AND 38).

FIRST USE 9-1-2010; IN COMMERCE 2-23-2011.

THE MARK CONSISTS OF STANDARD CHARACTERS WITHOUT CLAIM TO ANY PARTICULAR FONT, STYLE, SIZE, OR COLOR.

SER. NO. 85-471,925, FILED 11-14-2011.

STEPHANIE ALI, EXAMINING ATTORNEY



David J. Kybas

Director of the United States Patent and Trademark Office

United States of America

United States Patent and Trademark Office



Reg. No. 4,174,862

Registered July 17, 2012

Int. Cl.: 16

TRADEMARK

PRINCIPAL REGISTER

SAY PLEASE INC. (MASSACHUSETTS CORPORATION)
15 HANCOCK AVENUE
NEWTON, MA 02459

FOR: STATIONERY, NOTE CARDS AND GREETING CARDS, IN CLASS 16 (U.S. CLS. 2, 5, 22, 23, 29, 37, 38 AND 50).

FIRST USE 11-1-2006; IN COMMERCE 9-1-2007.

THE MARK CONSISTS OF A DESIGN OF A BEIGE COLORED HAND WEARING ORANGE AND BROWN BRACELETS REACHING INTO A BROWN BAG, PULLING OUT A BLUE CARD ON WHICH IS WRITTEN IN WHITE "BE KIND".

THE COLOR(S) BEIGE, ORANGE, BROWN, WHITE AND BLUE IS/ARE CLAIMED AS A FEATURE OF THE MARK.

SER. NO. 85-471,948, FILED 11-14-2011.

JACQUELINE A. LAVINE, EXAMINING ATTORNEY



David J. Kyffers

Director of the United States Patent and Trademark Office

United States of America

United States Patent and Trademark Office

PARENTING FOR HIS GLORY

Reg. No. 4,174,863

CREIGHTON, MELODY (UNITED STATES INDIVIDUAL)
220 SHELDON ST
EL SEGUNDO, CA 90245

Registered July 17, 2012

Int. Cl.: 41

FOR: EDUCATIONAL SERVICES, NAMELY, EDUCATIONAL AND FAITH-BASED PARENTING COURSE, IN CLASS 41 (U.S. CLS. 100, 101 AND 107).

SERVICE MARK

FIRST USE 2-6-2011; IN COMMERCE 2-6-2011.

PRINCIPAL REGISTER

THE MARK CONSISTS OF STANDARD CHARACTERS WITHOUT CLAIM TO ANY PARTICULAR FONT, STYLE, SIZE, OR COLOR.

NO CLAIM IS MADE TO THE EXCLUSIVE RIGHT TO USE "PARENTING", APART FROM THE MARK AS SHOWN.

SER. NO. 85-471,966, FILED 11-14-2011.

DAVID ELTON, EXAMINING ATTORNEY



David J. Kyfos

Director of the United States Patent and Trademark Office

United States of America

United States Patent and Trademark Office

*Hands-on
Branding!*

Reg. No. 4,174,864

Registered July 17, 2012

Int. Cl.: 42

SERVICE MARK

PRINCIPAL REGISTER

CODO DESIGN, INC. (INDIANA CORPORATION)
1500 N DELAWARE ST
INDIANAPOLIS, IN 46202

FOR: DESIGN, DEVELOPMENT, AND CONSULTING SERVICES RELATED THERETO IN THE FIELD OF PROMOTIONAL MATERIAL AND CORPORATE IDENTITY, LOGOS, AND BRAND IDENTITY, IN CLASS 42 (U.S. CLS. 100 AND 101).

FIRST USE 10-25-2010; IN COMMERCE 10-25-2010.

NO CLAIM IS MADE TO THE EXCLUSIVE RIGHT TO USE "BRANDING", APART FROM THE MARK AS SHOWN.

THE MARK CONSISTS OF A STYLIZED SCRIPT FONT THAT SAYS "HANDS-ON" ON TOP AND "BRANDING!" BELOW, ORIENTED TO AN UPWARD ANGLE.

SER. NO. 85-471,977, FILED 11-14-2011.

SKYE YOUNG, EXAMINING ATTORNEY



David J. Kyros

Director of the United States Patent and Trademark Office

United States of America

United States Patent and Trademark Office



Reg. No. 4,174,865

Registered July 17, 2012

Int. Cl.: 16

TRADEMARK

PRINCIPAL REGISTER

PILLS ANONYMOUS WORLD SERVICE, INC. (ARIZONA CORPORATION)
STE A-101-133
1855 E GUADALUPE RD.
TEMPE, AZ 85283

FOR: BOOK COVERS; PAPER BANNERS; PRINTED EDUCATIONAL MATERIALS IN THE FIELD OF PRESCRIPTION PILL ADDICTION, IN CLASS 16 (U.S. CLS. 2, 5, 22, 23, 29, 37, 38 AND 50).

FIRST USE 10-21-2011; IN COMMERCE 10-21-2011.

THE MARK CONSISTS OF A DESIGN OF A TRIANGLE INTERWOVEN WITH A CIRCLE WITH THE STYLIZED LETTERS "PA" IN THE CENTER ON A DIAGONAL.

SER. NO. 85-471,988, FILED 11-14-2011.

SKYE YOUNG, EXAMINING ATTORNEY



David J. Kyffers

Director of the United States Patent and Trademark Office

United States of America

United States Patent and Trademark Office

SAFETY SWING

Reg. No. 4,174,866

CLARK TRANSPORTATION SERVICES, LLC (ILLINOIS LIMITED LIABILITY COMPANY)
12940 PITTSBURG ROAD
MARION, IL 62959

Registered July 17, 2012

Int. Cl.: 6

FOR: FRAMEWORKS OF METAL, IN CLASS 6 (U.S. CLS. 2, 12, 13, 14, 23, 25 AND 50).

TRADEMARK

FIRST USE 8-1-2011; IN COMMERCE 8-1-2011.

PRINCIPAL REGISTER

THE MARK CONSISTS OF STANDARD CHARACTERS WITHOUT CLAIM TO ANY PARTICULAR FONT, STYLE, SIZE, OR COLOR.

NO CLAIM IS MADE TO THE EXCLUSIVE RIGHT TO USE "SAFETY", APART FROM THE MARK AS SHOWN.

SER. NO. 85-472,111, FILED 11-14-2011.

RICHARD WHITE, EXAMINING ATTORNEY



David J. Kyffers

Director of the United States Patent and Trademark Office

United States of America

United States Patent and Trademark Office

FURUKAWA ROCK DRILL

Reg. No. 4,174,867

Registered July 17, 2012

Int. Cl.: 7

TRADEMARK

PRINCIPAL REGISTER

FURUKAWA ROCK DRILL CO., LTD. (JAPAN CORPORATION)
3-14, 2-CHOME, NIHONBASHI MUROMACHI
CHUO-KU; TOKYO, JAPAN 103-0022

FOR: LOADING-UNLOADING MACHINES; WASTE COMPACTING MACHINES; WASTE CRUSHING MACHINES; SNOW PLOWS, IN CLASS 7 (U.S. CLS. 13, 19, 21, 23, 31, 34 AND 35).

OWNER OF JAPAN REG. NO. 5283393, DATED 11-27-2009, EXPIRES 11-27-2019.

OWNER OF U.S. REG. NO. 3,953,526.

NO CLAIM IS MADE TO THE EXCLUSIVE RIGHT TO USE "ROCK DRILL", APART FROM THE MARK AS SHOWN.

THE MARK CONSISTS OF THE WORDS "FURUKAWA ROCK DRILL" IN STYLIZED LETTERING.

SEC. 2(F).

SER. NO. 85-472,157, FILED 11-14-2011.

ANNE MADDEN, EXAMINING ATTORNEY



David J. Kybas

Director of the United States Patent and Trademark Office

United States of America

United States Patent and Trademark Office



AIRCAREFACTS
TRAINING

Reg. No. 4,174,868

Registered July 17, 2012

Int. Cl.: 41

SERVICE MARK

PRINCIPAL REGISTER

ROBERTS, JEFFREY D. (UNITED STATES INDIVIDUAL), DBA THE STUB FARLOW
COMPANY
324 WEST BAY DRIVE SUITE 200
OLYMPIA, WA 98502

FOR: EDUCATIONAL SERVICES, NAMELY, CONDUCTING CREW MEMBER EMERGENCY PROCEDURES TRAINING IN THE FIELDS OF AVIATION AND DISTRIBUTION OF TRAINING MATERIALS IN CONNECTION THEREWITH, IN CLASS 41 (U.S. CLS. 100, 101 AND 107).

FIRST USE 10-1-2011; IN COMMERCE 10-7-2011.

OWNER OF U.S. REG. NOS. 1,714,310, 4,025,030 AND OTHERS.

NO CLAIM IS MADE TO THE EXCLUSIVE RIGHT TO USE "AIRCARE FACTS TRAINING", APART FROM THE MARK AS SHOWN.

THE MARK CONSISTS OF A TRIANGLE CONTAINING AN AIRCRAFT WITH A CONTRAIL, THE DESIGN OF WHICH FORMS THE LETTER "A". A SECOND TRIANGLE, INVERTED AND CONTAINING THE LETTER "F", SITS DIRECTLY TO THE RIGHT OF THE FIRST TRIANGLE. THE WORDS "AIRCARE FACTS TRAINING" ARE TO THE RIGHT OF THE MARK.

SER. NO. 85-472,176, FILED 11-14-2011.

DAVID I, EXAMINING ATTORNEY



David J. Kyffers

Director of the United States Patent and Trademark Office

United States of America

United States Patent and Trademark Office

KINETIC BOOKS

Reg. No. 4,174,869

Registered July 17, 2012

Int. Cl.: 41

SERVICE MARK

PRINCIPAL REGISTER

PERFECTION LEARNING CORPORATION (IOWA CORPORATION)
2680 BERKSHIRE PARKWAY
CLIVE, IA 50325

FOR: NON-DOWNLOADABLE ELECTRONIC PUBLICATIONS, NAMELY PROVIDING WEB-BASED INSTRUCTIONAL AND TEACHING MATERIALS FOR STUDENTS AND TEACHERS FEATURING SCIENCE AND MATHEMATICS STUDIES; INTERACTIVE EDUCATIONAL SERVICES, NAMELY, PROVIDING ELECTRONIC INTERACTIVE EDUCATIONAL MATERIALS FOR STUDENTS AND TEACHERS FEATURING SCIENCE AND MATHEMATICS STUDIES, IN CLASS 41 (U.S. CLS. 100, 101 AND 107).

FIRST USE 11-1-2006; IN COMMERCE 11-1-2006.

THE MARK CONSISTS OF STANDARD CHARACTERS WITHOUT CLAIM TO ANY PARTICULAR FONT, STYLE, SIZE, OR COLOR.

OWNER OF U.S. REG. NO. 3,013,738.

NO CLAIM IS MADE TO THE EXCLUSIVE RIGHT TO USE BOOKS, APART FROM THE MARK AS SHOWN.

SER. NO. 85-472,177, FILED 11-14-2011.

ANNE MADDEN, EXAMINING ATTORNEY



David J. Kyffers

Director of the United States Patent and Trademark Office

United States of America

United States Patent and Trademark Office



Reg. No. 4,174,870

Registered July 17, 2012

Int. Cl.: 43

SERVICE MARK

PRINCIPAL REGISTER

TANGO DEVELOPMENT, LLC (TEXAS LIMITED LIABILITY COMPANY)
4026 TREY DR.
HOUSTON, TX 77084

FOR: RESTAURANT SERVICES, IN CLASS 43 (U.S. CLS. 100 AND 101).

FIRST USE 9-26-2011; IN COMMERCE 9-26-2011.

THE MARK CONSISTS OF A CARICATURE OF A MAN WITH UNKEMPT BLACK HAIR AND MOUSTACHE AND HAIRY LEGS, WEARING A YELLOW SOMBRERO WITH A PINK BAND, A PURPLE, ORANGE AND GREEN HAWAIIAN SHIRT, YELLOW CARGO SHORTS AND PURPLE AND BROWN SANDALS, HOLDING IN HIS LEFT HAND A WHITE PLATE WITH A TACO AND FLASHING THE PEACE SIGN WITH HIS RIGHT HAND.

THE COLOR(S) BLACK, YELLOW, PINK, PURPLE, ORANGE, GREEN, BROWN, AND WHITE IS/ARE CLAIMED AS A FEATURE OF THE MARK.

SER. NO. 85-472,182, FILED 11-14-2011.

GISELLE AGOSTO, EXAMINING ATTORNEY



David J. Kyffers

Director of the United States Patent and Trademark Office

United States of America

United States Patent and Trademark Office

Pungoteague Creek Oyster

Reg. No. 4,174,871

WAR SHORE OYSTER COMPANY, LLC (VIRGINIA LIMITED LIABILITY COMPANY)
414 S COLUMBUS STREET
ALEXANDRIA, VA 22314

Registered July 17, 2012

Int. Cl.: 31

FOR: LIVE OYSTERS, IN CLASS 31 (U.S. CLS. 1 AND 46).

TRADEMARK

FIRST USE 10-19-2009; IN COMMERCE 11-11-2010.

PRINCIPAL REGISTER

THE MARK CONSISTS OF STANDARD CHARACTERS WITHOUT CLAIM TO ANY PARTICULAR FONT, STYLE, SIZE, OR COLOR.

NO CLAIM IS MADE TO THE EXCLUSIVE RIGHT TO USE "OYSTER", APART FROM THE MARK AS SHOWN.

SER. NO. 85-472,218, FILED 11-14-2011.

JILL C. ALT, EXAMINING ATTORNEY



David J. Kyffers

Director of the United States Patent and Trademark Office

United States of America

United States Patent and Trademark Office



AIRCARECREWS
STAFFING

Reg. No. 4,174,872

Registered July 17, 2012

Int. Cl.: 35

SERVICE MARK

PRINCIPAL REGISTER

ROBERTS, JEFFREY D. (UNITED STATES INDIVIDUAL), DBA THE STUB FARLOW
COMPANY
324 WEST BAY DRIVE SUITE 200
OLYMPIA, WA 98502

FOR: EMPLOYMENT STAFFING IN THE FIELD OF AVIATION, IN CLASS 35 (U.S. CLS.
100, 101 AND 102).

FIRST USE 10-1-2011; IN COMMERCE 10-7-2011.

OWNER OF U.S. REG. NOS. 4,021,632 AND 4,021,635.

NO CLAIM IS MADE TO THE EXCLUSIVE RIGHT TO USE "AIRCARE CREWS STAFFING",
APART FROM THE MARK AS SHOWN.

THE MARK CONSISTS OF A TRIANGLE CONTAINING AN AIRCRAFT WITH A CONTRAIL,
THE DESIGN OF WHICH FORMS THE LETTER "A". A SECOND TRIANGLE, INVERTED
AND CONTAINING THE LETTER "C", SITS DIRECTLY TO THE RIGHT OF THE FIRST
TRIANGLE. THE WORDS "AIRCARE CREWS STAFFING" ARE TO THE RIGHT OF THE
MARK.

SER. NO. 85-472,227, FILED 11-14-2011.

DAVID I, EXAMINING ATTORNEY



David J. Kyffers

Director of the United States Patent and Trademark Office

United States of America

United States Patent and Trademark Office

OFFICIAL PAYMENTS

Reg. No. 4,174,873

OFFICIAL PAYMENTS CORP. (CALIFORNIA CORPORATION)
ONE LANDMARK SQUARE, SUITE 400
STAMFORD, CT 06901

Registered July 17, 2012

**Int. Cls.: 35, 36, 37 and
42**

FOR: MARKETING AND ADVERTISING FOR OTHERS RELATED TO ELECTRONIC BILL
PAYMENT SERVICES, IN CLASS 35 (U.S. CLS. 100, 101 AND 102).

FIRST USE 5-30-2002; IN COMMERCE 5-30-2002.

SERVICE MARK

FOR: ELECTRONIC PAYMENT AND PROCESSING SERVICES, NAMELY, PROCESSING
ELECTRONIC PAYMENTS MADE THROUGH PREPAID CARDS, CREDIT CARDS, DEBIT
CARDS, ELECTRONIC FUNDS TRANSFER, ACH, ELECTRONIC CHECK AND ELECTRONIC
PAYMENTS, AND TRANSMISSION AND PROCESSING OF BILL PAYMENT DATA, IN
CLASS 36 (U.S. CLS. 100, 101 AND 102).

FIRST USE 5-30-2002; IN COMMERCE 5-30-2002.

PRINCIPAL REGISTER

FOR: MAINTENANCE OF COMPUTER NETWORKS, WEBSITES FOR OTHERS, AND
COMPUTER HARDWARE FOR INTERACTIVE VOICE RESPONSE (IVR) SYSTEMS, IVR
KIOSKS, AND PAYMENT PROCESSING SYSTEMS, IN CLASS 37 (U.S. CLS. 100, 103 AND
106).

FIRST USE 5-30-2002; IN COMMERCE 5-30-2002.



FOR: COMPUTER SERVICES, NAMELY, CREATING, HOSTING AND MAINTAINING
ELECTRONIC COMMERCE WEBSITES FOR OTHERS, INTERACTIVE COMPUTER KIOSKS,
IN PERSON POINT OF SALE PROCESSING SYSTEMS, AND INTERACTIVE VOICE RE-
SPONSE (IVR) SYSTEMS FOR OTHERS; COMPUTER SERVICES, NAMELY, DESIGNING
AND IMPLEMENTING NETWORK WEB PAGES FOR OTHERS; COMPUTER SERVICES,
NAMELY, DESIGNING AND IMPLEMENTING WEBSITES, INTERACTIVE COMPUTER
KIOSKS, AND IVR SYSTEMS FOR OTHERS; COMPUTER SITE DESIGN, INSTALLATION
OF COMPUTER SOFTWARE, UP-DATING OF COMPUTER SOFTWARE; COMPUTER
SOFTWARE DESIGN FOR OTHERS; COMPUTER SYSTEMS ANALYSIS; DATABASE DE-
VELOPMENT SERVICES; DATA CONVERSION OF COMPUTER PROGRAM DATA OR
INFORMATION; COMPUTER PROGRAMMING FOR OTHERS; ON-LINE BATCH COM-
PUTER SERVICES, NAMELY, CONFIGURATION OF MULTIPLE FILES INTO A SINGLE
GROUP; COMPUTER CONSULTATION SERVICES RELATING TO SETTING UP INTERACT-

David J. Kyros

Director of the United States Patent and Trademark Office

Reg. No. 4,174,873 IVE PAYMENT AND PROCESSING NETWORKS AND DATA PROCESSING SYSTEMS FOR THE TRANSMISSION OF DATA; DESIGN AND DEVELOPMENT OF EQUIPMENT FOR CREDIT AUTHORIZATION, AND PROCESSING BILLING AND PAYMENT TO UTILITIES COMPANIES, COLLEGES AND UNIVERSITIES, K-12 SCHOOLS, INSURANCE COMPANIES, PROPERTY RENTAL COMPANIES, AND LOCAL, STATE AND FEDERAL GOVERNMENTAL ENTITIES; DESIGNING AND DEVELOPING EQUIPMENT FOR IDENTIFICATION, VERIFICATION, AUTHENTICATION OF PERSONAL IDENTIFICATION INFORMATION AND CASHLESS ELECTRONIC PAYMENT, IN CLASS 42 (U.S. CLS. 100 AND 101).

FIRST USE 5-30-2002; IN COMMERCE 5-30-2002.

THE MARK CONSISTS OF STANDARD CHARACTERS WITHOUT CLAIM TO ANY PARTICULAR FONT, STYLE, SIZE, OR COLOR.

OWNER OF U.S. REG. NOS. 2,533,394 AND 2,637,962.

NO CLAIM IS MADE TO THE EXCLUSIVE RIGHT TO USE "PAYMENTS", APART FROM THE MARK AS SHOWN.

SER. NO. 85-472,241, FILED 11-14-2011.

WENDY JUN, EXAMINING ATTORNEY

United States of America

United States Patent and Trademark Office



AIRCARE ACCESS
ASSISTANCE

Reg. No. 4,174,874

Registered July 17, 2012

Int. Cls.: 44 and 45

SERVICE MARK

PRINCIPAL REGISTER

ROBERTS, JEFFREY D. (UNITED STATES INDIVIDUAL), DBA THE STUB FARLOW
COMPANY
324 WEST BAY DRIVE SUITE 200
OLYMPIA, WA 98502

FOR: EMERGENCY MEDICAL ASSISTANCE, IN CLASS 44 (U.S. CLS. 100 AND 101).

FIRST USE 10-1-2011; IN COMMERCE 10-7-2011.

FOR: SECURITY SERVICES FOR INDIVIDUALS AND BUSINESS PERSONS TRAVELING
INTERNATIONALLY AND DOMESTICALLY, NAMELY, PROVIDING FOREIGN COUNTRY
SECURITY BRIEFINGS, EMBASSY INFORMATION FOR SECURITY PURPOSES AND SE-
CURITY REPORTS, IN CLASS 45 (U.S. CLS. 100 AND 101).

FIRST USE 10-1-2011; IN COMMERCE 10-7-2011.

OWNER OF U.S. REG. NOS. 4,021,632, 4,021,634, AND 4,021,635.

NO CLAIM IS MADE TO THE EXCLUSIVE RIGHT TO USE "AIRCARE" AND "ASSISTANCE",
APART FROM THE MARK AS SHOWN.

THE MARK CONSISTS OF A TRIANGLE CONTAINING AN AIRCRAFT WITH A CONTRAIL,
THE DESIGN OF WHICH FORMS THE LETTER "A". A SECOND TRIANGLE, INVERTED
AND CONTAINING THE LETTER "A", SITS DIRECTLY TO THE RIGHT OF THE FIRST
TRIANGLE. THE WORDS "AIRCARE ACCESS ASSISTANCE" ARE TO THE RIGHT SIDE
OF THE MARK.

SER. NO. 85-472,266, FILED 11-14-2011.

DAVID I, EXAMINING ATTORNEY



David J. Kyffers

Director of the United States Patent and Trademark Office

United States of America

United States Patent and Trademark Office



Reg. No. 4,174,875

KAI MEDICAL, INC. (HAWAII CORPORATION)

Registered July 17, 2012

3465 WAIALAE AVENUE, SUITE 370
HONOLULU, HI 96816

Int. Cl.: 10

TRADEMARK

PRINCIPAL REGISTER

FOR: MEDICAL APPARATUS AND INSTRUMENTS FOR MONITORING BLOOD PROPERTIES AND RESPIRATORY EVENTS; MEDICAL APPARATUS AND INSTRUMENTS FOR MONITORING OXYMETORY, GAS ANALYSIS AND VITAL SIGNS; MEDICAL APPARATUS AND INSTRUMENTS FOR MONITORING OXYMETORY, GAS ANALYSIS, VITAL SIGNS, BLOOD PROPERTIES AND RESPIRATORY EVENTS; MEDICAL APPARATUS AND INSTRUMENTS FOR MONITORING OXYMETORY, GAS ANALYSIS, VITAL SIGNS, BLOOD PROPERTIES AND RESPIRATORY EVENTS AND SOFTWARE SOLD THEREWITH AS A UNIT; MEDICAL APPARATUS AND INSTRUMENTS FOR MONITORING VITAL SIGNS, BLOOD PROPERTIES AND RESPIRATORY EVENTS; MEDICAL APPARATUS FOR MONITORING VITAL SIGNS OF PATIENTS; MEDICAL APPARATUS, NAMELY, RESPIRATORY EQUIPMENT AND MONITORS THEREFOR; MEDICAL DEVICES FOR MONITORING BLOOD PROPERTIES AND RESPIRATORY EVENTS; MEDICAL DEVICES FOR MONITORING OXYMETORY, GAS ANALYSIS AND VITAL SIGNS; MEDICAL DEVICES FOR MONITORING OXYMETORY, GAS ANALYSIS, VITAL SIGNS, BLOOD PROPERTIES AND RESPIRATORY EVENTS; MEDICAL DEVICES FOR MONITORING OXYMETORY, GAS ANALYSIS, VITAL SIGNS, BLOOD PROPERTIES AND RESPIRATORY EVENTS AND SOFTWARE SOLD AS A UNIT THEREWITH; MEDICAL DEVICES FOR MONITORING OXYMETORY, GAS ANALYSIS, VITAL SIGNS, BLOOD PROPERTIES AND RESPIRATORY EVENTS AND SYSTEM THAT TRANSMIT THE DATA THROUGH THE INTERNET; MEDICAL DEVICES FOR MONITORING VITAL SIGNS, BLOOD PROPERTIES AND RESPIRATORY EVENTS; MEDICAL DEVICES, NAMELY, PATIENT MONITORS AND PATIENT SENSORS FOR MONITORING AND MEASURING BLOOD PROPERTIES AND RESPIRATORY EVENTS; METERS FOR MEDICAL USE, NAMELY, FOR RESPIRATION; PATIENT MEDICAL MONITORS FOR MONITORING RESPIRATION; PATIENT MONITORING SENSORS AND ALARMS; RESPIRATION MONITORS, IN CLASS 10 (U.S. CLS. 26, 39 AND 44).

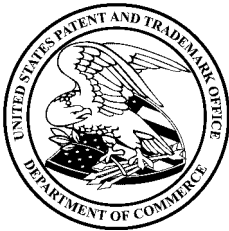

FIRST USE 5-1-2010; IN COMMERCE 5-1-2010.

OWNER OF U.S. REG. NOS. 3,550,101 AND 3,852,995.

David J. Kyffers

NO CLAIM IS MADE TO THE EXCLUSIVE RIGHT TO USE "CONTINUOUS RESPIRATION MONITOR", APART FROM THE MARK AS SHOWN.

Reg. No. 4,174,875 THE MARK CONSISTS OF THE WORDS "KAI" AND "CONTINUOUS" AND "RESPIRATION MONITOR", AND FEATURES THREE CURVED LINES OVERLAPPING THE "A" IN "KAI", AND A DOT IN THE SECOND "O" IN "CONTINUOUS".

THE ENGLISH TRANSLATION OF "KAI" IN THE MARK IS "OCEAN".

SEC. 2(F).

SER. NO. 85-472,304, FILED 11-14-2011.

SEAN CROWLEY, EXAMINING ATTORNEY

United States of America

United States Patent and Trademark Office

SIC

Reg. No. 4,174,876

Registered July 17, 2012

Int. Cl.: 28

TRADEMARK

PRINCIPAL REGISTER

DING KING FIBERGLASS WORKS, INC. (HAWAII CORPORATION)
WWW.SICMAUI.COM
875 HALIIMAILE ROAD
MAKAWAO, HI 96768

FOR: PADDLE SURFBOARDS, IN CLASS 28 (U.S. CLS. 22, 23, 38 AND 50).

FIRST USE 11-30-2005; IN COMMERCE 11-30-2005.

THE MARK CONSISTS OF STANDARD CHARACTERS WITHOUT CLAIM TO ANY PARTICULAR FONT, STYLE, SIZE, OR COLOR.

SER. NO. 85-472,306, FILED 11-14-2011.

ROSELLE HERRERA, EXAMINING ATTORNEY



David J. Kyffers

Director of the United States Patent and Trademark Office

United States of America

United States Patent and Trademark Office

COMMUNITY BIBLE STUDY

Reg. No. 4,174,877

COMMUNITY BIBLE STUDY (VIRGINIA NON-PROFIT CORPORATION)
790 STOUT ROAD
COLORADO SPRINGS, CO 80921

Registered July 17, 2012

Int. Cl.: 9

FOR: DOWNLOADABLE ELECTRONIC PUBLICATIONS IN THE NATURE OF NEWSLETTERS, CALENDARS, STUDY GUIDES AND LESSONS IN THE FIELD OF CHRISTIAN RELIGION; PRE-RECORDED ELECTRONIC AND DIGITAL MEDIA IN THE FIELD OF CHRISTIAN RELIGION, IN CLASS 9 (U.S. CLS. 21, 23, 26, 36 AND 38).

TRADEMARK

PRINCIPAL REGISTER

FIRST USE 12-31-1979; IN COMMERCE 12-31-1979.

THE MARK CONSISTS OF STANDARD CHARACTERS WITHOUT CLAIM TO ANY PARTICULAR FONT, STYLE, SIZE, OR COLOR.

SEC. 2(F).

SER. NO. 85-472,339, FILED 11-14-2011.

BRIDGETT SMITH, EXAMINING ATTORNEY



David J. Kybas

Director of the United States Patent and Trademark Office

United States of America

United States Patent and Trademark Office

COMMUNITY BIBLE STUDY

Reg. No. 4,174,878

COMMUNITY BIBLE STUDY (VIRGINIA NON-PROFIT CORPORATION)
790 STOUT ROAD
COLORADO SPRINGS, CO 80921

Registered July 17, 2012

Int. Cl.: 25

FOR: SHIRTS; T-SHIRTS; POLO SHIRTS; SPORTS SHIRTS; BLOUSES; VESTS; SWEATER VESTS; FLEECE VESTS; FLEECE TOPS; FLEECE JACKETS; JACKETS; SWEAT SHIRTS; SWEAT PANTS; PULLOVERS; SWEATERS; APRONS; HATS; CAPS AND VISORS, IN CLASS 25 (U.S. CLS. 22 AND 39).

TRADEMARK

PRINCIPAL REGISTER

FIRST USE 12-31-1980; IN COMMERCE 12-31-1980.

THE MARK CONSISTS OF STANDARD CHARACTERS WITHOUT CLAIM TO ANY PARTICULAR FONT, STYLE, SIZE, OR COLOR.

SER. NO. 85-472,342, FILED 11-14-2011.

BRIDGETT SMITH, EXAMINING ATTORNEY



David J. Kybas

Director of the United States Patent and Trademark Office

United States of America

United States Patent and Trademark Office

Jedamid

Reg. No. 4,174,879

JEDA POLYMERS, LLC (ILLINOIS LIMITED LIABILITY COMPANY)
560 TAYLOR RD
ROMEDEVILLE, IL 60446

Registered July 17, 2012

Int. Cl.: 1

FOR: SYNTHETIC RESINS, NAMELY, NYLON RESIN USED FOR INJECTION MOLDING AND EXTRUSION, IN CLASS 1 (U.S. CLS. 1, 5, 6, 10, 26 AND 46).

TRADEMARK

FIRST USE 5-15-2009; IN COMMERCE 5-15-2009.

PRINCIPAL REGISTER

THE MARK CONSISTS OF STANDARD CHARACTERS WITHOUT CLAIM TO ANY PARTICULAR FONT, STYLE, SIZE, OR COLOR.

SER. NO. 85-472,348, FILED 11-14-2011.

ANDREA K. NADELMAN, EXAMINING ATTORNEY



David J. Kybas

Director of the United States Patent and Trademark Office

United States of America

United States Patent and Trademark Office



Reg. No. 4,174,880

Registered July 17, 2012

Int. Cl.: 36

SERVICE MARK

PRINCIPAL REGISTER

FERNANDEZ, JAIME (UNITED STATES INDIVIDUAL)
LISTWITHJAIME@GMAIL.COM
6289 NAPA AVE.
ALTA LOMA, CA 91701

FOR: COMMERCIAL AND RESIDENTIAL REAL ESTATE AGENCY SERVICES; EVALUATION OF REAL PROPERTY; FINANCIAL VALUATION OF PERSONAL PROPERTY AND REAL ESTATE; PROVIDING A DATABASE OF INFORMATION ABOUT RESIDENTIAL REAL ESTATE LISTINGS IN DIFFERENT NEIGHBORHOODS AND COMMUNITIES; PROVIDING AN INTERNET WEBSITE PORTAL OFFERING INFORMATION IN THE FIELDS OF REAL ESTATE CONCERNING THE PURCHASE AND SALE OF NEW AND RESALE HOMES AND CONDOS; PROVIDING INFORMATION IN THE FIELD OF REAL ESTATE BY MEANS OF LINKING THE WEB SITE TO OTHER WEB SITES FEATURING REAL ESTATE INFORMATION; PROVIDING INFORMATION IN THE FIELD OF REAL ESTATE VIA THE INTERNET; PROVIDING REAL ESTATE LISTINGS AND REAL ESTATE INFORMATION VIA THE INTERNET; REAL ESTATE AGENCIES; REAL ESTATE CONSULTATION; REAL ESTATE LISTING; REAL ESTATE MULTIPLE LISTING SERVICES; RESIDENTIAL REAL ESTATE AGENCY SERVICES, IN CLASS 36 (U.S. CLS. 100, 101 AND 102).

FIRST USE 1-1-2009; IN COMMERCE 1-1-2009.

NO CLAIM IS MADE TO THE EXCLUSIVE RIGHT TO USE ".COM", APART FROM THE MARK AS SHOWN.

THE COLOR(S) RED AND WHITE IS/ARE CLAIMED AS A FEATURE OF THE MARK.

THE MARK CONSISTS OF "LIST WITH JAIME .COM" IN WHITE STACKED LETTERING PLACED IN A STYLIZED RED SQUARE WITH ROUNDED LEFT TOP AND BOTTOM RIGHT CORNERS. VARIOUS SHADING AND LIGHTING GIVES THE STYLIZED RED SQUARE AN EMBOSSED AND GLOSSY APPEARANCE.

SER. NO. 85-472,453, FILED 11-14-2011.

MARK RADEMACHER, EXAMINING ATTORNEY



David J. Kyjars

Director of the United States Patent and Trademark Office

United States of America

United States Patent and Trademark Office

MEDIGROUP

Reg. No. 4,174,881

Registered July 17, 2012

Int. Cl.: 35

SERVICE MARK

PRINCIPAL REGISTER

MEDIGROUP PHYSICIAN SERVICES, LLC (DELAWARE LIMITED LIABILITY COMPANY)
7704 QUARTERFIELD ROAD, STE E
GLEN BURNIE, MD 21061

FOR: ADMINISTERING DISCOUNT MEDICAL, COSMETIC AND AESTHETIC SERVICE PROGRAMS, NAMELY, NEGOTIATING CONTRACTS WITH PROVIDERS OF MEDICAL, COSMETIC AND AESTHETIC SERVICES, TO ENABLE PARTICIPANT MEMBERS TO OBTAIN DISCOUNTS ON THE PURCHASE OF MEDICAL, COSMETIC AND AESTHETIC PRODUCTS AND SERVICES THROUGH THE USE OF DISCOUNT MEMBERSHIP CARDS; ADVERTISING AND BUSINESS SERVICES, NAMELY, SECURING AIRTIME ON ALL FORMS OF MEDIA COMMUNICATIONS STATIONS, SYSTEMS, NETWORKS, AND SERVICES FOR THE PURPOSE OF PROMOTING THE GOODS AND SERVICES OF OTHERS; ADVERTISING AND MARKETING SERVICES PROVIDED BY MEANS OF INDIRECT METHODS OF MARKETING COMMUNICATIONS, NAMELY, SOCIAL MEDIA, SEARCH ENGINE MARKETING, INQUIRY MARKETING, INTERNET MARKETING, MOBILE MARKETING, BLOGGING AND OTHER FORMS OF PASSIVE, SHARABLE OR VIRAL COMMUNICATIONS CHANNELS; ARRANGING OF MANAGED CARE CONTRACTUAL SERVICES IN THE FIELDS OF DIAGNOSTIC IMAGING, HOME HEALTH CARE, DURABLE MEDICAL EQUIPMENT, SPECIALTY PHARMACY, AND DIAGNOSTIC LAB SERVICES; ASSET MANAGEMENT SERVICES, NAMELY, REPORTING ON SERVICE HISTORIES, UTILIZATION OF THE MEDICAL ASSETS, END OF PRODUCT LIFE INFORMATION AND REPLACEMENT COSTS ALL RELATED TO MEDICAL DIAGNOSTIC, CLINICAL AND BIOMEDICAL EQUIPMENT; BUSINESS COLLABORATION SERVICES, NAMELY, PROVIDING A NATIONAL COMPUTER-BASED NETWORKING WEB SITE FOR HEALTH CARE EDUCATORS AND MEDICAL EDUCATORS TO COLLABORATE ACROSS DISCIPLINES TO HELP IMPROVE HEALTH CARE EDUCATION AND MEDICAL EDUCATION; BUSINESS CONSULTING AND MANAGEMENT IN THE FIELD OF CLINICAL TRIALS, NAMELY, CLINICAL DATA AND REGULATORY SUBMISSION MANAGEMENT ON BEHALF OF MEDICAL, BIOPHARMACEUTICAL AND BIOTECHNOLOGY COMPANIES TO ASSIST THEM WITH CLINICAL RESEARCH, CLINICAL TRIALS AND APPLICATIONS FOR DRUG APPROVAL; BUSINESS CONSULTING SERVICE IN THE FIELD OF MEDICAL IMAGING CENTERS; BUSINESS MANAGEMENT CONSULTANCY IN THE FIELD OF PURCHASES, NAMELY, ASSISTING BUSINESSES IN IMPROVEMENT OF PURCHASING FUNCTIONS; BUSINESS MANAGEMENT CONSULTING, STRATEGIC PLANNING AND BUSINESS ADVISORY SERVICES PROVIDED TO THE VETERINARY MEDICAL PROFESSION; BUSINESS SERVICES, NAMELY, COMBINED STRATEGIC GOODS OR SERVICES SOURCING AND COOPERATIVE PURCHASING FOR OTHERS; BUSINESS SERVICES,



David J. Kybas

Director of the United States Patent and Trademark Office

Reg. No. 4,174,881 NAMELY, INDEPENDENT MEDICAL MANAGEMENT SERVICES FOR SELF-FUNDED MAJOR MEDICAL HEALTH PLANS; BUSINESS SERVICES, NAMELY, PROVIDING COMPUTER DATABASES REGARDING THE PURCHASE AND SALE OF A WIDE VARIETY OF PRODUCTS AND SERVICES OF OTHERS; CONSULTING SERVICES IN THE FIELD OF MEDICAL PRODUCT APPROVAL FOR COMMERCIAL PURPOSES; CONSULTING SERVICES, NAMELY, TO EMPLOYERS, COMMUNITY ORGANIZATIONS, BROKERS AND BENEFICIARIES, RELATED TO CONSUMER INFORMATION REGARDING HEALTH CARE PLAN OPTIONS, PRODUCTS AND PROGRAMS IN THE FIELD OF MANAGED CARE AND STATE AND FEDERAL MEDICAL CARE PROGRAMS; DENTIST REFERRALS; DOCTOR REFERRALS; GENERAL BUSINESS NETWORKING REFERRAL SERVICES, NAMELY, PROMOTING THE GOODS AND SERVICES OF OTHERS BY PASSING BUSINESS LEADS AND REFERRALS AMONG GROUP MEMBERS; INTERACTIVE RECORD-KEEPING SERVICES FOR USE IN RISK MANAGEMENT AND REGULATORY COMPLIANCE BY INSURERS AND PROFESSIONALS IN THE MEDICAL FIELD; MAINTAINING REGISTRY OF CERTIFIED MEDICAL TECHNICAL PROFESSIONALS; MARKETING SERVICES, NAMELY, PROVIDING ON-LINE NON-DOWNLOADABLE VIDEOS TO PROMOTE DOCTORS AND MEDICAL PRACTICES; MEDIA BUYING ADVICE, NAMELY, ADVISING THE CLIENT HOW MUCH MEDIA TIME, AND AT WHAT TIMES THE CLIENT SHOULD BE PURCHASING ADVERTISING; MEDIA MONITORING SERVICES, NAMELY, MONITORING PRINT MEDIA, TELEVISION, RADIO, AND OTHER MEDIA FOR CUSTOMER-SPECIFIED TOPICS, GATHERING RELEVANT CONTENT ON THOSE TOPICS, AND PROVIDING DOCUMENTATION AND ANALYSIS OF THAT MEDIA CONTENT TO OTHERS FOR BUSINESS PURPOSES; MEDIATION OF AGREEMENTS REGARDING THE SALE AND PURCHASE OF GOODS; MEDIATION OF CONTRACTS FOR PURCHASE AND SALE OF PRODUCTS; MEDICAL BILLING OUTSOURCING SERVICES; MEDICAL BILLING SUPPORT SERVICES; MEDICAL CLAIMS MANAGEMENT SERVICES, NAMELY, ELECTRONIC RE-PRICING OF PHYSICIAN, HOSPITAL, AND ANCILLARY MEDICAL CARE PROVIDER TRANSACTIONS VIA THE GLOBAL INFORMATION NETWORK; MEDICAL CLAIMS MANAGEMENT SERVICES, NAMELY, RECEIVING, DATA ENTERING, AND RE-PRICING OF TRANSACTIONS THAT ARE ORIGINATED BY PHYSICIANS, HOSPITALS, AND ANCILLARY MEDICAL CARE PROVIDERS; MEDICAL COST MANAGEMENT; MEDICAL PERSONNEL RECRUITMENT SERVICES AND CONSULTATION RELATED THERETO; MEDICAL REFERRALS; MEDICAL TRANSCRIPTION SERVICES; MERCHANDISING SERVICES FOR INDUCING THE PURCHASING PUBLIC TO BUY THE GOODS OF OTHERS THROUGH A PROMOTIONAL GIFT REDEMPTION PROGRAM; ORGANISATION OF PROMOTIONS USING AUDIOVISUAL MEDIA; PHYSICIAN REFERRALS; PREPARATION AND REALIZATION OF MEDIA AND ADVERTISING PLANS AND CONCEPTS; PROCURING OF CONTRACTS FOR THE PURCHASE AND SALE OF GOODS; PROMOTING COLLABORATION WITHIN THE SCIENTIFIC, RESEARCH AND MEDICAL COMMUNITIES TO ACHIEVE ADVANCES IN THE FIELD OF HEALTHCARE; PROMOTING THE EXCHANGE OF INFORMATION AND RESOURCES WITHIN THE SCIENTIFIC RESEARCH AND MEDICAL COMMUNITIES TO ACHIEVE ADVANCES IN THE FIELD OF HEALTHCARE; PROMOTING THE GOODS AND SERVICES OF OTHERS BY PROVIDING AN INTERACTIVE WEBSITE WHERE USERS CAN INCREASE THE CURRENT VALUE OF AN ONLINE DISCOUNT BEING OFFERED BY PURCHASING THE GOODS AND SERVICES ASSOCIATED WITH THAT DISCOUNT IN THE FORM OF AN ONLINE COUPON, VOUCHER OR GIFT CARD; PROMOTIONAL MARKETING SERVICES USING AUDIOVISUAL MEDIA; PROVIDING A WEB SITE THAT ASSISTS MEDICAL PROFESSIONALS DRAFT A LETTER OF MEDICAL NECESSITY OR OTHER NECESSARY DOCUMENTATION FOR SUBMISSION TO A THIRD PARTY PAYOR ON BEHALF OF A PATIENT; PROVIDING ADVERTISING, MARKETING AND PROMOTIONAL SERVICES FOR THE PHARMACEUTICAL AND MEDICAL INDUSTRY; PROVIDING ADVERTISING, MARKETING AND PROMOTIONAL SERVICES FOR THE PHARMACEUTICAL AND MEDICAL PRODUCTS OF OTHERS; PROVIDING AN INTERNET-BASED DATABASE OF PATIENT MEDICAL INFORMATION DESIGNED TO FACILITATE PATIENT-AUTHORIZED, HIPAA-COMPLIANT SHARING AND MAINTENANCE OF PATIENT MEDICAL INFORMATION AMONGST A PATIENT'S DOCTORS SUCH THAT THIS INFORMATION CAN BE DIRECTLY INSERTED INTO THE DOCTOR'S MEDICAL REPORTS AS A MEANS OF INCREASING MEDICAL RECORD GENERATION EFFI-

Reg. No. 4,174,881 CIENCY AND ACCURACY; PROVIDING AN ON-LINE DATABASE PROVIDING BUSINESS INTELLIGENCE IN THE FIELDS OF MEDICAL DEVICES, PHARMACEUTICALS AND LIFE SCIENCES; PROVIDING AN ONLINE MARKETING COLLABORATION NETWORK FOR SOCIAL MEDIA AND ONLINE MARKETING PROFESSIONALS FOR THE PURPOSE OF SYNDICATING CONTENT THROUGH THE NETWORK TO BE SHARED BY OTHERS; PROVIDING BUSINESS INTELLIGENCE SERVICES IN THE FIELDS OF MEDICAL DEVICES, PHARMACEUTICALS AND THE LIFE SCIENCES; PROVIDING CONSULTING SERVICES IN THE FIELD OF FACILITATING THE PLANNING, BUYING, AND SELLING OF MEDIA; PROVIDING CONSULTING SERVICES IN THE FIELD OF REGULATORY SUBMISSION MANAGEMENT TO MEDICAL COMPANIES TO ASSIST THEM WITH APPLICATIONS FOR MEDICAL DEVICE APPROVAL; PROVIDING HEALTH INSURANCE EXCHANGES IN THE NATURE OF A MARKETPLACE THAT OFFERS PURCHASERS OF HEALTH INSURANCE A VARIETY OF PLANS FROM DIFFERENT INSURANCE PROVIDERS; PROVIDING INCENTIVE AWARD PROGRAMS FOR CUSTOMERS THROUGH ISSUANCE AND PROCESSING OF LOYALTY POINTS FOR ON-LINE PURCHASE OF COMPANY'S GOODS AND SERVICES; PROVIDING INSURANCE AGENT REFERRALS; PROVIDING PROMOTIONAL MARKETING SERVICES TO BUSINESSES IN THE BROADBAND AND MEDIA INDUSTRIES; PROVISION OF INFORMATION AND ADVICE TO CONSUMERS REGARDING THE SELECTION OF PRODUCTS AND ITEMS TO BE PURCHASED; PURCHASING AGENTS; PURCHASING AND PROCUREMENT SERVICES, NAMELY, PROCURING OF CONTRACTS FOR OTHERS FOR THE PURCHASE OF GOODS AND LABOR CONTRACTING SERVICES; SOCIAL MEDIA STRATEGY AND MARKETING CONSULTANCY FOCUSING ON HELPING CLIENTS CREATE AND EXTEND THEIR PRODUCT AND BRAND STRATEGIES BY BUILDING VIRALLY ENGAGING MARKETING SOLUTIONS, IN CLASS 35 (U.S. CLS. 100, 101 AND 102).

FIRST USE 10-1-1999; IN COMMERCE 10-1-1999.

THE MARK CONSISTS OF STANDARD CHARACTERS WITHOUT CLAIM TO ANY PARTICULAR FONT, STYLE, SIZE, OR COLOR.

SER. NO. 85-472,464, FILED 11-15-2011.

ALLISON SCHRODY, EXAMINING ATTORNEY

United States of America

United States Patent and Trademark Office



Reg. No. 4,174,882

MOTIONSPOET LLC (CONNECTICUT LIMITED LIABILITY COMPANY)
PO BOX 1169
LA JOLLA, CA 92038

Registered July 17, 2012

Int. Cl.: 28

FOR: RACKETS FOR TENNIS, BADMINTON, SQUASH, RACQUETBALL, TABLE TENNIS,
IN CLASS 28 (U.S. CLS. 22, 23, 38 AND 50).

TRADEMARK

FIRST USE 10-0-2011; IN COMMERCE 10-0-2011.

PRINCIPAL REGISTER

THE MARK CONSISTS OF A STYLIZED X DESIGN.

SER. NO. 85-472,465, FILED 11-15-2011.

KATHRYN COWARD, EXAMINING ATTORNEY



David J. Kybas

Director of the United States Patent and Trademark Office

United States of America

United States Patent and Trademark Office

HighQuest

Reg. No. 4,174,883

SAXENA, PRADEEP (UNITED STATES INDIVIDUAL)
37 SPRINGBROOK DRIVE
NORTH CHILI, NY 14514

Registered July 17, 2012

Int. Cl.: 42

FOR: TECHNOLOGICAL CONSULTATION IN THE TECHNOLOGY FIELD OF COMPUTERS, NAMELY, COMPUTER HARDWARE, SOFTWARE AND COMPUTER NETWORKS; AND COMPUTER INFORMATION TECHNOLOGY CONSULTATION, IN CLASS 42 (U.S. CLS. 100 AND 101).

SERVICE MARK

PRINCIPAL REGISTER

FIRST USE 2-5-1997; IN COMMERCE 8-25-1999.

THE MARK CONSISTS OF STANDARD CHARACTERS WITHOUT CLAIM TO ANY PARTICULAR FONT, STYLE, SIZE, OR COLOR.

SER. NO. 85-472,511, FILED 11-15-2011.

KATHRYN COWARD, EXAMINING ATTORNEY



David J. Kyffers

Director of the United States Patent and Trademark Office

United States of America

United States Patent and Trademark Office

Three Sisters

Reg. No. 4,174,884

CHAD HARGROVE (UNITED STATES INDIVIDUAL)
7935 BLUE DUCK TRAIL
ARLINGTON, TX 76002

Registered July 17, 2012

Int. Cl.: 25

FOR: BUTTON DOWN SHIRTS; HATS; KNITTED CAPS; T-SHIRTS, IN CLASS 25 (U.S. CLS. 22 AND 39).

TRADEMARK

FIRST USE 11-14-2011; IN COMMERCE 11-14-2011.

PRINCIPAL REGISTER

THE MARK CONSISTS OF STANDARD CHARACTERS WITHOUT CLAIM TO ANY PARTICULAR FONT, STYLE, SIZE, OR COLOR.

SER. NO. 85-472,560, FILED 11-15-2011.

STEVEN R. FINE, EXAMINING ATTORNEY



David J. Kybas

Director of the United States Patent and Trademark Office

United States of America

United States Patent and Trademark Office

intruderology

Reg. No. 4,174,885

S.A.F.E. CONSULTING, LLC (MISSOURI LIMITED LIABILITY COMPANY)
P.O. BOX 105995

Registered July 17, 2012

JEFFERSON CITY, MO 65101

Int. Cl.: 41

FOR: TRAINING SERVICES IN THE FIELD OF THE PREVENTION AND MITIGATION OF SCHOOL AND WORKPLACE VIOLENCE, IN CLASS 41 (U.S. CLS. 100, 101 AND 107).

SERVICE MARK

FIRST USE 4-1-2011; IN COMMERCE 6-1-2011.

PRINCIPAL REGISTER

THE MARK CONSISTS OF STANDARD CHARACTERS WITHOUT CLAIM TO ANY PARTICULAR FONT, STYLE, SIZE, OR COLOR.

SER. NO. 85-472,566, FILED 11-15-2011.

CHARLOTTE CORWIN, EXAMINING ATTORNEY



David J. Kybas

Director of the United States Patent and Trademark Office

United States of America
United States Patent and Trademark Office

FRITTLE

Reg. No. 4,174,886

PATRICIA CARRIE ABBOTT (UNITED STATES INDIVIDUAL)
7850 SCARBOROUGH BLVD. S. DR.
INDIANAPOLIS, IN 46256

Registered July 17, 2012

Int. Cl.: 30

FOR: CANDY, IN CLASS 30 (U.S. CL. 46).

TRADEMARK

FIRST USE 9-10-2011; IN COMMERCE 9-10-2011.

PRINCIPAL REGISTER

THE MARK CONSISTS OF STANDARD CHARACTERS WITHOUT CLAIM TO ANY PARTICULAR FONT, STYLE, SIZE, OR COLOR.

SER. NO. 85-472,569, FILED 11-15-2011.

AMEEN IMAM, EXAMINING ATTORNEY



David J. Kyffers

Director of the United States Patent and Trademark Office

United States of America

United States Patent and Trademark Office

GENIUS

Reg. No. 4,174,887

JOB MACHINERY INC. (MINNESOTA CORPORATION)

Registered July 17, 2012

16085 ASTERBILT LANE
LAKEVILLE, MN 55044

Int. Cl.: 7

FOR: GENERATORS, NAMELY, ELECTRIC GENERATORS POWERED HYDRAULICALLY OR BY DIESEL ENGINE FOR USE WITH LIFT MAGNETS IN THE METALS RECYCLING INDUSTRY, IN CLASS 7 (U.S. CLS. 13, 19, 21, 23, 31, 34 AND 35).

TRADEMARK

FIRST USE 10-0-2008; IN COMMERCE 11-0-2008.

PRINCIPAL REGISTER

THE MARK CONSISTS OF STANDARD CHARACTERS WITHOUT CLAIM TO ANY PARTICULAR FONT, STYLE, SIZE, OR COLOR.

SER. NO. 85-472,585, FILED 11-15-2011.

CHARLOTTE CORWIN, EXAMINING ATTORNEY



David J. Kyffers

Director of the United States Patent and Trademark Office

United States of America

United States Patent and Trademark Office



Reg. No. 4,174,888

Registered July 17, 2012

Int. Cls.: 25 and 28

TRADEMARK

PRINCIPAL REGISTER

REEL HUNTER OUTDOORS, LLC (FLORIDA LIMITED LIABILITY COMPANY)
701 ORANGE AVE.
ST. CLOUD, FL 34769

FOR: CLOTHING, NAMELY, SHORT SLEEVE T-SHIRTS, LONG SLEEVE T-SHIRTS, DRESS SHIRTS, PANTS, SHORTS, SWIM WEAR, COATS, JACKETS, HATS, SUN VISORS, BEANIES, HUNTING GLOVES POLO SHIRTS, HUNTING SHIRTS, SWEATSHIRTS, THERMAL UNDERWEAR, SWEAT PANTS, WOMENS PAJAMAS, TANK TOPS, CAMOUFLAGE PANTS, CAMOUFLAGE SHIRTS, CAMOUFLAGE SWEATSHIRTS, CAMOUFLAGE JACKETS AND FISHING SHIRTS, IN CLASS 25 (U.S. CLS. 22 AND 39).

FIRST USE 3-0-2011; IN COMMERCE 3-0-2011.

FOR: FISHING LURES, IN CLASS 28 (U.S. CLS. 22, 23, 38 AND 50).

FIRST USE 3-0-2011; IN COMMERCE 3-0-2011.

NO CLAIM IS MADE TO THE EXCLUSIVE RIGHT TO USE "HUNTER", APART FROM THE MARK AS SHOWN.

THE MARK CONSISTS OF THE STYLIZED TEXT "REEL HUNTER" WITH AN IMAGE OF DEER ANTLERS BETWEEN THE TWO WORDS. THE BOTTOM OF THE ANTLERS IS STYLIZED AS A FISHING HOOK.

SER. NO. 85-472,605, FILED 11-15-2011.

CARYN GLASSER, EXAMINING ATTORNEY



David J. Kybas

Director of the United States Patent and Trademark Office

United States of America

United States Patent and Trademark Office

AMERICAN
Dreamer

Reg. No. 4,174,889

NOVUS VENALICIUM, INC. (OREGON CORPORATION)
PO BOX 4102
SALEM, OR 97302

Registered July 17, 2012

Int. Cl.: 16

FOR: MAGAZINES FEATURING CONTENT TO INSPIRE, ENTERTAIN, INFORM AND ASSIST READERS IN TAKING CARE OF THEIR FAMILIES, FREEDOM AND HEALTH, IN CLASS 16 (U.S. CLS. 2, 5, 22, 23, 29, 37, 38 AND 50).

TRADEMARK

FIRST USE 10-7-2011; IN COMMERCE 10-7-2011.

PRINCIPAL REGISTER

THE MARK CONSISTS OF THE STYLIZED TERM "AMERICAN" IN BLUE AND ALL CAPITAL LETTERS. THE STYLIZED TERM "DREAMER" IS IN RED AND IS WRITTEN DIAGONALLY.

THE COLOR(S) BLUE AND RED IS/ARE CLAIMED AS A FEATURE OF THE MARK.

SER. NO. 85-472,606, FILED 11-15-2011.

ANDREW LEASER, EXAMINING ATTORNEY



David J. Kypos

Director of the United States Patent and Trademark Office

United States of America

United States Patent and Trademark Office

BRAINWAVE

Reg. No. 4,174,890

Registered July 17, 2012

Int. Cl.: 41

SERVICE MARK

PRINCIPAL REGISTER

RUBIN MUSEUM OF ART A/K/A/ THE SHELLEY AND DONALD RUBIN FOUNDATION
(NEW YORK CHARITABLE TRUST)
150 WEST 17TH STREET
NEW YORK, NY 10011

FOR: ENTERTAINMENT AND EDUCATIONAL SERVICES, NAMELY, THE PRESENTATION OF TALKS FEATURING A MIND SCIENTIST AND A PERSON FROM ANOTHER DISCIPLINE DISCUSSING MATTERS RELATING TO THE BRAIN SUCH AS DREAMING, IN CLASS 41 (U.S. CLS. 100, 101 AND 107).

FIRST USE 1-31-2008; IN COMMERCE 1-31-2008.

THE MARK CONSISTS OF STANDARD CHARACTERS WITHOUT CLAIM TO ANY PARTICULAR FONT, STYLE, SIZE, OR COLOR.

SER. NO. 85-472,610, FILED 11-15-2011.

LINDSEY RUBIN, EXAMINING ATTORNEY



David J. Kyjars

Director of the United States Patent and Trademark Office

United States of America

United States Patent and Trademark Office

The Big German

Reg. No. 4,174,891

TRB IP HOLDINGS, LLC (TEXAS LIMITED LIABILITY COMPANY)
3102 MAPLE AVENUE, SUITE 400
DALLAS, TX 75201

Registered July 17, 2012

Int. Cl.: 29

FOR: PREPARED MEAL CONSISTING PRIMARILY OF A BEEF PATTY, TURKEY PATTY, BISON PATTY OR VEGETARIAN PATTY, ALSO CONTAINING VARIOUS TOPPING AND SAUCES, FOR CONSUMPTION ON OR OFF THE PREMISES, IN CLASS 29 (U.S. CL. 46).

TRADEMARK

FIRST USE 5-3-2010; IN COMMERCE 5-3-2010.

PRINCIPAL REGISTER

THE MARK CONSISTS OF STANDARD CHARACTERS WITHOUT CLAIM TO ANY PARTICULAR FONT, STYLE, SIZE, OR COLOR.

NO CLAIM IS MADE TO THE EXCLUSIVE RIGHT TO USE "GERMAN", APART FROM THE MARK AS SHOWN.

SER. NO. 85-472,629, FILED 11-15-2011.

ESTHER A. BORSUK, EXAMINING ATTORNEY



David J. Kybas

Director of the United States Patent and Trademark Office

United States of America

United States Patent and Trademark Office



Reg. No. 4,174,892

Registered July 17, 2012

Int. Cl.: 42

SERVICE MARK

PRINCIPAL REGISTER

CARROLL, KEN (UNITED STATES INDIVIDUAL), DBA INTEGRIS DESIGN
46 SYDNEY LANE
ASHEVILLE, NC 28806

FOR: COMPUTER SERVICES, NAMELY, SEARCH ENGINE OPTIMIZATION; GRAPHIC DESIGN; WEB SITE DESIGN, IN CLASS 42 (U.S. CLS. 100 AND 101).

FIRST USE 1-0-2009; IN COMMERCE 1-0-2009.

THE MARK CONSISTS OF A BLACK RECTANGLE CONTAINING A RED LETTER "I" TO THE LEFT OF THE OUTLINE OF A WHITE LION HEAD, IN A PROFILE FORMAT FACING LEFT, SLIGHTLY COVERING THE BOTTOM PORTION OF THE LETTER "I"; THE FUR UNDER THE LION'S CHIN IS SHADED BLACK, ALONG WITH THE NOSE, OUTLINE OF THE EAR, AND THE EYE.

THE COLOR(S) RED, WHITE, AND BLACK IS/ARE CLAIMED AS A FEATURE OF THE MARK.

SER. NO. 85-472,649, FILED 11-15-2011.

MAYUR VAGHANI, EXAMINING ATTORNEY



David J. Kybas

Director of the United States Patent and Trademark Office

United States of America

United States Patent and Trademark Office

Brickologist

Reg. No. 4,174,893

WEIS, BETH (UNITED STATES INDIVIDUAL)
1648 CENTRAL AVENUE
DEERFIELD, IL 60015

Registered July 17, 2012

Int. Cl.: 41

FOR: ENTERTAINMENT IN THE NATURE OF LIVE PERFORMANCES BY AN ARTIST
USING TOY BUILDING BRICKS, IN CLASS 41 (U.S. CLS. 100, 101 AND 107).

SERVICE MARK

FIRST USE 1-1-2009; IN COMMERCE 1-1-2009.

PRINCIPAL REGISTER

THE MARK CONSISTS OF STANDARD CHARACTERS WITHOUT CLAIM TO ANY PARTICULAR FONT, STYLE, SIZE, OR COLOR.

OWNER OF U.S. REG. NO. 4,018,996.

SER. NO. 85-472,653, FILED 11-15-2011.

ERNEST SHOSHO, EXAMINING ATTORNEY



David J. Kybas

Director of the United States Patent and Trademark Office

United States of America

United States Patent and Trademark Office

INTEGRISDESIGN

Reg. No. 4,174,894

CARROLL, KEN (UNITED STATES INDIVIDUAL), DBA INTEGRIS DESIGN
46 SYDNEY LANE

Registered July 17, 2012

ASHEVILLE, NC 28806

Int. Cl.: 42

FOR: COMPUTER SERVICES, NAMELY, SEARCH ENGINE OPTIMIZATION; GRAPHIC DESIGN; WEB SITE DESIGN, IN CLASS 42 (U.S. CLS. 100 AND 101).

SERVICE MARK

FIRST USE 9-0-2011; IN COMMERCE 9-0-2011.

PRINCIPAL REGISTER

THE MARK CONSISTS OF STANDARD CHARACTERS WITHOUT CLAIM TO ANY PARTICULAR FONT, STYLE, SIZE, OR COLOR.

SER. NO. 85-472,666, FILED 11-15-2011.

MAYUR VAGHANI, EXAMINING ATTORNEY



David J. Kybas

Director of the United States Patent and Trademark Office

United States of America

United States Patent and Trademark Office



Reg. No. 4,174,895

SIMPLI PRETTI (OHIO LIMITED LIABILITY COMPANY)
7246 LINDA TRACE
REYNOLDSBURG, OH 43068

Registered July 17, 2012

Int. Cl.: 25

FOR: BRAS; PANTIES; PANTS; SHIRTS; SHOES; SWIMWEAR, IN CLASS 25 (U.S. CLS. 22 AND 39).

TRADEMARK

FIRST USE 4-1-2011; IN COMMERCE 7-15-2011.

PRINCIPAL REGISTER

NO CLAIM IS MADE TO THE EXCLUSIVE RIGHT TO USE "FASHIONS", APART FROM THE MARK AS SHOWN.

THE MARK CONSISTS OF THE WORDS "SIMPLI PRETTI FASHIONS" IN FANCY SCRIPT, ABOVE THE WORDS "LOOK, FEEL, WEAR SIMPLI PRETTI!" IN BLOCK PRINT, ALL ADJACENT TO A BUTTERFLY DESIGN WITH THE LETTERS "S P" IN FANCY SCRIPT INSIDE.

SER. NO. 85-472,714, FILED 11-15-2011.

AMY KELLY, EXAMINING ATTORNEY



David J. Kyfos

Director of the United States Patent and Trademark Office

United States of America

United States Patent and Trademark Office

WEHELPWOMEN.COM

Reg. No. 4,174,896

Registered July 17, 2012

Int. Cl.: 41

SERVICE MARK

PRINCIPAL REGISTER

FRESH START WOMEN'S FOUNDATION (ARIZONA NON-PROFIT CORPORATION)
1130 E. MCDOWELL ROAD
PHOENIX, AZ 85006

FOR: DESIGNING AND RECOMMENDING ONLINE CUSTOM EDUCATIONAL CURRICULA FOR OTHERS BY CONDUCTING ON-LINE PERSONAL LIFESTYLE ASSESSMENTS IN THE FIELDS OF PERSONAL EMPOWERMENT, COMMUNICATION, LEADERSHIP, PERSONAL FINANCIAL SKILLS, CAREER DEVELOPMENT AND CAREER MANAGEMENT BASED ON THE RESULTS OF THE ASSESSMENTS; EDUCATIONAL SERVICES, NAMELY, PROVIDING ON-LINE CLASSES, SEMINARS, WORKSHOPS, PRESENTATIONS, AND BLOGS DIRECTED TO THE PERSONAL EMPOWERMENT AND PERSONAL LIFE IMPROVEMENT OF WOMEN, AND PROVIDING ONLINE NONDOWNLOADABLE VIDEOS AND ARTICLES AS SUPPLEMENTAL MATERIALS FOR USE IN CONJUNCTION WITH ALL OF THE FOREGOING EDUCATIONAL SERVICES, IN CLASS 41 (U.S. CLS. 100, 101 AND 107).

FIRST USE 9-21-2011; IN COMMERCE 9-21-2011.

THE MARK CONSISTS OF STANDARD CHARACTERS WITHOUT CLAIM TO ANY PARTICULAR FONT, STYLE, SIZE, OR COLOR.

SER. NO. 85-472,718, FILED 11-15-2011.

CHRISTOPHER LAW, EXAMINING ATTORNEY



David J. Kyros

Director of the United States Patent and Trademark Office

United States of America

United States Patent and Trademark Office



Reg. No. 4,174,897

FRESH START WOMEN'S FOUNDATION (ARIZONA NON-PROFIT CORPORATION)
1130 E. MCDOWELL ROAD
PHOENIX, AZ 85006

Registered July 17, 2012

Int. Cl.: 41

FOR: DESIGNING AND RECOMMENDING ONLINE CUSTOM EDUCATIONAL CURRICULA FOR OTHERS BY CONDUCTING ON-LINE PERSONAL LIFESTYLE ASSESSMENTS IN THE FIELDS OF PERSONAL EMPOWERMENT, COMMUNICATION, LEADERSHIP, PERSONAL FINANCIAL SKILLS, CAREER DEVELOPMENT AND CAREER MANAGEMENT BASED ON THE RESULTS OF THE ASSESSMENTS; EDUCATIONAL SERVICES, NAMELY, PROVIDING ON-LINE CLASSES, SEMINARS, WORKSHOPS, PRESENTATIONS, AND BLOGS DIRECTED TO THE PERSONAL EMPOWERMENT AND PERSONAL LIFE IMPROVEMENT OF WOMEN, AND PROVIDING ONLINE NONDOWNLOADABLE VIDEOS AND ARTICLES AS SUPPLEMENTAL MATERIALS FOR USE IN CONJUNCTION WITH ALL OF THE FOREGOING EDUCATIONAL SERVICES, IN CLASS 41 (U.S. CLS. 100, 101 AND 107).

SERVICE MARK

PRINCIPAL REGISTER

FIRST USE 9-21-2011; IN COMMERCE 9-21-2011.

OWNER OF U.S. REG. NOS. 4,073,599, 4,073,603 AND OTHERS.

NO CLAIM IS MADE TO THE EXCLUSIVE RIGHT TO USE "WOMEN'S FOUNDATION RESOURCE", APART FROM THE MARK AS SHOWN.

THE MARK CONSISTS OF THE WORDS "WEHELPMEN.COM" ABOVE THE WORDS "A FRESH START WOMEN'S FOUNDATION RESOURCE" AND THE DESIGN ELEMENTS OF THE SILHOUETTE OF THE UPPER HALF OF A WOMAN WITH HER ARMS RAISED ABOVE HER HEAD AGAINST A SHADED OVAL BACKGROUND DESIGN.

SER. NO. 85-472,729, FILED 11-15-2011.

CHRISTOPHER LAW, EXAMINING ATTORNEY



David J. Kybas

Director of the United States Patent and Trademark Office

United States of America

United States Patent and Trademark Office

AMERICAN DREAMER

Reg. No. 4,174,898

NOVUS VENALICIUM, INC. (OREGON CORPORATION)

Registered July 17, 2012

PO BOX 4102
SALEM, OR 97302

Int. Cl.: 16

FOR: MAGAZINES FEATURING CONTENT TO INSPIRE, ENTERTAIN, INFORM AND ASSIST READERS IN TAKING CARE OF THEIR FAMILIES, FREEDOM AND HEALTH, IN CLASS 16 (U.S. CLS. 2, 5, 22, 23, 29, 37, 38 AND 50).

TRADEMARK

FIRST USE 10-7-2011; IN COMMERCE 10-7-2011.

PRINCIPAL REGISTER

THE MARK CONSISTS OF STANDARD CHARACTERS WITHOUT CLAIM TO ANY PARTICULAR FONT, STYLE, SIZE, OR COLOR.

SER. NO. 85-472,735, FILED 11-15-2011.

ANDREW LEASER, EXAMINING ATTORNEY



David J. Kyffers

Director of the United States Patent and Trademark Office

United States of America

United States Patent and Trademark Office

MyAccountProtector

Reg. No. 4,174,899

Registered July 17, 2012

Int. Cl.: 36

SERVICE MARK

PRINCIPAL REGISTER

HSBC FINANCE CORPORATION (DELAWARE CORPORATION)
5 SW LEGAL
26525 N. RIVERWOODS BOULEVARD
METTAWA, IL 60045

FOR: FINANCIAL SERVICES, NAMELY, A PLAN FOR SUSPENDING OR WAIVING A CREDIT CARD ACCOUNT BALANCE UPON CERTAIN QUALIFYING EVENTS, IN CLASS 36 (U.S. CLS. 100, 101 AND 102).

FIRST USE 9-0-2008; IN COMMERCE 9-0-2008.

THE MARK CONSISTS OF STANDARD CHARACTERS WITHOUT CLAIM TO ANY PARTICULAR FONT, STYLE, SIZE, OR COLOR.

SER. NO. 85-472,747, FILED 11-15-2011.

ANDREW LEASER, EXAMINING ATTORNEY



David J. Kyffers

Director of the United States Patent and Trademark Office

United States of America

United States Patent and Trademark Office

Lead Apparel

Reg. No. 4,174,900

Registered July 17, 2012

Int. Cl.: 40

SERVICE MARK

PRINCIPAL REGISTER

FLUENT SLANG INC. (ILLINOIS CORPORATION)
SUITE 1204
1305 S. MICHIGAN AVE.
CHICAGO, IL 60605

FOR: EMBROIDERY SERVICES, IN CLASS 40 (U.S. CLS. 100, 103 AND 106).

FIRST USE 9-1-2006; IN COMMERCE 9-1-2006.

THE MARK CONSISTS OF STANDARD CHARACTERS WITHOUT CLAIM TO ANY PARTICULAR FONT, STYLE, SIZE, OR COLOR.

OWNER OF U.S. REG. NO. 3,512,001.

NO CLAIM IS MADE TO THE EXCLUSIVE RIGHT TO USE "APPAREL", APART FROM THE MARK AS SHOWN.

SER. NO. 85-472,755, FILED 11-15-2011.

ANDREW LEASER, EXAMINING ATTORNEY



David J. Kybas

Director of the United States Patent and Trademark Office

United States of America

United States Patent and Trademark Office

LL&H LIFE, LIBERTY & HAPPINESS

Reg. No. 4,174,901

NOVUS VENALICIUM, INC. (OREGON CORPORATION)
PO BOX 4102

Registered July 17, 2012

SALEM, OR 97302

Int. Cl.: 16

FOR: MAGAZINES FEATURING CONTENT TO INSPIRE, ENTERTAIN, INFORM AND ASSIST READERS IN TAKING CARE OF THEIR FAMILIES, FREEDOM AND HEALTH, IN CLASS 16 (U.S. CLS. 2, 5, 22, 23, 29, 37, 38 AND 50).

TRADEMARK

FIRST USE 8-0-2011; IN COMMERCE 8-0-2011.

PRINCIPAL REGISTER

THE MARK CONSISTS OF STANDARD CHARACTERS WITHOUT CLAIM TO ANY PARTICULAR FONT, STYLE, SIZE, OR COLOR.

SER. NO. 85-472,764, FILED 11-15-2011.

ANDREW LEASER, EXAMINING ATTORNEY



David J. Kyros

Director of the United States Patent and Trademark Office

United States of America

United States Patent and Trademark Office

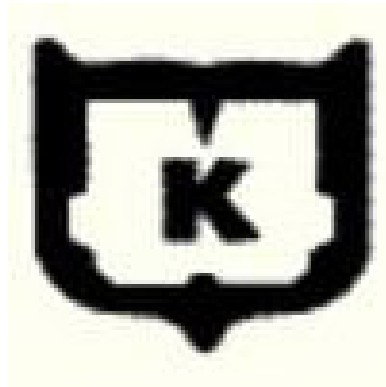

Reg. No. 4,174,902

Registered July 17, 2012

CERTIFICATION MARK

PRINCIPAL REGISTER

GOLDMAN, EZRA N. (UNITED STATES INDIVIDUAL)
1490
2000 TOWN CENTER
SOUTHFIELD, MI 48075

FOR: FOODS, IN CLASS A (U.S. CL. A).

FIRST USE 0-0-1980; IN COMMERCE 0-0-1980.

NO CLAIM IS MADE TO THE EXCLUSIVE RIGHT TO USE "K", APART FROM THE MARK AS SHOWN.

THE MARK CONSISTS OF THE LETTER "K" IN A STYLIZED SHIELD.

THE CERTIFICATION MARK CERTIFIES THE KOSHER QUALITY OF FOODS.

SER. NO. 85-472,771, FILED 11-15-2011.

ANDREW LEASER, EXAMINING ATTORNEY



David J. Kyjars

Director of the United States Patent and Trademark Office

United States of America

United States Patent and Trademark Office

Turbo·Brite Teeth Whitening Systems

Reg. No. 4,174,903

Registered July 17, 2012

Int. Cl.: 3

TRADEMARK

PRINCIPAL REGISTER

BULKX, LLC (TEXAS LIMITED LIABILITY COMPANY)
SUITE A
2708 SUNSET STRIP
GREENVILLE, TX 75402

FOR: TEETH WHITENING KIT, IN CLASS 3 (U.S. CLS. 1, 4, 6, 50, 51 AND 52).

FIRST USE 2-15-2011; IN COMMERCE 2-15-2011.

THE MARK CONSISTS OF STANDARD CHARACTERS WITHOUT CLAIM TO ANY PARTICULAR FONT, STYLE, SIZE, OR COLOR.

NO CLAIM IS MADE TO THE EXCLUSIVE RIGHT TO USE "TEETH WHITENING SYSTEMS", APART FROM THE MARK AS SHOWN.

SER. NO. 85-472,774, FILED 11-15-2011.

KATHERINE CONNOLLY, EXAMINING ATTORNEY



David J. Kybas

Director of the United States Patent and Trademark Office

United States of America

United States Patent and Trademark Office

Ancient Olive soap

Reg. No. 4,174,904

WUNDERLEY, INC. (PENNSYLVANIA CORPORATION)
128 WILSON AVE
GREENSBURG, PA 15601

Registered July 17, 2012

Int. Cl.: 3

FOR: NATURAL SOAP BARS FEATURING OLIVE OIL, IN CLASS 3 (U.S. CLS. 1, 4, 6, 50, 51 AND 52).

TRADEMARK

FIRST USE 1-1-2011; IN COMMERCE 1-1-2011.

PRINCIPAL REGISTER

THE MARK CONSISTS OF STANDARD CHARACTERS WITHOUT CLAIM TO ANY PARTICULAR FONT, STYLE, SIZE, OR COLOR.

NO CLAIM IS MADE TO THE EXCLUSIVE RIGHT TO USE "OLIVE SOAP", APART FROM THE MARK AS SHOWN.

SER. NO. 85-472,779, FILED 11-15-2011.

MELISSA VALLILLO, EXAMINING ATTORNEY



David J. Kybas

Director of the United States Patent and Trademark Office

United States of America

United States Patent and Trademark Office

The Spicy Goat

Reg. No. 4,174,905

TRB IP HOLDINGS, LLC (TEXAS LIMITED LIABILITY COMPANY)
8350 N. CENTRAL EXPRESSWAY, SUITE 925
DALLAS, TX 75206

Registered July 17, 2012

Int. Cl.: 29

FOR: PREPARED MEAL CONSISTING PRIMARILY OF A BEEF PATTY, TURKEY PATTY, BISON PATTY OR VEGETARIAN PATTY, ALSO CONTAINING VARIOUS TOPPING AND SAUCES, FOR CONSUMPTION ON OR OFF THE PREMISES, IN CLASS 29 (U.S. CL. 46).

TRADEMARK

FIRST USE 5-3-2010; IN COMMERCE 5-3-2010.

PRINCIPAL REGISTER

THE MARK CONSISTS OF STANDARD CHARACTERS WITHOUT CLAIM TO ANY PARTICULAR FONT, STYLE, SIZE, OR COLOR.

NO CLAIM IS MADE TO THE EXCLUSIVE RIGHT TO USE "GOAT", APART FROM THE MARK AS SHOWN.

SER. NO. 85-472,792, FILED 11-15-2011.

ESTHER A. BORSUK, EXAMINING ATTORNEY



David J. Kyffers

Director of the United States Patent and Trademark Office

United States of America

United States Patent and Trademark Office



Reg. No. 4,174,906

YOUR SOURCE PRODUCTS, INC. (FLORIDA CORPORATION)
1721 S. KINGS AVENUE
BRANDON, FL 33511

Registered July 17, 2012

Int. Cl.: 11

FOR: AIR CONDITIONING APPARATUS; AIR CONDITIONING UNITS; AIR HANDLERS;
HEAT PUMPS; HVAC UNITS, IN CLASS 11 (U.S. CLS. 13, 21, 23, 31 AND 34).

TRADEMARK

FIRST USE 5-1-2011; IN COMMERCE 5-1-2011.

PRINCIPAL REGISTER

NO CLAIM IS MADE TO THE EXCLUSIVE RIGHT TO USE "AIR CONDITIONING", APART
FROM THE MARK AS SHOWN.

THE COLOR(S) RED AND WHITE IS/ARE CLAIMED AS A FEATURE OF THE MARK.

THE MARK CONSISTS OF A RED HEXAGON WITH THE WORD "BROTHERS" CENTERED
ABOVE THE WORDS "AIR CONDITIONING" ALL WORDS CONTAINED INSIDE THE
HEXAGON IN WHITE STYLIZED LETTERS.

SER. NO. 85-472,816, FILED 11-15-2011.

WANDA KAY PRICE, EXAMINING ATTORNEY



David J. Kyffers

Director of the United States Patent and Trademark Office

United States of America

United States Patent and Trademark Office

W Nails & Spa

Reg. No. 4,174,907

Registered July 17, 2012

Int. Cl.: 44

SERVICE MARK

PRINCIPAL REGISTER

W NAILS & SPA, INC. (VIRGINIA CORPORATION), DBA W NAILS & SPA
1417 S. FERN STREET
ARLINGTON, VA 22202

FOR: NAIL CARE SALONS; NAIL CARE SERVICES, IN CLASS 44 (U.S. CLS. 100 AND 101).

FIRST USE 1-2-2010; IN COMMERCE 2-1-2010.

THE MARK CONSISTS OF STANDARD CHARACTERS WITHOUT CLAIM TO ANY PARTICULAR FONT, STYLE, SIZE, OR COLOR.

NO CLAIM IS MADE TO THE EXCLUSIVE RIGHT TO USE "NAILS & SPA", APART FROM THE MARK AS SHOWN.

SER. NO. 85-472,817, FILED 11-15-2011.

DANNEAN HETZEL, EXAMINING ATTORNEY



David J. Kyffers

Director of the United States Patent and Trademark Office

United States of America

United States Patent and Trademark Office

Mouthee

Reg. No. 4,174,908

MOUTHEE MEDIA LLC (DELAWARE LIMITED LIABILITY COMPANY)
175 EAST DELAWARE PLACE, STE 7206
CHICAGO, IL 60611

Registered July 17, 2012

Int. Cl.: 45

FOR: INTERNET-BASED SOCIAL NETWORKING SERVICES, IN CLASS 45 (U.S. CLS. 100 AND 101).

SERVICE MARK

FIRST USE 9-7-2011; IN COMMERCE 9-7-2011.

PRINCIPAL REGISTER

THE MARK CONSISTS OF STANDARD CHARACTERS WITHOUT CLAIM TO ANY PARTICULAR FONT, STYLE, SIZE, OR COLOR.

SER. NO. 85-472,818, FILED 11-15-2011.

TINA BROWN, EXAMINING ATTORNEY



David J. Kybas

Director of the United States Patent and Trademark Office

United States of America

United States Patent and Trademark Office

PROCON CONSTRUCTION SERVICES, LLC

Reg. No. 4,174,909

Registered July 17, 2012

Int. Cl.: 37

SERVICE MARK

PRINCIPAL REGISTER

PROCON CONSTRUCTION SERVICES, LLC (GEORGIA LIMITED LIABILITY COMPANY)
P. O. BOX 2340
VIDALIA, GA 30475

FOR: CONSTRUCTION SERVICES, NAMELY, COMMERCIAL, MULTI-FAMILY AND SINGLE FAMILY NEW CONSTRUCTION AND RENOVATION PROJECTS, IN CLASS 37 (U.S. CLS. 100, 103 AND 106).

FIRST USE 6-30-2008; IN COMMERCE 6-30-2008.

THE MARK CONSISTS OF STANDARD CHARACTERS WITHOUT CLAIM TO ANY PARTICULAR FONT, STYLE, SIZE, OR COLOR.

NO CLAIM IS MADE TO THE EXCLUSIVE RIGHT TO USE "CONSTRUCTION SERVICES, LLC", APART FROM THE MARK AS SHOWN.

SER. NO. 85-472,826, FILED 11-15-2011.

JAMES GRIFFIN, EXAMINING ATTORNEY



David J. Kyffers

Director of the United States Patent and Trademark Office

United States of America

United States Patent and Trademark Office

Lots-A-Shroom

Reg. No. 4,174,910

TRB IP HOLDINGS, LLC (TEXAS LIMITED LIABILITY COMPANY)
8350 N. CENTRAL EXPRESSWAY, SUITE 925
DALLAS, TX 75206

Registered July 17, 2012

Int. Cl.: 29

FOR: PREPARED MEAL CONSISTING PRIMARILY OF A BEEF PATTY, BISON PATTY OR VEGETARIAN PATTY, ALSO CONTAINING VARIOUS TOPPING AND SAUCES, FOR CONSUMPTION ON OR OFF THE PREMISES, IN CLASS 29 (U.S. CL. 46).

TRADEMARK

FIRST USE 5-3-2010; IN COMMERCE 5-3-2010.

PRINCIPAL REGISTER

THE MARK CONSISTS OF STANDARD CHARACTERS WITHOUT CLAIM TO ANY PARTICULAR FONT, STYLE, SIZE, OR COLOR.

SER. NO. 85-472,828, FILED 11-15-2011.

ESTHER A. BORSUK, EXAMINING ATTORNEY



David J. Kyffers

Director of the United States Patent and Trademark Office

United States of America

United States Patent and Trademark Office



Reg. No. 4,174,911

Registered July 17, 2012

Int. Cl.: 37

SERVICE MARK

PRINCIPAL REGISTER

PROCON CONSTRUCTION SERVICES, LLC (GEORGIA LIMITED LIABILITY COMPANY)
P. O. BOX 2340
VIDALIA, GA 30475

FOR: CONSTRUCTION SERVICES, NAMELY, COMMERCIAL, MULTI-FAMILY AND SINGLE FAMILY NEW CONSTRUCTION AND RENOVATION PROJECTS, IN CLASS 37 (U.S. CLS. 100, 103 AND 106).

FIRST USE 8-31-2009; IN COMMERCE 8-31-2009.

NO CLAIM IS MADE TO THE EXCLUSIVE RIGHT TO USE "PROFESSIONAL" OR "CONSTRUCTION SERVICES, LLC", APART FROM THE MARK AS SHOWN.

THE MARK CONSISTS OF IMAGE OF HAMMER HITTING NAIL, WITH WORD, "PROFESSIONAL", PRINTED TO THE SIDE OF THE HEAD OF THE HAMMER, AND THE WORDS, "PROCON CONSTRUCTION SERVICES, LLC", BENEATH THE BODY OF THE HAMMER AND NAIL.

SER. NO. 85-472,870, FILED 11-15-2011.

JAMES GRIFFIN, EXAMINING ATTORNEY



David J. Kyffers

Director of the United States Patent and Trademark Office

United States of America

United States Patent and Trademark Office



Reg. No. 4,174,912

Registered July 17, 2012

Int. Cl.: 3

TRADEMARK

PRINCIPAL REGISTER

MARGARITA ABURTO ZALDIVAR (MEXICO INDIVIDUAL)
PROL. EMILIANO ZAPATA #97, COL. CENTRO
TEMIXCO, MORELOS, MEXICO 62580

FOR: ANTI-AGING CREAMS; COSMETIC MASSAGE CREAMS; COSMETIC PREPARATIONS, NAMELY, FIRING LOTIONS; FACIAL BEAUTY MASKS; GEL FOR SKIN SCULPTING AND FIRING AND CELLULITE REDUCTION; MAKE-UP REMOVING MILK, GEL, LOTIONS AND CREAMS; NON-MEDICATED SKIN CARE PREPARATIONS, NAMELY, HERBAL PREPARATIONS FOR CELLULITE REDUCTION, CIRCULATORY PROBLEMS, RESPIRATORY PROBLEMS, POSTPARTUM, WEIGHT LOSE, BATH AND SHOWER AND ICE THERAPY, IN CLASS 3 (U.S. CLS. 1, 4, 6, 50, 51 AND 52).

FIRST USE 8-31-2006; IN COMMERCE 8-31-2006.

THE NAME "MARGARITA ABURTO" IDENTIFIES A LIVING INDIVIDUAL WHOSE CONSENT IS OF RECORD.

THE MARK CONSISTS OF A DEPICTION OF A WOMAN IN A DRESS BEHIND THE WORDS "MARGARITA ABURTO" IN A SPECIAL FONT AND UNDERLINED WITH A LINE THAT COMES FROM THICK IN THE LEFT TO THIN AT THE RIGHT END.

SER. NO. 85-472,884, FILED 11-15-2011.

BRIDGETT SMITH, EXAMINING ATTORNEY



David J. Kybas

Director of the United States Patent and Trademark Office

United States of America

United States Patent and Trademark Office

FREE FLOW 300

Reg. No. 4,174,913

FREE FLOW TECHNOLOGIES, LTD. (ILLINOIS CORPORATION)
9918 N. ALPINE ROAD
MACHESNEY PARK, IL 611158211

Registered July 17, 2012

Int. Cl.: 1

FOR: CHEMICAL ADDITIVES FOR TREATMENT OF HAZARDOUS AND NON-HAZARDOUS HEAVY METAL WASTES FOR INDUSTRIAL USE, IN CLASS 1 (U.S. CLS. 1, 5, 6, 10, 26 AND 46).

TRADEMARK

FIRST USE 4-29-2011; IN COMMERCE 4-29-2011.

PRINCIPAL REGISTER

THE MARK CONSISTS OF STANDARD CHARACTERS WITHOUT CLAIM TO ANY PARTICULAR FONT, STYLE, SIZE, OR COLOR.

OWNER OF U.S. REG. NOS. 2,416,820 AND 2,502,447.

SER. NO. 85-472,913, FILED 11-15-2011.

WENDY GOODMAN, EXAMINING ATTORNEY



David J. Kyjars

Director of the United States Patent and Trademark Office

United States of America

United States Patent and Trademark Office

FOCUS ALONG

Reg. No. 4,174,914

Registered July 17, 2012

Int. Cl.: 9

TRADEMARK

PRINCIPAL REGISTER

ROSS, ARLENE (UNITED STATES INDIVIDUAL)
PO BOX 659
CENTRAL VALLEY, NY 10917

FOR: DVDS FEATURING ACTIVITIES TO HELP CHILDREN CONCENTRATE AND FOCUS;
PRE-RECORDED DVDS FEATURING ACTIVITIES TO HELP CHILDREN CONCENTRATE
AND FOCUS, IN CLASS 9 (U.S. CLS. 21, 23, 26, 36 AND 38).

FIRST USE 4-0-2005; IN COMMERCE 4-0-2005.

THE MARK CONSISTS OF STANDARD CHARACTERS WITHOUT CLAIM TO ANY PAR-
TICULAR FONT, STYLE, SIZE, OR COLOR.

NO CLAIM IS MADE TO THE EXCLUSIVE RIGHT TO USE "FOCUS", APART FROM THE
MARK AS SHOWN.

SER. NO. 85-472,930, FILED 11-15-2011.

WENDY GOODMAN, EXAMINING ATTORNEY



David J. Kyffers

Director of the United States Patent and Trademark Office

United States of America

United States Patent and Trademark Office

California NOW

Reg. No. 4,174,915

Registered July 17, 2012

Int. Cls.: 16, 35 and 36

TRADEMARK

SERVICE MARK

PRINCIPAL REGISTER

CALIFORNIA NOW (CALIFORNIA CORPORATION), AKA CALIFORNIA NATIONAL ORGANIZATION FOR WOMEN
915 L STREET, C245
SACRAMENTO, CA 95814

FOR: PRINTED REPORTS, NEWSLETTERS AND BROCHURES RELATING TO WOMEN'S SOCIAL, ECONOMIC AND POLITICAL, IN CLASS 16 (U.S. CLS. 2, 5, 22, 23, 29, 37, 38 AND 50).

FIRST USE 3-23-1975; IN COMMERCE 3-23-1975.

FOR: ASSOCIATION SERVICES, NAMELY, PROMOTING SOCIAL, ECONOMIC AND POLITICAL EQUALITY FOR ALL WOMEN, IN CLASS 35 (U.S. CLS. 100, 101 AND 102).

FIRST USE 3-23-1975; IN COMMERCE 3-23-1975.

FOR: PUBLIC INTEREST FUNDRAISING FOR OTHERS IN THE FIELD OF WOMEN'S SOCIAL, ECONOMIC AND POLITICAL EQUALITY, IN CLASS 36 (U.S. CLS. 100, 101 AND 102).

FIRST USE 3-23-1975; IN COMMERCE 3-23-1975.

THE MARK CONSISTS OF STANDARD CHARACTERS WITHOUT CLAIM TO ANY PARTICULAR FONT, STYLE, SIZE, OR COLOR.

NO CLAIM IS MADE TO THE EXCLUSIVE RIGHT TO USE "CALIFORNIA", APART FROM THE MARK AS SHOWN.

SER. NO. 85-472,932, FILED 11-15-2011.

DAVID MURRAY, EXAMINING ATTORNEY



David J. Kyffers

Director of the United States Patent and Trademark Office

United States of America

United States Patent and Trademark Office

ExperienceCreditUnions

Reg. No. 4,174,916

EXPERIENCE CREDITUNIONS, LLC (OHIO LIMITED LIABILITY COMPANY)
5112 BRESSLER DR.
HILLIARD, OH 43026

Registered July 17, 2012

Int. Cl.: 35

FOR: PROVIDING A SEARCHABLE ONLINE ADVERTISING WEBSITE AND INFORMATIONAL GUIDE FEATURING THE GOODS AND SERVICES OF OTHER VENDORS VIA THE INTERNET IN THE FIELD OF CREDIT UNIONS AND OTHER FINANCIAL SERVICE PROVIDERS, IN CLASS 35 (U.S. CLS. 100, 101 AND 102).

SERVICE MARK

PRINCIPAL REGISTER

FIRST USE 8-24-2011; IN COMMERCE 9-1-2011.

THE MARKS CONSISTS OF THE WORDING "EXPERIENCECREDITUNIONS". THE WORD "EXPERIENCE" IS IN GREEN AND THE WORDING "CREDITUNIONS" IS IN GRAY.

THE COLOR(S) GREEN AND GRAY IS/ARE CLAIMED AS A FEATURE OF THE MARK.

SER. NO. 85-472,939, FILED 11-15-2011.

TARAH HARDY, EXAMINING ATTORNEY



David J. Kybas

Director of the United States Patent and Trademark Office

United States of America

United States Patent and Trademark Office

SynGold

Reg. No. 4,174,917

Registered July 17, 2012

Int. Cl.: 4

TRADEMARK

PRINCIPAL REGISTER

CHAMPION BRANDS, LLC (MISSOURI LIMITED LIABILITY COMPANY)
1001 GOLDEN DRIVE
CLINTON, MO 64735

FOR: ALL PURPOSE LUBRICANTS; AUTOMOBILE LUBRICANTS; AUTOMOTIVE LUBRICANTS; INDUSTRIAL AND VEHICULAR LUBRICANTS; INDUSTRIAL LUBRICANTS; LUBRICANTS FOR AIRCRAFT ENGINES; LUBRICANTS FOR INDUSTRIAL MACHINERY; LUBRICATING GREASES; LUBRICATING OIL FOR MOTOR VEHICLE ENGINES; LUBRICATING OILS; LUBRICATING OILS; LUBRICATING OILS AND GREASES; LUBRICATING OILS FOR AUTOMOTIVE/INDUSTRIAL; LUBRICATION GREASE FOR VEHICLES; MARINE LUBRICANTS; MINERAL LUBRICATING OILS; MOTOR VEHICLE LUBRICANTS; PREMIUM SPECIALTY INDUSTRIAL LUBRICANTS, IN CLASS 4 (U.S. CLS. 1, 6 AND 15).

FIRST USE 1-1-2009; IN COMMERCE 2-1-2009.

THE MARK CONSISTS OF STANDARD CHARACTERS WITHOUT CLAIM TO ANY PARTICULAR FONT, STYLE, SIZE, OR COLOR.

SER. NO. 85-472,955, FILED 11-15-2011.

GINA HAYES, EXAMINING ATTORNEY



David J. Kyros

Director of the United States Patent and Trademark Office

United States of America

United States Patent and Trademark Office

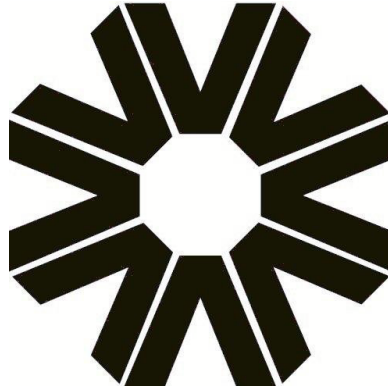

Reg. No. 4,174,918

Registered July 17, 2012

Int. Cl.: 7

TRADEMARK

PRINCIPAL REGISTER

VANMARK EQUIPMENT, LLC (OHIO LIMITED LIABILITY COMPANY)
1160 GAHANNA PARKWAY
COLUMBUS, OH 43230

FOR: VEGETABLE HANDLING AND PROCESSING EQUIPMENT, NAMELY CROSS FEED CONVEYORS, CRATE FILLERS, MECHANICALLY OPERATED BULK STORAGE AND SURGE BINS, HYDRAULICALLY OPERATED CRATE BUMPERS, DESTONERS FOR SEPARATING FOREIGN MATTER FROM VEGETABLES, PEELER-WASHER UNITS, VEGETABLE INSPECTION CONVEYORS, VERTICAL ELEVATORS, INCLINED FEEDERS AND VEGETABLE CUTTING MACHINES, IN CLASS 7 (U.S. CLS. 13, 19, 21, 23, 31, 34 AND 35).

FIRST USE 11-1-1967; IN COMMERCE 11-1-1967.

OWNER OF U.S. REG. NO. 993,027.

THE MARK CONSISTS OF A PLURALITY OF LETTERS "V" FORMING A CIRCLE.

SER. NO. 85-472,967, FILED 11-15-2011.

GINA HAYES, EXAMINING ATTORNEY



David J. Kyjars

Director of the United States Patent and Trademark Office

United States of America

United States Patent and Trademark Office



Reg. No. 4,174,919

ECHO, INC. (INDIANA CORPORATION)
17391 DURRANCE ROAD
N. FORT MEYERS, FL 33917

Registered July 17, 2012

Int. Cl.: 44

FOR: PROVIDING INFORMATION IN THE FIELD OF AGRICULTURE TO DISADVANTAGED PEOPLE; CHARITABLE SERVICES, NAMELY, PROVIDING AGRICULTURAL TRAINING TO DISADVANTAGED PEOPLE AND PROVIDING SEEDS FOR AGRICULTURAL USE, IN CLASS 44 (U.S. CLS. 100 AND 101).

SERVICE MARK

PRINCIPAL REGISTER

FIRST USE 12-31-2002; IN COMMERCE 12-31-2002.

THE MARK CONSISTS OF A GLOBE WITH LEAF DESIGN AND THE WORDS ECHO NEXT TO THE GLOBE.

SER. NO. 85-472,977, FILED 11-15-2011.

GINA HAYES, EXAMINING ATTORNEY



David J. Kybas

Director of the United States Patent and Trademark Office

United States of America

United States Patent and Trademark Office



Reg. No. 4,174,920

Registered July 17, 2012

Int. Cl.: 35

SERVICE MARK

PRINCIPAL REGISTER

AUTOMARKETSHOP.COM, LLC (MARYLAND LIMITED LIABILITY COMPANY)

#D

12305 SILVERGATE WAY
GERMANTOWN, MD 20874

FOR: MARKETING CONSULTING; ON-LINE ADVERTISING AND MARKETING SERVICES,
IN CLASS 35 (U.S. CLS. 100, 101 AND 102).

FIRST USE 7-12-2011; IN COMMERCE 9-27-2011.

NO CLAIM IS MADE TO THE EXCLUSIVE RIGHT TO USE "APPRAISE. MARKET. SELL",
APART FROM THE MARK AS SHOWN.

THE STIPPLING IS FOR SHADING PURPOSES ONLY.

THE MARK CONSISTS OF AN OUTLINE OF THE UPPER PORTION OF A CAR WITH A
TINTED WINDSHIELD ABOVE THE NAME "AUTOMARKETSHOP.COM" WHICH IS ABOVE
AND TO THE RIGHT OF THE WORDS "APPRAISE. MARKET. SELL".

SER. NO. 85-472,991, FILED 11-15-2011.

JOHN WILKE, EXAMINING ATTORNEY



David J. Kyffers

Director of the United States Patent and Trademark Office

United States of America

United States Patent and Trademark Office

BETTERWEATHER

Reg. No. 4,174,921

Registered July 17, 2012

Int. Cl.: 42

SERVICE MARK

PRINCIPAL REGISTER

BETTERWEATHER, INC. (COLORADO CORPORATION)
#203
3457 RIGSBY CT.
DENVER, CO 80216

FOR: MULTIDISCIPLINARY GRAPHIC DESIGN SERVICES; PROVIDING GRAPHIC AND MULTIMEDIA DESIGN SERVICES FOR THE PURPOSE OF PROMOTING THE GOODS AND SERVICES OF OTHERS, IN CLASS 42 (U.S. CLS. 100 AND 101).

FIRST USE 4-2-2010; IN COMMERCE 4-2-2010.

THE MARK CONSISTS OF STANDARD CHARACTERS WITHOUT CLAIM TO ANY PARTICULAR FONT, STYLE, SIZE, OR COLOR.

SER. NO. 85-472,993, FILED 11-15-2011.

PRISCILLA MILTON, EXAMINING ATTORNEY



David J. Kybas

Director of the United States Patent and Trademark Office

United States of America

United States Patent and Trademark Office

brothers air conditioning

Reg. No. 4,174,922

YOUR SOURCE PRODUCTS, INC. (FLORIDA CORPORATION)
1721 S. KINGS AVENUE
BRANDON, FL 33511

Registered July 17, 2012

Int. Cl.: 11

FOR: AIR CONDITIONING APPARATUS; AIR CONDITIONING UNITS; AIR HANDLERS;
HEAT PUMPS; HVAC UNITS, IN CLASS 11 (U.S. CLS. 13, 21, 23, 31 AND 34).

TRADEMARK

FIRST USE 5-1-2011; IN COMMERCE 5-1-2011.

PRINCIPAL REGISTER

THE MARK CONSISTS OF STANDARD CHARACTERS WITHOUT CLAIM TO ANY PARTICULAR FONT, STYLE, SIZE, OR COLOR.

NO CLAIM IS MADE TO THE EXCLUSIVE RIGHT TO USE "AIR CONDITIONING", APART FROM THE MARK AS SHOWN.

SER. NO. 85-473,046, FILED 11-15-2011.

WANDA KAY PRICE, EXAMINING ATTORNEY



David J. Kybas

Director of the United States Patent and Trademark Office

United States of America

United States Patent and Trademark Office

PLUS+ ADVANTAGE

Reg. No. 4,174,923

MATTRESS SAFE, INC. (GEORGIA CORPORATION)

Registered July 17, 2012

P.O. BOX 2267
CUMMING, GA 30041

Int. Cl.: 24

FOR: ENCASUREMENTS FOR BED PRODUCTS, NAMELY, MATTRESS AND BOX SPRING COVERS, IN CLASS 24 (U.S. CLS. 42 AND 50).

TRADEMARK

FIRST USE 8-0-2010; IN COMMERCE 8-0-2010.

PRINCIPAL REGISTER

THE MARK CONSISTS OF STANDARD CHARACTERS WITHOUT CLAIM TO ANY PARTICULAR FONT, STYLE, SIZE, OR COLOR.

SER. NO. 85-473,082, FILED 11-15-2011.

JENNIFER VASQUEZ, EXAMINING ATTORNEY



David J. Kybas

Director of the United States Patent and Trademark Office

United States of America

United States Patent and Trademark Office

UCCELLO CHOCOLATES

Reg. No. 4,174,924

WALSHON, REBECCA (ILLINOIS SOLE PROPRIETORSHIP)
4526 W. HOWDY LANE
ALSIP, IL 60803

Registered July 17, 2012

Int. Cl.: 30

FOR: CAKES; CHOCOLATE; CHOCOLATE CANDIES; CHOCOLATE COVERED FRUIT;
CHOCOLATE TRUFFLES; COOKIES; CUP CAKES, IN CLASS 30 (U.S. CL. 46).

TRADEMARK

FIRST USE 10-0-2011; IN COMMERCE 10-0-2011.

PRINCIPAL REGISTER

THE MARK CONSISTS OF STANDARD CHARACTERS WITHOUT CLAIM TO ANY PARTICULAR FONT, STYLE, SIZE, OR COLOR.

NO CLAIM IS MADE TO THE EXCLUSIVE RIGHT TO USE "CHOCOLATES", APART FROM THE MARK AS SHOWN.

THE ENGLISH TRANSLATION OF "UCCELLO" IN THE MARK IS "BIRD".

SER. NO. 85-473,084, FILED 11-15-2011.

CURTIS FRENCH, EXAMINING ATTORNEY



David J. Kybas

Director of the United States Patent and Trademark Office

United States of America

United States Patent and Trademark Office



Reg. No. 4,174,925

Registered July 17, 2012

Int. Cl.: 3

TRADEMARK

PRINCIPAL REGISTER

DUBOSE, CHRISTINE S. (UNITED STATES INDIVIDUAL)
8095 DOAR ROAD
AWENDAW, SC 29429

FOR: 3-IN-1 HAIR SHAMPOOS; HAIR SHAMPOOS AND CONDITIONERS; HAIR STYLING FIXATIVE IN THE NATURE OF HAIR WAX; HAIR STYLING PREPARATIONS; HAIR STYLING SPRAY; STYLING GELS; STYLING LOTIONS; STYLING MOUSSE; STYLING PASTE FOR HAIR, IN CLASS 3 (U.S. CLS. 1, 4, 6, 50, 51 AND 52).

FIRST USE 9-0-2011; IN COMMERCE 9-0-2011.

THE MARK CONSISTS OF THE WORDS "MER" "CHIC" AND A DRAWING OF A SKELETON MERMAID.

SER. NO. 85-473,098, FILED 11-15-2011.

SUNG IN, EXAMINING ATTORNEY



David J. Kyffers

Director of the United States Patent and Trademark Office

United States of America

United States Patent and Trademark Office

VRIDE

Reg. No. 4,174,926

Registered July 17, 2012

Int. Cls.: 39 and 45

SERVICE MARK

PRINCIPAL REGISTER

VPSI, INC. (DELAWARE CORPORATION)
1220 RANKIN STREET
TROY, MI 48083

FOR: CARPOOL AND VANPOOL TRANSPORTATION SERVICES, NAMELY, TRANSPORTING PEOPLE, VEHICLE LEASING SERVICES AND CONSULTING SERVICES IN CONNECTION THEREWITH, IN CLASS 39 (U.S. CLS. 100 AND 105).

FIRST USE 7-1-2010; IN COMMERCE 7-1-2010.

FOR: ON-LINE SOCIAL NETWORKING SERVICES, IN CLASS 45 (U.S. CLS. 100 AND 101).

FIRST USE 7-1-2010; IN COMMERCE 7-1-2010.

THE MARK CONSISTS OF STANDARD CHARACTERS WITHOUT CLAIM TO ANY PARTICULAR FONT, STYLE, SIZE, OR COLOR.

OWNER OF U.S. REG. NO. 4,048,130.

SER. NO. 85-473,108, FILED 11-15-2011.

NAKIA HENRY, EXAMINING ATTORNEY



David J. Kyffers

Director of the United States Patent and Trademark Office

United States of America

United States Patent and Trademark Office

DOLCI DELLA DEA GODDESS SWEETS

Reg. No. 4,174,927

GODDESS IN YOU, LLC (NEW JERSEY LIMITED LIABILITY COMPANY)
223 WANAQUE AVENUE
POMPTON LAKES, NJ 07442

Registered July 17, 2012

Int. Cl.: 30

FOR: BAKERY PRODUCTS, BAKERY GOODS, BAKERY DESSERTS, CANNOLI SHELLS AND FILLING FOR THE SHELLS, TARTLET SHELLS AND FILLING FOR THE SHELLS, BROWNIES, CHOCOLATES, DESSERT PUDDINGS, DESSERT MOUSSE, CUSTARDS, GELATO, CHOCOLATE COVERED DRIED FRUIT, CHOCOLATE COVERED NUTS, AND YOGURT-COVERED NUTS, IN CLASS 30 (U.S. CL. 46).

TRADEMARK

PRINCIPAL REGISTER

FIRST USE 8-24-2011; IN COMMERCE 8-24-2011.

THE MARK CONSISTS OF STANDARD CHARACTERS WITHOUT CLAIM TO ANY PARTICULAR FONT, STYLE, SIZE, OR COLOR.

THE ENGLISH TRANSLATION OF "DOLCI DELLA DEA" IN THE MARK IS "SWEETS OF THE GODDESS".

SER. NO. 85-473,128, FILED 11-15-2011.

NAKIA HENRY, EXAMINING ATTORNEY



David J. Kybas

Director of the United States Patent and Trademark Office

United States of America

United States Patent and Trademark Office



Reg. No. 4,174,928

Registered July 17, 2012

Int. Cls.: 29, 30 and 43

TRADEMARK

SERVICE MARK

PRINCIPAL REGISTER

DUNN BROS COFFEE FRANCHISING, INC. (MINNESOTA CORPORATION)
111 THIRD AVENUE SOUTH, SUITE 220
MINNEAPOLIS, MN 55401

FOR: SOUPS; VEGETABLE SALADS, IN CLASS 29 (U.S. CL. 46).

FIRST USE 8-6-2011; IN COMMERCE 8-6-2011.

FOR: BAKERY DESSERTS; BREAD AND PASTRY; COCOA-BASED BEVERAGES; COFFEE BEANS; MUFFINS; PREPARED COFFEE AND COFFEE-BASED BEVERAGES; SANDWICHES; SCONES, IN CLASS 30 (U.S. CL. 46).

FIRST USE 8-6-2011; IN COMMERCE 8-6-2011.

FOR: RESTAURANT SERVICES, NAMELY, PROVIDING OF FOOD AND BEVERAGES FOR CONSUMPTION ON AND OFF THE PREMISES, IN CLASS 43 (U.S. CLS. 100 AND 101).

FIRST USE 8-6-2011; IN COMMERCE 8-6-2011.

OWNER OF U.S. REG. NOS. 1,923,915, 2,869,470, AND 2,874,629.

NO CLAIM IS MADE TO THE EXCLUSIVE RIGHT TO USE "PROVISIONS" AND "BROS. BAKERY CAFE", APART FROM THE MARK AS SHOWN.

THE MARK CONSISTS OF THE LETTER "P" WITHIN A CIRCLE ABOVE A RECTANGULAR SHAPE CONTAINING TWO CROSSED WHEAT STEMS ABOVE THE WORDS "PROVISIONS DUNN BROS BAKERY CAFE".

SER. NO. 85-473,132, FILED 11-15-2011.

FLORENTINA BLANDU, EXAMINING ATTORNEY



David J. Kybas

Director of the United States Patent and Trademark Office

United States of America

United States Patent and Trademark Office

QUEEN CITY CLASSIC

Reg. No. 4,174,929

Registered July 17, 2012

Int. Cl.: 41

SERVICE MARK

PRINCIPAL REGISTER

PROSCAN INVESTMENTS, LLC (OHIO CORPORATION)
5400 KENNEDY AVENUE
CINCINNATI, OH 45213

FOR: EDUCATIONAL AND ENTERTAINMENT SERVICES IN THE NATURE OF COMPETITIONS AND TOURNAMENTS, INCLUDING CHESS TOURNAMENTS, TO ASSIST YOUNG PEOPLE IN MENTAL, PHYSICAL, AND SOCIAL DEVELOPMENT, IN CLASS 41 (U.S. CLS. 100, 101 AND 107).

FIRST USE 4-5-2002; IN COMMERCE 4-5-2002.

THE MARK CONSISTS OF STANDARD CHARACTERS WITHOUT CLAIM TO ANY PARTICULAR FONT, STYLE, SIZE, OR COLOR.

OWNER OF U.S. REG. NOS. 3,022,234 AND 3,067,553.

SEC. 2(F).

SER. NO. 85-473,152, FILED 11-15-2011.

LUCY ARANT, EXAMINING ATTORNEY



David J. Kyffers

Director of the United States Patent and Trademark Office

United States of America

United States Patent and Trademark Office

SPONSORLINK

Reg. No. 4,174,930

REPUCOM AMERICA, LLC (DELAWARE LIMITED LIABILITY COMPANY), DBA REPUCOM
422 SUMMER STREET
STAMFORD, CT 06901

Registered July 17, 2012

Int. Cl.: 35

FOR: MARKET ANALYSIS AND RESEARCH SERVICES FOR THE SPORTS AND SPONSORSHIP INDUSTRIES, IN CLASS 35 (U.S. CLS. 100, 101 AND 102).

SERVICE MARK

FIRST USE 11-1-2011; IN COMMERCE 11-1-2011.

PRINCIPAL REGISTER

THE MARK CONSISTS OF THE WORD "SPONSORLINK", WITH "SPONSOR" IN GREEN AND "LINK" IN BLACK.

THE COLOR(S) GREEN AND BLACK IS/ARE CLAIMED AS A FEATURE OF THE MARK.

SER. NO. 85-473,160, FILED 11-15-2011.

ANTHONY RINKER, EXAMINING ATTORNEY



David J. Kyffers

Director of the United States Patent and Trademark Office

United States of America

United States Patent and Trademark Office

Your Trusted Bullion Dealer

Reg. No. 4,174,931

SILVER GOLD BULL, INC. (CANADA CORPORATION)
P.O. BOX 2621 ROCKY MOUNTAIN HOUSE
ALBERTA, CANADA T4T1L6

Registered July 17, 2012

Int. Cl.: 35

FOR: RETAIL STORE SERVICES FEATURING PRECIOUS METALS, IN CLASS 35 (U.S. CLS. 100, 101 AND 102).

SERVICE MARK

FIRST USE 1-1-2010; IN COMMERCE 1-1-2010.

PRINCIPAL REGISTER

THE MARK CONSISTS OF STANDARD CHARACTERS WITHOUT CLAIM TO ANY PARTICULAR FONT, STYLE, SIZE, OR COLOR.

NO CLAIM IS MADE TO THE EXCLUSIVE RIGHT TO USE "BULLION DEALER", APART FROM THE MARK AS SHOWN.

SER. NO. 85-473,173, FILED 11-15-2011.

KRISTIN DAHLING, EXAMINING ATTORNEY



David J. Kyffers

Director of the United States Patent and Trademark Office

United States of America

United States Patent and Trademark Office

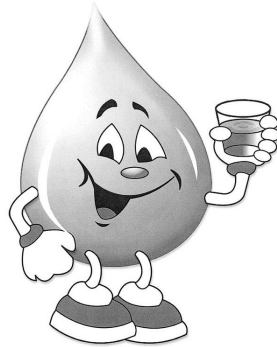

Reg. No. 4,174,932

Registered July 17, 2012

Int. Cls.: 35, 39 and 43

SERVICE MARK

PRINCIPAL REGISTER

PRESTIGE VENDING SERVICES, INC. (NEW YORK CORPORATION)
53A OTIS STREET
WEST BABYLON, NY 11704

FOR: VENDING MACHINE SERVICES FEATURING PREPACKAGED BEVERAGES AND FOODS; VENDING MACHINE RENTAL AND STOCKING OF VENDING MACHINES WITH PREPACKAGED BEVERAGES AND FOODS; RETAIL VENDING MACHINE SERVICES THROUGH DIRECT SOLICITATION BY DISTRIBUTORS TO END-USERS; LEASING OF VENDING MACHINES; COFFEE VENDING MACHINE SERVICES, IN CLASS 35 (U.S. CLS. 100, 101 AND 102).

FIRST USE 11-30-2005; IN COMMERCE 11-30-2005.

FOR: WATER SUPPLY AND DISTRIBUTION SERVICES; PROVIDING HOME AND OFFICE WATER DELIVERY SERVICES, BOTTLED DRINKING WATER, FLUORIDATED WATER AND PURIFIED WATER FOR HUMAN CONSUMPTION; DELIVERY OF COFFEE, COFFEE RELATED ITEMS, BEVERAGES AND PREPACKAGED FOODS; DELIVERY OF GOODS; DISTRIBUTION SERVICES, NAMELY, DELIVERY OF JANITORIAL AND CLEANING SUPPLIES, IN CLASS 39 (U.S. CLS. 100 AND 105).

FIRST USE 11-30-2005; IN COMMERCE 11-30-2005.

FOR: RENTAL OF OFFICE COFFEE SUPPLY EQUIPMENT; OFFICE COFFEE SUPPLY SERVICES; RENTAL OF DRINKING WATER EQUIPMENT, NAMELY, WATER COOLERS AND HOT AND COLD DISPENSING CONSOLES, IN CLASS 43 (U.S. CLS. 100 AND 101).

FIRST USE 11-30-2005; IN COMMERCE 11-30-2005.

THE MARK CONSISTS OF A CHARACTER FORMED OF A SINGLE DROP OF WATER WITH A FACE, ARMS AND LEGS REPRESENTING A PERSON. THE WATER DROP CHARACTER HOLDS A PARTIALLY FILLED CUP IN ITS RAISED LEFT HAND.

SER. NO. 85-473,185, FILED 11-15-2011.

JUDITH HELFMAN, EXAMINING ATTORNEY



David J. Kyffers

Director of the United States Patent and Trademark Office

United States of America

United States Patent and Trademark Office



Reg. No. 4,174,933

MINNEAPOLIS RAG STOCK COMPANY (MINNESOTA CORPORATION), DBA RAGSTOCK
830 N &TH ST
MINNEAPOLIS, MN 55411

Registered July 17, 2012

Int. Cl.: 35

FOR: ONLINE RETAIL STORE SERVICES FEATURING SWEATERS, IN CLASS 35 (U.S. CLS. 100, 101 AND 102).

SERVICE MARK

FIRST USE 6-27-2011; IN COMMERCE 6-27-2011.

PRINCIPAL REGISTER

NO CLAIM IS MADE TO THE EXCLUSIVE RIGHT TO USE "THE SWEATER STORE .COM", APART FROM THE MARK AS SHOWN.

THE MARK CONSISTS OF AN IRREGULAR RECTANGULAR SHAPE IN SOLID COLOR WITH THE WORDS "THE SWEATER STORE.COM" LINED UP AGAINST THE RIGHT SIDE OF THE INSIDE OF THE RECTANGLE WITH A HALF OF SNOWFLAKE PROTRUDING FROM THE RIGHT SIDE OF THE RECTANGLE.

SER. NO. 85-473,194, FILED 11-15-2011.

KRISTINA MORRIS, EXAMINING ATTORNEY



David J. Kybas

Director of the United States Patent and Trademark Office

United States of America

United States Patent and Trademark Office

Text to Sex

Reg. No. 4,174,934

APB PRODUCTIONS, INC. (CALIFORNIA CORPORATION), DBA ABCS OF ATTRACTION
8350 WILSHIRE BL. SUITE 200
LOS ANGELES, CA 90211

Registered July 17, 2012

Int. Cl.: 41

FOR: PROVIDING EDUCATION COURSES IN THE FIELD OF DATING OFFERED THROUGH
ONLINE, NON-DOWNLOADABLE VIDEOS AND INSTRUCTOR ASSISTANCE , IN CLASS
41 (U.S. CLS. 100, 101 AND 107).

SERVICE MARK

FIRST USE 11-19-2009; IN COMMERCE 2-2-2011.

PRINCIPAL REGISTER

THE MARK CONSISTS OF STANDARD CHARACTERS WITHOUT CLAIM TO ANY PAR-
TICULAR FONT, STYLE, SIZE, OR COLOR.

SER. NO. 85-473,241, FILED 11-15-2011.

TASHIA BUNCH, EXAMINING ATTORNEY



David J. Kyffers

Director of the United States Patent and Trademark Office

United States of America

United States Patent and Trademark Office



Reg. No. 4,174,935

Registered July 17, 2012

Int. Cl.: 35

SERVICE MARK

PRINCIPAL REGISTER

LOOTOK, LTD. (NEW YORK CORPORATION)
228 PARK AVENUE SOUTH, SUITE 25440
NEW YORK, NY 10003

FOR: BUSINESS MANAGEMENT CONSULTATION IN THE FIELD OF DISASTER RECOVERY AND BUSINESS CONTINUITY PLANNING, IN CLASS 35 (U.S. CLS. 100, 101 AND 102).

FIRST USE 2-26-2009; IN COMMERCE 2-26-2009.

THE MARK CONSISTS OF THE STYLIZED SHOWING OF WOVEN STRIPS IN A ROUND SHAPE.

SER. NO. 85-473,251, FILED 11-15-2011.

ELLEN PERKINS, EXAMINING ATTORNEY



David J. Kyffers

Director of the United States Patent and Trademark Office

United States of America
United States Patent and Trademark Office

LOOTOK

Reg. No. 4,174,936

LOOTOK, LTD. (NEW YORK CORPORATION)
228 PARK AVENUE SOUTH, SUITE 25440
NEW YORK, NY 10003

Registered July 17, 2012

Int. Cl.: 35

FOR: BUSINESS MANAGEMENT AND CONSULTATION IN THE FIELD OF DISASTER RECOVERY AND BUSINESS CONTINUITY PLANNING, IN CLASS 35 (U.S. CLS. 100, 101 AND 102).

SERVICE MARK

FIRST USE 2-26-2009; IN COMMERCE 2-26-2009.

PRINCIPAL REGISTER

THE MARK CONSISTS OF STANDARD CHARACTERS WITHOUT CLAIM TO ANY PARTICULAR FONT, STYLE, SIZE, OR COLOR.

THE WORDING "LOOTOK" HAS NO MEANING IN A FOREIGN LANGUAGE.

SER. NO. 85-473,275, FILED 11-15-2011.

ELLEN PERKINS, EXAMINING ATTORNEY



David J. Kyffers

Director of the United States Patent and Trademark Office

United States of America

United States Patent and Trademark Office

Semper Fidelis All-American Bowl

Reg. No. 4,174,937

JUNIORRANK SPORTS (ILLINOIS CORPORATION)

Registered July 17, 2012

1750 EAST MAIN ST
ST. CHARLES, IL 60174

Int. Cl.: 41

FOR: ARRANGING AND CONDUCTING YOUTH FOOTBALL PROGRAMS; ENTERTAINMENT IN THE NATURE OF FOOTBALL GAMES; ORGANISATION OF SPORTS EVENTS IN THE FIELD OF FOOTBALL; SPORT CAMPS , IN CLASS 41 (U.S. CLS. 100, 101 AND 107).

SERVICE MARK

FIRST USE 3-1-2011; IN COMMERCE 3-10-2011.

PRINCIPAL REGISTER

THE MARK CONSISTS OF STANDARD CHARACTERS WITHOUT CLAIM TO ANY PARTICULAR FONT, STYLE, SIZE, OR COLOR.

NO CLAIM IS MADE TO THE EXCLUSIVE RIGHT TO USE "ALL-AMERICAN BOWL", APART FROM THE MARK AS SHOWN.

SER. NO. 85-473,293, FILED 11-15-2011.

DOUGLAS LEE, EXAMINING ATTORNEY



David J. Kyfos

Director of the United States Patent and Trademark Office

United States of America

United States Patent and Trademark Office

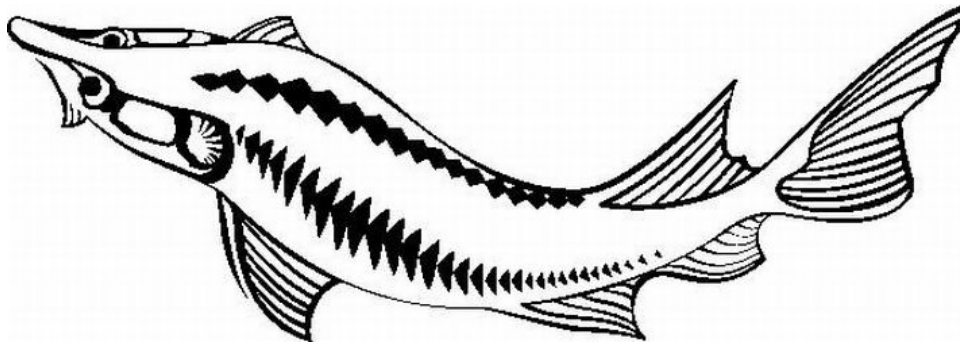

Reg. No. 4,174,938

Registered July 17, 2012

Int. Cl.: 33

TRADEMARK

PRINCIPAL REGISTER

SCILLARD INVESTMENTS LIMITED (CYPRUS LIMITED LIABILITY COMPANY)
VIOM. PER. AGIOU ATHANASIOU, LINOPETRA
5, MICHAEL PSELLOU
LIMASSOL, CYPRUS 4105

FOR: VODKA, IN CLASS 33 (U.S. CLS. 47 AND 49).

FIRST USE 9-0-2009; IN COMMERCE 9-0-2009.

THE MARK CONSISTS OF THE FANCIFUL REPRESENTATION OF FISH.

SER. NO. 85-473,303, FILED 11-15-2011.

ROSELLE HERRERA, EXAMINING ATTORNEY



David J. Kyffers

Director of the United States Patent and Trademark Office

United States of America

United States Patent and Trademark Office

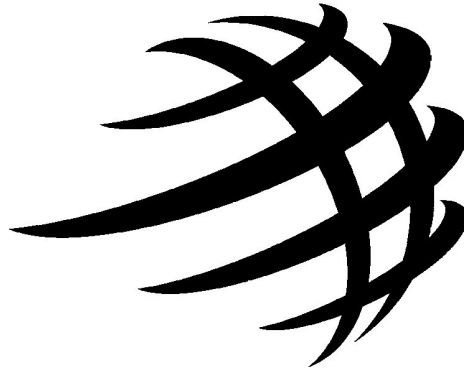

Reg. No. 4,174,939

Registered July 17, 2012

Int. Cl.: 42

SERVICE MARK

PRINCIPAL REGISTER

GLOBAL DATA MANAGEMENT SYSTEMS, LLC (DELAWARE LIMITED LIABILITY COMPANY)
1816 WEST POINT PIKE
LANSDALE, PA 19446

FOR: SOFTWARE AS A SERVICE (SAAS) SERVICES FEATURING SOFTWARE FOR VENDOR MANAGEMENT USED IN THE REAL ESTATE VALUATION AND LENDING INDUSTRY , IN CLASS 42 (U.S. CLS. 100 AND 101).

FIRST USE 6-30-2003; IN COMMERCE 6-30-2003.

THE MARK CONSISTS OF AN IMAGE OF A FUTURISTIC SPHERE THAT APPEARS TO BE MADE OF MESH.

SER. NO. 85-473,458, FILED 11-15-2011.

DEZMONA MIZELLE, EXAMINING ATTORNEY



David J. Kyffers

Director of the United States Patent and Trademark Office

United States of America

United States Patent and Trademark Office

Rubio's

Reg. No. 4,174,940

Registered July 17, 2012

Int. Cl.: 43

SERVICE MARK

PRINCIPAL REGISTER

RUBIO'S RESTAURANTS, INC (DELAWARE CORPORATION)
1902 WRIGHT PLACE, SUITE 300
CARLSBAD, CA 92008

FOR: RESTAURANT SERVICES, IN CLASS 43 (U.S. CLS. 100 AND 101).

FIRST USE 1-23-1983; IN COMMERCE 1-23-1983.

THE MARK CONSISTS OF STANDARD CHARACTERS WITHOUT CLAIM TO ANY PARTICULAR FONT, STYLE, SIZE, OR COLOR.

OWNER OF U.S. REG. NOS. 1,503,438, 1,973,747 AND OTHERS.

THE NAME(S), PORTRAIT(S), AND/OR SIGNATURE(S) SHOWN IN THE MARK DOES NOT IDENTIFY A PARTICULAR LIVING INDIVIDUAL.

SER. NO. 85-473,465, FILED 11-15-2011.

DEZMONA MIZELLE, EXAMINING ATTORNEY



David J. Kybas

Director of the United States Patent and Trademark Office

United States of America

United States Patent and Trademark Office

DIY

Reg. No. 4,174,941

Registered July 17, 2012

Int. Cl.: 9

TRADEMARK

PRINCIPAL REGISTER

LUXI ELECTRONICS CORP. (CALIFORNIA CORPORATION)
4146 SALACIA DR.
IRVINE, CA 92620

FOR: ELECTRONIC VIDEO AND AUDIO SIGNAL COMPONENTS, NAMELY, MULTIMEDIA INTERFACE CABLES FOR VIDEO AND AUDIO USE, MULTIMEDIA INTERFACE CABLE CONNECTORS FOR VIDEO AND AUDIO USE, SIGNAL EXTENDERS IN THE NATURE OF DISTRIBUTION AMPLIFIERS FOR AUDIO AND VIDEO SIGNALS, IN CLASS 9 (U.S. CLS. 21, 23, 26, 36 AND 38).

FIRST USE 7-17-2009; IN COMMERCE 7-21-2009.

THE MARK CONSISTS OF STANDARD CHARACTERS WITHOUT CLAIM TO ANY PARTICULAR FONT, STYLE, SIZE, OR COLOR.

SER. NO. 85-473,504, FILED 11-15-2011.

MICHAEL TANNER, EXAMINING ATTORNEY



David J. Kyffers

Director of the United States Patent and Trademark Office

United States of America

United States Patent and Trademark Office

BIZ-STAY

Reg. No. 4,174,942

Registered July 17, 2012

Int. Cl.: 35

SERVICE MARK

PRINCIPAL REGISTER

KNIGHT, KERRY (UNITED STATES INDIVIDUAL), DBA BIZ-STAY
SUITE 270
180 NEWPORT CENTER DRIVE
NEWPORT BEACH, CA 92660

FOR: ON-LINE BUSINESS DIRECTORY SERVICES FEATURING WORLDWIDE LODGINGS
AND ACCOMMODATIONS, IN CLASS 35 (U.S. CLS. 100, 101 AND 102).

FIRST USE 0-0-2000; IN COMMERCE 0-0-2000.

THE MARK CONSISTS OF STANDARD CHARACTERS WITHOUT CLAIM TO ANY PAR-
TICULAR FONT, STYLE, SIZE, OR COLOR.

SER. NO. 85-473,525, FILED 11-15-2011.

MICHAEL KEATING, EXAMINING ATTORNEY



David J. Kybas

Director of the United States Patent and Trademark Office

United States of America

United States Patent and Trademark Office

Rocco blu band

Reg. No. 4,174,943

Registered July 17, 2012

Int. Cl.: 41

SERVICE MARK

PRINCIPAL REGISTER

ARGO, DUANE (UNITED STATES INDIVIDUAL)
#106
2280 SHEPARD ST.
JACKSONVILLE, FL 32211 AND

PALMER, JEFF (UNITED STATES INDIVIDUAL)
#106
2280 SHEPARD ST.
JACKSONVILLE, FL 32211

FOR: ENTERTAINMENT, NAMELY, LIVE PERFORMANCES BY A MUSICAL BAND , IN CLASS 41 (U.S. CLS. 100, 101 AND 107).

FIRST USE 11-27-2009; IN COMMERCE 1-10-2010.

THE MARK CONSISTS OF STANDARD CHARACTERS WITHOUT CLAIM TO ANY PARTICULAR FONT, STYLE, SIZE, OR COLOR.

NO CLAIM IS MADE TO THE EXCLUSIVE RIGHT TO USE "BAND", APART FROM THE MARK AS SHOWN.

SER. NO. 85-473,545, FILED 11-15-2011.

REGINA DRUMMOND, EXAMINING ATTORNEY



David J. Kyros

Director of the United States Patent and Trademark Office

United States of America

United States Patent and Trademark Office

BUSINESS 2100

Reg. No. 4,174,944

Registered July 17, 2012

Int. Cls.: 35 and 41

SERVICE MARK

PRINCIPAL REGISTER

BUSINESS MANAGEMENT CLUB, INC. (NEVADA CORPORATION)
#172
1223 WILSHIRE BLVD.
SANTA MONICA, CA 90403

FOR: PROVIDING LIVE AND ON-LINE INFORMATION IN THE FIELD OF BUSINESS MANAGEMENT, IN CLASS 35 (U.S. CLS. 100, 101 AND 102).

FIRST USE 9-1-2011; IN COMMERCE 9-1-2011.

FOR: EDUCATION SERVICES, NAMELY, PROVIDING LIVE AND ON-LINE TUTORIALS, CLASSES, SEMINARS AND WORKSHOPS IN THE FIELD OF BUSINESS MANAGEMENT, IN CLASS 41 (U.S. CLS. 100, 101 AND 107).

FIRST USE 9-1-2011; IN COMMERCE 9-1-2011.

THE MARK CONSISTS OF STANDARD CHARACTERS WITHOUT CLAIM TO ANY PARTICULAR FONT, STYLE, SIZE, OR COLOR.

NO CLAIM IS MADE TO THE EXCLUSIVE RIGHT TO USE "BUSINESS", APART FROM THE MARK AS SHOWN.

SER. NO. 85-473,552, FILED 11-15-2011.

RICHARD WHITE, EXAMINING ATTORNEY



David J. Kyros

Director of the United States Patent and Trademark Office

United States of America

United States Patent and Trademark Office

Hip Hop Mulisha

Reg. No. 4,174,945

HIP HOP MULISHA, LLC (SOUTH CAROLINA LIMITED LIABILITY COMPANY)
1016 BAFFIN BAY RD
COLUMBIA, SC 29212

Registered July 17, 2012

Int. Cl.: 25

FOR: DANCE COSTUMES; HATS; HOODED SWEATSHIRTS; SHOES; SHORTS; SWEATBANDS; SWEATPANTS; T-SHIRTS; TANK TOPS, IN CLASS 25 (U.S. CLS. 22 AND 39).

TRADEMARK

FIRST USE 2-0-2011; IN COMMERCE 2-0-2011.

PRINCIPAL REGISTER

THE MARK CONSISTS OF STANDARD CHARACTERS WITHOUT CLAIM TO ANY PARTICULAR FONT, STYLE, SIZE, OR COLOR.

NO CLAIM IS MADE TO THE EXCLUSIVE RIGHT TO USE "HIP HOP", APART FROM THE MARK AS SHOWN.

SER. NO. 85-473,566, FILED 11-15-2011.

JAMES LOVELACE, EXAMINING ATTORNEY



David J. Kyffers

Director of the United States Patent and Trademark Office

United States of America

United States Patent and Trademark Office

Muuyu

Reg. No. 4,174,946

Registered July 17, 2012

Int. Cl.: 41

SERVICE MARK

PRINCIPAL REGISTER

DEVINE, MATTHEW J (UNITED KINGDOM INDIVIDUAL)
SEVEN STARS EAST ST, DASHANZI 798
BEIJING, CHINA 100015

FOR: EDUCATIONAL SERVICES, NAMELY, PROVIDING ON-LINE CLASSES IN THE
FIELD OF WELLNESS, IN CLASS 41 (U.S. CLS. 100, 101 AND 107).

FIRST USE 7-11-2007; IN COMMERCE 10-16-2010.

THE MARK CONSISTS OF STANDARD CHARACTERS WITHOUT CLAIM TO ANY PAR-
TICULAR FONT, STYLE, SIZE, OR COLOR.

THE ENGLISH TRANSLATION OF "MUUYU" IS "BAOBAB TREE".

SER. NO. 85-473,567, FILED 11-15-2011.

JOHN WILKE, EXAMINING ATTORNEY



David J. Kybas

Director of the United States Patent and Trademark Office

United States of America
United States Patent and Trademark Office

Doxiecareier

Reg. No. 4,174,947

TOBY'S PET TREASURES LLC (TEXAS LIMITED LIABILITY COMPANY)
21427 ROSEVILLE DR
SPRING, TX 77388

Registered July 17, 2012

Int. Cl.: 18

FOR: ANIMAL CARRIER WORN ON THE BODY AS A SLING THAT CAN BE USED TO CARRY INJURED OR CONVALESCENT PETS AS WELL AS HEALTHY PETS, IN CLASS 18 (U.S. CLS. 1, 2, 3, 22 AND 41).

TRADEMARK

FIRST USE 3-5-2011; IN COMMERCE 3-5-2011.

PRINCIPAL REGISTER

THE MARK CONSISTS OF STANDARD CHARACTERS WITHOUT CLAIM TO ANY PARTICULAR FONT, STYLE, SIZE, OR COLOR.

SER. NO. 85-473,589, FILED 11-15-2011.

EMILY CHUO, EXAMINING ATTORNEY



David J. Kybas

Director of the United States Patent and Trademark Office

United States of America

United States Patent and Trademark Office

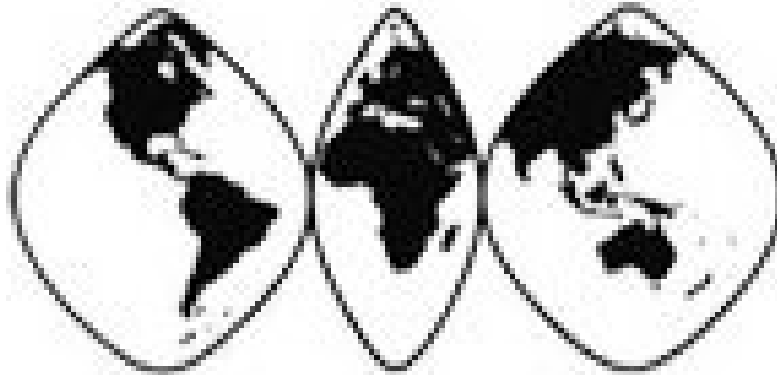

Reg. No. 4,174,948

Registered July 17, 2012

Int. Cl.: 16

TRADEMARK

PRINCIPAL REGISTER

WORLD TRADE CENTERS ASSOCIATION, INC. (DELAWARE NON-PROFIT CORPORATION)
420 LEXINGTON AVENUE, SUITE 518
NEW YORK, NY 10170

FOR: ATLASES, GLOBES, BINDERS, CARDS NOT MAGNETICALLY CODED FOR USE IN BUSINESS TRANSACTIONS, PENS, PENCILS, DICTIONARIES, MEMBERSHIP DIRECTORIES, MAPS, PUBLICATIONS, NAMELY, NEWS BULLETINS, NEWSLETTERS, NEWSPAPERS, BROCHURES, PAMPHLETS AND MAGAZINES IN THE FIELDS OF BUSINESS, FINANCE AND INTERNATIONAL TRADE, IN CLASS 16 (U.S. CLS. 2, 5, 22, 23, 29, 37, 38 AND 50).

FIRST USE 5-0-1973; IN COMMERCE 5-0-1973.

THE MARK CONSISTS OF THREE CONJOINED OVAL MAPS/ATLASES.

SEC. 2(F).

SER. NO. 85-473,603, FILED 11-15-2011.

PATRICIA EVANKO, EXAMINING ATTORNEY



David J. Kyffers

Director of the United States Patent and Trademark Office

United States of America

United States Patent and Trademark Office



Reg. No. 4,174,949

Registered July 17, 2012

Int. Cl.: 1

TRADEMARK

PRINCIPAL REGISTER

TISHAU PRODUCTS LP (CALIFORNIA CORPORATION), DBA DZR SHOES
121 MINNA ST.
SAN FRANCISCO, CA 94105

FOR: SHOES, IN CLASS 1 (U.S. CLS. 1, 5, 6, 10, 26 AND 46).

FIRST USE 1-1-2009; IN COMMERCE 8-1-2010.

THE MARK CONSISTS OF THE WORDING "DZR" WITH A CHAIN LINK.

SER. NO. 85-473,606, FILED 11-15-2011.

MIDGE BUTLER, EXAMINING ATTORNEY



David J. Kyffers

Director of the United States Patent and Trademark Office

United States of America

United States Patent and Trademark Office

EchoMRI MRI That Counts

Reg. No. 4,174,950

Registered July 17, 2012

Int. Cl.: 9

TRADEMARK

PRINCIPAL REGISTER

ECHO MEDICAL SYSTEMS LLC (TEXAS LIMITED LIABILITY COMPANY)
11191 WESTHEIMER ROAD #223
HOUSTON, TX 77042

FOR: ELECTRONIC MEASURING APPARATUS, NAMELY, SPECTROMETERS FOR MEASURING PHYSICAL AND CHEMICAL PROPERTIES OF LIVING ORGANISMS FOR PHYSICAL AND CHEMICAL TESTS FOR NUCLEAR MAGNETIC RESONANCE; AND ELECTRONIC DATA PROCESSING SYSTEMS COMPRISING COMPUTER HARDWARE AND COMPUTER SOFTWARE FOR COMPOSITION ANALYSIS OF LIVING ORGANISMS FROM NUCLEAR MAGNETIC RESONANCE MEASUREMENTS, IN CLASS 9 (U.S. CLS. 21, 23, 26, 36 AND 38).

FIRST USE 10-9-2000; IN COMMERCE 10-9-2000.

THE MARK CONSISTS OF STANDARD CHARACTERS WITHOUT CLAIM TO ANY PARTICULAR FONT, STYLE, SIZE, OR COLOR.

NO CLAIM IS MADE TO THE EXCLUSIVE RIGHT TO USE "ECHOMRI" AND "MRI" , APART FROM THE MARK AS SHOWN.

SER. NO. 85-473,667, FILED 11-16-2011.

CAROLINE WOOD, EXAMINING ATTORNEY



David J. Kyros

Director of the United States Patent and Trademark Office

United States of America

United States Patent and Trademark Office

ALLPOINTS COMMUNITY CHURCH

Reg. No. 4,174,951

Registered July 17, 2012

Int. Cl.: 45

SERVICE MARK

PRINCIPAL REGISTER

ALLPOINTS COMMUNITY CHURCH, INC. (GEORGIA CORPORATION)
6488 HICKORY FLAT HIGHWAY, SUITE B
CANTON, GA 30115

FOR: CONDUCTING RELIGIOUS PRAYER SERVICES; EVANGELISTIC AND MINISTERIAL SERVICES; EVANGELISTIC MINISTERIAL SERVICES; MINISTERIAL SERVICES; MINISTERIAL SERVICES, NAMELY, HOLDING SPIRITUAL RETREATS TO ASSIST RELIGIOUS LEADERS, BOTH CLERGY AND LAY, TO DEVELOP AND ENHANCE THEIR SPIRITUAL LIVES; ON-LINE MINISTERIAL SERVICES; RELIGIOUS AND SPIRITUAL SERVICES, NAMELY, CONDUCTING RELIGIOUS WORSHIP, MARRIAGE CEREMONIES, BAPTISMAL CEREMONIES, BABY DEDICATIONS, BEREAVEMENT CEREMONIES, AND RELIGIOUS COUNSELING; RELIGIOUS AND SPIRITUAL SERVICES, NAMELY, PROVIDING GATHERINGS AND RETREATS TO DEVELOP AND ENHANCE THE SPIRITUAL LIVES OF INDIVIDUALS; RELIGIOUS SERVICES, NAMELY, PRAYER MEETINGS; SPIRITUAL COUNSELING, IN CLASS 45 (U.S. CLS. 100 AND 101).

FIRST USE 12-0-2003; IN COMMERCE 12-0-2003.

THE MARK CONSISTS OF STANDARD CHARACTERS WITHOUT CLAIM TO ANY PARTICULAR FONT, STYLE, SIZE, OR COLOR.

NO CLAIM IS MADE TO THE EXCLUSIVE RIGHT TO USE "COMMUNITY CHURCH", APART FROM THE MARK AS SHOWN.

SER. NO. 85-473,674, FILED 11-16-2011.

CAROLINE WOOD, EXAMINING ATTORNEY



David J. Kyffers

Director of the United States Patent and Trademark Office

United States of America

United States Patent and Trademark Office



Reg. No. 4,174,952

Registered July 17, 2012

Int. Cl.: 45

SERVICE MARK

PRINCIPAL REGISTER

ALLPOINTS COMMUNITY CHURCH, INC. (GEORGIA CORPORATION)
6488 HICKORY FLAT HIGHWAY, SUITE B
CANTON, GA 30115

FOR: CONDUCTING RELIGIOUS PRAYER SERVICES; EVANGELISTIC AND MINISTERIAL SERVICES; EVANGELISTIC MINISTERIAL SERVICES; MINISTERIAL SERVICES; MINISTERIAL SERVICES, NAMELY, HOLDING SPIRITUAL RETREATS TO ASSIST RELIGIOUS LEADERS, BOTH CLERGY AND LAY, TO DEVELOP AND ENHANCE THEIR SPIRITUAL LIVES; ON-LINE MINISTERIAL SERVICES; RELIGIOUS AND SPIRITUAL SERVICES, NAMELY, CONDUCTING RELIGIOUS WORSHIP, MARRIAGE CEREMONIES, BAPTISMAL CEREMONIES, BABY DEDICATIONS, BEREAVEMENT CEREMONIES, AND RELIGIOUS COUNSELING; RELIGIOUS AND SPIRITUAL SERVICES, NAMELY, PROVIDING GATHERINGS AND RETREATS TO DEVELOP AND ENHANCE THE SPIRITUAL LIVES OF INDIVIDUALS; RELIGIOUS SERVICES, NAMELY, PRAYER MEETINGS; SPIRITUAL COUNSELING, IN CLASS 45 (U.S. CLS. 100 AND 101).

FIRST USE 8-2-2011; IN COMMERCE 8-2-2011.

NO CLAIM IS MADE TO THE EXCLUSIVE RIGHT TO USE "CHURCH", APART FROM THE MARK AS SHOWN.

THE MARK CONSISTS OF THE WORD "ALLPOINTS" DIRECTLY ABOVE THE WORD "CHURCH", WITH THE "O" IN "ALLPOINTS" REPLACED BY TWO CONCENTRIC CIRCLES WITH A CROSS DEVICE ARISING FROM THE CENTER OF THIS DEVICE, AND TO THE RIGHTS OF THE WORDS "ALLPOINTS CHURCH" IS A LARGER VERSION OF THE SAME CONCENTRIC CIRCLE/CROSS DEVICE.

SER. NO. 85-473,675, FILED 11-16-2011.

CAROLINE WOOD, EXAMINING ATTORNEY



David J. Kyjars

Director of the United States Patent and Trademark Office

United States of America

United States Patent and Trademark Office

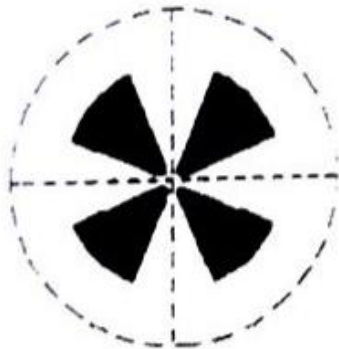

Reg. No. 4,174,953

Registered July 17, 2012

Int. Cl.: 28

TRADEMARK

PRINCIPAL REGISTER

DRAGONFLY FOOTBALLS LIMITED (CANADA CORPORATION)
2 WOODSIDE DRIVE
RIVERVIEW, CANADA E1B4G9

FOR: FOOTBALLS, IN CLASS 28 (U.S. CLS. 22, 23, 38 AND 50).

FIRST USE 1-31-2006; IN COMMERCE 1-31-2006.

OWNER OF U.S. REG. NO. 2,776,961.

THE MARK CONSISTS OF A GEOMETRIC FIGURE FORMED BY FOUR ISOSCELES TRIANGLES. THE DOTTED LINES SHOW PLACEMENT ON THE END OF THE GOODS AND ARE NOT CLAIMED AS A FEATURE OF THE MARK.

SEC. 2(F).

SER. NO. 85-473,706, FILED 11-16-2011.

KATHERINE CHANG, EXAMINING ATTORNEY



David J. Kyjars

Director of the United States Patent and Trademark Office

United States of America

United States Patent and Trademark Office

ENCHANTED GABLES

Reg. No. 4,174,954

STURM, JEANINE (UNITED STATES INDIVIDUAL)
995 BEECHMEADOW LANE
CINCINNATI, OH 45238

Registered July 17, 2012

Int. Cl.: 35

FOR: ON-LINE RETAIL STORE SERVICES FEATURING CHARMS, COLLECTIBLES,
CLOTHING, TOYS, DOLLS, JEWELRY, IN CLASS 35 (U.S. CLS. 100, 101 AND 102).

SERVICE MARK

FIRST USE 4-2-2010; IN COMMERCE 4-2-2010.

PRINCIPAL REGISTER

THE MARK CONSISTS OF STANDARD CHARACTERS WITHOUT CLAIM TO ANY PAR-
TICULAR FONT, STYLE, SIZE, OR COLOR.

SER. NO. 85-473,713, FILED 11-16-2011.

KATHERINE CHANG, EXAMINING ATTORNEY



David J. Kybas

Director of the United States Patent and Trademark Office

United States of America

United States Patent and Trademark Office



Reg. No. 4,174,955

Registered July 17, 2012

Int. Cl.: 25

TRADEMARK

PRINCIPAL REGISTER

WARWEAR, LLC (MARYLAND LIMITED LIABILITY COMPANY)
4979 MERCANTILE ROAD
SUITE D
BALTIMORE, MD 21236

FOR: CLOTHING, NAMELY, ATHLETIC T-SHIRTS, ATHLETIC TANK TOPS, ATHLETIC LONG SLEEVE SHIRTS, POLO SHIRTS, SPORTS BRAS; HEADGEAR, NAMELY, KNIT HATS AND BASEBALL CAPS, IN CLASS 25 (U.S. CLS. 22 AND 39).

FIRST USE 6-13-2009; IN COMMERCE 6-13-2009.

THE MARK CONSISTS OF A STYLIZED LETTER "W" WITH A HORIZONTAL LINE BE-
NEATH IT. THE WORD "WARWEAR" APPEARS BELOW THE HORIZONTAL LINE.

SER. NO. 85-473,723, FILED 11-16-2011.

LINDA M. KING, EXAMINING ATTORNEY



David J. Kybas

Director of the United States Patent and Trademark Office

United States of America
United States Patent and Trademark Office

SKWOOSH

Reg. No. 4,174,956

Registered July 17, 2012

Int. Cl.: 28

TRADEMARK

PRINCIPAL REGISTER

I-TEK, INC. (MASSACHUSETTS CORPORATION)
360 MERRIMACK STREET
BLDG. 5
LAWRENCE, MA 01843

FOR: SAFETY AND PROTECTIVE PADDING, NAMELY, CUSHIONS TO AID IN COMFORT, PRESSURE RELIEF AND IMPACT PROTECTION WITH THE EFFECTIVE COMPONENT COMPRISED OF BONDED MICROSPHERES , IN CLASS 28 (U.S. CLS. 22, 23, 38 AND 50).

FIRST USE 1-31-2003; IN COMMERCE 3-1-2003.

THE MARK CONSISTS OF STANDARD CHARACTERS WITHOUT CLAIM TO ANY PARTICULAR FONT, STYLE, SIZE, OR COLOR.

SER. NO. 85-473,727, FILED 11-16-2011.

FRANK LATTUCA, EXAMINING ATTORNEY



David J. Kyffers

Director of the United States Patent and Trademark Office

United States of America

United States Patent and Trademark Office

whytake.net

Reg. No. 4,174,957

Registered July 17, 2012

Int. Cl.: 42

SERVICE MARK

PRINCIPAL REGISTER

WHYTAKE, LLC (DELAWARE LIMITED LIABILITY COMPANY)
3411 SILVERSIDE RD.
RODNEY BLDG, STE 105
WILMINGTON, DE 19810

FOR: COMPUTER SERVICES, NAMELY, CREATING AN ON-LINE COMMUNITY FOR REGISTERED USERS TO PARTICIPATE IN DISCUSSIONS, GET FEEDBACK FROM THEIR PEERS, FORM VIRTUAL COMMUNITIES AND ENGAGE IN SOCIAL NETWORKING, IN CLASS 42 (U.S. CLS. 100 AND 101).

FIRST USE 9-9-2011; IN COMMERCE 9-9-2011.

THE MARK CONSISTS OF STANDARD CHARACTERS WITHOUT CLAIM TO ANY PARTICULAR FONT, STYLE, SIZE, OR COLOR.

SER. NO. 85-473,728, FILED 11-16-2011.

FRANK LATTUCA, EXAMINING ATTORNEY



David J. Kyffers

Director of the United States Patent and Trademark Office

United States of America

United States Patent and Trademark Office

readMedia

Reg. No. 4,174,958

Registered July 17, 2012

Int. Cl.: 42

SERVICE MARK

PRINCIPAL REGISTER

READMEDIA, INC. (DELAWARE CORPORATION)
418 BROADWAY
4TH FLOOR
ALBANY, NY 12207

FOR: PROVIDING A WEBSITE FEATURING ON-LINE NON-DOWNLOADABLE SOFTWARE THAT ENABLES USERS TO CREATE, POST, DISTRIBUTE AND AWARD ACHIEVEMENTS AND ACTIVITIES TO, AND CREATE ONLINE PROFILES BASED ON THOSE ACHIEVEMENTS OF, MEMBERS OF THEIR ORGANIZATION OR PEOPLE ASSOCIATED WITH THAT ORGANIZATION, AND FOR THOSE AWARDEES AND INTERESTED PARTIES TO INTERACT WITH THOSE ACHIEVEMENTS AND PROFILES, IN CLASS 42 (U.S. CLS. 100 AND 101).

FIRST USE 1-1-2007; IN COMMERCE 3-16-2007.

THE MARK CONSISTS OF STANDARD CHARACTERS WITHOUT CLAIM TO ANY PARTICULAR FONT, STYLE, SIZE, OR COLOR.

SER. NO. 85-473,729, FILED 11-16-2011.

FRANK LATTUCA, EXAMINING ATTORNEY



David J. Kyffers

Director of the United States Patent and Trademark Office

United States of America

United States Patent and Trademark Office

The Summer Place

Reg. No. 4,174,959

ASTOLOS, MICHAEL ALLEN (UNITED STATES INDIVIDUAL)
11130 1/2 FRANKSTOWN ROAD
PITTSBURGH, PA 15235

Registered July 17, 2012

Int. Cl.: 43

FOR: RESTAURANT SERVICES, IN CLASS 43 (U.S. CLS. 100 AND 101).

SERVICE MARK

FIRST USE 4-0-2010; IN COMMERCE 4-0-2010.

PRINCIPAL REGISTER

THE MARK CONSISTS OF STANDARD CHARACTERS WITHOUT CLAIM TO ANY PARTICULAR FONT, STYLE, SIZE, OR COLOR.

SER. NO. 85-473,738, FILED 11-16-2011.

MARK SPARACINO, EXAMINING ATTORNEY



David J. Kyffers

Director of the United States Patent and Trademark Office

United States of America

United States Patent and Trademark Office



The Summer Place
Bar-B-Que Foods & So Much More

Reg. No. 4,174,960

ASTOLOS, MICHAEL ALLEN (UNITED STATES INDIVIDUAL)
11130 1/2 FRANKSTOWN ROAD
PITTSBURGH, PA 15235

Registered July 17, 2012

Int. Cl.: 43

FOR: RESTAURANT SERVICES, IN CLASS 43 (U.S. CLS. 100 AND 101).

SERVICE MARK

FIRST USE 4-0-2010; IN COMMERCE 4-0-2010.

PRINCIPAL REGISTER

THE MARK CONSISTS OF A WHITE CHICKEN DESIGN AGAINST A RED FLAME DESIGN BACKGROUND, WITH THE TEXT "THE SUMMER PLACE" IN BLACK AND POSITIONED DIRECTLY UNDERNEATH THE CHICKEN DESIGN AND THE TEXT "BAR-B-QUE FOODS & SO MUCH MORE" IN BLACK AND POSITIONED DIRECTLY UNDERNEATH THE "THE SUMMER PLACE" TEXT.

THE COLOR(S) RED, WHITE AND BLACK IS/ARE CLAIMED AS A FEATURE OF THE MARK.

SER. NO. 85-473,742, FILED 11-16-2011.

MARK SPARACINO, EXAMINING ATTORNEY



David J. Kybas

Director of the United States Patent and Trademark Office

United States of America

United States Patent and Trademark Office

Spot of Chocolate

Reg. No. 4,174,961

SPOT OF CHOCOLATE LLC (SOUTH DAKOTA LIMITED LIABILITY COMPANY)
17 EAST BIG SKY PLACE
SIOUX FALLS, SD 57110

Registered July 17, 2012

Int. Cl.: 30

FOR: CHOCOLATE AND CHOCOLATES; CHOCOLATE TRUFFLES, IN CLASS 30 (U.S. CL. 46).

TRADEMARK

FIRST USE 10-26-2011; IN COMMERCE 11-2-2011.

PRINCIPAL REGISTER

THE MARK CONSISTS OF STANDARD CHARACTERS WITHOUT CLAIM TO ANY PARTICULAR FONT, STYLE, SIZE, OR COLOR.

NO CLAIM IS MADE TO THE EXCLUSIVE RIGHT TO USE "CHOCOLATE", APART FROM THE MARK AS SHOWN.

SER. NO. 85-473,750, FILED 11-16-2011.

MICHELE SWAIN, EXAMINING ATTORNEY



David J. Kybas

Director of the United States Patent and Trademark Office

United States of America

United States Patent and Trademark Office

Om Schooled

Reg. No. 4,174,962

Registered July 17, 2012

Int. Cl.: 41

SERVICE MARK

PRINCIPAL REGISTER

HERRINGTON, SARAH (UNITED STATES INDIVIDUAL)
150 E. 7TH STREET
#5D
NEW YORK, NY 10009

FOR: EDUCATIONAL SERVICES, NAMELY, DEVELOPING, ARRANGING, AND CONDUCTING EDUCATIONAL CONFERENCES AND PROGRAMS AND PROVIDING COURSES OF INSTRUCTION IN THE FIELD OF YOGA INSTRUCTION, IN CLASS 41 (U.S. CLS. 100, 101 AND 107).

FIRST USE 9-1-2010; IN COMMERCE 9-1-2010.

THE MARK CONSISTS OF STANDARD CHARACTERS WITHOUT CLAIM TO ANY PARTICULAR FONT, STYLE, SIZE, OR COLOR.

SER. NO. 85-473,758, FILED 11-16-2011.

APRIL ROACH, EXAMINING ATTORNEY



David J. Kyffers

Director of the United States Patent and Trademark Office

United States of America

United States Patent and Trademark Office

HANDYQUICK

Reg. No. 4,174,963

33RD COMPANY, INC. (MINNESOTA CORPORATION)
10451 GLEN EAGLE CIRCLE
WOODBURY, MN 55129

Registered July 17, 2012

Int. Cl.: 37

FOR: HANDYMAN SERVICE, NAMELY, BUILDING REPAIR AND MAINTENANCE, IN CLASS 37 (U.S. CLS. 100, 103 AND 106).

SERVICE MARK

FIRST USE 11-6-2006; IN COMMERCE 11-6-2006.

PRINCIPAL REGISTER

THE MARK CONSISTS OF STANDARD CHARACTERS WITHOUT CLAIM TO ANY PARTICULAR FONT, STYLE, SIZE, OR COLOR.

SEC. 2(F).

SER. NO. 85-473,775, FILED 11-16-2011.

EDWARD NELSON, EXAMINING ATTORNEY



David J. Kyffers

Director of the United States Patent and Trademark Office

United States of America

United States Patent and Trademark Office



Reg. No. 4,174,964

GRAND FALLS CASINO RESORT, LLC (IOWA LIMITED LIABILITY COMPANY)
1415 GRAND FALLS BOULEVARD
LARCHWOOD, IA 51241

Registered July 17, 2012

Int. Cls.: 25, 41 and 43

FOR: CLOTHING, NAMELY, T-SHIRTS, POLO SHIRTS, WIND SHIRTS, VESTS, JACKETS, SWEATERS, AND SWEATSHIRTS; HATS, IN CLASS 25 (U.S. CLS. 22 AND 39).

TRADEMARK

FIRST USE 6-9-2011; IN COMMERCE 6-9-2011.

SERVICE MARK

FOR: CASINO SERVICES; GOLF CLUB SERVICES, IN CLASS 41 (U.S. CLS. 100, 101 AND 107).

PRINCIPAL REGISTER

FIRST USE 6-9-2011; IN COMMERCE 6-9-2011.

FOR: RESORT HOTEL, IN CLASS 43 (U.S. CLS. 100 AND 101).

FIRST USE 6-9-2011; IN COMMERCE 6-9-2011.

THE MARK CONSISTS OF STYLIZED LETTERS "G" AND "F".

SER. NO. 85-473,784, FILED 11-16-2011.

SHAILA SETTLES, EXAMINING ATTORNEY



David J. Kyffers

Director of the United States Patent and Trademark Office

United States of America

United States Patent and Trademark Office

Rain Brothers

Reg. No. 4,174,965

RAIN BROTHERS, LLC (OHIO LIMITED LIABILITY COMPANY)
503 WEST WALNUT
COLUMBUS, OH 43215

Registered July 17, 2012

Int. Cl.: 35

FOR: RETAIL AND ONLINE RETAIL STORE SERVICES FEATURING RAINWATER HARVESTING PRODUCTS, IN CLASS 35 (U.S. CLS. 100, 101 AND 102).

SERVICE MARK

FIRST USE 7-20-2007; IN COMMERCE 7-31-2007.

PRINCIPAL REGISTER

THE MARK CONSISTS OF STANDARD CHARACTERS WITHOUT CLAIM TO ANY PARTICULAR FONT, STYLE, SIZE, OR COLOR.

SER. NO. 85-473,788, FILED 11-16-2011.

ALYSSA STEEL, EXAMINING ATTORNEY



David J. Kybas

Director of the United States Patent and Trademark Office

United States of America

United States Patent and Trademark Office

SANIS

Reg. No. 4,174,966

Registered July 17, 2012

Int. Cls.: 3, 5, 21 and 35

CINTAS HOLDINGS, LLC (OHIO LIMITED LIABILITY COMPANY)
6800 CINTAS BOULEVARD
MASON, OH 45040

FOR: HAND SOAP, IN CLASS 3 (U.S. CLS. 1, 4, 6, 50, 51 AND 52).

FIRST USE 12-31-1987; IN COMMERCE 12-31-1987.

TRADEMARK

FOR: AIR FRESHENERS, IN CLASS 5 (U.S. CLS. 6, 18, 44, 46, 51 AND 52).

SERVICE MARK

FIRST USE 12-31-1987; IN COMMERCE 12-31-1987.

PRINCIPAL REGISTER

FOR: DISPENSERS FOR RESTROOMS, NAMELY, DISPENSERS FOR TOILET PAPER, SOAP, TOILET SEAT COVERS, PAPER AND CLOTH TOWELS, AND SANITARY NAPKINS, IN CLASS 21 (U.S. CLS. 2, 13, 23, 29, 30, 33, 40 AND 50).

FIRST USE 12-31-1987; IN COMMERCE 12-31-1987.

FOR: DISTRIBUTORSHIP SERVICES FEATURING PRODUCTS FOR USE IN RESTROOMS, NAMELY, TOILET PAPER, SOAP, TOWELS, TOILET SEAT COVERS, DEODORIZERS, AND DISPENSERS FOR THE ABOVE-LISTED ITEMS, IN CLASS 35 (U.S. CLS. 100, 101 AND 102).

FIRST USE 12-31-1987; IN COMMERCE 12-31-1987.

THE MARK CONSISTS OF STANDARD CHARACTERS WITHOUT CLAIM TO ANY PARTICULAR FONT, STYLE, SIZE, OR COLOR.

OWNER OF U.S. REG. NOS. 1,771,857, 3,313,598 AND OTHERS.

SER. NO. 85-473,791, FILED 11-16-2011.

KIMBERLY FRYE, EXAMINING ATTORNEY

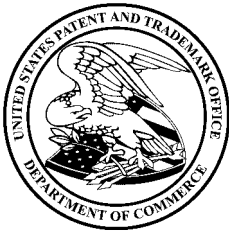

David J. Kyffers

Director of the United States Patent and Trademark Office

United States of America

United States Patent and Trademark Office



Reg. No. 4,174,967

Registered July 17, 2012

Int. Cl.: 16

TRADEMARK

PRINCIPAL REGISTER

BERRY, LAURA A. (UNITED STATES INDIVIDUAL), DBA BIG CAT DESIGNS
STE 203
24002 VIA FABRICANTE
MISSION VIEJO, CA 92691

FOR: ILLUSTRATIONS, IN CLASS 16 (U.S. CLS. 2, 5, 22, 23, 29, 37, 38 AND 50).

FIRST USE 6-15-2000; IN COMMERCE 6-15-2000.

NO CLAIM IS MADE TO THE EXCLUSIVE RIGHT TO USE "CAT DESIGNS", APART FROM THE MARK AS SHOWN.

THE COLOR(S) RED, BLACK, WHITE, GRAY, ORANGE, YELLOW, BROWN, AND GREEN IS/ARE CLAIMED AS A FEATURE OF THE MARK.

THE MARK CONSISTS OF THE STYLIZED WORDING "BIG CAT DESIGNS" WITH THE DESIGN OF A SEATED TABBY CAT IN BETWEEN THE WORDS "BIG" AND "CAT." THE COLOR BLACK APPEARS IN THE WORD "DESIGNS," IN THE OUTLINE OF "BIG CAT," IN THE IRISES OF THE CAT'S EYES, IN THE CAT'S EYEBROWS AND WHISKERS, AND IN THE OUTLINE OF THE CAT. THE COLOR BLACK ALSO APPEARS IN THE CAT'S NOSE, EXCEPT FOR THE CENTER DOT IN THE NOSE. THE CENTER DOTS IN EACH OF THE CAT'S EYES AND THE CAT'S NOSE ARE WHITE. THE COLOR RED APPEARS IN THE WORDING "BIG CAT." THE COLOR GREEN APPEARS IN THE BACKGROUND OF THE CAT'S EYES. THE COLORS YELLOW AND ORANGE APPEAR INTERMIXED IN THE ARMS, LEGS AND FACE OF THE CAT, EXCEPT NEAR THE CAT'S MOUTH AND NOSE. THE COLOR ORANGE ALSO APPEARS INSIDE THE CAT'S EARS AND IN THE CIRCULAR AND OVULAR DESIGNS REPRESENTING THE PADDED PORTIONS OF THE CAT'S FEET. THE COLOR BROWN APPEARS IN THE TIPS OF THE CAT'S EARS AND IN THE LINES ON THE CAT. THE COLOR GRAY APPEARS IN THE SHADED AREAS IN THE CHIN, MOUTH, BELLY AND PAWS OF THE CAT. THE COLOR WHITE APPEARS IN THE MOUTH, CHIN, BELLY, PAWS AND FEET OF THE CAT, EXCEPT FOR THE CIRCULAR AND OVULAR DESIGNS REPRESENTING THE PADDED PORTIONS OF THE CAT'S FEET. THE REMAINDER OF THE WHITE IN THE DRAWING REPRESENTS BACKGROUND AREAS ONLY AND IS NOT PART OF THE MARK.



David J. Kybas

SER. NO. 85-473,801, FILED 11-16-2011.

Director of the United States Patent and Trademark Office

Reg. No. 4,174,967 MAUREEN DALL, EXAMINING ATTORNEY

United States of America

United States Patent and Trademark Office

CHILDREN'S NATIONAL MEDICAL CENTER

Reg. No. 4,174,968

CHILDREN'S NATIONAL MEDICAL CENTER (D.C. NON-PROFIT CORPORATION)
111 MICHIGAN AVE., N.W.
WASHINGTON, DC 20010

Registered July 17, 2012

**Int. Cls.: 35, 41, 42 and
44**

FOR: PUBLIC ADVOCACY ON BEHALF OF CHILDREN AND CHILDREN'S HEALTH ISSUES,
IN CLASS 35 (U.S. CLS. 100, 101 AND 102).

FIRST USE 7-1-1989; IN COMMERCE 7-1-1989.

SERVICE MARK

FOR: EDUCATIONAL SERVICES, NAMELY, OFFERING RESIDENCY TRAINING PROGRAMS FOR PHYSICIANS; CONDUCTING SEMINARS, CLASSES AND WORKSHOPS IN THE COMMUNITY WITH REGARD TO PEDIATRIC HEALTH CARE; PROVIDING INTERNSHIPS, FELLOWSHIPS, GRADUATE MEDICAL CLASSES AND TRAINING PROGRAMS, AND CONTINUING MEDICAL EDUCATION CLASSES AND TRAINING PROGRAMS FOR DOCTORS AND HEALTHCARE PROFESSIONALS, IN CLASS 41 (U.S. CLS. 100, 101 AND 107).

FIRST USE 7-1-1989; IN COMMERCE 7-1-1989.

PRINCIPAL REGISTER

FOR: MEDICAL RESEARCH AND CONDUCTING CLINICAL TRIALS ON CHILDREN'S HEALTH ISSUES, IN CLASS 42 (U.S. CLS. 100 AND 101).

FIRST USE 7-1-1989; IN COMMERCE 7-1-1989.

FOR: MEDICAL SERVICES; PEDIATRIC HEALTH CARE SERVICES, IN CLASS 44 (U.S. CLS. 100 AND 101).

FIRST USE 7-1-1989; IN COMMERCE 7-1-1989.

THE MARK CONSISTS OF STANDARD CHARACTERS WITHOUT CLAIM TO ANY PARTICULAR FONT, STYLE, SIZE, OR COLOR.

OWNER OF U.S. REG. NO. 1,592,569.

NO CLAIM IS MADE TO THE EXCLUSIVE RIGHT TO USE "MEDICAL CENTER", APART FROM THE MARK AS SHOWN.



David J. Kyros

Director of the United States Patent and Trademark Office

Reg. No. 4,174,968 SEC. 2(F).

SER. NO. 85-473,809, FILED 11-16-2011.

ZACHARY BELLO, EXAMINING ATTORNEY

United States of America

United States Patent and Trademark Office

FloraTummys

Reg. No. 4,174,969

CONSUMER PRODUCTS DETAILING LLC (NEW JERSEY LIMITED LIABILITY COMPANY)
9019 WALL STREET 6F

Registered July 17, 2012

NORTH BERGEN, NJ 07047

Int. Cl.: 5

FOR: NUTRITIONAL SUPPLEMENTS, NAMELY, PROBIOTIC COMPOSITIONS, IN CLASS
5 (U.S. CLS. 6, 18, 44, 46, 51 AND 52).

TRADEMARK

FIRST USE 11-14-2011; IN COMMERCE 11-15-2011.

PRINCIPAL REGISTER

THE MARK CONSISTS OF STANDARD CHARACTERS WITHOUT CLAIM TO ANY PAR-
TICULAR FONT, STYLE, SIZE, OR COLOR.

SER. NO. 85-473,815, FILED 11-16-2011.

ZACHARY BELLO, EXAMINING ATTORNEY



David J. Kyffers

Director of the United States Patent and Trademark Office

United States of America

United States Patent and Trademark Office



Reg. No. 4,174,970

J-TREND SYSTEMS, INC (NEW JERSEY CORPORATION)
2402 CITY PLACE
EDGEWATER, NJ 07020

Registered July 17, 2012

Int. Cl.: 16

FOR: DISPOSABLE HOUSEBREAKING PADS FOR USE IN TRAINING PUPPIES; PLASTIC BAGS FOR DISPOSING OF PET WASTE; PLASTIC FOOD STORAGE BAGS FOR HOUSEHOLD USE; TRASH BAGS; TRASH CAN LINERS, IN CLASS 16 (U.S. CLS. 2, 5, 22, 23, 29, 37, 38 AND 50).

TRADEMARK

PRINCIPAL REGISTER

FIRST USE 2-1-2010; IN COMMERCE 2-1-2010.

THE MARK CONSISTS OF A ROUNDED CIRCLE WHICH INCLUDES THE TEXT "GREEN 'N' PACK" STACKED AT THE CENTER, A LEAF ON THE LEFT AND RIGHT OF THE "N", AND THE TEXT "WWW.GREEN-N-PACK.COM WWW.GREEN-N-PACK.COM" ALONG THE INSIDE OF THE CIRCLE.

SER. NO. 85-473,823, FILED 11-16-2011.

MICHELE SWAIN, EXAMINING ATTORNEY



David J. Kybas

Director of the United States Patent and Trademark Office

United States of America

United States Patent and Trademark Office

Creating awareness with attitude!

Reg. No. 4,174,971

MYSASSYSLEEVE, LLC (COLORADO LIMITED LIABILITY COMPANY)
4824 BLUE SPRUCE RD
EVERGREEN, CO 80439

Registered July 17, 2012

Int. Cl.: 35

FOR: ON-LINE RETAIL STORE SERVICES FEATURING DECORATIVE, NON-MEDICAL, NYLON SLEEVES WITH TATTOO-INSPIRED DESIGNS THAT CAN BE WORN OVER COMPRESSION SLEEVES OR ON A BARE ARM; WHOLESALE DISTRIBUTORSHIPS FEATURING DECORATIVE, NON-MEDICAL, NYLON SLEEVES WITH TATTOO-INSPIRED DESIGNS THAT CAN BE WORN OVER COMPRESSION SLEEVES OR ON A BARE ARM, IN CLASS 35 (U.S. CLS. 100, 101 AND 102).

SERVICE MARK

PRINCIPAL REGISTER

FIRST USE 8-4-2009; IN COMMERCE 8-4-2009.

THE MARK CONSISTS OF STANDARD CHARACTERS WITHOUT CLAIM TO ANY PARTICULAR FONT, STYLE, SIZE, OR COLOR.

SER. NO. 85-473,853, FILED 11-16-2011.

YAT SYE, LEE, EXAMINING ATTORNEY



David J. Kyffers

Director of the United States Patent and Trademark Office

United States of America

United States Patent and Trademark Office

NeatCare

Reg. No. 4,174,972

Registered July 17, 2012

Int. Cl.: 35

SERVICE MARK

PRINCIPAL REGISTER

THE NEAT COMPANY, INC. (PENNSYLVANIA CORPORATION)
SUITE 3500
1601 MARKET STREET
PHILADELPHIA, PA 19103

FOR: CUSTOMER SERVICES, NAMELY, RESPONDING TO CUSTOMERS INQUIRIES FOR OTHERS IN THE FIELD OF COMPUTER SOFTWARE AND HARDWARE FOR THE ELECTRONIC ORGANIZATION, MANAGEMENT, READING, SCANNING AND FILING OF BUSINESS RECEIPTS, EXPENSE REPORTS, BUSINESS CARDS, PERSONAL DOCUMENTS, TAX DOCUMENTS, AND BUSINESS DOCUMENTS, IN CLASS 35 (U.S. CLS. 100, 101 AND 102).

FIRST USE 10-0-2010; IN COMMERCE 10-0-2010.

THE MARK CONSISTS OF STANDARD CHARACTERS WITHOUT CLAIM TO ANY PARTICULAR FONT, STYLE, SIZE, OR COLOR.

OWNER OF U.S. REG. NOS. 2,953,372, 3,622,574, AND 3,622,576.

SER. NO. 85-473,864, FILED 11-16-2011.

PAUL MORENO, EXAMINING ATTORNEY



David J. Kyffers

Director of the United States Patent and Trademark Office

United States of America

United States Patent and Trademark Office

STREET SMART

Reg. No. 4,174,973

Registered July 17, 2012

Int. Cl.: 41

SERVICE MARK

PRINCIPAL REGISTER

SOUTHWESTERN ENERGY COMPANY (DELAWARE CORPORATION)
SUITE 125
2350 NORTH SAM HOUSTON PARKWAY EAST
HOUSTON, TX 77032

FOR: EDUCATIONAL SERVICES, NAMELY, A TRAINING PROGRAM IN THE FIELD OF ROADWAY SAFETY PROVIDED TO TRUCK DRIVERS TRANSPORTING NATURAL GAS, IN CLASS 41 (U.S. CLS. 100, 101 AND 107).

FIRST USE 10-30-2008; IN COMMERCE 10-30-2008.

THE MARK CONSISTS OF STANDARD CHARACTERS WITHOUT CLAIM TO ANY PARTICULAR FONT, STYLE, SIZE, OR COLOR.

SER. NO. 85-473,874, FILED 11-16-2011.

WENDY GOODMAN, EXAMINING ATTORNEY



David J. Kyros

Director of the United States Patent and Trademark Office

United States of America

United States Patent and Trademark Office

healthconnection

Reg. No. 4,174,974

Registered July 17, 2012

Int. Cls.: 9 and 16

TRADEMARK

PRINCIPAL REGISTER

AMERISOURCEBERGEN DRUG CORPORATION (DELAWARE CORPORATION)
1300 MORRIS DRIVE
CHESTERBROOK, PA 19087

FOR: DOWNLOADABLE PERIODIC ELECTRONIC PUBLICATIONS IN THE NATURE OF INFORMATIONAL FLYERS FEATURING HEALTH AND WELLNESS TOPICS, IN CLASS 9 (U.S. CLS. 21, 23, 26, 36 AND 38).

FIRST USE 12-31-2010; IN COMMERCE 12-31-2010.

FOR: PRINTED PERIODIC PUBLICATIONS, NAMELY, NEWSLETTERS AND PAMPHLETS FEATURING HEALTH AND WELLNESS TOPICS, IN CLASS 16 (U.S. CLS. 2, 5, 22, 23, 29, 37, 38 AND 50).

FIRST USE 12-31-2010; IN COMMERCE 12-31-2010.

THE MARK CONSISTS OF A STYLIZED TYPE FONT OF ALL LOWER CASE LETTERS WITH A PORTION OF THE "H" (SECOND OCCURRENCE IN "HEALTH") FORMING A PORTION OF THE "C" (FIRST OCCURRENCE IN "CONNECTION") AND WITH "HEALTH" AND "CONNECTION" BEING OF CONTRASTING COLORS.

SER. NO. 85-473,876, FILED 11-16-2011.

KIMBERLY PERRY, EXAMINING ATTORNEY



David J. Kybas

Director of the United States Patent and Trademark Office

United States of America

United States Patent and Trademark Office

SPICYPEEPS

Reg. No. 4,174,975

Registered July 17, 2012

Int. Cls.: 42 and 45

SERVICE MARK

PRINCIPAL REGISTER

GLOBAL BOOST MD LLC (DELAWARE LIMITED LIABILITY COMPANY)
2711 CENTERVILLE RD.
SUITE 400
WILMINGTON, DE 19808

FOR: COMPUTER SERVICES, NAMELY, CREATING AN ON-LINE COMMUNITY FOR REGISTERED USERS TO ENGAGE IN SOCIAL NETWORKING, IN CLASS 42 (U.S. CLS. 100 AND 101).

FIRST USE 12-0-2010; IN COMMERCE 12-0-2010.

FOR: INTERNET-BASED SOCIAL NETWORKING SERVICES; ON-LINE SOCIAL NETWORKING SERVICES, IN CLASS 45 (U.S. CLS. 100 AND 101).

FIRST USE 12-0-2010; IN COMMERCE 12-0-2010.

THE MARK CONSISTS OF STANDARD CHARACTERS WITHOUT CLAIM TO ANY PARTICULAR FONT, STYLE, SIZE, OR COLOR.

SER. NO. 85-473,877, FILED 11-16-2011.

KIMBERLY PERRY, EXAMINING ATTORNEY



David J. Kyros

Director of the United States Patent and Trademark Office

United States of America

United States Patent and Trademark Office

CLUB UNIVISION

Reg. No. 4,174,976

UNIVISION COMMUNICATIONS INC. (DELAWARE CORPORATION)

Registered July 17, 2012

5999 CENTER DRIVE
LOS ANGELES, CA 90045

Int. Cl.: 35

FOR: PROVIDING A MEMBER LOYALTY PROGRAM THAT PROVIDES MEMBERS CONSUMER INFORMATION AND DISCOUNTS AND REBATES FOR THIRD PARTY GOODS AND SERVICES, IN CLASS 35 (U.S. CLS. 100, 101 AND 102).

SERVICE MARK

FIRST USE 8-30-2011; IN COMMERCE 8-30-2011.

PRINCIPAL REGISTER

THE MARK CONSISTS OF STANDARD CHARACTERS WITHOUT CLAIM TO ANY PARTICULAR FONT, STYLE, SIZE, OR COLOR.

OWNER OF U.S. REG. NOS. 2,518,240, 3,568,848 AND OTHERS.

NO CLAIM IS MADE TO THE EXCLUSIVE RIGHT TO USE "CLUB", APART FROM THE MARK AS SHOWN.

SER. NO. 85-473,891, FILED 11-16-2011.

HEATHER BIDDULPH, EXAMINING ATTORNEY



David J. Kyros

Director of the United States Patent and Trademark Office

United States of America

United States Patent and Trademark Office



Reg. No. 4,174,977

NEXCO, INC. (TEXAS CORPORATION), DBA SAVVY CONSULTING AND TRAINING
4530 INDEPENDENCE TRAIL
EVERGREEN, CO 804395801

Registered July 17, 2012

Int. Cl.: 41

FOR: COMPUTER EDUCATION TRAINING SERVICES, IN CLASS 41 (U.S. CLS. 100, 101 AND 107).

SERVICE MARK

FIRST USE 10-30-1998; IN COMMERCE 11-23-1998.

PRINCIPAL REGISTER

THE MARK CONSISTS OF A STYLIZED LETTER "S" AGAINST A DARK TRIANGULAR BACKGROUND.

SER. NO. 85-473,894, FILED 11-16-2011.

ROBERT C. CLARK JR., EXAMINING ATTORNEY



David J. Kyffers

Director of the United States Patent and Trademark Office

United States of America

United States Patent and Trademark Office



Street Smart

SPONSORED BY SOUTHWESTERN ENERGY

Reg. No. 4,174,978

Registered July 17, 2012

Int. Cl.: 41

SERVICE MARK

PRINCIPAL REGISTER

SOUTHWESTERN ENERGY COMPANY (DELAWARE CORPORATION)
SUITE 125
2350 NORTH SAM HOUSTON PARKWAY EAST
HOUSTON, TX 77032

FOR: EDUCATIONAL SERVICES, NAMELY, A TRAINING PROGRAM IN THE FIELD OF ROADWAY SAFETY PROVIDED TO TRUCK DRIVERS TRANSPORTING NATURAL GAS, IN CLASS 41 (U.S. CLS. 100, 101 AND 107).

FIRST USE 10-30-2008; IN COMMERCE 10-30-2008.

OWNER OF U.S. REG. NO. 2,976,459.

NO CLAIM IS MADE TO THE EXCLUSIVE RIGHT TO USE "ENERGY", APART FROM THE MARK AS SHOWN.

THE MARK CONSISTS OF OPPOSITELY DIRECTED ARROWS APPEARING IN THE FORM OF THE LETTER "S" TO THE LEFT OF THE WORDS "STREET SMART". THE MARK ALSO CONTAINS THE PHRASE "SPONSORED BY SOUTHWESTERN ENERGY" APPEARING IN SMALLER TYPEFACE DIRECTLY BELOW THE WORDS "STREET SMART".

SER. NO. 85-473,901, FILED 11-16-2011.

WENDY GOODMAN, EXAMINING ATTORNEY



David J. Kyjars

Director of the United States Patent and Trademark Office

United States of America

United States Patent and Trademark Office



Reg. No. 4,174,979

SIGUE MI MUSICA (COLORADO LIMITED LIABILITY COMPANY)
P O BOX 1019
BRIGHTON, CO 80602

Registered July 17, 2012

Int. Cl.: 41

FOR: ENTERTAINMENT SERVICES, NAMELY, PROVIDING AN ON-GOING RADIO PROGRAM IN THE FIELD OF MUSIC; ENTERTAINMENT SERVICES, NAMELY, PROVIDING RADIO PROGRAMS IN THE FIELD OF MUSIC VIA A GLOBAL COMPUTER NETWORK; PRODUCTION OF RADIO PROGRAMS, IN CLASS 41 (U.S. CLS. 100, 101 AND 107).

SERVICE MARK

PRINCIPAL REGISTER

FIRST USE 8-1-2011; IN COMMERCE 9-1-2011.

THE MARK CONSISTS OF A DESIGN THAT DEPICTS A MUSICAL NOTE IN THE LEFT PORTION OF THE MARK. THE TOP PORTION OF THE MUSICAL NOTE IS IN THE COLOR GREY, THE BOTTOM PORTION OF THE MUSICAL NOTE IS IN THE COLOR OF BLUE AND HAS A TRIANGULAR DESIGN THAT INTERCEPTS IN THE COLOR OF PURPLE. DIRECTLY TO THE RIGHT IS THE WORDING "SIGUE" IN STYLIZED FONT AND IN THE COLOR OF LIGHT BLUE. THE WORDING "MI" IN STYLIZED FONT AND IN THE COLOR OF PINK. DIRECTLY BELOW THE WORDING "SIGUE MI" IS THE WORDING "MUSICA" IN STYLIZED FONT AND IN THE COLOR OF GREY.

THE COLOR(S) BLUE, GREY, PINK, AND PURPLE IS/ARE CLAIMED AS A FEATURE OF THE MARK.

THE ENGLISH TRANSLATION OF "SIGUE MI MUSICA" IN THE MARK IS "FOLLOW MY MUSIC".

SER. NO. 85-473,928, FILED 11-16-2011.

KIMBERLY FRYE, EXAMINING ATTORNEY



David J. Kybas

Director of the United States Patent and Trademark Office

United States of America

United States Patent and Trademark Office

Mi Wild

Reg. No. 4,174,980

BARONE, MICHELLE (UNITED STATES INDIVIDUAL)
16 NASSAU ST.

Registered July 17, 2012

POUGHKEEPSIE, NY 12601

Int. Cl.: 41

FOR: ENTERTAINMENT SERVICES IN THE NATURE OF LIVE MUSICAL PERFORMANCES
BY AN INDIVIDUAL OR GROUP, IN CLASS 41 (U.S. CLS. 100, 101 AND 107).

SERVICE MARK

FIRST USE 9-7-2011; IN COMMERCE 9-7-2011.

PRINCIPAL REGISTER

THE MARK CONSISTS OF STANDARD CHARACTERS WITHOUT CLAIM TO ANY PAR-
TICULAR FONT, STYLE, SIZE, OR COLOR.

"MI WILD" IDENTIFIES THE STAGE NAME OF MICHELLE BARONE, A LIVING INDIVIDU-
AL WHOSE CONSENT IS OF RECORD.

SER. NO. 85-473,929, FILED 11-16-2011.

KIMBERLY FRYE, EXAMINING ATTORNEY



David J. Kyffers

Director of the United States Patent and Trademark Office

United States of America

United States Patent and Trademark Office

Cottage Landing

Reg. No. 4,174,981

Registered July 17, 2012

Int. Cl.: 36

SERVICE MARK

PRINCIPAL REGISTER

COTTAGE LANDING PARTNERS, LLC (GEORGIA LIMITED LIABILITY COMPANY)
SUITE 400W
1117 PERIMETER CENTER WEST
ATLANTA, GA 30338

FOR: APARTMENT AND OFFICE RENTALS; APARTMENT HOUSE MANAGEMENT; BUILDING MANAGEMENT; HOUSING SERVICES, NAMELY, RENTAL OF STUDENT HOUSING; LEASING OF APARTMENTS; LEASING OF REAL ESTATE; LEASING OF REAL PROPERTY; LEASING OR RENTING OF BUILDINGS; MANAGEMENT OF APARTMENTS; MANAGEMENT OF BUILDINGS; REAL ESTATE MANAGEMENT SERVICES; REAL ESTATE RENTAL SERVICES, NAMELY, RENTAL OF RESIDENTIAL HOUSING; REAL ESTATE SERVICE, NAMELY, RENTAL PROPERTY MANAGEMENT; REAL ESTATE SERVICES, NAMELY, RENTAL OF SHORT-TERM FURNISHED APARTMENTS; RENTAL OF APARTMENTS; RENTAL OF APARTMENTS IN AN APARTMENT COMMUNITY; RENTING OF APARTMENTS , IN CLASS 36 (U.S. CLS. 100, 101 AND 102).

FIRST USE 11-2-2011; IN COMMERCE 11-2-2011.

THE MARK CONSISTS OF STANDARD CHARACTERS WITHOUT CLAIM TO ANY PARTICULAR FONT, STYLE, SIZE, OR COLOR.

NO CLAIM IS MADE TO THE EXCLUSIVE RIGHT TO USE "COTTAGE", APART FROM THE MARK AS SHOWN.

SER. NO. 85-473,936, FILED 11-16-2011.

SAMUEL E. SHARPER JR., EXAMINING ATTORNEY



David J. Kyffers

Director of the United States Patent and Trademark Office

United States of America

United States Patent and Trademark Office

HOOK. LINE. DINNER.

Reg. No. 4,174,982

Registered July 17, 2012

Int. Cl.: 35

SERVICE MARK

PRINCIPAL REGISTER

OFF THE HOOK, LLC (D.C. LIMITED LIABILITY COMPANY), DBA GO FISH
1900 FENWICK STREET, NE
WASHINGTON, DC 20002

FOR: RETAIL MARKETS FEATURING FISH AND SEAFOOD; RETAIL OUTLETS FEATURING FISH AND SEAFOOD; RETAIL STORE SERVICES FEATURING FISH AND SEAFOOD, IN CLASS 35 (U.S. CLS. 100, 101 AND 102).

FIRST USE 7-0-2011; IN COMMERCE 7-0-2011.

THE MARK CONSISTS OF STANDARD CHARACTERS WITHOUT CLAIM TO ANY PARTICULAR FONT, STYLE, SIZE, OR COLOR.

SER. NO. 85-473,939, FILED 11-16-2011.

SAMUEL E. SHARPER JR., EXAMINING ATTORNEY



David J. Kyffers

Director of the United States Patent and Trademark Office

United States of America

United States Patent and Trademark Office



Reg. No. 4,174,983

Registered July 17, 2012

Int. Cl.: 9

TRADEMARK

PRINCIPAL REGISTER

UNITY USA (VIRGINIA CORPORATION), DBA SMARTISIGHT
1125 DUCHESS DR
MCLEAN, VA 22102

FOR: CAMERA HARDWARE SYSTEMS FOR IP (INTERNET PROTOCOL) VIDEO SURVEILLANCE, IN CLASS 9 (U.S. CLS. 21, 23, 26, 36 AND 38).

FIRST USE 5-15-2008; IN COMMERCE 5-15-2008.

THE MARK CONSISTS OF "SMARTISIGHT" WITH A SYMBOL ABOVE THE "I" REPRESENTING THE DOT. IT IS BLUE AND WHITE WITH BLACK IN THE CENTER OF THE BLUE EYE SHAPE. THE LETTERS "SMART" AND "SIGHT" IN "SMARTISIGHT" ARE DARK GREY AND THE MIDDLE "I" IS BLUE.

THE COLOR(S) BLUE, WHITE, DARK GREY, BLACK IS/ARE CLAIMED AS A FEATURE OF THE MARK.

SER. NO. 85-473,948, FILED 11-16-2011.

SAMUEL E. SHARPER JR., EXAMINING ATTORNEY



David J. Kyros

Director of the United States Patent and Trademark Office

United States of America

United States Patent and Trademark Office

NoBoss

Reg. No. 4,174,984

NOBOSS LLC (CONNECTICUT LIMITED LIABILITY COMPANY)
191 POST ROAD WEST SUITE #20
WESTPORT, CT 06880

Registered July 17, 2012

Int. Cl.: 35

FOR: BUSINESS INFORMATION SERVICES IN THE NATURE OF PROVIDING INFORMATION ON BUSINESS OPPORTUNITIES, IN CLASS 35 (U.S. CLS. 100, 101 AND 102).

SERVICE MARK

FIRST USE 12-31-1977; IN COMMERCE 12-31-1977.

PRINCIPAL REGISTER

THE MARK CONSISTS OF STANDARD CHARACTERS WITHOUT CLAIM TO ANY PARTICULAR FONT, STYLE, SIZE, OR COLOR.

SER. NO. 85-473,954, FILED 11-16-2011.

RONALD MCMORROW, EXAMINING ATTORNEY



David J. Kyffers

Director of the United States Patent and Trademark Office

United States of America

United States Patent and Trademark Office

PACIMALS

Reg. No. 4,174,985

DISTRO INTERNATIONAL LLC (GEORGIA LIMITED LIABILITY COMPANY)
165 COURTLAND ST., NW
ATLANTA, GA 30303

Registered July 17, 2012

Int. Cl.: 28

FOR: STUFFED AND PLUSH TOYS, IN CLASS 28 (U.S. CLS. 22, 23, 38 AND 50).

TRADEMARK

FIRST USE 10-1-2007; IN COMMERCE 12-1-2008.

PRINCIPAL REGISTER

THE MARK CONSISTS OF STANDARD CHARACTERS WITHOUT CLAIM TO ANY PARTICULAR FONT, STYLE, SIZE, OR COLOR.

SER. NO. 85-473,962, FILED 11-16-2011.

RONALD MCMORROW, EXAMINING ATTORNEY



David J. Kyffers

Director of the United States Patent and Trademark Office

United States of America
United States Patent and Trademark Office

MATLAW'S

Reg. No. 4,174,986

Registered July 17, 2012

Int. Cl.: 29

TRADEMARK

PRINCIPAL REGISTER

NATIONAL FISH AND SEAFOOD, INC. (MASSACHUSETTS CORPORATION), AKA
NATIONAL FISH & SEAFOOD, INC.
11-15 PARKER STREET
GLOUCESTER, MA 01930

FOR: FROZEN PREPARED AND UNPREPARED SEAFOOD, IN CLASS 29 (U.S. CL. 46).

FIRST USE 7-7-2006; IN COMMERCE 7-7-2006.

THE MARK CONSISTS OF STANDARD CHARACTERS WITHOUT CLAIM TO ANY PARTICULAR FONT, STYLE, SIZE, OR COLOR.

OWNER OF U.S. REG. NO. 1,249,154.

SER. NO. 85-473,965, FILED 11-16-2011.

TRICIA SONNEBORN, EXAMINING ATTORNEY



David J. Kyffers

Director of the United States Patent and Trademark Office

United States of America

United States Patent and Trademark Office

Zyno

Reg. No. 4,174,987

Registered July 17, 2012

Int. Cl.: 10

TRADEMARK

PRINCIPAL REGISTER

ZYNO MEDICAL LLC (DELAWARE LIMITED LIABILITY COMPANY), DBA ZYNO
MEDICAL LLC
10 TECH CIRCLE
NATICK, MA 01760

FOR: MEDICAL DEVICES, NAMELY, INFUSION PUMPS FOR DELIVERING MEASURED AMOUNTS OF SOLUTIONS INTO THE BLOODSTREAM OVER TIME; MEDICAL TUBING FOR ADMINISTERING DRUGS, IN CLASS 10 (U.S. CLS. 26, 39 AND 44).

FIRST USE 2-22-2008; IN COMMERCE 5-14-2008.

THE MARK CONSISTS OF STANDARD CHARACTERS WITHOUT CLAIM TO ANY PARTICULAR FONT, STYLE, SIZE, OR COLOR.

THE WORDING "ZYNO" HAS NO MEANING IN A FOREIGN LANGUAGE.

SER. NO. 85-473,966, FILED 11-16-2011.

TRICIA SONNEBORN, EXAMINING ATTORNEY



David J. Kybas

Director of the United States Patent and Trademark Office

United States of America

United States Patent and Trademark Office



Reg. No. 4,174,988

TREASE, MARK (UNITED STATES INDIVIDUAL)
643 HEARST AVENUE
SAN FRANCISCO, CA 94112

Registered July 17, 2012

Int. Cl.: 41

FOR: EDUCATION SERVICES, NAMELY, PROVIDING WORKSHOPS IN THE FIELD OF PERMACULTURE, IN CLASS 41 (U.S. CLS. 100, 101 AND 107).

SERVICE MARK

FIRST USE 1-1-2011; IN COMMERCE 1-1-2011.

PRINCIPAL REGISTER

NO CLAIM IS MADE TO THE EXCLUSIVE RIGHT TO USE "PERMACULTURE", APART FROM THE MARK AS SHOWN.

THE MARK CONSISTS OF AN ANTHROPOMORPHISED TREE CONSISTING OF A FEMALE FIGURE WITH ARMS TRANSFORMING TO BRANCHES AND FEET INTO ROOTS. BELOW THE ROOTS OF THE TREE IS THE STYLIZED TEXT "DUNMOR PERMACULTURE" WHERE "DUNMOR" APPEARS ABOVE "PERMACULTURE". THE WORD "DUNMOR" IS DISPLAYED WITH THE SYMBOL KNOWN AS "OTHALLA" REPRESENTING THE LETTER "O".

SER. NO. 85-473,967, FILED 11-16-2011.

TRICIA SONNEBORN, EXAMINING ATTORNEY



David J. Kyffers

Director of the United States Patent and Trademark Office

United States of America

United States Patent and Trademark Office

BATTALIONS OF BEAUTY

Reg. No. 4,174,989

BATTALIONS OF BEAUTY, LLC (CALIFORNIA LIMITED LIABILITY COMPANY)
202-A ARGONNE AVE.

Registered July 17, 2012

LONG BEACH, CA 90803

Int. Cl.: 35

FOR: RETAIL STORE SERVICES FEATURING BODY AND BEAUTY CARE COSMETICS, COSMETIC PREPARATIONS FOR SKIN CARE, LIQUID PERFUMES, BODY AND BEAUTY LOTIONS, MAKE-UP, BRUSHES FOR MAKE-UP, COSMETIC BAGS SOLD EMPTY, PERFUMED CANDLES, BATH SOAPS, NAIL POLISH, NAIL POLISH REMOVER, MEDITATION MATS, AND PET CARE KITS COMPRISING SHAMPOO, CONDITIONER, AND BODY SPRAY; ONLINE-RETAIL STORE SERVICES FEATURING BODY AND BEAUTY CARE COSMETICS, COSMETIC PREPARATIONS FOR SKIN CARE, LIQUID PERFUMES, BODY AND BEAUTY LOTIONS, MAKE-UP, BRUSHES FOR MAKE-UP, COSMETIC BAGS SOLD EMPTY, PERFUMED CANDLES, BATH SOAPS, NAIL POLISH, NAIL POLISH REMOVER, MEDITATION MATS, AND PET CARE KITS COMPRISING SHAMPOO, CONDITIONER, AND BODY SPRAY, IN CLASS 35 (U.S. CLS. 100, 101 AND 102).

SERVICE MARK

PRINCIPAL REGISTER

FIRST USE 6-24-2011; IN COMMERCE 8-17-2011.

THE MARK CONSISTS OF STANDARD CHARACTERS WITHOUT CLAIM TO ANY PARTICULAR FONT, STYLE, SIZE, OR COLOR.

NO CLAIM IS MADE TO THE EXCLUSIVE RIGHT TO USE "BEAUTY", APART FROM THE MARK AS SHOWN.

SER. NO. 85-473,976, FILED 11-16-2011.

JOHN DWYER, EXAMINING ATTORNEY



David J. Kyros

Director of the United States Patent and Trademark Office

United States of America

United States Patent and Trademark Office

MaintenanceLogin

Reg. No. 4,174,990

Registered July 17, 2012

Int. Cl.: 42

SERVICE MARK

PRINCIPAL REGISTER

RAYBURN CORPORATION (CALIFORNIA CORPORATION)
28241 CROWN VALLEY PKWY.
SUITE F-140
LAGUNA NIGUEL, CA 92677

FOR: PROVIDING TEMPORARY USE OF A WEB-BASED SOFTWARE APPLICATION FOR WORK ORDER MANAGEMENT, IN CLASS 42 (U.S. CLS. 100 AND 101).

FIRST USE 9-1-2006; IN COMMERCE 4-16-2007.

THE MARK CONSISTS OF STANDARD CHARACTERS WITHOUT CLAIM TO ANY PARTICULAR FONT, STYLE, SIZE, OR COLOR.

SER. NO. 85-473,977, FILED 11-16-2011.

AMY KELLY, EXAMINING ATTORNEY



David J. Kyffers

Director of the United States Patent and Trademark Office

United States of America

United States Patent and Trademark Office



Reg. No. 4,174,991

Registered July 17, 2012

Int. Cl.: 9

TRADEMARK

PRINCIPAL REGISTER

IC INTRACOM HOLDINGS, LLC (DELAWARE LIMITED LIABILITY COMPANY)
550 COMMERCE BLVD.
OLDSMAR, FL 34677

FOR: COMPUTER HARDWARE AND PERIPHERALS, NAMELY, COMPUTER CABLES, COMPUTER KEYBOARDS, COMPUTER HARDWARE FOR TELECOMMUNICATIONS, COMPUTER MOUSE, COMPUTER SPEAKERS, COMPUTER CPU AND SYSTEM COOLERS, COMPUTER PERIPHERALS, COMPUTER NETWORK HUBS, SWITCHES AND ROUTERS, COMPUTER CARRYING CASES, COMPUTER CHASSIS, COMPUTER MOUSE PADS, WIRELESS COMPUTER PERIPHERALS, COMPUTER HEAT SINKS, COMPUTER POWER PROTECTION DEVICES, NAMELY, VOLTAGE SURGE PROTECTORS, IN CLASS 9 (U.S. CLS. 21, 23, 26, 36 AND 38).

FIRST USE 7-28-2006; IN COMMERCE 7-28-2006.

THE MARK CONSISTS OF A STYLIZED LETTER "M" WITH LINES TRANSPOSED THROUGHOUT.

SER. NO. 85-473,979, FILED 11-16-2011.

LINDSEY RUBIN, EXAMINING ATTORNEY



David J. Kyffers

Director of the United States Patent and Trademark Office

United States of America

United States Patent and Trademark Office

Family of Heroes

Reg. No. 4,174,992

Registered July 17, 2012

Int. Cl.: 41

SERVICE MARK

PRINCIPAL REGISTER

KOGNITO SOLUTIONS LLC (NEW YORK LIMITED LIABILITY COMPANY)
SUITE 1001
130 WEST 25 STREET
NEW YORK, NY 10001

FOR: PROVIDING EDUCATIONAL SERVICES, NAMELY, ONLINE HEALTH, COMMUNICATION, AND LIFE-SKILLS COURSES IN THE FIELDS OF SUICIDE PREVENTION, BEHAVIORAL HEALTH, AND GENERAL HEALTH, IN CLASS 41 (U.S. CLS. 100, 101 AND 107).

FIRST USE 9-1-2011; IN COMMERCE 9-1-2011.

THE MARK CONSISTS OF THE STYLIZED TEXT "FAMILY OF HEROES." TO THE RIGHT OF THE TEXT IS A SILHOUETTE OF FOUR FAMILY MEMBERS COMPRISED OF TWO ADULTS AND TWO KIDS HOLDING HANDS.

SER. NO. 85-473,983, FILED 11-16-2011.

LINDSEY RUBIN, EXAMINING ATTORNEY



David J. Kyffers

Director of the United States Patent and Trademark Office

United States of America

United States Patent and Trademark Office

SimplStor

Reg. No. 4,174,993

ZEROWAIT CORPORATION (DELAWARE CORPORATION)
707 KIRKWOOD HWY
WILMINGTON, DE 19805

Registered July 17, 2012

Int. Cl.: 9

FOR: DATA STORAGE DEVICES, NAMELY, NETWORK-ATTACHED STORAGE APPLI-
ANCES AND STORAGE AREA NETWORK SERVERS, IN CLASS 9 (U.S. CLS. 21, 23, 26, 36
AND 38).

TRADEMARK

FIRST USE 2-12-2010; IN COMMERCE 2-12-2010.

PRINCIPAL REGISTER

THE MARK CONSISTS OF STANDARD CHARACTERS WITHOUT CLAIM TO ANY PAR-
TICULAR FONT, STYLE, SIZE, OR COLOR.

SER. NO. 85-474,011, FILED 11-16-2011.

WILLIAM JACKSON, EXAMINING ATTORNEY



David J. Kyffers

Director of the United States Patent and Trademark Office

United States of America

United States Patent and Trademark Office

GotYa

Reg. No. 4,174,994

Registered July 17, 2012

Int. Cl.: 28

TRADEMARK

PRINCIPAL REGISTER

HOLLINGER, JULIE A (ILLINOIS SOLE PROPRIETORSHIP), DBA NOELLAS
1021 E CLEVELAND ST
LADD, IL 61329

FOR: STUFFED TOYS, IN CLASS 28 (U.S. CLS. 22, 23, 38 AND 50).

FIRST USE 5-28-2011; IN COMMERCE 10-17-2011.

THE MARK CONSISTS OF STANDARD CHARACTERS WITHOUT CLAIM TO ANY PARTICULAR FONT, STYLE, SIZE, OR COLOR.

SER. NO. 85-474,025, FILED 11-16-2011.

TAMARA FRAZIER, EXAMINING ATTORNEY



David J. Kyffers

Director of the United States Patent and Trademark Office

United States of America
United States Patent and Trademark Office

SimplStor

Reg. No. 4,174,995

Registered July 17, 2012

Int. Cl.: 9

TRADEMARK

PRINCIPAL REGISTER

ZEROWAIT CORPORATION (DELAWARE CORPORATION)
707 KIRKWOOD HWY
WILMINGTON, DE 19805

FOR: DATA STORAGE DEVICES, NAMELY, NETWORK-ATTACHED STORAGE APPLI-
ANCES AND STORAGE AREA NETWORK SERVERS, IN CLASS 9 (U.S. CLS. 21, 23, 26, 36
AND 38).

FIRST USE 2-12-2010; IN COMMERCE 2-12-2010.

THE MARK CONSISTS OF THE PHRASE "SIMPLSTOR", WITH THE LETTERS "ST" AND
"R" IN BLOCK LETTERS AND THE LETTER "O" IN THE FORM OF A THREE-DIMENSIONAL
CD OR CD-ROM WITH CURVED LINES ABOVE THE "O" ON THE UPPER LEFT AND BE-
LOW THE "O" ON LOWER RIGHT.

SER. NO. 85-474,037, FILED 11-16-2011.

WILLIAM JACKSON, EXAMINING ATTORNEY



David J. Kyffers

Director of the United States Patent and Trademark Office

United States of America

United States Patent and Trademark Office

THINKER LINKERS

Reg. No. 4,174,996

Registered July 17, 2012

Int. Cl.: 28

TRADEMARK

PRINCIPAL REGISTER

MURRAH WOODCRAFT, LLC (NORTH CAROLINA LIMITED LIABILITY COMPANY)
1320 OLD OXFORD HWY
UNIT 6
DURHAM, NC 27704

FOR: TOY BUILDING PIECES CAPABLE OF INTERCONNECTION, IN CLASS 28 (U.S. CLS. 22, 23, 38 AND 50).

FIRST USE 5-23-2011; IN COMMERCE 6-16-2011.

THE MARK CONSISTS OF STANDARD CHARACTERS WITHOUT CLAIM TO ANY PARTICULAR FONT, STYLE, SIZE, OR COLOR.

SER. NO. 85-474,038, FILED 11-16-2011.

WILLIAM JACKSON, EXAMINING ATTORNEY



David J. Kyffers

Director of the United States Patent and Trademark Office

United States of America

United States Patent and Trademark Office

CREATING CHANCES

Reg. No. 4,174,997

Registered July 17, 2012

Int. Cl.: 36

SERVICE MARK

PRINCIPAL REGISTER

U.S. SOCCER FOUNDATION (DELAWARE NON-PROFIT CORPORATION)
1211 CONNECTICUT AVE., NW
STE 500
WASHINGTON, DC 20036

FOR: CHARITABLE FUNDRAISING SERVICES, IN CLASS 36 (U.S. CLS. 100, 101 AND 102).

FIRST USE 10-31-2011; IN COMMERCE 10-31-2011.

THE MARK CONSISTS OF STANDARD CHARACTERS WITHOUT CLAIM TO ANY PARTICULAR FONT, STYLE, SIZE, OR COLOR.

SER. NO. 85-474,060, FILED 11-16-2011.

RUSS HERMAN, EXAMINING ATTORNEY



David J. Kybas

Director of the United States Patent and Trademark Office

United States of America

United States Patent and Trademark Office

SIDE EFFECT

Reg. No. 4,174,998

Registered July 17, 2012

Int. Cl.: 5

TRADEMARK

PRINCIPAL REGISTER

FUTUREGENX L.L.C. (IDAHO LIMITED LIABILITY COMPANY)
#294
104 EAST FAIRVIEW
MERIDIAN, ID 83642

FOR: AMINO ACIDS FOR NUTRITIONAL PURPOSES; BEE POLLEN FOR USE AS A DIETARY FOOD SUPPLEMENT; CAFFEINE PREPARATIONS FOR STIMULATIVE USE; CAFFEINE PREPARATIONS FOR STIMULATIVE USE IN THE FORM OF CHEWING GUM; CALCIUM SUPPLEMENTS; DIET CAPSULES; DIET PILLS; DIETARY AND NUTRITIONAL SUPPLEMENTS; DIETARY AND NUTRITIONAL SUPPLEMENTS CONTAINING CREATINE; DIETARY AND NUTRITIONAL SUPPLEMENTS FOR ENDURANCE SPORTS; DIETARY AND NUTRITIONAL SUPPLEMENTS USED FOR WEIGHT LOSS; DIETARY BEVERAGE SUPPLEMENTS FOR HUMAN CONSUMPTION IN LIQUID AND DRY MIX FORM FOR THERAPEUTIC PURPOSES; DIETARY DRINK MIX FOR USE AS A MEAL REPLACEMENT; DIETARY FIBER AS AN ADDITIVE FOR FOOD PRODUCTS; DIETARY FOOD SUPPLEMENTS; DIETARY SUPPLEMENT BEVERAGE FOR ENERGY; DIETARY SUPPLEMENT FOR ELIMINATING TOXINS FROM THE INTESTINAL TRACT; DIETARY SUPPLEMENTAL DRINKS; DIETARY SUPPLEMENTAL DRINKS IN THE NATURE OF VITAMIN AND MINERAL BEVERAGES; DIETARY SUPPLEMENTS; DIETARY SUPPLEMENTS FOR CONTROLLING CHOLESTEROL; DIETARY SUPPLEMENTS FOR HUMAN CONSUMPTION; DIETARY SUPPLEMENTS FOR URINARY HEALTH; DIETARY SUPPLEMENTS FOR HUMANS; DIETARY SUPPLEMENTS IN THE NATURE OF WEIGHT LOSS POWDERS; DIETING PILLS AND POWDER PREPARATIONS TO PROMOTE FAT BURNING; ELECTROLYTES; ENERGY BOOSTING BARS FOR USE AS A MEAL SUBSTITUTE; ENERGY BOOSTING MOUTH DISSOLVABLE FLAVORED EDIBLE FILMS; FOOD SUPPLEMENTS; FOOD SUPPLEMENTS FOR HUMANS; FOOD SUPPLEMENTS, NAMELY, ANTI-OXIDANTS; FOODS AND SNACKS WHICH ARE FREE OF SOY TO ACCOMMODATE SPECIAL MEDICAL AND HEALTH CONDITIONS; GUMMY VITAMINS; HAIR GROWTH STIMULANTS; HEADACHE TREATMENT PREPARATIONS; HEALTH FOOD SUPPLEMENTS; HERBAL DRINKS USED TO AID IN SLEEP AND RELAXATION; HERBAL SUPPLEMENTS; HERBAL SUPPLEMENTS FOR SLEEPING PROBLEMS; HERBAL SUPPLEMENTS FOR BOOSTING ENERGY; LIQUID NUTRITIONAL SUPPLEMENT; LIQUID PROTEIN SUPPLEMENTS; LIQUID VITAMIN SUPPLEMENTS; LYSINE PREPARATIONS; MEAL REPLACEMENT AND DIETARY SUPPLEMENT DRINK MIXES; MEAL REPLACEMENT BARS; MEAL REPLACEMENT DRINKS; MEAL REPLACEMENT POWDERS; MEAL REPLACEMENT SHAKES; MEAL REPLACEMENT SNACKS; MINERAL FOOD SUPPLEMENTS; MINERAL NUTRITIONAL SUPPLEMENTS; MINERAL SUPPLEMENTS; MINERAL, VITAMIN, OR NUTRITIONALLY EN-



David J. Kybas

Director of the United States Patent and Trademark Office

Reg. No. 4,174,998 HANCED WATER; MIXED VITAMIN PREPARATIONS; MULTI-VITAMIN PREPARATIONS; MULTIVITAMIN PREPARATIONS; NATURAL SUPPLEMENTS FOR TREATING DEPRESSION AND ANXIETY; NATURAL SUPPLEMENTS FOR TREATING ERECTILE DYSFUNCTION; NUTRACEUTICALS FOR USE AS A DIETARY SUPPLEMENT; NUTRACEUTICALS FOR USE AS A DIETARY SUPPLEMENT FOR MUSCLE GROWTH; NUTRITIONAL ADDITIVES FOR MEDICAL PURPOSES USED IN FOODS AND DIETARY SUPPLEMENTS FOR HUMAN CONSUMPTION; NUTRITIONAL DRINK MIX FOR USE AS A MEAL REPLACEMENT; NUTRITIONAL DRINKS USED FOR MEAL REPLACEMENT; NUTRITIONAL ENERGY BARS FOR USE AS A MEAL SUBSTITUTE; NUTRITIONAL FOOD BARS FOR USE AS A MEAL REPLACEMENT; NUTRITIONAL MEAL REPLACEMENT BARS FOR INDIVIDUALS UNDERGOING MEDICAL TREATMENTS; NUTRITIONAL SUPPLEMENT FOR ELIMINATING TOXINS FROM THE BODY; NUTRITIONAL SUPPLEMENT FOR ELIMINATING TOXINS FROM THE INTESTINAL TRACT; NUTRITIONAL SUPPLEMENT IN THE NATURE OF A NUTRIENT-DENSE, PROTEIN-BASED DRINK MIX; NUTRITIONAL SUPPLEMENTS; NUTRITIONAL SUPPLEMENTS FOR FAT LOSS; NUTRITIONAL SUPPLEMENTS IN LOTION FORM SOLD AS A COMPONENT OF NUTRITIONAL SKIN CARE PRODUCTS; NUTRITIONAL SUPPLEMENTS IN THE FORM OF TABLETS AND POWDERS; NUTRITIONAL SUPPLEMENTS IN THE NATURE OF NUTRITIONALLY FORTIFIED SOFT CHEWS; NUTRITIONAL SUPPLEMENTS, NAMELY, CARBOHYDRATES IN POWDERED FORM; NUTRITIONAL SUPPLEMENTS, NAMELY, PROBIOTIC COMPOSITIONS; POWDERED FRUIT-FLAVORED DIETARY SUPPLEMENT DRINK MIX; POWDERED NUTRITIONAL SUPPLEMENT CONCENTRATE; POWDERED NUTRITIONAL SUPPLEMENT DRINK MIX; POWDERED NUTRITIONAL SUPPLEMENT DRINK MIX AND CONCENTRATE; PROTEIN SUPPLEMENTS; PROTEIN-BASED MEAL REPLACEMENT SHAKES; VITAMIN AND MINERAL FORMED AND PACKAGED AS BARS; VITAMIN AND MINERAL SUPPLEMENTS; VITAMIN B PREPARATIONS; VITAMIN C PREPARATIONS; VITAMIN D PREPARATIONS; VITAMIN DROPS; VITAMIN ENRICHED CHEWING GUM; VITAMIN ENRICHED WATER; VITAMIN FORTIFIED BEVERAGES; VITAMIN PREPARATIONS; VITAMIN SUPPLEMENT IN TABLET FORM FOR USE IN MAKING AN EFFERVESCENT BEVERAGE WHEN ADDED TO WATER; VITAMIN SUPPLEMENTS; VITAMIN TABLETS; VITAMINS; VITAMINS AND VITAMIN PREPARATIONS; WEIGHT MANAGEMENT SUPPLEMENTS; WHEY PROTEIN SUPPLEMENTS; ZINC SUPPLEMENT LOZENGES, IN CLASS 5 (U.S. CLS. 6, 18, 44, 46, 51 AND 52).

FIRST USE 10-3-2011; IN COMMERCE 10-3-2011.

THE MARK CONSISTS OF TWO WORDS, "SIDE" AND "EFFECT" IN BOLD CAPITAL LETTERS USING RIGHT ANGLE ITALICS. "SIDE" IS SITUATED ABOVE "EFFECT", AND DUE TO FORMATTING, THE WORD "EFFECT" EXTENDS FURTHER RIGHT OF THE ABOVE WORD "SIDE". IN BETWEEN THE WORDS "SIDE" AND "EFFECT" APPEARS A HORIZONTAL LINE. THIS HORIZONTAL LINE BEGINS SLIGHTLY TO THE RIGHT OF THE FIRST CHARACTER "S", IN THE WORD "SIDE", AND CONTINUES HORIZONTALLY STRAIGHT UNTIL IT REACHES THE END OF THE LAST CHARACTER "E", IN THE WORD "SIDE". WHERE UPON THE HORIZONTAL LINE FORMS AN UPWARD AND DOWNWARD WAVE THAT REPEATS IN A RANDOM UPWARD AND DOWNWARD VERTICAL LINE AT DIFFERENT ALTITUDES. THE HORIZONTAL LINE REPRESENTS A TELEMETRY WAVE COMMONLY ASSOCIATED WITH A CARDIAC WAVE AS SEEN ON AN OSCILLOSCOPE.

SER. NO. 85-474,081, FILED 11-16-2011.

Laurie Kaufman, Examining Attorney

United States of America

United States Patent and Trademark Office



Reg. No. 4,174,999

USNER, JEFFREY (UNITED STATES INDIVIDUAL), DBA COUPON COACH
819 WATER STREET, #104
KERRVILLE, TX 78028

Registered July 17, 2012

Int. Cl.: 41

FOR: EDUCATIONAL SERVICES, NAMELY, PROVIDING ONLINE INSTRUCTION IN THE FIELD OF COUPONING, IN CLASS 41 (U.S. CLS. 100, 101 AND 107).

SERVICE MARK

FIRST USE 11-3-2011; IN COMMERCE 11-3-2011.

PRINCIPAL REGISTER

NO CLAIM IS MADE TO THE EXCLUSIVE RIGHT TO USE "COUPON COACH", APART FROM THE MARK AS SHOWN.

THE COLOR(S) SKY BLUE, WHITE, AND BLACK IS/ARE CLAIMED AS A FEATURE OF THE MARK.

THE MARK CONSISTS OF A SKY BLUE RECTANGLE ENCLOSED BY TWO BORDERS: AN INNER WHITE BORDER AND AN OUTER BLACK, DOTTED LINE BORDER IN BOLD FONT. THE DESIGN IN THE UPPER LEFT-HAND CORNER OF THE MARK IS DEPICTED TO LOOK LIKE SCISSORS CLIPPING A COUPON. THE WORDS "COUPON" AND "COACH" ARE FEATURED AT THE CENTER OF THE RECTANGLE IN WHITE STYLIZED FONT AND CAPITAL LETTERS.

SER. NO. 85-474,093, FILED 11-16-2011.

HEATHER THOMPSON, EXAMINING ATTORNEY



David J. Kybas

Director of the United States Patent and Trademark Office

United States of America

United States Patent and Trademark Office

ENVIROREEL

Reg. No. 4,175,000

PERFECTVISION MANUFACTURING INC. (ARKANSAS CORPORATION)
3901 PROGRESS STREET
NORTH LITTLE ROCK, AR 72114

Registered July 17, 2012

Int. Cl.: 20

FOR: NONMETAL CONTAINERS FOR USE IN TRANSPORT OF COAXIAL CABLE FOR
COMMERCIAL OR INDUSTRIAL USE, IN CLASS 20 (U.S. CLS. 2, 13, 22, 25, 32 AND 50).

TRADEMARK

FIRST USE 9-14-2011; IN COMMERCE 9-14-2011.

PRINCIPAL REGISTER

THE MARK CONSISTS OF STANDARD CHARACTERS WITHOUT CLAIM TO ANY PAR-
TICULAR FONT, STYLE, SIZE, OR COLOR.

SER. NO. 85-474,111, FILED 11-16-2011.

FLORENTINA BLANDU, EXAMINING ATTORNEY



David J. Kyffers

Director of the United States Patent and Trademark Office

United States of America

United States Patent and Trademark Office

Sonobi Media

Reg. No. 4,175,001

Registered July 17, 2012

Int. Cls.: 35 and 42

SERVICE MARK

PRINCIPAL REGISTER

CONTECH IP, LLC (FLORIDA LIMITED LIABILITY COMPANY)
125 E. INDIANA AVENUE, SUITE B
DELAND, FL 32724

FOR: ADVERTISING AND ADVERTISEMENT SERVICES, ADVERTISING AND MARKETING CONSULTANCY, NAMELY, ON-LINE ADVERTISING OPTIMIZATION, DEVELOPMENT AND IMPLEMENTATION OF ADVERTISING CAMPAIGNS AND ANALYSIS OF THE EFFECTIVENESS OF ADVERTISING CAMPAIGNS, SPECIFICALLY VIA THE INTERNET; DISSEMINATION OF ADVERTISING FOR OTHERS VIA THE INTERNET; INTERNET ADVERTISING SERVICES; ON-LINE ADVERTISING AND MARKETING SERVICES; ON-LINE ADVERTISING SERVICES FOR OTHERS; ON-LINE AUCTION SERVICES, NAMELY, AN ON-LINE AUCTION EXCHANGE FOR BUYING AND SELLING ADVERTISING SPACE, IN CLASS 35 (U.S. CLS. 100, 101 AND 102).

FIRST USE 9-1-2011; IN COMMERCE 9-1-2011.

FOR: PROVIDING A WEB SITE FEATURING TEMPORARY USE OF NON-DOWNLOADABLE SOFTWARE FOR USE IN THE OPTIMIZATION OF ON LINE ADVERTISING AND PARTICIPATION IN ON LINE ADVERTISING AUCTIONS, IN CLASS 42 (U.S. CLS. 100 AND 101).

FIRST USE 9-1-2011; IN COMMERCE 9-1-2011.

THE MARK CONSISTS OF STANDARD CHARACTERS WITHOUT CLAIM TO ANY PARTICULAR FONT, STYLE, SIZE, OR COLOR.

NO CLAIM IS MADE TO THE EXCLUSIVE RIGHT TO USE "MEDIA", APART FROM THE MARK AS SHOWN.

SER. NO. 85-474,136, FILED 11-16-2011.

RENEE MCCRAY, EXAMINING ATTORNEY



David J. Kyffers

Director of the United States Patent and Trademark Office

United States of America

United States Patent and Trademark Office

Sonobi Mobile

Reg. No. 4,175,002

Registered July 17, 2012

Int. Cl.: 42

SERVICE MARK

PRINCIPAL REGISTER

CONTECH IP, LLC (FLORIDA LIMITED LIABILITY COMPANY)
125 E. INDIANA AVENUE, SUITE B
DELAND, FL 32724

FOR: APPLICATION SERVICE PROVIDER, NAMELY, HOSTING, MANAGING, DEVELOPING, AND MAINTAINING MOBILE APPLICATIONS, IN THE FIELD OF ADVERTISING, IN CLASS 42 (U.S. CLS. 100 AND 101).

FIRST USE 9-1-2011; IN COMMERCE 9-1-2011.

THE MARK CONSISTS OF STANDARD CHARACTERS WITHOUT CLAIM TO ANY PARTICULAR FONT, STYLE, SIZE, OR COLOR.

NO CLAIM IS MADE TO THE EXCLUSIVE RIGHT TO USE "MOBILE", APART FROM THE MARK AS SHOWN.

SER. NO. 85-474,144, FILED 11-16-2011.

RENEE MCCRAY, EXAMINING ATTORNEY



David J. Kyffers

Director of the United States Patent and Trademark Office

United States of America

United States Patent and Trademark Office

CONMORÉ

Reg. No. 4,175,003

CRAFTMASTER MANUFACTURING, INC. (DELAWARE CORPORATION)
500 WEST MONROE STREET, SUITE 2010
CHICAGO, IL 60661

Registered July 17, 2012

Int. Cl.: 19

FOR: NON-METAL MOLDED DOORS AND NON-METAL MOLDED DOOR FACINGS, IN CLASS 19 (U.S. CLS. 1, 12, 33 AND 50).

TRADEMARK

FIRST USE 6-30-2011; IN COMMERCE 6-30-2011.

PRINCIPAL REGISTER

THE MARK CONSISTS OF STANDARD CHARACTERS WITHOUT CLAIM TO ANY PARTICULAR FONT, STYLE, SIZE, OR COLOR.

SER. NO. 85-474,145, FILED 11-16-2011.

HOWARD SMIGA, EXAMINING ATTORNEY



David J. Kyffers

Director of the United States Patent and Trademark Office

United States of America

United States Patent and Trademark Office



Reg. No. 4,175,004

HISTORIVISION, LLC (VIRGINIA LIMITED LIABILITY COMPANY)
2737 NORTH WAKEFIELD STREET
ARLINGTON, VA 22207

Registered July 17, 2012

Int. Cl.: 41

FOR: MULTIMEDIA ENTERTAINMENT AND EDUCATIONAL SOFTWARE PRODUCTION SERVICES OF SOFTWARE FEATURING MULTIMEDIA EDUCATIONAL AND ENTERTAINING HISTORY PRESENTATIONS; MULTIMEDIA ENTERTAINMENT SERVICES IN THE NATURE OF RECORDING, PRODUCTION AND POST-PRODUCTION IN THE FIELD OF VIDEO AND FILMS FEATURING MULTIMEDIA HISTORY PRESENTATIONS; ENTERTAINMENT SERVICES, NAMELY, PROVIDING A WEBSITE FEATURING PHOTOGRAPHIC, AUDIO AND VIDEO PRESENTATIONS FEATURING HISTORY; ENTERTAINMENT AND EDUCATIONAL SERVICES, NAMELY, CONDUCTING EXHIBITIONS FEATURING MULTIMEDIA HISTORY PRESENTATIONS AND VIDEO GAMES, IN CLASS 41 (U.S. CLS. 100, 101 AND 107).

SERVICE MARK

PRINCIPAL REGISTER

FIRST USE 10-1-2011; IN COMMERCE 10-15-2011.

OWNER OF U.S. REG. NO. 3,658,529.

NO CLAIM IS MADE TO THE EXCLUSIVE RIGHT TO USE "AMAZING OPS", APART FROM THE MARK AS SHOWN.

THE MARK CONSISTS OF THE WORDING "HISTORIVISION" WITH A STAR DESIGN SUPERIMPOSED OVER THE LETTER O, APPEARING ABOVE THE WORDING "AMAZING OPS".

SER. NO. 85-474,147, FILED 11-16-2011.

WENDY GOODMAN, EXAMINING ATTORNEY



David J. Kyjars

Director of the United States Patent and Trademark Office

United States of America

United States Patent and Trademark Office

TRAINING LEADERS GLOBALLY TO IMPACT THEIR WORLD LOCALLY

Reg. No. 4,175,005

Registered July 17, 2012

Int. Cls.: 16, 41 and 45

TRADEMARK

SERVICE MARK

PRINCIPAL REGISTER

HAGGAI INSTITUTE FOR ADVANCED LEADERSHIP TRAINING, INC. (GEORGIA CORPORATION)
4725 PEACHTREE CORNERS CIRCLE
NORCROSS, GA 30092

FOR: PRINTED MATERIALS, NAMELY, NEWSLETTERS AND TEACHING MATERIALS FOR USE IN THE FIELD OF EVANGELIZATION AND FOR USE IN THE TRAINING OF OTHERS TO MORE EFFECTIVELY EVANGELIZE, IN CLASS 16 (U.S. CLS. 2, 5, 22, 23, 29, 37, 38 AND 50).

FIRST USE 8-2-2011; IN COMMERCE 8-2-2011.

FOR: CONDUCTING SEMINARS AND CONFERENCES IN THE FIELD OF EVANGELIZATION AND FOR USE IN THE TRAINING OF OTHERS TO MORE EFFECTIVELY EVANGELIZE; EDUCATIONAL SERVICES, NAMELY, PROVIDING COURSES AND SEMINARS TO PROMOTE AND ENCOURAGE EVANGELIZATION OF THE CHRISTIAN FAITH BY OTHERS, IN CLASS 41 (U.S. CLS. 100, 101 AND 107).

FIRST USE 8-2-2011; IN COMMERCE 8-2-2011.

FOR: EVANGELIZATION SERVICES; EVANGELIZATION SERVICES, NAMELY, PROMOTING AND ENCOURAGING EVANGELIZATION OF THE CHRISTIAN FAITH BY OTHERS BY EVANGELIZING TO THOSE OTHERS, BY PROVIDING PRINTED MATERIALS TO THOSE OTHERS AND BY PROVIDING CONSULTATION AND GUIDANCE IN CONNECTION WITH EVANGELIZATION, IN CLASS 45 (U.S. CLS. 100 AND 101).

FIRST USE 8-2-2011; IN COMMERCE 8-2-2011.

THE MARK CONSISTS OF STANDARD CHARACTERS WITHOUT CLAIM TO ANY PARTICULAR FONT, STYLE, SIZE, OR COLOR.

OWNER OF U.S. REG. NO. 2,161,444.

SER. NO. 85-474,148, FILED 11-17-2011.

GINA HAYES, EXAMINING ATTORNEY



David J. Kyjars

Director of the United States Patent and Trademark Office

United States of America

United States Patent and Trademark Office

MORSEKODE

Reg. No. 4,175,006

Registered July 17, 2012

Int. Cl.: 35

SERVICE MARK

PRINCIPAL REGISTER

MORSEKODE, LTD. (MINNESOTA CORPORATION)
7900 INTERNATIONAL DRIVE
SUITE 140
BLOOMINGTON, MN 55425

FOR: BRANDING SERVICES, NAMELY, CONSULTING, DEVELOPMENT, MANAGEMENT AND MARKETING OF BRANDS FOR BUSINESSES; BUSINESS MARKETING SERVICES, IN CLASS 35 (U.S. CLS. 100, 101 AND 102).

FIRST USE 3-6-2002; IN COMMERCE 4-1-2002.

THE MARK CONSISTS OF STANDARD CHARACTERS WITHOUT CLAIM TO ANY PARTICULAR FONT, STYLE, SIZE, OR COLOR.

SER. NO. 85-474,158, FILED 11-16-2011.

PAUL E. FAHRENKOPF, EXAMINING ATTORNEY



David J. Kyffers

Director of the United States Patent and Trademark Office

United States of America

United States Patent and Trademark Office

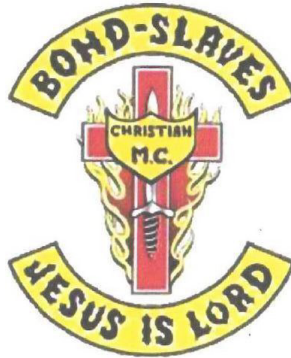

Reg. No. 4,175,007

Registered July 17, 2012

**COLLECTIVE
MEMBERSHIP**

PRINCIPAL REGISTER

BOND-SLAVES MC (MINNESOTA CORPORATION)
33448 HELIUM STREET, NW
CAMBRIDGE, MN 55008

FOR: INDICATING MEMBERSHIP IN A SERVICE ORGANIZATION OF MOTORCYCLISTS HAVING A COMMON FAITH, IN CLASS 200 (U.S. CL. 200).

FIRST USE 8-7-2006; IN COMMERCE 8-7-2006.

NO CLAIM IS MADE TO THE EXCLUSIVE RIGHT TO USE "CHRISTIAN M.C." AND "JESUS IS LORD", APART FROM THE MARK AS SHOWN.

THE COLOR(S) BLACK, YELLOW AND RED IS/ARE CLAIMED AS A FEATURE OF THE MARK.

THE MARK CONSISTS OF AN ARC OF YELLOW OUTLINED IN BLACK CONTAINING THE WORDS "BOND-SLAVES" IN BLACK, THE ARC BEING LOCATED ABOVE A RED CROSS ON A FIELD OF RED FLAMES, THE CROSS INCLUDING A SWORD BELOW A SHIELD OF YELLOW CONTAINING THE WORDS "CHRISTIAN M.C." IN BLACK, AND AN ARC OF YELLOW OUTLINED IN BLACK BELOW THE CROSS CONTAINING THE WORDS "JESUS IS LORD" IN BLACK.

SER. NO. 85-474,163, FILED 11-16-2011.

JOHN E. MICHOS, EXAMINING ATTORNEY



David J. Kyjars

Director of the United States Patent and Trademark Office

United States of America

United States Patent and Trademark Office

LECTRI-FLO

Reg. No. 4,175,008

BAY ELECTRIC INC. (ARKANSAS CORPORATION)
500 MAIN STREET
BAY, AR 72411

Registered July 17, 2012

Int. Cl.: 7

FOR: MOTORS, NAMELY, ALTERNATING CURRENT MOTORS NOT FOR LAND VEHICLES,
IN CLASS 7 (U.S. CLS. 13, 19, 21, 23, 31, 34 AND 35).

TRADEMARK

FIRST USE 3-18-2011; IN COMMERCE 3-18-2011.

PRINCIPAL REGISTER

THE MARK CONSISTS OF STANDARD CHARACTERS WITHOUT CLAIM TO ANY PARTICULAR FONT, STYLE, SIZE, OR COLOR.

SER. NO. 85-474,180, FILED 11-16-2011.

TINA MAI, EXAMINING ATTORNEY



David J. Kyffers

Director of the United States Patent and Trademark Office

United States of America

United States Patent and Trademark Office

FAT ALBERT

Reg. No. 4,175,009

Registered July 17, 2012

Int. Cl.: 25

TRADEMARK

PRINCIPAL REGISTER

WILLIAM H. COSBY JR. (UNITED STATES INDIVIDUAL)
C/O PATTERSON BELKNAP WEBB & TYLER LLP
1133 AVENUE OF THE AMERICAS
NEW YORK, NY 10036

FOR: CLOTHING, NAMELY, T-SHIRTS, IN CLASS 25 (U.S. CLS. 22 AND 39).

FIRST USE 2-28-2010; IN COMMERCE 4-30-2010.

THE MARK CONSISTS OF STANDARD CHARACTERS WITHOUT CLAIM TO ANY PARTICULAR FONT, STYLE, SIZE, OR COLOR.

OWNER OF U.S. REG. NO. 3,958,154.

SER. NO. 85-474,185, FILED 11-16-2011.

ALICIA COLLINS, EXAMINING ATTORNEY



David J. Kyjars

Director of the United States Patent and Trademark Office

United States of America

United States Patent and Trademark Office

GRIMEY LEAGUE

Reg. No. 4,175,010

POINT BLANK PRODUCTIONS, INC. (ILLINOIS CORPORATION)

Registered July 17, 2012

1507 E. 53RD STREET #875
CHICAGO, IL 606154573

Int. Cl.: 25

FOR: ATHLETIC APPAREL, NAMELY, SHIRTS, PANTS, JACKETS, FOOTWEAR, HATS AND CAPS, ATHLETIC UNIFORMS; HATS; HOODED SWEATSHIRTS; JACKETS; JEANS; SWEATSHIRTS; TOPS; WEARABLE GARMENTS AND CLOTHING, NAMELY, SHIRTS; WOMEN'S CLOTHING, NAMELY, SHIRTS, DRESSES, SKIRTS, BLOUSES, IN CLASS 25 (U.S. CLS. 22 AND 39).

TRADEMARK

PRINCIPAL REGISTER

FIRST USE 8-15-2007; IN COMMERCE 11-15-2010.

THE MARK CONSISTS OF STANDARD CHARACTERS WITHOUT CLAIM TO ANY PARTICULAR FONT, STYLE, SIZE, OR COLOR.

SER. NO. 85-474,187, FILED 11-16-2011.

ANDREA HACK, EXAMINING ATTORNEY



David J. Kybas

Director of the United States Patent and Trademark Office

United States of America

United States Patent and Trademark Office

Play 4Kay

Reg. No. 4,175,011

Registered July 17, 2012

Int. Cls.: 35 and 36

SERVICE MARK

PRINCIPAL REGISTER

KAY YOW CANCER FOUNDATION, INC. (GEORGIA NON-PROFIT CORPORATION), AKA
KAY YOW CANCER FUND
P.O. BOX 3369
CARY, NC 275193369

FOR: PROMOTING THE PUBLIC AWARENESS OF THE NEED FOR FINDING A CURE FOR
CANCER, CANCER RESEARCH AND ASSISTING THE UNDERSERVED, IN CLASS 35 (U.S.
CLS. 100, 101 AND 102).

FIRST USE 9-1-2011; IN COMMERCE 9-1-2011.

FOR: CHARITABLE FUND RAISING SERVICES, IN CLASS 36 (U.S. CLS. 100, 101 AND
102).

FIRST USE 9-1-2011; IN COMMERCE 9-1-2011.

THE MARK CONSISTS OF STANDARD CHARACTERS WITHOUT CLAIM TO ANY PAR-
TICULAR FONT, STYLE, SIZE, OR COLOR.

OWNER OF U.S. REG. NOS. 3,686,422 AND 3,754,549.

SER. NO. 85-474,193, FILED 11-16-2011.

CHRISTOPHER LAW, EXAMINING ATTORNEY



David J. Kyros

Director of the United States Patent and Trademark Office

United States of America

United States Patent and Trademark Office



Reg. No. 4,175,012

ROYAL ELECTRICAL SERVICES, INC. (COLORADO CORPORATION)
820 W. 2ND ST.
PUEBLO, CO 81003

Registered July 17, 2012

Int. Cl.: 37

FOR: ELECTRICAL CONTRACTOR SERVICES; HVAC CONTRACTOR SERVICES, IN CLASS 37 (U.S. CLS. 100, 103 AND 106).

SERVICE MARK

FIRST USE 11-1-1993; IN COMMERCE 11-1-1993.

PRINCIPAL REGISTER

NO CLAIM IS MADE TO THE EXCLUSIVE RIGHT TO USE "ELECTRICAL SERVICES INC.", APART FROM THE MARK AS SHOWN.

THE COLOR(S) BLUE AND RED IS/ARE CLAIMED AS A FEATURE OF THE MARK.

THE MARK CONSISTS OF THE WORD, "ROYAL" IN BLUE WITH A RED OUTLINE. THERE IS A PICTURE OF AN ELECTRICAL PLUG WITH IN THE LETTER "O" AND "A". THERE IS A LIGHTNING BOLT COMING OUT THE LETTER "Y". THE WORDS "ELECTRICAL SERVICES" ARE UNDER "ROYAL" AND THE WORD "INC" IS UNDER THE LIGHTNING BOLT.

SER. NO. 85-474,201, FILED 11-16-2011.

CHRISTOPHER LAW, EXAMINING ATTORNEY



David J. Kyffers

Director of the United States Patent and Trademark Office

United States of America

United States Patent and Trademark Office

FOR THE LOVE OF WALLPAPER

Reg. No. 4,175,013

Registered July 17, 2012

Int. Cl.: 35

SERVICE MARK

PRINCIPAL REGISTER

THE MELA GROUP, LTD (OHIO LIMITED LIABILITY COMPANY)
2 BRATENAHL PLACE
SUITE 2D
CLEVELAND, OH 44108

FOR: COMPUTERIZED ON-LINE RETAIL STORE SERVICES FEATURING WALLCOVERINGS AND INSTALLATION SUPPLIES RELATED THERETO, IN CLASS 35 (U.S. CLS. 100, 101 AND 102).

FIRST USE 1-31-2011; IN COMMERCE 1-31-2011.

THE MARK CONSISTS OF STANDARD CHARACTERS WITHOUT CLAIM TO ANY PARTICULAR FONT, STYLE, SIZE, OR COLOR.

NO CLAIM IS MADE TO THE EXCLUSIVE RIGHT TO USE "WALLPAPER", APART FROM THE MARK AS SHOWN.

SER. NO. 85-474,202, FILED 11-16-2011.

CHRISTOPHER LAW, EXAMINING ATTORNEY



David J. Kyros

Director of the United States Patent and Trademark Office

United States of America

United States Patent and Trademark Office



Reg. No. 4,175,014

Registered July 17, 2012

Int. Cl.: 28

TRADEMARK

PRINCIPAL REGISTER

LES PRODUITS D'ACIER FAMONT INC. (CANADA CORPORATION)
6780, P.E. LAMARCHE STREET
SAINT-LEONARD QC, CANADA H1P1K1

FOR: PLAYGROUND EQUIPMENT, NAMELY, CLIMBING NETS, CLIMBING ROTATING NETS, SWINGS, TRAMPOLINES, MERRY-GO-ROUND, IN CLASS 28 (U.S. CLS. 22, 23, 38 AND 50).

FIRST USE 9-0-2007; IN COMMERCE 9-0-2007.

OWNER OF U.S. REG. NO. 3,672,385.

NO CLAIM IS MADE TO THE EXCLUSIVE RIGHT TO USE "PLAY", APART FROM THE MARK AS SHOWN.

THE MARK CONSISTS OF AN ELEPHANT DESIGN WITH THE WORD "ELEPHANT" TO THE LEFT OF AN ELEPHANT DESIGN CONTAINING THE WORD "PLAY". THE WORDING "OUT OF THIS WORLD" IS BELOW IS THE TERM "ELEPHANT".

SER. NO. 85-474,206, FILED 11-16-2011.

TRACY WHITTAKER-BROWN, EXAMINING ATTORNEY



David J. Kybas

Director of the United States Patent and Trademark Office

United States of America

United States Patent and Trademark Office

CHAMPIONS IN LIFE

Reg. No. 4,175,015

SANCHEZ, ORLANDO (UNITED STATES INDIVIDUAL)
2580 MORNINGSIDE STREET
PASADENA, CA 91107

Registered July 17, 2012

Int. Cl.: 41

FOR: PROVIDING CLASSES AND INSTRUCTION IN THE FIELDS OF BRAZILIAN JIU JITSU AND MIXED MARTIAL ARTS, IN CLASS 41 (U.S. CLS. 100, 101 AND 107).

SERVICE MARK

FIRST USE 1-1-2011; IN COMMERCE 1-1-2011.

PRINCIPAL REGISTER

THE MARK CONSISTS OF STANDARD CHARACTERS WITHOUT CLAIM TO ANY PARTICULAR FONT, STYLE, SIZE, OR COLOR.

SER. NO. 85-474,208, FILED 11-16-2011.

KARANENDRA S. CHHINA, EXAMINING ATTORNEY



David J. Kybas

Director of the United States Patent and Trademark Office

United States of America

United States Patent and Trademark Office

THE WHOLE SHABANG

Reg. No. 4,175,016

CENTRIC GROUP, LLC (DELAWARE LIMITED LIABILITY COMPANY)
1260 ANDES BLVD.

Registered July 17, 2012

ST. LOUIS, MO 63132

Int. Cl.: 29

FOR: POTATO CHIPS, IN CLASS 29 (U.S. CL. 46).

TRADEMARK

FIRST USE 0-0-2002; IN COMMERCE 0-0-2002.

PRINCIPAL REGISTER

THE MARK CONSISTS OF STANDARD CHARACTERS WITHOUT CLAIM TO ANY PARTICULAR FONT, STYLE, SIZE, OR COLOR.

SER. NO. 85-474,214, FILED 11-16-2011.

APRIL ROACH, EXAMINING ATTORNEY



David J. Kyffers

Director of the United States Patent and Trademark Office

United States of America

United States Patent and Trademark Office

LIFEIMAGE

Reg. No. 4,175,017

Registered July 17, 2012

Int. Cl.: 42

SERVICE MARK

PRINCIPAL REGISTER

LIFE IMAGE INC. (DELAWARE CORPORATION)
SUITE 507
ONE GATEWAY CENTER
NEWTON, MA 02458

FOR: SOFTWARE AS A SERVICE (SAAS) SERVICES FEATURING SOFTWARE FOR FACILITATING THE EXCHANGE OF CLINICAL INFORMATION, NAMELY, MEDICAL IMAGES, REPORTS AND TEST RESULTS WITHIN AND ACROSS DIAGNOSTIC INSTITUTIONS, BETWEEN PHYSICIANS AND BETWEEN PHYSICIANS AND PATIENTS, ALL FOR USE IN THE FIELD OF CLINICAL CARE, IN CLASS 42 (U.S. CLS. 100 AND 101).

FIRST USE 11-23-2009; IN COMMERCE 11-23-2009.

THE MARK CONSISTS OF STANDARD CHARACTERS WITHOUT CLAIM TO ANY PARTICULAR FONT, STYLE, SIZE, OR COLOR.

SER. NO. 85-474,237, FILED 11-16-2011.

NANCY CLARKE, EXAMINING ATTORNEY



David J. Kybas

Director of the United States Patent and Trademark Office

United States of America

United States Patent and Trademark Office

THE MAGIC OF MOVIES AND MORE

Reg. No. 4,175,018

Registered July 17, 2012

Int. Cl.: 41

SERVICE MARK

PRINCIPAL REGISTER

EMAGINE ENTERTAINMENT, INC. (MICHIGAN CORPORATION)
303 GRAY WOODS LANE
LAKE ANGELUS, MI 48326

FOR: MOVIE THEATERS, IN CLASS 41 (U.S. CLS. 100, 101 AND 107).

FIRST USE 10-0-2002; IN COMMERCE 10-0-2002.

THE MARK CONSISTS OF STANDARD CHARACTERS WITHOUT CLAIM TO ANY PARTICULAR FONT, STYLE, SIZE, OR COLOR.

SER. NO. 85-474,244, FILED 11-16-2011.

ARETHA SOMERVILLE, EXAMINING ATTORNEY



David J. Kyffers

Director of the United States Patent and Trademark Office

United States of America

United States Patent and Trademark Office



Reg. No. 4,175,019

GILEAD SCIENCES INC. (CALIFORNIA CORPORATION)
333 LAKESIDE DRIVE
FOSTER CITY, CA 94404

Registered July 17, 2012

Int. Cl.: 16

FOR: PRINTED MATTER AND PUBLICATIONS, NAMELY, NEWSLETTERS, POSTERS, FLYERS, PAMPHLETS, BROCHURES, AND REPORTS IN THE FIELD OF PHARMACEUTICALS, DISEASES AND MEDICAL CONDITIONS AND TREATMENTS, IN CLASS 16 (U.S. CLS. 2, 5, 22, 23, 29, 37, 38 AND 50).

TRADEMARK

PRINCIPAL REGISTER

FIRST USE 1-10-2012; IN COMMERCE 1-10-2012.

OWNER OF U.S. REG. NO. 3,630,622.

NO CLAIM IS MADE TO THE EXCLUSIVE RIGHT TO USE "LIVER HEALTH AWARENESS INITIATIVE" AND "HEPATITIS B", APART FROM THE MARK AS SHOWN.

THE MARK CONSISTS OF A RECTANGLE DESIGN SEPARATED IN THREE SQUARE SECTIONS, WITH THE FIRST SQUARE CONTAINING A STYLIZED LIVER DESIGN, WITH THE SECOND SQUARE CONTAINING THE UNDERLINED WORDING "LIVER HEALTH" ABOVE THE WORDING "AWARENESS INITIATIVE" AND THE THIRD SQUARE CONTAINING THE WORD "HEPATITIS" WITHIN A STYLIZED LETTER "B".

SER. NO. 85-474,246, FILED 11-16-2011.

PRISCILLA MILTON, EXAMINING ATTORNEY



David J. Kyjars

Director of the United States Patent and Trademark Office

United States of America

United States Patent and Trademark Office

Making It M.I.N.E.

Reg. No. 4,175,020

CLARK, ELAINE A. (UNITED STATES INDIVIDUAL)
665 THIRD STREET, SUITE 227
SAN FRANCISCO, CA 94107

Registered July 17, 2012

Int. Cl.: 41

FOR: EDUCATION SERVICES, NAMELY, PROVIDING CLASSES IN THE FIELD OF ACTING AND VOICE OVERS, IN CLASS 41 (U.S. CLS. 100, 101 AND 107).

SERVICE MARK

FIRST USE 9-1-1994; IN COMMERCE 9-1-1994.

PRINCIPAL REGISTER

THE MARK CONSISTS OF STANDARD CHARACTERS WITHOUT CLAIM TO ANY PARTICULAR FONT, STYLE, SIZE, OR COLOR.

SER. NO. 85-474,255, FILED 11-16-2011.

WILLIAM JACKSON, EXAMINING ATTORNEY



David J. Kybas

Director of the United States Patent and Trademark Office

United States of America

United States Patent and Trademark Office



Reg. No. 4,175,021

Registered July 17, 2012

Int. Cl.: 41

SERVICE MARK

PRINCIPAL REGISTER

TRIATTIC LLC (FLORIDA LIMITED LIABILITY COMPANY)
2611 63RD TERR. N.
ST. PETERSBURG, FL 33702

FOR: PERSONAL COACHING SERVICES IN THE FIELD OF SWIMMING, BIKING, RUNNING, AND TRIATHLON EVENTS; PROVIDING GROUP COACHING IN THE FIELD OF SWIMMING, BIKING, RUNNING AND TRIATHLON EVENTS; PROVIDING INFORMATION AND INSTRUCTION IN THE FIELD OF TRIATHLON EVENTS, IN CLASS 41 (U.S. CLS. 100, 101 AND 107).

FIRST USE 7-1-2011; IN COMMERCE 7-1-2011.

THE MARK CONSISTS OF A STYLIZED TRIANGLE DESIGN. AT THE TOP ARE FIVE RED DIAGONAL LINES. BELOW IS A BLACK ROAD WITH YELLOW CENTER LINES. THE BLACK ROAD, SWIRLS INTO A GREEN WAVE LIKE DESIGN. AT THE VERY BOTTOM IS THE STYLIZED TERM "TRIATTIC" IN BLACK.

THE COLOR(S) RED, YELLOW, BLACK AND GREEN IS/ARE CLAIMED AS A FEATURE OF THE MARK.

SER. NO. 85-474,258, FILED 11-16-2011.

DANIEL BRODY, EXAMINING ATTORNEY



David J. Kyffers

Director of the United States Patent and Trademark Office

United States of America

United States Patent and Trademark Office

GIA'S PIZZA

Reg. No. 4,175,022

FKG OIL COMPANY (MISSOURI CORPORATION)
721 WEST MAIN STREET
BELLEVILLE, IL 62220

Registered July 17, 2012

Int. Cl.: 43

FOR: RESTAURANT SERVICES, IN CLASS 43 (U.S. CLS. 100 AND 101).

SERVICE MARK

FIRST USE 11-1-2011; IN COMMERCE 11-1-2011.

PRINCIPAL REGISTER

THE MARK CONSISTS OF STANDARD CHARACTERS WITHOUT CLAIM TO ANY PARTICULAR FONT, STYLE, SIZE, OR COLOR.

NO CLAIM IS MADE TO THE EXCLUSIVE RIGHT TO USE "PIZZA", APART FROM THE MARK AS SHOWN.

SER. NO. 85-474,300, FILED 11-16-2011.

COLLEEN DOMBROW, EXAMINING ATTORNEY



David J. Kyffers

Director of the United States Patent and Trademark Office

United States of America

United States Patent and Trademark Office

RUN REAL

Reg. No. 4,175,023

SKORA, INC. (DELAWARE CORPORATION)
2505 SE 11TH AVE., SUITE 313
PORTLAND, OR 97202

Registered July 17, 2012

Int. Cl.: 25

FOR: ATHLETIC FOOTWEAR; ATHLETIC APPAREL, NAMELY, T-SHIRTS, LONG SLEEVE SHIRTS, AND SHORTS, IN CLASS 25 (U.S. CLS. 22 AND 39).

TRADEMARK

FIRST USE 7-25-2011; IN COMMERCE 7-25-2011.

PRINCIPAL REGISTER

THE MARK CONSISTS OF STANDARD CHARACTERS WITHOUT CLAIM TO ANY PARTICULAR FONT, STYLE, SIZE, OR COLOR.

NO CLAIM IS MADE TO THE EXCLUSIVE RIGHT TO USE "RUN", APART FROM THE MARK AS SHOWN.

SER. NO. 85-474,307, FILED 11-16-2011.

JOHN DALIER, EXAMINING ATTORNEY



David J. Kyffers

Director of the United States Patent and Trademark Office

United States of America

United States Patent and Trademark Office

RECIPES & RECORDS

Reg. No. 4,175,024

Registered July 17, 2012

Int. Cl.: 9

TRADEMARK

PRINCIPAL REGISTER

AEROSPACE SPECIAL PROCESS CONSULTANTS, INC. (SOUTH CAROLINA CORPORATION)
834 PENNYPACKER COURT
GREER, SC 29650

FOR: COMPUTER SOFTWARE FOR CONTROLLING AND MONITORING MANUFACTURING PROCESSES AND PROVIDING QUALITY ASSURANCE ANALYSIS, IN CLASS 9 (U.S. CLS. 21, 23, 26, 36 AND 38).

FIRST USE 9-0-2010; IN COMMERCE 2-19-2011.

THE MARK CONSISTS OF STANDARD CHARACTERS WITHOUT CLAIM TO ANY PARTICULAR FONT, STYLE, SIZE, OR COLOR.

SER. NO. 85-474,312, FILED 11-16-2011.

RENEE MCCRAY, EXAMINING ATTORNEY



David J. Kyffers

Director of the United States Patent and Trademark Office

United States of America

United States Patent and Trademark Office

MERIT

Reg. No. 4,175,025

Registered July 17, 2012

Int. Cls.: 8 and 16

TRADEMARK

PRINCIPAL REGISTER

CALICO DISTRIBUTORS, INC. (MASSACHUSETTS CORPORATION)
90 PRINCE HENRY DRIVE
TAUNTON, MA 02780

FOR: PLASTIC CUTLERY, NAMELY, KNIVES, FORKS AND SPOONS, IN CLASS 8 (U.S. CLS. 23, 28 AND 44).

FIRST USE 1-1-2007; IN COMMERCE 1-1-2007.

FOR: PAPER GOODS, NAMELY, PAPER TOWELS AND TISSUE PAPER, IN CLASS 16 (U.S. CLS. 2, 5, 22, 23, 29, 37, 38 AND 50).

FIRST USE 1-1-2007; IN COMMERCE 1-1-2007.

THE MARK CONSISTS OF STANDARD CHARACTERS WITHOUT CLAIM TO ANY PARTICULAR FONT, STYLE, SIZE, OR COLOR.

SER. NO. 85-474,325, FILED 11-16-2011.

ELLEN PERKINS, EXAMINING ATTORNEY



David J. Kyffers

Director of the United States Patent and Trademark Office

United States of America

United States Patent and Trademark Office

H&W

Reg. No. 4,175,026

HAWTHORNE & WREN, INC. (LOUISIANA CORPORATION)
2350 PHYLDEN DRIVE
SALT LAKE CITY, UT 84117

Registered July 17, 2012

Int. Cl.: 35

FOR: ON-LINE RETAIL GIFT SHOPS, IN CLASS 35 (U.S. CLS. 100, 101 AND 102).

SERVICE MARK

FIRST USE 11-8-2011; IN COMMERCE 11-8-2011.

PRINCIPAL REGISTER

THE MARK CONSISTS OF STANDARD CHARACTERS WITHOUT CLAIM TO ANY PARTICULAR FONT, STYLE, SIZE, OR COLOR.

SER. NO. 85-474,334, FILED 11-16-2011.

FRED CARL, EXAMINING ATTORNEY



David J. Kyffers

Director of the United States Patent and Trademark Office

United States of America

United States Patent and Trademark Office



Reg. No. 4,175,027

ARGABRIGHT, LONNIE (UNITED STATES INDIVIDUAL)
2726 VIA MONTEZUMA
SAN CLEMENTE, CA 92672

Registered July 17, 2012

Int. Cl.: 35

FOR: ASSOCIATION SERVICES, NAMELY, PROMOTING THE INTERESTS OF SURFERS,
IN CLASS 35 (U.S. CLS. 100, 101 AND 102).

SERVICE MARK

FIRST USE 2-0-1960; IN COMMERCE 2-0-1960.

PRINCIPAL REGISTER

NO CLAIM IS MADE TO THE EXCLUSIVE RIGHT TO USE "SURFING CLUB", APART
FROM THE MARK AS SHOWN.

THE COLOR(S) BLACK, YELLOW AND WHITE IS/ARE CLAIMED AS A FEATURE OF THE
MARK.

THE NAME(S), PORTRAIT(S), AND/OR SIGNATURE(S) SHOWN IN THE MARK DOES NOT
IDENTIFY A PARTICULAR LIVING INDIVIDUAL.

THE MARK CONSISTS OF THE STYLIZED TERMS "HAGGERTY'S SURFING CLUB" IN
YELLOW FONT. IN THE BACKGROUND IS A STYLIZED WAVE DESIGN IN WHITE AND
BLACK. ALL DESIGN AND LITERAL ELEMENTS ARE ENCASED IN A YELLOW OVAL.

SER. NO. 85-474,343, FILED 11-16-2011.

GIANCARLO CASTRO, EXAMINING ATTORNEY



David J. Kybas

Director of the United States Patent and Trademark Office

United States of America

United States Patent and Trademark Office

FAITHFUL HOUND

Reg. No. 4,175,028

Registered July 17, 2012

Int. Cl.: 33

TRADEMARK

PRINCIPAL REGISTER

BON VIEW TRADING 92 (PTY) LTD (SOUTH AFRICA PROPRIETARY LIMITED COMPANY
(P/L OR PTY. LTD.))
P.O. BOX 12817
DIE BOORD
STELLENBOSCH, SOUTH AFRICA 7613

FOR: WINE, IN CLASS 33 (U.S. CLS. 47 AND 49).

FIRST USE 9-30-1995; IN COMMERCE 9-30-1995.

THE MARK CONSISTS OF STANDARD CHARACTERS WITHOUT CLAIM TO ANY PARTICULAR FONT, STYLE, SIZE, OR COLOR.

SER. NO. 85-474,383, FILED 11-16-2011.

MARLENE BELL, EXAMINING ATTORNEY



David J. Kyffers

Director of the United States Patent and Trademark Office

United States of America

United States Patent and Trademark Office

Dressage Under The Stars

Reg. No. 4,175,029

Registered July 17, 2012

Int. Cl.: 41

SERVICE MARK

PRINCIPAL REGISTER

WILLIAMS, STEPHEN A. (FLORIDA SOLE PROPRIETORSHIP), DBA DRESSAGE UNDER THE STARS
34 WALNUT STREET
RUTHERFORD, NJ 07070

FOR: HORSE SHOWING, IN CLASS 41 (U.S. CLS. 100, 101 AND 107).

FIRST USE 2-2-2011; IN COMMERCE 2-2-2011.

THE MARK CONSISTS OF STANDARD CHARACTERS WITHOUT CLAIM TO ANY PARTICULAR FONT, STYLE, SIZE, OR COLOR.

NO CLAIM IS MADE TO THE EXCLUSIVE RIGHT TO USE "DRESSAGE", APART FROM THE MARK AS SHOWN.

SER. NO. 85-474,401, FILED 11-16-2011.

TINA MAI, EXAMINING ATTORNEY



David J. Kyffers

Director of the United States Patent and Trademark Office

United States of America

United States Patent and Trademark Office

SKY

Reg. No. 4,175,030

RESTEK CORPORATION (PENNSYLVANIA CORPORATION)
110 BENNER CIRCLE
BELLEFONTE, PA 16823

Registered July 17, 2012

Int. Cl.: 9

FOR: CHROMATOGRAPHY SUPPLIES, NAMELY, INLET LINERS, IN CLASS 9 (U.S. CLS. 21, 23, 26, 36 AND 38).

TRADEMARK

FIRST USE 1-4-2011; IN COMMERCE 1-4-2011.

PRINCIPAL REGISTER

THE MARK CONSISTS OF STANDARD CHARACTERS WITHOUT CLAIM TO ANY PARTICULAR FONT, STYLE, SIZE, OR COLOR.

SER. NO. 85-474,415, FILED 11-16-2011.

ANGELA DUONG, EXAMINING ATTORNEY



David J. Kyffers

Director of the United States Patent and Trademark Office

United States of America

United States Patent and Trademark Office



Reg. No. 4,175,031

GILEAD SCIENCES INC. (CALIFORNIA CORPORATION)
333 LAKESIDE DRIVE
FOSTER CITY, CA 94404

Registered July 17, 2012

Int. Cl.: 44

FOR: MEDICAL SERVICES, NAMELY, PROVIDING INFORMATION ON LIVER DISEASES AND ON AVAILABLE TREATMENTS, IN CLASS 44 (U.S. CLS. 100 AND 101).

SERVICE MARK

FIRST USE 1-10-2012; IN COMMERCE 1-10-2012.

PRINCIPAL REGISTER

OWNER OF U.S. REG. NO. 3,630,622.

NO CLAIM IS MADE TO THE EXCLUSIVE RIGHT TO USE "LIVER HEALTH AWARENESS INITIATIVE" AND "HEPATITIS B", APART FROM THE MARK AS SHOWN.

THE MARK CONSISTS OF A RECTANGLE DESIGN SEPARATED IN THREE SQUARE SECTIONS, WITH THE FIRST SQUARE CONTAINING A STYLIZED LIVER DESIGN, WITH THE SECOND SQUARE CONTAINING THE UNDERLINED WORDING "LIVER HEALTH" ABOVE THE WORDING "AWARENESS INITIATIVE" AND THE THIRD SQUARE CONTAINING THE WORD "HEPATITIS" WITHIN A STYLIZED LETTER "B".

SER. NO. 85-474,419, FILED 11-16-2011.

PRISCILLA MILTON, EXAMINING ATTORNEY



David J. Kyros

Director of the United States Patent and Trademark Office

United States of America

United States Patent and Trademark Office

AMERICAN FRICTION WELDING

Reg. No. 4,175,032

AMERICAN FRICTION WELDING, INC (WISCONSIN CORPORATION)
115 NORTH JANACEK ROAD
BROOKFIELD, WI 53045

Registered July 17, 2012

Int. Cl.: 40

FOR: WELDING SERVICES, IN CLASS 40 (U.S. CLS. 100, 103 AND 106).

SERVICE MARK

FIRST USE 12-31-1997; IN COMMERCE 12-31-1997.

PRINCIPAL REGISTER

THE MARK CONSISTS OF STANDARD CHARACTERS WITHOUT CLAIM TO ANY PARTICULAR FONT, STYLE, SIZE, OR COLOR.

NO CLAIM IS MADE TO THE EXCLUSIVE RIGHT TO USE "FRICTION WELDING", APART FROM THE MARK AS SHOWN.

SEC. 2(F).

SER. NO. 85-474,428, FILED 11-16-2011.

JAMES MACFARLANE, EXAMINING ATTORNEY



David J. Kyffers

Director of the United States Patent and Trademark Office

United States of America

United States Patent and Trademark Office

NMI

Reg. No. 4,175,033

NEWPORT MEDIA, INC. (CALIFORNIA CORPORATION)
1 SPECTRUM POINTE DR. SUITE 225
LAKE FOREST, CA 92630

Registered July 17, 2012

Int. Cl.: 42

FOR: COMPUTER HARDWARE DEVELOPMENT; CUSTOMIZATION OF COMPUTER HARDWARE AND SOFTWARE; DESIGN FOR OTHERS OF INTEGRATED CIRCUITS AND INTEGRATED CIRCUIT CORES FOR USE IN WIRELESS COMMUNICATIONS AND WIRELESS COMMUNICATION EQUIPMENT AND APPARATI AND DIGITAL SIGNAL PROCESSORS (DSP); DESIGN OF COMPUTER HARDWARE, INTEGRATED CIRCUITS, COMMUNICATIONS HARDWARE AND SOFTWARE AND COMPUTER NETWORKS FOR OTHERS; PROVIDING PLANNING AND ENGINEERING SERVICES IN THE FIELD OF INFORMATION AND COMMUNICATIONS NETWORKS; TECHNOLOGY CONSULTATION IN THE FIELD OF REAL-TIME RECONFIGURABLE WIRELESS COMMUNICATION HANDSETS AND NETWORK EQUIPMENT FOR USE IN WIDEBAND COMMUNICATIONS , IN CLASS 42 (U.S. CLS. 100 AND 101).

SERVICE MARK

PRINCIPAL REGISTER

FIRST USE 10-18-2011; IN COMMERCE 10-18-2011.

OWNER OF U.S. REG. NO. 3,475,834.

THE MARK CONSISTS OF THE LETTERS "NMI" WITH THE LETTER "M" DISPLAYED IN THE NEGATIVE SPACE.

SER. NO. 85-474,463, FILED 11-16-2011.

ANGELA DUONG, EXAMINING ATTORNEY



David J. Kybas

Director of the United States Patent and Trademark Office

United States of America

United States Patent and Trademark Office

bübi

Reg. No. 4,175,034

MADAUS, CRAIG A. (UNITED STATES INDIVIDUAL)
123 E. 82ND STREET 4C
NEW YORK, NY 10028

Registered July 17, 2012

Int. Cl.: 21

FOR: BOTTLES, SOLD EMPTY; EMPTY WATER BOTTLES FOR BICYCLES; PLASTIC BOTTLE WITH BLOWN CAVITY INSERT SOLD EMPTY; PLASTIC WATER BOTTLE HOLDERS AND ATTACHED CARABINER CLIP SOLD AS A UNIT; PLASTIC WATER BOTTLES SOLD EMPTY; REUSABLE PLASTIC WATER BOTTLES SOLD EMPTY; SPORTS BOTTLES SOLD EMPTY, IN CLASS 21 (U.S. CLS. 2, 13, 23, 29, 30, 33, 40 AND 50).

TRADEMARK

PRINCIPAL REGISTER

FIRST USE 9-12-2011; IN COMMERCE 10-18-2011.

THE MARK CONSISTS OF STANDARD CHARACTERS WITHOUT CLAIM TO ANY PARTICULAR FONT, STYLE, SIZE, OR COLOR.

SER. NO. 85-474,480, FILED 11-16-2011.

CYNTHIA TRIPI, EXAMINING ATTORNEY



David J. Kyffers

Director of the United States Patent and Trademark Office

United States of America

United States Patent and Trademark Office



Reg. No. 4,175,035

BERNSTEIN, BENJAMIN (UNITED STATES INDIVIDUAL)
842 52ND STREET
OAKLAND, CA 94608

Registered July 17, 2012

Int. Cl.: 45

FOR: PERSONAL GROWTH AND MOTIVATION CONSULTING SERVICES, IN CLASS 45
(U.S. CLS. 100 AND 101).

SERVICE MARK

FIRST USE 0-0-2001; IN COMMERCE 0-0-2001.

PRINCIPAL REGISTER

OWNER OF U.S. REG. NO. 3,025,522.

THE COLOR(S) BLUE, WHITE AND GRAY IS/ARE CLAIMED AS A FEATURE OF THE MARK.

THE MARK CONSISTS OF THE WORDS "SPARK AVENUE" IN WHITE LETTERING WITHIN A GRAY COLORED STREET SIGN SHAPE WITH A BLUE BACKGROUND. STREET SIGN SHAPE IS TOPPED WITH A WHITE STAR ON A BLUE BACKGROUND.

SER. NO. 85-474,484, FILED 11-16-2011.

FRED CARL, EXAMINING ATTORNEY



David J. Kyfos

Director of the United States Patent and Trademark Office

United States of America

United States Patent and Trademark Office



Reg. No. 4,175,036

Registered July 17, 2012

Int. Cl.: 33

TRADEMARK

PRINCIPAL REGISTER

ABSOLUT HOLDING INC. C/O ABSOLUT HOLDING FILIAL (DELAWARE CORPORATION)
BOX 47170, 100 74
STOCKHOLM, SWEDEN

FOR: ALCOHOLIC BEVERAGES EXCEPT BEERS, IN CLASS 33 (U.S. CLS. 47 AND 49).

FIRST USE 0-0-1980; IN COMMERCE 0-0-1980.

OWNER OF U.S. REG. NOS. 1,374,134, 3,816,881 AND OTHERS.

THE MARK CONSISTS OF TWO PALM TREES AGAINST A SETTING SUN.

SER. NO. 85-474,500, FILED 11-16-2011.

KATINA MISTER, EXAMINING ATTORNEY



David J. Kyffers

Director of the United States Patent and Trademark Office

United States of America

United States Patent and Trademark Office

SMIDGEN

Reg. No. 4,175,037

Registered July 17, 2012

Int. Cl.: 9

TRADEMARK

PRINCIPAL REGISTER

BRAND DESIGN COMPANY, INC. (DELAWARE CORPORATION), DBA HOUSE INDUSTRIES
1145 YORKLYN ROAD, P.O. BOX 166
YORKLYN, DE 19736

FOR: PRINTING FONTS THAT CAN BE DOWNLOADED PROVIDED BY MEANS OF ELECTRONIC TRANSMISSION; TYPEFACE FONTS RECORDED ON MAGNETIC MEDIA, IN CLASS 9 (U.S. CLS. 21, 23, 26, 36 AND 38).

FIRST USE 11-14-2011; IN COMMERCE 11-14-2011.

THE MARK CONSISTS OF STANDARD CHARACTERS WITHOUT CLAIM TO ANY PARTICULAR FONT, STYLE, SIZE, OR COLOR.

SER. NO. 85-474,506, FILED 11-16-2011.

KRISTINA MORRIS, EXAMINING ATTORNEY



David J. Kyffers

Director of the United States Patent and Trademark Office

United States of America

United States Patent and Trademark Office

Flex 151

Reg. No. 4,175,038

FLEX 151, LLC (INDIANA LIMITED LIABILITY COMPANY)
300 W. JENNINGS ST.
NEWBURGH, IN 47630

Registered July 17, 2012

Int. Cl.: 41

FOR: GYMNASIUMS; PERSONAL TRAINING PROVIDED IN CONNECTION WITH WEIGHT LOSS AND EXERCISE PROGRAMS, IN CLASS 41 (U.S. CLS. 100, 101 AND 107).

SERVICE MARK

FIRST USE 10-31-2010; IN COMMERCE 10-31-2010.

PRINCIPAL REGISTER

THE MARK CONSISTS OF STANDARD CHARACTERS WITHOUT CLAIM TO ANY PARTICULAR FONT, STYLE, SIZE, OR COLOR.

SER. NO. 85-474,535, FILED 11-16-2011.

ELI HELLMAN, EXAMINING ATTORNEY



David J. Kyffers

Director of the United States Patent and Trademark Office

United States of America

United States Patent and Trademark Office

EZY-TORQ

Reg. No. 4,175,039

Registered July 17, 2012

Int. Cl.: 7

TRADEMARK

PRINCIPAL REGISTER

SMITH INTERNATIONAL, INC. (DELAWARE CORPORATION)
1310 RANKIN ROAD
BOX 45
HOUSTON, TX 77073

FOR: HYDRAULIC CATHEADS USED IN OILFIELD DRILLING, IN CLASS 7 (U.S. CLS. 13, 19, 21, 23, 31, 34 AND 35).

FIRST USE 3-31-1970; IN COMMERCE 3-31-1970.

THE MARK CONSISTS OF STANDARD CHARACTERS WITHOUT CLAIM TO ANY PARTICULAR FONT, STYLE, SIZE, OR COLOR.

SER. NO. 85-474,561, FILED 11-16-2011.

PAUL E. FAHRENKOPF, EXAMINING ATTORNEY



David J. Kyffers

Director of the United States Patent and Trademark Office

United States of America

United States Patent and Trademark Office

VASTER

Reg. No. 4,175,040

Registered July 17, 2012

Int. Cl.: 9

TRADEMARK

PRINCIPAL REGISTER

SHIH, RICHARD WANYI (UNITED STATES INDIVIDUAL)
1142 S. DIAMOND BAR BLVD., #371
DIAMOND BAR, CA 91765 AND

DU, BETTY JIE (UNITED STATES INDIVIDUAL)
1142 S. DIAMOND BAR BLVD., #371
DIAMOND BAR, CA 91765

FOR: COMPUTER ACCESSORIES NAMELY, COMPUTER CABLES, MONITOR CABLES, SURGE PROTECTORS, AND COMPUTER SWITCHBOXES, IN CLASS 9 (U.S. CLS. 21, 23, 26, 36 AND 38).

FIRST USE 6-1-1999; IN COMMERCE 4-1-2000.

THE MARK CONSISTS OF STANDARD CHARACTERS WITHOUT CLAIM TO ANY PARTICULAR FONT, STYLE, SIZE, OR COLOR.

OWNER OF U.S. REG. NO. 3,241,408.

SER. NO. 85-474,567, FILED 11-16-2011.

PAUL E. FAHRENKOPF, EXAMINING ATTORNEY



David J. Kyffers

Director of the United States Patent and Trademark Office

United States of America

United States Patent and Trademark Office



Reg. No. 4,175,041

CHARPENTIER FAMILY DENTISTRY, L.L.C. (LOUISIANA LIMITED LIABILITY COMPANY)
112 CHURCH ALLEY
NEW IBERIA, LA 70560

Registered July 17, 2012

Int. Cl.: 44

FOR: DENTISTRY, IN CLASS 44 (U.S. CLS. 100 AND 101).

SERVICE MARK

FIRST USE 1-1-2011; IN COMMERCE 1-1-2011.

PRINCIPAL REGISTER

NO CLAIM IS MADE TO THE EXCLUSIVE RIGHT TO USE "FAMILY DENTISTRY", APART FROM THE MARK AS SHOWN.

THE MARK CONSISTS OF A FLEUR-DE-LIS TO THE LEFT OF THE STYLIZED TEXT "CHARPENTIER FAMILY DENTISTRY". "CHARPENTIER" IS ABOVE "FAMILY DENTISTRY" AND THE LETTER "P" IN "CHARPENTIER" EXTENDS BETWEEN "FAMILY" AND "DENTISTRY".

SER. NO. 85-474,578, FILED 11-16-2011.

MARILYN IZZI, EXAMINING ATTORNEY



David J. Kyffers

Director of the United States Patent and Trademark Office

United States of America

United States Patent and Trademark Office

RIGHT THERE WITH YOU

Reg. No. 4,175,042

Registered July 17, 2012

Int. Cl.: 45

SERVICE MARK

PRINCIPAL REGISTER

CHUHAK & TECSON, P.C. (ILLINOIS CORPORATION)
30 S. WACKER DRIVE, SUITE 2600
CHICAGO, IL 60606

FOR: LEGAL SERVICES, IN CLASS 45 (U.S. CLS. 100 AND 101).

FIRST USE 3-4-2010; IN COMMERCE 6-23-2010.

THE MARK CONSISTS OF STANDARD CHARACTERS WITHOUT CLAIM TO ANY PARTICULAR FONT, STYLE, SIZE, OR COLOR.

SER. NO. 85-474,582, FILED 11-16-2011.

PAUL MORENO, EXAMINING ATTORNEY



David J. Kyffers

Director of the United States Patent and Trademark Office

United States of America

United States Patent and Trademark Office

Makeup Geek

Reg. No. 4,175,043

Registered July 17, 2012

Int. Cls.: 3, 21 and 35

TRADEMARK

SERVICE MARK

PRINCIPAL REGISTER

MAKEUP GEEK, LLC (MICHIGAN LIMITED LIABILITY COMPANY)
SUITE A
2282 SPRINGPORT RD.
JACKSON, MI 49202

FOR: BLUSH; EYESHADOWS; LIPSTICK; LIPSTICKS, IN CLASS 3 (U.S. CLS. 1, 4, 6, 50, 51 AND 52).

FIRST USE 3-8-2008; IN COMMERCE 3-8-2008.

FOR: COSMETIC BRUSHES, IN CLASS 21 (U.S. CLS. 2, 13, 23, 29, 30, 33, 40 AND 50).

FIRST USE 3-8-2008; IN COMMERCE 3-8-2008.

FOR: ON-LINE RETAIL STORE SERVICES FEATURING COSMETICS AND COSMETIC-RELATED PRODUCTS, IN CLASS 35 (U.S. CLS. 100, 101 AND 102).

FIRST USE 3-8-2008; IN COMMERCE 3-8-2008.

THE MARK CONSISTS OF STANDARD CHARACTERS WITHOUT CLAIM TO ANY PARTICULAR FONT, STYLE, SIZE, OR COLOR.

NO CLAIM IS MADE TO THE EXCLUSIVE RIGHT TO USE "MAKEUP", APART FROM THE MARK AS SHOWN.

SER. NO. 85-474,587, FILED 11-16-2011.

DOMINIC FATHY, EXAMINING ATTORNEY



David J. Kyros

Director of the United States Patent and Trademark Office

United States of America

United States Patent and Trademark Office

CITY OF HOPE

Reg. No. 4,175,044

CITY OF HOPE (CALIFORNIA NON-PROFIT PUBLIC BENEFIT CORPORATION)
1500 EAST DUARTE ROAD
DUARTE, CA 91010

Registered July 17, 2012

Int. Cl.: 42

FOR: MEDICAL AND SCIENTIFIC RESEARCH, NAMELY, CONDUCTING CLINICAL TRIALS, IN CLASS 42 (U.S. CLS. 100 AND 101).

SERVICE MARK

FIRST USE 0-0-1981; IN COMMERCE 0-0-1981.

PRINCIPAL REGISTER

THE MARK CONSISTS OF STANDARD CHARACTERS WITHOUT CLAIM TO ANY PARTICULAR FONT, STYLE, SIZE, OR COLOR.

OWNER OF U.S. REG. NOS. 1,307,558, 2,357,571 AND OTHERS.

SER. NO. 85-474,593, FILED 11-16-2011.

DOMINIC FATHY, EXAMINING ATTORNEY



David J. Kyros

Director of the United States Patent and Trademark Office

United States of America

United States Patent and Trademark Office

CITY OF HOPE

Reg. No. 4,175,045

CITY OF HOPE (CALIFORNIA NON-PROFIT PUBLIC BENEFIT CORPORATION)
1500 EAST DUARTE ROAD
DUARTE, CA 91010

Registered July 17, 2012

Int. Cl.: 43

FOR: PROVIDING TEMPORARY HOUSING ACCOMMODATIONS TO PATIENTS AND FAMILIES, IN CLASS 43 (U.S. CLS. 100 AND 101).

SERVICE MARK

FIRST USE 0-0-1950; IN COMMERCE 0-0-1950.

PRINCIPAL REGISTER

THE MARK CONSISTS OF STANDARD CHARACTERS WITHOUT CLAIM TO ANY PARTICULAR FONT, STYLE, SIZE, OR COLOR.

OWNER OF U.S. REG. NOS. 1,307,558, 2,357,571 AND OTHERS.

SER. NO. 85-474,596, FILED 11-16-2011.

DOMINIC FATHY, EXAMINING ATTORNEY



David J. Kybas

Director of the United States Patent and Trademark Office

United States of America

United States Patent and Trademark Office

CITY OF HOPE

Reg. No. 4,175,046

Registered July 17, 2012

Int. Cl.: 44

SERVICE MARK

PRINCIPAL REGISTER

CITY OF HOPE (CALIFORNIA NON-PROFIT PUBLIC BENEFIT CORPORATION)
1500 EAST DUARTE ROAD
DUARTE, CA 91010

FOR: HEALTHCARE SERVICES, IN CLASS 44 (U.S. CLS. 100 AND 101).

FIRST USE 0-0-1949; IN COMMERCE 0-0-1949.

THE MARK CONSISTS OF STANDARD CHARACTERS WITHOUT CLAIM TO ANY PARTICULAR FONT, STYLE, SIZE, OR COLOR.

OWNER OF U.S. REG. NOS. 1,307,558, 2,357,571 AND OTHERS.

SER. NO. 85-474,599, FILED 11-16-2011.

DOMINIC FATHY, EXAMINING ATTORNEY



David J. Kyffers

Director of the United States Patent and Trademark Office

United States of America

United States Patent and Trademark Office

Doug the Bug

Reg. No. 4,175,047

Registered July 17, 2012

Int. Cl.: 37

SERVICE MARK

PRINCIPAL REGISTER

DOUG THE BUG TERMITE AND PEST CONTROL INC. (FLORIDA CORPORATION)
SUITE 307
4445 EAST BAY DR.
CLEARWATER, FL 33764

FOR: PEST CONTROL, IN CLASS 37 (U.S. CLS. 100, 103 AND 106).

FIRST USE 10-8-1982; IN COMMERCE 10-8-1982.

THE MARK CONSISTS OF STANDARD CHARACTERS WITHOUT CLAIM TO ANY PARTICULAR FONT, STYLE, SIZE, OR COLOR.

SER. NO. 85-474,606, FILED 11-16-2011.

DAWN HAN, EXAMINING ATTORNEY



David J. Kyffers

Director of the United States Patent and Trademark Office

United States of America

United States Patent and Trademark Office



Reg. No. 4,175,048

SUNDERLAND GROUP LTD. (NORTH DAKOTA CORPORATION)
2102 GREAT NORTHERN DRIVE
FARGO, ND 58102

Registered July 17, 2012

Int. Cl.: 42

FOR: PROVIDING A WEB SITE FEATURING A SEARCH ENGINE FOR MEDICARE INFORMATION AND QUOTES, IN CLASS 42 (U.S. CLS. 100 AND 101).

SERVICE MARK

FIRST USE 1-12-2011; IN COMMERCE 1-12-2011.

PRINCIPAL REGISTER

NO CLAIM IS MADE TO THE EXCLUSIVE RIGHT TO USE "MEDICARE", APART FROM THE MARK AS SHOWN.

THE MARK CONSISTS OF THE WORDS "MEDICARE GENIE" WITH THE DESIGN OF A GENIE RISING FROM THE LETTER D IN "MEDICARE". THE GENIE IS HOLDING A HEART SHAPE THAT EXTENDS BETWEEN HIS OUTSTRETCHED HANDS.

SER. NO. 85-474,635, FILED 11-16-2011.

H. M. FISHER, EXAMINING ATTORNEY



David J. Kybas

Director of the United States Patent and Trademark Office

United States of America

United States Patent and Trademark Office

Pinnix & Martin LLC.

Reg. No. 4,175,049

Registered July 17, 2012

Int. Cl.: 36

SERVICE MARK

PRINCIPAL REGISTER

MARTIN, JOYCE (UNITED STATES INDIVIDUAL)
#204
6801 HANESBROOK CIR
CLEMMONS, NC 27012

FOR: CAPITAL INVESTMENT CONSULTING, IN CLASS 36 (U.S. CLS. 100, 101 AND 102).

FIRST USE 10-0-2011; IN COMMERCE 10-0-2011.

THE MARK CONSISTS OF STANDARD CHARACTERS WITHOUT CLAIM TO ANY PARTICULAR FONT, STYLE, SIZE, OR COLOR.

NO CLAIM IS MADE TO THE EXCLUSIVE RIGHT TO USE "LLC.", APART FROM THE MARK AS SHOWN.

SER. NO. 85-474,653, FILED 11-16-2011.

ELI HELLMAN, EXAMINING ATTORNEY



David J. Kyffers

Director of the United States Patent and Trademark Office

United States of America

United States Patent and Trademark Office

MeetingPost

Reg. No. 4,175,050

Registered July 17, 2012

Int. Cl.: 42

SERVICE MARK

PRINCIPAL REGISTER

WHOMP, LLC (CALIFORNIA LIMITED LIABILITY COMPANY)
1915 OAK STREET
SAN FRANCISCO, CA 94117

FOR: COMPUTER SERVICES, NAMELY, HOSTING ONLINE WEB FACILITIES FOR OTHERS, WITH THE FACILITIES BEING USED FOR LISTING MEDIA, NAMELY, MUSIC, VIDEO, AND IMAGES; COMPUTER SERVICES IN THE NATURE OF CUSTOMIZED WEB PAGES FEATURING USER-DEFINED INFORMATION, PERSONAL PROFILES AND INFORMATION, IN CLASS 42 (U.S. CLS. 100 AND 101).

FIRST USE 11-16-2011; IN COMMERCE 11-16-2011.

THE MARK CONSISTS OF STANDARD CHARACTERS WITHOUT CLAIM TO ANY PARTICULAR FONT, STYLE, SIZE, OR COLOR.

SER. NO. 85-474,664, FILED 11-16-2011.

ESTHER BELENKER, EXAMINING ATTORNEY



David J. Kyffers

Director of the United States Patent and Trademark Office

United States of America

United States Patent and Trademark Office

KAYU

Reg. No. 4,175,051

Registered July 17, 2012

Int. Cl.: 19

TRADEMARK

PRINCIPAL REGISTER

KAYU INTERNATIONAL, INC. (OREGON CORPORATION)
PO BOX 368
WEST LINN, OR 97068

FOR: BUILDING MATERIALS, NAMELY, NON-METAL DECKING, HARDWOOD DECKING, DIMENSIONAL LUMBER, FLOOR BOARDS, NON-METAL POSTS, NON-METAL BALUSTERS, NON-METAL SOFFITS; WOODEN FLOORING; NON-METAL DECORATIVE MOLDINGS FOR USE IN BUILDING CONSTRUCTION; NON-METAL ARCHITECTURAL MOULDINGS AND FINISH TRIM; NON-METAL CEILING PANELS, IN CLASS 19 (U.S. CLS. 1, 12, 33 AND 50).

FIRST USE 1-1-1995; IN COMMERCE 1-1-1995.

THE MARK CONSISTS OF STANDARD CHARACTERS WITHOUT CLAIM TO ANY PARTICULAR FONT, STYLE, SIZE, OR COLOR.

THE ENGLISH TRANSLATION OF THE WORD "KAYU" IN THE MARK IS "TIMBER".

SEC. 2(F).

SER. NO. 85-474,714, FILED 11-16-2011.

JAY BESCH, EXAMINING ATTORNEY



David J. Kybas

Director of the United States Patent and Trademark Office

United States of America

United States Patent and Trademark Office



Reg. No. 4,175,052

Registered July 17, 2012

Int. Cl.: 29

TRADEMARK

PRINCIPAL REGISTER

NATIONAL PASTEURIZED EGGS, LLC (ILLINOIS LIMITED LIABILITY COMPANY)
2963 BERNICE ROAD
LANSING, IL 60438

FOR: PASTEURIZED IN-SHELL EGGS, IN CLASS 29 (U.S. CL. 46).

FIRST USE 10-18-2011; IN COMMERCE 10-18-2011.

OWNER OF U.S. REG. NOS. 2,970,608, 3,487,479 AND OTHERS.

THE COLOR(S) RED, WHITE AND BLUE IS/ARE CLAIMED AS A FEATURE OF THE MARK.

NO CLAIM IS MADE TO THE EXCLUSIVE RIGHT TO USE "ALL NATURAL", APART FROM THE MARK AS SHOWN.

THE MARK CONSISTS OF THE WORD "DAVIDSON'S" IN BLUE ARCHED ABOVE A CURVED RED BANNER OUTLINED IN BLUE CONTAINING THE WORDS "SAFEST CHOICE" IN WHITE. IMMEDIATELY BELOW THE CURVED BANNER IS A LARGE RED LETTER P IN A RED CIRCLE ON A WHITE BACKGROUND. IMMEDIATELY BELOW THE CIRCLED P IS A HORIZONTAL NAVY BLUE BANNER CONTAINING THE WORDS "ALL NATURAL" IN WHITE. ALL OF THE ABOVE ELEMENTS ARE IN FRONT OF A WHITE EGG.

SER. NO. 85-474,718, FILED 11-16-2011.

WILLIAM JACKSON, EXAMINING ATTORNEY



David J. Kybas

Director of the United States Patent and Trademark Office

United States of America

United States Patent and Trademark Office

NATURALLY PASTEURIZED... MADE SAFER

Reg. No. 4,175,053

NATIONAL PASTEURIZED EGGS, LLC (ILLINOIS LIMITED LIABILITY COMPANY)
2963 BERNICE ROAD
LANSING, IL 60438

Registered July 17, 2012

Int. Cl.: 29

FOR: PASTEURIZED IN-SHELL EGGS, IN CLASS 29 (U.S. CL. 46).

TRADEMARK

FIRST USE 10-18-2011; IN COMMERCE 10-18-2011.

PRINCIPAL REGISTER

THE MARK CONSISTS OF STANDARD CHARACTERS WITHOUT CLAIM TO ANY PARTICULAR FONT, STYLE, SIZE, OR COLOR.

OWNER OF U.S. REG. NO. 3,966,045.

SER. NO. 85-474,727, FILED 11-16-2011.

WILLIAM JACKSON, EXAMINING ATTORNEY



David J. Kyffers

Director of the United States Patent and Trademark Office

United States of America

United States Patent and Trademark Office



Middlesex Care
providers Inc.

Reg. No. 4,175,054

Registered July 17, 2012

Int. Cl.: 44

SERVICE MARK

PRINCIPAL REGISTER

MUNOKO, GEOFFREY (UNITED STATES INDIVIDUAL)
#U-2
1201 WESTFORD ST
LOWELL, MA 01851 AND

NGANGA, CLEMENT (UNITED STATES INDIVIDUAL)
#U-2
1201 WESTFORD ST
LOWELL, MA 01851

FOR: HOME HEALTH CARE SERVICES, IN CLASS 44 (U.S. CLS. 100 AND 101).

FIRST USE 8-1-2011; IN COMMERCE 8-1-2011.

NO CLAIM IS MADE TO THE EXCLUSIVE RIGHT TO USE "MIDDLESEX CARE PROVIDERS INC.", APART FROM THE MARK AS SHOWN.

THE STIPPLING IS FOR SHADING PURPOSES ONLY.

THE MARK CONSISTS OF A STYLIZED DESIGN OF A FLOWER TO THE LEFT OF WORDING. THE WORDS "MIDDLESEX CARE" APPEAR IN LARGE LETTERS ABOVE THE WORDING "PROVIDERS INC."

SER. NO. 85-474,738, FILED 11-16-2011.

CORY BOONE, EXAMINING ATTORNEY



David J. Kybas

Director of the United States Patent and Trademark Office

United States of America

United States Patent and Trademark Office

The Do-Over

Reg. No. 4,175,055

Registered July 17, 2012

Int. Cl.: 41

SERVICE MARK

PRINCIPAL REGISTER

DO-OVER GROUP, INC. (CALIFORNIA CORPORATION), AKA THE DO-OVER
2810 ST. GEORGE STREET
LOS ANGELES, CA 90027

FOR: ARRANGING AND CONDUCTING NIGHTCLUB ENTERTAINMENT EVENTS; ARRANGING AND CONDUCTING NIGHTCLUB PARTIES; ARRANGING AND CONDUCTING OF CONCERTS , IN CLASS 41 (U.S. CLS. 100, 101 AND 107).

FIRST USE 4-13-2005; IN COMMERCE 4-13-2005.

THE MARK CONSISTS OF STANDARD CHARACTERS WITHOUT CLAIM TO ANY PARTICULAR FONT, STYLE, SIZE, OR COLOR.

SER. NO. 85-474,742, FILED 11-16-2011.

CORY BOONE, EXAMINING ATTORNEY



David J. Kyffers

Director of the United States Patent and Trademark Office

United States of America

United States Patent and Trademark Office

Jet Squirrel

Reg. No. 4,175,056

THOMAS LI (UNITED STATES INDIVIDUAL)
290 BLOOM DR
MONTERREY PARK, CA 91775 AND

Registered July 17, 2012

Int. Cl.: 9

CHUL HYUN KIM (UNITED STATES INDIVIDUAL)
1487 MLVILLE STREET
FULLERTON, CA 92833

TRADEMARK

FOR: ANTENNA, IN CLASS 9 (U.S. CLS. 21, 23, 26, 36 AND 38).

PRINCIPAL REGISTER

FIRST USE 11-1-2011; IN COMMERCE 11-1-2011.

THE MARK CONSISTS OF STANDARD CHARACTERS WITHOUT CLAIM TO ANY PARTICULAR FONT, STYLE, SIZE, OR COLOR.

SER. NO. 85-474,754, FILED 11-16-2011.

SHAUNIA CARLYLE, EXAMINING ATTORNEY



David J. Kybas

Director of the United States Patent and Trademark Office

United States of America

United States Patent and Trademark Office

CUBEDGE

Reg. No. 4,175,057

Registered July 17, 2012

Int. Cl.: 9

TRADEMARK

PRINCIPAL REGISTER

CUBEDGE INC. (TEXAS CORPORATION)
360 NUECES STREET
SUITE 1415
AUSTIN, TX 78701

FOR: WIRELESS COMMUNICATION DEVICES FOR VOICE, DATA OR IMAGE TRANSMISSION, IN CLASS 9 (U.S. CLS. 21, 23, 26, 36 AND 38).

FIRST USE 11-1-2011; IN COMMERCE 11-1-2011.

THE MARK CONSISTS OF THE WORDING "CUBEDGE" AND AN IMAGE OF A CUBE WITH A CUT CENTER CORNER & THE LETTER "E" ON THE TOP SIDE.

SER. NO. 85-474,772, FILED 11-16-2011.

SANJEEV VOHRA, EXAMINING ATTORNEY



David J. Kyffers

Director of the United States Patent and Trademark Office

United States of America

United States Patent and Trademark Office



Reg. No. 4,175,058

VINCE'S TOPS IN DETAIL, LLC (FLORIDA LIMITED LIABILITY COMPANY)
4936 S. ORANGE AVE.
ORLANDO, FL 32806

Registered July 17, 2012

Int. Cl.: 37

FOR: MAINTENANCE AND/OR REPAIR OF VEHICLES; RESTORATION IN THE FIELD OF VEHICLES; VEHICLE DETAILING, IN CLASS 37 (U.S. CLS. 100, 103 AND 106).

SERVICE MARK

FIRST USE 7-0-1985; IN COMMERCE 7-0-1985.

PRINCIPAL REGISTER

NO CLAIM IS MADE TO THE EXCLUSIVE RIGHT TO USE "DETAIL", APART FROM THE MARK AS SHOWN.

THE MARK CONSISTS OF THE WORDING "TOPS IN DETAIL" SURROUNDED BY AN OVAL, WITH A TOP HAT TO THE LEFT OF THE OVAL.

SER. NO. 85-474,778, FILED 11-16-2011.

SANJEEV VOHRA, EXAMINING ATTORNEY



David J. Kybas

Director of the United States Patent and Trademark Office

United States of America

United States Patent and Trademark Office

Toy Chest

Reg. No. 4,175,059

Registered July 17, 2012

Int. Cl.: 16

TRADEMARK

PRINCIPAL REGISTER

DIAMOND COMIC DISTRIBUTORS, INC. (MARYLAND CORPORATION)
SUITE 300
1966 GREENSPRING DRIVE
TIMONIUM, MD 21093

FOR: PUBLICATIONS, NAMELY, NEWSLETTERS, PAMPHLETS AND BROCHURES FOCUSED ON POP-CULTURE RELATED TOY ITEMS, SENT TO RETAILERS IN THE FIELD OF COMIC BOOKS AND RELATED ITEMS FEATURING PRODUCT NEWS, INDUSTRY NEWS, INDUSTRY ANALYSIS AND PRODUCT RELEASE DATES, IN CLASS 16 (U.S. CLS. 2, 5, 22, 23, 29, 37, 38 AND 50).

FIRST USE 5-15-2001; IN COMMERCE 5-15-2001.

THE MARK CONSISTS OF STANDARD CHARACTERS WITHOUT CLAIM TO ANY PARTICULAR FONT, STYLE, SIZE, OR COLOR.

NO CLAIM IS MADE TO THE EXCLUSIVE RIGHT TO USE "TOY", APART FROM THE MARK AS SHOWN.

SER. NO. 85-474,808, FILED 11-17-2011.

ELLEN BURNS, EXAMINING ATTORNEY



David J. Kyffers

Director of the United States Patent and Trademark Office

United States of America

United States Patent and Trademark Office

Tropical Fruit Stand

Reg. No. 4,175,060

Registered July 17, 2012

Int. Cl.: 29

TRADEMARK

PRINCIPAL REGISTER

PRASHAN YAPA (UNITED STATES INDIVIDUAL), DBA PK YAPA COMPANY
NONE
25417 CALCUTTA PASS LANE
SANTA CLARITA, CA 91350

FOR: JAMS, IN CLASS 29 (U.S. CL. 46).

FIRST USE 11-5-2011; IN COMMERCE 11-11-2011.

THE MARK CONSISTS OF STANDARD CHARACTERS WITHOUT CLAIM TO ANY PARTICULAR FONT, STYLE, SIZE, OR COLOR.

NO CLAIM IS MADE TO THE EXCLUSIVE RIGHT TO USE "TROPICAL FRUIT", APART FROM THE MARK AS SHOWN.

SER. NO. 85-474,809, FILED 11-17-2011.

BARBARA BROWN, EXAMINING ATTORNEY



David J. Kyffers

Director of the United States Patent and Trademark Office

United States of America

United States Patent and Trademark Office

I.S

Reg. No. 4,175,061

ALTER EGO HAIR GROUP, LLC (PENNSYLVANIA LIMITED LIABILITY COMPANY)
608 PETERSBURG DRIVE, SUITE 101
LANCASTER, PA 17601

Registered July 17, 2012

Int. Cl.: 44

FOR: HAIR SALON SERVICES, IN CLASS 44 (U.S. CLS. 100 AND 101).

SERVICE MARK

FIRST USE 10-28-2011; IN COMMERCE 10-28-2011.

PRINCIPAL REGISTER

THE MARK CONSISTS OF STANDARD CHARACTERS WITHOUT CLAIM TO ANY PARTICULAR FONT, STYLE, SIZE, OR COLOR.

SER. NO. 85-474,811, FILED 11-17-2011.

BARBARA BROWN, EXAMINING ATTORNEY



David J. Kyffers

Director of the United States Patent and Trademark Office

United States of America

United States Patent and Trademark Office



Reg. No. 4,175,062

Registered July 17, 2012

Int. Cl.: 13

TRADEMARK

PRINCIPAL REGISTER

BEIHAI KYLIN FIREWORKS CO., LTD. (CHINA LIMITED COMPANY)
B1001, DEVELOPING BUILDING
CHONGQING ROAD
BEIHAI, GUANGXI, CHINA

FOR: FIREWORKS, NAMELY, SPARKLERS; FIRECRACKERS; PYROTECHNICS, IN CLASS 13 (U.S. CLS. 2 AND 9).

FIRST USE 4-30-2005; IN COMMERCE 3-31-2006.

THE MARK CONSISTS OF A DRAGON IN TWO CONCENTRIC CIRCLES WITH THE WORD "KYLIN KING".

SER. NO. 85-474,819, FILED 11-17-2011.

KIM MONINGHOFF, EXAMINING ATTORNEY



David J. Kyffers

Director of the United States Patent and Trademark Office

United States of America

United States Patent and Trademark Office

Resham

Reg. No. 4,175,063

SONA SPICES USA INC. (CALIFORNIA CORPORATION)
22565 PECAN PLACE
SAUGUS, CA 91390

Registered July 17, 2012

Int. Cl.: 3

FOR: BODY CREAMS; COSMETICS; HAIR CARE PREPARATIONS; HENNA FOR COSMETIC PURPOSES; SKIN CREAMS; SKIN SOAP, IN CLASS 3 (U.S. CLS. 1, 4, 6, 50, 51 AND 52).

TRADEMARK

FIRST USE 1-1-1998; IN COMMERCE 1-1-1998.

PRINCIPAL REGISTER

THE MARK CONSISTS OF STANDARD CHARACTERS WITHOUT CLAIM TO ANY PARTICULAR FONT, STYLE, SIZE, OR COLOR.

THE ENGLISH TRANSLATION OF "RESHAM" IN THE MARK IS "SILK".

SER. NO. 85-474,832, FILED 11-17-2011.

TARAH HARDY, EXAMINING ATTORNEY



David J. Kyffers

Director of the United States Patent and Trademark Office

United States of America

United States Patent and Trademark Office

THE ART OF FLIRTING

Reg. No. 4,175,064

Registered July 17, 2012

Int. Cl.: 41

SERVICE MARK

PRINCIPAL REGISTER

CUPID'S COVERAGE LLC (CALIFORNIA LIMITED LIABILITY COMPANY)
#227
23765 EL TORO RD
LAKE FOREST, CA 92630

FOR: ARRANGING AND CONDUCTING SEMINARS IN THE FIELD OF FLIRTING; EDUCATION SERVICES, NAMELY, PROVIDING ON-LINE SEMINARS, WORKSHOPS IN THE FIELD OF FLIRTING; PROVIDING ON-LINE PUBLICATIONS IN THE NATURE OF AN E-BOOK IN THE FIELD OF FLIRTING; PRODUCTION AND DISTRIBUTION OF VIDEOS IN THE FIELD OF FLIRTING; PRODUCTION AND DISTRIBUTION OF CDS IN THE FIELD OF FLIRTING, IN CLASS 41 (U.S. CLS. 100, 101 AND 107).

FIRST USE 9-1-2011; IN COMMERCE 9-7-2011.

THE MARK CONSISTS OF STANDARD CHARACTERS WITHOUT CLAIM TO ANY PARTICULAR FONT, STYLE, SIZE, OR COLOR.

NO CLAIM IS MADE TO THE EXCLUSIVE RIGHT TO USE "FLIRTING", APART FROM THE MARK AS SHOWN.

SER. NO. 85-474,833, FILED 11-17-2011.

TARAH HARDY, EXAMINING ATTORNEY



David J. Kyros

Director of the United States Patent and Trademark Office

United States of America

United States Patent and Trademark Office

Stop Scrooging Around

Reg. No. 4,175,065

NOUSVO INC. (CALIFORNIA CORPORATION), DBA MISS PROFESSIONAL NAIL
2121 W. 139TH ST.
GARDENA, CA 90249

Registered July 17, 2012

Int. Cl.: 3

FOR: NAIL GROOMING PRODUCTS, NAMELY, TIPS, GLUE, LACQUER AND GLITTER,
IN CLASS 3 (U.S. CLS. 1, 4, 6, 50, 51 AND 52).

TRADEMARK

FIRST USE 11-1-2011; IN COMMERCE 11-1-2011.

PRINCIPAL REGISTER

THE MARK CONSISTS OF STANDARD CHARACTERS WITHOUT CLAIM TO ANY PAR-
TICULAR FONT, STYLE, SIZE, OR COLOR.

SER. NO. 85-474,841, FILED 11-17-2011.

LINDA LAVACHE, EXAMINING ATTORNEY



David J. Kyffers

Director of the United States Patent and Trademark Office

United States of America

United States Patent and Trademark Office



Reg. No. 4,175,066

Registered July 17, 2012

Int. Cls.: 16, 41 and 45

TRADEMARK

SERVICE MARK

PRINCIPAL REGISTER

HAGGAI INSTITUTE FOR ADVANCED LEADERSHIP TRAINING, INC. (GEORGIA CORPORATION)
4725 PEACHTREE CORNERS CIRCLE
NORCROSS, GA 30092

FOR: PRINTED MATERIALS, NAMELY, NEWSLETTERS AND TEACHING MATERIALS FOR USE IN THE FIELD OF EVANGELIZATION AND FOR USE IN THE TRAINING OF OTHERS TO MORE EFFECTIVELY EVANGELIZE, IN CLASS 16 (U.S. CLS. 2, 5, 22, 23, 29, 37, 38 AND 50).

FIRST USE 8-2-2011; IN COMMERCE 8-2-2011.

FOR: CONDUCTING SEMINARS AND CONFERENCES IN THE FIELD OF EVANGELIZATION AND FOR USE IN THE TRAINING OF OTHERS TO MORE EFFECTIVELY EVANGELIZE; EDUCATIONAL SERVICES, NAMELY, PROVIDING COURSES AND SEMINARS TO PROMOTE AND ENCOURAGE EVANGELIZATION OF THE CHRISTIAN FAITH BY OTHERS, IN CLASS 41 (U.S. CLS. 100, 101 AND 107).

FIRST USE 8-2-2011; IN COMMERCE 8-2-2011.

FOR: EVANGELIZATION SERVICES; EVANGELIZATION SERVICES, NAMELY, PROMOTING AND ENCOURAGING EVANGELIZATION OF THE CHRISTIAN FAITH BY OTHERS BY EVANGELIZING TO THOSE OTHERS, BY PROVIDING PRINTED MATERIALS TO THOSE OTHERS AND BY PROVIDING CONSULTATION AND GUIDANCE IN CONNECTION WITH EVANGELIZATION, IN CLASS 45 (U.S. CLS. 100 AND 101).

FIRST USE 8-2-2011; IN COMMERCE 8-2-2011.

OWNER OF U.S. REG. NO. 2,161,444.

NO CLAIM IS MADE TO THE EXCLUSIVE RIGHT TO USE "INSTITUTE", APART FROM THE MARK AS SHOWN.

THE MARK CONSISTS OF A REPRESENTATION OF A PARTIAL GLOBE AND THE WORDING "HAGGAI INSTITUTE".

SER. NO. 85-474,844, FILED 11-17-2011.



David J. Kyffers

Director of the United States Patent and Trademark Office

Reg. No. 4,175,066 GINA HAYES, EXAMINING ATTORNEY

United States of America

United States Patent and Trademark Office

KULA

Reg. No. 4,175,067

Registered July 17, 2012

Int. Cls.: 9 and 35

TRADEMARK

SERVICE MARK

PRINCIPAL REGISTER

KULA ENTERPRISES, LLC (DELAWARE LIMITED LIABILITY COMPANY)
321 NORTH CLARK STREET
CHICAGO, IL 60654

FOR: SOFTWARE TO ENABLE SHARING, BUYING AND/OR SELLING GOODS AND SERVICES OVER THE INTERNET OR OTHER COMMUNICATIONS NETWORK WITHIN PARTICULAR GEOGRAPHIC LOCALES AND SPECIFIC ONLINE SOCIAL NETWORKS, IN CLASS 9 (U.S. CLS. 21, 23, 26, 36 AND 38).

FIRST USE 7-19-2011; IN COMMERCE 7-19-2011.

FOR: PROVIDING A SEARCHABLE ONLINE DATABASE FOR SHARING GOODS AND SERVICES WITHIN PARTICULAR GEOGRAPHIC LOCALES; PROVIDING A SEARCHABLE ONLINE MARKETPLACE FOR BUYING AND/OR SELLING GOODS AND SERVICES WITHIN PARTICULAR GEOGRAPHIC LOCALES; PROVIDING AN ONLINE MARKETPLACE FOR SHARING, BUYING, AND/OR SELLING PRODUCTS, SERVICES, PLACES IN LINE, SEATS RESERVED OR OTHERWISE, TICKETS, RIDES, AND PARKING SPOTS; OPERATING AN ONLINE MARKETPLACE WHICH ALLOWS THE USER TO CREATE TIME AND/OR LOCATION PREFERENCES FOR SHARING, BUYING, AND/OR SELLING GOODS AND SERVICES; PROVIDING A WEB SITE WHERE USERS OF AN ONLINE MARKETPLACE CAN POST RATINGS AND PROVIDE FEEDBACK ON GOODS AND SERVICES; PROVIDING A MOBILE MARKETPLACE FOR OFFERING LOCATION-BASED SERVICES BASED ON USER'S REAL-TIME PROXIMITY TO OTHER USERS; PROVIDING A MOBILE COMMERCE PLATFORM TO FACILITATE SHARING, BUYING AND/OR SELLING GOODS; PROVIDING A MOBILE COMMUNICATION AND COLLABORATION PLATFORM THAT ENABLES USERS TO ADVERTISE, PROMOTE, NEGOTIATE, AND OTHERWISE COMMUNICATION TO MAKE A DEAL, IN CLASS 35 (U.S. CLS. 100, 101 AND 102).

FIRST USE 7-19-2011; IN COMMERCE 7-19-2011.

THE MARK CONSISTS OF STANDARD CHARACTERS WITHOUT CLAIM TO ANY PARTICULAR FONT, STYLE, SIZE, OR COLOR.

SER. NO. 85-474,854, FILED 11-17-2011.

GINA HAYES, EXAMINING ATTORNEY



David J. Kyffers

Director of the United States Patent and Trademark Office

United States of America

United States Patent and Trademark Office



Reg. No. 4,175,068

Registered July 17, 2012

Int. Cl.: 41

SERVICE MARK

PRINCIPAL REGISTER

LEE HAVIS (UNITED STATES INDIVIDUAL)
6812 DARTMOUTH AVE.
COLLEGE PARK, MD 20740

FOR: EDUCATIONAL SERVICES, NAMELY, CONDUCTING CLASSES, SEMINARS, CONFERENCES, WORKSHOPS IN THE FIELD OF MONTESSORI EDUCATION AND DISTRIBUTION OF EDUCATIONAL MATERIALS IN CONNECTION THEREWITH, IN CLASS 41 (U.S. CLS. 100, 101 AND 107).

FIRST USE 12-24-1979; IN COMMERCE 12-24-1979.

OWNER OF U.S. REG. NO. 1,243,316.

THE MARK CONSISTS OF THE LETTERS "IMS" AND GLOBE.

SER. NO. 85-474,859, FILED 11-17-2011.

GINA HAYES, EXAMINING ATTORNEY



David J. Kyffers

Director of the United States Patent and Trademark Office

United States of America

United States Patent and Trademark Office

RENT THIS YARD

Reg. No. 4,175,069

RENT THIS YARD LLC (DELAWARE LIMITED LIABILITY COMPANY)
230 SPARROW DRIVE
WOODSTOCK, IL 60098

Registered July 17, 2012

Int. Cl.: 36

FOR: CLASSIFIED REAL ESTATE LISTINGS OF APARTMENT RENTALS AND HOUSING RENTALS, IN CLASS 36 (U.S. CLS. 100, 101 AND 102).

SERVICE MARK

FIRST USE 9-1-2011; IN COMMERCE 11-1-2011.

PRINCIPAL REGISTER

THE MARK CONSISTS OF STANDARD CHARACTERS WITHOUT CLAIM TO ANY PARTICULAR FONT, STYLE, SIZE, OR COLOR.

SER. NO. 85-474,861, FILED 11-17-2011.

GINA HAYES, EXAMINING ATTORNEY



David J. Kybas

Director of the United States Patent and Trademark Office

United States of America

United States Patent and Trademark Office

SIMPLY POLISHED

Reg. No. 4,175,070

SIMPLY POLISHED STYLING, LLC (NEW YORK LIMITED LIABILITY COMPANY)
442 WEST 54TH STREET, #5

Registered July 17, 2012

NEW YORK, NY 10019

Int. Cl.: 45

FOR: COLOR ANALYSIS FOR WARDROBE AND FASHION SELECTION; CONCIERGE SERVICES FOR OTHERS COMPRISING MAKING REQUESTED PERSONAL ARRANGEMENTS AND RESERVATIONS AND PROVIDING CUSTOMER-SPECIFIC INFORMATION TO MEET INDIVIDUAL NEEDS RENDERED TOGETHER IN A RESIDENTIAL, BUSINESS, OR ONLINE ENVIRONMENT; PERSONAL FASHION CONSULTING SERVICES; PERSONAL SHOPPING FOR OTHERS; PERSONAL WARDROBE STYLING SERVICES; PROVIDING FASHION INFORMATION; PROVISION OF A WEB SITE FEATURING INFORMATION ON FASHION, IN CLASS 45 (U.S. CLS. 100 AND 101).

SERVICE MARK

PRINCIPAL REGISTER

FIRST USE 7-0-2011; IN COMMERCE 7-0-2011.

THE MARK CONSISTS OF STANDARD CHARACTERS WITHOUT CLAIM TO ANY PARTICULAR FONT, STYLE, SIZE, OR COLOR.

SER. NO. 85-474,862, FILED 11-17-2011.

GINA HAYES, EXAMINING ATTORNEY



David J. Kybas

Director of the United States Patent and Trademark Office

United States of America

United States Patent and Trademark Office

BIG STORY BLOG

Reg. No. 4,175,071

MINNESOTA PUBLIC RADIO (MINNESOTA NON-PROFIT CORPORATION)
480 CEDAR STREET
ST. PAUL, MN 55101

Registered July 17, 2012

Int. Cl.: 41

FOR: NEWS REPORTER SERVICES IN THE NATURE OF NEWS ANALYSIS AND NEWS COMMENTARY; ONLINE JOURNALS, NAMELY, BLOGS FEATURING NEWS, POLITICS, INFORMATION, CURRENT EVENTS AND COMMENTARY, IN CLASS 41 (U.S. CLS. 100, 101 AND 107).

SERVICE MARK

PRINCIPAL REGISTER

FIRST USE 10-0-2011; IN COMMERCE 10-0-2011.

THE MARK CONSISTS OF STANDARD CHARACTERS WITHOUT CLAIM TO ANY PARTICULAR FONT, STYLE, SIZE, OR COLOR.

NO CLAIM IS MADE TO THE EXCLUSIVE RIGHT TO USE "BLOG", APART FROM THE MARK AS SHOWN.

SER. NO. 85-474,865, FILED 11-17-2011.

GINA HAYES, EXAMINING ATTORNEY



David J. Kyffers

Director of the United States Patent and Trademark Office

United States of America

United States Patent and Trademark Office

Satisfy Your Soul

Reg. No. 4,175,072

SATISFY YOUR SOUL, LLC (NORTH CAROLINA LIMITED LIABILITY COMPANY)
1183 UNIVERSITY DRIVE SUITE 105-214
BURLINGTON, NC 27215

Registered July 17, 2012

Int. Cl.: 30

FOR: CHUTNEYS; FLAVOURINGS AND SEASONINGS; FOOD CONDIMENT CONSISTING PRIMARILY OF KETCHUP AND SALSA; FOOD SEASONINGS; SAUCE MIXES; SAUCES; SEASONING MIXES; SEASONINGS; SPICE BLENDS; SPICE RUBS; SPICES, IN CLASS 30 (U.S. CL. 46).

TRADEMARK

PRINCIPAL REGISTER

FIRST USE 9-20-2009; IN COMMERCE 9-20-2009.

THE MARK CONSISTS OF STANDARD CHARACTERS WITHOUT CLAIM TO ANY PARTICULAR FONT, STYLE, SIZE, OR COLOR.

SER. NO. 85-474,874, FILED 11-17-2011.

JOHN KELLY, EXAMINING ATTORNEY



David J. Kyros

Director of the United States Patent and Trademark Office

United States of America

United States Patent and Trademark Office

STETSBAR

Reg. No. 4,175,073

Registered July 17, 2012

Int. Cl.: 15

TRADEMARK

PRINCIPAL REGISTER

STETS METAL ARTS INC. (NEW YORK CORPORATION)
P. O. BOX 125
50 EAST & WEST ROAD
WEST SENECA, NY 14224

FOR: MUSICAL INSTRUMENTS, NAMELY, ELECTRIC GUITARS, TREMOLOS FOR MUSICAL INSTRUMENTS; BRIDGES FOR MUSICAL INSTRUMENTS; STRINGS FOR MUSICAL INSTRUMENTS, IN CLASS 15 (U.S. CLS. 2, 21 AND 36).

FIRST USE 2-28-1995; IN COMMERCE 2-28-1995.

THE MARK CONSISTS OF STANDARD CHARACTERS WITHOUT CLAIM TO ANY PARTICULAR FONT, STYLE, SIZE, OR COLOR.

SER. NO. 85-474,897, FILED 11-17-2011.

STEVEN JACKSON, EXAMINING ATTORNEY



David J. Kyffers

Director of the United States Patent and Trademark Office

United States of America

United States Patent and Trademark Office

Lily and Laura

Reg. No. 4,175,074

THE LAURA LEWIS GROUP, INC. (COLORADO CORPORATION), DBA LILY AND LAURA
PO BOX 473
NEDERLAND, CO 80466

Registered July 17, 2012

Int. Cl.: 14

FOR: BRACELETS; NECKLACES; WOMEN'S JEWELRY, IN CLASS 14 (U.S. CLS. 2, 27, 28 AND 50).

TRADEMARK

FIRST USE 9-30-2010; IN COMMERCE 9-30-2010.

PRINCIPAL REGISTER

THE MARK CONSISTS OF STANDARD CHARACTERS WITHOUT CLAIM TO ANY PARTICULAR FONT, STYLE, SIZE, OR COLOR.

SER. NO. 85-474,904, FILED 11-17-2011.

RONALD MCMORROW, EXAMINING ATTORNEY



David J. Kyffers

Director of the United States Patent and Trademark Office

United States of America

United States Patent and Trademark Office

ESSENTIAL WORSHIP

Reg. No. 4,175,075

Registered July 17, 2012

Int. Cl.: 9

PROVIDENT LABEL GROUP LLC (DELAWARE LIMITED LIABILITY COMPANY)
RM. 2325
550 MADISON AVENUE
NEW YORK, NY 10022

FOR: MUSICAL SOUND RECORDINGS, IN CLASS 9 (U.S. CLS. 21, 23, 26, 36 AND 38).

TRADEMARK

FIRST USE 1-1-2011; IN COMMERCE 1-1-2011.

PRINCIPAL REGISTER

THE MARK CONSISTS OF STANDARD CHARACTERS WITHOUT CLAIM TO ANY PARTICULAR FONT, STYLE, SIZE, OR COLOR.

OWNER OF U.S. REG. NO. 2,518,527.

NO CLAIM IS MADE TO THE EXCLUSIVE RIGHT TO USE "WORSHIP", APART FROM THE MARK AS SHOWN.

SER. NO. 85-474,906, FILED 11-17-2011.

RONALD MCMORROW, EXAMINING ATTORNEY



David J. Kybas

Director of the United States Patent and Trademark Office

United States of America

United States Patent and Trademark Office

imbookin

Reg. No. 4,175,076

POGBY, INC (DELAWARE CORPORATION)
141A MCGUINNESS BLVD
BROOKLYN, NY 11222

Registered July 17, 2012

Int. Cl.: 42

FOR: COMPUTER SERVICES, NAMELY, PROVIDING A WEB SITE FOR OTHERS THAT AUTOMATES PARTY AND ENTERTAINMENT EVENTS MANAGEMENT INFORMATION CONSISTING OF LOCATION AND SERVICE PROVIDER SEARCHING, REVIEWS, PRICING, AVAILABILITY, COMMUNICATION AND BOOKING, IN CLASS 42 (U.S. CLS. 100 AND 101).

SERVICE MARK

PRINCIPAL REGISTER

FIRST USE 1-1-2011; IN COMMERCE 8-1-2011.

THE MARK CONSISTS OF STANDARD CHARACTERS WITHOUT CLAIM TO ANY PARTICULAR FONT, STYLE, SIZE, OR COLOR.

SER. NO. 85-474,937, FILED 11-17-2011.

KARANENDRA S. CHHINA, EXAMINING ATTORNEY



David J. Kyffers

Director of the United States Patent and Trademark Office

United States of America

United States Patent and Trademark Office

TOP STREET

Reg. No. 4,175,077

WOODLE, ALAN (UNITED STATES INDIVIDUAL), DBA TOP STREET
1070 BUENA VISTA RD
HOLLISTER, CA 95023

Registered July 17, 2012

Int. Cl.: 37

FOR: RESTORATION IN THE FIELD OF AUTOMOBILES, IN CLASS 37 (U.S. CLS. 100, 103 AND 106).

SERVICE MARK

FIRST USE 0-0-1979; IN COMMERCE 0-0-1979.

PRINCIPAL REGISTER

THE MARK CONSISTS OF STANDARD CHARACTERS WITHOUT CLAIM TO ANY PARTICULAR FONT, STYLE, SIZE, OR COLOR.

SER. NO. 85-474,979, FILED 11-17-2011.

JOHN KELLY, EXAMINING ATTORNEY



David J. Kyffers

Director of the United States Patent and Trademark Office

United States of America

United States Patent and Trademark Office



Reg. No. 4,175,078

Registered July 17, 2012

Int. Cl.: 30

TRADEMARK

PRINCIPAL REGISTER

SATISFY YOUR SOUL, LLC (NORTH CAROLINA LIMITED LIABILITY COMPANY)
1183 UNIVERSITY DRIVE SUITE 105-214
BURLINGTON, NC 27215

FOR: CHUTNEYS; FLAVOURINGS AND SEASONINGS; FOOD CONDIMENT CONSISTING PRIMARILY OF KETCHUP AND SALSA; FOOD SEASONINGS; SAUCE MIXES; SAUCES; SEASONING MIXES; SEASONINGS; SPICE BLENDS; SPICE RUBS; SPICES, IN CLASS 30 (U.S. CL. 46).

FIRST USE 9-20-2009; IN COMMERCE 9-20-2009.

THE MARK CONSISTS OF THE FOLLOWING: AN ORANGE SHADED CIRCLE THAT IS OUTLINED IN BLACK, AND THE BLACK WORDING "SATISFY YOUR SOUL" IN STYLIZED FONT.

THE COLOR(S) ORANGE AND BLACK IS/ARE CLAIMED AS A FEATURE OF THE MARK.

SER. NO. 85-474,990, FILED 11-17-2011.

JOHN KELLY, EXAMINING ATTORNEY



David J. Kybas

Director of the United States Patent and Trademark Office

United States of America

United States Patent and Trademark Office



Reg. No. 4,175,079

Registered July 17, 2012

Int. Cls.: 25 and 41

TRADEMARK

SERVICE MARK

PRINCIPAL REGISTER

WILSON, REGINALD B. (UNITED STATES INDIVIDUAL)
#1304
639 GARDEN WALK BLVD.
COLLEGE PARK, GA 30349

FOR: T-SHIRTS, IN CLASS 25 (U.S. CLS. 22 AND 39).

FIRST USE 7-15-2010; IN COMMERCE 7-15-2010.

FOR: ENTERTAINMENT IN THE NATURE OF ON-GOING TELEVISION PROGRAMS IN THE FIELD OF PERSONAL RELATIONSHIPS, HEALTH, FITNESS, DIET, EXERCISE, LIFESTYLE AND NUTRITION, IN CLASS 41 (U.S. CLS. 100, 101 AND 107).

FIRST USE 7-15-2010; IN COMMERCE 7-15-2010.

THE MARK CONSISTS OF ONE MAN IN THE CENTER OF TWO WOMEN. BELOW THE DESIGN OF THE MAN AND WOMEN IS THE STYLIZED TEXT "MR. HE GOT GAME". THE IMAGES OF THE WOMEN ARE A LIGHT SHADE OF BLUE, THE IMAGE OF THE MAN AND THE WORDING ARE A DARKER SHADE OF BLUE.

THE COLOR(S) BLUE IS/ARE CLAIMED AS A FEATURE OF THE MARK.

SER. NO. 85-475,003, FILED 11-17-2011.

VIVIAN MICZNIK FIRST, EXAMINING ATTORNEY



David J. Kybas

Director of the United States Patent and Trademark Office

United States of America

United States Patent and Trademark Office

THE DARLENE SISTERS

Reg. No. 4,175,080

WAINRIGHT, JAMIE G. (UNITED STATES INDIVIDUAL)
15 CRAWFORD CIRCLE
SPRINGFIELD, MA 01108

Registered July 17, 2012

Int. Cls.: 16 and 35

FOR: ART PRINTS; CARTOON PRINTS; GRAPHIC ART PRINTS; GREETINGS CARDS AND POSTCARDS; ILLUSTRATIONS; NOTE CARDS; STATIONERY WRITING PAPER AND ENVELOPES; STORY BOOKS, IN CLASS 16 (U.S. CLS. 2, 5, 22, 23, 29, 37, 38 AND 50).

TRADEMARK

FIRST USE 4-29-1991; IN COMMERCE 8-20-2011.

SERVICE MARK

PRINCIPAL REGISTER

FOR: ON-LINE RETAIL STORE SERVICES FEATURING ART PRINTS, CARTOON PRINTS, GRAPHIC ART PRINTS, GREETING CARDS AND POST CARDS, STATIONERY PAPER AND ENVELOPES, NOTE CARDS, ILLUSTRATIONS, AND STORY BOOKS, IN CLASS 35 (U.S. CLS. 100, 101 AND 102).

FIRST USE 8-20-2011; IN COMMERCE 8-20-2011.

THE MARK CONSISTS OF STANDARD CHARACTERS WITHOUT CLAIM TO ANY PARTICULAR FONT, STYLE, SIZE, OR COLOR.

SER. NO. 85-475,017, FILED 11-17-2011.

CURTIS FRENCH, EXAMINING ATTORNEY



David J. Kybas

Director of the United States Patent and Trademark Office

United States of America

United States Patent and Trademark Office

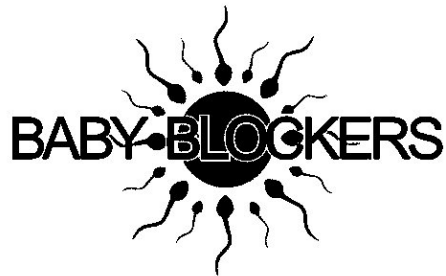

Reg. No. 4,175,081

DUVALL, CHAD (UNITED STATES INDIVIDUAL)
6780 NW 60TH ST.
OCALA, FL 34482

Registered July 17, 2012

Int. Cl.: 10

FOR: CONDOMS, IN CLASS 10 (U.S. CLS. 26, 39 AND 44).

TRADEMARK

FIRST USE 10-0-2011; IN COMMERCE 10-0-2011.

PRINCIPAL REGISTER

THE MARK CONSISTS OF THE LITERAL ELEMENT "BABY BLOCKERS" WITH A BACKGROUND OF SPERM ICONS SURROUNDING A CIRCLE ICON, TOGETHER FORMING SHAPE OF A SUN.

SER. NO. 85-475,031, FILED 11-17-2011.

SUZANNE BLANE, EXAMINING ATTORNEY



David J. Kyffers

Director of the United States Patent and Trademark Office

United States of America

United States Patent and Trademark Office

DISTILLERY PURE

Reg. No. 4,175,082

SIDE POCKET FOODS CO. (OREGON CORPORATION)
1780 CARNEGIE WAY
COTTAGE GROVE, OR 97424

Registered July 17, 2012

Int. Cl.: 33

FOR: DISTILLED SPIRITS, IN CLASS 33 (U.S. CLS. 47 AND 49).

TRADEMARK

FIRST USE 7-0-2008; IN COMMERCE 7-0-2008.

PRINCIPAL REGISTER

THE MARK CONSISTS OF STANDARD CHARACTERS WITHOUT CLAIM TO ANY PARTICULAR FONT, STYLE, SIZE, OR COLOR.

NO CLAIM IS MADE TO THE EXCLUSIVE RIGHT TO USE "DISTILLERY", APART FROM THE MARK AS SHOWN.

SER. NO. 85-475,062, FILED 11-17-2011.

NAPOLEON SHARMA, EXAMINING ATTORNEY



David J. Kyffers

Director of the United States Patent and Trademark Office

United States of America

United States Patent and Trademark Office



Reg. No. 4,175,083

Registered July 17, 2012

Int. Cl.: 35

SERVICE MARK

PRINCIPAL REGISTER

FRIZZELL, MARJORIE (UNITED STATES INDIVIDUAL)
3306 N MILITARY HIGHWAY
NORFOLK, VA 23518

FOR: ON-LINE RETAIL STORE SERVICES FEATURING BOAT TRAILERS, BRAKES, AXLES, TIRES, FRAME COMPONENTS, WINCHES, TONGUE JACKS, LIGHTS AND WIRING, AND ROLLERS; RETAIL STORE SERVICES FEATURING BOAT TRAILERS, BRAKES, AXLES, TIRES, FRAME COMPONENTS, WINCHES, TONGUE JACKS, LIGHTS AND WIRING, AND ROLLERS, IN CLASS 35 (U.S. CLS. 100, 101 AND 102).

FIRST USE 5-1-2005; IN COMMERCE 5-1-2005.

NO CLAIM IS MADE TO THE EXCLUSIVE RIGHT TO USE "BOAT TRAILER SERVICE 757-857-8687 INC PARTS SALES SERVICE", APART FROM THE MARK AS SHOWN.

THE MARK CONSISTS OF A TRAILER WITH THE STYLIZED TEXT "BOAT TRAILER SERVICE 757-857-8687 INC" WRITTEN ON THE BACK. ON THE TOP THERE IS A SUN WITH BIRDS, A BOAT, AND WATER. ON THE TOP THERE IS A SUN WITH BIRDS AND A BOAT ON THE WATER AND IT IS SITTING DOWN INSIDE OF A BOAT TRAILER. BELOW THERE IS THE STYLIZED TEXT "PARTS · SALES · SERVICE".

SER. NO. 85-475,087, FILED 11-17-2011.

ALICIA COLLINS, EXAMINING ATTORNEY



David J. Kybas

Director of the United States Patent and Trademark Office

United States of America
United States Patent and Trademark Office



S P E E D C L E A N

Reg. No. 4,175,084

GLOBAL GREEN TECHNOLOGY, LLC (IDAHO LIMITED LIABILITY COMPANY)
3720 N BLACK BUTTE CT
NAMPA, ID 83687

Registered July 17, 2012

Int. Cls.: 1 and 3

FOR: DEGREASING AGENTS; FERTILIZERS, IN CLASS 1 (U.S. CLS. 1, 5, 6, 10, 26 AND 46).

TRADEMARK

FIRST USE 8-0-2009; IN COMMERCE 8-0-2009.

PRINCIPAL REGISTER

FOR: ALL-PURPOSE CLEANERS; AUTOMOBILE CLEANERS, IN CLASS 3 (U.S. CLS. 1, 4, 6, 50, 51 AND 52).

FIRST USE 8-0-2009; IN COMMERCE 8-0-2009.

NO CLAIM IS MADE TO THE EXCLUSIVE RIGHT TO USE "CLEAN", APART FROM THE MARK AS SHOWN.

THE MARK CONSISTS OF THE STYLIZED WORDING "GGT SPEED CLEAN" AND ABSTRACT PLANT AND CIRCLE DESIGN. THE INITIALS "GGT" APPEAR TO THE RIGHT OF THE PLANT DESIGN, WHICH CONSISTS OF A CIRCLE WITH BREAKS AT THE TOP AND BOTTOM, BRACKETED ON THE LEFT AND RIGHT SIDES EACH BY TWO ELONGATED OVAL FORMS RESEMBLING LEAVES. THE BOTTOM PORTION OF THE CIRCLE EXTENDS UP ON EACH SIDE INTO THE INTERIOR OF THE CIRCLE, NESTLING THREE LEAVES, ONE ON THE LEFT, TWO ON THE RIGHT, RESEMBLING A PLANT SEEDLING. UNDERNEATH THE DESIGN AND INITIALS APPEARS THE STYLIZED WORDING "SPEED CLEAN".



SER. NO. 85-475,092, FILED 11-17-2011.

JERI J. FICKES, EXAMINING ATTORNEY

David J. Kybas

Director of the United States Patent and Trademark Office

United States of America

United States Patent and Trademark Office

GREAT OCEAN

Reg. No. 4,175,085

Registered July 17, 2012

Int. Cl.: 29

TRADEMARK

PRINCIPAL REGISTER

CAMERICAN INTERNATIONAL, INC. (DELAWARE CORPORATION)
45 EISENHOWER DRIVE
PARAMUS, NJ 07652

FOR: CANNED FISH AND CANNED CRAB MEAT, IN CLASS 29 (U.S. CL. 46).

FIRST USE 0-0-1955; IN COMMERCE 0-0-1955.

THE MARK CONSISTS OF STANDARD CHARACTERS WITHOUT CLAIM TO ANY PARTICULAR FONT, STYLE, SIZE, OR COLOR.

OWNER OF U.S. REG. NO. 1,150,565.

SER. NO. 85-475,101, FILED 11-17-2011.

NAPOLEON SHARMA, EXAMINING ATTORNEY



David J. Kyffers

Director of the United States Patent and Trademark Office

United States of America

United States Patent and Trademark Office



Reg. No. 4,175,086

TRACTOR SUPPLY CO. OF TEXAS, LP (TEXAS LIMITED PARTNERSHIP)
200 POWELL PLACE
BRENTWOOD, TN 37027

Registered July 17, 2012

Int. Cl.: 21

FOR: COOKWARE, NAMELY, POTS AND PANS, IN CLASS 21 (U.S. CLS. 2, 13, 23, 29, 30, 33, 40 AND 50).

TRADEMARK

FIRST USE 10-1-2011; IN COMMERCE 10-1-2011.

PRINCIPAL REGISTER

THE MARK CONSISTS OF THE WORD "RED" WITH A SMALL CIRCLE ABOVE AND TO THE RIGHT OF THE LETTER "D" IN "RED" AND THE WORD "STONE" APPEARING DIRECTLY UNDER THE WORD "RED".

SER. NO. 85-475,111, FILED 11-17-2011.

CHRISTOPHER LAW, EXAMINING ATTORNEY



David J. Kybas

Director of the United States Patent and Trademark Office

United States of America

United States Patent and Trademark Office

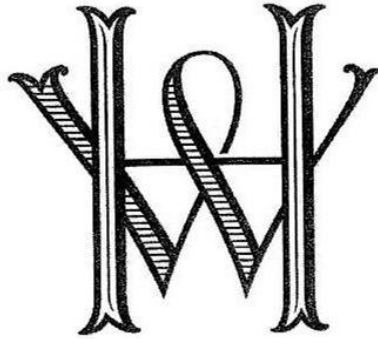

Reg. No. 4,175,087

HAWTHORNE & WREN, INC. (LOUISIANA CORPORATION)
2350 PHYLDEN DRIVE
SALT LAKE CITY, UT 84117

Registered July 17, 2012

Int. Cl.: 35

FOR: ON-LINE RETAIL GIFT SHOPS, IN CLASS 35 (U.S. CLS. 100, 101 AND 102).

SERVICE MARK

FIRST USE 11-8-2011; IN COMMERCE 11-8-2011.

PRINCIPAL REGISTER

THE MARK CONSISTS OF THE LETTER "H" WITH THE LETTER "W" SUPERIMPOSED, LOOPING THROUGH THE LETTER "H", WITH THE LOOP REPRESENTING THE AMPERSAND SYMBOL.

SER. NO. 85-475,116, FILED 11-17-2011.

FRED CARL, EXAMINING ATTORNEY



David J. Kyffers

Director of the United States Patent and Trademark Office

United States of America

United States Patent and Trademark Office

SCHEME-IT

Reg. No. 4,175,088

Registered July 17, 2012

Int. Cl.: 42

SERVICE MARK

PRINCIPAL REGISTER

DIGI-KEY CORPORATION (MINNESOTA CORPORATION)
701 BROOKS AVENUE SOUTH
THIEF RIVER FALLS, MN 56701

FOR: CLOUD COMPUTING FEATURING SOFTWARE FOR USE CREATING ELECTRONIC CIRCUIT DESIGNS AND OTHER SCHEMATIC DRAWINGS; PROVIDING A WEBSITE FEATURING TECHNOLOGY THAT ENABLES USERS TO CREATE ELECTRONIC CIRCUIT DESIGNS AND OTHER SCHEMATIC DRAWINGS; PROVIDING AN ONLINE NON-DOWNLOADABLE INTERNET-BASED SYSTEM APPLICATION FEATURING TECHNOLOGY ENABLING USERS TO CREATE ELECTRONIC CIRCUIT DESIGNS AND OTHER SCHEMATIC DRAWINGS; SOFTWARE AS A SERVICE (SAAS) SERVICES FEATURING SOFTWARE FOR CREATING ELECTRONIC CIRCUIT DESIGNS AND OTHER SCHEMATIC DRAWINGS, IN CLASS 42 (U.S. CLS. 100 AND 101).

FIRST USE 11-23-2011; IN COMMERCE 11-23-2011.

THE MARK CONSISTS OF STANDARD CHARACTERS WITHOUT CLAIM TO ANY PARTICULAR FONT, STYLE, SIZE, OR COLOR.

SER. NO. 85-475,130, FILED 11-17-2011.

WILLIAM JACKSON, EXAMINING ATTORNEY



David J. Kyfos

Director of the United States Patent and Trademark Office

United States of America

United States Patent and Trademark Office

Endurance

Reg. No. 4,175,089

POWELL PRODUCTS, INC. (CALIFORNIA CORPORATION)
33 COMMERCIAL BLVD. SUITE C
NOVATO, CA 94947

Registered July 17, 2012

Int. Cl.: 28

FOR: FISHING POLES; FISHING ROD BLANKS; FISHING RODS, IN CLASS 28 (U.S. CLS. 22, 23, 38 AND 50).

TRADEMARK

FIRST USE 9-15-2010; IN COMMERCE 9-15-2010.

PRINCIPAL REGISTER

THE MARK CONSISTS OF STANDARD CHARACTERS WITHOUT CLAIM TO ANY PARTICULAR FONT, STYLE, SIZE, OR COLOR.

SER. NO. 85-475,131, FILED 11-17-2011.

FONG HSU, EXAMINING ATTORNEY



David J. Kyffers

Director of the United States Patent and Trademark Office

United States of America

United States Patent and Trademark Office

Totel

Reg. No. 4,175,090

Registered July 17, 2012

Int. Cl.: 38

SERVICE MARK

PRINCIPAL REGISTER

TOTEL COMMUNICATIONS, INC. (CALIFORNIA CORPORATION)
SUITE C
2455 EL CAMINO REAL
PALO ALTO, CA 94306

FOR: INTERNET TELEPHONY SERVICES, IN CLASS 38 (U.S. CLS. 100, 101 AND 104).

FIRST USE 8-5-2010; IN COMMERCE 8-5-2010.

THE MARK CONSISTS OF STANDARD CHARACTERS WITHOUT CLAIM TO ANY PARTICULAR FONT, STYLE, SIZE, OR COLOR.

SER. NO. 85-475,136, FILED 11-17-2011.

JAMES STEIN, EXAMINING ATTORNEY



David J. Kyffers

Director of the United States Patent and Trademark Office

United States of America

United States Patent and Trademark Office

Kaneraï

Reg. No. 4,175,091

Registered July 17, 2012

Int. Cl.: 42

SERVICE MARK

PRINCIPAL REGISTER

CLARITY SOLUTIONS GROUP, LLC (DELAWARE LIMITED LIABILITY COMPANY), DBA
KANERAI
P.O. BOX 4668 #36110
NEW YORK, NY 101634558

FOR: COMPUTER SERVICES, NAMELY, HOSTING AN INTERACTIVE WEB SITE THAT
ALLOWS FINANCIAL INSTITUTIONS TO ACCESS FINANCIAL ANALYTICS ON SECUR-
ITIZED FINANCIAL INSTRUMENTS AND ASSET-BACKED SECURITIES, IN CLASS 42
(U.S. CLS. 100 AND 101).

FIRST USE 1-1-2011; IN COMMERCE 1-1-2011.

THE MARK CONSISTS OF STANDARD CHARACTERS WITHOUT CLAIM TO ANY PAR-
TICULAR FONT, STYLE, SIZE, OR COLOR.

THE NAME(S), PORTRAIT(S), AND/OR SIGNATURE(S) SHOWN IN THE MARK DOES NOT
IDENTIFY A PARTICULAR LIVING INDIVIDUAL.

THE WORDING "KANERAI" HAS NO MEANING IN A FOREIGN LANGUAGE.

SER. NO. 85-475,154, FILED 11-17-2011.

MARGARET POWER, EXAMINING ATTORNEY



David J. Kyffers

Director of the United States Patent and Trademark Office

United States of America

United States Patent and Trademark Office

NET10

Reg. No. 4,175,092

Registered July 17, 2012

Int. Cl.: 35

SERVICE MARK

PRINCIPAL REGISTER

TRACFONE WIRELESS, INC. (DELAWARE CORPORATION)
9700 NW 112 AVENUE
MIAMI, FL 33178

FOR: ON-LINE RETAIL STORE SERVICES FEATURING CELLULAR TELEPHONES, PREPAID WIRELESS AIR TIME CARDS, CELLULAR TELEPHONE ACCESSORIES AND WIRELESS SERVICES; DISTRIBUTORSHIP SERVICES FEATURING CELLULAR TELEPHONES, PREPAID AIR TIME CELLULAR TELEPHONE AND PREPAID AIR TIME DEBIT CARDS AND SOFTWARE FOR CONTROLLING AND MONITORING PREPAID AIR TIME CELLULAR SERVICE, IN CLASS 35 (U.S. CLS. 100, 101 AND 102).

FIRST USE 12-31-2005; IN COMMERCE 12-31-2005.

THE MARK CONSISTS OF STANDARD CHARACTERS WITHOUT CLAIM TO ANY PARTICULAR FONT, STYLE, SIZE, OR COLOR.

OWNER OF U.S. REG. NOS. 3,118,250, 3,457,105 AND OTHERS.

SER. NO. 85-475,157, FILED 11-17-2011.

MARGARET POWER, EXAMINING ATTORNEY



David J. Kyffers

Director of the United States Patent and Trademark Office

United States of America

United States Patent and Trademark Office

the art + science of frozen yogurt

Reg. No. 4,175,093

Registered July 17, 2012

Int. Cl.: 30

TRADEMARK

PRINCIPAL REGISTER

YOGURTOLOGY FRANCHISING LLC (ARIZONA LIMITED LIABILITY COMPANY)
#B107
15029 N THOMPSON PEAK PKWY
SCOTTSDALE, AZ 85260

FOR: FROZEN YOGURT, IN CLASS 30 (U.S. CL. 46).

FIRST USE 2-0-2009; IN COMMERCE 2-0-2009.

THE MARK CONSISTS OF STANDARD CHARACTERS WITHOUT CLAIM TO ANY PARTICULAR FONT, STYLE, SIZE, OR COLOR.

SER. NO. 85-475,158, FILED 11-17-2011.

MARGARET POWER, EXAMINING ATTORNEY



David J. Kybas

Director of the United States Patent and Trademark Office

United States of America

United States Patent and Trademark Office

LIL LOVE

Reg. No. 4,175,094

Registered July 17, 2012

Int. Cl.: 25

TRADEMARK

PRINCIPAL REGISTER

LIL LOVE APPAREL, LLC (TEXAS LIMITED LIABILITY COMPANY)
12708 RIATA VISTA CIRCLE
SUITE B-101
AUSTIN, TX 78727

FOR: WEARABLE GARMENTS AND CLOTHING, NAMELY, SHIRTS, IN CLASS 25 (U.S. CLS. 22 AND 39).

FIRST USE 1-28-2011; IN COMMERCE 1-28-2011.

THE MARK CONSISTS OF STANDARD CHARACTERS WITHOUT CLAIM TO ANY PARTICULAR FONT, STYLE, SIZE, OR COLOR.

SER. NO. 85-475,164, FILED 11-17-2011.

CHRISTOPHER LAW, EXAMINING ATTORNEY



David J. Kybas

Director of the United States Patent and Trademark Office

United States of America

United States Patent and Trademark Office

EVOLVING GODDESS

Reg. No. 4,175,095

Registered July 17, 2012

Int. Cl.: 45

SERVICE MARK

PRINCIPAL REGISTER

ANN THOMAS COACHING AND CONSULTING, LLC. (NEW JERSEY LIMITED LIABILITY COMPANY)
PO BOX 413
FANWOOD, NJ 07023

FOR: PROVIDING ON-LINE INFORMATION IN THE FIELD OF SPIRITUALITY, SELF-HELP, AND PERSONAL EMPOWERMENT SUBJECT MATTERS, IN CLASS 45 (U.S. CLS. 100 AND 101).

FIRST USE 1-21-2011; IN COMMERCE 1-21-2011.

THE MARK CONSISTS OF STANDARD CHARACTERS WITHOUT CLAIM TO ANY PARTICULAR FONT, STYLE, SIZE, OR COLOR.

SER. NO. 85-475,172, FILED 11-17-2011.

LINDA POWELL, EXAMINING ATTORNEY



David J. Kyffers

Director of the United States Patent and Trademark Office

United States of America

United States Patent and Trademark Office

FRONTECH

Reg. No. 4,175,096

Registered July 17, 2012

Int. Cls.: 41 and 42

SERVICE MARK

PRINCIPAL REGISTER

AMIABLE TECH SOLUTION, INC. (VIRGINIA CORPORATION)
SUITE 305
4900 LEESBURG PIKE
ALEXANDRIA, VA 22302

FOR: IT TRAINING SERVICES, IN CLASS 41 (U.S. CLS. 100, 101 AND 107).

FIRST USE 5-1-2007; IN COMMERCE 5-1-2007.

FOR: IT CONSULTING SERVICES , IN CLASS 42 (U.S. CLS. 100 AND 101).

FIRST USE 5-1-2007; IN COMMERCE 5-1-2007.

THE MARK CONSISTS OF STANDARD CHARACTERS WITHOUT CLAIM TO ANY PARTICULAR FONT, STYLE, SIZE, OR COLOR.

SER. NO. 85-475,183, FILED 11-17-2011.

ALLISON SCHRODY, EXAMINING ATTORNEY



David J. Kybas

Director of the United States Patent and Trademark Office

United States of America

United States Patent and Trademark Office



Reg. No. 4,175,097

Registered July 17, 2012

Int. Cl.: 45

SERVICE MARK

PRINCIPAL REGISTER

ANN THOMAS COACHING AND CONSULTING, LLC. (NEW JERSEY LIMITED LIABILITY COMPANY)
P.O BOX 413
FANWOOD, NJ 07023

FOR: PROVIDING ON-LINE INFORMATION IN THE FIELD OF SPIRITUALITY, SELF-HELP, AND PERSONAL EMPOWERMENT SUBJECT MATTERS, IN CLASS 45 (U.S. CLS. 100 AND 101).

FIRST USE 3-29-2010; IN COMMERCE 3-29-2010.

THE MARK CONSISTS OF THE STYLIZED DRAWING OF A FIGURE WITH ITS ARMS UPRAISED, THE FIGURE STANDING IN WITHIN THE STYLIZED DRAWING OF A LOTUS FLOWER.

SER. NO. 85-475,192, FILED 11-17-2011.

LINDA POWELL, EXAMINING ATTORNEY



David J. Kybas

Director of the United States Patent and Trademark Office

United States of America

United States Patent and Trademark Office

maternal instinct

Reg. No. 4,175,098

Registered July 17, 2012

Int. Cl.: 35

SERVICE MARK

PRINCIPAL REGISTER

MATERNAL INSTINCT (CALIFORNIA LIMITED LIABILITY COMPANY)
415 CAMBRIDGE AVENUE
SUITE 2
PALO ALTO, CA 94306

FOR: ADVERTISING SERVICES, PUBLIC RELATIONS AND MARKETING SERVICES, NAMELY, PROMOTING AND MARKETING THE GOODS AND SERVICES OF OTHERS THROUGH ALL PUBLIC COMMUNICATION MEANS, IN CLASS 35 (U.S. CLS. 100, 101 AND 102).

FIRST USE 1-3-2008; IN COMMERCE 1-3-2008.

THE MARK CONSISTS OF A HORIZONTAL LOGO WITH STITCHED BORDER AND THE TEXT "MATERNAL INSTINCT" RENDERED IN CURSIVE SCRIPT (MI MIMA FONT) INSIDE THE LOGO.

SER. NO. 85-475,203, FILED 11-17-2011.

FONG HSU, EXAMINING ATTORNEY



David J. Kyffers

Director of the United States Patent and Trademark Office

United States of America

United States Patent and Trademark Office

Sports Vein

Reg. No. 4,175,099

M & B COURTSIDE VENTURES, INC. (FLORIDA CORPORATION)
PO BOX 551260

Registered July 17, 2012

JACKSONVILLE, FL 32255

Int. Cl.: 41

FOR: PROVIDING A WEBSITE FOR ENTERTAINMENT PURPOSES WHERE USERS CAN VIEW AND POST PHOTOS, COMMENTS AND WAGERS FEATURING SPORTS-RELATED SUBJECT MATTER, IN CLASS 41 (U.S. CLS. 100, 101 AND 107).

SERVICE MARK

FIRST USE 6-1-2011; IN COMMERCE 6-1-2011.

PRINCIPAL REGISTER

THE MARK CONSISTS OF STANDARD CHARACTERS WITHOUT CLAIM TO ANY PARTICULAR FONT, STYLE, SIZE, OR COLOR.

SER. NO. 85-475,205, FILED 11-17-2011.

FONG HSU, EXAMINING ATTORNEY



David J. Kyffers

Director of the United States Patent and Trademark Office

United States of America

United States Patent and Trademark Office

SCoRE

Reg. No. 4,175,100

LEAD PITTSBURGH (PENNSYLVANIA NON-PROFIT CORPORATION)
625 LIBERTY AVENUE, SUITE 3110
PITTSBURGH, PA 15222

Registered July 17, 2012

Int. Cl.: 41

FOR: EDUCATION SERVICES, NAMELY, PROVIDING WEB-BASED AND CLASSROOM TRAINING THAT TEACHES STUDENTS ABOUT ENHANCING MENTAL HEALTH WELLNESS THROUGH DEVELOPING AND STRENGTHENING RESILIENCE SKILLS, IN CLASS 41 (U.S. CLS. 100, 101 AND 107).

SERVICE MARK

PRINCIPAL REGISTER

FIRST USE 8-0-2011; IN COMMERCE 8-0-2011.

THE MARK CONSISTS OF STANDARD CHARACTERS WITHOUT CLAIM TO ANY PARTICULAR FONT, STYLE, SIZE, OR COLOR.

SER. NO. 85-475,209, FILED 11-17-2011.

DEBORAH LOBO, EXAMINING ATTORNEY



David J. Kyjars

Director of the United States Patent and Trademark Office

United States of America

United States Patent and Trademark Office

SCORE STUDENT CURRICULUM ON RESILIENCE EDUCATION

Reg. No. 4,175,101

LEAD PITTSBURGH (PENNSYLVANIA NON-PROFIT CORPORATION)
625 LIBERTY AVENUE, SUITE 3110
PITTSBURGH, PA 15222

Registered July 17, 2012

Int. Cl.: 41

FOR: EDUCATION SERVICES, NAMELY, PROVIDING WEB-BASED AND CLASSROOM TRAINING THAT TEACHES STUDENTS ABOUT ENHANCING MENTAL HEALTH WELLNESS THROUGH DEVELOPING AND STRENGTHENING RESILIENCE SKILLS, IN CLASS 41 (U.S. CLS. 100, 101 AND 107).

SERVICE MARK

PRINCIPAL REGISTER

FIRST USE 8-0-2011; IN COMMERCE 8-0-2011.

THE MARK CONSISTS OF STANDARD CHARACTERS WITHOUT CLAIM TO ANY PARTICULAR FONT, STYLE, SIZE, OR COLOR.

NO CLAIM IS MADE TO THE EXCLUSIVE RIGHT TO USE "STUDENT CURRICULUM ON RESILIENCE EDUCATION", APART FROM THE MARK AS SHOWN.

SER. NO. 85-475,221, FILED 11-17-2011.

DEBORAH LOBO, EXAMINING ATTORNEY



David J. Kybas

Director of the United States Patent and Trademark Office

United States of America

United States Patent and Trademark Office

WHITE ICE

Reg. No. 4,175,102

Registered July 17, 2012

Int. Cl.: 19

TRADEMARK

PRINCIPAL REGISTER

SURFACES SOUTHEAST, LLC (FLORIDA LIMITED LIABILITY COMPANY)
3009 NW 75TH AVENUE
MIAMI, FL 33172

FOR: GLASS TILES, IN CLASS 19 (U.S. CLS. 1, 12, 33 AND 50).

FIRST USE 9-1-2009; IN COMMERCE 9-1-2009.

THE MARK CONSISTS OF STANDARD CHARACTERS WITHOUT CLAIM TO ANY PARTICULAR FONT, STYLE, SIZE, OR COLOR.

SER. NO. 85-475,224, FILED 11-17-2011.

CHRISTOPHER LAW, EXAMINING ATTORNEY



David J. Kyffers

Director of the United States Patent and Trademark Office

United States of America

United States Patent and Trademark Office

DAMSEL IN DEFENSE

Reg. No. 4,175,103

DID, LLC (IDAHO LIMITED LIABILITY COMPANY)
1129 E PINE STE 104
MERIDIAN, ID 83642

Registered July 17, 2012

Int. Cl.: 13

FOR: PEPPER SPRAY; STUN GUNS, IN CLASS 13 (U.S. CLS. 2 AND 9).

TRADEMARK

FIRST USE 9-13-2011; IN COMMERCE 9-13-2011.

PRINCIPAL REGISTER

THE MARK CONSISTS OF STANDARD CHARACTERS WITHOUT CLAIM TO ANY PARTICULAR FONT, STYLE, SIZE, OR COLOR.

SER. NO. 85-475,248, FILED 11-17-2011.

COLLEEN DOMBROW, EXAMINING ATTORNEY



David J. Kybas

Director of the United States Patent and Trademark Office

United States of America

United States Patent and Trademark Office

The Perfect Place to Make a Difference

Reg. No. 4,175,104

GIVETOPIA, INC. (NEVADA CORPORATION)
3726 LAS VEGAS BLVD SOUTH UNIT 2310

Registered July 17, 2012

LAS VEGAS, NV 89158

Int. Cl.: 36

FOR: CHARITABLE FUNDRAISING SERVICES BY MEANS OF SELLING GOODS TO RAISE FUNDS, IN CLASS 36 (U.S. CLS. 100, 101 AND 102).

SERVICE MARK

FIRST USE 1-30-2011; IN COMMERCE 1-30-2011.

PRINCIPAL REGISTER

THE MARK CONSISTS OF STANDARD CHARACTERS WITHOUT CLAIM TO ANY PARTICULAR FONT, STYLE, SIZE, OR COLOR.

SER. NO. 85-475,261, FILED 11-17-2011.

SHANNON TWOHIG, EXAMINING ATTORNEY



David J. Kyffers

Director of the United States Patent and Trademark Office

United States of America
United States Patent and Trademark Office

LATOUR

Reg. No. 4,175,105

Registered July 17, 2012

Int. Cl.: 39

SERVICE MARK

PRINCIPAL REGISTER

ISRAM WHOLESALE TOURS AND TRAVEL LTD. (NEW YORK CORPORATION)
10TH FLOOR
233 PARK AVENUE SOUTH
NEW YORK, NY 10003

FOR: WHOLESALE TRAVEL TOUR SERVICES, IN CLASS 39 (U.S. CLS. 100 AND 105).

FIRST USE 5-0-1998; IN COMMERCE 5-0-1998.

THE MARK CONSISTS OF STANDARD CHARACTERS WITHOUT CLAIM TO ANY PARTICULAR FONT, STYLE, SIZE, OR COLOR.

OWNER OF U.S. REG. NO. 2,793,241.

THE NAME(S), PORTRAIT(S), AND/OR SIGNATURE(S) SHOWN IN THE MARK DOES NOT IDENTIFY A PARTICULAR LIVING INDIVIDUAL.

SEC. 2(F).

SER. NO. 85-475,275, FILED 11-17-2011.

JOHN HWANG, EXAMINING ATTORNEY



David J. Kybas

Director of the United States Patent and Trademark Office

United States of America

United States Patent and Trademark Office

Q HANDMADE

Reg. No. 4,175,106

Registered July 17, 2012

Int. Cl.: 14

TRADEMARK

PRINCIPAL REGISTER

Q HANDMADE (CALIFORNIA SOLE PROPRIETORSHIP)
951 SANDPIPER CIRCLE
WESTLAKE VILLAGE, CA 91361

FOR: BRACELETS; EARRINGS; JEWELRY; NECKLACES, IN CLASS 14 (U.S. CLS. 2, 27, 28 AND 50).

FIRST USE 9-1-2008; IN COMMERCE 9-1-2008.

THE MARK CONSISTS OF STANDARD CHARACTERS WITHOUT CLAIM TO ANY PARTICULAR FONT, STYLE, SIZE, OR COLOR.

NO CLAIM IS MADE TO THE EXCLUSIVE RIGHT TO USE "HANDMADE", APART FROM THE MARK AS SHOWN.

SER. NO. 85-475,283, FILED 11-17-2011.

JOHN WILKE, EXAMINING ATTORNEY



David J. Kyffers

Director of the United States Patent and Trademark Office

United States of America

United States Patent and Trademark Office

SPARSOL

Reg. No. 4,175,107

Registered July 17, 2012

Int. Cl.: 9

TRADEMARK

PRINCIPAL REGISTER

NEUROK SOFTWARE, LLC (DELAWARE LIMITED LIABILITY COMPANY)
SUITE 230
4555 MANSELL ROAD
ALPHARETTA, GA 30022

FOR: DOWNLOADABLE COMPUTER SOFTWARE FOR SOLVING COMPLEX SYSTEMS OF EQUATIONS, IN CLASS 9 (U.S. CLS. 21, 23, 26, 36 AND 38).

FIRST USE 1-1-2003; IN COMMERCE 1-1-2003.

THE MARK CONSISTS OF STANDARD CHARACTERS WITHOUT CLAIM TO ANY PARTICULAR FONT, STYLE, SIZE, OR COLOR.

SER. NO. 85-475,291, FILED 11-17-2011.

JACLYN KIDWELL WALKER, EXAMINING ATTORNEY



David J. Kybas

Director of the United States Patent and Trademark Office

United States of America
United States Patent and Trademark Office

COCONOT

Reg. No. 4,175,108

Registered July 17, 2012

Int. Cl.: 1

TRADEMARK

PRINCIPAL REGISTER

BIO-ORGANIC SOLUTIONS, INC. (CALIFORNIA CORPORATION)
4265 DULUTH AVENUE
ROCKLIN, CA 95765

FOR: GROWING MEDIA FOR PLANTS, IN CLASS 1 (U.S. CLS. 1, 5, 6, 10, 26 AND 46).

FIRST USE 11-3-2009; IN COMMERCE 11-3-2009.

THE MARK CONSISTS OF STANDARD CHARACTERS WITHOUT CLAIM TO ANY PARTICULAR FONT, STYLE, SIZE, OR COLOR.

SER. NO. 85-475,325, FILED 11-17-2011.

RONALD AIKENS, EXAMINING ATTORNEY



David J. Kyffers

Director of the United States Patent and Trademark Office

United States of America

United States Patent and Trademark Office



Reg. No. 4,175,109

Registered July 17, 2012

Int. Cl.: 41

SERVICE MARK

PRINCIPAL REGISTER

KEEP KIDS FIRE SAFE FOUNDATION, INC. (ARKANSAS CORPORATION)
SUITE 200
106 EAST POPLAR STREET
CLARKSVILLE, AR 72830

FOR: EDUCATION SERVICES, NAMELY, PROVIDING SEMINARS, CLASSES AND WORKSHOPS IN THE FIELD OF CHILDREN'S FIRE SAFETY AWARENESS, IN CLASS 41 (U.S. CLS. 100, 101 AND 107).

FIRST USE 11-15-2011; IN COMMERCE 11-15-2011.

OWNER OF U.S. REG. NO. 3,765,661.

NO CLAIM IS MADE TO THE EXCLUSIVE RIGHT TO USE "KEEP KIDS" AND "FIRE SAFE", APART FROM THE MARK AS SHOWN.

THE MARK CONSISTS OF DOG HEAD WITH A HELMET BEARING NUMBER "52", THE HEAD DISPOSED IN THE MIDDLE OF CONCENTRIC CIRCLES SURROUNDED BY A TWO-LINE SOMEWHAT OCTAGONAL BORDER, WITH WORDING "KEEP KIDS" ON TOP, "FIRE SAFE" ON THE BOTTOM, AND WITH DOG PAWS ON THE LEFT AND RIGHT.

SER. NO. 85-475,326, FILED 11-17-2011.

JACLYN KIDWELL WALKER, EXAMINING ATTORNEY



David J. Kyros

Director of the United States Patent and Trademark Office

United States of America

United States Patent and Trademark Office



Reg. No. 4,175,110

Registered July 17, 2012

Int. Cl.: 44

SERVICE MARK

PRINCIPAL REGISTER

NEW BEGINNINGS SPEECHMOBILE, LLC (MARYLAND LIMITED LIABILITY COMPANY)
6431 ROSALIE LANE
RIVERDALE, MD 20737

FOR: SPEECH THERAPY SERVICES, IN CLASS 44 (U.S. CLS. 100 AND 101).

FIRST USE 11-16-2011; IN COMMERCE 11-16-2011.

NO CLAIM IS MADE TO THE EXCLUSIVE RIGHT TO USE "LLC", APART FROM THE MARK AS SHOWN.

THE COLOR(S) GOLD, PURPLE, BROWN, WHITE AND RED IS/ARE CLAIMED AS A FEATURE OF THE MARK.

THE MARK CONSISTS OF THE STYLIZED PURPLE WORDS "NEW BEGINNINGS" ABOVE THE RED WORD "SPEECHMOBILE", WITH THE SMALLER WORD "LLC" IN GOLD BELOW THE "ILE" IN "SPEECHMOBILE". BELOW THE WORDS IS A STYLIZED IMAGE OF A GOLD RV WITH PURPLE WINDOWS. THE BODY OF THE RV CONTAINS PURPLE AND WHITE OUTLINED TRIM, PURPLE BANDS, AND WHITE HEADLIGHTS LINED IN PURPLE. THE TIRES ARE WHITE AND PURPLE. THERE IS A WOMAN HANGING OUT OF THE DRIVER SIDE'S WINDOW WITH A BROWN FACE AND BROWN HAND FADING TO PURPLE WAIVING, PURPLE HAIR, PURPLE BROWS, WHITE AND PURPLE HAIR AS WELL AS WEARING A PURPLE AND WHITE OUTFIT. THE ROAD BELOW THE RV IS OUTLINED IN PURPLE.

SER. NO. 85-475,328, FILED 11-17-2011.

JACLYN KIDWELL WALKER, EXAMINING ATTORNEY



David J. Kybas

Director of the United States Patent and Trademark Office

United States of America

United States Patent and Trademark Office

Zadoozy

Reg. No. 4,175,111

Registered July 17, 2012

Int. Cl.: 35

SERVICE MARK

PRINCIPAL REGISTER

ZADOOZY, LLC (DELAWARE LIMITED LIABILITY COMPANY)
1029
1000 BUTTERFIELD ROAD
VERNON HILLS, IL 60061

FOR: ON-LINE RETAIL STORE SERVICES FEATURING A WIDE VARIETY OF CONSUMER GOODS OF OTHERS, IN CLASS 35 (U.S. CLS. 100, 101 AND 102).

FIRST USE 12-15-2010; IN COMMERCE 11-1-2011.

THE MARK CONSISTS OF STANDARD CHARACTERS WITHOUT CLAIM TO ANY PARTICULAR FONT, STYLE, SIZE, OR COLOR.

SER. NO. 85-475,343, FILED 11-17-2011.

JANICE KIM, EXAMINING ATTORNEY



David J. Kyffers

Director of the United States Patent and Trademark Office

United States of America

United States Patent and Trademark Office

AMERICAN VALOR

Reg. No. 4,175,112

Registered July 17, 2012

**Int. Cls.: 6, 14, 16, 25
and 26**

TRADEMARK

PRINCIPAL REGISTER

EAGLE CREST, INC. (FLORIDA CORPORATION)
5737 RAMONA BOULEVARD
JACKSONVILLE, FL 32205

FOR: METAL ITEMS, NAMELY, DOG TAGS, IN CLASS 6 (U.S. CLS. 2, 12, 13, 14, 23, 25 AND 50).

FIRST USE 10-25-2011; IN COMMERCE 10-25-2011.

FOR: JEWELRY; NON-PRECIOUS METAL COINS, IN CLASS 14 (U.S. CLS. 2, 27, 28 AND 50).

FIRST USE 10-25-2011; IN COMMERCE 10-25-2011.

FOR: DECALS, IN CLASS 16 (U.S. CLS. 2, 5, 22, 23, 29, 37, 38 AND 50).

FIRST USE 10-25-2011; IN COMMERCE 10-25-2011.

FOR: CLOTHING, NAMELY, SHIRTS; JACKETS; AND HEADWEAR, IN CLASS 25 (U.S. CLS. 22 AND 39).

FIRST USE 10-25-2011; IN COMMERCE 10-25-2011.

FOR: EMBROIDERED PATCHES FOR CLOTHING, IN CLASS 26 (U.S. CLS. 37, 39, 40, 42 AND 50).

FIRST USE 10-25-2011; IN COMMERCE 10-25-2011.

THE MARK CONSISTS OF STANDARD CHARACTERS WITHOUT CLAIM TO ANY PARTICULAR FONT, STYLE, SIZE, OR COLOR.

NO CLAIM IS MADE TO THE EXCLUSIVE RIGHT TO USE "AMERICAN", APART FROM THE MARK AS SHOWN.

SER. NO. 85-475,353, FILED 11-17-2011.

PAM WILLIS, EXAMINING ATTORNEY



David J. Kyros

Director of the United States Patent and Trademark Office

United States of America

United States Patent and Trademark Office

VIDEO FREEZE

Reg. No. 4,175,113

Registered July 17, 2012

Int. Cl.: 9

TRADEMARK

PRINCIPAL REGISTER

MED ASSOCIATES, INC. (PENNSYLVANIA CORPORATION)
P.O. BOX 319
ST. ALBANS, VT 05478

FOR: COMPUTER SOFTWARE FOR ESTABLISHING AND MANAGING A RESEARCH PROGRAM AND MONITORING THE EFFECTS OF FEAR CONDITIONING IN RODENT SPECIES IN LABORATORY TESTING; COMPUTER SOFTWARE FOR ESTABLISHING AND MANAGING A RESEARCH PROGRAM AND MONITORING THE EFFECTS OF FEAR CONDITIONING IN RODENT SPECIES IN LABORATORY TESTING THAT MAY BE DOWNLOADED FROM A GLOBAL COMPUTER NETWORK, IN CLASS 9 (U.S. CLS. 21, 23, 26, 36 AND 38).

FIRST USE 1-1-2005; IN COMMERCE 1-1-2005.

THE MARK CONSISTS OF STANDARD CHARACTERS WITHOUT CLAIM TO ANY PARTICULAR FONT, STYLE, SIZE, OR COLOR.

NO CLAIM IS MADE TO THE EXCLUSIVE RIGHT TO USE "VIDEO", APART FROM THE MARK AS SHOWN.

SER. NO. 85-475,364, FILED 11-17-2011.

LAKEISHA LEWIS, EXAMINING ATTORNEY



David J. Kyffers

Director of the United States Patent and Trademark Office

United States of America

United States Patent and Trademark Office

WIRELIFE

Reg. No. 4,175,114

LUBRICATION ENGINEERS, INC. (TEXAS CORPORATION)
300 BAILEY AVE.

Registered July 17, 2012

FORT WORTH, TX 76107

Int. Cl.: 4

FOR: LUBRICATING OILS AND GREASES, IN CLASS 4 (U.S. CLS. 1, 6 AND 15).

TRADEMARK

FIRST USE 1-13-2010; IN COMMERCE 1-13-2010.

PRINCIPAL REGISTER

THE MARK CONSISTS OF STANDARD CHARACTERS WITHOUT CLAIM TO ANY PARTICULAR FONT, STYLE, SIZE, OR COLOR.

SER. NO. 85-475,371, FILED 11-17-2011.

COLLEEN DOMBROW, EXAMINING ATTORNEY



David J. Kybas

Director of the United States Patent and Trademark Office

United States of America

United States Patent and Trademark Office

PARTNERS + NAPIER

Reg. No. 4,175,115

Registered July 17, 2012

Int. Cls.: 35 and 42

SERVICE MARK

PRINCIPAL REGISTER

PARTNERS & NAPIER, INC. (DELAWARE CORPORATION)
THE PARTNERS BUILDING
192 MILL STREET - SUITE 600
ROCHESTER, NY 14614

FOR: ADVERTISING AGENCIES, NAMELY, PROMOTING THE GOODS AND SERVICES OF OTHERS; ADVERTISING SERVICES, NAMELY, PROMOTING AND MARKETING THE GOODS AND SERVICES OF OTHERS THROUGH ALL PUBLIC COMMUNICATION MEANS; PUBLIC RELATIONS; BUSINESS MARKETING CONSULTING SERVICES; BRANDING SERVICES, NAMELY, CONSULTING, DEVELOPMENT, MANAGEMENT AND MARKETING OF BRANDS FOR BUSINESSES; MARKET ANALYSIS AND RESEARCH SERVICES; CONDUCTING MARKETING STUDIES; DIRECT MARKETING ADVERTISING FOR OTHERS; CUSTOMER RELATIONSHIP MANAGEMENT; EVENT PLANNING AND MANAGEMENT FOR MARKETING, BRANDING, PROMOTING OR ADVERTISING THE GOODS AND SERVICES OF OTHERS; PUBLICITY AND SALES PROMOTION SERVICES; BUSINESS TO BUSINESS DIRECT MARKETING SERVICES; ADVERTISING AND MARKETING SERVICES PROVIDED BY MEANS OF INDIRECT METHODS OF MARKETING COMMUNICATIONS, NAMELY, SOCIAL MEDIA, SEARCH ENGINE MARKETING, INQUIRY MARKETING, INTERNET MARKETING, MOBILE MARKETING, BLOGGING AND OTHER FORMS OF PASSIVE, SHARABLE OR VIRAL COMMUNICATIONS CHANNELS, IN CLASS 35 (U.S. CLS. 100, 101 AND 102).

FIRST USE 2-4-2004; IN COMMERCE 2-4-2004.

FOR: DESIGN, DEVELOPMENT, AND CONSULTING SERVICES RELATED THERETO IN THE FIELD OF WEBSITES FOR OTHERS; PACKAGING DESIGN FOR OTHERS; GRAPHIC DESIGN SERVICES; COMPUTER GRAPHICS DESIGN SERVICES, NAMELY, CREATING ANIMATIONS FOR OTHERS, IN CLASS 42 (U.S. CLS. 100 AND 101).

FIRST USE 2-4-2004; IN COMMERCE 2-4-2004.

THE MARK CONSISTS OF STANDARD CHARACTERS WITHOUT CLAIM TO ANY PARTICULAR FONT, STYLE, SIZE, OR COLOR.

SER. NO. 85-475,375, FILED 11-17-2011.

JUDITH HELFMAN, EXAMINING ATTORNEY



David J. Kyffers

Director of the United States Patent and Trademark Office

United States of America

United States Patent and Trademark Office

NOW WHAT

Reg. No. 4,175,116

Registered July 17, 2012

Int. Cls.: 35 and 42

SERVICE MARK

PRINCIPAL REGISTER

PAUL BARNETT, INC. (NEW YORK CORPORATION), DBA NOW WHAT RESEARCH
69 MERCER ST., PH
NEW YORK, NY 10012

FOR: ADVERTISING AND MARKETING CONSULTANCY; ADVERTISING SERVICES, NAMELY, CREATING CORPORATE AND BRAND IDENTITY FOR OTHERS; BRAND CONCEPT AND BRAND DEVELOPMENT SERVICES FOR CORPORATE AND INDIVIDUAL CLIENTS; BRANDING SERVICES, NAMELY, CONSULTING, DEVELOPMENT, MANAGEMENT AND MARKETING OF BRANDS FOR BUSINESSES; BUSINESS MANAGEMENT CONSULTING WITH RELATION TO STRATEGY, MARKETING, SALES, OPERATION, PRODUCT DESIGN PARTICULARLY SPECIALIZING IN THE USE OF ANALYTIC AND STATISTIC MODELS FOR THE UNDERSTANDING AND PREDICTING OF CONSUMERS, BUSINESSES, AND MARKET TRENDS AND ACTIONS; BUSINESS RESEARCH USING FOCUS GROUPS; BUSINESS SERVICES, NAMELY, CONSUMER RESEARCH AND CONSULTING RELATED THERETO; BUSINESS STRATEGIC PLANNING SERVICES; CONCEPT AND BRAND DEVELOPMENT SERVICES FOR CORPORATE CLIENTS; CONDUCTING BUSINESS AND MARKET RESEARCH SURVEYS; CONSUMER MARKETING RESEARCH AND CONSULTING RELATED THERETO; MARKET ANALYSIS AND RESEARCH SERVICES; MARKET RESEARCH AND MARKET INTELLIGENCE SERVICES; MARKETING SERVICES, NAMELY, CONSUMER MARKETING RESEARCH, IN CLASS 35 (U.S. CLS. 100, 101 AND 102).

FIRST USE 12-31-2004; IN COMMERCE 12-31-2004.

FOR: INNOVATION CONSULTING SERVICES, NAMELY, ADVISING OTHERS IN THE AREAS OF PRODUCT DEVELOPMENT, IN CLASS 42 (U.S. CLS. 100 AND 101).

FIRST USE 12-31-2004; IN COMMERCE 12-31-2004.

THE MARK CONSISTS OF STANDARD CHARACTERS WITHOUT CLAIM TO ANY PARTICULAR FONT, STYLE, SIZE, OR COLOR.

SER. NO. 85-475,377, FILED 11-17-2011.

JACLYN KIDWELL WALKER, EXAMINING ATTORNEY



David J. Kyffers

Director of the United States Patent and Trademark Office

United States of America

United States Patent and Trademark Office

A SYMBOL IS WORTH A THOUSAND WORDS

Reg. No. 4,175,117

Registered July 17, 2012

Int. Cl.: 9

TRADEMARK

PRINCIPAL REGISTER

RANATECKK LLC (OHIO LIMITED LIABILITY COMPANY)
570 SOUTH SPRING STREET
WESTERVILLE, OH 43081

FOR: COMPUTER SOFTWARE FOR USE IN ADDING IMAGES TO PROJECT AND PROCESS MANAGEMENT COMPUTER PROGRAM APPLICATIONS; COMPUTER SOFTWARE FOR USE IN ADDING IMAGES TO PROJECT AND PROCESS MANAGEMENT COMPUTER PROGRAM APPLICATIONS THAT MAY BE DOWNLOADED FROM A GLOBAL COMPUTER NETWORK, IN CLASS 9 (U.S. CLS. 21, 23, 26, 36 AND 38).

FIRST USE 7-26-2011; IN COMMERCE 11-4-2011.

THE MARK CONSISTS OF STANDARD CHARACTERS WITHOUT CLAIM TO ANY PARTICULAR FONT, STYLE, SIZE, OR COLOR.

SER. NO. 85-475,381, FILED 11-17-2011.

MICHAEL WEBSTER, EXAMINING ATTORNEY



David J. Kyffers

Director of the United States Patent and Trademark Office

United States of America

United States Patent and Trademark Office

Strong for Life

Reg. No. 4,175,118

Registered July 17, 2012

Int. Cl.: 18

TRADEMARK

PRINCIPAL REGISTER

DAVID KAHNG (UNITED STATES INDIVIDUAL)
310 WEST 106TH STREET
NEW YORK, NY 10025

FOR: UMBRELLAS, IN CLASS 18 (U.S. CLS. 1, 2, 3, 22 AND 41).

FIRST USE 9-1-2005; IN COMMERCE 1-2-2006.

THE MARK CONSISTS OF STANDARD CHARACTERS WITHOUT CLAIM TO ANY PARTICULAR FONT, STYLE, SIZE, OR COLOR.

SER. NO. 85-475,389, FILED 11-17-2011.

KEVON CHISOLM, EXAMINING ATTORNEY



David J. Kyffers

Director of the United States Patent and Trademark Office

United States of America

United States Patent and Trademark Office

Eat Well Global

Reg. No. 4,175,119

EAT WELL GLOBAL INC. (DELAWARE CORPORATION)
405 SECOND STREET
BROOKLYN, NY 11215

Registered July 17, 2012

Int. Cl.: 44

FOR: FOOD NUTRITION CONSULTATION; NUTRITION COUNSELING, IN CLASS 44 (U.S. CLS. 100 AND 101).

SERVICE MARK

FIRST USE 3-20-2011; IN COMMERCE 3-20-2011.

PRINCIPAL REGISTER

THE MARK CONSISTS OF STANDARD CHARACTERS WITHOUT CLAIM TO ANY PARTICULAR FONT, STYLE, SIZE, OR COLOR.

NO CLAIM IS MADE TO THE EXCLUSIVE RIGHT TO USE "GLOBAL", APART FROM THE MARK AS SHOWN.

SER. NO. 85-475,393, FILED 11-17-2011.

ANDREA BUTLER, EXAMINING ATTORNEY



David J. Kyffers

Director of the United States Patent and Trademark Office

United States of America

United States Patent and Trademark Office

GUANTANAMERA

Reg. No. 4,175,120

ZARATE, RAMON MARIO (UNITED STATES INDIVIDUAL)
321 EAST 69TH STREET
NEW YORK, NY 10021

Registered July 17, 2012

Int. Cl.: 43

FOR: RESTAURANT SERVICES, IN CLASS 43 (U.S. CLS. 100 AND 101).

SERVICE MARK

FIRST USE 11-30-2006; IN COMMERCE 11-30-2006.

PRINCIPAL REGISTER

THE MARK CONSISTS OF STANDARD CHARACTERS WITHOUT CLAIM TO ANY PARTICULAR FONT, STYLE, SIZE, OR COLOR.

THE ENGLISH TRANSLATION OF "GUANTANAMERA" IS GIRL/LADY FROM GUANTANAMO.

SER. NO. 85-475,403, FILED 11-17-2011.

LAKEISHA LEWIS, EXAMINING ATTORNEY



David J. Kyffers

Director of the United States Patent and Trademark Office

United States of America

United States Patent and Trademark Office

SCENIUM

Reg. No. 4,175,121

Registered July 17, 2012

Int. Cl.: 16

TRADEMARK

PRINCIPAL REGISTER

MONTBLANC-SIMPLO GMBH (FED REP GERMANY GESELLSCHAFT MIT
BESCHRÄNKTER HAFTUNG (GMBH))
HELLGRUNDWEG 100
22525 HAMBURG, FED REP GERMANY

FOR: WRITING INSTRUMENTS; FOUNTAIN PENS; BALL-POINT PENS; PENCILS; FELT-TIP PENS; ROLLER BALL PENS; DOCUMENT MARKERS; POUCHES FOR WRITING INSTRUMENTS, GIFT CASES FOR WRITING INSTRUMENTS; PEN INK REFILLS; NOTE PAPER; WRITING PAPER; DIARIES; ORGANIZERS FOR STATIONERY USE; PAPERWEIGHTS; PEN AND PENCIL HOLDERS, IN CLASS 16 (U.S. CLS. 2, 5, 22, 23, 29, 37, 38 AND 50).

THE MARK CONSISTS OF STANDARD CHARACTERS WITHOUT CLAIM TO ANY PARTICULAR FONT, STYLE, SIZE, OR COLOR.

OWNER OF FED REP GERMANY REG. NO. 30343479, DATED 11-28-2003, EXPIRES 8-31-2013.

THE WORDING "SCENIUM" HAS NO MEANING IN A FOREIGN LANGUAGE.

SER. NO. 85-475,410, FILED 11-17-2011.

EVELYN BRADLEY, EXAMINING ATTORNEY



David J. Kybas

Director of the United States Patent and Trademark Office

United States of America

United States Patent and Trademark Office



Reg. No. 4,175,122

Registered July 17, 2012

Int. Cls.: 35 and 42

SERVICE MARK

PRINCIPAL REGISTER

PARTNERS & NAPIER, INC. (DELAWARE CORPORATION)
THE PARTNERS BUILDING
192 MILL STREET - SUITE 600
ROCHESTER, NY 14614

FOR: ADVERTISING AGENCIES, NAMELY, PROMOTING THE GOODS AND SERVICES OF OTHERS; ADVERTISING SERVICES, NAMELY, PROMOTING AND MARKETING THE GOODS AND SERVICES OF OTHERS THROUGH ALL PUBLIC COMMUNICATION MEANS; PUBLIC RELATIONS; BUSINESS MARKETING CONSULTING SERVICES; BRANDING SERVICES, NAMELY, CONSULTING, DEVELOPMENT, MANAGEMENT AND MARKETING OF BRANDS FOR BUSINESSES; MARKET ANALYSIS AND RESEARCH SERVICES; CONDUCTING MARKETING STUDIES; DIRECT MARKETING ADVERTISING FOR OTHERS; CUSTOMER RELATIONSHIP MANAGEMENT; EVENT PLANNING AND MANAGEMENT FOR MARKETING, BRANDING, PROMOTING OR ADVERTISING THE GOODS AND SERVICES OF OTHERS; PUBLICITY AND SALES PROMOTION SERVICES; BUSINESS TO BUSINESS DIRECT MARKETING SERVICES; ADVERTISING AND MARKETING SERVICES PROVIDED BY MEANS OF INDIRECT METHODS OF MARKETING COMMUNICATIONS, NAMELY, SOCIAL MEDIA, SEARCH ENGINE MARKETING, INQUIRY MARKETING, INTERNET MARKETING, MOBILE MARKETING, BLOGGING AND OTHER FORMS OF PASSIVE, SHARABLE OR VIRAL COMMUNICATIONS CHANNELS, IN CLASS 35 (U.S. CLS. 100, 101 AND 102).

FIRST USE 2-4-2004; IN COMMERCE 2-4-2004.

FOR: DESIGN, DEVELOPMENT, AND CONSULTING SERVICES RELATED THERETO IN THE FIELD OF WEBSITES FOR OTHERS; PACKAGING DESIGN FOR OTHERS; GRAPHIC DESIGN SERVICES; COMPUTER GRAPHICS DESIGN SERVICES, NAMELY, CREATING ANIMATIONS FOR OTHERS, IN CLASS 42 (U.S. CLS. 100 AND 101).

FIRST USE 2-4-2004; IN COMMERCE 2-4-2004.

SER. NO. 85-475,415, FILED 11-17-2011.

JUDITH HELFMAN, EXAMINING ATTORNEY



David J. Kyjars

Director of the United States Patent and Trademark Office

United States of America

United States Patent and Trademark Office

SHORE STOP

Reg. No. 4,175,123

GPM INVESTMENTS LLC (DELAWARE LIMITED LIABILITY COMPANY)
8565 MAGELLAN PARKWAY, SUITE 400
RICHMOND, VA 23227

Registered July 17, 2012

Int. Cl.: 35

FOR: RETAIL STORE SERVICES FEATURING CONVENIENCE STORE ITEMS AND GASOLINE, IN CLASS 35 (U.S. CLS. 100, 101 AND 102).

SERVICE MARK

FIRST USE 3-9-1981; IN COMMERCE 3-9-1981.

PRINCIPAL REGISTER

THE MARK CONSISTS OF STANDARD CHARACTERS WITHOUT CLAIM TO ANY PARTICULAR FONT, STYLE, SIZE, OR COLOR.

OWNER OF U.S. REG. NO. 1,205,721.

SER. NO. 85-475,432, FILED 11-17-2011.

KEVON CHISOLM, EXAMINING ATTORNEY



David J. Kyffers

Director of the United States Patent and Trademark Office

United States of America

United States Patent and Trademark Office

Sanglier

Reg. No. 4,175,124

Registered July 17, 2012

Int. Cl.: 33

TRADEMARK

PRINCIPAL REGISTER

SANGLIER CELLARS (CALIFORNIA LIMITED LIABILITY COMPANY)
1720 RIVER ROAD
FULTON, CA 95439

FOR: WINE, IN CLASS 33 (U.S. CLS. 47 AND 49).

FIRST USE 5-1-2007; IN COMMERCE 5-1-2007.

THE MARK CONSISTS OF STANDARD CHARACTERS WITHOUT CLAIM TO ANY PARTICULAR FONT, STYLE, SIZE, OR COLOR.

SER. NO. 85-475,440, FILED 11-17-2011.

KEVON CHISOLM, EXAMINING ATTORNEY



David J. Kybas

Director of the United States Patent and Trademark Office

United States of America

United States Patent and Trademark Office

SHELLMONT INN

Reg. No. 4,175,125

SHELLMONT BED & BREAKFAST LODGE, INC.KG (GEORGIA CORPORATION)
821 PIEDMONT AVENUE, NE
ATLANTA, GA 30308

Registered July 17, 2012

Int. Cl.: 43

FOR: BED AND BREAKFAST INN SERVICES, IN CLASS 43 (U.S. CLS. 100 AND 101).

SERVICE MARK

FIRST USE 9-16-1983; IN COMMERCE 6-21-1984.

PRINCIPAL REGISTER

THE MARK CONSISTS OF STANDARD CHARACTERS WITHOUT CLAIM TO ANY PARTICULAR FONT, STYLE, SIZE, OR COLOR.

NO CLAIM IS MADE TO THE EXCLUSIVE RIGHT TO USE "INN", APART FROM THE MARK AS SHOWN.

SER. NO. 85-475,451, FILED 11-17-2011.

SUSAN STIGLITZ, EXAMINING ATTORNEY



David J. Kyffers

Director of the United States Patent and Trademark Office

United States of America

United States Patent and Trademark Office

MAKE FRIENDS, NOT ADS

Reg. No. 4,175,126

Registered July 17, 2012

Int. Cl.: 35

SERVICE MARK

PRINCIPAL REGISTER

THE CRAMER-KRASSELT CO. (DELAWARE CORPORATION)
225 NORTH MICHIGAN AVENUE
CHICAGO, IL 60601

FOR: ADVERTISING AGENCY SERVICES; MARKETING CONSULTING SERVICES; PUBLIC RELATIONS; MARKET RESEARCH AND ANALYSIS; BUSINESS MARKETING CONSULTING SERVICES IN THE FIELD OF ADVERTISING, MARKETING COMMUNICATIONS, MEDIA PLANNING, AND BRAND DEVELOPMENT, BRAND IDENTITY AND BRAND MARKETING; INTERACTIVE AND DIGITAL ADVERTISING AND MARKETING; MEDIA PLANNING, NAMELY, ADVISING THE CLIENT ON THE CORRECT TIMES AND STATIONS TO ADVERTISE BASED ON MEDIA ANALYSIS OF THE MARKET FOR THAT MEDIA AND MEDIA BUYING ADVICE, NAMELY, ADVISING THE CLIENT HOW MUCH MEDIA TIME, AND AT WHAT TIMES THE CLIENT SHOULD BE PURCHASING ADVERTISING; DIRECT MARKETING ADVERTISING SERVICES FOR OTHERS; CUSTOMER RELATIONSHIP MANAGEMENT SERVICES; ARRANGING AND CONDUCTING MARKETING PROMOTIONAL EVENTS FOR OTHERS; SALES PROMOTION SERVICES, IN CLASS 35 (U.S. CLS. 100, 101 AND 102).

FIRST USE 9-27-2010; IN COMMERCE 9-27-2010.

THE MARK CONSISTS OF STANDARD CHARACTERS WITHOUT CLAIM TO ANY PARTICULAR FONT, STYLE, SIZE, OR COLOR.

SER. NO. 85-475,455, FILED 11-17-2011.

SUSAN STIGLITZ, EXAMINING ATTORNEY



David J. Kybas

Director of the United States Patent and Trademark Office

United States of America

United States Patent and Trademark Office



Reg. No. 4,175,127

Registered July 17, 2012

Int. Cl.: 41

SERVICE MARK

PRINCIPAL REGISTER

PHOTO UNO LLC (NEW YORK LIMITED LIABILITY COMPANY)
SUITE 303 S
222 E 46 ST
NEW YORK, NY 10017

FOR: EDUCATIONAL SERVICES IN THE NATURE OF PHOTOGRAPHY SCHOOLS, IN CLASS 41 (U.S. CLS. 100, 101 AND 107).

FIRST USE 8-1-2011; IN COMMERCE 8-1-2011.

NO CLAIM IS MADE TO THE EXCLUSIVE RIGHT TO USE PHOTOGRAPHY SCHOOL, APART FROM THE MARK AS SHOWN.

THE MARK CONSISTS OF A CARTOON DESIGNED FACE WITH A CAMERA ON HIS LEFT EYE, FOLLOWED BY THE WORD "PHOTOUNO", AND THE WORDS "PHOTOGRAPHY SCHOOL" BELOW "PHOTOUNO".

SER. NO. 85-475,456, FILED 11-17-2011.

MIDGE BUTLER, EXAMINING ATTORNEY



David J. Kybas

Director of the United States Patent and Trademark Office

United States of America

United States Patent and Trademark Office

New Jupiter Media

Reg. No. 4,175,128

NEW JUPITER MEDIA, INC. (NEW JERSEY CORPORATION)
52 BROAD ST.
KEYPORT, NJ 07735

Registered July 17, 2012

Int. Cl.: 35

FOR: ON-LINE ADVERTISING AND MARKETING SERVICES, IN CLASS 35 (U.S. CLS. 100, 101 AND 102).

SERVICE MARK

FIRST USE 10-1-2007; IN COMMERCE 10-1-2007.

PRINCIPAL REGISTER

THE MARK CONSISTS OF STANDARD CHARACTERS WITHOUT CLAIM TO ANY PARTICULAR FONT, STYLE, SIZE, OR COLOR.

NO CLAIM IS MADE TO THE EXCLUSIVE RIGHT TO USE "MEDIA", APART FROM THE MARK AS SHOWN.

SER. NO. 85-475,486, FILED 11-17-2011.

HANNO RITTNER, EXAMINING ATTORNEY



David J. Kybas

Director of the United States Patent and Trademark Office

United States of America

United States Patent and Trademark Office

The Dynamic Alternative to the Static Lease

Reg. No. 4,175,129

Registered July 17, 2012

Int. Cl.: 36

SERVICE MARK

PRINCIPAL REGISTER

JAMES B. COPELAN (UNITED STATES INDIVIDUAL)
POST OFFICE BOX 50783
PASADENA, CA 91115

FOR: FINANCIAL SERVICES, NAMELY, PROVIDING FINANCING IN THE NATURE OF COMPREHENSIVE CONSUMER, COMMERCIAL AND MANUFACTURER FINANCING OF AUTOMOBILE, VEHICLE AND EQUIPMENT SALES AND LEASES, PROVIDING CREDIT CARD, INSURANCE AND WARRANTY FINANCING, PROVIDING FINANCIAL INFORMATION BY ELECTRONIC AND GLOBAL COMPUTER NETWORK MEANS, IN CLASS 36 (U.S. CLS. 100, 101 AND 102).

FIRST USE 8-7-2010; IN COMMERCE 8-7-2010.

THE MARK CONSISTS OF STANDARD CHARACTERS WITHOUT CLAIM TO ANY PARTICULAR FONT, STYLE, SIZE, OR COLOR.

SER. NO. 85-475,490, FILED 11-17-2011.

HANNO RITTNER, EXAMINING ATTORNEY



David J. Kyffers

Director of the United States Patent and Trademark Office

United States of America

United States Patent and Trademark Office



Reg. No. 4,175,130

Registered July 17, 2012

Int. Cl.: 42

SERVICE MARK

PRINCIPAL REGISTER

CONTROL DATA, INC (OHIO CORPORATION)
400-203
11715 FOX ROAD
INDIANAPOLIS, IN 46236

FOR: CLOUD COMPUTING FEATURING SOFTWARE FOR USE IN CONDUCTING AUCTIONS, SUPPLIER MANAGEMENT, CONTRACT MANAGEMENT, CREATING PURCHASE ORDERS AND INVOICING, AND SPENDING MANAGEMENT , IN CLASS 42 (U.S. CLS. 100 AND 101).

FIRST USE 7-1-2009; IN COMMERCE 9-10-2011.

NO CLAIM IS MADE TO THE EXCLUSIVE RIGHT TO USE "ESOURCING ONDEMAND", APART FROM THE MARK AS SHOWN.

THE MARK CONSISTS OF AN EARTH SYMBOL AND RIBBONS TO THE LEFT OF THE STYLIZED TEXT "PROCUREPORT ESOURCING ONDEMAND".

SER. NO. 85-475,491, FILED 11-17-2011.

HANNO RITTNER, EXAMINING ATTORNEY



David J. Kyffers

Director of the United States Patent and Trademark Office

United States of America

United States Patent and Trademark Office

SMARTSTACK

Reg. No. 4,175,131

MAXTEC, INC. (UTAH CORPORATION)
6526 SOUTH COTTONWOOD STREET
SALT LAKE CITY, UT 84107

Registered July 17, 2012

Int. Cl.: 10

FOR: IV STANDS COMPRISING MOVABLE BASES WITH SUPPORT POLES FOR HOLDING MEDICAL FLUID CONTAINERS, NAMELY, IV BAGS, IN CLASS 10 (U.S. CLS. 26, 39 AND 44).

TRADEMARK

FIRST USE 1-19-2009; IN COMMERCE 1-19-2009.

PRINCIPAL REGISTER

THE MARK CONSISTS OF STANDARD CHARACTERS WITHOUT CLAIM TO ANY PARTICULAR FONT, STYLE, SIZE, OR COLOR.

SER. NO. 85-475,494, FILED 11-17-2011.

KEVIN DINALLO, EXAMINING ATTORNEY



David J. Kyffers

Director of the United States Patent and Trademark Office

United States of America

United States Patent and Trademark Office



Reg. No. 4,175,132

Registered July 17, 2012

Int. Cl.: 9

TRADEMARK

PRINCIPAL REGISTER

HUMONGOUS, INC. (DELAWARE CORPORATION)
417 FIFTH AVENUE
NEW YORK, NY 10016

FOR: DOWNLOADABLE ELECTRONIC GAMES VIA THE INTERNET; ELECTRONIC, VIDEO AND MULTIMEDIA GAME SOFTWARE FOR USE ON PERSONAL COMPUTERS AND ELECTRONIC GAME PLAYING MACHINES; DOWNLOADABLE RECORDED COMPUTER GAME SOFTWARE PROGRAMS; GAME SOFTWARE FOR COMPUTERS, DOWNLOADABLE VIDEO GAME SOFTWARE, IN CLASS 9 (U.S. CLS. 21, 23, 26, 36 AND 38).

FIRST USE 9-26-2006; IN COMMERCE 9-26-2006.

OWNER OF U.S. REG. NOS. 2,071,712 AND 2,071,719.

THE MARK CONSISTS OF A SOLID CIRCLE WITH THE WORD "HUMONGOUS" AND THE LETTER "H" ON THE CIRCLE.

SER. NO. 85-475,498, FILED 11-17-2011.

MARK T. MULLEN, EXAMINING ATTORNEY



David J. Kyffers

Director of the United States Patent and Trademark Office

United States of America

United States Patent and Trademark Office

ONRAD

Reg. No. 4,175,133

Registered July 17, 2012

Int. Cl.: 44

SERVICE MARK

PRINCIPAL REGISTER

ONRAD, INC (DELAWARE CORPORATION)
SUITE 280
1770 IOWA AVENUE
RIVERSIDE, CA 92507

FOR: MEDICAL RADIOLOGY SERVICES, IN CLASS 44 (U.S. CLS. 100 AND 101).

FIRST USE 12-31-2010; IN COMMERCE 12-31-2010.

THE MARK CONSISTS OF STANDARD CHARACTERS WITHOUT CLAIM TO ANY PARTICULAR FONT, STYLE, SIZE, OR COLOR.

OWNER OF U.S. REG. NO. 3,416,577.

SER. NO. 85-475,509, FILED 11-17-2011.

LESLIE RICHARDS, EXAMINING ATTORNEY



David J. Kyffers

Director of the United States Patent and Trademark Office

United States of America

United States Patent and Trademark Office

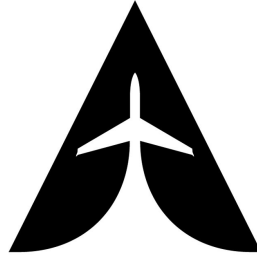

AIRCARE
SOLUTIONS GROUP

Reg. No. 4,175,134

Registered July 17, 2012

**Int. Cls.: 35, 37, 41, 44
and 45**

SERVICE MARK

PRINCIPAL REGISTER

ROBERTS, JEFFREY D. (UNITED STATES INDIVIDUAL), DBA THE STUB FARLOW
COMPANY
324 WEST BAY DRIVE SUITE 200
OLYMPIA, WA 98502

FOR: EMPLOYMENT STAFFING IN THE FIELD OF AVIATION, IN CLASS 35 (U.S. CLS. 100, 101 AND 102).

FIRST USE 10-1-2011; IN COMMERCE 10-7-2011.

FOR: AIRCRAFT EQUIPMENT REPAIR SERVICES, NAMELY, THE REPAIR AND REFUR-
BISHING OF EMERGENCY MEDICAL KITS, DEFIBRILLATORS AND SURVIVAL KITS,
IN CLASS 37 (U.S. CLS. 100, 103 AND 106).

FIRST USE 10-1-2011; IN COMMERCE 10-7-2011.

FOR: EDUCATIONAL SERVICES, NAMELY, CONDUCTING CREW MEMBER EMERGENCY
TRAINING IN THE FIELDS OF AVIATION AND DISTRIBUTION OF TRAINING MATERIALS
IN CONNECTION THEREWITH, IN CLASS 41 (U.S. CLS. 100, 101 AND 107).

FIRST USE 10-1-2011; IN COMMERCE 10-7-2011.

FOR: EMERGENCY MEDICAL ASSISTANCE, IN CLASS 44 (U.S. CLS. 100 AND 101).

FIRST USE 10-1-2011; IN COMMERCE 10-7-2011.

FOR: SECURITY SERVICES FOR INDIVIDUALS AND BUSINESS PERSONS TRAVELING
INTERNATIONALLY AND DOMESTICALLY, NAMELY, PROVIDING FOREIGN COUNTRY
SECURITY BRIEFINGS, EMBASSY INFORMATION FOR SECURITY PURPOSES AND SE-
CURITY REPORTS, IN CLASS 45 (U.S. CLS. 100 AND 101).

FIRST USE 10-1-2011; IN COMMERCE 10-7-2011.

OWNER OF U.S. REG. NOS. 4,021,632 AND 4,021,635.

NO CLAIM IS MADE TO THE EXCLUSIVE RIGHT TO USE "AIRCARE SOLUTIONS GROUP",
APART FROM THE MARK AS SHOWN.



David J. Kybas

Director of the United States Patent and Trademark Office

Reg. No. 4,175,134 THE MARK CONSISTS OF A TRIANGLE CONTAINING AN AIRCRAFT WITH A CONTRAIL, WHICH FORMS THE LETTER "A". THE WORDS "AIRCARE SOLUTIONS GROUP" ARE AT THE BOTTOM OF THE MARK.

SER. NO. 85-475,511, FILED 11-17-2011.

DAVID I, EXAMINING ATTORNEY

United States of America

United States Patent and Trademark Office

Threaded to Perfection

Reg. No. 4,175,135

Registered July 17, 2012

Int. Cl.: 25

TRADEMARK

PRINCIPAL REGISTER

JEFF POLLACK (UNITED STATES INDIVIDUAL)
#913
7061 N. KEDZIE
CHICAGO, IL 60645

FOR: DENIM JACKETS; DENIMS; HOODED SWEAT SHIRTS; SHIRTS; SWEAT PANTS; T-SHIRTS, IN CLASS 25 (U.S. CLS. 22 AND 39).

FIRST USE 11-15-2011; IN COMMERCE 11-15-2011.

THE MARK CONSISTS OF STANDARD CHARACTERS WITHOUT CLAIM TO ANY PARTICULAR FONT, STYLE, SIZE, OR COLOR.

SER. NO. 85-475,512, FILED 11-17-2011.

LESLIE RICHARDS, EXAMINING ATTORNEY



David J. Kyffers

Director of the United States Patent and Trademark Office

United States of America

United States Patent and Trademark Office

WORKSMART

Reg. No. 4,175,136

Registered July 17, 2012

Int. Cl.: 41

SERVICE MARK

PRINCIPAL REGISTER

SOUTHWESTERN ENERGY COMPANY (DELAWARE CORPORATION)
SUITE 125
2350 NORTH SAM HOUSTON PARKWAY EAST
HOUSTON, TX 77032

FOR: EDUCATIONAL SERVICES, NAMELY, PROVIDING TRAINING PROGRAMS FOR INCREASING PERFORMANCE AND ENSURING CONSISTENCY OF OPERATIONS FROM VENDORS IN THE NATURAL GAS AND CRUDE OIL EXPLORATION, DEVELOPMENT AND PRODUCTION INDUSTRY, IN CLASS 41 (U.S. CLS. 100, 101 AND 107).

FIRST USE 2-5-2010; IN COMMERCE 2-5-2010.

THE MARK CONSISTS OF STANDARD CHARACTERS WITHOUT CLAIM TO ANY PARTICULAR FONT, STYLE, SIZE, OR COLOR.

SER. NO. 85-475,540, FILED 11-17-2011.

WENDY GOODMAN, EXAMINING ATTORNEY



David J. Kyffers

Director of the United States Patent and Trademark Office

United States of America

United States Patent and Trademark Office



Reg. No. 4,175,137

Registered July 17, 2012

Int. Cl.: 44

SERVICE MARK

PRINCIPAL REGISTER

CHILDREN'S HOSPITAL COLORADO (COLORADO NON-PROFIT CORPORATION)
13123 EAST 16TH AVENUE
AURORA, CO 80045

FOR: HEALTH CARE, IN CLASS 44 (U.S. CLS. 100 AND 101).

FIRST USE 6-11-2011; IN COMMERCE 6-11-2011.

NO CLAIM IS MADE TO THE EXCLUSIVE RIGHT TO USE "COLORADO INSTITUTE FOR MATERNAL & FETAL HEALTH", APART FROM THE MARK AS SHOWN.

THE COLOR(S) LIGHT BLUE, GREY AND YELLOW IS/ARE CLAIMED AS A FEATURE OF THE MARK.

THE MARK CONSISTS OF THE WORDS "COLORADO INSTITUTE FOR MATERNAL & FETAL HEALTH" IN GREY WITH A YELLOW AMPERSAND AGAINST A LIGHT BLUE CIRCLE BACKGROUND.

SER. NO. 85-475,545, FILED 11-17-2011.

ELLEN B. AWRICH, EXAMINING ATTORNEY



David J. Kyffers

Director of the United States Patent and Trademark Office

United States of America

United States Patent and Trademark Office

PAINTED BY PATRICK

Reg. No. 4,175,138

Registered July 17, 2012

Int. Cl.: 44

SERVICE MARK

PRINCIPAL REGISTER

SPILLANE, DAVID (UNITED STATES INDIVIDUAL)
1524 W. ELMDALE AVENUE, #3
CHICAGO, IL 60660 AND

RYAN, PATRICK (UNITED STATES INDIVIDUAL)
1524 W. ELMDALE AVENUE, #3
CHICAGO, IL 60660

FOR: HAIR SALON SERVICES, IN CLASS 44 (U.S. CLS. 100 AND 101).

FIRST USE 3-19-2009; IN COMMERCE 3-19-2009.

THE MARK CONSISTS OF STANDARD CHARACTERS WITHOUT CLAIM TO ANY PARTICULAR FONT, STYLE, SIZE, OR COLOR.

SER. NO. 85-475,547, FILED 11-17-2011.

PAUL MORENO, EXAMINING ATTORNEY



David J. Kyffers

Director of the United States Patent and Trademark Office

United States of America

United States Patent and Trademark Office



Reg. No. 4,175,139

Registered July 17, 2012

Int. Cl.: 36

SERVICE MARK

PRINCIPAL REGISTER

CHARTER CAPITAL MANAGEMENT, LLC (FLORIDA LIMITED LIABILITY COMPANY)
SUITE 270
495 GRAND BLVD.
DESTIN, FL 32550

FOR: FINANCIAL INVESTMENT SERVICES, NAMELY, PROVIDING INVESTMENT ADVICE,
INVESTMENT MANAGEMENT, INVESTMENT CONSULTATION, AND INVESTMENT OF
FUNDS FOR OTHERS, IN CLASS 36 (U.S. CLS. 100, 101 AND 102).

FIRST USE 10-31-2011; IN COMMERCE 10-31-2011.

THE MARK CONSISTS OF A SEXTANT SURROUNDED BY THREE CIRCLES.

SER. NO. 85-475,553, FILED 11-17-2011.

JANET LEE, EXAMINING ATTORNEY



David J. Kyffers

Director of the United States Patent and Trademark Office

United States of America

United States Patent and Trademark Office

JOHN BALES

Reg. No. 4,175,140

Registered July 17, 2012

Int. Cl.: 45

SERVICE MARK

PRINCIPAL REGISTER

A BALES PROFESSIONAL ASSOCIATION (FLORIDA CORPORATION)
SUITE 400
9700 MARTIN LUTHER KING JR. ST. N.
ST. PETERSBURG, FL 33702

FOR: LEGAL SERVICES, IN CLASS 45 (U.S. CLS. 100 AND 101).

FIRST USE 10-26-1982; IN COMMERCE 10-26-1982.

THE MARK CONSISTS OF STANDARD CHARACTERS WITHOUT CLAIM TO ANY PARTICULAR FONT, STYLE, SIZE, OR COLOR.

THE NAME(S), PORTRAIT(S), AND/OR SIGNATURE(S) SHOWN IN THE MARK IDENTIFIES "JOHN BALES", WHOSE CONSENT(S) TO REGISTER IS MADE OF RECORD.

SER. NO. 85-475,558, FILED 11-17-2011.

BARNEY CHARLON, EXAMINING ATTORNEY



David J. Kyjars

Director of the United States Patent and Trademark Office

United States of America

United States Patent and Trademark Office

WELL DONE DO

Reg. No. 4,175,141

Registered July 17, 2012

Int. Cl.: 44

SERVICE MARK

PRINCIPAL REGISTER

SPILLANE, DAVID (UNITED STATES INDIVIDUAL)
1524 W. ELMDALE AVENUE, #3
CHICAGO, IL 60660 AND

RYAN, PATRICK (UNITED STATES INDIVIDUAL)
1524 W. ELMDALE AVENUE, #3
CHICAGO, IL 60660

FOR: HAIR SALON SERVICES, IN CLASS 44 (U.S. CLS. 100 AND 101).

FIRST USE 5-29-2009; IN COMMERCE 5-29-2009.

THE MARK CONSISTS OF STANDARD CHARACTERS WITHOUT CLAIM TO ANY PARTICULAR FONT, STYLE, SIZE, OR COLOR.

SER. NO. 85-475,561, FILED 11-17-2011.

PAUL MORENO, EXAMINING ATTORNEY



David J. Kyffers

Director of the United States Patent and Trademark Office

United States of America

United States Patent and Trademark Office

FURROW CRUISER

Reg. No. 4,175,142

Registered July 17, 2012

Int. Cl.: 7

TRADEMARK

PRINCIPAL REGISTER

COPPERHEAD AGRICULTURAL PRODUCTS, LLC (SOUTH DAKOTA LIMITED LIABILITY COMPANY)
26119 S. ROBIN DR.
SIOUX FALLS, SD 57107

FOR: AGRICULTURAL PLANTER ATTACHMENTS, NAMELY, SPIKED CLOSING WHEELS FOR CORN PLANTERS, IN CLASS 7 (U.S. CLS. 13, 19, 21, 23, 31, 34 AND 35).

FIRST USE 6-1-2009; IN COMMERCE 9-1-2009.

THE MARK CONSISTS OF STANDARD CHARACTERS WITHOUT CLAIM TO ANY PARTICULAR FONT, STYLE, SIZE, OR COLOR.

NO CLAIM IS MADE TO THE EXCLUSIVE RIGHT TO USE "FURROW", APART FROM THE MARK AS SHOWN.

SER. NO. 85-475,568, FILED 11-17-2011.

MARK T. MULLEN, EXAMINING ATTORNEY



David J. Kyffers

Director of the United States Patent and Trademark Office

United States of America

United States Patent and Trademark Office

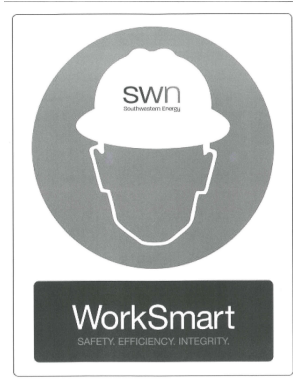

Reg. No. 4,175,143

Registered July 17, 2012

Int. Cl.: 41

SERVICE MARK

PRINCIPAL REGISTER

SOUTHWESTERN ENERGY COMPANY (DELAWARE CORPORATION)
2350 NORTH SAM HOUSTON PARKWAY EAST
SUITE 125
HOUSTON, TX 77032

FOR: EDUCATIONAL SERVICES, NAMELY, PROVIDING TRAINING PROGRAMS FOR INCREASING PERFORMANCE AND ENSURING CONSISTENCY OF OPERATIONS FROM VENDORS IN THE NATURAL GAS AND CRUDE OIL EXPLORATION, DEVELOPMENT AND PRODUCTION INDUSTRY, IN CLASS 41 (U.S. CLS. 100, 101 AND 107).

FIRST USE 2-5-2010; IN COMMERCE 2-5-2010.

OWNER OF U.S. REG. NO. 2,976,459.

NO CLAIM IS MADE TO THE EXCLUSIVE RIGHT TO USE "ENERGY", "SAFETY" AND "EFFICIENCY", APART FROM THE MARK AS SHOWN.

THE MARK CONSISTS OF AN OUTLINE OF A PERSON'S HELMETED HEAD SURROUNDED BY A CIRCLE. THE HELMET CONTAINS THE LETTERS "SWN" WITH THE WORDS "SOUTHWESTERN ENERGY" APPEARING BELOW THE LETTERS. A RECTANGLE APPEARS BELOW THE ENCIRCLED HEAD, CONTAINING THE WORD "WORKSMART" ABOVE THE WORDS "SAFETY." "EFFICIENCY." "INTEGRITY.".

SER. NO. 85-475,588, FILED 11-17-2011.

WENDY GOODMAN, EXAMINING ATTORNEY



David J. Kybas

Director of the United States Patent and Trademark Office

United States of America

United States Patent and Trademark Office

BREAKING RECORDS

Reg. No. 4,175,144

Registered July 17, 2012

Int. Cl.: 16

TRADEMARK

PRINCIPAL REGISTER

TOOLE, MICHAEL (UNITED STATES INDIVIDUAL)
138 WEST INTERNATIONAL SPEED WAY BLVD
DAYTONA BEACH, FL 32114

FOR: POSTERS, IN CLASS 16 (U.S. CLS. 2, 5, 22, 23, 29, 37, 38 AND 50).

FIRST USE 9-15-2011; IN COMMERCE 9-19-2011.

THE MARK CONSISTS OF STANDARD CHARACTERS WITHOUT CLAIM TO ANY PARTICULAR FONT, STYLE, SIZE, OR COLOR.

SER. NO. 85-475,592, FILED 11-17-2011.

KATHERINE CONNOLLY, EXAMINING ATTORNEY



David J. Kybas

Director of the United States Patent and Trademark Office

United States of America

United States Patent and Trademark Office

JOHN BALES ATTORNEYS

Reg. No. 4,175,145

Registered July 17, 2012

Int. Cl.: 45

SERVICE MARK

PRINCIPAL REGISTER

A BALES PROFESSIONAL ASSOCIATION (FLORIDA CORPORATION)
SUITE 400
9700 MARTIN LUTHER KING JR. ST. N.
ST. PETERSBURG, FL 33702

FOR: LEGAL SERVICES, IN CLASS 45 (U.S. CLS. 100 AND 101).

FIRST USE 8-25-2006; IN COMMERCE 8-25-2006.

THE MARK CONSISTS OF STANDARD CHARACTERS WITHOUT CLAIM TO ANY PARTICULAR FONT, STYLE, SIZE, OR COLOR.

NO CLAIM IS MADE TO THE EXCLUSIVE RIGHT TO USE "ATTORNEYS", APART FROM THE MARK AS SHOWN.

THE NAME(S), PORTRAIT(S), AND/OR SIGNATURE(S) SHOWN IN THE MARK IDENTIFIES "JOHN BALES", WHOSE CONSENT(S) TO REGISTER IS MADE OF RECORD.

SER. NO. 85-475,593, FILED 11-17-2011.

BARNEY CHARLON, EXAMINING ATTORNEY



David J. Kyros

Director of the United States Patent and Trademark Office

United States of America

United States Patent and Trademark Office



Reg. No. 4,175,146

WYKLE, ROGER (UNITED STATES INDIVIDUAL)
255 CALLE LA MESA
MORAGA, CA 94556

Registered July 17, 2012

Int. Cl.: 37

FOR: GENERAL CONSTRUCTION CONTRACTING, IN CLASS 37 (U.S. CLS. 100, 103 AND 106).

SERVICE MARK

FIRST USE 9-30-2011; IN COMMERCE 9-30-2011.

PRINCIPAL REGISTER

NO CLAIM IS MADE TO THE EXCLUSIVE RIGHT TO USE "SUSTAINABLE GROUP", APART FROM THE MARK AS SHOWN.

THE MARK CONSISTS OF A ROUND SYMBOL WITH A YING AND YANG STYLE WITH A LEAF ON THE BOTTOM AND ROLLING WAVES ON THE TOP. TO THE RIGHT OF THE DESIGN IS THE STYLIZED TEXT "SUSTAINABLE GROUP". THE WORD "SUSTAINABLE" IS ABOVE THE WORD "GROUP".

SER. NO. 85-475,622, FILED 11-17-2011.

HELENE LIWINSKI, EXAMINING ATTORNEY



David J. Kybas

Director of the United States Patent and Trademark Office

United States of America

United States Patent and Trademark Office



iScentify *the fragrance finder.*

Reg. No. 4,175,147

Registered July 17, 2012

Int. Cl.: 35

SERVICE MARK

PRINCIPAL REGISTER

LISA HOFFMAN BEAUTY, LLC (CALIFORNIA LIMITED LIABILITY COMPANY)
LEGAL DEPARTMENT
11661 SAN VICENTE BLVD, SUITE 222
LOS ANGELES, CA 90049

FOR: ONLINE RETAIL STORE AND RETAIL STORE SERVICES FEATURING FRAGRANCES
BASED ON CUSTOMER PREFERENCES , IN CLASS 35 (U.S. CLS. 100, 101 AND 102).

FIRST USE 10-1-2011; IN COMMERCE 10-1-2011.

NO CLAIM IS MADE TO THE EXCLUSIVE RIGHT TO USE "FRAGRANCE FINDER", APART
FROM THE MARK AS SHOWN.

THE MARK CONSISTS OF A LOGO AND STYLIZED WORDS. THE LOGO CONSISTS OF
A PLURALITY OF PERFUME VIALS HAVING METALLIC CAPS AND FORMING A CIRCLE.
THE WORDS "ISCENTIFY THE FRAGRANCE FINDER" APPEARS DIRECTLY TO THE
RIGHT OF THE LOGO IN STYLIZED FONT.

SER. NO. 85-475,649, FILED 11-17-2011.

JOHN HWANG, EXAMINING ATTORNEY



David J. Kybas

Director of the United States Patent and Trademark Office

United States of America

United States Patent and Trademark Office

STRETCHY STRINGY SEXY BLINGY

Reg. No. 4,175,148

Registered July 17, 2012

Int. Cl.: 26

TRADEMARK

PRINCIPAL REGISTER

GAME DAY BEADS, LLC (ARIZONA LIMITED LIABILITY COMPANY), DBA BLINGY
BEADS
931 EAST SOUTHERN AVENUE
MESA, AZ 85204

FOR: ORNAMENTS FOR THE HAIR; HAIR EXTENSIONS; HAIR EXTENSIONS IN THE FORM OF BEADS; HAIR ACCESSORIES, NAMELY, DECORATIVE HAIR EXTENSIONS, TWISTERS, CLAW CLIPS, SNAP CLIPS, JAW CLIPS, HAIR STICKS; HAIR ORNAMENTS NOT OF PRECIOUS METAL; HAIR ORNAMENTS OF PRECIOUS METAL; HAIR CLIPS; HAIR ORNAMENTS IN THE NATURE OF HAIR WRAPS; HAIR ORNAMENTS IN THE FORM OF COMBS; AND HAIR ORNAMENTS IN THE FORM OF BEADS, IN CLASS 26 (U.S. CLS. 37, 39, 40, 42 AND 50).

FIRST USE 8-4-2011; IN COMMERCE 8-4-2011.

THE MARK CONSISTS OF STANDARD CHARACTERS WITHOUT CLAIM TO ANY PARTICULAR FONT, STYLE, SIZE, OR COLOR.

SER. NO. 85-475,655, FILED 11-17-2011.

KRISTIN DAHLING, EXAMINING ATTORNEY



David J. Kyffers

Director of the United States Patent and Trademark Office

United States of America

United States Patent and Trademark Office

BLINGY BEADS

Reg. No. 4,175,149

Registered July 17, 2012

Int. Cl.: 26

TRADEMARK

PRINCIPAL REGISTER

GAME DAY BEADS, LLC (ARIZONA LIMITED LIABILITY COMPANY), DBA BLINGY BEADS
931 EAST SOUTHERN AVENUE
MESA, AZ 85204

FOR: ORNAMENTS FOR THE HAIR; HAIR EXTENSIONS; HAIR EXTENSIONS IN THE FORM OF BEADS; HAIR ACCESSORIES, NAMELY, DECORATIVE HAIR EXTENSIONS, TWISTERS, CLAW CLIPS, SNAP CLIPS, JAW CLIPS, HAIR STICKS; HAIR ORNAMENTS NOT OF PRECIOUS METAL; HAIR ORNAMENTS OF PRECIOUS METAL; HAIR CLIPS; HAIR ORNAMENTS IN THE NATURE OF HAIR WRAPS; HAIR ORNAMENTS IN THE FORM OF COMBS; AND HAIR ORNAMENTS IN THE FORM OF BEADS, IN CLASS 26 (U.S. CLS. 37, 39, 40, 42 AND 50).

FIRST USE 8-4-2011; IN COMMERCE 8-4-2011.

THE MARK CONSISTS OF STANDARD CHARACTERS WITHOUT CLAIM TO ANY PARTICULAR FONT, STYLE, SIZE, OR COLOR.

NO CLAIM IS MADE TO THE EXCLUSIVE RIGHT TO USE "BEADS", APART FROM THE MARK AS SHOWN.

SER. NO. 85-475,658, FILED 11-17-2011.

KRISTIN DAHLING, EXAMINING ATTORNEY



David J. Kybas

Director of the United States Patent and Trademark Office

United States of America

United States Patent and Trademark Office

CYBERFLASHING

Reg. No. 4,175,150

Registered July 17, 2012

Int. Cl.: 9

TRADEMARK

PRINCIPAL REGISTER

CYBERFLASHING.COM, LLC (COLORADO LIMITED LIABILITY COMPANY)
STE 970
2851 S. PARKER RD.
AURORA, CO 80014

FOR: COMPUTER SOFTWARE FOR PROGRAMMING MOBILE PHONES, IN CLASS 9 (U.S. CLS. 21, 23, 26, 36 AND 38).

FIRST USE 2-15-2011; IN COMMERCE 2-15-2011.

THE MARK CONSISTS OF STANDARD CHARACTERS WITHOUT CLAIM TO ANY PARTICULAR FONT, STYLE, SIZE, OR COLOR.

SER. NO. 85-475,659, FILED 11-17-2011.

JOHN HWANG, EXAMINING ATTORNEY



David J. Kyffers

Director of the United States Patent and Trademark Office

United States of America

United States Patent and Trademark Office

Supreme Hold Fuse

Reg. No. 4,175,151

Registered July 17, 2012

Int. Cl.: 3

TRADEMARK

PRINCIPAL REGISTER

ETGON ENTERPRISES INC. (CALIFORNIA CORPORATION)
8216 LANKERSHIM BLVD #21
NORTH HOLLYWOOD, CA 91605

FOR: COSMETIC HAIR DRESSING PREPARATIONS; GEL FOR HAIR; HAIR GEL; HAIR GEL AND HAIR MOUSSE; HAIR GELS; HAIR SPRAYS; HAIR STYLING GEL; HAIR STYLING PREPARATIONS, IN CLASS 3 (U.S. CLS. 1, 4, 6, 50, 51 AND 52).

FIRST USE 2-1-2010; IN COMMERCE 2-1-2010.

THE MARK CONSISTS OF STANDARD CHARACTERS WITHOUT CLAIM TO ANY PARTICULAR FONT, STYLE, SIZE, OR COLOR.

NO CLAIM IS MADE TO THE EXCLUSIVE RIGHT TO USE "SUPREME HOLD", APART FROM THE MARK AS SHOWN.

SER. NO. 85-475,676, FILED 11-17-2011.

ZHALEH DELANEY, EXAMINING ATTORNEY



David J. Kyros

Director of the United States Patent and Trademark Office

United States of America

United States Patent and Trademark Office

Rock Darling

Reg. No. 4,175,152

Registered July 17, 2012

Int. Cl.: 14

TRADEMARK

PRINCIPAL REGISTER

RENYER, MARY MARCY MICHELLE (UNITED STATES INDIVIDUAL), DBA ROCK
DARLING DESIGNS
7520 W. 144TH STREET
OVERLAND PARK, KS 66223

FOR: BRACELETS; COSTUME JEWELRY; EARRINGS; JEWELRY CHAINS; JEWELRY,
NAMELY, ARM CUFFS; JEWELRY, NAMELY, CROSSES; NECKLACES; RINGS; RINGS
BEING JEWELRY, IN CLASS 14 (U.S. CLS. 2, 27, 28 AND 50).

FIRST USE 9-13-2006; IN COMMERCE 9-13-2006.

THE MARK CONSISTS OF STANDARD CHARACTERS WITHOUT CLAIM TO ANY PAR-
TICULAR FONT, STYLE, SIZE, OR COLOR.

SER. NO. 85-475,679, FILED 11-17-2011.

MATTHEW KLINE, EXAMINING ATTORNEY



David J. Kyffers

Director of the United States Patent and Trademark Office

United States of America

United States Patent and Trademark Office

EDGECELL

Reg. No. 4,175,153

Registered July 17, 2012

Int. Cl.: 9

TRADEMARK

PRINCIPAL REGISTER

HAEMONETICS CORPORATION (MASSACHUSETTS CORPORATION)
400 WOOD ROAD
BRAINTREE, MA 02184

FOR: COMPUTER SOFTWARE FOR USE IN CONNECTION WITH MANAGEMENT AND TRACKING OF ORGANS, TISSUES AND CELLS, IN CLASS 9 (U.S. CLS. 21, 23, 26, 36 AND 38).

FIRST USE 2-18-2010; IN COMMERCE 12-10-2010.

THE MARK CONSISTS OF STANDARD CHARACTERS WITHOUT CLAIM TO ANY PARTICULAR FONT, STYLE, SIZE, OR COLOR.

SER. NO. 85-475,690, FILED 11-17-2011.

LINDA ORNDORFF, EXAMINING ATTORNEY



David J. Kyffers

Director of the United States Patent and Trademark Office

United States of America

United States Patent and Trademark Office

LiveWello

Reg. No. 4,175,154

LIVEWELLO, LLC (SOUTH CAROLINA LIMITED LIABILITY COMPANY)
1310 NEWPORT COURT
CHARLESTON, SC 29492

Registered July 17, 2012

Int. Cl.: 38

FOR: ELECTRONIC EXCHANGE OF MEDICAL RECORDS ACROSS A NATIONWIDE HEALTH INFORMATION NETWORK, IN CLASS 38 (U.S. CLS. 100, 101 AND 104).

SERVICE MARK

FIRST USE 8-1-2011; IN COMMERCE 10-1-2011.

PRINCIPAL REGISTER

THE MARK CONSISTS OF STANDARD CHARACTERS WITHOUT CLAIM TO ANY PARTICULAR FONT, STYLE, SIZE, OR COLOR.

SER. NO. 85-475,692, FILED 11-17-2011.

JENNIFER MARTIN, EXAMINING ATTORNEY



David J. Kybas

Director of the United States Patent and Trademark Office

United States of America

United States Patent and Trademark Office

INTUITION ALE WORKS

Reg. No. 4,175,155

Registered July 17, 2012

Int. Cls.: 32 and 40

TRADEMARK

SERVICE MARK

PRINCIPAL REGISTER

RPD MANAGEMENT, LLC (FLORIDA LIMITED LIABILITY COMPANY)
SUITE 406
1022 PARK STREET
JACKSONVILLE, FL 32204

FOR: BEER, IN CLASS 32 (U.S. CLS. 45, 46 AND 48).

FIRST USE 11-1-2010; IN COMMERCE 11-1-2010.

FOR: BREWERY SERVICES, IN CLASS 40 (U.S. CLS. 100, 103 AND 106).

FIRST USE 11-20-2010; IN COMMERCE 11-20-2010.

THE MARK CONSISTS OF STANDARD CHARACTERS WITHOUT CLAIM TO ANY PARTICULAR FONT, STYLE, SIZE, OR COLOR.

NO CLAIM IS MADE TO THE EXCLUSIVE RIGHT TO USE "ALE WORKS", APART FROM THE MARK AS SHOWN.

SER. NO. 85-475,718, FILED 11-17-2011.

ANDREA HACK, EXAMINING ATTORNEY



David J. Kybas

Director of the United States Patent and Trademark Office

United States of America

United States Patent and Trademark Office

Rock Darling

Reg. No. 4,175,156

Registered July 17, 2012

Int. Cl.: 35

SERVICE MARK

PRINCIPAL REGISTER

RENYER, MARY MARCY MICHELLE (UNITED STATES INDIVIDUAL), DBA ROCK
DARLING DESIGNS
7520 W. 144TH STREET
OVERLAND PARK, KS 66223

FOR: ON-LINE RETAIL STORE SERVICES FEATURING JEWELRY AND ACCESSORIES,
NAMELY, EARRINGS, RINGS, WRIST CUFFS, NECKLACES, ROSARIES, HATS, BAGS,
AND WALLETS, IN CLASS 35 (U.S. CLS. 100, 101 AND 102).

FIRST USE 9-1-2007; IN COMMERCE 9-1-2007.

THE MARK CONSISTS OF STANDARD CHARACTERS WITHOUT CLAIM TO ANY PAR-
TICULAR FONT, STYLE, SIZE, OR COLOR.

SER. NO. 85-475,721, FILED 11-17-2011.

MATTHEW KLINE, EXAMINING ATTORNEY



David J. Kyffers

Director of the United States Patent and Trademark Office

United States of America

United States Patent and Trademark Office

SANKATY SENIOR LOAN FUND

Reg. No. 4,175,157

Registered July 17, 2012

Int. Cl.: 36

SERVICE MARK

PRINCIPAL REGISTER

SANKATY ADVISORS, LLC (DELAWARE LIMITED LIABILITY COMPANY)
JOHN HANCOCK TOWER, 200 CLARENDON STREET
BOSTON, MA 02116

FOR: LONG TERM INVESTMENT SERVICES, NAMELY, FINANCIAL INVESTMENT IN THE FIELDS OF DEBT AND MEZANINE INVESTMENTS; INVESTMENT OF FUNDS FOR OTHERS , IN CLASS 36 (U.S. CLS. 100, 101 AND 102).

FIRST USE 12-31-2010; IN COMMERCE 12-31-2010.

THE MARK CONSISTS OF STANDARD CHARACTERS WITHOUT CLAIM TO ANY PARTICULAR FONT, STYLE, SIZE, OR COLOR.

OWNER OF U.S. REG. NO. 3,298,060.

NO CLAIM IS MADE TO THE EXCLUSIVE RIGHT TO USE "SENIOR LOAN FUND", APART FROM THE MARK AS SHOWN.

SER. NO. 85-475,728, FILED 11-17-2011.

NAPOLEON SHARMA, EXAMINING ATTORNEY



David J. Kyffers

Director of the United States Patent and Trademark Office

United States of America

United States Patent and Trademark Office

SSLF

Reg. No. 4,175,158

Registered July 17, 2012

Int. Cl.: 36

SERVICE MARK

PRINCIPAL REGISTER

SANKATY ADVISORS, LLC (DELAWARE LIMITED LIABILITY COMPANY)
JOHN HANCOCK TOWER, 200 CLARENDON STREET
BOSTON, MA 02116

FOR: LONG TERM INVESTMENT SERVICES, NAMELY, FINANCIAL INVESTMENT IN THE FIELDS OF DEBT AND MEZANINE INVESTMENTS; INVESTMENT OF FUNDS FOR OTHERS, IN CLASS 36 (U.S. CLS. 100, 101 AND 102).

FIRST USE 12-31-2010; IN COMMERCE 12-31-2010.

THE MARK CONSISTS OF STANDARD CHARACTERS WITHOUT CLAIM TO ANY PARTICULAR FONT, STYLE, SIZE, OR COLOR.

SER. NO. 85-475,738, FILED 11-17-2011.

NAPOLEON SHARMA, EXAMINING ATTORNEY



David J. Kyffers

Director of the United States Patent and Trademark Office

United States of America

United States Patent and Trademark Office

See the Crowd

Reg. No. 4,175,159

Registered July 17, 2012

Int. Cl.: 35

SERVICE MARK

PRINCIPAL REGISTER

STC LLC (NEW YORK LIMITED LIABILITY COMPANY), AKA SEE THE CROWD
ROOM 1B
71 EAST 2ND ST.
NEW YORK, NY 10003

FOR: ADVERTISING AND PROMOTIONAL SERVICES; PROVIDING A SEARCHABLE WEBSITE FEATURING THE GOODS AND SERVICES OF OTHER VENDORS; PROVIDING ON-LINE DIRECTORY INFORMATION SERVICES ALSO FEATURING HYPERLINKS TO OTHER WEB SITES, IN CLASS 35 (U.S. CLS. 100, 101 AND 102).

FIRST USE 8-28-2009; IN COMMERCE 8-28-2009.

THE MARK CONSISTS OF STANDARD CHARACTERS WITHOUT CLAIM TO ANY PARTICULAR FONT, STYLE, SIZE, OR COLOR.

SER. NO. 85-475,740, FILED 11-17-2011.

ANDREA K. NADELMAN, EXAMINING ATTORNEY



David J. Kybas

Director of the United States Patent and Trademark Office

United States of America

United States Patent and Trademark Office

SANKATY HIGH INCOME PARTNERSHIP

Reg. No. 4,175,160

Registered July 17, 2012

Int. Cl.: 36

SERVICE MARK

PRINCIPAL REGISTER

SANKATY ADVISORS, LLC (DELAWARE LIMITED LIABILITY COMPANY)
JOHN HANCOCK TOWER, 200 CLARENDON STREET
BOSTON, MA 02116

FOR: LONG TERM INVESTMENT SERVICES, NAMELY, FINANCIAL INVESTMENT IN THE FIELDS OF DEBT AND MEZANINE INVESTMENTS; INVESTMENT OF FUNDS FOR OTHERS , IN CLASS 36 (U.S. CLS. 100, 101 AND 102).

FIRST USE 12-31-2010; IN COMMERCE 12-31-2010.

THE MARK CONSISTS OF STANDARD CHARACTERS WITHOUT CLAIM TO ANY PARTICULAR FONT, STYLE, SIZE, OR COLOR.

OWNER OF U.S. REG. NO. 3,298,060.

NO CLAIM IS MADE TO THE EXCLUSIVE RIGHT TO USE "HIGH INCOME PARTNERSHIP", APART FROM THE MARK AS SHOWN.

SER. NO. 85-475,744, FILED 11-17-2011.

NAPOLEON SHARMA, EXAMINING ATTORNEY



David J. Kyjars

Director of the United States Patent and Trademark Office

United States of America

United States Patent and Trademark Office

SHIP

Reg. No. 4,175,161

Registered July 17, 2012

Int. Cl.: 36

SERVICE MARK

PRINCIPAL REGISTER

SANKATY ADVISORS, LLC (DELAWARE LIMITED LIABILITY COMPANY)
JOHN HANCOCK TOWER, 200 CLARENDON STREET
BOSTON, MA 02116

FOR: LONG TERM INVESTMENT SERVICES, NAMELY, FINANCIAL INVESTMENT IN THE FIELDS OF DEBT AND MEZANINE INVESTMENTS; INVESTMENT OF FUNDS FOR OTHERS , IN CLASS 36 (U.S. CLS. 100, 101 AND 102).

FIRST USE 12-31-2010; IN COMMERCE 12-31-2010.

THE MARK CONSISTS OF STANDARD CHARACTERS WITHOUT CLAIM TO ANY PARTICULAR FONT, STYLE, SIZE, OR COLOR.

SER. NO. 85-475,754, FILED 11-17-2011.

NAPOLEON SHARMA, EXAMINING ATTORNEY



David J. Kybas

Director of the United States Patent and Trademark Office

United States of America

United States Patent and Trademark Office

ORGANIC POLYESTER PRODUCTIONS

Reg. No. 4,175,162

Registered July 17, 2012

Int. Cl.: 41

SERVICE MARK

PRINCIPAL REGISTER

ORGANIC POLYESTER PRODUCTIONS, INC. (CALIFORNIA CORPORATION)
12810 CASWELL AVENUE, SUITE 202
LOS ANGELES, CA 90066

FOR: MEDIA PRODUCTION SERVICES, NAMELY, VIDEO AND FILM PRODUCTION; ENTERTAINMENT MEDIA PRODUCTION SERVICES FOR MOTION PICTURES, TELEVISION AND INTERNET; ENTERTAINMENT SERVICES IN THE NATURE OF DEVELOPMENT, CREATION, PRODUCTION AND POST-PRODUCTION SERVICES OF MULTIMEDIA ENTERTAINMENT CONTENT; FILM AND VIDEO PRODUCTION CONSULTING SERVICES; MOTION PICTURE, VIDEO, TELEVISION PROGRAM AND INTERNET WEBISODE PRODUCTION SERVICES; RENTAL AND LEASING OF FILM MAKING EQUIPMENT, NAMELY, CAMERAS, RIGS, LENSES, SOUND EQUIPMENT, LIGHTING EQUIPMENT, TRIPODS, STANDS, IN CLASS 41 (U.S. CLS. 100, 101 AND 107).

FIRST USE 11-16-2007; IN COMMERCE 11-16-2007.

THE MARK CONSISTS OF STANDARD CHARACTERS WITHOUT CLAIM TO ANY PARTICULAR FONT, STYLE, SIZE, OR COLOR.

OWNER OF U.S. REG. NO. 3,437,629.

NO CLAIM IS MADE TO THE EXCLUSIVE RIGHT TO USE "PRODUCTIONS", APART FROM THE MARK AS SHOWN.

SER. NO. 85-475,755, FILED 11-17-2011.

ROBIN MITTLER, EXAMINING ATTORNEY



David J. Kyffers

Director of the United States Patent and Trademark Office

United States of America

United States Patent and Trademark Office

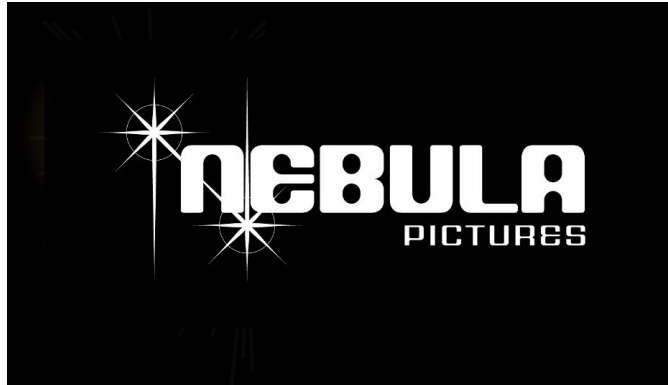

Reg. No. 4,175,163

Registered July 17, 2012

Int. Cl.: 41

SERVICE MARK

PRINCIPAL REGISTER

ORGANIC POLYESTER PRODUCTIONS, INC. (CALIFORNIA CORPORATION)
12810 CASWELL AVENUE, SUITE 202
LOS ANGELES, CA 90066

FOR: MEDIA PRODUCTION SERVICES, NAMELY, VIDEO AND FILM PRODUCTION; ENTERTAINMENT MEDIA PRODUCTION SERVICES FOR MOTION PICTURES, TELEVISION AND INTERNET; ENTERTAINMENT SERVICES IN THE NATURE OF DEVELOPMENT, CREATION, PRODUCTION AND POST-PRODUCTION SERVICES OF MULTIMEDIA ENTERTAINMENT CONTENT; FILM AND VIDEO PRODUCTION CONSULTING SERVICES; MOTION PICTURE, VIDEO, TELEVISION PROGRAM AND INTERNET WEBISODE PRODUCTION SERVICES, IN CLASS 41 (U.S. CLS. 100, 101 AND 107).

FIRST USE 1-0-2010; IN COMMERCE 10-28-2011.

NO CLAIM IS MADE TO THE EXCLUSIVE RIGHT TO USE "PICTURES", APART FROM THE MARK AS SHOWN.

THE MARK CONSISTS OF THE WORD "NEBULA" IN LARGE FONT SURROUNDED BY TWO STARS, ONE IN THE UPPER LEFT AND THE OTHER TO THE LOWER RIGHT BELOW THE LETTER "N" AND THE WORD "PICTURES" IN SMALLER FONT UNDERNEATH THE LETTERS "ULA" IN "NEBULA". THE BODIES OF THE STARS ARE SURROUNDED BY FLARES, AND EACH STAR CONTAINS RAYS THAT EXTEND BEYOND THEM.

SER. NO. 85-475,763, FILED 11-17-2011.

ROBIN MITTLER, EXAMINING ATTORNEY



David J. Kybas

Director of the United States Patent and Trademark Office

United States of America

United States Patent and Trademark Office

SANKATY MIDDLE MARKET OPPORTUNITIES FUND

Reg. No. 4,175,164

Registered July 17, 2012

Int. Cl.: 36

SERVICE MARK

PRINCIPAL REGISTER

SANKATY ADVISORS, LLC (DELAWARE LIMITED LIABILITY COMPANY)
JOHN HANCOCK TOWER, 200 CLARENDON STREET
BOSTON, MA 02116

FOR: LONG TERM INVESTMENT SERVICES, NAMELY, FINANCIAL INVESTMENT IN THE FIELDS OF DEBT AND MEZANINE INVESTMENTS; INVESTMENT OF FUNDS FOR OTHERS, IN CLASS 36 (U.S. CLS. 100, 101 AND 102).

FIRST USE 8-31-2009; IN COMMERCE 8-31-2009.

THE MARK CONSISTS OF STANDARD CHARACTERS WITHOUT CLAIM TO ANY PARTICULAR FONT, STYLE, SIZE, OR COLOR.

OWNER OF U.S. REG. NO. 3,298,060.

NO CLAIM IS MADE TO THE EXCLUSIVE RIGHT TO USE "MIDDLE MARKET OPPORTUNITIES FUND", APART FROM THE MARK AS SHOWN.

SER. NO. 85-475,767, FILED 11-17-2011.

NAPOLEON SHARMA, EXAMINING ATTORNEY



David J. Kyros

Director of the United States Patent and Trademark Office

United States of America

United States Patent and Trademark Office

AUTO-PAX PRODUCTS

Reg. No. 4,175,165

CARDINAL INDUSTRIES INC. (TEXAS CORPORATION)
6977 E. COMMERCE ST.
ODESSA, TX 79762

Registered July 17, 2012

Int. Cl.: 7

FOR: PARTS FOR OIL PUMPS FOR OIL WELLS, NAMELY, STUFFING BOXES, IN CLASS 7 (U.S. CLS. 13, 19, 21, 23, 31, 34 AND 35).

TRADEMARK

FIRST USE 3-1-1996; IN COMMERCE 3-11-1996.

PRINCIPAL REGISTER

THE MARK CONSISTS OF STANDARD CHARACTERS WITHOUT CLAIM TO ANY PARTICULAR FONT, STYLE, SIZE, OR COLOR.

NO CLAIM IS MADE TO THE EXCLUSIVE RIGHT TO USE "PRODUCTS", APART FROM THE MARK AS SHOWN.

SER. NO. 85-475,775, FILED 11-17-2011.

ELLEN B. AWRICH, EXAMINING ATTORNEY



David J. Kybas

Director of the United States Patent and Trademark Office

United States of America

United States Patent and Trademark Office

MMOPS

Reg. No. 4,175,166

Registered July 17, 2012

Int. Cl.: 36

SERVICE MARK

PRINCIPAL REGISTER

SANKATY ADVISORS, LLC (DELAWARE LIMITED LIABILITY COMPANY)
JOHN HANCOCK TOWER, 200 CLARENDON STREET
BOSTON, MA 02116

FOR: LONG TERM INVESTMENT SERVICES, NAMELY, FINANCIAL INVESTMENT IN THE FIELDS OF DEBT AND MEZANINE INVESTMENTS; INVESTMENT OF FUNDS FOR OTHERS , IN CLASS 36 (U.S. CLS. 100, 101 AND 102).

FIRST USE 8-31-2011; IN COMMERCE 8-31-2011.

THE MARK CONSISTS OF STANDARD CHARACTERS WITHOUT CLAIM TO ANY PARTICULAR FONT, STYLE, SIZE, OR COLOR.

SER. NO. 85-475,778, FILED 11-17-2011.

NAPOLEON SHARMA, EXAMINING ATTORNEY



David J. Kyffers

Director of the United States Patent and Trademark Office

United States of America

United States Patent and Trademark Office

stay all day

Reg. No. 4,175,167

Registered July 17, 2012

Int. Cl.: 3

TRADEMARK

PRINCIPAL REGISTER

STILA STYLES LLC (DELAWARE LIMITED LIABILITY COMPANY)
111 W. WILSON AVE.
GLENDALE, CA 91203

FOR: COSMETIC PREPARATIONS FOR EYE LASHES; COSMETIC PREPARATIONS FOR SKIN CARE; COSMETICS AND COSMETIC PREPARATIONS; COSMETICS AND MAKE-UP; COSMETICS, NAMELY, LIP PRIMER, IN CLASS 3 (U.S. CLS. 1, 4, 6, 50, 51 AND 52).

FIRST USE 6-1-2009; IN COMMERCE 6-1-2009.

THE MARK CONSISTS OF STANDARD CHARACTERS WITHOUT CLAIM TO ANY PARTICULAR FONT, STYLE, SIZE, OR COLOR.

SER. NO. 85-475,786, FILED 11-17-2011.

CHRISTINA SOBRAL, EXAMINING ATTORNEY



David J. Kyjars

Director of the United States Patent and Trademark Office

United States of America

United States Patent and Trademark Office

CLASSMATES

Reg. No. 4,175,168

Registered July 17, 2012

Int. Cls.: 35 and 45

SERVICE MARK

PRINCIPAL REGISTER

MEMORY LANE, INC. (WASHINGTON CORPORATION), FORMERLY CLASSMATES
ONLINE, INC.
333 ELLIOTT AVENUE WEST, SUITE 500
SEATTLE, WA 98119

FOR: ON-LINE RETAIL STORE SERVICES FEATURING SCHOOL YEARBOOKS, IN CLASS
35 (U.S. CLS. 100, 101 AND 102).

FIRST USE 6-9-2010; IN COMMERCE 9-16-2010.

FOR: ON-LINE SOCIAL NETWORKING SERVICES; ONLINE SOCIAL NETWORKING SER-
VICES IN THE FIELD OF SCHOOLS, COLLEGES, MILITARY, FAMILIES, COLLEAGUES,
INTEREST GROUPS, FRIENDS, ACQUAINTANCES AND REUNIONS; ONLINE SOCIAL
NETWORKING SERVICES IN THE FIELD OF SCHOOLS, COLLEGES, MILITARY, FAMILIES,
COLLEAGUES, INTEREST GROUPS, FRIENDS, ACQUAINTANCES AND RE-
UNIONS PROVIDED VIA A WEBSITE; PROVIDING ON-LINE COMPUTER DATABASES
AND ON-LINE SEARCHABLE DATABASES IN THE FIELD OF SOCIAL NETWORKING,
IN CLASS 45 (U.S. CLS. 100 AND 101).

FIRST USE 12-0-1995; IN COMMERCE 12-0-1995.

THE MARK CONSISTS OF STANDARD CHARACTERS WITHOUT CLAIM TO ANY PAR-
TICULAR FONT, STYLE, SIZE, OR COLOR.

OWNER OF U.S. REG. NOS. 2,584,325, 2,758,007 AND OTHERS.

SEC. 2(F).

SER. NO. 85-475,789, FILED 11-17-2011.

TRICIA SONNEBORN, EXAMINING ATTORNEY



David J. Kyffers

Director of the United States Patent and Trademark Office

United States of America

United States Patent and Trademark Office

NYCTOPHOBIA

Reg. No. 4,175,169

EXISTENCE MEDIA, INC. (NEW YORK CORPORATION)
51 BEECHWOOD DR.
MANORVILLE, NY 11949

Registered July 17, 2012

Int. Cls.: 25 and 41

FOR: T-SHIRTS; WRIST BANDS, IN CLASS 25 (U.S. CLS. 22 AND 39).

TRADEMARK

FIRST USE 10-1-2010; IN COMMERCE 10-1-2010.

SERVICE MARK

FOR: CONDUCTING ENTERTAINMENT EXHIBITIONS IN THE NATURE OF HAUNTED HOUSES, IN CLASS 41 (U.S. CLS. 100, 101 AND 107).

PRINCIPAL REGISTER

FIRST USE 10-1-2010; IN COMMERCE 10-1-2010.

THE MARK CONSISTS OF STANDARD CHARACTERS WITHOUT CLAIM TO ANY PARTICULAR FONT, STYLE, SIZE, OR COLOR.

SER. NO. 85-475,804, FILED 11-17-2011.

MATTHEW KLINE, EXAMINING ATTORNEY



David J. Kyffers

Director of the United States Patent and Trademark Office

United States of America

United States Patent and Trademark Office

WE ARE HEBER VALLEY

Reg. No. 4,175,170

ASSOCIATED FOOD STORES, INC. (UTAH CORPORATION)
1850 WEST 2100 SOUTH
SALT LAKE CITY, UT 84119

Registered July 17, 2012

Int. Cl.: 35

FOR: RETAIL GROCERY STORE SERVICES, IN CLASS 35 (U.S. CLS. 100, 101 AND 102).

SERVICE MARK

FIRST USE 9-7-2011; IN COMMERCE 9-7-2011.

PRINCIPAL REGISTER

THE MARK CONSISTS OF STANDARD CHARACTERS WITHOUT CLAIM TO ANY PARTICULAR FONT, STYLE, SIZE, OR COLOR.

NO CLAIM IS MADE TO THE EXCLUSIVE RIGHT TO USE "HEBER VALLEY", APART FROM THE MARK AS SHOWN.

SER. NO. 85-475,843, FILED 11-17-2011.

TASNEEM HUSSAIN, EXAMINING ATTORNEY



David J. Kyffers

Director of the United States Patent and Trademark Office

United States of America

United States Patent and Trademark Office

HIGH NOON

Reg. No. 4,175,171

L.A. HIGHNOON, INC. (CALIFORNIA CORPORATION)
9929 VENICE BLVD

Registered July 17, 2012

LOS ANGELES, CA 90034

Int. Cl.: 35

FOR: ARRANGING AND CONDUCTING AUCTIONS IN THE FIELD OF WESTERN AMERICANA; ORGANIZING EXHIBITIONS FOR WESTERN AMERICANA AND ANTIQUES, IN CLASS 35 (U.S. CLS. 100, 101 AND 102).

SERVICE MARK

FIRST USE 1-0-1992; IN COMMERCE 1-0-1992.

PRINCIPAL REGISTER

THE MARK CONSISTS OF STANDARD CHARACTERS WITHOUT CLAIM TO ANY PARTICULAR FONT, STYLE, SIZE, OR COLOR.

SER. NO. 85-475,858, FILED 11-17-2011.

MARTHA FROMM, EXAMINING ATTORNEY



David J. Kyffers

Director of the United States Patent and Trademark Office

United States of America

United States Patent and Trademark Office

8 FACTORS

Reg. No. 4,175,172

Registered July 17, 2012

Int. Cl.: 35

SERVICE MARK

PRINCIPAL REGISTER

EIGHT FACTORS, INC. (CALIFORNIA CORPORATION)
SUITE 103
3030 ASHBY AVENUE
BERKELEY, CA 94705

FOR: BUSINESS DEVELOPMENT CONSULTING SERVICES, IN CLASS 35 (U.S. CLS. 100, 101 AND 102).

FIRST USE 12-0-2007; IN COMMERCE 12-0-2007.

THE MARK CONSISTS OF STANDARD CHARACTERS WITHOUT CLAIM TO ANY PARTICULAR FONT, STYLE, SIZE, OR COLOR.

SER. NO. 85-475,867, FILED 11-17-2011.

DOUGLAS LEE, EXAMINING ATTORNEY



David J. Kyffers

Director of the United States Patent and Trademark Office

United States of America

United States Patent and Trademark Office

go roma

Reg. No. 4,175,173

Registered July 17, 2012

Int. Cl.: 43

SERVICE MARK

PRINCIPAL REGISTER

FAST FRESH ITALIAN, LLC (ILLINOIS LIMITED LIABILITY COMPANY)
221 MAIN STREET, SUITE 1230
SAN FRANCISCO, CA 94105

FOR: RESTAURANT AND CATERING SERVICES, IN CLASS 43 (U.S. CLS. 100 AND 101).

FIRST USE 12-31-2007; IN COMMERCE 12-31-2007.

OWNER OF U.S. REG. NOS. 2,861,134 AND 2,917,512.

THE MARK CONSISTS OF THE WORDS "GO ROMA". THE LETTER "O" IN ROMA IS REPLACED WITH A TOMATO.

THE ENGLISH TRANSLATION OF THE WORD "ROMA" IN THE MARK IS "ROME".

SER. NO. 85-475,881, FILED 11-17-2011.

DOUGLAS LEE, EXAMINING ATTORNEY



David J. Kyffers

Director of the United States Patent and Trademark Office

United States of America
United States Patent and Trademark Office

BLASTERS

Reg. No. 4,175,174

LITTLE BUSY BODIES, INC. (DELAWARE CORPORATION)
7874 SW NIMBUS
BEAVERTON, OR 97008

Registered July 17, 2012

Int. Cl.: 3

FOR: DISPOSABLE NASAL WIPES IMPREGNATED WITH SALINE; DISPOSABLE WIPES IMPREGNATED WITH SALINE FOR PERSONAL HYGIENE; PRE-MOISTENED COSMETIC WIPES; SCENT-INFUSED PRE-MOISTENED COSMETIC WIPES; MOISTURIZING DISPOSABLE WIPES IMPREGNATED WITH CLEANSING CHEMICALS OR COMPOUNDS FOR PERSONAL HYGIENE, IN CLASS 3 (U.S. CLS. 1, 4, 6, 50, 51 AND 52).

TRADEMARK

PRINCIPAL REGISTER

FIRST USE 9-4-2011; IN COMMERCE 9-4-2011.

THE MARK CONSISTS OF STANDARD CHARACTERS WITHOUT CLAIM TO ANY PARTICULAR FONT, STYLE, SIZE, OR COLOR.

SER. NO. 85-475,889, FILED 11-17-2011.

ESTHER BELENKER, EXAMINING ATTORNEY



David J. Kyffers

Director of the United States Patent and Trademark Office

United States of America

United States Patent and Trademark Office

Orion & At'eed

Reg. No. 4,175,175

Registered July 17, 2012

Int. Cl.: 25

TRADEMARK

PRINCIPAL REGISTER

FANG YAN (CHINA INDIVIDUAL)
C/O CPAPLACE
PO BOX 93723
CITY OF INDUSTRY, CA 917153723

FOR: APPAREL FOR DANCERS, NAMELY, TEE SHIRTS, SWEATSHIRTS, PANTS, LEGGINGS, SHORTS AND JACKETS; ATHLETIC APPAREL, NAMELY, SHIRTS, PANTS, JACKETS, FOOTWEAR, HATS AND CAPS, ATHLETIC UNIFORMS; ATHLETIC SHOES; BATHING SUITS; BELTS; BLAZERS; BLOUSES; BOOTS; BRAS; CHILDREN'S AND INFANT'S APPAREL, NAMELY, JUMPERS, OVERALL SLEEPWEAR, PAJAMAS, ROMPERS AND ONE-PIECE GARMENTS; CLOTHING FOR BABIES, TODDLERS AND CHILDREN, TREATED WITH FIRE AND HEAT RETARDANTS, NAMELY, PAJAMAS, JACKETS, SHIRTS, PANTS, JUMPERS; COATS; DENIM JACKETS; DENIMS; DRESSES; GLOVES; HATS; INFANT WEAR; JACKETS; JEANS; NIGHTGOWNS; PANTS; RAINCOATS; RAINWEAR; ROBES; SCARVES; SHAWLS; SHIRTS; SHOES; SHORTS; SKI WEAR; SLIPPERS; SOCKS; SPORTS JACKETS; STOCKINGS; SUITS; SURF WEAR; SWEATERS; SWIM WEAR; T-SHIRTS; TANK TOPS; TIGHTS; UNDERWEAR; VESTS, IN CLASS 25 (U.S. CLS. 22 AND 39).

FIRST USE 9-9-2009; IN COMMERCE 9-9-2009.

THE MARK CONSISTS OF STANDARD CHARACTERS WITHOUT CLAIM TO ANY PARTICULAR FONT, STYLE, SIZE, OR COLOR.

"ORION" ORIGINATED FROM GREEK FOR "SON OF FIRE" AND "AT'EED" ORIGINATED FROM NAVAJO FOR "GIRL".

SER. NO. 85-475,905, FILED 11-17-2011.

NAAKWAMA ANKRAH, EXAMINING ATTORNEY



David J. Kypos

Director of the United States Patent and Trademark Office

United States of America
United States Patent and Trademark Office

Aqua Soul

Reg. No. 4,175,176

BELLONI, LAUREN M (UNITED STATES INDIVIDUAL)
373 VALVERDE LANE
ST. AUGUSTINE, FL 32086

Registered July 17, 2012

Int. Cls.: 25 and 28

FOR: SHIRTS; SURF WEAR, IN CLASS 25 (U.S. CLS. 22 AND 39).

TRADEMARK

FIRST USE 11-1-2011; IN COMMERCE 11-1-2011.

PRINCIPAL REGISTER

FOR: SURFBOARD WAX, IN CLASS 28 (U.S. CLS. 22, 23, 38 AND 50).

FIRST USE 11-1-2011; IN COMMERCE 11-1-2011.

THE MARK CONSISTS OF STANDARD CHARACTERS WITHOUT CLAIM TO ANY PARTICULAR FONT, STYLE, SIZE, OR COLOR.

SER. NO. 85-475,942, FILED 11-17-2011.

JENNIFER VASQUEZ, EXAMINING ATTORNEY



David J. Kybas

Director of the United States Patent and Trademark Office

United States of America

United States Patent and Trademark Office

TRIARCHY

Reg. No. 4,175,177

Registered July 17, 2012

Int. Cl.: 41

SERVICE MARK

PRINCIPAL REGISTER

BEECK, ALBERTO M (UNITED STATES INDIVIDUAL)
575 CRANDON BLVD., APT. 502
KEY BISCAYNE, FL 33149

FOR: DISC JOCKEY SERVICES; ENTERTAINMENT SERVICES IN THE NATURE OF LIVE MUSICAL PERFORMANCES; ENTERTAINMENT SERVICES, NAMELY, PROVIDING A WEB SITE FEATURING NON-DOWNLOADABLE MUSICAL PERFORMANCES, MUSICAL VIDEOS, RELATED FILM CLIPS, PHOTOGRAPHS, AND OTHER MULTIMEDIA MATERIALS FEATURING MUSIC, IN CLASS 41 (U.S. CLS. 100, 101 AND 107).

FIRST USE 9-11-2009; IN COMMERCE 9-11-2009.

THE MARK CONSISTS OF STANDARD CHARACTERS WITHOUT CLAIM TO ANY PARTICULAR FONT, STYLE, SIZE, OR COLOR.

SER. NO. 85-475,951, FILED 11-17-2011.

BARNEY CHARLON, EXAMINING ATTORNEY



David J. Kyffers

Director of the United States Patent and Trademark Office

United States of America

United States Patent and Trademark Office

WE DIDN'T INVENT
DENTISTRY. WE JUST MADE IT
BETTER.

Reg. No. 4,175,178

CUSTOM DENTAL PC (OKLAHOMA CORPORATION)
6316 HERITAGE COURT
EDMOND, OK 73025

Registered July 17, 2012

Int. Cl.: 44

FOR: DENTIST SERVICES; DENTISTRY, IN CLASS 44 (U.S. CLS. 100 AND 101).

SERVICE MARK

FIRST USE 0-0-2009; IN COMMERCE 0-0-2009.

PRINCIPAL REGISTER

THE MARK CONSISTS OF STANDARD CHARACTERS WITHOUT CLAIM TO ANY PARTICULAR FONT, STYLE, SIZE, OR COLOR.

SER. NO. 85-475,954, FILED 11-17-2011.

HOWARD B. LEVINE, EXAMINING ATTORNEY



David J. Kyffers

Director of the United States Patent and Trademark Office

United States of America

United States Patent and Trademark Office

Vread

Reg. No. 4,175,179

KACHLER, KARIN I. (UNITED STATES INDIVIDUAL)
1597 GRANDOLA AVE
LOS ANGELES, CA 90041

Registered July 17, 2012

Int. Cl.: 30

FOR: BREAD, IN CLASS 30 (U.S. CL. 46).

TRADEMARK

FIRST USE 1-1-2008; IN COMMERCE 10-29-2011.

PRINCIPAL REGISTER

THE MARK CONSISTS OF STANDARD CHARACTERS WITHOUT CLAIM TO ANY PARTICULAR FONT, STYLE, SIZE, OR COLOR.

SER. NO. 85-475,964, FILED 11-17-2011.

JAY FLOWERS, EXAMINING ATTORNEY



David J. Kyffers

Director of the United States Patent and Trademark Office

United States of America

United States Patent and Trademark Office

ALL-AMERICAN BOOSTERS

Reg. No. 4,175,180

Registered July 17, 2012

Int. Cl.: 36

SERVICE MARK

PRINCIPAL REGISTER

ALL-AMERICAN PUBLISHING, LLC (IDAHO LIMITED LIABILITY COMPANY)
5411 WEST KENDALL STREET
BOISE, ID 837061229

FOR: PROVIDING AN ON-LINE WEBSITE PLATFORM DESIGNED TO ASSIST SCHOOLS AND OTHER ORGANIZATIONS IN RAISING FUNDS FOR ACTIVITIES AND SPORTS PROGRAMS , IN CLASS 36 (U.S. CLS. 100, 101 AND 102).

FIRST USE 2-7-2011; IN COMMERCE 3-17-2011.

THE MARK CONSISTS OF STANDARD CHARACTERS WITHOUT CLAIM TO ANY PARTICULAR FONT, STYLE, SIZE, OR COLOR.

NO CLAIM IS MADE TO THE EXCLUSIVE RIGHT TO USE "BOOSTERS", APART FROM THE MARK AS SHOWN.

SER. NO. 85-475,965, FILED 11-17-2011.

JAY FLOWERS, EXAMINING ATTORNEY



David J. Kybas

Director of the United States Patent and Trademark Office

United States of America

United States Patent and Trademark Office

Vaffles

Reg. No. 4,175,181

KACHLER, KARIN I. (UNITED STATES INDIVIDUAL)
1597 GRANDOLA AVE
LOS ANGELES, CA 90041

Registered July 17, 2012

Int. Cl.: 30

FOR: WAFFLES, IN CLASS 30 (U.S. CL. 46).

TRADEMARK

FIRST USE 1-1-2006; IN COMMERCE 10-29-2011.

PRINCIPAL REGISTER

THE MARK CONSISTS OF STANDARD CHARACTERS WITHOUT CLAIM TO ANY PARTICULAR FONT, STYLE, SIZE, OR COLOR.

SER. NO. 85-475,970, FILED 11-17-2011.

JAY FLOWERS, EXAMINING ATTORNEY



David J. Kybas

Director of the United States Patent and Trademark Office

United States of America

United States Patent and Trademark Office

CHERRY GROVE VINEYARD

Reg. No. 4,175,182

CHERRY GROVE VINEYARD LLC (OREGON LIMITED LIABILITY COMPANY)
50045 PATTON VALLEY RD.
GASTON, OR 97119

Registered July 17, 2012

Int. Cl.: 33

FOR: WINE, IN CLASS 33 (U.S. CLS. 47 AND 49).

FIRST USE 11-20-2001; IN COMMERCE 11-1-2006.

TRADEMARK

THE MARK CONSISTS OF STANDARD CHARACTERS WITHOUT CLAIM TO ANY PARTICULAR FONT, STYLE, SIZE, OR COLOR.

PRINCIPAL REGISTER

NO CLAIM IS MADE TO THE EXCLUSIVE RIGHT TO USE "VINEYARD", APART FROM THE MARK AS SHOWN.

SER. NO. 85-475,971, FILED 11-17-2011.

JAY FLOWERS, EXAMINING ATTORNEY



David J. Kyffers

Director of the United States Patent and Trademark Office

United States of America
United States Patent and Trademark Office

EUPHURIA

Reg. No. 4,175,183

LISA BODHAINE (UNITED STATES INDIVIDUAL), DBA EUPHURIA
10538 MAGNOLIA BLVD.

Registered July 17, 2012

NORTH HOLLYWOOD, CA 91601

Int. Cl.: 44

FOR: PET CARE SERVICES, NAMELY, DOG WALKING, DOG BATHING AND NON-MEDICATED PET GROOMING; PET DENTIST SERVICES; PET GROOMING SERVICES , IN CLASS 44 (U.S. CLS. 100 AND 101).

SERVICE MARK

FIRST USE 7-1-1997; IN COMMERCE 7-1-1997.

PRINCIPAL REGISTER

THE MARK CONSISTS OF STANDARD CHARACTERS WITHOUT CLAIM TO ANY PARTICULAR FONT, STYLE, SIZE, OR COLOR.

SER. NO. 85-475,976, FILED 11-17-2011.

GEORGE LORENZO, EXAMINING ATTORNEY



David J. Kyffers

Director of the United States Patent and Trademark Office

United States of America

United States Patent and Trademark Office

LITTLE FRIENDS FOUNDATION

Reg. No. 4,175,184

Registered July 17, 2012

Int. Cl.: 45

SERVICE MARK

PRINCIPAL REGISTER

LITTLE FRIENDS INC. (NEVADA CORPORATION)
6631 SURREY STREET
LAS VEGAS, NV 89119

FOR: ANIMAL RESCUE SERVICES, NAMELY, ARRANGING FOR THE ADOPTION OF RESCUED ANIMALS; PROVIDING A WEB SITE FEATURING LISTINGS AND PHOTOGRAPHS OF PETS AVAILABLE FOR ADOPTION AND RELATED INFORMATION CONCERNING PET ADOPTION; PROVIDING INFORMATION ABOUT PET ADOPTION, IN CLASS 45 (U.S. CLS. 100 AND 101).

FIRST USE 3-15-2011; IN COMMERCE 3-15-2011.

THE MARK CONSISTS OF STANDARD CHARACTERS WITHOUT CLAIM TO ANY PARTICULAR FONT, STYLE, SIZE, OR COLOR.

NO CLAIM IS MADE TO THE EXCLUSIVE RIGHT TO USE "FOUNDATION", APART FROM THE MARK AS SHOWN.

SER. NO. 85-475,982, FILED 11-17-2011.

CHRISTOPHER BUONGIORNO, EXAMINING ATTORNEY



David J. Kybas

Director of the United States Patent and Trademark Office

United States of America

United States Patent and Trademark Office

DREAM-MARRIAGE

Reg. No. 4,175,185

DREAM MARRIAGE GROUP, INC. (NEVADA CORPORATION)
2533 N. CARSON ST., STE #3988
CARSON CITY, NV 89706

Registered July 17, 2012

Int. Cl.: 45

FOR: DATING SERVICES; DATING SERVICES, NAMELY, PROVIDING AN ON-LINE COMPUTER DATABASE FEATURING SINGLE PEOPLE INTERESTED IN MEETING OTHER SINGLE PEOPLE; MARRIAGE PARTNER INTRODUCTION OR DATING SERVICES; MATCHMAKING SERVICES, IN CLASS 45 (U.S. CLS. 100 AND 101).

SERVICE MARK

PRINCIPAL REGISTER

FIRST USE 12-17-2003; IN COMMERCE 12-17-2003.

THE MARK CONSISTS OF STANDARD CHARACTERS WITHOUT CLAIM TO ANY PARTICULAR FONT, STYLE, SIZE, OR COLOR.

OWNER OF U.S. REG. NO. 3,760,949.

SER. NO. 85-475,984, FILED 11-17-2011.

JOHN HWANG, EXAMINING ATTORNEY



David J. Kybas

Director of the United States Patent and Trademark Office

United States of America

United States Patent and Trademark Office



Reg. No. 4,175,186

Registered July 17, 2012

Int. Cl.: 16

TRADEMARK

PRINCIPAL REGISTER

INTERNATIONAL COUNCIL OF E-COMMERCE CONSULTANTS (NEVADA CORPORATION), AKA EC-COUNCIL
6330
RIVERSIDE PLAZA LANE NW
ALBUQUERQUE, NM 87120

FOR: EDUCATIONAL KITS SOLD AS A UNIT IN THE FIELD OF ETHICAL HACKING CONSISTING PRIMARILY OF EDUCATIONAL BOOKS AND ALSO INCLUDING DVDS AND T-SHIRTS, IN CLASS 16 (U.S. CLS. 2, 5, 22, 23, 29, 37, 38 AND 50).

FIRST USE 10-23-2001, THE MARK WAS FIRST USED ANYWHERE IN A DIFFERENT FORM OTHER THAN THAT SOUGHT TO BE REGISTERED AT LEAST AS EARLY AS 10/23/2001; IN COMMERCE 10-23-2001, THE MARK WAS FIRST USED IN COMMERCE IN A DIFFERENT FORM OTHER THAN THAT SOUGHT TO BE REGISTERED AT LEAST AS EARLY AS 10/23/2001.

NO CLAIM IS MADE TO THE EXCLUSIVE RIGHT TO USE "CERTIFIED" AND "HACKER", APART FROM THE MARK AS SHOWN.

THE MARK CONSISTS OF THE WORDING "C|EH" WITH "CERTIFIED", "ETHICAL", AND "HACKER" POSITIONED UNDERNEATH EACH LETTERING RESPECTIVELY, IN BLACK.

SEC. 2(F).

SER. NO. 85-476,001, FILED 11-18-2011.

C. DIONNE CLYBURN, EXAMINING ATTORNEY



David J. Kyffers

Director of the United States Patent and Trademark Office

United States of America

United States Patent and Trademark Office

MISEETX

Reg. No. 4,175,187

Registered July 17, 2012

Int. Cl.: 9

TRADEMARK

PRINCIPAL REGISTER

CTX VIRTUAL TECHNOLOGIES INC. (DELAWARE CORPORATION)
SUITE 726
2425 MATHESON BLVD EAST,
MISSISSAUGA, CANADA L4W5K4

FOR: COMPUTERS; LAPTOPS; NOTEBOOK COMPUTERS; HANDHELD COMPUTERS;
COMPUTER THAT FEATURES A PROJECTION KEYBOARD, PROJECTION MOUSE, TOUCH
SCREEN, AND PROJECTOR; COMPUTER THAT FEATURES ALL BUILT-IN INPUT AND
OUTPUT; AND MULTIMEDIA PROJECTORS, IN CLASS 9 (U.S. CLS. 21, 23, 26, 36 AND
38).

FIRST USE 10-1-2010; IN COMMERCE 1-8-2011.

THE MARK CONSISTS OF STANDARD CHARACTERS WITHOUT CLAIM TO ANY PAR-
TICULAR FONT, STYLE, SIZE, OR COLOR.

SER. NO. 85-476,019, FILED 11-18-2011.

DORITT L. CARROLL, EXAMINING ATTORNEY



David J. Kyffers

Director of the United States Patent and Trademark Office

United States of America
United States Patent and Trademark Office

FASTCOM

Reg. No. 4,175,188

FASTCOM, INC. (MICHIGAN CORPORATION)
6627 E MT HOPE HWY
GRAND LEDGE, MI 48837

Registered July 17, 2012

Int. Cl.: 37

FOR: LOW VOLTAGE VOICE, DATA, AND VIDEO NETWORK CABLING INFRASTRUCTURE INSTALLATION AND REPAIR SERVICES; VOICE, DATA, AND VIDEO NETWORK REPAIR SERVICES, IN CLASS 37 (U.S. CLS. 100, 103 AND 106).

SERVICE MARK

FIRST USE 1-1-2004; IN COMMERCE 1-1-2004.

PRINCIPAL REGISTER

THE MARK CONSISTS OF STANDARD CHARACTERS WITHOUT CLAIM TO ANY PARTICULAR FONT, STYLE, SIZE, OR COLOR.

SER. NO. 85-476,024, FILED 11-18-2011.

SHAUNIA CARLYLE, EXAMINING ATTORNEY



David J. Kyffers

Director of the United States Patent and Trademark Office

United States of America

United States Patent and Trademark Office

DRIPBOOK

Reg. No. 4,175,189

Registered July 17, 2012

Int. Cl.: 35

SERVICE MARK

PRINCIPAL REGISTER

DADAPHILE, INC (DELAWARE CORPORATION)
P.O. BOX 41837
AUSTIN, TX 78704

FOR: PROMOTIONAL SERVICES, NAMELY, PROVIDING A WEBSITE AT WHICH ARTISTS CAN SHOWCASE THEIR TALENTS VIA AN ONLINE PORTFOLIO, IN CLASS 35 (U.S. CLS. 100, 101 AND 102).

FIRST USE 4-1-2007; IN COMMERCE 12-20-2007.

THE MARK CONSISTS OF STANDARD CHARACTERS WITHOUT CLAIM TO ANY PARTICULAR FONT, STYLE, SIZE, OR COLOR.

SER. NO. 85-476,040, FILED 11-18-2011.

DAVID TOOLEY, EXAMINING ATTORNEY



David J. Kyffers

Director of the United States Patent and Trademark Office

United States of America

United States Patent and Trademark Office

KIDGOPHER

Reg. No. 4,175,190

Registered July 17, 2012

Int. Cl.: 9

TRADEMARK

PRINCIPAL REGISTER

CYNERGI SYSTEMS, LLC (SOUTH CAROLINA LIMITED LIABILITY COMPANY), DBA
CQ MEDIA
215 PARKWAY EAST
DUNCAN, SC 29334

FOR: COMPUTER SOFTWARE AND HARDWARE FOR PROVIDING A SECURE CHILD PICKUP SYSTEM FOR PLACING STUDENTS WITH THE PROPER INDIVIDUAL RETRIEVING THE STUDENT FROM A SCHOOL LOCATION, IN CLASS 9 (U.S. CLS. 21, 23, 26, 36 AND 38).

FIRST USE 8-19-2011; IN COMMERCE 8-19-2011.

THE MARK CONSISTS OF STANDARD CHARACTERS WITHOUT CLAIM TO ANY PARTICULAR FONT, STYLE, SIZE, OR COLOR.

SER. NO. 85-476,048, FILED 11-18-2011.

TOBY BULLOFF, EXAMINING ATTORNEY



David J. Kyffers

Director of the United States Patent and Trademark Office

United States of America

United States Patent and Trademark Office

ADVANCING CLEAN. DRIVING INNOVATION.

Reg. No. 4,175,191

INTERNATIONAL SANITARY SUPPLY ASSOCIATION (ILLINOIS CORPORATION)
7373 NORTH LINCOLN AVENUE
LINCOLNWOOD, IL 607121799

Registered July 17, 2012

Int. Cl.: 41

FOR: EDUCATION SERVICES, NAMELY, CONDUCTING WORKSHOPS, SEMINARS AND CLASSES IN THE FIELD OF CLEANING AND MAINTENANCE, IN CLASS 41 (U.S. CLS. 100, 101 AND 107).

SERVICE MARK

FIRST USE 10-3-2011; IN COMMERCE 10-3-2011.

PRINCIPAL REGISTER

THE MARK CONSISTS OF STANDARD CHARACTERS WITHOUT CLAIM TO ANY PARTICULAR FONT, STYLE, SIZE, OR COLOR.

SER. NO. 85-476,066, FILED 11-18-2011.

REBECCA GILBERT, EXAMINING ATTORNEY



David J. Kyjars

Director of the United States Patent and Trademark Office

United States of America

United States Patent and Trademark Office

WEARBLUSH

Reg. No. 4,175,192

Registered July 17, 2012

Int. Cl.: 25

TRADEMARK

PRINCIPAL REGISTER

UPRISING COMMUNICATIONS GROUP, LLC (CALIFORNIA LIMITED LIABILITY COMPANY)

3295 LAGUNA CANYON ROAD, SUITE G
LAGUNA BEACH, CA 92651

FOR: SHORTS; TANK TOPS; T-SHIRTS; SHIRTS, IN CLASS 25 (U.S. CLS. 22 AND 39).

FIRST USE 6-0-2010; IN COMMERCE 6-0-2010.

THE MARK CONSISTS OF STANDARD CHARACTERS WITHOUT CLAIM TO ANY PARTICULAR FONT, STYLE, SIZE, OR COLOR.

SER. NO. 85-476,072, FILED 11-18-2011.

ODESSA BIBBINS, EXAMINING ATTORNEY



David J. Kyffers

Director of the United States Patent and Trademark Office

United States of America

United States Patent and Trademark Office

SAFE, EASY & EFFECTIVE FUNDING

Reg. No. 4,175,193

CENTURY RESOURCES, INC. (OHIO CORPORATION)
3730 LOCKBOURNE ROAD
COLUMBUS, OH 43207

Registered July 17, 2012

Int. Cl.: 36

FOR: CHARITABLE FUNDRAISING SERVICES BY MEANS OF SELLING GOODS TO RAISE FUNDS, IN CLASS 36 (U.S. CLS. 100, 101 AND 102).

SERVICE MARK

FIRST USE 9-1-2008; IN COMMERCE 9-1-2008.

PRINCIPAL REGISTER

THE MARK CONSISTS OF STANDARD CHARACTERS WITHOUT CLAIM TO ANY PARTICULAR FONT, STYLE, SIZE, OR COLOR.

SER. NO. 85-476,081, FILED 11-18-2011.

MICHAEL TANNER, EXAMINING ATTORNEY



David J. Kybas

Director of the United States Patent and Trademark Office

United States of America

United States Patent and Trademark Office

THALO

Reg. No. 4,175,194

Registered July 17, 2012

Int. Cl.: 9

TRADEMARK

PRINCIPAL REGISTER

CHARTPAK, INC. (DELAWARE CORPORATION)
SUITE 205
510 BROAD HOLLOW ROAD
MELVILLE, NY 11747

FOR: AUDIO AND VIDEO RECORDINGS IN THE FIELD OF ART, IN CLASS 9 (U.S. CLS. 21, 23, 26, 36 AND 38).

FIRST USE 7-1-2011; IN COMMERCE 7-1-2011.

THE MARK CONSISTS OF STANDARD CHARACTERS WITHOUT CLAIM TO ANY PARTICULAR FONT, STYLE, SIZE, OR COLOR.

OWNER OF U.S. REG. NOS. 508,554 AND 4,029,697.

SER. NO. 85-476,098, FILED 11-18-2011.

REBECCA POVARCHUK, EXAMINING ATTORNEY



David J. Kybas

Director of the United States Patent and Trademark Office

United States of America

United States Patent and Trademark Office

BURN RUBBER TO HELP ANOTHER

Reg. No. 4,175,195

Registered July 17, 2012

Int. Cl.: 36

SERVICE MARK

PRINCIPAL REGISTER

INSPIRED ATHLETES, INC. (VIRGINIA NON-PROFIT CORPORATION)
POST OFFICE BOX 52
WOODBIDGE, VA 22194

FOR: CHARITABLE FUNDRAISING SERVICES, IN CLASS 36 (U.S. CLS. 100, 101 AND 102).

FIRST USE 3-3-2011; IN COMMERCE 3-3-2011.

THE MARK CONSISTS OF STANDARD CHARACTERS WITHOUT CLAIM TO ANY PARTICULAR FONT, STYLE, SIZE, OR COLOR.

SER. NO. 85-476,128, FILED 11-18-2011.

COLLEEN DOMBROW, EXAMINING ATTORNEY



David J. Kyffers

Director of the United States Patent and Trademark Office

United States of America

United States Patent and Trademark Office

delivered fresh to your dog

Reg. No. 4,175,196

Registered July 17, 2012

Int. Cl.: 31

TRADEMARK

PRINCIPAL REGISTER

SLAWSKY HOLDINGS LLC (KENTUCKY LIMITED LIABILITY COMPANY), DBA ROCKO'S
REWARDS
1818 SHERWOOD AVE
LOUISVILLE, KY 40205

FOR: PET TREATS, IN CLASS 31 (U.S. CLS. 1 AND 46).

FIRST USE 12-10-2007; IN COMMERCE 12-10-2007.

THE MARK CONSISTS OF STANDARD CHARACTERS WITHOUT CLAIM TO ANY PARTICULAR FONT, STYLE, SIZE, OR COLOR.

SER. NO. 85-476,166, FILED 11-18-2011.

BRIAN NEVILLE, EXAMINING ATTORNEY



David J. Kyffers

Director of the United States Patent and Trademark Office

United States of America

United States Patent and Trademark Office



Reg. No. 4,175,197

Registered July 17, 2012

Int. Cl.: 25

TRADEMARK

PRINCIPAL REGISTER

NTA ENTERPRISE (PENNSYLVANIA CORPORATION)
RJ CASEY INDUSTRIAL PARK
COLUMBUS AVE
PITTSBURGH, PA 15233

FOR: BIB OVERALLS; BIB OVERALLS FOR HUNTING; CAMOUFLAGE JACKETS; CAMOUFLAGE PANTS; EAR MUFFS; GLOVES; GLOVES AS CLOTHING; GLOVES FOR APPAREL; HATS; HUNTING JACKETS; HUNTING PANTS; HUNTING SHIRTS; HUNTING VESTS; JACKETS AND SOCKS; MUFFS; OUTDOOR GLOVES; OUTER JACKETS; OVERALLS; PANTS; SCARVES; SLEEVED OR SLEEVELESS JACKETS; SOCKS; THERMAL SOCKS, IN CLASS 25 (U.S. CLS. 22 AND 39).

FIRST USE 2-11-2011; IN COMMERCE 2-11-2011.

OWNER OF U.S. REG. NO. 3,350,941.

THE MARK CONSISTS OF AN IMAGE OF A BIFURCATED BULLET WITH ANTLERS EXTENDING FROM EACH BULLET HALF AND WITH THE PAIR OF ANTLERS FORMING AN ANTLER RACK, AND THE WORD HUNTWORTH CENTERED BELOW THE IMAGE.

SER. NO. 85-476,233, FILED 11-18-2011.

MIDGE BUTLER, EXAMINING ATTORNEY



David J. Kybas

Director of the United States Patent and Trademark Office

United States of America

United States Patent and Trademark Office

Revolutionary Trading

Reg. No. 4,175,198

Registered July 17, 2012

Int. Cl.: 41

SERVICE MARK

PRINCIPAL REGISTER

REVOLUTIONARYTRADING (COLORADO LIMITED LIABILITY COMPANY)
SUITE 400
1745 SHEA CENTER DRIVE
HIGHLANDS RANCH, CO 80129

FOR: EDUCATIONAL SERVICES, NAMELY, CONDUCTING ON-LINE AND LIVE WORKSHOPS, COURSES, SEMINARS, EDUCATIONAL PROGRAMS, COACHING, AND MENTORING IN THE FIELD OF STOCK MARKET EQUITIES AND OTHER SECURITIES FOR SELF-DIRECTED TRADING AND INVESTING MANAGEMENT AND STOCK MARKET EQUITY TRADING AND INVESTING STRATEGIES AND DISTRIBUTION OF EDUCATIONAL MATERIALS IN CONNECTION THEREWITH, IN CLASS 41 (U.S. CLS. 100, 101 AND 107).

FIRST USE 3-5-2010; IN COMMERCE 3-5-2010.

THE MARK CONSISTS OF STANDARD CHARACTERS WITHOUT CLAIM TO ANY PARTICULAR FONT, STYLE, SIZE, OR COLOR.

NO CLAIM IS MADE TO THE EXCLUSIVE RIGHT TO USE "TRADING" , APART FROM THE MARK AS SHOWN.

SER. NO. 85-476,251, FILED 11-18-2011.

LAURIE MAYES, EXAMINING ATTORNEY



David J. Kyros

Director of the United States Patent and Trademark Office

United States of America

United States Patent and Trademark Office

SKITTLES

Reg. No. 4,175,199

Registered July 17, 2012

Int. Cl.: 3

TRADEMARK

PRINCIPAL REGISTER

WM. WRIGLEY JR. COMPANY (DELAWARE CORPORATION)
410 NORTH MICHIGAN AVENUE
CHICAGO, IL 60611

FOR: LIP BALM, IN CLASS 3 (U.S. CLS. 1, 4, 6, 50, 51 AND 52).

FIRST USE 3-0-2004; IN COMMERCE 3-0-2004.

THE MARK CONSISTS OF STANDARD CHARACTERS WITHOUT CLAIM TO ANY PARTICULAR FONT, STYLE, SIZE, OR COLOR.

SER. NO. 85-476,253, FILED 11-18-2011.

KATHLEEN LORENZO, EXAMINING ATTORNEY



David J. Kybas

Director of the United States Patent and Trademark Office

United States of America

United States Patent and Trademark Office

ZEYKOH

Reg. No. 4,175,200

AVANTITEK, CORP. (FLORIDA CORPORATION)
7620 NW 25TH STREET
MIAMI, FL 33122

Registered July 17, 2012

Int. Cl.: 9

FOR: CLOSED CIRCUIT TV SYSTEMS FOR SECURITY AND SURVEILLANCE, NAMELY, CAMERAS, SWITCHERS, MONITORS, MICROPHONES, AND RECORDERS; ELECTRONIC EQUIPMENT, NAMELY, TRANSFORMERS, BALUNS, CABLES USED IN CONNECTION WITH COMPUTERS, COMPUTER PERIPHERAL DEVICES, TELEVISIONS, AUDIO-VIDEO EQUIPMENT, CLOSED-CIRCUIT TV EQUIPMENT AND TELECOMMUNICATION EQUIPMENT, IN CLASS 9 (U.S. CLS. 21, 23, 26, 36 AND 38).

TRADEMARK

PRINCIPAL REGISTER

FIRST USE 3-1-2011; IN COMMERCE 4-1-2011.

THE MARK CONSISTS OF STANDARD CHARACTERS WITHOUT CLAIM TO ANY PARTICULAR FONT, STYLE, SIZE, OR COLOR.

THE WORDING "ZEYKOH" HAS NO MEANING IN A FOREIGN LANGUAGE.

SER. NO. 85-476,259, FILED 11-18-2011.

ROBIN MITTLER, EXAMINING ATTORNEY



David J. Kybas

Director of the United States Patent and Trademark Office

United States of America

United States Patent and Trademark Office

YOUR ONE STOP HOOD SHOP

Reg. No. 4,175,201

HOODMART, INC. (OHIO CORPORATION)

Registered July 17, 2012

P.O. BOX 1808
CAMBRIDGE, OH 43725

Int. Cl.: 11

FOR: EXHAUST HOODS FOR KITCHENS; FILTERS FOR AIR EXTRACTOR HOODS; HOODS FOR RANGES; LABORATORY VENTILATION HOODS; OVEN VENTILATOR HOODS; RANGE HOODS; RANGE HOODS; VENTILATING EXHAUST FANS; VENTILATION HOODS; VENTILATION HOODS FOR STOVES, IN CLASS 11 (U.S. CLS. 13, 21, 23, 31 AND 34).

TRADEMARK

PRINCIPAL REGISTER

FIRST USE 9-14-2004; IN COMMERCE 9-14-2004.

THE MARK CONSISTS OF STANDARD CHARACTERS WITHOUT CLAIM TO ANY PARTICULAR FONT, STYLE, SIZE, OR COLOR.

SER. NO. 85-476,270, FILED 11-18-2011.

MIDGE BUTLER, EXAMINING ATTORNEY



David J. Kyffers

Director of the United States Patent and Trademark Office

United States of America

United States Patent and Trademark Office



Reg. No. 4,175,202

Registered July 17, 2012

Int. Cls.: 7, 10, 17 and 25

SOCIETE D'IMPORTATION DE DIFFUSION OU DISTRIBUTION D'ARTICLES DE SPORT
S.I.D.A.S. (FRANCE SOCIÉTÉ PAR ACTIONS SIMPLIFIÉE (SAS))
ZAC CHAMPFEUILLET
18 RUE LÉON BÉRIDOT
VOIRON, FRANCE 38500

TRADEMARK

PRINCIPAL REGISTER

FOR: MACHINES USED IN ORTHOPAEDICS, CHIROPODY AND PEDICURE FOR THE REPRODUCTION OF THE SHAPE OF THE FOOT BY MOULDING, TAKING OF FOOTPRINTS AND THE MANUFACTURE OF ORTHOPAEDIC SOLES; MACHINES FOR MOULDING OF SOLES OF THERMO-FORMED MATERIALS, IN CLASS 7 (U.S. CLS. 13, 19, 21, 23, 31, 34 AND 35).

FIRST USE 7-0-2011; IN COMMERCE 8-0-2011.

FOR: ORTHOPAEDIC SHOES; ORTHOPAEDIC SOLES FOR SHOES, ORTHOPAEDIC SOLES OF THERMO-FORMED MATERIALS, IN CLASS 10 (U.S. CLS. 26, 39 AND 44).

FIRST USE 7-0-2011; IN COMMERCE 8-0-2011.

FOR: NATURAL OR SYNTHETIC RUBBER BASED MATERIALS ALL FOR THE FABRICATION OF SHOE INSOLES, LINING OF ORTHOPAEDIC FOOTWEAR AND SHELLS AND BODIES OF HEELS, IN CLASS 17 (U.S. CLS. 1, 5, 12, 13, 35 AND 50).

FIRST USE 7-0-2011; IN COMMERCE 8-0-2011.

FOR: SHOES, FLIP-FLOPS, SLIPPERS, INNER SLIPPERS FOR SHOES, SANDALS, SOLES, INNER SOLES FOR SHOES, HEELS AND HEELPIECES FOR SHOES; BOOTS; SOCKS, IN CLASS 25 (U.S. CLS. 22 AND 39).

FIRST USE 7-0-2011; IN COMMERCE 8-0-2011.

THE MARK CONSISTS OF A DESIGN OF TWO FEET WITHIN A CIRCLE.

SER. NO. 85-476,281, FILED 11-18-2011.

EVELYN BRADLEY, EXAMINING ATTORNEY



David J. Kyros

Director of the United States Patent and Trademark Office

United States of America

United States Patent and Trademark Office

Ramona Ranch

Reg. No. 4,175,203

RAMONA RANCH WINERY LLC (CALIFORNIA LIMITED LIABILITY COMPANY)
23578 HIGHWAY 78
RAMONA, CA 92065

Registered July 17, 2012

Int. Cl.: 33

FOR: WINES, IN CLASS 33 (U.S. CLS. 47 AND 49).

FIRST USE 9-1-2011; IN COMMERCE 9-1-2011.

TRADEMARK

THE MARK CONSISTS OF STANDARD CHARACTERS WITHOUT CLAIM TO ANY PARTICULAR FONT, STYLE, SIZE, OR COLOR.

PRINCIPAL REGISTER

NO CLAIM IS MADE TO THE EXCLUSIVE RIGHT TO USE "RAMONA", APART FROM THE MARK AS SHOWN.

SER. NO. 85-476,287, FILED 11-18-2011.

KATHY DE JONGE, EXAMINING ATTORNEY



David J. Kyffers

Director of the United States Patent and Trademark Office

United States of America

United States Patent and Trademark Office

VERMISOIL

Reg. No. 4,175,204

Registered July 17, 2012

Int. Cl.: 1

TRADEMARK

PRINCIPAL REGISTER

BIO-ORGANIC SOLUTIONS, INC. (CALIFORNIA CORPORATION)
4265 DULUTH AVENUE
ROCKLIN, CA 95765

FOR: POTTING SOIL, IN CLASS 1 (U.S. CLS. 1, 5, 6, 10, 26 AND 46).

FIRST USE 12-5-2008; IN COMMERCE 12-5-2008.

THE MARK CONSISTS OF STANDARD CHARACTERS WITHOUT CLAIM TO ANY PARTICULAR FONT, STYLE, SIZE, OR COLOR.

OWNER OF U.S. REG. NO. 3,408,907.

SER. NO. 85-476,293, FILED 11-18-2011.

RONALD AIKENS, EXAMINING ATTORNEY



David J. Kyffers

Director of the United States Patent and Trademark Office

United States of America

United States Patent and Trademark Office

TRASHSTASH

Reg. No. 4,175,205

TALUS CORPORATION (MAINE CORPORATION)
470 RIVERSIDE STREET
PORTLAND, ME 04103

Registered July 17, 2012

Int. Cl.: 12

FOR: AUTO ACCESSORIES, NAMELY, AUTOMOBILE LITTER BAGS, IN CLASS 12 (U.S. CLS. 19, 21, 23, 31, 35 AND 44).

TRADEMARK

FIRST USE 0-0-1990; IN COMMERCE 0-0-1990.

PRINCIPAL REGISTER

THE MARK CONSISTS OF STANDARD CHARACTERS WITHOUT CLAIM TO ANY PARTICULAR FONT, STYLE, SIZE, OR COLOR.

SER. NO. 85-476,295, FILED 11-18-2011.

MIDGE BUTLER, EXAMINING ATTORNEY



David J. Kyffers

Director of the United States Patent and Trademark Office

United States of America

United States Patent and Trademark Office

CLEAN, LEAN
and Sexy

Reg. No. 4,175,206

Registered July 17, 2012

Int. Cl.: 41

SERVICE MARK

PRINCIPAL REGISTER

SUZIE CARPENTER HEALTH COACHING (PENNSYLVANIA SOLE PROPRIETORSHIP)
ONE PARK PLAZA
WYOMISSING, PA 19610

FOR: PERSONAL COACHING SERVICES IN THE FIELD OF HEALTH, WELLNESS AND NUTRITION; PROVIDING INDIVIDUAL AND GROUP COACHING IN THE FIELD OF HEALTH, WELLNESS AND NUTRITION, IN CLASS 41 (U.S. CLS. 100, 101 AND 107).

FIRST USE 9-18-2011; IN COMMERCE 9-18-2011.

THE MARK CONSISTS OF THE PHRASE "CLEAN, LEAN" IN BLOCK LETTERS AND IS ABOVE THE PHRASE "AND SEXY," WHICH IS IN SCRIPT. A HORIZONTAL LINE EXTENDS BENEATH THE PHRASE "AND SEXY."

SER. NO. 85-476,308, FILED 11-18-2011.

JASON BLAIR, EXAMINING ATTORNEY



David J. Kyffers

Director of the United States Patent and Trademark Office

United States of America

United States Patent and Trademark Office



Reg. No. 4,175,207

THE BOSL GROUP, INC. (VIRGINIA CORPORATION)
1021 NORTH GARFIELD STREET, SUITE 727
ARLINGTON, VA 22201

Registered July 17, 2012

Int. Cl.: 36

FOR: PROVIDING REAL ESTATE LISTINGS AND REAL ESTATE INFORMATION VIA THE INTERNET; REAL ESTATE BROKERAGE SERVICES; PROVIDING AN INTERNET WEBSITE OFFERING INFORMATION IN THE FIELDS OF REAL ESTATE CONCERNING THE PURCHASE, SALE, AND LEASING OF NEW AND RESALE REAL ESTATE, IN CLASS 36 (U.S. CLS. 100, 101 AND 102).

SERVICE MARK

PRINCIPAL REGISTER

FIRST USE 11-11-2011; IN COMMERCE 11-11-2011.

THE MARK CONSISTS OF THE WORDS "THE CONDOHUB", IN WHICH THE FINAL "O" IN "CONDO" CONSISTS OF CONCENTRIC CIRCLES ATTACHED TO THREE SPOKES AND CIRCLES AT THE END OF THE SPOKES. THE GRAY REPRESENTS SHADING.

SER. NO. 85-476,343, FILED 11-18-2011.

JAMES LOVELACE, EXAMINING ATTORNEY



David J. Kyffers

Director of the United States Patent and Trademark Office

United States of America

United States Patent and Trademark Office

twilight

Reg. No. 4,175,208

SUMMIT ENTERTAINMENT, LLC (DELAWARE LIMITED LIABILITY COMPANY)
1630 STEWART STREET, SUITE 120
SANTA MONICA, CA 90404

Registered July 17, 2012

Int. Cl.: 11

FOR: HAND-HELD ELECTRIC HAIR DRYERS, IN CLASS 11 (U.S. CLS. 13, 21, 23, 31 AND 34).

TRADEMARK

FIRST USE 9-23-2011; IN COMMERCE 9-23-2011.

PRINCIPAL REGISTER

OWNER OF U.S. REG. NOS. 3,817,079, 3,884,386 AND OTHERS.

THE MARK CONSISTS OF THE WORD "TWILIGHT" IN A STYLIZED FONT.

SER. NO. 85-476,363, FILED 11-18-2011.

BARBARA RUTLAND, EXAMINING ATTORNEY



David J. Kyffers

Director of the United States Patent and Trademark Office

United States of America

United States Patent and Trademark Office

SimplySkin Rx

Reg. No. 4,175,209

Registered July 17, 2012

Int. Cl.: 3

TRADEMARK

PRINCIPAL REGISTER

SIMPLYSKIN RX, LLC (ALABAMA LIMITED LIABILITY COMPANY)
SUITE J
2422-J DANVILLE ROAD SW
DECATUR, AL 35603

FOR: COSMETIC CREAMS FOR SKIN CARE, IN CLASS 3 (U.S. CLS. 1, 4, 6, 50, 51 AND 52).

FIRST USE 6-17-2011; IN COMMERCE 9-1-2011.

THE MARK CONSISTS OF STANDARD CHARACTERS WITHOUT CLAIM TO ANY PARTICULAR FONT, STYLE, SIZE, OR COLOR.

NO CLAIM IS MADE TO THE EXCLUSIVE RIGHT TO USE "RX", APART FROM THE MARK AS SHOWN.

SER. NO. 85-476,367, FILED 11-18-2011.

MIDGE BUTLER, EXAMINING ATTORNEY



David J. Kyffers

Director of the United States Patent and Trademark Office

United States of America

United States Patent and Trademark Office

Boomerang Promotions

Reg. No. 4,175,210

BOOMERANG PROMOTIONS, INC. (VIRGINIA CORPORATION)

Registered July 17, 2012

256 MEDLOCK LANE
ALEXANDRIA, VA 22304

Int. Cl.: 40

FOR: CUSTOMIZED PRINTING, CUTTING, SHAPING, POLISHING BY ABRASION, ENGRAVING, AND METAL COATING OF COMPANY NAMES AND LOGOS FOR PROMOTIONAL AND ADVERTISING PURPOSES ON THE GOODS OF OTHERS, IN CLASS 40 (U.S. CLS. 100, 103 AND 106).

SERVICE MARK

PRINCIPAL REGISTER

FIRST USE 7-31-2002; IN COMMERCE 7-31-2002.

THE MARK CONSISTS OF STANDARD CHARACTERS WITHOUT CLAIM TO ANY PARTICULAR FONT, STYLE, SIZE, OR COLOR.

NO CLAIM IS MADE TO THE EXCLUSIVE RIGHT TO USE "PROMOTIONS", APART FROM THE MARK AS SHOWN.

SER. NO. 85-476,370, FILED 11-18-2011.

TARAH HARDY, EXAMINING ATTORNEY



David J. Kyfos

Director of the United States Patent and Trademark Office

United States of America
United States Patent and Trademark Office

Boomerang

Reg. No. 4,175,211

BOOMERANG PROMOTIONS, INC. (VIRGINIA CORPORATION)
256 MEDLOCK LANE
ALEXANDRIA, VA 22304

Registered July 17, 2012

Int. Cl.: 40

FOR: CUSTOMIZED PRINTING, CUTTING, SHAPING, POLISHING BY ABRASION, ENGRAVING, AND METAL COATING OF COMPANY NAMES AND LOGOS FOR PROMOTIONAL AND ADVERTISING PURPOSES ON THE GOODS OF OTHERS, IN CLASS 40 (U.S. CLS. 100, 103 AND 106).

SERVICE MARK

PRINCIPAL REGISTER

FIRST USE 7-31-2002; IN COMMERCE 7-31-2002.

THE MARK CONSISTS OF STANDARD CHARACTERS WITHOUT CLAIM TO ANY PARTICULAR FONT, STYLE, SIZE, OR COLOR.

SER. NO. 85-476,377, FILED 11-18-2011.

TARAH HARDY, EXAMINING ATTORNEY



David J. Kyffers

Director of the United States Patent and Trademark Office

United States of America

United States Patent and Trademark Office

VERMI T

Reg. No. 4,175,212

BIO-ORGANIC SOLUTIONS, INC. (CALIFORNIA CORPORATION)
4265 DULUTH AVENUE
ROCKLIN, CA 95765

Registered July 17, 2012

Int. Cl.: 1

FOR: FERTILIZERS, IN CLASS 1 (U.S. CLS. 1, 5, 6, 10, 26 AND 46).

TRADEMARK

FIRST USE 8-17-2007; IN COMMERCE 8-17-2007.

PRINCIPAL REGISTER

THE MARK CONSISTS OF STANDARD CHARACTERS WITHOUT CLAIM TO ANY PARTICULAR FONT, STYLE, SIZE, OR COLOR.

OWNER OF U.S. REG. NO. 3,408,907.

SER. NO. 85-476,396, FILED 11-18-2011.

RONALD AIKENS, EXAMINING ATTORNEY



David J. Kyffers

Director of the United States Patent and Trademark Office

United States of America

United States Patent and Trademark Office

CHOCK STYX

Reg. No. 4,175,213

Registered July 17, 2012

Int. Cl.: 20

TRADEMARK

PRINCIPAL REGISTER

CHOCK STYX (CALIFORNIA PARTNERSHIP)
555 W COUNTRY CLUB LANE, C175
ESCONDIDO, CA 92026

FOR: PLASTIC WHEEL CHOCKS, IN CLASS 20 (U.S. CLS. 2, 13, 22, 25, 32 AND 50).

FIRST USE 11-1-2011; IN COMMERCE 11-1-2011.

THE MARK CONSISTS OF STANDARD CHARACTERS WITHOUT CLAIM TO ANY PARTICULAR FONT, STYLE, SIZE, OR COLOR.

NO CLAIM IS MADE TO THE EXCLUSIVE RIGHT TO USE "CHOCK", APART FROM THE MARK AS SHOWN.

SER. NO. 85-476,402, FILED 11-18-2011.

ANTHONY RINKER, EXAMINING ATTORNEY



David J. Kyffers

Director of the United States Patent and Trademark Office

United States of America

United States Patent and Trademark Office

KH

Reg. No. 4,175,214

Registered July 17, 2012

Int. Cl.: 15

TRADEMARK

PRINCIPAL REGISTER

KIRK HAMMETT (UNITED STATES INDIVIDUAL)
C/O PROVIDENT FINANCIAL MANAGEMENT
2020 UNION STREET
SAN FRANCISCO, CA 94123

FOR: MUSICAL INSTRUMENTS AND STRAPS THEREFORE; CARRYING CASES FOR
MUSICAL INSTRUMENTS, IN CLASS 15 (U.S. CLS. 2, 21 AND 36).

FIRST USE 1-22-2011; IN COMMERCE 1-22-2011.

THE MARK CONSISTS OF STANDARD CHARACTERS WITHOUT CLAIM TO ANY PAR-
TICULAR FONT, STYLE, SIZE, OR COLOR.

SER. NO. 85-476,416, FILED 11-18-2011.

DAVID MURRAY, EXAMINING ATTORNEY



David J. Kyffers

Director of the United States Patent and Trademark Office

United States of America

United States Patent and Trademark Office

MidnightBox

Reg. No. 4,175,215

DIGITALFIX.COM, LLC (NEW YORK LIMITED LIABILITY COMPANY)
3253 WALDEN AVENUE
DEPEW, NY 14043

Registered July 17, 2012

Int. Cl.: 35

FOR: ON-LINE RETAIL STORE SERVICES FEATURING A WIDE VARIETY OF CONSUMER GOODS OF OTHERS; COMPUTERIZED ON-LINE ORDERING FEATURING GENERAL MERCHANDISE AND GENERAL CONSUMER GOODS, IN CLASS 35 (U.S. CLS. 100, 101 AND 102).

SERVICE MARK

PRINCIPAL REGISTER

FIRST USE 5-23-2005; IN COMMERCE 5-23-2005.

THE MARK CONSISTS OF STANDARD CHARACTERS WITHOUT CLAIM TO ANY PARTICULAR FONT, STYLE, SIZE, OR COLOR.

SER. NO. 85-476,431, FILED 11-18-2011.

APRIL HESIK, EXAMINING ATTORNEY



David J. Kyffers

Director of the United States Patent and Trademark Office

United States of America

United States Patent and Trademark Office

cororganic

Reg. No. 4,175,216

Registered July 17, 2012

Int. Cl.: 35

SERVICE MARK

PRINCIPAL REGISTER

TASLAKIAN, PETER (UNITED STATES INDIVIDUAL), DBA CORORGANIC
8834 DEMPSEY AVE
8546 SEPULVEDA BLVD, # 4
NORTH HILLS, CA 913434828

FOR: WHOLESALE FOOD DISTRIBUTORSHIP SERVICES FEATURING ORGANIC FOODS,
IN CLASS 35 (U.S. CLS. 100, 101 AND 102).

FIRST USE 11-11-2011; IN COMMERCE 11-11-2011.

THE MARK CONSISTS OF STANDARD CHARACTERS WITHOUT CLAIM TO ANY PAR-
TICULAR FONT, STYLE, SIZE, OR COLOR.

SER. NO. 85-476,432, FILED 11-18-2011.

APRIL HESIK, EXAMINING ATTORNEY



David J. Kyros

Director of the United States Patent and Trademark Office

United States of America

United States Patent and Trademark Office

AgileStamp

Reg. No. 4,175,217

BRAUN INTERTEC CORPORATION (MINNESOTA CORPORATION)
11001 HAMPSHIRE AVENUE SOUTH
MINNEAPOLIS, MN 55438

Registered July 17, 2012

Int. Cl.: 42

FOR: SOFTWARE AS A SERVICE (SAAS) SERVICES FEATURING SOFTWARE FOR SERVICES TO CREATE, FACILITATE, VIEW, CAPTURE AND STORE ELECTRONIC AND DIGITAL SIGNATURES FOR DOCUMENTS AND FILES RELATED TO ELECTRONIC DATA TRANSMITTED VIA A COMPUTER NETWORK; PROVIDING A WEBSITE THAT ALLOWS USERS TO UPLOAD AND ATTACH ELECTRONIC AND DIGITAL SIGNATURES TO A DOCUMENT OR FILE FOR COMMUNICATION VIA A GLOBAL COMPUTER NETWORK, IN CLASS 42 (U.S. CLS. 100 AND 101).

SERVICE MARK

PRINCIPAL REGISTER

FIRST USE 10-4-2011; IN COMMERCE 10-4-2011.

THE MARK CONSISTS OF STANDARD CHARACTERS WITHOUT CLAIM TO ANY PARTICULAR FONT, STYLE, SIZE, OR COLOR.

SER. NO. 85-476,433, FILED 11-18-2011.

MIDGE BUTLER, EXAMINING ATTORNEY



David J. Kyffers

Director of the United States Patent and Trademark Office

United States of America

United States Patent and Trademark Office

CONVICTED 2 CHANGE

Reg. No. 4,175,218

RODERICK N. WILLIAMS (UNITED STATES INDIVIDUAL)
1422 N ORLEANS STREET #4S
CHICAGO, IL 60610

Registered July 17, 2012

Int. Cl.: 41

FOR: EDUCATIONAL SERVICES, NAMELY, PROVIDING FAITH-BASED CLASSES, WORKSHOPS AND SEMINARS FOR INCARCERATED AND FORMERLY INCARCERATED INDIVIDUALS IN THE FIELD OF SPIRITUALITY, PERSONAL GROWTH AND DEVELOPMENT AND RELATIONSHIPS, IN CLASS 41 (U.S. CLS. 100, 101 AND 107).

SERVICE MARK

PRINCIPAL REGISTER

FIRST USE 5-31-2009; IN COMMERCE 5-31-2009.

THE MARK CONSISTS OF STANDARD CHARACTERS WITHOUT CLAIM TO ANY PARTICULAR FONT, STYLE, SIZE, OR COLOR.

SER. NO. 85-476,435, FILED 11-18-2011.

DAVID MURRAY, EXAMINING ATTORNEY



David J. Kyffers

Director of the United States Patent and Trademark Office

United States of America

United States Patent and Trademark Office

gardeninmyeyes

Reg. No. 4,175,219

GIANNOSA, MARCIANNE (UNITED STATES INDIVIDUAL)
23828 LYNNHURST
MACOMB, MI 48042

Registered July 17, 2012

Int. Cl.: 16

FOR: CALENDARS; GREETING CARDS; POSTERS, IN CLASS 16 (U.S. CLS. 2, 5, 22, 23, 29, 37, 38 AND 50).

TRADEMARK

FIRST USE 9-2-2011; IN COMMERCE 9-2-2011.

PRINCIPAL REGISTER

THE MARK CONSISTS OF STANDARD CHARACTERS WITHOUT CLAIM TO ANY PARTICULAR FONT, STYLE, SIZE, OR COLOR.

SER. NO. 85-476,441, FILED 11-18-2011.

BARNEY CHARLON, EXAMINING ATTORNEY



David J. Kyffers

Director of the United States Patent and Trademark Office

United States of America

United States Patent and Trademark Office

FIRST NESTERS

Reg. No. 4,175,220

Registered July 17, 2012

Int. Cl.: 43

SERVICE MARK

PRINCIPAL REGISTER

FORD, JERRY (UNITED STATES INDIVIDUAL)
2602 SOUTH DUNDEE STREET
TAMPA, FL 33629 AND

FORD, JANE (UNITED STATES INDIVIDUAL)
2602 SOUTH DUNDEE STREET
TAMPA, FL 33629

FOR: CHARITABLE SERVICES, NAMELY, PROVIDING FURNITURE AND HOUSEHOLD ITEMS FOR PEOPLE IN NEED, IN CLASS 43 (U.S. CLS. 100 AND 101).

FIRST USE 7-0-2011; IN COMMERCE 7-0-2011.

THE MARK CONSISTS OF STANDARD CHARACTERS WITHOUT CLAIM TO ANY PARTICULAR FONT, STYLE, SIZE, OR COLOR.

SER. NO. 85-476,447, FILED 11-18-2011.

HOWARD B. LEVINE, EXAMINING ATTORNEY



David J. Kybas

Director of the United States Patent and Trademark Office

United States of America

United States Patent and Trademark Office

Phoenix Trading

Reg. No. 4,175,221

Registered July 17, 2012

Int. Cls.: 35 and 39

SERVICE MARK

PRINCIPAL REGISTER

PHOENIX TRADING INC. (MARYLAND CORPORATION)
UNIT G
647 LOFSTRAND LANE
ROCKVILLE, MD 20850

FOR: WHOLESALE DISTRIBUTORSHIPS FEATURING GROUND SUPPORT EQUIPMENT AND PARTS FOR THE AVIATION INDUSTRY AND EQUIPMENT AND PARTS FOR THE CONSTRUCTION, MINING, AND OIL, GAS AND PETROLEUM INDUSTRIES, AND EQUIPMENT AND PARTS FOR THE MILITARY, IN CLASS 35 (U.S. CLS. 100, 101 AND 102).

FIRST USE 10-31-2006; IN COMMERCE 10-31-2006.

FOR: SPECIALIZED PACKAGING SERVICES FOR MILITARY EQUIPMENT AND PARTS, IN CLASS 39 (U.S. CLS. 100 AND 105).

FIRST USE 10-31-2006; IN COMMERCE 10-31-2006.

THE MARK CONSISTS OF STANDARD CHARACTERS WITHOUT CLAIM TO ANY PARTICULAR FONT, STYLE, SIZE, OR COLOR.

NO CLAIM IS MADE TO THE EXCLUSIVE RIGHT TO USE "TRADING", APART FROM THE MARK AS SHOWN.

SER. NO. 85-476,452, FILED 11-18-2011.

JORDAN BAKER, EXAMINING ATTORNEY



David J. Kyffers

Director of the United States Patent and Trademark Office

United States of America

United States Patent and Trademark Office

AgilePort

Reg. No. 4,175,222

Registered July 17, 2012

Int. Cl.: 42

SERVICE MARK

PRINCIPAL REGISTER

BRAUN INTERTEC CORPORATION (MINNESOTA CORPORATION)
11001 HAMPSHIRE AVENUE SOUTH
MINNEAPOLIS, MN 55438

FOR: SOFTWARE AS A SERVICE (SAAS) SERVICES FEATURING SOFTWARE FOR USE ON INTERNAL COMPUTER NETWORKS AND GLOBAL COMMUNICATION NETWORKS, NAMELY, SOFTWARE FOR CREATING, EDITING AND DELIVERING TEXTUAL AND GRAPHIC INFORMATION, LOCALLY AND REMOTELY, AND SOFTWARE FOR USE IN COMPUTERIZED PROJECT MANAGEMENT TO FACILITATE WORKGROUP COLLABORATION, DATABASE MANAGEMENT AND DOCUMENT CREATION AND MANAGEMENT, IN CLASS 42 (U.S. CLS. 100 AND 101).

FIRST USE 11-2-2011; IN COMMERCE 11-2-2011.

THE MARK CONSISTS OF STANDARD CHARACTERS WITHOUT CLAIM TO ANY PARTICULAR FONT, STYLE, SIZE, OR COLOR.

SER. NO. 85-476,464, FILED 11-18-2011.

MIDGE BUTLER, EXAMINING ATTORNEY



David J. Kyffers

Director of the United States Patent and Trademark Office

United States of America

United States Patent and Trademark Office



Reg. No. 4,175,223

ASBESTOS CORPORATION OF AMERICA (NEW YORK CORPORATION)
791 NEPPERHAN AVENUE
YONKERS, NY 10703

Registered July 17, 2012

Int. Cl.: 37

FOR: ASBESTOS ABATEMENT SERVICES, NAMELY, REMOVING, ENCAPSULATING, AND BUILDING ENCLOSURES AROUND ASBESTOS; LEAD ABATEMENT SERVICES, NAMELY, CLEANING, REMOVAL, AND WASTE DISPOSAL OF LEAD AND LEAD BASED PRODUCTS, IN CLASS 37 (U.S. CLS. 100, 103 AND 106).

SERVICE MARK

PRINCIPAL REGISTER

FIRST USE 6-14-1988; IN COMMERCE 6-14-1988.

THE MARK CONSISTS OF THE LETTERS "ACA" WRITTEN IN A STYLIZED FORM.

SER. NO. 85-476,471, FILED 11-18-2011.

SHAUNIA CARLYLE, EXAMINING ATTORNEY



David J. Kybas

Director of the United States Patent and Trademark Office

United States of America

United States Patent and Trademark Office

DXI-SERIES

Reg. No. 4,175,224

Registered July 17, 2012

Int. Cls.: 9 and 16

TRADEMARK

PRINCIPAL REGISTER

QUANTUM CORPORATION (DELAWARE CORPORATION)
1650 TECHNOLOGY DRIVE
SUITE 700
SAN JOSE, CA 95110

FOR: DISK-BASED COMPUTER STORAGE DEVICES, NAMELY, HIGH-SPEED DISK AND SOFTWARE STORAGE SUBSYSTEMS FOR DEDUPLICATION, REPLICATION, STORAGE, BACKUP AND DISASTER RECOVERY OF ELECTRONIC DATA EITHER LOCALLY OR VIA A TELECOMMUNICATIONS NETWORK, IN CLASS 9 (U.S. CLS. 21, 23, 26, 36 AND 38).

FIRST USE 12-1-2006; IN COMMERCE 1-17-2007.

FOR: PRINTED MATERIALS IN THE FORM OF OPERATING MANUALS, USER GUIDES, PAMPHLETS AND BROCHURES ABOUT, FOR USE WITH, AND DIRECTED TO, DISK-BASED COMPUTER STORAGE DEVICES, NAMELY, HIGH-SPEED DISK AND SOFTWARE STORAGE SUBSYSTEMS FOR DEDUPLICATION, REPLICATION, STORAGE, BACKUP AND DISASTER RECOVERY OF ELECTRONIC DATA EITHER LOCALLY OR VIA A TELECOMMUNICATIONS NETWORK, IN CLASS 16 (U.S. CLS. 2, 5, 22, 23, 29, 37, 38 AND 50).

FIRST USE 12-1-2006; IN COMMERCE 1-17-2007.

THE MARK CONSISTS OF STANDARD CHARACTERS WITHOUT CLAIM TO ANY PARTICULAR FONT, STYLE, SIZE, OR COLOR.

SER. NO. 85-476,473, FILED 11-18-2011.

MARK SPARACINO, EXAMINING ATTORNEY



David J. Kypos

Director of the United States Patent and Trademark Office

United States of America

United States Patent and Trademark Office

PHOENIX
TRADING INC.

Reg. No. 4,175,225

Registered July 17, 2012

Int. Cls.: 35 and 39

SERVICE MARK

PRINCIPAL REGISTER

PHOENIX TRADING INC. (MARYLAND CORPORATION)
UNIT G
647 LOFSTRAND LANE
ROCKVILLE, MD 20850

FOR: WHOLESALE DISTRIBUTORSHIPS FEATURING GROUND SUPPORT EQUIPMENT AND PARTS FOR THE AVIATION INDUSTRY AND EQUIPMENT AND PARTS FOR THE CONSTRUCTION, MINING, AND OIL, GAS AND PETROLEUM INDUSTRIES AND EQUIPMENT AND PARTS FOR THE MILITARY, IN CLASS 35 (U.S. CLS. 100, 101 AND 102).

FIRST USE 5-1-2010; IN COMMERCE 5-1-2010.

FOR: SPECIALIZED PACKAGING SERVICES FOR MILITARY EQUIPMENT AND PARTS, IN CLASS 39 (U.S. CLS. 100 AND 105).

FIRST USE 5-1-2010; IN COMMERCE 5-10-2010.

NO CLAIM IS MADE TO THE EXCLUSIVE RIGHT TO USE "TRADING INC.", APART FROM THE MARK AS SHOWN.

THE MARK CONSISTS OF THE WORDS "PHOENIX TRADING INC." WITH AN IMAGE OF A "PHOENIX" IN THE LETTER "O".

SER. NO. 85-476,493, FILED 11-18-2011.

JORDAN BAKER, EXAMINING ATTORNEY



David J. Kyffers

Director of the United States Patent and Trademark Office

United States of America

United States Patent and Trademark Office



Reg. No. 4,175,226

Registered July 17, 2012

Int. Cls.: 35 and 39

SERVICE MARK

PRINCIPAL REGISTER

PHOENIX TRADING INC. (MARYLAND CORPORATION)
UNIT G
647 LOFSTRAND LANE
ROCKVILLE, MD 20850

FOR: WHOLESALE DISTRIBUTORSHIPS FEATURING GROUND SUPPORT EQUIPMENT AND PARTS FOR THE AVIATION INDUSTRY AND EQUIPMENT AND PARTS FOR THE CONSTRUCTION, MINING, AND OIL AND GAS AND PETROLEUM INDUSTRIES, AND EQUIPMENT AND PARTS FOR THE MILITARY, IN CLASS 35 (U.S. CLS. 100, 101 AND 102).

FIRST USE 5-1-2010; IN COMMERCE 5-1-2010.

FOR: SPECIALIZED PACKAGING SERVICES FOR MILITARY EQUIPMENT AND PARTS, IN CLASS 39 (U.S. CLS. 100 AND 105).

FIRST USE 5-1-2010; IN COMMERCE 5-1-2010.

THE MARK CONSISTS OF A PHOENIX BIRD IN A CIRCLE.

SER. NO. 85-476,513, FILED 11-18-2011.

JORDAN BAKER, EXAMINING ATTORNEY



David J. Kybas

Director of the United States Patent and Trademark Office

United States of America

United States Patent and Trademark Office

COMMON SENSE LOANS AT UNCOMMON SPEED

Reg. No. 4,175,227

SECURITY GROUP, INC. (SOUTH CAROLINA CORPORATION)
181 SECURITY PLACE
SPARTANBURG, SC 29307

Registered July 17, 2012

Int. Cl.: 36

FOR: AUTOMOTIVE FINANCING FOR CONSUMERS BY PURCHASING MOTOR VEHICLE
RETAIL INSTALLMENT SALES CONTRACTS FROM AUTOMOBILE DEALERS; CREDIT
AND LOAN SERVICES, IN CLASS 36 (U.S. CLS. 100, 101 AND 102).

SERVICE MARK

FIRST USE 12-31-2007; IN COMMERCE 12-31-2007.

PRINCIPAL REGISTER

THE MARK CONSISTS OF STANDARD CHARACTERS WITHOUT CLAIM TO ANY PAR-
TICULAR FONT, STYLE, SIZE, OR COLOR.

SER. NO. 85-476,540, FILED 11-18-2011.

Laurie Kaufman, Examining Attorney



David J. Kybas

Director of the United States Patent and Trademark Office

United States of America

United States Patent and Trademark Office

Pyrolites Firestarters
When you just want to get your fire going!

Reg. No. 4,175,228

MOSBACHER, KENNETH P. (UNITED STATES INDIVIDUAL)
13675 AXLE CT.

Registered July 17, 2012

GRASS VALLEY, CA 95945

Int. Cl.: 4

FOR: SOLID FIRE STARTERS, IN CLASS 4 (U.S. CLS. 1, 6 AND 15).

TRADEMARK

FIRST USE 2-17-1994; IN COMMERCE 12-19-1994.

PRINCIPAL REGISTER

NO CLAIM IS MADE TO THE EXCLUSIVE RIGHT TO USE "FIRESTARTERS" , APART FROM THE MARK AS SHOWN.

THE MARK CONSISTS OF THE STYLIZED TEXT "PYROLITES" ANGLED UP TOWARD THE RIGHT, WHERE THE LETTER "I" HAS A FLAME REPRESENTING THE DOT ABOVE THE LETTER. TO THE RIGHT OF THIS TEXT IS THE STYLIZED TEXT "FIRESTARTERS". BELOW THESE TWO WORDS IS THE STYLIZED TEXT "WHEN YOU JUST WANT TO GET YOUR FIRE GOING!" WHERE THE EXCLAMATION POINT IS REPRESENTED BY A FLAME WITH A DOT BELOW IT.

SER. NO. 85-476,571, FILED 11-18-2011.

KATHERINE CONNOLLY, EXAMINING ATTORNEY



David J. Kybas

Director of the United States Patent and Trademark Office

United States of America

United States Patent and Trademark Office

Think.Live.Work Global

Reg. No. 4,175,229

FITZGERALD, MEGAN (UNITED STATES INDIVIDUAL)
1718 SELVA MARINA DRIVE
ATLANTIC BEACH, FL 32233

Registered July 17, 2012

Int. Cl.: 41

FOR: PROFESSIONAL COACHING SERVICES IN THE FIELD OF CAREER AND BUSINESS,
IN CLASS 41 (U.S. CLS. 100, 101 AND 107).

SERVICE MARK

FIRST USE 7-1-2011; IN COMMERCE 7-1-2011.

PRINCIPAL REGISTER

THE MARK CONSISTS OF STANDARD CHARACTERS WITHOUT CLAIM TO ANY PAR-
TICULAR FONT, STYLE, SIZE, OR COLOR.

SER. NO. 85-476,580, FILED 11-18-2011.

ROBERT STRUCK, EXAMINING ATTORNEY



David J. Kyffers

Director of the United States Patent and Trademark Office

United States of America

United States Patent and Trademark Office

The Movement

Reg. No. 4,175,230

SSWANSON, LLC (INDIANA LIMITED LIABILITY COMPANY)
9010 MERCER DRIVE
FISHERS, IN 46038

Registered July 17, 2012

Int. Cl.: 25

FOR: GYM SHORTS; HOODED SWEATSHIRTS; SHORT-SLEEVED OR LONG-SLEEVED T-SHIRTS; SHORTS; SWEATPANTS; SWEATSHIRTS, IN CLASS 25 (U.S. CLS. 22 AND 39).

TRADEMARK

FIRST USE 6-27-2011; IN COMMERCE 6-27-2011.

PRINCIPAL REGISTER

THE MARK CONSISTS OF STANDARD CHARACTERS WITHOUT CLAIM TO ANY PARTICULAR FONT, STYLE, SIZE, OR COLOR.

SER. NO. 85-476,588, FILED 11-18-2011.

GINA FINK, EXAMINING ATTORNEY



David J. Kyffers

Director of the United States Patent and Trademark Office

United States of America

United States Patent and Trademark Office

Comlink

Reg. No. 4,175,231

GREAT LAKES COMNET, INC. (MICHIGAN CORPORATION)
1515 TURF LANE, SUITE 100
EAST LANSING, MI 48823

Registered July 17, 2012

Int. Cls.: 38, 39 and 42

FOR: TELECOMMUNICATION SERVICES, NAMELY, PROVIDING FIBER OPTIC NETWORK SERVICES AND OTHER BROADBAND NETWORK SERVICES, AND VOICE OVER INTERNET PROTOCOL (VOIP) SERVICES; TELECOMMUNICATIONS CONSULTATION, IN CLASS 38 (U.S. CLS. 100, 101 AND 104).

SERVICE MARK

PRINCIPAL REGISTER

FIRST USE 9-30-2004; IN COMMERCE 9-30-2004.

FOR: STORAGE SERVICES FOR ARCHIVING ELECTRONIC DATA, IN CLASS 39 (U.S. CLS. 100 AND 105).

FIRST USE 9-30-2004; IN COMMERCE 9-30-2004.

FOR: COMPUTER SERVICES, NAMELY, REMOTE AND ON-SITE MANAGEMENT OF CLOUD COMPUTING SYSTEMS AND APPLICATIONS FOR OTHERS; ENCRYPTED DATA RECOVERY SERVICES; COMPUTER CONSULTING SERVICES, TECHNICAL SUPPORT, NAMELY, MONITORING OF NETWORK SYSTEMS, IN CLASS 42 (U.S. CLS. 100 AND 101).

FIRST USE 9-30-2004; IN COMMERCE 9-30-2004.

THE MARK CONSISTS OF STANDARD CHARACTERS WITHOUT CLAIM TO ANY PARTICULAR FONT, STYLE, SIZE, OR COLOR.

SER. NO. 85-476,590, FILED 11-18-2011.

GINA FINK, EXAMINING ATTORNEY



David J. Kybas

Director of the United States Patent and Trademark Office

United States of America

United States Patent and Trademark Office



Reg. No. 4,175,232

Registered July 17, 2012

Int. Cls.: 9, 35 and 42

TRADEMARK

SERVICE MARK

PRINCIPAL REGISTER

SHOPKEEP.COM, INC. (DELAWARE CORPORATION)
55 BROAD STREET, 13TH FLOOR
NEW YORK, NY 10004

FOR: COMPUTER SOFTWARE FOR BUSINESS MANAGEMENT, NAMELY, SALES TRANSACTION DATA MANAGEMENT, SALE TRANSACTION PROCESSING, INVENTORY MANAGEMENT, CONTACT MANAGEMENT, PAYROLL MANAGEMENT, VENDOR PAYMENT MANAGEMENT, MARKETING, SCHEDULING, IN CLASS 9 (U.S. CLS. 21, 23, 26, 36 AND 38).

FIRST USE 1-20-2010; IN COMMERCE 1-20-2010.

FOR: BUSINESS SERVICES, NAMELY, DATA PROCESSING OF BUSINESS MANAGEMENT DATA, NAMELY, SALES TRANSACTION DATA, INVENTORY MANAGEMENT DATA, CONTACT MANAGEMENT DATA, PAYROLL MANAGEMENT DATA, VENDOR PAYMENT MANAGEMENT DATA, MARKETING DATA AND SCHEDULING DATA, IN CLASS 35 (U.S. CLS. 100, 101 AND 102).

FIRST USE 1-20-2010; IN COMMERCE 1-20-2010.

FOR: OPERATING A WEBSITE PROVIDING SOFTWARE AS A SERVICE (SAAS) FOR USE WITH BUSINESS MANAGEMENT, NAMELY, SALES TRANSACTION DATA MANAGEMENT, SALE TRANSACTION PROCESSING, INVENTORY MANAGEMENT, CONTACT MANAGEMENT, PAYROLL MANAGEMENT, VENDOR PAYMENT MANAGEMENT, MARKETING, SCHEDULING, IN CLASS 42 (U.S. CLS. 100 AND 101).

FIRST USE 1-20-2010; IN COMMERCE 1-20-2010.

OWNER OF U.S. REG. NO. 3,936,441.

THE COLOR(S) GRAY-GREEN, LIGHT GREEN AND WHITE IS/ARE CLAIMED AS A FEATURE OF THE MARK.

THE MARK CONSISTS OF A STYLIZED ABSTRACTED PERSON IN GRAY-GREEN COMPOSED OF A CIRCLE FOR THE HEAD AND POINTED SHAPES FOR THE ARMS AND LEGS. THE FIGURE WEARS A RECTANGULAR SHAPED LIGHT GREEN GARMENT THAT FEATURES THE LETTERS "SK" IN WHITE.



David J. Kybas

Director of the United States Patent and Trademark Office

Reg. No. 4,175,232 SER. NO. 85-476,593, FILED 11-18-2011.

SHANNON TWOHIG, EXAMINING ATTORNEY

United States of America

United States Patent and Trademark Office



Southwire

Reg. No. 4,175,233

Registered July 17, 2012

Int. Cl.: 9

TRADEMARK

PRINCIPAL REGISTER

SOUTHWIRE COMPANY (DELAWARE CORPORATION)
ONE SOUTHWIRE DRIVE
CARROLLTON, GA 30119

FOR: ELECTRIC WIRE AND CABLE, IN CLASS 9 (U.S. CLS. 21, 23, 26, 36 AND 38).

FIRST USE 7-31-1995; IN COMMERCE 7-31-1995.

OWNER OF U.S. REG. NOS. 635,490 AND 2,033,689.

THE MARK CONSISTS OF THE TERM "SOUTHWIRE" BELOW A TRI-CABLE SWIRL DESIGN.

SER. NO. 85-476,605, FILED 11-18-2011.

JUSTINE D. PARKER, EXAMINING ATTORNEY



David J. Kyffers

Director of the United States Patent and Trademark Office

United States of America

United States Patent and Trademark Office

ICHOLESTEROL

Reg. No. 4,175,234

Registered July 17, 2012

Int. Cl.: 9

TRADEMARK

PRINCIPAL REGISTER

AKAMAS VENTURES LLC (NEW JERSEY LIMITED LIABILITY COMPANY)
2001 ROUTE 46, WATERVIEW PLAZA, STE. 310
PARSIPPANY, NJ 07054

FOR: COMPUTER APPLICATION SOFTWARE FOR MOBILE PHONES AND HANDHELD COMPUTERS, NAMELY, SOFTWARE FOR MONITORING AND TRACKING LIPID PROFILES , IN CLASS 9 (U.S. CLS. 21, 23, 26, 36 AND 38).

FIRST USE 2-0-2009; IN COMMERCE 2-0-2009.

THE MARK CONSISTS OF STANDARD CHARACTERS WITHOUT CLAIM TO ANY PARTICULAR FONT, STYLE, SIZE, OR COLOR.

SER. NO. 85-476,632, FILED 11-18-2011.

KATHRYN COWARD, EXAMINING ATTORNEY



David J. Kyjars

Director of the United States Patent and Trademark Office

United States of America

United States Patent and Trademark Office

Maximum Athlete Exposure on the Open Internet

Reg. No. 4,175,235

Registered July 17, 2012

Int. Cls.: 35 and 42

SERVICE MARK

PRINCIPAL REGISTER

ANCIENT RIVER, LLC (GEORGIA LIMITED LIABILITY COMPANY), DBA REAL DEAL RECRUITS, LLC
WWW.REALDEALRECRUITS.COM
520 MARSH PARK DRIVE
DULUTH, GA 30097

FOR: SPORTS RECRUITING SERVICES FOR HIGH SCHOOL ATHLETES, IN CLASS 35 (U.S. CLS. 100, 101 AND 102).

FIRST USE 10-7-2011; IN COMMERCE 10-7-2011.

FOR: CREATING AN ON-LINE COMMUNITY FOR ATHLETES FOR THE PURPOSE OF EXPOSURE TO COLLEGES AND TO COACHES, IN CLASS 42 (U.S. CLS. 100 AND 101).

FIRST USE 10-7-2011; IN COMMERCE 10-7-2011.

THE MARK CONSISTS OF STANDARD CHARACTERS WITHOUT CLAIM TO ANY PARTICULAR FONT, STYLE, SIZE, OR COLOR.

SER. NO. 85-476,633, FILED 11-18-2011.

HOWARD B. LEVINE, EXAMINING ATTORNEY



David J. Kybas

Director of the United States Patent and Trademark Office

United States of America

United States Patent and Trademark Office

SyncCreation

Reg. No. 4,175,236

GALLENBERGER, JOSEPH MARK (UNITED STATES INDIVIDUAL)
120 GARDEN HILL DRIVE
HENDERSONVILLE, NC 28739

Registered July 17, 2012

Int. Cl.: 41

FOR: EDUCATION SERVICES, NAMELY, PROVIDING WORKSHOPS AND COURSES IN THE FIELD OF PSYCHOLOGY, IN CLASS 41 (U.S. CLS. 100, 101 AND 107).

SERVICE MARK

FIRST USE 1-1-2002; IN COMMERCE 1-1-2003.

PRINCIPAL REGISTER

THE MARK CONSISTS OF STANDARD CHARACTERS WITHOUT CLAIM TO ANY PARTICULAR FONT, STYLE, SIZE, OR COLOR.

SER. NO. 85-476,646, FILED 11-18-2011.

KHANH LE, EXAMINING ATTORNEY



David J. Kyffers

Director of the United States Patent and Trademark Office

United States of America

United States Patent and Trademark Office



Reg. No. 4,175,237

Registered July 17, 2012

Int. Cl.: 5

TRADEMARK

PRINCIPAL REGISTER

GRUVOLO BOTANICALS LLC (NEW YORK LIMITED LIABILITY COMPANY)
SUITE 829
250 W. 57TH ST.
NEW YORK, NY 10107

FOR: HERBAL TOPICAL CREAMS, GELS, SALVES, SPRAYS, POWDER, BALMS, LINIMENT AND OINTMENTS FOR THE RELIEF OF ACHES AND PAIN, IN CLASS 5 (U.S. CLS. 6, 18, 44, 46, 51 AND 52).

FIRST USE 10-11-2011; IN COMMERCE 10-11-2011.

THE MARK CONSISTS OF THE STYLIZED WORDING "TATGEVITY" WITH A DRAGON INSIDE THE STYLIZED LETTERING.

SER. NO. 85-476,658, FILED 11-18-2011.

HOWARD B. LEVINE, EXAMINING ATTORNEY



David J. Kybas

Director of the United States Patent and Trademark Office

United States of America

United States Patent and Trademark Office

DONNYBROOK

Reg. No. 4,175,238

VICTORY BREWING COMPANY (PENNSYLVANIA CORPORATION)
420 ACORN LANE
DOWNTOWN, PA 19335

Registered July 17, 2012

Int. Cl.: 32

FOR: BEVERAGES, NAMELY, BEER AND ALE, IN CLASS 32 (U.S. CLS. 45, 46 AND 48).

TRADEMARK

FIRST USE 2-28-2007; IN COMMERCE 2-28-2007.

PRINCIPAL REGISTER

THE MARK CONSISTS OF STANDARD CHARACTERS WITHOUT CLAIM TO ANY PARTICULAR FONT, STYLE, SIZE, OR COLOR.

SER. NO. 85-476,674, FILED 11-18-2011.

RUSS HERMAN, EXAMINING ATTORNEY



David J. Kybas

Director of the United States Patent and Trademark Office

United States of America

United States Patent and Trademark Office

WHOLETREES

Reg. No. 4,175,239

Registered July 17, 2012

Int. Cl.: 37

SERVICE MARK

PRINCIPAL REGISTER

WHOLE TREES, LLC (WISCONSIN LIMITED LIABILITY COMPANY)
E2890 LORENZ ROAD
STODDARD, WI 54658

FOR: BUILDING CONSTRUCTION; BUILDING CONSTRUCTION SERVICES; CONSTRUCTION SERVICES, NAMELY, PLANNING, LAYING OUT AND CUSTOM CONSTRUCTION OF COMMERCIAL BUILDINGS; CONSULTING IN THE FIELD OF BUILDING CONSTRUCTION; CUSTOM CONSTRUCTION OF HOMES; GENERAL BUILDING CONTRACTOR SERVICES; TECHNICAL CONSULTATION IN THE FIELD OF BUILDING CONSTRUCTION, IN CLASS 37 (U.S. CLS. 100, 103 AND 106).

FIRST USE 3-12-2007; IN COMMERCE 3-12-2007.

THE MARK CONSISTS OF STANDARD CHARACTERS WITHOUT CLAIM TO ANY PARTICULAR FONT, STYLE, SIZE, OR COLOR.

SER. NO. 85-476,679, FILED 11-18-2011.

JAY BESCH, EXAMINING ATTORNEY



David J. Kybas

Director of the United States Patent and Trademark Office

United States of America

United States Patent and Trademark Office

Your EMR Friend

Reg. No. 4,175,240

SMARTDOC, INC. (FLORIDA CORPORATION)
5700 MEMORIAL HIGHWAY, SUITE 200
TAMPA, FL 33615

Registered July 17, 2012

Int. Cl.: 35

FOR: ELECTRONIC RECORD-KEEPING AND MANAGEMENT SERVICES, NAMELY, DATABASE MANAGEMENT OF ELECTRONIC MEDICAL RECORDS AND OTHER RECORDS FOR MEDICAL, LEGAL AND OTHER PROVIDERS AND BUSINESSES, IN CLASS 35 (U.S. CLS. 100, 101 AND 102).

SERVICE MARK

PRINCIPAL REGISTER

FIRST USE 11-15-2011; IN COMMERCE 11-15-2011.

THE MARK CONSISTS OF STANDARD CHARACTERS WITHOUT CLAIM TO ANY PARTICULAR FONT, STYLE, SIZE, OR COLOR.

NO CLAIM IS MADE TO THE EXCLUSIVE RIGHT TO USE "EMR", APART FROM THE MARK AS SHOWN.

SER. NO. 85-476,698, FILED 11-18-2011.

MARK T. MULLEN, EXAMINING ATTORNEY



David J. Kyffers

Director of the United States Patent and Trademark Office

United States of America

United States Patent and Trademark Office

CANTERBURY DESIGN

Reg. No. 4,175,241

Registered July 17, 2012

Int. Cl.: 42

SERVICE MARK

PRINCIPAL REGISTER

CANTERBURY DESIGN KITCHEN INTERIORS, LLC (NEW JERSEY LIMITED LIABILITY COMPANY)
103 RIDGEDALE AVENUE
MORRISTOWN, NJ 07962

FOR: COMPUTER AIDED DESIGN FOR OTHERS IN THE FIELDS OF INTERIOR CONSTRUCTION, DESIGN AND REMODELING; CUSTOM DESIGN OF KITCHENS, BATHROOMS, BEDROOMS, RETAIL AND OFFICE SPACE BASED ON PERSONAL SELECTIONS MADE BY THE CUSTOMER; DESIGN, DEVELOPMENT AND CONSULTING SERVICES RELATED THERETO IN THE FIELD OF INTERIOR DESIGN AND REMODELING; INTERIOR DESIGN SERVICES; PLANNING AND LAYOUT DESIGN SERVICES FOR THE INTERIOR SPACE OF RESIDENTIAL PROPERTY, OFFICES AND BUSINESS ESTABLISHMENTS, IN CLASS 42 (U.S. CLS. 100 AND 101).

FIRST USE 1-1-1997; IN COMMERCE 1-1-1997.

THE MARK CONSISTS OF STANDARD CHARACTERS WITHOUT CLAIM TO ANY PARTICULAR FONT, STYLE, SIZE, OR COLOR.

NO CLAIM IS MADE TO THE EXCLUSIVE RIGHT TO USE "DESIGN", APART FROM THE MARK AS SHOWN.

SER. NO. 85-476,724, FILED 11-18-2011.

IRA J. GOODSaid, EXAMINING ATTORNEY



David J. Kyffers

Director of the United States Patent and Trademark Office

United States of America

United States Patent and Trademark Office

DON'T CAGE THEM UP, LET
THEM RUN FREE

Reg. No. 4,175,242

CAMP CANINE, INC. (FLORIDA CORPORATION)
201 SW FIRST AVENUE
BOCA RATON, FL 33432

Registered July 17, 2012

Int. Cl.: 43

FOR: PET BOARDING; PET DAY CARE SERVICES; KENNEL SERVICES, NAMELY, BOARDING FOR PETS; OVERNIGHT AND LONG-TERM PET LODGING SERVICES, IN CLASS 43 (U.S. CLS. 100 AND 101).

SERVICE MARK

FIRST USE 4-3-2001; IN COMMERCE 10-1-2010.

PRINCIPAL REGISTER

THE MARK CONSISTS OF STANDARD CHARACTERS WITHOUT CLAIM TO ANY PARTICULAR FONT, STYLE, SIZE, OR COLOR.

SER. NO. 85-476,746, FILED 11-18-2011.

KIMBERLY PERRY, EXAMINING ATTORNEY



David J. Kyjars

Director of the United States Patent and Trademark Office

United States of America

United States Patent and Trademark Office

STEINGER, ISCOE & GREENE

Reg. No. 4,175,243

Registered July 17, 2012

Int. Cl.: 45

SERVICE MARK

PRINCIPAL REGISTER

STEINGER, ISCOE & GREENE, P.A. (FLORIDA CORPORATION)
1645 PALM BEACH LAKES, BLVD.
9TH FLOOR
WEST PALM BEACH, FL 33401

FOR: LEGAL SERVICES, IN CLASS 45 (U.S. CLS. 100 AND 101).

FIRST USE 5-1-2005; IN COMMERCE 5-1-2005.

THE MARK CONSISTS OF STANDARD CHARACTERS WITHOUT CLAIM TO ANY PARTICULAR FONT, STYLE, SIZE, OR COLOR.

SER. NO. 85-476,749, FILED 11-18-2011.

SHANNON TWOHIG, EXAMINING ATTORNEY



David J. Kybas

Director of the United States Patent and Trademark Office

United States of America

United States Patent and Trademark Office

HEY, HOT SHOT!

Reg. No. 4,175,244

Registered July 17, 2012

Int. Cl.: 41

SERVICE MARK

PRINCIPAL REGISTER

JEN BEKMAN PROJECTS, INC. (DELAWARE CORPORATION)
4TH FLOOR
6 EAST 32ND STREET
NEW YORK, NY 10016

FOR: ORGANIZING AND CONDUCTING PHOTOGRAPHY COMPETITIONS; PROVIDING A WEBSITE WHERE USERS CAN VIEW PHOTOGRAPHS AND INFORMATION ABOUT PHOTOGRAPHERS, THEIR EXHIBITIONS, HONORS, AND GRANTS; ARRANGING AND CONDUCTING PHOTOGRAPHY EXHIBITIONS; PROVIDING A WEBSITE WHERE USERS CAN PARTICIPATE IN PHOTOGRAPHY COMPETITIONS; ENTERTAINMENT AND EDUCATIONAL SERVICES IN THE NATURE OF PHOTOGRAPHY COMPETITIONS AND ON-LINE EXHIBITIONS IN THE FIELD OF PHOTOGRAPHY, IN CLASS 41 (U.S. CLS. 100, 101 AND 107).

FIRST USE 3-17-2005; IN COMMERCE 3-17-2005.

THE MARK CONSISTS OF STANDARD CHARACTERS WITHOUT CLAIM TO ANY PARTICULAR FONT, STYLE, SIZE, OR COLOR.

SER. NO. 85-476,756, FILED 11-18-2011.

MARK T. MULLEN, EXAMINING ATTORNEY



David J. Kyffers

Director of the United States Patent and Trademark Office

United States of America

United States Patent and Trademark Office

WINGS OF WONDER WHEN LEARNING TAKES FLIGHT

Reg. No. 4,175,245

Registered July 17, 2012

Int. Cl.: 41

SERVICE MARK

PRINCIPAL REGISTER

WILDLIFE HABITAT COUNCIL (MARYLAND NON-PROFIT CORPORATION)
8737 COLESVILLE ROAD
SUITE 800
SILVER SPRING, MD 20910

FOR: EDUCATIONAL SERVICES, NAMELY, CONDUCTING PROGRAMS IN THE FIELD OF WILDLIFE HABITATS AND WILDLIFE HABITAT CONSERVATION, IN CLASS 41 (U.S. CLS. 100, 101 AND 107).

FIRST USE 12-31-2000; IN COMMERCE 12-31-2000.

THE MARK CONSISTS OF STANDARD CHARACTERS WITHOUT CLAIM TO ANY PARTICULAR FONT, STYLE, SIZE, OR COLOR.

OWNER OF U.S. REG. NO. 3,126,065.

SER. NO. 85-476,767, FILED 11-18-2011.

ELLEN B. AWRICH, EXAMINING ATTORNEY



David J. Kyffers

Director of the United States Patent and Trademark Office

United States of America

United States Patent and Trademark Office

Spoke ID

Reg. No. 4,175,246

ANDERSON, BRAD (UNITED STATES INDIVIDUAL)
3655 KENWOOD AVE
MEMPHIS, TN 38122

Registered July 17, 2012

Int. Cl.: 6

FOR: METAL IDENTIFICATION BRACELETS, IN CLASS 6 (U.S. CLS. 2, 12, 13, 14, 23, 25 AND 50).

TRADEMARK

FIRST USE 9-23-2011; IN COMMERCE 9-23-2011.

PRINCIPAL REGISTER

THE MARK CONSISTS OF STANDARD CHARACTERS WITHOUT CLAIM TO ANY PARTICULAR FONT, STYLE, SIZE, OR COLOR.

NO CLAIM IS MADE TO THE EXCLUSIVE RIGHT TO USE "ID", APART FROM THE MARK AS SHOWN.

SER. NO. 85-476,782, FILED 11-18-2011.

TOBY BULLOFF, EXAMINING ATTORNEY



David J. Kyffers

Director of the United States Patent and Trademark Office

United States of America

United States Patent and Trademark Office

EGGNOG LIKE IT USED TO TASTE

Reg. No. 4,175,247

Registered July 17, 2012

Int. Cl.: 29

ARETHUSA FARM, LLC (CONNECTICUT LIMITED LIABILITY COMPANY)
C/O MANOLO BLAHNIK
31 WEST 54TH STREET
NEW YORK, NY 10019

FOR: NON-ALCOHOLIC EGG NOG, IN CLASS 29 (U.S. CL. 46).

TRADEMARK

FIRST USE 11-15-2010; IN COMMERCE 11-15-2010.

PRINCIPAL REGISTER

THE MARK CONSISTS OF STANDARD CHARACTERS WITHOUT CLAIM TO ANY PARTICULAR FONT, STYLE, SIZE, OR COLOR.

OWNER OF U.S. REG. NO. 4,094,459.

SER. NO. 85-476,797, FILED 11-18-2011.

REBECCA POVARCHUK, EXAMINING ATTORNEY



David J. Kybas

Director of the United States Patent and Trademark Office

United States of America

United States Patent and Trademark Office

VALET BARKING

Reg. No. 4,175,248

Registered July 17, 2012

Int. Cls.: 43 and 44

SERVICE MARK

PRINCIPAL REGISTER

CAMP CANINE, INC. (FLORIDA CORPORATION)
201 SW FIRST AVENUE
BOCA RATON, FL 33432

FOR: PET BOARDING; PET DAY CARE SERVICES; KENNEL SERVICES, NAMELY, BOARDING FOR PETS; OVERNIGHT AND LONG-TERM PET LODGING SERVICES, IN CLASS 43 (U.S. CLS. 100 AND 101).

FIRST USE 7-1-2008; IN COMMERCE 7-6-2010.

FOR: PET GROOMING SERVICES; PET SALON SERVICES; NAIL CLIPPING, NAIL PAINTING, BATHING, HAIR-STYLING, MASSAGE AND TEETH BRUSHING SERVICES FOR PETS, IN CLASS 44 (U.S. CLS. 100 AND 101).

FIRST USE 7-1-2008; IN COMMERCE 7-6-2010.

THE MARK CONSISTS OF STANDARD CHARACTERS WITHOUT CLAIM TO ANY PARTICULAR FONT, STYLE, SIZE, OR COLOR.

SER. NO. 85-476,813, FILED 11-18-2011.

KIMBERLY PERRY, EXAMINING ATTORNEY



David J. Kyros

Director of the United States Patent and Trademark Office

United States of America

United States Patent and Trademark Office

Dynacart

Reg. No. 4,175,249

Registered July 17, 2012

Int. Cls.: 36 and 45

SERVICE MARK

PRINCIPAL REGISTER

DYNACART SOLUTIONS LTD (IRELAND CORPORATION)
OFFICE 5
UPPER FITZWILLIAM STREET
DUBLIN, IRELAND

FOR: PROVIDING FINANCIAL RISK MANAGEMENT SERVICES FOR ELECTRONIC FUNDS TRANSFER, CREDIT AND DEBIT CARD AND ELECTRONIC CHECK TRANSACTIONS VIA A GLOBAL COMPUTER NETWORK, IN CLASS 36 (U.S. CLS. 100, 101 AND 102).

FIRST USE 10-10-2011; IN COMMERCE 10-10-2011.

FOR: PROVIDING FRAUD DETECTION SERVICES FOR ELECTRONIC FUNDS TRANSFER, CREDIT AND DEBIT CARD AND ELECTRONIC CHECK TRANSACTIONS VIA A GLOBAL COMPUTER NETWORK, IN CLASS 45 (U.S. CLS. 100 AND 101).

FIRST USE 10-10-2011; IN COMMERCE 10-10-2011.

THE MARK CONSISTS OF STANDARD CHARACTERS WITHOUT CLAIM TO ANY PARTICULAR FONT, STYLE, SIZE, OR COLOR.

SER. NO. 85-476,819, FILED 11-18-2011.

ALYSSA STEEL, EXAMINING ATTORNEY



David J. Kybas

Director of the United States Patent and Trademark Office

United States of America

United States Patent and Trademark Office

PIHCINTU

Reg. No. 4,175,250

PIHCINTU (MAINE NON-PROFIT CORPORATION)
36 EMERSON DRIVE
WINDHAM, ME 04062

Registered July 17, 2012

Int. Cl.: 41

FOR: ENTERTAINMENT IN THE NATURE OF COMPETITIONS IN THE FIELD OF CHORAL SINGING; ENTERTAINMENT IN THE NATURE OF LIVE PERFORMANCES BY A CHORUS; ENTERTAINMENT IN THE NATURE OF VISUAL AND AUDIO PERFORMANCES BY A CHORUS, IN CLASS 41 (U.S. CLS. 100, 101 AND 107).

SERVICE MARK

PRINCIPAL REGISTER

FIRST USE 11-1-2004; IN COMMERCE 11-1-2004.

THE MARK CONSISTS OF STANDARD CHARACTERS WITHOUT CLAIM TO ANY PARTICULAR FONT, STYLE, SIZE, OR COLOR.

SER. NO. 85-476,822, FILED 11-18-2011.

SARA BENJAMIN, EXAMINING ATTORNEY



David J. Kyffers

Director of the United States Patent and Trademark Office

United States of America

United States Patent and Trademark Office

Cubitac

Reg. No. 4,175,251

CUBITAC (NEW YORK CORPORATION)
30 BERGEN TURNPIKE
RIDGEFIELD PARK, NJ 07660

Registered July 17, 2012

Int. Cl.: 35

FOR: WHOLESALE DISTRIBUTORSHIPS FEATURING KITCHEN CABINETS, VANITIES,
AND COUNTER TOPS, IN CLASS 35 (U.S. CLS. 100, 101 AND 102).

SERVICE MARK

FIRST USE 1-0-2011; IN COMMERCE 6-0-2011.

PRINCIPAL REGISTER

THE MARK CONSISTS OF STANDARD CHARACTERS WITHOUT CLAIM TO ANY PAR-
TICULAR FONT, STYLE, SIZE, OR COLOR.

SER. NO. 85-476,823, FILED 11-18-2011.

BRIAN CALLAGHAN, EXAMINING ATTORNEY



David J. Kybas

Director of the United States Patent and Trademark Office

United States of America

United States Patent and Trademark Office

PS I Love You

Reg. No. 4,175,252

PS I LOVE YOU MINISTRIES (SOUTH CAROLINA CORPORATION)
5555 PARRIS BRIDGE RD
BOILING SPRINGS, SC 29316

Registered July 17, 2012

Int. Cl.: 43

FOR: CHARITABLE SERVICES, NAMELY, PROVIDING CHILD CARE FOR SOCIAL AND LEGAL ORPHANS, IN CLASS 43 (U.S. CLS. 100 AND 101).

SERVICE MARK

FIRST USE 2-20-2010; IN COMMERCE 2-20-2010.

PRINCIPAL REGISTER

THE MARK CONSISTS OF STANDARD CHARACTERS WITHOUT CLAIM TO ANY PARTICULAR FONT, STYLE, SIZE, OR COLOR.

SER. NO. 85-476,835, FILED 11-18-2011.

SUSAN STIGLITZ, EXAMINING ATTORNEY



David J. Kybas

Director of the United States Patent and Trademark Office

United States of America

United States Patent and Trademark Office

Brandr Studio

Reg. No. 4,175,253

Registered July 17, 2012

Int. Cls.: 35 and 42

SERVICE MARK

PRINCIPAL REGISTER

BRANDR STUDIO, LLC (TENNESSEE LIMITED LIABILITY COMPANY)
SUITE 104
9724 KINGSTON PIKE
KNOXVILLE, TN 37922

FOR: BRAND CONCEPT AND BRAND DEVELOPMENT SERVICES FOR CORPORATE AND INDIVIDUAL CLIENTS, IN CLASS 35 (U.S. CLS. 100, 101 AND 102).

FIRST USE 11-7-2011; IN COMMERCE 11-7-2011.

FOR: WEBSITE DESIGN AND DEVELOPMENT FOR OTHERS, IN CLASS 42 (U.S. CLS. 100 AND 101).

FIRST USE 11-17-2011; IN COMMERCE 11-17-2011.

THE MARK CONSISTS OF STANDARD CHARACTERS WITHOUT CLAIM TO ANY PARTICULAR FONT, STYLE, SIZE, OR COLOR.

NO CLAIM IS MADE TO THE EXCLUSIVE RIGHT TO USE "STUDIO", APART FROM THE MARK AS SHOWN.

SER. NO. 85-476,839, FILED 11-18-2011.

JEFFREY LOOK, EXAMINING ATTORNEY



David J. Kyffers

Director of the United States Patent and Trademark Office

United States of America

United States Patent and Trademark Office

TABUK

Reg. No. 4,175,254

Registered July 17, 2012

Int. Cl.: 13

TRADEMARK

PRINCIPAL REGISTER

TWO RIVERS ARMS, L.L.C. (OKLAHOMA LIMITED LIABILITY COMPANY)
8620 SW 74TH
OKLAHOMA CITY, OK 73169

FOR: FIREARMS, IN CLASS 13 (U.S. CLS. 2 AND 9).

FIRST USE 2-2-2010; IN COMMERCE 2-6-2010.

THE MARK CONSISTS OF STANDARD CHARACTERS WITHOUT CLAIM TO ANY PARTICULAR FONT, STYLE, SIZE, OR COLOR.

SER. NO. 85-476,857, FILED 11-18-2011.

ELLEN B. AWRICH, EXAMINING ATTORNEY



David J. Kybas

Director of the United States Patent and Trademark Office

United States of America

United States Patent and Trademark Office

MATCHBOX GROUP

Reg. No. 4,175,255

Registered July 17, 2012

Int. Cl.: 35

SERVICE MARK

PRINCIPAL REGISTER

MATCHBOX GROUP (NEW HAMPSHIRE LIMITED LIABILITY COMPANY)
27 HARRISON AVE
PORTSMOUTH, NH 038015719

FOR: BUSINESS MANAGEMENT AND ORGANIZATION CONSULTANCY, IN CLASS 35
(U.S. CLS. 100, 101 AND 102).

FIRST USE 2-16-2010; IN COMMERCE 2-16-2010.

THE MARK CONSISTS OF STANDARD CHARACTERS WITHOUT CLAIM TO ANY PARTICULAR FONT, STYLE, SIZE, OR COLOR.

NO CLAIM IS MADE TO THE EXCLUSIVE RIGHT TO USE "GROUP", APART FROM THE MARK AS SHOWN.

SER. NO. 85-476,868, FILED 11-18-2011.

ALYSSA STEEL, EXAMINING ATTORNEY



David J. Kyffers

Director of the United States Patent and Trademark Office

United States of America

United States Patent and Trademark Office

wineluv♥

Reg. No. 4,175,256

Registered July 17, 2012

Int. Cl.: 35

SERVICE MARK

PRINCIPAL REGISTER

WINELUV, INC. (DELAWARE CORPORATION)
3 BAYSIDE VILLAGE PLACE, UNIT 111
SAN FRANCISCO, CA 94107

FOR: ADVERTISING AND MARKETING SERVICES; PROMOTING THE GOODS AND SERVICES OF OTHERS BY PROVIDING A WEBSITE FEATURING COUPONS, REBATES, LINKS TO THE RETAIL WEBSITES OF OTHERS AND DISCOUNT INFORMATION; ON-LINE RETAIL STORE SERVICES FEATURING A WIDE VARIETY OF CONSUMER GOODS AND SERVICES OF OTHERS; ADVERTISING, PROMOTION AND MARKETING SERVICES IN THE NATURE OF E-MAIL ADVERTISEMENTS FOR OTHERS, IN CLASS 35 (U.S. CLS. 100, 101 AND 102).

FIRST USE 8-8-2011; IN COMMERCE 8-8-2011.

THE MARK CONSISTS OF STYLIZED WORD "WINELUV" WITH A STYLIZED "V" IN THE FORM OF A HEART.

SER. NO. 85-476,879, FILED 11-18-2011.

JEFFREY LOOK, EXAMINING ATTORNEY



David J. Kyffers

Director of the United States Patent and Trademark Office

United States of America

United States Patent and Trademark Office



ZOORYDERS

Reg. No. 4,175,257

Registered July 17, 2012

Int. Cl.: 35

SERVICE MARK

PRINCIPAL REGISTER

HOLLINS, JR., CHARLES (UNITED STATES INDIVIDUAL)
107
1311 KAREN BLVD
CAPITOL HEIGHTS, MD 20743

FOR: CLUB SERVICES, NAMELY, PROMOTING THE INTERESTS OF MOTORCYCLE ENTHUSIASTS, IN CLASS 35 (U.S. CLS. 100, 101 AND 102).

FIRST USE 7-1-2006; IN COMMERCE 7-1-2006.

THE MARK CONSISTS OF A CIRCLE WITH THE STYLIZED TEXT "ZL". BELOW THERE IS THE STYLIZED TEXT "ZOORYDERS".

SER. NO. 85-476,890, FILED 11-18-2011.

JEFFREY LOOK, EXAMINING ATTORNEY



David J. Kybas

Director of the United States Patent and Trademark Office

United States of America
United States Patent and Trademark Office

brandr. B

Reg. No. 4,175,258

Registered July 17, 2012

Int. Cls.: 35 and 42

SERVICE MARK

PRINCIPAL REGISTER

BRANDR STUDIO, LLC (TENNESSEE LIMITED LIABILITY COMPANY)
SUITE 104
9724 KINGSTON PIKE
KNOXVILLE, TN 37922

FOR: BRAND CONCEPT AND BRAND DEVELOPMENT SERVICES FOR CORPORATE AND INDIVIDUAL CLIENTS, IN CLASS 35 (U.S. CLS. 100, 101 AND 102).

FIRST USE 11-7-2011; IN COMMERCE 11-7-2011.

FOR: WEBSITE DESIGN AND DEVELOPMENT FOR OTHERS, IN CLASS 42 (U.S. CLS. 100 AND 101).

FIRST USE 11-17-2011; IN COMMERCE 11-17-2011.

THE MARK CONSISTS OF THE WORD "BRANDR.", IN LOWER CASE LETTERS, FOLLOWED BY A LARGE, CAPITAL STYLISTIC LETTER "B".

SER. NO. 85-476,891, FILED 11-18-2011.

JEFFREY LOOK, EXAMINING ATTORNEY



David J. Kypos

Director of the United States Patent and Trademark Office

United States of America

United States Patent and Trademark Office

Smart Minute

Reg. No. 4,175,259

Registered July 17, 2012

Int. Cl.: 29

TRADEMARK

PRINCIPAL REGISTER

SMART COOKING LLC (TEXAS LIMITED LIABILITY COMPANY)
SUITE B
701 RIO GRANDE STREET
AUSTIN, TX 787012778

FOR: BACON; BEEF; BEEF PATTIES; BONELESS SKINLESS CHICKEN TENDERLOIN; CHICKEN; CHICKEN NUGGETS; CODS; FISH FILLETS; FISH, NAMELY, PREPARED AND FROZEN SALMON, COD AND TILAPIA; FROZEN EGGS; FROZEN PRE-PACKAGED ENTREES CONSISTING PRIMARILY OF SEAFOOD; PORK; PORK CUTLETS; POULTRY; PRE-PACKAGED DINNERS CONSISTING OF MEAT, SEAFOOD OR POULTRY SERVED WITH RICE AND VEGETABLES; PREPARED AND PREPACKAGED MEALS AND ENTREES CONSISTING PRIMARILY OF EGG WITH ONE OR MORE OF MEAT, FISH, POULTRY, VEGETABLE, CHEESE OR ONION; PREPARED BEEF; PREPARED ENTREES CONSISTING PRIMARILY OF SEAFOOD; PREPARED FOOD KITS COMPOSED OF MEAT, POULTRY, FISH, SEAFOOD, AND/OR VEGETABLES AND ALSO INCLUDING SAUCES OR SEASONINGS, READY FOR COOKING AND ASSEMBLY AS A MEAL; PROCESSED EGGS; PROCESSED MEAT, NAMELY, SEASONED GROUND TURKEY PATTIES AND SMOKED TURKEY SAUSAGES; SALMON; SAUSAGES; SEAFOOD, NAMELY, PREPARED AND FROZEN COD, SALMON AND TILAPIA ENTREES; SEASONED MEATS, SEAFOOD, FISH, POULTRY AND VEGETABLES; TURKEY BURGER PATTIES; FROZEN ENTREES CONSISTING PRIMARILY OF MEAT, FISH, POULTRY OR VEGETABLES; FROZEN MEALS CONSISTING PRIMARILY OF MEAT, FISH, POULTRY OR VEGETABLES, IN CLASS 29 (U.S. CL. 46).

FIRST USE 3-15-2011; IN COMMERCE 3-15-2011.

THE MARK CONSISTS OF STANDARD CHARACTERS WITHOUT CLAIM TO ANY PARTICULAR FONT, STYLE, SIZE, OR COLOR.

SER. NO. 85-476,926, FILED 11-18-2011.

AMY C. KEAN, EXAMINING ATTORNEY



David J. Kappas

Director of the United States Patent and Trademark Office

United States of America

United States Patent and Trademark Office

CHEF'S CHOICE

Reg. No. 4,175,260

Registered July 17, 2012

Int. Cl.: 30

TRADEMARK

PRINCIPAL REGISTER

EDGECRAFT CORPORATION (DELAWARE CORPORATION)
825 SOUTHWOOD ROAD
AVONDALE, PA 19311

FOR: PIZZELLE AND WAFFLE CONE MIX, IN CLASS 30 (U.S. CL. 46).

FIRST USE 6-6-2001; IN COMMERCE 6-6-2001.

THE MARK CONSISTS OF STANDARD CHARACTERS WITHOUT CLAIM TO ANY PARTICULAR FONT, STYLE, SIZE, OR COLOR.

OWNER OF U.S. REG. NOS. 1,441,039, 2,425,064 AND OTHERS.

SER. NO. 85-476,953, FILED 11-18-2011.

LINDA POWELL, EXAMINING ATTORNEY



David J. Kyffers

Director of the United States Patent and Trademark Office

United States of America

United States Patent and Trademark Office

INVISI BRAKE

Reg. No. 4,175,261

ROADMASTER, INC. (OREGON CORPORATION)
6110 NE 127TH AVENUE
VANCOUVER, WA 98682

Registered July 17, 2012

Int. Cl.: 12

FOR: BRAKING SYSTEM FOR VEHICLES; SUPPLEMENTAL BRAKING SYSTEM FOR VEHICLES, IN CLASS 12 (U.S. CLS. 19, 21, 23, 31, 35 AND 44).

TRADEMARK

FIRST USE 11-30-2010; IN COMMERCE 5-25-2011.

PRINCIPAL REGISTER

THE MARK CONSISTS OF STANDARD CHARACTERS WITHOUT CLAIM TO ANY PARTICULAR FONT, STYLE, SIZE, OR COLOR.

OWNER OF U.S. REG. NOS. 3,254,179, 3,341,040, AND 3,434,873.

NO CLAIM IS MADE TO THE EXCLUSIVE RIGHT TO USE "BRAKE", APART FROM THE MARK AS SHOWN.

SER. NO. 85-476,958, FILED 11-18-2011.

AMY C. KEAN, EXAMINING ATTORNEY



David J. Kappas

Director of the United States Patent and Trademark Office

United States of America

United States Patent and Trademark Office

GROUND KONTROL

Reg. No. 4,175,262

TIMEWARP, INCORPORATED (OREGON CORPORATION), DBA GROUND KONTROL
511 NW COUCH ST.

Registered July 17, 2012

PORTLAND, OR 97209

Int. Cls.: 35, 41 and 43

FOR: RETAIL STORE SERVICES FEATURING NOVELTY ITEMS AND PROMOTIONAL ITEMS, IN CLASS 35 (U.S. CLS. 100, 101 AND 102).

SERVICE MARK

FIRST USE 4-0-1999; IN COMMERCE 7-17-2003.

PRINCIPAL REGISTER

FOR: VIDEO AND PINBALL ARCADE SERVICES; ENTERTAINMENT, NAMELY, HOSTING DJS AND LIVE MUSIC, IN CLASS 41 (U.S. CLS. 100, 101 AND 107).

FIRST USE 4-0-1999; IN COMMERCE 12-0-1999.

FOR: CATERING, RESTAURANT AND BAR SERVICES, IN CLASS 43 (U.S. CLS. 100 AND 101).

FIRST USE 4-0-1999; IN COMMERCE 7-17-2003.

THE MARK CONSISTS OF STANDARD CHARACTERS WITHOUT CLAIM TO ANY PARTICULAR FONT, STYLE, SIZE, OR COLOR.

SER. NO. 85-476,960, FILED 11-18-2011.

DEIRDRE ROBERTSON, EXAMINING ATTORNEY



David J. Kybas

Director of the United States Patent and Trademark Office

United States of America

United States Patent and Trademark Office

ABSOLUTELY SOLAR

Reg. No. 4,175,263

Registered July 17, 2012

Int. Cl.: 37

SERVICE MARK

PRINCIPAL REGISTER

ABSOLUTELY SOLAR, INC. (CALIFORNIA CORPORATION)
2146 LEMOYNE ST.
LOS ANGELES, CA 90026

FOR: BUILDING CONSTRUCTION SERVICES; BUILDING CONSTRUCTION SUPERVISION; CONSTRUCTION PROJECT MANAGEMENT SERVICES; CONSULTATION SERVICES IN THE FIELD OF CONSTRUCTION OF ENVIRONMENTALLY-CONSCIOUS BUILDINGS; HOME ENERGY ASSESSMENT SERVICES FOR THE PURPOSE OF DETERMINING HOME IMPROVEMENTS NEEDED TO IMPROVE ENERGY USE AND EFFICIENCY; INSTALLATION AND MAINTENANCE OF PHOTOVOLTAIC INSTALLATIONS; INSTALLATION OF RENEWABLE ENERGY GENERATION EQUIPMENT; INSTALLATION OF SOLAR ENERGY SYSTEMS AND ALTERNATIVE ENERGY PRODUCTS FOR RESIDENTIAL AND COMMERCIAL USE, IN CLASS 37 (U.S. CLS. 100, 103 AND 106).

FIRST USE 6-1-2001; IN COMMERCE 9-1-2009.

THE MARK CONSISTS OF STANDARD CHARACTERS WITHOUT CLAIM TO ANY PARTICULAR FONT, STYLE, SIZE, OR COLOR.

NO CLAIM IS MADE TO THE EXCLUSIVE RIGHT TO USE "SOLAR", APART FROM THE MARK AS SHOWN.

SER. NO. 85-477,016, FILED 11-18-2011.

AHSEN KHAN, EXAMINING ATTORNEY



David J. Kybas

Director of the United States Patent and Trademark Office

United States of America

United States Patent and Trademark Office

RACE-KRED

Reg. No. 4,175,264

RACE-KRED, LLC (GEORGIA LIMITED LIABILITY COMPANY)
3016 W ROXBORO ROAD
ATLANTA, GA 30324

Registered July 17, 2012

Int. Cl.: 14

FOR: MEDALS FOR USE AS AWARDS, IN CLASS 14 (U.S. CLS. 2, 27, 28 AND 50).

TRADEMARK

FIRST USE 10-18-2011; IN COMMERCE 10-18-2011.

PRINCIPAL REGISTER

THE MARK CONSISTS OF STANDARD CHARACTERS WITHOUT CLAIM TO ANY PARTICULAR FONT, STYLE, SIZE, OR COLOR.

SER. NO. 85-477,032, FILED 11-18-2011.

MARIA-VICTORIA SUAREZ, EXAMINING ATTORNEY



David J. Kyffers

Director of the United States Patent and Trademark Office

United States of America

United States Patent and Trademark Office

PEBBLE

Reg. No. 4,175,265

ENHANCED VISION SYSTEMS, INC. (CALIFORNIA CORPORATION)
5882 MACHINE DRIVE
HUNTINGTON BEACH, CA 92649

Registered July 17, 2012

Int. Cl.: 9

FOR: PORTABLE ELECTRONIC VIDEO MAGNIFIERS, IN CLASS 9 (U.S. CLS. 21, 23, 26, 36 AND 38).

TRADEMARK

FIRST USE 3-10-2009; IN COMMERCE 3-10-2009.

PRINCIPAL REGISTER

THE MARK CONSISTS OF STANDARD CHARACTERS WITHOUT CLAIM TO ANY PARTICULAR FONT, STYLE, SIZE, OR COLOR.

SER. NO. 85-477,044, FILED 11-18-2011.

MARIA-VICTORIA SUAREZ, EXAMINING ATTORNEY



David J. Kybas

Director of the United States Patent and Trademark Office

United States of America

United States Patent and Trademark Office

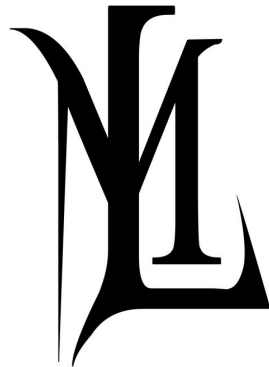

Reg. No. 4,175,266

Registered July 17, 2012

Int. Cl.: 25

TRADEMARK

PRINCIPAL REGISTER

LEGEND BY MCLANE, INC. (CALIFORNIA CORPORATION)
4735 SEPULVEDA BLVD. #204
HTTP://LEGENDBYMCLANE.COM
SHERMAN OAKS, CA 91403

FOR: CLOTHING; NAMELY, WOMEN'S SHIRTS, SHORTS, SWIMWEAR, TANK TOPS AND HOODED SWEATSHIRTS; MEN'S SHIRTS, SWIMWEAR, HOODED SWEATSHIRTS AND HATS, IN CLASS 25 (U.S. CLS. 22 AND 39).

FIRST USE 12-18-2010; IN COMMERCE 8-1-2011.

THE MARK CONSISTS OF UNIQUELY DESIGNED LETTER CAPITAL "L" INTERLACED WITH A UNIQUELY DESIGNED CAPITAL LETTER "M".

SER. NO. 85-477,046, FILED 11-18-2011.

MARIA-VICTORIA SUAREZ, EXAMINING ATTORNEY



David J. Kyffers

Director of the United States Patent and Trademark Office

United States of America

United States Patent and Trademark Office

Project Nightlight

Reg. No. 4,175,267

Registered July 17, 2012

Int. Cl.: 41

SERVICE MARK

PRINCIPAL REGISTER

PROJECT NIGHTLIGHT (CALIFORNIA CORPORATION)
2633 LINCOLN BLVD, SUITE 249
SANTA MONICA, CA 90405

FOR: EDUCATION SERVICES, NAMELY, CONDUCTING WORKSHOPS ON THE TOPIC OF RECOGNIZING, REPORTING AND PREVENTING CHILD ABUSE AND NEGLECT, IN CLASS 41 (U.S. CLS. 100, 101 AND 107).

FIRST USE 9-23-2003; IN COMMERCE 10-1-2003.

THE MARK CONSISTS OF STANDARD CHARACTERS WITHOUT CLAIM TO ANY PARTICULAR FONT, STYLE, SIZE, OR COLOR.

OWNER OF U.S. REG. NO. 3,049,234.

NO CLAIM IS MADE TO THE EXCLUSIVE RIGHT TO USE "PROJECT", APART FROM THE MARK AS SHOWN.

SER. NO. 85-477,052, FILED 11-18-2011.

ROBERT C. CLARK JR., EXAMINING ATTORNEY



David J. Kyffers

Director of the United States Patent and Trademark Office

United States of America

United States Patent and Trademark Office

ZERO-SELLING FUNDRAISER

Reg. No. 4,175,268

ALL-AMERICAN PUBLISHING, LLC (IDAHO LIMITED LIABILITY COMPANY)
5411 KENDALL STREET
BOISE, ID 83706

Registered July 17, 2012

Int. Cl.: 36

FOR: PROVIDING AN ON-LINE WEBSITE PLATFORM DESIGNED TO ASSIST SCHOOLS AND OTHER ORGANIZATIONS IN RAISING FUNDS FOR ACTIVITIES AND SPORTS PROGRAMS , IN CLASS 36 (U.S. CLS. 100, 101 AND 102).

SERVICE MARK

FIRST USE 7-0-2011; IN COMMERCE 7-0-2011.

PRINCIPAL REGISTER

THE MARK CONSISTS OF STANDARD CHARACTERS WITHOUT CLAIM TO ANY PARTICULAR FONT, STYLE, SIZE, OR COLOR.

NO CLAIM IS MADE TO THE EXCLUSIVE RIGHT TO USE "FUNDRAISING", APART FROM THE MARK AS SHOWN.

SER. NO. 85-477,067, FILED 11-18-2011.

JAY FLOWERS, EXAMINING ATTORNEY



David J. Kybas

Director of the United States Patent and Trademark Office

United States of America

United States Patent and Trademark Office

The Scootabaker

Reg. No. 4,175,269

WONG, WENDIE HEATHER (UNITED STATES INDIVIDUAL), DBA THE SCOOTABAKER
PO BOX 29141

Registered July 17, 2012

LOS ANGELES, CA 90029

Int. Cl.: 40

FOR: BAKERY SERVICES, NAMELY, THE MANUFACTURE OF BAKERY PRODUCTS TO ORDER AND/OR SPECIFICATION OF OTHERS, IN CLASS 40 (U.S. CLS. 100, 103 AND 106).

SERVICE MARK

FIRST USE 12-7-2010; IN COMMERCE 12-7-2010.

PRINCIPAL REGISTER

THE MARK CONSISTS OF STANDARD CHARACTERS WITHOUT CLAIM TO ANY PARTICULAR FONT, STYLE, SIZE, OR COLOR.

SER. NO. 85-477,135, FILED 11-19-2011.

SANI KHOURI, EXAMINING ATTORNEY



David J. Kybas

Director of the United States Patent and Trademark Office

United States of America

United States Patent and Trademark Office

TTABULATOR

Reg. No. 4,175,270

ERIK M. PELTON & ASSOCIATES, PLLC (VIRGINIA LIMITED LIABILITY COMPANY)
PO BOX 100637
ARLINGTON, VA 22210

Registered July 17, 2012

Int. Cl.: 41

FOR: ON-LINE JOURNALS, NAMELY, BLOGS FEATURING INFORMATION IN THE FIELDS OF LAW, TRADEMARKS AND INTELLECTUAL PROPERTY, IN CLASS 41 (U.S. CLS. 100, 101 AND 107).

SERVICE MARK

FIRST USE 10-31-2011; IN COMMERCE 11-2-2011.

PRINCIPAL REGISTER

THE MARK CONSISTS OF STANDARD CHARACTERS WITHOUT CLAIM TO ANY PARTICULAR FONT, STYLE, SIZE, OR COLOR.

SER. NO. 85-477,138, FILED 11-19-2011.

SEAN CROWLEY, EXAMINING ATTORNEY



David J. Kyffers

Director of the United States Patent and Trademark Office

United States of America

United States Patent and Trademark Office

Buying This

Reg. No. 4,175,271

Registered July 17, 2012

Int. Cl.: 9

TRADEMARK

PRINCIPAL REGISTER

ALTAVOZ, INC. (MARYLAND CORPORATION), DBA ALTAVOZ DISTRIBUTION
622 HUNGERFORD DR. STE 2
ROCKVILLE, MD 20850

FOR: COMPUTER E-COMMERCE SOFTWARE TO ALLOW USERS TO PERFORM ELECTRONIC BUSINESS TRANSACTIONS VIA A GLOBAL COMPUTER NETWORK, IN CLASS 9 (U.S. CLS. 21, 23, 26, 36 AND 38).

FIRST USE 5-12-2011; IN COMMERCE 6-19-2011.

THE MARK CONSISTS OF STANDARD CHARACTERS WITHOUT CLAIM TO ANY PARTICULAR FONT, STYLE, SIZE, OR COLOR.

SER. NO. 85-477,181, FILED 11-19-2011.

JOHN WILKE, EXAMINING ATTORNEY



David J. Kyffers

Director of the United States Patent and Trademark Office

United States of America
United States Patent and Trademark Office

hairbanglez

Reg. No. 4,175,272

ZANNELLA, KARIN (UNITED STATES INDIVIDUAL), DBA HAIRBANGLEZ
56 ROBSON PLACE
FAIRFIELD, CT 06824

Registered July 17, 2012

Int. Cl.: 14

FOR: BANGLE BRACELETS, IN CLASS 14 (U.S. CLS. 2, 27, 28 AND 50).

TRADEMARK

FIRST USE 11-15-2011; IN COMMERCE 11-15-2011.

PRINCIPAL REGISTER

THE MARK CONSISTS OF STANDARD CHARACTERS WITHOUT CLAIM TO ANY PARTICULAR FONT, STYLE, SIZE, OR COLOR.

SER. NO. 85-477,225, FILED 11-20-2011.

KATHLEEN M. VANSTON, EXAMINING ATTORNEY



David J. Kyffers

Director of the United States Patent and Trademark Office

United States of America

United States Patent and Trademark Office

Elite Science

Reg. No. 4,175,273

ELITE SCIENCE LLC (NEVADA LIMITED LIABILITY COMPANY)
433 HEIGHTS DRIVE
GIBSONIA, PA 15044

Registered July 17, 2012

Int. Cl.: 5

FOR: DIETARY AND NUTRITIONAL SUPPLEMENTS; DIETARY SUPPLEMENTS FOR ANIMALS; DIETARY SUPPLEMENTS FOR HUMAN CONSUMPTION; DIETARY SUPPLEMENTS FOR PETS; TOPICAL ANALGESIC CREAMS, IN CLASS 5 (U.S. CLS. 6, 18, 44, 46, 51 AND 52).

TRADEMARK

PRINCIPAL REGISTER

FIRST USE 11-1-2011; IN COMMERCE 12-12-2011.

THE MARK CONSISTS OF STANDARD CHARACTERS WITHOUT CLAIM TO ANY PARTICULAR FONT, STYLE, SIZE, OR COLOR.

SER. NO. 85-477,242, FILED 11-20-2011.

JAMES A. RAUEN, EXAMINING ATTORNEY



David J. Kyffers

Director of the United States Patent and Trademark Office

United States of America

United States Patent and Trademark Office



Reg. No. 4,175,274

BEST PRODUCTS LLC (OREGON LIMITED LIABILITY COMPANY), DBA POWER BANDZ
104 DAFFNEY CT.
CENTRAL POINT, OR 97502

Registered July 17, 2012

Int. Cls.: 14 and 16

FOR: BRACELETS MADE OF SILICONE, IN CLASS 14 (U.S. CLS. 2, 27, 28 AND 50).

TRADEMARK

FIRST USE 1-20-2011; IN COMMERCE 1-20-2011.

PRINCIPAL REGISTER

FOR: PRINTED HOLOGRAMS, IN CLASS 16 (U.S. CLS. 2, 5, 22, 23, 29, 37, 38 AND 50).

FIRST USE 1-20-2011; IN COMMERCE 1-20-2011.

THE MARK CONSISTS OF A STYLIZED LETTER "Z" WITH ITS TAIL WIDENING AS IT EXTENDS UPWARD AND ENDING IN A FLAT HORIZONTAL POSITION.

SER. NO. 85-477,294, FILED 11-20-2011.

AMY KERTGATE, EXAMINING ATTORNEY



David J. Kybas

Director of the United States Patent and Trademark Office

United States of America

United States Patent and Trademark Office

nomad22c
NOMAD TWENTY SECOND CENTURY

Reg. No. 4,175,275

Registered July 17, 2012

Int. Cl.: 20

TRADEMARK

PRINCIPAL REGISTER

THE TRUSTEE OF THE MICHAEL H. COON REVOCABLE TRUST, AN IOWA TRUST, THE TRUSTEES COMPRISING MICHAEL H. COON, A UNITED STATES CITIZEN (IOWA TRUST)

3425 WAUKON AVENUE
LOHRVILLE, IA 51453

FOR: FURNITURE, IN CLASS 20 (U.S. CLS. 2, 13, 22, 25, 32 AND 50).

FIRST USE 11-2-2011; IN COMMERCE 11-2-2011.

THE MARK CONSISTS OF STANDARD CHARACTERS WITHOUT CLAIM TO ANY PARTICULAR FONT, STYLE, SIZE, OR COLOR.

SER. NO. 85-477,299, FILED 11-20-2011.

SAMUEL E. SHARPER JR., EXAMINING ATTORNEY



David J. Kyffers

Director of the United States Patent and Trademark Office

United States of America

United States Patent and Trademark Office

THERE IS AN ACUPOINT FOR THAT

Reg. No. 4,175,276

Registered July 17, 2012

Int. Cl.: 44

SERVICE MARK

PRINCIPAL REGISTER

DAVIES, EUDOXIE (CONNECTICUT SOLE PROPRIETORSHIP), DBA THERE IS AN ACUPOINT FOR THAT
27 NORTHILL STREET, #3W
STAMFORD, CT 06907

FOR: ACUPUNCTURE SERVICES, IN CLASS 44 (U.S. CLS. 100 AND 101).

FIRST USE 9-14-2011; IN COMMERCE 9-14-2011.

THE MARK CONSISTS OF STANDARD CHARACTERS WITHOUT CLAIM TO ANY PARTICULAR FONT, STYLE, SIZE, OR COLOR.

SER. NO. 85-477,301, FILED 11-20-2011.

SAMUEL E. SHARPER JR., EXAMINING ATTORNEY



David J. Kyffers

Director of the United States Patent and Trademark Office

United States of America

United States Patent and Trademark Office

THAW AND CURE

Reg. No. 4,175,277

BARRY CONCRETE, INC. (MAINE CORPORATION), DBA THAW AND CURE CO.
510 BATH RD.

Registered July 17, 2012

WISCASSET, ME 04578

Int. Cl.: 40

FOR: RENTAL OF SPACE HEATING APPARATUS, IN CLASS 40 (U.S. CLS. 100, 103 AND 106).

SERVICE MARK

FIRST USE 2-1-2010; IN COMMERCE 2-1-2010.

PRINCIPAL REGISTER

THE MARK CONSISTS OF STANDARD CHARACTERS WITHOUT CLAIM TO ANY PARTICULAR FONT, STYLE, SIZE, OR COLOR.

SER. NO. 85-477,309, FILED 11-20-2011.

SAMUEL E. SHARPER JR., EXAMINING ATTORNEY



David J. Kybas

Director of the United States Patent and Trademark Office

United States of America
United States Patent and Trademark Office

RENAPLEX

Reg. No. 4,175,278

NEPHRO-TECH, INC. (KANSAS CORPORATION)
PO BOX 16106
SHAWNEE, KS 66203

Registered July 17, 2012

Int. Cl.: 5

FOR: DIETARY SUPPLEMENTS FOR USE BY PEOPLE WITH CONCERNS FOR RENAL HEALTH, IN CLASS 5 (U.S. CLS. 6, 18, 44, 46, 51 AND 52).

TRADEMARK

FIRST USE 11-21-2001; IN COMMERCE 11-21-2001.

PRINCIPAL REGISTER

THE MARK CONSISTS OF STANDARD CHARACTERS WITHOUT CLAIM TO ANY PARTICULAR FONT, STYLE, SIZE, OR COLOR.

SER. NO. 85-477,312, FILED 11-20-2011.

SAMUEL E. SHARPER JR., EXAMINING ATTORNEY



David J. Kybas

Director of the United States Patent and Trademark Office

United States of America

United States Patent and Trademark Office

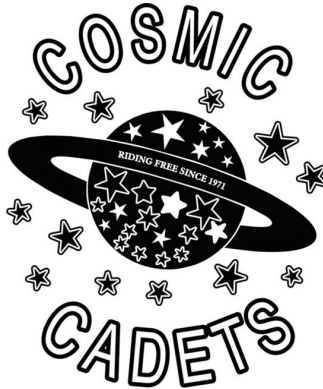

Reg. No. 4,175,279

Registered July 17, 2012

Int. Cl.: 41

SERVICE MARK

PRINCIPAL REGISTER

CROCKETT, PAUL (UNITED STATES INDIVIDUAL)
17 LUTHER RD
BURLINGTON, MA 01803

FOR: SOCIAL CLUB SERVICES, NAMELY, ARRANGING, ORGANIZING, AND HOSTING SOCIAL EVENTS, GET-TOGETHERS, AND PARTIES FOR CLUB MEMBERS, IN CLASS 41 (U.S. CLS. 100, 101 AND 107).

FIRST USE 0-0-1975; IN COMMERCE 0-0-2001.

NO CLAIM IS MADE TO THE EXCLUSIVE RIGHT TO USE "SINCE 1971", APART FROM THE MARK AS SHOWN.

THE MARK CONSISTS OF THE WORD "COSMIC" ABOVE A PLANET. THE WORD "CADETS" IS BELOW THE PLANET. THE PLANET HAS A RING AROUND IT AND IN THE RING ARE THE WORDS "RIDING FREE SINCE 1971". THE MARK ALSO HAS 22 STARS ON THE PLANET AND 12 STARS AROUND IT.

SER. NO. 85-477,337, FILED 11-20-2011.

TINA MAI, EXAMINING ATTORNEY



David J. Kyros

Director of the United States Patent and Trademark Office

United States of America

United States Patent and Trademark Office

STIRRUP QUEENS

Reg. No. 4,175,280

FORD, MELISSA S. (UNITED STATES INDIVIDUAL)

Registered July 17, 2012

PO BOX 1405
OLNEY, MD 20830

Int. Cl.: 41

FOR: ONLINE JOURNALS, MAINLY, BLOGS FEATURING INFORMATION ABOUT INFERTILITY, ADOPTION, PREGNANCY LOSS, PARENTING, PUBLISHING, WRITING, AND SOCIAL MEDIA; WRITING OF ARTICLES FOR JOURNALS OTHER THAN FOR ADVERTISING OR PUBLICITY; WRITTEN TEXT EDITING; PROVIDING AN INTERNET WEBSITE PORTAL FEATURING LINKS TO NEWS STORIES AND ARTICLES IN THE FIELD OF CURRENT EVENTS, IN CLASS 41 (U.S. CLS. 100, 101 AND 107).

SERVICE MARK

PRINCIPAL REGISTER

FIRST USE 6-20-2006; IN COMMERCE 6-20-2006.

THE MARK CONSISTS OF STANDARD CHARACTERS WITHOUT CLAIM TO ANY PARTICULAR FONT, STYLE, SIZE, OR COLOR.

SER. NO. 85-477,354, FILED 11-20-2011.

KARANENDRA S. CHHINA, EXAMINING ATTORNEY



David J. Kyffers

Director of the United States Patent and Trademark Office

United States of America

United States Patent and Trademark Office

TILG

Reg. No. 4,175,281

Registered July 17, 2012

Int. Cl.: 45

SERVICE MARK

PRINCIPAL REGISTER

ADLI, KAVON (UNITED STATES INDIVIDUAL), DBA THE INTERNET LAW GROUP
9107 WILSHIRE BOULEVARD
SUITE 500
BEVERLY HILLS, CA 90210

FOR: LEGAL CONSULTING SERVICES IN THE FIELD OF INTERNET BUSINESS; LEGAL RESEARCH; LEGAL SERVICES; LEGAL SERVICES, NAMELY, INTELLECTUAL PROPERTY CONSULTING SERVICES IN THE FIELD OF IDENTIFICATION, STRATEGY, ANALYTICS, AND INVENTION; LEGAL SERVICES, NAMELY, PREPARATION OF APPLICATIONS FOR TRADEMARK REGISTRATION; LEGAL SERVICES, NAMELY, PROVIDING CUSTOMIZED DOCUMENTATION, INFORMATION, COUNSELING, ADVICE AND CONSULTATION SERVICES IN ALL AREAS OF INTERNET AND BUSINESS LAW; LEGAL SERVICES, NAMELY, PROVIDING CUSTOMIZED INFORMATION, COUNSELING, ADVICE AND LITIGATION SERVICES IN ALL AREAS OF EMPLOYMENT AND LABOR LAW FOR BOTH EMPLOYEES AND EMPLOYERS; LEGAL SERVICES, NAMELY, PROVIDING CUSTOMIZED INFORMATION, COUNSELING, ADVICE AND LITIGATION SERVICES IN ALL AREAS OF INTERNATIONAL LAW; LEGAL SERVICES, NAMELY, TRADEMARK SEARCHING AND CLEARANCE SERVICES, IN CLASS 45 (U.S. CLS. 100 AND 101).

FIRST USE 11-1-2008; IN COMMERCE 11-1-2008.

THE MARK CONSISTS OF STANDARD CHARACTERS WITHOUT CLAIM TO ANY PARTICULAR FONT, STYLE, SIZE, OR COLOR.

SER. NO. 85-477,357, FILED 11-20-2011.

ANN E. SAPPENFIELD, EXAMINING ATTORNEY



David J. Kyjars

Director of the United States Patent and Trademark Office

United States of America

United States Patent and Trademark Office

Bamboo

Reg. No. 4,175,282

Registered July 17, 2012

Int. Cl.: 2

TRADEMARK

PRINCIPAL REGISTER

MACKANESS, SYLVAN H (UNITED STATES INDIVIDUAL), DBA DURAPERM
4800 VENETIAN BLVD NE
ST PETERSBURG, FL 33703

FOR: ANTI-FOULING PAINTS; ANTICORROSIVE PAINTS; BACTERICIDAL PAINTS; CHEMICALPROOF PAINTS; COATING PREPARATIONS HAVING WATER REPELLENT PROPERTIES; COATINGS FOR WOOD AS PAINTS; COLORANTS FOR USE IN THE MANUFACTURE OF PAINT; COLORANTS, PAINTS AND DYES FOR GENERAL INDUSTRIAL USE; DAMP PROOFING PAINTS; EXTERIOR PAINT; FLOOR PAINTS; HOUSE PAINT; INTERIOR PAINT; MIXED PAINTS; PAINT ADDITIVE MADE OF RECYCLED MATERIAL TO ADD TEXTURE, COLOR, OR REFLECTION; PAINT FOR CONCRETE FLOORS; PAINT FOR INDUSTRIAL EQUIPMENT AND MACHINERY; PAINT FOR USE IN THE MANUFACTURE OF FURNITURE; PAINT PRIMERS; PAINT SEALERS; PAINTS; PRIMERS FOR PREPARING SURFACES TO BE PAINTED; SYNTHETIC RESIN PAINTS; TEXTURED ADDITIVES FOR PAINT; WATER REPELLENT PAINTS; WATER-BASED PAINTS; WATERPROOF PAINTS; WEATHERPROOFING COATINGS, IN CLASS 2 (U.S. CLS. 6, 11 AND 16).

FIRST USE 11-1-2007; IN COMMERCE 7-7-2011.

THE MARK CONSISTS OF STANDARD CHARACTERS WITHOUT CLAIM TO ANY PARTICULAR FONT, STYLE, SIZE, OR COLOR.

SER. NO. 85-477,369, FILED 11-20-2011.

TINA MAI, EXAMINING ATTORNEY



David J. Kybas

Director of the United States Patent and Trademark Office

United States of America

United States Patent and Trademark Office

Quantum Psychic

Reg. No. 4,175,283

Registered July 17, 2012

Int. Cl.: 45

SERVICE MARK

PRINCIPAL REGISTER

SWEETE, JENNIFER B. (UNITED STATES INDIVIDUAL)
PO BOX 561
CONIFER, CO 80433

FOR: PSYCHIC READING SERVICES, IN CLASS 45 (U.S. CLS. 100 AND 101).

FIRST USE 6-19-1988; IN COMMERCE 6-19-1988.

THE MARK CONSISTS OF STANDARD CHARACTERS WITHOUT CLAIM TO ANY PARTICULAR FONT, STYLE, SIZE, OR COLOR.

NO CLAIM IS MADE TO THE EXCLUSIVE RIGHT TO USE "PSYCHIC", APART FROM THE MARK AS SHOWN.

SER. NO. 85-477,387, FILED 11-21-2011.

LINDSEY RUBIN, EXAMINING ATTORNEY



David J. Kyffers

Director of the United States Patent and Trademark Office

United States of America

United States Patent and Trademark Office

LACE AFFAIR

Reg. No. 4,175,284

Registered July 17, 2012

Int. Cl.: 35

SERVICE MARK

PRINCIPAL REGISTER

LACE AFFAIR, INC. (MASSACHUSETTS CORPORATION)
24 WALLINGFORD RD.
APT 8
BRIGHTON, MA 02135

FOR: ONLINE RETAIL STORE SERVICES AND RETAIL STORE SERVICES FEATURING CLOTHING AND ACCESSORIES, NAMELY, FOOTWEAR, HEADWEAR, TOPS, BOTTOMS, SHIRTS, PANTS, CARDIGANS, DRESSES, OUTERWEAR, HANDBAGS, SCARVES, EARRINGS, AND NECKLACES, IN CLASS 35 (U.S. CLS. 100, 101 AND 102).

FIRST USE 1-19-2011; IN COMMERCE 5-10-2011.

THE MARK CONSISTS OF STANDARD CHARACTERS WITHOUT CLAIM TO ANY PARTICULAR FONT, STYLE, SIZE, OR COLOR.

SER. NO. 85-477,413, FILED 11-21-2011.

MICHAEL KEATING, EXAMINING ATTORNEY



David J. Kyffers

Director of the United States Patent and Trademark Office

United States of America

United States Patent and Trademark Office

Outthinker

Reg. No. 4,175,285

KRIPPENDORFF, KAIHAN (UNITED STATES INDIVIDUAL)
4 GREY ROCK DR.
GREENWICH, CT 06831

Registered July 17, 2012

Int. Cls.: 35 and 36

FOR: BUSINESS CONSULTANCY, IN CLASS 35 (U.S. CLS. 100, 101 AND 102).

SERVICE MARK

FIRST USE 7-1-2011; IN COMMERCE 7-1-2011.

PRINCIPAL REGISTER

FOR: PROVIDING VENTURE CAPITAL, DEVELOPMENT CAPITAL, PRIVATE EQUITY
AND INVESTMENT FUNDING, IN CLASS 36 (U.S. CLS. 100, 101 AND 102).

FIRST USE 7-1-2011; IN COMMERCE 7-1-2011.

THE MARK CONSISTS OF STANDARD CHARACTERS WITHOUT CLAIM TO ANY PARTICULAR FONT, STYLE, SIZE, OR COLOR.

SER. NO. 85-477,421, FILED 11-21-2011.

MARGERY A. TIERNEY, EXAMINING ATTORNEY



David J. Kybas

Director of the United States Patent and Trademark Office

United States of America

United States Patent and Trademark Office

ERGOSQUISH

Reg. No. 4,175,286

RICHARD MORRISON (UNITED STATES INDIVIDUAL)
6947 WIND RIVER DRIVE
REYNOLDSBURG, OH 43068

Registered July 17, 2012

Int. Cl.: 8

FOR: APPARATUS FOR TATTOOING; TATTOO NEEDLES, IN CLASS 8 (U.S. CLS. 23, 28 AND 44).

TRADEMARK

FIRST USE 8-1-2011; IN COMMERCE 10-2-2011.

PRINCIPAL REGISTER

THE MARK CONSISTS OF STANDARD CHARACTERS WITHOUT CLAIM TO ANY PARTICULAR FONT, STYLE, SIZE, OR COLOR.

SER. NO. 85-477,448, FILED 11-21-2011.

JENNIFER VASQUEZ, EXAMINING ATTORNEY



David J. Kybas

Director of the United States Patent and Trademark Office

United States of America

United States Patent and Trademark Office

Xingo

Reg. No. 4,175,287

Registered July 17, 2012

Int. Cl.: 9

TRADEMARK

PRINCIPAL REGISTER

TRANSCRIPTIX INC. (DELAWARE CORPORATION)
31762 TIMBERLAKE DR
EXCELSIOR SPRINGS, MO 64024

FOR: COMPUTER APPLICATION SOFTWARE FOR MOBILE PHONES, NAMELY, SOFTWARE FOR RELAY OF VOICE, TEXT, PICTURES, AND VIDEO, IN CLASS 9 (U.S. CLS. 21, 23, 26, 36 AND 38).

FIRST USE 10-0-2011; IN COMMERCE 10-0-2011.

THE MARK CONSISTS OF STANDARD CHARACTERS WITHOUT CLAIM TO ANY PARTICULAR FONT, STYLE, SIZE, OR COLOR.

SER. NO. 85-477,451, FILED 11-21-2011.

JILL C. ALT, EXAMINING ATTORNEY



David J. Kyffers

Director of the United States Patent and Trademark Office

United States of America
United States Patent and Trademark Office

AMBUCARE

Reg. No. 4,175,288

AMBUCARE, INC. (GEORGIA CORPORATION)
1196 HIGHTOWER ROAD
BREMEN, GA 30110

Registered July 17, 2012

Int. Cl.: 44

FOR: EMERGENCY MEDICAL ASSISTANCE; EMERGENCY MEDICAL RESPONSE SERVICES, IN CLASS 44 (U.S. CLS. 100 AND 101).

SERVICE MARK

FIRST USE 4-17-1995; IN COMMERCE 4-17-1995.

PRINCIPAL REGISTER

THE MARK CONSISTS OF STANDARD CHARACTERS WITHOUT CLAIM TO ANY PARTICULAR FONT, STYLE, SIZE, OR COLOR.

SER. NO. 85-477,464, FILED 11-21-2011.

DANIEL CAPSHAW, EXAMINING ATTORNEY



David J. Kyffers

Director of the United States Patent and Trademark Office

United States of America

United States Patent and Trademark Office

ROYAL SCRIBE

Reg. No. 4,175,289

ROYAL SCRIBE (NEW YORK CORPORATION)
2310 HEMPSTEAD TURNPIKE, SUITE 202
EAST MEADOW, NY 11554

Registered July 17, 2012

Int. Cl.: 41

FOR: PUBLISHING OF BOOKS, E-BOOKS, AUDIO BOOKS, MUSIC AND ILLUSTRATIONS,
IN CLASS 41 (U.S. CLS. 100, 101 AND 107).

SERVICE MARK

FIRST USE 11-1-2011; IN COMMERCE 11-1-2011.

PRINCIPAL REGISTER

THE MARK CONSISTS OF STANDARD CHARACTERS WITHOUT CLAIM TO ANY PAR-
TICULAR FONT, STYLE, SIZE, OR COLOR.

SER. NO. 85-477,474, FILED 11-21-2011.

ANTHONY RINKER, EXAMINING ATTORNEY



David J. Kybas

Director of the United States Patent and Trademark Office

United States of America
United States Patent and Trademark Office

BRAVURA

Reg. No. 4,175,290

CENTRAL INDIANA HARDWARE CO., INC. (INDIANA CORPORATION)
9190 CORPORATION DRIVE
INDIANAPOLIS, IN 46256

Registered July 17, 2012

Int. Cl.: 6

FOR: DOOR HARDWARE MADE OF METAL, NAMELY, KNOBS, HANDLES, HANDLE SETS, LOCKS, DEADBOLTS, HINGES, IN CLASS 6 (U.S. CLS. 2, 12, 13, 14, 23, 25 AND 50).

TRADEMARK

FIRST USE 7-1-2002; IN COMMERCE 7-1-2002.

PRINCIPAL REGISTER

THE MARK CONSISTS OF STANDARD CHARACTERS WITHOUT CLAIM TO ANY PARTICULAR FONT, STYLE, SIZE, OR COLOR.

SER. NO. 85-477,482, FILED 11-21-2011.

KRISTIN DAHLING, EXAMINING ATTORNEY



David J. Kyffers

Director of the United States Patent and Trademark Office

United States of America

United States Patent and Trademark Office

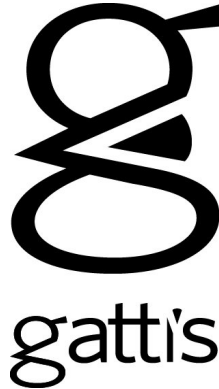

Reg. No. 4,175,291

Registered July 17, 2012

Int. Cl.: 43

SERVICE MARK

PRINCIPAL REGISTER

MR. GATTI'S, LP (TEXAS LIMITED PARTNERSHIP)
5912 BALCONES DRIVE, SUITE 200
AUSTIN, TX 78731

FOR: RESTAURANT AND CAFE SERVICES, IN CLASS 43 (U.S. CLS. 100 AND 101).

FIRST USE 10-25-2011; IN COMMERCE 10-25-2011.

OWNER OF U.S. REG. NOS. 2,810,201, 3,208,009 AND OTHERS.

THE MARK CONSISTS OF A STYLIZED, LOWERCASE LETTER "G" WITH A SHADED SILHOUETTE OF A SLICE OF PIZZA TO THE RIGHT OF THIS LETTER, FOLLOWED BELOW BY THE TERM "GATTI'S" IN LOWERCASE FONT.

SER. NO. 85-477,484, FILED 11-21-2011.

LINDA E. BLOHM, EXAMINING ATTORNEY



David J. Kyffers

Director of the United States Patent and Trademark Office

United States of America

United States Patent and Trademark Office

S-TEC

Reg. No. 4,175,292

Registered July 17, 2012

Int. Cl.: 9

TRADEMARK

PRINCIPAL REGISTER

S-TEC CORPORATION (TEXAS CORPORATION)
ONE S-TEC WAY
MINERAL WELLS, TX 76067

FOR: AVIONICS EQUIPMENT, NAMELY, AIRCRAFT ELECTRONICS COMPRISED OF AUTO PILOTS, NAVIGATION AND COMMUNICATION RADIOS, TRANSPONDERS, AND ASSOCIATED PARTS THERETO, IN CLASS 9 (U.S. CLS. 21, 23, 26, 36 AND 38).

FIRST USE 9-30-1979; IN COMMERCE 9-30-1979.

THE MARK CONSISTS OF STANDARD CHARACTERS WITHOUT CLAIM TO ANY PARTICULAR FONT, STYLE, SIZE, OR COLOR.

SER. NO. 85-477,490, FILED 11-21-2011.

JAMES GRIFFIN, EXAMINING ATTORNEY



David J. Kyffers

Director of the United States Patent and Trademark Office

United States of America

United States Patent and Trademark Office

ABNB

Reg. No. 4,175,293

Registered July 17, 2012

Int. Cl.: 36

SERVICE MARK

PRINCIPAL REGISTER

ABNB FEDERAL CREDIT UNION (UNITED STATES FEDERALLY CHARTERED CREDIT UNION)
830 GREENBRIER CIRCLE
CHESAPEAKE, VA 23320

FOR: CREDIT UNION SERVICES, IN CLASS 36 (U.S. CLS. 100, 101 AND 102).

FIRST USE 3-5-2003; IN COMMERCE 3-5-2003.

THE MARK CONSISTS OF STANDARD CHARACTERS WITHOUT CLAIM TO ANY PARTICULAR FONT, STYLE, SIZE, OR COLOR.

SER. NO. 85-477,497, FILED 11-21-2011.

MICHAEL WEBSTER, EXAMINING ATTORNEY



David J. Kybas

Director of the United States Patent and Trademark Office

United States of America

United States Patent and Trademark Office



Reg. No. 4,175,294

Registered July 17, 2012

Int. Cl.: 25

TRADEMARK

PRINCIPAL REGISTER

NEW YORK JETS LLC (DELAWARE LIMITED LIABILITY COMPANY)
ATLANTIC HEALTH JETS TRAINING CENTER
1 JETS DRIVE
FLORHAM PARK, NJ 07932

FOR: HEADWEAR, IN CLASS 25 (U.S. CLS. 22 AND 39).

FIRST USE 8-0-2010; IN COMMERCE 8-0-2010.

THE MARK CONSISTS OF A STYLIZED LETTER "J".

SER. NO. 85-477,501, FILED 11-21-2011.

MICHAEL WEBSTER, EXAMINING ATTORNEY



David J. Kyffers

Director of the United States Patent and Trademark Office

United States of America

United States Patent and Trademark Office

THE CLEARWATER COLLECTION

Reg. No. 4,175,295

FLYWHEEL, LLC (WASHINGTON LIMITED LIABILITY COMPANY)
14729 23RD AVE. NE
SHORELINE, WA 98155

Registered July 17, 2012

Int. Cl.: 14

FOR: BRACELETS; EARRINGS; JEWELRY; NECKLACES; WOMEN'S JEWELRY, IN CLASS 14 (U.S. CLS. 2, 27, 28 AND 50).

TRADEMARK

FIRST USE 7-14-2005; IN COMMERCE 7-14-2005.

PRINCIPAL REGISTER

THE MARK CONSISTS OF STANDARD CHARACTERS WITHOUT CLAIM TO ANY PARTICULAR FONT, STYLE, SIZE, OR COLOR.

NO CLAIM IS MADE TO THE EXCLUSIVE RIGHT TO USE "COLLECTION", APART FROM THE MARK AS SHOWN.

SER. NO. 85-477,507, FILED 11-21-2011.

BRIAN CALLAGHAN, EXAMINING ATTORNEY



David J. Kybas

Director of the United States Patent and Trademark Office

United States of America

United States Patent and Trademark Office

Leadership Elements

Reg. No. 4,175,296

LEADERSHIP ELEMENTS, LLC (FLORIDA LIMITED LIABILITY COMPANY)
2914 BREAKERS DRIVE
FERNANDINA BEACH, FL 32034

Registered July 17, 2012

Int. Cl.: 35

FOR: BUSINESS CONSULTATION IN THE FIELD OF BUSINESS LEADERSHIP DEVELOPMENT, IN CLASS 35 (U.S. CLS. 100, 101 AND 102).

SERVICE MARK

FIRST USE 10-1-2011; IN COMMERCE 10-1-2011.

PRINCIPAL REGISTER

THE MARK CONSISTS OF STANDARD CHARACTERS WITHOUT CLAIM TO ANY PARTICULAR FONT, STYLE, SIZE, OR COLOR.

NO CLAIM IS MADE TO THE EXCLUSIVE RIGHT TO USE "LEADERSHIP", APART FROM THE MARK AS SHOWN.

SER. NO. 85-477,525, FILED 11-21-2011.

DAVID MURRAY, EXAMINING ATTORNEY



David J. Kyffers

Director of the United States Patent and Trademark Office

United States of America

United States Patent and Trademark Office

expatride

Reg. No. 4,175,297

EXPATRIDE INTERNATIONAL, INC. (FLORIDA CORPORATION)
506 NW 39TH CIRCLE
BOCA RATON, FL 33431

Registered July 17, 2012

Int. Cl.: 35

FOR: PROMOTION OF FINANCIAL AND INSURANCE SERVICES, ON BEHALF OF THIRD PARTIES, IN CLASS 35 (U.S. CLS. 100, 101 AND 102).

SERVICE MARK

FIRST USE 7-1-2011; IN COMMERCE 7-1-2011.

PRINCIPAL REGISTER

THE MARK CONSISTS OF STANDARD CHARACTERS WITHOUT CLAIM TO ANY PARTICULAR FONT, STYLE, SIZE, OR COLOR.

SER. NO. 85-477,532, FILED 11-21-2011.

ANTHONY RINKER, EXAMINING ATTORNEY



David J. Kybas

Director of the United States Patent and Trademark Office

United States of America

United States Patent and Trademark Office

INSIGHT AS A SERVICE

Reg. No. 4,175,298

Registered July 17, 2012

Int. Cl.: 35

SERVICE MARK

PRINCIPAL REGISTER

AQUIRE SOLUTIONS, INC. (TEXAS CORPORATION)
400 E. LAS COLINAS BLVD
SUITE 500
IRVING, TX 75039

FOR: PERSONNEL MANAGEMENT CONSULTING, IN CLASS 35 (U.S. CLS. 100, 101 AND 102).

FIRST USE 4-30-2010; IN COMMERCE 4-30-2010.

THE MARK CONSISTS OF STANDARD CHARACTERS WITHOUT CLAIM TO ANY PARTICULAR FONT, STYLE, SIZE, OR COLOR.

SER. NO. 85-477,533, FILED 11-21-2011.

ANTHONY RINKER, EXAMINING ATTORNEY



David J. Kyffers

Director of the United States Patent and Trademark Office

United States of America

United States Patent and Trademark Office

DONNA DRESSLER

Reg. No. 4,175,299

Registered July 17, 2012

Int. Cl.: 14

TRADEMARK

PRINCIPAL REGISTER

DONNA DRESSLER DESIGNS, LLC (RHODE ISLAND LIMITED LIABILITY COMPANY)
12 SYLVIA LANE
LINCOLN, RI 02865

FOR: JEWELRY, IN CLASS 14 (U.S. CLS. 2, 27, 28 AND 50).

FIRST USE 1-1-2006; IN COMMERCE 1-1-2006.

THE MARK CONSISTS OF STANDARD CHARACTERS WITHOUT CLAIM TO ANY PARTICULAR FONT, STYLE, SIZE, OR COLOR.

THE NAME(S), PORTRAIT(S), AND/OR SIGNATURE(S) SHOWN IN THE MARK IDENTIFIES "DONNA DRESSLER", AN INDIVIDUAL, WHOSE CONSENT(S) TO REGISTER IS MADE OF RECORD.

SER. NO. 85-477,548, FILED 11-21-2011.

JAMES GRIFFIN, EXAMINING ATTORNEY



David J. Kyffers

Director of the United States Patent and Trademark Office

United States of America

United States Patent and Trademark Office

What Size Should I Be?

Reg. No. 4,175,300

R&D CONCEPTS, LLC (SOUTH CAROLINA LIMITED LIABILITY COMPANY)
2206 WEEPOOLOW TRAIL
CHARLESTON, SC 29407

Registered July 17, 2012

Int. Cl.: 44

FOR: EDUCATIONAL INFORMATIONAL SERVICES, NAMELY, PROVIDING INFORMATION VIA A WEBSITE CONCERNING BREAST SURGERY OPTIONS, BREAST AUGMENTATION AND BREAST IMPLANTS , IN CLASS 44 (U.S. CLS. 100 AND 101).

SERVICE MARK

FIRST USE 11-27-2007; IN COMMERCE 11-27-2007.

PRINCIPAL REGISTER

THE MARK CONSISTS OF STANDARD CHARACTERS WITHOUT CLAIM TO ANY PARTICULAR FONT, STYLE, SIZE, OR COLOR.

SER. NO. 85-477,553, FILED 11-21-2011.

JEAN IM, EXAMINING ATTORNEY



David J. Kyffers

Director of the United States Patent and Trademark Office

United States of America

United States Patent and Trademark Office

curiator

Reg. No. 4,175,301

Registered July 17, 2012

Int. Cl.: 35

SERVICE MARK

PRINCIPAL REGISTER

GOLDEN BANANAS (NEW YORK LIMITED LIABILITY COMPANY)

²
59 GRAND
NEW YORK, NY 10013

FOR: ON-LINE ART GALLERIES, IN CLASS 35 (U.S. CLS. 100, 101 AND 102).

FIRST USE 6-15-2011; IN COMMERCE 6-15-2011.

THE MARK CONSISTS OF STANDARD CHARACTERS WITHOUT CLAIM TO ANY PARTICULAR FONT, STYLE, SIZE, OR COLOR.

SER. NO. 85-477,564, FILED 11-21-2011.

LINDA MICKLEBURGH, EXAMINING ATTORNEY



David J. Kybas

Director of the United States Patent and Trademark Office

United States of America

United States Patent and Trademark Office



leadership | elements

Reg. No. 4,175,302

LEADERSHIP ELEMENTS, LLC (FLORIDA LIMITED LIABILITY COMPANY)
2914 BREAKERS DRIVE
FERNANDINA BEACH, FL 32034

Registered July 17, 2012

Int. Cl.: 35

FOR: BUSINESS CONSULTATION IN THE FIELD OF BUSINESS LEADERSHIP DEVELOPMENT, IN CLASS 35 (U.S. CLS. 100, 101 AND 102).

SERVICE MARK

FIRST USE 10-1-2011; IN COMMERCE 10-1-2011.

PRINCIPAL REGISTER

NO CLAIM IS MADE TO THE EXCLUSIVE RIGHT TO USE "LEADERSHIP", APART FROM THE MARK AS SHOWN.

THE COLOR(S) RED, WHITE, BLACK AND GRAY IS/ARE CLAIMED AS A FEATURE OF THE MARK.

THE MARK CONSISTS OF A RED "L" WITH WHITE INTERLINE AND GRAY DISC WITH WHITE "E" INSIDE, ABOVE RED "LEADERSHIP" GRAY "ELEMENTS" DIVIDED BY VERTICAL BLACK LINE.

SER. NO. 85-477,566, FILED 11-21-2011.

DAVID MURRAY, EXAMINING ATTORNEY



David J. Kyffers

Director of the United States Patent and Trademark Office

United States of America

United States Patent and Trademark Office

WEBFORCE1

Reg. No. 4,175,303

Registered July 17, 2012

Int. Cl.: 42

SERVICE MARK

PRINCIPAL REGISTER

WEBFORCE1, LLC. (NEVADA LIMITED LIABILITY COMPANY)
SUITE 3100
200 SOUTH WACKER DR
CHICAGO, IL 60606

FOR: CONSULTING SERVICES IN THE FIELD OF CLOUD COMPUTING; IT CONSULTING SERVICES, IN CLASS 42 (U.S. CLS. 100 AND 101).

FIRST USE 11-0-2009; IN COMMERCE 11-0-2009.

THE MARK CONSISTS OF THE STYLIZED TEXT "WEBFORCE1". THE LETTER "O" IS SYMBOLIZED BY AN IMAGE OF PLANET EARTH.

SER. NO. 85-477,568, FILED 11-21-2011.

LINDA MICKLEBURGH, EXAMINING ATTORNEY



David J. Kyros

Director of the United States Patent and Trademark Office

United States of America

United States Patent and Trademark Office

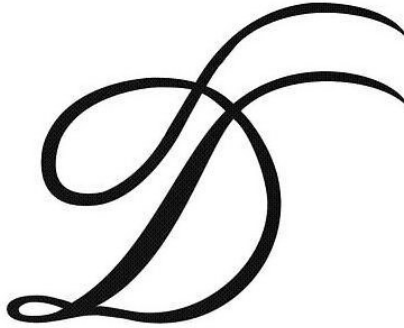

Reg. No. 4,175,304

Registered July 17, 2012

Int. Cl.: 14

TRADEMARK

PRINCIPAL REGISTER

DONNA DRESSLER DESIGNS, LLC (RHODE ISLAND LIMITED LIABILITY COMPANY)
12 SYLVIA LANE
LINCOLN, RI 02865

FOR: JEWELRY, IN CLASS 14 (U.S. CLS. 2, 27, 28 AND 50).

FIRST USE 1-1-2006; IN COMMERCE 1-1-2006.

THE MARK CONSISTS OF A STYLIZED LETTER "D".

SER. NO. 85-477,581, FILED 11-21-2011.

JAMES GRIFFIN, EXAMINING ATTORNEY



David J. Kyffers

Director of the United States Patent and Trademark Office

United States of America

United States Patent and Trademark Office

IVIEW

Reg. No. 4,175,305

Registered July 17, 2012

Int. Cl.: 38

SERVICE MARK

PRINCIPAL REGISTER

BCS GLOBAL NETWORKS LIMITED (UNITED KINGDOM PRIVATE LIMITED COMPANY)
REGAL COURT
42-44 HIGH STREET
SLOUGH, BERKSHIRE, UNITED KINGDOM SL11EL

FOR: THE PROVISION OF VIDEO CONFERENCING SERVICES ENABLING REAL-TIME COLLABORATION AND EXCHANGE OF VIDEO, AUDIO, AND DATA COMMUNICATIONS ON NETWORKS AND MOBILE DEVICES, ALL VIA THE INTERNET OR PRIVATE NETWORKS, IN CLASS 38 (U.S. CLS. 100, 101 AND 104).

FIRST USE 10-0-2006; IN COMMERCE 10-0-2006.

THE MARK CONSISTS OF STANDARD CHARACTERS WITHOUT CLAIM TO ANY PARTICULAR FONT, STYLE, SIZE, OR COLOR.

SER. NO. 85-477,593, FILED 11-21-2011.

HENRY S. ZAK, EXAMINING ATTORNEY



David J. Kyffers

Director of the United States Patent and Trademark Office

United States of America

United States Patent and Trademark Office

EARTHMATE

Reg. No. 4,175,306

Registered July 17, 2012

Int. Cl.: 3

TRADEMARK

PRINCIPAL REGISTER

SIMPLEX CHEMICAL CORP. (MASSACHUSETTS CORPORATION)
6 COMMERCIAL STREET
SHARON, MA 02067

FOR: CLEANING PREPARATIONS, IN CLASS 3 (U.S. CLS. 1, 4, 6, 50, 51 AND 52).

FIRST USE 6-30-2010; IN COMMERCE 6-30-2010.

THE MARK CONSISTS OF STANDARD CHARACTERS WITHOUT CLAIM TO ANY PARTICULAR FONT, STYLE, SIZE, OR COLOR.

SER. NO. 85-477,606, FILED 11-21-2011.

DAWN FELDMAN, EXAMINING ATTORNEY



David J. Kybas

Director of the United States Patent and Trademark Office

United States of America

United States Patent and Trademark Office

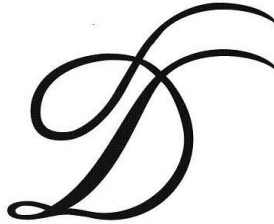

DONNA DRESSLER

Reg. No. 4,175,307

Registered July 17, 2012

Int. Cl.: 14

TRADEMARK

PRINCIPAL REGISTER

DONNA DRESSLER DESIGNS, LLC (RHODE ISLAND LIMITED LIABILITY COMPANY)
12 SYLVIA LANE
LINCOLN, RI 02865

FOR: JEWELRY, IN CLASS 14 (U.S. CLS. 2, 27, 28 AND 50).

FIRST USE 1-1-2006; IN COMMERCE 1-1-2006.

THE NAME(S), PORTRAIT(S), AND/OR SIGNATURE(S) SHOWN IN THE MARK IDENTIFIES "DONNA DRESSLER", AN INDIVIDUAL, WHOSE CONSENT(S) TO REGISTER IS MADE OF RECORD.

THE MARK CONSISTS OF A STYLIZED LETTER "D" AND THE NAME "DONNA DRESSLER".

SER. NO. 85-477,613, FILED 11-21-2011.

JAMES GRIFFIN, EXAMINING ATTORNEY



David J. Kyffers

Director of the United States Patent and Trademark Office

United States of America

United States Patent and Trademark Office



Reg. No. 4,175,308

Registered July 17, 2012

Int. Cl.: 41

SERVICE MARK

PRINCIPAL REGISTER

DUNCANVILLE INDEPENDENT SCHOOL DISTRICT (TEXAS INDEPENDENT SCHOOL DISTRICT, A POLITICAL SUBDIVISION OF THE STATE OF TEXAS)
802 SOUTH MAIN STREET
DUNCANVILLE, TX 75137

FOR: EDUCATIONAL SERVICES, NAMELY, PROVIDING COURSES OF INSTRUCTION AT THE ELEMENTARY, MIDDLE SCHOOL, AND HIGH SCHOOL LEVEL AND DISTRIBUTION OF COURSE MATERIAL IN CONNECTION THEREWITH, IN CLASS 41 (U.S. CLS. 100, 101 AND 107).

FIRST USE 1-1-2010; IN COMMERCE 1-1-2010.

THE MARK CONSISTS OF THE STYLIZED WORDING "RED" IN RED LETTERING OVER THE STYLIZED WORDING "BLUE" IN BLUE LETTERING WITH THE DESIGN OF AN AMPERSAND IN WHITE APPEARING OVER THE LETTERS "D" IN "RED" AND "UE" IN "BLUE" ALL OVER THE WORDING "IS IT IN YOU" IN WHITE LETTERING ALL OVER A SQUARE BACKGROUND WITH CURVED CORNERS IN BLACK.

THE COLOR(S) RED, BLUE, WHITE, AND BLACK IS/ARE CLAIMED AS A FEATURE OF THE MARK.

SER. NO. 85-477,614, FILED 11-21-2011.

AMY C. KEAN, EXAMINING ATTORNEY



David J. Kappas

Director of the United States Patent and Trademark Office

United States of America

United States Patent and Trademark Office

Orbrium

Reg. No. 4,175,309

Registered July 17, 2012

Int. Cl.: 28

TRADEMARK

PRINCIPAL REGISTER

Z-XCHANGE, LLC (TEXAS LIMITED LIABILITY COMPANY), DBA ORBRIUM TOYS
407 INTERNATIONAL PARKWAY #400
RICHARDSON, TX 75081

FOR: CASES FOR TOY STRUCTURES; CASES FOR TOY VEHICLES; CHILDREN'S MULTIPLE ACTIVITY TOYS; CONSTRUCTION TOYS; TOY TRAINS AND PARTS AND ACCESSORIES THEREFOR; TOY VEHICLE TRACK SETS AND ROADWAYS AND ACCESSORIES THEREFOR; TOY VEHICLES; TOY VEHICLES AND ACCESSORIES THEREFOR, IN CLASS 28 (U.S. CLS. 22, 23, 38 AND 50).

FIRST USE 1-1-2011; IN COMMERCE 1-1-2011.

THE MARK CONSISTS OF STANDARD CHARACTERS WITHOUT CLAIM TO ANY PARTICULAR FONT, STYLE, SIZE, OR COLOR.

SER. NO. 85-477,624, FILED 11-21-2011.

JAMES GRIFFIN, EXAMINING ATTORNEY



David J. Kyffers

Director of the United States Patent and Trademark Office

United States of America

United States Patent and Trademark Office

Sophisticated counsel for sophisticated clients

Reg. No. 4,175,310

MAROLD LAW FIRM, PLLC (TEXAS LIMITED LIABILITY COMPANY)
310 S. SAINT MARYS STREET, SUITE 1260
SAN ANTONIO, TX 78205

Registered July 17, 2012

Int. Cl.: 45

FOR: LEGAL SERVICES, NAMELY, PROVIDING CUSTOMIZED INFORMATION, COUNSELING, ADVICE AND LITIGATION SERVICES IN ALL AREAS OF TAX LAW , IN CLASS 45 (U.S. CLS. 100 AND 101).

SERVICE MARK

FIRST USE 10-10-2011; IN COMMERCE 10-10-2011.

PRINCIPAL REGISTER

THE MARK CONSISTS OF STANDARD CHARACTERS WITHOUT CLAIM TO ANY PARTICULAR FONT, STYLE, SIZE, OR COLOR.

SER. NO. 85-477,627, FILED 11-21-2011.

JAMES GRIFFIN, EXAMINING ATTORNEY



David J. Kyffers

Director of the United States Patent and Trademark Office

United States of America

United States Patent and Trademark Office



Reg. No. 4,175,311

Registered July 17, 2012

Int. Cl.: 9

TRADEMARK

PRINCIPAL REGISTER

S-TEC CORPORATION (TEXAS CORPORATION)
ONE S-TEC WAY
MINERAL WELLS, TX 76067

FOR: AVIONICS EQUIPMENT, NAMELY, AIRCRAFT ELECTRONICS COMPRISED OF AUTOPILOTS, NAVIGATION AND COMMUNICATION RADIOS, TRANSPONDERS, AND ASSOCIATED PARTS THERETO, IN CLASS 9 (U.S. CLS. 21, 23, 26, 36 AND 38).

FIRST USE 9-30-1979; IN COMMERCE 9-30-1979.

THE MARK CONSISTS OF A FIRST PAIR OF PARALLEL LINES THAT EXTEND UPWARD IN A STRAIGHT LINE AND CURVE TO THE LEFT WHERE IT EXTENDS TO THE RIGHT IN A STRAIGHT LINE TO FORM THE TOP CURVE OF AN "S". THERE IS ALSO A SECOND PAIR OF PARALLEL LINES THAT EXTEND DOWNWARD IN A STRAIGHT LINE AND CURVE TO THE LEFT AND EXTEND LEFTWARD IN A STRAIGHT LINE TO FORM THE BOTTOM CURVE OF THE "S". THE ENDS OF ALL THE LINES HAVE PARALLEL TAPERED ENDS TO DEFINE A THREE DIMENSIONAL GENERALLY RECTANGULAR TUBE SHAPE.

SER. NO. 85-477,628, FILED 11-21-2011.

JAMES GRIFFIN, EXAMINING ATTORNEY



David J. Kyffers

Director of the United States Patent and Trademark Office

United States of America

United States Patent and Trademark Office

IRICO

Reg. No. 4,175,312

Registered July 17, 2012

Int. Cl.: 9

TRADEMARK

PRINCIPAL REGISTER

YIN, GUANGPU (CANADA INDIVIDUAL)
27 GARDINER CRES
RICHMOND HILL, CANADA L4B2G7

FOR: TELEVISION MONITORS; TELEVISION MONITORS WITH TELEVISION TUNERS;
TELEVISION RECEIVERS; TELEVISION SETS; TELEVISIONS; TELEVISIONS AND
MONITORS, IN CLASS 9 (U.S. CLS. 21, 23, 26, 36 AND 38).

FIRST USE 2-15-2010; IN COMMERCE 4-13-2011.

THE MARK CONSISTS OF STANDARD CHARACTERS WITHOUT CLAIM TO ANY PAR-
TICULAR FONT, STYLE, SIZE, OR COLOR.

SER. NO. 85-477,632, FILED 11-21-2011.

JAMES GRIFFIN, EXAMINING ATTORNEY



David J. Kyffers

Director of the United States Patent and Trademark Office

United States of America

United States Patent and Trademark Office

Save on the hotel. Spend
on the fun.

Reg. No. 4,175,313

Registered July 17, 2012

Int. Cls.: 35 and 43

SERVICE MARK

PRINCIPAL REGISTER

BUDGETPLACES, LLC (NEW YORK LIMITED LIABILITY COMPANY)
C/O GLEASON & KOATZ, LLP
122 EAST 42ND STREET, SUIT 518
NEW YORK, NY 10168

FOR: PROVIDING HOTEL RATE COMPARISON INFORMATION; PROVIDING PRICE COMPARISON SERVICES IN THE FIELD OF HOTELS VIA THE INTERNET, IN CLASS 35 (U.S. CLS. 100, 101 AND 102).

FIRST USE 2-1-2009; IN COMMERCE 2-1-2009.

FOR: HOTEL ACCOMMODATION SERVICES; HOTEL SERVICES; MAKING HOTEL RESERVATIONS FOR OTHERS; MAKING RESERVATIONS AND BOOKINGS FOR OTHERS FOR ACCOMMODATIONS AND MEALS AT HOTEL; MAKING RESERVATIONS AND BOOKINGS FOR TEMPORARY LODGING; PROVIDING A WEBSITE FOR MAKING RESERVATIONS AND BOOKING OF ECO-LODGING; PROVIDING EXTENDED-STAY HOTELS; PROVIDING INFORMATION AND ADVICE ON HOTELS AND RESTAURANTS TO TOURISTS AND BUSINESS TRAVELERS; PROVIDING INFORMATION IN THE FIELD OF TEMPORARY ACCOMMODATIONS FOR TRAVELERS; PROVIDING ON-LINE REVIEWS OF RESTAURANTS AND HOTELS; PROVIDING PERSONALIZED INFORMATION ABOUT HOTELS AND TEMPORARY ACCOMMODATIONS FOR TRAVEL VIA THE INTERNET; TRAVEL AGENCY SERVICES, NAMELY, MAKING RESERVATIONS AND BOOKING FOR TEMPORARY LODGING, IN CLASS 43 (U.S. CLS. 100 AND 101).

FIRST USE 2-1-2009; IN COMMERCE 2-1-2009.

THE MARK CONSISTS OF STANDARD CHARACTERS WITHOUT CLAIM TO ANY PARTICULAR FONT, STYLE, SIZE, OR COLOR.

SER. NO. 85-477,642, FILED 11-21-2011.

JILL PRATER, EXAMINING ATTORNEY



David J. Kyffers

Director of the United States Patent and Trademark Office

United States of America

United States Patent and Trademark Office

EARLY AGES ECO

Reg. No. 4,175,314

DART INDUSTRIES INC. (DELAWARE CORPORATION)
14901 SOUTH ORANGE BLOSSOM TRAIL
ORLANDO, FL 32837

Registered July 17, 2012

Int. Cl.: 21

FOR: CHILDREN'S FEEDING SET CONSISTING OF PLASTIC CUPS, BOWLS, INFANT POWDER FORMULA DISPENSERS AND FEEDING SPOONS, IN CLASS 21 (U.S. CLS. 2, 13, 23, 29, 30, 33, 40 AND 50).

TRADEMARK

FIRST USE 8-28-2010; IN COMMERCE 8-28-2010.

PRINCIPAL REGISTER

THE MARK CONSISTS OF STANDARD CHARACTERS WITHOUT CLAIM TO ANY PARTICULAR FONT, STYLE, SIZE, OR COLOR.

OWNER OF U.S. REG. NO. 4,080,883.

SER. NO. 85-477,672, FILED 11-21-2011.

ANDREA BUTLER, EXAMINING ATTORNEY



David J. Kyffers

Director of the United States Patent and Trademark Office

United States of America

United States Patent and Trademark Office

SECURELIFE MEDCARD

Reg. No. 4,175,315

SECURE AUTHENTICATION SYSTEMS INC. (NEVADA CORPORATION)
3655 W TROPICANA AVE STE 3044
LAS VEGAS, NV 89103

Registered July 17, 2012

Int. Cl.: 9

FOR: ENCODED SMART CARDS CONTAINING PROGRAMMING USED FOR STORING CRITICAL PERSONAL MEDICAL INFORMATION FOR EMERGENCY PERSONNEL AND TO PROVIDE UNIQUE SECURE ACCESS TO A PERSONALIZED WEB ADDRESS TO ACCESS PERSONAL MEDICAL RECORDS, IN CLASS 9 (U.S. CLS. 21, 23, 26, 36 AND 38).

TRADEMARK

PRINCIPAL REGISTER

FIRST USE 9-11-2011; IN COMMERCE 9-11-2011.

THE MARK CONSISTS OF STANDARD CHARACTERS WITHOUT CLAIM TO ANY PARTICULAR FONT, STYLE, SIZE, OR COLOR.

NO CLAIM IS MADE TO THE EXCLUSIVE RIGHT TO USE "MEDCARD", APART FROM THE MARK AS SHOWN.

SER. NO. 85-477,673, FILED 11-21-2011.

ANDREA BUTLER, EXAMINING ATTORNEY



David J. Kyffers

Director of the United States Patent and Trademark Office

United States of America

United States Patent and Trademark Office

STEMS BY MARTHA

Reg. No. 4,175,316

ROBERTS, MARTHA FRENCH (UNITED STATES INDIVIDUAL)
524 E. 118TH ST.
JENKS, OK 74037

Registered July 17, 2012

Int. Cl.: 14

FOR: JEWELRY, IN CLASS 14 (U.S. CLS. 2, 27, 28 AND 50).

TRADEMARK

FIRST USE 12-14-2007; IN COMMERCE 12-14-2007.

PRINCIPAL REGISTER

THE MARK CONSISTS OF STANDARD CHARACTERS WITHOUT CLAIM TO ANY PARTICULAR FONT, STYLE, SIZE, OR COLOR.

SER. NO. 85-477,707, FILED 11-21-2011.

SHAILA SETTLES, EXAMINING ATTORNEY



David J. Kyffers

Director of the United States Patent and Trademark Office

United States of America

United States Patent and Trademark Office

TELL ME MORE

Reg. No. 4,175,317

AURALOG S.A. (FRANCE CORPORATION)

Registered July 17, 2012

6, RUE JEAN-PIERRE TIMBAUD
MONTIGNY-LE-BRETONNEUX, FRANCE 78180

Int. Cl.: 42

FOR: PROVIDING ON-LINE NON-DOWNLOADABLE SOFTWARE FOR TEACHING FOREIGN LANGUAGES, IN CLASS 42 (U.S. CLS. 100 AND 101).

SERVICE MARK

FIRST USE 12-31-2001; IN COMMERCE 12-31-2001.

PRINCIPAL REGISTER

THE MARK CONSISTS OF STANDARD CHARACTERS WITHOUT CLAIM TO ANY PARTICULAR FONT, STYLE, SIZE, OR COLOR.

OWNER OF U.S. REG. NOS. 2,464,224 AND 3,714,722.

SER. NO. 85-477,710, FILED 11-21-2011.

ANDREW LEASER, EXAMINING ATTORNEY



David J. Kyffers

Director of the United States Patent and Trademark Office

United States of America

United States Patent and Trademark Office

BEAVER
— BEER —



Reg. No. 4,175,318

Registered July 17, 2012

Int. Cl.: 32

TRADEMARK

PRINCIPAL REGISTER

O'BRIEN, WILLIAM A. (UNITED STATES INDIVIDUAL)
307 GREENS FARMS ROAD
WESTPORT, CT 06880

FOR: BEER, ALE, LAGER, STOUT, PORTER, SHANDY; MALT LIQUOR, IN CLASS 32 (U.S. CLS. 45, 46 AND 48).

FIRST USE 7-6-2011; IN COMMERCE 11-1-2011.

OWNER OF U.S. REG. NOS. 2,364,789 AND 4,109,477.

NO CLAIM IS MADE TO THE EXCLUSIVE RIGHT TO USE "BEER", APART FROM THE MARK AS SHOWN.

THE MARK CONSISTS OF THE WORDS "BEAVER BEER", WITH THE A HORIZONTAL LINE APPEARING ON BOTH SIDES OF THE WORD "BEER", AND A LINE DRAWING OF A BEAVER BETWEEN TWO BRANCHES WITH MOUNTAINS IN THE BACKGROUND.

SER. NO. 85-477,714, FILED 11-21-2011.

ANDREW LEASER, EXAMINING ATTORNEY



David J. Kyfos

Director of the United States Patent and Trademark Office

United States of America

United States Patent and Trademark Office



Reg. No. 4,175,319

Registered July 17, 2012

Int. Cls.: 35, 36 and 41

SERVICE MARK

PRINCIPAL REGISTER

FASTBOATS.COM SALES COMPANY, LLC (FLORIDA LIMITED LIABILITY COMPANY)
1490 N. FEDERAL HIGHWAY
POMPANO BEACH, FL 33062

FOR: RETAIL STORE SERVICES IN THE FIELD OF NEW AND USED MARINE BOAT PARTS, IN CLASS 35 (U.S. CLS. 100, 101 AND 102).

FIRST USE 11-1-2009; IN COMMERCE 11-1-2009.

FOR: BROKERAGE IN THE FIELD OF NEW AND USED YACHTS, FISHING BOATS, EXPRESS CRUISERS, POWERBOATS, HIGH PERFORMANCE BOATS, AND PERSONAL WATERCRAFT; MARINE FINANCING SERVICES, IN CLASS 36 (U.S. CLS. 100, 101 AND 102).

FIRST USE 11-1-2009; IN COMMERCE 11-1-2009.

FOR: ENTERTAINMENT SERVICES IN THE NATURE OF OFFSHORE POWERBOAT RACING AND EXHIBITIONS, IN CLASS 41 (U.S. CLS. 100, 101 AND 107).

FIRST USE 11-1-2009; IN COMMERCE 11-1-2009.

THE MARK CONSISTS OF THE LETTERS "F" AND "B" APPEARING IN CAPITAL LETTERS WHERE THE LETTER "F" IS DISPLAYED IN A BACKWARDS-FACING FONT, AND THE LETTERING IS POSITIONED INSIDE OF A CREST-SHAPED DESIGN.

SER. NO. 85-477,716, FILED 11-21-2011.

ANDREW LEASER, EXAMINING ATTORNEY



David J. Kybas

Director of the United States Patent and Trademark Office

United States of America

United States Patent and Trademark Office

CABINETGIANT

Reg. No. 4,175,320

Registered July 17, 2012

Int. Cl.: 20

TRADEMARK

PRINCIPAL REGISTER

PINNACLE HOME PRODUCTS, LLC (MISSOURI LIMITED LIABILITY COMPANY)
7600 GARDNER AVE
KANSAS CITY, MO 64120

FOR: KITCHEN AND BATHROOM CABINETS; CABINETS, IN CLASS 20 (U.S. CLS. 2, 13, 22, 25, 32 AND 50).

FIRST USE 5-15-2009; IN COMMERCE 6-1-2009.

NO CLAIM IS MADE TO THE EXCLUSIVE RIGHT TO USE "CABINET", APART FROM THE MARK AS SHOWN.

THE MARK CONSISTS OF THE STYLIZED TEXT "CABINET GIANT".

SER. NO. 85-477,746, FILED 11-21-2011.

ANDREW LEASER, EXAMINING ATTORNEY



David J. Kyffers

Director of the United States Patent and Trademark Office

United States of America

United States Patent and Trademark Office

Counters for a Cause

Reg. No. 4,175,321

Registered July 17, 2012

Int. Cl.: 36

SERVICE MARK

PRINCIPAL REGISTER

ARCHITECTURAL GRANITE & MARBLE (TEXAS LIMITED LIABILITY COMPANY), AKA
AG&M
19012 HWY. 71 WEST
SPICEWOOD, TX 78669

FOR: CHARITABLE FUNDRAISING SERVICES BY MEANS OF SELLING GOODS TO RAISE
FUNDS, IN CLASS 36 (U.S. CLS. 100, 101 AND 102).

FIRST USE 10-1-2011; IN COMMERCE 10-1-2011.

THE MARK CONSISTS OF STANDARD CHARACTERS WITHOUT CLAIM TO ANY PAR-
TICULAR FONT, STYLE, SIZE, OR COLOR.

SER. NO. 85-477,778, FILED 11-21-2011.

SANDRA BUJA, EXAMINING ATTORNEY



David J. Kyffers

Director of the United States Patent and Trademark Office

United States of America

United States Patent and Trademark Office

CRUMBSNATCHERS

Reg. No. 4,175,322

Registered July 17, 2012

Int. Cl.: 16

TRADEMARK

PRINCIPAL REGISTER

GAM ADVENTURES, INC. (NEVADA CORPORATION)
SUITE A
1011 E. ALEXANDER RD.
NORTH LAS VEGAS, NV 89030

FOR: BOOKS IN THE FIELD OF PREPARING AND SERVING HEALTHY FOOD FOR CHILDREN; COOK BOOKS; PUBLICATIONS, NAMELY, BOOKS, HANDOUTS AND WORKBOOKS IN THE FIELDS OF COOKING AND HEALTHY NUTRITION, IN CLASS 16 (U.S. CLS. 2, 5, 22, 23, 29, 37, 38 AND 50).

FIRST USE 1-9-2010; IN COMMERCE 1-9-2010.

THE MARK CONSISTS OF STANDARD CHARACTERS WITHOUT CLAIM TO ANY PARTICULAR FONT, STYLE, SIZE, OR COLOR.

OWNER OF U.S. REG. NO. 3,847,784.

SER. NO. 85-477,797, FILED 11-21-2011.

ELISSA GARBER KON, EXAMINING ATTORNEY



David J. Kybas

Director of the United States Patent and Trademark Office

United States of America

United States Patent and Trademark Office

DB TRAC

Reg. No. 4,175,323

DEUTSCHE BANK AKTIENGESELLSCHAFT (FED REP GERMANY CORPORATION)
TAUNUSANLAGE 12

Registered July 17, 2012

FRANKFURT AM MAIN, FED REP GERMANY D-60325

Int. Cl.: 36

FOR: FINANCIAL SERVICES, NAMELY, PROVIDING A WEB-BASED CLIENT REPORTING PLATFORM FOR CLIENT ASSETS TO ALLOW FOR THE USER TO REVIEW, ANALYZE AND MEASURE POSITIONS, TRANSACTIONS AND RISK IN INVESTMENT PORTFOLIOS, IN CLASS 36 (U.S. CLS. 100, 101 AND 102).

SERVICE MARK

PRINCIPAL REGISTER

FIRST USE 9-12-2011; IN COMMERCE 9-12-2011.

THE MARK CONSISTS OF STANDARD CHARACTERS WITHOUT CLAIM TO ANY PARTICULAR FONT, STYLE, SIZE, OR COLOR.

OWNER OF U.S. REG. NOS. 2,472,857, 2,521,641 AND OTHERS.

SER. NO. 85-477,798, FILED 11-21-2011.

MIDGE BUTLER, EXAMINING ATTORNEY



David J. Kyjars

Director of the United States Patent and Trademark Office

United States of America

United States Patent and Trademark Office



Reg. No. 4,175,324

KAHLER AUTOMATION CORPORATION (MINNESOTA CORPORATION)
808 TIMBERLAKE RD
FAIRMONT, MN 56031

Registered July 17, 2012

Int. Cl.: 9

FOR: INDUSTRIAL AUTOMATION CONTROLS, IN CLASS 9 (U.S. CLS. 21, 23, 26, 36 AND 38).

TRADEMARK

FIRST USE 3-15-1990; IN COMMERCE 3-15-1990.

PRINCIPAL REGISTER

NO CLAIM IS MADE TO THE EXCLUSIVE RIGHT TO USE "AUTOMATION", APART FROM THE MARK AS SHOWN.

THE MARK CONSISTS OF GEOMETRIC SHAPES OF RETRIANGLES AND TRIANGLES FORMING A STYLIZED LETTER "K" PROCEEDING THE WORDING "KAHLER AUTOMATION".

SER. NO. 85-477,803, FILED 11-21-2011.

JOHN WILKE, EXAMINING ATTORNEY



David J. Kybas

Director of the United States Patent and Trademark Office

United States of America

United States Patent and Trademark Office

CURE BY DESIGN

Reg. No. 4,175,325

AMERICAN CANCER SOCIETY, INC. (NEW YORK NON-PROFIT CORPORATION)
250 WILLIAM STREET
ATLANTA, GA 30303

Registered July 17, 2012

Int. Cls.: 35 and 36

FOR: PROMOTING PUBLIC AWARENESS OF CANCER RESEARCH, PREVENTION, DETECTION, AND TREATMENT, IN CLASS 35 (U.S. CLS. 100, 101 AND 102).

SERVICE MARK

FIRST USE 12-1-1999; IN COMMERCE 12-1-1999.

PRINCIPAL REGISTER

FOR: CHARITABLE FUNDRAISING SERVICES TO SUPPORT CANCER RESEARCH, EDUCATION, ADVOCACY, PREVENTION, DETECTION, TREATMENT, AND PATIENT AND FAMILY SERVICES, IN CLASS 36 (U.S. CLS. 100, 101 AND 102).

FIRST USE 12-1-1999; IN COMMERCE 12-1-1999.

THE MARK CONSISTS OF STANDARD CHARACTERS WITHOUT CLAIM TO ANY PARTICULAR FONT, STYLE, SIZE, OR COLOR.

SER. NO. 85-477,825, FILED 11-21-2011.

ELISSA GARBER KON, EXAMINING ATTORNEY



David J. Kybas

Director of the United States Patent and Trademark Office

United States of America

United States Patent and Trademark Office

MERRIMACK

Reg. No. 4,175,326

Registered July 17, 2012

Int. Cl.: 12

TRADEMARK

PRINCIPAL REGISTER

MERRIMACK CANOE COMPANY, LLC (MARYLAND LIMITED LIABILITY COMPANY)
2815 COVINGTON ROAD
SILVER SPRING, MD 20910

FOR: CANOES, IN CLASS 12 (U.S. CLS. 19, 21, 23, 31, 35 AND 44).

FIRST USE 0-0-1954; IN COMMERCE 0-0-1954.

THE MARK CONSISTS OF STANDARD CHARACTERS WITHOUT CLAIM TO ANY PARTICULAR FONT, STYLE, SIZE, OR COLOR.

SER. NO. 85-477,830, FILED 11-21-2011.

DORITT L. CARROLL, EXAMINING ATTORNEY



David J. Kyffers

Director of the United States Patent and Trademark Office

United States of America

United States Patent and Trademark Office



Reg. No. 4,175,327

CARTER, JACLYN (UNITED STATES INDIVIDUAL), DBA LOVE JAC
P.O. BOX 24198

Registered July 17, 2012

BROOKLYN, NY 112024198

Int. Cl.: 16

FOR: CARDS, NAMELY, GREETING CARD, IN CLASS 16 (U.S. CLS. 2, 5, 22, 23, 29, 37, 38 AND 50).

TRADEMARK

FIRST USE 2-28-2009; IN COMMERCE 12-31-2009.

PRINCIPAL REGISTER

THE MARK CONSISTS OF A SOLID HEART GRAPHIC; THE STYLIZED WORDING "JAC" POSITIONED TO THE RIGHT OF THE SOLID HEART GRAPHIC; AND A RECTANGULAR BORDER WITH UNEVEN THICKNESS SURROUNDING THE SOLID HEART GRAPHIC AND STYLIZED WORDING, THE RECTANGULAR BORDER BEING OPEN IN THE LOWER LEFT-HAND CORNER.

SER. NO. 85-477,838, FILED 11-21-2011.

MIDGE BUTLER, EXAMINING ATTORNEY



David J. Kyffers

Director of the United States Patent and Trademark Office

United States of America

United States Patent and Trademark Office

THE BRAM STOKER AWARDS

Reg. No. 4,175,328

Registered July 17, 2012

Int. Cl.: 41

SERVICE MARK

PRINCIPAL REGISTER

HORROR WRITERS ASSOCIATION (OHIO CORPORATION)
SUITE 2767
244 5TH AVE.
NEW YORK, NY 10001

FOR: EDUCATIONAL SERVICES, NAMELY, PROVIDING INCENTIVES TO WRITERS TO DEMONSTRATE EXCELLENCE IN THE FIELD OF HORROR WRITING THROUGH THE ISSUANCE OF AWARDS, IN CLASS 41 (U.S. CLS. 100, 101 AND 107).

FIRST USE 12-31-1988; IN COMMERCE 12-31-1988.

THE MARK CONSISTS OF STANDARD CHARACTERS WITHOUT CLAIM TO ANY PARTICULAR FONT, STYLE, SIZE, OR COLOR.

NO CLAIM IS MADE TO THE EXCLUSIVE RIGHT TO USE "AWARDS", APART FROM THE MARK AS SHOWN.

SER. NO. 85-477,841, FILED 11-21-2011.

SAIMA MAKHDOOM, EXAMINING ATTORNEY



David J. Kybas

Director of the United States Patent and Trademark Office

United States of America

United States Patent and Trademark Office

ej

Reg. No. 4,175,329

ENLACE CHRISTIAN TELEVISION, INC. (TEXAS CORPORATION)
2823 W. IRVING BLVD., STE 200
IRVING, TX 75061

Registered July 17, 2012

Int. Cl.: 38

FOR: BROADCASTING OF CHRISTIAN TELEVISION PROGRAMMING OVER THE INTERNET AND VIA MOBILE DEVICES, IN CLASS 38 (U.S. CLS. 100, 101 AND 104).

SERVICE MARK

FIRST USE 1-19-2007; IN COMMERCE 1-19-2007.

PRINCIPAL REGISTER

THE MARK CONSISTS OF STANDARD CHARACTERS WITHOUT CLAIM TO ANY PARTICULAR FONT, STYLE, SIZE, OR COLOR.

SER. NO. 85-477,885, FILED 11-21-2011.

TOBY BULLOFF, EXAMINING ATTORNEY



David J. Kyffers

Director of the United States Patent and Trademark Office

United States of America

United States Patent and Trademark Office

DRIVING LOYALTY.COM

Reg. No. 4,175,330

Registered July 17, 2012

Int. Cl.: 35

SERVICE MARK

PRINCIPAL REGISTER

DRIVING LOYALTY.COM, LLC (DELAWARE LIMITED LIABILITY COMPANY)
315 CLAY STREET
CEDAR FALLS, IA 50613

FOR: ADVERTISING SERVICES, NAMELY, PROMOTING CAR DEALERSHIPS OF OTHERS; ADVERTISING, MARKETING AND PROMOTION SERVICES IN THE FIELD OF AUTOMOBILE DEALERSHIPS; MARKETING AND ADVERTISING SERVICES FOR AUTOMOBILE DEALERSHIPS; MARKETING SERVICES, NAMELY, PROMOTING OR ADVERTISING THE GOODS AND SERVICES OF OTHERS; PROVIDING INFORMATION ABOUT AUTOMOBILES FOR SALE BY MEANS OF THE INTERNET, IN CLASS 35 (U.S. CLS. 100, 101 AND 102).

FIRST USE 9-30-2011; IN COMMERCE 9-30-2011.

THE MARK CONSISTS OF STANDARD CHARACTERS WITHOUT CLAIM TO ANY PARTICULAR FONT, STYLE, SIZE, OR COLOR.

SER. NO. 85-477,887, FILED 11-21-2011.

DORITT L. CARROLL, EXAMINING ATTORNEY



David J. Kybas

Director of the United States Patent and Trademark Office

United States of America

United States Patent and Trademark Office

GeneGPS

Reg. No. 4,175,331

Registered July 17, 2012

Int. Cl.: 42

SERVICE MARK

PRINCIPAL REGISTER

DNA2.0 (CALIFORNIA CORPORATION)
SUITE A
1140 O'BRIEN DRIVE
MENLO PARK, CA 94025

FOR: CONSULTING SERVICES IN THE FIELDS OF BIOTECHNOLOGY, PHARMACEUTICAL RESEARCH AND DEVELOPMENT AND GENETIC SCIENCE; DNA ANALYSIS SERVICES; RESEARCH AND DEVELOPMENT IN THE PHARMACEUTICAL AND BIOTECHNOLOGY FIELDS; SCIENTIFIC RESEARCH CONSULTING IN THE FIELD OF BIOTECHNOLOGY AND BIOENGINEERING, IN CLASS 42 (U.S. CLS. 100 AND 101).

FIRST USE 4-1-2011; IN COMMERCE 4-1-2011.

THE MARK CONSISTS OF STANDARD CHARACTERS WITHOUT CLAIM TO ANY PARTICULAR FONT, STYLE, SIZE, OR COLOR.

SER. NO. 85-477,894, FILED 11-21-2011.

MICHAEL TANNER, EXAMINING ATTORNEY



David J. Kybas

Director of the United States Patent and Trademark Office

United States of America

United States Patent and Trademark Office

HandPlus

Reg. No. 4,175,332

AMERICAN HEALTHCARE PRODUCTS, INC. (CALIFORNIA CORPORATION)
1028 WESTMINSTER AVE
ALHAMBRA, CA 91803

Registered July 17, 2012

Int. Cl.: 21

FOR: INDUSTRIAL DISPOSABLE LATEX, NITRILE, VINYL, POLYETHYLENE AND NON-WOVEN GLOVES, IN CLASS 21 (U.S. CLS. 2, 13, 23, 29, 30, 33, 40 AND 50).

TRADEMARK

FIRST USE 6-15-1996; IN COMMERCE 6-15-1996.

PRINCIPAL REGISTER

THE MARK CONSISTS OF STANDARD CHARACTERS WITHOUT CLAIM TO ANY PARTICULAR FONT, STYLE, SIZE, OR COLOR.

SER. NO. 85-477,909, FILED 11-21-2011.

KIM MONINGHOFF, EXAMINING ATTORNEY



David J. Kyffers

Director of the United States Patent and Trademark Office

United States of America

United States Patent and Trademark Office



Reg. No. 4,175,333

Registered July 17, 2012

Int. Cl.: 35

SERVICE MARK

PRINCIPAL REGISTER

DRIVING LOYALTY.COM, LLC (DELAWARE LIMITED LIABILITY COMPANY)
315 CLAY STREET
CEDAR FALLS, IA 50613

FOR: ADVERTISING SERVICES, NAMELY, PROMOTING CAR DEALERSHIPS OF OTHERS; ADVERTISING, MARKETING AND PROMOTION SERVICES IN THE FIELD OF AUTOMOBILE DEALERSHIPS; MARKETING AND ADVERTISING SERVICES FOR AUTOMOBILE DEALERSHIPS; MARKETING SERVICES, NAMELY, PROMOTING OR ADVERTISING THE GOODS AND SERVICES OF OTHERS; PROVIDING INFORMATION ABOUT AUTOMOBILES FOR SALE BY MEANS OF THE INTERNET, IN CLASS 35 (U.S. CLS. 100, 101 AND 102).

FIRST USE 9-30-2011; IN COMMERCE 9-30-2011.

THE MARK CONSISTS OF THE WORDING "DRIVING LOYALTY.COM" NEXT TO A SQUARE BOX WITH TWO CURVED LINES INSIDE THE SQUARE BOX WITH ONE OF THE LINES HAVING A TIP.

SER. NO. 85-477,910, FILED 11-21-2011.

DORITT L. CARROLL, EXAMINING ATTORNEY



David J. Kybas

Director of the United States Patent and Trademark Office

United States of America

United States Patent and Trademark Office

STEAL THIS LOOK

Reg. No. 4,175,334

Registered July 17, 2012

Int. Cl.: 41

SERVICE MARK

PRINCIPAL REGISTER

SAY MEDIA, INC. (DELAWARE CORPORATION)
3RD FLOOR
180 TOWNSEND STREET
SAN FRANCISCO, CA 94107

FOR: PROVIDING ON-LINE MAGAZINE COLUMNS IN THE FIELD OF DESIGN, IN CLASS 41 (U.S. CLS. 100, 101 AND 107).

FIRST USE 8-23-2007; IN COMMERCE 8-23-2007.

THE MARK CONSISTS OF STANDARD CHARACTERS WITHOUT CLAIM TO ANY PARTICULAR FONT, STYLE, SIZE, OR COLOR.

SER. NO. 85-477,942, FILED 11-21-2011.

JESSICA A. POWERS, EXAMINING ATTORNEY



David J. Kyffers

Director of the United States Patent and Trademark Office

United States of America

United States Patent and Trademark Office



Reg. No. 4,175,335

SPORTS COVERAGE, INC. (TEXAS CORPORATION)
5535 MILITARY PKWAY
DALLAS, TX 75227

Registered July 17, 2012

Int. Cl.: 24

FOR: COMFORTERS; PILLOW SHAMS; SHOWER CURTAINS, IN CLASS 24 (U.S. CLS. 42 AND 50).

TRADEMARK

FIRST USE 10-1-2003; IN COMMERCE 10-1-2003.

PRINCIPAL REGISTER

NO CLAIM IS MADE TO THE EXCLUSIVE RIGHT TO USE "COLLECTION", APART FROM THE MARK AS SHOWN.

THE STIPPLING IS FOR SHADING PURPOSES ONLY.

THE MARK CONSISTS OF THE NAME "SIDELINES" WRITTEN IN A STYLIZED AND SLANTED FORM WITH THE WORD "COLLECTION" BELOW.

SER. NO. 85-477,955, FILED 11-21-2011.

CAROLINE WOOD, EXAMINING ATTORNEY



David J. Kyffers

Director of the United States Patent and Trademark Office

United States of America

United States Patent and Trademark Office



Reg. No. 4,175,336

Registered July 17, 2012

Int. Cl.: 11

TRADEMARK

PRINCIPAL REGISTER

ADVANCED MODERN TECHNOLOGIES CORPORATION (CALIFORNIA CORPORATION),
DBA AMTC
19800 NORDHOFF PLACE
CHATSWORTH, CA 91311

FOR: AUTOMATIC FAUCETS; AUTOMATIC FLUSH VALVES FOR TOILETS; FAUCET
AERATORS; FAUCET HANDLES; FAUCETS; FLUSHOMETER VALVES; FLUSHOMETERS;
MIXER FAUCETS FOR WATER PIPES; TAPS; URINALS; URINALS, IN CLASS 11 (U.S.
CLS. 13, 21, 23, 31 AND 34).

FIRST USE 7-22-2002; IN COMMERCE 10-31-2003.

THE MARK CONSISTS OF "BRV" WITH A LINE AND A CIRCLE ON TOP OF THE "B".

SER. NO. 85-477,960, FILED 11-21-2011.

KATHRYN COWARD, EXAMINING ATTORNEY



David J. Kybas

Director of the United States Patent and Trademark Office

United States of America

United States Patent and Trademark Office

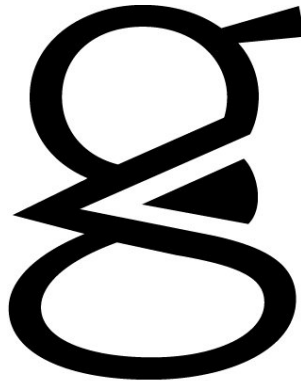

Reg. No. 4,175,337

Registered July 17, 2012

Int. Cl.: 43

SERVICE MARK

PRINCIPAL REGISTER

MR. GATTI'S, LP (TEXAS LIMITED PARTNERSHIP)
5912 BALCONES DRIVE, SUITE 200
AUSTIN, TX 78731

FOR: RESTAURANT AND CAFE SERVICES, IN CLASS 43 (U.S. CLS. 100 AND 101).

FIRST USE 10-25-2011; IN COMMERCE 10-25-2011.

THE MARK CONSISTS OF A STYLIZED, LOWERCASE LETTER "G" WITH A SHADED SILHOUETTE OF A SLICE OF PIZZA TO THE RIGHT OF THE LETTER "G"

SER. NO. 85-477,964, FILED 11-21-2011.

LINDA E. BLOHM, EXAMINING ATTORNEY



David J. Kyffers

Director of the United States Patent and Trademark Office

United States of America

United States Patent and Trademark Office

DESIGN SLEUTH

Reg. No. 4,175,338

Registered July 17, 2012

Int. Cl.: 41

SERVICE MARK

PRINCIPAL REGISTER

SAY MEDIA, INC. (DELAWARE CORPORATION)
3RD FLOOR
180 TOWNSEND STREET
SAN FRANCISCO, CA 94107

FOR: PROVIDING ON-LINE MAGAZINE COLUMNS IN THE FIELD OF DESIGN, IN CLASS 41 (U.S. CLS. 100, 101 AND 107).

FIRST USE 8-23-2007; IN COMMERCE 8-23-2007.

THE MARK CONSISTS OF STANDARD CHARACTERS WITHOUT CLAIM TO ANY PARTICULAR FONT, STYLE, SIZE, OR COLOR.

NO CLAIM IS MADE TO THE EXCLUSIVE RIGHT TO USE "DESIGN", APART FROM THE MARK AS SHOWN.

SER. NO. 85-477,994, FILED 11-21-2011.

JESSICA A. POWERS, EXAMINING ATTORNEY



David J. Kyffers

Director of the United States Patent and Trademark Office

United States of America
United States Patent and Trademark Office

Additel

Reg. No. 4,175,339

ADDITEL CORPORATION (CALIFORNIA CORPORATION)
22865 SAVI RANCH PARKWAY SUITE F
YORBA LINDA, CA 92887

Registered July 17, 2012

Int. Cl.: 9

FOR: CALIBRATION DEVICES FOR CALIBRATING THERMOCOUPLE, PRESSURE, AND ELECTRICAL EQUIPMENT, IN CLASS 9 (U.S. CLS. 21, 23, 26, 36 AND 38).

TRADEMARK

FIRST USE 4-30-2011; IN COMMERCE 4-30-2011.

PRINCIPAL REGISTER

THE MARK CONSISTS OF THE WORD "ADDITEL" WITH THE DOT OF THE "I" BEING AN UPSIDE DOWN TRIANGLE.

SER. NO. 85-478,001, FILED 11-21-2011.

WILLIAM BRECKENFELD, EXAMINING ATTORNEY



David J. Kyfos

Director of the United States Patent and Trademark Office

United States of America

United States Patent and Trademark Office

SCARprin

Reg. No. 4,175,340

DOCTOR'S ASSOCIATES RX, INC. (FLORIDA CORPORATION)
PO BOX 1637
LUTZ, FL 33548

Registered July 17, 2012

Int. Cl.: 3

FOR: MOISTURIZING SOLUTIONS FOR THE SKIN; NON-MEDICATED SERUMS FOR USE ON SKIN, IN CLASS 3 (U.S. CLS. 1, 4, 6, 50, 51 AND 52).

TRADEMARK

FIRST USE 8-20-2009; IN COMMERCE 8-20-2009.

PRINCIPAL REGISTER

THE MARK CONSISTS OF STANDARD CHARACTERS WITHOUT CLAIM TO ANY PARTICULAR FONT, STYLE, SIZE, OR COLOR.

SER. NO. 85-478,003, FILED 11-21-2011.

SANJEEV VOHRA, EXAMINING ATTORNEY



David J. Kyros

Director of the United States Patent and Trademark Office

United States of America

United States Patent and Trademark Office

POSITION YOU

Reg. No. 4,175,341

DIGITALVALIANCE, LLC (CALIFORNIA LIMITED LIABILITY COMPANY)
555 4TH STREET #915

Registered July 17, 2012

SAN FRANCISCO, CA 94107

Int. Cl.: 42

FOR: COMPUTER SERVICES, NAMELY, SEARCH ENGINE OPTIMIZATION; PROVIDING ON-LINE NON-DOWNLOADABLE SOFTWARE FOR SEARCH ENGINE OPTIMIZATION , IN CLASS 42 (U.S. CLS. 100 AND 101).

SERVICE MARK

FIRST USE 10-0-2011; IN COMMERCE 10-0-2011.

PRINCIPAL REGISTER

THE MARK CONSISTS OF STANDARD CHARACTERS WITHOUT CLAIM TO ANY PARTICULAR FONT, STYLE, SIZE, OR COLOR.

SER. NO. 85-478,025, FILED 11-21-2011.

HOWARD B. LEVINE, EXAMINING ATTORNEY



David J. Kyffers

Director of the United States Patent and Trademark Office

United States of America

United States Patent and Trademark Office

CCCR

Reg. No. 4,175,342

Registered July 17, 2012

Int. Cl.: 43

SERVICE MARK

PRINCIPAL REGISTER

CANINE COZY CARE RESORT LLC (WASHINGTON LIMITED LIABILITY COMPANY),
AKA CCCR
2919 317TH STREET NW
STANWOOD, WA 98292

FOR: PET BOARDING SERVICES; PET DAY CARE SERVICES, IN CLASS 43 (U.S. CLS. 100 AND 101).

FIRST USE 3-10-2007; IN COMMERCE 3-10-2007.

THE MARK CONSISTS OF STANDARD CHARACTERS WITHOUT CLAIM TO ANY PARTICULAR FONT, STYLE, SIZE, OR COLOR.

SER. NO. 85-478,028, FILED 11-21-2011.

JENNIFER WILLISTON, EXAMINING ATTORNEY



David J. Kybas

Director of the United States Patent and Trademark Office

United States of America

United States Patent and Trademark Office

MARY MARY

Reg. No. 4,175,343

Registered July 17, 2012

Int. Cls.: 9 and 41

TRADEMARK

SERVICE MARK

PRINCIPAL REGISTER

A SONG FOR MARY MARY INC. (CALIFORNIA CORPORATION)
21700 OXNARD STREET, SUITE 2030
WOODLAND HILLS, CA 91367

FOR: SERIES OF MUSICAL SOUND RECORDINGS, IN CLASS 9 (U.S. CLS. 21, 23, 26, 36 AND 38).

FIRST USE 5-2-2000; IN COMMERCE 5-2-2000.

FOR: ENTERTAINMENT SERVICES RENDERED BY A LIVE MUSICAL GROUP, IN CLASS 41 (U.S. CLS. 100, 101 AND 107).

FIRST USE 0-0-1999; IN COMMERCE 0-0-1999.

THE MARK CONSISTS OF STANDARD CHARACTERS WITHOUT CLAIM TO ANY PARTICULAR FONT, STYLE, SIZE, OR COLOR.

SER. NO. 85-478,031, FILED 11-21-2011.

DAVID MURRAY, EXAMINING ATTORNEY



David J. Kyfos

Director of the United States Patent and Trademark Office

United States of America
United States Patent and Trademark Office

STARBURST

Reg. No. 4,175,344

Registered July 17, 2012

Int. Cl.: 3

TRADEMARK

PRINCIPAL REGISTER

WM. WRIGLEY JR. COMPANY (DELAWARE CORPORATION)
410 NORTH MICHIGAN AVENUE
CHICAGO, IL 60611

FOR: LIP GLOSS, IN CLASS 3 (U.S. CLS. 1, 4, 6, 50, 51 AND 52).

FIRST USE 12-0-2005; IN COMMERCE 1-0-2006.

THE MARK CONSISTS OF STANDARD CHARACTERS WITHOUT CLAIM TO ANY PARTICULAR FONT, STYLE, SIZE, OR COLOR.

SER. NO. 85-478,034, FILED 11-21-2011.

KATHLEEN LORENZO, EXAMINING ATTORNEY



David J. Kyffers

Director of the United States Patent and Trademark Office

United States of America

United States Patent and Trademark Office

OCS

Reg. No. 4,175,345

Registered July 17, 2012

Int. Cls.: 35 and 40

SERVICE MARK

PRINCIPAL REGISTER

OMNI COMPUTER SERVICES, INC. (MARYLAND CORPORATION), AKA OCS
7501 VILLAGE ROAD
SYKESVILLE, MD 21784

FOR: BUSINESS MARKETING AND DIRECT MAIL CONSULTING SERVICES, IN CLASS 35 (U.S. CLS. 100, 101 AND 102).

FIRST USE 12-2-1998; IN COMMERCE 12-2-1998.

FOR: CUSTOMIZED PRINTING SERVICES, NAMELY, PRINTING OF BUSINESS CARDS, FORMS, LABELS, TAGS, STATIONERY, LETTERHEAD AND ENVELOPES AND OTHER BUSINESS-RELATED PRINTED MATTER, IN CLASS 40 (U.S. CLS. 100, 103 AND 106).

FIRST USE 12-2-1998; IN COMMERCE 12-2-1998.

THE MARK CONSISTS OF STANDARD CHARACTERS WITHOUT CLAIM TO ANY PARTICULAR FONT, STYLE, SIZE, OR COLOR.

SER. NO. 85-478,035, FILED 11-21-2011.

JOHN WILKE, EXAMINING ATTORNEY



David J. Kybas

Director of the United States Patent and Trademark Office

United States of America

United States Patent and Trademark Office

E-vita

Reg. No. 4,175,346

Registered July 17, 2012

Int. Cl.: 10

TRADEMARK

PRINCIPAL REGISTER

JOTEC GMBH (FED REP GERMANY GESELLSCHAFT MIT BESCHRÄNKTER HAFTUNG
(GMBH))
LOTZENÄCKER 23
HECHINGEN, FED REP GERMANY D-72379

FOR: STENT GRAFTS FOR VESSELS, IN CLASS 10 (U.S. CLS. 26, 39 AND 44).

OWNER OF FED REP GERMANY REG. NO. 30340459, DATED 10-17-2003, EXPIRES 8-31-2013.

OWNER OF U.S. REG. NO. 3,018,046.

THE MARK CONSISTS OF A STYLIZED "E" TO THE LEFT OF "-VITA".

SER. NO. 85-478,059, FILED 11-21-2011.

ELISSA GARBER KON, EXAMINING ATTORNEY



David J. Kybas

Director of the United States Patent and Trademark Office

United States of America

United States Patent and Trademark Office

ZYMÖL

Reg. No. 4,175,347

Registered July 17, 2012

Int. Cl.: 3

TRADEMARK

PRINCIPAL REGISTER

PHITECH, LLC (CONNECTICUT LIMITED LIABILITY COMPANY)
28 MADISON HOLLOW
KILLINGWORTH, CT 06419

FOR: AUTOMOBILE CLEANING PREPARATIONS, NAMELY, LEATHER AND VINYL CONDITIONERS, WAXES, POLISHES, GLASS CLEANERS, WHEEL CLEANERS, AND FABRIC CLEANERS, IN CLASS 3 (U.S. CLS. 1, 4, 6, 50, 51 AND 52).

FIRST USE 10-31-1983; IN COMMERCE 10-31-1983.

THE MARK CONSISTS OF STANDARD CHARACTERS WITHOUT CLAIM TO ANY PARTICULAR FONT, STYLE, SIZE, OR COLOR.

SER. NO. 85-478,064, FILED 11-21-2011.

WILLIAM BRECKENFELD, EXAMINING ATTORNEY



David J. Kyffers

Director of the United States Patent and Trademark Office

United States of America

United States Patent and Trademark Office



Reg. No. 4,175,348

Registered July 17, 2012

Int. Cl.: 44

SERVICE MARK

PRINCIPAL REGISTER

THERAPY MANAGEMENT CORPORATION (FLORIDA CORPORATION)
8477 S. SUNCOAST BVLD.
HOMOSASSA, FL 34446

FOR: REHABILITATION SERVICES, NAMELY, PHYSICAL THERAPY, OCCUPATIONAL THERAPY, AND SPEECH AND LANGUAGE THERAPY SERVICES, IN CLASS 44 (U.S. CLS. 100 AND 101).

FIRST USE 7-14-2011; IN COMMERCE 7-15-2011.

THE MARK CONSISTS OF "COMMITTED TO SERVICE EXCELLENCE" IN AN ARC APPEARING OVER A PARTIALLY EXPOSED SUN RISING OVER A SINGLE WAVE OF WATER WITH A FLYING SEABIRD WITH SPREAD WINGS IN FRONT OF THE RISING SUN AND OVER THE WAVE OF WATER.

SER. NO. 85-478,078, FILED 11-21-2011.

KATHY DE JONGE, EXAMINING ATTORNEY



David J. Kyffers

Director of the United States Patent and Trademark Office

United States of America

United States Patent and Trademark Office

BREATHALEYES

Reg. No. 4,175,349

XPLOR CORPS LLC (TENNESSEE LIMITED LIABILITY COMPANY)
1021 EDWIN WARNER DRIVE
NASHVILLE, TN 37205

Registered July 17, 2012

Int. Cl.: 9

FOR: DOWNLOADABLE SOFTWARE IN THE NATURE OF A MOBILE APPLICATION FOR IDENTIFYING THE LIKELY BLOOD ALCOHOL CONTENT OF A PERSON BASED ON NYSTAGMUS CONDITIONS , IN CLASS 9 (U.S. CLS. 21, 23, 26, 36 AND 38).

TRADEMARK

FIRST USE 11-21-2011; IN COMMERCE 11-21-2011.

PRINCIPAL REGISTER

THE MARK CONSISTS OF STANDARD CHARACTERS WITHOUT CLAIM TO ANY PARTICULAR FONT, STYLE, SIZE, OR COLOR.

SER. NO. 85-478,083, FILED 11-21-2011.

ELISSA GARBER KON, EXAMINING ATTORNEY



David J. Kyjars

Director of the United States Patent and Trademark Office

United States of America

United States Patent and Trademark Office

IF YOU HAVE A DING, GIVE
ME A RING

Reg. No. 4,175,350

Registered July 17, 2012

Int. Cl.: 37

SERVICE MARK

PRINCIPAL REGISTER

FINISHING TOUCH CAR CARE, INC. (MINNESOTA CORPORATION)
SUITE A
50 GREYSTONE AVENUE NORTH
OAKDALE, MN 55128

FOR: REPAIR OF AUTOMOBILES, NAMELY, AUTOMOBILE BODY REPAIR, IN CLASS
37 (U.S. CLS. 100, 103 AND 106).

FIRST USE 0-0-1993; IN COMMERCE 0-0-1993.

THE MARK CONSISTS OF STANDARD CHARACTERS WITHOUT CLAIM TO ANY PAR-
TICULAR FONT, STYLE, SIZE, OR COLOR.

SER. NO. 85-478,104, FILED 11-21-2011.

WILLIAM ROSSMAN, EXAMINING ATTORNEY



David J. Kyffers

Director of the United States Patent and Trademark Office

United States of America

United States Patent and Trademark Office

HUBSPOT

Reg. No. 4,175,351

HUBSPOT, INC. (DELAWARE CORPORATION)
ONE BROADWAY, 10TH FLOOR
CAMBRIDGE, MA 02142

Registered July 17, 2012

Int. Cl.: 42

FOR: PROVIDING A WEBSITE FEATURING NON-DOWNLOADABLE MARKETING SOFTWARE USED TO MARKET BLOGS, LANDING PAGES AND SOCIAL MEDIA USING MARKETING ANALYTICS, CONTENT MANAGEMENT, SEO, CRM INTEGRATION AND E-MAIL, IN CLASS 42 (U.S. CLS. 100 AND 101).

SERVICE MARK

PRINCIPAL REGISTER

FIRST USE 2-6-2005; IN COMMERCE 2-6-2005.

THE MARK CONSISTS OF STANDARD CHARACTERS WITHOUT CLAIM TO ANY PARTICULAR FONT, STYLE, SIZE, OR COLOR.

OWNER OF U.S. REG. NO. 3,646,105.

SER. NO. 85-478,109, FILED 11-21-2011.

CHRISTINA SOBRAL, EXAMINING ATTORNEY



David J. Kyffers

Director of the United States Patent and Trademark Office

United States of America

United States Patent and Trademark Office



Reg. No. 4,175,352

Registered July 17, 2012

Int. Cl.: 25

TRADEMARK

PRINCIPAL REGISTER

RECREATIONAL EQUIPMENT, INC. (WASHINGTON CORPORATION)
6750 SOUTH 228TH STREET
KENT, WA 98032

FOR: RAINWEAR, RAINCOATS, UNDERWEAR, HATS, GLOVES, PANTS, CAPRIS, BIB OVERALLS, CHILDREN'S BIB OVERALLS, INFANT SUITS, SHORTS, WATER SHORTS, BOARD SHORTS, SKIWEAR, VESTS, SHOES, SOCKS, SWEATERS, JACKETS, PULLOVERS, SHIRTS, JERSEYS, T-SHIRTS, TANK TOPS, BOOTS, BELTS, SCARFS, BANDANAS, FOOTWEAR, FLIP FLOPS, SWEATPANTS, SWEATSHIRTS, SKIRTS, DRESSES, SLEEPWEAR, TIGHTS, UNDERWEAR, BRAS, SPORTS BRAS, SOCKS, GAITERS, SUSPENDERS, GLOVES, MITTENS, HEADWEAR, HATS, CAPS, VISORS, SWIMSUITS, SWIM COVER UPS, NAMELY, SWIM WEAR FOR GENTLEMEN AND LADIES AND BEACH COVER-UPS, RASH GUARDS, IN CLASS 25 (U.S. CLS. 22 AND 39).

FIRST USE 0-0-1984; IN COMMERCE 0-0-1984.

OWNER OF U.S. REG. NOS. 2,830,181, 2,978,797 AND OTHERS.

THE MARK CONSISTS OF A TREE ADJACENT TO TWO TRIANGULAR MOUNTAIN PEAKS WHICH ARE OVER THE LETTERS "REI".

SER. NO. 85-478,110, FILED 11-21-2011.

CARYN GLASSER, EXAMINING ATTORNEY



David J. Kybas

Director of the United States Patent and Trademark Office

United States of America

United States Patent and Trademark Office

CAUSE OF ACTION

Reg. No. 4,175,353

Registered July 17, 2012

Int. Cl.: 35

SERVICE MARK

PRINCIPAL REGISTER

FREEDOM THROUGH JUSTICE FOUNDATION, INC. (DELAWARE NON-PROFIT CORPORATION), DBA CAUSE OF ACTION
2100 M STREET, N.W., SUITE 170-247
WASHINGTON, DC 200371233

FOR: ADVOCACY SERVICES; NAMELY, UTILIZING PUBLIC ADVOCACY AND LEGAL REFORM STRATEGIES TO ENSURE GREATER TRANSPARENCY IN GOVERNMENT, PROTECT TAXPAYER INTERESTS, AND PROMOTE ECONOMIC FREEDOM, IN CLASS 35 (U.S. CLS. 100, 101 AND 102).

FIRST USE 10-21-2011; IN COMMERCE 10-21-2011.

THE MARK CONSISTS OF STANDARD CHARACTERS WITHOUT CLAIM TO ANY PARTICULAR FONT, STYLE, SIZE, OR COLOR.

SER. NO. 85-478,133, FILED 11-21-2011.

GISELLE AGOSTO, EXAMINING ATTORNEY



David J. Kyjars

Director of the United States Patent and Trademark Office

United States of America

United States Patent and Trademark Office



MONSERRAT

TAX & BUSINESS CENTER, LLC

Reg. No. 4,175,354

RAMIREZ, JOEL (UNITED STATES INDIVIDUAL)
45 ALTA VISTA AVE
WATSONVILLE, CA 95076

Registered July 17, 2012

Int. Cl.: 35

FOR: ACCOUNTING SERVICES; BOOKKEEPING; INCOME TAX PREPARATION; PAYROLL PREPARATION, IN CLASS 35 (U.S. CLS. 100, 101 AND 102).

SERVICE MARK

FIRST USE 7-1-1993; IN COMMERCE 7-1-1993.

PRINCIPAL REGISTER

NO CLAIM IS MADE TO THE EXCLUSIVE RIGHT TO USE "TAX & BUSINESS CENTER, LLC", APART FROM THE MARK AS SHOWN.

THE MARK CONSISTS OF A DESIGN OF A BUTTERFLY WITH OPEN WINGS INSIDE A CIRCLE. UNDER IS THE STYLIZED TEXT "MONSERRAT TAX & BUSINESS CENTER, LLC".

SER. NO. 85-478,166, FILED 11-21-2011.

CHRISTINA SOBRAL, EXAMINING ATTORNEY



David J. Kybas

Director of the United States Patent and Trademark Office

United States of America

United States Patent and Trademark Office

SWIFT WEATHER

Reg. No. 4,175,355

Registered July 17, 2012

Int. Cl.: 42

SERVICE MARK

PRINCIPAL REGISTER

GROVES INTERNET CONSULTING, INC. (MINNESOTA CORPORATION), DBA SWIFT WEATHER
2200 WEST 66TH STREET #145
MINNEAPOLIS, MN 55423

FOR: WEATHER INFORMATION SERVICES, IN CLASS 42 (U.S. CLS. 100 AND 101).

FIRST USE 10-24-2007; IN COMMERCE 10-24-2007.

THE MARK CONSISTS OF STANDARD CHARACTERS WITHOUT CLAIM TO ANY PARTICULAR FONT, STYLE, SIZE, OR COLOR.

NO CLAIM IS MADE TO THE EXCLUSIVE RIGHT TO USE "WEATHER", APART FROM THE MARK AS SHOWN.

SER. NO. 85-478,174, FILED 11-21-2011.

BILL DAWE, EXAMINING ATTORNEY



David J. Kybas

Director of the United States Patent and Trademark Office

United States of America

United States Patent and Trademark Office

The logo for Norman Studios features the word "Norman" in a large, elegant, cursive script. Below it, the word "Studios" is written in a similar cursive font, but the end of the letter "S" is elongated and curves into a film strip that extends to the right.

Reg. No. 4,175,356

Registered July 17, 2012

Int. Cl.: 9

TRADEMARK

PRINCIPAL REGISTER

NORMAN STUDIOS SILENT FILM MUSEUM, INC. (FLORIDA NON-PROFIT CORPORATION)
109 MALLARD TRAIL
PONTE VEDRA BEACH, FL 32082

FOR: AUDIOVISUAL RECORDINGS, NAMELY, DVDS FEATURING THE LIFE AND WORKS
OF RICHARD EDWARD NORMAN, IN CLASS 9 (U.S. CLS. 21, 23, 26, 36 AND 38).

FIRST USE 10-0-2010; IN COMMERCE 10-0-2010.

NO CLAIM IS MADE TO THE EXCLUSIVE RIGHT TO USE "STUDIOS", APART FROM THE
MARK AS SHOWN.

THE NAME(S), PORTRAIT(S), AND/OR SIGNATURE(S) SHOWN IN THE MARK DOES NOT
IDENTIFY A PARTICULAR LIVING INDIVIDUAL.

THE MARK CONSISTS OF CURSE LETTERS "NORMAN STUDIOS" WHERE THE END OF
THE LETTER "N" IS ELONGATED AND TURNS INTO A FILM STRIP THAT UNDERLINES
THE WORD "STUDIOS".

SER. NO. 85-478,180, FILED 11-21-2011.

ALYSSA STEEL, EXAMINING ATTORNEY

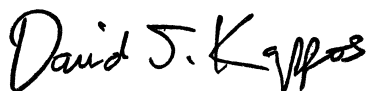
A handwritten signature in black ink that reads "David J. Kyffers".

Director of the United States Patent and Trademark Office

United States of America

United States Patent and Trademark Office

PLUSCOMPARE

Reg. No. 4,175,357

Registered July 17, 2012

Int. Cl.: 35

SERVICE MARK

PRINCIPAL REGISTER

NUMEN MEDIA (WYOMING LIMITED LIABILITY COMPANY)
PO BOX 2441
YORKTOWN, VA 23692

FOR: COMPARISON SHOPPING SERVICES; PROMOTING THE GOODS AND SERVICES OF OTHERS BY PROVIDING A WEBSITE FEATURING COUPONS, PRICE-COMPARISON INFORMATION, PRODUCT-COMPARISON INFORMATION, PRODUCT REVIEWS, LINKS TO THE RETAIL WEBSITES OF OTHERS, AND DISCOUNT INFORMATION, IN CLASS 35 (U.S. CLS. 100, 101 AND 102).

FIRST USE 11-11-2011; IN COMMERCE 11-19-2011.

THE MARK CONSISTS OF STANDARD CHARACTERS WITHOUT CLAIM TO ANY PARTICULAR FONT, STYLE, SIZE, OR COLOR.

SER. NO. 85-478,181, FILED 11-21-2011.

MARY CRAWFORD, EXAMINING ATTORNEY



David J. Kyffers

Director of the United States Patent and Trademark Office

United States of America

United States Patent and Trademark Office

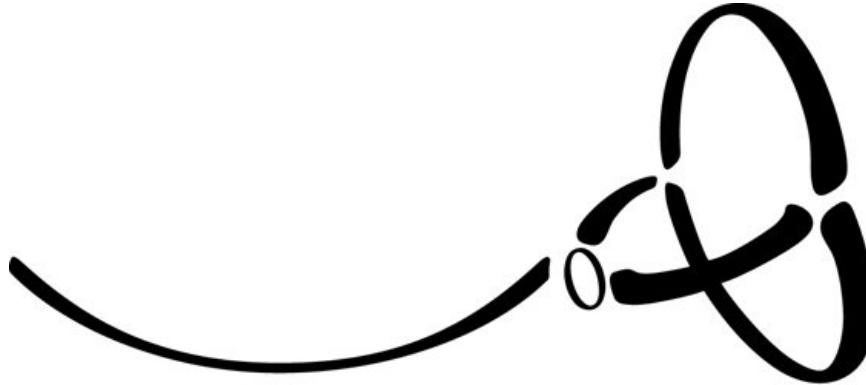

Reg. No. 4,175,358

Registered July 17, 2012

Int. Cl.: 18

TRADEMARK

PRINCIPAL REGISTER

SOFTOUCH CONCEPTS, INC. (CALIFORNIA CORPORATION)
29460 UNION CITY BOULEVARD
UNION CITY, CA 94587

FOR: HARNESES, IN CLASS 18 (U.S. CLS. 1, 2, 3, 22 AND 41).

FIRST USE 9-0-2011; IN COMMERCE 9-0-2011.

THE MARK CONSISTS OF A STYLIZED HARNESS AND A LEASH.

SER. NO. 85-478,192, FILED 11-21-2011.

DANIEL BRODY, EXAMINING ATTORNEY



David J. Kyffers

Director of the United States Patent and Trademark Office

United States of America

United States Patent and Trademark Office

XPO Logistics

Reg. No. 4,175,359

XPO LOGISTICS, INC. (DELAWARE CORPORATION)
429 POST ROAD
BUCHANAN, MI 49107

Registered July 17, 2012

Int. Cl.: 39

FOR: LOGISTICS AND SUPPLY CHAIN SERVICES, NAMELY, STORAGE, TRANSPORTATION AND DELIVERY OF GOODS FOR OTHERS BY AIR, SHIP OR TRUCK; TRANSPORTATION AND DELIVERY SERVICES BY AIR, ROAD AND SEA; FREIGHT AND TRANSPORTATION BROKERAGE SERVICES, IN CLASS 39 (U.S. CLS. 100 AND 105).

SERVICE MARK

PRINCIPAL REGISTER

FIRST USE 9-20-2011; IN COMMERCE 9-20-2011.

THE MARK CONSISTS OF THE LETTERS "XPO" IN RED AND THE WORD "LOGISTICS" IN BLACK.

THE COLOR(S) RED AND BLACK IS/ARE CLAIMED AS A FEATURE OF THE MARK.

SER. NO. 85-478,195, FILED 11-21-2011.

KATHRYN COWARD, EXAMINING ATTORNEY



David J. Kyffers

Director of the United States Patent and Trademark Office

United States of America

United States Patent and Trademark Office



Reg. No. 4,175,360

Registered July 17, 2012

Int. Cl.: 37

SERVICE MARK

PRINCIPAL REGISTER

BEST CHOICE ROOFING & HOME IMPROVEMENT, INC. (TENNESSEE CORPORATION)
224 OLD SHACKLE ISLAND RD.
HENDERSONVILLE, TN 37075

FOR: ROOFING SERVICES, BUILDING REPAIR AND MAINTENANCE, IN CLASS 37 (U.S. CLS. 100, 103 AND 106).

FIRST USE 5-15-2009; IN COMMERCE 5-15-2009.

NO CLAIM IS MADE TO THE EXCLUSIVE RIGHT TO USE "ROOFING", APART FROM THE MARK AS SHOWN.

THE COLOR(S) BLACK AND RED IS/ARE CLAIMED AS A FEATURE OF THE MARK.

THE MARK CONSISTS OF THE DESIGN OF A BLACK ROOF OVER THE WORDING "BCR BEST CHOICE ROOFING YOU CHOSE THE BEST!" IN BLACK SAVE FOR THE WORDING "C" AND "BEST CHOICE ROOFING" IN RED.

SER. NO. 85-478,201, FILED 11-21-2011.

DANIEL BRODY, EXAMINING ATTORNEY



David J. Kybas

Director of the United States Patent and Trademark Office

United States of America

United States Patent and Trademark Office



Reg. No. 4,175,361

Registered July 17, 2012

Int. Cl.: 43

SERVICE MARK

PRINCIPAL REGISTER

STEBENS INC. (COLORADO CORPORATION), DBA STEUBEN'S, INC.
523 EAST 17TH AVENUE
DENVER, CO 80203

FOR: RESTAURANT SERVICES, NAMELY, PROVIDING OF FOOD AND BEVERAGES FOR CONSUMPTION ON AND OFF THE PREMISES, IN CLASS 43 (U.S. CLS. 100 AND 101).

FIRST USE 6-19-2006; IN COMMERCE 6-19-2006.

NO CLAIM IS MADE TO THE EXCLUSIVE RIGHT TO USE "EST. 2006" AND "FOOD SERVICE", APART FROM THE MARK AS SHOWN.

THE COLOR(S) BROWN AND CREAM IS/ARE CLAIMED AS A FEATURE OF THE MARK.

THE MARK CONSISTS OF A BROWN CIRCLE WITH A CREAM INNER CIRCLE AND THE WORD STEUBEN'S IN A CUSTOM FONT IN THE COLOR OF BROWN ON A GENERALLY RECTANGULAR SHAPED CREAM COLORED BACKGROUND, WITH THE CREAM COLORED WORDS AND NUMBERS "EST. 2006" ABOVE THE WORD STEUBEN'S AND "FOOD SERVICE" BELOW THE WORD "STEUBEN'S". THREE CREAM COLORED LINES RUN FROM THE TOP AND BOTTOM OF THE WORD STEUBEN'S AND OUT THROUGH THE BROWN CIRCLE BECOMING THE COLOR BROWN ONCE OUTSIDE THE CIRCLE.

SER. NO. 85-478,203, FILED 11-21-2011.

GISELLE AGOSTO, EXAMINING ATTORNEY



David J. Kybas

Director of the United States Patent and Trademark Office

United States of America

United States Patent and Trademark Office

Dearly Departed Connection

Reg. No. 4,175,362

SWEETE, JENNIFER B. (UNITED STATES INDIVIDUAL)

Registered July 17, 2012

PO BOX 561
CONIFER, CO 80433

Int. Cl.: 41

FOR: ENTERTAINMENT SERVICES, NAMELY, THE PROVISION OF CONTINUING PROGRAMS AND SHOWS FEATURING PSYCHIC AND MEDIUM REALITY AND READINGS DELIVERED BY TELEVISION, RADIO, SATELLITE, THE INTERNET, AND LIVE, IN CLASS 41 (U.S. CLS. 100, 101 AND 107).

SERVICE MARK

PRINCIPAL REGISTER

FIRST USE 1-6-2010; IN COMMERCE 1-6-2010.

THE MARK CONSISTS OF STANDARD CHARACTERS WITHOUT CLAIM TO ANY PARTICULAR FONT, STYLE, SIZE, OR COLOR.

NO CLAIM IS MADE TO THE EXCLUSIVE RIGHT TO USE "CONNECTION", APART FROM THE MARK AS SHOWN.

SER. NO. 85-478,213, FILED 11-21-2011.

LINDSEY RUBIN, EXAMINING ATTORNEY



David J. Kyffers

Director of the United States Patent and Trademark Office

United States of America

United States Patent and Trademark Office

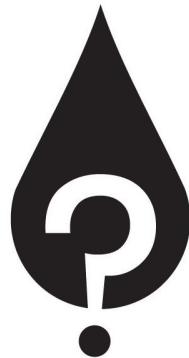

Reg. No. 4,175,363

Registered July 17, 2012

Int. Cl.: 44

SERVICE MARK

PRINCIPAL REGISTER

MEMORIAL BLOOD CENTERS (MINNESOTA NON-PROFIT CORPORATION)
737 PELHAM BOULEVARD
ST. PAUL, MN 551141739

FOR: BLOOD BANK SERVICES, IN CLASS 44 (U.S. CLS. 100 AND 101).

FIRST USE 4-23-2009; IN COMMERCE 4-23-2009.

THE MARK CONSISTS OF A STYLIZED BLOOD DROPLET WITH A "?" WITHIN THE LOWER PORTION OF THE DESIGN.

SER. NO. 85-478,225, FILED 11-21-2011.

HOWARD SMIGA, EXAMINING ATTORNEY



David J. Kybas

Director of the United States Patent and Trademark Office

United States of America

United States Patent and Trademark Office

BEST OF PHOENIX

Reg. No. 4,175,364

Registered July 17, 2012

Int. Cls.: 16 and 41

TRADEMARK

SERVICE MARK

PRINCIPAL REGISTER

VILLAGE VOICE MEDIA HOLDINGS, LLC (DELAWARE LIMITED LIABILITY COMPANY)
1201 EAST JEFFERSON STREET
PHOENIX, AZ 85034

FOR: ANNUAL NEWSPAPER SUPPLEMENTS IN THE FIELD OF LISTING INDIVIDUALS AND BUSINESSES THAT HAVE ACHIEVED EXCELLENCE IN AREAS OF INTEREST TO THE GENERAL PUBLIC, IN CLASS 16 (U.S. CLS. 2, 5, 22, 23, 29, 37, 38 AND 50).

FIRST USE 3-28-1979; IN COMMERCE 3-28-1979.

FOR: CONDUCTING AWARDS PROGRAMS HONORING INDIVIDUALS AND COMPANIES THAT HAVE DEMONSTRATED EXCELLENCE IN THEIR FIELDS, IN THE QUALITY OF THEIR PRODUCTS AND SERVICES AND IN CUSTOMER SERVICE, IN CLASS 41 (U.S. CLS. 100, 101 AND 107).

FIRST USE 3-28-1979; IN COMMERCE 3-28-1979.

THE MARK CONSISTS OF STANDARD CHARACTERS WITHOUT CLAIM TO ANY PARTICULAR FONT, STYLE, SIZE, OR COLOR.

OWNER OF U.S. REG. NO. 2,098,989.

SEC. 2(F).

SER. NO. 85-478,231, FILED 11-21-2011.

KATHERINE CONNOLLY, EXAMINING ATTORNEY



David J. Kyros

Director of the United States Patent and Trademark Office

United States of America

United States Patent and Trademark Office

Country Lane

Reg. No. 4,175,365

Registered July 17, 2012

Int. Cl.: 29

TRADEMARK

PRINCIPAL REGISTER

SPARBOE FOODS LLC (MINNESOTA LIMITED LIABILITY COMPANY)
PO BOX 309
23577 MN HIGHWAY 22
LITCHFIELD, MN 55355

FOR: DRIED EGGS; EGG WHITES; EGG YOLKS; EGGS; FROZEN EGGS, IN CLASS 29 (U.S. CL. 46).

FIRST USE 11-21-2011; IN COMMERCE 11-21-2011.

THE MARK CONSISTS OF STANDARD CHARACTERS WITHOUT CLAIM TO ANY PARTICULAR FONT, STYLE, SIZE, OR COLOR.

SER. NO. 85-478,233, FILED 11-21-2011.

LINDA MICKLEBURGH, EXAMINING ATTORNEY



David J. Kybas

Director of the United States Patent and Trademark Office

United States of America

United States Patent and Trademark Office

Animose

Reg. No. 4,175,366

ANIMOSE STUDIOS LLC (TEXAS LIMITED LIABILITY COMPANY)
5019 WILLOW WAY
RICHMOND, TX 77406

Registered July 17, 2012

Int. Cls.: 9, 41 and 42

FOR: SOUND RECORDINGS FEATURING MUSIC, IN CLASS 9 (U.S. CLS. 21, 23, 26, 36 AND 38).

TRADEMARK

FIRST USE 8-1-2004; IN COMMERCE 4-1-2006.

SERVICE MARK

FOR: ENTERTAINMENT SERVICES, NAMELY, MULTIMEDIA PRODUCTION SERVICES; PHOTOGRAPHY SERVICES; PRODUCTION OF AUDIO RECORDING; RECORDING STUDIO SERVICES; VIDEO PRODUCTION SERVICES, IN CLASS 41 (U.S. CLS. 100, 101 AND 107).

PRINCIPAL REGISTER

FIRST USE 8-1-2004; IN COMMERCE 4-1-2006.

FOR: COMPUTER SOFTWARE DEVELOPMENT; GRAPHIC DESIGN; SOFTWARE DESIGN AND DEVELOPMENT, IN CLASS 42 (U.S. CLS. 100 AND 101).

FIRST USE 8-1-2004; IN COMMERCE 4-1-2006.

THE MARK CONSISTS OF STANDARD CHARACTERS WITHOUT CLAIM TO ANY PARTICULAR FONT, STYLE, SIZE, OR COLOR.

THE ENGLISH TRANSLATION OF THE ITALIAN WORD "ANIMOSE" IN THE MARK IS "COURAGEOUS".

SER. NO. 85-478,296, FILED 11-21-2011.

BARBARA A. GOLD, EXAMINING ATTORNEY



David J. Kybas

Director of the United States Patent and Trademark Office

United States of America

United States Patent and Trademark Office

LET'S STAY TOGETHER

Reg. No. 4,175,367

Registered July 17, 2012

Int. Cl.: 36

SERVICE MARK

PRINCIPAL REGISTER

HOMEAWAY.COM, INC. (DELAWARE CORPORATION)
SUITE 300
1011 W. FIFTH STREET
AUSTIN, TX 78703

FOR: PROVIDING A WEBSITE PROVIDING REAL ESTATE INFORMATION RELATED TO REAL ESTATE BEING OFFERED FOR RENT OR PURCHASE; PROVIDING REAL ESTATE LISTING SERVICES FOR THE RENTAL OR PURCHASE OF REAL ESTATE; PROVIDING REAL ESTATE LISTING SERVICES FOR THE RENTAL OR PURCHASE OF VACATION REAL ESTATE; PROVIDING REAL ESTATE LISTING SERVICES VIA A GLOBAL COMPUTER NETWORK; PROVIDING INFORMATION ON THE RENTAL OF VACATION HOMES VIA THE INTERNET; PROVIDING A DATABASE OF INFORMATION ABOUT RESIDENTIAL REAL ESTATE LISTINGS IN DIFFERENT NEIGHBORHOODS AND COMMUNITIES; PROVIDING INFORMATION IN THE FIELD OF REAL ESTATE VIA THE INTERNET; PROVIDING REAL ESTATE LISTINGS AND REAL ESTATE INFORMATION VIA THE INTERNET; PROVIDING REAL ESTATE LISTINGS VIA THE INTERNET; REAL ESTATE LISTING SERVICES FOR HOUSING RENTALS AND APARTMENT RENTALS; RESIDENTIAL REAL ESTATE AGENCY SERVICES, IN CLASS 36 (U.S. CLS. 100, 101 AND 102).

FIRST USE 10-11-2011; IN COMMERCE 12-1-2011.

THE MARK CONSISTS OF STANDARD CHARACTERS WITHOUT CLAIM TO ANY PARTICULAR FONT, STYLE, SIZE, OR COLOR.

SER. NO. 85-478,297, FILED 11-21-2011.

ALEX KEAM, EXAMINING ATTORNEY



David J. Kyffers

Director of the United States Patent and Trademark Office

United States of America

United States Patent and Trademark Office

EYES ONLY

Reg. No. 4,175,368

Registered July 17, 2012

Int. Cl.: 35

SERVICE MARK

PRINCIPAL REGISTER

WIDEN, PATRICK (UNITED STATES INDIVIDUAL)
SUITE 1407
600 12TH AVENUE SOUTH
NASHVILLE, TN 37203

FOR: COMPILING OF INFORMATION INTO COMPUTER DATABASES; ADVERTISING, MARKETING AND PROMOTION SERVICES; PROVIDING MARKET RESEARCH AND MARKET RESEARCH INFORMATION; ADVERTISING SERVICES, NAMELY, PROMOTING THE GOODS AND SERVICES OF OTHERS VIA COMPUTER AND COMMUNICATION NETWORKS; ADVERTISING AND PUBLICITY SERVICES, NAMELY, PROMOTING THE GOODS, SERVICES, BRAND IDENTITY AND COMMERCIAL INFORMATION AND NEWS OF THIRD PARTIES THROUGH PRINT, AUDIO, VIDEO, DIGITAL, AND ON-LINE MEDIUM; OPERATING ON-LINE MARKETPLACES FOR SELLERS OF GOODS AND/OR SERVICES; ADVICE ON THE ANALYSIS OF CONSUMER BUYING HABITS AND NEEDS PROVIDED WITH THE HELP OF SENSORY, QUALITY, AND QUANTITY-RELATED DATA, IN CLASS 35 (U.S. CLS. 100, 101 AND 102).

FIRST USE 1-1-2011; IN COMMERCE 10-1-2011.

THE MARK CONSISTS OF STANDARD CHARACTERS WITHOUT CLAIM TO ANY PARTICULAR FONT, STYLE, SIZE, OR COLOR.

SER. NO. 85-478,301, FILED 11-21-2011.

DAVID YONTEF, EXAMINING ATTORNEY



David J. Kyffers

Director of the United States Patent and Trademark Office

United States of America

United States Patent and Trademark Office

TOP

Reg. No. 4,175,369

TARRANT CAPITAL IP, LLC (DELAWARE LIMITED LIABILITY COMPANY)
301 COMMERCE STREET, SUITE 3300
FORT WORTH, TX 76102

Registered July 17, 2012

Int. Cl.: 36

FOR: FINANCIAL SERVICES, NAMELY, INVESTMENT ADVICE, INVESTMENT MANAGEMENT, INVESTMENT CONSULTATION, INVESTMENT OF FUNDS FOR OTHERS, AND RAISING DEBT AND EQUITY CAPITAL FOR THE FUNDING OF INVESTMENTS, IN CLASS 36 (U.S. CLS. 100, 101 AND 102).

SERVICE MARK

PRINCIPAL REGISTER

FIRST USE 12-31-2009; IN COMMERCE 12-31-2009.

THE MARK CONSISTS OF STANDARD CHARACTERS WITHOUT CLAIM TO ANY PARTICULAR FONT, STYLE, SIZE, OR COLOR.

SER. NO. 85-478,309, FILED 11-21-2011.

KELLY TRUSILO, EXAMINING ATTORNEY



David J. Kyffers

Director of the United States Patent and Trademark Office

United States of America

United States Patent and Trademark Office

TPG OPPORTUNITIES

Reg. No. 4,175,370

TARRANT CAPITAL IP, LLC (DELAWARE LIMITED LIABILITY COMPANY)
301 COMMERCE STREET, SUITE 3300
FORT WORTH, TX 76102

Registered July 17, 2012

Int. Cl.: 36

FOR: FINANCIAL SERVICES, NAMELY, INVESTMENT ADVICE, INVESTMENT MANAGEMENT, INVESTMENT CONSULTATION, INVESTMENT OF FUNDS FOR OTHERS, AND RAISING DEBT AND EQUITY CAPITAL FOR THE FUNDING OF INVESTMENTS, IN CLASS 36 (U.S. CLS. 100, 101 AND 102).

SERVICE MARK

PRINCIPAL REGISTER

FIRST USE 5-31-2009; IN COMMERCE 5-31-2009.

THE MARK CONSISTS OF STANDARD CHARACTERS WITHOUT CLAIM TO ANY PARTICULAR FONT, STYLE, SIZE, OR COLOR.

SER. NO. 85-478,315, FILED 11-21-2011.

KELLY TRUSILO, EXAMINING ATTORNEY



David J. Kyffers

Director of the United States Patent and Trademark Office

United States of America

United States Patent and Trademark Office

WASTE TO WAVES

Reg. No. 4,175,371

Registered July 17, 2012

Int. Cl.: 37

SERVICE MARK

PRINCIPAL REGISTER

WHILDEN, KEVIN (UNITED STATES INDIVIDUAL)
APT. 1
109 CORONADO LN.
SAN CLEMENTE, CA 92672

FOR: COLLECTION OF THERMOCOL, CLOSED-CELL EXTRUDED POLYSTYRENE FOAM, EXPANDED POLYSTYRENE, POLYSTYRENE FOAM, FOAM, FOAM PLASTICS, POLYMER FOAMS, POLYSTYRENE, PLASTIC, POLYSTYRENE PACKAGING, POLYPROPYLENE, POLYVINYL CHLORIDE, POLYETHYLENE, POLYETHYLENE TEREPHTHALATE, RECYCLED POLYETHYLENE TEREPHTHALATE, HIGH DENSITY POLYETHYLENE, HARD, RIGID, COLORED PLASTIC, POLYURETHANE, NEOPRENE RUBBER, RUBBER, COTTON, WOOL, NYLON, BAMBOO, GLASS, HEMP, FLAX, PAPER, CORK, HOUSEHOLD AND COMMERCIAL PRODUCTS AND FURNISHINGS MADE FROM PLASTIC, RUBBER, COTTON, WOOL, BAMBOO, PAPER, GLASS, HEMP, FLAX, AND/OR CORK FOR RECYCLING, IN CLASS 37 (U.S. CLS. 100, 103 AND 106).

FIRST USE 6-27-2011; IN COMMERCE 11-21-2011.

THE MARK CONSISTS OF STANDARD CHARACTERS WITHOUT CLAIM TO ANY PARTICULAR FONT, STYLE, SIZE, OR COLOR.

SER. NO. 85-478,324, FILED 11-21-2011.

JEFFREY LOOK, EXAMINING ATTORNEY



David J. Kybas

Director of the United States Patent and Trademark Office

United States of America

United States Patent and Trademark Office



Reg. No. 4,175,372

Registered July 17, 2012

Int. Cl.: 9

TRADEMARK

PRINCIPAL REGISTER

KNOWWHO, INC. (VIRGINIA CORPORATION)
P.O. BOX 62
MOUNT VERNON, VA 22121

FOR: COMPUTER SOFTWARE FOR ACCESSING INFORMATION DIRECTORIES THAT MAY BE DOWNLOADED FROM THE GLOBAL COMPUTER NETWORK; COMPUTER SOFTWARE FOR APPLICATION AND DATABASE INTEGRATION; COMPUTER SOFTWARE FOR CREATING SEARCHABLE DATABASES OF INFORMATION AND DATA, IN CLASS 9 (U.S. CLS. 21, 23, 26, 36 AND 38).

FIRST USE 4-27-2007; IN COMMERCE 4-27-2007.

THE MARK CONSISTS OF A STYLIZED PORTION OF THE AMERICAN FLAG APPEARING TO THE LEFT OF THE MIXED CASE TEXT "MYGOVERNMENT".

SER. NO. 85-478,336, FILED 11-21-2011.

HENRY S. ZAK, EXAMINING ATTORNEY



David J. Kyffers

Director of the United States Patent and Trademark Office

United States of America

United States Patent and Trademark Office

LET'S STAY TOGETHER

Reg. No. 4,175,373

Registered July 17, 2012

Int. Cl.: 39

SERVICE MARK

PRINCIPAL REGISTER

HOMEAWAY.COM, INC. (DELAWARE CORPORATION)
SUITE 300
1011 W. FIFTH STREET
AUSTIN, TX 78703

FOR: COORDINATING TRAVEL ARRANGEMENTS FOR INDIVIDUALS AND FOR GROUPS; PROVIDING A WEBSITE FOR THE ARRANGEMENT AND BOOKING OF ECOTRAVEL AND ECO-TOURS; PROVIDING A WEB SITE AND WEB SITE LINKS TO GEOGRAPHIC INFORMATION, MAP IMAGES, AND TRIP ROUTING; PROVIDING A WEB SITE FEATURING TRAVEL INFORMATION AND COMMENTARY; PROVIDING AN ON-LINE COMPUTER DATABASE IN THE FIELD OF TRAVEL INFORMATION SERVICES; PROVIDING AN ON-LINE SEARCHABLE COMPUTER DATABASE FEATURING INFORMATION ON TRAVEL; PROVIDING INFORMATION, NEWS AND COMMENTARY IN THE FIELD OF TRAVEL; PROVIDING LINKS TO WEB SITES OF OTHERS FEATURING TRAVEL; PROVIDING REVIEWS OF TRAVEL SERVICE PROVIDERS; TRAVEL GUIDE AND TRAVEL INFORMATION SERVICES, IN CLASS 39 (U.S. CLS. 100 AND 105).

FIRST USE 10-11-2011; IN COMMERCE 12-1-2011.

THE MARK CONSISTS OF STANDARD CHARACTERS WITHOUT CLAIM TO ANY PARTICULAR FONT, STYLE, SIZE, OR COLOR.

SER. NO. 85-478,340, FILED 11-21-2011.

ALEX KEAM, EXAMINING ATTORNEY



David J. Kybas

Director of the United States Patent and Trademark Office

United States of America

United States Patent and Trademark Office



Reg. No. 4,175,374

Registered July 17, 2012

Int. Cl.: 25

RUNWAY GLOBAL LIMITED (HONG KONG PRIVATE COMPANY LIMITED BY SHARES (PRC))
PARK BUILDING, 14TH FLOOR
476 CASTLE PEAK ROAD
CHEUNG SHA WAN, KOWLOO, HONG KONG

TRADEMARK

PRINCIPAL REGISTER

FOR: CLOTHING, NAMELY, WOMEN'S AND GIRL'S KNIT JACKETS, KNIT AND WOVEN PANTS, WOOL JACKETS, WOOL COATS, CASUAL WOVEN COATS, CASUAL WOVEN JACKETS, OUTDOOR VESTS, WOVEN TRENCH COATS; CASUAL WEAR, NAMELY, SHORTS, SKIRTS, PANTS, JACKETS, SOCKS, SHOES AND HATS, IN CLASS 25 (U.S. CLS. 22 AND 39).

FIRST USE 6-0-2011; IN COMMERCE 6-0-2011.

NO CLAIM IS MADE TO THE EXCLUSIVE RIGHT TO USE "NEW YORK", APART FROM THE MARK AS SHOWN.

THE COLOR(S) BLACK AND ORANGE IS/ARE CLAIMED AS A FEATURE OF THE MARK.

THE MARK CONSISTS OF THE WORD "RUNWAY" IN LARGER LOWER CASE LETTERS ABOVE THE WORDS "NEW YORK" IN SMALLER UPPER CASE LETTERS WITH BOTH WORDS IN THE COLOR ORANGE AGAINST A BLACK BACKGROUND.

SER. NO. 85-478,367, FILED 11-21-2011.

FLORENTINA BLANDU, EXAMINING ATTORNEY



David J. Kyffers

Director of the United States Patent and Trademark Office

United States of America

United States Patent and Trademark Office

Ten Thousand Hands

Reg. No. 4,175,375

TEN THOUSAND HANDS (OREGON NON-PROFIT CORPORATION)
1435 NE 81ST
PORTLAND, OR 97213

Registered July 17, 2012

Int. Cl.: 36

FOR: CHARITABLE FUNDRAISING, IN CLASS 36 (U.S. CLS. 100, 101 AND 102).

SERVICE MARK

FIRST USE 1-5-2005; IN COMMERCE 3-5-2005.

PRINCIPAL REGISTER

THE MARK CONSISTS OF STANDARD CHARACTERS WITHOUT CLAIM TO ANY PARTICULAR FONT, STYLE, SIZE, OR COLOR.

SER. NO. 85-478,391, FILED 11-21-2011.

ALEX KEAM, EXAMINING ATTORNEY



David J. Kybas

Director of the United States Patent and Trademark Office

United States of America

United States Patent and Trademark Office

Soulshine

Reg. No. 4,175,376

FRANTI, MICHAEL (UNITED STATES INDIVIDUAL)
16133 VENTURA BOULEVARD - SUITE 1270
ENCINO, CA 91436

Registered July 17, 2012

Int. Cl.: 43

FOR: RESORT HOTEL SERVICES; RESORT LODGING SERVICES, IN CLASS 43 (U.S. CLS. 100 AND 101).

SERVICE MARK

FIRST USE 1-1-2011; IN COMMERCE 1-1-2011.

PRINCIPAL REGISTER

THE MARK CONSISTS OF STANDARD CHARACTERS WITHOUT CLAIM TO ANY PARTICULAR FONT, STYLE, SIZE, OR COLOR.

SER. NO. 85-478,441, FILED 11-21-2011.

CHRIS WELLS, EXAMINING ATTORNEY



David J. Kybas

Director of the United States Patent and Trademark Office

United States of America

United States Patent and Trademark Office

MEDISIGN

Reg. No. 4,175,377

ROMANOFF PRODUCTS, INC. (CONNECTICUT CORPORATION)
11 BROOKSIDE AVENUE
CHATHAM, NY 12037

Registered July 17, 2012

Int. Cl.: 20

FOR: FIRST AID AND MEDICINE CABINETS, IN CLASS 20 (U.S. CLS. 2, 13, 22, 25, 32 AND 50).

TRADEMARK

FIRST USE 11-30-1977; IN COMMERCE 11-30-1977.

PRINCIPAL REGISTER

THE MARK CONSISTS OF STANDARD CHARACTERS WITHOUT CLAIM TO ANY PARTICULAR FONT, STYLE, SIZE, OR COLOR.

SER. NO. 85-478,452, FILED 11-21-2011.

CHRIS WELLS, EXAMINING ATTORNEY



David J. Kyffers

Director of the United States Patent and Trademark Office

United States of America

United States Patent and Trademark Office

ViaPhoto

Reg. No. 4,175,378

VIAPHOTO, INC. (CALIFORNIA CORPORATION)
15091 BEACH BLVD
WESTMINSTER, CA 92683

Registered July 17, 2012

Int. Cl.: 42

FOR: PROVIDING A WEBSITE FEATURING NON-DOWNLOADABLE SOFTWARE FOR PHOTO ALBUM DESIGN, COLLABORATION, AND PROOFING, IN CLASS 42 (U.S. CLS. 100 AND 101).

SERVICE MARK

FIRST USE 11-11-2011; IN COMMERCE 11-11-2011.

PRINCIPAL REGISTER

THE MARK CONSISTS OF STANDARD CHARACTERS WITHOUT CLAIM TO ANY PARTICULAR FONT, STYLE, SIZE, OR COLOR.

SER. NO. 85-478,457, FILED 11-21-2011.

STEVEN R. FINE, EXAMINING ATTORNEY



David J. Kybas

Director of the United States Patent and Trademark Office

United States of America

United States Patent and Trademark Office

Ozark River

Reg. No. 4,175,379

MARTIN JAMES WATTS (UNITED STATES INDIVIDUAL)
280 CR 4285

Registered July 17, 2012

SALEM, MO 65560

Int. Cl.: 11

FOR: SINKS, IN CLASS 11 (U.S. CLS. 13, 21, 23, 31 AND 34).

TRADEMARK

FIRST USE 5-1-2007; IN COMMERCE 5-1-2007.

PRINCIPAL REGISTER

THE MARK CONSISTS OF STANDARD CHARACTERS WITHOUT CLAIM TO ANY PARTICULAR FONT, STYLE, SIZE, OR COLOR.

SER. NO. 85-478,473, FILED 11-22-2011.

PAM WILLIS, EXAMINING ATTORNEY



David J. Kyffers

Director of the United States Patent and Trademark Office

United States of America

United States Patent and Trademark Office



Reg. No. 4,175,380

Registered July 17, 2012

Int. Cl.: 41

SERVICE MARK

PRINCIPAL REGISTER

NOW TO PLAY GAME LIMITED (CHINA CORPORATION), DBA OPERATION OF BROWSER GAMES
ROOM 102, BUILDING NO.28
FULI ROAD, LIWAN AREA
GUANGZHOU, GUANGDONG, CHINA 510000

FOR: ENTERTAINMENT SERVICES, NAMELY, PROVIDING ON-LINE COMPUTER GAMES; PROVIDING A COMPUTER GAME FOR USE NETWORK-WIDE BY NETWORK USERS, IN CLASS 41 (U.S. CLS. 100, 101 AND 107).

FIRST USE 10-27-2011; IN COMMERCE 11-9-2011.

THE MARK CONSISTS OF YELLOW CHARACTERS "CROWN QUEST" WITH RED STROKES AND SHADING; A YELLOW AND RED CROWN WITH RED, BLUE GEMSTONES AND WHITE PEARLS DECORATED.

THE COLOR(S) YELLOW, RED, BLUE AND WHITE IS/ARE CLAIMED AS A FEATURE OF THE MARK.

SER. NO. 85-478,474, FILED 11-22-2011.

PAM WILLIS, EXAMINING ATTORNEY



David J. Kyffers

Director of the United States Patent and Trademark Office

United States of America

United States Patent and Trademark Office

QUANTUM DXI-SERIES

Reg. No. 4,175,381

Registered July 17, 2012

Int. Cls.: 9 and 16

TRADEMARK

PRINCIPAL REGISTER

QUANTUM CORPORATION (DELAWARE CORPORATION)
1650 TECHNOLOGY DRIVE
SUITE 700
SAN JOSE, CA 95110

FOR: DISK-BASED COMPUTER STORAGE DEVICES, NAMELY, HIGH-SPEED DISK AND SOFTWARE STORAGE SUBSYSTEMS FOR DEDUPLICATION, REPLICATION, STORAGE, BACKUP AND DISASTER RECOVERY OF ELECTRONIC DATA EITHER LOCALLY OR VIA A TELECOMMUNICATIONS NETWORK, IN CLASS 9 (U.S. CLS. 21, 23, 26, 36 AND 38).

FIRST USE 12-1-2006; IN COMMERCE 1-17-2007.

FOR: PRINTED MATERIALS IN THE FORM OF OPERATING MANUALS, USER GUIDES, PAMPHLETS AND BROCHURES ABOUT, FOR USE WITH, AND DIRECTED TO, DISK-BASED COMPUTER STORAGE DEVICES, NAMELY, HIGH-SPEED DISK AND SOFTWARE STORAGE SUBSYSTEMS FOR DEDUPLICATION, REPLICATION, STORAGE, BACKUP AND DISASTER RECOVERY OF ELECTRONIC DATA EITHER LOCALLY OR VIA A TELECOMMUNICATIONS NETWORK, IN CLASS 16 (U.S. CLS. 2, 5, 22, 23, 29, 37, 38 AND 50).

FIRST USE 12-1-2006; IN COMMERCE 1-17-2007.

THE MARK CONSISTS OF STANDARD CHARACTERS WITHOUT CLAIM TO ANY PARTICULAR FONT, STYLE, SIZE, OR COLOR.

SER. NO. 85-478,509, FILED 11-22-2011.

MARK SPARACINO, EXAMINING ATTORNEY



David J. Kybas

Director of the United States Patent and Trademark Office

United States of America
United States Patent and Trademark Office

JUNKSHOW

Reg. No. 4,175,382

RODGERS, STEVEN (UNITED STATES INDIVIDUAL)
1828 E. BROADWAY ST.
HELENA, MT 59601

Registered July 17, 2012

Int. Cl.: 25

FOR: HATS; JACKETS; PANTS; SCARVES; SHIRTS; SHOES; SHORTS; SOCKS; SWEAT-SHIRTS; UNDERWEAR, IN CLASS 25 (U.S. CLS. 22 AND 39).

TRADEMARK

FIRST USE 10-0-2011; IN COMMERCE 10-0-2011.

PRINCIPAL REGISTER

THE MARK CONSISTS OF STANDARD CHARACTERS WITHOUT CLAIM TO ANY PARTICULAR FONT, STYLE, SIZE, OR COLOR.

SER. NO. 85-478,546, FILED 11-22-2011.

ZACHARY BELLO, EXAMINING ATTORNEY



David J. Kyffers

Director of the United States Patent and Trademark Office

United States of America

United States Patent and Trademark Office

DELIBERATE PRODUCTIONS

Reg. No. 4,175,383

Registered July 17, 2012

Int. Cl.: 41

SERVICE MARK

PRINCIPAL REGISTER

DELIBERATE PRODUCTIONS, LLC (CALIFORNIA LIMITED LIABILITY COMPANY)
301
647 ORANGE GROVE AVENUE
SOUTH PASADENA, CA 91030

FOR: MOTION PICTURE FILM PRODUCTION, IN CLASS 41 (U.S. CLS. 100, 101 AND 107).

FIRST USE 4-18-2010; IN COMMERCE 4-18-2010.

THE MARK CONSISTS OF STANDARD CHARACTERS WITHOUT CLAIM TO ANY PARTICULAR FONT, STYLE, SIZE, OR COLOR.

NO CLAIM IS MADE TO THE EXCLUSIVE RIGHT TO USE "PRODUCTIONS", APART FROM THE MARK AS SHOWN.

SER. NO. 85-478,558, FILED 11-22-2011.

FLORENTINA BLANDU, EXAMINING ATTORNEY



David J. Kybas

Director of the United States Patent and Trademark Office

United States of America

United States Patent and Trademark Office

GO FISH!

Reg. No. 4,175,384

MISSOURI DEPARTMENT OF CONSERVATION (MISSOURI STATE AGENCY)
PO BOX 180

Registered July 17, 2012

JEFFERSON CITY, MO 65102

Int. Cl.: 41

FOR: EDUCATIONAL SERVICES, NAMELY, CONDUCTING CLASSES FOR CHILDREN
IN THE FIELD OF FISHING, IN CLASS 41 (U.S. CLS. 100, 101 AND 107).

SERVICE MARK

FIRST USE 4-30-2011; IN COMMERCE 4-30-2011.

PRINCIPAL REGISTER

THE MARK CONSISTS OF STANDARD CHARACTERS WITHOUT CLAIM TO ANY PAR-
TICULAR FONT, STYLE, SIZE, OR COLOR.

SER. NO. 85-478,570, FILED 11-22-2011.

FLORENTINA BLANDU, EXAMINING ATTORNEY



David J. Kybas

Director of the United States Patent and Trademark Office

United States of America

United States Patent and Trademark Office



Reg. No. 4,175,385

Registered July 17, 2012

Int. Cl.: 31

TRADEMARK

PRINCIPAL REGISTER

B&W QUALITY GROWERS, INC. (FLORIDA CORPORATION)
17825 79TH STREET
FELLSMERE, FL 32948

FOR: FRESH SPECIALTY LEAF VEGETABLES, NAMELY, WATERCRESS, SPINACH, PEA TENDRILS, BABY ARUGULA AND OTHER BABY LEAF VEGETABLES, IN CLASS 31 (U.S. CLS. 1 AND 46).

FIRST USE 10-15-2011; IN COMMERCE 10-15-2011.

OWNER OF U.S. REG. NO. 2,019,435.

THE COLOR(S) DARK GREEN, LIGHT GREEN, YELLOW AND WHITE IS/ARE CLAIMED AS A FEATURE OF THE MARK.

NO CLAIM IS MADE TO THE EXCLUSIVE RIGHT TO USE "LEAF WATERCRESS RICH IN VITAMINS A, C, & K FLAVORFUL", APART FROM THE MARK AS SHOWN.

THE MARK CONSISTS OF THE WORDS "THE SUPER LEAF" IN WHITE STYLIZED PRINT, WITH "THE" IN LOWER CASE ITALICS AND THE OTHER WORDS ALL IN UPPER CASE, PRINTED ON THE DESIGN OF A DARK GREEN LEAF, WITHIN A CIRCLE. THE WORDS "RICH IN VITAMINS A, C & K", "WATERCRESS" AND "FLAVORFUL POWERHOUSE", SEPARATED BY STAR SYMBOLS, ENCIRCLE THE LEAF IN THE SAME DARK GREEN, AND ARE IN THEMSELVES ENCIRCLED BY A DARK GREEN CIRCLE. THE INNER AREA OF THE CIRCLE IS A YELLOW SUNBURST DESIGN WITH WHITE SUN RAYS. THE TAIL OF THE LEAF SEPARATES THE LETTER "K" AND "FLAVORFUL".

SER. NO. 85-478,573, FILED 11-22-2011.

FLORENTINA BLANDU, EXAMINING ATTORNEY



David J. Kybas

Director of the United States Patent and Trademark Office

United States of America

United States Patent and Trademark Office



Reg. No. 4,175,386

NEXT LEVEL ATHLETICS (CALIFORNIA LIMITED LIABILITY COMPANY)
17545 REGENCY WAY
GRANADA HILLS, CA 91344

Registered July 17, 2012

Int. Cl.: 5

FOR: SPORTS NUTRITIONAL SUPPLEMENTS, IN CLASS 5 (U.S. CLS. 6, 18, 44, 46, 51 AND 52).

TRADEMARK

FIRST USE 11-1-2011; IN COMMERCE 11-1-2011.

PRINCIPAL REGISTER

NO CLAIM IS MADE TO THE EXCLUSIVE RIGHT TO USE "PERFORMANCE", APART FROM THE MARK AS SHOWN.

THE MARK CONSISTS OF THE LETTERS AND WORDS "NLA PERFORMANCE THE CHOICE OF CHAMPIONS". AN IMAGE OF AN ABSTRACT DESIGN TO THE LEFT OF THE TEXT.

SER. NO. 85-478,574, FILED 11-22-2011.

DAVID MURRAY, EXAMINING ATTORNEY



David J. Kybas

Director of the United States Patent and Trademark Office

United States of America

United States Patent and Trademark Office

LITTLE BIGS

Reg. No. 4,175,387

FUTURE THINK LLC (NEW YORK LIMITED LIABILITY COMPANY)
380 LEXINGTON AVE. SUITE 1743
NEW YORK, NY 10168

Registered July 17, 2012

Int. Cl.: 41

FOR: EDUCATIONAL SERVICES, NAMELY, CONDUCTING WORKSHOPS, LECTURES AND KEYNOTE SEMINARS IN THE FIELDS OF INNOVATION, BUSINESS MANAGEMENT AND PROBLEM SOLVING RELATING TO BUSINESS GROWTH AND DISTRIBUTION OF TRAINING MATERIALS IN CONNECTION THEREWITH, IN CLASS 41 (U.S. CLS. 100, 101 AND 107).

SERVICE MARK

PRINCIPAL REGISTER

FIRST USE 6-8-2011; IN COMMERCE 6-8-2011.

THE MARK CONSISTS OF STANDARD CHARACTERS WITHOUT CLAIM TO ANY PARTICULAR FONT, STYLE, SIZE, OR COLOR.

SER. NO. 85-478,586, FILED 11-22-2011.

JESSICA A. POWERS, EXAMINING ATTORNEY



David J. Kyffers

Director of the United States Patent and Trademark Office

United States of America

United States Patent and Trademark Office

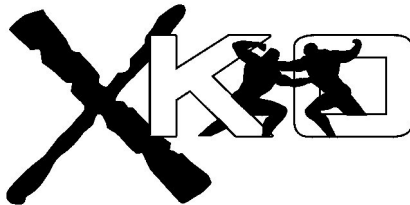

Reg. No. 4,175,388

Registered July 17, 2012

Int. Cl.: 41

SERVICE MARK

PRINCIPAL REGISTER

BACK ALLEY PROMOTIONS, INC (TEXAS CORPORATION)
921 W. MAYFIELD ROAD, SUITE #112
ARLINGTON, TX 76015

FOR: ENTERTAINMENT SERVICES IN THE NATURE OF LIVE MIXED MARTIAL ARTS (MMA) EVENTS; MARTIAL ARTS INSTRUCTION; EDUCATION SERVICES, NAMELY, PROVIDING SEMINARS IN THE FIELD OF MIXED MARTIAL ARTS; ARRANGING AND CONDUCTING SPECIAL EVENTS FOR SOCIAL ENTERTAINMENT PURPOSES; ENTERTAINMENT IN THE NATURE OF ON-GOING TELEVISION PROGRAMS IN THE FIELD OF MIXED MARTIAL ARTS; PROVIDING A WEBSITE FEATURING NON-DOWNLOADABLE VIDEOS IN THE FIELD OF MIXED MARTIAL ARTS, IN CLASS 41 (U.S. CLS. 100, 101 AND 107).

FIRST USE 1-12-2002; IN COMMERCE 1-12-2002.

THE MARK CONSISTS OF THE STYLIZED LETTERS "XKO". AN IMAGE OF TWO FIGHTERS INSIDE THE LETTERS "KO".

SER. NO. 85-478,607, FILED 11-22-2011.

JENNY PARK, EXAMINING ATTORNEY



David J. Kyffers

Director of the United States Patent and Trademark Office

United States of America

United States Patent and Trademark Office

BILL CRISPIN

Reg. No. 4,175,389

Registered July 17, 2012

Int. Cls.: 35 and 37

SERVICE MARK

PRINCIPAL REGISTER

BILL CRISPIN CHEVROLET, INC. (MICHIGAN CORPORATION)
7112 E. MICHIGAN AVENUE, P.O. BOX 95
SALINE, MI 48176

FOR: AUTOMOBILE DEALERSHIPS, IN CLASS 35 (U.S. CLS. 100, 101 AND 102).

FIRST USE 6-0-1975; IN COMMERCE 6-0-1975.

FOR: AUTOMOBILE REPAIR AND MAINTENANCE, IN CLASS 37 (U.S. CLS. 100, 103 AND 106).

FIRST USE 6-0-1975; IN COMMERCE 6-0-1975.

THE MARK CONSISTS OF STANDARD CHARACTERS WITHOUT CLAIM TO ANY PARTICULAR FONT, STYLE, SIZE, OR COLOR.

THE NAME(S), PORTRAIT(S), AND/OR SIGNATURE(S) SHOWN IN THE MARK IDENTIFIES "BILL CRISPIN", WHOSE CONSENT(S) TO REGISTER IS MADE OF RECORD.

SER. NO. 85-478,608, FILED 11-22-2011.

CIMMERIAN COLEMAN, EXAMINING ATTORNEY



David J. Kyffers

Director of the United States Patent and Trademark Office

United States of America

United States Patent and Trademark Office

DUSTGRIP

Reg. No. 4,175,390

Registered July 17, 2012

Int. Cl.: 1

TRADEMARK

PRINCIPAL REGISTER

QUAKER CHEMICAL CORPORATION (DELAWARE CORPORATION)
SILVERSIDE CARR EXECUTIVE CENTER
501 SILVERSIDE ROAD
WILMINGTON, DE 198091374

FOR: CHEMICAL PREPARATIONS FOR STABILIZING SOIL AND DUST; CHEMICAL DUST SUPPRESSANT PREPARATIONS THAT ARE NOT PETROLEUM, OIL OR GREASE-BASED, NAMELY, DUST SUPPRESSING CHEMICALS IN LIQUID FORM FOR USE WITH OR ON UNPAVED ROADS, MINERAL STOCKPILES, CONVEYORS, EMBANKMENTS AND PILES, AND MINE SURFACES; AND HYGROSCOPIC CHEMICALS AND OTHER CHEMICAL PREPARATIONS, NAMELY, DUST SUPPRESSING CHEMICALS THAT ARE NOT PETROLEUM, OIL, OR GREASE-BASED FOR ABSORBING AND SUPPRESSING DUST AND AIRBORNE SOIL PARTICULATES, IN CLASS 1 (U.S. CLS. 1, 5, 6, 10, 26 AND 46).

FIRST USE 6-18-2009; IN COMMERCE 6-18-2009.

THE MARK CONSISTS OF STANDARD CHARACTERS WITHOUT CLAIM TO ANY PARTICULAR FONT, STYLE, SIZE, OR COLOR.

SER. NO. 85-478,611, FILED 11-22-2011.

CIMMERIAN COLEMAN, EXAMINING ATTORNEY



David J. Kypos

Director of the United States Patent and Trademark Office

United States of America

United States Patent and Trademark Office

BUSINESS IS PERSONAL

Reg. No. 4,175,391

HORIZON MEDIA, INC. (NEW YORK CORPORATION)
75 VARICK STREET
NEW YORK, NY 10013

Registered July 17, 2012

Int. Cl.: 35

FOR: ADVERTISING SERVICES FOR OTHERS, NAMELY, ACQUIRING AND SELLING ADVERTISING SPACE AND PLACEMENT OF ADVERTISEMENT, IN CLASS 35 (U.S. CLS. 100, 101 AND 102).

SERVICE MARK

FIRST USE 12-31-2007; IN COMMERCE 12-31-2007.

PRINCIPAL REGISTER

THE MARK CONSISTS OF STANDARD CHARACTERS WITHOUT CLAIM TO ANY PARTICULAR FONT, STYLE, SIZE, OR COLOR.

SER. NO. 85-478,626, FILED 11-22-2011.

EDWARD FENNESSY, EXAMINING ATTORNEY



David J. Kyffers

Director of the United States Patent and Trademark Office

United States of America

United States Patent and Trademark Office

Fortunate Face Minerals

Reg. No. 4,175,392

KAREN WELCH (MASSACHUSETTS SOLE PROPRIETORSHIP), DBA KARRIE WELCH
467 SPRINGDALE RD
WESTFIELD, MA 01085

Registered July 17, 2012

Int. Cls.: 3 and 44

FOR: COSMETICS AND MAKE-UP, IN CLASS 3 (U.S. CLS. 1, 4, 6, 50, 51 AND 52).

TRADEMARK

FIRST USE 7-23-2008; IN COMMERCE 7-23-2008.

SERVICE MARK

FOR: BEAUTY CONSULTATION SERVICES IN THE SELECTION AND USE OF COSMETICS, FRAGRANCES, BEAUTY AIDS, PERSONAL CARE PRODUCTS, AND BATH, BODY AND BEAUTY PRODUCTS, IN CLASS 44 (U.S. CLS. 100 AND 101).

PRINCIPAL REGISTER

FIRST USE 7-23-2008; IN COMMERCE 7-23-2008.

THE MARK CONSISTS OF STANDARD CHARACTERS WITHOUT CLAIM TO ANY PARTICULAR FONT, STYLE, SIZE, OR COLOR.

NO CLAIM IS MADE TO THE EXCLUSIVE RIGHT TO USE "FACE MINERALS", APART FROM THE MARK AS SHOWN.

SER. NO. 85-478,635, FILED 11-22-2011.

ANDREA K. NADELMAN, EXAMINING ATTORNEY



David J. Kybas

Director of the United States Patent and Trademark Office

United States of America

United States Patent and Trademark Office



Reg. No. 4,175,393

Registered July 17, 2012

Int. Cls.: 16 and 24

TRADEMARK

PRINCIPAL REGISTER

TARTELLA, INC. (ILLINOIS CORPORATION)
1804 GREENLEAF ST.
EVANSTON, IL 60202

FOR: RECIPE CARD HOLDERS; PRINTED RECIPE CARDS; BOOK MARKS; PAPER GIFT TAGS; PAPER WINE GIFT BAGS; TEXTILE WINE GIFT BAGS; ART PRINTS , IN CLASS 16 (U.S. CLS. 2, 5, 22, 23, 29, 37, 38 AND 50).

FIRST USE 5-1-2008; IN COMMERCE 5-1-2008.

FOR: TEA TOWELS; FABRIC TABLE RUNNERS; TEXTILE NAPKINS; TEXTILE TABLE-CLOTHS, IN CLASS 24 (U.S. CLS. 42 AND 50).

FIRST USE 5-1-2008; IN COMMERCE 5-1-2008.

THE MARK CONSISTS OF A STYLIZED FONT WITH THE WORD "TARTELLA" (LOWER CASE) IN BETWEEN THE FROSTING AND THE BOTTOM OF A CUPCAKE, AND THE CUPCAKE FROSTING HAS A CHERRY ON TOP.

SER. NO. 85-478,639, FILED 11-22-2011.

ELLEN PERKINS, EXAMINING ATTORNEY



David J. Kybas

Director of the United States Patent and Trademark Office

United States of America

United States Patent and Trademark Office

Too Young To Retire

Reg. No. 4,175,394

PAUL G. WARD (UNITED STATES INDIVIDUAL)
235 AGOR LANE
MAHOPAC, NY 10541

Registered July 17, 2012

Int. Cl.: 41

FOR: EDUCATIONAL SERVICES, NAMELY, DEVELOPING AND CONDUCTING LECTURES, PRESENTATIONS, CLASSES, COURSES, TELESEMINARS, TELECLASSES, AND WORKSHOPS, MENTORING INDIVIDUALS AND GROUPS, AND DISTRIBUTION OF TRAINING MATERIALS IN CONNECTION THEREWITH, TO RETIREES AND BUSINESSES ABOUT RETIREMENT OPTIONS AND LIFESTYLES, IN CLASS 41 (U.S. CLS. 100, 101 AND 107).

SERVICE MARK

PRINCIPAL REGISTER

FIRST USE 9-1-2010; IN COMMERCE 9-1-2010.

THE MARK CONSISTS OF STANDARD CHARACTERS WITHOUT CLAIM TO ANY PARTICULAR FONT, STYLE, SIZE, OR COLOR.

SER. NO. 85-478,651, FILED 11-22-2011.

DAVID H. STINE, EXAMINING ATTORNEY



David J. Kyffers

Director of the United States Patent and Trademark Office

United States of America

United States Patent and Trademark Office

Clickipedia

Reg. No. 4,175,395

Registered July 17, 2012

Int. Cl.: 35

SERVICE MARK

PRINCIPAL REGISTER

CLICKIPEDIA, LLC (CALIFORNIA LIMITED LIABILITY COMPANY)
201
150 S GLENOAKS BLVD
BURBANK, CA 91502

FOR: ON-LINE ADVERTISING AND MARKETING SERVICES, IN CLASS 35 (U.S. CLS. 100, 101 AND 102).

FIRST USE 11-1-2009; IN COMMERCE 11-1-2009.

THE MARK CONSISTS OF STANDARD CHARACTERS WITHOUT CLAIM TO ANY PARTICULAR FONT, STYLE, SIZE, OR COLOR.

SER. NO. 85-478,656, FILED 11-22-2011.

JOHN SCHUYLER YARD, EXAMINING ATTORNEY



David J. Kyros

Director of the United States Patent and Trademark Office

United States of America

United States Patent and Trademark Office

GOODRX

Reg. No. 4,175,396

Registered July 17, 2012

Int. Cl.: 35

SERVICE MARK

PRINCIPAL REGISTER

GOODRX, INC. (DELAWARE CORPORATION)
2644 30TH STREET SUITE 101
SANTA MONICA, CA 90405

FOR: PROVIDING ONLINE PRICE COMPARISONS, COST ANALYSIS AND PRICE QUOTATIONS OF PHARMACEUTICALS AND OVER THE COUNTER MEDICATIONS FOR CONSUMERS, PROVIDERS, ADMINISTRATORS, AND OTHER PARTICIPANTS IN THE HEALTHCARE INDUSTRY; PROVIDING ONLINE CONSUMER PRODUCT INFORMATION FOR THE PURPOSE OF SELECTION OF PHARMACEUTICALS AND OVER THE COUNTER MEDICATIONS TO MEET THE CONSUMERS SPECIFICATIONS, IN CLASS 35 (U.S. CLS. 100, 101 AND 102).

FIRST USE 9-1-2011; IN COMMERCE 9-21-2011.

THE MARK CONSISTS OF STANDARD CHARACTERS WITHOUT CLAIM TO ANY PARTICULAR FONT, STYLE, SIZE, OR COLOR.

SER. NO. 85-478,660, FILED 11-22-2011.

JOHN SCHUYLER YARD, EXAMINING ATTORNEY



David J. Kyros

Director of the United States Patent and Trademark Office

United States of America

United States Patent and Trademark Office

CANDLEBOX

Reg. No. 4,175,397

Registered July 17, 2012

Int. Cl.: 41

SERVICE MARK

PRINCIPAL REGISTER

PETER KLETT (UNITED STATES INDIVIDUAL)
3RD FL
C/O NICK FERRARA, 119 5TH AVE.
NEW YORK, NY 10003 AND

KEVIN MARTIN (UNITED STATES INDIVIDUAL)
3RD FLOOR
C/O NICK FERRARA, 119 5TH AVE.
NEW YORK, NY 10003

FOR: ENTERTAINMENT IN THE NATURE OF LIVE PERFORMANCES BY A MUSICAL GROUP; ENTERTAINMENT SERVICES IN THE NATURE OF LIVE MUSICAL PERFORMANCES; ENTERTAINMENT SERVICES, NAMELY, PERSONAL APPEARANCES BY A MUSICAL GROUP, IN CLASS 41 (U.S. CLS. 100, 101 AND 107).

FIRST USE 11-1-1991; IN COMMERCE 11-1-1991.

THE MARK CONSISTS OF STANDARD CHARACTERS WITHOUT CLAIM TO ANY PARTICULAR FONT, STYLE, SIZE, OR COLOR.

SER. NO. 85-478,686, FILED 11-22-2011.

JUDITH HELFMAN, EXAMINING ATTORNEY



David J. Kybas

Director of the United States Patent and Trademark Office

United States of America

United States Patent and Trademark Office

LET'S PLAY POKER

Reg. No. 4,175,398

LAS VEGAS SANDS CORP. (NEVADA CORPORATION)
3355 LAS VEGAS BOULEVARD SOUTH
LAS VEGAS, NV 89109

Registered July 17, 2012

Int. Cl.: 41

FOR: CASINO SERVICES; ENTERTAINMENT SERVICES, NAMELY, CONDUCTING LIVE POKER GAMES, IN CLASS 41 (U.S. CLS. 100, 101 AND 107).

SERVICE MARK

FIRST USE 5-11-2011; IN COMMERCE 5-11-2011.

PRINCIPAL REGISTER

THE MARK CONSISTS OF STANDARD CHARACTERS WITHOUT CLAIM TO ANY PARTICULAR FONT, STYLE, SIZE, OR COLOR.

NO CLAIM IS MADE TO THE EXCLUSIVE RIGHT TO USE "POKER", APART FROM THE MARK AS SHOWN.

SER. NO. 85-478,707, FILED 11-22-2011.

NAKIA HENRY, EXAMINING ATTORNEY



David J. Kyffers

Director of the United States Patent and Trademark Office

United States of America

United States Patent and Trademark Office

WHOLETREES

Reg. No. 4,175,399

WHOLE TREES, LLC (WISCONSIN LIMITED LIABILITY COMPANY)
E2890 LORENZ ROAD
STODDARD, WI 54658

Registered July 17, 2012

Int. Cl.: 42

FOR: ARCHITECTURAL DESIGN IN THE FIELD OF COMMERCIAL, INSTITUTIONAL, AND RESIDENTIAL STRUCTURES, SITE ANALYSIS, SITE PLANNING, AND PASSIVE SOLAR DESIGN STRATEGY; ARCHITECTURAL SERVICES, IN CLASS 42 (U.S. CLS. 100 AND 101).

SERVICE MARK

PRINCIPAL REGISTER

FIRST USE 3-12-2007; IN COMMERCE 3-12-2007.

THE MARK CONSISTS OF STANDARD CHARACTERS WITHOUT CLAIM TO ANY PARTICULAR FONT, STYLE, SIZE, OR COLOR.

SER. NO. 85-478,751, FILED 11-22-2011.

JAY BESCH, EXAMINING ATTORNEY



David J. Kyffers

Director of the United States Patent and Trademark Office

United States of America

United States Patent and Trademark Office

SAFE-T

Reg. No. 4,175,400

Registered July 17, 2012

Int. Cl.: 16

TRADEMARK

PRINCIPAL REGISTER

SCREENING FOR MENTAL HEALTH, INC. (MASSACHUSETTS NON-PROFIT CORPORATION)

SUITE 304
ONE WASHINGTON STREET
WELLESLEY HILLS, MA 02481

FOR: PRINTED CARD CONTAINING GUIDELINES FOR SUICIDE RISK ASSESSMENT FOR USE BY MENTAL HEALTH PROFESSIONALS, IN CLASS 16 (U.S. CLS. 2, 5, 22, 23, 29, 37, 38 AND 50).

FIRST USE 1-1-2007; IN COMMERCE 1-1-2007.

THE MARK CONSISTS OF STANDARD CHARACTERS WITHOUT CLAIM TO ANY PARTICULAR FONT, STYLE, SIZE, OR COLOR.

SER. NO. 85-478,762, FILED 11-22-2011.

LINDSEY RUBIN, EXAMINING ATTORNEY



David J. Kyffers

Director of the United States Patent and Trademark Office

United States of America

United States Patent and Trademark Office

STOP THE PAIN

Reg. No. 4,175,401

GOULD & LAMB, LLC (FLORIDA LIMITED LIABILITY COMPANY)
101 RIVERFRONT BLVD., SUITE 100
BRADENTON, FL 34205

Registered July 17, 2012

Int. Cl.: 35

FOR: PHARMACEUTICAL COST MANAGEMENT SERVICES AND DRUG UTILIZATION
REVIEW SERVICES, IN CLASS 35 (U.S. CLS. 100, 101 AND 102).

SERVICE MARK

FIRST USE 11-9-2011; IN COMMERCE 11-9-2011.

PRINCIPAL REGISTER

THE MARK CONSISTS OF STANDARD CHARACTERS WITHOUT CLAIM TO ANY PAR-
TICULAR FONT, STYLE, SIZE, OR COLOR.

SER. NO. 85-478,788, FILED 11-22-2011.

KEVON CHISOLM, EXAMINING ATTORNEY



David J. Kyffers

Director of the United States Patent and Trademark Office

United States of America

United States Patent and Trademark Office



Reg. No. 4,175,402

PASTABLITZ OF MONTPELIER, INC. (MARYLAND CORPORATION)
7312 SHADY GLEN DRIVE
COLUMBIA, MD 21046

Registered July 17, 2012

Int. Cl.: 43

FOR: RESTAURANT SERVICES, NAMELY, PROVIDING OF FOOD AND BEVERAGES FOR CONSUMPTION ON AND OFF THE PREMISES, IN CLASS 43 (U.S. CLS. 100 AND 101).

SERVICE MARK

FIRST USE 11-13-2011; IN COMMERCE 11-13-2011.

PRINCIPAL REGISTER

NO CLAIM IS MADE TO THE EXCLUSIVE RIGHT TO USE "RISTORANTE WOOD FIRE PIZZA WINE BAR", APART FROM THE MARK AS SHOWN.

THE COLOR(S) WHITE, BLACK AND GREEN IS/ARE CLAIMED AS A FEATURE OF THE MARK.

THE MARK CONSISTS OF THE STYLIZED WORD "FACCI" APPEARING IN WHITE WITH A GREEN AND WHITE OLIVE AND LEAF DESIGN FORMING THE TOP OF THE LETTER "I", ALL APPEARING OVER THE WHITE WORDING "RISTORANTE · WOOD FIRE PIZZA · WINE BAR" AND ALL AGAINST A BLACK RECTANGULAR BACKGROUND.

THE ENGLISH TRANSLATION OF THE WORD "RISTORANTE" IN THE MARK IS "RESTAURANT".

SER. NO. 85-478,806, FILED 11-22-2011.

CHRISTINE MARTIN, EXAMINING ATTORNEY



David J. Kybas

Director of the United States Patent and Trademark Office

United States of America

United States Patent and Trademark Office

VIVA WIRELESS

Reg. No. 4,175,403

Registered July 17, 2012

Int. Cl.: 35

SERVICE MARK

PRINCIPAL REGISTER

WIRELESS AMERICA, LLC (WISCONSIN LIMITED LIABILITY COMPANY), DBA VIVA WIRELESS
7003 PRESIDENTS DRIVE, SUITE 700
ORLANDO, FL 32809

FOR: RETAIL STORE SERVICES FEATURING WIRELESS TELEPHONES AND ACCESSORIES, IN CLASS 35 (U.S. CLS. 100, 101 AND 102).

FIRST USE 2-15-2002; IN COMMERCE 6-1-2002.

THE MARK CONSISTS OF STANDARD CHARACTERS WITHOUT CLAIM TO ANY PARTICULAR FONT, STYLE, SIZE, OR COLOR.

THE ENGLISH TRANSLATION OF "VIVA" IN THE MARK IS "LIVING".

SER. NO. 85-478,812, FILED 11-22-2011.

JEAN IM, EXAMINING ATTORNEY



David J. Kyros

Director of the United States Patent and Trademark Office

United States of America
United States Patent and Trademark Office

Health Hut

Reg. No. 4,175,404

BOOTZIN TRUST (CALIFORNIA TRUST)
4302 AMBROSE AVE
LOS ANGELES, CA 900272113

Registered July 17, 2012

Int. Cl.: 43

FOR: JUICE BAR SERVICES; RESTAURANT SERVICES, IN CLASS 43 (U.S. CLS. 100 AND 101).

SERVICE MARK

FIRST USE 0-0-1959; IN COMMERCE 0-0-1959.

PRINCIPAL REGISTER

THE MARK CONSISTS OF STANDARD CHARACTERS WITHOUT CLAIM TO ANY PARTICULAR FONT, STYLE, SIZE, OR COLOR.

NO CLAIM IS MADE TO THE EXCLUSIVE RIGHT TO USE "HEALTH", APART FROM THE MARK AS SHOWN.

SER. NO. 85-478,823, FILED 11-22-2011.

MARC LEIPZIG, EXAMINING ATTORNEY



David J. Kybas

Director of the United States Patent and Trademark Office

United States of America

United States Patent and Trademark Office

TOUCHPOINT

Reg. No. 4,175,405

CENTERPOINT ENERGY RESOURCES CORP. (DELAWARE CORPORATION)
800 LASALLE AVENUE

Registered July 17, 2012

MINNEAPOLIS, MN 554590038

Int. Cl.: 16

FOR: NEWSLETTERS FOR UTILITY CUSTOMERS CONCERNING ENERGY UTILIZATION AND CONSERVATION AND NEWS OF UTILITY ACTIVITIES, IN CLASS 16 (U.S. CLS. 2, 5, 22, 23, 29, 37, 38 AND 50).

TRADEMARK

FIRST USE 11-30-2002; IN COMMERCE 5-31-2008.

PRINCIPAL REGISTER

THE MARK CONSISTS OF STANDARD CHARACTERS WITHOUT CLAIM TO ANY PARTICULAR FONT, STYLE, SIZE, OR COLOR.

SER. NO. 85-478,834, FILED 11-22-2011.

KIM MONINGHOFF, EXAMINING ATTORNEY



David J. Kyffers

Director of the United States Patent and Trademark Office

United States of America

United States Patent and Trademark Office

GenRock

Reg. No. 4,175,406

LUSID TECHNOLOGIES INCORPORATED (UTAH CORPORATION)
5195 W 4700 S
KEARNS, UT 84118

Registered July 17, 2012

Int. Cl.: 2

FOR: PAINTS FOR AUTOMOTIVE FINISHES, TRAILER FINISHING, GOLF SHAFTS, BOAT FINISHES, TANK FINISHES, AND PROTECTIVE AND DECORATIVE COATINGS IN THE NATURE OF PAINTS FOR USE ON METAL, FIBERGLASS AND PLASTICS PRODUCTS, IN CLASS 2 (U.S. CLS. 6, 11 AND 16).

TRADEMARK

PRINCIPAL REGISTER

FIRST USE 9-14-2009; IN COMMERCE 9-14-2009.

THE MARK CONSISTS OF STANDARD CHARACTERS WITHOUT CLAIM TO ANY PARTICULAR FONT, STYLE, SIZE, OR COLOR.

SER. NO. 85-478,857, FILED 11-22-2011.

YAT SYE, LEE, EXAMINING ATTORNEY



David J. Kyffers

Director of the United States Patent and Trademark Office

United States of America

United States Patent and Trademark Office

TIME4WRITING

Reg. No. 4,175,407

VKIDZ, INC. (FLORIDA CORPORATION)
3041 NE 43RD STREET

Registered July 17, 2012

FT. LAUDERDALE, FL 33308

Int. Cl.: 41

FOR: EDUCATION SERVICES, NAMELY, PROVIDING ON-LINE COURSES IN THE FIELD OF WRITING, IN CLASS 41 (U.S. CLS. 100, 101 AND 107).

SERVICE MARK

FIRST USE 3-0-2008; IN COMMERCE 3-0-2008.

PRINCIPAL REGISTER

THE MARK CONSISTS OF STANDARD CHARACTERS WITHOUT CLAIM TO ANY PARTICULAR FONT, STYLE, SIZE, OR COLOR.

SER. NO. 85-478,865, FILED 11-22-2011.

DAVID C. REIHNER, EXAMINING ATTORNEY



David J. Kybas

Director of the United States Patent and Trademark Office

United States of America

United States Patent and Trademark Office



Reg. No. 4,175,408

Registered July 17, 2012

Int. Cl.: 9

TRADEMARK

PRINCIPAL REGISTER

DATA SCIENCE AUTOMATION, INC. (PENNSYLVANIA CORPORATION)
375 VALLEY BROOK ROAD
MCMURRAY, PA 15317

FOR: COMPUTER HARDWARE AND SOFTWARE SYSTEMS FOR CONTROLLING AND TESTING INDUSTRIAL ASSEMBLY MACHINES; COMPUTER HARDWARE AND SOFTWARE FOR MOTION CONTROL OF INDUSTRIAL ASSEMBLY MACHINES; COMPUTER HARDWARE AND SOFTWARE FOR MACHINE VISION CONTROL OF INDUSTRIAL ASSEMBLY MACHINES, IN CLASS 9 (U.S. CLS. 21, 23, 26, 36 AND 38).

FIRST USE 4-16-2002; IN COMMERCE 4-16-2002.

NO CLAIM IS MADE TO THE EXCLUSIVE RIGHT TO USE "DATA" OR "AUTOMATION", APART FROM THE MARK AS SHOWN.

THE MARK CONSISTS OF THE LETTERS "DSA" WITH AN ARROW FORMING A CIRCLE AROUND THE LETTERS "DS" ON THE FIRST LINE AND "DATA SCIENCE AUTOMATION" IN BLOCK LETTERS STARTING UNDER THE S OF "DSA."

SER. NO. 85-478,866, FILED 11-22-2011.

IRA J. GOODSaid, EXAMINING ATTORNEY



David J. Kyffers

Director of the United States Patent and Trademark Office

United States of America

United States Patent and Trademark Office

LET'S STAY TOGETHER

Reg. No. 4,175,409

Registered July 17, 2012

Int. Cl.: 42

SERVICE MARK

PRINCIPAL REGISTER

HOMEAWAY.COM, INC. (DELAWARE CORPORATION)
SUITE 300
1011 W. FIFTH STREET
AUSTIN, TX 78703

FOR: COMPUTER SERVICES, NAMELY, PROVIDING SEARCH PLATFORMS RELATED TO REAL ESTATE TO ALLOW USERS TO REQUEST CONTENT FROM AND RECEIVE CONTENT TO A COMPUTER OR MOBILE DEVICE; ASP FEATURING SOFTWARE FOR USE BY REAL ESTATE AND TRAVEL-BASED COMPANIES AND INDIVIDUALS TO ADVERTISE SPECIALS, MAKE RESERVATIONS, OFFER COUPONS, SPECIALS, DISCOUNTS, AND DIRECTIONS AND FOR USE IN INTERACTIVE CUSTOMER SERVICES RELATED TO THE RENTAL OR PURCHASE OF REAL ESTATE; DESIGN AND DEVELOPMENT OF VISUALIZATION TECHNOLOGIES FOR ADVERTISEMENT OF REAL-ESTATE AND BUSINESS OF OTHERS; APPLICATION SERVICE PROVIDER, NAMELY, HOSTING, MANAGING, DEVELOPING, ANALYZING, AND MAINTAINING APPLICATIONS, SOFTWARE, AND WEB SITES, OF OTHERS IN THE FIELDS OF ADVERTISING AND MARKETING; COMPUTER SERVICES, NAMELY, ACTING AS AN APPLICATION SERVICE PROVIDER IN THE FIELD OF KNOWLEDGE MANAGEMENT TO HOST COMPUTER APPLICATION SOFTWARE FOR CREATING SEARCHABLE DATABASES OF INFORMATION AND DATA; COMPUTER SERVICES IN THE NATURE OF CUSTOMIZED WEB PAGES FEATURING USER-DEFINED INFORMATION AND PERSONAL PROFILES; COMPUTER SERVICES, NAMELY, PROVIDING SEARCH ENGINES FOR OBTAINING DATA ON A GLOBAL COMPUTER NETWORK; PROVIDING A WEBSITE THAT GIVES USERS THE ABILITY TO CREATE CUSTOMIZED WEB PAGES FEATURING USER-DEFINED INFORMATION, IN CLASS 42 (U.S. CLS. 100 AND 101).



FIRST USE 10-11-2011; IN COMMERCE 12-1-2011.

THE MARK CONSISTS OF STANDARD CHARACTERS WITHOUT CLAIM TO ANY PARTICULAR FONT, STYLE, SIZE, OR COLOR.

SER. NO. 85-478,868, FILED 11-22-2011.

ALEX KEAM, EXAMINING ATTORNEY

David J. Keam

Director of the United States Patent and Trademark Office

United States of America

United States Patent and Trademark Office

LET'S STAY TOGETHER

Reg. No. 4,175,410

Registered July 17, 2012

Int. Cl.: 43

SERVICE MARK

PRINCIPAL REGISTER

HOMEAWAY.COM, INC. (DELAWARE CORPORATION)
SUITE 300
1011 W. FIFTH STREET
AUSTIN, TX 78703

FOR: AGENCY SERVICES FOR THE RESERVATION OF TEMPORARY ACCOMMODATION; PROVIDING A WEBSITE FOR MAKING RESERVATIONS AND BOOKING OF ECO-LODGING; PROVIDING TRAVEL LODGING INFORMATION SERVICES AND TRAVEL LODGING BOOKING AGENCY SERVICES FOR TRAVELERS; PROVIDING AN INTERACTIVE WEBSITE FOR MAKING RESERVATIONS FOR TEMPORARY LODGING AND ARRANGING TEMPORARY HOUSING ACCOMMODATIONS, IN CLASS 43 (U.S. CLS. 100 AND 101).

FIRST USE 10-11-2011; IN COMMERCE 12-1-2011.

THE MARK CONSISTS OF STANDARD CHARACTERS WITHOUT CLAIM TO ANY PARTICULAR FONT, STYLE, SIZE, OR COLOR.

SER. NO. 85-478,871, FILED 11-22-2011.

ALEX KEAM, EXAMINING ATTORNEY



David J. Kypos

Director of the United States Patent and Trademark Office

United States of America

United States Patent and Trademark Office

ECU PIRATES

Reg. No. 4,175,411

Registered July 17, 2012

Int. Cls.: 25 and 41

TRADEMARK

SERVICE MARK

PRINCIPAL REGISTER

EAST CAROLINA UNIVERSITY (NORTH CAROLINA STATE UNIVERSITY)
210 SPILMAN BUILDING
GREENVILLE, NC 27858

FOR: ARTICLES OF CLOTHING, NAMELY, SWEATSHIRTS, SOCKS, SHORT SLEEVED T-SHIRTS, INFANT ROMPERS, AND SWEAT PANTS, IN CLASS 25 (U.S. CLS. 22 AND 39).

FIRST USE 12-31-1968; IN COMMERCE 12-31-1968.

FOR: EDUCATION SERVICES, NAMELY, PROVIDING COURSES OF INSTRUCTION AT COLLEGE, GRADUATE AND POST-GRADUATE LEVELS; PUBLIC LECTURES, AND WORKSHOPS, SEMINARS AND CONFERENCES IN THE FIELD OF EDUCATION; ENTERTAINMENT SERVICES, NAMELY, PROVIDING SPORTS EVENTS IN THE NATURE OF MEN'S FOOTBALL, BASEBALL, GOLF, BASKETBALL, SOCCER, SWIMMING, TENNIS, CROSS COUNTRY AND TRACK GAMES, MATCHES OR MEETS AND IN THE NATURE OF WOMEN'S SOFTBALL, VOLLEYBALL, SOCCER, SWIMMING, TENNIS, CROSS COUNTRY AND TRACK GAMES, MATCHES OR MEETS, IN CLASS 41 (U.S. CLS. 100, 101 AND 107).

FIRST USE 12-31-1968; IN COMMERCE 12-31-1968.

THE MARK CONSISTS OF STANDARD CHARACTERS WITHOUT CLAIM TO ANY PARTICULAR FONT, STYLE, SIZE, OR COLOR.

SER. NO. 85-478,886, FILED 11-22-2011.

KARANENDRA S. CHHINA, EXAMINING ATTORNEY



David J. Kyros

Director of the United States Patent and Trademark Office

United States of America

United States Patent and Trademark Office

EAST CAROLINA PIRATES

Reg. No. 4,175,412

Registered July 17, 2012

Int. Cls.: 25 and 41

TRADEMARK

SERVICE MARK

PRINCIPAL REGISTER

EAST CAROLINA UNIVERSITY (NORTH CAROLINA STATE UNIVERSITY)
210 SPILMAN BUILDING
GREENVILLE, NC 27858

FOR: ARTICLES OF CLOTHING, NAMELY, LONG SLEEVED AND SHORT SLEEVED T-SHIRTS, SWEAT SHIRTS, SWEATERS, PAJAMA PANTS, SOCKS, BOXER SHORTS, IN CLASS 25 (U.S. CLS. 22 AND 39).

FIRST USE 12-31-1957; IN COMMERCE 12-31-1957.

FOR: EDUCATION SERVICES, NAMELY, PROVIDING COURSES OF INSTRUCTION AT COLLEGE, GRADUATE AND POST-GRADUATE LEVELS; PUBLIC LECTURES, AND WORKSHOPS, SEMINARS AND CONFERENCES IN THE FIELD OF EDUCATION; ENTERTAINMENT SERVICES, NAMELY, PROVIDING SPORTS EVENTS IN THE NATURE OF MEN'S FOOTBALL, BASEBALL, GOLF, BASKETBALL, SOCCER, SWIMMING, TENNIS, CROSS COUNTRY AND TRACK GAMES, MATCHES OR MEETS AND IN THE NATURE OF WOMEN'S SOFTBALL, VOLLEYBALL, SOCCER, SWIMMING, TENNIS, CROSS COUNTRY AND TRACK GAMES, MATCHES OR MEETS, IN CLASS 41 (U.S. CLS. 100, 101 AND 107).

FIRST USE 12-31-1957; IN COMMERCE 12-31-1957.

THE MARK CONSISTS OF STANDARD CHARACTERS WITHOUT CLAIM TO ANY PARTICULAR FONT, STYLE, SIZE, OR COLOR.

OWNER OF U.S. REG. NO. 3,368,153.

SEC. 2(F) AS TO "EAST CAROLINA".

SER. NO. 85-478,905, FILED 11-22-2011.

KARANENDRA S. CHHINA, EXAMINING ATTORNEY



David J. Kyffers

Director of the United States Patent and Trademark Office

United States of America
United States Patent and Trademark Office

CELLUVERA

Reg. No. 4,175,413

DOCTOR'S ASSOCIATES RX, INC. (FLORIDA CORPORATION)
PO BOX 1637
LUTZ, FL 33548

Registered July 17, 2012

Int. Cl.: 3

FOR: CREAMS FOR CELLULITE REDUCTION; LOTIONS FOR CELLULITE REDUCTION,
IN CLASS 3 (U.S. CLS. 1, 4, 6, 50, 51 AND 52).

TRADEMARK

FIRST USE 11-21-2011; IN COMMERCE 11-21-2011.

PRINCIPAL REGISTER

THE MARK CONSISTS OF STANDARD CHARACTERS WITHOUT CLAIM TO ANY PAR-
TICULAR FONT, STYLE, SIZE, OR COLOR.

SER. NO. 85-478,913, FILED 11-22-2011.

SANJEEV VOHRA, EXAMINING ATTORNEY



David J. Kybas

Director of the United States Patent and Trademark Office

United States of America

United States Patent and Trademark Office

EyeFormatics

Reg. No. 4,175,414

Registered July 17, 2012

Int. Cl.: 42

SERVICE MARK

PRINCIPAL REGISTER

CRANMER, KEVIN BURKE (UNITED STATES INDIVIDUAL), DBA EYEFORMATICS
33 ADELIN PLACE
MANSFIELD CENTER, CT 06250

FOR: APPLICATION SERVICE PROVIDER, NAMELY, HOSTING, MANAGING, DEVELOPING, ANALYZING, AND MAINTAINING APPLICATIONS, SOFTWARE, AND WEB SITES, OF OTHERS IN THE FIELDS OF HEALTHCARE, BENEFITS PROGRAMS, EMPLOYEE PRODUCTIVITY, RISK MANAGEMENT; COMPUTER SERVICES, NAMELY, REMOTE MANAGEMENT OF ELECTRONIC MEDICAL RECORDS FOR OTHERS; COMPUTER SOFTWARE DESIGN FOR OTHERS; COMPUTER SOFTWARE DEVELOPMENT IN THE FIELD OF OPHTHALMOLOGY; DESIGN, DEVELOPMENT, INSTALLATION AND MAINTENANCE OF COMPUTER SOFTWARE; SOFTWARE AS A SERVICE (SAAS) SERVICES FEATURING SOFTWARE IN THE FIELD OF OPHTHALMOLOGY, IN CLASS 42 (U.S. CLS. 100 AND 101).

FIRST USE 11-22-2011; IN COMMERCE 11-22-2011.

THE MARK CONSISTS OF STANDARD CHARACTERS WITHOUT CLAIM TO ANY PARTICULAR FONT, STYLE, SIZE, OR COLOR.

SER. NO. 85-478,933, FILED 11-22-2011.

ALYSSA STEEL, EXAMINING ATTORNEY



David J. Kyjars

Director of the United States Patent and Trademark Office

United States of America

United States Patent and Trademark Office

Marksplex

Reg. No. 4,175,415

DOCTOR'S ASSOCIATES RX, INC. (FLORIDA CORPORATION)
PO BOX 1637
LUTZ, FL 33548

Registered July 17, 2012

Int. Cl.: 3

FOR: LOTIONS FOR FACE AND BODY CARE; NON-MEDICATED SKIN CARE CREAMS AND LOTIONS; SKIN LOTION, IN CLASS 3 (U.S. CLS. 1, 4, 6, 50, 51 AND 52).

TRADEMARK

FIRST USE 11-21-2011; IN COMMERCE 11-21-2011.

PRINCIPAL REGISTER

THE MARK CONSISTS OF STANDARD CHARACTERS WITHOUT CLAIM TO ANY PARTICULAR FONT, STYLE, SIZE, OR COLOR.

SER. NO. 85-478,940, FILED 11-22-2011.

SANJEEV VOHRA, EXAMINING ATTORNEY



David J. Kybas

Director of the United States Patent and Trademark Office

United States of America

United States Patent and Trademark Office

YOUCAST

Reg. No. 4,175,416

Registered July 17, 2012

Int. Cl.: 42

SERVICE MARK

PRINCIPAL REGISTER

SOCIALCHORUS, INC. (DELAWARE CORPORATION)
703 MARKET STREET, SUITE 470
SAN FRANCISCO, CA 94103

FOR: PROVIDING TEMPORARY USE BY OTHERS OF ONLINE NON-DOWNLOADABLE SOFTWARE FOR USE IN WEB-BASED PUBLISHING; PROVIDING TEMPORARY USE BY OTHERS OF ONLINE NON-DOWNLOADABLE SOFTWARE FOR USE IN SALES, MARKETING, AND BUSINESS PROMOTION SERVICES; PROVIDING TEMPORARY USE BY OTHERS OF ONLINE NON-DOWNLOADABLE SOFTWARE FOR GENERATING SALES AND MARKETING LEADS, REFERRALS, AND ADVOCATES; PROVIDING TEMPORARY USE BY OTHERS OF ONLINE NON-DOWNLOADABLE SOFTWARE FOR GENERATING CUSTOMER REPORTS, REVIEWS, TESTIMONIALS, ADVOCACY AND RECOMMENDATIONS; PROVIDING TEMPORARY USE BY OTHERS OF ONLINE NON-DOWNLOADABLE SOFTWARE FOR TRACKING THE RESULTS OF CUSTOMER REPORTS, REVIEWS, TESTIMONIALS, ADVOCACY AND RECOMMENDATIONS, AND SALES, MARKETING AND BUSINESS PROMOTION EFFORT; PROVIDING TEMPORARY USE BY OTHERS OF ONLINE NON-DOWNLOADABLE SOFTWARE FOR USE BY OTHERS IN PROMOTING AND MARKETING THE PRODUCTS AND SERVICES OF OTHERS VIA SOCIAL NETWORKS, STATUS UPDATES, BLOGS, MICROBLOGS, WEBSITES, FORUMS, ELECTRONIC BULLETIN BOARDS, SOCIAL CONVERSATIONS OVER GLOBAL INFORMATION COMPUTER NETWORK, E-MAILS, ELECTRONIC MESSAGES, INSTANT MESSAGES, TEXT MESSAGES, AND MULTIMEDIA MESSAGES; COMPUTER SERVICES, NAMELY, CREATING AN ONLINE COMMUNITY FOR REGISTERED USERS TO PARTICIPATE IN DISCUSSIONS, GET FEEDBACK FROM THEIR PEERS, FORM VIRTUAL COMMUNITIES, AND ENGAGE IN SOCIAL NETWORKING FEATURING SOCIAL MEDIA AND PRODUCTS AND SERVICES RECOMMENDED BY THE COMMUNITY OR SOME PORTION THEREOF; PROVIDING TEMPORARY USE BY OTHERS OF ONLINE NON-DOWNLOADABLE SOFTWARE IN THE FIELD OF ENABLING THE SUBMISSION AND DISPLAY OF USER GENERATED CONTENT; COMPUTER SERVICES, NAMELY, CREATING, DESIGNING, IMPLEMENTING, AND MAINTAINING WEBSITES FOR OTHERS, IN CLASS 42 (U.S. CLS. 100 AND 101).



FIRST USE 9-0-2006; IN COMMERCE 9-0-2006.

David J. Kyjars

THE MARK CONSISTS OF STANDARD CHARACTERS WITHOUT CLAIM TO ANY PARTICULAR FONT, STYLE, SIZE, OR COLOR.

SER. NO. 85-478,984, FILED 11-22-2011.

Reg. No. 4,175,416 CHRISTINA SOBRAL, EXAMINING ATTORNEY

United States of America

United States Patent and Trademark Office

COUPA

Reg. No. 4,175,417

Registered July 17, 2012

Int. Cl.: 42

SERVICE MARK

PRINCIPAL REGISTER

COUPA SOFTWARE INCORPORATED (DELAWARE CORPORATION)
100 S. ELLSWORTH AVENUE, SUITE 100
SAN MATEO, CA 94401

FOR: SOFTWARE AS A SERVICE (SAAS) SERVICES FEATURING SOFTWARE TO FACILITATE ELECTRONIC PROCUREMENT SERVICES AND EXPENSE MANAGEMENT , IN CLASS 42 (U.S. CLS. 100 AND 101).

FIRST USE 0-0-2007; IN COMMERCE 0-0-2007.

THE MARK CONSISTS OF STANDARD CHARACTERS WITHOUT CLAIM TO ANY PARTICULAR FONT, STYLE, SIZE, OR COLOR.

SER. NO. 85-478,996, FILED 11-22-2011.

JAY FLOWERS, EXAMINING ATTORNEY



David J. Kybas

Director of the United States Patent and Trademark Office

United States of America

United States Patent and Trademark Office

TESTRIDE

Reg. No. 4,175,418

CHROME CAPITAL, LLC (FLORIDA LIMITED LIABILITY COMPANY)
3073 S. HORSESHOE DRIVE SOUTH, SUITE 206
NAPLES, FL 34104

Registered July 17, 2012

Int. Cl.: 36

FOR: MOTORCYCLE LEASE FINANCING, IN CLASS 36 (U.S. CLS. 100, 101 AND 102).

SERVICE MARK

FIRST USE 11-15-2011; IN COMMERCE 11-15-2011.

PRINCIPAL REGISTER

THE MARK CONSISTS OF STANDARD CHARACTERS WITHOUT CLAIM TO ANY PARTICULAR FONT, STYLE, SIZE, OR COLOR.

SER. NO. 85-478,998, FILED 11-22-2011.

JAY FLOWERS, EXAMINING ATTORNEY



David J. Kyffers

Director of the United States Patent and Trademark Office

United States of America

United States Patent and Trademark Office

TRANSFERMAGIC.COM

Reg. No. 4,175,419

Registered July 17, 2012

Int. Cls.: 16 and 35

TRADEMARK

SERVICE MARK

PRINCIPAL REGISTER

TRANSFERMAGIC.COM LLC (INDIANA LIMITED LIABILITY COMPANY)
2500 EAST 10TH STREET
ANDERSON, IN 46012

FOR: HEAT TRANSFER PAPER, IN CLASS 16 (U.S. CLS. 2, 5, 22, 23, 29, 37, 38 AND 50).

FIRST USE 4-30-1999; IN COMMERCE 4-30-1999.

FOR: ON-LINE RETAIL STORE SERVICES FEATURING APPAREL, TRANSFER PAPERS,
BLANK IMPRINTABLE PRODUCTS, HEAT PRESSES AND SOFTWARE, IN CLASS 35 (U.S.
CLS. 100, 101 AND 102).

FIRST USE 4-30-1999; IN COMMERCE 4-30-1999.

THE MARK CONSISTS OF STANDARD CHARACTERS WITHOUT CLAIM TO ANY PAR-
TICULAR FONT, STYLE, SIZE, OR COLOR.

SER. NO. 85-479,017, FILED 11-22-2011.

ERIN FALK, EXAMINING ATTORNEY



David J. Kyjars

Director of the United States Patent and Trademark Office

United States of America

United States Patent and Trademark Office

TRANSFERMAGIC

Reg. No. 4,175,420

TRANSFERMAGIC.COM LLC (INDIANA LIMITED LIABILITY COMPANY)
2500 EAST 10TH STREET
ANDERSON, IN 46012

Registered July 17, 2012

Int. Cls.: 16 and 35

FOR: HEAT TRANSFER PAPER, IN CLASS 16 (U.S. CLS. 2, 5, 22, 23, 29, 37, 38 AND 50).

FIRST USE 4-30-1999; IN COMMERCE 4-30-1999.

TRADEMARK

FOR: ON-LINE RETAIL STORE SERVICES FEATURING APPAREL, TRANSFER PAPERS, BLANK IMPRINTABLE PRODUCTS, HEAT PRESSES AND SOFTWARE, IN CLASS 35 (U.S. CLS. 100, 101 AND 102).

SERVICE MARK

PRINCIPAL REGISTER

FIRST USE 4-30-1999; IN COMMERCE 4-30-1999.

THE MARK CONSISTS OF STANDARD CHARACTERS WITHOUT CLAIM TO ANY PARTICULAR FONT, STYLE, SIZE, OR COLOR.

SER. NO. 85-479,019, FILED 11-22-2011.

ERIN FALK, EXAMINING ATTORNEY



David J. Kyffers

Director of the United States Patent and Trademark Office

United States of America

United States Patent and Trademark Office

KAYOS PRODUCTIONS

Reg. No. 4,175,421

Registered July 17, 2012

Int. Cl.: 35

SERVICE MARK

PRINCIPAL REGISTER

KAYOS PRODUCTIONS, INC. (NEW YORK CORPORATION)
928 BROADWAY SUITE #405
NEW YORK, NY 10010

FOR: ADVERTISING AND BUSINESS MANAGEMENT CONSULTANCY; ADVERTISING AND PUBLICITY SERVICES; ADVERTISING AND PUBLICITY SERVICES, NAMELY, PROMOTING THE GOODS, SERVICES, BRAND IDENTITY AND COMMERCIAL INFORMATION AND NEWS OF THIRD PARTIES THROUGH PRINT, AUDIO, VIDEO, DIGITAL AND ON-LINE MEDIUM; ADVERTISING BY TRANSMISSION OF ON-LINE PUBLICITY FOR THIRD PARTIES THROUGH ELECTRONIC COMMUNICATIONS NETWORKS; ADVERTISING SERVICES, PUBLIC RELATIONS AND MARKETING SERVICES, NAMELY, PROMOTING AND MARKETING THE GOODS AND SERVICES OF OTHERS THROUGH ALL PUBLIC COMMUNICATION MEANS; CONSULTING SERVICES RELATING TO PUBLICITY; PUBLIC RELATIONS; PUBLICITY AGENTS; PUBLICITY CONSULTATION , IN CLASS 35 (U.S. CLS. 100, 101 AND 102).

FIRST USE 3-1-1988; IN COMMERCE 3-1-1988.

THE MARK CONSISTS OF STANDARD CHARACTERS WITHOUT CLAIM TO ANY PARTICULAR FONT, STYLE, SIZE, OR COLOR.

NO CLAIM IS MADE TO THE EXCLUSIVE RIGHT TO USE "PRODUCTIONS", APART FROM THE MARK AS SHOWN.

SER. NO. 85-479,038, FILED 11-22-2011.

JENNIFER MARTIN, EXAMINING ATTORNEY



David J. Kypos

Director of the United States Patent and Trademark Office

United States of America

United States Patent and Trademark Office

esencialcore

Reg. No. 4,175,422

ESENCIAL CORE, INC. (WASHINGTON CORPORATION)
1506 145TH PLACE SE
BELLEVUE, WA 98007

Registered July 17, 2012

Int. Cl.: 5

FOR: WHEY PROTEIN SUPPLEMENTS, IN CLASS 5 (U.S. CLS. 6, 18, 44, 46, 51 AND 52).

FIRST USE 9-3-2011; IN COMMERCE 10-3-2011.

TRADEMARK

THE MARK CONSISTS OF STANDARD CHARACTERS WITHOUT CLAIM TO ANY PARTICULAR FONT, STYLE, SIZE, OR COLOR.

PRINCIPAL REGISTER

THE ENGLISH TRANSLATION OF "ESENCIAL" IN THE MARK IS ESSENTIAL. THE WORDING "ESENCIALCORE" HAS NO MEANING IN A FOREIGN LANGUAGE.

SER. NO. 85-479,105, FILED 11-22-2011.

DANIEL CAPSHAW, EXAMINING ATTORNEY



David J. Kyffers

Director of the United States Patent and Trademark Office

United States of America

United States Patent and Trademark Office

HALL OF FAME

Reg. No. 4,175,423

FOUR THE HEADS, LLC (CALIFORNIA LIMITED LIABILITY COMPANY)
449 N. FAIRFAX AVE
LOS ANGELES, CA 90036

Registered July 17, 2012

Int. Cl.: 25

FOR: HATS; HOODED SWEATSHIRTS; SHIRTS, IN CLASS 25 (U.S. CLS. 22 AND 39).

TRADEMARK

FIRST USE 5-20-2007; IN COMMERCE 5-20-2007.

PRINCIPAL REGISTER

THE MARK CONSISTS OF STANDARD CHARACTERS WITHOUT CLAIM TO ANY PARTICULAR FONT, STYLE, SIZE, OR COLOR.

SER. NO. 85-479,146, FILED 11-22-2011.

DAVID YONTEF, EXAMINING ATTORNEY



David J. Kyffers

Director of the United States Patent and Trademark Office

United States of America

United States Patent and Trademark Office

THE DRAGONS OF BLIZZARD ISLAND

Reg. No. 4,175,424

BIG BANG INC. (NEW JERSEY CORPORATION)
219 SHERMAN STREET
BOONTON, NJ 07005

Registered July 17, 2012

Int. Cl.: 41

FOR: ENTERTAINMENT SERVICES, NAMELY, PROVIDING AN ON-LINE COMPUTER GAME, IN CLASS 41 (U.S. CLS. 100, 101 AND 107).

SERVICE MARK

FIRST USE 8-0-2011; IN COMMERCE 8-0-2011.

PRINCIPAL REGISTER

THE MARK CONSISTS OF STANDARD CHARACTERS WITHOUT CLAIM TO ANY PARTICULAR FONT, STYLE, SIZE, OR COLOR.

OWNER OF U.S. REG. NO. 3,693,559.

SER. NO. 85-479,156, FILED 11-22-2011.

DOMINIC J. FERRAIUOLO, EXAMINING ATTORNEY



David J. Kyffers

Director of the United States Patent and Trademark Office

United States of America

United States Patent and Trademark Office

SIR ISAAC

Reg. No. 4,175,425

NEWTON MARKETING, LLC (MASSACHUSETTS LIMITED LIABILITY COMPANY)
33 MANTON ROAD
SWAMPSCOTT, MA 01907

Registered July 17, 2012

Int. Cl.: 35

FOR: BRANDING SERVICES, NAMELY, DEVELOPMENT, MANAGEMENT AND MARKETING OF BRANDS; ADVERTISING AND MARKETING SERVICES; PUBLIC RELATIONS; CONDUCTING MARKETING STUDIES; ARRANGING AND CONDUCTING MARKETING PROMOTIONAL EVENTS, IN CLASS 35 (U.S. CLS. 100, 101 AND 102).

SERVICE MARK

PRINCIPAL REGISTER

FIRST USE 11-17-2011; IN COMMERCE 11-17-2011.

THE MARK CONSISTS OF STANDARD CHARACTERS WITHOUT CLAIM TO ANY PARTICULAR FONT, STYLE, SIZE, OR COLOR.

SER. NO. 85-479,200, FILED 11-22-2011.

DORITT L. CARROLL, EXAMINING ATTORNEY



David J. Kybas

Director of the United States Patent and Trademark Office

United States of America

United States Patent and Trademark Office

DIDDY'S

Reg. No. 4,175,426

DIDDY'S YOGURT SHOPPE, INC. (TEXAS CORPORATION)
305 W LOOP 281

Registered July 17, 2012

LONGVIEW, TX 75605

Int. Cl.: 35

FOR: SELF-SERVE FROZEN YOGURT SHOP SERVICES, IN CLASS 35 (U.S. CLS. 100, 101 AND 102).

SERVICE MARK

FIRST USE 1-1-2011; IN COMMERCE 1-1-2011.

PRINCIPAL REGISTER

THE MARK CONSISTS OF STANDARD CHARACTERS WITHOUT CLAIM TO ANY PARTICULAR FONT, STYLE, SIZE, OR COLOR.

SER. NO. 85-479,209, FILED 11-22-2011.

DORITT L. CARROLL, EXAMINING ATTORNEY



David J. Kybas

Director of the United States Patent and Trademark Office

United States of America

United States Patent and Trademark Office



Reg. No. 4,175,427

METRO WATER-PROOFING, INC. (GEORGIA CORPORATION)
2935 ALCOVE DRIVE
SCOTTDALE, GA 30079

Registered July 17, 2012

Int. Cl.: 37

FOR: CONSTRUCTION SERVICES, NAMELY, INSTALLATION OF EXPANSION JOINTS AND CONSTRUCTION OF ROOF DECKS INTENDED FOR PLANTING AND LANDSCAPING, IN CLASS 37 (U.S. CLS. 100, 103 AND 106).

SERVICE MARK

FIRST USE 11-1-2009; IN COMMERCE 11-1-2009.

PRINCIPAL REGISTER

THE MARK CONSISTS OF A LIGHTER CAPITALIZED "M" FOLLOWED BY A DARKER CAPITALIZED "W" WITH A SEMI-CIRCULAR SWOOSH BEGINNING FROM THE BOTTOM LEFT OF THE "M" AND DISAPPEARING BEHIND THE CENTER OF THE "W".

SER. NO. 85-479,220, FILED 11-22-2011.

DOMINIC J. FERRAIUOLO, EXAMINING ATTORNEY



David J. Kybas

Director of the United States Patent and Trademark Office

United States of America

United States Patent and Trademark Office



Reg. No. 4,175,428

Registered July 17, 2012

Int. Cl.: 37

SERVICE MARK

PRINCIPAL REGISTER

METRO WATER-PROOFING, INC. (GEORGIA CORPORATION)
2935 ALCOVE DRIVE
SCOTTDALE, GA 30079

FOR: CONSTRUCTION SERVICES, NAMELY, INSTALLATION OF EXPANSION JOINTS AND CONSTRUCTION OF ROOF DECKS INTENDED FOR PLANTING AND LANDSCAPING, IN CLASS 37 (U.S. CLS. 100, 103 AND 106).

FIRST USE 1-1-2002; IN COMMERCE 1-1-2002.

THE MARK CONSISTS OF A LIGHTER CAPITALIZED "M" FOLLOWED BY A DARKER CAPITALIZED "W" WITH BOTH LETTERS CENTERED INSIDE A HORIZONTAL OVAL CONTAINING A DARK AND LIGHT WAVE PATTERN.

SER. NO. 85-479,226, FILED 11-22-2011.

DOMINIC J. FERRAIUOLO, EXAMINING ATTORNEY



David J. Kyffers

Director of the United States Patent and Trademark Office

United States of America

United States Patent and Trademark Office

RentScan

Reg. No. 4,175,429

ECHOSTONE INC (NORTH CAROLINA CORPORATION)

Registered July 17, 2012

P.O. BO 77326
CHARLOTTE, NC 28271

Int. Cls.: 35 and 42

FOR: RENTAL OF OFFICE MACHINERY AND EQUIPMENT, IN CLASS 35 (U.S. CLS. 100, 101 AND 102).

SERVICE MARK

FIRST USE 1-1-2010; IN COMMERCE 1-1-2010.

PRINCIPAL REGISTER

FOR: COMPUTER AND COMPUTER SOFTWARE RENTAL; COMPUTER SOFTWARE RENTAL; RENTAL AND MAINTENANCE OF COMPUTER SOFTWARE; RENTAL OF COMPUTER HARDWARE; RENTAL OF COMPUTER HARDWARE AND COMPUTER PERIPHERALS; RENTAL OF COMPUTER HARDWARE AND COMPUTER SOFTWARE; RENTAL OF COMPUTER SOFTWARE; RENTAL OF COMPUTER SOFTWARE AND PROGRAMS; RENTAL OF COMPUTER SOFTWARE, DATA PROCESSING EQUIPMENT AND COMPUTER PERIPHERAL DEVICES; RENTAL OF COMPUTERS; RENTAL OF COMPUTERS AND SOFTWARE; RENTING COMPUTER SOFTWARE; RENTING OUT HARDWARE AND SOFTWARE; UPDATING AND RENTAL OF SOFTWARE FOR DATA PROCESSING, IN CLASS 42 (U.S. CLS. 100 AND 101).

FIRST USE 1-1-2010; IN COMMERCE 1-1-2010.

THE MARK CONSISTS OF STANDARD CHARACTERS WITHOUT CLAIM TO ANY PARTICULAR FONT, STYLE, SIZE, OR COLOR.

SER. NO. 85-479,227, FILED 11-22-2011.

TARAH HARDY, EXAMINING ATTORNEY



David J. Kyros

Director of the United States Patent and Trademark Office

United States of America

United States Patent and Trademark Office

REINCARNATION

Reg. No. 4,175,430

REINCARNATION, LLC (OHIO LIMITED LIABILITY COMPANY)
9046 GOLD PARK DRIVE
HAMILTON, OH 45011

Registered July 17, 2012

Int. Cl.: 37

FOR: AUTOMOBILE BODY REPAIR AND FINISHING FOR OTHERS, IN CLASS 37 (U.S. CLS. 100, 103 AND 106).

SERVICE MARK

FIRST USE 7-1-2009; IN COMMERCE 7-1-2009.

PRINCIPAL REGISTER

THE MARK CONSISTS OF STANDARD CHARACTERS WITHOUT CLAIM TO ANY PARTICULAR FONT, STYLE, SIZE, OR COLOR.

SER. NO. 85-479,233, FILED 11-22-2011.

DOMINIC J. FERRAIUOLO, EXAMINING ATTORNEY



David J. Kybas

Director of the United States Patent and Trademark Office

United States of America

United States Patent and Trademark Office

Tensorbond

Reg. No. 4,175,431

APPLICHEM (NEBRASKA CORPORATION)

Registered July 17, 2012

5710 F ST
OMAHA, NE 68117

Int. Cl.: 1

FOR: ADHESIVE MATERIALS FOR THE BUILDING INDUSTRY AND TILES; ADHESIVE SUBSTANCES FOR USE IN INDUSTRY; ADHESIVES AND GLUES FOR INDUSTRIAL AND COMMERCIAL USE; ADHESIVES AND GLUES FOR INDUSTRIAL PURPOSES; ADHESIVES FOR APPLYING FLOOR TILES; ADHESIVES FOR INDUSTRIAL PURPOSES; ADHESIVES FOR INDUSTRIAL USE; ADHESIVES FOR USE IN INDUSTRY; ADHESIVES FOR USE IN THE MANUFACTURE OF FURNITURE, IN CLASS 1 (U.S. CLS. 1, 5, 6, 10, 26 AND 46).

TRADEMARK

PRINCIPAL REGISTER

FIRST USE 2-15-2009; IN COMMERCE 2-16-2009.

THE MARK CONSISTS OF STANDARD CHARACTERS WITHOUT CLAIM TO ANY PARTICULAR FONT, STYLE, SIZE, OR COLOR.

SER. NO. 85-479,234, FILED 11-22-2011.

DOMINIC J. FERRAIUOLO, EXAMINING ATTORNEY



David J. Kyffers

Director of the United States Patent and Trademark Office

United States of America

United States Patent and Trademark Office

Metro Waterproofing

Reg. No. 4,175,432

METRO WATER-PROOFING, INC. (GEORGIA CORPORATION)
2935 ALCOVE DRIVE
SCOTTDALE, GA 30079

Registered July 17, 2012

Int. Cl.: 37

FOR: CONSTRUCTION SERVICES, NAMELY, INSTALLATION OF EXPANSION JOINTS AND CONSTRUCTION OF ROOF DECKS INTENDED FOR PLANTING AND LANDSCAPING, IN CLASS 37 (U.S. CLS. 100, 103 AND 106).

SERVICE MARK

FIRST USE 1-13-1972; IN COMMERCE 1-13-1972.

PRINCIPAL REGISTER

THE MARK CONSISTS OF STANDARD CHARACTERS WITHOUT CLAIM TO ANY PARTICULAR FONT, STYLE, SIZE, OR COLOR.

SER. NO. 85-479,241, FILED 11-22-2011.

DOMINIC J. FERRAIUOLO, EXAMINING ATTORNEY



David J. Kyffers

Director of the United States Patent and Trademark Office

United States of America

United States Patent and Trademark Office



OFFICIAL PAYMENTS

Reg. No. 4,175,433

Registered July 17, 2012

**Int. Cls.: 35, 36, 37 and
42**

OFFICIAL PAYMENTS CORP. (DELAWARE CORPORATION)
ONE LANDMARK SQUARE, SUITE 400
STAMFORD, CT 06901

FOR: MARKETING AND ADVERTISING FOR OTHERS RELATED TO ELECTRONIC BILL
PAYMENT SERVICES, IN CLASS 35 (U.S. CLS. 100, 101 AND 102).

FIRST USE 5-1-2006; IN COMMERCE 5-1-2006.

SERVICE MARK

PRINCIPAL REGISTER

FOR: ELECTRONIC PAYMENT AND PROCESSING SERVICES, NAMELY, PROCESSING
ELECTRONIC PAYMENTS MADE THROUGH PREPAID CARDS, CREDIT CARDS, DEBIT
CARDS, ELECTRONIC FUNDS TRANSFER, ACH, ELECTRONIC CHECK AND ELECTRONIC
PAYMENTS, AND TRANSMISSION AND PROCESSING OF BILL PAYMENT DATA, IN
CLASS 36 (U.S. CLS. 100, 101 AND 102).

FIRST USE 5-1-2006; IN COMMERCE 5-1-2006.

FOR: MAINTENANCE OF COMPUTER NETWORKS, WEBSITES FOR OTHERS, AND
COMPUTER HARDWARE FOR INTERACTIVE VOICE RESPONSE (IVR) SYSTEMS, IVR
KIOSKS, AND PAYMENT PROCESSING SYSTEMS, IN CLASS 37 (U.S. CLS. 100, 103 AND
106).

FIRST USE 5-1-2006; IN COMMERCE 5-1-2006.



FOR: COMPUTER SERVICES, NAMELY, CREATING, HOSTING AND MAINTAINING
ELECTRONIC COMMERCE WEBSITES FOR OTHERS, INTERACTIVE COMPUTER KIOSKS,
IN PERSON POINT OF SALE PROCESSING SYSTEMS, AND INTERACTIVE VOICE RE-
SPONSE (IVR) SYSTEMS FOR OTHERS; COMPUTER SERVICES, NAMELY, DESIGNING
AND IMPLEMENTING NETWORK WEB PAGES FOR OTHERS; COMPUTER SERVICES,
NAMELY, DESIGNING AND IMPLEMENTING WEBSITES, INTERACTIVE COMPUTER
KIOSKS, AND IVR SYSTEMS FOR OTHERS; COMPUTER SITE DESIGN, INSTALLATION
OF COMPUTER SOFTWARE, UP-DATING OF COMPUTER SOFTWARE; COMPUTER
SOFTWARE DESIGN FOR OTHERS; COMPUTER SYSTEMS ANALYSIS; DATABASE DE-
VELOPMENT SERVICES; DATA CONVERSION OF COMPUTER PROGRAM DATA OR
INFORMATION, COMPUTER PROGRAMMING FOR OTHERS, ON-LINE BATCH COMPUTER
SERVICES, NAMELY, CONFIGURATION OF MULTIPLE FILES INTO A SINGLE GROUP;
COMPUTER CONSULTATION SERVICES RELATING TO SETTING UP INTERACTIVE

David J. Kyffers

Director of the United States Patent and Trademark Office

Reg. No. 4,175,433 PAYMENT AND PROCESSING NETWORKS AND DATA PROCESSING SYSTEMS FOR THE TRANSMISSION OF DATA; DESIGN AND DEVELOPMENT OF EQUIPMENT FOR CREDIT AUTHORIZATION, AND PROCESSING BILLING AND PAYMENT TO UTILITIES COMPANIES, COLLEGES AND UNIVERSITIES, K-12 SCHOOLS, INSURANCE COMPANIES, PROPERTY RENTAL COMPANIES, AND LOCAL, STATE AND FEDERAL GOVERNMENTAL ENTITIES; DESIGNING AND DEVELOPING EQUIPMENT FOR IDENTIFICATION, VERIFICATION, AUTHENTICATION OF PERSONAL IDENTIFICATION INFORMATION AND CASHLESS ELECTRONIC PAYMENT, IN CLASS 42 (U.S. CLS. 100 AND 101).

FIRST USE 5-1-2006; IN COMMERCE 5-1-2006.

OWNER OF U.S. REG. NOS. 2,533,394 AND 2,637,962.

THE COLOR(S) GREEN AND BLACK IS/ARE CLAIMED AS A FEATURE OF THE MARK.

NO CLAIM IS MADE TO THE EXCLUSIVE RIGHT TO USE "PAYMENTS", APART FROM THE MARK AS SHOWN.

THE MARK CONSISTS OF A GREEN ROMAN COLUMN DESIGN TO THE LEFT OF THE WORDS "OFFICIAL PAYMENTS" IN THE COLOR BLACK.

SER. NO. 85-479,245, FILED 11-22-2011.

WENDY JUN, EXAMINING ATTORNEY

United States of America

United States Patent and Trademark Office

PROTURF GREEN

Reg. No. 4,175,434

CENTENNIAL PLASTICS, INC. (NEBRASKA CORPORATION)
1830 CENTENNIAL AVENUE
HASTINGS, NE 68901

Registered July 17, 2012

Int. Cl.: 17

FOR: FLEXIBLE POLYETHYLENE PIPE USED AS A WATER TRANSMISSION LINE FOR UNDERGROUND SPRINKLER SYSTEMS, IN CLASS 17 (U.S. CLS. 1, 5, 12, 13, 35 AND 50).

TRADEMARK

FIRST USE 4-2-2001; IN COMMERCE 4-2-2001.

PRINCIPAL REGISTER

THE MARK CONSISTS OF STANDARD CHARACTERS WITHOUT CLAIM TO ANY PARTICULAR FONT, STYLE, SIZE, OR COLOR.

NO CLAIM IS MADE TO THE EXCLUSIVE RIGHT TO USE "GREEN", APART FROM THE MARK AS SHOWN.

SER. NO. 85-479,249, FILED 11-22-2011.

DOMINIC J. FERRAIUOLO, EXAMINING ATTORNEY



David J. Kybas

Director of the United States Patent and Trademark Office

United States of America

United States Patent and Trademark Office

UPTUAL

Reg. No. 4,175,435

Registered July 17, 2012

Int. Cl.: 35

SERVICE MARK

PRINCIPAL REGISTER

CAPITAL ENTERPRISE GROUP, LLC (NEVADA LIMITED LIABILITY COMPANY)
112 NORTH CURRY STREET
CARSON CITY, NV 89703

FOR: ADVERTISING AND COMMERCIAL INFORMATION SERVICES, VIA THE INTERNET; ADVERTISING AND MARKETING SERVICES PROVIDED BY MEANS OF INDIRECT METHODS OF MARKETING COMMUNICATIONS, NAMELY, SOCIAL MEDIA, SEARCH ENGINE MARKETING, INQUIRY MARKETING, INTERNET MARKETING, MOBILE MARKETING, BLOGGING AND OTHER FORMS OF PASSIVE, SHARABLE OR VIRAL COMMUNICATIONS CHANNELS; BUSINESS ADVISORY SERVICES, NAMELY, SEARCH FOR AND SELECTION OF THE BEST POTENTIAL SUPPLIERS FOR OTHERS; BUSINESS SERVICES, NAMELY, PROCURING QUALIFIED AND CREDENTIALLED THIRD-PARTY EXPERTS, PROFESSIONALS AND OTHER QUALIFIED PERSONNEL, AND DOCUMENTATION AND INFORMATION ALL ON BEHALF OF OTHERS; BUSINESS SERVICES, NAMELY, REGISTERING, SCREENING, CREDENTIALING, AND ORGANIZING THIRD-PARTY VENDORS, SUPPLIERS, AND CONTRACTORS, AND DOCUMENTATION AND INFORMATION ON BEHALF OF OTHERS; GENERAL BUSINESS NETWORKING REFERRAL SERVICES, NAMELY, PROMOTING THE GOODS AND SERVICES OF OTHERS BY PASSING BUSINESS LEADS AND REFERRALS AMONG GROUP MEMBERS; INTERNET ADVERTISING SERVICES; NEGOTIATION AND CONCLUSION OF COMMERCIAL TRANSACTIONS FOR THIRD PARTIES VIA TELECOMMUNICATION SYSTEMS; ON-LINE AUCTIONEERING SERVICES VIA THE INTERNET; ON-LINE BUSINESS DIRECTORIES FEATURING ALL TYPES OF PROFESSIONALS; ON-LINE BUSINESS NETWORKING SERVICES; ONLINE ADVERTISING VIA A COMPUTER COMMUNICATIONS NETWORK; ONLINE SERVICE FOR CONNECTING SOCIAL NETWORK USERS WITH RETAILERS FOR THE PURPOSE OF FACILITATING DISCOUNTED PURCHASES; OPERATING ON-LINE MARKETPLACES FOR SELLERS OF GOODS AND/OR SERVICES; ORGANIZATION OF INTERNET AUCTIONS; PROMOTING THE GOODS AND SERVICES OF OTHERS BY MEANS OF DISTRIBUTING ADVERTISING ON THE INTERNET; PROMOTING THE GOODS AND SERVICES OF OTHERS THROUGH SEARCH ENGINE REFERRAL TRAFFIC ANALYSIS AND REPORTING; PROVIDING A SEARCHABLE ON-LINE ADVERTISING WEBSITE AND GUIDE FEATURING THE GOODS AND SERVICES OF OTHER VENDORS VIA THE INTERNET; PROVIDING A SEARCHABLE ONLINE ADVERTISING GUIDE FEATURING THE GOODS AND SERVICES OF ONLINE VENDORS; PROVIDING A WEBSITE FEATURING AN ONLINE MARKETPLACE FOR EXCHANGING GOODS AND SERVICES WITH OTHER USERS; PROVIDING A WEBSITE FOR CONNECTING SELLERS WITH BUYERS; PROVIDING A WEBSITE FOR USERS WITH SPECIFIC INFORMED RECOMMENDATIONS OF SPECIFIC CONSUMER PRODUCTS



David J. Kybas

Director of the United States Patent and Trademark Office

Reg. No. 4,175,435 AND SERVICES VALIDATED BY THE USERS' INPUTTED PREFERENCES AND SOCIAL NETWORK; PROVIDING AN ON-LINE COMMERCIAL INFORMATION DIRECTORY ON THE INTERNET; PROVIDING AN ON-LINE DIRECTORY INFORMATION SERVICE FEATURING INFORMATION REGARDING ALL TYPES OF PROFESSIONALS; PROVIDING BUSINESS INFORMATION, NAMELY, COMMERCIAL CORPORATE AND STATISTICAL INFORMATION PROVIDED ON-LINE FROM A COMPUTER DATABASE OR THE INTERNET; PROVIDING INDEPENDENT RATINGS AND REVIEWS OF OTHER BUSINESSES FOR COMMERCIAL PURPOSES; PROVIDING INFORMATION PERTAINING TO PROCUREMENT, BUYING, SELLING AND TENDERING INFORMATION AND OPPORTUNITIES RELATING TO GOODS, SERVICES, AND CONSTRUCTION VIA COMPUTER, COMPUTER NETWORKS, TELEPHONE, THE INTERNET OR ELECTRONIC MAIL; SHOPPING FACILITATION SERVICES, NAMELY, PROVIDING AN ONLINE COMPARISON-SHOPPING SEARCH ENGINE FOR OBTAINING PURCHASING INFORMATION; THE BRINGING TOGETHER, FOR THE BENEFIT OF OTHERS, OF A VARIETY OF GOODS AND SERVICES, ENABLING CUSTOMERS TO CONVENIENTLY VIEW AND PURCHASE THOSE GOODS AND SERVICES FROM AN INTERNET WEB SITE PARTICULARLY SPECIALIZING IN THE MARKETING OF THE SALE OF GOODS AND SERVICES OF OTHERS, IN CLASS 35 (U.S. CLS. 100, 101 AND 102).

FIRST USE 1-11-2011; IN COMMERCE 2-22-2011.

THE MARK CONSISTS OF STANDARD CHARACTERS WITHOUT CLAIM TO ANY PARTICULAR FONT, STYLE, SIZE, OR COLOR.

SER. NO. 85-479,272, FILED 11-22-2011.

AMY KERTGATE, EXAMINING ATTORNEY

United States of America

United States Patent and Trademark Office

TACTICAL RANCH

Reg. No. 4,175,436

Registered July 17, 2012

Int. Cl.: 41

SERVICE MARK

PRINCIPAL REGISTER

COVENANT SPECIAL PROJECTS, LLC. (ILLINOIS LIMITED LIABILITY COMPANY)
P.O. BOX 221108
EL PASO, TX 79913

FOR: TRAINING SERVICES IN THE FIELD OF FIREARMS TACTICS, COMBAT FIREARMS AND TACTICS, MARKSMANSHIP, COUNTER AMBUSH, COUNTER TERRORISM IN THE NATURE OF CLOSE QUARTERS BATTLE, AND FORCE PROTECTION, ALL FOR MILITARY, LAW ENFORCEMENT, AND PRIVATE SECURITY PERSONNEL, IN CLASS 41 (U.S. CLS. 100, 101 AND 107).

FIRST USE 1-1-2010; IN COMMERCE 1-1-2010.

THE MARK CONSISTS OF STANDARD CHARACTERS WITHOUT CLAIM TO ANY PARTICULAR FONT, STYLE, SIZE, OR COLOR.

NO CLAIM IS MADE TO THE EXCLUSIVE RIGHT TO USE "TACTICAL", APART FROM THE MARK AS SHOWN.

SER. NO. 85-479,275, FILED 11-22-2011.

AMY KERTGATE, EXAMINING ATTORNEY



David J. Kybas

Director of the United States Patent and Trademark Office

United States of America

United States Patent and Trademark Office

THE STRAIGHT TRUTH

Reg. No. 4,175,437

GALINDO CONSULTING, INC. (UTAH CORPORATION)
PO BOX 681248

Registered July 17, 2012

PARK CITY, UT 840681248

Int. Cl.: 35

FOR: BUSINESS CONSULTING AND INFORMATION SERVICES, IN CLASS 35 (U.S. CLS. 100, 101 AND 102).

SERVICE MARK

FIRST USE 1-1-2010; IN COMMERCE 1-1-2010.

PRINCIPAL REGISTER

THE MARK CONSISTS OF STANDARD CHARACTERS WITHOUT CLAIM TO ANY PARTICULAR FONT, STYLE, SIZE, OR COLOR.

SER. NO. 85-479,278, FILED 11-22-2011.

ROBIN CHOSID, EXAMINING ATTORNEY



David J. Kyffers

Director of the United States Patent and Trademark Office

United States of America

United States Patent and Trademark Office

Twixtor

Reg. No. 4,175,438

Registered July 17, 2012

Int. Cl.: 9

TRADEMARK

PRINCIPAL REGISTER

RE: VISION EFFECTS, INC. (CALIFORNIA CORPORATION)
18 VICKSBURG STREET
SAN FRANCISCO, CA 94114

FOR: COMPUTER SOFTWARE FOR PROCESSING DIGITAL IMAGES; COMPUTER SOFTWARE FOR USE IN RELATION TO DIGITAL ANIMATION AND SPECIAL EFFECTS OF IMAGES, IN CLASS 9 (U.S. CLS. 21, 23, 26, 36 AND 38).

FIRST USE 11-2-2000; IN COMMERCE 11-2-2000.

THE MARK CONSISTS OF STANDARD CHARACTERS WITHOUT CLAIM TO ANY PARTICULAR FONT, STYLE, SIZE, OR COLOR.

SER. NO. 85-479,285, FILED 11-22-2011.

AMY KERTGATE, EXAMINING ATTORNEY



David J. Kyffers

Director of the United States Patent and Trademark Office

United States of America

United States Patent and Trademark Office

HORN

Reg. No. 4,175,439

Registered July 17, 2012

Int. Cl.: 35

SERVICE MARK

PRINCIPAL REGISTER

E. T. HORN COMPANY (CALIFORNIA CORPORATION)
16050 CANARY AVENUE
LA MIRADA, CA 90638

FOR: WHOLESALE DISTRIBUTORSHIPS FEATURING INGREDIENTS FOR USE IN THE MANUFACTURE OF COSMETICS, PERFUMES, PERSONAL CARE PRODUCTS, ADVANCED MATERIALS, FOOD, COATINGS, BUILDING MATERIALS, ADHESIVES, INKS AND GRAPHIC ARTS, CERAMICS, NUTRACEUTICALS, AND ANIMAL WELLNESS PRODUCTS, IN CLASS 35 (U.S. CLS. 100, 101 AND 102).

FIRST USE 10-1-2011; IN COMMERCE 10-1-2011.

THE MARK CONSISTS OF STANDARD CHARACTERS WITHOUT CLAIM TO ANY PARTICULAR FONT, STYLE, SIZE, OR COLOR.

SER. NO. 85-479,292, FILED 11-22-2011.

HEATHER THOMPSON, EXAMINING ATTORNEY



David J. Kyffers

Director of the United States Patent and Trademark Office

United States of America

United States Patent and Trademark Office

VERMIBLEND

Reg. No. 4,175,440

Registered July 17, 2012

Int. Cl.: 1

TRADEMARK

PRINCIPAL REGISTER

BIO-ORGANIC SOLUTIONS, INC. (CALIFORNIA CORPORATION)
4265 DULUTH AVENUE
ROCKLIN, CA 95765

FOR: FERTILIZERS; SOIL AMENDMENTS, IN CLASS 1 (U.S. CLS. 1, 5, 6, 10, 26 AND 46).

FIRST USE 8-17-2007; IN COMMERCE 8-17-2007.

THE MARK CONSISTS OF STANDARD CHARACTERS WITHOUT CLAIM TO ANY PARTICULAR FONT, STYLE, SIZE, OR COLOR.

OWNER OF U.S. REG. NO. 3,408,907.

SER. NO. 85-479,308, FILED 11-22-2011.

RONALD AIKENS, EXAMINING ATTORNEY



David J. Kyffers

Director of the United States Patent and Trademark Office

United States of America

United States Patent and Trademark Office

inkberries

Reg. No. 4,175,441

Registered July 17, 2012

Int. Cl.: 35

SERVICE MARK

PRINCIPAL REGISTER

INKBERRIES ROCKS CORP. (FLORIDA CORPORATION)
SUITE 200
55 MERRICK WAY
CORAL GABLES, FL 33134

FOR: CREATIVE MARKETING DESIGN SERVICES; DESIGN OF ADVERTISING BROCHURES FOR OTHERS; DESIGN OF INTERNET ADVERTISING; MARKETING CONSULTING, NAMELY, DESIGN AND DEVELOPMENT OF ADVERTISING, MARKETING, AND BRANDING CAMPAIGNS FOR OTHERS, IN CLASS 35 (U.S. CLS. 100, 101 AND 102).

FIRST USE 9-1-2008; IN COMMERCE 9-1-2008.

THE MARK CONSISTS OF THE STYLIZED TEXT "INKBERRIES".

SER. NO. 85-479,356, FILED 11-22-2011.

SHARON MEIER, EXAMINING ATTORNEY



David J. Kyffers

Director of the United States Patent and Trademark Office

United States of America

United States Patent and Trademark Office

inkberries

Reg. No. 4,175,442

Registered July 17, 2012

Int. Cl.: 42

SERVICE MARK

PRINCIPAL REGISTER

INKBERRIES ROCKS CORP. (FLORIDA CORPORATION)
SUITE 200
55 MERRICK WAY
CORAL GABLES, FL 33134

FOR: DESIGN AND CREATING WEB SITES FOR OTHERS; DESIGN SERVICES FOR PACKAGING; GRAPHIC ART DESIGN; MULTIDISCIPLINARY GRAPHIC DESIGN SERVICES, IN CLASS 42 (U.S. CLS. 100 AND 101).

FIRST USE 9-1-2008; IN COMMERCE 9-1-2008.

THE MARK CONSISTS OF THE STYLIZED TEXT "INKBERRIES".

SER. NO. 85-479,358, FILED 11-22-2011.

SHARON MEIER, EXAMINING ATTORNEY



David J. Kyros

Director of the United States Patent and Trademark Office

United States of America

United States Patent and Trademark Office

ONE CUSTOMER

Reg. No. 4,175,443

BERNSTEIN-REIN ADVERTISING, INC. (MISSOURI CORPORATION)
4600 MADISON, SUITE 1500

Registered July 17, 2012

KANSAS CITY, MO 64112

Int. Cl.: 35

FOR: ADVERTISING AND MARKETING SERVICES, IN CLASS 35 (U.S. CLS. 100, 101 AND 102).

SERVICE MARK

FIRST USE 5-26-2009; IN COMMERCE 5-26-2009.

PRINCIPAL REGISTER

THE MARK CONSISTS OF STANDARD CHARACTERS WITHOUT CLAIM TO ANY PARTICULAR FONT, STYLE, SIZE, OR COLOR.

SER. NO. 85-479,375, FILED 11-22-2011.

DOUGLAS LEE, EXAMINING ATTORNEY



David J. Kyffers

Director of the United States Patent and Trademark Office

United States of America

United States Patent and Trademark Office

NewSpring CHURCH

Reg. No. 4,175,444

Registered July 17, 2012

**Int. Cls.: 9, 16, 25, 41
and 45**

TRADEMARK

SERVICE MARK

PRINCIPAL REGISTER

NEWSRING CHURCH, INC. (SOUTH CAROLINA CORPORATION)
ATTENTION: CRISTIN COOPER
2940 CONCORD ROAD
ANDERSON, SC 29621

FOR: DIGITAL MEDIA, NAMELY, PRE-RECORDED AUDIO AND VIDEO TAPES, DOWNLOADABLE AUDIO AND VIDEO RECORDINGS, CDS AND DVDS FEATURING RELIGION, EVANGELISM, DISCIPLESHIP, CHRISTIAN LIFESTYLES AND FAMILY VALUES; DOWNLOADABLE PODCASTS IN THE FIELD OF RELIGION, EVANGELISM, DISCIPLESHIP, CHRISTIAN LIFESTYLES AND FAMILY VALUES; DOWNLOADABLE WEBINARS IN THE FIELD OF RELIGION, EVANGELISM, DISCIPLESHIP, CHRISTIAN LIFESTYLES AND FAMILY VALUES, IN CLASS 9 (U.S. CLS. 21, 23, 26, 36 AND 38).

FIRST USE 7-17-2008; IN COMMERCE 7-17-2008.

FOR: PRAYER BOOKS; PRINTED INSTRUCTIONAL, EDUCATIONAL, AND TEACHING MATERIALS IN THE FIELD OF RELIGION, EVANGELISM, DISCIPLESHIP, CHRISTIAN LIFESTYLES AND FAMILY VALUES; PRINTED MATTER, NAMELY, PAPER SIGNS, BOOKS, MANUALS, CURRICULUM, NEWSLETTERS, INFORMATIONAL CARDS AND BROCHURES IN THE FIELD OF RELIGION, EVANGELISM, DISCIPLESHIP, CHRISTIAN LIFESTYLES AND FAMILY VALUES, IN CLASS 16 (U.S. CLS. 2, 5, 22, 23, 29, 37, 38 AND 50).

FIRST USE 7-17-2008; IN COMMERCE 7-17-2008.

FOR: HEADGEAR, NAMELY, CAPS AND HATS; SHIRTS; SHORT-SLEEVED OR LONG-SLEEVED T-SHIRTS; SWEAT SHIRTS, IN CLASS 25 (U.S. CLS. 22 AND 39).

FIRST USE 7-17-2008; IN COMMERCE 7-17-2008.

FOR: EDUCATIONAL AND ENTERTAINMENT SERVICES, NAMELY, A CONTINUING PROGRAM ABOUT RELIGION, EVANGELISM, DISCIPLESHIP, CHRISTIAN LIFESTYLES AND FAMILY VALUES ACCESSIBLE BY RADIO, TELEVISION, SATELLITE, AUDIO, VIDEO AND COMPUTER NETWORKS; EDUCATIONAL SERVICES, NAMELY, CONDUCTING CLASSES, SEMINARS, WORKSHOPS AND CONFERENCES IN THE FIELDS OF RELIGION, EVANGELISM, DISCIPLESHIP, CHRISTIAN LIFESTYLES AND FAMILY VALUES AND DISTRIBUTION OF TRAINING MATERIALS IN CONNECTION THEREWITH; ON-



David J. Kybas

Director of the United States Patent and Trademark Office

Reg. No. 4,175,444 LINE JOURNALS, NAMELY, BLOGS FEATURING RELIGION, EVANGELISM, DISCIPLESHIP, CHRISTIAN LIFESTYLES AND FAMILY VALUES; PROVIDING ON-LINE RELIGIOUS INSTRUCTION PROMOTING CHRISTIAN AND FAMILY VALUES, IN CLASS 41 (U.S. CLS. 100, 101 AND 107).

FIRST USE 7-17-2008; IN COMMERCE 7-17-2008.

FOR: CONDUCTING RELIGIOUS PRAYER SERVICES; EVANGELISTIC AND MINISTERIAL SERVICES; ONLINE SOCIAL NETWORKING SERVICES IN THE FIELD OF RELIGION, EVANGELISM, DISCIPLESHIP, CHRISTIAN LIFESTYLES AND FAMILY VALUES; PROVIDING A WEBSITE FEATURING INFORMATION ABOUT MINISTERIAL SERVICES; PROVIDING A WEBSITE FEATURING INFORMATION ABOUT RELIGIOUS BELIEF SYSTEMS, IN CLASS 45 (U.S. CLS. 100 AND 101).

FIRST USE 7-17-2008; IN COMMERCE 7-17-2008.

NO CLAIM IS MADE TO THE EXCLUSIVE RIGHT TO USE "CHURCH", APART FROM THE MARK AS SHOWN.

THE MARK CONSISTS OF THE WORDS "NEWSRING CHURCH" IN A MIXED-CASE FORMAT WITH SEVEN CIRCLES EMANATING FROM THE LOWERCASE "I" AND ARCING OVER THE TEXT WITH EACH CIRCLE SMALLER THAN THE PRECEDING CIRCLE.

SER. NO. 85-479,384, FILED 11-22-2011.

HEATHER THOMPSON, EXAMINING ATTORNEY

United States of America

United States Patent and Trademark Office

Sleep Nation

Reg. No. 4,175,445

SEAN SUTTON (UNITED STATES INDIVIDUAL), DBA SLEEP NATION
10083 PARK MEADOWS DR #209

Registered July 17, 2012

LONE TREE, CO 80124

Int. Cl.: 35

FOR: RETAIL STORE SERVICES FEATURING MATTRESSES, IN CLASS 35 (U.S. CLS. 100, 101 AND 102).

SERVICE MARK

FIRST USE 7-1-2010; IN COMMERCE 3-1-2011.

PRINCIPAL REGISTER

THE MARK CONSISTS OF STANDARD CHARACTERS WITHOUT CLAIM TO ANY PARTICULAR FONT, STYLE, SIZE, OR COLOR.

SER. NO. 85-479,386, FILED 11-22-2011.

HEATHER THOMPSON, EXAMINING ATTORNEY



David J. Kybas

Director of the United States Patent and Trademark Office

United States of America
United States Patent and Trademark Office

LARCENY

Reg. No. 4,175,446

SPORT MASKA INC. (CANADA CORPORATION)
ST. LAURENT 3400

Registered July 17, 2012

RAYMOND LASNIER QUEBEC, CANADA H4R3L3

Int. Cl.: 28

FOR: ICE HOCKEY EQUIPMENT, NAMELY, GOALIE PADS, GOALIE GLOVES AND GOALIE BLOCKERS, IN CLASS 28 (U.S. CLS. 22, 23, 38 AND 50).

TRADEMARK

FIRST USE 2-0-2011; IN COMMERCE 2-0-2011.

PRINCIPAL REGISTER

THE MARK CONSISTS OF STANDARD CHARACTERS WITHOUT CLAIM TO ANY PARTICULAR FONT, STYLE, SIZE, OR COLOR.

SER. NO. 85-479,398, FILED 11-22-2011.

REBECCA POVARCHUK, EXAMINING ATTORNEY



David J. Kybas

Director of the United States Patent and Trademark Office

United States of America

United States Patent and Trademark Office

WHERE EXPERIENCE OPENS
DOORS.

Reg. No. 4,175,447

Registered July 17, 2012

Int. Cl.: 36

SERVICE MARK

PRINCIPAL REGISTER

AXIOM FINANCIAL, LLC (UTAH LIMITED LIABILITY COMPANY)
SUITE 140
9350 SOUTH 150 EAST
SANDY, UT 84070

FOR: MORTGAGE LENDING AND BROKERAGE SERVICES, IN CLASS 36 (U.S. CLS. 100, 101 AND 102).

FIRST USE 10-11-2011; IN COMMERCE 10-11-2011.

THE MARK CONSISTS OF STANDARD CHARACTERS WITHOUT CLAIM TO ANY PARTICULAR FONT, STYLE, SIZE, OR COLOR.

SER. NO. 85-479,403, FILED 11-22-2011.

WILLIAM BRECKENFELD, EXAMINING ATTORNEY



David J. Kyffers

Director of the United States Patent and Trademark Office

United States of America

United States Patent and Trademark Office

YOUR TRUSTED WAY HOME.

Reg. No. 4,175,448

Registered July 17, 2012

Int. Cl.: 36

SERVICE MARK

PRINCIPAL REGISTER

AXIOM FINANCIAL, LLC (UTAH LIMITED LIABILITY COMPANY)
SUITE 140
9350 SOUTH 150 EAST
SANDY, UT 84070

FOR: MORTGAGE LENDING AND BROKERAGE SERVICES, IN CLASS 36 (U.S. CLS. 100, 101 AND 102).

FIRST USE 10-11-2011; IN COMMERCE 10-11-2011.

THE MARK CONSISTS OF STANDARD CHARACTERS WITHOUT CLAIM TO ANY PARTICULAR FONT, STYLE, SIZE, OR COLOR.

SER. NO. 85-479,404, FILED 11-22-2011.

WILLIAM BRECKENFELD, EXAMINING ATTORNEY



David J. Kybas

Director of the United States Patent and Trademark Office

United States of America

United States Patent and Trademark Office

KARNATION

Reg. No. 4,175,449

KARNATION INTIMATE APPAREL, INC. (IDAHO CORPORATION)
P.O. BOX 6297

Registered July 17, 2012

POCATELLO, ID 83205

Int. Cl.: 35

FOR: ON-LINE RETAIL STORE SERVICES FEATURING INTIMATE APPAREL AND ADULT INTIMACY PRODUCTS.; RETAIL STORE SERVICES FEATURING INTIMATE APPAREL AND ADULT INTIMACY PRODUCTS , IN CLASS 35 (U.S. CLS. 100, 101 AND 102).

SERVICE MARK

FIRST USE 1-1-2000; IN COMMERCE 1-1-2000.

PRINCIPAL REGISTER

THE MARK CONSISTS OF STANDARD CHARACTERS WITHOUT CLAIM TO ANY PARTICULAR FONT, STYLE, SIZE, OR COLOR.

SER. NO. 85-479,418, FILED 11-22-2011.

MICHAEL TANNER, EXAMINING ATTORNEY



David J. Kybas

Director of the United States Patent and Trademark Office

United States of America

United States Patent and Trademark Office

inzombnia

Reg. No. 4,175,450

LIQUID SOUL ENTERTAINMENT (NEW YORK CORPORATION)
182 NORTH BELLMORE ROAD
LEVITTOWN, NY 11756

Registered July 17, 2012

Int. Cl.: 41

FOR: ENTERTAINMENT, NAMELY, A CONTINUING HORROR SHOW BROADCAST OVER INTERNET, IN CLASS 41 (U.S. CLS. 100, 101 AND 107).

SERVICE MARK

FIRST USE 8-0-2011; IN COMMERCE 8-0-2011.

PRINCIPAL REGISTER

THE MARK CONSISTS OF STANDARD CHARACTERS WITHOUT CLAIM TO ANY PARTICULAR FONT, STYLE, SIZE, OR COLOR.

SER. NO. 85-479,422, FILED 11-22-2011.

SUNG IN, EXAMINING ATTORNEY



David J. Kyffers

Director of the United States Patent and Trademark Office

United States of America
United States Patent and Trademark Office

INSUTROL

Reg. No. 4,175,451

Registered July 17, 2012

Int. Cl.: 5

TRADEMARK

PRINCIPAL REGISTER

CORTISLIM INTERNATIONAL, INC. (DELAWARE CORPORATION)
28241 CROWN VALLEY PARKWAY
SUITE F-415
LAGUNA NIGUEL, CA 92677

FOR: DIETARY SUPPLEMENTS, IN CLASS 5 (U.S. CLS. 6, 18, 44, 46, 51 AND 52).

FIRST USE 2-14-2004; IN COMMERCE 2-15-2004.

THE MARK CONSISTS OF STANDARD CHARACTERS WITHOUT CLAIM TO ANY PARTICULAR FONT, STYLE, SIZE, OR COLOR.

SER. NO. 85-479,436, FILED 11-22-2011.

REBECCA POVARCHUK, EXAMINING ATTORNEY



David J. Kybas

Director of the United States Patent and Trademark Office

United States of America

United States Patent and Trademark Office



Reg. No. 4,175,452

Registered July 17, 2012

Int. Cl.: 41

SERVICE MARK

PRINCIPAL REGISTER

WILLIAM FRASER & CO LLC (ALASKA LIMITED LIABILITY COMPANY)
SUITE 205
611 E 12TH AVE.
ANCHORAGE, AK 99501

FOR: PROVIDING A WEBSITE FEATURING ENTERTAINMENT INFORMATION;
PROVIDING AN INTERNET WEBSITE PORTAL IN THE FIELD OF ENTERTAINMENT AND
ARTS; PHOTOGRAPHY SERVICES; DIGITAL VIDEO, AUDIO, AND MULTIMEDIA PUB-
LISHING SERVICES, IN CLASS 41 (U.S. CLS. 100, 101 AND 107).

FIRST USE 6-21-2011; IN COMMERCE 6-21-2011.

NO CLAIM IS MADE TO THE EXCLUSIVE RIGHT TO USE "907 NITELIFE", APART FROM
THE MARK AS SHOWN.

THE MARK CONSISTS OF A CIRCLE THAT IS HALF SOLID AT AN ANGLE, WITH THE
SOLID HALF BEING ON THE BOTTOM, AND THE NUMBER "907" ABOVE THE MID-LINE
IN BOLD STYLIZED FONT, AND THE WORD "NITELIFE" IN STYLIZED FONT BELOW
THE MID-LINE.

SER. NO. 85-479,444, FILED 11-22-2011.

SANDRA BUJA, EXAMINING ATTORNEY



David J. Kyffers

Director of the United States Patent and Trademark Office

United States of America

United States Patent and Trademark Office



Reg. No. 4,175,453

Registered July 17, 2012

Int. Cl.: 41

SERVICE MARK

PRINCIPAL REGISTER

LEARNING MATTERS EDUCATIONAL GROUP, LLC (ARIZONA LIMITED LIABILITY COMPANY)
4744 W. GROVERS AVENUE
GLENDALE, AZ 85309

FOR: EDUCATIONAL SERVICES IN THE NATURE OF CHARTER SCHOOLS AND DEVELOPING CURRICULUM FOR OTHERS IN THE FIELD OF PRIMARY AND SECONDARY EDUCATION, IN CLASS 41 (U.S. CLS. 100, 101 AND 107).

FIRST USE 9-1-2010; IN COMMERCE 9-1-2010.

THE MARK CONSISTS OF A SILHOUETTE OF A PERSON JUMPING WITH THEIR ARMS UP WITH A ROAD LEADING TO A SETTING SUN IN THE BACKGROUND.

SER. NO. 85-479,472, FILED 11-22-2011.

AISHA CLARKE, EXAMINING ATTORNEY



David J. Kyffers

Director of the United States Patent and Trademark Office

United States of America

United States Patent and Trademark Office

WOMEN WHO **STAND**/

Reg. No. 4,175,454

Registered July 17, 2012

Int. Cl.: 35

SERVICE MARK

PRINCIPAL REGISTER

WORLD RELIEF CORPORATION OF THE NATIONAL ASSOCIATION OF EVANGELICALS
(DELAWARE NON-PROFIT CORPORATION)
7 EAST BALTIMORE STREET
BALTIMORE, MD 21202

FOR: CHARITABLE SERVICES, NAMELY, ORGANIZING AND DEVELOPING PROJECTS THAT AIM TO IMPROVE THE LIVES OF UNDERPRIVILEGED AND IMPOVERISHED PEOPLE AND JOB PLACEMENT SERVICES FOR UNDERPRIVILEGED AND IMPOVERISHED PEOPLE; PROMOTING PUBLIC AWARENESS ABOUT POVERTY, HUNGER, DISEASE, AND VIOLENCE, IN CLASS 35 (U.S. CLS. 100, 101 AND 102).

FIRST USE 2-0-2011; IN COMMERCE 2-0-2011.

THE MARK CONSISTS OF THE WORDS "WOMEN WHO STAND" WITH THE "A" AS AN UPSIDE DOWN "V" AND A SLASH MARK AFTER "STAND".

SER. NO. 85-479,480, FILED 11-22-2011.

KARANENDRA S. CHHINA, EXAMINING ATTORNEY



David J. Kybas

Director of the United States Patent and Trademark Office

United States of America

United States Patent and Trademark Office

Alpha Bookshelf Bed Rail

Reg. No. 4,175,455

Registered July 17, 2012

Int. Cl.: 20

TRADEMARK

PRINCIPAL REGISTER

TAMBINO LLC (CALIFORNIA LIMITED LIABILITY COMPANY)
270 REDWOOD SHORES PKWY. BOX 83
REDWOOD CITY, CA 94065

FOR: FURNITURE, IN CLASS 20 (U.S. CLS. 2, 13, 22, 25, 32 AND 50).

FIRST USE 8-1-2010; IN COMMERCE 8-2-2010.

THE MARK CONSISTS OF STANDARD CHARACTERS WITHOUT CLAIM TO ANY PARTICULAR FONT, STYLE, SIZE, OR COLOR.

NO CLAIM IS MADE TO THE EXCLUSIVE RIGHT TO USE "BOOKSHELF BED RAIL", APART FROM THE MARK AS SHOWN.

SER. NO. 85-479,489, FILED 11-22-2011.

SAIMA MAKHDOOM, EXAMINING ATTORNEY



David J. Kybas

Director of the United States Patent and Trademark Office

United States of America

United States Patent and Trademark Office

twilight

Reg. No. 4,175,456

Registered July 17, 2012

Int. Cl.: 9

TRADEMARK

PRINCIPAL REGISTER

SUMMIT ENTERTAINMENT, LLC (DELAWARE LIMITED LIABILITY COMPANY)
1630 STEWART STREET
SUITE 130
SANTA MONICA, CA 90404

FOR: ELECTRIC HAIR STRAIGHTENING IRONS; ELECTRIC HAIR CURLING IRONS;
ELECTRIC HAIR STYLING IRONS; AND ELECTRIC HAIR CURLERS, IN CLASS 9 (U.S.
CLS. 21, 23, 26, 36 AND 38).

FIRST USE 10-1-2011; IN COMMERCE 10-1-2011.

OWNER OF U.S. REG. NOS. 3,817,079, 3,884,386 AND OTHERS.

THE MARK CONSISTS OF THE WORD "TWILIGHT" IN LOWER CASE LETTERS AND A
STYLIZED FONT.

SER. NO. 85-479,492, FILED 11-22-2011.

BARBARA RUTLAND, EXAMINING ATTORNEY



David J. Kyffers

Director of the United States Patent and Trademark Office

United States of America

United States Patent and Trademark Office

fiveseed

Reg. No. 4,175,457

FIVESEED, LLC (COLORADO LIMITED LIABILITY COMPANY)
16443 HOMESTEAD COURT
PARKER, CO 80134

Registered July 17, 2012

Int. Cl.: 35

FOR: ADVERTISING AND MARKETING SERVICES, NAMELY, PROMOTING THE GOODS AND SERVICES OF OTHERS, IN CLASS 35 (U.S. CLS. 100, 101 AND 102).

SERVICE MARK

FIRST USE 12-0-2008; IN COMMERCE 12-0-2008.

PRINCIPAL REGISTER

THE MARK CONSISTS OF STANDARD CHARACTERS WITHOUT CLAIM TO ANY PARTICULAR FONT, STYLE, SIZE, OR COLOR.

SER. NO. 85-479,496, FILED 11-22-2011.

KARANENDRA S. CHHINA, EXAMINING ATTORNEY



David J. Kybas

Director of the United States Patent and Trademark Office

United States of America

United States Patent and Trademark Office

WOMEN WHO **STAND**/

Reg. No. 4,175,458

Registered July 17, 2012

Int. Cl.: 36

SERVICE MARK

PRINCIPAL REGISTER

WORLD RELIEF CORPORATION OF THE NATIONAL ASSOCIATION OF EVANGELICALS
(DELAWARE NON-PROFIT CORPORATION)
7 EAST BALTIMORE STREET
BALTIMORE, MD 21202

FOR: CHARITABLE FUND-RAISING SERVICES, IN CLASS 36 (U.S. CLS. 100, 101 AND 102).

FIRST USE 2-0-2011; IN COMMERCE 2-0-2011.

THE MARK CONSISTS OF THE WORDS "WOMEN WHO STAND" WITH THE "A" AS AN UPSIDE DOWN V AND A SLASH MARK AFTER "STAND".

SER. NO. 85-479,497, FILED 11-22-2011.

KARANENDRA S. CHHINA, EXAMINING ATTORNEY



David J. Kybas

Director of the United States Patent and Trademark Office

United States of America

United States Patent and Trademark Office

HAYS WORTHINGTON

Reg. No. 4,175,459

HAYS WORTHINGTON CORP. (DELAWARE CORPORATION)
589 FIFTH AVENUE, SUITE 1300
NEW YORK, NY 10017

Registered July 17, 2012

Int. Cl.: 14

FOR: JEWELRY, IN CLASS 14 (U.S. CLS. 2, 27, 28 AND 50).

TRADEMARK

FIRST USE 12-29-2011; IN COMMERCE 12-29-2011.

PRINCIPAL REGISTER

THE MARK CONSISTS OF STANDARD CHARACTERS WITHOUT CLAIM TO ANY PARTICULAR FONT, STYLE, SIZE, OR COLOR.

THE NAME "HAYS WORTHINGTON" DOES NOT IDENTIFY A LIVING INDIVIDUAL.

SER. NO. 85-479,499, FILED 11-22-2011.

DAVID TOOLEY, EXAMINING ATTORNEY



David J. Kyffers

Director of the United States Patent and Trademark Office

United States of America

United States Patent and Trademark Office



HAYS WORTHINGTON

Reg. No. 4,175,460

HAYS WORTHINGTON CORP. (DELAWARE CORPORATION)
589 FIFTH AVENUE, SUITE 1300
NEW YORK, NY 10017

Registered July 17, 2012

Int. Cl.: 14

FOR: JEWELRY, IN CLASS 14 (U.S. CLS. 2, 27, 28 AND 50).

TRADEMARK

FIRST USE 2-2-2012; IN COMMERCE 2-2-2012.

PRINCIPAL REGISTER

THE NAME "HAYS WORTHINGTON" DOES NOT IDENTIFY A LIVING INDIVIDUAL.

THE MARK CONSISTS OF A SOLID LETTER "H" INTERLOCKING WITH A HORIZONTALLY STRIPED LETTER "W" ABOVE THE WORDS "HAYS WORTHINGTON".

SER. NO. 85-479,501, FILED 11-22-2011.

DAVID TOOLEY, EXAMINING ATTORNEY



David J. Kyffers

Director of the United States Patent and Trademark Office

United States of America

United States Patent and Trademark Office

The Wedding Elite

Reg. No. 4,175,461

MIZELL, MATTHEW (UNITED STATES INDIVIDUAL)
8136 SAND SPRINGS CIR NW
ALBUQUERQUE, NM 87114

Registered July 17, 2012

Int. Cl.: 16

FOR: MAGAZINES IN THE FIELD OF WEDDING PREPARATION AND VENDORS, IN CLASS 16 (U.S. CLS. 2, 5, 22, 23, 29, 37, 38 AND 50).

TRADEMARK

FIRST USE 3-19-2010; IN COMMERCE 3-19-2010.

PRINCIPAL REGISTER

THE MARK CONSISTS OF STANDARD CHARACTERS WITHOUT CLAIM TO ANY PARTICULAR FONT, STYLE, SIZE, OR COLOR.

NO CLAIM IS MADE TO THE EXCLUSIVE RIGHT TO USE "WEDDING", APART FROM THE MARK AS SHOWN.

SER. NO. 85-479,516, FILED 11-22-2011.

COLLEEN KEARNEY, EXAMINING ATTORNEY



David J. Kybas

Director of the United States Patent and Trademark Office

United States of America

United States Patent and Trademark Office

Energy System of Acting, ESA

Reg. No. 4,175,462

FINE, LAURA (UNITED STATES INDIVIDUAL)
5520 DONNA AVE
TARZANA, CA 91356

Registered July 17, 2012

Int. Cl.: 41

FOR: INSTRUCTION IN THE FIELD OF ENERGY DYNAMICS THAT ARE SUBTLY EXPERIENCED WITHIN ONESELF AND EXCHANGED BETWEEN PEOPLE, IN CLASS 41 (U.S. CLS. 100, 101 AND 107).

SERVICE MARK

FIRST USE 6-1-1994; IN COMMERCE 1-1-1997.

PRINCIPAL REGISTER

THE MARK CONSISTS OF STANDARD CHARACTERS WITHOUT CLAIM TO ANY PARTICULAR FONT, STYLE, SIZE, OR COLOR.

NO CLAIM IS MADE TO THE EXCLUSIVE RIGHT TO USE "SYSTEM OF ACTING", APART FROM THE MARK AS SHOWN.

SER. NO. 85-479,530, FILED 11-22-2011.

APRIL ROACH, EXAMINING ATTORNEY



David J. Kyfos

Director of the United States Patent and Trademark Office

United States of America

United States Patent and Trademark Office

DISCONNECTED
SALON

Reg. No. 4,175,463

DISCONNECTED SALON, LLC (CALIFORNIA LIMITED LIABILITY COMPANY)
3830 30TH STREET
SAN DIEGO, CA 92104

Registered July 17, 2012

Int. Cl.: 44

FOR: HAIR SALON SERVICES, IN CLASS 44 (U.S. CLS. 100 AND 101).

SERVICE MARK

FIRST USE 12-0-2005; IN COMMERCE 11-1-2007.

PRINCIPAL REGISTER

NO CLAIM IS MADE TO THE EXCLUSIVE RIGHT TO USE "SALON", APART FROM THE MARK AS SHOWN.

THE MARK CONSISTS OF THE LETTERING "DIS", ROTATED TO THE LEFT WITH A BACKWARDS "S", APPEARING TO THE LEFT OF THE WORD "CONNECTED", WHERE THE LETTER "O" IS IN STYLIZED LETTERING, ALL OF WHICH APPEARS ABOVE THE WORD "SALON".

SER. NO. 85-479,556, FILED 11-22-2011.

MARC LEIPZIG, EXAMINING ATTORNEY



David J. Kyffers

Director of the United States Patent and Trademark Office

United States of America

United States Patent and Trademark Office

Bag It!

Reg. No. 4,175,464

Registered July 17, 2012

Int. Cl.: 9

TRADEMARK

PRINCIPAL REGISTER

HIDDEN VARIABLE STUDIOS, LLC (CALIFORNIA LIMITED LIABILITY COMPANY)
5355 CARTWRIGHT AVENUE
SUITE 322
NORTH HOLLYWOOD, CA 91601

FOR: COMPUTER GAME PROGRAMMES DOWNLOADABLE VIA THE INTERNET; COMPUTER GAME PROGRAMS; COMPUTER GAME SOFTWARE; COMPUTER GAME SOFTWARE DOWNLOADABLE FROM A GLOBAL COMPUTER NETWORK; COMPUTER GAME SOFTWARE FOR USE ON MOBILE AND CELLULAR PHONES; DOWNLOADABLE COMPUTER GAME PROGRAMS; DOWNLOADABLE COMPUTER GAME SOFTWARE VIA A GLOBAL COMPUTER NETWORK AND WIRELESS DEVICES, IN CLASS 9 (U.S. CLS. 21, 23, 26, 36 AND 38).

FIRST USE 11-16-2011; IN COMMERCE 11-16-2011.

THE MARK CONSISTS OF STANDARD CHARACTERS WITHOUT CLAIM TO ANY PARTICULAR FONT, STYLE, SIZE, OR COLOR.

SER. NO. 85-479,560, FILED 11-22-2011.

AISHA SALEM, EXAMINING ATTORNEY



David J. Kyffers

Director of the United States Patent and Trademark Office

United States of America

United States Patent and Trademark Office

Lean Machines Healthy Vending

Reg. No. 4,175,465

Registered July 17, 2012

Int. Cl.: 35

LEAN MACHINES HEALTHY VENDING LLC (WASHINGTON LIMITED LIABILITY COMPANY)
SUITE #58
624 S. LANDER ST.
SEATTLE, WA 98134

SERVICE MARK

PRINCIPAL REGISTER

FOR: VENDING MACHINE SERVICES, IN CLASS 35 (U.S. CLS. 100, 101 AND 102).

FIRST USE 3-1-2010; IN COMMERCE 1-15-2011.

THE MARK CONSISTS OF STANDARD CHARACTERS WITHOUT CLAIM TO ANY PARTICULAR FONT, STYLE, SIZE, OR COLOR.

NO CLAIM IS MADE TO THE EXCLUSIVE RIGHT TO USE "MACHINES HEALTHY VENDING", APART FROM THE MARK AS SHOWN.

SER. NO. 85-479,580, FILED 11-22-2011.

JAMES LOVELACE, EXAMINING ATTORNEY



David J. Kyffers

Director of the United States Patent and Trademark Office

United States of America

United States Patent and Trademark Office

Look Good. Be Good.

Reg. No. 4,175,466

SYNTHESYS INNOVATION LLC (NEVADA LIMITED LIABILITY COMPANY)
991 AMSTERDAM AVE, APT 3
NEW YORK, NY 10025

Registered July 17, 2012

Int. Cl.: 25

FOR: NECKWEAR, IN CLASS 25 (U.S. CLS. 22 AND 39).

TRADEMARK

FIRST USE 10-10-2010; IN COMMERCE 10-10-2010.

PRINCIPAL REGISTER

THE MARK CONSISTS OF STANDARD CHARACTERS WITHOUT CLAIM TO ANY PARTICULAR FONT, STYLE, SIZE, OR COLOR.

SER. NO. 85-479,595, FILED 11-22-2011.

NAAKWAMA ANKRAH, EXAMINING ATTORNEY



David J. Kyffers

Director of the United States Patent and Trademark Office

United States of America

United States Patent and Trademark Office

WONDERFOX

Reg. No. 4,175,467

VALENCIA, ISABEL (UNITED STATES INDIVIDUAL)
7548 LEXINGTON AVE APT #2
WEST HOLLYWOOD, CA 90046

Registered July 17, 2012

Int. Cl.: 41

FOR: ENTERTAINMENT, NAMELY, LIVE PERFORMANCES BY A MUSICAL BAND, IN CLASS 41 (U.S. CLS. 100, 101 AND 107).

SERVICE MARK

FIRST USE 11-21-2011; IN COMMERCE 11-21-2011.

PRINCIPAL REGISTER

THE MARK CONSISTS OF STANDARD CHARACTERS WITHOUT CLAIM TO ANY PARTICULAR FONT, STYLE, SIZE, OR COLOR.

SER. NO. 85-479,597, FILED 11-22-2011.

NAAKWAMA ANKRAH, EXAMINING ATTORNEY



David J. Kyffers

Director of the United States Patent and Trademark Office

United States of America
United States Patent and Trademark Office

TAPATERIA

Reg. No. 4,175,468

Registered July 17, 2012

Int. Cl.: 43

SERVICE MARK

PRINCIPAL REGISTER

TAPATERIA LLC (COLORADO LIMITED LIABILITY COMPANY)
2607 W. COLORADO AVE.
COLORADO SPRINGS, CO 80904

FOR: RESTAURANT AND CAFE SERVICES; RESTAURANT SERVICES, INCLUDING SIT-DOWN SERVICE OF FOOD AND TAKE-OUT RESTAURANT SERVICES, IN CLASS 43 (U.S. CLS. 100 AND 101).

FIRST USE 10-30-2010; IN COMMERCE 10-30-2010.

THE MARK CONSISTS OF STANDARD CHARACTERS WITHOUT CLAIM TO ANY PARTICULAR FONT, STYLE, SIZE, OR COLOR.

SER. NO. 85-479,602, FILED 11-22-2011.

KRISTIN DAHLING, EXAMINING ATTORNEY



David J. Kybas

Director of the United States Patent and Trademark Office

United States of America

United States Patent and Trademark Office

The Winning Team

Reg. No. 4,175,469

THE WINNING TEAM, INC. (CALIFORNIA CORPORATION)
24922 ANZA DRIVE UNIT E
VALENCIA, CA 91355

Registered July 17, 2012

Int. Cl.: 40

FOR: CUSTOM MANUFACTURE OF CLOTHING, NAMELY, JACKETS, SHIRTS, PANTS AND HATS, FOR FURTHER EMBROIDERY BY OTHERS; CUSTOM MANUFACTURE AND EMBROIDERY OF CLOTHING, NAMELY, JACKETS, SHIRTS, PANTS AND HATS, IN CLASS 40 (U.S. CLS. 100, 103 AND 106).

SERVICE MARK

PRINCIPAL REGISTER

FIRST USE 1-1-1994; IN COMMERCE 1-1-1994.

THE MARK CONSISTS OF STANDARD CHARACTERS WITHOUT CLAIM TO ANY PARTICULAR FONT, STYLE, SIZE, OR COLOR.

SER. NO. 85-479,607, FILED 11-22-2011.

EUGENIA MARTIN, EXAMINING ATTORNEY



David J. Kyffers

Director of the United States Patent and Trademark Office

United States of America

United States Patent and Trademark Office

ERINFOCARD

Reg. No. 4,175,470

CPD HEALTH CONSULTANTS, LLC (TEXAS LIMITED LIABILITY COMPANY)
19345 STRAUSS

Registered July 17, 2012

SAN ANTONIO, TX 78256

Int. Cl.: 9

FOR: USB FLASH DRIVES THAT ARE PREPROGRAMED TO PROVIDE USERS WITH AN EASY, PORTABLE AND PASSWORD ENCRYPTED WAY TO KEEP THEIR MEDICAL DOCUMENTS UP TO DATE , IN CLASS 9 (U.S. CLS. 21, 23, 26, 36 AND 38).

TRADEMARK

FIRST USE 10-30-2011; IN COMMERCE 11-8-2011.

PRINCIPAL REGISTER

THE MARK CONSISTS OF STANDARD CHARACTERS WITHOUT CLAIM TO ANY PARTICULAR FONT, STYLE, SIZE, OR COLOR.

SER. NO. 85-479,644, FILED 11-23-2011.

DAVID MURRAY, EXAMINING ATTORNEY



David J. Kyffers

Director of the United States Patent and Trademark Office

United States of America

United States Patent and Trademark Office

Explored All Seven

Reg. No. 4,175,471

MCDONOUGH, DAVID (TEXAS SOLE PROPRIETORSHIP)
901 SOUTH PARK STREET
SAN ANGELO, TX 76901

Registered July 17, 2012

Int. Cl.: 16

FOR: PHOTOGRAPHIC PRINTS, IN CLASS 16 (U.S. CLS. 2, 5, 22, 23, 29, 37, 38 AND 50).

TRADEMARK

FIRST USE 5-24-2010; IN COMMERCE 11-11-2011.

PRINCIPAL REGISTER

THE MARK CONSISTS OF STANDARD CHARACTERS WITHOUT CLAIM TO ANY PARTICULAR FONT, STYLE, SIZE, OR COLOR.

SER. NO. 85-479,646, FILED 11-23-2011.

STEVEN R. FINE, EXAMINING ATTORNEY



David J. Kyffers

Director of the United States Patent and Trademark Office

United States of America

United States Patent and Trademark Office

laughing river

Reg. No. 4,175,472

Registered July 17, 2012

Int. Cl.: 41

SERVICE MARK

PRINCIPAL REGISTER

DINO J. BLANCHE (UNITED STATES INDIVIDUAL)
94-17 41ST AVENUE
ELMHURST, NY 11373

FOR: MARTIAL ARTS INSTRUCTION; MEDITATION TRAINING; OPERATING OF MARTIAL ARTS' STUDIOS; PROVIDING A WEB SITE FEATURING NON-DOWNLOADABLE INSTRUCTIONAL VIDEOS IN THE FIELD OF MARTIAL ARTS; PROVIDING CLASSES, WORKSHOPS, SEMINARS AND CAMPS IN THE FIELDS OF FITNESS, EXERCISE, BOXING, KICK BOXING AND MIXED MARTIAL ARTS, IN CLASS 41 (U.S. CLS. 100, 101 AND 107).

FIRST USE 3-28-2000; IN COMMERCE 3-28-2000.

THE MARK CONSISTS OF STANDARD CHARACTERS WITHOUT CLAIM TO ANY PARTICULAR FONT, STYLE, SIZE, OR COLOR.

SER. NO. 85-479,662, FILED 11-23-2011.

MYRIAH HABEEB, EXAMINING ATTORNEY



David J. Kyffers

Director of the United States Patent and Trademark Office

United States of America
United States Patent and Trademark Office

CoreALM

Reg. No. 4,175,473

COREALM CORP (CALIFORNIA CORPORATION)
100 W. FOOTHILL BLVD. SUITE 202
SAN DIMAS, CA 91773

Registered July 17, 2012

Int. Cl.: 42

FOR: CONSULTING IN THE FIELD OF INFORMATION TECHNOLOGY, IN CLASS 42 (U.S. CLS. 100 AND 101).

SERVICE MARK

FIRST USE 2-1-2011; IN COMMERCE 2-1-2011.

PRINCIPAL REGISTER

THE MARK CONSISTS OF STANDARD CHARACTERS WITHOUT CLAIM TO ANY PARTICULAR FONT, STYLE, SIZE, OR COLOR.

SER. NO. 85-479,677, FILED 11-23-2011.

CHRISTINA SOBRAL, EXAMINING ATTORNEY



David J. Kybas

Director of the United States Patent and Trademark Office

United States of America

United States Patent and Trademark Office

Hearts & Halos

Reg. No. 4,175,474

KELLY M. LARUE (UNITED STATES INDIVIDUAL)
1335 MALLARDS WAY
O'FALLON, MO 63368

Registered July 17, 2012

Int. Cl.: 36

FOR: CHARITABLE FUNDRAISING TO SUPPORT FAMILIES WHO EXPERIENCE AN ANENCEPHALIC PREGNANCY/BIRTH, IN CLASS 36 (U.S. CLS. 100, 101 AND 102).

SERVICE MARK

FIRST USE 11-21-2011; IN COMMERCE 11-21-2011.

PRINCIPAL REGISTER

THE MARK CONSISTS OF STANDARD CHARACTERS WITHOUT CLAIM TO ANY PARTICULAR FONT, STYLE, SIZE, OR COLOR.

SER. NO. 85-479,693, FILED 11-23-2011.

DAVID HOFFMAN, EXAMINING ATTORNEY



David J. Kyffers

Director of the United States Patent and Trademark Office

United States of America

United States Patent and Trademark Office

NUT BUSTER

Reg. No. 4,175,475

Registered July 17, 2012

Int. Cl.: 7

TRADEMARK

PRINCIPAL REGISTER

MACHINERY SERVICE & DESIGN, INC. (WISCONSIN CORPORATION)
SUITE 400
W232 N2960 ROUNDY CIRCLE WEST
PEWAUKEE, WI 53072

FOR: HYDRAULIC TORQUE WRENCH, IN CLASS 7 (U.S. CLS. 13, 19, 21, 23, 31, 34 AND 35).

FIRST USE 1-1-1998; IN COMMERCE 1-1-1998.

THE MARK CONSISTS OF STANDARD CHARACTERS WITHOUT CLAIM TO ANY PARTICULAR FONT, STYLE, SIZE, OR COLOR.

SER. NO. 85-479,697, FILED 11-23-2011.

BARBARA RUTLAND, EXAMINING ATTORNEY



David J. Kyffers

Director of the United States Patent and Trademark Office

United States of America

United States Patent and Trademark Office

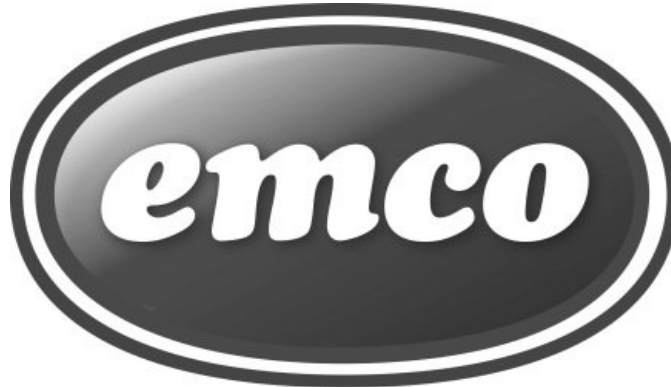

Reg. No. 4,175,476

Registered July 17, 2012

Int. Cl.: 30

TRADEMARK

PRINCIPAL REGISTER

EMCO SPOL. S R.O. (CZECH REPUBLIC SPOLECNOST S RUCENIM OMEZENYM (SPOL S.R.O.))
TŮRKOVA 2319/5B
PRAHA 4, CZECH REPUBLIC 14900

FOR: BREAKFAST CEREALS, IN CLASS 30 (U.S. CL. 46).

FIRST USE 3-22-1995; IN COMMERCE 9-0-2011.

THE MARK CONSISTS OF THE LETTERS "EMCO" INSIDE AN OVAL.

SER. NO. 85-479,723, FILED 11-23-2011.

ELI HELLMAN, EXAMINING ATTORNEY



David J. Kybas

Director of the United States Patent and Trademark Office

United States of America

United States Patent and Trademark Office

Confident Choice

Reg. No. 4,175,477

PETER D GEISMAR (UNITED STATES INDIVIDUAL)
135 PROSPECT PARK WEST, #33
BROOKLYN, NY 11215

Registered July 17, 2012

Int. Cl.: 36

FOR: INSURANCE AND FINANCIAL INFORMATION AND CONSULTANCY SERVICES,
IN CLASS 36 (U.S. CLS. 100, 101 AND 102).

SERVICE MARK

FIRST USE 11-1-2011; IN COMMERCE 11-1-2011.

PRINCIPAL REGISTER

THE MARK CONSISTS OF STANDARD CHARACTERS WITHOUT CLAIM TO ANY PARTICULAR FONT, STYLE, SIZE, OR COLOR.

SER. NO. 85-479,724, FILED 11-23-2011.

ELI HELLMAN, EXAMINING ATTORNEY



David J. Kyffers

Director of the United States Patent and Trademark Office

United States of America

United States Patent and Trademark Office



Reg. No. 4,175,478

JS CONSULTING, LLC (MARYLAND LIMITED LIABILITY COMPANY)
10104 CEDAR LANE
KENSINGTON, MD 20895

Registered July 17, 2012

Int. Cls.: 35, 37, 40 and 42

FOR: PROVIDING A WEBSITE WHERE CONSUMERS CAN SELL PHONES, BATTERIES, AND OTHER MOBILE ELECTRONIC DEVICES; PROVIDING A BUY-BACK PROGRAM OF PHONES, BATTERIES, AND OTHER MOBILE ELECTRONIC DEVICES; BUSINESS CONSULTING SERVICES IN THE FIELD OF TELECOMMUNICATIONS TECHNOLOGY, IN CLASS 35 (U.S. CLS. 100, 101 AND 102).

SERVICE MARK

PRINCIPAL REGISTER

FIRST USE 6-1-2009; IN COMMERCE 6-1-2009.

FOR: WASTE DISPOSAL FOR OTHERS, NAMELY, DISPOSAL OF PHONES, BATTERIES, AND OTHER MOBILE ELECTRONIC DEVICES; REFURBISHING OF PHONES, BATTERIES, AND OTHER MOBILE ELECTRONIC DEVICES, IN CLASS 37 (U.S. CLS. 100, 103 AND 106).

FIRST USE 6-1-2009; IN COMMERCE 6-1-2009.

FOR: RECYCLING; RECYCLING SERVICES, NAMELY, RECYCLING OF PHONES, BATTERIES, AND OTHER MOBILE ELECTRONIC DEVICES; PROVIDING A WEBSITE WHERE CONSUMERS CAN RECYCLE PHONES, BATTERIES, AND OTHER MOBILE ELECTRONIC DEVICES, IN CLASS 40 (U.S. CLS. 100, 103 AND 106).

FIRST USE 6-1-2009; IN COMMERCE 6-1-2009.

FOR: COMPUTER SOFTWARE DEVELOPMENT IN THE FIELD OF MOBILE APPLICATIONS; BUSINESS CONSULTING SERVICES IN THE FIELD OF TELECOMMUNICATIONS TECHNOLOGY; SOFTWARE INTEGRATION SERVICES, NAMELY, INTEGRATION OF COMPUTER SOFTWARE INTO MULTIPLE SYSTEMS AND NETWORKS, IN CLASS 42 (U.S. CLS. 100 AND 101).

FIRST USE 6-1-2009; IN COMMERCE 6-1-2009.

THE MARK CONSISTS OF A STYLIZED ARROW WITHIN A CIRCLE.

SER. NO. 85-479,726, FILED 11-23-2011.



David J. Kyffers

Director of the United States Patent and Trademark Office

Reg. No. 4,175,478 CHRISTOPHER LAW, EXAMINING ATTORNEY

United States of America

United States Patent and Trademark Office

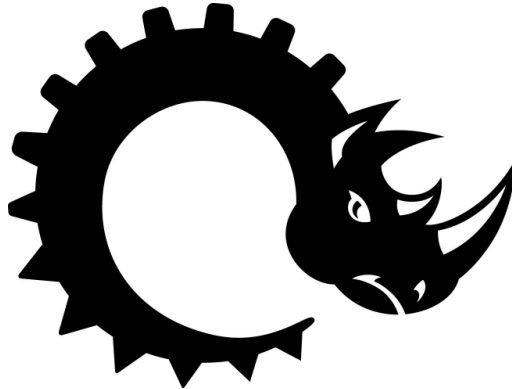

Reg. No. 4,175,479

Registered July 17, 2012

Int. Cl.: 12

TRADEMARK

PRINCIPAL REGISTER

DAWSON TIRE SERVICE, INC. (NEBRASKA CORPORATION)
806 8TH STREET
GOTHENBURG, NE 69138

FOR: TIRES, IN CLASS 12 (U.S. CLS. 19, 21, 23, 31, 35 AND 44).

FIRST USE 4-30-2011; IN COMMERCE 4-30-2011.

THE MARK CONSISTS OF A SEMI-CIRCLE HAVING A BOTTOM END RESEMBLING AN ALLIGATOR'S TAIL, THE SEMI-CIRCLE CURVING CLOCKWISE FROM THE BOTTOM WITH A PLURALITY OF PROTRUSIONS GRADUALLY SHIFTING FROM TRIANGULAR IN FORM TO RECTANGULAR AND RESEMBLING A TIRE TREAD BY THE ZENITH OF THE ARC, THE SEMI-CIRCLE CONTINUING CLOCKWISE AND DOWNWARD INTO A FORM RESEMBLING A HEAD OF A RHINO.

SER. NO. 85-479,728, FILED 11-23-2011.

PAUL MORENO, EXAMINING ATTORNEY



David J. Kyffers

Director of the United States Patent and Trademark Office

United States of America

United States Patent and Trademark Office

CGSP

Reg. No. 4,175,480

Registered July 17, 2012

Int. Cls.: 41 and 42

SERVICE MARK

PRINCIPAL REGISTER

THE AMERICAN HOTEL & LODGING EDUCATIONAL INSTITUTE (MICHIGAN CORPORATION)
SUITE 300
800 NORTH MAGNOLIA AVENUE
ORLANDO, FL 32803

FOR: EDUCATIONAL SERVICES, NAMELY, DEVELOPING, CONDUCTING, ADMINISTERING AND SCORING EDUCATIONAL EXAMINATIONS IN THE FIELDS OF HOSPITALITY AND LODGING GUEST SERVICE, IN CLASS 41 (U.S. CLS. 100, 101 AND 107).

FIRST USE 4-0-2011; IN COMMERCE 4-0-2011.

FOR: TESTING, ANALYSIS AND EVALUATION OF THE KNOWLEDGE, SKILLS AND ABILITIES OF OTHERS FOR THE PURPOSE OF CERTIFICATION AND RE-CERTIFICATION IN THE FIELDS OF HOSPITALITY AND LODGING GUEST SERVICE, IN CLASS 42 (U.S. CLS. 100 AND 101).

FIRST USE 4-0-2011; IN COMMERCE 4-0-2011.

THE MARK CONSISTS OF STANDARD CHARACTERS WITHOUT CLAIM TO ANY PARTICULAR FONT, STYLE, SIZE, OR COLOR.

SER. NO. 85-479,735, FILED 11-23-2011.

DOMINIC J. FERRAIUOLO, EXAMINING ATTORNEY



David J. Kyffers

Director of the United States Patent and Trademark Office

United States of America

United States Patent and Trademark Office

my life at speed

Reg. No. 4,175,481

TRACHY, GREG (UNITED STATES INDIVIDUAL)
152 ARGONNE AVE

Registered July 17, 2012

LONG BEACH, CA 90803

Int. Cl.: 41

FOR: ON-LINE JOURNALS, NAMELY, BLOGS FEATURING ALL THINGS FAST, IN CLASS 41 (U.S. CLS. 100, 101 AND 107).

SERVICE MARK

FIRST USE 11-20-2010; IN COMMERCE 12-0-2010.

PRINCIPAL REGISTER

THE MARK CONSISTS OF STANDARD CHARACTERS WITHOUT CLAIM TO ANY PARTICULAR FONT, STYLE, SIZE, OR COLOR.

SER. NO. 85-479,805, FILED 11-23-2011.

JERI J. FICKES, EXAMINING ATTORNEY



David J. Kyffers

Director of the United States Patent and Trademark Office

United States of America

United States Patent and Trademark Office

OWNERPLUS

Reg. No. 4,175,482

Registered July 17, 2012

Int. Cl.: 35

SERVICE MARK

PRINCIPAL REGISTER

WYNDHAM EXCHANGE AND RENTALS, INC. (DELAWARE CORPORATION)
7 SYLVAN WAY
PARSIPPANY, NJ 07054

FOR: PROMOTING PARTICIPATION IN A VACATION RENTAL PROGRAM THROUGH THE OFFERING OF HOMEOWNER INCENTIVE AND LOYALTY PROGRAMS, IN CLASS 35 (U.S. CLS. 100, 101 AND 102).

FIRST USE 1-5-2012; IN COMMERCE 1-5-2012.

THE MARK CONSISTS OF STANDARD CHARACTERS WITHOUT CLAIM TO ANY PARTICULAR FONT, STYLE, SIZE, OR COLOR.

SER. NO. 85-479,841, FILED 11-23-2011.

ALEXANDER L. POWERS, EXAMINING ATTORNEY



David J. Kyffers

Director of the United States Patent and Trademark Office

United States of America

United States Patent and Trademark Office



Reg. No. 4,175,483

Registered July 17, 2012

Int. Cl.: 44

SERVICE MARK

PRINCIPAL REGISTER

HOUSE CALL MEDICAL SERVICES OF NEW YORK (NEW YORK LIMITED LIABILITY COMPANY)
2015 GRAND CONCOURSE
BRONX, NY 10453

FOR: MEDICAL SERVICES, IN CLASS 44 (U.S. CLS. 100 AND 101).

FIRST USE 7-1-2005; IN COMMERCE 7-1-2005.

NO CLAIM IS MADE TO THE EXCLUSIVE RIGHT TO USE "HOUSECALL MEDICAL SERVICES WE BRING THE DOCTOR TO YOU", APART FROM THE MARK AS SHOWN.

THE MARK CONSISTS OF THE TEXT "HOUSECALL" AT THE TOP WITH A ROOF ABOVE "HOUSE" AND A STETHOSCOPE FOR THE "C" IN "CALL", "MEDICAL SERVICES" BELOW "HOUSECALL", AND "WE BRING THE DOCTOR TO YOU" BELOW "MEDICAL SERVICES".

SER. NO. 85-479,856, FILED 11-23-2011.

ERIN FALK, EXAMINING ATTORNEY



David J. Kybas

Director of the United States Patent and Trademark Office

United States of America

United States Patent and Trademark Office

MADE FOR ME

Reg. No. 4,175,484

Registered July 17, 2012

Int. Cl.: 30

TRADEMARK

PRINCIPAL REGISTER

HUNT FAMILY PROPERTIES, LLC (TENNESSEE LIMITED LIABILITY COMPANY)
4020 JORDONIA STATION ROAD
NASHVILLE, TN 37218

FOR: PIZZA, IN CLASS 30 (U.S. CL. 46).

FIRST USE 4-27-2011; IN COMMERCE 4-27-2011.

THE MARK CONSISTS OF STANDARD CHARACTERS WITHOUT CLAIM TO ANY PARTICULAR FONT, STYLE, SIZE, OR COLOR.

SER. NO. 85-479,893, FILED 11-23-2011.

LIEF MARTIN, EXAMINING ATTORNEY



David J. Kybas

Director of the United States Patent and Trademark Office

United States of America

United States Patent and Trademark Office

JUSTTRUTHIT

Reg. No. 4,175,485

Registered July 17, 2012

Int. Cl.: 41

SERVICE MARK

PRINCIPAL REGISTER

THE LIVING TRUTH FELLOWSHIP INC. (INDIANA NON-PROFIT CORPORATION)
SUITE 252
7399 N. SHADELAND AVE.
INDIANAPOLIS, IN 46250

FOR: RELIGIOUS INSTRUCTION SERVICES, IN CLASS 41 (U.S. CLS. 100, 101 AND 107).

FIRST USE 11-15-2011; IN COMMERCE 11-15-2011.

THE MARK CONSISTS OF STANDARD CHARACTERS WITHOUT CLAIM TO ANY PARTICULAR FONT, STYLE, SIZE, OR COLOR.

SER. NO. 85-479,894, FILED 11-23-2011.

DAVID COLLIER, EXAMINING ATTORNEY



David J. Kyffers

Director of the United States Patent and Trademark Office

United States of America

United States Patent and Trademark Office

KNITS ALL GOOD

Reg. No. 4,175,486

NICHOLSON, ANNE B. (UNITED STATES INDIVIDUAL)
2 COOPER SQ. #5F
NEW YORK, NY 10003

Registered July 17, 2012

Int. Cl.: 35

FOR: COMPUTERIZED ON-LINE RETAIL STORE SERVICES IN THE FIELD OF KNITTED GOODS, IN CLASS 35 (U.S. CLS. 100, 101 AND 102).

SERVICE MARK

FIRST USE 5-5-2011; IN COMMERCE 5-5-2011.

PRINCIPAL REGISTER

THE MARK CONSISTS OF STANDARD CHARACTERS WITHOUT CLAIM TO ANY PARTICULAR FONT, STYLE, SIZE, OR COLOR.

SER. NO. 85-479,905, FILED 11-23-2011.

NICHOLAS COLEMAN, EXAMINING ATTORNEY



David J. Kybas

Director of the United States Patent and Trademark Office

United States of America
United States Patent and Trademark Office

AWESOOS

Reg. No. 4,175,487

AWESOOS ENTERTAINMENT LLC (ARIZONA LIMITED LIABILITY COMPANY)
38919 S. FARLONG CT.
TUCSON, AZ 85739

Registered July 17, 2012

Int. Cl.: 41

FOR: RENTAL OF PORTABLE PHOTOGRAPHY AND/OR VIDEOGRAPHY BOOTHS FOR
TAKING OF PICTURES AND VIDEOS, IN CLASS 41 (U.S. CLS. 100, 101 AND 107).

SERVICE MARK

FIRST USE 1-15-2012; IN COMMERCE 1-15-2012.

PRINCIPAL REGISTER

THE MARK CONSISTS OF STANDARD CHARACTERS WITHOUT CLAIM TO ANY PAR-
TICULAR FONT, STYLE, SIZE, OR COLOR.

SER. NO. 85-479,926, FILED 11-23-2011.

JAMES STEIN, EXAMINING ATTORNEY



David J. Kyffers

Director of the United States Patent and Trademark Office

United States of America

United States Patent and Trademark Office

ALICE + OLIVIA

Reg. No. 4,175,488

ALICE + OLIVIA, LLC (NEW YORK LIMITED LIABILITY COMPANY)
80 WEST 40TH STREET
NEW YORK, NY 10018

Registered July 17, 2012

Int. Cl.: 35

FOR: RETAIL STORE AND ON-LINE RETAIL STORE SERVICES FEATURING CLOTHING ACCESSORIES, COSMETICS, FRAGRANCE, SUNGLASSES, EYEWEAR, JEWELRY, HANDBAGS, PURSES, CLUTCHES, CLOTHING, FOOTWEAR AND HEADWEAR, IN CLASS 35 (U.S. CLS. 100, 101 AND 102).

SERVICE MARK

PRINCIPAL REGISTER

FIRST USE 5-0-2006; IN COMMERCE 5-0-2006.

THE MARK CONSISTS OF STANDARD CHARACTERS WITHOUT CLAIM TO ANY PARTICULAR FONT, STYLE, SIZE, OR COLOR.

OWNER OF U.S. REG. NOS. 3,690,591, 4,029,466 AND OTHERS.

SER. NO. 85-479,927, FILED 11-23-2011.

DAVID COLLIER, EXAMINING ATTORNEY



David J. Kyffers

Director of the United States Patent and Trademark Office

United States of America

United States Patent and Trademark Office

CORTIPLX

Reg. No. 4,175,489

Registered July 17, 2012

Int. Cl.: 5

TRADEMARK

PRINCIPAL REGISTER

CORTISLIM INTERNATIONAL, INC. (DELAWARE CORPORATION)
28241 CROWN VALLEY PARKWAY
SUITE F-415
LAGUNA NIGUEL, CA 92677

FOR: DIETARY SUPPLEMENTS, IN CLASS 5 (U.S. CLS. 6, 18, 44, 46, 51 AND 52).

FIRST USE 7-20-2003; IN COMMERCE 7-20-2003.

THE MARK CONSISTS OF STANDARD CHARACTERS WITHOUT CLAIM TO ANY PARTICULAR FONT, STYLE, SIZE, OR COLOR.

SER. NO. 85-479,980, FILED 11-23-2011.

REBECCA POVARCHUK, EXAMINING ATTORNEY



David J. Kybas

Director of the United States Patent and Trademark Office

United States of America

United States Patent and Trademark Office

H.E.R.O.

Reg. No. 4,175,490

DUCLAW BREWERY LLC (MARYLAND LIMITED LIABILITY COMPANY)
16A BEL AIR SOUTH PARKWAY
BEL AIR, MD 21015

Registered July 17, 2012

Int. Cl.: 32

FOR: BEER, ALE AND PORTER, IN CLASS 32 (U.S. CLS. 45, 46 AND 48).

TRADEMARK

FIRST USE 7-1-2011; IN COMMERCE 7-1-2011.

PRINCIPAL REGISTER

THE MARK CONSISTS OF STANDARD CHARACTERS WITHOUT CLAIM TO ANY PARTICULAR FONT, STYLE, SIZE, OR COLOR.

SER. NO. 85-479,991, FILED 11-23-2011.

RONALD MCMORROW, EXAMINING ATTORNEY



David J. Kyffers

Director of the United States Patent and Trademark Office

United States of America

United States Patent and Trademark Office

OUR BOARDS ARE BETTER

Reg. No. 4,175,491

Registered July 17, 2012

Int. Cl.: 9

TRADEMARK

PRINCIPAL REGISTER

LIVE ACTION MEDIA INCORPORATED (ILLINOIS CORPORATION)
846 N. MOZART
CHICAGO, IL 60622

FOR: PRE-RECORDED CDS FEATURING COMMERCIALS, ADVERTISEMENTS AND OTHER MESSAGES FOR USE WITH ELECTRONIC DISPLAYS AND SCREENS, IN CLASS 9 (U.S. CLS. 21, 23, 26, 36 AND 38).

FIRST USE 7-26-2005; IN COMMERCE 7-26-2005.

THE MARK CONSISTS OF STANDARD CHARACTERS WITHOUT CLAIM TO ANY PARTICULAR FONT, STYLE, SIZE, OR COLOR.

OWNER OF U.S. REG. NO. 3,137,337.

SEC. 2(F).

SER. NO. 85-479,992, FILED 11-23-2011.

ANDREA HACK, EXAMINING ATTORNEY



David J. Kybas

Director of the United States Patent and Trademark Office

United States of America
United States Patent and Trademark Office

CORTITRIM

Reg. No. 4,175,492

Registered July 17, 2012

Int. Cl.: 5

TRADEMARK

PRINCIPAL REGISTER

CORTISLIM INTERNATIONAL, INC. (DELAWARE CORPORATION)
28241 CROWN VALLEY PARKWAY
SUITE F-415
LAGUNA NIGUEL, CA 92677

FOR: DIETARY SUPPLEMENTS, IN CLASS 5 (U.S. CLS. 6, 18, 44, 46, 51 AND 52).

FIRST USE 11-19-2004; IN COMMERCE 11-19-2004.

THE MARK CONSISTS OF STANDARD CHARACTERS WITHOUT CLAIM TO ANY PARTICULAR FONT, STYLE, SIZE, OR COLOR.

SER. NO. 85-480,004, FILED 11-23-2011.

REBECCA POVARCHUK, EXAMINING ATTORNEY



David J. Kybas

Director of the United States Patent and Trademark Office

United States of America

United States Patent and Trademark Office

CAFÉ BUSTELO

Reg. No. 4,175,493

Registered July 17, 2012

Int. Cl.: 30

TRADEMARK

PRINCIPAL REGISTER

ROWLAND COFFEE ROASTERS, INC. (OHIO CORPORATION)
ONE STRAWBERRY LANE
ORRVILLE, OH 44667

FOR: COFFEE, IN CLASS 30 (U.S. CL. 46).

FIRST USE 9-11-1936; IN COMMERCE 9-11-1936.

THE MARK CONSISTS OF STANDARD CHARACTERS WITHOUT CLAIM TO ANY PARTICULAR FONT, STYLE, SIZE, OR COLOR.

OWNER OF U.S. REG. NOS. 864,636, 3,525,548 AND OTHERS.

NO CLAIM IS MADE TO THE EXCLUSIVE RIGHT TO USE "CAFE", APART FROM THE MARK AS SHOWN.

THE WORDING "BUSTELO" HAS NO MEANING IN A FOREIGN LANGUAGE.

SER. NO. 85-480,009, FILED 11-23-2011.

THEODORE MCBRIDE, EXAMINING ATTORNEY



David J. Kyffers

Director of the United States Patent and Trademark Office

United States of America

United States Patent and Trademark Office



Reg. No. 4,175,494

Registered July 17, 2012

Int. Cl.: 35

SERVICE MARK

PRINCIPAL REGISTER

UNITED TALENT AGENCY, INC. (CALIFORNIA CORPORATION)
9560 WILSHIRE BLVD.
BEVERLY HILLS, CA 90212

FOR: TALENT AGENCY SERVICES, IN CLASS 35 (U.S. CLS. 100, 101 AND 102).

FIRST USE 10-13-2011; IN COMMERCE 10-13-2011.

OWNER OF U.S. REG. NOS. 2,695,035 AND 3,439,155.

THE MARK CONSISTS OF "UTA".

SER. NO. 85-480,013, FILED 11-23-2011.

NICHOLAS ALTREE, EXAMINING ATTORNEY



David J. Kyffers

Director of the United States Patent and Trademark Office

United States of America

United States Patent and Trademark Office

RustBlast

Reg. No. 4,175,495

Registered July 17, 2012

Int. Cl.: 3

TRADEMARK

PRINCIPAL REGISTER

ADVANCED PROTECTIVE TECHNOLOGIES LLC (INDIANA LIMITED LIABILITY COMPANY), AKA KBS COATINGS
1101 CUMBERLAND CROSSING #180
VALPARAISO, IN 46383

FOR: RUST REMOVING PREPARATIONS, IN CLASS 3 (U.S. CLS. 1, 4, 6, 50, 51 AND 52).

FIRST USE 7-15-2006; IN COMMERCE 8-1-2006.

THE MARK CONSISTS OF STANDARD CHARACTERS WITHOUT CLAIM TO ANY PARTICULAR FONT, STYLE, SIZE, OR COLOR.

SER. NO. 85-480,020, FILED 11-23-2011.

RONALD MCMORROW, EXAMINING ATTORNEY



David J. Kyffers

Director of the United States Patent and Trademark Office

United States of America

United States Patent and Trademark Office

APPOINTY

Reg. No. 4,175,496

Registered July 17, 2012

Int. Cl.: 42

SERVICE MARK

PRINCIPAL REGISTER

APPOINTY, INC. (FLORIDA CORPORATION)
1301 EAST BROWARD BLVD, SUITE 330
FORT LAUDERDALE, FL 33301

FOR: PROVIDING ON-LINE NON-DOWNLOADABLE SOFTWARE FOR APPOINTMENT SCHEDULING; PROVIDING ACCESS TO SOFTWARE APPLICATIONS THAT PROVIDE FOR ONLINE APPOINTMENT SCHEDULING SERVICES, NAMELY, APPLICATION SERVICE PROVIDER FEATURING SOFTWARE FOR USE IN APPOINTMENT SCHEDULING, IN CLASS 42 (U.S. CLS. 100 AND 101).

FIRST USE 11-0-2006; IN COMMERCE 11-0-2006.

THE MARK CONSISTS OF STANDARD CHARACTERS WITHOUT CLAIM TO ANY PARTICULAR FONT, STYLE, SIZE, OR COLOR.

SER. NO. 85-480,032, FILED 11-23-2011.

RENEE MCCRAY, EXAMINING ATTORNEY



David J. Kyffers

Director of the United States Patent and Trademark Office

United States of America

United States Patent and Trademark Office

CANDLEBOX

Reg. No. 4,175,497

Registered July 17, 2012

Int. Cl.: 25

TRADEMARK

PRINCIPAL REGISTER

PETER KLETT (UNITED STATES INDIVIDUAL)
3RD FL
C/O NICK FERRARA, 119 5TH AVE.
NEW YORK, NY 10003 AND

KEVIN MARTIN (UNITED STATES INDIVIDUAL)
3RD FL
C/O NICK FERRARA, 119 5TH AVE.
NEW YORK, NY 10003

FOR: CLOTHING, NAMELY, T-SHIRTS, SWEATSHIRTS, HOODED SWEATSHIRTS, HATS,
IN CLASS 25 (U.S. CLS. 22 AND 39).

FIRST USE 5-1-1992; IN COMMERCE 5-1-1992.

THE MARK CONSISTS OF STANDARD CHARACTERS WITHOUT CLAIM TO ANY PAR-
TICULAR FONT, STYLE, SIZE, OR COLOR.

SER. NO. 85-480,041, FILED 11-23-2011.

JUDITH HELFMAN, EXAMINING ATTORNEY



David J. Kyros

Director of the United States Patent and Trademark Office

United States of America

United States Patent and Trademark Office

Project City Bus

Reg. No. 4,175,498

GRHK IP, LLC (FLORIDA LIMITED LIABILITY COMPANY)
12388 SW 82 AVENUE
MIAMI, FL 33156

Registered July 17, 2012

Int. Cl.: 41

FOR: ENTERTAINMENT SERVICES, NAMELY, PROVIDING A WEB SITE FEATURING PHOTOGRAPHIC, AUDIO, VIDEO AND PROSE PRESENTATIONS FEATURING ADULT-ORIENTED SUBJECT MATTER, IN CLASS 41 (U.S. CLS. 100, 101 AND 107).

SERVICE MARK

FIRST USE 11-9-2011; IN COMMERCE 11-9-2011.

PRINCIPAL REGISTER

THE MARK CONSISTS OF STANDARD CHARACTERS WITHOUT CLAIM TO ANY PARTICULAR FONT, STYLE, SIZE, OR COLOR.

SER. NO. 85-480,060, FILED 11-23-2011.

TASNEEM HUSSAIN, EXAMINING ATTORNEY



David J. Kybas

Director of the United States Patent and Trademark Office

United States of America

United States Patent and Trademark Office

ENDORECUR

Reg. No. 4,175,499

OVAGENE ONCOLOGY, INC. (CALIFORNIA CORPORATION)
10 PASTEUR, SUITE 150
IRVINE, CA 92618

Registered July 17, 2012

Int. Cls.: 42 and 44

FOR: MEDICAL LABORATORY SERVICES, IN CLASS 42 (U.S. CLS. 100 AND 101).

SERVICE MARK

FIRST USE 3-4-2011; IN COMMERCE 3-4-2011.

PRINCIPAL REGISTER

FOR: MEDICAL TESTING FOR DIAGNOSTIC OR TREATMENT PURPOSES, IN CLASS 44
(U.S. CLS. 100 AND 101).

FIRST USE 3-4-2011; IN COMMERCE 3-4-2011.

THE MARK CONSISTS OF STANDARD CHARACTERS WITHOUT CLAIM TO ANY PARTICULAR FONT, STYLE, SIZE, OR COLOR.

SER. NO. 85-480,079, FILED 11-23-2011.

LIEF MARTIN, EXAMINING ATTORNEY



David J. Kybas

Director of the United States Patent and Trademark Office

United States of America

United States Patent and Trademark Office

c:naptics



Reg. No. 4,175,500

CNAPTICS CORPORATION (DELAWARE CORPORATION)

Registered July 17, 2012

P.O. BOX 173
NEW YORK, NY 10159

Int. Cl.: 42

FOR: APPLICATION SERVICE PROVIDER, NAMELY, HOSTING, MANAGING, DEVELOPING, ANALYZING, AND MAINTAINING APPLICATIONS, SOFTWARE, AND WEB SITES, OF OTHERS IN THE FIELDS OF ADVERTISING AND MARKETING; COMPUTER SERVICES, NAMELY, PROVIDING SEARCH ENGINES FOR OBTAINING DATA ON A GLOBAL COMPUTER NETWORK; DESIGN, DEVELOPMENT AND IMPLEMENTATION OF SOFTWARE; PROVIDING COMPUTER PROGRAMMING SERVICES TO CUSTOMERS THAT ENABLES THEM TO PROVIDE VIDEO AND AUDIO CONTENT ON THEIR WEB SITES; SOFTWARE AS A SERVICE (SAAS) SERVICES FEATURING SOFTWARE FOR CREATING AND MANAGING ADVERTISING AND MARKETING MATERIALS, IN CLASS 42 (U.S. CLS. 100 AND 101).

SERVICE MARK

PRINCIPAL REGISTER

FIRST USE 10-4-2011; IN COMMERCE 10-4-2011.

THE MARK CONSISTS OF THE WORD "C:NAPTICS" IN STYLIZED FONT AND A DOWNWARD-POINTING ARROW DESIGN.

SER. NO. 85-480,093, FILED 11-23-2011.

DAVID YONTEF, EXAMINING ATTORNEY



David J. Kyffers

Director of the United States Patent and Trademark Office

United States of America

United States Patent and Trademark Office

MOMS IN BLISS

Reg. No. 4,175,501

Registered July 17, 2012

Int. Cl.: 25

TRADEMARK

PRINCIPAL REGISTER

BY AMALON (PENNSYLVANIA CORPORATION)
APT. 12303
4700 CITY AVENUE
PHILADELPHIA, PA 19131

FOR: VESTS, IN CLASS 25 (U.S. CLS. 22 AND 39).

FIRST USE 11-9-2011; IN COMMERCE 11-9-2011.

THE MARK CONSISTS OF STANDARD CHARACTERS WITHOUT CLAIM TO ANY PARTICULAR FONT, STYLE, SIZE, OR COLOR.

SER. NO. 85-480,128, FILED 11-23-2011.

LINDA MICKLEBURGH, EXAMINING ATTORNEY



David J. Kybas

Director of the United States Patent and Trademark Office

United States of America

United States Patent and Trademark Office

Hooray for Play!

Reg. No. 4,175,502

Registered July 17, 2012

Int. Cl.: 16

TRADEMARK

PRINCIPAL REGISTER

DRL BOOKS, INC. (NEW YORK CORPORATION)
10TH FLOOR
37 EAST 18TH STREET
NEW YORK, NY 10003

FOR: PRINTED INSTRUCTIONAL, EDUCATIONAL, AND TEACHING MATERIALS IN THE FIELD OF EARLY CHILDHOOD EDUCATION, IN CLASS 16 (U.S. CLS. 2, 5, 22, 23, 29, 37, 38 AND 50).

FIRST USE 10-27-2011; IN COMMERCE 10-27-2011.

THE MARK CONSISTS OF STANDARD CHARACTERS WITHOUT CLAIM TO ANY PARTICULAR FONT, STYLE, SIZE, OR COLOR.

SER. NO. 85-480,143, FILED 11-23-2011.

SHAILA SETTLES, EXAMINING ATTORNEY



David J. Kyffers

Director of the United States Patent and Trademark Office

United States of America

United States Patent and Trademark Office



Reg. No. 4,175,503

Registered July 17, 2012

Int. Cl.: 39

SERVICE MARK

PRINCIPAL REGISTER

SEAPLANES TOURS LLC (FLORIDA LIMITED LIABILITY COMPANY)
4650 NW 74TH AVENUE
MIAMI, FL 33166

FOR: AIR CHARTER SERVICES; ARRANGING TRAVEL TOURS; TRANSPORT OF TRAVELLERS; TRANSPORTATION CONSULTING SERVICES, IN CLASS 39 (U.S. CLS. 100 AND 105).

FIRST USE 11-1-2011; IN COMMERCE 11-1-2011.

THE MARK CONSISTS OF THE STYLIZED IMAGE OF A PROPELLER.

SER. NO. 85-480,153, FILED 11-23-2011.

MATTHEW EINSTEIN, EXAMINING ATTORNEY



David J. Kyffers

Director of the United States Patent and Trademark Office

United States of America

United States Patent and Trademark Office

BUSTELO COOL

Reg. No. 4,175,504

Registered July 17, 2012

Int. Cl.: 30

TRADEMARK

PRINCIPAL REGISTER

ROWLAND COFFEE ROASTERS, INC. (OHIO CORPORATION)
ONE STRAWBERRY LANE
ORRVILLE, OH 44667

FOR: COFFEE BASED BEVERAGES, IN CLASS 30 (U.S. CL. 46).

FIRST USE 12-31-2007; IN COMMERCE 12-31-2007.

THE MARK CONSISTS OF STANDARD CHARACTERS WITHOUT CLAIM TO ANY PARTICULAR FONT, STYLE, SIZE, OR COLOR.

OWNER OF U.S. REG. NOS. 864,636, 3,525,548 AND OTHERS.

THE WORDING "BUSTELO" HAS NO MEANING IN A FOREIGN LANGUAGE.

SER. NO. 85-480,177, FILED 11-23-2011.

THEODORE MCBRIDE, EXAMINING ATTORNEY



David J. Kyffers

Director of the United States Patent and Trademark Office

United States of America

United States Patent and Trademark Office



Reg. No. 4,175,505

MAYFIELD, SABRINA (UNITED STATES INDIVIDUAL), DBA GIGGLES FOR YOU
P.O. BOX 807

Registered July 17, 2012

NAVASOTA, TX 77868

Int. Cl.: 35

FOR: ON-LINE RETAIL STORE SERVICES FEATURING DVDS, CDS, BOOKS, COLORING BOOKS, CLOTHING, STATIONERY, CALENDARS, PRE-PACKAGED GOURMET FOODS AND GREETING CARDS; RETAIL STORE SERVICES FEATURING DVDS, CDS, BOOKS, COLORING BOOKS, CLOTHING, STATIONERY, CALENDARS, PRE-PACKAGED GOURMET FOODS AND GREETING CARDS, IN CLASS 35 (U.S. CLS. 100, 101 AND 102).

SERVICE MARK

PRINCIPAL REGISTER

FIRST USE 11-10-2010; IN COMMERCE 11-10-2010.

THE MARK CONSISTS OF THE STYLIZED WORD "GIGGLES" ABOVE THE WORDS "FOR YOU" IN STYLIZED FONT. A PAW PRINT FORMS THE DOT OF THE "I" IN "GIGGLES". A DRAWING OF A SMILE IS POSITIONED TO THE LEFT OF THE WORDS "FOR YOU".

SER. NO. 85-480,237, FILED 11-23-2011.

ANTHONY RINKER, EXAMINING ATTORNEY



David J. Kybas

Director of the United States Patent and Trademark Office

United States of America

United States Patent and Trademark Office

FOR THOSE WHO SERVE AND THOSE WHO SUPPORT

Reg. No. 4,175,506

Registered July 17, 2012

Int. Cl.: 35

SERVICE MARK

PRINCIPAL REGISTER

DEPARTMENT OF DEFENSE (UNITED STATES AGENCY OF THE UNITED STATES
GOVERNMENT)
THE PENTAGON
WASHINGTON, DC 20301

FOR: PROMOTING PUBLIC AWARENESS OF THE RESOURCES, BENEFITS AND SUPPORT
SERVICES AVAILABLE TO MEMBERS OF THE U.S. MILITARY AND THEIR FAMILIES
BEFORE, DURING AND AFTER DEPLOYMENTS, IN CLASS 35 (U.S. CLS. 100, 101 AND
102).

FIRST USE 0-0-2008; IN COMMERCE 0-0-2008.

THE MARK CONSISTS OF STANDARD CHARACTERS WITHOUT CLAIM TO ANY PAR-
TICULAR FONT, STYLE, SIZE, OR COLOR.

SER. NO. 85-480,280, FILED 11-23-2011.

DAVID ELTON, EXAMINING ATTORNEY



David J. Kyffers

Director of the United States Patent and Trademark Office

United States of America

United States Patent and Trademark Office

QUOTIT

Reg. No. 4,175,507

Registered July 17, 2012

Int. Cl.: 36

SERVICE MARK

PRINCIPAL REGISTER

WORD & BROWN INSURANCE ADMINISTRATORS, INC. (CALIFORNIA CORPORATION)
SUITE 300
721 SOUTH PARKER
ORANGE, CA 92868

FOR: PROVIDING INFORMATION IN THE FIELD OF INSURANCE AND FINANCIAL SERVICES, NAMELY, PROVIDING QUOTES FOR HEALTH INSURANCE, LIFE INSURANCE, DENTAL INSURANCE, VISION INSURANCE, AND LONG TERM DISABILITY INSURANCE, IN CLASS 36 (U.S. CLS. 100, 101 AND 102).

FIRST USE 7-1-1997; IN COMMERCE 7-1-1997.

THE MARK CONSISTS OF STANDARD CHARACTERS WITHOUT CLAIM TO ANY PARTICULAR FONT, STYLE, SIZE, OR COLOR.

SER. NO. 85-480,285, FILED 11-23-2011.

KATINA MISTER, EXAMINING ATTORNEY



David J. Kybas

Director of the United States Patent and Trademark Office

United States of America

United States Patent and Trademark Office

Mr. Thirsty

Reg. No. 4,175,508

ZIRC COMPANY (MINNESOTA CORPORATION)
3918 HIGHWAY 55 SE
BUFFALO, MN 55313

Registered July 17, 2012

Int. Cl.: 10

FOR: SALIVA EJECTOR FOR USE IN DENTAL PROCEDURES, IN CLASS 10 (U.S. CLS. 26, 39 AND 44).

TRADEMARK

FIRST USE 6-15-1998; IN COMMERCE 6-15-1998.

PRINCIPAL REGISTER

THE MARK CONSISTS OF STANDARD CHARACTERS WITHOUT CLAIM TO ANY PARTICULAR FONT, STYLE, SIZE, OR COLOR.

SER. NO. 85-480,286, FILED 11-23-2011.

WENDY JUN, EXAMINING ATTORNEY



David J. Kyffers

Director of the United States Patent and Trademark Office

United States of America

United States Patent and Trademark Office

TOTAL FREEDOM DENTAL IMPLANT CENTER

Reg. No. 4,175,509

SIMS, THOMAS (UNITED STATES INDIVIDUAL)
9002 E. DESERT COVE AVE.
SCOTTSDALE, AZ 85260

Registered July 17, 2012

Int. Cl.: 44

FOR: ORAL SURGERY AND DENTAL IMPLANT SERVICES; DENTAL HYGIENIST SERVICES; DENTIST SERVICES, IN CLASS 44 (U.S. CLS. 100 AND 101).

SERVICE MARK

FIRST USE 7-30-2010; IN COMMERCE 8-9-2011.

PRINCIPAL REGISTER

THE MARK CONSISTS OF STANDARD CHARACTERS WITHOUT CLAIM TO ANY PARTICULAR FONT, STYLE, SIZE, OR COLOR.

NO CLAIM IS MADE TO THE EXCLUSIVE RIGHT TO USE "DENTAL IMPLANT CENTER", APART FROM THE MARK AS SHOWN.

SER. NO. 85-480,292, FILED 11-23-2011.

TINA MAI, EXAMINING ATTORNEY



David J. Kyffers

Director of the United States Patent and Trademark Office

United States of America

United States Patent and Trademark Office

TrendLend

Reg. No. 4,175,510

TRENLEND LLC (NEW JERSEY LIMITED LIABILITY COMPANY)
2475 ARBOR COURT

Registered July 17, 2012

MAYS LANDING, NJ 08330

Int. Cl.: 42

FOR: COMPUTER SERVICES, NAMELY, CREATING AN ON-LINE COMMUNITY FOR REGISTERED USERS TO PARTICIPATE IN DISCUSSIONS, GET FEEDBACK FROM THEIR PEERS, FORM VIRTUAL COMMUNITIES, AND ENGAGE IN SOCIAL NETWORKING SERVICES IN THE FIELD OF FASHION, IN CLASS 42 (U.S. CLS. 100 AND 101).

SERVICE MARK

PRINCIPAL REGISTER

FIRST USE 8-25-2011; IN COMMERCE 8-25-2011.

THE MARK CONSISTS OF STANDARD CHARACTERS WITHOUT CLAIM TO ANY PARTICULAR FONT, STYLE, SIZE, OR COLOR.

SER. NO. 85-480,310, FILED 11-23-2011.

ANNE MADDEN, EXAMINING ATTORNEY



David J. Kyffers

Director of the United States Patent and Trademark Office

United States of America

United States Patent and Trademark Office

TRENLEND

Reg. No. 4,175,511

TRENLEND LLC (NEW JERSEY LIMITED LIABILITY COMPANY)
2475 ARBOR COURT

Registered July 17, 2012

MAYS LANDING, NJ 08330

Int. Cl.: 42

FOR: COMPUTER SERVICES, NAMELY, CREATING AN ON-LINE COMMUNITY FOR REGISTERED USERS TO PARTICIPATE IN DISCUSSIONS, GET FEEDBACK FROM THEIR PEERS, FORM VIRTUAL COMMUNITIES, AND ENGAGE IN SOCIAL NETWORKING SERVICES IN THE FIELD OF FASHION, IN CLASS 42 (U.S. CLS. 100 AND 101).

SERVICE MARK

PRINCIPAL REGISTER

FIRST USE 8-25-2011; IN COMMERCE 11-15-2011.

THE MARK CONSISTS OF THE WORD "TRENLEND" IN A PARTICULAR FONT.

SER. NO. 85-480,327, FILED 11-23-2011.

ANNE MADDEN, EXAMINING ATTORNEY



David J. Kyffers

Director of the United States Patent and Trademark Office

United States of America

United States Patent and Trademark Office



Reg. No. 4,175,512

Registered July 17, 2012

Int. Cl.: 35

SERVICE MARK

PRINCIPAL REGISTER

DEPARTMENT OF DEFENSE (UNITED STATES AGENCY OF THE UNITED STATES GOVERNMENT)
THE PENTAGON
WASHINGTON, DC 20301

FOR: PROMOTING PUBLIC AWARENESS OF THE RESOURCES, BENEFITS AND SUPPORT SERVICES AVAILABLE TO MEMBERS OF THE U.S. MILITARY AND THEIR FAMILIES BEFORE, DURING AND AFTER DEPLOYMENTS, IN CLASS 35 (U.S. CLS. 100, 101 AND 102).

FIRST USE 2-0-2009; IN COMMERCE 2-0-2009.

THE MARK CONSISTS OF A STYLIZED YELLOW RIBBON CURVED TO SUGGEST THE LETTER R APPEARING IN FRONT OF A PURPLE RECTANGLE.

THE COLOR(S) YELLOW AND PURPLE IS/ARE CLAIMED AS A FEATURE OF THE MARK.

SER. NO. 85-480,330, FILED 11-23-2011.

DAVID ELTON, EXAMINING ATTORNEY



David J. Kyffers

Director of the United States Patent and Trademark Office

United States of America

United States Patent and Trademark Office

TRIPLE TOWN

Reg. No. 4,175,513

SPRY FOX LLC (WASHINGTON LIMITED LIABILITY COMPANY)
8730 NE 124TH STREET
KIRKLAND, WA 98043

Registered July 17, 2012

Int. Cl.: 9

FOR: COMPUTER GAME SOFTWARE FOR PERSONAL COMPUTERS AND HOME VIDEO GAME CONSOLES; COMPUTER GAME SOFTWARE FOR USE ON MOBILE AND CELLULAR PHONES; ELECTRONIC GAME SOFTWARE FOR WIRELESS DEVICES, IN CLASS 9 (U.S. CLS. 21, 23, 26, 36 AND 38).

TRADEMARK

PRINCIPAL REGISTER

FIRST USE 10-14-2010; IN COMMERCE 10-14-2010.

THE MARK CONSISTS OF STANDARD CHARACTERS WITHOUT CLAIM TO ANY PARTICULAR FONT, STYLE, SIZE, OR COLOR.

SER. NO. 85-480,331, FILED 11-23-2011.

DAVID ELTON, EXAMINING ATTORNEY



David J. Kyffers

Director of the United States Patent and Trademark Office

United States of America

United States Patent and Trademark Office

LOADMASTER

Reg. No. 4,175,514

HOLTGREVEN SCALE & ELECTRONICS CORPORATION (OHIO CORPORATION)
420 EAST LINCOLN STREET
FINDLAY, OH 45840

Registered July 17, 2012

Int. Cl.: 9

FOR: WEIGHING MACHINES; WEIGHING SCALES, IN CLASS 9 (U.S. CLS. 21, 23, 26, 36 AND 38).

TRADEMARK

FIRST USE 11-17-1978; IN COMMERCE 11-17-1978.

PRINCIPAL REGISTER

THE MARK CONSISTS OF STANDARD CHARACTERS WITHOUT CLAIM TO ANY PARTICULAR FONT, STYLE, SIZE, OR COLOR.

SER. NO. 85-480,342, FILED 11-23-2011.

ANNE MADDEN, EXAMINING ATTORNEY



David J. Kyffers

Director of the United States Patent and Trademark Office

United States of America
United States Patent and Trademark Office

PICASSO

Reg. No. 4,175,515

Registered July 17, 2012

Int. Cl.: 5

TRADEMARK

PRINCIPAL REGISTER

MYCONE DENTAL SUPPLY CO., INC. (NEW YORK CORPORATION), AKA LINCOLN
DENTAL SUPPLY
616 HOLLYWOOD AVENUE
CHERRY HILL, NJ 08002

FOR: DENTAL WAX, IN CLASS 5 (U.S. CLS. 6, 18, 44, 46, 51 AND 52).

FIRST USE 10-31-2011; IN COMMERCE 10-31-2011.

THE MARK CONSISTS OF STANDARD CHARACTERS WITHOUT CLAIM TO ANY PARTICULAR FONT, STYLE, SIZE, OR COLOR.

SER. NO. 85-480,349, FILED 11-23-2011.

LESLIE RICHARDS, EXAMINING ATTORNEY



David J. Kyffers

Director of the United States Patent and Trademark Office

United States of America

United States Patent and Trademark Office

ATTACK STINK

Reg. No. 4,175,516

Registered July 17, 2012

Int. Cl.: 5

TRADEMARK

PRINCIPAL REGISTER

NATURE'S APPEAL MANUFACTURING CORPORATION (ILLINOIS CORPORATION)
1788 WHISPERING COURT
ADDISON, IL 60101

FOR: AIR DEODORIZER; AIR PURIFYING PREPARATIONS; DEODORIZING PRODUCTS, NAMELY, ALL PURPOSE DEODORIZER PREPARATIONS FOR HOUSEHOLD, COMMERCIAL AND INDUSTRIAL USE, IN CLASS 5 (U.S. CLS. 6, 18, 44, 46, 51 AND 52).

FIRST USE 7-14-2010; IN COMMERCE 7-14-2010.

THE MARK CONSISTS OF STANDARD CHARACTERS WITHOUT CLAIM TO ANY PARTICULAR FONT, STYLE, SIZE, OR COLOR.

NO CLAIM IS MADE TO THE EXCLUSIVE RIGHT TO USE "STINK", APART FROM THE MARK AS SHOWN.

SER. NO. 85-480,360, FILED 11-23-2011.

LESLIE RICHARDS, EXAMINING ATTORNEY



David J. Kyffers

Director of the United States Patent and Trademark Office

United States of America

United States Patent and Trademark Office

PICASSO

Reg. No. 4,175,517

Registered July 17, 2012

Int. Cl.: 5

TRADEMARK

PRINCIPAL REGISTER

MYCONE DENTAL SUPPLY CO., INC. (NEW YORK CORPORATION), AKA LINCOLN
DENTAL SUPPLY
616 HOLLYWOOD AVENUE
CHERRY HILL, NJ 08002

FOR: DENTAL WAX, IN CLASS 5 (U.S. CLS. 6, 18, 44, 46, 51 AND 52).

FIRST USE 10-31-2011; IN COMMERCE 10-31-2011.

THE MARK CONSISTS OF A STYLIZED VERSION OF THE WORD "PICASSO".

SER. NO. 85-480,361, FILED 11-23-2011.

LESLIE RICHARDS, EXAMINING ATTORNEY



David J. Kybas

Director of the United States Patent and Trademark Office

United States of America

United States Patent and Trademark Office



Reg. No. 4,175,518

Registered July 17, 2012

Int. Cl.: 25

TRADEMARK

PRINCIPAL REGISTER

D9 COLLECTION, LLC (CALIFORNIA LIMITED LIABILITY COMPANY)
1839 W. 169TH ST. SUITE A
GARDENA, CA 90247

FOR: APPAREL, NAMELY, SHIRTS, PANTS, HATS, SHORTS, SWEATERS, JACKETS, SCARVES, GLOVES, SHOES, SOCKS AND UNDERGARMENTS, IN CLASS 25 (U.S. CLS. 22 AND 39).

FIRST USE 1-16-2010; IN COMMERCE 1-16-2010.

THE MARK CONSISTS OF THE DELTA SYMBOL WHICH IS AN ISOSCELES TRIANGLE WITH A "D" IN ITS CENTER AND A NUMERIC "9" TO THE RIGHT OF THE TRIANGLE WITH "RESERVE" WRITTEN IN CAPITAL LETTERS BENEATH THE BASE OF THE DELTA SYMBOL.

SER. NO. 85-480,412, FILED 11-23-2011.

NAAKWAMA ANKRAH, EXAMINING ATTORNEY



David J. Kyffers

Director of the United States Patent and Trademark Office

United States of America

United States Patent and Trademark Office

DEZSO

Reg. No. 4,175,519

BELTRAN, SARA ISABEL (UNITED STATES INDIVIDUAL)
374 MORNING STAR
EL PASO, TX 79912

Registered July 17, 2012

Int. Cl.: 14

FOR: JEWELRY, IN CLASS 14 (U.S. CLS. 2, 27, 28 AND 50).

TRADEMARK

FIRST USE 0-0-2004; IN COMMERCE 0-0-2004.

PRINCIPAL REGISTER

THE MARK CONSISTS OF STANDARD CHARACTERS WITHOUT CLAIM TO ANY PARTICULAR FONT, STYLE, SIZE, OR COLOR.

SER. NO. 85-480,432, FILED 11-23-2011.

JEFF DEFORD, EXAMINING ATTORNEY



David J. Kyffers

Director of the United States Patent and Trademark Office

United States of America

United States Patent and Trademark Office

RICHWOODS

Reg. No. 4,175,520

RICHWOODS DEVELOPMENT, LLC (TEXAS LIMITED LIABILITY COMPANY)
4050 W. PARK BLVD.
PLANO, TX 75093

Registered July 17, 2012

Int. Cl.: 37

FOR: PLANNING AND LAYING OUT OF RESIDENTIAL COMMUNITIES, RECREATIONAL FACILITIES, SOCIAL AND COMMUNITY FACILITIES; REAL ESTATE DEVELOPMENT SERVICES, IN CLASS 37 (U.S. CLS. 100, 103 AND 106).

SERVICE MARK

FIRST USE 7-1-2011; IN COMMERCE 7-1-2011.

PRINCIPAL REGISTER

THE MARK CONSISTS OF STANDARD CHARACTERS WITHOUT CLAIM TO ANY PARTICULAR FONT, STYLE, SIZE, OR COLOR.

SER. NO. 85-480,456, FILED 11-23-2011.

CHRISTOPHER BUONGIORNO, EXAMINING ATTORNEY



David J. Kybas

Director of the United States Patent and Trademark Office

United States of America

United States Patent and Trademark Office

OFFERPOP

Reg. No. 4,175,521

Registered July 17, 2012

Int. Cl.: 35

SERVICE MARK

PRINCIPAL REGISTER

OFFERPOP CORPORATION (DELAWARE CORPORATION)
25 W. 36TH STREET, 11TH FLOOR
NEW YORK, NY 10018

FOR: ADVERTISING, MARKETING AND PROMOTION SERVICES PROVIDED BY MEANS OF DIRECT AND INDIRECT METHODS OF MARKETING COMMUNICATIONS, NAMELY, SOCIAL MEDIA, E-MAIL BLAST CAMPAIGNS, MOBILE MARKETING, SEARCH ENGINE MARKETING, INQUIRY MARKETING, INTERNET MARKETING, BLOGGING AND OTHER FORMS OF PASSIVE, SHARABLE OR VIRAL COMMUNICATIONS CHANNELS, IN CLASS 35 (U.S. CLS. 100, 101 AND 102).

FIRST USE 2-18-2010; IN COMMERCE 2-18-2010.

THE MARK CONSISTS OF STANDARD CHARACTERS WITHOUT CLAIM TO ANY PARTICULAR FONT, STYLE, SIZE, OR COLOR.

SER. NO. 85-480,459, FILED 11-23-2011.

JENNIFER MARTIN, EXAMINING ATTORNEY



David J. Kyffers

Director of the United States Patent and Trademark Office

United States of America

United States Patent and Trademark Office

LIST

Reg. No. 4,175,522

Registered July 17, 2012

Int. Cl.: 1

TRADEMARK

PRINCIPAL REGISTER

LIST BIOLOGICAL LABORATORIES, INC. (CALIFORNIA CORPORATION)
540 DIVISION STREET
SAN JOSE, CA 95008

FOR: CHEMICALS FOR USE IN SCIENTIFIC RESEARCH, NAMELY, AMINO ACIDS, POLYPEPTIDES, PEPTIDES, NEUROTOXIN FROM BACTERIA, ANTISERA AND INMMUNOTOXINS, LIPOPOLYSACCHARIDES; CHEMICAL ANALYSIS KITS FOR TESTING NEUROTOXIN AND OTHER TOXINS, IN CLASS 1 (U.S. CLS. 1, 5, 6, 10, 26 AND 46).

FIRST USE 12-31-1978; IN COMMERCE 8-22-1983.

THE MARK CONSISTS OF STANDARD CHARACTERS WITHOUT CLAIM TO ANY PARTICULAR FONT, STYLE, SIZE, OR COLOR.

OWNER OF U.S. REG. NO. 2,945,893.

SER. NO. 85-480,461, FILED 11-23-2011.

JOHN HWANG, EXAMINING ATTORNEY



David J. Kyjars

Director of the United States Patent and Trademark Office

United States of America

United States Patent and Trademark Office

Skilloy

Reg. No. 4,175,523

Registered July 17, 2012

Int. Cl.: 35

SERVICE MARK

PRINCIPAL REGISTER

SKILLOY, INC. (DELAWARE CORPORATION)
5725 COMMONWEALTH BLVD.
SUGARLAND, TX 77479

FOR: PROVIDING A WEBSITE FEATURING AN ONLINE MARKETPLACE FOR EXCHANGING GOODS AND SERVICES WITH OTHER USERS, IN CLASS 35 (U.S. CLS. 100, 101 AND 102).

FIRST USE 9-6-2011; IN COMMERCE 10-11-2011.

THE MARK CONSISTS OF STANDARD CHARACTERS WITHOUT CLAIM TO ANY PARTICULAR FONT, STYLE, SIZE, OR COLOR.

SER. NO. 85-480,462, FILED 11-23-2011.

JENNIFER MARTIN, EXAMINING ATTORNEY



David J. Kyros

Director of the United States Patent and Trademark Office

United States of America

United States Patent and Trademark Office

LIST

Reg. No. 4,175,524

Registered July 17, 2012

Int. Cl.: 42

SERVICE MARK

PRINCIPAL REGISTER

LIST BIOLOGICAL LABORATORIES, INC. (CALIFORNIA CORPORATION)
540 DIVISION ST.
SAN JOSE, CA 95008

FOR: CHEMICAL LABORATORIES; CHEMICAL RESEARCH; CHEMICAL ANALYSIS, IN CLASS 42 (U.S. CLS. 100 AND 101).

FIRST USE 12-31-1978; IN COMMERCE 8-22-1983.

THE MARK CONSISTS OF STANDARD CHARACTERS WITHOUT CLAIM TO ANY PARTICULAR FONT, STYLE, SIZE, OR COLOR.

OWNER OF U.S. REG. NO. 2,945,893.

SER. NO. 85-480,488, FILED 11-23-2011.

JOHN HWANG, EXAMINING ATTORNEY



David J. Kyffers

Director of the United States Patent and Trademark Office

United States of America

United States Patent and Trademark Office

BOLT

Reg. No. 4,175,525

BOLT CYCLING LLC (OREGON LIMITED LIABILITY COMPANY)
19445 AMBER MEADOW DRIVE
BEND, OR 97702

Registered July 17, 2012

Int. Cl.: 12

FOR: WHEELS FOR BICYCLES, CYCLES, IN CLASS 12 (U.S. CLS. 19, 21, 23, 31, 35 AND 44).

TRADEMARK

FIRST USE 10-28-2011; IN COMMERCE 11-18-2011.

PRINCIPAL REGISTER

THE MARK CONSISTS OF STANDARD CHARACTERS WITHOUT CLAIM TO ANY PARTICULAR FONT, STYLE, SIZE, OR COLOR.

SER. NO. 85-480,503, FILED 11-23-2011.

JENNIFER MARTIN, EXAMINING ATTORNEY



David J. Kyffers

Director of the United States Patent and Trademark Office

United States of America

United States Patent and Trademark Office

FASTRACK DIVORCE

Reg. No. 4,175,526

Registered July 17, 2012

Int. Cl.: 35

SERVICE MARK

PRINCIPAL REGISTER

FASTRACK DIVORCE, LLC (WASHINGTON LIMITED LIABILITY COMPANY)
5400 CARILLON POINT, BLDG. 5000, 4TH FL.
KIRKLAND, WA 98033

FOR: ATTORNEY REFERRALS, IN CLASS 35 (U.S. CLS. 100, 101 AND 102).

FIRST USE 6-10-2010; IN COMMERCE 8-4-2010.

THE MARK CONSISTS OF STANDARD CHARACTERS WITHOUT CLAIM TO ANY PARTICULAR FONT, STYLE, SIZE, OR COLOR.

NO CLAIM IS MADE TO THE EXCLUSIVE RIGHT TO USE "DIVORCE", APART FROM THE MARK AS SHOWN.

SER. NO. 85-480,512, FILED 11-23-2011.

BARBARA GAYNOR, EXAMINING ATTORNEY



David J. Kyffers

Director of the United States Patent and Trademark Office

United States of America

United States Patent and Trademark Office

CRADLEPEDIC

Reg. No. 4,175,527

JEFFCO FIBRES, INC. (MASSACHUSETTS CORPORATION)
12 PARK STREET
WEBSTER, MA 01570

Registered July 17, 2012

Int. Cl.: 20

FOR: BED PILLOWS; HEAD SUPPORTING PILLOWS; NECK-SUPPORTING PILLOWS;
PILLOWS, IN CLASS 20 (U.S. CLS. 2, 13, 22, 25, 32 AND 50).

TRADEMARK

FIRST USE 1-31-2011; IN COMMERCE 1-31-2011.

PRINCIPAL REGISTER

THE MARK CONSISTS OF STANDARD CHARACTERS WITHOUT CLAIM TO ANY PARTICULAR FONT, STYLE, SIZE, OR COLOR.

SER. NO. 85-480,552, FILED 11-23-2011.

ANTHONY RINKER, EXAMINING ATTORNEY



David J. Kybas

Director of the United States Patent and Trademark Office

United States of America

United States Patent and Trademark Office

ZAYCON

Reg. No. 4,175,528

ZAYCON FOODS, LLC (WASHINGTON LIMITED LIABILITY COMPANY)
16114 E. INDIANA AVE, STE 115
VERADALE, AZ 99037

Registered July 17, 2012

Int. Cls.: 29 and 35

FOR: MEAT, IN CLASS 29 (U.S. CL. 46).

TRADEMARK

FIRST USE 9-30-2009; IN COMMERCE 10-31-2009.

SERVICE MARK

FOR: WHOLESALE FOOD DISTRIBUTORSHIP SERVICES, IN CLASS 35 (U.S. CLS. 100, 101 AND 102).

PRINCIPAL REGISTER

FIRST USE 9-30-2009; IN COMMERCE 10-31-2009.

THE MARK CONSISTS OF STANDARD CHARACTERS WITHOUT CLAIM TO ANY PARTICULAR FONT, STYLE, SIZE, OR COLOR.

SER. NO. 85-480,604, FILED 11-23-2011.

DOMINIC FATHY, EXAMINING ATTORNEY



David J. Kybas

Director of the United States Patent and Trademark Office

United States of America

United States Patent and Trademark Office

ZAYCON FOODS

Reg. No. 4,175,529

ZAYCON FOODS, LLC (WASHINGTON LIMITED LIABILITY COMPANY)
16114 E. INDIANA AVE, STE 115
VERADALE, AZ 99037

Registered July 17, 2012

Int. Cls.: 29 and 35

FOR: MEAT, IN CLASS 29 (U.S. CL. 46).

TRADEMARK

FIRST USE 9-30-2009; IN COMMERCE 10-31-2009.

SERVICE MARK

FOR: WHOLESALE FOOD DISTRIBUTORSHIP SERVICES, IN CLASS 35 (U.S. CLS. 100, 101 AND 102).

PRINCIPAL REGISTER

FIRST USE 9-30-2009; IN COMMERCE 10-31-2009.

THE MARK CONSISTS OF STANDARD CHARACTERS WITHOUT CLAIM TO ANY PARTICULAR FONT, STYLE, SIZE, OR COLOR.

NO CLAIM IS MADE TO THE EXCLUSIVE RIGHT TO USE "FOODS", APART FROM THE MARK AS SHOWN.

SER. NO. 85-480,605, FILED 11-23-2011.

DOMINIC FATHY, EXAMINING ATTORNEY



David J. Kybas

Director of the United States Patent and Trademark Office

United States of America

United States Patent and Trademark Office

YOU'RE SMART. GET HIRED.

Reg. No. 4,175,530

Registered July 17, 2012

Int. Cl.: 35

SERVICE MARK

PRINCIPAL REGISTER

REEVES, LARRY (UNITED STATES INDIVIDUAL)
221 OLD HICKORY ROAD
WOODSTOCK, GA 30188

FOR: EMPLOYMENT AGENCIES; EMPLOYMENT COUNSELING AND RECRUITING;
PROVIDING ON-LINE INTERACTIVE EMPLOYMENT COUNSELING AND RECRUITMENT
SERVICES; PROVIDING ON-LINE EMPLOYMENT PLACEMENT SERVICES, NAMELY,
MATCHING RESUMES AND POTENTIAL EMPLOYERS VIA A GLOBAL COMPUTER
NETWORK, IN CLASS 35 (U.S. CLS. 100, 101 AND 102).

FIRST USE 2-1-2011; IN COMMERCE 10-21-2011.

THE MARK CONSISTS OF STANDARD CHARACTERS WITHOUT CLAIM TO ANY PAR-
TICULAR FONT, STYLE, SIZE, OR COLOR.

SER. NO. 85-480,628, FILED 11-24-2011.

SANDRA BUJA, EXAMINING ATTORNEY



David J. Kyffers

Director of the United States Patent and Trademark Office

United States of America

United States Patent and Trademark Office

MADATHLETE

Reg. No. 4,175,531

AREQUIP, LLC (MASSACHUSETTS LIMITED LIABILITY COMPANY)
40 TOWN WAY
WINCHESTER, MA 01890

Registered July 17, 2012

Int. Cl.: 35

FOR: RETAIL STORE AND ONLINE RETAIL STORE SERVICES FEATURING GEAR FOR CYCLISTS, CLIMBERS, CAMPERS, TREKKERS, PADDLERS, TRIATHLETES, TRAIL RUNNERS AND ADVENTURE RACERS , IN CLASS 35 (U.S. CLS. 100, 101 AND 102).

SERVICE MARK

FIRST USE 4-17-2007; IN COMMERCE 8-21-2007.

PRINCIPAL REGISTER

THE MARK CONSISTS OF STANDARD CHARACTERS WITHOUT CLAIM TO ANY PARTICULAR FONT, STYLE, SIZE, OR COLOR.

SER. NO. 85-480,637, FILED 11-24-2011.

EVELYN BRADLEY, EXAMINING ATTORNEY



David J. Kyros

Director of the United States Patent and Trademark Office

United States of America

United States Patent and Trademark Office

BPSX

Reg. No. 4,175,532

Registered July 17, 2012

Int. Cl.: 9

TRADEMARK

PRINCIPAL REGISTER

APSX, LLC (OHIO LIMITED LIABILITY COMPANY), AKA BETTERPARTX.COM
11192 SNIDER RD
CINCINNATI, OH 45249

FOR: AUTOMOTIVE MEASURING INSTRUMENTS, NAMELY, WATER TEMPERATURE GAUGES, AIR FUEL/RATIO GAUGES, BOOST GAUGES, VACUUM GAUGES AND EXHAUST GAS TEMPERATURE GAUGES; ELECTRONIC CONTROLS FOR MOTORS, IN CLASS 9 (U.S. CLS. 21, 23, 26, 36 AND 38).

FIRST USE 12-1-2010; IN COMMERCE 12-3-2010.

THE MARK CONSISTS OF STANDARD CHARACTERS WITHOUT CLAIM TO ANY PARTICULAR FONT, STYLE, SIZE, OR COLOR.

SER. NO. 85-480,692, FILED 11-24-2011.

SUSAN STIGLITZ, EXAMINING ATTORNEY



David J. Kyffers

Director of the United States Patent and Trademark Office

United States of America

United States Patent and Trademark Office

AgroPOD

Reg. No. 4,175,533

CUTTER, ERIK C (UNITED STATES INDIVIDUAL)
1575 BLUEBIRD CANYON DRIVE
LAGUNA BEACH, CA 92651

Registered July 17, 2012

Int. Cl.: 11

FOR: AEROPONIC GROW CABINET IN THE NATURE OF A CLOSED ENVIRONMENT WITH LIGHTS, EXHAUST SYSTEM, AEROPONIC MISTING CHAMBER AND AUTOMATED CONTROL SYSTEM; AIR-CONDITIONING, AIR COOLING AND VENTILATION APPARATUS AND INSTRUMENTS; HYDROPONICS GROW BOX IN THE NATURE OF A CLOSED ENVIRONMENT EQUIPPED WITH LIGHTS, EXHAUST SYSTEM, HYDROPONICS GROWING CONTAINER AND ODOR CONTROL SYSTEM; LED (LIGHT EMITTING DIODE) LIGHTING FIXTURES; LIGHT EMITTING DIODE (LED) PLANT GROW LIGHT; LIGHTS FOR USE IN GROWING PLANTS; SOLAR COLLECTORS; SOLAR LIGHT FIXTURES, NAMELY, INDOOR AND OUTDOOR SOLAR POWERED LIGHTING UNITS AND FIXTURES; SOLAR THERMAL AIR SYSTEMS FOR HEATING PURPOSES; SOLAR-POWERED COOLING UNITS; VENTILATING EXHAUST FANS, IN CLASS 11 (U.S. CLS. 13, 21, 23, 31 AND 34).

TRADEMARK

PRINCIPAL REGISTER

FIRST USE 5-1-2011; IN COMMERCE 5-1-2011.

THE MARK CONSISTS OF STANDARD CHARACTERS WITHOUT CLAIM TO ANY PARTICULAR FONT, STYLE, SIZE, OR COLOR.

SER. NO. 85-480,710, FILED 11-24-2011.

FLORENTINA BLANDU, EXAMINING ATTORNEY



David J. Kyffers

Director of the United States Patent and Trademark Office

United States of America
United States Patent and Trademark Office

Hintworthy

Reg. No. 4,175,534

HINTWORTHY, LLC (MINNESOTA LIMITED LIABILITY COMPANY)
1009 PARK AVENUE #301
MINNEAPOLIS, MN 55404

Registered July 17, 2012

Int. Cl.: 38

FOR: DELIVERY OF PERSONALIZED GIFT SUGGESTIONS THROUGH ELECTRONIC COMMUNICATIONS, IN CLASS 38 (U.S. CLS. 100, 101 AND 104).

SERVICE MARK

FIRST USE 10-30-2011; IN COMMERCE 11-24-2011.

PRINCIPAL REGISTER

THE MARK CONSISTS OF STANDARD CHARACTERS WITHOUT CLAIM TO ANY PARTICULAR FONT, STYLE, SIZE, OR COLOR.

SER. NO. 85-480,724, FILED 11-24-2011.

DAVID MURRAY, EXAMINING ATTORNEY



David J. Kybas

Director of the United States Patent and Trademark Office

United States of America

United States Patent and Trademark Office

COOL AND CHILL

Reg. No. 4,175,535

Registered July 17, 2012

Int. Cl.: 30

TRADEMARK

PRINCIPAL REGISTER

COOL AND CHILL INC. (CALIFORNIA CORPORATION)
140 HILLSHIRE CIRCLE
CORONA, CA 92882

FOR: ICE CREAM, IN CLASS 30 (U.S. CL. 46).

FIRST USE 3-20-2009; IN COMMERCE 3-20-2009.

THE MARK CONSISTS OF STANDARD CHARACTERS WITHOUT CLAIM TO ANY PARTICULAR FONT, STYLE, SIZE, OR COLOR.

SER. NO. 85-480,752, FILED 11-25-2011.

JENNIFER WILLISTON, EXAMINING ATTORNEY



David J. Kyffers

Director of the United States Patent and Trademark Office

United States of America

United States Patent and Trademark Office



Reg. No. 4,175,536

NATURE'S NUTRITIONAL LABS LLC (TEXAS LIMITED LIABILITY COMPANY)
11700 PRESTON ROAD, SUITE 660-339
DALLAS, TX 75230

Registered July 17, 2012

Int. Cl.: 5

FOR: BABY FOOD; INFANT FORMULA, IN CLASS 5 (U.S. CLS. 6, 18, 44, 46, 51 AND 52).

FIRST USE 9-1-2011; IN COMMERCE 9-1-2011.

TRADEMARK

NO CLAIM IS MADE TO THE EXCLUSIVE RIGHT TO USE "BABY FORMULA", APART FROM THE MARK AS SHOWN.

PRINCIPAL REGISTER

THE MARK CONSISTS OF THE WORDING "NATURE'S BABY FORMULA" WHEREIN THE APOSTROPHE IS DEPICTED AS A HEART DESIGN, FLANKED BY TWO STYLIZED LEAF DESIGNS, ALL INSIDE A RECTANGULAR SHAPED BANNER WITH SHADING ALONG THE UPPER LEFT AND LOWER RIGHT CORNERS.

SER. NO. 85-480,758, FILED 11-25-2011.

AMY KELLY, EXAMINING ATTORNEY



David J. Kybas

Director of the United States Patent and Trademark Office

United States of America

United States Patent and Trademark Office

peis

Reg. No. 4,175,537

Registered July 17, 2012

Int. Cl.: 9

TRADEMARK

PRINCIPAL REGISTER

LI ZHE (CHINA INDIVIDUAL)
ZHUANGYUAN TOWN, LONGWAN ZONE
SHANGJING, SANLANGQIAO VILLAGE
WENZHOU, ZHEJIANG, CHINA AND

LI YIHAI (CHINA INDIVIDUAL)
NO 1, 46 LANE, HANGBIAO ROAD
HONGDIAN STREET, LUCHENG ZONE
WENZHOU, ZHEJIANG, CHINA

FOR: AUTOMATIC ELECTRICAL DISTRIBUTION APPARATUS; CINEMATOGRAPHIC MACHINES AND APPARATUS; DIGITAL SIGNAL PROCESSORS; ELECTRICAL AND OPTICAL CABLES; LIFE JACKETS; RADIATION-MEASURING INSTRUMENTS; RADIO RECEIVERS AND RADIO SIGNAL TUNERS; SURVEYING INSTRUMENTS; TECHNICAL MEASURING, TESTING AND CHECKING APPARATUS AND INSTRUMENTS FOR MEASURING, TESTING AND CHECKING THE TEMPERATURE, PRESSURE, QUANTITY AND CONCENTRATION OF GAS AND LIQUIDS; VIDEO DISC PLAYERS, IN CLASS 9 (U.S. CLS. 21, 23, 26, 36 AND 38).

FIRST USE 2-1-2005; IN COMMERCE 3-1-2009.

THE MARK CONSISTS OF STANDARD CHARACTERS WITHOUT CLAIM TO ANY PARTICULAR FONT, STYLE, SIZE, OR COLOR.

THE WORDING "PEIS" HAS NO MEANING IN A FOREIGN LANGUAGE.

SER. NO. 85-480,766, FILED 11-25-2011.

JENNIFER WILLISTON, EXAMINING ATTORNEY



David J. Kyros

Director of the United States Patent and Trademark Office

United States of America

United States Patent and Trademark Office

THG

Reg. No. 4,175,538

Registered July 17, 2012

Int. Cl.: 7

TRADEMARK

PRINCIPAL REGISTER

TONG HONG AUTOMOBILE PARTS CO. LTD. (TAIWAN LIMITED PARTNERSHIP)
XINGYE ROAD, XINSHI DISTRICT
NO.1
TAINAN, TAIWAN

FOR: AUTOMOTIVE ENGINE BLOCKS; AUTOMOTIVE EXHAUST PIPE; AUTOMOTIVE INTAKE MANIFOLDS; AUTOMOTIVE PARTS, NAMELY, ENGINE SEALS; ENGINE PARTS, NAMELY, CONTACT POINTS; GASKETS FOR INTERNAL COMBUSTION ENGINES; INTERNAL COMBUSTION ENGINE PARTS, NAMELY, HEADS; INTERNAL COMBUSTION ENGINE PARTS, NAMELY, PISTON RINGS; INTERNAL COMBUSTION ENGINE PARTS, NAMELY, PISTONS; INTERNAL COMBUSTION ENGINES FOR MACHINE OPERATION AND REPLACEMENT PARTS THEREFOR; INTERNAL COMBUSTION ENGINES LAND VEHICLE PARTS, NAMELY, COILS; INTERNAL COMBUSTION ENGINES LAND VEHICLE PARTS, NAMELY, DISTRIBUTOR CAPS; INTERNAL COMBUSTION ENGINES LAND VEHICLE PARTS, NAMELY, DISTRIBUTOR ROTORS; INTERNAL COMBUSTION LAND VEHICLE ENGINE PARTS, NAMELY, CONNECTING RODS; METAL ENGINE GASKETS FOR VEHICLES; NON-METAL ENGINE GASKET FOR VEHICLES, IN CLASS 7 (U.S. CLS. 13, 19, 21, 23, 31, 34 AND 35).

FIRST USE 6-1-1969; IN COMMERCE 6-1-1969.

THE MARK CONSISTS OF STANDARD CHARACTERS WITHOUT CLAIM TO ANY PARTICULAR FONT, STYLE, SIZE, OR COLOR.

SER. NO. 85-480,827, FILED 11-25-2011.

MARK SHINER, EXAMINING ATTORNEY



David J. Kybas

Director of the United States Patent and Trademark Office

United States of America

United States Patent and Trademark Office

BUMPANISTA

Reg. No. 4,175,539

EBIZIE, TRYPHENA C. (UNITED STATES INDIVIDUAL)
11211 SAGE CANYON DRIVE
HOUSTON, TX 77089

Registered July 17, 2012

Int. Cl.: 41

FOR: ONLINE JOURNAL AND BLOG FEATURING COMMENTARY AND OPINIONS ON FASHION, WELLNESS, MATERNITY APPAREL, ENTERTAINMENT, FAMILY, AND WORK/LIFE BALANCE, IN CLASS 41 (U.S. CLS. 100, 101 AND 107).

SERVICE MARK

FIRST USE 11-13-2011; IN COMMERCE 11-13-2011.

PRINCIPAL REGISTER

THE MARK CONSISTS OF STANDARD CHARACTERS WITHOUT CLAIM TO ANY PARTICULAR FONT, STYLE, SIZE, OR COLOR.

SER. NO. 85-480,892, FILED 11-25-2011.

ESTHER BELENKER, EXAMINING ATTORNEY



David J. Kyffers

Director of the United States Patent and Trademark Office

United States of America

United States Patent and Trademark Office

Cat Tucky

Reg. No. 4,175,540

WILES, CHARLES GORDON (UNITED STATES INDIVIDUAL)
109 WILDWOOD DRIVE
SOMERSET, KY 42503

Registered July 17, 2012

Int. Cl.: 40

FOR: IMPRINTING MESSAGES ON WEARING APPAREL, ACCESSORIES AND MUGS, IN CLASS 40 (U.S. CLS. 100, 103 AND 106).

SERVICE MARK

FIRST USE 11-21-2011; IN COMMERCE 11-21-2011.

PRINCIPAL REGISTER

THE MARK CONSISTS OF STANDARD CHARACTERS WITHOUT CLAIM TO ANY PARTICULAR FONT, STYLE, SIZE, OR COLOR.

SER. NO. 85-480,901, FILED 11-25-2011.

SANDRA BUJA, EXAMINING ATTORNEY



David J. Kyffers

Director of the United States Patent and Trademark Office

United States of America

United States Patent and Trademark Office

Trade-a-Blade

Reg. No. 4,175,541

Registered July 17, 2012

Int. Cl.: 7

TRADEMARK

PRINCIPAL REGISTER

LEO D. TRUDGEON (UNITED STATES INDIVIDUAL)
4101 78TH PL NE
SIBKIS CORPORATION
MARYSVILLE, WA 98270

FOR: BLADES FOR POWER SAWS; BLADES FOR POWER TOOLS; CIRCULAR SAWS;
MACHINE PARTS, NAMELY, BLADES; POWER SAW BLADES, IN CLASS 7 (U.S. CLS. 13,
19, 21, 23, 31, 34 AND 35).

FIRST USE 3-31-1975; IN COMMERCE 3-31-1975.

THE MARK CONSISTS OF STANDARD CHARACTERS WITHOUT CLAIM TO ANY PAR-
TICULAR FONT, STYLE, SIZE, OR COLOR.

SER. NO. 85-480,915, FILED 11-25-2011.

JENNIFER VASQUEZ, EXAMINING ATTORNEY



David J. Kyffers

Director of the United States Patent and Trademark Office

United States of America

United States Patent and Trademark Office

Cerulia

Reg. No. 4,175,542

Registered July 17, 2012

Int. Cl.: 41

SERVICE MARK

PRINCIPAL REGISTER

CUMMINGS, KUYPER KNOX (UNITED STATES INDIVIDUAL)
3532 PEPPERMINT HILLS DR.
MARYVILLE, TN 37804 AND

COKER, BENJAMIN ASHER (UNITED STATES INDIVIDUAL)
7410 BALL CAMP PIKE
KNOXVILLE, TN 37931 AND

SENSENBACH, CHARLES BLAKELY (UNITED STATES INDIVIDUAL)
528 LOST TREE LANE
KNOXVILLE, TN 37934

FOR: ENTERTAINMENT SERVICES IN THE NATURE OF PRESENTING LIVE MUSICAL PERFORMANCES, IN CLASS 41 (U.S. CLS. 100, 101 AND 107).

FIRST USE 11-0-2011; IN COMMERCE 11-0-2011.

THE MARK CONSISTS OF STANDARD CHARACTERS WITHOUT CLAIM TO ANY PARTICULAR FONT, STYLE, SIZE, OR COLOR.

SER. NO. 85-480,918, FILED 11-25-2011.

SHARON MEIER, EXAMINING ATTORNEY



David J. Kyjars

Director of the United States Patent and Trademark Office

United States of America

United States Patent and Trademark Office

GRAPESHARE

Reg. No. 4,175,543

PINHEIRO, EDUARDO S (UNITED STATES INDIVIDUAL)
340 S LEMON AVE #6543
WALNUT, CA 91789

Registered July 17, 2012

Int. Cl.: 42

FOR: PROVIDING A WEBSITE FEATURING TECHNOLOGY THAT ENABLES USERS TO SHARE, SEARCH, COMMENT ON AND RATE WINES, FOLLOW OTHER USERS AND RECEIVE RECOMMENDATIONS ABOUT WINE , IN CLASS 42 (U.S. CLS. 100 AND 101).

SERVICE MARK

FIRST USE 6-8-2011; IN COMMERCE 9-17-2011.

PRINCIPAL REGISTER

THE MARK CONSISTS OF STANDARD CHARACTERS WITHOUT CLAIM TO ANY PARTICULAR FONT, STYLE, SIZE, OR COLOR.

SER. NO. 85-480,919, FILED 11-25-2011.

SHARON MEIER, EXAMINING ATTORNEY



David J. Kyros

Director of the United States Patent and Trademark Office

United States of America

United States Patent and Trademark Office



Reg. No. 4,175,544

Registered July 17, 2012

Int. Cl.: 25

TRADEMARK

PRINCIPAL REGISTER

VICTOR EDUARDO CALOCA RAMIREZ (UNITED STATES INDIVIDUAL)
684 LENREY AVE.
EL CENTRO, CA 92243

FOR: ATHLETIC APPAREL, NAMELY, SHIRTS, PANTS, JACKETS, FOOTWEAR, HATS AND CAPS, ATHLETIC UNIFORMS; HOODED SWEAT SHIRTS; LONG-SLEEVED SHIRTS; SHIRTS; SHIRTS AND SHORT-SLEEVED SHIRTS; SHORT-SLEEVED OR LONG-SLEEVED T-SHIRTS; SWEAT SHIRTS; T-SHIRTS; WEARABLE GARMENTS AND CLOTHING, NAMELY, SHIRTS, IN CLASS 25 (U.S. CLS. 22 AND 39).

FIRST USE 8-25-2011; IN COMMERCE 10-1-2011.

THE MARK CONSISTS OF A CAPITAL LETTER "C" WITH ANOTHER LETTER "C" WITH A BACKSLASH THROUGH IT MAKING IT APPEAR TO BE A "CENTS" SIGN. THIS SECOND "C" IS SLIGHTLY BEHIND AND BELOW THE FIRST LETTER. THE FIRST "C" HAS A BORDER AROUND IT, THE SECOND DOES NOT.

SER. NO. 85-480,931, FILED 11-25-2011.

ELI HELLMAN, EXAMINING ATTORNEY



David J. Kybas

Director of the United States Patent and Trademark Office

United States of America

United States Patent and Trademark Office

THE BEST OF YOUR HOMETOWN

Reg. No. 4,175,545

Registered July 17, 2012

Int. Cl.: 35

SERVICE MARK

PRINCIPAL REGISTER

BASSETT PUBLICATIONS, LLC (WISCONSIN LIMITED LIABILITY COMPANY)
34120 SPRING PRAIRIE ROAD
BURLINGTON, WI 53105

FOR: PROMOTING THE GOODS AND SERVICES OF OTHERS BY DISTRIBUTING COUPONS AND PROVIDING DIRECT MAIL ADVERTISING SERVICES, IN CLASS 35 (U.S. CLS. 100, 101 AND 102).

FIRST USE 1-15-2008; IN COMMERCE 1-15-2008.

THE MARK CONSISTS OF STANDARD CHARACTERS WITHOUT CLAIM TO ANY PARTICULAR FONT, STYLE, SIZE, OR COLOR.

SER. NO. 85-480,932, FILED 11-25-2011.

ELI HELLMAN, EXAMINING ATTORNEY



David J. Kyffers

Director of the United States Patent and Trademark Office

United States of America

United States Patent and Trademark Office

Wahooee

Reg. No. 4,175,546

Registered July 17, 2012

Int. Cl.: 32

TRADEMARK

PRINCIPAL REGISTER

WILLIAMS, ANSON (UNITED STATES INDIVIDUAL)
15928 VENTURA BLVD STE 227-229
ENCINO, CA 91436 AND

CONNELL JOANNA (UNITED STATES INDIVIDUAL)
15928 VENTURA BLVD STE 227-229
ENCINO, CA 91436

FOR: ENERGY DRINKS; ENERGY DRINKS ENHANCED WITH VITAMIN B , IN CLASS 32
(U.S. CLS. 45, 46 AND 48).

FIRST USE 5-14-2011; IN COMMERCE 11-7-2011.

THE MARK CONSISTS OF STANDARD CHARACTERS WITHOUT CLAIM TO ANY PARTICULAR FONT, STYLE, SIZE, OR COLOR.

SER. NO. 85-480,935, FILED 11-25-2011.

ELI HELLMAN, EXAMINING ATTORNEY



David J. Kyffers

Director of the United States Patent and Trademark Office

United States of America

United States Patent and Trademark Office

No Waste Wasted

Reg. No. 4,175,547

Registered July 17, 2012

Int. Cl.: 40

SERVICE MARK

PRINCIPAL REGISTER

STEWARDSMITH (OREGON LIMITED LIABILITY COMPANY)
STE 231
13215 SE MILL PLAIN BLVD, BLDG C8
VANCOUVER, WA 98684

FOR: PRODUCTION OF ENERGY VIA ANIMAL WASTE DIGESTION AND CONVERSION;
PROVIDING TECHNICAL INFORMATION IN THE FIELD OF WASTE MANAGEMENT;
PROVISION OF INFORMATION, ADVICE AND CONSULTANCY IN RELATION TO THE
PRODUCTION OF ENERGY, AND THE TREATMENT, MANAGEMENT, RECYCLING,
TRANSFORMATION AND INCINERATION OF WASTE; WASTE-TO-ENERGY GENERATION
SERVICES, IN CLASS 40 (U.S. CLS. 100, 103 AND 106).

FIRST USE 1-1-2006; IN COMMERCE 1-1-2006.

THE MARK CONSISTS OF STANDARD CHARACTERS WITHOUT CLAIM TO ANY PARTICULAR FONT, STYLE, SIZE, OR COLOR.

NO CLAIM IS MADE TO THE EXCLUSIVE RIGHT TO USE "WASTE", APART FROM THE MARK AS SHOWN.

SER. NO. 85-480,942, FILED 11-25-2011.

JOHN SCHUYLER YARD, EXAMINING ATTORNEY



David J. Kybas

Director of the United States Patent and Trademark Office

United States of America

United States Patent and Trademark Office

Korma Sutra

Reg. No. 4,175,548

BALJIT SINGH (UNITED STATES INDIVIDUAL)
5910 ROLAND DRIVE
MISSION, KS 66205

Registered July 17, 2012

Int. Cl.: 43

FOR: RESTAURANT AND CAFE SERVICES; RESTAURANT AND CATERING SERVICES;
RESTAURANT SERVICES FEATURING INDIAN AND PAKISTANI CUISINE, IN CLASS 43
(U.S. CLS. 100 AND 101).

SERVICE MARK

FIRST USE 3-30-2004; IN COMMERCE 3-30-2004.

PRINCIPAL REGISTER

THE MARK CONSISTS OF STANDARD CHARACTERS WITHOUT CLAIM TO ANY PARTICULAR FONT, STYLE, SIZE, OR COLOR.

NO CLAIM IS MADE TO THE EXCLUSIVE RIGHT TO USE "KORMA", APART FROM THE MARK AS SHOWN.

SER. NO. 85-480,967, FILED 11-26-2011.

TASHIA BUNCH, EXAMINING ATTORNEY



David J. Kyros

Director of the United States Patent and Trademark Office

United States of America

United States Patent and Trademark Office

TVANDJOY

Reg. No. 4,175,549

Registered July 17, 2012

Int. Cl.: 9

TRADEMARK

PRINCIPAL REGISTER

SHENZHEN GENIATECH INC.,LTD. (CHINA CORPORATION)
5 F SHENJIAN BUILDING, M4 BUILDING
HIGH-TECH INDUSTRIAL PARK, NANSHAN
DISTRICT ,SHENZHEN, CHINA

FOR: AMUSEMENT APPARATUS ADAPTED FOR USE WITH TELEVISION RECEIVERS ONLY; AMUSEMENT APPARATUS AND GAMES ADAPTED FOR USE WITH TELEVISION RECEIVERS OR WITH VIDEO OR COMPUTER MONITORS; AMUSEMENT APPARATUS FOR USE WITH A TELEVISION SCREEN; ANTENNAS FOR RADIO, FOR TELEVISION; ANTI-GLARE FILTERS FOR TELEVISIONS AND COMPUTER MONITORS; AUDIO AND VIDEO CASSETTE RECORDERS; AUDIO AND VIDEO RECORDINGS FEATURING MUSIC AND ARTISTIC PERFORMANCES; BLANK VIDEO CASSETTES; BLANK VIDEO TAPES; BRACKETS SPECIALLY ADAPTED FOR SETTING UP FLAT SCREEN TV SETS; CABLE TELEVISION CONVERTERS; CABLE TELEVISION TRANSMITTERS; CAR TELEVISIONS; CAR VIDEO RECORDERS; CLOSED CIRCUIT TV SYSTEMS FOR SECURITY AND SURVEILLANCE, NAMELY, CAMERAS, SWITCHERS, MONITORS, MICROPHONES, AND RECORDERS; COIN-OPERATED MECHANISMS FOR TELEVISION SETS; COLOR FILTERS FOR TELEVISION AND MOTION PICTURE FILM CAMERAS; COMPUTER GAME SOFTWARE FOR USE WITH PERSONAL COMPUTERS, HOME VIDEO GAME CONSOLES USED WITH TELEVISIONS AND ARCADE-BASED VIDEO GAME CONSOLES; COMPUTER HARDWARE AND SOFTWARE SYSTEM FOR TRACKING PEOPLE, OBJECTS AND PETS USING GPS DATA ON A DEVICE ON THE TRACKED PEOPLE, OBJECTS AND PETS; COMPUTER-GAMING SOFTWARE; COMPUTERS; COMPUTERS AND COMPUTER HARDWARE; COMPUTERS AND COMPUTER PERIPHERALS; DIGITAL AUDIO AND VIDEO RECORDERS AND PLAYERS; DIGITAL AUDIO PLAYERS; DIGITAL AUDIO TAPE PLAYERS; DIGITAL AUDIO TAPE RECORDERS; DIGITAL BOOK READERS; DIGITAL CAMERA ACCESSORY IN THE NATURE OF A DIGITAL PHOTO VIEWER; DIGITAL CAMERAS; DIGITAL CAMERAS FOR INDUSTRIAL USE; DIGITAL CELLULAR PHONES; DIGITAL COLOR COPIERS; DIGITAL COLOR PRINTERS; DIGITAL DISC DRIVES; DIGITAL ENTERTAINMENT SYSTEMS FOR WATCHING, STORING AND SHARING DIGITAL CONTENT ON A HOME COMPUTER NETWORK; DIGITAL FILM SCANNERS; DIGITAL INPUT AND OUTPUT SCANNERS; DIGITAL MEDIA HUBS; DIGITAL MEDIA RECEIVERS; DIGITAL MEDIA SERVERS; DIGITAL MEDIA STREAMING DEVICES; DIGITAL MULTIMETERS; DIGITAL MUSIC DOWNLOADABLE FROM THE INTERNET; DIGITAL MUSIC SYSTEM THAT SYNCHRONIZES DIGITAL MUSIC FILES STORED ON A HOME UNIT AND A CAR UNIT; DIGITAL MUSIC SYSTEMS THAT SYNCHRONIZES DIGITAL RADIO FILES STORED ON A HOME UNIT, A CAR UNIT, OR PORTABLE UNIT AND THAT MAY



David J. Kybas

Director of the United States Patent and Trademark Office

Reg. No. 4,175,549 BE BACKED UP TO AN INTERNET DEPOSITORY; DIGITAL PHONES; DIGITAL PHOTO FRAMES FOR DISPLAYING DIGITAL PICTURES, VIDEO CLIPS AND MUSIC; DIGITAL PHOTO IMAGE CONVERTERS; DIGITAL PLOTTERS; DIGITAL SIGNAGE MONITORS; DIGITAL SIGNAL PROCESSORS; DIGITAL SWITCHING SYSTEMS COMPRISED OF INTERCONNECTED ELECTROMECHANICAL AND SOLID-STATE POWER MANAGEMENT ENCLOSURES WITH STANDARD AND CUSTOM KEYPADS FOR USER REMOTE CONTROL, THE FOREGOING FOR USE ON MARINE HELMS AND LAND-BASED VEHICLE DASHBOARDS; DIGITAL TELEPHONE PLATFORMS AND SOFTWARE; DIGITAL TELEPHONE SWITCHING APPARATUS; DIGITAL TELEPHONES; DIGITAL VERSATILE DISC PLAYER; DIGITAL VIDEO CAMERAS; DIGITAL VIDEO DISC DRIVES; DIGITAL VIDEO RECORDERS; DIGITAL VIDEO RECORDING SOFTWARE FOR IP (INTERNET PROTOCOL) VIDEO SURVEILLANCE; DIGITAL VOICE RECORDERS; ELECTRONIC AND OPTICAL COMMUNICATIONS INSTRUMENTS AND COMPONENTS, NAMELY, CABLE TELEVISION TRANSMITTERS; ELECTRONIC AND OPTICAL COMMUNICATIONS INSTRUMENTS AND COMPONENTS, NAMELY, DIGITAL TRANSMITTERS; ELECTRONIC APPARATUS AND DEVICES FOR CONTROLLING ACCESS TO PAY-TELEVISION SERVICES; ELECTRONIC DEVICES FOR ANIMAL LOCATING AND TRACKING PROGRAMMED TO USE GLOBAL POSITIONING SYSTEMS (GPS) AND CELLULAR COMMUNICATIONS; ELECTRONIC DISPLAYS, NAMELY, DIGITAL SIGNAGE; ELECTRONIC EQUIPMENT, NAMELY, TRANSFORMERS, BALUNS, CABLES USED IN CONNECTION WITH COMPUTERS, COMPUTER PERIPHERAL DEVICES, TELEVISIONS, AUDIO-VIDEO EQUIPMENT, CLOSED-CIRCUIT TV EQUIPMENT AND TELECOMMUNICATION EQUIPMENT; GAMES ADAPTED FOR USE WITH TELEVISION RECEIVERS; GLOBAL POSITIONING SYSTEM (GPS); GLOBAL POSITIONING SYSTEM (GPS) CONSISTING OF COMPUTERS, COMPUTER SOFTWARE, TRANSMITTERS, RECEIVERS, AND NETWORK INTERFACE DEVICES; GPS DATA LOGGER FOR RECORDING TRIPS AND CLASSIFYING THEM INTO DIFFERENT ACCOUNTS; GPS NAVIGATION DEVICE; HARDWARE AND SOFTWARE ADAPTER FOR COUPLING A GPS RECEIVER TO THE MICROPHONE INPUT OF A DIGITAL CAMCORDER; PORT SECURITY AND SHIPPING CONTAINER SCANNING SYSTEM COMPRISING ELECTRONIC X-RAY SCANNERS, VIDEO CAMERAS AND RECORDERS, AND GPS TRANSCIEVERS; PROTECTIVE CARRYING CASES SPECIALLY ADAPTED FOR GLOBAL POSITIONING SYSTEM (GPS) APPARATUS; RELAYS FOR RADIO AND TV STATIONS; REMOTELY-CONTROLLED SUB-AQUATIC VIDEO CAMERA CONTAINING A TV CAMERA, TRANSMITTER, RECEIVER AND MICROPHONE TO RECORD, DETECT, MEASURE, SURVEY AND LOCATE OBJECTS UNDERWATER; SATELLITE NAVIGATIONAL SYSTEM, NAMELY, A GLOBAL POSITIONING SYSTEM (GPS); TELEVISION AND VIDEO CONVERTERS; TELEVISION ANTENNAS; TELEVISION APPARATUS FOR PROJECTION PURPOSES; TELEVISION CAMERAS; TELEVISION DECODER; TELEVISION MONITORS; TELEVISION MONITORS WITH TELEVISION TUNERS; TELEVISION RECEIVERS; TELEVISION SCREEN PROTECTORS IN THE NATURE OF ACRYLIC SHIELDS TO BE MOUNTED OVER TELEVISION SCREENS; TELEVISION SETS; TELEVISION TRANSMITTERS; TELEVISIONS; TELEVISIONS AND MONITORS; TELEVISIONS AND VIDEO RECORDERS; TRANSMITTING AND RECEIVING APPARATUS FOR RADIO AND TELEVISION BROADCASTING AND FOR LONG-DISTANCE TRANSMISSION; TV CAMERAS; TV MONITORS; VEHICLE LOCATOR AND RECOVERY DEVICE PROGRAMMED TO USE GLOBAL POSITIONING SYSTEMS (GPS) AND CELLULAR TELECOMMUNICATIONS; VEHICLE MOUNTED GPS SENSOR FOR DETERMINING THE RATE OF MOTION FOR A VEHICLE; VIDEO AND COMPUTER GAME PROGRAMS; VIDEO CABLES; VIDEO CAMERAS; VIDEO CAPTURE CARDS; VIDEO CASSETTE RECORDERS; VIDEO CASSETTE RECORDERS AND PLAYERS, COMPACT DISC PLAYERS, DIGITAL AUDIO TAPE RECORDERS AND PLAYERS, ELECTRONIC DIARIES; VIDEO CIRCUIT BOARDS; VIDEO DISC PLAYERS; VIDEO DISK PLAYERS; VIDEO DISKS AND VIDEO TAPES WITH RECORDED ANIMATED CARTOONS; VIDEO DISPLAY CARDS; VIDEO DISPLAYS MOUNTED IN EYEGLASSES; VIDEO DISPLAYS THAT MAY BE WORN ON THE BODY; VIDEO GAME CARTRIDGES; VIDEO GAME CARTRIDGES AND CASSETTES; VIDEO GAME CARTRIDGES AND DISCS; VIDEO GAME CONSOLES FOR USE WITH AN EXTERNAL DISPLAY SCREEN OR MONITOR; VIDEO GAME DISCS; VIDEO GAME INTERACTIVE CONTROL FLOOR PADS OR MATS; VIDEO GAME INTERACTIVE HAND HELD REMOTE CONTROLS FOR PLAYING ELECTRONIC

Reg. No. 4,175,549 GAMES; VIDEO GAME INTERACTIVE REMOTE CONTROL UNITS; VIDEO GAME JOY-STICKS; VIDEO GAME MACHINES FOR USE WITH TELEVISIONS; VIDEO GAME SOFTWARE; VIDEO GAME SOFTWARE, NAMELY, A VIDEO CRAPS GAME; VIDEO GRAPHICS ACCELERATOR; VIDEO GRAPHICS CONTROLLER; VIDEO INJECTION SYSTEM, NAMELY, OPTICAL AND ELECTRONIC HARDWARE AND COMPUTER SOFTWARE, SIMULATING THE EFFECTS OF TRACER ROUND FLY-OUTS AND BURSTS ON TARGET, WHICH ALLOWS FOR ON-VEHICLE PRECISION GUNNERY WITHOUT EXPENDING ACTUAL AMMUNITION; VIDEO LOTTERY TERMINALS; VIDEO MONITORS; VIDEO MULTIPLEXERS; VIDEO OUTPUT GAME MACHINES FOR USE WITH EXTERNAL DISPLAY SCREEN OR MONITOR; VIDEO OUTPUT GAME MACHINES FOR USE WITH TELEVISIONS; VIDEO PHONES; VIDEO PROCESSORS; VIDEO PROJECTORS; VIDEO RECEIVERS; VIDEO RECORDERS; VIDEO RECORDERS AND VIDEO REPRODUCING APPARATUS; VIDEO SCREENS; VIDEO TAPE RECORDERS; VIDEO TELEPHONES; VIDEO TRANSMISSION APPARATUS; VIDEO-TELEPHONES; VINYL COVERS SPECIALLY ADAPTED FOR CELL PHONES, MP3 PLAYERS, LAPTOPS, COMPUTERS, PORTABLE SATELLITE RADIOS, PERSONAL DIGITAL ASSISTANTS, REMOTE CONTROLS, AND TELEVISION SATELLITE RECORDERS; WIRELESS TELEVISION SET FOR PROVIDING VIDEO CONFERENCING AND TELEPHONE SERVICE OVER THE INTERNET, IN CLASS 9 (U.S. CLS. 21, 23, 26, 36 AND 38).

FIRST USE 1-28-2011; IN COMMERCE 6-8-2011.

THE MARK CONSISTS OF THE WORDING "TVANDJOY" IN STYLIZED FORM.

THE WORDING "TVANDJOY" HAS NO MEANING IN A FOREIGN LANGUAGE.

SER. NO. 85-480,978, FILED 11-26-2011.

JASON TURNER, EXAMINING ATTORNEY

United States of America

United States Patent and Trademark Office

Bellabe

Reg. No. 4,175,550

Registered July 17, 2012

Int. Cl.: 8

TRADEMARK

PRINCIPAL REGISTER

GEMINI GROUP USA, INC. (MICHIGAN CORPORATION), DBA
WWW.FACIALHAIRTHREADING.COM
3247 HONEYSUCKLE DRIVE
ANN ARBOR, MI 48103

FOR: EPILATORY APPLIANCES, IN CLASS 8 (U.S. CLS. 23, 28 AND 44).

FIRST USE 11-24-2008; IN COMMERCE 11-24-2008.

THE MARK CONSISTS OF STANDARD CHARACTERS WITHOUT CLAIM TO ANY PARTICULAR FONT, STYLE, SIZE, OR COLOR.

SER. NO. 85-481,091, FILED 11-27-2011.

NORA BUCHANAN WILL, EXAMINING ATTORNEY



David J. Kybas

Director of the United States Patent and Trademark Office

United States of America

United States Patent and Trademark Office

GLOMESH

Reg. No. 4,175,551

Registered July 17, 2012

Int. Cl.: 18

TRADEMARK

PRINCIPAL REGISTER

GLOMESH INTERNATIONAL PTY. LTD. (AUSTRALIA CORPORATION), DBA GLOMESH INTERNATIONAL PTY. LTD.
PO BOX 2126 BONDI JUNCTION
PO BOX 2126 BONDI JUNCTION
SYDNEY NSW 1355, AUSTRALIA

FOR: EVENING HANDBAGS; FASHION HANDBAGS; HANDBAGS, IN CLASS 18 (U.S. CLS. 1, 2, 3, 22 AND 41).

THE MARK CONSISTS OF STANDARD CHARACTERS WITHOUT CLAIM TO ANY PARTICULAR FONT, STYLE, SIZE, OR COLOR.

OWNER OF AUSTRALIA REG. NO. 1406066, DATED 1-29-2011, EXPIRES 1-29-2021.

SER. NO. 85-481,133, FILED 11-27-2011.

PRISCILLA MILTON, EXAMINING ATTORNEY



David J. Kyffers

Director of the United States Patent and Trademark Office

United States of America

United States Patent and Trademark Office

PULL THRU

Reg. No. 4,175,552

Registered July 17, 2012

Int. Cl.: 21

TRADEMARK

PRINCIPAL REGISTER

F R GALANTAI MANUFACTURING COMPANY LIMITED (NEW ZEALAND LIMITED LIABILITY COMPANY), DBA F R GALANTAI MANUFACTURING COMPANY LIMITED
11 BANCROFT CRESCENT
AUCKLAND, NEW ZEALAND 0602

FOR: BRUSHES USED FOR CLEANING MEDICAL INSTRUMENTS , IN CLASS 21 (U.S. CLS. 2, 13, 23, 29, 30, 33, 40 AND 50).

FIRST USE 10-1-2009; IN COMMERCE 10-1-2009.

THE MARK CONSISTS OF THE WORDS "PULL THRU" ENCLOSED IN A RECTANGULAR BORDER WITH ROUNDED CORNERS.

SER. NO. 85-481,142, FILED 11-27-2011.

ANTHONY RINKER, EXAMINING ATTORNEY



David J. Kyffers

Director of the United States Patent and Trademark Office

United States of America

United States Patent and Trademark Office

T-GEN

Reg. No. 4,175,553

Registered July 17, 2012

Int. Cl.: 5

UNIMED INTERNATIONAL INC. (NEW JERSEY CORPORATION), AKA CHAMONIX
NUTRACEUTICALS
105 NEWFIELD AVE
SUITE F
EDISON, NJ 08837

TRADEMARK

FOR: DIETARY AND NUTRITIONAL SUPPLEMENTS; NUTRITIONAL SUPPLEMENTS, IN CLASS 5 (U.S. CLS. 6, 18, 44, 46, 51 AND 52).

PRINCIPAL REGISTER

FIRST USE 9-1-2011; IN COMMERCE 9-1-2011.

THE MARK CONSISTS OF STANDARD CHARACTERS WITHOUT CLAIM TO ANY PARTICULAR FONT, STYLE, SIZE, OR COLOR.

SER. NO. 85-481,144, FILED 11-27-2011.

ANTHONY RINKER, EXAMINING ATTORNEY



David J. Kybas

Director of the United States Patent and Trademark Office

United States of America

United States Patent and Trademark Office

The Tulips

Reg. No. 4,175,554

PETRICH, JARED (UNITED STATES INDIVIDUAL)
2505 CORTE DEL MARQUES
WALNUT CREEK, CA 94598

Registered July 17, 2012

Int. Cl.: 41

FOR: ENTERTAINMENT SERVICES, NAMELY, LIVE PERFORMANCES BY A VOCAL AND INSTRUMENTAL GROUP, IN CLASS 41 (U.S. CLS. 100, 101 AND 107).

SERVICE MARK

FIRST USE 12-10-2008; IN COMMERCE 12-31-2008.

PRINCIPAL REGISTER

THE MARK CONSISTS OF STANDARD CHARACTERS WITHOUT CLAIM TO ANY PARTICULAR FONT, STYLE, SIZE, OR COLOR.

SER. NO. 85-481,156, FILED 11-27-2011.

COURTNEY ALVAREZ, EXAMINING ATTORNEY



David J. Kybas

Director of the United States Patent and Trademark Office

United States of America

United States Patent and Trademark Office

I'm So Good I WoN'T MAKE
you CRy!

Reg. No. 4,175,555

GREAT LAKES INTERNATIONAL TRADING INC. (MICHIGAN CORPORATION)
858 BUSINESS PARK DR.
TRAVERSE CITY, MI 49686

Registered July 17, 2012

Int. Cl.: 31

FOR: FRESH ONIONS, IN CLASS 31 (U.S. CLS. 1 AND 46).

TRADEMARK

FIRST USE 10-19-2011; IN COMMERCE 10-19-2011.

PRINCIPAL REGISTER

THE MARK CONSISTS OF STANDARD CHARACTERS WITHOUT CLAIM TO ANY PARTICULAR FONT, STYLE, SIZE, OR COLOR.

SER. NO. 85-481,257, FILED 11-28-2011.

JEFF DEFORD, EXAMINING ATTORNEY



David J. Kybas

Director of the United States Patent and Trademark Office

United States of America

United States Patent and Trademark Office

HAWKPARTNERS

Reg. No. 4,175,556

HAWKPARTNERS, LLC (MASSACHUSETTS LIMITED LIABILITY COMPANY)
1100 MASSACHUSETTS AVENUE, STE. 301
CAMBRIDGE, MA 02138

Registered July 17, 2012

Int. Cl.: 35

FOR: BUSINESS MANAGEMENT CONSULTING WITH RELATION TO STRATEGY, MARKETING, MARKET RESEARCH, AND MARKETING EFFECTIVENESS, IN CLASS 35 (U.S. CLS. 100, 101 AND 102).

SERVICE MARK

FIRST USE 7-28-2003; IN COMMERCE 7-28-2003.

PRINCIPAL REGISTER

THE MARK CONSISTS OF STANDARD CHARACTERS WITHOUT CLAIM TO ANY PARTICULAR FONT, STYLE, SIZE, OR COLOR.

SER. NO. 85-481,476, FILED 11-28-2011.

TINA MAI, EXAMINING ATTORNEY



David J. Kybas

Director of the United States Patent and Trademark Office

United States of America

United States Patent and Trademark Office

iKites

Reg. No. 4,175,557

Registered July 17, 2012

Int. Cl.: 28

TRADEMARK

PRINCIPAL REGISTER

LYON ADVERTISING, INC. (TEXAS CORPORATION)
1317 WEST 6TH STREET
AUSTIN, TX 78703

FOR: TOYS, NAMELY, KITES AND ACCESSORIES FOR KITES, NAMELY, KITE HANDLES, KITE LINES, KITE REELS, KITE STRING AND KITE TAILS, IN CLASS 28 (U.S. CLS. 22, 23, 38 AND 50).

FIRST USE 6-14-2000; IN COMMERCE 6-14-2000.

THE MARK CONSISTS OF STANDARD CHARACTERS WITHOUT CLAIM TO ANY PARTICULAR FONT, STYLE, SIZE, OR COLOR.

SER. NO. 85-481,478, FILED 11-28-2011.

ZACHARY BELLO, EXAMINING ATTORNEY



David J. Kyffers

Director of the United States Patent and Trademark Office

United States of America
United States Patent and Trademark Office

4Life

Reg. No. 4,175,558

4LIFE TRADEMARKS, LLC (UTAH LIMITED LIABILITY COMPANY)
9850 SOUTH 300 WEST
SANDY, UT 84070

Registered July 17, 2012

Int. Cl.: 32

FOR: FRUIT JUICES; FRUIT BASED DRINK; AND FRUIT BASED BEVERAGES, IN CLASS 32 (U.S. CLS. 45, 46 AND 48).

TRADEMARK

FIRST USE 5-1-2005; IN COMMERCE 5-1-2005.

PRINCIPAL REGISTER

OWNER OF U.S. REG. NOS. 2,475,300, 3,922,645 AND OTHERS.

THE MARK CONSISTS OF "4LIFE" IN STYLIZED LETTERING WITH A SUN-LIKE DESIGN USED FOR THE DOT OF THE "I".

SER. NO. 85-481,494, FILED 11-28-2011.

DANNEAN HETZEL, EXAMINING ATTORNEY



David J. Kybas

Director of the United States Patent and Trademark Office

United States of America

United States Patent and Trademark Office

WELCOME TO THE FUTURE OF READING EDUCATION

Reg. No. 4,175,559

Registered July 17, 2012

Int. Cl.: 42

SERVICE MARK

PRINCIPAL REGISTER

LEXIA LEARNING SYSTEMS, INC. (MASSACHUSETTS CORPORATION)
SUITE 315
200 BAKER AVENUE
CONCORD, MA 01742

FOR: PROVIDING ON-LINE NON-DOWNLOADABLE SOFTWARE FOR SCHOOL DISTRICTS, TEACHERS, AND OTHER ADMINISTRATORS TO MONITOR, EVALUATE, AND REPORT ON STUDENT PERFORMANCE, IN CLASS 42 (U.S. CLS. 100 AND 101).

FIRST USE 6-0-2010; IN COMMERCE 6-0-2010.

THE MARK CONSISTS OF STANDARD CHARACTERS WITHOUT CLAIM TO ANY PARTICULAR FONT, STYLE, SIZE, OR COLOR.

SER. NO. 85-481,512, FILED 11-28-2011.

B. PARADEWELAI, EXAMINING ATTORNEY



David J. Kyffers

Director of the United States Patent and Trademark Office

United States of America

United States Patent and Trademark Office

THE FUTURE OF READING EDUCATION

Reg. No. 4,175,560

Registered July 17, 2012

Int. Cl.: 42

SERVICE MARK

PRINCIPAL REGISTER

LEXIA LEARNING SYSTEMS, INC. (MASSACHUSETTS CORPORATION)
SUITE 315
200 BAKER AVENUE
CONCORD, MA 01742

FOR: PROVIDING ON-LINE NON-DOWNLOADABLE SOFTWARE MODULE FOR SCHOOL DISTRICTS, TEACHERS, AND OTHER ADMINISTRATORS TO MONITOR, EVALUATE, AND REPORT ON STUDENT PERFORMANCE, IN CLASS 42 (U.S. CLS. 100 AND 101).

FIRST USE 6-0-2010; IN COMMERCE 6-0-2010.

THE MARK CONSISTS OF STANDARD CHARACTERS WITHOUT CLAIM TO ANY PARTICULAR FONT, STYLE, SIZE, OR COLOR.

SER. NO. 85-481,531, FILED 11-28-2011.

B. PARADEWELAI, EXAMINING ATTORNEY



David J. Kyffers

Director of the United States Patent and Trademark Office

United States of America

United States Patent and Trademark Office

MAXILL

Reg. No. 4,175,561

Registered July 17, 2012

Int. Cls.: 10 and 21

TRADEMARK

PRINCIPAL REGISTER

MAXILL INC. (CANADA CORPORATION), DBA MAXILL
80 ELM STREET
ST. THOMAS, ONTARIO, CANADA N5R6C8

FOR: MASKS FOR USE BY MEDICAL PERSONNEL; MEDICAL GLOVES; SANITARY MASKS FOR MEDICAL PURPOSES, IN CLASS 10 (U.S. CLS. 26, 39 AND 44).

FIRST USE 1-3-2010; IN COMMERCE 1-21-2010.

FOR: DENTAL FLOSS; TOOTH BRUSHES, IN CLASS 21 (U.S. CLS. 2, 13, 23, 29, 30, 33, 40 AND 50).

FIRST USE 1-3-2010; IN COMMERCE 1-3-2010.

THE MARK CONSISTS OF STANDARD CHARACTERS WITHOUT CLAIM TO ANY PARTICULAR FONT, STYLE, SIZE, OR COLOR.

SER. NO. 85-481,534, FILED 11-28-2011.

JACQUELINE A. LAVINE, EXAMINING ATTORNEY



David J. Kybas

Director of the United States Patent and Trademark Office

United States of America

United States Patent and Trademark Office

PRECIOUS MOMENTS

Reg. No. 4,175,562

Registered July 17, 2012

Int. Cl.: 20

TRADEMARK

PRINCIPAL REGISTER

PRECIOUS MOMENTS, INCORPORATED (ILLINOIS CORPORATION)
2850 WEST GOLF ROAD, SUITE 250
ROLLING MEADOWS, IL 60008

FOR: COLD CAST RESIN FIGURINES; FIGURINES OF WOOD, PLASTIC OR PLASTER;
PICTURE FRAMES; PILLOWS; SCULPTURES OF WOOD, PLASTIC OR PLASTER; WALL
PLAQUES MADE OF WOOD, PLASTIC OR PLASTER, IN CLASS 20 (U.S. CLS. 2, 13, 22, 25,
32 AND 50).

FIRST USE 1-24-2006; IN COMMERCE 1-24-2006.

THE MARK CONSISTS OF STANDARD CHARACTERS WITHOUT CLAIM TO ANY PAR-
TICULAR FONT, STYLE, SIZE, OR COLOR.

OWNER OF U.S. REG. NOS. 1,423,818, 1,450,861 AND OTHERS.

SER. NO. 85-481,557, FILED 11-28-2011.

MARCIE MILONE, EXAMINING ATTORNEY



David J. Kyffers

Director of the United States Patent and Trademark Office

United States of America

United States Patent and Trademark Office

maxill

Reg. No. 4,175,563

Registered July 17, 2012

Int. Cls.: 10 and 21

TRADEMARK

PRINCIPAL REGISTER

MAXILL INC. (CANADA CORPORATION), DBA MAXILL
80 ELM STREET
ST. THOMAS, ONTARIO, CANADA N5R6C8

FOR: MASKS FOR USE BY MEDICAL PERSONNEL; MEDICAL GLOVES; SANITARY MASKS FOR MEDICAL PURPOSES, IN CLASS 10 (U.S. CLS. 26, 39 AND 44).

FIRST USE 1-3-2010; IN COMMERCE 1-21-2010.

FOR: DENTAL FLOSS; TOOTH BRUSHES, IN CLASS 21 (U.S. CLS. 2, 13, 23, 29, 30, 33, 40 AND 50).

FIRST USE 1-3-2010; IN COMMERCE 1-3-2010.

THE MARK CONSISTS OF THE LITERAL ELEMENT "MAXILL" IN STYLIZED TEXT.

SER. NO. 85-481,568, FILED 11-28-2011.

JACQUELINE A. LAVINE, EXAMINING ATTORNEY



David J. Kybas

Director of the United States Patent and Trademark Office

United States of America

United States Patent and Trademark Office



Reg. No. 4,175,564

SUMO STEAKS LLC (PENNSYLVANIA LIMITED LIABILITY COMPANY)
2805 NORTH 22ND STREET
PHILADELPHIA, PA 19132

Registered July 17, 2012

Int. Cl.: 43

FOR: CATERING SERVICES; RESTAURANT SERVICES, IN CLASS 43 (U.S. CLS. 100 AND 101).

SERVICE MARK

FIRST USE 11-1-2010; IN COMMERCE 11-1-2010.

PRINCIPAL REGISTER

NO CLAIM IS MADE TO THE EXCLUSIVE RIGHT TO USE "STEAKS", APART FROM THE MARK AS SHOWN.

THE MARK CONSISTS OF THE WORDING "SUMO STEAKS" SEPARATED BY A CIRCLE DESIGN FEATURING A STYLIZED DEPICTION OF A SUMO WRESTLER.

SER. NO. 85-481,610, FILED 11-28-2011.

AMY KELLY, EXAMINING ATTORNEY



David J. Kyffers

Director of the United States Patent and Trademark Office

United States of America

United States Patent and Trademark Office



Reg. No. 4,175,565

RAICO INTERNATIONAL CORP. (FLORIDA CORPORATION)
7848 NW 71 ST.
MIAMI, FL 33166

Registered July 17, 2012

Int. Cl.: 39

FOR: AIR FREIGHT SHIPPING SERVICES; COURIER SERVICES; FREIGHT FORWARDING SERVICES, IN CLASS 39 (U.S. CLS. 100 AND 105).

SERVICE MARK

FIRST USE 1-1-2000; IN COMMERCE 1-1-2000.

PRINCIPAL REGISTER

THE MARK CONSISTS OF THE WORD "RAICONET" WITH ARCED LINES ABOVE AND BELOW.

SER. NO. 85-481,668, FILED 11-28-2011.

PAM WILLIS, EXAMINING ATTORNEY



David J. Kybas

Director of the United States Patent and Trademark Office

United States of America

United States Patent and Trademark Office

CONNECTIONPOINT

Reg. No. 4,175,566

CONNECTIONPOINT SERVICES LLC (GEORGIA LIMITED LIABILITY COMPANY)
600 AVIGNON COURT
ATLANTA, GA 30350

Registered July 17, 2012

Int. Cl.: 41

FOR: EDUCATION SERVICES, NAMELY, PROVIDING SEMINARS, WORKSHOPS, LECTURES AND CLASSES IN THE FIELD OF LEADERSHIP AND MANAGEMENT, AND DISTRIBUTION OF COURSE MATERIALS IN CONNECTION THEREWITH, IN CLASS 41 (U.S. CLS. 100, 101 AND 107).

SERVICE MARK

PRINCIPAL REGISTER

FIRST USE 5-30-2008; IN COMMERCE 5-30-2008.

THE MARK CONSISTS OF STANDARD CHARACTERS WITHOUT CLAIM TO ANY PARTICULAR FONT, STYLE, SIZE, OR COLOR.

SER. NO. 85-481,677, FILED 11-28-2011.

KATINA MISTER, EXAMINING ATTORNEY



David J. Kybas

Director of the United States Patent and Trademark Office

United States of America

United States Patent and Trademark Office

ENGAGEMENT CODE

Reg. No. 4,175,567

CONNECTIONPOINT SERVICES LLC (GEORGIA LIMITED LIABILITY COMPANY)
600 AVIGNON COURT
ATLANTA, GA 30350

Registered July 17, 2012

Int. Cl.: 41

FOR: EDUCATION SERVICES, NAMELY, PROVIDING SEMINARS, WORKSHOPS, LECTURES AND CLASSES IN THE FIELD OF LEADERSHIP AND MANAGEMENT, AND DISTRIBUTION OF COURSE MATERIALS IN CONNECTION THEREWITH, IN CLASS 41 (U.S. CLS. 100, 101 AND 107).

SERVICE MARK

PRINCIPAL REGISTER

FIRST USE 5-30-2011; IN COMMERCE 5-30-2011.

THE MARK CONSISTS OF STANDARD CHARACTERS WITHOUT CLAIM TO ANY PARTICULAR FONT, STYLE, SIZE, OR COLOR.

SER. NO. 85-481,689, FILED 11-28-2011.

KATINA MISTER, EXAMINING ATTORNEY



David J. Kyffers

Director of the United States Patent and Trademark Office

United States of America

United States Patent and Trademark Office

30-MINUTES TO FITNESS

Reg. No. 4,175,568

COFFEYFIT, LLC (NEW JERSEY LIMITED LIABILITY COMPANY)
33 BANK STREET
MEDFORD, NJ 08055

Registered July 17, 2012

Int. Cl.: 9

FOR: PRE-RECORDED DVDS FEATURING FITNESS INSTRUCTION, IN CLASS 9 (U.S. CLS. 21, 23, 26, 36 AND 38).

TRADEMARK

FIRST USE 2-1-2008; IN COMMERCE 2-1-2008.

PRINCIPAL REGISTER

THE MARK CONSISTS OF STANDARD CHARACTERS WITHOUT CLAIM TO ANY PARTICULAR FONT, STYLE, SIZE, OR COLOR.

SER. NO. 85-481,791, FILED 11-28-2011.

MARTHA SANTOMARTINO, EXAMINING ATTORNEY



David J. Kybas

Director of the United States Patent and Trademark Office

United States of America

United States Patent and Trademark Office

Outfit Your Logo

Reg. No. 4,175,569

Registered July 17, 2012

Int. Cl.: 40

SERVICE MARK

PRINCIPAL REGISTER

WILLIAMS, SARAH J. (UNITED STATES INDIVIDUAL)
SUITE 4
6565 KINNE ROAD
SYRACUSE, NY 13214

FOR: CUSTOMIZED IMPRINTING OF COMPANY NAMES AND LOGOS ON THE GOODS OF OTHERS, NAMELY, ON PROMOTIONAL MERCHANDISE, APPAREL AND CORPORATE GIFTS; PRINTING SERVICES, IN CLASS 40 (U.S. CLS. 100, 103 AND 106).

FIRST USE 4-1-1994; IN COMMERCE 4-1-1994.

THE MARK CONSISTS OF STANDARD CHARACTERS WITHOUT CLAIM TO ANY PARTICULAR FONT, STYLE, SIZE, OR COLOR.

SER. NO. 85-481,820, FILED 11-28-2011.

BRENDAN MCCAULEY, EXAMINING ATTORNEY



David J. Kyffers

Director of the United States Patent and Trademark Office

United States of America

United States Patent and Trademark Office

BIG SHOT

Reg. No. 4,175,570

LOUISVILLE BEDDING COMPANY (DELAWARE CORPORATION)
10400 BUNSEN WAY
LOUISVILLE, KY 40299

Registered July 17, 2012

Int. Cl.: 24

FOR: MATTRESS PADS, IN CLASS 24 (U.S. CLS. 42 AND 50).

TRADEMARK

FIRST USE 4-11-2011; IN COMMERCE 4-11-2011.

PRINCIPAL REGISTER

THE MARK CONSISTS OF STANDARD CHARACTERS WITHOUT CLAIM TO ANY PARTICULAR FONT, STYLE, SIZE, OR COLOR.

SER. NO. 85-481,855, FILED 11-28-2011.

WENDY GOODMAN, EXAMINING ATTORNEY



David J. Kyffers

Director of the United States Patent and Trademark Office

United States of America

United States Patent and Trademark Office

"MEET ME AT THIRD & FAIRFAX"

Reg. No. 4,175,571

A.F. GILMORE COMPANY (CALIFORNIA CORPORATION)
6301 WEST THIRD STREET
LOS ANGELES, CA 90036

Registered July 17, 2012

Int. Cls.: 18, 35 and 41

FOR: REUSABLE TOTE SHOPPING BAGS, IN CLASS 18 (U.S. CLS. 1, 2, 3, 22 AND 41).

TRADEMARK

FIRST USE 3-11-2011; IN COMMERCE 6-0-2011.

SERVICE MARK

FOR: FARMERS' MARKET, FEATURING A VARIETY OF FOOD AND MERCHANDISE VENDORS, IN CLASS 35 (U.S. CLS. 100, 101 AND 102).

PRINCIPAL REGISTER

FIRST USE 0-0-1960; IN COMMERCE 0-0-1985.

FOR: ORGANIZING COMMUNITY FESTIVALS FEATURING A VARIETY OF ACTIVITIES, NAMELY, LIVE MUSIC AND ENTERTAINMENT, ARTS AND CRAFTS, HOLIDAY FESTIVITIES, AND THE LIKE, IN CLASS 41 (U.S. CLS. 100, 101 AND 107).

FIRST USE 0-0-1960; IN COMMERCE 0-0-1985.

THE MARK CONSISTS OF STANDARD CHARACTERS WITHOUT CLAIM TO ANY PARTICULAR FONT, STYLE, SIZE, OR COLOR.

SER. NO. 85-481,881, FILED 11-28-2011.

NICHOLAS ALTREE, EXAMINING ATTORNEY



David J. Kyffers

Director of the United States Patent and Trademark Office

United States of America

United States Patent and Trademark Office



Reg. No. 4,175,572

NOVARTIS AG (SWITZERLAND CORPORATION)
CH-4002

Registered July 17, 2012

BASEL, SWITZERLAND

Int. Cl.: 10

FOR: SURGICAL APPARATUS AND INSTRUMENTS FOR USE IN OPHTHALMIC SURGERY,
IN CLASS 10 (U.S. CLS. 26, 39 AND 44).

TRADEMARK

OWNER OF SWITZERLAND REG. NO. 620405, DATED 9-19-2011, EXPIRES 5-27-2021.

PRINCIPAL REGISTER

OWNER OF U.S. REG. NOS. 3,972,937, 4,028,862, AND 4,062,615.

THE MARK CONSISTS OF AN ABSTRACT DESIGN OF A ROMAN ARMY OFFICER OR
GLADIATOR HELMET WITH THE WORD "CENTURION" IN BLOCK LETTERS TO THE
RIGHT OF THE DESIGN.

SER. NO. 85-481,896, FILED 11-28-2011.

AMY C. KEAN, EXAMINING ATTORNEY



David J. Kappas

Director of the United States Patent and Trademark Office

United States of America

United States Patent and Trademark Office

KOWABUNGA

Reg. No. 4,175,573

Registered July 17, 2012

Int. Cl.: 35

SERVICE MARK

PRINCIPAL REGISTER

INUVO, INC. (NEVADA CORPORATION)
SUITE 300
15550 LIGHTWAVE DRIVE
CLEARWATER, FL 33760

FOR: PROMOTING THE GOODS AND SERVICES OF OTHERS BY PROVIDING A WEBSITE FEATURING COUPONS, REBATES, PRICE-COMPARISON INFORMATION, PRODUCT REVIEWS, LINKS TO THE RETAIL WEBSITES OF OTHERS, AND DISCOUNT INFORMATION, IN CLASS 35 (U.S. CLS. 100, 101 AND 102).

FIRST USE 9-1-2011; IN COMMERCE 9-1-2011.

THE MARK CONSISTS OF STANDARD CHARACTERS WITHOUT CLAIM TO ANY PARTICULAR FONT, STYLE, SIZE, OR COLOR.

OWNER OF U.S. REG. NO. 3,141,494.

SER. NO. 85-481,919, FILED 11-28-2011.

JENNIFER VASQUEZ, EXAMINING ATTORNEY



David J. Kyros

Director of the United States Patent and Trademark Office

United States of America

United States Patent and Trademark Office

INSPIRING TRANSITIONS

Reg. No. 4,175,574

INSPIRING TRANSITIONS, LLC (ARIZONA LIMITED LIABILITY COMPANY)
5827 EAST LARKSPUR DRIVE
SCOTTSDALE, AZ 85254

Registered July 17, 2012

Int. Cl.: 41

FOR: EDUCATIONAL SERVICES, NAMELY, CONDUCTING TELESEMINARS, SEMINARS AND WORKSHOPS IN THE FIELD OF LEADERSHIP AND PERSONAL DEVELOPMENT; PERSONAL COACHING SERVICES IN THE FIELD OF LEADERSHIP AND PERSONAL DEVELOPMENT, IN CLASS 41 (U.S. CLS. 100, 101 AND 107).

SERVICE MARK

PRINCIPAL REGISTER

FIRST USE 10-8-2010; IN COMMERCE 3-24-2011.

THE MARK CONSISTS OF STANDARD CHARACTERS WITHOUT CLAIM TO ANY PARTICULAR FONT, STYLE, SIZE, OR COLOR.

SER. NO. 85-481,958, FILED 11-28-2011.

JULIE GUTTADAURO, EXAMINING ATTORNEY



David J. Kyffers

Director of the United States Patent and Trademark Office

United States of America

United States Patent and Trademark Office

KREATE

Reg. No. 4,175,575

Registered July 17, 2012

Int. Cl.: 5

TRADEMARK

PRINCIPAL REGISTER

SWOLE SPORTS NUTRITION, LLC (FLORIDA LIMITED LIABILITY COMPANY), DBA
SWOLE; SWOLE SPORTS; GET SWOLE, SWOLE SPORTS NUTRITION
221
6574 N STATE ROAD 7
COCONUT CREEK, FL 33073

FOR: DIETARY AND NUTRITIONAL SUPPLEMENTS, IN CLASS 5 (U.S. CLS. 6, 18, 44, 46,
51 AND 52).

FIRST USE 7-18-2011; IN COMMERCE 7-27-2011.

THE MARK CONSISTS OF STANDARD CHARACTERS WITHOUT CLAIM TO ANY PAR-
TICULAR FONT, STYLE, SIZE, OR COLOR.

SER. NO. 85-482,013, FILED 11-28-2011.

DOMINICK J. SALEMI, EXAMINING ATTORNEY



David J. Kyffers

Director of the United States Patent and Trademark Office

United States of America

United States Patent and Trademark Office

Summer Time

Reg. No. 4,175,576

HAZE TOBACCO, LLC (TEXAS LIMITED LIABILITY COMPANY)
10350 FOUNTAINGATE DR.
STAFFORD, TX 77477

Registered July 17, 2012

Int. Cl.: 34

FOR: HOOKAH TOBACCO; TOBACCO, IN CLASS 34 (U.S. CLS. 2, 8, 9 AND 17).

TRADEMARK

FIRST USE 11-17-2011; IN COMMERCE 11-17-2011.

PRINCIPAL REGISTER

THE MARK CONSISTS OF STANDARD CHARACTERS WITHOUT CLAIM TO ANY PARTICULAR FONT, STYLE, SIZE, OR COLOR.

SER. NO. 85-482,029, FILED 11-28-2011.

CHERYL CLAYTON, EXAMINING ATTORNEY



David J. Kyffers

Director of the United States Patent and Trademark Office

United States of America

United States Patent and Trademark Office

DRAFT PICK

Reg. No. 4,175,577

BALDIRAMA, LLC (TEXAS LIMITED LIABILITY COMPANY)
11940 MANCHACA RD STE 102
AUSTIN, TX 78748

Registered July 17, 2012

Int. Cl.: 43

FOR: BAR SERVICES; CATERING SERVICES; PREPARATION OF FOOD AND BEVERAGES; PROVIDING OF FOOD AND DRINK; PUBS; RESTAURANT AND CATERING SERVICES; RESTAURANT SERVICES; RESTAURANT SERVICES FEATURING BAR AND GRILL FOOD; RESTAURANT SERVICES, INCLUDING SIT-DOWN SERVICE OF FOOD AND TAKE-OUT RESTAURANT SERVICES; RESTAURANT SERVICES, NAMELY, PROVIDING OF FOOD AND BEVERAGES FOR CONSUMPTION ON AND OFF THE PREMISES; SERVING FOOD AND DRINKS, IN CLASS 43 (U.S. CLS. 100 AND 101).

SERVICE MARK

PRINCIPAL REGISTER

FIRST USE 3-17-2011; IN COMMERCE 3-17-2011.

THE MARK CONSISTS OF STANDARD CHARACTERS WITHOUT CLAIM TO ANY PARTICULAR FONT, STYLE, SIZE, OR COLOR.

SER. NO. 85-482,035, FILED 11-28-2011.

TARAH HARDY, EXAMINING ATTORNEY



David J. Kyffers

Director of the United States Patent and Trademark Office

United States of America

United States Patent and Trademark Office

Wild Women Wine

Reg. No. 4,175,578

CHARLENE MERIWETHER (UNITED STATES INDIVIDUAL)
1020 15TH ST. UNIT 31C
DENVER, CO 80202

Registered July 17, 2012

Int. Cl.: 33

FOR: ALCOHOLIC BEVERAGES, NAMELY, WINES, IN CLASS 33 (U.S. CLS. 47 AND 49).

FIRST USE 4-13-2008; IN COMMERCE 5-2-2008.

TRADEMARK

THE MARK CONSISTS OF STANDARD CHARACTERS WITHOUT CLAIM TO ANY PARTICULAR FONT, STYLE, SIZE, OR COLOR.

PRINCIPAL REGISTER

NO CLAIM IS MADE TO THE EXCLUSIVE RIGHT TO USE "WINE", APART FROM THE MARK AS SHOWN.

SER. NO. 85-482,059, FILED 11-28-2011.

KATHERINE STOIDES, EXAMINING ATTORNEY



David J. Kybas

Director of the United States Patent and Trademark Office

United States of America

United States Patent and Trademark Office

Route 66 Marine

Reg. No. 4,175,579

ROUTE 66 MARINE, LLC (CALIFORNIA LIMITED LIABILITY COMPANY)
1320 W. EL SEGUNDO BL #F
GARDENA, CA 90247

Registered July 17, 2012

Int. Cl.: 35

FOR: WHOLESALE STORE SERVICES FEATURING AQUARIUM LIVESTOCK, IN CLASS 35 (U.S. CLS. 100, 101 AND 102).

SERVICE MARK

FIRST USE 10-21-2008; IN COMMERCE 10-21-2008.

PRINCIPAL REGISTER

THE MARK CONSISTS OF STANDARD CHARACTERS WITHOUT CLAIM TO ANY PARTICULAR FONT, STYLE, SIZE, OR COLOR.

NO CLAIM IS MADE TO THE EXCLUSIVE RIGHT TO USE "MARINE", APART FROM THE MARK AS SHOWN.

SER. NO. 85-482,064, FILED 11-28-2011.

KATHERINE STOIDES, EXAMINING ATTORNEY



David J. Kybas

Director of the United States Patent and Trademark Office

United States of America

United States Patent and Trademark Office

THE POWERFUL DIFFERENCE

Reg. No. 4,175,580

Registered July 17, 2012

Int. Cls.: 37 and 39

SERVICE MARK

PRINCIPAL REGISTER

COLUMBIA HELICOPTERS, INC. (OREGON CORPORATION)
14452 ARNDT ROAD NE
AURORA, OR 97002

FOR: AIRCRAFT MAINTENANCE OR REPAIR; AIRCRAFT REPAIR AND MAINTENANCE; FUELING SERVICES FOR AIRCRAFT; INFORMATION WITH RELATION TO AIRCRAFT CONSTRUCTION, REPAIR AND MAINTENANCE; OUTER AND INNER CLEANING OF AIRCRAFT; REPAIR AND MAINTENANCE OF AIRCRAFT; TECHNICAL SUPPORT SERVICES, NAMELY, PROVIDING TECHNICAL ADVICE IN THE FIELD OF AIRCRAFT ENGINE AND REPAIR, IN CLASS 37 (U.S. CLS. 100, 103 AND 106).

FIRST USE 1-1-1980; IN COMMERCE 1-1-1980.

FOR: HELICOPTER TRANSPORT; RENTAL OF AIRCRAFT; CHARTERING OF HELICOPTERS AND OTHER AIRCRAFT, IN CLASS 39 (U.S. CLS. 100 AND 105).

FIRST USE 1-1-1980; IN COMMERCE 1-1-1980.

THE MARK CONSISTS OF STANDARD CHARACTERS WITHOUT CLAIM TO ANY PARTICULAR FONT, STYLE, SIZE, OR COLOR.

SER. NO. 85-482,069, FILED 11-28-2011.

JENNIFER MARTIN, EXAMINING ATTORNEY



David J. Kybas

Director of the United States Patent and Trademark Office

United States of America

United States Patent and Trademark Office

Generation-Next

Reg. No. 4,175,581

Registered July 17, 2012

Int. Cl.: 41

SERVICE MARK

PRINCIPAL REGISTER

GENERATION-NEXT (VIRGINIA CORPORATION)
#514
5405 DUKE ST
ALEXANDRIA, VA 22304

FOR: ORGANIZING, ARRANGING, AND CONDUCTING SPECIAL EVENTS FOR SOCIAL ENTERTAINMENT FOR YOUNG BLACK PROFESSIONAL LEADERS; EDUCATIONAL SERVICES PROVIDED BY AND FOR YOUNG BLACK PROFESSIONAL LEADERS, NAMELY, CONDUCTING SEMINARS IN FINANCIAL LITERACY AND MENTORSHIP, IN CLASS 41 (U.S. CLS. 100, 101 AND 107).

FIRST USE 8-15-2011; IN COMMERCE 8-15-2011.

THE MARK CONSISTS OF STANDARD CHARACTERS WITHOUT CLAIM TO ANY PARTICULAR FONT, STYLE, SIZE, OR COLOR.

SER. NO. 85-482,087, FILED 11-28-2011.

KATHERINE STOIDES, EXAMINING ATTORNEY



David J. Kybas

Director of the United States Patent and Trademark Office

United States of America

United States Patent and Trademark Office

OANAMASSAGE

Reg. No. 4,175,582

Registered July 17, 2012

Int. Cl.: 44

SERVICE MARK

PRINCIPAL REGISTER

KARINA YANKU INC. (NEW YORK CORPORATION)
APT.# B7
1060 OCEAN AVENUE
BROOKLYN, NY 11226

FOR: MASSAGE THERAPY SERVICES, IN CLASS 44 (U.S. CLS. 100 AND 101).

FIRST USE 7-10-2011; IN COMMERCE 7-10-2011.

THE MARK CONSISTS OF STANDARD CHARACTERS WITHOUT CLAIM TO ANY PARTICULAR FONT, STYLE, SIZE, OR COLOR.

SER. NO. 85-482,090, FILED 11-28-2011.

NORA BUCHANAN WILL, EXAMINING ATTORNEY



David J. Kybas

Director of the United States Patent and Trademark Office

United States of America

United States Patent and Trademark Office

NEUBUILT

Reg. No. 4,175,583

CHRISTOPHER G. NEUMAN (UNITED STATES INDIVIDUAL)
38A FAIRWAY AVENUE
PERKASIE, PA 18944

Registered July 17, 2012

Int. Cl.: 12

FOR: BICYCLE FRAMES; BICYCLES; FRAMES FOR BICYCLES; MOUNTAIN BICYCLES;
STRUCTURAL PARTS OF BICYCLES, IN CLASS 12 (U.S. CLS. 19, 21, 23, 31, 35 AND 44).

TRADEMARK

FIRST USE 10-1-2011; IN COMMERCE 10-1-2011.

PRINCIPAL REGISTER

THE MARK CONSISTS OF STANDARD CHARACTERS WITHOUT CLAIM TO ANY PARTICULAR FONT, STYLE, SIZE, OR COLOR.

SER. NO. 85-482,096, FILED 11-28-2011.

NORA BUCHANAN WILL, EXAMINING ATTORNEY



David J. Kyffers

Director of the United States Patent and Trademark Office

United States of America

United States Patent and Trademark Office

TELOMERANCE



Reg. No. 4,175,584

Registered July 17, 2012

Int. Cl.: 5

TRADEMARK

PRINCIPAL REGISTER

STOUPNIKOV, MAXIM (UNITED STATES INDIVIDUAL)
101 FRANKLIN STREET, #4L
BROOKLYN, NY 11222

FOR: DIETARY AND NUTRITIONAL SUPPLEMENTS; DIETARY AND NUTRITIONAL SUPPLEMENTS CONTAINING TELOMERASE ENZYMES; ENZYME FOOD SUPPLEMENTS; LIQUID NUTRITIONAL SUPPLEMENT, IN CLASS 5 (U.S. CLS. 6, 18, 44, 46, 51 AND 52).

FIRST USE 11-27-2011; IN COMMERCE 11-27-2011.

THE MARK CONSISTS OF THE WORD "TELOMERANCE" IN A DARK BLUE GOTHAM FONT, WITH TWO GREEN PEOPLE DANCING WITHIN A GREEN SINGLE LINE CIRCLE WHILE HOLDING GREEN BRANCHES AND LEAVES AGAINST A LIGHT BLUE BACKGROUND

THE COLOR(S) DARK BLUE, LIGHT BLUE AND GREEN IS/ARE CLAIMED AS A FEATURE OF THE MARK.

SER. NO. 85-482,100, FILED 11-28-2011.

NORA BUCHANAN WILL, EXAMINING ATTORNEY



David J. Kyjars

Director of the United States Patent and Trademark Office

United States of America

United States Patent and Trademark Office

Dairi-O

Reg. No. 4,175,585

Registered July 17, 2012

Int. Cl.: 43

SERVICE MARK

PRINCIPAL REGISTER

DAIRI-O OF KING, INC. (NORTH CAROLINA CORPORATION)
365 EAST DALTON STREET
KING, NC 27021

FOR: FAST-FOOD RESTAURANT SERVICES, IN CLASS 43 (U.S. CLS. 100 AND 101).

FIRST USE 1-1-1960; IN COMMERCE 1-1-1960.

THE MARK CONSISTS OF STANDARD CHARACTERS WITHOUT CLAIM TO ANY PARTICULAR FONT, STYLE, SIZE, OR COLOR.

SER. NO. 85-482,153, FILED 11-28-2011.

KAELIE KUNG, EXAMINING ATTORNEY



David J. Kyros

Director of the United States Patent and Trademark Office

United States of America

United States Patent and Trademark Office

Fixate

Reg. No. 4,175,586

WEST CENTRAL, INC. (MINNESOTA CORPORATION)
2700 TROTT AVE. SW
WILLMAR, MN 56201

Registered July 17, 2012

Int. Cl.: 1

FOR: ADJUVANT FOR USE WITH AGRICULTURAL CHEMICALS; ADJUVANTS FOR USE WITH PESTICIDES; SURFACTANTS FOR USE IN CONNECTION WITH AGRICULTURAL PESTICIDES, IN CLASS 1 (U.S. CLS. 1, 5, 6, 10, 26 AND 46).

TRADEMARK

FIRST USE 5-24-2011; IN COMMERCE 5-31-2011.

PRINCIPAL REGISTER

THE MARK CONSISTS OF STANDARD CHARACTERS WITHOUT CLAIM TO ANY PARTICULAR FONT, STYLE, SIZE, OR COLOR.

SER. NO. 85-482,334, FILED 11-29-2011.

NICHOLAS ALTREE, EXAMINING ATTORNEY



David J. Kybas

Director of the United States Patent and Trademark Office

United States of America

United States Patent and Trademark Office

Luminous

Reg. No. 4,175,587

CRT INC. (WEST VIRGINIA CORPORATION), DBA DAVIS DISTRIBUTION SYSTEMS
#52 QUAKER STATE ROAD
NEWELL, WV 26050

Registered July 17, 2012

Int. Cl.: 35

FOR: WHOLESALE DISTRIBUTORSHIPS FEATURING AUTOMOTIVE LIGHTING, IN CLASS 35 (U.S. CLS. 100, 101 AND 102).

SERVICE MARK

FIRST USE 4-1-2011; IN COMMERCE 4-1-2011.

PRINCIPAL REGISTER

THE MARK CONSISTS OF STANDARD CHARACTERS WITHOUT CLAIM TO ANY PARTICULAR FONT, STYLE, SIZE, OR COLOR.

SER. NO. 85-482,355, FILED 11-29-2011.

DOMINICK J. SALEMI, EXAMINING ATTORNEY



David J. Kybas

Director of the United States Patent and Trademark Office

United States of America

United States Patent and Trademark Office

The logo for the trademark 'Pro-form' features the word 'Pro-form' in a stylized, serif font. The 'P' is significantly larger and more prominent than the other letters. The entire word is enclosed within a thin, curved line that arches over the top and under the bottom, resembling a stylized 'U' or a protective shield.

Reg. No. 4,175,588

Registered July 17, 2012

Int. Cls.: 1 and 7

TRADEMARK

PRINCIPAL REGISTER

MYCONE DENTAL SUPPLY CO., INC. (NEW YORK CORPORATION), AKA KEYSTONE INDUSTRIES
616 HOLLYWOOD AVENUE
CHERRY HILL, NJ 08002

FOR: PLASTIC MOLDING COMPOUNDS FOR USE IN THE MANUFACTURE OF MOLDED PLASTIC ARTICLES FOR USE IN THE DENTAL INDUSTRY, IN CLASS 1 (U.S. CLS. 1, 5, 6, 10, 26 AND 46).

FIRST USE 12-31-1982; IN COMMERCE 12-31-1982.

FOR: VACUUM PACKING MACHINES FOR USE IN THE DENTAL INDUSTRY, IN CLASS 7 (U.S. CLS. 13, 19, 21, 23, 31, 34 AND 35).

FIRST USE 12-31-1982; IN COMMERCE 12-31-1982.

THE MARK CONSISTS OF THE CHARACTERS "PRO-FORM" WITH A CAPITALIZED "P" AND A CURVED LINE SURROUNDING THE MARK.

SER. NO. 85-482,415, FILED 11-29-2011.

LESLIE RICHARDS, EXAMINING ATTORNEY



David J. Kyffers

Director of the United States Patent and Trademark Office

United States of America

United States Patent and Trademark Office

MUNICIPAL

Reg. No. 4,175,589

Registered July 17, 2012

Int. Cl.: 9

TRADEMARK

PRINCIPAL REGISTER

BRAND DESIGN COMPANY, INC. (DELAWARE CORPORATION), DBA HOUSE INDUSTRIES
1145 YORKLYN ROAD, PO BOX 166
YORKLYN, DE 19736

FOR: PRINTING FONTS THAT CAN BE DOWNLOADED PROVIDED BY MEANS OF ELECTRONIC TRANSMISSION; TYPEFACE FONTS RECORDED ON MAGNETIC MEDIA, IN CLASS 9 (U.S. CLS. 21, 23, 26, 36 AND 38).

FIRST USE 11-23-2011; IN COMMERCE 11-23-2011.

THE MARK CONSISTS OF STANDARD CHARACTERS WITHOUT CLAIM TO ANY PARTICULAR FONT, STYLE, SIZE, OR COLOR.

SER. NO. 85-482,430, FILED 11-29-2011.

KRISTINA MORRIS, EXAMINING ATTORNEY



David J. Kyffers

Director of the United States Patent and Trademark Office

United States of America

United States Patent and Trademark Office

WORTHE

Reg. No. 4,175,590

Registered July 17, 2012

Int. Cl.: 9

TRADEMARK

PRINCIPAL REGISTER

BRAND DESIGN COMPANY, INC. (DELAWARE CORPORATION), DBA HOUSE INDUSTRIES
1145 YORKLYN ROAD, PO BOX 166
YORKLYN, DE 19736

FOR: PRINTING FONTS THAT CAN BE DOWNLOADED PROVIDED BY MEANS OF ELECTRONIC TRANSMISSION; TYPEFACE FONTS RECORDED ON MAGNETIC MEDIA , IN CLASS 9 (U.S. CLS. 21, 23, 26, 36 AND 38).

FIRST USE 11-25-2011; IN COMMERCE 11-25-2011.

THE MARK CONSISTS OF STANDARD CHARACTERS WITHOUT CLAIM TO ANY PARTICULAR FONT, STYLE, SIZE, OR COLOR.

SER. NO. 85-482,519, FILED 11-29-2011.

KRISTINA MORRIS, EXAMINING ATTORNEY



David J. Kyffers

Director of the United States Patent and Trademark Office

United States of America

United States Patent and Trademark Office

DODIPETTO

Reg. No. 4,175,591

MINICONF S.R.L. (ITALY LIMITED LIABILITY COMPANY)
VIA PROVINCIALE 1/A
ORTIGNANO RAGGIOLO-AR, ITALY 52010

Registered July 17, 2012

Int. Cl.: 25

FOR: CLOTHING, NAMELY, SHIRTS, BLOUSES, T-SHIRTS, SWEATERS, JUMPERS, JACKETS, PADDED JACKETS, COATS, OVERCOATS, JEANS, SHORTS, TROUSERS, SKIRTS, SCARVES, PINAFORE DRESSES, DRESSES, SOCKS, PYJAMAS, ROMPERS, BATHING SUITS, UNDERSHIRTS, UNDERPANTS, HATS AND FOOTWEAR, IN CLASS 25 (U.S. CLS. 22 AND 39).

TRADEMARK

PRINCIPAL REGISTER

THE MARK CONSISTS OF STANDARD CHARACTERS WITHOUT CLAIM TO ANY PARTICULAR FONT, STYLE, SIZE, OR COLOR.

OWNER OF ITALY REG. NO. 1272491, DATED 4-16-2010, EXPIRES 10-22-2019.

THE WORDING "DODIPETTO" HAS NO MEANING IN A FOREIGN LANGUAGE.

SER. NO. 85-482,607, FILED 11-29-2011.

DOUGLAS LEE, EXAMINING ATTORNEY



David J. Kyffers

Director of the United States Patent and Trademark Office

United States of America

United States Patent and Trademark Office

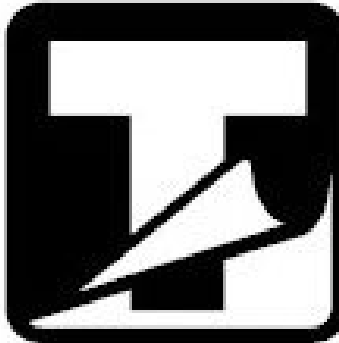

Reg. No. 4,175,592

Registered July 17, 2012

Int. Cl.: 35

SERVICE MARK

PRINCIPAL REGISTER

INTERNATIONAL SANITARY SUPPLY ASSOCIATION (ILLINOIS CORPORATION)
7373 NORTH LINCOLN AVENUE
LINCOLNWOOD, IL 607121799 AND

ECOFORM, LLC (TENNESSEE LIMITED LIABILITY COMPANY)
9417 STATES VIEW DRIVE
KNOXVILLE, TN 37922

FOR: ASSOCIATION SERVICES, NAMELY, PROMOTING ENVIRONMENTAL SAFETY, RESPONSIBILITY AND INFORMATION IN THE CLEANING AND MAINTENANCE INDUSTRY, IN CLASS 35 (U.S. CLS. 100, 101 AND 102).

FIRST USE 10-17-2011; IN COMMERCE 10-17-2011.

SER. NO. 85-482,760, FILED 11-29-2011.

REBECCA GILBERT, EXAMINING ATTORNEY



David J. Kyffers

Director of the United States Patent and Trademark Office

United States of America

United States Patent and Trademark Office

OVERCASE

Reg. No. 4,175,593

AMOSA, ADRIAN (UNITED STATES INDIVIDUAL)
5302 DELONG ST.
CYPRESS, CA 90630

Registered July 17, 2012

Int. Cl.: 9

FOR: COMPUTER KEYBOARDS; COMPUTER PERIPHERAL DEVICES; COMPUTERS;
COMPUTER MONITORS, IN CLASS 9 (U.S. CLS. 21, 23, 26, 36 AND 38).

TRADEMARK

FIRST USE 2-22-2008; IN COMMERCE 2-22-2008.

PRINCIPAL REGISTER

THE MARK CONSISTS OF STANDARD CHARACTERS WITHOUT CLAIM TO ANY PARTICULAR FONT, STYLE, SIZE, OR COLOR.

SER. NO. 85-482,763, FILED 11-29-2011.

LAKEISHA LEWIS, EXAMINING ATTORNEY



David J. Kyros

Director of the United States Patent and Trademark Office

United States of America

United States Patent and Trademark Office



Reg. No. 4,175,594

Registered July 17, 2012

Int. Cl.: 35

SERVICE MARK

PRINCIPAL REGISTER

CITY OF TUPELO (MISSISSIPPI MUNICIPAL CORPORATION)
P.O. BOX 1485
TUPELO, MS 38802

FOR: ADVERTISING, MARKETING AND PROMOTION SERVICES IN THE FIELD OF ENCOURAGING HEALTHY FOOD CHOICES, IN CLASS 35 (U.S. CLS. 100, 101 AND 102).

FIRST USE 4-15-2011; IN COMMERCE 4-15-2011.

THE MARK CONSISTS OF A HORIZONTAL GUITAR FEATURING THE IMAGES OF VARIOUS FRUITS AND VEGETABLES ON THE BODY OF THE GUITAR ACCOMPANIED BY THE WORDS "HEALTH ON A SHELF".

SER. NO. 85-482,780, FILED 11-29-2011.

SIMON TENG, EXAMINING ATTORNEY



David J. Kybas

Director of the United States Patent and Trademark Office

United States of America

United States Patent and Trademark Office



Reg. No. 4,175,595

AMOS, ADRIAN (UNITED STATES INDIVIDUAL)
5302 DELONG ST.
CYPRESS, CA 90630

Registered July 17, 2012

Int. Cl.: 9

FOR: COMPUTER KEYBOARDS; COMPUTER PERIPHERAL DEVICES; COMPUTERS;
COMPUTER MONITORS, IN CLASS 9 (U.S. CLS. 21, 23, 26, 36 AND 38).

TRADEMARK

FIRST USE 2-22-2008; IN COMMERCE 2-22-2008.

PRINCIPAL REGISTER

THE MARK CONSISTS OF LITERAL ELEMENT "OVERCASE" WHEREIN WORD "OVER"
IS WRITTEN ABOVE THE WORD "CASE" AS SHOWN IN THE MARK.

SER. NO. 85-482,822, FILED 11-29-2011.

LAKEISHA LEWIS, EXAMINING ATTORNEY



David J. Kyjars

Director of the United States Patent and Trademark Office

United States of America

United States Patent and Trademark Office

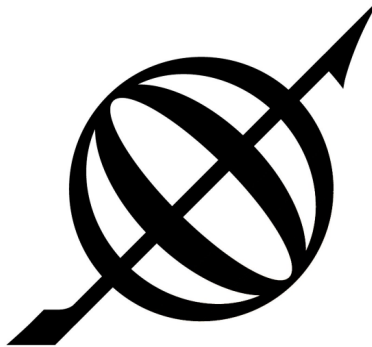

Reg. No. 4,175,596

Registered July 17, 2012

Int. Cl.: 36

SERVICE MARK

PRINCIPAL REGISTER

AXIOM FINANCIAL, LLC (UTAH LIMITED LIABILITY COMPANY)
SUITE 140
9350 SOUTH 150 EAST
SANDY, UT 84070

FOR: MORTGAGE LENDING AND BROKERAGE SERVICES, IN CLASS 36 (U.S. CLS. 100, 101 AND 102).

FIRST USE 10-11-2011; IN COMMERCE 10-11-2011.

THE MARK CONSISTS OF A CIRCLE CONTAINING AN OVAL WITH AN ARROW TYPE LINE DIAGONALLY CROSSING BOTH THE CIRCLE AND OVAL SHAPES.

SER. NO. 85-483,115, FILED 11-29-2011.

WILLIAM BRECKENFELD, EXAMINING ATTORNEY



David J. Kybas

Director of the United States Patent and Trademark Office

United States of America

United States Patent and Trademark Office

HAZEL EYEZ

Reg. No. 4,175,597

HAZE TOBACCO, LLC (TEXAS LIMITED LIABILITY COMPANY)
10350 FOUNTAINGATE DR.
STAFFORD, TX 77477

Registered July 17, 2012

Int. Cl.: 34

FOR: HOOKAH TOBACCO; SMOKING TOBACCO; TOBACCO, IN CLASS 34 (U.S. CLS. 2, 8, 9 AND 17).

TRADEMARK

FIRST USE 11-17-2011; IN COMMERCE 11-17-2011.

PRINCIPAL REGISTER

THE MARK CONSISTS OF STANDARD CHARACTERS WITHOUT CLAIM TO ANY PARTICULAR FONT, STYLE, SIZE, OR COLOR.

SER. NO. 85-483,132, FILED 11-29-2011.

CHERYL CLAYTON, EXAMINING ATTORNEY



David J. Kyffers

Director of the United States Patent and Trademark Office

United States of America

United States Patent and Trademark Office

OMG

Reg. No. 4,175,598

HAZE TOBACCO, LLC (TEXAS LIMITED LIABILITY COMPANY)
10350 FOUNTAINGATE DR.
STAFFORD, TX 77477

Registered July 17, 2012

Int. Cl.: 34

FOR: HOOKAH TOBACCO; SMOKING TOBACCO; TOBACCO, IN CLASS 34 (U.S. CLS. 2, 8, 9 AND 17).

TRADEMARK

FIRST USE 11-17-2011; IN COMMERCE 11-17-2011.

PRINCIPAL REGISTER

THE MARK CONSISTS OF STANDARD CHARACTERS WITHOUT CLAIM TO ANY PARTICULAR FONT, STYLE, SIZE, OR COLOR.

SER. NO. 85-483,173, FILED 11-29-2011.

CHERYL CLAYTON, EXAMINING ATTORNEY



David J. Kyffers

Director of the United States Patent and Trademark Office

United States of America
United States Patent and Trademark Office

HARDCORE

Reg. No. 4,175,599

HAZE TOBACCO, LLC (TEXAS LIMITED LIABILITY COMPANY)
10350 FOUNTAINGATE DR.
STAFFORD, TX 77477

Registered July 17, 2012

Int. Cl.: 34

FOR: HOOKAH TOBACCO; SMOKING TOBACCO; TOBACCO, IN CLASS 34 (U.S. CLS. 2, 8, 9 AND 17).

TRADEMARK

FIRST USE 11-17-2011; IN COMMERCE 11-17-2011.

PRINCIPAL REGISTER

THE MARK CONSISTS OF STANDARD CHARACTERS WITHOUT CLAIM TO ANY PARTICULAR FONT, STYLE, SIZE, OR COLOR.

SER. NO. 85-483,189, FILED 11-29-2011.

CHERYL CLAYTON, EXAMINING ATTORNEY



David J. Kyjars

Director of the United States Patent and Trademark Office

United States of America
United States Patent and Trademark Office

DoodleArt

Reg. No. 4,175,600

DOODLEART WORLD MARKETING AND SALES INC. (CANADA CORPORATION)
1553 WEST 75TH AVENUE
VANCOUVER, BC, CANADA

Registered July 17, 2012

Int. Cl.: 16

FOR: POSTERS, MARKERS, AND PACKAGED KITS COMPRISED PRIMARILY OF GRAPHIC POSTERS AND COLORING MARKERS, IN CLASS 16 (U.S. CLS. 2, 5, 22, 23, 29, 37, 38 AND 50).

TRADEMARK

FIRST USE 0-0-1972; IN COMMERCE 0-0-1973.

PRINCIPAL REGISTER

THE MARK CONSISTS OF THE WORD "DOODLEART" IN STYLIZED FONT.

SER. NO. 85-483,238, FILED 11-30-2011.

RAMONA ORTIGA, EXAMINING ATTORNEY



David J. Kyffers

Director of the United States Patent and Trademark Office

United States of America

United States Patent and Trademark Office

SECRET CHURCH

Reg. No. 4,175,601

Registered July 17, 2012

Int. Cls.: 9, 41 and 45

TRADEMARK

SERVICE MARK

PRINCIPAL REGISTER

THE PSALM 67 FOUNDATION (ALABAMA TRUST)
C/O JIM WARREN
2500 ACTON ROAD
BIRMINGHAM, AL 35243

FOR: AUDIO AND VIDEO RECORDINGS FEATURING CHRISTIAN TEACHING AND INSPIRATION; COMPACT DISCS FEATURING CHRISTIAN TEACHING AND INSPIRATION; DVDS FEATURING CHRISTIAN TEACHING AND INSPIRATION; PRERECORDED VIDEO CASSETTES FEATURING CHRISTIAN TEACHING AND INSPIRATION, IN CLASS 9 (U.S. CLS. 21, 23, 26, 36 AND 38).

FIRST USE 11-1-2006; IN COMMERCE 11-1-2006.

FOR: EDUCATIONAL SERVICES, NAMELY, CONDUCTING SEMINARS, WORKSHOPS, CLASSES VIA SIMULCAST AND LIVE EVENTS IN THE NATURE OF CLASSES IN THE FIELDS OF CHRISTIAN MUSIC, TEACHING, AND INSPIRATION AND DISTRIBUTION OF TRAINING MATERIALS IN CONNECTION THEREWITH; ENTERTAINMENT SERVICES, NAMELY, PROVIDING WEBCASTS IN THE FIELD OF CHRISTIAN MUSIC, TEACHING AND INSPIRATION, IN CLASS 41 (U.S. CLS. 100, 101 AND 107).

FIRST USE 11-1-2006; IN COMMERCE 11-1-2006.

FOR: CHRISTIAN MINISTRY SERVICES, IN CLASS 45 (U.S. CLS. 100 AND 101).

FIRST USE 11-1-2006; IN COMMERCE 11-1-2006.

THE MARK CONSISTS OF STANDARD CHARACTERS WITHOUT CLAIM TO ANY PARTICULAR FONT, STYLE, SIZE, OR COLOR.

NO CLAIM IS MADE TO THE EXCLUSIVE RIGHT TO USE "CHURCH" , APART FROM THE MARK AS SHOWN.

SER. NO. 85-483,257, FILED 11-30-2011.

TASNEEM HUSSAIN, EXAMINING ATTORNEY



David J. Kyffers

Director of the United States Patent and Trademark Office

United States of America

United States Patent and Trademark Office



Reg. No. 4,175,602

Registered July 17, 2012

Int. Cls.: 9, 41 and 45

TRADEMARK

SERVICE MARK

PRINCIPAL REGISTER

THE PSALM 67 FOUNDATION (ALABAMA TRUST)
C/O JIM WARREN
2500 ACTON ROAD
BIRMINGHAM, AL 35243

FOR: AUDIO AND VIDEO RECORDINGS FEATURING CHRISTIAN TEACHING AND INSPIRATION; COMPACT DISCS FEATURING CHRISTIAN TEACHING AND INSPIRATION; DVDS FEATURING CHRISTIAN TEACHING AND INSPIRATION; PRERECORDED VIDEO CASSETTES FEATURING CHRISTIAN TEACHING AND INSPIRATION, IN CLASS 9 (U.S. CLS. 21, 23, 26, 36 AND 38).

FIRST USE 11-1-2006; IN COMMERCE 11-1-2006.

FOR: EDUCATIONAL SERVICES, NAMELY, CONDUCTING SEMINARS, WORKSHOPS, CLASSES VIA SIMULCAST AND LIVE EVENTS IN THE NATURE OF CLASSES IN THE FIELDS OF CHRISTIAN MUSIC, TEACHING, AND INSPIRATION AND DISTRIBUTION OF TRAINING MATERIALS IN CONNECTION THEREWITH; ENTERTAINMENT SERVICES, NAMELY, PROVIDING WEBCASTS IN THE FIELD OF CHRISTIAN MUSIC, TEACHING AND INSPIRATION, IN CLASS 41 (U.S. CLS. 100, 101 AND 107).

FIRST USE 11-1-2006; IN COMMERCE 11-1-2006.

FOR: CHRISTIAN MINISTRY SERVICES, IN CLASS 45 (U.S. CLS. 100 AND 101).

FIRST USE 11-1-2006; IN COMMERCE 11-1-2006.

THE MARK CONSISTS OF A DRAWING OF A SHIELD WITH A CROSS IN THE RIGHT CENTER OF THE SHIELD.

SER. NO. 85-483,267, FILED 11-30-2011.

TASNEEM HUSSAIN, EXAMINING ATTORNEY



David J. Kybas

Director of the United States Patent and Trademark Office

United States of America

United States Patent and Trademark Office



Reg. No. 4,175,603

Registered July 17, 2012

Int. Cls.: 41 and 45

SERVICE MARK

PRINCIPAL REGISTER

THE PSALM 67 FOUNDATION (ALABAMA TRUST)
C/O JIM WARREN
2500 ACTON ROAD
BIRMINGHAM, AL 35243

FOR: EDUCATIONAL SERVICES, NAMELY, CONDUCTING SEMINARS, WORKSHOPS, CLASSES VIA SIMULCAST AND LIVE EVENTS IN THE NATURE OF CLASSES IN THE FIELDS OF CHRISTIAN MUSIC, TEACHING, AND INSPIRATION AND DISTRIBUTION OF TRAINING MATERIALS IN CONNECTION THEREWITH; ENTERTAINMENT SERVICES, NAMELY, PROVIDING WEBCASTS IN THE FIELD OF CHRISTIAN MUSIC, TEACHING AND INSPIRATION, IN CLASS 41 (U.S. CLS. 100, 101 AND 107).

FIRST USE 11-1-2006; IN COMMERCE 11-1-2006.

FOR: CHRISTIAN MINISTRY SERVICES, IN CLASS 45 (U.S. CLS. 100 AND 101).

FIRST USE 11-1-2006; IN COMMERCE 11-1-2006.

NO CLAIM IS MADE TO THE EXCLUSIVE RIGHT TO USE "CHURCH" , APART FROM THE MARK AS SHOWN.

THE MARK CONSISTS OF A STYLIZED VERSION OF THE WORDS "SECRET CHURCH," WITH A DRAWN IMAGE OF A SHIELD AND CROSS, WITH THE CROSS ON THE RIGHT CENTER OF THE SHIELD, IN BETWEEN THE WORDS "SECRET" AND "CHURCH".

SER. NO. 85-483,280, FILED 11-30-2011.

TASNEEM HUSSAIN, EXAMINING ATTORNEY



David J. Kyffers

Director of the United States Patent and Trademark Office

United States of America

United States Patent and Trademark Office

Voxy

Reg. No. 4,175,604

Registered July 17, 2012

Int. Cl.: 41

SERVICE MARK

PRINCIPAL REGISTER

VOXY, INC. (DELAWARE CORPORATION)
85 EAST 10TH ST., SUITE 5M
NEW YORK, NY 10003

FOR: PROVIDING AN INTERNET NEWS PORTAL FEATURING LINKS TO NEWS STORIES AND ARTICLES IN THE FIELD OF CURRENT EVENTS; PROVIDING INFORMATION, NEWS AND COMMENTARY IN THE FIELD OF ENTERTAINMENT; PROVIDING NEWS AND INFORMATION IN THE FIELD OF SPORTS; PROVIDING NEWS IN THE NATURE OF CURRENT EVENT REPORTING, IN CLASS 41 (U.S. CLS. 100, 101 AND 107).

FIRST USE 9-1-2010; IN COMMERCE 2-23-2011.

THE MARK CONSISTS OF STANDARD CHARACTERS WITHOUT CLAIM TO ANY PARTICULAR FONT, STYLE, SIZE, OR COLOR.

SER. NO. 85-483,564, FILED 11-30-2011.

STEPHANIE ALI, EXAMINING ATTORNEY



David J. Kybas

Director of the United States Patent and Trademark Office

United States of America

United States Patent and Trademark Office



Reg. No. 4,175,605

Registered July 17, 2012

Int. Cl.: 30

TRADEMARK

PRINCIPAL REGISTER

IT'S YOGURT CAPITAL VENTURES, LLC (PUERTO RICO LIMITED LIABILITY COMPANY),
DBA MOYO
PMB 538 AVE WINSTON CHURCHILL 138
SAN JUAN, PUERTO RICO 00926

FOR: FROZEN YOGURT; FROZEN YOGURT CONFECTIONS; FROZEN YOGURT MIXES;
YOGURT-COVERED FRUIT; YOGURT-COVERED NUTS; YOGURT-COVERED PRETZELS,
IN CLASS 30 (U.S. CL. 46).

FIRST USE 2-10-2012; IN COMMERCE 2-10-2012.

NO CLAIM IS MADE TO THE EXCLUSIVE RIGHT TO USE "FROZEN YOGURT LOUNGE",
APART FROM THE MARK AS SHOWN.

THE COLOR(S) FUCHSIA, LIGHT GREEN, BROWN IS/ARE CLAIMED AS A FEATURE OF
THE MARK.

THE MARK CONSISTS OF A HEART SHAPED SYMBOL IN THE LEFT SIDE IN LIGHT
GREEN AND FUCHSIA FOLLOWED BY THE WORD "MOYO". THE "M" IS CAPITALIZED
IN LIGHT GREEN FOLLOWED BY THE LETTER "O" ALSO IN LIGHT GREEN, THEN THE
LETTER "Y" IN FUCHSIA FOLLOWED BY THE LETTER "O" ALSO IN FUCHSIA. BELOW
IS THE PHRASE "FROZENYOGURTLounge" WITH THE WORDS "FROZEN" AND
"LOUNGE" IN BROWN AND "YOGURT" IN FUCHSIA.

THE WORDING "MOYO" HAS NO MEANING IN A FOREIGN LANGUAGE.

SER. NO. 85-483,951, FILED 11-30-2011.

AMY HELLA, EXAMINING ATTORNEY



David J. Kyffers

Director of the United States Patent and Trademark Office

United States of America

United States Patent and Trademark Office

COMBAT2CAREER

Reg. No. 4,175,606

Registered July 17, 2012

Int. Cls.: 35 and 41

SERVICE MARK

PRINCIPAL REGISTER

C2C, LLC (CONNECTICUT LIMITED LIABILITY COMPANY), DBA COMBAT2CAREER
41 SHINGLE MILL ROAD
WEST SIMSBURY, CT 06092

FOR: PROVIDING ON-LINE EMPLOYMENT INFORMATION IN THE FIELDS OF RECRUITMENT, CAREERS, JOB RESOURCES AND LISTINGS, AND RESUMES; PROVIDING AN INTERACTIVE WEB SITE THAT FACILITATES THE PREPARATION OF RESUMES; PROVIDING ON-LINE EMPLOYMENT PLACEMENT SERVICES, NAMELY, MATCHING RESUMES AND POTENTIAL EMPLOYERS VIA A GLOBAL COMPUTER NETWORK; PROVIDING A DATABASE OF RESUMES OF PROSPECTIVE EMPLOYEES, IN CLASS 35 (U.S. CLS. 100, 101 AND 102).

FIRST USE 5-31-2011; IN COMMERCE 6-3-2011.

FOR: PROVIDING A WEB-BASED SYSTEM AND ONLINE PORTAL THAT ALLOWS VETERANS TO SEARCH FOR AND APPLY TO VETERAN-FRIENDLY EDUCATIONAL PROGRAMS BASED ON VETERAN-SPECIFIC CRITERIA; CAREER COUNSELING, NAMELY, PROVIDING ADVICE TO VETERANS CONCERNING EDUCATION OPTIONS TO PURSUE CAREER OPPORTUNITIES, AND TO FACILITATE THE TRANSITION FROM HIGHER EDUCATION TO THE CIVILIAN WORKFORCE BY PROVIDING VETERANS WITH THE ABILITY TO DEVELOP RELATIONSHIPS WITH VETERAN-FRIENDLY BUSINESSES, IN CLASS 41 (U.S. CLS. 100, 101 AND 107).

FIRST USE 5-31-2011; IN COMMERCE 6-3-2011.

THE MARK CONSISTS OF STANDARD CHARACTERS WITHOUT CLAIM TO ANY PARTICULAR FONT, STYLE, SIZE, OR COLOR.

SER. NO. 85-484,041, FILED 11-30-2011.

DARRYL SPRUILL, EXAMINING ATTORNEY



David J. Kypos

Director of the United States Patent and Trademark Office

United States of America

United States Patent and Trademark Office

Unleash

Reg. No. 4,175,607

Registered July 17, 2012

Int. Cls.: 9, 16, 41 and 45

TRADEMARK

SERVICE MARK

PRINCIPAL REGISTER

NEWSPRING CHURCH, INC. (SOUTH CAROLINA CORPORATION)
ATTENTION: CRISTIN COOPER
2940 CONCORD ROAD
ANDERSON, SC 29621

FOR: DIGITAL MEDIA, NAMELY, PRE-RECORDED AUDIO AND VIDEO TAPES, DOWNLOADABLE AUDIO AND VIDEO RECORDINGS, CDS AND DVDS FEATURING RELIGION, EVANGELISM, DISCIPLESHIP, LEADERSHIP TRAINING, MINISTRY DEVELOPMENT, COMMUNITY OUTREACH, CHRISTIAN LIFESTYLES AND FAMILY VALUES; DOWNLOADABLE PODCASTS IN THE FIELD OF RELIGION, EVANGELISM, DISCIPLESHIP, LEADERSHIP TRAINING, MINISTRY DEVELOPMENT, COMMUNITY OUTREACH, CHRISTIAN LIFESTYLES AND FAMILY VALUES; DOWNLOADABLE WEBINARS IN THE FIELD OF RELIGION, EVANGELISM, DISCIPLESHIP, LEADERSHIP TRAINING, MINISTRY DEVELOPMENT, COMMUNITY OUTREACH, CHRISTIAN LIFESTYLES AND FAMILY VALUES, IN CLASS 9 (U.S. CLS. 21, 23, 26, 36 AND 38).

FIRST USE 3-1-2007; IN COMMERCE 3-1-2007.

FOR: PRINTED INSTRUCTIONAL, EDUCATIONAL, AND TEACHING MATERIALS IN THE FIELD OF RELIGION, EVANGELISM, DISCIPLESHIP, LEADERSHIP TRAINING, MINISTRY DEVELOPMENT, COMMUNITY OUTREACH, CHRISTIAN LIFESTYLES AND FAMILY VALUES; PRINTED MATTER, NAMELY, PAPER SIGNS, BOOKS, MANUALS, CURRICULUM, NEWSLETTERS, INFORMATIONAL CARDS AND BROCHURES IN THE FIELD OF RELIGION, EVANGELISM, DISCIPLESHIP, LEADERSHIP TRAINING, MINISTRY DEVELOPMENT, COMMUNITY OUTREACH, CHRISTIAN LIFESTYLES AND FAMILY VALUES, IN CLASS 16 (U.S. CLS. 2, 5, 22, 23, 29, 37, 38 AND 50).

FIRST USE 3-1-2007; IN COMMERCE 3-1-2007.

FOR: EDUCATIONAL AND ENTERTAINMENT SERVICES, NAMELY, A CONTINUING PROGRAM ABOUT RELIGION, EVANGELISM, DISCIPLESHIP, LEADERSHIP TRAINING, MINISTRY DEVELOPMENT, COMMUNITY OUTREACH, CHRISTIAN LIFESTYLES AND FAMILY VALUES ACCESSIBLE BY RADIO, TELEVISION, SATELLITE, AUDIO, VIDEO AND COMPUTER NETWORKS; EDUCATIONAL SERVICES, NAMELY, CONDUCTING CLASSES, SEMINARS, WORKSHOPS AND CONFERENCES IN THE FIELD OF RELIGION, EVANGELISM, DISCIPLESHIP, LEADERSHIP TRAINING, MINISTRY DEVELOPMENT, COMMUNITY OUTREACH, CHRISTIAN LIFESTYLES AND FAMILY VALUES AND DIS-



David J. Kybas

Director of the United States Patent and Trademark Office

Reg. No. 4,175,607 TRIBUTION OF TRAINING MATERIAL IN CONNECTION THEREWITH; ON-LINE JOURNALS, NAMELY, BLOGS FEATURING RELIGION, EVANGELISM, DISCIPLESHIP, LEADERSHIP TRAINING, MINISTRY DEVELOPMENT, COMMUNITY OUTREACH, CHRISTIAN LIFESTYLES AND FAMILY VALUES; PROVIDING ON-LINE RELIGIOUS INSTRUCTION PROMOTING CHRISTIAN AND FAMILY VALUES, IN CLASS 41 (U.S. CLS. 100, 101 AND 107).

FIRST USE 3-1-2007; IN COMMERCE 3-1-2007.

FOR: CONDUCTING RELIGIOUS PRAYER SERVICES; EVANGELISTIC AND MINISTERIAL SERVICES; ONLINE SOCIAL NETWORKING SERVICES IN THE FIELD OF RELIGION, EVANGELISM, DISCIPLESHIP, LEADERSHIP TRAINING, MINISTRY DEVELOPMENT, COMMUNITY OUTREACH, CHRISTIAN LIFESTYLES AND FAMILY VALUES ; PROVIDING A WEBSITE FEATURING INFORMATION ABOUT MINISTERIAL SERVICES; PROVIDING A WEBSITE FEATURING INFORMATION ABOUT RELIGIOUS BELIEF SYSTEMS, IN CLASS 45 (U.S. CLS. 100 AND 101).

FIRST USE 3-1-2007; IN COMMERCE 3-1-2007.

THE MARK CONSISTS OF STANDARD CHARACTERS WITHOUT CLAIM TO ANY PARTICULAR FONT, STYLE, SIZE, OR COLOR.

SER. NO. 85-484,114, FILED 11-30-2011.

HEATHER THOMPSON, EXAMINING ATTORNEY

United States of America

United States Patent and Trademark Office

EARTH DANCE

Reg. No. 4,175,608

Registered July 17, 2012

Int. Cl.: 41

SERVICE MARK

PRINCIPAL REGISTER

EARTH DANCE GLOBAL, LLC (CALIFORNIA LIMITED LIABILITY COMPANY)
PO BOX 2723
WESTPORT, CT 06880

FOR: ENTERTAINMENT SERVICES IN THE NATURE OF PRESENTING LIVE MUSICAL PERFORMANCES; ENTERTAINMENT SERVICES IN THE NATURE OF LIVE MUSICAL AND DANCE PERFORMANCES; ENTERTAINMENT, NAMELY, PRODUCTION OF LIVE MUSICAL AND DANCE PERFORMANCES; ORGANIZATION OF EXHIBITIONS FOR MUSICAL ENTERTAINMENT; ORGANIZING AND ARRANGING EXHIBITIONS FOR ENTERTAINMENT PURPOSES; ORGANIZING COMMUNITY FESTIVALS FEATURING PRIMARILY MUSIC AND DANCE PERFORMANCES; PROVIDING A WEBSITE FEATURING ENTERTAINMENT INFORMATION; PROVIDING A WEBSITE FEATURING INFORMATION IN THE FIELD OF MUSIC AND ENTERTAINMENT; PROVIDING INFORMATION, NEWS AND COMMENTARY IN THE FIELD OF ENTERTAINMENT; PROVISION OF INFORMATION RELATING TO LIVE ENTERTAINMENT, IN CLASS 41 (U.S. CLS. 100, 101 AND 107).

FIRST USE 1-1-1997; IN COMMERCE 1-1-1997.

THE MARK CONSISTS OF STANDARD CHARACTERS WITHOUT CLAIM TO ANY PARTICULAR FONT, STYLE, SIZE, OR COLOR.

SER. NO. 85-484,437, FILED 11-30-2011.

REGINA DRUMMOND, EXAMINING ATTORNEY



David J. Kybas

Director of the United States Patent and Trademark Office

United States of America

United States Patent and Trademark Office



Reg. No. 4,175,609

Registered July 17, 2012

Int. Cl.: 9

TRADEMARK

PRINCIPAL REGISTER

GIGA-BYTE TECHNOLOGY CO., LTD. (TAIWAN CORPORATION)
NO. 6, BAU CHIANG RD. HSIN-TIEN
TAIPEI, TAIWAN 231

FOR: MOTHERBOARDS, IN CLASS 9 (U.S. CLS. 21, 23, 26, 36 AND 38).

FIRST USE 6-1-2010; IN COMMERCE 6-1-2010.

THE MARK CONSISTS OF THE WORDS "UNLOCKED POWER" IN TWO ROWS LOCATED ABOVE A PARTIAL MOTHERBOARD IMAGE, OF WHICH ELECTRICITY AND RAY OF LIGHT PATTERNS ARE PRESENTED.

SER. NO. 85-484,446, FILED 11-30-2011.

KHANH LE, EXAMINING ATTORNEY



David J. Kybas

Director of the United States Patent and Trademark Office

United States of America

United States Patent and Trademark Office

Stormin' Norman's

Reg. No. 4,175,610

OPPER, NORMAN (UNITED STATES INDIVIDUAL)
18420 LONG LAKE DR.

Registered July 17, 2012

BOCA RATON, FL 33496

Int. Cl.: 35

FOR: WHOLESALE DISTRIBUTORSHIPS FEATURING OPTICAL SUPPLIES, CUSTOM PRINTED OPTICAL SUPPLIES FOR PROMOTIONAL PURPOSES, DENTAL SUPPLIES, AND MEDICAL SUPPLIES, THAT ARE FOR USE IN OPTICAL OFFICES, MEDICAL OFFICES, RETAIL STORES, AND DENTAL OFFICES, IN CLASS 35 (U.S. CLS. 100, 101 AND 102).

SERVICE MARK

PRINCIPAL REGISTER

FIRST USE 2-2-1995; IN COMMERCE 2-9-1995.

THE MARK CONSISTS OF STANDARD CHARACTERS WITHOUT CLAIM TO ANY PARTICULAR FONT, STYLE, SIZE, OR COLOR.

OWNER OF U.S. REG. NO. 2,260,536.

THE NAME(S), PORTRAIT(S), AND/OR SIGNATURE(S) SHOWN IN THE MARK IDENTIFIES "NORMAN OPPER", WHOSE CONSENT(S) TO REGISTER IS MADE OF RECORD.

SER. NO. 85-484,465, FILED 12-1-2011.

JEAN IM, EXAMINING ATTORNEY



David J. Kyffers

Director of the United States Patent and Trademark Office

United States of America

United States Patent and Trademark Office



Reg. No. 4,175,611

Registered July 17, 2012

Int. Cl.: 3

TRADEMARK

PRINCIPAL REGISTER

2 J-A 1476, S.L. (SPAIN SOCIEDAD DE RESPONSABILIDAD LIMITADA (SL))
JOSE VICEDO N 6 2A
APARTADO DE CORREOS 506
ASPE, SPAIN 03680

FOR: SOAPS, PERFUMERY, ESSENTIAL OILS, COSMETICS, IN CLASS 3 (U.S. CLS. 1, 4, 6, 50, 51 AND 52).

FIRST USE 10-20-2011; IN COMMERCE 10-20-2011.

OWNER OF U.S. REG. NOS. 4,041,035 AND 4,085,082.

THE MARK CONSISTS OF THE WORDING "VELLÍSIMO CENTER," WITH THE LETTERS "VE" SUPERIMPOSED ON A SHADED CIRCLE RESEMBLING A SPHERE, AND THE WORD "CENTER" APPEARING BELOW "VELLÍSIMO".

SER. NO. 85-484,774, FILED 12-1-2011.

JASON BLAIR, EXAMINING ATTORNEY



David J. Kybas

Director of the United States Patent and Trademark Office

United States of America

United States Patent and Trademark Office

WILD PATAGONIA

Reg. No. 4,175,612

Registered July 17, 2012

Int. Cl.: 9

TRADEMARK

PRINCIPAL REGISTER

ARISTOCRAT TECHNOLOGIES AUSTRALIA PTY LTD. (AUSTRALIA CORPORATION)
85 EPPING ROAD
BUILDING A, PINNACLE OFFICE PARK
NORTH RYDE, NSW, AUSTRALIA 2113

FOR: ELECTRONIC GAMING MACHINES, NAMELY, DEVICES WHICH ACCEPT A WAGER,
IN CLASS 9 (U.S. CLS. 21, 23, 26, 36 AND 38).

FIRST USE 4-1-2011; IN COMMERCE 4-1-2011.

THE MARK CONSISTS OF STANDARD CHARACTERS WITHOUT CLAIM TO ANY PAR-
TICULAR FONT, STYLE, SIZE, OR COLOR.

SER. NO. 85-484,797, FILED 12-1-2011.

JIM RINGLE, EXAMINING ATTORNEY



David J. Kyffers

Director of the United States Patent and Trademark Office

United States of America

United States Patent and Trademark Office

Carl Bright Inc.

Reg. No. 4,175,613

CARL BRIGHT INC. (OKLAHOMA CORPORATION)
20821 GOLD STREET
HARRAH, OK 73045

Registered July 17, 2012

Int. Cl.: 9

FOR: GAS DETECTORS FOR DETECTING THE PRESENCE OF GAS, IN CLASS 9 (U.S. CLS. 21, 23, 26, 36 AND 38).

TRADEMARK

FIRST USE 10-4-2006; IN COMMERCE 11-28-2011.

PRINCIPAL REGISTER

THE MARK CONSISTS OF STANDARD CHARACTERS WITHOUT CLAIM TO ANY PARTICULAR FONT, STYLE, SIZE, OR COLOR.

NO CLAIM IS MADE TO THE EXCLUSIVE RIGHT TO USE "INC.", APART FROM THE MARK AS SHOWN.

THE NAME "CARL BRIGHT" IDENTIFIES A LIVING INDIVIDUAL WHOSE CONSENT IS OF RECORD.

SER. NO. 85-484,830, FILED 12-1-2011.

JACLYN KIDWELL WALKER, EXAMINING ATTORNEY



David J. Kyffers

Director of the United States Patent and Trademark Office

United States of America

United States Patent and Trademark Office

50 DRAGONS

Reg. No. 4,175,614

Registered July 17, 2012

Int. Cl.: 9

TRADEMARK

PRINCIPAL REGISTER

ARISTOCRAT TECHNOLOGIES AUSTRALIA PTY LTD. (AUSTRALIA CORPORATION)
BUILDING A, PINNACLE OFFICE PARK
85 EPPING ROAD
NORTH RYDE, NSW, AUSTRALIA 2113

FOR: ELECTRONIC GAMING MACHINES, NAMELY, DEVICES WHICH ACCEPT A WAGER,
IN CLASS 9 (U.S. CLS. 21, 23, 26, 36 AND 38).

FIRST USE 11-1-2007; IN COMMERCE 11-1-2007.

THE MARK CONSISTS OF STANDARD CHARACTERS WITHOUT CLAIM TO ANY PAR-
TICULAR FONT, STYLE, SIZE, OR COLOR.

SER. NO. 85-484,833, FILED 12-1-2011.

JIM RINGLE, EXAMINING ATTORNEY



David J. Kyffers

Director of the United States Patent and Trademark Office

United States of America

United States Patent and Trademark Office



Reg. No. 4,175,615

Registered July 17, 2012

Int. Cl.: 41

SERVICE MARK

PRINCIPAL REGISTER

NEWBRIDGE COLLEGE (CALIFORNIA CORPORATION)
1840 E. 17TH STREET
SANTA ANA, CA 92705

FOR: EDUCATIONAL SERVICES, NAMELY, CONDUCTING DISTANCE LEARNING INSTRUCTION AT THE POSTSECONDARY AND PROFESSIONAL LEVEL LEVEL; EDUCATIONAL SERVICES, NAMELY, PROVIDING COURSES OF INSTRUCTION AT THE POSTSECONDARY AND PROFESSIONAL LEVEL LEVEL AND DISTRIBUTION OF COURSE MATERIAL IN CONNECTION THEREWITH, IN CLASS 41 (U.S. CLS. 100, 101 AND 107).

FIRST USE 1-14-2006; IN COMMERCE 1-14-2006.

NO CLAIM IS MADE TO THE EXCLUSIVE RIGHT TO USE "COLLEGE" AND "1976", APART FROM THE MARK AS SHOWN.

THE MARK CONSISTS OF A SCHOOL SEAL COMPRISING AN OUTER RING AND AN INNER CIRCLE, WHEREIN THE INNER CIRCLE CONTAINS THE LETTER "N" WITH A TORCH IN FRONT OF IT AND THE OUTER RING CONTAINS THE WORDS "NEWBRIDGE COLLEGE" ON THE TOP HALF AND THE YEAR "1976" IN THE BOTTOM HALF.

SER. NO. 85-485,031, FILED 12-1-2011.

JOHN DALIER, EXAMINING ATTORNEY



David J. Kyffers

Director of the United States Patent and Trademark Office

United States of America

United States Patent and Trademark Office

REVO

Reg. No. 4,175,616

Registered July 17, 2012

Int. Cl.: 2

TRADEMARK

PRINCIPAL REGISTER

MCCORMICK PAINTS (MARYLAND CORPORATION)
2355 LEWIS AVENUE
ROCKVILLE, MD 208512391

FOR: PAINTS, IN CLASS 2 (U.S. CLS. 6, 11 AND 16).

FIRST USE 1-31-2012; IN COMMERCE 2-2-2012.

THE MARK CONSISTS OF STANDARD CHARACTERS WITHOUT CLAIM TO ANY PARTICULAR FONT, STYLE, SIZE, OR COLOR.

SER. NO. 85-485,044, FILED 12-1-2011.

JENNIFER MARTIN, EXAMINING ATTORNEY



David J. Kybas

Director of the United States Patent and Trademark Office

United States of America

United States Patent and Trademark Office

Blackwood

Reg. No. 4,175,617

BLACKWOOD PET FOOD, LLC (OHIO LIMITED LIABILITY COMPANY)
38251 INDUSTRIAL PARK RD.
LISBON, OH 44432

Registered July 17, 2012

Int. Cl.: 31

FOR: PET FOOD AND PET TREATS, IN CLASS 31 (U.S. CLS. 1 AND 46).

TRADEMARK

FIRST USE 5-1-1993; IN COMMERCE 5-1-1993.

PRINCIPAL REGISTER

THE MARK CONSISTS OF STANDARD CHARACTERS WITHOUT CLAIM TO ANY PARTICULAR FONT, STYLE, SIZE, OR COLOR.

SEC. 2(F).

SER. NO. 85-485,056, FILED 12-1-2011.

FRED CARL, EXAMINING ATTORNEY



David J. Kybas

Director of the United States Patent and Trademark Office

United States of America

United States Patent and Trademark Office

EVERYTHINGGIRL.COM

Reg. No. 4,175,618

Registered July 17, 2012

Int. Cl.: 41

SERVICE MARK

PRINCIPAL REGISTER

MATTEL, INC. (DELAWARE CORPORATION)
M1-1518
333 CONTINENTAL BOULEVARD
EL SEGUNDO, CA 90245

FOR: PROVIDING ONLINE COMPUTER GAMES, IN CLASS 41 (U.S. CLS. 100, 101 AND 107).

FIRST USE 11-30-2011; IN COMMERCE 11-30-2011.

THE MARK CONSISTS OF STANDARD CHARACTERS WITHOUT CLAIM TO ANY PARTICULAR FONT, STYLE, SIZE, OR COLOR.

SER. NO. 85-485,220, FILED 12-1-2011.

PATRICIA EVANKO, EXAMINING ATTORNEY



David J. Kybas

Director of the United States Patent and Trademark Office

United States of America

United States Patent and Trademark Office

Essential Stress Melts White Cat Candle Collection

Reg. No. 4,175,619

RUDES WORLD INC (FLORIDA CORPORATION), AKA ESSENTIAL STRESS MELTS
2122 DEWITT STREET

Registered July 17, 2012

PORT CHARLOTTE, FL 33952

Int. Cl.: 4

FOR: AROMATHERAPY FRAGRANCE CANDLES; CANDLE CONTAINED IN A CLAM-SHELL; CANDLES; CANDLES FOR LIGHTING; PERFUMED CANDLES; SCENTED CANDLES; SCENTED WAX FOR USE IN CANDLE WARMERS; TEA LIGHT CANDLES, IN CLASS 4 (U.S. CLS. 1, 6 AND 15).

TRADEMARK

PRINCIPAL REGISTER

FIRST USE 11-11-2011; IN COMMERCE 11-11-2011.

THE MARK CONSISTS OF STANDARD CHARACTERS WITHOUT CLAIM TO ANY PARTICULAR FONT, STYLE, SIZE, OR COLOR.

OWNER OF U.S. REG. NOS. 3,767,265 AND 3,767,448.

NO CLAIM IS MADE TO THE EXCLUSIVE RIGHT TO USE "CANDLE COLLECTION", APART FROM THE MARK AS SHOWN.

SER. NO. 85-485,251, FILED 12-1-2011.

JEFFERY COWARD, EXAMINING ATTORNEY



David J. Kyros

Director of the United States Patent and Trademark Office

United States of America

United States Patent and Trademark Office

METALCRAFT

Reg. No. 4,175,620

Registered July 17, 2012

Int. Cl.: 28

TRADEMARK

PRINCIPAL REGISTER

ALPHA INTERNATIONAL, INC. (IOWA CORPORATION)
SUITE C
517 3RD AVE SW
CEDAR RAPIDS, IA 52404

FOR: STAMPED STEEL TOYS AND COLLECTIBLES, NAMELY, SCALE REPLICAS OF VEHICLES, IN CLASS 28 (U.S. CLS. 22, 23, 38 AND 50).

FIRST USE 3-31-2001; IN COMMERCE 3-31-2001.

THE MARK CONSISTS OF STANDARD CHARACTERS WITHOUT CLAIM TO ANY PARTICULAR FONT, STYLE, SIZE, OR COLOR.

SER. NO. 85-485,255, FILED 12-1-2011.

LANA PHAM, EXAMINING ATTORNEY



David J. Kybas

Director of the United States Patent and Trademark Office

United States of America

United States Patent and Trademark Office

GIVE THE GIFT OF AROMA

Reg. No. 4,175,621

Registered July 17, 2012

Int. Cl.: 4

TRADEMARK

PRINCIPAL REGISTER

RUDES WORLD INC (FLORIDA CORPORATION), AKA ESSENTIAL STRESS MELTS
2122 DEWITT STREET
PT CHARLOTTE, FL 33952

FOR: AROMATHERAPY FRAGRANCE CANDLES; CANDLE CONTAINED IN A CLAM-SHELL; CANDLES; CANDLES AND WICKS FOR CANDLES FOR LIGHTING; CANDLES FOR LIGHTING; MELT TARTS, NAMELY, SCENTED WAX TO BE MELTED SLOWLY WITH A WARMER; PERFUMED CANDLES; SCENTED CANDLES; SCENTED WAX FOR USE IN CANDLE WARMERS; TEA LIGHT CANDLES, IN CLASS 4 (U.S. CLS. 1, 6 AND 15).

FIRST USE 11-11-2011; IN COMMERCE 11-11-2011.

THE MARK CONSISTS OF STANDARD CHARACTERS WITHOUT CLAIM TO ANY PARTICULAR FONT, STYLE, SIZE, OR COLOR.

SER. NO. 85-485,268, FILED 12-1-2011.

JEFFERY COWARD, EXAMINING ATTORNEY



David J. Kybas

Director of the United States Patent and Trademark Office

United States of America

United States Patent and Trademark Office

AlpiSLIM

Reg. No. 4,175,622

PADILLA, RODOLFO R (UNITED STATES INDIVIDUAL)
508 ANGELA LANE
EULESS, TX 76039 AND

Registered July 17, 2012

Int. Cl.: 5

PADILLA, HUMBERTO G (MEXICO INDIVIDUAL)
508 ANGELA LANE
EULESS, TX 76039 AND

TRADEMARK

PRINCIPAL REGISTER

PADILLA, ARNOLDO V (MEXICO INDIVIDUAL)
508 ANGELA LANE
EULESS, TX 76039

FOR: DIETARY AND NUTRITIONAL SUPPLEMENTS USED FOR WEIGHT LOSS, IN CLASS 5 (U.S. CLS. 6, 18, 44, 46, 51 AND 52).

FIRST USE 4-15-2011; IN COMMERCE 4-15-2011.

THE MARK CONSISTS OF THE STYLIZED WORDING OF "ALPISLIM" IN PURPLE LETTERING WITH A WHITE BORDER AROUND THE PURPLE LETTERS WITH A GREEN BORDER AROUND THE WHITE LETTERS.

THE COLOR(S) PURPLE, WHITE AND GREEN IS/ARE CLAIMED AS A FEATURE OF THE MARK.

THE WORDING "ALPISLIM" HAS NO MEANING IN A FOREIGN LANGUAGE.

SER. NO. 85-485,796, FILED 12-2-2011.

BRIAN NEVILLE, EXAMINING ATTORNEY



David J. Kybas

Director of the United States Patent and Trademark Office

United States of America

United States Patent and Trademark Office



Reg. No. 4,175,623

Registered July 17, 2012

Int. Cl.: 43

SERVICE MARK

PRINCIPAL REGISTER

BENNETT ENTERPRISES, INC. (OHIO CORPORATION)
27476 HOLIDAY LANE
PERRYSBURG, OH 43551

FOR: RESTAURANT SERVICES, IN CLASS 43 (U.S. CLS. 100 AND 101).

FIRST USE 9-5-2005; IN COMMERCE 9-5-2005.

OWNER OF U.S. REG. NO. 2,138,444.

THE COLOR(S) BLACK, RED, BLUE, WHITE AND GRAY IS/ARE CLAIMED AS A FEATURE OF THE MARK.

NO CLAIM IS MADE TO THE EXCLUSIVE RIGHT TO USE "EST. 1991" AND "FOOD SPORTS", APART FROM THE MARK AS SHOWN.

THE MARK CONSISTS OF A BLACK BOX CONTAINING A RED BOX CONTAINING A BLUE BOX WHERE GRAY STRIPES EXTEND VERTICALLY IN THE BLUE BOX, THE WORD "RALPHIE'S" IN ARCHED BLACK, WHITE AND RED LETTERS ABOVE A BLUE OVAL CONTAINING WHITE "EST. 1991" ABOVE BLUE "FOOD.SPORTS.FUN.".

SER. NO. 85-485,799, FILED 12-2-2011.

BRIAN NEVILLE, EXAMINING ATTORNEY



David J. Kyros

Director of the United States Patent and Trademark Office

United States of America

United States Patent and Trademark Office



Reg. No. 4,175,624

Registered July 17, 2012

Int. Cl.: 25

TRADEMARK

PRINCIPAL REGISTER

BOARD OF REGENTS, THE UNIVERSITY OF TEXAS SYSTEM (TEXAS STATE AGENCY)
201 WEST 7TH STREET
AUSTIN, TX 78701

FOR: CLOTHING, NAMELY, SHIRTS, FLEECE TOPS, TANK TOPS, JACKETS AND WARM-UP SUITS; HEADWEAR, NAMELY, BEANIES, BASEBALL CAPS AND HATS, IN CLASS 25 (U.S. CLS. 22 AND 39).

FIRST USE 3-0-2008; IN COMMERCE 3-0-2008.

OWNER OF U.S. REG. NO. 3,895,298.

THE MARK CONSISTS OF A REPRESENTATION OF THE HEAD OF A ROADRUNNER, IN PROFILE.

SER. NO. 85-485,824, FILED 12-2-2011.

TINA L. SNAPP, EXAMINING ATTORNEY



David J. Kyffers

Director of the United States Patent and Trademark Office

United States of America

United States Patent and Trademark Office

BABY DOLL

Reg. No. 4,175,625

HAZE TOBACCO, LLC (TEXAS LIMITED LIABILITY COMPANY)
10350 FOUNTAINGATE DR.
STAFFORD, TX 77477

Registered July 17, 2012

Int. Cl.: 34

FOR: HOOKAH TOBACCO; SMOKING TOBACCO; TOBACCO, IN CLASS 34 (U.S. CLS. 2, 8, 9 AND 17).

TRADEMARK

FIRST USE 11-17-2011; IN COMMERCE 11-17-2011.

PRINCIPAL REGISTER

THE MARK CONSISTS OF STANDARD CHARACTERS WITHOUT CLAIM TO ANY PARTICULAR FONT, STYLE, SIZE, OR COLOR.

SER. NO. 85-485,981, FILED 12-2-2011.

CHERYL CLAYTON, EXAMINING ATTORNEY



David J. Kybas

Director of the United States Patent and Trademark Office

United States of America

United States Patent and Trademark Office

EPIC

Reg. No. 4,175,626

ICON IP, INC. (UTAH CORPORATION)
1500 SOUTH 1000 WEST
LOGAN, UT 84321

Registered July 17, 2012

Int. Cl.: 28

FOR: PHYSICAL FITNESS EQUIPMENT, NAMELY, CHEST MACHINES, LEG EXTENSION MACHINES, LAT/HIGH ROW MACHINES, LEG CURL MACHINES, LEG PRESS MACHINES, FLY/REAR DELT MACHINES, HIP ABDUCTION/ADDUCTION MACHINES, SHOULDER MACHINES, BICEP CURL MACHINES, TRICEP MACHINES, ASSISTED DIP CHIN MACHINES, CALF EXTENSION MACHINES, PRONE LEG CURL MACHINES, BACK EXTENSION MACHINES, LATERAL RAISE MACHINES, SEATED ROW MACHINES, ROTARY TORSO MACHINES, ABDOMINAL MACHINES, GLUTE MACHINES, PLATE-LOADED MACHINES, PLATE-LOADED LEG PRESS, MILITARY PRESS MACHINES, WEIGHT LIFTING BENCHES, WEIGHT RACKS, 45 DEGREE BACK EXTENSION MACHINE, IN CLASS 28 (U.S. CLS. 22, 23, 38 AND 50).

TRADEMARK

PRINCIPAL REGISTER

FIRST USE 6-9-2005; IN COMMERCE 6-9-2005.

THE MARK CONSISTS OF STANDARD CHARACTERS WITHOUT CLAIM TO ANY PARTICULAR FONT, STYLE, SIZE, OR COLOR.

OWNER OF U.S. REG. NOS. 2,961,998 AND 4,068,009.

SER. NO. 85-486,071, FILED 12-2-2011.

JUSTINE D. PARKER, EXAMINING ATTORNEY



David J. Kybas

Director of the United States Patent and Trademark Office

United States of America

United States Patent and Trademark Office

wee chic

Reg. No. 4,175,627

WEE CHIC, INC. (MARYLAND CORPORATION)
10751 FALLS ROAD NO.101
LUTHERVILLE, MD 21903

Registered July 17, 2012

Int. Cl.: 35

FOR: RETAIL SHOPS FEATURING BABY, TODDLER AND CHILDREN'S CLOTHING, IN CLASS 35 (U.S. CLS. 100, 101 AND 102).

SERVICE MARK

FIRST USE 3-27-2009; IN COMMERCE 5-29-2009.

PRINCIPAL REGISTER

THE MARK CONSISTS OF STANDARD CHARACTERS WITHOUT CLAIM TO ANY PARTICULAR FONT, STYLE, SIZE, OR COLOR.

SER. NO. 85-486,095, FILED 12-2-2011.

PAUL E. FAHRENKOPF, EXAMINING ATTORNEY



David J. Kyffers

Director of the United States Patent and Trademark Office

United States of America

United States Patent and Trademark Office

ICE BERG

Reg. No. 4,175,628

HAZE TOBACCO, LLC (TEXAS LIMITED LIABILITY COMPANY)
10350 FOUNTAINGATE DR.
STAFFORD, TX 77477

Registered July 17, 2012

Int. Cl.: 34

FOR: HOOKAH TOBACCO; SMOKING TOBACCO; TOBACCO, IN CLASS 34 (U.S. CLS. 2, 8, 9 AND 17).

TRADEMARK

FIRST USE 11-17-2011; IN COMMERCE 11-17-2011.

PRINCIPAL REGISTER

THE MARK CONSISTS OF STANDARD CHARACTERS WITHOUT CLAIM TO ANY PARTICULAR FONT, STYLE, SIZE, OR COLOR.

SER. NO. 85-486,215, FILED 12-2-2011.

CHERYL CLAYTON, EXAMINING ATTORNEY



David J. Kyffers

Director of the United States Patent and Trademark Office

United States of America

United States Patent and Trademark Office

LEATHERX

Reg. No. 4,175,629

Registered July 17, 2012

Int. Cl.: 9

TRADEMARK

PRINCIPAL REGISTER

STREAK PRODUCTS INC. (NEW YORK CORPORATION)
11 HARBOR PARK DRIVE
PORT WASHINGTON, NY 11050

FOR: USB (UNIVERSAL SERIAL BUS) OPERATING SOFTWARE, USB (UNIVERSAL SERIAL BUS) HARDWARE, HDD ENCLOSURES, NAMELY, HARD DISC DRIVE ENCLOSURES, IN CLASS 9 (U.S. CLS. 21, 23, 26, 36 AND 38).

FIRST USE 7-1-2010; IN COMMERCE 7-1-2010.

THE MARK CONSISTS OF STANDARD CHARACTERS WITHOUT CLAIM TO ANY PARTICULAR FONT, STYLE, SIZE, OR COLOR.

SER. NO. 85-486,294, FILED 12-2-2011.

MARK T. MULLEN, EXAMINING ATTORNEY



David J. Kyffers

Director of the United States Patent and Trademark Office

United States of America

United States Patent and Trademark Office

Color Vibe

Reg. No. 4,175,630

Registered July 17, 2012

Int. Cl.: 3

TRADEMARK

PRINCIPAL REGISTER

ETGON ENTERPRISES INC. (CALIFORNIA CORPORATION)
8216 LANKERSHIM BLVD.
#21
NORTH HOLLYWOOD, CA 91605

FOR: 3-IN-1 HAIR SHAMPOOS; AROMATIC BODY CARE PRODUCTS, NAMELY, BODY LOTION, SHOWER GEL, CUTICLE CREAM, SHAMPOO, CONDITIONER, NON-MEDICATED LIP BALM, SOAP, BODY POLISH, BODY AND FOOT SCRUB AND NON-MEDICATED FOOT CREAM; BABY SHAMPOO; HAIR SHAMPOO; HAIR SHAMPOOS AND CONDITIONERS; SHAMPOOS FOR BABIES, IN CLASS 3 (U.S. CLS. 1, 4, 6, 50, 51 AND 52).

FIRST USE 9-1-2010; IN COMMERCE 9-10-2010.

THE MARK CONSISTS OF STANDARD CHARACTERS WITHOUT CLAIM TO ANY PARTICULAR FONT, STYLE, SIZE, OR COLOR.

NO CLAIM IS MADE TO THE EXCLUSIVE RIGHT TO USE "COLOR", APART FROM THE MARK AS SHOWN.

SER. NO. 85-486,569, FILED 12-3-2011.

ZHALEH DELANEY, EXAMINING ATTORNEY



David J. Kyffers

Director of the United States Patent and Trademark Office

United States of America

United States Patent and Trademark Office

Twist. Squeeze. Done.

Reg. No. 4,175,631

IPPOLITO, ALESSANDRO (UNITED STATES INDIVIDUAL)
111 RIDGEDALE ROAD
TEMPLE TERRACE, FL 33617

Registered July 17, 2012

Int. Cl.: 21

FOR: LEMON SQUEEZERS; NON-ELECTRIC FRUIT SQUEEZERS; NON-ELECTRIC JUICERS,
IN CLASS 21 (U.S. CLS. 2, 13, 23, 29, 30, 33, 40 AND 50).

TRADEMARK

FIRST USE 12-4-2011; IN COMMERCE 12-4-2011.

PRINCIPAL REGISTER

THE MARK CONSISTS OF STANDARD CHARACTERS WITHOUT CLAIM TO ANY PARTICULAR FONT, STYLE, SIZE, OR COLOR.

NO CLAIM IS MADE TO THE EXCLUSIVE RIGHT TO USE "SQUEEZE", APART FROM THE MARK AS SHOWN.

SER. NO. 85-486,630, FILED 12-4-2011.

LUCY ARANT, EXAMINING ATTORNEY



David J. Kyffers

Director of the United States Patent and Trademark Office

United States of America

United States Patent and Trademark Office



Reg. No. 4,175,632

Registered July 17, 2012

Int. Cls.: 35 and 42

SERVICE MARK

PRINCIPAL REGISTER

FLATWORLD SOLUTIONS INC. (DELAWARE CORPORATION)
SUITE 200 116 VILLAGE BOULEVARD
PRINCETON, NJ 08540

FOR: OPERATION AND MANAGEMENT OF TELEPHONE CALL CENTERS FOR OTHERS; DATA PROCESSING SERVICES; DATA ENTRY SERVICES; ACCOUNTING SERVICES; BOOKKEEPING; TAX PREPARATION; ACCOUNTS RECEIVABLE AND PAYABLE DEBITING MANAGEMENT FOR OTHERS; MEDICAL TRANSCRIPTION AND TRANSCRIPTION OF DICTATIONS, INTERVIEWS, DISCUSSIONS, CONFERENCES AND TELEPHONE CALLS SERVICES, FROM VOICE TO TEXT, IN CLASS 35 (U.S. CLS. 100, 101 AND 102).

FIRST USE 2-23-2006; IN COMMERCE 2-23-2006.

FOR: COMPUTER SOFTWARE DESIGN AND DEVELOPMENT IN THE FIELD OF WEB APPLICATION DEVELOPMENT AND SOFTWARE DEVELOPMENT FOR MOBILE DEVICES; DRAFTING; DATA CONVERSION OF ELECTRONIC INFORMATION AND COMPUTER PROGRAMS; CONVERSION OF DATA OR DOCUMENTS FROM PHYSICAL TO ELECTRONIC MEDIA, IN CLASS 42 (U.S. CLS. 100 AND 101).

FIRST USE 2-23-2006; IN COMMERCE 2-23-2006.

OWNER OF U.S. REG. NOS. 3,798,893, 4,078,929 AND OTHERS.

NO CLAIM IS MADE TO THE EXCLUSIVE RIGHT TO USE "SOLUTIONS", APART FROM THE MARK AS SHOWN.

THE MARK CONSISTS OF THE STYLIZED WORDING "FLATWORLD SOLUTIONS" TO THE RIGHT OF A STYLIZED DESIGN COMPRISED OF A DARK OVAL FEATURING A LIGHT INFINITY SYMBOL WITHIN.

SER. NO. 85-486,902, FILED 12-5-2011.

TASNEEM HUSSAIN, EXAMINING ATTORNEY



David J. Kyffers

Director of the United States Patent and Trademark Office

United States of America

United States Patent and Trademark Office

Buck Jitters

Reg. No. 4,175,633

KENNEDY, GARY F. (UNITED STATES INDIVIDUAL)
1000 PALOMINO DRIVE
TEXARKANA, AR 71854

Registered July 17, 2012

Int. Cl.: 28

FOR: EQUIPMENT SOLD AS A UNIT FOR PLAYING CARD GAMES, NAMELY, A DECK OF UNIQUE CARDS AND THE RULES OF PLAY, IN CLASS 28 (U.S. CLS. 22, 23, 38 AND 50).

TRADEMARK

FIRST USE 11-1-2011; IN COMMERCE 11-1-2011.

PRINCIPAL REGISTER

THE MARK CONSISTS OF STANDARD CHARACTERS WITHOUT CLAIM TO ANY PARTICULAR FONT, STYLE, SIZE, OR COLOR.

SER. NO. 85-486,973, FILED 12-5-2011.

DAVID HOFFMAN, EXAMINING ATTORNEY



David J. Kyffers

Director of the United States Patent and Trademark Office

United States of America

United States Patent and Trademark Office

HELP CONTROL THE PIZZA POPULATION!

Reg. No. 4,175,634

PIZZA INN, INC. (MISSOURI CORPORATION)

Registered July 17, 2012

3551 PLANO PARKWAY
THE COLONY, TX 75056

Int. Cl.: 43

FOR: RESTAURANT SERVICES; CARRY-OUT RESTAURANT SERVICES, IN CLASS 43
(U.S. CLS. 100 AND 101).

SERVICE MARK

FIRST USE 6-30-2011; IN COMMERCE 6-30-2011.

PRINCIPAL REGISTER

THE MARK CONSISTS OF STANDARD CHARACTERS WITHOUT CLAIM TO ANY PARTICULAR FONT, STYLE, SIZE, OR COLOR.

SER. NO. 85-487,045, FILED 12-5-2011.

MARK T. MULLEN, EXAMINING ATTORNEY



David J. Kybas

Director of the United States Patent and Trademark Office

United States of America

United States Patent and Trademark Office

UED

Reg. No. 4,175,635

Registered July 17, 2012

Int. Cl.: 35

SERVICE MARK

PRINCIPAL REGISTER

PENTON MEDIA, INC. (DELAWARE CORPORATION)
4TH FLOOR
249 WEST 17TH STREET
NEW YORK, NY 10011

FOR: ON-LINE BUSINESS DIRECTORIES FEATURING USED MACHINERY, MACHINE TOOLS, INDUSTRIAL EQUIPMENT, AND ELECTRICAL AND POWER APPARATUS; ON-LINE LISTING, NOT ON-LINE PUBLICATION, IN CLASS 35 (U.S. CLS. 100, 101 AND 102).

FIRST USE 0-0-2007; IN COMMERCE 0-0-2007.

THE MARK CONSISTS OF STANDARD CHARACTERS WITHOUT CLAIM TO ANY PARTICULAR FONT, STYLE, SIZE, OR COLOR.

OWNER OF U.S. REG. NO. 977,322.

SER. NO. 85-487,053, FILED 12-5-2011.

TIMOTHY FINNEGAN, EXAMINING ATTORNEY



David J. Kyffers

Director of the United States Patent and Trademark Office

United States of America

United States Patent and Trademark Office

YOU'RE USELESS WITHOUT IT

Reg. No. 4,175,636

WHITEYBOARD INC. (DELAWARE CORPORATION)

Registered July 17, 2012

11920 LAUREL HILL RD
STUDIO CITY, CA 91604

Int. Cl.: 16

FOR: STICK-ON WHITEBOARDS AND DRY-ERASE BOARDS, IN CLASS 16 (U.S. CLS. 2, 5, 22, 23, 29, 37, 38 AND 50).

TRADEMARK

FIRST USE 4-14-2011; IN COMMERCE 4-14-2011.

PRINCIPAL REGISTER

THE MARK CONSISTS OF STANDARD CHARACTERS WITHOUT CLAIM TO ANY PARTICULAR FONT, STYLE, SIZE, OR COLOR.

SER. NO. 85-487,755, FILED 12-6-2011.

PAM WILLIS, EXAMINING ATTORNEY



David J. Kyffers

Director of the United States Patent and Trademark Office

United States of America

United States Patent and Trademark Office

Lake Michigan College

Reg. No. 4,175,637

LAKE MICHIGAN COLLEGE (MICHIGAN STATE COLLEGE)
2755 E. NAPIER AVENUE

Registered July 17, 2012

BENTON HARBOR, MI 490221899

Int. Cl.: 41

FOR: EDUCATING AT UNIVERSITY OR COLLEGES, IN CLASS 41 (U.S. CLS. 100, 101 AND 107).

SERVICE MARK

FIRST USE 7-1-1964; IN COMMERCE 7-1-1964.

PRINCIPAL REGISTER

THE MARK CONSISTS OF STANDARD CHARACTERS WITHOUT CLAIM TO ANY PARTICULAR FONT, STYLE, SIZE, OR COLOR.

NO CLAIM IS MADE TO THE EXCLUSIVE RIGHT TO USE "COLLEGE", APART FROM THE MARK AS SHOWN.

SEC. 2(F).

SER. NO. 85-487,813, FILED 12-6-2011.

BERNICE MIDDLETON, EXAMINING ATTORNEY



David J. Kybas

Director of the United States Patent and Trademark Office

United States of America

United States Patent and Trademark Office

MUSCLEPRIME

Reg. No. 4,175,638

Registered July 17, 2012

Int. Cl.: 5

TRADEMARK

PRINCIPAL REGISTER

ALLMAX NUTRITION INC (CANADA CORPORATION)
4576 YONGE STREET, SUITE 509
NORTH YORK
ONTARIO, M2N 6N4, CANADA

FOR: DIETARY AND NUTRITIONAL SUPPLEMENTS CONTAINING AMINO ACIDS; DIETARY SUPPLEMENTS; NUTRITIONAL SUPPLEMENTS; NUTRITIONAL SUPPLEMENTS FOR BOOSTING ENERGY; POWDERED NUTRITIONAL SUPPLEMENT DRINK MIX, IN CLASS 5 (U.S. CLS. 6, 18, 44, 46, 51 AND 52).

FIRST USE 12-29-2008; IN COMMERCE 1-5-2009.

THE MARK CONSISTS OF STANDARD CHARACTERS WITHOUT CLAIM TO ANY PARTICULAR FONT, STYLE, SIZE, OR COLOR.

OWNER OF U.S. REG. NO. 3,759,781.

SER. NO. 85-487,818, FILED 12-6-2011.

MYRIAH HABEEB, EXAMINING ATTORNEY



David J. Kyjars

Director of the United States Patent and Trademark Office

United States of America
United States Patent and Trademark Office

FRAT PACK

Reg. No. 4,175,639

NEXT LEVEL ATHLETICS (CALIFORNIA LIMITED LIABILITY COMPANY)
17545 REGENCY WAY
GRANADA HILLS, CA 91344

Registered July 17, 2012

Int. Cl.: 5

FOR: MULTIVITAMIN SPORTS SUPPLEMENTS, IN CLASS 5 (U.S. CLS. 6, 18, 44, 46, 51 AND 52).

TRADEMARK

FIRST USE 11-12-2011; IN COMMERCE 11-12-2011.

PRINCIPAL REGISTER

THE MARK CONSISTS OF STANDARD CHARACTERS WITHOUT CLAIM TO ANY PARTICULAR FONT, STYLE, SIZE, OR COLOR.

NO CLAIM IS MADE TO THE EXCLUSIVE RIGHT TO USE "PACK", APART FROM THE MARK AS SHOWN.

SER. NO. 85-487,974, FILED 12-6-2011.

DAVID MURRAY, EXAMINING ATTORNEY



David J. Kyfos

Director of the United States Patent and Trademark Office

United States of America

United States Patent and Trademark Office

Soul Octopus

Reg. No. 4,175,640

Registered July 17, 2012

Int. Cl.: 25

TRADEMARK

PRINCIPAL REGISTER

PETER MISERLIS (UNITED STATES INDIVIDUAL)
1049 CAMINO DEL MAR
SUITE H
DEL MAR, CA 92014 AND

KEVIN R. MARKELL (UNITED STATES INDIVIDUAL)
332 MELROSE DRIVE
OXNARD, CA 93035

FOR: BASEBALL CAPS AND HATS; BEACH COVER-UPS; BEANIES; BIKINIS; BOARD SHORTS; CAPRI PANTS; CARGO PANTS; JACKETS; PANTS; SHORT-SLEEVED OR LONG-SLEEVED T-SHIRTS; SWEAT PANTS; SWEAT SHIRTS; SWIM WEAR; T-SHIRTS, IN CLASS 25 (U.S. CLS. 22 AND 39).

FIRST USE 1-1-2000; IN COMMERCE 1-1-2000.

THE MARK CONSISTS OF STANDARD CHARACTERS WITHOUT CLAIM TO ANY PARTICULAR FONT, STYLE, SIZE, OR COLOR.

SER. NO. 85-488,114, FILED 12-6-2011.

JOHN DWYER, EXAMINING ATTORNEY



David J. Kyffers

Director of the United States Patent and Trademark Office

United States of America

United States Patent and Trademark Office

Ramco Automotive



Reg. No. 4,175,641

RAMCO MIRACLE HOLDINGS, LLC (FLORIDA LIMITED LIABILITY COMPANY)
1629 N. TREASURE DRIVE

Registered July 17, 2012

N. BAY VILLAGE, FL 33141

Int. Cl.: 7

FOR: AUTOMOBILE ENGINE VALVE COVERS; DISTRIBUTORS FOR VEHICLES; FUEL FILTERS; FUEL INJECTORS; FUEL PUMPS FOR LAND VEHICLES; INTERNAL COMBUSTION ENGINES LAND VEHICLE PARTS, NAMELY, COILS; INTERNAL COMBUSTION ENGINES LAND VEHICLE PARTS, NAMELY, DISTRIBUTOR CAPS; INTERNAL COMBUSTION ENGINES LAND VEHICLE PARTS, NAMELY, DISTRIBUTOR ROTORS; LAND VEHICLE PARTS, NAMELY, SPARK PLUG WIRES; PRESSURE REGULATORS BEING PARTS OF MACHINES; PRESSURE SWITCHES AS PARTS OF MACHINES; VALVES BEING PARTS OF MACHINES, IN CLASS 7 (U.S. CLS. 13, 19, 21, 23, 31, 34 AND 35).

TRADEMARK

PRINCIPAL REGISTER

FIRST USE 12-15-2008; IN COMMERCE 12-15-2008.

NO CLAIM IS MADE TO THE EXCLUSIVE RIGHT TO USE "AUTOMOTIVE", APART FROM THE MARK AS SHOWN.

THE COLOR(S) BLUE, WHITE, AND BLACK IS/ARE CLAIMED AS A FEATURE OF THE MARK.

THE MARK CONSISTS OF THE INITIALS "R" AND "A" IN WHITE WITH BLACK SHADOWS, AND THE DESIGN OF WHITE DOTS AND DASHES INSIDE A BLUE BOX WITH BLUE AND WHITE BORDERS ON A BLUE BACKGROUND, BELOW THE WORDS "RAMCO AUTOMOTIVE" IN BLUE ON A WHITE BACKGROUND.

SER. NO. 85-488,203, FILED 12-6-2011.

TASHIA BUNCH, EXAMINING ATTORNEY



David J. Kyffers

Director of the United States Patent and Trademark Office

United States of America

United States Patent and Trademark Office

Ramco Automotive



Reg. No. 4,175,642

Registered July 17, 2012

Int. Cl.: 9

TRADEMARK

PRINCIPAL REGISTER

RAMCO MIRACLE HOLDINGS, LLC (FLORIDA LIMITED LIABILITY COMPANY)
1629
1629 N. TREASURE DRIVE
N. BAY VILLAGE, FL 33141

FOR: ACCELERATION SENSORS; AUTOMATIC VALVES; CONTROL VALVES FOR REGULATING THE FLOW OF GASES AND LIQUIDS; COOLANT-TEMPERATURE SENSORS; ELECTRIC RELAYS; ELECTRIC SENSORS; ELECTRONIC CONTROLS FOR GASOLINE ENGINES FOR LAND VEHICLES; ILLUMINATION REGULATORS; INDUCTION VOLTAGE REGULATORS; LIGHT SYSTEMS COMPRISING LIGHT SENSORS AND SWITCHES; LIQUID LEVEL SENSORS; OXYGEN REGULATORS; VOLTAGE REGULATORS, IN CLASS 9 (U.S. CLS. 21, 23, 26, 36 AND 38).

FIRST USE 12-15-2008; IN COMMERCE 12-15-2008.

NO CLAIM IS MADE TO THE EXCLUSIVE RIGHT TO USE "AUTOMOTIVE", APART FROM THE MARK AS SHOWN.

THE COLOR(S) BLUE, WHITE AND BLACK IS/ARE CLAIMED AS A FEATURE OF THE MARK.

THE MARK CONSISTS OF THE INITIALS "R" AND "A" IN WHITE WITH BLACK SHADOWS, AND THE DESIGN OF WHITE DOTS AND DASHES INSIDE A BLUE BOX WITH BLUE AND WHITE BORDERS ON A BLUE BACKGROUND, BELOW THE WORDS "RAMCO AUTOMOTIVE" IN BLUE ON A WHITE BACKGROUND.

SER. NO. 85-488,249, FILED 12-6-2011.

TASHIA BUNCH, EXAMINING ATTORNEY



David J. Kyffers

Director of the United States Patent and Trademark Office

United States of America

United States Patent and Trademark Office

Ramco Automotive



Reg. No. 4,175,643

Registered July 17, 2012

Int. Cl.: 12

TRADEMARK

PRINCIPAL REGISTER

RAMCO MIRACLE HOLDINGS, LLC (FLORIDA LIMITED LIABILITY COMPANY)
1629
1629 N. TREASURE DRIVE
N. BAY VILLAGE, FL 33141

FOR: AUTOMOBILE SUSPENSION DEVICES, NAMELY, COILOVERS; AUTOMOBILE SUSPENSION SYSTEM COMPONENTS, NAMELY, SPRING PERCHES; CHASSIS FOR MOTOR VEHICLES; LAND VEHICLE SUSPENSION PARTS, NAMELY, COIL SPRINGS; LAND VEHICLE SUSPENSION PARTS, NAMELY, EQUALIZERS; LAND VEHICLE SUSPENSION PARTS, NAMELY, LEAF SPRINGS; LAND VEHICLE SUSPENSION PARTS, NAMELY, TORSION/SWAY BARS; LAND VEHICLE TRANSMISSIONS AND REPLACEMENT PARTS THEREOF; MOTORS FOR AUTOMOBILES; SUSPENSION SYSTEMS FOR AUTOMOBILES; VEHICLE PARTS, NAMELY, SUSPENSION STRUTS; WHEEL SUSPENSIONS, IN CLASS 12 (U.S. CLS. 19, 21, 23, 31, 35 AND 44).

FIRST USE 12-15-2008; IN COMMERCE 12-15-2008.

NO CLAIM IS MADE TO THE EXCLUSIVE RIGHT TO USE "AUTOMOTIVE", APART FROM THE MARK AS SHOWN.

THE COLOR(S) BLUE, WHITE AND BLACK IS/ARE CLAIMED AS A FEATURE OF THE MARK.

THE MARK CONSISTS OF THE INITIALS "R" AND "A" IN WHITE WITH BLACK SHADOWS, AND THE DESIGN OF WHITE DOTS AND DASHES INSIDE A BLUE BOX WITH BLUE AND WHITE BORDERS ON A BLUE BACKGROUND, BELOW THE WORDS "RAMCO AUTOMOTIVE" IN BLUE ON A WHITE BACKGROUND.

SER. NO. 85-488,273, FILED 12-6-2011.

TASHIA BUNCH, EXAMINING ATTORNEY



David J. Kyjars

Director of the United States Patent and Trademark Office

United States of America

United States Patent and Trademark Office

EGG STARTS

Reg. No. 4,175,644

Registered July 17, 2012

Int. Cl.: 29

TRADEMARK

PRINCIPAL REGISTER

MICHAEL FOODS OF DELAWARE, INC. (DELAWARE CORPORATION)
301 CARLSON PARKWAY, SUITE 400
MINNETONKA, MN 55305

FOR: EGG PRODUCT; EGG SUBSTITUTE; EGG WHITES; PROCESSED EGGS, IN CLASS 29 (U.S. CL. 46).

FIRST USE 5-31-1990; IN COMMERCE 5-31-1990.

THE MARK CONSISTS OF STANDARD CHARACTERS WITHOUT CLAIM TO ANY PARTICULAR FONT, STYLE, SIZE, OR COLOR.

OWNER OF U.S. REG. NO. 1,673,895.

NO CLAIM IS MADE TO THE EXCLUSIVE RIGHT TO USE "EGG", APART FROM THE MARK AS SHOWN.

SER. NO. 85-488,439, FILED 12-6-2011.

EUGENIA MARTIN, EXAMINING ATTORNEY



David J. Kyffers

Director of the United States Patent and Trademark Office

United States of America

United States Patent and Trademark Office

Creating effective memory interventions

Reg. No. 4,175,645

Registered July 17, 2012

Int. Cl.: 41

LINDA-&-CAMERON, INC. (OHIO CORPORATION), DBA CENTER FOR APPLIED RESEARCH IN DEMENTIA

#182
34208 AURORA RD
SOLON, OH 44139

SERVICE MARK

PRINCIPAL REGISTER

FOR: EDUCATIONAL SERVICES, NAMELY, CONDUCTING CONFERENCES AND TRAINING IN THE FIELDS OF GERONTOLOGY, DEMENTIA, ADULT DEVELOPMENT AND AGING, AND DISTRIBUTION OF TRAINING MATERIALS IN CONNECTION THEREWITH; EDUCATIONAL SERVICES, NAMELY, CONDUCTING TRAINING PROGRAM EVALUATION AND SURVEYS FOR THE PURPOSE OF IMPROVING TEACHING PROCEDURES IN THE FIELDS OF GERONTOLOGY, DEMENTIA, AND ADULT DEVELOPMENT AND AGING, IN CLASS 41 (U.S. CLS. 100, 101 AND 107).

FIRST USE 7-5-2011; IN COMMERCE 7-5-2011.

THE MARK CONSISTS OF STANDARD CHARACTERS WITHOUT CLAIM TO ANY PARTICULAR FONT, STYLE, SIZE, OR COLOR.

SER. NO. 85-488,465, FILED 12-6-2011.

AMY KELLY, EXAMINING ATTORNEY



David J. Kyffers

Director of the United States Patent and Trademark Office

United States of America

United States Patent and Trademark Office



Reg. No. 4,175,646

LAKE MICHIGAN COLLEGE (MICHIGAN STATE COLLEGE)
2755 E. NAPIER AVENUE
BENTON HARBOR, MI 490221899

Registered July 17, 2012

Int. Cl.: 41

FOR: EDUCATING AT UNIVERSITY OR COLLEGES, IN CLASS 41 (U.S. CLS. 100, 101 AND 107).

SERVICE MARK

FIRST USE 12-14-1999; IN COMMERCE 12-14-1999.

PRINCIPAL REGISTER

THE MARK CONSISTS OF A SINGLE WAVE APPEARING IN THE CENTER OF A BOX WHICH IS OUTLINED BY A BOX.

SER. NO. 85-488,548, FILED 12-6-2011.

BERNICE MIDDLETON, EXAMINING ATTORNEY



David J. Kybas

Director of the United States Patent and Trademark Office

United States of America

United States Patent and Trademark Office

Joyful Heart Wellness

Reg. No. 4,175,647

Registered July 17, 2012

Int. Cls.: 44 and 45

SERVICE MARK

PRINCIPAL REGISTER

SARA JOY SOBROFSKI (UNITED STATES INDIVIDUAL), DBA JOYFUL HEART WELLNESS
& SPIRIT
2312 N GRANDVIEW BLVD SUITE 205
WAUKESHA, WI 53188

FOR: COUNSELING SERVICES IN THE FIELDS OF HEALTH, HERBALISM, AND LIFESTYLE WELLNESS; COUNSELING SERVICES IN THE FIELDS OF HEALTH, NUTRITION AND LIFESTYLE WELLNESS; PROVIDING A WEBSITE FEATURING INFORMATION CONCERNING ALTERNATIVE HEALTH AND HEALING; PROVIDING IN-PERSON ENERGY HEALING SERVICES; PROVIDING IN-PERSON VIBRATIONAL ENERGY HEALING SERVICES; PROVIDING LONG-DISTANCE ENERGY HEALING SERVICES; REIKI HEALING SERVICES, IN CLASS 44 (U.S. CLS. 100 AND 101).

FIRST USE 2-15-2010; IN COMMERCE 3-15-2010.

FOR: PSYCHIC READING SERVICES, IN CLASS 45 (U.S. CLS. 100 AND 101).

FIRST USE 2-15-2010; IN COMMERCE 3-15-2010.

THE MARK CONSISTS OF STANDARD CHARACTERS WITHOUT CLAIM TO ANY PARTICULAR FONT, STYLE, SIZE, OR COLOR.

NO CLAIM IS MADE TO THE EXCLUSIVE RIGHT TO USE "WELLNESS", APART FROM THE MARK AS SHOWN.

SER. NO. 85-488,633, FILED 12-6-2011.

KRISTINA MORRIS, EXAMINING ATTORNEY



David J. Kybas

Director of the United States Patent and Trademark Office

United States of America

United States Patent and Trademark Office

Square One

Reg. No. 4,175,648

Registered July 17, 2012

Int. Cl.: 10

TRADEMARK

PRINCIPAL REGISTER

NATURE BRIGHT COMPANY (CALIFORNIA CORPORATION), DBA NATURE BRIGHT
COMPANY
19200 VON KARMAN AVE SUITE 600
19200 VON KARMAN AVE. SUITE 600
IRVINE, CA 92612

FOR: PHOTOTHERAPY AND LIGHT THERAPY UNIT FOR TREATMENT OF SEASONAL
AFFECTIVE DISORDER, WINTER DEPRESSION, PREGNANCY DEPRESSION, MAJOR
DEPRESSIVE DISORDERS, SLEEP DISORDERS, CIRCADIAN RHYTHM DISORDERS, IN
CLASS 10 (U.S. CLS. 26, 39 AND 44).

FIRST USE 10-20-2011; IN COMMERCE 10-20-2011.

THE MARK CONSISTS OF STANDARD CHARACTERS WITHOUT CLAIM TO ANY PAR-
TICULAR FONT, STYLE, SIZE, OR COLOR.

SER. NO. 85-488,747, FILED 12-6-2011.

KELLEY WELLS, EXAMINING ATTORNEY



David J. Kyffers

Director of the United States Patent and Trademark Office

United States of America

United States Patent and Trademark Office

URBAN

Reg. No. 4,175,649

Registered July 17, 2012

Int. Cl.: 11

TRADEMARK

PRINCIPAL REGISTER

LIGHT & MOTION INDUSTRIES (CALIFORNIA CORPORATION)
300 CANNERY ROW
MONTEREY, CA 93940

FOR: BICYCLE LIGHTS, IN CLASS 11 (U.S. CLS. 13, 21, 23, 31 AND 34).

FIRST USE 8-16-2011; IN COMMERCE 8-16-2011.

THE MARK CONSISTS OF STANDARD CHARACTERS WITHOUT CLAIM TO ANY PARTICULAR FONT, STYLE, SIZE, OR COLOR.

SER. NO. 85-488,840, FILED 12-6-2011.

IRA J. GOODSaid, EXAMINING ATTORNEY



David J. Kyffers

Director of the United States Patent and Trademark Office

United States of America

United States Patent and Trademark Office



Reg. No. 4,175,650

AXESS ULTRASOUND, LLC (INDIANA LIMITED LIABILITY COMPANY)
8148 WOODLAND DRIVE
INDIANAPOLIS, IN 46278

Registered July 17, 2012

Int. Cl.: 37

FOR: REPAIR OR MAINTENANCE OF MEDICAL MACHINES AND APPARATUS, IN CLASS 37 (U.S. CLS. 100, 103 AND 106).

SERVICE MARK

FIRST USE 12-5-2005; IN COMMERCE 12-5-2005.

PRINCIPAL REGISTER

OWNER OF U.S. REG. NO. 3,193,998.

THE MARK CONSISTS OF THE LETTER "A" WITH A SQUARE IN THE MIDDLE AND THREE UPWARD FACING ARCS EMANATING FROM THE BOTTOM OF THE LETTER TO GIVE THE IMPRESSION OF SOUND WAVES.

SER. NO. 85-489,018, FILED 12-7-2011.

JIM RINGLE, EXAMINING ATTORNEY



David J. Kybas

Director of the United States Patent and Trademark Office

United States of America

United States Patent and Trademark Office

SAFINE

Reg. No. 4,175,651

Registered July 17, 2012

**Int. Cls.: 9, 18, 20, 25
and 28**

TRADEMARK

PRINCIPAL REGISTER

IIC-INTERSPORT INTERNATIONAL CORPORATION GMBH (SWITZERLAND CORPORATION)
WÖFLISTRASSE 2
3006 BERN, SWITZERLAND

FOR: PROTECTIVE HELMETS FOR SPORT; PEDOMETERS; INDIVIDUAL REFLECTIVE DISCS, BANDS AND EQUIPMENT FOR THE PREVENTION OF TRAFFIC ACCIDENTS, IN PARTICULAR FOR JOGGING, WALKING AND TRAINING; SPORT WHISTLES; HELMETS FOR SKIING AND SNOWBOARDING, HELMETS FOR HOCKEY; LIFE JACKETS; SWIMMING FLOATS AND JACKETS WITH STRAPS FOR SAFETY PURPOSES; DIVING SUITS, GLOVES AND EAR PLUGS FOR DIVING; BIVOUAC BAGS, NAMELY, WIND AND WATER RESISTANT BAGS INTO WHICH A PERSON CAN FIT TO PROTECT THEMSELVES FROM EXPOSURE TO THE ELEMENTS; SNORKELS, IN CLASS 9 (U.S. CLS. 21, 23, 26, 36 AND 38).

FOR: UNIVERSAL SPORTS BAGS, SPORT AND TRAVEL BAGS, MOUNTAIN BAGS, RUCKSACKS; SLING BAGS FOR CARRYING INFANTS; POUCHES, NAMELY, POUCHES OF TEXTILE, POUCHES OF LEATHER, HUNTER GAME BAGS AND RUCKSACKS FOR HUNTING; BEACH BAGS; BUMBAGS, NAMELY, BUMBAGS FOR THE PRACTICE OF RUNNING; WALKING STICKS; SADDLERY, IN CLASS 18 (U.S. CLS. 1, 2, 3, 22 AND 41).

FOR: NON-INFLATABLE AND INFLATABLE MATTRESSES FOR CAMPING, TABLES AND CHAIRS FOR CAMPING, EASY CHAIRS, NON-METALLIC BENCHES FOR FISHING; SLEEPING BAGS FOR CAMPING; CUSHIONS AND PILLOWS; CASES OF WOOD OR OF PLASTIC; STAKES AND PEGS NOT OF METAL FOR CAMPING TENTS, IN CLASS 20 (U.S. CLS. 2, 13, 22, 25, 32 AND 50).

FOR: CLOTHING, NAMELY, SKI WEAR, SNOWBOARD WEAR, TENNIS WEAR, SWIM WEAR, BEACH WEAR, SWEATSUITS, SWEAT SHIRTS, JOGGING SUITS, POLO SHIRTS, VESTS, SHIRTS, TOPS, SHORTS, UNDERWEAR, UNDERWEAR FOR SPORTS, SOCKS, ANORAKS, OVERALLS, OVERCOATS, TROUSERS, PANTS, JACKETS, RAINCOATS, PULLOVERS, TEE-SHIRTS, SCARVES, LEGGINGS, STOCKINGS, GLOVES, GLOVES FOR SKIING, BELTS, SKIING TROUSERS ADAPTABLE TO SHOES, GAITERS; FOOTWEAR, NAMELY, BOOTS, SHOES, SANDALS, BOOTS AND SHOES ADAPTED FOR SKIING, CROSS-COUNTRY SKI BOOTS, MOUNTAINEERING BOOTS AND SHOES, TENNIS SHOES, SQUASH SHOES, BASKETBALL SHOES, AEROBIC SHOES, GYMNASTIC SHOES, RUNNING SHOES, WALKING SHOES, CROSS-COUNTRY SHOES, JOGGING SHOES, AFTER-SKI



David J. Kyffers

Director of the United States Patent and Trademark Office

Reg. No. 4,175,651 BOOTS, SOFT WINTER-SPORT BOOTS, SKATEBOARD SHOES AND TREND SHOES; HEADGEAR, NAMELY, CAPS, HATS, HEADBANDS, SWIMMING CAPS; WETSUITS, IN CLASS 25 (U.S. CLS. 22 AND 39).

FOR: SPORTING ARTICLES INCLUDED IN THIS CLASS, NAMELY, WRIST PADS, ELBOW GUARDS, SHOULDER PADS, ANKLE PADS, SHIN GUARDS AND KNEE GUARDS; BAGS SPECIALLY ADAPTED FOR TRANSPORTING SPORTING ARTICLES; PROTECTIVE PADDINGS AS PARTS OF SPORTS SUITS, NAMELY, PROTECTIVE PADDING FOR SKIING, SNOWBOARDING, CYCLING, ROLLER SKATING, SKATEBOARDING, ICE HOCKEY AND ICE SKATING; ROLLER SKATES, ICE SKATES; SKATEBOARDS; SNOWBOARDS, SKIS, SKI AND SNOWBOARD BINDINGS, SKI POLES, SKI BRAKES; COVERS ESPECIALLY DESIGNED FOR SKIS; SNOW SLEDS FOR RECREATIONAL USE; SPORTS BALLS, NAMELY, HANDBALLS, VOLLEYBALLS, BASKETBALLS, BEACH VOLLEYBALLS, FOOTBALLS, RUGBY BALLS, PUMPS TO INFLATE SPORTS BALLS; GOALKEEPER GLOVES; SPORT TRAINING MATERIAL, NAMELY, CONES, HURDLES, POLES AND GOALS, FLOORBALL STICKS, FIELD HOCKEY STICKS, HOCKEY PUCKS AND STICKS; WEIGHT LIFTING BELTS FOR SPORTS; TENNIS, BADMINTON AND TABLE TENNIS NETS; TENNIS, SQUASH, BADMINTON, TABLE TENNIS AND RACKET-BALL RACKETS; COVERS AND BAGS FOR RACKETS; RACKET STRINGS; RACKET GRIPS; BALLS AND SHUTTLECOCKS, TABLE TENNIS TABLES; PROTECTIVE COVERS FOR TABLE TENNIS TABLES; RUBBER RINGS, FLIPPERS FOR SWIMMING AND DIVING; SPORTING ARTICLES INCLUDED IN THIS CLASS, NAMELY, GOLF CLUBS, GOLF BALLS; SWIMMING BELTS; SWIM FLOATS FOR RECREATIONAL USE; BACKPACKS, IN PARTICULAR RUCKSACKS MADE IN WATERPROOF MATERIAL, ESPECIALLY DESIGNED FOR SKIING; RAIN COVERS FOR SKI BAGS, RAIN COVERS FOR GOLF BAGS; FLY FISHING STRIPPER BASKETS , IN CLASS 28 (U.S. CLS. 22, 23, 38 AND 50).

THE MARK CONSISTS OF STANDARD CHARACTERS WITHOUT CLAIM TO ANY PARTICULAR FONT, STYLE, SIZE, OR COLOR.

PRIORITY CLAIMED UNDER SEC. 44(D) ON SWITZERLAND APPLICATION NO. 57538/2011, FILED 6-28-2011, REG. NO. 619646, DATED 9-5-2011, EXPIRES 6-28-2021.

SER. NO. 85-489,066, FILED 12-7-2011.

JAMES GRIFFIN, EXAMINING ATTORNEY

United States of America

United States Patent and Trademark Office

HOLE BUNCHES

Reg. No. 4,175,652

QUIKTRIP WEST, INC. (KANSAS CORPORATION)
5929 WEST CENTRAL
WICHITA, KS 67277

Registered July 17, 2012

Int. Cl.: 30

FOR: DONUTS AND BAKERY GOODS FOR CONSUMPTION ON OR OFF THE PREMISES,
IN CLASS 30 (U.S. CL. 46).

TRADEMARK

FIRST USE 9-30-2008; IN COMMERCE 9-30-2008.

PRINCIPAL REGISTER

THE MARK CONSISTS OF STANDARD CHARACTERS WITHOUT CLAIM TO ANY PAR-
TICULAR FONT, STYLE, SIZE, OR COLOR.

SER. NO. 85-489,279, FILED 12-7-2011.

TINA BROWN, EXAMINING ATTORNEY



David J. Kybas

Director of the United States Patent and Trademark Office

United States of America

United States Patent and Trademark Office

Amour Creative

Reg. No. 4,175,653

LOMAS, ALICIA (UNITED STATES INDIVIDUAL)
3225 GRAFTON AVE.
DALLAS, TX 75211

Registered July 17, 2012

Int. Cl.: 42

FOR: GRAPHIC DESIGN SERVICES; GRAPHIC ART DESIGN; WEB SITE DESIGN, IN CLASS 42 (U.S. CLS. 100 AND 101).

SERVICE MARK

FIRST USE 8-1-2004; IN COMMERCE 5-1-2008.

PRINCIPAL REGISTER

THE MARK CONSISTS OF STANDARD CHARACTERS WITHOUT CLAIM TO ANY PARTICULAR FONT, STYLE, SIZE, OR COLOR.

NO CLAIM IS MADE TO THE EXCLUSIVE RIGHT TO USE "CREATIVE", APART FROM THE MARK AS SHOWN.

SER. NO. 85-489,317, FILED 12-7-2011.

ALEXANDER L. POWERS, EXAMINING ATTORNEY



David J. Kyffers

Director of the United States Patent and Trademark Office

United States of America

United States Patent and Trademark Office

INNOVATIVE WORLDWIDE LOGISTICS, INC.

Reg. No. 4,175,654

Registered July 17, 2012

Int. Cl.: 39

SERVICE MARK

PRINCIPAL REGISTER

INNOVATIVE WORLDWIDE LOGISTICS, INC. (TENNESSEE CORPORATION)
3848 FOUNTAIN VALLEY DRIVE
KNOXVILLE, TN 37918

FOR: FREIGHT BROKERAGE, IN CLASS 39 (U.S. CLS. 100 AND 105).

FIRST USE 5-1-1999; IN COMMERCE 5-3-1999.

THE MARK CONSISTS OF STANDARD CHARACTERS WITHOUT CLAIM TO ANY PARTICULAR FONT, STYLE, SIZE, OR COLOR.

OWNER OF U.S. REG. NO. 2,505,914.

NO CLAIM IS MADE TO THE EXCLUSIVE RIGHT TO USE "WORLDWIDE LOGISTICS, INC.", APART FROM THE MARK AS SHOWN.

SER. NO. 85-489,341, FILED 12-7-2011.

ADA HAN, EXAMINING ATTORNEY



David J. Kyffers

Director of the United States Patent and Trademark Office

United States of America

United States Patent and Trademark Office

VIDOOVY

Reg. No. 4,175,655

DIRECT IGNITION, LLC (DELAWARE LIMITED LIABILITY COMPANY)
50 OAK CREST ROAD
WEST ORANGE, NJ 07052

Registered July 17, 2012

Int. Cl.: 41

FOR: VIDEO PRODUCTION SERVICES; VIDEO PRODUCTION SERVICES IN THE FIELD OF BUSINESS PROMOTION, IN CLASS 41 (U.S. CLS. 100, 101 AND 107).

SERVICE MARK

FIRST USE 0-0-2010; IN COMMERCE 0-0-2010.

PRINCIPAL REGISTER

THE MARK CONSISTS OF STANDARD CHARACTERS WITHOUT CLAIM TO ANY PARTICULAR FONT, STYLE, SIZE, OR COLOR.

SER. NO. 85-489,655, FILED 12-7-2011.

TIMOTHY FINNEGAN, EXAMINING ATTORNEY



David J. Kyffers

Director of the United States Patent and Trademark Office

United States of America

United States Patent and Trademark Office

SPACEPLEX

Reg. No. 4,175,656

Registered July 17, 2012

Int. Cl.: 42

SERVICE MARK

PRINCIPAL REGISTER

GENERAL DYNAMICS C4 SYSTEMS, INC. (DELAWARE CORPORATION)
8201 E. MCDOWELL ROAD
MD H3250
SCOTTSDALE, AZ 85257

FOR: ENGINEERING SERVICES FOR SPACE AND SATELLITE COMMUNICATIONS GROUND SYSTEMS; TECHNICAL SUPPORT SERVICES, NAMELY, TROUBLESHOOTING IN THE NATURE OF DIAGNOSING COMPUTER HARDWARE AND SOFTWARE PROBLEMS IN THE FIELD OF SPACE AND SATELLITE COMMUNICATIONS GROUND SYSTEMS AND SATELLITE OPERATIONS, IN CLASS 42 (U.S. CLS. 100 AND 101).

FIRST USE 5-11-2000; IN COMMERCE 5-11-2000.

THE MARK CONSISTS OF STANDARD CHARACTERS WITHOUT CLAIM TO ANY PARTICULAR FONT, STYLE, SIZE, OR COLOR.

SER. NO. 85-489,890, FILED 12-7-2011.

JIM RINGLE, EXAMINING ATTORNEY



David J. Kyffers

Director of the United States Patent and Trademark Office

United States of America

United States Patent and Trademark Office

BEST OF DENVER

Reg. No. 4,175,657

Registered July 17, 2012

Int. Cls.: 16 and 41

TRADEMARK

SERVICE MARK

PRINCIPAL REGISTER

VILLAGE VOICE MEDIA HOLDINGS, LLC (DELAWARE LIMITED LIABILITY COMPANY)
1201 EAST JEFFERSON STREET
PHOENIX, AZ 85034

FOR: ANNUAL NEWSPAPER SUPPLEMENTS IN THE FIELD OF LISTING INDIVIDUALS AND BUSINESSES THAT HAVE ACHIEVED EXCELLENCE IN AREAS OF INTEREST TO THE GENERAL PUBLIC, IN CLASS 16 (U.S. CLS. 2, 5, 22, 23, 29, 37, 38 AND 50).

FIRST USE 4-1-1984; IN COMMERCE 4-1-1984.

FOR: CONDUCTING AWARDS PROGRAMS HONORING INDIVIDUALS AND COMPANIES THAT HAVE DEMONSTRATED EXCELLENCE IN THEIR FIELDS, IN THE QUALITY OF THEIR PRODUCTS AND SERVICES AND IN CUSTOMER SERVICE, IN CLASS 41 (U.S. CLS. 100, 101 AND 107).

FIRST USE 4-1-1984; IN COMMERCE 4-1-1984.

THE MARK CONSISTS OF STANDARD CHARACTERS WITHOUT CLAIM TO ANY PARTICULAR FONT, STYLE, SIZE, OR COLOR.

OWNER OF U.S. REG. NO. 2,098,909.

SEC. 2(F).

SER. NO. 85-490,251, FILED 12-8-2011.

KATHERINE CONNOLLY, EXAMINING ATTORNEY



David J. Kyros

Director of the United States Patent and Trademark Office

United States of America

United States Patent and Trademark Office

BEST OF MIAMI

Reg. No. 4,175,658

Registered July 17, 2012

Int. Cls.: 16 and 41

TRADEMARK

SERVICE MARK

PRINCIPAL REGISTER

VILLAGE VOICE MEDIA HOLDINGS, LLC (DELAWARE LIMITED LIABILITY COMPANY)
1201 EAST JEFFERSON STREET
PHOENIX, AZ 85034

FOR: ANNUAL NEWSPAPER SUPPLEMENTS IN THE FIELD OF LISTING INDIVIDUALS AND BUSINESSES THAT HAVE ACHIEVED EXCELLENCE IN AREAS OF INTEREST TO THE GENERAL PUBLIC, IN CLASS 16 (U.S. CLS. 2, 5, 22, 23, 29, 37, 38 AND 50).

FIRST USE 2-14-1990; IN COMMERCE 2-14-1990.

FOR: CONDUCTING AWARDS PROGRAMS HONORING INDIVIDUALS AND COMPANIES THAT HAVE DEMONSTRATED EXCELLENCE IN THEIR FIELDS, IN THE QUALITY OF THEIR PRODUCTS AND SERVICES AND IN CUSTOMER SERVICE, IN CLASS 41 (U.S. CLS. 100, 101 AND 107).

FIRST USE 2-14-1990; IN COMMERCE 2-14-1990.

THE MARK CONSISTS OF STANDARD CHARACTERS WITHOUT CLAIM TO ANY PARTICULAR FONT, STYLE, SIZE, OR COLOR.

OWNER OF U.S. REG. NO. 2,094,511.

SEC. 2(F).

SER. NO. 85-490,340, FILED 12-8-2011.

KATHERINE CONNOLLY, EXAMINING ATTORNEY



David J. Kyros

Director of the United States Patent and Trademark Office

United States of America

United States Patent and Trademark Office

Vacuulation

Reg. No. 4,175,659

Registered July 17, 2012

Int. Cl.: 42

SERVICE MARK

PRINCIPAL REGISTER

VACUUM TECHNOLOGY, INCORPORATED OF TENNESSEE (GEORGIA CORPORATION),
AKA VTI
1003 ALVIN WEINBERG DRIVE
OAK RIDGE, TN 37830

FOR: TESTING, ANALYSIS AND EVALUATION OF THE GOODS OF OTHERS FOR THE
PURPOSE OF CERTIFICATION, IN CLASS 42 (U.S. CLS. 100 AND 101).

FIRST USE 10-26-2011; IN COMMERCE 10-26-2011.

THE MARK CONSISTS OF STANDARD CHARACTERS WITHOUT CLAIM TO ANY PAR-
TICULAR FONT, STYLE, SIZE, OR COLOR.

SER. NO. 85-490,531, FILED 12-8-2011.

KIMBERLY PERRY, EXAMINING ATTORNEY



David J. Kyffers

Director of the United States Patent and Trademark Office

United States of America

United States Patent and Trademark Office

LOCKERROOM

Reg. No. 4,175,660

LOCKERROOM MARKETING LTD. (CANADA CORPORATION)
694 DERWENT WAY
DELTA, CANADA V3M5P8

Registered July 17, 2012

Int. Cl.: 35

FOR: ON-LINE RETAIL STORE SERVICES FEATURING ADULT TOYS AND SEXUAL STIMULATION AIDS, IN CLASS 35 (U.S. CLS. 100, 101 AND 102).

SERVICE MARK

FIRST USE 10-8-1999; IN COMMERCE 10-8-1999.

PRINCIPAL REGISTER

THE MARK CONSISTS OF STANDARD CHARACTERS WITHOUT CLAIM TO ANY PARTICULAR FONT, STYLE, SIZE, OR COLOR.

SER. NO. 85-490,578, FILED 12-8-2011.

PAUL E. FAHRENKOPF, EXAMINING ATTORNEY



David J. Kybas

Director of the United States Patent and Trademark Office

United States of America

United States Patent and Trademark Office

BEST OF DALLAS

Reg. No. 4,175,661

Registered July 17, 2012

Int. Cls.: 16 and 41

TRADEMARK

SERVICE MARK

PRINCIPAL REGISTER

VILLAGE VOICE MEDIA HOLDINGS, LLC (DELAWARE LIMITED LIABILITY COMPANY)
1201 EAST JEFFERSON STREET
PHOENIX, AZ 85034

FOR: ANNUAL NEWSPAPER SUPPLEMENTS IN THE FIELD OF LISTING INDIVIDUALS AND BUSINESSES THAT HAVE ACHIEVED EXCELLENCE IN AREAS OF INTEREST TO THE GENERAL PUBLIC, IN CLASS 16 (U.S. CLS. 2, 5, 22, 23, 29, 37, 38 AND 50).

FIRST USE 7-12-1984; IN COMMERCE 7-12-1984.

FOR: CONDUCTING AWARDS PROGRAMS HONORING INDIVIDUALS AND COMPANIES THAT HAVE DEMONSTRATED EXCELLENCE IN THEIR FIELDS, IN THE QUALITY OF THEIR PRODUCTS AND SERVICES AND IN CUSTOMER SERVICE, IN CLASS 41 (U.S. CLS. 100, 101 AND 107).

FIRST USE 7-12-1984; IN COMMERCE 7-12-1984.

THE MARK CONSISTS OF STANDARD CHARACTERS WITHOUT CLAIM TO ANY PARTICULAR FONT, STYLE, SIZE, OR COLOR.

OWNER OF U.S. REG. NO. 2,098,988.

SEC. 2(F).

SER. NO. 85-491,316, FILED 12-9-2011.

KATHERINE CONNOLLY, EXAMINING ATTORNEY



David J. Kyros

Director of the United States Patent and Trademark Office

United States of America

United States Patent and Trademark Office

Define the Cloud

Reg. No. 4,175,662

DEFINE THE CLOUD, LLC (MISSOURI LIMITED LIABILITY COMPANY)
15208 APPLEROCK DR.
O FALLON, MO 63368

Registered July 17, 2012

Int. Cl.: 42

FOR: CONSULTING SERVICES IN THE FIELD OF CLOUD COMPUTING, IN CLASS 42
(U.S. CLS. 100 AND 101).

SERVICE MARK

FIRST USE 3-10-2010; IN COMMERCE 3-10-2010.

PRINCIPAL REGISTER

THE MARK CONSISTS OF STANDARD CHARACTERS WITHOUT CLAIM TO ANY PARTICULAR FONT, STYLE, SIZE, OR COLOR.

NO CLAIM IS MADE TO THE EXCLUSIVE RIGHT TO USE "CLOUD", APART FROM THE MARK AS SHOWN.

SER. NO. 85-491,371, FILED 12-9-2011.

TRACY CROSS, EXAMINING ATTORNEY



David J. Kyffers

Director of the United States Patent and Trademark Office

United States of America
United States Patent and Trademark Office

VACURECT

Reg. No. 4,175,663

MARIA EMMERENTIA BONTHUYS (SOUTH AFRICA INDIVIDUAL)
730 TETRA AVENUE, MORELETA PARK
PRETORIA, GAUTENG, SOUTH AFRICA

Registered July 17, 2012

Int. Cl.: 10

FOR: ERECTION DEVICE FOR USE IN CREATING AND MAINTAINING PENILE RIGIDITY
IN MEN WITH ERECTILE DYSFUNCTION, IN CLASS 10 (U.S. CLS. 26, 39 AND 44).

TRADEMARK

FIRST USE 11-18-2002; IN COMMERCE 11-18-2002.

PRINCIPAL REGISTER

THE MARK CONSISTS OF STANDARD CHARACTERS WITHOUT CLAIM TO ANY PAR-
TICULAR FONT, STYLE, SIZE, OR COLOR.

SER. NO. 85-491,382, FILED 12-9-2011.

TRACY CROSS, EXAMINING ATTORNEY



David J. Kybas

Director of the United States Patent and Trademark Office

United States of America

United States Patent and Trademark Office

BEST OF HOUSTON

Reg. No. 4,175,664

Registered July 17, 2012

Int. Cls.: 16 and 41

TRADEMARK

SERVICE MARK

PRINCIPAL REGISTER

VILLAGE VOICE MEDIA HOLDINGS, LLC (DELAWARE LIMITED LIABILITY COMPANY)
1201 EAST JEFFERSON STREET
PHOENIX, AZ 85034

FOR: ANNUAL NEWSPAPER SUPPLEMENTS IN THE FIELD OF LISTING INDIVIDUALS AND BUSINESSES THAT HAVE ACHIEVED EXCELLENCE IN AREAS OF INTEREST TO THE GENERAL PUBLIC, IN CLASS 16 (U.S. CLS. 2, 5, 22, 23, 29, 37, 38 AND 50).

FIRST USE 9-27-1990; IN COMMERCE 9-27-1990.

FOR: CONDUCTING AWARDS PROGRAMS HONORING INDIVIDUALS AND COMPANIES THAT HAVE DEMONSTRATED EXCELLENCE IN THEIR FIELDS, IN THE QUALITY OF THEIR PRODUCTS AND SERVICES AND IN CUSTOMER SERVICE, IN CLASS 41 (U.S. CLS. 100, 101 AND 107).

FIRST USE 9-27-1990; IN COMMERCE 9-27-1990.

THE MARK CONSISTS OF STANDARD CHARACTERS WITHOUT CLAIM TO ANY PARTICULAR FONT, STYLE, SIZE, OR COLOR.

OWNER OF U.S. REG. NO. 2,102,832.

SEC. 2(F).

SER. NO. 85-491,418, FILED 12-9-2011.

KATHERINE CONNOLLY, EXAMINING ATTORNEY



David J. Kyros

Director of the United States Patent and Trademark Office

United States of America

United States Patent and Trademark Office



Center for Applied
Research in Dementia
Creating effective memory interventions

Reg. No. 4,175,665

Registered July 17, 2012

Int. Cl.: 41

LINDA-&-CAMERON, INC. (OHIO CORPORATION), DBA CENTER FOR APPLIED
RESEARCH IN DEMENTIA

#182
34208 AURORA RD
SOLON, OH 44139

SERVICE MARK

PRINCIPAL REGISTER

FOR: EDUCATIONAL SERVICES, NAMELY, CONDUCTING CONFERENCES AND TRAINING IN THE FIELDS OF GERONTOLOGY, DEMENTIA, ADULT DEVELOPMENT AND AGING, AND DISTRIBUTION OF TRAINING MATERIALS IN CONNECTION THEREWITH; EDUCATIONAL SERVICES, NAMELY, CONDUCTING TRAINING PROGRAM EVALUATION AND SURVEYS FOR THE PURPOSE OF IMPROVING TEACHING PROCEDURES IN THE FIELDS OF GERONTOLOGY, DEMENTIA, AND ADULT DEVELOPMENT AND AGING, IN CLASS 41 (U.S. CLS. 100, 101 AND 107).

FIRST USE 7-5-2011; IN COMMERCE 7-5-2011.

NO CLAIM IS MADE TO THE EXCLUSIVE RIGHT TO USE "CENTER FOR APPLIED RESEARCH IN DEMENTIA", APART FROM THE MARK AS SHOWN.

THE COLOR(S) GREEN AND BLACK AND WHITE IS/ARE CLAIMED AS A FEATURE OF THE MARK.

THE MARK CONSISTS OF A GREEN CIRCLE CONTAINING TWO WHITE LEAVES WITH BLACK STEMS AND TWO WHITE CURVING LINES WITH SHADOWING DEPICTED BELOW, AND TO THE RIGHT APPEARS THE WORDING "CENTER FOR APPLIED RESEARCH IN DEMENTIA" IN BLACK AND THE WORDING "CREATING EFFECTIVE MEMORY INTERVENTIONS" IN GREEN; OTHER THAN AS DESCRIBED, THE COLOR WHITE IS NOT PART OF THE MARK BUT REPRESENTS TRANSPARENT BACKGROUND.

SER. NO. 85-491,693, FILED 12-9-2011.

AMY KELLY, EXAMINING ATTORNEY



David J. Kyjars

Director of the United States Patent and Trademark Office

United States of America

United States Patent and Trademark Office

The Power of Wall Street. The Promise of Main Street.

Reg. No. 4,175,666

RW SMITH & ASSOCIATES (WASHINGTON CORPORATION)

Registered July 17, 2012

2825 EAST COTTONWOOD PARKWAY, STE. 500
SALT LAKE CITY, UT 84121

Int. Cl.: 36

FOR: FINANCIAL SERVICES, NAMELY, INTER-BROKER DEALER SERVICES AND MUNICIPAL SECURITIES BROKER'S BROKERS SERVICES, IN CLASS 36 (U.S. CLS. 100, 101 AND 102).

SERVICE MARK

FIRST USE 12-15-2011; IN COMMERCE 1-1-2012.

PRINCIPAL REGISTER

THE MARK CONSISTS OF STANDARD CHARACTERS WITHOUT CLAIM TO ANY PARTICULAR FONT, STYLE, SIZE, OR COLOR.

SER. NO. 85-491,858, FILED 12-9-2011.

GRETТА YAO, EXAMINING ATTORNEY



David J. Kyffers

Director of the United States Patent and Trademark Office

United States of America

United States Patent and Trademark Office



Reg. No. 4,175,667

Registered July 17, 2012

Int. Cl.: 30

TRADEMARK

PRINCIPAL REGISTER

VASSALLO FOODS, INC. (MONTANA CORPORATION)
46835 US HWY 93
POLSON, MT 59860

FOR: DRIED PASTA AND NOODLES, IN CLASS 30 (U.S. CL. 46).

FIRST USE 12-2-2004; IN COMMERCE 12-2-2004.

OWNER OF U.S. REG. NO. 1,821,557.

NO CLAIM IS MADE TO THE EXCLUSIVE RIGHT TO USE "PASTA" AND "HOMEMADE STYLE EGG PASTA", APART FROM THE MARK AS SHOWN.

THE MARK CONSISTS OF THE STYLIZED WORDS "COUNTRY PASTA" ABOVE THE WORDS "HOMEMADE STYLE EGG PASTA" IN AN OVAL WITH A CHECKERED BORDER AND TWO WHEAT STALKS EXTENDING FROM LEFT OF CENTER OF THE BOTTOM LEFT OF THE OVAL BEHIND THE WORDING AND OUT TO THE RIGHT OF CENTER FROM THE TOP OF THE OVAL.

SER. NO. 85-491,983, FILED 12-9-2011.

KATHLEEN KOLACZ, EXAMINING ATTORNEY



David J. Kybas

Director of the United States Patent and Trademark Office

United States of America

United States Patent and Trademark Office

IT'S ALL ABOUT THE FLAVOR

Reg. No. 4,175,668

B&W QUALITY GROWERS, INC. (FLORIDA CORPORATION)
17825 79TH STREET
FELLSMERE, FL 32948

Registered July 17, 2012

Int. Cl.: 31

FOR: FRESH SPECIALTY LEAF VEGETABLES, NAMELY, WATERCRESS, BABY ARUGULA, PEA TENDRILS AND SPINACH, IN CLASS 31 (U.S. CLS. 1 AND 46).

TRADEMARK

FIRST USE 10-15-2011; IN COMMERCE 11-1-2011.

PRINCIPAL REGISTER

THE MARK CONSISTS OF STANDARD CHARACTERS WITHOUT CLAIM TO ANY PARTICULAR FONT, STYLE, SIZE, OR COLOR.

SER. NO. 85-492,810, FILED 12-12-2011.

FLORENTINA BLANDU, EXAMINING ATTORNEY



David J. Kyjars

Director of the United States Patent and Trademark Office

United States of America

United States Patent and Trademark Office

1479V

Reg. No. 4,175,669

KABUSHIKI KAISHA TANITA (JAPAN JOINT STOCK COMPANY)
14-2, 1-CHOME, MAENOCHO, ITABASHI-KU
TOKYO, JAPAN

Registered July 17, 2012

Int. Cl.: 9

FOR: SCALES; DIGITAL SCALES; MINI SCALES; POCKET SCALES; SCALES FOR
WEIGHING PRECIOUS METAL, IN CLASS 9 (U.S. CLS. 21, 23, 26, 36 AND 38).

TRADEMARK

FIRST USE 6-20-1990; IN COMMERCE 6-20-1990.

PRINCIPAL REGISTER

THE MARK CONSISTS OF STANDARD CHARACTERS WITHOUT CLAIM TO ANY PAR-
TICULAR FONT, STYLE, SIZE, OR COLOR.

SER. NO. 85-493,231, FILED 12-12-2011.

AMY HELLA, EXAMINING ATTORNEY



David J. Kyjars

Director of the United States Patent and Trademark Office

United States of America

United States Patent and Trademark Office

GLOWMAX

Reg. No. 4,175,670

Registered July 17, 2012

Int. Cl.: 11

TRADEMARK

PRINCIPAL REGISTER

THE BATTERY SPOT LLC (MICHIGAN LIMITED LIABILITY COMPANY)
513 PAMELA DR
COLDWATER, MI 49036

FOR: FLASHLIGHTS; LED LIGHTS FOR LIGHTING PURPOSES INCORPORATED INTO KEY CHAINS, SMALL TOYS OR OTHER SIMILAR PERSONAL ITEMS; OUTDOOR PORTABLE LIGHTING PRODUCTS, NAMELY, HEADLAMPS; SPOTLIGHTS; LED FLASHLIGHTS; BICYCLE LIGHTS; ELECTRIC HOLIDAY LIGHTS; LANTERNS; ELECTRIC TORCHES FOR LIGHTING; PORTABLE BATTERY-OPERATED LIGHTS THAT CAN BE PLACED ON SURFACES WHERE OTHER LIGHT SOURCES ARE UNAVAILABLE; SOLAR-POWERED ALL-WEATHER LIGHTS, IN CLASS 11 (U.S. CLS. 13, 21, 23, 31 AND 34).

FIRST USE 5-1-2011; IN COMMERCE 6-1-2011.

THE MARK CONSISTS OF THE WORD "GLOWMAX" AND ONE ARM OF THE "X" IS A FLASHLIGHT.

SER. NO. 85-493,285, FILED 12-12-2011.

TASNEEM HUSSAIN, EXAMINING ATTORNEY



David J. Kybas

Director of the United States Patent and Trademark Office

United States of America

United States Patent and Trademark Office

geotelematic

Reg. No. 4,175,671

Registered July 17, 2012

Int. Cls.: 9 and 42

TRADEMARK

SERVICE MARK

PRINCIPAL REGISTER

GEOTELEMATIC SOLUTIONS, INC. (NEVADA CORPORATION)
PMB 201
664-A FREEMAN LANE
GRASS VALLEY, CA 95949

FOR: COMPUTER HARDWARE AND SOFTWARE SYSTEM FOR TRACKING PEOPLE, OBJECTS AND PETS USING GPS DATA ON A DEVICE ON THE TRACKED PEOPLE, OBJECTS AND PETS, IN CLASS 9 (U.S. CLS. 21, 23, 26, 36 AND 38).

FIRST USE 10-4-2007; IN COMMERCE 1-1-2008.

FOR: COMPUTER SOFTWARE DEVELOPMENT, IN CLASS 42 (U.S. CLS. 100 AND 101).

FIRST USE 10-4-2007; IN COMMERCE 1-1-2008.

THE MARK CONSISTS OF STANDARD CHARACTERS WITHOUT CLAIM TO ANY PARTICULAR FONT, STYLE, SIZE, OR COLOR.

SER. NO. 85-493,436, FILED 12-12-2011.

APRIL HESIK, EXAMINING ATTORNEY



David J. Kypos

Director of the United States Patent and Trademark Office

United States of America

United States Patent and Trademark Office



Reg. No. 4,175,672

CLG PROFESSIONAL SERVICES, LLC (TEXAS LIMITED LIABILITY COMPANY)
121-H NORTH GREENVILLE AVE.
ALLEN, TX 75002

Registered July 17, 2012

Int. Cl.: 36

FOR: FINANCIAL CONSULTANCY; ONLINE, REAL-TIME TAX PAYMENT PROCESSING, TAX PAYMENT MANAGEMENT, AND TAX PAYMENT ANALYSIS SERVICES, IN CLASS 36 (U.S. CLS. 100, 101 AND 102).

SERVICE MARK

FIRST USE 1-30-2010; IN COMMERCE 1-30-2010.

PRINCIPAL REGISTER

THE MARK CONSISTS OF BLUE STYLIZED GLOBE WITH "CLG" IN GRAY STYLIZED FONT TO THE RIGHT. THE COLOR WHITE REPRESENTS BACKGROUND OR TRANSPARENT AREA AND IS NOT CLAIMED AS PART OF THE MARK.

THE COLOR(S) GRAY AND BLUE IS/ARE CLAIMED AS A FEATURE OF THE MARK.

SER. NO. 85-493,567, FILED 12-13-2011.

LINDA ESTRADA, EXAMINING ATTORNEY



David J. Kybas

Director of the United States Patent and Trademark Office

United States of America

United States Patent and Trademark Office



Reg. No. 4,175,673

Registered July 17, 2012

Int. Cl.: 1

TRADEMARK

PRINCIPAL REGISTER

LEFT FIELD PRODUCTIONS, LLC (WISCONSIN LIMITED LIABILITY COMPANY), DBA
EASTSIDE SHOE REPAIR
1937 WINNEBAGO STREET
MADISON, WI 53704

FOR: WATERPROOFING COMPOSITIONS FOR ARTICLES OF LEATHER, IN CLASS 1 (U.S.
CLS. 1, 5, 6, 10, 26 AND 46).

FIRST USE 12-9-2011; IN COMMERCE 12-9-2011.

THE MARK CONSISTS OF A FRONT VIEW OF THE HEAD AND NECK OF A COW WITH
WINGS PROTRUDING FROM EACH SIDE OF THE LOWER PORTION OF THE NECK.

SER. NO. 85-494,088, FILED 12-13-2011.

RONALD DELGIZZI, EXAMINING ATTORNEY



David J. Kybas

Director of the United States Patent and Trademark Office

United States of America

United States Patent and Trademark Office



Reg. No. 4,175,674

WALLTOOL, LLC (CALIFORNIA LIMITED LIABILITY COMPANY)
646 FLAMING STAR AVENUE
THOUSAND OAKS, CA 91360

Registered July 17, 2012

Int. Cls.: 25 and 28

FOR: MOUNTAINEERING BOOTS, IN CLASS 25 (U.S. CLS. 22 AND 39).

FIRST USE 4-22-2011; IN COMMERCE 4-22-2011.

TRADEMARK

FOR: CLIMBERS' HARNESSES , IN CLASS 28 (U.S. CLS. 22, 23, 38 AND 50).

PRINCIPAL REGISTER

FIRST USE 4-22-2011; IN COMMERCE 4-22-2011.

THE MARK CONSISTS OF A CAPITAL LETTER "W" FOLLOWED BY THE WORDS "ALL" IN ALL CAPITAL LETTERS PLACED IN THE UPPER HALF AND THE WORDS "TOOL" IN ALL CAPITAL LETTERS PLACED IN THE LOWER HALF OF THE SPACE THAT DIRECTLY FOLLOWS THE CAPITAL LETTER "W".

SER. NO. 85-494,515, FILED 12-13-2011.

CHRISTOPHER LAW, EXAMINING ATTORNEY



David J. Kybas

Director of the United States Patent and Trademark Office

United States of America
United States Patent and Trademark Office

TRUTECH

Reg. No. 4,175,675

TRUTECH, LLC (DELAWARE LIMITED LIABILITY COMPANY)
2170 PIEDMONT ROAD, NE
ATLANTA, GA 30324

Registered July 17, 2012

Int. Cl.: 37

FOR: PEST, WILDLIFE, ANIMAL AND BIRD CONTROL SERVICES, IN CLASS 37 (U.S. CLS. 100, 103 AND 106).

SERVICE MARK

FIRST USE 9-20-1984; IN COMMERCE 9-20-1984.

PRINCIPAL REGISTER

THE MARK CONSISTS OF STANDARD CHARACTERS WITHOUT CLAIM TO ANY PARTICULAR FONT, STYLE, SIZE, OR COLOR.

OWNER OF U.S. REG. NOS. 3,023,338, 3,475,682, AND 3,919,426.

SER. NO. 85-495,199, FILED 12-14-2011.

SKYE YOUNG, EXAMINING ATTORNEY



David J. Kybas

Director of the United States Patent and Trademark Office

United States of America

United States Patent and Trademark Office

NEWSOK

Reg. No. 4,175,676

Registered July 17, 2012

Int. Cl.: 41

SERVICE MARK

PRINCIPAL REGISTER

THE OKLAHOMA PUBLISHING COMPANY (DELAWARE CORPORATION)
9000 NORTH BROADWAY
OKLAHOMA CITY, OK 73114

FOR: PROVIDING AN ONLINE NON-DOWNLOADABLE NEWSPAPER FEATURING INFORMATION IN THE FIELDS OF NEWS, POLITICS, WEATHER, SPORTS, BUSINESS, HEALTH, REAL ESTATE, ENTERTAINMENT, TRAVEL, AND CLASSIFIED ADVERTISING, IN CLASS 41 (U.S. CLS. 100, 101 AND 107).

FIRST USE 9-16-2001; IN COMMERCE 9-16-2001.

THE MARK CONSISTS OF STANDARD CHARACTERS WITHOUT CLAIM TO ANY PARTICULAR FONT, STYLE, SIZE, OR COLOR.

OWNER OF U.S. REG. NO. 2,954,538.

SER. NO. 85-495,229, FILED 12-14-2011.

RON FAIRBANKS, EXAMINING ATTORNEY



David J. Kyffers

Director of the United States Patent and Trademark Office

United States of America

United States Patent and Trademark Office

TANDENT



Reg. No. 4,175,677

Registered July 17, 2012

Int. Cls.: 9 and 35

TRADEMARK

SERVICE MARK

PRINCIPAL REGISTER

TANDENT VISION SCIENCE, INC. (DELAWARE CORPORATION)
505 MONTGOMERY STREET, STE 1100
SAN FRANCISCO, CA 94111

FOR: COMPUTER SOFTWARE PROGRAMS FOR OBJECT RECOGNITION, IMAGING, AND IMAGE ANALYSIS FOR USE IN COMPUTER VISION; COMPUTER SOFTWARE DEVELOPMENT TOOLS FOR USE IN COMPUTER VISION, IMAGING, AND IMAGE ANALYSIS; COMPUTER SOFTWARE PROGRAMS FOR OBJECT RECOGNITION, IMAGING, AND IMAGE ANALYSIS FOR USE IN COMPUTER VISION, NAMELY, COMPUTER SOFTWARE PROGRAMS FOR PREPROCESSING AND EXTRACTING INFORMATION FROM AN IMAGE FOR REAL-TIME FACIAL RECOGNITION AND CAPTURE OF REAL-WORLD TEXTURE MAPS FOR USE IN VIDEO SURVEILLANCE SYSTEMS, REAL-TIME IDENTIFICATION OF BIOMETRIC INDICATORS, COMPUTER GRAPHICS, AND GAMING; COMPUTER SOFTWARE DEVELOPMENT TOOLS FOR USE IN EXTRACTING INFORMATION FROM AN IMAGE, IMAGE RECOGNITION, AND IMAGE ANALYSIS FOR USE IN VIDEO SURVEILLANCE SYSTEMS, REAL-TIME IDENTIFICATION OF BIOMETRIC INDICATORS, COMPUTER GRAPHICS, AND GAMING, IN CLASS 9 (U.S. CLS. 21, 23, 26, 36 AND 38).

FIRST USE 4-20-2010; IN COMMERCE 4-20-2010.

FOR: BUSINESS RESEARCH IN FIELDS OF COMPUTER VISION, IMAGING, AND IMAGE ANALYSIS; BUSINESS RESEARCH IN FIELDS OF COMPUTER VISION, IMAGING, AND IMAGE ANALYSIS ALL FOR USE IN VIDEO SURVEILLANCE SYSTEMS, REAL-TIME IDENTIFICATION OF BIOMETRIC INDICATORS, COMPUTER GRAPHICS, AND GAMING, IN CLASS 35 (U.S. CLS. 100, 101 AND 102).

FIRST USE 7-21-2006; IN COMMERCE 7-21-2006.

OWNER OF U.S. REG. NOS. 3,808,612 AND 3,812,251.

THE COLOR(S) BLACK, BLUE, GREEN, RED AND ORANGE IS/ARE CLAIMED AS A FEATURE OF THE MARK.

THE MARK CONSISTS OF THE STYLIZED BLACK WORD "TANDENT" FOLLOWED BY FOUR STYLIZED BLACK BULLET STREAKS, ONE HAVING BLUE, ONE HAVING GREEN, ONE HAVING RED, AND ONE HAVING ORANGE AT THE TIP.



David J. Kyjars

Director of the United States Patent and Trademark Office

Reg. No. 4,175,677 SER. NO. 85-495,487, FILED 12-14-2011.

DAVID TOOLEY, EXAMINING ATTORNEY

United States of America

United States Patent and Trademark Office

AMERICAN CAMP ASSOCIATION, NEW YORK AND NEW JERSEY

Reg. No. 4,175,678

Registered July 17, 2012

Int. Cl.: 35

SERVICE MARK

PRINCIPAL REGISTER

AMERICAN CAMPING ASSOCIATION, INC. (INDIANA CORPORATION)
5000 STATE ROAD 67 NORTH
MARTINSVILLE, IN 46151

FOR: ASSOCIATION SERVICES, NAMELY, PROMOTING THE INTERESTS OF PERSONS INTERESTED IN ORGANIZED CAMPING AND RELATED CONFERENCE AND RETREAT CENTERS FOR YOUTH AND ADULTS, IN CLASS 35 (U.S. CLS. 100, 101 AND 102).

FIRST USE 11-30-2010; IN COMMERCE 11-30-2010.

THE MARK CONSISTS OF STANDARD CHARACTERS WITHOUT CLAIM TO ANY PARTICULAR FONT, STYLE, SIZE, OR COLOR.

OWNER OF U.S. REG. NOS. 3,043,665, 3,910,954 AND OTHERS.

NO CLAIM IS MADE TO THE EXCLUSIVE RIGHT TO USE "CAMP ASSOCIATION, NEW YORK AND NEW JERSEY", APART FROM THE MARK AS SHOWN.

SEC. 2(F) AS TO "AMERICAN CAMP ASSOCIATION".

SER. NO. 85-495,964, FILED 12-15-2011.

BRIAN CALLAGHAN, EXAMINING ATTORNEY



David J. Kyffers

Director of the United States Patent and Trademark Office

United States of America

United States Patent and Trademark Office

TWIN SPARK

Reg. No. 4,175,679

FIAT AUTO S.P.A. (ITALY SOCIETÀ PER AZIONI (SPA))
CORSO GIOVANNI AGNELLI, 200
TORINO, ITALY 10135

Registered July 17, 2012

Int. Cls.: 9 and 12

FOR: ELECTRIC CONTROL PANELS AND CONTROL WARNING LIGHTS FOR VEHICLES; COMPUTERS FOR MOTOR VEHICLES; RADIO SETS, RADIOS FOR VEHICLES; AUDIO CASSETTE RECORDERS, STEREO CASSETTE PLAYERS, RECORD PLAYERS, CALCULATORS, PHOTOGRAPHIC CAMERAS, EYEGLASSES AND STRUCTURAL PARTS THEREFOR, EYEGLASS CASES, CONTROL UNITS FOR MOTOR VEHICLE ENGINES, IN CLASS 9 (U.S. CLS. 21, 23, 26, 36 AND 38).

TRADEMARK

PRINCIPAL REGISTER

FOR: LAND VEHICLES, NAMELY AUTOMOBILES, OFF-ROAD ALL-TERRAIN MOTOR VEHICLES, TRUCKS, LORRIES, VANS, BUSES AND STRUCTURAL PARTS THEREFOR; VEHICLES FOR LOCOMOTION BY WATER, NAMELY, MOTORBOATS, SEAPLANES AND STRUCTURAL PARTS THEREFOR; VEHICLES FOR LOCOMOTION BY AIR, NAMELY, AIRPLANES, HELICOPTERS, GLIDERS, AND STRUCTURAL PARTS THEREFOR; VEHICLE ACCESSORIES, NAMELY, STEERING WHEELS, HEAD RESTS FOR VEHICLE SEATS, SEAT BELTS FOR USE IN VEHICLES, VEHICLE SEAT COVERS, ANTI-SKID TIRE CHAINS, REAR VIEW MIRRORS, HEAD LAMP WIPERS, WINDSHIELD WIPERS, BACKLIGHT WIPERS, ALLOY WHEELS, MUD FLAPS, SUN ROOFS, CAR DEFLECTORS, AND SKI, LUGGAGE AND MULTIPURPOSE RACKS; VEHICLE PARTS, NAMELY, FRONT AND REAR BUMPERS, FENDERS, VEHICLE ENGINE HOODS, VEHICLE LUGGAGE SPACE HOOD, FRONT GRILLS, DOOR PANELS, WHEELS, WINDSHIELDS, REAR AND LATERAL GLASS WINDOWS, SHOCK ABSORBERS, DISKS BRAKES AND PADS, MUFFLERS, VEHICLE SUSPENSION PARTS, NAMELY, LEAF SPRINGS; VEHICLE STEERING GEARS; VEHICLE AXLE SHAFTS; ENGINE PARTS FOR LAND VEHICLES, NAMELY, CYLINDER LINERS, DRIVE BELTS, CAMSHAFT DRIVE BELTS; ELECTRONIC ANTI-THEFT ALARMS FOR VEHICLES, IN CLASS 12 (U.S. CLS. 19, 21, 23, 31, 35 AND 44).



THE MARK CONSISTS OF STANDARD CHARACTERS WITHOUT CLAIM TO ANY PARTICULAR FONT, STYLE, SIZE, OR COLOR.

OWNER OF ITALY REG. NO. 1297249, DATED 4-1-1988, EXPIRES 4-1-2018.

David J. Kyffers

SER. NO. 85-496,076, FILED 12-15-2011.

SKYE YOUNG, EXAMINING ATTORNEY

United States of America

United States Patent and Trademark Office

OWNERPLUS



Reg. No. 4,175,680

WYNDHAM EXCHANGE AND RENTALS, INC. (DELAWARE CORPORATION)
7 SYLVAN WAY

Registered July 17, 2012

PARSIPPANY, NJ 07054

Int. Cl.: 35

FOR: PROMOTING PARTICIPATION IN A VACATION RENTAL PROGRAM THROUGH THE OFFERING OF HOMEOWNER INCENTIVE AND LOYALTY PROGRAMS, IN CLASS 35 (U.S. CLS. 100, 101 AND 102).

SERVICE MARK

FIRST USE 1-5-2012; IN COMMERCE 1-5-2012.

PRINCIPAL REGISTER

THE MARK CONSISTS OF THE WORDS "OWNERPLUS" WITH A KEY RING HANGING OFF THE BOTTOM OF THE LETTER "U" IN THE WORD "PLUS" WITH A ROUND HEADED KEY ON THE KEY RING AND A SQUARE KEY TAG ON THE KEY RING WITH THE PLUS SYMBOL IN THE CENTER OF THE KEY TAG.

SER. NO. 85-496,172, FILED 12-15-2011.

ALEXANDER L. POWERS, EXAMINING ATTORNEY



David J. Kyffers

Director of the United States Patent and Trademark Office

United States of America

United States Patent and Trademark Office

Future PLUS

Reg. No. 4,175,681

Registered July 17, 2012

Int. Cl.: 35

SERVICE MARK

PRINCIPAL REGISTER

PROFESSIONAL LIABILITY UNDERWRITING SOCIETY (MINNESOTA NON-PROFIT CORPORATION)

SUITE 600
5353 WAYZATA BOULEVARD
MINNEAPOLIS, MN 55416

FOR: ASSOCIATION SERVICES, NAMELY, PROMOTING THE INTERESTS OF THE PROFESSIONAL LIABILITY UNDERWRITING INSURANCE INDUSTRY, IN CLASS 35 (U.S. CLS. 100, 101 AND 102).

FIRST USE 6-0-2011; IN COMMERCE 6-0-2011.

THE MARK CONSISTS OF STANDARD CHARACTERS WITHOUT CLAIM TO ANY PARTICULAR FONT, STYLE, SIZE, OR COLOR.

SER. NO. 85-498,393, FILED 12-19-2011.

PAULA MAHONEY, EXAMINING ATTORNEY



David J. Kyffers

Director of the United States Patent and Trademark Office

United States of America

United States Patent and Trademark Office

Hilander

Reg. No. 4,175,682

Registered July 17, 2012

Int. Cl.: 35

SERVICE MARK

PRINCIPAL REGISTER

SCHNUCK MARKETS, INC. (MISSOURI CORPORATION), DBA SCHNUCKS MARKETS,
INC.
11420 LACKLAND RD.
ST. LOUIS, MO 63301

FOR: RETAIL GROCERY STORES, IN CLASS 35 (U.S. CLS. 100, 101 AND 102).

FIRST USE 9-26-2011; IN COMMERCE 9-26-2011.

THE MARK CONSISTS OF STANDARD CHARACTERS WITHOUT CLAIM TO ANY PARTICULAR FONT, STYLE, SIZE, OR COLOR.

SER. NO. 85-499,140, FILED 12-19-2011.

WENDY JUN, EXAMINING ATTORNEY



David J. Kyffers

Director of the United States Patent and Trademark Office

United States of America

United States Patent and Trademark Office

FLOTEZE

Reg. No. 4,175,683

MAIDLA, TEET (UNITED STATES INDIVIDUAL)
105 CRILLY LANE
CARY, NC 27518

Registered July 17, 2012

Int. Cl.: 9

FOR: EYEWEAR ACCESSORIES, NAMELY STRAPS, NECK CORDS, HEAD STRAPS WHICH RESTRAIN EYEWEAR FROM MOVEMENT ON A WEARER, A FLOATATION DEVICE FOR EYEWEAR ARMS, IN CLASS 9 (U.S. CLS. 21, 23, 26, 36 AND 38).

TRADEMARK

FIRST USE 2-1-2012; IN COMMERCE 2-1-2012.

PRINCIPAL REGISTER

THE MARK CONSISTS OF STANDARD CHARACTERS WITHOUT CLAIM TO ANY PARTICULAR FONT, STYLE, SIZE, OR COLOR.

SER. NO. 85-499,188, FILED 12-19-2011.

WILLIAM P. SHANAHAN, EXAMINING ATTORNEY



David J. Kyros

Director of the United States Patent and Trademark Office

United States of America

United States Patent and Trademark Office



Reg. No. 4,175,684

Registered July 17, 2012

Int. Cl.: 1

TRADEMARK

PRINCIPAL REGISTER

CROP INTERNATIONAL PTY LTD (AUSTRALIA LIMITED LIABILITY COMPANY)
BOX 1076
MEADOWBANK, NSW, AUSTRALIA 2114

FOR: HYDROPONIC FERTILIZERS AND PLANT GROWTH NUTRIENTS FOR DOMESTIC AND AGRICULTURAL USE MADE IN SUBSTANTIAL PART OF ORGANIC EXTRACTS , IN CLASS 1 (U.S. CLS. 1, 5, 6, 10, 26 AND 46).

FIRST USE 1-1-2005; IN COMMERCE 11-15-2007.

NO CLAIM IS MADE TO THE EXCLUSIVE RIGHT TO USE "ORGANIC EXTRACTS", APART FROM THE MARK AS SHOWN.

THE MARK CONSISTS OF AN ERUPTING VOLCANO IN THE BACKGROUND TO THE STYLIZED WORDS "BUD BOOST"; BELOW THE WORDING IS A STYLIZED DRAWING OF A RECTANGLE; UNDERNEATH ARE THE STYLIZED WORDS "ORGANIC EXTRACTS", WHICH IS ABOVE THREE OBLONG DESIGNS.

SER. NO. 85-499,326, FILED 12-19-2011.

AMEEN IMAM, EXAMINING ATTORNEY



David J. Kyros

Director of the United States Patent and Trademark Office

United States of America

United States Patent and Trademark Office

COMPLIANCE CONNECTION

Reg. No. 4,175,685

Registered July 17, 2012

Int. Cl.: 42

SERVICE MARK

PRINCIPAL REGISTER

THE GARRETSON FIRM RESOLUTION GROUP, INC. (DELAWARE CORPORATION)
7775 COOPER ROAD
CINCINNATI, OH 45242

FOR: PROVIDING ON-LINE NON-DOWNLOADABLE SOFTWARE FOR LIEN RESOLUTION ADMINISTRATIVE SERVICES AND CLAIMS ADMINISTRATION SERVICES, NAMELY, HEALTHCARE CLAIM AND LIEN EVALUATION, CODING, AND RESOLUTION, WORKER'S COMPENSATION LIEN EVALUATION AND RESOLUTION; PROVIDING ON-LINE NON-DOWNLOADABLE SOFTWARE FOR SETTLEMENT ALLOCATION SERVICES, NAMELY, CLAIMS ADMINISTRATION, FUND MANAGEMENT, AND SETTLEMENT ALLOCATION IN MASS TORT AND CLASS ACTIONS; PROVIDING ON-LINE NON-DOWNLOADABLE SOFTWARE FOR BANKRUPTCY AND PROBATE COORDINATION SERVICES; PROVIDING ON-LINE NON-DOWNLOADABLE SOFTWARE FOR HEALTHCARE CONSULTING SERVICES, NAMELY, HEALTHCARE CODING, HEALTHCARE COMPLIANCE CONSULTING, GOVERNMENT BENEFIT PRESERVATION CONSULTING, AND MEDICARE SET ASIDE ALLOCATION; PROVIDING ON-LINE NON-DOWNLOADABLE SOFTWARE FOR FIDUCIARY SERVICES, NAMELY, FIDUCIARY REPRESENTATIVE SERVICES; PROVIDING ON-LINE NON-DOWNLOADABLE SOFTWARE FOR TRUSTEE SERVICES, IN CLASS 42 (U.S. CLS. 100 AND 101).

FIRST USE 11-0-2010; IN COMMERCE 11-0-2010.

THE MARK CONSISTS OF STANDARD CHARACTERS WITHOUT CLAIM TO ANY PARTICULAR FONT, STYLE, SIZE, OR COLOR.

NO CLAIM IS MADE TO THE EXCLUSIVE RIGHT TO USE "COMPLIANCE", APART FROM THE MARK AS SHOWN.

SER. NO. 85-501,334, FILED 12-21-2011.

JAY FLOWERS, EXAMINING ATTORNEY



David J. Kyffers

Director of the United States Patent and Trademark Office

United States of America

United States Patent and Trademark Office



Reg. No. 4,175,686

Registered July 17, 2012

Int. Cl.: 1

TRADEMARK

PRINCIPAL REGISTER

CROP INTERNATIONAL PTY LTD (AUSTRALIA LIMITED LIABILITY COMPANY)
BOX 1076
MEADOWBANK, NSW, AUSTRALIA 2114

FOR: HYDROPONIC FERTILIZERS AND PLANT GROWTH NUTRIENTS FOR DOMESTIC AND AGRICULTURAL USE, IN CLASS 1 (U.S. CLS. 1, 5, 6, 10, 26 AND 46).

FIRST USE 1-1-2005; IN COMMERCE 8-21-2008.

NO CLAIM IS MADE TO THE EXCLUSIVE RIGHT TO USE "'A'" AND "COMPLETE NUTRITION FOR EVERY MEDIUM", APART FROM THE MARK AS SHOWN.

THE MARK CONSISTS OF ONE HUNDRED DOLLAR BILLS FLOATING IN WATER, AND AIR BUBBLES BEHIND THE UNDERLINED WORDS "SHIVA "'A'" ON TOP OF A RECTANGLE; THE WORDS "COMPLETE NUTRITION FOR EVERY MEDIUM" APPEARS BELOW ABOVE THREE OBLONG DESIGNS.

SER. NO. 85-501,494, FILED 12-21-2011.

AMEEN IMAM, EXAMINING ATTORNEY



David J. Kybas

Director of the United States Patent and Trademark Office

United States of America

United States Patent and Trademark Office

WHAT WILL YOU GAIN WHEN YOU LOSE?

Reg. No. 4,175,687

KELLOGG NORTH AMERICA COMPANY (DELAWARE CORPORATION)
ONE KELLOGG SQUARE, PO BOX 3599
BATTLE CREEK, MI 490163599

Registered July 17, 2012

Int. Cl.: 5

FOR: PROTEIN MEAL REPLACEMENT BARS, IN CLASS 5 (U.S. CLS. 6, 18, 44, 46, 51 AND 52).

TRADEMARK

FIRST USE 1-0-2011; IN COMMERCE 1-0-2011.

PRINCIPAL REGISTER

THE MARK CONSISTS OF STANDARD CHARACTERS WITHOUT CLAIM TO ANY PARTICULAR FONT, STYLE, SIZE, OR COLOR.

SER. NO. 85-501,931, FILED 12-22-2011.

AMY KELLY, EXAMINING ATTORNEY



David J. Kyffers

Director of the United States Patent and Trademark Office

United States of America

United States Patent and Trademark Office

MAP

Reg. No. 4,175,688

Registered July 17, 2012

Int. Cls.: 35 and 36

SERVICE MARK

PRINCIPAL REGISTER

ENTERPRISE FINANCIAL GROUP, INC. (TEXAS CORPORATION)
122 W. CARPENTER FREEWAY; 6TH FLOOR
IRVING, TX 75039

FOR: ARRANGING OF CONTRACTUAL SERVICES WITH THIRD PARTIES, NAMELY, ARRANGING MOTOR VEHICLE TIRE AND WHEEL REPAIR AND REPLACEMENT SERVICES CONTRACTS BETWEEN MOTOR VEHICLE TIRE AND WHEEL REPAIR AND REPLACEMENT PROVIDERS AND AUTOMOBILE DEALERSHIPS; ARRANGING OF CONTRACTUAL SERVICES WITH THIRD PARTIES, NAMELY, ARRANGING MOTOR VEHICLE SERVICE CONTRACTS AND CAR WINDSHIELD AND DENT REPAIR SERVICES AND MOTOR VEHICLE TIRE AND WHEEL REPAIR AND REPLACEMENT SERVICES CONTRACTS BETWEEN EMERGENCY ROADSIDE SERVICE PROVIDERS, CAR WINDSHIELD REPAIR PROVIDERS, CAR DENT REPAIR PROVIDERS, MOTOR VEHICLE TIRE AND WHEEL REPAIR AND REPLACEMENT SERVICES AND AUTOMOBILE DEALERSHIPS, IN CLASS 35 (U.S. CLS. 100, 101 AND 102).

FIRST USE 8-2-2011; IN COMMERCE 8-2-2011.

FOR: EXTENDED WARRANTY SERVICES, NAMELY, SERVICE CONTRACTS, IN CLASS 36 (U.S. CLS. 100, 101 AND 102).

FIRST USE 8-2-2011; IN COMMERCE 8-2-2011.

THE MARK CONSISTS OF STANDARD CHARACTERS WITHOUT CLAIM TO ANY PARTICULAR FONT, STYLE, SIZE, OR COLOR.

OWNER OF U.S. REG. NOS. 3,307,262 AND 3,385,563.

SER. NO. 85-502,319, FILED 12-22-2011.

MARILYN IZZI, EXAMINING ATTORNEY



David J. Kybas

Director of the United States Patent and Trademark Office

United States of America

United States Patent and Trademark Office

FERNHILL

Reg. No. 4,175,689

Registered July 17, 2012

Int. Cl.: 36

SERVICE MARK

PRINCIPAL REGISTER

WELLS FARGO & COMPANY (DELAWARE CORPORATION)
17TH FLOOR, MAC N9305-176
SIXTH & MARQUETTE
MINNEAPOLIS, MN 55479

FOR: FINANCIAL PLANNING AND INVESTMENT ADVISORY SERVICES, FINANCIAL ASSET MANAGEMENT, INVESTMENT MANAGEMENT, INVESTMENT CONSULTATION, FINANCIAL PORTFOLIO MANAGEMENT SERVICES, WEALTH MANAGEMENT CONSULTING SERVICES, PROVIDING INFORMATION AND ADVICE IN THE FIELD OF FINANCE, FINANCIAL INVESTMENTS, FINANCIAL VALUATIONS, AND THE FINANCIAL ASPECTS OF RETIREMENT, IN CLASS 36 (U.S. CLS. 100, 101 AND 102).

FIRST USE 6-30-2003; IN COMMERCE 6-30-2003.

THE MARK CONSISTS OF STANDARD CHARACTERS WITHOUT CLAIM TO ANY PARTICULAR FONT, STYLE, SIZE, OR COLOR.

SER. NO. 85-503,328, FILED 12-23-2011.

KIM MONINGHOFF, EXAMINING ATTORNEY



David J. Kyjars

Director of the United States Patent and Trademark Office

United States of America

United States Patent and Trademark Office

TOPCODER OPEN

Reg. No. 4,175,690

Registered July 17, 2012

Int. Cls.: 35 and 41

SERVICE MARK

PRINCIPAL REGISTER

TOPCODER, INC. (DELAWARE CORPORATION)
95 GLASTONBURY BLVD.
GLASTONBURY, CT 06033

FOR: ARRANGING AND CONDUCTING SPECIAL EVENTS FOR BUSINESS PURPOSES; BUSINESS MANAGEMENT SERVICES, NAMELY, ADMINISTRATION OF COMPETITIONS FOR GRAPHIC DESIGN, CREATIVE DESIGN, COMPUTER SOFTWARE USER INTERFACE DESIGN, WEB SITE DESIGN AND COMPUTER SOFTWARE DESIGN AND DEVELOPMENT; ORGANIZING OF BUSINESS COMPETITIONS; PROMOTING THE GOODS AND SERVICES OF OTHERS BY ARRANGING FOR SPONSORS TO AFFILIATE THEIR GOODS AND SERVICES WITH GRAPHIC DESIGN, CREATIVE DESIGN, COMPUTER SOFTWARE USER INTERFACE DESIGN, WEB SITE DESIGN AND COMPUTER SOFTWARE DESIGN AND DEVELOPMENT COMPETITIONS AND EVENTS, IN CLASS 35 (U.S. CLS. 100, 101 AND 102).

FIRST USE 10-7-2003; IN COMMERCE 10-7-2003.

FOR: ENTERTAINMENT IN THE NATURE OF COMPETITIONS IN THE FIELD OF GRAPHIC DESIGN, CREATIVE DESIGN, COMPUTER SOFTWARE USER INTERFACE DESIGN, WEB SITE DESIGN AND COMPUTER SOFTWARE DESIGN AND DEVELOPMENT; ENTERTAINMENT SERVICES, NAMELY, CONDUCTING CONTESTS; ORGANIZING, ARRANGING, AND CONDUCTING GRAPHIC DESIGN, CREATIVE DESIGN, COMPUTER SOFTWARE USER INTERFACE DESIGN, WEB SITE DESIGN AND COMPUTER SOFTWARE DESIGN AND DEVELOPMENT EVENTS, IN CLASS 41 (U.S. CLS. 100, 101 AND 107).

FIRST USE 10-7-2003; IN COMMERCE 10-7-2003.

THE MARK CONSISTS OF STANDARD CHARACTERS WITHOUT CLAIM TO ANY PARTICULAR FONT, STYLE, SIZE, OR COLOR.

OWNER OF U.S. REG. NOS. 2,813,438, 3,470,798 AND OTHERS.

NO CLAIM IS MADE TO THE EXCLUSIVE RIGHT TO USE "OPEN", APART FROM THE MARK AS SHOWN.

SER. NO. 85-503,387, FILED 12-23-2011.



David J. Kyffers

Director of the United States Patent and Trademark Office

Reg. No. 4,175,690 JOSETTE BEVERLY, EXAMINING ATTORNEY

United States of America

United States Patent and Trademark Office

401(K)OLLEGE

Reg. No. 4,175,691

NUVEEN INVESTMENTS, INC. (DELAWARE CORPORATION)
333 WEST WACKER DRIVE
CHICAGO, IL 60606

Registered July 17, 2012

Int. Cl.: 41

FOR: EDUCATIONAL SERVICES, NAMELY, CONDUCTING TRAINING, CONFERENCES, SEMINARS AND WORKSHOPS IN THE FIELDS OF FINANCIAL PLANNING, MUTUAL FUNDS, RETIREMENT PLANNING, FINANCIAL INVESTMENTS AND CLIENT DEVELOPMENT, IN CLASS 41 (U.S. CLS. 100, 101 AND 107).

SERVICE MARK

PRINCIPAL REGISTER

FIRST USE 10-19-2011; IN COMMERCE 10-19-2011.

THE MARK CONSISTS OF STANDARD CHARACTERS WITHOUT CLAIM TO ANY PARTICULAR FONT, STYLE, SIZE, OR COLOR.

SER. NO. 85-504,321, FILED 12-27-2011.

REBECCA POVARCHUK, EXAMINING ATTORNEY



David J. Kyffers

Director of the United States Patent and Trademark Office

United States of America

United States Patent and Trademark Office



Reg. No. 4,175,692

AMERICAN FOOD & VENDING CORPORATION (NEW YORK CORPORATION)
124 METROPOLITAN PARK DRIVE
SYRACUSE, NY 13088

Registered July 17, 2012

Int. Cl.: 43

FOR: CAFE SERVICES; CATERING SERVICES; RESTAURANT SERVICES, NAMELY, PROVIDING OF FOOD AND BEVERAGES FOR CONSUMPTION ON AND OFF THE PREMISES, IN CLASS 43 (U.S. CLS. 100 AND 101).

SERVICE MARK

FIRST USE 12-23-2011; IN COMMERCE 12-23-2011.

PRINCIPAL REGISTER

NO CLAIM IS MADE TO THE EXCLUSIVE RIGHT TO USE "AMERICAN DINING", APART FROM THE MARK AS SHOWN.

THE MARK CONSISTS OF THE WORDS "AMERICAN DINING CREATIONS" INSIDE A BOX.

SER. NO. 85-504,868, FILED 12-28-2011.

TARAH HARDY, EXAMINING ATTORNEY



David J. Kyffers

Director of the United States Patent and Trademark Office

United States of America

United States Patent and Trademark Office



Reg. No. 4,175,693

FRESH EXPRESS INCORPORATED (DELAWARE CORPORATION)
PO BOX 80599
SALINAS, CA 93912

Registered July 17, 2012

Int. Cls.: 29 and 30

FOR: PRECUT PACKAGED FRESH VEGETABLES AND GARDEN SALADS, IN CLASS 29 (U.S. CL. 46).

TRADEMARK

FIRST USE 7-26-2006; IN COMMERCE 7-26-2006.

PRINCIPAL REGISTER

FOR: SALAD DRESSINGS, IN CLASS 30 (U.S. CL. 46).

FIRST USE 7-26-2006; IN COMMERCE 7-26-2006.

NO CLAIM IS MADE TO THE EXCLUSIVE RIGHT TO USE "FRESH" AND "FRESH GUARANTEED", APART FROM THE MARK AS SHOWN.

THE MARK CONSISTS OF THE WORDS "FRESH EXPRESS PROMISE" IN A MEDALLION WITH THE WORDS "FRESH GUARANTEED" FOLLOWED BY AN EXCLAMATION MARK TO THE RIGHT OF THE MEDALLION, SUPERIMPOSED ON A RIBBON BANNER.

SER. NO. 85-505,025, FILED 12-28-2011.

ANNE E. GUSTASON, EXAMINING ATTORNEY



David J. Kybas

Director of the United States Patent and Trademark Office

United States of America

United States Patent and Trademark Office

etrac

Reg. No. 4,175,694

Registered July 17, 2012

Int. Cl.: 42

GLOBAL DATA MANAGEMENT SYSTEMS, LLC (DELAWARE LIMITED LIABILITY COMPANY)
SUITE 210
1816 WEST POINT PIKE
LANSDALE, PA 19446

SERVICE MARK

PRINCIPAL REGISTER

FOR: SOFTWARE AS A SERVICE (SAAS) SERVICES FEATURING SOFTWARE FOR VENDOR WORKFLOW FOR MORTGAGE LENDERS AND REAL ESTATE LENDERS IN THE REAL ESTATE VALUATION INDUSTRY, IN CLASS 42 (U.S. CLS. 100 AND 101).

FIRST USE 6-1-2003; IN COMMERCE 6-1-2003.

THE MARK CONSISTS OF STANDARD CHARACTERS WITHOUT CLAIM TO ANY PARTICULAR FONT, STYLE, SIZE, OR COLOR.

SER. NO. 85-506,009, FILED 12-29-2011.

LINDA E. BLOHM, EXAMINING ATTORNEY



David J. Kyjars

Director of the United States Patent and Trademark Office

United States of America

United States Patent and Trademark Office



RJ Health Systems

Make Sense of Drug Intelligence

Reg. No. 4,175,695

Registered July 17, 2012

Int. Cls.: 35 and 42

SERVICE MARK

PRINCIPAL REGISTER

RJ HEALTH SYSTEMS INTERNATIONAL, LLC (CONNECTICUT LIMITED LIABILITY COMPANY)
30 COLD SPRING ROAD
ROCKY HILL, CT 06067

FOR: SERVICES CONSISTING OF THE REGISTRATION, TRANSCRIPTION, COMPOSITION, COMPILATION, OR SYSTEMIZATION OF WRITTEN COMMUNICATIONS AND REGISTRATIONS AND COMPILATION OF MATHEMATICAL OR STATISTICAL DATA WITH RESPECT TO PHARMACEUTICAL AND HEALTHCARE-RELATED DATA, IN CLASS 35 (U.S. CLS. 100, 101 AND 102).

FIRST USE 1-1-2005; IN COMMERCE 1-1-2005.

FOR: PHARMACEUTICAL AND SCIENTIFIC HEALTHCARE RESEARCH, PREPARATION OF REPORTS RELATED THERETO AND EVALUATIONS, IN CLASS 42 (U.S. CLS. 100 AND 101).

FIRST USE 1-1-2005; IN COMMERCE 1-1-2005.

NO CLAIM IS MADE TO THE EXCLUSIVE RIGHT TO USE "HEALTH SYSTEMS" , APART FROM THE MARK AS SHOWN.

THE COLOR(S) NAVY BLUE AND MEDIUM BLUE IS/ARE CLAIMED AS A FEATURE OF THE MARK.

THE MARK CONSISTS OF A DESIGN WITH THREE NAVY-BLUE LINES, WITH LITTLE SPACE BETWEEN THEM, CURVING DOWNWARD, ON THE LEFT SIDE, AND ONE THICKER, MEDIUM BLUE CURVING LINE, ON THE RIGHT SIDE, CURVING UPWARD, WHICH APPEARS TO FLOW FROM THE THREE CURVING NAVY BLUE LINES ON THE LEFT SIDE. BELOW THIS DESIGN ARE THE WORDS: "RJ HEALTH SYSTEMS," IN NAVY BLUE, AND BELOW THAT, THE WORDS "MAKE SENSE OF DRUG INTELLIGENCE," IN MEDIUM BLUE, AND IN SMALLER TYPE.

SER. NO. 85-506,376, FILED 12-30-2011.

VIVIAN MICZNIK FIRST, EXAMINING ATTORNEY



David J. Kyjars

Director of the United States Patent and Trademark Office

United States of America

United States Patent and Trademark Office

SLIM BALANCE

Reg. No. 4,175,696

GONZALEZ, JOSE (UNITED STATES INDIVIDUAL)
3345 E. SLAUSON AVENUE
VERNON, CA 90058

Registered July 17, 2012

Int. Cl.: 30

FOR: DRIED PROCESSED HERBS AND TEA, IN CLASS 30 (U.S. CL. 46).

TRADEMARK

FIRST USE 11-30-2011; IN COMMERCE 11-30-2011.

PRINCIPAL REGISTER

THE MARK CONSISTS OF STANDARD CHARACTERS WITHOUT CLAIM TO ANY PARTICULAR FONT, STYLE, SIZE, OR COLOR.

SER. NO. 85-506,682, FILED 12-30-2011.

MARK RADEMACHER, EXAMINING ATTORNEY



David J. Kyffers

Director of the United States Patent and Trademark Office

United States of America

United States Patent and Trademark Office

IMMUNITY NOW

Reg. No. 4,175,697

GONZALEZ, JOSE (UNITED STATES INDIVIDUAL)
3345 E. SLAUSON AVENUE
VERNON, CA 90058

Registered July 17, 2012

Int. Cl.: 30

FOR: DRIED PROCESSED HERBS AND TEA, IN CLASS 30 (U.S. CL. 46).

TRADEMARK

FIRST USE 11-30-2011; IN COMMERCE 11-30-2011.

PRINCIPAL REGISTER

THE MARK CONSISTS OF STANDARD CHARACTERS WITHOUT CLAIM TO ANY PARTICULAR FONT, STYLE, SIZE, OR COLOR.

NO CLAIM IS MADE TO THE EXCLUSIVE RIGHT TO USE "IMMUNITY", APART FROM THE MARK AS SHOWN.

SER. NO. 85-506,705, FILED 12-30-2011.

MARK RADEMACHER, EXAMINING ATTORNEY



David J. Kyffers

Director of the United States Patent and Trademark Office

United States of America

United States Patent and Trademark Office

RESPIRATORY BALANCE

Reg. No. 4,175,698

GONZALEZ, JOSE (UNITED STATES INDIVIDUAL)
3345 E. SLAUSON AVENUE
VERNON, CA 90058

Registered July 17, 2012

Int. Cl.: 30

FOR: DRIED PROCESSED HERBS AND TEA, IN CLASS 30 (U.S. CL. 46).

TRADEMARK

FIRST USE 11-30-2011; IN COMMERCE 11-30-2011.

PRINCIPAL REGISTER

THE MARK CONSISTS OF STANDARD CHARACTERS WITHOUT CLAIM TO ANY PARTICULAR FONT, STYLE, SIZE, OR COLOR.

NO CLAIM IS MADE TO THE EXCLUSIVE RIGHT TO USE "RESPIRATORY", APART FROM THE MARK AS SHOWN.

SER. NO. 85-506,713, FILED 12-30-2011.

MARK RADEMACHER, EXAMINING ATTORNEY



David J. Kyffers

Director of the United States Patent and Trademark Office

United States of America

United States Patent and Trademark Office

SERENE SLUMBER

Reg. No. 4,175,699

GONZALEZ, JOSE (UNITED STATES INDIVIDUAL)
3345 E. SLAUSON AVENUE
VERNON, CA 90058

Registered July 17, 2012

Int. Cl.: 30

FOR: DRIED PROCESSED HERBS AND TEA, IN CLASS 30 (U.S. CL. 46).

TRADEMARK

FIRST USE 11-30-2011; IN COMMERCE 11-30-2011.

PRINCIPAL REGISTER

THE MARK CONSISTS OF STANDARD CHARACTERS WITHOUT CLAIM TO ANY PARTICULAR FONT, STYLE, SIZE, OR COLOR.

NO CLAIM IS MADE TO THE EXCLUSIVE RIGHT TO USE "SLUMBER", APART FROM THE MARK AS SHOWN.

SER. NO. 85-506,714, FILED 12-30-2011.

MARK RADEMACHER, EXAMINING ATTORNEY



David J. Kyffers

Director of the United States Patent and Trademark Office

United States of America

United States Patent and Trademark Office

VARIETY ENTERTAINMENT & TECHNOLOGY SUMMIT

Reg. No. 4,175,700

Registered July 17, 2012

Int. Cl.: 35

SERVICE MARK

PRINCIPAL REGISTER

REED ELSEVIER PROPERTIES INC. (DELAWARE CORPORATION)
1105 NORTH MARKET STREET
WILMINGTON, DE 19801

FOR: ORGANIZING AND CONDUCTING CONFERENCES FOR BUSINESS PURPOSES IN THE FIELD OF ENTERTAINMENT, NAMELY, MOTION PICTURE, TELEVISION AND VIDEO PRODUCTION, FINANCING, DISTRIBUTION, PROGRAMMING, LICENSING, TECHNOLOGY, AND MULTIMEDIA ENTERTAINMENT, IN CLASS 35 (U.S. CLS. 100, 101 AND 102).

FIRST USE 10-8-2009; IN COMMERCE 10-8-2009.

THE MARK CONSISTS OF STANDARD CHARACTERS WITHOUT CLAIM TO ANY PARTICULAR FONT, STYLE, SIZE, OR COLOR.

OWNER OF U.S. REG. NOS. 2,417,890 AND 2,476,922.

NO CLAIM IS MADE TO THE EXCLUSIVE RIGHT TO USE "ENTERTAINMENT & TECHNOLOGY SUMMIT", APART FROM THE MARK AS SHOWN.

SER. NO. 85-507,137, FILED 1-2-2012.

Laurie Mayes, Examining Attorney



David J. Kyffers

Director of the United States Patent and Trademark Office

United States of America

United States Patent and Trademark Office

SKY RISE

Reg. No. 4,175,701

COTY US LLC (DELAWARE LIMITED LIABILITY COMPANY)
2 PARK AVENUE

Registered July 17, 2012

NEW YORK, NY 10016

Int. Cl.: 3

FOR: COSMETICS FOR FACE, BODY, NAILS, SKIN, IN CLASS 3 (U.S. CLS. 1, 4, 6, 50, 51 AND 52).

TRADEMARK

FIRST USE 3-31-2011; IN COMMERCE 3-31-2011.

PRINCIPAL REGISTER

THE MARK CONSISTS OF STANDARD CHARACTERS WITHOUT CLAIM TO ANY PARTICULAR FONT, STYLE, SIZE, OR COLOR.

SER. NO. 85-507,174, FILED 1-2-2012.

SHANNON TWOHIG, EXAMINING ATTORNEY



David J. Kyffers

Director of the United States Patent and Trademark Office

United States of America

United States Patent and Trademark Office

VARIETY VENTURE CAPITAL & NEW MEDIA SUMMIT

Reg. No. 4,175,702

REED ELSEVIER PROPERTIES INC. (DELAWARE CORPORATION)
1105 NORTH MARKET STREET
WILMINGTON, DE 19801

Registered July 17, 2012

Int. Cl.: 35

FOR: ORGANIZING AND CONDUCTING CONFERENCES FOR BUSINESS PURPOSES IN THE FIELD OF ENTERTAINMENT, NAMELY, MOTION PICTURE, TELEVISION AND VIDEO PRODUCTION, FINANCING, DISTRIBUTION, PROGRAMMING, LICENSING, TECHNOLOGY, AND MULTIMEDIA ENTERTAINMENT, IN CLASS 35 (U.S. CLS. 100, 101 AND 102).

SERVICE MARK

PRINCIPAL REGISTER

FIRST USE 5-25-2011; IN COMMERCE 5-25-2011.

THE MARK CONSISTS OF STANDARD CHARACTERS WITHOUT CLAIM TO ANY PARTICULAR FONT, STYLE, SIZE, OR COLOR.

OWNER OF U.S. REG. NOS. 2,417,890 AND 2,476,922.

NO CLAIM IS MADE TO THE EXCLUSIVE RIGHT TO USE "VENTURE CAPITAL & NEW MEDIA SUMMIT", APART FROM THE MARK AS SHOWN.

SER. NO. 85-507,190, FILED 1-2-2012.

Laurie Mayes, Examining Attorney



David J. Kyjars

Director of the United States Patent and Trademark Office

United States of America

United States Patent and Trademark Office



Reg. No. 4,175,703

Registered July 17, 2012

Int. Cl.: 25

TRADEMARK

PRINCIPAL REGISTER

MACK TRUCKS, INC. (PENNSYLVANIA CORPORATION)
2100 MACK BOULEVARD
ALLENTOWN, PA 18105

FOR: CAPS; T-SHIRTS, IN CLASS 25 (U.S. CLS. 22 AND 39).

FIRST USE 12-31-2010; IN COMMERCE 12-31-2010.

OWNER OF U.S. REG. NO. 2,605,068.

THE MARK CONSISTS OF A CIRCLE, WITHIN SAID CIRCLE IS THE LETTER "I" SUPER-IMPOSED OVER A STYLIZED LETTER "M".

SER. NO. 85-507,442, FILED 1-3-2012.

MARILYN IZZI, EXAMINING ATTORNEY



David J. Kyffers

Director of the United States Patent and Trademark Office

United States of America

United States Patent and Trademark Office

CREWCUTKIDS.COM

Reg. No. 4,175,704

Registered July 17, 2012

Int. Cl.: 35

SERVICE MARK

PRINCIPAL REGISTER

J. CREW INTERNATIONAL, INC. (DELAWARE CORPORATION)
802 WEST STREET, SUITE 102
WILMINGTON, DE 19801

FOR: RETAIL STORE AND ONLINE RETAIL STORE SERVICES IN THE FIELDS OF CLOTHING, FOOTWEAR, BAGS, AND FASHION ACCESSORIES, IN CLASS 35 (U.S. CLS. 100, 101 AND 102).

FIRST USE 7-31-2011; IN COMMERCE 7-31-2011.

THE MARK CONSISTS OF STANDARD CHARACTERS WITHOUT CLAIM TO ANY PARTICULAR FONT, STYLE, SIZE, OR COLOR.

OWNER OF U.S. REG. NOS. 2,929,166, 3,107,778, AND 3,163,866.

SER. NO. 85-507,623, FILED 1-3-2012.

EDWARD NELSON, EXAMINING ATTORNEY



David J. Kyffers

Director of the United States Patent and Trademark Office

United States of America

United States Patent and Trademark Office

IH

Reg. No. 4,175,705

LING HUI KONG (CHINA INDIVIDUAL)
10322 E. RUSH ST.
SOUTH EL MONTE, CA 91733

Registered July 17, 2012

Int. Cl.: 25

FOR: SHOES, FOOTWEAR, IN CLASS 25 (U.S. CLS. 22 AND 39).

TRADEMARK

FIRST USE 12-12-2011; IN COMMERCE 12-12-2011.

PRINCIPAL REGISTER

THE MARK CONSISTS OF ITALICIZED AND CAPITALIZED LETTERS "I", "H".

SER. NO. 85-507,831, FILED 1-3-2012.

RONALD MCMORROW, EXAMINING ATTORNEY



David J. Kyffers

Director of the United States Patent and Trademark Office

United States of America

United States Patent and Trademark Office

Imaginary Kidz

Reg. No. 4,175,706

THE NOVELTY GROUP, LLC. (RHODE ISLAND LIMITED LIABILITY COMPANY)
4 STRAWBERRY LN.
CRANSTON, RI 02921

Registered July 17, 2012

Int. Cl.: 35

FOR: ON-LINE ORDERING SERVICES FEATURING TOYS, PLUSH TOYS, GAMES AND CLOTHING, IN CLASS 35 (U.S. CLS. 100, 101 AND 102).

SERVICE MARK

FIRST USE 1-1-2010; IN COMMERCE 1-1-2010.

PRINCIPAL REGISTER

THE MARK CONSISTS OF STANDARD CHARACTERS WITHOUT CLAIM TO ANY PARTICULAR FONT, STYLE, SIZE, OR COLOR.

SER. NO. 85-508,330, FILED 1-4-2012.

RAUL CORDOVA, EXAMINING ATTORNEY



David J. Kybas

Director of the United States Patent and Trademark Office

United States of America

United States Patent and Trademark Office

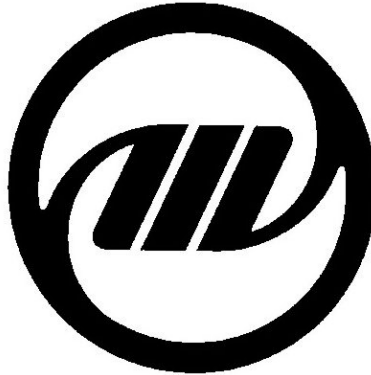

Reg. No. 4,175,707

Registered July 17, 2012

Int. Cl.: 25

TRADEMARK

PRINCIPAL REGISTER

TOTES ISOTONER CORPORATION (OHIO CORPORATION)
9655 INTERNATIONAL BOULEVARD
CINCINNATI, OH 45246

FOR: GLOVES, IN CLASS 25 (U.S. CLS. 22 AND 39).

FIRST USE 7-1-2006; IN COMMERCE 7-1-2006.

THE MARK CONSISTS OF THE LETTER "M" INSIDE OF A CIRCLE WITH LINES CONNECTING THE EDGES OF THE LETTER TO THE CIRCLE.

SER. NO. 85-508,408, FILED 1-4-2012.

KEVON CHISOLM, EXAMINING ATTORNEY



David J. Kyffers

Director of the United States Patent and Trademark Office

United States of America

United States Patent and Trademark Office



Reg. No. 4,175,708

Registered July 17, 2012

Int. Cl.: 3

TRADEMARK

PRINCIPAL REGISTER

NATURE'S NUTRITIONAL LABS LLC (TEXAS LIMITED LIABILITY COMPANY)
11700 PRESTON ROAD, SUITE 660-339
DALLAS, TX 75230

FOR: BODY CREAMS; BODY LOTION; BODY WASH; BUBBLE BATH; CONDITIONERS; FACIAL CLEANSERS; MOISTURIZING CREAMS; MOISTURIZING PREPARATIONS FOR THE SKIN; NON-MEDICATED BUBBLE BATH PREPARATIONS; NON-MEDICATED FOOT CREAM; NON-MEDICATED SKIN CARE PREPARATIONS; NON-MEDICATED SKIN CARE PREPARATIONS, NAMELY, LOTIONS AND CREAMS; SHAMPOOS; SKIN CLEANSERS; SKIN MOISTURIZER; TOPICAL HERBAL CREAM FOR FIRING AND ENHANCING BREASTS, IN CLASS 3 (U.S. CLS. 1, 4, 6, 50, 51 AND 52).

FIRST USE 12-0-2011; IN COMMERCE 12-0-2011.

NO CLAIM IS MADE TO THE EXCLUSIVE RIGHT TO USE "MOTHER", APART FROM THE MARK AS SHOWN.

THE MARK CONSISTS OF THE WORDING "NATURE'S MOTHER" FEATURING A STYLIZED LEAF DESIGN TO THE LOWER RIGHT, ALL INSIDE A RECTANGULAR SHAPED BANNER WITH SHADING ALONG THE UPPER LEFT AND LOWER RIGHT CORNERS.

SER. NO. 85-508,991, FILED 1-5-2012.

AMY KELLY, EXAMINING ATTORNEY



David J. Kybas

Director of the United States Patent and Trademark Office

United States of America

United States Patent and Trademark Office



Reg. No. 4,175,709

Registered July 17, 2012

Int. Cl.: 33

TRADEMARK

PRINCIPAL REGISTER

PAGOS DEL REY, S.L. (SPAIN SOCIEDAD DE RESPONSABILIDAD LIMITADA (SL))
AUTOVIA DEL SUR KM 199
VALDEPENAS-CIUDAD REAL, SPAIN 13300

FOR: WINE, IN CLASS 33 (U.S. CLS. 47 AND 49).

FIRST USE 4-0-2008; IN COMMERCE 4-0-2008.

THE MARK CONSISTS OF THE WORD "BLUME" AND THE LETTER "B" WITH A FLORAL DESIGN ALL APPEARING ON A LABEL.

SER. NO. 85-509,393, FILED 1-5-2012.

JOHN DALIER, EXAMINING ATTORNEY



David J. Kybas

Director of the United States Patent and Trademark Office

United States of America

United States Patent and Trademark Office

WHEELHOUSE

Reg. No. 4,175,710

WEST CENTRAL, INC. (MINNESOTA CORPORATION)
2700 TROTT AVE. SW.
WILLMAR, MN 56201

Registered July 17, 2012

Int. Cl.: 1

FOR: ADJUVANT FOR USE WITH AGRICULTURAL CHEMICALS; ADJUVANTS FOR USE WITH PESTICIDES; SURFACTANTS FOR USE IN CONNECTION WITH AGRICULTURAL PESTICIDES, IN CLASS 1 (U.S. CLS. 1, 5, 6, 10, 26 AND 46).

TRADEMARK

FIRST USE 5-24-2011; IN COMMERCE 5-31-2011.

PRINCIPAL REGISTER

THE MARK CONSISTS OF STANDARD CHARACTERS WITHOUT CLAIM TO ANY PARTICULAR FONT, STYLE, SIZE, OR COLOR.

SER. NO. 85-511,738, FILED 1-9-2012.

NICHOLAS ALTREE, EXAMINING ATTORNEY



David J. Kyffers

Director of the United States Patent and Trademark Office

United States of America

United States Patent and Trademark Office

STAY FLUFF

Reg. No. 4,175,711

PACIFIC COAST FEATHER COMPANY (WASHINGTON CORPORATION)
P.O. BOX 80385
SEATTLE, WA 98108

Registered July 17, 2012

Int. Cl.: 20

FOR: FEATHERBEDS, IN CLASS 20 (U.S. CLS. 2, 13, 22, 25, 32 AND 50).

TRADEMARK

FIRST USE 4-27-2004; IN COMMERCE 5-5-2004.

PRINCIPAL REGISTER

THE MARK CONSISTS OF STANDARD CHARACTERS WITHOUT CLAIM TO ANY PARTICULAR FONT, STYLE, SIZE, OR COLOR.

OWNER OF U.S. REG. NO. 3,877,872.

SER. NO. 85-512,102, FILED 1-9-2012.

JOHN E. MICHOS, EXAMINING ATTORNEY



David J. Kyffers

Director of the United States Patent and Trademark Office

United States of America

United States Patent and Trademark Office



Reg. No. 4,175,712

Registered July 17, 2012

Int. Cl.: 9

TRADEMARK

PRINCIPAL REGISTER

THE INSTITUTE OF ELECTRICAL AND ELECTRONICS ENGINEERS, INC. (NEW YORK CORPORATION)
445 HOES LANE
PISCATAWAY, NJ 08855

FOR: DOWNLOADABLE ELECTRONIC PUBLICATIONS IN THE NATURE OF JOURNALS IN THE FIELD OF MANAGEMENT THEORY AND PRACTICE FOR THE TECHNOLOGY PROFESSION, IN CLASS 9 (U.S. CLS. 21, 23, 26, 36 AND 38).

FIRST USE 3-31-2009; IN COMMERCE 3-31-2009.

OWNER OF U.S. REG. NOS. 3,666,752, 4,008,885 AND OTHERS.

NO CLAIM IS MADE TO THE EXCLUSIVE RIGHT TO USE "TECHNOLOGY MANAGEMENT", APART FROM THE MARK AS SHOWN.

THE MARK CONSISTS OF THE LETTERS "IEEE" APPEARING WITHIN THE DESIGN OF A GLOBE COMPRISED OF LATITUDINAL AND LONGITUDINAL LINES. THE GLOBE IS SURROUNDED BY THE WORDS "TECHNOLOGY MANAGEMENT" CONTAINED WITHIN A SEMICIRCLE SHAPED LIKE THE LETTER "C". SMALL DIAMOND SHAPES APPEAR ON EITHER SIDE OF THE LETTERS "IEEE".

SER. NO. 85-512,186, FILED 1-9-2012.

ELISSA GARBER KON, EXAMINING ATTORNEY



David J. Kyjars

Director of the United States Patent and Trademark Office

United States of America

United States Patent and Trademark Office

Haze Her

Reg. No. 4,175,713

GRHK IP, LLC (FLORIDA LIMITED LIABILITY COMPANY)
6955 NW 52ND STREET
MIAMI, FL 33166

Registered July 17, 2012

Int. Cl.: 41

FOR: ENTERTAINMENT SERVICES, NAMELY, PROVIDING A WEB SITE FEATURING PHOTOGRAPHIC, AUDIO, VIDEO AND PROSE PRESENTATIONS FEATURING ADULT-ORIENTED SUBJECT MATTER, IN CLASS 41 (U.S. CLS. 100, 101 AND 107).

SERVICE MARK

FIRST USE 11-14-2011; IN COMMERCE 11-14-2011.

PRINCIPAL REGISTER

THE MARK CONSISTS OF STANDARD CHARACTERS WITHOUT CLAIM TO ANY PARTICULAR FONT, STYLE, SIZE, OR COLOR.

OWNER OF U.S. REG. NO. 3,955,125.

SER. NO. 85-512,290, FILED 1-9-2012.

TASNEEM HUSSAIN, EXAMINING ATTORNEY



David J. Kyffers

Director of the United States Patent and Trademark Office

United States of America

United States Patent and Trademark Office



Reg. No. 4,175,714

Registered July 17, 2012

Int. Cl.: 9

TRADEMARK

PRINCIPAL REGISTER

THE INSTITUTE OF ELECTRICAL AND ELECTRONICS ENGINEERS, INC. (NEW YORK CORPORATION)
445 HOES LANE
PISCATAWAY, NJ 08855

FOR: DOWNLOADABLE ELECTRONIC PUBLICATIONS IN THE NATURE OF MAGAZINES IN THE FIELDS OF THE THEORY AND PRACTICE OF ELECTRICAL ENGINEERING APPLIED TO LAND TRANSPORTATION, RAILROAD AND MASS TRANSIT, MOBILE COMMUNICATIONS, VEHICULAR ELECTROTECHNOLOGY EQUIPMENT AND SYSTEMS, AND MOBILE SERVICES, IN CLASS 9 (U.S. CLS. 21, 23, 26, 36 AND 38).

FIRST USE 5-9-2011; IN COMMERCE 5-9-2011.

OWNER OF U.S. REG. NOS. 3,666,752, 4,008,885 AND OTHERS.

THE MARK CONSISTS OF THE LETTERS "VTS", CONNECTED AT THE TOP BY HORIZONTAL STRIPES. ABOVE THE LEFT SIDE OF THE LETTER "V" ARE THE LETTERS "IEEE".

SER. NO. 85-512,554, FILED 1-10-2012.

ELISSA GARBER KON, EXAMINING ATTORNEY



David J. Kyjars

Director of the United States Patent and Trademark Office

United States of America

United States Patent and Trademark Office



Reg. No. 4,175,715

Registered July 17, 2012

Int. Cl.: 16

TRADEMARK

PRINCIPAL REGISTER

THE INSTITUTE OF ELECTRICAL AND ELECTRONICS ENGINEERS, INC. (NEW YORK CORPORATION)
445 HOES LANE
PISCATAWAY, NJ 08855

FOR: MAGAZINES IN THE FIELDS OF THE THEORY AND PRACTICE OF ELECTRICAL ENGINEERING APPLIED TO LAND TRANSPORTATION, RAILROAD AND MASS TRANSIT, MOBILE COMMUNICATIONS, VEHICULAR ELECTROTECHNOLOGY EQUIPMENT AND SYSTEMS, AND MOBILE SERVICES, IN CLASS 16 (U.S. CLS. 2, 5, 22, 23, 29, 37, 38 AND 50).

FIRST USE 6-30-2011; IN COMMERCE 6-30-2011.

OWNER OF U.S. REG. NOS. 1,913,246, 2,862,848 AND OTHERS.

THE MARK CONSISTS OF THE LETTERS "VTS," CONNECTED AT THE TOP BY HORIZONTAL STRIPES. ABOVE THE LEFT SIDE OF THE LETTER "V" ARE THE LETTERS "IEEE".

SER. NO. 85-512,653, FILED 1-10-2012.

ELISSA GARBER KON, EXAMINING ATTORNEY



David J. Kyjars

Director of the United States Patent and Trademark Office

United States of America

United States Patent and Trademark Office



Reg. No. 4,175,716

Registered July 17, 2012

Int. Cl.: 41

SERVICE MARK

PRINCIPAL REGISTER

THE INSTITUTE OF ELECTRICAL AND ELECTRONICS ENGINEERS, INC. (NEW YORK CORPORATION)
445 HOES LANE
PISCATAWAY, NJ 08855

FOR: EDUCATIONAL SERVICES, NAMELY, DEVELOPING, ARRANGING, AND CONDUCTING CONFERENCES, SYMPOSIA, AND LECTURES, ALL IN THE FIELDS OF THE THEORY AND PRACTICE OF ELECTRICAL ENGINEERING APPLIED TO LAND TRANSPORTATION, RAILROAD AND MASS TRANSIT, MOBILE COMMUNICATIONS, VEHICULAR ELECTROTECHNOLOGY EQUIPMENT AND SYSTEMS, AND MOBILE SERVICES, AND DISTRIBUTION OF TRAINING MATERIAL IN CONNECTION THEREWITH; PROVIDING ONLINE NEWSLETTERS IN THE FIELDS OF THE THEORY AND PRACTICE OF ELECTRICAL ENGINEERING APPLIED TO LAND TRANSPORTATION, RAILROAD AND MASS TRANSIT, MOBILE COMMUNICATIONS, VEHICULAR ELECTROTECHNOLOGY EQUIPMENT AND SYSTEMS, AND MOBILE SERVICES, VIA E-MAIL, IN CLASS 41 (U.S. CLS. 100, 101 AND 107).

FIRST USE 10-6-2003; IN COMMERCE 10-6-2003.

OWNER OF U.S. REG. NOS. 1,770,511, 2,862,848 AND OTHERS.

THE MARK CONSISTS OF THE LETTERS "VTS," CONNECTED AT THE TOP BY HORIZONTAL STRIPES. ABOVE THE LEFT SIDE OF THE LETTER "V" ARE THE LETTERS "IEEE".

SER. NO. 85-512,671, FILED 1-10-2012.

ELISSA GARBER KON, EXAMINING ATTORNEY



David J. Kybas

Director of the United States Patent and Trademark Office

United States of America

United States Patent and Trademark Office

PlannerTech

Reg. No. 4,175,717

POGBY, INC (DELAWARE CORPORATION), DBA IMBOOKIN
141A MCGUINNESS BLVD
BROOKLYN, NY 11222

Registered July 17, 2012

Int. Cl.: 35

FOR: ORGANIZING, PROMOTING AND CONDUCTING EXHIBITIONS, TRADESHOWS AND EVENTS FOR BUSINESS PURPOSES, IN CLASS 35 (U.S. CLS. 100, 101 AND 102).

SERVICE MARK

FIRST USE 4-1-2011; IN COMMERCE 6-6-2011.

PRINCIPAL REGISTER

THE MARK CONSISTS OF STANDARD CHARACTERS WITHOUT CLAIM TO ANY PARTICULAR FONT, STYLE, SIZE, OR COLOR.

SER. NO. 85-514,370, FILED 1-11-2012.

KARANENDRA S. CHHINA, EXAMINING ATTORNEY



David J. Kybas

Director of the United States Patent and Trademark Office

United States of America

United States Patent and Trademark Office

The logo for VExPrT features a stylized letter 'V' on the left. The 'V' is formed by a small triangle at the top and four quadrilaterals filling its interior. To the right of the 'V' are the letters 'ExPrT' in a bold, sans-serif font.

Reg. No. 4,175,718

DATA SCIENCE AUTOMATION, INC. (PENNSYLVANIA CORPORATION)
375 VALLEY BROOK ROAD, SUITE 106
MCMURRAY, PA 15317

Registered July 17, 2012

Int. Cl.: 9

FOR: COMPUTER HARDWARE AND SOFTWARE FOR AUTOMATED VISION INSPECTION OF MANUFACTURED PARTS, IN CLASS 9 (U.S. CLS. 21, 23, 26, 36 AND 38).

TRADEMARK

FIRST USE 8-27-2010; IN COMMERCE 8-27-2010.

PRINCIPAL REGISTER

THE MARK CONSISTS OF THE TERM "VEXPRT" WITH A TRIANGLE FORMED BY A LITTLE TRIANGLE AND FOUR QUADRILATERALS FILLING THE INSIDE OF THE LETTER "V".

SER. NO. 85-514,634, FILED 1-12-2012.

IRA J. GOODSaid, EXAMINING ATTORNEY



David J. Kyffers

Director of the United States Patent and Trademark Office

United States of America

United States Patent and Trademark Office

Datasphere

Reg. No. 4,175,719

GREAT LAKES COMNET, INC. (MICHIGAN CORPORATION)

Registered July 17, 2012

1515 TURF LANE
EAST LANSING, MI 48823

Int. Cl.: 42

FOR: COMPUTER SERVICES, NAMELY, REMOTE AND ON-SITE MANAGEMENT OF CLOUD COMPUTING SYSTEMS AND APPLICATIONS FOR OTHERS; ENCRYPTED DATA RECOVERY SERVICES; COMPUTER CONSULTING SERVICES AND TECHNICAL SUPPORT, NAMELY, MONITORING OF NETWORK SYSTEMS, IN CLASS 42 (U.S. CLS. 100 AND 101).

SERVICE MARK

PRINCIPAL REGISTER

FIRST USE 10-31-2011; IN COMMERCE 10-31-2011.

THE MARK CONSISTS OF STANDARD CHARACTERS WITHOUT CLAIM TO ANY PARTICULAR FONT, STYLE, SIZE, OR COLOR.

SER. NO. 85-515,028, FILED 1-12-2012.

GINA FINK, EXAMINING ATTORNEY



David J. Kyjars

Director of the United States Patent and Trademark Office

United States of America

United States Patent and Trademark Office

FOGO PLATINUM

Reg. No. 4,175,720

FOGO CIGAR COMPANY LLC (FLORIDA LIMITED LIABILITY COMPANY)
4364 SW 74TH AVENUE
MIAMI, FL 33155

Registered July 17, 2012

Int. Cl.: 34

FOR: CIGAR BOXES; CIGARS, IN CLASS 34 (U.S. CLS. 2, 8, 9 AND 17).

TRADEMARK

FIRST USE 11-1-2011; IN COMMERCE 11-1-2011.

PRINCIPAL REGISTER

THE MARK CONSISTS OF STANDARD CHARACTERS WITHOUT CLAIM TO ANY PARTICULAR FONT, STYLE, SIZE, OR COLOR.

THE ENGLISH TRANSLATION OF "FOGO" IN THE MARK IS "FIRE".

SER. NO. 85-516,825, FILED 1-15-2012.

ODESSA BIBBINS, EXAMINING ATTORNEY



David J. Kyffers

Director of the United States Patent and Trademark Office

United States of America

United States Patent and Trademark Office

DEFENDER

Reg. No. 4,175,721

L&P PROPERTY MANAGEMENT COMPANY (DELAWARE CORPORATION)
4095 FIRESTONE BOULEVARD
SOUTH GATE, CA 90280

Registered July 17, 2012

Int. Cl.: 27

FOR: CUSHIONED CARPET UNDERLAY, IN CLASS 27 (U.S. CLS. 19, 20, 37, 42 AND 50).

FIRST USE 12-3-2003; IN COMMERCE 1-2-2004.

TRADEMARK

THE MARK CONSISTS OF STANDARD CHARACTERS WITHOUT CLAIM TO ANY PARTICULAR FONT, STYLE, SIZE, OR COLOR.

PRINCIPAL REGISTER

SER. NO. 85-517,159, FILED 1-16-2012.

BENJAMIN OKEKE, EXAMINING ATTORNEY



David J. Kyffers

Director of the United States Patent and Trademark Office

United States of America

United States Patent and Trademark Office

FANTASYMODA

Reg. No. 4,175,722

Registered July 17, 2012

Int. Cl.: 35

SERVICE MARK

PRINCIPAL REGISTER

YAPUR, ANUAR (MEXICO INDIVIDUAL)
PASEO DE LOS TAMARINDOS NO. 100, P.B.
MEXICO, D.F., MEXICO 05120 AND

YAPUR, JESUS ANTONIO (MEXICO INDIVIDUAL)
PASEO DE LOS TAMARINDOS NO. 100, P.B.
MEXICO, D.F., MEXICO 05120 AND

YAPUR, SIMON (MEXICO INDIVIDUAL)
PASEO DE LOS TAMARINDOS NO. 100, P.B.
MEXICO 05120

FOR: ADVERTISING AND MARKETING SERVICES, NAMELY, PROMOTING THE GOODS AND SERVICES OF OTHERS; BUSINESS ADMINISTRATION AND OFFICE WORK; BUSINESS MANAGEMENT, IN CLASS 35 (U.S. CLS. 100, 101 AND 102).

THE MARK CONSISTS OF STANDARD CHARACTERS WITHOUT CLAIM TO ANY PARTICULAR FONT, STYLE, SIZE, OR COLOR.

OWNER OF MEXICO REG. NO. 888992, DATED 9-23-2008, EXPIRES 10-15-2017.

SER. NO. 85-517,554, FILED 1-16-2012.

WILLIAM ROSSMAN, EXAMINING ATTORNEY



David J. Kyffers

Director of the United States Patent and Trademark Office

United States of America

United States Patent and Trademark Office

Spa Station

Reg. No. 4,175,723

ZHADANOV, ELI (UNITED STATES INDIVIDUAL)
1315 EAST ELIZABETH AVE.
LINDEN, NJ 07036

Registered July 17, 2012

Int. Cl.: 11

FOR: SHOWERHEADS, IN CLASS 11 (U.S. CLS. 13, 21, 23, 31 AND 34).

TRADEMARK

FIRST USE 11-2-2011; IN COMMERCE 11-2-2011.

PRINCIPAL REGISTER

THE MARK CONSISTS OF STANDARD CHARACTERS WITHOUT CLAIM TO ANY PARTICULAR FONT, STYLE, SIZE, OR COLOR.

NO CLAIM IS MADE TO THE EXCLUSIVE RIGHT TO USE "SPA", APART FROM THE MARK AS SHOWN.

SER. NO. 85-517,878, FILED 1-17-2012.

MICHAEL TANNER, EXAMINING ATTORNEY



David J. Kyffers

Director of the United States Patent and Trademark Office

United States of America

United States Patent and Trademark Office

COMFORT TO GO

Reg. No. 4,175,724

Registered July 17, 2012

Int. Cl.: 25

TRADEMARK

PRINCIPAL REGISTER

TOTES ISOTONER CORPORATION (OHIO CORPORATION)
9655 INTERNATIONAL BOULEVARD
CINCINNATI, OH 45246

FOR: FOOTWEAR AND SLIPPERS, IN CLASS 25 (U.S. CLS. 22 AND 39).

FIRST USE 8-0-2011; IN COMMERCE 8-0-2011.

THE MARK CONSISTS OF STANDARD CHARACTERS WITHOUT CLAIM TO ANY PARTICULAR FONT, STYLE, SIZE, OR COLOR.

SER. NO. 85-518,860, FILED 1-18-2012.

KEVON CHISOLM, EXAMINING ATTORNEY



David J. Kyffers

Director of the United States Patent and Trademark Office

United States of America

United States Patent and Trademark Office

IDEAS TO SNACK ON

Reg. No. 4,175,725

KELLOGG NORTH AMERICA COMPANY (DELAWARE CORPORATION)
ONE KELLOGG SQUARE, PO BOX 3599
BATTLE CREEK, MI 490163599

Registered July 17, 2012

Int. Cls.: 30 and 43

FOR: COOKIES; CRACKERS; CEREAL BARS; CEREAL BASED SNACK FOOD, IN CLASS 30 (U.S. CL. 46).

TRADEMARK

FIRST USE 7-31-2010; IN COMMERCE 7-31-2010.

SERVICE MARK

FOR: PROVIDING AN ONLINE COMPUTER DATABASE TO CONSUMERS AND THE GENERAL PUBLIC CONCERNING RECIPES, FOOD PRODUCT INGREDIENTS, AND COOKING INFORMATION, IN CLASS 43 (U.S. CLS. 100 AND 101).

PRINCIPAL REGISTER

FIRST USE 7-9-2010; IN COMMERCE 7-9-2010.

THE MARK CONSISTS OF STANDARD CHARACTERS WITHOUT CLAIM TO ANY PARTICULAR FONT, STYLE, SIZE, OR COLOR.

SER. NO. 85-519,068, FILED 1-18-2012.

AMY KELLY, EXAMINING ATTORNEY



David J. Kybas

Director of the United States Patent and Trademark Office

United States of America

United States Patent and Trademark Office

REVOYOUTION

Reg. No. 4,175,726

GLOBAL BOOST MD LLC (DELAWARE LIMITED LIABILITY COMPANY)
ONE COMMERCE CENTER 1202 ORANGE ST. #600
WILMINGTON, DE 19899

Registered July 17, 2012

Int. Cl.: 35

FOR: ON-LINE RETAIL CONSIGNMENT STORES FEATURING HEALTH AND BEAUTY PRODUCTS, IN CLASS 35 (U.S. CLS. 100, 101 AND 102).

SERVICE MARK

FIRST USE 1-6-2012; IN COMMERCE 1-6-2012.

PRINCIPAL REGISTER

THE MARK CONSISTS OF STANDARD CHARACTERS WITHOUT CLAIM TO ANY PARTICULAR FONT, STYLE, SIZE, OR COLOR.

THE WORDING "REVOYOUTION" HAS NO MEANING IN A FOREIGN LANGUAGE.

SER. NO. 85-520,266, FILED 1-19-2012.

KIMBERLY PERRY, EXAMINING ATTORNEY



David J. Kybas

Director of the United States Patent and Trademark Office

United States of America

United States Patent and Trademark Office

MEAN GREEN

Reg. No. 4,175,727

UNIVERSITY OF NORTH TEXAS (TEXAS STATE UNIVERSITY)
1501 W. CHESTNUT STREET
DENTON, TX 76201

Registered July 17, 2012

Int. Cl.: 26

FOR: BUTTONS; NOVELTY BUTTONS; SHIRT BUTTONS, IN CLASS 26 (U.S. CLS. 37, 39, 40, 42 AND 50).

TRADEMARK

FIRST USE 7-0-2009; IN COMMERCE 7-0-2009.

PRINCIPAL REGISTER

THE MARK CONSISTS OF STANDARD CHARACTERS WITHOUT CLAIM TO ANY PARTICULAR FONT, STYLE, SIZE, OR COLOR.

OWNER OF U.S. REG. NO. 4,086,208.

SER. NO. 85-520,417, FILED 1-19-2012.

AISHA CLARKE, EXAMINING ATTORNEY



David J. Kyffers

Director of the United States Patent and Trademark Office

United States of America

United States Patent and Trademark Office



Reg. No. 4,175,728

Registered July 17, 2012

Int. Cl.: 43

SERVICE MARK

PRINCIPAL REGISTER

THE MARCUS CORPORATION (WISCONSIN CORPORATION)
100 EAST WISCONSIN AVENUE, STE. 1900
MILWAUKEE, WI 53202

FOR: HOTEL SERVICES, IN CLASS 43 (U.S. CLS. 100 AND 101).

FIRST USE 10-20-2011; IN COMMERCE 10-20-2011.

THE MARK CONSISTS OF A CIRCULAR PROFILE OF A WOMAN'S HEAD THAT IS LOOKING UP. THE WOMAN IS WEARING A HEAD DRESS AND HAS A WINGED ARM THAT IS MADE OUT OF FEATHERS THAT IS RAISED IN FRONT OF HER FACE.

SER. NO. 85-520,612, FILED 1-19-2012.

LESLIE RICHARDS, EXAMINING ATTORNEY



David J. Kyffers

Director of the United States Patent and Trademark Office

United States of America

United States Patent and Trademark Office



Reg. No. 4,175,729

Registered July 17, 2012

Int. Cl.: 16

TRADEMARK

PRINCIPAL REGISTER

THE INSTITUTE OF ELECTRICAL AND ELECTRONICS ENGINEERS, INC. (NEW YORK CORPORATION)
445 HOES LANE
PISCATAWAY, NJ 08855

FOR: PRINTED PUBLICATIONS, NAMELY, JOURNALS AND MAGAZINES IN THE FIELD OF ELECTRICAL AND ELECTRONICS ENGINEERING, DIELECTRICS, AND ELECTRICAL INSULATION, IN CLASS 16 (U.S. CLS. 2, 5, 22, 23, 29, 37, 38 AND 50).

FIRST USE 1-31-1989; IN COMMERCE 1-31-1989.

OWNER OF U.S. REG. NO. 4,065,953.

THE MARK CONSISTS OF THE STYLIZED LETTERS "D", "E", "I", "S" ABOVE AND TO THE RIGHT OF A STYLIZED DEPICTION OF A SINE WAVE.

SER. NO. 85-521,035, FILED 1-20-2012.

ELISSA GARBER KON, EXAMINING ATTORNEY



David J. Kyjars

Director of the United States Patent and Trademark Office

United States of America

United States Patent and Trademark Office



Reg. No. 4,175,730

Registered July 17, 2012

Int. Cl.: 41

SERVICE MARK

PRINCIPAL REGISTER

THE INSTITUTE OF ELECTRICAL AND ELECTRONICS ENGINEERS, INC. (NEW YORK CORPORATION)
445 HOES LANE
PISCATAWAY, NJ 08855

FOR: EDUCATIONAL SERVICES, NAMELY, DEVELOPING, ARRANGING, AND CONDUCTING CONFERENCES IN THE FIELD OF ELECTRICAL AND ELECTRONICS ENGINEERING, DIELECTRICS, AND ELECTRICAL INSULATION, AND DISTRIBUTION OF COURSE MATERIALS IN CONNECTION THEREWITH, IN CLASS 41 (U.S. CLS. 100, 101 AND 107).

FIRST USE 12-31-1998; IN COMMERCE 12-31-1998.

OWNER OF U.S. REG. NO. 4,065,953.

THE MARK CONSISTS OF THE STYLIZED LETTERS "DEIS" ABOVE AND TO THE RIGHT OF A STYLIZED DEPICTION OF A SINE WAVE.

SER. NO. 85-521,062, FILED 1-20-2012.

ELISSA GARBER KON, EXAMINING ATTORNEY



David J. Kyjars

Director of the United States Patent and Trademark Office

United States of America
United States Patent and Trademark Office

GORDON

Reg. No. 4,175,731

HARBOR FREIGHT TOOLS USA, INC. (DELAWARE CORPORATION)
26541 AGOURA ROAD
CALABASAS, CA 91302

Registered July 17, 2012

Int. Cl.: 8

FOR: UTILITY KNIVES AND BLADES FOR UTILITY KNIVES, IN CLASS 8 (U.S. CLS. 23, 28 AND 44).

TRADEMARK

FIRST USE 10-1-2003; IN COMMERCE 10-1-2003.

PRINCIPAL REGISTER

THE MARK CONSISTS OF STANDARD CHARACTERS WITHOUT CLAIM TO ANY PARTICULAR FONT, STYLE, SIZE, OR COLOR.

SER. NO. 85-521,122, FILED 1-20-2012.

STEVEN PEREZ, EXAMINING ATTORNEY



David J. Kybas

Director of the United States Patent and Trademark Office

United States of America

United States Patent and Trademark Office

ROCK YOUR REGISTRY

Reg. No. 4,175,732

BED BATH & BEYOND PROCUREMENT CO. INC. (NEW YORK CORPORATION)
110 BI-COUNTY BLVD., SUITE 114
FARMINGDALE, NY 11735

Registered July 17, 2012

Int. Cls.: 35 and 41

FOR: RETAIL STORE SERVICES AND ONLINE RETAIL STORE SERVICES FEATURING A WIDE VARIETY OF CONSUMER GOODS OF OTHERS; GIFT REGISTRY SERVICES, IN CLASS 35 (U.S. CLS. 100, 101 AND 102).

SERVICE MARK

FIRST USE 1-5-2012; IN COMMERCE 1-5-2012.

PRINCIPAL REGISTER

FOR: ARRANGING, ORGANIZING, CONDUCTING, AND HOSTING SOCIAL ENTERTAINMENT EVENTS, IN CLASS 41 (U.S. CLS. 100, 101 AND 107).

FIRST USE 1-5-2012; IN COMMERCE 1-5-2012.

THE MARK CONSISTS OF STANDARD CHARACTERS WITHOUT CLAIM TO ANY PARTICULAR FONT, STYLE, SIZE, OR COLOR.

SER. NO. 85-521,183, FILED 1-20-2012.

JASON TURNER, EXAMINING ATTORNEY



David J. Kypos

Director of the United States Patent and Trademark Office

United States of America

United States Patent and Trademark Office

Pilot
TRAVEL CENTERS
LLC



Reg. No. 4,175,733

PILOT TRAVEL CENTERS LLC (DELAWARE LIMITED LIABILITY COMPANY)
P.O. BOX 10146
KNOXVILLE, TN 379390146

Registered July 17, 2012

Int. Cl.: 35

FOR: RETAIL STORE SERVICES IN THE FIELD OF FOOD PRODUCTS, GASOLINE AND MOTOR OIL, IN CLASS 35 (U.S. CLS. 100, 101 AND 102).

SERVICE MARK

FIRST USE 8-31-2010; IN COMMERCE 8-31-2010.

PRINCIPAL REGISTER

OWNER OF U.S. REG. NOS. 1,329,189, 4,046,487 AND OTHERS.

NO CLAIM IS MADE TO THE EXCLUSIVE RIGHT TO USE "TRAVEL CENTERS LLC", APART FROM THE MARK AS SHOWN.

THE MARK CONSISTS OF WORDING AND DESIGNS. IN THE LEFT HALF OF THE MARK, THE WORDING "PILOT" APPEARS IN LARGE UNDERLINED LETTERING, ALL ABOVE THE WORDING "TRAVEL CENTERS" WITH THE LETTERS "L", "L", "C" APPEARING IN VERY SMALL LETTERING UNDER ALL OF THE OTHER WORDING. IN THE RIGHT HALF OF THE MARK, THE WORDING "FLYING J" APPEARS BELOW A DESIGN OF THE LETTER "J" STYLIZED TO LOOK LIKE AN AIRPLANE POINTING UPWARD. THE DESIGN APPEARS WITHIN A CIRCLE.

SER. NO. 85-522,368, FILED 1-23-2012.

CORY BOONE, EXAMINING ATTORNEY



David J. Kyjars

Director of the United States Patent and Trademark Office

United States of America

United States Patent and Trademark Office

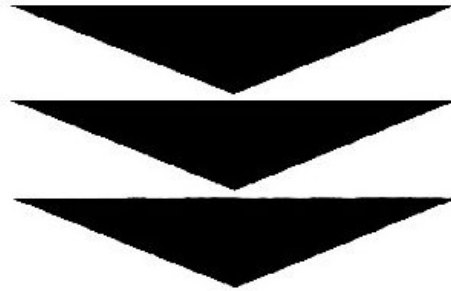

Reg. No. 4,175,734

Registered July 17, 2012

Int. Cl.: 25

TRADEMARK

PRINCIPAL REGISTER

GOLDTOEMORETZ, LLC (DELAWARE LIMITED LIABILITY COMPANY)
514 WEST 21ST STREET; P.O. BOX 580
NEWTON, NC 28658

FOR: SOCKS, IN CLASS 25 (U.S. CLS. 22 AND 39).

FIRST USE 0-0-1979; IN COMMERCE 0-0-1979.

OWNER OF U.S. REG. NOS. 1,624,975, 3,947,965 AND OTHERS.

THE MARK CONSISTS OF THREE STACKED INVERTED ELONGATE TRIANGLES.

SER. NO. 85-522,371, FILED 1-23-2012.

STEVEN JACKSON, EXAMINING ATTORNEY



David J. Kyffers

Director of the United States Patent and Trademark Office

United States of America

United States Patent and Trademark Office

Dinero Loco

Reg. No. 4,175,735

PROGRAM THREE, LLC (FLORIDA LIMITED LIABILITY COMPANY)
12388 SW 82 AVE
MIAMI, FL 33156

Registered July 17, 2012

Int. Cl.: 35

FOR: ADVERTISING SERVICES, NAMELY, COST-PER-ACTION ON-LINE ADVERTISING,
IN CLASS 35 (U.S. CLS. 100, 101 AND 102).

SERVICE MARK

FIRST USE 12-1-2011; IN COMMERCE 12-1-2011.

PRINCIPAL REGISTER

THE MARK CONSISTS OF STANDARD CHARACTERS WITHOUT CLAIM TO ANY PARTICULAR FONT, STYLE, SIZE, OR COLOR.

NO CLAIM IS MADE TO THE EXCLUSIVE RIGHT TO USE "DINERO", APART FROM THE MARK AS SHOWN.

THE ENGLISH TRANSLATION OF "DINERO" IS "MONEY". THE ENGLISH TRANSLATION OF "LOCO" IS "CRAZY".

SER. NO. 85-523,217, FILED 1-23-2012.

KIMBERLY PERRY, EXAMINING ATTORNEY



David J. Kyros

Director of the United States Patent and Trademark Office

United States of America

United States Patent and Trademark Office

RENT WITH YOUR REMOTE

Reg. No. 4,175,736

Registered July 17, 2012

Int. Cl.: 41

SERVICE MARK

PRINCIPAL REGISTER

PARAMOUNT PICTURES CORPORATION (DELAWARE CORPORATION)
5555 MELROSE AVENUE
HOLLYWOOD, CA 90038

FOR: ENTERTAINMENT SERVICES, NAMELY, PROVISION OF NON-DOWNLOADABLE FILMS AND TELEVISION SERIES VIA A VIDEO-ON-DEMAND SERVICE, IN CLASS 41 (U.S. CLS. 100, 101 AND 107).

FIRST USE 3-1-2005; IN COMMERCE 3-1-2005.

THE MARK CONSISTS OF STANDARD CHARACTERS WITHOUT CLAIM TO ANY PARTICULAR FONT, STYLE, SIZE, OR COLOR.

OWNER OF U.S. REG. NO. 3,199,897.

SEC. 2(F).

SER. NO. 85-523,278, FILED 1-23-2012.

JEFF DEFORD, EXAMINING ATTORNEY



David J. Kyffers

Director of the United States Patent and Trademark Office

United States of America

United States Patent and Trademark Office

GlobalDMS

Reg. No. 4,175,737

Registered July 17, 2012

Int. Cl.: 42

GLOBAL DATA MANAGEMENT SYSTEMS, LLC (DELAWARE LIMITED LIABILITY COMPANY)
SUITE 210
1816 WEST POINT PIKE
LANSDALE, PA 19446

SERVICE MARK

PRINCIPAL REGISTER

FOR: SOFTWARE AS A SERVICE (SAAS) SERVICES FEATURING SOFTWARE FOR VENDOR WORKFLOW FOR MORTGAGE LENDERS AND REAL ESTATE LENDERS IN THE REAL ESTATE VALUATION INDUSTRY, IN CLASS 42 (U.S. CLS. 100 AND 101).

FIRST USE 6-1-2003; IN COMMERCE 6-1-2003.

THE MARK CONSISTS OF STANDARD CHARACTERS WITHOUT CLAIM TO ANY PARTICULAR FONT, STYLE, SIZE, OR COLOR.

SER. NO. 85-523,565, FILED 1-24-2012.

LINDA E. BLOHM, EXAMINING ATTORNEY



David J. Kyffers

Director of the United States Patent and Trademark Office

United States of America

United States Patent and Trademark Office

Battle Creek Oyster

Reg. No. 4,175,738

WAR SHORE OYSTER COMPANY, LLC (VIRGINIA LIMITED LIABILITY COMPANY)
414 S COLUMBUS STREET
ALEXANDRIA, VA 22314

Registered July 17, 2012

Int. Cl.: 31

FOR: LIVE OYSTERS, IN CLASS 31 (U.S. CLS. 1 AND 46).

TRADEMARK

FIRST USE 1-9-2012; IN COMMERCE 1-9-2012.

PRINCIPAL REGISTER

THE MARK CONSISTS OF STANDARD CHARACTERS WITHOUT CLAIM TO ANY PARTICULAR FONT, STYLE, SIZE, OR COLOR.

NO CLAIM IS MADE TO THE EXCLUSIVE RIGHT TO USE "OYSTER", APART FROM THE MARK AS SHOWN.

SER. NO. 85-523,573, FILED 1-24-2012.

JILL C. ALT, EXAMINING ATTORNEY



David J. Kyffers

Director of the United States Patent and Trademark Office

United States of America

United States Patent and Trademark Office

Don't Chase the American
Dream. Buy it!

Reg. No. 4,175,739

ETAGE REAL ESTATE, LLC (NEW YORK LIMITED LIABILITY COMPANY)
140 E. 80TH ST
NEW YORK, NY 10075

Registered July 17, 2012

Int. Cl.: 36

FOR: REAL ESTATE SERVICES, NAMELY, REAL ESTATE CONSULTATION, MANAGEMENT AND BROKERAGE, IN CLASS 36 (U.S. CLS. 100, 101 AND 102).

SERVICE MARK

FIRST USE 1-10-2011; IN COMMERCE 1-10-2011.

PRINCIPAL REGISTER

THE MARK CONSISTS OF STANDARD CHARACTERS WITHOUT CLAIM TO ANY PARTICULAR FONT, STYLE, SIZE, OR COLOR.

SER. NO. 85-524,382, FILED 1-24-2012.

BRIAN CALLAGHAN, EXAMINING ATTORNEY



David J. Kybas

Director of the United States Patent and Trademark Office

United States of America

United States Patent and Trademark Office

O ROCK

Reg. No. 4,175,740

Registered July 17, 2012

Int. Cl.: 25

TRADEMARK

PRINCIPAL REGISTER

ALPHA & OMEGA STOREHOUSE, LLC (MASSACHUSETTS LIMITED LIABILITY COMPANY)
PO BOX 71, 8 THATCHER'S ROW
MIDDLEBOROUGH, MA 023460071

FOR: APPAREL FOR DANCERS, NAMELY, TEE SHIRTS, SWEATSHIRTS, PANTS, LEGGINGS, SHORTS AND JACKETS; ATHLETIC APPAREL, NAMELY, SHIRTS, PANTS, JACKETS, FOOTWEAR, HATS AND CAPS, ATHLETIC UNIFORMS, IN CLASS 25 (U.S. CLS. 22 AND 39).

FIRST USE 12-20-2011; IN COMMERCE 1-6-2012.

THE MARK CONSISTS OF STANDARD CHARACTERS WITHOUT CLAIM TO ANY PARTICULAR FONT, STYLE, SIZE, OR COLOR.

SER. NO. 85-524,511, FILED 1-25-2012.

MICHELE SWAIN, EXAMINING ATTORNEY



David J. Kyffers

Director of the United States Patent and Trademark Office

United States of America

United States Patent and Trademark Office

Who IS Who WAS Who IS COMING...

Reg. No. 4,175,741

Registered July 17, 2012

Int. Cl.: 25

TRADEMARK

PRINCIPAL REGISTER

ALPHA & OMEGA STOREHOUSE, LLC (MASSACHUSETTS LIMITED LIABILITY COMPANY)

PO BOX 71, 8 THATCHER'S ROW
MIDDLEBOROUGH, MA 023460071

FOR: APPAREL FOR DANCERS, NAMELY, TEE SHIRTS, SWEATSHIRTS, PANTS, LEGGINGS, SHORTS AND JACKETS; ATHLETIC APPAREL, NAMELY, SHIRTS, PANTS, JACKETS, FOOTWEAR, HATS AND CAPS, ATHLETIC UNIFORMS, IN CLASS 25 (U.S. CLS. 22 AND 39).

FIRST USE 12-20-2011; IN COMMERCE 1-6-2012.

THE MARK CONSISTS OF STANDARD CHARACTERS WITHOUT CLAIM TO ANY PARTICULAR FONT, STYLE, SIZE, OR COLOR.

SER. NO. 85-524,522, FILED 1-25-2012.

MICHELE SWAIN, EXAMINING ATTORNEY



David J. Kyffers

Director of the United States Patent and Trademark Office

United States of America

United States Patent and Trademark Office



Reg. No. 4,175,742

Registered July 17, 2012

Int. Cl.: 11

TRADEMARK

PRINCIPAL REGISTER

CAMBRIA COMPANY LLC (MINNESOTA LIMITED LIABILITY COMPANY)
704 NORTH MAIN STREET
LE SUEUR, MN 56058

FOR: SINKS; SURROUNDS FOR BATHROOM AND VANITY UNITS, IN CLASS 11 (U.S. CLS. 13, 21, 23, 31 AND 34).

FIRST USE 7-20-2000; IN COMMERCE 7-20-2000.

OWNER OF U.S. REG. NO. 2,555,408.

THE MARK CONSISTS OF A DRAGON.

SER. NO. 85-524,659, FILED 1-25-2012.

LOURDES AYALA, EXAMINING ATTORNEY



David J. Kyffers

Director of the United States Patent and Trademark Office

United States of America

United States Patent and Trademark Office



Reg. No. 4,175,743

Registered July 17, 2012

Int. Cl.: 19

TRADEMARK

PRINCIPAL REGISTER

CAMBRIA COMPANY LLC (MINNESOTA LIMITED LIABILITY COMPANY)
704 NORTH MAIN STREET
LE SUEUR, MN 56058

FOR: BUILDING MATERIALS, NAMELY, TILES, FLOORING, FIREPLACE SURROUNDS
AND SLABS MADE PRIMARILY OF QUARTZ, ROCKS AND STONES, IN CLASS 19 (U.S.
CLS. 1, 12, 33 AND 50).

FIRST USE 7-20-2000; IN COMMERCE 7-20-2000.

OWNER OF U.S. REG. NO. 2,555,408.

THE MARK CONSISTS OF A DRAGON.

SER. NO. 85-524,667, FILED 1-25-2012.

LOURDES AYALA, EXAMINING ATTORNEY



David J. Kyffers

Director of the United States Patent and Trademark Office

United States of America

United States Patent and Trademark Office

BIG BOB'S FLOORING OUTLET

Reg. No. 4,175,744

BIG BOB'S FLOORING OUTLET OF AMERICA, INC. (MISSOURI CORPORATION)
10001 W. 75TH STREET
SHAWNEE MISSION, KS 66204

Registered July 17, 2012

Int. Cl.: 35

FOR: FRANCHISING, NAMELY, TECHNICAL ASSISTANCE IN THE ESTABLISHMENT AND/OR OPERATION OF RETAIL STORE SERVICES FOR THE SALE OF CARPET AND FLOOR COVERING; RETAIL STORE SERVICES IN THE FIELD OF CARPET AND FLOOR COVERING, IN CLASS 35 (U.S. CLS. 100, 101 AND 102).

SERVICE MARK

PRINCIPAL REGISTER

FIRST USE 12-1-2003; IN COMMERCE 12-1-2003.

THE MARK CONSISTS OF STANDARD CHARACTERS WITHOUT CLAIM TO ANY PARTICULAR FONT, STYLE, SIZE, OR COLOR.

OWNER OF U.S. REG. NOS. 3,025,215, 3,451,710 AND OTHERS.

NO CLAIM IS MADE TO THE EXCLUSIVE RIGHT TO USE "FLOORING OUTLET", APART FROM THE MARK AS SHOWN.

SER. NO. 85-524,743, FILED 1-25-2012.

KELLY BOULTON, EXAMINING ATTORNEY



David J. Kyffers

Director of the United States Patent and Trademark Office

United States of America

United States Patent and Trademark Office

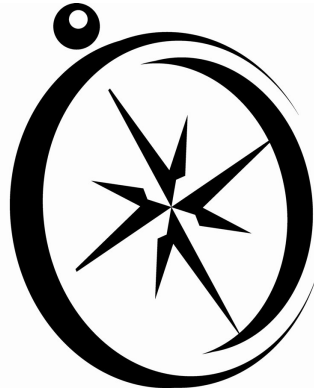

Reg. No. 4,175,745

Registered July 17, 2012

Int. Cl.: 44

SERVICE MARK

PRINCIPAL REGISTER

CENTRAL RECOVERY HOLDINGS, LLC (NEVADA LIMITED LIABILITY COMPANY)
3321 NORTH BUFFALO DRIVE, SUITE 200
LAS VEGAS, NV 89129

FOR: ADDICTION TREATMENT SERVICES, NAMELY, MEDICALLY-MANAGED WITHDRAWAL AND CHEMICAL DEPENDENCY SERVICES; MEDICAL EVALUATION SERVICES, NAMELY, FUNCTIONAL ASSESSMENT PROGRAM FOR CLIENTS RECEIVING MEDICAL REHABILITATION SERVICES FOR PURPOSES OF GUIDING TREATMENT AND ASSESSING PROGRAM EFFECTIVENESS, IN CLASS 44 (U.S. CLS. 100 AND 101).

FIRST USE 2-23-2006; IN COMMERCE 2-23-2006.

THE MARK CONSISTS OF AN EIGHT POINT STAR CENTERED INSIDE A RING WITH A SPHERE OUTSIDE THE RING.

SER. NO. 85-525,038, FILED 1-25-2012.

ROBERT C. CLARK JR., EXAMINING ATTORNEY



David J. Kyffers

Director of the United States Patent and Trademark Office

United States of America

United States Patent and Trademark Office

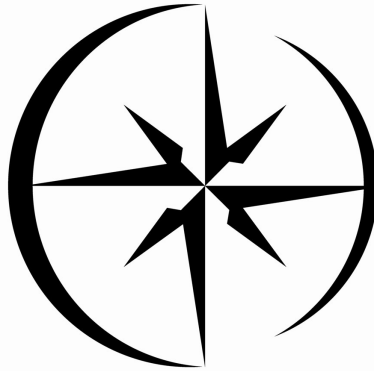

Reg. No. 4,175,746

Registered July 17, 2012

Int. Cl.: 44

SERVICE MARK

PRINCIPAL REGISTER

CENTRAL RECOVERY HOLDINGS, LLC (NEVADA LIMITED LIABILITY COMPANY)
3321 NORTH BUFFALO DRIVE, SUITE 200
LAS VEGAS, NV 89129

FOR: ADDICTION TREATMENT SERVICES, NAMELY, MEDICALLY-MANAGED WITHDRAWAL AND CHEMICAL DEPENDENCY SERVICES; MEDICAL EVALUATION SERVICES, NAMELY, FUNCTIONAL ASSESSMENT PROGRAM FOR CLIENTS RECEIVING MEDICAL REHABILITATION SERVICES FOR PURPOSES OF GUIDING TREATMENT AND ASSESSING PROGRAM EFFECTIVENESS, IN CLASS 44 (U.S. CLS. 100 AND 101).

FIRST USE 2-23-2006; IN COMMERCE 2-23-2006.

THE MARK CONSISTS OF AN EIGHT POINT STAR CENTERED BETWEEN TWO CRESCENT SHAPES.

SER. NO. 85-525,112, FILED 1-25-2012.

ROBERT C. CLARK JR., EXAMINING ATTORNEY



David J. Kyffers

Director of the United States Patent and Trademark Office

United States of America
United States Patent and Trademark Office

ACADEMY

Reg. No. 4,175,747

Registered July 17, 2012

Int. Cl.: 16

TRADEMARK

PRINCIPAL REGISTER

CHARTPAK, INC. (DELAWARE CORPORATION)
SUITE 205
510 BROAD HOLLOW ROAD
MELVILLE, NY 11747

FOR: ARTISTS' BRUSHES, IN CLASS 16 (U.S. CLS. 2, 5, 22, 23, 29, 37, 38 AND 50).

FIRST USE 1-8-2008; IN COMMERCE 1-8-2008.

THE MARK CONSISTS OF STANDARD CHARACTERS WITHOUT CLAIM TO ANY PARTICULAR FONT, STYLE, SIZE, OR COLOR.

OWNER OF U.S. REG. NOS. 1,293,655 AND 3,319,560.

SER. NO. 85-525,621, FILED 1-26-2012.

REBECCA POVARCHUK, EXAMINING ATTORNEY



David J. Kyffers

Director of the United States Patent and Trademark Office

United States of America

United States Patent and Trademark Office

Masculus

Reg. No. 4,175,748

Registered July 17, 2012

Int. Cls.: 18 and 25

TRADEMARK

PRINCIPAL REGISTER

MILITTI SALES & PROMOTIONS, LLC (NEBRASKA LIMITED LIABILITY COMPANY)
13424 INDUSTRIAL ROAD
OMAHA, NE 68137

FOR: BUSINESS CARD CASES, CALLING CARD CASES, CREDIT CARD CASES, NAMELY, CARD CASES, KEY CASES, HANDBAGS, BEACH BAGS, SHOULDER BAGS, CLUTCH BAGS, BACKPACKS, ATHLETIC BAGS, BOOK BAGS, DUFFEL BAGS, CARRY-ON BAGS, GARMENT BAGS, GYM BAGS, TOTE BAGS, TRAVEL BAGS, TRUNKS, TRAVELING TRUNKS, SPORTSMAN'S BAGS, MESSENGER BAGS, BRIEFCASES, COIN PURSES, WAIST PACKS, HANDBAGS, WINE BAGS WITH HANDLES FOR CARRYING OR HOLDING WINE, HAVERSACKS, KEY CASES, LUGGAGE, PURSES, SCHOOL BAGS, SUITCASES, HUNTING BAGS, KNAPSACKS FOR CLIMBERS, UMBRELLAS AND WALLETS, IN CLASS 18 (U.S. CLS. 1, 2, 3, 22 AND 41).

FIRST USE 1-22-2012; IN COMMERCE 1-22-2012.

FOR: CLOTHING, NAMELY, MEN'S, WOMEN'S AND CHILDREN'S PANTS, SLACKS, TROUSERS, JEANS, SHORTS, OVERALLS, SHIRTS, T-SHIRTS, VESTS, SKIRTS, JACKETS, COATS, SPORT COATS, SWEATSHIRTS, SWEATERS, SWEATPANTS, SUITS, DRESSES, SKIRTS, TIES, NECKTIES, SCARVES, PONCHOS, BELTS, SOCKS, FOOTWEAR, DRESSING GOWNS, HATS, DRESSES AND BATHING SUITS; CLOTHING MADE WHOLLY OR PARTIALLY OF FUR, NAMELY, FUR COATS, FUR TRIMMED COATS, FUR AND FUR LINED JACKETS, FUR CAPES, FUR PONCHOS, FUR BOOTS, FUR HATS, FUR PANTS, IN CLASS 25 (U.S. CLS. 22 AND 39).

FIRST USE 1-22-2012; IN COMMERCE 1-22-2012.

THE MARK CONSISTS OF STANDARD CHARACTERS WITHOUT CLAIM TO ANY PARTICULAR FONT, STYLE, SIZE, OR COLOR.

SER. NO. 85-526,767, FILED 1-27-2012.

RONALD MCMORROW, EXAMINING ATTORNEY



David J. Kypos

Director of the United States Patent and Trademark Office

United States of America

United States Patent and Trademark Office



Reg. No. 4,175,749

Registered July 17, 2012

Int. Cl.: 3

TRADEMARK

PRINCIPAL REGISTER

EXPRESS, LLC (DELAWARE LIMITED LIABILITY COMPANY)
ATTN: KATHY HAMILTON
1 EXPRESS DRIVE
COLUMBUS, OH 43230

FOR: PERSONAL CARE PRODUCTS, NAMELY, COLOGNE, HAIR WASH, NAMELY, HAIR SHAMPOO, BODY WASH AND BODY SPRAYS, IN CLASS 3 (U.S. CLS. 1, 4, 6, 50, 51 AND 52).

FIRST USE 5-8-2010; IN COMMERCE 5-8-2010.

OWNER OF U.S. REG. NOS. 3,090,209, 3,953,464, AND 4,094,722.

THE MARK CONSISTS OF A HERALDIC LION DESIGN.

SER. NO. 85-526,906, FILED 1-27-2012.

BILL DAWE, EXAMINING ATTORNEY



David J. Kyffers

Director of the United States Patent and Trademark Office

United States of America

United States Patent and Trademark Office

Amistar

Reg. No. 4,175,750

SYNGENTA LIMITED (SWITZERLAND CORPORATION)
SYNGENTA EUROPEAN RESEARCH CENTRE
GUILDFORD, SURREY, UNITED KINGDOM

Registered July 17, 2012

Int. Cl.: 5

FOR: FUNGICIDES FOR AGRICULTURAL USE, IN CLASS 5 (U.S. CLS. 6, 18, 44, 46, 51 AND 52).

TRADEMARK

FIRST USE 3-1-2003; IN COMMERCE 3-1-2003.

PRINCIPAL REGISTER

THE MARK CONSISTS OF STANDARD CHARACTERS WITHOUT CLAIM TO ANY PARTICULAR FONT, STYLE, SIZE, OR COLOR.

SER. NO. 85-527,188, FILED 1-27-2012.

JENNIFER DIXON, EXAMINING ATTORNEY



David J. Kybas

Director of the United States Patent and Trademark Office

United States of America

United States Patent and Trademark Office

BFF

Reg. No. 4,175,751

AMY'S COUNTRY CANDLES, LLC (LOUISIANA LIMITED LIABILITY COMPANY)
314 HIGHWAY 3185
THIBODAUX, LA 70301

Registered July 17, 2012

Int. Cl.: 4

FOR: SCENTED CANDLES; SCENTED WAX FOR USE IN CANDLE WARMERS, IN CLASS 4 (U.S. CLS. 1, 6 AND 15).

TRADEMARK

FIRST USE 1-15-2012; IN COMMERCE 1-15-2012.

PRINCIPAL REGISTER

THE MARK CONSISTS OF STANDARD CHARACTERS WITHOUT CLAIM TO ANY PARTICULAR FONT, STYLE, SIZE, OR COLOR.

SER. NO. 85-527,661, FILED 1-27-2012.

JACQUELINE A. LAVINE, EXAMINING ATTORNEY



David J. Kybas

Director of the United States Patent and Trademark Office

United States of America

United States Patent and Trademark Office

True Love

Reg. No. 4,175,752

AMY'S COUNTRY CANDLES, LLC (LOUISIANA LIMITED LIABILITY COMPANY)
314 HIGHWAY 3185
THIBODAUX, LA 70301

Registered July 17, 2012

Int. Cl.: 4

FOR: SCENTED CANDLES; SCENTED WAX FOR USE IN CANDLE WARMERS, IN CLASS 4 (U.S. CLS. 1, 6 AND 15).

TRADEMARK

FIRST USE 4-12-2011; IN COMMERCE 4-12-2011.

PRINCIPAL REGISTER

THE MARK CONSISTS OF STANDARD CHARACTERS WITHOUT CLAIM TO ANY PARTICULAR FONT, STYLE, SIZE, OR COLOR.

SER. NO. 85-527,662, FILED 1-27-2012.

JACQUELINE A. LAVINE, EXAMINING ATTORNEY



David J. Kybas

Director of the United States Patent and Trademark Office

United States of America

United States Patent and Trademark Office

Ya Ya Gumbo

Reg. No. 4,175,753

AMY'S COUNTRY CANDLES, LLC (LOUISIANA LIMITED LIABILITY COMPANY)
314 HIGHWAY 3185
THIBODAUX, LA 70301

Registered July 17, 2012

Int. Cl.: 4

FOR: SCENTED CANDLES; SCENTED WAX FOR USE IN CANDLE WARMERS, IN CLASS 4 (U.S. CLS. 1, 6 AND 15).

TRADEMARK

FIRST USE 1-15-2012; IN COMMERCE 1-15-2012.

PRINCIPAL REGISTER

THE MARK CONSISTS OF STANDARD CHARACTERS WITHOUT CLAIM TO ANY PARTICULAR FONT, STYLE, SIZE, OR COLOR.

SER. NO. 85-527,664, FILED 1-27-2012.

JACQUELINE A. LAVINE, EXAMINING ATTORNEY



David J. Kybas

Director of the United States Patent and Trademark Office

United States of America

United States Patent and Trademark Office



Reg. No. 4,175,754

Registered July 17, 2012

Int. Cl.: 34

JMG INTERNATIONAL, INC. (CALIFORNIA CORPORATION)
SUITE 104
1440 KOLL CIRCLE
SAN JOSE, CA 95112

FOR: CIGARS, IN CLASS 34 (U.S. CLS. 2, 8, 9 AND 17).

TRADEMARK

FIRST USE 11-1-2011; IN COMMERCE 11-1-2011.

PRINCIPAL REGISTER

NO CLAIM IS MADE TO THE EXCLUSIVE RIGHT TO USE "TOBACCONISTS" AND "CIGARS", APART FROM THE MARK AS SHOWN.

THE MARK CONSISTS OF THE WORD "TOC" IN THE CENTER OF A DIAMOND WITH A BOXER IN A SMALLER DIAMOND ON EITHER SIDE OF THE CENTER DIAMOND, AND THE WORD "KNOCKOUT" IN AN OVAL ABOVE "TOC" WITH THE WORD "TOBACCONISTS" UNDER THE OVAL, AND THE WORD "CIGARS" IN AN OVAL UNDERNEATH "TOC" WITH THE WORD "ONLY" ABOVE THE OVAL.

SER. NO. 85-528,075, FILED 1-29-2012.

APRIL ROACH, EXAMINING ATTORNEY



David J. Kyffers

Director of the United States Patent and Trademark Office

United States of America

United States Patent and Trademark Office



Reg. No. 4,175,755

Registered July 17, 2012

Int. Cl.: 42

SERVICE MARK

PRINCIPAL REGISTER

INTERNATIONAL COUNCIL OF E-COMMERCE CONSULTANTS (NEVADA CORPORATION), AKA EC-COUNCIL
6330 RIVERSIDE PLAZA LANE, NW STE 210
ALBUQUERQUE, NM 87120

FOR: TESTING, ANALYSIS, AND EVALUATION OF THE KNOWLEDGE, SKILLS AND ABILITIES OF OTHERS FOR THE PURPOSE OF CERTIFICATION AND RE-CERTIFICATION IN THE FIELD OF INFORMATION TECHNOLOGY SECURITY EDUCATION, IN CLASS 42 (U.S. CLS. 100 AND 101).

FIRST USE 1-1-2011; IN COMMERCE 1-1-2011.

NO CLAIM IS MADE TO THE EXCLUSIVE RIGHT TO USE "CERTIFIED, CHIEF, INFORMATION, SECURITY, OFFICER", APART FROM THE MARK AS SHOWN.

THE MARK CONSISTS OF THE WORDING "C|CISO CERTIFIED CHIEF INFORMATION SECURITY OFFICER" IN PLAIN LETTERS.

SEC. 2(F).

SER. NO. 85-528,092, FILED 1-29-2012.

C. DIONNE CLYBURN, EXAMINING ATTORNEY



David J. Kyffers

Director of the United States Patent and Trademark Office

United States of America

United States Patent and Trademark Office



Reg. No. 4,175,756

Registered July 17, 2012

Int. Cl.: 38

SERVICE MARK

PRINCIPAL REGISTER

BANDWIDTH.COM, INC. (DELAWARE CORPORATION)
4001 WESTON PARKWAY, SUITE 100
CARY, NC 27101

FOR: PROVIDING UNIFIED COMMUNICATIONS SERVICES VIA COMPUTER AND TELECOMMUNICATIONS NETWORKS; INTERNET TELEPHONY SERVICES; VOICE OVER INTERNET PROTOCOL (VOIP) SERVICES, IN CLASS 38 (U.S. CLS. 100, 101 AND 104).

FIRST USE 11-8-2011; IN COMMERCE 11-8-2011.

THE MARK CONSISTS OF A GREEN ARC.

THE COLOR(S) GREEN IS/ARE CLAIMED AS A FEATURE OF THE MARK.

SER. NO. 85-528,166, FILED 1-30-2012.

JULIE VEPPUMTHARA, EXAMINING ATTORNEY



David J. Kyffers

Director of the United States Patent and Trademark Office

United States of America
United States Patent and Trademark Office

BADLAND

Reg. No. 4,175,757

HARBOR FREIGHT TOOLS USA, INC. (DELAWARE CORPORATION)
26541 AGOURA ROAD
CALABASAS, CA 91302

Registered July 17, 2012

Int. Cl.: 7

FOR: WINCHES, IN CLASS 7 (U.S. CLS. 13, 19, 21, 23, 31, 34 AND 35).

TRADEMARK

FIRST USE 12-1-2010; IN COMMERCE 12-1-2010.

PRINCIPAL REGISTER

THE MARK CONSISTS OF STANDARD CHARACTERS WITHOUT CLAIM TO ANY PARTICULAR FONT, STYLE, SIZE, OR COLOR.

SER. NO. 85-528,188, FILED 1-30-2012.

STEVEN PEREZ, EXAMINING ATTORNEY



David J. Kyffers

Director of the United States Patent and Trademark Office

United States of America

United States Patent and Trademark Office



Reg. No. 4,175,758

Registered July 17, 2012

Int. Cl.: 35

SERVICE MARK

PRINCIPAL REGISTER

COLDWELL BANKER REAL ESTATE LLC (CALIFORNIA LIMITED LIABILITY COMPANY)
1 CAMPUS DRIVE
PARSIPPANY, NJ 07054

FOR: REAL ESTATE BROKERAGE FRANCHISING SERVICES, NAMELY, RENDERING TECHNICAL ASSISTANCE TO OTHERS IN THE ESTABLISHMENT AND/OR OPERATIONS OF REAL ESTATE BROKERAGE BUSINESSES, IN CLASS 35 (U.S. CLS. 100, 101 AND 102).

FIRST USE 3-31-2010; IN COMMERCE 3-31-2010.

OWNER OF U.S. REG. NOS. 1,215,241, 2,745,034 AND OTHERS.

THE COLOR(S) DARK BLUE, MEDIUM BLUE, LIGHT BLUE, WHITE AND GREY IS/ARE CLAIMED AS A FEATURE OF THE MARK.

THE MARK CONSISTS OF A LARGE WHITE RECTANGULAR BOX WITH GREY SHADING AND A SHADOW ALONG THE BOTTOM WITH GREY SHADING LEADING INTO WHITE GOING UP THE SIDES. INSIDE THE WHITE RECTANGULAR BOX IS A RECTANGULAR BOX IN THE COLORS LIGHT BLUE, MEDIUM BLUE, AND DARK BLUE, WITH THE STYLIZED WHITE WORDING "COLDWELL" OVER THE STYLIZED WHITE WORDING "BANKER", WITH THE AFOREMENTIONED WORDING HAVING GREY, DARK BLUE, AND LIGHT BLUE SHADING; THE STYLIZED LETTERS "CB" APPEAR IN DARK BLUE UPON A SMALL WHITE SQUARE BOX WITH ROUNDED CORNERS, WITH SAID BOX APPEARING TO THE RIGHT OF THE WORD "BANKER". THE WORDS, LETTERS AND SMALL WHITE BOX INSIDE THE LIGHT, BLUE, MEDIUM BLUE, AND DARK BLUE RECTANGLE APPEAR TO RAISED BY THE DARK BLUE SHADOW THAT OUTLINES THE WORDS AND THE SMALL WHITE BOX. THE RECTANGULAR BOX CONTAINING THE AFOREMENTIONED BLUE SHADES LIGHT BLUE AT THE TOP, BECOMES DARK BLUE AROUND THE WORDS AND THE WHITE BOX, AND THEN BECOMES MEDIUM BLUE TOWARDS THE BOTTOM.



SER. NO. 85-528,560, FILED 1-30-2012.

KEVIN CORWIN, EXAMINING ATTORNEY

David J. Kyffers

Director of the United States Patent and Trademark Office

United States of America

United States Patent and Trademark Office



Reg. No. 4,175,759

COLDWELL BANKER REAL ESTATE LLC (CALIFORNIA LIMITED LIABILITY COMPANY)
1 CAMPUS DRIVE
PARSIPPANY, NJ 07054

Registered July 17, 2012

Int. Cl.: 36

FOR: REAL ESTATE BROKERAGE, MORTGAGE LENDING, ASSET MANAGEMENT AND ESCROW SERVICES, AND ARRANGING FOR TITLE INSURANCE AND REAL ESTATE FINANCING FOR OTHERS; REAL ESTATE PROPERTY MANAGEMENT SERVICES, IN CLASS 36 (U.S. CLS. 100, 101 AND 102).

SERVICE MARK

PRINCIPAL REGISTER

FIRST USE 3-31-2010; IN COMMERCE 3-31-2010.

OWNER OF U.S. REG. NOS. 1,215,241, 2,745,034 AND OTHERS.

THE COLOR(S) DARK BLUE, MEDIUM BLUE, LIGHT BLUE, WHITE AND GREY IS/ARE CLAIMED AS A FEATURE OF THE MARK.

THE MARK CONSISTS OF A LARGE WHITE RECTANGULAR BOX WITH GREY SHADING AND A SHADOW ALONG THE BOTTOM WITH GREY SHADING LEADING INTO WHITE GOING UP THE SIDES. INSIDE THE WHITE RECTANGULAR BOX IS A RECTANGULAR BOX IN THE COLORS LIGHT BLUE, MEDIUM BLUE, AND DARK BLUE, WITH THE STYLIZED WHITE WORDING "COLDWELL" OVER THE STYLIZED WHITE WORDING "BANKER", WITH THE AFOREMENTIONED WORDING HAVING GREY, DARK BLUE, AND LIGHT BLUE SHADING; THE STYLIZED LETTERS "CB" APPEAR IN DARK BLUE UPON A SMALL WHITE SQUARE BOX WITH ROUNDED CORNERS, WITH SAID BOX APPEARING TO THE RIGHT OF THE WORD "BANKER". THE WORDS, LETTERS AND SMALL WHITE BOX INSIDE THE LIGHT, BLUE, MEDIUM BLUE, AND DARK BLUE RECTANGLE APPEAR TO RAISED BY THE DARK BLUE SHADOW THAT OUTLINES THE WORDS AND THE SMALL WHITE BOX. THE RECTANGULAR BOX CONTAINING THE AFOREMENTIONED BLUE SHADES LIGHT BLUE AT THE TOP, BECOMES DARK BLUE AROUND THE WORDS AND THE WHITE BOX, AND THEN BECOMES MEDIUM BLUE TOWARDS THE BOTTOM.



David J. Kyppas

SER. NO. 85-528,627, FILED 1-30-2012.

KEVIN CORWIN, EXAMINING ATTORNEY

United States of America

United States Patent and Trademark Office

Where Fashion Meets Social

Reg. No. 4,175,760

TRENLEND LLC (NEW JERSEY LIMITED LIABILITY COMPANY)

Registered July 17, 2012

7201 BLACK HORSE PIKE
MAYS LANDING, NJ 08330

Int. Cl.: 42

FOR: COMPUTER SERVICES, NAMELY, CREATING AN ON-LINE COMMUNITY FOR REGISTERED USERS TO PARTICIPATE IN DISCUSSIONS, GET FEEDBACK FROM THEIR PEERS, FORM VIRTUAL COMMUNITIES, AND ENGAGE IN SOCIAL NETWORKING SERVICES IN THE FIELD OF FASHION, IN CLASS 42 (U.S. CLS. 100 AND 101).

SERVICE MARK

PRINCIPAL REGISTER

FIRST USE 1-26-2012; IN COMMERCE 1-26-2012.

THE MARK CONSISTS OF STANDARD CHARACTERS WITHOUT CLAIM TO ANY PARTICULAR FONT, STYLE, SIZE, OR COLOR.

SER. NO. 85-528,718, FILED 1-30-2012.

ANNE MADDEN, EXAMINING ATTORNEY



David J. Kyffers

Director of the United States Patent and Trademark Office

United States of America

United States Patent and Trademark Office

VICTORY

Reg. No. 4,175,761

Registered July 17, 2012

Int. Cl.: 32

TRADEMARK

PRINCIPAL REGISTER

VICTORY BREWING COMPANY (PENNSYLVANIA CORPORATION)
420 ACORN LANE
DOWNTOWN, PA 19335

FOR: SOFT DRINKS, NAMELY, SODA, IN CLASS 32 (U.S. CLS. 45, 46 AND 48).

FIRST USE 5-31-2011; IN COMMERCE 5-31-2011.

THE MARK CONSISTS OF STANDARD CHARACTERS WITHOUT CLAIM TO ANY PARTICULAR FONT, STYLE, SIZE, OR COLOR.

OWNER OF U.S. REG. NO. 2,829,014.

SER. NO. 85-528,741, FILED 1-30-2012.

RUSS HERMAN, EXAMINING ATTORNEY



David J. Kyffers

Director of the United States Patent and Trademark Office

United States of America

United States Patent and Trademark Office

A VICTORY FOR YOUR TASTE

Reg. No. 4,175,762

Registered July 17, 2012

Int. Cl.: 32

TRADEMARK

PRINCIPAL REGISTER

VICTORY BREWING COMPANY (PENNSYLVANIA CORPORATION)
420 ACORN LANE
DOWNTOWN, PA 19335

FOR: BEVERAGES, NAMELY, BEER AND ALE, IN CLASS 32 (U.S. CLS. 45, 46 AND 48).

FIRST USE 3-31-1998; IN COMMERCE 3-31-1998.

THE MARK CONSISTS OF STANDARD CHARACTERS WITHOUT CLAIM TO ANY PARTICULAR FONT, STYLE, SIZE, OR COLOR.

OWNER OF U.S. REG. NO. 2,829,014.

SER. NO. 85-528,806, FILED 1-30-2012.

RUSS HERMAN, EXAMINING ATTORNEY



David J. Kyffers

Director of the United States Patent and Trademark Office

United States of America

United States Patent and Trademark Office

AgileMap

Reg. No. 4,175,763

Registered July 17, 2012

Int. Cl.: 42

SERVICE MARK

PRINCIPAL REGISTER

BRAUN INTERTEC CORPORATION (MINNESOTA CORPORATION)
11001 HAMPSHIRE AVENUE SOUTH
MINNEAPOLIS, MN 55438

FOR: SOFTWARE AS A SERVICE (SAAS) SERVICES FEATURING SOFTWARE FOR USE ON INTERNAL COMPUTER NETWORKS AND GLOBAL COMMUNICATION NETWORKS, NAMELY, SOFTWARE FOR PROJECT MANAGEMENT INCORPORATING GEOGRAPHIC INFORMATION SYSTEMS (GIS) CAPABILITIES, COLLABORATION AND WORK PROCESSES FOR THE ARCHITECTURE, ENGINEERING AND CONSTRUCTION (AEC) FIELD, IN CLASS 42 (U.S. CLS. 100 AND 101).

FIRST USE 1-23-2012; IN COMMERCE 1-23-2012.

THE MARK CONSISTS OF STANDARD CHARACTERS WITHOUT CLAIM TO ANY PARTICULAR FONT, STYLE, SIZE, OR COLOR.

OWNER OF U.S. REG. NO. 4,087,091.

SER. NO. 85-528,838, FILED 1-30-2012.

MIDGE BUTLER, EXAMINING ATTORNEY



David J. Kyffers

Director of the United States Patent and Trademark Office

United States of America

United States Patent and Trademark Office

MARIO BATALI

Reg. No. 4,175,764

Registered July 17, 2012

Int. Cl.: 30

MARIO BATALI (UNITED STATES INDIVIDUAL)
C/O OTTO ENOTECA
ONE FIFTH AVENUE
NEW YORK, NY 10003

FOR: PASTA, IN CLASS 30 (U.S. CL. 46).

TRADEMARK

FIRST USE 9-30-2010; IN COMMERCE 9-30-2010.

PRINCIPAL REGISTER

THE MARK CONSISTS OF STANDARD CHARACTERS WITHOUT CLAIM TO ANY PARTICULAR FONT, STYLE, SIZE, OR COLOR.

OWNER OF U.S. REG. NOS. 2,788,274, 4,025,840, AND 4,053,860.

SER. NO. 85-529,308, FILED 1-31-2012.

MARGARET POWER, EXAMINING ATTORNEY



David J. Kyffers

Director of the United States Patent and Trademark Office

United States of America

United States Patent and Trademark Office



Reg. No. 4,175,765

COLDWELL BANKER REAL ESTATE LLC (CALIFORNIA LIMITED LIABILITY COMPANY)
1 CAMPUS DRIVE
PARSIPPANY, NJ 07054

Registered July 17, 2012

Int. Cl.: 35

FOR: COMMERCIAL REAL ESTATE BROKERAGE FRANCHISING SERVICES, NAMELY, RENDERING TECHNICAL ASSISTANCE TO OTHERS IN THE ESTABLISHMENT AND/OR OPERATION OF COMMERCIAL REAL ESTATE BROKERAGE BUSINESSES, IN CLASS 35 (U.S. CLS. 100, 101 AND 102).

SERVICE MARK

PRINCIPAL REGISTER

FIRST USE 6-30-2010; IN COMMERCE 6-30-2010.

OWNER OF U.S. REG. NOS. 1,215,241, 2,745,034 AND OTHERS.

THE COLOR(S) DARK BLUE, BLUE, WHITE AND GREY IS/ARE CLAIMED AS A FEATURE OF THE MARK.

NO CLAIM IS MADE TO THE EXCLUSIVE RIGHT TO USE "COMMERCIAL", APART FROM THE MARK AS SHOWN.

THE MARK CONSISTS OF A LARGE BLUE RECTANGULAR BOX. INSIDE THE BLUE RECTANGULAR BOX ON THE LEFT HAND SIDE ARE THE INTERLOCKING LETTERS "CB" IN WHITE INSIDE OF A WHITE SQUARE FRAME WITH A GREY BORDER ALONG THE TOP AND RIGHT SIDE OF THE FRAME AND A GREY BORDER ALONG THE LEFT INSIDE EDGE OF THE FRAME WITH A DARK BLUE SHADOW OF THE FRAME APPEARING INSIDE ALONG THE TOP AND LEFT EDGES. THE WHITE INTERLOCKING LETTERS ARE ALSO OUTLINED IN GREY WITH A DARK BLUE SHADOW OF THE LETTERS UNDERNEATH. TO THE RIGHT OF THE FRAMED "CB" ARE THE WORDS "COLDWELL" OVER THE WORD "BANKER" OVER THE WORD "COMMERCIAL". ALL THREE WORDS APPEAR IN WHITE WITH DARK BLUE SHADOWS UNDER THE LETTERING. THE WORDS, LETTERS AND WHITE FRAME BOX INSIDE THE BLUE RECTANGLE APPEAR RAISED BY THE DARK BLUE SHADOW THAT OUTLINES THE WORDS AND THE SMALL WHITE BOX. THE BLUE RECTANGULAR BOX IS LIGHTER AT THE TOP AND BECOMES DARKER AROUND THE WORDS, THE WHITE BOX AND THE INTERLOCKING LETTERS AND THEN BECOMES A DARK BLUE TOWARDS THE BOTTOM.



David J. Kyffers

SER. NO. 85-529,640, FILED 1-31-2012.

Reg. No. 4,175,765 KEVIN CORWIN, EXAMINING ATTORNEY

United States of America

United States Patent and Trademark Office



Reg. No. 4,175,766

COLDWELL BANKER REAL ESTATE LLC (CALIFORNIA LIMITED LIABILITY COMPANY)
1 CAMPUS DRIVE
PARSIPPANY, NJ 07054

Registered July 17, 2012

Int. Cl.: 36

FOR: COMMERCIAL REAL ESTATE SERVICES, SPECIFICALLY, PROPERTY MANAGEMENT SERVICES, REAL ESTATE BROKERAGE, MORTGAGE LENDING, ASSET MANAGEMENT, ESCROW SERVICES AND ARRANGING FOR TITLE INSURANCE AND REAL ESTATE FINANCING FOR OTHERS, IN CLASS 36 (U.S. CLS. 100, 101 AND 102).

SERVICE MARK

PRINCIPAL REGISTER

FIRST USE 6-30-2010; IN COMMERCE 6-30-2010.

OWNER OF U.S. REG. NOS. 1,215,241, 2,745,034 AND OTHERS.

THE COLOR(S) DARK BLUE, BLUE, WHITE AND GREY IS/ARE CLAIMED AS A FEATURE OF THE MARK.

NO CLAIM IS MADE TO THE EXCLUSIVE RIGHT TO USE "COMMERCIAL", APART FROM THE MARK AS SHOWN.

THE MARK CONSISTS OF A LARGE BLUE RECTANGULAR BOX. INSIDE THE BLUE RECTANGULAR BOX ON THE LEFT HAND SIDE ARE THE INTERLOCKING LETTERS "CB" IN WHITE INSIDE OF A WHITE SQUARE FRAME WITH A GREY BORDER ALONG THE TOP AND RIGHT SIDE OF THE FRAME AND A GREY BORDER ALONG THE LEFT INSIDE EDGE OF THE FRAME WITH A DARK BLUE SHADOW OF THE FRAME APPEARING INSIDE ALONG THE TOP AND LEFT EDGES. THE WHITE INTERLOCKING LETTERS ARE ALSO OUTLINED IN GREY WITH A DARK BLUE SHADOW OF THE LETTERS UNDERNEATH. TO THE RIGHT OF THE FRAMED "CB" ARE THE WORDS "COLDWELL" OVER THE WORD "BANKER" OVER THE WORD "COMMERCIAL". ALL THREE WORDS APPEAR IN WHITE WITH DARK BLUE SHADOWS UNDER THE LETTERING. THE WORDS, LETTERS AND WHITE FRAME BOX INSIDE THE BLUE RECTANGLE APPEAR RAISED BY THE DARK BLUE SHADOW THAT OUTLINES THE WORDS AND THE SMALL WHITE BOX. THE BLUE RECTANGULAR BOX IS LIGHTER AT THE TOP AND BECOMES DARKER AROUND THE WORDS, THE WHITE BOX AND THE INTERLOCKING LETTERS AND THEN BECOMES A DARK BLUE TOWARDS THE BOTTOM.



David J. Kybas

SER. NO. 85-529,643, FILED 1-31-2012.

Reg. No. 4,175,766 KEVIN CORWIN, EXAMINING ATTORNEY

United States of America

United States Patent and Trademark Office



MagMutual

Reg. No. 4,175,767

Registered July 17, 2012

Int. Cl.: 36

SERVICE MARK

PRINCIPAL REGISTER

MAG MUTUAL INSURANCE COMPANY (GEORGIA CORPORATION)
3525 PIEDMONT ROAD; BLDG 8-600
ATLANTA, GA 30305

FOR: INSURANCE AGENCY AND BROKERAGE, INSURANCE UNDERWRITING AND REINSURANCE UNDERWRITING FOR HEALTHCARE PROVIDERS ALL IN THE FIELDS OF LIFE, HEALTH, PROPERTY AND CASUALTY INSURANCE; PROVIDING INSURANCE POLICY INFORMATION VIA THE INTERNET TO HEALTHCARE PROVIDERS IN THE FIELDS OF LIFE, HEALTH, PROPERTY AND CASUALTY INSURANCE; INSURANCE UNDERWRITING AND REINSURANCE UNDERWRITING FOR OTHER INSURANCE AGENCIES ALL IN THE FIELDS OF LIFE, HEALTH, PROPERTY AND CASUALTY INSURANCE, IN CLASS 36 (U.S. CLS. 100, 101 AND 102).

FIRST USE 1-3-2012; IN COMMERCE 1-30-2012.

OWNER OF U.S. REG. NOS. 2,205,195, 3,626,114 AND OTHERS.

NO CLAIM IS MADE TO THE EXCLUSIVE RIGHT TO USE THE PICTORIAL REPRESENTATION OF THE CADUCEUS SYMBOL, APART FROM THE MARK AS SHOWN.

THE MARK CONSISTS OF THE WORD "MAGMUTUAL" IN STYLIZED FONT ALONGSIDE A CADUCEUS SYMBOL SUPERIMPOSED OVER TWO INTERSECTING RECTANGLES.

SER. NO. 85-529,778, FILED 1-31-2012.

DAVID YONTEF, EXAMINING ATTORNEY



David J. Kyffers

Director of the United States Patent and Trademark Office

United States of America

United States Patent and Trademark Office

SMALL SIZE BIG COLOR

Reg. No. 4,175,768

CRAYOLA PROPERTIES, INC. (DELAWARE CORPORATION)
1100 CHURCH LANE
EASTON, PA 18042

Registered July 17, 2012

Int. Cl.: 16

FOR: MARKERS; COLOR PENCILS; GLITTER GLUE FOR STATIONERY PURPOSES, IN CLASS 16 (U.S. CLS. 2, 5, 22, 23, 29, 37, 38 AND 50).

TRADEMARK

FIRST USE 12-28-2004; IN COMMERCE 12-28-2004.

PRINCIPAL REGISTER

THE MARK CONSISTS OF STANDARD CHARACTERS WITHOUT CLAIM TO ANY PARTICULAR FONT, STYLE, SIZE, OR COLOR.

SER. NO. 85-530,005, FILED 1-31-2012.

CURTIS FRENCH, EXAMINING ATTORNEY



David J. Kyffers

Director of the United States Patent and Trademark Office

United States of America

United States Patent and Trademark Office

NITRAFLEX

Reg. No. 4,175,769

WORLD HEALTH PRODUCTS, LLC (CONNECTICUT LIMITED LIABILITY COMPANY)
64 SUNNYSIDE AVE.
STAMFORD, CT 06902

Registered July 17, 2012

Int. Cl.: 5

FOR: DIETARY SUPPLEMENTS, IN CLASS 5 (U.S. CLS. 6, 18, 44, 46, 51 AND 52).

TRADEMARK

FIRST USE 3-0-2011; IN COMMERCE 3-0-2011.

PRINCIPAL REGISTER

THE MARK CONSISTS OF STANDARD CHARACTERS WITHOUT CLAIM TO ANY PARTICULAR FONT, STYLE, SIZE, OR COLOR.

SER. NO. 85-531,167, FILED 2-1-2012.

JAMES LOVELACE, EXAMINING ATTORNEY



David J. Kyffers

Director of the United States Patent and Trademark Office

United States of America

United States Patent and Trademark Office



Reg. No. 4,175,770

Registered July 17, 2012

Int. Cl.: 32

TRADEMARK

PRINCIPAL REGISTER

ACAVA LIMITED (MALTA LIMITED COMPANY (LTD.))
167, MERCHANTS STREET
VALLETA VLT, MALTA 1174

FOR: SOFT DRINKS, IN CLASS 32 (U.S. CLS. 45, 46 AND 48).

FIRST USE 6-6-2011; IN COMMERCE 7-22-2011.

THE MARK CONSISTS OF THE STYLIZED WORD "ORO" IN YELLOW WITH THE STYLIZED WORDS "SABOR DE" IN YELLOW, SMALLER FONT APPEARING ABOVE THE FIRST LETTER "O" OF "ORO". THE BACKGROUND OF THE MARK CONSISTS OF A BLUE WAVE DESIGN IN THE UPPER LEFT COMBINING IN THE MIDDLE OF THE MARK WITH A LIGHT BLUE AND BLUE POLKA DOTS WAVE DESIGN IN THE LOWER RIGHT. ORANGE AND GRAY ACCENT MARKINGS APPEAR BELOW THE FIRST LETTER "O" AND ABOVE THE SECOND LETTER "O" OF THE WORD "ORO".

THE COLOR(S) BLUE, LIGHT BLUE, YELLOW, ORANGE, AND GRAY IS/ARE CLAIMED AS A FEATURE OF THE MARK.

THE ENGLISH TRANSLATION OF "SABOR DE ORO" IN THE MARK IS "GOLD FLAVOR".

SER. NO. 85-532,930, FILED 2-3-2012.

DAVID MURRAY, EXAMINING ATTORNEY



David J. Kyffers

Director of the United States Patent and Trademark Office

United States of America

United States Patent and Trademark Office



Reg. No. 4,175,771

RAYNALDO GARZA (UNITED STATES INDIVIDUAL)
2245 NORTH GREEN VALLEY PARKWAY # 282
HENDERSON, NV 89014

Registered July 17, 2012

Int. Cl.: 35

FOR: PRODUCT MERCHANDISING, IN CLASS 35 (U.S. CLS. 100, 101 AND 102).

SERVICE MARK

FIRST USE 11-2-2004; IN COMMERCE 1-25-2005.

PRINCIPAL REGISTER

OWNER OF U.S. REG. NOS. 3,311,287 AND 3,741,517.

THE COLOR(S) RED AND BLACK IS/ARE CLAIMED AS A FEATURE OF THE MARK.

NO CLAIM IS MADE TO THE EXCLUSIVE RIGHT TO USE "LV", APART FROM THE MARK AS SHOWN.

THE MARK CONSISTS OF THE LETTERS "I" AND "LV" IN BLACK, WITH A RED HEART BETWEEN THE LETTERS.

SER. NO. 85-533,417, FILED 2-3-2012.

CARRIE GENOVESE, EXAMINING ATTORNEY



David J. Kybas

Director of the United States Patent and Trademark Office

United States of America

United States Patent and Trademark Office

BUCKHORN

Reg. No. 4,175,772

WEST CENTRAL, INC. (MINNESOTA CORPORATION)
2700 TROTT AVE. SW
WILLMAR, MN 56201

Registered July 17, 2012

Int. Cl.: 1

FOR: ADJUVANT FOR USE WITH AGRICULTURAL CHEMICALS; ADJUVANTS FOR USE WITH PESTICIDES, IN CLASS 1 (U.S. CLS. 1, 5, 6, 10, 26 AND 46).

TRADEMARK

FIRST USE 10-12-2011; IN COMMERCE 10-14-2011.

PRINCIPAL REGISTER

THE MARK CONSISTS OF STANDARD CHARACTERS WITHOUT CLAIM TO ANY PARTICULAR FONT, STYLE, SIZE, OR COLOR.

SER. NO. 85-534,493, FILED 2-6-2012.

NICHOLAS ALTREE, EXAMINING ATTORNEY



David J. Kybas

Director of the United States Patent and Trademark Office

United States of America

United States Patent and Trademark Office



MAKING A DIFFERENCE.

Reg. No. 4,175,773

CINTAS HOLDINGS, LLC (OHIO LIMITED LIABILITY COMPANY)
6800 CINTAS BOULEVARD
MASON, OH 45040

Registered July 17, 2012

Int. Cl.: 35

FOR: CHARITABLE SERVICES, NAMELY, ORGANIZING AND CONDUCTING VOLUNTEER PROGRAMS AND COMMUNITY SERVICE PROJECTS, IN CLASS 35 (U.S. CLS. 100, 101 AND 102).

SERVICE MARK

FIRST USE 11-1-2007; IN COMMERCE 11-1-2007.

PRINCIPAL REGISTER

OWNER OF U.S. REG. NOS. 985,550, 1,003,590 AND OTHERS.

THE MARK CONSISTS OF THE WORD "CINTAS" ABOVE THE STYLIZED WORDS "CLOTHE THE KIDS" INSIDE A BOX, ABOVE THE WORDS "MAKING A DIFFERENCE".

SER. NO. 85-534,534, FILED 2-6-2012.

KIMBERLY FRYE, EXAMINING ATTORNEY



David J. Kyffers

Director of the United States Patent and Trademark Office

United States of America

United States Patent and Trademark Office

STRESS SHIELD NIGHTTIME

Reg. No. 4,175,774

COUNTRY LIFE, LLC (NEW YORK LIMITED LIABILITY COMPANY)
180 VANDERBILT MOTOR PARKWAY
HAUPPAUGE, NY 11788

Registered July 17, 2012

Int. Cl.: 5

FOR: DIETARY AND NUTRITIONAL SUPPLEMENTS, IN CLASS 5 (U.S. CLS. 6, 18, 44, 46, 51 AND 52).

TRADEMARK

FIRST USE 9-21-2011; IN COMMERCE 9-21-2011.

PRINCIPAL REGISTER

THE MARK CONSISTS OF STANDARD CHARACTERS WITHOUT CLAIM TO ANY PARTICULAR FONT, STYLE, SIZE, OR COLOR.

OWNER OF U.S. REG. NO. 3,786,127.

NO CLAIM IS MADE TO THE EXCLUSIVE RIGHT TO USE "STRESS" AND "NIGHTTIME", APART FROM THE MARK AS SHOWN.

SER. NO. 85-534,751, FILED 2-6-2012.

KELLEY WELLS, EXAMINING ATTORNEY



David J. Kyffers

Director of the United States Patent and Trademark Office

United States of America

United States Patent and Trademark Office

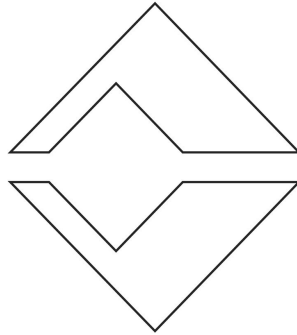

Reg. No. 4,175,775

Registered July 17, 2012

**Int. Cls.: 6, 19, 20, 35, 37
and 40**

TRADEMARK

SERVICE MARK

PRINCIPAL REGISTER

TRULITE GLASS & ALUMINUM SOLUTIONS, LLC (DELAWARE LIMITED LIABILITY COMPANY)
800 FAIRWAY DRIVE SUITE 200
DEERFIELD BEACH, FL 33441

FOR: METAL BUILDING PRODUCTS, NAMELY, GLASS FRAMING SYSTEMS, CONSISTING PRIMARILY OF SPACER BARS, CURTAIN WALLS, ENTRANCE DOORS AND WINDOWS, FRAMES AND MULLIONS FOR USE IN RESIDENTIAL, RETAIL, INDUSTRIAL AND COMMERCIAL BUILDINGS, STOREFRONTS AND ENTRANCEWAYS, IN CLASS 6 (U.S. CLS. 2, 12, 13, 14, 23, 25 AND 50).

FIRST USE 8-0-2011; IN COMMERCE 8-0-2011.

FOR: BUILDING MATERIALS AND ARCHITECTURAL PRODUCTS, NAMELY, DECORATIVE GLASS; GLASS FOR BUILDING; COLORED SHEET GLASS; GLASS PANELS FOR BUILDING CONSTRUCTION PURPOSES; INSULATED GLASS; INSULATING GLASS FOR WINDOWS FOR BUILDING PURPOSES; LAMINATED FLAT GLASS; SAFETY GLASS FOR BUILDING PURPOSES; FLAT GLASS, NAMELY, TEMPERED AND HEAT-STRENGTHENED GLASS PANELS FOR BUILDING CONSTRUCTION PURPOSES IMPRINTED WITH IMAGES VIA A SILKSCREEN PROCESS; COMMON SHEET GLASS; WIRE GLASS, NAMELY, A SAFETY GLASS FOR BUILDING PURPOSES FEATURING REINFORCING METAL WIRE; HEAT-TREATED GLASS FOR BUILDING; NON-METAL SPANDRELS; GLASS HANDRAILS FOR CONSTRUCTION PURPOSES; CLAD NON-METAL DOORS AND GLASS DOORS, IN CLASS 19 (U.S. CLS. 1, 12, 33 AND 50).

FIRST USE 8-0-2011; IN COMMERCE 8-0-2011.

FOR: MIRRORS, IN CLASS 20 (U.S. CLS. 2, 13, 22, 25, 32 AND 50).

FIRST USE 8-0-2011; IN COMMERCE 8-0-2011.

FOR: DISTRIBUTORSHIP SERVICES IN THE FIELD OF GLASS, METAL AND NON-METAL GLASS-RELATED PRODUCTS AND METAL AND NON-METAL ARCHITECTURAL PRODUCTS, IN CLASS 35 (U.S. CLS. 100, 101 AND 102).

FIRST USE 8-0-2011; IN COMMERCE 8-0-2011.



David J. Kybas

Director of the United States Patent and Trademark Office

Reg. No. 4,175,775 FOR: APPLYING DECORATIVE COATINGS TO GLASS; INSTALLATION OF CUSTOM SKYLIGHT SYSTEMS, COMMERCIAL AND RESIDENTIAL GLASS PRODUCTS, IN CLASS 37 (U.S. CLS. 100, 103 AND 106).

FIRST USE 8-0-2011; IN COMMERCE 8-0-2011.

FOR: MANUFACTURING OF BUILDING PRODUCTS FOR OTHERS, NAMELY, ALUMINUM FRAMING SYSTEMS FOR GLASS, STOREFRONTS, CURTAIN WALLS, DOORS AND WINDOWS FOR OTHERS; FABRICATION OF GLASS PRODUCTS FOR OTHERS, NAMELY, INSULATED, LAMINATED, TEMPERED, DECORATIVE, BULLET AND BLAST RESISTANT GLASS, AND MIRRORS, IN CLASS 40 (U.S. CLS. 100, 103 AND 106).

FIRST USE 8-0-2011; IN COMMERCE 8-0-2011.

THE MARK CONSISTS OF A GEOMETRIC DESIGN OF A GENERALLY DIAMOND SHAPE, COMPRISED OF TWO LETTER "V" CHARACTERS, ARRANGED SO AS TO MIRROR EACH OTHER.

SER. NO. 85-535,099, FILED 2-6-2012.

MICHAEL GAAFAR, EXAMINING ATTORNEY

United States of America

United States Patent and Trademark Office

ALLEGRO

Reg. No. 4,175,776

WHOLE FOODS MARKET IP, L.P. (DELAWARE LIMITED PARTNERSHIP)
550 BOWIE STREET, 6TH FLOOR
AUSTIN, TX 78703

Registered July 17, 2012

Int. Cl.: 30

FOR: PREPARED COCOA AND COCOA-BASED BEVERAGES; COCOA BEVERAGES WITH MILK; PREPARATIONS FOR MAKING CHOCOLATE OR COCOA BASED DRINKS, NAMELY, POWDERED CHOCOLATE MIX AND POWDERED COCOA MIX, IN CLASS 30 (U.S. CL. 46).

TRADEMARK

PRINCIPAL REGISTER

FIRST USE 11-0-2000; IN COMMERCE 11-0-2000.

THE MARK CONSISTS OF STANDARD CHARACTERS WITHOUT CLAIM TO ANY PARTICULAR FONT, STYLE, SIZE, OR COLOR.

OWNER OF U.S. REG. NOS. 1,654,990, 3,183,880 AND OTHERS.

SER. NO. 85-535,907, FILED 2-7-2012.

JILL C. ALT, EXAMINING ATTORNEY



David J. Kyffers

Director of the United States Patent and Trademark Office

United States of America

United States Patent and Trademark Office

ECO-FIX

Reg. No. 4,175,777

MENA, RAUL R. (UNITED STATES INDIVIDUAL)
201 N. UNIVERSITY DRIVE, SUITE 101
PLANTATION, FL 33324

Registered July 17, 2012

Int. Cl.: 10

FOR: DENTAL IMPLANTS, DENTAL PROSTHESES, IN CLASS 10 (U.S. CLS. 26, 39 AND 44).

TRADEMARK

FIRST USE 1-1-2011; IN COMMERCE 1-1-2011.

PRINCIPAL REGISTER

THE MARK CONSISTS OF STANDARD CHARACTERS WITHOUT CLAIM TO ANY PARTICULAR FONT, STYLE, SIZE, OR COLOR.

SER. NO. 85-535,922, FILED 2-7-2012.

DAVID TAYLOR, EXAMINING ATTORNEY



David J. Kyffers

Director of the United States Patent and Trademark Office

United States of America

United States Patent and Trademark Office

IDI

Reg. No. 4,175,778

Registered July 17, 2012

Int. Cls.: 17 and 40

TRADEMARK

SERVICE MARK

PRINCIPAL REGISTER

INDUSTRIAL DIELECTRICS, INC. (INDIANA CORPORATION)
407 S. 7TH STEET
NOBLESVILLE, IN 46060

FOR: SEMI-PROCESSED THERMOSET COMPOUNDS SOLD IN BULK, SHEET AND EXTRUDED LOGS, NAMELY, THERMOSET ELASTOMER RESINS AND THERMOSET CONCENTRATES MADE FROM POLYESTER, VINYL ESTER, POLYURETHANE, AND EPOXY RESINS; SEMI-PROCESSED THERMOSET ELASTOMER RESINS COMPRISED OF POLYESTER, VINYL ESTER, POLYURETHANE, AND EPOXY RESINS, FOR USE IN FURTHER MANUFACTURE AND SOLD IN BULK, SHEET AND EXTRUDED LOGS, IN CLASS 17 (U.S. CLS. 1, 5, 12, 13, 35 AND 50).

FIRST USE 0-0-2006; IN COMMERCE 0-0-2006.

FOR: CUSTOM MANUFACTURING OF THERMOSET MOLDING COMPOUNDS FOR OTHERS, IN CLASS 40 (U.S. CLS. 100, 103 AND 106).

FIRST USE 0-0-2006; IN COMMERCE 0-0-2006.

THE MARK CONSISTS OF STANDARD CHARACTERS WITHOUT CLAIM TO ANY PARTICULAR FONT, STYLE, SIZE, OR COLOR.

SER. NO. 85-536,214, FILED 2-7-2012.

ROBIN CHOSID, EXAMINING ATTORNEY



David J. Kybas

Director of the United States Patent and Trademark Office

United States of America

United States Patent and Trademark Office

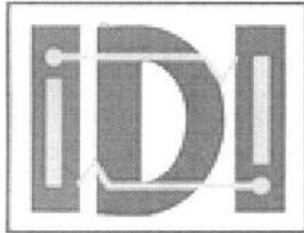

Reg. No. 4,175,779

INDUSTRIAL DIELECTRICS, INC. (INDIANA CORPORATION)
407 S. 7TH STREET
NOBLESVILLE, IN 46060

Registered July 17, 2012

Int. Cl.: 40

FOR: CUSTOM MANUFACTURING OF THERMOSET MOLDING COMPOUNDS FOR OTHERS, IN CLASS 40 (U.S. CLS. 100, 103 AND 106).

SERVICE MARK

FIRST USE 0-0-2006; IN COMMERCE 0-0-2006.

PRINCIPAL REGISTER

THE MARK CONSISTS OF THE BLOCK LETTERS IDI WITHIN A RECTANGULAR BOX AND HAVING ON THEIR FACE TWO HORIZONTAL LINEAR DESIGNS WITH SOLID CIRCLES AT ONE END AND PARTIAL TRIANGLES AT THE OTHER, AND TWO VERTICAL BARS, ONE OVER EACH LETTER "I".

SER. NO. 85-536,316, FILED 2-7-2012.

ROBIN CHOSID, EXAMINING ATTORNEY



David J. Kybas

Director of the United States Patent and Trademark Office

United States of America

United States Patent and Trademark Office

UNIBEARSTY

Reg. No. 4,175,780

RAYNALDO GARZA (UNITED STATES INDIVIDUAL)
2245 NORTH GREEN VALLEY PARKWAY # 282
HENDERSON, NV 89014

Registered July 17, 2012

Int. Cl.: 16

FOR: POSTERS, GREETING CARDS, STICKERS, POST CARDS, THREE-RING BINDERS, POSTAGE STAMPS, CALENDARS, NOTE CARDS, DAY PLANNERS, STATIONERY, ENVELOPES, INVITATION CARDS AND CHRISTMAS CARDS, IN CLASS 16 (U.S. CLS. 2, 5, 22, 23, 29, 37, 38 AND 50).

TRADEMARK

PRINCIPAL REGISTER

FIRST USE 9-10-2001; IN COMMERCE 2-5-2012.

THE MARK CONSISTS OF STANDARD CHARACTERS WITHOUT CLAIM TO ANY PARTICULAR FONT, STYLE, SIZE, OR COLOR.

OWNER OF U.S. REG. NO. 3,674,509.

SER. NO. 85-536,563, FILED 2-8-2012.

CARRIE GENOVESE, EXAMINING ATTORNEY



David J. Kyjars

Director of the United States Patent and Trademark Office

United States of America

United States Patent and Trademark Office

SAGEWORKS ANALYST

Reg. No. 4,175,781

Registered July 17, 2012

Int. Cl.: 42

SERVICE MARK

PRINCIPAL REGISTER

SAGEWORKS, INC. (NORTH CAROLINA CORPORATION)
SUITE 201
5565 CENTERVIEW DRIVE
RALEIGH, NC 27606

FOR: PROVIDING USE OF ONLINE NON-DOWNLOADABLE SOFTWARE FOR CONDUCTING FINANCIAL ANALYSIS, CREDIT AND LOAN ANALYSIS, AND BUSINESS ANALYSIS IN THE FIELDS OF FINANCE, BANKING, AND ACCOUNTING, IN CLASS 42 (U.S. CLS. 100 AND 101).

FIRST USE 11-1-2005; IN COMMERCE 11-1-2005.

THE MARK CONSISTS OF STANDARD CHARACTERS WITHOUT CLAIM TO ANY PARTICULAR FONT, STYLE, SIZE, OR COLOR.

SER. NO. 85-536,842, FILED 2-8-2012.

JOHN HWANG, EXAMINING ATTORNEY



David J. Kyffers

Director of the United States Patent and Trademark Office

United States of America

United States Patent and Trademark Office

CAPCOM

Reg. No. 4,175,782

Registered July 17, 2012

Int. Cl.: 16

TRADEMARK

PRINCIPAL REGISTER

CAPCOM CO., LTD. (JAPAN CORPORATION)
3-1-3 UCHIHIRANOMACHI, CHUO-KU
OSAKA, JAPAN

FOR: VIDEO GAME AND COMPUTER GAME STRATEGY GUIDEBOOKS; VIDEO GAME AND COMPUTER GAME INSTRUCTION MANUALS; BOOKS AND MAGAZINES IN THE FIELD OF VIDEO GAME AND COMPUTER GAME STRATEGY; BOOKS AND MAGAZINES FEATURING VIDEO GAME AND COMPUTER GAME; A SERIES OF BOOKS FEATURING FICTIONAL OR FANTASY STORIES; COMIC BOOKS; GRAPHIC NOVELS; TRADING CARDS AND COLLECTORS CARDS FEATURING VIDEO GAME AND COMIC BOOK CHARACTERS; STATIONERY, IN CLASS 16 (U.S. CLS. 2, 5, 22, 23, 29, 37, 38 AND 50).

FIRST USE 0-0-1992; IN COMMERCE 0-0-1999.

OWNER OF U.S. REG. NOS. 1,447,723, 3,711,697 AND OTHERS.

THE COLOR(S) BLUE AND YELLOW IS/ARE CLAIMED AS A FEATURE OF THE MARK.

THE MARK CONSISTS OF THE WORD "CAPCOM" IN YELLOW LETTERS. THE COLOR BLUE OUTLINES THE YELLOW LETTERS AND ALSO APPEARS INSIDE THE LETTERS "A", "P", THE SECOND LETTER "C" AND "O".

SER. NO. 85-538,272, FILED 2-9-2012.

GINA FINK, EXAMINING ATTORNEY



David J. Kybas

Director of the United States Patent and Trademark Office

United States of America

United States Patent and Trademark Office

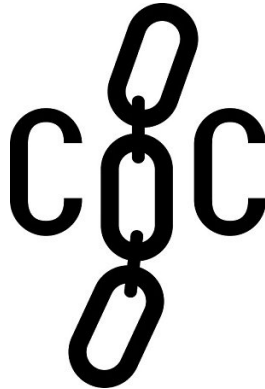

Reg. No. 4,175,783

DART INDUSTRIES INC. (DELAWARE CORPORATION)
14901 S. ORANGE BLOSSOM TRAIL
ORLANDO, FL 32837

Registered July 17, 2012

Int. Cls.: 36 and 38

FOR: FINANCIAL SPONSORSHIP OF PROGRAMS DIRECTED TO CHILDREN, IN CLASS 36 (U.S. CLS. 100, 101 AND 102).

SERVICE MARK

FIRST USE 5-31-2011; IN COMMERCE 5-31-2011.

PRINCIPAL REGISTER

FOR: PROVIDING AN ON-LINE FORUM FOR TRANSMISSION OF MESSAGES AMONG COMPUTER USERS CONCERNING TOPICS OF GENERAL INTEREST TO WOMEN, IN CLASS 38 (U.S. CLS. 100, 101 AND 104).

FIRST USE 5-31-2011; IN COMMERCE 5-31-2011.

THE MARK CONSISTS OF THE LETTERS "COC" WITH THE "O" FORMING PART OF A CHAIN LINK DESIGN.

SER. NO. 85-538,463, FILED 2-9-2012.

ANDREA BUTLER, EXAMINING ATTORNEY



David J. Kybas

Director of the United States Patent and Trademark Office

United States of America

United States Patent and Trademark Office



Reg. No. 4,175,784

Registered July 17, 2012

Int. Cl.: 35

SERVICE MARK

PRINCIPAL REGISTER

RAYNALDO GARZA (UNITED STATES INDIVIDUAL)
2245 NORTH GREEN VALLEY PARKWAY # 282
HENDERSON, NV 89014

FOR: PRODUCT MERCHANDISING, IN CLASS 35 (U.S. CLS. 100, 101 AND 102).

FIRST USE 12-24-2010; IN COMMERCE 2-11-2012.

OWNER OF U.S. REG. NOS. 3,311,287 AND 3,741,517.

THE COLOR(S) RED AND BLACK IS/ARE CLAIMED AS A FEATURE OF THE MARK.

NO CLAIM IS MADE TO THE EXCLUSIVE RIGHT TO USE "LV", APART FROM THE MARK AS SHOWN.

THE MARK CONSISTS OF THE LETTERS "I" AND "LV" IN THE COLOR BLACK WITH THE LIPS IN RED.

SER. NO. 85-541,679, FILED 2-14-2012.

CARRIE GENOVESE, EXAMINING ATTORNEY



David J. Kyffers

Director of the United States Patent and Trademark Office

United States of America

United States Patent and Trademark Office

Las Vegas!

Reg. No. 4,175,785

RAYNALDO GARZA (UNITED STATES INDIVIDUAL)
2245 NORTH GREEN VALLEY PARKWAY, # 282
HENDERSON, NV 89014

Registered July 17, 2012

Int. Cl.: 25

FOR: MEN'S, WOMEN'S, CHILDREN'S AND BABY APPAREL, NAMELY, T-SHIRTS, POLO SHIRTS, TANK TOPS, SWEAT SHIRTS, ATHLETIC SHIRTS, COLLARED SHIRTS, JEANS, SWEAT PANTS, SWEAT JACKETS, HOODED SWEATSHIRTS, LEATHER JACKETS, ATHLETIC JACKETS, SHORTS, UNDERGARMENTS, LINGERIE, PAJAMAS, TENNIS SHIRTS, SKIRTS, DRESSES, WRIST BANDS, BELTS, BANDANAS, SWEATERS, NECKTIES; FOOTWEAR, NAMELY, ATHLETIC SHOES, SNEAKERS, SANDALS, FLIP FLOP SHOES, BOOTS, STOCKINGS, SOCKS; HEADWEAR, NAMELY, HATS, CAPS, VISORS, COWBOY HATS, TENNIS HATS, BASEBALL HATS, HEAD BANDS, IN CLASS 25 (U.S. CLS. 22 AND 39).

TRADEMARK

PRINCIPAL REGISTER

FIRST USE 11-12-2011; IN COMMERCE 12-10-2011.

NO CLAIM IS MADE TO THE EXCLUSIVE RIGHT TO USE "LAS VEGAS", APART FROM THE MARK AS SHOWN.

THE MARK CONSISTS OF THE LETTERS "LAS VEGAS" WITH AN EXCLAMATION MARK AND THREE STARS ABOVE THE LETTERS.

SER. NO. 85-542,295, FILED 2-14-2012.

CARRIE GENOVESE, EXAMINING ATTORNEY



David J. Kyffers

Director of the United States Patent and Trademark Office

United States of America

United States Patent and Trademark Office



Reg. No. 4,175,786

CAMP SAMOSET III, LLC (MASSACHUSETTS LIMITED LIABILITY COMPANY)
130 LITCHFIELD ROAD
EDGARTOWN, MA 02539

Registered July 17, 2012

Int. Cl.: 41

FOR: PROVIDING A WEBSITE FEATURING SOCIAL EVENT INFORMATION FOR ALUMNI OF CAMP SAMOSET; ORGANIZING AND HOSTING SOCIAL EVENTS IN THE NATURE OF REUNIONS FOR ALUMNI OF CAMP SAMOSET, IN CLASS 41 (U.S. CLS. 100, 101 AND 107).

SERVICE MARK

PRINCIPAL REGISTER

FIRST USE 8-10-2010; IN COMMERCE 8-10-2010.

THE MARK CONSISTS OF A NATIVE AMERICAN IN PROFILE WEARING A HEADDRESS.

SER. NO. 85-542,370, FILED 2-14-2012.

KATHLEEN M. VANSTON, EXAMINING ATTORNEY



David J. Kyffers

Director of the United States Patent and Trademark Office

United States of America

United States Patent and Trademark Office

ACCOUNTSECURE PLUS

Reg. No. 4,175,787

Registered July 17, 2012

Int. Cl.: 36

SERVICE MARK

PRINCIPAL REGISTER

HSBC FINANCE CORPORATION (DELAWARE CORPORATION)
55W LEGAL 10206
26525 N. RIVERWOODS BLVD.
METTAWA, IL 60045

FOR: FINANCIAL SERVICES, NAMELY, A PLAN FOR SUSPENDING OR WAIVING A CREDIT CARD ACCOUNT BALANCE UPON CERTAIN QUALIFYING EVENTS, IN CLASS 36 (U.S. CLS. 100, 101 AND 102).

FIRST USE 4-0-2001; IN COMMERCE 4-0-2001.

THE MARK CONSISTS OF STANDARD CHARACTERS WITHOUT CLAIM TO ANY PARTICULAR FONT, STYLE, SIZE, OR COLOR.

OWNER OF U.S. REG. NO. 2,581,814.

SER. NO. 85-543,761, FILED 2-15-2012.

ANDREW LEASER, EXAMINING ATTORNEY



David J. Kyffers

Director of the United States Patent and Trademark Office

United States of America

United States Patent and Trademark Office

SPLASHDOME

Reg. No. 4,175,788

SPLASHTACULAR, INC. (KANSAS CORPORATION)

Registered July 17, 2012

78-365 HIGHWAY 111, #424
LA QUINTA, CA 92253

Int. Cls.: 40 and 41

FOR: CUSTOM FABRICATION AND CONSTRUCTION OF AQUATIC PLAYGROUND EQUIPMENT, IN CLASS 40 (U.S. CLS. 100, 103 AND 106).

SERVICE MARK

FIRST USE 1-0-2012; IN COMMERCE 1-0-2012.

PRINCIPAL REGISTER

FOR: ENTERTAINMENT IN THE NATURE OF AN AMUSEMENT PARK RIDE, IN CLASS 41 (U.S. CLS. 100, 101 AND 107).

FIRST USE 1-0-2012; IN COMMERCE 1-0-2012.

THE MARK CONSISTS OF STANDARD CHARACTERS WITHOUT CLAIM TO ANY PARTICULAR FONT, STYLE, SIZE, OR COLOR.

SER. NO. 85-544,485, FILED 2-16-2012.

SHARON MEIER, EXAMINING ATTORNEY



David J. Kybas

Director of the United States Patent and Trademark Office

United States of America

United States Patent and Trademark Office

CIES

Reg. No. 4,175,789

Registered July 17, 2012

Int. Cls.: 35 and 41

SERVICE MARK

PRINCIPAL REGISTER

INSTITUTE OF INTERNATIONAL EDUCATION, INC. (NEW YORK NON-PROFIT CORPORATION)
809 UNITED NATIONS PLAZA
NEW YORK, NY 10017

FOR: ADMINISTRATION OF EDUCATION AND PROFESSIONAL EXCHANGE PROGRAMS, IN CLASS 35 (U.S. CLS. 100, 101 AND 102).

FIRST USE 2-13-1975; IN COMMERCE 8-1-1976.

FOR: EDUCATIONAL SERVICES, NAMELY, THE DEVELOPMENT OF EDUCATIONAL EXCHANGE PROGRAMS, IN CLASS 41 (U.S. CLS. 100, 101 AND 107).

FIRST USE 10-1-1999; IN COMMERCE 10-1-1999.

THE MARK CONSISTS OF STANDARD CHARACTERS WITHOUT CLAIM TO ANY PARTICULAR FONT, STYLE, SIZE, OR COLOR.

SER. NO. 85-544,810, FILED 2-16-2012.

KIMBERLY PERRY, EXAMINING ATTORNEY



David J. Kyffers

Director of the United States Patent and Trademark Office

United States of America

United States Patent and Trademark Office

CADENA DE CONFIANZA

Reg. No. 4,175,790

DART INDUSTRIES INC. (DELAWARE CORPORATION)
14901 S. ORANGE BLOSSOM TRAIL
ORLANDO, FL 32837

Registered July 17, 2012

Int. Cl.: 36

FOR: FINANCIAL SPONSORSHIP OF PROGRAMS DIRECTED TO CHILDREN, IN CLASS 36 (U.S. CLS. 100, 101 AND 102).

SERVICE MARK

FIRST USE 1-1-2010; IN COMMERCE 1-1-2010.

PRINCIPAL REGISTER

THE MARK CONSISTS OF STANDARD CHARACTERS WITHOUT CLAIM TO ANY PARTICULAR FONT, STYLE, SIZE, OR COLOR.

OWNER OF U.S. REG. NOS. 3,415,409 AND 3,666,767.

THE ENGLISH TRANSLATION OF "CADENA DE CONFIANZA" IN THE MARK IS "CHAIN OF CONFIDENCE".

SER. NO. 85-546,098, FILED 2-17-2012.

ANDREA BUTLER, EXAMINING ATTORNEY



David J. Kyffers

Director of the United States Patent and Trademark Office

United States of America

United States Patent and Trademark Office



Reg. No. 4,175,791

Registered July 17, 2012

Int. Cl.: 41

SERVICE MARK

PRINCIPAL REGISTER

SEMINOLE TRIBE OF FLORIDA (UNITED STATES FEDERALLY-RECOGNIZED INDIAN TRIBE)
6300 STIRLING ROAD
HOLLYWOOD, FL 33024

FOR: PROVIDING CASINO SERVICES FEATURING A CASINO PLAYERS REWARDS PROGRAM, IN CLASS 41 (U.S. CLS. 100, 101 AND 107).

FIRST USE 2-2-2012; IN COMMERCE 2-2-2012.

THE MARK CONSISTS OF THE STYLIZED LETTERS "PC".

SER. NO. 85-546,886, FILED 2-19-2012.

KATHLEEN M. VANSTON, EXAMINING ATTORNEY



David J. Kybas

Director of the United States Patent and Trademark Office

United States of America

United States Patent and Trademark Office



Reg. No. 4,175,792

Registered July 17, 2012

Int. Cl.: 41

SERVICE MARK

PRINCIPAL REGISTER

SEMINOLE TRIBE OF FLORIDA (UNITED STATES FEDERALLY-RECOGNIZED INDIAN TRIBE)
6300 STIRLING ROAD
HOLLYWOOD, FL 33024

FOR: ENTERTAINMENT IN THE NATURE OF A FESTIVAL PRIMARILY FEATURING LIVE MUSIC, CULINARY COMPETITIONS AND ALSO PROVIDING FOOD AND ALCOHOLIC BEVERAGES, IN CLASS 41 (U.S. CLS. 100, 101 AND 107).

FIRST USE 10-0-2011; IN COMMERCE 11-18-2011.

NO CLAIM IS MADE TO THE EXCLUSIVE RIGHT TO USE "CHAMPIONSHIP RIB COOK-OFF", APART FROM THE MARK AS SHOWN.

THE MARK CONSISTS OF THE STYLIZED WORDS "PIGS IN PARADISE" ACROSS, AND PROTRUDING FROM, A CIRCLE WITH THE WORDS "CHAMPIONSHIP RIB COOK-OFF" AROUND THE TOP BORDER OF THE CIRCLE. A PIG APPEARS ABOVE THE WORD "PIGS" AND THERE ARE TWO FIVE-POINT STARS AT THE SIDES OF THE CIRCLE.

SER. NO. 85-547,878, FILED 2-21-2012.

KATHLEEN M. VANSTON, EXAMINING ATTORNEY



David J. Kyffers

Director of the United States Patent and Trademark Office

United States of America

United States Patent and Trademark Office

MAR AZUL

Reg. No. 4,175,793

Registered July 17, 2012

Int. Cl.: 33

TRADEMARK

PRINCIPAL REGISTER

SUTTON, SUSANA P (UNITED STATES INDIVIDUAL)
SUTIE B
622 WEST RHAPSODY DRIVE
SAN ANTONIO, TX 78216

FOR: TEQUILA, IN CLASS 33 (U.S. CLS. 47 AND 49).

FIRST USE 1-1-2010; IN COMMERCE 1-1-2010.

THE MARK CONSISTS OF STANDARD CHARACTERS WITHOUT CLAIM TO ANY PARTICULAR FONT, STYLE, SIZE, OR COLOR.

THE ENGLISH TRANSLATION OF "MAR AZUL" IN THE MARK IS "BLUE SEA".

SER. NO. 85-558,387, FILED 3-2-2012.

RONALD MCMORROW, EXAMINING ATTORNEY



David J. Kyffers

Director of the United States Patent and Trademark Office

United States of America

United States Patent and Trademark Office



Reg. No. 4,175,794

Registered July 17, 2012

Int. Cls.: 16 and 28

TRADEMARK

PRINCIPAL REGISTER

CRYPTOZOIC ENTERTAINMENT, LLC (CALIFORNIA LIMITED LIABILITY COMPANY)
16279 LAGUNA CANYON ROAD
IRVINE, CA 92618

FOR: PAPER GOODS, NAMELY, COMIC BOOKS, TRADING CARDS, COLORING BOOKS, ADHESIVE STICKERS, RUB-ON TRANSFERS, NOTEBOOKS AND STATIONERY-TYPE PORTFOLIOS; POSTERS, GREETING CARDS, CALENDARS; MANUALS FOR COMPUTER GAMES, ADVERTISEMENT BOARDS OF PAPER OR CARDBOARD, PICTURES, CATALOGUES ON A VARIETY OF SUBJECTS, PHOTOGRAPHS AND PRINTS, IN CLASS 16 (U.S. CLS. 2, 5, 22, 23, 29, 37, 38 AND 50).

FIRST USE 7-1-2010; IN COMMERCE 7-1-2010.

FOR: TOYS, NAMELY, TOY ACTION FIGURES AND ACTION FIGURE ACCESSORIES; PLAYING CARDS, TRADING CARD GAMES, BOARD GAMES, IN CLASS 28 (U.S. CLS. 22, 23, 38 AND 50).

FIRST USE 7-1-2010; IN COMMERCE 7-1-2010.

THE MARK CONSISTS OF A STYLIZED IMAGE OF SKULL WEARING A SHIRT WITH ONE HORN COMING OUT OF THE FRONT OF THE SKULL SUPERIMPOSED ON TOP OF A SHIELD.

SER. NO. 85-975,088, FILED 8-4-2010.

REBECCA SMITH, EXAMINING ATTORNEY



David J. Kybas

Director of the United States Patent and Trademark Office

United States of America

United States Patent and Trademark Office

VICTORY

Reg. No. 4,175,795

Registered July 17, 2012

Int. Cl.: 32

TRADEMARK

PRINCIPAL REGISTER

VICTORY BREWING COMPANY (PENNSYLVANIA CORPORATION)
420 ACORN LANE
DOWNTOWN, PA 19335

FOR: BEVERAGES, NAMELY, BEER AND ALE, IN CLASS 32 (U.S. CLS. 45, 46 AND 48).

FIRST USE 6-27-1994; IN COMMERCE 6-27-1994.

THE MARK CONSISTS OF STANDARD CHARACTERS WITHOUT CLAIM TO ANY PARTICULAR FONT, STYLE, SIZE, OR COLOR.

OWNER OF U.S. REG. NOS. 2,751,912 AND 2,829,014.

SER. NO. 85-976,376, FILED 3-11-2011.

SANJEEV VOHRA, EXAMINING ATTORNEY



David J. Kyros

Director of the United States Patent and Trademark Office

United States of America

United States Patent and Trademark Office

FULL COUNT

Reg. No. 4,175,796

MLB ADVANCED MEDIA, L.P. (DELAWARE LIMITED PARTNERSHIP)
75 NINTH AVENUE
NEW YORK, NY 10011

Registered July 17, 2012

Int. Cls.: 38 and 41

FOR: TELECOMMUNICATION SERVICES, NAMELY, PROVIDING ELECTRONIC MESSAGE ALERTS VIA A GLOBAL COMPUTER NETWORK AND OTHER ELECTRONIC MEDIA NOTIFYING INDIVIDUALS OF NOTEWORTHY BASEBALL EVENTS; STREAMING OF AUDIO, VISUAL AND AUDIOVISUAL MATERIAL ALL IN THE FIELD OF BASEBALL VIA A GLOBAL COMPUTER NETWORK AND OTHER ELECTRONIC MEDIA, IN CLASS 38 (U.S. CLS. 100, 101 AND 104).

SERVICE MARK

PRINCIPAL REGISTER

FIRST USE 9-13-2011; IN COMMERCE 9-13-2011.

FOR: ENTERTAINMENT, EDUCATION AND INFORMATION SERVICES, NAMELY, BASEBALL GAMES, COMPETITIONS AND EXHIBITIONS RENDERED VIA A GLOBAL COMPUTER NETWORK AND OTHER ELECTRONIC MEDIA, IN CLASS 41 (U.S. CLS. 100, 101 AND 107).

FIRST USE 9-13-2011; IN COMMERCE 9-13-2011.

THE MARK CONSISTS OF STANDARD CHARACTERS WITHOUT CLAIM TO ANY PARTICULAR FONT, STYLE, SIZE, OR COLOR.

SER. NO. 85-976,387, FILED 4-15-2011.

TRICIA SONNEBORN, EXAMINING ATTORNEY



David J. Kyffers

Director of the United States Patent and Trademark Office

United States of America

United States Patent and Trademark Office

STUCK ON YOU

Reg. No. 4,175,797

Registered July 17, 2012

**Int. Cls.: 14, 16, 18, 21,
24 and 28**

STUCK ON YOU PTY LTD. (AUSTRALIA CORPORATION)
P.O. BOX 3068
GEELONG, VICTORIA, AUSTRALIA 3220

FOR: PERSONALIZED CLOCKS, IN CLASS 14 (U.S. CLS. 2, 27, 28 AND 50).

FIRST USE 12-0-2010; IN COMMERCE 12-0-2010.

TRADEMARK

PRINCIPAL REGISTER

FOR: VINYL STICKERS; CHILDREN'S WALL STICKERS AND MURALS; ADHESIVE LABELS; PAPER LABELS; ADDRESS LABELS; NOTEPADS; INVITATION CARDS; STATIONERY; CALENDARS; DIARIES; PRINTED INVITATIONS; TEMPORARY TATTOO STICKERS; LUNCH BAGS; PERSONALIZED PAPER PLACE MATS; CHARTS FOR DISPLAYING DATA ABOUT HUMAN HEIGHT AND ALSO DISPLAYING A RULER FOR MEASURING A PERSON'S HEIGHT; PAPER HAND-TOWELS; PERSONALIZED BOOKS FOR CHILDREN; BUSINESS CARDS; SCHOOL SUPPLY KITS CONTAINING VARIOUS COMBINATIONS OF SELECTED SCHOOL SUPPLIES, NAMELY, WRITING INSTRUMENTS, PENS, PENCILS, MECHANICAL PENCILS, ERASERS, MARKERS, CRAYONS, HIGHLIGHTER PENS, FOLDERS, NOTEBOOKS, PAPER, PENCIL SHARPENERS, AND BOOK MARKS, IN CLASS 16 (U.S. CLS. 2, 5, 22, 23, 29, 37, 38 AND 50).

FIRST USE 4-0-1996; IN COMMERCE 6-0-1997.

FOR: BACKPACKS; TOILETRY BAGS; OVERNIGHT BAGS; SWIM WEAR BAGS; LIBRARY BOOK BAGS; HANDBAGS; LUGGAGE TAGS; HANDBAG TAGS; WHEELIE LUGGAGE BAGS; PERSONALIZED HANDBAGS; WALLETS; UMBRELLAS; PET TAGS SPECIALLY ADAPTED FOR ATTACHING TO PET LEASHES OR COLLARS, IN CLASS 18 (U.S. CLS. 1, 2, 3, 22 AND 41).

FIRST USE 1-0-1999; IN COMMERCE 1-0-1999.

FOR: LUNCH BOXES; HAIR, TOOTH AND NAIL BRUSHES; REUSABLE PLASTIC WATER BOTTLES SOLD EMPTY; REUSABLE STAINLESS STEEL WATER BOTTLES SOLD EMPTY; PERSONALIZED PLASTIC STORAGE CONTAINERS FOR HOUSEHOLD OR DOMESTIC USE, IN CLASS 21 (U.S. CLS. 2, 13, 23, 29, 30, 33, 40 AND 50).

FIRST USE 12-0-2009; IN COMMERCE 12-0-2009.



David J. Kyffers

Director of the United States Patent and Trademark Office

Reg. No. 4,175,797 FOR: BED AND TABLE LINEN; PLACE MATS, NOT OF PAPER; BATH TOWELS; BEACH TOWELS; CHILDREN'S TOWELS, IN CLASS 24 (U.S. CLS. 42 AND 50).

FIRST USE 12-0-2010; IN COMMERCE 12-0-2010.

FOR: PARTY FAVORS IN THE NATURE OF SMALL TOYS; CHILDREN'S TOYS, NAMELY, PLUSH TOYS AND CHRISTMAS TREE ORNAMENTS AND DECORATIONS; CHILDREN'S GAMES, NAMELY, WOODEN PUZZLES; PLAY HOUSES AND TOY ACCESSORIES THEREFOR; TOY FURNITURE, IN CLASS 28 (U.S. CLS. 22, 23, 38 AND 50).

FIRST USE 12-0-2000; IN COMMERCE 12-0-2000.

THE MARK CONSISTS OF STANDARD CHARACTERS WITHOUT CLAIM TO ANY PARTICULAR FONT, STYLE, SIZE, OR COLOR.

OWNER OF U.S. REG. NOS. 2,642,174 AND 2,653,732.

SER. NO. 85-976,397, FILED 6-24-2011.

WILLIAM VERHOSEK, EXAMINING ATTORNEY

United States of America

United States Patent and Trademark Office

COURSERANK

Reg. No. 4,175,798

Registered July 17, 2012

Int. Cl.: 41

SERVICE MARK

PRINCIPAL REGISTER

CHEGG, INC. (DELAWARE CORPORATION)
SUITE 1400
2350 MISSION COLLEGE BLVD.
SANTA CLARA, CA 95054

FOR: EDUCATIONAL SERVICES, NAMELY, ASSISTING STUDENTS WITH SCHEDULING AND PLANNING OF ACADEMIC COURSEWORK AND EDUCATIONAL COLLEGE LIFE ACTIVITIES, IN CLASS 41 (U.S. CLS. 100, 101 AND 107).

FIRST USE 4-4-2007; IN COMMERCE 12-4-2007.

THE MARK CONSISTS OF STANDARD CHARACTERS WITHOUT CLAIM TO ANY PARTICULAR FONT, STYLE, SIZE, OR COLOR.

SER. NO. 85-976,420, FILED S.R. 11-1-2010 AM. P.R. 3-19-2012.

LIEF MARTIN, EXAMINING ATTORNEY



David J. Kybas

Director of the United States Patent and Trademark Office

United States of America

United States Patent and Trademark Office

THE STUDENT LEADERSHIP CHALLENGE

Reg. No. 4,175,799

Registered July 17, 2012

Int. Cl.: 41

SERVICE MARK

PRINCIPAL REGISTER

JOHN WILEY & SONS, INC. (NEW YORK CORPORATION)
111 RIVER STREET
HOBOKEN, NJ 07030

FOR: EDUCATIONAL SERVICES, NAMELY, CONDUCTING A CONTINUING SERIES OF CLASSES, SEMINARS, CONFERENCES, AND WORKSHOPS IN THE FIELD OF LEADERSHIP DEVELOPMENT AND DISTRIBUTING COURSE MATERIALS IN CONNECTION THEREWITH; WORKSHOPS AND SEMINARS IN THE FIELD OF LEADERSHIP, IN CLASS 41 (U.S. CLS. 100, 101 AND 107).

FIRST USE 7-21-2008; IN COMMERCE 7-21-2008.

THE MARK CONSISTS OF STANDARD CHARACTERS WITHOUT CLAIM TO ANY PARTICULAR FONT, STYLE, SIZE, OR COLOR.

OWNER OF U.S. REG. NOS. 3,456,556, 3,456,875, AND 3,456,876.

NO CLAIM IS MADE TO THE EXCLUSIVE RIGHT TO USE "STUDENT LEADERSHIP", APART FROM THE MARK AS SHOWN.

SER. NO. 85-976,485, FILED 9-19-2011.

B. PARADEWELAI, EXAMINING ATTORNEY



David J. Kyffers

Director of the United States Patent and Trademark Office

United States of America

United States Patent and Trademark Office

THE TWILIGHT SAGA

Reg. No. 4,175,800

Registered July 17, 2012

Int. Cl.: 41

SERVICE MARK

PRINCIPAL REGISTER

SUMMIT ENTERTAINMENT, LLC (DELAWARE LIMITED LIABILITY COMPANY)
1630 STEWART STREET, SUITE 120
SANTA MONICA, CA 90404

FOR: PRODUCTION AND DISTRIBUTION OF MOTION PICTURES; PROVIDING INFORMATION RELATING TO MOTION PICTURES; PROVIDING A WEBSITE FEATURING NON-DOWNLOADABLE FILM CLIPS AND MUSIC VIDEOS, AND INFORMATION ON MOTION PICTURES, LITERARY WORKS, AND MUSIC; ORGANIZATION OF CONVENTIONS IN THE FIELDS OF MOTION PICTURES AND ENTERTAINMENT; FAN CLUB SERVICES; PROVIDING PODCASTS RELATING TO MUSIC AND MOTION PICTURES, IN CLASS 41 (U.S. CLS. 100, 101 AND 107).

FIRST USE 1-1-2009; IN COMMERCE 1-1-2009.

THE MARK CONSISTS OF STANDARD CHARACTERS WITHOUT CLAIM TO ANY PARTICULAR FONT, STYLE, SIZE, OR COLOR.

OWNER OF U.S. REG. NOS. 3,756,560, 3,884,386 AND OTHERS.

SER. NO. 85-976,643, FILED 3-29-2011.

KATHERINE E. HALMEN, EXAMINING ATTORNEY



David J. Kyros

Director of the United States Patent and Trademark Office

United States of America

United States Patent and Trademark Office

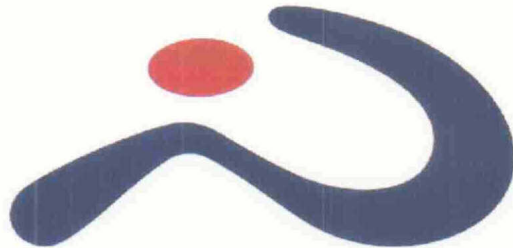

Reg. No. 4,175,801

NITTO DENKO CORPORATION (JAPAN CORPORATION)
1-2, SHIMOHUZUMI 1-CHOME
IBARAKI-SHI, OSAKA, JAPAN

Registered July 17, 2012

**Int. Cls.: 4, 5, 7, 9, 10, 11,
16, 17, 20, 21, and 40**

FOR: (BASED ON 44(E)) STICK FUEL FOR JAPANESE POCKET WARMERS KAIRO-BAI,
IN CLASS 4 (U.S. CLS. 1, 6 AND 15).

TRADEMARK

SERVICE MARK

PRINCIPAL REGISTER

FOR: (BASED ON 44(E)) TRANSDERMAL PATCH FOR THE TREATMENT OF ISCHEMIC HEART DISEASE; TRANSDERMAL PATCH FOR THE TREATMENT OF EXPANDING BRONCHUS; OILED PAPER FOR MEDICAL PURPOSES; GAUZE FOR DRESSINGS; EYE PATCHES FOR MEDICAL USE; ADHESIVE BANDAGES FOR EARS; MENSTRUATION BANDAGES; MENSTRUATION TAMPONS; SANITARY NAPKINS; INCONTINENCE GARMENTS IN THE NATURE OF SANITARY PANTIES; ABSORBENT COTTON FOR MEDICAL USE; ADHESIVE PLASTERS FOR MEDICAL USE; ADHESIVE TAPES FOR MEDICAL PURPOSES; BANDAGES FOR DRESSINGS; COLLODION FOR MEDICAL PURPOSES; BREAST-NURSING PADS; TRANSDERMAL PATCH WITH ANESTHETIC FOR DENTAL USE; BRACELETS FOR MEDICAL PURPOSES; INCONTINENCE DIAPERS; FLY CATCHING PAPER; MOTHPROOFING PAPER; POWDERED MILK FOR BABIES; SEMEN FOR ARTIFICIAL INSEMINATION; MEDICAL HERB EXTRACTS, NAMELY, GRANULAR EXTRACTS FROM GINSENG; MEDICAL ADHESIVE TAPE, NAMELY, CLOTH BASED ADHESIVE TAPES FOR FIXING DISEASED PART; PHARMACEUTICAL PHEROMONE USED FOR PEST CONTROL FOR AGRICULTURAL AND DOMESTIC USE; SEX PHEROMONE TAPES FOR PEST CONTROL FOR AGRICULTURAL AND DOMESTIC USE, IN CLASS 5 (U.S. CLS. 6, 18, 44, 46, 51 AND 52).



David J. Kybas

Director of the United States Patent and Trademark Office

FOR: (BASED ON 44(E)) LOADING AND UNLOADING MACHINES; INDUSTRIAL LABEL PRINTER; SEWING MACHINES; AGRICULTURE MACHINES, NAMELY, BLIGHT PREVENTION MACHINE IN THE NATURE OF POWER-OPERATED SPRAYERS FOR INSECTICIDES; PACKING MACHINES AND WRAPPING MACHINES; POWER-OPERATED POTTER'S WHEELS; PLASTIC PROCESSING MACHINES AND APPARATUS, NAMELY, INJECTION PLASTIC MOLDING MACHINES AND EXTRUSION MOLDING MACHINES; SEMICONDUCTOR MANUFACTURING MACHINES; ADHESIVE TAPE DISPENSING MACHINES; AUTOMATIC STAMPING MACHINES; DISH WASHING MACHINES; ELECTRIC WAX-POLISHING MACHINES FOR INDUSTRIAL USE; CLOTHES AND FLOOR WASHING MACHINES; VACUUM CLEANERS; ELECTRIC FOOD BLENDERS; VEHICLE WASHING INSTALLATIONS; POWER OPERATED SPRAYERS FOR DISINFECTANTS, INSECTICIDES AND DEODORANTS NOT FOR AGRICULTURAL PURPOSES; LAWNMOWERS; WASTE

Reg. No. 4,175,801 CRUSHING MACHINES; STARTERS FOR MOTORS AND ENGINES; AC GENERATORS; DC GENERATORS; DYNAMO BRUSHES; SEMICONDUCTOR TAPING MACHINE COMPRISING TAPING UNIT THAT USES ADHESIVE TAPES FOR TAPING SEMICONDUCTOR WAFERS IN SEMICONDUCTOR MANUFACTURING; SEMICONDUCTOR MANUFACTURING MACHINES FOR USE IN PROTECTING AND AFFIXING ADHESIVE TAPES FOR PROCESSING SEMI CONDUCTOR WAFERS; PEST-MONITORING SYSTEM COMPRISING MECHANICAL TRAP FOR CATCHING INSECT FOR AGRICULTURAL USE; BELTS FOR MACHINES, NAMELY, POLYIMIDE BELT FOR PRINTERS, POLYIMIDE BELT FOR DUPLICATORS AND POLYIMIDE SEAMLESS BELTS FOR DUPLICATORS AND PRINTERS, IN CLASS 7 (U.S. CLS. 13, 19, 21, 23, 31, 34 AND 35).

FOR: (BASED ON USE) TRANSPARENT ELECTRICAL PLASTIC CONDUCTIVE FILM FOR USE IN LIQUID CRYSTAL DISPLAYS; PLASTIC FILMS WITH CONDUCTIVE PATHS FOR USE IN LIQUID CRYSTAL DISPLAYS; (BASED ON 44(E)) OZONISERS; ELECTROLYSERS; EGG-CANDLERS; CASH REGISTERS; COIN COUNTING AND SORTING MACHINES; ELECTRIC SIGN BOARDS FOR DISPLAYING TARGET FIGURES, CURRENT OUTPUTS AND THE LIKE; PHOTOCOPYING MACHINES; TIME AND DATE STAMPING MACHINES; TIME CLOCKS; VOTING MACHINES; VENDING MACHINES; COIN-OPERATED GATES FOR CAR PARKING FACILITIES; FIRE EXTINGUISHERS; FIRE HYDRANTS; FIRE HOSE NOZZLES; SPRINKLER SYSTEMS FOR FIRE PROTECTION; FIRE ALARMS; PROTECTIVE HELMETS; RAILWAY SIGNALS; VEHICLE BREAKDOWN WARNING TRIANGLES; LUMINOUS OR MECHANICAL ROAD SIGNS; ELECTRIC DOOR OPENERS; VEHICLE DRIVE TRAINING SIMULATORS; SPORTS TRAINING SIMULATORS; CINEMATOGRAPHIC MACHINES AND APPARATUS; PROJECTION SCREEN; OPTICAL APPARATUS, NAMELY, OPTICAL LENSES; ROTARY CONVERTERS; BATTERIES AND SOLAR AND FUEL CELLS; ELECTRIC AND MAGNETIC METERS AND TESTERS, NAMELY, MAGNETOMETERS, GALVANOMETERS; ELECTRIC WIRES AND CABLES; ELECTRIC FLAT IRONS; ELECTRIC HAIR-CURLERS; ELECTRIC BUZZERS; TELECOMMUNICATION MACHINES AND APPARATUS, NAMELY, TELEPHONES, PORTABLE TELEPHONES, PORTABLE RADIO COMMUNICATION MACHINES; ELECTRONIC MACHINES AND APPARATUS AND THEIR PARTS, NAMELY, WORD PROCESSORS; VIDEO CAMERAS; VIDEO DISK PLAYER; VIDEOTAPE RECORDER; ELECTRIC CAPACITORS; FLEXIBLE PRINTED CIRCUIT; COMPUTERS; ELECTROSTATIC COPYING MACHINES; INTEGRATED CIRCUIT, POLARIZING FILM SOLD AS AN INTEGRAL COMPONENT OF LIQUID CRYSTAL DISPLAY; MAGNETIC CORES; RESISTANCE WIRES; ELECTRODES; FIRE BOATS; FIRE ENGINES; CIGAR LIGHTERS FOR AUTOMOBILES; GLOVES FOR PROTECTION AGAINST ACCIDENTS; DUST MASKS; GAS MASKS; WELDING MASKS; FIREPROOF GARMENTS; SPECTACLES; CONSUMER VIDEOGAMES CARTRIDGES; PRERECORDED ELECTRIC CIRCUITS AND CD-ROMS FOR USE IN AMUSEMENT GAME MACHINES FOR REPRODUCING MUSIC, SPEECH AND SPECIAL EFFECTS FOR HANDHELD GAMES WITH LIQUID CRYSTAL DISPLAYS; SLOT MACHINES; WEIGHT BELTS FOR SCUBA DIVING; PROTECTIVE HELMETS FOR SPORTS; AIR TANKS FOR SCUBA DIVING; REGULATORS FOR SCUBA DIVING; PHONOGRAPH RECORDS FEATURING MUSIC; METRONOMES; PRERECORDED ELECTRONIC CIRCUITS AND CD-ROMS FEATURING RECORDED AUTOMATIC PERFORMANCE PROGRAMS FOR USE IN ELECTRONIC MUSICAL INSTRUMENTS; SLIDE-RULES; EXPOSED CINEMATOGRAPHIC FILM; EXPOSED SLIDE FILMS; SLIDE FILM MOUNTS; PRERECORDED VIDEO DISCS AND VIDEO TAPES FEATURING MUSIC; FLEXIBLE PRINTED CIRCUIT; FLEXIBLE PRINTED CIRCUIT FOR AUTOMOBILE EQUIPMENT; FLEXIBLE PRINTED CIRCUIT FOR HOUSEHOLD APPLIANCES; FLEXIBLE PRINTED CIRCUIT FOR INDUSTRIAL EQUIPMENT; FLEXIBLE PRINTED CIRCUIT FOR MOBILE COMMUNICATION EQUIPMENT; FLEXIBLE PRINTED CIRCUIT FOR COMPONENTS; FLEXIBLE PRINTED CIRCUIT FOR COMPUTERS AND PERIPHERALS; ANISOTROPIC CONDUCTIVE FILMS FOR TESTING USE OF ELECTRONIC PARTS; BLUEPRINTING MACHINES; TRANSPARENT ELECTRICAL CONDUCTIVE FILMS FOR TOUCH PANELS; LAMINATED PLASTIC FILMS WITH CONDUCTIVE PATHS FOR USE IN LIQUID CRYSTAL DISPLAYS, IN CLASS 9 (U.S. CLS. 21, 23, 26, 36 AND 38).

FIRST USE 1-0-2005; IN COMMERCE 7-0-2007.

Reg. No. 4,175,801 FOR: (BASED ON 44(E)) SANITARY MASKS, NAMELY, DUST MASKS FOR USE BY MEDICAL PERSONNEL, IN CLASS 10 (U.S. CLS. 26, 39 AND 44).

FOR: (BASED ON 44(E)) STEAM GENERATORS AND STEAMERS FOR CHEMICAL PROCESSING; EVAPORATORS FOR CHEMICAL PROCESSING; DISTILLERS FOR CHEMICAL PROCESSING; HEAT EXCHANGERS FOR CHEMICAL PROCESSING; MILK STERILIZERS; INDUSTRIAL FURNACES; NUCLEAR REACTORS; INDUSTRIAL BOILERS; CLOTHES DRYING MACHINES FOR INDUSTRIAL PURPOSE; INDUSTRIAL DISH DRYING MACHINES; DISH DISINFECTANT APPARATUS FOR INDUSTRIAL PURPOSES; TAP WATER FAUCETS; PLUMBING FITTINGS, NAMELY, LEVEL CONTROLLING VALVES FOR TANKS; PIPE LINE COCKS; WASTE WATER TREATMENT TANKS FOR INDUSTRIAL PURPOSES, NAMELY, ULTRAVIOLET STERILIZATION UNITS; SEPTIC TANKS FOR INDUSTRIAL PURPOSES; GARBAGE INCINERATORS; SOLAR WATER HEATERS; WATER PURIFYING APPARATUS; KITCHEN SINKS; ICE CHESTS FOR HOUSEHOLD PURPOSES NOT FOR CARRYING WITH; ICE-COOLING REFRIGERATORS FOR HOUSEHOLD PURPOSES; HOUSEHOLD TAP-WATER FILTERS; BATHTUBS AND SHOWER TUBS; STANDING PAPER LANTERNS (ANDON); PORTABLE PAPER LANTERNS (CHOCHIN); GAS LAMPS; OIL LAMPS; LAMP CHIMNEYS; NON-ELECTRIC WARMING PANS FOR BEDS; NON-ELECTRIC POCKET WARMERS, NAMELY, CHEMICALLY-ACTIVATED HEATING PACKETS FOR WARMING HANDS; HOT WATER BOTTLES FOR WARMING ONE'S FEET IN BED; TOILET STOOL UNITS WITH A WASHING WATER SQUIRTER; DISINFECTANT DISPENSERS FOR TOILETS; TOILET BOWLS; SEATS FOR USE WITH JAPANESE STYLE TOILET BOWLS; SEPTIC TANKS FOR HOUSEHOLD PURPOSES; HEATING AND COOLING PACKS FILLED WITH CHEMICAL SUBSTANCES READY TO REACT WHEN REQUIRED FOR WARMING BODY; FILTERING MATERIALS, NAMELY, REVERSE OSMOSIS MEMBRANES USED IN WATER PURIFICATION; FILTERING MATERIALS, NAMELY, REVERSE OSMOSIS MEMBRANE USED IN SEA WATER PURIFICATION; ULTRA FILTRATION MEMBRANE FILTER CARTRIDGE FOR WATER PURIFYING APPARATUS, MICRO-FILTRATION MEMBRANE FILTER CARTRIDGE FOR WATER PURIFYING APPARATUS, IN CLASS 11 (U.S. CLS. 13, 21, 23, 31 AND 34).

FOR: (BASED ON 44(E)) PASTES AND OTHER ADHESIVES FOR STATIONERY OR HOUSEHOLD PURPOSES; SEALING WAX; PRINTING TYPES; ADDRESSING MACHINES; INKING RIBBONS; ELECTRIC STAPLERS FOR OFFICES; ENVELOPE SEALING MACHINES FOR OFFICES; STAMP OBLITERATING MACHINES; DRAWING INSTRUMENTS; TYPEWRITERS; MIMEOGRAPHS; PAPER SHREDDERS FOR OFFICE USE; FRANKING MACHINES; ROTARY DUPLICATORS; MARKING TEMPLATES; ELECTRIC PENCIL SHARPENERS; DECORATOR'S PAINTBRUSHES; BABIES' DIAPERS OF PAPER; INDUSTRIAL PACKING CONTAINERS OF PAPER; FOOD WRAPPING PLASTIC FILM, FOR HOUSEHOLD USE; GARBAGE BAGS OF PAPER FOR HOUSEHOLD USE; GARBAGE BAGS OF PLASTIC FOR HOUSEHOLD USE; PAPER PATTERNS FOR DRESSES, KNITTING; TAILOR'S CHALK; BANNERS OF PAPER; FLAGS OF PAPER; HYGIENIC PAPER; TOWELS OF PAPER; TABLE NAPKINS OF PAPER; HAND TOWELS OF PAPER; HANDKERCHIEFS OF PAPER; PRINTED LOTTERY TICKETS OTHER THAN TOYS; TABLE CLOTHS OF PAPER; PAPER AND CARDBOARD; STATIONERY, NAMELY, ADHESIVE TAPES FOR STATIONERY OR HOUSEHOLD PURPOSES AND ADDRESS LABELS; PAINTINGS AND CALLIGRAPHIC WORKS; PHOTOGRAPHS; DOUBLE COATED ADHESIVE TAPES FOR HOUSEHOLD USE; TRANSPARENT DOUBLE-COATED ADHESIVE TAPES FOR HOUSEHOLD USE; ON-SITE LABEL PRINTING MACHINES, IN CLASS 16 (U.S. CLS. 2, 5, 22, 23, 29, 37, 38 AND 50).

FOR: (BASED ON USE) ADHESIVE COATED PLASTIC FORM SHEET; (BASED ON 44(E)) RAW OR PARTLY PROCESSED MICA; VALVES OF RUBBER OR VULCANIZED FIBER NOT INCLUDING MACHINE ELEMENTS; NON-METAL JUNCTIONS FOR DUST WATER PIPES NOT OF METAL; PACKINGS, NAMELY, PACKING FOAM IN SHEET FORM; FIRE HOSES; ASBESTOS FIRE CURTAINS; FLOATING ANTI-POLLUTION BARRIERS; ELECTRICAL INSULATING MATERIALS; WASHERS OF RUBBER OR VULCANIZED FIBER; HORSESHOES NOT OF METAL; CHEMICAL FIBER FOR USE AS BUILDING INSULATOR; ASBESTOS, NAMELY, ASBESTOS FIRE CURTAIN; ROCK WOOL; SLAG WOOL FOR USE

Reg. No. 4,175,801 AS A BUILDING INSULATOR; RUBBER THREAD AND COVERED RUBBER YARN NOT FOR TEXTILE USE; CHEMICAL FIBER YARN AND THREAD FOR USE AS A BUILDING INSULATOR; ASBESTOS YARN; ASBESTOS FABRICS FOR USE AS CABLE INSULATION; ASBESTOS FELT; INSULATING GLOVES; RUBBER CORDS AND LACES; ASBESTOS CORDS AND STRINGS; ASBESTOS NETS; INDUSTRIAL PACKAGING CONTAINERS OF RUBBER; RUBBER STOPPERS FOR INDUSTRIAL PACKAGING CONTAINERS; RUBBER LIDS AND CAPS FOR INDUSTRIAL PACKAGING CONTAINER; PLASTIC SHEETING FOR AGRICULTURAL PURPOSES; INSULATION MATERIALS, NAMELY, CONDENSER PAPER; ASBESTOS PAPER; VULCANIZED FIBER; PLASTIC AS SEMI-WORKED PRODUCTS FOR USE AS MATERIAL IN FORM OF RODS, BLOCKS; ADHESIVE TAPES FOR COMMERCIAL AND INDUSTRIAL USE; RAW OR SEMI-WORKED RUBBER; SOUNDPROOFING MATERIALS OF ROCK WOOL NOT FOR BUILDING PURPOSES; ASBESTOS BOARDS; ASBESTOS POWDER; REINFORCEMENT AND DAMPING THERMOSETTING RESIN SHEET FOR USE IN AUTOMOBILE STEEL PANELS; FORMED RUBBER RODS AND SHEETS FOR AUTOMOBILE SEALING USE; RUBBER SHEET FOR SOUND PROOFING DRAINPIPES; RUBBER SHEET FOR SOUND PROOFING OF RAIN DROPS; RUBBER SHEET FOR SEALING; FLAME-RETARDANT SOUNDPROOF RUBBER FORM FOR USE IN BUILDINGS AND MACHINERY; PAPER TYPE MASKING ADHESIVE TAPES FOR AUTOMOBILE BODY COATING; MASKING ADHESIVE TAPES FOR ARCHITECTURAL PAINTING; MASKING ADHESIVE TAPE FOR PRINTED CIRCUIT BOARDS; PROTECTIVE PLASTIC FILMS FOR USE IN AUTOMOBILE BODIES; SURFACE PROTECTION ADHESIVE TAPES FOR ELECTRIC DEVICES FOR INDUSTRIAL AND COMMERCIAL USE; DOUBLE COATED ADHESIVE TAPES FOR FIXING AUTOMOBILE PARTS FOR INDUSTRIAL AND COMMERCIAL USE; DOUBLE-COATED ADHESIVE TAPES FOR LIGHT-SHIELDING OR REFLECTIVE FOR USE IN FLAT PANEL DISPLAYS FOR INDUSTRIAL AND COMMERCIAL USE; PEELABLE DOUBLE-COATED ADHESIVE TAPES FOR INDUSTRIAL AND COMMERCIAL USE; WATER-SOLUBLE DOUBLE-COATED ADHESIVE TAPES FOR AUTO-SPLICING IN PAPER MAKING PROCESSES FOR INDUSTRIAL AND COMMERCIAL USE; DOUBLE COATED ADHESIVE TAPES FOR RUBBER FIXING FOR INDUSTRIAL AND COMMERCIAL USE; DOUBLE-COATED ADHESIVE TAPES FOR UV COATED SURFACE FOR INDUSTRIAL AND COMMERCIAL USE AND FOR AUTOMOBILE WINDOW; DOUBLE-COATED ADHESIVE TAPES FOR HOLDING FOR INDUSTRIAL AND COMMERCIAL USE; PIPE JOINT SEALANT, NAMELY, HEAT SHRINKABLE SHEET AND SLEEVE FOR STEEL PIPE JOINT; SILICONE-FREE ADHESIVE TAPES FOR INDUSTRIAL AND COMMERCIAL USE; HEAT PEELABLE ADHESIVE TAPES FOR INDUSTRIAL AND COMMERCIAL USE; POLYESTER ADHESIVE TAPES FOR ELECTRICAL INSULATION; POLYIMIDE ADHESIVE TAPES FOR ELECTRICAL INSULATION; POLY-PHENYLENE SULFIDE ADHESIVE TAPES FOR ALUMINUM ELECTROLYTIC CONDENSERS; POLYPROPYLENE ADHESIVE TAPES FOR INSULATION OF ELECTRODES IN LITHIUM ION SECONDARY BATTERIES; COVER TAPES FOR SURFACE MOUNTING ELECTRIC COMPONENT FOR INDUSTRIAL AND COMMERCIAL USE; ADHESIVE PAPER CARRIER TAPES FOR ELECTRONIC COMPONENTS FOR INDUSTRIAL AND COMMERCIAL USE; ELECTRICAL INSULATING ADHESIVE TAPES; ADHESIVE TAPES USING METAL FOIL FOR THERMAL CONDUCTIVITY AND ELECTROMAGNETIC WAVE SHIELD FOR INDUSTRIAL AND COMMERCIAL USE; ADHESIVE TAPES FOR CLEANING OFF PRINTED INK FROM SCREEN PRINTED BOARD; NON-PVC ADHESIVE PLASTIC TAPES FOR INDUSTRIAL AND COMMERCIAL USE; EPOXY ENCAPSULATION RESIN COMPOUNDS FOR INSULATING SEMICONDUCTOR; UNDERFILL TAPES FOR SEMICONDUCTOR ENCAPSULATION; TRANSPARENT EPOXY ENCAPSULATION RESIN COMPOUNDS FOR INSULATING OPTICAL-SEMICONDUCTOR; CLEANING RUBBER SHEET FOR SEMICONDUCTOR ENCAPSULATING MOLD; GEL LIKE ACRYLIC RUBBER; WATERPROOFING, DUST-PROOFING AND AIR-PERMEABLE FLUOROPLASTIC POROUS MEMBRANES FOR INDUSTRIAL AND COMMERCIAL USE; WATERPROOFING AND BREATHABLE FLUOROPLASTIC POROUS MEMBRANES FOR HEAD LAMPS AND FOG LAMPS OF AUTOMOBILE; FLUOROPLASTIC ADHESIVE TAPES FOR INDUSTRIAL AND COMMERCIAL USE; ULTRAHIGH-MOLECULAR WEIGHT POROUS POLYETHYLENE FILM FOR INDUSTRIAL AND COMMERCIAL USE; FLUOROPLASTIC ADHESIVE TAPE FOR PIPE SEALING; GLASS CLOTH TAPES IMPREGNATED WITH FLUOROPLASTIC FOR INDUSTRIAL AND COMMERCIAL USE; POLARIZING PLASTIC FILMS FOR USE IN LIQUID

Reg. No. 4,175,801 CRYSTAL DISPLAYS; LAMINATED POLARIZING PLASTIC FILMS FOR USE IN LIQUID CRYSTAL DISPLAYS; POLARIZING FILMS FOR LIQUID CRYSTAL DISPLAYS; COMPENSATION FILMS FOR LIQUID CRYSTAL DISPLAYS; POLARIZING CONVERSION FILMS FOR LIQUID CRYSTAL DISPLAYS; RETARDATION FILMS LAMINATED WITH POLARIZING FILM FOR LIQUID CRYSTAL DISPLAYS, IN CLASS 17 (U.S. CLS. 1, 5, 12, 13, 35 AND 50).

FIRST USE 1-0-2005; IN COMMERCE 7-0-2007.

FOR: (BASED ON 44(E)) SILICONE LABEL FOR STATIONERY, IN CLASS 20 (U.S. CLS. 2, 13, 22, 25, 32 AND 50).

FOR: (BASED ON 44(E)) CERAMIC LABEL FOR USE IN OFFICE AUTOMATION; DUST CLEANING ADHESIVE ROLL WITH ROLLED ADHESIVE TAPES, IN CLASS 21 (U.S. CLS. 2, 13, 23, 29, 30, 33, 40 AND 50).

FOR: (BASED ON 44(E)) REMOVAL OF RADIATION RAYS, NAMELY, DECONTAMINATION OF HAZARDOUS WASTE; TREATMENT OR PROCESSING OF CLOTH, CLOTHING OR FUR, NAMELY, MOTHPROOFING OF FUR AND CREASE TREATMENT OF CLOTHING; TAILORING OR DRESSMAKING; EMBROIDERY; METALWORK, NAMELY, METAL CASTING; PROCESSING OF RUBBER, NAMELY, LAMINATING RUBBER SHEET; PROCESSING OF PLASTICS, NAMELY, LAMINATING PLASTIC SHEETS; CERAMIC PROCESSING, NAMELY, CERAMIC GLAZING; WOOD-WORKING; PAPER TREATING AND WORKING, NAMELY, PAPER TREATMENT, PAPER FINISHING; STONE-WORKING, NAMELY, SCULPTING FIGURINES TO THE ORDER AND SPECIFICATION OF OTHERS; TAXIDERMISTRY; PROCESSING OF BAMBOO, TREE BARKS, RATTAN, SPECTACLE TEMPLES AND OTHER MINERAL VEGETABLE MATERIALS OTHER THAN PROCESSING OF INGREDIENTS, NAMELY, WATERPROOFING OF RATTAN; FOOD PROCESSING; CUSTOM MANUFACTURE OF ARTIFICIAL LIMBS AND ARTIFICIAL TEETH; CUSTOM MANUFACTURE OF MEDICAL MATERIALS, NAMELY, SCALPELS; PROCESSING OF CINEMATOGRAPHIC FILMS; PHOTOGRAPHIC ENLARGING; PHOTOGRAPHIC PRINTING; PHOTOGRAPHIC FILM DEVELOPMENT; BOOKBINDING; WATER TREATING; RECYCLING OF WASTE; NUCLEAR FUEL REPROCESSING; ENGRAVING OF SEALING STAMPS; PHOTOGRAVURE; RENTAL OF TEXTILE MANUFACTURING, CUTTING, TREATMENT MACHINES AND APPARATUS; RENTAL OF MACHINES AND APPARATUS FOR FILM DEVELOPMENT, PHOTOGRAPH PRINTING, PHOTOGRAPH ENLARGEMENT AND PHOTOGRAPH FINISHING; RENTAL OF METAL TREATING MACHINES AND TOOLS; RENTAL OF BOOKBINDING MACHINES; RENTAL OF MACHINES AND APPARATUS FOR PROCESSING FOODS AND BEVERAGES; RENTAL OF MACHINES AND APPARATUS FOR LUMBERING, WOODWORKING, OR VENEERING OR PLYWOOD MAKING; RENTAL OF MACHINES AND APPARATUS FOR PULP--MAKING, PAPERMAKING OR PAPER-WORKING; RENTAL OF WATER PURIFYING APPARATUS; RENTAL OF WASTE COMPACTING MACHINES AND APPARATUS; RENTAL OF WASTE CRUSHING MACHINES AND APPARATUS; RENTAL OF CHEMICAL PROCESSING MACHINES AND APPARATUS; RENTAL OF GLASSWARE MANUFACTURING MACHINES AND APPARATUS; RENTAL OF SHOE MAKING MACHINES; RENTAL OF TOBACCO PROCESSING MACHINES; PROVIDING MATERIAL TREATMENT INFORMATION; PRINTING; RENTAL OF KNITTING MACHINES; RENTAL OF SEWING MACHINES; RENTAL OF PRINTING MACHINES AND APPARATUS, IN CLASS 40 (U.S. CLS. 100, 103 AND 106).

PRIORITY CLAIMED UNDER SEC. 44(D) ON JAPAN APPLICATION NO. 2004-058172, FILED 6-11-2004, REG. NO. 4953931, DATED 5-19-2006, EXPIRES 5-19-2016.

THE COLOR(S) RED AND BLUE IS/ARE CLAIMED AS A FEATURE OF THE MARK.

PRIORITY CLAIMED UNDER SEC. 44(D) ON JAPAN APPLICATION NO. 2004-050013, FILED 5-31-2004, REG. NO. 4832583, DATED 1-14-2005, EXPIRES 1-14-2015.

Reg. No. 4,175,801 THE MARK CONSISTS OF A BLUE DEVICE RESEMBLING A HOOK. A RED OVAL APPEARS ABOVE THE HOOK DEVICE. THE COLOR RED APPEARS IN THE OVAL AND THE COLOR BLUE APPEARS IN THE HOOKED SHAPED DESIGN ELEMENT.

SN 76-614,582, FILED 10-5-2004.

LEIGH LOWRY, EXAMINING ATTORNEY

United States of America

United States Patent and Trademark Office

EPOP

Reg. No. 4,175,802

Registered July 17, 2012

Int. Cl.: 9

TRADEMARK

PRINCIPAL REGISTER

ZBD DISPLAYS LIMITED (UNITED KINGDOM CORPORATION)
MALVERN HILLS SCIENCE PARK
GERALDINE ROAD
MALVERN, UNITED KINGDOM WR14 3SZ

FOR: LIQUID CRYSTAL DISPLAYS; ELECTRONIC LIQUID CRYSTAL DISPLAYS; LIQUID CRYSTAL DISPLAYS FOR PROVIDING RETAIL OR PRODUCT INFORMATION AND/OR ADVERTISING; LIQUID CRYSTAL DISPLAY MODULES; WIRELESSLY NETWORKED LIQUID CRYSTAL DISPLAYS; LOW POWER, INCLUDING ZERO POWER, ELECTRONIC LIQUID CRYSTAL DISPLAYS; PRODUCT INFORMATION LIQUID CRYSTAL DISPLAYS; ELECTRONIC PAPER, NAMELY, ELECTRONIC DISPLAYS WITH PAPER-LIKE QUALITIES; CONTROLS FOR DISPLAY NETWORKS; COMPUTER SOFTWARE FOR CONTROL OF DISPLAYS; COMPUTER SOFTWARE FOR DISPLAY NETWORK CONTROL; COMPUTER SOFTWARE FOR INFORMATION CONTROL AND DISPLAY; COMPUTER SOFTWARE FOR PRODUCT OR RETAIL INFORMATION OR ADVERTISING DISPLAY, IN CLASS 9 (U.S. CLS. 21, 23, 26, 36 AND 38).

FIRST USE 3-1-2012; IN COMMERCE 3-28-2012.

THE MARK CONSISTS OF STANDARD CHARACTERS WITHOUT CLAIM TO ANY PARTICULAR FONT, STYLE, SIZE, OR COLOR.

SN 76-674,335, FILED 3-20-2007.

CAROLYN CATALDO, EXAMINING ATTORNEY



David J. Kyffers

Director of the United States Patent and Trademark Office

United States of America

United States Patent and Trademark Office



Reg. No. 4,175,803

Registered July 17, 2012

Int. Cl.: 41

SERVICE MARK

PRINCIPAL REGISTER

LOPEZ, REINALDO GARCIA (MEXICO INDIVIDUAL)
ALDAMA #1 BUENA VISTA DE CAÑEDO.
MPIO. SAN MARTIN HIDALGO, JALISCO.
, MEXICO C.P.46775

FOR: ENTERTAINMENT SERVICES, NAMELY, LIVE PERFORMANCES BY A MUSICAL BAND, IN CLASS 41 (U.S. CLS. 100, 101 AND 107).

FIRST USE 9-2-2011; IN COMMERCE 9-2-2011.

NO CLAIM IS MADE TO THE EXCLUSIVE RIGHT TO USE "BANDA", APART FROM THE MARK AS SHOWN.

THE COLOR(S) RED, BLACK AND WHITE IS/ARE CLAIMED AS A FEATURE OF THE MARK.

THE MARK CONSISTS OF THE STYLIZED WORDING "BANDA PELILLOS" WITH THE DESIGN OF A MAN WITH A CAP APPEARING ABOVE HIS HEAD WHICH APPEARS OVER THE LETTER "O" IN THE TERM "PELILLOS". THE COLOR RED APPEARS IN THE LETTERING FOR THE WORDING "BANDA PELILLOS" AND THE DESIGN OF THE MAN'S SHIRT AND HAT, THE COLOR BLACK APPEARS IN THE OUTLINING FOR TERM "PELILLOS", IN THE DESIGN OF THE MAN AND HIS HAT AND THE COLOR WHITE APPEARS IN THE INTERIOR OUTLINING OF THE TERM "PELILLO" AND IN THE DESIGN OF THE MAN.

THE ENGLISH TRANSLATION OF "BANDA PELILLOS" IS TRIFLES BAND.

SN 76-690,299, FILED 6-6-2008.

AMY C. KEAN, EXAMINING ATTORNEY



David J. Kypas

Director of the United States Patent and Trademark Office

United States of America

United States Patent and Trademark Office

TARGET

Reg. No. 4,175,804

VAREL INTERNATIONAL IND., L.P. (DELAWARE LIMITED LIABILITY PARTNERSHIP)
1434 PATTON, SUITE 106
CARROLLTON, TX 75007

Registered July 17, 2012

Int. Cl.: 7

FOR: DRILLING BITS, NAMELY, DRILL BITS FOR EARTH BORING DRILLING EQUIPMENT, IN CLASS 7 (U.S. CLS. 13, 19, 21, 23, 31, 34 AND 35).

TRADEMARK

FIRST USE 5-25-2012; IN COMMERCE 5-25-2012.

PRINCIPAL REGISTER

THE MARK CONSISTS OF STANDARD CHARACTERS WITHOUT CLAIM TO ANY PARTICULAR FONT, STYLE, SIZE, OR COLOR.

SN 76-694,421, FILED 11-24-2008.

KATHERINE CONNOLLY, EXAMINING ATTORNEY



David J. Kybas

Director of the United States Patent and Trademark Office

United States of America

United States Patent and Trademark Office

佛光緣美術館

FO GUANG YUAN ART GALLERY

Reg. No. 4,175,805

Registered July 17, 2012

Int. Cl.: 41

FO KUANG SHAN FOUNDATION FOR BUDDHIST CULTURE & EDUCATION (TAIWAN
NON-PROFIT ASSOCIATION)
NO.153, SINGTIAN RD.
DASHU TOWNSHIP
KAOHSIUNG COUNTY, TAIWAN 840

SERVICE MARK

PRINCIPAL REGISTER

FOR: PUBLICATION OF BOOKS, PERIODICALS AND MAGAZINES IN THE FIELD OF RELIGION AND THE ARTS; RENTAL OF BOOKS AND MAGAZINES; INSTRUCTION OF KNOWLEDGE OR TECHNOLOGY AND CONDUCTING VARIOUS COURSES, NAMELY, EDUCATIONAL SERVICES, NAMELY, CONDUCTING CLASSES, SEMINARS, CONFERENCES, AND WORKSHOPS IN THE FIELD OF RELIGION AND THE ARTS; CONDUCTING CULTURAL AND EDUCATIONAL EXHIBITIONS PROVIDING INFORMATION ABOUT LEISURE ACTIVITIES AND ENTERTAINMENT IN THE NATURE OF COMPETITIONS IN THE FIELD OF EDUCATION AND GENERAL KNOWLEDGE; PRODUCTION AND DISTRIBUTION OF MOVIE FILMS AND VIDEO FILMS FEATURING MUSIC AND DOCUMENTARIES, DRAMAS, COMEDIES, AND CARTOONS ON RELIGION, THE ARTS, SELF IMPROVEMENT, SELF HELP, PERSONAL GROWTH, AND INSPIRATIONAL TOPICS, IN CLASS 41 (U.S. CLS. 100, 101 AND 107).

FIRST USE 8-1-2002; IN COMMERCE 3-10-2007.

NO CLAIM IS MADE TO THE EXCLUSIVE RIGHT TO USE "ART GALLERY" AND THE NON-LATIN CHARACTERS THAT TRANSLITERATE TO "ART GALLERY", APART FROM THE MARK AS SHOWN.

THE NON-LATIN CHARACTERS IN THE MARK TRANSLITERATE TO "FO GUANG YUAN ART GALLERY" AND THIS MEANS PREDESTINED RELATIONSHIP OF THE BUDDHA'S LIGHT ART GALLERY IN ENGLISH.

THE ENGLISH TRANSLATION OF "FO GUANG YUAN" IN THE MARK IS PREDESTINED RELATIONSHIP OF THE BUDDHA'S LIGHT.

SN 76-695,184, FILED 1-7-2009.

SCOTT BIBB, EXAMINING ATTORNEY



David J. Kybas

Director of the United States Patent and Trademark Office

United States of America

United States Patent and Trademark Office

PANDA BRAND

Reg. No. 4,175,806

Registered July 17, 2012

Int. Cl.: 30

TRADEMARK

PRINCIPAL REGISTER

LEE KUM KEE COMPANY LIMITED (HONG KONG COMPANY)
TAI PO INDUSTRIAL ESTATE
2-4 DAI FAT STREET
TAI PO, NEW TERRITORIES, HONG KONG

FOR: SAUCES AND CONDIMENTS, NAMELY, SALAD DRESSING; SEASONINGS; MARINADES; CHILI SAUCE, IN CLASS 30 (U.S. CL. 46).

FIRST USE 4-0-2008; IN COMMERCE 4-0-2008.

THE MARK CONSISTS OF STANDARD CHARACTERS WITHOUT CLAIM TO ANY PARTICULAR FONT, STYLE, SIZE, OR COLOR.

OWNER OF U.S. REG. NOS. 1,369,326, 1,707,010, AND OTHERS.

NO CLAIM IS MADE TO THE EXCLUSIVE RIGHT TO USE "BRAND", APART FROM THE MARK AS SHOWN.

SN 76-696,703, FILED 4-6-2009.

ELI HELLMAN, EXAMINING ATTORNEY



David J. Kypos

Director of the United States Patent and Trademark Office

United States of America

United States Patent and Trademark Office

OG

Reg. No. 4,175,807

AKRUM ALRAHIB (UNITED STATES INDIVIDUAL)
6001 E. SLAUSON AVE
COMMERCE, CA 90040

Registered July 17, 2012

Int. Cl.: 34

FOR: TOBACCO PRODUCTS, NAMELY, FLAVORED TOBACCO, CIGARS, CIGAR WRAPS AND CIGARETTES, IN CLASS 34 (U.S. CLS. 2, 8, 9 AND 17).

TRADEMARK

FIRST USE 4-15-2011; IN COMMERCE 4-15-2011.

PRINCIPAL REGISTER

THE MARK CONSISTS OF STANDARD CHARACTERS WITHOUT CLAIM TO ANY PARTICULAR FONT, STYLE, SIZE, OR COLOR.

SN 76-700,556, FILED 11-27-2009.

JOHN WILKE, EXAMINING ATTORNEY



David J. Kybas

Director of the United States Patent and Trademark Office

United States of America

United States Patent and Trademark Office

SWAG

Reg. No. 4,175,808

AKRUM ALRAHIB (UNITED STATES INDIVIDUAL)
6001 E. SLAUSON AVE
COMMERCE, CA 90040

Registered July 17, 2012

Int. Cl.: 34

FOR: TOBACCO PRODUCTS, NAMELY, FLAVORED TOBACCO, CIGARS, CIGAR WRAPS AND CIGARETTES, IN CLASS 34 (U.S. CLS. 2, 8, 9 AND 17).

TRADEMARK

FIRST USE 4-15-2011; IN COMMERCE 4-15-2011.

PRINCIPAL REGISTER

THE MARK CONSISTS OF STANDARD CHARACTERS WITHOUT CLAIM TO ANY PARTICULAR FONT, STYLE, SIZE, OR COLOR.

SN 76-700,559, FILED 11-27-2009.

JOHN WILKE, EXAMINING ATTORNEY



David J. Kyffers

Director of the United States Patent and Trademark Office

United States of America

United States Patent and Trademark Office

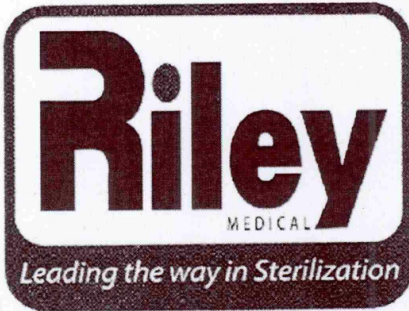

Reg. No. 4,175,809

Registered July 17, 2012

Int. Cl.: 10

TRADEMARK

PRINCIPAL REGISTER

SYMMETRY MEDICAL, INC. (INDIANA CORPORATION)
3724 N. ST. RD. 15
WARSAW, IN 46582

FOR: STERILIZATION UNITS FOR MEDICAL PURPOSES AND RELATED ACCESSORIES,
NAMELY, STORAGE CONTAINERS AND TRAYS, IN CLASS 10 (U.S. CLS. 26, 39 AND 44).

FIRST USE 3-0-2009; IN COMMERCE 3-0-2009.

NO CLAIM IS MADE TO THE EXCLUSIVE RIGHT TO USE "MEDICAL", APART FROM
THE MARK AS SHOWN.

SN 76-704,215, FILED 8-23-2010.

JOSETTE BEVERLY, EXAMINING ATTORNEY



David J. Kybas

Director of the United States Patent and Trademark Office

United States of America

United States Patent and Trademark Office

SHELMEDIA

Reg. No. 4,175,810

Registered July 17, 2012

Int. Cl.: 35

SERVICE MARK

PRINCIPAL REGISTER

SHELMEDIA, LLC (NEW JERSEY LIMITED LIABILITY COMPANY)
350 CLARK DRIVE, SUITE 104
BUDD LAKE, NJ 07828

FOR: PROFESSIONAL SERVICE FOR CONNECTING SOCIAL NETWORK USERS WITH COMPANIES AND PROFESSIONAL SERVICE PROVIDERS, FOR THE PURPOSE OF FACILITATING THE PROMOTION AND SALE OF GOODS AND SERVICES BY SAID COMPANIES AND PROFESSIONALS, VIA A VARIETY OF SOCIAL NETWORK TOOLS TO STAY CONNECTED FOR THE PURPOSES OF COMMERCE, IN CLASS 35 (U.S. CLS. 100, 101 AND 102).

FIRST USE 4-24-2012; IN COMMERCE 4-24-2012.

THE MARK CONSISTS OF STANDARD CHARACTERS WITHOUT CLAIM TO ANY PARTICULAR FONT, STYLE, SIZE, OR COLOR.

SN 76-705,617, FILED 12-9-2010.

MICHAEL WEBSTER, EXAMINING ATTORNEY



David J. Kyffers

Director of the United States Patent and Trademark Office

United States of America

United States Patent and Trademark Office

STOUT TOOL

Reg. No. 4,175,811

MERITool L.L.C. (NEW YORK LIMITED LIABILITY COMPANY)
5 PARK AVENUE
ELLICOTTVILLE, NY 14731

Registered July 17, 2012

Int. Cl.: 7

FOR: POWER OPERATED HAND TOOLS, NAMELY, BAND SAWS, IN CLASS 7 (U.S. CLS. 13, 19, 21, 23, 31, 34 AND 35).

TRADEMARK

FIRST USE 1-1-2012; IN COMMERCE 1-1-2012.

PRINCIPAL REGISTER

THE MARK CONSISTS OF STANDARD CHARACTERS WITHOUT CLAIM TO ANY PARTICULAR FONT, STYLE, SIZE, OR COLOR.

OWNER OF U.S. REG. NO. 2,954,837.

NO CLAIM IS MADE TO THE EXCLUSIVE RIGHT TO USE "TOOL", APART FROM THE MARK AS SHOWN.

SN 76-705,925, FILED 1-7-2011.

DAYNA BROWNE, EXAMINING ATTORNEY



David J. Kyfos

Director of the United States Patent and Trademark Office

United States of America

United States Patent and Trademark Office

STD DEVELOPMENT

Reg. No. 4,175,812

Registered July 17, 2012

Int. Cls.: 7 and 12

TRADEMARK

PRINCIPAL REGISTER

CAHILL, BILL MC (UNITED STATES INDIVIDUAL)
SPYKE, INC.
12155 PANGBORN AVE.
DOWNEY, CA 90241

FOR: MOTORCYCLE ENGINE PARTS, NAMELY, CYLINDER HEADS, ENGINE CASES, CRANKSHAFTS, CONNECTING RODS, PISTONS, ENGINE CYLINDERS, ENGINE CYLINDER AND PISTON SETS COMPRISED OF ENGINE CYLINDERS AND PISTONS, INTAKE AND EXHAUST VALVES, CAMSHAFTS, ENGINE TIMING COMPONENTS IN THE NATURE OF CAM SPROCKETS AND TIMING CHAINS, CARBURETORS, FUEL INJECTORS, METAL AND NON-METAL ENGINE GASKETS, OIL PUMPS, FUEL AND OIL FILTERS, SPARK PLUGS, IGNITION WIRES, ELECTRONIC IGNITIONS, AND STARTER MOTORS, IN CLASS 7 (U.S. CLS. 13, 19, 21, 23, 31, 34 AND 35).

FIRST USE 5-4-2011; IN COMMERCE 5-4-2011.

FOR: MOTORCYCLE ENGINES; TRANSMISSION CASES FOR LAND VEHICLES, NAMELY, TRANSMISSION CASES FOR MOTORCYCLES; PRIMARY COVERS FOR MOTORCYCLE TRANSMISSIONS, IN CLASS 12 (U.S. CLS. 19, 21, 23, 31, 35 AND 44).

FIRST USE 5-4-2011; IN COMMERCE 5-4-2011.

SN 76-706,544, FILED 2-24-2011.

KATHERINE E. HALMEN, EXAMINING ATTORNEY



David J. Kypos

Director of the United States Patent and Trademark Office

United States of America

United States Patent and Trademark Office



FORENSIC MEDICAL

Reg. No. 4,175,813

Registered July 17, 2012

Int. Cls.: 35, 44, and 45

SERVICE MARK

PRINCIPAL REGISTER

FORENSIC MEDICAL MANAGEMENT SERVICES, PLC (TENNESSEE LIMITED LIABILITY COMPANY)
850 R. S. GASS BOULEVARD
NASHVILLE, TN 372162640

FOR: PROVIDING FORENSIC MEDICAL SERVICES, NAMELY, MEDICAL EXAMINER SERVICES IN THE NATURE OF MANAGEMENT OF FORENSIC MEDICAL CENTERS, NAMELY, BUSINESS MANAGEMENT OF FORENSIC AUTOPSY CENTERS, PHYSICIAN STAFFING, AND STAFFING OF ANCILLARY PERSONNEL, IN CLASS 35 (U.S. CLS. 100, 101 AND 102).

FIRST USE 1-0-2011; IN COMMERCE 1-0-2011.

FOR: PROVIDING FORENSIC MEDICAL SERVICES, NAMELY, MEDICAL EXAMINER SERVICES, NAMELY, FORENSIC AUTOPSY SERVICES, NAMELY, DEATH INVESTIGATION IN THE NATURE OF AUTOPSY PATHOLOGY SERVICES, AND FORENSIC PATHOLOGY SERVICES IN THE NATURE OF AUTOPSY PATHOLOGY SERVICES, IN CLASS 44 (U.S. CLS. 100 AND 101).

FIRST USE 1-0-2011; IN COMMERCE 1-0-2011.

FOR: PROVIDING FORENSIC MEDICAL SERVICES, NAMELY, FORENSIC TESTIMONY, NAMELY, EXPERT WITNESS SERVICES IN LEGAL MATTERS THROUGH TESTIMONY IN THE FIELD OF FORENSIC PATHOLOGY FOLLOWING THE COMPLETION OF A FORENSIC AUTOPSY; FORENSIC TESTIMONY IN THE NATURE OF PROVIDING MEDICALLY BASED OPINIONS FOLLOWING REVIEW OF MEDICAL RECORDS, NAMELY, EXPERT WITNESS SERVICES IN LEGAL MATTERS IN THE FIELD OF CRIMINAL FORENSICS, IN CLASS 45 (U.S. CLS. 100 AND 101).

FIRST USE 1-0-2011; IN COMMERCE 1-0-2011.

NO CLAIM IS MADE TO THE EXCLUSIVE RIGHT TO USE "FORENSIC MEDICAL", APART FROM THE MARK AS SHOWN.

THE MARK CONSISTS OF A STYLIZED DESIGN OF A CADUCEUS WITHIN TWO CONCENTRIC VERTICAL OVALS. THE CADUCEUS DESIGN INCLUDES TWO HANGING



David J. Kyjars

Director of the United States Patent and Trademark Office

Reg. No. 4,175,813 BASKETS TO THE LEFT AND RIGHT OF THE CADUCEUS AND RESEMBLING A WEIGHT SCALE. TO THE RIGHT OF THE DESIGN IS THE WORDING "FORENSIC MEDICAL".

SN 76-706,692, FILED 3-8-2011.

ANNE FARRELL, EXAMINING ATTORNEY

United States of America

United States Patent and Trademark Office



Reg. No. 4,175,814

Registered July 17, 2012

Int. Cls.: 7 and 12

TRADEMARK

PRINCIPAL REGISTER

MC CAHILL, BILL (UNITED STATES INDIVIDUAL)
12155 PANGBORN AVE.
SPYKE, INC.
DOWNEY, CA 90241

FOR: MOTORCYCLE ENGINE PARTS, NAMELY, CYLINDER HEADS, ENGINE AND TRANSMISSION CASES, CRANKSHAFTS, CONNECTING RODS, PISTONS, ENGINE CYLINDERS, ENGINE CYLINDER AND PISTON SETS, INTAKE AND EXHAUST VALVES, CAMSHAFTS, CAM SPROCKETS AND TIMING CHAINS, PRIMARY COVERS, CARBUR-ETORS, FUEL INJECTORS, GASKETS, OIL PUMPS, FUEL AND OIL FILTERS, SPARK PLUGS, IGNITION WIRES, ELECTRONIC IGNITIONS, AND STARTER MOTORS, IN CLASS 7 (U.S. CLS. 13, 19, 21, 23, 31, 34 AND 35).

FIRST USE 5-4-2011; IN COMMERCE 5-4-2011.

FOR: MOTORCYCLE ENGINES, IN CLASS 12 (U.S. CLS. 19, 21, 23, 31, 35 AND 44).

FIRST USE 5-4-2011; IN COMMERCE 5-4-2011.

THE MARK CONSISTS OF THE LETTERS "STD" SEPARATED BY SMALL CIRCLES OR DOTS INSIDE OF AN OVAL.

SN 76-706,757, FILED 3-11-2011.

RONALD MCMORROW, EXAMINING ATTORNEY



David J. Kybas

Director of the United States Patent and Trademark Office

United States of America

United States Patent and Trademark Office

Turn Key

Reg. No. 4,175,815

E&B GIFTWARE, LLC (DELAWARE LIMITED LIABILITY COMPANY)
4 EXECUTIVE PLAZA
YONKERS, NY 10701

Registered July 17, 2012

Int. Cl.: 28

FOR: MANUALLY OPERATED HAND HELD EXERCISE EQUIPMENT, IN CLASS 28 (U.S. CLS. 22, 23, 38 AND 50).

TRADEMARK

FIRST USE 9-30-2011; IN COMMERCE 9-30-2011.

PRINCIPAL REGISTER

THE MARK CONSISTS OF STANDARD CHARACTERS WITHOUT CLAIM TO ANY PARTICULAR FONT, STYLE, SIZE, OR COLOR.

SN 76-707,238, FILED 4-12-2011.

ALLISON HOLTZ, EXAMINING ATTORNEY



David J. Kyffers

Director of the United States Patent and Trademark Office

United States of America

United States Patent and Trademark Office

OXYGENICS POWERSELECT

Reg. No. 4,175,816

FAN FI INTERNATIONAL, INC. (NEVADA CORPORATION)
976 UNITED CIRCLE
SPARKS, NV 894316514

Registered July 17, 2012

Int. Cl.: 11

FOR: SHOWERHEADS, IN CLASS 11 (U.S. CLS. 13, 21, 23, 31 AND 34).

TRADEMARK

FIRST USE 8-0-2011; IN COMMERCE 8-0-2011.

PRINCIPAL REGISTER

THE MARK CONSISTS OF STANDARD CHARACTERS WITHOUT CLAIM TO ANY PARTICULAR FONT, STYLE, SIZE, OR COLOR.

OWNER OF U.S. REG. NOS. 3,709,028, 3,941,005, AND OTHERS.

SN 76-707,522, FILED 5-9-2011.

DAVID I, EXAMINING ATTORNEY



David J. Kyfos

Director of the United States Patent and Trademark Office

United States of America

United States Patent and Trademark Office

CATALYST MORTGAGE

Reg. No. 4,175,817

CATALYST MORTGAGE INC. (CALIFORNIA CORPORATION)
1375 EXPOSITION BLVD., SUITE 207
SACRAMENTO, CA 95815

Registered July 17, 2012

Int. Cl.: 36

FOR: MORTGAGE BROKERAGE; MORTGAGE PROCUREMENT FOR OTHERS, IN CLASS 36 (U.S. CLS. 100, 101 AND 102).

SERVICE MARK

FIRST USE 4-17-2012; IN COMMERCE 4-17-2012.

PRINCIPAL REGISTER

THE MARK CONSISTS OF STANDARD CHARACTERS WITHOUT CLAIM TO ANY PARTICULAR FONT, STYLE, SIZE, OR COLOR.

NO CLAIM IS MADE TO THE EXCLUSIVE RIGHT TO USE "MORTGAGE", APART FROM THE MARK AS SHOWN.

SN 76-707,677, FILED 5-20-2011.

TRACY FLETCHER, EXAMINING ATTORNEY



David J. Kybas

Director of the United States Patent and Trademark Office

United States of America

United States Patent and Trademark Office

FLOWT

Reg. No. 4,175,818

M SHIP CO., LLC. (NEW MEXICO LIMITED LIABILITY COMPANY)
401 WEST "A" STREET, SUITE 2125
SAN DIEGO, CA 92101

Registered July 17, 2012

Int. Cl.: 12

FOR: TRAILERABLE AND NON-TRAILERABLE POWERED WATERCRAFT IN THE NATURE OF BOATS FOR SUPPORTING MODEL HULLS IN, AND DRIVING THE MODEL HULLS THROUGH, A BODY OF WATER FOR MODEL-HULL TESTING PURPOSES, IN CLASS 12 (U.S. CLS. 19, 21, 23, 31, 35 AND 44).

TRADEMARK

PRINCIPAL REGISTER

FIRST USE 1-19-2012; IN COMMERCE 1-19-2012.

THE MARK CONSISTS OF STANDARD CHARACTERS WITHOUT CLAIM TO ANY PARTICULAR FONT, STYLE, SIZE, OR COLOR.

SN 76-708,056, FILED 6-20-2011.

AMY HELLA, EXAMINING ATTORNEY



David J. Kyffers

Director of the United States Patent and Trademark Office

United States of America

United States Patent and Trademark Office

FLOW-T

Reg. No. 4,175,819

M SHIP CO., LLC. (NEW MEXICO LIMITED LIABILITY COMPANY)
401 WEST "A" STREET, SUITE 2125
SAN DIEGO, CA 92101

Registered July 17, 2012

Int. Cl.: 12

FOR: TRAILERABLE AND NON-TRAILERABLE POWERED WATERCRAFT IN THE NATURE OF BOATS FOR SUPPORTING MODEL HULLS IN, AND DRIVING THE MODEL HULLS THROUGH, A BODY OF WATER FOR MODEL-HULL TESTING PURPOSES, IN CLASS 12 (U.S. CLS. 19, 21, 23, 31, 35 AND 44).

TRADEMARK

PRINCIPAL REGISTER

FIRST USE 1-19-2012; IN COMMERCE 1-19-2012.

THE MARK CONSISTS OF STANDARD CHARACTERS WITHOUT CLAIM TO ANY PARTICULAR FONT, STYLE, SIZE, OR COLOR.

SN 76-708,057, FILED 6-20-2011.

AMY HELLA, EXAMINING ATTORNEY



David J. Kyffers

Director of the United States Patent and Trademark Office

United States of America

United States Patent and Trademark Office

ACCUFUEL SPOUT

Reg. No. 4,175,820

HUSKY CORPORATION (MISSOURI CORPORATION)
2325 HUSKY WAY
PACIFIC, MO 63069

Registered July 17, 2012

Int. Cl.: 9

FOR: FUEL NOZZLES FOR USE WITH FUEL DISPENSERS FOR SERVICE STATIONS, IN CLASS 9 (U.S. CLS. 21, 23, 26, 36 AND 38).

TRADEMARK

FIRST USE 8-15-2011; IN COMMERCE 6-1-2012.

PRINCIPAL REGISTER

THE MARK CONSISTS OF STANDARD CHARACTERS WITHOUT CLAIM TO ANY PARTICULAR FONT, STYLE, SIZE, OR COLOR.

NO CLAIM IS MADE TO THE EXCLUSIVE RIGHT TO USE "SPOUT", APART FROM THE MARK AS SHOWN.

SN 76-708,153, FILED 6-27-2011.

STEVEN R. FINE, EXAMINING ATTORNEY



David J. Kyffers

Director of the United States Patent and Trademark Office

United States of America

United States Patent and Trademark Office

SILENUS WINERY

Reg. No. 4,175,821

Registered July 17, 2012

Int. Cls.: 29 and 33

TRADEMARK

PRINCIPAL REGISTER

SILENUS INTERNATIONAL GROUP, INC. (CALIFORNIA CORPORATION)
5225 SOLANO AVENUE
NAPA, CA 94558

FOR: OLIVE OIL, IN CLASS 29 (U.S. CL. 46).

FIRST USE 9-1-2011; IN COMMERCE 9-1-2011.

FOR: WINE, IN CLASS 33 (U.S. CLS. 47 AND 49).

FIRST USE 9-1-2011; IN COMMERCE 9-1-2011.

THE MARK CONSISTS OF STANDARD CHARACTERS WITHOUT CLAIM TO ANY PARTICULAR FONT, STYLE, SIZE, OR COLOR.

OWNER OF U.S. REG. NO. 3,536,390.

NO CLAIM IS MADE TO THE EXCLUSIVE RIGHT TO USE "WINERY", APART FROM THE MARK AS SHOWN.

SN 76-708,471, FILED 7-26-2011.

APRIL HESIK, EXAMINING ATTORNEY



David J. Kybas

Director of the United States Patent and Trademark Office

United States of America

United States Patent and Trademark Office

LIP-SYNC COSMETICS

Reg. No. 4,175,822

BOTKIN, HILDA ISABEL (SOUTH AFRICA INDIVIDUAL)

Registered July 17, 2012

P.O. BOX 16321
PORTLAND, OR 97292

Int. Cl.: 3

FOR: COSMETIC LIPSTICK AND EYEBROW LINER SEALERS, IN CLASS 3 (U.S. CLS. 1, 4, 6, 50, 51 AND 52).

TRADEMARK

FIRST USE 5-7-2012; IN COMMERCE 5-7-2012.

PRINCIPAL REGISTER

THE MARK CONSISTS OF STANDARD CHARACTERS WITHOUT CLAIM TO ANY PARTICULAR FONT, STYLE, SIZE, OR COLOR.

NO CLAIM IS MADE TO THE EXCLUSIVE RIGHT TO USE "COSMETICS", APART FROM THE MARK AS SHOWN.

SN 76-708,993, FILED 9-6-2011.

GENE MACIOL, EXAMINING ATTORNEY



David J. Kybas

Director of the United States Patent and Trademark Office

United States of America

United States Patent and Trademark Office

Versa*Flame

Reg. No. 4,175,823

RANKAM (CHINA) MANUFACTURING CO., LTD. (HONG KONG CORPORATION)
18F NEW LEE WAH CENTRE
KOWLOON, HONG KONG

Registered July 17, 2012

Int. Cl.: 11

FOR: OUTDOOR GAS AND CHARCOAL GRILLS AND SMOKERS, IN CLASS 11 (U.S. CLS. 13, 21, 23, 31 AND 34).

TRADEMARK

FIRST USE 11-12-2011; IN COMMERCE 11-12-2011.

PRINCIPAL REGISTER

THE MARK CONSISTS OF STANDARD CHARACTERS WITHOUT CLAIM TO ANY PARTICULAR FONT, STYLE, SIZE, OR COLOR.

SN 76-709,055, FILED 9-13-2011.

DARRYL SPRUILL, EXAMINING ATTORNEY



David J. Kybas

Director of the United States Patent and Trademark Office

United States of America

United States Patent and Trademark Office

X

Reg. No. 4,175,824

BOMBARDIER RECREATIONAL PRODUCTS INC. (CANADA CORPORATION)

726 ST-JOSEPH STREET

Registered July 17, 2012

VALCOURT, QUEBEC J0E 2L0

**Int. Cls.: 9, 12, 16, 18, 20,
28, and 35**

FOR: RECREATIONAL VEHICLE HELMETS, NAMELY, SNOWMOBILE HELMETS, PERSONAL WATERCRAFT HELMETS, AND ALL-TERRAIN VEHICLE HELMETS; NEON SIGNS; PERSONAL FLOATATION DEVICES, NAMELY, LIFE VESTS AND LIFE SAVING RAFTS; HELMET BAGS, IN CLASS 9 (U.S. CLS. 21, 23, 26, 36 AND 38).

TRADEMARK

FIRST USE 12-31-2009; IN COMMERCE 12-31-2009.

SERVICE MARK

FOR: RECREATIONAL VEHICLES, NAMELY, SNOWMOBILES, AND ALL-TERRAIN VEHICLES; LICENSE PLATE HOLDERS; FITTED AND SEMI-FITTED VEHICLE COVER, IN CLASS 12 (U.S. CLS. 19, 21, 23, 31, 35 AND 44).

PRINCIPAL REGISTER

FIRST USE 12-31-2000; IN COMMERCE 12-31-2000.

FOR: PAPER GOODS, NAMELY, POSTERS; CALENDARS; DECALS; PAPER FLAGS, PAPER BANNERS, AND PAPER PENNANTS; TEMPORARY TATTOO TRANSFERS, IN CLASS 16 (U.S. CLS. 2, 5, 22, 23, 29, 37, 38 AND 50).

FIRST USE 12-31-2008; IN COMMERCE 12-31-2008.

FOR: BAGS AND CASES, NAMELY, SPORTS BAGS, GYM BAGS, KEY CASES; UMBRELLAS, LAWN UMBRELLAS, BEACH UMBRELLAS, IN CLASS 18 (U.S. CLS. 1, 2, 3, 22 AND 41).

FIRST USE 12-31-2007; IN COMMERCE 12-31-2007.

FOR: PLASTIC OBJECTS, NAMELY, KEY-CHAIN TRINKETS NOT OF METAL, FLAGS, BANNERS, PENNANTS, IN CLASS 20 (U.S. CLS. 2, 13, 22, 25, 32 AND 50).

FIRST USE 9-30-2011; IN COMMERCE 9-30-2011.

FOR: SNOW SLEDS FOR RECREATIONAL USE, IN CLASS 28 (U.S. CLS. 22, 23, 38 AND 50).

FIRST USE 12-31-2010; IN COMMERCE 12-31-2010.

FOR: RETAIL STORE SERVICES FEATURING RECREATIONAL VEHICLES, NAMELY, SNOWMOBILES, ALL-TERRAIN VEHICLES AND PERSONAL WATERCRAFT, NAMELY, SINGLE AND MULTIPLE PASSENGER RECREATIONAL JET BOATS, IN CLASS 35 (U.S. CLS. 100, 101 AND 102).

FIRST USE 12-31-2007; IN COMMERCE 12-31-2007.



David J. Kyjars

Director of the United States Patent and Trademark Office

Reg. No. 4,175,824 OWNER OF U.S. REG. NOS. 4,116,926 AND 4,116,927.

SN 76-979,101, FILED 9-21-2000.

DARRYL SPRUILL, EXAMINING ATTORNEY

United States of America

United States Patent and Trademark Office

GORMITI

Reg. No. 4,175,825

GIOCHI PREZIOSI S.P.A. (ITALY JOINT STOCK COMPANY)
VIA GIOBERTI 1
MILANO, ITALY 20123

Registered July 17, 2012

Int. Cl.: 28

FOR: CARD GAMES, IN CLASS 28 (U.S. CLS. 22, 23, 38 AND 50).

TRADEMARK

FIRST USE 11-1-2005; IN COMMERCE 2-1-2009.

PRINCIPAL REGISTER

THE MARK CONSISTS OF STANDARD CHARACTERS WITHOUT CLAIM TO ANY PARTICULAR FONT, STYLE, SIZE, OR COLOR.

SN 77-086,836, FILED 1-19-2007.

EDWARD NELSON, EXAMINING ATTORNEY



David J. Kybas

Director of the United States Patent and Trademark Office

United States of America

United States Patent and Trademark Office



Reg. No. 4,175,826

Registered July 17, 2012

Int. Cl.: 41

SERVICE MARK

PRINCIPAL REGISTER

THE ADMINISTRATORS OF THE TULANE EDUCATIONAL FUND (LOUISIANA
NON-PROFIT CORPORATION)
300 GIBSON HALL
6823 ST. CHARLES AVENUE
NEW ORLEANS, LA 70118

FOR: ENTERTAINMENT SERVICES, NAMELY, CLASS REUNIONS AND ALUMNAE
PROGRAMMING, NAMELY, SOCIAL EVENTS FOR ALUMNAE AND CURRENT STUDENTS,
IN CLASS 41 (U.S. CLS. 100, 101 AND 107).

FIRST USE 1-1-1983; IN COMMERCE 1-1-1983.

SN 77-182,953, FILED 5-16-2007.

LINDA M. KING, EXAMINING ATTORNEY



David J. Kyffers

Director of the United States Patent and Trademark Office

United States of America

United States Patent and Trademark Office

EXPLORE

Reg. No. 4,175,827

Registered July 17, 2012

Int. Cls.: 16 and 18

TRADEMARK

PRINCIPAL REGISTER

EXPLORE ANNENBERG LLC (DELAWARE LIMITED LIABILITY COMPANY)
SUITE 1000
2000 AVENUE OF THE STARS
LOS ANGELES, CA 90067

FOR: PRINTED EDUCATIONAL MATERIALS IN THE FIELD OF NATIONAL AND INTERNATIONAL CULTURES, NATIONAL AND INTERNATIONAL PLACES, AND PEOPLE OF DIFFERENT NATIONALITIES, IN CLASS 16 (U.S. CLS. 2, 5, 22, 23, 29, 37, 38 AND 50).

FIRST USE 6-30-2009; IN COMMERCE 6-30-2009.

FOR: BACKPACKS, IN CLASS 18 (U.S. CLS. 1, 2, 3, 22 AND 41).

FIRST USE 1-0-2007; IN COMMERCE 1-0-2007.

THE MARK CONSISTS OF STANDARD CHARACTERS WITHOUT CLAIM TO ANY PARTICULAR FONT, STYLE, SIZE, OR COLOR.

SN 77-232,262, FILED 7-18-2007.

SANDRA BUJA, EXAMINING ATTORNEY



David J. Kyffers

Director of the United States Patent and Trademark Office

United States of America

United States Patent and Trademark Office

explore

Reg. No. 4,175,828

Registered July 17, 2012

Int. Cls.: 16 and 18

TRADEMARK

PRINCIPAL REGISTER

EXPLORE ANNEBERG LLC (DELAWARE LIMITED LIABILITY COMPANY)
SUITE 1000
2000 AVENUE OF THE STARS
LOS ANGELES, CA 90067

FOR: PRINTED EDUCATIONAL MATERIALS IN THE FIELD OF NATIONAL AND INTERNATIONAL CULTURES, NATIONAL AND INTERNATIONAL PLACES, AND PEOPLE OF DIFFERENT NATIONALITIES; WRITING INSTRUMENTS, IN CLASS 16 (U.S. CLS. 2, 5, 22, 23, 29, 37, 38 AND 50).

FIRST USE 6-30-2009; IN COMMERCE 6-30-2009.

FOR: BACKPACKS, IN CLASS 18 (U.S. CLS. 1, 2, 3, 22 AND 41).

FIRST USE 1-0-2007; IN COMMERCE 1-0-2007.

SN 77-232,390, FILED 7-18-2007.

SANDRA BUJA, EXAMINING ATTORNEY



David J. Kyffers

Director of the United States Patent and Trademark Office

United States of America

United States Patent and Trademark Office

TOP SHELF

Reg. No. 4,175,829

Registered July 17, 2012

Int. Cls.: 3 and 24

TRADEMARK

PRINCIPAL REGISTER

THE FINAL DETAIL COMPANY (PENNSYLVANIA CORPORATION)
2101 MARKET STREET, SUITE 2006
THE MURANO
PHILADELPHIA, PA 19103

FOR: KITS COMPRISING CLEANING PREPARATIONS FOR VEHICLES; AUTOMOTIVE CLEANING PREPARATIONS, NAMELY, WHEEL CLEANERS, WHEEL BRIGHTENER, TIRE SHINE; VEHICLE CLEANING PREPARATIONS IN THE NATURE OF EFFERVESCENT TABLETS; AUTOMOTIVE WAX, IN CLASS 3 (U.S. CLS. 1, 4, 6, 50, 51 AND 52).

FIRST USE 6-11-2010; IN COMMERCE 6-11-2010.

FOR: TOWELS, NAMELY, MICROFIBER CLEANING TOWELS FOR VEHICLE USE, IN CLASS 24 (U.S. CLS. 42 AND 50).

FIRST USE 3-2-2011; IN COMMERCE 3-2-2011.

THE MARK CONSISTS OF STANDARD CHARACTERS WITHOUT CLAIM TO ANY PARTICULAR FONT, STYLE, SIZE, OR COLOR.

SN 77-240,280, FILED 7-27-2007.

JENNIFER MARTIN, EXAMINING ATTORNEY



David J. Kyjars

Director of the United States Patent and Trademark Office

United States of America

United States Patent and Trademark Office

TADASHI SHOJI

Reg. No. 4,175,830

Registered July 17, 2012

Int. Cls.: 14 and 18

TRADEMARK

PRINCIPAL REGISTER

T S COLLECTION, INC. (CALIFORNIA CORPORATION)
3016 EAST 44TH STREET
LOS ANGELES, CA 90058

FOR: BRACELETS; BROOCHES; EARRINGS; JEWELRY; NECKLACES, IN CLASS 14 (U.S. CLS. 2, 27, 28 AND 50).

FIRST USE 6-3-2011; IN COMMERCE 6-3-2011.

FOR: HANDBAGS, IN CLASS 18 (U.S. CLS. 1, 2, 3, 22 AND 41).

FIRST USE 11-5-2010; IN COMMERCE 11-5-2010.

THE MARK CONSISTS OF STANDARD CHARACTERS WITHOUT CLAIM TO ANY PARTICULAR FONT, STYLE, SIZE, OR COLOR.

OWNER OF U.S. REG. NOS. 2,682,363, 3,054,263, AND 3,339,021.

THE NAME "TADASHI SHOJI" IDENTIFIES A LIVING INDIVIDUAL WHOSE CONSENT IS OF RECORD.

SN 77-255,396, FILED 8-14-2007.

JAY BESCH, EXAMINING ATTORNEY



David J. Kybas

Director of the United States Patent and Trademark Office

United States of America

United States Patent and Trademark Office

LEGENDARY

Reg. No. 4,175,831

Registered July 17, 2012

Int. Cl.: 9

TRADEMARK

PRINCIPAL REGISTER

MCINTOSH LABORATORY, INC. (DELAWARE CORPORATION)
2 CHAMBERS STREET
BINGHAMTON, NY 139032699

FOR: AUDIO AND VIDEO EQUIPMENT, NAMELY, TUNERS, PREAMPS, AMPLIFIERS, RECEIVERS, LOUDSPEAKERS, ENVIRONMENTAL EQUALIZERS, SYSTEM CONTROLLERS AND SWITCHES, REMOTE CONTROL DEVICES, AND COMPACT DISC PLAYERS, IN CLASS 9 (U.S. CLS. 21, 23, 26, 36 AND 38).

FIRST USE 5-1-2010; IN COMMERCE 5-1-2010.

THE MARK CONSISTS OF STANDARD CHARACTERS WITHOUT CLAIM TO ANY PARTICULAR FONT, STYLE, SIZE, OR COLOR.

SN 77-268,646, FILED 8-30-2007.

KATINA MISTER, EXAMINING ATTORNEY



David J. Kyffers

Director of the United States Patent and Trademark Office

United States of America

United States Patent and Trademark Office

PLANET SUN

Reg. No. 4,175,832

PLANET SUN LLC (HAWAII LIMITED LIABILITY COMPANY)
251 ILIHAU STREET
KAILUA, HI 96734

Registered July 17, 2012

Int. Cls.: 3, 9, 25, and 35

FOR: AFTER-SUN LOTIONS; SUN CARE LOTIONS; SUN SCREEN; SUN-BLOCK LOTIONS; AFTER SUN CREAMS; AFTER-SUN GELS; AFTER-SUN OILS; COSMETIC SUN-PROTECTING PREPARATIONS; SUN BLOCK; LIP BALM, IN CLASS 3 (U.S. CLS. 1, 4, 6, 50, 51 AND 52).

TRADEMARK

SERVICE MARK

FIRST USE 2-16-2008; IN COMMERCE 2-16-2008.

PRINCIPAL REGISTER

FOR: PROTECTIVE CLOTHING, IN CLASS 9 (U.S. CLS. 21, 23, 26, 36 AND 38).

FIRST USE 6-15-2008; IN COMMERCE 6-15-2008.

FOR: SUN SLEEVES; SUN VISORS, IN CLASS 25 (U.S. CLS. 22 AND 39).

FIRST USE 6-1-2010; IN COMMERCE 6-1-2010.

FOR: CATALOG ORDERING SERVICE FEATURING SUN AND UV PROTECTIVE CLOTHING AND SUNCARE PRODUCTS; COMPUTERIZED ON-LINE RETAIL STORE SERVICES IN THE FIELD OF SUN AND UV PROTECTIVE CLOTHING AND SUNCARE PRODUCTS; DISCOUNT STORES IN THE FIELD OF SUN AND UV PROTECTIVE CLOTHING AND SUNCARE PRODUCTS; DISTRIBUTORSHIPS IN THE FIELD OF SUN AND UV PROTECTIVE CLOTHING AND SUNCARE PRODUCTS; MAIL ORDER CATALOG SERVICES FEATURING SUN AND UV PROTECTIVE CLOTHING AND SUNCARE PRODUCTS; MAIL ORDER SERVICES FEATURING SUN AND UV PROTECTIVE CLOTHING AND SUNCARE PRODUCTS; ON-LINE RETAIL STORE SERVICES FEATURING SUN AND UV PROTECTIVE CLOTHING AND SUNCARE PRODUCTS; ONLINE RETAIL CONSIGNMENT STORES FEATURING SUN AND UV PROTECTIVE CLOTHING AND SUNCARE PRODUCTS; RETAIL APPAREL STORES; RETAIL CLOTHING BOUTIQUES; RETAIL CLOTHING STORES; RETAIL CONSIGNMENT STORES FEATURING SUN AND UV PROTECTIVE CLOTHING AND SUNCARE PRODUCTS; RETAIL CONSIGNMENT STORES IN THE FIELD OF SUN AND UV PROTECTIVE CLOTHING AND SUNCARE PRODUCTS; RETAIL CONVENIENCE STORES; RETAIL SERVICES BY DIRECT SOLICITATION BY SALES AGENTS IN THE FIELD OF SUN AND UV PROTECTIVE CLOTHING AND SUNCARE PRODUCTS; RETAIL STORE SERVICES, AVAILABLE THROUGH COMPUTER COMMUNICATIONS AND IN-



David J. Kyjars

Director of the United States Patent and Trademark Office

Reg. No. 4,175,832 INTERACTIVE TELEVISION, FEATURING SUN AND UV PROTECTIVE CLOTHING AND SUNCARE PRODUCTS; RETAIL VARIETY STORES; TEMPORARY RETAIL STORES SET UP ON-SITE AT SCHOOLS TO PROVIDE SHOPPING FACILITIES FOR STUDENTS; WHOLESALE DISTRIBUTORSHIPS FEATURING SUN AND UV PROTECTIVE CLOTHING AND SUNCARE PRODUCTS; WHOLESALE STORES FEATURING SUN AND UV PROTECTIVE CLOTHING AND SUNCARE PRODUCTS, IN CLASS 35 (U.S. CLS. 100, 101 AND 102).

FIRST USE 2-16-2008; IN COMMERCE 2-16-2008.

NO CLAIM IS MADE TO THE EXCLUSIVE RIGHT TO USE "SUN", APART FROM THE MARK AS SHOWN.

THE COLOR(S) ORANGE, GRAY, AND WHITE IS/ARE CLAIMED AS A FEATURE OF THE MARK.

THE MARK CONSISTS OF AN ORANGE BORDER WITH A WHITE BACKGROUND, ORANGE LETTERING WITH A GRAY OUTLINE.

SN 77-272,623, FILED 9-6-2007.

JAMES A. RAUEN, EXAMINING ATTORNEY

United States of America

United States Patent and Trademark Office

CDHC

Reg. No. 4,175,833

Registered July 17, 2012

Int. Cl.: 42

SERVICE MARK

PRINCIPAL REGISTER

AMERICAN DENTAL ASSOCIATION (ILLINOIS CORPORATION)
211 EAST CHICAGO AVE.
CHICAGO, IL 60611

FOR: ACCREDITATION SERVICES, NAMELY, SETTING AND PROVIDING STANDARDS FOR THE NECESSARY EDUCATION, TRAINING, EXPERIENCE AND BACKGROUND OF INDIVIDUAL ORAL HEALTH CARE TEAM MEMBERS QUALIFIED TO PROVIDE DENTAL SERVICES UNDER THE DIRECTION OF A DENTIST IN ORDER TO MAINTAIN THE DENTAL HEALTH OF PATIENTS IN HEALTH AND COMMUNITY SETTINGS FOR THE PURPOSE OF ACCREDITATION, IN CLASS 42 (U.S. CLS. 100 AND 101).

FIRST USE 0-0-2010; IN COMMERCE 0-0-2010.

THE MARK CONSISTS OF STANDARD CHARACTERS WITHOUT CLAIM TO ANY PARTICULAR FONT, STYLE, SIZE, OR COLOR.

SN 77-310,067, FILED 10-22-2007.

TRACY FLETCHER, EXAMINING ATTORNEY



David J. Kyffers

Director of the United States Patent and Trademark Office

United States of America
United States Patent and Trademark Office

BAYWATCH

Reg. No. 4,175,834

THE BAYWATCH PRODUCTION COMPANY (CALIFORNIA CORPORATION)
4000 W. ALAMEDA AVENUE, 3RD FLOOR
BURBANK, CA 91505

Registered July 17, 2012

Int. Cl.: 16

FOR: PRINTED MATTER, NAMELY, GREETING CARDS, IN CLASS 16 (U.S. CLS. 2, 5, 22, 23, 29, 37, 38 AND 50).

TRADEMARK

FIRST USE 3-1-2009; IN COMMERCE 3-1-2009.

PRINCIPAL REGISTER

THE MARK CONSISTS OF STANDARD CHARACTERS WITHOUT CLAIM TO ANY PARTICULAR FONT, STYLE, SIZE, OR COLOR.

OWNER OF U.S. REG. NOS. 2,050,465, 2,324,685, AND OTHERS.

SN 77-322,463, FILED 11-6-2007.

BARBARA RUTLAND, EXAMINING ATTORNEY



David J. Kyros

Director of the United States Patent and Trademark Office

United States of America

United States Patent and Trademark Office

The logo for AMT&C features the letters 'A', 'M', 'T', and '&C' in a bold, sans-serif font. The 'A' and '&C' are blue, while the 'M' and 'T' are red. The 'M' is stylized with a red arrow pointing downwards from its top right corner. The logo is set against a light blue background that tapers to a point on either side.

Reg. No. 4,175,835

Registered July 17, 2012

Int. Cls.: 7, 9, and 42

TRADEMARK

SERVICE MARK

PRINCIPAL REGISTER

AMT&C GROUP LTD (UNITED KINGDOM LIMITED LIABILITY COMPANY)
OFFICE 4, 59-60 RUSSELL SQUARE
LONDON, UNITED KINGDOM WC1B4HP

FOR: ELECTRIC MOTORS FOR MACHINES, OTHER THAN FOR LAND VEHICLES; ELECTRICAL EQUIPMENT FOR VEHICLES, NAMELY, ELECTRIC MOTORS FOR OPERATION OF POWER STEERING, SCREEN WIPERS, WINDOW RAISERS, HEADLIGHT WASHERS, SCREEN WASHERS, DIRECTION INDICATORS, SEAT HEATING, GLASS HEATING; GENERATORS OF ELECTRICITY; STARTERS FOR MOTORS AND ENGINES; COMPONENT REPLACEMENT PARTS OF THE AFOREMENTIONED GOODS, INCLUDING PERMANENT MAGNETS AND SOFT MAGNETIC MATERIALS; CENTRIFUGAL IRON SEPARATORS; DRUM MAGNETIC CYCLONE SEPARATORS; MAGNETIC STREET SWEEPERS, IN CLASS 7 (U.S. CLS. 13, 19, 21, 23, 31, 34 AND 35).

FIRST USE 10-1-1999; IN COMMERCE 10-1-1999.

FOR: NON-POWER OPERATED APPARATUS AND INSTRUMENTS IN THE NATURE OF MAGNETIC SEPARATION APPARATUS, NAMELY, HANDING IRON SEPARATORS FOR CONVEYOR LINES, SELF-EMPTYING IRON SEPARATORS, MAGNETIC LATTICES, PULLEY-TYPE SEPARATORS AND IRON SEPARATORS, DRUM MAGNETIC SEPARATORS FOR BULK MATERIALS, DRUM MAGNETIC SEPARATORS FOR LIQUIDS, PERMANENT-MAGNETIC CHUCKS, MAGNETIC SEPARATORS FOR PIPING SYSTEMS FOR LIQUIDS FOR INDUSTRIAL USE; DEVICES FOR GENERATING MAGNETIC FIELDS, NAMELY, AXIAL MAGNETIC FIELD SOURCES, MAGNETIC FIELD SOURCES FOR MAGNETIC FLAW DETECTION, HIGH-INTENSITY MAGNETIC FIELD SOURCES, CONTROLLED RATE MAGNETIC FIELD SOURCES, MAGNETIC FIELD SOURCES FOR NONDESTRUCTIVE INSPECTION, SOURCES FOR PREDETERMINED CONFIGURATION MAGNETOSTATIC FIELD; MAGNETIC BLOCKS FOR INDUSTRIAL USE; MAGNETIC PROBES FOR DETECTING FERROMAGNETIC INCLUSIONS IN NONMAGNETIC MATERIALS; SUSPENDED MAGNETIC PLATES FOR MAGNETIC SEPARATION; MAGNETIC FIXATION DEVICES FOR WELDING, NAMELY, MAGNETIC WELDING HOLDERS; AUTOMATED COMPACT VIBRATING SAMPLE MAGNETOMETER; MAGNETIC WELDING POSITIONERS; HAND OPERATED CLAMPS, NAMELY, MAGNETIC FIXATION DEVICES, MAGNETIC DEVICES FOR WELDING, IN CLASS 9 (U.S. CLS. 21, 23, 26, 36 AND 38).

FIRST USE 10-1-1999; IN COMMERCE 10-1-1999.



David J. Kyjars

Director of the United States Patent and Trademark Office

Reg. No. 4,175,835 FOR: SCIENTIFIC AND TECHNICAL CONSULTING SERVICES AND RESEARCH AND DESIGN RELATING THERETO IN THE FIELD OF USING MAGNETS FOR INDUSTRY, SCIENCE, MEDICINE, ADVERTISING; INDUSTRIAL ANALYSIS AND RESEARCH SERVICES IN THE FIELD OF USING MAGNETS FOR INDUSTRY, SCIENCE, MEDICINE, ADVERTISING; DESIGN AND DEVELOPMENT OF COMPUTER HARDWARE AND SOFTWARE, IN CLASS 42 (U.S. CLS. 100 AND 101).

FIRST USE 10-1-1999; IN COMMERCE 10-1-1999.

PRIORITY CLAIMED UNDER SEC. 44(D) ON ERPN CMNTY TM OFC APPLICATION NO. 006075519, FILED 7-6-2007, REG. NO. 006075519, DATED 10-17-2008, EXPIRES 7-6-2017.

THE COLOR(S) RED, SKY BLUE AND BLUE IS/ARE CLAIMED AS A FEATURE OF THE MARK.

THE MARK CONSISTS OF LETTERS "AMT" AND "C" DIVIDED BY SYMBOL "&". THESE ELEMENTS ARE PRESENTED AGAINST THE BACKGROUND OF A BAND WHICH CONVERGES IN THE CENTER. LETTER "M" IS STYLIZED AND PRESENTED IN RED. THE BAND HAS A BLEND FROM BLUE IN THE CENTER TO SKY BLUE IN THE PERIPHERAL PARTS. OTHER ELEMENTS OF THE MARK ARE PRESENTED IN BLUE.

SN 77-339,571, FILED 11-29-2007.

ANTHONY RINKER, EXAMINING ATTORNEY

United States of America

United States Patent and Trademark Office

SAN CRISTOBAL

Reg. No. 4,175,836

UNITED STATES AUTO CLUB, MOTORING DIVISION, INC. (INDIANA CORPORATION)
3410 MIDCOURT ROAD, SUITE 215
CARROLLTON, TX 75006

Registered July 17, 2012

Int. Cl.: 39

FOR: VEHICLE TOWING SERVICES, IN CLASS 39 (U.S. CLS. 100 AND 105).

SERVICE MARK

FIRST USE 6-24-2011; IN COMMERCE 7-28-2011.

PRINCIPAL REGISTER

THE MARK CONSISTS OF STANDARD CHARACTERS WITHOUT CLAIM TO ANY PARTICULAR FONT, STYLE, SIZE, OR COLOR.

THE FOREIGN WORDING IN THE MARK TRANSLATES INTO ENGLISH AS ST. CHRISTOPHER.

SN 77-364,300, FILED 1-4-2008.

TRICIA SONNEBORN, EXAMINING ATTORNEY



David J. Kybas

Director of the United States Patent and Trademark Office

United States of America

United States Patent and Trademark Office



Reg. No. 4,175,837

Registered July 17, 2012

Int. Cls.: 35 and 43

SERVICE MARK

PRINCIPAL REGISTER

SOCIETE POUR L'EXPANSION DES VENTES DES PRODUITS AGRICOLES ET ALIMENTAIRES (FRANCE CORPORATION)
11 BIS, RUE TORRICELLI
PARIS, FRANCE 75017

FOR: ORGANIZING TRADE SHOW EXHIBITIONS IN THE FIELD OF AGRICULTURAL PRODUCTS AND FOODSTUFFS; CONDUCTING TRADE SHOWS AND FAIRS IN THE FIELD OF AGRICULTURAL PRODUCTS AND FOODSTUFFS FOR COMMERCIAL OR ADVERTISING PURPOSES; PROVIDING AN ONLINE COMPUTER DATABASE IN THE FIELD OF ADVERTISING AND MARKETING, IN CLASS 35 (U.S. CLS. 100, 101 AND 102).

FIRST USE 5-0-2008; IN COMMERCE 5-0-2008.

FOR: PROVIDING FACILITIES FOR EXHIBITIONS, IN CLASS 43 (U.S. CLS. 100 AND 101).

FIRST USE 5-0-2008; IN COMMERCE 5-0-2008.

THE MARK CONSISTS OF THE LETTERS "S" "I" "A" "L" IN BLUE WITH A GREEN DASH SEPARATING THE "S" AND "I", A YELLOW DASH SEPARATING THE "I" AND "A", AND A RED DASH SEPARATING THE "A" AND "L".

THE COLOR(S) BLUE, GREEN, YELLOW AND RED IS/ARE CLAIMED AS A FEATURE OF THE MARK.

SN 77-379,755, FILED 1-24-2008.

YAT SYE, LEE, EXAMINING ATTORNEY



David J. Kybas

Director of the United States Patent and Trademark Office

United States of America

United States Patent and Trademark Office

ROTOTRADE

Reg. No. 4,175,838

Registered July 17, 2012

Int. Cl.: 35

SERVICE MARK

PRINCIPAL REGISTER

JSJ PRODUCTIONS INC. (TEXAS CORPORATION)
14101 WEST HWY 290, STE. 1600-B
AUSTIN, TX 78737

FOR: MARKETING, ADVERTISING, AND PROMOTING THE GOODS AND SERVICES OF OTHERS; ARRANGING, ORGANIZING AND PROVIDING TRADE SHOWS FOR OTHERS; PROVIDING INFORMATION OF AND PROMOTING THE PRODUCTS AND SERVICES OF OTHERS VIA THE GLOBAL COMPUTER NETWORK AND THROUGH PUBLIC COMMUNICATION NETWORKS AND MEDIA; DISPLAYING ADVERTISEMENTS FOR OTHERS; DISTRIBUTION AND DISSEMINATION OF ADVERTISING MATERIALS FOR OTHERS; DEVELOPING BUSINESS FOR OTHERS THROUGH ADVERTISING, PROMOTION, LEAD GENERATION AND REFERRALS FOR AND ON BEHALF OF OTHERS; BUSINESS NETWORKING REFERRAL SERVICES, NAMELY, PROMOTING THE GOODS AND SERVICES OF OTHERS BY PASSING BUSINESS LEADS AND REFERENCES; PROMOTING PUBLIC AWARENESS AND INTEREST IN THE GOODS AND SERVICES OF OTHERS; ONLINE ADVERTISING AND MARKETING FOR OTHERS; ONLINE BUSINESS DIRECTORY SERVICES FOR VENDORS AND CUSTOMERS OF GOODS AND SERVICES OTHERS; AND CONDUCTING ONLINE TRADE SHOWS FOR OTHERS; ALL IN THE FIELD OF ROTATIONAL MOLDING AND GOODS AND SERVICES AVAILABLE TO AND FROM THE FIELD OF ROTATIONAL MOLDING, IN CLASS 35 (U.S. CLS. 100, 101 AND 102).

FIRST USE 1-31-2010; IN COMMERCE 1-31-2010.

THE MARK CONSISTS OF STANDARD CHARACTERS WITHOUT CLAIM TO ANY PARTICULAR FONT, STYLE, SIZE, OR COLOR.

SN 77-383,854, FILED 1-30-2008.

Alice Benmaman, Examining Attorney



David J. Kyjars

Director of the United States Patent and Trademark Office

United States of America

United States Patent and Trademark Office

MAKING A DIFFERENCE

Reg. No. 4,175,839

Registered July 17, 2012

Int. Cl.: 41

SERVICE MARK

PRINCIPAL REGISTER

DIETLIN ENTERTAINMENT GROUP (ILLINOIS CORPORATION)
UNIT A
1816 NORTH ROCKWELL STREET
CHICAGO, IL 60647

FOR: ENTERTAINMENT SERVICES RENDERED THROUGH THE MEDIUM OF TELEVISION IN THE NATURE OF A VARIETY TALK SHOW SERIES FEATURING PHILANTHROPIC SUBJECTS; AND COMPUTER SERVICES, NAMELY, PROVIDING INFORMATION VIA AN INTERNET WEB SITE FEATURING INFORMATION ON THE SUBJECT MATTER OF APPLICANT'S TELEVISION PROGRAMS, IN CLASS 41 (U.S. CLS. 100, 101 AND 107).

FIRST USE 11-22-2010; IN COMMERCE 11-22-2010.

THE MARK CONSISTS OF STANDARD CHARACTERS WITHOUT CLAIM TO ANY PARTICULAR FONT, STYLE, SIZE, OR COLOR.

SN 77-388,547, FILED 2-5-2008.

BRENDAN MCCAULEY, EXAMINING ATTORNEY



David J. Kyffers

Director of the United States Patent and Trademark Office

United States of America
United States Patent and Trademark Office

BIOSERVE

Reg. No. 4,175,840

Registered July 17, 2012

Int. Cl.: 8

TRADEMARK

PRINCIPAL REGISTER

L.C. IND, INC. (NORTH CAROLINA CORPORATION)
4500 EMPEROR BOULEVARD
DURHAM, NC 27703

FOR: CUTLERY, IN CLASS 8 (U.S. CLS. 23, 28 AND 44).

FIRST USE 6-0-2008; IN COMMERCE 6-0-2008.

THE MARK CONSISTS OF STANDARD CHARACTERS WITHOUT CLAIM TO ANY PARTICULAR FONT, STYLE, SIZE, OR COLOR.

SN 77-393,790, FILED 2-11-2008.

RICHARD WHITE, EXAMINING ATTORNEY



David J. Kyffers

Director of the United States Patent and Trademark Office

United States of America

United States Patent and Trademark Office

REEL TUBE

Reg. No. 4,175,841

Registered July 17, 2012

Int. Cl.: 9

TRADEMARK

PRINCIPAL REGISTER

ARISTOCRAT TECHNOLOGIES AUSTRALIA PTY LTD (AUSTRALIA CORPORATION)
85 EPPING ROAD
BUILDING A, PINNACLE OFFICE PARK
NORTH RYDE, NSW, AUSTRALIA 2113

FOR: GAMING MACHINES, NAMELY, DEVICES WHICH ACCEPT A WAGER, IN CLASS
9 (U.S. CLS. 21, 23, 26, 36 AND 38).

FIRST USE 10-1-2011; IN COMMERCE 10-1-2011.

THE MARK CONSISTS OF STANDARD CHARACTERS WITHOUT CLAIM TO ANY PAR-
TICULAR FONT, STYLE, SIZE, OR COLOR.

PRIORITY CLAIMED UNDER SEC. 44(D) ON AUSTRALIA APPLICATION NO. 1196095,
FILED 8-30-2007, REG. NO. 1196095, DATED 8-30-2007, EXPIRES 8-30-2017.

SN 77-394,301, FILED 2-11-2008.

NAAKWAMA ANKRAH, EXAMINING ATTORNEY



David J. Kyffers

Director of the United States Patent and Trademark Office

United States of America

United States Patent and Trademark Office

Flog
DAILY

Reg. No. 4,175,842

Registered July 17, 2012

Int. Cl.: 16

TRADEMARK

PRINCIPAL REGISTER

MIELY PUBLISHING, INC. (CALIFORNIA CORPORATION)
9068 MCBRIDE RIVER AVE.
FOUNTAIN VALLEY, CA 92708

FOR: PUBLISHED COMPANION TOOLS IN THE FORM OF BOOKS AND JOURNALS IN THE FIELDS OF EXERCISE, NUTRITION, FOOD, AND FITNESS, IN CLASS 16 (U.S. CLS. 2, 5, 22, 23, 29, 37, 38 AND 50).

FIRST USE 9-3-2008; IN COMMERCE 9-3-2008.

NO CLAIM IS MADE TO THE EXCLUSIVE RIGHT TO USE "DAILY", APART FROM THE MARK AS SHOWN.

SN 77-409,207, FILED 2-28-2008.

MICHAEL GAFFAR, EXAMINING ATTORNEY



David J. Kyffers

Director of the United States Patent and Trademark Office

United States of America

United States Patent and Trademark Office

CLARO

Reg. No. 4,175,843

Registered July 17, 2012

Int. Cl.: 10

TRADEMARK

PRINCIPAL REGISTER

CLRS TECHNOLOGY CORPORATION (CALIFORNIA CORPORATION)
3183 A-1 AIRWAY AVENUE
COSTA MESA, CA 92626

FOR: MEDICAL DEVICES, NAMELY, PHOTOTHERAPEUTIC APPARATUS FOR MEDICAL PURPOSES, NAMELY, DEVICES FOR USE IN THE TREATMENT OF DERMATOLOGICAL CONDITIONS INCLUDING ACNE, IN CLASS 10 (U.S. CLS. 26, 39 AND 44).

FIRST USE 9-26-2008; IN COMMERCE 9-26-2008.

THE MARK CONSISTS OF STANDARD CHARACTERS WITHOUT CLAIM TO ANY PARTICULAR FONT, STYLE, SIZE, OR COLOR.

OWNER OF U.S. REG. NO. 3,846,433.

THE FOREIGN WORDING IN THE MARK TRANSLATES INTO ENGLISH AS "CLEAR".

SN 77-410,281, FILED 2-29-2008.

MICHAEL SOUDERS, EXAMINING ATTORNEY



David J. Kyros

Director of the United States Patent and Trademark Office

United States of America

United States Patent and Trademark Office

HAVANA TIME

Reg. No. 4,175,844

G & R BRANDS, LLC (NEVADA LIMITED LIABILITY COMPANY)
6525 SOUTH BRUCE STREET
LAS VEGAS, NV 89119

Registered July 17, 2012

Int. Cl.: 34

FOR: CIGAR AND CIGARETTE BOXES NOT OF PRECIOUS METAL; CIGAR CUTTERS; CIGAR HUMIDIFIERS; CIGARETTE ASH RECEPTACLES; CIGARETTE CASES, NOT OF PRECIOUS METAL; NON-ELECTRIC CIGAR LIGHTERS NOT OF PRECIOUS METAL, IN CLASS 34 (U.S. CLS. 2, 8, 9 AND 17).

TRADEMARK

PRINCIPAL REGISTER

FIRST USE 4-11-2012; IN COMMERCE 4-11-2012.

THE MARK CONSISTS OF STANDARD CHARACTERS WITHOUT CLAIM TO ANY PARTICULAR FONT, STYLE, SIZE, OR COLOR.

NO CLAIM IS MADE TO THE EXCLUSIVE RIGHT TO USE "HAVANA", APART FROM THE MARK AS SHOWN.

SN 77-417,467, FILED 3-10-2008.

DAVID C. REIHNER, EXAMINING ATTORNEY



David J. Kyfos

Director of the United States Patent and Trademark Office

United States of America

United States Patent and Trademark Office



Reg. No. 4,175,845

Registered July 17, 2012

**Int. Cls.: 4, 16, 21, 24,
and 28**

VARIETY STORES, INC. (DELAWARE CORPORATION)
218 SOUTH GRANETT STREET
HENDERSON, NC 27536

FOR: CANDLES, IN CLASS 4 (U.S. CLS. 1, 6 AND 15).

FIRST USE 9-0-2008; IN COMMERCE 9-0-2008.

TRADEMARK

PRINCIPAL REGISTER

FOR: CHRISTMAS WRAP AND STATIONERY, NAMELY, WRAPPING PAPER, PAPER GIFT TAGS, FOIL PAPER GIFT TAGS, PAPER SEALS, BOXED CARDS, PAPER GIFT BAGS, FOIL PAPER GIFT BAGS, PAPER GIFT BOXES, AND FOIL COATED PAPER GIFT BOXES, IN CLASS 16 (U.S. CLS. 2, 5, 22, 23, 29, 37, 38 AND 50).

FIRST USE 9-0-2008; IN COMMERCE 9-0-2008.

FOR: CHRISTMAS HOUSEWARES, NAMELY, DINNERWARE MADE OF MELAMINE; DINNERWARE ACCESSORIES MADE OF MELAMINE, NAMELY, SERVING PLATTERS, VEGETABLE BOWLS, SERVING TRAYS, CANISTERS, GRAVY BOATS, GRAVY BOAT STANDS, LADLES, SPOON RESTS, CANDY DISHES, SOAP LOTION DISPENSERS, AND SALT AND PEPPER SHAKERS; DINNERWARE MADE OF STONEWARE; DINNERWARE ACCESSORIES MADE OF STONEWARE, NAMELY, COOKIE JARS, SERVING PLATTERS, VEGETABLE BOWLS, SERVING TRAYS, CANISTERS, GRAVY BOATS, GRAVY BOAT STANDS, LADLES, SPOON RESTS, SOAP LOTION DISPENSERS, SALT AND PEPPER SHAKERS, NAPKIN RINGS; DINNERWARE MADE OF PORCELAIN; DINNERWARE ACCESSORIES MADE OF PORCELAIN, NAMELY, COOKIE JARS, SERVING PLATTERS, VEGETABLE BOWLS, SERVING TRAYS, CANISTERS, GRAVY BOATS, STANDS FOR GRAVY BOATS, AND LADLES; NOVELTY GLASS AND CERAMIC ITEMS, NAMELY, HIGHBALL GLASSES, ICE TEA GLASSES, PILSNER GLASSES, WINE GLASSES, FROSTY MUGS, PITCHERS, MUGS, BEER MUGS, MARTINI GLASSES, MARGARITA GLASSES, AND SHOT GLASSES, IN CLASS 21 (U.S. CLS. 2, 13, 23, 29, 30, 33, 40 AND 50).

FIRST USE 9-0-2008; IN COMMERCE 9-0-2008.



David J. Kyjars

Director of the United States Patent and Trademark Office

FOR: CHRISTMAS LINENS, NAMELY, THROWS AND BLANKETS, BATH TOWELS, HAND TOWELS, FINGERTIP TOWELS, TABLECLOTHS, TEXTILE NAPKINS, TABLE RUNNERS, TEXTILE PLACE-MATS, KITCHEN TOWELS, POTHOLDERS, OVEN MITTS, COTTON CALENDAR TOWELS, IN CLASS 24 (U.S. CLS. 42 AND 50).

Reg. No. 4,175,845 FIRST USE 9-0-2008; IN COMMERCE 9-0-2008.

FOR: CHRISTMAS INDOOR AND OUTDOOR DECORATIONS, NAMELY, ARTIFICIAL CHRISTMAS TREES, CHRISTMAS TREE STANDS, CHRISTMAS TREE SKIRTS, CHRISTMAS TREE ORNAMENTS MADE OF PLASTIC AND GLASS, ARTIFICIAL CHRISTMAS GARLANDS, ARTIFICIAL CHRISTMAS WREATHS, IN CLASS 28 (U.S. CLS. 22, 23, 38 AND 50).

FIRST USE 9-0-2008; IN COMMERCE 9-0-2008.

NO CLAIM IS MADE TO THE EXCLUSIVE RIGHT TO USE "HOLIDAY", APART FROM THE MARK AS SHOWN.

THE MARK CONSISTS OF THE STYLIZED WORDS "SIMPLY HOLIDAY" WITH A RIBBON DESIGN RUNNING THROUGH THE WORDS AND ORNAMENTS AND HOLLY LEAVES INSIDE THE LETTER "O" OF THE WORD "HOLIDAY".

SN 77-429,743, FILED 3-24-2008.

BRENDAN REGAN, EXAMINING ATTORNEY

United States of America

United States Patent and Trademark Office

SIMPLY HOLIDAY

Reg. No. 4,175,846

Registered July 17, 2012

**Int. Cls.: 4, 16, 21, 24,
and 28**

TRADEMARK

PRINCIPAL REGISTER

VARIETY STORES, INC. (DELAWARE CORPORATION)
218 SOUTH GARNETT STREET
HENDERSON, NC 27536

FOR: CANDLES, IN CLASS 4 (U.S. CLS. 1, 6 AND 15).

FIRST USE 9-0-2008; IN COMMERCE 9-0-2008.

FOR: CHRISTMAS WRAP AND STATIONERY, NAMELY, WRAPPING PAPER, PAPER GIFT TAGS, FOIL PAPER GIFT TAGS, PAPER SEALS, BOXED CARDS, PAPER GIFT BAGS, FOIL PAPER GIFT BAGS, PAPER GIFT BOXES, AND FOIL COATED PAPER GIFT BOXES, IN CLASS 16 (U.S. CLS. 2, 5, 22, 23, 29, 37, 38 AND 50).

FIRST USE 9-0-2008; IN COMMERCE 9-0-2008.

FOR: CHRISTMAS HOUSEWARES, NAMELY, DINNERWARE MADE OF MELAMINE; DINNERWARE ACCESSORIES MADE OF MELAMINE, NAMELY, SERVING PLATTERS, VEGETABLE BOWLS, SERVING TRAYS, CANISTERS, GRAVY BOATS, GRAVY BOAT STANDS, LADLES, SPOON RESTS, CANDY DISHES, SOAP LOTION DISPENSERS, AND SALT AND PEPPER SHAKERS; DINNERWARE MADE OF STONEWARE; DINNERWARE ACCESSORIES MADE OF STONEWARE, NAMELY, COOKIE JARS, SERVING PLATTERS, VEGETABLE BOWLS, SERVING TRAYS, CANISTERS, GRAVY BOATS, GRAVY BOAT STANDS, LADLES, SPOON RESTS, SOAP LOTION DISPENSERS, SALT AND PEPPER SHAKERS, NAPKIN RINGS; DINNERWARE MADE OF PORCELAIN; DINNERWARE ACCESSORIES MADE OF PORCELAIN, NAMELY, COOKIE JARS, SERVING PLATTERS, VEGETABLE BOWLS, SERVING TRAYS, CANISTERS, GRAVY BOATS, STANDS FOR GRAVY BOATS, AND LADLES; NOVELTY GLASS AND CERAMIC ITEMS, NAMELY, HIGHBALL GLASSES, ICE TEA GLASSES, PILSNER GLASSES, WINE GLASSES, FROSTY MUGS, PITCHERS, MUGS, BEER MUGS, MARTINI GLASSES, MARGARITA GLASSES, AND SHOT GLASSES, IN CLASS 21 (U.S. CLS. 2, 13, 23, 29, 30, 33, 40 AND 50).

FIRST USE 9-0-2008; IN COMMERCE 9-0-2008.

FOR: CHRISTMAS LINENS, NAMELY, THROWS AND BLANKETS, BATH TOWELS, HAND TOWELS, FINGERTIP TOWELS, TABLECLOTHS, TEXTILE NAPKINS, TABLE RUNNERS, TEXTILE PLACE-MATS, KITCHEN TOWELS, POTHOLDERS, OVEN MITTS, COTTON CALENDAR TOWELS, IN CLASS 24 (U.S. CLS. 42 AND 50).



David J. Kyffers

Director of the United States Patent and Trademark Office

Reg. No. 4,175,846 FIRST USE 9-0-2008; IN COMMERCE 9-0-2008.

FOR: CHRISTMAS INDOOR AND OUTDOOR DECORATIONS, NAMELY, ARTIFICIAL CHRISTMAS TREES, CHRISTMAS TREE STANDS, CHRISTMAS TREE SKIRTS, CHRISTMAS TREE ORNAMENTS MADE OF PLASTIC AND GLASS, ARTIFICIAL CHRISTMAS GARLANDS, ARTIFICIAL CHRISTMAS WREATHS, IN CLASS 28 (U.S. CLS. 22, 23, 38 AND 50).

FIRST USE 9-0-2008; IN COMMERCE 9-0-2008.

THE MARK CONSISTS OF STANDARD CHARACTERS WITHOUT CLAIM TO ANY PARTICULAR FONT, STYLE, SIZE, OR COLOR.

NO CLAIM IS MADE TO THE EXCLUSIVE RIGHT TO USE "HOLIDAY", APART FROM THE MARK AS SHOWN.

SN 77-429,764, FILED 3-24-2008.

BRENDAN REGAN, EXAMINING ATTORNEY

United States of America

United States Patent and Trademark Office

Jay Leno's
Garage

Reg. No. 4,175,847

Registered July 17, 2012

Int. Cls.: 21 and 25

TRADEMARK

PRINCIPAL REGISTER

JAY LENO'S GARAGE, INC. (CALIFORNIA CORPORATION)
P.O. BOX 8817
C/O BERG AND BERG, L.L.P.
CALABASAS, CA 913728817

FOR: MERCHANDISE, NAMELY, COFFEE CUPS, TEA CUPS, MUGS, CUPS, MUGS NOT OF PRECIOUS METAL, AND PORCELAIN MUGS, IN CLASS 21 (U.S. CLS. 2, 13, 23, 29, 30, 33, 40 AND 50).

FIRST USE 1-1-2010; IN COMMERCE 1-1-2010.

FOR: CLOTHING, NAMELY, BASEBALL CAPS, BEANIES, BOXER SHORTS, CAP VISORS, CAPS, COATS, DENIM JACKETS, GLOVES, HATS, HOODED PULLOVERS, HOODED SWEATSHIRTS, JACKETS, KNITTED CAPS, LEATHER COATS, LEATHER JACKETS, LONG-SLEEVED SHIRTS, MOTORCYCLE GLOVES, SHIRTS, SHORT SLEEVED OR LONG SLEEVED T-SHIRTS, SWEATERS, SWEATSHIRTS, TANK TOPS, TEE SHIRTS, T-SHIRTS, V-NECK SWEATERS, AND WIND-RESISTANT JACKETS, IN CLASS 25 (U.S. CLS. 22 AND 39).

FIRST USE 1-1-2010; IN COMMERCE 1-1-2010.

THE NAME(S), PORTRAIT(S), AND/OR SIGNATURE(S) SHOWN IN THE MARK IDENTIFIES "JAY LENO", WHOSE CONSENT(S) TO REGISTER IS MADE OF RECORD.

THE COLOR(S) RED AND CHROME IS/ARE CLAIMED AS A FEATURE OF THE MARK.

THE MARK CONSISTS OF THE WORDS "JAY LENO'S" IN RED COLORED CURSIVE LETTERS ABOVE THE TWO "G'S IN THE WORD "GARAGE". THE WORD "GARAGE" IS IN A CHROME COLORED RELIEF WIDE SPACED CURSIVE FONT MADE TO LOOK LIKE A VINTAGE CAR EMBLEM.

SN 77-430,185, FILED 3-24-2008.

LEIGH CAROLINE CASE, EXAMINING ATTORNEY



David J. Kyffers

Director of the United States Patent and Trademark Office

United States of America

United States Patent and Trademark Office

JAY GODFREY

Reg. No. 4,175,848

YUD YUD, LLC (NEW YORK LIMITED LIABILITY COMPANY)
333 WEST 39TH STREET
NEW YORK, NY 10018

Registered July 17, 2012

Int. Cl.: 14

FOR: JEWELRY AND WATCHES, IN CLASS 14 (U.S. CLS. 2, 27, 28 AND 50).

TRADEMARK

FIRST USE 3-31-2012; IN COMMERCE 3-31-2012.

PRINCIPAL REGISTER

THE NAME "JAY GODFREY" IDENTIFIES A LIVING INDIVIDUAL WHOSE CONSENT IS OF RECORD.

SN 77-432,089, FILED 3-26-2008.

WILLIAM P. SHANAHAN, EXAMINING ATTORNEY



David J. Kybas

Director of the United States Patent and Trademark Office

United States of America

United States Patent and Trademark Office

GROW YOUR OWN

Reg. No. 4,175,849

TIGHT TIGHT, LLC (MICHIGAN LIMITED LIABILITY COMPANY)
P.O. BOX 569

Registered July 17, 2012

LAKE ORION, MI 48371

Int. Cl.: 25

FOR: SHIRTS, IN CLASS 25 (U.S. CLS. 22 AND 39).

TRADEMARK

FIRST USE 7-1-2011; IN COMMERCE 8-15-2011.

PRINCIPAL REGISTER

THE MARK CONSISTS OF STANDARD CHARACTERS WITHOUT CLAIM TO ANY PARTICULAR FONT, STYLE, SIZE, OR COLOR.

SN 77-435,711, FILED 3-31-2008.

ALEX KEAM, EXAMINING ATTORNEY



David J. Kybas

Director of the United States Patent and Trademark Office

United States of America

United States Patent and Trademark Office

CARLOS III

Reg. No. 4,175,850

Registered July 17, 2012

Int. Cl.: 34

TRADEMARK

PRINCIPAL REGISTER

FUENTE MARKETING LTD. (BR. VIRGIN ISLANDS CORPORATION)
SALT MILLS PLAZA, UNIT 48C
GRACE BAY ROAD
PROVIDENCIALES, TURKS/CAICOS IS. 00000

FOR: CIGARS, IN CLASS 34 (U.S. CLS. 2, 8, 9 AND 17).

FIRST USE 3-23-2012; IN COMMERCE 3-23-2012.

THE MARK CONSISTS OF STANDARD CHARACTERS WITHOUT CLAIM TO ANY PARTICULAR FONT, STYLE, SIZE, OR COLOR.

OWNER OF U.S. REG. NOS. 2,330,649, 3,144,715, AND OTHERS.

SN 77-441,585, FILED 4-7-2008.

KAREN SEVERSON, EXAMINING ATTORNEY



David J. Kybas

Director of the United States Patent and Trademark Office

United States of America

United States Patent and Trademark Office



Reg. No. 4,175,851

Registered July 17, 2012

Int. Cl.: 30

TRADEMARK

PRINCIPAL REGISTER

TIMBERLAND TRADING INC. (PANAMA LIMITED LIABILITY COMPANY)
SUITE 143 C/O WEISS BROWN PLLC
6263 NORTH SCOTTSDALE ROAD
SCOTTSDALE, AZ 85250 AND

MADEIRA SERVICES (BR. VIRGIN ISLANDS LIMITED LIABILITY COMPANY)
SUITE 143 C/O WEISS BROWN, PLLC
6263 NORTH SCOTTSDALE ROAD
SCOTTSDALE, AZ 85250

FOR: HAMBURGER SANDWICHES, IN CLASS 30 (U.S. CL. 46).

FIRST USE 5-28-2012; IN COMMERCE 5-28-2012.

NO CLAIM IS MADE TO THE EXCLUSIVE RIGHT TO USE "HAMBURGUESAS, LA RECETA ORIGINAL", APART FROM THE MARK AS SHOWN.

THE COLOR(S) YELLOW, LIGHT BROWN, ORANGE AND WHITE IS/ARE CLAIMED AS A FEATURE OF THE MARK.

THE MARK CONSISTS OF A LIGHT BROWN RECTANGLE WITH AN ORANGE LINING ENCLOSED IN A YELLOW SEMI-CIRCLE, WITH A BROWN FENCE AT THE LEFT AND RIGHT HAND CORNERS OF THE SEMI-CIRCLE. THE WORDS "EL CORRAL" ARE IN ORANGE WITH A WHITE LINING AND ENCLOSED IN THE LIGHT BROWN RECTANGLE WITH ORANGE LINING. THE WORD "HAMBURGUESAS" IS IN WHITE COLOR WITH BROWN LINING IN THE UPPER END OF THE YELLOW SEMI-CIRCLE. THE WORDS "LA RECETA ORIGINAL" ARE IN WHITE COLOR AND BROWN LINING LOCATED AT THE LOWER END OF THE YELLOW SEMI-CIRCLE.

THE FOREIGN WORDING IN THE MARK TRANSLATES INTO ENGLISH AS "HAMBURGERS, THE CORRAL, THE ORIGINAL RECIPE".

SN 77-441,940, FILED 4-7-2008.

LEIGH CAROLINE CASE, EXAMINING ATTORNEY



David J. Kappas

Director of the United States Patent and Trademark Office

United States of America

United States Patent and Trademark Office

Hospital Critterz

Reg. No. 4,175,852

STRATEGIC PARTNERS, INC. (CALIFORNIA CORPORATION)
9800 DE SOTO AVE.
CHATSWORTH, CA 91311

Registered July 17, 2012

Int. Cl.: 25

FOR: NURSE'S APPAREL, NAMELY, SCRUBS NOT FOR MEDICAL PURPOSES, IN CLASS 25 (U.S. CLS. 22 AND 39).

TRADEMARK

FIRST USE 4-1-2012; IN COMMERCE 4-1-2012.

PRINCIPAL REGISTER

THE MARK CONSISTS OF STANDARD CHARACTERS WITHOUT CLAIM TO ANY PARTICULAR FONT, STYLE, SIZE, OR COLOR.

NO CLAIM IS MADE TO THE EXCLUSIVE RIGHT TO USE "HOSPITAL", APART FROM THE MARK AS SHOWN.

SN 77-443,406, FILED 4-8-2008.

DEZMONA MIZELLE, EXAMINING ATTORNEY



David J. Kyffers

Director of the United States Patent and Trademark Office

United States of America

United States Patent and Trademark Office

AVEC ERIC

Reg. No. 4,175,853

Registered July 17, 2012

Int. Cl.: 41

SERVICE MARK

PRINCIPAL REGISTER

AVEC ERIC, LLC (DELAWARE LIMITED LIABILITY COMPANY)
C/O ANOMALY CORPORATE ENTERPRISES, LLC
536 BROADWAY
NEW YORK, NY 10012

FOR: ENTERTAINMENT, NAMELY, A CONTINUING COOKING, FOOD AND TRAVEL SHOW BROADCAST OVER TELEVISION, SATELLITE TELEVISION, AND THE INTERNET, IN CLASS 41 (U.S. CLS. 100, 101 AND 107).

FIRST USE 1-3-2009; IN COMMERCE 1-3-2009.

THE MARK CONSISTS OF STANDARD CHARACTERS WITHOUT CLAIM TO ANY PARTICULAR FONT, STYLE, SIZE, OR COLOR.

THE ENGLISH TRANSLATION OF "AVEC" IN THE MARK IS "WITH."

SN 77-461,498, FILED 4-30-2008.

LESLIE RICHARDS, EXAMINING ATTORNEY



David J. Kybas

Director of the United States Patent and Trademark Office

United States of America

United States Patent and Trademark Office

SLICES OF INDULGENCE

Reg. No. 4,175,854

Registered July 17, 2012

Int. Cl.: 30

TRADEMARK

PRINCIPAL REGISTER

HAB ENTERPRISES, INC. (CALIFORNIA CORPORATION)
4427 LONGRIDGE AVENUE
SHERMAN OAKS, CA 91423

FOR: PIES, IN CLASS 30 (U.S. CL. 46).

FIRST USE 5-24-2012; IN COMMERCE 5-24-2012.

THE MARK CONSISTS OF STANDARD CHARACTERS WITHOUT CLAIM TO ANY PARTICULAR FONT, STYLE, SIZE, OR COLOR.

SN 77-471,832, FILED 5-12-2008.

FRANK LATTUCA, EXAMINING ATTORNEY



David J. Kyffers

Director of the United States Patent and Trademark Office

United States of America

United States Patent and Trademark Office

PIELICIOUS!

Reg. No. 4,175,855

Registered July 17, 2012

Int. Cl.: 30

TRADEMARK

PRINCIPAL REGISTER

HAB ENTERPRISES, INC. (CALIFORNIA CORPORATION)
4427 LONGRIDGE AVENUE
SHERMAN OAKS, CA 91423

FOR: PIES, IN CLASS 30 (U.S. CL. 46).

FIRST USE 5-24-2012; IN COMMERCE 5-24-2012.

THE MARK CONSISTS OF STANDARD CHARACTERS WITHOUT CLAIM TO ANY PARTICULAR FONT, STYLE, SIZE, OR COLOR.

SN 77-479,590, FILED 5-20-2008.

FRANK LATTUCA, EXAMINING ATTORNEY



David J. Kyffers

Director of the United States Patent and Trademark Office

United States of America

United States Patent and Trademark Office

ALABAMA-COUSHATTA

Reg. No. 4,175,856

Registered July 17, 2012

Int. Cl.: 43

SERVICE MARK

PRINCIPAL REGISTER

ALABAMA-COUSHATTA TRIBE OF TEXAS (UNITED STATES FEDERALLY-RECOGNIZED INDIAN TRIBE)
571 STATE PARK ROAD 56
LIVINGSTON, TX 77351

FOR: PROVIDING ELDER CARE; CHILD DAY CARE SERVICES; PROVIDING A HOME BOUND MEAL DELIVERY SERVICE PROGRAM FOR THE ELDERLY; PROVIDING CAMPGROUND FACILITIES, IN CLASS 43 (U.S. CLS. 100 AND 101).

FIRST USE 12-31-1989; IN COMMERCE 12-31-1989.

THE MARK CONSISTS OF STANDARD CHARACTERS WITHOUT CLAIM TO ANY PARTICULAR FONT, STYLE, SIZE, OR COLOR.

SN 77-480,247, FILED 5-21-2008.

KATHY DE JONGE, EXAMINING ATTORNEY



David J. Kyjars

Director of the United States Patent and Trademark Office

United States of America

United States Patent and Trademark Office

ALABAMA-COUSHATTA TRIBE OF TEXAS

Reg. No. 4,175,857

Registered July 17, 2012

Int. Cl.: 43

SERVICE MARK

PRINCIPAL REGISTER

ALABAMA-COUSHATTA TRIBE OF TEXAS (UNITED STATES FEDERALLY-RECOGNIZED INDIAN TRIBE)
571 STATE PARK ROAD 56
LIVINGSTON, TX 77351

FOR: PROVIDING ELDER CARE; CHILD DAY CARE SERVICES; PROVIDING A HOME BOUND MEAL DELIVERY SERVICE PROGRAM FOR THE ELDERLY; PROVIDING CAMPGROUND FACILITIES, IN CLASS 43 (U.S. CLS. 100 AND 101).

FIRST USE 12-31-1989; IN COMMERCE 12-31-1989.

THE MARK CONSISTS OF STANDARD CHARACTERS WITHOUT CLAIM TO ANY PARTICULAR FONT, STYLE, SIZE, OR COLOR.

NO CLAIM IS MADE TO THE EXCLUSIVE RIGHT TO USE "TRIBE OF TEXAS", APART FROM THE MARK AS SHOWN.

SN 77-480,353, FILED 5-21-2008.

KATHY DE JONGE, EXAMINING ATTORNEY



David J. Kyjars

Director of the United States Patent and Trademark Office

United States of America

United States Patent and Trademark Office

WILD GRINDERS

Reg. No. 4,175,858

DYRDEK ENTERPRISES, INC. (NEVADA CORPORATION)

Registered July 17, 2012

777 SOUTH MISSION ROAD
LOS ANGELES, CA 90023

Int. Cl.: 41

FOR: ENTERTAINMENT SERVICES, NAMELY, PRODUCTION OF A TELEVISION SERIES FEATURING SKATEBOARDING; PRODUCTION OF TELEVISION PROGRAMS FEATURING SKATEBOARDS AND SKATEBOARDING, IN CLASS 41 (U.S. CLS. 100, 101 AND 107).

SERVICE MARK

FIRST USE 9-20-2009; IN COMMERCE 9-20-2009.

PRINCIPAL REGISTER

THE MARK CONSISTS OF STANDARD CHARACTERS WITHOUT CLAIM TO ANY PARTICULAR FONT, STYLE, SIZE, OR COLOR.

NO CLAIM IS MADE TO THE EXCLUSIVE RIGHT TO USE "GRINDERS", APART FROM THE MARK AS SHOWN.

SN 77-489,021, FILED 6-2-2008.

JORDAN BAKER, EXAMINING ATTORNEY



David J. Kyffers

Director of the United States Patent and Trademark Office

United States of America

United States Patent and Trademark Office

ART PLACE

Reg. No. 4,175,859

Registered July 17, 2012

Int. Cls.: 36 and 37

SERVICE MARK

PRINCIPAL REGISTER

MORRIS AND GWENDOLYN CAFRITZ FOUNDATION, THE (D.C. CORPORATION)
SUITE 1400
1825 K STREET, NW
WASHINGTON, DC 20006

FOR: REAL ESTATE BROKERAGE; MANAGEMENT AND LEASING A COMMERCIAL AND RESIDENTIAL COMMUNITY ENCOMPASSING RETAIL STORES, RESTAURANTS, OFFICES, RESIDENTIAL UNITS, COMMUNITY MEETING SPACE, PARK, PUBLIC LIBRARY, THEATRE, CULTURE CENTER AND CHILDREN'S MUSEUM, IN CLASS 36 (U.S. CLS. 100, 101 AND 102).

FIRST USE 4-10-2012; IN COMMERCE 4-10-2012.

FOR: CONSTRUCTION SERVICES, NAMELY, PLANNING, LAYING OUT AND CONSTRUCTION OF A MULTI-USE COMMERCIAL AND RESIDENTIAL COMMUNITY; REAL ESTATE DEVELOPMENT; CONSTRUCTION AND DEVELOPMENT, NAMELY, PLANNING AND LAYING OUT OF COMMERCIAL AND RESIDENTIAL COMMUNITY ENCOMPASSING RETAIL STORES, RESTAURANTS, OFFICES, RESIDENTIAL UNITS, COMMUNITY MEETING SPACE, PARK, PUBLIC LIBRARY, THEATRE, CULTURE CENTER AND CHILDREN'S MUSEUM, IN CLASS 37 (U.S. CLS. 100, 103 AND 106).

FIRST USE 4-10-2012; IN COMMERCE 4-10-2012.

THE MARK CONSISTS OF STANDARD CHARACTERS WITHOUT CLAIM TO ANY PARTICULAR FONT, STYLE, SIZE, OR COLOR.

SN 77-511,216, FILED 6-30-2008.

ALAIN LAPTEK, EXAMINING ATTORNEY



David J. Kyffers

Director of the United States Patent and Trademark Office

United States of America

United States Patent and Trademark Office

morph*i*k

Reg. No. 4,175,860

MORPHIK INC. (NEVADA CORPORATION)
32 CLARET
IRVINE, CA 92614

Registered July 17, 2012

Int. Cl.: 14

FOR: JEWELRY, IN CLASS 14 (U.S. CLS. 2, 27, 28 AND 50).

TRADEMARK

FIRST USE 2-28-2012; IN COMMERCE 2-28-2012.

PRINCIPAL REGISTER

THE MARK CONSISTS OF THE MARK HAS ONLY ONE DESIGN ELEMENT OUTSIDE THE NAME "MORPHIK" AND THAT IS THE CIRCLE AROUND THE "I".

SN 77-526,829, FILED S.R. 7-21-2008; AM. P.R. 4-20-2009.

CHRIS WELLS, EXAMINING ATTORNEY



David J. Kyffers

Director of the United States Patent and Trademark Office

United States of America

United States Patent and Trademark Office

SWITCHEASY

Reg. No. 4,175,861

Registered July 17, 2012

Int. Cl.: 9

TRADEMARK

PRINCIPAL REGISTER

SWITCHEASY LIMITED (HONG KONG LIMITED LIABILITY COMPANY)
RM. 314, SING WIN FACTORY BUILDING
NO. 15-17 SHING YIP STREET, KWUN TONG
KOWLOON, HONG KONG

FOR: ACCESSORIES FOR USE WITH PARTICULAR PERSONAL ELECTRONIC DEVICES, NAMELY, WITH PORTABLE COMPUTING DEVICES, PORTABLE DIGITAL DATA STORAGE MEDIA AND DEVICES, HANDHELD PERSONAL ELECTRONIC DEVICES, NAMELY, DIGITAL MEDIA PLAYER DEVICES, AUDIO AND VIDEO PLAYERS, PERSONAL DIGITAL ASSISTANT, HANDHELD WIRELESS DEVICES, CELLULAR HANDSETS, AND HANDHELD DIGITAL AUDIO AND/OR VIDEO CAPTURE DEVICES, SAID ACCESSORIES BEING ELECTRONIC AND NON-ELECTRONIC USER INTERFACE AND INTERACTIVE DEVICES, NAMELY, USER INPUT DEVICES, PROTECTIVE CASES, CARRYING CASES, HOLSTERS, NON-ELECTRICAL COUPLINGS, NON-ELECTRICAL ADAPTORS, STANDS, IN CLASS 9 (U.S. CLS. 21, 23, 26, 36 AND 38).

FIRST USE 7-1-2007; IN COMMERCE 7-1-2007.

THE MARK CONSISTS OF STANDARD CHARACTERS WITHOUT CLAIM TO ANY PARTICULAR FONT, STYLE, SIZE, OR COLOR.

SN 77-533,208, FILED 7-29-2008.

BRENDAN REGAN, EXAMINING ATTORNEY



David J. Kyffers

Director of the United States Patent and Trademark Office

United States of America

United States Patent and Trademark Office

KORN/FERRY

Reg. No. 4,175,862

KORN/FERRY INTERNATIONAL (DELAWARE CORPORATION)
1900 AVENUE OF THE STARS, SUITE 2600
LOS ANGELES, CA 90067

Registered July 17, 2012

Int. Cl.: 41

FOR: EDUCATIONAL SERVICES, NAMELY, CONDUCTING CLASSES, WORKSHOPS, AND CONFERENCES IN THE FIELD OF HUMAN RESOURCES AND DISTRIBUTING COURSE MATERIALS IN CONNECTION THEREWITH; EXECUTIVE COACHING, IN CLASS 41 (U.S. CLS. 100, 101 AND 107).

SERVICE MARK

PRINCIPAL REGISTER

FIRST USE 8-0-2011; IN COMMERCE 8-0-2011.

THE MARK CONSISTS OF STANDARD CHARACTERS WITHOUT CLAIM TO ANY PARTICULAR FONT, STYLE, SIZE, OR COLOR.

OWNER OF U.S. REG. NOS. 1,761,642 AND 2,566,066.

SN 77-546,443, FILED 8-13-2008.

WON TEAK OH, EXAMINING ATTORNEY



David J. Kyfos

Director of the United States Patent and Trademark Office

United States of America

United States Patent and Trademark Office

KORN/FERRY INTERNATIONAL

Reg. No. 4,175,863

KORN/FERRY INTERNATIONAL (DELAWARE CORPORATION)
1900 AVENUE OF THE STARS, SUITE 2600
LOS ANGELES, CA 90067

Registered July 17, 2012

Int. Cl.: 45

FOR: LICENSING OF INTELLECTUAL PROPERTY IN THE FIELD OF HUMAN RESOURCES FOR THE ASSESSMENT, EVALUATION, MANAGEMENT AND DEVELOPMENT OF COMPETENCIES, JOB PERFORMANCE, AND LEADERSHIP SKILLS FOR INDIVIDUALS AND ORGANIZATIONS, IN CLASS 45 (U.S. CLS. 100 AND 101).

SERVICE MARK

PRINCIPAL REGISTER

FIRST USE 6-0-2006; IN COMMERCE 6-0-2006.

THE MARK CONSISTS OF STANDARD CHARACTERS WITHOUT CLAIM TO ANY PARTICULAR FONT, STYLE, SIZE, OR COLOR.

OWNER OF U.S. REG. NOS. 1,761,642 AND 2,566,066.

NO CLAIM IS MADE TO THE EXCLUSIVE RIGHT TO USE "INTERNATIONAL", APART FROM THE MARK AS SHOWN.

SN 77-546,453, FILED 8-13-2008.

WON TEAK OH, EXAMINING ATTORNEY



David J. Kyros

Director of the United States Patent and Trademark Office

United States of America

United States Patent and Trademark Office



Reg. No. 4,175,864

KORN/FERRY INTERNATIONAL (DELAWARE CORPORATION)
1900 AVENUE OF THE STARS, SUITE 2600
LOS ANGELES, CA 90067

Registered July 17, 2012

Int. Cl.: 45

FOR: LICENSING OF INTELLECTUAL PROPERTY IN THE FIELD OF HUMAN RESOURCES FOR THE ASSESSMENT, EVALUATION, MANAGEMENT AND DEVELOPMENT OF COMPETENCIES, JOB PERFORMANCE, AND LEADERSHIP SKILLS FOR INDIVIDUALS AND ORGANIZATIONS, IN CLASS 45 (U.S. CLS. 100 AND 101).

SERVICE MARK

PRINCIPAL REGISTER

FIRST USE 6-0-2006; IN COMMERCE 6-0-2006.

OWNER OF U.S. REG. NO. 1,751,508.

THE MARK CONSISTS OF THE LETTERS "KF" IN A STYLIZED FONT.

SN 77-546,464, FILED 8-13-2008.

WON TEAK OH, EXAMINING ATTORNEY



David J. Kyffers

Director of the United States Patent and Trademark Office

United States of America

United States Patent and Trademark Office



Reg. No. 4,175,865

KORN/FERRY INTERNATIONAL (DELAWARE CORPORATION)
1900 AVENUE OF THE STARS, SUITE 2600
LOS ANGELES, CA 90067

Registered July 17, 2012

Int. Cl.: 16

FOR: PRINTED PRODUCTS, NAMELY, EDUCATIONAL MATERIALS FOR USE BY INDIVIDUALS AND BUSINESSES TO EVALUATE LEADERSHIP AND MANAGERIAL APTITUDES AND SKILLS FOR THE PURPOSE OF DEVELOPING AND IMPLEMENTING LEADERSHIP DEVELOPMENT AND SUCCESSION PLANS FOR BUSINESSES, WORKING UNITS AND INDIVIDUALS, IN CLASS 16 (U.S. CLS. 2, 5, 22, 23, 29, 37, 38 AND 50).

TRADEMARK

PRINCIPAL REGISTER

FIRST USE 4-0-2007; IN COMMERCE 10-31-2008.

OWNER OF U.S. REG. NOS. 1,761,642 AND 2,566,066.

NO CLAIM IS MADE TO THE EXCLUSIVE RIGHT TO USE "INSTITUTE", APART FROM THE MARK AS SHOWN.

THE MARK CONSISTS OF THE WORDS "THE KORN/FERRY INSTITUTE" WITH A DESIGN OF A FEATHER.

SN 77-546,471, FILED 8-13-2008.

WON TEAK OH, EXAMINING ATTORNEY



David J. Kyffers

Director of the United States Patent and Trademark Office

United States of America

United States Patent and Trademark Office

Fishing With Dynamite

Reg. No. 4,175,866

STYCZEN, CONRAD J (UNITED STATES INDIVIDUAL)
465 S MIDDLETON AVE
PALATINE, IL 60067

Registered July 17, 2012

Int. Cl.: 3

FOR: FRAGRANCES; PERFUMES, AFTERSHAVES AND COLOGNES, IN CLASS 3 (U.S. CLS. 1, 4, 6, 50, 51 AND 52).

TRADEMARK

FIRST USE 3-31-2011; IN COMMERCE 3-31-2011.

PRINCIPAL REGISTER

THE MARK CONSISTS OF STANDARD CHARACTERS WITHOUT CLAIM TO ANY PARTICULAR FONT, STYLE, SIZE, OR COLOR.

SN 77-547,753, FILED 8-15-2008.

GINA HAYES, EXAMINING ATTORNEY



David J. Kyffers

Director of the United States Patent and Trademark Office

United States of America

United States Patent and Trademark Office

MIRIMICHI

Reg. No. 4,175,867

Registered July 17, 2012

**Int. Cls.: 21, 24, 25, 41,
and 43**

TRADEMARK

SERVICE MARK

PRINCIPAL REGISTER

BIG CREEK GOLF, LLC (TENNESSEE LIMITED LIABILITY COMPANY)
6195 WOODSTOCK-CUBA RD
MILLINGTON, TN 38053

FOR: BEVERAGE WARE, NAMELY, GLASSWARE, GLASS AND CERAMIC TUMBLERS, GLASS DECANTERS; CUPS AND MUGS; PORTABLE COOLERS AND INSULATED CONTAINERS FOR CANS FOR DOMESTIC USE, IN CLASS 21 (U.S. CLS. 2, 13, 23, 29, 30, 33, 40 AND 50).

FIRST USE 9-4-2011; IN COMMERCE 9-4-2011.

FOR: GOLF BAG TOWELS; SPA AND BATH TOWELS, IN CLASS 24 (U.S. CLS. 42 AND 50).

FIRST USE 9-4-2011; IN COMMERCE 9-4-2011.

FOR: CLOTHING, NAMELY, HATS, SHORTS, SHIRTS, PANTS, SWEATERS, VISORS, SKIRTS, SOCKS, SHOES; SPIKES AND CLEATS FOR ATTACHMENTS TO GOLF SHOES TO PREVENT SLIPPING; VESTS; JACKETS; COATS; SUN VISORS; BELTS; RESORT AND SPA CLOTHING, NAMELY, TANK TOPS, CAPS WITH VISORS, JOGGING SUITS, SWEAT PANTS, SWEAT SHIRTS, WARM UP SUITS, T-SHIRTS, SKORTS, LEGGINGS, LEOTARDS; BATH ROBES AND SLIPPERS; SWIMWEAR, IN CLASS 25 (U.S. CLS. 22 AND 39).

FIRST USE 9-4-2011; IN COMMERCE 9-4-2011.

FOR: PROVIDING GOLF FACILITIES; CONDUCTING, ORGANIZING AND SPONSORING GOLF TOURNAMENTS; GOLF CLUB SERVICES; PROVIDING NEWS AND INFORMATION ON THE SPORT OF GOLF; PROVIDING A WEB SITE WITH INFORMATION ON GOLF COURSES, GOLF LESSONS AND GOLF TOURNAMENTS; RENTAL OF GOLF EQUIPMENT; PROVIDING GOLF INSTRUCTION; HEALTH CLUB SERVICES, NAMELY, PROVIDING INSTRUCTION AND CONSULTATION IN THE FIELD OF PHYSICAL EXERCISE; PROVIDING USE OF EXERCISE EQUIPMENT; PROVIDING FITNESS AND EXERCISE FACILITIES, IN CLASS 41 (U.S. CLS. 100, 101 AND 107).

FIRST USE 9-4-2011; IN COMMERCE 9-4-2011.

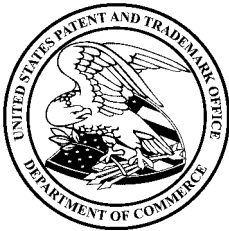

David J. Kyffers

Director of the United States Patent and Trademark Office

Reg. No. 4,175,867 FOR: RESTAURANT SERVICES, BAR AND COCKTAIL LOUNGE SERVICES; PROVISION OF GENERAL PURPOSES FACILITIES FOR MEETINGS, CONFERENCES AND EXHIBITIONS; PROVISION OF BANQUET AND SOCIAL FUNCTION FACILITIES FOR SPECIAL OCCASIONS, IN CLASS 43 (U.S. CLS. 100 AND 101).

FIRST USE 9-4-2011; IN COMMERCE 9-4-2011.

THE MARK CONSISTS OF STANDARD CHARACTERS WITHOUT CLAIM TO ANY PARTICULAR FONT, STYLE, SIZE, OR COLOR.

SN 77-548,666, FILED 8-15-2008.

CHRIS WELLS, EXAMINING ATTORNEY

United States of America

United States Patent and Trademark Office

OFFICE MESSENGER

Reg. No. 4,175,868

Registered July 17, 2012

Int. Cl.: 9

TRADEMARK

PRINCIPAL REGISTER

MASON, JR., JOSEPH M. (UNITED STATES INDIVIDUAL)
P.O. BOX 1900
BROOKSVILLE, FL 34605

FOR: COMPUTER SOFTWARE PROGRAM USED FOR TRACKING, DISPLAYING AND STORING TELEPHONE CALL AND RELATED CONTACT INFORMATION, IN CLASS 9 (U.S. CLS. 21, 23, 26, 36 AND 38).

FIRST USE 5-19-2012; IN COMMERCE 5-19-2012.

THE MARK CONSISTS OF STANDARD CHARACTERS WITHOUT CLAIM TO ANY PARTICULAR FONT, STYLE, SIZE, OR COLOR.

NO CLAIM IS MADE TO THE EXCLUSIVE RIGHT TO USE "OFFICE", APART FROM THE MARK AS SHOWN.

SN 77-551,307, FILED 8-20-2008.

DOMINIC J. FERRAIUOLO, EXAMINING ATTORNEY



David J. Kyffers

Director of the United States Patent and Trademark Office

United States of America

United States Patent and Trademark Office

Craving Calories

Reg. No. 4,175,869

Registered July 17, 2012

Int. Cl.: 16

TRADEMARK

PRINCIPAL REGISTER

CRAVING CALORIES, LLC (PENNSYLVANIA LIMITED LIABILITY COMPANY)
736 CASTLEWOOD DRIVE
DRESHER, PA 19025

FOR: COOK BOOKS, IN CLASS 16 (U.S. CLS. 2, 5, 22, 23, 29, 37, 38 AND 50).

FIRST USE 4-21-2012; IN COMMERCE 4-21-2012.

THE MARK CONSISTS OF STANDARD CHARACTERS WITHOUT CLAIM TO ANY PARTICULAR FONT, STYLE, SIZE, OR COLOR.

NO CLAIM IS MADE TO THE EXCLUSIVE RIGHT TO USE "CALORIES", APART FROM THE MARK AS SHOWN.

SN 77-554,322, FILED 8-24-2008.

TRACY CROSS, EXAMINING ATTORNEY



David J. Kyffers

Director of the United States Patent and Trademark Office

United States of America

United States Patent and Trademark Office

BOOZEBERRIES

Reg. No. 4,175,870

SPIRITED DRINKS LTD. (IRELAND CORPORATION)
62 THE BELFRY

Registered July 17, 2012

DROMORE, COUNTY DOWN, IRELAND BT25 1TR

Int. Cl.: 33

FOR: SPIRITS AND LIQUEURS, IN CLASS 33 (U.S. CLS. 47 AND 49).

TRADEMARK

FIRST USE 3-0-2011; IN COMMERCE 12-31-2011.

PRINCIPAL REGISTER

THE MARK CONSISTS OF STANDARD CHARACTERS WITHOUT CLAIM TO ANY PARTICULAR FONT, STYLE, SIZE, OR COLOR.

SN 77-554,533, FILED 8-25-2008.

CHRIS WELLS, EXAMINING ATTORNEY



David J. Kybas

Director of the United States Patent and Trademark Office

United States of America

United States Patent and Trademark Office

PAPER HAT

Reg. No. 4,175,871

SHOJI, YOONAH (UNITED STATES INDIVIDUAL), DBA PAPER HAT,
5013 CATHANN ST.
TORRANCE, CA 90503

Registered July 17, 2012

Int. Cl.: 25

FOR: HATS NOT MADE OF PAPER; PANTS; SHIRTS; SKIRTS; TRAVEL CLOTHING
CONTAINED IN A PACKAGE COMPRISING REVERSIBLE JACKETS, PANTS, SKIRTS,
TOPS AND A BELT OR SCARF, IN CLASS 25 (U.S. CLS. 22 AND 39).

TRADEMARK

FIRST USE 9-0-2009; IN COMMERCE 9-0-2009.

PRINCIPAL REGISTER

THE MARK CONSISTS OF STANDARD CHARACTERS WITHOUT CLAIM TO ANY PAR-
TICULAR FONT, STYLE, SIZE, OR COLOR.

NO CLAIM IS MADE TO THE EXCLUSIVE RIGHT TO USE "HAT", APART FROM THE
MARK AS SHOWN.

SN 77-558,944, FILED 8-29-2008.

RONALD DELGIZZI, EXAMINING ATTORNEY



David J. Kypos

Director of the United States Patent and Trademark Office

United States of America

United States Patent and Trademark Office

Stella-Jones



Reg. No. 4,175,872

Registered July 17, 2012

Int. Cls.: 19 and 40

TRADEMARK

SERVICE MARK

PRINCIPAL REGISTER

STELLA-JONES INC. (CANADA CORPORATION)
3100 CÔTE-VERTU ROAD, SUITE 300
MONTREAL, QUEBEC, CANADA H4R2J8

FOR: PRESSURE TREATED WOOD PRODUCTS IN THE NATURE OF TREATED WOOD POLES FOR UTILITY AND TELECOMMUNICATIONS COMPANIES, WOOD POLES FOR OVERHEAD LINES; PRESSURE TREATED WOOD RAILWAY TIES, PRESSURE TREATED WOOD MARINE AND FOUNDATION PILINGS, CONSTRUCTION TIMBERS, PRESSURE TREATED WOOD HIGHWAY GUARDRAIL POSTS, CONSUMER LUMBER FOR USE IN DECKS, FENCES AND OTHER RESIDENTIAL USES, IN CLASS 19 (U.S. CLS. 1, 12, 33 AND 50).

FIRST USE 8-0-2007; IN COMMERCE 8-0-2007.

FOR: CUSTOMIZED SERVICES TO LUMBER COMPANIES AND TO WHOLESALERS FOR THE TREATMENT OF CONSUMER LUMBER PRODUCTS FOR OUTDOOR APPLICATIONS , IN CLASS 40 (U.S. CLS. 100, 103 AND 106).

FIRST USE 8-0-2007; IN COMMERCE 8-0-2007.

THE MARK CONSISTS OF THE WORDS "STELLA-JONES" WITHIN TWO HORIZONTAL LINES, ALL POSITIONED ABOVE THE LETTERS "S","J" WITHIN A RECTANGLE WITH A HORIZONTAL LINE ALONG THE BOTTOM PORTION OF THE RECTANGLE.

SN 77-561,538, FILED 9-3-2008.

DAVID COLLIER, EXAMINING ATTORNEY



David J. Kypos

Director of the United States Patent and Trademark Office

United States of America

United States Patent and Trademark Office



Reg. No. 4,175,873

THE BASKETBALL MARKETING COMPANY, INC. (DELAWARE CORPORATION)
5881 N OBISPO AVE, SUITE 101
LONG BEACH, CA 90805

Registered July 17, 2012

Int. Cls.: 18 and 25

FOR: BAGS, NAMELY, ALL-PURPOSE ATHLETIC BAGS, ALL-PURPOSE SPORTS BAGS, DUFFEL BAGS, AND GYM BAGS, IN CLASS 18 (U.S. CLS. 1, 2, 3, 22 AND 41).

TRADEMARK

FIRST USE 1-15-2012; IN COMMERCE 1-15-2012.

PRINCIPAL REGISTER

FOR: CLOTHING, NAMELY, T-SHIRTS, SWEATSHIRTS, TANK TOPS, POLO SHIRTS, JERSEYS, SPORT SHIRTS, JACKETS, WARM-UP SUITS, PANTS, SHORTS, SWEAT PANTS, CAPS, HATS, SWEAT BANDS AND SOCKS; FOOTWEAR, IN CLASS 25 (U.S. CLS. 22 AND 39).

FIRST USE 1-15-2012; IN COMMERCE 1-15-2012.

OWNER OF U.S. REG. NOS. 1,898,164, 2,969,524, AND OTHERS.

NO CLAIM IS MADE TO THE EXCLUSIVE RIGHT TO USE "BASKETBALL COMPANY", APART FROM THE MARK AS SHOWN.

THE MARK CONSISTS OF THE WORDING, "AND1" OVER THE WORDING, "BASKETBALL COMPANY," ALL IN STYLIZED LETTERING.

SN 77-562,714, FILED 9-4-2008.

DARRYL SPRUILL, EXAMINING ATTORNEY



David J. Kybas

Director of the United States Patent and Trademark Office

United States of America

United States Patent and Trademark Office

CLEAN SPORT

Reg. No. 4,175,874

SMITH, DANIEL S. (UNITED STATES INDIVIDUAL)
10950 B INDUSTRIAL WAY
TRUCKEE, CA 96161

Registered July 17, 2012

**Int. Cls.: 5, 16, 41, and
42**

FOR: NUTRICEUTICALS, NAMELY, VITAMINS, NUTRIENTS, MINERALS, AMINO ACIDS, ESSENTIAL FATTY ACIDS IN THE NATURE OF LIQUID HERBAL, POWDER, CAPSULES, TABLETS, SUBLINGUALS AND TOPICAL CREAMS, FOR USE AS A DIETARY SUPPLEMENT, IN CLASS 5 (U.S. CLS. 6, 18, 44, 46, 51 AND 52).

TRADEMARK

FIRST USE 5-9-2012; IN COMMERCE 5-9-2012.

SERVICE MARK

PRINCIPAL REGISTER

FOR: PRINTED INSTRUCTIONAL, EDUCATIONAL AND TEACHING MATERIALS AND PUBLICATIONS, NAMELY, BROCHURES, NEWSLETTERS, BOOKLETS, FLYERS, HANDOUTS, HANDBOOKS ALL IN THE FIELD OF NUTRITION CONCEPTS AND THEIR EFFECTS ON SPORTS PERFORMANCE, DESIGNER NUTRICEUTICALS, BRAIN BALANCING TECHNOLOGY FOR ENHANCING SPORTS ACTIVITIES, MEDITATION AND DIAGNOSTICS FOR ENHANCING SPORTS ACTIVITIES, EDUCATING ADOLESCENTS, ADULTS AND SENIOR CITIZENS FOR OPTIMAL HEALTH AND WELLNESS, IN CLASS 16 (U.S. CLS. 2, 5, 22, 23, 29, 37, 38 AND 50).

FIRST USE 5-9-2012; IN COMMERCE 5-9-2012.



FOR: EDUCATIONAL SERVICES, NAMELY, CLASSES, LECTURES, SEMINARS, AND WORKSHOPS AND TRAINING SERVICES IN THE FIELD OF NUTRITION CONCEPTS AND THEIR EFFECTS ON SPORTS PERFORMANCE, DESIGNER NUTRICEUTICALS, BRAIN BALANCING TECHNOLOGY FOR ENHANCING SPORTS ACTIVITIES, MEDITATION AND DIAGNOSTICS FOR ENHANCING SPORTS ACTIVITIES, EDUCATING ADOLESCENTS, ADULTS AND SENIOR CITIZENS FOR OPTIMAL HEALTH AND WELLNESS, IN CLASS 41 (U.S. CLS. 100, 101 AND 107).

FIRST USE 5-9-2012; IN COMMERCE 5-9-2012.

David J. Kyros

Director of the United States Patent and Trademark Office

FOR: SCIENTIFIC RESEARCH AND DEVELOPMENT AND CONSULTATION RELATED THERETO IN THE FIELD OF NUTRITION AND OPTIMAL SPORTS PERFORMANCE, NAMELY, GENETIC RESEARCH, AND DEVELOPMENT OF NUTRICEUTICALS AND THEIR IMPACT ON OPTIMIZING SPORTS PERFORMANCE; RESEARCH AND DEVELOPMENT OF GENETIC DIAGNOSTICS FOR MARKERS DETECTING THE EFFECTS OF NU-

Reg. No. 4,175,874 TRICEUTICALS RELATED TO OPTIMAL SPORTS PERFORMANCE; RESEARCH AND DEVELOPMENT OF SPORTS PSYCHOLOGY FOR OPTIMAL SPORTS PERFORMANCE; RESEARCH AND DEVELOPMENT OF NUTRICEUTICALS FOR OPTIMAL SPORTS PERFORMANCE; AND DEVELOPMENT OF HYPERBARIC OXYGEN CHAMBERS FOR OPTIMAL SPORTS PERFORMANCE; RESEARCH AND DEVELOPMENT OF NEW TECHNOLOGIES TO AID IN OPTIMAL SPORTS PERFORMANCE , IN CLASS 42 (U.S. CLS. 100 AND 101).

FIRST USE 5-9-2012; IN COMMERCE 5-9-2012.

THE MARK CONSISTS OF STANDARD CHARACTERS WITHOUT CLAIM TO ANY PARTICULAR FONT, STYLE, SIZE, OR COLOR.

SN 77-562,960, FILED 9-5-2008.

PRISCILLA MILTON, EXAMINING ATTORNEY

United States of America

United States Patent and Trademark Office

FARM

Reg. No. 4,175,875

Registered July 17, 2012

Int. Cl.: 25

TRADEMARK

PRINCIPAL REGISTER

PLANTAGE CONFECÇAO E COMERCIO DE ROUPAS LTDA (BRAZIL LIMITED PARTNERSHIP)
COPACABANA
RUA HILARIO DE GOUVEIA 36, 6, ANDAR
RIO DE JANEIRO - RJ, BRAZIL

FOR: WOMEN'S CLOTHING, NAMELY, SCARVES, PANTIES, JACKETS, VETS, DRESSES, GOWNS, BLOUSES, T-SHIRTS, DUNGAREES, SHORTS, PANTS, BERMUDAS, BIKINIS, COATS, RAIN COATS, SKIRTS, UNDERWEAR, BRAS, AND NIGHTGOWNS AND WOMEN'S FOOTWEAR, IN CLASS 25 (U.S. CLS. 22 AND 39).

FIRST USE 4-16-2012; IN COMMERCE 4-16-2012.

THE MARK CONSISTS OF STANDARD CHARACTERS WITHOUT CLAIM TO ANY PARTICULAR FONT, STYLE, SIZE, OR COLOR.

SN 77-564,333, FILED 9-8-2008.

CAROLYN CATALDO, EXAMINING ATTORNEY



David J. Kyffers

Director of the United States Patent and Trademark Office

United States of America

United States Patent and Trademark Office

Active For Life

Reg. No. 4,175,876

DINUBILE, NICHOLAS A. (UNITED STATES INDIVIDUAL)
510 W. DARBY ROAD
HAVERTOWN, PA 19083

Registered July 17, 2012

Int. Cl.: 16

FOR: A SERIES OF NON-FICTION BOOKS IN THE FIELD OF EXERCISE, FITNESS, REHABILITATION, SPORTS MEDICINE, INJURY PREVENTION AND ORTHOPAEDIC AILMENTS , IN CLASS 16 (U.S. CLS. 2, 5, 22, 23, 29, 37, 38 AND 50).

TRADEMARK

FIRST USE 12-24-2010; IN COMMERCE 12-24-2010.

PRINCIPAL REGISTER

THE MARK CONSISTS OF STANDARD CHARACTERS WITHOUT CLAIM TO ANY PARTICULAR FONT, STYLE, SIZE, OR COLOR.

SN 77-565,670, FILED 9-9-2008.

COURTNEY ALVAREZ, EXAMINING ATTORNEY



David J. Kybas

Director of the United States Patent and Trademark Office

United States of America

United States Patent and Trademark Office

CLOUDWORLD

Reg. No. 4,175,877

Registered July 17, 2012

Int. Cl.: 42

SERVICE MARK

PRINCIPAL REGISTER

INTERNATIONAL DATA GROUP, INC. (MASSACHUSETTS CORPORATION)
IDG 08-024
5 SPEEN STREET
FRAMINGHAM, MA 01701

FOR: PROVIDING A WEBSITE THAT FEATURES INFORMATION CONCERNING WEB-BASED SOFTWARE, COMPUTER NETWORK INFRASTRUCTURE, HIGH TECHNOLOGY AND INFORMATION TECHNOLOGY , IN CLASS 42 (U.S. CLS. 100 AND 101).

FIRST USE 4-26-2012; IN COMMERCE 4-26-2012.

THE MARK CONSISTS OF STANDARD CHARACTERS WITHOUT CLAIM TO ANY PARTICULAR FONT, STYLE, SIZE, OR COLOR.

SN 77-571,209, FILED 9-16-2008.

BARBARA RUTLAND, EXAMINING ATTORNEY



David J. Kyjars

Director of the United States Patent and Trademark Office

United States of America

United States Patent and Trademark Office

BOTTLE CODDLE

Reg. No. 4,175,878

KATHERINE TYMCZYNA (UNITED STATES INDIVIDUAL)
7911 W. CATHERINE

Registered July 17, 2012

NORWOOD PARK TOWNSHIP, IL 60656

Int. Cl.: 26

FOR: BOTTLE SLEEVES COMPOSED OF LIQUID-ABSORBING MICRO FIBER FABRIC,
IN CLASS 26 (U.S. CLS. 37, 39, 40, 42 AND 50).

TRADEMARK

FIRST USE 5-23-2012; IN COMMERCE 5-23-2012.

PRINCIPAL REGISTER

THE MARK CONSISTS OF STANDARD CHARACTERS WITHOUT CLAIM TO ANY PAR-
TICULAR FONT, STYLE, SIZE, OR COLOR.

NO CLAIM IS MADE TO THE EXCLUSIVE RIGHT TO USE "BOTTLE", APART FROM THE
MARK AS SHOWN.

SN 77-574,139, FILED 9-19-2008.

LIEF MARTIN, EXAMINING ATTORNEY



David J. Kybas

Director of the United States Patent and Trademark Office

United States of America

United States Patent and Trademark Office

HANDBAG HANDCUFF

Reg. No. 4,175,879

BETH A. CORETS (UNITED STATES INDIVIDUAL)
558 WILCOX AVENUE
LOS ANGELES, CA 90004

Registered July 17, 2012

Int. Cl.: 18

FOR: STRAPS FOR PERSONAL BAGS, NAMELY, PURSES, BRIEFCASES, AND ATHLETIC BAGS, IN CLASS 18 (U.S. CLS. 1, 2, 3, 22 AND 41).

TRADEMARK

FIRST USE 4-15-2012; IN COMMERCE 4-15-2012.

PRINCIPAL REGISTER

THE MARK CONSISTS OF STANDARD CHARACTERS WITHOUT CLAIM TO ANY PARTICULAR FONT, STYLE, SIZE, OR COLOR.

NO CLAIM IS MADE TO THE EXCLUSIVE RIGHT TO USE "HANDBAG", APART FROM THE MARK AS SHOWN.

SN 77-574,219, FILED 9-19-2008.

HAI-LY LAM, EXAMINING ATTORNEY



David J. Kybas

Director of the United States Patent and Trademark Office

United States of America

United States Patent and Trademark Office

Flick Bowling

Reg. No. 4,175,880

FREEVERSE CORPORATION (NEW YORK CORPORATION)

Registered July 17, 2012

45 MAIN STREET #506
BROOKLYN, NY 11201

Int. Cl.: 9

FOR: COMPUTER APPLICATION SOFTWARE FOR MOBILE PHONES; COMPUTER GAME SOFTWARE, IN CLASS 9 (U.S. CLS. 21, 23, 26, 36 AND 38).

TRADEMARK

FIRST USE 9-24-2008; IN COMMERCE 9-24-2008.

PRINCIPAL REGISTER

THE MARK CONSISTS OF STANDARD CHARACTERS WITHOUT CLAIM TO ANY PARTICULAR FONT, STYLE, SIZE, OR COLOR.

NO CLAIM IS MADE TO THE EXCLUSIVE RIGHT TO USE "BOWLING", APART FROM THE MARK AS SHOWN.

SN 77-578,947, FILED 9-25-2008.

KRISTIN CARLSON, EXAMINING ATTORNEY



David J. Kyffers

Director of the United States Patent and Trademark Office

United States of America
United States Patent and Trademark Office

VITAWASH

Reg. No. 4,175,881

GOLDEN PRODUCTS LLC. (NEW YORK LIMITED LIABILITY COMPANY)
159-21 CROSSBAY BLVD.

Registered July 17, 2012

HOWARD BEACH, NY 11414

Int. Cl.: 3

FOR: ORAL HYGIENE PRODUCTS, NAMELY, TOOTHPASTE AND MOUTHWASH, IN CLASS 3 (U.S. CLS. 1, 4, 6, 50, 51 AND 52).

TRADEMARK

FIRST USE 3-29-2012; IN COMMERCE 3-29-2012.

PRINCIPAL REGISTER

THE MARK CONSISTS OF STANDARD CHARACTERS WITHOUT CLAIM TO ANY PARTICULAR FONT, STYLE, SIZE, OR COLOR.

SN 77-579,780, FILED 9-26-2008.

CHARLES L. JENKINS, EXAMINING ATTORNEY



David J. Kybas

Director of the United States Patent and Trademark Office

United States of America

United States Patent and Trademark Office

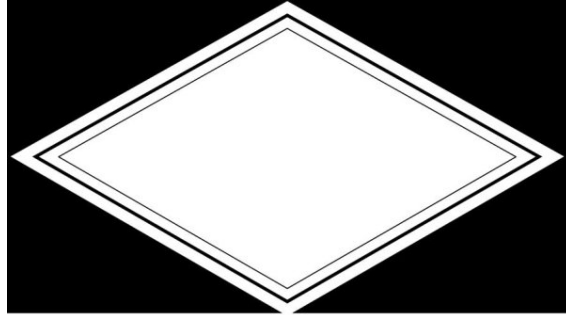

CROWDER

Reg. No. 4,175,882

Registered July 17, 2012

Int. Cl.: 37

SERVICE MARK

PRINCIPAL REGISTER

CROWDER CONSTRUCTION COMPANY (NORTH CAROLINA CORPORATION)
6425 BROOKSHIRE BLVD.; P.O. BOX 30007
CHARLOTTE, NC 28216

FOR: CONSTRUCTION, INSTALLATION AND REPAIR OF ROADS, BRIDGES, PARKING LOTS, WATER AND WASTE WATER TREATMENT PLANTS, PIPELINES, AND PUMP STATIONS, IN CLASS 37 (U.S. CLS. 100, 103 AND 106).

FIRST USE 12-31-1947; IN COMMERCE 12-31-1947.

OWNER OF U.S. REG. NOS. 2,436,251, 2,464,920, AND 2,670,734.

THE MARK CONSISTS OF THE WORD "CROWDER" IN ALL CAPITAL LETTERS BENEATH A DIAMOND DESIGN WITHIN A BLACK RECTANGLE.

SN 77-582,894, FILED 10-1-2008.

COLLEEN KEARNEY, EXAMINING ATTORNEY



David J. Kybas

Director of the United States Patent and Trademark Office

United States of America

United States Patent and Trademark Office

GROWN & SEWN

Reg. No. 4,175,883

MAGNESS DESIGN, INC. (NEW YORK CORPORATION)
71 NASSAU STREET
NEW YORK, NY 10038

Registered July 17, 2012

Int. Cl.: 25

FOR: JACKETS, IN CLASS 25 (U.S. CLS. 22 AND 39).

TRADEMARK

FIRST USE 11-19-2009; IN COMMERCE 11-19-2009.

PRINCIPAL REGISTER

THE MARK CONSISTS OF STANDARD CHARACTERS WITHOUT CLAIM TO ANY PARTICULAR FONT, STYLE, SIZE, OR COLOR.

SN 77-582,902, FILED 10-1-2008.

COLLEEN KEARNEY, EXAMINING ATTORNEY



David J. Kyffers

Director of the United States Patent and Trademark Office

United States of America

United States Patent and Trademark Office

Flick Baseball

Reg. No. 4,175,884

FREEVERSE CORPORATION (NEW YORK CORPORATION)
45 MAIN STREET #506
BROOKLYN, NY 11201

Registered July 17, 2012

Int. Cl.: 9

FOR: COMPUTER GAME SOFTWARE, IN CLASS 9 (U.S. CLS. 21, 23, 26, 36 AND 38).

TRADEMARK

FIRST USE 5-5-2010; IN COMMERCE 5-5-2010.

PRINCIPAL REGISTER

THE MARK CONSISTS OF STANDARD CHARACTERS WITHOUT CLAIM TO ANY PARTICULAR FONT, STYLE, SIZE, OR COLOR.

NO CLAIM IS MADE TO THE EXCLUSIVE RIGHT TO USE "BASEBALL", APART FROM THE MARK AS SHOWN.

SN 77-587,548, FILED 10-7-2008.

KRISTIN CARLSON, EXAMINING ATTORNEY



David J. Kyffers

Director of the United States Patent and Trademark Office

United States of America

United States Patent and Trademark Office

Flick Fishing

Reg. No. 4,175,885

Registered July 17, 2012

Int. Cl.: 9

TRADEMARK

PRINCIPAL REGISTER

FREEVERSE CORPORATION (NEW YORK CORPORATION)
45 MAIN STREET #506
BROOKLYN, NY 11201

FOR: COMPUTER GAME SOFTWARE, IN CLASS 9 (U.S. CLS. 21, 23, 26, 36 AND 38).

FIRST USE 11-7-2008; IN COMMERCE 11-7-2008.

THE MARK CONSISTS OF STANDARD CHARACTERS WITHOUT CLAIM TO ANY PARTICULAR FONT, STYLE, SIZE, OR COLOR.

NO CLAIM IS MADE TO THE EXCLUSIVE RIGHT TO USE "FISHING", APART FROM THE MARK AS SHOWN.

SN 77-587,561, FILED 10-7-2008.

KRISTIN CARLSON, EXAMINING ATTORNEY



David J. Kyffers

Director of the United States Patent and Trademark Office

United States of America

United States Patent and Trademark Office

MISTRESS OF THE DARK

Reg. No. 4,175,886

Registered July 17, 2012

Int. Cls.: 25 and 41

TRADEMARK

SERVICE MARK

PRINCIPAL REGISTER

QUEEN "B" PRODUCTIONS (CALIFORNIA CORPORATION)
C/O THE HABER CORP.
16830 VENTURA BLVD., SUITE 501
ENCINO, CA 91436

FOR: CLOTHING, NAMELY, T-SHIRTS; HALLOWEEN COSTUMES, IN CLASS 25 (U.S. CLS. 22 AND 39).

FIRST USE 6-1-2011; IN COMMERCE 6-1-2011.

FOR: ENTERTAINMENT SERVICES, NAMELY, HOSTING OF TELEVISION SHOWS AND HOSTING OF ENTERTAINMENT SHOWS PRESENTED BY WEBCAST, PODCAST AND BY THE INTERNET; PRODUCTION AND DISTRIBUTION OF MOTION PICTURE FILMS DISTRIBUTED BY THEATRICAL DISTRIBUTION, TELEVISION, CABLE TELEVISION AND THE INTERNET; ENTERTAINMENT SERVICES, NAMELY, PROVIDING TEMPORARY USE OF NON-DOWNLOADABLE FILMS AND TELEVISION PROGRAMS VIA A VIDEO-ON-DEMAND SERVICE AND THE INTERNET; ENTERTAINMENT SERVICES IN THE NATURE OF ON-GOING ANIMATED TELEVISION PROGRAMS IN THE FIELD OF CHILDREN'S ENTERTAINMENT; PRODUCTION OF ANIMATED FILMS; ENTERTAINMENT SERVICES IN THE NATURE OF A HAUNTED HOUSE; ENTERTAINMENT SERVICES, NAMELY, PROVIDING TEMPORARY USE OF NON-DOWNLOADABLE VIDEO GAMES; ENTERTAINMENT SERVICES, NAMELY, PROVIDING TEMPORARY USE OF NON-DOWNLOADABLE VIDEO GAMES FOR A MOBILE WIRELESS DEVICE; ENTERTAINMENT SERVICES, NAMELY, PROVIDING A WEB SITE FEATURING ENTERTAINMENT, NAMELY, MUSICAL PERFORMANCES, MUSICAL VIDEOS, RELATED FILM CLIPS, PHOTOGRAPHS, AND OTHER MULTIMEDIA MATERIALS; ENTERTAINMENT SERVICES, NAMELY, NON-DOWNLOADABLE RINGTONES, PRE-RECORDED MUSIC, VIDEO AND GRAPHICS PRESENTED TO MOBILE COMMUNICATIONS DEVICES VIA THE INTERNET AND WIRELESS NETWORKS, IN CLASS 41 (U.S. CLS. 100, 101 AND 107).

FIRST USE 6-1-2011; IN COMMERCE 6-1-2011.

THE MARK CONSISTS OF STANDARD CHARACTERS WITHOUT CLAIM TO ANY PARTICULAR FONT, STYLE, SIZE, OR COLOR.

SN 77-587,584, FILED 10-7-2008.



David J. Kyjars

Director of the United States Patent and Trademark Office

Reg. No. 4,175,886 JEFF DEFORD, EXAMINING ATTORNEY

United States of America

United States Patent and Trademark Office

RADIO DATE

Reg. No. 4,175,887

Registered July 17, 2012

Int. Cl.: 41

SERVICE MARK

PRINCIPAL REGISTER

PEOPLE MEDIA, LLC (ARIZONA LIMITED LIABILITY COMPANY)
3RD FLOOR
8800 SUNSET BOULEVARD
WEST HOLLYWOOD, CA 90028

FOR: ENTERTAINMENT SERVICES, NAMELY, PRODUCTION OF RADIO PROGRAMS FEATURING RELATIONSHIP ADVICE AND SOCIAL NETWORKING PROVIDED THROUGH THE INTERNET, IN CLASS 41 (U.S. CLS. 100, 101 AND 107).

FIRST USE 1-7-2009; IN COMMERCE 1-7-2009.

THE MARK CONSISTS OF STANDARD CHARACTERS WITHOUT CLAIM TO ANY PARTICULAR FONT, STYLE, SIZE, OR COLOR.

NO CLAIM IS MADE TO THE EXCLUSIVE RIGHT TO USE "RADIO", APART FROM THE MARK AS SHOWN.

SN 77-587,718, FILED 10-7-2008.

AMY KERTGATE, EXAMINING ATTORNEY



David J. Kyros

Director of the United States Patent and Trademark Office

United States of America

United States Patent and Trademark Office

ProAlgen

Reg. No. 4,175,888

Registered July 17, 2012

Int. Cl.: 5

TRADEMARK

PRINCIPAL REGISTER

NORDIC NATURALS, INC. (CALIFORNIA CORPORATION)
111 JENNINGS DRIVE
WATSONVILLE, CA 95076

FOR: DIETARY AND NUTRITIONAL SUPPLEMENTS; DIETARY SUPPLEMENTS; DIETARY SUPPLEMENTS FOR HUMAN CONSUMPTION; NUTRITIONAL SUPPLEMENTS, IN CLASS 5 (U.S. CLS. 6, 18, 44, 46, 51 AND 52).

FIRST USE 3-19-2009; IN COMMERCE 3-19-2012.

THE MARK CONSISTS OF STANDARD CHARACTERS WITHOUT CLAIM TO ANY PARTICULAR FONT, STYLE, SIZE, OR COLOR.

THE WORDING "PROALGEN" HAS NO MEANING IN A FOREIGN LANGUAGE.

SN 77-587,872, FILED 10-7-2008.

ANDREW RHIM, EXAMINING ATTORNEY



David J. Kybas

Director of the United States Patent and Trademark Office

United States of America
United States Patent and Trademark Office

LAREDO

Reg. No. 4,175,889

CHATAM INTERNATIONAL INCORPORATED (DELAWARE CORPORATION)
1105 N. MARKET STREET, SUITE 1300
WILMINGTON, DE 19801

Registered July 17, 2012

Int. Cl.: 33

FOR: ALCOHOLIC BEVERAGES EXCEPT BEERS, IN CLASS 33 (U.S. CLS. 47 AND 49).

TRADEMARK

FIRST USE 4-17-2012; IN COMMERCE 4-17-2012.

PRINCIPAL REGISTER

THE MARK CONSISTS OF STANDARD CHARACTERS WITHOUT CLAIM TO ANY PARTICULAR FONT, STYLE, SIZE, OR COLOR.

SN 77-595,028, FILED 10-17-2008.

RONALD DELGIZZI, EXAMINING ATTORNEY



David J. Kyffers

Director of the United States Patent and Trademark Office

United States of America

United States Patent and Trademark Office

HAPPY EAGLE

Reg. No. 4,175,890

HAPPY EAGLE FOOD INDUSTRIES CORPORATION (ILLINOIS CORPORATION)
1127 S. 12TH STREET
ST. CHARLES, IL 60174

Registered July 17, 2012

Int. Cls.: 35 and 40

FOR: DISTRIBUTORSHIP SERVICES IN THE FIELD OF FOOD PRODUCTS, IN CLASS 35
(U.S. CLS. 100, 101 AND 102).

SERVICE MARK

FIRST USE 5-10-2012; IN COMMERCE 5-10-2012.

PRINCIPAL REGISTER

FOR: FOOD PROCESSING, IN CLASS 40 (U.S. CLS. 100, 103 AND 106).

FIRST USE 5-10-2012; IN COMMERCE 5-10-2012.

THE MARK CONSISTS OF STANDARD CHARACTERS WITHOUT CLAIM TO ANY PARTICULAR FONT, STYLE, SIZE, OR COLOR.

SN 77-595,094, FILED 10-17-2008.

SAIMA MAKHDOOM, EXAMINING ATTORNEY



David J. Kybas

Director of the United States Patent and Trademark Office

United States of America

United States Patent and Trademark Office

UNLTD.

Reg. No. 4,175,891

IP HOLDINGS UNLTD LLC (DELAWARE LIMITED LIABILITY COMPANY)
1450 BROADWAY

Registered July 17, 2012

NEW YORK, NY 10018

Int. Cl.: 25

FOR: CLOTHING, NAMELY, SHIRTS, SWEATSHIRTS, PANTS, JEANS, SHORTS, SOCKS, BELTS, SLEEPWEAR AND UNDERWEAR; OUTERWEAR, NAMELY, JACKETS AND COATS; HEADWEAR; FOOTWEAR, IN CLASS 25 (U.S. CLS. 22 AND 39).

TRADEMARK

FIRST USE 1-1-2002; IN COMMERCE 1-1-2002.

PRINCIPAL REGISTER

THE MARK CONSISTS OF STANDARD CHARACTERS WITHOUT CLAIM TO ANY PARTICULAR FONT, STYLE, SIZE, OR COLOR.

OWNER OF U.S. REG. NO. 3,088,851.

SN 77-600,241, FILED 10-24-2008.

DAYNA BROWNE, EXAMINING ATTORNEY



David J. Kyffers

Director of the United States Patent and Trademark Office

United States of America

United States Patent and Trademark Office

SPECIAL SPARKLE

Reg. No. 4,175,892

SY KESSLER SALES, INC. (TEXAS CORPORATION)
10455 OLYMPIC DRIVE
DALLAS, TX 75220

Registered July 17, 2012

Int. Cl.: 3

FOR: CLEANING PREPARATIONS FOR USE IN ULTRASONIC CLEANING MACHINES,
IN CLASS 3 (U.S. CLS. 1, 4, 6, 50, 51 AND 52).

TRADEMARK

FIRST USE 6-4-2012; IN COMMERCE 6-4-2012.

PRINCIPAL REGISTER

THE MARK CONSISTS OF STANDARD CHARACTERS WITHOUT CLAIM TO ANY PAR-
TICULAR FONT, STYLE, SIZE, OR COLOR.

SN 77-600,879, FILED 10-27-2008.

CHRISTINE MARTIN, EXAMINING ATTORNEY



David J. Kyffers

Director of the United States Patent and Trademark Office

United States of America

United States Patent and Trademark Office

SKILLFUL LIVING

Reg. No. 4,175,893

Registered July 17, 2012

Int. Cls.: 44 and 45

SERVICE MARK

PRINCIPAL REGISTER

MICHAEL B. FINKELSTEIN, M.D. (UNITED STATES INDIVIDUAL)
501 GUARD HILL ROAD
BEDFORD, NY 10506

FOR: HEALTH CARE SERVICES; PROVIDING HOLISTIC HEALTH CARE SERVICES;
HEALTH CARE SERVICES, NAMELY, PROVIDING WELLNESS PROGRAMS, IN CLASS
44 (U.S. CLS. 100 AND 101).

FIRST USE 0-0-2008; IN COMMERCE 0-0-2008.

FOR: PROVIDING IN-PERSON SPIRITUAL AND HOLISTIC SPIRITUAL COUNSELING
SERVICES, IN CLASS 45 (U.S. CLS. 100 AND 101).

FIRST USE 0-0-2008; IN COMMERCE 0-0-2008.

THE MARK CONSISTS OF STANDARD CHARACTERS WITHOUT CLAIM TO ANY PAR-
TICULAR FONT, STYLE, SIZE, OR COLOR.

SN 77-601,792, FILED 10-28-2008.

MICHAEL KEATING, EXAMINING ATTORNEY



David J. Kyros

Director of the United States Patent and Trademark Office

United States of America

United States Patent and Trademark Office

SPEEDIJUST

Reg. No. 4,175,894

PHOTOGRAPHIC RESEARCH ORGANIZATION, INC. (DELAWARE CORPORATION)
360 TUNXIS HILL ROAD
FAIRFIELD, CT 06825

Registered July 17, 2012

Int. Cl.: 9

FOR: TRIPODS FOR CAMERAS, IN CLASS 9 (U.S. CLS. 21, 23, 26, 36 AND 38).

TRADEMARK

FIRST USE 4-9-2012; IN COMMERCE 4-9-2012.

PRINCIPAL REGISTER

THE MARK CONSISTS OF STANDARD CHARACTERS WITHOUT CLAIM TO ANY PARTICULAR FONT, STYLE, SIZE, OR COLOR.

SN 77-604,056, FILED 10-30-2008.

AMY HELLA, EXAMINING ATTORNEY



David J. Kyffers

Director of the United States Patent and Trademark Office

United States of America

United States Patent and Trademark Office

Harumika

Reg. No. 4,175,895

SUNRISE INC (JAPAN CORPORATION)

Registered July 17, 2012

2-44-10 KAMIIGUSA

SUGINAMI-KU, TOKYO, JAPAN 167-0023

Int. Cl.: 28

FOR: DOLL CASES; DOLL CLOTHING; DOLLS AND ACCESSORIES THEREFOR; DOLLS AND PLAYSETS THEREFOR; DOLLS' CLOTHES; HOBBY CRAFT KIT COMPRISING OF FABRICS; HOBBY CRAFT SETS FOR DESIGNING AND MAKING DOLL FASHIONS AND FASHION ACCESSORIES; PLAYSETS FOR DOLLS; PLAYSETS FOR DOLLS COMPRISED OF DOLL FURNITURE, INCLUDING BEDS, CLOSET, WARDROBES, RUNWAYS; PHOTOGRAPHY STUDIO PLAYSETS FOR DOLLS INCLUDING TOY ACCESSORIES THEREFOR; SHOES FOR DOLLS, IN CLASS 28 (U.S. CLS. 22, 23, 38 AND 50).

TRADEMARK

PRINCIPAL REGISTER

FIRST USE 7-1-2009; IN COMMERCE 7-1-2009.

THE MARK CONSISTS OF STANDARD CHARACTERS WITHOUT CLAIM TO ANY PARTICULAR FONT, STYLE, SIZE, OR COLOR.

SN 77-606,373, FILED 11-3-2008.

ANDREW LEASER, EXAMINING ATTORNEY



David J. Kypos

Director of the United States Patent and Trademark Office

United States of America

United States Patent and Trademark Office

MOTOR EXCELLENCE

Reg. No. 4,175,896

Registered July 17, 2012

Int. Cls.: 7 and 40

TRADEMARK

SERVICE MARK

PRINCIPAL REGISTER

MOTOR EXCELLENCE, LLC (ARIZONA LIMITED LIABILITY COMPANY)
1359 E. BUTLER AVENUE
FLAGSTAFF, AZ 860015920

FOR: ELECTRIC MOTORS FOR MACHINES, IN CLASS 7 (U.S. CLS. 13, 19, 21, 23, 31, 34 AND 35).

FIRST USE 5-1-2012; IN COMMERCE 5-1-2012.

FOR: THE MANUFACTURE OF ELECTRIC MOTORS TO THE ORDER AND SPECIFICATION OF OTHERS, IN CLASS 40 (U.S. CLS. 100, 103 AND 106).

FIRST USE 5-1-2012; IN COMMERCE 5-1-2012.

THE MARK CONSISTS OF STANDARD CHARACTERS WITHOUT CLAIM TO ANY PARTICULAR FONT, STYLE, SIZE, OR COLOR.

NO CLAIM IS MADE TO THE EXCLUSIVE RIGHT TO USE "MOTOR", APART FROM THE MARK AS SHOWN.

SN 77-608,119, FILED 11-5-2008.

DEZMONA MIZELLE, EXAMINING ATTORNEY



David J. Kybas

Director of the United States Patent and Trademark Office

United States of America

United States Patent and Trademark Office

34TH STREET FILMS

Reg. No. 4,175,897

Registered July 17, 2012

Int. Cls.: 9, 16, and 41

TRADEMARK

SERVICE MARK

PRINCIPAL REGISTER

TYLER PERRY STUDIOS, LLC (GEORGIA LIMITED LIABILITY COMPANY)
C/O ZIFFREN, BRITTENHAM ET AL.
1800 CENTURY PARK WEST
LOS ANGELES, CA 90067

FOR: PRERECORDED AUDIO AND VIDEO DISCS, TAPES AND DOWNLOADS FEATURING MUSICAL, DRAMATIC AND COMEDY PERFORMANCES, IN CLASS 9 (U.S. CLS. 21, 23, 26, 36 AND 38).

FIRST USE 9-22-2008; IN COMMERCE 9-30-2009.

FOR: PAPER AND PAPER ARTICLES, NAMELY, POSTERS, IN CLASS 16 (U.S. CLS. 2, 5, 22, 23, 29, 37, 38 AND 50).

FIRST USE 11-5-2010; IN COMMERCE 11-5-2010.

FOR: ENTERTAINMENT SERVICES, NAMELY, ARRANGING AND CONDUCTING THEATRICAL EXHIBITIONS, CELEBRITY APPEARANCES, AND PRODUCING TELEVISION PROGRAMS, MOTION PICTURE FILMS, AND INTERACTIVE AUDIOVISUAL WORKS FOR COMPUTER, ALL FEATURING MUSICAL, DRAMATIC AND COMEDY PERFORMANCES; ENTERTAINMENT SERVICES, NAMELY, TELEVISION AND MOTION PICTURE FILM PRODUCTION SERVICES, INTERACTIVE MULTIMEDIA PRODUCTION SERVICES, IN CLASS 41 (U.S. CLS. 100, 101 AND 107).

FIRST USE 9-22-2008; IN COMMERCE 9-30-2009.

THE MARK CONSISTS OF STANDARD CHARACTERS WITHOUT CLAIM TO ANY PARTICULAR FONT, STYLE, SIZE, OR COLOR.

NO CLAIM IS MADE TO THE EXCLUSIVE RIGHT TO USE "FILMS" , APART FROM THE MARK AS SHOWN.

SN 77-610,250, FILED 11-7-2008.

JOHN DWYER, EXAMINING ATTORNEY



David J. Kyffers

Director of the United States Patent and Trademark Office

United States of America

United States Patent and Trademark Office



MAGNUM

Reg. No. 4,175,898

CRIF CORPORATION (FLORIDA CORPORATION)
3505 E. FRONTAGE ROAD
TAMPA, FL 336071762

Registered July 17, 2012

Int. Cls.: 35, 36, and 42

FOR: INFORMATION AND DATA COMPILING AND ANALYZING RELATING TO BUSINESS MANAGEMENT, IN CLASS 35 (U.S. CLS. 100, 101 AND 102).

SERVICE MARK

FIRST USE 3-1-2008; IN COMMERCE 3-1-2008.

PRINCIPAL REGISTER

FOR: FINANCIAL SERVICES, NAMELY, FINANCIAL ADVICE AND FINANCIAL RISK MANAGEMENT SERVICES CONCERNING CREDIT DECISIONS AND THE CREDIT DECISION PROCESS, IN CLASS 36 (U.S. CLS. 100, 101 AND 102).

FIRST USE 3-1-2008; IN COMMERCE 3-1-2008.

FOR: DESIGN AND DEVELOPMENT OF COMPUTER SOFTWARE; DATA AUTOMATION AND COLLECTION SERVICE USING PROPRIETARY SOFTWARE TO EVALUATE, ANALYZE AND COLLECT SERVICE DATA, IN CLASS 42 (U.S. CLS. 100 AND 101).

FIRST USE 3-1-2008; IN COMMERCE 3-1-2008.

OWNER OF U.S. REG. NOS. 2,706,243, 2,941,239, AND 3,038,994.

THE MARK CONSISTS OF THE WORD "MAGNUM" WRITTEN IN SLANTED LETTERS WITH SPACE WITHIN THE LETTERS "A", "G" AND "U", AND AN ABSTRACT SHAPE AT THE TOP LEFT.

SN 77-616,569, FILED 11-18-2008.

PRISCILLA MILTON, EXAMINING ATTORNEY



David J. Kyros

Director of the United States Patent and Trademark Office

United States of America

United States Patent and Trademark Office

UNLOADED

Reg. No. 4,175,899

BLUNT WRAP U.S.A., INC. (LOUISIANA CORPORATION)

Registered July 17, 2012

P.O. BOX 1935
MANDEVILLE, LA 70470

Int. Cl.: 34

FOR: TOBACCO PRODUCTS, ACCESSORIES, AND SMOKING ARTICLES, NAMELY, CIGARS, IN CLASS 34 (U.S. CLS. 2, 8, 9 AND 17).

TRADEMARK

FIRST USE 5-18-2012; IN COMMERCE 5-18-2012.

PRINCIPAL REGISTER

THE MARK CONSISTS OF STANDARD CHARACTERS WITHOUT CLAIM TO ANY PARTICULAR FONT, STYLE, SIZE, OR COLOR.

SN 77-622,236, FILED 11-26-2008.

CHERYL CLAYTON, EXAMINING ATTORNEY



David J. Kybas

Director of the United States Patent and Trademark Office

United States of America

United States Patent and Trademark Office

IMPACT PRO COACHING

Reg. No. 4,175,900

Registered July 17, 2012

Int. Cl.: 41

SERVICE MARK

PRINCIPAL REGISTER

IMPACT PRO COACHING, L.L.C. (DELAWARE LIMITED LIABILITY COMPANY)
4TH FLOOR
99 WOOD AVENUE SOUTH
ISELIN, NJ 08830

FOR: PROVIDING GROUP COACHING AND LEARNING FORUMS IN THE FIELD OF LEADERSHIP DEVELOPMENT, IN CLASS 41 (U.S. CLS. 100, 101 AND 107).

FIRST USE 2-27-2012; IN COMMERCE 2-27-2012.

THE MARK CONSISTS OF STANDARD CHARACTERS WITHOUT CLAIM TO ANY PARTICULAR FONT, STYLE, SIZE, OR COLOR.

NO CLAIM IS MADE TO THE EXCLUSIVE RIGHT TO USE "PRO COACHING", APART FROM THE MARK AS SHOWN.

SN 77-626,278, FILED 12-4-2008.

EDWARD NELSON, EXAMINING ATTORNEY



David J. Kyffers

Director of the United States Patent and Trademark Office

United States of America

United States Patent and Trademark Office

Everyday 7

Reg. No. 4,175,901

MANA PRODUCTS, INC. (NEW YORK CORPORATION)
32-02 QUEENS BOULEVARD
LONG ISLAND CITY, NY 11101

Registered July 17, 2012

Int. Cl.: 3

FOR: COSMETICS, NONMEDICATED SKINCARE PREPARATIONS, NONMEDICATED HAIRCARE PREPARATIONS AND NONMEDICATED BODYCARE PREPARATIONS, NAMELY, COSMETIC PREPARATIONS FOR THE BODY, IN CLASS 3 (U.S. CLS. 1, 4, 6, 50, 51 AND 52).

TRADEMARK

PRINCIPAL REGISTER

FIRST USE 6-30-2010; IN COMMERCE 6-30-2010.

THE MARK CONSISTS OF STANDARD CHARACTERS WITHOUT CLAIM TO ANY PARTICULAR FONT, STYLE, SIZE, OR COLOR.

SN 77-626,999, FILED 12-4-2008.

LINDA M. KING, EXAMINING ATTORNEY



David J. Kyffers

Director of the United States Patent and Trademark Office

United States of America

United States Patent and Trademark Office

POWER BUGGZ

Reg. No. 4,175,902

Registered July 17, 2012

Int. Cl.: 28

TRADEMARK

PRINCIPAL REGISTER

ME, LLC (CALIFORNIA LIMITED LIABILITY COMPANY)
SUITE #2320
2101 ROSECRANS AVE
EL SEGUNDO, CA 90245

FOR: ACTION FIGURES; ACCESSORIES FOR ACTION FIGURES; COLLECTIBLE DOLLS AND TOY FIGURES AND ACCESSORIES FOR COLLECTIBLE DOLLS AND TOY FIGURES, IN CLASS 28 (U.S. CLS. 22, 23, 38 AND 50).

FIRST USE 5-0-2011; IN COMMERCE 5-0-2011.

THE MARK CONSISTS OF STANDARD CHARACTERS WITHOUT CLAIM TO ANY PARTICULAR FONT, STYLE, SIZE, OR COLOR.

SN 77-629,720, FILED 12-9-2008.

NAKIA HENRY, EXAMINING ATTORNEY



David J. Kyffers

Director of the United States Patent and Trademark Office

United States of America

United States Patent and Trademark Office

CASTELLANO

Reg. No. 4,175,903

VARGAS, ANTHONY (UNITED STATES INDIVIDUAL)
7815 S. MOODY AVE.
BURBANK, IL 60459 AND

Registered July 17, 2012

Int. Cl.: 41

RAMIREZ, OMAR (UNITED STATES INDIVIDUAL)
5602 S. RICHMOND AVE.
CHICAGO, IL 60629 AND

SERVICE MARK

PRINCIPAL REGISTER

VILLEGAS, EDGAR (MEXICO INDIVIDUAL)
3414 FORESTVIEW DR.
JOLIET, IL 60431 AND

ESTRADA, NOEL (UNITED STATES INDIVIDUAL)
3400 S. MARSHFIELD
CHICAGO, IL 60608



David J. Kyros

Director of the United States Patent and Trademark Office

FOR: CHARITABLE SERVICES, NAMELY, PROVIDING MUSICAL INSTRUMENTS TO THOSE IN NEED; COMPOSITION OF MUSIC FOR OTHERS; CONSULTATION AND ADVICE REGARDING MUSICAL SELECTIONS AND ARRANGEMENTS FOR SOUND RECORDINGS AND LIVE PERFORMANCES; ENTERTAINMENT AND EDUCATION SERVICES IN THE NATURE OF LIVE DANCE AND MUSICAL PERFORMANCES; ENTERTAINMENT AND EDUCATIONAL SERVICES, NAMELY, PROVIDING ADVICE AND INFORMATION FOR MUSIC, VIDEO AND FILM CONCEPT AND SCRIPT DEVELOPMENT; ENTERTAINMENT IN THE NATURE OF AN ON-GOING SPECIAL VARIETY, NEWS, MUSIC OR COMEDY SHOW FEATURING MUSICAL PERFORMANCES BROADCAST OVER TELEVISION, SATELLITE, AUDIO, AND VIDEO MEDIA; ENTERTAINMENT IN THE NATURE OF VISUAL AND AUDIO PERFORMANCES, AND MUSICAL, VARIETY, NEWS AND COMEDY SHOWS; ENTERTAINMENT IN THE NATURE OF VISUAL AND AUDIO PERFORMANCES, NAMELY, MUSICAL BAND, ROCK GROUP, GYMNASTIC, DANCE, AND BALLET PERFORMANCES; ENTERTAINMENT IN THE NATURE OF MUSICAL PERFORMANCES; ENTERTAINMENT SERVICES IN THE NATURE OF LIVE MUSICAL PERFORMANCES; ENTERTAINMENT SERVICES, NAMELY, AN ON-LINE ACTIVITY WHERE YOU CREATE YOUR OWN MUSIC VIDEOS; ENTERTAINMENT SERVICES, NAMELY, NON-DOWNLOADABLE RINGTONES, PRE-RECORDED MUSIC, VIDEO AND GRAPHICS PRESENTED TO MOBILE COMMUNICATIONS DEVICES VIA A GLOBAL COMPUTER NETWORK AND WIRELESS NETWORKS; ENTERTAINMENT SERVICES, NAMELY, PROVIDING A WEB SITE FEATURING MUSICAL PERFORMANCES, MUSICAL VIDEOS, RELATED FILM

Reg. No. 4,175,903 CLIPS, PHOTOGRAPHS, AND OTHER MULTIMEDIA MATERIALS FEATURING MUSICAL PERFORMANCES; ENTERTAINMENT SERVICES, NAMELY, PROVIDING PRERECORDED MUSIC, INFORMATION IN THE FIELD OF MUSIC, AND COMMENTARY AND ARTICLES ABOUT MUSIC, ALL ON-LINE VIA A GLOBAL COMPUTER NETWORK; ENTERTAINMENT SERVICES, NAMELY, THE PRESENTATION OF LIVE CHRISTMAS MUSICAL PRODUCTIONS; ENTERTAINMENT, NAMELY, LIVE MUSIC CONCERTS; ENTERTAINMENT, NAMELY, LIVE PERFORMANCES BY A MUSICAL BAND; ENTERTAINMENT, NAMELY, LIVE PERFORMANCES BY MUSICAL BANDS; HOSTING A BACK TO SCHOOL EVENT IN A SHOPPING CENTER FEATURING PRIZES, GAMES, MUSIC, AND A FASHION SHOW; MULTIMEDIA ENTERTAINMENT SERVICES IN THE NATURE OF RECORDING, PRODUCTION AND POST-PRODUCTION SERVICES IN THE FIELDS OF MUSIC, VIDEO, AND FILMS; MULTIMEDIA PUBLISHING OF BOOKS, MAGAZINES, JOURNALS, SOFTWARE, GAMES, MUSIC, AND ELECTRONIC PUBLICATIONS; MUSIC COMPOSITION AND TRANSCRIPTION FOR OTHERS; MUSIC COMPOSITION FOR OTHERS; MUSIC PRODUCTION SERVICES; MUSIC PUBLISHING SERVICES; MUSIC SELECTION SERVICES FOR USE IN TELEVISION, FILM, RADIO AND VIDEO GAMES; MUSIC TRANSCRIPTION FOR OTHERS; MUSIC VIDEO PRODUCTION; MUSIC-HALLS; PLANNING ARRANGEMENT OF SHOWING MOVIES, SHOWS, PLAYS OR MUSICAL PERFORMANCES; POST-PRODUCTION EDITING SERVICES IN THE FIELD OF MUSIC, VIDEOS AND FILMS; PRESENTATION OF MUSICAL PERFORMANCE; PRODUCTION OF SOUND AND MUSIC VIDEO RECORDINGS; PROVIDING AN INTERNET WEBSITE PORTAL FEATURING LINKS TO MUSICAL ARTIST WEBSITES AND MUSIC PERFORMANCE TICKET INFORMATION; PROVIDING AN INTERNET WEBSITE PORTAL IN THE FIELD OF MUSIC; PROVIDING FACILITIES FOR MOVIES, SHOWS, PLAYS, MUSIC OR EDUCATIONAL TRAINING; PROVIDING INFORMATION ON TEACHING METHODOLOGY AND EDUCATION ISSUES TO MUSIC EDUCATORS; PROVIDING RATINGS FOR TELEVISION, MOVIE, MUSIC, VIDEO AND VIDEO GAME CONTENT; PUBLICATION OF MUSICAL TEXTS; RENTAL OF MUSICAL INSTRUMENTS; RENTAL OF PHONOGRAPHIC AND MUSIC RECORDINGS; THEATRICAL AND MUSICAL FLOOR SHOWS PROVIDED AT DISCOTHEQUES AND NIGHTCLUBS; THEATRICAL AND MUSICAL FLOOR SHOWS PROVIDED AT PERFORMANCE VENUES, IN CLASS 41 (U.S. CLS. 100, 101 AND 107).

FIRST USE 8-29-2007; IN COMMERCE 4-19-2008.

THE MARK CONSISTS OF STANDARD CHARACTERS WITHOUT CLAIM TO ANY PARTICULAR FONT, STYLE, SIZE, OR COLOR.

THE FOREIGN WORDING IN THE MARK TRANSLATES INTO ENGLISH AS "CASTILIAN".

SN 77-633,048, FILED 12-15-2008.

JAMES A. RAUEN, EXAMINING ATTORNEY

United States of America

United States Patent and Trademark Office

TeqX

Reg. No. 4,175,904

VARADY, MICHAEL JAMES (UNITED STATES INDIVIDUAL)
14005 CANTERBURY
LEAWOOD, KS 66224

Registered July 17, 2012

Int. Cl.: 33

FOR: ALCOHOLIC BEVERAGES, NAMELY, TEQUILA AND OTHER SPIRITS NOT INCLUDING BEER AND RELATED PRODUCTS SUCH AS ALE, PORTER, STOUT; TEQUILA, IN CLASS 33 (U.S. CLS. 47 AND 49).

TRADEMARK

FIRST USE 3-20-2012; IN COMMERCE 3-20-2012.

PRINCIPAL REGISTER

THE MARK CONSISTS OF STANDARD CHARACTERS WITHOUT CLAIM TO ANY PARTICULAR FONT, STYLE, SIZE, OR COLOR.

NO CLAIM IS MADE TO THE EXCLUSIVE RIGHT TO USE NO CLAIM IS MADE TO THE EXCLUSIVE RIGHT TO USE "TEQUILA" APART FROM THE MARK AS SHOWN., APART FROM THE MARK AS SHOWN.

SN 77-639,811, FILED 12-24-2008.

RONALD MCMORROW, EXAMINING ATTORNEY



David J. Kybas

Director of the United States Patent and Trademark Office

United States of America

United States Patent and Trademark Office

TWILIGHT

Reg. No. 4,175,905

Registered July 17, 2012

Int. Cl.: 4

TRADEMARK

PRINCIPAL REGISTER

SUMMIT ENTERTAINMENT, LLC (DELAWARE LIMITED LIABILITY COMPANY)
1630 STEWART STREET
SUITE 120
SANTA MONICA, CA 90404

FOR: CANDLES, IN CLASS 4 (U.S. CLS. 1, 6 AND 15).

FIRST USE 9-1-2008; IN COMMERCE 9-1-2008.

THE MARK CONSISTS OF STANDARD CHARACTERS WITHOUT CLAIM TO ANY PARTICULAR FONT, STYLE, SIZE, OR COLOR.

SN 77-640,048, FILED 12-25-2008.

CYNTHIA TRIPI, EXAMINING ATTORNEY



David J. Kybas

Director of the United States Patent and Trademark Office

United States of America

United States Patent and Trademark Office

STRIKER

Reg. No. 4,175,906

TRUCK SHIELDS, LLC (UTAH LIMITED LIABILITY COMPANY)
1490 NORTH 2200 WEST

Registered July 17, 2012

SALT LAKE CITY, UT 84116

Int. Cl.: 12

FOR: VEHICULAR ACCESSORIES, NAMELY, HUNTING-THEMED SEAT COVERS AND STEERING WHEEL COVERS, IN CLASS 12 (U.S. CLS. 19, 21, 23, 31, 35 AND 44).

TRADEMARK

FIRST USE 10-24-2011; IN COMMERCE 10-24-2011.

PRINCIPAL REGISTER

THE MARK CONSISTS OF STANDARD CHARACTERS WITHOUT CLAIM TO ANY PARTICULAR FONT, STYLE, SIZE, OR COLOR.

SN 77-647,603, FILED 1-12-2009.

JESSICA A. POWERS, EXAMINING ATTORNEY



David J. Kyffers

Director of the United States Patent and Trademark Office

United States of America

United States Patent and Trademark Office

MERCY VINEYARDS

Reg. No. 4,175,907

FUTUREWINE, LLC (CALIFORNIA LIMITED LIABILITY COMPANY)
2524 CENTRAL AVENUE
ALAMEDA, CA 94501

Registered July 17, 2012

Int. Cl.: 33

FOR: WINES, IN CLASS 33 (U.S. CLS. 47 AND 49).

TRADEMARK

FIRST USE 4-17-2012; IN COMMERCE 4-17-2012.

PRINCIPAL REGISTER

THE MARK CONSISTS OF STANDARD CHARACTERS WITHOUT CLAIM TO ANY PARTICULAR FONT, STYLE, SIZE, OR COLOR.

NO CLAIM IS MADE TO THE EXCLUSIVE RIGHT TO USE "VINEYARDS", APART FROM THE MARK AS SHOWN.

SN 77-655,240, FILED 1-23-2009.

KHANH LE, EXAMINING ATTORNEY



David J. Kyffers

Director of the United States Patent and Trademark Office

United States of America

United States Patent and Trademark Office

TANGO CARD

Reg. No. 4,175,908

Registered July 17, 2012

Int. Cl.: 36

SERVICE MARK

PRINCIPAL REGISTER

TANGO CARD, INC. (WASHINGTON CORPORATION)
3517 SW HANFORD STREET
SEATTLE, WA 98126

FOR: FINANCIAL SERVICES, NAMELY, PROVIDING ONLINE STORED VALUE CARD ACCOUNTS IN AN ELECTRONIC ENVIRONMENT; PROVIDING ONLINE STORED VALUE CARD SERVICES, IN CLASS 36 (U.S. CLS. 100, 101 AND 102).

FIRST USE 8-31-2009; IN COMMERCE 8-31-2009.

THE MARK CONSISTS OF STANDARD CHARACTERS WITHOUT CLAIM TO ANY PARTICULAR FONT, STYLE, SIZE, OR COLOR.

NO CLAIM IS MADE TO THE EXCLUSIVE RIGHT TO USE "CARD", APART FROM THE MARK AS SHOWN.

SN 77-657,840, FILED 1-27-2009.

AISHA SALEM, EXAMINING ATTORNEY



David J. Kyffers

Director of the United States Patent and Trademark Office

United States of America

United States Patent and Trademark Office

TANGO CARD

Reg. No. 4,175,909

TANGO CARD, INC. (WASHINGTON CORPORATION)
3517 SW HANFORD STREET
SEATTLE, WA 98126

Registered July 17, 2012

Int. Cl.: 42

FOR: PROVIDING A WEBSITE THAT GIVES USERS THE ABILITY TO CREATE CUSTOMIZED WEB PAGES FEATURING USER-DEFINED INFORMATION IN THE FIELD OF CREATION, MANAGEMENT, PROMOTION, SALE AND EXCHANGE OF GIFT CARDS AND STORED VALUE CARDS, IN CLASS 42 (U.S. CLS. 100 AND 101).

SERVICE MARK

PRINCIPAL REGISTER

FIRST USE 8-31-2009; IN COMMERCE 8-31-2009.

THE MARK CONSISTS OF STANDARD CHARACTERS WITHOUT CLAIM TO ANY PARTICULAR FONT, STYLE, SIZE, OR COLOR.

NO CLAIM IS MADE TO THE EXCLUSIVE RIGHT TO USE "CARD", APART FROM THE MARK AS SHOWN.

SN 77-657,848, FILED 1-27-2009.

AISHA SALEM, EXAMINING ATTORNEY



David J. Kyros

Director of the United States Patent and Trademark Office

United States of America

United States Patent and Trademark Office



BIOFRESH

Reg. No. 4,175,910

PHOENIX DENTAL, INC. (MICHIGAN CORPORATION)
3452 WEST THOMPSON ROAD
FENTON, MI 48430

Registered July 17, 2012

Int. Cl.: 3

FOR: NON-MEDICATED DENTAL RINSE; NON-MEDICATED MOUTH RINSE; NON-MEDICATED MOUTH WASH AND RINSE, IN CLASS 3 (U.S. CLS. 1, 4, 6, 50, 51 AND 52).

TRADEMARK

FIRST USE 4-1-2012; IN COMMERCE 4-1-2012.

PRINCIPAL REGISTER

THE MARK CONSISTS OF THE WORD "BIO" IN BLUE AND THE WORD "FRESH" IS IN GREEN.

THE COLOR(S) BLUE AND GREEN IS/ARE CLAIMED AS A FEATURE OF THE MARK.

SN 77-660,091, FILED 1-30-2009.

GRETCHEN ULRICH, EXAMINING ATTORNEY



David J. Kyros

Director of the United States Patent and Trademark Office

United States of America

United States Patent and Trademark Office

Retro Valve

Reg. No. 4,175,911

ROBERTS RETROVALVE, INC (WASHINGTON CORPORATION)
15106 SE 40TH PL
BELLEVUE, WA 98006

Registered July 17, 2012

Int. Cl.: 9

FOR: VACUUM TUBE REPLACEMENT DEVICES, NAMELY, SOLID-STATE VACUUM TUBE EMULATORS, IN CLASS 9 (U.S. CLS. 21, 23, 26, 36 AND 38).

TRADEMARK

FIRST USE 4-25-2012; IN COMMERCE 4-25-2012.

PRINCIPAL REGISTER

THE MARK CONSISTS OF STANDARD CHARACTERS WITHOUT CLAIM TO ANY PARTICULAR FONT, STYLE, SIZE, OR COLOR.

SN 77-666,820, FILED 2-9-2009.

DEIRDRE ROBERTSON, EXAMINING ATTORNEY



David J. Kybas

Director of the United States Patent and Trademark Office

United States of America

United States Patent and Trademark Office

AQUADVANTAGE

Reg. No. 4,175,912

AQUABOUNTY TECHNOLOGIES, INC. (DELAWARE CORPORATION)
TWO CLOCK TOWER PLACE, SUITE 395
MAYNARD, MA 01754

Registered July 17, 2012

Int. Cl.: 31

FOR: FISH FOR PROPAGATION USE; FERTILIZED EGGS OF FISH FOR PROPAGATION USE, IN CLASS 31 (U.S. CLS. 1 AND 46).

TRADEMARK

FIRST USE 4-1-2009; IN COMMERCE 4-1-2009.

PRINCIPAL REGISTER

THE MARK CONSISTS OF STANDARD CHARACTERS WITHOUT CLAIM TO ANY PARTICULAR FONT, STYLE, SIZE, OR COLOR.

OWNER OF U.S. REG. NO. 2,147,668.

SN 77-675,801, FILED 2-23-2009.

LINDA LAVACHE, EXAMINING ATTORNEY



David J. Kyffers

Director of the United States Patent and Trademark Office

United States of America

United States Patent and Trademark Office

TERRA & ÁGUA

Reg. No. 4,175,913

Registered July 17, 2012

Int. Cl.: 25

TRADEMARK

PRINCIPAL REGISTER

INDUSTRIA DE CALCADOS VIVO LTDA. (BRAZIL CORPORATION)
BAIRRO PLANALTO
RUA JAIME ROSSLER
FARROUPILHA-RS, BRAZIL

FOR: BOOTS, SLIPPERS, SANDALS, SHOES, SHOES FOR SPORT AND TENNIS SHOES FOR WOMEN, IN CLASS 25 (U.S. CLS. 22 AND 39).

FIRST USE 4-12-2010; IN COMMERCE 4-12-2010.

THE MARK CONSISTS OF THE WORDS "TERRA & ÁGUA" IN THE COLOR BLUE WITH EACH LETTER "A" REPRESENTED BY AN INVERTED "V".

THE COLOR(S) BLUE IS/ARE CLAIMED AS A FEATURE OF THE MARK.

THE ENGLISH TRANSLATION OF THE WORDING "TERRA" AND "ÁGUA" IN THE MARK IS EARTH AND WATER.

SN 77-684,429, FILED 3-5-2009.

ESTHER A. BORSUK, EXAMINING ATTORNEY



David J. Kyffers

Director of the United States Patent and Trademark Office

United States of America

United States Patent and Trademark Office

GREEDY GRAFFITI

Reg. No. 4,175,914

CHARLES T. FULP (UNITED STATES INDIVIDUAL)
1300 NORTH LUMINA AVENUE
WRIGHTSVILLE BEACH, NC 28480

Registered July 17, 2012

Int. Cl.: 9

FOR: DOWNLOADABLE AUDIO AND VIDEO FILES RELATING TO MUSIC, IN CLASS 9
(U.S. CLS. 21, 23, 26, 36 AND 38).

TRADEMARK

FIRST USE 11-22-2011; IN COMMERCE 11-22-2011.

PRINCIPAL REGISTER

THE MARK CONSISTS OF STANDARD CHARACTERS WITHOUT CLAIM TO ANY PARTICULAR FONT, STYLE, SIZE, OR COLOR.

SN 77-684,500, FILED 3-5-2009.

SALLY SHIH, EXAMINING ATTORNEY



David J. Kybas

Director of the United States Patent and Trademark Office

United States of America

United States Patent and Trademark Office

GeezEdit

Reg. No. 4,175,915

Registered July 17, 2012

Int. Cl.: 9

TRADEMARK

PRINCIPAL REGISTER

MOLLA, ABERRA (UNITED STATES INDIVIDUAL), DBA ABSHA/ETHIOPIAN COMPUTERS
& SOFTWARE,
10145 E. 143 WAY
BRIGHTON, CO 80602

FOR: COMPUTER SOFTWARE FOR USING KEYSTROKE INPUTS TO RENDER FOREIGN
CHARACTERS, IN CLASS 9 (U.S. CLS. 21, 23, 26, 36 AND 38).

FIRST USE 3-0-2012; IN COMMERCE 3-0-2012.

THE MARK CONSISTS OF STANDARD CHARACTERS WITHOUT CLAIM TO ANY PAR-
TICULAR FONT, STYLE, SIZE, OR COLOR.

SN 77-684,503, FILED 3-5-2009.

MARGARET POWER, EXAMINING ATTORNEY



David J. Kybas

Director of the United States Patent and Trademark Office

United States of America

United States Patent and Trademark Office

BION

Reg. No. 4,175,916

Registered July 17, 2012

Int. Cl.: 1

TRADEMARK

PRINCIPAL REGISTER

MERCK KGAA (FED REP GERMANY PARTNERSHIP LIMITED BY SHARES)
FRANKFURTER STRASSE 250
DARMSTADT, FED REP GERMANY

FOR: CHEMICAL PREPARATIONS FOR USE IN AGRICULTURE, NAMELY, CHEMICAL PREPARATIONS FOR THE TREATMENT OF SEEDS, IN CLASS 1 (U.S. CLS. 1, 5, 6, 10, 26 AND 46).

FIRST USE 12-15-2011; IN COMMERCE 12-15-2011.

THE MARK CONSISTS OF STANDARD CHARACTERS WITHOUT CLAIM TO ANY PARTICULAR FONT, STYLE, SIZE, OR COLOR.

OWNER OF U.S. REG. NO. 2,706,034.

SN 77-688,445, FILED 3-11-2009.

ZACHARY BELLO, EXAMINING ATTORNEY



David J. Kyffers

Director of the United States Patent and Trademark Office

United States of America

United States Patent and Trademark Office

HA8000

Reg. No. 4,175,917

Registered July 17, 2012

Int. Cl.: 9

TRADEMARK

PRINCIPAL REGISTER

KABUSHIKI KAISHA HITACHI SEISAKUSHO (JAPAN CORPORATION), DBA HITACHI, LTD.,
6-6, MARUNOUCHI 1-CHOME, CHIYODA-KU
TOKYO, JAPAN

FOR: PC SERVERS AND COMPUTER SERVERS, IN CLASS 9 (U.S. CLS. 21, 23, 26, 36 AND 38).

FIRST USE 6-1-1996; IN COMMERCE 10-30-2010.

THE MARK CONSISTS OF STANDARD CHARACTERS WITHOUT CLAIM TO ANY PARTICULAR FONT, STYLE, SIZE, OR COLOR.

SN 77-690,218, FILED 3-13-2009.

DARRYL SPRUILL, EXAMINING ATTORNEY



David J. Kybas

Director of the United States Patent and Trademark Office

United States of America

United States Patent and Trademark Office

MARATHON MEN

Reg. No. 4,175,918

Registered July 17, 2012

Int. Cl.: 25

TRADEMARK

PRINCIPAL REGISTER

JOHN R. GOAT (UNITED STATES INDIVIDUAL), DBA HOLY SHIRT!,
221 SPRINGFIELD ROAD
SYRACUSE, NY 13214

FOR: MEN'S, WOMEN'S AND CHILDREN'S CLOTHING, NAMELY, JERSEYS, TANK TOPS, SWEAT SHIRTS, SWEAT PANTS, SWEAT BANDS, AND HATS; MEN'S, WOMEN'S AND CHILDREN'S CLOTHING, NAMELY, T-SHIRTS, IN CLASS 25 (U.S. CLS. 22 AND 39).

FIRST USE 3-13-2009; IN COMMERCE 3-13-2009.

THE MARK CONSISTS OF STANDARD CHARACTERS WITHOUT CLAIM TO ANY PARTICULAR FONT, STYLE, SIZE, OR COLOR.

SN 77-691,927, FILED 3-16-2009.

RENEE MCCRAY, EXAMINING ATTORNEY



David J. Kybas

Director of the United States Patent and Trademark Office

United States of America

United States Patent and Trademark Office

PICK-A-PECK PICKLES

Reg. No. 4,175,919

Registered July 17, 2012

Int. Cl.: 29

TRADEMARK

PRINCIPAL REGISTER

PICK A PECK PICKLES, INC. (CALIFORNIA CORPORATION)
945 STARLITE LANE
YUBA CITY, CA 95991

FOR: PICKLED VEGETABLES, IN CLASS 29 (U.S. CL. 46).

FIRST USE 7-1-2009; IN COMMERCE 7-1-2009.

THE MARK CONSISTS OF STANDARD CHARACTERS WITHOUT CLAIM TO ANY PARTICULAR FONT, STYLE, SIZE, OR COLOR.

NO CLAIM IS MADE TO THE EXCLUSIVE RIGHT TO USE "PICKLES", APART FROM THE MARK AS SHOWN.

SN 77-702,516, FILED 3-30-2009.

NELSON SNYDER, EXAMINING ATTORNEY



David J. Kyffers

Director of the United States Patent and Trademark Office

United States of America

United States Patent and Trademark Office

MIGHTY PLAY

Reg. No. 4,175,920

Registered July 17, 2012

Int. Cl.: 41

SERVICE MARK

PRINCIPAL REGISTER

MIGHTY PLAY LLC (CALIFORNIA LIMITED LIABILITY COMPANY)
SUITE 310
1620 MONTGOMERY STREET
SAN FRANCISCO, CA 94111

FOR: PRODUCTION OF MULTIMEDIA PRODUCTS, NAMELY, MULTIMEDIA ENTERTAINMENT SOFTWARE PRODUCTION SERVICES, IN CLASS 41 (U.S. CLS. 100, 101 AND 107).

FIRST USE 2-7-2008; IN COMMERCE 2-7-2008.

THE MARK CONSISTS OF STANDARD CHARACTERS WITHOUT CLAIM TO ANY PARTICULAR FONT, STYLE, SIZE, OR COLOR.

SN 77-702,609, FILED 3-30-2009.

KEVIN CORWIN, EXAMINING ATTORNEY



David J. Kyffers

Director of the United States Patent and Trademark Office

United States of America

United States Patent and Trademark Office

DISNEY FRIENDS FOR CHANGE

Reg. No. 4,175,921

DISNEY ENTERPRISES, INC. (DELAWARE CORPORATION)
500 SOUTH BUENA VISTA STREET
BURBANK, CA 91521

Registered July 17, 2012

Int. Cl.: 35

FOR: RETAIL STORE SERVICES FEATURING CLOTHING, BAGS AND TABLEWARE, IN CLASS 35 (U.S. CLS. 100, 101 AND 102).

SERVICE MARK

FIRST USE 4-9-2012; IN COMMERCE 4-9-2012.

PRINCIPAL REGISTER

THE MARK CONSISTS OF STANDARD CHARACTERS WITHOUT CLAIM TO ANY PARTICULAR FONT, STYLE, SIZE, OR COLOR.

SN 77-706,284, FILED 4-3-2009.

RONALD MCMORROW, EXAMINING ATTORNEY



David J. Kyffers

Director of the United States Patent and Trademark Office

United States of America

United States Patent and Trademark Office

THE HEIDRICK & STRUGGLES LEADERSHIP INSTITUTE

Reg. No. 4,175,922

HEIDRICK & STRUGGLES INTERNATIONAL, INC. (DELAWARE CORPORATION)
233 S. WACKER DR., SUITE 4200
CHICAGO, IL 60606

Registered July 17, 2012

Int. Cl.: 41

FOR: EDUCATIONAL SERVICES, NAMELY, CONDUCTING COURSES, SEMINARS, WORKSHOPS AND CLASSES IN THE FIELDS OF BUSINESS, BUSINESS MANAGEMENT AND MANAGEMENT TRAINING; EDUCATION, TEACHING AND TRAINING, NAMELY, CONDUCTING RETREATS FOR EDUCATION, TEACHING AND TRAINING IN THE FIELDS OF BUSINESS, BUSINESS DEVELOPMENT, PERSONAL DEVELOPMENT AND LEADERSHIP TRAINING; ORGANIZING AND CONDUCTING CLASSES, SEMINARS, CONFERENCES, WORKSHOPS AND EXHIBITIONS IN THE FIELD OF BUSINESS DEVELOPMENT, PERSONAL DEVELOPMENT AND LEADERSHIP, IN CLASS 41 (U.S. CLS. 100, 101 AND 107).

SERVICE MARK

PRINCIPAL REGISTER

FIRST USE 5-0-2012; IN COMMERCE 5-0-2012.

THE MARK CONSISTS OF STANDARD CHARACTERS WITHOUT CLAIM TO ANY PARTICULAR FONT, STYLE, SIZE, OR COLOR.

OWNER OF U.S. REG. NOS. 1,323,628 AND 2,299,112.

NO CLAIM IS MADE TO THE EXCLUSIVE RIGHT TO USE "LEADERSHIP INSTITUTE", APART FROM THE MARK AS SHOWN.

SN 77-706,648, FILED 4-3-2009.

JOHN SCHUYLER YARD, EXAMINING ATTORNEY



David J. Kypos

Director of the United States Patent and Trademark Office

United States of America

United States Patent and Trademark Office

VIRTUAL PEAK PLANT

Reg. No. 4,175,923

Registered July 17, 2012

Int. Cl.: 9

TRADEMARK

PRINCIPAL REGISTER

CONSERT, INC. (DELAWARE CORPORATION)
4700 FALLS OF NEUSE ROAD
SUITE 340
RALEIGH, NC 27609

FOR: ENERGY MANAGEMENT SOFTWARE, NAMELY, COMPUTER SOFTWARE FOR USE BY UTILITIES AND THEIR BUSINESS AND RESIDENTIAL CUSTOMERS IN THE OPERATION OF ELECTRICITY-MONITORING DEVICES, ENERGY REPORTING DEVICES, ELECTRICAL ENERGY MANAGEMENT DEVICES AND ELECTRICAL LOAD-SHEDDING DEVICES, IN CLASS 9 (U.S. CLS. 21, 23, 26, 36 AND 38).

FIRST USE 8-25-2011; IN COMMERCE 8-25-2011.

THE MARK CONSISTS OF STANDARD CHARACTERS WITHOUT CLAIM TO ANY PARTICULAR FONT, STYLE, SIZE, OR COLOR.

NO CLAIM IS MADE TO THE EXCLUSIVE RIGHT TO USE "VIRTUAL", APART FROM THE MARK AS SHOWN.

SN 77-711,255, FILED 4-10-2009.

SHAUNIA CARLYLE, EXAMINING ATTORNEY



David J. Kybas

Director of the United States Patent and Trademark Office

United States of America
United States Patent and Trademark Office

SIMPLISSE

Reg. No. 4,175,924

SIMPLISSE, INC. (MISSOURI CORPORATION)
4433 FYLER AVENUE
ST. LOUIS, MO 63116

Registered July 17, 2012

Int. Cl.: 20

FOR: NURSING PILLOWS, IN CLASS 20 (U.S. CLS. 2, 13, 22, 25, 32 AND 50).

TRADEMARK

FIRST USE 11-8-2010; IN COMMERCE 11-8-2010.

PRINCIPAL REGISTER

THE MARK CONSISTS OF STANDARD CHARACTERS WITHOUT CLAIM TO ANY PARTICULAR FONT, STYLE, SIZE, OR COLOR.

SN 77-712,810, FILED 4-13-2009.

EUGENIA MARTIN, EXAMINING ATTORNEY



David J. Kybas

Director of the United States Patent and Trademark Office

United States of America

United States Patent and Trademark Office

FITNESS ARCH

Reg. No. 4,175,925

FITNESS ARCH, INC. (WASHINGTON CORPORATION)

Registered July 17, 2012

23303 CEDAR WAY T204
MOUNTLAKE TERRACE, WA 98043

Int. Cl.: 10

FOR: EXERCISE MACHINES FOR THERAPEUTIC PURPOSES, IN CLASS 10 (U.S. CLS. 26, 39 AND 44).

TRADEMARK

FIRST USE 11-20-2011; IN COMMERCE 11-20-2011.

PRINCIPAL REGISTER

THE MARK CONSISTS OF STANDARD CHARACTERS WITHOUT CLAIM TO ANY PARTICULAR FONT, STYLE, SIZE, OR COLOR.

NO CLAIM IS MADE TO THE EXCLUSIVE RIGHT TO USE "FITNESS", APART FROM THE MARK AS SHOWN.

SN 77-718,698, FILED 4-21-2009.

DAVID COLLIER, EXAMINING ATTORNEY



David J. Kyffers

Director of the United States Patent and Trademark Office

United States of America

United States Patent and Trademark Office

FORCE 3

Reg. No. 4,175,926

Registered July 17, 2012

Int. Cls.: 35, 37, and 42

SERVICE MARK

PRINCIPAL REGISTER

FORCE 3, INC. (MARYLAND CORPORATION)
2151 PRIEST BRIDGE DRIVE
CROFTON, MD 21114

FOR: ACQUISITION SERVICES, NAMELY, PURCHASING INFORMATION TECHNOLOGY EQUIPMENT AND INFORMATION TECHNOLOGY PRODUCTS FOR OTHERS IN THE SECURITY, NETWORKING, TELEPHONY AND DATA CENTER INDUSTRIES; WHOLESALE DISTRIBUTORSHIPS FEATURING INFORMATION TECHNOLOGY EQUIPMENT AND INFORMATION TECHNOLOGY PRODUCTS FOR OTHERS IN THE SECURITY, NETWORKING, TELEPHONY AND DATA CENTER INDUSTRIES, IN CLASS 35 (U.S. CLS. 100, 101 AND 102).

FIRST USE 12-13-1997; IN COMMERCE 12-13-1997.

FOR: INFORMATION TECHNOLOGY SERVICES, NAMELY, INSTALLATION OF INFORMATION TECHNOLOGY EQUIPMENT AND INFORMATION TECHNOLOGY NETWORKS, DATA CENTER HARDWARE AND TELEPHONIC EQUIPMENT, IN CLASS 37 (U.S. CLS. 100, 103 AND 106).

FIRST USE 12-0-1991; IN COMMERCE 12-0-1991.

FOR: INFORMATION TECHNOLOGY SERVICES, NAMELY, ASSESSMENT, DESIGN, AND IMPLEMENTATION OF INFORMATION TECHNOLOGY EQUIPMENT AND INFORMATION TECHNOLOGY NETWORKS, DATA CENTERS, AND TELEPHONIC EQUIPMENT; DESIGN AND CUSTOMIZATION OF INFORMATION TECHNOLOGY PRODUCTS FOR SECURITY, NETWORKING, TELEPHONY AND DATA CENTERS; MAINTENANCE AND REPAIR OF INFORMATION TECHNOLOGY PRODUCTS IN THE NATURE OF COMPUTER SOFTWARE USED IN THE SECURITY, NETWORKING, TELEPHONY AND DATA CENTER INDUSTRIES; TECHNICAL SUPPORT SERVICES, NAMELY, TROUBLESHOOTING IN THE NATURE OF DIAGNOSING COMPUTER HARDWARE AND SOFTWARE PROBLEMS FOR INFORMATION TECHNOLOGY PRODUCTS USED IN THE SECURITY, NETWORKING, TELEPHONY AND DATA CENTER INDUSTRIES, IN CLASS 42 (U.S. CLS. 100 AND 101).

FIRST USE 12-0-1991; IN COMMERCE 12-0-1991.

THE MARK CONSISTS OF STANDARD CHARACTERS WITHOUT CLAIM TO ANY PARTICULAR FONT, STYLE, SIZE, OR COLOR.



David J. Kyjars

Director of the United States Patent and Trademark Office

Reg. No. 4,175,926 SN 77-720,223, FILED 4-22-2009.

MARTHA FROMM, EXAMINING ATTORNEY

United States of America

United States Patent and Trademark Office

Redi Reach

Reg. No. 4,175,927

REDI REACH LLC (NEW YORK LIMITED LIABILITY COMPANY)
4 IRONWOOD DRIVE
FAIRPORT, NY 14450

Registered July 17, 2012

Int. Cl.: 20

FOR: SHELVING AND COMPONENT PARTS THEREOF, NAMELY, SHELVES AND BRACKETS SOLD AS A UNIT, IN CLASS 20 (U.S. CLS. 2, 13, 22, 25, 32 AND 50).

TRADEMARK

FIRST USE 2-13-2009; IN COMMERCE 2-13-2012.

PRINCIPAL REGISTER

THE MARK CONSISTS OF STANDARD CHARACTERS WITHOUT CLAIM TO ANY PARTICULAR FONT, STYLE, SIZE, OR COLOR.

SN 77-721,530, FILED 4-24-2009.

PRISCILLA MILTON, EXAMINING ATTORNEY



David J. Kybas

Director of the United States Patent and Trademark Office

United States of America

United States Patent and Trademark Office

TRIPLEASURE

Reg. No. 4,175,928

TRIPLEASURE LLC (CALIFORNIA LIMITED LIABILITY COMPANY), DBA TRIPLEASURE,
46921 WARM SPRINGS BLVD, SUITE 201D
FREMONT, CA 94539

Registered July 17, 2012

Int. Cl.: 39

FOR: TRAVEL AGENCY SERVICES, NAMELY, MAKING RESERVATIONS AND BOOKINGS
FOR TRANSPORTATION, IN CLASS 39 (U.S. CLS. 100 AND 105).

SERVICE MARK

FIRST USE 10-8-2008; IN COMMERCE 2-12-2009.

PRINCIPAL REGISTER

THE MARK CONSISTS OF STANDARD CHARACTERS WITHOUT CLAIM TO ANY PAR-
TICULAR FONT, STYLE, SIZE, OR COLOR.

SN 77-723,586, FILED 4-28-2009.

NICHOLAS ALTREE, EXAMINING ATTORNEY



David J. Kybas

Director of the United States Patent and Trademark Office

United States of America

United States Patent and Trademark Office

SIMPLY GREAT FOOD

Reg. No. 4,175,929

Registered July 17, 2012

Int. Cl.: 35

SERVICE MARK

PRINCIPAL REGISTER

AHOLD LICENSING SARL (SWITZERLAND LIMITED LIABILITY COMPANY)
2 RUE JEAN-PETITOT
GENEVA, SWITZERLAND 1204

FOR: SUPERMARKETS, IN CLASS 35 (U.S. CLS. 100, 101 AND 102).

FIRST USE 8-0-2008; IN COMMERCE 8-0-2008.

THE MARK CONSISTS OF STANDARD CHARACTERS WITHOUT CLAIM TO ANY PARTICULAR FONT, STYLE, SIZE, OR COLOR.

NO CLAIM IS MADE TO THE EXCLUSIVE RIGHT TO USE "GREAT FOOD", APART FROM THE MARK AS SHOWN.

SN 77-725,194, FILED 4-29-2009.

LINDA MICKLEBURGH, EXAMINING ATTORNEY



David J. Kyffers

Director of the United States Patent and Trademark Office

United States of America

United States Patent and Trademark Office



Reg. No. 4,175,930

Registered July 17, 2012

Int. Cls.: 15 and 25

TRADEMARK

PRINCIPAL REGISTER

TWO OLD HIPPIES, LLC (IOWA LIMITED LIABILITY COMPANY)
P.O. BOX 557
SPIRIT LAKE, IA 51360

FOR: MUSICAL INSTRUMENTS, NAMELY, GUITARS, ACOUSTIC GUITARS; PARTS AND ACCESSORIES FOR MUSICAL INSTRUMENTS, NAMELY, GUITAR BODIES, GUITAR NECKS GUITAR STRINGS, MACHINE HEADS, BRIDGE AND NUT ASSEMBLIES, GUITAR CASES AND BAGS, GUITAR STRAPS, AND GUITAR PICKS, IN CLASS 15 (U.S. CLS. 2, 21 AND 36).

FIRST USE 3-0-2009; IN COMMERCE 3-0-2009.

FOR: CLOTHING, NAMELY, SHIRTS, TOPS, SWEATSHIRTS, JACKETS, HATS, AND CAPS, IN CLASS 25 (U.S. CLS. 22 AND 39).

FIRST USE 3-0-2009; IN COMMERCE 3-0-2009.

THE MARK CONSISTS OF A STYLIZED OVAL WITH TWO SUPERIMPOSED SLOPING DESIGNS ON EITHER SIDE OF ONE CENTRAL VERTICAL DESIGN, ALL MEETING AT THE TOP CENTER OF THE OVAL, AND TOGETHER FORMING A STYLIZED PEACE SIGN.

SN 77-726,168, FILED 4-30-2009.

KAELIE KUNG, EXAMINING ATTORNEY



David J. Kybas

Director of the United States Patent and Trademark Office

United States of America

United States Patent and Trademark Office

TEA RANCH

Reg. No. 4,175,931

SAGE GROUP INTERNATIONAL, LLC (WASHINGTON LIMITED LIABILITY COMPANY)
P.O. BOX 9577
SEATTLE, WA 98109

Registered July 17, 2012

Int. Cl.: 35

FOR: RETAIL STORE SERVICES FEATURING BEVERAGES, IN CLASS 35 (U.S. CLS. 100, 101 AND 102).

SERVICE MARK

FIRST USE 5-29-2012; IN COMMERCE 5-29-2012.

PRINCIPAL REGISTER

THE MARK CONSISTS OF STANDARD CHARACTERS WITHOUT CLAIM TO ANY PARTICULAR FONT, STYLE, SIZE, OR COLOR.

OWNER OF U.S. REG. NO. 3,497,233.

NO CLAIM IS MADE TO THE EXCLUSIVE RIGHT TO USE "TEA", APART FROM THE MARK AS SHOWN.

SN 77-726,235, FILED 4-30-2009.

SALLY SHIH, EXAMINING ATTORNEY



David J. Kybas

Director of the United States Patent and Trademark Office

United States of America

United States Patent and Trademark Office

BROOKLYN NETS

Reg. No. 4,175,932

Registered July 17, 2012

Int. Cl.: 25

TRADEMARK

PRINCIPAL REGISTER

NEW JERSEY BASKETBALL, LLC (NEW JERSEY LIMITED LIABILITY COMPANY)
390 MURRAY HILL PARKWAY
EAST RUTHERFORD, NJ 07073

FOR: CLOTHING, NAMELY, HOSIERY, FOOTWEAR, BASKETBALL SHOES, BASKETBALL SNEAKERS, T-SHIRTS, SHIRTS, POLO SHIRTS, SWEATSHIRTS, SWEATPANTS, PANTS, TANK TOPS, JERSEYS, SHORTS, PAJAMAS, SPORT SHIRTS, RUGBY SHIRTS, SWEATERS, BELTS, TIES, NIGHTSHIRTS, HATS, CAPS, VISORS, WARM-UP SUITS, WARM-UP PANTS, WARM-UP TOPS, SHOOTING SHIRTS, JACKETS, WIND RESISTANT JACKETS, PARKAS, COATS, BABY BIBS NOT OF PAPER, HEAD BANDS, WRIST BANDS, APRONS, UNDERGARMENTS, BOXER SHORTS, SLACKS, EAR MUFFS, GLOVES, MITTENS, SCARVES, WOVEN AND KNIT SHIRTS, JERSEY DRESSES, DRESSES, CHEERLEADING DRESSES AND UNIFORMS, SWIM WEAR, BATHING SUITS, SWIMSUITS, BIKINIS, TANKINIS, SWIM TRUNKS, BATHING TRUNKS, BOARD SHORTS, WET SUITS, BEACH COVER-UPS, BATHING SUIT COVER-UPS, BATHING SUIT WRAPS, SANDALS, BEACH SANDALS, BEACH HATS, SUN VISORS, SWIM CAPS, BATHING CAPS, NOVELTY HEADWEAR WITH ATTACHED WIGS, IN CLASS 25 (U.S. CLS. 22 AND 39).

FIRST USE 4-30-2012; IN COMMERCE 4-30-2012.

THE MARK CONSISTS OF STANDARD CHARACTERS WITHOUT CLAIM TO ANY PARTICULAR FONT, STYLE, SIZE, OR COLOR.

NO CLAIM IS MADE TO THE EXCLUSIVE RIGHT TO USE "BROOKLYN", APART FROM THE MARK AS SHOWN.

SN 77-728,208, FILED 5-4-2009.

TRACY WHITTAKER-BROWN, EXAMINING ATTORNEY



David J. Kypos

Director of the United States Patent and Trademark Office

United States of America

United States Patent and Trademark Office

GRAYSKULL

Reg. No. 4,175,933

Registered July 17, 2012

Int. Cl.: 28

TRADEMARK

PRINCIPAL REGISTER

MATTEL, INC. (DELAWARE CORPORATION)
M1-1518
333 CONTINENTAL BOULEVARD
EL SEGUNDO, CA 90245

FOR: TOYS, GAMES AND PLAYTHINGS, NAMELY, TOY ACTION FIGURES AND ACCESSORIES THEREFOR, IN CLASS 28 (U.S. CLS. 22, 23, 38 AND 50).

FIRST USE 1-17-2012; IN COMMERCE 1-17-2012.

THE MARK CONSISTS OF STANDARD CHARACTERS WITHOUT CLAIM TO ANY PARTICULAR FONT, STYLE, SIZE, OR COLOR.

OWNER OF U.S. REG. NOS. 1,212,575, 2,854,996, AND 2,916,555.

SN 77-729,316, FILED 5-5-2009.

JASON BLAIR, EXAMINING ATTORNEY



David J. Kybas

Director of the United States Patent and Trademark Office

United States of America

United States Patent and Trademark Office

MEMBRAIN STRATA

Reg. No. 4,175,934

Registered July 17, 2012

Int. Cl.: 22

TRADEMARK

PRINCIPAL REGISTER

MARMOT MOUNTAIN, LLC (DELAWARE LIMITED LIABILITY COMPANY)
2321 CIRCADIAN WAY
SANTA ROSA, CA 95407

FOR: TENTS, IN CLASS 22 (U.S. CLS. 1, 2, 7, 19, 22, 42 AND 50).

FIRST USE 1-0-2010; IN COMMERCE 1-0-2010.

THE MARK CONSISTS OF STANDARD CHARACTERS WITHOUT CLAIM TO ANY PARTICULAR FONT, STYLE, SIZE, OR COLOR.

OWNER OF U.S. REG. NO. 2,826,222.

SN 77-731,363, FILED 5-7-2009.

SHAILA SETTLES, EXAMINING ATTORNEY



David J. Kyffers

Director of the United States Patent and Trademark Office

United States of America

United States Patent and Trademark Office

MEMBRAIN STRATA

Reg. No. 4,175,935

Registered July 17, 2012

Int. Cl.: 20

TRADEMARK

PRINCIPAL REGISTER

MARMOT MOUNTAIN, LLC (DELAWARE LIMITED LIABILITY COMPANY)
2321 CIRCADIAN WAY
SANTA ROSA, CA 95407

FOR: SLEEPING BAGS, IN CLASS 20 (U.S. CLS. 2, 13, 22, 25, 32 AND 50).

FIRST USE 1-0-2010; IN COMMERCE 1-0-2010.

THE MARK CONSISTS OF STANDARD CHARACTERS WITHOUT CLAIM TO ANY PARTICULAR FONT, STYLE, SIZE, OR COLOR.

OWNER OF U.S. REG. NO. 2,826,222.

SN 77-731,364, FILED 5-7-2009.

SHAILA SETTLES, EXAMINING ATTORNEY



David J. Kyffers

Director of the United States Patent and Trademark Office

United States of America

United States Patent and Trademark Office

HELP

Reg. No. 4,175,936

INTERNATIONAL TRANSPORT EQUIPMENT CORPORATION (FLORIDA CORPORATION)
PO BOX 800006
AVENTURA, FL 33160

Registered July 17, 2012

Int. Cl.: 19

FOR: MANUFACTURED HOUSING, NAMELY, TRANSPORTABLE HOMES, IN CLASS 19
(U.S. CLS. 1, 12, 33 AND 50).

TRADEMARK

FIRST USE 6-22-2010; IN COMMERCE 6-22-2010.

PRINCIPAL REGISTER

THE MARK CONSISTS OF STANDARD CHARACTERS WITHOUT CLAIM TO ANY PARTICULAR FONT, STYLE, SIZE, OR COLOR.

SN 77-735,013, FILED 5-12-2009.

MARTHA FROMM, EXAMINING ATTORNEY



David J. Kyffers

Director of the United States Patent and Trademark Office

United States of America

United States Patent and Trademark Office

AMAZONENCORE

Reg. No. 4,175,937

AMAZON TECHNOLOGIES, INC. (NEVADA CORPORATION)
PO BOX 8102, ATTN: TRADEMARKS
RENO, NV 89507

Registered July 17, 2012

Int. Cls.: 16, 35, 40, and 41

FOR: SERIES OF FICTION AND NON-FICTION BOOKS ON A VARIETY OF TOPICS, IN CLASS 16 (U.S. CLS. 2, 5, 22, 23, 29, 37, 38 AND 50).

FIRST USE 5-13-2009; IN COMMERCE 5-13-2009.

TRADEMARK

FOR: RETAIL STORE SERVICES FEATURING PRINTED MATTER AND BOOKS; DISTRIBUTORSHIP SERVICES IN THE FIELD OF PRINTED MATTER AND BOOKS; ADVERTISING, MARKETING AND PROMOTIONAL SERVICES IN THE FIELD OF PRINTED MATTER AND BOOKS; PROVIDING AN ONLINE SEARCHABLE DATABASE FEATURING BOOKS OFFERED FOR SALE, FOR COMMERCIAL PURPOSES; ORDER FULFILLMENT SERVICES, IN CLASS 35 (U.S. CLS. 100, 101 AND 102).

SERVICE MARK

FIRST USE 5-13-2009; IN COMMERCE 5-13-2009.

PRINCIPAL REGISTER

FOR: PRINTING OF PRINTED MATTER AND BOOKS, IN CLASS 40 (U.S. CLS. 100, 103 AND 106).

FIRST USE 5-13-2009; IN COMMERCE 5-13-2009.



FOR: PUBLISHING OF PRINTED MATTER AND BOOKS; PROVIDING INFORMATION IN THE FIELD OF PUBLISHING; ENTERTAINMENT SERVICES, NAMELY, PROVIDING INFORMATION AND COMMENTARY IN THE FIELDS OF AUTHORS, BOOKS, LITERARY WORKS AND RECOMMENDATIONS AS TO THE SAME; PUBLISHING OF REVIEWS OF LITERARY WORKS; PROVIDING A WEB SITE WHERE USERS CAN POST RATINGS, REVIEWS AND RECOMMENDATIONS ON LITERARY WORKS, BOOKS AND PRINTED MATTER; CONSULTING SERVICES IN THE FIELD OF PUBLISHING BOOKS, IN CLASS 41 (U.S. CLS. 100, 101 AND 107).

FIRST USE 5-13-2009; IN COMMERCE 5-13-2009.

David J. Kyros

THE MARK CONSISTS OF STANDARD CHARACTERS WITHOUT CLAIM TO ANY PARTICULAR FONT, STYLE, SIZE, OR COLOR.

Reg. No. 4,175,937 SN 77-736,392, FILED 5-13-2009.

AMY ALFIERI, EXAMINING ATTORNEY

United States of America

United States Patent and Trademark Office

GO ROOF TUNE UP

Reg. No. 4,175,938

GO ROOF TUNE UP, INC (CALIFORNIA CORPORATION)
13733 VALLEY BOULEVARD
FONTANA, CA 92335

Registered July 17, 2012

Int. Cl.: 37

FOR: ROOFING CONTRACTING; ROOFING INSTALLATION; ROOFING REPAIR; ROOFING SERVICES, IN CLASS 37 (U.S. CLS. 100, 103 AND 106).

SERVICE MARK

FIRST USE 12-2-2010; IN COMMERCE 12-2-2010.

PRINCIPAL REGISTER

THE MARK CONSISTS OF STANDARD CHARACTERS WITHOUT CLAIM TO ANY PARTICULAR FONT, STYLE, SIZE, OR COLOR.

NO CLAIM IS MADE TO THE EXCLUSIVE RIGHT TO USE "ROOF", APART FROM THE MARK AS SHOWN.

SN 77-737,978, FILED 5-15-2009.

STEVEN JACKSON, EXAMINING ATTORNEY



David J. Kybas

Director of the United States Patent and Trademark Office

United States of America

United States Patent and Trademark Office

SPEAKENING

Reg. No. 4,175,939

DEPONTE, JOHN (UNITED STATES INDIVIDUAL)
140 NORMA PLACE
STATEN ISLAND, NY 10301

Registered July 17, 2012

Int. Cl.: 41

FOR: EDUCATION SERVICES, NAMELY, PROVIDING CLASSES, SEMINARS AND WORKSHOPS IN THE FIELD OF LANGUAGE INSTRUCTION THROUGH THE USE OF PICTORIAL REPRESENTATIONS IN THE FORMS OF ICONS AND STORYBOARDS, IN CLASS 41 (U.S. CLS. 100, 101 AND 107).

SERVICE MARK

PRINCIPAL REGISTER

FIRST USE 4-27-2012; IN COMMERCE 4-27-2012.

THE MARK CONSISTS OF STANDARD CHARACTERS WITHOUT CLAIM TO ANY PARTICULAR FONT, STYLE, SIZE, OR COLOR.

SN 77-739,483, FILED 5-18-2009.

ANDREW LEASER, EXAMINING ATTORNEY



David J. Kyffers

Director of the United States Patent and Trademark Office

United States of America

United States Patent and Trademark Office

WEBSTERCARE

Reg. No. 4,175,940

Registered July 17, 2012

Int. Cls.: 7, 8, and 16

TRADEMARK

PRINCIPAL REGISTER

MANREX PTY. LTD (AUSTRALIA CORPORATION)
17-19 MOORE STREET
LEICHHARDT, AUSTRALIA NSW2040

FOR: MACHINES FOR SEALING-UP BLISTER PACKAGES AND PARTS OF SUCH APPARATUS; MACHINES FOR CRUSHING TABLETS; MACHINES FOR LOADING CONTAINERS WITH SMALL OBJECTS SELECTED FROM RESPECTIVE STORAGES AND REPLACEMENT PARTS AND FITTINGS FOR THE AFORESAID GOODS; MACHINES FOR MANUFACTURING AND DISPENSING PACKAGING MATERIALS, IN CLASS 7 (U.S. CLS. 13, 19, 21, 23, 31, 34 AND 35).

FIRST USE 8-31-2002; IN COMMERCE 8-31-2002.

FOR: HAND-TOOL FOR SEALING UP BLISTER PACKAGES, NAMELY, PRESSURE APPLICATION TOOLS RELYING ON PRESSURE AND/OR HEAT TO SECURE SEALING OF THE BLISTER PACKAGES; HAND-TOOLS FOR CRUSHING TABLETS INTO A POWDER AND IN THE FORM OF A LEVER-OPERATED HEAD FOR CRUSHING A TABLET AGAINST A SUPPORT SURFACE, IN CLASS 8 (U.S. CLS. 23, 28 AND 44).

FIRST USE 8-31-2002; IN COMMERCE 8-31-2002.

FOR: INSTRUCTIONAL AND PROMOTIONAL MATERIALS RELATING TO THE USE OF PRESCRIBED PHARMACEUTICAL MEDICATIONS, PREPRINTED PAPER LABELS; RING-BINDERS FOR HOLDING MEDICATION PACKAGE FOLDERS; INSTRUCTION MANUALS FOR ASSISTING IN PHARMACY OPERATIONS; PACKAGING, NAMELY, BLISTER CARDS HAVING SEALED ENCLOSURES PROVIDING WELLS FOR RECEIVING MEDICATION DOSES; PRINTED MATTER, NAMELY, PUBLICATIONS, REPORTS, NEWSLETTER, BROCHURES, BOOKS, CATALOGUES, WRITTEN ARTICLES, AND IN THE FIELD OF PRESCRIBED PHARMACEUTICAL MEDICATIONS; PHOTOGRAPHS; STATIONERY; OFFICE REQUISITES, NAMELY, BLISTER CARD SEALING MACHINES; PRINTED INSTRUCTIONAL AND TEACHING MATERIALS IN THE FIELD OF PRESCRIBED PHARMACEUTICAL MEDICATIONS; PRINTED DISPLAY VISUALS IN THE NATURE OF PROMOTIONAL AND PACKAGING MATERIALS MADE OF RECYCLED PAPER; PAPER DISPLAY BOXES AND CARDBOARD BOXES FOR HOLDING, DISPLAYING AND DISPENSING PRESCRIBED PHARMACEUTICAL MEDICATIONS; MOLDED FOLDER TRAYS FOR HOLDING MEDICATION PACKAGE FOLDERS; MEDICATION PACKAGES FOR CONTAINING SEPARATE PRESCRIBED DOSES OF MEDICATION REQUIRED BY A PATIENT; MULTI-DOSE MED-



David J. Kyffers

Director of the United States Patent and Trademark Office

Reg. No. 4,175,940 ICATION PACKAGES TO BE PERSONALIZED FOR RESPECTIVE PATIENTS AND FOR CONTAINING PRESCRIBED DOSES OF MEDICATION; TRANSPARENT BLISTER SHEETS FOR PACKAGING MEDICATION DOSES; BACKING STRIPS TO BE ATTACHED TO A BLISTER SHEET TO CLOSE THE BLISTERS AND RETAIN MEDICATION DOSES IN THE BLISTERS; HOLDERS FOR RECEIVING MEDICATION PACKAGES; PROTECTIVE FOLDERS FOR HOLDING MEDICATION PACKAGES; CARDBOARD; CARDBOARD ARTICLES IN THE FORM OF BOXES, BACKING SHEETS, HOLDERS FOR RECEIVING MEDICATION PACKAGES; HEADER CARDS FOR ATTACHMENT TO A MEDICATION PACKAGE TO PROVIDE USAGE OR PATIENT INFORMATION, IN CLASS 16 (U.S. CLS. 2, 5, 22, 23, 29, 37, 38 AND 50).

FIRST USE 8-31-2002; IN COMMERCE 8-31-2002.

THE MARK CONSISTS OF STANDARD CHARACTERS WITHOUT CLAIM TO ANY PARTICULAR FONT, STYLE, SIZE, OR COLOR.

OWNER OF AUSTRALIA REG. NO. 1267897, DATED 10-17-2008, EXPIRES 10-17-2018.

OWNER OF U.S. REG. NO. 2,198,258.

SN 77-748,374, FILED 5-30-2009.

GINA HAYES, EXAMINING ATTORNEY

United States of America

United States Patent and Trademark Office

DEPENDABILITY PLUS

Reg. No. 4,175,941

Registered July 17, 2012

Int. Cl.: 36

SERVICE MARK

PRINCIPAL REGISTER

MAYTAG PROPERTIES, LLC (MICHIGAN LIMITED LIABILITY COMPANY)
500 RENAISSANCE DRIVE
SUITE 101
ST. JOSEPH, MI 49085

FOR: EXTENDED SERVICE PLANS PROVIDING WARRANTY COVERAGE EXTENSION FOR HOME APPLIANCES AND ELECTRONICS STARTING AFTER EXPIRATION OF ORIGINAL MANUFACTURER'S WARRANTY, IN CLASS 36 (U.S. CLS. 100, 101 AND 102).

FIRST USE 11-14-2011; IN COMMERCE 11-14-2011.

THE MARK CONSISTS OF STANDARD CHARACTERS WITHOUT CLAIM TO ANY PARTICULAR FONT, STYLE, SIZE, OR COLOR.

SN 77-749,166, FILED 6-1-2009.

DEIRDRE ROBERTSON, EXAMINING ATTORNEY



David J. Kyros

Director of the United States Patent and Trademark Office

United States of America

United States Patent and Trademark Office

RED DEAD REDEMPTION

Reg. No. 4,175,942

Registered July 17, 2012

Int. Cls.: 9, 16, 25, and 41

TRADEMARK

SERVICE MARK

PRINCIPAL REGISTER

TAKE-TWO INTERACTIVE SOFTWARE, INC. (DELAWARE CORPORATION)
622 BROADWAY
NEW YORK, NY 10012

FOR: COMPUTER AND VIDEO GAME PROGRAMS AND SOFTWARE; DOWNLOADABLE COMPUTER AND VIDEO GAME PROGRAMS AND SOFTWARE; DOWNLOADABLE DIGITAL MATERIALS, NAMELY, RING TONES, WALLPAPERS, SCREENSAVERS, DIGITAL MUSIC FILES, AND GRAPHICS, VIDEOS, FILMS, MULTIMEDIA FILES, LIVE ACTION PROGRAMS, MOTION PICTURES, AND ANIMATION IN THE FIELD OF VIDEO GAMES AND COMPUTER GAMES, ALL DELIVERED VIA GLOBAL COMPUTER NETWORKS AND WIRELESS NETWORKS; PRE-RECORDED DIGITAL MEDIA FEATURING COMPUTER GAMES AND VIDEO GAMES, WALLPAPERS, SCREENSAVERS, DIGITAL MUSIC FILES, AND GRAPHICS, VIDEOS, FILMS, MULTIMEDIA FILES, LIVE ACTION PROGRAMS, MOTION PICTURES, AND ANIMATION IN THE FIELD OF VIDEO GAMES AND COMPUTER GAMES, IN CLASS 9 (U.S. CLS. 21, 23, 26, 36 AND 38).

FIRST USE 5-18-2010; IN COMMERCE 5-18-2010.

FOR: PRINTED MATERIALS, NAMELY, MANUALS, PAMPHLETS, BOOKLETS, BOOKS, MAGAZINES, POSTERS AND GUIDES IN THE FIELD OF COMPUTER AND VIDEO GAMES, IN CLASS 16 (U.S. CLS. 2, 5, 22, 23, 29, 37, 38 AND 50).

FIRST USE 5-18-2010; IN COMMERCE 5-18-2010.

FOR: CLOTHING, NAMELY, SHIRTS, T-SHIRTS, IN CLASS 25 (U.S. CLS. 22 AND 39).

FIRST USE 3-18-2010; IN COMMERCE 3-18-2010.

FOR: ENTERTAINMENT SERVICES, NAMELY, PROVIDING ONLINE GAMES, PROVIDING A WEBSITE FEATURING COMPUTER GAMES AND VIDEO GAMES, AND NEWS, INFORMATION, TIPS, HINTS, CONTESTS, COMPUTER INTERFACE THEMES, ENHANCEMENTS, AUDIO-VISUAL CONTENT, MUSIC, FILMS, VIDEOS, TELEVISION PROGRAMS, ANIMATED SERIES, AND OTHER MULTIMEDIA MATERIALS IN THE FIELD OF COMPUTER GAMES AND VIDEO GAMES; PROVIDING INFORMATION, NEWS AND COMMENTARY IN THE FIELD OF COMPUTER GAMES AND VIDEO GAMES, IN CLASS 41 (U.S. CLS. 100, 101 AND 107).



David J. Kyffers

Director of the United States Patent and Trademark Office

Reg. No. 4,175,942 FIRST USE 2-25-2010; IN COMMERCE 2-25-2010.

THE MARK CONSISTS OF STANDARD CHARACTERS WITHOUT CLAIM TO ANY PARTICULAR FONT, STYLE, SIZE, OR COLOR.

OWNER OF U.S. REG. NO. 3,036,636.

SN 77-754,076, FILED 6-8-2009.

KAREN SEVERSON, EXAMINING ATTORNEY

United States of America

United States Patent and Trademark Office

SIMPLIFIED SAFETY

Reg. No. 4,175,943

Registered July 17, 2012

Int. Cls.: 6, 9, and 35

TRADEMARK

SERVICE MARK

PRINCIPAL REGISTER

SIMPLIFIED SAFETY INC. (DELAWARE CORPORATION)
1209 ORANGE STREET
WILMINGTON, NEW CASTLE, DE 19801

FOR: ARTICLES OF METAL FOR AVOIDING AND ARRESTING THE FALL OF PERSONS FROM HEIGHTS, NAMELY, ANCHORS, ANCHOR POINTS, CRAWLING BOARD CLAMPS, LADDER HOOKS, ANCHOR WEIGHTS, AND STRUCTURAL PARTS AND FITTINGS FOR ALL OF THE AFORESAID GOODS; ANCHORS AND ANCHORING SYSTEMS, NAMELY, ANCHORS, ANCHOR POINTS, METAL CABLE WIRE, METAL CLIPS FOR AVOIDING AND ARRESTING THE FALL OF PERSONS FROM HEIGHTS, METAL CLAMPS, METAL STRAPPING, AND METAL TIE DOWNS; FIXING, FASTENING, CLAMPING AND ANCHORING DEVICES, NAMELY, METAL THREADED FASTENERS, ANCHORS, METAL CLAMPS, METAL CLIPS FOR AVOIDING AND ARRESTING THE FALL OF PERSONS FROM HEIGHTS, AND METAL THREADED FASTENERS; METAL LADDER HOOKS, CLAMPS, BRACKETS, LADDER TIES, EYE BOLTS, AND METAL PEDESTALS, NAMELY, METAL POSTS, CONSTRUCTION SUPPORT ELEMENTS MADE OF METAL, AND METAL ANCHOR WEIGHTS; PERIMETER PROTECTION SYSTEMS, NAMELY, METAL PIPES, TUBES, CLAMPS, METAL FENCES, AND METAL BARRIER RAILS; METAL TUBING; METAL PIPES; METAL PIPE CONNECTORS; METAL TUBE AND METAL PIPE FITTINGS; METAL RAILINGS FOR FORMING ROOF EDGE BARRIERS, BALCONIES, BRIDGES, AND WORK PLATFORMS; METAL BARRIERS FOR PEDESTRIAN CONTROL, MARKING HAZARDOUS AREAS, AND ROOF EDGE FENCING; PORTABLE METAL FREE-STANDING SAFETY BARRIERS; METAL HAND RAILS, METAL HANDLES FOR DOORS, FOR AIDING CLIMB AND GRIP IN BUILDING AND ROOF TOP WORKING; METAL GUARD RAILS; METAL CLAMPS; METAL STAIR TREADS; METAL GRATINGS; FREE STANDING DEMARCATION SYSTEMS, NAMELY, METAL BARRIERS FOR PEDESTRIAN TRAFFIC CONTROL, METAL RAILINGS, METAL CHAINS, METAL POLES AND METAL ANCHOR WEIGHTS ALL USED AS TEMPORARY STRUCTURES TO SEPARATE DESIGNATED AREAS OR POTENTIAL HAZARDS, IN CLASS 6 (U.S. CLS. 2, 12, 13, 14, 23, 25 AND 50).



FIRST USE 5-0-2009; IN COMMERCE 5-0-2009.

David J. Kyffers

Director of the United States Patent and Trademark Office

FOR: SAFETY LINE SYSTEMS, NAMELY, FALL PROTECTION HARNESSSES, SAFETY LINES, WEIGHTS AND ANCHORS; FALL PROTECTION EQUIPMENT FOR FALL RESTRAINT AND FALL ARREST, NAMELY, SAFETY LINES, BEAM GRIPS, ANCHORS, ANCHORAGE CONNECTORS AND STRUCTURAL PARTS AND FITTINGS FOR ALL THE AFORESAID GOODS; SAFETY HARNESSSES; SAFETY HARNESSSES FOR PERSONS

Reg. No. 4,175,943 WORKING AT HEIGHTS; LANYARDS FOR SAFETY PURPOSES FOR FALL PROTECTION; SAFETY EQUIPMENT, NAMELY, EMERGENCY ESCAPE LADDERS AND HELMET SAFETY LIGHTS; WORK WEAR, NAMELY, SAFETY CLOTHING FOR PROTECTION AGAINST ACCIDENT, IRRADIATION AND FIRE; FOOTWEAR AND BOOTS FOR PROTECTION AGAINST ACCIDENTS AND FIRE; SAFETY GLASSES, EAR DEFENDERS, NAMELY, PROTECTIVE EAR COVERINGS AND EAR PLUGS FOR SOUNDPROOFING; SAFETY EYEWEAR; FACE-PROTECTION SHIELDS; PROTECTION MASKS, IN CLASS 9 (U.S. CLS. 21, 23, 26, 36 AND 38).

FIRST USE 5-0-2009; IN COMMERCE 5-0-2009.

FOR: WHOLESALE STORE SERVICES AND ELECTRONIC SHOPPING SERVICES IN THE NATURE OF ONLINE RETAILS STORE SERVICES AND MAIL ORDER SERVICES ALL FEATURING SAFETY APPARATUS AND EQUIPMENT, RAILINGS, BARRIERS, PERIMETER PROTECTION SYSTEMS, ROOF EDGE PROTECTION SYSTEMS, FALL PREVENTION SYSTEMS, BALUSTRADES, MAN ANCHOR EQUIPMENT, CLAMPS, METAL TUBING, PIPES, CONNECTORS AND FITTINGS, GRATINGS, INDUSTRIAL FLOORINGS, ACCESS SYSTEMS AND RAMPS; PROVIDING A SEARCHABLE WEBSITE FEATURING THE GOODS AND SERVICES OF OTHER VENDORS; BUSINESS CONSULTANCY, ADVISORY AND INFORMATION SERVICES RELATING TO THE AFORESAID, IN CLASS 35 (U.S. CLS. 100, 101 AND 102).

FIRST USE 5-0-2009; IN COMMERCE 5-0-2009.

THE MARK CONSISTS OF STANDARD CHARACTERS WITHOUT CLAIM TO ANY PARTICULAR FONT, STYLE, SIZE, OR COLOR.

NO CLAIM IS MADE TO THE EXCLUSIVE RIGHT TO USE "SAFETY", APART FROM THE MARK AS SHOWN.

SN 77-763,813, FILED 6-19-2009.

CHARISMA HAMPTON, EXAMINING ATTORNEY

United States of America

United States Patent and Trademark Office

VIRIDIAN

Reg. No. 4,175,944

Registered July 17, 2012

Int. Cl.: 35

SERVICE MARK

PRINCIPAL REGISTER

VIRIDIAN STRATEGIES, LLC (MASSACHUSETTS LIMITED LIABILITY COMPANY)
3 MEADOW VIEW LANE
ANDOVER, MA 01810

FOR: PROVIDING BUSINESS CONSULTING SERVICES TO DRUG COMPANIES AND BIOTECHNOLOGY COMPANIES TO AID IN THE MANAGEMENT OF CLINICAL TRIALS, NAMELY, THE IMPLEMENTATION OF CLINICAL TRIALS, THE MANAGEMENT OF VENDORS INVOLVED IN CLINICAL TRIALS, AND THE RESOLUTION OF ISSUES ARISING IN CLINICAL DEVELOPMENT PROGRAMS; REGULATORY SUBMISSION MANAGEMENT, NAMELY, ASSISTING OTHERS IN PREPARING AND FILING APPLICATIONS FOR NEW DRUGS WITH GOVERNMENTAL REGULATORY BODIES; PROVIDING INDEPENDENT REVIEW OF CLINICAL TRIALS FOR BUSINESS PURPOSES; BUSINESS CONSULTING AND MANAGEMENT IN THE FIELD OF CLINICAL TRIALS, NAMELY, CLINICAL DATA AND REGULATORY SUBMISSION MANAGEMENT ON BEHALF OF MEDICAL, BIOPHARMACEUTICAL AND BIOTECHNOLOGY COMPANIES TO ASSIST THEM WITH CLINICAL RESEARCH, CLINICAL TRIALS AND APPLICATIONS FOR DRUG APPROVAL; PROVIDING TECHNICAL CONSULTING SERVICES AND INFORMATION MANAGEMENT SERVICES, NAMELY, CLINICAL DATA AND REGULATORY SUBMISSION MANAGEMENT TO MEDICAL, BIOPHARMACEUTICAL AND BIOTECHNOLOGY COMPANIES TO ASSIST THEM WITH CLINICAL RESEARCH, CLINICAL TRIALS AND APPLICATIONS FOR DRUG APPROVAL, IN CLASS 35 (U.S. CLS. 100, 101 AND 102).

FIRST USE 6-30-2009; IN COMMERCE 6-30-2009.

THE MARK CONSISTS OF STANDARD CHARACTERS WITHOUT CLAIM TO ANY PARTICULAR FONT, STYLE, SIZE, OR COLOR.

SN 77-766,321, FILED 6-23-2009.

BARBARA RUTLAND, EXAMINING ATTORNEY



David J. Kyjars

Director of the United States Patent and Trademark Office

United States of America

United States Patent and Trademark Office

BOLLYHOOD

Reg. No. 4,175,945

Registered July 17, 2012

Int. Cl.: 9

TRADEMARK

PRINCIPAL REGISTER

PARMAR, RAJE SHWARI (UNITED STATES INDIVIDUAL)
SUITE 294
230 N. MAPLE AVE.
MARLTON, NJ 08053

FOR: SERIES OF AUDIO RECORDINGS FEATURING MUSIC; DOWNLOADABLE MUSICAL SOUND RECORDINGS; MUSICAL SOUND RECORDINGS; MUSICAL VIDEO RECORDINGS; PRE-RECORDED CDS, VIDEO TAPES, LASER DISKS AND DVDS FEATURING MUSIC, IN CLASS 9 (U.S. CLS. 21, 23, 26, 36 AND 38).

FIRST USE 7-1-2008; IN COMMERCE 9-20-2011.

THE MARK CONSISTS OF STANDARD CHARACTERS WITHOUT CLAIM TO ANY PARTICULAR FONT, STYLE, SIZE, OR COLOR.

SN 77-768,891, FILED 6-26-2009.

WENDY JUN, EXAMINING ATTORNEY



David J. Kybas

Director of the United States Patent and Trademark Office

United States of America

United States Patent and Trademark Office

VOLTURI

Reg. No. 4,175,946

SUMMIT ENTERTAINMENT, LLC (DELAWARE LIMITED LIABILITY COMPANY)
1630 STEWART STREET, SUITE 120
SANTA MONICA, CA 90404

Registered July 17, 2012

Int. Cl.: 9

FOR: CELL PHONE COVERS; CASES FOR MOBILE PHONES; CASES FOR PDAS, PRE-RECORDED DVDS, AND OTHER AUDIOVISUAL RECORDINGS FEATURING MOTION PICTURES; MOTION PICTURE FILMS IN THE FIELDS OF DRAMA AND ROMANCE; MOUSE PADS, IN CLASS 9 (U.S. CLS. 21, 23, 26, 36 AND 38).

TRADEMARK

PRINCIPAL REGISTER

FIRST USE 11-16-2009; IN COMMERCE 11-16-2009.

THE MARK CONSISTS OF STANDARD CHARACTERS WITHOUT CLAIM TO ANY PARTICULAR FONT, STYLE, SIZE, OR COLOR.

SN 77-770,777, FILED 6-30-2009.

DEZMONA MIZELLE, EXAMINING ATTORNEY



David J. Kyffers

Director of the United States Patent and Trademark Office

United States of America
United States Patent and Trademark Office

VOLTURI

Reg. No. 4,175,947

SUMMIT ENTERTAINMENT, LLC (DELAWARE LIMITED LIABILITY COMPANY)
1630 STEWART STREET, SUITE 120
SANTA MONICA, CA 90404

Registered July 17, 2012

Int. Cl.: 25

FOR: CLOTHING, NAMELY, JACKETS AND FOOTWEAR, IN CLASS 25 (U.S. CLS. 22 AND 39).

TRADEMARK

FIRST USE 12-19-2011; IN COMMERCE 12-19-2011.

PRINCIPAL REGISTER

THE MARK CONSISTS OF STANDARD CHARACTERS WITHOUT CLAIM TO ANY PARTICULAR FONT, STYLE, SIZE, OR COLOR.

SN 77-770,785, FILED 6-30-2009.

JAY FLOWERS, EXAMINING ATTORNEY



David J. Kyffers

Director of the United States Patent and Trademark Office

United States of America

United States Patent and Trademark Office

CONCORDIS

Reg. No. 4,175,948

Registered July 17, 2012

Int. Cls.: 35 and 36

SERVICE MARK

PRINCIPAL REGISTER

CONCORDIS REAL ESTATE ADVISORS, LLC (DELAWARE LIMITED LIABILITY COMPANY)

SUITE 1101
1835 MARKET STREET
PHILADELPHIA, PA 19103

FOR: NEGOTIATION FOR OTHERS OF COMMERCIAL REAL ESTATE PURCHASE AGREEMENTS AND LEASE AGREEMENTS , IN CLASS 35 (U.S. CLS. 100, 101 AND 102).

FIRST USE 12-0-2002; IN COMMERCE 12-0-2002.

FOR: REAL ESTATE SERVICES, NAMELY, COMMERCIAL REAL ESTATE AGENCY SERVICES; COMMERCIAL REAL ESTATE AGREEMENT BROKERAGE, CONSULTATION, EVALUATION, INVESTMENT, VALUATION, MANAGEMENT, AND MANAGEMENT CONSULTATION, IN CLASS 36 (U.S. CLS. 100, 101 AND 102).

FIRST USE 12-0-2002; IN COMMERCE 12-0-2002.

THE MARK CONSISTS OF STANDARD CHARACTERS WITHOUT CLAIM TO ANY PARTICULAR FONT, STYLE, SIZE, OR COLOR.

SN 77-772,597, FILED 7-1-2009.

CHERYL CLAYTON, EXAMINING ATTORNEY



David J. Kyjars

Director of the United States Patent and Trademark Office

United States of America

United States Patent and Trademark Office



CONCORDIS ADVISORS

Reg. No. 4,175,949

Registered July 17, 2012

Int. Cls.: 35 and 36

SERVICE MARK

PRINCIPAL REGISTER

CONCORDIS REAL ESTATE ADVISORS, LLC (DELAWARE LIMITED LIABILITY COMPANY)

SUITE 1101
1835 MARKET STREET
PHILADELPHIA, PA 19103

FOR: NEGOTIATION FOR OTHERS OF COMMERCIAL REAL ESTATE PURCHASE AGREEMENTS AND LEASE AGREEMENTS, IN CLASS 35 (U.S. CLS. 100, 101 AND 102).

FIRST USE 3-0-2009; IN COMMERCE 3-0-2009.

FOR: REAL ESTATE SERVICES, NAMELY, COMMERCIAL REAL ESTATE AGENCY SERVICES; COMMERCIAL REAL ESTATE AGREEMENT BROKERAGE, CONSULTATION, EVALUATION, INVESTMENT, VALUATION, MANAGEMENT, AND MANAGEMENT CONSULTATION, IN CLASS 36 (U.S. CLS. 100, 101 AND 102).

FIRST USE 3-0-2009; IN COMMERCE 3-0-2009.

NO CLAIM IS MADE TO THE EXCLUSIVE RIGHT TO USE "ADVISORS", APART FROM THE MARK AS SHOWN.

THE MARK CONSISTS OF FOUR CONCENTRIC INCOMPLETE CIRCLES ABOVE THE WORDS "CONCORDIS ADVISORS".

SN 77-772,635, FILED 7-1-2009.

CHERYL CLAYTON, EXAMINING ATTORNEY



David J. Kyffers

Director of the United States Patent and Trademark Office

United States of America

United States Patent and Trademark Office

Portfolio Creative

Reg. No. 4,175,950

Registered July 17, 2012

Int. Cl.: 35

SERVICE MARK

PRINCIPAL REGISTER

PORTFOLIO CREATIVE, LLC (OHIO LIMITED LIABILITY COMPANY), DBA PORTFOLIO CREATIVE,
777 GOODALE BLVD., SUITE 300
COLUMBUS, OH 43212

FOR: EMPLOYMENT HIRING, RECRUITING, PLACEMENT, STAFFING AND CAREER NETWORKING SERVICES, NAMELY, TEMPORARY, TEMP-TO-HIRE AND FULL-TIME PLACEMENT AGENCY FOR ARTISTS AND CREATIVE INDIVIDUALS, IN CLASS 35 (U.S. CLS. 100, 101 AND 102).

FIRST USE 9-25-2009; IN COMMERCE 9-25-2009.

THE MARK CONSISTS OF STANDARD CHARACTERS WITHOUT CLAIM TO ANY PARTICULAR FONT, STYLE, SIZE, OR COLOR.

SN 77-773,307, FILED 7-2-2009.

KATHLEEN LORENZO, EXAMINING ATTORNEY



David J. Kyffers

Director of the United States Patent and Trademark Office

United States of America

United States Patent and Trademark Office

MISYS ENVIRONMENTAL TRADING PLATFORM

Reg. No. 4,175,951

Registered July 17, 2012

**Int. Cls.: 9, 16, 35, and
38**

TRADEMARK

SERVICE MARK

PRINCIPAL REGISTER

MISYS OPEN SOURCE SOLUTIONS LLC (DELAWARE CORPORATION)
103 FOULK ROAD, SUITE 202
WILMINGTON, DE 19803

FOR: COMPUTER SOFTWARE, COMPUTER PROGRAMS AND DOWNLOADABLE ELECTRONIC MANUALS FOR USE IN RELATION TO THE PROVISION OF FINANCIAL SERVICES, GREEN COMMERCE, CARBON FOOT-PRINTING, CARBON MANAGEMENT, CARBON TRACKING, CARBON REPORTING, AND CARBON REGISTRATION, CARBON TRADING AND CARBON OFFSETTING; COMPUTER SOFTWARE TO ENABLE DATABASE MANAGEMENT AND THE DEVELOPMENT AND HOSTING OF INTERNET WEBSITES FOR USE IN THE FIELDS OF FINANCE, GREEN COMMERCE, CARBON FOOT-PRINTING, CARBON MANAGEMENT, CARBON TRACKING, CARBON REPORTING, AND CARBON REGISTRATION, CARBON TRADING AND CARBON OFFSETTING; COMPUTER SOFTWARE TO ENABLE THE PROVISION OF AN INTERNET-BASED PLATFORM TO ENABLE CARBON TRADING TO ASSIST END USERS AND CUSTOMERS TO REDUCE THEIR CARBON FOOTPRINTS; DATA RECORDINGS CONTAINING INFORMATION RELATING TO FINANCE, GREEN COMMERCE, CARBON FOOT-PRINTING, CARBON MANAGEMENT, CARBON TRACKING, CARBON REPORTING, AND CARBON REGISTRATION, CARBON TRADING AND CARBON OFFSETTING, IN CLASS 9 (U.S. CLS. 21, 23, 26, 36 AND 38).

FIRST USE 6-1-2010; IN COMMERCE 6-1-2010.



FOR: MANUALS AND PRINTED INSTRUCTIONAL TEACHING MATERIALS IN THE FIELDS OF FINANCE, GREEN COMMERCE, CARBON FOOT-PRINTING, CARBON MANAGEMENT, CARBON TRACKING, CARBON REPORTING, AND CARBON REGISTRATION, CARBON TRADING AND CARBON OFFSETTING; MARKETING MATERIALS IN THE NATURE OF CATALOGUES, BROCHURES AND PRINTED PRESENTATIONS IN THE FIELDS OF FINANCE, GREEN COMMERCE, CARBON FOOT-PRINTING, CARBON MANAGEMENT, CARBON TRACKING, CARBON REPORTING, AND CARBON REGISTRATION, CARBON TRADING AND CARBON OFFSETTING, IN CLASS 16 (U.S. CLS. 2, 5, 22, 23, 29, 37, 38 AND 50).

FIRST USE 6-1-2010; IN COMMERCE 6-1-2010.

David J. Kyffers

Director of the United States Patent and Trademark Office

FOR: BUSINESS CONSULTATION, BUSINESS INFORMATION AND RESEARCH IN THE FIELDS OF FINANCIAL SERVICES, GREEN COMMERCE, CARBON FOOT-PRINTING, CARBON MANAGEMENT, CARBON TRACKING, CARBON REPORTING, AND CARBON

Reg. No. 4,175,951 REGISTRATION, CARBON TRADING AND CARBON OFFSETTING, IN CLASS 35 (U.S. CLS. 100, 101 AND 102).

FIRST USE 6-1-2010; IN COMMERCE 6-1-2010.

FOR: TELECOMMUNICATIONS SERVICES, NAMELY, TRANSMISSION OF DATA RELATING TO FINANCE, GREEN COMMERCE, CARBON FOOT-PRINTING, CARBON MANAGEMENT, CARBON TRACKING, CARBON REPORTING, AND CARBON REGISTRATION, CARBON TRADING AND CARBON OFFSETTING VIA COMPUTER NETWORKS; INTERNET PORTAL SERVICES, NAMELY, PROVIDING AN ONLINE FORUM FOR TRANSMISSION OF MESSAGES AMONG COMPUTER USERS REGARDING FINANCE, GREEN COMMERCE, CARBON TRADING AND CARBON OFFSETTING, IN CLASS 38 (U.S. CLS. 100, 101 AND 104).

FIRST USE 6-1-2010; IN COMMERCE 6-1-2010.

THE MARK CONSISTS OF STANDARD CHARACTERS WITHOUT CLAIM TO ANY PARTICULAR FONT, STYLE, SIZE, OR COLOR.

NO CLAIM IS MADE TO THE EXCLUSIVE RIGHT TO USE "ENVIRONMENTAL TRADING PLATFORM", APART FROM THE MARK AS SHOWN.

SN 77-779,340, FILED 7-13-2009.

ANDREA HACK, EXAMINING ATTORNEY

United States of America

United States Patent and Trademark Office

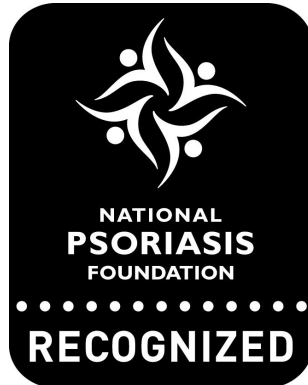

Reg. No. 4,175,952

Registered July 17, 2012

**CERTIFICATION MARK
GOODS**

PRINCIPAL REGISTER

NATIONAL PSORIASIS FOUNDATION (OREGON CORPORATION)
6600 SW 92ND AVE., SUITE 300
PORTLAND, OR 972237195

FOR: SHAMPOOS; PHARMACEUTICAL PREPARATIONS; MEDICATIONS; MEDICATED OINTMENTS; COSMETIC OINTMENTS, IN CLASS A (U.S. CL. A).

FIRST USE 12-0-2011; IN COMMERCE 12-0-2011.

OWNER OF U.S. REG. NOS. 1,674,028, 2,908,232, AND 3,545,766.

SEC. 2(F) AS TO "NATIONAL PSORIASIS FOUNDATION".

NO CLAIM IS MADE TO THE EXCLUSIVE RIGHT TO USE "FOUNDATION" OR "RECOGNIZED", APART FROM THE MARK AS SHOWN.

THE MARK CONSISTS OF A RECTANGLE WITH ROUNDED CORNERS. INSIDE THE RECTANGLE THERE IS A STYLIZED REPRESENTATION OF FOUR PEOPLE ARRANGED IN A CIRCLE. THE WORDS "NATIONAL PSORIASIS FOUNDATION" APPEAR DIRECTLY BENEATH THAT REPRESENTATION, FOLLOWED BY A HORIZONTAL DOTTED LINE, FOLLOWED BY THE WORD "RECOGNIZED".

THE CERTIFICATION MARK, AS INTENDED TO BE USED BY AUTHORIZED PERSONS, IS INTENDED TO CERTIFY THAT THEIR GOODS AND SERVICES HAVE MET THE CERTIFIER'S STANDARDS AND GUIDELINES RELATED TO MANAGEMENT AND TREATMENT OF PSORIASIS AND PSORIATIC ARTHRITIS.

SN 77-781,060, FILED 7-14-2009.

MICHAEL GAAFAR, EXAMINING ATTORNEY



David J. Kyffers

Director of the United States Patent and Trademark Office

United States of America

United States Patent and Trademark Office

THERMAGE CPT

Reg. No. 4,175,953

SOLTA MEDICAL, INC. (DELAWARE CORPORATION)
25881 INDUSTRIAL BOULEVARD
HAYWARD, CA 94545

Registered July 17, 2012

Int. Cls.: 10 and 44

FOR: MEDICAL DEVICES FOR CONTRACTING SKIN, BODY SCULPTING, AND SOFT TISSUE RECONSTRUCTION IN A NON-INVASIVE MANNER, IN CLASS 10 (U.S. CLS. 26, 39 AND 44).

TRADEMARK

FIRST USE 9-29-2009; IN COMMERCE 9-29-2009.

SERVICE MARK

FOR: MEDICAL TREATMENT SERVICES, NAMELY, COSMETIC AND DERMATOLOGICAL TREATMENT SERVICES; AESTHETIC AND THERAPEUTIC SKIN AND BODY TREATMENT SERVICES, IN CLASS 44 (U.S. CLS. 100 AND 101).

PRINCIPAL REGISTER

FIRST USE 9-29-2009; IN COMMERCE 9-29-2009.

THE MARK CONSISTS OF STANDARD CHARACTERS WITHOUT CLAIM TO ANY PARTICULAR FONT, STYLE, SIZE, OR COLOR.

OWNER OF U.S. REG. NO. 2,534,746.

SN 77-782,893, FILED 7-16-2009.

ESTHER A. BORSUK, EXAMINING ATTORNEY



David J. Kyros

Director of the United States Patent and Trademark Office

United States of America

United States Patent and Trademark Office

FORMICAL

Reg. No. 4,175,954

NEPHRO-TECH I, LLC (KANSAS LIMITED LIABILITY COMPANY)

Registered July 17, 2012

PO BOX 16106
SHAWNEE, KS 66203

Int. Cl.: 5

FOR: DIETARY AND NUTRITIONAL SUPPLEMENTS, IN CLASS 5 (U.S. CLS. 6, 18, 44, 46, 51 AND 52).

TRADEMARK

FIRST USE 3-1-2011; IN COMMERCE 3-1-2011.

PRINCIPAL REGISTER

THE MARK CONSISTS OF STANDARD CHARACTERS WITHOUT CLAIM TO ANY PARTICULAR FONT, STYLE, SIZE, OR COLOR.

SN 77-784,678, FILED 7-20-2009.

EDWARD FENNESSY, EXAMINING ATTORNEY



David J. Kyffers

Director of the United States Patent and Trademark Office

United States of America

United States Patent and Trademark Office

MARGARITAVILLE

Reg. No. 4,175,955

Registered July 17, 2012

Int. Cl.: 20

TRADEMARK

PRINCIPAL REGISTER

MARGARITAVILLE ENTERPRISES, LLC (DELAWARE LIMITED LIABILITY COMPANY)
256 WORTH AVENUE, SUITE Q-R
PALM BEACH, FL 33480

FOR: FURNITURE, IN CLASS 20 (U.S. CLS. 2, 13, 22, 25, 32 AND 50).

FIRST USE 0-0-2008; IN COMMERCE 0-0-2008.

THE MARK CONSISTS OF STANDARD CHARACTERS WITHOUT CLAIM TO ANY PARTICULAR FONT, STYLE, SIZE, OR COLOR.

OWNER OF U.S. REG. NOS. 2,729,442, 3,007,784, AND OTHERS.

SN 77-786,963, FILED 7-22-2009.

LINDA M. KING, EXAMINING ATTORNEY



David J. Kybas

Director of the United States Patent and Trademark Office

United States of America

United States Patent and Trademark Office

RAW MATERIALS

Reg. No. 4,175,956

BEEKMAN, ANNA (UNITED STATES INDIVIDUAL)
353 CORALYNN COURT
WILLOWBROOK, IL 60527

Registered July 17, 2012

Int. Cl.: 25

FOR: WEARABLE GARMENTS AND CLOTHING, NAMELY, SHIRTS, T-SHIRTS, HATS AND SWEAT SHIRTS, EXCLUDING THE FOREGOING GOODS MADE IN WHOLE OR IN SUBSTANTIAL PART FROM DENIM OR ANY TEXTILE EVOKING DENIM JEANS IN COLOR OR STYLING, IN CLASS 25 (U.S. CLS. 22 AND 39).

TRADEMARK

PRINCIPAL REGISTER

FIRST USE 7-1-2011; IN COMMERCE 7-1-2011.

THE MARK CONSISTS OF STANDARD CHARACTERS WITHOUT CLAIM TO ANY PARTICULAR FONT, STYLE, SIZE, OR COLOR.

OWNER OF U.S. REG. NO. 3,628,938.

SN 77-791,008, FILED 7-28-2009.

BARBARA RUTLAND, EXAMINING ATTORNEY



David J. Kyros

Director of the United States Patent and Trademark Office

United States of America

United States Patent and Trademark Office

M-Pack

Reg. No. 4,175,957

JUNO TECHNOLOGIES LLC (FLORIDA LIMITED LIABILITY COMPANY)
141 OAKWOOD LANE

Registered July 17, 2012

PALM BEACH GARDENS, FL 33410

Int. Cl.: 21

FOR: PILL BOXES FOR PERSONAL USE, IN CLASS 21 (U.S. CLS. 2, 13, 23, 29, 30, 33, 40 AND 50).

TRADEMARK

FIRST USE 2-15-2012; IN COMMERCE 2-15-2012.

PRINCIPAL REGISTER

THE MARK CONSISTS OF STANDARD CHARACTERS WITHOUT CLAIM TO ANY PARTICULAR FONT, STYLE, SIZE, OR COLOR.

SN 77-794,819, FILED 7-31-2009.

JESSICA A. POWERS, EXAMINING ATTORNEY



David J. Kyffers

Director of the United States Patent and Trademark Office

United States of America

United States Patent and Trademark Office

MBS COCKTALE COLLECTION

Reg. No. 4,175,958

SINGLETON, WILLIAM (UNITED STATES INDIVIDUAL)
897 CAMBRIDGE

Registered July 17, 2012

CLEVELAND HEIGHTS, OH 44121

Int. Cl.: 25

FOR: WEARING APPAREL, NAMELY, HATS, DRESS SHIRTS, SPORT SHIRTS, KNIT SHIRTS, SWEATSHIRTS, T-SHIRTS, AND PULL-OVER SHIRTS, IN CLASS 25 (U.S. CLS. 22 AND 39).

TRADEMARK

FIRST USE 5-18-2012; IN COMMERCE 5-18-2012.

PRINCIPAL REGISTER

THE MARK CONSISTS OF STANDARD CHARACTERS WITHOUT CLAIM TO ANY PARTICULAR FONT, STYLE, SIZE, OR COLOR.

NO CLAIM IS MADE TO THE EXCLUSIVE RIGHT TO USE "COCKTAIL COLLECTION", APART FROM THE MARK AS SHOWN.

SN 77-797,702, FILED 8-5-2009.

JUSTINE D. PARKER, EXAMINING ATTORNEY



David J. Kyros

Director of the United States Patent and Trademark Office

United States of America

United States Patent and Trademark Office

willa



Reg. No. 4,175,959

WILLAGIRL LLC (NEW YORK LIMITED LIABILITY COMPANY)
11 PALMER LANE
RIVERSIDE, CT 06878

Registered July 17, 2012

Int. Cl.: 3

FOR: BATH FOAMS; BEAUTY CREAMS AND LOTIONS FOR FACE AND BODY CARE; BEAUTY SERUMS; FACE WASHES; NON-MEDICATED LIP BALM; LIP GLOSS; SKIN MOISTURIZERS; SUN CARE LOTIONS; FACE AND BODY SHIMMER LOTIONS, IN CLASS 3 (U.S. CLS. 1, 4, 6, 50, 51 AND 52).

TRADEMARK

PRINCIPAL REGISTER

FIRST USE 2-28-2010; IN COMMERCE 2-28-2010.

THE MARK CONSISTS OF THE DESIGN OF A GIRL'S HEAD WITH LONG EYELASHES AND LONG HAIR, WITHIN AN OVAL CAMEO WITH THE BORDER FORMED BY CONNECTED SHADED SEMICIRCLES, AND THE TERM, "WILLA", IN STYLIZED FORM ABOVE THE CAMEO.

SN 77-799,443, FILED 8-7-2009.

BARBARA A. GOLD, EXAMINING ATTORNEY



David J. Kyjars

Director of the United States Patent and Trademark Office

United States of America

United States Patent and Trademark Office

COMFY THROW

Reg. No. 4,175,960

Registered July 17, 2012

Int. Cl.: 24

TRADEMARK

PRINCIPAL REGISTER

THE NORTHWEST COMPANY LLC (NORTH CAROLINA LIMITED LIABILITY COMPANY)
P.O. BOX 263
ROSLYN, NY 11576

FOR: BLANKET THROWS, IN CLASS 24 (U.S. CLS. 42 AND 50).

FIRST USE 7-31-2009; IN COMMERCE 7-31-2009.

THE MARK CONSISTS OF STANDARD CHARACTERS WITHOUT CLAIM TO ANY PARTICULAR FONT, STYLE, SIZE, OR COLOR.

NO CLAIM IS MADE TO THE EXCLUSIVE RIGHT TO USE "THROW", APART FROM THE MARK AS SHOWN.

SN 77-802,589, FILED 8-12-2009.

GINA HAYES, EXAMINING ATTORNEY



David J. Kyffers

Director of the United States Patent and Trademark Office

United States of America

United States Patent and Trademark Office

Old School Fantasy Sports

Reg. No. 4,175,961

Registered July 17, 2012

Int. Cl.: 41

SERVICE MARK

PRINCIPAL REGISTER

FOUR O'CLOCK FANTASY SPORTS CONCEPTS, LLC (GEORGIA LIMITED LIABILITY COMPANY), DBA OLD SCHOOL FANTASY SPORTS,
1075 LONGLEY AVE
ATLANTA, GA 30318

FOR: ENTERTAINMENT SERVICES IN THE NATURE OF FANTASY SPORTS LEAGUES,
IN CLASS 41 (U.S. CLS. 100, 101 AND 107).

FIRST USE 4-27-2012; IN COMMERCE 4-27-2012.

THE MARK CONSISTS OF STANDARD CHARACTERS WITHOUT CLAIM TO ANY PARTICULAR FONT, STYLE, SIZE, OR COLOR.

NO CLAIM IS MADE TO THE EXCLUSIVE RIGHT TO USE "FANTASY SPORTS", APART FROM THE MARK AS SHOWN.

SN 77-803,466, FILED 8-12-2009.

AMY KERTGATE, EXAMINING ATTORNEY



David J. Kyffers

Director of the United States Patent and Trademark Office

United States of America

United States Patent and Trademark Office

Mascot Race

Reg. No. 4,175,962

SPENCE, THOMAS HARRY III (UNITED STATES INDIVIDUAL)
5610 TRENTON LN N
PLYMOUTH, MN 55442

Registered July 17, 2012

Int. Cl.: 35

FOR: INTERNET ADVERTISING SERVICES, IN CLASS 35 (U.S. CLS. 100, 101 AND 102).

SERVICE MARK

FIRST USE 3-15-2012; IN COMMERCE 3-15-2012.

PRINCIPAL REGISTER

THE MARK CONSISTS OF STANDARD CHARACTERS WITHOUT CLAIM TO ANY PARTICULAR FONT, STYLE, SIZE, OR COLOR.

SN 77-805,607, FILED 8-17-2009.

LEIGH CAROLINE CASE, EXAMINING ATTORNEY



David J. Kyffers

Director of the United States Patent and Trademark Office

United States of America

United States Patent and Trademark Office

FACTORY BY ERIK HART

Reg. No. 4,175,963

HART GOODMAN, ERIK (UNITED STATES INDIVIDUAL)
1746 IVAR AVENUE
LOS ANGELES, CA 90028

Registered July 17, 2012

Int. Cl.: 25

FOR: CLOTHING FOR MEN AND WOMEN, NAMELY, JACKETS, SWEATSHIRTS, SWEATERS, SHIRTS, T-SHIRTS, TANK TOPS, VESTS, BOTTOMS, SKIRTS, DRESSES, KNITWEAR, NAMELY, TOPS AND BOTTOMS, AND WOVENS, NAMELY, TOPS AND BOTTOMS, IN CLASS 25 (U.S. CLS. 22 AND 39).

TRADEMARK

PRINCIPAL REGISTER

FIRST USE 1-1-2010; IN COMMERCE 1-1-2010.

THE MARK CONSISTS OF STANDARD CHARACTERS WITHOUT CLAIM TO ANY PARTICULAR FONT, STYLE, SIZE, OR COLOR.

THE NAME(S), PORTRAIT(S), AND/OR SIGNATURE(S) SHOWN IN THE MARK IDENTIFIES "ERIK HART", WHOSE CONSENT(S) TO REGISTER IS MADE OF RECORD.

SN 77-806,037, FILED 8-17-2009.

GINA HAYES, EXAMINING ATTORNEY



David J. Kybas

Director of the United States Patent and Trademark Office

United States of America

United States Patent and Trademark Office

BEN 10 ULTIMATE ALIEN

Reg. No. 4,175,964

Registered July 17, 2012

Int. Cl.: 28

TRADEMARK

PRINCIPAL REGISTER

THE CARTOON NETWORK, INC. (DELAWARE CORPORATION)
ONE CNN CENTER, 10N
C/O TURNER BROADCASTING SYSTEM, INC.
ATLANTA, GA 30303

FOR: GAMES AND PLAYTHINGS, NAMELY, TOY FIGURES AND ACCESSORIES
THEREFOR, IN CLASS 28 (U.S. CLS. 22, 23, 38 AND 50).

FIRST USE 7-1-2010; IN COMMERCE 7-1-2010.

THE MARK CONSISTS OF STANDARD CHARACTERS WITHOUT CLAIM TO ANY PAR-
TICULAR FONT, STYLE, SIZE, OR COLOR.

OWNER OF U.S. REG. NOS. 3,080,336, 3,206,776, AND OTHERS.

SN 77-811,301, FILED 8-24-2009.

DAVID ELTON, EXAMINING ATTORNEY



David J. Kyffers

Director of the United States Patent and Trademark Office

United States of America

United States Patent and Trademark Office



Reg. No. 4,175,965

Registered July 17, 2012

Int. Cl.: 35

SERVICE MARK

PRINCIPAL REGISTER

JETRO HOLDINGS, LLC (DELAWARE LIMITED LIABILITY COMPANY)
15-24 132ND STREET
FLUSHING, NY 11356

FOR: ONLINE WHOLESALE DISTRIBUTORSHIP SERVICES IN THE FIELD OF GROCERIES AND RESTAURANT SUPPLIES AND EQUIPMENT, IN CLASS 35 (U.S. CLS. 100, 101 AND 102).

FIRST USE 1-3-2009; IN COMMERCE 1-3-2009.

NO CLAIM IS MADE TO THE EXCLUSIVE RIGHT TO USE "STORE" AND ".COM", APART FROM THE MARK AS SHOWN.

THE COLOR(S) BLUE, YELLOW, ORANGE, WHITE AND BLACK IS/ARE CLAIMED AS A FEATURE OF THE MARK.

THE MARK CONSISTS OF THE STYLIZED WORDING "THERDSTORE.COM". THE WORDING "THE" AND "STORE" APPEARS IN THE COLOR BLUE. THE WORDING "RD" APPEARS IN THE COLOR YELLOW. A DESIGN OF AN ORANGE TAG ATTACHED TO A BLACK STRING CONTAINS THE WORDING ".COM". THE WORDING ".COM" APPEARS IN THE COLOR WHITE. THE WORDING "RDSTORE" IS DISPLAYED ON A REFLECTIVE SURFACE CREATING A BLUE AND YELLOW MIRROR IMAGE OF THE WORDING.

SN 77-812,422, FILED 8-25-2009.

CIMMERIAN COLEMAN, EXAMINING ATTORNEY



David J. Kybas

Director of the United States Patent and Trademark Office

United States of America

United States Patent and Trademark Office

BOLT WALLET

Reg. No. 4,175,966

Registered July 17, 2012

Int. Cl.: 36

SERVICE MARK

PRINCIPAL REGISTER

CHARGE ANYWHERE, LLC (DELAWARE LIMITED LIABILITY COMPANY)
SUITE A
9693 GERWIG LANE
COLUMBIA, MD 21046

FOR: ELECTRONIC PAYMENT PROCESSING SERVICES, NAMELY, ENABLING CONSUMERS/ENTITIES TO INITIATE PAYMENTS FOR GOODS AND SERVICES PURCHASED FROM MERCHANTS VIA A MOBILE DEVICE, SPECIFICALLY, FOR RETAIL MERCHANDISE, GOODS OR SERVICES USING ESTABLISHED ACCOUNTS TO SECURELY PURCHASE GOODS AND SERVICES FROM A MOBILE DEVICE VIA THE INTERNET, AND REAL-TIME ELECTRONIC PAYMENT AUTHORIZATION TO MERCHANTS IN THE NATURE OF CASHLESS PURCHASING FOR CONSUMERS/ENTITIES TO INITIATE PAYMENTS TO MERCHANTS WHEREBY PURCHASE MONIES ARE SENT VIA EXISTING RELATIONSHIPS TO MERCHANTS UPON SALES TO CONSUMERS/ENTITIES, IN CLASS 36 (U.S. CLS. 100, 101 AND 102).

FIRST USE 4-11-2012; IN COMMERCE 4-11-2012.

THE MARK CONSISTS OF STANDARD CHARACTERS WITHOUT CLAIM TO ANY PARTICULAR FONT, STYLE, SIZE, OR COLOR.

SN 77-812,852, FILED 8-26-2009.

CHARLOTTE CORWIN, EXAMINING ATTORNEY



David J. Kyffers

Director of the United States Patent and Trademark Office

United States of America

United States Patent and Trademark Office

BOLT PAYMENTS

Reg. No. 4,175,967

Registered July 17, 2012

Int. Cl.: 36

SERVICE MARK

PRINCIPAL REGISTER

CHARGE ANYWHERE, LLC (DELAWARE LIMITED LIABILITY COMPANY)
SUITE A
9693 GERWIG LANE
COLUMBIA, MD 21046

FOR: ELECTRONIC PAYMENT PROCESSING SERVICES, NAMELY, ENABLING CONSUMERS/ENTITIES TO INITIATE PAYMENTS FOR GOODS AND SERVICES PURCHASED FROM MERCHANTS VIA A MOBILE DEVICE, SPECIFICALLY, FOR RETAIL MERCHANDISE, GOODS OR SERVICES USING ESTABLISHED ACCOUNTS TO SECURELY PURCHASE GOODS AND SERVICES FROM A MOBILE DEVICE VIA THE INTERNET, AND REAL-TIME ELECTRONIC PAYMENT AUTHORIZATION TO MERCHANTS IN THE NATURE OF CASHLESS PURCHASING FOR CONSUMERS/ENTITIES TO INITIATE PAYMENTS TO MERCHANTS WHEREBY PURCHASE MONIES ARE SENT VIA EXISTING RELATIONSHIPS TO MERCHANTS UPON SALES TO CONSUMERS/ENTITIES, IN CLASS 36 (U.S. CLS. 100, 101 AND 102).

FIRST USE 4-11-2012; IN COMMERCE 4-11-2012.

THE MARK CONSISTS OF STANDARD CHARACTERS WITHOUT CLAIM TO ANY PARTICULAR FONT, STYLE, SIZE, OR COLOR.

NO CLAIM IS MADE TO THE EXCLUSIVE RIGHT TO USE "PAYMENTS", APART FROM THE MARK AS SHOWN.

SN 77-812,854, FILED 8-26-2009.

CHARLOTTE CORWIN, EXAMINING ATTORNEY



David J. Kyros

Director of the United States Patent and Trademark Office

United States of America

United States Patent and Trademark Office

UNIVERSITY OF THE SCIENCES

Reg. No. 4,175,968

Registered July 17, 2012

**Int. Cls.: 35, 36, 41, and
42**

SERVICE MARK

PRINCIPAL REGISTER

UNIVERSITY OF THE SCIENCES IN PHILADELPHIA (PENNSYLVANIA NON-PROFIT CORPORATION)
600 SOUTH 43RD STREET
PHILADELPHIA, PA 19104

FOR: BUSINESS CONSULTING SERVICES FOR THE PHARMACEUTICAL AND HEALTH CARE INDUSTRIES, NAMELY, PHARMACEUTICAL CARE MANAGEMENT PROGRAMS IN THE NATURE OF COST MANAGEMENT AND DRUG UTILIZATION REVIEW FOR PHARMACEUTICAL BENEFIT PLANS FOR PRIVATE AND PUBLIC AGENCIES, ORGANIZATIONS, INSTITUTIONS, AND INDIVIDUALS; BUSINESS RESEARCH SERVICES, NAMELY, PROVIDING AND FACILITATING PHARMACOECONOMICS RESEARCH PROJECTS AND RESEARCH TEAMS FOR IMPROVING DRUG THERAPY UTILIZATION AND COSTS REIMBURSEMENTS THROUGH APPLIED PHARMACOECONOMICS FOR THE PHARMACEUTICAL AND HEALTH CARE INDUSTRIES; AND PROVIDING AND FACILITATING GERIATRICS-FOCUSED RESEARCH PROGRAMS DEDICATED TO ASSESSING HEALTH CARE OF THE ELDERLY, NAMELY, DRUG UTILIZATION REVIEW RESEARCH FOR THE PHARMACEUTICAL AND HEALTH CARE INDUSTRIES, IN CLASS 35 (U.S. CLS. 100, 101 AND 102).

FIRST USE 7-1-1998; IN COMMERCE 7-1-1998.

FOR: PROVIDING AND FACILITATING PHARMACOECONOMICS RESEARCH PROJECTS AND RESEARCH TEAMS FOR IMPROVING DRUG THERAPY REIMBURSEMENTS THROUGH APPLIED PHARMACOECONOMICS FOR THE PHARMACEUTICAL AND HEALTH CARE INDUSTRIES, NAMELY, RESEARCH ABOUT PATIENT REIMBURSEMENT FOR PHARMACEUTICALS AND FINANCING THE RESEARCH OF OTHERS IN THE FIELD OF PHARMACOECONOMICS; AND PROVIDING AND FACILITATING GERIATRICS-FOCUSED RESEARCH PROGRAMS DEDICATED TO ASSESSING HEALTH CARE OF THE ELDERLY BY OUTCOMES ASSESSMENT AND DRUG USE AND UTILIZATION FOR THE PHARMACEUTICAL AND HEALTH CARE INDUSTRIES, NAMELY, FINANCING THE RESEARCH OF OTHERS, IN CLASS 36 (U.S. CLS. 100, 101 AND 102).

FIRST USE 7-1-1998; IN COMMERCE 7-1-1998.

FOR: EDUCATIONAL SERVICES, NAMELY, PROVIDING COURSES OF INSTRUCTION AT THE UNDERGRADUATE, GRADUATE, AND POST-GRADUATE LEVELS; PROVIDING EDUCATIONAL RESEARCH PROGRAMS FOR ALL ASPECTS OF PHARMACEUTICAL



David J. Kyjars

Director of the United States Patent and Trademark Office

Reg. No. 4,175,968 STUDY; PROVIDING CONTINUING EDUCATION CONFERENCES, SEMINARS AND WORKSHOPS IN THE FIELDS OF PHARMACEUTICAL STUDY, HEALTH CARE, AND HEALTH SCIENCES; CONDUCTING EDUCATIONAL CONFERENCES AND SEMINARS IN THE FIELDS OF THE STUDY OF PHARMACY AND THE PHARMACEUTICAL AND HEALTH CARE INDUSTRIES; PUBLICATION OF NEWSLETTERS, NEWS BRIEFS, AND MONOGRAPHS FOR PHARMACISTS AND HEALTH CARE PROFESSIONALS; ENTERTAINMENT SERVICES IN THE NATURE OF PRESENTATION OF A VARIETY OF INTERCOLLEGIATE SPORTING EVENTS, NAMELY, CROSS-COUNTRY, CHEERLEADING, RIFLE, BASKETBALL, BASEBALL, GOLF, TENNIS, SOFTBALL, AND VOLLEYBALL, IN CLASS 41 (U.S. CLS. 100, 101 AND 107).

FIRST USE 7-1-1998; IN COMMERCE 7-1-1998.

FOR: TECHNICAL CONSULTING SERVICES IN THE NATURE OF PHARMACEUTICAL TECHNOLOGY CONSULTING FOR PHARMACEUTICAL CARE MANAGEMENT PROGRAMS PROVIDED TO PRIVATE AND PUBLIC AGENCIES, ORGANIZATIONS, INSTITUTIONS, AND INDIVIDUALS FOR THE PHARMACEUTICAL AND HEALTH CARE INDUSTRIES; RESEARCH CONSULTING SERVICES IN THE NATURE OF PHARMACEUTICAL RESEARCH SERVICES FOR PHARMACEUTICAL CARE MANAGEMENT PROGRAMS FOR PRIVATE AND PUBLIC AGENCIES, ORGANIZATIONS, INSTITUTIONS, AND INDIVIDUALS IN THE PHARMACEUTICAL AND HEALTH CARE INDUSTRIES; PROVIDING AND FACILITATING PHARMACOECONOMICS RESEARCH PROJECTS AND RESEARCH TEAMS FOR IMPROVING DRUG THERAPY SELECTION, UTILIZATION, COSTS, AND REIMBURSEMENTS THROUGH APPLIED PHARMACOECONOMICS FOR THE PHARMACEUTICAL AND HEALTH CARE INDUSTRIES, NAMELY, PHARMACEUTICAL RESEARCH SERVICES; AND PROVIDING AND FACILITATING GERIATRICS-FOCUSED RESEARCH PROGRAMS DEDICATED TO ASSESSING HEALTH CARE OF THE ELDERLY BY OUTCOMES ASSESSMENT AND DRUG USE AND UTILIZATION FOR THE PHARMACEUTICAL AND HEALTH CARE INDUSTRIES, NAMELY, RESEARCH IN THE FIELD OF PHARMACEUTICALS, IN CLASS 42 (U.S. CLS. 100 AND 101).

FIRST USE 7-1-1998; IN COMMERCE 7-1-1998.

THE MARK CONSISTS OF STANDARD CHARACTERS WITHOUT CLAIM TO ANY PARTICULAR FONT, STYLE, SIZE, OR COLOR.

SEC. 2(F).

OWNER OF U.S. REG. NO. 2,390,738.

NO CLAIM IS MADE TO THE EXCLUSIVE RIGHT TO USE "UNIVERSITY", APART FROM THE MARK AS SHOWN.

SN 77-813,531, FILED 8-26-2009.

APRIL ROACH, EXAMINING ATTORNEY

United States of America

United States Patent and Trademark Office



Reg. No. 4,175,969

SECURELOGIX CORPORATION (TEXAS CORPORATION)

Registered July 17, 2012

13750 SAN PEDRO
SAN ANTONIO, TX 78232

Int. Cl.: 9

FOR: TELECOMMUNICATION EQUIPMENT AND SOFTWARE, NAMELY, ELECTRONIC DEVICES AND SOFTWARE FOR MONITORING, MANAGING, CONTROLLING AND SECURING COMMUNICATIONS FOR VOICE, DATA AND IMAGE TRANSMISSION, AND MANUAL SOLD AS A UNIT THEREWITH, IN CLASS 9 (U.S. CLS. 21, 23, 26, 36 AND 38).

TRADEMARK

PRINCIPAL REGISTER

FIRST USE 11-30-2009; IN COMMERCE 11-30-2009.

THE MARK CONSISTS OF CURVED LINES SYMBOLIZING A STYLIZED LETTER "S" THAT SURROUNDS THREE ROWS OF THREE DOTS RESEMBLING A BUTTON.

SN 77-813,899, FILED 8-27-2009.

HAI-LY LAM, EXAMINING ATTORNEY



David J. Kybas

Director of the United States Patent and Trademark Office

United States of America

United States Patent and Trademark Office

T.H.R.I.V.E

Reg. No. 4,175,970

TRULAND SYSTEMS CORPORATION (D.C. CORPORATION)

Registered July 17, 2012

1900 ORACLE WAY, SUITE 700
RESTON, VA 20190

Int. Cl.: 41

SERVICE MARK

PRINCIPAL REGISTER

FOR: EDUCATIONAL SERVICES, NAMELY, WORK-STUDY PROGRAMS AT THE SECONDARY, UNDERGRADUATE AND GRADUATE LEVELS FOR VOCATIONAL, PROFESSIONAL AND OCCUPATIONAL TRADES IN THE FIELD OF MECHANICS, ENGINEERING, TECHNICAL SCIENCES, COMPUTER SCIENCE, COMPUTER PROGRAMMING AND COMPUTER NETWORKING, BUSINESS AND BUSINESS ADMINISTRATION, MECHANICAL AND ENGINEERING EDUCATION; EDUCATIONAL SERVICES, NAMELY, PROVIDING MENTORING, TUTORING, CLASSES, SEMINARS AND WORKSHOPS IN FOR VOCATIONAL, PROFESSIONAL AND OCCUPATIONAL TRADES IN THE FIELD OF MECHANICS, ENGINEERING, TECHNICAL SCIENCES, COMPUTER SCIENCE, COMPUTER PROGRAMMING AND COMPUTER NETWORKING, BUSINESS AND BUSINESS ADMINISTRATION, MECHANICAL AND ENGINEERING EDUCATION; EDUCATIONAL SERVICES, NAMELY, BUSINESS INTERNSHIP AND MENTORING PROGRAMS FOR VOCATIONAL, PROFESSIONAL AND OCCUPATIONAL TRADES IN THE FIELD OF MECHANICS, ENGINEERING, TECHNICAL SCIENCES, COMPUTER SCIENCE, COMPUTER PROGRAMMING AND COMPUTER NETWORKING, BUSINESS AND BUSINESS ADMINISTRATION, MECHANICAL AND ENGINEERING EDUCATION, IN CLASS 41 (U.S. CLS. 100, 101 AND 107).

FIRST USE 5-20-2009; IN COMMERCE 5-20-2009.

THE MARK CONSISTS OF STANDARD CHARACTERS WITHOUT CLAIM TO ANY PARTICULAR FONT, STYLE, SIZE, OR COLOR.

SN 77-814,530, FILED 8-27-2009.

ESTHER A. BORSUK, EXAMINING ATTORNEY



David J. Kyjars

Director of the United States Patent and Trademark Office

United States of America

United States Patent and Trademark Office

SMARTCURRENTS

Reg. No. 4,175,971

DTE ENERGY COMPANY (MICHIGAN CORPORATION)
2000 SECOND AVENUE
DETROIT, MI 48226

Registered July 17, 2012

Int. Cls.: 39 and 42

FOR: TRANSMISSION, DISTRIBUTION AND STORAGE OF ENERGY AND ELECTRICITY,
IN CLASS 39 (U.S. CLS. 100 AND 105).

SERVICE MARK

FIRST USE 4-27-2010; IN COMMERCE 4-27-2010.

PRINCIPAL REGISTER

FOR: NETWORKING OF HOME CONTROLS, NAMELY, WIRELESS AND WIRED LIGHTING CONTROLS, THERMOSTAT AND HEATING CONTROLS, ROLLING SHUTTERS AND DOOR CONTROLS, APPLIANCE CONTROLS, NAMELY, OVEN, WASHER, DRYER, REFRIGERATOR, DISHWASHER, LAWN AND GARDEN IRRIGATION CONTROLS, HOME AUDIO AND VIDEO CONTROLS; PROVIDING INFORMATION TECHNOLOGY IN THE ELECTRICITY INDUSTRY; ON-LINE SYSTEM MANAGEMENT SERVICES THAT ALLOW USERS TO REMOTELY VIEW, MONITOR, PROGRAM, OPERATE AND CONTROL LARGE AND SMALL APPLIANCES, ELECTRICAL SYSTEMS AND SECURITY SYSTEMS IN HOMES, IN CLASS 42 (U.S. CLS. 100 AND 101).

FIRST USE 4-27-2010; IN COMMERCE 4-27-2010.

THE MARK CONSISTS OF STANDARD CHARACTERS WITHOUT CLAIM TO ANY PARTICULAR FONT, STYLE, SIZE, OR COLOR.

SN 77-815,028, FILED 8-28-2009.

HENRY S. ZAK, EXAMINING ATTORNEY



David J. Kyffers

Director of the United States Patent and Trademark Office

United States of America

United States Patent and Trademark Office

ACCU-TRAC

Reg. No. 4,175,972

Registered July 17, 2012

Int. Cls.: 9, 35, 40, and 44

TRADEMARK

SERVICE MARK

PRINCIPAL REGISTER

MWI VETERINARY SUPPLY CO. (IDAHO CORPORATION)
651 STRATFORD DRIVE, STE. 100
MERIDIAN, ID 83642

FOR: COMPUTERS AND COMPUTER PROGRAMS SOLD SEPARATELY AND TOGETHER FOR RECORDING LIVESTOCK DATA ON AN INDIVIDUAL ANIMAL AND HERD BASIS AND FOR MANAGING LIVESTOCK, NAMELY, INDIVIDUAL ANIMALS AND HERDS OF ANIMALS THAT PRODUCE DAIRY AND MEAT PRODUCTS, SUCH PROGRAMS COMPRISED OF COMPUTER PROGRAMS FOR MANAGING INVENTORIES OF PHARMACEUTICALS, FEED AND OTHER CONSUMED PRODUCTS, FOR MANAGING QUALITY ASSURANCE BY MONITORING THE BACKGROUND, BIRTH, WEANING WEIGHTS, HEALTH HISTORIES, MEASUREMENTS AND PERFORMANCE OF INDIVIDUAL ANIMALS WITH MILK OR MEAT WITHHOLDS, FOR PROVIDING INDIVIDUAL ANIMAL IDENTIFICATION, TRACKING AND TRACE-BACK THROUGH SUPPLY CHAINS AND FOR COMPLIANCE WITH PROCESS, AGE, SOURCE AND N.A.I.S. REQUIREMENTS FOR CREATING AND MANAGING FEED RATIONS AND MONITORING THE NUTRIENTS IN COMPONENTS OF SUCH RATIONS, FOR CREATING MANAGEMENT REPORTS CONCERNING THE FOREGOING ON AN INDIVIDUAL ANIMAL AND HERD BASIS, SUCH REPORTS CONTAINING FINANCIAL REPORTS AND GRAPHS, PROFIT AND LOSS STATEMENTS, MILK AND MEAT PRODUCTION REPORTS AND GRAPHS, MEDICAL AND HEALTH REPORTS INCLUDING VACCINATIONS, TREATMENT HISTORIES AND FUTURE PROTOCOL TREATMENTS, FEED RATION INTAKE AND ADJUSTMENT REPORTS, AND INDIVIDUAL ANIMAL EXPENSE REPORTS, IN CLASS 9 (U.S. CLS. 21, 23, 26, 36 AND 38).

FIRST USE 12-0-1999; IN COMMERCE 12-0-1999.



David J. Kyffers

Director of the United States Patent and Trademark Office

FOR: LIVESTOCK MANAGEMENT SERVICES FOR MANAGING LIVESTOCK FOR OTHERS ON AN INDIVIDUAL ANIMAL AND HERD BASIS FOR BOTH DAIRY ANIMALS AND MEAT PRODUCING ANIMALS, NAMELY, PROVIDING CUSTOMIZED BUSINESS MANAGEMENT PROGRAMS FOR INDIVIDUAL ANIMAL INFORMATION COLLECTION AND BUSINESS MANAGEMENT; PROVIDING INFORMATION ON MARKETING IN THE FIELD OF ANIMAL MANAGEMENT; RECORDING AND MANAGING INVENTORIES OF PHARMACEUTICALS, FEED AND OTHER CONSUMED PRODUCTS, MANAGING QUALITY ASSURANCE BY MONITORING NUTRITION, WEIGHT AND HEALTH OF INDIVIDUAL ANIMALS WITH MILK OR MEAT WITHHOLDS, PROVIDING INDIVIDUAL ANIMAL IDENTIFICATION TRACKING, TRACE-BACK AND MONITORING SERVICES THROUGH ITS SUPPLY CHAIN FOR COMPLIANCE WITH PROCESS, AGE, SOURCE AND N.A.I.S.

Reg. No. 4,175,972 REQUIREMENTS, CREATING MANAGEMENT REPORTS CONCERNING THE FOREGOING ON AN INDIVIDUAL ANIMAL AND HERD BASIS, NAMELY, CREATING FINANCIAL REPORTS, AND GRAPHS, PROFIT AND LOSS STATEMENTS, MILK AND/OR MEAT PRODUCTS REPORTS AND GRAPHS, MEDICAL AND HEALTH REPORTS AND GRAPHS, TREATMENT HISTORIES AND FUTURE PROTOCOL TREATMENTS, FEED RATION INTAKE AND ADJUSTMENT REPORTS, AND INDIVIDUAL ANIMAL EXPENSE REPORTS; RECORDING AND MANAGING INVENTORIES OF PHARMACEUTICALS, FEED AND OTHER CONSUMED PRODUCTS, MANAGING QUALITY ASSURANCE BY MONITORING THE HEALTH AND WEIGHT OF INDIVIDUAL ANIMALS WITH MILK OR MEAT WITHHOLDS, PROVIDING INDIVIDUAL ANIMAL IDENTIFICATION TRACKING, TRACE-BACK AND MONITORING SERVICES THROUGH ITS SUPPLY CHAIN FOR COMPLIANCE WITH PROCESS, AGE, SOURCE AND N.A.I.S. REQUIREMENTS, CREATING MANAGEMENT REPORTS CONCERNING THE FOREGOING ON AN INDIVIDUAL ANIMAL AND HERD BASIS, NAMELY, CREATING FINANCIAL REPORTS, AND GRAPHS, PROFIT AND LOSS STATEMENTS, MILK AND/OR MEAT PRODUCTS REPORTS AND GRAPHS, MEDICAL AND HEALTH REPORTS AND GRAPHS, TREATMENT HISTORIES AND FUTURE PROTOCOL TREATMENTS, FEED RATION INTAKE AND ADJUSTMENT REPORTS, AND INDIVIDUAL ANIMAL EXPENSE REPORTS, IN CLASS 35 (U.S. CLS. 100, 101 AND 102).

FIRST USE 12-0-1999; IN COMMERCE 12-0-1999.

FOR: CUSTOM CREATION OF FEED RATIONS, IN CLASS 40 (U.S. CLS. 100, 103 AND 106).

FIRST USE 12-0-1999; IN COMMERCE 12-0-1999.

FOR: PROVIDING INFORMATION ON HEALTH AND NUTRITION IN THE FIELD OF ANIMAL MANAGEMENT; CONSULTING SERVICES IN THE FIELD OF ANIMAL MANAGEMENT, NAMELY, RESEARCH, DEVELOPMENT, ANALYSIS AND IDENTIFICATION OF PROCESSES TO EFFICIENTLY RAISE INDIVIDUAL ANIMALS, IN CLASS 44 (U.S. CLS. 100 AND 101).

FIRST USE 12-0-1999; IN COMMERCE 12-0-1999.

THE MARK CONSISTS OF STANDARD CHARACTERS WITHOUT CLAIM TO ANY PARTICULAR FONT, STYLE, SIZE, OR COLOR.

OWNER OF U.S. REG. NO. 2,010,408.

SN 77-817,919, FILED 9-1-2009.

EUGENIA MARTIN, EXAMINING ATTORNEY

United States of America

United States Patent and Trademark Office

YOUR CONNECTION TO PROFIT

Reg. No. 4,175,973

MWI VETERINARY SUPPLY CO. (IDAHO CORPORATION)
651 STRATFORD DRIVE, STE. 100
MERIDIAN, ID 83642

Registered July 17, 2012

Int. Cls.: 35, 42, and 44

FOR: LIVESTOCK MANAGEMENT SERVICES, NAMELY, PROVIDING CUSTOMIZED BUSINESS MANAGEMENT PROGRAMS FOR INDIVIDUAL ANIMAL INFORMATION COLLECTION AND BUSINESS MANAGEMENT; PROVIDING INFORMATION ON MARKETING IN THE FIELD OF ANIMAL MANAGEMENT; DISTRIBUTORSHIP SERVICES FOR LIVESTOCK AND COMMERCIAL FEEDMILLS IN THE FIELD OF LIVESTOCK MEDICATIONS, CHEMICALS, NUTRIENTS, AND GROWTH STIMULANTS; RETAIL SERVICES BY DIRECT SOLICITATION BY SALES AGENTS FEATURING COMPUTER HARDWARE, COMPUTER SOFTWARE, RADIO FREQUENCY ANIMAL IDENTIFICATION TAGS, AND RADIO FREQUENCY IDENTIFICATION TAG TECHNOLOGY, ALL CAPABLE OF UTILIZING A UNIFORM SET OF DATABASE STANDARDS FOR TRACKING AND TRACING BACK MOVEMENTS OF INDIVIDUAL ANIMALS IN THE MEAT AND DAIRY INDUSTRIES THROUGH A SUPPLY CHAIN FROM PRODUCERS TO PROCESSOR BACK TO MARKET, IN CLASS 35 (U.S. CLS. 100, 101 AND 102).

SERVICE MARK

PRINCIPAL REGISTER

FIRST USE 2-0-2007; IN COMMERCE 2-0-2007.

FOR: LEASING OF COMPUTER HARDWARE, COMPUTER SOFTWARE, RADIO FREQUENCY ANIMAL IDENTIFICATION TAGS, AND RADIO FREQUENCY IDENTIFICATION TAG TECHNOLOGY, ALL CAPABLE OF UTILIZING A UNIFORM SET OF DATABASE STANDARDS FOR TRACKING AND TRACING BACK MOVEMENTS OF INDIVIDUAL ANIMALS IN THE MEAT AND DAIRY INDUSTRIES THROUGH A SUPPLY CHAIN FROM PRODUCERS TO PROCESSOR BACK TO MARKET, NAMELY, ANIMAL RECONCILIATION PROCESSING, INDIVIDUAL ANIMAL DATA COLLECTION AND TRACEBACK, IN CLASS 42 (U.S. CLS. 100 AND 101).

FIRST USE 2-0-2007; IN COMMERCE 2-0-2007.

FOR: PROVIDING INFORMATION ON HEALTH AND NUTRITION IN THE FIELD OF ANIMAL MANAGEMENT; CONSULTING SERVICES IN THE FIELD OF ANIMAL MANAGEMENT, NAMELY, RESEARCH, DEVELOPMENT, ANALYSIS AND IDENTIFICATION OF PROCESSES TO EFFICIENTLY RAISE INDIVIDUAL ANIMALS, IN CLASS 44 (U.S. CLS. 100 AND 101).



David J. Kybas

Director of the United States Patent and Trademark Office

Reg. No. 4,175,973 FIRST USE 2-0-2007; IN COMMERCE 2-0-2007.

THE MARK CONSISTS OF STANDARD CHARACTERS WITHOUT CLAIM TO ANY PARTICULAR FONT, STYLE, SIZE, OR COLOR.

SN 77-817,921, FILED 9-1-2009.

EUGENIA MARTIN, EXAMINING ATTORNEY

United States of America

United States Patent and Trademark Office



Reg. No. 4,175,974

Registered July 17, 2012

**Int. Cls.: 7, 9, 11, 35, 42,
and 44**

TRADEMARK

SERVICE MARK

PRINCIPAL REGISTER

MWI VETERINARY SUPPLY CO. (IDAHO CORPORATION)
651 STRATFORD DRIVE, STE. 100
MERIDIAN, ID 83642

FOR: COMPUTERIZED LIVESTOCK FEED MIXING MACHINES; APPARATUS FOR BATCHING ANIMAL FEEDS IN A FEEDMILL, NAMELY, A BATCHING MACHINE THAT INCLUDES A PROGRAMMABLE FEEDMILL CONTROL SYSTEM COMPRISING A COMPUTER AND COMPUTER SOFTWARE FOR BATCHING FEED FROM INDIVIDUAL INGREDIENT BINS TO THE FINISHED FEEDS; ANIMAL FEED ADDITIVE FORMULATING APPARATUS, NAMELY, MIXING AND DISPENSING MACHINES, SOME HAVING PROGRAMMABLE SUBASSEMBLIES, FOR DISPENSING LIQUID AND DRY FEED ADDITIVES IN WEIGHED OR MEASURED AMOUNTS TO MIX WITH ANIMAL FEED RATIONS; COMPUTERIZED MACHINES FOR SEPARATING LIVESTOCK INTO DIFFERENT PENS BY PHYSICAL CRITERIA, NAMELY, WEIGHT, DIMENSIONS AND/OR OTHER PHYSICAL CHARACTERISTICS, IN CLASS 7 (U.S. CLS. 13, 19, 21, 23, 31, 34 AND 35).

FIRST USE 1-0-2000; IN COMMERCE 1-0-2000.

FOR: COMPUTER SOFTWARE FOR USE BY THE LIVESTOCK INDUSTRY THAT UTILIZES A UNIFORM SET OF DATABASE STANDARDS FOR USE IN TRACKING AND TRACING BACK MOVEMENTS OF INDIVIDUAL ANIMALS THROUGH A SUPPLY CHAIN FROM PRODUCERS TO PROCESSOR TO MARKET, NAMELY, SOFTWARE FOR TRACEBACK COMPLIANCE AND MANAGEMENT; WEB-BASED SOFTWARE PROGRAM, NAMELY, DOWNLOADABLE COMPUTER SOFTWARE FOR CATTLE OWNERS TO HELP THEM MANAGE THEIR RISK, NAMELY, SOFTWARE FOR REDUCING INEFFICIENCIES AND OPTIMIZE PERFORMANCE, INCLUDING FEED MANAGEMENT, HEALTH MANAGEMENT, INFORMATION MANAGEMENT, AND MARKETING MANAGEMENT, AND NATIONAL ANIMAL IDENTIFICATION SYSTEM (NAIS) COMPLIANCE, IN CLASS 9 (U.S. CLS. 21, 23, 26, 36 AND 38).

FIRST USE 1-0-2000; IN COMMERCE 1-0-2000.

FOR: APPARATUS FOR MAINTAINING A TEMPERATURE-CONTROLLED LIQUID SUSPENSION OF LIVE PROBIOTIC ANAEROBIC BACTERIA AND DELIVERING THE SUSPENSION INTO ANIMAL FEED, NAMELY, TEMPERATURE CONTROLLED DISPENSERS FOR DISPENSING LIQUID SUSPENSIONS OF LIVE PROBIOTIC ANAEROBIC BACTERIA INTO ANIMAL FEED, IN CLASS 11 (U.S. CLS. 13, 21, 23, 31 AND 34).



David J. Kybas

Director of the United States Patent and Trademark Office

Reg. No. 4,175,974 FIRST USE 1-0-2000; IN COMMERCE 1-0-2000.

FOR: DISTRIBUTORSHIP SERVICES FOR LIVESTOCK AND COMMERCIAL FEEDMILLS IN THE FIELD OF LIVESTOCK MEDICATIONS, CHEMICALS, NUTRIENTS, AND GROWTH STIMULANTS; RETAIL SERVICES BY DIRECT SOLICITATION BY SALES AGENTS FEATURING COMPUTER HARDWARE, COMPUTER SOFTWARE, RADIO FREQUENCY ANIMAL IDENTIFICATION TAGS, AND RADIO FREQUENCY IDENTIFICATION TAG TECHNOLOGY, ALL CAPABLE OF UTILIZING A UNIFORM SET OF DATABASE STANDARDS FOR TRACKING AND TRACING BACK MOVEMENTS OF INDIVIDUAL ANIMALS IN THE MEAT AND DAIRY INDUSTRIES THROUGH A SUPPLY CHAIN FROM PRODUCERS TO PROCESSOR BACK TO MARKET; LIVESTOCK MANAGEMENT SERVICES, NAMELY, PROVIDING CUSTOMIZED BUSINESS MANAGEMENT PROGRAMS FOR INDIVIDUAL ANIMAL INFORMATION COLLECTION AND BUSINESS MANAGEMENT; PROVIDING INFORMATION ON MARKETING IN THE FIELD OF ANIMAL MANAGEMENT, IN CLASS 35 (U.S. CLS. 100, 101 AND 102).

FIRST USE 1-0-2000; IN COMMERCE 1-0-2000.

FOR: LEASING OF COMPUTER HARDWARE, COMPUTER SOFTWARE, RADIO FREQUENCY ANIMAL IDENTIFICATION TAGS, AND RADIO FREQUENCY IDENTIFICATION TAG TECHNOLOGY, ALL CAPABLE OF UTILIZING A UNIFORM SET OF DATABASE STANDARDS FOR TRACKING AND TRACING BACK MOVEMENTS OF INDIVIDUAL ANIMALS IN THE MEAT AND DAIRY INDUSTRIES THROUGH A SUPPLY CHAIN FROM PRODUCERS TO PROCESSOR BACK TO MARKET, NAMELY, ANIMAL RECONCILIATION PROCESSING, INDIVIDUAL ANIMAL DATA COLLECTION AND TRACEBACK, IN CLASS 42 (U.S. CLS. 100 AND 101).

FIRST USE 1-0-2000; IN COMMERCE 1-0-2000.

FOR: PROVIDING INFORMATION ON HEALTH AND NUTRITION IN THE FIELD OF ANIMAL MANAGEMENT; CONSULTING SERVICES IN THE FIELD OF ANIMAL MANAGEMENT, NAMELY, RESEARCH, DEVELOPMENT, ANALYSIS AND IDENTIFICATION OF PROCESSES TO EFFICIENTLY RAISE INDIVIDUAL ANIMALS, IN CLASS 44 (U.S. CLS. 100 AND 101).

FIRST USE 1-0-2000; IN COMMERCE 1-0-2000.

THE MARK CONSISTS OF A DIAMOND SHAPE WITH THE SHAPE OF A CATTLEHEAD IN THE MIDDLE.

SN 77-817,932, FILED 9-1-2009.

EUGENIA MARTIN, EXAMINING ATTORNEY

United States of America

United States Patent and Trademark Office



Reg. No. 4,175,975

Registered July 17, 2012

**Int. Cls.: 7, 9, 11, 35, 42,
and 44**

TRADEMARK

SERVICE MARK

PRINCIPAL REGISTER

MWI VETERINARY SUPPLY CO. (IDAHO CORPORATION)
651 STRATFORD DRIVE, STE. 100
MERIDIAN, ID 83642

FOR: COMPUTERIZED LIVESTOCK FEED MIXING MACHINES; APPARATUS FOR BATCHING ANIMAL FEEDS IN A FEEDMILL, NAMELY, A BATCHING MACHINE THAT INCLUDES A PROGRAMMABLE FEEDMILL CONTROL SYSTEM COMPRISING A COMPUTER AND COMPUTER SOFTWARE FOR BATCHING FEED FROM INDIVIDUAL INGREDIENT BINS TO THE FINISHED FEEDS; ANIMAL FEED ADDITIVE FORMULATING APPARATUS, NAMELY, MIXING AND DISPENSING MACHINES, SOME HAVING PROGRAMMABLE SUBASSEMBLIES, FOR DISPENSING LIQUID AND DRY FEED ADDITIVES IN WEIGHED OR MEASURED AMOUNTS TO MIX WITH ANIMAL FEED RATIONS; COMPUTERIZED MACHINES FOR SEPARATING LIVESTOCK INTO DIFFERENT PENS BY PHYSICAL CRITERIA, NAMELY, WEIGHT, DIMENSIONS AND/OR OTHER PHYSICAL CHARACTERISTICS, IN CLASS 7 (U.S. CLS. 13, 19, 21, 23, 31, 34 AND 35).

FIRST USE 1-0-2000; IN COMMERCE 1-0-2000.

FOR: COMPUTER SOFTWARE FOR USE BY THE LIVESTOCK INDUSTRY THAT UTILIZES A UNIFORM SET OF DATABASE STANDARDS FOR USE IN TRACKING AND TRACING BACK MOVEMENTS OF INDIVIDUAL ANIMALS THROUGH A SUPPLY CHAIN FROM PRODUCERS TO PROCESSOR TO MARKET, NAMELY, SOFTWARE FOR TRACEBACK COMPLIANCE AND MANAGEMENT; WEB-BASED SOFTWARE PROGRAM, NAMELY, DOWNLOADABLE COMPUTER SOFTWARE FOR CATTLE OWNERS TO HELP THEM MANAGE THEIR RISK, NAMELY, SOFTWARE FOR REDUCING INEFFICIENCIES AND OPTIMIZE PERFORMANCE, INCLUDING FEED MANAGEMENT, HEALTH MANAGEMENT, INFORMATION MANAGEMENT, AND MARKETING MANAGEMENT, AND NATIONAL ANIMAL IDENTIFICATION SYSTEM (NAIS) COMPLIANCE, IN CLASS 9 (U.S. CLS. 21, 23, 26, 36 AND 38).

FIRST USE 1-0-2000; IN COMMERCE 1-0-2000.

FOR: APPARATUS FOR MAINTAINING A TEMPERATURE-CONTROLLED LIQUID SUSPENSION OF LIVE PROBIOTIC ANAEROBIC BACTERIA AND DELIVERING THE SUSPENSION INTO ANIMAL FEED, NAMELY, TEMPERATURE CONTROLLED DISPENSERS FOR DISPENSING LIQUID SUSPENSIONS OF LIVE PROBIOTIC ANAEROBIC BACTERIA INTO ANIMAL FEED, IN CLASS 11 (U.S. CLS. 13, 21, 23, 31 AND 34).



David J. Kyjars

Director of the United States Patent and Trademark Office

Reg. No. 4,175,975 FIRST USE 1-0-2000; IN COMMERCE 1-0-2000.

FOR: DISTRIBUTORSHIP SERVICES FOR LIVESTOCK AND COMMERCIAL FEEDMILLS IN THE FIELD OF LIVESTOCK MEDICATIONS, CHEMICALS, NUTRIENTS, AND GROWTH STIMULANTS; RETAIL SERVICES BY DIRECT SOLICITATION BY SALES AGENTS FEATURING COMPUTER HARDWARE, COMPUTER SOFTWARE, RADIO FREQUENCY ANIMAL IDENTIFICATION TAGS, AND RADIO FREQUENCY IDENTIFICATION TAG TECHNOLOGY, ALL CAPABLE OF UTILIZING A UNIFORM SET OF DATABASE STANDARDS FOR TRACKING AND TRACING BACK MOVEMENTS OF INDIVIDUAL ANIMALS IN THE MEAT AND DAIRY INDUSTRIES THROUGH A SUPPLY CHAIN FROM PRODUCERS TO PROCESSOR BACK TO MARKET; LIVESTOCK MANAGEMENT SERVICES, NAMELY, PROVIDING CUSTOMIZED BUSINESS MANAGEMENT PROGRAMS FOR INDIVIDUAL ANIMAL INFORMATION COLLECTION AND BUSINESS MANAGEMENT; PROVIDING INFORMATION ON MARKETING IN THE FIELD OF ANIMAL MANAGEMENT, IN CLASS 35 (U.S. CLS. 100, 101 AND 102).

FIRST USE 1-0-2000; IN COMMERCE 1-0-2000.

FOR: LEASING OF COMPUTER HARDWARE, COMPUTER SOFTWARE, RADIO FREQUENCY ANIMAL IDENTIFICATION TAGS, AND RADIO FREQUENCY IDENTIFICATION TAG TECHNOLOGY, ALL CAPABLE OF UTILIZING A UNIFORM SET OF DATABASE STANDARDS FOR TRACKING AND TRACING BACK MOVEMENTS OF INDIVIDUAL ANIMALS IN THE MEAT AND DAIRY INDUSTRIES THROUGH A SUPPLY CHAIN FROM PRODUCERS TO PROCESSOR BACK TO MARKET, NAMELY, ANIMAL RECONCILIATION PROCESSING, INDIVIDUAL ANIMAL DATA COLLECTION AND TRACEBACK, IN CLASS 42 (U.S. CLS. 100 AND 101).

FIRST USE 1-0-2000; IN COMMERCE 1-0-2000.

FOR: PROVIDING INFORMATION ON HEALTH AND NUTRITION IN THE FIELD OF ANIMAL MANAGEMENT; CONSULTING SERVICES IN THE FIELD OF ANIMAL MANAGEMENT, NAMELY, RESEARCH, DEVELOPMENT, ANALYSIS AND IDENTIFICATION OF PROCESSES TO EFFICIENTLY RAISE INDIVIDUAL ANIMALS, IN CLASS 44 (U.S. CLS. 100 AND 101).

FIRST USE 1-0-2000; IN COMMERCE 1-0-2000.

OWNER OF U.S. REG. NO. 2,459,923.

THE MARK CONSISTS OF A DIAMOND SHAPE WITH THE SHAPE OF A CATTLEHEAD IN THE MIDDLE TOGETHER WITH THE WORD "MICRO".

SN 77-817,933, FILED 9-1-2009.

EUGENIA MARTIN, EXAMINING ATTORNEY

United States of America

United States Patent and Trademark Office

WEST POINT

Reg. No. 4,175,976

Registered July 17, 2012

Int. Cl.: 20

TRADEMARK

PRINCIPAL REGISTER

MATTHEWS RESOURCES, INC. (DELAWARE CORPORATION)
SUITE 619
1105 NORTH MARKET STREET
WILMINGTON, DE 19801

FOR: CASKETS, EXCLUDING MILITARY CASKETS, IN CLASS 20 (U.S. CLS. 2, 13, 22, 25, 32 AND 50).

FIRST USE 11-1-2009; IN COMMERCE 11-1-2009.

THE MARK CONSISTS OF STANDARD CHARACTERS WITHOUT CLAIM TO ANY PARTICULAR FONT, STYLE, SIZE, OR COLOR.

SN 77-819,697, FILED 9-3-2009.

BRENDAN REGAN, EXAMINING ATTORNEY



David J. Kybas

Director of the United States Patent and Trademark Office

United States of America

United States Patent and Trademark Office



Reg. No. 4,175,977

Registered July 17, 2012

Int. Cls.: 5 and 44

TRADEMARK

SERVICE MARK

PRINCIPAL REGISTER

JOON-SHIK SHIN (REPUBLIC OF KOREA INDIVIDUAL)
635, SHINSA-DONG, GANGNAM-GU
SEOUL, REPUBLIC OF KOREA 135-896

FOR: HERBAL SUPPLEMENTS FOR INCREASING ENERGY, VIGOR AND STAMINA, AND FOR ALLEVIATING STRESS, FADING MEMORY, INSOMNIA AND OVER SENSITIVENESS, HERB TEAS FOR MEDICINAL PURPOSES; HERBS FOR MEDICINAL PURPOSES, MEDICINAL HERBS, MEDICINAL HERBS IN DRIED OR PRESERVED FORM, MINERAL FOOD SUPPLEMENTS, PROCESSED ANIMAL ANTLERS FOR USE AS HEALTH FOOD SUPPLEMENTS, IN CLASS 5 (U.S. CLS. 6, 18, 44, 46, 51 AND 52).

FIRST USE 3-15-2009; IN COMMERCE 3-15-2009.

FOR: HERB CLINICS, NAMELY, CLINICS FOR PROVIDING MEDICINAL HERBS IN DRIED OR PRESERVED FORM AND HERBAL SUPPLEMENT FOR INCREASING ENERGY, VIGOR AND STAMINA, AND FOR ALLEVIATING STRESS, FADING MEMORY, INSOMNIA AND OVER-SENSITIVENESS, NAMELY, ALTERNATIVE MEDICINE SERVICES; MEDICAL CLINICS; HEALTH CARE SERVICES, NAMELY, WELLNESS PROGRAMS, MANAGED HEALTH CARE SERVICES, HERB PHYSIOTHERAPY, ACUPUNCTURE SERVICES, AND MOXIBUSTION SERVICES, IN CLASS 44 (U.S. CLS. 100 AND 101).

FIRST USE 1-1-2000; IN COMMERCE 1-1-2000.

THE NON-LATIN CHARACTERS IN THE MARK TRANSLITERATE TO JASENG AND THIS HAS NO MEANING IN A FOREIGN LANGUAGE.

SN 77-822,264, FILED 9-8-2009.

MYRIAH HABEEB, EXAMINING ATTORNEY



David J. Kybas

Director of the United States Patent and Trademark Office

United States of America

United States Patent and Trademark Office

THE DESIGNATED DRIVER

Reg. No. 4,175,978

Registered July 17, 2012

Int. Cl.: 28

TRADEMARK

PRINCIPAL REGISTER

DEWHURST SOLUTION LLC (RHODE ISLAND LIMITED LIABILITY COMPANY)
138 WOODVILLE ROAD
HOPE VALLEY, RI 02832

FOR: GOLF CLUB HEADS; GOLF CLUBS, IN CLASS 28 (U.S. CLS. 22, 23, 38 AND 50).

FIRST USE 11-15-2011; IN COMMERCE 11-15-2011.

THE MARK CONSISTS OF STANDARD CHARACTERS WITHOUT CLAIM TO ANY PARTICULAR FONT, STYLE, SIZE, OR COLOR.

NO CLAIM IS MADE TO THE EXCLUSIVE RIGHT TO USE "DRIVER", APART FROM THE MARK AS SHOWN.

SN 77-827,703, FILED 9-16-2009.

BERYL GARDNER, EXAMINING ATTORNEY



David J. Kyffers

Director of the United States Patent and Trademark Office

United States of America

United States Patent and Trademark Office

RAM

Reg. No. 4,175,979

NIKKEN, INC. (CALIFORNIA CORPORATION)
52 DISCOVERY
IRVINE, CA 92618

Registered July 17, 2012

Int. Cl.: 10

FOR: PERMANENT MAGNETS SOLD AS A COMPONENT OF FINISHED APPARATUS FOR MAGNET THERAPY TO BE SOLD THROUGH A DIRECT SALES, MULTILEVEL MARKETING, OR PERSON-TO-PERSON SALES FORMAT , IN CLASS 10 (U.S. CLS. 26, 39 AND 44).

TRADEMARK

FIRST USE 10-23-2009; IN COMMERCE 10-23-2009.

PRINCIPAL REGISTER

THE MARK CONSISTS OF STANDARD CHARACTERS WITHOUT CLAIM TO ANY PARTICULAR FONT, STYLE, SIZE, OR COLOR.

SN 77-832,019, FILED 9-22-2009.

TRACY WHITTAKER-BROWN, EXAMINING ATTORNEY



David J. Kyffers

Director of the United States Patent and Trademark Office

United States of America

United States Patent and Trademark Office

RUE LA LA

Reg. No. 4,175,980

Registered July 17, 2012

Int. Cl.: 35

SERVICE MARK

PRINCIPAL REGISTER

RUELALA, INC. (DELAWARE CORPORATION)
20 CHANNEL CENTER
3RD FLOOR
BOSTON, MA 02210

FOR: ON-LINE RETAIL STORE SERVICES FEATURING PERFUME AND FRAGRANCES, COSMETICS, HAIR CARE PREPARATIONS, SHAMPOOS, CONDITIONERS, SKIN LOTIONS AND OILS, BODY SOAPS AND CLEANERS, PERSONAL CARE ITEMS, WINE, TRAVEL PACKAGES AND CERTIFICATES, CRUISE LINE PACKAGES AND CERTIFICATES, AIRLINE TRAVEL PACKAGES AND CERTIFICATES, ADVENTURE TOUR PACKAGES AND CERTIFICATES, HOTEL PACKAGES AND CERTIFICATES, AND HEALTH SPA PACKAGES AND CERTIFICATES ALL ON A LIMITED TIME SALES EVENT BASIS, IN CLASS 35 (U.S. CLS. 100, 101 AND 102).

FIRST USE 5-14-2009; IN COMMERCE 5-14-2009.

THE MARK CONSISTS OF STANDARD CHARACTERS WITHOUT CLAIM TO ANY PARTICULAR FONT, STYLE, SIZE, OR COLOR.

OWNER OF U.S. REG. NOS. 3,484,375 AND 3,484,376.

SN 77-832,710, FILED 9-23-2009.

BRENDAN MCCAULEY, EXAMINING ATTORNEY



David J. Kybas

Director of the United States Patent and Trademark Office

United States of America

United States Patent and Trademark Office

γ Gamma-bsm

Reg. No. 4,175,981

ETEX CORPORATION (DELAWARE CORPORATION)
38 SIDNEY STREET
CAMBRIDGE, MA 02139

Registered July 17, 2012

Int. Cl.: 10

FOR: ARTIFICIAL BONE SUBSTITUTION MATERIAL, IN CLASS 10 (U.S. CLS. 26, 39 AND 44).

TRADEMARK

FIRST USE 5-27-2009; IN COMMERCE 6-30-2009.

PRINCIPAL REGISTER

THE MARK CONSISTS OF THE GREEK LETTER GAMMA TO THE LEFT OF THE WORDS "GAMMA-BSM".

SN 77-834,591, FILED 9-24-2009.

BARNEY CHARLON, EXAMINING ATTORNEY



David J. Kyffers

Director of the United States Patent and Trademark Office

United States of America

United States Patent and Trademark Office

SDIX GENOMIC ANTIBODY TECHNOLOGY

Reg. No. 4,175,982

STRATEGIC DIAGNOSTICS INC. (DELAWARE CORPORATION)
111 PENCADER DRIVE
NEWARK, DE 19702

Registered July 17, 2012

Int. Cls.: 40 and 42

FOR: ANTIBODY SERVICES, NAMELY, CUSTOM ANTIBODY PRODUCTION AND GENERATION; CUSTOM MANUFACTURE OF ANTIBODIES FOR OTHERS, IN CLASS 40 (U.S. CLS. 100, 103 AND 106).

SERVICE MARK

FIRST USE 4-0-2011; IN COMMERCE 4-0-2011.

PRINCIPAL REGISTER

FOR: SCIENTIFIC RESEARCH AND DEVELOPMENT, NAMELY, DEVELOPMENT OF ANTIBODIES FOR OTHERS, IN CLASS 42 (U.S. CLS. 100 AND 101).

FIRST USE 4-0-2011; IN COMMERCE 4-0-2011.

THE MARK CONSISTS OF STANDARD CHARACTERS WITHOUT CLAIM TO ANY PARTICULAR FONT, STYLE, SIZE, OR COLOR.

OWNER OF U.S. REG. NO. 3,219,042.

NO CLAIM IS MADE TO THE EXCLUSIVE RIGHT TO USE "GENOMIC ANTIBODY TECHNOLOGY", APART FROM THE MARK AS SHOWN.

SN 77-835,241, FILED 9-25-2009.

DEZMONA MIZELLE, EXAMINING ATTORNEY



David J. Kyjars

Director of the United States Patent and Trademark Office

United States of America

United States Patent and Trademark Office

Snazzy Jazzy Pet

Reg. No. 4,175,983

DEWAR, NANCY (UNITED STATES INDIVIDUAL)
6 QUINLAN LANE
HAMPTON, NH 03842

Registered July 17, 2012

Int. Cl.: 35

FOR: ON-LINE RETAIL STORE SERVICES IN THE FIELD OF CLOTHING, PET PRODUCTS AND GENERAL MERCHANDISE, IN CLASS 35 (U.S. CLS. 100, 101 AND 102).

SERVICE MARK

FIRST USE 10-1-2010; IN COMMERCE 12-15-2010.

PRINCIPAL REGISTER

THE MARK CONSISTS OF STANDARD CHARACTERS WITHOUT CLAIM TO ANY PARTICULAR FONT, STYLE, SIZE, OR COLOR.

NO CLAIM IS MADE TO THE EXCLUSIVE RIGHT TO USE "PET", APART FROM THE MARK AS SHOWN.

SN 77-836,412, FILED 9-28-2009.

KATHY DE JONGE, EXAMINING ATTORNEY



David J. Kyffers

Director of the United States Patent and Trademark Office

United States of America

United States Patent and Trademark Office

SIMPLY CRANBERRY COCKTAIL

Reg. No. 4,175,984

SIMPLY ORANGE JUICE COMPANY (FLORIDA CORPORATION)
2659 ORANGE AVENUE
APOPKA, FL 32703

Registered July 17, 2012

Int. Cl.: 32

FOR: FRUIT DRINKS AND FRUIT JUICES, IN CLASS 32 (U.S. CLS. 45, 46 AND 48).

TRADEMARK

FIRST USE 1-23-2012; IN COMMERCE 1-23-2012.

PRINCIPAL REGISTER

THE MARK CONSISTS OF STANDARD CHARACTERS WITHOUT CLAIM TO ANY PARTICULAR FONT, STYLE, SIZE, OR COLOR.

OWNER OF U.S. REG. NOS. 2,692,046, 3,163,864, AND OTHERS.

NO CLAIM IS MADE TO THE EXCLUSIVE RIGHT TO USE "CRANBERRY COCKTAIL", APART FROM THE MARK AS SHOWN.

SN 77-836,913, FILED 9-29-2009.

REGINA DRUMMOND, EXAMINING ATTORNEY



David J. Kybas

Director of the United States Patent and Trademark Office

United States of America

United States Patent and Trademark Office

Estrovera

Reg. No. 4,175,985

METAGENICS, INC. (DELAWARE CORPORATION)
100 AVENIDA LA PATA
SAN CLEMENTE, CA 92673

Registered July 17, 2012

Int. Cl.: 5

FOR: DIETARY SUPPLEMENTS, IN CLASS 5 (U.S. CLS. 6, 18, 44, 46, 51 AND 52).

TRADEMARK

FIRST USE 12-16-2009; IN COMMERCE 12-16-2009.

PRINCIPAL REGISTER

THE MARK CONSISTS OF STANDARD CHARACTERS WITHOUT CLAIM TO ANY PARTICULAR FONT, STYLE, SIZE, OR COLOR.

SN 77-838,629, FILED 9-30-2009.

KELLY TRUSILO, EXAMINING ATTORNEY



David J. Kybas

Director of the United States Patent and Trademark Office

United States of America

United States Patent and Trademark Office

EVOLUTION

Reg. No. 4,175,986

Registered July 17, 2012

Int. Cl.: 8

TRADEMARK

PRINCIPAL REGISTER

JB HANN CO, INC. (NEW JERSEY CORPORATION)
255 PASSAIC AVENUE
STIRLING, NJ 07980

FOR: SCISSORS, IN CLASS 8 (U.S. CLS. 23, 28 AND 44).

FIRST USE 5-9-2012; IN COMMERCE 5-29-2012.

THE MARK CONSISTS OF STANDARD CHARACTERS WITHOUT CLAIM TO ANY PARTICULAR FONT, STYLE, SIZE, OR COLOR.

SN 77-843,339, FILED 10-7-2009.

VIVIAN MICZNIK FIRST, EXAMINING ATTORNEY



David J. Kybas

Director of the United States Patent and Trademark Office

United States of America

United States Patent and Trademark Office

BERKLEY OIL & GAS SPECIALTY SERVICES

Reg. No. 4,175,987

Registered July 17, 2012

Int. Cl.: 36

SERVICE MARK

PRINCIPAL REGISTER

W. R. BERKLEY CORPORATION (DELAWARE CORPORATION)
475 STEAMBOAT ROAD
GREENWICH, CT 06830

FOR: INSURANCE ADMINISTRATION; INSURANCE UNDERWRITING IN THE FIELD OF PROPERTY AND CASUALTY INSURANCE AND WORKERS COMPENSATION FOR THE OIL AND GAS INDUSTRY, IN CLASS 36 (U.S. CLS. 100, 101 AND 102).

FIRST USE 9-18-2009; IN COMMERCE 9-18-2009.

THE MARK CONSISTS OF STANDARD CHARACTERS WITHOUT CLAIM TO ANY PARTICULAR FONT, STYLE, SIZE, OR COLOR.

SEC. 2(F) AS TO "BERKLEY".

OWNER OF U.S. REG. NOS. 2,317,515, 3,312,178, AND OTHERS.

NO CLAIM IS MADE TO THE EXCLUSIVE RIGHT TO USE "OIL & GAS SPECIALTY SERVICES", APART FROM THE MARK AS SHOWN.

SN 77-844,090, FILED 10-8-2009.

KIMBERLY PERRY, EXAMINING ATTORNEY



David J. Kyros

Director of the United States Patent and Trademark Office

United States of America
United States Patent and Trademark Office

LOADSTAR

Reg. No. 4,175,988

Registered July 17, 2012

Int. Cl.: 12

TRADEMARK

PRINCIPAL REGISTER

INTERNATIONAL TRUCK INTELLECTUAL PROPERTY COMPANY LLC (ILLINOIS
LIMITED LIABILITY COMPANY)
2701 NAVISTAR DRIVE
LISLE, IL 60532

FOR: MOTOR VEHICLES, NAMELY, WASTE RECOVERY AND CONSTRUCTION TRUCKS,
IN CLASS 12 (U.S. CLS. 19, 21, 23, 31, 35 AND 44).

FIRST USE 3-22-2012; IN COMMERCE 3-22-2012.

THE MARK CONSISTS OF STANDARD CHARACTERS WITHOUT CLAIM TO ANY PAR-
TICULAR FONT, STYLE, SIZE, OR COLOR.

SN 77-844,296, FILED 10-8-2009.

JENNY PARK, EXAMINING ATTORNEY



David J. Kyffers

Director of the United States Patent and Trademark Office

United States of America

United States Patent and Trademark Office

SPACEFILE

Reg. No. 4,175,989

RAINTREE ESSIX INC. (DELAWARE CORPORATION)
1209 ORANGE STREET
WILMINGTON, DE 19801

Registered July 17, 2012

Int. Cl.: 10

FOR: DENTAL INSTRUMENTS FOR USE IN REDUCING OR CONTOURING TOOTH COATING, IN CLASS 10 (U.S. CLS. 26, 39 AND 44).

TRADEMARK

FIRST USE 3-19-2012; IN COMMERCE 3-19-2012.

PRINCIPAL REGISTER

THE MARK CONSISTS OF STANDARD CHARACTERS WITHOUT CLAIM TO ANY PARTICULAR FONT, STYLE, SIZE, OR COLOR.

SN 77-845,791, FILED 10-9-2009.

MEGHAN REINHART, EXAMINING ATTORNEY



David J. Kybas

Director of the United States Patent and Trademark Office

United States of America

United States Patent and Trademark Office

MADNOMORE

Reg. No. 4,175,990

INTEGRATED TECHNOLOGY EDGE CORP. (WASHINGTON CORPORATION)
1617 SOUTH 325TH STREET
FEDERAL WAY, WA 98003

Registered July 17, 2012

Int. Cl.: 25

FOR: CLOTHING, NAMELY, SHIRTS, PANTS, HOODED SWEATSHIRTS, JACKETS AND VESTS, IN CLASS 25 (U.S. CLS. 22 AND 39).

TRADEMARK

FIRST USE 9-0-2011; IN COMMERCE 5-0-2012.

PRINCIPAL REGISTER

THE MARK CONSISTS OF STANDARD CHARACTERS WITHOUT CLAIM TO ANY PARTICULAR FONT, STYLE, SIZE, OR COLOR.

SN 77-845,993, FILED 10-9-2009.

GENE MACIOL, EXAMINING ATTORNEY



David J. Kyfos

Director of the United States Patent and Trademark Office

United States of America

United States Patent and Trademark Office

THERMOBOLICS

Reg. No. 4,175,991

WINDMILL HEALTH PRODUCTS, LLC. (NEW JERSEY LIMITED LIABILITY COMPANY)
6 HENDERSON DR

Registered July 17, 2012

WEST CALDWELL, NJ 07006

Int. Cl.: 5

FOR: DIETARY AND NUTRITIONAL SUPPLEMENTS, IN CLASS 5 (U.S. CLS. 6, 18, 44, 46, 51 AND 52).

TRADEMARK

FIRST USE 10-1-1998; IN COMMERCE 10-1-1998.

PRINCIPAL REGISTER

THE MARK CONSISTS OF STANDARD CHARACTERS WITHOUT CLAIM TO ANY PARTICULAR FONT, STYLE, SIZE, OR COLOR.

SN 77-846,356, FILED 10-12-2009.

WENDY GOODMAN, EXAMINING ATTORNEY



David J. Kybas

Director of the United States Patent and Trademark Office

United States of America

United States Patent and Trademark Office



Reg. No. 4,175,992

Registered July 17, 2012

Int. Cl.: 24

TRADEMARK

PRINCIPAL REGISTER

LF, LLC (DELAWARE LIMITED LIABILITY COMPANY)
P.O. BOX 39
MOUNT MOURNE, NC 28123

FOR: TEXTILE SHOP TOWELS, IN CLASS 24 (U.S. CLS. 42 AND 50).

FIRST USE 9-0-2011; IN COMMERCE 9-0-2011.

THE MARK CONSISTS OF A FLYING HAWK WITH THE WORDS "BLUE HAWK" TO THE RIGHT OF THE IMAGE.

SN 77-846,515, FILED 10-12-2009.

KIM SAITO, EXAMINING ATTORNEY



David J. Kybas

Director of the United States Patent and Trademark Office

United States of America

United States Patent and Trademark Office

JUNIT

Reg. No. 4,175,993

Registered July 17, 2012

Int. Cl.: 9

TRADEMARK

PRINCIPAL REGISTER

TOM WARHOVER (UNITED STATES INDIVIDUAL)
525 JUNCTION ROAD, SUITE 8200
MADISON, WI 53717

FOR: COMPUTER SOFTWARE PROGRAMS FOR THE INTEGRATION OF TEXT, AUDIO, GRAPHICS, STILL IMAGES, AND VIDEO CONTENT FOR MULTIMEDIA APPLICATIONS, IN CLASS 9 (U.S. CLS. 21, 23, 26, 36 AND 38).

FIRST USE 7-1-2011; IN COMMERCE 7-1-2011.

THE MARK CONSISTS OF STANDARD CHARACTERS WITHOUT CLAIM TO ANY PARTICULAR FONT, STYLE, SIZE, OR COLOR.

SN 77-846,813, FILED 10-12-2009.

KIM SAITO, EXAMINING ATTORNEY



David J. Kyffers

Director of the United States Patent and Trademark Office

United States of America

United States Patent and Trademark Office

PRO-FLEX

Reg. No. 4,175,994

THE PROCTER & GAMBLE COMPANY (OHIO CORPORATION)
ONE PROCTER & GAMBLE PLAZA
CINCINNATI, OH 45202

Registered July 17, 2012

Int. Cl.: 21

FOR: TOOTHBRUSHES, IN CLASS 21 (U.S. CLS. 2, 13, 23, 29, 30, 33, 40 AND 50).

TRADEMARK

FIRST USE 2-21-2012; IN COMMERCE 2-21-2012.

PRINCIPAL REGISTER

THE MARK CONSISTS OF STANDARD CHARACTERS WITHOUT CLAIM TO ANY PARTICULAR FONT, STYLE, SIZE, OR COLOR.

SN 77-848,137, FILED 10-14-2009.

IRA J. GOODSaid, EXAMINING ATTORNEY



David J. Kyffers

Director of the United States Patent and Trademark Office

United States of America

United States Patent and Trademark Office

FRESH FEET

Reg. No. 4,175,995

DELTA GALIL USA, INC. (DELAWARE CORPORATION)
150 MEADOWLAND PARKWAY
SECAUCUS, NJ 07094

Registered July 17, 2012

Int. Cl.: 25

FOR: MEN'S, WOMEN'S AND CHILDREN'S HOSIERY, IN CLASS 25 (U.S. CLS. 22 AND 39).

FIRST USE 5-10-2012; IN COMMERCE 5-10-2012.

TRADEMARK

THE MARK CONSISTS OF STANDARD CHARACTERS WITHOUT CLAIM TO ANY PARTICULAR FONT, STYLE, SIZE, OR COLOR.

PRINCIPAL REGISTER

NO CLAIM IS MADE TO THE EXCLUSIVE RIGHT TO USE "FEET", APART FROM THE MARK AS SHOWN.

SN 77-849,498, FILED 10-15-2009.

RONALD MCMORROW, EXAMINING ATTORNEY



David J. Kyffers

Director of the United States Patent and Trademark Office

United States of America

United States Patent and Trademark Office



Reg. No. 4,175,996

Registered July 17, 2012

Int. Cls.: 6 and 20

TRADEMARK

PRINCIPAL REGISTER

LH LICENSED PRODUCTS, INC. (CALIFORNIA CORPORATION)
860 EAST SANDHILL AVENUE
CARSON, CA 90746

FOR: METAL SAFES; METAL DOOR LOCKS; METAL DOOR LOCKS AND KEYS SOLD AS A UNIT; METAL CASH BOXES, IN CLASS 6 (U.S. CLS. 2, 12, 13, 14, 23, 25 AND 50).

FIRST USE 5-0-2011; IN COMMERCE 5-0-2011.

FOR: NON-METAL SAFES, IN CLASS 20 (U.S. CLS. 2, 13, 22, 25, 32 AND 50).

FIRST USE 5-0-2011; IN COMMERCE 5-0-2011.

THE MARK CONSISTS OF THE LETTERS "LH" IN A SQUARE.

SN 77-850,218, FILED 10-16-2009.

ALYSSA STEEL, EXAMINING ATTORNEY



David J. Kybas

Director of the United States Patent and Trademark Office

United States of America

United States Patent and Trademark Office

COCU KIDS

Reg. No. 4,175,997

Registered July 17, 2012

Int. Cl.: 9

TRADEMARK

PRINCIPAL REGISTER

COCU KIDS, LLC (NEW JERSEY LIMITED LIABILITY COMPANY)
4 BEACON HILL ROAD
FLORHAM PARK, NJ 07932

FOR: DIGITAL MEDIA, NAMELY, DVD'S, VIDEOTAPES, AUDIOVISUAL CD'S, AUDIO CD'S, CD-ROM'S, AND DOWNLOADABLE AUDIOVISUAL FILES FEATURING EDUCATIONAL MATERIAL, ENTERTAINMENT MATERIAL AND LEARNING ACTIVITIES FOR BABIES AND CHILDREN; CHILDREN'S EDUCATIONAL AND ENTERTAINMENT AUDIOVISUAL CD'S AND DVD'S; VIDEO RECORDINGS FEATURING EDUCATIONAL MATERIAL, ENTERTAINMENT MATERIAL AND LEARNING ACTIVITIES FOR BABIES AND CHILDREN; VIDEOS IN THE FIELD OF CHILDREN'S EDUCATION AND ENTERTAINMENT, IN CLASS 9 (U.S. CLS. 21, 23, 26, 36 AND 38).

FIRST USE 2-14-2012; IN COMMERCE 4-12-2012.

THE MARK CONSISTS OF STANDARD CHARACTERS WITHOUT CLAIM TO ANY PARTICULAR FONT, STYLE, SIZE, OR COLOR.

NO CLAIM IS MADE TO THE EXCLUSIVE RIGHT TO USE "KIDS", APART FROM THE MARK AS SHOWN.

THE WORDING "COCU" HAS NO MEANING IN A FOREIGN LANGUAGE.

SN 77-850,602, FILED 10-16-2009.

ELLEN BURNS, EXAMINING ATTORNEY



David J. Kyffers

Director of the United States Patent and Trademark Office

United States of America

United States Patent and Trademark Office

MARIE BISHARA

Reg. No. 4,175,998

Registered July 17, 2012

Int. Cls.: 18 and 25

TRADEMARK

PRINCIPAL REGISTER

BISHARA TEXTILE & GARMENT MANUFACTURING CO. (EGYPT CORPORATION)
10TH OF RAMDAN CITY, INDUSTRIAL ZONE B2
GOVERNORATE, A.R.E., EGYPT

FOR: LEATHER AND IMITATIONS OF LEATHER, AND GOODS MADE OF THESE MATERIALS, NAMELY, LEATHER BAGS; TRAVELING BAGS, IN CLASS 18 (U.S. CLS. 1, 2, 3, 22 AND 41).

FIRST USE 8-1-2008; IN COMMERCE 8-1-2008.

FOR: CLOTHING, NAMELY, TUXEDOS, SUITS, SHIRTS, TIES AND SOCKS; FOOTWEAR; LEATHER BELTS, IN CLASS 25 (U.S. CLS. 22 AND 39).

FIRST USE 8-1-2008; IN COMMERCE 8-1-2008.

THE NAME(S), PORTRAIT(S), AND/OR SIGNATURE(S) SHOWN IN THE MARK IDENTIFIES "MARIE BISHARA", WHOSE CONSENT(S) TO REGISTER IS MADE OF RECORD.

SN 77-851,002, FILED 10-16-2009.

SIMON TENG, EXAMINING ATTORNEY



David J. Kyffers

Director of the United States Patent and Trademark Office

United States of America

United States Patent and Trademark Office

APECS

Reg. No. 4,175,999

Registered July 17, 2012

Int. Cl.: 43

SERVICE MARK

PRINCIPAL REGISTER

CPC PROPERTIES, INC. (DELAWARE CORPORATION)
SUITE 202
103 FOULK ROAD
WILMINGTON, DE 19803

FOR: RESTAURANT AND BAR SERVICES, IN CLASS 43 (U.S. CLS. 100 AND 101).

FIRST USE 11-17-2009; IN COMMERCE 11-17-2009.

THE MARK CONSISTS OF STANDARD CHARACTERS WITHOUT CLAIM TO ANY PARTICULAR FONT, STYLE, SIZE, OR COLOR.

SN 77-853,468, FILED 10-21-2009.

MARC LEIPZIG, EXAMINING ATTORNEY



David J. Kybas

Director of the United States Patent and Trademark Office

United States of America

United States Patent and Trademark Office

OMNISEXUAL

Reg. No. 4,176,000

Registered July 17, 2012

Int. Cl.: 3

TRADEMARK

PRINCIPAL REGISTER

DOUGLAS BENDER (UNITED STATES INDIVIDUAL)
APT 3
306 COURT STREET
BROOKLYN, NY 11231

FOR: PERFUME, COLOGNE, FRAGRANCES, NON-MEDICATED SKIN CARE PREPARATIONS, AND SOAPS, NAMELY, LIQUID SOAPS, PERFUMED SOAPS, IN CLASS 3 (U.S. CLS. 1, 4, 6, 50, 51 AND 52).

FIRST USE 4-1-2012; IN COMMERCE 4-1-2012.

THE MARK CONSISTS OF STANDARD CHARACTERS WITHOUT CLAIM TO ANY PARTICULAR FONT, STYLE, SIZE, OR COLOR.

SN 77-854,447, FILED 10-21-2009.

MARLENE BELL, EXAMINING ATTORNEY



David J. Kybas

Director of the United States Patent and Trademark Office

United States of America

United States Patent and Trademark Office

STRATOSPHERE

Reg. No. 4,176,001

DATAPIPE, INC. (DELAWARE CORPORATION)
10 EXCHANGE PLACE
JERSEY CITY, NJ 07302

Registered July 17, 2012

Int. Cl.: 38

FOR: PROVIDING MULTIPLE USER ACCESS TO THE INTERNET IN THE FORM OF INTERNET BANDWIDTH DATA CONNECTION SERVICES, IN CLASS 38 (U.S. CLS. 100, 101 AND 104).

SERVICE MARK

FIRST USE 10-31-2009; IN COMMERCE 10-31-2009.

PRINCIPAL REGISTER

THE MARK CONSISTS OF STANDARD CHARACTERS WITHOUT CLAIM TO ANY PARTICULAR FONT, STYLE, SIZE, OR COLOR.

SN 77-855,432, FILED 10-22-2009.

ERIN FALK, EXAMINING ATTORNEY



David J. Kyffers

Director of the United States Patent and Trademark Office

United States of America

United States Patent and Trademark Office

STRATOSPHERE

Reg. No. 4,176,002

DATAPIPE, INC. (DELAWARE CORPORATION)
10 EXCHANGE PLACE
JERSEY CITY, NJ 07302

Registered July 17, 2012

Int. Cl.: 42

FOR: COMPUTER SERVICES, NAMELY, PROVIDING MANAGED WEB HOSTING SERVICES, NAMELY, HOSTING OF DIGITAL CONTENT ON THE INTERNET; WEB SITE SECURITY SERVICES TO PREVENT UNAUTHORIZED ACCESS TO CLIENT WEB SITES AND DATABASES, IN CLASS 42 (U.S. CLS. 100 AND 101).

SERVICE MARK

PRINCIPAL REGISTER

FIRST USE 10-31-2009; IN COMMERCE 10-31-2009.

THE MARK CONSISTS OF STANDARD CHARACTERS WITHOUT CLAIM TO ANY PARTICULAR FONT, STYLE, SIZE, OR COLOR.

SN 77-855,437, FILED 10-22-2009.

ERIN FALK, EXAMINING ATTORNEY



David J. Kyffers

Director of the United States Patent and Trademark Office

United States of America

United States Patent and Trademark Office

STRATOSPHERE REACH BEYOND THE CLOUD

Reg. No. 4,176,003

DATAPIPE, INC. (DELAWARE CORPORATION)
10 EXCHANGE PLACE
JERSEY CITY, NJ 07302

Registered July 17, 2012

Int. Cl.: 42

FOR: COMPUTER SERVICES, NAMELY, PROVIDING MANAGED WEB HOSTING SERVICES, NAMELY, HOSTING OF DIGITAL CONTENT ON THE INTERNET; WEB SITE SECURITY SERVICES TO PREVENT UNAUTHORIZED ACCESS TO CLIENT WEB SITES AND DATABASES, IN CLASS 42 (U.S. CLS. 100 AND 101).

SERVICE MARK

PRINCIPAL REGISTER

FIRST USE 10-31-2009; IN COMMERCE 10-31-2009.

THE MARK CONSISTS OF STANDARD CHARACTERS WITHOUT CLAIM TO ANY PARTICULAR FONT, STYLE, SIZE, OR COLOR.

SN 77-855,454, FILED 10-22-2009.

ERIN FALK, EXAMINING ATTORNEY



David J. Kyffers

Director of the United States Patent and Trademark Office

United States of America

United States Patent and Trademark Office

CASA ARAMARA

Reg. No. 4,176,004

Registered July 17, 2012

Int. Cl.: 25

TRADEMARK

PRINCIPAL REGISTER

PATH MEDIA HOLDINGS, LLC (ST.KITTS-NEVIS LIMITED LIABILITY COMPANY)
HUNKINS PLAZA, MAIN STREET
P.O. BOX 556
CHARLESTOWN, ST.KITTS-NEVIS

FOR: CLOTHING, NAMELY, SHIRTS, ROBES, SLEEPWEAR, IN CLASS 25 (U.S. CLS. 22 AND 39).

FIRST USE 10-31-2010; IN COMMERCE 10-31-2010.

THE MARK CONSISTS OF STANDARD CHARACTERS WITHOUT CLAIM TO ANY PARTICULAR FONT, STYLE, SIZE, OR COLOR.

THE ENGLISH TRANSLATION OF "CASA ARAMARA" IS "A SACRED HOUSE BY THE OCEAN".

SN 77-856,764, FILED 10-25-2009.

ODESSA BIBBINS, EXAMINING ATTORNEY



David J. Kyros

Director of the United States Patent and Trademark Office

United States of America

United States Patent and Trademark Office



Reg. No. 4,176,005

Registered July 17, 2012

Int. Cl.: 43

SERVICE MARK

PRINCIPAL REGISTER

PATH MEDIA HOLDINGS, LLC (ST.KITTS-NEVIS LIMITED LIABILITY COMPANY)
HUNKINS PLAZA, MAIN STREET
P.O. BOX 556
CHARLESTOWN, ST.KITTS-NEVIS

FOR: HOTEL SERVICES FOR PREFERRED CUSTOMERS, HOTEL SERVICES, RESORT HOTEL SERVICES, MOTEL SERVICES, HEALTH RESORT SERVICES, NAMELY, PROVIDING FOOD AND LODGING THAT SPECIALIZE IN PROMOTING PATRONS' GENERAL HEALTH AND WELL-BEING, HOTELS, MOTELS, RESORT HOTELS, BAR SERVICES, TRAVEL AGENCY SERVICES, NAMELY, MAKING RESERVATIONS AND BOOKING FOR TEMPORARY LODGING, PROVIDING A WEB SITE FOR MAKING RESERVATIONS AND BOOKING FOR TEMPORARY LODGING, IN CLASS 43 (U.S. CLS. 100 AND 101).

FIRST USE 5-31-2003; IN COMMERCE 5-31-2003.

NO CLAIM IS MADE TO THE EXCLUSIVE RIGHT TO USE "CASA", APART FROM THE MARK AS SHOWN.

THE MARK CONSISTS OF A SHADED CIRCLE WITH AN UNEVEN HORIZONTAL LINE BELOW, WITH THE WORDING, "CASA" IN SMALL CAPS BELOW THE UNEVEN HORIZONTAL LINE, WITH THE WORD "ARAMARA" IN LARGE CAPS BELOW, "CASA".

CASA ARAMARA TRANSLATES TO "A SACRED HOUSE BY THE OCEAN".

SN 77-856,777, FILED 10-25-2009.

ODESSA BIBBINS, EXAMINING ATTORNEY



David J. Kyffers

Director of the United States Patent and Trademark Office

United States of America

United States Patent and Trademark Office



**SHAPELL
INDUSTRIES**

Reg. No. 4,176,006

Registered July 17, 2012

Int. Cl.: 36

SERVICE MARK

PRINCIPAL REGISTER

SHAPELL INDUSTRIES, INC. (DELAWARE CORPORATION)
8383 WILSHIRE BOULEVARD, SUITE 700
BEVERLY HILLS, CA 90211

FOR: REAL ESTATE INVESTMENT, IN CLASS 36 (U.S. CLS. 100, 101 AND 102).

FIRST USE 10-1-2009; IN COMMERCE 10-12-2009.

NO CLAIM IS MADE TO THE EXCLUSIVE RIGHT TO USE "INDUSTRIES", APART FROM THE MARK AS SHOWN.

THE MARK CONSISTS OF A RECTANGLE DESIGN WITH A STYLIZED LETTER "S" WITH THE WORDS "SHAPELL INDUSTRIES" APPEARING UNDERNEATH.

SN 77-860,888, FILED 10-29-2009.

MICHELE SWAIN, EXAMINING ATTORNEY



David J. Kyffers

Director of the United States Patent and Trademark Office

United States of America

United States Patent and Trademark Office



Reg. No. 4,176,007

CHRISTOPHER & BANKS COMPANY (MINNESOTA CORPORATION)
2400 XENIUM LANE NORTH
PLYMOUTH, MN 55441

Registered July 17, 2012

Int. Cl.: 35

FOR: RETAIL STORE AND ON-LINE RETAIL STORE SERVICES FEATURING WOMEN'S CLOTHING AND APPAREL, AND CLOTHING ACCESSORIES, IN CLASS 35 (U.S. CLS. 100, 101 AND 102).

SERVICE MARK

FIRST USE 9-30-2008; IN COMMERCE 9-30-2008.

PRINCIPAL REGISTER

THE MARK CONSISTS OF THE LETTERS "CB" IN WHITE FONT, WITH THE "C" SLIGHTLY HIGHER THAN THE "B", AND THE LETTERS "CB" IN A SOLID BLACK CIRCLE.

SN 77-864,188, FILED 11-3-2009.

JEFF DEFORD, EXAMINING ATTORNEY



David J. Kybas

Director of the United States Patent and Trademark Office

United States of America

United States Patent and Trademark Office

MISSION BELL

Reg. No. 4,176,008

Registered July 17, 2012

Int. Cl.: 33

TRADEMARK

PRINCIPAL REGISTER

E. & J. GALLO WINERY (CALIFORNIA CORPORATION)
600 YOSEMITE BOULEVARD
MODESTO, CA 95354

FOR: WINES, IN CLASS 33 (U.S. CLS. 47 AND 49).

FIRST USE 3-31-2012; IN COMMERCE 3-31-2012.

THE MARK CONSISTS OF STANDARD CHARACTERS WITHOUT CLAIM TO ANY PARTICULAR FONT, STYLE, SIZE, OR COLOR.

SN 77-868,261, FILED 11-9-2009.

DAVID I, EXAMINING ATTORNEY



David J. Kyfos

Director of the United States Patent and Trademark Office

United States of America

United States Patent and Trademark Office



Reg. No. 4,176,009

Registered July 17, 2012

Int. Cls.: 7 and 9

TRADEMARK

PRINCIPAL REGISTER

BAUMULLER NURNBERG GMBH (FED REP GERMANY LIMITED LIABILITY COMPANY)
OSTENDSTRASSE 80
NURNBERG, FED REP GERMANY 90482

FOR: ELECTRIC MOTORS, EXCEPT FOR LAND VEHICLES; ELECTRIC DRIVING MOTORS FOR MACHINES, IN CLASS 7 (U.S. CLS. 13, 19, 21, 23, 31, 34 AND 35).

FIRST USE 5-3-2012; IN COMMERCE 5-3-2012.

FOR: ELECTRICAL CONTROLLERS; PRODUCTS FOR HEAVY CURRENT ENGINEERING IN THE FIELDS OF POWER SUPPLYING TRANSFORMING, ACCUMULATING AND CONTROL, NAMELY, CONVERTERS; COMPUTER PROGRAMS FOR MONITORING, DIAGNOSIS AND CONTROL OF ELECTRIC DRIVE SYSTEMS; COMPUTER PROGRAMS FOR TESTING, DIAGNOSIS, REGULATING AND CONTROL PURPOSES; COMPUTER PROGRAMS FOR THE COMMISSIONING, OPERATING AND MAINTENANCE OF ELECTRIC AND ELECTRONIC REGULATING AND CONTROL SYSTEMS, INCLUDING POWER CONVERTERS, IN CLASS 9 (U.S. CLS. 21, 23, 26, 36 AND 38).

FIRST USE 10-15-2009; IN COMMERCE 10-15-2009.

THE MARK CONSISTS OF THE WORD "SAFETY" ENCLOSED IN A RECTANGULAR FRAME WITH THE LETTERS "SAFE" IN A SHADE THAT CONTRASTS WITH THE LETTERS "TY" AND HAVING A CONTRASTING BACKGROUND.

SN 77-871,245, FILED 11-12-2009.

TOBY BULLOFF, EXAMINING ATTORNEY



David J. Kyjars

Director of the United States Patent and Trademark Office

United States of America

United States Patent and Trademark Office

DIVOT TUTOR

Reg. No. 4,176,010

Registered July 17, 2012

Int. Cl.: 28

TRADEMARK

PRINCIPAL REGISTER

TOME, ROBERT (UNITED STATES INDIVIDUAL)
16816 MAGNOLIA BOULEVARD
ENCINO, CA 91436 AND

CICCOLELLA, TOM (UNITED STATES INDIVIDUAL)
16816 MAGNOLIA BOULEVARD
ENCINO, CA 91436

FOR: GOLF CLUB SWING AIDS, NAMELY, A FAIRWAY SIMULATING PRACTICE MAT
, IN CLASS 28 (U.S. CLS. 22, 23, 38 AND 50).

FIRST USE 4-24-2012; IN COMMERCE 4-24-2012.

THE MARK CONSISTS OF STANDARD CHARACTERS WITHOUT CLAIM TO ANY PAR-
TICULAR FONT, STYLE, SIZE, OR COLOR.

SN 77-871,344, FILED 11-12-2009.

BRENDAN MCCAULEY, EXAMINING ATTORNEY



David J. Kyffers

Director of the United States Patent and Trademark Office

United States of America

United States Patent and Trademark Office

iopener

Reg. No. 4,176,011

Registered July 17, 2012

Int. Cl.: 9

TRADEMARK

PRINCIPAL REGISTER

THOMAS RAMIES (UNITED STATES INDIVIDUAL), DBA WEST 280,
143 CRESCENT AVE
PORTOLA VALLEY, CA 94028 AND

CLAY BAKER (UNITED STATES INDIVIDUAL), DBA WEST 280,
143 CRESCENT AVE
PORTOLA VALLEY, CA 94028

FOR: CASES FOR SMARTPHONES AND PORTABLE MEDIA PLAYERS HAVING BEVERAGE CAP REMOVAL TOOLS INTEGRATED INTO THE CASES; CASES FOR SMARTPHONES AND PORTABLE MEDIA LAYERS HAVING WINE CORK REMOVAL TOOLS INTEGRATED INTO THE CASES, IN CLASS 9 (U.S. CLS. 21, 23, 26, 36 AND 38).

FIRST USE 12-18-2010; IN COMMERCE 12-18-2010.

THE MARK CONSISTS OF STANDARD CHARACTERS WITHOUT CLAIM TO ANY PARTICULAR FONT, STYLE, SIZE, OR COLOR.

SN 77-871,631, FILED 11-12-2009.

SIMON TENG, EXAMINING ATTORNEY



David J. Kybas

Director of the United States Patent and Trademark Office

United States of America

United States Patent and Trademark Office

MORE FUN 4 LESS

Reg. No. 4,176,012

Registered July 17, 2012

Int. Cl.: 35

SERVICE MARK

PRINCIPAL REGISTER

SEMPRIS, LLC (DELAWARE LIMITED LIABILITY COMPANY)
10900 WAYZATA BOULEVARD
SUITE 700
MINNEAPOLIS, MN 55305

FOR: BUYING CLUB SERVICES; ONLINE, PHONE AND MAIL ORDER SERVICES FOR GOODS AND SERVICES, INCLUDING THE PROVISION OF MERCHANDISE AND SERVICES DISCOUNTS AND ORDER SAVINGS CERTIFICATES, ALL FEATURING GENERAL MERCHANDISE AND SERVICES; PROMOTING THE SALE OF THE GOODS AND SERVICES OF OTHERS THROUGH THE DISTRIBUTION OF COUPONS AND DISCOUNT OFFERS, IN CLASS 35 (U.S. CLS. 100, 101 AND 102).

FIRST USE 9-1-2010; IN COMMERCE 9-1-2010.

THE MARK CONSISTS OF STANDARD CHARACTERS WITHOUT CLAIM TO ANY PARTICULAR FONT, STYLE, SIZE, OR COLOR.

OWNER OF U.S. REG. NO. 3,514,891.

SN 77-871,705, FILED 11-12-2009.

SHAUNIA CARLYLE, EXAMINING ATTORNEY



David J. Kyros

Director of the United States Patent and Trademark Office

United States of America

United States Patent and Trademark Office

DRAKE SYSTEMS GROUP

Reg. No. 4,176,013

Registered July 17, 2012

Int. Cls.: 9 and 42

TRADEMARK

SERVICE MARK

PRINCIPAL REGISTER

DRAKE SYSTEMS GROUP (CALIFORNIA CORPORATION)
SUITE G
23655 VIA DEL RIO
YORBA LINDA, CA 92887

FOR: AUDIO/VISUAL SYSTEMS FOR USE IN THE HEALTHCARE INDUSTRY COMPRISED OF COMPUTERS, COMPUTER MONITORS, LCD MONITORS, ELECTRONIC DISPLAY INTERFACES AND MULTIMEDIA PROJECTORS, AUDIO PROCESSING EQUIPMENT, NAMELY, LIMITERS AND COMPRESSORS, MULTIMEDIA PROJECTORS, ELECTRICAL CONTROLLING DEVICES, CAMERAS, SIGNAL DISTRIBUTION DEVICES, NAMELY, DISTRIBUTION AMPLIFIERS FOR AUDIO AND VIDEO SIGNALS, AND ELECTRONIC DATA RECORDERS, IN CLASS 9 (U.S. CLS. 21, 23, 26, 36 AND 38).

FIRST USE 8-31-2004; IN COMMERCE 8-31-2004.

FOR: COMPUTER CONSULTING SERVICES RELATED TO DESIGN, IMPLEMENTATION AND ANALYSIS OF AUDIO/VISUAL COMPUTER SOFTWARE AND HARDWARE SYSTEMS DEPLOYED IN THE HEALTHCARE INDUSTRY; INSTALLATION OF AUDIO/VISUAL COMPUTER SOFTWARE DEPLOYED IN THE HEALTHCARE INDUSTRY, IN CLASS 42 (U.S. CLS. 100 AND 101).

FIRST USE 10-31-2003; IN COMMERCE 10-31-2003.

THE MARK CONSISTS OF STANDARD CHARACTERS WITHOUT CLAIM TO ANY PARTICULAR FONT, STYLE, SIZE, OR COLOR.

NO CLAIM IS MADE TO THE EXCLUSIVE RIGHT TO USE "SYSTEMS GROUP", APART FROM THE MARK AS SHOWN.

SN 77-872,536, FILED 11-13-2009.

KATHERINE E. HALMEN, EXAMINING ATTORNEY



David J. Kyffers

Director of the United States Patent and Trademark Office

United States of America

United States Patent and Trademark Office

DSG

Reg. No. 4,176,014

Registered July 17, 2012

Int. Cls.: 9 and 42

TRADEMARK

SERVICE MARK

PRINCIPAL REGISTER

DRAKE SYSTEMS GROUP (CALIFORNIA CORPORATION)
SUITE G
23655 VIA DEL RIO
YORBA LINDA, CA 92887

FOR: AUDIO/VISUAL SYSTEMS FOR USE IN THE HEALTHCARE INDUSTRY COMPRISED OF COMPUTERS, COMPUTER MONITORS, LCD MONITORS, ELECTRONIC DISPLAY INTERFACES AND MULTIMEDIA PROJECTORS, AUDIO PROCESSING EQUIPMENT, NAMELY, LIMITERS AND COMPRESSORS, MULTIMEDIA PROJECTORS, ELECTRICAL CONTROLLING DEVICES, CAMERAS, SIGNAL DISTRIBUTION DEVICES, NAMELY, DISTRIBUTION AMPLIFIERS FOR AUDIO AND VIDEO SIGNALS, AND ELECTRONIC DATA RECORDERS, IN CLASS 9 (U.S. CLS. 21, 23, 26, 36 AND 38).

FIRST USE 3-26-2009; IN COMMERCE 3-26-2009.

FOR: COMPUTER CONSULTING SERVICES RELATED TO DESIGN, IMPLEMENTATION AND ANALYSIS OF AUDIO/VISUAL COMPUTER SOFTWARE AND HARDWARE SYSTEMS DEPLOYED IN THE HEALTHCARE INDUSTRY; INSTALLATION OF AUDIO/VISUAL COMPUTER SOFTWARE DEPLOYED IN THE HEALTHCARE INDUSTRY, IN CLASS 42 (U.S. CLS. 100 AND 101).

FIRST USE 3-13-2009; IN COMMERCE 3-13-2009.

THE MARK CONSISTS OF STANDARD CHARACTERS WITHOUT CLAIM TO ANY PARTICULAR FONT, STYLE, SIZE, OR COLOR.

SN 77-872,543, FILED 11-13-2009.

KATHERINE E. HALMEN, EXAMINING ATTORNEY



David J. Kyffers

Director of the United States Patent and Trademark Office

United States of America

United States Patent and Trademark Office

COCOBODY

Reg. No. 4,176,015

Registered July 17, 2012

Int. Cls.: 3 and 35

ORGANIX SOLUTIONS, INC (PHILIPPINES CORPORATION), DBA ORGANIX SOLUTIONS, INC.,
B161 ALEXANDRA CONDOMINIUM
29 MERALCO AVE
PASIG CITY, PHILIPPINES 1600

TRADEMARK

SERVICE MARK

PRINCIPAL REGISTER

FOR: AROMATHERAPY BODY CARE PRODUCTS, NAMELY, BODY LOTION, SHOWER GEL, CUTICLE CREAM, SHAMPOO, CONDITIONER, NON-MEDICATED LIP BALM, SOAP, BODY POLISH, BODY AND FOOT SCRUB AND NON-MEDICATED FOOT CREAM; BATH OILS FOR COSMETIC PURPOSES; BEAUTY CREAMS FOR BODY CARE; BODY AND BEAUTY CARE COSMETICS; COSMETIC CREAMS FOR SKIN CARE; COSMETIC OILS FOR THE EPIDERMIS; COSMETIC PREPARATIONS FOR BODY CARE; COSMETIC SOAPS; COSMETIC SUNTAN LOTIONS; ESSENTIAL OILS FOR PERSONAL USE; HAIR CARE CREAMS; HAIR CARE LOTIONS; HAIR CARE PREPARATIONS CONSISTING OF ORGANIC COCONUT VIRGIN OIL AND COCONUT VIRGIN OIL; LOTIONS FOR FACE AND BODY CARE; NON-MEDICATED COSMETIC SKIN CARE PREPARATIONS CONSISTING OF ORGANIC COCONUT VIRGIN OIL AND COCONUT VIRGIN OIL; NON-MEDICATED LIP CARE PREPARATIONS; NON-MEDICATED MOUTHWASH AND GARGLE; NON-MEDICATED PREPARATIONS ALL FOR THE CARE OF SKIN, HAIR AND SCALP; SOAPS FOR BODY CARE; SOAPS FOR PERSONAL USE, IN CLASS 3 (U.S. CLS. 1, 4, 6, 50, 51 AND 52).

FIRST USE 1-1-2010; IN COMMERCE 1-1-2010.



FOR: RETAIL SHOP-AT-HOME PARTY SERVICES IN THE FIELD OF BEAUTY PRODUCTS, COSMETICS, TOILETRIES, SKIN CARE PREPARATIONS, HAIR CARE PREPARATIONS, FRAGRANCES, AND PERSONAL CARE PRODUCTS; COMPUTERISED ON-LINE ORDERING SERVICES FEATURING BEAUTY PRODUCTS, COSMETICS, SKIN CARE PRODUCTS, FRAGRANCES, AND RELATED PRODUCTS; RETAIL STORE AND ON-LINE RETAIL STORE SERVICES FEATURING BEAUTY PRODUCTS, COSMETICS, TOILETRIES, SKIN CARE PREPARATIONS, HAIR CARE PREPARATIONS, FRAGRANCES, AND PERSONAL CARE PRODUCTS, IN CLASS 35 (U.S. CLS. 100, 101 AND 102).

FIRST USE 1-1-2010; IN COMMERCE 1-1-2010.

David J. Kyffers

THE MARK CONSISTS OF STANDARD CHARACTERS WITHOUT CLAIM TO ANY PARTICULAR FONT, STYLE, SIZE, OR COLOR.

Reg. No. 4,176,015 NO CLAIM IS MADE TO THE EXCLUSIVE RIGHT TO USE "COCO", APART FROM THE MARK AS SHOWN.

SN 77-872,644, FILED 11-13-2009.

RONALD DELGIZZI, EXAMINING ATTORNEY

United States of America

United States Patent and Trademark Office

INGREDIENTS MATTER

Reg. No. 4,176,016

PURE PLANT BEAUTY, INC. (CALIFORNIA CORPORATION)

Registered July 17, 2012

10 MEDLAR
IRVINE, CA 92618

Int. Cl.: 3

FOR: SKIN CARE PRODUCTS, NAMELY, BODY CARE PRODUCTS, NAMELY, BODY CREAMS AND LOTIONS, BODY SCRUBS; BATH PRODUCTS, NAMELY, BATH AND SHOWER GELS, BUBBLE BATHS, NON-MEDICATED BATH SALTS, BODY WASHES, IN CLASS 3 (U.S. CLS. 1, 4, 6, 50, 51 AND 52).

TRADEMARK

PRINCIPAL REGISTER

FIRST USE 12-0-2011; IN COMMERCE 12-0-2011.

THE MARK CONSISTS OF STANDARD CHARACTERS WITHOUT CLAIM TO ANY PARTICULAR FONT, STYLE, SIZE, OR COLOR.

SN 77-873,719, FILED 11-16-2009.

FLORENTINA BLANDU, EXAMINING ATTORNEY



David J. Kyffers

Director of the United States Patent and Trademark Office

United States of America

United States Patent and Trademark Office

ZUUM

Reg. No. 4,176,017

Registered July 17, 2012

Int. Cl.: 44

SERVICE MARK

PRINCIPAL REGISTER

THE WASHINGTON UNIVERSITY (MISSOURI CORPORATION)
ONE BROOKINGS DRIVE
ST. LOUIS, MO 63130

FOR: PROVIDING ONLINE HEALTH INFORMATION IN THE FIELDS OF WELLNESS, HEALTH RISK ASSESSMENT, AND HEALTH MAINTENANCE, IN CLASS 44 (U.S. CLS. 100 AND 101).

FIRST USE 4-27-2012; IN COMMERCE 4-27-2012.

THE MARK CONSISTS OF STANDARD CHARACTERS WITHOUT CLAIM TO ANY PARTICULAR FONT, STYLE, SIZE, OR COLOR.

SN 77-876,368, FILED 11-19-2009.

SIMON TENG, EXAMINING ATTORNEY



David J. Kyffers

Director of the United States Patent and Trademark Office

United States of America

United States Patent and Trademark Office

LUISCO

Reg. No. 4,176,018

SHEEHAN GENETICS, LLC (CALIFORNIA LIMITED LIABILITY COMPANY)
2500 S. FOWLER AVE.
FRESNO, CA 93725

Registered July 17, 2012

Int. Cl.: 31

FOR: AGRICULTURAL PRODUCTS, NAMELY, LIVE GRAPEVINES AND FRESH FRUIT PRODUCED THEREFROM, AND PARTS OF PLANTS USED IN THE PROPAGATION OF GRAPEVINES, NAMELY, FRESH CUTTINGS AND GRAFTS, IN CLASS 31 (U.S. CLS. 1 AND 46).

TRADEMARK

PRINCIPAL REGISTER

FIRST USE 10-1-2007; IN COMMERCE 10-1-2007.

THE MARK CONSISTS OF STANDARD CHARACTERS WITHOUT CLAIM TO ANY PARTICULAR FONT, STYLE, SIZE, OR COLOR.

THE WORDING "LUISCO" HAS NO MEANING IN A FOREIGN LANGUAGE.

SN 77-876,973, FILED 11-19-2009.

LINDSEY RUBIN, EXAMINING ATTORNEY



David J. Kybas

Director of the United States Patent and Trademark Office

United States of America

United States Patent and Trademark Office

What you don't know could
kill you.

Reg. No. 4,176,019

Registered July 17, 2012

Int. Cl.: 44

SERVICE MARK

PRINCIPAL REGISTER

IMPLANT AND PERIODONTAL THERAPY (FLORIDA CORPORATION)
TAMPA
3450 EAST FLETCHER AVENUE, SUITE 340
TAMPA, FL 33637

FOR: DENTIST SERVICES, IN CLASS 44 (U.S. CLS. 100 AND 101).

FIRST USE 1-1-2011; IN COMMERCE 1-1-2011.

THE MARK CONSISTS OF STANDARD CHARACTERS WITHOUT CLAIM TO ANY PARTICULAR FONT, STYLE, SIZE, OR COLOR.

SN 77-878,305, FILED 11-22-2009.

DARRYL SPRUILL, EXAMINING ATTORNEY



David J. Kyffers

Director of the United States Patent and Trademark Office

United States of America

United States Patent and Trademark Office

ALL IN, FIRST OUT

Reg. No. 4,176,020

KEUCK, DARREL (UNITED STATES INDIVIDUAL)
16100 N. 71ST STREET
SCOTTSDALE, AZ 85254

Registered July 17, 2012

Int. Cl.: 36

FOR: FINANCIAL SERVICES, NAMELY, CONSULTATION REGARDING ANNUITIES AND DISTRIBUTION OF ANNUITIES, IN CLASS 36 (U.S. CLS. 100, 101 AND 102).

SERVICE MARK

FIRST USE 10-12-2011; IN COMMERCE 10-12-2011.

PRINCIPAL REGISTER

THE MARK CONSISTS OF STANDARD CHARACTERS WITHOUT CLAIM TO ANY PARTICULAR FONT, STYLE, SIZE, OR COLOR.

SN 77-879,589, FILED 11-24-2009.

NAAKWAMA ANKRAH, EXAMINING ATTORNEY



David J. Kyfos

Director of the United States Patent and Trademark Office

United States of America

United States Patent and Trademark Office

BONGO BUILT

Reg. No. 4,176,021

EISENBACH III, WILLIAM (UNITED STATES INDIVIDUAL)
3790 TAYLORSVILLE RD
STATESVILLE, NC 28625

Registered July 17, 2012

Int. Cl.: 15

FOR: DRUMS, IN CLASS 15 (U.S. CLS. 2, 21 AND 36).

TRADEMARK

FIRST USE 2-22-2010; IN COMMERCE 4-4-2010.

PRINCIPAL REGISTER

THE MARK CONSISTS OF STANDARD CHARACTERS WITHOUT CLAIM TO ANY PARTICULAR FONT, STYLE, SIZE, OR COLOR.

SN 77-882,225, FILED 11-30-2009.

REBECCA POVARCHUK, EXAMINING ATTORNEY



David J. Kyffers

Director of the United States Patent and Trademark Office

United States of America

United States Patent and Trademark Office

INTERSECT

Reg. No. 4,176,022

Registered July 17, 2012

Int. Cl.: 10

TRADEMARK

PRINCIPAL REGISTER

INTERSECT ENT, INC. (DELAWARE CORPORATION)
1049 ELWELL COURT
PALO ALTO, CA 94303

FOR: MEDICAL DEVICES CONSISTING OF ARTIFICIAL MATERIALS FOR THE TREATMENT OF EAR, NOSE, THROAT, SINUS AND RESPIRATORY-RELATED CONDITIONS AND SYMPTOMS, NAMELY, IMPLANTS COMPRISED OF DRUG-ELUTING STENTS; DRUG DELIVERY SYSTEMS; SURGICAL DEVICES AND INSTRUMENTS FOR THE TREATMENT OF EAR, NOSE, THROAT, SINUS AND RESPIRATORY-RELATED CONDITIONS AND SYMPTOMS, IN CLASS 10 (U.S. CLS. 26, 39 AND 44).

FIRST USE 8-31-2010; IN COMMERCE 8-30-2011.

THE MARK CONSISTS OF STANDARD CHARACTERS WITHOUT CLAIM TO ANY PARTICULAR FONT, STYLE, SIZE, OR COLOR.

SN 77-882,268, FILED 11-30-2009.

LEIGH CAROLINE CASE, EXAMINING ATTORNEY



David J. Kyffers

Director of the United States Patent and Trademark Office

United States of America

United States Patent and Trademark Office

FRESH CRAFTED NEVER FROZEN

Reg. No. 4,176,023

EAST COAST WINGS CORPORATION (NORTH CAROLINA CORPORATION)
100 CAMBRIDGE PARK
WINSTON-SALEM, NC 27104

Registered July 17, 2012

Int. Cl.: 43

FOR: RESTAURANT SERVICES, IN CLASS 43 (U.S. CLS. 100 AND 101).

SERVICE MARK

FIRST USE 3-8-2010; IN COMMERCE 3-8-2010.

PRINCIPAL REGISTER

THE MARK CONSISTS OF STANDARD CHARACTERS WITHOUT CLAIM TO ANY PARTICULAR FONT, STYLE, SIZE, OR COLOR.

SN 77-883,148, FILED 12-1-2009.

DAVID H. STINE, EXAMINING ATTORNEY



David J. Kyffers

Director of the United States Patent and Trademark Office

United States of America

United States Patent and Trademark Office

MUPPETS

Reg. No. 4,176,024

THE MUPPETS STUDIO, LLC (DELAWARE LIMITED LIABILITY COMPANY)
500 SOUTH BUENA VISTA STREET
BURBANK, CA 91521

Registered July 17, 2012

Int. Cl.: 30

FOR: CAKE DECORATIONS MADE OF CANDY; CANDIES; COOKIES, IN CLASS 30 (U.S. CL. 46).

TRADEMARK

FIRST USE 10-31-2011; IN COMMERCE 10-31-2011.

PRINCIPAL REGISTER

THE MARK CONSISTS OF STANDARD CHARACTERS WITHOUT CLAIM TO ANY PARTICULAR FONT, STYLE, SIZE, OR COLOR.

OWNER OF U.S. REG. NOS. 949,135, 3,314,910, AND OTHERS.

SN 77-883,579, FILED 12-1-2009.

KELLY BOULTON, EXAMINING ATTORNEY



David J. Kyjars

Director of the United States Patent and Trademark Office

United States of America

United States Patent and Trademark Office

MUPPETS

Reg. No. 4,176,025

Registered July 17, 2012

Int. Cl.: 28

TRADEMARK

PRINCIPAL REGISTER

THE MUPPETS STUDIO, LLC (DELAWARE LIMITED LIABILITY COMPANY)
500 SOUTH BUENA VISTA STREET
BURBANK, CA 91521

FOR: ACTION FIGURES AND ACCESSORIES THEREFOR; BEAN BAG DOLLS; CHRISTMAS TREE DECORATIONS EXCEPT CONFECTIONARY OR ILLUMINATION ARTICLES; COLLECTABLE TOY FIGURES; DOLL CLOTHING; DOLL ACCESSORIES; PARLOR GAMES; STUFFED TOYS; TEDDY BEARS; TOY VEHICLES; TOY CARS; TOY FIGURES, IN CLASS 28 (U.S. CLS. 22, 23, 38 AND 50).

FIRST USE 10-31-2011; IN COMMERCE 10-31-2011.

THE MARK CONSISTS OF STANDARD CHARACTERS WITHOUT CLAIM TO ANY PARTICULAR FONT, STYLE, SIZE, OR COLOR.

OWNER OF U.S. REG. NOS. 949,135, 3,314,910, AND OTHERS.

SN 77-884,777, FILED 12-2-2009.

KELLY BOULTON, EXAMINING ATTORNEY



David J. Kyros

Director of the United States Patent and Trademark Office

United States of America

United States Patent and Trademark Office

iMASTERS

Reg. No. 4,176,026

AUGUSTA NATIONAL, INC. (GEORGIA CORPORATION)
2604 WASHINGTON ROAD
AUGUSTA, GA 30904

Registered July 17, 2012

Int. Cl.: 38

FOR: COMPUTER-AIDED ELECTRONIC TRANSMISSION AND ELECTRONIC DELIVERY OF VOICE, DATA, IMAGES, MESSAGES IN THE FIELD OF GOLF TOURNAMENT AND GOLF RELATED SPORTS ENTERTAINMENT, VIA COMPUTER NETWORKS, INTERACTIVE TELEVISION AND THE INTERNET, IN CLASS 38 (U.S. CLS. 100, 101 AND 104).

SERVICE MARK

PRINCIPAL REGISTER

FIRST USE 3-13-2012; IN COMMERCE 3-13-2012.

THE MARK CONSISTS OF STANDARD CHARACTERS WITHOUT CLAIM TO ANY PARTICULAR FONT, STYLE, SIZE, OR COLOR.

OWNER OF U.S. REG. NOS. 361,678, 1,470,536, AND OTHERS.

SN 77-887,811, FILED 12-7-2009.

ANGELA M. MICHELI, EXAMINING ATTORNEY



David J. Kyffers

Director of the United States Patent and Trademark Office

United States of America

United States Patent and Trademark Office

eMASTERS

Reg. No. 4,176,027

AUGUSTA NATIONAL, INC. (GEORGIA CORPORATION)
2604 WASHINGTON ROAD
AUGUSTA, GA 30904

Registered July 17, 2012

Int. Cl.: 38

FOR: COMPUTER-AIDED ELECTRONIC TRANSMISSION AND ELECTRONIC DELIVERY OF VOICE, DATA, IMAGES, MESSAGES IN THE FIELD OF GOLF TOURNAMENT AND GOLF RELATED SPORTS ENTERTAINMENT, VIA COMPUTER NETWORKS, INTERACTIVE TELEVISION AND THE INTERNET, IN CLASS 38 (U.S. CLS. 100, 101 AND 104).

SERVICE MARK

PRINCIPAL REGISTER

FIRST USE 3-13-2012; IN COMMERCE 3-13-2012.

THE MARK CONSISTS OF STANDARD CHARACTERS WITHOUT CLAIM TO ANY PARTICULAR FONT, STYLE, SIZE, OR COLOR.

OWNER OF U.S. REG. NOS. 361,678, 1,470,536, AND OTHERS.

SN 77-887,873, FILED 12-7-2009.

ANGELA M. MICHELI, EXAMINING ATTORNEY



David J. Kyros

Director of the United States Patent and Trademark Office

United States of America

United States Patent and Trademark Office

THE CRIB LIFE

Reg. No. 4,176,028

HASBRO, INC. (RHODE ISLAND CORPORATION)
1027 NEWPORT AVENUE
PAWTUCKET, RI 02862

Registered July 17, 2012

Int. Cl.: 28

FOR: DOLLS, DOLL CLOTHING AND DOLL ACCESSORIES, IN CLASS 28 (U.S. CLS. 22, 23, 38 AND 50).

TRADEMARK

FIRST USE 6-1-2011; IN COMMERCE 6-1-2011.

PRINCIPAL REGISTER

THE MARK CONSISTS OF STANDARD CHARACTERS WITHOUT CLAIM TO ANY PARTICULAR FONT, STYLE, SIZE, OR COLOR.

NO CLAIM IS MADE TO THE EXCLUSIVE RIGHT TO USE "CRIB", APART FROM THE MARK AS SHOWN.

SN 77-888,217, FILED 12-8-2009.

ANDREA HACK, EXAMINING ATTORNEY



David J. Kyffers

Director of the United States Patent and Trademark Office

United States of America

United States Patent and Trademark Office

Guava Kids

Reg. No. 4,176,029

GUAVA KIDS LLC (OREGON CORPORATION)
14845 SW MURRAY SCHOLLS DR., STE 110-340
BEAVERTON, OR 97007

Registered July 17, 2012

Int. Cl.: 25

FOR: MITTENS; SWADDLING CLOTHES, IN CLASS 25 (U.S. CLS. 22 AND 39).

TRADEMARK

FIRST USE 9-0-2011; IN COMMERCE 3-5-2012.

PRINCIPAL REGISTER

THE MARK CONSISTS OF STANDARD CHARACTERS WITHOUT CLAIM TO ANY PARTICULAR FONT, STYLE, SIZE, OR COLOR.

NO CLAIM IS MADE TO THE EXCLUSIVE RIGHT TO USE "KIDS", APART FROM THE MARK AS SHOWN.

SN 77-888,491, FILED 12-8-2009.

NAPOLEON SHARMA, EXAMINING ATTORNEY



David J. Kyffers

Director of the United States Patent and Trademark Office

United States of America

United States Patent and Trademark Office

JEANSHAPER

Reg. No. 4,176,030

A & H SPORTSWEAR CO., INC. (PENNSYLVANIA CORPORATION)
110 COMMERCE WAY
STOCKERTOWN, PA 18083

Registered July 17, 2012

Int. Cl.: 25

FOR: JEANS; SPORTSWEAR, NAMELY, BOTTOMS AND PANTS, IN CLASS 25 (U.S. CLS. 22 AND 39).

TRADEMARK

FIRST USE 4-2-2012; IN COMMERCE 4-2-2012.

PRINCIPAL REGISTER

THE MARK CONSISTS OF STANDARD CHARACTERS WITHOUT CLAIM TO ANY PARTICULAR FONT, STYLE, SIZE, OR COLOR.

SN 77-889,364, FILED 12-9-2009.

STEVEN R. FINE, EXAMINING ATTORNEY



David J. Kybas

Director of the United States Patent and Trademark Office

United States of America

United States Patent and Trademark Office

SLIMSHAPER

Reg. No. 4,176,031

A & H SPORTSWEAR CO., INC. (PENNSYLVANIA CORPORATION)
110 COMMERCE WAY
STOCKERTOWN, PA 18083

Registered July 17, 2012

Int. Cl.: 25

FOR: JEANS; SPORTSWEAR, NAMELY, TOPS, BOTTOMS, DRESSES, SKIRTS, SHIRTS, PANTS AND SHORTS, IN CLASS 25 (U.S. CLS. 22 AND 39).

TRADEMARK

FIRST USE 9-21-2011; IN COMMERCE 9-21-2011.

PRINCIPAL REGISTER

THE MARK CONSISTS OF STANDARD CHARACTERS WITHOUT CLAIM TO ANY PARTICULAR FONT, STYLE, SIZE, OR COLOR.

OWNER OF U.S. REG. NO. 3,503,007.

SN 77-889,370, FILED 12-9-2009.

STEVEN R. FINE, EXAMINING ATTORNEY



David J. Kyffers

Director of the United States Patent and Trademark Office

United States of America

United States Patent and Trademark Office

ION TORRENT

Reg. No. 4,176,032

LIFE TECHNOLOGIES CORPORATION (DELAWARE CORPORATION)
5791 VAN ALLEN WAY
CARLSBAD, CA 92008

Registered July 17, 2012

Int. Cls.: 1 and 9

FOR: KITS COMPRISING PRIMARILY OF REAGENTS, ENZYMES AND/OR NUCLEOTIDES FOR GENETIC RESEARCH, IN CLASS 1 (U.S. CLS. 1, 5, 6, 10, 26 AND 46).

TRADEMARK

FIRST USE 12-17-2009; IN COMMERCE 12-14-2010.

PRINCIPAL REGISTER

FOR: SCIENTIFIC EQUIPMENT AND INSTRUMENTS, NAMELY, SEMICONDUCTOR CHIPS WITH INTEGRATED SENSORS FOR NUCLEIC ACID SEQUENCING, SEMICONDUCTOR CHIP READERS AND RELATED COMPUTER SOFTWARE USED FOR NUCLEIC ACID SEQUENCING AND ANALYSIS; NUCLEIC ACID POLYMER PARTICLES FOR USE IN GENETIC SEQUENCING; GENOME ANALYZER MACHINES AND RELATED COMPUTER OPERATING SOFTWARE; COMPUTER SOFTWARE FOR MONITORING OF GENOME ANALYZER MACHINES FROM HANDHELD OR MOBILE WIRELESS COMMUNICATION DEVICES CAPABLE OF VOICE, DATA AND/OR IMAGE TRANSMISSION, IN CLASS 9 (U.S. CLS. 21, 23, 26, 36 AND 38).

FIRST USE 12-17-2009; IN COMMERCE 12-14-2010.

THE MARK CONSISTS OF STANDARD CHARACTERS WITHOUT CLAIM TO ANY PARTICULAR FONT, STYLE, SIZE, OR COLOR.

SN 77-890,932, FILED 12-10-2009.

LINDA E. BLOHM, EXAMINING ATTORNEY



David J. Kypos

Director of the United States Patent and Trademark Office

United States of America

United States Patent and Trademark Office

ENASAVE

Reg. No. 4,176,033

SUMITOMO RUBBER INDUSTRIES, LTD. (JAPAN CORPORATION)
6-9, 3-CHOME, WAKINOHAMA-CHO
CHUO-KU, KOBE 651, JAPAN

Registered July 17, 2012

Int. Cl.: 12

FOR: VEHICLE TIRES, IN CLASS 12 (U.S. CLS. 19, 21, 23, 31, 35 AND 44).

TRADEMARK

FIRST USE 12-31-2011; IN COMMERCE 12-31-2011.

PRINCIPAL REGISTER

THE MARK CONSISTS OF STANDARD CHARACTERS WITHOUT CLAIM TO ANY PARTICULAR FONT, STYLE, SIZE, OR COLOR.

SN 77-891,124, FILED 12-11-2009.

LINDA POWELL, EXAMINING ATTORNEY



David J. Kybas

Director of the United States Patent and Trademark Office

United States of America

United States Patent and Trademark Office

ARCTIC CHILL

Reg. No. 4,176,034

PERIO, INC. (OHIO CORPORATION)
6156 WILCOX ROAD
DUBLIN, OH 43016

Registered July 17, 2012

Int. Cl.: 3

FOR: AFTERSHAVE; BODY WASH; DEODORANT FOR PERSONAL USE; SHAVING PREPARATIONS, IN CLASS 3 (U.S. CLS. 1, 4, 6, 50, 51 AND 52).

TRADEMARK

FIRST USE 12-0-2010; IN COMMERCE 12-0-2010.

PRINCIPAL REGISTER

THE MARK CONSISTS OF STANDARD CHARACTERS WITHOUT CLAIM TO ANY PARTICULAR FONT, STYLE, SIZE, OR COLOR.

SN 77-895,717, FILED 12-17-2009.

JESSICA FATHY, EXAMINING ATTORNEY



David J. Kyffers

Director of the United States Patent and Trademark Office

United States of America

United States Patent and Trademark Office

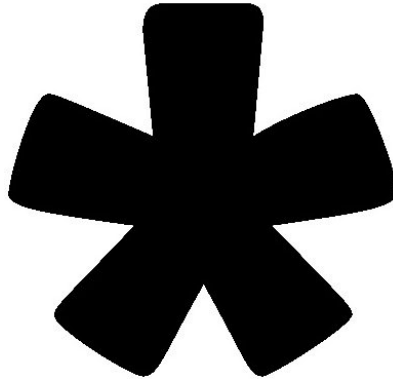

Reg. No. 4,176,035

Registered July 17, 2012

Int. Cl.: 35

SERVICE MARK

PRINCIPAL REGISTER

FAMOS LLC (CALIFORNIA LIMITED LIABILITY COMPANY)
8645 HOLLOWAY DRIVE
WEST HOLLYWOOD, CA 90069

FOR: ADVERTISING AND BUSINESS SERVICES, NAMELY, PROVIDING AN ONLINE WEBSITE WHERE ADVERTISERS, MARKETERS, AND CONTENT PROVIDERS CAN INTERACT WITH USERS FOR ADVERTISING, BRANDING, AND PROMOTING KNOWLEDGE, PRODUCTS, AND SERVICES, AND TRADESHOWS, ON BEHALF OF THEMSELVES AND OTHERS, AND FOR EVALUATING AND RATING THE SAME, ALL THE FOREGOING RELEVANT TO HUMAN ACTIVITIES AFFECTING CLIMATE CHANGE AND RELATED FIELDS; ADVERTISING AND DIRECTORY SERVICES, NAMELY, PROMOTING THE SERVICES OF OTHERS BY PROVIDING A WEB PAGE FEATURING LINKS TO THE WEBSITES OF OTHERS; ADVERTISING AND PUBLICITY SERVICES, NAMELY, PROMOTING THE GOODS, SERVICES, BRAND IDENTITY AND COMMERCIAL INFORMATION AND NEWS OF THIRD PARTIES THROUGH PRINT, AUDIO, VIDEO, DIGITAL AND ON-LINE MEDIUM; ADVERTISING SERVICES, NAMELY, COST-PER-ACTION ON-LINE ADVERTISING; INTERNET ADVERTISING SERVICES; MARKETING AND CONSULTING SERVICES IN THE FIELD OF PROMOTING AND TRACKING THE GOODS, SERVICES, AND BRANDS OF OTHERS THROUGH ALL PUBLIC COMMUNICATION MEANS, PARTICULARLY SPECIALIZING IN THE USE OF MOBILE, SOCIAL, AND PRINT MEDIA TO DRIVE CONSUMER INTEREST, ENGAGEMENT AND ACTION; MARKETING SERVICES, NAMELY, PROVIDING INFORMATIONAL WEB PAGES DESIGNED TO GENERATE SALES TRAFFIC VIA HYPERLINKS TO OTHER WEB SITES, IN CLASS 35 (U.S. CLS. 100, 101 AND 102).

FIRST USE 8-31-2010; IN COMMERCE 8-31-2010.

THE MARK CONSISTS OF A FIVE-POINT STAR WITH ROUNDED EDGES AND BLUNTED ENDS.

SN 77-897,835, FILED 12-21-2009.

MARIA-VICTORIA SUAREZ, EXAMINING ATTORNEY



David J. Kyffers

Director of the United States Patent and Trademark Office

United States of America

United States Patent and Trademark Office

5-PEAT

Reg. No. 4,176,036

PLEBAN, DAVID J. (UNITED STATES INDIVIDUAL)
21150 FALLS RIDGE WAY
BOCA RATON, FL 33428

Registered July 17, 2012

Int. Cl.: 25

FOR: T-SHIRTS, SHIRTS, IN CLASS 25 (U.S. CLS. 22 AND 39).

TRADEMARK

FIRST USE 5-15-2012; IN COMMERCE 5-15-2012.

PRINCIPAL REGISTER

THE MARK CONSISTS OF STANDARD CHARACTERS WITHOUT CLAIM TO ANY PARTICULAR FONT, STYLE, SIZE, OR COLOR.

SN 77-900,786, FILED 12-24-2009.

ELIZABETH KAJUBI, EXAMINING ATTORNEY



David J. Kyffers

Director of the United States Patent and Trademark Office

United States of America

United States Patent and Trademark Office



GOLDEN OAK

Reg. No. 4,176,037

Registered July 17, 2012

Int. Cl.: 45

SERVICE MARK

PRINCIPAL REGISTER

DISNEY ENTERPRISES, INC. (DELAWARE CORPORATION)
500 SOUTH BUENA VISTA STREET
BURBANK, CA 91521

FOR: PERSONAL CONCIERGE SERVICES FOR OTHERS COMPRISING MAKING REQUESTED PERSONAL ARRANGEMENTS AND RESERVATIONS, RUNNING ERRANDS AND PROVIDING CUSTOMER SPECIFIC INFORMATION TO MEET INDIVIDUAL NEEDS, ALL RENDERED IN HOTELS, RESIDENTIAL COMPLEXES AND HOMES, IN CLASS 45 (U.S. CLS. 100 AND 101).

FIRST USE 11-0-2011; IN COMMERCE 11-0-2011.

THE MARK CONSISTS OF A TREE IMAGE DESIGN WITH THE WORDING "GOLDEN OAK" UNDERNEATH.

SN 77-908,153, FILED 1-8-2010.

REGINA DRUMMOND, EXAMINING ATTORNEY



David J. Kyjars

Director of the United States Patent and Trademark Office

United States of America

United States Patent and Trademark Office

MILK MAGIC

Reg. No. 4,176,038

Registered July 17, 2012

Int. Cl.: 21

TRADEMARK

PRINCIPAL REGISTER

FDR MARKETING LLC (NEW YORK LIMITED LIABILITY COMPANY)
1 UNION SQUARE WEST
SUITE 205
NEW YORK, NY 10003

FOR: MILK CHURNS, IN CLASS 21 (U.S. CLS. 2, 13, 23, 29, 30, 33, 40 AND 50).

FIRST USE 10-31-2011; IN COMMERCE 10-31-2011.

THE MARK CONSISTS OF STANDARD CHARACTERS WITHOUT CLAIM TO ANY PARTICULAR FONT, STYLE, SIZE, OR COLOR.

NO CLAIM IS MADE TO THE EXCLUSIVE RIGHT TO USE "MILK", APART FROM THE MARK AS SHOWN.

SN 77-909,558, FILED 1-11-2010.

TIMOTHY FINNEGAN, EXAMINING ATTORNEY



David J. Kybas

Director of the United States Patent and Trademark Office

United States of America

United States Patent and Trademark Office

Performance You Demand.
Reliability You Trust.

Reg. No. 4,176,039

QUINCY COMPRESSOR LLC (DELAWARE LIMITED LIABILITY COMPANY)
701 NORTH DOBSON AVE.
BAY MINETTE, AL 36507

Registered July 17, 2012

Int. Cl.: 7

FOR: AIR COMPRESSORS AND PARTS THEREFOR, IN CLASS 7 (U.S. CLS. 13, 19, 21, 23, 31, 34 AND 35).

TRADEMARK

FIRST USE 0-0-2010; IN COMMERCE 0-0-2010.

PRINCIPAL REGISTER

THE MARK CONSISTS OF STANDARD CHARACTERS WITHOUT CLAIM TO ANY PARTICULAR FONT, STYLE, SIZE, OR COLOR.

SN 77-911,337, FILED 1-13-2010.

MICHELE SWAIN, EXAMINING ATTORNEY



David J. Kybas

Director of the United States Patent and Trademark Office

United States of America
United States Patent and Trademark Office

INFINETA

Reg. No. 4,176,040

INFINETA SYSTEMS, INC. (DELAWARE CORPORATION)
2870 ZANKER RD., #100
SAN JOSE, CA 95134

Registered July 17, 2012

Int. Cl.: 9

FOR: COMPUTER NETWORKING HARDWARE, IN CLASS 9 (U.S. CLS. 21, 23, 26, 36 AND 38).

TRADEMARK

FIRST USE 7-28-2011; IN COMMERCE 7-28-2011.

PRINCIPAL REGISTER

THE MARK CONSISTS OF STANDARD CHARACTERS WITHOUT CLAIM TO ANY PARTICULAR FONT, STYLE, SIZE, OR COLOR.

SN 77-911,523, FILED 1-13-2010.

KATHERINE CONNOLLY, EXAMINING ATTORNEY



David J. Kybas

Director of the United States Patent and Trademark Office

United States of America

United States Patent and Trademark Office



Lincoln
Financial Group

Reg. No. 4,176,041

Registered July 17, 2012

Int. Cl.: 36

SERVICE MARK

PRINCIPAL REGISTER

LINCOLN NATIONAL CORPORATION (INDIANA CORPORATION)
150 N RADNOR CHESTER ROAD
RADNOR, PA 19087

FOR: FINANCIAL AND INSURANCE SERVICES, NAMELY, LIFE INSURANCE AND ANNUITY UNDERWRITING SERVICES; FINANCIAL SERVICES IN THE NATURE OF ANNUITY INVESTMENT; FINANCIAL AND INSURANCE SERVICES, NAMELY, ADMINISTRATION AND MANAGEMENT OF ANNUITY CONTRACTS AND CONSULTATION IN THE FIELD OF DEVELOPING ANNUITY PRODUCTS FOR OTHERS; FINANCIAL CONSULTATION, NAMELY, MUTUAL FUND ADVISORY SERVICES; MUTUAL FUND INVESTMENT; ESTABLISHING MUTUAL FUNDS FOR OTHERS; FINANCIAL PLANNING AND INVESTMENT ADVISORY SERVICES; INSTITUTIONAL INVESTMENT MANAGEMENT SERVICES; INVESTMENT PLANNING SERVICES, NAMELY, INVESTMENT CONSULTATION AND ADVICE; PROVIDING INVESTMENT AND EMPLOYEE BENEFIT PROGRAMS, NAMELY, DEFERRED COMPENSATION FOR PRIVATE, PUBLIC AND TAX EXEMPT EMPLOYERS AND THEIR EMPLOYEES; AND OFFERING INDIVIDUAL RETIREMENT ACCOUNTS FOR INDIVIDUAL RETIREMENT, IN CLASS 36 (U.S. CLS. 100, 101 AND 102).

FIRST USE 6-1-2010; IN COMMERCE 6-1-2010.

OWNER OF U.S. REG. NOS. 1,169,573, 2,265,715, AND OTHERS.

NO CLAIM IS MADE TO THE EXCLUSIVE RIGHT TO USE "FINANCIAL GROUP", APART FROM THE MARK AS SHOWN.

THE MARK CONSISTS OF THE SILHOUETTE OF ABRAHAM LINCOLN WITH THE WORDS "LINCOLN FINANCIAL GROUP" STACKED BELOW THE SILHOUETTE.

SN 77-912,513, FILED 1-15-2010.

DAVID I, EXAMINING ATTORNEY



David J. Kybas

Director of the United States Patent and Trademark Office

United States of America

United States Patent and Trademark Office

ST ANDREWS LINKS

Reg. No. 4,176,042

Registered July 17, 2012

Int. Cls.: 9, 28, and 41

TRADEMARK

SERVICE MARK

PRINCIPAL REGISTER

ST ANDREWS LINKS, LTD. (UNITED KINGDOM CORPORATION)
PILMOUR HOUSE
ST ANDREWS
FIFE, UNITED KINGDOM KY16

FOR: COMPUTER GAMES SOFTWARE; COMPUTER GAME PROGRAMMES; DOWNLOAD-
ABLE COMPUTER GAMES, IN CLASS 9 (U.S. CLS. 21, 23, 26, 36 AND 38).

FIRST USE 10-27-2002; IN COMMERCE 10-27-2002.

FOR: COMPUTERIZED INTERACTIVE INDOOR GOLF SIMULATORS; AMUSEMENT
MACHINES, NAMELY, STAND-ALONE VIDEO GAME MACHINES FEATURING THE
GAME OF GOLF, IN CLASS 28 (U.S. CLS. 22, 23, 38 AND 50).

FIRST USE 6-4-2007; IN COMMERCE 6-4-2007.

FOR: ENTERTAINMENT SERVICES, NAMELY, PROVIDING AN ON-LINE COMPUTER
GAME, IN CLASS 41 (U.S. CLS. 100, 101 AND 107).

FIRST USE 6-25-2009; IN COMMERCE 6-25-2009.

THE MARK CONSISTS OF STANDARD CHARACTERS WITHOUT CLAIM TO ANY PAR-
TICULAR FONT, STYLE, SIZE, OR COLOR.

SEC. 2(F).

OWNER OF ERPN CMNTY TM OFC REG. NO. 001536317, DATED 5-23-2001, EXPIRES 3-
2-2020.

OWNER OF U.S. REG. NOS. 3,571,702, 3,594,357, AND OTHERS.

SN 77-912,917, FILED 1-15-2010.

MARY CRAWFORD, EXAMINING ATTORNEY

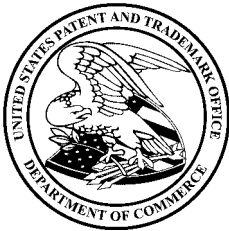

David J. Kyffers

Director of the United States Patent and Trademark Office

United States of America

United States Patent and Trademark Office



Reg. No. 4,176,043

Registered July 17, 2012

Int. Cls.: 29 and 43

TRADEMARK

SERVICE MARK

PRINCIPAL REGISTER

JONMOR INVESTMENTS, INC. (DELAWARE CORPORATION)
BAYNARD BUILDING, SUITE 103
3411 SILVERSIDE ROAD
WILMINGTON, DE 19810

FOR: MEAT, PEPPERONI, FRANKFURTERS, MEATBALLS, DELI MEATS, LUNCH KITS CONSISTING PRIMARILY OF MEAT OR CHEESE, SNACK STICKS CONSISTING PRIMARILY OF MEAT, IN CLASS 29 (U.S. CL. 46).

FIRST USE 3-31-2010; IN COMMERCE 3-31-2010.

FOR: PROVIDING INFORMATION IN THE FIELD OF RECIPES AND COOKING INFORMATION, IN CLASS 43 (U.S. CLS. 100 AND 101).

FIRST USE 3-31-2010; IN COMMERCE 3-31-2010.

OWNER OF U.S. REG. NOS. 2,532,917, 2,734,279, AND OTHERS.

THE COLOR(S) YELLOW, RED, WHITE AND BLACK IS/ARE CLAIMED AS A FEATURE OF THE MARK.

THE MARK CONSISTS OF A DEPICTION OF THE WORD "ARMOUR" IN WHITE BLOCK LETTERS WITH A LARGER "A". THE WORD "ARMOUR" IS HORIZONTAL AND INSIDE A RED OVAL WITH A YELLOW BORDER. THERE ARE THREE SMALL YELLOW STARS ABOVE THE LETTERS "R" AND "M" WHICH LEAD TO A LARGER YELLOW STAR WITH AN INSIDE BLACK STAR BORDER WHICH IS LOCATED ABOVE THE LETTERS "O" AND "U" AND POSITIONED HALF WAY IN THE RED OVAL, OVERLAYING THE YELLOW BORDER, AND OUTSIDE THE YELLOW BORDER.

SN 77-914,462, FILED 1-19-2010.

AMY KELLY, EXAMINING ATTORNEY



David J. Kyffers

Director of the United States Patent and Trademark Office

United States of America

United States Patent and Trademark Office

TOTEM CIRQUE DU SOLEIL

Reg. No. 4,176,044

CIRQUE DU SOLEIL HOLDING USA, INC. (DELAWARE CORPORATION)
980 KELLY JOHNSON DRIVE

Registered July 17, 2012

LAS VEGAS, NV 89119

**Int. Cls.: 6, 9, 16, 18, 21,
25, 28, and 41**

FOR: METAL KEY CHAINS, METAL KEY RINGS, IN CLASS 6 (U.S. CLS. 2, 12, 13, 14, 23, 25 AND 50).

FIRST USE 3-3-2011; IN COMMERCE 3-3-2011.

TRADEMARK

FOR: PRE-RECORDED MEDIA FOR THE STORAGE AND REPRODUCTION OF SOUND AND/OR VIDEO, FEATURING MUSIC AND/OR THEATRICAL OR DRAMATIC PERFORMANCES, NAMELY, AUDIO DISCS; MOTION PICTURE FILMS FEATURING MUSICAL, THEATRICAL AND DRAMATIC PERFORMANCES; CASES FOR HOLDING DISCS; MUSICAL SOUND AND VIDEO RECORDINGS; DOWNLOADABLE MUSICAL SOUND AND VIDEO RECORDINGS, IN CLASS 9 (U.S. CLS. 21, 23, 26, 36 AND 38).

SERVICE MARK

FIRST USE 4-8-2010; IN COMMERCE 4-8-2010.

PRINCIPAL REGISTER

FOR: PAPER GOODS, NAMELY, SOUVENIR PROGRAMS, BOOKS AND COMMEMORATIVE BOOKS IN THE FIELD OF CIRCUSES AND THE ARTS, IN CLASS 16 (U.S. CLS. 2, 5, 22, 23, 29, 37, 38 AND 50).

FIRST USE 3-3-2011; IN COMMERCE 3-3-2011.



FOR: BAGS AND CASES, NAMELY, TOTE BAGS, IN CLASS 18 (U.S. CLS. 1, 2, 3, 22 AND 41).

FIRST USE 3-3-2011; IN COMMERCE 3-3-2011.

FOR: HOUSEHOLD AND NOVELTY ITEMS, NAMELY, MUGS, CUPS, PAPER AND PLASTIC CUPS, DRINKING GLASSES, IN CLASS 21 (U.S. CLS. 2, 13, 23, 29, 30, 33, 40 AND 50).

FIRST USE 3-3-2011; IN COMMERCE 3-3-2011.

David J. Kybas

FOR: CLOTHING, WEARING APPAREL AND ACCESSORIES, NAMELY, T-SHIRTS; HEADGEAR, NAMELY, CAPS, IN CLASS 25 (U.S. CLS. 22 AND 39).

Reg. No. 4,176,044 FIRST USE 3-3-2011; IN COMMERCE 3-3-2011.

FOR: CHRISTMAS TREE DECORATIONS, IN CLASS 28 (U.S. CLS. 22, 23, 38 AND 50).

FIRST USE 3-3-2011; IN COMMERCE 3-3-2011.

FOR: ENTERTAINMENT SERVICES, NAMELY, CONCEPTION, CREATION, PRODUCTION, AND PRESENTATION OF THEATRICAL PERFORMANCES FEATURING ARTISTIC ACTS, COMICAL ACTS, CHOREOGRAPHY AND/OR DANCE; CONCEPTION, CREATION, PRODUCTION AND PRESENTATION OF AUDIO-VISUAL WORKS, NAMELY, TELEVISION PROGRAMS, RADIO PROGRAMS, AND MOTION PICTURE FILMS; PRODUCTION OF MULTIMEDIA THEATRICAL PERFORMANCES, IN CLASS 41 (U.S. CLS. 100, 101 AND 107).

FIRST USE 4-8-2010; IN COMMERCE 4-8-2010.

THE MARK CONSISTS OF STANDARD CHARACTERS WITHOUT CLAIM TO ANY PARTICULAR FONT, STYLE, SIZE, OR COLOR.

OWNER OF U.S. REG. NOS. 1,947,479, 2,006,591, AND OTHERS.

THE ENGLISH TRANSLATION OF "CIRQUE DU SOLEIL" IN THE MARK IS "CIRCUS OF THE SUN".

SN 77-915,460, FILED 1-20-2010.

JEFF DEFORD, EXAMINING ATTORNEY

United States of America

United States Patent and Trademark Office

IRON BOW
TECHNOLOGIES

Reg. No. 4,176,045

IRON BOW TECHNOLOGIES, LLC (VIRGINIA LIMITED LIABILITY COMPANY)
4800 WESTFIELDS BOULEVARD, SUITE 300
CHANTILLY, VA 20151

Registered July 17, 2012

Int. Cls.: 35, 38, and 42

FOR: BUSINESS CONSULTING AND INFORMATION SERVICES, IN CLASS 35 (U.S. CLS. 100, 101 AND 102).

SERVICE MARK

FIRST USE 1-25-2010; IN COMMERCE 1-25-2010.

PRINCIPAL REGISTER

FOR: ELECTRONIC MAIL AND MESSAGING SERVICES; SATELLITE COMMUNICATION SERVICES; TELECOMMUNICATION CONSULTATION IN THE NATURE OF TECHNICAL CONSULTING IN THE FIELD OF AUDIO, TEXT AND VISUAL DATA TRANSMISSION AND COMMUNICATION; TELECOMMUNICATIONS CONSULTATION; TELEPHONY COMMUNICATION SERVICES; TRANSMISSION OF INFORMATION BY ELECTRONIC COMMUNICATIONS NETWORKS; VOICE OVER IP SERVICES; WIRELESS BROADBAND COMMUNICATION SERVICES, IN CLASS 38 (U.S. CLS. 100, 101 AND 104).

FIRST USE 1-25-2010; IN COMMERCE 1-25-2010.

FOR: BACK-UP SERVICES FOR COMPUTER HARD DRIVE DATA; BUSINESS TECHNOLOGY SOFTWARE CONSULTATION SERVICES; COMPUTER CONSULTATION; COMPUTER CONSULTATION IN THE FIELD OF COMPUTER SECURITY; COMPUTER DISASTER RECOVERY PLANNING; COMPUTER HARDWARE AND SOFTWARE DESIGN; COMPUTER NETWORK DESIGN FOR OTHERS; COMPUTER PROGRAMMING SERVICES; COMPUTER PROJECT MANAGEMENT SERVICES; COMPUTER SECURITY CONSULTANCY; COMPUTER SERVICE, NAMELY, ACTING AS AN APPLICATION SERVICE PROVIDER IN THE FIELD OF KNOWLEDGE MANAGEMENT TO HOST COMPUTER APPLICATION SOFTWARE FOR CREATING SEARCHABLE DATABASES OF INFORMATION AND DATA; COMPUTER SERVICES, NAMELY, COMPUTER SYSTEM ADMINISTRATION FOR OTHERS; COMPUTER SERVICES, NAMELY, DATA RECOVERY SERVICES; COMPUTER SERVICES, NAMELY, REMOTE AND ON-SITE MANAGEMENT OF THE INFORMATION TECHNOLOGY (IT) SYSTEMS OF OTHERS; COMPUTER SOFTWARE CONSULTING; COMPUTER SYSTEMS INTEGRATION SERVICES; CONSULTING IN THE FIELD OF CONFIGURATION MANAGEMENT FOR COMPUTER HARDWARE AND SOFTWARE; CONSULTING IN THE FIELD OF INFORMATION TECHNOLOGY; CONSULTING IN THE FIELD OF IT PROJECT MANAGEMENT; CONSULTING IN THE FIELD OF TELECOMMUNICATIONS TECHNOLOGY; CONSULTING IN THE FIELD OF VIRTUALIZATION TECHNOLOGIES FOR ENTERPRISES



David J. Kybas

Director of the United States Patent and Trademark Office

Reg. No. 4,176,045 AND BUSINESSES; DATA CONVERSION OF ELECTRONIC INFORMATION; DATA MIGRATION SERVICES; DATA WAREHOUSING; DESIGN AND DEVELOPMENT OF NETWORKS; DESIGN AND DEVELOPMENT OF WIRELESS COMPUTER NETWORKS; DESIGN, DEPLOYMENT AND MANAGEMENT OF WIRELESS NETWORKS FOR OTHERS; DEVELOPMENT OF SECURITY SYSTEMS AND CONTINGENCY PLANNING FOR INFORMATION SYSTEMS; ENGINEERING; INFORMATION TECHNOLOGY CONSULTATION; INTEGRATION OF COMPUTER SYSTEMS AND NETWORKS; IT CONSULTING SERVICES; IT INTEGRATION SERVICES; MAINTENANCE OF COMPUTER SOFTWARE RELATING TO COMPUTER SECURITY AND PREVENTION OF COMPUTER RISKS; PLANNING AND DEVELOPMENT OF ELECTRONIC COMMUNICATIONS NETWORKS; PLANNING, DESIGN AND IMPLEMENTATION OF VIRTUALIZATION TECHNOLOGIES FOR ENTERPRISES AND BUSINESSES; PROFESSIONAL COMPUTER SERVICES, NAMELY, NETWORK ANALYSIS, LAN/WAN DESIGN, WIRELESS ENGINEERING, VIRTUALIZATION AND COMPUTER PROJECT MANAGEMENT; PROVIDING PLANNING AND ENGINEERING SERVICES IN THE FIELD OF INFORMATION AND COMMUNICATIONS NETWORKS; RECOVERY OF COMPUTER DATA; REMOTE COMPUTER BACKUP SERVICES; REMOTE COMPUTER NETWORK TECHNICAL MONITORING AND SOFTWARE MAINTENANCE SERVICES; SATELLITE TELECOMMUNICATIONS TECHNOLOGY SERVICE TO ALLOW EFFICIENCIES OF THE CARRIER BY CREATING EFFICIENT USE OF BANDWIDTH ON A SATELLITE TRANSPONDER; TECHNICAL CONSULTATION IN THE FIELD OF REAL-TIME RECONFIGURABLE WIRELESS COMMUNICATION HANDSETS AND NETWORK EQUIPMENT FOR USE IN WIDEBAND COMMUNICATIONS; TECHNICAL CONSULTING AND ASSISTANCE WITH COMPUTER-BASED INFORMATION SYSTEMS AND COMPONENTS; TECHNICAL SUPPORT SERVICES, NAMELY, TROUBLESHOOTING IN THE NATURE OF DIAGNOSING COMPUTER HARDWARE AND SOFTWARE PROBLEMS; TECHNICAL SUPPORT, NAMELY, MONITORING OF NETWORK SYSTEMS; TECHNICAL SUPPORT, NAMELY, PROVIDING BACK-UP COMPUTER PROGRAMS AND FACILITIES, IN CLASS 42 (U.S. CLS. 100 AND 101).

FIRST USE 1-25-2010; IN COMMERCE 1-25-2010.

NO CLAIM IS MADE TO THE EXCLUSIVE RIGHT TO USE "TECHNOLOGIES", APART FROM THE MARK AS SHOWN.

THE MARK CONSISTS OF THE WORDING "IRON BOW", WITH AN ARCHING LINE BETWEEN "IRON" AND "BOW", AND THE WORD "TECHNOLOGIES" UNDER THE "BOW".

SN 77-919,017, FILED 1-25-2010.

KHANH LE, EXAMINING ATTORNEY

United States of America

United States Patent and Trademark Office

INTRODUCING THE WORLD...ONE NAME BADGE AT A TIME

Reg. No. 4,176,046

CONTEMPORARY, INC. (WISCONSIN CORPORATION)

Registered July 17, 2012

1544 NORTH 8TH STREET
MANITOWOC, WI 54221

**Int. Cls.: 6, 9, 14, 20, 26,
and 40**

FOR: NAME BADGES, NAME PLATES AND NON-MECHANICAL, NON-LUMINOUS SIGNS MADE OF METAL AND PLASTIC, BUT PRIMARILY OF METAL; WALL PLAQUES MADE OF COMMON METAL; AWARD ADAPTERS, NAMELY, METAL ADAPTERS FOR ATTACHING TO BADGES TO HOLD AWARD MEDALLIONS OR ACHIEVEMENT RECOGNITION TAGS, IN CLASS 6 (U.S. CLS. 2, 12, 13, 14, 23, 25 AND 50).

TRADEMARK

SERVICE MARK

FIRST USE 8-1-2010; IN COMMERCE 8-1-2010.

PRINCIPAL REGISTER

FOR: SOFTWARE FOR PRINTING NAME BADGES, IN CLASS 9 (U.S. CLS. 21, 23, 26, 36 AND 38).

FIRST USE 8-1-2010; IN COMMERCE 8-1-2010.

FOR: MERIT PINS, ORNAMENTAL MERIT PINS, IN CLASS 14 (U.S. CLS. 2, 27, 28 AND 50).

FIRST USE 8-1-2010; IN COMMERCE 8-1-2010.



FOR: DECORATIVE PLAQUES OF PLASTIC OR WOOD; PANELS AND DECORATIVE PLATES OF PLASTIC OR WOOD FOR USE AS PART OF DECORATIVE PLAQUES; WALL PLAQUES MADE OF PLASTIC OR WOOD; SELF-ADHERING BLANK IDENTIFICATION PLATES MADE PRIMARILY OF PLASTIC; PLASTIC HOLDERS FOR BADGES; PLASTIC DOMES FOR AFFIXING TO AND COVERING GRAPHICS AND TEXT ON IDENTIFICATION, NAME OR RECOGNITION BADGES; AWARD ADAPTERS, NAMELY, PLASTIC ADAPTERS FOR ATTACHING TO BADGES TO HOLD AWARD MEDALLIONS OR ACHIEVEMENT RECOGNITION TAGS, IN CLASS 20 (U.S. CLS. 2, 13, 22, 25, 32 AND 50).

FIRST USE 8-1-2010; IN COMMERCE 8-1-2010.

David J. Kyffers

FOR: DECORATIVE RIBBONS, IN CLASS 26 (U.S. CLS. 37, 39, 40, 42 AND 50).

FIRST USE 8-1-2010; IN COMMERCE 8-1-2010.

Reg. No. 4,176,046 FOR: CUSTOM ENGRAVING OF IDENTIFICATION PLATES, PLAQUES AND SIGNS TO THE ORDER AND SPECIFICATION OF OTHERS, IN CLASS 40 (U.S. CLS. 100, 103 AND 106).

FIRST USE 8-1-2010; IN COMMERCE 8-1-2010.

THE MARK CONSISTS OF STANDARD CHARACTERS WITHOUT CLAIM TO ANY PARTICULAR FONT, STYLE, SIZE, OR COLOR.

SN 77-919,465, FILED 1-25-2010.

DOUGLAS LEE, EXAMINING ATTORNEY

United States of America

United States Patent and Trademark Office

LAURA LYNN

Reg. No. 4,176,047

INGLES MARKETS, INC. (NORTH CAROLINA CORPORATION)
P. O. BOX 6676
ASHEVILLE, NC 28816

Registered July 17, 2012

**Int. Cls.: 3, 8, 9, 11, 16,
21, 22, 29, 30, 31, and 32**

FOR: DETERGENT SOAPS , IN CLASS 3 (U.S. CLS. 1, 4, 6, 50, 51 AND 52).
FIRST USE 10-5-1993; IN COMMERCE 10-5-1993.

TRADEMARK

FOR: CUTLERY; FORKS, SPOONS, CAN OPENERS; EATING UTENSILS, NAMELY, KNIVES;
ICE TONGS, IN CLASS 8 (U.S. CLS. 23, 28 AND 44).

PRINCIPAL REGISTER

FIRST USE 8-12-2003; IN COMMERCE 8-12-2003.

FOR: MEASURING UTENSILS, NAMELY, MEASURING SPOONS; THERMOMETERS, IN
CLASS 9 (U.S. CLS. 21, 23, 26, 36 AND 38).

FIRST USE 2-6-2007; IN COMMERCE 2-6-2007.

FOR: APPARATUS FOR LIGHTING, NAMELY, LIGHT BULBS AND FLASHLIGHTS, IN
CLASS 11 (U.S. CLS. 13, 21, 23, 31 AND 34).

FIRST USE 3-28-2000; IN COMMERCE 3-28-2000.

FOR: BATHROOM TISSUE; PAPER FILTERS FOR COFFEE MAKERS; PAPER DIAPERS;
FACIAL TISSUE; PAPER NAPKINS, AND PAPER TOWELS; PLASTIC FOOD STORAGE
BAGS FOR HOUSEHOLD USE; CARDBOARD BOXES BEING GIFT CONTAINERS; REFUSE-
COLLECTION BAGS OF PAPER; REFUSE-COLLECTION BAGS OF PLASTIC, IN CLASS
16 (U.S. CLS. 2, 5, 22, 23, 29, 37, 38 AND 50).

FIRST USE 7-28-1990; IN COMMERCE 7-28-1990.

FOR: HOUSEHOLD OR KITCHEN UTENSILS, NAMELY, SERVING UTENSILS BEING
SPATULAS, SERVING SPOONS, MIXING BOWLS, CHEESE GRATERS, SERVING TONGS,
CUTTING BOARDS, STRAINERS, GARLIC PRESS, SQUEEGEES OF VARIOUS TYPES,
AND CONTAINERS FOR HOUSEHOLD OR KITCHEN USE; COMBS AND CLEANING
SPONGES; ARTICLES FOR CLEANING PURPOSES, NAMELY, CLEANING BRUSHES FOR
HOUSEHOLD USE, WASTE CONTAINERS FOR HOUSEHOLD USE, TOILET BOWL



David J. Kyffers

Director of the United States Patent and Trademark Office

Reg. No. 4,176,047 CLEANER TOOL BEING A WAND WITH A BRUSH, WINDOW SQUEEGEE; CUPS, PLATES; HOUSEHOLD CONTAINERS FOR FOOD , IN CLASS 21 (U.S. CLS. 2, 13, 23, 29, 30, 33, 40 AND 50).

FIRST USE 1-10-1994; IN COMMERCE 1-10-1994.

FOR: SACKS AND BAGS FOR THE TRANSPORTATION OR STORAGE OF MATERIALS IN BULK, IN CLASS 22 (U.S. CLS. 1, 2, 7, 19, 22, 42 AND 50).

FIRST USE 7-28-1990; IN COMMERCE 7-28-1990.

FOR: APPLESAUCE, BACON, BAKED BEANS, BUTTER AND MARGARINE, CANNED FRUIT, CANNED COOKED MEAT; CANNED MILK; CANNED SOUP; CANNED VEGETABLES; CHEESE; NON-DAIRY COFFEE CREAMERS; COOKING OIL, COTTAGE CHEESE, CREAM CHEESE; NON-DAIRY CREAMERS, EGGS; DIPS EXCLUDING SALSA AND OTHER SAUCES USED AS DIPS; DRIED FRUIT; DRIED BEANS; DRIED SOUP; EGG SUBSTITUTES; FROZEN CHICKEN; FROZEN ENTREES CONSISTING PRIMARILY OF MEAT, FISH, POULTRY OR VEGETABLES; FROZEN FISH; FROZEN FRUIT; FROZEN MEAT; FROZEN ONION RINGS; FROZEN POTATOES; FROZEN SHRIMP; FROZEN VEGETABLES SOLD IN BAGS; FROZEN WHIPPED TOPPING; FRUIT-BASED SNACK FOODS; INSTANT POTATOES; JELLY; LUNCHEON MEATS; MILK; PROCESSED NUTS; ROASTED NUTS; PROCESSED OLIVES; PARMESAN CHEESE; PEANUT BUTTER; PICKLES; FRUIT-BASED PIE FILLING; POTATO CHIPS; REFRIGERATED DAIRY-BASED DIPS; REFRIGERATED MILK; SAUSAGE; SHORTENING; SNACK MIX CONSISTING PRIMARILY OF PROCESSED FRUITS, PROCESSED NUTS AND/OR RAISINS; SOUR CREAM; AND YOGURT, ALL FOR SALE IN RETAIL GROCERY STORES, IN CLASS 29 (U.S. CL. 46).

FIRST USE 5-22-1985; IN COMMERCE 5-22-1985.

FOR: RICE SOLD IN BAGS AND BOXES; BAGELS; BAKING MIXES, NAMELY, CAKE MIXES; FROSTING; BREAD; BREAD CRUMBS; READY-TO-EAT CHOCOLATE-BASED BREAKFAST FOOD BARS AND CEREAL DERIVED FOOD BARS, AND GRAIN-BASED BREAKFAST FOOD BARS; CANDY; CANNED PASTA, PROCESSED CEREALS, BREAKFAST CEREALS; FROZEN, PREPARED AND PACKAGED CHINESE FOOD MEALS CONSISTING PRIMARILY OF PASTA OR RICE; COCOA; COFFEE; CONDIMENTS, NAMELY, MUSTARD AND KETCHUP; COOKIES AND CRACKERS, CROUTONS; DESSERTS, NAMELY, BAKERY DESSERTS; SALAD DRESSING MIXES; DRIED PASTA; FLOUR AND CORNMEAL; FROZEN BREAD; FROZEN ENTREES CONSISTING PRIMARILY OF PASTA OR RICE; FROZEN HUSHPUPPIES; FROZEN PIE SHELLS; FROZEN PIZZA; GRITS; HONEY; ICE CREAM; CONES FOR ICE CREAM; MARSHMALLOWS; MAYONNAISE; FROZEN, PREPARED AND PACKAGED MEXICAN FOOD MEALS CONSISTING PRIMARILY OF PASTA OR RICE; MICROWAVE POPCORN; OATMEAL; PANCAKE MIX; CHOCOLATE-BASED PIE FILLINGS; CUSTARD-BASED PIE FILLINGS; POPCORN; PRETZELS; REFRIGERATED DOUGH; REFRIGERATED PUDDING; REFRIGERATED TORTILLAS; RICE CAKES; SALAD DRESSINGS; SAUCES; SHERBET; SNACK CAKES; SNACK CRACKERS; SNACK MIX CONSISTING PRIMARILY OF CRACKERS, PRETZELS, CANDIED NUTS AND/OR POPPED POPCORN; SPAGHETTI SAUCE; SPICES; STUFFING MIXES CONTAINING BREAD; SUGAR, CORN SYRUP AND TABLE SYRUP; TEA; TOASTER PASTRIES; VINEGAR, IN CLASS 30 (U.S. CL. 46).

FIRST USE 7-14-1990; IN COMMERCE 7-14-1990.

FOR: CAT FOOD; UNPROCESSED CEREALS; DOG BISCUITS; DOG TREATS; AND DOG FOODS, IN CLASS 31 (U.S. CLS. 1 AND 46).

FIRST USE 7-28-1990; IN COMMERCE 7-28-1990.

Reg. No. 4,176,047 FOR: BEVERAGES, NAMELY, MINERAL WATER AND SPARKLING WATER, BOTTLED APPLE JUICE AND PINEAPPLE JUICE; CANNED APPLE JUICE AND PINEAPPLE JUICE; CHILLED APPLE JUICE AND PINEAPPLE JUICE; FRUIT FLAVORED DRINKS; POWDERS USED FOR MIX-AT-HOME DRINKS BEING FRUIT-BASED BEVERAGES; FLAVORED WATERS; FROZEN APPLE JUICE AND PINEAPPLE JUICE; SOFT DRINKS, DRINKING WATER; AND BOTTLED WATER, IN CLASS 32 (U.S. CLS. 45, 46 AND 48).

FIRST USE 7-28-1990; IN COMMERCE 7-28-1990.

THE MARK CONSISTS OF STANDARD CHARACTERS WITHOUT CLAIM TO ANY PARTICULAR FONT, STYLE, SIZE, OR COLOR.

OWNER OF U.S. REG. NO. 1,270,102.

THE NAME "LAURA LYNN" IDENTIFIES A LIVING INDIVIDUAL WHOSE CONSENT IS OF RECORD.

SN 77-924,899, FILED 2-1-2010.

BRENDAN REGAN, EXAMINING ATTORNEY

United States of America

United States Patent and Trademark Office

ABZIL

Reg. No. 4,176,048

Registered July 17, 2012

Int. Cl.: 10

TRADEMARK

PRINCIPAL REGISTER

3M COMPANY (DELAWARE CORPORATION)
3M CENTER
2501 HUDSON ROAD
ST. PAUL, MN 55144

FOR: ORTHODONTIC APPLIANCES, IN CLASS 10 (U.S. CLS. 26, 39 AND 44).

FIRST USE 1-0-2012; IN COMMERCE 1-0-2012.

THE MARK CONSISTS OF STANDARD CHARACTERS WITHOUT CLAIM TO ANY PARTICULAR FONT, STYLE, SIZE, OR COLOR.

THE WORDING "ABZIL" HAS NO MEANING IN A FOREIGN LANGUAGE.

SN 77-926,219, FILED 2-2-2010.

RONALD DELGIZZI, EXAMINING ATTORNEY



David J. Kybas

Director of the United States Patent and Trademark Office

United States of America

United States Patent and Trademark Office

Imaginary Disasters

Reg. No. 4,176,049

PRINCE, ALAN (UNITED STATES INDIVIDUAL)

Registered July 17, 2012

P.O. BOX 193
DOWNERS GROVE, IL 60515

Int. Cl.: 41

FOR: ENTERTAINMENT, NAMELY, LIVE MUSIC CONCERTS; ENTERTAINMENT, NAMELY, LIVE PERFORMANCES BY A MUSICAL BAND, IN CLASS 41 (U.S. CLS. 100, 101 AND 107).

SERVICE MARK

FIRST USE 2-1-2009; IN COMMERCE 5-1-2009.

PRINCIPAL REGISTER

THE MARK CONSISTS OF STANDARD CHARACTERS WITHOUT CLAIM TO ANY PARTICULAR FONT, STYLE, SIZE, OR COLOR.

SN 77-928,444, FILED 2-4-2010.

TRACY CROSS, EXAMINING ATTORNEY



David J. Kyffers

Director of the United States Patent and Trademark Office

United States of America
United States Patent and Trademark Office

EARDISH

Reg. No. 4,176,050

Registered July 17, 2012

Int. Cl.: 41

SERVICE MARK

PRINCIPAL REGISTER

EARDISH CORPORATION (NEVADA CORPORATION)
SUITE 200
11400 W. OLYMPIC BLVD
LOS ANGELES, CA 90064

FOR: PROVIDING INFORMATION ABOUT MUSICAL ARTISTS, PERFORMERS, AND LIVE
MUSIC ENTERTAINMENT EVENTS, IN CLASS 41 (U.S. CLS. 100, 101 AND 107).

FIRST USE 5-11-2012; IN COMMERCE 5-11-2012.

THE MARK CONSISTS OF STANDARD CHARACTERS WITHOUT CLAIM TO ANY PAR-
TICULAR FONT, STYLE, SIZE, OR COLOR.

SN 77-930,919, FILED 2-8-2010.

JEFF DEFORD, EXAMINING ATTORNEY



David J. Kyros

Director of the United States Patent and Trademark Office

United States of America

United States Patent and Trademark Office

STORYSPARKS

Reg. No. 4,176,051

BARNESANDNOBLE.COM LLC (DELAWARE LIMITED LIABILITY COMPANY)
76 9TH AVENUE

Registered July 17, 2012

NEW YORK, NY 10011

Int. Cls.: 41 and 42

FOR: PROVIDING INTERACTIVE STORY BOOK TEMPLATES FOR USE IN CREATING STORIES FEATURING IDEAS FOR STORIES, CHARACTERS, FIRST LINES OF THE STORIES, WRITING HINTS, PLOT SUGGESTIONS AND DIGITAL IMAGES, IN CLASS 41 (U.S. CLS. 100, 101 AND 107).

SERVICE MARK

PRINCIPAL REGISTER

FIRST USE 10-31-2009; IN COMMERCE 10-31-2009.

FOR: PROVIDING A WEB SITE FEATURING TECHNOLOGY THAT ENABLES USERS TO CREATE STORIES FEATURING IDEAS FOR STORIES, CHARACTERS, FIRST LINES OF THE STORIES, WRITING HINTS, PLOT SUGGESTIONS AND DIGITAL IMAGES; PROVIDING A WEB-BASED SERVICE FEATURING TECHNOLOGY THAT ENABLES USERS TO CREATE AND MANAGE THE PRODUCTION AND PUBLICATION OF ELECTRONIC BOOKS (E-BOOKS), HARD AND SOFT COVER BOOKS AND RELATED DIGITAL CONTENT AND OFFER THEM FOR SALE TO THE GENERAL PUBLIC, IN CLASS 42 (U.S. CLS. 100 AND 101).

FIRST USE 10-31-2009; IN COMMERCE 10-31-2009.

THE MARK CONSISTS OF STANDARD CHARACTERS WITHOUT CLAIM TO ANY PARTICULAR FONT, STYLE, SIZE, OR COLOR.

SN 77-934,314, FILED 2-12-2010.

HOWARD FRIEDMAN, EXAMINING ATTORNEY



David J. Kyros

Director of the United States Patent and Trademark Office

United States of America

United States Patent and Trademark Office

Edward Van Halen

Reg. No. 4,176,052

Registered July 17, 2012

Int. Cl.: 25

TRADEMARK

PRINCIPAL REGISTER

ELVH INC (CALIFORNIA CORPORATION)
STE 1300
10100 SANTA MONICA BLVD C/O NIGRO KARLIN
LOS ANGELES, CA 90067

FOR: T-SHIRTS; TOPS, IN CLASS 25 (U.S. CLS. 22 AND 39).

FIRST USE 11-20-2009; IN COMMERCE 11-20-2009.

THE MARK CONSISTS OF STANDARD CHARACTERS WITHOUT CLAIM TO ANY PARTICULAR FONT, STYLE, SIZE, OR COLOR.

OWNER OF U.S. REG. NOS. 2,853,393, 3,701,926, AND OTHERS.

THE NAME(S), PORTRAIT(S), AND/OR SIGNATURE(S) SHOWN IN THE MARK IDENTIFIES "EDWARD VAN HALEN", WHOSE CONSENT(S) TO REGISTER IS MADE OF RECORD.

SN 77-935,059, FILED 2-12-2010.

DAVID I, EXAMINING ATTORNEY



David J. Kyfos

Director of the United States Patent and Trademark Office

United States of America

United States Patent and Trademark Office

OBVIOUS

Reg. No. 4,176,053

Registered July 17, 2012

Int. Cl.: 25

TRADEMARK

PRINCIPAL REGISTER

KARMAN, INC. (COLORADO CORPORATION)
14100 EAST 35TH PLACE
SUITE 100
AURORA, CO 80011

FOR: FOOTWEAR, HEADWEAR AND CLOTHING, NAMELY, SHIRTS, IN CLASS 25 (U.S. CLS. 22 AND 39).

FIRST USE 7-22-2010; IN COMMERCE 7-22-2010.

THE MARK CONSISTS OF STANDARD CHARACTERS WITHOUT CLAIM TO ANY PARTICULAR FONT, STYLE, SIZE, OR COLOR.

SN 77-935,437, FILED 2-14-2010.

DEIRDRE ROBERTSON, EXAMINING ATTORNEY



David J. Kybas

Director of the United States Patent and Trademark Office

United States of America

United States Patent and Trademark Office



Reg. No. 4,176,054

FAIR OAKS FARMS BRANDS, INC. (DELAWARE CORPORATION)
1001 WEST ADAMS STREET
CHICAGO, IL 60607

Registered July 17, 2012

Int. Cls.: 5 and 32

FOR: DIETARY AND NUTRITIONAL SUPPLEMENTS, DIETARY SUPPLEMENTAL DRINKS, NUTRITIONAL DRINKS USED FOR MEAL REPLACEMENT, AND NUTRITIONAL SUPPLEMENTS, ALL OF THE FOREGOING CONTAINING MILK AND HONEY, IN CLASS 5 (U.S. CLS. 6, 18, 44, 46, 51 AND 52).

TRADEMARK

PRINCIPAL REGISTER

FIRST USE 5-20-2010; IN COMMERCE 5-20-2010.

FOR: ENERGY DRINKS CONTAINING MILK AND HONEY, IN CLASS 32 (U.S. CLS. 45, 46 AND 48).

FIRST USE 5-20-2010; IN COMMERCE 5-20-2010.

OWNER OF U.S. REG. NOS. 3,776,424 AND 3,779,656.

THE COLOR(S) ORANGE, GOLD, BLACK AND WHITE IS/ARE CLAIMED AS A FEATURE OF THE MARK.

SEC. 2(F).

NO CLAIM IS MADE TO THE EXCLUSIVE RIGHT TO USE "HONEY MILK", APART FROM THE MARK AS SHOWN.

THE MARK CONSISTS OF THE PHRASE "ATHLETES HONEY MILK" IN STYLIZED FONT AT AN ANGLE FROM LOWER LEFT TO UPPER RIGHT WITH THE WORD "ATHLETES" IN ORANGE IMMEDIATELY ABOVE THE WORD "HONEY" IN GOLD WITH ORANGE ACCENTS IMMEDIATELY ABOVE THE WORD "MILK" IN WHITE, THE WORDS "HONEY" AND "MILK" BEING OUTLINED IN BLACK.

SN 77-936,403, FILED 2-16-2010.

SARA BENJAMIN, EXAMINING ATTORNEY



David J. Kyros

Director of the United States Patent and Trademark Office

United States of America

United States Patent and Trademark Office

RADISPHERE

Reg. No. 4,176,055

Registered July 17, 2012

Int. Cl.: 44

SERVICE MARK

PRINCIPAL REGISTER

RADISPHERE NATIONAL RADIOLOGY GROUP, INC. (DELAWARE CORPORATION)
23625 COMMERCE PARK, SUITE 204
BEACHWOOD, OH 44122

FOR: MEDICAL SERVICES, NAMELY, PROVIDING MEDICAL INFORMATION, MEDICAL EVALUATION IN THE NATURE OF MEDICAL ASSESSMENT OF RADIOLOGICAL IMAGES, AND MEDICAL CONSULTANCY AND ADVICE IN THE FIELD OF RADIOLOGY AND MEDICAL IMAGING; PREPARING RADIOLOGY INTERPRETATION REPORTS FOR PHYSICIANS, HEALTHCARE PROVIDERS, AND MEDICAL IMAGING CENTERS, IN CLASS 44 (U.S. CLS. 100 AND 101).

FIRST USE 4-7-2010; IN COMMERCE 4-7-2010.

THE MARK CONSISTS OF STANDARD CHARACTERS WITHOUT CLAIM TO ANY PARTICULAR FONT, STYLE, SIZE, OR COLOR.

SN 77-937,090, FILED 2-16-2010.

DARRYL SPRUILL, EXAMINING ATTORNEY



David J. Kyffers

Director of the United States Patent and Trademark Office

United States of America

United States Patent and Trademark Office

DIG PINK

Reg. No. 4,176,056

THE SIDE-OUT FOUNDATION (VIRGINIA CORPORATION)
3935 UNIVERSITY DRIVE #8
FAIRFAX, VA 22030

Registered July 17, 2012

Int. Cl.: 25

FOR: ATHLETIC APPAREL, NAMELY, SHIRTS AND ATHLETIC UNIFORMS, IN CLASS 25 (U.S. CLS. 22 AND 39).

TRADEMARK

FIRST USE 7-0-2009; IN COMMERCE 7-0-2009.

PRINCIPAL REGISTER

THE MARK CONSISTS OF STANDARD CHARACTERS WITHOUT CLAIM TO ANY PARTICULAR FONT, STYLE, SIZE, OR COLOR.

OWNER OF U.S. REG. NO. 3,575,528.

NO CLAIM IS MADE TO THE EXCLUSIVE RIGHT TO USE "PINK", APART FROM THE MARK AS SHOWN.

SN 77-938,408, FILED 2-18-2010.

MICHAEL WIENER, EXAMINING ATTORNEY



David J. Kybas

Director of the United States Patent and Trademark Office

United States of America

United States Patent and Trademark Office

CUPID INTIMATES THE BETTER WHY? COMPANY

Reg. No. 4,176,057

CUPID FOUNDATIONS, INC. (NEW YORK CORPORATION)
475 PARK AVENUE SOUTH
NEW YORK, NY 10016

Registered July 17, 2012

Int. Cl.: 25

FOR: UNDERGARMENTS, IN CLASS 25 (U.S. CLS. 22 AND 39).

TRADEMARK

FIRST USE 12-21-2011; IN COMMERCE 12-21-2011.

PRINCIPAL REGISTER

THE MARK CONSISTS OF STANDARD CHARACTERS WITHOUT CLAIM TO ANY PARTICULAR FONT, STYLE, SIZE, OR COLOR.

OWNER OF U.S. REG. NOS. 1,394,983 AND 3,699,658.

NO CLAIM IS MADE TO THE EXCLUSIVE RIGHT TO USE "INTIMATES", APART FROM THE MARK AS SHOWN.

SN 77-940,177, FILED 2-19-2010.

JASON TURNER, EXAMINING ATTORNEY



David J. Kyffers

Director of the United States Patent and Trademark Office

United States of America

United States Patent and Trademark Office

PALFLEET TRUCK EQUIPMENT

Reg. No. 4,176,058

Registered July 17, 2012

Int. Cl.: 12

TRADEMARK

PRINCIPAL REGISTER

PALTEC TRUCK EQUIPMENT COMPANY (DELAWARE CORPORATION)
4151 WEST STATE ROUTE 18
TIFFIN, OH 44883

FOR: SERVICE TRUCKS, SERVICE VANS, SPECIAL DUTY TRUCKS, SPECIAL DUTY VANS FEATURING SPECIAL PURPOSE TRUCK BODIES AND STORAGE BINS SOLD THEREWITH WITH ASSOCIATED EQUIPMENT AND ACCESSORIES, IN THE NATURE OF TRUCK MOUNTED MATERIAL HANDLING EQUIPMENT, TRUCK MOUNTED AIR COMPRESSORS, SPECIAL PURPOSE PUMPS, TRUCK MOUNTED POWER INVERTERS, TRUCK MOUNTED WELDER/GENERATORS, HYDRAULIC SYSTEMS, WET LINE KITS, SPECIAL PURPOSE TOOLS, SPECIAL PURPOSE LIGHTING, TOOL STORAGE, HOSE REELS, CARGO SECURING EQUIPMENT, TOWING EQUIPMENT, FIFTH WHEELS, SPECIAL PURPOSE RACKS, RAIL GEAR, SPECIAL PURPOSE BUMPERS AND DOT SAFETY PLACARDS AND REFLECTORS ALL SOLD AS A FEATURE OF THE TRUCKS; SERVICE TRUCKS, MECHANICS TRUCKS AND SPECIAL DUTY TRUCKS FEATURING SPECIAL PURPOSE TRUCK BODIES, STORAGE BINS AND CRANES SOLD THEREWITH WITH ASSOCIATED EQUIPMENT AND ACCESSORIES IN THE NATURE OF MOUNTED AIR COMPRESSORS, SPECIAL PURPOSE PUMPS, TRUCK MOUNTED POWER INVERTERS, TRUCK MOUNTED WELDER/GENERATORS, HYDRAULIC SYSTEMS, WET LINE KITS, SPECIAL PURPOSE TOOLS, SPECIAL PURPOSE LIGHTING, TOOL STORAGE, HOSE REELS, CARGO SECURING EQUIPMENT, TOWING EQUIPMENT, FIFTH WHEELS, SPECIAL PURPOSE RACKS, RAIL GEAR, SPECIAL PURPOSE BUMPERS AND DOT SAFETY PLACARDS AND REFLECTORS ALL SOLD AS A FEATURE OF THE TRUCKS; SERVICE TRUCKS AND SPECIAL DUTY TRUCKS FEATURING AERIAL BUCKETS SOLD THEREWITH WITH ASSOCIATED EQUIPMENT AND ACCESSORIES IN THE NATURE OF TRUCK MOUNTED AIR COMPRESSORS, SPECIAL PURPOSE PUMPS, TRUCK MOUNTED POWER INVERTERS, TRUCK MOUNTED WELDER/GENERATORS, HYDRAULIC SYSTEMS, WET LINE KITS, SPECIAL PURPOSE TOOLS, SPECIAL PURPOSE LIGHTING, TOOL STORAGE, HOSE REELS, CARGO SECURING EQUIPMENT, TOWING EQUIPMENT, FIFTH WHEELS, SPECIAL PURPOSE RACKS, RAIL GEAR, SPECIAL PURPOSE BUMPERS, AUXILIARY AXLES AND DOT SAFETY PLACARDS AND REFLECTORS ALL SOLD AS A FEATURE OF THE TRUCKS; SPECIAL DUTY TRUCKS AND TRAILERS FEATURING SPECIAL PURPOSE BODY WITH ARTICULATING CRANE SOLD THEREWITH AND ASSOCIATED EQUIPMENT AND ACCESSORIES IN THE NATURE OF TRUCK MOUNTED AIR COMPRESSORS, SPECIAL PURPOSE PUMPS, TRUCK MOUNTED POWER INVERTERS, TRUCK MOUNTED WELDER/GENERATORS, HYDRAULIC SYSTEMS, WET LINE KITS, SPECIAL PURPOSE TOOLS, SPECIAL PURPOSE LIGHTING, TOOL STORAGE, HOSE REELS, CARGO



David J. Kypos

Director of the United States Patent and Trademark Office

Reg. No. 4,176,058 SECURING EQUIPMENT, TOWING EQUIPMENT, FIFTH WHEELS, SPECIAL PURPOSE RACKS, RAIL GEAR, SPECIAL PURPOSE BUMPERS, AUXILIARY AXLES AND DOT SAFETY PLACARDS AND REFLECTORS ALL SOLD AS A FEATURE OF THE TRUCKS; SPECIAL DUTY TRUCKS FEATURING CABLE ROLL-OFF HOIST SOLD THEREWITH WITH ASSOCIATED EQUIPMENT AND ACCESSORIES IN THE NATURE OF HYDRAULIC SYSTEMS, SPECIAL PURPOSE TOOLS, SPECIAL PURPOSE LIGHTING, TOOL STORAGE, HOSE REELS, CARGO SECURING EQUIPMENT, TOWING EQUIPMENT, SPECIAL PURPOSE RACKS, SPECIAL PURPOSE BUMPERS, AUXILIARY AXLES AND DOT SAFETY PLACARDS AND REFLECTORS ALL SOLD AS A FEATURE OF THE TRUCKS; SPECIAL DUTY TRUCKS FEATURING HOOK LIFT HOIST SOLD THEREWITH WITH ASSOCIATED EQUIPMENT AND ACCESSORIES IN THE NATURE OF HYDRAULIC SYSTEMS, WET LINE KITS, SPECIAL PURPOSE TOOLS, SPECIAL PURPOSE LIGHTING, TOOL STORAGE, HOSE REELS, CARGO SECURING EQUIPMENT, TOWING EQUIPMENT, FIFTH WHEELS, SPECIAL PURPOSE RACKS, SPECIAL PURPOSE BUMPERS, AUXILIARY AXLES AND DOT SAFETY PLACARDS AND REFLECTORS ALL SOLD AS A FEATURE OF THE TRUCKS; SPECIAL DUTY TRUCKS FEATURING CONTAINER HANDLING HOISTS SOLD THEREWITH WITH ASSOCIATED EQUIPMENT AND ACCESSORIES IN THE NATURE OF HYDRAULIC SYSTEMS, WET LINE KITS, SPECIAL PURPOSE TOOLS, SPECIAL PURPOSE LIGHTING, TOOL STORAGE, HOSE REELS, CARGO SECURING EQUIPMENT, TOWING EQUIPMENT, FIFTH WHEELS, SPECIAL PURPOSE RACKS, SPECIAL PURPOSE BUMPERS AND DOT SAFETY PLACARDS AND REFLECTORS ALL SOLD AS A FEATURE OF THE TRUCKS; SPECIAL DUTY TRUCKS FEATURING HOISTS WITH DUMP BODIES SOLD THEREWITH AND ASSOCIATED EQUIPMENT AND ACCESSORIES IN THE NATURE OF HYDRAULIC SYSTEMS, SPECIAL PURPOSE TOOLS, SPECIAL PURPOSE LIGHTING, TOOL STORAGE, HOSE REELS, CARGO SECURING EQUIPMENT, TOWING EQUIPMENT, SPECIAL PURPOSE RACKS, SPECIAL PURPOSE BUMPERS, AUXILIARY AXLES AND DOT SAFETY PLACARDS AND REFLECTORS ALL SOLD AS A FEATURE OF THE TRUCKS; SPECIAL DUTY TRUCKS FEATURING SNOW REMOVAL AND DE-ICING EQUIPMENT WITH ASSOCIATED EQUIPMENT AND ACCESSORIES INCLUDING HYDRAULIC SYSTEMS, SPECIAL PURPOSE TOOLS, SPECIAL PURPOSE LIGHTING, TOOL STORAGE, HOSE REELS, CARGO SECURING EQUIPMENT, TOWING EQUIPMENT, SPECIAL PURPOSE RACKS, SPECIAL PURPOSE BUMPERS, AUXILIARY AXLES AND DOT SAFETY PLACARDS AND REFLECTORS ALL SOLD AS A FEATURE OF THE TRUCKS; TRUCKS AND TRUCK BODIES FEATURING LIFT GATES SOLD THEREWITH, IN CLASS 12 (U.S. CLS. 19, 21, 23, 31, 35 AND 44).

FIRST USE 5-5-2010; IN COMMERCE 5-5-2010.

THE MARK CONSISTS OF STANDARD CHARACTERS WITHOUT CLAIM TO ANY PARTICULAR FONT, STYLE, SIZE, OR COLOR.

NO CLAIM IS MADE TO THE EXCLUSIVE RIGHT TO USE "TRUCK EQUIPMENT", APART FROM THE MARK AS SHOWN.

SN 77-941,223, FILED 2-22-2010.

ELIZABETH KAJUBI, EXAMINING ATTORNEY

United States of America
United States Patent and Trademark Office

CHEMOSAT

Reg. No. 4,176,059

DEL CATH SYSTEMS, INC. (DELAWARE CORPORATION)
810 SEVENTH AVENUE, 35TH FLOOR
NEW YORK, NY 10019

Registered July 17, 2012

Int. Cl.: 10

FOR: DRUG DELIVERY SYSTEMS, IN CLASS 10 (U.S. CLS. 26, 39 AND 44).

TRADEMARK

FIRST USE 1-18-2012; IN COMMERCE 1-18-2012.

PRINCIPAL REGISTER

THE MARK CONSISTS OF STANDARD CHARACTERS WITHOUT CLAIM TO ANY PARTICULAR FONT, STYLE, SIZE, OR COLOR.

SN 77-944,997, FILED 2-25-2010.

MATTHEW KLINE, EXAMINING ATTORNEY



David J. Kappas

Director of the United States Patent and Trademark Office

United States of America
United States Patent and Trademark Office

PROBEAM

Reg. No. 4,176,060

VARIAN MEDICAL SYSTEMS, INC. (DELAWARE CORPORATION)
3100 HANSEN WAY
PALO ALTO, CA 94304

Registered July 17, 2012

Int. Cl.: 10

FOR: MEDICAL APPARATUS FOR ADMINISTERING PROTON THERAPY USED IN THE TREATMENT OF CANCER, IN CLASS 10 (U.S. CLS. 26, 39 AND 44).

TRADEMARK

FIRST USE 4-29-2010; IN COMMERCE 4-29-2010.

PRINCIPAL REGISTER

THE MARK CONSISTS OF STANDARD CHARACTERS WITHOUT CLAIM TO ANY PARTICULAR FONT, STYLE, SIZE, OR COLOR.

SN 77-945,402, FILED 2-25-2010.

ANGELA M. MICHELI, EXAMINING ATTORNEY



David J. Kyffers

Director of the United States Patent and Trademark Office

United States of America

United States Patent and Trademark Office

DUBL-OPEN

Reg. No. 4,176,061

PDOC, LLC (DELAWARE LIMITED LIABILITY COMPANY)
3900 W. 43RD STREET
CHICAGO, IL 60632

Registered July 17, 2012

Int. Cl.: 16

FOR: PAPER BAGS; PLASTIC OR PAPER BAGS FOR PACKAGING PREPARED FOOD PRODUCTS, IN CLASS 16 (U.S. CLS. 2, 5, 22, 23, 29, 37, 38 AND 50).

TRADEMARK

FIRST USE 4-20-2011; IN COMMERCE 4-20-2011.

PRINCIPAL REGISTER

THE MARK CONSISTS OF STANDARD CHARACTERS WITHOUT CLAIM TO ANY PARTICULAR FONT, STYLE, SIZE, OR COLOR.

SN 77-945,963, FILED 2-26-2010.

LINDA ORNDORFF, EXAMINING ATTORNEY



David J. Kyffers

Director of the United States Patent and Trademark Office

United States of America

United States Patent and Trademark Office

VIRGIN

Reg. No. 4,176,062

Registered July 17, 2012

Int. Cls.: 35, 36, and 42

SERVICE MARK

PRINCIPAL REGISTER

VIRGIN ENTERPRISES LIMITED (UNITED KINGDOM LIMITED COMPANY)
THE SCHOOL HOUSE
50 BROOK GREEN
LONDON, UNITED KINGDOM W67RR

FOR: ADVISORY AND CONSULTANCY SERVICES RELATED TO RESOURCE EFFICIENCY, ENERGY USAGE MANAGEMENT AND ENERGY EFFICIENCY, IN CLASS 35 (U.S. CLS. 100, 101 AND 102).

FIRST USE 9-12-2007; IN COMMERCE 9-12-2007.

FOR: CREATION, MANAGEMENT AND ADMINISTRATION OF INVESTMENT FUNDS, VENTURE CAPITAL FUNDS AND PRIVATE EQUITY FUNDS, FUND INVESTMENT SERVICES, INCLUDING FUND INVESTMENT SERVICES AND FUND INVESTMENT MANAGEMENT SERVICES IN THE RENEWABLE ENERGY, RESOURCE EFFICIENCY, ENERGY EFFICIENCY, CLEAN TECHNOLOGY AND ALTERNATIVE ENERGY SECTORS; ADVISORY AND CONSULTANCY SERVICES IN RELATION TO THE AFORESAID AND IN RELATION TO THE EVALUATION, CONSUMMATION, ADMINISTRATION AND MANAGEMENT OF INVESTMENTS IN BUSINESSES OPERATING IN THE RENEWABLE ENERGY, RESOURCE EFFICIENCY, ENERGY EFFICIENCY, CLEAN TECHNOLOGY AND ALTERNATIVE ENERGY SECTORS, IN CLASS 36 (U.S. CLS. 100, 101 AND 102).

FIRST USE 9-12-2007; IN COMMERCE 9-12-2007.

FOR: ADVISORY AND CONSULTANCY SERVICES RELATING TO THE DESIGN AND DEVELOPMENT OF RENEWABLE ENERGY SOURCES AND RELATED TO ENERGY MEASUREMENT TO IMPROVE ENERGY EFFICIENCY, IN CLASS 42 (U.S. CLS. 100 AND 101).

FIRST USE 9-12-2007; IN COMMERCE 9-12-2007.

THE MARK CONSISTS OF STANDARD CHARACTERS WITHOUT CLAIM TO ANY PARTICULAR FONT, STYLE, SIZE, OR COLOR.

OWNER OF U.S. REG. NOS. 3,298,420, 3,398,248, AND OTHERS.

SN 77-946,459, FILED 2-26-2010.



David J. Kyffers

Director of the United States Patent and Trademark Office

Reg. No. 4,176,062 ALICIA COLLINS, EXAMINING ATTORNEY

United States of America
United States Patent and Trademark Office

SICKBIRD

Reg. No. 4,176,063

Registered July 17, 2012

Int. Cl.: 25

TRADEMARK

PRINCIPAL REGISTER

RECON PROTECTION, LLC (COLORADO LIMITED LIABILITY COMPANY)
350 THUNDERBOWL LANE
ASPEN, CO 81611

FOR: CLOTHING, NAMELY, PANTS AND TOPS, IN CLASS 25 (U.S. CLS. 22 AND 39).

FIRST USE 2-15-2010; IN COMMERCE 12-27-2010.

THE MARK CONSISTS OF STANDARD CHARACTERS WITHOUT CLAIM TO ANY PARTICULAR FONT, STYLE, SIZE, OR COLOR.

SN 77-946,755, FILED 2-28-2010.

TIMOTHY FINNEGAN, EXAMINING ATTORNEY



David J. Kyffers

Director of the United States Patent and Trademark Office

United States of America

United States Patent and Trademark Office

2Kings

Reg. No. 4,176,064

Registered July 17, 2012

Int. Cl.: 35

SERVICE MARK

PRINCIPAL REGISTER

S. CARTER ENTERPRISES, LLC (DELAWARE LIMITED LIABILITY COMPANY)
SIX LANDMARK SQUARE
C/O ANDREW KUPINSE @ CUMMINGS & LOCKWOOD
STAMFORD, CT 06901

FOR: BUSINESS NETWORKING, IN CLASS 35 (U.S. CLS. 100, 101 AND 102).

FIRST USE 2-17-2007; IN COMMERCE 2-17-2007.

THE MARK CONSISTS OF "2KINGS" IN A STYLIZED FORMAT.

SN 77-947,628, FILED 3-1-2010.

AMY KERTGATE, EXAMINING ATTORNEY



David J. Kappas

Director of the United States Patent and Trademark Office

United States of America

United States Patent and Trademark Office

FAMOUS RACING SAUSAGES

Reg. No. 4,176,065

Registered July 17, 2012

Int. Cl.: 28

TRADEMARK

PRINCIPAL REGISTER

MILWAUKEE BREWERS BASEBALL CLUB, LIMITED PARTNERSHIP (WISCONSIN LIMITED PARTNERSHIP)
MILLER PARK, ONE BREWERS WAY
MILWAUKEE, WI 53214

FOR: TOYS AND SPORTING GOODS, NAMELY, STUFFED TOYS, PLUSH TOYS, TOY FIGURES, DOLLS, BOBBING HEAD DOLLS, MINIATURE BASEBALL BATS, TOY NECKLACES, BASEBALLS, BASEBALL BATS, ACTION FIGURES, BALLS FOR GAMES, CHRISTMAS TREE ORNAMENTS, LOTTERY TICKETS, IN CLASS 28 (U.S. CLS. 22, 23, 38 AND 50).

FIRST USE 4-9-2010; IN COMMERCE 4-9-2010.

THE MARK CONSISTS OF STANDARD CHARACTERS WITHOUT CLAIM TO ANY PARTICULAR FONT, STYLE, SIZE, OR COLOR.

SN 77-948,193, FILED 3-2-2010.

KAELIE KUNG, EXAMINING ATTORNEY



David J. Kyffers

Director of the United States Patent and Trademark Office

United States of America

United States Patent and Trademark Office

FAMOUS RACING SAUSAGES

Reg. No. 4,176,066

Registered July 17, 2012

Int. Cl.: 25

TRADEMARK

PRINCIPAL REGISTER

MILWAUKEE BREWERS BASEBALL CLUB, LIMITED PARTNERSHIP (WISCONSIN LIMITED PARTNERSHIP)
MILLER PARK, ONE BREWERS WAY
MILWAUKEE, WI 53214

FOR: CLOTHING, NAMELY, HEAD WEAR, SHIRTS, CLOTH BIBS, SOCKS, HOSIERY, IN CLASS 25 (U.S. CLS. 22 AND 39).

FIRST USE 4-15-2010; IN COMMERCE 4-15-2010.

THE MARK CONSISTS OF STANDARD CHARACTERS WITHOUT CLAIM TO ANY PARTICULAR FONT, STYLE, SIZE, OR COLOR.

SN 77-948,194, FILED 3-2-2010.

KAELIE KUNG, EXAMINING ATTORNEY



David J. Kybas

Director of the United States Patent and Trademark Office

United States of America

United States Patent and Trademark Office



Gen7

Reg. No. 4,176,067

Registered July 17, 2012

Int. Cls.: 6 and 40

TRADEMARK

SERVICE MARK

PRINCIPAL REGISTER

AMERICAN MODULAR SYSTEMS, INC. (CALIFORNIA CORPORATION)
787 SPRECKELS AVENUE
MANTECA, CA 95336

FOR: PRE-FABRICATED BUILDINGS OF METAL, IN CLASS 6 (U.S. CLS. 2, 12, 13, 14, 23, 25 AND 50).

FIRST USE 6-1-2009; IN COMMERCE 6-1-2009.

FOR: MANUFACTURE AND ASSEMBLY OF PRE-FABRICATED BUILDINGS FOR OTHERS, IN CLASS 40 (U.S. CLS. 100, 103 AND 106).

FIRST USE 6-1-2009; IN COMMERCE 6-1-2009.

THE MARK CONSISTS OF A TRANSLUCENT CUBE WITH A SOLID SPHERE IN THE MIDDLE WITH A SHADOW UNDER THE CUBE AND THE WORD "GEN7" TO THE RIGHT OF THE IMAGE.

SN 77-948,363, FILED 3-2-2010.

ALICIA COLLINS, EXAMINING ATTORNEY



David J. Kybas

Director of the United States Patent and Trademark Office

United States of America

United States Patent and Trademark Office

NAV-X STEERABLE BLADE

Reg. No. 4,176,068

ARTHREX, INC. (DELAWARE CORPORATION)

Registered July 17, 2012

1370 CREEKSIDE BLVD.
NAPLES, FL 34108

Int. Cl.: 10

FOR: MEDICAL DEVICES, NAMELY, SURGICAL DEVICES THAT FACILITATE THE AB-
LATION OF BIOLOGICAL TISSUE USING RADIO FREQUENCIES, IN CLASS 10 (U.S. CLS.
26, 39 AND 44).

TRADEMARK

FIRST USE 5-30-2012; IN COMMERCE 5-30-2012.

PRINCIPAL REGISTER

THE MARK CONSISTS OF STANDARD CHARACTERS WITHOUT CLAIM TO ANY PAR-
TICULAR FONT, STYLE, SIZE, OR COLOR.

NO CLAIM IS MADE TO THE EXCLUSIVE RIGHT TO USE "STEERABLE BLADE", APART
FROM THE MARK AS SHOWN.

SN 77-948,922, FILED 3-2-2010.

ESTHER BELENKER, EXAMINING ATTORNEY



David J. Kyffers

Director of the United States Patent and Trademark Office

United States of America

United States Patent and Trademark Office

NAV-X STEERABLE HOOK

Reg. No. 4,176,069

ARTHREX, INC. (DELAWARE CORPORATION)

Registered July 17, 2012

1370 CREEKSIDE BLVD.
NAPLES, FL 34108

Int. Cl.: 10

FOR: MEDICAL DEVICES, NAMELY, SURGICAL DEVICES THAT FACILITATE THE AB-
LATION OF BIOLOGICAL TISSUE USING RADIO FREQUENCIES, IN CLASS 10 (U.S. CLS.
26, 39 AND 44).

TRADEMARK

FIRST USE 5-30-2012; IN COMMERCE 5-30-2012.

PRINCIPAL REGISTER

THE MARK CONSISTS OF STANDARD CHARACTERS WITHOUT CLAIM TO ANY PAR-
TICULAR FONT, STYLE, SIZE, OR COLOR.

NO CLAIM IS MADE TO THE EXCLUSIVE RIGHT TO USE "STEERABLE HOOK", APART
FROM THE MARK AS SHOWN.

SN 77-948,924, FILED 3-2-2010.

ESTHER BELENKER, EXAMINING ATTORNEY



David J. Kyffers

Director of the United States Patent and Trademark Office

United States of America

United States Patent and Trademark Office

EMBELLISH YOUR STORY

Reg. No. 4,176,070

DD TRADERS, INC. (DELAWARE CORPORATION), DBA DEMDACO,
500 WEST 134TH STREET
LEAWOOD, KS 66209

Registered July 17, 2012

Int. Cls.: 6, 9, 16, and 20

FOR: DECORATIVE FIGURES IN THE FORM OF WORDS MADE OF COMMON METAL;
FIGURES OF COMMON METAL; SCULPTURES MADE OF COMMON METAL; WALL
PLAQUES MADE OF COMMON METAL, IN CLASS 6 (U.S. CLS. 2, 12, 13, 14, 23, 25 AND
50).

TRADEMARK

PRINCIPAL REGISTER

FIRST USE 1-0-2010; IN COMMERCE 1-0-2010.

FOR: DECORATIVE MAGNETS, IN CLASS 9 (U.S. CLS. 21, 23, 26, 36 AND 38).

FIRST USE 1-0-2010; IN COMMERCE 1-0-2010.

FOR: MAGNETIC BOARDS; MAGNETIC BOARDS, NAMELY, BOARDS MADE OF COMMON
METAL FOR USE IN DISPLAYING DECORATIVE MAGNETS, IN CLASS 16 (U.S. CLS. 2,
5, 22, 23, 29, 37, 38 AND 50).

FIRST USE 1-0-2010; IN COMMERCE 1-0-2010.

FOR: METAL DISPLAY STANDS, NAMELY, DECORATIVE STANDS MADE OF COMMON
METAL AND STANDS MADE OF COMMON METAL FOR USE IN DISPLAYING DECOR-
ATIVE MAGNETS, IN CLASS 20 (U.S. CLS. 2, 13, 22, 25, 32 AND 50).

FIRST USE 1-0-2010; IN COMMERCE 1-0-2010.

THE MARK CONSISTS OF STANDARD CHARACTERS WITHOUT CLAIM TO ANY PAR-
TICULAR FONT, STYLE, SIZE, OR COLOR.

SN 77-949,679, FILED 3-3-2010.

LESLIE RICHARDS, EXAMINING ATTORNEY



David J. Kyffers

Director of the United States Patent and Trademark Office

United States of America

United States Patent and Trademark Office

Flat Classroom

Reg. No. 4,176,071

ADAMS DAVIS, VICTORIA (UNITED STATES INDIVIDUAL)
411 MOULTRIE ROAD
CAMILLA, GA 31730 AND

Registered July 17, 2012

**Int. Cls.: 9, 16, 35, and
41**

LINDSAY, JULIE (AUSTRALIA INDIVIDUAL)
5 REGINA ST, UNIT 2
RINGWOOD, MELBOURNE, AUSTRALIA 3134

TRADEMARK

FOR: DOWNLOADABLE MP3 FILES, MP3 RECORDINGS, ON-LINE DISCUSSION BOARDS, WEBCASTS, WEBINARS AND PODCASTS FEATURING MUSIC, AUDIO BOOKS AND NEWS BROADCASTS, IN CLASS 9 (U.S. CLS. 21, 23, 26, 36 AND 38).

SERVICE MARK

PRINCIPAL REGISTER

FIRST USE 8-7-2007; IN COMMERCE 8-7-2007.

FOR: A SERIES OF BOOKS, WRITTEN ARTICLES, HANDOUTS AND WORKSHEETS IN THE FIELD OF COLLABORATIVE EDUCATION METHODS, IN CLASS 16 (U.S. CLS. 2, 5, 22, 23, 29, 37, 38 AND 50).

FIRST USE 11-15-2006; IN COMMERCE 11-15-2006.

FOR: EDUCATION LEADERSHIP DEVELOPMENT, IN CLASS 35 (U.S. CLS. 100, 101 AND 102).

FIRST USE 6-27-2007; IN COMMERCE 6-27-2007.

FOR: EDUCATIONAL SERVICES, NAMELY, DEVELOPING CURRICULUM FOR EDUCATORS; EDUCATIONAL SERVICES, NAMELY, DEVELOPING, ARRANGING, AND CONDUCTING EDUCATIONAL CONFERENCES AND PROGRAMS AND PROVIDING COURSES OF INSTRUCTION IN THE FIELD OF COLLABORATIVE EDUCATION METHODS, IN CLASS 41 (U.S. CLS. 100, 101 AND 107).

FIRST USE 6-27-2007; IN COMMERCE 6-27-2007.

THE MARK CONSISTS OF STANDARD CHARACTERS WITHOUT CLAIM TO ANY PARTICULAR FONT, STYLE, SIZE, OR COLOR.



David J. Kyros

Director of the United States Patent and Trademark Office

Reg. No. 4,176,071 NO CLAIM IS MADE TO THE EXCLUSIVE RIGHT TO USE "CLASSROOM", APART FROM THE MARK AS SHOWN.

SN 77-950,735, FILED 3-4-2010.

MATTHEW PAPPAS, EXAMINING ATTORNEY

United States of America

United States Patent and Trademark Office



Reg. No. 4,176,072

Registered July 17, 2012

Int. Cl.: 9

TRADEMARK

PRINCIPAL REGISTER

SPRINT COMMUNICATIONS COMPANY L.P. (DELAWARE LIMITED PARTNERSHIP)
6200 SPRINT PARKWAY
OVERLAND PARK, KS 66251

FOR: MOBILE PHONES, IN CLASS 9 (U.S. CLS. 21, 23, 26, 36 AND 38).

FIRST USE 6-6-2010; IN COMMERCE 6-6-2010.

THE MARK CONSISTS OF A PLANT-LIKE DESIGN COMPRISED OF TWO SEPARATE LEAFS AT THE BOTTOM TOPPED BY A TELEPHONE DESIGN.

SN 77-953,386, FILED 3-8-2010.

KAELIE KUNG, EXAMINING ATTORNEY



David J. Kyffers

Director of the United States Patent and Trademark Office

United States of America

United States Patent and Trademark Office

UGO365

Reg. No. 4,176,073

Registered July 17, 2012

Int. Cl.: 9

TRADEMARK

PRINCIPAL REGISTER

PREMIER AGENDAS, INC. (WASHINGTON CORPORATION)
2000 KENTUCKY STREET
BELLINGHAM, WA 98229

FOR: DOWNLOADABLE PUBLICATIONS IN THE NATURE OF LESSON PLANS, NEWS-LETTERS, ALL DIRECTED TO TEACHING EDUCATORS AND PARENTS TO HELP STUDENTS BE MORE ORGANIZED, EFFECTIVE AND EFFICIENT, IN CLASS 9 (U.S. CLS. 21, 23, 26, 36 AND 38).

FIRST USE 8-2-2010; IN COMMERCE 8-2-2010.

THE MARK CONSISTS OF STANDARD CHARACTERS WITHOUT CLAIM TO ANY PARTICULAR FONT, STYLE, SIZE, OR COLOR.

SN 77-954,006, FILED 3-9-2010.

DAVID I, EXAMINING ATTORNEY



David J. Kyfos

Director of the United States Patent and Trademark Office

United States of America

United States Patent and Trademark Office

J.E.M. JEWELLERY ETHICALLY MINDED

Reg. No. 4,176,074

Registered July 17, 2012

Int. Cls.: 14 and 35

TRADEMARK

SERVICE MARK

PRINCIPAL REGISTER

J.E.L JEWELLERY ETHICAL LUXURY (FRANCE CORPORATION)
25 RUE GODOT DE MAUROY
75009 PARIS, FRANCE

FOR: JEWELRY; GEMSTONES; BRACELETS; NECK CHAINS; MEDALS; TIMEPIECES AND CHRONOMETRIC INSTRUMENTS; PRECIOUS METAL ALLOYS; NON-MONETARY COINS; MONETARY COINS SET FOR COLLECTING PURPOSES; JEWELRY BOXES; DECORATIVE BOXES MADE OF PRECIOUS METALS; JEWELRY CASES MADE OF PRECIOUS METALS; WATCHES; WATCH GLASSES AND CLOCK SPRINGS; KEY RINGS AND KEY CHAINS MADE OF PRECIOUS METALS; FIGURINES MADE OF PRECIOUS METALS; JEWELRY CASES AND JEWELRY CASKETS FOR WATCHES; SCULPTURES MADE OF PRECIOUS METAL, IN CLASS 14 (U.S. CLS. 2, 27, 28 AND 50).

FIRST USE 2-23-2011; IN COMMERCE 2-23-2011.

FOR: ON-LINE AND IN STORE RETAIL STORE SERVICES FEATURING JEWELRY, IN CLASS 35 (U.S. CLS. 100, 101 AND 102).

FIRST USE 1-19-2012; IN COMMERCE 1-19-2012.

THE MARK CONSISTS OF STANDARD CHARACTERS WITHOUT CLAIM TO ANY PARTICULAR FONT, STYLE, SIZE, OR COLOR.

NO CLAIM IS MADE TO THE EXCLUSIVE RIGHT TO USE "GEM" AND "JEWELLERY", APART FROM THE MARK AS SHOWN.

SN 77-954,414, FILED 3-9-2010.

NAPOLEON SHARMA, EXAMINING ATTORNEY



David J. Kyffers

Director of the United States Patent and Trademark Office

United States of America

United States Patent and Trademark Office

THE PAYROLL SOLUTION THAT WORX

Reg. No. 4,176,075

Registered July 17, 2012

Int. Cls.: 35 and 36

SERVICE MARK

PRINCIPAL REGISTER

PAPERLESS PROS, INC. (NEW YORK CORPORATION)
6175 SUNRISE HIGHWAY
MASSAPEQUA, NY 11758

FOR: HUMAN RESOURCE SERVICES, NAMELY, PAYROLL PREPARATION, BUSINESS ADMINISTRATION AND MANAGEMENT SERVICES, COST MANAGEMENT FOR THE HEALTH BENEFIT PLANS OF OTHERS; ACCOUNTING SERVICES, NAMELY, ADMINISTRATION, BILLING AND RECONCILIATION OF BANK ACCOUNTS ON BEHALF OF EMPLOYERS AND WAGE PAYROLL PREPARATION IN THE NATURE OF GARNISHING EMPLOYEE SALARIES; HUMAN RESOURCE ANALYSIS AND CONSULTING SERVICES, IN CLASS 35 (U.S. CLS. 100, 101 AND 102).

FIRST USE 11-30-2010; IN COMMERCE 11-30-2010.

FOR: ADMINISTRATION FOR EMPLOYERS OF EMPLOYEE BENEFIT PLANS CONCERNING INSURANCE, FINANCE AND RETIREMENT; BILL PAYMENT SERVICES, IN CLASS 36 (U.S. CLS. 100, 101 AND 102).

FIRST USE 11-30-2010; IN COMMERCE 11-30-2010.

THE MARK CONSISTS OF STANDARD CHARACTERS WITHOUT CLAIM TO ANY PARTICULAR FONT, STYLE, SIZE, OR COLOR.

NO CLAIM IS MADE TO THE EXCLUSIVE RIGHT TO USE "PAYROLL SOLUTION", APART FROM THE MARK AS SHOWN.

SN 77-955,692, FILED 3-10-2010.

JENNIFER MARTIN, EXAMINING ATTORNEY



David J. Kyros

Director of the United States Patent and Trademark Office

United States of America

United States Patent and Trademark Office

MAGIC MAT

Reg. No. 4,176,076

YOGAFLAIR, LLC (CALIFORNIA LIMITED LIABILITY COMPANY)
2321 TORRANCE BOULEVARD
TORRANCE, CA 90501

Registered July 17, 2012

Int. Cl.: 28

FOR: PERSONAL EXERCISE MATS, IN CLASS 28 (U.S. CLS. 22, 23, 38 AND 50).

TRADEMARK

FIRST USE 8-8-2010; IN COMMERCE 8-3-2010.

PRINCIPAL REGISTER

THE MARK CONSISTS OF STANDARD CHARACTERS WITHOUT CLAIM TO ANY PARTICULAR FONT, STYLE, SIZE, OR COLOR.

NO CLAIM IS MADE TO THE EXCLUSIVE RIGHT TO USE "MAT", APART FROM THE MARK AS SHOWN.

SN 77-957,138, FILED 3-11-2010.

JAY BESCH, EXAMINING ATTORNEY



David J. Kyffers

Director of the United States Patent and Trademark Office

United States of America

United States Patent and Trademark Office



Reg. No. 4,176,077

Registered July 17, 2012

Int. Cl.: 9

TRADEMARK

PRINCIPAL REGISTER

NENG FENG WANG (CHINA INDIVIDUAL)
8TH DIVISION, HARVEST BLDG.,
LUCHENG WEST JIAN BIN RD.
12B#6, WENZHOU, CHINA, CHINA

FOR: EYEWEAR; SUNGLASSES; SUNGLASSES AND SPECTACLES, IN CLASS 9 (U.S. CLS. 21, 23, 26, 36 AND 38).

FIRST USE 10-29-2010; IN COMMERCE 10-29-2010.

THE MARK CONSISTS OF THE SILHOUETTE OF A KNIGHT IN ARMOR, CARRYING A SPEAR OR LANCE ON REARING OR CHARGING HORSE.

SN 77-958,312, FILED 3-13-2010.

HENRY S. ZAK, EXAMINING ATTORNEY



David J. Kyffers

Director of the United States Patent and Trademark Office

United States of America

United States Patent and Trademark Office

SPOTLIGHT SOLAR

Reg. No. 4,176,078

Registered July 17, 2012

Int. Cls.: 6 and 42

TRADEMARK

SERVICE MARK

PRINCIPAL REGISTER

SPOTLIGHT SOLAR, LLC (NORTH CAROLINA LIMITED LIABILITY COMPANY)
#30
710 MARKET STREET
CHAPEL HILL, NC 27516

FOR: METAL MOUNTING STRUCTURES FOR SOLAR EQUIPMENT, IN CLASS 6 (U.S. CLS. 2, 12, 13, 14, 23, 25 AND 50).

FIRST USE 1-8-2011; IN COMMERCE 1-8-2011.

FOR: DESIGN OF MOUNTING STRUCTURES FOR SOLAR EQUIPMENT, IN CLASS 42 (U.S. CLS. 100 AND 101).

FIRST USE 1-8-2011; IN COMMERCE 1-8-2011.

THE MARK CONSISTS OF STANDARD CHARACTERS WITHOUT CLAIM TO ANY PARTICULAR FONT, STYLE, SIZE, OR COLOR.

NO CLAIM IS MADE TO THE EXCLUSIVE RIGHT TO USE "SOLAR", APART FROM THE MARK AS SHOWN.

SN 77-958,791, FILED 3-15-2010.

PAULA MAHONEY, EXAMINING ATTORNEY



David J. Kyros

Director of the United States Patent and Trademark Office

United States of America

United States Patent and Trademark Office

TRAXTION

Reg. No. 4,176,079

U.S. ENDOSCOPY GROUP, INC. (OHIO CORPORATION)
5976 HEISLEY ROAD
MENTOR, OH 44060

Registered July 17, 2012

Int. Cl.: 10

FOR: MEDICAL DEVICES FOR USE WITH ENDOSCOPES, NAMELY, TISSUE SNARES AND TISSUE RETRIEVAL DEVICES, IN CLASS 10 (U.S. CLS. 26, 39 AND 44).

TRADEMARK

FIRST USE 5-11-2010; IN COMMERCE 5-11-2010.

PRINCIPAL REGISTER

THE MARK CONSISTS OF STANDARD CHARACTERS WITHOUT CLAIM TO ANY PARTICULAR FONT, STYLE, SIZE, OR COLOR.

SN 77-958,948, FILED 3-15-2010.

KAREN SEVERSON, EXAMINING ATTORNEY



David J. Kybas

Director of the United States Patent and Trademark Office

United States of America

United States Patent and Trademark Office



Reg. No. 4,176,080

KABUSHIKI KAISHA ASABIRAKI (JAPAN JOINT STOCK COMPANY)
10-34, DAIJIJI-CHO
MORIOKA, IWATE PREF., JAPAN

Registered July 17, 2012

Int. Cl.: 33

FOR: JAPANESE SAKE, RICE WINE, IN CLASS 33 (U.S. CLS. 47 AND 49).

TRADEMARK

FIRST USE 10-10-2003; IN COMMERCE 2-25-2004.

PRINCIPAL REGISTER

THE MARK CONSISTS OF THE WORD "SUIJIN" IN ENGLISH AND IN JAPANESE CHARACTERS.

THE NON-LATIN CHARACTERS IN THE MARK TRANSLITERATE TO "SUIJIN" AND THIS MEANS "WATER KAMI" OR "WATER DEITY" IN ENGLISH.

SN 77-960,110, FILED 3-16-2010.

SCOTT BIBB, EXAMINING ATTORNEY



David J. Kybas

Director of the United States Patent and Trademark Office

United States of America

United States Patent and Trademark Office

TILE FORCE

Reg. No. 4,176,081

Registered July 17, 2012

Int. Cl.: 8

TRADEMARK

PRINCIPAL REGISTER

Q.E.P. CO., INC. (DELAWARE CORPORATION)
1001 BROKEN SOUND PARKWAY NW, SUITE A
BOCA RATON, FL 33487

FOR: HAND TOOLS, NAMELY, BACKERBOARD AND UTILITY KNIVES; TILE, CARPET, DRYWALL, AND BRICK CUTTERS; TROWELS; PLIERS; NIPPERS; SCRAPERS; SANDERS; FILES; SPREADERS FOR GROUT, MORTAR, CEMENT OR ADHESIVES; FLOATS FOR GROUT, MORTAR, CEMENT OR ADHESIVES; SAWS AND BLADES THEREFOR; FLOOR AND WALL TILE INSTALLATION AND REPAIR KITS CONSISTING PRIMARILY OF HAND TOOLS, NAMELY, TROWELS, NIPPERS, TILE SPACERS, SAW BLADES AND TILE PLIERS/CUTTERS, ADHESIVE SPREADERS AND FLOATS, OR TROWELS, FLOATS, NIPPERS, TILE SPACERS, WIPES AND DISPOSABLE GLOVES, EACH SOLD AS A UNIT, IN CLASS 8 (U.S. CLS. 23, 28 AND 44).

FIRST USE 10-0-2010; IN COMMERCE 10-0-2010.

THE MARK CONSISTS OF STANDARD CHARACTERS WITHOUT CLAIM TO ANY PARTICULAR FONT, STYLE, SIZE, OR COLOR.

NO CLAIM IS MADE TO THE EXCLUSIVE RIGHT TO USE "TILE", APART FROM THE MARK AS SHOWN.

SN 77-960,138, FILED 3-16-2010.

JOSETTE BEVERLY, EXAMINING ATTORNEY



David J. Kyros

Director of the United States Patent and Trademark Office

United States of America

United States Patent and Trademark Office

壹電視

Reg. No. 4,176,082

Registered July 17, 2012

Int. Cl.: 38

SERVICE MARK

PRINCIPAL REGISTER

NEXT TV BROADCASTING LIMITED (TAIWAN LIMITED COMPANY (LTD.))
2F., NO.16, SEC. 6, MINCHUAN E. RD.
NEIHU DIST.
TAIPEI CITY, TAIWAN 11466

FOR: TRANSMISSION OF NEWS, TELEVISION BROADCASTING, CABLE TELEVISION BROADCASTING, INTERNET PROTOCOL TELEVISION BROADCASTING, RADIO BROADCASTING, TELECOMMUNICATIONS, NAMELY, PROVIDING VIDEO MATERIAL OVER MOBILE TELEPHONY NETWORKS, SATELLITE NETWORKS AND INTERNET PROTOCOL TELEVISION NETWORKS; PROVIDING SERVICES FOR BROADCASTERS AND OPERATORS TO ENABLE SIMULTANEOUS MASS PARTICIPATION INTERACTIVITY FOR TELEVISION VIEWERS, INTERNET VIEWERS AND MOBILE PHONE USERS; RADIO PAGING SERVICE, PROVIDING TELECOMMUNICATIONS CONNECTIONS TO THE INTERNET, COMMUNICATIONS BY TELEGRAMS, COMMUNICATIONS BY FIBER OPTIC NETWORKS, FACSIMILE TRANSMISSION, SATELLITE TRANSMISSION SERVICES; TELECOMMUNICATIONS FOR VALUE ADDED NETWORK, NAMELY, PROVIDING USER ACCESS TO ELECTRONIC OR OPTICAL NETWORKS FOR TRANSMISSION AND BROADCASTING OF SOUND, IMAGE AND MESSAGES, IN CLASS 38 (U.S. CLS. 100, 101 AND 104).

FIRST USE 12-15-2011; IN COMMERCE 1-1-2012.

NO CLAIM IS MADE TO THE EXCLUSIVE RIGHT TO USE THE NON-LATIN CHARACTERS THAT TRANSLITERATE TO TV, APART FROM THE MARK AS SHOWN.

THE NON-LATIN CHARACTERS IN THE MARK TRANSLITERATE TO YI DIAN SHI AND THIS MEANS ONE TV OR FIRST TV IN ENGLISH.

THE MARK CONSISTS OF THE CHINESE CHARACTERS FOR THE WORDS YI DIAN SHI.

SN 77-960,235, FILED 3-16-2010.

LINDA MICKLEBURGH, EXAMINING ATTORNEY



David J. Kyros

Director of the United States Patent and Trademark Office

United States of America

United States Patent and Trademark Office

FOUNDATION

GAMING GROUP

Reg. No. 4,176,083

Registered July 17, 2012

Int. Cl.: 35

SERVICE MARK

PRINCIPAL REGISTER

THE JAY DANIEL COMPANY LLC (MISSISSIPPI LIMITED LIABILITY COMPANY)
2310 19TH STREET
GULFPORT, MS 39501

FOR: CONSULTING SERVICES IN THE FIELD OF CASINO MANAGEMENT; CONSULTANCY SERVICES REGARDING BUSINESS STRATEGIES IN THE FIELD OF CASINOS; PROVIDING BUSINESS CONSULTATION SERVICES TO OWNERS AND OPERATORS OF CASINOS IN THE AREAS OF CASINO DEVELOPMENT; BUSINESS MANAGEMENT CONSULTING SERVICES IN THE FIELD OF CASINOS AND CASINO OPERATIONS; BUSINESS MANAGEMENT, MARKETING, AND ADVISORY SERVICES RELATING TO CASINO OPERATIONS, IN CLASS 35 (U.S. CLS. 100, 101 AND 102).

FIRST USE 11-1-2010; IN COMMERCE 11-1-2010.

NO CLAIM IS MADE TO THE EXCLUSIVE RIGHT TO USE "GAMING GROUP", APART FROM THE MARK AS SHOWN.

THE MARK CONSISTS OF THE WORD "FOUNDATION" PLACED OVER THE WORDS "GAMING GROUP", SEPARATED BY A HORIZONTAL LINE. THE "A" IN THE WORD "FOUNDATION" HAS BEEN REPLACED WITH A SPADE SYMBOL OF THE SORT SEEN ON PLAYING CARDS.

SN 77-960,244, FILED 3-16-2010.

ANNE FARRELL, EXAMINING ATTORNEY



David J. Kyffers

Director of the United States Patent and Trademark Office

United States of America

United States Patent and Trademark Office

SURFACIDE

Reg. No. 4,176,084

WALDEMAR LYSLO (UNITED STATES INDIVIDUAL)
3447 KELLER LANE
NAPERVILLE, IL 60565

Registered July 17, 2012

Int. Cls.: 11 and 37

FOR: UV LIGHT SANITIZER FOR USE IN DISINFECTING HARD SURFACES, IN CLASS 11 (U.S. CLS. 13, 21, 23, 31 AND 34).

TRADEMARK

FIRST USE 4-9-2012; IN COMMERCE 4-10-2012.

SERVICE MARK

FOR: CONSULTING IN THE FIELD OF DISINFECTING HARD SURFACES IN AN ENCLOSED SPACE, IN CLASS 37 (U.S. CLS. 100, 103 AND 106).

PRINCIPAL REGISTER

FIRST USE 4-9-2012; IN COMMERCE 4-10-2012.

THE MARK CONSISTS OF STANDARD CHARACTERS WITHOUT CLAIM TO ANY PARTICULAR FONT, STYLE, SIZE, OR COLOR.

SN 77-961,339, FILED 3-17-2010.

DORITT L. CARROLL, EXAMINING ATTORNEY



David J. Kyros

Director of the United States Patent and Trademark Office

United States of America

United States Patent and Trademark Office

82Go

Reg. No. 4,176,085

PLASTECH INNOVATIONS, LLC (FLORIDA LIMITED LIABILITY COMPANY)
117 N.E. 1ST AVENUE, PH 1
MIAMI, FL 33132

Registered July 17, 2012

Int. Cl.: 32

FOR: BEVERAGES, NAMELY, WATER, IN CLASS 32 (U.S. CLS. 45, 46 AND 48).

TRADEMARK

FIRST USE 11-24-2011; IN COMMERCE 11-24-2011.

PRINCIPAL REGISTER

THE MARK CONSISTS OF STANDARD CHARACTERS WITHOUT CLAIM TO ANY PARTICULAR FONT, STYLE, SIZE, OR COLOR.

SN 77-962,500, FILED 3-18-2010.

ROBIN MITTLER, EXAMINING ATTORNEY



David J. Kyffers

Director of the United States Patent and Trademark Office

United States of America

United States Patent and Trademark Office

OPEN SPACE YOGA

Reg. No. 4,176,086

BASTIEN, MARY (UNITED STATES INDIVIDUAL)
2027 LANIHULI DR
HONOLULU, HI 96822

Registered July 17, 2012

Int. Cl.: 41

FOR: PHYSICAL FITNESS STUDIO SERVICES, NAMELY, YOGA INSTRUCTION CLASSES AND YOGA TRAINING, IN CLASS 41 (U.S. CLS. 100, 101 AND 107).

SERVICE MARK

FIRST USE 11-1-2004; IN COMMERCE 4-1-2006.

PRINCIPAL REGISTER

THE MARK CONSISTS OF STANDARD CHARACTERS WITHOUT CLAIM TO ANY PARTICULAR FONT, STYLE, SIZE, OR COLOR.

NO CLAIM IS MADE TO THE EXCLUSIVE RIGHT TO USE "YOGA", APART FROM THE MARK AS SHOWN.

SN 77-962,897, FILED 3-19-2010.

CHERYL CLAYTON, EXAMINING ATTORNEY



David J. Kybas

Director of the United States Patent and Trademark Office

United States of America

United States Patent and Trademark Office

DOUBLE TROUBLE

Reg. No. 4,176,087

ROCKET GAMING SYSTEMS, LLC (DELAWARE LIMITED LIABILITY COMPANY)
66201 E. 290 ROAD
GROVE, OK 74344

Registered July 17, 2012

Int. Cl.: 9

FOR: GAMING MACHINES, NAMELY, BINGO-RELATED GAMES AND SLOT MACHINES,
IN CLASS 9 (U.S. CLS. 21, 23, 26, 36 AND 38).

TRADEMARK

FIRST USE 3-4-2011; IN COMMERCE 3-4-2011.

PRINCIPAL REGISTER

THE MARK CONSISTS OF STANDARD CHARACTERS WITHOUT CLAIM TO ANY PAR-
TICULAR FONT, STYLE, SIZE, OR COLOR.

SN 77-963,040, FILED 3-19-2010.

CHARISMA HAMPTON, EXAMINING ATTORNEY



David J. Kyffers

Director of the United States Patent and Trademark Office

United States of America

United States Patent and Trademark Office

reperi

Reg. No. 4,176,088

REPERI LLC (DELAWARE LIMITED LIABILITY COMPANY)
PO BOX 5540
WHITEFISH, MT 59937

Registered July 17, 2012

Int. Cls.: 35, 42, and 45

FOR: BUSINESS MANAGEMENT AND CONSULTATION, IN CLASS 35 (U.S. CLS. 100, 101 AND 102).

SERVICE MARK

FIRST USE 1-1-2010; IN COMMERCE 1-1-2010.

PRINCIPAL REGISTER

FOR: TECHNOLOGY CONSULTATION AND RESEARCH IN THE FIELD OF AEROSPACE, ENERGY, TELECOMMUNICATIONS, INFORMATION TECHNOLOGY, IN CLASS 42 (U.S. CLS. 100 AND 101).

FIRST USE 1-1-2010; IN COMMERCE 1-1-2010.

FOR: CONSULTING SERVICES IN THE FIELD OF NATIONAL SECURITY, IN CLASS 45 (U.S. CLS. 100 AND 101).

FIRST USE 1-1-2010; IN COMMERCE 1-1-2010.

THE MARK CONSISTS OF STANDARD CHARACTERS WITHOUT CLAIM TO ANY PARTICULAR FONT, STYLE, SIZE, OR COLOR.

THE ENGLISH TRANSLATION OF "REPERI" IN THE MARK IS "TO DISCOVER", "LEARN", "LIGHT ON", "OBTAIN", "FIND OUT", OR "INVENT".

SN 77-963,262, FILED 3-19-2010.

DAVID C. REIHNER, EXAMINING ATTORNEY



David J. Kybas

Director of the United States Patent and Trademark Office

United States of America

United States Patent and Trademark Office

JETSET BUILD!

Reg. No. 4,176,089

Registered July 17, 2012

Int. Cl.: 41

SERVICE MARK

PRINCIPAL REGISTER

SCHAD, BRENDA (UNITED STATES INDIVIDUAL)
349 EAST 19TH ST
NEW YORK, NY 10003

FOR: ENTERTAINMENT SERVICES IN THE NATURE OF AN ON-GOING REALITY-BASED TELEVISION SERIES; EDUCATIONAL AND ENTERTAINMENT SERVICES IN THE NATURE OF ONLINE SERIES OF PROGRAMS, WEBISODES AND DOCUMENTARIES FEATURING A PREVIOUSLY TELEVISED ENTERTAINMENT SERIES FOR DISTRIBUTION VIA ANY MOBILE DEVICES AND A GLOBAL COMPUTER NETWORK; PROVIDING ONLINE NON-DOWNLOADABLE VIDEO CLIPS FEATURING A PREVIOUSLY TELEVISED ENTERTAINMENT SERIES; ENTERTAINMENT SERVICES, NAMELY, PROVIDING A WEBSITE FEATURING NEWS AND INFORMATION ABOUT A TELEVISION PROGRAM, RELATED FILM CLIPS, PHOTOGRAPHS, AND OTHER MULTIMEDIA MATERIALS, IN CLASS 41 (U.S. CLS. 100, 101 AND 107).

FIRST USE 1-1-2011; IN COMMERCE 9-20-2011.

THE MARK CONSISTS OF STANDARD CHARACTERS WITHOUT CLAIM TO ANY PARTICULAR FONT, STYLE, SIZE, OR COLOR.

SN 77-964,002, FILED 3-19-2010.

MARK T. MULLEN, EXAMINING ATTORNEY



David J. Kyros

Director of the United States Patent and Trademark Office

United States of America

United States Patent and Trademark Office

SUPER EASY. SUPER FAST.

Reg. No. 4,176,090

Registered July 17, 2012

Int. Cl.: 3

TRADEMARK

PRINCIPAL REGISTER

SUPERCLEAN BRANDS, LLC (MINNESOTA LIMITED LIABILITY COMPANY)
SUITE 107
1380 CORPORATE CENTER CURVE
EAGAN, MN 55121

FOR: ALL-PURPOSE CLEANING AND DEGREASING PREPARATIONS; HOUSEHOLD CLEANING PREPARATIONS; AUTOMOTIVE CLEANING PREPARATIONS, IN CLASS 3 (U.S. CLS. 1, 4, 6, 50, 51 AND 52).

FIRST USE 9-26-2011; IN COMMERCE 9-26-2011.

THE MARK CONSISTS OF STANDARD CHARACTERS WITHOUT CLAIM TO ANY PARTICULAR FONT, STYLE, SIZE, OR COLOR.

OWNER OF U.S. REG. NOS. 2,883,428 AND 3,665,176.

SN 77-965,219, FILED 3-22-2010.

SANI KHOURI, EXAMINING ATTORNEY



David J. Kyffers

Director of the United States Patent and Trademark Office

United States of America

United States Patent and Trademark Office



Reg. No. 4,176,091

SHIELD SECURITY SYSTEMS, L.L.C. (COLORADO LIMITED LIABILITY COMPANY)
7456 WEST 5TH AVENUE

Registered July 17, 2012

LAKESWOOD, CO 80226

Int. Cls.: 39 and 45

FOR: DISTRIBUTION SERVICES IN THE NATURE OF DELIVERY TO OTHERS OF ACCESS DEVICES IN THE NATURE OF KEYS, MECHANICAL KEYS, ELECTRONIC KEYS, PIN CODES, SAFE COMBINATIONS, BIOMETRIC IDENTIFICATION SCANNERS, AND FOBS, IN CLASS 39 (U.S. CLS. 100 AND 105).

SERVICE MARK

PRINCIPAL REGISTER

FIRST USE 6-21-2011; IN COMMERCE 6-21-2011.

FOR: SECURITY CONSULTANCY SERVICES, NAMELY, CONSULTING SERVICES IN THE FIELD OF ACCESS DEVICES, INCLUDING ACCESS SYSTEMS THAT FEATURE MECHANICAL KEY CONTROLS; DEVELOPMENT, OPERATION, AND ADMINISTRATION OF ACCESS DEVICE SYSTEMS FOR OTHERS, NAMELY, TRACKING AND MONITORING OF ACCESS SYSTEMS FEATURING KEYS, MECHANICAL KEYS, ELECTRONIC KEYS, PIN CODES, SAFE COMBINATION, BIOMETRIC IDENTIFICATION SCANS, OR FOBS, ALL FOR SECURITY PURPOSES, IN CLASS 45 (U.S. CLS. 100 AND 101).

FIRST USE 6-21-2011; IN COMMERCE 6-21-2011.

OWNER OF U.S. REG. NO. 1,836,549.

NO CLAIM IS MADE TO THE EXCLUSIVE RIGHT TO USE "KEY CONTROL", APART FROM THE MARK AS SHOWN.

THE MARK CONSISTS OF A WAFER STACK DESIGN ADJACENT TO THE WORD "KEY-CONTROL".

SN 77-965,993, FILED 3-23-2010.

KRISTIN DAHLING, EXAMINING ATTORNEY



David J. Kyjars

Director of the United States Patent and Trademark Office

United States of America

United States Patent and Trademark Office

HUMMINGBIRD

Reg. No. 4,176,092

COLLINE, JULIANA ZHANG (UNITED STATES INDIVIDUAL)
293 MOUNTAIRE PARKWAY
CLAYTON, CA 94517 AND

Registered July 17, 2012

Int. Cl.: 29

COLLINE, CHRISTIAN (UNITED STATES INDIVIDUAL)
293 MOUNTAIRE PARKWAY
CLAYTON, CA 94517

TRADEMARK

PRINCIPAL REGISTER

FOR: DRIED FRUIT-BASED SNACKS; DRIED FRUITS; FRUIT-BASED SNACK FOOD;
PROCESSED NUTS; ROASTED NUTS; SHELLED NUTS, IN CLASS 29 (U.S. CL. 46).

FIRST USE 10-1-2011; IN COMMERCE 12-10-2011.

THE MARK CONSISTS OF STANDARD CHARACTERS WITHOUT CLAIM TO ANY PARTICULAR FONT, STYLE, SIZE, OR COLOR.

SN 77-969,025, FILED 3-25-2010.

BERNICE MIDDLETON, EXAMINING ATTORNEY



David J. Kyros

Director of the United States Patent and Trademark Office

United States of America

United States Patent and Trademark Office

LINESTREAM

Reg. No. 4,176,093

Registered July 17, 2012

Int. Cl.: 42

SERVICE MARK

PRINCIPAL REGISTER

LINESTREAM TECHNOLOGIES, INC. (OHIO CORPORATION)
SUITE 1700
1801 EAST 9TH STREET
CLEVELAND, OH 44114

FOR: COMPUTER PROGRAMMING, COMPUTER CONSULTATION AND ENGINEERING SERVICES ALL IN THE FIELDS OF AUTOMATIC FEEDBACK CONTROLLER DEVELOPMENT, AUTOMATIC FEEDBACK CONTROLLER IMPLEMENTATION, AUTOMATIC FEEDBACK CONTROLLER MONITORING, CHARACTERIZATION OF SYSTEMS, INDUSTRIAL SYSTEMS, INDUSTRIAL PROCESSES, MECHANICAL SYSTEMS, ROBOTIC AND AUTOMATED SYSTEMS, AND ELECTRONIC SYSTEMS, IN CLASS 42 (U.S. CLS. 100 AND 101).

FIRST USE 3-12-2012; IN COMMERCE 3-12-2012.

THE MARK CONSISTS OF STANDARD CHARACTERS WITHOUT CLAIM TO ANY PARTICULAR FONT, STYLE, SIZE, OR COLOR.

SN 77-969,183, FILED 3-26-2010.

LEIGH CAROLINE CASE, EXAMINING ATTORNEY



David J. Kypos

Director of the United States Patent and Trademark Office

United States of America

United States Patent and Trademark Office

EDIE PARKER

Reg. No. 4,176,094

Registered July 17, 2012

Int. Cl.: 18

TRADEMARK

PRINCIPAL REGISTER

EDIE PARKER LLC (NEW YORK LIMITED LIABILITY COMPANY)
125 EAST 72ND STREET
#13D
NEW YORK, NY 10021

FOR: LADIES' HANDBAGS, IN CLASS 18 (U.S. CLS. 1, 2, 3, 22 AND 41).

FIRST USE 12-0-2010; IN COMMERCE 12-0-2010.

THE MARK CONSISTS OF STANDARD CHARACTERS WITHOUT CLAIM TO ANY PARTICULAR FONT, STYLE, SIZE, OR COLOR.

THE NAME(S), PORTRAIT(S), AND/OR SIGNATURE(S) SHOWN IN THE MARK IDENTIFIES "EDIE PARKER", WHOSE CONSENT(S) TO REGISTER IS MADE OF RECORD.

SN 77-969,395, FILED 3-26-2010.

EUGENIA MARTIN, EXAMINING ATTORNEY



David J. Kybas

Director of the United States Patent and Trademark Office

United States of America

United States Patent and Trademark Office

FLAVOR THE POSSIBILITIES

Reg. No. 4,176,095

CITROMAX FLAVORS, INC. (NEW JERSEY CORPORATION)
444 WASHINGTON AVENUE
CARLSTADT, NJ 07072

Registered July 17, 2012

Int. Cls.: 1, 3, and 30

FOR: CITRIC ACID; FOOD PRESERVATIVE COMPOSITIONS, IN CLASS 1 (U.S. CLS. 1, 5, 6, 10, 26 AND 46).

TRADEMARK

FIRST USE 5-1-2011; IN COMMERCE 5-1-2011.

PRINCIPAL REGISTER

FOR: FOOD FLAVORING, BEING ESSENTIAL OILS; FOOD FLAVORINGS PREPARED FROM ESSENTIAL OILS; ESSENTIAL OILS, IN CLASS 3 (U.S. CLS. 1, 4, 6, 50, 51 AND 52).

FIRST USE 5-1-2011; IN COMMERCE 5-1-2011.

FOR: FLAVORINGS; FLAVORINGS AND SEASONINGS; FLAVORING ADDITIVES FOR NON-NUTRITIONAL PURPOSES; FLAVORING SYRUP, IN CLASS 30 (U.S. CL. 46).

FIRST USE 5-1-2011; IN COMMERCE 5-1-2011.

THE MARK CONSISTS OF STANDARD CHARACTERS WITHOUT CLAIM TO ANY PARTICULAR FONT, STYLE, SIZE, OR COLOR.

SN 77-982,385, FILED 3-13-2009.

JULIE GUTTADAURO, EXAMINING ATTORNEY



David J. Kybas

Director of the United States Patent and Trademark Office

United States of America

United States Patent and Trademark Office

SKINNYGIRL

Reg. No. 4,176,096

JIM BEAM BRANDS CO. (DELAWARE CORPORATION)
510 LAKE COOK ROAD
DEERFIELD, IL 60015

Registered July 17, 2012

Int. Cl.: 33

FOR: ALCOHOLIC COCKTAIL MIXES, IN CLASS 33 (U.S. CLS. 47 AND 49).

TRADEMARK

FIRST USE 9-23-2009; IN COMMERCE 9-23-2009.

PRINCIPAL REGISTER

THE MARK CONSISTS OF STANDARD CHARACTERS WITHOUT CLAIM TO ANY PARTICULAR FONT, STYLE, SIZE, OR COLOR.

SN 77-982,634, FILED 11-25-2008.

BRENDAN REGAN, EXAMINING ATTORNEY



David J. Kybas

Director of the United States Patent and Trademark Office

United States of America

United States Patent and Trademark Office

INVISIBLE DESIGN

Reg. No. 4,176,097

Registered July 17, 2012

Int. Cls.: 6 and 37

TRADEMARK

SERVICE MARK

PRINCIPAL REGISTER

VISPLAY INTERNATIONAL AG (SWITZERLAND AKTIENGESELLSCHAFT)
KLÜNENFELDSTRASSE 22
MUTTENZ, SWITZERLAND 4127BIRSF

FOR: METAL GOODS, NAMELY, METAL WALL SUPPORTS AND SHELF SUPPORTS WITH ATTACHED HOLDERS, SHELF HOLDERS AND CLOTHES RAILS FOR USE IN FASHION SHOPS; NON-LUMINOUS AND NON-MECHANICAL METAL PRICE AND SIZE SIGNS AND TAGS; METAL FRONT ARM HOLDERS AND PROFILE RAILS FOR USE IN FASHION SHOPS; METAL SHELF BRACKETS; METAL PLACARD WALLS AND PLACARD STANDS FOR USE IN FASHION SHOPS; METAL PLACARD COLUMNS; AND METAL PLACARD BOARDS; TRANSPORTABLE METAL BUILDING ELEMENTS, NAMELY, BACK WALLS AND PARTITION WALLS FOR SHOP INTERIORS, IN CLASS 6 (U.S. CLS. 2, 12, 13, 14, 23, 25 AND 50).

FIRST USE 1-1-2011; IN COMMERCE 1-1-2011.

FOR: CONSTRUCTION CONSULTANCY; CONSTRUCTION OF FURNITURE AND DISPLAY FIXTURES FOR SHOPS, WINDOWS DISPLAYS, TRADE SHOW BOOTHS, RECEPTION AREAS, OFFICES AND PRIVATE HOUSEHOLDS, IN CLASS 37 (U.S. CLS. 100, 103 AND 106).

FIRST USE 1-1-2011; IN COMMERCE 1-1-2011.

THE MARK CONSISTS OF STANDARD CHARACTERS WITHOUT CLAIM TO ANY PARTICULAR FONT, STYLE, SIZE, OR COLOR.

NO CLAIM IS MADE TO THE EXCLUSIVE RIGHT TO USE "DESIGN", APART FROM THE MARK AS SHOWN.

SN 77-982,968, FILED 1-22-2010.

CHRISTOPHER BUONGIORNO, EXAMINING ATTORNEY



David J. Kybas

Director of the United States Patent and Trademark Office

United States of America

United States Patent and Trademark Office

PLAYPORTT

Reg. No. 4,176,098

TOUCHTUNES MUSIC CORPORATION (DELAWARE CORPORATION)
850 THIRD AVE., SUITE 15-C
NEW YORK, NY 10022

Registered July 17, 2012

Int. Cls.: 35, 41, and 42

FOR: REMOTE DATA PROCESSING SERVICES VIA SATELLITE, WIRE, WIRELESS DATA OR CABLE, NAMELY, TELEPROCESSING ELECTRONIC DATA FOR THE TRANSFER OF AUDIO OR VIDEO DIGITAL INFORMATION, MAINTENANCE INFORMATION FOR REMOTE MAINTENANCE, AND FOR THE COLLECTION AND DISSEMINATION OF MUSICAL, GAME, ENTERTAINMENT, AND STATISTICAL INFORMATION; ADVERTISING AND MARKETING OF VIDEO GAMES, IN CLASS 35 (U.S. CLS. 100, 101 AND 102).

SERVICE MARK

PRINCIPAL REGISTER

FIRST USE 0-0-2009; IN COMMERCE 0-0-2009.

FOR: ENTERTAINMENT SERVICES, NAMELY, PROVIDING ONLINE COMPUTER GAMES AND MUSICAL PERFORMANCES, IN CLASS 41 (U.S. CLS. 100, 101 AND 107).

FIRST USE 0-0-2009; IN COMMERCE 0-0-2009.

FOR: REMOTE MAINTENANCE OF COMPUTER SOFTWARE FOR OTHERS VIA A GLOBAL COMPUTER NETWORK; MONITORING SERVICES OF GAME, ENTERTAINMENT AND MUSIC SYSTEMS, DIGITAL JUKEBOXES AND RELATED SERVICES, NAMELY, MONITORING SATELLITE, WIRE, CABLE ONE OR MORE OF THE FOLLOWING WIRELESS, OR RF OR INFRARED OR OPTICAL FIBER TELECOMMUNICATION NETWORKS, DISKS, SPEAKERS, DIGITAL SOUND BOARDS, TOUCH SCREENS, DISPLAY MONITORS, MOUSE, KEYBOARDS AND COMPUTER CABLES; COMPUTER SERVICES, NAMELY, FACILITATING THE DOWNLOADING OF GAMES, SONGS, SOFTWARE, AND VIDEOS TO BE EXECUTED ON THE JUKEBOX OR TO ANY ELECTRONIC DEVICE ABLE TO PROVIDE GAMES, ENTERTAINMENT, ADVERTISING, SONGS OR VIDEOS BY USE OF DIGITAL INFORMATION; AND VIDEO GAME SOFTWARE REPAIR AND INSTALLATION OF COMPUTER SOFTWARE, IN CLASS 42 (U.S. CLS. 100 AND 101).

FIRST USE 0-0-2009; IN COMMERCE 0-0-2009.

THE MARK CONSISTS OF STANDARD CHARACTERS WITHOUT CLAIM TO ANY PARTICULAR FONT, STYLE, SIZE, OR COLOR.



David J. Kyros

Director of the United States Patent and Trademark Office

SN 77-983,078, FILED 10-15-2008.

Reg. No. 4,176,098 LINDA M. KING, EXAMINING ATTORNEY

United States of America

United States Patent and Trademark Office

ONE-CLICK PLANNING

Reg. No. 4,176,099

Registered July 17, 2012

Int. Cl.: 42

SERVICE MARK

PRINCIPAL REGISTER

STEELWEDGE SOFTWARE, INC. (CALIFORNIA CORPORATION)
SUITE 155
3825 HOPYARD ROAD
PLEASANTON, CA 94588

FOR: PROVIDING TEMPORARY USE OF ON-LINE NON-DOWNLOADABLE SOFTWARE FOR ASSISTANCE IN CAPTURING, MANAGING, TRACKING, MONITORING, MAINTAINING, REPORTING AND ANALYZING DATA, AND FACILITATING AND AUTOMATING COLLABORATION, TO BE USED IN THE FIELDS OF SALES AND OPERATIONS PLANNING, INTEGRATED BUSINESS PLANNING, DEMAND FORECASTING, DEMAND PLANNING, REVENUE PLANNING, SUPPLY PLANNING, PERFORMANCE MANAGEMENT AND ANALYTICS; PROVIDING TEMPORARY USE OF ON-LINE NON-DOWNLOADABLE SOFTWARE FOR ASSISTANCE IN APPLICATION DEVELOPMENT AND CONFIGURATION TOOLS; COMPUTER SERVICES, NAMELY, HOSTING AN ONLINE WEBSITE TO PROVIDE ASSISTANCE IN DESIGNING, DEVELOPING, IMPLEMENTING, CONFIGURING, AND MAINTAINING COMPUTER SOFTWARE APPLICATIONS FOR OTHERS, IN CLASS 42 (U.S. CLS. 100 AND 101).

FIRST USE 4-14-2008; IN COMMERCE 4-14-2008.

THE MARK CONSISTS OF STANDARD CHARACTERS WITHOUT CLAIM TO ANY PARTICULAR FONT, STYLE, SIZE, OR COLOR.

NO CLAIM IS MADE TO THE EXCLUSIVE RIGHT TO USE "PLANNING", APART FROM THE MARK AS SHOWN.

SN 77-983,152, FILED 3-6-2010.

KATHERINE CHANG, EXAMINING ATTORNEY



David J. Kyros

Director of the United States Patent and Trademark Office

United States of America

United States Patent and Trademark Office

SKYZIP

Reg. No. 4,176,100

Registered July 17, 2012

Int. Cl.: 41

SERVICE MARK

PRINCIPAL REGISTER

THE DOLLYWOOD COMPANY (TENNESSEE JOINT VENTURE)
1020 DOLLYWOOD LANE
PIGEON FORGE, TN 37863

FOR: THEME PARK SERVICES, NAMELY, AN AREA OF A THEME PARK FEATURING RECREATIONAL AND ADVENTURE RIDES AND ZIPLINES, IN CLASS 41 (U.S. CLS. 100, 101 AND 107).

FIRST USE 5-22-2009; IN COMMERCE 5-22-2009.

THE MARK CONSISTS OF STANDARD CHARACTERS WITHOUT CLAIM TO ANY PARTICULAR FONT, STYLE, SIZE, OR COLOR.

SN 77-983,169, FILED 3-9-2009.

MARY CRAWFORD, EXAMINING ATTORNEY



David J. Kyffers

Director of the United States Patent and Trademark Office

United States of America

United States Patent and Trademark Office

TELEQT

Reg. No. 4,176,101

WYETH LLC (DELAWARE LIMITED LIABILITY COMPANY)
FIVE GIRALDA FARMS
MADISON, NJ 07940

Registered July 17, 2012

Int. Cl.: 5

FOR: PHARMACEUTICAL PREPARATIONS FOR THE TREATMENT OF CENTRAL NERVOUS SYSTEM AND NEUROLOGICAL DISEASES AND DISORDERS, IN CLASS 5 (U.S. CLS. 6, 18, 44, 46, 51 AND 52).

TRADEMARK

FIRST USE 1-25-2012; IN COMMERCE 1-25-2012.

PRINCIPAL REGISTER

THE MARK CONSISTS OF STANDARD CHARACTERS WITHOUT CLAIM TO ANY PARTICULAR FONT, STYLE, SIZE, OR COLOR.

THE WORDING "TELEQT" HAS NO MEANING IN A FOREIGN LANGUAGE.

SN 77-983,175, FILED 3-10-2010.

ELISSA GARBER KON, EXAMINING ATTORNEY



David J. Kyffers

Director of the United States Patent and Trademark Office

United States of America

United States Patent and Trademark Office

MINSAVAN

Reg. No. 4,176,102

WYETH LLC (DELAWARE LIMITED LIABILITY COMPANY)
FIVE GIRALDA FARMS
MADISON, NJ 07940

Registered July 17, 2012

Int. Cl.: 5

FOR: PHARMACEUTICAL PREPARATIONS FOR THE TREATMENT OF CENTRAL NERVOUS SYSTEM AND NEUROLOGICAL DISEASES AND DISORDERS, IN CLASS 5 (U.S. CLS. 6, 18, 44, 46, 51 AND 52).

TRADEMARK

FIRST USE 1-25-2012; IN COMMERCE 1-25-2012.

PRINCIPAL REGISTER

THE MARK CONSISTS OF STANDARD CHARACTERS WITHOUT CLAIM TO ANY PARTICULAR FONT, STYLE, SIZE, OR COLOR.

THE WORDING "MINSAVAN" HAS NO MEANING IN A FOREIGN LANGUAGE.

SN 77-983,176, FILED 3-10-2010.

ELISSA GARBER KON, EXAMINING ATTORNEY



David J. Kyffers

Director of the United States Patent and Trademark Office

United States of America

United States Patent and Trademark Office

Sweet Gwendoline

Reg. No. 4,176,103

MCGEARTY, LARRY (UNITED STATES INDIVIDUAL)
50 PLAZA STREET EAST #7D
BROOKLYN, NY 11238 AND

Registered July 17, 2012

Int. Cl.: 25

SZYMBORSKI, JOSEPH JOHN (UNITED STATES INDIVIDUAL)
19 WEST JUDITH DRIVE
HAMMONTON, NJ 08037

TRADEMARK

PRINCIPAL REGISTER

FOR: ADULT NOVELTY GAG CLOTHING ITEM, NAMELY, SOCKS; BABY LAYETTES FOR CLOTHING; BELTS; BELTS FOR CLOTHING; BELTS MADE OUT OF CLOTH; BIBS NOT OF CLOTH OR PAPER; BOTTOMS; CHILDREN'S AND INFANTS' CLOTH BIBS; CHILDREN'S CLOTH EATING BIBS; CLOTH BIBS; CLOTH BIBS FOR ADULT DINERS; CLOTH BIBS FOR USE BY SENIOR CITIZENS OR PHYSICALLY- OR MENTALLY-CHALLENGED PERSONS; CLOTH DIAPERS; CLOTHING FOR ATHLETIC USE, NAMELY, PADDED ELBOW COMPRESSION SLEEVES; CLOTHING FOR ATHLETIC USE, NAMELY, PADDED PANTS; CLOTHING FOR ATHLETIC USE, NAMELY, PADDED SHIRTS; CLOTHING FOR ATHLETIC USE, NAMELY, PADDED SHORTS; CLOTHING FOR WEAR IN JUDO PRACTICES; CLOTHING FOR WEAR IN WRESTLING GAMES; CLOTHING ITEMS, NAMELY, ADHESIVE POCKETS THAT MAY BE AFFIXED DIRECTLY TO THE BODY AS A DECORATIVE PIECE OF CLOTHING WITH UTILITY; CLOTHING ITEMS, NAMELY, ADHESIVE POCKETS THAT MAY BE AFFIXED DIRECTLY TO THE INSIDE OF CLOTHING FOR STORAGE AND SAFEKEEPING OF PERSONAL ITEMS; CLOTHING, NAMELY, ARM WARMERS; CLOTHING, NAMELY, BASE LAYERS; CLOTHING, NAMELY, FOLK COSTUMES; CLOTHING, NAMELY, HAND-WARMERS; CLOTHING, NAMELY, KHAKIS; CLOTHING, NAMELY, KNEE WARMERS; CLOTHING, NAMELY, MATERNITY BANDS; CLOTHING, NAMELY, NECK TUBES; CLOTHING, NAMELY, THOBES; CLOTHING, NAMELY, WRAP-AROUNDS; CORSETS; DUSTERS; EYESHADES; FOULARDS; GLOVES AS CLOTHING; HEADBANDS FOR CLOTHING; HOODS; INFANT AND TODDLER ONE PIECE CLOTHING; INFANT CLOTH DIAPERS; JACKETS; JERSEYS; LEATHER BELTS; MANTLES; MUFFLERS; NON-DISPOSABLE CLOTH TRAINING PANTS; PAPER HATS FOR USE AS CLOTHING ITEMS; PARTS OF CLOTHING, NAMELY, GUSSETS FOR TIGHTS, GUSSETS FOR STOCKINGS, GUSSETS FOR BATHING SUITS, GUSSETS FOR UNDERWEAR, GUSSETS FOR LEOTARDS AND GUSSETS FOR FOOTLETS; PARTS OF CLOTHING, NAMELY, UNDERARM GUSSETS; PARTY HATS; PERSPIRATION ABSORBENT UNDERWEAR CLOTHING; POCKET SQUARES; SHIRTS; SHORT SETS; SHOULDER WRAPS; SHOULDER WRAPS FOR CLOTHING; SWADDLING CLOTHES; TIES; TOPS; TRAVEL CLOTHING CONTAINED IN A PACKAGE COMPRISING REVERSIBLE JACKETS, PANTS,

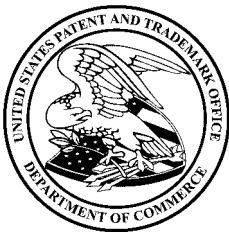

David J. Kyros

Director of the United States Patent and Trademark Office

Reg. No. 4,176,103 SKIRTS, TOPS AND A BELT OR SCARF; TRIATHLON CLOTHING, NAMELY, TRIATHLON TIGHTS, TRIATHLON SHORTS, TRIATHLON SINGLET, TRIATHLON SHIRTS, TRIATHLON SUITS; UNDERARM CLOTHING SHIELDS; WEARABLE GARMENTS AND CLOTHING, NAMELY, SHIRTS; WRAPS, IN CLASS 25 (U.S. CLS. 22 AND 39).

FIRST USE 1-1-2012; IN COMMERCE 1-1-2012.

THE MARK CONSISTS OF STANDARD CHARACTERS WITHOUT CLAIM TO ANY PARTICULAR FONT, STYLE, SIZE, OR COLOR.

SN 77-983,182, FILED 8-2-2009.

CHARLOTTE CORWIN, EXAMINING ATTORNEY

United States of America
United States Patent and Trademark Office

EMM KUO

Reg. No. 4,176,104

EKR DESIGNS LLC (NEW YORK LIMITED LIABILITY COMPANY)
65 WEST 13 STREET 4H
NEW YORK, NY 10011

Registered July 17, 2012

Int. Cl.: 18

FOR: HANDBAGS, POCKET BOOKS, SHOULDER BAGS, BEACH BAGS, TRAVEL BAGS, TOTE BAGS, PURSES, EVENING HANDBAGS, HANDBAGS FOR MEN, TOILETRY BAGS SOLD EMPTY, SACHELS, IN CLASS 18 (U.S. CLS. 1, 2, 3, 22 AND 41).

TRADEMARK

FIRST USE 3-0-2011; IN COMMERCE 3-0-2011.

PRINCIPAL REGISTER

THE MARK CONSISTS OF STANDARD CHARACTERS WITHOUT CLAIM TO ANY PARTICULAR FONT, STYLE, SIZE, OR COLOR.

THE NAME(S), PORTRAIT(S), AND/OR SIGNATURE(S) SHOWN IN THE MARK IDENTIFIES EMMALINE KUO RANZMAN, WHOSE CONSENT(S) TO REGISTER IS MADE OF RECORD.

SN 77-983,184, FILED 3-19-2010.

KAPIL BHANOT, EXAMINING ATTORNEY



David J. Kybas

Director of the United States Patent and Trademark Office

United States of America

United States Patent and Trademark Office

BEATS BY DR. DRE

Reg. No. 4,176,105

Registered July 17, 2012

Int. Cls.: 9 and 25

TRADEMARK

PRINCIPAL REGISTER

BEATS ELECTRONICS, LLC (DELAWARE LIMITED LIABILITY COMPANY)
1601 CLOVERFIELD BLVD., SUITE 5000N
SANTA MONICA, CA 90404

FOR: MEDIA PLAYERS FOR AUTOMOBILES; DVD PLAYERS FOR AUTOMOBILES; CD PLAYERS FOR AUTOMOBILES; DIGITAL AUDIO PLAYERS FOR AUTOMOBILES; AUDIO SPEAKERS; CAR AUDIO SPEAKERS; LOUDSPEAKERS; LOUDSPEAKER CABINETS; HORNS FOR LOUDSPEAKERS; HEADPHONES; PERSONAL HEADPHONES FOR USE WITH SOUND TRANSMITTING SYSTEMS; MEDIA PLAYERS FOR AUTOMOBILES, IN CLASS 9 (U.S. CLS. 21, 23, 26, 36 AND 38).

FIRST USE 10-14-2010; IN COMMERCE 10-14-2010.

FOR: T-SHIRTS, IN CLASS 25 (U.S. CLS. 22 AND 39).

FIRST USE 11-5-2011; IN COMMERCE 11-5-2011.

THE MARK CONSISTS OF STANDARD CHARACTERS WITHOUT CLAIM TO ANY PARTICULAR FONT, STYLE, SIZE, OR COLOR.

PRIORITY CLAIMED UNDER SEC. 44(D) ON ERPN CMNTY TM OFC APPLICATION NO. 008370827, FILED 6-17-2009.

OWNER OF U.S. REG. NO. 3,532,627.

THE NAME(S), PORTRAIT(S), AND/OR SIGNATURE(S) SHOWN IN THE MARK IDENTIFIES "ANDRE YOUNG" A/K/A "DR. DRE", WHOSE CONSENT(S) TO REGISTER IS MADE OF RECORD.

SN 77-983,185, FILED 7-21-2009.

BENJAMIN OKEKE, EXAMINING ATTORNEY



David J. Kyffers

Director of the United States Patent and Trademark Office

United States of America

United States Patent and Trademark Office



Reg. No. 4,176,106

Registered July 17, 2012

Int. Cl.: 41

SERVICE MARK

PRINCIPAL REGISTER

THE BOARD OF REGENTS OF THE UNIVERSITY OF TEXAS SYSTEM (TEXAS STATE AGENCY)
201 WEST 7TH STREET
AUSTIN, TX 78701 AND

TEXAS A&M UNIVERSITY (TEXAS INSTITUTION OF HIGHER EDUCATION)
TEXAS A & M SYSTEM BUILDING, SUITE 2079
200 TECHNOLOGY WAY
COLLEGE STATION, TX 77840

FOR: ENTERTAINMENT IN THE NATURE OF COMPETITIONS IN THE FIELD OF COLLEGE ATHLETICS, IN CLASS 41 (U.S. CLS. 100, 101 AND 107).

FIRST USE 11-0-2004; IN COMMERCE 11-0-2004.

NO CLAIM IS MADE TO THE EXCLUSIVE RIGHT TO USE "THE DESIGN OF THE STATE OF TEXAS", APART FROM THE MARK AS SHOWN.

SEC. 2(F) AS TO "LONE STAR".

THE MARK CONSISTS OF STYLIZED STAR BACKGROUND WITH THE WORDS "LONE STAR SHOWDOWN, ATM" AND THE ABBREVIATED FOR OF VERSUS (VS.) AND AN OUTLINE OF THE STATE OF TEXAS AND A LONGHORN STEER HEAD SUPERIMPOSED.

SN 77-983,199, FILED 11-17-2008.

LAKEISHA LEWIS, EXAMINING ATTORNEY



David J. Kyjars

Director of the United States Patent and Trademark Office

United States of America

United States Patent and Trademark Office

INSPIRATION'S HOMETOWN

Reg. No. 4,176,107

BALDINO, SANDRA K. (UNITED STATES INDIVIDUAL)
106 BELLEFAIR LANE
WEST CHESTER, PA 19382

Registered July 17, 2012

Int. Cl.: 41

FOR: PROVIDING ON-LINE PUBLICATIONS IN THE NATURE OF MAGAZINES AND NEWSLETTERS FEATURING EDUCATIONAL INFORMATION ABOUT COMMUNITY INVOLVEMENT, VOLUNTEERISM, PHILANTHROPY AND SOCIAL RESPONSIBILITY, IN CLASS 41 (U.S. CLS. 100, 101 AND 107).

SERVICE MARK

PRINCIPAL REGISTER

FIRST USE 1-31-2012; IN COMMERCE 1-31-2012.

THE MARK CONSISTS OF STANDARD CHARACTERS WITHOUT CLAIM TO ANY PARTICULAR FONT, STYLE, SIZE, OR COLOR.

SN 77-983,201, FILED 4-7-2009.

BERYL GARDNER, EXAMINING ATTORNEY



David J. Kyffers

Director of the United States Patent and Trademark Office

United States of America

United States Patent and Trademark Office

REZNARE

Reg. No. 4,176,108

PFIZER INC. (DELAWARE CORPORATION)
235 EAST 42ND STREET
NEW YORK, NY 10017

Registered July 17, 2012

Int. Cl.: 5

FOR: PHARMACEUTICAL PREPARATIONS FOR THE TREATMENT OF CENTRAL NERVOUS SYSTEM, NEUROLOGICAL DISEASES AND DISORDERS; PHARMACEUTICAL PREPARATIONS FOR THE TREATMENT OF ALZHEIMER'S DISEASE, IN CLASS 5 (U.S. CLS. 6, 18, 44, 46, 51 AND 52).

TRADEMARK

PRINCIPAL REGISTER

FIRST USE 1-25-2012; IN COMMERCE 1-25-2012.

THE MARK CONSISTS OF STANDARD CHARACTERS WITHOUT CLAIM TO ANY PARTICULAR FONT, STYLE, SIZE, OR COLOR.

SN 77-983,202, FILED 2-20-2009.

ELLEN PERKINS, EXAMINING ATTORNEY



David J. Kyffers

Director of the United States Patent and Trademark Office

United States of America

United States Patent and Trademark Office

Tu futuro comienza hoy.

Reg. No. 4,176,109

Registered July 17, 2012

Int. Cl.: 41

SERVICE MARK

PRINCIPAL REGISTER

MASSACHUSETTS MUTUAL LIFE INSURANCE COMPANY (MASSACHUSETTS CORPORATION)
1295 STATE STREET
SPRINGFIELD, MA 01111

FOR: EDUCATIONAL SERVICES, NAMELY, CONDUCTING SEMINARS IN THE FIELD OF RETIREMENT SERVICES AND INVESTMENTS, IN CLASS 41 (U.S. CLS. 100, 101 AND 107).

FIRST USE 8-9-2011; IN COMMERCE 8-9-2011.

THE MARK CONSISTS OF STANDARD CHARACTERS WITHOUT CLAIM TO ANY PARTICULAR FONT, STYLE, SIZE, OR COLOR.

THE ENGLISH TRANSLATION OF "TU FUTURO COMIENZA HOY" IN THE MARK IS "YOUR FUTURE BEGINS TODAY".

SN 77-983,220, FILED 6-24-2009.

LINDSEY RUBIN, EXAMINING ATTORNEY



David J. Kybas

Director of the United States Patent and Trademark Office

United States of America
United States Patent and Trademark Office

INTREXON

Reg. No. 4,176,110

Registered July 17, 2012

Int. Cl.: 44

SERVICE MARK

PRINCIPAL REGISTER

INTREXON CORPORATION (VIRGINIA CORPORATION)
SUITE 1400
1872 PRATT STREET
BLACKSBURG, VA 24060

FOR: MEDICAL SERVICES; MEDICAL SERVICES, NAMELY, GENE THERAPY SERVICES,
IN CLASS 44 (U.S. CLS. 100 AND 101).

FIRST USE 8-0-2010; IN COMMERCE 8-0-2010.

THE MARK CONSISTS OF STANDARD CHARACTERS WITHOUT CLAIM TO ANY PAR-
TICULAR FONT, STYLE, SIZE, OR COLOR.

OWNER OF U.S. REG. NO. 3,320,302.

SN 77-983,221, FILED 7-22-2008.

BRENDAN REGAN, EXAMINING ATTORNEY



David J. Kybas

Director of the United States Patent and Trademark Office

United States of America

United States Patent and Trademark Office



Reg. No. 4,176,111

SEATTLE'S BEST COFFEE LLC (WASHINGTON LIMITED LIABILITY COMPANY)
2401 UTAH AVENUE SOUTH
SEATTLE, WA 98134

Registered July 17, 2012

**Int. Cls.: 7, 9, 11, 16, 21,
29, 30, 32, 35, and 43**

FOR: ELECTRIC COFFEE GRINDERS FOR COMMERCIAL USE, IN CLASS 7 (U.S. CLS. 13, 19, 21, 23, 31, 34 AND 35).

FIRST USE 3-31-2011; IN COMMERCE 3-31-2011.

TRADEMARK

FOR: VENDING MACHINES, IN CLASS 9 (U.S. CLS. 21, 23, 26, 36 AND 38).

SERVICE MARK

FIRST USE 3-31-2011; IN COMMERCE 3-31-2011.

PRINCIPAL REGISTER

FOR: ELECTRICAL APPLIANCES, NAMELY, ESPRESSO MAKERS AND COFFEE MAKERS FOR COMMERCIAL USE, IN CLASS 11 (U.S. CLS. 13, 21, 23, 31 AND 34).

FIRST USE 3-31-2011; IN COMMERCE 3-31-2011.

FOR: PAPER BAGS, IN CLASS 16 (U.S. CLS. 2, 5, 22, 23, 29, 37, 38 AND 50).

FIRST USE 9-30-2010; IN COMMERCE 9-30-2010.

FOR: COFFEE CUPS; TEA CUPS AND MUGS; DISHES; CUPS; CUP SLEEVES, IN CLASS 21 (U.S. CLS. 2, 13, 23, 29, 30, 33, 40 AND 50).

FIRST USE 7-20-2011; IN COMMERCE 7-20-2011.

FOR: FLAVORED MILK AND MILK BASED BEVERAGES; LIQUID BEVERAGE MIXES USED TO MAKE MILK-BASED FOOD BEVERAGES EXCLUDING MILK SHAKES, IN CLASS 29 (U.S. CL. 46).

FIRST USE 7-20-2011; IN COMMERCE 7-20-2011.

FOR: GROUND AND WHOLE BEAN COFFEE; COCOA; HERBAL AND NON-HERBAL TEA; COFFEE, TEA, COCOA AND ESPRESSO BEVERAGES, AND BEVERAGES MADE WITH A BASE OF COFFEE AND/OR ESPRESSO; BEVERAGES MADE WITH A BASE OF TEA; SAUCES TO ADD TO BEVERAGES; CHOCOLATE SYRUP; FLAVORING SYRUPS TO ADD



David J. Kybas

Director of the United States Patent and Trademark Office

Reg. No. 4,176,111 TO BEVERAGES; BAKED GOODS INCLUDING MUFFINS, SCONES, BISCUITS, COOKIES, PASTRIES AND BREADS; READY-TO-DRINK COFFEE; CHOCOLATE; CANDY; FRUIT SAUCES EXCLUDING CRANBERRY SAUCE AND APPLESAUCE, IN CLASS 30 (U.S. CL. 46).

FIRST USE 11-10-2010; IN COMMERCE 11-10-2010.

FOR: NON-ALCOHOLIC DRINKS, NAMELY, FRUIT JUICE BASED BEVERAGES; FRUIT DRINKS; FRUIT DRINKS CONTAINING FRUIT JUICES; SAUCES FOR MAKING BEVERAGES; FLAVORING SYRUPS FOR MAKING BEVERAGES; FROZEN FRUIT BEVERAGES AND FROZEN FRUIT-BASED BEVERAGES, IN CLASS 32 (U.S. CLS. 45, 46 AND 48).

FIRST USE 7-20-2011; IN COMMERCE 7-20-2011.

FOR: BUSINESS ADMINISTRATION; BUSINESS MANAGEMENT; FRANCHISING, NAMELY, PROVIDING BUSINESS MANAGEMENT ASSISTANCE IN THE ESTABLISHMENT AND OR OPERATION OF RESTAURANTS, CAFES, COFFEE HOUSES AND SNACK BARS; RETAIL STORE SERVICES IN THE FIELD OF COFFEE, TEA, COCOA, PACKAGED AND PREPARED FOODS, NON-ELECTRIC APPLIANCES, HOUSEWARES, KITCHENWARE, BOOKS, MUSICAL RECORDINGS; WHOLESALE DISTRIBUTORSHIPS, AND WHOLESALE ORDERING SERVICES ALL IN THE FIELD OF COFFEE, TEA, AND COCOA; COMPUTERIZED ON-LINE ORDERING SERVICES, COMPUTERIZED ON-LINE RETAIL STORE SERVICES, ON-LINE ORDERING SERVICES AND ON-LINE RETAIL STORE SERVICES ALL IN THE FIELD OF COFFEE, TEA, COCOA, ELECTRIC APPLIANCES, HOUSEWARES, AND KITCHENWARE; RETAIL STORE SERVICES FEATURING CARRY OUT FOODS AND BEVERAGES, IN CLASS 35 (U.S. CLS. 100, 101 AND 102).

FIRST USE 5-12-2010; IN COMMERCE 5-12-2010.

FOR: RESTAURANT, CAFE, CAFETERIA, SNACK BAR, COFFEE BAR AND COFFEE HOUSE, CARRY OUT RESTAURANT, AND TAKE OUT RESTAURANT SERVICES; CATERING SERVICES; COFFEE SUPPLY SERVICES FOR OFFICES; CONTRACT FOOD SERVICES; FOOD PREPARATION; PREPARATION OF CARRY OUT FOODS AND BEVERAGES, IN CLASS 43 (U.S. CLS. 100 AND 101).

FIRST USE 11-10-2010; IN COMMERCE 11-10-2010.

OWNER OF U.S. REG. NOS. 1,910,161, 3,346,344, AND OTHERS.

SEC. 2(F) AS TO "SEATTLE'S BEST COFFEE".

NO CLAIM IS MADE TO THE EXCLUSIVE RIGHT TO USE "COFFEE", APART FROM THE MARK AS SHOWN.

THE MARK CONSISTS OF A CIRCULAR BAND SURROUNDING AN INTERNAL CIRCLE IN WHICH THE BOTTOM HALF CONTAINS A HALF CIRCLE AND TEAR DROP AND THE UPPER HALF DISPLAYS THE WORDING "SEATTLE'S BEST COFFEE".

SN 77-983,235, FILED 3-4-2010.

MATTHEW PAPPAS, EXAMINING ATTORNEY

United States of America

United States Patent and Trademark Office

FALCHI BY FALCHI

Reg. No. 4,176,112

Registered July 17, 2012

Int. Cls.: 14 and 18

TRADEMARK

PRINCIPAL REGISTER

FALCHI IP, LLC (DELAWARE LIMITED LIABILITY COMPANY)
260 WEST 39TH STREET
NEW YORK, NY 10018

FOR: JEWELRY, IN CLASS 14 (U.S. CLS. 2, 27, 28 AND 50).

FIRST USE 5-15-2012; IN COMMERCE 5-15-2012.

FOR: CLUTCH BAGS; HANDBAGS; LUGGAGE; LEATHER AND IMITATION LEATHER BAGS; LEATHER BAGS, OVERNIGHT BAGS; PURSES; AND TOTE BAGS, IN CLASS 18 (U.S. CLS. 1, 2, 3, 22 AND 41).

FIRST USE 5-15-2012; IN COMMERCE 5-15-2012.

THE MARK CONSISTS OF STANDARD CHARACTERS WITHOUT CLAIM TO ANY PARTICULAR FONT, STYLE, SIZE, OR COLOR.

OWNER OF U.S. REG. NOS. 1,116,624, 3,694,489, AND OTHERS.

SN 77-983,240, FILED 8-23-2007.

SETH A. RAPPAPORT, EXAMINING ATTORNEY

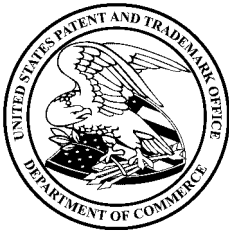

David J. Kyros

Director of the United States Patent and Trademark Office

United States of America

United States Patent and Trademark Office

FUTURE FITNESS CENTERS

Reg. No. 4,176,113

CDS CONSULTING, INC. (NEW JERSEY CORPORATION)

Registered July 17, 2012

545 ROUTE 73
WEST BERLIN, NJ 08091

Int. Cl.: 41

FOR: HEALTH CLUB SERVICES, NAMELY, PROVIDING INSTRUCTION AND EQUIPMENT IN THE FIELD OF PHYSICAL EXERCISE, IN CLASS 41 (U.S. CLS. 100, 101 AND 107).

SERVICE MARK

FIRST USE 1-1-2003; IN COMMERCE 1-1-2003.

PRINCIPAL REGISTER

NO CLAIM IS MADE TO THE EXCLUSIVE RIGHT TO USE "FITNESS CENTERS", APART FROM THE MARK AS SHOWN.

SN 78-275,270, FILED 7-16-2003.

DAVID COLLIER, EXAMINING ATTORNEY



David J. Kyffers

Director of the United States Patent and Trademark Office

United States of America

United States Patent and Trademark Office

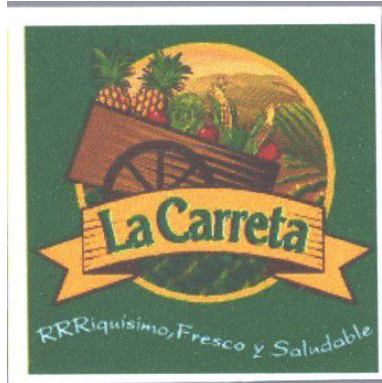

Reg. No. 4,176,114

Registered July 17, 2012

Int. Cl.: 31

TRADEMARK

PRINCIPAL REGISTER

AGROPECUARIA POPOYAN, SOCIEDAD ANONIMA (GUATEMALA CORPORATION)
6A, CALLE 5-47, ZONA 9 EDIFICIO VASIL
GUATEMALA CITY, GUATEMALA

FOR: FRESH FRUITS AND FRESH VEGETABLES, EXCLUDING BEANS, IN CLASS 31 (U.S. CLS. 1 AND 46).

FIRST USE 0-0-2003; IN COMMERCE 0-0-2003.

NO CLAIM IS MADE TO THE EXCLUSIVE RIGHT TO USE "RRRIQUISIMO, FRESCO & SALUDABLE", APART FROM THE MARK AS SHOWN.

THE COLORS GREEN, GOLD, BROWN AND RED ARE CLAIMED AS FEATURES OF THE MARK.

THE MARK CONSISTS OF THE WORDS "LA CARRETA" IN GREEN, OUTLINED IN GOLD, ON A BROWN RIBBON, A DRAWING OF A BROWN CART BEARING BROWN, RED, GREEN AND GOLD FRUITS AND VEGETABLES, SUPERIMPOSED ON A CIRCULAR BACKGROUND OF BROWN AND GREEN HILLS, ON A GREEN SQUARE, WITH THE WORDS "RRRIQUISIMO, FRESCO & SALUDABLE".

THE ENGLISH TRANSLATION OF THE SPANISH PHRASES "LA CARRETA" AND "RIQUISIMO, FRESCO Y SALUDABLE" ARE "THE CART" AND "VERY RICH, FRESH AND HEALTHFUL".

SN 78-337,070, FILED 12-5-2003.

CHRISTOPHER BUONGIORNO, EXAMINING ATTORNEY



David J. Kyros

Director of the United States Patent and Trademark Office

United States of America

United States Patent and Trademark Office

MEMORY MAGIC

Reg. No. 4,176,115

Registered July 17, 2012

Int. Cl.: 28

TRADEMARK

PRINCIPAL REGISTER

CREATIVE ACTION, LLC (OHIO LIMITED LIABILITY COMPANY)
680 NORTH PORTAGE PATH
AKRON, OH 44303

FOR: THERAPEUTIC ACTIVITY AND PROGRAM MATERIALS FOR INDIVIDUALS AND GROUPS OF PEOPLE WITH COGNITIVE IMPAIRMENTS SUCH AS DEMENTIA, HEAD TRAUMA OR STROKE LIVING IN LONG TERM CARE FACILITIES, ATTENDING ADULT DAY CARE CENTERS, LIVING AT HOME, OR STAYING IN HOSPITALS, COMPRISED OF PRINTED 'CALLING' CARDS THAT CONTAIN TRIVIA QUESTIONS AND RELATED PROMPTS FOR DISCUSSION, PRINTED CARDS THAT CONTAIN AN ARRAY OF POTENTIAL ANSWERS TO THE TRIVIA QUESTIONS, AND BOARDS USED TO HOLD THE PRINTED ANSWER CARDS, IN CLASS 28 (U.S. CLS. 22, 23, 38 AND 50).

FIRST USE 8-5-2004; IN COMMERCE 3-14-2005.

THE MARK CONSISTS OF STANDARD CHARACTERS WITHOUT CLAIM TO ANY PARTICULAR FONT, STYLE, SIZE, OR COLOR.

NO CLAIM IS MADE TO THE EXCLUSIVE RIGHT TO USE "MEMORY", APART FROM THE MARK AS SHOWN.

SN 78-359,895, FILED 1-30-2004.

CAROLYN CATALDO, EXAMINING ATTORNEY



David J. Kyros

Director of the United States Patent and Trademark Office

United States of America

United States Patent and Trademark Office

SENSES

Reg. No. 4,176,116

SEARS BRANDS, LLC (ILLINOIS LIMITED LIABILITY COMPANY)
3333 BEVERLY DRIVE

Registered July 17, 2012

HOFFMAN ESTATES, IL 60179

Int. Cl.: 24

FOR: BASIC AND FASHION BEDDING, NAMELY, BED BLANKETS, BED SHEETS, BED SKIRTS AND BED LINENS, IN CLASS 24 (U.S. CLS. 42 AND 50).

TRADEMARK

FIRST USE 9-0-2007; IN COMMERCE 9-0-2007.

PRINCIPAL REGISTER

THE MARK CONSISTS OF STANDARD CHARACTERS WITHOUT CLAIM TO ANY PARTICULAR FONT, STYLE, SIZE, OR COLOR.

SN 78-630,024, FILED 5-13-2005.

ALICE BENMAMAN, EXAMINING ATTORNEY



David J. Kybas

Director of the United States Patent and Trademark Office

United States of America

United States Patent and Trademark Office



Reg. No. 4,176,117

Registered July 17, 2012

Int. Cl.: 3

TRADEMARK

PRINCIPAL REGISTER

UAN'S INTERNATIONAL INC. (CANADA CORPORATION)
5 - 9225 LESLIE STREET
RICHMOND HILL, ONTARIO, CANADA L4B 3H6

FOR: HAIR CARE AND TREATMENT PRODUCTS, NAMELY, SHAMPOO, RINSE, CONDITIONER, LOTION, SPRAY, COLOUR BLEACH, PEROXIDE, HAIR PERMANENT WAVING COMPOSITION AND STRAIGHTENING COMPOSITION, IN CLASS 3 (U.S. CLS. 1, 4, 6, 50, 51 AND 52).

FIRST USE 12-31-2006; IN COMMERCE 12-31-2006.

PRIORITY CLAIMED UNDER SEC. 44(D) ON CANADA APPLICATION NO. 1283969, FILED 12-21-2005.

SN 78-788,731, FILED 1-10-2006.

WILLIAM P. SHANAHAN, EXAMINING ATTORNEY



David J. Kyffers

Director of the United States Patent and Trademark Office

United States of America

United States Patent and Trademark Office

IJAMS.COM

Reg. No. 4,176,118

Registered July 17, 2012

Int. Cls.: 38 and 41

SERVICE MARK

PRINCIPAL REGISTER

DOMAIN SOURCE, INC. (CALIFORNIA CORPORATION)
301 RIO DEL MAR BLVD
APTOS, CA 95003

FOR: PROVIDING ONLINE ELECTRONIC BULLETIN BOARDS FOR TRANSMISSION OF MESSAGES AMONG COMPUTER USERS CONCERNING MUSIC, IN CLASS 38 (U.S. CLS. 100, 101 AND 104).

FIRST USE 5-15-2012; IN COMMERCE 5-15-2012.

FOR: ENTERTAINMENT SERVICES, NAMELY, A WEBSITE PROVIDING PRERECORDED MUSIC, INFORMATION IN THE FIELD OF MUSIC, AND COMMENTARY ABOUT MUSIC, IN CLASS 41 (U.S. CLS. 100, 101 AND 107).

FIRST USE 5-15-2012; IN COMMERCE 5-15-2012.

THE MARK CONSISTS OF STANDARD CHARACTERS WITHOUT CLAIM TO ANY PARTICULAR FONT, STYLE, SIZE, OR COLOR.

SN 78-806,878, FILED 2-3-2006.

PAULA MAHONEY, EXAMINING ATTORNEY



David J. Kyffers

Director of the United States Patent and Trademark Office

United States of America

United States Patent and Trademark Office

PCD

Reg. No. 4,176,119

Registered July 17, 2012

Int. Cl.: 25

TRADEMARK

PRINCIPAL REGISTER

PUSSYCAT DOLLS, LLC (DELAWARE LIMITED LIABILITY COMPANY)
2220 COLORADO AVENUE
SANTA MONICA, CA 90404

FOR: BANDANAS; BLOUSES; UNDERWEAR; UNDERGARMENTS; GLOVES; HATS; CAPS; HOSIERY; JACKETS; LINGERIE; PAJAMAS; PANTS; SCARVES; SHORTS; SHIRTS; SWEAT SHIRTS; SWEAT PANTS; SWEAT JACKETS; SWEATERS; T-SHIRTS; TANK TOPS; SOCKS; TOPS; WRIST BANDS, IN CLASS 25 (U.S. CLS. 22 AND 39).

FIRST USE 9-1-2005; IN COMMERCE 9-1-2005.

THE MARK CONSISTS OF STANDARD CHARACTERS WITHOUT CLAIM TO ANY PARTICULAR FONT, STYLE, SIZE, OR COLOR.

SN 78-862,918, FILED 4-17-2006.

KATHERINE CONNOLLY, EXAMINING ATTORNEY



David J. Kybas

Director of the United States Patent and Trademark Office

United States of America

United States Patent and Trademark Office



Reg. No. 4,176,120

Registered July 17, 2012

Int. Cl.: 33

TRADEMARK

PRINCIPAL REGISTER

DIAGEO NORTH AMERICA, INC. (CONNECTICUT CORPORATION)
801 MAIN AVENUE
NORWALK, CT 06851

FOR: ALCOHOLIC BEVERAGES EXCEPT BEERS, IN CLASS 33 (U.S. CLS. 47 AND 49).

FIRST USE 2-1-2011; IN COMMERCE 2-1-2011.

NO CLAIM IS MADE TO THE EXCLUSIVE RIGHT TO USE "FREEZE & SHAKE", APART FROM THE MARK AS SHOWN.

THE MARK CONSISTS OF THE WORDS "FREEZE & SHAKE" WITH THE DESIGN OF A COCKTAIL SHAKER CONTAINING A SNOWFLAKE.

SN 85-000,540, FILED 3-29-2010.

HEATHER THOMPSON, EXAMINING ATTORNEY



David J. Kyffers

Director of the United States Patent and Trademark Office

United States of America

United States Patent and Trademark Office

FREEZERIGHT

Reg. No. 4,176,121

AIRGAS, INC. (DELAWARE CORPORATION)
259 NORTH RADNOR-CHESTER ROAD
RADNOR, PA 19087

Registered July 17, 2012

Int. Cl.: 11

FOR: COOLING AND FREEZING EQUIPMENT USING LIQUID NITROGEN AND CARBON DIOXIDE, NAMELY, CRYOGENIC FREEZERS, IN CLASS 11 (U.S. CLS. 13, 21, 23, 31 AND 34).

TRADEMARK

FIRST USE 1-0-2010; IN COMMERCE 1-0-2010.

PRINCIPAL REGISTER

THE MARK CONSISTS OF STANDARD CHARACTERS WITHOUT CLAIM TO ANY PARTICULAR FONT, STYLE, SIZE, OR COLOR.

SN 85-000,570, FILED 3-29-2010.

CURTIS FRENCH, EXAMINING ATTORNEY



David J. Kyffers

Director of the United States Patent and Trademark Office

United States of America

United States Patent and Trademark Office

ERGOTEC

Reg. No. 4,176,122

WILHELM HUMPERT GMBH & CO. KG (FED REP GERMANY LIMITED PARTNERSHIP)
ERLENSTRASSE 25

Registered July 17, 2012

58739 WICKEDE/RUHR, FED REP GERMANY

Int. Cl.: 12

FOR: BICYCLE PARTS, NAMELY, HANDLE BARS, BAR-ENDS, STEMS, FORKS, FRAMES, SEAT POSTS, SADDLES, WHEELS, RIMS, HUBS, STEERING HEAD BEARINGS, KICK-STANDS, BRAKES, LUGGAGE CARRIERS, HANDLE BAR GRIPS, DRINKING BOTTLE HOLDERS AND PEDALS, IN CLASS 12 (U.S. CLS. 19, 21, 23, 31, 35 AND 44).

TRADEMARK

PRINCIPAL REGISTER

FIRST USE 8-1-2008; IN COMMERCE 8-1-2008.

THE MARK CONSISTS OF STANDARD CHARACTERS WITHOUT CLAIM TO ANY PARTICULAR FONT, STYLE, SIZE, OR COLOR.

SN 85-000,671, FILED 3-29-2010.

JEFF DEFORD, EXAMINING ATTORNEY



David J. Kyjars

Director of the United States Patent and Trademark Office

United States of America

United States Patent and Trademark Office

CONDUIT 2

Reg. No. 4,176,123

HIGH VOLTAGE SOFTWARE, INC. (ILLINOIS CORPORATION)
2345 PEMBROKE AVENUE
HOFFMAN ESTATES, IL 60195

Registered July 17, 2012

Int. Cl.: 9

FOR: COMPUTER PROGRAMS FOR VIDEO GAMES, IN CLASS 9 (U.S. CLS. 21, 23, 26, 36 AND 38).

TRADEMARK

FIRST USE 4-19-2011; IN COMMERCE 4-19-2011.

PRINCIPAL REGISTER

THE MARK CONSISTS OF STANDARD CHARACTERS WITHOUT CLAIM TO ANY PARTICULAR FONT, STYLE, SIZE, OR COLOR.

SN 85-003,207, FILED 3-31-2010.

REGINA DRUMMOND, EXAMINING ATTORNEY



David J. Kyffers

Director of the United States Patent and Trademark Office

United States of America

United States Patent and Trademark Office

Twiiitch

Reg. No. 4,176,124

Registered July 17, 2012

Int. Cl.: 42

SERVICE MARK

PRINCIPAL REGISTER

SHANE STEVENS (AUSTRALIA INDIVIDUAL)
17/161 GREVILLE STREET
PRAHAN, VICTORIA, AUSTRALIA 3181

FOR: COMPUTER SOFTWARE CREATION; COMPUTER SOFTWARE AUTHORING;
COMPUTER SOFTWARE ENGINEERING; DEVELOPMENT OF COMPUTER SOFTWARE
FOR OTHERS; DEVELOPMENT OF COMPUTER SOFTWARE FOR USE WITH MOBILE
PLATFORMS, IN CLASS 42 (U.S. CLS. 100 AND 101).

FIRST USE 2-28-2010; IN COMMERCE 3-9-2012.

THE MARK CONSISTS OF STANDARD CHARACTERS WITHOUT CLAIM TO ANY PAR-
TICULAR FONT, STYLE, SIZE, OR COLOR.

SN 85-004,175, FILED 4-1-2010.

REGINA DRUMMOND, EXAMINING ATTORNEY



David J. Kyffers

Director of the United States Patent and Trademark Office

United States of America

United States Patent and Trademark Office



Reg. No. 4,176,125

V2 WINE GROUP, LLC (CALIFORNIA LIMITED LIABILITY COMPANY)
567 1ST STREET E
SONOMA, CA 95476

Registered July 17, 2012

Int. Cl.: 33

FOR: WINES, IN CLASS 33 (U.S. CLS. 47 AND 49).

TRADEMARK

FIRST USE 11-26-2011; IN COMMERCE 11-26-2011.

PRINCIPAL REGISTER

THE MARK CONSISTS OF THE WORD "SEISMIC" IN HANDWRITTEN FONT IN RED LOCATED TO THE LEFT OF THE BLACK LINES OF A SEISMOGRAM.

THE COLOR(S) RED AND BLACK IS/ARE CLAIMED AS A FEATURE OF THE MARK.

SN 85-005,363, FILED 4-2-2010.

ODESSA BIBBINS, EXAMINING ATTORNEY



David J. Kybas

Director of the United States Patent and Trademark Office

United States of America

United States Patent and Trademark Office



Reg. No. 4,176,126

Registered July 17, 2012

Int. Cl.: 35

SERVICE MARK

PRINCIPAL REGISTER

GEM MINT 10 ENTERPRISES LLC (TENNESSEE LIMITED LIABILITY COMPANY)
7051 HIGHWAY 70S; #282
NASHVILLE, TN 37221

FOR: MARKETING SERVICES, NAMELY, PROMOTING AND MARKETING THE GOODS AND SERVICES OF OTHERS THROUGH ALL PUBLIC COMMUNICATION MEANS, IN CLASS 35 (U.S. CLS. 100, 101 AND 102).

FIRST USE 3-15-2010; IN COMMERCE 5-1-2010.

NO CLAIM IS MADE TO THE EXCLUSIVE RIGHT TO USE "DEALS", APART FROM THE MARK AS SHOWN.

THE MARK CONSISTS OF AN OBLONG OVAL WITH THE STYLIZED WORDS "WILD WEST DEALS" IN IT, AND FOUR BARS BURSTING OUT OF THE SIDE OF THE OVAL.

SN 85-005,571, FILED 4-2-2010.

BRENDAN REGAN, EXAMINING ATTORNEY



David J. Kybas

Director of the United States Patent and Trademark Office

United States of America

United States Patent and Trademark Office

GRANUMEIST

Reg. No. 4,176,127

Registered July 17, 2012

Int. Cl.: 7

TRADEMARK

PRINCIPAL REGISTER

FREUND CORPORATION (JAPAN CORPORATION)
SHINJUKU-KU
8-1, NICHISHINJUKU 6-CHOME
TOKYO, JAPAN 163-6034

FOR: GRANULATING MACHINES; GRANULATING MACHINES FOR CHEMICAL PROCESSING, IN CLASS 7 (U.S. CLS. 13, 19, 21, 23, 31, 34 AND 35).

FIRST USE 3-5-2012; IN COMMERCE 3-5-2012.

THE MARK CONSISTS OF STANDARD CHARACTERS WITHOUT CLAIM TO ANY PARTICULAR FONT, STYLE, SIZE, OR COLOR.

SN 85-005,948, FILED 4-5-2010.

DAVID C. REIHNER, EXAMINING ATTORNEY



David J. Kyffers

Director of the United States Patent and Trademark Office

United States of America

United States Patent and Trademark Office

URBAN LUX

Reg. No. 4,176,128

JME, INCORPORATED (CALIFORNIA CORPORATION), DBA TMB,
10643 GLENOAKS BOULEVARD
PACOIMA, CA 91331

Registered July 17, 2012

Int. Cl.: 11

FOR: LED LIGHT ASSEMBLIES FOR STREET LIGHTS, IN CLASS 11 (U.S. CLS. 13, 21, 23, 31 AND 34).

TRADEMARK

FIRST USE 5-16-2011; IN COMMERCE 5-16-2011.

PRINCIPAL REGISTER

THE MARK CONSISTS OF STANDARD CHARACTERS WITHOUT CLAIM TO ANY PARTICULAR FONT, STYLE, SIZE, OR COLOR.

NO CLAIM IS MADE TO THE EXCLUSIVE RIGHT TO USE "URBAN", APART FROM THE MARK AS SHOWN.

SN 85-006,206, FILED 4-5-2010.

NATALIE POLZER, EXAMINING ATTORNEY



David J. Kybas

Director of the United States Patent and Trademark Office

United States of America

United States Patent and Trademark Office



Reg. No. 4,176,129

Registered July 17, 2012

Int. Cl.: 9

TRADEMARK

PRINCIPAL REGISTER

SUMMIT ENTERTAINMENT, LLC (DELAWARE LIMITED LIABILITY COMPANY)
1630 STEWART STREET, SUITE 120
SANTA MONICA, CA 90404

FOR: CASES FOR PDAS; DECORATIVE CHARMS FOR CELL PHONES; MOUSEPADS, IN CLASS 9 (U.S. CLS. 21, 23, 26, 36 AND 38).

FIRST USE 5-23-2012; IN COMMERCE 5-23-2012.

THE MARK CONSISTS OF A CIRCULAR TRIBAL TATTOO DESIGN DEPICTING TWO WOLVES FACING ONE ANOTHER IN A HOWLING POSITION, SET AMONGST NUMEROUS INTERWOVEN LINES AND SHAPES AND ALL WITHIN THE CIRCLE.

SN 85-006,907, FILED 4-6-2010.

TRACY FLETCHER, EXAMINING ATTORNEY



David J. Kybas

Director of the United States Patent and Trademark Office

United States of America

United States Patent and Trademark Office



Reg. No. 4,176,130

Registered July 17, 2012

Int. Cl.: 5

TRADEMARK

PRINCIPAL REGISTER

JOHNSON & JOHNSON (NEW JERSEY CORPORATION)
ONE JOHNSON & JOHNSON PLAZA
NEW BRUNSWICK, NJ 089337001

FOR: PHARMACEUTICAL PREPARATIONS ANALGESICS, IN CLASS 5 (U.S. CLS. 6, 18, 44, 46, 51 AND 52).

FIRST USE 8-22-2011; IN COMMERCE 8-22-2011.

THE MARK CONSISTS OF THE STYLIZED WORD "HI!" IN WHITE INSIDE A RED CARTOON-STYLE SPEECH BALLOON.

THE COLOR(S) RED AND WHITE IS/ARE CLAIMED AS A FEATURE OF THE MARK.

SN 85-006,948, FILED 4-6-2010.

CIMMERIAN COLEMAN, EXAMINING ATTORNEY



David J. Kyffers

Director of the United States Patent and Trademark Office

United States of America

United States Patent and Trademark Office



Reg. No. 4,176,131

Registered July 17, 2012

Int. Cl.: 5

TRADEMARK

PRINCIPAL REGISTER

JOHNSON & JOHNSON (NEW JERSEY CORPORATION)
ONE JOHNSON & JOHNSON PLAZA
NEW BRUNSWICK, NJ 089337001

FOR: PHARMACEUTICAL PREPARATIONS ANALGESICS, IN CLASS 5 (U.S. CLS. 6, 18, 44, 46, 51 AND 52).

FIRST USE 8-22-2011; IN COMMERCE 8-22-2011.

THE MARK CONSISTS OF THE STYLIZED WORD "HI!" INSIDE A CARTOON-STYLE SPEECH BALLOON.

SN 85-006,958, FILED 4-6-2010.

CIMMERIAN COLEMAN, EXAMINING ATTORNEY



David J. Kyffers

Director of the United States Patent and Trademark Office

United States of America

United States Patent and Trademark Office

DETECT

Reg. No. 4,176,132

Registered July 17, 2012

Int. Cl.: 31

TRADEMARK

PRINCIPAL REGISTER

NULLODOR USA, LLC (FLORIDA LIMITED LIABILITY COMPANY)
P.O. BOX 6406
MIRAMAR BEACH, FL 32550

FOR: CAT LITTER ADDITIVE, NAMELY, ODOR ELIMINATING SAND FOR USE IN CAT LITTER CONTAINING COMPOUNDS ABLE TO DISCERN PH BALANCE, MICROSCOPIC BLOOD, PROTEIN, AND BILIRUBIN , IN CLASS 31 (U.S. CLS. 1 AND 46).

FIRST USE 1-1-2008; IN COMMERCE 1-1-2008.

THE MARK CONSISTS OF STANDARD CHARACTERS WITHOUT CLAIM TO ANY PARTICULAR FONT, STYLE, SIZE, OR COLOR.

OWNER OF U.S. REG. NO. 3,611,953.

SN 85-007,207, FILED 4-6-2010.

KATHERINE E. HALMEN, EXAMINING ATTORNEY



David J. Kyros

Director of the United States Patent and Trademark Office

United States of America

United States Patent and Trademark Office

HEALTH METER EARLY DETECTION TECHNOLOGY

Reg. No. 4,176,133

NULLODOR USA, LLC (FLORIDA LIMITED LIABILITY COMPANY)
P.O. BOX 6406

Registered July 17, 2012

MIRAMAR BEACH, FL 32550

Int. Cl.: 31

FOR: CAT LITTER; CAT LITTER ADDITIVE, NAMELY, ODOR ELIMINATING SAND FOR USE IN CAT LITTER CONTAINING COMPOUNDS ABLE TO DISCERN PH BALANCE, MICROSCOPIC BLOOD, PROTEIN, AND BILIRUBIN , IN CLASS 31 (U.S. CLS. 1 AND 46).

TRADEMARK

FIRST USE 1-1-2008; IN COMMERCE 1-1-2008.

PRINCIPAL REGISTER

THE MARK CONSISTS OF STANDARD CHARACTERS WITHOUT CLAIM TO ANY PARTICULAR FONT, STYLE, SIZE, OR COLOR.

OWNER OF U.S. REG. NO. 3,445,562.

NO CLAIM IS MADE TO THE EXCLUSIVE RIGHT TO USE "EARLY DETECTION TECHNOLOGY", APART FROM THE MARK AS SHOWN.

SN 85-007,223, FILED 4-6-2010.

KATHERINE E. HALMEN, EXAMINING ATTORNEY



David J. Kybas

Director of the United States Patent and Trademark Office

United States of America

United States Patent and Trademark Office

JOIE DE VIVRE FINE FOODS

Reg. No. 4,176,134

BARBIER, ANNE-ISABEL (UNITED STATES INDIVIDUAL)
13815 WAKLEY COURT
CENTREVILLE, VA 20121

Registered July 17, 2012

Int. Cl.: 30

FOR: SALAD DRESSINGS; SPICES, IN CLASS 30 (U.S. CL. 46).

TRADEMARK

FIRST USE 5-25-2010; IN COMMERCE 6-8-2010.

PRINCIPAL REGISTER

THE MARK CONSISTS OF STANDARD CHARACTERS WITHOUT CLAIM TO ANY PARTICULAR FONT, STYLE, SIZE, OR COLOR.

NO CLAIM IS MADE TO THE EXCLUSIVE RIGHT TO USE "FINE FOODS", APART FROM THE MARK AS SHOWN.

THE ENGLISH TRANSLATION OF "JOIE DE VIVRE" IN THE MARK IS "JOY OF LIFE".

SN 85-008,225, FILED 4-7-2010.

GINA FINK, EXAMINING ATTORNEY



David J. Kybas

Director of the United States Patent and Trademark Office

United States of America

United States Patent and Trademark Office



Reg. No. 4,176,135

Registered July 17, 2012

Int. Cl.: 31

TRADEMARK

PRINCIPAL REGISTER

NULLODOR USA, LLC (FLORIDA LIMITED LIABILITY COMPANY)
P.O. BOX 6406
MIRAMAR BEACH, FL 32550

FOR: CAT LITTER ADDITIVE, NAMELY, ODOR ELIMINATING SAND FOR USE IN CAT LITTER CONTAINING COMPOUNDS ABLE TO DISCERN PH BALANCE, MICROSCOPIC BLOOD, PROTEIN, AND BILIRUBIN , IN CLASS 31 (U.S. CLS. 1 AND 46).

FIRST USE 1-1-2008; IN COMMERCE 1-1-2008.

OWNER OF U.S. REG. NO. 3,611,953.

THE COLOR(S) BLUE, WHITE, AND BLACK IS/ARE CLAIMED AS A FEATURE OF THE MARK.

THE MARK CONSISTS OF THE STYLIZED WORD "DETECT" IN WHITE LETTERS WITH BLACK SHADING ON A BLUE BANNER.

SN 85-008,280, FILED 4-7-2010.

KATHERINE E. HALMEN, EXAMINING ATTORNEY



David J. Kyjars

Director of the United States Patent and Trademark Office

United States of America

United States Patent and Trademark Office

CLAP WITH ME

Reg. No. 4,176,136

PETER SUI LUN FONG (CHINA INDIVIDUAL)
297F SOUTH ATLANTIC BLVD.
MONTEREY PARK, CA 91754

Registered July 17, 2012

Int. Cl.: 28

FOR: TOYS, NAMELY, SOFT TOYS, STUFFED TOYS, PLUSH TOYS, AND INTERACTIVE ELECTRONIC ACTION TOYS; PLASTIC TOYS, NAMELY, PLASTIC TOY FIGURES, PLASTIC CHARACTER TOYS; ANIMATED TOYS, NAMELY, BATTERY OPERATED ACTION TOYS, IN CLASS 28 (U.S. CLS. 22, 23, 38 AND 50).

TRADEMARK

PRINCIPAL REGISTER

FIRST USE 1-3-2012; IN COMMERCE 2-12-2012.

THE MARK CONSISTS OF STANDARD CHARACTERS WITHOUT CLAIM TO ANY PARTICULAR FONT, STYLE, SIZE, OR COLOR.

SN 85-009,481, FILED 4-8-2010.

PRISCILLA MILTON, EXAMINING ATTORNEY



David J. Kybas

Director of the United States Patent and Trademark Office

United States of America

United States Patent and Trademark Office

PORE NEUROTIGHT

Reg. No. 4,176,137

NG, KENDRICK (UNITED STATES INDIVIDUAL)
205 W NORMAN AVE
ARCADIA, CA 91007

Registered July 17, 2012

Int. Cl.: 3

FOR: PREPARATIONS FOR TIGHTENING PORES, DECREASING OIL PRODUCTION, IMPROVING SKIN COMPLEXION, AND REDUCING ACNE, SOLD AS AN INGREDIENT COMPONENT OF COSMETICS AND MAKE-UP, IN CLASS 3 (U.S. CLS. 1, 4, 6, 50, 51 AND 52).

TRADEMARK

PRINCIPAL REGISTER

FIRST USE 5-2-2011; IN COMMERCE 5-2-2011.

THE MARK CONSISTS OF STANDARD CHARACTERS WITHOUT CLAIM TO ANY PARTICULAR FONT, STYLE, SIZE, OR COLOR.

NO CLAIM IS MADE TO THE EXCLUSIVE RIGHT TO USE "PORE", APART FROM THE MARK AS SHOWN.

SN 85-010,030, FILED 4-9-2010.

JASON BLAIR, EXAMINING ATTORNEY



David J. Kyffers

Director of the United States Patent and Trademark Office

United States of America

United States Patent and Trademark Office

ROXIONOW

Reg. No. 4,176,138

Registered July 17, 2012

Int. Cl.: 9

TRADEMARK

PRINCIPAL REGISTER

COREL CORPORATION (CANADA CORPORATION)
1600 CARLING AVENUE
OTTAWA, CANADA K1Z 8R7

FOR: DOWNLOADABLE MOTION PICTURES, FILMS, MOVIES AND TELEVISION SERIES IN A VARIETY OF GENRES, FEATURING ACTION, ADVENTURE, ANIMATION, COMEDY, DOCUMENTARY, DRAMA, FAMILY, FANTASY, MUSIC, NEWS, REALITY, ROMANCE, SCIENCE FICTION AND SPORTS; DOWNLOADABLE MUSIC VIDEOS AND OTHER AUDIO AND AUDIO VISUAL RECORDINGS FEATURING MUSIC; COMPUTER SOFTWARE TO DOWNLOAD, STORE, PLAY, AND MANAGE MEDIA CONTENT, DATA, IMAGES, AUDIO AND VIDEO FILES TO AND BETWEEN COMPUTERS, LAPTOPS, ELECTRONIC STORAGE DEVICES, DIGITAL VIDEO RECORDERS, VIDEO AND MEDIA PLAYERS, TELEVISION SET-TOP BOXES, MOBILE AND SMART PHONES, AND PORTABLE AND HANDHELD ELECTRONIC DEVICES, IN CLASS 9 (U.S. CLS. 21, 23, 26, 36 AND 38).

FIRST USE 6-30-2010; IN COMMERCE 6-30-2010.

THE MARK CONSISTS OF STANDARD CHARACTERS WITHOUT CLAIM TO ANY PARTICULAR FONT, STYLE, SIZE, OR COLOR.

OWNER OF U.S. REG. NO. 2,616,676.

SN 85-010,807, FILED 4-9-2010.

TAMARA FRAZIER, EXAMINING ATTORNEY



David J. Kyffers

Director of the United States Patent and Trademark Office

United States of America

United States Patent and Trademark Office

LSRS

Reg. No. 4,176,139

Registered July 17, 2012

Int. Cl.: 10

TRADEMARK

PRINCIPAL REGISTER

PLEXUS BIOMEDICAL, INC. (TENNESSEE CORPORATION)
70 CLAY STREET, SUITE 2
OAKLAND, TN 38060

FOR: STRAPS AND ADHESIVE PADS FOR SURGICAL USE, NAMELY, TO MOBILIZE SKIN AND UNDERLYING BODY STRUCTURES TO PROVIDE APPROPRIATE ACCESS TO A SURGICAL SITE, IN CLASS 10 (U.S. CLS. 26, 39 AND 44).

FIRST USE 8-16-2010; IN COMMERCE 8-16-2010.

THE MARK CONSISTS OF STANDARD CHARACTERS WITHOUT CLAIM TO ANY PARTICULAR FONT, STYLE, SIZE, OR COLOR.

SN 85-011,836, FILED 4-12-2010.

RON FAIRBANKS, EXAMINING ATTORNEY



David J. Kybas

Director of the United States Patent and Trademark Office

United States of America

United States Patent and Trademark Office

CSRS

Reg. No. 4,176,140

Registered July 17, 2012

Int. Cl.: 10

TRADEMARK

PRINCIPAL REGISTER

PLEXUS BIOMEDICAL, INC. (TENNESSEE CORPORATION)
70 CLAY STREET, SUITE 2
OAKLAND, TN 38060

FOR: STRAPS AND ADHESIVE PADS FOR SURGICAL USE, NAMELY, TO MOBILIZE SKIN AND UNDERLYING BODY STRUCTURES TO PROVIDE APPROPRIATE ACCESS TO A SURGICAL SITE, IN CLASS 10 (U.S. CLS. 26, 39 AND 44).

FIRST USE 8-16-2010; IN COMMERCE 8-16-2010.

THE MARK CONSISTS OF STANDARD CHARACTERS WITHOUT CLAIM TO ANY PARTICULAR FONT, STYLE, SIZE, OR COLOR.

SN 85-011,838, FILED 4-12-2010.

RON FAIRBANKS, EXAMINING ATTORNEY



David J. Kyffers

Director of the United States Patent and Trademark Office

United States of America

United States Patent and Trademark Office

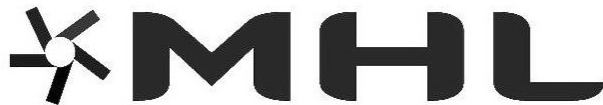

Reg. No. 4,176,141

Registered July 17, 2012

Int. Cls.: 9, 35, and 42

TRADEMARK

SERVICE MARK

PRINCIPAL REGISTER

MHL, LLC (DELAWARE LIMITED LIABILITY COMPANY)
1140 E. ARQUES AVENUE
SUNNYVALE, CA 94085

FOR: CABLES, NAMELY, CABLES FOR TRANSMISSION OF SOUNDS AND IMAGES, COMPUTER CABLES, CONNECTION CABLES, ELECTRONIC CABLES, TELECOMMUNICATION CABLES, AND PARTS THEREOF; COMMUNICATIONS HARDWARE, HARDWARE COMPONENTS, NAMELY, MULTIMEDIA SWITCHES, AND PERIPHERALS; COMPACT AUDIO/VIDEO CONNECTOR INTERFACE EQUIPMENT FOR TRANSMITTING UNCOMPRESSED DIGITAL VIDEO AND AUDIO STREAMS; AUDIO/VIDEO INTERFACE EQUIPMENT FOR USE WITH CELL PHONES, MOBILE AND HANDHELD DEVICES AND PDAS WITH HIGH DEFINITION MONITORS AND TELEVISIONS; COMPUTER CHIP; COMPUTER HARDWARE; COMPUTER PERIPHERALS; COMPUTER SOFTWARE FOR THE INTEROPERABILITY OF COMPUTERS AND CONSUMER ELECTRONICS TO RECEIVE AND PLAY DIGITAL CONTENT AND INSTRUCTIONAL MANUALS; COMPUTER SOFTWARE FOR USE AS AN INTERFACE BETWEEN AUDIO/VIDEO SOURCES AND AUDIO/VIDEO REPEATER DEVICES; COMPUTER SOFTWARE FOR USE AS AN INTERFACE BETWEEN AUDIO/VIDEO SOURCES AND AUDIO/VIDEO MONITORS; COMPUTER SOFTWARE FOR USE AS AN INTERFACE BETWEEN AUDIO/VIDEO SOURCES AND AUDIO/VIDEO REPEATER DEVICES; COMPUTER SOFTWARE FOR USE AS AN INTERFACE BETWEEN AUDIO/VIDEO SOURCES AND AUDIO/VIDEO MONITORS; COMPUTER SOFTWARE INTERFACE FOR USE IN CONNECTING, CONTROLLING AND NETWORKING A WIDE VARIETY OF COMPUTER AND COMMUNICATIONS HARDWARE, CONSUMER ELECTRONIC DEVICES, COMPONENTS, AND PERIPHERALS; CONNECTORS, CABLES, AND COMPONENTS THEREOF; COMPUTER HARDWARE, HARDWARE COMPONENTS, NAMELY, COMPUTER MONITORS, AND PERIPHERALS; CONNECTORS, NAMELY, CABLE CONNECTORS, PLUG CONNECTORS, ELECTRONIC CONNECTORS, AND PARTS THEREOF; COMPUTER ELECTRONICS DEVICES, NAMELY, AUDIO/VIDEO RECEIVERS, INTEGRATED TELEVISIONS, AND TELEVISION MONITORS; HAND-HELD ELECTRONIC DEVICES, NAMELY, PORTABLE AUDIO, VIDEO, MULTIMEDIA AND DIGITAL DEVICES, NAMELY, PORTABLE MEDIA PLAYERS; INTEGRATED CIRCUITS AND SEMICONDUCTORS; INTERNET TELEVISION HARDWARE, NAMELY, CONVERTERS, TRANSMITTERS, RECEIVERS AND MONITORS; TELEVISIONS; TUNERS, NAMELY, STEREO TUNERS; VIDEO MONITORS, IN CLASS 9 (U.S. CLS. 21, 23, 26, 36 AND 38).



David J. Kyjars

FIRST USE 5-15-2011; IN COMMERCE 5-15-2011.

Reg. No. 4,176,141 FOR: ASSOCIATION SERVICES, NAMELY, PROMOTING THE DEVELOPMENT AND ADOPTION OF A SPECIFICATION FOR INTEROPERABILITY OF COMPUTERS AND CONSUMER ELECTRONICS TO RECEIVE AND PLAY DIGITAL CONTENT; ASSOCIATION SERVICES, NAMELY, PROMOTING THE DEVELOPMENT AND ADOPTION OF A VOLUNTARY DIGITAL INTERFACE SPECIFICATION THAT PROVIDES AN INTEROPERABLE METHOD OF CONNECTING COMPUTER AND COMMUNICATIONS HARDWARE, CONSUMER ELECTRONICS DEVICES, COMPONENTS, AND PERIPHERALS; ELECTRONIC COMMERCE SERVICES, NAMELY, PROVIDING CONSUMER PRODUCT INFORMATION VIA THE INTERNET, IN CLASS 35 (U.S. CLS. 100, 101 AND 102).

FIRST USE 4-14-2010; IN COMMERCE 4-14-2010.

FOR: COMPUTER SERVICES, NAMELY, DEVELOPING INTEROPERABILITY AND SECURITY STANDARDS FOR RECEIVING AND PLAYING DIGITAL CONTENT ACROSS CONSUMER ELECTRONIC DEVICES AND COMPUTERS; TECHNICAL SUPPORT SERVICES, NAMELY, TROUBLESHOOTING COMPUTER SOFTWARE AND HARDWARE PROBLEMS, IN CLASS 42 (U.S. CLS. 100 AND 101).

FIRST USE 12-21-2010; IN COMMERCE 12-21-2010.

THE MARK CONSISTS OF FIVE LINES JOINED, AND THE STYLIZED LETTERS "MHL".

SN 85-012,133, FILED 4-12-2010.

DAVID I, EXAMINING ATTORNEY

United States of America

United States Patent and Trademark Office

PUREHD

Reg. No. 4,176,142

Registered July 17, 2012

Int. Cl.: 19

TRADEMARK

PRINCIPAL REGISTER

J.R. FOUR LTD. (WASHINGTON CORPORATION)
8107 BRACKEN PLACE SE
SNOQUALMIE, WA 98065

FOR: BUILDING GLASS, NAMELY, DECORATIVE GLASS, FIRE-RATED GLASS, GLASS PANES, STRUCTURAL GLASS, IMPACT SAFETY-RATED GLASS, BULLET-RESISTANT GLASS, SECURITY GLASS, WIRED GLASS, SIDELIGHTS, WINDOW GLASS AND TRANSOMS, IN CLASS 19 (U.S. CLS. 1, 12, 33 AND 50).

FIRST USE 2-0-2012; IN COMMERCE 2-0-2012.

THE MARK CONSISTS OF STANDARD CHARACTERS WITHOUT CLAIM TO ANY PARTICULAR FONT, STYLE, SIZE, OR COLOR.

SN 85-013,214, FILED 4-13-2010.

MARY I. SPARROW, EXAMINING ATTORNEY



David J. Kyffers

Director of the United States Patent and Trademark Office

United States of America

United States Patent and Trademark Office

CHICK NIGHT

Reg. No. 4,176,143

Registered July 17, 2012

Int. Cl.: 35

SERVICE MARK

PRINCIPAL REGISTER

KLEVEN, COLLEEN (CANADA INDIVIDUAL)
APARTMENT 5
4533 NOTRE DAME AVENUE
HANMER, ONTARIO, CANADA P3P1X5

FOR: BUSINESS NETWORKING; CLUB SERVICES, NAMELY, PROMOTING THE INTERESTS OF WOMEN; GENERAL BUSINESS NETWORKING REFERRAL SERVICES, NAMELY, PROMOTING THE GOODS AND SERVICES OF OTHERS BY PASSING BUSINESS LEADS AND REFERRALS AMONG GROUP MEMBERS; ON-LINE PROFESSIONAL NETWORKING SERVICES; PRODUCT MERCHANDISING, IN CLASS 35 (U.S. CLS. 100, 101 AND 102).

FIRST USE 7-8-2011; IN COMMERCE 7-8-2011.

THE MARK CONSISTS OF STANDARD CHARACTERS WITHOUT CLAIM TO ANY PARTICULAR FONT, STYLE, SIZE, OR COLOR.

SN 85-013,222, FILED 4-13-2010.

ANDREA K. NADELMAN, EXAMINING ATTORNEY



David J. Kybas

Director of the United States Patent and Trademark Office

United States of America

United States Patent and Trademark Office

Clutch Records

Reg. No. 4,176,144

HUTCHISON, GLENN R. (UNITED STATES INDIVIDUAL)
433 SUNSET VALLEY ROAD
NEW CASTLE, PA 16105

Registered July 17, 2012

Int. Cl.: 35

FOR: ADVERTISING, MARKETING AND PROMOTION SERVICES FOR MUSICIANS; RETAIL AND ONLINE STORE SERVICES FEATURING MUSIC DISCS, IN CLASS 35 (U.S. CLS. 100, 101 AND 102).

SERVICE MARK

FIRST USE 8-27-2010; IN COMMERCE 8-27-2010.

PRINCIPAL REGISTER

THE MARK CONSISTS OF STANDARD CHARACTERS WITHOUT CLAIM TO ANY PARTICULAR FONT, STYLE, SIZE, OR COLOR.

NO CLAIM IS MADE TO THE EXCLUSIVE RIGHT TO USE "RECORDS", APART FROM THE MARK AS SHOWN.

SN 85-015,508, FILED 4-16-2010.

TEJBIR SINGH, EXAMINING ATTORNEY



David J. Kyffers

Director of the United States Patent and Trademark Office

United States of America

United States Patent and Trademark Office

LCS

Reg. No. 4,176,145

Registered July 17, 2012

Int. Cl.: 36

SERVICE MARK

PRINCIPAL REGISTER

LCS RECEIVABLES MANAGEMENT, LLC (COLORADO LIMITED LIABILITY COMPANY)
6782 SOUTH POTOMAC STREET
SUITE 125
CENTENNIAL, CO 80112

FOR: FINANCIAL SERVICES, NAMELY, LOAN SERVICING, STAGED DEBT COLLECTION AND LOSS MITIGATION SERVICES FOR UNDER OR NON-PERFORMING LOANS AND MORTGAGE LOANS; ARRANGING AND FACILITATING HOME SHORT SALES, NAMELY, ARRANGING OF MODIFIED LOAN TERMS; MORTGAGE REFINANCING; PORTFOLIO PRICING, NAMELY, FINANCIAL PORTFOLIO MANAGEMENT; DEBT ACQUISITION AND SALES, NAMELY, DEBT COLLECTION AND SETTLEMENT, IN CLASS 36 (U.S. CLS. 100, 101 AND 102).

FIRST USE 2-28-2009; IN COMMERCE 2-28-2009.

THE MARK CONSISTS OF STANDARD CHARACTERS WITHOUT CLAIM TO ANY PARTICULAR FONT, STYLE, SIZE, OR COLOR.

SN 85-016,221, FILED 4-16-2010.

DANIEL BRODY, EXAMINING ATTORNEY



David J. Kyffers

Director of the United States Patent and Trademark Office

United States of America

United States Patent and Trademark Office

ZEUS THUNDER

Reg. No. 4,176,146

Registered July 17, 2012

Int. Cl.: 20

TRADEMARK

PRINCIPAL REGISTER

COMFORT RESEARCH, LLC (MICHIGAN LIMITED LIABILITY COMPANY)
3860 ROGER B. CHAFFEE SE
GRAND RAPIDS, MI 49548

FOR: FURNITURE, IN CLASS 20 (U.S. CLS. 2, 13, 22, 25, 32 AND 50).

FIRST USE 5-9-2012; IN COMMERCE 5-9-2012.

THE MARK CONSISTS OF STANDARD CHARACTERS WITHOUT CLAIM TO ANY PARTICULAR FONT, STYLE, SIZE, OR COLOR.

SN 85-016,628, FILED 4-18-2010.

MARY ROSSMAN, EXAMINING ATTORNEY



David J. Kyffers

Director of the United States Patent and Trademark Office

United States of America

United States Patent and Trademark Office

LINEN

Reg. No. 4,176,147

Registered July 17, 2012

Int. Cl.: 33

TRADEMARK

PRINCIPAL REGISTER

BERGEVIN LANE VINEYARDS, LLC (WASHINGTON LIMITED LIABILITY COMPANY)
1215 W. POPLAR ST.
WALLA WALLA, WA 99362

FOR: WINES, IN CLASS 33 (U.S. CLS. 47 AND 49).

FIRST USE 10-1-2009; IN COMMERCE 10-1-2009.

THE MARK CONSISTS OF STANDARD CHARACTERS WITHOUT CLAIM TO ANY PARTICULAR FONT, STYLE, SIZE, OR COLOR.

SN 85-017,186, FILED 4-19-2010.

ANDREA K. NADELMAN, EXAMINING ATTORNEY



David J. Kyffers

Director of the United States Patent and Trademark Office

United States of America

United States Patent and Trademark Office

We're working at high RPMs
to better serve you

Reg. No. 4,176,148

Registered July 17, 2012

Int. Cl.: 44

SERVICE MARK

PRINCIPAL REGISTER

VALLEY EMERGENCY PHYSICIANS MEDICAL GROUP, INC. (CALIFORNIA CORPORATION)
1990 N. CALIFORNIA BLVD., STE. 400
WALNUT CREEK, CA 94596

FOR: PHYSICIAN SERVICES, IN CLASS 44 (U.S. CLS. 100 AND 101).

FIRST USE 4-16-2012; IN COMMERCE 4-16-2012.

THE MARK CONSISTS OF STANDARD CHARACTERS WITHOUT CLAIM TO ANY PARTICULAR FONT, STYLE, SIZE, OR COLOR.

SN 85-017,628, FILED 4-19-2010.

TIMOTHY FINNEGAN, EXAMINING ATTORNEY



David J. Kybas

Director of the United States Patent and Trademark Office

United States of America

United States Patent and Trademark Office

RPM

Reg. No. 4,176,149

Registered July 17, 2012

Int. Cl.: 44

SERVICE MARK

PRINCIPAL REGISTER

VALLEY EMERGENCY PHYSICIANS MEDICAL GROUP, INC. (CALIFORNIA CORPORATION)
1990 N. CALIFORNIA BLVD., STE. 400
WALNUT CREEK, CA 94596

FOR: PHYSICIAN SERVICES, IN CLASS 44 (U.S. CLS. 100 AND 101).

FIRST USE 4-16-2012; IN COMMERCE 4-16-2010.

THE MARK CONSISTS OF STANDARD CHARACTERS WITHOUT CLAIM TO ANY PARTICULAR FONT, STYLE, SIZE, OR COLOR.

SN 85-017,633, FILED 4-19-2010.

TIMOTHY FINNEGAN, EXAMINING ATTORNEY



David J. Kybas

Director of the United States Patent and Trademark Office

United States of America

United States Patent and Trademark Office

BANDA CARNAVAL

Reg. No. 4,176,150

TIRADO CASTAÑEDA, JESUS (MEXICO INDIVIDUAL)
DEL RISCO 1163
TIJUANA, MEXICO

Registered July 17, 2012

Int. Cls.: 9 and 41

FOR: AUDIO AND VIDEO RECORDINGS FEATURING MUSIC AND ARTISTIC PERFORMANCES BY BANDA CARNAVAL, IN CLASS 9 (U.S. CLS. 21, 23, 26, 36 AND 38).

TRADEMARK

FIRST USE 5-5-2001; IN COMMERCE 2-16-2010.

SERVICE MARK

FOR: ENTERTAINMENT, NAMELY, LIVE PERFORMANCES BY A MUSICAL BAND, IN CLASS 41 (U.S. CLS. 100, 101 AND 107).

PRINCIPAL REGISTER

FIRST USE 5-5-2001; IN COMMERCE 2-16-2010.

THE MARK CONSISTS OF STANDARD CHARACTERS WITHOUT CLAIM TO ANY PARTICULAR FONT, STYLE, SIZE, OR COLOR.

NO CLAIM IS MADE TO THE EXCLUSIVE RIGHT TO USE "BANDA", APART FROM THE MARK AS SHOWN.

THE ENGLISH TRANSLATION OF THE WORDS "BANDA CARNAVAL" IN THE MARK IS "CARNIVAL BAND".

SN 85-018,388, FILED 4-20-2010.

APRIL HESIK, EXAMINING ATTORNEY



David J. Kyros

Director of the United States Patent and Trademark Office

United States of America

United States Patent and Trademark Office

Watchdog City

Reg. No. 4,176,151

WATCHDOG CITY LLC (FLORIDA LIMITED LIABILITY COMPANY)
8141 LAS PALMAS WAY
NAPLES, FL 34109

Registered July 17, 2012

Int. Cl.: 35

FOR: PROVIDING A WEB SITE THAT FEATURES AN ON-LINE MARKETPLACE FOR USERS TO POST, READ, BUY AND SELL WRITTEN, AUDIO AND VIDEO WORKS VIA A GLOBAL COMPUTER NETWORK, IN CLASS 35 (U.S. CLS. 100, 101 AND 102).

SERVICE MARK

FIRST USE 6-1-2010; IN COMMERCE 6-1-2010.

PRINCIPAL REGISTER

THE MARK CONSISTS OF STANDARD CHARACTERS WITHOUT CLAIM TO ANY PARTICULAR FONT, STYLE, SIZE, OR COLOR.

SN 85-018,784, FILED 4-20-2010.

BENJAMIN OKEKE, EXAMINING ATTORNEY



David J. Kyffers

Director of the United States Patent and Trademark Office

United States of America

United States Patent and Trademark Office

SIGMET

Reg. No. 4,176,152

VAISALA OYJ (FINLAND JULKINEN OSAKEYHTIÖ (OYJ))
P.O. BOX 26

Registered July 17, 2012

HELSINKI, FINLAND FI-00421

Int. Cl.: 9

FOR: WEATHER RADAR SYSTEM COMPONENTS, NAMELY, DIGITAL RECEIVERS, DIGITAL TRANSMITTERS AND SIGNAL AND DATA PROCESSORS, RADAR AND ANTENNA CONTROL PROCESSORS; SOFTWARE FOR THE CONTROL AND OPERATION OF WEATHER RADAR SYSTEMS; SOFTWARE FOR PROCESSING AND MANAGEMENT OF WEATHER RADAR DATA, IN CLASS 9 (U.S. CLS. 21, 23, 26, 36 AND 38).

TRADEMARK

PRINCIPAL REGISTER

FIRST USE 6-0-1992; IN COMMERCE 6-0-1992.

THE MARK CONSISTS OF STANDARD CHARACTERS WITHOUT CLAIM TO ANY PARTICULAR FONT, STYLE, SIZE, OR COLOR.

SN 85-019,842, FILED 4-21-2010.

CHARLOTTE CORWIN, EXAMINING ATTORNEY



David J. Kyffers

Director of the United States Patent and Trademark Office

United States of America

United States Patent and Trademark Office

RETURN

Reg. No. 4,176,153

Registered July 17, 2012

Int. Cl.: 21

TRADEMARK

PRINCIPAL REGISTER

YUMI ECOSOLUTIONS, INC. (DELAWARE CORPORATION)
4 BRUCE LANE
WESTPORT, CT 06880

FOR: BIODEGRADABLE DISPOSABLE DINNERWARE, NAMELY, PLATES, BOWLS, CUPS, TRAYS, LIDS SPECIFICALLY ADAPTED FOR PLATES, BOWLS, CUPS AND TRAYS, SERVING FORKS, SERVING SPOONS, TRAYS, NAMELY, SINGLE AND MULTI-COMPARTMENT TRAYS WITH ATTACHED LIDS, IN CLASS 21 (U.S. CLS. 2, 13, 23, 29, 30, 33, 40 AND 50).

FIRST USE 2-1-2012; IN COMMERCE 2-1-2012.

THE MARK CONSISTS OF STANDARD CHARACTERS WITHOUT CLAIM TO ANY PARTICULAR FONT, STYLE, SIZE, OR COLOR.

SN 85-019,932, FILED 4-21-2010.

TRACY FLETCHER, EXAMINING ATTORNEY



David J. Kyffers

Director of the United States Patent and Trademark Office

United States of America

United States Patent and Trademark Office

AUDREYSHOPS

Reg. No. 4,176,154

KYUNGHO TOM KIM (UNITED STATES INDIVIDUAL)
15235 CARAVACA ROAD
LA MIRADA, CA 90638

Registered July 17, 2012

Int. Cls.: 14 and 25

FOR: JEWELRY, IN CLASS 14 (U.S. CLS. 2, 27, 28 AND 50).

TRADEMARK

FIRST USE 11-30-2009; IN COMMERCE 11-30-2009.

PRINCIPAL REGISTER

FOR: DRESSES, LINGERIE, SLEEPWEAR, JACKETS, COATS, JUMPSUITS, ROMPERS, LEGGINGS, PANTS, SHORTS, SKIRTS, SWEATERS, SWEATSHIRTS, HOODED SWEATSHIRTS, T-SHIRTS, TOPS, SHOES, BELTS, HEADWEAR, SCARVES, IN CLASS 25 (U.S. CLS. 22 AND 39).

FIRST USE 11-30-2009; IN COMMERCE 11-30-2009.

THE MARK CONSISTS OF STANDARD CHARACTERS WITHOUT CLAIM TO ANY PARTICULAR FONT, STYLE, SIZE, OR COLOR.

SN 85-020,845, FILED 4-22-2010.

LINDA M. KING, EXAMINING ATTORNEY



David J. Kyffers

Director of the United States Patent and Trademark Office

United States of America

United States Patent and Trademark Office

SELECTRIC

Reg. No. 4,176,155

DISPENSING DYNAMICS INTERNATIONAL (CALIFORNIA CORPORATION)
1020 BIXBY DRIVE
CITY OF INDUSTRY, CA 91745

Registered July 17, 2012

Int. Cl.: 21

FOR: DISPENSERS FOR PAPER TOWELS, IN CLASS 21 (U.S. CLS. 2, 13, 23, 29, 30, 33, 40 AND 50).

TRADEMARK

FIRST USE 4-10-2012; IN COMMERCE 4-10-2012.

PRINCIPAL REGISTER

THE MARK CONSISTS OF STANDARD CHARACTERS WITHOUT CLAIM TO ANY PARTICULAR FONT, STYLE, SIZE, OR COLOR.

SN 85-023,336, FILED 4-26-2010.

ELIZABETH KAJUBI, EXAMINING ATTORNEY



David J. Kyffers

Director of the United States Patent and Trademark Office

United States of America

United States Patent and Trademark Office

SERVICE HEAR

Reg. No. 4,176,156

PAN-OSTON CO. (DELAWARE CORPORATION)
6944 LOUISVILLE ROAD
BOWLING GREEN, KY 42101

Registered July 17, 2012

Int. Cl.: 10

FOR: ASSISTIVE LISTENING DEVICE KITS FOR ELIMINATION OF BACKGROUND NOISE AND FACILITATION OF PRIVATE COMMUNICATIONS BETWEEN CUSTOMERS WITH HEARING AIDS AND CUSTOMER SERVICE PERSONNEL , IN CLASS 10 (U.S. CLS. 26, 39 AND 44).

TRADEMARK

PRINCIPAL REGISTER

FIRST USE 10-31-2009; IN COMMERCE 10-10-2011.

THE MARK CONSISTS OF STANDARD CHARACTERS WITHOUT CLAIM TO ANY PARTICULAR FONT, STYLE, SIZE, OR COLOR.

SN 85-024,240, FILED 4-27-2010.

LIEF MARTIN, EXAMINING ATTORNEY



David J. Kyffers

Director of the United States Patent and Trademark Office

United States of America

United States Patent and Trademark Office

JACOB DAVIS

Reg. No. 4,176,157

SQUEEZEBOX, INC. (CALIFORNIA CORPORATION)

Registered July 17, 2012

6750 WEDGEWOOD PLACE
LOS ANGELES, CA 90068

Int. Cl.: 25

FOR: BELTS; HATS; JACKETS; JEANS; PANTS; SHIRTS; SHOES; SHORTS; SLACKS;
SWEAT SHIRTS; SWEATERS; T-SHIRTS; TROUSERS, IN CLASS 25 (U.S. CLS. 22 AND 39).

TRADEMARK

FIRST USE 1-1-2012; IN COMMERCE 1-1-2012.

PRINCIPAL REGISTER

THE MARK CONSISTS OF STANDARD CHARACTERS WITHOUT CLAIM TO ANY PARTICULAR FONT, STYLE, SIZE, OR COLOR.

THE NAME(S), PORTRAIT(S), AND/OR SIGNATURE(S) SHOWN IN THE MARK DOES NOT IDENTIFY A PARTICULAR LIVING INDIVIDUAL.

SN 85-024,672, FILED 4-27-2010.

EDWARD FENNESSY, EXAMINING ATTORNEY



David J. Kyffers

Director of the United States Patent and Trademark Office

United States of America

United States Patent and Trademark Office

SERVICE HEAR

Reg. No. 4,176,158

PAN-OSTON CO. (DELAWARE CORPORATION)
6944 LOUISVILLE ROAD
BOWLING GREEN, KY 42101

Registered July 17, 2012

Int. Cl.: 10

FOR: ASSISTIVE LISTENING DEVICE KITS FOR ELIMINATION OF BACKGROUND NOISE AND FACILITATION OF PRIVATE COMMUNICATIONS BETWEEN CUSTOMERS WITH HEARING AIDS AND CUSTOMER SERVICE PERSONNEL , IN CLASS 10 (U.S. CLS. 26, 39 AND 44).

TRADEMARK

PRINCIPAL REGISTER

FIRST USE 10-31-2009; IN COMMERCE 10-10-2011.

THE MARK CONSISTS OF A STYLIZED EAR WITH THE LETTER "S" IN THE MIDDLE AND TWO CURVED LINES ABOVE THE EAR, BETWEEN THE WORDS "SERVICE" AND "HEAR".

SN 85-026,133, FILED 4-29-2010.

LIEF MARTIN, EXAMINING ATTORNEY



David J. Kyffers

Director of the United States Patent and Trademark Office

United States of America

United States Patent and Trademark Office

SHOP HEAR

Reg. No. 4,176,159

PAN-OSTON CO. (DELAWARE CORPORATION)
6944 LOUISVILLE ROAD
BOWLING GREEN, KY 42101

Registered July 17, 2012

Int. Cl.: 10

FOR: ASSISTIVE LISTENING DEVICE KITS FOR ELIMINATION OF BACKGROUND NOISE AND FACILITATION OF PRIVATE COMMUNICATION BETWEEN CUSTOMERS WITH HEARING AIDS AND COUNTER ATTENDANTS IN RETAIL STORES, IN CLASS 10 (U.S. CLS. 26, 39 AND 44).

TRADEMARK

PRINCIPAL REGISTER

FIRST USE 5-12-2009; IN COMMERCE 10-10-2011.

THE MARK CONSISTS OF A STYLIZED EAR WITH THE LETTER "S" IN THE MIDDLE AND TWO CURVED LINES ABOVE THE EAR, BETWEEN THE WORDS "SHOP" AND "HEAR".

SN 85-026,152, FILED 4-29-2010.

LIEF MARTIN, EXAMINING ATTORNEY



David J. Kyffers

Director of the United States Patent and Trademark Office

United States of America

United States Patent and Trademark Office

WILLOW TREE RECOVERY

Reg. No. 4,176,160

WILLOW TREE RECOVERY, LLC (UTAH LIMITED LIABILITY COMPANY)
1123 NORTH 160 EAST
AMERICAN FORK, UT 84003

Registered July 17, 2012

Int. Cl.: 44

FOR: TREATMENT OF DRUG AND ALCOHOL ADDICTION, IN CLASS 44 (U.S. CLS. 100 AND 101).

SERVICE MARK

FIRST USE 8-31-2011; IN COMMERCE 8-31-2011.

PRINCIPAL REGISTER

THE MARK CONSISTS OF STANDARD CHARACTERS WITHOUT CLAIM TO ANY PARTICULAR FONT, STYLE, SIZE, OR COLOR.

NO CLAIM IS MADE TO THE EXCLUSIVE RIGHT TO USE "RECOVERY", APART FROM THE MARK AS SHOWN.

SN 85-027,939, FILED 4-30-2010.

KATHRYN COWARD, EXAMINING ATTORNEY



David J. Kybas

Director of the United States Patent and Trademark Office

United States of America

United States Patent and Trademark Office

AUXSOL

Reg. No. 4,176,161

PASON SYSTEMS CORP. (CANADA CORPORATION)

Registered July 17, 2012

6130 - 3RD STREET S.E.

CALGARY, ALBERTA, CANADA T2H1K4

Int. Cls.: 35 and 40

FOR: CONSULTING SERVICES RELATED TO THE ADMINISTRATION OF WATER PURIFICATION STRATEGIES; WASTE MANAGEMENT, NAMELY, MANAGEMENT OF WASTE WATER COLLECTION AND TREATMENT SYSTEMS FOR OTHERS, IN CLASS 35 (U.S. CLS. 100, 101 AND 102).

SERVICE MARK

PRINCIPAL REGISTER

FIRST USE 7-1-2009; IN COMMERCE 7-1-2009.

FOR: SUSTAINABLE ONSITE WATER RECYCLING AND WASTEWATER TREATMENT SERVICES; WATER TREATMENT SERVICES; WASTE WATER TREATMENT SERVICES; WASTE WATER TREATMENT SERVICES FOR INDUSTRIAL PURPOSES; RECYCLING SERVICES, NAMELY, RECLAMATION OF WASTE WATER FOR PRODUCTION OF POST-RECYCLING COMMERCIAL AND INDUSTRIAL USE; ENVIRONMENTAL REMEDIATION SERVICES, NAMELY, SOIL, WASTE AND/OR WATER TREATMENT SERVICES; RENTAL OF WATER FILTRATION UNITS FOR COMMERCIAL USE; CONSULTING SERVICES RELATED TO ENVIRONMENTAL REMEDIATION, NAMELY, WASTE AND WASTE WATER TREATMENT, IN CLASS 40 (U.S. CLS. 100, 103 AND 106).

FIRST USE 7-1-2009; IN COMMERCE 7-1-2009.

THE MARK CONSISTS OF STANDARD CHARACTERS WITHOUT CLAIM TO ANY PARTICULAR FONT, STYLE, SIZE, OR COLOR.

PRIORITY CLAIMED UNDER SEC. 44(D) ON CANADA APPLICATION NO. 1478041, FILED 4-22-2010.

SN 85-028,411, FILED 5-3-2010.

JEAN IM, EXAMINING ATTORNEY



David J. Kypos

Director of the United States Patent and Trademark Office

United States of America
United States Patent and Trademark Office

EMPULSE

Reg. No. 4,176,162

BRAMMO, INC. (DELAWARE CORPORATION)
550 CLOVER LANE
ASHLAND, OR 97520

Registered July 17, 2012

Int. Cl.: 12

FOR: MOTORCYCLES AND STRUCTURAL PARTS THEREFOR, IN CLASS 12 (U.S. CLS. 19, 21, 23, 31, 35 AND 44).

TRADEMARK

FIRST USE 5-7-2012; IN COMMERCE 5-7-2012.

PRINCIPAL REGISTER

THE MARK CONSISTS OF STANDARD CHARACTERS WITHOUT CLAIM TO ANY PARTICULAR FONT, STYLE, SIZE, OR COLOR.

SN 85-028,792, FILED 5-3-2010.

LINDA M. KING, EXAMINING ATTORNEY



David J. Kyffers

Director of the United States Patent and Trademark Office

United States of America

United States Patent and Trademark Office

GreenDustries

Reg. No. 4,176,163

GREENDUSTRIES INTERNATIONAL S.A. (BELGIUM CORPORATION)
AVENUE CLEMENCEAU NUMERO 94
A ANDERLECHT, BELGIUM

Registered July 17, 2012

Int. Cl.: 16

FOR: PAPER FOOD WRAP; PAPER PACKAGING AND CONTAINERS FOR FOOD AND BEVERAGES COMPRISED OF MATERIALS DESIGNED TO LESSEN ADVERSE EFFECTS ON THE ENVIRONMENT, IN CLASS 16 (U.S. CLS. 2, 5, 22, 23, 29, 37, 38 AND 50).

TRADEMARK

FIRST USE 4-4-2011; IN COMMERCE 4-4-2011.

PRINCIPAL REGISTER

THE MARK CONSISTS OF STANDARD CHARACTERS WITHOUT CLAIM TO ANY PARTICULAR FONT, STYLE, SIZE, OR COLOR.

SN 85-029,810, FILED 5-4-2010.

ESTHER A. BORSUK, EXAMINING ATTORNEY



David J. Kyjars

Director of the United States Patent and Trademark Office

United States of America

United States Patent and Trademark Office

TOP ▼ NOTCH

Reg. No. 4,176,164

Registered July 17, 2012

Int. Cl.: 33

TRADEMARK

PRINCIPAL REGISTER

MERRYVALE VINEYARDS LLC (CALIFORNIA LIMITED LIABILITY COMPANY)
1000 MAIN STREET
ST. HELENA, CA 94574

FOR: WINE, IN CLASS 33 (U.S. CLS. 47 AND 49).

FIRST USE 4-24-2012; IN COMMERCE 4-24-2012.

OWNER OF U.S. REG. NO. 3,645,727.

THE MARK CONSISTS OF THE WORDS "TOP NOTCH" SEPARATED BY A TRIANGULAR DESIGN FORMING A V.

SN 85-030,465, FILED 5-5-2010.

KATHERINE CONNOLLY, EXAMINING ATTORNEY



David J. Kyffers

Director of the United States Patent and Trademark Office

United States of America

United States Patent and Trademark Office

EcoCosm, Inc.

Reg. No. 4,176,165

Registered July 17, 2012

Int. Cls.: 35 and 42

SERVICE MARK

PRINCIPAL REGISTER

ECOCOSM, INC. (CALIFORNIA CORPORATION), FORMERLY BEAR STATE RENEWABLES, INC.,
403 CARLOTTA, NEWPORT BEACH, CA. 92660
NEWPORT BEACH, CA 92660

FOR: BUSINESS CONSULTING AND ADVISORY SERVICES IN THE FIELD OF ENERGY EFFICIENCY, IN CLASS 35 (U.S. CLS. 100, 101 AND 102).

FIRST USE 7-1-2011; IN COMMERCE 7-1-2011.

FOR: CONSULTING SERVICES IN THE FIELD OF ENVIRONMENTAL ASSESSMENT AND PLANNING; ENVIRONMENTAL SERVICES, NAMELY, ENGINEERING SERVICES AND CONSULTATION FOR THE DETECTION OF CONTAMINANTS IN AIR, IN CLASS 42 (U.S. CLS. 100 AND 101).

FIRST USE 7-1-2011; IN COMMERCE 7-1-2011.

THE MARK CONSISTS OF STANDARD CHARACTERS WITHOUT CLAIM TO ANY PARTICULAR FONT, STYLE, SIZE, OR COLOR.

NO CLAIM IS MADE TO THE EXCLUSIVE RIGHT TO USE "INC.", APART FROM THE MARK AS SHOWN.

SN 85-031,174, FILED 5-5-2010.

DAVID MURRAY, EXAMINING ATTORNEY



David J. Kyros

Director of the United States Patent and Trademark Office

United States of America

United States Patent and Trademark Office



Reg. No. 4,176,166

Registered July 17, 2012

Int. Cl.: 25

TRADEMARK

PRINCIPAL REGISTER

BUNCH, ANGIE (UNITED STATES INDIVIDUAL)
2110 HANCOCK STREET, SUITE 200
SAN DIEGO, CA 92110

FOR: T-SHIRTS, SHIRTS, TANK TOPS, SWEATSHIRTS, SWEAT PANTS, DANCE PANTS,
HATS, CAPS, VISORS, IN CLASS 25 (U.S. CLS. 22 AND 39).

FIRST USE 5-20-2012; IN COMMERCE 5-20-2012.

OWNER OF U.S. REG. NO. 3,646,410.

THE MARK CONSISTS OF TWO OVAL CONCENTRIC CONFIGURATIONS WITH TWO
STYLIZED HUMAN FIGURES FORMED BY GEOMETRIC SHAPES INSIDE THE INNER
OVAL WITH OUTSTRETCHED ARMS.

SN 85-032,012, FILED 5-6-2010.

EDWARD NELSON, EXAMINING ATTORNEY



David J. Kyffers

Director of the United States Patent and Trademark Office

United States of America

United States Patent and Trademark Office

DIGABIT

Reg. No. 4,176,167

DIGABIT INC. (COLORADO CORPORATION)
195 SOUTH UNION BOULEVARD, #200
LAKEWOOD, CO 80228

Registered July 17, 2012

Int. Cl.: 42

FOR: PROVIDING USE OF WEB-BASED NON-DOWNLOADABLE SOFTWARE APPLICATION FOR STORING, ORGANIZING, ACCESSING AND SEARCHING TECHNICAL DOCUMENTATION AND INFORMATION, IN CLASS 42 (U.S. CLS. 100 AND 101).

SERVICE MARK

FIRST USE 4-30-2010; IN COMMERCE 4-30-2010.

PRINCIPAL REGISTER

THE MARK CONSISTS OF STANDARD CHARACTERS WITHOUT CLAIM TO ANY PARTICULAR FONT, STYLE, SIZE, OR COLOR.

SN 85-035,142, FILED 5-11-2010.

SAMUEL E. SHARPER JR., EXAMINING ATTORNEY



David J. Kyjars

Director of the United States Patent and Trademark Office

United States of America

United States Patent and Trademark Office

DOCUMOTO

Reg. No. 4,176,168

DIGABIT INC. (COLORADO CORPORATION)
195 SOUTH UNION BOULEVARD, #200
LAKEWOOD, CO 80228

Registered July 17, 2012

Int. Cl.: 42

FOR: PROVIDING USE OF WEB-BASED NON-DOWNLOADABLE SOFTWARE APPLICATION FOR STORING, ORGANIZING, ACCESSING AND SEARCHING TECHNICAL DOCUMENTATION AND INFORMATION, IN CLASS 42 (U.S. CLS. 100 AND 101).

SERVICE MARK

FIRST USE 4-30-2010; IN COMMERCE 4-30-2010.

PRINCIPAL REGISTER

THE MARK CONSISTS OF STANDARD CHARACTERS WITHOUT CLAIM TO ANY PARTICULAR FONT, STYLE, SIZE, OR COLOR.

SN 85-035,146, FILED 5-11-2010.

SAMUEL E. SHARPER JR., EXAMINING ATTORNEY



David J. Kyffers

Director of the United States Patent and Trademark Office

United States of America

United States Patent and Trademark Office



Reg. No. 4,176,169

Registered July 17, 2012

Int. Cl.: 9

TRADEMARK

PRINCIPAL REGISTER

EPV GROUP LLC (TEXAS LIMITED LIABILITY COMPANY)
#A
671 S. MESA HILLS
EL PASO, TX 79912

FOR: ONTOLOGY-BASED COMPUTER SOFTWARE THAT ALLOWS MULTIPLE INTELLIGENT COLLABORATIVE SOFTWARE AGENTS (CSAS) TO INTEGRATE WITH MANY OTHER INFORMATION SERVICES TO MONITOR AND SHIELD CONVEYANCES AND THEIR CARGO, IN CLASS 9 (U.S. CLS. 21, 23, 26, 36 AND 38).

FIRST USE 10-1-2010; IN COMMERCE 1-15-2011.

NO CLAIM IS MADE TO THE EXCLUSIVE RIGHT TO USE "INTELLIGENT TECHNOLOGY", APART FROM THE MARK AS SHOWN.

THE MARK CONSISTS OF A FADED "C" SURROUNDING "OBJECT" AND "INTELLIGENT TECHNOLOGY" UNDER THE WORD "SHIELD".

SN 85-035,920, FILED 5-11-2010.

DEIRDRE ROBERTSON, EXAMINING ATTORNEY



David J. Kyffers

Director of the United States Patent and Trademark Office

United States of America

United States Patent and Trademark Office

Romeo's Pizza

Reg. No. 4,176,170

SEAN BRAUSER (OHIO CORPORATION), DBA ROMEO'S PIZZA, INC.,
2737 MATTHEW DRIVE
MEDINA, OH 44256

Registered July 17, 2012

Int. Cl.: 43

FOR: BAR AND RESTAURANT SERVICES; RESTAURANT SERVICES, INCLUDING SIT-DOWN SERVICE OF FOOD AND TAKE-OUT RESTAURANT SERVICES, IN CLASS 43 (U.S. CLS. 100 AND 101).

SERVICE MARK

FIRST USE 4-0-2011; IN COMMERCE 4-0-2011.

PRINCIPAL REGISTER

THE MARK CONSISTS OF STANDARD CHARACTERS WITHOUT CLAIM TO ANY PARTICULAR FONT, STYLE, SIZE, OR COLOR.

NO CLAIM IS MADE TO THE EXCLUSIVE RIGHT TO USE "PIZZA", APART FROM THE MARK AS SHOWN.

SN 85-038,770, FILED 5-14-2010.

C. DIONNE CLYBURN, EXAMINING ATTORNEY



David J. Kyffers

Director of the United States Patent and Trademark Office

United States of America

United States Patent and Trademark Office



Reg. No. 4,176,171

Registered July 17, 2012

Int. Cl.: 43

SERVICE MARK

PRINCIPAL REGISTER

SEAN BRAUSER (OHIO CORPORATION), DBA ROMEO'S PIZZA, INC.,
2737 MATTHEW DRIVE
MEDINA, OH 44256

FOR: BAR AND RESTAURANT SERVICES; RESTAURANT SERVICES, INCLUDING SIT-DOWN SERVICE OF FOOD AND TAKE-OUT RESTAURANT SERVICES, IN CLASS 43 (U.S. CLS. 100 AND 101).

FIRST USE 4-0-2011; IN COMMERCE 4-0-2011.

NO CLAIM IS MADE TO THE EXCLUSIVE RIGHT TO USE "PIZZA", APART FROM THE MARK AS SHOWN.

THE COLOR(S) BLACK, RED, WHITE, GREEN, GRAY, AND TAN IS/ARE CLAIMED AS A FEATURE OF THE MARK.

THE MARK CONSISTS OF A MAN WHOSE FACE AND HAND APPEAR IN THE COLOR TAN. HE HAS A BLACK MUSTACHE, A BLACK EYE BROW AND EYE, AND GRAY HAIR. HE IS WEARING A BLACK SUIT WITH GRAY PIN STRIPES, A WHITE-COLLAR SHIRT, A RED TIE, AND A WHITE CUFF WITH A BLACK BUTTON. HE IS WEARING A BLACK HAT WITH A WHITE BAND AND A RED FEATHER. THE WORD "ROMEO'S" IS DISPLAYED IN RED CAPITAL LETTERS, OUTLINED IN WHITE, BELOW THE MAN. A GREEN BANNER WITH THE WORD "PIZZA" IN WHITE CAPITAL LETTERS APPEARS BELOW THE WORD "ROMEO'S".

SN 85-038,797, FILED 5-14-2010.

C. DIONNE CLYBURN, EXAMINING ATTORNEY



David J. Kybas

Director of the United States Patent and Trademark Office

United States of America

United States Patent and Trademark Office

TX

Reg. No. 4,176,172

ELEVATION PARTNERS LLC (KANSAS LIMITED LIABILITY COMPANY)
916 1/2 MASSACHUSETTS ST.
LAWRENCE, KS 66044

Registered July 17, 2012

Int. Cl.: 41

FOR: ENTERTAINMENT SERVICES, NAMELY, PRODUCING TELEVISION PROGRAMS, VIDEO PROGRAMS, AUDIO PROGRAMS AND PODCASTS IN THE FIELDS OF INCOME TAX AND FINANCIAL PLANNING, IN CLASS 41 (U.S. CLS. 100, 101 AND 107).

SERVICE MARK

FIRST USE 2-6-2012; IN COMMERCE 2-6-2012.

PRINCIPAL REGISTER

THE MARK CONSISTS OF STANDARD CHARACTERS WITHOUT CLAIM TO ANY PARTICULAR FONT, STYLE, SIZE, OR COLOR.

SN 85-039,875, FILED 5-17-2010.

JASON BLAIR, EXAMINING ATTORNEY



David J. Kybas

Director of the United States Patent and Trademark Office

United States of America

United States Patent and Trademark Office



Reg. No. 4,176,173

Registered July 17, 2012

Int. Cl.: 36

SERVICE MARK

PRINCIPAL REGISTER

AKINA AG (SWITZERLAND AKTIENGESELLSCHAFT)
SIHLSTRASSE 20, 4TH FLOOR
ZURICH, SWITZERLAND 8021

FOR: MANAGEMENT OF PRIVATE EQUITY FUNDS; PRIVATE EQUITY CONSULTANT SERVICES; PRIVATE EQUITY FUND INVESTMENT SERVICES; PRIVATE EQUITY INVESTMENT MANAGEMENT; PROVIDING PRIVATE EQUITY INVESTMENT FUNDS, NAMELY, RAISING EQUITY CAPITAL FROM OTHERS TO BE INVESTED DIRECTLY OR INDIRECTLY INTO THIRD PARTY COMPANIES; INVESTMENT ADVISORY SERVICES; INVESTMENT MANAGEMENT; INVESTMENT OF FUNDS FOR OTHERS; INVESTMENT SERVICES, NAMELY, ASSET ACQUISITION, CONSULTATION, DEVELOPMENT AND MANAGEMENT SERVICES; INVESTMENT MANAGEMENT AND ADVICE, NAMELY, SELECTION OF INVESTMENT VEHICLES; INVESTMENT PORTFOLIO MANAGEMENT; ALTERNATIVE FINANCIAL ASSET MANAGEMENT, IN CLASS 36 (U.S. CLS. 100, 101 AND 102).

FIRST USE 5-27-2010; IN COMMERCE 5-27-2010.

NO CLAIM IS MADE TO THE EXCLUSIVE RIGHT TO USE "ACTIVE INVESTORS", APART FROM THE MARK AS SHOWN.

THE MARK CONSISTS OF THE WORD "AKINA" IN LARGE, BOLD, LOWER-CASE LETTERS PRINTED ABOVE THE WORDS "ACTIVE INVESTORS ACROSS BORDERS", WITH THE "A" OF THE WORD "ACTIVE" PRINTED IN UPPER-CASE AND THE REST OF THE LETTERS PRINTED IN LOWER-CASE. ABOVE THE WORD "AKINA" IS AN IMAGE OF NUMEROUS POINTS CONNECTED BY STRAIGHT LINES.

THE ENGLISH TRANSLATION OF THE WORD "AKINA" IN THE MARK IS "BLOSSOMING SPRING GARDEN".

SN 85-040,041, FILED 5-17-2010.

MARK PILARO, EXAMINING ATTORNEY



David J. Kyffers

Director of the United States Patent and Trademark Office

United States of America

United States Patent and Trademark Office

Hatha Systems

Reg. No. 4,176,174

HATHA SYSTEMS LLC (MARYLAND LIMITED LIABILITY COMPANY)
10 LIGHT STREET
BALTIMORE, MD 21202

Registered July 17, 2012

Int. Cls.: 9, 35, and 42

FOR: COMPUTER SOFTWARE FOR ANALYSIS AND MODERNIZATION OF SOFTWARE SYSTEMS, IN CLASS 9 (U.S. CLS. 21, 23, 26, 36 AND 38).

TRADEMARK

FIRST USE 3-12-2009; IN COMMERCE 3-12-2009.

SERVICE MARK

FOR: BUSINESS CONSULTATION SERVICES, NAMELY, BUSINESS PROCESS IMPROVEMENT AND ENTERPRISE ARCHITECTURE DESIGN, IN CLASS 35 (U.S. CLS. 100, 101 AND 102).

PRINCIPAL REGISTER

FIRST USE 2-28-2006; IN COMMERCE 2-28-2006.

FOR: COMPUTER PROGRAMMING AND COMPUTER SYSTEM ANALYSIS, IN CLASS 42 (U.S. CLS. 100 AND 101).

FIRST USE 3-12-2009; IN COMMERCE 3-12-2009.

THE MARK CONSISTS OF STANDARD CHARACTERS WITHOUT CLAIM TO ANY PARTICULAR FONT, STYLE, SIZE, OR COLOR.

NO CLAIM IS MADE TO THE EXCLUSIVE RIGHT TO USE "SYSTEMS", APART FROM THE MARK AS SHOWN.

SN 85-040,794, FILED 5-17-2010.

SALLY SHIH, EXAMINING ATTORNEY



David J. Kyros

Director of the United States Patent and Trademark Office

United States of America

United States Patent and Trademark Office

SOARINGMUSEUMS

Reg. No. 4,176,175

SOARINGWORDS, INC. (NEW YORK CORPORATION)
505 EIGHTH AVENUE, STE. 1000
WASHINGTON, DC 10018

Registered July 17, 2012

Int. Cl.: 41

FOR: CHARITABLE SERVICES, NAMELY, PROVIDING GUIDED VIRTUAL TOURS OF MUSEUMS, EXCLUDING MUSEUMS RELATED TO MOTORLESS FLIGHT, AND ART EXHIBITIONS VIA AN INTERNET WEBSITE FOR USE BY CHILDREN WITH SERIOUS ILLNESS AND THEIR FAMILIES, IN CLASS 41 (U.S. CLS. 100, 101 AND 107).

SERVICE MARK

PRINCIPAL REGISTER

FIRST USE 5-0-2009; IN COMMERCE 5-0-2009.

THE MARK CONSISTS OF STANDARD CHARACTERS WITHOUT CLAIM TO ANY PARTICULAR FONT, STYLE, SIZE, OR COLOR.

OWNER OF U.S. REG. NOS. 3,407,806, 3,407,808, AND OTHERS.

SN 85-041,385, FILED 5-18-2010.

ROBERT C. CLARK JR., EXAMINING ATTORNEY



David J. Kyffers

Director of the United States Patent and Trademark Office

United States of America

United States Patent and Trademark Office

Wild Sorbet

Reg. No. 4,176,176

PERSNIPPITY, INC. (ALABAMA CORPORATION)
2251 COUNTY ROAD 28
FLORENCE, AL 35634

Registered July 17, 2012

Int. Cls.: 40 and 42

FOR: CUSTOM MANUFACTURE OF FRAMES AND ART MOUNTS FOR PROFESSIONAL PHOTOGRAPHERS AND INTERIOR DESIGNERS; MANUFACTURE OF FRAMES AND OTHER INTERIOR DESIGN PRODUCTS, NAMELY, ART MOUNTS FOR RETAIL MARKET, IN CLASS 40 (U.S. CLS. 100, 103 AND 106).

SERVICE MARK

PRINCIPAL REGISTER

FIRST USE 8-30-2005; IN COMMERCE 8-30-2005.

FOR: CUSTOM DESIGN OF FRAMES AND ART MOUNTS FOR PROFESSIONAL PHOTOGRAPHERS AND INTERIOR DESIGNERS. PROVIDING INTERIOR STUDIO DESIGN CONSULTATION, SOFTWARE DESIGN SERVICES AND CONSULTATION REGARDING CUSTOM COLOR AND DESIGN SELECTIONS FOR FRAMES AND OTHER INTERIOR DESIGN PRODUCTS; DESIGN OF FRAMES AND OTHER INTERIOR DESIGN PRODUCTS, NAMELY, ART MOUNTS FOR RETAIL MARKETS, IN CLASS 42 (U.S. CLS. 100 AND 101).

FIRST USE 8-30-2005; IN COMMERCE 8-30-2005.

THE MARK CONSISTS OF STANDARD CHARACTERS WITHOUT CLAIM TO ANY PARTICULAR FONT, STYLE, SIZE, OR COLOR.

SN 85-041,626, FILED 5-18-2010.

JENNIFER VASQUEZ, EXAMINING ATTORNEY



David J. Kyffers

Director of the United States Patent and Trademark Office

United States of America

United States Patent and Trademark Office



Reg. No. 4,176,177

Registered July 17, 2012

Int. Cl.: 35

SERVICE MARK

PRINCIPAL REGISTER

HEINKE, JEFFREY (UNITED STATES INDIVIDUAL)
222 AUSTIN HIGHWAY, SUITE 4
SAN ANTONIO, TX 78209

FOR: ADVERTISING AND BUSINESS SERVICES, NAMELY, ADVERTISING, ADVERTISING AGENCIES, AND LAYOUT SERVICES FOR ADVERTISING PURPOSES FOR CONSUMERS, IN CLASS 35 (U.S. CLS. 100, 101 AND 102).

FIRST USE 8-1-2011; IN COMMERCE 8-15-2011.

NO CLAIM IS MADE TO THE EXCLUSIVE RIGHT TO USE "DESIGN", APART FROM THE MARK AS SHOWN.

THE NAME(S), PORTRAIT(S), AND/OR SIGNATURE(S) SHOWN IN THE MARK IDENTIFIES "JEFFREY HEINKE", WHOSE CONSENT(S) TO REGISTER IS MADE OF RECORD.

THE MARK CONSISTS THE LETTERS "JHD" INSIDE A RECTANGULAR CARRIER WITH CURVED CORNERS, WHEREIN THE LETTER "D" IS HIGHLY STYLIZED. THE WORD "JEFFREY" IS WRITTEN BELOW THE CARRIER CONTAINING LETTERS "JHD", THE WORD "HEINKE" IS WRITTEN BELOW THE WORD "JEFFREY" AND THE WORD "DESIGN" IS WRITTEN BELOW THE WORD "HEINKE". ALL OF THE FOREGOING ELEMENTS APPEAR INSIDE A SHADED RECTANGULAR CARRIER.

SN 85-042,138, FILED 5-19-2010.

BERNICE MIDDLETON, EXAMINING ATTORNEY



David J. Kybas

Director of the United States Patent and Trademark Office

United States of America

United States Patent and Trademark Office



Reg. No. 4,176,178

Registered July 17, 2012

Int. Cl.: 25

TRADEMARK

PRINCIPAL REGISTER

AMERICAN INTELLECTUAL PROPERTY LAW ASSOCIATION, INC. (VIRGINIA
NON-STOCK CORPORATION)
241 18TH STREET SOUTH, SUITE 700
ARLINGTON, VA 22202

FOR: CLOTHING, NAMELY, SHIRTS, IN CLASS 25 (U.S. CLS. 22 AND 39).

FIRST USE 10-15-2010; IN COMMERCE 10-15-2010.

NO CLAIM IS MADE TO THE EXCLUSIVE RIGHT TO USE "®" AS PART OF THE DESIGN
ELEMENT OF THE MARK, APART FROM THE MARK AS SHOWN.

THE MARK CONSISTS OF A STYLIZED TREE WITH A REACHING HAND REPRESENTING
THE TRUNK AND BRANCHES, SWIRLS AS LEAVES, AND THE FOLLOWING SYMBOLS
AS BLOOMS: TECHNOLOGY SYMBOLS RELATED TO PATENTS INCLUDING A BEAKER
CONTAINING A REACTING LIQUID, AN ATOMIC MODEL, A GEAR, A SERIES OF WAVY
LINES REPRESENTING A WAVEFORM, 2 LEAVES REPRESENTING BIOTECHNOLOGY
AND GREEN TECHNOLOGY, AND A SERIES OF BINARY NUMBERS REPRESENTING
COMPUTER LANGUAGE AND SOFTWARE; ARTISTIC SYMBOLS RELATED TO COPY-
RIGHT INCLUDING A TREBLE CLEF, A BASS CLEF, AND A SECTION OF PHOTOGRAPHIC
FILM; AND THE TRADITIONAL CIRCLE R SYMBOL RELATING TO TRADEMARKS.

SN 85-042,959, FILED 5-19-2010.

MICHAEL KEATING, EXAMINING ATTORNEY



David J. Kybas

Director of the United States Patent and Trademark Office

United States of America

United States Patent and Trademark Office

ELEMENT

Reg. No. 4,176,179

Registered July 17, 2012

Int. Cl.: 7

TRADEMARK

PRINCIPAL REGISTER

H-P PRODUCTS, INC. (OHIO CORPORATION)
512 W. GORGAS STREET
LOUISVILLE, OH 446410912

FOR: CLEANING SYSTEMS WHICH COMPRISE A CENTRAL VACUUM UNIT AND CONNECTED CONDUITS AND CLEANING NOZZLES AND PARTS THEREFOR; CLEANING KIT COMPRISED OF A TURBINE-POWERED OR ELECTRIC NOZZLE, WANDS, HOSES, BRUSHES AND ATTACHMENT CADDY, IN CLASS 7 (U.S. CLS. 13, 19, 21, 23, 31, 34 AND 35).

FIRST USE 8-11-2010; IN COMMERCE 8-11-2010.

THE MARK CONSISTS OF STANDARD CHARACTERS WITHOUT CLAIM TO ANY PARTICULAR FONT, STYLE, SIZE, OR COLOR.

SN 85-042,992, FILED 5-19-2010.

CHRIS WELLS, EXAMINING ATTORNEY



David J. Kyffers

Director of the United States Patent and Trademark Office

United States of America

United States Patent and Trademark Office



Reg. No. 4,176,180

Registered July 17, 2012

Int. Cl.: 36

SERVICE MARK

PRINCIPAL REGISTER

RODGERS INSURANCE GROUP (PENNSYLVANIA CORPORATION)
651 HOLIDAY DRIVE
PITTSBURGH, PA 15220

FOR: BROKERAGE IN THE FIELD OF INSURANCE, IN CLASS 36 (U.S. CLS. 100, 101 AND 102).

FIRST USE 12-31-2009; IN COMMERCE 12-31-2009.

NO CLAIM IS MADE TO THE EXCLUSIVE RIGHT TO USE "INSURANCE GROUP", APART FROM THE MARK AS SHOWN.

THE COLOR(S) RED, WHITE AND BLACK IS/ARE CLAIMED AS A FEATURE OF THE MARK.

THE MARK CONSISTS OF A STYLIZED LETTER "R" APPEARING IN THE COLOR WHITE AGAINST A SQUARE BACKGROUND OF THE COLOR RED AND PLACED ON THE LEFT SIDE OF THE WORDS "RODGERS INSURANCE GROUP" APPEARING IN THE COLOR BLACK.

SN 85-046,302, FILED 5-24-2010.

KATHERINE CONNOLLY, EXAMINING ATTORNEY



David J. Kyffers

Director of the United States Patent and Trademark Office

United States of America

United States Patent and Trademark Office

DMITRI SUITE

Reg. No. 4,176,181

Registered July 17, 2012

Int. Cls.: 41 and 42

SERVICE MARK

PRINCIPAL REGISTER

CRAWFORD & COMPANY (GEORGIA CORPORATION)
1001 SUMMIT BOULEVARD, 9TH FLOOR
ATLANTA, GA 30319

FOR: WEB-BASED, ON-SITE OR OFF-SITE COMPUTER SOFTWARE TRAINING AND EDUCATION SERVICES, NAMELY, TRAINING AND EDUCATING OTHERS IN THE USE OF WEB-BASED AND WEB ACCESSIBLE COMPUTER SOFTWARE THAT PROVIDES ACCESS TO APPLICATIONS AND SERVICES THAT ASSISTS INSURED, INSURANCE BROKERS AND INSURANCE AGENTS IN ANALYZING, FORMATTING AND REPORTING CLAIM AND LOSS INFORMATION AND MEDICAL MANAGEMENT DATA IN THE FIELD OF RISK MANAGEMENT, IN CLASS 41 (U.S. CLS. 100, 101 AND 107).

FIRST USE 4-0-2011; IN COMMERCE 4-0-2011.

FOR: COMPUTER SOFTWARE SUPPORT, NAMELY, APPLICATION SERVICE PROVIDER (ASP) FEATURING SOFTWARE THAT ALLOWS WEB-BASED ACCESS TO INSURANCE AND MEDICAL CLAIMS INFORMATION RELATED TO RISK MANAGEMENT OVER A GLOBAL COMPUTER NETWORK; HOSTING THE WEB SITES AND DATABASES OF OTHERS ON A COMPUTER SERVER FOR A GLOBAL COMPUTER NETWORK; PROVIDING TEMPORARY USE OF ONLINE NON-DOWNLOADABLE WEB-BASED AND WEB ACCESSIBLE COMPUTER SOFTWARE THAT PROVIDES ACCESS TO APPLICATIONS AND SERVICES THAT ASSISTS INSURED, INSURANCE BROKERS AND INSURANCE AGENTS IN ANALYZING, FORMATTING AND REPORTING CLAIM AND LOSS INFORMATION AND MEDICAL MANAGEMENT DATA IN THE FIELD OF RISK MANAGEMENT; PROVIDING TEMPORARY USE OF ONLINE NON-DOWNLOADABLE WEB-BASED AND WEB ACCESSIBLE COMPUTER SOFTWARE THAT PROVIDES REAL-TIME ACCESS TO CLAIM AND LOSS INFORMATION AND MEDICAL MANAGEMENT DATA IN THE FIELD OF RISK MANAGEMENT BY COMBINING INFORMATION FROM VARIOUS DATABASES AND PRESENTING IT IN AN EASY-TO-UNDERSTAND USER INTERFACE; PROVIDING TEMPORARY USE OF ONLINE NON-DOWNLOADABLE WEB-BASED AND WEB ACCESSIBLE COMPUTER SOFTWARE FOR ACCESSING, ANALYZING AND MANAGING REPORTS RELATED TO CLAIM AND LOSS INFORMATION, MEDICAL MANAGEMENT DATA AND CLAIM MANAGEMENT PROFILES ALL IN THE FIELD OF RISK MANAGEMENT; PROVIDING TEMPORARY USE OF ONLINE NON-DOWNLOADABLE WEB-BASED AND WEB ACCESSIBLE COMPUTER SOFTWARE THAT OFFERS A SCALABLE SOLUTION FOR COMBINING INFORMATION RELATED TO CLAIMS, LITIGATION, RISK CONTROL, EXPOSURE AND POLICY INFORMATION FROM MULTIPLE SOURCES TO PROVIDE IN-



David J. Kyjars

Director of the United States Patent and Trademark Office

Reg. No. 4,176,181 SUREDS, INSURANCE BROKERS AND INSURANCE AGENTS WITH AD HOC REPORTING, FORMATTING, ANALYTIC AND TRACKING CAPABILITIES, IN CLASS 42 (U.S. CLS. 100 AND 101).

FIRST USE 4-0-2011; IN COMMERCE 4-0-2011.

NO CLAIM IS MADE TO THE EXCLUSIVE RIGHT TO USE "SUITE", APART FROM THE MARK AS SHOWN.

THE MARK CONSISTS OF AN "X" SYMBOL FOLLOWED BY THE WORDS "DMITRI SUITE".

SN 85-048,454, FILED 5-26-2010.

ANNE MADDEN, EXAMINING ATTORNEY

United States of America

United States Patent and Trademark Office



Reg. No. 4,176,182

Registered July 17, 2012

Int. Cls.: 35 and 41

SERVICE MARK

PRINCIPAL REGISTER

ALL AMERICAN GAMES, LLC (NEW JERSEY LIMITED LIABILITY COMPANY)
175 NORTH MAIN STREET
WHARTON, NJ 07885

FOR: SPORTS MARKETING SERVICES; ADVERTISING, MARKETING AND PROMOTION SERVICES IN THE FIELD OF SPORTS MANAGEMENT; ADVERTISING, INCLUDING PROMOTION OF PRODUCTS AND SERVICES OF THIRD PARTIES THROUGH SPONSORING ARRANGEMENTS AND LICENSE AGREEMENTS RELATING TO YOUTH AND HIGH SCHOOL SPORTS EVENTS; PROVIDING MARKETING AND PROMOTION OF SPECIAL EVENTS; PUBLIC RELATIONS SERVICES IN THE FIELD OF SPORTS MARKETING, SPONSORSHIP, ADVERTISING, PROMOTIONS AND EVENT PROGRAMS; PROMOTING THE GOODS AND SERVICES OF OTHERS BY ARRANGING FOR SPONSORS TO AFFILIATE THEIR GOODS AND SERVICES WITH AN AWARDS PROGRAM, A SPORTS COMPETITION AND SPORTING ACTIVITIES; PROMOTING THE INTERESTS OF PEOPLE INVOLVED AND CONCERNED WITH YOUTH SPORTS; PROMOTING SPORTS COMPETITIONS AND/OR EVENTS OF OTHERS; ARRANGING AND CONDUCTING SPECIAL EVENTS FOR COMMERCIAL, PROMOTIONAL OR ADVERTISING PURPOSES; MANAGING HIGH SCHOOL AND YOUTH SPORTING EVENTS OF OTHERS, IN CLASS 35 (U.S. CLS. 100, 101 AND 102).

FIRST USE 6-20-2010; IN COMMERCE 6-20-2010.



David J. Kyffers

Director of the United States Patent and Trademark Office

FOR: ARRANGING AND CONDUCTING SPECIAL EVENTS FOR SOCIAL ENTERTAINMENT PURPOSES; SPECIAL EVENT PLANNING FOR SOCIAL ENTERTAINMENT PURPOSES; ATHLETIC AND SPORTS EVENT SERVICES, NAMELY, ARRANGING, ORGANIZING, OPERATING AND CONDUCTING HIGH SCHOOL AND YOUTH SPORTING EVENTS; ENTERTAINMENT IN THE NATURE OF HIGH SCHOOL AND YOUTH FOOTBALL, BASEBALL AND BASKETBALL GAMES; OPERATION OF SPORTS CAMPS; SPORTS CAMP SERVICES; ORGANIZATION OF SPORTS COMPETITIONS; PROVISION OF INFORMATION RELATING TO SPORTS AND SPORTING EVENTS; PROVIDING A WEB SITE FEATURING INFORMATION ON YOUTH AND HIGH-SCHOOL SPORTS; ENTERTAINMENT SERVICES IN THE NATURE OF AN ON-GOING REALITY BASED TELEVISION PROGRAM; ENTERTAINMENT SERVICES IN THE NATURE OF AN ON-GOING TELEVISION PROGRAM IN THE FIELD OF SPORTS; ENTERTAINMENT SERVICES, NAMELY, PROVIDING INFORMATION CONCERNING A REALITY BASED TELEVISION SERIES BY MEANS OF A GLOBAL COMPUTER NETWORK, IN CLASS 41 (U.S. CLS. 100, 101 AND 107).

FIRST USE 6-20-2010; IN COMMERCE 6-20-2010.

Reg. No. 4,176,182 NO CLAIM IS MADE TO THE EXCLUSIVE RIGHT TO USE "ALL AMERICAN GAMES",
APART FROM THE MARK AS SHOWN.

SN 85-049,174, FILED 5-27-2010.

MARIA-VICTORIA SUAREZ, EXAMINING ATTORNEY

United States of America

United States Patent and Trademark Office



Reg. No. 4,176,183

DEBRA M. PAINE (UNITED STATES INDIVIDUAL)
13261 NORTH JOAN D'ARC
PHOENIX, AZ 85032 AND

Registered July 17, 2012

Int. Cl.: 35

HERBERT J. PAINE (UNITED STATES INDIVIDUAL)
13261 NORTH JOAN D'ARC
PHOENIX, AZ 85032

SERVICE MARK

PRINCIPAL REGISTER

FOR: RETAIL STORE, WHOLESALE STORE, ONLINE RETAIL AND WHOLESALE STORE,
AND MAIL ORDER SERVICES FEATURING COOKIES, BROWNIES, MUFFINS, CAKES,
CUPCAKES AND CANDIES, IN CLASS 35 (U.S. CLS. 100, 101 AND 102).

FIRST USE 4-1-2012; IN COMMERCE 4-1-2012.

THE MARK CONSISTS OF THE WORD "GOOSEBUMPS" WITH THE DESIGN OF A CHEF
IN ONE LETTER "O" AND THE DESIGN OF A COOKIE IN THE OTHER LETTER "O".

SN 85-049,483, FILED 5-27-2010.

WENDY JUN, EXAMINING ATTORNEY



David J. Kybas

Director of the United States Patent and Trademark Office

United States of America

United States Patent and Trademark Office

ACTIVETRAINER

Reg. No. 4,176,184

Registered July 17, 2012

Int. Cls.: 38 and 41

SERVICE MARK

PRINCIPAL REGISTER

THE ACTIVE NETWORK, INC. (DELAWARE CORPORATION)
10182 TELESIS COURT, SUITE 300
SAN DIEGO, CA 92121

FOR: PROVIDING ON-LINE FORUMS FOR TRANSMISSION OF MESSAGES AMONG COMPUTER USERS CONCERNING SPORTS, ATHLETIC, EXERCISE, AND FITNESS TRAINING, IN CLASS 38 (U.S. CLS. 100, 101 AND 104).

FIRST USE 5-20-2006; IN COMMERCE 5-20-2006.

FOR: PROVIDING A WEBSITE FEATURING ONLINE SPORTS, ATHLETIC, EXERCISE, FITNESS TRAINING, AND TRAINING ADVICE, THE RECORDING OF TRAINING SESSIONS, AND TRAINING REPORTS, IN CLASS 41 (U.S. CLS. 100, 101 AND 107).

FIRST USE 5-20-2006; IN COMMERCE 5-20-2006.

THE MARK CONSISTS OF STANDARD CHARACTERS WITHOUT CLAIM TO ANY PARTICULAR FONT, STYLE, SIZE, OR COLOR.

SN 85-050,461, FILED 5-28-2010.

ERIN FALK, EXAMINING ATTORNEY



David J. Kybas

Director of the United States Patent and Trademark Office

United States of America

United States Patent and Trademark Office

VERSOLEIL

Reg. No. 4,176,185

Registered July 17, 2012

Int. Cl.: 6

TRADEMARK

PRINCIPAL REGISTER

ALCOA INC. (PENNSYLVANIA CORPORATION)
ALCOA CORPORATE CENTER
201 ISABELLA STREET
PITTSBURGH, PA 152125858

FOR: ARCHITECTURAL EXTERIOR SHADING SYSTEMS OF ALUMINUM USED FOR THE COMMERCIAL CONSTRUCTION INDUSTRY AND COMPRISED OF ALUMINUM METAL EXTERIOR PANELS IN THE NATURE ALUMINUM BLADES, IN CLASS 6 (U.S. CLS. 2, 12, 13, 14, 23, 25 AND 50).

FIRST USE 9-19-2011; IN COMMERCE 9-19-2011.

THE MARK CONSISTS OF STANDARD CHARACTERS WITHOUT CLAIM TO ANY PARTICULAR FONT, STYLE, SIZE, OR COLOR.

SN 85-052,395, FILED 6-2-2010.

WILLIAM ROSSMAN, EXAMINING ATTORNEY



David J. Kybas

Director of the United States Patent and Trademark Office

United States of America

United States Patent and Trademark Office

TRUE LOVE

Reg. No. 4,176,186

Registered July 17, 2012

Int. Cl.: 33

TRADEMARK

PRINCIPAL REGISTER

EINIG-ZENZEN GMBH & CO. KG (FED REP GERMANY LIMITED PARTNERSHIP)
CARL-FRIEDRICH-BENZ-STRASSE 8
56759 KAISERSESCH, FED REP GERMANY

FOR: WINE, IN CLASS 33 (U.S. CLS. 47 AND 49).

FIRST USE 4-19-2012; IN COMMERCE 4-19-2012.

THE MARK CONSISTS OF STANDARD CHARACTERS WITHOUT CLAIM TO ANY PARTICULAR FONT, STYLE, SIZE, OR COLOR.

SN 85-053,161, FILED 6-2-2010.

JOSETTE BEVERLY, EXAMINING ATTORNEY



David J. Kybas

Director of the United States Patent and Trademark Office

United States of America

United States Patent and Trademark Office

SUNVETRO

Reg. No. 4,176,187

Registered July 17, 2012

Int. Cl.: 2

TRADEMARK

PRINCIPAL REGISTER

SUN CHEMICAL CORPORATION (DELAWARE CORPORATION)
35 WATERVIEW BLVD.
PARSIPPANY, NJ 07054

FOR: PRINTING INKS, IN CLASS 2 (U.S. CLS. 6, 11 AND 16).

FIRST USE 10-1-2011; IN COMMERCE 10-1-2011.

THE MARK CONSISTS OF STANDARD CHARACTERS WITHOUT CLAIM TO ANY PARTICULAR FONT, STYLE, SIZE, OR COLOR.

SN 85-053,281, FILED 6-2-2010.

KEVON CHISOLM, EXAMINING ATTORNEY



David J. Kyffers

Director of the United States Patent and Trademark Office

United States of America

United States Patent and Trademark Office



Reg. No. 4,176,188

Registered July 17, 2012

Int. Cl.: 35

SERVICE MARK

PRINCIPAL REGISTER

PET HEALTH USA INC. (FLORIDA CORPORATION)
12717 W SUNRISE BLVD SUITE 396
SUNRISE, FL 33323

FOR: ON-LINE RETAIL STORE SERVICES FEATURING PET PRODUCTS, IN CLASS 35
(U.S. CLS. 100, 101 AND 102).

FIRST USE 1-16-2011; IN COMMERCE 1-16-2011.

NO CLAIM IS MADE TO THE EXCLUSIVE RIGHT TO USE "PET HEALTH USA .COM"
AND "WHERE PET PARENTS SHOP", APART FROM THE MARK AS SHOWN.

THE MARK CONSISTS OF THE IMAGE OF A PET PAW INTERTWINED WITH A HEART,
SEPARATED FROM THE WORDING "PET HEALTH USA .COM WHERE PET PARENTS
SHOP" BY A VERTICAL LINE. THE WORDS "PET" AND "HEALTH" ARE UNDERLINED.

SN 85-054,512, FILED 6-4-2010.

STEVEN JACKSON, EXAMINING ATTORNEY



David J. Kyros

Director of the United States Patent and Trademark Office

United States of America

United States Patent and Trademark Office

LIFELINE

Reg. No. 4,176,189

Registered July 17, 2012

Int. Cl.: 45

SERVICE MARK

PRINCIPAL REGISTER

PICA CORPORATION (OHIO CORPORATION)
551 S. THIRD ST.
COLOMBUS, OH 43215

FOR: SECURITY SERVICES, NAMELY, THREAT ANALYSIS, MITIGATION AND CRISIS RESPONSE; PROVIDING EXECUTIVE PROTECTION AND EVACUATION, IN CLASS 45 (U.S. CLS. 100 AND 101).

FIRST USE 1-1-2012; IN COMMERCE 1-1-2012.

THE MARK CONSISTS OF STANDARD CHARACTERS WITHOUT CLAIM TO ANY PARTICULAR FONT, STYLE, SIZE, OR COLOR.

SN 85-055,061, FILED 6-4-2010.

MICHAEL SOUDERS, EXAMINING ATTORNEY



David J. Kybas

Director of the United States Patent and Trademark Office

United States of America

United States Patent and Trademark Office

MEOW MIX TENDER CENTERS

Reg. No. 4,176,190

Registered July 17, 2012

Int. Cl.: 31

TRADEMARK

PRINCIPAL REGISTER

DEL MONTE CORPORATION (DELAWARE CORPORATION)
P.O. BOX 193575
SAN FRANCISCO, CA 941193575

FOR: PET FOOD, IN CLASS 31 (U.S. CLS. 1 AND 46).

FIRST USE 12-14-2011; IN COMMERCE 12-14-2011.

THE MARK CONSISTS OF STANDARD CHARACTERS WITHOUT CLAIM TO ANY PARTICULAR FONT, STYLE, SIZE, OR COLOR.

OWNER OF U.S. REG. NOS. 1,995,276, 3,641,270, AND OTHERS.

NO CLAIM IS MADE TO THE EXCLUSIVE RIGHT TO USE "TENDER CENTERS", APART FROM THE MARK AS SHOWN.

SN 85-057,911, FILED 6-8-2010.

TRACY CROSS, EXAMINING ATTORNEY



David J. Kyffers

Director of the United States Patent and Trademark Office

United States of America

United States Patent and Trademark Office

TAKE IT TO THE MAX

Reg. No. 4,176,191

Registered July 17, 2012

Int. Cl.: 19

TRADEMARK

PRINCIPAL REGISTER

MAX WINDSOR FLOORS (CALIFORNIA CORPORATION)
11818 SAN MARINO ST.
RANCHO CUCAMONGA, CA 91730

FOR: FLOORING PRODUCTS, NAMELY, ATHLETIC FLOORING, BAMBOO FLOORING, CERAMIC TILES FOR FLOORING AND FACING, CERAMIC TILES FOR FLOORING AND LINING, CHEMICALLY TREATED WOOD, NAMELY, WOOD BEAMS, WOOD BOARDS, WOOD JOISTS, WOOD RAFTERS, WOOD SIDING, WOOD TILE FLOORS AND FLOORING, WOOD TRIM, WOODEN BEAMS, WOODEN FLOORING, WOODEN RAILINGS, AND WOODEN WAINSCOTING, ALL OF THE ABOVE CONTAINING A FIRE RETARDANT CHEMICAL; FABRIC FOR UNDERLAYMENT OF FLOORING, FLOORING UNDERLAYMENT, FLOORING UNDERLAYMENT MADE OF CORK, LAMINATE FLOORING, PARQUET FLOORING AND PARQUET SLABS; PARQUET FLOORING MADE OF CORK, PARQUET FLOORING MADE OF WOOD, PARQUET FLOORING OF CORK, PARQUET FLOORING MADE OF WOOD, PARQUET WOOD FLOORING, ROCK MATERIALS USED IN THE MANUFACTURE OF FLOORING, ROOFING, COUNTERTOPS, WALLS, CLADDING AND FIREPLACES, RUBBER FLOORING, SYNTHETIC FLOORING MATERIALS OR WALLCLADDINGS, AND WOODEN FLOORING, IN CLASS 19 (U.S. CLS. 1, 12, 33 AND 50).

FIRST USE 2-0-2010; IN COMMERCE 2-0-2010.

THE MARK CONSISTS OF STANDARD CHARACTERS WITHOUT CLAIM TO ANY PARTICULAR FONT, STYLE, SIZE, OR COLOR.

SN 85-059,070, FILED 6-10-2010.

RONALD MCMORROW, EXAMINING ATTORNEY



David J. Kyffers

Director of the United States Patent and Trademark Office

United States of America

United States Patent and Trademark Office

Champions Square

Reg. No. 4,176,192

ZELIA, LLC (LOUISIANA LIMITED LIABILITY COMPANY)
5800 AIRLINE DRIVE
METAIRIE, LA 70003

Registered July 17, 2012

Int. Cl.: 43

FOR: ENTERTAINMENT AND RECREATIONAL SERVICES, NAMELY, PROVIDING PLAZA AND PAVILION FACILITIES FOR ENTERTAINMENT, SPORTING, AND RECREATIONAL EVENTS, IN CLASS 43 (U.S. CLS. 100 AND 101).

SERVICE MARK

FIRST USE 6-8-2011; IN COMMERCE 6-8-2011.

PRINCIPAL REGISTER

THE MARK CONSISTS OF STANDARD CHARACTERS WITHOUT CLAIM TO ANY PARTICULAR FONT, STYLE, SIZE, OR COLOR.

NO CLAIM IS MADE TO THE EXCLUSIVE RIGHT TO USE "SQUARE", APART FROM THE MARK AS SHOWN.

SN 85-060,542, FILED 6-11-2010.

MICHAEL KEATING, EXAMINING ATTORNEY



David J. Kyffers

Director of the United States Patent and Trademark Office

United States of America

United States Patent and Trademark Office

DYNASTAR

Reg. No. 4,176,193

INTERNATIONAL VIDEO & ELECTRONICS (ILLINOIS CORPORATION)
546 CROSSEN AVE

Registered July 17, 2012

ELK GROVE VILLAGE, IL 60007

Int. Cl.: 9

FOR: DVD PLAYERS; ELECTRIC VOLTAGE TRANSFORMERS; TELEVISIONS, IN CLASS
9 (U.S. CLS. 21, 23, 26, 36 AND 38).

TRADEMARK

FIRST USE 6-1-2011; IN COMMERCE 6-1-2011.

PRINCIPAL REGISTER

THE MARK CONSISTS OF STANDARD CHARACTERS WITHOUT CLAIM TO ANY PAR-
TICULAR FONT, STYLE, SIZE, OR COLOR.

SN 85-062,958, FILED 6-15-2010.

LEIGH LOWRY, EXAMINING ATTORNEY



David J. Kyffers

Director of the United States Patent and Trademark Office

United States of America

United States Patent and Trademark Office

HAVE YOUR WAY

Reg. No. 4,176,194

Registered July 17, 2012

Int. Cl.: 41

SERVICE MARK

PRINCIPAL REGISTER

HAVE YOUR WAY, LLC (OHIO LIMITED LIABILITY COMPANY)
SUITE 240
70 BIRCH ALLEY
BEAVERCREEK, OH 45440

FOR: PUBLICATION OF BOOKS, E-BOOKS, AUDIO BOOKS AND ILLUSTRATIONS, IN CLASS 41 (U.S. CLS. 100, 101 AND 107).

FIRST USE 3-0-2010; IN COMMERCE 3-0-2010.

THE MARK CONSISTS OF STANDARD CHARACTERS WITHOUT CLAIM TO ANY PARTICULAR FONT, STYLE, SIZE, OR COLOR.

SN 85-063,115, FILED 6-15-2010.

RICHARD WHITE, EXAMINING ATTORNEY



David J. Kybas

Director of the United States Patent and Trademark Office

United States of America

United States Patent and Trademark Office



Reg. No. 4,176,195

Registered July 17, 2012

Int. Cl.: 41

SERVICE MARK

PRINCIPAL REGISTER

HAVE YOUR WAY, LLC (OHIO LIMITED LIABILITY COMPANY)
SUITE 240
70 BIRCH ALLEY
BEAVERCREEK, OH 45440

FOR: PUBLICATION OF BOOKS, E-BOOKS, AUDIO BOOKS AND ILLUSTRATIONS, IN CLASS 41 (U.S. CLS. 100, 101 AND 107).

FIRST USE 3-0-2010; IN COMMERCE 3-0-2010.

NO CLAIM IS MADE TO THE EXCLUSIVE RIGHT TO USE "PUBLISHING COMPANY", APART FROM THE MARK AS SHOWN.

THE MARK CONSISTS OF THE DESIGN OF ROLLING HILLS AND A CROSS WITH A STYLIZED REPRESENTATION OF THE SUN BELOW THE PHASE "HAVE YOUR WAY". THE WORDING "PUBLISHING COMPANY" APPEARS BELOW THE DESIGN.

SN 85-063,131, FILED 6-15-2010.

RICHARD WHITE, EXAMINING ATTORNEY



David J. Kybas

Director of the United States Patent and Trademark Office

United States of America

United States Patent and Trademark Office

VEO

Reg. No. 4,176,196

GENERAL ELECTRIC COMPANY (NEW YORK CORPORATION)
1 RIVER ROAD
SCHENECTADY, NY 12345

Registered July 17, 2012

Int. Cl.: 9

FOR: COMPUTER SOFTWARE FOR CREATING DIAGNOSTIC MEDICAL IMAGES FROM DIAGNOSTIC MEDICAL IMAGING APPARATUS SCAN DATA, IN CLASS 9 (U.S. CLS. 21, 23, 26, 36 AND 38).

TRADEMARK

FIRST USE 11-6-2011; IN COMMERCE 11-6-2011.

PRINCIPAL REGISTER

THE MARK CONSISTS OF STANDARD CHARACTERS WITHOUT CLAIM TO ANY PARTICULAR FONT, STYLE, SIZE, OR COLOR.

THE ENGLISH TRANSLATION OF "VEO" IN THE MARK IS "I SEE".

SN 85-066,153, FILED 6-18-2010.

JULIE VEPPUMTHARA, EXAMINING ATTORNEY



David J. Kybas

Director of the United States Patent and Trademark Office

United States of America

United States Patent and Trademark Office

BOSS PAWS

Reg. No. 4,176,197

GAMBILL, SHANNON (UNITED STATES INDIVIDUAL)
2536 RIDGEWOOD AVENUE
LOUISVILLE, KY 40217

Registered July 17, 2012

Int. Cl.: 14

FOR: TRINKETS, NAMELY, NECKLACES, BRACELETS AND ANKLE BRACELETS, FOR WEAR AROUND THE NECK, ANKLES AND WRISTS, IN CLASS 14 (U.S. CLS. 2, 27, 28 AND 50).

TRADEMARK

FIRST USE 3-31-2012; IN COMMERCE 3-31-2012.

PRINCIPAL REGISTER

THE MARK CONSISTS OF STANDARD CHARACTERS WITHOUT CLAIM TO ANY PARTICULAR FONT, STYLE, SIZE, OR COLOR.

SN 85-066,422, FILED 6-18-2010.

JILL PRATER, EXAMINING ATTORNEY



David J. Kyffers

Director of the United States Patent and Trademark Office

United States of America

United States Patent and Trademark Office

IF YOU SEE SOMETHING DO
SOMETHING

Reg. No. 4,176,198

JON J. BLOOMBERG (UNITED STATES INDIVIDUAL)
APT 5U EAST
11 RIVERSIDE DRIVE
NEW YORK, NY 10023

Registered July 17, 2012

Int. Cl.: 41

FOR: MEDICAL TRAINING AND TEACHING, IN CLASS 41 (U.S. CLS. 100, 101 AND 107).

SERVICE MARK

FIRST USE 1-1-2011; IN COMMERCE 1-1-2011.

PRINCIPAL REGISTER

THE MARK CONSISTS OF STANDARD CHARACTERS WITHOUT CLAIM TO ANY PARTICULAR FONT, STYLE, SIZE, OR COLOR.

SN 85-067,020, FILED 6-19-2010.

COLLEEN DOMBROW, EXAMINING ATTORNEY



David J. Kybas

Director of the United States Patent and Trademark Office

United States of America

United States Patent and Trademark Office

DAVID J. WITCHELL

Reg. No. 4,176,199

DAVID J. WITCHELL SALON & SPA, INC. (PENNSYLVANIA CORPORATION)
25 SOUTH STATE STREET
NEWTOWN, PA 18940

Registered July 17, 2012

Int. Cls.: 3, 4, 5, 35, and 44

FOR: BATH AND BODY PRODUCTS, NAMELY, HAIR SHAMPOO AND CONDITIONER, BODY LOTION, MASSAGE OILS, AND BODY WASH, IN CLASS 3 (U.S. CLS. 1, 4, 6, 50, 51 AND 52).

TRADEMARK

FIRST USE 0-0-1996; IN COMMERCE 0-0-1996.

SERVICE MARK

FOR: CANDLES, IN CLASS 4 (U.S. CLS. 1, 6 AND 15).

PRINCIPAL REGISTER

FIRST USE 0-0-1996; IN COMMERCE 0-0-1996.

FOR: HAND SANITIZING PREPARATIONS, IN CLASS 5 (U.S. CLS. 6, 18, 44, 46, 51 AND 52).

FIRST USE 0-0-1996; IN COMMERCE 0-0-1996.

FOR: RETAIL CLOTHING BOUTIQUE SERVICES, IN CLASS 35 (U.S. CLS. 100, 101 AND 102).

FIRST USE 0-0-1996; IN COMMERCE 0-0-1996.

FOR: HAIR AND NAIL CARE SALON SERVICES; BEAUTY SPA SERVICES, NAMELY, COSMETIC BODY CARE, IN CLASS 44 (U.S. CLS. 100 AND 101).

FIRST USE 0-0-1996; IN COMMERCE 0-0-1996.

THE MARK CONSISTS OF STANDARD CHARACTERS WITHOUT CLAIM TO ANY PARTICULAR FONT, STYLE, SIZE, OR COLOR.

THE NAME "DAVID J. WITCHELL" IDENTIFIES A LIVING INDIVIDUAL WHOSE CONSENT IS OF RECORD.

SN 85-068,146, FILED 6-21-2010.



David J. Kyros

Director of the United States Patent and Trademark Office

Reg. No. 4,176,199 MARTHA FROMM, EXAMINING ATTORNEY

United States of America

United States Patent and Trademark Office



ASTE-P

Reg. No. 4,176,200

Registered July 17, 2012

Int. Cl.: 9

TRADEMARK

PRINCIPAL REGISTER

ADVANCED DYNAMICS, INC. (KENTUCKY CORPORATION)
1500 BULL LEA ROAD, SUITE 203
LEXINGTON, KY 40511

FOR: COMPUTER GRAPHICS SOFTWARE; COMPUTER SOFTWARE THAT ALLOWS PEOPLE OR ORGANIZATIONS TO CREATE A VOTING EVENT, VOTE ON THE ISSUE, CHANGE THEIR VOTE AT WILL AND TRACK THE INPUT AND DISPLAY IT IN A UNIQUE GRAPHICAL WAY; COMPUTER SOFTWARE THAT ASSISTS COMPUTERS IN DEPLOYING PARALLEL APPLICATIONS AND PERFORMING PARALLEL COMPUTATIONS; FLIGHT SIMULATORS; FLIGHT SIMULATORS FOR AIRCRAFT, IN CLASS 9 (U.S. CLS. 21, 23, 26, 36 AND 38).

FIRST USE 12-29-2009; IN COMMERCE 4-1-2011.

THE MARK CONSISTS OF A DESIGN COMPONENT CREATED BY A SHADED SQUARE EDGED IN DARK BLUE AND SHADING TO LIGHT BLUE AT THE CENTER WHERE TWO WHITE ORBITAL PATHS INTERSECT, APPEARING TO MOVE IN DIFFERENT DIRECTIONS, WITH A SMALL BRIGHT RED DOT AT THE CENTER OF THE SQUARE. THE LITERAL PORTION OF THE MARK APPEARS TO THE RIGHT OF THE DESIGN AND CONSISTS OF THE WORD "ASTE-P" IN STYLIZED BLUE LETTERS AS TO "ASTE" AND STYLIZED HYPHEN AND RED LETTER WITH RESPECT TO "-P".

THE COLOR(S) BLUE, WHITE AND RED IS/ARE CLAIMED AS A FEATURE OF THE MARK.

SN 85-069,195, FILED 6-22-2010.

JILL C. ALT, EXAMINING ATTORNEY



David J. Kyjars

Director of the United States Patent and Trademark Office

United States of America

United States Patent and Trademark Office

BERGOLIN

Reg. No. 4,176,201

Registered July 17, 2012

Int. Cls.: 1, 2, and 17

TRADEMARK

PRINCIPAL REGISTER

BERGOLIN GMBH & CO. KG (FED REP GERMANY CORPORATION)
SACHSENRING 1
27711 OSTERHOLZ-SCHARMBECK, FED REP GERMANY 27721

FOR: ADHESIVES USED IN INDUSTRY; PLASTIC COMPOUNDS, BEING FINISHED GOODS FOR FILLING, POURING, INJECTING AND CALENDERING, FOR COATING WOOD, METAL, CONCRETE, PAPER AND CARDBOARD, IN PASTE AND LIQUID FORM, NAMELY, IN COMBINATION WITH FIBRES AND NONWOVENS FOR MANUFACTURING WALL AND FLOOR COVERINGS AND COVERINGS FOR SHIPS' DECKS, CONTAINER AND TANK COATINGS, INTERIOR AND EXTERIOR; UNPROCESSED PLASTICS/ARTIFICIAL RESINS IN LIQUID FORM, UNPROCESSED PLASTIC COMPOUNDS IN LIQUID AND PASTE FORM, NAMELY, PLASTIC CASTING COMPOUNDS AND PLASTIC INJECTION COMPOUNDS IN PASTE AND LIQUID FORM, FOR MANUFACTURING COATINGS, FOILS AND COVERINGS, NAMELY, FOR FLOORS, WALLS, SHIPS' DECKS AND CONTAINERS, IN CLASS 1 (U.S. CLS. 1, 5, 6, 10, 26 AND 46).

FIRST USE 11-29-1996; IN COMMERCE 9-2-2009.

FOR: PAINTS, LIQUID PLASTICS FOR LACQUERING, COATING, FINISHING AND PROTECTING SURFACES OF METAL, WOOD, DERIVED TIMBER PRODUCTS, PLASTIC, CONCRETE, PLASTER AND GLASS AGAINST CHEMICAL AND MECHANICAL INFLUENCES; PRIMERS, PAINT SEALER FOR WOOD, DERIVED TIMBER PRODUCTS, GLASS, METALS, PLASTICS, AND FOR PLASTERS AND CONCRETE, IN CLASS 2 (U.S. CLS. 6, 11 AND 16).

FIRST USE 10-6-2008; IN COMMERCE 7-5-2010.

FOR: SEMI-PROCESSED PLASTICS WITH A BASE OF HARDENABLE AND THERMOPLASTIC RAW MATERIALS BEING SEMI-PROCESSED GOODS IN LIQUID AND PASTE FORM, NAMELY, FOR INJECTION, CASTING AND BEING CASTING COMPOUNDS; PLASTIC COMPOUNDS, ARTIFICIAL RESIN COMPOUNDS, BEING SEMI-PROCESSED GOODS FOR FILLING, POURING, INJECTING AND CALENDERING, FOR COATING WOOD, METAL, CONCRETE, PAPER AND CARDBOARD, IN PASTE AND LIQUID FORM, NAMELY, IN COMBINATION WITH FIBRES AND NONWOVENS FOR MANUFACTURING WALL AND FLOOR COVERINGS AND COVERINGS FOR SHIPS' DECKS, CONTAINER AND TANK COATINGS, INTERIOR AND EXTERIOR; NON-PERMANENT ADHESIVE PUTTY, FILLING AND JOINTING PASTE FOR WOOD, DERIVED TIMBER PRODUCTS, GLASS, METALS,



David J. Kybas

Director of the United States Patent and Trademark Office

Reg. No. 4,176,201 PLASTICS, AND FOR PLASTERS AND CONCRETE, IN CLASS 17 (U.S. CLS. 1, 5, 12, 13, 35 AND 50).

FIRST USE 5-6-2003; IN COMMERCE 9-2-2009.

THE MARK CONSISTS OF STANDARD CHARACTERS WITHOUT CLAIM TO ANY PARTICULAR FONT, STYLE, SIZE, OR COLOR.

OWNER OF FED REP GERMANY REG. NO. 1160266, DATED 6-21-1990, EXPIRES 5-31-2018.

SN 85-070,908, FILED 6-24-2010.

ROSELLE HERRERA, EXAMINING ATTORNEY

United States of America

United States Patent and Trademark Office

FINAPP

Reg. No. 4,176,202

Registered July 17, 2012

Int. Cls.: 9, 35, and 42

TRADEMARK

SERVICE MARK

PRINCIPAL REGISTER

YODLEE, INC. (DELAWARE CORPORATION)
3600 BRIDGE PARKWAY, SUITE 200
REDWOOD CITY, CA 94065

FOR: COMPUTER SOFTWARE FOR FINANCIAL APPLICATIONS, FINANCIAL MANAGEMENT, ONLINE PAYMENTS AND FINANCIAL SERVICES ACCESS, ONLINE FINANCIAL TRANSACTIONS, TAX PREPARATION AND FILING, SAVINGS AND BUDGETING GUIDANCE, AND FOR IMPLEMENTING AND TRACKING REWARDS AND LOYALTY PROGRAMS; COMPUTER PROGRAM DEVELOPMENT TOOLS FOR THE CREATION, DEVELOPMENT, DISTRIBUTION AND CONTROL OF COMPUTER SOFTWARE FOR FINANCIAL APPLICATIONS, FINANCIAL MANAGEMENT SOFTWARE, ONLINE PAYMENTS AND FINANCIAL SERVICES ACCESS, TAX PREPARATION AND FILING, SAVINGS AND BUDGETING GUIDANCE AND IMPLEMENTING AND TRACKING REWARDS AND LOYALTY PROGRAMS; COMPUTER SOFTWARE FOR THE CREATION AND OPERATION OF AN ONLINE RETAIL STORE SITE FOR THE PURCHASE AND DOWNLOAD OF COMPUTER SOFTWARE APPLICATIONS, IN CLASS 9 (U.S. CLS. 21, 23, 26, 36 AND 38).

FIRST USE 2-23-2010; IN COMMERCE 2-23-2010.

FOR: ONLINE RETAIL STORE SERVICES FEATURING DOWNLOADABLE COMPUTER SOFTWARE APPLICATIONS; ONLINE RETAIL STORE SERVICES FEATURING CUSTOMIZABLE COMPUTER SOFTWARE APPLICATIONS INTO AN INTEGRATED SUITE OF SOFTWARE PRODUCTS AND THE ONLINE USE THEREOF; ONLINE RETAIL STORE SERVICES FEATURING COMPUTER SOFTWARE FOR FINANCIAL APPLICATIONS, FINANCIAL MANAGEMENT, ONLINE PAYMENTS AND FINANCIAL SERVICES ACCESS, ONLINE FINANCIAL TRANSACTIONS, TAX PREPARATION AND FILING, SAVINGS AND BUDGETING GUIDANCE, AND FOR IMPLEMENTING AND TRACKING REWARDS AND LOYALTY PROGRAMS, IN CLASS 35 (U.S. CLS. 100, 101 AND 102).

FIRST USE 7-4-2010; IN COMMERCE 7-4-2010.

FOR: COMPUTER SERVICES, NAMELY, CREATING AN ONLINE VIRTUAL ENVIRONMENT FOR THE CREATION, DEVELOPMENT, DISTRIBUTION AND CONTROL OF COMPUTER SOFTWARE FOR FINANCIAL APPLICATIONS, FINANCIAL MANAGEMENT SOFTWARE, ONLINE PAYMENTS AND FINANCIAL SERVICES ACCESS, TAX PREPARATION AND FILING, SAVINGS AND BUDGETING GUIDANCE AND IMPLEMENTING AND TRACKING REWARDS AND LOYALTY PROGRAMS; DEVELOPING AND HOSTING A SERVER ON



David J. Kyffers

Director of the United States Patent and Trademark Office

Reg. No. 4,176,202 A COMPUTER NETWORK FOR THE PURPOSE OF FACILITATING E-COMMERCE VIA SUCH A SERVER FEATURING COMPUTER SOFTWARE APPLICATIONS, IN CLASS 42 (U.S. CLS. 100 AND 101).

FIRST USE 2-23-2010; IN COMMERCE 2-23-2010.

THE MARK CONSISTS OF STANDARD CHARACTERS WITHOUT CLAIM TO ANY PARTICULAR FONT, STYLE, SIZE, OR COLOR.

SN 85-071,164, FILED 6-24-2010.

AISHA SALEM, EXAMINING ATTORNEY

United States of America

United States Patent and Trademark Office



Reg. No. 4,176,203

Registered July 17, 2012

Int. Cl.: 32

TRADEMARK

PRINCIPAL REGISTER

XL ENERGY DRINK CORP. (NEW YORK CORPORATION)
32ND FLOOR
521 5TH AVENUE
NEW YORK, NY 10175

FOR: NON-ALCOHOLIC BEVERAGES, NAMELY, ENERGY DRINKS, IN CLASS 32 (U.S. CLS. 45, 46 AND 48).

FIRST USE 5-30-2012; IN COMMERCE 5-30-2012.

OWNER OF U.S. REG. NOS. 3,339,184, 3,796,008, AND OTHERS.

THE COLOR(S) RED, GREY AND BLACK IS/ARE CLAIMED AS A FEATURE OF THE MARK.

NO CLAIM IS MADE TO THE EXCLUSIVE RIGHT TO USE "USA" AND "CRANBERRY ENERGY", APART FROM THE MARK AS SHOWN.

THE MARK CONSISTS OF THE LETTERS "USA" IN STYLIZED FONT IN GRAY AND TO THE LEFT OF THE LETTERS "XL" WHICH APPEAR IN STYLIZED FONT IN RED BORDERED IN BLACK AND GRAY WITH THE WORDING "CRANBERRY ENERGY" IN STYLIZED FONT IN GRAY AND BELOW THE LETTERS "XL". THE ENTIRE MARK HAS A RED BACKGROUND THAT HAS A BLACK BUBBLE TYPE DESIGN AT THE TOP AND AT THE BOTTOM WITH A FADING TO A SOLID BLACK BACKGROUND ON THE BOTTOM.

SN 85-071,233, FILED 6-24-2010.

JULIE WATSON, EXAMINING ATTORNEY



David J. Kyffers

Director of the United States Patent and Trademark Office

United States of America

United States Patent and Trademark Office



Reg. No. 4,176,204

Registered July 17, 2012

Int. Cl.: 32

TRADEMARK

PRINCIPAL REGISTER

XL ENERGY DRINK CORP. (NEW YORK CORPORATION)
32ND FLOOR
521 5TH AVENUE
NEW YORK, NY 10175

FOR: NON-ALCOHOLIC BEVERAGES, NAMELY, ENERGY DRINKS, IN CLASS 32 (U.S. CLS. 45, 46 AND 48).

FIRST USE 5-23-2012; IN COMMERCE 5-23-2012.

OWNER OF U.S. REG. NOS. 3,339,184, 3,796,008, AND OTHERS.

THE COLOR(S) RED, GREY AND GREEN IS/ARE CLAIMED AS A FEATURE OF THE MARK.

NO CLAIM IS MADE TO THE EXCLUSIVE RIGHT TO USE "USA" AND "LIME&LEMON ENERGY", APART FROM THE MARK AS SHOWN.

THE MARK CONSISTS OF THE LETTERS "USA" IN STYLIZED FONT IN DARK GREEN WITH A GRAY BORDER AND TO THE LEFT OF THE LETTERS "XL" WHICH APPEAR IN STYLIZED FONT IN RED BORDERED IN DARK GREEN AND GRAY WITH THE WORDING "LIME&LEMON ENERGY" IN STYLIZED FONT IN DARK GREEN WITH A GRAY BORDER AND BELOW THE LETTERS "XL". THE ENTIRE MARK HAS A LIGHT GREEN BACKGROUND THAT HAS A DARK GREEN BUBBLE TYPE DESIGN AT THE TOP AND AT THE BOTTOM WITH A FADING TO A SOLID DARK GREEN BACKGROUND ON THE BOTTOM.

SN 85-071,236, FILED 6-24-2010.

JULIE WATSON, EXAMINING ATTORNEY



David J. Kybas

Director of the United States Patent and Trademark Office

United States of America

United States Patent and Trademark Office



LARSON
Financial Group, LLC
The Physician's Specialist

Reg. No. 4,176,205

Registered July 17, 2012

Int. Cl.: 36

SERVICE MARK

PRINCIPAL REGISTER

LARSON FINANCIAL GROUP, LLC (MISSOURI LIMITED LIABILITY COMPANY)
ATTN: SARAH JACOBS
ONE CITY PLACE DRIVE STE 100
SAINT LOUIS, MO 63141

FOR: FINANCIAL PLANNING AND INVESTMENT ADVISORY SERVICES, IN CLASS 36
(U.S. CLS. 100, 101 AND 102).

FIRST USE 6-1-2004; IN COMMERCE 6-1-2004.

NO CLAIM IS MADE TO THE EXCLUSIVE RIGHT TO USE "FINANCIAL GROUP, LLC"
AND "THE PHYSICIAN'S SPECIALIST", APART FROM THE MARK AS SHOWN.

THE COLOR(S) GOLD AND GREEN IS/ARE CLAIMED AS A FEATURE OF THE MARK.

THE MARK CONSISTS OF A GOLD SWAN WITH FLAMING STAFF TO THE LEFT OF THE
GREEN WORDING "LARSON FINANCIAL GROUP, LLC", IN BETWEEN TWO GOLD HO-
RIZONTAL BARS WITH THE WORDING "THE PHYSICIAN'S SPECIALIST" IN GREEN
UNDERNEATH.

SN 85-072,801, FILED 6-28-2010.

LINDSEY RUBIN, EXAMINING ATTORNEY



David J. Kyjars

Director of the United States Patent and Trademark Office

United States of America
United States Patent and Trademark Office

AMBUSH

Reg. No. 4,176,206

NON TYPICAL, INC. (WISCONSIN CORPORATION)
2256 AMERICAN BLVD.
DE PERE, WI 54115

Registered July 17, 2012

Int. Cl.: 9

FOR: GAME SURVEILLANCE CAMERAS FOR HUNTERS, IN CLASS 9 (U.S. CLS. 21, 23, 26, 36 AND 38).

TRADEMARK

FIRST USE 1-27-2012; IN COMMERCE 1-27-2012.

PRINCIPAL REGISTER

THE MARK CONSISTS OF STANDARD CHARACTERS WITHOUT CLAIM TO ANY PARTICULAR FONT, STYLE, SIZE, OR COLOR.

SN 85-073,603, FILED 6-29-2010.

BARBARA RUTLAND, EXAMINING ATTORNEY



David J. Kybas

Director of the United States Patent and Trademark Office

United States of America

United States Patent and Trademark Office

VITUS

Reg. No. 4,176,207

Registered July 17, 2012

Int. Cl.: 37

SERVICE MARK

PRINCIPAL REGISTER

VITUS GROUP, INC. (DELAWARE CORPORATION)
1700 SEVENTH AVENUE, SUITE 2075
SEATTLE, WA 98101

FOR: REAL ESTATE DEVELOPMENT SERVICES; CONSULTING SERVICES IN THE FIELD OF REAL ESTATE DEVELOPMENT; CONSULTING SERVICES IN THE FIELD OF AFFORDABLE HOUSING DEVELOPMENT, NAMELY, IN THE AREA OF DEVELOPMENT OF AFFORDABLE RESIDENTIAL HOUSING PROPERTIES, IN CLASS 37 (U.S. CLS. 100, 103 AND 106).

FIRST USE 6-0-2010; IN COMMERCE 6-0-2010.

THE MARK CONSISTS OF STANDARD CHARACTERS WITHOUT CLAIM TO ANY PARTICULAR FONT, STYLE, SIZE, OR COLOR.

SN 85-076,858, FILED 7-2-2010.

EUGENIA MARTIN, EXAMINING ATTORNEY



David J. Kyffers

Director of the United States Patent and Trademark Office

United States of America

United States Patent and Trademark Office

VITUS INNOVATIVE DEVELOPMENT

Reg. No. 4,176,208

Registered July 17, 2012

Int. Cl.: 37

SERVICE MARK

PRINCIPAL REGISTER

VITUS GROUP, INC. (DELAWARE CORPORATION)
1700 SEVENTH AVENUE, SUITE 2075
SEATTLE, WA 98101

FOR: REAL ESTATE DEVELOPMENT SERVICES; CONSULTING SERVICES IN THE FIELD OF REAL ESTATE DEVELOPMENT; CONSULTING SERVICES IN THE FIELD OF AFFORDABLE HOUSING DEVELOPMENT, NAMELY, IN THE AREA OF DEVELOPMENT OF AFFORDABLE RESIDENTIAL HOUSING PROPERTIES, IN CLASS 37 (U.S. CLS. 100, 103 AND 106).

FIRST USE 6-0-2010; IN COMMERCE 6-0-2010.

THE MARK CONSISTS OF STANDARD CHARACTERS WITHOUT CLAIM TO ANY PARTICULAR FONT, STYLE, SIZE, OR COLOR.

NO CLAIM IS MADE TO THE EXCLUSIVE RIGHT TO USE "DEVELOPMENT", APART FROM THE MARK AS SHOWN.

SN 85-076,879, FILED 7-2-2010.

EUGENIA MARTIN, EXAMINING ATTORNEY



David J. Kypos

Director of the United States Patent and Trademark Office

United States of America

United States Patent and Trademark Office

PARENTING IS FUN WORK.

Reg. No. 4,176,209

CALLAHAN III, JOSEPH J. (UNITED STATES INDIVIDUAL)
58 WEYHAM RD.

Registered July 17, 2012

N. WEYMOUTH, MA 02191

Int. Cl.: 25

FOR: TEE SHIRTS; WRISTBANDS, IN CLASS 25 (U.S. CLS. 22 AND 39).

TRADEMARK

FIRST USE 1-15-2011; IN COMMERCE 6-15-2011.

PRINCIPAL REGISTER

THE MARK CONSISTS OF STANDARD CHARACTERS WITHOUT CLAIM TO ANY PARTICULAR FONT, STYLE, SIZE, OR COLOR.

SN 85-078,366, FILED 7-6-2010.

EDWARD NELSON, EXAMINING ATTORNEY



David J. Kyffers

Director of the United States Patent and Trademark Office

United States of America

United States Patent and Trademark Office

PLANET PEEK-A-BOO

Reg. No. 4,176,210

BARKER, GINA R. (UNITED STATES INDIVIDUAL)
5311 LEXINGTON DRIVE
PARRISH, FL 34219

Registered July 17, 2012

Int. Cl.: 9

FOR: DIGITAL MEDIA, NAMELY, DVDS, CDS, AND COMPUTER AND VIDEO GAME PROGRAMS FEATURING ANIMATED CARTOON CHARACTERS, IN CLASS 9 (U.S. CLS. 21, 23, 26, 36 AND 38).

TRADEMARK

FIRST USE 12-9-2011; IN COMMERCE 12-9-2011.

PRINCIPAL REGISTER

THE MARK CONSISTS OF STANDARD CHARACTERS WITHOUT CLAIM TO ANY PARTICULAR FONT, STYLE, SIZE, OR COLOR.

SN 85-080,306, FILED 7-8-2010.

TIMOTHY FINNEGAN, EXAMINING ATTORNEY



David J. Kyffers

Director of the United States Patent and Trademark Office

United States of America

United States Patent and Trademark Office

PLANET PEEK-A-BOO

Reg. No. 4,176,211

BARKER, GINA R. (UNITED STATES INDIVIDUAL)
5311 LEXINGTON DRIVE
PARRISH, FL 34219

Registered July 17, 2012

Int. Cl.: 41

FOR: ENTERTAINMENT IN THE NATURE OF PROVIDING LIVE THEATRICAL PERFORMANCES, DISPLAYING A SERIES OF FILMS, AND AN ONGOING TELEVISION PROGRAM IN THE FIELD OF CHILDREN'S ENTERTAINMENT FEATURING COLORFUL ANIMATED CHARACTERS AND CARTOONS; EDUCATIONAL AND ENTERTAINMENT SERVICES, NAMELY, PROVIDING ON-LINE INTERACTIVE CHILDREN'S STORIES FEATURING COLORFUL ANIMATED CHARACTERS AND CARTOONS, IN CLASS 41 (U.S. CLS. 100, 101 AND 107).

SERVICE MARK

PRINCIPAL REGISTER

FIRST USE 11-21-2010; IN COMMERCE 11-21-2010.

THE MARK CONSISTS OF STANDARD CHARACTERS WITHOUT CLAIM TO ANY PARTICULAR FONT, STYLE, SIZE, OR COLOR.

SN 85-080,357, FILED 7-8-2010.

TIMOTHY FINNEGAN, EXAMINING ATTORNEY



David J. Kybas

Director of the United States Patent and Trademark Office

United States of America

United States Patent and Trademark Office



Reg. No. 4,176,212

MYSTIC LLC. (GEORGIA LIMITED LIABILITY COMPANY)
4080 MCGINNIS FERRY RD, SUITE 1202
ALPHARETTA, GA 30005

Registered July 17, 2012

Int. Cl.: 35

FOR: WHOLESALE STORE SERVICES FEATURING WOMEN'S APPAREL, IN CLASS 35
(U.S. CLS. 100, 101 AND 102).

SERVICE MARK

FIRST USE 7-12-2010; IN COMMERCE 2-10-2011.

PRINCIPAL REGISTER

THE MARK CONSISTS OF THE WORDING "PAPER LACE" INSIDE A LACE BOX.

SN 85-082,043, FILED 7-11-2010.

JAMES STEIN, EXAMINING ATTORNEY



David J. Kybas

Director of the United States Patent and Trademark Office

United States of America

United States Patent and Trademark Office

CUSHION WRAP

Reg. No. 4,176,213

Registered July 17, 2012

Int. Cl.: 10

ICON MEDICAL (DELAWARE CORPORATION), AKA ICON INTERVENTIONAL SYSTEMS, INC.,
SUITE 500
387 TECHNOLOGY CIRCLE, NW
ATLANTA, GA 30313

TRADEMARK

PRINCIPAL REGISTER

FOR: BIOCOMPATIBLE COATED STENTS; COATINGS SOLD AS AN INTEGRAL COMPONENT OF MEDICAL STENTS AND OTHER IMPLANTABLE MEDICAL DEVICES; MEDICAL INSTRUMENTS FOR INTRALUMINAL EMPLACEMENT OF STENTS OR OF SYNTHETIC STENT GRAFTS, NAMELY, STENT OR SYNTHETIC STENT GRAFT DELIVERY SYSTEMS; MEDICAL STENTS; STENT DELIVERY SYSTEMS; STENTS; SYNTHETIC STENT GRAFTS, IN CLASS 10 (U.S. CLS. 26, 39 AND 44).

FIRST USE 5-11-2012; IN COMMERCE 5-11-2012.

THE MARK CONSISTS OF STANDARD CHARACTERS WITHOUT CLAIM TO ANY PARTICULAR FONT, STYLE, SIZE, OR COLOR.

NO CLAIM IS MADE TO THE EXCLUSIVE RIGHT TO USE "WRAP", APART FROM THE MARK AS SHOWN.

SN 85-082,203, FILED 7-12-2010.

DAVID I, EXAMINING ATTORNEY



David J. Kyffers

Director of the United States Patent and Trademark Office

United States of America

United States Patent and Trademark Office

THE GENERATOR CONNECTION

Reg. No. 4,176,214

Registered July 17, 2012

Int. Cls.: 35, 37, and 40

SERVICE MARK

PRINCIPAL REGISTER

THE GENERATOR CONNECTION, INC. (NEW HAMPSHIRE CORPORATION)
P.O. BOX 471
80 ROUTE 125
BARRINGTON, NH 03825

FOR: RETAIL STORE SERVICES FEATURING PORTABLE AND STANDBY GENERATORS AND REPLACEMENT PARTS THEREOF AND ACCESSORIES THEREFOR; ONLINE RETAIL STORE SERVICES FEATURING PORTABLE AND STANDBY GENERATORS AND REPLACEMENT PARTS THEREOF AND ACCESSORIES THEREFOR; MAIL ORDER CATALOG SERVICES FEATURING PORTABLE AND STANDBY GENERATORS AND REPLACEMENT PARTS THEREOF AND ACCESSORIES THEREFOR, IN CLASS 35 (U.S. CLS. 100, 101 AND 102).

FIRST USE 10-27-2001; IN COMMERCE 11-12-2001.

FOR: INSTALLATION, MAINTENANCE, AND REPAIR OF PORTABLE AND STANDBY GENERATORS AND REPLACEMENT PARTS THEREOF AND ACCESSORIES THEREFOR, IN CLASS 37 (U.S. CLS. 100, 103 AND 106).

FIRST USE 10-27-2001; IN COMMERCE 11-12-2001.

FOR: RENTAL OF PORTABLE GENERATORS, IN CLASS 40 (U.S. CLS. 100, 103 AND 106).

FIRST USE 2-26-2010; IN COMMERCE 5-24-2010.

THE MARK CONSISTS OF STANDARD CHARACTERS WITHOUT CLAIM TO ANY PARTICULAR FONT, STYLE, SIZE, OR COLOR.

NO CLAIM IS MADE TO THE EXCLUSIVE RIGHT TO USE "GENERATOR", APART FROM THE MARK AS SHOWN.

SN 85-083,261, FILED 7-13-2010.

SHANNON TWOHIG, EXAMINING ATTORNEY



David J. Kyffers

Director of the United States Patent and Trademark Office

United States of America

United States Patent and Trademark Office

Xtreme Duty Pro XDP

Reg. No. 4,176,215

YAMADA AMERICA, INC (ILLINOIS CORPORATION)
955 EAST ALGONQUIN ROAD
ARLINGTON HEIGHTS, IL 61008

Registered July 17, 2012

Int. Cl.: 7

FOR: COMPRESSED AIR PUMPS, NAMELY, DOUBLE DIAPHRAGM AIR OPERATED PUMPS, IN CLASS 7 (U.S. CLS. 13, 19, 21, 23, 31, 34 AND 35).

TRADEMARK

FIRST USE 9-16-2010; IN COMMERCE 9-16-2010.

PRINCIPAL REGISTER

THE MARK CONSISTS OF STANDARD CHARACTERS WITHOUT CLAIM TO ANY PARTICULAR FONT, STYLE, SIZE, OR COLOR.

SN 85-083,727, FILED 7-13-2010.

DAVID C. REIHNER, EXAMINING ATTORNEY



David J. Kyfos

Director of the United States Patent and Trademark Office

United States of America

United States Patent and Trademark Office



Reg. No. 4,176,216

AMERICAN COUNCIL ON EXERCISE (CALIFORNIA CORPORATION)
4851 PARAMOUNT DRIVE
SAN DIEGO, CA 92123

Registered July 17, 2012

Int. Cls.: 9, 16, and 41

FOR: PRE-RECORDED DVDS FEATURING INFORMATION ON HEALTH AND FITNESS; DOWNLOADABLE MULTIMEDIA FILES, TEXT FILES, AND WRITTEN DOCUMENTS, FEATURING INFORMATION IN THE FIELDS OF EXERCISE AND FITNESS, IN CLASS 9 (U.S. CLS. 21, 23, 26, 36 AND 38).

TRADEMARK

SERVICE MARK

FIRST USE 9-1-2011; IN COMMERCE 10-10-2011.

PRINCIPAL REGISTER

FOR: PRINTED INFORMATIONAL MATERIALS, NAMELY, WRITTEN DOCUMENTS AND FLYERS IN THE FIELDS OF EXERCISE AND FITNESS, IN CLASS 16 (U.S. CLS. 2, 5, 22, 23, 29, 37, 38 AND 50).

FIRST USE 5-20-2010; IN COMMERCE 6-30-2010.

FOR: PROVIDING A WEBSITE FEATURING FITNESS INFORMATION; PROVIDING AN-ON LINE JOURNAL, NAMELY, BLOGS FEATURING INFORMATION ON HEALTH AND FITNESS, IN CLASS 41 (U.S. CLS. 100, 101 AND 107).

FIRST USE 4-27-2010; IN COMMERCE 4-30-2010.

OWNER OF U.S. REG. NOS. 2,674,347, 3,688,831, AND OTHERS.

THE COLOR(S) RED, BLACK, BROWN AND GRAY IS/ARE CLAIMED AS A FEATURE OF THE MARK.

SEC. 2(F) AS TO "AMERICAN COUNCIL ON EXERCISE".

THE MARK CONSISTS OF THE WORDS "WORKOUT WATCHDOG" IN RED WITH THE "O" IN "WORKOUT" BEING REPLACED WITH A BROWN MAGNIFYING GLASS WITH GRAY GLASS AND THE WORD "WATCHDOG" UNDERNEATH "WORKOUT" AND OFFSET TO THE RIGHT. THE WORDS "AMERICAN COUNCIL ON EXERCISE" IN BLACK APPEAR UNDER "WATCHDOG".



David J. Kyjars

Director of the United States Patent and Trademark Office

SN 85-086,755, FILED 7-16-2010.

Reg. No. 4,176,216 MICHAEL WEBSTER, EXAMINING ATTORNEY

United States of America

United States Patent and Trademark Office

COMFORTBLEND

Reg. No. 4,176,217

Registered July 17, 2012

Int. Cl.: 25

TRADEMARK

PRINCIPAL REGISTER

HBI BRANDED APPAREL LIMITED, INC. (DELAWARE CORPORATION)
1000 EAST HANES MILL ROAD
WINSTON-SALEM, NC 27105

FOR: SHIRTS; T-SHIRTS, IN CLASS 25 (U.S. CLS. 22 AND 39).

FIRST USE 12-31-2010; IN COMMERCE 12-31-2010.

THE MARK CONSISTS OF STANDARD CHARACTERS WITHOUT CLAIM TO ANY PARTICULAR FONT, STYLE, SIZE, OR COLOR.

OWNER OF U.S. REG. NO. 2,109,989.

SN 85-089,232, FILED 7-21-2010.

KATHY DE JONGE, EXAMINING ATTORNEY



David J. Kyffers

Director of the United States Patent and Trademark Office

United States of America

United States Patent and Trademark Office

Harm's Way Energy Drink

Reg. No. 4,176,218

JOHN FILMER WEAVER (UNITED STATES INDIVIDUAL)
40 LOUISE SREET
SAN RAFAEL, CA 94901

Registered July 17, 2012

Int. Cl.: 32

FOR: ENERGY DRINK, IN CLASS 32 (U.S. CLS. 45, 46 AND 48).

TRADEMARK

FIRST USE 7-23-2010; IN COMMERCE 5-15-2012.

PRINCIPAL REGISTER

THE MARK CONSISTS OF STANDARD CHARACTERS WITHOUT CLAIM TO ANY PARTICULAR FONT, STYLE, SIZE, OR COLOR.

NO CLAIM IS MADE TO THE EXCLUSIVE RIGHT TO USE "ENERGY DRINK", APART FROM THE MARK AS SHOWN.

SN 85-091,605, FILED 7-23-2010.

ANNE E. GUSTASON, EXAMINING ATTORNEY



David J. Kyffers

Director of the United States Patent and Trademark Office

United States of America

United States Patent and Trademark Office

PARCEL SELECT LIGHTWEIGHT

Reg. No. 4,176,219

Registered July 17, 2012

Int. Cls.: 16, 35, and 39

UNITED STATES POSTAL SERVICE (UNITED STATES INDEPENDENT ESTABLISHMENT OF THE EXECUTIVE BRANCH OF THE GOVERNMENT OF THE UNITED STATES OF AMERICA)

475 L'ENFANT PLAZA, SW
WASHINGTON, DC 202601136

TRADEMARK

FOR: ENVELOPES AND BOXES OF PAPER OR CARDBOARD FOR SHIPPING AND PACKAGING; PRE-PRINTED SHIPPING LABELS, IN CLASS 16 (U.S. CLS. 2, 5, 22, 23, 29, 37, 38 AND 50).

SERVICE MARK

FIRST USE 1-22-2012; IN COMMERCE 1-22-2012.

PRINCIPAL REGISTER

FOR: SORTING, HANDLING, AND RECEIVING PACKAGES AND LETTERS, IN CLASS 35 (U.S. CLS. 100, 101 AND 102).

FIRST USE 1-22-2012; IN COMMERCE 1-22-2012.

FOR: PICKUP, TRANSPORTATION AND DELIVERY OF PACKAGES AND DOCUMENTS BY VARIOUS MODES OF TRANSPORTATION, IN CLASS 39 (U.S. CLS. 100 AND 105).

FIRST USE 1-22-2012; IN COMMERCE 1-22-2012.

THE MARK CONSISTS OF STANDARD CHARACTERS WITHOUT CLAIM TO ANY PARTICULAR FONT, STYLE, SIZE, OR COLOR.

OWNER OF U.S. REG. NO. 2,540,117.

NO CLAIM IS MADE TO THE EXCLUSIVE RIGHT TO USE "PARCEL" OR "LIGHTWEIGHT", APART FROM THE MARK AS SHOWN.

SN 85-091,695, FILED 7-23-2010.

JEFFERY COWARD, EXAMINING ATTORNEY



David J. Kyffers

Director of the United States Patent and Trademark Office

United States of America

United States Patent and Trademark Office

DATORAY

Reg. No. 4,176,220

Registered July 17, 2012

Int. Cl.: 9

TRADEMARK

PRINCIPAL REGISTER

ZURADO CORPORATION (CALIFORNIA CORPORATION), DBA ZURADO SYSTEMS,
4950 MIDDLETON PLACE
PLEASANTON, CA 94566

FOR: ELECTRONIC SYSTEM FOR DELIVERING INFORMATION ABOUT NEARBY OBJECTS
IN THE NATURE OF PEOPLE, PLACES, AND THINGS, COMPRISING DOWNLOADABLE
COMPUTER APPLICATION SOFTWARE FOR MOBILE DEVICES, COMPUTER SOFTWARE
FOR DATABASE MANAGEMENT, AND ELECTRONIC TAGS FOR IDENTIFYING OBJECTS,
IN CLASS 9 (U.S. CLS. 21, 23, 26, 36 AND 38).

FIRST USE 7-27-2011; IN COMMERCE 7-27-2011.

THE MARK CONSISTS OF STANDARD CHARACTERS WITHOUT CLAIM TO ANY PAR-
TICULAR FONT, STYLE, SIZE, OR COLOR.

THE WORDING "DATORAY" HAS NO MEANING IN A FOREIGN LANGUAGE.

SN 85-093,406, FILED 7-27-2010.

RONALD DELGIZZI, EXAMINING ATTORNEY



David J. Kyffers

Director of the United States Patent and Trademark Office

United States of America

United States Patent and Trademark Office

GRINDER GEAR

Reg. No. 4,176,221

BUSTOUT POKER, LLC (SOUTH CAROLINA LIMITED LIABILITY COMPANY)
7001 ST. ANDREWS ROAD, SUITE 373
COLUMBIA, SC 29212

Registered July 17, 2012

Int. Cl.: 25

FOR: HATS; HOODED SWEAT SHIRTS; JACKETS; SHIRTS; SHORT-SLEEVED OR LONG-SLEEVED T-SHIRTS; SWEAT SHIRTS, IN CLASS 25 (U.S. CLS. 22 AND 39).

TRADEMARK

FIRST USE 4-15-2012; IN COMMERCE 4-15-2012.

PRINCIPAL REGISTER

THE MARK CONSISTS OF STANDARD CHARACTERS WITHOUT CLAIM TO ANY PARTICULAR FONT, STYLE, SIZE, OR COLOR.

NO CLAIM IS MADE TO THE EXCLUSIVE RIGHT TO USE "GEAR", APART FROM THE MARK AS SHOWN.

SN 85-098,892, FILED 8-3-2010.

AMEEN IMAM, EXAMINING ATTORNEY



David J. Kyffers

Director of the United States Patent and Trademark Office

United States of America

United States Patent and Trademark Office

VIZME

Reg. No. 4,176,222

Registered July 17, 2012

Int. Cl.: 42

SERVICE MARK

PRINCIPAL REGISTER

KAIBRIDGE, INC. (OREGON CORPORATION), DBA VIZME, INC.,
2680 VAN NESS STREET
EUGENE, OR 97403

FOR: PROVIDING TEMPORARY USE OF A WEB-BASED SOFTWARE APPLICATION THAT
ALLOWS USERS TO UPLOAD, POST, AND DISPLAY CUSTOMIZED TOKENS IN THE
NATURE OF DIGITAL CONTENT WHICH ENABLES USERS TO CREATE, SHARE, AND
MODIFY INFORMATION, IMAGES, VIDEOS, AUDIO, AND TEXT OVER THE INTERNET,
IN CLASS 42 (U.S. CLS. 100 AND 101).

FIRST USE 6-5-2010; IN COMMERCE 6-5-2010.

THE MARK CONSISTS OF STANDARD CHARACTERS WITHOUT CLAIM TO ANY PAR-
TICULAR FONT, STYLE, SIZE, OR COLOR.

SN 85-099,422, FILED 8-3-2010.

BARBARA RUTLAND, EXAMINING ATTORNEY



David J. Kyffers

Director of the United States Patent and Trademark Office

United States of America

United States Patent and Trademark Office

RIP N LIP OUTFITTERS

Reg. No. 4,176,223

Registered July 17, 2012

Int. Cl.: 25

TRADEMARK

PRINCIPAL REGISTER

WILLIAM C. PIGOTT III (UNITED STATES INDIVIDUAL)
35 OAK STREET
NORTH FORT MYERS, FL 33903

FOR: AQUA SHOES; BELTS; BOARD SHORTS; BOAT SHOES; CAMOUFLAGE SHIRTS; CLOTHING, NAMELY, KHAKIS; CLOTHING, NAMELY, WRAP-AROUNDS; COLLARED SHIRTS; DECK-SHOES; DRESS SHIRTS; EYESHADES; FISHING SHIRTS; GLOVES AS CLOTHING; HATS; HEADBANDS FOR CLOTHING; HOODED SWEAT SHIRTS; HOODS; HUNTING SHIRTS; JACKETS; JERSEYS; LEATHER BELTS; LONG-SLEEVED SHIRTS; SHIRTS; SHIRTS AND SHORT-SLEEVED SHIRTS; SHOES; SHORT SETS; SHORT-SLEEVED SHIRTS; SHORTS; SPORT SHIRTS; SPORTS SHIRTS WITH SHORT SLEEVES; T-SHIRTS; TEE SHIRTS; TOPS; WALKING SHORTS; WEARABLE GARMENTS AND CLOTHING, NAMELY, SHIRTS; WIND SHIRTS, IN CLASS 25 (U.S. CLS. 22 AND 39).

FIRST USE 8-3-2010; IN COMMERCE 8-11-2010.

THE MARK CONSISTS OF STANDARD CHARACTERS WITHOUT CLAIM TO ANY PARTICULAR FONT, STYLE, SIZE, OR COLOR.

NO CLAIM IS MADE TO THE EXCLUSIVE RIGHT TO USE "OUTFITTERS", APART FROM THE MARK AS SHOWN.

SN 85-099,508, FILED 8-3-2010.

BRIAN PINO, EXAMINING ATTORNEY



David J. Kybas

Director of the United States Patent and Trademark Office

United States of America

United States Patent and Trademark Office

UScreen

Reg. No. 4,176,224

U.S. DIAGNOSTICS, INC. (ALABAMA CORPORATION)
2007 BOB WALLACE AVENUE
HUNTSVILLE, AL 35805

Registered July 17, 2012

Int. Cl.: 10

FOR: MULTI-DRUG TESTING CUPS FOR DRUG USE TESTING PURPOSES, IN CLASS 10
(U.S. CLS. 26, 39 AND 44).

TRADEMARK

FIRST USE 1-31-2011; IN COMMERCE 1-31-2011.

PRINCIPAL REGISTER

THE MARK CONSISTS OF STANDARD CHARACTERS WITHOUT CLAIM TO ANY PARTICULAR FONT, STYLE, SIZE, OR COLOR.

SN 85-099,735, FILED 8-4-2010.

PRISCILLA MILTON, EXAMINING ATTORNEY



David J. Kybas

Director of the United States Patent and Trademark Office

United States of America

United States Patent and Trademark Office

Born Hippie

Reg. No. 4,176,225

TWO OLD HIPPIES, LLC (IOWA LIMITED LIABILITY COMPANY)
P.O. BOX 557

Registered July 17, 2012

SPIRIT LAKE, IA 51360

Int. Cl.: 15

FOR: MUSICAL INSTRUMENTS AND ACCESSORIES, NAMELY, GUITARS, STORAGE BAGS, CARRYING BAGS, AND GIG BAGS, IN CLASS 15 (U.S. CLS. 2, 21 AND 36).

TRADEMARK

FIRST USE 2-1-2011; IN COMMERCE 2-1-2011.

PRINCIPAL REGISTER

THE MARK CONSISTS OF STANDARD CHARACTERS WITHOUT CLAIM TO ANY PARTICULAR FONT, STYLE, SIZE, OR COLOR.

SN 85-100,045, FILED 8-4-2010.

KATHLEEN LORENZO, EXAMINING ATTORNEY



David J. Kybas

Director of the United States Patent and Trademark Office

United States of America

United States Patent and Trademark Office

SAVE THE BOWS!

Reg. No. 4,176,226

MISH, WILLIAM CHARLES (UNITED STATES INDIVIDUAL)
3722 N. WRIGHT ROAD
JANESVILLE, WI 53546

Registered July 17, 2012

Int. Cl.: 28

FOR: CHRISTMAS TREE ORNAMENTS AND DECORATIONS, IN CLASS 28 (U.S. CLS. 22, 23, 38 AND 50).

TRADEMARK

FIRST USE 8-5-2010; IN COMMERCE 12-1-2010.

PRINCIPAL REGISTER

THE MARK CONSISTS OF STANDARD CHARACTERS WITHOUT CLAIM TO ANY PARTICULAR FONT, STYLE, SIZE, OR COLOR.

SN 85-101,205, FILED 8-5-2010.

CHRISTINE COOPER, EXAMINING ATTORNEY



David J. Kyffers

Director of the United States Patent and Trademark Office

United States of America

United States Patent and Trademark Office



Reg. No. 4,176,227

Registered July 17, 2012

CERTIFICATION MARK

GOODS

PRINCIPAL REGISTER

SMALL WIND CERTIFICATION COUNCIL (SWCC) (NEVADA NON-PROFIT CORPORATION)
56 CLIFTON COUNTRY ROAD, SUITE 202
CLIFTON PARK, NY 12065

FOR: SMALL WIND TURBINES, IN CLASS A (U.S. CL. A).

FIRST USE 2-16-2012; IN COMMERCE 2-16-2012.

NO CLAIM IS MADE TO THE EXCLUSIVE RIGHT TO USE "SMALL WIND CERTIFICATION COUNCIL" AND "CERTIFIED SMALL WIND TURBINE", APART FROM THE MARK AS SHOWN.

THE MARK CONSISTS OF THE LETTERS "SWCC", AND THE WORDS "SMALL WIND CERTIFICATION COUNCIL" AND "CERTIFIED SMALL WIND TURBINE". A CIRCLE APPEARS AROUND THE LETTERS "SWCC" AND THE WORDS "SMALL WIND CERTIFICATION COUNCIL". THE WORDS "CERTIFIED SMALL WIND TURBINE" APPEAR UNDER THE CIRCLE. THE WHITE SHOWN IN THE MARK REPRESENTS BACKGROUND ONLY AND IS NOT INTENDED AS A FEATURE OF THE MARK.

THE CERTIFICATION MARK, AS INTENDED TO BE USED BY AUTHORIZED PERSONS, IS INTENDED TO CERTIFY THAT THE GOODS CONFORM TO POWER PERFORMANCE, ACOUSTIC, DURATION, AND SAFETY AND FUNCTION REQUIREMENTS DESIGNATED BY THE CERTIFIER.

SN 85-101,715, FILED 8-6-2010.

MICHELLE DUBOIS, EXAMINING ATTORNEY



David J. Kybas

Director of the United States Patent and Trademark Office

United States of America

United States Patent and Trademark Office

INTELLIFIELD

Reg. No. 4,176,228

KONGSBERG OIL & GAS TECHNOLOGIES AS (NORWAY CORPORATION)
PO BOX 306
1301 SANDVIKA, NORWAY

Registered July 17, 2012

Int. Cls.: 37, 38, 39, and 42

FOR: OIL AND GAS WELL SERVICES, NAMELY, PROVIDING AN ON-LINE DATABASE ON GLOBAL COMPUTER NETWORKS AND INTRANETS FOR REAL-TIME DRILLING INFORMATION FOR THE ONSHORE AND OFFSHORE OIL AND GAS INDUSTRY, IN CLASS 37 (U.S. CLS. 100, 103 AND 106).

SERVICE MARK

FIRST USE 1-2-2004; IN COMMERCE 1-2-2004.

PRINCIPAL REGISTER

FOR: TRANSMISSION OF REAL-TIME DRILLING INFORMATION FOR THE ONSHORE AND OFFSHORE OIL AND GAS INDUSTRY, IN CLASS 38 (U.S. CLS. 100, 101 AND 104).

FIRST USE 1-2-2004; IN COMMERCE 1-2-2004.

FOR: ELECTRONIC STORAGE AND RETRIEVAL OF REAL-TIME DRILLING INFORMATION FOR THE ONSHORE AND OFFSHORE OIL AND GAS INDUSTRY, IN CLASS 39 (U.S. CLS. 100 AND 105).

FIRST USE 1-2-2004; IN COMMERCE 1-2-2004.

FOR: COMPUTER SERVICES, NAMELY, ELECTRONICALLY GATHERING, ANALYZING AND FORMATTING DATA TO TRACK, LOCATE, MONITOR AND LOG OPERATIONS IN THE OIL AND GAS INDUSTRY; PROVIDING ON-LINE NON-DOWNLOADABLE SOFTWARE FOR ANALYSIS, VISUALIZATION, AND MODELING OF DATA IN CONNECTION WITH EXPLORATION AND PRODUCTION OF OIL AND NATURAL GAS, IN CLASS 42 (U.S. CLS. 100 AND 101).

FIRST USE 1-2-2004; IN COMMERCE 1-2-2004.

THE MARK CONSISTS OF STANDARD CHARACTERS WITHOUT CLAIM TO ANY PARTICULAR FONT, STYLE, SIZE, OR COLOR.

OWNER OF NORWAY REG. NO. 258428, DATED 1-27-2011, EXPIRES 7-1-2020.

SN 85-102,534, FILED 8-7-2010.



David J. Kyffers

Director of the United States Patent and Trademark Office

Reg. No. 4,176,228 BRIAN NEVILLE, EXAMINING ATTORNEY

United States of America

United States Patent and Trademark Office

GE

Reg. No. 4,176,229

Registered July 17, 2012

Int. Cl.: 9

TRADEMARK

PRINCIPAL REGISTER

GENERAL ELECTRIC COMPANY (NEW YORK CORPORATION)
1 RIVER ROAD
SCHENECTADY, NY 12345

FOR: AVIONIC SENSOR SYSTEMS, NAMELY, NAVIGATION SYSTEMS; COMPUTER HARDWARE AND SOFTWARE, FOR USE WITH MEDICAL PATIENT MONITORING EQUIPMENT, FOR RECEIVING, PROCESSING, TRANSMITTING AND DISPLAYING DATA; COMPUTER SOFTWARE FOR ACCESSING INFORMATION DIRECTORIES THAT MAY BE DOWNLOADED FROM THE GLOBAL COMPUTER NETWORK; COMPUTER SOFTWARE FOR CONTROLLING AND MANAGING PATIENT MEDICAL INFORMATION; ELECTRIC CONTROL DEVICES FOR HEATING AND ENERGY MANAGEMENT; ELECTRICAL APPARATUS, NAMELY, CHARGING STATIONS FOR CHARGING ELECTRIC VEHICLES; ELECTRICAL POWER DISTRIBUTION UNITS; ELECTRONIC SIGNALING MECHANISM, NAMELY, A TRAIN CONTROL SYSTEM USED IN THE RAILWAY INDUSTRY FOR DETECTING AND CONTROLLING TRAINS, GROUND FAULTS, BROKEN RAILS, POWER FAILURES, TRACK SWITCHES AND LIGHTS, IN CLASS 9 (U.S. CLS. 21, 23, 26, 36 AND 38).

FIRST USE 4-30-2011; IN COMMERCE 4-30-2011.

THE MARK CONSISTS OF STANDARD CHARACTERS WITHOUT CLAIM TO ANY PARTICULAR FONT, STYLE, SIZE, OR COLOR.

OWNER OF U.S. REG. NOS. 2,652,010, 3,363,509, AND OTHERS.

SN 85-103,320, FILED 8-9-2010.

ANDREA HACK, EXAMINING ATTORNEY



David J. Kyffers

Director of the United States Patent and Trademark Office

United States of America

United States Patent and Trademark Office

GE

Reg. No. 4,176,230

GENERAL ELECTRIC COMPANY (NEW YORK CORPORATION)
1 RIVER ROAD
SCHENECTADY, NY 12345

Registered July 17, 2012

Int. Cl.: 37

FOR: CHARGING STATION SERVICES FOR ELECTRIC VEHICLES; INSTALLATION OF WIRING AND POWER SUPPLY EQUIPMENT FOR TRANSMISSION AND DISTRIBUTION OF ELECTRICITY SUITABLE FOR ELECTRIC VEHICLE RECHARGING STATIONS, IN CLASS 37 (U.S. CLS. 100, 103 AND 106).

SERVICE MARK

PRINCIPAL REGISTER

FIRST USE 2-28-2012; IN COMMERCE 2-28-2012.

THE MARK CONSISTS OF STANDARD CHARACTERS WITHOUT CLAIM TO ANY PARTICULAR FONT, STYLE, SIZE, OR COLOR.

OWNER OF U.S. REG. NOS. 2,831,792, 3,624,272, AND OTHERS.

SN 85-103,345, FILED 8-9-2010.

ANDREA HACK, EXAMINING ATTORNEY



David J. Kyros

Director of the United States Patent and Trademark Office

United States of America

United States Patent and Trademark Office

IMAGINATION AT WORK

Reg. No. 4,176,231

GENERAL ELECTRIC COMPANY (NEW YORK CORPORATION)

Registered July 17, 2012

1 RIVER ROAD
SCHENECTADY, NY 12345

Int. Cl.: 37

FOR: CHARGING STATION SERVICES FOR ELECTRIC VEHICLES; INSTALLATION OF WIRING AND POWER SUPPLY EQUIPMENT FOR TRANSMISSION AND DISTRIBUTION OF ELECTRICITY SUITABLE FOR ELECTRIC VEHICLE RECHARGING STATIONS, IN CLASS 37 (U.S. CLS. 100, 103 AND 106).

SERVICE MARK

PRINCIPAL REGISTER

FIRST USE 2-28-2011; IN COMMERCE 2-28-2011.

THE MARK CONSISTS OF STANDARD CHARACTERS WITHOUT CLAIM TO ANY PARTICULAR FONT, STYLE, SIZE, OR COLOR.

OWNER OF U.S. REG. NOS. 3,032,781, 3,235,333, AND OTHERS.

SN 85-104,227, FILED 8-10-2010.

ANDREA HACK, EXAMINING ATTORNEY



David J. Kyffers

Director of the United States Patent and Trademark Office

United States of America

United States Patent and Trademark Office

SHARPENS ON THE SAW, ON THE JOB, IN SECONDS

Reg. No. 4,176,232

BLOUNT, INC. (DELAWARE CORPORATION)
4909 SE INTERNATIONAL WAY
PORTLAND, OR 97222

Registered July 17, 2012

Int. Cls.: 7 and 8

FOR: EQUIPMENT AND ACCESSORIES FOR CHAIN SAWS, NAMELY, SAW CHAIN AND GUIDE BARS, IN CLASS 7 (U.S. CLS. 13, 19, 21, 23, 31, 34 AND 35).

TRADEMARK

FIRST USE 5-0-2010; IN COMMERCE 5-0-2010.

PRINCIPAL REGISTER

FOR: SHARPENING STONES FOR SAW CHAIN, IN CLASS 8 (U.S. CLS. 23, 28 AND 44).

FIRST USE 5-0-2010; IN COMMERCE 5-0-2010.

THE MARK CONSISTS OF STANDARD CHARACTERS WITHOUT CLAIM TO ANY PARTICULAR FONT, STYLE, SIZE, OR COLOR.

SN 85-105,262, FILED 8-11-2010.

DOMINICK J. SALEMI, EXAMINING ATTORNEY



David J. Kyffers

Director of the United States Patent and Trademark Office

United States of America

United States Patent and Trademark Office

PROTECTAGEN

Reg. No. 4,176,233

Registered July 17, 2012

Int. Cls.: 1 and 3

TRADEMARK

PRINCIPAL REGISTER

ISP INVESTMENTS INC. (DELAWARE CORPORATION)
SUITE 315
1011 CENTRE ROAD
WILMINGTON, DE 19805

FOR: CHEMICAL PRODUCTS FOR USE IN INDUSTRY AND SCIENCE, NAMELY, RICE EXTRACTS AND HYDROLYZED RICE PROTEINS FOR USE IN THE MANUFACTURE OF HAIR CARE PRODUCTS, IN CLASS 1 (U.S. CLS. 1, 5, 6, 10, 26 AND 46).

FIRST USE 1-0-2012; IN COMMERCE 1-0-2012.

FOR: NON MEDICATED HAIR CARE PREPARATIONS, NAMELY, NON MEDICATED HAIR AND SCALP TREATMENTS IN THE FORM OF CREAMS, LOTIONS, MASKS AND NOURISHERS, HAIR SHAMPOO, HAIR CONDITIONER, HAIR RINSE, HAIR CREAM, HAIR LOTION AND HAIR SERUMS AND HAIR STYLING PREPARATIONS, NAMELY, HAIR GEL, HAIR MOUSSE, HAIR POMADES, HAIR LACQUERS AND HAIR SPRAY, IN CLASS 3 (U.S. CLS. 1, 4, 6, 50, 51 AND 52).

FIRST USE 1-0-2012; IN COMMERCE 1-0-2012.

THE MARK CONSISTS OF STANDARD CHARACTERS WITHOUT CLAIM TO ANY PARTICULAR FONT, STYLE, SIZE, OR COLOR.

SN 85-105,382, FILED 8-11-2010.

EMILY CARLSEN, EXAMINING ATTORNEY



David J. Kybas

Director of the United States Patent and Trademark Office

United States of America

United States Patent and Trademark Office



Reg. No. 4,176,234

YOU WISE UP, INC. (NORTH CAROLINA CORPORATION)
P.O. BOX 130
WINSTON-SALEM, NC 27106

Registered July 17, 2012

Int. Cl.: 16

FOR: WORKBOOKS DIRECTED TO INFORMATION AND TIME MANAGEMENT, IN CLASS 16 (U.S. CLS. 2, 5, 22, 23, 29, 37, 38 AND 50).

TRADEMARK

FIRST USE 2-15-2012; IN COMMERCE 2-15-2012.

PRINCIPAL REGISTER

THE MARK CONSISTS OF "WISE UP!" WITH A STYLIZED OWL.

SN 85-107,383, FILED 8-13-2010.

KAREN BRACEY, EXAMINING ATTORNEY



David J. Kybas

Director of the United States Patent and Trademark Office

United States of America

United States Patent and Trademark Office

Cruz

Reg. No. 4,176,235

NRG RECORDING SERVICES, INC. (CALIFORNIA CORPORATION)
1128 WEDDINGTON STREET
NORTH HOLLYWOOD, CA 91601

Registered July 17, 2012

Int. Cl.: 41

FOR: ENTERTAINMENT SERVICES IN THE NATURE OF LIVE MUSICAL PERFORMANCES,
IN CLASS 41 (U.S. CLS. 100, 101 AND 107).

SERVICE MARK

FIRST USE 10-19-2009; IN COMMERCE 10-19-2009.

PRINCIPAL REGISTER

THE MARK CONSISTS OF STANDARD CHARACTERS WITHOUT CLAIM TO ANY PARTICULAR FONT, STYLE, SIZE, OR COLOR.

THE ENGLISH TRANSLATION OF "CRUZ" IN THE MARK IS "CROSS".

SN 85-107,730, FILED 8-14-2010.

KATHRYN COWARD, EXAMINING ATTORNEY



David J. Kyros

Director of the United States Patent and Trademark Office

United States of America

United States Patent and Trademark Office

BROOKLYNIZED

Reg. No. 4,176,236

THE ORIGINAL BROOKLYN WATER BAGEL CO., INC. (FLORIDA CORPORATION)
5355 TOWN CENTER DRIVE, SUITE 702

Registered July 17, 2012

BOCA RATON, FL 33486

Int. Cls.: 5, 30, and 32

FOR: NUTRITIONALLY FORTIFIED WATER AND VITAMIN ENRICHED WATER, IN CLASS 5 (U.S. CLS. 6, 18, 44, 46, 51 AND 52).

TRADEMARK

FIRST USE 4-10-2009; IN COMMERCE 4-10-2009.

PRINCIPAL REGISTER

FOR: BAGELS, PIZZA, PIZZA DOUGH AND PASTA, IN CLASS 30 (U.S. CL. 46).

FIRST USE 4-10-2009; IN COMMERCE 4-10-2009.

FOR: BOTTLED DRINKING WATER, BOTTLED WATER, DRINKING WATER, WATER BEVERAGES AND FLAVORED WATER, IN CLASS 32 (U.S. CLS. 45, 46 AND 48).

FIRST USE 4-10-2009; IN COMMERCE 4-10-2009.

THE MARK CONSISTS OF STANDARD CHARACTERS WITHOUT CLAIM TO ANY PARTICULAR FONT, STYLE, SIZE, OR COLOR.

SN 85-107,788, FILED 8-15-2010.

RUSS HERMAN, EXAMINING ATTORNEY



David J. Kyffers

Director of the United States Patent and Trademark Office

United States of America
United States Patent and Trademark Office

LADY BUG

Reg. No. 4,176,237

LACEBARK, INC. (OKLAHOMA CORPORATION)
2104 NORTH COTTONWOOD ROAD
STILLWATER, OK 74075

Registered July 17, 2012

Int. Cl.: 31

FOR: LIVE PLANTS, NAMELY, CRAPE MYRTLES, IN CLASS 31 (U.S. CLS. 1 AND 46).

TRADEMARK

FIRST USE 4-5-2012; IN COMMERCE 4-5-2012.

PRINCIPAL REGISTER

THE MARK CONSISTS OF STANDARD CHARACTERS WITHOUT CLAIM TO ANY PARTICULAR FONT, STYLE, SIZE, OR COLOR.

SN 85-110,514, FILED 8-18-2010.

KATHLEEN LORENZO, EXAMINING ATTORNEY



David J. Kyffers

Director of the United States Patent and Trademark Office

United States of America

United States Patent and Trademark Office



Reg. No. 4,176,238

Registered July 17, 2012

Int. Cls.: 9 and 15

TRADEMARK

PRINCIPAL REGISTER

RED CHIP COMPANY LTD. (BR.VIRGIN ISLANDS CORPORATION)
P.O. BOX 146
TRIDENT CHAMBERS, WICKHAMS CAY
ROAD TOWN, TORTOLA, BR.VIRGIN ISLANDS

FOR: APPARATUS FOR RECORDING, TRANSMISSION, PROCESSING, AND REPRODUCTION OF SOUND; APPARATUS FOR CREATING, RETRIEVAL, MANIPULATION OF SOUND, NAMELY, AUDIO MIXERS; FEEDBACK SUPPRESSORS; AUDIO ENHANCERS AND EXCITERS; MICROPHONES; MICROPHONE PREAMPLIFIERS; DIRECT INPUT BOXES; MIXING CONSOLES; DYNAMIC PROCESSORS; EFFECTS AND SIGNAL PROCESSORS; EQUALIZERS; CROSSOVERS; AUDIO CONTROLLERS; AUDIO INTERFACES; SIGNAL DISTRIBUTION DEVICES; SIGNAL CONVERTERS; HEADPHONE AMPLIFIERS; HEADPHONES; POWER AMPLIFIERS; LOUDSPEAKERS; LIGHTING CONTROLS; COMPUTER SOFTWARE FOR CREATING, RECORDING, TRANSMISSION, PROCESSING, RETRIEVAL, MANIPULATION AND REPRODUCTION OF SOUND; DOWNLOADABLE ELECTRONIC PUBLICATIONS, NAMELY, MANUALS IN THE FIELD OF MUSIC, E.G. MUSICAL INSTRUMENTS AND ACCESSORIES, AND ELECTRONIC SOUND EQUIPMENT RELATED THERETO, IN CLASS 9 (U.S. CLS. 21, 23, 26, 36 AND 38).

FIRST USE 8-5-2010; IN COMMERCE 11-1-2011.

FOR: MUSICAL INSTRUMENTS; GUITARS; PIANOS; SYNTHESIZERS; MUSICAL INSTRUMENT ACCESSORIES, NAMELY, STRINGS, CARRYING BAGS, STORAGE BAGS; CASES AND FOOT PEDALS FOR MUSICAL INSTRUMENTS; TUNING APPARATUS FOR MUSICAL INSTRUMENTS; AND REPLACEMENT PARTS THEREFOR, IN CLASS 15 (U.S. CLS. 2, 21 AND 36).

FIRST USE 8-5-2010; IN COMMERCE 11-1-2011.

OWNER OF U.S. REG. NOS. 2,145,051 AND 3,128,660.

THE MARK CONSISTS OF A TRIANGLE WITH ROUND EDGES WITH A STYLIZED EAR COMPRISED OF TWO PARTIAL OVALS INSIDE, AND THE WORD "BEHRINGER" IN LOWER CASE LETTERS APPEARING UNDERNEATH.

SN 85-110,878, FILED 8-19-2010.



David J. Kybas

Director of the United States Patent and Trademark Office

Reg. No. 4,176,238 JOHN SCHUYLER YARD, EXAMINING ATTORNEY

United States of America

United States Patent and Trademark Office

C-SOAR

Reg. No. 4,176,239

PRITCHARD, ANDREW F. (UNITED KINGDOM INDIVIDUAL)
3622 PETE DYE BOULEVARD
CARMEL, IN 46033

Registered July 17, 2012

Int. Cl.: 35

FOR: BUSINESS CONSULTING SERVICES, IN CLASS 35 (U.S. CLS. 100, 101 AND 102).

SERVICE MARK

FIRST USE 8-12-2010; IN COMMERCE 2-25-2011.

PRINCIPAL REGISTER

THE MARK CONSISTS OF STANDARD CHARACTERS WITHOUT CLAIM TO ANY PARTICULAR FONT, STYLE, SIZE, OR COLOR.

SN 85-111,658, FILED 8-19-2010.

SKYE YOUNG, EXAMINING ATTORNEY



David J. Kybas

Director of the United States Patent and Trademark Office

United States of America

United States Patent and Trademark Office



KAILOS GENETICS

Reg. No. 4,176,240

KAILOS GENETICS, INC. (DELAWARE CORPORATION)
601 GENOME WAY
HUNTSVILLE, AL 35806

Registered July 17, 2012

Int. Cls.: 42 and 44

FOR: SCIENTIFIC RESEARCH IN THE FIELD OF MOLECULAR BASED GENE SEQUENCES AND MUTATIONS, IN CLASS 42 (U.S. CLS. 100 AND 101).

SERVICE MARK

FIRST USE 3-31-2012; IN COMMERCE 3-31-2012.

PRINCIPAL REGISTER

FOR: GENETIC TESTING FOR MEDICAL PURPOSES IN THE FIELD OF IDENTIFICATION OF GENE SEQUENCES AND MUTATIONS, IN CLASS 44 (U.S. CLS. 100 AND 101).

FIRST USE 3-31-2012; IN COMMERCE 3-31-2012.

NO CLAIM IS MADE TO THE EXCLUSIVE RIGHT TO USE "GENETICS", APART FROM THE MARK AS SHOWN.

THE MARK CONSISTS OF THE REPRESENTATION OF TWO HUMAN FIGURES, EACH IN THE SHAPE OF THE LETTER "X" WHICH ARE COMPRISED OF TWO RIBBON-LIKE LINES THAT INTERSECT AT THE MID-POINTS OF EACH OF THE LETTERS "X", WITH A SPHERE REPRESENTING THE FIGURES' HEADS CENTERED SLIGHTLY ABOVE THE UPRaised ARMS REPRESENTED BY THE UPPER-HALF OF THE LETTERS "X"; THE LOWER-HALF OF THE LETTERS "X" REPRESENT THE LOWER-HALF OF THE FIGURES' BODIES; THE TWO LETTERS "X" ARE CENTERED ABOVE THE WORDS "KAILOS GENETICS".

SN 85-111,668, FILED 8-19-2010.

HOWARD B. LEVINE, EXAMINING ATTORNEY



David J. Kybas

Director of the United States Patent and Trademark Office

United States of America

United States Patent and Trademark Office

H

Hazuki

Reg. No. 4,176,241

Registered July 17, 2012

Int. Cl.: 9

TRADEMARK

PRINCIPAL REGISTER

PRIVÉE AG KABUSHIKI KAISHA (JAPAN CORPORATION), AKA PRIVÉE AG CORPORATION,
1-6-1, ROPPONGI, MINATO-KU
TOKYO, JAPAN

FOR: MAGNIFYING GLASSES; MAGNIFYING GLASSES THAT FIT ON THE USER'S FACE
IN THE MANNER OF EYEGLASSES, IN CLASS 9 (U.S. CLS. 21, 23, 26, 36 AND 38).

FIRST USE 9-0-2010; IN COMMERCE 3-1-2012.

THE MARK CONSISTS OF THE LETTER "H" AND THE TERM "HAZUKI".

THE ENGLISH TRANSLATION OF "HAZUKI" IN THE MARK IS "AUGUST" (IN OLDEN
JAPANESE).

SN 85-111,858, FILED 8-19-2010.

RONALD DELGIZZI, EXAMINING ATTORNEY



David J. Kyffers

Director of the United States Patent and Trademark Office

United States of America

United States Patent and Trademark Office

LABELLEPLUIE

Reg. No. 4,176,242

Registered July 17, 2012

Int. Cl.: 18

TRADEMARK

PRINCIPAL REGISTER

HATCLO PROTECTORS, LLC (NEW YORK LIMITED LIABILITY COMPANY)
APT. 1
41 CHAPIN AVENUE
PROVIDENCE, RI 02909

FOR: UMBRELLAS, IN CLASS 18 (U.S. CLS. 1, 2, 3, 22 AND 41).

FIRST USE 3-23-2012; IN COMMERCE 3-27-2012.

THE MARK CONSISTS OF STANDARD CHARACTERS WITHOUT CLAIM TO ANY PARTICULAR FONT, STYLE, SIZE, OR COLOR.

THE ENGLISH TRANSLATION OF THE WORD "LABELLEPLUIE" IN THE MARK IS THE BEAUTIFUL RAIN.

SN 85-113,528, FILED 8-23-2010.

WENDY JUN, EXAMINING ATTORNEY



David J. Kybas

Director of the United States Patent and Trademark Office

United States of America

United States Patent and Trademark Office

BOND NO. 9 SAG HARBOR

Reg. No. 4,176,243

LAURICE EL BADRY RAHME LTD. DBA LAURICE & CO (NEW YORK CORPORATION)
9 BOND STREET
NEW YORK, NY 10012

Registered July 17, 2012

Int. Cl.: 3

FOR: FRAGRANCES FOR PERSONAL USE, NAMELY, PERFUMES AND COLOGNES, IN CLASS 3 (U.S. CLS. 1, 4, 6, 50, 51 AND 52).

TRADEMARK

FIRST USE 5-3-2012; IN COMMERCE 5-3-2012.

PRINCIPAL REGISTER

THE MARK CONSISTS OF STANDARD CHARACTERS WITHOUT CLAIM TO ANY PARTICULAR FONT, STYLE, SIZE, OR COLOR.

OWNER OF U.S. REG. NO. 2,742,675.

SN 85-114,168, FILED 8-24-2010.

B. PARADEWELAI, EXAMINING ATTORNEY



David J. Kyffers

Director of the United States Patent and Trademark Office

United States of America

United States Patent and Trademark Office

ICONOCLAST EQUINE

Reg. No. 4,176,244

WESTERN LEGACY SALES, LLC (TEXAS LIMITED LIABILITY COMPANY)
6849 EAST COUNTY ROAD 405

Registered July 17, 2012

ALVARADO, TX 76009

Int. Cl.: 18

FOR: EQUINE PRODUCTS AND ACCESSORIES, NAMELY, NON-MEDICATED EQUINE SUPPORT BOOTS IN THE NATURE OF LEG WRAPS, IN CLASS 18 (U.S. CLS. 1, 2, 3, 22 AND 41).

TRADEMARK

FIRST USE 2-29-2012; IN COMMERCE 2-29-2012.

PRINCIPAL REGISTER

THE MARK CONSISTS OF STANDARD CHARACTERS WITHOUT CLAIM TO ANY PARTICULAR FONT, STYLE, SIZE, OR COLOR.

OWNER OF U.S. REG. NO. 3,509,445.

NO CLAIM IS MADE TO THE EXCLUSIVE RIGHT TO USE "EQUINE", APART FROM THE MARK AS SHOWN.

SN 85-114,390, FILED 8-24-2010.

LOURDES AYALA, EXAMINING ATTORNEY



David J. Kyffers

Director of the United States Patent and Trademark Office

United States of America

United States Patent and Trademark Office



Reg. No. 4,176,245

Registered July 17, 2012

Int. Cl.: 9

TRADEMARK

PRINCIPAL REGISTER

KUBICA CORP. (MICHIGAN CORPORATION), DBA PRIME TECHNOLOGIES, INC.,
P.O. BOX 812
NORTHVILLE, MI 48167

FOR: INDUSTRIAL PROCESS CONTROL SOFTWARE; COMPUTER SOFTWARE TO MONITOR AND CONTROL FACTORY MANUFACTURING AND INDUSTRIAL PROCESSES; COMPUTER SOFTWARE TO MONITOR AND CONTROL TREATMENT, HANDLING AND STORAGE OF WATER, SEWAGE AND LIQUID WASTE; COMPUTER HARDWARE, NAMELY, CONTROL PANELS FOR MONITORING AND CONTROLLING MANUFACTURING AND INDUSTRIAL PROCESSES; COMPUTER HARDWARE, NAMELY, CONTROL PANELS FOR MONITORING AND CONTROLLING PROCESSES FOR TREATMENT, HANDLING AND STORAGE OF WATER, SEWAGE AND LIQUID WASTE; AUTOMATED PROCESS CONTROL SYSTEM, NAMELY, COMPUTER HARDWARE AND SOFTWARE FOR MONITORING AND CONTROLLING FACTORY MANUFACTURING AND INDUSTRIAL PROCESSES; AUTOMATED PROCESS CONTROL SYSTEM, NAMELY, COMPUTER HARDWARE AND SOFTWARE FOR MONITORING AND CONTROLLING PROCESSES FOR TREATMENT, HANDLING AND STORAGE OF WATER, SEWAGE AND LIQUID WASTE, IN CLASS 9 (U.S. CLS. 21, 23, 26, 36 AND 38).

FIRST USE 4-14-2011; IN COMMERCE 4-14-2011.

THE MARK CONSISTS OF THE LOWER CASE GREEK LETTER PHI FOLLOWED BY THE LETTERING "ZX".

SN 85-114,500, FILED 8-24-2010.

WENDY GOODMAN, EXAMINING ATTORNEY



David J. Kyffers

Director of the United States Patent and Trademark Office

United States of America

United States Patent and Trademark Office



Reg. No. 4,176,246

Registered July 17, 2012

Int. Cl.: 9

TRADEMARK

PRINCIPAL REGISTER

KUBICA CORP. (MICHIGAN CORPORATION), DBA PRIME TECHNOLOGIES, INC.,
P.O. BOX 812
NORTHVILLE, MI 48167

FOR: INDUSTRIAL PROCESS CONTROL SOFTWARE; COMPUTER SOFTWARE TO MONITOR AND CONTROL FACTORY MANUFACTURING AND INDUSTRIAL PROCESSES; COMPUTER SOFTWARE TO MONITOR AND CONTROL TREATMENT, HANDLING AND STORAGE OF WATER, SEWAGE AND LIQUID WASTE; COMPUTER HARDWARE, NAMELY, CONTROL PANELS FOR MONITORING AND CONTROLLING MANUFACTURING AND INDUSTRIAL PROCESSES; COMPUTER HARDWARE, NAMELY, CONTROL PANELS FOR MONITORING AND CONTROLLING PROCESSES FOR TREATMENT, HANDLING AND STORAGE OF WATER, SEWAGE AND LIQUID WASTE; AUTOMATED PROCESS CONTROL SYSTEM, NAMELY, COMPUTER HARDWARE AND SOFTWARE FOR MONITORING AND CONTROLLING FACTORY MANUFACTURING AND INDUSTRIAL PROCESSES; AUTOMATED PROCESS CONTROL SYSTEM, NAMELY, COMPUTER HARDWARE AND SOFTWARE FOR MONITORING AND CONTROLLING PROCESSES FOR TREATMENT, HANDLING AND STORAGE OF WATER, SEWAGE AND LIQUID WASTE, IN CLASS 9 (U.S. CLS. 21, 23, 26, 36 AND 38).

FIRST USE 4-1-2011; IN COMMERCE 4-1-2011.

THE MARK CONSISTS OF THE LOWER CASE GREEK LETTER "PHI" FOLLOWED BY THE LETTERING "PHIZX".

SN 85-114,507, FILED 8-24-2010.

WENDY GOODMAN, EXAMINING ATTORNEY



David J. Kyffers

Director of the United States Patent and Trademark Office

United States of America

United States Patent and Trademark Office

DTRAX

Reg. No. 4,176,247

Registered July 17, 2012

Int. Cl.: 10

TRADEMARK

PRINCIPAL REGISTER

PROVIDENCE MEDICAL TECHNOLOGY, INC. (CALIFORNIA CORPORATION)
2320 SUTTER STREET, SUITE 202
SAN FRANCISCO, CA 94115

FOR: MEDICAL DEVICES AND APPARATUS FOR PERCUTANEOUS DISTRACTION OF THE SPINE, NAMELY, PREPARATORY AND DELIVERY TOOLS FOR PREPARING, DISTRACTING AND IMMOBILIZING SPINAL JOINTS, DELIVERY TOOLS FOR DISTRACTING SPINAL JOINTS, DELIVERY TOOLS FOR POSITIONING SPINAL IMPLANTS, SPINAL IMPLANTS COMPOSED OF NATURAL OR ARTIFICIAL MATERIAL FOR DISTRACTION OF SPINAL JOINTS, SPINAL IMPLANTS COMPOSED OF NATURAL OR ARTIFICIAL MATERIAL FOR IMPLANTATION IN SPINAL JOINTS, ANCHORING MATERIALS FOR MAINTAINING THE POSITION OF SPINAL IMPLANTS, ANCHORING MATERIALS FOR MAINTAINING THE DISTRACTED POSITION OF SPINAL JOINTS, SPINAL JOINT DECORTICATION TOOLS, DELIVERY TOOLS FOR SPINAL JOINT GRAFTING MATERIAL; KITS FOR PERCUTANEOUS DISTRACTION OF THE SPINE COMPRISING THE FOREGOING; MEDICAL DEVICES, NAMELY, TOOLS FOR DECORTICATION OF SPINAL JOINTS; MEDICAL DEVICES, NAMELY, TOOLS FOR DELIVERY OF NATURAL OR ARTIFICIAL BONE GRAFTING MATERIALS; STRUCTURAL PARTS FOR ALL THE FOREGOING, IN CLASS 10 (U.S. CLS. 26, 39 AND 44).

FIRST USE 2-14-2012; IN COMMERCE 2-14-2012.

THE MARK CONSISTS OF STANDARD CHARACTERS WITHOUT CLAIM TO ANY PARTICULAR FONT, STYLE, SIZE, OR COLOR.

SN 85-115,258, FILED 8-25-2010.

JEFF DEFORD, EXAMINING ATTORNEY



David J. Kybas

Director of the United States Patent and Trademark Office

United States of America

United States Patent and Trademark Office

NOVOSERUM

Reg. No. 4,176,248

NOVO SOLUTIONS, MD, LLC (ARIZONA LIMITED LIABILITY COMPANY)
5434 E. LINCOLN DRIVE
PHOENIX, AZ 85253

Registered July 17, 2012

Int. Cl.: 3

FOR: SKIN CARE PRODUCTS AND BEAUTY PRODUCTS FOR THE FACE AND BODY, NAMELY, THE PROPRIETARY INGREDIENT DERIVED FROM UMBILICAL CORDS THAT WILL BE USED IN BEAUTY SERUMS, ANTI-AGING SERUMS, LOTIONS, SUN SCREENS, TONERS, AND SOAPS, IN CLASS 3 (U.S. CLS. 1, 4, 6, 50, 51 AND 52).

TRADEMARK

PRINCIPAL REGISTER

FIRST USE 6-8-2011; IN COMMERCE 6-8-2011.

THE MARK CONSISTS OF STANDARD CHARACTERS WITHOUT CLAIM TO ANY PARTICULAR FONT, STYLE, SIZE, OR COLOR.

SN 85-115,637, FILED 8-25-2010.

RAUL CORDOVA, EXAMINING ATTORNEY



David J. Kyffers

Director of the United States Patent and Trademark Office

United States of America

United States Patent and Trademark Office

BUON GIORNIO GENOA

Reg. No. 4,176,249

Registered July 17, 2012

Int. Cl.: 3

TRADEMARK

PRINCIPAL REGISTER

ALOXXI INTERNATIONAL CORPORATION (CALIFORNIA CORPORATION)
14144 VENTURA BOULEVARD, SUITE 110
SHERMAN OAKS, CA 91423

FOR: HAIR BLEACHING PREPARATIONS, NON-MEDICATED HAIR CARE PREPARATIONS, HAIR CLEANING PREPARATIONS, HAIR COLOR REMOVERS, HAIR COLORING PREPARATIONS, HAIR LIGHTENERS, HAIR COLORING RINSE, HAIR LIGHTENING BLEACH, HAIR RINSES, HAIR COLORANTS, ALL IN THE FORM OF LIQUID, GEL AND CREAM, IN CLASS 3 (U.S. CLS. 1, 4, 6, 50, 51 AND 52).

FIRST USE 10-1-2011; IN COMMERCE 10-1-2011.

THE MARK CONSISTS OF STANDARD CHARACTERS WITHOUT CLAIM TO ANY PARTICULAR FONT, STYLE, SIZE, OR COLOR.

NO CLAIM IS MADE TO THE EXCLUSIVE RIGHT TO USE "GENOA", APART FROM THE MARK AS SHOWN.

THE ENGLISH TRANSLATION OF "BUON GIORNIO" IS "GOOD MORNING".

SN 85-116,309, FILED 8-26-2010.

JOHN GARTNER, EXAMINING ATTORNEY



David J. Kyffers

Director of the United States Patent and Trademark Office

United States of America

United States Patent and Trademark Office

CIAO BELLA

Reg. No. 4,176,250

Registered July 17, 2012

Int. Cl.: 3

TRADEMARK

PRINCIPAL REGISTER

ALOXXI INTERNATIONAL CORPORATION (CALIFORNIA CORPORATION)
14144 VENTURA BOULEVARD, SUITE 110
SHERMAN OAKS, CA 91423

FOR: HAIR BLEACHING PREPARATIONS, NON-MEDICATED HAIR CARE PREPARATIONS, HAIR CLEANING PREPARATIONS, HAIR COLOR REMOVERS, HAIR COLORING PREPARATIONS, HAIR LIGHTENERS, HAIR COLORING RINSE, HAIR LIGHTENING BLEACH, HAIR RINSES, HAIR COLORANTS, ALL IN THE FORM OF LIQUID, GEL AND CREAM, IN CLASS 3 (U.S. CLS. 1, 4, 6, 50, 51 AND 52).

FIRST USE 7-1-2011; IN COMMERCE 7-1-2011.

THE MARK CONSISTS OF STANDARD CHARACTERS WITHOUT CLAIM TO ANY PARTICULAR FONT, STYLE, SIZE, OR COLOR.

THE ENGLISH TRANSLATION OF "CIAO BELLA" IN THE MARK IS "HELLO BEAUTIFUL" OR "GOODBYE BEAUTIFUL".

SN 85-116,329, FILED 8-26-2010.

JOHN GARTNER, EXAMINING ATTORNEY



David J. Kyros

Director of the United States Patent and Trademark Office

United States of America

United States Patent and Trademark Office

ORGANOLA

Reg. No. 4,176,251

CIUCCIOMEI, MAXIMILIANO (UNITED STATES INDIVIDUAL)
VIA SOLFERINO 23
CASTELFIDARDO, ITALY

Registered July 17, 2012

Int. Cl.: 15

FOR: MUSICAL INSTRUMENTS, NAMELY, ACCORDIONS, CONCERTINAS, HARMONICA
AND DIATONIC ACCORDIONS, IN CLASS 15 (U.S. CLS. 2, 21 AND 36).

TRADEMARK

FIRST USE 2-1-2012; IN COMMERCE 2-1-2012.

PRINCIPAL REGISTER

THE MARK CONSISTS OF STANDARD CHARACTERS WITHOUT CLAIM TO ANY PAR-
TICULAR FONT, STYLE, SIZE, OR COLOR.

THE WORD(S) "ORGANOLA" HAS NO MEANING IN A FOREIGN LANGUAGE.

SN 85-117,154, FILED 8-27-2010.

TRACY FLETCHER, EXAMINING ATTORNEY



David J. Kybas

Director of the United States Patent and Trademark Office

United States of America

United States Patent and Trademark Office

SANTA MARSALA

Reg. No. 4,176,252

CIUCCIOMEI, MAXIMILIANO (ITALY INDIVIDUAL)
VIA SOLFERINO 23
CASTELFIDARDO, ITALY

Registered July 17, 2012

Int. Cl.: 15

FOR: MUSICAL INSTRUMENTS, IN CLASS 15 (U.S. CLS. 2, 21 AND 36).

TRADEMARK

FIRST USE 2-28-2012; IN COMMERCE 2-28-2012.

PRINCIPAL REGISTER

THE MARK CONSISTS OF STANDARD CHARACTERS WITHOUT CLAIM TO ANY PARTICULAR FONT, STYLE, SIZE, OR COLOR.

THE ENGLISH TRANSLATION OF "SANTA MARSALA" IS "SAINT MARSALA".

SN 85-117,159, FILED 8-27-2010.

TRACY FLETCHER, EXAMINING ATTORNEY



David J. Kybas

Director of the United States Patent and Trademark Office

United States of America

United States Patent and Trademark Office



Reg. No. 4,176,253

Registered July 17, 2012

Int. Cls.: 3, 16, 18, and 28

TRADEMARK

PRINCIPAL REGISTER

AHOLD LICENSING SARL (SWITZERLAND LIMITED LIABILITY COMPANY)
2 RUE JEAN-PETITOT
GENEVA, SWITZERLAND 1204

FOR: PET ODOR REMOVERS; PET SHAMPOO; PET STAIN REMOVERS, IN CLASS 3 (U.S. CLS. 1, 4, 6, 50, 51 AND 52).

FIRST USE 11-0-2011; IN COMMERCE 11-0-2011.

FOR: DISPOSABLE HOUSEBREAKING PADS FOR PETS; PLASTIC BAGS FOR DISPOSING OF PET WASTE, IN CLASS 16 (U.S. CLS. 2, 5, 22, 23, 29, 37, 38 AND 50).

FIRST USE 11-0-2011; IN COMMERCE 11-0-2011.

FOR: COLLARS FOR PETS; LEASHES FOR ANIMALS; RAWHIDE CHEWS FOR DOGS, IN CLASS 18 (U.S. CLS. 1, 2, 3, 22 AND 41).

FIRST USE 11-0-2011; IN COMMERCE 11-0-2011.

FOR: PET TOYS, IN CLASS 28 (U.S. CLS. 22, 23, 38 AND 50).

FIRST USE 11-0-2011; IN COMMERCE 11-0-2011.

OWNER OF U.S. REG. NOS. 3,544,836, 3,731,995, AND OTHERS.

THE COLOR(S) BLUE, WHITE, YELLOW, ORANGE, PURPLE AND GREEN IS/ARE CLAIMED AS A FEATURE OF THE MARK.

THE MARK CONSISTS OF A GENERALLY OVAL-SHAPED BLUE DESIGN FEATURES THE WORD "COMPANION" IN WHITE, WITH A DESIGN OVER THE LETTER "M" FEATURING FOUR WEDGE SHAPES IN VARYING SIZES AND DEGREES OF ROTATION. THE WEDGE SHAPES APPEAR IN YELLOW, ORANGE, PURPLE AND GREEN. "YOUR TRUSTED FRIEND" APPEARS IN YELLOW BELOW "COMPANION".

SN 85-117,216, FILED 8-27-2010.

BRIDGETT SMITH, EXAMINING ATTORNEY



David J. Kyros

Director of the United States Patent and Trademark Office

United States of America

United States Patent and Trademark Office

RELIANCE

Reg. No. 4,176,254

Registered July 17, 2012

Int. Cl.: 8

TRADEMARK

PRINCIPAL REGISTER

SOLO CUP OPERATING CORPORATION (DELAWARE CORPORATION)
SUITE 150
150 SOUTH SAUNDERS ROAD
LAKE FOREST, IL 60045

FOR: DISPOSABLE TABLEWARE, NAMELY, KNIVES, FORKS AND SPOONS, IN CLASS
8 (U.S. CLS. 23, 28 AND 44).

FIRST USE 1-19-2011; IN COMMERCE 1-19-2011.

THE MARK CONSISTS OF STANDARD CHARACTERS WITHOUT CLAIM TO ANY PAR-
TICULAR FONT, STYLE, SIZE, OR COLOR.

SN 85-117,344, FILED 8-27-2010.

EMILY CHUO, EXAMINING ATTORNEY



David J. Kyros

Director of the United States Patent and Trademark Office

United States of America

United States Patent and Trademark Office

AGAMA

Reg. No. 4,176,255

Registered July 17, 2012

Int. Cl.: 7

TRADEMARK

PRINCIPAL REGISTER

KYE SYSTEMS CORP. (TAIWAN CORPORATION)
NO. 492, SEC. 5, CHUNG HSIN RD.
SAN CHUNG CITY
TAIPEI HSIEN, TAIWAN 241

FOR: COMPRESSOR CLEANING MACHINES; DRY-CLEANING MACHINES; MACHINES FOR CLEANING SURFACES USING HIGH PRESSURE WATER; STEAM CLEANING MACHINES; POWER-DRIVEN CLEANING LANCES USING EXPLOSIVE MATERIALS; MACHINES FOR BLAST CLEANING A SURFACE; CLEANING DEVICES AND MACHINES, NAMELY, FLOOR CLEANING MACHINES, VACUUM CLEANERS, FLOOR WASHING MACHINES, ELECTRIC WASHING MACHINES, WAXING MACHINERY; FLOOR CLEANING MACHINES; VACUUM CLEANERS; FLOOR WASHING MACHINES; ELECTRIC WASHING MACHINES FOR HOUSEHOLD PURPOSES; HIGH PRESSURE PUMPS FOR WASHING APPLIANCES AND INSTALLATIONS; PRESSURE WASHING MACHINES; HOSES FOR VACUUM CLEANERS; ELECTRIC VACUUM CLEANERS AND THEIR COMPONENTS; DUST FILTERS AND BAGS FOR VACUUM CLEANERS; SUCTION NOZZLES FOR VACUUM CLEANERS; AUTOMATIC FLOOR SCRUBBERS; ROBOTIC VACUUM CLEANERS; FLOOR CLEANING ROBOTS WITH WIRELESS IP CAMERA FOR SECURITY MONITORING FUNCTION; ROBOT VACUUM CLEANERS WITH WIRELESS IP CAMERA FOR SECURITY MONITORING FUNCTION; MOTORS, EXCEPT FOR LAND VEHICLES, NAMELY, MOTORS FOR VACUUM CLEANERS, MOTORS FOR SMALL ELECTRIC HOUSEHOLD APPLIANCES; FILTERS AND PUMPS NOT INCLUDED IN OTHER CLASSES, NAMELY, VACUUM CLEANER FILTERS AND FILTERS FOR AIR-CLEANERS AND AIR PURIFIERS; ELECTRIC APPARATUS FOR DOMESTIC USE NOT INCLUDED IN OTHER CLASSES, NAMELY, VACUUM CLEANERS, ELECTRIC FLOOR POLISHERS, ELECTRIC CARPET SWEEPERS, ELECTRIC FOOD BLENDERS, IN CLASS 7 (U.S. CLS. 13, 19, 21, 23, 31, 34 AND 35).

FIRST USE 4-15-2012; IN COMMERCE 4-15-2012.

OWNER OF U.S. REG. NO. 3,804,276.

THE MARK CONSISTS OF A STYLIZED MARK OF "AGAMA".

THE ENGLISH TRANSLATION OF "AGAMA" IN THE MARK IS LIZARDS.

SN 85-118,207, FILED 8-29-2010.



David J. Kyjars

Director of the United States Patent and Trademark Office

Reg. No. 4,176,255 SUE LAWRENCE, EXAMINING ATTORNEY

United States of America

United States Patent and Trademark Office

SE_KU SKATEWEAR

Reg. No. 4,176,256

SE---KU SKATEWEAR, INC. (CALIFORNIA CORPORATION)
719 S. LOS ANGELES STREET, #1002
LOS ANGELES, CA 90014

Registered July 17, 2012

Int. Cl.: 28

FOR: ATHLETIC PROTECTIVE PADS FOR ICE SKATING AND PRACTICING ICE SKATING MANEUVERS ON LAND; ATHLETIC EQUIPMENT, NAMELY, PROTECTIVE ATHLETIC APPAREL IN THE NATURE OF PADDING, IN CLASS 28 (U.S. CLS. 22, 23, 38 AND 50).

TRADEMARK

FIRST USE 10-25-2010; IN COMMERCE 11-5-2010.

PRINCIPAL REGISTER

THE MARK CONSISTS OF STANDARD CHARACTERS WITHOUT CLAIM TO ANY PARTICULAR FONT, STYLE, SIZE, OR COLOR.

OWNER OF U.S. REG. NO. 2,920,719.

NO CLAIM IS MADE TO THE EXCLUSIVE RIGHT TO USE "SKATEWEAR", APART FROM THE MARK AS SHOWN.

SN 85-118,742, FILED 8-30-2010.

LINDA ESTRADA, EXAMINING ATTORNEY



David J. Kyffers

Director of the United States Patent and Trademark Office

United States of America

United States Patent and Trademark Office

FLATCLEAN

Reg. No. 4,176,257

GATES MECTROL, INC. (DELAWARE CORPORATION)
9 NORTHWESTERN DRIVE
SALEM, NH 03079

Registered July 17, 2012

Int. Cl.: 7

FOR: CONVEYOR BELTS COMPRISED OF POLYURETHANE AND HAVING TENSILE CORDS FOR USE IN MACHINES, IN CLASS 7 (U.S. CLS. 13, 19, 21, 23, 31, 34 AND 35).

TRADEMARK

FIRST USE 1-12-2011; IN COMMERCE 9-20-2011.

PRINCIPAL REGISTER

THE MARK CONSISTS OF STANDARD CHARACTERS WITHOUT CLAIM TO ANY PARTICULAR FONT, STYLE, SIZE, OR COLOR.

SN 85-118,767, FILED 8-30-2010.

KARANENDRA S. CHHINA, EXAMINING ATTORNEY



David J. Kybas

Director of the United States Patent and Trademark Office

United States of America

United States Patent and Trademark Office



THOSE BABY BASICS

Reg. No. 4,176,258

Registered July 17, 2012

Int. Cl.: 25

TRADEMARK

PRINCIPAL REGISTER

THOSE BABY BASICS, LLC (FLORIDA LIMITED LIABILITY COMPANY)
68 EGRET TRAIL
PALM COAST, FL 32164

FOR: BABY CLOTHING, NAMELY, TOPS, BOTTOMS, HATS, JUMPSUITS, VESTS, AND PAJAMAS, IN CLASS 25 (U.S. CLS. 22 AND 39).

FIRST USE 5-4-2012; IN COMMERCE 5-4-2012.

NO CLAIM IS MADE TO THE EXCLUSIVE RIGHT TO USE "BABY BASICS", APART FROM THE MARK AS SHOWN.

THE MARK CONSISTS OF THE ARTISTIC RENDERING OF A BABY'S OUTFIT WITH THE STYLIZED WORDS "THOSE BABY BASICS" APPEARING BELOW THE AFOREMENTIONED ARTISTIC RENDERING.

SN 85-119,350, FILED 8-31-2010.

ADA HAN, EXAMINING ATTORNEY



David J. Kyffers

Director of the United States Patent and Trademark Office

United States of America

United States Patent and Trademark Office

HANDS ON!

Reg. No. 4,176,259

HANDS ON! A MUSICAL EXPERIENCE, INC. (NEW YORK CORPORATION)
PO BOX 252

Registered July 17, 2012

NEW YORK, NY 10024

Int. Cls.: 35 and 41

FOR: FRANCHISING, NAMELY, OFFERING BUSINESS MANAGEMENT ASSISTANCE IN THE ESTABLISHMENT AND/OR OPERATION OF EDUCATIONAL SERVICES FOR CONDUCTING CLASSES IN MUSIC AND ART FOR INFANTS THROUGH 5 YEAR OLDS, IN CLASS 35 (U.S. CLS. 100, 101 AND 102).

SERVICE MARK

PRINCIPAL REGISTER

FIRST USE 11-30-2011; IN COMMERCE 3-1-2012.

FOR: CHILDREN'S EDUCATIONAL SERVICES, NAMELY, CONDUCTING CLASSES FOR INFANTS THROUGH 5 YEAR OLDS TO EXPOSE THEM TO APPRECIATION OF MUSIC AND ART, IN CLASS 41 (U.S. CLS. 100, 101 AND 107).

FIRST USE 10-20-1999; IN COMMERCE 10-20-1999.

THE MARK CONSISTS OF STANDARD CHARACTERS WITHOUT CLAIM TO ANY PARTICULAR FONT, STYLE, SIZE, OR COLOR.

OWNER OF U.S. REG. NO. 2,546,466.

SN 85-120,196, FILED 8-31-2010.

JEFF DEFORD, EXAMINING ATTORNEY



David J. Kypos

Director of the United States Patent and Trademark Office

United States of America

United States Patent and Trademark Office

ALADDIN & THE MAGIC QUEST

Reg. No. 4,176,260

Registered July 17, 2012

Int. Cl.: 9

TRADEMARK

PRINCIPAL REGISTER

WMS GAMING INC. (DELAWARE CORPORATION)
800 SOUTH NORTHPOINT BOULEVARD
WAUKEGAN, IL 60085

FOR: COMPONENTS FOR GAMING MACHINES THAT GENERATE OR DISPLAY WAGER OUTCOMES, NAMELY, CONTROLLERS, DISPLAYS, BUTTON PANELS, BOLSTERS, ELECTRICAL WIRING, AND COMPUTER HARDWARE AND SOFTWARE ASSOCIATED THEREWITH; GAMING MACHINES, NAMELY, DEVICES WHICH ACCEPT A WAGER; GAMING SOFTWARE THAT GENERATES OR DISPLAYS WAGER OUTCOMES OF GAMING MACHINES, IN CLASS 9 (U.S. CLS. 21, 23, 26, 36 AND 38).

FIRST USE 10-4-2011; IN COMMERCE 10-4-2011.

THE MARK CONSISTS OF STANDARD CHARACTERS WITHOUT CLAIM TO ANY PARTICULAR FONT, STYLE, SIZE, OR COLOR.

SN 85-120,803, FILED 9-1-2010.

LESLIE RICHARDS, EXAMINING ATTORNEY



David J. Kyffers

Director of the United States Patent and Trademark Office

United States of America

United States Patent and Trademark Office

THE BEST PUBLISHING EXPERIENCE

Reg. No. 4,176,261

VANTAGE PRESS, INC. (NEW YORK CORPORATION)
419 PARK AVENUE SOUTH
NEW YORK, NY 10016

Registered July 17, 2012

Int. Cl.: 41

FOR: BOOK PUBLISHING, IN CLASS 41 (U.S. CLS. 100, 101 AND 107).

SERVICE MARK

FIRST USE 8-16-2010; IN COMMERCE 8-16-2010.

PRINCIPAL REGISTER

THE MARK CONSISTS OF STANDARD CHARACTERS WITHOUT CLAIM TO ANY PARTICULAR FONT, STYLE, SIZE, OR COLOR.

NO CLAIM IS MADE TO THE EXCLUSIVE RIGHT TO USE "THE BEST PUBLISHING", APART FROM THE MARK AS SHOWN.

SN 85-121,012, FILED 9-1-2010.

MEGHAN REINHART, EXAMINING ATTORNEY



David J. Kybas

Director of the United States Patent and Trademark Office

United States of America

United States Patent and Trademark Office

MOROCCAN ELIXIR

Reg. No. 4,176,262

THE HERBAN ALCHEMIST, INC. (NEW YORK CORPORATION)
143 GRAND STREET
NEW YORK, NY 10013

Registered July 17, 2012

Int. Cl.: 3

FOR: ANTI-AGING MOISTURIZER; AROMATIC ESSENTIAL OILS; BODY AND BEAUTY CARE COSMETICS; BODY OILS; COSMETIC OILS; ESSENTIAL OILS; ESSENTIAL OILS FOR AROMATHERAPY USE; NON-MEDICATED SKIN CARE PREPARATIONS, NAMELY, CREAMS AND LOTIONS; OILS FOR COSMETIC PURPOSES, IN CLASS 3 (U.S. CLS. 1, 4, 6, 50, 51 AND 52).

TRADEMARK

PRINCIPAL REGISTER

FIRST USE 11-0-2010; IN COMMERCE 11-0-2010.

THE MARK CONSISTS OF STANDARD CHARACTERS WITHOUT CLAIM TO ANY PARTICULAR FONT, STYLE, SIZE, OR COLOR.

NO CLAIM IS MADE TO THE EXCLUSIVE RIGHT TO USE "MOROCCAN", APART FROM THE MARK AS SHOWN.

SN 85-121,057, FILED 9-1-2010.

ELIZABETH KAJUBI, EXAMINING ATTORNEY



David J. Kyfos

Director of the United States Patent and Trademark Office

United States of America

United States Patent and Trademark Office

KROME PHOTOS

Reg. No. 4,176,263

Registered July 17, 2012

Int. Cl.: 40

SERVICE MARK

PRINCIPAL REGISTER

KROME PHOTOS, INC. (CALIFORNIA CORPORATION)
36 CHURCHILL AVENUE
PALO ALTO, CA 94306

FOR: PHOTOGRAPHIC IMAGE PROCESSING; ALTERATION AND RETOUCHING OF PHOTOGRAPHIC IMAGES VIA A GLOBAL COMPUTER NETWORK, IN CLASS 40 (U.S. CLS. 100, 103 AND 106).

FIRST USE 6-1-2010; IN COMMERCE 8-17-2010.

THE MARK CONSISTS OF STANDARD CHARACTERS WITHOUT CLAIM TO ANY PARTICULAR FONT, STYLE, SIZE, OR COLOR.

NO CLAIM IS MADE TO THE EXCLUSIVE RIGHT TO USE "PHOTOS", APART FROM THE MARK AS SHOWN.

SN 85-121,196, FILED 9-1-2010.

JESSICA A. POWERS, EXAMINING ATTORNEY



David J. Kyffers

Director of the United States Patent and Trademark Office

United States of America

United States Patent and Trademark Office

KROME

Reg. No. 4,176,264

Registered July 17, 2012

Int. Cl.: 40

SERVICE MARK

PRINCIPAL REGISTER

KROME PHOTOS, INC. (CALIFORNIA CORPORATION)
36 CHURCHILL AVENUE
PALO ALTO, CA 94306

FOR: PHOTOGRAPHIC IMAGE PROCESSING; ALTERATION AND RETOUCHING OF PHOTOGRAPHIC IMAGES VIA A GLOBAL COMPUTER NETWORK, IN CLASS 40 (U.S. CLS. 100, 103 AND 106).

FIRST USE 6-1-2010; IN COMMERCE 8-17-2010.

THE MARK CONSISTS OF STANDARD CHARACTERS WITHOUT CLAIM TO ANY PARTICULAR FONT, STYLE, SIZE, OR COLOR.

SN 85-121,206, FILED 9-1-2010.

JESSICA A. POWERS, EXAMINING ATTORNEY



David J. Kyffers

Director of the United States Patent and Trademark Office

United States of America

United States Patent and Trademark Office

Sonic-Pro

Reg. No. 4,176,265

SAGE MANUFACTURING CORPORATION (WASHINGTON CORPORATION)
8500 NORTHEAST DAY ROAD
BAINBRIDGE ISLAND, WA 98110

Registered July 17, 2012

Int. Cl.: 25

FOR: FISHING WADERS; FISHERMEN'S JACKETS; MEN'S AND WOMEN'S JACKETS, IN CLASS 25 (U.S. CLS. 22 AND 39).

TRADEMARK

FIRST USE 2-1-2011; IN COMMERCE 2-1-2011.

PRINCIPAL REGISTER

THE MARK CONSISTS OF STANDARD CHARACTERS WITHOUT CLAIM TO ANY PARTICULAR FONT, STYLE, SIZE, OR COLOR.

SN 85-122,128, FILED 9-2-2010.

JAMES GRIFFIN, EXAMINING ATTORNEY



David J. Kyffers

Director of the United States Patent and Trademark Office

United States of America

United States Patent and Trademark Office

EPOH

Reg. No. 4,176,266

Registered July 17, 2012

Int. Cl.: 9

TRADEMARK

PRINCIPAL REGISTER

LIGHT GIVES HEAT, INC. (COLORADO CORPORATION)
2507 WESLO AVENUE
GRAND JUNCTION, CO 81505

FOR: LAPTOP CARRYING CASES, IN CLASS 9 (U.S. CLS. 21, 23, 26, 36 AND 38).

FIRST USE 10-1-2011; IN COMMERCE 10-1-2011.

THE MARK CONSISTS OF STANDARD CHARACTERS WITHOUT CLAIM TO ANY PARTICULAR FONT, STYLE, SIZE, OR COLOR.

SN 85-123,239, FILED 9-3-2010.

CURTIS FRENCH, EXAMINING ATTORNEY



David J. Kyffers

Director of the United States Patent and Trademark Office

United States of America

United States Patent and Trademark Office

SAINTS & SINNERS

Reg. No. 4,176,267

WINGS OF STEEL PRODUCTIONS, INC. (CALIFORNIA CORPORATION)
P.O. BOX 565

Registered July 17, 2012

NORTH HOLLYWOOD, CA 91603

Int. Cl.: 9

FOR: LEATHER CASES DESIGNED SPECIFICALLY FOR SMART PHONES; AND LEATHER CASES DESIGNED SPECIFICALLY FOR TABLET COMPUTERS, IN CLASS 9 (U.S. CLS. 21, 23, 26, 36 AND 38).

TRADEMARK

FIRST USE 1-1-2005; IN COMMERCE 1-1-2005.

PRINCIPAL REGISTER

THE MARK CONSISTS OF STANDARD CHARACTERS WITHOUT CLAIM TO ANY PARTICULAR FONT, STYLE, SIZE, OR COLOR.

SN 85-123,465, FILED 9-5-2010.

CURTIS FRENCH, EXAMINING ATTORNEY



David J. Kyffers

Director of the United States Patent and Trademark Office

United States of America

United States Patent and Trademark Office

BRING OUT THE HEALTH WITHIN

Reg. No. 4,176,268

BOIRON (FRANCE SOCIÉTÉ ANONYME (SA))
20 ROUTE DE LA LIBERATION
SAINTE FOY LES LYON, FRANCE 69110

Registered July 17, 2012

Int. Cl.: 5

FOR: FULL LINE OF HOMEOPATHIC PHARMACEUTICALS FOR HUMAN USE, IN CLASS 5 (U.S. CLS. 6, 18, 44, 46, 51 AND 52).

TRADEMARK

FIRST USE 9-0-2010; IN COMMERCE 9-0-2010.

PRINCIPAL REGISTER

THE MARK CONSISTS OF STANDARD CHARACTERS WITHOUT CLAIM TO ANY PARTICULAR FONT, STYLE, SIZE, OR COLOR.

SN 85-123,699, FILED 9-7-2010.

GINA FINK, EXAMINING ATTORNEY



David J. Kybas

Director of the United States Patent and Trademark Office

United States of America

United States Patent and Trademark Office



Reg. No. 4,176,269

TMTD, LLC (DELAWARE LIMITED LIABILITY COMPANY)
6300 CARMEL RD, SUITE 110
CHARLOTTE, NC 28226

Registered July 17, 2012

Int. Cl.: 43

FOR: BAR AND RESTAURANT SERVICES, IN CLASS 43 (U.S. CLS. 100 AND 101).

SERVICE MARK

FIRST USE 7-31-2010; IN COMMERCE 7-31-2010.

PRINCIPAL REGISTER

NO CLAIM IS MADE TO THE EXCLUSIVE RIGHT TO USE "CLUB", APART FROM THE MARK AS SHOWN.

THE COLOR(S) WHITE, ORANGE, RED, YELLOW AND BLUE IS/ARE CLAIMED AS A FEATURE OF THE MARK.

THE MARK CONSISTS OF THE WORDS "THE GOOD LIFE CLUB" IN STYLIZED FONT WITH THE WORD "THE" APPEARING IN YELLOW ABOVE THE WORD "GOOD" APPEARING IN RED, BOTH OF WHICH APPEAR TO THE LEFT OF THE WORD "LIFE" WITH THE LETTER "L" APPEARING IN ORANGE, THE LETTER "I" APPEARING IN RED, THE LETTER "F" APPEARING IN YELLOW AND THE LETTER "E" APPEARING IN BLUE, AND THE WORD "CLUB" APPEARING IN WHITE ABOVE THE BACKGROUND OF A BLUE RECTANGLE APPEARING UNDER THE WORD "LIFE".

SN 85-124,385, FILED 9-7-2010.

JUSTINE D. PARKER, EXAMINING ATTORNEY



David J. Kyros

Director of the United States Patent and Trademark Office

United States of America

United States Patent and Trademark Office

SKYCERA

Reg. No. 4,176,270

Registered July 17, 2012

Int. Cl.: 20

TRADEMARK

PRINCIPAL REGISTER

SHENGKAI INNOVATIONS, INC. (FLORIDA CORPORATION)
NO. 106 ZHONGHUAN SOUTH ROAD
AIRPORT INDUSTRIAL PARK
TIANJIN, CHINA 300308

FOR: MANUALLY OPERATED CERAMIC VALVES FOR INDUSTRIAL APPLICATIONS, OTHER THAN PARTS OF MACHINES; SPARE PARTS FOR MANUALLY OPERATED CERAMIC VALVES FOR INDUSTRIAL APPLICATIONS, OTHER THAN PARTS OF MACHINES, IN CLASS 20 (U.S. CLS. 2, 13, 22, 25, 32 AND 50).

FIRST USE 4-30-2012; IN COMMERCE 4-30-2012.

THE MARK CONSISTS OF STANDARD CHARACTERS WITHOUT CLAIM TO ANY PARTICULAR FONT, STYLE, SIZE, OR COLOR.

SN 85-124,898, FILED 9-8-2010.

LEIGH CAROLINE CASE, EXAMINING ATTORNEY



David J. Kyffers

Director of the United States Patent and Trademark Office

United States of America

United States Patent and Trademark Office

MATTRESS INNOVATIONS

Reg. No. 4,176,271

Registered July 17, 2012

Int. Cl.: 35

SERVICE MARK

PRINCIPAL REGISTER

LASELLE FURNITURE L.L.C. (OHIO LIMITED LIABILITY COMPANY), DBA MATTRESS INNOVATIONS,
2935 MIAMISBURG CENTERVILLE RD
MIAMISBURG, OH 45342

FOR: RETAIL STORE SERVICES FEATURING MATTRESSES AND BEDDING ACCESSORIES INCLUDING BEDDING, BASES, FRAMES, FUTONS, PILLOWS, MATTRESS PROTECTORS AND SHEETS; ON-LINE STORE SERVICES FEATURING MATTRESSES AND BEDDING ACCESSORIES INCLUDING BEDDING, BASES, FRAMES, FUTONS, PILLOWS, MATTRESS PROTECTORS AND SHEETS, IN CLASS 35 (U.S. CLS. 100, 101 AND 102).

FIRST USE 1-0-2010; IN COMMERCE 1-0-2010.

THE MARK CONSISTS OF STANDARD CHARACTERS WITHOUT CLAIM TO ANY PARTICULAR FONT, STYLE, SIZE, OR COLOR.

OWNER OF U.S. REG. NO. 2,907,010.

NO CLAIM IS MADE TO THE EXCLUSIVE RIGHT TO USE "MATTRESS" , APART FROM THE MARK AS SHOWN.

SN 85-125,307, FILED 9-8-2010.

WENDY GOODMAN, EXAMINING ATTORNEY



David J. Kybas

Director of the United States Patent and Trademark Office

United States of America

United States Patent and Trademark Office

QUALITY. POWER. SOUND.

Reg. No. 4,176,272

CAR SOUND EXHAUST SYSTEM, INC. (CALIFORNIA CORPORATION)
22961 ARROYO VISTA

Registered July 17, 2012

RANCHO SANTA MARGARITA, CA 92688

Int. Cl.: 7

FOR: CATALYTIC CONVERTERS, MUFFLERS, EXHAUST PIPES, EXHAUST SYSTEMS COMPRISED OF A COMBINATION OF MUFFLERS, CATALYTIC CONVERTERS, EXHAUST AND MUFFLER TIPS, HANGERS AND TUBING, AND EXHAUST AND MUFFLER TIPS, ALL OF THE FOREGOING FOR MOTORS AND ENGINES, IN CLASS 7 (U.S. CLS. 13, 19, 21, 23, 31, 34 AND 35).

TRADEMARK

PRINCIPAL REGISTER

FIRST USE 8-1-2008; IN COMMERCE 8-1-2008.

THE MARK CONSISTS OF STANDARD CHARACTERS WITHOUT CLAIM TO ANY PARTICULAR FONT, STYLE, SIZE, OR COLOR.

SN 85-127,182, FILED 9-10-2010.

KARANENDRA S. CHHINA, EXAMINING ATTORNEY



David J. Kyros

Director of the United States Patent and Trademark Office

United States of America

United States Patent and Trademark Office

BLOOM.COM

Reg. No. 4,176,273

Registered July 17, 2012

Int. Cl.: 42

SERVICE MARK

PRINCIPAL REGISTER

XUBA, LLC (DELAWARE LIMITED LIABILITY COMPANY)
SUITE 230
9394 WEST DODGE ROAD
OMAHA, NE 68114

FOR: COMPUTER SERVICES, NAMELY, CREATING AN ON-LINE COMMUNITY FOR REGISTERED USERS TO PARTICIPATE IN DISCUSSIONS, GET FEEDBACK FROM THEIR PEERS, FORM VIRTUAL COMMUNITIES, AND ENGAGE IN SOCIAL NETWORKING IN THE FIELDS OF HEALTH AND BEAUTY PRODUCTS, IN CLASS 42 (U.S. CLS. 100 AND 101).

FIRST USE 4-1-2010; IN COMMERCE 4-1-2010.

THE MARK CONSISTS OF STANDARD CHARACTERS WITHOUT CLAIM TO ANY PARTICULAR FONT, STYLE, SIZE, OR COLOR.

SN 85-127,268, FILED 9-10-2010.

JENNIFER MARTIN, EXAMINING ATTORNEY



David J. Kyffers

Director of the United States Patent and Trademark Office

United States of America

United States Patent and Trademark Office

NATURAL INSPIRATIONS

Reg. No. 4,176,274

FRAGRANCE MARKETING GROUP, LLC (MINNESOTA LIMITED LIABILITY COMPANY)
17683 BALLANTRAE CIRCLE
EDEN PRAIRIE, MN 55347

Registered July 17, 2012

Int. Cl.: 3

FOR: BATH AND BODY CARE PRODUCTS, NAMELY, BODY LOTION, BODY BUTTER, SHOWER GEL, SOAP, LIP BALM; HAIR CARE PREPARATIONS; SHAMPOO; NON-MEDICATED SKIN CARE PREPARATIONS; NON-MEDICATED COSMETIC TOWELETTES, IN CLASS 3 (U.S. CLS. 1, 4, 6, 50, 51 AND 52).

TRADEMARK

PRINCIPAL REGISTER

FIRST USE 3-31-2011; IN COMMERCE 3-31-2011.

THE MARK CONSISTS OF STANDARD CHARACTERS WITHOUT CLAIM TO ANY PARTICULAR FONT, STYLE, SIZE, OR COLOR.

NO CLAIM IS MADE TO THE EXCLUSIVE RIGHT TO USE "NATURAL", APART FROM THE MARK AS SHOWN.

SN 85-127,281, FILED 9-10-2010.

JILL PRATER, EXAMINING ATTORNEY



David J. Kybas

Director of the United States Patent and Trademark Office

United States of America

United States Patent and Trademark Office

KING KOIL...QUALITY BEGINS ON THE INSIDE

Reg. No. 4,176,275

KING KOIL LICENSING COMPANY, INC. (DELAWARE CORPORATION)
7501 S. QUINCY STREET, SUITE 130
WILLOWBROOK, IL 605275574

Registered July 17, 2012

Int. Cl.: 20

FOR: BEDS; BOX SPRINGS; MATTRESSES, IN CLASS 20 (U.S. CLS. 2, 13, 22, 25, 32 AND 50).

TRADEMARK

FIRST USE 10-31-2010; IN COMMERCE 10-31-2010.

PRINCIPAL REGISTER

THE MARK CONSISTS OF STANDARD CHARACTERS WITHOUT CLAIM TO ANY PARTICULAR FONT, STYLE, SIZE, OR COLOR.

SN 85-127,842, FILED 9-13-2010.

PAM WILLIS, EXAMINING ATTORNEY



David J. Kyffers

Director of the United States Patent and Trademark Office

United States of America

United States Patent and Trademark Office

SURE CONNECT

Reg. No. 4,176,276

SECURITY FORCE, INC. (DELAWARE CORPORATION)
3631 BASTION DRIVE
RALEIGH, NC 27604

Registered July 17, 2012

Int. Cl.: 37

FOR: INSTALLATION AND MAINTENANCE OF BURGLAR AND/OR FIRE ALARMS; INSTALLATION, MAINTENANCE AND REPAIR OF SECURITY AND FIRE DETECTORS AND ALARMS FOR RESIDENTIAL AND COMMERCIAL PROPERTIES, IN CLASS 37 (U.S. CLS. 100, 103 AND 106).

SERVICE MARK

PRINCIPAL REGISTER

FIRST USE 10-1-2010; IN COMMERCE 10-1-2010.

THE MARK CONSISTS OF STANDARD CHARACTERS WITHOUT CLAIM TO ANY PARTICULAR FONT, STYLE, SIZE, OR COLOR.

SN 85-128,145, FILED 9-13-2010.

SAIMA MAKHDOOM, EXAMINING ATTORNEY



David J. Kyffers

Director of the United States Patent and Trademark Office

United States of America

United States Patent and Trademark Office

ECOFINING

Reg. No. 4,176,277

Registered July 17, 2012

Int. Cls.: 40 and 42

SERVICE MARK

PRINCIPAL REGISTER

UOP LLC (DELAWARE LIMITED LIABILITY COMPANY)
25 EAST ALGONQUIN ROAD
DES PLAINS, IL 60017

FOR: CONSULTING SERVICES IN THE FIELD OF FUEL REFINING, IN CLASS 40 (U.S. CLS. 100, 103 AND 106).

FIRST USE 5-1-2012; IN COMMERCE 5-1-2012.

FOR: ENGINEERING SERVICES IN THE FIELD OF FUEL REFINING, IN CLASS 42 (U.S. CLS. 100 AND 101).

FIRST USE 5-1-2012; IN COMMERCE 5-1-2012.

THE MARK CONSISTS OF STANDARD CHARACTERS WITHOUT CLAIM TO ANY PARTICULAR FONT, STYLE, SIZE, OR COLOR.

SN 85-128,272, FILED 9-13-2010.

JASON TURNER, EXAMINING ATTORNEY



David J. Kybas

Director of the United States Patent and Trademark Office

United States of America
United States Patent and Trademark Office

DIALOG

Reg. No. 4,176,278

Registered July 17, 2012

Int. Cl.: 42

SERVICE MARK

PRINCIPAL REGISTER

DIALOG (CANADA PARTNERSHIP)
300, 134 11TH AVENUE SE
CALGARY, ALBERTA, CANADA T2G0X5

FOR: ARCHITECTURAL SERVICES; ENGINEERING SERVICES, NAMELY, STRUCTURAL, MECHANICAL AND ELECTRICAL ENGINEERING SERVICES; URBAN PLANNING SERVICES; INTERIOR DESIGN SERVICES; AND LANDSCAPE ARCHITECTURAL DESIGN SERVICES, IN CLASS 42 (U.S. CLS. 100 AND 101).

FIRST USE 6-1-2011; IN COMMERCE 9-15-2011.

THE MARK CONSISTS OF THE WORD "DIALOG" IN STYLIZED CAPITAL LETTERS.

SN 85-128,593, FILED 9-13-2010.

CURTIS FRENCH, EXAMINING ATTORNEY



David J. Kyffers

Director of the United States Patent and Trademark Office

United States of America
United States Patent and Trademark Office

FORTIVA

Reg. No. 4,176,279

Registered July 17, 2012

Int. Cl.: 36

SERVICE MARK

PRINCIPAL REGISTER

COMPUCREDIT INTELLECTUAL PROPERTY HOLDINGS CORP. II (NEVADA CORPORATION)
SUITE 850-15C
101 CONVENTION CENTER DRIVE
LAS VEGAS, NV 89109

FOR: FINANCIAL SERVICES, NAMELY, LENDING, SHORT TERM LOANS, LONG TERM LOANS AND REVOLVING LOANS , IN CLASS 36 (U.S. CLS. 100, 101 AND 102).

FIRST USE 10-13-2010; IN COMMERCE 10-13-2010.

THE MARK CONSISTS OF STANDARD CHARACTERS WITHOUT CLAIM TO ANY PARTICULAR FONT, STYLE, SIZE, OR COLOR.

SN 85-129,231, FILED 9-14-2010.

LIEF MARTIN, EXAMINING ATTORNEY



David J. Kyffers

Director of the United States Patent and Trademark Office

United States of America

United States Patent and Trademark Office

IKAATI

Reg. No. 4,176,280

RENEU CONCEPTS CORPORATION (MINNESOTA CORPORATION)
2300 KENNEDY STREET NE, SUITE 250
MINNEAPOLIS, MN 55413

Registered July 17, 2012

Int. Cls.: 5 and 30

FOR: HERBAL TEAS FOR MEDICINAL PURPOSES, IN CLASS 5 (U.S. CLS. 6, 18, 44, 46, 51 AND 52).

TRADEMARK

FIRST USE 5-25-2011; IN COMMERCE 5-25-2011.

PRINCIPAL REGISTER

FOR: TEA; TEA BAGS; HERBAL TEA, IN CLASS 30 (U.S. CL. 46).

FIRST USE 5-25-2011; IN COMMERCE 5-25-2011.

THE MARK CONSISTS OF STANDARD CHARACTERS WITHOUT CLAIM TO ANY PARTICULAR FONT, STYLE, SIZE, OR COLOR.

THE WORDING "IKAATI" HAS NO MEANING IN A FOREIGN LANGUAGE.

SN 85-129,233, FILED 9-14-2010.

PRISCILLA MILTON, EXAMINING ATTORNEY



David J. Kyffers

Director of the United States Patent and Trademark Office

United States of America

United States Patent and Trademark Office

MESA RIDGE

Reg. No. 4,176,281

OPEN RANGE RV COMPANY, INC. (INDIANA CORPORATION)
3195 N. S.R. 5

Registered July 17, 2012

SHIPSHEWANA, IN 46565

Int. Cl.: 12

FOR: RECREATIONAL VEHICLES, NAMELY, TRAVEL TRAILERS AND FIFTH-WHEEL TRAVEL TRAILERS, IN CLASS 12 (U.S. CLS. 19, 21, 23, 31, 35 AND 44).

TRADEMARK

FIRST USE 7-1-2010; IN COMMERCE 7-15-2010.

PRINCIPAL REGISTER

THE MARK CONSISTS OF STANDARD CHARACTERS WITHOUT CLAIM TO ANY PARTICULAR FONT, STYLE, SIZE, OR COLOR.

SN 85-129,788, FILED 9-15-2010.

EUGENIA MARTIN, EXAMINING ATTORNEY



David J. Kyffers

Director of the United States Patent and Trademark Office

United States of America

United States Patent and Trademark Office

XactPay Xpress

Reg. No. 4,176,282

HARTFORD FIRE INSURANCE COMPANY (CONNECTICUT CORPORATION)
ONE HARTFORD PLAZA
HARTFORD, CT 06155

Registered July 17, 2012

Int. Cl.: 36

FOR: WORKERS' COMPENSATION SERVICES, NAMELY, ELECTRONIC PROCESSING AND TRANSMISSION OF WORKERS' COMPENSATION PREMIUMS FOR CUSTOMERS WHO ENTER THEIR PAYROLL ONLINE TO CALCULATE AND COLLECT WORKERS' COMPENSATION PREMIUMS, IN CLASS 36 (U.S. CLS. 100, 101 AND 102).

SERVICE MARK

PRINCIPAL REGISTER

FIRST USE 12-31-2010; IN COMMERCE 12-31-2010.

THE MARK CONSISTS OF STANDARD CHARACTERS WITHOUT CLAIM TO ANY PARTICULAR FONT, STYLE, SIZE, OR COLOR.

OWNER OF U.S. REG. NOS. 3,133,851, 3,467,749, AND 3,467,750.

SN 85-129,791, FILED 9-15-2010.

HOWARD B. LEVINE, EXAMINING ATTORNEY



David J. Kyffers

Director of the United States Patent and Trademark Office

United States of America

United States Patent and Trademark Office

DO NORTH

Reg. No. 4,176,283

Registered July 17, 2012

Int. Cl.: 41

SERVICE MARK

PRINCIPAL REGISTER

CHICAGO HORTICULTURAL SOCIETY (ILLINOIS NON-PROFIT CORPORATION)
1000 LAKE COOK ROAD
GLENCOE, IL 60022

FOR: ENTERTAINMENT SERVICES, NAMELY, ORGANIZING AND CONDUCTING CULTURAL ACTIVITIES, SPECIFICALLY BOTANIC GARDENS, FLOWER EXHIBITIONS, BIRDING, MUSEUMS, EDUCATIONAL EXHIBITS AND DISPLAYS FOR CHILDREN PROMOTING EFFECTIVE LEARNING AND SELF-DIRECTED LEARNING IN THE FIELDS OF GARDENING, CONSERVATION, MUSIC AND THEATER, MUSICAL FESTIVALS AND LIVE MUSIC PERFORMANCES, THEATRICAL PLAYS AND PERFORMANCES, IN CLASS 41 (U.S. CLS. 100, 101 AND 107).

FIRST USE 3-10-2011; IN COMMERCE 3-10-2011.

THE MARK CONSISTS OF STANDARD CHARACTERS WITHOUT CLAIM TO ANY PARTICULAR FONT, STYLE, SIZE, OR COLOR.

SN 85-130,157, FILED 9-15-2010.

EUGENIA MARTIN, EXAMINING ATTORNEY



David J. Kyffers

Director of the United States Patent and Trademark Office

United States of America

United States Patent and Trademark Office



Reg. No. 4,176,284

Registered July 17, 2012

Int. Cl.: 41

SERVICE MARK

PRINCIPAL REGISTER

CHICAGO HORTICULTURAL SOCIETY (ILLINOIS NON-PROFIT CORPORATION)
1000 LAKE COOK ROAD
GLENCOE, IL 60022

FOR: ENTERTAINMENT SERVICES, NAMELY, ORGANIZING AND CONDUCTING CULTURAL ACTIVITIES, SPECIFICALLY BOTANIC GARDENS, FLOWER EXHIBITIONS, BIRDING, MUSEUMS, EDUCATIONAL EXHIBITS AND DISPLAYS FOR CHILDREN PROMOTING EFFECTIVE LEARNING AND SELF-DIRECTED LEARNING IN THE FIELDS OF GARDENING, CONSERVATION, MUSIC AND THEATER, MUSICAL FESTIVALS AND LIVE MUSIC PERFORMANCES, THEATRICAL PLAYS AND PERFORMANCES, IN CLASS 41 (U.S. CLS. 100, 101 AND 107).

FIRST USE 3-10-2011; IN COMMERCE 3-10-2011.

THE MARK CONSISTS OF THE TERM "DO" POSITIONED HORIZONTALLY ALONGSIDE THE TERM "NORTH" POSITIONED VERTICALLY WITHIN A RECTANGULAR FIGURE.

SN 85-130,173, FILED 9-15-2010.

EUGENIA MARTIN, EXAMINING ATTORNEY



David J. Kyffers

Director of the United States Patent and Trademark Office

United States of America

United States Patent and Trademark Office



Reg. No. 4,176,285

BRINKS INVESTIGATION-RESTORATION SERVICES, INC. (CALIFORNIA CORPORATION)
7976 ENGINEER ROAD STE 100
SAN DIEGO, CA 92111

Registered July 17, 2012

Int. Cl.: 11

FOR: FILTERING UNITS FOR WATER; WATER FILTERING APPARATUS; WATER FILTERS,
IN CLASS 11 (U.S. CLS. 13, 21, 23, 31 AND 34).

TRADEMARK

FIRST USE 2-0-2012; IN COMMERCE 2-0-2012.

PRINCIPAL REGISTER

NO CLAIM IS MADE TO THE EXCLUSIVE RIGHT TO USE "CLEAN PUREWATER", APART
FROM THE MARK AS SHOWN.

THE COLOR(S) LIGHT BLUE, DARK BLUE, WHITE AND PURPLE IS/ARE CLAIMED AS
A FEATURE OF THE MARK.

THE MARK CONSISTS OF THE WORDING "CLEAN PUREWATER" WHERE "CLEAN"
APPEARS IN WHITE INSIDE A RECTANGLE APPEARING IN THE COLOR DARK BLUE.
THE WORDING "PURE" APPEARS IN THE COLOR LIGHT BLUE AND THE WORD "WATER"
APPEARS IN THE COLOR DARK BLUE. THE DESIGN OF THREE WAVES APPEAR BELOW
THE WORDING, FROM LEFT TO RIGHT, IN THE COLORS OF DARK BLUE, PURPLE AND
LIGHT BLUE.

SN 85-130,687, FILED 9-15-2010.

CHARISMA HAMPTON, EXAMINING ATTORNEY



David J. Kybas

Director of the United States Patent and Trademark Office

United States of America

United States Patent and Trademark Office



Reg. No. 4,176,286

Registered July 17, 2012

Int. Cl.: 5

TRADEMARK

PRINCIPAL REGISTER

JOHNSON & JOHNSON (NEW JERSEY CORPORATION)
ONE JOHNSON & JOHNSON PLAZA
NEW BRUNSWICK, NJ 089337001

FOR: SANITARY PROTECTION PRODUCTS, NAMELY, PANTILINERS, IN CLASS 5 (U.S. CLS. 6, 18, 44, 46, 51 AND 52).

FIRST USE 4-4-2011; IN COMMERCE 4-4-2011.

THE MARK CONSISTS OF AN IMAGE OF PINK AND WHITE FLOWER.

THE COLOR(S) PINK AND WHITE IS/ARE CLAIMED AS A FEATURE OF THE MARK.

SN 85-131,073, FILED 9-16-2010.

SUZANNE BLANE, EXAMINING ATTORNEY



David J. Kyffers

Director of the United States Patent and Trademark Office

United States of America

United States Patent and Trademark Office

CLIQ CABINetry

Reg. No. 4,176,287

Registered July 17, 2012

Int. Cl.: 20

TRADEMARK

PRINCIPAL REGISTER

CLIQSTUDIOS.COM, LLC (DELAWARE LIMITED LIABILITY COMPANY)
455 FERNDALe ROAD NORTH
WAYZATA, MN 55391

FOR: CABINETS, NAMELY, KITCHEN CABINETS, PANTRY CABINETS, BATHROOM CABINETS, BEDROOM CABINETS, FAMILY ROOM CABINETS; NON-METAL CABINET DOOR CATCHES; NON-METAL CABINET STOPS; CABINET DRAWERS FOR FURNITURE CABINETS; CABINET DOORS FOR FURNITURE CABINETS; BATHROOM VANITIES; DRAWER ORGANIZERS FOR BATHROOMS AND KITCHENS, IN CLASS 20 (U.S. CLS. 2, 13, 22, 25, 32 AND 50).

FIRST USE 10-14-2010; IN COMMERCE 10-14-2010.

THE MARK CONSISTS OF STANDARD CHARACTERS WITHOUT CLAIM TO ANY PARTICULAR FONT, STYLE, SIZE, OR COLOR.

NO CLAIM IS MADE TO THE EXCLUSIVE RIGHT TO USE "CABINetry", APART FROM THE MARK AS SHOWN.

SN 85-131,239, FILED 9-16-2010.

DOMINIC FATHY, EXAMINING ATTORNEY



David J. Kyros

Director of the United States Patent and Trademark Office

United States of America

United States Patent and Trademark Office

HC FLEX

Reg. No. 4,176,288

Registered July 17, 2012

Int. Cl.: 16

TRADEMARK

PRINCIPAL REGISTER

PREGIS INNOVATIVE PACKAGING, INC. (DELAWARE CORPORATION)
SUITE 400
1650 LAKE COOK ROAD
DEERFIELD, IL 600154747

FOR: PLASTIC PROTECTIVE PACKAGING, NAMELY, PLASTIC AIR CUSHIONS FOR WRAPPING, PACKAGING OR VOID-FILL, IN CLASS 16 (U.S. CLS. 2, 5, 22, 23, 29, 37, 38 AND 50).

FIRST USE 5-0-2011; IN COMMERCE 5-0-2011.

THE MARK CONSISTS OF STANDARD CHARACTERS WITHOUT CLAIM TO ANY PARTICULAR FONT, STYLE, SIZE, OR COLOR.

SN 85-131,339, FILED 9-16-2010.

NAPOLEON SHARMA, EXAMINING ATTORNEY



David J. Kypos

Director of the United States Patent and Trademark Office

United States of America

United States Patent and Trademark Office

LETTER LABYRINTH

Reg. No. 4,176,289

NAMCO BANDAI GAMES INC. (JAPAN CORPORATION)
4-5-15 HIGASHI SHINAGAWA

Registered July 17, 2012

SHINAGAWA-KU TOKYO, JAPAN 140-8590

Int. Cl.: 9

FOR: COMPUTER GAME PROGRAMS; COMPUTER GAME SOFTWARE; DOWNLOADABLE
COMPUTER GAME PROGRAMS; DOWNLOADABLE COMPUTER GAME SOFTWARE VIA
A GLOBAL COMPUTER NETWORK AND WIRELESS DEVICES; VIDEO GAME SOFTWARE,
IN CLASS 9 (U.S. CLS. 21, 23, 26, 36 AND 38).

TRADEMARK

PRINCIPAL REGISTER

FIRST USE 11-10-2010; IN COMMERCE 11-10-2010.

THE MARK CONSISTS OF STANDARD CHARACTERS WITHOUT CLAIM TO ANY PAR-
TICULAR FONT, STYLE, SIZE, OR COLOR.

SN 85-133,121, FILED 9-20-2010.

PATRICIA EVANKO, EXAMINING ATTORNEY



David J. Kybas

Director of the United States Patent and Trademark Office

United States of America

United States Patent and Trademark Office

LETTER LABYRINTH

Reg. No. 4,176,290

NAMCO BANDAI GAMES INC. (JAPAN CORPORATION)
4-5-15 HIGASHI SHINAGAWA

Registered July 17, 2012

SHINAGAWA-KU TOKYO, JAPAN 140-8590

Int. Cl.: 41

FOR: ENTERTAINMENT SERVICES, NAMELY, PROVIDING ON-LINE COMPUTER GAMES,
IN CLASS 41 (U.S. CLS. 100, 101 AND 107).

SERVICE MARK

FIRST USE 11-10-2010; IN COMMERCE 11-10-2010.

PRINCIPAL REGISTER

THE MARK CONSISTS OF STANDARD CHARACTERS WITHOUT CLAIM TO ANY PAR-
TICULAR FONT, STYLE, SIZE, OR COLOR.

SN 85-133,122, FILED 9-20-2010.

PATRICIA EVANKO, EXAMINING ATTORNEY



David J. Kybas

Director of the United States Patent and Trademark Office

United States of America

United States Patent and Trademark Office

REFLECTIONS Brighter Ideas in Silver

Reg. No. 4,176,291

HALLMARK SWEET, INC. (RHODE ISLAND CORPORATION)
49 PEARL STREET

Registered July 17, 2012

ATTLEBORO, MA 02703

Int. Cl.: 14

FOR: BEADS FOR USE IN THE MANUFACTURE OF SILVER JEWELRY; SILVER INGOTS OF PRECIOUS METAL; SILVER JEWELRY CHAIN OF PRECIOUS METAL FOR BRACELETS; SILVER JEWELRY; SILVER JEWELRY CHAINS; SILVER JEWELRY FINDINGS; METAL WIRE FOR USE IN THE MAKING OF JEWELRY, NAMELY, SILVER JEWELRY CABLE; PRECIOUS METAL ALLOYS OF SILVER; PRECIOUS SILVER METALS; PROCESSED OR SEMI-PROCESSED PRECIOUS SILVER METALS; SILVER SHEET METAL OF PRECIOUS METAL; SHEETS OF PRECIOUS SILVER METAL, IN CLASS 14 (U.S. CLS. 2, 27, 28 AND 50).

TRADEMARK

PRINCIPAL REGISTER

FIRST USE 11-0-2011; IN COMMERCE 1-0-2012.

THE MARK CONSISTS OF STANDARD CHARACTERS WITHOUT CLAIM TO ANY PARTICULAR FONT, STYLE, SIZE, OR COLOR.

SN 85-134,334, FILED 9-21-2010.

ALEXANDER L. POWERS, EXAMINING ATTORNEY



David J. Kyros

Director of the United States Patent and Trademark Office

United States of America

United States Patent and Trademark Office



Reg. No. 4,176,292

Registered July 17, 2012

Int. Cl.: 25

TRADEMARK

PRINCIPAL REGISTER

HURBERT DEAN (UNITED STATES INDIVIDUAL)
17192 MURPHY AVE. #16755
IRVINE, CA 92623

FOR: ATHLETIC APPAREL, NAMELY, SHIRTS, PANTS, JACKETS, FOOTWEAR, HATS AND CAPS, ATHLETIC UNIFORMS; BOXING SHORTS; CAPS; FLIP FLOPS; FOOTWEAR; GYM SHORTS; MARTIAL ARTS UNIFORMS; MARTIAL ARTS UNIFORMS, NAMELY, GIS; MIXED MARTIAL ARTS SUITS, IN CLASS 25 (U.S. CLS. 22 AND 39).

FIRST USE 4-2-2004; IN COMMERCE 2-3-2005.

THE MARK CONSISTS OF A COMIC DRAWING OF A GRAY HAND OUTLINED IN BLACK POSING IN A SIGNAL. INDEX AND MIDDLE FINGERS ARE STRAIGHT, THUMB IS FOLDED TO LEFT TOUCHING THE RING AND LITTLE (PINKY) FINGERS THAT ARE FOLDED TO THE RIGHT. THE WHITE TEXT "BLACK GLOVE" APPEARS IN CLOSE PROXIMITY TO THE HAND. THE RED TEXT "HD" APPEARS ON THE PALM OF THE HAND. THE BACKGROUND IS BLACK.

THE COLOR(S) BLACK, WHITE, GRAY AND RED IS/ARE CLAIMED AS A FEATURE OF THE MARK.

SN 85-135,002, FILED 9-21-2010.

MARTHA SANTOMARTINO, EXAMINING ATTORNEY



David J. Kybas

Director of the United States Patent and Trademark Office

United States of America

United States Patent and Trademark Office



Reg. No. 4,176,293

Registered July 17, 2012

Int. Cl.: 16

TRADEMARK

PRINCIPAL REGISTER

KALLISTA PRESS, LLC (FLORIDA LIMITED LIABILITY COMPANY)
110 WASHINGTON AVE #2612
MIAMI BEACH, FL 33139

FOR: GREETING CARDS, IN CLASS 16 (U.S. CLS. 2, 5, 22, 23, 29, 37, 38 AND 50).

FIRST USE 5-1-2012; IN COMMERCE 5-1-2012.

THE MARK CONSISTS OF A STYLIZED DRAGONFLY.

SN 85-135,462, FILED 9-22-2010.

MARIA-VICTORIA SUAREZ, EXAMINING ATTORNEY



David J. Kyffers

Director of the United States Patent and Trademark Office

United States of America

United States Patent and Trademark Office

TRACER

Reg. No. 4,176,294

J.R. SIMPLOT COMPANY (NEVADA CORPORATION)
P.O. BOX 27
BOISE, ID 83707

Registered July 17, 2012

Int. Cl.: 2

FOR: WATER-SOLUBLE COLORANT FOR USE AS A SPRAY PATTERN INDICATOR, IN CLASS 2 (U.S. CLS. 6, 11 AND 16).

TRADEMARK

FIRST USE 4-10-2012; IN COMMERCE 4-10-2012.

PRINCIPAL REGISTER

THE MARK CONSISTS OF STANDARD CHARACTERS WITHOUT CLAIM TO ANY PARTICULAR FONT, STYLE, SIZE, OR COLOR.

SN 85-135,559, FILED 9-22-2010.

JILL C. ALT, EXAMINING ATTORNEY



David J. Kyffers

Director of the United States Patent and Trademark Office

United States of America

United States Patent and Trademark Office



Reg. No. 4,176,295

Registered July 17, 2012

Int. Cl.: 42

SERVICE MARK

PRINCIPAL REGISTER

SPENDGO, INC. (DELAWARE CORPORATION)
1883 LANDINGS DRIVE
MOUNTAIN VIEW, CA 94043

FOR: PROVIDING A SECURED-ACCESS, MEMBERS ONLY WEBSITE FEATURING TECHNOLOGY THAT GIVES MEMBERS THE ABILITY TO TRACK RECEIPTS, INVOICES, AND WARRANTY INFORMATION; ASP AND SOFTWARE AS A SERVICE (SAAS) PROVIDER FEATURING SOFTWARE IN THE FIELDS OF RETAIL SALES AND CONSUMER PURCHASING FOR THE PURPOSE OF GENERATING, STORING, FORWARDING, AND CATALOGING ELECTRONIC RECEIPTS, SALES TRANSACTION INFORMATION, WARRANTY INFORMATION, AND INVENTORY INFORMATION; ASP AND SOFTWARE AS A SERVICE (SAAS) PROVIDER FEATURING SOFTWARE IN THE FIELD OF RETAIL SALES FOR INVENTORY MANAGEMENT, INVENTORY ANALYTICS, AND INVENTORY MONITORING; ASP AND SOFTWARE AS A SERVICE (SAAS) PROVIDER FEATURING SOFTWARE FOR PROVIDING AN ON-LINE DATABASE IN THE FIELD OF RETAIL SALES TRANSACTION PROCESSING TO UPLOAD TRANSACTIONAL DATA, PROVIDE STATISTICAL ANALYSIS, AND PRODUCE NOTIFICATIONS AND REPORTS; ASP AND SOFTWARE AS A SERVICE (SAAS) PROVIDER FEATURING SOFTWARE THAT ENABLES USERS TO PREPARE AND TRACK EXPENSE REPORTS OVER THE INTERNET OR WIRELESSLY AND THAT ENABLES USERS TO TRACK, APPROVE, PROCESS, AND PREPARE REIMBURSEMENTS BASED ON USER EXPENSE REPORTS; ASP AND SOFTWARE AS A SERVICE (SAAS) PROVIDER FEATURING SOFTWARE THAT ENABLES USERS TO ANALYZE, REPORT, AND MANAGE INVENTORY, SALES INFORMATION, AND PURCHASING INFORMATION; ASP AND SOFTWARE AS A SERVICE (SAAS) PROVIDER FEATURING SOFTWARE FOR ACCESSING, PRINTING, EXPORTING AND MANAGING STORED RETAIL RECEIPTS AND FINANCIAL INFORMATION AND REPORTS FOR THE SAME; ASP AND SOFTWARE AS A SERVICE (SAAS) PROVIDER SERVICES FEATURING SOFTWARE FOR CAPTURING CREDIT, DEBIT, CASH AND CHECK TRANSACTIONS AND GENERATING REPORTS FOR THE SAME; ASP AND SOFTWARE AS A SERVICE (SAAS) PROVIDER FEATURING SOFTWARE FOR USE IN THE RETAIL SALES FIELD FOR CREATING MARKET AND PRODUCT INVENTORY REPORTS; ASP AND SOFTWARE AS A SERVICE (SAAS) PROVIDER FEATURING SOFTWARE FOR PROVIDING RECEIPT RECONCILIATION INFORMATION IN THE FIELDS OF RETAIL SALES AND PURCHASES, RETURN AUTHORIZATION, COUPONS, AND INVENTORY INFORMATION; ASP AND SOFTWARE AS A SERVICE (SAAS) PROVIDER FEATURING SOFTWARE FOR ALLOWING RETAILERS TO DETECT AND STOP FRAUDULENT AND ABUSIVE RETURN BEHAVIOR AS WELL AS INCREASE SALES AND CUSTOMER LOY-



David J. Kybas

Director of the United States Patent and Trademark Office

Reg. No. 4,176,295 ALTY; ASP AND SOFTWARE AS A SERVICE (SAAS) PROVIDER FEATURING SOFTWARE FOR STORING INFORMATION ABOUT CUSTOMERS' PURCHASING HISTORY; ASP AND SOFTWARE AS A SERVICE (SAAS) PROVIDER FEATURING SOFTWARE FOR USE BY RETAIL STORE OPERATORS TO EVALUATE AND TRACK FINANCIAL PERFORMANCE, CUSTOMER SERVICES PERFORMANCE, CONSUMER INFORMATION, COUPON ACTIVITY, INVENTORY INFORMATION, PURCHASE HISTORY, RETURN HISTORY, AND AVAILABLE REWARDS; ASP AND SOFTWARE AS A SERVICE (SAAS) PROVIDER FEATURING SOFTWARE FOR ELECTRONICALLY GATHERING, ANALYZING AND FORMATTING DATA FROM AN INDIVIDUAL USER'S RETAIL ACCOUNTS TO TRACK, MONITOR AND LOG THE INDIVIDUAL'S SPENDING, SAVING AND PAYMENT PATTERNS; AND ASP AND SOFTWARE AS A SERVICE (SAAS) PROVIDER FEATURING SOFTWARE FOR ACCOUNTING, TRANSACTION PROCESSING, FINANCIAL PLANNING, FINANCIAL MANAGEMENT, FINANCIAL REPORTING, BILL TRACKING, TAX PREPARATION AND PLANNING, BUSINESS PROCESS MANAGEMENT, AND EXPENSE MANAGEMENT, IN CLASS 42 (U.S. CLS. 100 AND 101).

FIRST USE 4-19-2011; IN COMMERCE 4-19-2011.

THE MARK CONSISTS OF A CLOVER DESIGN INSIDE OF A CIRCLE.

SN 85-135,660, FILED 9-22-2010.

JENNIFER VASQUEZ, EXAMINING ATTORNEY

United States of America

United States Patent and Trademark Office

GCTB

Reg. No. 4,176,296

Registered July 17, 2012

Int. Cl.: 9

TRADEMARK

PRINCIPAL REGISTER

GCTB, INC. (FLORIDA CORPORATION)
10002 PRINCESS PALM AVENUE
TAMPA, FL 33619

FOR: ENCODED ELECTRONIC DEBIT AND STORED VALUE CARDS, IN CLASS 9 (U.S. CLS. 21, 23, 26, 36 AND 38).

FIRST USE 4-30-2010; IN COMMERCE 4-30-2010.

THE MARK CONSISTS OF STANDARD CHARACTERS WITHOUT CLAIM TO ANY PARTICULAR FONT, STYLE, SIZE, OR COLOR.

SN 85-136,652, FILED 9-23-2010.

ANGELA DUONG, EXAMINING ATTORNEY



David J. Kybas

Director of the United States Patent and Trademark Office

United States of America

United States Patent and Trademark Office



Reg. No. 4,176,297

RANGER ELECTRONIC COMMUNICATIONS, INC. (TAIWAN CORPORATION)
70 PEI NEI STREET
SHULIN, TAIWAN 238

Registered July 17, 2012

Int. Cl.: 11

FOR: PLASTIC CONNECTORS FOR PLASTIC PLUMBING LINES, IN CLASS 11 (U.S. CLS. 13, 21, 23, 31 AND 34).

TRADEMARK

FIRST USE 10-28-2011; IN COMMERCE 10-28-2011.

PRINCIPAL REGISTER

THE MARK CONSISTS OF THE ENCIRCLED LETTERS "C", "N", "X".

SN 85-136,952, FILED 9-23-2010.

CAROLYN CATALDO, EXAMINING ATTORNEY



David J. Kybas

Director of the United States Patent and Trademark Office

United States of America

United States Patent and Trademark Office

ABACE

Reg. No. 4,176,298

NATIONAL BUSINESS AVIATION ASSOCIATION, INC. (D.C. NON-PROFIT CORPORATION)
1200 EIGHTEENTH STREET, NW, SUITE 400
WASHINGTON, DC 20036

Registered July 17, 2012

Int. Cls.: 16, 35, and 41

FOR: PRINTED PUBLICATIONS, NAMELY, MAGAZINES RELATING TO AVIATION INCLUDING BUSINESS AVIATION, IN CLASS 16 (U.S. CLS. 2, 5, 22, 23, 29, 37, 38 AND 50).

TRADEMARK

FIRST USE 3-27-2012; IN COMMERCE 3-27-2012.

SERVICE MARK

FOR: ORGANIZATION AND CONDUCT OF TRADE SHOWS, TRADE FAIRS, TRADE EXHIBITIONS, AND EXPOSITIONS IN THE FIELD OF BUSINESS AVIATION; ASSOCIATION SERVICES, NAMELY, PROMOTING THE INTERESTS OF BUSINESS AVIATION; INFORMATION, ADVISORY AND CONSULTANCY SERVICES ALL RELATING TO THE AFOREMENTIONED SERVICES, IN CLASS 35 (U.S. CLS. 100, 101 AND 102).

PRINCIPAL REGISTER

FIRST USE 0-0-2005; IN COMMERCE 0-0-2005.

FOR: TRAINING IN THE FIELD OF AVIATION, INCLUDING BUSINESS AVIATION; ORGANIZATION AND CONDUCT OF EDUCATIONAL CONFERENCES, SEMINARS, LECTURES AND WORKSHOPS IN THE FIELD OF BUSINESS AVIATION, AND DISTRIBUTING EDUCATIONAL MATERIALS IN CONNECTION THEREWITH; ORGANIZATION OF EXHIBITIONS FOR EDUCATIONAL PURPOSES; INFORMATION, ADVISORY AND CONSULTANCY SERVICES RELATING TO ALL THE AFOREMENTIONED SERVICES, IN CLASS 41 (U.S. CLS. 100, 101 AND 107).

FIRST USE 0-0-2005; IN COMMERCE 0-0-2005.

THE MARK CONSISTS OF STANDARD CHARACTERS WITHOUT CLAIM TO ANY PARTICULAR FONT, STYLE, SIZE, OR COLOR.

OWNER OF U.S. REG. NOS. 3,021,373, 3,085,837, AND OTHERS.

SN 85-137,319, FILED 9-24-2010.

ELIZABETH HUGHITT, EXAMINING ATTORNEY



David J. Kyros

Director of the United States Patent and Trademark Office

United States of America

United States Patent and Trademark Office



ABACE

Reg. No. 4,176,299

Registered July 17, 2012

Int. Cls.: 35 and 41

SERVICE MARK

PRINCIPAL REGISTER

NATIONAL BUSINESS AVIATION ASSOCIATION, INC. (D.C. NON-PROFIT CORPORATION)
1200 EIGHTEENTH STREET, NW, SUITE 400
WASHINGTON, DC 20036

FOR: ORGANIZATION AND CONDUCT OF TRADE SHOWS, TRADE FAIRS, TRADE EXHIBITIONS, AND EXPOSITIONS IN THE FIELD OF BUSINESS AVIATION; ASSOCIATION SERVICES, NAMELY, PROMOTING THE INTERESTS OF BUSINESS AVIATION; INFORMATION, ADVISORY AND CONSULTANCY SERVICES ALL RELATING TO THE AFOREMENTIONED SERVICES, IN CLASS 35 (U.S. CLS. 100, 101 AND 102).

FIRST USE 0-0-2005; IN COMMERCE 0-0-2005.

FOR: TRAINING IN THE FIELD OF AVIATION, INCLUDING BUSINESS AVIATION; ORGANIZATION AND CONDUCT OF EDUCATIONAL CONFERENCES, SEMINARS, LECTURES AND WORKSHOPS IN THE FIELD OF BUSINESS AVIATION, AND DISTRIBUTING EDUCATIONAL MATERIALS IN CONNECTION THEREWITH; ORGANIZATION OF EXHIBITIONS FOR EDUCATIONAL PURPOSES; INFORMATION, ADVISORY AND CONSULTANCY SERVICES RELATING TO ALL THE AFOREMENTIONED SERVICES, IN CLASS 41 (U.S. CLS. 100, 101 AND 107).

FIRST USE 0-0-2005; IN COMMERCE 0-0-2005.

OWNER OF U.S. REG. NOS. 3,021,373, 3,085,837, AND OTHERS.

THE MARK CONSISTS OF THE WORD "ABACE" WITH A CIRCLE CENTERED DIRECTLY ABOVE IT, WITH AN INNER CIRCLE INSIDE THAT. INSIDE THE SHADED-IN INNER CIRCLE IS A STYLIZED LETTER "A" AT THE BOTTOM AND THREE WAVE-LIKE LINES INSERTED DIAGONALLY IN THE TOP RIGHT CORNER.

SN 85-137,322, FILED 9-24-2010.

ELIZABETH HUGHITT, EXAMINING ATTORNEY



David J. Kyjars

Director of the United States Patent and Trademark Office

United States of America

United States Patent and Trademark Office

MASTER BLEND

Reg. No. 4,176,300

Registered July 17, 2012

Int. Cl.: 3

TRADEMARK

PRINCIPAL REGISTER

KELLY VAN GOGH HAIR COLOR COSMETICS, LLC (DELAWARE LIMITED LIABILITY COMPANY)
245 EAST 93RD STREET #22B
NEW YORK, NY 10128

FOR: NON-MEDICATED HAIR CARE PREPARATIONS, NAMELY, SHAMPOOS, CONDITIONERS, GELS, COLORANTS, AND TONICS; HAIR CARE KITS COMPRISING NON-MEDICATED HAIR CARE PREPARATIONS, NAMELY, SHAMPOOS, CONDITIONERS, GELS, COLORANTS, AND TONICS, AND HAIR CARE PREPARATION APPLICATION TOOLS, NAMELY, APPLICATORS AND MIXING RECEPTACLES ALL OF WHICH ARE SOLD TOGETHER AS A UNIT, IN CLASS 3 (U.S. CLS. 1, 4, 6, 50, 51 AND 52).

FIRST USE 11-0-2010; IN COMMERCE 11-0-2010.

THE MARK CONSISTS OF STANDARD CHARACTERS WITHOUT CLAIM TO ANY PARTICULAR FONT, STYLE, SIZE, OR COLOR.

NO CLAIM IS MADE TO THE EXCLUSIVE RIGHT TO USE "BLEND" , APART FROM THE MARK AS SHOWN.

SN 85-137,741, FILED 9-24-2010.

APRIL ROACH, EXAMINING ATTORNEY



David J. Kyros

Director of the United States Patent and Trademark Office

United States of America

United States Patent and Trademark Office

SETTING YOURSELF UP TO WIN

Reg. No. 4,176,301

Registered July 17, 2012

Int. Cl.: 41

SERVICE MARK

PRINCIPAL REGISTER

TRANSFORMATIONAL TECHNOLOGIES INTERNATIONAL LLC (FLORIDA LIMITED LIABILITY COMPANY)
2635 AVOCADO BLVD.
BUNNELL, FL 32110

FOR: CONDUCTING WORKSHOPS AND SEMINARS IN THE FIELDS OF PERSONAL DEVELOPMENT, RELATIONSHIPS, PERSONAL EMPOWERMENT, SPIRITUALITY AND BUSINESS; EDUCATIONAL SERVICES, NAMELY, PROVIDING ON-LINE SEMINARS IN THE FIELD OF PERSONAL DEVELOPMENT, RELATIONSHIPS, PERSONAL EMPOWERMENT, SPIRITUALITY AND BUSINESS, IN CLASS 41 (U.S. CLS. 100, 101 AND 107).

FIRST USE 8-1-2011; IN COMMERCE 8-1-2011.

THE MARK CONSISTS OF STANDARD CHARACTERS WITHOUT CLAIM TO ANY PARTICULAR FONT, STYLE, SIZE, OR COLOR.

SN 85-138,206, FILED 9-25-2010.

JEFFREY LOOK, EXAMINING ATTORNEY



David J. Kyffers

Director of the United States Patent and Trademark Office

United States of America

United States Patent and Trademark Office

SANTA CLARA

Reg. No. 4,176,302

Registered July 17, 2012

Int. Cl.: 30

TRADEMARK

PRINCIPAL REGISTER

LIDESTRI FOODS, INC. (NEW YORK CORPORATION)
815 W. WHITNEY ROAD
FAIRPORT, NY 14450

FOR: PICANTE SAUCE; SALSA, IN CLASS 30 (U.S. CL. 46).

FIRST USE 2-10-2011; IN COMMERCE 2-10-2011.

THE MARK CONSISTS OF STANDARD CHARACTERS WITHOUT CLAIM TO ANY PARTICULAR FONT, STYLE, SIZE, OR COLOR.

SN 85-139,090, FILED 9-27-2010.

SKYE YOUNG, EXAMINING ATTORNEY



David J. Kyffers

Director of the United States Patent and Trademark Office

United States of America

United States Patent and Trademark Office

BREWSTER BANFF AIRPORT EXPRESS

Reg. No. 4,176,303

Registered July 17, 2012

Int. Cl.: 39

SERVICE MARK

PRINCIPAL REGISTER

BREWSTER INC. (CANADA CORPORATION)
100 GOPHER STREET
P. O. BOX 1140
BANFF, ALBERTA, CANADA T1L 1J3

FOR: AIRPORT PASSENGER SHUTTLE SERVICES BETWEEN THE AIRPORT PARKING FACILITIES AND THE AIRPORT; TRANSPORTATION RESERVATION SERVICES FOR AIRPORT SHUTTLES , IN CLASS 39 (U.S. CLS. 100 AND 105).

FIRST USE 10-31-2010, THE MARK WAS FIRST USED ANYWHERE IN A DIFFERENT FORM OTHER THAN THAT SOUGHT TO BE REGISTERED AT LEAST AS EARLY AS 00/00/1892.; IN COMMERCE 10-31-2010, THE MARK WAS FIRST USED IN COMMERCE IN A DIFFERENT FORM OTHER THAN THAT SOUGHT TO BE REGISTERED AT LEAST AS EARLY AS 00/00/1892..

THE MARK CONSISTS OF STANDARD CHARACTERS WITHOUT CLAIM TO ANY PARTICULAR FONT, STYLE, SIZE, OR COLOR.

PRIORITY CLAIMED UNDER SEC. 44(D) ON CANADA APPLICATION NO. 1474571, FILED 3-25-2010.

OWNER OF U.S. REG. NOS. 2,726,525 AND 3,688,182.

NO CLAIM IS MADE TO THE EXCLUSIVE RIGHT TO USE "AIRPORT EXPRESS", APART FROM THE MARK AS SHOWN.

SN 85-139,124, FILED 9-27-2010.

REBECCA SMITH, EXAMINING ATTORNEY



David J. Kyros

Director of the United States Patent and Trademark Office

United States of America

United States Patent and Trademark Office

SPENDGO

Reg. No. 4,176,304

Registered July 17, 2012

**Int. Cls.: 9, 35, 36, 38,
and 42**

TRADEMARK

SERVICE MARK

PRINCIPAL REGISTER

SPENDGO, INC. (DELAWARE CORPORATION)
1883 LANDINGS DRIVE
MOUNTAIN VIEW, CA 94043

FOR: COMPUTER HARDWARE; COMPUTER HARDWARE USED IN THE FIELD OF RETAIL TRANSACTIONS; COMPUTER HARDWARE AND SOFTWARE FOR DISSEMINATING, CATALOGING, TRACKING, STORING, ANALYZING AND COLLECTING RECEIPTS, INVOICES, AND WARRANTY INFORMATION FOR OTHERS; ELECTRONIC SYSTEMS COMPRISING COMPUTER HARDWARE AND COMPUTER SOFTWARE USED TO STORE RECEIPTS AND WARRANTY INFORMATION; COMPUTER HARDWARE AND SOFTWARE FOR ACCESSING, PRINTING, EXPORTING AND MANAGING STORED RETAIL RECEIPTS AND FINANCIAL INFORMATION AND REPORTS FOR THE SAME; COMPUTER HARDWARE AND SOFTWARE FOR CAPTURING CREDIT, DEBIT, CASH AND CHECK TRANSACTIONS AND GENERATING REPORTS FOR THE SAME; COMPUTER HARDWARE AND SOFTWARE FOR USE IN THE RETAIL SALES FIELD FOR CREATING MARKET AND PRODUCT INVENTORY REPORTS; COMPUTER HARDWARE AND SOFTWARE FOR USE IN TRANSACTION PROCESSING, ACCOUNTING, RECEIPT PRINTING, CUSTOMER RELATIONSHIP MANAGEMENT, INVENTORY MANAGEMENT AND OPERATIONS MANAGEMENT; COMPUTER HARDWARE AND SOFTWARE FOR USE IN THE RETAIL SALES FIELD FOR ANALYZING AND MANAGING INVENTORY, SALES INFORMATION, AND PURCHASING INFORMATION; POINT-OF-SALE TERMINALS FOR POS (POINT OF SALES) SYSTEMS, BAR CODE READERS FOR POS SYSTEMS, OPTICAL READERS FOR POS SYSTEMS, DISPLAYS AND MONITORS FOR POS SYSTEMS, KEYBOARDS FOR POS SYSTEMS, DRAWERS FOR POS SYSTEMS, PRINTERS FOR POS SYSTEMS, SCANNERS FOR POS SYSTEMS, RADIO COMMUNICATION APPARATUS, NAMELY, RADIO TRANSMITTERS AND RADIO RECEIVERS FOR POS SYSTEMS, COMPUTER HARDWARE FOR POS SYSTEMS, COMPUTER SOFTWARE FOR OPERATING POS SYSTEMS; COMPUTER HARDWARE AND SOFTWARE FOR TRACKING SPENDING AND PURCHASING INFORMATION, COLLECTING AND CATALOGING REIMBURSEMENT INFORMATION, AND GENERATING REPORTS AND EXPENSE REPORTING; COMPUTER HARDWARE AND SOFTWARE THAT ENABLES POINT-OF-SALE TERMINALS AND SYSTEMS TO SECURELY EXCHANGE, RECEIPTS, COUPONS, VOUCHERS, OR GIFT, MEMBERSHIP AND LOYALTY CARDS AND RELATED TRANSACTIONAL INFORMATION; COMPUTER SOFTWARE FOR PROVIDING AN ON-LINE DATABASE IN THE FIELD OF RETAIL SALES TRANSACTION PROCESSING TO UPLOAD TRANSACTIONAL DATA, PROVIDE STATISTICAL ANALYSIS, AND PRODUCE NOTIFICATIONS AND REPORTS; SOFTWARE FOR USE IN DATABASE MANAGEMENT IN THE FIELDS OF E-COMMERCE, INVOICE AND



David J. Kyros

Director of the United States Patent and Trademark Office

Reg. No. 4,176,304 PAYMENT PROCESSING, INVOICE AND RECEIPT TRACKING AND REPORTING, INVENTORY MANAGEMENT AND INVENTORY CONTROL; SOFTWARE, NAMELY, POINT-OF-SALE SOFTWARE FOR TABLE MANAGEMENT OF RECEIPTS; COMPUTER SOFTWARE FOR MANAGING AND CONDUCTING BUSINESS PROCESSES, IN THE FIELDS OF RETAIL, WHOLESALE AND DISTRIBUTION; COMPUTER SOFTWARE FOR USE IN MANAGING AND ACCESSING DATABASES FOR THE GENERATION OF DIGITAL PURCHASE RECEIPTS, WARRANTY INFORMATION, AND INVENTORY INFORMATION; COMPUTER SOFTWARE FOR STORING AND RETRIEVING ELECTRONIC RECEIPTS, WARRANTY INFORMATION, AND INVENTORY INFORMATION; COMPUTER SOFTWARE FOR PROVIDING RECEIPT RECONCILIATION INFORMATION IN THE FIELDS OF RETAIL SALES AND PURCHASES, RETURN AUTHORIZATION, COUPONS, AND INVENTORY INFORMATION; COMPUTER SOFTWARE FOR ALLOWING RETAILERS TO DETECT AND STOP FRAUDULENT AND ABUSIVE RETURN BEHAVIOR AS WELL AS INCREASE SALES AND CUSTOMER LOYALTY; COMPUTER SOFTWARE FOR STORING INFORMATION ABOUT CUSTOMERS' PURCHASING HISTORY; COMPUTER SOFTWARE FOR USE BY RETAIL STORE OPERATORS TO EVALUATE AND TRACK FINANCIAL PERFORMANCE, CUSTOMER SERVICES PERFORMANCE, CUSTOMER AND CONSUMER INFORMATION, COUPON ACTIVITY, INVENTORY INFORMATION, PURCHASE HISTORY, RETURN HISTORY, AND AVAILABLE REWARDS; COMPUTER HARDWARE AND SOFTWARE FOR AUTHENTICATION, ACCESS CONTROL AND OTHER SECURITY FEATURES IN RELATION TO CONSUMER PURCHASES; COMPUTER HARDWARE AND SOFTWARE FOR AUTHENTICATING CONSUMER TRANSACTIONS AND PURCHASES; COMPUTER HARDWARE AND PERIPHERALS, COMPUTER SOFTWARE FOR ENCRYPTING AND PROTECTING THE INTEGRITY OF DATA AND ELECTRONIC COMMUNICATIONS OVER COMPUTER NETWORKS; COMPUTER SOFTWARE FOR IMPLEMENTING ENCRYPTION, AUTHENTICATION, ACCESS CONTROL AND OTHER SECURITY FEATURES WITHIN COMPUTER NETWORKS AND THROUGH EXTERNAL CONNECTIONS; COMPUTER SOFTWARE FOR TRACKING AND MANAGING LOYALTY PROGRAMS; COMPUTER SOFTWARE FOR USE BY INDIVIDUALS TO EVALUATE AND TRACK FINANCIAL TRANSACTIONS AND PURCHASES, COUPON ACTIVITY, INVENTORY INFORMATION, PURCHASE HISTORY, RETURN HISTORY, AND AVAILABLE REWARDS; COMPUTER SOFTWARE FOR ACCOUNTING, TRANSACTION PROCESSING, FINANCIAL PLANNING, FINANCIAL MANAGEMENT, FINANCIAL REPORTING, TAX PREPARATION AND PLANNING, BUSINESS PROCESS MANAGEMENT, AND EXPENSE MANAGEMENT; WIRELESS COMMUNICATION DEVICES FOR VOICE, DATA OR IMAGE TRANSMISSION; COMPUTER SOFTWARE FOR USE IN TRACKING DATA GENERATED BY CUSTOMERS AND BY CUSTOMER LOYALTY PROGRAMS , IN CLASS 9 (U.S. CLS. 21, 23, 26, 36 AND 38).

FIRST USE 4-19-2011; IN COMMERCE 4-19-2011.

FOR: PROVIDING A BUSINESS ORIENTED WEBSITE TO TRACK RECEIPTS, INVOICES, LOYALTY PROGRAM DOCUMENTS AND WARRANTY DOCUMENTATION INFORMATION; PROMOTING THE GOODS AND SERVICES OF OTHERS BY PROVIDING A WEB SITE FEATURING COUPONS, REBATES, PRICE-COMPARISON INFORMATION, PRODUCT REVIEWS, LINKS TO THE RETAIL WEB SITES OF OTHERS, AND DISCOUNT INFORMATION; CUSTOMER LOYALTY SERVICES AND CUSTOMER CLUB SERVICES, FOR COMMERCIAL, PROMOTIONAL AND/OR ADVERTISING PURPOSES; ON-LINE POSTING OF REWARDS FOR INFORMATION; ADVERTISING SERVICES, NAMELY, PROMOTING THE GOODS AND SERVICES OF OTHERS BY PROVIDING HYPERTEXT LINKS TO THE WEB SITES OF OTHERS; BUSINESS SERVICES, NAMELY, PROVIDING CONSUMER PRODUCT INFORMATION VIA THE INTERNET AND ELECTRONIC COMMUNICATION NETWORKS; ADVERTISEMENT FOR OTHERS ON THE INTERNET; ADVERTISEMENT VIA MOBILE PHONE NETWORKS; ADVERTISING AND BUSINESS SERVICES, NAMELY, PROVIDING AN ONLINE WEBSITE WHERE ADVERTISERS, MARKETERS, AND CONTENT PROVIDERS CAN INTERACT WITH USERS FOR ADVERTISING, BRANDING, AND PROMOTING KNOWLEDGE, PRODUCTS, AND SERVICES, AND TRADESHOWS, ON BEHALF OF THEMSELVES AND OTHERS, AND FOR EVALUATING AND RATING THE SAME, ALL

Reg. No. 4,176,304 THE FOREGOING RELEVANT TO HUMAN ACTIVITIES AND RELATED FIELDS; ADVERTISING AND MARKETING; ADVERTISING ON THE INTERNET FOR OTHERS; ADVERTISING SERVICES, NAMELY, PROMOTING THE GIFT CARDS OF OTHERS; ADVERTISING SERVICES, NAMELY, COST-PER-ACTION ON-LINE ADVERTISING; ADVERTISING, INCLUDING PROMOTION RELATING TO THE SALE OF ARTICLES AND SERVICES FOR THIRD PARTIES BY THE TRANSMISSION OF ADVERTISING MATERIAL AND THE DISSEMINATION OF ADVERTISING MESSAGES ON COMPUTER NETWORKS; ADVERTISING, INCLUDING ON-LINE ADVERTISING ON A COMPUTER NETWORK; DISPLAYING ADVERTISEMENTS FOR OTHERS; DISSEMINATION OF ADVERTISING FOR OTHERS VIA THE INTERNET; DISSEMINATION OF ADVERTISING FOR OTHERS VIA AN ON-LINE COMMUNICATIONS NETWORK ON THE INTERNET; DISSEMINATION OF ADVERTISING FOR OTHERS VIA PUBLIC AND PRIVATE WIRELESS NETWORKS FOR DISPLAY ON MOBILE DEVICES; INTERNET ADVERTISING SERVICES; MARKETING, ADVERTISING, AND PROMOTING THE RETAIL GOODS AND SERVICES OF OTHERS TO WIRELESS ELECTRONIC DEVICES; MARKETING, PROMOTIONAL AND ADVERTISING SERVICES PROVIDED BY MOBILE TELEPHONE CONNECTIONS; ONLINE SERVICE FOR CONNECTING SOCIAL NETWORK USERS WITH RETAILERS FOR THE PURPOSE OF FACILITATING DISCOUNTED PURCHASES; ONLINE ADVERTISING SERVICES FOR OTHERS; ON-LINE RETAIL STORE SERVICES FEATURING A WIDE VARIETY OF CONSUMER GOODS OF OTHERS; PROMOTING THE GOODS AND SERVICES OF OTHERS THROUGH THE DISTRIBUTION OF DISCOUNT CARDS; PROMOTING THE GOODS AND SERVICES OF OTHERS BY PROVIDING HYPERTEXT LINKS TO THE WEB SITES OF OTHERS; PROMOTING THE GOODS AND SERVICES OF OTHERS BY PROVIDING A WEB SITE AT WHICH USERS CAN LINK TO BRANDED PRODUCT INFO AND WEBSITES OF OTHERS; PROMOTING THE GOODS AND SERVICES OF OTHERS BY MEANS OF A PREFERRED CUSTOMER PROGRAM FEATURING REWARDS, POINTS, SPECIAL PROMOTIONS, DISCOUNTS AND OTHER DEAL OFFERS; PROMOTING THE GOODS AND SERVICES OF OTHERS BY MEANS OF THE ISSUANCE OF LOYALTY REWARDS CARDS; PROMOTING THE GOODS OF OTHERS, NAMELY, PROVIDING COUPONS, REBATES AND VOUCHERS FOR THE GOODS OF OTHERS; PROMOTING THE GOODS OF OTHERS, NAMELY, PROVIDING INFORMATION REGARDING DISCOUNTS, COUPONS, REBATES, VOUCHERS AND SPECIAL OFFERS FOR THE GOODS OF OTHERS; PROMOTING THE SALE OF GOODS AND SERVICES OF OTHERS THROUGH ELECTRONIC COUPONING, PROMOTIONS AND DISCOUNTS; PROMOTIONAL SERVICES, NAMELY, PROMOTING THE GOODS OF OTHERS BY MEANS OF PROVIDING ONLINE COUPONS; PROVIDING A SEARCHABLE WEBSITE FEATURING THE GOODS AND SERVICES OF OTHER VENDORS; PROVIDING A SEARCHABLE ON-LINE ADVERTISING WEBSITE AND GUIDE FEATURING THE GOODS AND SERVICES OF OTHER VENDORS VIA THE INTERNET; PROVIDING A SEARCHABLE ONLINE ADVERTISING GUIDE FEATURING THE GOODS AND SERVICES OF ONLINE VENDORS; PROVIDING A WEB-BASED SYSTEM AND ONLINE PORTALS IN THE FIELD OF CONSUMER-TO-BUSINESS COMMERCE FOR CONSUMERS TO ENTER, MANAGE AND MODIFY THEIR CONSUMER PREFERENCE INFORMATION FOR USE BY MERCHANTS TO CREATE AND MANAGE OFFERS FOR DELIVERY TO CONSUMERS; PROVIDING AN ON-LINE COMPUTER DATABASE IN THE FIELD OF LOCATING PRODUCTS, DESCRIBING PRODUCTS, RATING PRODUCTS, PRICING PRODUCTS AND COMPARING PRICES OF PRODUCTS; PROVIDING AND RENTAL OF ADVERTISING SPACE ON THE INTERNET; PROVIDING CONSUMER PRODUCT INFORMATION VIA THE INTERNET; PROVIDING INCENTIVE AWARD PROGRAMS FOR CUSTOMERS THROUGH THE ISSUANCE AND PROCESSING OF LOYALTY COUPONS FOR FREQUENT USE OF PARTICIPATING BUSINESSES; PROVIDING INCENTIVE AWARD PROGRAMS FOR CUSTOMERS THROUGH ISSUANCE AND PROCESSING OF LOYALTY POINTS FOR ON-LINE PURCHASE OF COMPANY'S GOODS AND SERVICES; PROVIDING SPACE AT A WEB SITE FOR THE ADVERTISEMENT OF THE GOODS AND SERVICES OF OTHERS; PROVIDING AN INTERACTIVE BUSINESS AND CONSUMER INFORMATION WEB SITE FOR USE IN TRACKING CONSUMER PURCHASES AND FINANCIAL TRANSACTIONS, IN CLASS 35 (U.S. CLS. 100, 101 AND 102).

FIRST USE 4-19-2011; IN COMMERCE 4-19-2011.

Reg. No. 4,176,304 FOR: PROVIDING AN INTERACTIVE WEB SITE FEATURING FINANCIAL INFORMATION; LOYALTY COUPON PAYMENT PROCESSING SERVICES; LOYALTY PROGRAM PAYMENT PROCESSING SERVICES; PROVIDING WEB-BASED, LOYALTY COUPON AND LOYALTY PROGRAM FINANCIAL TRACKING SERVICES; PROVIDING WEB-BASED, AUTOMATED AND CUSTOMIZED PERSONAL FINANCIAL MANAGEMENT SERVICES, NAMELY, CUSTOMIZED MANAGEMENT OF NON-INVESTMENT PERSONAL FINANCIAL ACCOUNTS, DAILY MONITORING OF TRANSACTIONS, AND BUDGET AND SPENDING REPORTING THROUGH A GLOBAL COMPUTER NETWORK; PROVIDING FINANCIAL INFORMATION THROUGH A GLOBAL COMPUTER NETWORK; AND PROVIDING A WEB SITE FEATURING PERSONAL FINANCIAL INFORMATION AND FINANCIAL ADVICE, IN CLASS 36 (U.S. CLS. 100, 101 AND 102).

FIRST USE 4-19-2011; IN COMMERCE 4-19-2011.

FOR: PROVIDING ELECTRONIC TRANSMISSION OF CREDIT CARD TRANSACTION DATA AND ELECTRONIC PAYMENT DATA VIA A GLOBAL COMPUTER NETWORK; TRANSMISSION OF DATA AND OF INFORMATION BY ELECTRONIC MEANS INCLUDING BUT NOT LIMITED TO COMPUTER, INTERNET OR ELECTRONIC MAIL MEANS; RECEIPT AND DELIVERY OF MESSAGES, DOCUMENTS AND OTHER DATA BY ELECTRONIC TRANSMISSION; TRANSMISSION OF DATA AND INFORMATION BY ELECTRONIC MAIL; ELECTRONIC MAIL; ELECTRONIC TRANSMISSION OF MESSAGES AND DATA; ELECTRONIC TRANSMISSION OF MAIL AND MESSAGES; MESSAGE SENDING AND RECEIVING SERVICES; AND MESSAGE SENDING VIA A WEBSITE, IN CLASS 38 (U.S. CLS. 100, 101 AND 104).

FIRST USE 4-19-2011; IN COMMERCE 4-19-2011.

FOR: PROVIDING A SECURED-ACCESS, MEMBERS ONLY WEBSITE FEATURING TECHNOLOGY THAT GIVES MEMBERS THE ABILITY TO TRACK RECEIPTS, INVOICES, AND WARRANTY INFORMATION; PROVIDING A SECURED-ACCESS, MEMBERS ONLY WEBSITE FEATURING TECHNOLOGY THAT GIVES MEMBERS THE ABILITY TO TRACK AND MANAGE LOYALTY COUPON AND LOYALTY PROGRAMS; PROVIDING TEMPORARY USE OF ON-LINE, NON-DOWNLOADABLE SOFTWARE FOR CREATING AND FORWARDING RECEIPTS AND WARRANTY INFORMATION; ASP AND SOFTWARE AS A SERVICE (SAAS) PROVIDER FEATURING SOFTWARE IN THE FIELDS OF RETAIL SALES AND CONSUMER PURCHASING FOR THE PURPOSE OF GENERATING, STORING, FORWARDING, AND CATALOGING ELECTRONIC RECEIPTS, SALES TRANSACTION INFORMATION, WARRANTY INFORMATION, AND INVENTORY INFORMATION; ASP AND SOFTWARE AS A SERVICE (SAAS) PROVIDER FEATURING SOFTWARE IN THE FIELD OF RETAIL SALES FOR INVENTORY MANAGEMENT, INVENTORY ANALYTICS, AND INVENTORY MONITORING; ASP AND SOFTWARE AS A SERVICE (SAAS) PROVIDER FEATURING SOFTWARE FOR PROVIDING AN ON-LINE DATABASE IN THE FIELD OF RETAIL SALES TRANSACTION PROCESSING TO UPLOAD TRANSACTIONAL DATA, PROVIDE STATISTICAL ANALYSIS, AND PRODUCE NOTIFICATIONS AND REPORTS; ASP AND SOFTWARE AS A SERVICE (SAAS) PROVIDER FEATURING SOFTWARE THAT ENABLES USERS TO PREPARE AND TRACK EXPENSE REPORTS OVER THE INTERNET OR WIRELESSLY AND THAT ENABLES USERS TO TRACK, APPROVE, PROCESS, AND PREPARE REIMBURSEMENTS BASED ON USER EXPENSE REPORTS; ASP AND SOFTWARE AS A SERVICE (SAAS) PROVIDER FEATURING SOFTWARE THAT ENABLES USERS TO ANALYZE, REPORT, AND MANAGE INVENTORY, SALES INFORMATION, AND PURCHASING INFORMATION; ASP AND SOFTWARE AS A SERVICE (SAAS) PROVIDER FEATURING SOFTWARE FOR ACCESSING, PRINTING, EXPORTING AND MANAGING STORED RETAIL RECEIPTS AND FINANCIAL INFORMATION AND REPORTS FOR THE SAME; ASP AND SOFTWARE AS A SERVICE (SAAS) PROVIDER SERVICES FEATURING SOFTWARE FOR CAPTURING CREDIT, DEBIT, CASH AND CHECK TRANSACTIONS AND GENERATING REPORTS FOR THE SAME; ASP AND SOFTWARE AS A SERVICE (SAAS) PROVIDER FEATURING SOFTWARE FOR USE IN THE RETAIL SALES FIELD FOR CREATING MARKET AND PRODUCT INVENTORY REPORTS; ASP

Reg. No. 4,176,304 AND SOFTWARE AS A SERVICE (SAAS) PROVIDER FEATURING SOFTWARE FOR PROVIDING RECEIPT RECONCILIATION INFORMATION IN THE FIELDS OF RETAIL SALES AND PURCHASES, RETURN AUTHORIZATION, COUPONS, AND INVENTORY INFORMATION; ASP AND SOFTWARE AS A SERVICE (SAAS) PROVIDER FEATURING SOFTWARE FOR ALLOWING RETAILERS TO DETECT AND STOP FRAUDULENT AND ABUSIVE RETURN BEHAVIOR AS WELL AS INCREASE SALES AND CUSTOMER LOYALTY; ASP AND SOFTWARE AS A SERVICE (SAAS) PROVIDER FEATURING SOFTWARE FOR STORING INFORMATION ABOUT CUSTOMERS' PURCHASING HISTORY; ASP AND SOFTWARE AS A SERVICE (SAAS) PROVIDER FEATURING SOFTWARE FOR USE BY RETAIL STORE OPERATORS TO EVALUATE AND TRACK FINANCIAL PERFORMANCE, CUSTOMER SERVICES PERFORMANCE, CUSTOMER AND CONSUMER INFORMATION, COUPON ACTIVITY, INVENTORY INFORMATION, PURCHASE HISTORY, RETURN HISTORY, AND AVAILABLE REWARDS; ASP AND SOFTWARE AS A SERVICE (SAAS) PROVIDER FEATURING SOFTWARE FOR ELECTRONICALLY GATHERING, ANALYZING AND FORMATTING DATA FROM AN INDIVIDUAL USER'S ONLINE BANK, CREDIT CARD, RETAIL ACCOUNTS TO TRACK, MONITOR AND LOG THE INDIVIDUAL'S SPENDING, SAVING AND PAYMENT PATTERNS; COMPUTER SERVICES, NAMELY, CREATING AN ON-LINE COMMUNITY FOR REGISTERED USERS TO PARTICIPATE IN DISCUSSIONS, GET FEEDBACK FROM THEIR PEERS, FORM VIRTUAL COMMUNITIES, AND ENGAGE IN SOCIAL NETWORKING; COMPUTER SERVICES, NAMELY, CREATING AN ON-LINE COMMUNITY FOR REGISTERED USERS TO PARTICIPATE IN DISCUSSIONS, GET FEEDBACK FROM THEIR PEERS, FORM VIRTUAL COMMUNITIES, AND ENGAGE IN SOCIAL NETWORKING FEATURING INFORMATION ON FINANCIAL ISSUES AND CONSUMER PURCHASES; AND ASP AND SOFTWARE AS A SERVICE (SAAS) PROVIDER FEATURING SOFTWARE FOR ACCOUNTING, TRANSACTION PROCESSING, FINANCIAL PLANNING, FINANCIAL MANAGEMENT, FINANCIAL REPORTING, TAX PREPARATION AND PLANNING, BUSINESS PROCESS MANAGEMENT, AND EXPENSE MANAGEMENT; HOSTING A SECURE ON-LINE BILLING GATEWAY FOR RECEIVING ORDER INFORMATION, GENERATING INVOICES, PROCESSING PAYMENT INFORMATION AND CREATING AND FORWARDING RECEIPTS RELATING TO PURCHASE OF GOODS AND SERVICES ON THE INTERNET; ASP AND SOFTWARE AS A SERVICE (SAAS) PROVIDER SERVICES FEATURING SOFTWARE FOR USE IN TRACKING DATA GENERATED BY CUSTOMERS AND BY CUSTOMER LOYALTY PROGRAMS, IN CLASS 42 (U.S. CLS. 100 AND 101).

FIRST USE 4-19-2011; IN COMMERCE 4-19-2011.

THE MARK CONSISTS OF STANDARD CHARACTERS WITHOUT CLAIM TO ANY PARTICULAR FONT, STYLE, SIZE, OR COLOR.

SN 85-139,400, FILED 9-27-2010.

JENNIFER VASQUEZ, EXAMINING ATTORNEY

United States of America

United States Patent and Trademark Office

AB CARVER

Reg. No. 4,176,305

Registered July 17, 2012

Int. Cl.: 28

TRADEMARK

PRINCIPAL REGISTER

IMPLUS FOOTCARE, LLC (DELAWARE LIMITED LIABILITY COMPANY)
2001 T.W. ALEXANDER DRIVE
BOX 13925
DURHAM, NC 277093925

FOR: MANUALLY-OPERATED EXERCISE EQUIPMENT, IN CLASS 28 (U.S. CLS. 22, 23, 38 AND 50).

FIRST USE 5-11-2012; IN COMMERCE 5-11-2012.

THE MARK CONSISTS OF STANDARD CHARACTERS WITHOUT CLAIM TO ANY PARTICULAR FONT, STYLE, SIZE, OR COLOR.

OWNER OF U.S. REG. NOS. 3,300,090, 3,667,526, AND OTHERS.

NO CLAIM IS MADE TO THE EXCLUSIVE RIGHT TO USE "AB", APART FROM THE MARK AS SHOWN.

SN 85-139,535, FILED 9-28-2010.

JEFF DEFORD, EXAMINING ATTORNEY



David J. Kyffers

Director of the United States Patent and Trademark Office

United States of America

United States Patent and Trademark Office

COMPLIMENTS GUARANTEED

Reg. No. 4,176,306

Registered July 17, 2012

Int. Cls.: 29, 30, and 35

TRADEMARK

SERVICE MARK

PRINCIPAL REGISTER

HBH LIMITED PARTNERSHIP (MICHIGAN LIMITED PARTNERSHIP)
SUITE 200
11935 MASON-MONTGOMERY ROAD
CINCINNATI, OH 45249

FOR: POULTRY, NAMELY, CHICKEN AND TURKEY; BEEF, NAMELY, BEEF RIBS AND ROASTS; PORK, NAMELY, HAM, BACON, PORK LOINS, PORK RIBS AND CANADIAN BACON; VEGETABLE SALADS; AND SOUP, IN CLASS 29 (U.S. CL. 46).

FIRST USE 10-1-2010; IN COMMERCE 10-1-2010.

FOR: CONFECTIONERIES, NAMELY, CHEESECAKES AND FRUIT AND NUT PIES; CONDIMENTS, NAMELY, RELISHES; AND SAUCES, IN CLASS 30 (U.S. CL. 46).

FIRST USE 10-1-2010; IN COMMERCE 10-1-2010.

FOR: MAIL ORDER CATALOG SERVICES FEATURING PREPARED FOODS; ONLINE RETAIL STORE SERVICES FEATURING PREPARED FOODS, IN CLASS 35 (U.S. CLS. 100, 101 AND 102).

FIRST USE 10-1-2010; IN COMMERCE 10-1-2010.

THE MARK CONSISTS OF STANDARD CHARACTERS WITHOUT CLAIM TO ANY PARTICULAR FONT, STYLE, SIZE, OR COLOR.

SN 85-139,677, FILED 9-28-2010.

JENNIFER VASQUEZ, EXAMINING ATTORNEY



David J. Kyros

Director of the United States Patent and Trademark Office

United States of America

United States Patent and Trademark Office



Reg. No. 4,176,307

Registered July 17, 2012

Int. Cls.: 9, 16, and 41

TRADEMARK

SERVICE MARK

PRINCIPAL REGISTER

ISABELLA & FERDINAND LLC (D.C. LIMITED LIABILITY COMPANY)
5117 MACARTHUR BLVD., NW
WASHINGTON, DC 20016

FOR: CHILDREN'S EDUCATIONAL MUSIC CDS AND DVDS, AUDIO AND VIDEO RECORDINGS FEATURING MUSIC, DIGITAL MUSIC DOWNLOADABLE FROM THE INTERNET, DOWNLOADABLE MP3 FILES, MP3 RECORDINGS AND AUDIO BOOKS IN THE FIELD OF LANGUAGE INSTRUCTION, IN CLASS 9 (U.S. CLS. 21, 23, 26, 36 AND 38).

FIRST USE 4-19-2011; IN COMMERCE 4-19-2011.

FOR: EDUCATIONAL PUBLICATIONS, NAMELY, EDUCATIONAL LEARNING CARDS, FLASH CARDS, ACTIVITY CARDS, WORKBOOKS, TEXTBOOKS, ACTIVITY BOOKS, SONG BOOKS, STORY BOOKS, PUZZLE BOOKS, PRINTED PUZZLES, MANUALS, POSTERS AND EDUCATIONAL BOOKLETS, TEACHER GUIDES AND TRAINING MANUALS IN THE FIELD OF FOREIGN LANGUAGES; PRINTED INSTRUCTIONAL, EDUCATIONAL AND TEACHING MATERIALS IN THE FIELD OF CHILDREN'S EDUCATION IN FOREIGN LANGUAGES, IN CLASS 16 (U.S. CLS. 2, 5, 22, 23, 29, 37, 38 AND 50).

FIRST USE 10-0-2009; IN COMMERCE 10-0-2009.

FOR: EDUCATIONAL SERVICES, NAMELY, DEVELOPING CURRICULUM FOR TEACHERS, PROVIDING CLASSES, SEMINARS AND WORKSHOPS IN THE FIELD OF FOREIGN LANGUAGE PROFICIENCY; DEVELOPMENT AND DISSEMINATION OF EDUCATIONAL MATERIALS IN THE FIELD OF LANGUAGE INSTRUCTION, NAMELY, FOREIGN LANGUAGE; PROVIDING TUTORING SERVICES IN THE FIELD OF FOREIGN LANGUAGE; ENTERTAINMENT SERVICES, NAMELY, MUSICAL COMPOSITION FOR OTHERS AND PRODUCTION OF MUSICAL SOUND RECORDINGS, IN CLASS 41 (U.S. CLS. 100, 101 AND 107).

FIRST USE 10-0-2009; IN COMMERCE 10-0-2009.

THE MARK CONSISTS OF A STYLIZED DESIGN OF A CROWN FEATURING FOUR GEMS. BETWEEN EACH JEWEL, A BLACK DOT APPEARS.

SN 85-139,729, FILED 9-28-2010.



David J. Kybas

Director of the United States Patent and Trademark Office

Reg. No. 4,176,307 MARILYN IZZI, EXAMINING ATTORNEY

United States of America

United States Patent and Trademark Office

LOOM DECOR

Reg. No. 4,176,308

Registered July 17, 2012

Int. Cl.: 24

TRADEMARK

PRINCIPAL REGISTER

PENNY LOAFER DESIGNS, LLC (MASSACHUSETTS LIMITED LIABILITY COMPANY)
7
40 REVERE STREET
BOSTON, MA 02114

FOR: FABRICS USED IN HOME DECORATION, NAMELY, TABLE LINENS, NAPKINS, BEDDING, WINDOW TREATMENTS, TOWELS, PILLOWS, SHOWER CURTAINS, PLACEMATS, WALL ART, APRONS AND FLOOR COVERINGS, IN CLASS 24 (U.S. CLS. 42 AND 50).

FIRST USE 1-2-2012; IN COMMERCE 1-2-2012.

THE MARK CONSISTS OF STANDARD CHARACTERS WITHOUT CLAIM TO ANY PARTICULAR FONT, STYLE, SIZE, OR COLOR.

NO CLAIM IS MADE TO THE EXCLUSIVE RIGHT TO USE "DECOR", APART FROM THE MARK AS SHOWN.

SN 85-139,800, FILED 9-28-2010.

TINA MAI, EXAMINING ATTORNEY



David J. Kyffers

Director of the United States Patent and Trademark Office

United States of America

United States Patent and Trademark Office

Pneumapsychosomatology

Reg. No. 4,176,309

Registered July 17, 2012

Int. Cls.: 41 and 45

SERVICE MARK

PRINCIPAL REGISTER

BE IN HEALTH, INC. (GEORGIA CORPORATION)
4178 CREST HIGHWAY
THOMASTON, GA 30286

FOR: PROVIDING ON-LINE RELIGIOUS INSTRUCTION PROMOTING CHRISTIAN AND FAMILY VALUES; RELIGIOUS INSTRUCTION SERVICES, IN CLASS 41 (U.S. CLS. 100, 101 AND 107).

FIRST USE 4-15-2012; IN COMMERCE 4-15-2012.

FOR: CONDUCTING RELIGIOUS PRAYER SERVICES; MINISTERIAL SERVICES, NAMELY, HOLDING SPIRITUAL RETREATS TO ASSIST RELIGIOUS LEADERS, BOTH CLERGY AND LAY, TO DEVELOP AND ENHANCE THEIR SPIRITUAL LIVES; PROVIDING A WEBSITE FEATURING INFORMATION ABOUT RELIGIOUS BELIEF SYSTEMS; PROVIDING BOTH IN-PERSON AND ON-LINE HOLISTIC SPIRITUAL COUNSELING SERVICES; PROVIDING ON-LINE INFORMATION IN THE FIELD OF SPIRITUALITY, SELF-HELP, AND PERSONAL EMPOWERMENT SUBJECT MATTERS; PROVIDING SPIRITUAL REHABILITATION SERVICES; PROVIDING SPIRITUAL RETREATS IN THE FIELD OF PHYSICAL, MENTAL, AND EMOTIONAL HEALTH; PROVIDING SPIRITUAL RETREATS IN THE FIELDS OF TOGETHERNESS AND HOW TO BE BETTER MEN; RELIGIOUS AND SPIRITUAL SERVICES, NAMELY, PROVIDING GATHERINGS AND RETREATS TO DEVELOP AND ENHANCE THE SPIRITUAL LIVES OF INDIVIDUALS; RELIGIOUS SERVICES, NAMELY, PRAYER MEETINGS; SPIRITUAL COUNSELING, IN CLASS 45 (U.S. CLS. 100 AND 101).

FIRST USE 4-15-2012; IN COMMERCE 4-15-2012.

THE MARK CONSISTS OF STANDARD CHARACTERS WITHOUT CLAIM TO ANY PARTICULAR FONT, STYLE, SIZE, OR COLOR.

SN 85-140,079, FILED 9-28-2010.

EMILY CHUO, EXAMINING ATTORNEY



David J. Kyros

Director of the United States Patent and Trademark Office

United States of America

United States Patent and Trademark Office

800 DENTIST

Reg. No. 4,176,310

Registered July 17, 2012

Int. Cl.: 35

SERVICE MARK

PRINCIPAL REGISTER

FUTUREDONTICS, INC. (CALIFORNIA CORPORATION)
6060 CENTER DRIVE
7TH FLOOR
LOS ANGELES, CA 92626

FOR: PROVIDING ONLINE REFERRALS OF MEDICAL AND DENTAL PROFESSIONALS AND REFERRALS IN THE FIELD OF MEDICINE AND DENTISTRY; PROVIDING ONLINE MARKETING FOR MEDICAL AND DENTAL PROFESSIONALS, IN CLASS 35 (U.S. CLS. 100, 101 AND 102).

FIRST USE 1-1-1996; IN COMMERCE 1-1-1996.

THE MARK CONSISTS OF STANDARD CHARACTERS WITHOUT CLAIM TO ANY PARTICULAR FONT, STYLE, SIZE, OR COLOR.

SEC. 2(F).

OWNER OF U.S. REG. NOS. 1,663,616, 3,877,773, AND OTHERS.

NO CLAIM IS MADE TO THE EXCLUSIVE RIGHT TO USE "DENTIST", APART FROM THE MARK AS SHOWN.

SN 85-140,467, FILED 9-28-2010.

MARK RADEMACHER, EXAMINING ATTORNEY



David J. Kybas

Director of the United States Patent and Trademark Office

United States of America

United States Patent and Trademark Office

800DENTIST

Reg. No. 4,176,311

Registered July 17, 2012

Int. Cl.: 35

SERVICE MARK

PRINCIPAL REGISTER

FUTUREDONTICS, INC. (CALIFORNIA CORPORATION)
6060 CENTER DRIVE
7TH FLOOR
LOS ANGELES, CA 90045

FOR: PROVIDING ONLINE REFERRALS OF MEDICAL AND DENTAL PROFESSIONALS AND REFERRALS IN THE FIELD OF MEDICINE AND DENTISTRY; PROVIDING ONLINE MARKETING, NAMELY, PROMOTING THE SERVICES OF MEDICAL AND DENTAL PROFESSIONALS, IN CLASS 35 (U.S. CLS. 100, 101 AND 102).

FIRST USE 1-1-1996; IN COMMERCE 1-1-1996.

THE MARK CONSISTS OF STANDARD CHARACTERS WITHOUT CLAIM TO ANY PARTICULAR FONT, STYLE, SIZE, OR COLOR.

SEC. 2(F).

OWNER OF U.S. REG. NOS. 1,663,616, 3,877,773, AND OTHERS.

SN 85-140,470, FILED 9-28-2010.

MARK RADEMACHER, EXAMINING ATTORNEY



David J. Kybas

Director of the United States Patent and Trademark Office

United States of America

United States Patent and Trademark Office

GLITTER'N GLOW

Reg. No. 4,176,312

Registered July 17, 2012

Int. Cl.: 28

TRADEMARK

PRINCIPAL REGISTER

TECH 4 KIDS INC. (CANADA CORPORATION)
UNIT 28
1200 AEROWOOD DRIVE
MISSISSAUGA, ONTARIO, CANADA L4W2S7

FOR: SNOW GLOBES; LIGHTED SNOW GLOBES, IN CLASS 28 (U.S. CLS. 22, 23, 38 AND 50).

FIRST USE 9-30-2011; IN COMMERCE 9-30-2011.

THE MARK CONSISTS OF STANDARD CHARACTERS WITHOUT CLAIM TO ANY PARTICULAR FONT, STYLE, SIZE, OR COLOR.

NO CLAIM IS MADE TO THE EXCLUSIVE RIGHT TO USE "GLOW", APART FROM THE MARK AS SHOWN.

SN 85-140,716, FILED 9-29-2010.

ALAIN LAPTER, EXAMINING ATTORNEY



David J. Kybas

Director of the United States Patent and Trademark Office

United States of America

United States Patent and Trademark Office

MEGA-LITE

Reg. No. 4,176,313

Registered July 17, 2012

Int. Cl.: 28

TRADEMARK

PRINCIPAL REGISTER

TECH 4 KIDS INC. (CANADA CORPORATION)
UNIT 28
1200 AEROWOOD DRIVE
MISSISSAUGA, ONTARIO, CANADA L4W2S7

FOR: TOY ACTION FIGURES; LIGHTED TOYS, NAMELY, LIGHTED ACTION FIGURES,
IN CLASS 28 (U.S. CLS. 22, 23, 38 AND 50).

FIRST USE 9-30-2009; IN COMMERCE 7-31-2011.

THE MARK CONSISTS OF STANDARD CHARACTERS WITHOUT CLAIM TO ANY PAR-
TICULAR FONT, STYLE, SIZE, OR COLOR.

SN 85-140,736, FILED 9-29-2010.

ALAIN LAPTER, EXAMINING ATTORNEY



David J. Kybas

Director of the United States Patent and Trademark Office

United States of America

United States Patent and Trademark Office

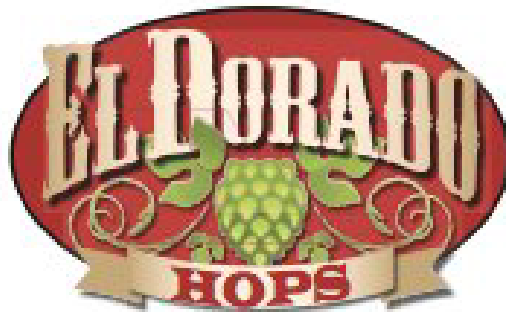

Reg. No. 4,176,314

Registered July 17, 2012

Int. Cl.: 31

TRADEMARK

PRINCIPAL REGISTER

CLS FARMS, LLC (WASHINGTON LIMITED LIABILITY COMPANY)
6605 DESMARAIS ROAD
YAKIMA, WA 98901

FOR: FRESH HOPS, IN CLASS 31 (U.S. CLS. 1 AND 46).

FIRST USE 3-1-2011; IN COMMERCE 3-1-2011.

NO CLAIM IS MADE TO THE EXCLUSIVE RIGHT TO USE "HOPS", APART FROM THE MARK AS SHOWN.

THE COLOR(S) RED, BLACK, GOLD AND GREEN IS/ARE CLAIMED AS A FEATURE OF THE MARK.

THE MARK CONSISTS OF THE WORDING "EL DORADO HOPS" AND DESIGN IN THE COLORS RED, BLACK, GOLD AND GREEN, WITH THE COLOR RED APPEARING IN THE BACKGROUND OVAL AND THE TERM "HOPS", THE COLOR GOLD APPEARING IN THE TERM "EL DORADO", THE BANNER AND THE SWIRL DESIGN, AND THE COLOR GREEN APPEARING IN THE DESIGN OF HOPS AND THE SWIRL DESIGN.

SN 85-141,574, FILED 9-29-2010.

LINDA M. KING, EXAMINING ATTORNEY



David J. Kyffers

Director of the United States Patent and Trademark Office

United States of America

United States Patent and Trademark Office

Eevah

Reg. No. 4,176,315

Registered July 17, 2012

Int. Cl.: 14

TRADEMARK

PRINCIPAL REGISTER

BIZPINS INCORPORATED (ILLINOIS CORPORATION)
2111 BIG TIMBER ROAD
ELGIN, IL 60123

FOR: JEWELRY AND IMITATION JEWELRY, IN CLASS 14 (U.S. CLS. 2, 27, 28 AND 50).

FIRST USE 3-22-2012; IN COMMERCE 3-22-2012.

THE MARK CONSISTS OF STANDARD CHARACTERS WITHOUT CLAIM TO ANY PARTICULAR FONT, STYLE, SIZE, OR COLOR.

SN 85-143,557, FILED 10-1-2010.

ELIZABETH HUGHITT, EXAMINING ATTORNEY



David J. Kybas

Director of the United States Patent and Trademark Office

United States of America

United States Patent and Trademark Office

BELLYSHELL

Reg. No. 4,176,316

Registered July 17, 2012

Int. Cl.: 12

TRADEMARK

PRINCIPAL REGISTER

SAFE ARRIVAL, LLC (OHIO LIMITED LIABILITY COMPANY)
205 NORTHMOOR PLACE
COLUMBUS, OH 43214

FOR: RIGID NON-METAL COVER THAT FITS OVER A PREGNANT WOMAN'S ABDOMEN, USED WITH SEATBELTS, FOR PROTECTION IN THE EVENT OF A MOTOR VEHICLE CRASH; FITTED FABRIC COVERS FOR RIGID COVER THAT FITS OVER A PREGNANT WOMAN'S ABDOMEN, USED WITH SEATBELTS, FOR PROTECTION IN THE EVENT OF A MOTOR VEHICLE CRASH, IN CLASS 12 (U.S. CLS. 19, 21, 23, 31, 35 AND 44).

FIRST USE 5-6-2012; IN COMMERCE 5-6-2012.

THE MARK CONSISTS OF STANDARD CHARACTERS WITHOUT CLAIM TO ANY PARTICULAR FONT, STYLE, SIZE, OR COLOR.

SN 85-144,179, FILED 10-4-2010.

DOUGLAS LEE, EXAMINING ATTORNEY



David J. Kyffers

Director of the United States Patent and Trademark Office

United States of America

United States Patent and Trademark Office

SAFE ARRIVAL

Reg. No. 4,176,317

Registered July 17, 2012

Int. Cl.: 12

TRADEMARK

PRINCIPAL REGISTER

SAFE ARRIVAL, LLC (OHIO LIMITED LIABILITY COMPANY)
205 NORTHMOOR PLACE
COLUMBUS, OH 43214

FOR: RIGID NON-METAL COVER THAT FITS OVER A PREGNANT WOMAN'S ABDOMEN, USED WITH SEATBELTS, FOR PROTECTION IN THE EVENT OF A MOTOR VEHICLE CRASH; FITTED FABRIC COVERS FOR RIGID COVER THAT FITS OVER A PREGNANT WOMAN'S ABDOMEN, USED WITH SEATBELTS, FOR PROTECTION IN THE EVENT OF A MOTOR VEHICLE CRASH, IN CLASS 12 (U.S. CLS. 19, 21, 23, 31, 35 AND 44).

FIRST USE 12-6-2011; IN COMMERCE 12-6-2011.

THE MARK CONSISTS OF STANDARD CHARACTERS WITHOUT CLAIM TO ANY PARTICULAR FONT, STYLE, SIZE, OR COLOR.

SN 85-144,181, FILED 10-4-2010.

DOUGLAS LEE, EXAMINING ATTORNEY



David J. Kyffers

Director of the United States Patent and Trademark Office

United States of America

United States Patent and Trademark Office

PEARSON THE BEAR

Reg. No. 4,176,318

PEARSON THE BEAR LLC (GEORGIA LIMITED LIABILITY COMPANY)
355 BIRCHFIELD DRIVE SUITE 427
ATLANTA, GA 30068

Registered July 17, 2012

Int. Cl.: 28

FOR: PLUSH TOYS, NAMELY, TEDDY BEARS, IN CLASS 28 (U.S. CLS. 22, 23, 38 AND 50).

TRADEMARK

FIRST USE 1-1-2011; IN COMMERCE 1-1-2011.

PRINCIPAL REGISTER

THE MARK CONSISTS OF STANDARD CHARACTERS WITHOUT CLAIM TO ANY PARTICULAR FONT, STYLE, SIZE, OR COLOR.

NO CLAIM IS MADE TO THE EXCLUSIVE RIGHT TO USE "BEAR", APART FROM THE MARK AS SHOWN.

SN 85-144,434, FILED 10-4-2010.

MELISSA VALLILLO, EXAMINING ATTORNEY



David J. Kyffers

Director of the United States Patent and Trademark Office

United States of America

United States Patent and Trademark Office



Reg. No. 4,176,319

Registered July 17, 2012

**Int. Cls.: 16, 18, 25, 35,
and 41**

TRADEMARK

SERVICE MARK

PRINCIPAL REGISTER

THE LUTHERAN UNIVERSITY ASSOCIATION, INC. (INDIANA NON-PROFIT CORPORATION)
1700 CHAPEL DRIVE
VALPARAISO, IN 46383

FOR: NEWSPAPERS, BOOKS, BROCHURES AND PAMPHLETS CONCERNING UNIVERSITY ADMISSIONS, ALUMNI ACTIVITIES AND GENERAL UNIVERSITY INFORMATION; STATIONERY; PRINTED INVITATIONS; POSTERS; NOTEBOOKS; NOTEPADS, IN CLASS 16 (U.S. CLS. 2, 5, 22, 23, 29, 37, 38 AND 50).

FIRST USE 12-0-2010; IN COMMERCE 12-0-2010.

FOR: TOTE BAGS; BACKPACKS; BRIEFCASE-TYPE LEATHER PORTFOLIOS; LEATHER KEY CHAINS; WALLETS; PURSES; UMBRELLAS, IN CLASS 18 (U.S. CLS. 1, 2, 3, 22 AND 41).

FIRST USE 8-20-2010; IN COMMERCE 8-20-2010.

FOR: CLOTHING AND ACCESSORIES, NAMELY, T-SHIRTS, HATS, SWEATSHIRTS, SHIRTS, SWEAT PANTS, SHORTS, TIES, FOOTWEAR AND BELTS, IN CLASS 25 (U.S. CLS. 22 AND 39).

FIRST USE 9-0-2011; IN COMMERCE 9-0-2011.

FOR: ASSOCIATION SERVICES, NAMELY, PROMOTING THE INTERESTS OF UNIVERSITY ALUMNI, IN CLASS 35 (U.S. CLS. 100, 101 AND 102).

FIRST USE 12-0-2010; IN COMMERCE 12-0-2010.

FOR: EDUCATIONAL SERVICES, NAMELY, PROVIDING INSTRUCTION AT THE UNIVERSITY LEVEL; EDUCATIONAL RESEARCH; ARRANGING AND CONDUCTING EDUCATIONAL CONFERENCES; ENTERTAINMENT SERVICES IN THE NATURE OF CONDUCTING COLLEGIATE SPORTING EVENTS; PROVIDING FACILITIES FOR RECREATIONAL ACTIVITIES, NAMELY, ATHLETIC TRAINING, BASEBALL, BASKETBALL, BOWLING, CROSS COUNTRY, FOOTBALL, GOLF, RECREATIONAL SPORTS, SOCCER, SOFTBALL, STRENGTH AND CONDITIONING, SWIMMING AND DIVING, TENNIS, TRACK AND FIELD, AND VOLLEYBALL; ARRANGING AND CONDUCTING ARTISTIC PERFORMANCES



David J. Kybas

Director of the United States Patent and Trademark Office

Reg. No. 4,176,319 AND CULTURAL EVENTS; PROVIDING ONLINE INFORMATION CONCERNING UNIVERSITY ADMISSIONS, ALUMNI ACTIVITIES AND GENERAL UNIVERSITY INFORMATION; BOOK AND JOURNAL PUBLISHING, IN CLASS 41 (U.S. CLS. 100, 101 AND 107).

FIRST USE 12-0-2010; IN COMMERCE 12-0-2010.

OWNER OF U.S. REG. NOS. 2,454,950, 2,479,369, AND OTHERS.

THE MARK CONSISTS OF A STYLIZED LETTER "V" WITH A FLAME AND SHIELD INSIDE OF AN OUTLINE OF A SHIELD.

SN 85-144,685, FILED 10-4-2010.

WON TEAK OH, EXAMINING ATTORNEY

United States of America

United States Patent and Trademark Office



Reg. No. 4,176,320

Registered July 17, 2012

**Int. Cls.: 12, 18, 21, 25,
35, and 41**

TRADEMARK

SERVICE MARK

PRINCIPAL REGISTER

THE LUTHERAN UNIVERSITY ASSOCIATION, INC. (INDIANA NON-PROFIT CORPORATION)
1700 CHAPEL DRIVE
VALPARAISO, IN 46383

FOR: LICENSE PLATE FRAMES , IN CLASS 12 (U.S. CLS. 19, 21, 23, 31, 35 AND 44).

FIRST USE 9-0-2011; IN COMMERCE 9-0-2011.

FOR: TOTE BAGS; BACKPACKS; BRIEFCASE-TYPE LEATHER PORTFOLIOS; LEATHER KEY CHAINS; WALLETS; PURSES; UMBRELLAS, IN CLASS 18 (U.S. CLS. 1, 2, 3, 22 AND 41).

FIRST USE 9-0-2011; IN COMMERCE 9-0-2011.

FOR: MUGS; CUPS; DRINKING GLASSWARE, IN CLASS 21 (U.S. CLS. 2, 13, 23, 29, 30, 33, 40 AND 50).

FIRST USE 9-0-2011; IN COMMERCE 9-0-2011.

FOR: CLOTHING AND ACCESSORIES, NAMELY, T-SHIRTS, HATS, SWEATSHIRTS, SHIRTS, SWEAT PANTS, SHORTS, TIES, FOOTWEAR AND BELTS, IN CLASS 25 (U.S. CLS. 22 AND 39).

FIRST USE 9-0-2011; IN COMMERCE 9-0-2011.

FOR: ASSOCIATION SERVICES, NAMELY, PROMOTING THE INTERESTS OF UNIVERSITY ALUMNI, IN CLASS 35 (U.S. CLS. 100, 101 AND 102).

FIRST USE 9-0-2011; IN COMMERCE 9-0-2011.

FOR: EDUCATIONAL SERVICES, NAMELY, PROVIDING INSTRUCTION AT THE UNIVERSITY LEVEL; EDUCATIONAL RESEARCH; ARRANGING AND CONDUCTING EDUCATIONAL CONFERENCES; ENTERTAINMENT SERVICES IN THE NATURE OF CONDUCTING COLLEGIATE SPORTING EVENTS; PROVIDING FACILITIES FOR RECREATIONAL ACTIVITIES, NAMELY, ATHLETIC TRAINING, BASEBALL, BASKETBALL, BOWLING, CROSS COUNTRY, FOOTBALL, GOLF, RECREATIONAL SPORTS, SOCCER, SOFTBALL,



David J. Kyjars

Director of the United States Patent and Trademark Office

Reg. No. 4,176,320 STRENGTH AND CONDITIONING, SWIMMING AND DIVING, TENNIS, TRACK AND FIELD, AND VOLLEYBALL; ARRANGING AND CONDUCTING ARTISTIC PERFORMANCES AND CULTURAL EVENTS; PROVIDING ONLINE INFORMATION CONCERNING UNIVERSITY ADMISSIONS, ALUMNI ACTIVITIES AND GENERAL UNIVERSITY INFORMATION; BOOK AND JOURNAL PUBLISHING, IN CLASS 41 (U.S. CLS. 100, 101 AND 107).

FIRST USE 9-17-2010; IN COMMERCE 9-17-2010.

OWNER OF U.S. REG. NOS. 2,454,950, 2,479,369, AND OTHERS.

THE MARK CONSISTS OF THE WORD "VALPO" IN BLOCK LETTERS ON TOP AND BEHIND A STYLIZED LETTER "V" WITH A FLAME AND SHIELD INSIDE OF AN OUTLINE OF A SHIELD.

SN 85-144,691, FILED 10-4-2010.

WON TEAK OH, EXAMINING ATTORNEY

United States of America

United States Patent and Trademark Office

EUROFILTER

Reg. No. 4,176,321

CHAMPION LABORATORIES, INC. (DELAWARE CORPORATION)
200 S. 4TH STREET
ALBION, IL 62806

Registered July 17, 2012

Int. Cls.: 7 and 11

FOR: HEAVY DUTY AIR FILTERS FOR GAS TURBINES FOR LAND VEHICLES, IN CLASS 7 (U.S. CLS. 13, 19, 21, 23, 31, 34 AND 35).

TRADEMARK

FIRST USE 7-0-2008; IN COMMERCE 7-0-2008.

PRINCIPAL REGISTER

FOR: HEAVY DUTY AIR FILTERS FOR INDUSTRIAL INSTALLATIONS FOR USE IN DUST COLLECTION, IN CLASS 11 (U.S. CLS. 13, 21, 23, 31 AND 34).

FIRST USE 7-0-2008; IN COMMERCE 7-0-2008.

THE MARK CONSISTS OF STANDARD CHARACTERS WITHOUT CLAIM TO ANY PARTICULAR FONT, STYLE, SIZE, OR COLOR.

SN 85-144,715, FILED 10-4-2010.

JAMES LOVELACE, EXAMINING ATTORNEY



David J. Kyfos

Director of the United States Patent and Trademark Office

United States of America

United States Patent and Trademark Office



Reg. No. 4,176,322

Registered July 17, 2012

Int. Cl.: 7

TRADEMARK

PRINCIPAL REGISTER

CONSOLIDATED BUSINESS SOLUTIONS PTY LTD (AUSTRALIA PROPRIETARY LIMITED COMPANY)
104 FERNTREE GULLY ROAD, OAKLEIGH EAST
SUITE 22
VICTORIA, AUSTRALIA 3166 AND

KLAUS-PETER SOHM SCHMIERSTOFFTECHNIK E.K (FED REP GERMANY SOLE PROPRIETORSHIP)
AM GUTERBAHNHOF 2
OFFENBURG, FED REP GERMANY 77652

FOR: LUBRICATING DEVICES AS PART OF MACHINES, NAMELY, GREASE CARTRIDGES, LUBRICATING CARTRIDGES, LUBRICATORS, PARTS OF THE AFORESAID GOODS IN THIS CLASS; LUBRICATING DEVICES COMPRISING POWER-OPERATED LUBRICANT DISPENSERS FOR MACHINES PRE-PACKED WITH LUBRICANT AND PARTS THEREFOR IN THIS CLASS; LUBRICATING MACHINES, NAMELY, LUBRICATORS INCLUDING AUTOMATIC LUBRICATORS; LUBRICATORS, NAMELY, PNEUMATIC GREASE GUNS, IN CLASS 7 (U.S. CLS. 13, 19, 21, 23, 31, 34 AND 35).

FIRST USE 11-0-1993; IN COMMERCE 11-0-1993.

NO CLAIM IS MADE TO THE EXCLUSIVE RIGHT TO USE "GREASE", APART FROM THE MARK AS SHOWN.

THE MARK CONSISTS OF THE WORDS "GREASE MAX" IN CAPITAL LETTERS, WITH THE WORD "GREASE" ABOVE THE WORD "MAX"; TO THE LEFT OF THE WORD "MAX", THERE IS A CARTOON HEAD OF A MAN WEARING A CAP AND A HAND WITH A THUMB RAISED, AND BELOW THE "M" IN "MAX" IS AN OIL DROP.

SN 85-145,134, FILED 10-5-2010.

MARK SPARACINO, EXAMINING ATTORNEY



David J. Kyffers

Director of the United States Patent and Trademark Office

United States of America

United States Patent and Trademark Office

RIGHTEOUS WAVE

Reg. No. 4,176,323

MONICA B. WOLVERTON (UNITED STATES INDIVIDUAL)
2840 KENSINGTON ROAD
WINSTON-SALEM, NC 27106

Registered July 17, 2012

Int. Cl.: 25

FOR: CLOTHING, NAMELY, T-SHIRTS, SURF WEAR, HATS, WETSUITS, IN CLASS 25 (U.S. CLS. 22 AND 39).

TRADEMARK

FIRST USE 4-25-2012; IN COMMERCE 4-25-2012.

PRINCIPAL REGISTER

THE MARK CONSISTS OF STANDARD CHARACTERS WITHOUT CLAIM TO ANY PARTICULAR FONT, STYLE, SIZE, OR COLOR.

SN 85-145,390, FILED 10-5-2010.

GINA HAYES, EXAMINING ATTORNEY



David J. Kyffers

Director of the United States Patent and Trademark Office

United States of America

United States Patent and Trademark Office

maternova

Tools & ideas that save mothers & newborns

Reg. No. 4,176,324

Registered July 17, 2012

Int. Cls.: 9 and 35

TRADEMARK

SERVICE MARK

PRINCIPAL REGISTER

MATERNOVA, INC. (RHODE ISLAND CORPORATION)
112 BENEFIT STREET
PROVIDENCE, RI 02903

FOR: MEASURING CUPS, IN CLASS 9 (U.S. CLS. 21, 23, 26, 36 AND 38).

FIRST USE 1-1-2011; IN COMMERCE 4-27-2012.

FOR: PROVIDING A SEARCHABLE WEBSITE FEATURING THE GOODS AND SERVICES OF OTHER VENDORS, IN CLASS 35 (U.S. CLS. 100, 101 AND 102).

FIRST USE 5-1-2009; IN COMMERCE 1-1-2011.

THE MARK CONSISTS OF THE WORD "MATERNOVA" IN RED COLOR AND THE WORDS "TOOLS & IDEAS THAT SAVE MOTHERS & NEWBORNS" BELOW IN ORANGE. THE SMALL HORIZONTAL LINE ABOVE THE LETTERS "MA" IN "MATERNOVA" IS ALSO ORANGE.

THE COLOR(S) RED AND ORANGE IS/ARE CLAIMED AS A FEATURE OF THE MARK.

SN 85-145,484, FILED 10-5-2010.

JAMES GRIFFIN, EXAMINING ATTORNEY



David J. Kyffers

Director of the United States Patent and Trademark Office

United States of America

United States Patent and Trademark Office



Reg. No. 4,176,325

Registered July 17, 2012

Int. Cls.: 35 and 45

SERVICE MARK

PRINCIPAL REGISTER

ITS COMPLIANCE, INC. (WISCONSIN CORPORATION)
137 S. BRISTOL STREET
SUN PRAIRIE, WI 53590

FOR: BUSINESS CONSULTATION SERVICES IN THE FIELD OF VEHICLE FLEET AND TRUCKING MANAGEMENT; STATE VEHICULAR REGISTRATION RENEWAL SERVICES; GATHERING AND MAINTAINING BUSINESS INFORMATION FOR USE BY OTHERS FOR THE REPORTING AND TRACKING OF FLEET VEHICLE AND TRUCKING MAINTENANCE AND EXPENSES FOR BUSINESS PURPOSES; BUSINESS INFORMATION SERVICES, NAMELY, TRACKING OF INFORMATION FOR USE BY OTHERS IN ARRANGING FOR THE ACQUISITION, PAYMENT AND DELIVERY OF STATE AND FEDERAL TRUCKING PERMITS; BUSINESS INFORMATION SERVICES, NAMELY, GATHERING AND MAINTAINING DRIVER AND FLEET VEHICLE INFORMATION SUCH AS VEHICLE IDENTIFICATION NUMBERS, YEAR, MAKE AND MODEL OF VEHICLES, TITLE INFORMATION, REGISTRATION INFORMATION, AND PERMITTING INFORMATION FOR BUSINESS PURPOSES; BUSINESS INFORMATION SERVICES, NAMELY, DRIVER VEHICLE INSPECTION RECORD AUDITING AND REPORTING FOR COMMERCIAL PURPOSES, IN CLASS 35 (U.S. CLS. 100, 101 AND 102).

FIRST USE 6-1-2011; IN COMMERCE 6-1-2011.



FOR: REGULATORY COMPLIANCE CONSULTING SERVICES IN THE FIELD OF FEDERAL AND STATE TRANSPORTATION RULES AND REGULATIONS, NAMELY, DRIVER AND EXEMPT LOG AUDIT AND REPORTING, MAINTENANCE AND MONITORING OF RECORDS OF COMMERCIAL DRIVERS FOR COMPLIANCE WITH FEDERAL AND STATE TRANSPORTATION RULES AND REGULATIONS; REGULATORY COMPLIANCE CONSULTING SERVICES IN THE FIELD OF FEDERAL AND STATE TRANSPORTATION RULES AND REGULATIONS, NAMELY, EVALUATION OF DRIVER DATA TO HELP ENSURE COMPLIANCE WITH FEDERAL AND STATE TRANSPORTATION RULES AND REGULATIONS, IN CLASS 45 (U.S. CLS. 100 AND 101).

FIRST USE 6-1-2011; IN COMMERCE 6-1-2011.

David J. Kybas

NO CLAIM IS MADE TO THE EXCLUSIVE RIGHT TO USE "INSTANT ACCESS" , APART FROM THE MARK AS SHOWN.

Reg. No. 4,176,325 THE MARK CONSISTS OF A FANCIFUL DESIGN OF A ROAD WITH THE WORDING "INSTANT ACCESS" PLACED HORIZONTALLY ACROSS THE DESIGN.

SN 85-145,983, FILED 10-6-2010.

JUSTINE D. PARKER, EXAMINING ATTORNEY

United States of America

United States Patent and Trademark Office

BLINX

Reg. No. 4,176,326

Registered July 17, 2012

Int. Cl.: 16

TRADEMARK

PRINCIPAL REGISTER

DCREATIONS, LLC (OHIO LIMITED LIABILITY COMPANY)
5365 MAPLEDALE WAY
MASON, OH 45040

FOR: MEMORY BOOKS; ANNIVERSARY BOOKS; BABY BOOKS; BIRTHDAY BOOKS; ENGAGEMENT BOOKS; PICTURE BOOKS; BOOKS IN THE FIELD OF PERSONALIZED PICTURE BOOKS; PUBLICATIONS, NAMELY, BOOKS IN THE FIELDS OF PERSONALIZED PICTURE BOOKS AND PERSONALIZED MEMORY BOOKS; SCRAPBOOKS; SCRAPBOOKS RELATED TO SORORITY, FRATERNITY, OR COLLEGE EVENTS; YEARBOOKS; YEARBOOKS RELATED TO SORORITY, FRATERNITY, OR COLLEGE EVENTS; PHOTO JOURNALS; PHOTO DIARIES; WEDDING PHOTO ALBUMS, IN CLASS 16 (U.S. CLS. 2, 5, 22, 23, 29, 37, 38 AND 50).

FIRST USE 6-7-2011; IN COMMERCE 6-7-2011.

THE MARK CONSISTS OF STANDARD CHARACTERS WITHOUT CLAIM TO ANY PARTICULAR FONT, STYLE, SIZE, OR COLOR.

SN 85-147,056, FILED 10-7-2010.

SUNG IN, EXAMINING ATTORNEY



David J. Kyfos

Director of the United States Patent and Trademark Office

United States of America

United States Patent and Trademark Office

Youngstown Shakedown

Reg. No. 4,176,327

Registered July 17, 2012

Int. Cl.: 9

TRADEMARK

PRINCIPAL REGISTER

KOVCOM, INC (OHIO CORPORATION)
SUITE 208
5208 MAHONING AVENUE
AUSTINTOWN, OH 44515

FOR: MOTION PICTURE FILMS FEATURING CRIME AND GANGSTER SUBJECT MATTER,
IN CLASS 9 (U.S. CLS. 21, 23, 26, 36 AND 38).

FIRST USE 10-1-2011; IN COMMERCE 10-1-2011.

THE MARK CONSISTS OF STANDARD CHARACTERS WITHOUT CLAIM TO ANY PAR-
TICULAR FONT, STYLE, SIZE, OR COLOR.

NO CLAIM IS MADE TO THE EXCLUSIVE RIGHT TO USE "YOUNGSTOWN", APART
FROM THE MARK AS SHOWN.

SN 85-147,119, FILED 10-7-2010.

LESLEY LAMOTHE, EXAMINING ATTORNEY



David J. Kyffers

Director of the United States Patent and Trademark Office

United States of America

United States Patent and Trademark Office

WHO DOESN'T LIKE PIE

Reg. No. 4,176,328

Registered July 17, 2012

Int. Cl.: 29

TRADEMARK

PRINCIPAL REGISTER

VOLPATI-KEDRA, PAOLO (UNITED STATES INDIVIDUAL)
#3
126 KILSYTH RD.
BRIGHTON, MA 02135

FOR: COMPONENTS FOR PIES, NAMELY, FRUIT-BASED PIE FILLINGS; TOPPINGS, NAMELY, FRUIT, NUT AND WHIPPED TOPPINGS; SOUPS AND PREPARATIONS FOR MAKING SOUPS, IN CLASS 29 (U.S. CL. 46).

FIRST USE 10-7-2010; IN COMMERCE 10-7-2010.

THE MARK CONSISTS OF STANDARD CHARACTERS WITHOUT CLAIM TO ANY PARTICULAR FONT, STYLE, SIZE, OR COLOR.

SN 85-147,135, FILED 10-7-2010.

STEVEN PEREZ, EXAMINING ATTORNEY



David J. Kyffers

Director of the United States Patent and Trademark Office

United States of America

United States Patent and Trademark Office

PURR-FECT MEDLEY

Reg. No. 4,176,329

Registered July 17, 2012

Int. Cl.: 31

TRADEMARK

PRINCIPAL REGISTER

TOPCO ASSOCIATES, LLC (DELAWARE LIMITED LIABILITY COMPANY)
7711 GROSS POINT ROAD
SKOKIE, IL 60077

FOR: CAT FOOD, IN CLASS 31 (U.S. CLS. 1 AND 46).

FIRST USE 6-0-2011; IN COMMERCE 6-0-2011.

THE MARK CONSISTS OF STANDARD CHARACTERS WITHOUT CLAIM TO ANY PARTICULAR FONT, STYLE, SIZE, OR COLOR.

OWNER OF U.S. REG. NO. 2,963,941.

SN 85-147,412, FILED 10-7-2010.

SUE LAWRENCE, EXAMINING ATTORNEY



David J. Kyffers

Director of the United States Patent and Trademark Office

United States of America

United States Patent and Trademark Office

THE AVENGER

Reg. No. 4,176,330

Registered July 17, 2012

Int. Cl.: 9

TRADEMARK

PRINCIPAL REGISTER

ICONTROL ENTERPRISES LLC (NEW YORK LIMITED LIABILITY COMPANY)
11 PINEHURST CIRCLE
MONROE, NY 10950

FOR: VIDEO GAME CONTROLLER ACCESSORIES, NAMELY, VIDEO GAME FITTED CONTROLLER COVERS FOR EXTENDED GAMEPLAY, FASTER GAMEPLAY, AND GAMEPLAY ENHANCEMENT, IN CLASS 9 (U.S. CLS. 21, 23, 26, 36 AND 38).

FIRST USE 1-10-2011; IN COMMERCE 1-10-2011.

THE MARK CONSISTS OF STANDARD CHARACTERS WITHOUT CLAIM TO ANY PARTICULAR FONT, STYLE, SIZE, OR COLOR.

SN 85-148,043, FILED 10-8-2010.

BILL DAWE, EXAMINING ATTORNEY



David J. Kyffers

Director of the United States Patent and Trademark Office

United States of America

United States Patent and Trademark Office

PAZ
RODRÍGUEZ

Reg. No. 4,176,331

Registered July 17, 2012

Int. Cl.: 25

TRADEMARK

PRINCIPAL REGISTER

CREACIONES PAZ RODRIGUEZ, S.L. (SPAIN CORPORATION)
PARQUE TECNOLÓGICO BEADE VALLADARES
CALLE C, NAVE B-4 TEXVIGO
VALLADARES, PONTEVEDRA, SPAIN 36315

FOR: CLOTHING FOR CHILDREN, NAMELY, SHIRTS, TROUSERS, PULLOVERS, SWEATERS, CARDIGANS, COATS AND SOCKS; FOOTWEAR FOR CHILDREN, NAMELY, SHOES, IN CLASS 25 (U.S. CLS. 22 AND 39).

FIRST USE 8-26-2010; IN COMMERCE 8-26-2010.

THE NAME(S), PORTRAIT(S), AND/OR SIGNATURE(S) SHOWN IN THE MARK DOES NOT IDENTIFY A PARTICULAR LIVING INDIVIDUAL.

THE COLOR(S) PINK, GREY AND BLUE IS/ARE CLAIMED AS A FEATURE OF THE MARK.

THE MARK CONSISTS OF THE WORDS "PAZ" RODRIGUEZ, "PAZ" WRITTEN IN STYLIZED LETTERS, THE LETTER "P" IS IN BLUE, THE LETTER "A" IS IN GREY AND THE LETTER "Z" IS IN PINK, BELOW THE WORD "PAZ" IS THE WORD RODRIGUEZ WRITTEN IN STYLIZED BLUE LETTERS OF SMALLER SIZE.

THE ENGLISH TRANSLATION OF "PAZ" IN THE MARK IS PEACE.

SN 85-148,634, FILED 10-8-2010.

SUSAN STIGLITZ, EXAMINING ATTORNEY



David J. Kybas

Director of the United States Patent and Trademark Office

United States of America

United States Patent and Trademark Office



Reg. No. 4,176,332

MAZZOLA, JASON (UNITED STATES INDIVIDUAL)
40 NOUVELLE WAY
NATICK, MA 01760

Registered July 17, 2012

Int. Cl.: 25

FOR: CLOTHING FOR WOMEN, NAMELY, SPORTS BRAS, TANK TOPS, SHORT SLEEVE ACTIVE TOPS, HOODED SWEATSHIRTS, PANTS, CAPRIS, AND SHORTS, IN CLASS 25 (U.S. CLS. 22 AND 39).

TRADEMARK

FIRST USE 2-15-2012; IN COMMERCE 2-15-2012.

PRINCIPAL REGISTER

THE MARK CONSISTS OF AN "S"-SHAPED STREAK, WITH THE STREAK SLIGHTLY TILTED IN AN DOWNWARD DIRECTION FACING THE RIGHT.

SN 85-149,008, FILED 10-9-2010.

LINDSEY RUBIN, EXAMINING ATTORNEY



David J. Kyffers

Director of the United States Patent and Trademark Office

United States of America

United States Patent and Trademark Office

TRM

Reg. No. 4,176,333

Registered July 17, 2012

Int. Cls.: 9, 35, and 36

TRADEMARK

SERVICE MARK

PRINCIPAL REGISTER

BULGER CAPITAL, LLC (DELAWARE LIMITED LIABILITY COMPANY), AKA BULGER CAPITAL PARTNERS,
130 TURNER STREET, 5TH FLOOR
WALTHAM, MA 02453

FOR: COMPUTER SOFTWARE FOR COLLECTING, MANAGING AND TRACKING DATA, PERFORMING ANALYSES, CONDUCTING STUDIES, AND CREATING AND GENERATING REPORTS IN THE FIELD OF MERGERS AND ACQUISITIONS, IN CLASS 9 (U.S. CLS. 21, 23, 26, 36 AND 38).

FIRST USE 10-31-2010; IN COMMERCE 10-31-2010.

FOR: BUSINESS MERGER AND ACQUISITION CONSULTING AND ADVISORY SERVICES; NEGOTIATION, SETTLEMENT AND CONCLUSION OF CORPORATE TRANSACTIONS FOR THIRD PARTIES, IN CLASS 35 (U.S. CLS. 100, 101 AND 102).

FIRST USE 10-31-2010; IN COMMERCE 10-31-2010.

FOR: DILIGENCING OF CORPORATE TRANSACTIONS FOR THIRD PARTIES, NAMELY, FINANCIAL DUE DILIGENCE, IN CLASS 36 (U.S. CLS. 100, 101 AND 102).

FIRST USE 10-31-2010; IN COMMERCE 10-31-2010.

THE MARK CONSISTS OF STANDARD CHARACTERS WITHOUT CLAIM TO ANY PARTICULAR FONT, STYLE, SIZE, OR COLOR.

SN 85-149,347, FILED 10-11-2010.

ROBERT STRUCK, EXAMINING ATTORNEY



David J. Kyffers

Director of the United States Patent and Trademark Office

United States of America
United States Patent and Trademark Office

KOVERALL

Reg. No. 4,176,334

CHEMINOVA, INC. (DELAWARE CORPORATION)
ONE PARK DRIVE, SUITE 150
RESEARCH TRIANGLE PARK, NC 27709

Registered July 17, 2012

Int. Cl.: 5

FOR: CROP FUNGICIDE, IN CLASS 5 (U.S. CLS. 6, 18, 44, 46, 51 AND 52).

TRADEMARK

FIRST USE 2-28-2012; IN COMMERCE 2-28-2012.

PRINCIPAL REGISTER

THE MARK CONSISTS OF STANDARD CHARACTERS WITHOUT CLAIM TO ANY PARTICULAR FONT, STYLE, SIZE, OR COLOR.

SN 85-150,252, FILED 10-12-2010.

SHAUNIA CARLYLE, EXAMINING ATTORNEY



David J. Kyffers

Director of the United States Patent and Trademark Office

United States of America

United States Patent and Trademark Office

Quit₄

Reg. No. 4,176,335

Registered July 17, 2012

Int. Cl.: 5

TRADEMARK

PRINCIPAL REGISTER

L. PERRIGO COMPANY (MICHIGAN CORPORATION)
515 EASTERN AVENUE
ALLEGAN, MI 49010

FOR: SMOKING CESSATION AIDS, NAMELY, NICOTINE GUM, IN CLASS 5 (U.S. CLS. 6, 18, 44, 46, 51 AND 52).

FIRST USE 5-9-2012; IN COMMERCE 5-9-2012.

THE MARK CONSISTS OF THE WORD "QUIT" WITH THE CURVED LINE ON THE "Q" FADING AND THE NUMERAL "4" IN SUBSCRIPT AFTER THE WORD "QUIT".

SN 85-150,484, FILED 10-12-2010.

ALEX KEAM, EXAMINING ATTORNEY



David J. Kybas

Director of the United States Patent and Trademark Office

United States of America

United States Patent and Trademark Office

Quit₂

Reg. No. 4,176,336

L. PERRIGO COMPANY (MICHIGAN CORPORATION)
515 EASTERN AVENUE
ALLEGAN, MI 49010

Registered July 17, 2012

Int. Cl.: 5

FOR: SMOKING CESSATION AIDS, NAMELY, NICOTINE GUM, IN CLASS 5 (U.S. CLS. 6, 18, 44, 46, 51 AND 52).

TRADEMARK

FIRST USE 5-9-2012; IN COMMERCE 5-9-2012.

PRINCIPAL REGISTER

THE MARK CONSISTS OF THE WORD "QUIT" WITH THE CURVED LINE ON THE "Q" FADING AND THE NUMERAL "2" IN SUBSCRIPT AFTER THE WORD "QUIT".

SN 85-150,490, FILED 10-12-2010.

ALEX KEAM, EXAMINING ATTORNEY



David J. Kybas

Director of the United States Patent and Trademark Office

United States of America

United States Patent and Trademark Office

OVILA

Reg. No. 4,176,337

Registered July 17, 2012

Int. Cl.: 32

TRADEMARK

PRINCIPAL REGISTER

ABBEY OF NEW CLAIRVAUX (CALIFORNIA CORPORATION)
26240 SEVENTH STREET
VINA, CA 960920080

FOR: ALE, IN CLASS 32 (U.S. CLS. 45, 46 AND 48).

FIRST USE 3-14-2011; IN COMMERCE 3-14-2011.

THE MARK CONSISTS OF STANDARD CHARACTERS WITHOUT CLAIM TO ANY PARTICULAR FONT, STYLE, SIZE, OR COLOR.

SN 85-150,705, FILED 10-12-2010.

JEFF DEFORD, EXAMINING ATTORNEY



David J. Kyffers

Director of the United States Patent and Trademark Office

United States of America

United States Patent and Trademark Office

STEMGENEX

Reg. No. 4,176,338

Registered July 17, 2012

Int. Cl.: 35

SERVICE MARK

PRINCIPAL REGISTER

INTERNATIONAL STEM CELL INSTITUTE (CALIFORNIA SOLE PROPRIETORSHIP)
P.O. BOX 1922
LA JOLLA, CA 92038

FOR: BUSINESS SERVICES, NAMELY, REFERRING INDIVIDUALS TO MEDICAL SERVICES RELATING TO STEM CELL THERAPIES; BUSINESS INTRODUCTION SERVICES, NAMELY, INTERFACING CLIENTS AND HEALTH CARE PRACTITIONERS AND THERAPISTS, NAMELY, MEDICAL REFERRAL SERVICES; PROVIDING MEDICAL, HEALTH AND STEM CELL THERAPEUTIC REFERRALS TO INDIVIDUALS AND PRACTITIONERS; PROVIDING REFERRAL SERVICES TO INDIVIDUALS IN THE FIELDS OF HEALTH CARE AND WELL-BEING, WELLNESS AND STEM CELL THERAPY, IN CLASS 35 (U.S. CLS. 100, 101 AND 102).

FIRST USE 7-6-2011; IN COMMERCE 7-6-2011.

THE MARK CONSISTS OF STANDARD CHARACTERS WITHOUT CLAIM TO ANY PARTICULAR FONT, STYLE, SIZE, OR COLOR.

SN 85-151,051, FILED 10-12-2010.

DEIRDRE ROBERTSON, EXAMINING ATTORNEY



David J. Kyros

Director of the United States Patent and Trademark Office

United States of America

United States Patent and Trademark Office

VNOMICS

Reg. No. 4,176,339

Registered July 17, 2012

Int. Cls.: 9 and 41

TRADEMARK

SERVICE MARK

PRINCIPAL REGISTER

VNOMICS, CORP. (DELAWARE CORPORATION)
175 SULLY'S TRAIL
SUITE 203
PITTSFORD, NY 14534

FOR: HARDWARE AND SOFTWARE FOR DETECTING AND MONITORING VEHICULAR FUEL USAGE, VEHICULAR LOAD, ENVIRONMENTAL CONDITIONS, OPERATOR EFFICIENCY AND SAFETY, VEHICULAR MAINTENANCE, VEHICULAR LOCATION, OPERATIONAL STATUS, OPERATIONAL SAFETY PROFILE; HARDWARE AND SOFTWARE FOR COLLECTING, STORING AND RELAYING DATA PERTAINING TO VEHICULAR OPERATIONAL EFFICIENCY, HEALTH, USAGE, AND SAFETY TO ONE OR MORE REMOTE LOCATIONS; HARDWARE AND SOFTWARE FOR MONITORING VEHICULAR OPERATIONAL PARAMETERS TO ENHANCE FUEL EFFICIENCY, SAFETY, AND MECHANICAL RELIABILITY, IN CLASS 9 (U.S. CLS. 21, 23, 26, 36 AND 38).

FIRST USE 10-4-2010; IN COMMERCE 10-4-2010.

FOR: DRIVER EDUCATION, TRAINING AND COACHING SERVICES, IN CLASS 41 (U.S. CLS. 100, 101 AND 107).

FIRST USE 10-4-2010; IN COMMERCE 10-4-2010.

THE MARK CONSISTS OF STANDARD CHARACTERS WITHOUT CLAIM TO ANY PARTICULAR FONT, STYLE, SIZE, OR COLOR.

SN 85-151,235, FILED 10-13-2010.

RONALD MCMORROW, EXAMINING ATTORNEY



David J. Kyffers

Director of the United States Patent and Trademark Office

United States of America

United States Patent and Trademark Office

Be in control of your beauty!

Reg. No. 4,176,340

BELLECI BEAUTE (CALIFORNIA CORPORATION), DBA BELLECI COSMETICS,
3494 CAMINO TASSAJARA ROAD
DANVILLE, CA 94506

Registered July 17, 2012

Int. Cl.: 3

FOR: BODY AND BEAUTY CARE COSMETICS; COSMETICS; COSMETICS AND COSMETIC PREPARATIONS; COSMETICS AND MAKE-UP, IN CLASS 3 (U.S. CLS. 1, 4, 6, 50, 51 AND 52).

TRADEMARK

FIRST USE 9-1-2011; IN COMMERCE 9-1-2011.

PRINCIPAL REGISTER

THE MARK CONSISTS OF THE FOLLOWING STYLIZED LETTERS AND EXCLAMATION POINT: "BE IN CONTROL OF YOUR BEAUTY!".

SN 85-152,780, FILED 10-14-2010.

DEIRDRE ROBERTSON, EXAMINING ATTORNEY



David J. Kyffers

Director of the United States Patent and Trademark Office

United States of America

United States Patent and Trademark Office

MIGHTYmini

Reg. No. 4,176,341

SHOP VAC CORPORATION (NEW JERSEY CORPORATION)
2323 REACH ROAD
WILLIAMSPORT, PA 17707

Registered July 17, 2012

Int. Cl.: 7

FOR: POWER OPERATED BLOWERS, IN CLASS 7 (U.S. CLS. 13, 19, 21, 23, 31, 34 AND 35).

FIRST USE 9-30-2010; IN COMMERCE 9-30-2010.

TRADEMARK

THE MARK CONSISTS OF STANDARD CHARACTERS WITHOUT CLAIM TO ANY PARTICULAR FONT, STYLE, SIZE, OR COLOR.

PRINCIPAL REGISTER

OWNER OF U.S. REG. NO. 1,218,995.

SN 85-152,860, FILED 10-14-2010.

GINA FINK, EXAMINING ATTORNEY



David J. Kyffers

Director of the United States Patent and Trademark Office

United States of America

United States Patent and Trademark Office

H.O.M.E. HELPING OUR MILITARY AND ENVIRONMENT

Reg. No. 4,176,342

Registered July 17, 2012

Int. Cls.: 18 and 36

TRADEMARK

SERVICE MARK

PRINCIPAL REGISTER

SPECIALTY RETAILERS, INC. (TEXAS CORPORATION)
10201 MAIN STREET
HOUSTON, TX 77025

FOR: REUSABLE SHOPPING BAGS, IN CLASS 18 (U.S. CLS. 1, 2, 3, 22 AND 41).

FIRST USE 2-0-2011; IN COMMERCE 2-0-2011.

FOR: CHARITABLE FUNDRAISING FOR MILITARY FAMILIES THROUGH RETAIL STORES BY THE SALE OF REUSABLE SHOPPING BAGS, IN CLASS 36 (U.S. CLS. 100, 101 AND 102).

FIRST USE 2-0-2011; IN COMMERCE 2-0-2011.

THE MARK CONSISTS OF STANDARD CHARACTERS WITHOUT CLAIM TO ANY PARTICULAR FONT, STYLE, SIZE, OR COLOR.

NO CLAIM IS MADE TO THE EXCLUSIVE RIGHT TO USE "MILITARY" AND "ENVIRONMENT", APART FROM THE MARK AS SHOWN.

SN 85-153,396, FILED 10-15-2010.

JOHN E. MICHOS, EXAMINING ATTORNEY



David J. Kyros

Director of the United States Patent and Trademark Office

United States of America

United States Patent and Trademark Office

JILL ZARIN

Reg. No. 4,176,343

Registered July 17, 2012

Int. Cl.: 41

SERVICE MARK

PRINCIPAL REGISTER

JBZ ENTERPRISES LLC (DELAWARE LIMITED LIABILITY COMPANY)
#30C
401 E. 60TH STREET
NEW YORK, NY 10022

FOR: ENTERTAINMENT SERVICES, NAMELY, AN ON-GOING SERIES FEATURING HOME STYLE, DECORATING, FASHION AND LIFE-STYLE TIPS PROVIDED THROUGH NETWORK TELEVISION, CABLE TELEVISION, WEBCASTS, RADIO BROADCASTS AND THE WORLD WIDE WEB; ENTERTAINMENT SERVICES, NAMELY, PERSONAL APPEARANCES BY A TELEVISION AND REALITY SHOW CELEBRITY, IN CLASS 41 (U.S. CLS. 100, 101 AND 107).

FIRST USE 0-0-2008; IN COMMERCE 0-0-2008.

THE MARK CONSISTS OF STANDARD CHARACTERS WITHOUT CLAIM TO ANY PARTICULAR FONT, STYLE, SIZE, OR COLOR.

THE NAME(S), PORTRAIT(S), AND/OR SIGNATURE(S) SHOWN IN THE MARK IDENTIFIES "JILL ZARIN", WHOSE CONSENT(S) TO REGISTER IS MADE OF RECORD.

SN 85-153,494, FILED 10-15-2010.

LINDA ORNDORFF, EXAMINING ATTORNEY



David J. Kybas

Director of the United States Patent and Trademark Office

United States of America

United States Patent and Trademark Office

RESPONDING TO THE PRESENT... BUILDING THE FUTURE

Reg. No. 4,176,344

Registered July 17, 2012

Int. Cl.: 14

TRADEMARK

PRINCIPAL REGISTER

GABRIEL & CO. (NEW YORK CORPORATION)
7TH FLOOR
64 WEST 48TH STREET
NEW YORK, NY 10036

FOR: JEWELRY, IN CLASS 14 (U.S. CLS. 2, 27, 28 AND 50).

FIRST USE 0-0-2005; IN COMMERCE 5-0-2010.

THE MARK CONSISTS OF STANDARD CHARACTERS WITHOUT CLAIM TO ANY PARTICULAR FONT, STYLE, SIZE, OR COLOR.

SN 85-153,726, FILED 10-15-2010.

REBECCA POVARCHUK, EXAMINING ATTORNEY



David J. Kybas

Director of the United States Patent and Trademark Office

United States of America

United States Patent and Trademark Office

JINK.TV

Reg. No. 4,176,345

Registered July 17, 2012

Int. Cl.: 41

SERVICE MARK

PRINCIPAL REGISTER

JINK.TV, INC. (NEVADA CORPORATION)
8600 SAGAMORE ROAD
LEAWOOD, KS 66206

FOR: ENTERTAINMENT IN THE NATURE OF VISUAL AND AUDIO PERFORMANCES, NAMELY, ONGOING VARIETY AND NEWS SHOWS BROADCAST VIA TELEVISION AND VIA AN ONLINE COMMUNICATIONS NETWORK; ENTERTAINMENT IN THE NATURE OF LIVE VISUAL AND AUDIO PERFORMANCES, NAMELY, VARIETY AND NEWS SHOWS; EDUCATION AND ENTERTAINMENT SERVICES, NAMELY, PRODUCTION AND DISTRIBUTION OF ONGOING AUDIOVISUAL PROGRAMS IN THE FIELD OF VIDEO GAMES; ENTERTAINMENT SERVICES, NAMELY, ORGANIZING, ARRANGING, AND CONDUCTING CONTESTS; PROVIDING ENTERTAINMENT INFORMATION ONLINE RELATING TO VIDEO GAMES, COMPUTER GAMES, VIDEO GAME HARDWARE AND SOFTWARE, ENHANCEMENTS FOR VIDEO GAMES, ELECTRONIC GAME ENTERTAINMENT, TOURNAMENTS, EVENTS, AND COMPETITIONS, IN CLASS 41 (U.S. CLS. 100, 101 AND 107).

FIRST USE 6-18-2011; IN COMMERCE 6-18-2011.

THE MARK CONSISTS OF STANDARD CHARACTERS WITHOUT CLAIM TO ANY PARTICULAR FONT, STYLE, SIZE, OR COLOR.

SN 85-153,880, FILED 10-15-2010.

TRACY FLETCHER, EXAMINING ATTORNEY



David J. Kyffers

Director of the United States Patent and Trademark Office

United States of America

United States Patent and Trademark Office

GO KIDS DAY

Reg. No. 4,176,346

Registered July 17, 2012

Int. Cl.: 35

SERVICE MARK

PRINCIPAL REGISTER

WILLIAM J. VEENEMAN (UNITED STATES INDIVIDUAL)
SUITE 1060
15 SOUTH FIFTH STREET
MINNEAPOLIS, MN 55402

FOR: PROMOTING THE GOODS AND SERVICES OF OTHERS BY PROVIDING ONLINE DATABASES AND DIRECTORIES FEATURING INFORMATION RELATED TO THE RETAIL OFFERINGS OF LOCAL BUSINESSES, AND LOYALTY PROGRAMS RELATING TO A PARTICULAR GEOGRAPHIC AREA, VIA AN ONLINE COMPUTER NETWORK, IN CLASS 35 (U.S. CLS. 100, 101 AND 102).

FIRST USE 12-31-2008; IN COMMERCE 3-9-2010.

THE MARK CONSISTS OF STANDARD CHARACTERS WITHOUT CLAIM TO ANY PARTICULAR FONT, STYLE, SIZE, OR COLOR.

NO CLAIM IS MADE TO THE EXCLUSIVE RIGHT TO USE "KIDS", APART FROM THE MARK AS SHOWN.

SN 85-153,922, FILED 10-15-2010.

ANDREA HACK, EXAMINING ATTORNEY



David J. Kyffers

Director of the United States Patent and Trademark Office

United States of America

United States Patent and Trademark Office

NPT

Reg. No. 4,176,347

Registered July 17, 2012

Int. Cl.: 25

TRADEMARK

PRINCIPAL REGISTER

SOLE ASSETS HOLDINGS, INC. (CALIFORNIA CORPORATION)
28632 ROADSIDE DRIVE
SUITE 150
AGOURA HILLS, CA 91301

FOR: CLOTHING, NAMELY, JERSEYS, ATHLETIC SHIRTS, T-SHIRTS, GOLF SHIRTS, SHORTS, PANTS, SWEATPANTS, SWEATSHIRTS, JACKETS, IN CLASS 25 (U.S. CLS. 22 AND 39).

FIRST USE 6-0-2009; IN COMMERCE 6-0-2009.

THE MARK CONSISTS OF STANDARD CHARACTERS WITHOUT CLAIM TO ANY PARTICULAR FONT, STYLE, SIZE, OR COLOR.

SN 85-154,101, FILED 10-15-2010.

BRIAN PINO, EXAMINING ATTORNEY



David J. Kyffers

Director of the United States Patent and Trademark Office

United States of America

United States Patent and Trademark Office

THE NERD

Reg. No. 4,176,348

ALIPHCOM (CALIFORNIA CORPORATION)
99 RHODE ISLAND, 3RD FLOOR
SAN FRANCISCO, CA 94103

Registered July 17, 2012

Int. Cl.: 9

FOR: WIRELESS COMMUNICATION DEVICES FOR VOICE, DATA, OR IMAGE TRANSMISSION, IN CLASS 9 (U.S. CLS. 21, 23, 26, 36 AND 38).

TRADEMARK

FIRST USE 8-0-2011; IN COMMERCE 8-0-2011.

PRINCIPAL REGISTER

THE MARK CONSISTS OF STANDARD CHARACTERS WITHOUT CLAIM TO ANY PARTICULAR FONT, STYLE, SIZE, OR COLOR.

SN 85-154,145, FILED 10-15-2010.

JOHN KELLY, EXAMINING ATTORNEY



David J. Kybas

Director of the United States Patent and Trademark Office

United States of America

United States Patent and Trademark Office

FAN INK

Reg. No. 4,176,349

Registered July 17, 2012

Int. Cl.: 25

TRADEMARK

PRINCIPAL REGISTER

FAN INK LIMITED (CANADA CORPORATION)
UNIT 6
7755 WARDEN AVENUE
MARKHAM, CANADA L3R 0N3

FOR: CLOTHING, NAMELY, SHIRTS, T-SHIRTS, LADIES UNDERWEAR, PANTS, JACKETS; SCREEN AND SUBLIMATION PRINTED CLOTHING, NAMELY, SHIRTS, T-SHIRTS, LADIES UNDERWEAR, PANTS, JACKETS; SCREEN AND SUBLIMATION PRINTED TRANSLUCENT CLOTHING, NAMELY, SHIRTS, T-SHIRTS, LADIES UNDERWEAR, PANTS, JACKETS; CLOTHING, NAMELY, NYLON SHIRTS, T-SHIRTS, LADIES UNDERWEAR, PANTS, JACKETS; SCREEN AND SUBLIMATION PRINTED CLOTHING, NAMELY, NYLON SHIRTS, T-SHIRTS, LADIES UNDERWEAR, PANTS, JACKETS; AND SCREEN AND SUBLIMATION PRINTED TRANSLUCENT CLOTHING, NAMELY, NYLON SHIRTS, T-SHIRTS, LADIES UNDERWEAR, PANTS, JACKETS; CLOTHING, NAMELY, HEADWEAR; CLOTHING, NAMELY, WEARABLE SLEEVES FEATURING DESIGN; SCREEN AND SUBLIMATION PRINTED CLOTHING, NAMELY, WEARABLE SLEEVES; SCREEN AND SUBLIMATION PRINTED TRANSLUCENT CLOTHING, NAMELY, WEARABLE SLEEVES, IN CLASS 25 (U.S. CLS. 22 AND 39).

FIRST USE 9-30-2008; IN COMMERCE 3-31-2009.

THE MARK CONSISTS OF STANDARD CHARACTERS WITHOUT CLAIM TO ANY PARTICULAR FONT, STYLE, SIZE, OR COLOR.

SN 85-155,069, FILED 10-18-2010.

JAY FLOWERS, EXAMINING ATTORNEY



David J. Kypos

Director of the United States Patent and Trademark Office

United States of America

United States Patent and Trademark Office

SLIP SOLVER

Reg. No. 4,176,350

ECOQUIP, INC. (INDIANA CORPORATION)
3020 DIEGO DRIVE
EVANSVILLE, IN 47715

Registered July 17, 2012

Int. Cl.: 1

FOR: CHEMICAL PREPARATION THAT CREATES A MICROSCOPIC TREAD ON SURFACES TO HELP INCREASE THE CO-EFFICIENT OF FRICTION FOR USE IN INDUSTRIAL, COMMERCIAL AND RESIDENTIAL AREAS THAT SEE HEAVY WALKING TRAFFIC, IN CLASS 1 (U.S. CLS. 1, 5, 6, 10, 26 AND 46).

TRADEMARK

PRINCIPAL REGISTER

FIRST USE 1-1-2011; IN COMMERCE 1-1-2011.

THE MARK CONSISTS OF STANDARD CHARACTERS WITHOUT CLAIM TO ANY PARTICULAR FONT, STYLE, SIZE, OR COLOR.

SN 85-155,702, FILED 10-19-2010.

DOMINIC J. FERRAIUOLO, EXAMINING ATTORNEY



David J. Kyffers

Director of the United States Patent and Trademark Office

United States of America

United States Patent and Trademark Office

CYLENCE GUARD

Reg. No. 4,176,351

BAYER AKTIENGESELLSCHAFT (FED REP GERMANY AKTIENGESELLSCHAFT)
KAISER-WILHELM-ALLEE
51373 LEVERKUSEN, FED REP GERMANY

Registered July 17, 2012

Int. Cl.: 5

FOR: ANTIPARASITIC EAR TAGS, IN CLASS 5 (U.S. CLS. 6, 18, 44, 46, 51 AND 52).

TRADEMARK

FIRST USE 3-31-2011; IN COMMERCE 3-31-2011.

PRINCIPAL REGISTER

THE MARK CONSISTS OF STANDARD CHARACTERS WITHOUT CLAIM TO ANY PARTICULAR FONT, STYLE, SIZE, OR COLOR.

OWNER OF U.S. REG. NOS. 1,960,578 AND 2,872,756.

SN 85-156,108, FILED 10-19-2010.

JOSETTE BEVERLY, EXAMINING ATTORNEY



David J. Kybas

Director of the United States Patent and Trademark Office

United States of America

United States Patent and Trademark Office

GENERATION 1ST DEGREE

Reg. No. 4,176,352

HISPANIC SCHOLARSHIP FUND (D.C. CORPORATION)

Registered July 17, 2012

55 SECOND STREET, SUITE 1500
SAN FRANCISCO, CA 94105

Int. Cl.: 41

FOR: EDUCATIONAL SERVICES, NAMELY, SEMINARS, WORKSHOPS, AND MENTOR PROGRAMS IN THE FIELD OF HIGHER EDUCATION; EDUCATIONAL SERVICES, NAMELY, PROVIDING EDUCATION INFORMATION IN THE FIELD OF HIGHER EDUCATION, IN CLASS 41 (U.S. CLS. 100, 101 AND 107).

SERVICE MARK

PRINCIPAL REGISTER

FIRST USE 11-0-2011; IN COMMERCE 11-0-2011.

THE MARK CONSISTS OF STANDARD CHARACTERS WITHOUT CLAIM TO ANY PARTICULAR FONT, STYLE, SIZE, OR COLOR.

SN 85-156,312, FILED 10-19-2010.

RICHARD WHITE, EXAMINING ATTORNEY



David J. Kyffers

Director of the United States Patent and Trademark Office

United States of America

United States Patent and Trademark Office

GENERATION 1ST DEGREE

Reg. No. 4,176,353

HISPANIC SCHOLARSHIP FUND (D.C. CORPORATION)
55 SECOND STREET, SUITE 1500
SAN FRANCISCO, CA 94105

Registered July 17, 2012

Int. Cl.: 36

FOR: FINANCIAL SERVICES IN THE FIELD OF EDUCATION, NAMELY, PROVIDING SCHOLARSHIP FUNDS, FINANCIAL ADMINISTRATION OF SCHOLARSHIP FUND PROGRAMS, AND CHARITABLE FUND RAISING TO BENEFIT SCHOLARSHIP FUNDS, IN CLASS 36 (U.S. CLS. 100, 101 AND 102).

SERVICE MARK

PRINCIPAL REGISTER

FIRST USE 11-0-2010; IN COMMERCE 11-0-2010.

THE MARK CONSISTS OF STANDARD CHARACTERS WITHOUT CLAIM TO ANY PARTICULAR FONT, STYLE, SIZE, OR COLOR.

SN 85-156,316, FILED 10-19-2010.

RICHARD WHITE, EXAMINING ATTORNEY



David J. Kyffers

Director of the United States Patent and Trademark Office

United States of America

United States Patent and Trademark Office

STUDENT LENS

Reg. No. 4,176,354

MSG VARSITY NETWORK LLC (DELAWARE LIMITED LIABILITY COMPANY)
1111 STEWART AVENUE
BETHPAGE, NY 11735

Registered July 17, 2012

Int. Cl.: 41

FOR: ENTERTAINMENT IN THE NATURE OF AN ON-GOING TELEVISION SHOW FEATURING SEGMENTS PRODUCED BY STUDENTS, IN CLASS 41 (U.S. CLS. 100, 101 AND 107).

SERVICE MARK

FIRST USE 10-26-2010; IN COMMERCE 10-26-2010.

PRINCIPAL REGISTER

THE MARK CONSISTS OF STANDARD CHARACTERS WITHOUT CLAIM TO ANY PARTICULAR FONT, STYLE, SIZE, OR COLOR.

NO CLAIM IS MADE TO THE EXCLUSIVE RIGHT TO USE "STUDENT", APART FROM THE MARK AS SHOWN.

SN 85-156,738, FILED 10-20-2010.

VERNA BETH RIRIE, EXAMINING ATTORNEY



David J. Kyffers

Director of the United States Patent and Trademark Office

United States of America

United States Patent and Trademark Office

CuraScents

Reg. No. 4,176,355

FLEER, JILLIAN E. (UNITED STATES INDIVIDUAL)
14011 VENTURA BLVD.

Registered July 17, 2012

SHERMAN OAKS, CA 91423

Int. Cl.: 5

FOR: FRAGRANCED BODY CARE PREPARATIONS, NAMELY, CURATIVE AROMATHERAPY OILS FOR THE TREATMENT OF STRESS, HEADACHES, ANXIETY; FRAGRANCED FACE CARE PREPARATIONS, NAMELY, CURATIVE AROMATHERAPY OILS FOR THE TREATMENT OF STRESS, HEADACHES, ANXIETY; FRAGRANCED SKIN CARE PREPARATIONS, NAMELY, CURATIVE AROMATHERAPY OILS FOR THE TREATMENT OF STRESS, HEADACHES, ANXIETY, IN CLASS 5 (U.S. CLS. 6, 18, 44, 46, 51 AND 52).

TRADEMARK

PRINCIPAL REGISTER

FIRST USE 12-9-2010; IN COMMERCE 12-9-2010.

THE MARK CONSISTS OF STANDARD CHARACTERS WITHOUT CLAIM TO ANY PARTICULAR FONT, STYLE, SIZE, OR COLOR.

SN 85-156,868, FILED 10-20-2010.

MARILYN IZZI, EXAMINING ATTORNEY



David J. Kyffers

Director of the United States Patent and Trademark Office

United States of America

United States Patent and Trademark Office

HANG TITE

Reg. No. 4,176,356

Registered July 17, 2012

Int. Cl.: 1

TRADEMARK

PRINCIPAL REGISTER

GRABBER CONSTRUCTION PRODUCTS, INC. (NEVADA CORPORATION)
SUITE 200
20 WEST MAIN STREET COURT
ALPINE, UT 840041889

FOR: SPRAY-ON CONSTRUCTION ADHESIVES CONTAINED IN A DISPENSING CONTAINER, IN CLASS 1 (U.S. CLS. 1, 5, 6, 10, 26 AND 46).

FIRST USE 1-31-2001; IN COMMERCE 1-31-2001.

THE MARK CONSISTS OF STANDARD CHARACTERS WITHOUT CLAIM TO ANY PARTICULAR FONT, STYLE, SIZE, OR COLOR.

SN 85-157,189, FILED 10-20-2010.

BRIDGETT SMITH, EXAMINING ATTORNEY



David J. Kyffers

Director of the United States Patent and Trademark Office

United States of America

United States Patent and Trademark Office

TEMPLE OF MYSTERY

Reg. No. 4,176,357

Registered July 17, 2012

Int. Cl.: 9

TRADEMARK

PRINCIPAL REGISTER

BALLY GAMING, INC. (NEVADA CORPORATION), DBA BALLY TECHNOLOGIES,
ATTN: PAMELA BOWSHER, LAW DEPT.
6601 SOUTH BERMUDA ROAD
LAS VEGAS, NV 89119

FOR: GAMING DEVICES, NAMELY, SLOT MACHINES, WITH OR WITHOUT VIDEO
OUTPUT, IN CLASS 9 (U.S. CLS. 21, 23, 26, 36 AND 38).

FIRST USE 6-30-2010; IN COMMERCE 6-30-2010.

THE MARK CONSISTS OF STANDARD CHARACTERS WITHOUT CLAIM TO ANY PAR-
TICULAR FONT, STYLE, SIZE, OR COLOR.

SN 85-157,499, FILED 10-20-2010.

ARETHA SOMERVILLE, EXAMINING ATTORNEY



David J. Kyffers

Director of the United States Patent and Trademark Office

United States of America

United States Patent and Trademark Office

PURR BY KATY PERRY

Reg. No. 4,176,358

KILLER QUEEN, LLC (CALIFORNIA LIMITED LIABILITY COMPANY)

Registered July 17, 2012

15260 VENTURA BLVD. #2100
SHERMAN OAKS, CA 91403

Int. Cl.: 3

FOR: FRAGRANCES, PERFUMES; EAU DE TOILETTES; BODY LOTIONS AND CREAMS, BODY WASHES, SHOWER GELS, SCENTED SOAPS; BODY POWDER, IN CLASS 3 (U.S. CLS. 1, 4, 6, 50, 51 AND 52).

TRADEMARK

FIRST USE 11-0-2010; IN COMMERCE 11-0-2010.

PRINCIPAL REGISTER

THE MARK CONSISTS OF STANDARD CHARACTERS WITHOUT CLAIM TO ANY PARTICULAR FONT, STYLE, SIZE, OR COLOR.

OWNER OF U.S. REG. NO. 3,682,086.

THE NAME(S), PORTRAIT(S), AND/OR SIGNATURE(S) SHOWN IN THE MARK IDENTIFIES "KATY PERRY", WHOSE CONSENT(S) TO REGISTER IS MADE OF RECORD.

SN 85-158,277, FILED 10-21-2010.

DOMINICK J. SALEMI, EXAMINING ATTORNEY



David J. Kyros

Director of the United States Patent and Trademark Office

United States of America

United States Patent and Trademark Office

LAS BUENAS MANOS DE CHICAGO

Reg. No. 4,176,359

ALLSTATE INSURANCE COMPANY (ILLINOIS CORPORATION)
ALLSTATE PLAZA
NORTHBROOK, IL 60062

Registered July 17, 2012

Int. Cl.: 36

FOR: INSURANCE SERVICES, NAMELY, WRITING AND UNDERWRITING INSURANCE IN THE FIELDS OF PROPERTY, LIABILITY, AND CASUALTY, AND PROVIDING ANCILLARY SERVICES THERETO, NAMELY, ADMINISTRATION AND CLAIMS ADJUSTMENT, IN CLASS 36 (U.S. CLS. 100, 101 AND 102).

SERVICE MARK

PRINCIPAL REGISTER

FIRST USE 8-1-2010; IN COMMERCE 8-1-2010.

THE MARK CONSISTS OF STANDARD CHARACTERS WITHOUT CLAIM TO ANY PARTICULAR FONT, STYLE, SIZE, OR COLOR.

OWNER OF U.S. REG. NOS. 2,542,964, 3,604,502, AND OTHERS.

NO CLAIM IS MADE TO THE EXCLUSIVE RIGHT TO USE "CHICAGO", APART FROM THE MARK AS SHOWN.

THE ENGLISH TRANSLATION OF "LAS BUENAS MANOS DE CHICAGO" IN THE MARK IS "THE GOOD HANDS OF CHICAGO".

SN 85-158,332, FILED 10-21-2010.

PAM WILLIS, EXAMINING ATTORNEY



David J. Kyros

Director of the United States Patent and Trademark Office

United States of America

United States Patent and Trademark Office

Sun Dynamics

Reg. No. 4,176,360

SUN DYNAMICS INC. (TEXAS CORPORATION)
3014 EDGEWOOD DR.
GARLAND, TX 75042

Registered July 17, 2012

Int. Cls.: 37 and 42

FOR: INSTALLATION OF SOLAR ENERGY SYSTEMS AND ALTERNATIVE ENERGY PRODUCTS FOR RESIDENTIAL AND COMMERCIAL USE, IN CLASS 37 (U.S. CLS. 100, 103 AND 106).

SERVICE MARK

FIRST USE 1-1-2010; IN COMMERCE 1-1-2011.

PRINCIPAL REGISTER

FOR: TECHNOLOGY CONSULTATION AND RESEARCH IN THE FIELD OF MATERIALS TO PRODUCE AND STORE ENERGY FROM SOLAR RADIATION, IN CLASS 42 (U.S. CLS. 100 AND 101).

FIRST USE 1-1-2010; IN COMMERCE 1-1-2011.

THE MARK CONSISTS OF STANDARD CHARACTERS WITHOUT CLAIM TO ANY PARTICULAR FONT, STYLE, SIZE, OR COLOR.

NO CLAIM IS MADE TO THE EXCLUSIVE RIGHT TO USE "SUN", APART FROM THE MARK AS SHOWN.

SN 85-158,355, FILED 10-21-2010.

ANGELA DUONG, EXAMINING ATTORNEY



David J. Kybas

Director of the United States Patent and Trademark Office

United States of America

United States Patent and Trademark Office

EOS

Reg. No. 4,176,361

Registered July 17, 2012

Int. Cl.: 11

TRADEMARK

PRINCIPAL REGISTER

AIR SYSTEM COMPONENTS, INC. (DELAWARE CORPORATION)
605 SHILOH ROAD, PLANO
PLANO, TX 75074

FOR: AIR CONDITIONING SYSTEMS COMPRISING GRILLES, REGISTERS, DIFFUSERS, VOLUME CONTROL DAMPERS, NON-RETURN DAMPERS, BACK DRAFT DAMPERS, GRAVITY SHUTTERS, LOUVERS, SAND TRAP LOUVERS, VARIABLE AIR VALVES, FAN COIL UNITS, FIRE DAMPERS, MOTORIZED SMOKE AND FIRE DAMPERS, JET NOZZLES AND SWIRL DIFFUSERS, IN CLASS 11 (U.S. CLS. 13, 21, 23, 31 AND 34).

FIRST USE 3-31-2011; IN COMMERCE 3-31-2011.

THE MARK CONSISTS OF STANDARD CHARACTERS WITHOUT CLAIM TO ANY PARTICULAR FONT, STYLE, SIZE, OR COLOR.

SN 85-158,739, FILED 10-22-2010.

TARAH HARDY, EXAMINING ATTORNEY



David J. Kyjars

Director of the United States Patent and Trademark Office

United States of America

United States Patent and Trademark Office

NINTENDO 3DS

Reg. No. 4,176,362

NINTENDO OF AMERICA INC. (WASHINGTON CORPORATION)
4600 - 150TH AVENUE SE
REDMOND, WA 98052

Registered July 17, 2012

Int. Cl.: 41

FOR: ENTERTAINMENT SERVICES, NAMELY, PROVIDING NON-DOWNLOADABLE VIDEO GAMES, ELECTRONIC GAMES, AND COMPUTER GAMES THAT CAN BE ACCESSED AND PLAYED OVER COMPUTER NETWORKS; ENTERTAINMENT SERVICES, NAMELY, PROVIDING ONLINE ELECTRONIC COMPUTER AND VIDEO GAMES; ENTERTAINMENT SERVICES, NAMELY, PROVIDING ON-LINE NON-DOWNLOADABLE MUSIC AND VIDEOS IN THE FIELD OF VIDEO GAMES AND SOUND RECORDINGS VIA A GLOBAL COMPUTER NETWORK; PROVIDING ENTERTAINMENT INFORMATION ALL RELATING TO VIDEO GAMES AND COMPUTER GAMES; PROVIDING NON-DOWNLOADABLE INTERACTIVE MULTIPLAYER COMPUTER AND VIDEO GAMES THAT MAY BE ACCESSED AND PLAYED OVER COMPUTER NETWORKS AND GLOBAL COMMUNICATIONS NETWORKS; PROVIDING ONLINE NEWS, INFORMATION AND GAME STRATEGIES ALL RELATED TO ELECTRONIC, COMPUTER AND VIDEO GAMES, IN CLASS 41 (U.S. CLS. 100, 101 AND 107).

SERVICE MARK

PRINCIPAL REGISTER

FIRST USE 1-19-2011; IN COMMERCE 1-19-2011.

THE MARK CONSISTS OF THE WORD "NINTENDO" IN STYLIZED LETTERING FOLLOWED BY "3DS" IN A LARGER FONT OF THE SAME TYPE OF LETTERING. BENEATH THE LETTER "O" IN "NINTENDO" IS A BLOCK.

SN 85-158,987, FILED 10-22-2010.

LEIGH LOWRY, EXAMINING ATTORNEY



David J. Kyros

Director of the United States Patent and Trademark Office

United States of America

United States Patent and Trademark Office

IPREVENT

Reg. No. 4,176,363

Registered July 17, 2012

Int. Cl.: 41

SERVICE MARK

PRINCIPAL REGISTER

SPORTS INJURY PREVENTION ACADEMY, LLC (DELAWARE LIMITED LIABILITY COMPANY)
4220 MUIRFIELD CIRCLE
PRESTO, PA 15142

FOR: EDUCATION AND SPORTS TRAINING SERVICES, NAMELY, VIDEO PROGRAMS ABOUT EXERCISE AND SPORTS INJURY AVOIDANCE ACCESSIBLE VIA MOBILE DISPLAY DEVICES, IN CLASS 41 (U.S. CLS. 100, 101 AND 107).

FIRST USE 8-7-2010; IN COMMERCE 8-7-2010.

THE MARK CONSISTS OF STANDARD CHARACTERS WITHOUT CLAIM TO ANY PARTICULAR FONT, STYLE, SIZE, OR COLOR.

SN 85-159,275, FILED 10-22-2010.

TEJBIR SINGH, EXAMINING ATTORNEY



David J. Kybas

Director of the United States Patent and Trademark Office

United States of America

United States Patent and Trademark Office

RELAIS

Reg. No. 4,176,364

Registered July 17, 2012

Int. Cl.: 20

TRADEMARK

PRINCIPAL REGISTER

JANUS ET CIE (CALIFORNIA CORPORATION)
8687 MELROSE AVENUE
WEST HOLLYWOOD, CA 90069

FOR: INDOOR AND OUTDOOR FURNITURE, NAMELY, ARMCHAIRS, ARMOIRES, BENCHES, BOOK STANDS, BOOKCASES, CABINETS, PLANT STANDS, HAND OPERATED NON-METAL GARDEN HOSE REELS, HOSE HANGERS NOT OF METAL, CHAIRS, ROCKING CHAIRS, CHAISE LOUNGES, SETTEES, BEDROOM FURNITURE, CHESTS OF DRAWERS, LOVE SEATS, COUCHES, CREDENZAS, PLASTIC TUBS, CUSHIONS, DESKS, DINING ROOM TABLES, COFFEE TABLES, CONSOLES, END TABLES, CAFE TABLES, SOFA TABLES, PEDESTAL TABLES, EXTENSION TABLES, OFFICE FURNITURE, CHILDREN'S FURNITURE, OTTOMANS, DRESSERS, WALL UNITS, SEATS, SOFAS AND STOOLS, IN CLASS 20 (U.S. CLS. 2, 13, 22, 25, 32 AND 50).

FIRST USE 10-0-2010; IN COMMERCE 10-0-2010.

THE MARK CONSISTS OF STANDARD CHARACTERS WITHOUT CLAIM TO ANY PARTICULAR FONT, STYLE, SIZE, OR COLOR.

SN 85-160,269, FILED 10-25-2010.

ANTHONY RINKER, EXAMINING ATTORNEY



David J. Kypos

Director of the United States Patent and Trademark Office

United States of America

United States Patent and Trademark Office

MPG YOGATONER

Reg. No. 4,176,365

DIMENSIONS 100 INC. (CANADA CORPORATION)
1109 WINNIPEG AVENUE

Registered July 17, 2012

WINNIPEG, MANITOBA, CANADA R3E0S2

Int. Cl.: 25

FOR: WOMEN'S COMPRESSION YOGA AND WORKOUT CLOTHING, NAMELY, TANK TOPS, TOPS, BRA TOPS, T-SHIRTS, SHORTS, CAPRIS, PANTS AND SOCKS; MEN'S COMPRESSION YOGA AND WORKOUT CLOTHING, NAMELY, TOPS, T-SHIRTS, SHORTS, PANTS AND SOCKS, IN CLASS 25 (U.S. CLS. 22 AND 39).

TRADEMARK

PRINCIPAL REGISTER

FIRST USE 8-12-2011; IN COMMERCE 8-12-2011.

THE MARK CONSISTS OF STANDARD CHARACTERS WITHOUT CLAIM TO ANY PARTICULAR FONT, STYLE, SIZE, OR COLOR.

OWNER OF U.S. REG. NOS. 3,329,989, 3,329,990, AND 3,793,386.

SN 85-160,299, FILED 10-25-2010.

CURTIS FRENCH, EXAMINING ATTORNEY



David J. Kybas

Director of the United States Patent and Trademark Office

United States of America

United States Patent and Trademark Office

DAILY SHELF

Reg. No. 4,176,366

Registered July 17, 2012

Int. Cl.: 9

TRADEMARK

PRINCIPAL REGISTER

BARNESANDNOBLE.COM LLC (DELAWARE LIMITED LIABILITY COMPANY)
76 NINTH AVENUE, 9TH FLOOR
NEW YORK, NY 10011

FOR: PORTABLE ELECTRONIC APPARATUS FOR READING, DISPLAYING, RECEIVING, PURCHASING, SHARING, LENDING, ACCESSING AND STORING DOWNLOADABLE ELECTRONIC PUBLICATIONS, NAMELY, BOOKS, E-BOOKS, MAGAZINES, NEWSPAPERS, TEXT, IMAGES, DIGITAL WEB SITE CONTENT AND DIGITAL MEDIA FEATURING MUSIC THROUGH WIRED AND WIRELESS INTERNET ACCESS, ACCESSORIES THEREFOR AND INSTRUCTIONAL MANUALS, SOLD AS A UNIT; COMPUTER SOFTWARE FOR DISPLAYING, RECEIVING, READING, PURCHASING, ACCESSING AND STORING DOWNLOADABLE ELECTRONIC PUBLICATIONS, SYNCING ELECTRONIC PUBLICATIONS WITH PORTABLE ELECTRONIC APPARATUS, LOANING AND SHARING ELECTRONIC PUBLICATIONS WITH THIRD PARTIES AND SAMPLING ELECTRONIC PUBLICATIONS; DOWNLOADABLE COMPUTER SOFTWARE FOR DISPLAYING, RECEIVING, READING AND STORING DOWNLOADABLE ELECTRONIC PUBLICATIONS AND SYNCING ELECTRONIC PUBLICATIONS WITH PORTABLE ELECTRONIC APPARATUS, LOANING AND SHARING ELECTRONIC PUBLICATIONS WITH THIRD PARTIES AND SAMPLING ELECTRONIC PUBLICATIONS; COMPUTER SOFTWARE FOR USE IN READING, DISPLAYING, PURCHASING, SHARING, LENDING AND ACCESSING ELECTRONIC PUBLICATIONS AND DIGITAL MEDIA FEATURING BOOKS, NEWSPAPERS, MAGAZINES, PERIODICALS, DIGITAL IMAGES, WEB SITES, MUSIC, GAMES AND OTHER DIGITAL ENTERTAINMENT, AND INSTRUCTIONAL MANUALS, SOLD AS A UNIT; DOWNLOADABLE COMPUTER SOFTWARE FOR USE IN READING, DISPLAYING, PURCHASING, SHARING, LENDING AND ACCESSING ELECTRONIC PUBLICATIONS AND DIGITAL MEDIA FEATURING BOOKS, NEWSPAPERS, MAGAZINES, DIGITAL IMAGES, WEB SITES, MUSIC, GAMES AND OTHER DIGITAL ENTERTAINMENT, AND INSTRUCTIONAL MANUALS, SOLD AS A UNIT, IN CLASS 9 (U.S. CLS. 21, 23, 26, 36 AND 38).



FIRST USE 10-26-2010; IN COMMERCE 10-26-2010.

THE MARK CONSISTS OF STANDARD CHARACTERS WITHOUT CLAIM TO ANY PARTICULAR FONT, STYLE, SIZE, OR COLOR.

David J. Kybas

NO CLAIM IS MADE TO THE EXCLUSIVE RIGHT TO USE "DAILY", APART FROM THE MARK AS SHOWN.

Reg. No. 4,176,366 SN 85-160,593, FILED 10-25-2010.

JOHN HWANG, EXAMINING ATTORNEY

United States of America

United States Patent and Trademark Office

PHX

Reg. No. 4,176,367

PHX PARTNERS, LLC (FLORIDA LIMITED LIABILITY COMPANY)
PO BOX 566240
PINECREST, FL 33256

Registered July 17, 2012

Int. Cl.: 5

FOR: DIETARY AND NUTRITIONAL SUPPLEMENTS, IN CLASS 5 (U.S. CLS. 6, 18, 44, 46, 51 AND 52).

TRADEMARK

FIRST USE 2-16-2012; IN COMMERCE 2-16-2012.

PRINCIPAL REGISTER

THE MARK CONSISTS OF STANDARD CHARACTERS WITHOUT CLAIM TO ANY PARTICULAR FONT, STYLE, SIZE, OR COLOR.

SN 85-160,635, FILED 10-25-2010.

FRANK LATTUCA, EXAMINING ATTORNEY



David J. Kybas

Director of the United States Patent and Trademark Office

United States of America

United States Patent and Trademark Office

MANAGEMENTPOD

Reg. No. 4,176,368

EMAT CAPITAL MANAGEMENT, LLC (CALIFORNIA LIMITED LIABILITY COMPANY)
7474 N. FIGUEROA STREET, SUITE A
LOS ANGELES, CA 90041

Registered July 17, 2012

Int. Cls.: 35 and 36

FOR: BUSINESS MANAGEMENT AND CONSULTATION, IN CLASS 35 (U.S. CLS. 100, 101 AND 102).

SERVICE MARK

FIRST USE 2-23-2012; IN COMMERCE 3-23-2012.

PRINCIPAL REGISTER

FOR: INVESTMENT SERVICES, NAMELY, ASSET ACQUISITION, CONSULTATION, DEVELOPMENT AND MANAGEMENT SERVICES, IN CLASS 36 (U.S. CLS. 100, 101 AND 102).

FIRST USE 2-23-2012; IN COMMERCE 2-23-2012.

THE MARK CONSISTS OF STANDARD CHARACTERS WITHOUT CLAIM TO ANY PARTICULAR FONT, STYLE, SIZE, OR COLOR.

SN 85-160,700, FILED 10-25-2010.

IRA J. GOODSID, EXAMINING ATTORNEY



David J. Kyffers

Director of the United States Patent and Trademark Office

United States of America

United States Patent and Trademark Office

CREO

Reg. No. 4,176,369

Registered July 17, 2012

Int. Cls.: 9, 41, and 42

TRADEMARK

SERVICE MARK

PRINCIPAL REGISTER

PARAMETRIC TECHNOLOGY CORPORATION (MASSACHUSETTS CORPORATION)
140 KENDRICK STREET
NEEDHAM, MA 024942714

FOR: COMPUTER SOFTWARE FOR COMPUTER AIDED DESIGN (CAD), COMPUTER AIDED MANUFACTURING (CAM), AND COMPUTER AIDED ENGINEERING (CAE); SOFTWARE FOR VISUALIZATION AND DIGITAL MOCKUP, NAMELY, SOFTWARE FOR PROVIDING TWO-DIMENSIONAL AND THREE-DIMENSIONAL VISUALIZATION AND GRAPHICAL CAPABILITIES FOR COMPUTER CREATED DRAWINGS, DESIGNS, MODELS AND RENDERINGS; SOFTWARE FOR THE MANAGEMENT OF THE PRODUCT DEVELOPMENT PROCESS, NAMELY, SOFTWARE FOR COMPUTER AIDED DESIGN (CAD) DATA MANAGEMENT, PRODUCT DATA MANAGEMENT (PDM), PRODUCT PROCESS AND PRODUCTION AUTOMATION; SOFTWARE FOR WORKFLOWS, AND SHARED WORKSPACES FOR THE PURPOSES OF PRODUCT LIFECYCLE MANAGEMENT (PLM), COLLABORATION, CONFIGURATION AND CHANGE MANAGEMENT, REQUIREMENTS MANAGEMENT, AND MANUFACTURING PLANNING; COMPUTER SOFTWARE DEVELOPMENT TOOLKITS COMPRISED OF COMPUTER PROGRAMS FOR USER INTERFACE DESIGN, COMPUTER UTILITY PROGRAMS, COMPILED LIBRARIES AND DYNAMICALLY LINKED LIBRARIES (DLL'S), AND SAMPLE CODE SPECIFICALLY FOR USE IN THE CUSTOMIZATION OF THE SOFTWARE OR THE DEVELOPMENT OF OTHER SOFTWARE PROGRAMS THAT INTERACT WITH THE SOFTWARE; AND ACCOMPANYING USER GUIDES SOLD WITH ALL THE FOREGOING COMPUTER SOFTWARE AS A UNIT, IN CLASS 9 (U.S. CLS. 21, 23, 26, 36 AND 38).

FIRST USE 6-20-2011; IN COMMERCE 6-20-2011.

FOR: COMPUTER EDUCATION TRAINING SERVICES, IN CLASS 41 (U.S. CLS. 100, 101 AND 107).

FIRST USE 6-20-2011; IN COMMERCE 6-20-2011.

FOR: TECHNICAL SUPPORT SERVICES, NAMELY, TROUBLESHOOTING OF COMPUTER SOFTWARE PROBLEMS VIA TELEPHONE; UPDATING OF COMPUTER SOFTWARE FOR OTHERS; MAINTENANCE OF COMPUTER SOFTWARE, NAMELY, MAINTENANCE AND ERROR CORRECTION SERVICES FOR COMPUTER SOFTWARE; COMPUTER CONSULTATION; PRODUCT DEVELOPMENT FOR OTHERS; PRODUCT DEVELOPMENT PROCESS



David J. Kybas

Director of the United States Patent and Trademark Office

Reg. No. 4,176,369 CONSULTATION; AND REPAIR OF COMPUTER SOFTWARE, IN CLASS 42 (U.S. CLS. 100 AND 101).

FIRST USE 6-20-2011; IN COMMERCE 6-20-2011.

THE MARK CONSISTS OF STANDARD CHARACTERS WITHOUT CLAIM TO ANY PARTICULAR FONT, STYLE, SIZE, OR COLOR.

THE ENGLISH TRANSLATION OF "CREO" IN THE MARK IS I CREATE.

SN 85-162,134, FILED 10-27-2010.

STEVEN JACKSON, EXAMINING ATTORNEY

United States of America

United States Patent and Trademark Office

The logo consists of the letters 'Mii' in a bold, sans-serif font. The 'M' is a single blocky letter, while the 'ii' are two thin vertical bars.

My لي Mon 我 Mi 吾

Reg. No. 4,176,370

Registered July 17, 2012

Int. Cl.: 3

TRADEMARK

PRINCIPAL REGISTER

INTERGANIC (UNITED ARAB EMIR. CORPORATION)
P.O. BOX 263232
DUBAI, UNITED ARAB EMIR.

FOR: ALL PURPOSE HOUSEHOLD CLEANERS AND DETERGENTS, NAMELY, MULTI-PURPOSE ALL-PURPOSE CLEANERS, FLOOR CLEANERS, DISH LIQUID DETERGENTS, STAIN REMOVERS, AND ALL-PURPOSE CLEANERS FOR CLEANING TOYS AND NURSERIES, IN CLASS 3 (U.S. CLS. 1, 4, 6, 50, 51 AND 52).

FIRST USE 3-1-2012; IN COMMERCE 3-1-2012.

THE MARK CONSISTS OF THE WORDING "MII" ABOVE THE WORDING "MY MON MI" WITH AN ARABIC CHARACTER BETWEEN THE WORDS "MY" AND "MON", AND AN ASIAN CHARACTER BETWEEN THE WORDS "MON" AND "MI" AND AN ASIAN CHARACTER AFTER THE WORD "MI".

THE NON-LATIN CHARACTERS IN THE MARK TRANSLITERATE TO "MY MY MY" AND THIS MEANS "MY MY MY" IN ENGLISH.

THE ENGLISH TRANSLATION OF "MY MON MI" IN THE MARK IS "MY MY MY". THE WORDING "MII" HAS NO MEANING IN A FOREIGN LANGUAGE.

SN 85-162,982, FILED 10-27-2010.

SETH A. RAPPAPORT, EXAMINING ATTORNEY



David J. Kyffers

Director of the United States Patent and Trademark Office

United States of America

United States Patent and Trademark Office

actiance

Reg. No. 4,176,371

Registered July 17, 2012

Int. Cls.: 9 and 35

TRADEMARK

SERVICE MARK

PRINCIPAL REGISTER

ACTIANCE, INC. (DELAWARE CORPORATION)
1301 SHOREWAY ROAD, SUITE 275
BELMONT, CA 94002

FOR: SECURITY AND COMPLIANCE SOFTWARE AND HARDWARE FOR COMMUNICATIONS, IN CLASS 9 (U.S. CLS. 21, 23, 26, 36 AND 38).

FIRST USE 1-0-2011; IN COMMERCE 1-0-2011.

FOR: BUSINESS MANAGEMENT SERVICES, NAMELY, PROVIDING SERVICES THAT ENABLE BUSINESSES TO MANAGE SECURITY AND COMPLIANCE FOR COMMUNICATIONS, IN CLASS 35 (U.S. CLS. 100, 101 AND 102).

FIRST USE 1-0-2011; IN COMMERCE 1-0-2011.

THE MARK CONSISTS OF THE WORD "ACTIANCE" WITH A MULTI-SHAPED DESIGN DISPLAYED ABOVE THE LETTER "I".

SN 85-163,001, FILED 10-27-2010.

GRETTA YAO, EXAMINING ATTORNEY



David J. Kyros

Director of the United States Patent and Trademark Office

United States of America

United States Patent and Trademark Office



Reg. No. 4,176,372

Registered July 17, 2012

Int. Cl.: 43

SERVICE MARK

PRINCIPAL REGISTER

CLUB DAIQUIRIS, INC. (LOUISIANA CORPORATION)
70437 HIGHWAY 21
COVINGTON, LA 70433

FOR: RESTAURANT AND BAR SERVICES, IN CLASS 43 (U.S. CLS. 100 AND 101).

FIRST USE 4-18-2012; IN COMMERCE 4-18-2012.

THE MARK CONSISTS OF A STYLIZED IGUANA COLORED GREEN AND GRAY WITH THE TOP OF ITS HEAD BEING YELLOW AND THE SPINES ON ITS HEAD AND TAIL BEING RED AND GREEN. THE IGUANA IS WEARING BLACK SUNGLASSES, A RED BRACELET ON ITS RIGHT ARM AND LEFT FOOT, BLUE SHORTS WITH A WHITE DRAWSTRING AND WITH ORANGE, WHITE AND YELLOW STRIPES, AND ORANGE SANDALS.

THE COLOR(S) GREEN, GRAY, RED, BLUE, ORANGE, WHITE, YELLOW AND BLACK IS/ARE CLAIMED AS A FEATURE OF THE MARK.

SN 85-163,852, FILED 10-28-2010.

ELIZABETH HUGHITT, EXAMINING ATTORNEY



David J. Kyffers

Director of the United States Patent and Trademark Office

United States of America

United States Patent and Trademark Office

PAM

Reg. No. 4,176,373

Registered July 17, 2012

Int. Cl.: 42

SERVICE MARK

PRINCIPAL REGISTER

THE NATIONAL BOARD OF EXAMINERS IN OPTOMETRY, INC. (MARYLAND CORPORATION)
200 SOUTH COLLEGE STREET
CHARLOTTE, NC 28202

FOR: COMPUTER SERVICES, NAMELY, PROVIDING ONLINE NON-DOWNLOADABLE SOFTWARE FEATURING TEST QUESTIONS AND TESTING MATERIALS IN THE FIELD OF OPTOMETRY, IN CLASS 42 (U.S. CLS. 100 AND 101).

FIRST USE 4-30-2012; IN COMMERCE 4-30-2012.

THE MARK CONSISTS OF STANDARD CHARACTERS WITHOUT CLAIM TO ANY PARTICULAR FONT, STYLE, SIZE, OR COLOR.

SN 85-163,866, FILED 10-28-2010.

LINDA POWELL, EXAMINING ATTORNEY



David J. Kybas

Director of the United States Patent and Trademark Office

United States of America

United States Patent and Trademark Office

TMOD

Reg. No. 4,176,374

Registered July 17, 2012

Int. Cl.: 42

SERVICE MARK

PRINCIPAL REGISTER

THE NATIONAL BOARD OF EXAMINERS IN OPTOMETRY, INC. (MARYLAND CORPORATION)
200 SOUTH COLLEGE STREET
CHARLOTTE, NC 28202

FOR: COMPUTER SERVICES, NAMELY, PROVIDING ONLINE NON-DOWNLOADABLE SOFTWARE FEATURING TEST QUESTIONS AND TESTING MATERIALS IN THE FIELD OF OPTOMETRY, IN CLASS 42 (U.S. CLS. 100 AND 101).

FIRST USE 4-30-2012; IN COMMERCE 4-30-2012.

THE MARK CONSISTS OF STANDARD CHARACTERS WITHOUT CLAIM TO ANY PARTICULAR FONT, STYLE, SIZE, OR COLOR.

OWNER OF U.S. REG. NO. 1,780,249.

SN 85-163,897, FILED 10-28-2010.

LINDA POWELL, EXAMINING ATTORNEY



David J. Kybas

Director of the United States Patent and Trademark Office

United States of America

United States Patent and Trademark Office

HYPERSWIPE

Reg. No. 4,176,375

Registered July 17, 2012

Int. Cl.: 28

TRADEMARK

PRINCIPAL REGISTER

THINKFUN IP HOLDINGS, INC. (VIRGINIA CORPORATION)
1321 CAMERON STREET
ALEXANDRIA, VA 22314

FOR: PARLOR GAMES, IN CLASS 28 (U.S. CLS. 22, 23, 38 AND 50).

FIRST USE 9-13-2011; IN COMMERCE 9-13-2011.

THE MARK CONSISTS OF STANDARD CHARACTERS WITHOUT CLAIM TO ANY PARTICULAR FONT, STYLE, SIZE, OR COLOR.

SN 85-163,950, FILED 10-28-2010.

TINA L. SNAPP, EXAMINING ATTORNEY



David J. Kybas

Director of the United States Patent and Trademark Office

United States of America

United States Patent and Trademark Office

CEOKARMA

Reg. No. 4,176,376

Registered July 17, 2012

Int. Cl.: 42

SERVICE MARK

PRINCIPAL REGISTER

PLANET ENLIGHTENMENT CORPORATION (CANADA CORPORATION)
SUITE 800
425 UNIVERSITY AVENUE
TORONTO, CANADA

FOR: COMPUTER SERVICES, NAMELY, HOSTING ELECTRONIC FACILITIES FOR OTHERS FOR ORGANIZING AND CONDUCTING MEETINGS, EVENTS AND INTERACTIVE DISCUSSIONS VIA THE INTERNET; COMPUTER SERVICES, NAMELY, CREATING AN ON-LINE COMMUNITY FOR REGISTERED USERS TO ORGANIZE GROUPS, EVENTS, PARTICIPATE IN DISCUSSIONS, SHARE INFORMATION AND RESOURCES, AND ENGAGE IN SOCIAL, BUSINESS AND COMMUNITY NETWORKING; PROVIDING TEMPORARY USE OF ON-LINE NON-DOWNLOADABLE SOFTWARE FOR ALLOWING WEB SITE USERS TO COMMUNICATE INFORMATION OF GENERAL INTEREST FOR PURPOSES OF SOCIAL, BUSINESS AND COMMUNITY NETWORKING; PROVIDING A WEBSITE FEATURING TEMPORARY USE OF NON-DOWNLOADABLE SOFTWARE ENABLING USERS TO SEARCH, LOCATE AND COMMUNICATE WITH OTHERS VIA ELECTRONIC COMMUNICATIONS NETWORK TO NETWORK; COMPUTER SERVICES IN THE NATURE OF CUSTOMIZED WEB PAGES FEATURING USER-DEFINED INFORMATION, PERSONAL PROFILES AND THAT ALLOWS USERS TO RECORD AND DISPLAY AUDIO AND VIDEO CONTENT; PROVIDING A WEB SITE FEATURING TEMPORARY USE OF NON-DOWNLOADABLE SOFTWARE ALLOWING WEB SITE USERS TO UPLOAD, POST AND DISPLAY ONLINE VIDEOS AND PHOTOS FOR SHARING WITH OTHERS FOR ENTERTAINMENT PURPOSES; COMPUTER SERVICES, NAMELY, CREATING AN ON-LINE COMMUNITY FOR REGISTERED USERS TO PARTICIPATE IN DISCUSSIONS, GET FEEDBACK FROM THEIR PEERS, FORM VIRTUAL COMMUNITIES, AND ENGAGE IN SOCIAL NETWORKING FEATURING SOCIAL MEDIA BY DISPLAYING PHOTOS, AUDIO AND VIDEO CONTENT ON GENERAL TOPICS OF SOCIAL INTEREST, IN CLASS 42 (U.S. CLS. 100 AND 101).



FIRST USE 1-1-2010; IN COMMERCE 1-1-2010.

THE MARK CONSISTS OF STANDARD CHARACTERS WITHOUT CLAIM TO ANY PARTICULAR FONT, STYLE, SIZE, OR COLOR.

SN 85-164,316, FILED 10-29-2010.

KAREN BRACEY, EXAMINING ATTORNEY

David J. Kyros

Director of the United States Patent and Trademark Office

United States of America

United States Patent and Trademark Office

Inventor Sherpa

Reg. No. 4,176,377

INTELLIPRENEUR CONSULTING LLC (PENNSYLVANIA LIMITED LIABILITY COMPANY)
157 HART AVENUE
DOYLESTOWN, PA 18901

Registered July 17, 2012

Int. Cl.: 41

FOR: EDUCATION SERVICES, NAMELY, PROVIDING LIVE AND ON-LINE TUTORIALS, CLASSES, WORKSHOPS, SEMINARS, TUTORING, AND MENTORING IN THE FIELD OF INVENTING / PATENTING, INCLUDING CREATION OF INVENTIVE CONCEPTS, SEARCHING AND ANALYSIS OF PATENT RELATED LITERATURE, AND PROTECTION OF INVENTIVE CONCEPTS, IN CLASS 41 (U.S. CLS. 100, 101 AND 107).

SERVICE MARK

PRINCIPAL REGISTER

FIRST USE 4-26-2012; IN COMMERCE 4-26-2012.

THE MARK CONSISTS OF STANDARD CHARACTERS WITHOUT CLAIM TO ANY PARTICULAR FONT, STYLE, SIZE, OR COLOR.

NO CLAIM IS MADE TO THE EXCLUSIVE RIGHT TO USE "INVENTOR", APART FROM THE MARK AS SHOWN.

SN 85-164,965, FILED 10-29-2010.

EMILY CHUO, EXAMINING ATTORNEY



David J. Kyffers

Director of the United States Patent and Trademark Office

United States of America

United States Patent and Trademark Office

BLOODY MACHETE

Reg. No. 4,176,378

Registered July 17, 2012

Int. Cl.: 30

TRADEMARK

PRINCIPAL REGISTER

BLOODY MACHETE ENTERPRISES, LLC (FLORIDA LIMITED LIABILITY COMPANY)
1555 PALM BEACH LAKES BLVD., SUITE 1010
WEST PALM BEACH, FL 33401

FOR: BARBEQUE SAUCE, IN CLASS 30 (U.S. CL. 46).

FIRST USE 11-6-2010; IN COMMERCE 11-6-2010.

THE MARK CONSISTS OF STANDARD CHARACTERS WITHOUT CLAIM TO ANY PARTICULAR FONT, STYLE, SIZE, OR COLOR.

SN 85-165,825, FILED 11-1-2010.

DOMINIC FATHY, EXAMINING ATTORNEY



David J. Kyffers

Director of the United States Patent and Trademark Office

United States of America

United States Patent and Trademark Office

Nature Wise

Reg. No. 4,176,379

Registered July 17, 2012

Int. Cls.: 5 and 31

TRADEMARK

PRINCIPAL REGISTER

CARGILL, INCORPORATED (DELAWARE CORPORATION)
15407 MCGINTY ROAD WEST
WAYZATA, MN 55391

FOR: MEDICATED ANIMAL FEED, IN CLASS 5 (U.S. CLS. 6, 18, 44, 46, 51 AND 52).

FIRST USE 1-28-2011; IN COMMERCE 1-28-2011.

FOR: ANIMAL FEED, IN CLASS 31 (U.S. CLS. 1 AND 46).

FIRST USE 1-28-2011; IN COMMERCE 1-28-2011.

OWNER OF U.S. REG. NO. 2,636,501.

THE MARK CONSISTS OF THE WORD "NATURE WISE" WITH STYLIZED LEAVES SURROUNDING THE "N".

SN 85-166,181, FILED 11-1-2010.

JOHN HWANG, EXAMINING ATTORNEY



David J. Kybas

Director of the United States Patent and Trademark Office

United States of America

United States Patent and Trademark Office

Who Wants Tacos?

Reg. No. 4,176,380

Registered July 17, 2012

Int. Cl.: 35

SERVICE MARK

PRINCIPAL REGISTER

DENVER TACO BELL RESTAURANT ADVERTISING ASSOCIATION INC. (COLORADO CORPORATION)
924 WEST COLFAX AVENUE, SUITE 302
DENVER, CO 80204

FOR: RETAIL STORE SERVICES FEATURING TACOS, IN CLASS 35 (U.S. CLS. 100, 101 AND 102).

FIRST USE 1-1-2011; IN COMMERCE 1-1-2011.

THE MARK CONSISTS OF STANDARD CHARACTERS WITHOUT CLAIM TO ANY PARTICULAR FONT, STYLE, SIZE, OR COLOR.

SN 85-166,317, FILED 11-1-2010.

EUGENIA MARTIN, EXAMINING ATTORNEY



David J. Kyffers

Director of the United States Patent and Trademark Office

United States of America

United States Patent and Trademark Office

AltRadio

Reg. No. 4,176,381

Registered July 17, 2012

Int. Cls.: 38 and 41

SERVICE MARK

PRINCIPAL REGISTER

HEIMERL & ASSOCIATES, INC. (VIRGINIA CORPORATION)
ATTN.: JOHN HEIMERL
1456 BRIDGE POINT TRAIL
SUFFOLK, VA 23432

FOR: STREAMING OF AUDIO AND VIDEO MATERIAL BY MUSICAL ARTISTS AND RECORDING LABELS ON THE INTERNET, IN CLASS 38 (U.S. CLS. 100, 101 AND 104).

FIRST USE 1-5-2011; IN COMMERCE 1-5-2011.

FOR: PROVIDING AN EDUCATIONAL WEBSITE IN THE FIELDS OF MUSIC, MUSIC VIDEOS, VIDEOS ABOUT MUSIC AND MUSICIANS, AND MUSIC INFORMATION BY MUSICAL ARTISTS AND RECORDING LABELS; PROVIDING AN INTERNET WEBSITE PORTAL IN THE FIELD OF MUSIC, MUSIC VIDEOS, VIDEOS ABOUT MUSIC AND MUSICIANS, AND MUSIC INFORMATION BY MUSICAL ARTISTS AND RECORDING LABELS, IN CLASS 41 (U.S. CLS. 100, 101 AND 107).

FIRST USE 1-5-2011; IN COMMERCE 1-5-2011.

THE MARK CONSISTS OF STANDARD CHARACTERS WITHOUT CLAIM TO ANY PARTICULAR FONT, STYLE, SIZE, OR COLOR.

OWNER OF U.S. REG. NO. 3,315,354.

SN 85-167,233, FILED 11-2-2010.

JANET LEE, EXAMINING ATTORNEY



David J. Kybas

Director of the United States Patent and Trademark Office

United States of America

United States Patent and Trademark Office

EZCROSS

Reg. No. 4,176,382

C. R. BARD, INC. (NEW JERSEY CORPORATION)
730 CENTRAL AVENUE
MURRAY HILL, NJ 07974

Registered July 17, 2012

Int. Cl.: 10

FOR: MEDICAL DEVICES AND APPARATUS FOR CARDIAC ABLATION PROCEDURES, NAMELY, INTRODUCER FOR VENOUS ACCESS, DILATOR AND GUIDE WIRE, AND PARTS AND FITTINGS THEREFOR, IN CLASS 10 (U.S. CLS. 26, 39 AND 44).

TRADEMARK

FIRST USE 2-24-2012; IN COMMERCE 2-24-2012.

PRINCIPAL REGISTER

THE MARK CONSISTS OF STANDARD CHARACTERS WITHOUT CLAIM TO ANY PARTICULAR FONT, STYLE, SIZE, OR COLOR.

SN 85-167,372, FILED 11-2-2010.

B. PARADEWELAI, EXAMINING ATTORNEY



David J. Kyffers

Director of the United States Patent and Trademark Office

United States of America
United States Patent and Trademark Office

R₂O

Reg. No. 4,176,383

SAMAN SINAI (UNITED STATES INDIVIDUAL)
1341 WOODRUFF AVE
LOS ANGELES, CA 90024

Registered July 17, 2012

Int. Cl.: 32

FOR: BOTTLED DRINKING WATER, IN CLASS 32 (U.S. CLS. 45, 46 AND 48).

TRADEMARK

FIRST USE 12-11-2011; IN COMMERCE 12-11-2011.

PRINCIPAL REGISTER

THE MARK CONSISTS OF "R2O" WITH THE NUMBER "2" EXISTING AS A SUBSCRIPT FOLLOWING THE "R" AND PRECEDING THE "O".

SN 85-167,470, FILED 11-2-2010.

COURTNEY ALVAREZ, EXAMINING ATTORNEY



David J. Kyffers

Director of the United States Patent and Trademark Office

United States of America

United States Patent and Trademark Office

BLACKBAUD GIVING SCORE

Reg. No. 4,176,384

BLACKBAUD, INC. (DELAWARE CORPORATION)
2000 DANIEL ISLAND DRIVE
CHARLESTON, SC 29427541

Registered July 17, 2012

Int. Cl.: 42

FOR: PROVIDING SOFTWARE AS A SERVICE (SAAS) FOR USE IN RATING INDIVIDUALS IN A DATABASE USING A PROPRIETARY ALGORITHM THAT RATES INDIVIDUALS BASED UPON FUNDRAISING CAPACITY AND THE RESULTING OUTPUT, IN CLASS 42 (U.S. CLS. 100 AND 101).

SERVICE MARK

PRINCIPAL REGISTER

FIRST USE 4-8-2010; IN COMMERCE 4-8-2010.

THE MARK CONSISTS OF STANDARD CHARACTERS WITHOUT CLAIM TO ANY PARTICULAR FONT, STYLE, SIZE, OR COLOR.

OWNER OF U.S. REG. NOS. 3,755,956, 3,846,462, AND OTHERS.

NO CLAIM IS MADE TO THE EXCLUSIVE RIGHT TO USE "GIVING SCORE", APART FROM THE MARK AS SHOWN.

SN 85-167,873, FILED 11-3-2010.

RENEE MCCRAY, EXAMINING ATTORNEY



David J. Kyros

Director of the United States Patent and Trademark Office

United States of America
United States Patent and Trademark Office

Provodine

Reg. No. 4,176,385

MICRODERMIS CORPORATION (DELAWARE CORPORATION)
103 CARNEGIE CENTER, SUITE 300
PRINCETON, NJ 08540

Registered July 17, 2012

Int. Cl.: 3

FOR: HAND CLEANING PREPARATIONS; HAND SCRUBS, IN CLASS 3 (U.S. CLS. 1, 4, 6, 50, 51 AND 52).

TRADEMARK

FIRST USE 4-30-2012; IN COMMERCE 4-30-2012.

PRINCIPAL REGISTER

THE MARK CONSISTS OF STANDARD CHARACTERS WITHOUT CLAIM TO ANY PARTICULAR FONT, STYLE, SIZE, OR COLOR.

SN 85-168,105, FILED 11-3-2010.

APRIL HESIK, EXAMINING ATTORNEY



David J. Kyffers

Director of the United States Patent and Trademark Office

United States of America

United States Patent and Trademark Office

SLAPSTICK

Reg. No. 4,176,386

ROMO, INC. (WISCONSIN CORPORATION)
800 HERITAGE ROAD
DE PERE, WI 54115

Registered July 17, 2012

Int. Cl.: 16

FOR: DRY ERASE WRITING SURFACE; ADHESIVE-BACKED DRY ERASE WRITING SURFACE, IN CLASS 16 (U.S. CLS. 2, 5, 22, 23, 29, 37, 38 AND 50).

TRADEMARK

FIRST USE 9-25-2008; IN COMMERCE 9-25-2008.

PRINCIPAL REGISTER

THE MARK CONSISTS OF STANDARD CHARACTERS WITHOUT CLAIM TO ANY PARTICULAR FONT, STYLE, SIZE, OR COLOR.

SN 85-168,390, FILED 11-3-2010.

INGA ERVIN, EXAMINING ATTORNEY



David J. Kyfos

Director of the United States Patent and Trademark Office

United States of America

United States Patent and Trademark Office

YARK

Reg. No. 4,176,387

CARR, COLLEEN M. (UNITED STATES INDIVIDUAL), DBA YARK DESIGNS,
31911 PASEO SAGRADO

Registered July 17, 2012

SAN JUAN CAPISTRANO, CA 92675

Int. Cl.: 18

FOR: PET PRODUCTS, NAMELY, LEASHES AND COLLARS, IN CLASS 18 (U.S. CLS. 1, 2,
3, 22 AND 41).

TRADEMARK

FIRST USE 2-21-2012; IN COMMERCE 2-21-2012.

PRINCIPAL REGISTER

THE MARK CONSISTS OF STANDARD CHARACTERS WITHOUT CLAIM TO ANY PAR-
TICULAR FONT, STYLE, SIZE, OR COLOR.

SN 85-168,534, FILED 11-3-2010.

MICHAEL SOUDERS, EXAMINING ATTORNEY



David J. Kybas

Director of the United States Patent and Trademark Office

United States of America

United States Patent and Trademark Office

COMFORT RECLINER BY AMERICAN LEATHER

Reg. No. 4,176,388

AMERICAN LEATHER, INC. (TEXAS CORPORATION)
4501 MOUNTAIN CREEK PARKWAY
DALLAS, TX 75236

Registered July 17, 2012

Int. Cl.: 20

FOR: FURNITURE MADE IN WHOLE OR SIGNIFICANT PART OF LEATHER, IN CLASS 20 (U.S. CLS. 2, 13, 22, 25, 32 AND 50).

TRADEMARK

FIRST USE 4-21-2012; IN COMMERCE 4-21-2012.

PRINCIPAL REGISTER

THE MARK CONSISTS OF STANDARD CHARACTERS WITHOUT CLAIM TO ANY PARTICULAR FONT, STYLE, SIZE, OR COLOR.

SEC. 2(F) AS TO "AMERICAN LEATHER".

OWNER OF U.S. REG. NOS. 2,575,878 AND 3,826,992.

NO CLAIM IS MADE TO THE EXCLUSIVE RIGHT TO USE "RECLINER" AND "LEATHER", APART FROM THE MARK AS SHOWN.

SN 85-168,579, FILED 11-3-2010.

RONALD MCMORROW, EXAMINING ATTORNEY



David J. Kyffers

Director of the United States Patent and Trademark Office

United States of America

United States Patent and Trademark Office

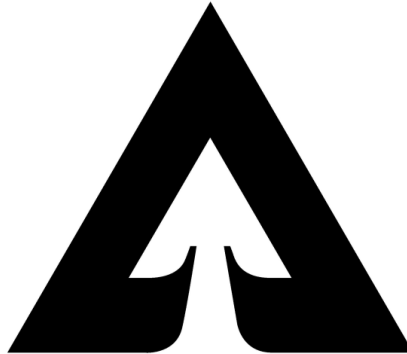

Reg. No. 4,176,389

Registered July 17, 2012

Int. Cl.: 19

TRADEMARK

PRINCIPAL REGISTER

WEYERHAEUSER NR COMPANY (WASHINGTON CORPORATION)
33663 WEYERHAEUSER WAY SOUTH
FEDERAL WAY, WA 98003

FOR: WOODEN FLOORING, IN CLASS 19 (U.S. CLS. 1, 12, 33 AND 50).

FIRST USE 4-30-2009; IN COMMERCE 4-30-2009.

OWNER OF U.S. REG. NOS. 698,826, 817,598, AND OTHERS.

THE MARK CONSISTS OF A STYLIZED TREE IN A TRIANGLE.

SN 85-169,087, FILED 11-4-2010.

WILLIAM P. SHANAHAN, EXAMINING ATTORNEY



David J. Kybas

Director of the United States Patent and Trademark Office

United States of America

United States Patent and Trademark Office

KNOWHOW

Reg. No. 4,176,390

Registered July 17, 2012

Int. Cl.: 35

SERVICE MARK

PRINCIPAL REGISTER

CONSTANT CONTACT, INC. (DELAWARE CORPORATION)
RESERVOIR PLACE
1601 TRAPELO ROAD, SUITE 329
WALTHAM, MA 02451

FOR: PROVIDING ONLINE MARKETING RESOURCES, NAMELY, A WEBSITE FEATURING MARKETING INFORMATION FOR CREATING, MANAGING, SENDING AND TRACKING ONLINE SERVICES, NAMELY, BLOG ENTRIES, RSS FEEDS, EVENT MARKETING CONTENT, AND SOCIAL MEDIA, IN CLASS 35 (U.S. CLS. 100, 101 AND 102).

FIRST USE 3-26-2011; IN COMMERCE 3-26-2011.

THE MARK CONSISTS OF STANDARD CHARACTERS WITHOUT CLAIM TO ANY PARTICULAR FONT, STYLE, SIZE, OR COLOR.

SN 85-169,286, FILED 11-4-2010.

KEVON CHISOLM, EXAMINING ATTORNEY



David J. Kyffers

Director of the United States Patent and Trademark Office

United States of America

United States Patent and Trademark Office

REV RACK

Reg. No. 4,176,391

MCMILLAN, MICHAEL B. (UNITED STATES INDIVIDUAL)
810 COOPERS COURT
CALDWELL, ID 83605

Registered July 17, 2012

Int. Cl.: 12

FOR: CARGO CARRIERS FOR VEHICLES, IN CLASS 12 (U.S. CLS. 19, 21, 23, 31, 35 AND 44).

TRADEMARK

FIRST USE 2-15-2011; IN COMMERCE 3-5-2011.

PRINCIPAL REGISTER

THE MARK CONSISTS OF STANDARD CHARACTERS WITHOUT CLAIM TO ANY PARTICULAR FONT, STYLE, SIZE, OR COLOR.

NO CLAIM IS MADE TO THE EXCLUSIVE RIGHT TO USE "RACK", APART FROM THE MARK AS SHOWN.

SN 85-169,785, FILED 11-4-2010.

RENEE MCCRAY, EXAMINING ATTORNEY



David J. Kyffers

Director of the United States Patent and Trademark Office

United States of America

United States Patent and Trademark Office

GREEN STREAK

Reg. No. 4,176,392

GLOBAL TRADEMARKS, INC. (NEVADA CORPORATION)
110 COMMERCE WAY
STOCKERTOWN, PA 18083

Registered July 17, 2012

Int. Cl.: 25

FOR: COVERUPS; SWIMWEAR, IN CLASS 25 (U.S. CLS. 22 AND 39).

TRADEMARK

FIRST USE 8-19-2011; IN COMMERCE 8-19-2011.

PRINCIPAL REGISTER

THE MARK CONSISTS OF STANDARD CHARACTERS WITHOUT CLAIM TO ANY PARTICULAR FONT, STYLE, SIZE, OR COLOR.

SN 85-170,149, FILED 11-5-2010.

BRENDAN REGAN, EXAMINING ATTORNEY



David J. Kybas

Director of the United States Patent and Trademark Office

United States of America

United States Patent and Trademark Office

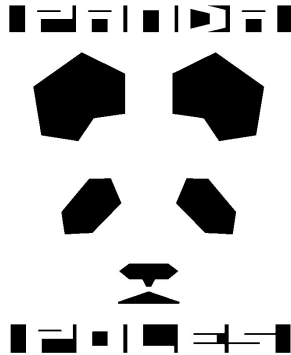

Reg. No. 4,176,393

Registered July 17, 2012

Int. Cl.: 40

SERVICE MARK

PRINCIPAL REGISTER

PANDA POLES (UTAH LIMITED LIABILITY COMPANY)
9086 KINGS HILL PL
SALT LAKE CITY, UT 84121

FOR: CUSTOM MANUFACTURE OF SKIS AND SPORTS EQUIPMENT, NAMELY, NORDIC WALKING POLES, IN CLASS 40 (U.S. CLS. 100, 103 AND 106).

FIRST USE 12-3-2010; IN COMMERCE 1-18-2011.

NO CLAIM IS MADE TO THE EXCLUSIVE RIGHT TO USE "POLES", APART FROM THE MARK AS SHOWN.

THE MARK CONSISTS OF A STYLIZED DEPICTION OF A PANDA'S FACE. ABOVE APPEARS THE TERM "PANDA" IN STYLIZED LETTERING; BENEATH APPEARS THE TERM "POLES" IN STYLIZED LETTERING.

SN 85-170,681, FILED 11-5-2010.

JIM RINGLE, EXAMINING ATTORNEY



David J. Kyffers

Director of the United States Patent and Trademark Office

United States of America

United States Patent and Trademark Office

EXCELLENCE THROUGH EVIDENCE

Reg. No. 4,176,394

Registered July 17, 2012

Int. Cls.: 35 and 42

SERVICE MARK

PRINCIPAL REGISTER

THE CENTER FOR ORTHOPEDIC AND RESEARCH EXCELLENCE, INC. (ARIZONA CORPORATION)
3010 WEST AGUA FRIA FREEWAY, SUITE 101
PHOENIX, AZ 85027

FOR: MARKETING SERVICES TO OBTAIN CONSUMER INSIGHTS AND DEVELOP BRANDING STRATEGIES, IN CLASS 35 (U.S. CLS. 100, 101 AND 102).

FIRST USE 1-1-2011; IN COMMERCE 1-1-2011.

FOR: PROVIDING QUALITY ASSURANCE SERVICES IN THE FIELD OF ORTHOPEDIC MEDICINE, IN CLASS 42 (U.S. CLS. 100 AND 101).

FIRST USE 1-1-2011; IN COMMERCE 1-1-2011.

THE MARK CONSISTS OF STANDARD CHARACTERS WITHOUT CLAIM TO ANY PARTICULAR FONT, STYLE, SIZE, OR COLOR.

SN 85-170,729, FILED 11-5-2010.

RICHARD WHITE, EXAMINING ATTORNEY



David J. Kyjars

Director of the United States Patent and Trademark Office

United States of America

United States Patent and Trademark Office



DriftingArt
Nature's Sculptures

Reg. No. 4,176,395

Registered July 17, 2012

Int. Cl.: 20

TRADEMARK

PRINCIPAL REGISTER

GREEN, MICHAEL D. (UNITED STATES INDIVIDUAL)
832 NEWTON RD
LAGRANGE, GA 30240

FOR: SCULPTURES OF WOOD, IN CLASS 20 (U.S. CLS. 2, 13, 22, 25, 32 AND 50).

FIRST USE 2-1-2011; IN COMMERCE 2-1-2011.

NO CLAIM IS MADE TO THE EXCLUSIVE RIGHT TO USE "SCULPTURES", APART FROM THE MARK AS SHOWN.

THE MARK CONSISTS OF AN ABSTRACT DESIGN WITH THE STYLIZED TEXT "DRIFTING ART NATURE'S SCULPTURES".

SN 85-170,786, FILED 11-5-2010.

KAREN BRACEY, EXAMINING ATTORNEY



David J. Kyffers

Director of the United States Patent and Trademark Office

United States of America

United States Patent and Trademark Office

iTwin

Reg. No. 4,176,396

Registered July 17, 2012

Int. Cl.: 42

SERVICE MARK

PRINCIPAL REGISTER

ITWIN PTE. LTD. (SINGAPORE PRIVATE LIMITED COMPANY)
20 AYER RAJAH CRESCENT
#08-27
SINGAPORE, SINGAPORE 139964

FOR: PROVIDING AN ONLINE NETWORK SERVICE THAT ENABLES USERS TO SECURELY CONNECT TWO COMPUTERS AND REMOTELY ACCESS, MANAGE, TRANSFER AND EDIT THEIR DATA , IN CLASS 42 (U.S. CLS. 100 AND 101).

FIRST USE 10-0-2010; IN COMMERCE 10-0-2010.

THE MARK CONSISTS OF STANDARD CHARACTERS WITHOUT CLAIM TO ANY PARTICULAR FONT, STYLE, SIZE, OR COLOR.

SN 85-171,842, FILED 11-8-2010.

LAKEISHA LEWIS, EXAMINING ATTORNEY



David J. Kyffers

Director of the United States Patent and Trademark Office

United States of America

United States Patent and Trademark Office

CHERRY JAM

Reg. No. 4,176,397

Registered July 17, 2012

Int. Cl.: 28

TRADEMARK

PRINCIPAL REGISTER

THOSE CHARACTERS FROM CLEVELAND, INC. (OHIO CORPORATION)
ONE AMERICAN ROAD
CLEVELAND, OH 44144

FOR: PLUSH TOYS; TOY FIGURES, IN CLASS 28 (U.S. CLS. 22, 23, 38 AND 50).

FIRST USE 9-30-2011; IN COMMERCE 9-30-2011.

THE MARK CONSISTS OF STANDARD CHARACTERS WITHOUT CLAIM TO ANY PARTICULAR FONT, STYLE, SIZE, OR COLOR.

SN 85-172,806, FILED 11-9-2010.

RENEE MCCRAY, EXAMINING ATTORNEY



David J. Kyffers

Director of the United States Patent and Trademark Office

United States of America

United States Patent and Trademark Office

WATCH, SHARE, PLAY

Reg. No. 4,176,398

Registered July 17, 2012

Int. Cl.: 42

SERVICE MARK

PRINCIPAL REGISTER

SMRTV, INC. (DELAWARE CORPORATION)
1400 65TH STREET
SUITE 300
EMERYVILLE, CA 94608

FOR: COMPUTER SERVICES, NAMELY, CREATING AN ON-LINE COMMUNITY FOR REGISTERED USERS TO PARTICIPATE IN DISCUSSIONS, GET FEEDBACK FROM THEIR PEERS, FORM VIRTUAL COMMUNITIES, AND ENGAGE IN SOCIAL NETWORKING FEATURING TOPICS IN THE FIELD OF INTERACTIVE TELEVISION, IN CLASS 42 (U.S. CLS. 100 AND 101).

FIRST USE 5-21-2012; IN COMMERCE 5-21-2012.

THE MARK CONSISTS OF STANDARD CHARACTERS WITHOUT CLAIM TO ANY PARTICULAR FONT, STYLE, SIZE, OR COLOR.

SN 85-172,876, FILED 11-9-2010.

WILLIAM P. SHANAHAN, EXAMINING ATTORNEY



David J. Kyffers

Director of the United States Patent and Trademark Office

United States of America

United States Patent and Trademark Office

TV TUNED INTO YOU

Reg. No. 4,176,399

Registered July 17, 2012

Int. Cl.: 42

SERVICE MARK

PRINCIPAL REGISTER

SMRTV, INC. (DELAWARE CORPORATION)
1400 65TH STREET
SUITE 300
EMERYVILLE, CA 94608

FOR: COMPUTER SERVICES, NAMELY, CREATING AN ON-LINE COMMUNITY FOR REGISTERED USERS TO PARTICIPATE IN DISCUSSIONS, GET FEEDBACK FROM THEIR PEERS, FORM VIRTUAL COMMUNITIES, AND ENGAGE IN SOCIAL NETWORKING FEATURING TOPICS IN THE FIELD OF INTERACTIVE TELEVISION, IN CLASS 42 (U.S. CLS. 100 AND 101).

FIRST USE 5-21-2012; IN COMMERCE 5-21-2012.

THE MARK CONSISTS OF STANDARD CHARACTERS WITHOUT CLAIM TO ANY PARTICULAR FONT, STYLE, SIZE, OR COLOR.

SN 85-172,884, FILED 11-9-2010.

WILLIAM P. SHANAHAN, EXAMINING ATTORNEY



David J. Kybas

Director of the United States Patent and Trademark Office

United States of America

United States Patent and Trademark Office

TV TUNED INTO ME

Reg. No. 4,176,400

Registered July 17, 2012

Int. Cl.: 42

SERVICE MARK

PRINCIPAL REGISTER

SMRTV, INC. (DELAWARE CORPORATION)
1400 65TH STREET
SUITE 300
EMERYVILLE, CA 94608

FOR: COMPUTER SERVICES, NAMELY, CREATING AN ON-LINE COMMUNITY FOR REGISTERED USERS TO PARTICIPATE IN DISCUSSIONS, GET FEEDBACK FROM THEIR PEERS, FORM VIRTUAL COMMUNITIES, AND ENGAGE IN SOCIAL NETWORKING FEATURING TOPICS IN THE FIELD OF INTERACTIVE TELEVISION, IN CLASS 42 (U.S. CLS. 100 AND 101).

FIRST USE 5-21-2012; IN COMMERCE 5-21-2012.

THE MARK CONSISTS OF STANDARD CHARACTERS WITHOUT CLAIM TO ANY PARTICULAR FONT, STYLE, SIZE, OR COLOR.

SN 85-172,887, FILED 11-9-2010.

WILLIAM P. SHANAHAN, EXAMINING ATTORNEY



David J. Kyffers

Director of the United States Patent and Trademark Office

United States of America

United States Patent and Trademark Office

Travel Fit Club

Reg. No. 4,176,401

FREEMOVE, JULIE D. (UNITED STATES INDIVIDUAL)
310 S TWIN OAKS VALLEY RD, # 107-337
SAN MARCOS, CA 920784387

Registered July 17, 2012

Int. Cl.: 41

FOR: EDUCATIONAL SERVICES THAT PROMOTE HEALTHY AGING THROUGH EVIDENCE-BASED, LIFESTYLE MODIFICATION, NAMELY, CONDUCTING CLASSES, SEMINARS, CONFERENCES, WORKSHOPS, PROGRAMS AND LECTURES IN THE FIELDS OF HEALTHY AGING AND FITNESS; HEALTH AND EDUCATION SERVICES THAT PROMOTE HEALTHY AGING THROUGH EVIDENCE-BASED, LIFESTYLE MODIFICATION, NAMELY, INSTRUCTION IN THE FIELDS OF PHYSICAL FITNESS, NUTRITION, DISEASE MANAGEMENT AND DISEASE PREVENTION, TRAVEL AND HEALTHY AGING LIFESTYLE INSTRUCTION, IN CLASS 41 (U.S. CLS. 100, 101 AND 107).

SERVICE MARK

PRINCIPAL REGISTER

FIRST USE 10-20-2011; IN COMMERCE 10-20-2011.

NO CLAIM IS MADE TO THE EXCLUSIVE RIGHT TO USE "TRAVEL FIT CLUB" , APART FROM THE MARK AS SHOWN.

THE MARK CONSISTS OF THE WORDS "TRAVEL FIT CLUB", WITH "TRAVEL" HAVING AN ENLARGED LETTER "V" AND A SOLID, OVAL-SHAPED DOT PLACED WITHIN THE "V".

SN 85-172,917, FILED 11-9-2010.

KATHERINE CONNOLLY, EXAMINING ATTORNEY



David J. Kypos

Director of the United States Patent and Trademark Office

United States of America

United States Patent and Trademark Office

SOULWATER

Reg. No. 4,176,402

SOULCYCLE, LLC (NEW YORK LIMITED LIABILITY COMPANY)
103 WARREN STREET
NEW YORK, NY 10007

Registered July 17, 2012

Int. Cl.: 32

FOR: BOTTLED WATER, IN CLASS 32 (U.S. CLS. 45, 46 AND 48).

TRADEMARK

FIRST USE 4-9-2012; IN COMMERCE 4-9-2012.

PRINCIPAL REGISTER

THE MARK CONSISTS OF STANDARD CHARACTERS WITHOUT CLAIM TO ANY PARTICULAR FONT, STYLE, SIZE, OR COLOR.

OWNER OF U.S. REG. NO. 2,496,683.

SN 85-173,479, FILED 11-10-2010.

BRENDAN REGAN, EXAMINING ATTORNEY



David J. Kyffers

Director of the United States Patent and Trademark Office

United States of America

United States Patent and Trademark Office



Reg. No. 4,176,403

RADIANT AUDIO ENGINEERING, INC. (CALIFORNIA CORPORATION)
600 N. BATAVIA STREET
ORANGE, CA 92868

Registered July 17, 2012

Int. Cl.: 9

FOR: PROFESSIONAL AUDIO EQUIPMENT, NAMELY, LOUDSPEAKERS, SUBWOOFERS, COAXIAL STAGE MONITORS, COAXIAL CEILING SPEAKERS, COAXIAL LOUDSPEAKERS, COMPRESSION DRIVERS, WOOFER DRIVERS AND ACOUSTIC DIAPHRAGMS, IN CLASS 9 (U.S. CLS. 21, 23, 26, 36 AND 38).

TRADEMARK

PRINCIPAL REGISTER

FIRST USE 1-29-1998; IN COMMERCE 1-29-1998.

THE MARK CONSISTS OF A SINGLE-LINE RECTANGULAR FRAME CONTAINING, ON THE LEFT, THE IMAGE OF A LOUDSPEAKER FACING RIGHT AND PROXIMATE TO THE WORD "RADIANT" IN HIGHLY STYLIZED CAPITAL LETTERS.

SN 85-173,483, FILED 11-10-2010.

JILL C. ALT, EXAMINING ATTORNEY



David J. Kyros

Director of the United States Patent and Trademark Office

United States of America

United States Patent and Trademark Office

RADIAN

Reg. No. 4,176,404

Registered July 17, 2012

Int. Cl.: 9

TRADEMARK

PRINCIPAL REGISTER

RADIAN AUDIO ENGINEERING, INC. (CALIFORNIA CORPORATION)
600 N. BATAVIA STREET
ORANGE, CA 92868

FOR: PROFESSIONAL AUDIO EQUIPMENT, NAMELY, LOUDSPEAKERS, SUBWOOFERS, COAXIAL STAGE MONITORS, COAXIAL CEILING SPEAKERS, COAXIAL LOUDSPEAKERS, COMPRESSION DRIVERS, WOOFER DRIVERS, AND ACOUSTIC DIAPHRAGMS, IN CLASS 9 (U.S. CLS. 21, 23, 26, 36 AND 38).

FIRST USE 3-31-1989; IN COMMERCE 3-31-1989.

THE MARK CONSISTS OF STANDARD CHARACTERS WITHOUT CLAIM TO ANY PARTICULAR FONT, STYLE, SIZE, OR COLOR.

SN 85-173,523, FILED 11-10-2010.

JILL C. ALT, EXAMINING ATTORNEY



David J. Kyffers

Director of the United States Patent and Trademark Office

United States of America

United States Patent and Trademark Office



Reg. No. 4,176,405

FOWLER, LYTHON EUGENE (UNITED STATES INDIVIDUAL)
303 W. LAKE DEVERNIA RD.
LONGVIEW, TX 75604

Registered July 17, 2012

Int. Cl.: 28

FOR: ARTIFICIAL FISHING LURES; FISH ATTRACTANTS; FISHING LURES; LURES FOR FISHING; LURES FOR HUNTING OR FISHING, IN CLASS 28 (U.S. CLS. 22, 23, 38 AND 50).

TRADEMARK

FIRST USE 9-22-2010; IN COMMERCE 9-22-2010.

PRINCIPAL REGISTER

NO CLAIM IS MADE TO THE EXCLUSIVE RIGHT TO USE "FISH HYPNOTIZER", APART FROM THE MARK AS SHOWN.

THE COLOR(S) BLUE, BROWN, RED, GREEN, YELLOW, WHITE, AND BLACK IS/ARE CLAIMED AS A FEATURE OF THE MARK.

THE MARK CONSISTS OF THE WORDS "FISH HYPNOTIZER" IN BLACK STYLIZED, UPPER-AND-LOWER-CASE LETTERING WITH A COIL DESIGN IN BLACK AND WHITE SERVING AS DOTS OVER THE "I'S IN BOTH WORDS. THE DESIGN COMPONENT OF THE MARK IS A CIRCLE SITUATED ABOVE THE CENTER OF THE TWO WORDS AND CONTAINING A REPRESENTATION OF A LEAPING FISH WITH BROWN FINS AND BACK MARKED WITH BLACK SPECKLES, RED EYES, LIPS AND MIDSECTION AND A WHITE UNDERBELLY. THE FISH IS CENTERED OVER A BLUE WAVE WITH A LIGHTER BLUE ABOVE THE FISH AND JUST OUTSIDE THE CIRCLE, LOOKING IN, IS A VERY SMALL FISHERMAN WITH A RED CAP IN A GREEN JACKET WITH A YELLOW COLLAR, HOLDING A FISHING ROD IN HIS RIGHT HAND FROM WHICH A FISHING LINE LOOPS BEHIND HIM, BEHIND THE CIRCLE, THEN OVER THE TOP OF THE CIRCLE, OVER THE FISH, LOOPING DOWN INTO THE LETTER "H" AND THEN BACK UP TO WHERE ITS HOOK IS CAUGHT SQUARELY IN THE LOWER LIP OF THE FISH. THE RED FISH EYES ARE THE EXACT DUPLICATES OF THE COILED CIRCLES DOTTING THE "I'S IN THE WORDS BELOW.



SN 85-173,784, FILED 11-10-2010.

David J. Kappas

JILL C. ALT, EXAMINING ATTORNEY

United States of America

United States Patent and Trademark Office

ART OF FACES

Reg. No. 4,176,406

Registered July 17, 2012

Int. Cl.: 44

SERVICE MARK

PRINCIPAL REGISTER

SIRXIA, INC. (WYOMING CORPORATION)
SUIT 627
2710 THOMES AVE
CHEYENNE, WY 82001

FOR: BEAUTY CONSULTATION SERVICES; BEAUTY CONSULTATION SERVICES IN THE SELECTION, USE, AND APPLICATION OF COSMETICS, MAKEUP, BEAUTY PRODUCTS, PERSONAL CARE PRODUCTS, AND SKIN CARE PRODUCTS; CONSULTATION SERVICES IN THE FIELD OF MAKEUP AND COSMETICS, NAMELY, IN-PERSON MAKEUP AND COSMETICS CONSULTATION AND APPLICATION SERVICES, IN CLASS 44 (U.S. CLS. 100 AND 101).

FIRST USE 4-14-2012; IN COMMERCE 4-14-2012.

THE MARK CONSISTS OF STANDARD CHARACTERS WITHOUT CLAIM TO ANY PARTICULAR FONT, STYLE, SIZE, OR COLOR.

SN 85-174,323, FILED 11-11-2010.

TARAH HARDY, EXAMINING ATTORNEY



David J. Kyros

Director of the United States Patent and Trademark Office

United States of America

United States Patent and Trademark Office

DISNEY CUDDLY BODYSUIT

Reg. No. 4,176,407

DISNEY ENTERPRISES, INC. (DELAWARE CORPORATION)
500 SOUTH BUENA VISTA STREET
BURBANK, CA 91521

Registered July 17, 2012

Int. Cl.: 25

FOR: CLOTHING, NAMELY, INFANTWEAR; HEADWEAR, IN CLASS 25 (U.S. CLS. 22 AND 39).

TRADEMARK

FIRST USE 6-1-2011; IN COMMERCE 6-1-2011.

PRINCIPAL REGISTER

THE MARK CONSISTS OF STANDARD CHARACTERS WITHOUT CLAIM TO ANY PARTICULAR FONT, STYLE, SIZE, OR COLOR.

OWNER OF U.S. REG. NOS. 3,088,198, 3,340,426, AND OTHERS.

NO CLAIM IS MADE TO THE EXCLUSIVE RIGHT TO USE "BODYSUIT", APART FROM THE MARK AS SHOWN.

SN 85-175,087, FILED 11-11-2010.

WILLIAM P. SHANAHAN, EXAMINING ATTORNEY



David J. Kyros

Director of the United States Patent and Trademark Office

United States of America

United States Patent and Trademark Office

PILLOW BOOSTER

Reg. No. 4,176,408

KAKON, SIMON (UNITED STATES INDIVIDUAL)
151 N NOB HILL RD #152

Registered July 17, 2012

DAVIE, FL 33328

Int. Cl.: 20

FOR: PILLOWS, IN CLASS 20 (U.S. CLS. 2, 13, 22, 25, 32 AND 50).

TRADEMARK

FIRST USE 3-1-2012; IN COMMERCE 5-14-2012.

PRINCIPAL REGISTER

THE MARK CONSISTS OF STANDARD CHARACTERS WITHOUT CLAIM TO ANY PARTICULAR FONT, STYLE, SIZE, OR COLOR.

NO CLAIM IS MADE TO THE EXCLUSIVE RIGHT TO USE "PILLOW", APART FROM THE MARK AS SHOWN.

SN 85-175,417, FILED 11-12-2010.

JANET LEE, EXAMINING ATTORNEY



David J. Kyffers

Director of the United States Patent and Trademark Office

United States of America

United States Patent and Trademark Office

CLOUDSTOR

Reg. No. 4,176,409

Registered July 17, 2012

Int. Cl.: 9

TRADEMARK

PRINCIPAL REGISTER

BUFFALO TECHNOLOGY (USA), INC. (DELAWARE CORPORATION)
SUITE 750
11100 METRIC BOULEVARD
AUSTIN, TX 78758

FOR: A SHARED NETWORK STORAGE DEVICE UTILIZING FILE SHARING TECHNOLOGY WHICH INCLUDES FREE ONLINE SERVICE FOR REMOTELY ACCESSING AND SHARING FILES THROUGH ANY WEB BROWSER, IN CLASS 9 (U.S. CLS. 21, 23, 26, 36 AND 38).

FIRST USE 1-10-2011; IN COMMERCE 1-10-2011.

THE MARK CONSISTS OF STANDARD CHARACTERS WITHOUT CLAIM TO ANY PARTICULAR FONT, STYLE, SIZE, OR COLOR.

SN 85-175,876, FILED 11-12-2010.

JESSICA A. POWERS, EXAMINING ATTORNEY



David J. Kyjars

Director of the United States Patent and Trademark Office

United States of America

United States Patent and Trademark Office



Reg. No. 4,176,410

Registered July 17, 2012

Int. Cls.: 35, 36, 41, and 45

SERVICE MARK

PRINCIPAL REGISTER

CULOTTA LAW FIRM, PLLC (TEXAS LIMITED LIABILITY COMPANY)
PO BOX 580586
HOUSTON, TX 772580586

FOR: BUSINESS SERVICES, NAMELY, STRUCTURING, OPTIMIZING AND CHANGE MANAGEMENT CONSULTING RELATED TO CORPORATE IN-HOUSE INTELLECTUAL PROPERTY DEPARTMENTS AND INTELLECTUAL PROPERTY ASSET MANAGEMENT PROGRAMS; CONSULTING REGARDING INTELLECTUAL PROPERTY BUSINESS RISK MITIGATION PROCESSES; CONSULTING SERVICES IN THE FIELD OF MANAGING INTELLECTUAL PROPERTIES, IN CLASS 35 (U.S. CLS. 100, 101 AND 102).

FIRST USE 11-10-2010; IN COMMERCE 1-7-2012.

FOR: ADVISING OTHERS CONCERNING INVESTMENTS IN INTELLECTUAL PROPERTY ASSETS AND INTANGIBLE BUSINESS ASSETS, BOTH DIRECTLY AND INDIRECTLY THROUGH OTHER ENTITIES; CONSULTING ON THE SUBJECT OF INTELLECTUAL PROPERTY VALUATION; INTELLECTUAL PROPERTY VALUATION SERVICES, IN CLASS 36 (U.S. CLS. 100, 101 AND 102).

FIRST USE 11-10-2010; IN COMMERCE 1-7-2012.

FOR: EDUCATIONAL SERVICES, NAMELY, CONDUCTING CLASSES, SEMINARS, CONFERENCES, WORKSHOPS BOTH IN-PERSON, ELECTRONICALLY DISTRIBUTED, LIVE OR RECORDED IN MACHINE-READABLE FORMAT IN THE FIELD OF INTELLECTUAL PROPERTY AND DISTRIBUTION OF EDUCATIONAL MATERIALS IN CONNECTION THEREWITH; EDUCATIONAL SERVICES, NAMELY, PROVIDING EDUCATIONAL SPEAKERS IN THE FIELD OF INTELLECTUAL PROPERTY, IN CLASS 41 (U.S. CLS. 100, 101 AND 107).

FIRST USE 11-10-2010; IN COMMERCE 1-7-2012.

FOR: CONSULTING IN THE FIELD OF INTELLECTUAL PROPERTY LICENSING; INTELLECTUAL PROPERTY CONSULTATION; INTELLECTUAL PROPERTY WATCH SERVICES; LEGAL SERVICES; LEGAL SERVICES, NAMELY, INTELLECTUAL PROPERTY CONSULTING SERVICES IN THE FIELD OF INVENTION, IDENTIFICATION, STRATEGY, ANALYTICS, AND INVENTION; LEGAL SERVICES, NAMELY, PREPARATION OF APPLICATIONS FOR TRADEMARK REGISTRATION; LICENSING OF INTELLECTUAL PROPERTY; PATENT



David J. Kyffers

Director of the United States Patent and Trademark Office

Reg. No. 4,176,410 AGENT SERVICES; PATENT LICENSING; PROVIDING INFORMATION IN THE FIELD OF INTELLECTUAL PROPERTY LEGAL SERVICES ; PROVIDING INFORMATION IN THE FIELD OF INTELLECTUAL PROPERTY, IN CLASS 45 (U.S. CLS. 100 AND 101).

FIRST USE 11-10-2010; IN COMMERCE 1-7-2012.

THE MARK CONSISTS OF NON-GENDER SPECIFIC DEPICTION OF A HUMAN BODY COLORED WHITE WITH A YELLOW ELECTRIC LIGHT BULB FOR A HEAD AND A RED EXCLAMATION POINT INSIDE THE YELLOW LIGHT BULB. BOTH PARTS OF THE EXCLAMATION POINT ARE RED. RAYS EMANATING FROM THE ELECTRIC LIGHT BULB HEAD ARE YELLOW. THE ELEMENTS OF THE BASE OF THE ELECTRIC LIGHT BULB EXTENDING OVER THE WHITE HUMAN BODY ARE BLACK. THE SKYSCRAPER IS BLACK. THE WINDOWS IN THE SKYSCRAPER ARE WHITE.

THE COLOR(S) YELLOW, RED, BLACK AND WHITE IS/ARE CLAIMED AS A FEATURE OF THE MARK.

SN 85-176,134, FILED 11-13-2010.

ROSELLE HERRERA, EXAMINING ATTORNEY

United States of America

United States Patent and Trademark Office

What are your ideas building for you?

Reg. No. 4,176,411

CULOTTA LAW FIRM, PLLC (TEXAS LIMITED LIABILITY COMPANY)
PO BOX 580586

Registered July 17, 2012

HOUSTON, TX 772580586

**Int. Cls.: 35, 36, 41, and
45**

FOR: BUSINESS SERVICES, NAMELY, STRUCTURING, OPTIMIZING AND CHANGE MANAGEMENT CONSULTING RELATED TO CORPORATE IN-HOUSE INTELLECTUAL PROPERTY DEPARTMENTS AND INTELLECTUAL PROPERTY ASSET MANAGEMENT PROGRAMS; CONSULTING REGARDING INTELLECTUAL PROPERTY BUSINESS RISK MITIGATION PROCESSES; CONSULTING SERVICES IN THE FIELD OF MANAGING INTELLECTUAL PROPERTIES, IN CLASS 35 (U.S. CLS. 100, 101 AND 102).

SERVICE MARK

PRINCIPAL REGISTER

FIRST USE 11-10-2010; IN COMMERCE 1-7-2012.

FOR: ADVISING OTHERS CONCERNING INVESTMENTS IN INTELLECTUAL PROPERTY ASSETS AND INTANGIBLE BUSINESS ASSETS, BOTH DIRECTLY AND INDIRECTLY THROUGH OTHER ENTITIES; CONSULTING ON THE SUBJECT OF INTELLECTUAL PROPERTY VALUATION; INTELLECTUAL PROPERTY VALUATION SERVICES, IN CLASS 36 (U.S. CLS. 100, 101 AND 102).

FIRST USE 11-10-2010; IN COMMERCE 1-7-2012.

FOR: EDUCATIONAL SERVICES, NAMELY, CONDUCTING CLASSES, SEMINARS, CONFERENCES, WORKSHOPS BOTH IN-PERSON, ELECTRONICALLY DISTRIBUTED, LIVE OR RECORDED IN MACHINE-READABLE FORMAT IN THE FIELD OF INTELLECTUAL PROPERTY AND DISTRIBUTION OF EDUCATIONAL MATERIALS IN CONNECTION THEREWITH; EDUCATIONAL SERVICES, NAMELY, PROVIDING EDUCATIONAL SPEAKERS IN THE FIELD OF INTELLECTUAL PROPERTY, IN CLASS 41 (U.S. CLS. 100, 101 AND 107).

FIRST USE 11-10-2010; IN COMMERCE 1-7-2012.

FOR: CONSULTING IN THE FIELD OF INTELLECTUAL PROPERTY LICENSING; INTELLECTUAL PROPERTY CONSULTATION; INTELLECTUAL PROPERTY WATCH SERVICES; LEGAL SERVICES; LEGAL SERVICES, NAMELY, INTELLECTUAL PROPERTY CONSULTING SERVICES IN THE FIELD OF INVENTION, IDENTIFICATION, STRATEGY, ANALYTICS, AND INVENTION; LEGAL SERVICES, NAMELY, PREPARATION OF APPLICATIONS FOR TRADEMARK REGISTRATION; LICENSING OF INTELLECTUAL PROPERTY; PATENT



David J. Kyffers

Director of the United States Patent and Trademark Office

Reg. No. 4,176,411 AGENT SERVICES; PATENT LICENSING; PROVIDING INFORMATION IN THE FIELD OF INTELLECTUAL PROPERTY LEGAL SERVICES ; PROVIDING INFORMATION IN THE FIELD OF INTELLECTUAL PROPERTY, IN CLASS 45 (U.S. CLS. 100 AND 101).

FIRST USE 11-10-2010; IN COMMERCE 1-7-2012.

THE MARK CONSISTS OF STANDARD CHARACTERS WITHOUT CLAIM TO ANY PARTICULAR FONT, STYLE, SIZE, OR COLOR.

SN 85-176,143, FILED 11-13-2010.

ROSELLE HERRERA, EXAMINING ATTORNEY

United States of America

United States Patent and Trademark Office

Aahs Entertainment

Reg. No. 4,176,412

SMITH, GWENDOLYN KAYE (UNITED STATES INDIVIDUAL)
10707 CAMARILLO STREET, UNIT 312
TOLUCA LAKE, CA 91602

Registered July 17, 2012

Int. Cl.: 41

FOR: ENTERTAINMENT SERVICES IN THE NATURE OF DEVELOPMENT, CREATION, PRODUCTION AND POST-PRODUCTION SERVICES OF MULTIMEDIA ENTERTAINMENT CONTENT, IN CLASS 41 (U.S. CLS. 100, 101 AND 107).

SERVICE MARK

FIRST USE 4-15-2011; IN COMMERCE 4-3-2012.

PRINCIPAL REGISTER

THE MARK CONSISTS OF STANDARD CHARACTERS WITHOUT CLAIM TO ANY PARTICULAR FONT, STYLE, SIZE, OR COLOR.

NO CLAIM IS MADE TO THE EXCLUSIVE RIGHT TO USE "ENTERTAINMENT", APART FROM THE MARK AS SHOWN.

SN 85-176,307, FILED 11-14-2010.

JASON TURNER, EXAMINING ATTORNEY



David J. Kyffers

Director of the United States Patent and Trademark Office

United States of America

United States Patent and Trademark Office

CentriFX

Reg. No. 4,176,413

Registered July 17, 2012

Int. Cl.: 10

TRADEMARK

PRINCIPAL REGISTER

ATRIUM MEDICAL CORPORATION (DELAWARE CORPORATION)
5 WENTWORTH DRIVE
HUDSON, NH 03051

FOR: HERNIA MESH, IN CLASS 10 (U.S. CLS. 26, 39 AND 44).

FIRST USE 2-3-2012; IN COMMERCE 3-15-2012.

THE MARK CONSISTS OF STANDARD CHARACTERS WITHOUT CLAIM TO ANY PARTICULAR FONT, STYLE, SIZE, OR COLOR.

SN 85-177,817, FILED 11-16-2010.

JAY BESCH, EXAMINING ATTORNEY



David J. Kypos

Director of the United States Patent and Trademark Office

United States of America

United States Patent and Trademark Office

HEADS UP

Reg. No. 4,176,414

Registered July 17, 2012

Int. Cl.: 41

SERVICE MARK

PRINCIPAL REGISTER

LIVING CHURCH OF GOD (INTERNATIONAL), INC. (NORTH CAROLINA NON-PROFIT CORPORATION)
2301 CROWN CENTRE DRIVE
CHARLOTTE, NC 28227

FOR: ENTERTAINMENT AND EDUCATIONAL SERVICES, NAMELY, PODCASTS FEATURING RELIGIOUS AND PROPHETIC PERSPECTIVES ON NEWS AND CURRENT EVENTS, IN CLASS 41 (U.S. CLS. 100, 101 AND 107).

FIRST USE 12-15-2010; IN COMMERCE 12-15-2010.

THE MARK CONSISTS OF STANDARD CHARACTERS WITHOUT CLAIM TO ANY PARTICULAR FONT, STYLE, SIZE, OR COLOR.

SN 85-178,007, FILED 11-16-2010.

JAY BESCH, EXAMINING ATTORNEY



David J. Kybas

Director of the United States Patent and Trademark Office

United States of America

United States Patent and Trademark Office

STUDENTS SHOULDER TO SHOULDER

Reg. No. 4,176,415

Registered July 17, 2012

Int. Cl.: 41

SERVICE MARK

PRINCIPAL REGISTER

ETHICALLY ENGAGED YOUTH, INC. (COLORADO CORPORATION)
3000 BOOTH FALLS ROAD
VAIL, CO 81657

FOR: EDUCATIONAL SERVICES, NAMELY, PROVIDING COURSES OF INSTRUCTION, CONDUCTING PROGRAMS AND FIELD TRIPS IN THE FIELD OF MORAL EDUCATION, ETHICS, COMMUNITY SERVICE, ENVIRONMENTAL PROTECTION, WORLD AFFAIRS, AND DIPLOMACY AND DISTRIBUTING INSTRUCTIONAL COURSE MATERIALS IN CONNECTION THEREWITH, IN CLASS 41 (U.S. CLS. 100, 101 AND 107).

FIRST USE 3-15-2012; IN COMMERCE 3-15-2012.

THE MARK CONSISTS OF STANDARD CHARACTERS WITHOUT CLAIM TO ANY PARTICULAR FONT, STYLE, SIZE, OR COLOR.

NO CLAIM IS MADE TO THE EXCLUSIVE RIGHT TO USE "STUDENTS", APART FROM THE MARK AS SHOWN.

SN 85-178,152, FILED 11-16-2010.

DOMINICK J. SALEMI, EXAMINING ATTORNEY



David J. Kybas

Director of the United States Patent and Trademark Office

United States of America
United States Patent and Trademark Office

PrimeGuard
MAX

Reg. No. 4,176,416

PRIMESOURCE BUILDING PRODUCTS, INC. (DELAWARE CORPORATION)
1321 GREENWAY DRIVE
IRVING, TX 75038

Registered July 17, 2012

Int. Cl.: 6

FOR: METAL FASTENERS, NAMELY, NAILS, SCREWS, COLLATED NAILS, AND COLLATED SCREWS; FASTENERS, NAMELY, STAINLESS STEEL NAILS, SCREWS, COLLATED NAILS AND COLLATED SCREWS, ALUMINUM NAILS, COPPER NAILS AND COLLATED COPPER NAILS, IN CLASS 6 (U.S. CLS. 2, 12, 13, 14, 23, 25 AND 50).

TRADEMARK

PRINCIPAL REGISTER

FIRST USE 7-26-2011; IN COMMERCE 7-26-2011.

OWNER OF U.S. REG. NOS. 1,936,855, 2,940,702, AND OTHERS.

THE MARK CONSISTS OF THE WORD "PRIMEGUARD" ABOVE THE WORD "MAX" SEPARATED BY A STYLIZED REPRESENTATION OF A DRILL BIT.

SN 85-178,549, FILED 11-17-2010.

HANNO RITTNER, EXAMINING ATTORNEY



David J. Kyffers

Director of the United States Patent and Trademark Office

United States of America

United States Patent and Trademark Office

PrimeGuard

MAX

COPPER

Reg. No. 4,176,417

Registered July 17, 2012

Int. Cl.: 6

TRADEMARK

PRINCIPAL REGISTER

PRIMESOURCE BUILDING PRODUCTS, INC. (DELAWARE CORPORATION)
1321 GREENWAY DRIVE
IRVING, TX 75038

FOR: FASTENERS, NAMELY, COPPER NAILS AND COLLATED COPPER NAILS, IN CLASS 6 (U.S. CLS. 2, 12, 13, 14, 23, 25 AND 50).

FIRST USE 5-0-2011; IN COMMERCE 5-0-2011.

OWNER OF U.S. REG. NOS. 1,936,855, 2,940,702, AND OTHERS.

NO CLAIM IS MADE TO THE EXCLUSIVE RIGHT TO USE "COPPER", APART FROM THE MARK AS SHOWN.

THE MARK CONSISTS OF THE WORD "PRIMEGUARD" ABOVE THE WORD "MAX" SEPARATED BY A STYLIZED REPRESENTATION OF A DRILL BIT ALL ABOVE THE WORD "COPPER".

SN 85-178,553, FILED 11-17-2010.

HANNO RITTNER, EXAMINING ATTORNEY



David J. Kyffers

Director of the United States Patent and Trademark Office

United States of America

United States Patent and Trademark Office

PrimeGuard

PLUS

LIFETIME COATING

Reg. No. 4,176,418

Registered July 17, 2012

Int. Cl.: 6

TRADEMARK

PRINCIPAL REGISTER

PRIMESOURCE BUILDING PRODUCTS, INC. (DELAWARE CORPORATION)
1321 GREENWAY DRIVE
IRVING, TX 75038

FOR: METAL FASTENERS, NAMELY, POLYMER COATED NAILS, SCREWS, COLLATED NAILS AND COLLATED SCREWS, IN CLASS 6 (U.S. CLS. 2, 12, 13, 14, 23, 25 AND 50).

FIRST USE 3-1-2012; IN COMMERCE 3-1-2012.

OWNER OF U.S. REG. NOS. 3,821,251 AND 3,821,253.

NO CLAIM IS MADE TO THE EXCLUSIVE RIGHT TO USE "LIFETIME COATING", APART FROM THE MARK AS SHOWN.

THE MARK CONSISTS OF THE WORD "PRIMEGUARD" ABOVE THE WORD "PLUS" SEPARATED BY A STYLIZED REPRESENTATION OF A DRILL BIT ALL ABOVE THE WORDS "LIFETIME COATING".

SN 85-178,555, FILED 11-17-2010.

HANNO RITTNER, EXAMINING ATTORNEY



David J. Kyfos

Director of the United States Patent and Trademark Office

United States of America

United States Patent and Trademark Office

Let the Good Times Pour!

Reg. No. 4,176,419

Registered July 17, 2012

**Int. Cls.: 35, 39, 41, 42,
and 43**

SERVICE MARK

PRINCIPAL REGISTER

SIXTHEYE INC. (DELAWARE CORPORATION), AKA LETSPOUR,
WWW.LETSPOUR.COM
704 228TH AVE NE, #832
SAMMAMISH, WA 98074

FOR: ADVERTISING AND MARKETING SERVICES PROVIDED BY MEANS OF INDIRECT METHODS OF MARKETING COMMUNICATIONS, NAMELY, SOCIAL MEDIA, SEARCH ENGINE MARKETING, INQUIRY MARKETING, INTERNET MARKETING, MOBILE MARKETING, BLOGGING AND OTHER FORMS OF PASSIVE, SHARABLE OR VIRAL COMMUNICATIONS CHANNELS; ADVERTISING SERVICES, NAMELY, PROMOTING THE FOOD AND WINE OF OTHERS; PROVIDING A WEBSITE WHERE USERS CAN POST RATINGS, REVIEWS AND RECOMMENDATIONS ON RESTAURANTS, FOOD AND WINE FOR COMMERCIAL PURPOSES; PROVIDING ADVERTISING SERVICE TO DISTRIBUTE ADVERTISEMENTS FOR DISPLAY ON INTERNET, NAMELY, IN WEBSITES, SOCIAL CONVERSATIONS OVER THE INTERNET, E-MAILS, MICROBLOGS, BLOGS, ELECTRONIC MESSAGES, INSTANT MESSAGES, TEXT MESSAGES, MULTIMEDIA MESSAGES, SOCIAL NETWORKS, STATUS UPDATES, FORUMS, ELECTRONIC BULLETIN BOARDS, IN CLASS 35 (U.S. CLS. 100, 101 AND 102).

FIRST USE 8-1-2010; IN COMMERCE 1-15-2011.

FOR: WINE CLUB SERVICES FEATURING PERIODIC SHIPMENTS OF WINE TO MEMBERS, IN CLASS 39 (U.S. CLS. 100 AND 105).

FIRST USE 8-1-2010; IN COMMERCE 1-2-2011.

FOR: CONDUCTING ENTERTAINMENT EXHIBITIONS IN THE NATURE OF WINE EVENTS; ENTERTAINMENT SERVICES, NAMELY, WINE AND FOOD TASTINGS; ENTERTAINMENT SERVICES, NAMELY, WINE TASTINGS; ON-LINE JOURNALS, NAMELY, BLOGS FEATURING WINES, IN CLASS 41 (U.S. CLS. 100, 101 AND 107).

FIRST USE 8-1-2010; IN COMMERCE 1-15-2011.

FOR: PROVIDING CUSTOMIZED ON-LINE WEB PAGES AND DATA FEEDS FEATURING USER-DEFINED INFORMATION, WHICH INCLUDES BLOG POSTS, NEW MEDIA CONTENT, OTHER ON-LINE CONTENT, AND ON-LINE WEB LINKS TO OTHER WEBSITES, IN CLASS 42 (U.S. CLS. 100 AND 101).



David J. Kyjars

Director of the United States Patent and Trademark Office

Reg. No. 4,176,419 FIRST USE 8-15-2010; IN COMMERCE 1-1-2011.

FOR: PROVIDING A WEB SITE WHERE USERS CAN POST RATINGS, REVIEWS AND RECOMMENDATIONS ON WINES FOR WINE APPRECIATION PURPOSES; PROVIDING INFORMATION ABOUT WINE CHARACTERISTICS; SOMMELIER SERVICES, NAMELY, PROVIDING ADVICE ON WINE AND WINE AND FOOD PAIRING; WINE BARS, IN CLASS 43 (U.S. CLS. 100 AND 101).

FIRST USE 8-15-2010; IN COMMERCE 1-15-2011.

THE MARK CONSISTS OF STANDARD CHARACTERS WITHOUT CLAIM TO ANY PARTICULAR FONT, STYLE, SIZE, OR COLOR.

SN 85-179,255, FILED 11-17-2010.

WON TEAK OH, EXAMINING ATTORNEY

United States of America

United States Patent and Trademark Office



Reg. No. 4,176,420

HEARTHWARE, INC. (ILLINOIS CORPORATION)
1795 BUTTERFIELD RD.
LIBERTYVILLE, IL 60048

Registered July 17, 2012

Int. Cls.: 7, 16, and 21

FOR: PLASTIC VACUUM PUMPS, IN CLASS 7 (U.S. CLS. 13, 19, 21, 23, 31, 34 AND 35).

FIRST USE 1-6-2012; IN COMMERCE 1-6-2012.

TRADEMARK

FOR: VACUUM SEALABLE FOOD STORAGE BAGS FOR HOUSEHOLD USE, IN CLASS 16 (U.S. CLS. 2, 5, 22, 23, 29, 37, 38 AND 50).

PRINCIPAL REGISTER

FIRST USE 1-6-2012; IN COMMERCE 1-6-2012.

FOR: VACUUM SEALABLE PLASTIC CONTAINERS AND COVERS FOR FOOD FOR HOUSEHOLD USE, IN CLASS 21 (U.S. CLS. 2, 13, 23, 29, 30, 33, 40 AND 50).

FIRST USE 1-6-2012; IN COMMERCE 1-6-2012.

THE MARK CONSISTS OF THE WORDS "FLAVOR LOCKERS" WITH A LOCK DESIGN.

SN 85-179,786, FILED 11-18-2010.

DAVID I, EXAMINING ATTORNEY



David J. Kyffers

Director of the United States Patent and Trademark Office

United States of America

United States Patent and Trademark Office

KOR

Reg. No. 4,176,421

YSI INCORPORATED (OHIO CORPORATION)
1700/1725 BRANNUM LANE
YELLOW SPRINGS, OH 45387

Registered July 17, 2012

Int. Cl.: 9

FOR: COMPUTER SHAREWARE FOR DATA COLLECTION, MANAGEMENT AND VISUAL DISPLAY OF DATA AND IMAGES FOR USE IN THE FIELD OF WATER QUALITY MONITORING, IN CLASS 9 (U.S. CLS. 21, 23, 26, 36 AND 38).

TRADEMARK

FIRST USE 3-12-2012; IN COMMERCE 3-12-2012.

PRINCIPAL REGISTER

THE MARK CONSISTS OF STANDARD CHARACTERS WITHOUT CLAIM TO ANY PARTICULAR FONT, STYLE, SIZE, OR COLOR.

SN 85-179,843, FILED 11-18-2010.

KATINA MISTER, EXAMINING ATTORNEY



David J. Kybas

Director of the United States Patent and Trademark Office

United States of America

United States Patent and Trademark Office

mYusic

Reg. No. 4,176,422

Registered July 17, 2012

Int. Cl.: 41

SERVICE MARK

PRINCIPAL REGISTER

KSG MEDIA & ENTERTAINMENT LLC (NEW JERSEY LIMITED LIABILITY COMPANY),
DBA MYUSIC,
27 KAREN DRIVE
NORWALK, CT 06851

FOR: ENTERTAINMENT SERVICES, NAMELY, PROVIDING NONDOWNLOADABLE
PRERECORDED MUSIC, INFORMATION IN THE FIELD OF MUSIC, AND COMMENTARY
AND ARTICLES ABOUT MUSIC, ALL ON-LINE VIA A GLOBAL COMPUTER NETWORK,
IN CLASS 41 (U.S. CLS. 100, 101 AND 107).

FIRST USE 7-1-2010; IN COMMERCE 3-6-2011.

THE MARK CONSISTS OF STANDARD CHARACTERS WITHOUT CLAIM TO ANY PAR-
TICULAR FONT, STYLE, SIZE, OR COLOR.

SN 85-180,565, FILED 11-18-2010.

AMY KERTGATE, EXAMINING ATTORNEY



David J. Kybas

Director of the United States Patent and Trademark Office

United States of America

United States Patent and Trademark Office

AESTHETISPA LASER AND WELLNESS CENTER

Reg. No. 4,176,423

QH ENTERPRISES, INC. (OREGON CORPORATION)
219 MESSINGER RD.

Registered July 17, 2012

GRANTS PASS, OR 97527

Int. Cl.: 44

FOR: LASER AND INTENSE PULSE LIGHT SKIN ENHANCEMENT PROCEDURES; HEALTH SPA SERVICES, NAMELY, LASER TREATMENTS FOR ACNE, REJUVENATION, SCARS, AND FOR FACIALS; PROVIDING LASER THERAPY FOR TREATING MEDICAL CONDITIONS, IN CLASS 44 (U.S. CLS. 100 AND 101).

SERVICE MARK

PRINCIPAL REGISTER

FIRST USE 6-7-2011; IN COMMERCE 11-1-2011.

THE MARK CONSISTS OF STANDARD CHARACTERS WITHOUT CLAIM TO ANY PARTICULAR FONT, STYLE, SIZE, OR COLOR.

NO CLAIM IS MADE TO THE EXCLUSIVE RIGHT TO USE "LASER AND WELLNESS CENTER", APART FROM THE MARK AS SHOWN.

SN 85-180,927, FILED 11-19-2010.

LAURIE MAYES, EXAMINING ATTORNEY



David J. Kyffers

Director of the United States Patent and Trademark Office

United States of America

United States Patent and Trademark Office



*For people with intellectual
and developmental disabilities*

Reg. No. 4,176,424

Registered July 17, 2012

**Int. Cls.: 35, 36, 39, 41,
43, 44, and 45**

SERVICE MARK

PRINCIPAL REGISTER

THE ARC OF THE UNITED STATES, INC. (MARYLAND CORPORATION)
1825 K STREET NW, SUITE 1200
WASHINGTON, DC 20006

FOR: PROMOTING PUBLIC AWARENESS OF THE NEEDS OF PEOPLE WITH INTELLECTUAL AND DEVELOPMENTAL DISABILITIES AND THEIR FAMILIES; ASSOCIATION SERVICES, NAMELY, PROMOTING THE INTERESTS OF PEOPLE WITH INTELLECTUAL AND DEVELOPMENTAL DISABILITIES; PROVIDING EMPLOYMENT AND OTHER PROGRAMS, SERVICES AND SUPPORTS TO ENABLE PEOPLE WITH INTELLECTUAL AND DEVELOPMENTAL DISABILITIES TO BE INCLUDED AND FULLY PARTICIPATE IN ALL ASPECTS OF SOCIETY THROUGHOUT THEIR LIFETIMES, NAMELY, JOB SEARCH AND PLACEMENT, AND EMPLOYMENT COUNSELING INFORMATION FOR TRANSITION FROM SCHOOL SPECIAL EDUCATION PROGRAMS TO ADULT EMPLOYMENT, IN CLASS 35 (U.S. CLS. 100, 101 AND 102).

FIRST USE 3-1-2011; IN COMMERCE 3-1-2011.

FOR: CHARITABLE FUNDRAISING TO SUPPORT AND EXPAND SERVICES FOR PEOPLE WITH INTELLECTUAL AND DEVELOPMENTAL DISABILITIES; FINANCIAL COUNSELING AND PLANNING SERVICES, NAMELY, CREATING PERSONALIZED STRATEGIES FOR ACHIEVING FINANCIAL INDEPENDENCE THROUGH A COMBINATION OF PUBLIC PROGRAMS, SUBSIDIZED PROGRAMS AND PERSONAL EARNINGS, AND FOR BUILDING A BETTER WORKING RELATIONSHIP WITH MONEY FOR PEOPLE WITH INTELLECTUAL AND DEVELOPMENTAL DISABILITIES; TRUST SERVICES, NAMELY, SPECIAL NEEDS TRUST MANAGEMENT ACCOUNTS, IN CLASS 36 (U.S. CLS. 100, 101 AND 102).

FIRST USE 3-1-2011; IN COMMERCE 3-1-2011.

FOR: TRANSPORTATION OF PASSENGERS BY CAR OF PEOPLE WITH INTELLECTUAL AND DEVELOPMENTAL DISABILITIES, IN CLASS 39 (U.S. CLS. 100 AND 105).

FIRST USE 3-1-2011; IN COMMERCE 3-1-2011.

FOR: EDUCATION SERVICES, NAMELY, PROVIDING CLASSES, SEMINARS, WORKSHOPS, PRESENTATIONS, CONFERENCES, RETREATS AND INSTRUCTION IN THE AREAS OF CONCERN FOR PEOPLE WITH INTELLECTUAL AND DEVELOPMENTAL DISABILITIES, AND CAREGIVERS OF PEOPLE WITH INTELLECTUAL AND DEVELOPMENTAL DISAB-



David J. Kyffers

Director of the United States Patent and Trademark Office

Reg. No. 4,176,424 ILITIES, NAMELY, PERSONAL CARE, JOB SKILLS, SPECIAL EDUCATION PROCESSES, INCLUDING PREPARING FOR INDIVIDUALIZED EDUCATION PROGRAM MEETINGS, FINANCIAL LITERACY AND COMMUNITY LIVING TRAINING, TO ENABLE PEOPLE WITH INTELLECTUAL AND DEVELOPMENTAL DISABILITIES TO BE INCLUDED AND FULLY PARTICIPATE IN ALL ASPECTS OF SOCIETY THROUGHOUT THEIR LIFETIMES; CONDUCTING RECREATIONAL CAMPS, AFTER SCHOOL EDUCATIONAL PROGRAMS, MENTORING AND TUTORING IN THE FIELD OF PEOPLE WITH INTELLECTUAL AND DEVELOPMENTAL DISABILITIES TO BE INCLUDED AND FULLY PARTICIPATE IN ALL ASPECTS OF SOCIETY THROUGHOUT THEIR LIFETIMES; EDUCATIONAL SERVICES, NAMELY, PROVIDING PRE-KINDERGARTEN THROUGH HIGH SCHOOL CLASSROOM INSTRUCTION AND VOCATIONAL INSTRUCTION FOR PEOPLE WITH INTELLECTUAL AND DEVELOPMENTAL DISABILITIES, IN CLASS 41 (U.S. CLS. 100, 101 AND 107).

FIRST USE 3-1-2011; IN COMMERCE 3-1-2011.

FOR: PROVIDING DAY CARE FOR PEOPLE WITH INTELLECTUAL AND DEVELOPMENTAL DISABILITIES; PROVIDING ACCOMMODATIONS, NAMELY, RESIDENTIAL GROUP HOMES, INDIVIDUAL HOMES AND APARTMENTS, SUBSIDIZED HOUSING, INDEPENDENT AND COMMUNITY LIVING FOR PEOPLE WITH INTELLECTUAL AND DEVELOPMENTAL DISABILITIES TO BE FULLY INCLUDED AND PARTICIPATE IN ALL ASPECTS OF SOCIETY THROUGHOUT THEIR LIFETIMES, IN CLASS 43 (U.S. CLS. 100 AND 101).

FIRST USE 3-1-2011; IN COMMERCE 3-1-2011.

FOR: MEDICAL AND DENTIST SERVICES FOR PEOPLE WITH INTELLECTUAL AND DEVELOPMENTAL DISABILITIES; PSYCHOLOGICAL SERVICES, NAMELY, PROVIDING DIAGNOSTIC AND THERAPEUTIC SERVICES TO PEOPLE WITH INTELLECTUAL AND DEVELOPMENTAL DISABILITIES AND THEIR FAMILIES AND CAREGIVERS; OCCUPATIONAL THERAPY SERVICES; SPEECH THERAPY SERVICES; PHYSICAL THERAPY IN THE NATURE OF MOVEMENT THERAPY, IN CLASS 44 (U.S. CLS. 100 AND 101).

FIRST USE 3-1-2011; IN COMMERCE 3-1-2011.

FOR: SOCIAL SERVICES, NAMELY, SUPPORT SERVICES FOR PEOPLE WITH INTELLECTUAL AND DEVELOPMENTAL DISABILITIES, NAMELY, PERSONAL CARE MANAGEMENT, HOUSEHOLD MANAGEMENT, AND GUARDIANSHIP SERVICES; LIFE QUALITY ASSESSMENTS FOR PEOPLE WITH INTELLECTUAL AND DEVELOPMENTAL DISABILITIES AND THEIR FAMILIES AND CAREGIVERS; PROVIDING PERSONAL SUPPORT SERVICES FOR CAREGIVERS OF PEOPLE WITH INTELLECTUAL AND DEVELOPMENTAL DISABILITIES, NAMELY, COMPANIONSHIP AND EMOTIONAL SUPPORT; RESPITE CARE TO PROVIDE THE CAREGIVER WITH TEMPORARY, INTERMITTENT, SUBSTITUTE CARE OF PEOPLE WITH INTELLECTUAL AND DEVELOPMENTAL DISABILITIES AND RELIEVE THE CAREGIVER FROM THE DAILY RESPONSIBILITIES OF CARING FOR PEOPLE WITH INTELLECTUAL AND DEVELOPMENTAL DISABILITIES IN THE NATURE OF THE SAME SERVICES PROVIDED WITH HOME CARE SERVICES, BUT ON AN INTERMITTENT OR TEMPORARY BASIS, IN CLASS 45 (U.S. CLS. 100 AND 101).

FIRST USE 3-1-2011; IN COMMERCE 3-1-2011.

OWNER OF U.S. REG. NOS. 1,975,735, 3,116,298, AND OTHERS.

NO CLAIM IS MADE TO THE EXCLUSIVE RIGHT TO USE "FOR PEOPLE WITH INTELLECTUAL AND DEVELOPMENTAL DISABILITIES", APART FROM THE MARK AS SHOWN.

THE MARK CONSISTS OF A SQUIGGLY LINE ABOVE THE WORDS "THE ARC" AND UNDERNEATH IS THE STYLIZED WORDING "FOR PEOPLE WITH INTELLECTUAL AND DEVELOPMENTAL DISABILITIES".

Reg. No. 4,176,424 SN 85-181,166, FILED 11-19-2010.

SCOTT BIBB, EXAMINING ATTORNEY

United States of America

United States Patent and Trademark Office

ACHIEVE WITH US

Reg. No. 4,176,425

Registered July 17, 2012

**Int. Cls.: 35, 36, 39, 41,
43, 44, and 45**

SERVICE MARK

PRINCIPAL REGISTER

THE ARC OF THE UNITED STATES, INC. (MARYLAND CORPORATION)
1825 K STREET NW, SUITE 1200
WASHINGTON, DC 20006

FOR: PROMOTING PUBLIC AWARENESS OF THE NEEDS OF PEOPLE WITH INTELLECTUAL AND DEVELOPMENTAL DISABILITIES AND THEIR FAMILIES; ASSOCIATION SERVICES, NAMELY, PROMOTING THE INTERESTS OF PEOPLE WITH INTELLECTUAL AND DEVELOPMENTAL DISABILITIES; PROVIDING EMPLOYMENT AND OTHER PROGRAMS, SERVICES AND SUPPORTS TO ENABLE PEOPLE WITH INTELLECTUAL AND DEVELOPMENTAL DISABILITIES TO BE INCLUDED AND FULLY PARTICIPATE IN ALL ASPECTS OF SOCIETY THROUGHOUT THEIR LIFETIMES, NAMELY, JOB SEARCH AND PLACEMENT, AND EMPLOYMENT COUNSELING INFORMATION FOR TRANSITION FROM SCHOOL SPECIAL EDUCATION PROGRAMS TO ADULT EMPLOYMENT, IN CLASS 35 (U.S. CLS. 100, 101 AND 102).

FIRST USE 3-1-2011; IN COMMERCE 3-1-2011.

FOR: CHARITABLE FUNDRAISING TO SUPPORT AND EXPAND SERVICES FOR PEOPLE WITH INTELLECTUAL AND DEVELOPMENTAL DISABILITIES; FINANCIAL COUNSELING AND PLANNING SERVICES, NAMELY, CREATING PERSONALIZED STRATEGIES FOR ACHIEVING FINANCIAL INDEPENDENCE THROUGH A COMBINATION OF PUBLIC PROGRAMS, SUBSIDIZED PROGRAMS AND PERSONAL EARNINGS, AND FOR BUILDING A BETTER WORKING RELATIONSHIP WITH MONEY FOR PEOPLE WITH INTELLECTUAL AND DEVELOPMENTAL DISABILITIES; TRUST SERVICES, NAMELY, SPECIAL NEEDS TRUST MANAGEMENT ACCOUNTS, IN CLASS 36 (U.S. CLS. 100, 101 AND 102).

FIRST USE 3-1-2011; IN COMMERCE 3-1-2011.

FOR: TRANSPORTATION OF PASSENGERS BY CAR OF PEOPLE WITH INTELLECTUAL AND DEVELOPMENTAL DISABILITIES, IN CLASS 39 (U.S. CLS. 100 AND 105).

FIRST USE 3-1-2011; IN COMMERCE 3-1-2011.

FOR: EDUCATION SERVICES, NAMELY, PROVIDING CLASSES, SEMINARS, WORKSHOPS, PRESENTATIONS, CONFERENCES, RETREATS AND INSTRUCTION IN THE AREAS OF CONCERN FOR PEOPLE WITH INTELLECTUAL AND DEVELOPMENTAL DISABILITIES, AND CAREGIVERS OF PEOPLE WITH INTELLECTUAL AND DEVELOPMENTAL DISAB-



David J. Kyffers

Director of the United States Patent and Trademark Office

Reg. No. 4,176,425 ILITIES, NAMELY, PERSONAL CARE, JOB SKILLS, SPECIAL EDUCATION PROCESSES, INCLUDING PREPARING FOR INDIVIDUALIZED EDUCATION PROGRAM MEETINGS, FINANCIAL LITERACY AND COMMUNITY LIVING TRAINING, TO ENABLE PEOPLE WITH INTELLECTUAL AND DEVELOPMENTAL DISABILITIES TO BE INCLUDED AND FULLY PARTICIPATE IN ALL ASPECTS OF SOCIETY THROUGHOUT THEIR LIFETIMES; CONDUCTING RECREATIONAL CAMPS, AFTER SCHOOL EDUCATIONAL PROGRAMS, MENTORING AND TUTORING IN THE FIELD OF PEOPLE WITH INTELLECTUAL AND DEVELOPMENTAL DISABILITIES TO BE INCLUDED AND FULLY PARTICIPATE IN ALL ASPECTS OF SOCIETY THROUGHOUT THEIR LIFETIMES; EDUCATIONAL SERVICES, NAMELY, PROVIDING PRE-KINDERGARTEN THROUGH HIGH SCHOOL CLASSROOM INSTRUCTION AND VOCATIONAL INSTRUCTION FOR PEOPLE WITH INTELLECTUAL AND DEVELOPMENTAL DISABILITIES, IN CLASS 41 (U.S. CLS. 100, 101 AND 107).

FIRST USE 3-1-2011; IN COMMERCE 3-1-2011.

FOR: PROVIDING DAY CARE FOR PEOPLE WITH INTELLECTUAL AND DEVELOPMENTAL DISABILITIES; PROVIDING ACCOMMODATIONS, NAMELY, RESIDENTIAL GROUP HOMES, INDIVIDUAL HOMES AND APARTMENTS, SUBSIDIZED HOUSING, INDEPENDENT AND COMMUNITY LIVING FOR PEOPLE WITH INTELLECTUAL AND DEVELOPMENTAL DISABILITIES TO BE FULLY INCLUDED AND PARTICIPATE IN ALL ASPECTS OF SOCIETY THROUGHOUT THEIR LIFETIMES, IN CLASS 43 (U.S. CLS. 100 AND 101).

FIRST USE 3-1-2011; IN COMMERCE 3-1-2011.

FOR: MEDICAL AND DENTIST SERVICES FOR PEOPLE WITH INTELLECTUAL AND DEVELOPMENTAL DISABILITIES; PSYCHOLOGICAL SERVICES, NAMELY, PROVIDING DIAGNOSTIC AND THERAPEUTIC SERVICES TO PEOPLE WITH INTELLECTUAL AND DEVELOPMENTAL DISABILITIES AND THEIR FAMILIES AND CAREGIVERS; OCCUPATIONAL THERAPY SERVICES; SPEECH THERAPY SERVICES; PHYSICAL THERAPY IN THE NATURE OF MOVEMENT THERAPY, IN CLASS 44 (U.S. CLS. 100 AND 101).

FIRST USE 3-1-2011; IN COMMERCE 3-1-2011.

FOR: SOCIAL SERVICES, NAMELY, SUPPORT SERVICES FOR PEOPLE WITH INTELLECTUAL AND DEVELOPMENTAL DISABILITIES, NAMELY, PERSONAL CARE MANAGEMENT, HOUSEHOLD MANAGEMENT, AND GUARDIANSHIP SERVICES; LIFE QUALITY ASSESSMENTS FOR PEOPLE WITH INTELLECTUAL AND DEVELOPMENTAL DISABILITIES AND THEIR FAMILIES AND CAREGIVERS; PROVIDING PERSONAL SUPPORT SERVICES FOR CAREGIVERS OF PEOPLE WITH INTELLECTUAL AND DEVELOPMENTAL DISABILITIES, NAMELY, COMPANIONSHIP AND EMOTIONAL SUPPORT; RESPITE CARE TO PROVIDE THE CAREGIVER WITH TEMPORARY, INTERMITTENT, SUBSTITUTE CARE OF PEOPLE WITH INTELLECTUAL AND DEVELOPMENTAL DISABILITIES AND RELIEVE THE CAREGIVER FROM THE DAILY RESPONSIBILITIES OF CARING FOR PEOPLE WITH INTELLECTUAL AND DEVELOPMENTAL DISABILITIES IN THE NATURE OF THE SAME SERVICES PROVIDED WITH HOME CARE SERVICES, BUT ON AN INTERMITTENT OR TEMPORARY BASIS, IN CLASS 45 (U.S. CLS. 100 AND 101).

FIRST USE 3-1-2011; IN COMMERCE 3-1-2011.

THE MARK CONSISTS OF STANDARD CHARACTERS WITHOUT CLAIM TO ANY PARTICULAR FONT, STYLE, SIZE, OR COLOR.

SN 85-181,197, FILED 11-19-2010.

SCOTT BIBB, EXAMINING ATTORNEY

United States of America

United States Patent and Trademark Office

STEALTH

Reg. No. 4,176,426

MP AUTOMOTIVE, LLC (MICHIGAN LIMITED LIABILITY COMPANY)
4129 HOLIDAY DRIVE
FLINT, MI 48507

Registered July 17, 2012

Int. Cl.: 7

FOR: EXHAUST MUFFLERS FOR MOTORS, ENGINE EXHAUST SYSTEMS COMPRISED OF PIPES, CONNECTORS AND MUFFLERS, IN CLASS 7 (U.S. CLS. 13, 19, 21, 23, 31, 34 AND 35).

TRADEMARK

FIRST USE 4-15-2012; IN COMMERCE 4-15-2012.

PRINCIPAL REGISTER

THE MARK CONSISTS OF STANDARD CHARACTERS WITHOUT CLAIM TO ANY PARTICULAR FONT, STYLE, SIZE, OR COLOR.

SN 85-181,200, FILED 11-19-2010.

LINDA E. BLOHM, EXAMINING ATTORNEY



David J. Kyffers

Director of the United States Patent and Trademark Office

United States of America
United States Patent and Trademark Office

whiteasylum

Reg. No. 4,176,427

Registered July 17, 2012

Int. Cl.: 25

TRADEMARK

PRINCIPAL REGISTER

ASYLUM LIMITED (HONG KONG LIMITED LIABILITY COMPANY)
RM D, 10/F., KA WING FACTORY BLDG.
19-24 NG FONG ST.
SAN PO KONG, KL, HONG KONG

FOR: ANORAK; BLOUSE; CARDIGAN; FLEECE PULLOVER; FLEECE TOPS; GLOVES;
HATS; JACKET; JEANS; KNIT DRESS; KNIT JACKETS; KNIT TOPS; PANTS; POLO KNIT
TOPS; POLO SHIRTS; PONCHOS; PULLOVER; SCARFS; SHIRTS; SHORTS; SHOULDER
WRAPS; SKIRTS AND DRESSES; SWEATSHIRTS; TANK-TOPS; VESTS, IN CLASS 25 (U.S.
CLS. 22 AND 39).

FIRST USE 1-28-2011; IN COMMERCE 1-28-2011.

THE MARK CONSISTS OF THE WORDING "WHITEASYLUM" IN STYLIZED FONT.

SN 85-182,025, FILED 11-22-2010.

EVELYN BRADLEY, EXAMINING ATTORNEY



David J. Kyffers

Director of the United States Patent and Trademark Office

United States of America

United States Patent and Trademark Office

DSTAR

Reg. No. 4,176,428

BAYER HEALTHCARE LLC (DELAWARE LIMITED LIABILITY COMPANY)
100 BAYER ROAD
PITTSBURGH, PA 15205

Registered July 17, 2012

Int. Cl.: 1

FOR: ADJUVANTS FOR USE IN THE MANUFACTURE OF INSECTICIDES, IN CLASS 1
(U.S. CLS. 1, 5, 6, 10, 26 AND 46).

TRADEMARK

FIRST USE 3-24-2011; IN COMMERCE 3-24-2011.

PRINCIPAL REGISTER

THE MARK CONSISTS OF STANDARD CHARACTERS WITHOUT CLAIM TO ANY PARTICULAR FONT, STYLE, SIZE, OR COLOR.

SN 85-183,098, FILED 11-23-2010.

TOBY BULLOFF, EXAMINING ATTORNEY



David J. Kyffers

Director of the United States Patent and Trademark Office

United States of America

United States Patent and Trademark Office

EL SAZON

Reg. No. 4,176,429

Registered July 17, 2012

Int. Cl.: 30

TRADEMARK

PRINCIPAL REGISTER

GOLOSINAS DE MEXICO, S.A. DE C.V. (MEXICO CORPORATION)
PROLONGACION AV. VALLARTA NO. 681
COL. EL. BAJIO C.P.
ZAPAPAN, JALISCO, MEXICO 45010

FOR: SAUCES; HOT AND TOMATO SAUCES, IN CLASS 30 (U.S. CL. 46).

FIRST USE 2-14-2011; IN COMMERCE 2-14-2011.

THE MARK CONSISTS OF STANDARD CHARACTERS WITHOUT CLAIM TO ANY PARTICULAR FONT, STYLE, SIZE, OR COLOR.

SN 85-183,563, FILED 11-23-2010.

KHANH LE, EXAMINING ATTORNEY



David J. Kyffers

Director of the United States Patent and Trademark Office

United States of America

United States Patent and Trademark Office

PROMAX. LIFE IS GO.

Reg. No. 4,176,430

Registered July 17, 2012

Int. Cls.: 5, 29, and 30

TRADEMARK

PRINCIPAL REGISTER

PROMAX NUTRITION CORPORATION (DELAWARE CORPORATION)
100 BAYVIEW CIRCLE, SUITE 550
NEWPORT BEACH, CA 92660

FOR: NUTRITION BARS, NAMELY, NUTRITIONAL ENERGY BARS FOR USE AS A MEAL SUBSTITUTE; AND MEAL REPLACEMENT BARS, IN CLASS 5 (U.S. CLS. 6, 18, 44, 46, 51 AND 52).

FIRST USE 5-31-2011; IN COMMERCE 5-31-2011.

FOR: PROCESSED FRUIT- AND NUT-BASED FOOD BARS; PROTEIN BASED, NUTRIENT-DENSE SNACK BARS, IN CLASS 29 (U.S. CL. 46).

FIRST USE 5-31-2011; IN COMMERCE 5-31-2011.

FOR: CEREAL BASED ENERGY BARS, IN CLASS 30 (U.S. CL. 46).

FIRST USE 3-31-2012; IN COMMERCE 3-31-2012.

THE MARK CONSISTS OF STANDARD CHARACTERS WITHOUT CLAIM TO ANY PARTICULAR FONT, STYLE, SIZE, OR COLOR.

OWNER OF U.S. REG. NOS. 2,785,177, 3,905,788, AND OTHERS.

SN 85-184,232, FILED 11-23-2010.

DOUGLAS LEE, EXAMINING ATTORNEY



David J. Kyros

Director of the United States Patent and Trademark Office

United States of America

United States Patent and Trademark Office

FUNATOUCH

Reg. No. 4,176,431

Registered July 17, 2012

Int. Cl.: 9

TRADEMARK

PRINCIPAL REGISTER

BEIJING FUNATE INNOVATION TECHNOLOGY CO., LTD. (CHINA CORPORATION)
B1115, R&D PLAZA, TSINGHUA SCIENCE PARK
SHUANGQING ROAD, HAIDIAN DISTRICT
BEIJING CITY, CHINA

FOR: TOUCH INPUT DEVICES, NAMELY, TOUCH PADS, TOUCH PANELS, AND TOUCH
SCREEN VIDEO AND COMPUTER MONITORS, IN CLASS 9 (U.S. CLS. 21, 23, 26, 36 AND
38).

FIRST USE 4-1-2012; IN COMMERCE 4-1-2012.

THE MARK CONSISTS OF STANDARD CHARACTERS WITHOUT CLAIM TO ANY PAR-
TICULAR FONT, STYLE, SIZE, OR COLOR.

SN 85-184,414, FILED 11-24-2010.

KHANH LE, EXAMINING ATTORNEY



David J. Kyffers

Director of the United States Patent and Trademark Office

United States of America

United States Patent and Trademark Office

SIMPLY ART

Reg. No. 4,176,432

LOEW-CORNELL, LLC (DELAWARE LIMITED LIABILITY COMPANY)
300 GAP WAY
ERLANGER, KY 41018

Registered July 17, 2012

Int. Cls.: 8, 16, and 21

FOR: KNIVES FOR USE IN PAINTING, IN CLASS 8 (U.S. CLS. 23, 28 AND 44).

FIRST USE 1-31-2010; IN COMMERCE 1-31-2010.

TRADEMARK

FOR: ARTIST MATERIALS, NAMELY, GRAPHITE AND CHARCOAL PENCILS, CRAYONS; DRAWING ACCESSORIES, NAMELY, CHAMOIS CLOTHS FOR THE APPLICATION AND BLENDING OF GRAPHITE AND CHARCOAL PENCILS; ART JOURNALS FOR PAINTING, SKETCHING, DRAWING, AND CALLIGRAPHY, IN CLASS 16 (U.S. CLS. 2, 5, 22, 23, 29, 37, 38 AND 50).

PRINCIPAL REGISTER

FIRST USE 1-31-2010; IN COMMERCE 1-31-2010.

FOR: STORAGE TOOLS, NAMELY, STORAGE CUPS AND STORAGE BINS FOR GENERAL PURPOSE HOUSEHOLD USE, INCLUDING FOR THE STORAGE OF ART SUPPLIES , IN CLASS 21 (U.S. CLS. 2, 13, 23, 29, 30, 33, 40 AND 50).

FIRST USE 1-31-2010; IN COMMERCE 1-31-2010.

THE MARK CONSISTS OF STANDARD CHARACTERS WITHOUT CLAIM TO ANY PARTICULAR FONT, STYLE, SIZE, OR COLOR.

OWNER OF U.S. REG. NO. 3,693,001.

NO CLAIM IS MADE TO THE EXCLUSIVE RIGHT TO USE "ART", APART FROM THE MARK AS SHOWN.

SN 85-184,633, FILED 11-24-2010.

KIMBERLY FRYE, EXAMINING ATTORNEY



David J. Kyffers

Director of the United States Patent and Trademark Office

United States of America
United States Patent and Trademark Office

SHELFARI

Reg. No. 4,176,433

Registered July 17, 2012

Int. Cl.: 35

SERVICE MARK

PRINCIPAL REGISTER

AMAZON TECHNOLOGIES, INC. (NEVADA CORPORATION)
ATTN: TRADEMARKS
PO BOX 8102
RENO, NV 89507

FOR: ON-LINE RETAIL STORE SERVICES FEATURING BOOKS, MUSIC, MOVIES, PERIODICALS AND OTHER MEDIA; OPERATING ON-LINE MARKETPLACES FOR SELLERS OF GOODS AND SERVICES; PROMOTING, ADVERTISING AND MARKETING THE ON-LINE WEBSITES OF OTHERS AND THE GOODS AND SERVICES OF OTHERS, IN CLASS 35 (U.S. CLS. 100, 101 AND 102).

FIRST USE 6-17-2008; IN COMMERCE 6-17-2008.

THE MARK CONSISTS OF STANDARD CHARACTERS WITHOUT CLAIM TO ANY PARTICULAR FONT, STYLE, SIZE, OR COLOR.

OWNER OF U.S. REG. NO. 3,742,741.

SN 85-184,769, FILED 11-24-2010.

PAULA MAHONEY, EXAMINING ATTORNEY



David J. Kyffers

Director of the United States Patent and Trademark Office

United States of America

United States Patent and Trademark Office

VERENTI

Reg. No. 4,176,434

Registered July 17, 2012

Int. Cl.: 12

TRADEMARK

PRINCIPAL REGISTER

OMNI UNITED (S) PTE LTD (SINGAPORE CORPORATION)
#30-03, ONE RAFFLES PLACE
1 RAFFLES PLACE
SINGAPORE 048616, SINGAPORE

FOR: TRUCK AND BUS RADIAL TIRES AND INNER TUBES; LIGHT TRUCK RADIAL TIRES AND INNER TUBES; PASSENGER CAR RADIAL TIRES AND INNER TUBES; OFF-ROAD RADIAL TIRES AND INNER TUBES FOR CARS, IN CLASS 12 (U.S. CLS. 19, 21, 23, 31, 35 AND 44).

FIRST USE 6-12-2011; IN COMMERCE 6-12-2011.

THE MARK CONSISTS OF STANDARD CHARACTERS WITHOUT CLAIM TO ANY PARTICULAR FONT, STYLE, SIZE, OR COLOR.

SN 85-184,776, FILED 11-24-2010.

BARBARA GAYNOR, EXAMINING ATTORNEY



David J. Kybas

Director of the United States Patent and Trademark Office

United States of America

United States Patent and Trademark Office

FLYING SQUIRREL NUTHOUSE

Reg. No. 4,176,435

Registered July 17, 2012

Int. Cls.: 29 and 30

TRADEMARK

PRINCIPAL REGISTER

FSNH, LLC (CALIFORNIA LIMITED LIABILITY COMPANY)
2434 BENEDICT CANYON DR.
BEVERLY HILLS, CA 90210

FOR: ROASTED NUTS; SEASONED NUTS; SHELLED NUTS; SNACK MIX CONSISTING PRIMARILY OF PROCESSED FRUITS, PROCESSED NUTS AND/OR RAISINS; NUT AND SEED-BASED SNACK BARS; CANDIED NUTS; TRAIL MIX CONSISTING PRIMARILY OF PROCESSED NUTS, SEEDS, DRIED FRUIT AND ALSO INCLUDING CHOCOLATE; JELLIES AND JAMS; FRUIT SPREADS; HAZELNUT SPREAD, IN CLASS 29 (U.S. CL. 46).

FIRST USE 9-24-2011; IN COMMERCE 9-24-2011.

FOR: CHOCOLATE COVERED NUTS; CHOCOLATE COVERED PRETZELS; CHOCOLATE COVERED FRUIT; GRANOLA; GRANOLA SNACKS; GRANOLA-BASED SNACK BARS; SNACK MIX CONSISTING PRIMARILY OF CRACKERS, PRETZELS AND/OR POPPED POPCORN; CRACKERS; COOKIES; FOOD PACKAGE COMBINATIONS CONSISTING PRIMARILY OF BREAD, CRACKERS AND/OR COOKIES; CANDY; CANDY BARS; CHOCOLATES AND CHOCOLATE BASED READY TO EAT CANDIES AND SNACKS; SPREAD CONTAINING CHOCOLATE AND NUTS, IN CLASS 30 (U.S. CL. 46).

FIRST USE 9-24-2011; IN COMMERCE 9-24-2011.

THE MARK CONSISTS OF STANDARD CHARACTERS WITHOUT CLAIM TO ANY PARTICULAR FONT, STYLE, SIZE, OR COLOR.

SN 85-184,823, FILED 11-24-2010.

SANDRA BUJA, EXAMINING ATTORNEY



David J. Kyros

Director of the United States Patent and Trademark Office

United States of America

United States Patent and Trademark Office

MASH EM'S

Reg. No. 4,176,436

Registered July 17, 2012

Int. Cl.: 28

TRADEMARK

PRINCIPAL REGISTER

TECH 4 KIDS INC. (CANADA CORPORATION)
UNIT 28
1200 AEROWOOD DRIVE
MISSISSAUGA, ONTARIO, CANADA L4W2S7

FOR: TOY BALLS, NAMELY, DEFORMABLE, SOFT SIDED, SQUEEZABLE BALLS;
SQUEEZE TOYS; TOY PROJECTILE LAUNCHERS, IN CLASS 28 (U.S. CLS. 22, 23, 38 AND
50).

FIRST USE 5-31-2011; IN COMMERCE 10-31-2011.

THE MARK CONSISTS OF STANDARD CHARACTERS WITHOUT CLAIM TO ANY PAR-
TICULAR FONT, STYLE, SIZE, OR COLOR.

SN 85-185,294, FILED 11-25-2010.

ALAIN LAPTER, EXAMINING ATTORNEY



David J. Kybas

Director of the United States Patent and Trademark Office

United States of America

United States Patent and Trademark Office

THADDEUS

Reg. No. 4,176,437

THADDEUS APPAREL GROUP, INC. (NEW YORK CORPORATION)
255 W. 23RD STREET #2BW

Registered July 17, 2012

NEW YORK, NY 10011

Int. Cl.: 25

FOR: CLOTHING, NAMELY, SHIRTS, SWEATERS, PANTS, SHORTS, JACKETS, OVERCOATS, SUITS, SPORTS COATS, VESTS, SCARVES, AND BATHING SUITS, IN CLASS 25 (U.S. CLS. 22 AND 39).

TRADEMARK

FIRST USE 1-17-2011; IN COMMERCE 1-17-2011.

PRINCIPAL REGISTER

THE MARK CONSISTS OF STANDARD CHARACTERS WITHOUT CLAIM TO ANY PARTICULAR FONT, STYLE, SIZE, OR COLOR.

SN 85-185,989, FILED 11-29-2010.

JENNY PARK, EXAMINING ATTORNEY



David J. Kybas

Director of the United States Patent and Trademark Office

United States of America

United States Patent and Trademark Office

BROADVIEW OFFICESUITE

Reg. No. 4,176,438

BROADVIEW NETWORKS, INC. (NEW YORK CORPORATION)
800 WESTCHESTER AVENUE
RYE BROOK, NY 10573

Registered July 17, 2012

Int. Cl.: 38

FOR: COMMUNICATION SERVICES, NAMELY, PROVIDING HIGH SPEED MULTIPLE USER ACCESS TO A GLOBAL OR PRIVATE NETWORK FOR VOICE AND DATA TRANSMISSIONS, IN CLASS 38 (U.S. CLS. 100, 101 AND 104).

SERVICE MARK

FIRST USE 4-30-2011; IN COMMERCE 4-30-2011.

PRINCIPAL REGISTER

THE MARK CONSISTS OF STANDARD CHARACTERS WITHOUT CLAIM TO ANY PARTICULAR FONT, STYLE, SIZE, OR COLOR.

OWNER OF U.S. REG. NOS. 2,494,916 AND 2,828,186.

SN 85-186,113, FILED 11-29-2010.

PRISCILLA MILTON, EXAMINING ATTORNEY



David J. Kyjars

Director of the United States Patent and Trademark Office

United States of America

United States Patent and Trademark Office



Reg. No. 4,176,439

Registered July 17, 2012

Int. Cl.: 41

SERVICE MARK

PRINCIPAL REGISTER

CREDIT UNION ASSOCIATION OF NEW MEXICO, INC. (NEW MEXICO NON-PROFIT CORPORATION)

C/O 121 SW MORRISON #600
PORTLAND, OR 97204

FOR: EDUCATION SERVICES FOR CREDIT UNION MEMBERS, NAMELY, PROVIDING CLASSES AND ONLINE INSTRUCTION ON PERSONAL FINANCIAL MANAGEMENT MATTERS INCLUDING MONEY MANAGEMENT, BUDGETING, BORROWING, SAVING, AND INVESTING, IN CLASS 41 (U.S. CLS. 100, 101 AND 107).

FIRST USE 11-18-2011; IN COMMERCE 11-18-2011.

NO CLAIM IS MADE TO THE EXCLUSIVE RIGHT TO USE "FINANCIAL EDUCATION RESOURCE", APART FROM THE MARK AS SHOWN.

THE MARK CONSISTS OF THE TERM "CUTHRU" PRINTED OVER THE WORDS "FINANCIAL EDUCATION RESOURCE" WITH A CURVED ARROW ARCING AROUND THE LEFT SIDE OF THE WORDS WITH THE ARROW POINT ENDING ABOVE THE "U" AND POINTING AT THE "T" IN "CUTHRU".

SN 85-186,180, FILED 11-29-2010.

MARK SPARACINO, EXAMINING ATTORNEY



David J. Kybas

Director of the United States Patent and Trademark Office

United States of America

United States Patent and Trademark Office

IMPAK HEALTH

Reg. No. 4,176,440

Registered July 17, 2012

Int. Cls.: 10 and 44

TRADEMARK

SERVICE MARK

PRINCIPAL REGISTER

MERIDIAN HEALTH SYSTEM, INC. (NEW JERSEY CORPORATION)
MONMOUTH SHORES CORPORATE PARK
1350 CAMPUS PARKWAY
NEPTUNE, NJ 07753

FOR: MEDICAL DEVICES, NAMELY, PORTABLE ELECTRONIC PATIENT MONITORS AND PATIENT SENSORS WITH AUTOMATED ALERT AND MONITORING CAPACITY FOR MONITORING AND MEASURING PATIENT REPORTED SYMPTOMS, HEART RATE, BLOOD PRESSURE, BODY TEMPERATURE, PAIN, BLOOD GLUCOSE LEVELS, THE OXYGEN SATURATION OF THE BLOOD AND OTHER VITAL SIGN AND DIAGNOSTIC PARAMETERS, IN CLASS 10 (U.S. CLS. 26, 39 AND 44).

FIRST USE 4-19-2011; IN COMMERCE 4-19-2011.

FOR: MEDICAL DIAGNOSTIC MONITORING AND REPORTING SERVICES FOR MEDICAL PROFESSIONALS AND MEDICAL PATIENTS PROVIDED VIA TELECOMMUNICATION NETWORKS AND/OR GLOBAL COMPUTER NETWORKS FEATURING MEDICAL INFORMATION IN THE NATURE OF PATIENT REPORTED SYMPTOMS, HEART RATE, BLOOD PRESSURE, BODY TEMPERATURE, PAIN, BLOOD GLUCOSE LEVELS, OXYGEN SATURATION OF THE BLOOD AND OTHER VITAL SIGN AND DIAGNOSTIC PARAMETERS, GATHERED FROM ELECTRONIC PATIENT MEDICAL MONITORING DEVICES WHICH FEED INFORMATION TO REMOTE LOCATIONS THAT CAN BE ACCESSED IN REAL-TIME BY MEDICAL PROFESSIONALS FOR PURPOSES OF MONITORING AND DIAGNOSING MEDICAL CONDITIONS FOR INDIVIDUALS WITH HEALTH PROBLEMS, IN CLASS 44 (U.S. CLS. 100 AND 101).

FIRST USE 8-8-2011; IN COMMERCE 8-8-2011.

THE MARK CONSISTS OF STANDARD CHARACTERS WITHOUT CLAIM TO ANY PARTICULAR FONT, STYLE, SIZE, OR COLOR.

NO CLAIM IS MADE TO THE EXCLUSIVE RIGHT TO USE "HEALTH", APART FROM THE MARK AS SHOWN.

SN 85-186,250, FILED 11-29-2010.

WENDY GOODMAN, EXAMINING ATTORNEY



David J. Kyros

Director of the United States Patent and Trademark Office

United States of America

United States Patent and Trademark Office

MAMBISHEETS

Reg. No. 4,176,441

ME & MY BIG IDEAS, INC. (CALIFORNIA CORPORATION)
20321 VALENCIA CIRCLE
LAKE FOREST, CA 92630

Registered July 17, 2012

Int. Cl.: 16

FOR: CRAFT PAPER; TISSUE PAPER; SCRAPBOOKING PAPER; DECORATIVE PAPER,
IN CLASS 16 (U.S. CLS. 2, 5, 22, 23, 29, 37, 38 AND 50).

TRADEMARK

FIRST USE 5-0-2011; IN COMMERCE 5-0-2011.

PRINCIPAL REGISTER

THE MARK CONSISTS OF STANDARD CHARACTERS WITHOUT CLAIM TO ANY PAR-
TICULAR FONT, STYLE, SIZE, OR COLOR.

SN 85-186,259, FILED 11-29-2010.

VERNA BETH RIRIE, EXAMINING ATTORNEY



David J. Kyffers

Director of the United States Patent and Trademark Office

United States of America

United States Patent and Trademark Office

DOCGREENS

Reg. No. 4,176,442

STAYRRA MANAGEMENT LLC (MICHIGAN LIMITED LIABILITY COMPANY)
37300 DEQUINDRE ROAD, SUITE 110
STERLING HEIGHTS, MI 48310

Registered July 17, 2012

Int. Cl.: 35

FOR: DISTRIBUTORSHIP AND ON-LINE RETAIL STORE SERVICES IN THE FIELD OF PRODUCTS FOR USE IN GARDENING AND GROWING PLANTS, IN CLASS 35 (U.S. CLS. 100, 101 AND 102).

SERVICE MARK

FIRST USE 3-0-2011; IN COMMERCE 3-0-2011.

PRINCIPAL REGISTER

THE MARK CONSISTS OF STANDARD CHARACTERS WITHOUT CLAIM TO ANY PARTICULAR FONT, STYLE, SIZE, OR COLOR.

SN 85-186,473, FILED 11-29-2010.

LINDSEY RUBIN, EXAMINING ATTORNEY



David J. Kyffers

Director of the United States Patent and Trademark Office

United States of America

United States Patent and Trademark Office



Reg. No. 4,176,443

Registered July 17, 2012

Int. Cls.: 10 and 44

TRADEMARK

SERVICE MARK

PRINCIPAL REGISTER

MERIDIAN HEALTH SYSTEM, INC. (NEW JERSEY LIMITED LIABILITY COMPANY)
MONMOUTH SHORES CORPORATE PARK
1350 CAMPUS PARKWAY
NEPTUNE, NJ 07753

FOR: MEDICAL DEVICES, NAMELY, PORTABLE ELECTRONIC PATIENT MONITORS AND PATIENT SENSORS WITH AUTOMATED ALERT AND MONITORING CAPACITY FOR MONITORING AND MEASURING PATIENT REPORTED SYMPTOMS, HEART RATE, BLOOD PRESSURE, BODY TEMPERATURE, PAIN, BLOOD GLUCOSE LEVELS, THE OXYGEN SATURATION OF THE BLOOD AND OTHER VITAL SIGN AND DIAGNOSTIC PARAMETERS, IN CLASS 10 (U.S. CLS. 26, 39 AND 44).

FIRST USE 4-19-2011; IN COMMERCE 4-19-2011.

FOR: MEDICAL DIAGNOSTIC MONITORING AND REPORTING SERVICES FOR MEDICAL PROFESSIONALS AND MEDICAL PATIENTS PROVIDED VIA TELECOMMUNICATION NETWORKS AND/OR GLOBAL COMPUTER NETWORKS FEATURING MEDICAL INFORMATION IN THE NATURE OF PATIENT REPORTED SYMPTOMS, HEART RATE, BLOOD PRESSURE, BODY TEMPERATURE, PAIN, BLOOD GLUCOSE LEVELS, OXYGEN SATURATION OF THE BLOOD AND OTHER VITAL SIGN AND DIAGNOSTIC PARAMETERS, GATHERED FROM ELECTRONIC PATIENT MEDICAL MONITORING DEVICES WHICH FEED INFORMATION TO REMOTE LOCATIONS THAT CAN BE ACCESSED IN REAL-TIME BY MEDICAL PROFESSIONALS FOR PURPOSES OF MONITORING AND DIAGNOSING MEDICAL CONDITIONS FOR INDIVIDUALS WITH HEALTH PROBLEMS, IN CLASS 44 (U.S. CLS. 100 AND 101).

FIRST USE 8-8-2011; IN COMMERCE 8-8-2011.

NO CLAIM IS MADE TO THE EXCLUSIVE RIGHT TO USE "HEALTH", APART FROM THE MARK AS SHOWN.

SN 85-186,524, FILED 11-29-2010.

WENDY GOODMAN, EXAMINING ATTORNEY

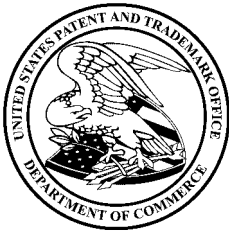

David J. Kyjars

Director of the United States Patent and Trademark Office

United States of America

United States Patent and Trademark Office



Reg. No. 4,176,444

Registered July 17, 2012

Int. Cl.: 43

SERVICE MARK

PRINCIPAL REGISTER

PROVO BEACH RESORT, LLC (UTAH LIMITED LIABILITY COMPANY)
86 NORTH UNIVERSITY AVENUE, SUITE 700
PROVO, UT 84601

FOR: RESTAURANT SERVICES AND JUICE BAR SERVICES; FAST FOOD RESTAURANT SERVICES; ICE CREAM PARLOR, IN CLASS 43 (U.S. CLS. 100 AND 101).

FIRST USE 11-15-2010; IN COMMERCE 1-14-2011.

NO CLAIM IS MADE TO THE EXCLUSIVE RIGHT TO USE "PROVO", APART FROM THE MARK AS SHOWN.

THE MARK CONSISTS OF THE SILHOUETTE IMAGE OF A CAROUSEL WITH THREE HORSES AND THE WORDS "PROVO BEACH RESORT" LOCATED UNDERNEATH THE CAROUSEL WITH TWO CONJOINED, CURVED LINEAR SHAPES UNDERNEATH THE WORDS.

SN 85-187,535, FILED 11-30-2010.

WARREN L. OLANDRIA, EXAMINING ATTORNEY



David J. Kybas

Director of the United States Patent and Trademark Office

United States of America

United States Patent and Trademark Office

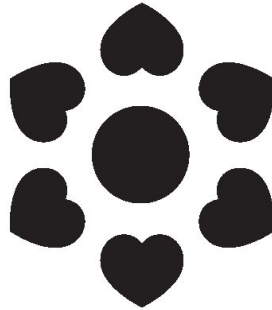

Reg. No. 4,176,445

DIMENSIONS 100 INC. (CANADA CORPORATION)
1109 WINNIPEG AVENUE
WINNIPEG, MANITOBA, CANADA R3E0S2

Registered July 17, 2012

Int. Cl.: 25

FOR: WOMEN'S AND GIRL'S CLOTHING, NAMELY, T-SHIRTS, TANK TOPS, TOPS, BRA TOPS, SHORTS, CAPRI PANTS, PANTS, JACKETS, SWEATSHIRTS, PULLOVERS, COATS, HATS, GLOVES, SOCKS AND BASE LAYER UNDERWEAR, NAMELY, TOPS AND BOTTOMS, IN CLASS 25 (U.S. CLS. 22 AND 39).

TRADEMARK

PRINCIPAL REGISTER

FIRST USE 5-16-2011; IN COMMERCE 5-16-2011.

THE MARK CONSISTS OF A DESIGN OF A CIRCLE/DOT SURROUNDED BY HEARTS.

SN 85-187,585, FILED 11-30-2010.

CURTIS FRENCH, EXAMINING ATTORNEY



David J. Kybas

Director of the United States Patent and Trademark Office

United States of America

United States Patent and Trademark Office

PERFORM

Patient Evaluation Resources For Opioid Risk Management

Reg. No. 4,176,446

PURDUE PHARMA L.P. (DELAWARE LIMITED PARTNERSHIP)
201 TRESSER BOULEVARD
STAMFORD, CT 06901

Registered July 17, 2012

Int. Cl.: 9

FOR: PRE-RECORDED CD-ROMS FEATURING INFORMATION ON OPIOID RISK ASSESSMENT BEST PRACTICES AND PAIN MANAGEMENT, IN CLASS 9 (U.S. CLS. 21, 23, 26, 36 AND 38).

TRADEMARK

FIRST USE 3-27-2012; IN COMMERCE 3-27-2012.

PRINCIPAL REGISTER

NO CLAIM IS MADE TO THE EXCLUSIVE RIGHT TO USE "PATIENT EVALUATION RESOURCES FOR OPIOID RISK MANAGEMENT", APART FROM THE MARK AS SHOWN.

THE COLOR(S) BLUE, GRAY, AND ORANGE IS/ARE CLAIMED AS A FEATURE OF THE MARK.

THE MARK CONSISTS OF THE WORD "PERFORM" IN BLUE WITH AN ORANGE CHECK MARK IN THE LETTER "O", ABOVE THE WORDS "PATIENT EVALUATION RESOURCES FOR OPIOID RISK MANAGEMENT" IN GRAY.

SN 85-188,001, FILED 12-1-2010.

AMY ALFIERI, EXAMINING ATTORNEY



David J. Kyros

Director of the United States Patent and Trademark Office

United States of America

United States Patent and Trademark Office

LA JARRILLITA

Reg. No. 4,176,447

LA CENTRO AMERICANA CORP. (NEW YORK CORPORATION)
2280 UNION BOULEVARD
BAY SHORE, NY 11706

Registered July 17, 2012

Int. Cl.: 30

FOR: COFFEE, IN CLASS 30 (U.S. CL. 46).

TRADEMARK

FIRST USE 12-8-2010; IN COMMERCE 12-16-2010.

PRINCIPAL REGISTER

THE MARK CONSISTS OF STANDARD CHARACTERS WITHOUT CLAIM TO ANY PARTICULAR FONT, STYLE, SIZE, OR COLOR.

THE ENGLISH TRANSLATION OF "LA JARRILLITA" IN THE MARK IS "LITTLE JAR".

SN 85-188,050, FILED 12-1-2010.

JENNIFER DIXON, EXAMINING ATTORNEY



David J. Kyffers

Director of the United States Patent and Trademark Office

United States of America

United States Patent and Trademark Office



Reg. No. 4,176,448

SOFTGATE SYSTEMS, INC. (DELAWARE CORPORATION)
330 PASSAIC AVENUE
FAIRFIELD, NJ 07004

Registered July 17, 2012

Int. Cl.: 36

FOR: ELECTRONIC PAYMENT, NAMELY, ELECTRONIC PROCESSING AND TRANSMISSION OF BILL PAYMENT DATA; PAYMENT SERVICES, NAMELY, ISSUING PREPAID DEBIT CARDS AND GIFT CARDS, AND DOMESTIC AND INTERNATIONAL PREPAID WIRELESS CARDS, IN CLASS 36 (U.S. CLS. 100, 101 AND 102).

SERVICE MARK

PRINCIPAL REGISTER

FIRST USE 1-28-2011; IN COMMERCE 1-28-2011.

NO CLAIM IS MADE TO THE EXCLUSIVE RIGHT TO USE "SYSTEMS", APART FROM THE MARK AS SHOWN.

THE MARK CONSISTS OF TWISTED MESH NETWORK WITH THE WORDS "SOFTGATE" AND "SYSTEMS" ADJACENT THERETO

SN 85-188,406, FILED 12-1-2010.

ANGELA DUONG, EXAMINING ATTORNEY



David J. Kybas

Director of the United States Patent and Trademark Office

United States of America

United States Patent and Trademark Office

AVANTOR

Reg. No. 4,176,449

Registered July 17, 2012

Int. Cls.: 1, 3, 5, and 9

TRADEMARK

PRINCIPAL REGISTER

AVANTOR PERFORMANCE MATERIALS, INC. (NEW JERSEY CORPORATION)
3477 CORPORATE PARKWAY
SUITE #200
CENTER VALLEY, PA 18034

FOR: CHEMICALS USED IN LABORATORIES, INDUSTRY, SCIENCE AND RESEARCH; CHEMICALS IN TAMPER-EVIDENT PACKAGING FOR USE IN LABORATORIES, INDUSTRY, SCIENCE AND RESEARCH; CHEMICALS FOR USE IN THE PHARMACEUTICAL, BIOPHARMACEUTICAL, ENVIRONMENTAL, HEALTHCARE, LIFE SCIENCE, NUTRACEUTICAL, ELECTRONICS, PHOTOVOLTAIC, SEMICONDUCTOR, FOOD, BEVERAGE AND FINE CHEMICAL INDUSTRIES; CHEMICALS AND ADDITIVES FOR USE IN THE MANUFACTURE OF FOODS, BEVERAGES, FLAT PANEL DISPLAYS, SEMICONDUCTORS, PHOTOVOLTAIC DEVICES, NUTRACEUTICALS, PHARMACEUTICALS, BIOPHARMACEUTICALS, FINE CHEMICALS, ELECTRONIC AND MICROELECTRONIC DEVICES; CHEMICALS AND ADDITIVES IN TAMPER-EVIDENT PACKAGING FOR USE IN THE MANUFACTURE OF FOODS, BEVERAGES, FLAT PANEL DISPLAYS, SEMICONDUCTORS, PHOTOVOLTAIC DEVICES NUTRACEUTICALS, PHARMACEUTICALS, BIOPHARMACEUTICALS, FINE CHEMICALS, ELECTRONIC AND MICROELECTRONIC DEVICES, IN CLASS 1 (U.S. CLS. 1, 5, 6, 10, 26 AND 46).

FIRST USE 10-1-2010; IN COMMERCE 10-1-2010.



FOR: ALL-PURPOSE CLEANERS; CLEANERS USED IN THE PHARMACEUTICAL AND BIOPHARMACEUTICAL INDUSTRIES FOR USE IN LABORATORIES AND MANUFACTURING ENVIRONMENTS, FOR GENERAL CLEANING APPLICATIONS, NAMELY, TO CLEAN RAW MATERIALS, CONTAINERS, GLOVES, TRANSFER VESSELS, PROCESSING EQUIPMENT, TANKS, CARTS, COUNTERTOPS, WALLS AND FLOORS; CHEMICAL COMPOSITION USED AS A SEMICONDUCTOR HARD SURFACE WAFER CLEANER, IN CLASS 3 (U.S. CLS. 1, 4, 6, 50, 51 AND 52).

FIRST USE 10-1-2010; IN COMMERCE 10-1-2010.

FOR: PHARMACEUTICAL PRODUCTS AND PHARMACEUTICAL DRUG DELIVERY SYSTEM, NAMELY, DRUG DELIVERY FORMULATIONS USED WITH VARIOUS ACTIVE INGREDIENTS FOR IMMEDIATE RELEASE OR CONTROLLED RELEASE OF ACTIVE INGREDIENT INTO THE BODY, IN CLASS 5 (U.S. CLS. 6, 18, 44, 46, 51 AND 52).

David J. Kybas

Director of the United States Patent and Trademark Office

Reg. No. 4,176,449 FIRST USE 10-1-2010; IN COMMERCE 10-1-2010.

FOR: CHROMATOGRAPHY COLUMNS; CHROMATOGRAPHY APPARATUS FOR LABORATORY USE; SCIENTIFIC LABORATORY APPARATUS, NAMELY, SOLID PHASE EXTRACTION COLUMNS AND DEVICES USING CHROMATOGRAPHIC SORBENTS FOR EXTRACTION OF CHEMICALS FROM SOLVENTS; SCIENTIFIC LABORATORY APPARATUS, NAMELY, A SOLID PHASE EXTRACTION SYSTEM COMPRISING A MANIFOLD AND AN EXTRACTION DISK HOLDER, IN CLASS 9 (U.S. CLS. 21, 23, 26, 36 AND 38).

FIRST USE 10-1-2010; IN COMMERCE 10-1-2010.

THE MARK CONSISTS OF STANDARD CHARACTERS WITHOUT CLAIM TO ANY PARTICULAR FONT, STYLE, SIZE, OR COLOR.

SN 85-189,149, FILED 12-2-2010.

JOHN WILKE, EXAMINING ATTORNEY

United States of America

United States Patent and Trademark Office

Nana's Bananas

Reg. No. 4,176,450

MARIA N. PERLMAN (UNITED STATES INDIVIDUAL), TA NANA'S BANANAS,
4241 PUNEE RD.

Registered July 17, 2012

KOLOA, HI 96756 AND

Int. Cl.: 29

JESSICA T. STEIN (UNITED STATES INDIVIDUAL)

4241 PUNEE RD.

KOLOA, HI 96756

TRADEMARK

FOR: DRIED BANANAS, IN CLASS 29 (U.S. CL. 46).

PRINCIPAL REGISTER

FIRST USE 1-26-2011; IN COMMERCE 1-26-2011.

THE MARK CONSISTS OF STANDARD CHARACTERS WITHOUT CLAIM TO ANY PARTICULAR FONT, STYLE, SIZE, OR COLOR.

NO CLAIM IS MADE TO THE EXCLUSIVE RIGHT TO USE "BANANAS", APART FROM THE MARK AS SHOWN.

SN 85-189,343, FILED 12-2-2010.

ALLISON HOLTZ, EXAMINING ATTORNEY



David J. Kyjars

Director of the United States Patent and Trademark Office

United States of America

United States Patent and Trademark Office

INCANDESCENCE

Reg. No. 4,176,451

Registered July 17, 2012

Int. Cls.: 11 and 21

TRADEMARK

PRINCIPAL REGISTER

DECO LAV, INC. (FLORIDA CORPORATION)
424 S.W. 12TH AVENUE
DEERFIELD BEACH, FL 33442

FOR: BATHROOM FIXTURES, NAMELY, TOILET SEAT LIDS, TOILET SEATS, SINKS, WASH BASINS, AND LAVATORIES; PLUMBING FITTINGS, NAMELY, DRAINS, TRAPS, AND MOUNTING RINGS IN THE NATURE OF A HOUSING WITH WASHERS OR GASKETS TO ENSURE A WATERTIGHT CONNECTION WITH AN ABOVE-COUNTER SINK AND THE COUNTER TO WHICH IT IS MOUNTED; AND FAUCET STANDS IN THE NATURE OF PLATFORMS UPON WHICH FAUCETS ARE MOUNTED, IN CLASS 11 (U.S. CLS. 13, 21, 23, 31 AND 34).

FIRST USE 6-1-2011; IN COMMERCE 6-1-2011.

FOR: BATHROOM FIXTURES, NAMELY, TOWEL BARS, TOWEL RINGS, TOILET RINGS, TOILET TISSUE HOLDERS, TOILET PAPER DISPENSERS, SOAP DISHES, SOAP DISPENSERS, AND WASH BASINS NOT PART OF SANITARY INSTALLATION, IN CLASS 21 (U.S. CLS. 2, 13, 23, 29, 30, 33, 40 AND 50).

FIRST USE 6-1-2011; IN COMMERCE 6-1-2011.

THE MARK CONSISTS OF STANDARD CHARACTERS WITHOUT CLAIM TO ANY PARTICULAR FONT, STYLE, SIZE, OR COLOR.

SN 85-189,953, FILED 12-3-2010.

MARIA-VICTORIA SUAREZ, EXAMINING ATTORNEY



David J. Kyffers

Director of the United States Patent and Trademark Office

United States of America

United States Patent and Trademark Office



Reg. No. 4,176,452

PERU FOOD IMPORTS, INC. (NEW JERSEY CORPORATION)
P.O. BOX 419

Registered July 17, 2012

WEST NEW YORK, NY 07093

Int. Cl.: 30

FOR: FRUIT JELLIES; MAIZE-BASED PUDDING DESSERT (MAZAMORRA MORADA), IN CLASS 30 (U.S. CL. 46).

TRADEMARK

FIRST USE 6-1-2011; IN COMMERCE 6-1-2011.

PRINCIPAL REGISTER

OWNER OF U.S. REG. NOS. 3,150,334, 3,152,500, AND 3,254,498.

THE COLOR(S) RED, WHITE, ORANGE, BLACK, GREEN IS/ARE CLAIMED AS A FEATURE OF THE MARK.

NO CLAIM IS MADE TO THE EXCLUSIVE RIGHT TO USE "PERU FOOD", APART FROM THE MARK AS SHOWN.

THE MARK CONSISTS OF THE WORDING "PERU FOOD" IN WHITE WITH BLACK SHADING INSIDE A RED BANNER WITH BLACK AND WHITE OUTLINING. ABOVE THE WORDING IS A PARALLELOGRAM WITH A BLACK OUTLINE INSIDE OF WHICH APPEARS A GREEN BODY OF WATER IN FRONT OF A GREEN MOUNTAIN WITH AN ORANGE SUNSET. BELOW THE BANNER IS THE WORDING "UNIVERSAL" IN RED WITH BLACK SHADING. ALL OF THE FOREGOING APPEARS ON TOP OF A BACKGROUND CONSISTING OF VERTICAL RED STRIPES TO THE RIGHT AND LEFT OF THE MARK WITH A VERTICAL WHITE STRIPE IN THE CENTER.



SN 85-190,122, FILED 12-3-2010.

RONALD MCMORROW, EXAMINING ATTORNEY

David J. Kybas

Director of the United States Patent and Trademark Office

United States of America

United States Patent and Trademark Office

WILD CASH

Reg. No. 4,176,453

Registered July 17, 2012

Int. Cl.: 9

MIAMI TRIBE OF OKLAHOMA BUSINESS DEVELOPMENT AUTHORITY, A TRIBAL ENTERPRISE OF THE MIAMI TRIBE OF OKLAHOMA (UNITED STATES FEDERALLY RECOGNIZED INDIAN TRIBE)
3410 P STREET NW
MIAMI, OK 74354

TRADEMARK

FOR: GAMING MACHINES, NAMELY, BINGO-RELATED GAMES AND SLOT MACHINES, IN CLASS 9 (U.S. CLS. 21, 23, 26, 36 AND 38).

PRINCIPAL REGISTER

FIRST USE 10-3-2011; IN COMMERCE 10-3-2011.

THE MARK CONSISTS OF STANDARD CHARACTERS WITHOUT CLAIM TO ANY PARTICULAR FONT, STYLE, SIZE, OR COLOR.

NO CLAIM IS MADE TO THE EXCLUSIVE RIGHT TO USE "CASH", APART FROM THE MARK AS SHOWN.

SN 85-190,565, FILED 12-3-2010.

KATHY DE JONGE, EXAMINING ATTORNEY



David J. Kybas

Director of the United States Patent and Trademark Office

United States of America

United States Patent and Trademark Office

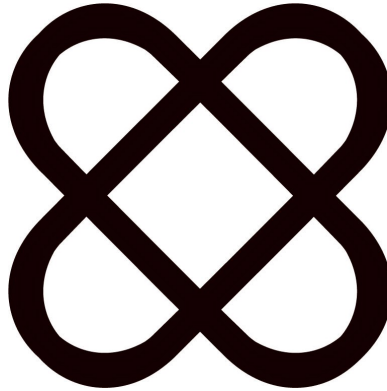

Reg. No. 4,176,454

Registered July 17, 2012

Int. Cl.: 28

TRADEMARK

PRINCIPAL REGISTER

TALI LEHAVI (UNITED STATES INDIVIDUAL), AKA TALI LEHAVI HAMER,
13370 N. 91ST STREET
SCOTTSDALE, AZ 85260

FOR: (BASED ON USE) COLLECTABLE TOY FIGURES IN 2D AND 3D, BATH DOLLS AND GAMES, NAMELY, RING GAMES, BUILDING GAMES, CHILDREN'S MULTIPLE ACTIVITY TOYS, FANTASY CHARACTER TOYS, PUZZLES, SOFT SCULPTURE DOLLS, TOY FIGURES, VINYL DOLLS, WATER TOYS, YOGA MATS, YOGA BLOCKS, TOYS AND GAMES AND ACCESSORIES THAT REFLECT IMAGES AND ADVENTURES FROM STORY BOOKS, NAMELY, ACTION FIGURES, DOLLS, MEMORY GAMES; TOYS AND GAMES AND ACCESSORIES THAT ENCOURAGE THE IMAGINATION AND ROLE PLAY, NAMELY, DOLLS, MEMORY GAMES; TOYS DESIGNED TO HANG ON THE ARM OR WRIST OR FINGER, NAMELY, STUFFED PLUSH TOYS, BATTERY-OPERATED TOYS, SOLAR-POWERED TOYS; TOYS AND GAMES THAT ENCOURAGE PHYSICAL ACTIVITY, PROMOTE HEALTH, CHARACTER EDUCATION VALUES, HEALTHY EATING, OR ADVANCE MATH AND SCIENCE, NAMELY, PUZZLE GAMES WITH PUZZLE PIECES THAT UNITE TO FORM CHARACTER EDUCATION VALUE IMAGES OR MATH CONCEPTS LIKE PARTS OF A WHOLE; ACTION SKILL GAMES, ACTION TARGET GAMES, ACTION-TYPE TARGET GAMES, AERO-DYNAMIC DISK FOR USE IN PLAYING CATCHING GAMES, ARCADE GAME MACHINES, ARCADE GAMES, ARCADE-TYPE ELECTRONIC EDUCATION VIDEO GAMES, ARCADE-TYPE ELECTRONIC VIDEO GAMES, ARTICLES OF CLOTHING FOR TOYS, ATTACHABLE, WEARABLE, MAGNETIC TOY FIGURINES, BABY MULTIPLE ACTIVITY TOYS, BALL-JOINTED DOLLS, BALL-JOINTED PORCELAIN DOLLS, BALL-JOINTED RESIN DOLLS, BALL-JOINTED VINYL DOLLS, BALLOONS, BALLS FOR GAMES, BATS FOR GAMES, BEAN BAG DOLLS, BENDABLE TOYS, BOARD GAMES, BOBBLE HEAD DOLLS, BOBBLEHEAD DOLLS, BUBBLE MAKING WAND AND SOLUTION SETS, CARD GAMES, CAT TOYS, CHESS GAMES, CHILDREN'S EDUCATIONAL TOYS FOR DEVELOPING FINE MOTOR, ORAL LANGUAGE, NUMBERS, COUNTING, COLORS AND ALPHABET SKILLS SOLD IN A FABRIC BAG WHICH HAS A CLEAR VINYL WINDOW FOR VIEWING SMALL TRINKETS AND TOYS SECURELY CONTAINED WITHIN THE BAG ITSELF, CHILDREN'S MULTIPLE ACTIVITY TOYS, CHRISTMAS DOLLS, CLOTHES FOR EUROPEAN DOLLS, COIN-OPERATED VIDEO GAMES, CRIB TOYS, DICE GAMES, DOG TOYS, DOLL ACCESSORIES, DOLL CASES, DOLL CLOTHING, DOLL COSTUMES, DOLL FURNITURE, DOLL HOUSE FURNISHINGS, DOLL HOUSES, DOLLS, DOLLS AND ACCESSORIES THEREFOR, DOLLS AND DOLL ACCESSORIES, NAMELY, CLOTHING FOR DOLLS, DOLL ROOMS, DOLL BEDS, DOLL HOUSES, TOY FABRICS AND LINENS FOR DOLLS AND STROLLERS FOR DOLLS, DOLLS AND DOLLS' CLOTHING, DOLLS



David J. Kyros

Director of the United States Patent and Trademark Office

Reg. No. 4,176,454 AND PLAYSETS THEREFOR, DOLLS FOR CHRISTMAS, DOLLS FOR PLAYING, DOLLS IN SITTING POSTURE, DOLLS' CLOTHES, DOLLS' FEEDING BOTTLES, DOLLS' HOUSES, DOLLS' ROOMS, DRAWING TOYS, EDUCATIONAL CARD GAMES, EDUCATIONAL TOY FOR THE PURPOSE OF THE DEMONSTRATION OF ALTERNATIVE ENERGY SOURCES, EDUCATIONAL TOYS FOR TEACHING MATH PRINCIPLES TO CHILDREN, NAMELY, MANIPULATIVE BLOCKS FOR DISPLAYING PATTERNS AND GROUPINGS, ELECTRIC ACTION TOYS, ELECTRONIC ACTION TOYS, ELECTRONIC DART GAMES, ELECTRONIC EDUCATIONAL GAME MACHINES FOR CHILDREN, ELECTRONIC GAME EQUIPMENT WITH A WATCH FUNCTION, ELECTRONIC GAMES FOR THE TEACHING OF CHILDREN, ELECTRONIC GAMES OTHER THAN THOSE ADAPTED FOR USE WITH TELEVISION RECEIVERS ONLY, ELECTRONIC LEARNING TOYS, ELECTRONIC NOVELTY TOYS, NAMELY, TOYS THAT ELECTRONICALLY RECORD, PLAY BACK, AND DISTORT OR MANIPULATE VOICES AND SOUNDS, ELECTRONIC TARGETS FOR GAMES AND SPORTS, ELECTRONIC TOY BUILDING BLOCKS THAT LIGHT UP AS A NIGHT LIGHT, ELECTRONIC TOY VEHICLES, EQUIPMENT FOR PLAYING A VERTICAL HOOP TARGET GAME, EQUIPMENT SOLD AS A UNIT FOR PLAYING BOARD GAMES, EQUIPMENT SOLD AS A UNIT FOR PLAYING CARD GAMES, EUROPEAN STYLE DOLLS, EXERCISE BALLS, EXERCISE EQUIPMENT, NAMELY, INFLATABLE BALLS, EXERCISE MACHINES INCORPORATING ELECTRONIC AND VIDEO GAME CONTROLLERS, FITNESS EQUIPMENT, NAMELY, A WEIGHTED BAR TO IMPROVE POSTURE AND OVERALL FITNESS, FITNESS EQUIPMENT, NAMELY, STRAPS USED FOR YOGA AND OTHER FITNESS ACTIVITIES AND FOR CARRYING A YOGA MAT, FITNESS MACHINES AND EQUIPMENT, NAMELY, WEIGHTS, TREADMILLS, ROWING MACHINES, STAIR STEPPING MACHINES, RESISTANCE MACHINES, STATIONARY CYCLES, FLYING SAUCERS, FURNITURE FOR DOLL'S HOUSES, GAME CARDS, GAME EQUIPMENT SET SOLD AS A UNIT COMPRISED PRIMARILY OF A PLAYING BOARD AND PLAYING CARDS AND ALSO INCLUDING RULES OF PLAY, DRY ERASE BOARDS AND ERASERS, MARKERS, A TIMER AND T-SHIRTS, GAME EQUIPMENT, NAMELY, CHIPS, GAME TABLES, GAMING PAPER, NAMELY, PAPER PRINTED WITH REGULAR GRID AND HEXAGON PATTERNS FOR USE IN PLAYING WAR GAMES, ROLE PLAYING GAMES AND MINIATURE GAMES, GIFT BASKETS COMPRISED PRIMARILY OF IMITATION TOYS, SPORTS PRODUCTS, NAMELY, TOY GAME BALLS AND ACCESSORIES THEREFORE, GIFT BASKETS COMPRISED PRIMARILY OF TOY IMITATION SPORTING GOODS, NAMELY, TOY GAME BALLS AND ACCESSORIES THEREFORE, GIFT BASKETS CONTAINING PLUSH TOYS, HAND HELD UNITS FOR PLAYING VIDEO GAMES OTHER THAN THOSE ADAPTED FOR USE WITH AN EXTERNAL DISPLAY SCREEN OR MONITOR, HAND-HELD GAMES WITH LIQUID CRYSTAL DISPLAYS, HAND-POWERED NON-MECHANICAL FLYING TOY, HEADGEAR FOR DOLLS, HORSESHOE GAMES, INFANT TOYS, INFLATABLE BATH TOYS, JIGSAW AND MANIPULATIVE PUZZLES, JIGSAW PUZZLES, LCD GAME MACHINES, MAH JONG GAMES, MANIPULATIVE GAMES, MANIPULATIVE PUZZLES, MANUALLY-OPERATED EXERCISE EQUIPMENT FOR PHYSICAL FITNESS PURPOSES, MARBLES FOR GAMES, MECHANICAL TOYS, MEMORY GAMES, MODEL TOY VEHICLES, MOLDED TOY FIGURES, MUSIC BOX TOYS, MUSICAL TOYS, NON-ELECTRONIC TOY VEHICLES, NON-RIDING TRANSPORTATION TOYS, PADDLE BALL GAMES, PAPER DOLLS, PARTY FAVORS IN THE NATURE OF SMALL TOYS, PARTY GAMES, PET TOYS, PINBALL-TYPE GAMES, PLASTIC CHARACTER TOYS, PLASTIC TOY HOOPS, PLAY BALLS AND PLAY BALLOONS, PLAY HOUSES AND TOY ACCESSORIES THEREFORE, PLAY MATS CONTAINING INFANT TOYS, PLAYING CARD GAME ACCESSORIES, NAMELY, PLAYING CARD CASES, PLAYING CARD HOLDERS, MATS FOR USE IN CONNECTION WITH PLAYING CARD GAMES, PLAYING CARD SHUFFLING DEVICES AND DICE, PLAYING CARDS AND CARD GAMES, PLAYSETS FOR DOLLS, PLUSH DOLLS, PLUSH DOLLS CREATED FROM CHILDREN'S DRAWINGS, PLUSH TOYS, POP UP TOYS, PORCELAIN DOLLS, POSITIONABLE PRINTED TOY FIGURES FOR USE IN GAMES, POSITIONABLE PRINTED TOY FIGURES FOR USE IN PUZZLES, POSITIONABLE THREE DIMENSIONAL TOYS FOR USE IN GAMES, POSITIONABLE TWO DIMENSIONAL TOYS FOR USE IN GAMES, POSITIONABLE WOODEN AND PLASTIC FIGURES FOR USE IN WOODEN AND PLASTIC PUZZLES, PRINTED POSITIONABLE TOYS FOR USE IN CHILDREN'S BOARD GAMES, PRINTING TOYS, PROMOTIONAL GAME CARDS, PROMOTIONAL GAME MA-

Reg. No. 4,176,454 TERIALS, PULL TOYS, PUNCHING BALLS, PUNCHING TOYS, PUSH TOYS, PUZZLE GAMES, PUZZLES, RACKET BALLS, RADIO CONTROLLED TOY VEHICLES, RAG DOLLS, RIDE-ON GAME MACHINES, RIDE-ON TOYS AND ACCESSORIES THEREFOR, ROLE PLAYING GAMES, ROLE PLAYING TOYS IN THE NATURE OF PLAY SETS FOR CHILDREN TO IMITATE REAL LIFE OCCUPATIONS, RUBBER CHARACTER TOYS, SAND TOYS, SCALE MODEL KITS, SCRATCH CARDS FOR PLAYING LOTTERY GAMES, SHOES FOR DOLLS, SOFT SCULPTURE PLUSH TOYS, SQUEEZABLE SQUEAKING TOYS, SQUEEZE TOYS, STACKING TOYS, STAND ALONE VIDEO GAME MACHINES, STRESS RELIEF BALLS FOR HAND EXERCISE, STRETCH BANDS USED FOR YOGA AND PHYSICAL FITNESS PURPOSES, STUFFED AND PLUSH TOYS, STUFFED DOLLS AND ANIMALS, STUFFED TOY ANIMALS, STUFFED TOY BEARS, TABLE-TENNIS BALLS, TABLETOP GAMES, TALKING DOLLS, TALKING TOYS, TARGET GAMES, TESSELATION TOYS, TETHER BALLS, TOY ACTION FIGURES, TOY AIRPLANES, TOY AND NOVELTY FACE MASKS, TOY ANIMALS, TOY ANIMALS AND ACCESSORIES THEREFORE, TOY BAKEWARE AND COOKWARE, TOY BALLOONS, TOY BOATS, TOY BOXES, TOY BUILDING BLOCKS, TOY BUILDING BLOCKS CAPABLE OF INTERCONNECTION, TOY BUILDINGS AND ACCESSORIES THEREFORE, TOY CARS, TOY CHRISTMAS TREES, TOY CLOCKS AND WATCHES, TOY CONSTRUCTION BLOCKS, TOY CONSTRUCTION SETS, TOY FOAM NOVELTY ITEMS, NAMELY, FOAM FINGERS AND HANDS, TOY FURNITURE, TOY GLIDERS, TOY HOUSES, TOY MAILBOXES, TOY MOBILES, TOY MODEL HOBBY-CRAFT KITS, TOY MODELING DOUGH, TOY NOISEMAKERS, TOY PUTTY, TOY ROBOTS, TOY SLING PLANES, TOY TELESCOPES, TOY TRAINS AND PARTS AND ACCESSORIES THEREFORE, TOY VEHICLES, TOY WATCHES, TOY XYLOPHONES, TOY, NAMELY, BATTERY-POWERED COMPUTER GAME WITH LCD SCREEN WHICH FEATURES ANIMATION AND SOUND EFFECTS, TOYS, NAMELY, A DISK TO TOSS IN PLAYING A GAME WHEREIN OTHER DISKS ARE FLIPPED AND COLLECTED, TOYS, NAMELY, BEAN BAG ANIMALS, TOYS, NAMELY, CHILDREN'S DRESS-UP ACCESSORIES, TOYS, NAMELY, KITES AND ACCESSORIES FOR KITES, NAMELY, KITE HANDLES, KITE LINES, KITE REELS, KITE STRING AND KITE TAILS, TRADING CARD GAMES, TRADITIONALLY DRESSED WESTERN DOLLS, TRANSFORMING ROBOTIC TOYS, TRIVIA GAME PLAYED WITH CARDS AND GAME COMPONENTS, TWO AND THREE DIMENSIONAL POSITIONABLE GAME FIGURES THAT MAY BE AFFIXED TO CLOTHING, TWO AND THREE DIMENSIONAL POSITIONABLE TOY FIGURES SOLD AS A UNIT WITH EDUCATIONAL BOOKS, TWO AND THREE DIMENSIONAL POSITIONABLE TOY FIGURES SOLD AS A UNIT WITH MEMORY TRAINING EQUIPMENT, TWO AND THREE DIMENSIONAL POSITIONABLE TOY FIGURES SOLD AS A UNIT WITH OTHER TOYS, VIBRATING APPARATUS USED IN FITNESS AND EXERCISE PROGRAMS TO STIMULATE MUSCLES AND INCREASE STRENGTH AND PHYSICAL PERFORMANCE, WIND-UP TOYS, WIND-UP WALKING TOYS, YOGA BOARDS, YOGA STRAPS, IN CLASS 28 (U.S. CLS. 22, 23, 38 AND 50).

FIRST USE 12-1-2000; IN COMMERCE 12-1-2000.

THE MARK CONSISTS OF TWO HEARTS OVERLAPPING IN OPPOSITE DIRECTIONS CREATING A HEART IN FOUR DIRECTIONS.

SN 85-190,971, FILED 12-6-2010.

KATINA MISTER, EXAMINING ATTORNEY

United States of America

United States Patent and Trademark Office

Just Add Heels

Reg. No. 4,176,455

DONNALEE BURPOS (UNITED STATES INDIVIDUAL), DBA JUST ADD HEELS,
202 N LAPEER DRIVE, #5
BEVERLY HILLS, CA 90211

Registered July 17, 2012

Int. Cl.: 25

FOR: BRAS; G-STRINGS; GARTER BELTS; HOSIERY; LINGERIE; NEGLIGEEES; PANTIES;
SLIPS; STOCKINGS; T-SHIRTS; TANK TOPS, IN CLASS 25 (U.S. CLS. 22 AND 39).

TRADEMARK

FIRST USE 10-5-2011; IN COMMERCE 10-12-2011.

PRINCIPAL REGISTER

THE MARK CONSISTS OF STANDARD CHARACTERS WITHOUT CLAIM TO ANY PAR-
TICULAR FONT, STYLE, SIZE, OR COLOR.

SN 85-191,214, FILED 12-6-2010.

KATINA MISTER, EXAMINING ATTORNEY



David J. Kyffers

Director of the United States Patent and Trademark Office

United States of America

United States Patent and Trademark Office

TENSIBELT

Reg. No. 4,176,456

Registered July 17, 2012

Int. Cl.: 9

TRADEMARK

PRINCIPAL REGISTER

OVERHEAD DOOR CORPORATION (INDIANA CORPORATION)
2501 SOUTH STATE HWY 121
SUITE 200
LEWISVILLE, TX 75067

FOR: ELECTRIC COMMERCIAL DOOR OPERATORS, IN CLASS 9 (U.S. CLS. 21, 23, 26, 36 AND 38).

FIRST USE 5-14-2012; IN COMMERCE 5-14-2012.

THE MARK CONSISTS OF STANDARD CHARACTERS WITHOUT CLAIM TO ANY PARTICULAR FONT, STYLE, SIZE, OR COLOR.

SN 85-191,448, FILED 12-6-2010.

JAY FLOWERS, EXAMINING ATTORNEY



David J. Kyffers

Director of the United States Patent and Trademark Office

United States of America

United States Patent and Trademark Office

Crime Pays

Reg. No. 4,176,457

Registered July 17, 2012

Int. Cl.: 25

TRADEMARK

PRINCIPAL REGISTER

BARRERA, URBELINO (UNITED STATES INDIVIDUAL)
APT 2
3438 90TH ST
JACKSON HEIGHTS, NY 11372

FOR: T-SHIRTS, IN CLASS 25 (U.S. CLS. 22 AND 39).

FIRST USE 12-15-2011; IN COMMERCE 12-15-2011.

THE MARK CONSISTS OF THE WORDS "CRIME PAYS" IN STYLIZED FORM COMPOSED OF CONNECTED SCRIPT "C" AND "P" WITH WINGS AT BOTH ENDS OF LOGO WITH DRIPS ON THE "C", THE "E", THE "S", AND THE DOT ON THE "I".

SN 85-191,611, FILED 12-6-2010.

EUGENIA MARTIN, EXAMINING ATTORNEY



David J. Kybas

Director of the United States Patent and Trademark Office

United States of America

United States Patent and Trademark Office

Intellipreneur Consulting

Reg. No. 4,176,458

INTELLIPRENEUR CONSULTING LLC (PENNSYLVANIA LIMITED LIABILITY COMPANY)
157 HART AVENUE
DOYLESTOWN, PA 18901

Registered July 17, 2012

Int. Cl.: 41

FOR: EDUCATION SERVICES, NAMELY, PROVIDING LIVE AND ON-LINE TUTORIALS, CLASSES, WORKSHOPS, SEMINARS, TUTORING, AND MENTORING IN THE FIELDS OF INVENTING AND PATENTING, IN CLASS 41 (U.S. CLS. 100, 101 AND 107).

SERVICE MARK

FIRST USE 4-26-2012; IN COMMERCE 4-26-2012.

PRINCIPAL REGISTER

THE MARK CONSISTS OF STANDARD CHARACTERS WITHOUT CLAIM TO ANY PARTICULAR FONT, STYLE, SIZE, OR COLOR.

NO CLAIM IS MADE TO THE EXCLUSIVE RIGHT TO USE "CONSULTING", APART FROM THE MARK AS SHOWN.

SN 85-192,018, FILED 12-7-2010.

EMILY CHUO, EXAMINING ATTORNEY



David J. Kyffers

Director of the United States Patent and Trademark Office

United States of America

United States Patent and Trademark Office

DRY.Q

Reg. No. 4,176,459

MOUNTAIN HARDWEAR, INC. (UTAH CORPORATION)
14375 NW SCIENCE PARK DRIVE
PORTLAND, OR 97229

Registered July 17, 2012

Int. Cls.: 9, 20, and 22

FOR: BIVOUAC SACKS, NAMELY, WIND AND WATER RESISTANT BAGS INTO WHICH A PERSON CAN FIT TO PROTECT THEMSELVES FROM EXPOSURE TO THE ELEMENTS, IN CLASS 9 (U.S. CLS. 21, 23, 26, 36 AND 38).

TRADEMARK

FIRST USE 2-1-2012; IN COMMERCE 2-1-2012.

PRINCIPAL REGISTER

FOR: SLEEPING BAGS, IN CLASS 20 (U.S. CLS. 2, 13, 22, 25, 32 AND 50).

FIRST USE 2-1-2012; IN COMMERCE 2-1-2012.

FOR: TENTS, IN CLASS 22 (U.S. CLS. 1, 2, 7, 19, 22, 42 AND 50).

FIRST USE 2-1-2012; IN COMMERCE 2-1-2012.

THE MARK CONSISTS OF STANDARD CHARACTERS WITHOUT CLAIM TO ANY PARTICULAR FONT, STYLE, SIZE, OR COLOR.

SN 85-192,293, FILED 12-7-2010.

JEFF DEFORD, EXAMINING ATTORNEY



David J. Kybas

Director of the United States Patent and Trademark Office

United States of America

United States Patent and Trademark Office

DRY.Q

Reg. No. 4,176,460

MOUNTAIN HARDWEAR, INC. (UTAH CORPORATION)
14375 NW SCIENCE PARK DRIVE
PORTLAND, OR 97229

Registered July 17, 2012

Int. Cl.: 25

FOR: GAITERS; HEADWEAR; JACKETS; PANTS; PARKAS; RAINWEAR; SKI BIBS;
SKIWEAR, IN CLASS 25 (U.S. CLS. 22 AND 39).

TRADEMARK

FIRST USE 8-1-2011; IN COMMERCE 8-1-2011.

PRINCIPAL REGISTER

THE MARK CONSISTS OF STANDARD CHARACTERS WITHOUT CLAIM TO ANY PARTICULAR FONT, STYLE, SIZE, OR COLOR.

SN 85-192,302, FILED 12-7-2010.

JEFF DEFORD, EXAMINING ATTORNEY



David J. Kybas

Director of the United States Patent and Trademark Office

United States of America

United States Patent and Trademark Office

Intellipreneur Consulting

Reg. No. 4,176,461

Registered July 17, 2012

Int. Cl.: 45

SERVICE MARK

PRINCIPAL REGISTER

INTELLIPRENEUR CONSULTING LLC (PENNSYLVANIA LIMITED LIABILITY COMPANY)
157 HART AVENUE
DOYLESTOWN, PA 18901

FOR: INTELLECTUAL PROPERTY CONSULTING SERVICES IN THE FIELD OF INVENTION, PROVIDING GUIDANCE TO INVENTORS AND OTHER INDIVIDUALS AND GROUPS PARTICIPATING IN THE CREATION, EXPANSION, DEVELOPMENT, PROTECTION, AND EXPLOITATION OF INVENTIVE CONCEPTS AND PARTICIPATING DIRECTLY AND INDIRECTLY IN CREATING AND EXPANDING INVENTIVE CONCEPTS; PATENT CONSULTATION, NAMELY, SEARCHING AND ANALYZING PATENT AND OPEN LITERATURE RELATED TO SPECIFIC INVENTIVE CONCEPTS AND PREPARING AND PROSECUTING PATENT APPLICATIONS, IN CLASS 45 (U.S. CLS. 100 AND 101).

FIRST USE 4-26-2012; IN COMMERCE 4-26-2012.

THE MARK CONSISTS OF STANDARD CHARACTERS WITHOUT CLAIM TO ANY PARTICULAR FONT, STYLE, SIZE, OR COLOR.

NO CLAIM IS MADE TO THE EXCLUSIVE RIGHT TO USE "CONSULTING", APART FROM THE MARK AS SHOWN.

SN 85-192,628, FILED 12-7-2010.

EMILY CHUO, EXAMINING ATTORNEY



David J. Kyjars

Director of the United States Patent and Trademark Office

United States of America

United States Patent and Trademark Office

CONCISIVE

Reg. No. 4,176,462

Registered July 17, 2012

Int. Cls.: 35 and 42

SERVICE MARK

PRINCIPAL REGISTER

WPP PROPERTIES (DELAWARE PARTNERSHIP)
4TH FLOOR
100 PARK AVENUE
NEW YORK, NY 10017

FOR: ADVERTISING AGENCY SERVICES; CUSTOMER RELATIONSHIP MANAGEMENT; MARKETING COMMUNICATIONS SERVICES, NAMELY, PROVIDING CUSTOMIZED COMMUNICATION PROGRAMS TO HELP BUSINESSES PROMOTE AND MARKET THEIR PRODUCTS AND SERVICES; PUBLIC RELATIONS; BUSINESS MARKETING CONSULTING IN THE FIELD OF BRAND CREATION, BRAND DEVELOPMENT, BRAND IDENTITY AND BRAND MARKETING; MARKET RESEARCH AND ANALYSIS; BUSINESS RESEARCH AND STRATEGIC PLANNING SERVICES FOR OTHERS IN THE FIELD OF ADVERTISING, MARKETING COMMUNICATIONS, PROMOTIONS, AND PUBLIC RELATIONS; INTERACTIVE AND DIGITAL MEDIA ADVERTISING; ADVERTISING; DIRECT MARKETING ADVERTISING SERVICES FOR OTHERS; CUSTOMER RELATIONSHIP MANAGEMENT; PROVIDING MARKETING AND PROMOTION OF SPECIAL EVENTS; ARRANGING AND CONDUCTING MARKETING PROMOTIONAL EVENTS FOR OTHERS; SALES PROMOTION SERVICES; MEDIA CONSULTING SERVICES, NAMELY, PLANNING, BUYING AND NEGOTIATING ADVERTISING AND MEDIA SPACE AND TIME, IN CLASS 35 (U.S. CLS. 100, 101 AND 102).

FIRST USE 1-1-2011; IN COMMERCE 1-1-2011.



FOR: CONSULTING SERVICES RELATING TO THE CREATION, DEVELOPMENT AND OPERATION OF INTERNET WEBSITES; CONSULTING SERVICES RELATING TO THE USE OF DIGITAL PLATFORMS AND MEDIA IN THE FIELD OF ADVERTISING AND MARKETING; HOSTING INTERNET WEBSITES IN THE FIELD OF ADVERTISING AND MARKETING; GRAPHIC DESIGN SERVICES; PRODUCT RESEARCH; CONSULTING SERVICES IN THE FIELD OF THE DESIGN OF PRODUCTS AND PACKAGING; PRODUCT AND PACKAGING DESIGN AND DEVELOPMENT; INDUSTRIAL DESIGN SERVICES, IN CLASS 42 (U.S. CLS. 100 AND 101).

FIRST USE 1-1-2011; IN COMMERCE 1-1-2011.

David J. Kyros

THE MARK CONSISTS OF STANDARD CHARACTERS WITHOUT CLAIM TO ANY PARTICULAR FONT, STYLE, SIZE, OR COLOR.

Reg. No. 4,176,462 SN 85-193,468, FILED 12-8-2010.

LINDA ORNDORFF, EXAMINING ATTORNEY

United States of America

United States Patent and Trademark Office

All in Veins

Reg. No. 4,176,463

Registered July 17, 2012

Int. Cl.: 44

SERVICE MARK

PRINCIPAL REGISTER

HOVORKA, JOHN (TEXAS LIMITED PARTNERSHIP), DBA J.W.H. & W.J.H. L.P.,
909 N. JACKSON RD.
MCALLEN, TX 78501

FOR: MEDICAL CLINIC PROVIDING WEIGHT LOSS SOLUTIONS, SERVICES AND PROGRAMS, NUTRITION COUNSELING, HORMONE THERAPY, INCLUDING, BIOIDENTICAL HORMONE REPLACEMENT, ANTI AGING THERAPY, AND NATURAL HORMONE THERAPY, MEDICAL AESTHETIC PROCEDURES, INCLUDING, LASER HAIR REMOVAL, LASER PEELS, BOTULINUM TOXIN TREATMENTS, MICRODERMABRASION, LIPOSUCTION, VEIN TREATMENTS, VEIN THERAPY, CELLULITE TREATMENTS, BODY CONTOURING TREATMENTS, INJECTABLE FILLER TREATMENTS, FACIALS, AND SKIN CARE, IN CLASS 44 (U.S. CLS. 100 AND 101).

FIRST USE 12-1-2011; IN COMMERCE 12-1-2011.

THE MARK CONSISTS OF STANDARD CHARACTERS WITHOUT CLAIM TO ANY PARTICULAR FONT, STYLE, SIZE, OR COLOR.

SN 85-193,986, FILED 12-9-2010.

SUZANNE BLANE, EXAMINING ATTORNEY



David J. Kyffers

Director of the United States Patent and Trademark Office

United States of America

United States Patent and Trademark Office

BEING HUMAN

Reg. No. 4,176,464

Registered July 17, 2012

Int. Cls.: 9 and 41

TRADEMARK

SERVICE MARK

PRINCIPAL REGISTER

THE BAUMANN FOUNDATION (CALIFORNIA CORPORATION)
#185
1770 POST STREET
SAN FRANCISCO, CA 94115

FOR: DIGITAL MATERIALS, NAMELY, DOWNLOADABLE FILES FEATURING INFORMATION IN THE FIELDS OF SCIENCE AND PHILOSOPHY, IN CLASS 9 (U.S. CLS. 21, 23, 26, 36 AND 38).

FIRST USE 12-19-2011; IN COMMERCE 12-19-2011.

FOR: EDUCATIONAL SERVICES, NAMELY, CONDUCTING CLASSES, SEMINARS, CONFERENCES, WORKSHOPS, AND PUBLIC PRESENTATIONS IN THE FIELD OF SCIENCE AND PHILOSOPHY AND DISTRIBUTION OF PRINTED MATERIALS IN CONNECTION THEREWITH IN HARD COPY OR ELECTRONIC FORMAT ON THE SAME TOPICS; PROVIDING A WEBSITE FEATURING EDUCATIONAL INFORMATION IN THE ACADEMIC FIELD OF SCIENCE AND PHILOSOPHY FOR THE PURPOSE OF ACADEMIC STUDY, IN CLASS 41 (U.S. CLS. 100, 101 AND 107).

FIRST USE 12-19-2011; IN COMMERCE 12-19-2011.

THE MARK CONSISTS OF STANDARD CHARACTERS WITHOUT CLAIM TO ANY PARTICULAR FONT, STYLE, SIZE, OR COLOR.

SN 85-195,289, FILED 12-10-2010.

JAMES LOVELACE, EXAMINING ATTORNEY



David J. Kyros

Director of the United States Patent and Trademark Office

United States of America

United States Patent and Trademark Office

THERMA ALL-WEATHER

Reg. No. 4,176,465

HUF, GERALD, D. (PENNSYLVANIA SOLE PROPRIETORSHIP), DBA NORTHWEST,
18941 PARK AVE. PLAZA
MEADVILLE, PA 16335

Registered July 17, 2012

Int. Cl.: 2

FOR: CERAMIC PAINTS; EXTERIOR PAINT; INTERIOR PAINT, IN CLASS 2 (U.S. CLS. 6,
11 AND 16).

TRADEMARK

FIRST USE 1-27-2011; IN COMMERCE 3-25-2011.

PRINCIPAL REGISTER

THE MARK CONSISTS OF STANDARD CHARACTERS WITHOUT CLAIM TO ANY PAR-
TICULAR FONT, STYLE, SIZE, OR COLOR.

NO CLAIM IS MADE TO THE EXCLUSIVE RIGHT TO USE "ALL WEATHER", APART
FROM THE MARK AS SHOWN.

SN 85-196,291, FILED 12-13-2010.

KATINA MISTER, EXAMINING ATTORNEY



David J. Kyffers

Director of the United States Patent and Trademark Office

United States of America

United States Patent and Trademark Office

DEXTECH

Reg. No. 4,176,466

COLUMBIA INSURANCE COMPANY (NEBRASKA CORPORATION)
3024 HARNEY STREET
OMAHA, NE 68131

Registered July 17, 2012

Int. Cl.: 25

FOR: FOOTWEAR, IN CLASS 25 (U.S. CLS. 22 AND 39).

TRADEMARK

FIRST USE 9-1-2011; IN COMMERCE 9-1-2011.

PRINCIPAL REGISTER

THE MARK CONSISTS OF STANDARD CHARACTERS WITHOUT CLAIM TO ANY PARTICULAR FONT, STYLE, SIZE, OR COLOR.

OWNER OF U.S. REG. NOS. 1,137,437, 2,042,063, AND OTHERS.

SN 85-196,593, FILED 12-13-2010.

ELLEN BURNS, EXAMINING ATTORNEY



David J. Kyffers

Director of the United States Patent and Trademark Office

United States of America

United States Patent and Trademark Office

WAYTOSERVE

Reg. No. 4,176,467

Registered July 17, 2012

Int. Cls.: 41 and 45

SERVICE MARK

PRINCIPAL REGISTER

STC.UNM (NEW MEXICO CORPORATION)
STE 101
801 UNIVERSITY BLVD., SE
ALBUQUERQUE, NM 87106

FOR: TRAINING INFORMATION SERVICES, NAMELY, PROVIDING INFORMATION REGARDING THE TRAINING OF PROFESSIONALS THAT SERVE ALCOHOL TO GUESTS AND PATRONS, IN CLASS 41 (U.S. CLS. 100, 101 AND 107).

FIRST USE 2-1-2011; IN COMMERCE 2-1-2011.

FOR: REGULATORY LICENSE COMPLIANCE INFORMATION REGARDING THE TRAINING OF PROFESSIONALS THAT SERVE ALCOHOL TO GUESTS AND PATRONS, IN CLASS 45 (U.S. CLS. 100 AND 101).

FIRST USE 2-1-2011; IN COMMERCE 2-1-2011.

THE MARK CONSISTS OF STANDARD CHARACTERS WITHOUT CLAIM TO ANY PARTICULAR FONT, STYLE, SIZE, OR COLOR.

SN 85-197,189, FILED 12-14-2010.

SUZANNE BLANE, EXAMINING ATTORNEY



David J. Kybas

Director of the United States Patent and Trademark Office

United States of America

United States Patent and Trademark Office

TENSION

Reg. No. 4,176,468

Registered July 17, 2012

Int. Cl.: 8

TRADEMARK

PRINCIPAL REGISTER

KAI U.S.A., LTD. (OREGON CORPORATION), DBA KERSHAW KNIVES,
18600 SOUTHWEST TETON AVENUE
TUALATIN, OR 97062

FOR: KNIVES, IN CLASS 8 (U.S. CLS. 23, 28 AND 44).

FIRST USE 12-21-2011; IN COMMERCE 12-21-2011.

THE MARK CONSISTS OF STANDARD CHARACTERS WITHOUT CLAIM TO ANY PARTICULAR FONT, STYLE, SIZE, OR COLOR.

SN 85-197,446, FILED 12-14-2010.

MARY CRAWFORD, EXAMINING ATTORNEY



David J. Kybas

Director of the United States Patent and Trademark Office

United States of America

United States Patent and Trademark Office

DIALOG

Reg. No. 4,176,469

Registered July 17, 2012

Int. Cl.: 42

SERVICE MARK

PRINCIPAL REGISTER

DIALOG (CANADA PARTNERSHIP)
300, 134 11TH AVENUE SE
CALGARY, ALBERTA, CANADA T2G0X5

FOR: ARCHITECTURAL SERVICES; ENGINEERING SERVICES, NAMELY, STRUCTURAL, MECHANICAL AND ELECTRICAL ENGINEERING SERVICES; URBAN PLANNING SERVICES; INTERIOR DESIGN SERVICES; AND LANDSCAPE ARCHITECTURAL DESIGN SERVICES, IN CLASS 42 (U.S. CLS. 100 AND 101).

FIRST USE 6-1-2011; IN COMMERCE 9-15-2011.

THE MARK CONSISTS OF STANDARD CHARACTERS WITHOUT CLAIM TO ANY PARTICULAR FONT, STYLE, SIZE, OR COLOR.

PRIORITY CLAIMED UNDER SEC. 44(D) ON CANADA APPLICATION NO. 1487968, FILED 7-8-2010, REG. NO. TMA800,892, DATED 6-28-2011, EXPIRES 6-28-2026.

SN 85-197,829, FILED 12-14-2010.

CURTIS FRENCH, EXAMINING ATTORNEY



David J. Kybas

Director of the United States Patent and Trademark Office

United States of America

United States Patent and Trademark Office

X-MILL

Reg. No. 4,176,470

XTREME DRILLING AND COIL SERVICES CORP. (CANADA CORPORATION)
1402-500 4TH AVE S.W.

Registered July 17, 2012

CALGARY ALBERTA, CANADA T2P 2V6

Int. Cl.: 37

FOR: OIL AND GAS DRILLING, NAMELY, PROVIDING AUTOMATED MILLING SERVICES TO THE OIL AND GAS INDUSTRY USING COIL TUBING, IN CLASS 37 (U.S. CLS. 100, 103 AND 106).

SERVICE MARK

FIRST USE 9-1-2011; IN COMMERCE 9-1-2011.

PRINCIPAL REGISTER

THE MARK CONSISTS OF STANDARD CHARACTERS WITHOUT CLAIM TO ANY PARTICULAR FONT, STYLE, SIZE, OR COLOR.

SN 85-198,510, FILED 12-15-2010.

MARIA-VICTORIA SUAREZ, EXAMINING ATTORNEY



David J. Kyffers

Director of the United States Patent and Trademark Office

United States of America

United States Patent and Trademark Office

CYREL

Reg. No. 4,176,471

Registered July 17, 2012

Int. Cl.: 7

TRADEMARK

PRINCIPAL REGISTER

E. I. DU PONT DE NEMOURS AND COMPANY (DELAWARE CORPORATION)
1007 N. MARKET STREET
TRADEMARKS & COPYRIGHT GROUP
WILMINGTON, DE 19805

FOR: PARTS FOR PRINTING MACHINES, NAMELY, COMPRESSIBLE ADAPTERS FOR PRINTING SLEEVES, IN CLASS 7 (U.S. CLS. 13, 19, 21, 23, 31, 34 AND 35).

FIRST USE 9-1-1973; IN COMMERCE 9-1-1973.

THE MARK CONSISTS OF STANDARD CHARACTERS WITHOUT CLAIM TO ANY PARTICULAR FONT, STYLE, SIZE, OR COLOR.

OWNER OF U.S. REG. NOS. 1,002,617, 2,175,339, AND OTHERS.

SN 85-199,192, FILED 12-16-2010.

JULIE WATSON, EXAMINING ATTORNEY



David J. Kyffers

Director of the United States Patent and Trademark Office

United States of America

United States Patent and Trademark Office

OCEAN FRESH

Reg. No. 4,176,472

RECKITT BENCKISER LLC (DELAWARE LIMITED LIABILITY COMPANY)
399 INTERPACE PARKWAY
PARSIPPANY, NJ 07054

Registered July 17, 2012

Int. Cls.: 3 and 5

FOR: DISPOSABLE WIPES IMPREGNATED WITH CLEANING COMPOUNDS FOR USE ON HOUSEHOLD SURFACES, IN CLASS 3 (U.S. CLS. 1, 4, 6, 50, 51 AND 52).

TRADEMARK

FIRST USE 8-15-2010; IN COMMERCE 8-15-2010.

PRINCIPAL REGISTER

FOR: DISPOSABLE WIPES IMPREGNATED WITH DISINFECTING AND FUNGICIDAL COMPOUNDS FOR USE ON HOUSEHOLD SURFACES; SANITIZING WIPES, IN CLASS 5 (U.S. CLS. 6, 18, 44, 46, 51 AND 52).

FIRST USE 8-15-2010; IN COMMERCE 8-15-2010.

THE MARK CONSISTS OF STANDARD CHARACTERS WITHOUT CLAIM TO ANY PARTICULAR FONT, STYLE, SIZE, OR COLOR.

SN 85-200,298, FILED 12-17-2010.

LINDSEY RUBIN, EXAMINING ATTORNEY



David J. Kybas

Director of the United States Patent and Trademark Office

United States of America

United States Patent and Trademark Office

IHEARTRADIO

Reg. No. 4,176,473

CLEAR CHANNEL BROADCASTING, INC. (NEVADA CORPORATION)
200 EAST BASSE ROAD
SAN ANTONIO, TX 78209

Registered July 17, 2012

**Int. Cls.: 9, 38, 41, and
42**

FOR: DOWNLOADABLE COMPUTER SOFTWARE FOR PROVIDING MUSIC; DOWNLOADABLE SOFTWARE IN THE NATURE OF A MOBILE APPLICATION FOR TELECOMMUNICATIONS SERVICES FOR PROVIDING TRANSMISSION OF VOICE, DATA, VIDEO, AND MEDIA CONTENT VIA THE INTERNET AND THE WORLDWIDE WEB, IN CLASS 9 (U.S. CLS. 21, 23, 26, 36 AND 38).

TRADEMARK

SERVICE MARK

FIRST USE 10-31-2008; IN COMMERCE 10-31-2008.

PRINCIPAL REGISTER

FOR: DIGITAL AUDIO BROADCASTING AND PODCASTING SERVICES PROVIDED VIA A GLOBAL COMMUNICATIONS NETWORK, IN CLASS 38 (U.S. CLS. 100, 101 AND 104).

FIRST USE 10-31-2008; IN COMMERCE 10-31-2008.

FOR: ENTERTAINMENT SERVICES, NAMELY, PROVIDING A WEBSITE FEATURING MUSICAL PERFORMANCES, MUSIC VIDEOS, RELATED FILM CLIPS, PHOTOGRAPHS, AND OTHER MULTIMEDIA MATERIALS IN THE FIELDS OF MUSIC AND RADIO; PROVIDING NON-DOWNLOADABLE PRERECORDED MUSIC, INFORMATION IN THE FIELDS OF MUSIC AND RADIO, AND COMMENTARY AND ARTICLES ABOUT MUSIC AND RADIO, ALL ON-LINE VIA A GLOBAL COMMUNICATIONS NETWORK; PROVIDING NON-DOWNLOADABLE PLAYBACK OF MUSIC AND PROVIDING NON-DOWNLOADABLE PRERECORDED MUSIC ACCORDING TO CONSUMER PREFERENCES, ALL VIA A GLOBAL COMMUNICATIONS NETWORK; PROVIDING AN INTERNET WEBSITE PORTAL AND PODCASTS IN THE FIELDS OF MUSIC AND RADIO, IN CLASS 41 (U.S. CLS. 100, 101 AND 107).

FIRST USE 10-31-2008; IN COMMERCE 10-31-2008.

FOR: PROVIDING AN INTERACTIVE WEBSITE FEATURING TECHNOLOGY THAT ALLOWS USERS TO CONSOLIDATE AND MANAGE VOICE, DATA, VIDEO, AND MEDIA CONTENT IN THE FIELDS OF MUSIC AND RADIO, IN CLASS 42 (U.S. CLS. 100 AND 101).

FIRST USE 10-31-2008; IN COMMERCE 10-31-2008.



David J. Kyffers

Director of the United States Patent and Trademark Office

Reg. No. 4,176,473 THE MARK CONSISTS OF STANDARD CHARACTERS WITHOUT CLAIM TO ANY PARTICULAR FONT, STYLE, SIZE, OR COLOR.

OWNER OF U.S. REG. NOS. 3,683,932 AND 3,698,295.

SN 85-201,586, FILED 12-20-2010.

NANCY CLARKE, EXAMINING ATTORNEY

United States of America

United States Patent and Trademark Office

HUR SMART ZONE

Reg. No. 4,176,474

Registered July 17, 2012

Int. Cl.: 28

TRADEMARK

PRINCIPAL REGISTER

HUR USA INC (DELAWARE CORPORATION)
SUITE 108
1500 SHERMER ROAD
NORTHBROOK, IL 60062

FOR: FITNESS MACHINES AND EQUIPMENT, NAMELY, MANUALLY-OPERATED EXERCISE EQUIPMENT FOR CIRCUIT TRAINING, IN CLASS 28 (U.S. CLS. 22, 23, 38 AND 50).

FIRST USE 7-16-2007; IN COMMERCE 6-30-2008.

THE MARK CONSISTS OF STANDARD CHARACTERS WITHOUT CLAIM TO ANY PARTICULAR FONT, STYLE, SIZE, OR COLOR.

THE WORD(S) "HUR" HAS NO MEANING IN A FOREIGN LANGUAGE.

SN 85-202,412, FILED 12-21-2010.

AMY KELLY, EXAMINING ATTORNEY



David J. Kyffers

Director of the United States Patent and Trademark Office

United States of America

United States Patent and Trademark Office

Chess King

Reg. No. 4,176,475

BRANDED, LLC (GEORGIA LIMITED LIABILITY COMPANY)
3333 LEE PARKWAY 6TH FLOOR
DALLAS, TX 75219

Registered July 17, 2012

Int. Cl.: 25

FOR: CLOTHING, NAMELY, T-SHIRTS, SHIRTS, SWEATERS, PANTS, SHORTS, JACKETS, COATS, SWEATSHIRTS, SOCKS, BELTS, SCARVES; FOOTWEAR; HEADWEAR, IN CLASS 25 (U.S. CLS. 22 AND 39).

TRADEMARK

FIRST USE 12-21-2010; IN COMMERCE 12-21-2010.

PRINCIPAL REGISTER

THE MARK CONSISTS OF STANDARD CHARACTERS WITHOUT CLAIM TO ANY PARTICULAR FONT, STYLE, SIZE, OR COLOR.

SN 85-202,420, FILED 12-21-2010.

RAMONA ORTIGA, EXAMINING ATTORNEY



David J. Kyffers

Director of the United States Patent and Trademark Office

United States of America

United States Patent and Trademark Office



Reg. No. 4,176,476

DONUT JOE'S, INC. (ALABAMA CORPORATION)
1101 INDEPENDENCE DRIVE
ALABASTER, AL 35007

Registered July 17, 2012

Int. Cls.: 25, 30, and 43

FOR: BASEBALL CAPS AND HATS; SHORT-SLEEVED OR LONG-SLEEVED T-SHIRTS,
IN CLASS 25 (U.S. CLS. 22 AND 39).

TRADEMARK

FIRST USE 12-12-2009; IN COMMERCE 12-12-2009.

SERVICE MARK

FOR: DOUGHNUTS; MIXES FOR BAKERY GOODS; PREPARED COFFEE AND COFFEE-
BASED BEVERAGES; ROASTED COFFEE BEANS, IN CLASS 30 (U.S. CL. 46).

PRINCIPAL REGISTER

FIRST USE 2-28-2009; IN COMMERCE 6-26-2009.

FOR: RESTAURANT AND CAFE SERVICES, IN CLASS 43 (U.S. CLS. 100 AND 101).

FIRST USE 2-28-2009; IN COMMERCE 6-26-2009.

THE MARK CONSISTS OF THE STYLIZED WORDING "DONUT JOE'S" AND A DESIGN
OF A DONUT WITH HUMAN ATTRIBUTES WEARING A CHEF'S HAT AND HOLDING A
CUP OF COFFEE, ON AN OVAL SHAPED BACKGROUND CARRIER, ABOVE A SMALLER
OVAL BACKGROUND CARRIER CONTAINING THE WORDS "FRESH COFFEE & DONUTS
TO GO!".

SN 85-202,472, FILED 12-21-2010.

PATRICIA EVANKO, EXAMINING ATTORNEY



David J. Kybas

Director of the United States Patent and Trademark Office

United States of America

United States Patent and Trademark Office

CRUZE

Reg. No. 4,176,477

Registered July 17, 2012

Int. Cl.: 11

TRADEMARK

PRINCIPAL REGISTER

COOPER TECHNOLOGIES COMPANY (DELAWARE CORPORATION)
600 TRAVIS, SUITE 5600
HOUSTON, TX 77002

FOR: ELECTRICAL LIGHTING FIXTURES, IN CLASS 11 (U.S. CLS. 13, 21, 23, 31 AND 34).

FIRST USE 10-31-2010; IN COMMERCE 10-31-2010.

THE MARK CONSISTS OF STANDARD CHARACTERS WITHOUT CLAIM TO ANY PARTICULAR FONT, STYLE, SIZE, OR COLOR.

SN 85-202,789, FILED 12-21-2010.

NANCY CLARKE, EXAMINING ATTORNEY



David J. Kyffers

Director of the United States Patent and Trademark Office

United States of America

United States Patent and Trademark Office

TRANSITIONS

Reg. No. 4,176,478

MEDAMERICA INSURANCE COMPANY (PENNSYLVANIA CORPORATION)
165 COURT STREET
ROCHESTER, NY 14647

Registered July 17, 2012

Int. Cl.: 36

FOR: INSURANCE UNDERWRITING SERVICES IN THE FIELD OF SHORT TERM CARE INSURANCE, IN CLASS 36 (U.S. CLS. 100, 101 AND 102).

SERVICE MARK

FIRST USE 10-3-2011; IN COMMERCE 10-3-2011.

PRINCIPAL REGISTER

THE MARK CONSISTS OF STANDARD CHARACTERS WITHOUT CLAIM TO ANY PARTICULAR FONT, STYLE, SIZE, OR COLOR.

SN 85-203,845, FILED 12-22-2010.

SUSAN STIGLITZ, EXAMINING ATTORNEY



David J. Kybas

Director of the United States Patent and Trademark Office

United States of America

United States Patent and Trademark Office

The Makeup Lab

Reg. No. 4,176,479

Registered July 17, 2012

Int. Cl.: 44

SERVICE MARK

PRINCIPAL REGISTER

THE MAKEUP LAB ARTISTRY (LOUISIANA PARTNERSHIP)
843 CARONDELET ST. STUDIO #4
NEW ORLEANS, LA 70130

FOR: APPLICATION SERVICES IN THE FIELD OF MAKEUP, NAMELY, IN PERSON MAKEUP CONSULTATION AND MAKEUP APPLICATION; ONLINE MAKEUP CONSULTATION SERVICES; ON-LOCATION MAKEUP APPLICATION SERVICES FOR WEDDINGS, PHOTO SHOTS, FASHION, SPECIAL EFFECTS, BODY PAINTING, TELEVISION, FILM, AND THEATER, IN CLASS 44 (U.S. CLS. 100 AND 101).

FIRST USE 1-1-2009; IN COMMERCE 1-1-2009.

THE MARK CONSISTS OF STANDARD CHARACTERS WITHOUT CLAIM TO ANY PARTICULAR FONT, STYLE, SIZE, OR COLOR.

NO CLAIM IS MADE TO THE EXCLUSIVE RIGHT TO USE "MAKEUP", APART FROM THE MARK AS SHOWN.

SN 85-205,368, FILED 12-23-2010.

ELIZABETH KAJUBI, EXAMINING ATTORNEY



David J. Kyffers

Director of the United States Patent and Trademark Office

United States of America

United States Patent and Trademark Office

TANUKI SAKE

Reg. No. 4,176,480

Registered July 17, 2012

Int. Cl.: 33

TRADEMARK

PRINCIPAL REGISTER

TATSUUMA-HONKE BREWING CO., LTD (JAPAN CORPORATION)
2-10, TATEISHI-CHO, NISHINOMIYA-SHI
HYOGO, JAPAN 662-8510

FOR: SAKE, IN CLASS 33 (U.S. CLS. 47 AND 49).

FIRST USE 2-27-2012; IN COMMERCE 2-27-2012.

THE MARK CONSISTS OF STANDARD CHARACTERS WITHOUT CLAIM TO ANY PARTICULAR FONT, STYLE, SIZE, OR COLOR.

NO CLAIM IS MADE TO THE EXCLUSIVE RIGHT TO USE "SAKE", APART FROM THE MARK AS SHOWN.

THE ENGLISH TRANSLATION OF "TANUKI" IN THE MARK IS RACCOON DOG.

SN 85-206,523, FILED 12-28-2010.

ALLISON HOLTZ, EXAMINING ATTORNEY



David J. Kybas

Director of the United States Patent and Trademark Office

United States of America

United States Patent and Trademark Office

LIFT by PCI

Reg. No. 4,176,481

PROGRAMMING CONCEPTS, LTD. (TEXAS LIMITED PARTNERSHIP)
4560 LOCKHILL SELMA ROAD, SUITE 100
SAN ANTONIO, TX 78249

Registered July 17, 2012

Int. Cls.: 9, 16, and 41

FOR: DIGITAL MATERIALS, NAMELY, CDS, DVDS, DOWNLOADABLE PDF FILES, AND DOWNLOADABLE COMPUTER SOFTWARE FEATURING READING-LANGUAGE ARTS, MATH, SOCIAL STUDIES, SCIENCE, AND LIFE SKILLS, IN CLASS 9 (U.S. CLS. 21, 23, 26, 36 AND 38).

TRADEMARK

SERVICE MARK

FIRST USE 2-1-2011; IN COMMERCE 2-1-2011.

PRINCIPAL REGISTER

FOR: PRINTED INSTRUCTIONAL, EDUCATIONAL, AND TEACHING MATERIALS IN THE FIELD OF READING-LANGUAGE ARTS, MATH, SOCIAL STUDIES, SCIENCE, AND LIFE SKILLS, IN CLASS 16 (U.S. CLS. 2, 5, 22, 23, 29, 37, 38 AND 50).

FIRST USE 2-1-2011; IN COMMERCE 2-1-2011.

FOR: EDUCATIONAL ASSESSMENT; INSTRUCTION IN THE FIELD OF READING-LANGUAGE ARTS, MATH, SOCIAL STUDIES, SCIENCE, AND LIFE SKILLS; TRAINING SERVICES IN THE FIELD OF READING-LANGUAGE ARTS, MATH, SOCIAL STUDIES, SCIENCE, AND LIFE SKILLS; EDUCATION SERVICES, NAMELY, PROVIDING WORKSHOPS IN THE FIELD OF READING-LANGUAGE ARTS, MATH, SOCIAL STUDIES, SCIENCE, AND LIFE SKILLS; EDUCATION SERVICES, NAMELY, PROVIDING ON-LINE WORKSHOPS IN THE FIELD OF READING-LANGUAGE ARTS, MATH, SOCIAL STUDIES, SCIENCE, AND LIFE SKILLS, IN CLASS 41 (U.S. CLS. 100, 101 AND 107).

FIRST USE 2-1-2011; IN COMMERCE 2-1-2011.

THE MARK CONSISTS OF STANDARD CHARACTERS WITHOUT CLAIM TO ANY PARTICULAR FONT, STYLE, SIZE, OR COLOR.

SN 85-206,688, FILED 12-28-2010.

ROBERT C. CLARK JR., EXAMINING ATTORNEY



David J. Kyffers

Director of the United States Patent and Trademark Office

United States of America

United States Patent and Trademark Office

INFILL

Reg. No. 4,176,482

Registered July 17, 2012

Int. Cl.: 10

TRADEMARK

PRINCIPAL REGISTER

PINNACLE SPINE GROUP, LLC (TEXAS LIMITED LIABILITY COMPANY)
1601 ELM STREET, SUITE 300
DALLAS, TX 75201

FOR: MEDICAL APPARATUS, NAMELY, A SPINAL FUSION DEVICE; SPINAL IMPLANTS COMPOSED OF ARTIFICIAL MATERIAL; SURGICAL INSTRUMENTS FOR USE IN ORTHOPEDIC AND SPINAL SURGERY, IN CLASS 10 (U.S. CLS. 26, 39 AND 44).

FIRST USE 8-11-2011; IN COMMERCE 8-11-2011.

THE MARK CONSISTS OF STANDARD CHARACTERS WITHOUT CLAIM TO ANY PARTICULAR FONT, STYLE, SIZE, OR COLOR.

SN 85-206,821, FILED 12-28-2010.

RONALD DELGIZZI, EXAMINING ATTORNEY



David J. Kybas

Director of the United States Patent and Trademark Office

United States of America

United States Patent and Trademark Office

Asset-Assure

Reg. No. 4,176,483

ASSET ARCHIVING SERVICES, INC. (OHIO CORPORATION)

Registered July 17, 2012

8965 LANES END DRIVE
NOVELTY, OH 44072

Int. Cl.: 45

FOR: COMPILING INVENTORIES OF PERSONAL ITEMS FOR OTHERS FOR INSURANCE, OR SECURITY, OR ESTATE PLANNING PURPOSES, IN CLASS 45 (U.S. CLS. 100 AND 101).

SERVICE MARK

FIRST USE 3-23-2012; IN COMMERCE 3-23-2012.

PRINCIPAL REGISTER

THE MARK CONSISTS OF STANDARD CHARACTERS WITHOUT CLAIM TO ANY PARTICULAR FONT, STYLE, SIZE, OR COLOR.

SN 85-207,013, FILED 12-29-2010.

JENNIFER MARTIN, EXAMINING ATTORNEY



David J. Kyffers

Director of the United States Patent and Trademark Office

United States of America

United States Patent and Trademark Office

INDEPENDENT. OPTIONS.

Reg. No. 4,176,484

LATHAM HI-TECH HYBRIDS, INC. (IOWA CORPORATION)
131 180TH STREET
ALEXANDER, IA 50420

Registered July 17, 2012

Int. Cl.: 31

FOR: AGRICULTURAL SEEDS, NAMELY, SOYBEAN SEEDS, HYBRID SEED CORN, ALFALFA SEEDS, IN CLASS 31 (U.S. CLS. 1 AND 46).

TRADEMARK

FIRST USE 12-1-2011; IN COMMERCE 12-1-2011.

PRINCIPAL REGISTER

THE MARK CONSISTS OF STANDARD CHARACTERS WITHOUT CLAIM TO ANY PARTICULAR FONT, STYLE, SIZE, OR COLOR.

SN 85-207,144, FILED 12-29-2010.

ALICIA COLLINS, EXAMINING ATTORNEY



David J. Kybas

Director of the United States Patent and Trademark Office

United States of America

United States Patent and Trademark Office

amalto
e-BusinessCloud

Reg. No. 4,176,485

Registered July 17, 2012

Int. Cl.: 42

SERVICE MARK

PRINCIPAL REGISTER

AMALTO TECHNOLOGIES CORPORATION (DELAWARE CORPORATION)
4545 POST OAK PLACE
HOUSTON, TX 94403

FOR: SOFTWARE AS A SERVICE (SAAS) ENABLING AUTOMATED AND SEAMLESS DATA EXCHANGE; CONSULTING SERVICES IN THE FIELD OF CLOUD COMPUTING; COMPUTER SOFTWARE CONSULTING SERVICES CONCERNING DATA EXCHANGES AND FACILITATING SYSTEM INTEGRATION; COMPUTER SOFTWARE DEVELOPMENT SERVICES CONCERNING DATA EXCHANGES AND FACILITATING SYSTEM INTEGRATION, IN CLASS 42 (U.S. CLS. 100 AND 101).

FIRST USE 10-13-2011; IN COMMERCE 10-13-2011.

NO CLAIM IS MADE TO THE EXCLUSIVE RIGHT TO USE "E-BUSINESSCLOUD", APART FROM THE MARK AS SHOWN.

THE COLOR(S) BLACK, GRAY AND GREEN IS/ARE CLAIMED AS A FEATURE OF THE MARK.

THE MARK CONSISTS OF THE WORDING "AMALTO E-BUSINESSCLOUD". THE LETTERS "AMALT" APPEAR IN BLACK WITH THE FOLLOWING "O" IN GREEN. THE LETTERING "E-BUSINESS" APPEARS IN BLACK WITH GRAY SHADING UNDERNEATH, WHILE THE WORDING "CLOUD" APPEARS IN GREEN WITH GREEN SHADING.

SN 85-207,478, FILED 12-29-2010.

JORDAN BAKER, EXAMINING ATTORNEY



David J. Kyffers

Director of the United States Patent and Trademark Office

United States of America

United States Patent and Trademark Office



Reg. No. 4,176,486

YI WU, RUAN (CHINA INDIVIDUAL), DBA AUDIO PRODUCTS MANUFACTURER,
220 ATHOL AVE.

Registered July 17, 2012

OAKLAND, CA 946061313

Int. Cl.: 9

FOR: AUDIO AMPLIFIERS; AUDIO CABLES; AUDIO CIRCUIT BOARDS; AUDIO ELECTRONIC COMPONENTS, NAMELY, SURROUND SOUND SYSTEMS; AUDIO EQUIPMENT FOR VEHICLES, NAMELY, LOUD SPEAKERS FOR AUTOMOTIVE AUDIO SYSTEMS; AUDIO EQUIPMENT FOR VEHICLES, NAMELY, SPEAKERS, AMPLIFIERS, CROSSOVERS AND SPEAKER HOUSINGS; AUDIO EQUIPMENT FOR VEHICLES, NAMELY, SUBWOOFERS; AUDIO SPEAKER ENCLOSURES; AUDIO SPEAKERS; AUDIO-FREQUENCY TRANSFORMERS; CONSUMER ELECTRONIC PRODUCTS, NAMELY, AUDIO AMPLIFIERS, AUDIO SPEAKERS, ELECTRICAL AUDIO AND SPEAKER CABLES AND CONNECTORS, HOME THEATER SYSTEMS; BOXES SPECIALLY ADAPTED FOR HOUSING AUDIO EQUIPMENT; ELECTRONIC INTER CONNECTERS FOR AUDIO AND VIDEO SIGNALS; DISTRIBUTION AMPLIFIERS FOR AUDIO AND VIDEO SIGNALS; ELECTRONIC EQUIPMENT, NAMELY, TRANSFORMERS; HOME THEATER SYSTEMS COMPRISING SPEAKERS, AMPLIFIERS; STANDS SPECIALLY ADAPTED FOR STEREOS AND AUDIO SPEAKERS, IN CLASS 9 (U.S. CLS. 21, 23, 26, 36 AND 38).

TRADEMARK

PRINCIPAL REGISTER

FIRST USE 5-1-2012; IN COMMERCE 5-1-2012.

NO CLAIM IS MADE TO THE EXCLUSIVE RIGHT TO USE "AUTHENTIC FIDELITY", APART FROM THE MARK AS SHOWN.

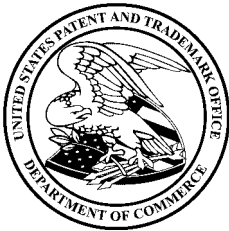

THE COLOR(S) RED, WHITE, AND BLACK IS/ARE CLAIMED AS A FEATURE OF THE MARK.

THE MARK CONSISTS OF THE WORDING "MBAUDIO" ON A BLACK BACKGROUND WITH THE WORDING "AUTHENTIC FIDELITY" APPEARING ON A RED RECTANGLE BENEATH "MBAUDIO". THE COLOR WHITE APPEARS IN THE WORDING "MBAUDIO AUTHENTIC FIDELITY". THE COLOR RED APPEARS IN THE RECTANGLE AND IN THE DOT OF THE "I" IN "MBAUDIO". THE COLOR BLACK APPEARS IN THE BACKGROUND OF THE MARK.

David J. Kypas

SN 85-207,690, FILED 12-30-2010.

Director of the United States Patent and Trademark Office

LAURIE KAUFMAN, EXAMINING ATTORNEY

United States of America

United States Patent and Trademark Office

BONA RECOAT SYSTEM

Reg. No. 4,176,487

Registered July 17, 2012

Int. Cls.: 2 and 3

TRADEMARK

PRINCIPAL REGISTER

BONA AB (SWEDEN CORPORATION)
P.O. BOX 21074, MURMANSGATAN 130
SE-200 21 MALMÖ, SWEDEN

FOR: COATINGS IN THE NATURE OF WOOD FLOOR FINISHES, IN CLASS 2 (U.S. CLS. 6, 11 AND 16).

FIRST USE 5-11-2012; IN COMMERCE 5-11-2012.

FOR: WOOD FLOOR CLEANERS, IN CLASS 3 (U.S. CLS. 1, 4, 6, 50, 51 AND 52).

FIRST USE 6-30-2011; IN COMMERCE 6-30-2011.

THE MARK CONSISTS OF STANDARD CHARACTERS WITHOUT CLAIM TO ANY PARTICULAR FONT, STYLE, SIZE, OR COLOR.

OWNER OF U.S. REG. NOS. 1,640,991, 3,457,098, AND OTHERS.

NO CLAIM IS MADE TO THE EXCLUSIVE RIGHT TO USE "RECOAT SYSTEM", APART FROM THE MARK AS SHOWN.

SN 85-208,292, FILED 12-30-2010.

JULIE WATSON, EXAMINING ATTORNEY



David J. Kyfos

Director of the United States Patent and Trademark Office

United States of America

United States Patent and Trademark Office

AMPEC

Reg. No. 4,176,488

Registered July 17, 2012

Int. Cls.: 9 and 11

TRADEMARK

PRINCIPAL REGISTER

AMPEC INNOVATIONS, INC. (TAIWAN CORPORATION)
16F.-5, NO. 33
TZU-HUI 3RD STREET, CHUNG-LI CITY
TAOYUAN COUNTY 32085, TAIWAN

FOR: ATTENUATORS; CABLE CONNECTORS; COAXIAL CABLES; JUMPER CABLES; THREADED CABLE CONNECTORS OF METAL; COAXIAL CABLE CONNECTORS, NAMELY, F-CONNECTORS, BNC CONNECTORS, SATELLITE CONNECTORS, MINI CONNECTORS, HEAD-END CONNECTORS, MINI HEAD-END CONNECTORS; COAXIAL CABLE JUMPERS; CATV HARDLINE CONNECTORS, IN CLASS 9 (U.S. CLS. 21, 23, 26, 36 AND 38).

FIRST USE 4-20-2012; IN COMMERCE 4-20-2012.

FOR: STREET LAMPS; AUTOMOTIVE LIGHTING HEADLIGHTS FOR VEHICLES; CEILING LIGHTS; DISCHARGE LAMPS AND THEIR FITTINGS; DIVING LIGHTS; ELECTRIC LAMPS; ELECTRIC LUMINARIES; ELECTRIC TRACK LIGHTING UNITS; FLASHLIGHT POINTERS; FLASHLIGHTS; FLAT PANEL LIGHTING APPARATUS; FLOODLIGHTS; HIGH INTENSITY SEARCH LIGHTS; LAMP REFLECTORS; LAMP SHADES; LAMP WHOSE LIGHT CAN BE TURNED IN ALL DIRECTIONS; LAMPS; LAMPS FOR OUTDOOR USE; LED LIGHT ASSEMBLIES FOR STREET LIGHTS, SIGNS, COMMERCIAL LIGHTING, AUTOMOBILES, BUILDINGS, AND OTHER ARCHITECTURAL USES; LED LIGHTING SYSTEMS, NAMELY, LED MODULES, POWER SUPPLIES, AND WIRING; LED LUMINARIES; LIGHT REFLECTORS; LIGHTING APPARATUS FOR SPORTS ARENAS; LIGHTS FOR FIREARMS; LIGHTS FOR VEHICLES; LUMINAIRE REFRACTORS; LUMINARIES, USING LIGHT EMITTING DIODES (LEDS) AS A LIGHT SOURCE, FOR STREET OR ROADWAY LIGHTING; LUMINARIES; MOBILE LIGHT TOWERS; OVERHEAD LAMPS; POCKET SEARCH LIGHTS; PORTABLE UTILITY LIGHTS; PROJECTOR LAMPS; ROADLIGHTS; SEARCHLIGHTS; SPOT LIGHTS; TACTICAL FLASHLIGHTS, IN CLASS 11 (U.S. CLS. 13, 21, 23, 31 AND 34).

FIRST USE 4-20-2012; IN COMMERCE 4-20-2012.

THE MARK CONSISTS OF SLIGHTLY STYLIZED LETTERS "AMPEC".

SN 85-208,630, FILED 12-31-2010.

LIEF MARTIN, EXAMINING ATTORNEY



David J. Kyros

Director of the United States Patent and Trademark Office

United States of America

United States Patent and Trademark Office



Reg. No. 4,176,489

Registered July 17, 2012

Int. Cl.: 5

TRADEMARK

PRINCIPAL REGISTER

ADVANCED DERMATOLOGIC SOLUTIONS, LLC (GEORGIA LIMITED LIABILITY COMPANY)
2900 DELK RD. STE 700-178
MARIETTA, GA 30067

FOR: DERMATOLOGICAL PHARMACEUTICAL PREPARATIONS, NAMELY, ORAL NEUTRACEUTICALS FOR THE TREATMENT OF ROSACEA, IN CLASS 5 (U.S. CLS. 6, 18, 44, 46, 51 AND 52).

FIRST USE 1-1-2012; IN COMMERCE 1-1-2012.

THE MARK CONSISTS OF THE STYLIZED LETTERS "RO" IN RED WITH THE LINE ABOVE THE LETTER "O" IN BLUE AND THE STYLIZED LETTERS "CLEARA" IN BLUE.

THE COLOR(S) RED AND BLUE IS/ARE CLAIMED AS A FEATURE OF THE MARK.

SN 85-208,738, FILED 12-31-2010.

HELENE LIWINSKI, EXAMINING ATTORNEY



David J. Kyjars

Director of the United States Patent and Trademark Office

United States of America

United States Patent and Trademark Office

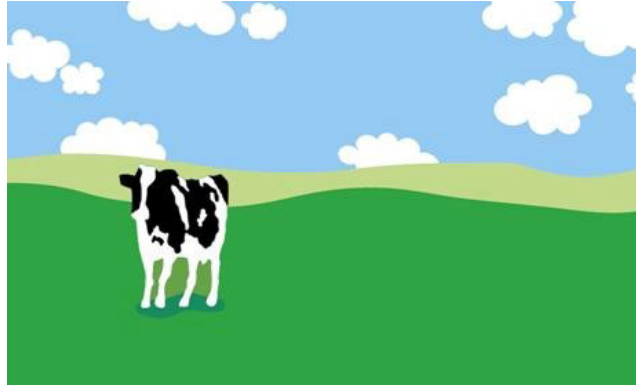

Reg. No. 4,176,490

Registered July 17, 2012

**Int. Cls.: 25, 29, 30, 32,
and 43**

TRADEMARK

SERVICE MARK

PRINCIPAL REGISTER

BEN & JERRY'S HOMEMADE, INC. (VERMONT CORPORATION)
30 COMMUNITY DRIVE, SUITE 1
SOUTH BURLINGTON, VT 054036828

FOR: CLOTHING, NAMELY, HATS, T-SHIRTS, SWEATERS, JACKETS, SOCKS, IN CLASS 25 (U.S. CLS. 22 AND 39).

FIRST USE 0-0-1986; IN COMMERCE 0-0-1986.

FOR: YOGHURT BASED PRODUCTS, NAMELY, YOGHURT BASED DRINKS, IN CLASS 29 (U.S. CL. 46).

FIRST USE 0-0-1986; IN COMMERCE 0-0-1986.

FOR: COFFEE, COOKIES AND BISCUITS; CONFECTIONERY, NAMELY, CHOCOLATES; ICE CREAMS; FROZEN CONFECTIONS; MILK SHAKES; FROZEN YOGHURT, IN CLASS 30 (U.S. CL. 46).

FIRST USE 0-0-1986; IN COMMERCE 0-0-1986.

FOR: NON-ALCOHOLIC DRINKS, NAMELY, SMOOTHIES, COFFEE BASED FROZEN DRINKS, IN CLASS 32 (U.S. CLS. 45, 46 AND 48).

FIRST USE 0-0-1986; IN COMMERCE 0-0-1986.

FOR: RESTAURANTS, ICE CREAM PARLOURS, IN CLASS 43 (U.S. CLS. 100 AND 101).

FIRST USE 0-0-1986; IN COMMERCE 0-0-1986.

THE MARK CONSISTS OF THE IMAGE OF A COW IN BLACK AND WHITE, STANDING ON GREEN PASTURE. THE PASTURE HAS A SHADE OF LIGHTER GREEN ON THE HORIZON WHERE IT MEETS AN IMAGE OF A BLUE SKY WITH WHITE CLOUDS AS PART OF THE BACKGROUND.

THE COLOR(S) BLACK, WHITE, GREEN AND BLUE IS/ARE CLAIMED AS A FEATURE OF THE MARK.



David J. Kybas

Director of the United States Patent and Trademark Office

Reg. No. 4,176,490 SN 85-208,791, FILED 1-1-2011.

RICHARD WHITE, EXAMINING ATTORNEY

United States of America

United States Patent and Trademark Office

PAWS PREMIUM

Reg. No. 4,176,491

Registered July 17, 2012

Int. Cl.: 18

TRADEMARK

PRINCIPAL REGISTER

TOPCO HOLDINGS, INC. (WISCONSIN CORPORATION)
7711 GROSS POINT ROAD
SKOKIE, IL 60077

FOR: RAWHIDE CHEWS FOR DOGS, IN CLASS 18 (U.S. CLS. 1, 2, 3, 22 AND 41).

FIRST USE 3-0-2011; IN COMMERCE 3-0-2011.

THE MARK CONSISTS OF STANDARD CHARACTERS WITHOUT CLAIM TO ANY PARTICULAR FONT, STYLE, SIZE, OR COLOR.

OWNER OF U.S. REG. NOS. 3,139,770, 3,230,447, AND 3,441,390.

NO CLAIM IS MADE TO THE EXCLUSIVE RIGHT TO USE "PREMIUM", APART FROM THE MARK AS SHOWN.

SN 85-209,355, FILED 1-3-2011.

TEJBIR SINGH, EXAMINING ATTORNEY



David J. Kyffers

Director of the United States Patent and Trademark Office

United States of America

United States Patent and Trademark Office

gypsee

Reg. No. 4,176,492

Registered July 17, 2012

Int. Cl.: 28

TRADEMARK

PRINCIPAL REGISTER

FAIOLA, MICHAEL (UNITED STATES INDIVIDUAL)
18700 FOUNTAIN TERRACE
HAGERSTOWN, MD 21742

FOR: PET TOYS, IN CLASS 28 (U.S. CLS. 22, 23, 38 AND 50).

FIRST USE 12-9-2011; IN COMMERCE 5-15-2012.

THE MARK CONSISTS OF STANDARD CHARACTERS WITHOUT CLAIM TO ANY PARTICULAR FONT, STYLE, SIZE, OR COLOR.

SN 85-209,560, FILED 1-3-2011.

ROBERT C. CLARK JR., EXAMINING ATTORNEY



David J. Kybas

Director of the United States Patent and Trademark Office

United States of America

United States Patent and Trademark Office

SHOULDN'T YOUR LAWN LOOK
AS GOOD AS YOU DO?

Reg. No. 4,176,493

TAMPA LAWN SALON, INC. (FLORIDA CORPORATION)

Registered July 17, 2012

P.O. BOX 46674
TAMPA, FL 33646

Int. Cl.: 44

FOR: APPLICATION OF FERTILIZER AND AGRICULTURAL CHEMICALS FOR OTHERS; FERTILIZER SPREADING; HORTICULTURAL SERVICES, NAMELY, INSTALLING SOD; LANDSCAPE DESIGN; LANDSCAPE GARDENING; LANDSCAPE GARDENING DESIGN FOR OTHERS; LAWN CARE; PEST CONTROL SERVICES FOR AGRICULTURE, HORTICULTURE OR FORESTRY, IN CLASS 44 (U.S. CLS. 100 AND 101).

SERVICE MARK

PRINCIPAL REGISTER

FIRST USE 4-0-2012; IN COMMERCE 4-0-2012.

THE MARK CONSISTS OF STANDARD CHARACTERS WITHOUT CLAIM TO ANY PARTICULAR FONT, STYLE, SIZE, OR COLOR.

SN 85-210,706, FILED 1-5-2011.

REGINA DRUMMOND, EXAMINING ATTORNEY



David J. Kyjars

Director of the United States Patent and Trademark Office

United States of America

United States Patent and Trademark Office

FRUIT RIDGE FARMS

Reg. No. 4,176,494

Registered July 17, 2012

Int. Cls.: 29 and 30

TRADEMARK

PRINCIPAL REGISTER

S. ABRAHAM & SONS, INC. (MICHIGAN CORPORATION)
4001--3 MILE ROAD NW
WALKER, MI 49504

FOR: SANDWICHES, PIGS-IN-A-BLANKET, GARDEN SALADS, COLESLAW, POTATO SALAD, FRUIT SALADS AND VEGETABLE SALADS AND PREPARED ENTREES CONSISTING PRIMARILY OF VEGETABLE SALADS , IN CLASS 29 (U.S. CL. 46).

FIRST USE 12-31-2010; IN COMMERCE 12-31-2010.

FOR: PASTA SALAD, IN CLASS 30 (U.S. CL. 46).

FIRST USE 12-31-2010; IN COMMERCE 12-31-2010.

THE MARK CONSISTS OF STANDARD CHARACTERS WITHOUT CLAIM TO ANY PARTICULAR FONT, STYLE, SIZE, OR COLOR.

NO CLAIM IS MADE TO THE EXCLUSIVE RIGHT TO USE "FARMS", APART FROM THE MARK AS SHOWN.

SN 85-210,970, FILED 1-5-2011.

LINDA MICKLEBURGH, EXAMINING ATTORNEY



David J. Kyros

Director of the United States Patent and Trademark Office

United States of America

United States Patent and Trademark Office



Reg. No. 4,176,495

Registered July 17, 2012

Int. Cls.: 29 and 30

TRADEMARK

PRINCIPAL REGISTER

S. ABRAHAM & SONS, INC. (MICHIGAN CORPORATION)
4001--3 MILE ROAD NW
WALKER, MI 49504

FOR: SANDWICHES, PIGS-IN-A-BLANKET, GARDEN SALADS, COLESLAW, POTATO SALAD, FRUIT SALADS AND VEGETABLE SALADS AND PREPARED ENTREES CONSISTING PRIMARILY OF VEGETABLE SALADS, IN CLASS 29 (U.S. CL. 46).

FIRST USE 12-31-2010; IN COMMERCE 12-31-2010.

FOR: PASTA SALAD, IN CLASS 30 (U.S. CL. 46).

FIRST USE 12-31-2010; IN COMMERCE 12-31-2010.

NO CLAIM IS MADE TO THE EXCLUSIVE RIGHT TO USE "FARMS" AND "QUALITY" AND "FRESH", APART FROM THE MARK AS SHOWN.

THE MARK CONSISTS OF AN OVAL CONTAINING A DESIGN OF FARM FIELDS WITH A BARN AND A BUSHEL BASKET AT THE FOREFRONT CONTAINING VEGETABLES AND FRUIT; AT THE TOP OF THE OVAL IS THE WORDS "FRUIT RIDGE FARMS"; AT THE BOTTOM THE TERM "QUALITY FRESH" SEPARATED BY A SMALL FLOWER.

SN 85-210,992, FILED 1-5-2011.

LINDA MICKLEBURGH, EXAMINING ATTORNEY



David J. Kyros

Director of the United States Patent and Trademark Office

United States of America

United States Patent and Trademark Office

SoftTouch

Reg. No. 4,176,496

AUDINA HEARING INSTRUMENTS, INC. (FLORIDA CORPORATION)
165 E. WILDMERE AVENUE
LONGWOOD, FL 32750

Registered July 17, 2012

Int. Cl.: 10

FOR: MEDICAL HEARING INSTRUMENTS AND PARTS OF SUCH DEVICES, IN CLASS 10 (U.S. CLS. 26, 39 AND 44).

TRADEMARK

FIRST USE 4-1-2011; IN COMMERCE 4-1-2011.

PRINCIPAL REGISTER

THE MARK CONSISTS OF STANDARD CHARACTERS WITHOUT CLAIM TO ANY PARTICULAR FONT, STYLE, SIZE, OR COLOR.

OWNER OF U.S. REG. NO. 3,800,096.

SN 85-211,089, FILED 1-5-2011.

MICHAEL WEBSTER, EXAMINING ATTORNEY



David J. Kyros

Director of the United States Patent and Trademark Office

United States of America

United States Patent and Trademark Office

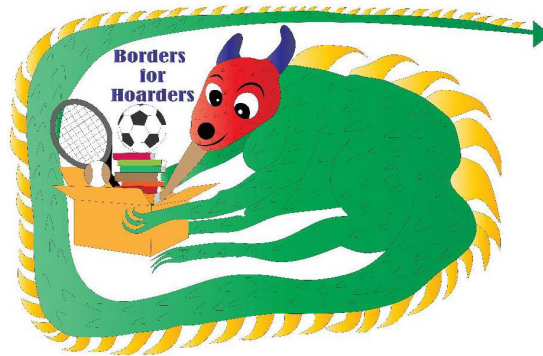

Reg. No. 4,176,497

Registered July 17, 2012

Int. Cl.: 35

SERVICE MARK

PRINCIPAL REGISTER

SCHMERGEL, JOANNA (UNITED STATES INDIVIDUAL)
99 PAULSON ROAD
WABAN, MA 02468

FOR: PROVIDING ORGANIZING SERVICES FOR INDIVIDUALS AT HOME, IN HOME OFFICES AND IN BUSINESS OFFICES, THAT PROVIDES HELP WITH TIME AND PAPER MANAGEMENT, IN CLASS 35 (U.S. CLS. 100, 101 AND 102).

FIRST USE 4-7-2011; IN COMMERCE 4-7-2011.

THE MARK CONSISTS OF THE WORDING "BORDERS FOR HOARDERS" IN BLUE AND A GREEN AND YELLOW DRAGON WITH A RED FACE, BLUE HORNS AND WHITE AND BLACK EYES CLUTCHING A YELLOW BOX WITH RED, GREEN, BROWN, ORANGE AND YELLOW BOOKS, A BROWN AND WHITE TENNIS BALL, A BLACK AND WHITE SOCCER BALL AND A GRAY TENNIS RACKET.

THE COLOR(S) GREEN, YELLOW, RED, BLUE, WHITE, BLACK, BROWN, ORANGE AND GRAY IS/ARE CLAIMED AS A FEATURE OF THE MARK.

SN 85-211,618, FILED 1-6-2011.

MARY ROSSMAN, EXAMINING ATTORNEY



David J. Kybas

Director of the United States Patent and Trademark Office

United States of America

United States Patent and Trademark Office

ZAVU

Reg. No. 4,176,498

Registered July 17, 2012

Int. Cl.: 41

SERVICE MARK

PRINCIPAL REGISTER

ROTTGER, GARY (UNITED STATES INDIVIDUAL)
1835 E HALLANDALE BEACH BLVD. #501
HALLANDALE, FL 33009

FOR: ENTERTAINMENT IN THE NATURE OF VISUAL AND AUDIO PERFORMANCES, NAMELY, MUSICAL BAND, ROCK GROUP, GYMNASTIC, DANCE, AND BALLET PERFORMANCES, IN CLASS 41 (U.S. CLS. 100, 101 AND 107).

FIRST USE 9-9-2009; IN COMMERCE 9-9-2011.

THE MARK CONSISTS OF STANDARD CHARACTERS WITHOUT CLAIM TO ANY PARTICULAR FONT, STYLE, SIZE, OR COLOR.

SN 85-212,877, FILED 1-7-2011.

KEVIN DINALLO, EXAMINING ATTORNEY



David J. Kyffers

Director of the United States Patent and Trademark Office

United States of America

United States Patent and Trademark Office

EZ LIMIT

Reg. No. 4,176,499

OVERHEAD DOOR CORPORATION (INDIANA CORPORATION)
2501 SOUTH STATE HWY 121, SUITE 200
LEWISVILLE, TX 75067

Registered July 17, 2012

Int. Cl.: 9

FOR: ELECTRONIC COMMERCIAL GARAGE DOOR OPENERS, IN CLASS 9 (U.S. CLS. 21, 23, 26, 36 AND 38).

TRADEMARK

FIRST USE 5-14-2012; IN COMMERCE 5-14-2012.

PRINCIPAL REGISTER

THE MARK CONSISTS OF STANDARD CHARACTERS WITHOUT CLAIM TO ANY PARTICULAR FONT, STYLE, SIZE, OR COLOR.

SN 85-213,254, FILED 1-7-2011.

JAY FLOWERS, EXAMINING ATTORNEY



David J. Kyffers

Director of the United States Patent and Trademark Office

United States of America

United States Patent and Trademark Office

Food Gang Industries

Reg. No. 4,176,500

Registered July 17, 2012

Int. Cl.: 25

TRADEMARK

PRINCIPAL REGISTER

RINCON, SERGIO (UNITED STATES INDIVIDUAL)
SUITE 120
6500 GREENVILLE AVE.
DALLAS, TX 75206

FOR: APRONS; CHEF'S COATS; CHEF'S HATS; HATS; JACKETS; SWEAT PANTS; SWEAT SHIRTS; SWEATERS; T-SHIRTS; UNIFORMS, IN CLASS 25 (U.S. CLS. 22 AND 39).

FIRST USE 12-28-2010; IN COMMERCE 5-7-2011.

THE MARK CONSISTS OF STANDARD CHARACTERS WITHOUT CLAIM TO ANY PARTICULAR FONT, STYLE, SIZE, OR COLOR.

NO CLAIM IS MADE TO THE EXCLUSIVE RIGHT TO USE "INDUSTRIES", APART FROM THE MARK AS SHOWN.

SN 85-213,342, FILED 1-7-2011.

RONALD DELGIZZI, EXAMINING ATTORNEY



David J. Kyffers

Director of the United States Patent and Trademark Office

United States of America

United States Patent and Trademark Office

LIPOSONIX.COM

Reg. No. 4,176,501

Registered July 17, 2012

Int. Cls.: 35 and 44

SERVICE MARK

PRINCIPAL REGISTER

LIPOSONIX, INC. (DELAWARE CORPORATION)
C/O SOLTA MEDICAL, INC.
25881 INDUSTRIAL BOULEVARD
HAYWARD, CA 945452991

FOR: RETAIL STORE SERVICES VIA GLOBAL COMPUTER NETWORK FEATURING MEDICAL INSTRUMENTS AND DEVICES, IN CLASS 35 (U.S. CLS. 100, 101 AND 102).

FIRST USE 10-17-2000; IN COMMERCE 10-17-2000.

FOR: PROVIDING A WEBSITE FEATURING INFORMATION IN THE FIELD OF MEDICAL SERVICES RELATING TO PROCEDURES IN THE NATURE OF BODY CONTOURING, IN CLASS 44 (U.S. CLS. 100 AND 101).

FIRST USE 10-17-2000; IN COMMERCE 10-17-2000.

THE MARK CONSISTS OF STANDARD CHARACTERS WITHOUT CLAIM TO ANY PARTICULAR FONT, STYLE, SIZE, OR COLOR.

OWNER OF U.S. REG. NO. 2,896,037.

SN 85-213,348, FILED 1-7-2011.

ZACHARY BELLO, EXAMINING ATTORNEY



David J. Kypos

Director of the United States Patent and Trademark Office

United States of America

United States Patent and Trademark Office

QUICK PRO

Reg. No. 4,176,502

Registered July 17, 2012

Int. Cl.: 36

SERVICE MARK

PRINCIPAL REGISTER

GREAT AMERICAN INSURANCE COMPANY (OHIO CORPORATION)
301 EAST FOURTH STREET
GREAT AMERICAN TOWER 15S
CINCINNATI, OH 45202

FOR: INSURANCE SERVICES, NAMELY, LIABILITY, GENERAL LIABILITY, EXCESS LIABILITY, UMBRELLA LIABILITY, DIRECTORS' AND OFFICERS' LIABILITY, EMPLOYMENT PRACTICES LIABILITY AND EMPLOYEE DISHONESTY, NAMELY, CRIME LIABILITY INSURANCE, IN CLASS 36 (U.S. CLS. 100, 101 AND 102).

FIRST USE 11-15-2010; IN COMMERCE 11-15-2010.

THE MARK CONSISTS OF STANDARD CHARACTERS WITHOUT CLAIM TO ANY PARTICULAR FONT, STYLE, SIZE, OR COLOR.

NO CLAIM IS MADE TO THE EXCLUSIVE RIGHT TO USE "PRO", APART FROM THE MARK AS SHOWN.

SN 85-215,182, FILED 1-11-2011.

INGA ERVIN, EXAMINING ATTORNEY



David J. Kyffers

Director of the United States Patent and Trademark Office

United States of America

United States Patent and Trademark Office

NEW BRIGHT LIFE

Reg. No. 4,176,503

NEW BRIGHT LIFE, LLC (FLORIDA LIMITED LIABILITY COMPANY)
PO BOX 110155

Registered July 17, 2012

LAKWOOD RANCH, FL 34211

Int. Cl.: 16

FOR: EDUCATIONAL PUBLICATIONS, NAMELY, BOOKS, HAND-OUTS, WORKBOOKS AND CHARTS IN THE FIELDS OF PERSONAL, PROFESSIONAL AND BUSINESS DEVELOPMENT; EDUCATIONAL PUBLICATIONS, NAMELY, DECISION MAKING AND PLANNING TOOLS, NAMELY, MAPS AND WRITTEN INSTRUCTIONS FOR PROCESS MAPPING AND FLOW-CHARTING, IN THE FIELDS OF PERSONAL, PROFESSIONAL AND BUSINESS DEVELOPMENT; PUBLICATIONS, NAMELY, BOOKS, HAND-OUTS, WORKBOOKS AND CHARTS IN THE FIELDS OF PERSONAL, PROFESSIONAL AND BUSINESS DEVELOPMENT, IN CLASS 16 (U.S. CLS. 2, 5, 22, 23, 29, 37, 38 AND 50).

TRADEMARK

PRINCIPAL REGISTER

FIRST USE 10-3-2011; IN COMMERCE 10-3-2011.

THE MARK CONSISTS OF STANDARD CHARACTERS WITHOUT CLAIM TO ANY PARTICULAR FONT, STYLE, SIZE, OR COLOR.

SN 85-216,148, FILED 1-12-2011.

SUSAN RICHARDS, EXAMINING ATTORNEY



David J. Kybas

Director of the United States Patent and Trademark Office

United States of America

United States Patent and Trademark Office

LES APERIZES

Reg. No. 4,176,504

Registered July 17, 2012

Int. Cl.: 25

TRADEMARK

PRINCIPAL REGISTER

LES APERIZES, LLC (CALIFORNIA LIMITED LIABILITY COMPANY)
3004 DEL MONTE DRIVE
LOS ANGELES, CA 90026

FOR: CLOTHING, NAMELY, DRESSES, SKIRTS, SUITS, JEANS, SWEATERS, SHIRTS, T-SHIRTS, TANK TOPS, BODYSUITS, JUMPERS, VESTS, GLOVES, SLEEP WEAR, ROBES, SWIMWEAR, BLOUSES, PANTS, SHORTS, JACKETS, COATS, SOCKS, HOSIERY, BELTS, SCARVES, UNDERWEAR; HEADWEAR; AND FOOTWEAR, IN CLASS 25 (U.S. CLS. 22 AND 39).

FIRST USE 9-12-2011; IN COMMERCE 9-12-2011.

THE MARK CONSISTS OF STANDARD CHARACTERS WITHOUT CLAIM TO ANY PARTICULAR FONT, STYLE, SIZE, OR COLOR.

THE ENGLISH TRANSLATION OF THE WORD "LES APERIZES" IN THE MARK IS "THE APERIZES".

SN 85-216,363, FILED 1-12-2011.

ANNE E. GUSTASON, EXAMINING ATTORNEY



David J. Kyffers

Director of the United States Patent and Trademark Office

United States of America

United States Patent and Trademark Office

ID THE V

Reg. No. 4,176,505

C.B. FLEET INVESTMENT CORPORATION (DELAWARE CORPORATION)
103 FOULK ROAD, SUITE 202
WILMINGTON, DE 19803

Registered July 17, 2012

Int. Cl.: 44

FOR: PROVIDING A WEBSITE FEATURING EDUCATIONAL INFORMATION FOR WOMEN
IN THE AREA OF WOMEN'S HEALTH, IN CLASS 44 (U.S. CLS. 100 AND 101).

SERVICE MARK

FIRST USE 1-25-2011; IN COMMERCE 1-25-2011.

PRINCIPAL REGISTER

THE MARK CONSISTS OF STANDARD CHARACTERS WITHOUT CLAIM TO ANY PAR-
TICULAR FONT, STYLE, SIZE, OR COLOR.

SN 85-217,494, FILED 1-13-2011.

EUGENIA MARTIN, EXAMINING ATTORNEY



David J. Kybas

Director of the United States Patent and Trademark Office

United States of America

United States Patent and Trademark Office



Reg. No. 4,176,506

Registered July 17, 2012

Int. Cl.: 5

TRADEMARK

PRINCIPAL REGISTER

OLYMPIAN LABS, INC. (ARIZONA CORPORATION)
8445 E. HARTFORD DRIVE
SCOTTSDALE, AZ 85225

FOR: NUTRITIONAL SUPPLEMENTS; VITAMINS, IN CLASS 5 (U.S. CLS. 6, 18, 44, 46, 51 AND 52).

FIRST USE 4-30-2011; IN COMMERCE 4-30-2011.

OWNER OF U.S. REG. NO. 2,275,779.

THE COLOR(S) BLUE, BLACK, WHITE AND GRAY IS/ARE CLAIMED AS A FEATURE OF THE MARK.

NO CLAIM IS MADE TO THE EXCLUSIVE RIGHT TO USE "LABS, INC.", APART FROM THE MARK AS SHOWN.

THE MARK CONSISTS OF THE LETTERS "OL" IN WHITE, WITH BLACK AND GRAY FOR SHADING AND DIMENSION, APPEARING ABOVE THE TEXT "OLYMPIAN LABS, INC." IN WHITE IN BETWEEN WHITE PARALLEL LINES, ALL WITHIN A BLUE PARALLELOGRAM WITH ROUNDED CORNERS, WITH WHITE INTERNAL BORDER.

SN 85-217,865, FILED 1-14-2011.

SALLY SHIH, EXAMINING ATTORNEY



David J. Kybas

Director of the United States Patent and Trademark Office

United States of America

United States Patent and Trademark Office

La Crème

Reg. No. 4,176,507

NATIONAL DAIRY, LLC (DELAWARE LIMITED LIABILITY COMPANY)
8750 N. CENTRAL EXPRESSWAY, SUITE 400
DALLAS, TX 75231

Registered July 17, 2012

Int. Cl.: 29

FOR: DAIRY PRODUCTS EXCLUDING ICE CREAM, ICE MILK AND FROZEN YOGURT,
IN CLASS 29 (U.S. CL. 46).

TRADEMARK

FIRST USE 1-31-2011; IN COMMERCE 1-31-2011.

PRINCIPAL REGISTER

THE MARK CONSISTS OF STANDARD CHARACTERS WITHOUT CLAIM TO ANY PARTICULAR FONT, STYLE, SIZE, OR COLOR.

THE ENGLISH TRANSLATION OF "LA CRÈME" IN THE MARK IS "THE CREAM".

SN 85-218,386, FILED 1-14-2011.

MICHELE SWAIN, EXAMINING ATTORNEY



David J. Kybas

Director of the United States Patent and Trademark Office

United States of America

United States Patent and Trademark Office

ORCHARD PEACH & RIPE MANGO

Reg. No. 4,176,508

Registered July 17, 2012

Int. Cl.: 30

TRADEMARK

PRINCIPAL REGISTER

KRAFT FOODS GLOBAL BRANDS LLC (DELAWARE LIMITED LIABILITY COMPANY)
THREE LAKES DRIVE
NORTHFIELD, IL 60093

FOR: CONFECTIONERY, NAMELY, CHEWING GUM, IN CLASS 30 (U.S. CL. 46).

FIRST USE 9-1-2011; IN COMMERCE 9-1-2011.

THE MARK CONSISTS OF STANDARD CHARACTERS WITHOUT CLAIM TO ANY PARTICULAR FONT, STYLE, SIZE, OR COLOR.

NO CLAIM IS MADE TO THE EXCLUSIVE RIGHT TO USE "PEACH & RIPE MANGO", APART FROM THE MARK AS SHOWN.

SN 85-219,912, FILED 1-18-2011.

EVELYN BRADLEY, EXAMINING ATTORNEY



David J. Kyffers

Director of the United States Patent and Trademark Office

United States of America

United States Patent and Trademark Office

EDGE INTERLOCK

Reg. No. 4,176,509

Registered July 17, 2012

Int. Cl.: 9

TRADEMARK

PRINCIPAL REGISTER

EDGE VELOCITY CORPORATION (NEW HAMPSHIRE CORPORATION)
68 STILES ROAD, SUITE G
SALEM, NH 03079

FOR: COMPUTER NETWORK HUBS, SWITCHES AND ROUTERS; GATEWAY ROUTERS IN THE NATURE OF COMPUTER CONTROL HARDWARE; COMMUNICATIONS SOFTWARE FOR CONNECTING COMPUTER NETWORK USERS, GLOBAL COMPUTER NETWORKS; COMPUTER SOFTWARE FOR CONNECTING COMPUTER NETWORKS AND COMPUTER NETWORK USERS; COMPUTER SOFTWARE FOR COMMUNICATING WITH USERS OF HAND-HELD AND MOBILE COMPUTERS; COMPUTER SOFTWARE FOR ADMINISTRATION OF COMPUTER LOCAL AND WIDE AREA NETWORKS; COMPUTER SOFTWARE FOR CONTROLLING AND MANAGING ACCESS SERVER APPLICATIONS; COMPUTER SOFTWARE FOR WIRELESS CONTENT DELIVERY; GLOBAL POSITIONING SYSTEM (GPS) CONSISTING OF COMPUTERS, COMPUTER SOFTWARE, TRANSMITTERS, RECEIVERS, AND NETWORK INTERFACE DEVICES, IN CLASS 9 (U.S. CLS. 21, 23, 26, 36 AND 38).

FIRST USE 3-24-2010; IN COMMERCE 3-24-2010.

THE MARK CONSISTS OF STANDARD CHARACTERS WITHOUT CLAIM TO ANY PARTICULAR FONT, STYLE, SIZE, OR COLOR.

NO CLAIM IS MADE TO THE EXCLUSIVE RIGHT TO USE "INTERLOCK", APART FROM THE MARK AS SHOWN.

SN 85-220,725, FILED 1-19-2011.

RENEE MCCRAY, EXAMINING ATTORNEY



David J. Kybas

Director of the United States Patent and Trademark Office

United States of America

United States Patent and Trademark Office



Reg. No. 4,176,510

Registered July 17, 2012

Int. Cls.: 9, 37, and 42

TRADEMARK

SERVICE MARK

PRINCIPAL REGISTER

CERTES NETWORKS, INC. (DELAWARE CORPORATION)
1401 SUNDAY DRIVE, SUITE 109
RALEIGH, NC 27607

FOR: COMPUTER HARDWARE AND SOFTWARE FOR SCALABLE SECURITY APPLICATIONS FOR HIGH PERFORMANCE NETWORKS, IN CLASS 9 (U.S. CLS. 21, 23, 26, 36 AND 38).

FIRST USE 1-19-2011; IN COMMERCE 1-19-2011.

FOR: INSTALLATION OF COMPUTER HARDWARE USED IN CONNECTION WITH SCALABLE SECURITY APPLICATIONS FOR HIGH PERFORMANCE NETWORKS, IN CLASS 37 (U.S. CLS. 100, 103 AND 106).

FIRST USE 5-7-2012; IN COMMERCE 5-7-2012.

FOR: TECHNICAL CONSULTING AND DESIGN SERVICES IN CONNECTION WITH COMPUTER HARDWARE AND SOFTWARE FOR SCALABLE SECURITY APPLICATIONS FOR HIGH PERFORMANCE NETWORKS; SOFTWARE INSTALLATION SERVICES IN CONNECTION WITH SCALABLE SECURITY APPLICATIONS FOR HIGH PERFORMANCE NETWORKS, IN CLASS 42 (U.S. CLS. 100 AND 101).

FIRST USE 5-7-2012; IN COMMERCE 5-7-2012.

NO CLAIM IS MADE TO THE EXCLUSIVE RIGHT TO USE "NETWORKS", APART FROM THE MARK AS SHOWN.

THE COLOR(S) BLUE AND BLACK IS/ARE CLAIMED AS A FEATURE OF THE MARK.

THE MARK CONSISTS OF "CERTES" IN BLUE LETTERS ABOVE "NETWORKS" IN BLACK LETTERS.

SN 85-220,854, FILED 1-19-2011.

KAREN SEVERSON, EXAMINING ATTORNEY



David J. Kyffers

Director of the United States Patent and Trademark Office

United States of America

United States Patent and Trademark Office

POWERTOUCH

Reg. No. 4,176,511

Registered July 17, 2012

Int. Cl.: 9

TRADEMARK

PRINCIPAL REGISTER

TENNRICH INTERNATIONAL CORP. (TAIWAN CORPORATION)
LUCHU HSIANG
NO.1-3, ALLEY 5, LN.305, HSIN-NANRD., SEC.1C.1
TAOYUAN HSIEH, TAIWAN

FOR: BATTERIES; RECHARGEABLE BATTERIES; BATTERY CHARGERS; SOLAR CELLS; ELECTRIC CONVERTERS; ELECTRIC SOCKETS; ELECTRICAL CONNECTORS; LITHIUM ION BATTERIES; COMPUTER CURSOR CONTROL DEVICES, NAMELY, COMPUTER MOUSE; ELECTRICAL POWER SUPPLIES; ADAPTORS, NAMELY, PLUG ADAPTERS, POWER SUPPLY CONNECTORS AND ADAPTORS FOR USE WITH PORTABLE ELECTRONIC DEVICES AND MUSICAL INSTRUMENT ADAPTORS, IN CLASS 9 (U.S. CLS. 21, 23, 26, 36 AND 38).

FIRST USE 1-9-2012; IN COMMERCE 1-9-2012.

THE MARK CONSISTS OF STANDARD CHARACTERS WITHOUT CLAIM TO ANY PARTICULAR FONT, STYLE, SIZE, OR COLOR.

SN 85-221,272, FILED 1-19-2011.

LINDA POWELL, EXAMINING ATTORNEY



David J. Kybas

Director of the United States Patent and Trademark Office

United States of America

United States Patent and Trademark Office

PUMP WORX

Reg. No. 4,176,512

PIPEDREAM PRODUCTS, INC. (CALIFORNIA CORPORATION)
21350 LASSEN ST.
CHATSWORTH, CA 91311

Registered July 17, 2012

Int. Cl.: 10

FOR: ADULT SEXUAL STIMULATION AIDS, NAMELY, PENIS ENLARGERS, IN CLASS 10 (U.S. CLS. 26, 39 AND 44).

TRADEMARK

FIRST USE 10-1-2011; IN COMMERCE 10-1-2011.

PRINCIPAL REGISTER

THE MARK CONSISTS OF STANDARD CHARACTERS WITHOUT CLAIM TO ANY PARTICULAR FONT, STYLE, SIZE, OR COLOR.

NO CLAIM IS MADE TO THE EXCLUSIVE RIGHT TO USE "PUMP", APART FROM THE MARK AS SHOWN.

SN 85-221,626, FILED 1-19-2011.

ANDREA K. NADELMAN, EXAMINING ATTORNEY



David J. Kyffers

Director of the United States Patent and Trademark Office

United States of America

United States Patent and Trademark Office

57 STARS

Reg. No. 4,176,513

57 STARS LLC (DELAWARE LIMITED LIABILITY COMPANY)
616 H STREET, N.W., SUITE 450
WASHINGTON, DC 20001

Registered July 17, 2012

Int. Cl.: 36

FOR: INVESTMENT ADVICE, CONSULTATION AND MANAGEMENT; INVESTMENT OF FUNDS FOR OTHERS; EQUITY CAPITAL INVESTMENT; INVESTMENT SERVICES, NAMELY, ASSET ACQUISITION, CONSULTATION, DEVELOPMENT AND MANAGEMENT SERVICES; CAPITAL INVESTMENT SERVICES, AND CONSULTING IN CONJUNCTION THEREWITH, IN CLASS 36 (U.S. CLS. 100, 101 AND 102).

SERVICE MARK

PRINCIPAL REGISTER

FIRST USE 2-14-2011; IN COMMERCE 2-14-2011.

THE MARK CONSISTS OF STANDARD CHARACTERS WITHOUT CLAIM TO ANY PARTICULAR FONT, STYLE, SIZE, OR COLOR.

SN 85-222,281, FILED 1-20-2011.

IRA J. GOODSaid, EXAMINING ATTORNEY



David J. Kyffers

Director of the United States Patent and Trademark Office

United States of America

United States Patent and Trademark Office

MY SISTER IS NASTY

Reg. No. 4,176,514

BARNES, TERESA (UNITED STATES INDIVIDUAL)
PO BOX 761
HOTCHKISS, CO 81419

Registered July 17, 2012

Int. Cl.: 16

FOR: STICKERS, IN CLASS 16 (U.S. CLS. 2, 5, 22, 23, 29, 37, 38 AND 50).

TRADEMARK

FIRST USE 3-23-2012; IN COMMERCE 3-23-2012.

PRINCIPAL REGISTER

THE MARK CONSISTS OF STANDARD CHARACTERS WITHOUT CLAIM TO ANY PARTICULAR FONT, STYLE, SIZE, OR COLOR.

SN 85-222,802, FILED 1-21-2011.

JULIE WATSON, EXAMINING ATTORNEY



David J. Kyffers

Director of the United States Patent and Trademark Office

United States of America

United States Patent and Trademark Office

Benchmark Health Systems

Reg. No. 4,176,515

NEERAJ BHUSHAN (UNITED STATES INDIVIDUAL)
1850 TOWN CENTER DR SUITE 410
RESTON, VA 20190

Registered July 17, 2012

Int. Cl.: 35

FOR: HEALTHCARE MANAGEMENT SERVICE ORGANIZATION (MSO) SERVICES, NAMELY, PROVIDING PRACTICE ORGANIZATION, MANAGEMENT AND ADMINISTRATIVE SUPPORT SERVICES TO INDIVIDUAL PHYSICIANS OR SMALL GROUP PRACTICES, IN CLASS 35 (U.S. CLS. 100, 101 AND 102).

SERVICE MARK

PRINCIPAL REGISTER

FIRST USE 2-9-2012; IN COMMERCE 2-9-2012.

THE MARK CONSISTS OF STANDARD CHARACTERS WITHOUT CLAIM TO ANY PARTICULAR FONT, STYLE, SIZE, OR COLOR.

NO CLAIM IS MADE TO THE EXCLUSIVE RIGHT TO USE "HEALTH", APART FROM THE MARK AS SHOWN.

SN 85-223,782, FILED 1-22-2011.

CURTIS FRENCH, EXAMINING ATTORNEY



David J. Kyffers

Director of the United States Patent and Trademark Office

United States of America

United States Patent and Trademark Office



Reg. No. 4,176,516

Registered July 17, 2012

Int. Cl.: 42

SERVICE MARK

PRINCIPAL REGISTER

ENERGY PASS, INC. (TAIWAN CORPORATION)
3F.
NO.6-2, DUXING RD., HSINCHU SCIENCE PARK
HSINCHU CITY 30078, TAIWAN

FOR: ARCHITECTURAL DESIGN; CIVIL ENGINEERING FOR THE DESIGN OF EDIFICES, BRIDGES, COMMERCIAL BUILDINGS, DOMESTIC BUILDINGS; ENVIRONMENTAL SERVICES, NAMELY, DESIGN FOR OTHERS IN THE FIELD OF ENVIRONMENTAL ENGINEERING FOR PREVENTING ENVIRONMENTAL POLLUTION; DESIGN OF INTERIOR DECOR; COMPUTER GRAPHICS DESIGN SERVICES, NAMELY, CREATING OF ANIMATIONS FOR OTHERS; COMPUTER GRAPHICS; COMPUTER SOFTWARE DESIGN; WEB SITE DESIGN; CONSULTING SERVICES IN THE FIELDS OF ENERGY MEASUREMENT TO IMPROVE ENERGY EFFICIENCY; RESEARCH IN THE FIELD OF ENVIRONMENTAL PROTECTION; TECHNICAL CONSULTANCY IN THE FIELD OF ENVIRONMENTAL SCIENCE FOR PREVENTING ENVIRONMENTAL POLLUTION; SCIENTIFIC AND TECHNOLOGICAL SERVICES, NAMELY, ANALYSIS IN THE FIELD OF POLLUTION DETECTION; TECHNICAL CONSULTING IN THE FIELD OF ENVIRONMENTAL ENGINEERING IN THE NATURE OF ENVIRONMENTAL PROTECTION; CONDUCTING ENGINEERING SURVEYS, NAMELY, ECOLOGICAL SURVEYS; TECHNOLOGY CONSULTATION IN THE FIELD OF ELECTRONIC ENGINEERING; DESIGN FOR OTHERS IN THE FIELD OF ENGINEERING OF INSTRUMENT CONTROLLING SYSTEMS; TECHNICAL RESEARCH IN THE FIELD OF POWER MANAGEMENT AND OPTIMIZATION; NEW PRODUCT DESIGN, NAMELY, DESIGN OF PRODUCT APPEARANCE; DESIGN OF INTEGRATED CIRCUITS FOR OTHERS; DESIGN OF COMPUTER HARDWARE FOR OTHERS, NAMELY, DESIGN OF SEMI-CONDUCTORS AND COMPUTER CHIPS, IN CLASS 42 (U.S. CLS. 100 AND 101).

FIRST USE 10-20-2010; IN COMMERCE 10-20-2010.

THE MARK CONSISTS OF THE STYLIZED LETTER "E" HAVING THREE INCLINED ARCUATE CONTOURS GENERALLY PARALLEL AND SPACED APART FROM EACH OTHER WITH ONE OF THE INCLINED ARCUATE CONTOURS BEING A TAIL SECTION OF THE LETTER "E" AND FORMED CONTINUOUSLY WITH A LOWER SECTION OF THE LETTER "E".

SN 85-223,824, FILED 1-22-2011.

ROBERT C. CLARK JR., EXAMINING ATTORNEY



David J. Kypos

Director of the United States Patent and Trademark Office

United States of America

United States Patent and Trademark Office

SWAB CUBE

Reg. No. 4,176,517

Registered July 17, 2012

Int. Cl.: 5

TRADEMARK

PRINCIPAL REGISTER

W.H.P.M., INC. (CALIFORNIA CORPORATION)
5358 IRWINDALE AVE.
IRWINDALE, CA 91706

FOR: SALIVA DRUG TEST KIT FOR DIAGNOSING MULTIPLE ILLICIT DRUGS THROUGH ORAL FLUIDS; PHARMACOLOGICAL TESTING KITS COMPRISED OF CLINICAL DIAGNOSTIC REAGENTS FOR THE DETECTION OF ELEVATED LEVELS OF ILLICIT DRUGS PRESENT IN BODILY FLUIDS OF HUMAN SUBJECTS FOR FORENSIC USE, IN CLASS 5 (U.S. CLS. 6, 18, 44, 46, 51 AND 52).

FIRST USE 5-12-2011; IN COMMERCE 6-28-2011.

THE MARK CONSISTS OF STANDARD CHARACTERS WITHOUT CLAIM TO ANY PARTICULAR FONT, STYLE, SIZE, OR COLOR.

OWNER OF U.S. REG. NO. 3,858,005.

NO CLAIM IS MADE TO THE EXCLUSIVE RIGHT TO USE "SWAB", APART FROM THE MARK AS SHOWN.

SN 85-225,083, FILED 1-25-2011.

LINDA POWELL, EXAMINING ATTORNEY



David J. Kyffers

Director of the United States Patent and Trademark Office

United States of America

United States Patent and Trademark Office

SMARTSTORE

Reg. No. 4,176,518

Registered July 17, 2012

Int. Cl.: 35

SERVICE MARK

PRINCIPAL REGISTER

PLAYBILL ENTERPRISES INCORPORATED (NEW YORK CORPORATION)
37-15 61ST STREET
WOODSIDE, NY 11377

FOR: PROVIDING ON-LINE RETAIL STORE SERVICES FEATURING THEATER RELATED BOOKS, ARTWORK, APPAREL, POSTERS, RECORDINGS AND OTHER THEATER RELATED MERCHANDISE, IN CLASS 35 (U.S. CLS. 100, 101 AND 102).

FIRST USE 3-1-2011; IN COMMERCE 3-1-2011.

THE MARK CONSISTS OF STANDARD CHARACTERS WITHOUT CLAIM TO ANY PARTICULAR FONT, STYLE, SIZE, OR COLOR.

SN 85-225,454, FILED 1-25-2011.

EVELYN BRADLEY, EXAMINING ATTORNEY



David J. Kybas

Director of the United States Patent and Trademark Office

United States of America

United States Patent and Trademark Office



Reg. No. 4,176,519

Registered July 17, 2012

Int. Cl.: 41

SERVICE MARK

PRINCIPAL REGISTER

WORLD MODEL ORGANIZATION LLC (DELAWARE LIMITED LIABILITY COMPANY)
1220 N. MARKET STREET, SUITE 804
WILMINGTON, DE 19801

FOR: ARRANGING AND CONDUCTING EDUCATIONAL CONFERENCES; ARRANGING OF BEAUTY CONTESTS; ARRANGING OF SEMINARS; ARRANGING, ORGANIZING, CONDUCTING, AND HOSTING SOCIAL ENTERTAINMENT EVENTS; ORGANIZATION OF EXHIBITIONS FOR CULTURAL OR EDUCATIONAL PURPOSES; ORGANIZATION OF FASHION SHOWS FOR ENTERTAINMENT PURPOSES; ORGANIZATION OF SPORTS COMPETITIONS; ORGANIZATION OF EXHIBITIONS FOR CULTURAL OR EDUCATIONAL PURPOSES; PRESENTATION OF LIVE SHOW PERFORMANCES; WEDDING PLANNING AND COORDINATION SERVICES, IN CLASS 41 (U.S. CLS. 100, 101 AND 107).

FIRST USE 12-1-2010; IN COMMERCE 1-1-2011.

NO CLAIM IS MADE TO THE EXCLUSIVE RIGHT TO USE "SUPER MODEL" AND "SINCE 1990", APART FROM THE MARK AS SHOWN.

THE MARK CONSISTS OF THE WORDS "WMO SUPER MODEL LOOK SINCE 1990" BETWEEN THE BORDER OF TWO CONCENTRIC CIRCLES. AT THE CENTER OF THE CIRCLES APPEARS A GLOBE DESIGN BELOW A CROWN SHAPE DESIGN.

SN 85-226,132, FILED 1-25-2011.

ALAIN LAPTER, EXAMINING ATTORNEY



David J. Kybas

Director of the United States Patent and Trademark Office

United States of America

United States Patent and Trademark Office

Dialatoke

Reg. No. 4,176,520

DESCAMP, WILLIAM CURTIS (UNITED STATES INDIVIDUAL)
1705 RAMADA DRIVE
WOODWAY, TX 76712

Registered July 17, 2012

Int. Cl.: 34

FOR: SMOKING PIPE CLEANERS; SMOKING PIPES, IN CLASS 34 (U.S. CLS. 2, 8, 9 AND 17).

TRADEMARK

FIRST USE 7-15-2007; IN COMMERCE 1-22-2012.

PRINCIPAL REGISTER

THE MARK CONSISTS OF STANDARD CHARACTERS WITHOUT CLAIM TO ANY PARTICULAR FONT, STYLE, SIZE, OR COLOR.

SN 85-226,136, FILED 1-25-2011.

ROBERT STRUCK, EXAMINING ATTORNEY



David J. Kyfos

Director of the United States Patent and Trademark Office

United States of America

United States Patent and Trademark Office

ECOSURE

Reg. No. 4,176,521

Registered July 17, 2012

Int. Cl.: 11

TRADEMARK

PRINCIPAL REGISTER

PALM COAST IMPORTS (DELAWARE LIMITED LIABILITY COMPANY)
ST 103
3059 FOREST HILL IRENE RD
GERMANTOWN, TN 38138

FOR: CEILING FANS AND RESIDENTIAL CEILING FAN LIGHTS, IN CLASS 11 (U.S. CLS. 13, 21, 23, 31 AND 34).

FIRST USE 10-31-2011; IN COMMERCE 10-31-2011.

THE MARK CONSISTS OF STANDARD CHARACTERS WITHOUT CLAIM TO ANY PARTICULAR FONT, STYLE, SIZE, OR COLOR.

SN 85-226,204, FILED 1-26-2011.

SARA BENJAMIN, EXAMINING ATTORNEY



David J. Kybas

Director of the United States Patent and Trademark Office

United States of America

United States Patent and Trademark Office

COLOR TECHNOLOGY

Reg. No. 4,176,522

AUSTRALIAN GOLD, LLC (INDIANA LIMITED LIABILITY COMPANY)
6270 CORPORATE DRIVE
INDIANAPOLIS, IN 46278

Registered July 17, 2012

Int. Cl.: 3

FOR: INDOOR AND OUTDOOR NON-MEDICATED SKIN TANNING PREPARATIONS, IN CLASS 3 (U.S. CLS. 1, 4, 6, 50, 51 AND 52).

TRADEMARK

FIRST USE 11-1-2011; IN COMMERCE 11-1-2011.

PRINCIPAL REGISTER

THE MARK CONSISTS OF STANDARD CHARACTERS WITHOUT CLAIM TO ANY PARTICULAR FONT, STYLE, SIZE, OR COLOR.

NO CLAIM IS MADE TO THE EXCLUSIVE RIGHT TO USE "TECHNOLOGY", APART FROM THE MARK AS SHOWN.

SN 85-226,599, FILED 1-26-2011.

FRANK LATTUCA, EXAMINING ATTORNEY



David J. Kyffers

Director of the United States Patent and Trademark Office

United States of America

United States Patent and Trademark Office

ConsReality

Reg. No. 4,176,523

Registered July 17, 2012

Int. Cl.: 16

TRADEMARK

PRINCIPAL REGISTER

CONSREALITY, INC. (TEXAS CORPORATION), DBA CONSREALITY, INC.,
P. O. BOX 742694
DALLAS, TX 75374

FOR: NON-FICTION BOOKS ON A VARIETY OF TOPICS; SERIES OF FICTION AND NON-FICTION BOOKS ON A VARIETY OF TOPICS, IN CLASS 16 (U.S. CLS. 2, 5, 22, 23, 29, 37, 38 AND 50).

FIRST USE 11-6-2010; IN COMMERCE 1-4-2012.

THE MARK CONSISTS OF STANDARD CHARACTERS WITHOUT CLAIM TO ANY PARTICULAR FONT, STYLE, SIZE, OR COLOR.

SN 85-226,693, FILED 1-26-2011.

SIMON TENG, EXAMINING ATTORNEY



David J. Kyffers

Director of the United States Patent and Trademark Office

United States of America

United States Patent and Trademark Office

IPQ

Reg. No. 4,176,524

Registered July 17, 2012

Int. Cls.: 35 and 42

SERVICE MARK

PRINCIPAL REGISTER

PATENTRATINGS, LLC (CALIFORNIA LIMITED LIABILITY COMPANY)
1 PARK PLAZA
SUITE 900
IRVINE, CA 92614

FOR: PROVIDING PREDICTIVE MODELING FOR BUSINESS OR COMMERCIAL PURPOSES FOR ASSESSING THE QUALITY, VALUE AND TRENDS WITH RESPECT TO INTELLECTUAL PROPERTY; PROVIDING BUSINESS INFORMATION SERVICES IN THE FIELDS OF MODELING, SCORING, AND ANALYTICS, RISK MANAGEMENT, AND STATISTICAL FORECASTING AND ANALYSIS, RELATED TO INTELLECTUAL PROPERTY, IN CLASS 35 (U.S. CLS. 100, 101 AND 102).

FIRST USE 1-0-2001; IN COMMERCE 1-0-2001.

FOR: PROVIDING A WEB-BASED SYSTEM FEATURING ON-LINE NON-DOWNLOADABLE SOFTWARE THAT ENABLES USERS TO ACCESS INFORMATION REGARDING INTELLECTUAL PROPERTY AND INTELLECTUAL PROPERTY VALUATION VIA REPORTS AND INFORMATION WITH RESPECT TO A SCORING METHODOLOGY FOR INTELLECTUAL PROPERTY ASSETS, IN CLASS 42 (U.S. CLS. 100 AND 101).

FIRST USE 1-0-2001; IN COMMERCE 1-0-2001.

THE MARK CONSISTS OF STANDARD CHARACTERS WITHOUT CLAIM TO ANY PARTICULAR FONT, STYLE, SIZE, OR COLOR.

OWNER OF U.S. REG. NO. 3,147,879.

SN 85-227,026, FILED 1-26-2011.

SETH A. RAPPAPORT, EXAMINING ATTORNEY



David J. Kybas

Director of the United States Patent and Trademark Office

United States of America

United States Patent and Trademark Office



PRESIDIO BANK

Reg. No. 4,176,525

Registered July 17, 2012

Int. Cl.: 36

SERVICE MARK

PRINCIPAL REGISTER

PRESIDIO BANK (CALIFORNIA CORPORATION)
ONE MONTGOMERY ST., SUITE 2300
SAN FRANCISCO, CA 94104

FOR: FINANCIAL SERVICES, NAMELY, BANKING AND CREDIT CARD SERVICES, IN CLASS 36 (U.S. CLS. 100, 101 AND 102).

FIRST USE 5-12-2011; IN COMMERCE 5-12-2011.

OWNER OF U.S. REG. NO. 3,206,977.

NO CLAIM IS MADE TO THE EXCLUSIVE RIGHT TO USE "BANK", APART FROM THE MARK AS SHOWN.

THE MARK CONSISTS OF THE WORDS "PRESIDIO BANK" WITH THE OUTLINE OF A SQUARE CENTERED OVER THE LETTER "I". THE OUTLINE OF THE SQUARE CONTAINS FOUR SMALLER SQUARES AT EACH CORNER AND THESE FOUR SMALLER SQUARES ARE SOLID. THE LETTER "E" IN THE WORD "PRESIDIO" IS STYLIZED AS THE MIDDLE HORIZONTAL PART OF THE LETTER PASSES THROUGH THE VERTICAL FORMING A TYPE OF PLUS.

SN 85-227,460, FILED 1-27-2011.

GENE MACIOL, EXAMINING ATTORNEY



David J. Kyffers

Director of the United States Patent and Trademark Office

United States of America

United States Patent and Trademark Office

TRANSFLO WEB

Reg. No. 4,176,526

PEGASUS TRANSTECH CORP. (FLORIDA CORPORATION)
4301 W. BOY SCOUT BLVD., SUITE 550
TAMPA, FL 33607

Registered July 17, 2012

Int. Cls.: 35 and 42

FOR: DOCUMENT MANAGEMENT FOR OTHERS THROUGH USE OF COMPUTER SOFTWARE FOR INDEXING AND TRACKING, IN CLASS 35 (U.S. CLS. 100, 101 AND 102).

SERVICE MARK

FIRST USE 3-15-2011; IN COMMERCE 3-15-2011.

PRINCIPAL REGISTER

FOR: COMPUTER SERVICES, NAMELY, APPLICATION SERVICE PROVIDER FEATURING SOFTWARE FOR USE IN BILLING, COLLECTIONS, PAYROLL, SETTLEMENTS, ACCOUNTS PAYABLE, CLAIMS, DRIVER QUALIFICATIONS, DRIVER LOGS, PERMITS, AND ACCOUNTING, ALL IN THE FIELD OF TRANSPORTATION, IN CLASS 42 (U.S. CLS. 100 AND 101).

FIRST USE 3-15-2011; IN COMMERCE 3-15-2011.

THE MARK CONSISTS OF STANDARD CHARACTERS WITHOUT CLAIM TO ANY PARTICULAR FONT, STYLE, SIZE, OR COLOR.

OWNER OF U.S. REG. NOS. 2,319,213, 2,680,371, AND 2,888,278.

NO CLAIM IS MADE TO THE EXCLUSIVE RIGHT TO USE "WEB", APART FROM THE MARK AS SHOWN.

SN 85-227,850, FILED 1-27-2011.

KATHLEEN M. VANSTON, EXAMINING ATTORNEY



David J. Kyjars

Director of the United States Patent and Trademark Office

United States of America

United States Patent and Trademark Office

Ecopia

Reg. No. 4,176,527

GREEN EARTH GREENS COMPANY (DELAWARE CORPORATION)
14690 HANCOCK COURT
LOS GATOS, CA 95032

Registered July 17, 2012

Int. Cls.: 31, 35, and 44

FOR: AGRICULTURAL PRODUCTS, NAMELY, FRESH FRUITS AND VEGETABLES, SEEDS FOR FLOWERS, SOWING SEEDS, NATURAL PLANTS AND FLOWERS, IN CLASS 31 (U.S. CLS. 1 AND 46).

TRADEMARK

FIRST USE 5-14-2011; IN COMMERCE 6-8-2011.

SERVICE MARK

FOR: BUSINESS MANAGEMENT SERVICES, NAMELY, ADMINISTRATION OF BUSINESSES ENGAGED IN FARMING, RETAIL SERVICES, AND DELIVERY OF FOODS AND PRODUCE; RETAIL STORE SERVICES FEATURING FOODS AND PRODUCE; BUSINESS CONSULTING SERVICES IN THE AGRICULTURAL FIELD, IN CLASS 35 (U.S. CLS. 100, 101 AND 102).

PRINCIPAL REGISTER

FIRST USE 5-14-2011; IN COMMERCE 6-8-2011.

FOR: FARMING FOR OTHERS; AGRICULTURAL SERVICES, NAMELY, PLANTING, GROWING, FERTILIZING, PRUNING AND PICKING ARTISAN LETTUCES, SPECIALTY GREENS, MICROGREENS, AND HERBS LOCAL TO THE AREA FOR OTHERS, IN CLASS 44 (U.S. CLS. 100 AND 101).

FIRST USE 5-14-2011; IN COMMERCE 6-8-2011.

THE MARK CONSISTS OF STANDARD CHARACTERS WITHOUT CLAIM TO ANY PARTICULAR FONT, STYLE, SIZE, OR COLOR.

SN 85-228,195, FILED 1-27-2011.

MICHAEL SOUDERS, EXAMINING ATTORNEY



David J. Kyros

Director of the United States Patent and Trademark Office

United States of America

United States Patent and Trademark Office

SafeBiz

Reg. No. 4,176,528

Registered July 17, 2012

Int. Cls.: 35 and 45

SERVICE MARK

PRINCIPAL REGISTER

NXG STRATEGIES LLC (TENNESSEE LIMITED LIABILITY COMPANY)
SUITE 160
214 OVERLOOK CIRCLE
BRENTWOOD, TN 37027

FOR: BUSINESS CONSULTATION, NAMELY, PROVIDING BUSINESS BREACH RESPONSE CONSULTING; PUBLIC RELATIONS SERVICES, IN CLASS 35 (U.S. CLS. 100, 101 AND 102).

FIRST USE 12-11-2011; IN COMMERCE 4-1-2012.

FOR: BUSINESS FRAUD AND IDENTITY THEFT PROTECTION SERVICES, NAMELY, PROVIDING BUSINESS ACCOUNT, CREDIT CARD, TAX IDS, NAME, AND CREDENTIALS MONITORING FOR ACCIDENTAL OR MALICIOUS USE; PROVIDING BUSINESS OR BUSINESS EMPLOYEE IDENTITY THEFT INVESTIGATION; PROVIDING BUSINESS BREACH RESPONSE CONSULTING, NAMELY, CONSULTATION IN THE FIELD OF IDENTITY THEFT PROTECTION AND RESOLUTION; PROVIDING BUSINESS OR BUSINESS EMPLOYEE IDENTITY THEFT RESOLUTION AND REMEDIATION ASSISTANCE, NAMELY, PROVIDING ADVICE AND CONSULTATION IN THE FIELD OF IDENTITY THEFT, IN CLASS 45 (U.S. CLS. 100 AND 101).

FIRST USE 12-11-2011; IN COMMERCE 4-1-2012.

THE MARK CONSISTS OF STANDARD CHARACTERS WITHOUT CLAIM TO ANY PARTICULAR FONT, STYLE, SIZE, OR COLOR.

SN 85-228,593, FILED 1-28-2011.

KATHERINE CONNOLLY, EXAMINING ATTORNEY



David J. Kyros

Director of the United States Patent and Trademark Office

United States of America

United States Patent and Trademark Office

The Ride

Reg. No. 4,176,529

PROSPERITY PRODUCTIONS, INC. (GEORGIA CORPORATION)
520 W. 48TH STREET, SUITE 5N
NEWYORK, NY 10036

Registered July 17, 2012

Int. Cl.: 41

FOR: CONDUCTING WORKSHOPS AND SEMINARS IN THE ART OF CONNECTING WITH YOUR CUSTOMER, IN CLASS 41 (U.S. CLS. 100, 101 AND 107).

SERVICE MARK

FIRST USE 4-7-2011; IN COMMERCE 4-7-2011.

PRINCIPAL REGISTER

THE MARK CONSISTS OF STANDARD CHARACTERS WITHOUT CLAIM TO ANY PARTICULAR FONT, STYLE, SIZE, OR COLOR.

SN 85-229,585, FILED 1-30-2011.

JENNIFER MARTIN, EXAMINING ATTORNEY



David J. Kybas

Director of the United States Patent and Trademark Office

United States of America

United States Patent and Trademark Office

NEUROCORE

Reg. No. 4,176,530

NORTHERN INNOVATIONS HOLDING CORP. (CANADA CORPORATION)
381 NORTH SERVICE ROAD WEST
OAKVILLE, ONTARIO, CANADA L6M 0H4

Registered July 17, 2012

Int. Cl.: 5

FOR: NUTRITIONAL AND DIETARY SUPPLEMENTS, IN CLASS 5 (U.S. CLS. 6, 18, 44, 46, 51 AND 52).

TRADEMARK

FIRST USE 6-17-2011; IN COMMERCE 6-17-2011.

PRINCIPAL REGISTER

THE MARK CONSISTS OF STANDARD CHARACTERS WITHOUT CLAIM TO ANY PARTICULAR FONT, STYLE, SIZE, OR COLOR.

SN 85-230,350, FILED 1-31-2011.

APRIL ROACH, EXAMINING ATTORNEY



David J. Kyffers

Director of the United States Patent and Trademark Office

United States of America

United States Patent and Trademark Office

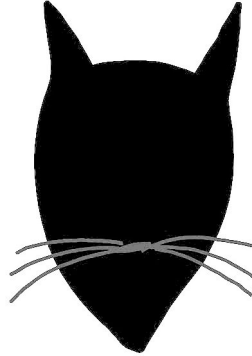

Reg. No. 4,176,531

Registered July 17, 2012

Int. Cl.: 33

TRADEMARK

PRINCIPAL REGISTER

BOTTLE TREE BEVERAGE COMPANY, LLC (MISSISSIPPI LIMITED LIABILITY COMPANY)
644 CHURCH ROAD, SUITE 1
MADISON, MS 39110

FOR: VODKA, IN CLASS 33 (U.S. CLS. 47 AND 49).

FIRST USE 11-1-2009; IN COMMERCE 5-1-2010.

THE MARK CONSISTS OF A SILHOUETTE OF A CAT FACE WITH A POINTED CHIN AND TWO POINTED EARS; THREE WHISKERS PROTRUDE FROM EACH SIDE OF THE LOWER PORTION OF THE FACE OF THE CAT.

SN 85-230,854, FILED 2-1-2011.

JOHN WILKE, EXAMINING ATTORNEY



David J. Kyffers

Director of the United States Patent and Trademark Office

United States of America

United States Patent and Trademark Office



Reg. No. 4,176,532

Registered July 17, 2012

Int. Cls.: 9, 16, and 36

TRADEMARK

SERVICE MARK

PRINCIPAL REGISTER

PRESIDIO BANK (CALIFORNIA CORPORATION)
ONE MONTGOMERY ST., SUITE 2300
SAN FRANCISCO, CA 94104

FOR: CREDIT CARDS WITH MAGNETIC STRIPS, IN CLASS 9 (U.S. CLS. 21, 23, 26, 36 AND 38).

FIRST USE 5-24-2011; IN COMMERCE 5-24-2011.

FOR: BANK CHECKS, IN CLASS 16 (U.S. CLS. 2, 5, 22, 23, 29, 37, 38 AND 50).

FIRST USE 5-13-2011; IN COMMERCE 5-13-2011.

FOR: FINANCIAL SERVICES, NAMELY, BANKING AND CREDIT CARD SERVICES, IN CLASS 36 (U.S. CLS. 100, 101 AND 102).

FIRST USE 5-12-2011; IN COMMERCE 5-12-2011.

THE MARK CONSISTS OF THE OUTLINE OF A SQUARE THAT CONTAINS FOUR SMALLER SQUARES AT EACH CORNER AND THESE FOUR SMALLER SQUARES ARE SOLID.

SN 85-231,209, FILED 2-1-2011.

GENE MACIOL, EXAMINING ATTORNEY



David J. Kybas

Director of the United States Patent and Trademark Office

United States of America

United States Patent and Trademark Office

Bunk Buster

Reg. No. 4,176,533

WINN, ROBERT T. (UNITED STATES INDIVIDUAL), DBA TEXAS CREEK FARMS,
2869 FM 1002

Registered July 17, 2012

BIG SANDY, TX 75755

Int. Cl.: 5

FOR: ANIMAL FEED SUPPLEMENTS, IN CLASS 5 (U.S. CLS. 6, 18, 44, 46, 51 AND 52).

TRADEMARK

FIRST USE 2-2-2011; IN COMMERCE 2-2-2011.

PRINCIPAL REGISTER

THE MARK CONSISTS OF STANDARD CHARACTERS WITHOUT CLAIM TO ANY PARTICULAR FONT, STYLE, SIZE, OR COLOR.

NO CLAIM IS MADE TO THE EXCLUSIVE RIGHT TO USE "BUNK", APART FROM THE MARK AS SHOWN.

SN 85-231,945, FILED 2-2-2011.

MARY CRAWFORD, EXAMINING ATTORNEY



David J. Kyffers

Director of the United States Patent and Trademark Office

United States of America

United States Patent and Trademark Office

**DON'T WAIT FOR THE
WHISTLE, START YOUR
MUNCH-BREAK NOW!**

Reg. No. 4,176,534

Registered July 17, 2012

Int. Cls.: 29 and 30

TRADEMARK

PRINCIPAL REGISTER

HERR HOLDINGS INC. (DELAWARE CORPORATION)
SUITE 210B, BAYNARD BUILDING
3411 SILVERSIDE ROAD
WILMINGTON, DE 198104812

FOR: SNACK FOODS, NAMELY, POTATO CHIPS AND BAKED POTATO CRISPS, IN CLASS 29 (U.S. CL. 46).

FIRST USE 11-2-2010; IN COMMERCE 11-2-2010.

FOR: CHEESE CURLS AND POPCORN, IN CLASS 30 (U.S. CL. 46).

FIRST USE 8-8-2011; IN COMMERCE 8-8-2011.

THE MARK CONSISTS OF STANDARD CHARACTERS WITHOUT CLAIM TO ANY PARTICULAR FONT, STYLE, SIZE, OR COLOR.

SN 85-232,005, FILED 2-2-2011.

KATHERINE CHANG, EXAMINING ATTORNEY



David J. Kybas

Director of the United States Patent and Trademark Office

United States of America

United States Patent and Trademark Office



Reg. No. 4,176,535

Registered July 17, 2012

Int. Cl.: 36

SERVICE MARK

PRINCIPAL REGISTER

ORT AMERICA, INC. (NEW YORK CORPORATION)
10TH FLOOR
75 MAIDEN LANE
NEW YORK, NY 10038

FOR: CHARITABLE FUNDRAISING SERVICES, IN CLASS 36 (U.S. CLS. 100, 101 AND 102).

FIRST USE 4-0-2011; IN COMMERCE 4-0-2011.

OWNER OF U.S. REG. NO. 2,533,494.

NO CLAIM IS MADE TO THE EXCLUSIVE RIGHT TO USE "AMERICA", APART FROM THE MARK AS SHOWN.

THE MARK CONSISTS OF THE WORDS "ORT AMERICA" WITH A GLOBE INSIDE THE LETTER "O" AND A MORTARBOARD SITTING ATOP OF THE SAME LETTER "O".

SN 85-232,631, FILED 2-2-2011.

ROBIN MITTLER, EXAMINING ATTORNEY



David J. Kybas

Director of the United States Patent and Trademark Office

United States of America

United States Patent and Trademark Office

FISH GEL

Reg. No. 4,176,536

RAINBOW LIGHT NUTRITIONAL SYSTEMS, INC. (DELAWARE CORPORATION)
125 MCPHERSON ST.
SANTA CRUZ, CA 95060

Registered July 17, 2012

Int. Cl.: 5

FOR: VITAMINS AND NUTRITIONAL SUPPLEMENTS THAT CONTAIN FISH OIL AND FISH GELATIN, IN CLASS 5 (U.S. CLS. 6, 18, 44, 46, 51 AND 52).

TRADEMARK

FIRST USE 3-16-2011; IN COMMERCE 3-16-2011.

PRINCIPAL REGISTER

NO CLAIM IS MADE TO THE EXCLUSIVE RIGHT TO USE "FISH GEL", APART FROM THE MARK AS SHOWN.

THE MARK CONSISTS OF THE WORD "FISH GEL" WITH A FISH DESIGN SURROUNDING THE WORD "GEL".

SN 85-232,801, FILED 2-2-2011.

IRA J. GOODSAY, EXAMINING ATTORNEY



David J. Kyffers

Director of the United States Patent and Trademark Office

United States of America

United States Patent and Trademark Office

DREAM GETAWAY

Reg. No. 4,176,537

Registered July 17, 2012

Int. Cl.: 41

SERVICE MARK

PRINCIPAL REGISTER

UNITED CHARITIES INTERNATIONAL, INC. (NEVADA CORPORATION)
SUITE 605
19321 US 19 NORTH
CLEARWATER, FL 33764

FOR: SWEEPSTAKE SERVICES, IN CLASS 41 (U.S. CLS. 100, 101 AND 107).

FIRST USE 10-1-2011; IN COMMERCE 10-1-2011.

THE MARK CONSISTS OF STANDARD CHARACTERS WITHOUT CLAIM TO ANY PARTICULAR FONT, STYLE, SIZE, OR COLOR.

NO CLAIM IS MADE TO THE EXCLUSIVE RIGHT TO USE "GETAWAY", APART FROM THE MARK AS SHOWN.

SN 85-232,992, FILED 2-3-2011.

MICHAEL WEBSTER, EXAMINING ATTORNEY



David J. Kyffers

Director of the United States Patent and Trademark Office

United States of America
United States Patent and Trademark Office

STAR ABS

Reg. No. 4,176,538

EY & L INC. (CALIFORNIA CORPORATION)
468 NORTH CAMDEN DRIVE, SUITE 200
BEVERLY HILLS, CA 90210

Registered July 17, 2012

Int. Cl.: 28

FOR: EXERCISE EQUIPMENT, NAMELY, ABDOMINAL EXERCISERS, IN CLASS 28 (U.S. CLS. 22, 23, 38 AND 50).

TRADEMARK

FIRST USE 3-29-2012; IN COMMERCE 3-29-2012.

PRINCIPAL REGISTER

THE MARK CONSISTS OF STANDARD CHARACTERS WITHOUT CLAIM TO ANY PARTICULAR FONT, STYLE, SIZE, OR COLOR.

NO CLAIM IS MADE TO THE EXCLUSIVE RIGHT TO USE "ABS", APART FROM THE MARK AS SHOWN.

SN 85-233,011, FILED 2-3-2011.

DORITT L. CARROLL, EXAMINING ATTORNEY



David J. Kyffers

Director of the United States Patent and Trademark Office

United States of America

United States Patent and Trademark Office



Reg. No. 4,176,539

Registered July 17, 2012

Int. Cl.: 21

TRADEMARK

PRINCIPAL REGISTER

WADHWANI, CHANDRU (UNITED STATES INDIVIDUAL)
12621 WESTERN AVE
GARDEN GROVE, CA 92841

FOR: HOUSEHOLD UTENSILS, NAMELY, POT AND PAN SCRAPERS, ROLLING PINS, SPATULAS, TURNERS, WHISKS, GRATERS, SIEVES, SPATULAS, STRAINERS, SKIMMERS, KITCHEN TONGS, SPLATTER SCREENS, POURING AND STRAINING SPOUTS, NON-METAL FLEXIBLE LID DESIGNED FOR DRAINING OR PRESSING LIQUIDS FROM A FOOD CAN, IN CLASS 21 (U.S. CLS. 2, 13, 23, 29, 30, 33, 40 AND 50).

FIRST USE 5-1-2011; IN COMMERCE 5-1-2011.

NO CLAIM IS MADE TO THE EXCLUSIVE RIGHT TO USE "HOME", APART FROM THE MARK AS SHOWN.

THE COLOR(S) GREEN, BLUE, GRAY, ORANGE AND BLACK IS/ARE CLAIMED AS A FEATURE OF THE MARK.

THE MARK CONSISTS OF WORD "HOME" STYLIZED ON FIRST LEVEL LETTER "H" IN GREEN, LETTER "O" IN BLUE, LETTER "M" IN GRAY AND LETTER "E" IN ORANGE. WORD "SENSE" IN CAPITALS IN BLACK ON SECOND LEVEL.

SN 85-233,070, FILED 2-3-2011.

GEORGE LORENZO, EXAMINING ATTORNEY



David J. Kyffers

Director of the United States Patent and Trademark Office

United States of America

United States Patent and Trademark Office



Reg. No. 4,176,540

A FAIR SHAKE FOR YOUTH INC. (NEW YORK CORPORATION)

Registered July 17, 2012

210 W. 101 ST. 7D
NEW YORK, NY 10025

Int. Cls.: 41 and 45

FOR: CHARITABLE SERVICES, NAMELY, PROVIDING MENTORING AND EDUCATION IN THE NATURE OF CLASSES, LECTURES, WORKSHOPS, AND PROGRAMS IN THE FIELD OF HUMANE PRINCIPLES, CARING FOR, INTERACTING WITH AND TRAINING DOMESTIC ANIMALS, IN CLASS 41 (U.S. CLS. 100, 101 AND 107).

SERVICE MARK

PRINCIPAL REGISTER

FIRST USE 9-0-2010; IN COMMERCE 9-0-2010.

FOR: CHARITABLE SERVICES, NAMELY, PROVIDING COUNSELING RELATING TO INTERACTING WITH AND UTILIZING HUMANE PRINCIPLES IN INTERACTING WITH DOMESTIC ANIMALS IN THE NATURE OF FORMING PERSONAL RELATIONS WITH, CARING FOR, AND IMPROVING SOCIAL SKILLS THROUGH DOMESTIC ANIMALS, IN CLASS 45 (U.S. CLS. 100 AND 101).

FIRST USE 9-0-2010; IN COMMERCE 9-0-2010.

NO CLAIM IS MADE TO THE EXCLUSIVE RIGHT TO USE "FOR YOUTH", APART FROM THE MARK AS SHOWN.

THE MARK CONSISTS OF A DOG WITH SPOTS WITH A RAISED PAW, THE WORDING "A FAIR SHAKE" AND THE WORDING "FOR YOUTH" IN A RECTANGLE.

SN 85-233,821, FILED 2-3-2011.

MELISSA VALLILLO, EXAMINING ATTORNEY



David J. Kybas

Director of the United States Patent and Trademark Office

United States of America

United States Patent and Trademark Office

INNOVATION SQUARE

Reg. No. 4,176,541

Registered July 17, 2012

**Int. Cls.: 35, 36, 41, and
42**

SERVICE MARK

PRINCIPAL REGISTER

UNIVERSITY OF FLORIDA RESEARCH FOUNDATION, INC. (FLORIDA NON-PROFIT CORPORATION)
223 GRINTER HALL
GAINESVILLE, FL 326115500

FOR: BUSINESS DEVELOPMENT SERVICES, NAMELY, PROVIDING START-UP SUPPORT FOR THE BUSINESSES OF OTHERS; BUSINESS MANAGEMENT CONSULTATION, NAMELY, CONSULTATION FOR THE DEVELOPMENT OF TECHNOLOGY BUSINESS; BUSINESS AND EARLY-STAGE COMPANY INCUBATOR SERVICES, NAMELY, PROVIDING WORK SPACE CONTAINING BUSINESS EQUIPMENT TO FREELANCERS, START-UPS, EXISTING BUSINESSES AND NON-PROFITS, TAILORED TO EARLY-STAGE COMPANIES; MANAGEMENT ADVICE, BUSINESS PLANNING, STRATEGIC PLANNING AND MARKETING COUNSELING; COUNSELING ASSISTANCE IN PREPARING AND PRESENTING FUNDING PRESENTATIONS AND REFERRALS TO PRIVATE INVESTORS AND VENTURE CAPITALISTS; ASSISTING START-UP COMPANIES IN THE DEVELOPMENT OF BUSINESS STRATEGIES, IN CLASS 35 (U.S. CLS. 100, 101 AND 102).

FIRST USE 8-22-2011; IN COMMERCE 8-22-2011.

FOR: VENTURE CAPITAL INVESTMENT MANAGEMENT AND INVESTMENT CONSULTATION FOR EARLY STAGE COMPANIES, NAMELY, SECURING SUPPORT FROM COMPANIES AND OTHER LOCAL, REGIONAL, NATIONAL AND INTERNATIONAL ORGANIZATIONS TO FOSTER DEVELOPMENT FOR HIGH TECHNOLOGY BUSINESSES; VENTURE CAPITAL INVESTMENT FUNDING SERVICES, NAMELY, AWARDING GRANTS AND PROVIDING LOANS TO START-UP COMPANIES; RENTAL AND LEASING OF OFFICE SPACE, IN CLASS 36 (U.S. CLS. 100, 101 AND 102).

FIRST USE 8-22-2011; IN COMMERCE 8-22-2011.

FOR: PROVIDING EDUCATIONAL MENTORING SERVICES AND PROGRAMS IN THE FIELDS OF BUSINESS GROWTH, BUSINESS MANAGEMENT AND BUSINESS DEVELOPMENT, IN CLASS 41 (U.S. CLS. 100, 101 AND 107).

FIRST USE 8-22-2011; IN COMMERCE 8-22-2011.

FOR: PRODUCT RESEARCH AND DEVELOPMENT, NAMELY, TECHNOLOGY INCUBATOR SERVICES FOR STIMULATING THE DEVELOPMENT OF HIGH TECHNOLOGY ENTRE-



David J. Kyffers

Director of the United States Patent and Trademark Office

Reg. No. 4,176,541 PRENEURS, NAMELY, CHEMICAL ANALYSIS SERVICES, PROTOTYPE DEVELOPMENT SERVICES; DESIGN AND TESTING FOR NEW PRODUCT DEVELOPMENT, NAMELY, TESTING THE PRODUCTS OF OTHERS IN TECHNICAL FIELDS, IN CLASS 42 (U.S. CLS. 100 AND 101).

FIRST USE 8-22-2011; IN COMMERCE 8-22-2011.

THE MARK CONSISTS OF STANDARD CHARACTERS WITHOUT CLAIM TO ANY PARTICULAR FONT, STYLE, SIZE, OR COLOR.

SN 85-234,039, FILED 2-4-2011.

TIMOTHY FINNEGAN, EXAMINING ATTORNEY

United States of America

United States Patent and Trademark Office

Neat's Boutique

Reg. No. 4,176,542

GAMBLE-WEBBE, BONITA L (UNITED STATES INDIVIDUAL)
509 BONIFANT RAOD
SILVER SPRING, MD 20905

Registered July 17, 2012

Int. Cl.: 14

FOR: JEWELRY, IN CLASS 14 (U.S. CLS. 2, 27, 28 AND 50).

TRADEMARK

FIRST USE 10-4-2004; IN COMMERCE 10-4-2004.

PRINCIPAL REGISTER

THE MARK CONSISTS OF STANDARD CHARACTERS WITHOUT CLAIM TO ANY PARTICULAR FONT, STYLE, SIZE, OR COLOR.

NO CLAIM IS MADE TO THE EXCLUSIVE RIGHT TO USE "BOUTIQUE", APART FROM THE MARK AS SHOWN.

SN 85-234,785, FILED 2-4-2011.

HANNO RITTNER, EXAMINING ATTORNEY



David J. Kyffers

Director of the United States Patent and Trademark Office

United States of America

United States Patent and Trademark Office

JOE'S MEGA HOT SAUCE

Reg. No. 4,176,543

Registered July 17, 2012

Int. Cl.: 5

TRADEMARK

PRINCIPAL REGISTER

BRADLEY, JOE L. (UNITED STATES INDIVIDUAL), DBA JOE'S MEGA HOT SAUCES,
11 PEBBLE PLACE
FREDERICKSBURG, VA 22405

FOR: BISCUITS, BREAD, BREAD ROLLS, CAKES, CEREAL PRODUCTS, CONFECTIONERY,
CRACKERS, NOODLES, FISH SAUCE, RELISH, SAUCES, CEREAL-BASED SNACK-FOODS
AND PREPARED DIETARY ITEMS ALL OF WHICH ARE GLUTEN-FREE TO ACCOMMOD-
ATE SPECIAL MEDICAL AND HEALTH CONDITIONS, IN CLASS 5 (U.S. CLS. 6, 18, 44,
46, 51 AND 52).

FIRST USE 6-11-2011; IN COMMERCE 6-11-2011.

THE MARK CONSISTS OF STANDARD CHARACTERS WITHOUT CLAIM TO ANY PAR-
TICULAR FONT, STYLE, SIZE, OR COLOR.

NO CLAIM IS MADE TO THE EXCLUSIVE RIGHT TO USE "HOT SAUCE", APART FROM
THE MARK AS SHOWN.

SN 85-235,023, FILED 2-5-2011.

DAWN FELDMAN, EXAMINING ATTORNEY



David J. Kyffers

Director of the United States Patent and Trademark Office

United States of America

United States Patent and Trademark Office

KINGS OF CONTENT

Reg. No. 4,176,544

KING FISH MEDIA, LLC (MASSACHUSETTS LIMITED LIABILITY COMPANY)
27 CONGRESS STREET
SALEM, MA 01970

Registered July 17, 2012

Int. Cl.: 41

FOR: ENTERTAINMENT SERVICES, NAMELY, PROVIDING A PODCAST ABOUT MARKETING, MEDIA, AND PUBLISHING FEATURING INTERVIEWS, ADVICE, ANALYSIS, CREATIVE PIECES AND NEWS IN THE FIELDS OF MARKETING, MEDIA AND PUBLISHING, IN CLASS 41 (U.S. CLS. 100, 101 AND 107).

SERVICE MARK

PRINCIPAL REGISTER

FIRST USE 4-7-2011; IN COMMERCE 4-7-2011.

THE MARK CONSISTS OF STANDARD CHARACTERS WITHOUT CLAIM TO ANY PARTICULAR FONT, STYLE, SIZE, OR COLOR.

SN 85-235,426, FILED 2-7-2011.

MATTHEW KLINE, EXAMINING ATTORNEY



David J. Kyjars

Director of the United States Patent and Trademark Office

United States of America

United States Patent and Trademark Office

HANES SIGNATURE

Reg. No. 4,176,545

HBI BRANDED APPAREL LIMITED, INC. (DELAWARE CORPORATION)
1000 EAST HANES MILL ROAD
WINSTON-SALEM, NC 27105

Registered July 17, 2012

Int. Cl.: 25

FOR: BLOUSES; COATS; DRESSES; HATS; JACKETS; LOUNGEWEAR; PANTS; SHIRTS;
SHORTS; SKIRTS; SLEEPWEAR; SWEAT PANTS; SWEAT SHIRTS; SWEATERS; T-SHIRTS;
TANK TOPS; TURTLENECKS, IN CLASS 25 (U.S. CLS. 22 AND 39).

TRADEMARK

FIRST USE 7-11-2011; IN COMMERCE 7-11-2011.

PRINCIPAL REGISTER

THE MARK CONSISTS OF STANDARD CHARACTERS WITHOUT CLAIM TO ANY PARTICULAR FONT, STYLE, SIZE, OR COLOR.

OWNER OF U.S. REG. NOS. 847,649, 2,121,985, AND OTHERS.

SN 85-235,638, FILED 2-7-2011.

KIM MONINGHOFF, EXAMINING ATTORNEY



David J. Kyffers

Director of the United States Patent and Trademark Office

United States of America

United States Patent and Trademark Office

GELLAS

Reg. No. 4,176,546

Registered July 17, 2012

Int. Cl.: 21

TRADEMARK

PRINCIPAL REGISTER

SHEDRAIN CORPORATION (OREGON CORPORATION)
8303 NE KILLINGSWORTH
PORTLAND, OR 97220

FOR: PLIABLE HANDLES FOR BARBEQUE TOOLS, NAMELY, TONGS, TURNERS, BRUSHES FOR CLEANING GRILLS, IN CLASS 21 (U.S. CLS. 2, 13, 23, 29, 30, 33, 40 AND 50).

FIRST USE 2-25-2011; IN COMMERCE 2-25-2011.

THE MARK CONSISTS OF STANDARD CHARACTERS WITHOUT CLAIM TO ANY PARTICULAR FONT, STYLE, SIZE, OR COLOR.

OWNER OF U.S. REG. NOS. 2,930,900 AND 3,951,471.

SN 85-235,877, FILED 2-7-2011.

DAVID I, EXAMINING ATTORNEY



David J. Kyffers

Director of the United States Patent and Trademark Office

United States of America

United States Patent and Trademark Office

VINCE CAMUTO

Reg. No. 4,176,547

Registered July 17, 2012

Int. Cl.: 3

TRADEMARK

PRINCIPAL REGISTER

CAMUTO CONSULTING, INC. (CONNECTICUT CORPORATION), DBA CAMUTO GROUP,
THIRD FLOOR
411 WEST PUTNAM AVENUE
GREENWICH, CT 06830

FOR: FRAGRANCES FOR PERSONAL USE, PERFUMES; BATH AND BODY PRODUCTS,
NAMELY, BODY LOTIONS, BODY CREME, BODY MIST, HAND CREME, BATH AND
SHOWER GEL, BODY SCRUB, MASSAGE OIL, DUSTING POWDER AND BATH SOAP,
SCENTED SHAMPOOS AND CONDITIONERS, IN CLASS 3 (U.S. CLS. 1, 4, 6, 50, 51 AND
52).

FIRST USE 9-1-2011; IN COMMERCE 9-1-2011.

THE MARK CONSISTS OF STANDARD CHARACTERS WITHOUT CLAIM TO ANY PAR-
TICULAR FONT, STYLE, SIZE, OR COLOR.

OWNER OF U.S. REG. NO. 3,161,347.

THE NAME(S), PORTRAIT(S), AND/OR SIGNATURE(S) SHOWN IN THE MARK IDENTIFIES
"VINCE CAMUTO", WHOSE CONSENT(S) TO REGISTER IS MADE OF RECORD.

SN 85-236,961, FILED 2-8-2011.

JOHN DALIER, EXAMINING ATTORNEY



David J. Kyffers

Director of the United States Patent and Trademark Office

United States of America

United States Patent and Trademark Office

THREE BAKERS

Reg. No. 4,176,548

GLUTEN FREE FOOD GROUP, LLC (NEVADA LIMITED LIABILITY COMPANY)
1187 WILMETTE AVENUE #219
WILMETTE, IL 60091

Registered July 17, 2012

Int. Cls.: 5 and 30

FOR: GLUTEN-FREE FOODS TO ACCOMMODATE SPECIAL HEALTH AND MEDICAL CONDITIONS, IN CLASS 5 (U.S. CLS. 6, 18, 44, 46, 51 AND 52).

TRADEMARK

FIRST USE 10-0-2011; IN COMMERCE 10-0-2011.

PRINCIPAL REGISTER

FOR: GLUTEN-FREE FOODS, NAMELY, GLUTEN-FREE PROCESSED GRAINS AND STARCHES FOR COOKING AND BAKING; GLUTEN-FREE BAKED GOODS, NAMELY, BREADS, ROLLS, BAGELS, BUNS, PASTRIES, BROWNIES; GLUTEN-FREE DRY AND FROZEN PASTAS AND NOODLES; GLUTEN-FREE MIXES FOR BAKERY GOODS; GLUTEN-FREE PROCESSED CEREALS; GLUTEN-FREE CRACKERS; GLUTEN-FREE SNACKS, NAMELY, COOKIES, CRACKERS, TORTILLA CHIPS; GLUTEN-FREE PROCESSED ENTREES CONSISTING PRIMARILY OF PASTA OR RICE; GLUTEN-FREE PIZZA, IN CLASS 30 (U.S. CL. 46).

FIRST USE 10-0-2011; IN COMMERCE 10-0-2011.

THE MARK CONSISTS OF STANDARD CHARACTERS WITHOUT CLAIM TO ANY PARTICULAR FONT, STYLE, SIZE, OR COLOR.

NO CLAIM IS MADE TO THE EXCLUSIVE RIGHT TO USE "BAKERS", APART FROM THE MARK AS SHOWN.

SN 85-238,394, FILED 2-9-2011.

CHARLOTTE CORWIN, EXAMINING ATTORNEY



David J. Kybas

Director of the United States Patent and Trademark Office

United States of America

United States Patent and Trademark Office



Reg. No. 4,176,549

NANOVIS, LLC (INDIANA LIMITED LIABILITY COMPANY)
5865 EAST STATE ROAD 14
COLUMBIA CITY, IN 46725

Registered July 17, 2012

Int. Cl.: 10

FOR: DENTAL IMPLANTS AND MEDICAL IMPLANTS, NAMELY, ORTHOPEDIC IMPLANTS, CARDIOVASCULAR IMPLANTS, GASTROINTESTINAL IMPLANTS, SOFT-TISSUE REPAIR IMPLANTS AND NEUROSURGICAL IMPLANTS, MADE WITH NANOSURFACED AND NANO-STRUCTURED MATERIALS AND MADE PRIMARILY WITH ARTIFICIAL MATERIALS, IN CLASS 10 (U.S. CLS. 26, 39 AND 44).

TRADEMARK

PRINCIPAL REGISTER

FIRST USE 6-14-2011; IN COMMERCE 6-14-2011.

THE MARK CONSISTS OF AN UPSIDE DOWN "V" WITH A SEMI-CIRCLE CONNECTING IT TO A RIGHT SIDE UP "V" REPLICATING A STYLIZED "N" THIS IS POSITIONED BEFORE THE WORD "NANOVIS".

SN 85-238,941, FILED 2-10-2011.

SUSAN STIGLITZ, EXAMINING ATTORNEY



David J. Kybas

Director of the United States Patent and Trademark Office

United States of America

United States Patent and Trademark Office

RAD RINGZ

Reg. No. 4,176,550

BCP IMPORTS, LLC (OHIO LIMITED LIABILITY COMPANY)
148 MAIN STREET
TOLEDO, OH 43605

Registered July 17, 2012

Int. Cl.: 14

FOR: FINGER RINGS FEATURING REMOVABLE AND INTERCHANGEABLE MESSAGES,
IN CLASS 14 (U.S. CLS. 2, 27, 28 AND 50).

TRADEMARK

FIRST USE 6-21-2011; IN COMMERCE 6-21-2011.

PRINCIPAL REGISTER

THE MARK CONSISTS OF STANDARD CHARACTERS WITHOUT CLAIM TO ANY PAR-
TICULAR FONT, STYLE, SIZE, OR COLOR.

NO CLAIM IS MADE TO THE EXCLUSIVE RIGHT TO USE "RINGS", APART FROM THE
MARK AS SHOWN.

SN 85-239,714, FILED 2-11-2011.

DARRYL SPRUILL, EXAMINING ATTORNEY



David J. Kyffers

Director of the United States Patent and Trademark Office

United States of America

United States Patent and Trademark Office

SpaSynergy

Reg. No. 4,176,551

Registered July 17, 2012

Int. Cl.: 9

TRADEMARK

PRINCIPAL REGISTER

PLANET BEACH FRANCHISING CORPORATION (DELAWARE CORPORATION)
5145 TARAVELLA ROAD
MARRERO, LA 70072

FOR: COMPUTER DATABASE MANAGEMENT SOFTWARE FOR USE IN PERSONALIZING THE CONTENT OF E-MAIL COMMUNICATIONS; COMPUTER OPERATING SOFTWARE; COMPUTER SOFTWARE FOR CREATING SEARCHABLE DATABASES OF INFORMATION AND DATA; COMPUTER SOFTWARE FOR PROVIDING AN ON-LINE DATABASE IN THE FIELD OF TRANSACTION PROCESSING TO UPLOAD TRANSACTIONAL DATA, PROVIDE STATISTICAL ANALYSIS, AND PRODUCE NOTIFICATIONS AND REPORTS; COMPUTER SOFTWARE FOR THE COLLECTION, EDITING, ORGANIZING, MODIFYING, BOOK MARKING, TRANSMISSION, STORAGE AND SHARING OF DATA AND INFORMATION; COMPUTER SOFTWARE FOR THE FIELD OF WAREHOUSING AND DISTRIBUTION, TO MANAGE TRANSACTIONAL DATA, PROVIDE STATISTICAL ANALYSIS, AND PRODUCE NOTIFICATIONS AND REPORTS; COMPUTER SOFTWARE FOR USE IN CUSTOMER RELATIONSHIP MANAGEMENT (CRM); COMPUTER SOFTWARE PLATFORMS FOR USE IN DATA MANAGEMENT IN THE FIELD OF SPA INDUSTRY; COMPUTER SOFTWARE THAT PROVIDES REAL-TIME, INTEGRATED BUSINESS MANAGEMENT INTELLIGENCE BY COMBINING INFORMATION FROM VARIOUS DATABASES AND PRESENTING IT IN AN EASY-TO-UNDERSTAND USER INTERFACE; DATABASE MANAGEMENT SOFTWARE FOR SPA CUSTOMER INFORMATION, RETAIL TRANSACTIONS, INVENTORY MANAGEMENT AND FINANCIAL RECORDS AND REPORTING, IN CLASS 9 (U.S. CLS. 21, 23, 26, 36 AND 38).

FIRST USE 11-15-2010; IN COMMERCE 8-19-2011.

THE MARK CONSISTS OF STANDARD CHARACTERS WITHOUT CLAIM TO ANY PARTICULAR FONT, STYLE, SIZE, OR COLOR.

SN 85-239,846, FILED 2-11-2011.

SALLY SHIH, EXAMINING ATTORNEY



David J. Kyros

Director of the United States Patent and Trademark Office

United States of America

United States Patent and Trademark Office



Reg. No. 4,176,552

Registered July 17, 2012

Int. Cl.: 35

SERVICE MARK

PRINCIPAL REGISTER

MB COMPUTER SYSTEMS LLC (NEW YORK LIMITED LIABILITY COMPANY)
59 VERBENA DRIVE
COMMACK, NY 11725

FOR: RETAIL STORE SERVICES FEATURING DESKTOP COMPUTERS, IN CLASS 35 (U.S. CLS. 100, 101 AND 102).

FIRST USE 10-8-2010; IN COMMERCE 12-1-2010.

NO CLAIM IS MADE TO THE EXCLUSIVE RIGHT TO USE "COMPUTER SYSTEMS", APART FROM THE MARK AS SHOWN.

THE COLOR(S) LIGHT BLUE, BLUE, DARK BLUE, AND WHITE IS/ARE CLAIMED AS A FEATURE OF THE MARK.

THE MARK CONSISTS OF THE STYLIZED BLUE, LIGHT BLUE, AND DARK BLUE LETTERS "MB" ABOVE THE STYLIZED LIGHT BLUE WORDING "COMPUTER SYSTEMS" SURROUNDED BY A BROKEN BLUE AND DARK BLUE CYLINDER ALL ON A WHITE BACKGROUND.

SN 85-239,920, FILED 2-11-2011.

MARILYN IZZI, EXAMINING ATTORNEY



David J. Kyffers

Director of the United States Patent and Trademark Office

United States of America

United States Patent and Trademark Office

vWoGo

Reg. No. 4,176,553

WOGO LLC (TEXAS LIMITED LIABILITY COMPANY)
302 N. MARKET ST., 3RD FLOOR
DALLAS, TX 75202

Registered July 17, 2012

Int. Cls.: 38, 41, and 42

FOR: INSTANT MESSAGING SERVICES TO INCLUDE ON-LINE CHAT; PROVIDING AN ON-LINE FORUM FOR COMPUTER GAMERS, IN CLASS 38 (U.S. CLS. 100, 101 AND 104).

SERVICE MARK

FIRST USE 12-15-2010; IN COMMERCE 2-1-2011.

PRINCIPAL REGISTER

FOR: PROVIDING A VIRTUAL GOODS MARKETPLACE ACROSS MULTIPLE VIRTUAL WORLDS FOR COMPUTER GAMERS; VIRTUAL GOODS MARKETPLACE ACROSS MULTIPLE VIRTUAL WORLDS; COMPUTER SERVICES, NAMELY, CREATING AN ON-LINE COMMUNITY FOR REGISTERED USERS TO CONNECT, REGISTER AND PARTICIPATE IN THIRD-PARTY WEBSITES AND PLATFORMS FOR GAMING SYSTEMS, GAMING PLATFORMS AND LOYALTY PLATFORMS FOR GAMERS, IN CLASS 41 (U.S. CLS. 100, 101 AND 107).

FIRST USE 12-15-2010; IN COMMERCE 2-1-2011.

FOR: COMPUTER SERVICES, NAMELY, CREATING AN ON-LINE COMMUNITY FOR REGISTERED USERS TO CONNECT, REGISTER AND PARTICIPATE IN THIRD-PARTY WEBSITES AND PLATFORMS VIA A SET OF APPLICATION PROGRAMMING INTERFACES (API), IN CLASS 42 (U.S. CLS. 100 AND 101).

FIRST USE 12-15-2010; IN COMMERCE 2-1-2011.

THE MARK CONSISTS OF STANDARD CHARACTERS WITHOUT CLAIM TO ANY PARTICULAR FONT, STYLE, SIZE, OR COLOR.

SN 85-240,587, FILED 2-11-2011.

RAUL CORDOVA, EXAMINING ATTORNEY



David J. Kyros

Director of the United States Patent and Trademark Office

United States of America

United States Patent and Trademark Office

123 JUMP

Reg. No. 4,176,554

SKYWALKER HOLDINGS, LLC (UTAH LIMITED LIABILITY COMPANY)
1095 N. 1000 W. #8

Registered July 17, 2012

BRIGHAM CITY, UT 84302

Int. Cl.: 28

FOR: TRAMPOLINES, IN CLASS 28 (U.S. CLS. 22, 23, 38 AND 50).

TRADEMARK

FIRST USE 8-18-2011; IN COMMERCE 8-18-2011.

PRINCIPAL REGISTER

THE MARK CONSISTS OF STANDARD CHARACTERS WITHOUT CLAIM TO ANY PARTICULAR FONT, STYLE, SIZE, OR COLOR.

SN 85-240,646, FILED 2-11-2011.

LINDA LAVACHE, EXAMINING ATTORNEY



David J. Kybas

Director of the United States Patent and Trademark Office

United States of America

United States Patent and Trademark Office

CHAHUA

Reg. No. 4,176,555

Registered July 17, 2012

Int. Cl.: 20

TRADEMARK

PRINCIPAL REGISTER

FUJIAN CHAHUA HOUSEHOLD PLASTICS CO., LTD. (CHINA LIMITED COMPANY (LTD.))
5 FUXING AVE.
FUXING ECONOMIC DEVELOPMENT ZONE, FUZHOU
FUJIAN, 350014, CHINA

FOR: BENCHES; CHAIRS; CLOTHES HANGERS; DECORATIONS OF PLASTIC FOR FOODSTUFFS; FURNITURE, NAMELY, SHOWCASES; NON-METAL BINS; NON-METAL CLOTHES HOOKS; NON-METAL PALLETS; PACKAGING CONTAINERS OF PLASTIC; VATS, NOT OF METAL, IN CLASS 20 (U.S. CLS. 2, 13, 22, 25, 32 AND 50).

FIRST USE 10-10-2008; IN COMMERCE 12-5-2008.

THE MARK CONSISTS OF STANDARD CHARACTERS WITHOUT CLAIM TO ANY PARTICULAR FONT, STYLE, SIZE, OR COLOR.

OWNER OF U.S. REG. NO. 3,139,353.

THE WORDING "CHAHUA" HAS NO MEANING IN A FOREIGN LANGUAGE.

SN 85-241,141, FILED 2-14-2011.

ANDREA HACK, EXAMINING ATTORNEY



David J. Kyros

Director of the United States Patent and Trademark Office

United States of America

United States Patent and Trademark Office

PAIN AWAY LASER

Reg. No. 4,176,556

MEDICAL QUANT USA, INC. (OHIO CORPORATION), DBA MULTI RADIANCE MEDICAL,
6565 COCHRAN ROAD
SOLON, OH 44139

Registered July 17, 2012

Int. Cl.: 10

FOR: LIGHT-BASED MEDICAL DEVICES, NAMELY, DEVICES USING LOW LEVEL LASERS, LIGHT EMITTING DIODES, INFRARED LIGHT AND PULSED LIGHT FOR TREATING DISEASES AND PROVIDING THERAPEUTIC MUSCLE, SKELETAL, NERVE AND SKIN THERAPIES, IN CLASS 10 (U.S. CLS. 26, 39 AND 44).

TRADEMARK

PRINCIPAL REGISTER

FIRST USE 2-1-2010; IN COMMERCE 2-1-2010.

THE MARK CONSISTS OF STANDARD CHARACTERS WITHOUT CLAIM TO ANY PARTICULAR FONT, STYLE, SIZE, OR COLOR.

NO CLAIM IS MADE TO THE EXCLUSIVE RIGHT TO USE "LASER", APART FROM THE MARK AS SHOWN.

SN 85-241,618, FILED 2-14-2011.

KAPIL BHANOT, EXAMINING ATTORNEY



David J. Kybas

Director of the United States Patent and Trademark Office

United States of America

United States Patent and Trademark Office

TURBOCONE

Reg. No. 4,176,557

WALTER MEIER (MANUFACTURING) INC. (WASHINGTON CORPORATION)
427 NEW SANFORD ROAD
LAVERGNE, TN 37086

Registered July 17, 2012

Int. Cl.: 7

FOR: DUST COLLECTING MACHINES FOR INDUSTRIAL AND MANUAL WORKSHOP
USE, IN CLASS 7 (U.S. CLS. 13, 19, 21, 23, 31, 34 AND 35).

TRADEMARK

FIRST USE 3-28-2011; IN COMMERCE 3-28-2011.

PRINCIPAL REGISTER

THE MARK CONSISTS OF STANDARD CHARACTERS WITHOUT CLAIM TO ANY PAR-
TICULAR FONT, STYLE, SIZE, OR COLOR.

SN 85-241,866, FILED 2-14-2011.

PRISCILLA MILTON, EXAMINING ATTORNEY



David J. Kyffers

Director of the United States Patent and Trademark Office

United States of America

United States Patent and Trademark Office

VORTEX CONE

Reg. No. 4,176,558

WALTER MEIER (MANUFACTURING) INC. (WASHINGTON CORPORATION)
427 NEW SANFORD ROAD
LAVERGNE, TN 37086

Registered July 17, 2012

Int. Cl.: 7

FOR: DUST COLLECTING MACHINES FOR INDUSTRIAL AND MANUAL WORKSHOP
USE, IN CLASS 7 (U.S. CLS. 13, 19, 21, 23, 31, 34 AND 35).

TRADEMARK

FIRST USE 3-28-2011; IN COMMERCE 3-28-2011.

PRINCIPAL REGISTER

THE MARK CONSISTS OF STANDARD CHARACTERS WITHOUT CLAIM TO ANY PAR-
TICULAR FONT, STYLE, SIZE, OR COLOR.

SN 85-241,876, FILED 2-14-2011.

PRISCILLA MILTON, EXAMINING ATTORNEY



David J. Kyffers

Director of the United States Patent and Trademark Office

United States of America

United States Patent and Trademark Office

PROGRESSIVE GROCER'S STORE BRANDS

Reg. No. 4,176,559

Registered July 17, 2012

Int. Cl.: 41

SERVICE MARK

PRINCIPAL REGISTER

STAGNITO PARTNERS, LLC (DELAWARE LIMITED LIABILITY COMPANY)
1313 N. MARKET STREET
SUITE 5100
WILMINGTON, DE 19801

FOR: EDUCATIONAL SERVICES, NAMELY, CONDUCTING CLASSES, SEMINARS, WORKSHOPS, CONFERENCES, AND SYMPOSIUMS IN THE FIELD OF PRODUCT BRANDING AND DISTRIBUTION OF COURSE MATERIALS IN CONNECTION THEREWITH, IN CLASS 41 (U.S. CLS. 100, 101 AND 107).

FIRST USE 10-20-2011; IN COMMERCE 11-13-2011.

THE MARK CONSISTS OF STANDARD CHARACTERS WITHOUT CLAIM TO ANY PARTICULAR FONT, STYLE, SIZE, OR COLOR.

OWNER OF U.S. REG. NO. 3,112,005.

NO CLAIM IS MADE TO THE EXCLUSIVE RIGHT TO USE "GROCER'S STORE BRANDS", APART FROM THE MARK AS SHOWN.

SN 85-242,151, FILED 2-14-2011.

KEVON CHISOLM, EXAMINING ATTORNEY



David J. Kyros

Director of the United States Patent and Trademark Office

United States of America

United States Patent and Trademark Office

THE PRINT COLLECTION

Reg. No. 4,176,560

YSL BEAUTE (FRANCE SOCIÉTÉ PAR ACTIONS SIMPLIFIÉE (SAS))
29-34, BOULEVARD DU PARC
NEUILLY SUR SEINE CEDEX, FRANCE 92521

Registered July 17, 2012

Int. Cl.: 3

FOR: PERFUMES, IN CLASS 3 (U.S. CLS. 1, 4, 6, 50, 51 AND 52).

TRADEMARK

FIRST USE 9-0-2011; IN COMMERCE 9-0-2011.

PRINCIPAL REGISTER

THE MARK CONSISTS OF STANDARD CHARACTERS WITHOUT CLAIM TO ANY PARTICULAR FONT, STYLE, SIZE, OR COLOR.

NO CLAIM IS MADE TO THE EXCLUSIVE RIGHT TO USE "COLLECTION", APART FROM THE MARK AS SHOWN.

SN 85-242,382, FILED 2-15-2011.

KAREN BRACEY, EXAMINING ATTORNEY



David J. Kybas

Director of the United States Patent and Trademark Office

United States of America

United States Patent and Trademark Office



Reg. No. 4,176,561

Registered July 17, 2012

Int. Cl.: 25

TRADEMARK

PRINCIPAL REGISTER

MUDDY BOOTS OUTFITTERS, LLC (MICHIGAN LIMITED LIABILITY COMPANY)
8550 PLEASANT MEADOWS DRIVE NE
ROCKFORD, MI 49341

FOR: CLOTHING, NAMELY, SHIRTS, SWEATSHIRTS, HEADWEAR, COATS, BANDANNAS,
IN CLASS 25 (U.S. CLS. 22 AND 39).

FIRST USE 6-7-2011; IN COMMERCE 7-28-2011.

NO CLAIM IS MADE TO THE EXCLUSIVE RIGHT TO USE "BOOTS OUTFITTERS", APART
FROM THE MARK AS SHOWN.

THE MARK CONSISTS OF THE WORDS "MUDDY BOOTS OUTFITTERS" ADJACENT TO
TWO BOOT PRINT DESIGNS FEATURING THE LETTERS "MBO".

SN 85-242,822, FILED 2-15-2011.

MARK SPARACINO, EXAMINING ATTORNEY



David J. Kyffers

Director of the United States Patent and Trademark Office

United States of America

United States Patent and Trademark Office



Reg. No. 4,176,562

Registered July 17, 2012

Int. Cl.: 35

SERVICE MARK

PRINCIPAL REGISTER

RECONNECTSTAFF LLC (VIRGINIA LIMITED LIABILITY COMPANY)
9409 HULL STREET RD., SUITE F-2
RICHMOND, VA 23236

FOR: TEMPORARY EMPLOYMENT AND PERSONNEL SERVICES, NAMELY, FILLING OF EMPLOYER JOB NEEDS BY PLACEMENT INTO SUCH JOBS RETIREES AND FORMER EMPLOYEES OF SUCH EMPLOYER, IN CLASS 35 (U.S. CLS. 100, 101 AND 102).

FIRST USE 4-30-2011; IN COMMERCE 4-30-2011.

NO CLAIM IS MADE TO THE EXCLUSIVE RIGHT TO USE "STAFF", APART FROM THE MARK AS SHOWN.

THE COLOR(S) BLACK AND DARK BLUE IS/ARE CLAIMED AS A FEATURE OF THE MARK.

THE MARK CONSISTS OF THE STYLIZED WORDING "RECONNECT STAFF" IN BLACK, WITH A CURVED DARK BLUE ARROW PLACED ABOVE THE STYLIZED WORDING "RECONNECT STAFF" AND A CURVED DARK BLUE ARROW PLACED BELOW THE STYLIZED WORDING "RECONNECT STAFF". THE AREAS SHOWN IN WHITE ARE NOT PART OF THE MARK, AND MERELY SHOW THE SURFACE UPON WHICH THE MARK IS AFFIXED.

SN 85-243,269, FILED 2-15-2011.

MICHAEL GAAFAR, EXAMINING ATTORNEY



David J. Kyffers

Director of the United States Patent and Trademark Office

United States of America

United States Patent and Trademark Office

StreetPass

Reg. No. 4,176,563

NINTENDO OF AMERICA INC. (WASHINGTON CORPORATION)
4600 150TH AVENUE NE
REDMOND, WA 98052

Registered July 17, 2012

Int. Cl.: 38

SERVICE MARK

PRINCIPAL REGISTER

FOR: TELECOMMUNICATION VIA ELECTRONIC BULLETIN BOARDS OR PROVIDING INFORMATION THEREOF; COMMUNICATION VIA CONSUMER VIDEO GAME APPARATUS; PROVIDING INFORMATION ON COMMUNICATION VIA CONSUMER VIDEO GAME APPARATUS; COMMUNICATION VIA HAND-HELD GAME APPARATUS WITH LIQUID CRYSTAL DISPLAYS; PROVIDING INFORMATION ON COMMUNICATION VIA HAND-HELD GAME APPARATUS WITH LIQUID CRYSTAL DISPLAYS; COMMUNICATION WITH MESSAGES AND IMAGES VIA COMPUTERS; TELECOMMUNICATION (NOT FOR BROADCASTING); COMMUNICATION SERVICES, NAMELY, ELECTRONIC TRANSMISSION OF DATA, IMAGES, VIDEOS, AND DOCUMENTS AMONG USERS OF VIDEO GAME COMPUTERS; PROVIDING ONLINE CHAT ROOMS AND ELECTRONIC BULLETIN BOARDS FOR TRANSMISSION OF MESSAGES AMONG USERS IN THE FIELD OF GENERAL INTEREST; PROVIDING ONLINE FORUMS FOR TRANSMISSION OF MESSAGES AMONG VIDEO GAME USERS; PROVIDING WIRELESS BROADBAND COMMUNICATION SERVICES FOR USE WITH VIDEO GAME COMPUTER NETWORKS AND THE INTERNET; STREAMING OF AUDIO AND VIDEO MATERIAL ON THE INTERNET; TEXT AND NUMERIC WIRELESS DIGITAL MESSAGING SERVICES; WEB MESSAGING SERVICES; WIRELESS ELECTRONIC TRANSMISSION OF VOICE SIGNALS, DATA, IMAGES, AND INFORMATION; INFORMATION AND DATA TRANSMISSION VIA ELECTRONIC COMMUNICATIONS NETWORKS, IN CLASS 38 (U.S. CLS. 100, 101 AND 104).

FIRST USE 3-27-2011; IN COMMERCE 3-27-2011.

THE MARK CONSISTS OF STANDARD CHARACTERS WITHOUT CLAIM TO ANY PARTICULAR FONT, STYLE, SIZE, OR COLOR.

PRIORITY CLAIMED UNDER SEC. 44(D) ON JAPAN APPLICATION NO. 2010-075852, FILED 9-28-2010, REG. NO. 5409320, DATED 4-28-2011, EXPIRES 4-28-2021.

SN 85-243,509, FILED 2-16-2011.

PATRICIA EVANKO, EXAMINING ATTORNEY



David J. Kyjars

Director of the United States Patent and Trademark Office

United States of America

United States Patent and Trademark Office

StreetPass

Reg. No. 4,176,564

NINTENDO OF AMERICA INC. (WASHINGTON CORPORATION)
4600 150TH AVENUE NE
REDMOND, WA 98052

Registered July 17, 2012

Int. Cl.: 41

FOR: (BASED ON USE IN COMMERCE) (BASED ON 44(E)) PROVIDING IMAGES VIA COMMUNICATION WITH HAND-HELD GAME APPARATUS WITH LIQUID CRYSTAL DISPLAYS; PROVIDING IMAGES VIA COMMUNICATION WITH CONSUMER VIDEO GAME APPARATUS; PROVIDING IMAGES VIA COMMUNICATION; PROVIDING GAMES VIA COMMUNICATION WITH HAND-HELD GAME APPARATUS WITH LIQUID CRYSTAL DISPLAYS; PROVIDING GAMES VIA COMMUNICATION WITH CONSUMER VIDEO GAME APPARATUS; PROVIDING GAMES VIA COMMUNICATION; PROVIDING GAMES FOR CONSUMER VIDEO GAME APPARATUS; PROVIDING GAMES FOR HAND-HELD GAME APPARATUS WITH LIQUID CRYSTAL DISPLAYS; PROVIDING GAMES MADE AVAILABLE VIA A COMMUNICATION NETWORK; PROVIDING ONLINE NEWS AND INFORMATION RELATED TO ELECTRONIC, COMPUTER, AND VIDEO GAMES (BASED ON 44(E)) PROVIDING VIDEOS VIA COMMUNICATION WITH HAND-HELD GAME APPARATUS WITH LIQUID CRYSTAL DISPLAYS; PROVIDING VIDEOS VIA COMMUNICATION WITH CONSUMER VIDEO GAME APPARATUS; PROVIDING VIDEOS VIA COMMUNICATION; PROVIDING MOVIES VIA COMMUNICATION WITH HAND-HELD GAME APPARATUS WITH LIQUID CRYSTAL DISPLAYS; PROVIDING MOVIES VIA COMMUNICATION WITH CONSUMER VIDEO GAME APPARATUS; PROVIDING MOVIES VIA COMMUNICATION; PROVIDING MUSIC AND AUDIO SOUND VIA COMMUNICATION WITH HAND-HELD GAME APPARATUS WITH LIQUID CRYSTAL DISPLAYS; PROVIDING MUSIC AND AUDIO SOUND VIA COMMUNICATION WITH CONSUMER VIDEO GAME APPARATUS; PROVIDING MUSIC AND AUDIO SOUND VIA COMMUNICATION; PLANNING, MANAGING AND CONDUCTING VIDEO GAME EVENTS; PROVIDING ONLINE GAME STRATEGIES ALL RELATED TO ELECTRONIC, COMPUTER, AND VIDEO GAMES; AND PUBLICATION OF ELECTRONIC MAGAZINES, IN CLASS 41 (U.S. CLS. 100, 101 AND 107).

SERVICE MARK

PRINCIPAL REGISTER



FIRST USE 3-27-2011; IN COMMERCE 3-27-2011.

THE MARK CONSISTS OF STANDARD CHARACTERS WITHOUT CLAIM TO ANY PARTICULAR FONT, STYLE, SIZE, OR COLOR.

David J. Kybas

PRIORITY CLAIMED UNDER SEC. 44(D) ON JAPAN APPLICATION NO. 2010-075852, FILED 9-28-2010, REG. NO. 5409320, DATED 4-28-2011, EXPIRES 4-28-2021.

Director of the United States Patent and Trademark Office

Reg. No. 4,176,564 SN 85-243,511, FILED 2-16-2011.

PATRICIA EVANKO, EXAMINING ATTORNEY

United States of America

United States Patent and Trademark Office

CASTLE STONE

Reg. No. 4,176,565

Registered July 17, 2012

Int. Cl.: 19

TRADEMARK

PRINCIPAL REGISTER

OLDCASTLE BUILDING PRODUCTS, INC. (DELAWARE CORPORATION)
900 ASHWOOD PARKWAY
C/O OLDCASTLE LAW GROUP
ATLANTA, GA 30338

FOR: ARTIFICIAL BUILDING STONE FOR EXTERIOR USE ONLY, ARCHITECTURAL CONCRETE MASONRY UNITS, NAMELY, CONCRETE STONES AND CONCRETE BLOCKS FOR EXTERIOR USE ONLY, IN CLASS 19 (U.S. CLS. 1, 12, 33 AND 50).

FIRST USE 3-14-2012; IN COMMERCE 3-14-2012.

THE MARK CONSISTS OF STANDARD CHARACTERS WITHOUT CLAIM TO ANY PARTICULAR FONT, STYLE, SIZE, OR COLOR.

NO CLAIM IS MADE TO THE EXCLUSIVE RIGHT TO USE "STONE", APART FROM THE MARK AS SHOWN.

SN 85-245,157, FILED 2-17-2011.

JAMES GRIFFIN, EXAMINING ATTORNEY



David J. Kyffers

Director of the United States Patent and Trademark Office

United States of America

United States Patent and Trademark Office

STRAWBERRY RHUBARB DERMAFOLIANT

Reg. No. 4,176,566

EMINENCE ORGANIC SKINCARE INC. (CANADA CORPORATION)
530 W. BROADWAY, #300

Registered July 17, 2012

VANCOUVER, B.C., CANADA V5Z-1E9

Int. Cl.: 3

FOR: EXFOLIANTS FOR FACIAL AND BODY MASKS; SKIN CLEANSERS, IN CLASS 3
(U.S. CLS. 1, 4, 6, 50, 51 AND 52).

TRADEMARK

FIRST USE 1-1-2009; IN COMMERCE 1-1-2009.

PRINCIPAL REGISTER

THE MARK CONSISTS OF STANDARD CHARACTERS WITHOUT CLAIM TO ANY PARTICULAR FONT, STYLE, SIZE, OR COLOR.

NO CLAIM IS MADE TO THE EXCLUSIVE RIGHT TO USE "STRAWBERRY RHUBARB", APART FROM THE MARK AS SHOWN.

SN 85-245,339, FILED 2-17-2011.

TARA PATE, EXAMINING ATTORNEY



David J. Kybas

Director of the United States Patent and Trademark Office

United States of America

United States Patent and Trademark Office

Squirt Blossom

Reg. No. 4,176,567

Registered July 17, 2012

Int. Cls.: 18 and 25

TRADEMARK

PRINCIPAL REGISTER

SQUIRT BLOSSOM, LLC (GEORGIA LIMITED LIABILITY COMPANY)
198 BLAIR VALLEY DRIVE
MARIETTA, GA 30060

FOR: ALL PURPOSE SPORT BAGS; ALL-PURPOSE CARRYING BAGS; BABY BACKPACKS; CLUTCH BAGS; COSMETIC BAGS SOLD EMPTY; DIAPER BAGS; DUFFEL BAGS; GARMENT BAGS FOR TRAVEL; HANDBAGS; LUGGAGE; LUGGAGE TAGS; OVERNIGHT BAGS; SCHOOL BAGS; SHOULDER BAGS; STRAPS FOR HOLDALLS; SUITCASES; TOTE BAGS; TRAVEL BAGS; WRISTLET BAGS, IN CLASS 18 (U.S. CLS. 1, 2, 3, 22 AND 41).

FIRST USE 1-11-2012; IN COMMERCE 1-11-2012.

FOR: APRONS; BIBS NOT OF CLOTH OR PAPER; CHILDREN'S AND INFANT'S APPAREL, NAMELY, JUMPERS, OVERALL SLEEPWEAR, PAJAMAS, ROMPERS AND ONE-PIECE GARMENTS; CHILDREN'S AND INFANTS' CLOTH BIBS; CHILDREN'S HEADWEAR; DRESSES; HEAD WEAR; INFANT AND TODDLER ONE PIECE CLOTHING; INFANTS' SHOES AND BOOTS; SKIRTS AND DRESSES; SMOCKS, IN CLASS 25 (U.S. CLS. 22 AND 39).

FIRST USE 1-11-2012; IN COMMERCE 1-11-2012.

THE MARK CONSISTS OF STANDARD CHARACTERS WITHOUT CLAIM TO ANY PARTICULAR FONT, STYLE, SIZE, OR COLOR.

SN 85-246,318, FILED 2-18-2011.

WON TEAK OH, EXAMINING ATTORNEY



David J. Kyffers

Director of the United States Patent and Trademark Office

United States of America
United States Patent and Trademark Office

mingo

Reg. No. 4,176,568

Registered July 17, 2012

Int. Cls.: 35 and 40

SERVICE MARK

PRINCIPAL REGISTER

MINGO PRESS, LLC (OKLAHOMA LIMITED LIABILITY COMPANY)
6732 EAST 41ST STREET
TULSA, OK 74145

FOR: DIRECT MAIL ADVERTISING SERVICES, IN CLASS 35 (U.S. CLS. 100, 101 AND 102).

FIRST USE 1-2-2012; IN COMMERCE 2-2-2012.

FOR: PRINTING SERVICES, IN CLASS 40 (U.S. CLS. 100, 103 AND 106).

FIRST USE 1-2-2012; IN COMMERCE 2-2-2012.

THE MARK CONSISTS OF THE WORD "MINGO" IN STYLIZED LOWERCASE FONT.

SN 85-248,007, FILED 2-22-2011.

STEVEN R. FINE, EXAMINING ATTORNEY



David J. Kyffers

Director of the United States Patent and Trademark Office

United States of America

United States Patent and Trademark Office

WE ARE AT THE HEART OF THE
ENGINES THAT KEEP MILLIONS
OF PEOPLE IN THE AIR EVERY
DAY

Reg. No. 4,176,569

Registered July 17, 2012

Int. Cl.: 40

SERVICE MARK

PRINCIPAL REGISTER

FIRTH RIXSON LIMITED (UNITED KINGDOM LIMITED COMPANY (LTD.))
FIRTH HOUSE, PO BOX 644
MEADOWHALL ROAD
SHEFFIELD, UNITED KINGDOM S91JD

FOR: FORGING AND WROUGHT PROCESSING OF METAL GOODS TO THE ORDER AND SPECIFICATION OF OTHERS IN THE AEROSPACE/AIRCRAFT INDUSTRY; FORGING AND WROUGHT PROCESSING OF METAL GOODS FOR AEROSPACE/AIRCRAFT ENGINES, IN CLASS 40 (U.S. CLS. 100, 103 AND 106).

FIRST USE 2-28-2011; IN COMMERCE 2-28-2011.

THE MARK CONSISTS OF STANDARD CHARACTERS WITHOUT CLAIM TO ANY PARTICULAR FONT, STYLE, SIZE, OR COLOR.

SN 85-248,577, FILED 2-22-2011.

JAMES MACFARLANE, EXAMINING ATTORNEY



David J. Kybas

Director of the United States Patent and Trademark Office

United States of America

United States Patent and Trademark Office

Waroe

Reg. No. 4,176,570

ASFAHA, DANIEL (UNITED STATES INDIVIDUAL)
6050 LOWELL STREET, SUITE 110
OAKLAND, CA 94608

Registered July 17, 2012

Int. Cl.: 35

FOR: ON-LINE RETAIL STORE SERVICES FEATURING CLOTHING, T-SHIRTS, POLO SHORTS, POLO SHIRTS, PANTS, AND HATS, IN CLASS 35 (U.S. CLS. 100, 101 AND 102).

SERVICE MARK

FIRST USE 9-12-2010; IN COMMERCE 3-10-2011.

PRINCIPAL REGISTER

THE MARK CONSISTS OF STANDARD CHARACTERS WITHOUT CLAIM TO ANY PARTICULAR FONT, STYLE, SIZE, OR COLOR.

SN 85-251,285, FILED 2-24-2011.

JACLYN KIDWELL WALKER, EXAMINING ATTORNEY



David J. Kyffers

Director of the United States Patent and Trademark Office

United States of America

United States Patent and Trademark Office

WALLSTREET SCANNER

Reg. No. 4,176,571

BULLOONS.COM LTD. (ISRAEL LIMITED COMPANY (LTD.))
4 HARAKUN ST.

Registered July 17, 2012 RAMAT-GAN, ISRAEL

Int. Cl.: 36

FOR: FINANCIAL SENTIMENT MONITORING, NAMELY, THE AGGREGATION AND COMPOSITE REVIEW AND ANALYSIS OF FINANCIAL REPORTS OF OTHERS FEATURING MARKET MOOD CHANGES AND FINANCIAL INFORMATION GATHERED FROM NEWS MEDIA OUTLETS, INVESTMENT PROFESSIONALS AND SOCIAL MEDIA OUTLETS, IN CLASS 36 (U.S. CLS. 100, 101 AND 102).

SERVICE MARK

PRINCIPAL REGISTER

FIRST USE 5-15-2011; IN COMMERCE 5-15-2011.

THE MARK CONSISTS OF STANDARD CHARACTERS WITHOUT CLAIM TO ANY PARTICULAR FONT, STYLE, SIZE, OR COLOR.

SN 85-251,342, FILED 2-24-2011.

REGINA DRUMMOND, EXAMINING ATTORNEY



David J. Kybas

Director of the United States Patent and Trademark Office

United States of America

United States Patent and Trademark Office

COLD NO. 7

Reg. No. 4,176,572

JACK DANIEL'S PROPERTIES, INC. (DELAWARE CORPORATION)
4040 CIVIC CENTER DR., SUITE 528
SAN RAFAEL, CA 94903

Registered July 17, 2012

Int. Cl.: 33

FOR: ALCOHOLIC BEVERAGES, NAMELY, PRE-MIXED ALCOHOLIC COCKTAILS, IN CLASS 33 (U.S. CLS. 47 AND 49).

TRADEMARK

FIRST USE 2-28-2011; IN COMMERCE 2-28-2011.

PRINCIPAL REGISTER

THE MARK CONSISTS OF STANDARD CHARACTERS WITHOUT CLAIM TO ANY PARTICULAR FONT, STYLE, SIZE, OR COLOR.

OWNER OF U.S. REG. NOS. 42,663 AND 2,418,109.

NO CLAIM IS MADE TO THE EXCLUSIVE RIGHT TO USE "COLD", APART FROM THE MARK AS SHOWN.

SN 85-251,731, FILED 2-25-2011.

PATRICIA EVANKO, EXAMINING ATTORNEY



David J. Kyffers

Director of the United States Patent and Trademark Office

United States of America

United States Patent and Trademark Office

LONG GREEN MUSIC

Reg. No. 4,176,573

Registered July 17, 2012

Int. Cl.: 41

SERVICE MARK

PRINCIPAL REGISTER

LG MUSIC LLC (TEXAS LIMITED LIABILITY COMPANY), AKA LONG GREEN MUSIC,
5201 MEMORIAL DR. SUITE 615
HOUSTON, TX 77007

FOR: RECORD PRODUCTION; MUSIC PRODUCTION; AUDIO RECORDING AND PRODUCTION; MOTION PICTURE SONG PRODUCTION; TELEVISION AND RADIO SONG PRODUCTION; THEATER SONG PRODUCTION; ENTERTAINMENT SERVICES, NAMELY, PRODUCING MUSICAL AUDIO AND VIDEO RECORDINGS, IN CLASS 41 (U.S. CLS. 100, 101 AND 107).

FIRST USE 4-14-2012; IN COMMERCE 4-14-2012.

THE MARK CONSISTS OF STANDARD CHARACTERS WITHOUT CLAIM TO ANY PARTICULAR FONT, STYLE, SIZE, OR COLOR.

NO CLAIM IS MADE TO THE EXCLUSIVE RIGHT TO USE "MUSIC", APART FROM THE MARK AS SHOWN.

SN 85-252,833, FILED 2-27-2011.

ELLEN B. AWRICH, EXAMINING ATTORNEY



David J. Kyffers

Director of the United States Patent and Trademark Office

United States of America

United States Patent and Trademark Office

LIONS LENS

Reg. No. 4,176,574

LIONS CLUBS INTERNATIONAL FOUNDATION (ILLINOIS NON-PROFIT CORPORATION)
300 22ND STREET
OAK BROOK, IL 60523

Registered July 17, 2012

Int. Cl.: 44

FOR: CHARITABLE SERVICES, NAMELY, PROVIDING GLASSES AND LENSES TO UNDERPRIVILEGED ADULTS AND CHILDREN, IN CLASS 44 (U.S. CLS. 100 AND 101).

SERVICE MARK

FIRST USE 2-0-2012; IN COMMERCE 2-0-2012.

PRINCIPAL REGISTER

THE MARK CONSISTS OF STANDARD CHARACTERS WITHOUT CLAIM TO ANY PARTICULAR FONT, STYLE, SIZE, OR COLOR.

OWNER OF U.S. REG. NOS. 1,241,093, 3,591,280, AND OTHERS.

NO CLAIM IS MADE TO THE EXCLUSIVE RIGHT TO USE "LENS", APART FROM THE MARK AS SHOWN.

SN 85-254,294, FILED 3-1-2011.

BILL DAWE, EXAMINING ATTORNEY



David J. Kyffers

Director of the United States Patent and Trademark Office

United States of America

United States Patent and Trademark Office

George Washington's Choice

Reg. No. 4,176,575

MAINE HERITAGE WEAVERS (MAINE CORPORATION)
41 CHESTNUT STREET
LEWISTON, ME 04240

Registered July 17, 2012

Int. Cl.: 24

FOR: BED SPREADS; COVERLETS; CURTAINS; DRAPERIES; SHAMS; THROWS, IN CLASS 24 (U.S. CLS. 42 AND 50).

TRADEMARK

FIRST USE 4-18-2012; IN COMMERCE 4-18-2012.

PRINCIPAL REGISTER

THE MARK CONSISTS OF STANDARD CHARACTERS WITHOUT CLAIM TO ANY PARTICULAR FONT, STYLE, SIZE, OR COLOR.

THE NAME "GEORGE WASHINGTON" DOES NOT IDENTIFY A LIVING INDIVIDUAL.

SN 85-254,831, FILED 3-1-2011.

MARGERY A. TIERNEY, EXAMINING ATTORNEY



David J. Kyffers

Director of the United States Patent and Trademark Office

United States of America

United States Patent and Trademark Office



Reg. No. 4,176,576

Registered July 17, 2012

Int. Cl.: 39

SERVICE MARK

PRINCIPAL REGISTER

CITY OF ANAHEIM (CALIFORNIA MUNICIPAL CORPORATION)
200 S. ANAHEIM BOULEVARD
ANAHEIM, CA 92805

FOR: PROVIDING A WEBSITE FOR COMMUTERS AND TRAVELERS FEATURING GEOGRAPHIC INFORMATION, TRIP ROUTING INFORMATION AND TRANSIT SCHEDULE INFORMATION FROM MULTIPLE SOURCES AND WEB LINKS THROUGH ONE PORTAL; PROVIDING A WEBSITE FOR COMMUTERS AND TRAVELERS PROVIDING ON-LINE TRANSPORTATION RESERVATION AND TRAVEL TICKET RESERVATION SERVICES FROM MULTIPLE SOURCES AND WEB LINKS THROUGH ONE PORTAL; PROVIDING A WEBSITE FEATURING CURRENT INFORMATION ON TRANSIT AND TRANSPORTATION SERVICES, INITIATIVES AND PROJECTS FOR USE BY COMMUTERS AND TRAVELERS, GATHERED FROM MULTIPLE SOURCES AND WEB LINKS AND ACCESSED THROUGH ONE PORTAL, IN CLASS 39 (U.S. CLS. 100 AND 105).

FIRST USE 7-22-2010; IN COMMERCE 7-22-2010.

NO CLAIM IS MADE TO THE EXCLUSIVE RIGHT TO USE "ANAHEIM TRANSIT", APART FROM THE MARK AS SHOWN.

THE MARK CONSISTS OF THE LETTER "A" NEXT TO A VERTICAL LINE WITH A CIRCLE SHAPE ON THE TOP AND BOTTOM OF THE VERTICAL LINE, NEXT TO THE WORD "CONNEXT", WHERE A PORTION OF THE "X" LETTER WITHIN "CONNEXT" IS SHAPED LIKE AN ARROW, ALL OVER THE PHRASE "ANAHEIM TRANSIT". "WHERE YOU WANT TO GO.", AND WHERE THE WORDS "ANAHEIM" AND "TRANSIT" ARE SEPARATED BY A TRIANGLE SHAPE WITHIN A CIRCLE.

SN 85-256,181, FILED 3-2-2011.

MARK SHINER, EXAMINING ATTORNEY



David J. Kypos

Director of the United States Patent and Trademark Office

United States of America

United States Patent and Trademark Office

LMA ATOMIZATION

Reg. No. 4,176,577

Registered July 17, 2012

Int. Cl.: 10

TRADEMARK

PRINCIPAL REGISTER

THE LARYNGEAL MASK COMPANY LIMITED (SEYCHELLES CORPORATION)
P.O. BOX 221, LE ROCHER
VICTORIA MAHE, SEYCHELLES

FOR: ATOMIZERS FOR MEDICAL USE; MEDICAL APPARATUS, NAMELY, SPRAYERS FOR USE WITH PHARMACEUTICAL AND MEDICATED SOLUTIONS AND PREPARATIONS; MEDICAL APPARATUS FOR INTRODUCING PHARMACEUTICAL PREPARATIONS INTO THE HUMAN BODY; PARTS AND FITTINGS FOR THE AFORESAID GOODS, IN CLASS 10 (U.S. CLS. 26, 39 AND 44).

FIRST USE 3-0-2011; IN COMMERCE 3-0-2011.

THE MARK CONSISTS OF STANDARD CHARACTERS WITHOUT CLAIM TO ANY PARTICULAR FONT, STYLE, SIZE, OR COLOR.

OWNER OF U.S. REG. NOS. 3,049,604, 3,514,103, AND OTHERS.

NO CLAIM IS MADE TO THE EXCLUSIVE RIGHT TO USE "ATOMIZATION", APART FROM THE MARK AS SHOWN.

SN 85-256,512, FILED 3-3-2011.

FLORENTINA BLANDU, EXAMINING ATTORNEY



David J. Kybas

Director of the United States Patent and Trademark Office

United States of America

United States Patent and Trademark Office

PR♥FILE-BUDDY.COM
write to the heart 

Reg. No. 4,176,578

PROFILE-BUDDY.COM LLC (NEW JERSEY LIMITED LIABILITY COMPANY)
302-O SHARON WAY
MONROE, NJ 08831

Registered July 17, 2012

Int. Cl.: 45

FOR: PERSONAL SERVICE, NAMELY, PROVIDING A SERVICE THAT PREPARES PERSONAL PROFILES FOR OTHERS AND ASSISTS THEM WITH COMMUNICATIONS INTENDED FOR USE BY CUSTOMERS OF DATING SERVICES, SOCIAL NETWORKING OR BUSINESS NETWORKING SERVICES, IN CLASS 45 (U.S. CLS. 100 AND 101).

SERVICE MARK

PRINCIPAL REGISTER

FIRST USE 5-3-2012; IN COMMERCE 5-3-2012.

THE MARK CONSISTS OF THE WORDS "PROFILE-BUDDY" IN LARGE BLUE CAPITALIZED BLOCK LETTERS IMMEDIATELY FOLLOWED BY ".COM" ALSO IN BLUE CAPITALIZED BLOCK LETTERS BUT IN A SMALLER FONT SIZE. THE LETTER "O" IN "PROFILE" IS REPLACED BY A RED HEART-SHAPE WITH A ROUNDED BOTTOM. THE COLOR OF THE HEART IS DARK RED AT THE BOTTOM AND GRADUALLY FADES TO A LIGHTER SHADE OF RED TOWARDS THE TOP. CENTERED BELOW THE WORDS "PROFILE-BUDDY.COM" ARE THE WORDS "WRITE TO THE HEART" WRITTEN IN LOWER-CASE BLACK IN A FONT-STYLE WHICH IS SIMILAR IN APPEARANCE TO HANDWRITING. BELOW THE WORDS "WRITE TO THE HEART" IS A BLACK CURVED LINE WITH THE APPEARANCE THAT IT IS A HAND-WRITTEN UNDERLINE OF "WRITE TO THE HEART". AT THE END OF THE WORD "HEART", DRAWN ON AN APPROXIMATELY 45 DEGREE ANGLE UP AND TO THE RIGHT IS A YELLOW PENCIL.

THE COLOR(S) BLUE, RED, BLACK AND YELLOW IS/ARE CLAIMED AS A FEATURE OF THE MARK.

SN 85-256,603, FILED 3-3-2011.

DARRYL SPRUILL, EXAMINING ATTORNEY



David J. Kyffers

Director of the United States Patent and Trademark Office

United States of America

United States Patent and Trademark Office



Reg. No. 4,176,579

Registered July 17, 2012

Int. Cl.: 9

TRADEMARK

PRINCIPAL REGISTER

DISC INTELLECTUAL PROPERTIES, LLC (CALIFORNIA LIMITED LIABILITY COMPANY)
ENTERTAINMENT PARTNERS
2835 NORTH NAOMI STREET
BURBANK, CA 91504

FOR: COMPUTER SOFTWARE FOR BUDGETING AND PRODUCTION COST ACCOUNTING
FOR THE ENTERTAINMENT INDUSTRY, AND MANUALS PROVIDED THEREWITH AS
A UNIT, IN CLASS 9 (U.S. CLS. 21, 23, 26, 36 AND 38).

FIRST USE 1-1-2011; IN COMMERCE 2-18-2011.

OWNER OF U.S. REG. NOS. 2,825,285, 2,991,598, AND 3,880,511.

THE MARK CONSISTS OF THE WORDING "EP" INSIDE AN OVAL WITH TWO BREAKS,
AND TO THE RIGHT, THE WORDING, "VISTA5", WITH THE NUMBER "5" APPEARING
AS AN EXPONENT OF THE TERM, "VISTA". THE MARK GRADUALLY TRANSITIONS
FROM SHADED, FROM THE BOTTOM LEFT CORNER TO LIGHTLY SHADED TO THE
UPPER TOP RIGHT CORNER.

SN 85-256,904, FILED 3-3-2011.

ODESSA BIBBINS, EXAMINING ATTORNEY



David J. Kyros

Director of the United States Patent and Trademark Office

United States of America

United States Patent and Trademark Office

BEAN TO BE WILD

Reg. No. 4,176,580

IGT (NEVADA CORPORATION)
9295 PROTOTYPE DRIVE
RENO, NV 895218986

Registered July 17, 2012

Int. Cl.: 9

FOR: GAMING MACHINES, NAMELY, DEVICES WHICH ACCEPT A WAGER, IN CLASS 9 (U.S. CLS. 21, 23, 26, 36 AND 38).

TRADEMARK

FIRST USE 3-14-2012; IN COMMERCE 3-19-2012.

PRINCIPAL REGISTER

THE MARK CONSISTS OF STANDARD CHARACTERS WITHOUT CLAIM TO ANY PARTICULAR FONT, STYLE, SIZE, OR COLOR.

SN 85-257,466, FILED 3-3-2011.

JAMES LOVELACE, EXAMINING ATTORNEY



David J. Kybas

Director of the United States Patent and Trademark Office

United States of America

United States Patent and Trademark Office

FREEFALL

Reg. No. 4,176,581

SIMPLYFUN, LLC (WASHINGTON LIMITED LIABILITY COMPANY)
11245 SE 6TH ST., SUITE 110
BELLEVUE, WA 98004

Registered July 17, 2012

Int. Cl.: 28

FOR: GAME EQUIPMENT SOLD AS A UNIT FOR PLAYING PARLOR GAMES AND EDUCATIONAL GAMES; GAMES, NAMELY, PARLOR GAMES AND EDUCATIONAL GAMES USING CARDS, A SCORING BOARD, AND PAWNS; GAMES, NAMELY, A BOARD GAME ABOUT PARACHUTING, IN CLASS 28 (U.S. CLS. 22, 23, 38 AND 50).

TRADEMARK

PRINCIPAL REGISTER

FIRST USE 7-31-2011; IN COMMERCE 7-31-2011.

THE MARK CONSISTS OF STANDARD CHARACTERS WITHOUT CLAIM TO ANY PARTICULAR FONT, STYLE, SIZE, OR COLOR.

SN 85-257,504, FILED 3-3-2011.

BRIAN NEVILLE, EXAMINING ATTORNEY



David J. Kyffers

Director of the United States Patent and Trademark Office

United States of America

United States Patent and Trademark Office

The Good Stuff

Reg. No. 4,176,582

AGRILIFE PROTEIN SOLUTIONS (LOUISIANA LIMITED LIABILITY COMPANY)
3140 HWY 568

Registered July 17, 2012

WATERPROOF, LA 71375

Int. Cl.: 28

FOR: FEED GRADE ATTRACTANT FOR WHITETAIL DEER, ELK, AND OTHER RUMINANT GAME ANIMALS, IN CLASS 28 (U.S. CLS. 22, 23, 38 AND 50).

TRADEMARK

FIRST USE 7-1-2011; IN COMMERCE 7-1-2011.

PRINCIPAL REGISTER

THE MARK CONSISTS OF STANDARD CHARACTERS WITHOUT CLAIM TO ANY PARTICULAR FONT, STYLE, SIZE, OR COLOR.

SN 85-257,722, FILED 3-4-2011.

MICHAEL SOUDERS, EXAMINING ATTORNEY



David J. Kyffers

Director of the United States Patent and Trademark Office

United States of America

United States Patent and Trademark Office

ULTRA TESTED

Reg. No. 4,176,583

KIRKMAN GROUP, INC. (OREGON CORPORATION)
6400 S.W. ROSEWOOD STREET
LAKE OSWEGO, OR 97035

Registered July 17, 2012

Int. Cl.: 5

FOR: PHARMACEUTICALS AND NUTRITIONAL PRODUCTS, NAMELY, DIETARY AND FOOD SUPPLEMENTS, IN CLASS 5 (U.S. CLS. 6, 18, 44, 46, 51 AND 52).

TRADEMARK

FIRST USE 5-1-2011; IN COMMERCE 5-1-2011.

PRINCIPAL REGISTER

THE MARK CONSISTS OF STANDARD CHARACTERS WITHOUT CLAIM TO ANY PARTICULAR FONT, STYLE, SIZE, OR COLOR.

SN 85-258,265, FILED 3-4-2011.

ARETHA SOMERVILLE, EXAMINING ATTORNEY



David J. Kyffers

Director of the United States Patent and Trademark Office

United States of America

United States Patent and Trademark Office

U ULTRA TESTED

Reg. No. 4,176,584

KIRKMAN GROUP, INC. (OREGON CORPORATION)
6400 S.W. ROSEWOOD STREET
LAKE OSWEGO, OR 97035

Registered July 17, 2012

Int. Cl.: 5

FOR: PHARMACEUTICALS AND NUTRITIONAL PRODUCTS, NAMELY, DIETARY AND FOOD SUPPLEMENTS, IN CLASS 5 (U.S. CLS. 6, 18, 44, 46, 51 AND 52).

TRADEMARK

FIRST USE 5-1-2011; IN COMMERCE 5-1-2011.

PRINCIPAL REGISTER

THE MARK CONSISTS OF THE WORDS "ULTRA TESTED" ADJACENT TO A MORTAR AND PESTLE LIKE DESIGN.

SN 85-258,279, FILED 3-4-2011.

ARETHA SOMERVILLE, EXAMINING ATTORNEY



David J. Kyffers

Director of the United States Patent and Trademark Office

United States of America

United States Patent and Trademark Office

NAVIGATE YOUR SPACE

Reg. No. 4,176,585

Registered July 17, 2012

Int. Cl.: 45

SERVICE MARK

PRINCIPAL REGISTER

POWELL, BARBARA (UNITED STATES INDIVIDUAL)
2355 ARCH CREEK DRIVE
NORTH MIAMI, FL 33181

FOR: ORGANIZATIONAL SERVICES FOR HOME OR PERSONAL PURPOSES, NAMELY, ORGANIZING KITCHENS, PANTRIES, FAMILY ROOMS, LIVING ROOMS, DINING ROOMS, BEDROOMS, BATHROOMS, LAUNDRY ROOMS, CLOTHES CLOSETS, LINEN CLOSETS, CHILDREN'S PLAYROOMS, STUDENT'S STUDY AREAS, CRAFT AND HOBBY ROOMS, GARAGES, STORAGE AREAS, AND HOME OFFICE SPACES, IN CLASS 45 (U.S. CLS. 100 AND 101).

FIRST USE 1-2-2012; IN COMMERCE 1-2-2012.

THE MARK CONSISTS OF STANDARD CHARACTERS WITHOUT CLAIM TO ANY PARTICULAR FONT, STYLE, SIZE, OR COLOR.

NO CLAIM IS MADE TO THE EXCLUSIVE RIGHT TO USE "YOUR SPACE", APART FROM THE MARK AS SHOWN.

SN 85-258,559, FILED 3-4-2011.

JOHN KELLY, EXAMINING ATTORNEY



David J. Kybas

Director of the United States Patent and Trademark Office

United States of America

United States Patent and Trademark Office

KEMA

Reg. No. 4,176,586

Registered July 17, 2012

Int. Cl.: 9

TRADEMARK

PRINCIPAL REGISTER

CAANES, LLC (NEW MEXICO LIMITED LIABILITY COMPANY)
BUILDING 1 SUITE 202
7801 ACADEMY RD NE
ALBUQUERQUE, NM 87109

FOR: COMPUTER SOFTWARE ALLOWING USERS TO PROVIDE ANALYSIS ON DIGITAL CONTENT FROM MULTIPLE SOURCES; COMPUTER SOFTWARE FOR USE IN THE AREA OF DIGITAL FORENSICS AND DIGITAL MEDIA, NAMELY, FOR COLLECTING AND ANALYZING DATA FOUND ON DIGITAL DEVICES, IN CLASS 9 (U.S. CLS. 21, 23, 26, 36 AND 38).

FIRST USE 2-10-2012; IN COMMERCE 2-10-2012.

THE MARK CONSISTS OF STANDARD CHARACTERS WITHOUT CLAIM TO ANY PARTICULAR FONT, STYLE, SIZE, OR COLOR.

SN 85-259,097, FILED 3-6-2011.

TOBY BULLOFF, EXAMINING ATTORNEY



David J. Kyffers

Director of the United States Patent and Trademark Office

United States of America

United States Patent and Trademark Office



Reg. No. 4,176,587

Registered July 17, 2012

Int. Cl.: 30

TRADEMARK

PRINCIPAL REGISTER

EXPORTADORA DE SAL, S.A. DE C.V. (MEXICO JOINT STOCK COMPANY)
PISO 8, COL. CUAUHTÉMOC
PASEO DE LA REFORMA NO. 287
MEXICO CITY, MEXICO 06500

FOR: SALT, IN CLASS 30 (U.S. CL. 46).

FIRST USE 3-31-2011; IN COMMERCE 3-31-2011.

OWNER OF U.S. REG. NO. 2,833,696.

THE COLOR(S) DARK BLUE, LIGHT BLUE, BLACK, WHITE, AND GRAY IS/ARE CLAIMED AS A FEATURE OF THE MARK.

NO CLAIM IS MADE TO THE EXCLUSIVE RIGHT TO USE "BAJA", APART FROM THE MARK AS SHOWN.

THE MARK CONSISTS OF THE WORDING "BAJA PACIFIC" IN BLACK LETTERS, WITH THE WORDING APPEARING ABOVE AND BELOW A STYLIZED WHALE AND WATER DESIGN. THE WHALES ARE BLACK AND APPEAR ON A BACKGROUND OF LIGHT BLUE, DARK BLUE, AND GRAY ELLIPSES INTENDED TO REPRESENT WATER. THE MARK APPEARS ON A WHITE BACKGROUND.

SN 85-259,755, FILED 3-7-2011.

KIMBERLY FRYE, EXAMINING ATTORNEY



David J. Kybas

Director of the United States Patent and Trademark Office

United States of America

United States Patent and Trademark Office

BUTTERCUP'S FROZEN YOGURT

Reg. No. 4,176,588

SPIRANAC, ALEXIS (UNITED STATES INDIVIDUAL)
1605 PEREGRINE VISTA HEIGHTS #304
COLORADO SPRINGS, CO 80921

Registered July 17, 2012

Int. Cl.: 43

FOR: FROZEN YOGURT SHOP SERVICES IN THE NATURE OF A RESTAURANT, IN CLASS 43 (U.S. CLS. 100 AND 101).

SERVICE MARK

FIRST USE 3-1-2011; IN COMMERCE 11-1-2011.

PRINCIPAL REGISTER

THE MARK CONSISTS OF STANDARD CHARACTERS WITHOUT CLAIM TO ANY PARTICULAR FONT, STYLE, SIZE, OR COLOR.

NO CLAIM IS MADE TO THE EXCLUSIVE RIGHT TO USE "FROZEN YOGURT", APART FROM THE MARK AS SHOWN.

SN 85-260,414, FILED 3-7-2011.

KATHERINE E. HALMEN, EXAMINING ATTORNEY



David J. Kybas

Director of the United States Patent and Trademark Office

United States of America

United States Patent and Trademark Office

MINDFUL HERO

Reg. No. 4,176,589

KATHLEEN A. HALL (UNITED STATES INDIVIDUAL)
495 OWLS NEST LANE
CLARKESVILLE, GA 30523

Registered July 17, 2012

Int. Cl.: 41

FOR: ENTERTAINMENT SERVICES, NAMELY, AN ONGOING SERIES FEATURING PHYSICAL, MENTAL AND SPIRITUAL HEALTH, HEALING AND WELLNESS, LIFESTYLE MANAGEMENT, DISEASE PREVENTION, AND IDENTIFYING, OVERCOMING AND AVOIDING STRESS AND DESTRUCTIVE BEHAVIOR PROVIDED THROUGH THE INTERNET, IN CLASS 41 (U.S. CLS. 100, 101 AND 107).

SERVICE MARK

PRINCIPAL REGISTER

FIRST USE 2-21-2011; IN COMMERCE 2-21-2011.

THE MARK CONSISTS OF STANDARD CHARACTERS WITHOUT CLAIM TO ANY PARTICULAR FONT, STYLE, SIZE, OR COLOR.

OWNER OF U.S. REG. NOS. 3,674,696, 3,877,402, AND OTHERS.

SN 85-260,489, FILED 3-8-2011.

TARA PATE, EXAMINING ATTORNEY



David J. Kyros

Director of the United States Patent and Trademark Office

United States of America

United States Patent and Trademark Office

MINDFUL YOU

Reg. No. 4,176,590

Registered July 17, 2012

Int. Cl.: 41

SERVICE MARK

PRINCIPAL REGISTER

KATHLEEN A. HALL (UNITED STATES INDIVIDUAL)
495 OWLS NEST LANE
CLARKESVILLE, GA 30523

FOR: ENTERTAINMENT SERVICES, NAMELY, AN ONGOING SERIES FEATURING PHYSICAL, MENTAL AND SPIRITUAL HEALTH, HEALING AND WELLNESS, LIFESTYLE MANAGEMENT, DISEASE PREVENTION, AND IDENTIFYING, OVERCOMING AND AVOIDING STRESS AND DESTRUCTIVE BEHAVIOR PROVIDED THROUGH THE INTERNET, IN CLASS 41 (U.S. CLS. 100, 101 AND 107).

FIRST USE 4-30-2011; IN COMMERCE 4-30-2011.

THE MARK CONSISTS OF STANDARD CHARACTERS WITHOUT CLAIM TO ANY PARTICULAR FONT, STYLE, SIZE, OR COLOR.

OWNER OF U.S. REG. NOS. 3,674,696, 3,877,402, AND OTHERS.

SN 85-260,506, FILED 3-8-2011.

TARA PATE, EXAMINING ATTORNEY



David J. Kybas

Director of the United States Patent and Trademark Office

United States of America

United States Patent and Trademark Office

MINDFUL ANIMAL

Reg. No. 4,176,591

Registered July 17, 2012

Int. Cl.: 41

SERVICE MARK

PRINCIPAL REGISTER

HALL, KATHLEEN A. (UNITED STATES INDIVIDUAL)
495 OWLS NEST LANE
CLARKESVILLE, GA 30523

FOR: ENTERTAINMENT SERVICES, NAMELY, AN ONGOING SERIES FEATURING PHYSICAL, MENTAL AND SPIRITUAL HEALTH, HEALING AND WELLNESS, LIFESTYLE MANAGEMENT, DISEASE PREVENTION, AND IDENTIFYING, OVERCOMING AND AVOIDING STRESS AND DESTRUCTIVE BEHAVIOR PROVIDED THROUGH THE INTERNET, IN CLASS 41 (U.S. CLS. 100, 101 AND 107).

FIRST USE 5-5-2011; IN COMMERCE 5-5-2011.

THE MARK CONSISTS OF STANDARD CHARACTERS WITHOUT CLAIM TO ANY PARTICULAR FONT, STYLE, SIZE, OR COLOR.

OWNER OF U.S. REG. NOS. 3,674,696, 3,877,402, AND OTHERS.

NO CLAIM IS MADE TO THE EXCLUSIVE RIGHT TO USE "ANIMAL", APART FROM THE MARK AS SHOWN.

SN 85-260,518, FILED 3-8-2011.

TARA PATE, EXAMINING ATTORNEY



David J. Kyffers

Director of the United States Patent and Trademark Office

United States of America

United States Patent and Trademark Office

MINDFUL APPLICATION

Reg. No. 4,176,592

Registered July 17, 2012

Int. Cl.: 41

SERVICE MARK

PRINCIPAL REGISTER

KATHLEEN A. HALL (UNITED STATES INDIVIDUAL)
495 OWLS NEST LANE
CLARKESVILLE, GA 30523

FOR: ENTERTAINMENT SERVICES, NAMELY, AN ONGOING SERIES FEATURING PHYSICAL, MENTAL AND SPIRITUAL HEALTH, HEALING AND WELLNESS, LIFESTYLE MANAGEMENT, DISEASE PREVENTION, AND IDENTIFYING, OVERCOMING AND AVOIDING STRESS AND DESTRUCTIVE BEHAVIOR PROVIDED THROUGH THE INTERNET, IN CLASS 41 (U.S. CLS. 100, 101 AND 107).

FIRST USE 10-12-2011; IN COMMERCE 10-12-2011.

THE MARK CONSISTS OF STANDARD CHARACTERS WITHOUT CLAIM TO ANY PARTICULAR FONT, STYLE, SIZE, OR COLOR.

OWNER OF U.S. REG. NOS. 3,674,696, 3,877,402, AND OTHERS.

NO CLAIM IS MADE TO THE EXCLUSIVE RIGHT TO USE "APPLICATION", APART FROM THE MARK AS SHOWN.

SN 85-260,528, FILED 3-8-2011.

TARA PATE, EXAMINING ATTORNEY



David J. Kyffers

Director of the United States Patent and Trademark Office

United States of America

United States Patent and Trademark Office

ROADMASTER

Reg. No. 4,176,593

Registered July 17, 2012

Int. Cl.: 11

TRADEMARK

PRINCIPAL REGISTER

LIGHTING SCIENCE GROUP CORPORATION (DELAWARE CORPORATION)
BUILDING 2A
1227 SOUTH PATRICK DRIVE
SATELLITE BEACH, FL 32937

FOR: LED-BASED OUTDOOR, STREET AND ROADWAY LIGHTS, IN CLASS 11 (U.S. CLS. 13, 21, 23, 31 AND 34).

FIRST USE 3-8-2012; IN COMMERCE 3-8-2012.

THE MARK CONSISTS OF STANDARD CHARACTERS WITHOUT CLAIM TO ANY PARTICULAR FONT, STYLE, SIZE, OR COLOR.

SN 85-260,785, FILED 3-8-2011.

HANNO RITTNER, EXAMINING ATTORNEY



David J. Kybas

Director of the United States Patent and Trademark Office

United States of America

United States Patent and Trademark Office

CARB CONSCIOUS

Reg. No. 4,176,594

Registered July 17, 2012

Int. Cl.: 30

TRADEMARK

PRINCIPAL REGISTER

TYSON FOODS, INC. (DELAWARE CORPORATION)
2200 DON TYSON PARKWAY
SPRINGDALE, AR 72762

FOR: TORTILLAS, IN CLASS 30 (U.S. CL. 46).

FIRST USE 3-4-2012; IN COMMERCE 3-4-2012.

THE MARK CONSISTS OF STANDARD CHARACTERS WITHOUT CLAIM TO ANY PARTICULAR FONT, STYLE, SIZE, OR COLOR.

OWNER OF U.S. REG. NO. 3,761,343.

NO CLAIM IS MADE TO THE EXCLUSIVE RIGHT TO USE "CARB", APART FROM THE MARK AS SHOWN.

SN 85-261,402, FILED 3-8-2011.

ELLEN BURNS, EXAMINING ATTORNEY



David J. Kyros

Director of the United States Patent and Trademark Office

United States of America

United States Patent and Trademark Office



Reg. No. 4,176,595

PROGRESSIVE BALLOONS, INC. (MISSOURI CORPORATION)
3100 INDUSTRIAL PARK PLACE WEST
ST. PETERS, MO 63376

Registered July 17, 2012

Int. Cl.: 28

FOR: PLUSH ANIMAL OR OTHER PLUSH CHARACTER ON A WRISTBAND, IN CLASS 28 (U.S. CLS. 22, 23, 38 AND 50).

TRADEMARK

FIRST USE 5-4-2011; IN COMMERCE 5-4-2011.

PRINCIPAL REGISTER

THE MARK CONSISTS OF AN OUTLINE OF A SIMPLIFIED HAND AND WRIST CONTAINING THE WORDING "WRISTPALS" WITH A SWIRL DOTTING THE "I". THE WORDING "THEY GO WHERE YOU GO!" APPEARS BELOW THE LOGO.

SN 85-262,174, FILED 3-9-2011.

BRENDAN REGAN, EXAMINING ATTORNEY



David J. Kybas

Director of the United States Patent and Trademark Office

United States of America

United States Patent and Trademark Office

FILMED BY FRIENDS. EDITED
BY PROS.

Reg. No. 4,176,596

BIRCH MEDIA SERVICES, LLC (MICHIGAN LIMITED LIABILITY COMPANY)
6501 SIMS DRIVE

Registered July 17, 2012

STERLING HEIGHTS, MI 48313

Int. Cl.: 41

FOR: AUDIO AND VIDEO RECORDING SERVICES; DIGITAL VIDEO, AUDIO, AND MULTIMEDIA PUBLISHING SERVICES; FILM AND VIDEO PRODUCTION; PHOTOGRAPHY; RENTAL OF CAMERAS; RENTAL SERVICES FOR AUDIO AND VIDEO EQUIPMENT; VIDEO EDITING; VIDEO MASTERING SERVICES; VIDEOGRAPHY SERVICES, IN CLASS 41 (U.S. CLS. 100, 101 AND 107).

SERVICE MARK

PRINCIPAL REGISTER

FIRST USE 6-0-2011; IN COMMERCE 7-0-2011.

THE MARK CONSISTS OF STANDARD CHARACTERS WITHOUT CLAIM TO ANY PARTICULAR FONT, STYLE, SIZE, OR COLOR.

NO CLAIM IS MADE TO THE EXCLUSIVE RIGHT TO USE "EDITED BY PROS", APART FROM THE MARK AS SHOWN.

SN 85-263,095, FILED 3-10-2011.

KATHERINE CONNOLLY, EXAMINING ATTORNEY



David J. Kyros

Director of the United States Patent and Trademark Office

United States of America
United States Patent and Trademark Office

SI-LOK

Reg. No. 4,176,597

GLOBUS MEDICAL INC. (DELAWARE CORPORATION)
2560 GENERAL ARMISTEAD AVENUE
AUDUBON, PA 19403

Registered July 17, 2012

Int. Cl.: 10

FOR: SPINAL IMPLANTS MADE FROM ARTIFICIAL MATERIALS FOR USE IN SPINE SURGERY, IN CLASS 10 (U.S. CLS. 26, 39 AND 44).

TRADEMARK

FIRST USE 12-21-2011; IN COMMERCE 12-22-2011.

PRINCIPAL REGISTER

THE MARK CONSISTS OF STANDARD CHARACTERS WITHOUT CLAIM TO ANY PARTICULAR FONT, STYLE, SIZE, OR COLOR.

SN 85-264,204, FILED 3-11-2011.

ARETHA SOMERVILLE, EXAMINING ATTORNEY



David J. Kybas

Director of the United States Patent and Trademark Office

United States of America

United States Patent and Trademark Office

TO KNOW IT IS TO LOVE IT

Reg. No. 4,176,598

C.B. FLEET INVESTMENT CORPORATION (DELAWARE CORPORATION)
103 FOULK ROAD, SUITE 202
WILMINGTON, DE 19803

Registered July 17, 2012

Int. Cl.: 44

FOR: PROVIDING A WEBSITE FEATURING EDUCATIONAL INFORMATION FOR WOMEN
IN THE AREA OF WOMEN'S HEALTH, IN CLASS 44 (U.S. CLS. 100 AND 101).

SERVICE MARK

FIRST USE 6-22-2011; IN COMMERCE 6-22-2011.

PRINCIPAL REGISTER

THE MARK CONSISTS OF STANDARD CHARACTERS WITHOUT CLAIM TO ANY PAR-
TICULAR FONT, STYLE, SIZE, OR COLOR.

SN 85-265,278, FILED 3-11-2011.

EUGENIA MARTIN, EXAMINING ATTORNEY



David J. Kybas

Director of the United States Patent and Trademark Office

United States of America

United States Patent and Trademark Office

WILD SPORTS

Reg. No. 4,176,599

Registered July 17, 2012

Int. Cl.: 28

TRADEMARK

PRINCIPAL REGISTER

WILD SALES, LLC (INDIANA LIMITED LIABILITY COMPANY)
SUITE A
17401 TILLER COURT
WESTFIELD, IN 46074

FOR: ACTION-TYPE TARGET GAMES AND EQUIPMENT SOLD AS A UNIT FOR PLAYING ACTION-TYPE TARGET GAMES; PORTABLE GAME TABLES, IN CLASS 28 (U.S. CLS. 22, 23, 38 AND 50).

FIRST USE 10-30-2011; IN COMMERCE 10-30-2011.

THE MARK CONSISTS OF STANDARD CHARACTERS WITHOUT CLAIM TO ANY PARTICULAR FONT, STYLE, SIZE, OR COLOR.

OWNER OF U.S. REG. NOS. 3,802,655, 3,802,658, AND OTHERS.

NO CLAIM IS MADE TO THE EXCLUSIVE RIGHT TO USE "SPORTS", APART FROM THE MARK AS SHOWN.

SN 85-266,185, FILED 3-14-2011.

LINDA POWELL, EXAMINING ATTORNEY



David J. Kyros

Director of the United States Patent and Trademark Office

United States of America

United States Patent and Trademark Office

WILD SPORTS

Reg. No. 4,176,600

Registered July 17, 2012

Int. Cl.: 35

SERVICE MARK

PRINCIPAL REGISTER

WILD SALES, LLC (INDIANA LIMITED LIABILITY COMPANY)
SUITE A
17401 TILLER COURT
WESTFIELD, IN 46074

FOR: ON-LINE RETAIL STORE SERVICES FEATURING FURNITURE, TOYS, GAMES, GAME TABLES, AND ACCESSORIES THEREFOR, IN CLASS 35 (U.S. CLS. 100, 101 AND 102).

FIRST USE 10-30-2011; IN COMMERCE 10-30-2011.

THE MARK CONSISTS OF STANDARD CHARACTERS WITHOUT CLAIM TO ANY PARTICULAR FONT, STYLE, SIZE, OR COLOR.

OWNER OF U.S. REG. NOS. 3,802,655, 3,802,656, AND 3,802,658.

NO CLAIM IS MADE TO THE EXCLUSIVE RIGHT TO USE "SPORTS", APART FROM THE MARK AS SHOWN.

SN 85-266,199, FILED 3-14-2011.

LINDA POWELL, EXAMINING ATTORNEY



David J. Kybas

Director of the United States Patent and Trademark Office

United States of America

United States Patent and Trademark Office



Reg. No. 4,176,601

DEVANAN, NETRANIE (UNITED STATES INDIVIDUAL)
58-72 MASPETH AVE
MASPETH, NY 11378

Registered July 17, 2012

Int. Cl.: 44

FOR: MASSAGE SERVICES, IN CLASS 44 (U.S. CLS. 100 AND 101).

SERVICE MARK

FIRST USE 1-13-2012; IN COMMERCE 1-13-2012.

PRINCIPAL REGISTER

NO CLAIM IS MADE TO THE EXCLUSIVE RIGHT TO USE "MASSAGE" OR "LLC" , APART FROM THE MARK AS SHOWN.

THE MARK CONSISTS OF THE LITERAL ELEMENTS "MASSAGE BY NETRANIE, LLC" FOUND INSIDE THE IMAGE OF A SUN; AROUND THE SUN THERE ARE SIX SMALL SEMI-CIRCLES.

SN 85-266,314, FILED 3-14-2011.

KELLY BOULTON, EXAMINING ATTORNEY



David J. Kyffers

Director of the United States Patent and Trademark Office

United States of America

United States Patent and Trademark Office

SHARE N PAY

Reg. No. 4,176,602

SHARE N PAY, INC. (UTAH CORPORATION)
270 BOGEY CIRCLE
NORTH SALT LAKE, UT 84054

Registered July 17, 2012

Int. Cl.: 35

FOR: FACILITATING GROUP PURCHASE OF BANKING SERVICES; PROVIDING A WEBSITE FEATURING AN ONLINE MARKETPLACE FOR EXCHANGING GOODS AND SERVICES WITH OTHER USERS, IN CLASS 35 (U.S. CLS. 100, 101 AND 102).

SERVICE MARK

FIRST USE 8-8-2011; IN COMMERCE 8-8-2011.

PRINCIPAL REGISTER

THE MARK CONSISTS OF STANDARD CHARACTERS WITHOUT CLAIM TO ANY PARTICULAR FONT, STYLE, SIZE, OR COLOR.

SN 85-266,533, FILED 3-14-2011.

GINA FINK, EXAMINING ATTORNEY



David J. Kyffers

Director of the United States Patent and Trademark Office

United States of America

United States Patent and Trademark Office

GO GO KIDDO

Reg. No. 4,176,603

Registered July 17, 2012

Int. Cl.: 9

TRADEMARK

PRINCIPAL REGISTER

GO GO KIDDO INC. (WASHINGTON CORPORATION)
P.O. BOX 7448
BELLEVUE, WA 98008

FOR: COMPUTER APPLICATION SOFTWARE FOR MOBILE DEVICES, NAMELY, SOFTWARE FOR USE IN OBTAINING INFORMATION FROM THE MOBILE DEVICE'S CAMERA, OR TOUCH SCREEN AND TRANSFERRING THAT INFORMATION ACROSS COMMUNICATION NETWORKS, FOR USE IN CUSTOMIZING CONTENT, AND FOR USE IN OBTAINING EDUCATIONAL AND ENTERTAINMENT CONTENT; DOWNLOADABLE CHILDREN'S BOOKS, DOWNLOADABLE VIDEO RECORDINGS FEATURING ANIMATION AND MUSIC, AND COMPUTER GAME SOFTWARE FOR USE ON MOBILE DEVICES, ALL OF THE ABOVE DELIVERED TO MOBILE DEVICES, IN CLASS 9 (U.S. CLS. 21, 23, 26, 36 AND 38).

FIRST USE 11-22-2011; IN COMMERCE 11-22-2011.

THE MARK CONSISTS OF STANDARD CHARACTERS WITHOUT CLAIM TO ANY PARTICULAR FONT, STYLE, SIZE, OR COLOR.

SN 85-266,654, FILED 3-14-2011.

KATHERINE E. HALMEN, EXAMINING ATTORNEY



David J. Kyros

Director of the United States Patent and Trademark Office

United States of America

United States Patent and Trademark Office



Reg. No. 4,176,604

Registered July 17, 2012

Int. Cl.: 41

SERVICE MARK

PRINCIPAL REGISTER

FOREIGN CIRCLES LLC (DELAWARE LIMITED LIABILITY COMPANY)
PO BOX 192
CHAPPAQUA, NY 10514

FOR: PROVIDING NEWS, INFORMATION AND COMMENTARY IN THE FIELD OF CURRENT EVENTS RELATING TO POLITICS, FINANCE AND PERSONAL FINANCE, THE MEDIA, ENTERTAINMENT, SPORTS, COMEDY, BUSINESS, FASHION, HEALTHY LIVING AND LIFESTYLE, WELLNESS, ENVIRONMENTALLY CONSCIOUS AND GREEN ISSUES, FOOD, TECHNOLOGY, TRAVEL, EDUCATION, BOOKS, FINE ARTS, AND PERFORMING ARTS; PROVIDING INFORMATION ABOUT EDUCATION AND PROVIDING INFORMATION IN THE FIELD OF ENTERTAINMENT VIA THE INTERNET, ALL OF THE AFORESAID TO A NATIONAL AND INTERNATIONAL AUDIENCE, IN CLASS 41 (U.S. CLS. 100, 101 AND 107).

FIRST USE 4-7-2011; IN COMMERCE 4-7-2011.

THE MARK CONSISTS OF FOUR ELLIPTICAL, SLANTED CIRCLES ON TOP OF A SHADOW WITH THE WORDS "FOREIGN CIRCLES" TO THE RIGHT OF THE DESIGN. THE COLOR ORANGE, YELLOW, GREEN AND BLUE APPEAR IN THE ELLIPTICAL CIRCLES, THE COLOR GREY APPEARS IN THE SHADOW, AND THE COLOR BLUE APPEARS IN THE TEXT "FOREIGN CIRCLES".

THE COLOR(S) ORANGE, YELLOW, GREEN, BLUE AND GREY IS/ARE CLAIMED AS A FEATURE OF THE MARK.

SN 85-266,859, FILED 3-15-2011.

CARYN GLASSER, EXAMINING ATTORNEY



David J. Kyjars

Director of the United States Patent and Trademark Office

United States of America

United States Patent and Trademark Office

Katie Bubbles

Reg. No. 4,176,605

Registered July 17, 2012

Int. Cl.: 16

TRADEMARK

PRINCIPAL REGISTER

MESSENGER HILL PUBLISHING, LLC (DELAWARE LIMITED LIABILITY COMPANY)
16192 COASTAL HIGHWAY
LEWES, DE 19958

FOR: BABY BOOKS; CHILDREN'S ACTIVITY BOOKS; CHILDREN'S BOOKS; CHILDREN'S INTERACTIVE EDUCATIONAL BOOKS; CHILDREN'S STORYBOOKS; COLORING BOOKS; COMIC BOOKS; EDUCATIONAL PUBLICATIONS, NAMELY, BOOKS, HAND-OUTS, WORKBOOKS, JOURNALS, PLAYBOOKS, WORKSHEETS AND CARDS IN THE FIELD OF RIGHT-BRAIN FITNESS; PERSONALIZED COLORING BOOKS FOR CHILDREN; PICTURE BOOKS; PRINTED MATERIALS, NAMELY, NOVELS AND SERIES OF FICTION BOOKS AND SHORT STORIES FEATURING SCENES AND CHARACTERS BASED ON VIDEO GAMES; SCHOOL WRITING BOOKS; SERIES OF FICTION BOOKS; SERIES OF FICTION WORKS, NAMELY, NOVELS AND BOOKS; SKETCH BOOKS; STORY BOOKS; TALKING CHILDREN'S BOOKS , IN CLASS 16 (U.S. CLS. 2, 5, 22, 23, 29, 37, 38 AND 50).

FIRST USE 1-8-2011; IN COMMERCE 8-10-2011.

THE MARK CONSISTS OF STANDARD CHARACTERS WITHOUT CLAIM TO ANY PARTICULAR FONT, STYLE, SIZE, OR COLOR.

THE NAME "KATIE BUBBLES" DOES NOT IDENTIFY A LIVING INDIVIDUAL.

SN 85-267,647, FILED 3-15-2011.

IRA J. GOODSID, EXAMINING ATTORNEY



David J. Kyros

Director of the United States Patent and Trademark Office

United States of America

United States Patent and Trademark Office

Screw Force Tools

Reg. No. 4,176,606

WALKER, BRENTON (UNITED STATES INDIVIDUAL)
2504 W. CHELTENHAM AVENUE
PHILADELPHIA, PA 19150

Registered July 17, 2012

Int. Cl.: 8

TRADEMARK

PRINCIPAL REGISTER

FOR: ABRADING TOOLS; DRAW TAPE REELS; EMERY FILES; EXPLOSIVE ACTUATED TOOLS FOR DRIVING RIVETS; EXTENSION BARS FOR HAND TOOLS; EXTENSIONS FOR HAND TOOLS; HAND TOOL IN THE NATURE OF A FITTING DEVICE FOR FITTING THE STEERING RACK BOOT IN A VEHICLE; HAND TOOL, NAMELY, RIGID AND ROD HAND BENDERS FOR USE ON PIPES AND CONDUITS; HAND TOOLS FOR REPAIR AND MAINTENANCE OF BICYCLES; HAND TOOLS, NAMELY, AUTOMOBILE SHEET METAL DENT REPAIR TOOL; HAND TOOLS, NAMELY, AWLS; HAND TOOLS, NAMELY, BAR CUTTERS; HAND TOOLS, NAMELY, BOLT CUTTERS; HAND TOOLS, NAMELY, BRASS-WORKER SPATULAS FOR STIRRING HOT METAL; HAND TOOLS, NAMELY, BUSHING DRIVERS; HAND TOOLS, NAMELY, CLAMPS; HAND TOOLS, NAMELY, CONCRETE MOVERS; HAND TOOLS, NAMELY, CRIMP WRENCH SETS; HAND TOOLS, NAMELY, CRIMP WRENCHES; HAND TOOLS, NAMELY, CRIMPING IRONS; HAND TOOLS, NAMELY, CUTTER BARS; HAND TOOLS, NAMELY, DICING BLADES, SLITTING BLADES, OPTICALLY TRANSPARENT BLADES, OPTICALLY TRANSMITTING BLADES; HAND TOOLS, NAMELY, DIE CHASERS; HAND TOOLS, NAMELY, DIE WRENCHES; HAND TOOLS, NAMELY, DIES; HAND TOOLS, NAMELY, DITCH BANK BLADES; HAND TOOLS, NAMELY, DRILLS; HAND TOOLS, NAMELY, ENGRAVERS; HAND TOOLS, NAMELY, EXPANDERS; HAND TOOLS, NAMELY, FARRIERS' KNIVES; HAND TOOLS, NAMELY, FILES; HAND TOOLS, NAMELY, FLARING TOOLS; HAND TOOLS, NAMELY, FLAT FINISHER BOXES; HAND TOOLS, NAMELY, FLOATS FOR GROUT, MORTAR OR CEMENT; HAND TOOLS, NAMELY, GOUGES; HAND TOOLS, NAMELY, GRAFTING TOOLS; HAND TOOLS, NAMELY, RASPS; HAND TOOLS, NAMELY, RATCHET WRENCHES; HAND TOOLS, NAMELY, RIVETERS; HAND TOOLS, NAMELY, SAWS; HAND TOOLS, NAMELY, SCRAPERS; HAND TOOLS, NAMELY, SCREW EXTRACTORS; HAND TOOLS, NAMELY, SCREWDRIVERS; HAND TOOLS, NAMELY, SOCKET SETS; HAND TOOLS, NAMELY, SOCKET WRENCHES; HAND TOOLS, NAMELY, STAMPING-OUT TOOLS; HAND TOOLS, NAMELY, STAMPS; HAND TOOLS, NAMELY, STRETCHERS FOR WIRE AND METAL BANDS; HAND TOOLS, NAMELY, TAP AND DIE SETS; HAND TOOLS, NAMELY, TAPS; HAND TOOLS, NAMELY, TORQUE MULTIPLIERS; HAND TOOLS, NAMELY, TRANSPLANTERS; HAND TOOLS, NAMELY, VICES; HAND TOOLS, NAMELY, WEDGES; HAND TOOLS, NAMELY, WRECKING BARS, STRIPPING BARS, SMALL BARS AND NAIL PULLERS, SAN ANGELO BARS, TAMPER BARS, WEDGE POINT BARS, PITCH POINT BARS; HAND TOOLS, NAMELY, WRENCHES; HAND-OPERATED AUTOMOTIVE REPAIR



David J. Kybas

Director of the United States Patent and Trademark Office

Reg. No. 4,176,606 TOOLS, NAMELY, BALL JOINT SEPARATORS; HAND-OPERATED AUTOMOTIVE REPAIR TOOLS, NAMELY, BRAKE CYLINDER HONES; HAND-OPERATED AUTOMOTIVE REPAIR TOOLS, NAMELY, BRAKE PAD SPREADERS; HAND-OPERATED AUTOMOTIVE REPAIR TOOLS, NAMELY, BRAKE SPRING REMOVERS; HAND-OPERATED AUTOMOTIVE REPAIR TOOLS, NAMELY, DISC BRAKE PISTON CUBES; HAND-OPERATED AUTOMOTIVE REPAIR TOOLS, NAMELY, DRUM BRAKE ADJUSTING TOOLS; HAND-OPERATED AUTOMOTIVE REPAIR TOOLS, NAMELY, ENGINE CYLINDER HONES; HAND-OPERATED AUTOMOTIVE REPAIR TOOLS, NAMELY, MAGNETIC PICK-UP TOOLS; HAND-OPERATED AUTOMOTIVE REPAIR TOOLS, NAMELY, RING COMPRESSORS; HAND-OPERATED AUTOMOTIVE REPAIR TOOLS, NAMELY, VALVE HOLDERS; HAND-OPERATED AUTOMOTIVE REPAIR TOOLS, NAMELY, VALVE SPRING COMPRESSORS; HAND-OPERATED AUTOMOTIVE REPAIR TOOLS, NAMELY, VALVE SPRING DEPRESSORS; HAND-OPERATED CUTTING TOOLS; HAND-OPERATED CUTTING TOOLS, NAMELY, BOX CUTTERS; HAND-OPERATED CUTTING TOOLS, NAMELY, SAFETY CUTTERS; HAND-OPERATED RIVETING TOOLS; HAND-OPERATED SHARPENING TOOLS AND INSTRUMENTS; HAND-TOOLS, NAMELY, WIRE CRIMPERS; KNIVES; MANUALLY OPERATED SHOP TOOLS FOR WORK ON MOTORCYCLES, NAMELY, CHAIN BREAKER TOOL, CHAIN RIVETING TOOL, CHAIN PRESS TOOL, CHAIN ALIGNMENT TOOL, CARBURETOR TUNING TOOL, CARBURETOR TUNING GAUGE SET, TIRE IRONS, TAPPET ADJUSTMENT TOOLS, VALVE SHIM TOOLS, TAPPET FEELER GAUGE, CARBURETOR JET WRENCHES, CLUTCH HOLDING TOOL, PISTON PIN REMOVING TOOL, SPRING REMOVING TOOL, TIMING COVER WRENCH, OIL FILTER WRENCH, SHOCK ABSORBER WRENCH, AXLE WRENCH, FLY WHEEL PULLER TOOL, CLUTCH PULLER TOOL AND MAGNETO FLY-WHEEL PULLER TOOL; MANUALLY OPERATED TOOLS, NAMELY, SHEET BENDING BRAKES AND COMPONENTS THEREOF; MANUALLY-OPERATED SPECIALIZED TOOL FOR THE PURPOSE OF PUSHING A MARINE BUSHING OUT OF THE STRUT; TOOL APRONS; TOOL BELTS; TOOL HOLDERS; TOOL POUCHES FOR ATTACHMENT TO TOOL BELTS, IN CLASS 8 (U.S. CLS. 23, 28 AND 44).

FIRST USE 10-15-2011; IN COMMERCE 10-15-2011.

THE MARK CONSISTS OF STANDARD CHARACTERS WITHOUT CLAIM TO ANY PARTICULAR FONT, STYLE, SIZE, OR COLOR.

NO CLAIM IS MADE TO THE EXCLUSIVE RIGHT TO USE "TOOLS", APART FROM THE MARK AS SHOWN.

SN 85-267,982, FILED 3-15-2011.

HOWARD SMIGA, EXAMINING ATTORNEY

United States of America

United States Patent and Trademark Office



Reg. No. 4,176,607

SMART CHOICE, LLC (DELAWARE LIMITED LIABILITY COMPANY)
203 NE FRONT STREET, SUITE 101
MILFORD, DE 19963

Registered July 17, 2012

Int. Cls.: 7, 9, 11, and 12

FOR: PUMPS FOR MOTOR VEHICLES, NAMELY, WATER PUMPS, SMOG AIR PUMPS AND VACUUM PUMPS; MOTORS FOR MOTOR VEHICLES, NAMELY, WIPER MOTORS, HEAD LAMP MOTORS, WINDOW WIPER MOTORS, WINDOW LIFT MOTORS, RADIATOR COOLING MOTORS AND TAILGATE MOTORS; ELECTRIC IGNITIONS FOR VEHICLES, IN CLASS 7 (U.S. CLS. 13, 19, 21, 23, 31, 34 AND 35).

TRADEMARK

PRINCIPAL REGISTER

FIRST USE 4-29-2011; IN COMMERCE 4-29-2011.

FOR: ENGINE CONTROL COMPUTERS AND COMPUTER CHIPS; ELECTRIC MASS AIR-FLOW SENSORS; ELECTRIC VANE AIRFLOW METERS; VEHICLE COMPUTERS, NAMELY, BODY CONTROL COMPUTERS AND PROM CHIPS; ELECTRIC VEHICLE CONTROLS, NAMELY, TRANSMISSION MODULES, CRUISE CONTROL MODULES, AIR SUPPLY MODULES AND ANTI-LOCK BRAKE MODULES, RADIOS AND GLOBAL POSITIONING SYSTEMS FOR MOTOR VEHICLES, IN CLASS 9 (U.S. CLS. 21, 23, 26, 36 AND 38).

FIRST USE 4-29-2011; IN COMMERCE 4-29-2011.

FOR: AUTOMOBILE HEADLIGHTS AND HEADLIGHT ASSEMBLIES; AUTOMOBILE TAIL LIGHTS AND TAIL LIGHT ASSEMBLIES, IN CLASS 11 (U.S. CLS. 13, 21, 23, 31 AND 34).

FIRST USE 4-29-2011; IN COMMERCE 4-29-2011.

FOR: BRAKE SYSTEMS AND BRAKE PARTS FOR LAND VEHICLES, NAMELY, BRAKE MASTER CYLINDERS, POWER BRAKE UNITS, DISC BRAKE CALIPERS, HYDRAULIC UNITS, LOADED DISK BRAKE CALIPERS AND POWER BRAKE BOOSTER PACKS; POWER STEERING SYSTEMS AND PARTS FOR LAND VEHICLES, NAMELY, POWER STEERING PUMPS, STEERING GEARS, RACK AND PINION STEERING UNITS, CONTROL VALVES, POWER CYLINDERS, POWER STEERING FILTERS; AUTOMOBILE FENDERS AND BUMPERS; AUTOMOBILE GRILLS, AUTOMOBILE BODY PARTS, NAMELY, SIDE PANELS, DOORS AND DOOR HANDLES, HOODS AND REAR VIEW MIRRORS; ARMRESTS AND SEATS, ALL FOR MOTOR VEHICLES; DRIVE SHAFTS AND PROPELLER SHAFTS, BOTH FOR MOTOR VEHICLES, IN CLASS 12 (U.S. CLS. 19, 21, 23, 31, 35 AND 44).



David J. Kybas

Director of the United States Patent and Trademark Office

Reg. No. 4,176,607 FIRST USE 4-29-2011; IN COMMERCE 4-29-2011.

NO CLAIM IS MADE TO THE EXCLUSIVE RIGHT TO USE "PREMIUM IMPACT PARTS", APART FROM THE MARK AS SHOWN.

THE COLOR(S) BLACK, WHITE AND BLUE IS/ARE CLAIMED AS A FEATURE OF THE MARK.

THE MARK CONSISTS OF THE WORDS "ASCENSION PREMIUM IMPACT PARTS". THE WORD "ASCENSION" IS SHOWN IN BLACK IN FULL CAPITAL LETTERS OUTLINED IN WHITE AND "PREMIUM IMPACT PARTS" IS SHOWN BENEATH "ASCENSION" IN BLUE OUTLINED IN WHITE IN SMALLER FULL CAPITAL LETTERS. ABOVE THE LITERAL ELEMENT IS A TRIANGULAR DESIGN COMPRISED OF A BLUE INNER TRIANGLE WITH ONE (1) WIDE PARALLEL BLACK LINE OUTLINED IN WHITE BORDERING THE TWO (2) VERTICAL EDGES OF THE BLUE TRIANGLE. THE ENTIRE MARK IS SHOWN ON A BLACK BACKGROUND.

SN 85-268,136, FILED 3-16-2011.

PAUL MORENO, EXAMINING ATTORNEY

United States of America

United States Patent and Trademark Office

PIT BOSS

Reg. No. 4,176,608

PURE FISHING, INC. (IOWA CORPORATION)
1900 18TH STREET
SPIRIT LAKE, IA 51360

Registered July 17, 2012

Int. Cl.: 28

FOR: ARTIFICIAL FISHING BAIT; FISHING TACKLE, IN CLASS 28 (U.S. CLS. 22, 23, 38 AND 50).

TRADEMARK

FIRST USE 1-0-2011; IN COMMERCE 1-0-2011.

PRINCIPAL REGISTER

THE MARK CONSISTS OF STANDARD CHARACTERS WITHOUT CLAIM TO ANY PARTICULAR FONT, STYLE, SIZE, OR COLOR.

SN 85-268,416, FILED 3-16-2011.

LAURA KOVALSKY, EXAMINING ATTORNEY



David J. Kybas

Director of the United States Patent and Trademark Office

United States of America

United States Patent and Trademark Office

CALLTEXTUAL

Reg. No. 4,176,609

Registered July 17, 2012

Int. Cl.: 35

SERVICE MARK

PRINCIPAL REGISTER

APPTERA, INC. (DELAWARE CORPORATION)
505 N. MATHILDA AVE., SUITE 110
SUNNYVALE, CA 94085

FOR: ADVERTISING AND MARKETING SERVICES PROVIDED BY MEANS OF DIRECT AND INDIRECT METHODS OF MARKETING COMMUNICATIONS, NAMELY, SOCIAL MEDIA, SEARCH ENGINE MARKETING, INQUIRY MARKETING, INTERNET MARKETING, MOBILE MARKETING, GEOGRAPHIC LOCATION BASED MARKETING, BLOGGING AND OTHER FORMS OF PASSIVE, SHARABLE OR VIRAL COMMUNICATIONS CHANNELS, IN CLASS 35 (U.S. CLS. 100, 101 AND 102).

FIRST USE 5-8-2012; IN COMMERCE 5-8-2012.

THE MARK CONSISTS OF STANDARD CHARACTERS WITHOUT CLAIM TO ANY PARTICULAR FONT, STYLE, SIZE, OR COLOR.

SN 85-268,583, FILED 3-16-2011.

KAREN SEVERSON, EXAMINING ATTORNEY



David J. Kyffers

Director of the United States Patent and Trademark Office

United States of America

United States Patent and Trademark Office

UP TO 65% OFF. 100% OF
THE TIME.

Reg. No. 4,176,610

CENTURY 21 INC. (NEW YORK CORPORATION)
22 CORTLANDT STREET
NEW YORK, NY 10017

Registered July 17, 2012

Int. Cl.: 35

FOR: RETAIL DEPARTMENT STORE SERVICES AND ONLINE RETAIL DEPARTMENT STORE SERVICES FEATURING MEN'S, LADIES AND CHILDREN'S CLOTHING AND FOOTWEAR, LINGERIE, LINENS, COSMETICS, ACCESSORIES, HANDBAGS, LUGGAGE, HOUSEWARES, GIFTWARE, CONSUMER ELECTRONICS PRODUCTS, FURNITURE AND HOME FURNISHINGS, LAMPS AND FRAMED ART, IN CLASS 35 (U.S. CLS. 100, 101 AND 102).

SERVICE MARK

PRINCIPAL REGISTER

FIRST USE 4-23-2012; IN COMMERCE 4-23-2012.

THE MARK CONSISTS OF STANDARD CHARACTERS WITHOUT CLAIM TO ANY PARTICULAR FONT, STYLE, SIZE, OR COLOR.

SN 85-268,871, FILED 3-16-2011.

NAAKWAMA ANKRAH, EXAMINING ATTORNEY



David J. Kyffers

Director of the United States Patent and Trademark Office

United States of America

United States Patent and Trademark Office

HIGH PERFORMANCE TEAMS

Reg. No. 4,176,611

Registered July 17, 2012

Int. Cl.: 35

SERVICE MARK

PRINCIPAL REGISTER

TRIXIA PARTNERS, INC. (GEORGIA CORPORATION)
SUITE 1650
900 CIRCLE 75 PARKWAY
ATLANTA, GA 30339

FOR: PROVIDING CONSULTING SERVICES, NAMELY, ORGANIZATIONAL DEVELOPMENT CONSULTING, BUSINESS MANAGEMENT CONSULTING IN THE FIELD OF TEAM DEVELOPMENT, AND CONSULTATION IN BUSINESS LEADERSHIP DEVELOPMENT TO NON-PROFIT, PROFIT AND GOVERNMENTAL ORGANIZATIONS IN THE ASSESSMENT OF THE ORGANIZATION, TEAMS AND INDIVIDUALS WITH CONSULTATION IN HELPING BUILD A POWERFUL TEAM FOR THE ORGANIZATION, IN CLASS 35 (U.S. CLS. 100, 101 AND 102).

FIRST USE 10-30-1983; IN COMMERCE 12-30-1983.

THE MARK CONSISTS OF STANDARD CHARACTERS WITHOUT CLAIM TO ANY PARTICULAR FONT, STYLE, SIZE, OR COLOR.

NO CLAIM IS MADE TO THE EXCLUSIVE RIGHT TO USE "TEAMS" , APART FROM THE MARK AS SHOWN.

SN 85-269,414, FILED 3-17-2011.

KRISTIN CARLSON, EXAMINING ATTORNEY



David J. Kybas

Director of the United States Patent and Trademark Office

United States of America

United States Patent and Trademark Office

▼ **ID** *the* **V**
to know it is to love it.

Reg. No. 4,176,612

C.B. FLEET INVESTMENT CORPORATION (DELAWARE CORPORATION)
103 FOULK ROAD, SUITE 202
WILMINGTON, DE 19803

Registered July 17, 2012

Int. Cl.: 44

FOR: PROVIDING A WEBSITE FEATURING EDUCATIONAL INFORMATION FOR WOMEN
IN THE AREA OF WOMEN'S HEALTH, IN CLASS 44 (U.S. CLS. 100 AND 101).

SERVICE MARK

FIRST USE 6-22-2011; IN COMMERCE 6-22-2011.

PRINCIPAL REGISTER

THE MARK CONSISTS OF THE STYLIZED WORDS "ID THE V TO KNOW IT IS TO LOVE
IT" AND A DOWNWARD POINTING ARROW ON THE LEFT SIDE OF THE MARK.

SN 85-269,423, FILED 3-17-2011.

EUGENIA MARTIN, EXAMINING ATTORNEY



David J. Kybas

Director of the United States Patent and Trademark Office

United States of America

United States Patent and Trademark Office



Reg. No. 4,176,613

Registered July 17, 2012

Int. Cl.: 33

TRADEMARK

PRINCIPAL REGISTER

FAIRWAY GROUP ACQUISITION COMPANY (DELAWARE CORPORATION)
2284 TWELFTH AVENUE
NEW YORK, NY 10027

FOR: WINE, IN CLASS 33 (U.S. CLS. 47 AND 49).

FIRST USE 12-16-2011; IN COMMERCE 12-16-2011.

OWNER OF U.S. REG. NOS. 3,545,835, 3,641,831, AND OTHERS.

NO CLAIM IS MADE TO THE EXCLUSIVE RIGHT TO USE "WINES & SPIRITS", APART FROM THE MARK AS SHOWN.

THE MARK CONSISTS OF THE REPRESENTATION OF A CORKSCREW, WITH THE WORD "FAIRWAY" UNDERLINED BY A THICK CURVED BAND, ALL INSIDE THE CORKSCREW; UNDERNEATH THE CORKSCREW ARE THE WORDS "WINES & SPIRITS" WITH THE SCREW FROM THE CORKSCREW FORMING THE "I" IN THE WORD "WINES" AND THE FIRST "I" IN THE WORD "SPIRITS", ALL ENCASED IN A SQUARE.

SN 85-269,732, FILED 3-17-2011.

CARYN GLASSER, EXAMINING ATTORNEY



David J. Kyffers

Director of the United States Patent and Trademark Office

United States of America
United States Patent and Trademark Office

TUFFBOND

Reg. No. 4,176,614

COLAS (FRANCE SOCIÉTÉ ANONYME (SA))
7, PLACE RENÉ CLAIR

Registered July 17, 2012

BOULOGNE BILLANCOURT, FRANCE 92100

Int. Cl.: 19

FOR: NON-METALLIC BITUMINOUS MATERIALS, NAMELY, ASPHALT EMULSIONS, ASPHALT SEALANTS, BITUMEN ASPHALT, ASPHALT AND AGGREGATES COMPOSED OF CRUSHED GRAVEL FOR MAKING AND COATING ROADS AS WELL AS OTHER TRAFFIC WAYS AND SURFACES, IN CLASS 19 (U.S. CLS. 1, 12, 33 AND 50).

TRADEMARK

PRINCIPAL REGISTER

FIRST USE 3-7-2012; IN COMMERCE 3-7-2012.

THE MARK CONSISTS OF STANDARD CHARACTERS WITHOUT CLAIM TO ANY PARTICULAR FONT, STYLE, SIZE, OR COLOR.

SN 85-269,869, FILED 3-17-2011.

DOMINICK J. SALEMI, EXAMINING ATTORNEY



David J. Kyros

Director of the United States Patent and Trademark Office

United States of America

United States Patent and Trademark Office

AIRE~IVF

Reg. No. 4,176,615

KATHRYN C. WORRILOW, PH.D. (UNITED STATES INDIVIDUAL)
8839 CLEARWATER CIRCLE
FOGELSVILLE, PA 18051

Registered July 17, 2012

Int. Cl.: 11

FOR: AIR PURIFICATION AND FILTRATION UNIT FOR IN VITRO FERTILIZATION FACILITIES, NAMELY, AIR PURIFICATION AND FILTRATION UNITS COMPRISED OF AIR PURIFIERS AND AIR FILTERS FOR PROVIDING AN AMBIENT AIR ENVIRONMENT OPTIMUM IN SUPPORTING HUMAN EMBRYOGENESIS, AND FOR CELL CULTURE LABORATORIES AND MEDICAL ENVIRONMENTS REQUIRING STABLE AND PRISTINE AMBIENT AIR QUALITY, IN CLASS 11 (U.S. CLS. 13, 21, 23, 31 AND 34).

TRADEMARK

PRINCIPAL REGISTER

FIRST USE 1-30-2012; IN COMMERCE 1-30-2012.

THE MARK CONSISTS OF STANDARD CHARACTERS WITHOUT CLAIM TO ANY PARTICULAR FONT, STYLE, SIZE, OR COLOR.

SN 85-270,340, FILED 3-18-2011.

KATHERINE E. HALMEN, EXAMINING ATTORNEY



David J. Kybas

Director of the United States Patent and Trademark Office

United States of America

United States Patent and Trademark Office



Reg. No. 4,176,616

Registered July 17, 2012

Int. Cl.: 9

TRADEMARK

PRINCIPAL REGISTER

GO GO KIDDO INC. (WASHINGTON CORPORATION)
P.O. BOX 7448
BELLEVUE, WA 98008

FOR: COMPUTER APPLICATION SOFTWARE FOR MOBILE DEVICES, NAMELY, SOFTWARE FOR USE IN OBTAINING INFORMATION FROM THE MOBILE DEVICE'S CAMERA, OR TOUCH SCREEN AND TRANSFERRING THAT INFORMATION ACROSS COMMUNICATION NETWORKS, FOR USE IN CUSTOMIZING CONTENT, AND FOR USE IN OBTAINING EDUCATIONAL AND ENTERTAINMENT CONTENT; DOWNLOADABLE CHILDREN'S BOOKS, DOWNLOADABLE VIDEO RECORDINGS FEATURING ANIMATION AND MUSIC, AND COMPUTER GAME SOFTWARE FOR USE ON MOBILE DEVICES, ALL OF THE ABOVE DELIVERED TO MOBILE DEVICES, IN CLASS 9 (U.S. CLS. 21, 23, 26, 36 AND 38).

FIRST USE 11-22-2011; IN COMMERCE 11-22-2011.

THE MARK CONSISTS OF THE WORDS "GO GO KIDDO". "GO GO" APPEARS ON A LINE ABOVE "KIDDO". THE "O" IN "KIDDO" IS A DESIGN OF A FACE.

SN 85-271,269, FILED 3-18-2011.

KATHERINE E. HALMEN, EXAMINING ATTORNEY



David J. Kybas

Director of the United States Patent and Trademark Office

United States of America

United States Patent and Trademark Office

OZ LAND

Reg. No. 4,176,617

Registered July 17, 2012

Int. Cls.: 9 and 41

TRADEMARK

SERVICE MARK

PRINCIPAL REGISTER

DOROTHY OF OZ, LLC (CALIFORNIA LIMITED LIABILITY COMPANY), DBA BOX OFFICE PRODUCTIONS III, LLC,
2600 WEST OLIVE AVE., SUITE 500
BURBANK, CA 91505

FOR: DOWNLOADABLE COMPUTER GAME SOFTWARE VIA A GLOBAL COMPUTER NETWORK AND WIRELESS DEVICES; DOWNLOADABLE COMPUTER SOFTWARE FOR GAMES, IN CLASS 9 (U.S. CLS. 21, 23, 26, 36 AND 38).

FIRST USE 3-19-2012; IN COMMERCE 3-19-2012.

FOR: ENTERTAINMENT SERVICES, NAMELY, PROVIDING ON-LINE COMPUTER GAMES, IN CLASS 41 (U.S. CLS. 100, 101 AND 107).

FIRST USE 3-19-2012; IN COMMERCE 3-19-2012.

THE MARK CONSISTS OF STANDARD CHARACTERS WITHOUT CLAIM TO ANY PARTICULAR FONT, STYLE, SIZE, OR COLOR.

SN 85-271,393, FILED 3-18-2011.

TRACY WHITTAKER-BROWN, EXAMINING ATTORNEY



David J. Kypos

Director of the United States Patent and Trademark Office

United States of America

United States Patent and Trademark Office

WE COLLECT RESULTS

Reg. No. 4,176,618

MARKOFF KRASNY LLC (ILLINOIS LIMITED LIABILITY COMPANY)
29 N. WACKER DRIVE #550
CHICAGO, IL 60606

Registered July 17, 2012

Int. Cl.: 36

FOR: DEBT COLLECTION, IN CLASS 36 (U.S. CLS. 100, 101 AND 102).

SERVICE MARK

FIRST USE 3-31-2011; IN COMMERCE 3-31-2011.

PRINCIPAL REGISTER

THE MARK CONSISTS OF STANDARD CHARACTERS WITHOUT CLAIM TO ANY PARTICULAR FONT, STYLE, SIZE, OR COLOR.

SN 85-271,427, FILED 3-19-2011.

BENJAMIN OKEKE, EXAMINING ATTORNEY



David J. Kybas

Director of the United States Patent and Trademark Office

United States of America

United States Patent and Trademark Office

Technogreen

Reg. No. 4,176,619

MANZAR, RICARDO (UNITED STATES INDIVIDUAL)
3807 PLANTATION GROVE BLVD. D 202
MISSION, TX 78572

Registered July 17, 2012

Int. Cls.: 1, 3, and 37

FOR: RADIATOR FLUSH, IN CLASS 1 (U.S. CLS. 1, 5, 6, 10, 26 AND 46).

FIRST USE 4-1-2011; IN COMMERCE 4-1-2011.

TRADEMARK

FOR: ALL PURPOSE CLEANING PREPARATIONS; CLEANING PREPARATIONS FOR HOUSEHOLD USE MADE FROM VOLCANIC ASH OR WAX; OILS FOR CLEANING PURPOSES; PREPARATION FOR CLEANING DENTURES, IN CLASS 3 (U.S. CLS. 1, 4, 6, 50, 51 AND 52).

SERVICE MARK

FIRST USE 4-1-2011; IN COMMERCE 4-1-2011.

PRINCIPAL REGISTER

FOR: CLEANING OF CLOTHING, BUILDINGS, RESIDENCES, VEHICLES, AND MACHINERY, IN CLASS 37 (U.S. CLS. 100, 103 AND 106).

FIRST USE 4-1-2011; IN COMMERCE 4-1-2011.

THE MARK CONSISTS OF STANDARD CHARACTERS WITHOUT CLAIM TO ANY PARTICULAR FONT, STYLE, SIZE, OR COLOR.

SN 85-272,079, FILED 3-21-2011.

ARETHA SOMERVILLE, EXAMINING ATTORNEY



David J. Kybas

Director of the United States Patent and Trademark Office

United States of America

United States Patent and Trademark Office

INTELLIGENT ITEMS

Reg. No. 4,176,620

Registered July 17, 2012

Int. Cl.: 35

SERVICE MARK

PRINCIPAL REGISTER

CORE EDUCATION AND CONSULTING SOLUTIONS, INC. (TENNESSEE CORPORATION)
STE. 1900
3 RAVINIA DRIVE
ATLANTA, GA 30346

FOR: COMPUTERIZED ON-LINE RETAIL STORE SERVICES IN THE FIELD OF EDUCATION;
ON-LINE RETAIL STORE SERVICES FEATURING ASSESSMENT ITEMS FOR USE IN THE
FIELD OF EDUCATION; ON-LINE RETAIL STORE SERVICES FEATURING DOWNLOAD-
ABLE ASSESSMENT ITEMS, IN CLASS 35 (U.S. CLS. 100, 101 AND 102).

FIRST USE 9-15-2011; IN COMMERCE 9-15-2011.

THE MARK CONSISTS OF STANDARD CHARACTERS WITHOUT CLAIM TO ANY PAR-
TICULAR FONT, STYLE, SIZE, OR COLOR.

SN 85-272,489, FILED 3-21-2011.

LINDA MICKLEBURGH, EXAMINING ATTORNEY



David J. Kyros

Director of the United States Patent and Trademark Office

United States of America

United States Patent and Trademark Office



THE CLUB
at harbor point

Reg. No. 4,176,621

Registered July 17, 2012

Int. Cl.: 41

SERVICE MARK

PRINCIPAL REGISTER

THE CLUB AT HARBOR POINT, LLC (CALIFORNIA LIMITED LIABILITY COMPANY)
2 HARBOR POINT DRIVE
MILL VALLEY, CA 94941

FOR: HEALTH CLUB SERVICES, NAMELY, PROVIDING INSTRUCTION AND CONSULTATION IN THE FIELD OF PHYSICAL EXERCISE; PROVIDING USE OF EXERCISE EQUIPMENT; PROVIDING FITNESS AND EXERCISE FACILITIES; COUNTRY CLUB SERVICES, NAMELY, PROVIDING TENNIS COURT FACILITIES, SWIMMING POOLS, FITNESS FACILITIES, RECREATION FACILITIES, IN CLASS 41 (U.S. CLS. 100, 101 AND 107).

FIRST USE 9-0-2011; IN COMMERCE 9-0-2011.

NO CLAIM IS MADE TO THE EXCLUSIVE RIGHT TO USE "CLUB", APART FROM THE MARK AS SHOWN.

THE MARK CONSISTS OF A STYLIZED WAVE FORMATION. TO THE RIGHT OF THE CIRCLE ARE THE WORDS "THE CLUB AT HARBOR POINT". THE WORD "THE" IS WRITTEN AT A 90 DEGREE ANGLE. THE WORDS "AT HARBOR POINT" ARE LOCATED BELOW THE WORDS "THE CLUB".

SN 85-272,742, FILED 3-21-2011.

CHARLOTTE CORWIN, EXAMINING ATTORNEY



David J. Kyffers

Director of the United States Patent and Trademark Office

United States of America

United States Patent and Trademark Office

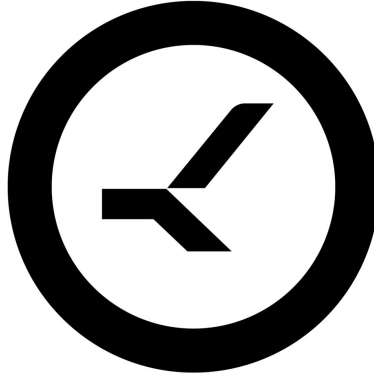

Reg. No. 4,176,622

Registered July 17, 2012

Int. Cl.: 32

TRADEMARK

PRINCIPAL REGISTER

ANHEUSER-BUSCH, LLC (MISSOURI LIMITED LIABILITY COMPANY)
ONE BUSCH PLACE
ST. LOUIS, MO 63118

FOR: BEER, IN CLASS 32 (U.S. CLS. 45, 46 AND 48).

FIRST USE 12-13-2011; IN COMMERCE 12-13-2011.

THE MARK CONSISTS OF A HANDLE IN A CIRCLE.

SN 85-273,568, FILED 3-22-2011.

EUGENIA MARTIN, EXAMINING ATTORNEY



David J. Kyffers

Director of the United States Patent and Trademark Office

United States of America

United States Patent and Trademark Office

SEEDITROL

Reg. No. 4,176,623

Registered July 17, 2012

Int. Cls.: 1 and 5

TRADEMARK

PRINCIPAL REGISTER

ALCOR SCIENTIFIC, INC. (RHODE ISLAND CORPORATION)
11 KNIGHT STREET, BUILDING F23
WARWICK, RI 02886

FOR: BI-LEVEL HUMAN WHOLE BLOOD BASED FLUID CONTROL DESIGNED TO MONITOR BOTH MANUAL AND AUTOMATED METHODS FOR MEASURING ERYTHROCYTE SEDIMENTATION RATES IN BLOOD CELLS; CALIBRATING AND QUALITY CONTROL FLUIDS FOR BLOOD ANALYZERS, NAMELY, VIAL CONTAINING BLOOD USED AS A CONTROL FOR MEASURING RESULTS FROM ERYTHROCYTE SEDIMENTATION RATE ANALYZERS, IN CLASS 1 (U.S. CLS. 1, 5, 6, 10, 26 AND 46).

FIRST USE 5-24-2011; IN COMMERCE 5-26-2011.

FOR: CLINICAL MEDICAL DIAGNOSTIC PREPARATIONS AND REAGENTS FOR MAINTAINING QUALITY CONTROL OF APPARATUS AND MEDICAL INSTRUMENTS USED FOR CLINICAL ANALYSIS AND IN MEDICAL LABORATORIES , IN CLASS 5 (U.S. CLS. 6, 18, 44, 46, 51 AND 52).

FIRST USE 5-24-2011; IN COMMERCE 5-26-2011.

THE MARK CONSISTS OF STANDARD CHARACTERS WITHOUT CLAIM TO ANY PARTICULAR FONT, STYLE, SIZE, OR COLOR.

SN 85-273,736, FILED 3-22-2011.

KATHLEEN LORENZO, EXAMINING ATTORNEY



David J. Kyjars

Director of the United States Patent and Trademark Office

United States of America

United States Patent and Trademark Office



Reg. No. 4,176,624

EAR PHONE CONNECTION, INC. (CALIFORNIA CORPORATION)
25139 AVE STANFORD
VALENCIA, CA 91355

Registered July 17, 2012

Int. Cl.: 9

FOR: MICROPHONES FOR TWO-WAY RADIOS, IN CLASS 9 (U.S. CLS. 21, 23, 26, 36 AND 38).

TRADEMARK

FIRST USE 4-5-2011; IN COMMERCE 4-5-2011.

PRINCIPAL REGISTER

THE MARK CONSISTS OF THE PROMINENT STYLIZED BLUE COLOR ACRONYM "BW", THE STYLIZED WORDING "BLUE-WI" WITH THE WORD "BLUE-" IN BLUE COLOR, AND THE WORD "WI" IN WHITE COLOR DEPICTED BELOW THE SAID ACRONYM "BW", AND A WHITE CURVED LINE, THE DEPICTION OF A BLUE COLOR BALL AT THE UPPER END OF SUCH A WHITE CURVED LINE AND THREE CURVED LINES DEPICTED AS REPRESENTING WAVES HAVING AS CENTER THE SAID BLUE BALL; AND THE RECTANGULAR BACKGROUND IS IN BLACK COLOR.

THE COLOR(S) BLUE, WHITE AND BLACK IS/ARE CLAIMED AS A FEATURE OF THE MARK.

SN 85-273,992, FILED 3-22-2011.

ZACHARY BELLO, EXAMINING ATTORNEY



David J. Kybas

Director of the United States Patent and Trademark Office

United States of America

United States Patent and Trademark Office

QSCRIPT

Reg. No. 4,176,625

GRIFFIN TECHNOLOGY, INC. (TENNESSEE CORPORATION)
2030 LINDELL AVENUE
NASHVILLE, TN 37203

Registered July 17, 2012

Int. Cl.: 9

FOR: OPERATING SOFTWARE FOR AN OFF-CAMERA DEVICE THAT DISPLAYS A MAGNIFIED SCRIPT SO THAT IT IS VISIBLE TO PERFORMERS OR SPEAKERS, IN CLASS 9 (U.S. CLS. 21, 23, 26, 36 AND 38).

TRADEMARK

FIRST USE 12-31-2011; IN COMMERCE 12-31-2011.

PRINCIPAL REGISTER

THE MARK CONSISTS OF STANDARD CHARACTERS WITHOUT CLAIM TO ANY PARTICULAR FONT, STYLE, SIZE, OR COLOR.

SN 85-274,070, FILED 3-23-2011.

TRACY WHITTAKER-BROWN, EXAMINING ATTORNEY



David J. Kyffers

Director of the United States Patent and Trademark Office

United States of America

United States Patent and Trademark Office

FELT TABLES

Reg. No. 4,176,626

NEW IMAGE GROUP LLC (SOUTH CAROLINA LIMITED LIABILITY COMPANY)
541 BUFFALO WEST SPRINGS HIGHWAY
UNION, SC 29379

Registered July 17, 2012

Int. Cl.: 16

FOR: ARTS AND CRAFT FELT KITS, IN CLASS 16 (U.S. CLS. 2, 5, 22, 23, 29, 37, 38 AND 50).

TRADEMARK

FIRST USE 8-24-2010; IN COMMERCE 8-31-2011.

PRINCIPAL REGISTER

THE MARK CONSISTS OF STANDARD CHARACTERS WITHOUT CLAIM TO ANY PARTICULAR FONT, STYLE, SIZE, OR COLOR.

SN 85-274,308, FILED 3-23-2011.

DOMINICK J. SALEMI, EXAMINING ATTORNEY



David J. Kyffers

Director of the United States Patent and Trademark Office

United States of America
United States Patent and Trademark Office

ARIZOLAC

Reg. No. 4,176,627

ERIE EUROPE SAS (FRANCE CORPORATION)
30 RUE SAINT LAZARE
PARIS, FRANCE 75009

Registered July 17, 2012

Int. Cl.: 29

FOR: SKIMMED MILK POWDER, IN CLASS 29 (U.S. CL. 46).

TRADEMARK

FIRST USE 12-9-2010; IN COMMERCE 12-9-2010.

PRINCIPAL REGISTER

THE MARK CONSISTS OF STANDARD CHARACTERS WITHOUT CLAIM TO ANY PARTICULAR FONT, STYLE, SIZE, OR COLOR.

SN 85-274,519, FILED 3-23-2011.

EDWARD NELSON, EXAMINING ATTORNEY



David J. Kybas

Director of the United States Patent and Trademark Office

United States of America

United States Patent and Trademark Office

FUELING A GREENER NEW ENGLAND

Reg. No. 4,176,628

NEWPORT BIODIESEL, LLC (RHODE ISLAND LIMITED LIABILITY COMPANY)
312 CONNELL HIGHWAY
NEWPORT, RI 02840

Registered July 17, 2012

Int. Cls.: 37 and 40

FOR: RECYCLING SERVICES, NAMELY, COLLECTING USED FAT OR VEGETABLE OIL OR COOKING OIL FOR PURPOSES OF CONVERTING IT TO BIOFUEL OR BLENDING IT WITH PETROLEUM DIESEL TO CREATE BIODIESEL FUEL, IN CLASS 37 (U.S. CLS. 100, 103 AND 106).

SERVICE MARK

PRINCIPAL REGISTER

FIRST USE 6-30-2007; IN COMMERCE 1-31-2008.

FOR: FAT, OIL, AND GREASE (FOG) MANAGEMENT SERVICES, NAMELY, CONVERTING COLLECTED SEWER GREASE AND FOG TO BIOFUELS; PRODUCTION, TREATMENT AND REFINEMENT OF FUEL, DIESEL FUEL, BIOFUEL AND BIODIESEL FUEL FOR OTHERS, IN CLASS 40 (U.S. CLS. 100, 103 AND 106).

FIRST USE 6-30-2007; IN COMMERCE 1-31-2008.

THE MARK CONSISTS OF STANDARD CHARACTERS WITHOUT CLAIM TO ANY PARTICULAR FONT, STYLE, SIZE, OR COLOR.

SN 85-275,048, FILED 3-23-2011.

MATTHEW MCDOWELL, EXAMINING ATTORNEY



David J. Kybas

Director of the United States Patent and Trademark Office

United States of America

United States Patent and Trademark Office

TEC
Skill Set

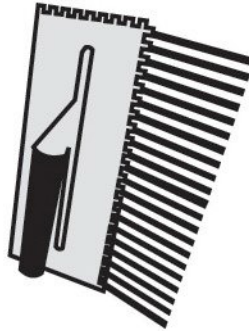

Reg. No. 4,176,629

Registered July 17, 2012

Int. Cl.: 1

TRADEMARK

PRINCIPAL REGISTER

H.B. FULLER CONSTRUCTION PRODUCTS INC. (MINNESOTA CORPORATION)
WLB-LAW
1200 WILLOW LAKE BOULEVARD
SAINT PAUL, MN 551105101

FOR: ADDITIVE FOR MORTARS, GROUTS AND CEMENTS; ADHESIVE FOR FLOOR AND WALL TILES, IN CLASS 1 (U.S. CLS. 1, 5, 6, 10, 26 AND 46).

FIRST USE 7-30-2011; IN COMMERCE 10-3-2011.

OWNER OF U.S. REG. NOS. 1,862,175, 1,863,424, AND OTHERS.

THE MARK CONSISTS OF THE WORDING "TEC SKILL SET" APPEARING TO THE LEFT OF A TROWEL WITH TROWELLING LINES ANGLED OFF ITS EDGE. THE WORDS "TEC" AND "SKILL SET" ARE SEPARATED BY A HORIZONTAL LINE.

SN 85-275,668, FILED 3-24-2011.

AMY KERTGATE, EXAMINING ATTORNEY



David J. Kybas

Director of the United States Patent and Trademark Office

United States of America

United States Patent and Trademark Office

TEC
Skill Set



Reg. No. 4,176,630

Registered July 17, 2012

Int. Cl.: 2

TRADEMARK

PRINCIPAL REGISTER

H.B. FULLER CONSTRUCTION PRODUCTS INC. (MINNESOTA CORPORATION)
WLB-LAW
1200 WILLOW LAKE BOULEVARD
SAINT PAUL, MN 551105101

FOR: FLOOR PRIMER FOR USE IN PREPARING SURFACES FOR FLOOR COVERINGS;
CEMENT BASED, SELF-LEVELING FLOORING PRIMER; COATING PREPARATION
HAVING WATER REPELLENT PROPERTIES; COLORANT APPLIED TO GROUT TO
CHANGE ITS EXISTING COLOR, IN CLASS 2 (U.S. CLS. 6, 11 AND 16).

FIRST USE 7-30-2011; IN COMMERCE 10-3-2011.

OWNER OF U.S. REG. NOS. 1,862,175, 1,863,424, AND OTHERS.

THE MARK CONSISTS OF THE WORDING "TEC SKILL SET" APPEARING TO THE LEFT
OF A TROWEL WITH TROWELLING LINES ANGLED OFF ITS EDGE. THE WORDS "TEC"
AND "SKILL SET" ARE SEPARATED BY A HORIZONTAL LINE.

SN 85-275,686, FILED 3-24-2011.

AMY KERTGATE, EXAMINING ATTORNEY



David J. Kyffers

Director of the United States Patent and Trademark Office

United States of America

United States Patent and Trademark Office

TEC
Skill Set

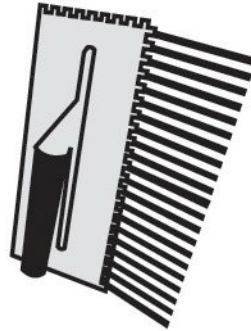

Reg. No. 4,176,631

Registered July 17, 2012

Int. Cl.: 19

TRADEMARK

PRINCIPAL REGISTER

H.B. FULLER CONSTRUCTION PRODUCTS INC. (MINNESOTA CORPORATION)
WLB-LAW
1200 WILLOW LAKE BOULEVARD
SAINT PAUL, MN 551105101

FOR: CEMENTITIOUS MORTARS; CEMENTITIOUS GROUTS; FLOOR OR WALL PATCHING COMPOUNDS IN THE NATURE OF CEMENTITIOUS MIXES, IN CLASS 19 (U.S. CLS. 1, 12, 33 AND 50).

FIRST USE 7-30-2011; IN COMMERCE 10-3-2011.

OWNER OF U.S. REG. NOS. 1,862,175, 1,863,424, AND OTHERS.

THE MARK CONSISTS OF THE WORDING "TEC SKILL SET" APPEARING TO THE LEFT OF A TROWEL WITH TROWELLING LINES ANGLED OFF ITS EDGE. THE WORDS "TEC" AND "SKILL SET" ARE SEPARATED BY A HORIZONTAL LINE.

SN 85-275,705, FILED 3-24-2011.

AMY KERTGATE, EXAMINING ATTORNEY



David J. Kyros

Director of the United States Patent and Trademark Office

United States of America

United States Patent and Trademark Office

Mentor Cloud

Reg. No. 4,176,632

GUNDLAPALLI, RAVISHANKAR (UNITED STATES INDIVIDUAL)
976 ORCHID WAY
SAN JOSE, CA 95117 AND

Registered July 17, 2012

Int. Cls.: 42 and 45

PARJANYA, INC (CALIFORNIA CORPORATION)
368 FAIRVIEW WAY
MILPITAS, CA 95035

SERVICE MARK

PRINCIPAL REGISTER

FOR: COMPUTER SERVICES, NAMELY, CREATING AN ON-LINE COMMUNITY FOR REGISTERED USERS TO PARTICIPATE IN DISCUSSIONS, GET FEEDBACK FROM THEIR PEERS, FORM VIRTUAL COMMUNITIES, AND ENGAGE IN SOCIAL NETWORKING, IN CLASS 42 (U.S. CLS. 100 AND 101).

FIRST USE 4-9-2009; IN COMMERCE 3-31-2011.

FOR: COUNSELING IN THE FIELD OF PERSONAL DEVELOPMENT, NAMELY, SELF-IMPROVEMENT, SELF-FULFILLMENT, AND INTERPERSONAL COMMUNICATIONS; INTERNET-BASED SOCIAL NETWORKING SERVICES; PERSONAL GROWTH AND MOTIVATION CONSULTING SERVICES, IN CLASS 45 (U.S. CLS. 100 AND 101).

FIRST USE 4-9-2009; IN COMMERCE 3-31-2011.

THE MARK CONSISTS OF STANDARD CHARACTERS WITHOUT CLAIM TO ANY PARTICULAR FONT, STYLE, SIZE, OR COLOR.

NO CLAIM IS MADE TO THE EXCLUSIVE RIGHT TO USE "CLOUD", APART FROM THE MARK AS SHOWN.

SN 85-275,791, FILED 3-24-2011.

RAUL CORDOVA, EXAMINING ATTORNEY



David J. Kyros

Director of the United States Patent and Trademark Office

United States of America

United States Patent and Trademark Office

BATTLE TESTED

Reg. No. 4,176,633

Registered July 17, 2012

Int. Cl.: 28

TRADEMARK

PRINCIPAL REGISTER

KEE ACTION SPORTS I LLC (DELAWARE LIMITED LIABILITY COMPANY)
570 MANTUA BOULEVARD
SEWELL, NJ 08080

FOR: PAINTBALLS, IN CLASS 28 (U.S. CLS. 22, 23, 38 AND 50).

FIRST USE 7-0-2009; IN COMMERCE 7-0-2009.

THE MARK CONSISTS OF STANDARD CHARACTERS WITHOUT CLAIM TO ANY PARTICULAR FONT, STYLE, SIZE, OR COLOR.

SN 85-275,906, FILED 3-24-2011.

ARETHA SOMERVILLE, EXAMINING ATTORNEY



David J. Kyffers

Director of the United States Patent and Trademark Office

United States of America

United States Patent and Trademark Office

MAKING HOMES GREAT!

Reg. No. 4,176,634

Registered July 17, 2012

Int. Cl.: 35

SERVICE MARK

PRINCIPAL REGISTER

MORRIS FURNITURE CO., INC. (OHIO CORPORATION), DBA MORRIS HOME
FURNISHINGS,
2377 COMMERCE CENTER BLVD.
DAYTON, OH 45324

FOR: RETAIL STORE SERVICES FEATURING FURNITURE, ELECTRONICS, CARPET,
FLOORING, MATTRESSES AND BEDDING; AND PROVIDING CONSUMER ADVICE RE-
LATING TO THE FOREGOING, IN CLASS 35 (U.S. CLS. 100, 101 AND 102).

FIRST USE 0-0-2011; IN COMMERCE 0-0-2011.

THE MARK CONSISTS OF STANDARD CHARACTERS WITHOUT CLAIM TO ANY PAR-
TICULAR FONT, STYLE, SIZE, OR COLOR.

SN 85-276,123, FILED 3-24-2011.

CAROLYN CATALDO, EXAMINING ATTORNEY



David J. Kyffers

Director of the United States Patent and Trademark Office

United States of America

United States Patent and Trademark Office

Compliance

Reg. No. 4,176,635

REGISTERED AGENT SOLUTIONS, INC. (CALIFORNIA CORPORATION), DBA RASI,
515 CONGRESS AVE., SUITE 2300
AUSTIN, TX 78701

Registered July 17, 2012

Int. Cl.: 35

FOR: BUSINESS RECORDS MANAGEMENT SERVICES RELATING TO BUSINESS ENTITY
FORMATION AND ASSOCIATED STATE REPORTING REQUIREMENTS, IN CLASS 35
(U.S. CLS. 100, 101 AND 102).

SERVICE MARK

FIRST USE 3-13-2012; IN COMMERCE 3-13-2012.

PRINCIPAL REGISTER

THE MARK CONSISTS OF STANDARD CHARACTERS WITHOUT CLAIM TO ANY PAR-
TICULAR FONT, STYLE, SIZE, OR COLOR.

SN 85-276,316, FILED 3-24-2011.

HELENE LIWINSKI, EXAMINING ATTORNEY



David J. Kyffers

Director of the United States Patent and Trademark Office

United States of America

United States Patent and Trademark Office



Reg. No. 4,176,636

Registered July 17, 2012

Int. Cl.: 16

TRADEMARK

PRINCIPAL REGISTER

MOORIM PAPER CO., LTD. (REPUBLIC OF KOREA CORPORATION)
#281-1, SANGPYEONG-DONG, JINJU-SI
GYEONGSANGNAM-DO, REPUBLIC OF KOREA AND

MOORIM SP CO., LTD. (REPUBLIC OF KOREA CORPORATION)
#505, SINSA-DONG, GANGNAM-GU
SEOUL, REPUBLIC OF KOREA AND

MOORIM P&P CO., LTD. (REPUBLIC OF KOREA CORPORATION)
#1, DANGWOL-RI, ONSAN-EUP, ULJU-GUN
ULSAN, REPUBLIC OF KOREA

FOR: PRINTING AND WRITING PAPER, NAMELY, COATED, WOOD-FREE MATTE PAPER, COATED, WOOD-FREE GLOSS PAPER, CAST-COATED PAPER, COATED, WOOD-FREE DULL PAPER, UNCOATED WOOD-FREE PRINTING PAPER, DRAWING PAPER, LIGHT-WEIGHT COATED ART PAPER, COPYING PAPER, SELF-ADHESIVE PAPER FOR USE IN MAKING DECALCOMANIAS, BOND PAPER, COATED, WHITE PAPER BOARD, CORRUGATED BOARD, NEWSPRINT PAPER, GIFT WRAPPING PAPER, CARDBOARD, SIGNBOARDS OF PAPER OR CARDBOARD, IN CLASS 16 (U.S. CLS. 2, 5, 22, 23, 29, 37, 38 AND 50).

FIRST USE 5-1-2011; IN COMMERCE 5-1-2011.

THE MARK CONSISTS OF THE WORD "NEO" OVER THE WORD "STAR", WITH A CURVED LINE ABOVE THE "E" AND A STAR ABOVE THE "O".

SN 85-276,991, FILED 3-25-2011.

CHRISTOPHER BUONGIORNO, EXAMINING ATTORNEY



David J. Kyjars

Director of the United States Patent and Trademark Office

United States of America

United States Patent and Trademark Office

OSIRIS

Reg. No. 4,176,637

Registered July 17, 2012

Int. Cl.: 32

TRADEMARK

PRINCIPAL REGISTER

SUN KING BREWING COMPANY, LLC (INDIANA LIMITED LIABILITY COMPANY)
135 N. COLLEGE AVENUE
INDIANAPOLIS, IN 46202

FOR: ALES; BEER, IN CLASS 32 (U.S. CLS. 45, 46 AND 48).

FIRST USE 7-1-2009; IN COMMERCE 7-1-2009.

THE MARK CONSISTS OF STANDARD CHARACTERS WITHOUT CLAIM TO ANY PARTICULAR FONT, STYLE, SIZE, OR COLOR.

SN 85-277,031, FILED 3-25-2011.

EDWARD FENNESSY, EXAMINING ATTORNEY



David J. Kyffers

Director of the United States Patent and Trademark Office

United States of America

United States Patent and Trademark Office

SUNLIGHT

Reg. No. 4,176,638

SUN KING BREWING COMPANY, LLC (INDIANA LIMITED LIABILITY COMPANY)
135 N. COLLEGE AVENUE
INDIANAPOLIS, IN 46202

Registered July 17, 2012

Int. Cl.: 32

FOR: ALES; BEER, IN CLASS 32 (U.S. CLS. 45, 46 AND 48).

TRADEMARK

FIRST USE 7-1-2009; IN COMMERCE 7-1-2009.

PRINCIPAL REGISTER

THE MARK CONSISTS OF STANDARD CHARACTERS WITHOUT CLAIM TO ANY PARTICULAR FONT, STYLE, SIZE, OR COLOR.

SN 85-277,067, FILED 3-25-2011.

EDWARD FENNESSY, EXAMINING ATTORNEY



David J. Kyffers

Director of the United States Patent and Trademark Office

United States of America

United States Patent and Trademark Office

WEE MAC

Reg. No. 4,176,639

SUN KING BREWING COMPANY, LLC (INDIANA LIMITED LIABILITY COMPANY)
135 N. COLLEGE AVENUE
INDIANAPOLIS, IN 46202

Registered July 17, 2012

Int. Cl.: 32

FOR: ALES; BEER, IN CLASS 32 (U.S. CLS. 45, 46 AND 48).

TRADEMARK

FIRST USE 7-1-2009; IN COMMERCE 7-1-2009.

PRINCIPAL REGISTER

THE MARK CONSISTS OF STANDARD CHARACTERS WITHOUT CLAIM TO ANY PARTICULAR FONT, STYLE, SIZE, OR COLOR.

SN 85-277,113, FILED 3-25-2011.

EDWARD FENNESSY, EXAMINING ATTORNEY



David J. Kyffers

Director of the United States Patent and Trademark Office

United States of America

United States Patent and Trademark Office

MULTIPEDAL

Reg. No. 4,176,640

PEDAL JAM LLC (WASHINGTON LIMITED LIABILITY COMPANY)
12518 130TH LANE NE
KIRKLAND, WA 98034

Registered July 17, 2012

Int. Cl.: 12

FOR: BICYCLE PEDALS, IN CLASS 12 (U.S. CLS. 19, 21, 23, 31, 35 AND 44).

TRADEMARK

FIRST USE 3-16-2011; IN COMMERCE 3-16-2011.

PRINCIPAL REGISTER

THE MARK CONSISTS OF STANDARD CHARACTERS WITHOUT CLAIM TO ANY PARTICULAR FONT, STYLE, SIZE, OR COLOR.

SN 85-277,388, FILED 3-25-2011.

KAREN K. BUSH, EXAMINING ATTORNEY



David J. Kyffers

Director of the United States Patent and Trademark Office

United States of America

United States Patent and Trademark Office



Reg. No. 4,176,641

Registered July 17, 2012

Int. Cl.: 42

SERVICE MARK

PRINCIPAL REGISTER

SHINN, JUDE (UNITED STATES INDIVIDUAL)
229 CENTER ST.
GRAYSLAKE, IL 60030 AND

ROBERT, DANA (UNITED STATES INDIVIDUAL)
229 CENTER ST.
GRAYSLAKE, IL 60030

FOR: CONSULTING IN THE FIELD OF IT PROJECT MANAGEMENT; IT CONSULTING SERVICES; TESTING, ANALYSIS, AND EVALUATION OF THE KNOWLEDGE, SKILLS AND ABILITIES OF OTHERS FOR THE PURPOSE OF CERTIFICATION AND RE-CERTIFICATION IN THE FIELD OF CLOUD COMPUTING, IN CLASS 42 (U.S. CLS. 100 AND 101).

FIRST USE 4-1-2011; IN COMMERCE 1-1-2012.

NO CLAIM IS MADE TO THE EXCLUSIVE RIGHT TO USE "CERTIFIED" AND "CLOUD", APART FROM THE MARK AS SHOWN.

THE MARK CONSISTS OF FOUR MAIN COMPONENTS: GRAPHIC LOGO MARK, CONSISTS OF AN "X" WITH A LINE EXTENDING PARALLEL OUTWARDS ON EITHER SIDE. THE LOGO MARK IS COMPRISED OF FOUR OF THESE "XS," ARRANGED IN A SYMMETRICAL COMPOSITION ON BOTH THE X AND Y AXIS. THE RESULTING COMPOSITION IS ROTATED 45 DEGREES OFF-AXIS UTILIZING THE CENTER POINT. THIS COMPOSITION IS CENTERED INSIDE A SOLID CIRCLE. THE WORDING APPEARS AS SHOWN, "CERTIFIED ENABLER", UTILIZING ALL UPPER CASE LETTERFORMS. THE "X" IN THE NAME IS CUSTOM DESIGNED; EACH END OF THE STROKE (GOING FROM UPPER LEFT TO LOWER RIGHT) FORMS A SHARP POINT. THE ENDS OF THE STROKE (GOING FROM LOWER LEFT TO UPPER RIGHT) END IN AN ORIGINAL SERIF. BOTH STROKES IN THE "X" EXTEND BEYOND THE CAP-LINE AND THE BASELINE. THE COMPANY NAME APPEARS AS SHOWN, "CLOUD SILVER LINING", UTILIZING ALL UPPER CASE LETTERFORMS. THE ENTIRE NAME IS TRACKED OUT WIDE, CREATING EXTRA SPACE BETWEEN EACH LETTER, AND FOLLOWING THE LOWER OUTER CURVE OF A SYMMETRICAL DIVISION OF THE CIRCLE AT ZERO DEGREES ALONG THE X AXIS. THE "V" IN THE NAME IS CUSTOM DESIGNED; THE LEFT STEM OF THE LETTERFORM RISES ABOVE THE CAP-LINE; EACH SIDE OF THE STEM CONVENES TOGETHER ON A LINEAR PATH TO FORM A SHARP POINT. BULLETS SERVE AS A DIVIDER BETWEEN THE UPPER TEXT, "CERTIFIED ENABLER", AND THE LOWER TEXT, "CLOUD SILVER LINING".



David J. Kybas

Director of the United States Patent and Trademark Office

Reg. No. 4,176,641 "XERTIFIED ENABLER" (UPPER CIRCULAR HEMISPHERE) AND "CLOUD SILVER LINING" (LOWER CIRCULAR HEMISPHERE) TOGETHER FORM A UNIFIED CIRCLE. CONTAINED INSIDE THIS CIRCLE IS THE GRAPHIC LOGO MARK, CENTERED ON BOTH THE VERTICAL AND HORIZONTAL AXIS IN RELATIVE POSITIONING TO THE UNIFIED CIRCUMFERENCE OF TEXT.

SN 85-277,845, FILED 3-26-2011.

LEIGH CAROLINE CASE, EXAMINING ATTORNEY

United States of America

United States Patent and Trademark Office

ERIESECURE PROPERTY

Reg. No. 4,176,642

ERIE INDEMNITY COMPANY (PENNSYLVANIA CORPORATION)
100 ERIE INSURANCE PLACE
ERIE, PA 16530

Registered July 17, 2012

Int. Cl.: 36

FOR: PROPERTY AND CASUALTY INSURANCE UNDERWRITING, IN CLASS 36 (U.S. CLS. 100, 101 AND 102).

SERVICE MARK

FIRST USE 3-13-2012; IN COMMERCE 3-13-2012.

PRINCIPAL REGISTER

THE MARK CONSISTS OF STANDARD CHARACTERS WITHOUT CLAIM TO ANY PARTICULAR FONT, STYLE, SIZE, OR COLOR.

OWNER OF U.S. REG. NOS. 3,841,039, 3,841,044, AND 3,841,050.

NO CLAIM IS MADE TO THE EXCLUSIVE RIGHT TO USE "PROPERTY", APART FROM THE MARK AS SHOWN.

SN 85-278,210, FILED 3-28-2011.

CHRISTINE COOPER, EXAMINING ATTORNEY



David J. Kybas

Director of the United States Patent and Trademark Office

United States of America

United States Patent and Trademark Office

Positioned. *Perfectly...*

Reg. No. 4,176,643

Registered July 17, 2012

Int. Cl.: 35

SERVICE MARK

PRINCIPAL REGISTER

CITY OF WEST DES MOINES, IOWA (IOWA MUNICIPAL CORPORATION)
4200 MILLS CIVIC PARKWAY
P.O. BOX 65320
WEST DES MOINES, IA 502650320

FOR: PROMOTING THE ECONOMIC DEVELOPMENT IN THE CITY OF WEST DES MOINES,
IOWA, IN CLASS 35 (U.S. CLS. 100, 101 AND 102).

FIRST USE 10-20-2011; IN COMMERCE 10-20-2011.

THE MARK CONSISTS OF THE STYLIZED WORDS "POSITIONED. PERFECTLY...".

SN 85-278,305, FILED 3-28-2011.

B. PARADEWELAI, EXAMINING ATTORNEY



David J. Kyffers

Director of the United States Patent and Trademark Office

United States of America

United States Patent and Trademark Office

RELIANCE LED

Reg. No. 4,176,644

Registered July 17, 2012

Int. Cl.: 11

TRADEMARK

PRINCIPAL REGISTER

RELIANCE LABORATORIES, LLC (WASHINGTON LIMITED LIABILITY COMPANY)
1240 WEST SIMS WAY
#137
PORT TOWNSEND, WA 98368

FOR: LED-BASED LIGHTING SYSTEMS COMPRISING LED LUMINAIRES, IN CLASS 11
(U.S. CLS. 13, 21, 23, 31 AND 34).

FIRST USE 7-31-2011; IN COMMERCE 7-31-2011.

THE MARK CONSISTS OF STANDARD CHARACTERS WITHOUT CLAIM TO ANY PARTICULAR FONT, STYLE, SIZE, OR COLOR.

NO CLAIM IS MADE TO THE EXCLUSIVE RIGHT TO USE "LED", APART FROM THE MARK AS SHOWN.

SN 85-278,696, FILED 3-28-2011.

STEVEN PEREZ, EXAMINING ATTORNEY



David J. Kyros

Director of the United States Patent and Trademark Office

United States of America

United States Patent and Trademark Office

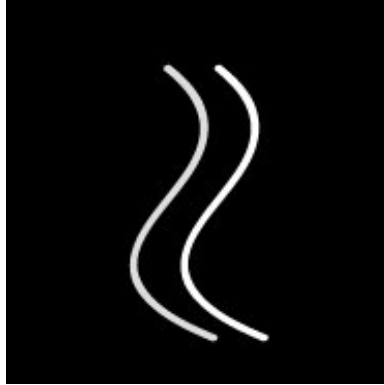

Reg. No. 4,176,645

Registered July 17, 2012

Int. Cls.: 9 and 45

TRADEMARK

SERVICE MARK

PRINCIPAL REGISTER

ATESSA, INC. (CALIFORNIA CORPORATION)
5000 HOPYARD ROAD, SUITE 460
PLEASANTON, CA 94588

FOR: COMPUTER SOFTWARE FOR ELECTRONIC DESIGN AUTOMATION; DOWNLOAD-ABLE ELECTRONIC PUBLICATIONS IN THE FIELD OF TECHNOLOGY, NAMELY, MANUALS, WHITE PAPERS, DATASHEETS AND PAMPHLETS, IN CLASS 9 (U.S. CLS. 21, 23, 26, 36 AND 38).

FIRST USE 3-10-2011; IN COMMERCE 3-10-2011.

FOR: LICENSING OF INTELLECTUAL PROPERTY; LICENSING OF COMPUTER SOFTWARE, IN CLASS 45 (U.S. CLS. 100 AND 101).

FIRST USE 3-10-2011; IN COMMERCE 3-10-2011.

THE MARK CONSISTS OF TWO PARALLEL BACKWARDS S SHAPED LINES.

SN 85-279,836, FILED 3-29-2011.

DAVID COLLIER, EXAMINING ATTORNEY



David J. Kybas

Director of the United States Patent and Trademark Office

United States of America

United States Patent and Trademark Office

JwAlkeR

Reg. No. 4,176,646

FEIST, JOSHUA (UNITED STATES INDIVIDUAL)
1717 SHERIDAN ROAD, #B38
BREMERTON, WA 98310

Registered July 17, 2012

Int. Cl.: 41

FOR: ENTERTAINMENT SERVICES IN THE NATURE OF LIVE MUSICAL PERFORMANCES; ENTERTAINMENT SERVICES, NAMELY, LIVE, TELEVISED AND MOVIE APPEARANCES BY A PROFESSIONAL ENTERTAINER; ENTERTAINMENT, NAMELY, LIVE MUSIC CONCERTS, IN CLASS 41 (U.S. CLS. 100, 101 AND 107).

SERVICE MARK

PRINCIPAL REGISTER

FIRST USE 1-22-2011; IN COMMERCE 4-30-2012.

THE MARK CONSISTS OF STANDARD CHARACTERS WITHOUT CLAIM TO ANY PARTICULAR FONT, STYLE, SIZE, OR COLOR.

THE NAME(S), PORTRAIT(S), AND/OR SIGNATURE(S) SHOWN IN THE MARK IDENTIFIES "JOSHUA FEIST", WHOSE CONSENT(S) TO REGISTER IS MADE OF RECORD.

SN 85-279,846, FILED 3-29-2011.

DAVID COLLIER, EXAMINING ATTORNEY



David J. Kyros

Director of the United States Patent and Trademark Office

United States of America

United States Patent and Trademark Office



Reg. No. 4,176,647

Registered July 17, 2012

Int. Cl.: 10

TRADEMARK

PRINCIPAL REGISTER

ORTHOSENSOR, INC. (DELAWARE CORPORATION)
4TH FLOOR
1560 SAWGRASS CORPORATE PKWY
SUNRISE, FL 33323

FOR: MEDICAL DIAGNOSTIC TESTING, MONITORING AND REPORTING SENSOR DEVICES FOR PATIENTS USED DURING SURGERIES, NAMELY, PATIENT MONITORING SENSORS AND ALARMS; MEDICAL DIAGNOSTIC TESTING, MONITORING, AND REPORTING DEVICE, NAMELY, MEDICAL SYSTEMS COMPRISED OF PATIENT MONITORING SENSORS AND ALARMS, AND COMPUTER HARDWARE AND SOFTWARE THAT COLLECT, PROCESS, AND DISTRIBUTE DATA GATHERED FROM SENSORS SOLD AS A UNIT, IN CLASS 10 (U.S. CLS. 26, 39 AND 44).

FIRST USE 9-1-2011; IN COMMERCE 9-1-2011.

THE MARK CONSISTS OF THREE CRESCENT SHAPES FORMING AN IRREGULAR-SHAPED TRIANGLE.

SN 85-279,961, FILED 3-29-2011.

GINA FINK, EXAMINING ATTORNEY



David J. Kyffers

Director of the United States Patent and Trademark Office

United States of America
United States Patent and Trademark Office

BLAGGO

Reg. No. 4,176,648

SCAMINACI, MICHAEL (UNITED STATES INDIVIDUAL)
956 S. BARTLETT ROAD, SUITE 309
BARTLETT, IL 60103

Registered July 17, 2012

Int. Cls.: 35 and 42

FOR: ON-LINE ADVERTISING SERVICES FOR OTHERS, IN CLASS 35 (U.S. CLS. 100, 101 AND 102).

SERVICE MARK

FIRST USE 2-1-2011; IN COMMERCE 3-1-2012.

PRINCIPAL REGISTER

FOR: PROVISION OF INTERNET SEARCH ENGINES, IN CLASS 42 (U.S. CLS. 100 AND 101).

FIRST USE 2-1-2011; IN COMMERCE 3-1-2012.

THE MARK CONSISTS OF STANDARD CHARACTERS WITHOUT CLAIM TO ANY PARTICULAR FONT, STYLE, SIZE, OR COLOR.

SN 85-280,541, FILED 3-29-2011.

STEVEN PEREZ, EXAMINING ATTORNEY



David J. Kyros

Director of the United States Patent and Trademark Office

United States of America

United States Patent and Trademark Office



Reg. No. 4,176,649

CINTAS, ASHLEY (CALIFORNIA SOLE PROPRIETORSHIP)
11809 DARLINGTON AVE #8
LOS ANGELES, CA 90049 AND

Registered July 17, 2012

Int. Cl.: 28

RABB, ALYSHA (CALIFORNIA SOLE PROPRIETORSHIP)
72670 HOMESTEAD RD
PALM DESERT, CA 92260

TRADEMARK

PRINCIPAL REGISTER

FOR: PERSONAL COVERS AND BAGS, SPECIALLY ADAPTED FOR CARRYING EXERCISE MATS AND EQUIPMENT FOR YOGA AND PILATES, IN CLASS 28 (U.S. CLS. 22, 23, 38 AND 50).

FIRST USE 4-25-2012; IN COMMERCE 4-25-2012.

THE MARK CONSISTS OF TWO LOWER CASE (A'S) THAT ARE MIRRORED BACK TO BACK (ONE LOWERCASE (A) FACING LEFT, ONE (A) POSITIONED ON THE RIGHT (FACING BACKWARDS) THAT CONNECT AT THE CENTER, TO FORM AN ABSTRACT OVAL OR CIRCLE. THE MARK SHOWS THE DEFINITION OF EACH LOWER CASE (A) BY THE COLOR TONE CHANGING ON EACH END OF THE DESIGN. THIS DESIGN IS BESIDE THE WORD "KOSHA".

ANY OF THE FIVE LAYERS OR SHEATHS OF PHYSICAL AND MENTAL BEING COMPOSING THE PERSONAL SELF, ATMAN BEING WITHIN THE INNERMOST LAYER.

SN 85-280,610, FILED 3-29-2011.

DEZMONA MIZELLE, EXAMINING ATTORNEY



David J. Kyros

Director of the United States Patent and Trademark Office

United States of America

United States Patent and Trademark Office

The Heart Machine

Reg. No. 4,176,650

NADERI, AHURA DAVID (UNITED STATES INDIVIDUAL)
26836 OSO PKWY #2102

Registered July 17, 2012

MISSION VIEJO, CA 92691 AND

Int. Cl.: 9

NAJARIAN, ARMEN HAGOP (UNITED STATES INDIVIDUAL)
2221 BASE LINE ROAD
LA VERNE, CA 91750

TRADEMARK

PRINCIPAL REGISTER

FOR: AUDIO AND VIDEO RECORDINGS FEATURING MUSIC AND ARTISTIC PERFORMANCES; AUDIO AND VIDEO RECORDINGS FEATURING THE HEART MACHINE AHURA DAVID NADERI AND ARMEN HAGOP NAJARIAN; AUDIO AND VISUAL HEADSETS FOR USE IN PLAYING VIDEO GAMES; AUDIO RECORDINGS FEATURING THE HEART MACHINE AHURA DAVID NADERI AND ARMEN HAGOP NAJARIAN; AUDIO TAPES FEATURING MUSIC; CELLULAR PHONE ACCESSORY CHARMS; COMPACT DISCS FEATURING MUSIC; DIGITAL MATERIALS, NAMELY, DVD'S, AND MOVIES FEATURING THE HEART MACHINE AHURA DAVID NADERI AND ARMEN HAGOP NAJARIAN; DIGITAL MEDIA, NAMELY, PRE-RECORDED DVDS, DOWNLOADABLE AUDIO AND VIDEO RECORDINGS, AND CDS FEATURING AND PROMOTING THE HEART MACHINE AHURA DAVID NADERI AND ARMEN HAGOP NAJARIAN; DIGITAL MEDIA, NAMELY, PRE-RECORDED VIDEO CASSETTES, DIGITAL VIDEO DISCS, DIGITAL VERSATILE DISCS, DOWNLOADABLE AUDIO AND VIDEO RECORDINGS, DVDS, AND HIGH DEFINITION DIGITAL DISCS FEATURING THE HEART MACHINE AHURA DAVID NADERI AND ARMEN HAGOP NAJARIAN; DIGITAL MUSIC DOWNLOADABLE FROM THE INTERNET; DOWNLOADABLE MP3 FILES AND MP3 RECORDINGS FEATURING THE HEART MACHINE AHURA DAVID NADERI AND ARMEN HAGOP NAJARIAN; DOWNLOADABLE MUSICAL SOUND RECORDINGS; DOWNLOADABLE RING TONES, GRAPHICS AND MUSIC VIA A GLOBAL COMPUTER NETWORK AND WIRELESS DEVICES; DOWNLOADABLE VIDEO RECORDINGS FEATURING THE HEART MACHINE AHURA DAVID NADERI AND ARMEN HAGOP NAJARIAN; DOWNLOADABLE MUSIC AND VIDEO VIA THE INTERNET AND WIRELESS DEVICES; ELECTRONIC PUBLICATIONS, NAMELY, PRESS RELEASES FEATURING THE HEART MACHINE AHURA DAVID NADERI AND ARMEN HAGOP NAJARIAN RECORDED ON COMPUTER MEDIA; MOTION PICTURE FILMS ABOUT THE HEART MACHINE AHURA DAVID NADERI AND ARMEN HAGOP NAJARIAN; MUSIC HEADPHONES; MUSICAL RECORDINGS; MUSICAL SOUND RECORDINGS; MUSICAL VIDEO RECORDINGS; SERIES OF MUSICAL SOUND RECORDINGS; SOUND RECORDINGS FEATURING THE HEART MACHINE AHURA DAVID NADERI AND ARMEN HAGOP NAJARIAN; VIDEO RECORDINGS FEATURING THE HEART MACHINE AHURA



David J. Kyros

Director of the United States Patent and Trademark Office

Reg. No. 4,176,650 DAVID NADERI AND ARMEN HAGOP NAJARIAN; VISUAL AND AUDIO RECORDINGS FEATURING THE HEART MACHINE AHURA DAVID NADERI AND ARMEN HAGOP NAJARIAN; VISUAL RECORDINGS AND AUDIOVISUAL RECORDINGS FEATURING MUSIC AND ANIMATION, IN CLASS 9 (U.S. CLS. 21, 23, 26, 36 AND 38).

FIRST USE 4-1-2012; IN COMMERCE 4-1-2012.

THE MARK CONSISTS OF STANDARD CHARACTERS WITHOUT CLAIM TO ANY PARTICULAR FONT, STYLE, SIZE, OR COLOR.

SN 85-280,725, FILED 3-30-2011.

JOHN WILKE, EXAMINING ATTORNEY

United States of America

United States Patent and Trademark Office

TOYS R US PETS

Reg. No. 4,176,651

Registered July 17, 2012

Int. Cl.: 28

TRADEMARK

PRINCIPAL REGISTER

GEOFFREY, LLC (DELAWARE LIMITED LIABILITY COMPANY)
ONE GEOFFREY WAY
WAYNE, NJ 07470

FOR: PET TOYS, IN CLASS 28 (U.S. CLS. 22, 23, 38 AND 50).

FIRST USE 5-7-2012; IN COMMERCE 5-7-2012.

THE MARK CONSISTS OF STANDARD CHARACTERS WITHOUT CLAIM TO ANY PARTICULAR FONT, STYLE, SIZE, OR COLOR.

OWNER OF U.S. REG. NOS. 2,970,366, 3,815,634, AND OTHERS.

NO CLAIM IS MADE TO THE EXCLUSIVE RIGHT TO USE "PETS", APART FROM THE MARK AS SHOWN.

SN 85-280,842, FILED 3-30-2011.

KAELIE KUNG, EXAMINING ATTORNEY



David J. Kyffers

Director of the United States Patent and Trademark Office

United States of America

United States Patent and Trademark Office



Reg. No. 4,176,652

AVRAHAM Y. GOLDRATT INSTITUTE, LP (CONNECTICUT LIMITED PARTNERSHIP)
442 ORANGE STREET
NEW HAVEN, CT 06511

Registered July 17, 2012

Int. Cl.: 16

FOR: PUBLICATIONS, NAMELY, BOOKS, COURSE BOOKS, WORK BOOKS, MANUALS, WRITTEN ARTICLES, HANDOUTS AND WORKSHEETS IN THE FIELDS OF BUSINESS MANAGEMENT, BUSINESS DECISION MAKING, BUSINESS STRATEGY, ETHICAL BUSINESS STANDARDS, ACCOUNTING, BUSINESS FINANCE, MANAGEMENT, MARKETING, LOGISTICS MANAGEMENT, MANUFACTURING, PRODUCTION MANAGEMENT, PROJECT MANAGEMENT, PRODUCT INVENTORY AND SUPPLY CHAIN MANAGEMENT, INVENTORY MANAGEMENT, PORTFOLIO MANAGEMENT, QUALITY ASSURANCE, PRODUCT DISTRIBUTION, BUSINESS PROGRAM MANAGEMENT, MULTI-PROJECT BUSINESS MANAGEMENT, SALES, SOFT SKILLS SALES TECHNIQUES, RESOURCE MANAGEMENT, TASK EXECUTION PRIORITIES AND UPDATES AND NEW PRODUCT DEVELOPMENT, IN CLASS 16 (U.S. CLS. 2, 5, 22, 23, 29, 37, 38 AND 50).

TRADEMARK

PRINCIPAL REGISTER

FIRST USE 2-28-2009; IN COMMERCE 2-28-2009.

OWNER OF U.S. REG. NOS. 3,769,193 AND 3,804,096.

THE COLOR(S) BLUE, LIGHT BLUE, WHITE AND GRAY IS/ARE CLAIMED AS A FEATURE OF THE MARK.

NO CLAIM IS MADE TO THE EXCLUSIVE RIGHT TO USE "SUPPLY CHAIN SUITE", APART FROM THE MARK AS SHOWN.



THE MARK CONSISTS OF THE WORDS "SUPPLY CHAIN SUITE" IN THE COLOR BLUE, A GLOBE WITH LATITUDE AND LONGITUDE LINES IN THE COLORS BLUE AND WHITE, THE LETTERS "AGI" APPEAR UPON THE GLOBE AND ARE IN WHITE, THE GLOBE HAS TWO ASTRONOMIC ORBITS IN LIGHT BLUE AND THE UNDER SIDE OF THE GLOBE HAS A SHADOW IN GRAY.

SN 85-281,212, FILED 3-30-2011.

EDWARD NELSON, EXAMINING ATTORNEY

David J. Kyffers

Director of the United States Patent and Trademark Office

United States of America

United States Patent and Trademark Office

MISS REPRESENTATION

Reg. No. 4,176,653

GIRLS' CLUB ENTERTAINMENT, LLC (CALIFORNIA LIMITED LIABILITY COMPANY)
30 SIR FRANCIS DRAKE BLVD.

Registered July 17, 2012

ROSS, CA 94960

Int. Cl.: 9

FOR: DOWNLOADABLE PUBLICATIONS, ARTICLES, BROCHURES AND ELECTRONIC NEWSLETTERS IN THE FIELD OF THE EMPOWERMENT OF WOMEN AND GIRLS, AND THE MISREPRESENTATION AND OBJECTIFICATION OF WOMEN AND GIRLS IN THE MEDIA AND OUR CULTURE AT LARGE, IN CLASS 9 (U.S. CLS. 21, 23, 26, 36 AND 38).

TRADEMARK

PRINCIPAL REGISTER

FIRST USE 7-13-2011; IN COMMERCE 7-13-2011.

THE MARK CONSISTS OF STANDARD CHARACTERS WITHOUT CLAIM TO ANY PARTICULAR FONT, STYLE, SIZE, OR COLOR.

SN 85-281,519, FILED 3-30-2011.

ALLISON SCHRODY, EXAMINING ATTORNEY



David J. Kyros

Director of the United States Patent and Trademark Office

United States of America

United States Patent and Trademark Office

PEG

Reg. No. 4,176,654

PAZARI LLC (ILLINOIS LIMITED LIABILITY COMPANY)
3430 N. LAKE SHORE DRIVE, 14K
CHICAGO, IL 60657

Registered July 17, 2012

Int. Cl.: 35

FOR: ON-LINE AUCTION SERVICES, IN CLASS 35 (U.S. CLS. 100, 101 AND 102).

SERVICE MARK

FIRST USE 4-12-2011; IN COMMERCE 4-12-2011.

PRINCIPAL REGISTER

THE MARK CONSISTS OF STANDARD CHARACTERS WITHOUT CLAIM TO ANY PARTICULAR FONT, STYLE, SIZE, OR COLOR.

SN 85-281,526, FILED 3-30-2011.

LINDSEY RUBIN, EXAMINING ATTORNEY



David J. Kybas

Director of the United States Patent and Trademark Office

United States of America

United States Patent and Trademark Office

MISS REPRESENTATION

Reg. No. 4,176,655

Registered July 17, 2012

Int. Cl.: 35

SERVICE MARK

PRINCIPAL REGISTER

GIRLS' CLUB ENTERTAINMENT, LLC (CALIFORNIA LIMITED LIABILITY COMPANY)
30 SIR FRANCIS DRAKE BLVD.
ROSS, CA 94960

FOR: ASSOCIATION SERVICES, NAMELY, PROMOTING THE INTERESTS OF WOMEN AND GIRLS IN THE FIELD OF EMPOWERING WOMEN AND GIRLS; CONDUCTING TRADE SHOWS AND EXHIBITIONS IN THE FIELD OF EMPOWERING WOMEN AND GIRLS; CHARITABLE SERVICES, NAMELY, PROMOTING PUBLIC AWARENESS OF THE EMPOWERMENT OF WOMEN AND GIRLS, AND MISREPRESENTATION AND OBJECTIFICATION OF WOMEN AND GIRLS IN THE MEDIA AND OUR CULTURE AT LARGE, IN CLASS 35 (U.S. CLS. 100, 101 AND 102).

FIRST USE 8-26-2011; IN COMMERCE 8-26-2011.

THE MARK CONSISTS OF STANDARD CHARACTERS WITHOUT CLAIM TO ANY PARTICULAR FONT, STYLE, SIZE, OR COLOR.

SN 85-281,539, FILED 3-30-2011.

ALLISON SCHRODY, EXAMINING ATTORNEY



David J. Kyros

Director of the United States Patent and Trademark Office

United States of America

United States Patent and Trademark Office

MISS REPRESENTATION

Reg. No. 4,176,656

GIRLS' CLUB ENTERTAINMENT, LLC (CALIFORNIA LIMITED LIABILITY COMPANY)
30 SIR FRANCIS DRAKE BLVD.

Registered July 17, 2012

ROSS, CA 94960

Int. Cl.: 36

FOR: CHARITABLE FUNDRAISING SERVICES FOR PROMOTING PUBLIC AWARENESS OF THE EMPOWERMENT OF WOMEN AND GIRLS, AND THE MISREPRESENTATION AND OBJECTIFICATION OF WOMEN AND GIRLS IN THE MEDIA AND OUR CULTURE AT LARGE, IN CLASS 36 (U.S. CLS. 100, 101 AND 102).

SERVICE MARK

PRINCIPAL REGISTER

FIRST USE 8-26-2011; IN COMMERCE 8-26-2011.

THE MARK CONSISTS OF STANDARD CHARACTERS WITHOUT CLAIM TO ANY PARTICULAR FONT, STYLE, SIZE, OR COLOR.

SN 85-281,553, FILED 3-30-2011.

ALLISON SCHRODY, EXAMINING ATTORNEY



David J. Kyros

Director of the United States Patent and Trademark Office

United States of America

United States Patent and Trademark Office

MISS REPRESENTATION

Reg. No. 4,176,657

Registered July 17, 2012

Int. Cl.: 41

SERVICE MARK

PRINCIPAL REGISTER

GIRLS' CLUB ENTERTAINMENT, LLC (CALIFORNIA LIMITED LIABILITY COMPANY)
30 SIR FRANCIS DRAKE BLVD.
SAN FRANCISCO, CA 94960

FOR: EDUCATIONAL SERVICES, NAMELY, ARRANGING AND CONDUCTING EDUCATIONAL CONFERENCES, CLASSES, SEMINARS AND WORKSHOPS IN THE FIELD OF EMPOWERING WOMEN AND GIRLS, AND THE OBJECTIFICATION AND MISREPRESENTATION OF WOMEN AND GIRLS IN THE MEDIA AND OUR CULTURE AT LARGE; ON-LINE JOURNALS, NAMELY, BLOGS FEATURING THE EMPOWERMENT OF WOMEN AND GIRLS, AND EDUCATING ABOUT THE OBJECTIFICATION AND MISREPRESENTATION OF WOMEN AND GIRLS IN THE MEDIA AND OUR CULTURE AT LARGE; PROVIDING A WEBSITE FEATURING BLOGS AND NON-DOWNLOADABLE PUBLICATIONS IN THE NATURE OF ARTICLES AND BROCHURES IN THE FIELD OF THE EMPOWERMENT OF WOMEN AND GIRLS, AND THE OBJECTIFICATION AND MISREPRESENTATION OF WOMEN AND GIRLS IN THE MEDIA AND OUR CULTURE AT LARGE; ENTERTAINMENT SERVICES, NAMELY, AN ON-GOING SERIES FEATURING WOMEN AND GIRLS WHO ARE MISREPRESENTED IN THE MEDIA AND OUR CULTURE AT LARGE, PROVIDED THROUGH CABLE TELEVISION, NETWORK TELEVISION, THEATERS, DVDS, WEBCASTS, AND RADIO BROADCASTS, IN CLASS 41 (U.S. CLS. 100, 101 AND 107).

FIRST USE 10-12-2011; IN COMMERCE 10-12-2011.

THE MARK CONSISTS OF STANDARD CHARACTERS WITHOUT CLAIM TO ANY PARTICULAR FONT, STYLE, SIZE, OR COLOR.

SN 85-281,565, FILED 3-30-2011.

ALLISON SCHRODY, EXAMINING ATTORNEY



David J. Kyjars

Director of the United States Patent and Trademark Office

United States of America

United States Patent and Trademark Office



Reg. No. 4,176,658

Registered July 17, 2012

Int. Cl.: 25

TRADEMARK

PRINCIPAL REGISTER

XIZE FASHION ACCESSORIES CO., LTD. (CHINA LIMITED LIABILITY COMPANY)
NO. 72, XINGYUN ROAD, SUXI TOWN,
YIWU CITY,, CHINA

FOR: BABY LAYETTES FOR CLOTHING; BATHING SUITS; BATHING SUITS FOR MEN; BELTS; BLAZERS; BLOUSES; BODY SHIRTS; BODY SUITS; COATS; DENIM JACKETS; DENIMS; DRESSES; EVENING DRESSES; GLOVES; GLOVES AS CLOTHING; HATS; JACKETS; JEANS; JOGGING OUTFITS; JOGGING PANTS; JOGGING SUITS; JUMPERS; JUMPSUITS; KNIT JACKETS; KNIT SHIRTS; KNITTED UNDERWEAR; LAYETTES; MANTILLAS; PANTS; POLO SHIRTS; SCARFS; SHIRTS; SHOES; SHORTS; SOCKS; SPORT SHIRTS; SPORTS JACKETS; SPORTS JERSEYS; SPORTS PANTS; SPORTS SHIRTS; SPORTS SHIRTS WITH SHORT SLEEVES; T-SHIRTS, IN CLASS 25 (U.S. CLS. 22 AND 39).

FIRST USE 3-7-2011; IN COMMERCE 4-15-2012.

THE MARK CONSISTS OF A WORD "XIZEFS" (WITH A BACKWARD Z), WHEREIN THE LETTERS "X", "ZEFS" ARE IN STYLIZED IN ORANGE COLOR; THE BLACK COLORED WORDS "2003% KEVIN & CICI" REPRESENT THE MIDDLE HORIZONTAL LINE OF LETTERS "E" AND "F"; A WOMAN FACING AND WALKING TO THE LEFT REPRESENTS THE LETTER "I", WHEREIN THE SKIN OF THE WOMAN IS IN PINKY-RED COLOR, THE SCARF IS IN GREEN COLOR, THE DRESS IS IN DARK BROWN COLOR, THE HANDBAG IS IN PINK COLOR, THE HAIR AND THE BOOTS ARE IN BLACK COLOR.

THE COLOR(S) ORANGE, BLACK, PINKY-RED, GREEN, DARK BROWN AND PINK IS/ARE CLAIMED AS A FEATURE OF THE MARK.

SN 85-281,936, FILED 3-31-2011.

KARANENDRA S. CHHINA, EXAMINING ATTORNEY



David J. Kybas

Director of the United States Patent and Trademark Office

United States of America

United States Patent and Trademark Office



Reg. No. 4,176,659

Registered July 17, 2012

Int. Cl.: 5

TRADEMARK

PRINCIPAL REGISTER

JOHNSON & JOHNSON (NEW JERSEY CORPORATION)
ONE JOHNSON & JOHNSON PLAZA
NEW BRUNSWICK, NJ 089337001

FOR: ANTIBIOTICS FOR USE IN THE TREATMENT OF GENERAL AND LOCAL BACTERIAL AND VIRUS INFECTIONS, IN CLASS 5 (U.S. CLS. 6, 18, 44, 46, 51 AND 52).

FIRST USE 12-0-2010; IN COMMERCE 12-0-2010.

OWNER OF U.S. REG. NOS. 572,764, 3,746,755, AND OTHERS.

THE COLOR(S) YELLOW, BLUE, ORANGE AND TEAL GREEN IS/ARE CLAIMED AS A FEATURE OF THE MARK.

NO CLAIM IS MADE TO THE EXCLUSIVE RIGHT TO USE THE CADUCEUS SYMBOL, APART FROM THE MARK AS SHOWN.

THE MARK CONSISTS OF A SQUARE YELLOW BOX WITH TWO BLUE LINES ACROSS IT WHERE THE TOP PART OF THE BOX CONTAINS SMALL ORANGE COLORED HEXAGONS. THERE IS AN IMAGE OF A YELLOW CADUCEUS INSIDE A DOUBLE CIRCLE IN ORANGE. A TEAL GREEN BOX IS ON THE LEFT PORTION OF THE MARK WITH TWO YELLOW HEXAGON SHAPES IN THE UPPER RIGHT SIDE AND A HEXAGON CUT-OUT AND AN IMAGE OF A BANDAGE WITH A LIQUID DROPLET OUTLINED IN TEAL. THE STYLIZED WORD "NEOSPORIN" APPEARS IN THE COLOR TEAL GREEN AT THE BOTTOM OF THE YELLOW BOX.

SN 85-282,173, FILED 3-31-2011.

MATTHEW MCDOWELL, EXAMINING ATTORNEY



David J. Kybas

Director of the United States Patent and Trademark Office

United States of America

United States Patent and Trademark Office

ALTERED EGOS

Reg. No. 4,176,660

Registered July 17, 2012

Int. Cl.: 16

TRADEMARK

PRINCIPAL REGISTER

SOURCE INTERLINK MAGAZINES, LLC (DELAWARE LIMITED LIABILITY COMPANY)
831 SOUTH DOUGLAS STREET
EL SEGUNDO, CA 90245

FOR: MAGAZINES FEATURING TATTOOS, THE PEOPLE HAVING SUCH TATTOOS, THE TATTOO CULTURE AND THE TATTOO ARTISTS CREATING THE TATTOOS , IN CLASS 16 (U.S. CLS. 2, 5, 22, 23, 29, 37, 38 AND 50).

FIRST USE 5-0-2011; IN COMMERCE 5-0-2011.

THE MARK CONSISTS OF STANDARD CHARACTERS WITHOUT CLAIM TO ANY PARTICULAR FONT, STYLE, SIZE, OR COLOR.

SN 85-282,367, FILED 3-31-2011.

SOPHIA S. KIM, EXAMINING ATTORNEY



David J. Kyffers

Director of the United States Patent and Trademark Office

United States of America

United States Patent and Trademark Office

WON'T BREAK THE BANK

Reg. No. 4,176,661

URBAN PLATES, LLC (DELAWARE LIMITED LIABILITY COMPANY)
2037 SAN ELIJO AVENUE
CARDIFF, CA 92007

Registered July 17, 2012

Int. Cl.: 43

FOR: RESTAURANT, RESTAURANT CARRYOUT, AND CATERING SERVICES; TAKE OUT RESTAURANT SERVICES FOR CONSUMPTION OF FOOD OFF THE PREMISES, IN CLASS 43 (U.S. CLS. 100 AND 101).

SERVICE MARK

FIRST USE 4-9-2012; IN COMMERCE 4-9-2012.

PRINCIPAL REGISTER

THE MARK CONSISTS OF STANDARD CHARACTERS WITHOUT CLAIM TO ANY PARTICULAR FONT, STYLE, SIZE, OR COLOR.

SN 85-282,713, FILED 3-31-2011.

MARGARET POWER, EXAMINING ATTORNEY



David J. Kyffers

Director of the United States Patent and Trademark Office

United States of America

United States Patent and Trademark Office

GRIPSHOT

Reg. No. 4,176,662

SOUTH AMERICAN SALES, INC. (FLORIDA CORPORATION)
345 NW 45TH TERRACE
DEERFIELD BEACH, FL 33442

Registered July 17, 2012

Int. Cl.: 13

FOR: RIFLE RAILS, IN CLASS 13 (U.S. CLS. 2 AND 9).

TRADEMARK

FIRST USE 9-5-2011; IN COMMERCE 9-5-2011.

PRINCIPAL REGISTER

THE MARK CONSISTS OF STANDARD CHARACTERS WITHOUT CLAIM TO ANY PARTICULAR FONT, STYLE, SIZE, OR COLOR.

SN 85-282,760, FILED 3-31-2011.

KARANENDRA S. CHHINA, EXAMINING ATTORNEY



David J. Kyffers

Director of the United States Patent and Trademark Office

United States of America

United States Patent and Trademark Office

HIPOGLÓS



Reg. No. 4,176,663

LABORATORIOS ANDROMACO S.A. (CHILE SOCIEDAD ANONIMA (SA))
AVENIDA QUILIN 5273, PENALOLEN
SANTIAGO, CHILE

Registered July 17, 2012

Int. Cl.: 5

FOR: MEDICATED OINTMENTS, NAMELY, DIAPER RASH OINTMENTS, IN CLASS 5 (U.S. CLS. 6, 18, 44, 46, 51 AND 52).

TRADEMARK

FIRST USE 5-19-2011; IN COMMERCE 5-19-2011.

PRINCIPAL REGISTER

OWNER OF U.S. REG. NOS. 3,462,243 AND 3,491,167.

THE COLOR(S) RED AND GREEN IS/ARE CLAIMED AS A FEATURE OF THE MARK.

THE MARK CONSISTS OF THE STYLIZED WORD "HIPOGLOS" IN RED WITH A VARIEGATED, GREEN, CURVED, UNDERLINE BELOW AND TWO GREEN BARS ON THE RIGHT SIDE.

SN 85-282,839, FILED 3-31-2011.

PAUL E. FAHRENKOPF, EXAMINING ATTORNEY



David J. Kybas

Director of the United States Patent and Trademark Office

United States of America

United States Patent and Trademark Office

GLOBAL PACKAGE SOLUTIONS

Reg. No. 4,176,664

THE NAVIGATORS GROUP, INC. (DELAWARE CORPORATION)
ONE PENN PLAZA
NEW YORK, NY 10119

Registered July 17, 2012

Int. Cl.: 36

FOR: INSURANCE UNDERWRITING SERVICES OF ALL TYPES OF INSURANCE, IN CLASS 36 (U.S. CLS. 100, 101 AND 102).

SERVICE MARK

FIRST USE 11-0-2011; IN COMMERCE 11-0-2011.

PRINCIPAL REGISTER

THE MARK CONSISTS OF STANDARD CHARACTERS WITHOUT CLAIM TO ANY PARTICULAR FONT, STYLE, SIZE, OR COLOR.

OWNER OF U.S. REG. NO. 3,954,660.

NO CLAIM IS MADE TO THE EXCLUSIVE RIGHT TO USE "GLOBAL", APART FROM THE MARK AS SHOWN.

SN 85-282,912, FILED 3-31-2011.

LINDA MICKLEBURGH, EXAMINING ATTORNEY



David J. Kybas

Director of the United States Patent and Trademark Office

United States of America

United States Patent and Trademark Office

LOVE YOUR BRAND.

Reg. No. 4,176,665

Registered July 17, 2012

Int. Cl.: 35

SERVICE MARK

PRINCIPAL REGISTER

EMB DESIGNS, INC. (OHIO CORPORATION)
211 E MAIN STREET
COLDWATER, OH 45828

FOR: BRANDING SERVICES, NAMELY, CONSULTING, DEVELOPMENT, MANAGEMENT AND MARKETING OF BRANDS FOR BUSINESSES; ADVERTISING, MARKETING AND PROMOTION SERVICES; BUSINESS MARKETING CONSULTING SERVICES; CREATIVE MARKETING DESIGN SERVICES; MARKETING ANALYSIS SERVICES; ON-LINE RETAIL STORE SERVICES FEATURING A WIDE VARIETY OF CONSUMER GOODS OF OTHERS; PROVIDING INFORMATION IN THE FIELD OF MARKETING AND ON-LINE MARKETING MEDIA VIA THE INTERNET; ADVERTISING SERVICES, NAMELY, CREATING PROMOTIONAL PRINTED BUSINESS PRODUCTS ADVERTISING THE GOODS AND SERVICES OF OTHERS, NAMELY, SIGNS, BANNERS, EMBROIDERY AND SCREEN PRINTING ON COMPANY AND TEAM APPAREL; PROVIDING WEB SITES FEATURING ADVERTISEMENTS FOR THE GOODS AND SERVICES OF OTHERS; CONSULTING SERVICES IN THE FIELD OF INTERNET MARKETING, IN CLASS 35 (U.S. CLS. 100, 101 AND 102).

FIRST USE 4-15-2011; IN COMMERCE 4-15-2011.

THE MARK CONSISTS OF STANDARD CHARACTERS WITHOUT CLAIM TO ANY PARTICULAR FONT, STYLE, SIZE, OR COLOR.

SN 85-283,217, FILED 3-31-2011.

SUE LAWRENCE, EXAMINING ATTORNEY



David J. Kyffers

Director of the United States Patent and Trademark Office

United States of America
United States Patent and Trademark Office

EXTREMIS

Reg. No. 4,176,666

RADIANS, INC. (TENNESSEE CORPORATION)
5305 DISTRIplex FARMS DRIVE
MEMPHIS, TN 381418231

Registered July 17, 2012

Int. Cl.: 9

FOR: PROTECTIVE EYEGLASSES; PROTECTIVE EYEWEAR; PROTECTIVE EYEWEAR
AND COMPONENT PARTS THEREOF, IN CLASS 9 (U.S. CLS. 21, 23, 26, 36 AND 38).

TRADEMARK

FIRST USE 4-24-2012; IN COMMERCE 4-24-2012.

PRINCIPAL REGISTER

THE MARK CONSISTS OF STANDARD CHARACTERS WITHOUT CLAIM TO ANY PAR-
TICULAR FONT, STYLE, SIZE, OR COLOR.

SN 85-283,278, FILED 3-31-2011.

JOHN WILKE, EXAMINING ATTORNEY



David J. Kyffers

Director of the United States Patent and Trademark Office

United States of America

United States Patent and Trademark Office

Where quality is a fundamental constant

Reg. No. 4,176,667

AVOGADRO NANALYTICAL, LLC (NEW HAMPSHIRE LIMITED LIABILITY COMPANY)
12 MANOR PARKWAY, SUITE 2A
SALEM, NH 030792862

Registered July 17, 2012

Int. Cl.: 42

FOR: LABORATORY SERVICES FOR THE CHARACTERIZATION OF MATERIALS BY
CHEMICAL AND STRUCTURAL ANALYSIS, IN CLASS 42 (U.S. CLS. 100 AND 101).

SERVICE MARK

FIRST USE 10-16-2010; IN COMMERCE 3-15-2012.

PRINCIPAL REGISTER

THE MARK CONSISTS OF STANDARD CHARACTERS WITHOUT CLAIM TO ANY PAR-
TICULAR FONT, STYLE, SIZE, OR COLOR.

SN 85-283,568, FILED 4-1-2011.

LEIGH LOWRY, EXAMINING ATTORNEY



David J. Kyffers

Director of the United States Patent and Trademark Office

United States of America

United States Patent and Trademark Office

Avogadro nAnalytical

Reg. No. 4,176,668

AVOGADRO NANALYTICAL, LLC (NEW HAMPSHIRE LIMITED LIABILITY COMPANY)
12 MANOR PARKWAY, SUITE 2A
SALEM, NH 030792862

Registered July 17, 2012

Int. Cl.: 42

FOR: LABORATORY SERVICES FOR THE CHARACTERIZATION OF MATERIALS BY
CHEMICAL AND STRUCTURAL ANALYSIS, IN CLASS 42 (U.S. CLS. 100 AND 101).

SERVICE MARK

FIRST USE 10-16-2010; IN COMMERCE 3-15-2012.

PRINCIPAL REGISTER

THE MARK CONSISTS OF STANDARD CHARACTERS WITHOUT CLAIM TO ANY PAR-
TICULAR FONT, STYLE, SIZE, OR COLOR.

SN 85-283,577, FILED 4-1-2011.

LEIGH LOWRY, EXAMINING ATTORNEY



David J. Kyffers

Director of the United States Patent and Trademark Office

United States of America

United States Patent and Trademark Office



Reg. No. 4,176,669

STATE UNIVERSITY OF NEW YORK AT NEW PALTZ (NEW YORK STATE UNIVERSITY)
1 HAWK DRIVE
NEW PALTZ, NY 12561

Registered July 17, 2012

Int. Cl.: 41

FOR: ENTERTAINMENT IN THE NATURE OF COMPETITIONS IN THE FIELD OF COLLEGE-LEVEL ATHLETICS, IN CLASS 41 (U.S. CLS. 100, 101 AND 107).

SERVICE MARK

FIRST USE 8-12-2010; IN COMMERCE 8-12-2010.

PRINCIPAL REGISTER

THE MARK CONSISTS OF A HAWK HEAD WITH THE LETTERS "NP" POSITIONED OVER THE LOGO.

SN 85-283,930, FILED 4-1-2011.

LEIGH CAROLINE CASE, EXAMINING ATTORNEY



David J. Kyffers

Director of the United States Patent and Trademark Office

United States of America

United States Patent and Trademark Office



Reg. No. 4,176,670

STATE UNIVERSITY OF NEW YORK AT NEW PALTZ (NEW YORK STATE UNIVERSITY)
1 HAWK DRIVE
NEW PALTZ, NY 12561

Registered July 17, 2012

Int. Cl.: 41

FOR: ENTERTAINMENT IN THE NATURE OF COMPETITIONS IN THE FIELD OF COLLEGE-
LEVEL ATHLETICS, IN CLASS 41 (U.S. CLS. 100, 101 AND 107).

SERVICE MARK

FIRST USE 5-3-2010; IN COMMERCE 5-3-2010.

PRINCIPAL REGISTER

THE MARK CONSISTS OF A HAWK.

SN 85-283,961, FILED 4-1-2011.

LEIGH CAROLINE CASE, EXAMINING ATTORNEY



David J. Kyffers

Director of the United States Patent and Trademark Office

United States of America

United States Patent and Trademark Office

VITAMIN FORTIFIED FUN

Reg. No. 4,176,671

Registered July 17, 2012

Int. Cl.: 9

TRADEMARK

PRINCIPAL REGISTER

GO GO KIDDO INC. (WASHINGTON CORPORATION)
P.O. BOX 7448
BELLEVUE, WA 98008

FOR: COMPUTER APPLICATION SOFTWARE FOR MOBILE DEVICES, NAMELY, SOFTWARE FOR USE IN OBTAINING INFORMATION FROM THE MOBILE DEVICE'S CAMERA, OR TOUCH SCREEN AND TRANSFERRING THAT INFORMATION ACROSS COMMUNICATION NETWORKS, FOR USE IN CUSTOMIZING CONTENT, AND FOR USE IN OBTAINING EDUCATIONAL AND ENTERTAINMENT CONTENT; DOWNLOADABLE CHILDREN'S BOOKS, DOWNLOADABLE VIDEO RECORDINGS FEATURING ANIMATION AND MUSIC, AND COMPUTER GAME SOFTWARE FOR USE ON MOBILE DEVICES, ALL OF THE ABOVE DELIVERED TO MOBILE DEVICES, IN CLASS 9 (U.S. CLS. 21, 23, 26, 36 AND 38).

FIRST USE 11-22-2011; IN COMMERCE 11-22-2011.

THE MARK CONSISTS OF STANDARD CHARACTERS WITHOUT CLAIM TO ANY PARTICULAR FONT, STYLE, SIZE, OR COLOR.

SN 85-284,191, FILED 4-1-2011.

KATHERINE E. HALMEN, EXAMINING ATTORNEY



David J. Kyros

Director of the United States Patent and Trademark Office

United States of America

United States Patent and Trademark Office

ColorMax

Reg. No. 4,176,672

Registered July 17, 2012

Int. Cl.: 28

TRADEMARK

PRINCIPAL REGISTER

BRAINSTORMPRODUCTS, LLC. (CALIFORNIA LIMITED LIABILITY COMPANY)
1011 S. ANDREASEN DR., SUITE #100
ESCONDIDO, CA 92029

FOR: TOYS, NAMELY, KITES AND ACCESSORIES FOR KITES, NAMELY, KITE HANDLES, KITE LINES, KITE REELS, KITE STRING AND KITE TAILS, IN CLASS 28 (U.S. CLS. 22, 23, 38 AND 50).

FIRST USE 10-21-2011; IN COMMERCE 10-26-2011.

THE MARK CONSISTS OF STANDARD CHARACTERS WITHOUT CLAIM TO ANY PARTICULAR FONT, STYLE, SIZE, OR COLOR.

SN 85-284,268, FILED 4-1-2011.

PAUL E. FAHRENKOPF, EXAMINING ATTORNEY



David J. Kyffers

Director of the United States Patent and Trademark Office

United States of America

United States Patent and Trademark Office



Reg. No. 4,176,673

Registered July 17, 2012

Int. Cl.: 35

SERVICE MARK

PRINCIPAL REGISTER

ALTRUSA INTERNATIONAL (INDIANA NON-PROFIT CORPORATION)
SUITE 1123
332 SOUTH MICHIGAN AVENUE
CHICAGO, IL 60604

FOR: CHARITABLE SERVICES, NAMELY, ORGANIZING AND CONDUCTING VOLUNTEER PROGRAMS AND COMMUNITY SERVICE PROJECTS, IN CLASS 35 (U.S. CLS. 100, 101 AND 102).

FIRST USE 7-25-2011; IN COMMERCE 7-25-2011.

NO CLAIM IS MADE TO THE EXCLUSIVE RIGHT TO USE "INTERNATIONAL", APART FROM THE MARK AS SHOWN.

THE MARK CONSISTS OF FOUR HORIZONTAL WAVY RIBBONS THAT CREATE THE FREE FORM LETTER "A" AND BEGIN AT THE TOP OF THE FIRST LETTER "A" IN THE NAME "ALTRUSA" AND ENDS AT THE WORD "COMMUNITY" IN THE TAG LINE. THE WORD "ALTRUSA" IS STACKED OVER THE WORD "INTERNATIONAL" AND IS DIVIDED FROM THE TAGLINE "LEADING TO A BETTER COMMUNITY" BY A THIN VERTICAL LINE.

SN 85-284,345, FILED 4-1-2011.

EUGENIA MARTIN, EXAMINING ATTORNEY



David J. Kyros

Director of the United States Patent and Trademark Office

United States of America
United States Patent and Trademark Office

BFF-Kins

Reg. No. 4,176,674

3HUGS, L.L.C. (VIRGINIA LIMITED LIABILITY COMPANY)
4704 REGAL OAKS RD.
GLEN ALLEN, VA 23059

Registered July 17, 2012

Int. Cl.: 16

FOR: PAPER NAPKINS, IN CLASS 16 (U.S. CLS. 2, 5, 22, 23, 29, 37, 38 AND 50).

TRADEMARK

FIRST USE 9-5-2011; IN COMMERCE 9-30-2011.

PRINCIPAL REGISTER

THE MARK CONSISTS OF THE STYLIZED WORDING "BFF-KINS" WITH A GRAPHIC OF A HEART APPEARING AS THE DOT OVER THE LETTER "I".

SN 85-284,623, FILED 4-2-2011.

ALYSSA STEEL, EXAMINING ATTORNEY



David J. Kyffers

Director of the United States Patent and Trademark Office

United States of America

United States Patent and Trademark Office

FANNY FRIENDS

Reg. No. 4,176,675

Registered July 17, 2012

Int. Cl.: 20

TRADEMARK

PRINCIPAL REGISTER

GOODWIN, ROBERT W. (UNITED STATES INDIVIDUAL)
249 DOLPHIN PL
BELLINGHAM, WA 98229

FOR: SEAT CUSHIONS, IN CLASS 20 (U.S. CLS. 2, 13, 22, 25, 32 AND 50).

FIRST USE 1-1-2012; IN COMMERCE 1-1-2012.

THE MARK CONSISTS OF STANDARD CHARACTERS WITHOUT CLAIM TO ANY PARTICULAR FONT, STYLE, SIZE, OR COLOR.

NO CLAIM IS MADE TO THE EXCLUSIVE RIGHT TO USE "FANNY", APART FROM THE MARK AS SHOWN.

SN 85-284,695, FILED 4-3-2011.

MATTHEW MCDOWELL, EXAMINING ATTORNEY



David J. Kybas

Director of the United States Patent and Trademark Office

United States of America

United States Patent and Trademark Office

JUST POP IT

Reg. No. 4,176,676

HARVEST DIRECT LLC (MASSACHUSETTS LIMITED LIABILITY COMPANY)
61 ACCORD PARK DRIVE
NORWELL, MA 02061

Registered July 17, 2012

Int. Cl.: 11

FOR: HOT AIR POPCORN MAKERS, ELECTRIC POPCORN POPPERS, IN CLASS 11 (U.S. CLS. 13, 21, 23, 31 AND 34).

TRADEMARK

FIRST USE 4-4-2011; IN COMMERCE 4-4-2011.

PRINCIPAL REGISTER

THE MARK CONSISTS OF STANDARD CHARACTERS WITHOUT CLAIM TO ANY PARTICULAR FONT, STYLE, SIZE, OR COLOR.

SN 85-285,248, FILED 4-4-2011.

SUE LAWRENCE, EXAMINING ATTORNEY



David J. Kybas

Director of the United States Patent and Trademark Office

United States of America

United States Patent and Trademark Office



Reg. No. 4,176,677

Registered July 17, 2012

DIVORCE COACHING, INC. (FLORIDA CORPORATION)
8729 BAY POINTE DRIVE
TAMPA, FL 33615

**CERTIFICATION MARK
SERVICES**

FOR: PERSONAL DIVORCE COACHING, IN CLASS B (U.S. CL. B).
FIRST USE 6-15-2011; IN COMMERCE 6-20-2011.

PRINCIPAL REGISTER

THE MARK CONSISTS OF THE STYLIZED LETTERS "CDC" BORDERED BY A LEFT TUSK-SHAPED FIGURE AND SMALLER RIGHT TUSK-SHAPED FIGURE EACH OF WHICH COMPRISES A BROAD BASE AND CURVES INWARDLY AS IT NARROWS TO A POINT. THE TIP OF THE LEFT TUSK-SHAPED FIGURE RESTS ABOVE THE FIRST TWO LETTERS "CD" AND PART OF THE LAST LETTER "C". THE TIP OF THE RIGHT TUSK-SHAPED FIGURE RESTS ABOVE THE LAST LETTER "C". A THICK LINE WITH ROUNDED ENDS IS LOCATED BELOW THE LETTERING AND THE TUSK-SHAPED FIGURES.

THE CERTIFICATION MARK, AS INTENDED TO BE USED BY AUTHORIZED PERSONS, IS INTENDED TO CERTIFY THAT THE PERSON DISPLAYING THE MARK HAS COMPLETED EDUCATION COURSE WORK REQUIREMENTS AND WORK EXPERIENCE REQUIREMENTS OF THE CERTIFIER, HAS COMPLETED EXAMINATIONS ADMINISTERED BY THE CERTIFIER IN A SATISFACTORY MANNER, HAS AGREED TO ADHERE TO THE CERTIFIER'S STANDARDS OF PROFESSIONAL RESPONSIBILITY, CONTINUING EDUCATION AND OTHER POST-CERTIFICATION REQUIREMENTS.

SN 85-285,268, FILED 4-4-2011.

TOBY BULLOFF, EXAMINING ATTORNEY



David J. Kybas

Director of the United States Patent and Trademark Office

United States of America

United States Patent and Trademark Office

FOR A BETTER YOU

Reg. No. 4,176,678

Registered July 17, 2012

Int. Cl.: 43

SERVICE MARK

PRINCIPAL REGISTER

WESTIN HOTEL MANAGEMENT, L.P. (DELAWARE LIMITED PARTNERSHIP)
1111 WESTCHESTER AVENUE
WHITE PLAINS, NY 10604

FOR: PROVIDING TEMPORARY ACCOMMODATION; PROVIDING FOOD AND BEVERAGES FOR CONSUMPTION ON OR OFF THE PREMISES; RESORT HOTELS, IN CLASS 43 (U.S. CLS. 100 AND 101).

FIRST USE 5-0-2011; IN COMMERCE 5-0-2011.

THE MARK CONSISTS OF STANDARD CHARACTERS WITHOUT CLAIM TO ANY PARTICULAR FONT, STYLE, SIZE, OR COLOR.

SN 85-285,399, FILED 4-4-2011.

H. M. FISHER, EXAMINING ATTORNEY



David J. Kybas

Director of the United States Patent and Trademark Office

United States of America

United States Patent and Trademark Office

PERFECTLY SIMPLE

Reg. No. 4,176,679

ABBOTT LABORATORIES (ILLINOIS CORPORATION)

Registered July 17, 2012

100 ABBOTT PARK ROAD
ABBOTT PARK, IL 60064

Int. Cls.: 5, 29, and 30

FOR: NUTRITIONAL SUPPLEMENTS, MEAL REPLACEMENT BARS, NUTRITIONAL ENERGY BARS FOR USE AS A MEAL SUBSTITUTE, IN CLASS 5 (U.S. CLS. 6, 18, 44, 46, 51 AND 52).

TRADEMARK

FIRST USE 2-24-2012; IN COMMERCE 2-24-2012.

PRINCIPAL REGISTER

FOR: PROTEIN BASED, NUTRIENT-DENSE SNACK BARS, IN CLASS 29 (U.S. CL. 46).

FIRST USE 2-24-2012; IN COMMERCE 2-24-2012.

FOR: CEREAL BASED ENERGY BARS, IN CLASS 30 (U.S. CL. 46).

FIRST USE 2-24-2012; IN COMMERCE 2-24-2012.

THE MARK CONSISTS OF STANDARD CHARACTERS WITHOUT CLAIM TO ANY PARTICULAR FONT, STYLE, SIZE, OR COLOR.

SN 85-285,507, FILED 4-4-2011.

EUGENIA MARTIN, EXAMINING ATTORNEY



David J. Kyros

Director of the United States Patent and Trademark Office

United States of America

United States Patent and Trademark Office



Reg. No. 4,176,680

Registered July 17, 2012

Int. Cl.: 9

TRADEMARK

PRINCIPAL REGISTER

APPCENTRAL, INC. (DELAWARE CORPORATION)
575 FLORIDA STREET, SUITE 125
SAN FRANCISCO, CA 94110

FOR: COMPUTER SOFTWARE, NAMELY, COMPUTER SOFTWARE FOR APPLICATION MANAGEMENT AND DISTRIBUTION FOR BUSINESS PURPOSES, PROVIDED USING A COMMUNICATIONS NETWORK, IN CLASS 9 (U.S. CLS. 21, 23, 26, 36 AND 38).

FIRST USE 7-25-2011; IN COMMERCE 7-25-2011.

THE MARK CONSISTS OF A TRIANGULAR SWIRL DESIGN.

SN 85-285,548, FILED 4-4-2011.

KYLE PEETE, EXAMINING ATTORNEY



David J. Kyffers

Director of the United States Patent and Trademark Office

United States of America

United States Patent and Trademark Office

RUCY

Reg. No. 4,176,681

Registered July 17, 2012

Int. Cl.: 1

TRADEMARK

PRINCIPAL REGISTER

TAKASAGO KORYO KOGYO KABUSHIKI KAISHA (JAPAN CORPORATION), TA
TAKASAGO INTERNATIONAL CORPORATION,
37-1, KAMATA 5-CHOME
OHTA-KU, TOKYO, JAPAN

FOR: CHEMICAL PRODUCTS, NAMELY, CHEMICAL CATALYSTS FOR CHEMICAL AND
BIOCHEMICAL PROCESSES, IN CLASS 1 (U.S. CLS. 1, 5, 6, 10, 26 AND 46).

FIRST USE 8-1-2011; IN COMMERCE 8-1-2011.

THE MARK CONSISTS OF STANDARD CHARACTERS WITHOUT CLAIM TO ANY PAR-
TICULAR FONT, STYLE, SIZE, OR COLOR.

SN 85-285,576, FILED 4-4-2011.

KAELIE KUNG, EXAMINING ATTORNEY



David J. Kybas

Director of the United States Patent and Trademark Office

United States of America

United States Patent and Trademark Office



Reg. No. 4,176,682

Registered July 17, 2012

Int. Cl.: 42

SERVICE MARK

PRINCIPAL REGISTER

APPCENTRAL, INC. (DELAWARE CORPORATION)
575 FLORIDA STREET, SUITE 125
SAN FRANCISCO, CA 94110

FOR: BUSINESS APPLICATION MANAGEMENT AND DISTRIBUTION SERVICES IN THE NATURE OF COMPUTER SERVICES FOR REMOTE SOFTWARE APPLICATION MANAGEMENT AND ACTING AS AN APPLICATION SERVICE PROVIDER IN THE FIELD OF INFORMATION MANAGEMENT TO HOST COMPUTER APPLICATION SOFTWARE FOR ENTERPRISE PURPOSES PROVIDED USING A COMMUNICATIONS NETWORK, IN CLASS 42 (U.S. CLS. 100 AND 101).

FIRST USE 4-25-2011; IN COMMERCE 4-25-2011.

THE MARK CONSISTS OF A TRIANGULAR SWIRL DESIGN.

SN 85-285,580, FILED 4-4-2011.

KYLE PEETE, EXAMINING ATTORNEY



David J. Kyros

Director of the United States Patent and Trademark Office

United States of America

United States Patent and Trademark Office

INYER CASE

Reg. No. 4,176,683

JOHN T. ZIEMBA (UNITED STATES INDIVIDUAL)
242 CENTRAL AVENUE
EDISON, NJ 08817

Registered July 17, 2012

Int. Cl.: 9

FOR: CARRYING CASES, SOLD EMPTY, SPECIFICALLY DESIGNED FOR THE STORAGE, PROTECTION, AND TRANSPORTATION OF HANDHELD ELECTRONICS, NAMELY, PORTABLE AUDIO DEVICES, WIRELESS TELEPHONES AND PERSONAL DIGITAL ASSISTANTS, IN CLASS 9 (U.S. CLS. 21, 23, 26, 36 AND 38).

TRADEMARK

PRINCIPAL REGISTER

FIRST USE 3-0-2011; IN COMMERCE 3-0-2011.

THE MARK CONSISTS OF STANDARD CHARACTERS WITHOUT CLAIM TO ANY PARTICULAR FONT, STYLE, SIZE, OR COLOR.

NO CLAIM IS MADE TO THE EXCLUSIVE RIGHT TO USE "CASE", APART FROM THE MARK AS SHOWN.

SN 85-285,630, FILED 4-4-2011.

NICHOLAS ALTREE, EXAMINING ATTORNEY



David J. Kyffers

Director of the United States Patent and Trademark Office

United States of America

United States Patent and Trademark Office

SKY CULTURE

Reg. No. 4,176,684

SKY CULTURE CLOTHING, LLC (DELAWARE LIMITED LIABILITY COMPANY)
19 HORIZON DRIVE
WAYNE, NJ 07470

Registered July 17, 2012

Int. Cl.: 25

FOR: HATS; SHIRTS; SWEAT SHIRTS; T-SHIRTS; TANK TOPS, IN CLASS 25 (U.S. CLS. 22 AND 39).

TRADEMARK

FIRST USE 6-20-2011; IN COMMERCE 6-20-2011.

PRINCIPAL REGISTER

THE MARK CONSISTS OF STANDARD CHARACTERS WITHOUT CLAIM TO ANY PARTICULAR FONT, STYLE, SIZE, OR COLOR.

SN 85-285,704, FILED 4-4-2011.

SUNG IN, EXAMINING ATTORNEY



David J. Kyffers

Director of the United States Patent and Trademark Office

United States of America

United States Patent and Trademark Office



Reg. No. 4,176,685

Registered July 17, 2012

Int. Cl.: 33

TRADEMARK

PRINCIPAL REGISTER

21ST CENTRUY SPIRITS, LLC (CALIFORNIA LIMITED LIABILITY COMPANY)
6560 E. WASHINGTON BLVD.
CITY OF COMMERCE, CA 90040

FOR: ALCOHOLIC BEVERAGES, NAMELY, VODKA, IN CLASS 33 (U.S. CLS. 47 AND 49).

FIRST USE 2-23-2012; IN COMMERCE 2-23-2012.

OWNER OF U.S. REG. NO. 276,132.

THE MARK CONSISTS OF A STYLIZED LETTER "G" WITH A STALK OF GRAIN AT THE TOP RIGHT OF THE LETTER "G" AND A DOT UNDERNEATH WITH THE STYLIZED WORDING "BLUE ICE" BELOW THE DOT.

SN 85-285,767, FILED 4-4-2011.

SUNG IN, EXAMINING ATTORNEY



David J. Kyffers

Director of the United States Patent and Trademark Office

United States of America

United States Patent and Trademark Office

The logo for FR101 features the letters 'FR' in a bold, black, sans-serif font. To the right of 'FR' is the number '101' in a bold, blue, sans-serif font. A thin black diagonal line extends from the bottom of the 'R' down to the bottom of the '1' in '101'. A small blue dot is positioned below the '0' in '101'.

Reg. No. 4,176,686

Registered July 17, 2012

Int. Cl.: 25

TRADEMARK

PRINCIPAL REGISTER

MINAMI, HIRO (UNITED STATES INDIVIDUAL), DBA FRESHMAN 101 CLOTHING COMPANY,
704 SW EVANS AVE
COLLEGE PLACE, WA 99324

FOR: BATHING SUITS; BELTS; CARDIGANS; FOOTWEAR; HATS; HOODED SWEAT-SHIRTS; JACKETS; JEANS; PANTS; SCARVES; SHIRTS; SHORTS; SOCKS; SWEATSHIRTS; T-SHIRTS; THERMAL SOCKS; THERMAL UNDERWEAR; TIES; VESTS, IN CLASS 25 (U.S. CLS. 22 AND 39).

FIRST USE 7-21-2008; IN COMMERCE 7-21-2008.

THE MARK CONSISTS OF THE STYLIZED "FR101". THE "FR" APPEARS IN BLACK, AND THE "101" APPEARS IN BLUE. BELOW THE "0" IN "101" IS A SMALL BLUE DOT.

THE COLOR(S) BLUE AND BLACK IS/ARE CLAIMED AS A FEATURE OF THE MARK.

SN 85-286,207, FILED 4-5-2011.

ODESSA BIBBINS, EXAMINING ATTORNEY



David J. Kyffers

Director of the United States Patent and Trademark Office

United States of America

United States Patent and Trademark Office

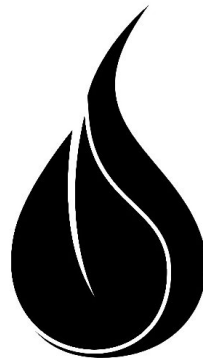

Reg. No. 4,176,687

Registered July 17, 2012

Int. Cls.: 4 and 11

TRADEMARK

PRINCIPAL REGISTER

COVANTA ENERGY CORPORATION (DELAWARE CORPORATION)
445 SOUTH STREET
MORRISTOWN, NJ 07960

FOR: BIOFUELS, DIESEL FUEL, IN CLASS 4 (U.S. CLS. 1, 6 AND 15).

FIRST USE 3-1-2012; IN COMMERCE 3-1-2012.

FOR: WASTE TREATMENT EQUIPMENT FOR THE CONVERSION OF WASTE TO FUEL,
IN CLASS 11 (U.S. CLS. 13, 21, 23, 31 AND 34).

FIRST USE 3-1-2012; IN COMMERCE 3-1-2012.

THE MARK CONSISTS OF A DROP COMPRISED OF THE DESIGN OF A SINGLE LEAF ON
THE LEFT HAND SIDE AND STYLIZED "S" DESIGN ON THE RIGHT HAND SIDE.

SN 85-286,300, FILED 4-5-2011.

REBECCA SMITH, EXAMINING ATTORNEY



David J. Kybas

Director of the United States Patent and Trademark Office

United States of America

United States Patent and Trademark Office

IQ

Reg. No. 4,176,688

Registered July 17, 2012

Int. Cl.: 9

TRADEMARK

PRINCIPAL REGISTER

INVERTIX CORPORATION (DELAWARE CORPORATION)
SUITE 800
8201 GRENSBORO DRIVE
MCLEAN, VA 221023819

FOR: ANTENNAS, IN CLASS 9 (U.S. CLS. 21, 23, 26, 36 AND 38).

FIRST USE 3-24-2011; IN COMMERCE 3-24-2011.

THE MARK CONSISTS OF STANDARD CHARACTERS WITHOUT CLAIM TO ANY PARTICULAR FONT, STYLE, SIZE, OR COLOR.

SN 85-286,302, FILED 4-5-2011.

SALLY SHIH, EXAMINING ATTORNEY



David J. Kybas

Director of the United States Patent and Trademark Office

United States of America

United States Patent and Trademark Office

LIFE PARTICLE

Reg. No. 4,176,689

Registered July 17, 2012

Int. Cl.: 41

SERVICE MARK

PRINCIPAL REGISTER

BR CONSULTING, INC. (NEW JERSEY CORPORATION)
340 JORDAN ROAD
SEDONA, AZ 86336

FOR: EDUCATION SERVICES, NAMELY, CONDUCTING CLASSES, SEMINARS AND WORKSHOPS TO ENHANCE MENTAL, EMOTIONAL AND PHYSICAL CAPABILITIES; EDUCATIONAL SERVICES, NAMELY, CONDUCTING CLASSES, SEMINARS AND WORKSHOPS IN THE FIELDS OF HEALTH AND SPIRITUALITY, IN CLASS 41 (U.S. CLS. 100, 101 AND 107).

FIRST USE 1-15-2011; IN COMMERCE 1-15-2011.

THE MARK CONSISTS OF STANDARD CHARACTERS WITHOUT CLAIM TO ANY PARTICULAR FONT, STYLE, SIZE, OR COLOR.

SN 85-286,684, FILED 4-5-2011.

RUDY R. SINGLETON, EXAMINING ATTORNEY



David J. Kybas

Director of the United States Patent and Trademark Office

United States of America

United States Patent and Trademark Office

MIND SCREEN

Reg. No. 4,176,690

Registered July 17, 2012

Int. Cl.: 41

SERVICE MARK

PRINCIPAL REGISTER

BR CONSULTING, INC. (NEW JERSEY CORPORATION)
340 JORDAN ROAD
SEDONA, AZ 86336

FOR: EDUCATION SERVICES, NAMELY, CONDUCTING CLASSES, SEMINARS AND WORKSHOPS TO ENHANCE MENTAL, EMOTIONAL AND PHYSICAL CAPABILITIES; EDUCATIONAL SERVICES, NAMELY, CONDUCTING CLASSES, SEMINARS AND WORKSHOPS IN THE FIELDS OF HEALTH AND SPIRITUALITY, IN CLASS 41 (U.S. CLS. 100, 101 AND 107).

FIRST USE 1-15-2011; IN COMMERCE 1-15-2011.

THE MARK CONSISTS OF STANDARD CHARACTERS WITHOUT CLAIM TO ANY PARTICULAR FONT, STYLE, SIZE, OR COLOR.

SN 85-286,690, FILED 4-5-2011.

RUDY R. SINGLETON, EXAMINING ATTORNEY



David J. Kyffers

Director of the United States Patent and Trademark Office

United States of America

United States Patent and Trademark Office

CITY CAMP

Reg. No. 4,176,691

Registered July 17, 2012

Int. Cl.: 20

TRADEMARK

PRINCIPAL REGISTER

DEDON GMBH (FED REP GERMANY CORPORATION)
ZEPPELINSTRASSE 22
21337 LÜNEBERG, FED REP GERMANY

FOR: FURNITURE, IN CLASS 20 (U.S. CLS. 2, 13, 22, 25, 32 AND 50).

FIRST USE 4-1-2012; IN COMMERCE 4-1-2012.

THE MARK CONSISTS OF STANDARD CHARACTERS WITHOUT CLAIM TO ANY PARTICULAR FONT, STYLE, SIZE, OR COLOR.

SN 85-286,915, FILED 4-5-2011.

CHERYL CLAYTON, EXAMINING ATTORNEY



David J. Kyros

Director of the United States Patent and Trademark Office

United States of America

United States Patent and Trademark Office

Frank Organics

Reg. No. 4,176,692

FRANK ORGANICS, LLC (INDIANA LIMITED LIABILITY COMPANY)

Registered July 17, 2012

53 PARK PLACE 5C
NEW YORK, NY 10007

Int. Cl.: 29

FOR: ORGANIC NUTRITIONAL OILS FOR FOOD PURPOSES; ORGANIC OILS AND FATS FOR FOOD; ORGANIC OLIVE OIL; ORGANIC VEGETABLE OILS AND FATS, IN CLASS 29 (U.S. CL. 46).

TRADEMARK

FIRST USE 10-3-2011; IN COMMERCE 10-3-2011.

PRINCIPAL REGISTER

THE MARK CONSISTS OF STANDARD CHARACTERS WITHOUT CLAIM TO ANY PARTICULAR FONT, STYLE, SIZE, OR COLOR.

NO CLAIM IS MADE TO THE EXCLUSIVE RIGHT TO USE "ORGANICS", APART FROM THE MARK AS SHOWN.

SN 85-286,917, FILED 4-5-2011.

INGA ERVIN, EXAMINING ATTORNEY



David J. Kyffers

Director of the United States Patent and Trademark Office

United States of America

United States Patent and Trademark Office

KLIXEL8

Reg. No. 4,176,693

BENEVOLTEK, INC. (MAINE CORPORATION)

Registered July 17, 2012

P.O. BOX 17797
PORTLAND, ME 041128787

Int. Cl.: 42

FOR: TECHNOLOGICAL PLANNING AND CONSULTING SERVICES IN THE FIELD OF DESIGN, SELECTION, AND IMPLEMENTATION OF SOFTWARE FOR OTHERS; SOFTWARE DESIGN AND DEVELOPMENT SERVICES, NAMELY, CREATING AN IMAGE MAP OF OR FOR USE WITH A DIGITAL IMAGE, IN CLASS 42 (U.S. CLS. 100 AND 101).

SERVICE MARK

PRINCIPAL REGISTER

FIRST USE 11-10-2011; IN COMMERCE 11-10-2011.

THE MARK CONSISTS OF STANDARD CHARACTERS WITHOUT CLAIM TO ANY PARTICULAR FONT, STYLE, SIZE, OR COLOR.

SN 85-287,212, FILED 4-5-2011.

RUDY R. SINGLETON, EXAMINING ATTORNEY



David J. Kyffers

Director of the United States Patent and Trademark Office

United States of America

United States Patent and Trademark Office

BubbleBuzz

Reg. No. 4,176,694

ELEMBABY, HAITHEM I (UNITED STATES INDIVIDUAL)
59 LINCOLN AVE E

Registered July 17, 2012

WEST HARRISON, NY 10604

Int. Cl.: 45

FOR: ONLINE SOCIAL NETWORKING SERVICES PROVIDED THROUGH A COMMUNITY WEBSITE, IN CLASS 45 (U.S. CLS. 100 AND 101).

SERVICE MARK

FIRST USE 1-1-2012; IN COMMERCE 1-1-2012.

PRINCIPAL REGISTER

THE MARK CONSISTS OF STANDARD CHARACTERS WITHOUT CLAIM TO ANY PARTICULAR FONT, STYLE, SIZE, OR COLOR.

SN 85-287,672, FILED 4-6-2011.

BRENDAN REGAN, EXAMINING ATTORNEY



David J. Kybas

Director of the United States Patent and Trademark Office

United States of America

United States Patent and Trademark Office

Art of Nature

Reg. No. 4,176,695

LJ WEST DIAMONDS, INC. (NEW YORK CORPORATION)

Registered July 17, 2012

LJ WEST DIAMONDS, 589 5TH AVE, ROOM 1102
NEW YORK, NY 10017

Int. Cl.: 14

FOR: CUT DIAMONDS; DIAMOND JEWELRY; DIAMONDS, IN CLASS 14 (U.S. CLS. 2, 27, 28 AND 50).

TRADEMARK

FIRST USE 7-28-2011; IN COMMERCE 7-28-2011.

PRINCIPAL REGISTER

THE MARK CONSISTS OF STANDARD CHARACTERS WITHOUT CLAIM TO ANY PARTICULAR FONT, STYLE, SIZE, OR COLOR.

SN 85-287,728, FILED 4-6-2011.

ANNE FARRELL, EXAMINING ATTORNEY



David J. Kybas

Director of the United States Patent and Trademark Office

United States of America

United States Patent and Trademark Office

WE ♥
LOCALS

Reg. No. 4,176,696

NP IP HOLDINGS LLC (NEVADA LIMITED LIABILITY COMPANY)
1505 SOUTH PAVILION CENTER DRIVE
LAS VEGAS, NV 89135

Registered July 17, 2012

Int. Cl.: 25

FOR: HEADGEAR, NAMELY, HATS AND CAPS; T-SHIRTS, IN CLASS 25 (U.S. CLS. 22 AND 39).

TRADEMARK

FIRST USE 12-5-2010; IN COMMERCE 12-5-2010.

PRINCIPAL REGISTER

THE MARK CONSISTS OF THE STYLIZED WORD "WE" WHICH IS TO THE LEFT OF A DRAWING OF A HEART BOTH OF WHICH ARE OVER THE STYLIZED WORD "LOCALS".

SN 85-288,139, FILED 4-6-2011.

KELLY BOULTON, EXAMINING ATTORNEY



David J. Kybas

Director of the United States Patent and Trademark Office

United States of America

United States Patent and Trademark Office



Reg. No. 4,176,697

CAGESPAWN, LLC (OHIO LIMITED LIABILITY COMPANY), DBA CAGESPAWN,
907 TURQUOISE ST #130
SAN DIEGO, CA 92109

Registered July 17, 2012

Int. Cl.: 25

FOR: ATHLETIC APPAREL, NAMELY, SHIRTS, PANTS, JACKETS, FOOTWEAR, HATS
AND CAPS, ATHLETIC UNIFORMS; GYM PANTS; HATS; HOODED SWEATSHIRTS;
SWEATSHIRTS; T-SHIRTS; WEARABLE GARMENTS AND CLOTHING, NAMELY, SHIRTS,
IN CLASS 25 (U.S. CLS. 22 AND 39).

TRADEMARK

PRINCIPAL REGISTER

FIRST USE 10-11-2011; IN COMMERCE 10-24-2011.

THE MARK CONSISTS OF STYLIZED LETTERS, COMPLETE WITH FLOURISHES AND
ACCENTS, THAT SPELL OUT THE WORD "CAGESPAWN".

SN 85-288,401, FILED 4-6-2011.

GINA HAYES, EXAMINING ATTORNEY



David J. Kybas

Director of the United States Patent and Trademark Office

United States of America

United States Patent and Trademark Office



Reg. No. 4,176,698

Registered July 17, 2012

Int. Cl.: 5

TRADEMARK

PRINCIPAL REGISTER

RECKITT BENCKISER LLC (DELAWARE LIMITED LIABILITY COMPANY)
399 INTERPACE PARKWAY
PARSIPPANY, NJ 07054

FOR: PHARMACEUTICAL PREPARATIONS FOR USE AS AN EXPECTORANT, IN CLASS 5 (U.S. CLS. 6, 18, 44, 46, 51 AND 52).

FIRST USE 7-1-2011; IN COMMERCE 7-1-2011.

OWNER OF U.S. REG. NO. 3,847,882.

NO CLAIM IS MADE TO THE EXCLUSIVE RIGHT TO USE "12 HOUR", APART FROM THE MARK AS SHOWN.

THE MARK CONSISTS OF A CLOCK DESIGN WITH "12 HOUR" APPEARING IN THE CENTER AND AN ARROW DESIGN BEGINNING AT THE 6 O'CLOCK POSITION ON THE CLOCK AND CURVING AROUND THE LEFT HAND SIDE OF THE CLOCK AND WIDENING AS IT REACHES THE "12" O'CLOCK POSITION; THE HEAD OF THE ARROW EXTENDS SLIGHTLY INTO THE CLOCK FACE AND ABOVE THE CLOCK FACE AND THE ARROW'S POINT IS DIRECTED TO THE RIGHT ABOVE THE 1 O'CLOCK POSITION WITH AN IMAGE OF A PILL APPEARING BELOW "12 HOUR" SLIGHTLY TO THE BOTTOM-RIGHT OF THE CLOCK DESIGN.

SN 85-288,509, FILED 4-7-2011.

PRISCILLA MILTON, EXAMINING ATTORNEY



David J. Kybas

Director of the United States Patent and Trademark Office

United States of America

United States Patent and Trademark Office



Reg. No. 4,176,699

AARC, LLC (DELAWARE LIMITED LIABILITY COMPANY)
135 NORTH CHURCH STREET
SPARTANBURG, SC 29306

Registered July 17, 2012

Int. Cl.: 36

FOR: CONSUMER LENDING SERVICES; FINANCIAL SERVICES IN THE NATURE OF MONEY LENDING, CHECK CASHING, DEFERRED DEPOSITS, FINANCIAL OVERDRAFT PROTECTION, AND SHORT-TERM CONSUMER LOANS, IN CLASS 36 (U.S. CLS. 100, 101 AND 102).

SERVICE MARK

PRINCIPAL REGISTER

FIRST USE 5-16-2011; IN COMMERCE 5-16-2011.

NO CLAIM IS MADE TO THE EXCLUSIVE RIGHT TO USE ".COM", APART FROM THE MARK AS SHOWN.

THE MARK CONSISTS OF THE WORDS "YOU MIGHT BE" ABOVE THE WORD "SURPRISED", WHICH IS ABOVE THE WORD ".COM"; THE GRAY BACKGROUND CARRIER IS NOT CLAIMED AS A FEATURE OF THE MARK.

SN 85-288,649, FILED 4-7-2011.

JOSETTE BEVERLY, EXAMINING ATTORNEY



David J. Kyffers

Director of the United States Patent and Trademark Office

United States of America

United States Patent and Trademark Office

Nectar Girl

Reg. No. 4,176,700

NECTAR GIRL LLC (TEXAS LIMITED LIABILITY COMPANY)
6436 PATRICK DRIVE
DALLAS, TX 75214

Registered July 17, 2012

Int. Cl.: 32

FOR: NON-ALCOHOLIC COCKTAIL MIXES, IN CLASS 32 (U.S. CLS. 45, 46 AND 48).

TRADEMARK

FIRST USE 9-1-2011; IN COMMERCE 10-2-2011.

PRINCIPAL REGISTER

THE MARK CONSISTS OF STANDARD CHARACTERS WITHOUT CLAIM TO ANY PARTICULAR FONT, STYLE, SIZE, OR COLOR.

NO CLAIM IS MADE TO THE EXCLUSIVE RIGHT TO USE "NECTAR", APART FROM THE MARK AS SHOWN.

SN 85-288,924, FILED 4-7-2011.

NAKIA HENRY, EXAMINING ATTORNEY



David J. Kyffers

Director of the United States Patent and Trademark Office

United States of America

United States Patent and Trademark Office

Navigos Capital Management

Reg. No. 4,176,701

Registered July 17, 2012

Int. Cl.: 36

SERVICE MARK

PRINCIPAL REGISTER

NAVIGOS CAPITAL MANAGEMENT LLC (NEW YORK LIMITED LIABILITY COMPANY)
FIFTH FLOOR
875 THIRD AVENUE
NEW YORK, NY 10022

FOR: CAPITAL INVESTMENT CONSULTING; FINANCIAL PORTFOLIO MANAGEMENT;
FINANCIAL SERVICES, NAMELY, INVESTMENT ADVICE, INVESTMENT MANAGEMENT,
INVESTMENT CONSULTATION AND INVESTMENT OF FUNDS FOR OTHERS, INCLUDING
PRIVATE AND PUBLIC EQUITY AND DEBT INVESTMENT SERVICES; INVESTMENT
CONSULTATION, IN CLASS 36 (U.S. CLS. 100, 101 AND 102).

FIRST USE 10-11-2011; IN COMMERCE 10-11-2011.

THE MARK CONSISTS OF STANDARD CHARACTERS WITHOUT CLAIM TO ANY PAR-
TICULAR FONT, STYLE, SIZE, OR COLOR.

NO CLAIM IS MADE TO THE EXCLUSIVE RIGHT TO USE "CAPITAL MANAGEMENT",
APART FROM THE MARK AS SHOWN.

SN 85-289,067, FILED 4-7-2011.

LINDA ESTRADA, EXAMINING ATTORNEY



David J. Kyffers

Director of the United States Patent and Trademark Office

United States of America

United States Patent and Trademark Office

FRANKLIN  BEN

Reg. No. 4,176,702

BEXCO ENTERPRISES, INC. (TEXAS CORPORATION)
841 WASHINGTON BOULEVARD
MONTEBELLO, CA 90640

Registered July 17, 2012

Int. Cl.: 20

FOR: INDOOR HOUSEHOLD FURNITURE FOR BABIES AND CHILDREN; INDOOR HOUSEHOLD FURNITURE FOR BABIES AND CHILDREN, NAMELY, DRESSERS, BUREAUS, ARMOIRES, ROCKING CHAIRS, CRIBS, TOY CHESTS, CHANGING TABLES, BEDS AND MATTRESSES, CONVERTIBLE BEDS, NAMELY, CRIBS WHICH CONVERT TO DAY BEDS OR FULL SIZE BEDS, AND TABLE AND CHAIR SETS, IN CLASS 20 (U.S. CLS. 2, 13, 22, 25, 32 AND 50).

TRADEMARK

PRINCIPAL REGISTER

FIRST USE 2-23-2012; IN COMMERCE 2-23-2012.

THE MARK CONSISTS OF THE WORDS "FRANKLIN" AND "BEN", SEPARATED BY A STYLIZED SEAL BEARING AN AMPERSAND.

SN 85-289,396, FILED 4-7-2011.

BRENDAN REGAN, EXAMINING ATTORNEY



David J. Kybas

Director of the United States Patent and Trademark Office

United States of America

United States Patent and Trademark Office



Reg. No. 4,176,703

IVENTIONZ, INC. (NEW YORK CORPORATION)
30 MANORHAVEN BLVD.
PORT WASHINGTON, NY 11050

Registered July 17, 2012

Int. Cl.: 35

FOR: ON-LINE WHOLESALE AND RETAIL STORE SERVICES FEATURING TOYS, IN CLASS 35 (U.S. CLS. 100, 101 AND 102).

SERVICE MARK

FIRST USE 4-25-2008; IN COMMERCE 2-28-2011.

PRINCIPAL REGISTER

NO CLAIM IS MADE TO THE EXCLUSIVE RIGHT TO USE "INC.", APART FROM THE MARK AS SHOWN.

THE MARK CONSISTS OF THE WORD "IVENTIONZ" MADE UP OF FUN CARTOON IMAGES, THE LETTER "I" IS A LIGHT BULB, THE "T" HAS A PROPELLER, THE OTHER "I" IS A SPRING AND GEAR, AND THE "Z" IS A CUTE SNAKE WITH EYES, AND THE TEXT "INC." BELOW.

SN 85-289,458, FILED 4-7-2011.

CURTIS FRENCH, EXAMINING ATTORNEY



David J. Kybas

Director of the United States Patent and Trademark Office

United States of America

United States Patent and Trademark Office



Landmark

Be Extraordinary

Reg. No. 4,176,704

LANDMARK EDUCATION LLC (DELAWARE LIMITED LIABILITY COMPANY)
353 SACRAMENTO STREET
SAN FRANCISCO, CA 94111

Registered July 17, 2012

Int. Cl.: 41

FOR: EDUCATIONAL SERVICES, NAMELY, CONDUCTING WORKSHOPS AND SEMINARS IN THE FIELDS OF EFFECTIVENESS, PRODUCTIVITY, COMMUNICATION, LEADERSHIP, MANAGEMENT, AND PERSONAL AND ORGANIZATIONAL DEVELOPMENT, IN CLASS 41 (U.S. CLS. 100, 101 AND 107).

SERVICE MARK

PRINCIPAL REGISTER

FIRST USE 4-0-2011; IN COMMERCE 4-0-2011.

OWNER OF U.S. REG. NOS. 2,432,988, 2,474,996, AND OTHERS.

SN 85-289,639, FILED 4-7-2011.

MARK RADEMACHER, EXAMINING ATTORNEY



David J. Kyjars

Director of the United States Patent and Trademark Office

United States of America

United States Patent and Trademark Office

MEGMEET

Reg. No. 4,176,705

Registered July 17, 2012

Int. Cl.: 9

MEGMEET ELECTRICAL HOLDING COMPANY LIMITED (CHINA LIMITED LIABILITY COMPANY)

5/F.,PURPLE LIGHT CYBERPORT,LANG SHAN RD
HIGH-TECH INDUSTRIAL PARK
NANSHAN, SHENZHEN, CHINA

TRADEMARK

PRINCIPAL REGISTER

FOR: CONTROL UNITS FOR REGULATING START-UP ELECTRICAL MOTORS; ELECTRONIC APPARATUS AND INSTRUMENTS FOR CONTROLLING, ADJUSTING AND TESTING OF DRIVES AND MOTORS; ELECTRONIC CONTROLS FOR MOTORS; ELECTRONIC CONTROLS FOR GASOLINE ENGINES FOR LAND VEHICLES; ELECTRONIC MOTOR SWITCHES FOR SWITCHING OFF MOTORS; ELECTRONIC POWER SUPPLIES FOR DRIVING ELECTRIC MOTORS; ELECTRONIC MOTOR VEHICLE IGNITION TUNING KITS COMPRISED OF AN ELECTRONIC CONTROL UNIT THAT MONITORS ENGINE PERFORMANCES AND DELIVERS RE-CALCULATED SENSOR VALUES TO THE ORIGINAL ENGINE CONTROL UNIT TO INCREASE ENGINE PERFORMANCE; ENGINE CUT-OUT DEVICES; SPEED LIMITERS FOR LIMITING VEHICLE ENGINE SPEED, NAMELY, AFTER-MARKET, ADD-ON DEVICES FOR VEHICLES IN ORDER TO LIMIT THE MAXIMUM SPEED OUTPUT OF AN AUTOMOBILE; VEHICLE ENGINE PARTS, NAMELY, THERMOSTATS; BICYCLE ACCESSORIES, NAMELY, ELECTRONIC SOUND MAKING DEVICES FOR USE ON BICYCLES; CUT-OUT SWITCHES; ELECTRIC CURRENT SWITCHES; ELECTRIC LIGHT SWITCHES; ELECTRIC SWITCHES; HIGH-FREQUENCY SWITCHING POWER SUPPLIES; LIGHT SWITCHES; POWER ADAPTERS; BATTERIES AND BATTERY CHARGERS; HANDHELD PERSONAL COMPUTERS; INTERFACES AND PERIPHERAL DEVICES FOR COMPUTERS, IN CLASS 9 (U.S. CLS. 21, 23, 26, 36 AND 38).



FIRST USE 7-8-2011; IN COMMERCE 7-8-2011.

THE MARK CONSISTS OF THE WORDING "MEGMEET".

SN 85-289,755, FILED 4-8-2011.

GENE MACIOL, EXAMINING ATTORNEY

David J. Kyffers

Director of the United States Patent and Trademark Office

United States of America

United States Patent and Trademark Office

EYECONIC

Reg. No. 4,176,706

Registered July 17, 2012

Int. Cl.: 31

TRADEMARK

PRINCIPAL REGISTER

CP (DELAWARE) INC. (DELAWARE CORPORATION)
103 FOULK ROAD, SUITE 202
P.O. BOX 1958
WILMINGTON, DE 19899

FOR: LIVE ROSE PLANTS, IN CLASS 31 (U.S. CLS. 1 AND 46).

FIRST USE 4-0-2011; IN COMMERCE 7-0-2011.

THE MARK CONSISTS OF STANDARD CHARACTERS WITHOUT CLAIM TO ANY PARTICULAR FONT, STYLE, SIZE, OR COLOR.

SN 85-290,137, FILED 4-8-2011.

KATHERINE E. HALMEN, EXAMINING ATTORNEY



David J. Kybas

Director of the United States Patent and Trademark Office

United States of America

United States Patent and Trademark Office

A PINT IN EVERY CAN

Reg. No. 4,176,707

SUN KING BREWING COMPANY, LLC (INDIANA LIMITED LIABILITY COMPANY)
135 N. COLLEGE AVENUE
INDIANAPOLIS, IN 46202

Registered July 17, 2012

Int. Cl.: 32

FOR: ALES; BEER; BEER, ALE AND LAGER, IN CLASS 32 (U.S. CLS. 45, 46 AND 48).

TRADEMARK

FIRST USE 7-1-2009; IN COMMERCE 7-1-2009.

PRINCIPAL REGISTER

THE MARK CONSISTS OF THE STYLIZED WORDS "A PINT IN EVERY CAN" IN TRADIZONE FONT.

SN 85-290,444, FILED 4-8-2011.

EDWARD FENNESSY, EXAMINING ATTORNEY



David J. Kyffers

Director of the United States Patent and Trademark Office

United States of America

United States Patent and Trademark Office



Reg. No. 4,176,708

Registered July 17, 2012

Int. Cl.: 30

THE W.E. LONG COMPANY - INDEPENDENT BAKERS' COOPERATIVE (ILLINOIS CORPORATION)
SUITE 650
20 NORTH CLARK STREET
CHICAGO, IL 60602

TRADEMARK

FOR: BREAD, BUNS, AND ROLLS, IN CLASS 30 (U.S. CL. 46).

PRINCIPAL REGISTER

FIRST USE 11-30-2011; IN COMMERCE 11-30-2011.

OWNER OF U.S. REG. NO. 1,928,775.

THE MARK CONSISTS OF A STAR IN AN OUTLINE CONFIGURATION WITH A HORIZONTAL BANNER ALSO HAVING AN OUTLINE CONFIGURATION WHICH CONTAINS THE STYLIZED WORD "HOLSUM" AND A SUBSTANTIALLY RECTANGULAR STRIPE DISPOSED BELOW THE BANNER.

SN 85-290,491, FILED 4-8-2011.

BARBARA RUTLAND, EXAMINING ATTORNEY



David J. Kyffers

Director of the United States Patent and Trademark Office

United States of America

United States Patent and Trademark Office



Reg. No. 4,176,709

Registered July 17, 2012

Int. Cl.: 30

TRADEMARK

PRINCIPAL REGISTER

THE W.E. LONG COMPANY - INDEPENDENT BAKERS' COOPERATIVE (ILLINOIS CORPORATION)
SUITE 650
20 NORTH CLARK STREET
CHICAGO, IL 60602

FOR: BREAD, BUNS, AND ROLLS, IN CLASS 30 (U.S. CL. 46).

FIRST USE 11-30-2011; IN COMMERCE 11-30-2011.

OWNER OF U.S. REG. NO. 1,928,775.

THE MARK CONSISTS OF A STAR DESIGN AND AN OUTLINED PARALLELOGRAM CONTAINING THE STYLIZED WORD "HOLSUM".

SN 85-290,496, FILED 4-8-2011.

BARBARA RUTLAND, EXAMINING ATTORNEY



David J. Kybas

Director of the United States Patent and Trademark Office

United States of America

United States Patent and Trademark Office

BRUVADO

Reg. No. 4,176,710

BLANCO BASURA BEVERAGE, INC. (DELAWARE CORPORATION)
111 INGALLS ST.
SANTA CRUZ, CA 95060

Registered July 17, 2012

Int. Cls.: 32 and 33

FOR: BEER, IN CLASS 32 (U.S. CLS. 45, 46 AND 48).

TRADEMARK

FIRST USE 7-1-2011; IN COMMERCE 7-1-2011.

PRINCIPAL REGISTER

FOR: ALCOHOLIC BEVERAGES EXCEPT BEERS, IN CLASS 33 (U.S. CLS. 47 AND 49).

FIRST USE 7-1-2011; IN COMMERCE 7-1-2011.

THE MARK CONSISTS OF STANDARD CHARACTERS WITHOUT CLAIM TO ANY PARTICULAR FONT, STYLE, SIZE, OR COLOR.

SN 85-290,637, FILED 4-8-2011.

ODESSA BIBBINS, EXAMINING ATTORNEY



David J. Kybas

Director of the United States Patent and Trademark Office

United States of America

United States Patent and Trademark Office



Reg. No. 4,176,711

SMITH III, EDDIE (UNITED STATES INDIVIDUAL)
3148 MONTWOOD DRIVE
MONTGOMERY, AL 36116

Registered July 17, 2012

Int. Cl.: 9

FOR: AUDIO RECORDINGS FEATURING MUSIC; VIDEO RECORDINGS FEATURING MUSIC, IN CLASS 9 (U.S. CLS. 21, 23, 26, 36 AND 38).

TRADEMARK

FIRST USE 2-21-2011; IN COMMERCE 12-17-2011.

PRINCIPAL REGISTER

NO CLAIM IS MADE TO THE EXCLUSIVE RIGHT TO USE "COUNTRY", APART FROM THE MARK AS SHOWN.

THE MARK CONSISTS OF A DUCK WITH HUMAN HAIR, WEARING SUNGLASSES AND OVERALLS, AND CARRYING A STICK WITH A BAG ATTACHED TO IT OVER THE DUCK'S SHOULDER AS IT WALKS MID STRIDE. THE WORDS "COUNTRY DUCK" APPEAR UNDER THE DUCK.

SN 85-290,750, FILED 4-8-2011.

MARY CRAWFORD, EXAMINING ATTORNEY



David J. Kyros

Director of the United States Patent and Trademark Office

United States of America

United States Patent and Trademark Office

T3 TACTICAL

Reg. No. 4,176,712

MAGENAV, INC. (NEW YORK CORPORATION), DBA STATGEAR,
141-02 68TH DRIVE
FLUSHING, NY 11367

Registered July 17, 2012

Int. Cl.: 10

FOR: MEDICAL APPARATUS AND INSTRUMENT ATTACHED TO A STETHOSCOPE INSIDE ITS OWN HOLSTER, NAMELY, A LIGHT TO ASSESS PUPIL REACTION AND A CUTTING BLADE, IN CLASS 10 (U.S. CLS. 26, 39 AND 44).

TRADEMARK

FIRST USE 4-2-2012; IN COMMERCE 4-2-2012.

PRINCIPAL REGISTER

THE MARK CONSISTS OF STANDARD CHARACTERS WITHOUT CLAIM TO ANY PARTICULAR FONT, STYLE, SIZE, OR COLOR.

NO CLAIM IS MADE TO THE EXCLUSIVE RIGHT TO USE "TACTICAL", APART FROM THE MARK AS SHOWN.

SN 85-290,778, FILED 4-8-2011.

DAVID C. REIHNER, EXAMINING ATTORNEY



David J. Kyffers

Director of the United States Patent and Trademark Office

United States of America

United States Patent and Trademark Office



Reg. No. 4,176,713

BAUGH, AYANA (UNITED STATES INDIVIDUAL)
2036 MOURNING DOVE DR
LOCUST GROVE, VA 22508

Registered July 17, 2012

Int. Cl.: 16

FOR: BOOK MARKS; CHILDREN'S BOOKS; COLORING BOOKS; STATIONERY; TRADING CARDS, IN CLASS 16 (U.S. CLS. 2, 5, 22, 23, 29, 37, 38 AND 50).

TRADEMARK

FIRST USE 4-18-2012; IN COMMERCE 4-18-2012.

PRINCIPAL REGISTER

THE STIPLING IS A FEATURE OF THE MARK.

THE MARK CONSISTS OF A CARTOON CHARACTER IN THE NATURE OF A CHIHUAHUA WEARING A HIPPOPOTAMUS COSTUME AND CASTING A SMALL SHADOW. THE CHARACTER IS STANDING UNDER THE STYLIZED WORDING "LOOPIETHOTAMUS" WHICH FORMS AN ARCH.

SN 85-290,857, FILED 4-8-2011.

CHRISTINE COOPER, EXAMINING ATTORNEY



David J. Kybas

Director of the United States Patent and Trademark Office

United States of America

United States Patent and Trademark Office

INDIVISIBLE

Reg. No. 4,176,714

Registered July 17, 2012

Int. Cl.: 9

TRADEMARK

PRINCIPAL REGISTER

TEEL, SHAWN T. (MARYLAND SOLE PROPRIETORSHIP), DBA SKRULUS/YOUR FLYNESS,
A CITIZEN OF THE UNITED STATES,
1117 DUTTON WAY
CAPITOL HEIGHTS, MD 20743

FOR: COMPACT DISCS FEATURING MUSIC; COMPACT DISCS FEATURING MUSIC AND
SPOKEN WORD IN THE FORM OF POETRY; DIGITAL MUSIC DOWNLOADABLE FROM
THE INTERNET; DIGITAL MUSIC SYSTEMS THAT SYNCHRONIZES DIGITAL RADIO
FILES STORED ON A HOME UNIT, A CAR UNIT, OR PORTABLE UNIT AND THAT MAY
BE BACKED UP TO AN INTERNET DEPOSITORY; DOWNLOADABLE MUSICAL SOUND
RECORDINGS; DOWNLOADABLE RING TONES, GRAPHICS AND MUSIC VIA A GLOBAL
COMPUTER NETWORK AND WIRELESS DEVICES; MUSICAL RECORDINGS; MUSICAL
SOUND RECORDINGS; MUSICAL VIDEO RECORDINGS; PHONOGRAPH RECORDS
FEATURING MUSIC; VISUAL RECORDINGS AND AUDIOVISUAL RECORDINGS FEATUR-
ING MUSIC AND ANIMATION, IN CLASS 9 (U.S. CLS. 21, 23, 26, 36 AND 38).

FIRST USE 1-0-2012; IN COMMERCE 1-0-2012.

THE MARK CONSISTS OF STANDARD CHARACTERS WITHOUT CLAIM TO ANY PAR-
TICULAR FONT, STYLE, SIZE, OR COLOR.

SN 85-291,021, FILED 4-9-2011.

DAVID C. REIHNER, EXAMINING ATTORNEY



David J. Kyffers

Director of the United States Patent and Trademark Office

United States of America

United States Patent and Trademark Office

hi5

Reg. No. 4,176,715

Registered July 17, 2012

Int. Cls.: 35, 38, and 45

SERVICE MARK

PRINCIPAL REGISTER

TAGGED ACQUISITION CORPORATION (DELAWARE CORPORATION)
840 BATTERY, 2ND FLOOR
SAN FRANCISCO, CA 94111

FOR: ON-LINE DIRECTORY-INFORMATION SERVICES FEATURING INFORMATION REGARDING VIRTUAL COMMUNITIES AND SOCIAL NETWORKING, IN CLASS 35 (U.S. CLS. 100, 101 AND 102).

FIRST USE 1-1-2010; IN COMMERCE 1-1-2010.

FOR: TELECOMMUNICATION SERVICES, NAMELY, THE RECEIPT AND DELIVERY OF MESSAGES, DOCUMENTS, IMAGES AND OTHER DATA BY ELECTRONIC TRANSMISSION; PROVIDING BULLETIN-BOARD, MESSAGE-BOARD AND CHAT-ROOM SERVICES TO REGISTERED USERS OF ONLINE DATING, SOCIAL INTRODUCTION AND SOCIAL-NETWORKING SERVICES; ELECTRONIC-MAIL SERVICES, IN CLASS 38 (U.S. CLS. 100, 101 AND 104).

FIRST USE 1-1-2010; IN COMMERCE 1-1-2010.

FOR: DATING AND INTRODUCTION SERVICES, AND SOCIAL NETWORKING SERVICES BY MEANS OF GLOBAL COMMUNICATION NETWORKS, IN CLASS 45 (U.S. CLS. 100 AND 101).

FIRST USE 1-1-2010; IN COMMERCE 1-1-2010.

THE MARK CONSISTS OF THE WORD "HI" IN LOWER CASE NEXT TO THE DIGIT "5" ALL OUTLINED IN BLACK.

SN 85-291,261, FILED 4-11-2011.

NAAKWAMA ANKRAH, EXAMINING ATTORNEY



David J. Kyffers

Director of the United States Patent and Trademark Office

United States of America

United States Patent and Trademark Office

CONNECT WITH THE PUBLIC

Reg. No. 4,176,716

CARLETON, PATRICK (CANADA INDIVIDUAL)

Registered July 17, 2012

906 - 1110 11 STREET S.W.
CALGARY, CANADA T2R1S5

Int. Cl.: 35

FOR: DISTRIBUTION AND DISSEMINATION OF ADVERTISING MATERIALS, NAMELY, CORPORATE ANNOUNCEMENTS, PRESS RELEASES AND CLASSIFIED ADVERTISEMENTS, IN CLASS 35 (U.S. CLS. 100, 101 AND 102).

SERVICE MARK

FIRST USE 3-21-2012; IN COMMERCE 3-21-2012.

PRINCIPAL REGISTER

THE MARK CONSISTS OF STANDARD CHARACTERS WITHOUT CLAIM TO ANY PARTICULAR FONT, STYLE, SIZE, OR COLOR.

SN 85-291,272, FILED 4-11-2011.

JEFF DEFORD, EXAMINING ATTORNEY



David J. Kybas

Director of the United States Patent and Trademark Office

United States of America

United States Patent and Trademark Office

neobail

Reg. No. 4,176,717

INSPIRED JEWELRY, INC (IOWA CORPORATION)
PO BOX 162
CEDAR RAPIDS, IA 52406

Registered July 17, 2012

Int. Cl.: 14

FOR: BRACELETS; CHARMS; CHARMS FOR COLLAR JEWELRY AND BRACELET; JEWELRY FINDINGS; JEWELRY, NAMELY, AMULETS; JEWELRY, NAMELY, CROSSES; JEWELRY, NAMELY, MAGNETIC NECKLACES; JEWELRY, NAMELY, MAGNETIC PENDANTS; WOMEN'S JEWELRY, IN CLASS 14 (U.S. CLS. 2, 27, 28 AND 50).

TRADEMARK

PRINCIPAL REGISTER

FIRST USE 4-1-2012; IN COMMERCE 4-1-2012.

THE MARK CONSISTS OF STANDARD CHARACTERS WITHOUT CLAIM TO ANY PARTICULAR FONT, STYLE, SIZE, OR COLOR.

SN 85-291,557, FILED 4-11-2011.

ANNE E. GUSTASON, EXAMINING ATTORNEY



David J. Kybas

Director of the United States Patent and Trademark Office

United States of America

United States Patent and Trademark Office

GO KETO!

Reg. No. 4,176,718

Registered July 17, 2012

Int. Cls.: 35, 41, and 44

THE WALKER CLINIC OF HEALTH AND WELLNESS, LLC (ARIZONA LIMITED LIABILITY COMPANY)
SUITE 200
7331 EAST OSBORN DRIVE
SCOTTSDALE, AZ 85251

SERVICE MARK

PRINCIPAL REGISTER

FOR: ADVERTISING AND PROMOTING GOODS AND SERVICES OF OTHERS IN THE FIELDS OF HUMAN PHYSIOLOGY, HEALTH, NUTRITION AND DIET PLANS, IN CLASS 35 (U.S. CLS. 100, 101 AND 102).

FIRST USE 4-4-2012; IN COMMERCE 4-4-2012.

FOR: EDUCATION SERVICES, NAMELY, SEMINARS, WORKSHOPS IN THE FIELDS OF HEALTH, DISEASE, NUTRITION, WEIGHT LOSS, WEIGHT CONTROL AND MAINTENANCE, DIET, RECIPES, MEAL PLANNING, AND LIFESTYLE WELLNESS; PUBLISHING BOOKS, PAMPHLET, FLIERS AND NEWSLETTERS IN THE FIELD OF HEALTH, DISEASE, NUTRITION, WEIGHT LOSS, WEIGHT CONTROL AND MAINTENANCE, DIET, RECIPES, MEAL PLANNING, AND LIFESTYLE WELLNESS; INTERNET POSTINGS, NAMELY, BLOGS ON THE SUBJECT OF HEALTH, DISEASE, NUTRITION, WEIGHT LOSS, WEIGHT CONTROL AND MAINTENANCE, DIET, RECIPES, MEAL PLANNING, AND LIFESTYLE WELLNESS, IN CLASS 41 (U.S. CLS. 100, 101 AND 107).

FIRST USE 4-4-2012; IN COMMERCE 4-4-2012.

FOR: HEALTH AND NUTRITION CONSULTATION SERVICES RELATING TO WEIGHT LOSS, DISEASES AND OVERALL WELLNESS, WEIGHT LOSS DIET PLANNING AND ADVISING ON PROTEIN, CARBOHYDRATE AND FAT IN-TAKE IN DIFFERENT PHASES OF A DESIGNED DIET PLAN, IN CLASS 44 (U.S. CLS. 100 AND 101).

FIRST USE 4-4-2012; IN COMMERCE 4-4-2012.

THE MARK CONSISTS OF STANDARD CHARACTERS WITHOUT CLAIM TO ANY PARTICULAR FONT, STYLE, SIZE, OR COLOR.

NO CLAIM IS MADE TO THE EXCLUSIVE RIGHT TO USE "KETO", APART FROM THE MARK AS SHOWN.



David J. Kyjars

Director of the United States Patent and Trademark Office

Reg. No. 4,176,718 SN 85-292,136, FILED 4-11-2011.

JEFFREY LOOK, EXAMINING ATTORNEY

United States of America

United States Patent and Trademark Office

COWBOY BEEF

Reg. No. 4,176,719

Registered July 17, 2012

Int. Cl.: 29

TRADEMARK

PRINCIPAL REGISTER

JOHN FERRENTINO (UNITED STATES INDIVIDUAL)
11 RAMSEY TERRACE
FAIR LAWN, NJ 07410

FOR: CHILI, IN CLASS 29 (U.S. CL. 46).

FIRST USE 5-24-2009; IN COMMERCE 7-4-2010.

THE MARK CONSISTS OF STANDARD CHARACTERS WITHOUT CLAIM TO ANY PARTICULAR FONT, STYLE, SIZE, OR COLOR.

NO CLAIM IS MADE TO THE EXCLUSIVE RIGHT TO USE "BEEF", APART FROM THE MARK AS SHOWN.

SN 85-292,237, FILED 4-11-2011.

MICHAEL WEBSTER, EXAMINING ATTORNEY



David J. Kybas

Director of the United States Patent and Trademark Office

United States of America

United States Patent and Trademark Office

BANZO MASALA

Reg. No. 4,176,720

JOHN FERRENTINO (UNITED STATES INDIVIDUAL)
11 RAMSEY TERRACE
FAIR LAWN, NJ 07410

Registered July 17, 2012

Int. Cl.: 29

FOR: CHILI, IN CLASS 29 (U.S. CL. 46).

TRADEMARK

FIRST USE 5-24-2009; IN COMMERCE 7-4-2010.

PRINCIPAL REGISTER

THE MARK CONSISTS OF STANDARD CHARACTERS WITHOUT CLAIM TO ANY PARTICULAR FONT, STYLE, SIZE, OR COLOR.

NO CLAIM IS MADE TO THE EXCLUSIVE RIGHT TO USE "MASALA", APART FROM THE MARK AS SHOWN.

THE ENGLISH TRANSLATION OF THE WORD "MASALA" IN THE MARK IS "SPICE".

SN 85-292,240, FILED 4-11-2011.

MICHAEL WEBSTER, EXAMINING ATTORNEY



David J. Kyffers

Director of the United States Patent and Trademark Office

United States of America

United States Patent and Trademark Office

BaBOOM! BEEF

Reg. No. 4,176,721

JOHN FERRENTINO (UNITED STATES INDIVIDUAL)
11 RAMSEY TERRACE
FAIR LAWN, NJ 07410

Registered July 17, 2012

Int. Cl.: 29

FOR: CHILI, IN CLASS 29 (U.S. CL. 46).

FIRST USE 5-24-2009; IN COMMERCE 7-4-2010.

TRADEMARK

THE MARK CONSISTS OF STANDARD CHARACTERS WITHOUT CLAIM TO ANY PARTICULAR FONT, STYLE, SIZE, OR COLOR.

PRINCIPAL REGISTER

NO CLAIM IS MADE TO THE EXCLUSIVE RIGHT TO USE "BEEF", APART FROM THE MARK AS SHOWN.

SN 85-292,245, FILED 4-11-2011.

MICHAEL WEBSTER, EXAMINING ATTORNEY



David J. Kybas

Director of the United States Patent and Trademark Office

United States of America

United States Patent and Trademark Office

ALL-STAR TURKEY

Reg. No. 4,176,722

JOHN FERRENTINO (UNITED STATES INDIVIDUAL)
11 RAMSEY TERRACE
FAIR LAWN, NJ 07410

Registered July 17, 2012

Int. Cl.: 29

FOR: CHILI, IN CLASS 29 (U.S. CL. 46).

TRADEMARK

FIRST USE 5-24-2009; IN COMMERCE 7-4-2010.

PRINCIPAL REGISTER

THE MARK CONSISTS OF STANDARD CHARACTERS WITHOUT CLAIM TO ANY PARTICULAR FONT, STYLE, SIZE, OR COLOR.

NO CLAIM IS MADE TO THE EXCLUSIVE RIGHT TO USE "TURKEY", APART FROM THE MARK AS SHOWN.

SN 85-292,247, FILED 4-11-2011.

MICHAEL WEBSTER, EXAMINING ATTORNEY



David J. Kybas

Director of the United States Patent and Trademark Office

United States of America

United States Patent and Trademark Office

STELLAR

Reg. No. 4,176,723

ENCOMPASS GROUPE, LLC (DELAWARE LIMITED LIABILITY COMPANY)
615 MACON STREET
MCDONOUGH, GA 30253

Registered July 17, 2012

Int. Cls.: 10 and 20

FOR: FOAM-FILLED POSITIONING PADS AND SUPPORT CUSHIONS FOR MEDICAL USE,
IN CLASS 10 (U.S. CLS. 26, 39 AND 44).

TRADEMARK

FIRST USE 5-8-2012; IN COMMERCE 5-8-2012.

PRINCIPAL REGISTER

FOR: PILLOWS, IN CLASS 20 (U.S. CLS. 2, 13, 22, 25, 32 AND 50).

FIRST USE 1-2-2012; IN COMMERCE 1-2-2012.

THE MARK CONSISTS OF STANDARD CHARACTERS WITHOUT CLAIM TO ANY PARTICULAR FONT, STYLE, SIZE, OR COLOR.

SN 85-292,847, FILED 4-12-2011.

JUDITH HELFMAN, EXAMINING ATTORNEY



David J. Kyros

Director of the United States Patent and Trademark Office

United States of America

United States Patent and Trademark Office

BehrPro



Reg. No. 4,176,724

BEHR PROCESS CORPORATION (CALIFORNIA CORPORATION)
3400 W. SEGERSTROM AVE.
SANTA ANA, CA 92704

Registered July 17, 2012

Int. Cl.: 39

FOR: DISTRIBUTION OF SERVICES, NAMELY, DELIVERY OF PAINT, IN CLASS 39 (U.S. CLS. 100 AND 105).

SERVICE MARK

FIRST USE 7-0-2011; IN COMMERCE 7-0-2011.

PRINCIPAL REGISTER

OWNER OF U.S. REG. NOS. 942,246, 1,551,547, AND OTHERS.

THE MARK CONSISTS OF THE WORD "BEHRPRO" OVER A SOLID RECTANGULAR BLOCK WITH A BEAR IN THE RIGHT CORNER OF THE RECTANGULAR BLOCK.

SN 85-292,937, FILED 4-12-2011.

MARTHA FROMM, EXAMINING ATTORNEY



David J. Kyffers

Director of the United States Patent and Trademark Office

United States of America

United States Patent and Trademark Office

SEAX

Reg. No. 4,176,725

Registered July 17, 2012

Int. Cl.: 20

TRADEMARK

PRINCIPAL REGISTER

DEDON GMBH (FED REP GERMANY CORPORATION)
ZEPPELINSTRASSE 22
LÜNEBERG, FED REP GERMANY 21337

FOR: FURNITURE, IN CLASS 20 (U.S. CLS. 2, 13, 22, 25, 32 AND 50).

FIRST USE 4-1-2012; IN COMMERCE 4-1-2012.

THE MARK CONSISTS OF STANDARD CHARACTERS WITHOUT CLAIM TO ANY PARTICULAR FONT, STYLE, SIZE, OR COLOR.

SN 85-292,960, FILED 4-12-2011.

CHERYL CLAYTON, EXAMINING ATTORNEY



David J. Kybas

Director of the United States Patent and Trademark Office

United States of America

United States Patent and Trademark Office

LEONARD'S MALASADAS

Reg. No. 4,176,726

LEONARD'S BAKERY, LTD. (HAWAII CORPORATION)
933 KAPAHULU AVE.
HONOLULU, HI 96816

Registered July 17, 2012

Int. Cl.: 25

FOR: CAPS; HATS; HEADGEAR, NAMELY, CAPS; SHIRTS; SHORTS; SWEAT SHIRTS; T-SHIRTS, IN CLASS 25 (U.S. CLS. 22 AND 39).

TRADEMARK

FIRST USE 4-13-2012; IN COMMERCE 4-13-2012.

PRINCIPAL REGISTER

THE MARK CONSISTS OF STANDARD CHARACTERS WITHOUT CLAIM TO ANY PARTICULAR FONT, STYLE, SIZE, OR COLOR.

OWNER OF U.S. REG. NOS. 3,372,611, 3,913,491, AND OTHERS.

THE NAME SHOWN IN THE MARK DOES NOT IDENTIFY A PARTICULAR LIVING INDIVIDUAL.

SN 85-293,435, FILED 4-12-2011.

KAREN K. BUSH, EXAMINING ATTORNEY



David J. Kybas

Director of the United States Patent and Trademark Office

United States of America

United States Patent and Trademark Office



Reg. No. 4,176,727

Registered July 17, 2012

Int. Cl.: 41

SERVICE MARK

PRINCIPAL REGISTER

ROSEHAVEN PRODUCTION, LLC (DELAWARE LIMITED LIABILITY COMPANY)
3915 SAXTON COURT
WHITE PLAINS, MD 20695

FOR: TELEVISION, VIDEO AND MOVIE FILMING SERVICES, IN CLASS 41 (U.S. CLS. 100, 101 AND 107).

FIRST USE 11-21-2011; IN COMMERCE 11-21-2011.

NO CLAIM IS MADE TO THE EXCLUSIVE RIGHT TO USE "PRODUCTION, LLC", APART FROM THE MARK AS SHOWN.

THE MARK CONSISTS OF THE LETTER "R" POSITIONED INSIDE BIRDS' WINGS, WITH THE WORDS "ROSEHAVEN PRODUCTION, LLC" HOVERING ABOVE IT.

SN 85-293,533, FILED 4-12-2011.

JAMES GRIFFIN, EXAMINING ATTORNEY



David J. Kyffers

Director of the United States Patent and Trademark Office

United States of America

United States Patent and Trademark Office

INCHEX

Reg. No. 4,176,728

HICKORY SPRINGS MANUFACTURING COMPANY (NORTH CAROLINA CORPORATION)
POST OFFICE BOX 128
HICKORY, NC 28603

Registered July 17, 2012

Int. Cl.: 20

FOR: MATTRESS INNERSPRING ASSEMBLY, NAMELY, A NETWORK OF A PLURALITY OF COIL SPRINGS INTERCONNECTED TOGETHER, IN CLASS 20 (U.S. CLS. 2, 13, 22, 25, 32 AND 50).

TRADEMARK

FIRST USE 4-4-2012; IN COMMERCE 4-4-2012.

PRINCIPAL REGISTER

THE MARK CONSISTS OF STANDARD CHARACTERS WITHOUT CLAIM TO ANY PARTICULAR FONT, STYLE, SIZE, OR COLOR.

SN 85-293,642, FILED 4-13-2011.

ALLISON HOLTZ, EXAMINING ATTORNEY



David J. Kyffers

Director of the United States Patent and Trademark Office

United States of America

United States Patent and Trademark Office



Reg. No. 4,176,729

Registered July 17, 2012

Int. Cl.: 29

TRADEMARK

PRINCIPAL REGISTER

R B & T'S EMPIRES, LLC (MISSOURI LIMITED LIABILITY COMPANY)
4993 LOUGHBOROUGH AVE.
ST. LOUIS, MO 63109

FOR: POTATO CHIPS, IN CLASS 29 (U.S. CL. 46).

FIRST USE 4-7-2011; IN COMMERCE 4-7-2011.

OWNER OF U.S. REG. NOS. 3,766,997 AND 3,860,438.

THE MARK CONSISTS OF AN IMAGE OF A KICKING GOAT.

SN 85-293,685, FILED 4-13-2011.

ALYSSA STEEL, EXAMINING ATTORNEY



David J. Kyffers

Director of the United States Patent and Trademark Office

United States of America

United States Patent and Trademark Office

MY BFF

Reg. No. 4,176,730

STAR EDUCATIONAL CONSULTING LLC (NEW YORK LIMITED LIABILITY COMPANY)
53 W. 86TH STREET, SUITE 1
NEW YORK, NY 10024

Registered July 17, 2012

Int. Cl.: 16

FOR: PERSONAL ORGANIZERS, NAMELY, A COMBINATION BINDER, FOLDER, FILER AND RELATED COMPONENTS, IN CLASS 16 (U.S. CLS. 2, 5, 22, 23, 29, 37, 38 AND 50).

TRADEMARK

FIRST USE 4-2-2012; IN COMMERCE 4-2-2012.

PRINCIPAL REGISTER

THE MARK CONSISTS OF STANDARD CHARACTERS WITHOUT CLAIM TO ANY PARTICULAR FONT, STYLE, SIZE, OR COLOR.

SN 85-293,738, FILED 4-13-2011.

JOHN WILKE, EXAMINING ATTORNEY



David J. Kyffers

Director of the United States Patent and Trademark Office

United States of America

United States Patent and Trademark Office

TroyCare

Reg. No. 4,176,731

Registered July 17, 2012

Int. Cls.: 1 and 5

TRADEMARK

PRINCIPAL REGISTER

TROY TECHNOLOGY CORPORATION, INC. (DELAWARE CORPORATION)
LEGAL DEPARTMENT
8 VREELAND ROAD
FLORHAM PARK, NJ 079320955

FOR: BACTERICIDES AND FUNGICIDES USED IN INDUSTRY AS GENERAL CHEMICALS FOR USE IN MANUFACTURING PERSONAL CARE PRODUCTS; AND BACTERICIDES AND FUNGICIDES USED IN INDUSTRY AS GENERAL CHEMICALS FOR USE IN MANUFACTURING PERSONAL CARE PRODUCTS, IN CLASS 1 (U.S. CLS. 1, 5, 6, 10, 26 AND 46).

FIRST USE 1-20-2012; IN COMMERCE 1-20-2012.

FOR: BACTERICIDES AND FUNGICIDES FOR LAUNDRY USE; BACTERICIDES AND FUNGICIDES FOR USE IN SOAPS; BACTERICIDES AND FUNGICIDES FOR USE IN COSMETICS; AND BACTERICIDES AND FUNGICIDES FOR USE AS PRESERVATIVES AND DISINFECTANTS, IN CLASS 5 (U.S. CLS. 6, 18, 44, 46, 51 AND 52).

FIRST USE 1-20-2012; IN COMMERCE 1-20-2012.

THE MARK CONSISTS OF STANDARD CHARACTERS WITHOUT CLAIM TO ANY PARTICULAR FONT, STYLE, SIZE, OR COLOR.

OWNER OF U.S. REG. NOS. 1,917,493, 1,994,352, AND 3,609,112.

SN 85-293,772, FILED 4-13-2011.

MICHAEL KEATING, EXAMINING ATTORNEY



David J. Kypos

Director of the United States Patent and Trademark Office

United States of America

United States Patent and Trademark Office

GENES@CO-OP

Reg. No. 4,176,732

BARNEY'S, INC. (NEW YORK CORPORATION)
575 FIFTH AVENUE; 11TH FLOOR
NEW YORK, NY 10017

Registered July 17, 2012

Int. Cl.: 43

FOR: RESTAURANT AND CAFE SERVICES, IN CLASS 43 (U.S. CLS. 100 AND 101).

SERVICE MARK

FIRST USE 11-1-2011; IN COMMERCE 11-1-2011.

PRINCIPAL REGISTER

THE MARK CONSISTS OF STANDARD CHARACTERS WITHOUT CLAIM TO ANY PARTICULAR FONT, STYLE, SIZE, OR COLOR.

SN 85-293,835, FILED 4-13-2011.

MATTHEW EINSTEIN, EXAMINING ATTORNEY



David J. Kappas

Director of the United States Patent and Trademark Office

United States of America

United States Patent and Trademark Office

SNACK SHACK

Reg. No. 4,176,733

Registered July 17, 2012

Int. Cl.: 30

TRADEMARK

PRINCIPAL REGISTER

NORTHERN TOOL & EQUIPMENT COMPANY, INC. (MINNESOTA CORPORATION)
2800 SOUTHCROSS DRIVE WEST
BURNSVILLE, MN 55306

FOR: CHOCOLATE COVERED PEANUTS; CRACKERS COATED IN SESAME SEEDS;
MAPLE-COATED NUTS; CEREAL BASED SNACK FOODS; YOGURT COVERED PRETZELS,
IN CLASS 30 (U.S. CL. 46).

FIRST USE 7-25-2011; IN COMMERCE 7-25-2011.

THE MARK CONSISTS OF STANDARD CHARACTERS WITHOUT CLAIM TO ANY PAR-
TICULAR FONT, STYLE, SIZE, OR COLOR.

OWNER OF U.S. REG. NO. 3,707,811.

NO CLAIM IS MADE TO THE EXCLUSIVE RIGHT TO USE "SNACK", APART FROM THE
MARK AS SHOWN.

SN 85-293,881, FILED 4-13-2011.

APRIL HESIK, EXAMINING ATTORNEY



David J. Kyffers

Director of the United States Patent and Trademark Office

United States of America

United States Patent and Trademark Office

KID SURE

Reg. No. 4,176,734

Registered July 17, 2012

Int. Cl.: 45

SERVICE MARK

PRINCIPAL REGISTER

INTERSECTIONS INC. (DELAWARE CORPORATION)
3901 STONECROFT BLVD.
CHANTILLY, VA 20151

FOR: IDENTITY THEFT PROTECTION AND IDENTITY FRAUD PROTECTION SERVICES; IDENTITY THEFT AND FRAUD PROTECTION SERVICES IN THE NATURE OF PERSONAL INFORMATION AND FINANCIAL IDENTITY MONITORING SERVICES; FRAUD RESOLUTION ASSISTANCE, NAMELY, PROVIDING ADVICE AND CONSULTATION IN THE FIELD OF IDENTITY THEFT AND DATA THEFT; IDENTITY THEFT AND FRAUD PROTECTION SERVICES, NAMELY, INTERNET SURVEILLANCE OF PERSONAL INFORMATION; MONITORING THE INTERNET, PUBLIC RECORDS, PRIVATE AND PUBLIC ELECTRONIC DATABASES TO FACILITATE THE DETECTION AND PREVENTION OF IDENTITY THEFT AND FRAUD; IDENTITY THEFT PROTECTION SERVICES, NAMELY, ANALYZING PUBLIC AND PERSONAL INFORMATION AND PROVIDING A REPORT ASSESSING RISK OF IDENTITY THEFT, IN CLASS 45 (U.S. CLS. 100 AND 101).

FIRST USE 10-17-2011; IN COMMERCE 10-17-2011.

THE MARK CONSISTS OF STANDARD CHARACTERS WITHOUT CLAIM TO ANY PARTICULAR FONT, STYLE, SIZE, OR COLOR.

NO CLAIM IS MADE TO THE EXCLUSIVE RIGHT TO USE "KID", APART FROM THE MARK AS SHOWN.

SN 85-293,926, FILED 4-13-2011.

MARC LEIPZIG, EXAMINING ATTORNEY



David J. Kypos

Director of the United States Patent and Trademark Office

United States of America

United States Patent and Trademark Office

VORTEX BLUE

Reg. No. 4,176,735

DENTSPLY INTERNATIONAL INC. (DELAWARE CORPORATION)
221 WEST PHILADELPHIA STREET
YORK, PA 174050872

Registered July 17, 2012

Int. Cl.: 10

FOR: DENTAL INSTRUMENTS, NAMELY, DENTAL ROOT FILES USED IN ROOT CANAL THERAPY PROCEDURES, IN CLASS 10 (U.S. CLS. 26, 39 AND 44).

TRADEMARK

FIRST USE 12-12-2011; IN COMMERCE 12-12-2011.

PRINCIPAL REGISTER

THE MARK CONSISTS OF STANDARD CHARACTERS WITHOUT CLAIM TO ANY PARTICULAR FONT, STYLE, SIZE, OR COLOR.

OWNER OF U.S. REG. NO. 3,859,687.

NO CLAIM IS MADE TO THE EXCLUSIVE RIGHT TO USE "BLUE", APART FROM THE MARK AS SHOWN.

SN 85-294,225, FILED 4-13-2011.

HEATHER THOMPSON, EXAMINING ATTORNEY



David J. Kyffers

Director of the United States Patent and Trademark Office

United States of America

United States Patent and Trademark Office

Cumbe: Center for African and Diaspora Dance

Reg. No. 4,176,736

Registered July 17, 2012

Int. Cl.: 41

SERVICE MARK

PRINCIPAL REGISTER

CUMBE CENTER FOR AFRICAN AND DIASPORA DANCE, L.P. (NEW YORK LIMITED PARTNERSHIP)
558 FULTON ST., 2ND FL.
BROOKLYN, NY 11217

FOR: CONDUCTING FITNESS CLASSES; DANCE EVENTS; DANCE INSTRUCTION; DANCE INSTRUCTION FOR CHILDREN; DANCE SCHOOLS; DANCE STUDIOS; EDUCATION SERVICES, NAMELY, PROVIDING CLASSES AND INSTRUCTION IN THE FIELD OF DANCE; ENTERTAINMENT AND EDUCATION SERVICES IN THE NATURE OF LIVE DANCE AND MUSICAL PERFORMANCES; ENTERTAINMENT AND EDUCATIONAL SERVICES, NAMELY, THE PRESENTATION OF SEMINARS, WORKSHOPS AND PANEL DISCUSSIONS, AND ONGOING TELEVISION AND RADIO SHOWS ALL IN THE FIELD OF AFRICAN AND AFRICAN DIASPORA DANCE AND MUSIC; ENTERTAINMENT IN THE NATURE OF DANCE PERFORMANCES; ORGANIZATION OF DANCING EVENTS; ORGANIZING COMMUNITY FESTIVALS FEATURING A VARIETY OF ACTIVITIES, NAMELY, ART EXHIBITIONS, HERITAGE MARKETS, ETHNIC DANCES, AND THE LIKE; RENTAL OF DANCE FLOORS; TRAINING OF DANCE INSTRUCTORS, IN CLASS 41 (U.S. CLS. 100, 101 AND 107).

FIRST USE 12-10-2011; IN COMMERCE 12-10-2011.

THE MARK CONSISTS OF STANDARD CHARACTERS WITHOUT CLAIM TO ANY PARTICULAR FONT, STYLE, SIZE, OR COLOR.

NO CLAIM IS MADE TO THE EXCLUSIVE RIGHT TO USE "CENTER FOR AFRICAN AND DIASPORA DANCE", APART FROM THE MARK AS SHOWN.

THE ENGLISH TRANSLATION OF THE WORD "CUMBE" IN THE MARK IS "ANY SOFT-BODIED, WORMLIKE ANIMAL AS LEECHES AND SLUGS".

SN 85-294,285, FILED 4-13-2011.

BILL DAWE, EXAMINING ATTORNEY



David J. Kyffers

Director of the United States Patent and Trademark Office

United States of America

United States Patent and Trademark Office

GALAPAGOS

Reg. No. 4,176,737

NATURAL PACK, INC. (CALIFORNIA CORPORATION)
PO BOX 30352

Registered July 17, 2012

SANTA BARBARA, CA 93130

Int. Cl.: 31

FOR: ANIMAL LITTER, IN CLASS 31 (U.S. CLS. 1 AND 46).

TRADEMARK

FIRST USE 2-5-2012; IN COMMERCE 2-5-2012.

PRINCIPAL REGISTER

THE MARK CONSISTS OF STANDARD CHARACTERS WITHOUT CLAIM TO ANY PARTICULAR FONT, STYLE, SIZE, OR COLOR.

SN 85-294,657, FILED 4-13-2011.

MIDGE BUTLER, EXAMINING ATTORNEY



David J. Kyffers

Director of the United States Patent and Trademark Office

United States of America

United States Patent and Trademark Office

OPERA ORGANICALLY

Reg. No. 4,176,738

Registered July 17, 2012

Int. Cl.: 41

SERVICE MARK

PRINCIPAL REGISTER

FROMHERZ, REBECCA (UNITED STATES INDIVIDUAL)
716 E ELLENDALE AVE
DALLAS, OR 97338

FOR: EDUCATIONAL AND ENTERTAINMENT SERVICES, NAMELY, CONDUCTING CLASSES IN THE FIELD OF VOICE LESSONS, GENERAL CLASSICAL ARTS AND MUSIC EDUCATION AND DISTRIBUTION OF COURSE MATERIALS IN CONNECTION THEREWITH, AND EDUCATION CONSULTING RELATED THERETO, IN CLASS 41 (U.S. CLS. 100, 101 AND 107).

FIRST USE 4-1-2011; IN COMMERCE 4-28-2011.

THE MARK CONSISTS OF STANDARD CHARACTERS WITHOUT CLAIM TO ANY PARTICULAR FONT, STYLE, SIZE, OR COLOR.

NO CLAIM IS MADE TO THE EXCLUSIVE RIGHT TO USE "OPERA", APART FROM THE MARK AS SHOWN.

SN 85-294,764, FILED 4-14-2011.

LINDA POWELL, EXAMINING ATTORNEY



David J. Kyffers

Director of the United States Patent and Trademark Office

United States of America

United States Patent and Trademark Office

MIDCURRENT

Reg. No. 4,176,739

MIDCURRENT, LLC (FLORIDA LIMITED LIABILITY COMPANY)
P.O. BOX 271163
FORT COLLINS, CO 80527

Registered July 17, 2012

Int. Cl.: 9

FOR: DVDS AND VIDEOS FEATURING INFORMATION ON THE SUBJECT OF FLY FISHING,
IN CLASS 9 (U.S. CLS. 21, 23, 26, 36 AND 38).

TRADEMARK

FIRST USE 5-31-2008; IN COMMERCE 5-31-2008.

PRINCIPAL REGISTER

THE MARK CONSISTS OF STANDARD CHARACTERS WITHOUT CLAIM TO ANY PAR-
TICULAR FONT, STYLE, SIZE, OR COLOR.

OWNER OF U.S. REG. NO. 3,209,179.

SN 85-294,862, FILED 4-14-2011.

EMILY CHUO, EXAMINING ATTORNEY



David J. Kybas

Director of the United States Patent and Trademark Office

United States of America

United States Patent and Trademark Office

GREEN FAIRY CHICKS

Reg. No. 4,176,740

OVERSTREET, J'ME (UNITED STATES INDIVIDUAL)
11420 STURBRIDGE ROAD
OKLAHOMA CITY, OK 73162

Registered July 17, 2012

Int. Cl.: 28

FOR: CHILDREN'S TOYS, NAMELY, DOLLS, DOLL CLOTHING AND DOLL ACCESSORIES,
IN CLASS 28 (U.S. CLS. 22, 23, 38 AND 50).

TRADEMARK

FIRST USE 5-1-2011; IN COMMERCE 11-29-2011.

PRINCIPAL REGISTER

THE MARK CONSISTS OF STANDARD CHARACTERS WITHOUT CLAIM TO ANY PARTICULAR FONT, STYLE, SIZE, OR COLOR.

SN 85-294,913, FILED 4-14-2011.

ELISSA GARBER KON, EXAMINING ATTORNEY



David J. Kybas

Director of the United States Patent and Trademark Office

United States of America

United States Patent and Trademark Office

KEYBANK ACCESS ACCOUNT

Reg. No. 4,176,741

KEYCORP (OHIO CORPORATION)
127 PUBLIC SQUARE
CLEVELAND, OH 44114

Registered July 17, 2012

Int. Cl.: 36

FOR: CHECKING ACCOUNT SERVICES; DEBIT CARD SERVICES, IN CLASS 36 (U.S. CLS. 100, 101 AND 102).

SERVICE MARK

FIRST USE 8-19-2011; IN COMMERCE 8-19-2011.

PRINCIPAL REGISTER

THE MARK CONSISTS OF STANDARD CHARACTERS WITHOUT CLAIM TO ANY PARTICULAR FONT, STYLE, SIZE, OR COLOR.

OWNER OF U.S. REG. NOS. 1,722,378, 2,926,357, AND OTHERS.

NO CLAIM IS MADE TO THE EXCLUSIVE RIGHT TO USE "ACCESS ACCOUNT", APART FROM THE MARK AS SHOWN.

SN 85-295,072, FILED 4-14-2011.

MARIA-VICTORIA SUAREZ, EXAMINING ATTORNEY



David J. Kybas

Director of the United States Patent and Trademark Office

United States of America

United States Patent and Trademark Office



Reg. No. 4,176,742

Registered July 17, 2012

Int. Cl.: 25

TRADEMARK

PRINCIPAL REGISTER

SULLIVAN, REGINALD W. (UNITED STATES INDIVIDUAL)
110-35 213TH ST.
QUEENS VILLAGE, NY 11429

FOR: SHIRTS; T-SHIRTS, IN CLASS 25 (U.S. CLS. 22 AND 39).

FIRST USE 11-28-2011; IN COMMERCE 11-28-2011.

NO CLAIM IS MADE TO THE EXCLUSIVE RIGHT TO USE "WORLDWIDE", APART FROM THE MARK AS SHOWN.

THE COLOR(S) RED, GRAY, WHITE AND BLACK IS/ARE CLAIMED AS A FEATURE OF THE MARK.

THE MARK CONSISTS OF THE WORDING "COULROPHOBIA WORLDWIDE" WITH THE BEGINNING WORD PORTION "COULRO" APPEARING AT THE TOP DEPICTED IN SHADES OF RED, GRAY AND WHITE AND OUTLINED IN BLACK, BENEATH THIS IS THE DESIGN OF AN EVIL CLOWN PAINTED IN SHADES OF RED, GRAY AND WHITE AND OUTLINED IN BLACK, BENEATH THIS DESIGN APPEARS THE ENDING WORD PORTION "PHOBIA" DEPICTED IN SHADES OF RED, GRAY AND WHITE AND OUTLINED IN BLACK, WITH THE LETTER "O" PRESENTED AS AN EVIL CLOWN DESIGN PAINTED IN SHADES OF RED, GRAY AND WHITE AND OUTLINED IN BLACK, AND BELOW ALL THIS APPEARS THE WORD "WORLDWIDE" IN THE COLOR BLACK.

SN 85-295,254, FILED 4-14-2011.

GENE MACIOL, EXAMINING ATTORNEY



David J. Kyffers

Director of the United States Patent and Trademark Office

United States of America

United States Patent and Trademark Office

RED, WHITE & BLUE

Reg. No. 4,176,743

Registered July 17, 2012

Int. Cl.: 14

TRADEMARK

PRINCIPAL REGISTER

MY DIAMOND PLACE, LTD. (BAHAMAS CORPORATION)
BRITISH COLONIAL CENTER OF COMMERCE,
ONE BAY STREET - 3RD FLOOR
NASSAU, BAHAMAS

FOR: DIAMONDS, IN CLASS 14 (U.S. CLS. 2, 27, 28 AND 50).

FIRST USE 4-20-2012; IN COMMERCE 4-20-2012.

THE MARK CONSISTS OF STANDARD CHARACTERS WITHOUT CLAIM TO ANY PARTICULAR FONT, STYLE, SIZE, OR COLOR.

SN 85-295,563, FILED 4-14-2011.

EDWARD NELSON, EXAMINING ATTORNEY



David J. Kybas

Director of the United States Patent and Trademark Office

United States of America

United States Patent and Trademark Office



Reg. No. 4,176,744

MANESS, CLINT (UNITED STATES INDIVIDUAL)
10 NORTH GAME COVE
POTTSVILLE, AR 72858

Registered July 17, 2012

Int. Cl.: 35

FOR: RETAIL STORE SERVICES FEATURING HUNTING VIDEOS, APPAREL, NAMELY, HATS, T-SHIRTS, SWEATSHIRTS, APRONS, FOAM DRINK HOLDERS, DECALS, KEY CHAINS, PENS, DRINK WARE, GLASSES, AND MUGS, IN CLASS 35 (U.S. CLS. 100, 101 AND 102).

SERVICE MARK

PRINCIPAL REGISTER

FIRST USE 5-23-2010; IN COMMERCE 2-18-2011.

NO CLAIM IS MADE TO THE EXCLUSIVE RIGHT TO USE "OUTDOORS", APART FROM THE MARK AS SHOWN.

THE MARK CONSISTS OF THE TEXT "RACK 'EM UP OUTDOORS" AND A DESIGN OF A WHITETAIL DEER SKULL TO THE LEFT OF THE TEXT.

SN 85-295,629, FILED 4-14-2011.

DOUGLAS LEE, EXAMINING ATTORNEY



David J. Kyffers

Director of the United States Patent and Trademark Office

United States of America

United States Patent and Trademark Office

ROCTANE

Reg. No. 4,176,745

ADVANCED FOOD CONCEPTS, INCORPORATED (CALIFORNIA CORPORATION)
1609 4TH STREET
BERKELEY, CA 94710

Registered July 17, 2012

Int. Cl.: 32

FOR: NON-ALCOHOLIC BEVERAGES, NAMELY, SPORTS DRINKS INFUSED WITH MALTODEXTRIN, PROTEIN, CARBOHYDRATES, VITAMINS AND ELECTROLYTES; ENERGY DRINKS; SPORTS DRINKS; CONCENTRATES, TABLETS AND POWDERS FOR USE IN PREPARATION OF SPORTS DRINKS, IN CLASS 32 (U.S. CLS. 45, 46 AND 48).

TRADEMARK

PRINCIPAL REGISTER

FIRST USE 5-0-2008; IN COMMERCE 5-0-2008.

THE MARK CONSISTS OF STANDARD CHARACTERS WITHOUT CLAIM TO ANY PARTICULAR FONT, STYLE, SIZE, OR COLOR.

OWNER OF U.S. REG. NO. 3,636,337.

SN 85-295,782, FILED 4-14-2011.

DORITT L. CARROLL, EXAMINING ATTORNEY



David J. Kyfos

Director of the United States Patent and Trademark Office

United States of America

United States Patent and Trademark Office

EVERYTHING ENDO!

Reg. No. 4,176,746

MEDIDENTA INTERNATIONAL, INC. (NEW YORK CORPORATION)

Registered July 17, 2012

3325 WEST ALI BABA LANE, SUITE 603
LAS VEGAS, NV 89118

Int. Cl.: 35

FOR: MAIL ORDER SERVICES FEATURING ENDODONTIC PRODUCTS FOR DENTISTS;
RETAIL STORE AND ON-LINE RETAIL STORE SERVICES FEATURING ENDODONTIC
PRODUCTS FOR DENTISTS; RETAIL STORE SERVICES FEATURING ENDODONTIC
PRODUCTS FOR DENTISTS ACCESSIBLE ON-LINE AND BY TELEPHONE, FACSIMILE
AND MAIL ORDER, IN CLASS 35 (U.S. CLS. 100, 101 AND 102).

SERVICE MARK

PRINCIPAL REGISTER

FIRST USE 3-0-2012; IN COMMERCE 3-0-2012.

THE MARK CONSISTS OF STANDARD CHARACTERS WITHOUT CLAIM TO ANY PAR-
TICULAR FONT, STYLE, SIZE, OR COLOR.

SN 85-295,884, FILED 4-15-2011.

FRANK LATTUCA, EXAMINING ATTORNEY



David J. Kyffers

Director of the United States Patent and Trademark Office

United States of America

United States Patent and Trademark Office

CENTERSTONE INN

Reg. No. 4,176,747

Registered July 17, 2012

Int. Cl.: 43

SERVICE MARK

PRINCIPAL REGISTER

VIMANA FRANCHISE SYSTEMS LLC (ALABAMA LIMITED LIABILITY COMPANY)
ONE OFFICE PARK CIRCLE
SUITE 101
BIRMINGHAM, AL 35223

FOR: HOTEL AND MOTEL SERVICES, IN CLASS 43 (U.S. CLS. 100 AND 101).

FIRST USE 8-23-2011; IN COMMERCE 8-23-2011.

THE MARK CONSISTS OF STANDARD CHARACTERS WITHOUT CLAIM TO ANY PARTICULAR FONT, STYLE, SIZE, OR COLOR.

NO CLAIM IS MADE TO THE EXCLUSIVE RIGHT TO USE "INN", APART FROM THE MARK AS SHOWN.

SN 85-295,944, FILED 4-15-2011.

TRICIA SONNEBORN, EXAMINING ATTORNEY



David J. Kyffers

Director of the United States Patent and Trademark Office

United States of America

United States Patent and Trademark Office

SAFETRAK

Reg. No. 4,176,748

RICHARDS-WILCOX, INC. (DELAWARE CORPORATION)
600 S. LAKE ST.
AURORA, IL 60506

Registered July 17, 2012

Int. Cl.: 20

FOR: ELECTRIC MOBILE SHELVING SYSTEM COMPRISED OF SHELVING, WHEELS, TRACKS AND ELECTRIC MOTORS, IN CLASS 20 (U.S. CLS. 2, 13, 22, 25, 32 AND 50).

TRADEMARK

FIRST USE 5-6-2011; IN COMMERCE 5-6-2011.

PRINCIPAL REGISTER

THE MARK CONSISTS OF STANDARD CHARACTERS WITHOUT CLAIM TO ANY PARTICULAR FONT, STYLE, SIZE, OR COLOR.

SN 85-296,095, FILED 4-15-2011.

JAY FLOWERS, EXAMINING ATTORNEY



David J. Kyffers

Director of the United States Patent and Trademark Office

United States of America

United States Patent and Trademark Office

InterlineMRO

Reg. No. 4,176,749

Registered July 17, 2012

Int. Cl.: 35

SERVICE MARK

PRINCIPAL REGISTER

INTERLINE BRANDS, INC. (NEW JERSEY CORPORATION)
18TH FLOOR
701 SAN MARCO BOULEVARD
JACKSONVILLE, FL 32207

FOR: DISTRIBUTORSHIP SERVICES FEATURING MAINTENANCE, REPAIR AND OPERATIONS PRODUCTS, NAMELY, PLUMBING, HVAC, LIGHTING, ELECTRICAL, HARDWARE, POOL, SAFETY AND SECURITY, AND LAWN AND GARDEN PRODUCTS, JANITORIAL AND CLEANING SUPPLIES, APPLIANCES, OFFICE SUPPLIES, TOOLS AND FIXTURES; ONLINE RETAIL AND WHOLESALE STORE SERVICES FEATURING MAINTENANCE, REPAIR AND OPERATIONS PRODUCTS, NAMELY, PLUMBING, HVAC, LIGHTING, ELECTRICAL, HARDWARE, POOL, SAFETY AND SECURITY, AND LAWN AND GARDEN PRODUCTS, JANITORIAL AND CLEANING SUPPLIES, APPLIANCES, OFFICE SUPPLIES, TOOLS AND FIXTURES, IN CLASS 35 (U.S. CLS. 100, 101 AND 102).

FIRST USE 4-5-2012; IN COMMERCE 4-5-2012.

THE MARK CONSISTS OF STANDARD CHARACTERS WITHOUT CLAIM TO ANY PARTICULAR FONT, STYLE, SIZE, OR COLOR.

OWNER OF U.S. REG. NOS. 2,759,591 AND 3,448,685.

SN 85-296,340, FILED 4-15-2011.

LAURIE KAUFMAN, EXAMINING ATTORNEY



David J. Kybas

Director of the United States Patent and Trademark Office

United States of America

United States Patent and Trademark Office

SECUREPLUS MARQUEE 10

Reg. No. 4,176,750

LIFE INSURANCE COMPANY OF THE SOUTHWEST (TEXAS CORPORATION)
1300 WEST MOCKINGBIRD LANE
DALLAS, TX 75247

Registered July 17, 2012

Int. Cl.: 36

FOR: ISSUANCE AND ADMINISTRATION OF ANNUITIES, IN CLASS 36 (U.S. CLS. 100, 101 AND 102).

SERVICE MARK

FIRST USE 0-0-2011; IN COMMERCE 0-0-2011.

PRINCIPAL REGISTER

THE MARK CONSISTS OF STANDARD CHARACTERS WITHOUT CLAIM TO ANY PARTICULAR FONT, STYLE, SIZE, OR COLOR.

OWNER OF U.S. REG. NOS. 2,218,582, 3,920,770, AND OTHERS.

NO CLAIM IS MADE TO THE EXCLUSIVE RIGHT TO USE "10", APART FROM THE MARK AS SHOWN.

SN 85-296,389, FILED 4-15-2011.

DAVID I, EXAMINING ATTORNEY



David J. Kyros

Director of the United States Patent and Trademark Office

United States of America

United States Patent and Trademark Office

Come Smell The Ocean in Your Hair

Reg. No. 4,176,751

HAHN CONSULTING SERVICES (COLORADO LIMITED LIABILITY COMPANY)
11632 QUIVAS WAY
WESTMINSTER, CO 80234

Registered July 17, 2012

Int. Cl.: 35

FOR: PROMOTING TOURISM IN THE CARIBBEAN AND HAWAIIAN ISLANDS AREA, IN CLASS 35 (U.S. CLS. 100, 101 AND 102).

SERVICE MARK

FIRST USE 4-13-2012; IN COMMERCE 4-13-2012.

PRINCIPAL REGISTER

THE MARK CONSISTS OF STANDARD CHARACTERS WITHOUT CLAIM TO ANY PARTICULAR FONT, STYLE, SIZE, OR COLOR.

SN 85-296,774, FILED 4-15-2011.

ALAIN LAPTER, EXAMINING ATTORNEY



David J. Kyffers

Director of the United States Patent and Trademark Office

United States of America

United States Patent and Trademark Office

MALACHI VENTURES

Reg. No. 4,176,752

MALACHI VENTURES, LLC (ARIZONA LIMITED LIABILITY COMPANY)
1928 E HIGHLAND AVE, SUITE F104-413
PHOENIX, AZ 85016

Registered July 17, 2012

Int. Cl.: 42

FOR: DESIGN, DEVELOPMENT AND IMPLEMENTATION OF SOFTWARE, IN CLASS 42
(U.S. CLS. 100 AND 101).

SERVICE MARK

FIRST USE 9-12-2011; IN COMMERCE 9-12-2011.

PRINCIPAL REGISTER

THE MARK CONSISTS OF STANDARD CHARACTERS WITHOUT CLAIM TO ANY PARTICULAR FONT, STYLE, SIZE, OR COLOR.

NO CLAIM IS MADE TO THE EXCLUSIVE RIGHT TO USE "VENTURES", APART FROM THE MARK AS SHOWN.

SN 85-296,845, FILED 4-15-2011.

STEVEN JACKSON, EXAMINING ATTORNEY



David J. Kybas

Director of the United States Patent and Trademark Office

United States of America

United States Patent and Trademark Office



Reg. No. 4,176,753

AGUILAR, ANTHONY (UNITED STATES INDIVIDUAL)
3344 BROADMOOR BLVD
SAN BERNARDINO, CA 92404

Registered July 17, 2012

Int. Cl.: 25

FOR: HATS; JACKETS; SHIRTS, IN CLASS 25 (U.S. CLS. 22 AND 39).

TRADEMARK

FIRST USE 5-1-2012; IN COMMERCE 5-1-2012.

PRINCIPAL REGISTER

THE MARK CONSISTS OF THE STYLIZED GREEK LETTERS ALPHA AND OMEGA OVERLAID OVER EACH OTHER AND A CROWN APPEARS ABOVE THE LETTERS.

SN 85-296,945, FILED 4-15-2011.

EDWARD NELSON, EXAMINING ATTORNEY



David J. Kyffers

Director of the United States Patent and Trademark Office

United States of America

United States Patent and Trademark Office



Reg. No. 4,176,754

Registered July 17, 2012

Int. Cl.: 35

SERVICE MARK

PRINCIPAL REGISTER

NATIONAL DELI, LLC (DELAWARE LIMITED LIABILITY COMPANY)
7250 N.W. 35 TERRACE
MIAMI, FL 33122

FOR: RETAIL STORE SERVICES FEATURING DELICATESSEN PRODUCTS, IN CLASS 35
(U.S. CLS. 100, 101 AND 102).

FIRST USE 11-0-2006; IN COMMERCE 11-0-2006.

OWNER OF U.S. REG. NO. 2,763,861.

THE COLOR(S) RED, BLUE, ORANGE, YELLOW AND GRAY IS/ARE CLAIMED AS A
FEATURE OF THE MARK.

SEC. 2(F) AS TO "NATIONAL DELI".

THE MARK CONSISTS OF A STANDING HOT DOG WEARING A BLUE HAT WITH A RED
BILL AND THE WORDS "NATIONAL DELI" ON THE FRONT; THE HOT DOG IS IN THE
COLOR ORANGE WITH A YELLOW BUN AND GRAY ARMS, WHITE HANDS AND GRAY
LEGS WITH BLUE SHOES, AND INCLUDES A SMILING FACE WITH ITS RIGHT ARM ON
ITS HIP AND ITS LEFT ARM EXTENDED OUTWARD WITH AN OPEN HAND; HE IS
STANDING FLATFOOTED.

SN 85-297,678, FILED 4-18-2011.

GEORGE LORENZO, EXAMINING ATTORNEY



David J. Kyros

Director of the United States Patent and Trademark Office

United States of America

United States Patent and Trademark Office

WE'RE GOING TO THE CAPE

Reg. No. 4,176,755

STEPHEN F. SCHAEFER (UNITED STATES INDIVIDUAL)
430 LONDON ROAD

Registered July 17, 2012

YORKTOWN HEIGHTS, NY 10598

Int. Cls.: 16 and 21

FOR: BUMPER STICKERS; MAGNETIC BUMPER STICKERS; STICKERS, IN CLASS 16 (U.S. CLS. 2, 5, 22, 23, 29, 37, 38 AND 50).

TRADEMARK

FIRST USE 8-1-2011; IN COMMERCE 8-1-2011.

PRINCIPAL REGISTER

FOR: COFFEE MUGS; CUPS AND MUGS, IN CLASS 21 (U.S. CLS. 2, 13, 23, 29, 30, 33, 40 AND 50).

FIRST USE 12-1-2011; IN COMMERCE 12-1-2011.

THE MARK CONSISTS OF STANDARD CHARACTERS WITHOUT CLAIM TO ANY PARTICULAR FONT, STYLE, SIZE, OR COLOR.

SN 85-297,782, FILED 4-18-2011.

TEJBIR SINGH, EXAMINING ATTORNEY



David J. Kybas

Director of the United States Patent and Trademark Office

United States of America

United States Patent and Trademark Office

COLORS BY CHINET

Reg. No. 4,176,756

HUHTAMAKI, INC. (KANSAS CORPORATION)
9201 PACKAGING DRIVE
DESOTO, KS 66018

Registered July 17, 2012

Int. Cl.: 21

FOR: MOLDED FIBER DINNERWARE, NAMELY, DISHES, PLATES, BOWLS, SERVING TRAYS AND PLATTERS, IN CLASS 21 (U.S. CLS. 2, 13, 23, 29, 30, 33, 40 AND 50).

TRADEMARK

FIRST USE 5-0-2011; IN COMMERCE 10-0-2011.

PRINCIPAL REGISTER

THE MARK CONSISTS OF STANDARD CHARACTERS WITHOUT CLAIM TO ANY PARTICULAR FONT, STYLE, SIZE, OR COLOR.

OWNER OF U.S. REG. NOS. 684,589, 2,539,447, AND OTHERS.

NO CLAIM IS MADE TO THE EXCLUSIVE RIGHT TO USE "COLORS", APART FROM THE MARK AS SHOWN.

SN 85-297,795, FILED 4-18-2011.

BARBARA RUTLAND, EXAMINING ATTORNEY



David J. Kybas

Director of the United States Patent and Trademark Office

United States of America

United States Patent and Trademark Office

ADLIFE

Reg. No. 4,176,757

Registered July 17, 2012

Int. Cl.: 35

SERVICE MARK

PRINCIPAL REGISTER

GRAVY NETWORK INC. (MICHIGAN CORPORATION)
23650 WOODWARD AVE.
SUITE 101
PLEASANT RIDGE, MI 48069

FOR: DISSEMINATION OF ADVERTISING FOR OTHERS VIA THE INTERNET FOR DISPLAY ON WIRELESS ELECTRONIC DEVICES FOR SPECIFIED PERIODS OF TIME; ADVERTISING SERVICES OVER A COMPUTER NETWORK DISPLAYING ADVERTISEMENTS FOR A DEFINED LENGTH OF TIME, IN CLASS 35 (U.S. CLS. 100, 101 AND 102).

FIRST USE 9-0-2011; IN COMMERCE 9-0-2011.

THE MARK CONSISTS OF STANDARD CHARACTERS WITHOUT CLAIM TO ANY PARTICULAR FONT, STYLE, SIZE, OR COLOR.

SN 85-298,237, FILED 4-18-2011.

RUSS HERMAN, EXAMINING ATTORNEY



David J. Kybas

Director of the United States Patent and Trademark Office

United States of America

United States Patent and Trademark Office

RECEIPTNOW

Reg. No. 4,176,758

BURROUGHS PAYMENT SYSTEMS, INC. (DELAWARE CORPORATION)
41100 PLYMOUTH ROAD
PLYMOUTH, MI 48170

Registered July 17, 2012

Int. Cl.: 9

FOR: PRINTERS, IN CLASS 9 (U.S. CLS. 21, 23, 26, 36 AND 38).

TRADEMARK

FIRST USE 1-20-2011; IN COMMERCE 1-20-2011.

PRINCIPAL REGISTER

THE MARK CONSISTS OF STANDARD CHARACTERS WITHOUT CLAIM TO ANY PARTICULAR FONT, STYLE, SIZE, OR COLOR.

SN 85-298,338, FILED 4-19-2011.

COURTNEY ALVAREZ, EXAMINING ATTORNEY



David J. Kyffers

Director of the United States Patent and Trademark Office

United States of America

United States Patent and Trademark Office

DREES HOMES

Reg. No. 4,176,759

Registered July 17, 2012

Int. Cls.: 37 and 42

SERVICE MARK

PRINCIPAL REGISTER

THE DREES COMPANY (KENTUCKY CORPORATION)
211 GRANDVIEW DRIVE
FORT MITCHELL, KY 41017

FOR: CONSTRUCTION SERVICES, NAMELY, PLANNING, LAYING OUT AND CONSTRUCTION OF RESIDENTIAL COMMUNITIES AND HOMES, IN CLASS 37 (U.S. CLS. 100, 103 AND 106).

FIRST USE 11-0-1984; IN COMMERCE 11-0-1984.

FOR: RESIDENTIAL BUILDING DESIGN, IN CLASS 42 (U.S. CLS. 100 AND 101).

FIRST USE 11-0-1984; IN COMMERCE 11-0-1984.

THE MARK CONSISTS OF STANDARD CHARACTERS WITHOUT CLAIM TO ANY PARTICULAR FONT, STYLE, SIZE, OR COLOR.

SEC. 2(F).

OWNER OF U.S. REG. NO. 3,516,853.

NO CLAIM IS MADE TO THE EXCLUSIVE RIGHT TO USE "HOMES", APART FROM THE MARK AS SHOWN.

SN 85-298,403, FILED 4-19-2011.

LEIGH CAROLINE CASE, EXAMINING ATTORNEY

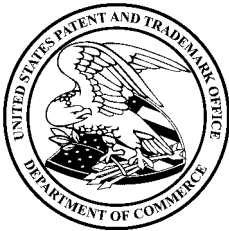

David J. Kyffers

Director of the United States Patent and Trademark Office

United States of America

United States Patent and Trademark Office



Reg. No. 4,176,760

Registered July 17, 2012

Int. Cl.: 36

SERVICE MARK

PRINCIPAL REGISTER

COVENTRY HEALTH CARE, INC. (DELAWARE CORPORATION)
8TH FLOOR
6720 B ROCKLEDGE DRIVE
BETHESDA, MD 20817

FOR: UNDERWRITING AND ADMINISTRATION OF PREPAID HEALTH INSURANCE BENEFIT PLANS, IN CLASS 36 (U.S. CLS. 100, 101 AND 102).

FIRST USE 4-18-2011; IN COMMERCE 7-20-2011.

THE MARK CONSISTS OF A STYLIZED VERSION OF THE UPPER HALF OF A BEAR CHARACTER DRESSED IN A LAB COAT WITH ID TAG, STETHOSCOPE, AND WEARING PINCE-NEZ EYEGLASSES.

SN 85-298,471, FILED 4-19-2011.

KAREN BRACEY, EXAMINING ATTORNEY



David J. Kyjars

Director of the United States Patent and Trademark Office

United States of America

United States Patent and Trademark Office

Kleen'yass

Reg. No. 4,176,761

DAVIS, RICHARD H. (UNITED STATES INDIVIDUAL)
2059 N. AVERS AVENUE
CHICAGO, IL 60647 AND

Registered July 17, 2012

Int. Cl.: 3

DAVIS, HEATHER (UNITED STATES INDIVIDUAL)
2059 N. AVERS AVENUE
CHICAGO, IL 60647

TRADEMARK

FOR: ORGANIC SOAP BARS, IN CLASS 3 (U.S. CLS. 1, 4, 6, 50, 51 AND 52).

PRINCIPAL REGISTER

FIRST USE 11-1-2011; IN COMMERCE 12-1-2011.

THE MARK CONSISTS OF STANDARD CHARACTERS WITHOUT CLAIM TO ANY PARTICULAR FONT, STYLE, SIZE, OR COLOR.

SN 85-298,551, FILED 4-19-2011.

ELIZABETH KAJUBI, EXAMINING ATTORNEY



David J. Kybas

Director of the United States Patent and Trademark Office

United States of America

United States Patent and Trademark Office

CELVER

Reg. No. 4,176,762

AG BIOTECH LLC. (FLORIDA LIMITED LIABILITY COMPANY)
2867-C INDUSTRIAL PLAZA
TALLAHASSEE, FL 32301

Registered July 17, 2012

Int. Cl.: 5

FOR: PROCESSED ANTIMICROBIAL CELLULOSE AS A COMPONENT OF BANDAGES FOR DRESSING, SANITIZING WIPES, ADHESIVE TAPE, TOPICAL FIRST AID GELS, ANTIBACTERIAL SPRAYS, AND MEDICATED FOOT POWDER FOR MEDICAL USE, IN CLASS 5 (U.S. CLS. 6, 18, 44, 46, 51 AND 52).

TRADEMARK

PRINCIPAL REGISTER

FIRST USE 7-19-2008; IN COMMERCE 5-27-2011.

THE MARK CONSISTS OF STANDARD CHARACTERS WITHOUT CLAIM TO ANY PARTICULAR FONT, STYLE, SIZE, OR COLOR.

SN 85-298,653, FILED 4-19-2011.

BRENDAN MCCAULEY, EXAMINING ATTORNEY



David J. Kyros

Director of the United States Patent and Trademark Office

United States of America

United States Patent and Trademark Office

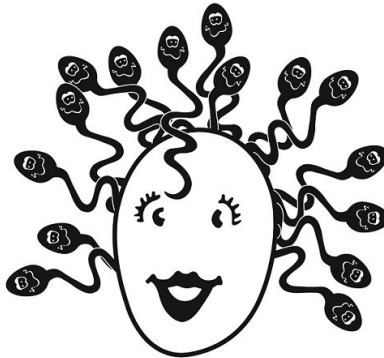

Reg. No. 4,176,763

Registered July 17, 2012

Int. Cl.: 28

TRADEMARK

PRINCIPAL REGISTER

DUNN, CLAUDETTE (UNITED STATES INDIVIDUAL)
27940 STAGE LINE ROAD
CASTAIC, CA 91384

FOR: BOARD GAMES, BALLOONS, IN CLASS 28 (U.S. CLS. 22, 23, 38 AND 50).

FIRST USE 12-31-2004; IN COMMERCE 12-31-2004.

THE MARK CONSISTS OF THE STYLIZED CARICATURE OF A SMILING FEMALE FACE FORMED BY AN EGG SHAPE, AND HAIR FORMED BY FIFTEEN SPERM, EACH HAVING A FACE.

SN 85-298,672, FILED 4-19-2011.

JAY BESCH, EXAMINING ATTORNEY



David J. Kyffers

Director of the United States Patent and Trademark Office

United States of America

United States Patent and Trademark Office

ROCKIN' KITCHEN

Reg. No. 4,176,764

NOISY S.O.D., INC. (NEW YORK CORPORATION)
46 SHORE ROAD
EAST SETAUKET, NY 11733 AND

Registered July 17, 2012

Int. Cl.: 41

LOU KATS ENTERTAINMENT GROUP (NEW YORK CORPORATION)
112 OLD FIELD ROAD
SETAUKET, NY 11733

SERVICE MARK

PRINCIPAL REGISTER

FOR: ENTERTAINMENT SERVICES, NAMELY, AN ON-GOING SERIES FEATURING COOKING PROVIDED THROUGH TELEVISION, CABLE, SATELLITE, RADIO AND INTERNET, IN CLASS 41 (U.S. CLS. 100, 101 AND 107).

FIRST USE 4-20-2011; IN COMMERCE 4-20-2011.

THE MARK CONSISTS OF STANDARD CHARACTERS WITHOUT CLAIM TO ANY PARTICULAR FONT, STYLE, SIZE, OR COLOR.

NO CLAIM IS MADE TO THE EXCLUSIVE RIGHT TO USE "KITCHEN", APART FROM THE MARK AS SHOWN.

SN 85-298,747, FILED 4-19-2011.

RENEE MCCRAY, EXAMINING ATTORNEY



David J. Kyros

Director of the United States Patent and Trademark Office

United States of America

United States Patent and Trademark Office

AMERICAN CELEBRATION

Reg. No. 4,176,765

Registered July 17, 2012

Int. Cl.: 9

TRADEMARK

PRINCIPAL REGISTER

BLUBERI JEUX ET TECHNOLOGIES INC. AKA BLUBERI GAMING TECHNOLOGIES INC.
(CANADA CORPORATION)
2120 LETENDRE STREET, SUITE 310
DRUMMONDVILLE, QUEBEC, CANADA J2C-7E9

FOR: SOFTWARE FOR GAMING MACHINES; GAMING MACHINES WITH VIDEO OUTPUT,
IN CLASS 9 (U.S. CLS. 21, 23, 26, 36 AND 38).

FIRST USE 10-29-2010; IN COMMERCE 4-15-2011.

THE MARK CONSISTS OF STANDARD CHARACTERS WITHOUT CLAIM TO ANY PAR-
TICULAR FONT, STYLE, SIZE, OR COLOR.

SN 85-298,826, FILED 4-19-2011.

WILLIAM P. SHANAHAN, EXAMINING ATTORNEY



David J. Kybas

Director of the United States Patent and Trademark Office

United States of America

United States Patent and Trademark Office

BURGLIN' BOB

Reg. No. 4,176,766

Registered July 17, 2012

Int. Cl.: 9

TRADEMARK

PRINCIPAL REGISTER

BLUBERI JEUX ET TECHNOLOGIES INC. AKA BLUBERI GAMING TECHNOLOGIES INC.
(CANADA CORPORATION)
2120 LETENDRE STREET, SUITE 310
DRUMMONDVILLE, QUEBEC, CANADA J2C-7E9

FOR: SOFTWARE FOR GAMING MACHINES; GAMING MACHINES WITH VIDEO OUTPUT,
IN CLASS 9 (U.S. CLS. 21, 23, 26, 36 AND 38).

FIRST USE 3-7-2011; IN COMMERCE 4-27-2011.

THE MARK CONSISTS OF STANDARD CHARACTERS WITHOUT CLAIM TO ANY PAR-
TICULAR FONT, STYLE, SIZE, OR COLOR.

SN 85-298,886, FILED 4-19-2011.

WILLIAM P. SHANAHAN, EXAMINING ATTORNEY



David J. Kyffers

Director of the United States Patent and Trademark Office

United States of America

United States Patent and Trademark Office

SWAP

Reg. No. 4,176,767

Registered July 17, 2012

Int. Cl.: 8

TRADEMARK

PRINCIPAL REGISTER

BKD ACQUISITION, INC. (DELAWARE CORPORATION)
SUITE 320
1111 W. 22ND ST.
OAKBROOK, IL 60523

FOR: SPOONS, IN CLASS 8 (U.S. CLS. 23, 28 AND 44).

FIRST USE 2-3-2012; IN COMMERCE 2-3-2012.

THE MARK CONSISTS OF STANDARD CHARACTERS WITHOUT CLAIM TO ANY PARTICULAR FONT, STYLE, SIZE, OR COLOR.

SN 85-299,021, FILED 4-19-2011.

SUE LAWRENCE, EXAMINING ATTORNEY



David J. Kybas

Director of the United States Patent and Trademark Office

United States of America

United States Patent and Trademark Office

TRÈS BELLE

Reg. No. 4,176,768

Registered July 17, 2012

Int. Cl.: 14

TRADEMARK

PRINCIPAL REGISTER

TOUCAN, INC. (CALIFORNIA CORPORATION)
P.O. BOX 4808
1275 8TH STREET
ARCATA, CA 95518

FOR: JEWELRY, IN CLASS 14 (U.S. CLS. 2, 27, 28 AND 50).

FIRST USE 5-24-2011; IN COMMERCE 5-24-2011.

THE MARK CONSISTS OF STANDARD CHARACTERS WITHOUT CLAIM TO ANY PARTICULAR FONT, STYLE, SIZE, OR COLOR.

THE ENGLISH TRANSLATION OF THE WORDING "TRES BELLE" IN THE MARK IS "VERY BEAUTIFUL".

SN 85-299,038, FILED 4-19-2011.

KELLY TRUSILO, EXAMINING ATTORNEY



David J. Kybas

Director of the United States Patent and Trademark Office

United States of America
United States Patent and Trademark Office

CocoBuzz

Reg. No. 4,176,769

STARBUZZ TOBACCO, INC. (CALIFORNIA CORPORATION)
2116 W. LINCOLN AVENUE
ANAHEIM, CA 92801

Registered July 17, 2012

Int. Cl.: 34

FOR: HOOKAH CHARCOAL, IN CLASS 34 (U.S. CLS. 2, 8, 9 AND 17).

TRADEMARK

FIRST USE 3-20-2012; IN COMMERCE 3-20-2012.

PRINCIPAL REGISTER

THE MARK CONSISTS OF STANDARD CHARACTERS WITHOUT CLAIM TO ANY PARTICULAR FONT, STYLE, SIZE, OR COLOR.

SN 85-299,385, FILED 4-19-2011.

GINA HAYES, EXAMINING ATTORNEY



David J. Kyffers

Director of the United States Patent and Trademark Office

United States of America

United States Patent and Trademark Office

AdoraPet

Reg. No. 4,176,770

ADORAPET LLC (NEW YORK LIMITED LIABILITY COMPANY)
301 CATHEDRAL PARKWAY, SUITE 12C
NEW YORK, NY 10026

Registered July 17, 2012

Int. Cls.: 16 and 28

FOR: CHILDREN'S BOOKS, IN CLASS 16 (U.S. CLS. 2, 5, 22, 23, 29, 37, 38 AND 50).

FIRST USE 9-5-2008; IN COMMERCE 11-30-2008.

TRADEMARK

FOR: ARTICLES OF CLOTHING FOR TOYS; CHILDREN'S MULTIPLE ACTIVITY TOYS; CHILDREN'S MULTIPLE ACTIVITY TOYS SOLD AS A UNIT WITH PRINTED BOOKS; DOLLS AND DOLL ACCESSORIES, NAMELY, CLOTHING FOR DOLLS, DOLL ROOMS, DOLL BEDS, DOLL HOUSES, TOY FABRICS AND LINENS FOR DOLLS AND STROLLERS FOR DOLLS; INFANT TOYS; PLUSH TOYS; STUFFED AND PLUSH TOYS; STUFFED TOY ANIMALS; STUFFED TOYS; TOY ANIMALS; TOY ANIMALS AND ACCESSORIES THEREFOR; TOYS, NAMELY, CHILDREN'S DRESS-UP ACCESSORIES, IN CLASS 28 (U.S. CLS. 22, 23, 38 AND 50).

PRINCIPAL REGISTER

FIRST USE 9-5-2008; IN COMMERCE 11-30-2008.

THE MARK CONSISTS OF STANDARD CHARACTERS WITHOUT CLAIM TO ANY PARTICULAR FONT, STYLE, SIZE, OR COLOR.

OWNER OF U.S. REG. NO. 3,695,109.

SN 85-299,451, FILED 4-20-2011.

DAVID HOFFMAN, EXAMINING ATTORNEY



David J. Kyffers

Director of the United States Patent and Trademark Office

United States of America

United States Patent and Trademark Office



Reg. No. 4,176,771

Registered July 17, 2012

Int. Cl.: 28

TRADEMARK

PRINCIPAL REGISTER

ADORAPET LLC (NEW YORK LIMITED LIABILITY COMPANY)
301 CATHEDRAL PARKWAY, SUITE 12C
NEW YORK, NY 10026

FOR: ARTICLES OF CLOTHING FOR TOYS; CHILDREN'S MULTIPLE ACTIVITY TOYS; CHILDREN'S MULTIPLE ACTIVITY TOYS SOLD AS A UNIT WITH PRINTED BOOKS; DOLLS AND DOLL ACCESSORIES, NAMELY, CLOTHING FOR DOLLS, DOLL ROOMS, DOLL BEDS, DOLL HOUSES, TOY FABRICS AND LINENS FOR DOLLS AND STROLLERS FOR DOLLS; INFANT TOYS; PLUSH TOYS; STUFFED AND PLUSH TOYS; STUFFED TOY ANIMALS; STUFFED TOYS; TOY ANIMALS; TOY ANIMALS AND ACCESSORIES THEREFOR; TOYS, NAMELY, CHILDREN'S DRESS-UP ACCESSORIES, IN CLASS 28 (U.S. CLS. 22, 23, 38 AND 50).

FIRST USE 11-15-2008; IN COMMERCE 11-30-2008.

THE MARK CONSISTS OF A PAW MADE UP OF A HEART. THE HEART IS MADE UP OF A STYLIZED LOWER-CASE LETTER "A" AND STYLIZED LOWER-CASE LETTER "P".

SN 85-299,462, FILED 4-20-2011.

DAVID HOFFMAN, EXAMINING ATTORNEY



David J. Kyffers

Director of the United States Patent and Trademark Office

United States of America

United States Patent and Trademark Office

SNAPFINDS

Reg. No. 4,176,772

SNAPRETAIL, LLC (DELAWARE LIMITED LIABILITY COMPANY)
1345 BEULAH ROAD
PITTSBURGH, PA 15235

Registered July 17, 2012

Int. Cl.: 35

FOR: PROMOTING THE GOODS AND SERVICES OF OTHERS, NAMELY, PROVIDING INFORMATION REGARDING DISCOUNTS, COUPONS, REBATES, VOUCHERS AND SPECIAL OFFERS FOR THE GOODS AND SERVICES OF OTHERS AND PROVIDING LINKS TO WEBSITES OF OTHERS, IN CLASS 35 (U.S. CLS. 100, 101 AND 102).

SERVICE MARK

PRINCIPAL REGISTER

FIRST USE 5-0-2011; IN COMMERCE 5-0-2011.

THE MARK CONSISTS OF STANDARD CHARACTERS WITHOUT CLAIM TO ANY PARTICULAR FONT, STYLE, SIZE, OR COLOR.

SN 85-299,618, FILED 4-20-2011.

LINDA ORNDORFF, EXAMINING ATTORNEY



David J. Kyffers

Director of the United States Patent and Trademark Office

United States of America

United States Patent and Trademark Office

MEDILOGIX

Reg. No. 4,176,773

Registered July 17, 2012

**Int. Cls.: 35, 37, 44, and
45**

SERVICE MARK

PRINCIPAL REGISTER

MEDILOGIX, LLC (DELAWARE LIMITED LIABILITY COMPANY)
SUITE 950
1512 LARIMER STREET
DENVER, CO 80202

FOR: WHOLESALE DISTRIBUTORSHIPS FEATURING MEDICAL EQUIPMENT; ASSET MANAGEMENT SERVICES IN THE FIELD OF MEDICAL EQUIPMENT; ASSET MANAGEMENT SERVICES, NAMELY, REPORTING ON SERVICE HISTORIES, UTILIZATION OF THE MEDICAL ASSETS, END OF PRODUCT LIFE INFORMATION AND REPLACEMENT COSTS ALL RELATED TO MEDICAL DIAGNOSTIC, CLINICAL AND BIOMEDICAL EQUIPMENT; LOGISTICS MANAGEMENT IN THE FIELD OF MEDICAL EQUIPMENT, IN CLASS 35 (U.S. CLS. 100, 101 AND 102).

FIRST USE 5-13-2011; IN COMMERCE 5-13-2011.

FOR: REPAIR AND MAINTENANCE OF MEDICAL EQUIPMENT, IN CLASS 37 (U.S. CLS. 100, 103 AND 106).

FIRST USE 5-13-2011; IN COMMERCE 5-13-2011.

FOR: LEASING OF MEDICAL EQUIPMENT; RENTAL OF MEDICAL EQUIPMENT; RESPIRATORY THERAPY SERVICES, IN CLASS 44 (U.S. CLS. 100 AND 101).

FIRST USE 5-13-2011; IN COMMERCE 5-13-2011.

FOR: CONSULTING SERVICES IN THE FIELD OF REGULATORY COMPLIANCE FOR MEDICAL EQUIPMENT, IN CLASS 45 (U.S. CLS. 100 AND 101).

FIRST USE 5-13-2011; IN COMMERCE 5-13-2011.

THE MARK CONSISTS OF STANDARD CHARACTERS WITHOUT CLAIM TO ANY PARTICULAR FONT, STYLE, SIZE, OR COLOR.

SN 85-299,757, FILED 4-20-2011.

MARILYN IZZI, EXAMINING ATTORNEY



David J. Kyfos

Director of the United States Patent and Trademark Office

United States of America
United States Patent and Trademark Office

MONOCLE

Reg. No. 4,176,774

WILLIAMS, KAREN S. (UNITED STATES INDIVIDUAL), DBA ACME WINE CO.,
1080 FULTON LANE
ST. HELENA, CA 94574

Registered July 17, 2012

Int. Cl.: 33

FOR: WINE, IN CLASS 33 (U.S. CLS. 47 AND 49).

TRADEMARK

FIRST USE 2-10-2012; IN COMMERCE 2-10-2012.

PRINCIPAL REGISTER

THE MARK CONSISTS OF STANDARD CHARACTERS WITHOUT CLAIM TO ANY PARTICULAR FONT, STYLE, SIZE, OR COLOR.

SN 85-299,858, FILED 4-20-2011.

DOUGLAS LEE, EXAMINING ATTORNEY



David J. Kyffers

Director of the United States Patent and Trademark Office

United States of America

United States Patent and Trademark Office



Reg. No. 4,176,775

Registered July 17, 2012

Int. Cl.: 25

TRADEMARK

PRINCIPAL REGISTER

THE PEOPLE'S MOVEMENT, INC. (DELAWARE CORPORATION)
426 N. CEDROS AVE.
SOLONA BEACH, CA 92075

FOR: DRESSES; FOOTWEAR; HATS; HEADWEAR; PANTS; SHIRTS; SHOES; SHORTS;
SKIRTS; SOCKS; SWEATERS; T-SHIRTS, IN CLASS 25 (U.S. CLS. 22 AND 39).

FIRST USE 2-24-2012; IN COMMERCE 2-24-2012.

THE LIKENESS (OR, "PORTRAIT") IN THE MARK DOES NOT IDENTIFY A LIVING INDIVIDUAL.

THE COLOR(S) RED, BLUE, AND WHITE IS/ARE CLAIMED AS A FEATURE OF THE MARK.

THE MARK CONSISTS OF A FANCIFUL IMAGE OF A MALE FIGURE WITH A WHITE FACE AND BLUE FEATURES, WEARING BLUE CLOTHING AND A WHITE SCARF AND APPEARING AGAINST A BACKDROP OF RED LINES RADIATING OUTWARD FROM A CENTRAL POINT. UNDERNEATH THE DESIGN IS THE WORDING "THE PEOPLE'S MOVEMENT", WITH "PEOPLE'S" IN BLUE AND "THE" AND "MOVEMENT" IN RED. THE OTHER WHITE IN THE MARK REPRESENTS BACKGROUND OR TRANSPARENCY AND IS NOT CLAIMED AS A FEATURE OF THE MARK.

SN 85-299,941, FILED 4-20-2011.

KIMBERLY FRYE, EXAMINING ATTORNEY



David J. Kyros

Director of the United States Patent and Trademark Office

United States of America

United States Patent and Trademark Office

FLYING SEVEN

Reg. No. 4,176,776

Registered July 17, 2012

Int. Cl.: 9

TRADEMARK

PRINCIPAL REGISTER

BLUBERI JEUX ET TECHNOLOGIES INC. AKA BLUBERI GAMING TECHNOLOGIES INC.
(CANADA CORPORATION)
2120 LETENDRE STREET, SUITE 310
DRUMMONDVILLE, QUEBEC, CANADA J2C-7E9

FOR: SOFTWARE FOR GAMING MACHINES; GAMING MACHINES WITH VIDEO OUTPUT,
IN CLASS 9 (U.S. CLS. 21, 23, 26, 36 AND 38).

FIRST USE 2-20-2012; IN COMMERCE 2-20-2012.

THE MARK CONSISTS OF STANDARD CHARACTERS WITHOUT CLAIM TO ANY PAR-
TICULAR FONT, STYLE, SIZE, OR COLOR.

SN 85-299,983, FILED 4-20-2011.

WILLIAM P. SHANAHAN, EXAMINING ATTORNEY



David J. Kybas

Director of the United States Patent and Trademark Office

United States of America

United States Patent and Trademark Office

MY UNO

Reg. No. 4,176,777

Registered July 17, 2012

Int. Cl.: 28

MATTEL, INC. (DELAWARE CORPORATION)
333 CONTINENTAL BOULEVARD
M1-1518
EL SEGUNDO, CA 90245

FOR: CARD GAMES, IN CLASS 28 (U.S. CLS. 22, 23, 38 AND 50).

TRADEMARK

FIRST USE 12-31-2011; IN COMMERCE 12-31-2011.

PRINCIPAL REGISTER

THE MARK CONSISTS OF STANDARD CHARACTERS WITHOUT CLAIM TO ANY PARTICULAR FONT, STYLE, SIZE, OR COLOR.

OWNER OF U.S. REG. NOS. 1,005,397, 2,232,917, AND OTHERS.

THE ENGLISH TRANSLATION OF "UNO" IS "ONE".

SN 85-300,377, FILED 4-20-2011.

JOHN GARTNER, EXAMINING ATTORNEY



David J. Kybas

Director of the United States Patent and Trademark Office

United States of America

United States Patent and Trademark Office

WAY GREEN

Reg. No. 4,176,778

SURVIVOR SOLUTIONS, LLC. (MONTANA LIMITED LIABILITY COMPANY)
101 MOUNTAIN VIEW DRIVE/ PO BOX 705
SAINT IGNATIUS, MT 59865

Registered July 17, 2012

Int. Cl.: 5

FOR: DIETARY AND NUTRITIONAL SUPPLEMENTS; DIETARY BEVERAGE SUPPLEMENTS FOR HUMAN CONSUMPTION IN DRY MIX FORM FOR THERAPEUTIC PURPOSES; POWDERED NUTRITIONAL SUPPLEMENT DRINK MIX, IN CLASS 5 (U.S. CLS. 6, 18, 44, 46, 51 AND 52).

TRADEMARK

PRINCIPAL REGISTER

FIRST USE 4-8-2012; IN COMMERCE 4-8-2012.

THE MARK CONSISTS OF STANDARD CHARACTERS WITHOUT CLAIM TO ANY PARTICULAR FONT, STYLE, SIZE, OR COLOR.

NO CLAIM IS MADE TO THE EXCLUSIVE RIGHT TO USE "GREEN", APART FROM THE MARK AS SHOWN.

SN 85-300,386, FILED 4-20-2011.

KATHRYN COWARD, EXAMINING ATTORNEY



David J. Kyffers

Director of the United States Patent and Trademark Office

United States of America

United States Patent and Trademark Office

ZIRCULES

Reg. No. 4,176,779

Registered July 17, 2012

Int. Cl.: 5

TRADEMARK

PRINCIPAL REGISTER

CLINICIAN'S CHOICE DENTAL PRODUCTS INC. (CANADA CORPORATION)
2ND FLOOR
167 CENTRAL AVENUE
LONDON, ONTARIO, CANADA N6A1M6

FOR: COMPOSITE MATERIALS FOR DENTAL RESTORATIONS, IN CLASS 5 (U.S. CLS. 6, 18, 44, 46, 51 AND 52).

FIRST USE 7-8-2011; IN COMMERCE 7-8-2011.

THE MARK CONSISTS OF STANDARD CHARACTERS WITHOUT CLAIM TO ANY PARTICULAR FONT, STYLE, SIZE, OR COLOR.

THE WORDING "ZIRCULES" HAS NO MEANING IN A FOREIGN LANGUAGE.

SN 85-300,574, FILED 4-20-2011.

JAY FLOWERS, EXAMINING ATTORNEY



David J. Kyffers

Director of the United States Patent and Trademark Office

United States of America

United States Patent and Trademark Office

LUCKY LUGGAGE TAG

Reg. No. 4,176,780

LITHO FLEXO GRAFICS, INC. (UTAH CORPORATION)
2400 SOUTH 600 WEST
SALT LAKE CITY, UT 84115

Registered July 17, 2012

Int. Cl.: 28

FOR: GAME PIECES OFFERING PRIZES THAT PROMOTE PRODUCTS AND SERVICES, WHERE THE GAME PIECES ARE ALSO USED TO IDENTIFY A PATRON'S BAGGAGE, IN CLASS 28 (U.S. CLS. 22, 23, 38 AND 50).

TRADEMARK

FIRST USE 2-25-2012; IN COMMERCE 2-25-2012.

PRINCIPAL REGISTER

THE MARK CONSISTS OF STANDARD CHARACTERS WITHOUT CLAIM TO ANY PARTICULAR FONT, STYLE, SIZE, OR COLOR.

NO CLAIM IS MADE TO THE EXCLUSIVE RIGHT TO USE "LUGGAGE TAG", APART FROM THE MARK AS SHOWN.

SN 85-300,585, FILED 4-20-2011.

LINDA LAVACHE, EXAMINING ATTORNEY



David J. Kyffers

Director of the United States Patent and Trademark Office

United States of America

United States Patent and Trademark Office



Reg. No. 4,176,781

Registered July 17, 2012

Int. Cl.: 29

TRADEMARK

PRINCIPAL REGISTER

GORTON'S INC. (DELAWARE CORPORATION)
128 ROGERS STREET
GLOUCESTER, MA 01930

FOR: FROZEN PRE-PACKAGED ENTREES CONSISTING PRIMARILY OF SEAFOOD; PREPARED ENTREES CONSISTING PRIMARILY OF SEAFOOD; SEAFOOD; PACKAGED FROZEN SEAFOOD CONTAINED IN COOKABLE OVEN BAGS AND SOLD AS A UNIT , IN CLASS 29 (U.S. CL. 46).

FIRST USE 1-0-2012; IN COMMERCE 1-0-2012.

NO CLAIM IS MADE TO THE EXCLUSIVE RIGHT TO USE "BAKE" AND "OVEN BAGS", APART FROM THE MARK AS SHOWN.

THE COLOR(S) YELLOW, WHITE, SILVER, BLACK, GRAY, AND GREEN IS/ARE CLAIMED AS A FEATURE OF THE MARK.

THE MARK CONSISTS OF A STYLIZED DEPICTION OF AN OVEN WITH AN OPEN DOOR; THE OVEN IS SILVER, GRAY, BLACK, AND WHITE; INSIDE THE OVEN APPEARS THE WORDING "BAKE PERFECT" IN SILVER ABOVE THE TERM "OVEN BAGS" IN SILVER; THERE IS A SILVER HORIZONTAL LINE ON EITHER SIDE OF THE TERM "OVEN BAGS"; ON THE OPEN DOOR RESTS A SILVER BAG WITH WHITE, BLACK, AND GRAY HIGHLIGHTS AND SHADOWING CONTAINING YELLOW FOOD WITH GREEN AND WHITE HIGHLIGHTS AND ACCENTS; THE BACKGROUND OF THE ENTIRE MARK IS TRANSLUCENT.

SN 85-300,783, FILED 4-21-2011.

JIM RINGLE, EXAMINING ATTORNEY



David J. Kybas

Director of the United States Patent and Trademark Office

United States of America

United States Patent and Trademark Office

WEXFORD

Reg. No. 4,176,782

WALGREEN CO. (ILLINOIS CORPORATION)
200 WILMOT ROAD
DEERFIELD, IL 60015

Registered July 17, 2012

Int. Cl.: 16

FOR: SHEET PROTECTORS, HANGING FILES, PROTRACTORS, RUBBER BANDS, ERASERS, PAPER CLIPS, RULERS, HIGHLIGHTER PENS, MARKERS, PENCILS, PEN AND PENCIL CASES, PENCIL SHARPENERS, FOLDERS, PORTFOLIOS, INDEX CARDS, IN CLASS 16 (U.S. CLS. 2, 5, 22, 23, 29, 37, 38 AND 50).

TRADEMARK

PRINCIPAL REGISTER

FIRST USE 6-6-2000; IN COMMERCE 6-6-2000.

THE MARK CONSISTS OF STANDARD CHARACTERS WITHOUT CLAIM TO ANY PARTICULAR FONT, STYLE, SIZE, OR COLOR.

OWNER OF U.S. REG. NOS. 2,803,119 AND 3,814,490.

SN 85-301,005, FILED 4-21-2011.

THOMAS MANOR, EXAMINING ATTORNEY



David J. Kypos

Director of the United States Patent and Trademark Office

United States of America

United States Patent and Trademark Office

SAF-T-TILT

Reg. No. 4,176,783

PDS ELECTRONICS, INC. (OHIO CORPORATION)
1200 SOUTHEAST AVENUE, P. O. BOX 909
AKRON, OH 44309

Registered July 17, 2012

Int. Cl.: 9

FOR: ANTENNA MOUNTING APPARATUS IN THE NATURE OF A METAL SUPPORT BASE SPECIALLY ADAPTED FOR HOLDING AND SUPPORTING A GROUND-BASED RADIO ANTENNA , IN CLASS 9 (U.S. CLS. 21, 23, 26, 36 AND 38).

TRADEMARK

FIRST USE 5-12-2011; IN COMMERCE 5-12-2011.

PRINCIPAL REGISTER

THE MARK CONSISTS OF STANDARD CHARACTERS WITHOUT CLAIM TO ANY PARTICULAR FONT, STYLE, SIZE, OR COLOR.

SN 85-301,111, FILED 4-21-2011.

NELSON SNYDER, EXAMINING ATTORNEY



David J. Kyfos

Director of the United States Patent and Trademark Office

United States of America

United States Patent and Trademark Office

Breath of Life Records

Reg. No. 4,176,784

BREATH OF LIFE RECORDS, LLC (CALIFORNIA LIMITED LIABILITY COMPANY)
15416 KESWICK STREET
VAN NUYS, CA 91406

Registered July 17, 2012

Int. Cl.: 41

FOR: PRODUCTION OF SOUND AND MUSIC VIDEO RECORDINGS, IN CLASS 41 (U.S. CLS. 100, 101 AND 107).

SERVICE MARK

FIRST USE 2-17-2011; IN COMMERCE 2-17-2011.

PRINCIPAL REGISTER

THE MARK CONSISTS OF STANDARD CHARACTERS WITHOUT CLAIM TO ANY PARTICULAR FONT, STYLE, SIZE, OR COLOR.

NO CLAIM IS MADE TO THE EXCLUSIVE RIGHT TO USE "RECORDS", APART FROM THE MARK AS SHOWN.

SN 85-301,129, FILED 4-21-2011.

AMY C. KEAN, EXAMINING ATTORNEY



David J. Kappas

Director of the United States Patent and Trademark Office

United States of America

United States Patent and Trademark Office

SUN FREEDOM AMERICA

Reg. No. 4,176,785

SUN FREEDOM AMERICA, LLC (TEXAS LIMITED LIABILITY COMPANY)
7344 CARIBOU

Registered July 17, 2012

SAN ANTONIO, TX 78238

Int. Cl.: 11

FOR: HOT WATER TANKS, DRAIN BACK TANKS AND SOLAR COLLECTORS, IN CLASS 11 (U.S. CLS. 13, 21, 23, 31 AND 34).

TRADEMARK

FIRST USE 1-25-2012; IN COMMERCE 1-25-2012.

PRINCIPAL REGISTER

THE MARK CONSISTS OF STANDARD CHARACTERS WITHOUT CLAIM TO ANY PARTICULAR FONT, STYLE, SIZE, OR COLOR.

NO CLAIM IS MADE TO THE EXCLUSIVE RIGHT TO USE "SUN" OR "AMERICA", APART FROM THE MARK AS SHOWN.

SN 85-301,169, FILED 4-21-2011.

REBECCA POVARCHUK, EXAMINING ATTORNEY



David J. Kyffers

Director of the United States Patent and Trademark Office

United States of America

United States Patent and Trademark Office

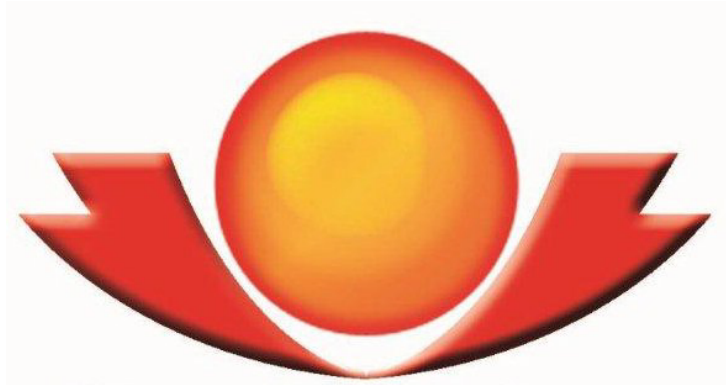

Reg. No. 4,176,786

SUN FREEDOM AMERICA, LLC (TEXAS LIMITED LIABILITY COMPANY)
7344 CARIBOU
SAN ANTONIO, TX 78238

Registered July 17, 2012

Int. Cl.: 11

FOR: HOT WATER TANKS, DRAIN BACK TANKS AND SOLAR COLLECTORS, IN CLASS 11 (U.S. CLS. 13, 21, 23, 31 AND 34).

TRADEMARK

FIRST USE 1-25-2012; IN COMMERCE 1-25-2012.

PRINCIPAL REGISTER

THE MARK CONSISTS OF A STYLIZED ORANGE SUN WITH A YELLOW CENTER, AN ORANGE RIBBON BELOW THE SUN WITH BLACK SHADING AT THE BOTTOM.

THE COLOR(S) YELLOW, ORANGE AND BLACK IS/ARE CLAIMED AS A FEATURE OF THE MARK.

SN 85-301,195, FILED 4-21-2011.

REBECCA POVARCHUK, EXAMINING ATTORNEY



David J. Kyffers

Director of the United States Patent and Trademark Office

United States of America

United States Patent and Trademark Office



Reg. No. 4,176,787

SUN FREEDOM AMERICA, LLC (TEXAS LIMITED LIABILITY COMPANY)
7344 CARIBOU
SAN ANTONIO, TX 78238

Registered July 17, 2012

Int. Cl.: 11

FOR: HOT WATER TANKS, DRAIN BACK TANKS AND SOLAR COLLECTORS, IN CLASS 11 (U.S. CLS. 13, 21, 23, 31 AND 34).

TRADEMARK

FIRST USE 1-25-2012; IN COMMERCE 1-25-2012.

PRINCIPAL REGISTER

NO CLAIM IS MADE TO THE EXCLUSIVE RIGHT TO USE "SUN" OR "AMERICA", APART FROM THE MARK AS SHOWN.

THE COLOR(S) ORANGE, YELLOW AND BLACK IS/ARE CLAIMED AS A FEATURE OF THE MARK.

THE MARK CONSISTS OF A STYLIZED ORANGE SUN WITH A YELLOW CENTER, AN ORANGE RIBBON BELOW THE SUN WITH BLACK SHADING AT THE BOTTOM, AND THE WORDING "SUN FREEDOM AMERICA" IN BLACK.

SN 85-301,221, FILED 4-21-2011.

REBECCA POVARCHUK, EXAMINING ATTORNEY



David J. Kybas

Director of the United States Patent and Trademark Office

United States of America

United States Patent and Trademark Office

see it. want it. wipit.

Reg. No. 4,176,788

ALLEGRO SYSTEMS, LLC (CALIFORNIA LIMITED LIABILITY COMPANY)
20362 WINDROW DRIVE SUITE 200

Registered July 17, 2012

LAKE FOREST, CA 92630

Int. Cl.: 9

FOR: COMPUTER APPLICATION SOFTWARE FOR MOBILE PHONES AND WEBSITES, NAMELY, SOFTWARE FOR ELECTRONIC PAYMENTS, IN CLASS 9 (U.S. CLS. 21, 23, 26, 36 AND 38).

TRADEMARK

FIRST USE 3-7-2011; IN COMMERCE 3-7-2011.

PRINCIPAL REGISTER

THE MARK CONSISTS OF STANDARD CHARACTERS WITHOUT CLAIM TO ANY PARTICULAR FONT, STYLE, SIZE, OR COLOR.

SN 85-301,867, FILED 4-22-2011.

DEIRDRE ROBERTSON, EXAMINING ATTORNEY



David J. Kyffers

Director of the United States Patent and Trademark Office

United States of America

United States Patent and Trademark Office

FIVE TACOS

Reg. No. 4,176,789

THE TACO JOINT, INC. (NEW YORK CORPORATION)
225 SEASPRAY AVE.

Registered July 17, 2012

PALM BEACH, FL 33480

Int. Cl.: 43

FOR: RESTAURANT SERVICES, IN CLASS 43 (U.S. CLS. 100 AND 101).

SERVICE MARK

FIRST USE 1-11-2012; IN COMMERCE 1-11-2012.

PRINCIPAL REGISTER

THE MARK CONSISTS OF STANDARD CHARACTERS WITHOUT CLAIM TO ANY PARTICULAR FONT, STYLE, SIZE, OR COLOR.

NO CLAIM IS MADE TO THE EXCLUSIVE RIGHT TO USE "TACOS", APART FROM THE MARK AS SHOWN.

SN 85-301,929, FILED 4-22-2011.

KELLEY WELLS, EXAMINING ATTORNEY



David J. Kyffers

Director of the United States Patent and Trademark Office

United States of America

United States Patent and Trademark Office

REGIONS NOW BANKING

Reg. No. 4,176,790

Registered July 17, 2012

Int. Cl.: 36

SERVICE MARK

PRINCIPAL REGISTER

REGIONS ASSET COMPANY (DELAWARE CORPORATION)
3501 SILVERSIDE ROAD; SUITE 209
WILMINGTON, DE 19810

FOR: BANKING SERVICES, IN CLASS 36 (U.S. CLS. 100, 101 AND 102).

FIRST USE 7-27-2011; IN COMMERCE 7-27-2011.

THE MARK CONSISTS OF STANDARD CHARACTERS WITHOUT CLAIM TO ANY PARTICULAR FONT, STYLE, SIZE, OR COLOR.

OWNER OF U.S. REG. NOS. 1,881,600, 3,505,814, AND OTHERS.

NO CLAIM IS MADE TO THE EXCLUSIVE RIGHT TO USE "BANKING", APART FROM THE MARK AS SHOWN.

SN 85-302,115, FILED 4-22-2011.

PAUL E. FAHRENKOPF, EXAMINING ATTORNEY



David J. Kyffers

Director of the United States Patent and Trademark Office

United States of America

United States Patent and Trademark Office

Naughty for Nice

Reg. No. 4,176,791

GOODMAN, MATTHEW J. (UNITED STATES INDIVIDUAL)
1 E. DELAWARE PLACE #25J
CHICAGO, IL 60611

Registered July 17, 2012

Int. Cl.: 25

FOR: LINGERIE, IN CLASS 25 (U.S. CLS. 22 AND 39).

TRADEMARK

FIRST USE 2-14-2012; IN COMMERCE 2-14-2012.

PRINCIPAL REGISTER

THE MARK CONSISTS OF STANDARD CHARACTERS WITHOUT CLAIM TO ANY PARTICULAR FONT, STYLE, SIZE, OR COLOR.

SN 85-302,299, FILED 4-22-2011.

KAPIL BHANOT, EXAMINING ATTORNEY



David J. Kybas

Director of the United States Patent and Trademark Office

United States of America

United States Patent and Trademark Office

RD Shady

Reg. No. 4,176,792

RED DOOR INTERIORS (WASHINGTON SOLE PROPRIETORSHIP)
430 WASHINGTON STREET SE
OLYMPIA, WA 98501

Registered July 17, 2012

Int. Cl.: 11

FOR: LIGHT FIXTURE ACCESSORIES, NAMELY, LAMP SHADES AND LAMP SHADE COVERS, IN CLASS 11 (U.S. CLS. 13, 21, 23, 31 AND 34).

TRADEMARK

FIRST USE 4-29-2012; IN COMMERCE 4-29-2012.

PRINCIPAL REGISTER

THE MARK CONSISTS OF STANDARD CHARACTERS WITHOUT CLAIM TO ANY PARTICULAR FONT, STYLE, SIZE, OR COLOR.

SN 85-302,649, FILED 4-22-2011.

KATHERINE CHANG, EXAMINING ATTORNEY



David J. Kybas

Director of the United States Patent and Trademark Office

United States of America

United States Patent and Trademark Office

Alpha Might

Reg. No. 4,176,793

PROACTIVE FORCE (CALIFORNIA LIMITED LIABILITY COMPANY)
730 SILVERWOOD PLACE
REDLANDS, CA 92373

Registered July 17, 2012

Int. Cl.: 5

FOR: DIETARY FOOD SUPPLEMENTS, NAMELY, PRE WORKOUT FORMULA, IN CLASS 5 (U.S. CLS. 6, 18, 44, 46, 51 AND 52).

TRADEMARK

FIRST USE 12-1-2011; IN COMMERCE 4-20-2012.

PRINCIPAL REGISTER

THE MARK CONSISTS OF STANDARD CHARACTERS WITHOUT CLAIM TO ANY PARTICULAR FONT, STYLE, SIZE, OR COLOR.

SN 85-303,006, FILED 4-23-2011.

ANDREW LEASER, EXAMINING ATTORNEY



David J. Kyffers

Director of the United States Patent and Trademark Office

United States of America

United States Patent and Trademark Office

THE BEST PART OF MEMORIES IS MAKING THEM

Reg. No. 4,176,794

Registered July 17, 2012

Int. Cl.: 35

SERVICE MARK

PRINCIPAL REGISTER

THE JACK AND JILL LATE STAGE CANCER FOUNDATION, INC. (GEORGIA CORPORATION)
3282 NORTHSIDE PARKWAY, SUITE 100
ATLANTA, GA 30327

FOR: PROMOTING PUBLIC AWARENESS OF THE IMPORTANCE OF FAMILY AND FAMILY EVENTS, IN CLASS 35 (U.S. CLS. 100, 101 AND 102).

FIRST USE 5-0-2011; IN COMMERCE 5-0-2011.

THE MARK CONSISTS OF STANDARD CHARACTERS WITHOUT CLAIM TO ANY PARTICULAR FONT, STYLE, SIZE, OR COLOR.

SN 85-303,225, FILED 4-25-2011.

CARYN GLASSER, EXAMINING ATTORNEY



David J. Kyjars

Director of the United States Patent and Trademark Office

United States of America

United States Patent and Trademark Office



Reg. No. 4,176,795

MSD CONSUMER CARE, INC. (DELAWARE CORPORATION)
3030 JACKSON AVENUE
MEMPHIS, TN 38151

Registered July 17, 2012

Int. Cl.: 35

FOR: RETAIL STORE SERVICES FEATURING FOOTWEAR, AND FOOT RELATED PRODUCTS, IN CLASS 35 (U.S. CLS. 100, 101 AND 102).

SERVICE MARK

FIRST USE 10-17-2011; IN COMMERCE 10-17-2011.

PRINCIPAL REGISTER

OWNER OF U.S. REG. NOS. 512,484, 3,967,759, AND OTHERS.

THE COLOR(S) YELLOW, BLUE, TEAL, GRAY, AND WHITE IS/ARE CLAIMED AS A FEATURE OF THE MARK.

NO CLAIM IS MADE TO THE EXCLUSIVE RIGHT TO USE "SHOES", APART FROM THE MARK AS SHOWN.

THE NAME(S), PORTRAIT(S), AND/OR SIGNATURE(S) SHOWN IN THE MARK DOES NOT IDENTIFY A PARTICULAR LIVING INDIVIDUAL.

THE MARK CONSISTS OF "DR. SCHOLL'S" IN YELLOW STYLIZED LETTERING, AND THE WORD "SHOES" IN BLUE STYLIZED LETTERING, ALL WITHIN A TEAL OVAL DESIGN, OUTLINED IN A BROKEN GRAY OVAL WITH A WHITE OVAL SEPARATING THE GRAY OUTLINE AND THE TEAL OVAL DESIGN.

SN 85-303,254, FILED 4-25-2011.

TINA L. SNAPP, EXAMINING ATTORNEY



David J. Kybas

Director of the United States Patent and Trademark Office

United States of America

United States Patent and Trademark Office

KNOWIT

Reg. No. 4,176,796

KNOWIT, INC. (DELAWARE CORPORATION)
604 DIXIE TRAIL
RALEIGH, NC 27607

Registered July 17, 2012

Int. Cl.: 9

FOR: SOFTWARE PLATFORM FOR THE PURPOSE OF INFORMATION MANAGEMENT FOR USE IN SEARCHING, RETRIEVING, COMPILING, ORGANIZING, MANAGING, ANALYZING, REPRESENTING, COMMUNICATING AND/OR INTEGRATING COMPLEX DATA SETS TO MANAGE AND MONITOR PERSONAL DATA, IN CLASS 9 (U.S. CLS. 21, 23, 26, 36 AND 38).

TRADEMARK

PRINCIPAL REGISTER

FIRST USE 10-26-2011; IN COMMERCE 10-26-2011.

THE MARK CONSISTS OF STANDARD CHARACTERS WITHOUT CLAIM TO ANY PARTICULAR FONT, STYLE, SIZE, OR COLOR.

SN 85-303,274, FILED 4-25-2011.

NAAKWAMA ANKRAH, EXAMINING ATTORNEY



David J. Kyffers

Director of the United States Patent and Trademark Office

United States of America

United States Patent and Trademark Office

NV Hotels & Resorts

Reg. No. 4,176,797

Registered July 17, 2012

Int. Cl.: 43

SERVICE MARK

PRINCIPAL REGISTER

SKY RESORT MANAGEMENT, LLC (FLORIDA LIMITED LIABILITY COMPANY)
SUITE 104
7011 GRAND NATIONAL DRIVE
ORLANDO, FL 32819

FOR: RESORT HOTELS; RESORT LODGING; HOTELS; HOTEL AND RESTAURANT SERVICES, IN CLASS 43 (U.S. CLS. 100 AND 101).

FIRST USE 4-30-2011; IN COMMERCE 4-30-2011.

THE MARK CONSISTS OF STANDARD CHARACTERS WITHOUT CLAIM TO ANY PARTICULAR FONT, STYLE, SIZE, OR COLOR.

NO CLAIM IS MADE TO THE EXCLUSIVE RIGHT TO USE "HOTELS & RESORTS", APART FROM THE MARK AS SHOWN.

SN 85-303,358, FILED 4-25-2011.

JAMES GRIFFIN, EXAMINING ATTORNEY



David J. Kyffers

Director of the United States Patent and Trademark Office

United States of America

United States Patent and Trademark Office

NORTH AMERICAN GOLDFIELDS

Reg. No. 4,176,798

Registered July 17, 2012

Int. Cl.: 36

SERVICE MARK

PRINCIPAL REGISTER

VICEROY FUNDS, LLC (GEORGIA LIMITED LIABILITY COMPANY)
SUITE 1700
3340 PEACHTREE ROAD
ATLANTA, GA 30326

FOR: EQUITY CAPITAL AND BOND INVESTMENT; FINANCIAL INVESTMENT ANALYSIS
AND STOCK RESEARCH, IN CLASS 36 (U.S. CLS. 100, 101 AND 102).

FIRST USE 5-31-2011; IN COMMERCE 5-31-2011.

THE MARK CONSISTS OF STANDARD CHARACTERS WITHOUT CLAIM TO ANY PAR-
TICULAR FONT, STYLE, SIZE, OR COLOR.

NO CLAIM IS MADE TO THE EXCLUSIVE RIGHT TO USE "NORTH AMERICAN", APART
FROM THE MARK AS SHOWN.

SN 85-303,444, FILED 4-25-2011.

KAREN K. BUSH, EXAMINING ATTORNEY



David J. Kyffers

Director of the United States Patent and Trademark Office

United States of America

United States Patent and Trademark Office

SorbitAll

Reg. No. 4,176,799

IVEY, GEORGE (CANADA INDIVIDUAL)
1397 STAG ROAD
CAMPBELL RIVER, CANADA V9W6C9

Registered July 17, 2012

Int. Cl.: 1

FOR: CHEMICALS FOR THE TREATMENT OF WATER AND WASTEWATER, IN CLASS 1 (U.S. CLS. 1, 5, 6, 10, 26 AND 46).

TRADEMARK

FIRST USE 3-20-2012; IN COMMERCE 3-20-2012.

PRINCIPAL REGISTER

THE MARK CONSISTS OF STANDARD CHARACTERS WITHOUT CLAIM TO ANY PARTICULAR FONT, STYLE, SIZE, OR COLOR.

SN 85-303,472, FILED 4-25-2011.

MICHAEL SOUDERS, EXAMINING ATTORNEY



David J. Kyros

Director of the United States Patent and Trademark Office

United States of America

United States Patent and Trademark Office



Reg. No. 4,176,800

Registered July 17, 2012

Int. Cl.: 36

SERVICE MARK

PRINCIPAL REGISTER

SNELL, JEFF (UNITED STATES INDIVIDUAL)
4012 E LONE MOUNTAIN RD
CAVE CREEK, AZ 85331

FOR: PROVIDING A WEBSITE FEATURING FINANCIAL INFORMATION IN THE NATURE OF STOCK INVESTMENT RECOMMENDATIONS TO INVESTORS LOOKING TO MAKE A PROFIT FROM THE STOCK MARKET, IN CLASS 36 (U.S. CLS. 100, 101 AND 102).

FIRST USE 4-3-2011; IN COMMERCE 6-24-2011.

NO CLAIM IS MADE TO THE EXCLUSIVE RIGHT TO USE ".COM", APART FROM THE MARK AS SHOWN.

THE MARK CONSISTS OF THE STYLIZED TEXT "STOCKWAVESURFER .COM" ABOVE A DESIGN OF A MAN ON A SURFBOARD RIDING A WAVE OF MONEY BILLS. UNDERNEATH IS THE STYLIZED TEXT "RIDE A WAVE TO STOCK MARKET PROFITS".

SN 85-303,499, FILED 4-25-2011.

JAY BESCH, EXAMINING ATTORNEY



David J. Kybas

Director of the United States Patent and Trademark Office

United States of America

United States Patent and Trademark Office

Herbal Angels

Reg. No. 4,176,801

Registered July 17, 2012

Int. Cl.: 5

TRADEMARK

PRINCIPAL REGISTER

HERBAL ANGELS LLC (MICHIGAN LIMITED LIABILITY COMPANY)
SUITE 204
214 S. MAIN STREET
ANN ARBOR, MI 48103

FOR: HERBAL TOPICAL CREAMS, GELS, SALVES, BALMS, LINIMENT AND OINTMENTS,
IN CLASS 5 (U.S. CLS. 6, 18, 44, 46, 51 AND 52).

FIRST USE 6-15-2011; IN COMMERCE 6-15-2011.

THE MARK CONSISTS OF STANDARD CHARACTERS WITHOUT CLAIM TO ANY PAR-
TICULAR FONT, STYLE, SIZE, OR COLOR.

NO CLAIM IS MADE TO THE EXCLUSIVE RIGHT TO USE "HERBAL", APART FROM THE
MARK AS SHOWN.

SN 85-303,588, FILED 4-25-2011.

MICHAEL SOUDERS, EXAMINING ATTORNEY



David J. Kyros

Director of the United States Patent and Trademark Office

United States of America

United States Patent and Trademark Office

CAMBRIA CLASSIC WOOD

Reg. No. 4,176,802

MSG MARKETING, INC. (ILLINOIS CORPORATION)
469 S. SPRING RD.
ELMHURST, IL 60126

Registered July 17, 2012

Int. Cl.: 20

FOR: DECORATIVE CURTAIN AND DRAPERY ACCESSORIES MADE OF WOOD, NAMELY, POLES, FINIALS, SPINDLE HOLDBACKS, CLIP RINGS, AND BRACKETS, IN CLASS 20 (U.S. CLS. 2, 13, 22, 25, 32 AND 50).

TRADEMARK

FIRST USE 10-15-2011; IN COMMERCE 10-15-2011.

PRINCIPAL REGISTER

THE MARK CONSISTS OF STANDARD CHARACTERS WITHOUT CLAIM TO ANY PARTICULAR FONT, STYLE, SIZE, OR COLOR.

OWNER OF U.S. REG. NOS. 3,091,437, 3,930,774, AND OTHERS.

NO CLAIM IS MADE TO THE EXCLUSIVE RIGHT TO USE "CLASSIC WOOD", APART FROM THE MARK AS SHOWN.

SN 85-303,750, FILED 4-25-2011.

DOUGLAS LEE, EXAMINING ATTORNEY



David J. Kyfos

Director of the United States Patent and Trademark Office

United States of America

United States Patent and Trademark Office

AUSSIE

Reg. No. 4,176,803

Registered July 17, 2012

Int. Cl.: 30

TRADEMARK

PRINCIPAL REGISTER

CHECKERS DRIVE-IN RESTAURANTS, INC. (DELAWARE CORPORATION)
4300 WEST CYPRESS STREET, SUITE 600
TAMPA, FL 33607

FOR: HAMBURGER SANDWICHES FOR CONSUMPTION ON OR OFF THE PREMISES, IN
CLASS 30 (U.S. CL. 46).

FIRST USE 5-7-2012; IN COMMERCE 5-7-2012.

THE MARK CONSISTS OF STANDARD CHARACTERS WITHOUT CLAIM TO ANY PAR-
TICULAR FONT, STYLE, SIZE, OR COLOR.

SN 85-303,843, FILED 4-25-2011.

TRACY CROSS, EXAMINING ATTORNEY



David J. Kyros

Director of the United States Patent and Trademark Office

United States of America

United States Patent and Trademark Office

CAMBRIA PREMIER WOOD

Reg. No. 4,176,804

MSG MARKETING, INC. (ILLINOIS CORPORATION)
469 S. SPRING RD.
ELMHURST, IL 60126

Registered July 17, 2012

Int. Cl.: 20

FOR: DECORATIVE CURTAIN AND DRAPERY ACCESSORIES MADE OF WOOD, NAMELY, POLES, FINIALS, SPINDLE HOLDBACKS, CLIP RINGS, AND BRACKETS, IN CLASS 20 (U.S. CLS. 2, 13, 22, 25, 32 AND 50).

TRADEMARK

FIRST USE 10-15-2011; IN COMMERCE 10-15-2011.

PRINCIPAL REGISTER

THE MARK CONSISTS OF STANDARD CHARACTERS WITHOUT CLAIM TO ANY PARTICULAR FONT, STYLE, SIZE, OR COLOR.

OWNER OF U.S. REG. NOS. 3,091,437, 3,930,774, AND OTHERS.

NO CLAIM IS MADE TO THE EXCLUSIVE RIGHT TO USE "PREMIER WOOD", APART FROM THE MARK AS SHOWN.

SN 85-303,848, FILED 4-25-2011.

DOUGLAS LEE, EXAMINING ATTORNEY



David J. Kyfos

Director of the United States Patent and Trademark Office

United States of America

United States Patent and Trademark Office

Mrs. G's Clean Solutions

Reg. No. 4,176,805

OSPREY BIOTECHNICS, INC. (FLORIDA CORPORATION)

Registered July 17, 2012

1833A 57TH STREET
SARASOTA, FL 34243

Int. Cl.: 3

FOR: ALL-PURPOSE CLEANERS; DRAIN OPENERS, IN CLASS 3 (U.S. CLS. 1, 4, 6, 50, 51 AND 52).

TRADEMARK

FIRST USE 11-30-2011; IN COMMERCE 4-3-2012.

PRINCIPAL REGISTER

THE MARK CONSISTS OF STANDARD CHARACTERS WITHOUT CLAIM TO ANY PARTICULAR FONT, STYLE, SIZE, OR COLOR.

NO CLAIM IS MADE TO THE EXCLUSIVE RIGHT TO USE "CLEAN SOLUTIONS", APART FROM THE MARK AS SHOWN.

SN 85-304,250, FILED 4-25-2011.

JEAN IM, EXAMINING ATTORNEY



David J. Kyffers

Director of the United States Patent and Trademark Office

United States of America

United States Patent and Trademark Office

EXPECT EXCELLENCE

Reg. No. 4,176,806

Registered July 17, 2012

Int. Cl.: 40

SERVICE MARK

PRINCIPAL REGISTER

KEYSTONE FOODS LLC (DELAWARE LIMITED LIABILITY COMPANY)
SUITE 600
FIVE TOWER BRIDGE, 300 BARR HARBOR DRIVE
WEST CONSHOHOCKEN, PA 19428

FOR: CUSTOM MANUFACTURE OF MEAT, POULTRY AND FISH PRODUCTS FOR OTHERS,
IN CLASS 40 (U.S. CLS. 100, 103 AND 106).

FIRST USE 7-0-2011; IN COMMERCE 7-0-2011.

THE MARK CONSISTS OF STANDARD CHARACTERS WITHOUT CLAIM TO ANY PAR-
TICULAR FONT, STYLE, SIZE, OR COLOR.

SN 85-304,431, FILED 4-26-2011.

LIEF MARTIN, EXAMINING ATTORNEY



David J. Kyffers

Director of the United States Patent and Trademark Office

United States of America

United States Patent and Trademark Office

SUP'N GIRLS

Reg. No. 4,176,807

THOMPSON, LINDA (UNITED STATES INDIVIDUAL)
504 DEER POINT DRIVE
GULF BREEZE, FL 32561

Registered July 17, 2012

Int. Cls.: 25 and 41

FOR: CLOTHING, NAMELY, T-SHIRTS, SHORTS AND HATS, IN CLASS 25 (U.S. CLS. 22 AND 39).

TRADEMARK

FIRST USE 4-1-2011; IN COMMERCE 4-15-2011.

SERVICE MARK

FOR: ORGANIZING, ARRANGING, AND CONDUCTING GATHERINGS, EXHIBITIONS AND RACE EVENTS FOR ENTHUSIASTS OF STAND UP PADDLE SURFING, IN CLASS 41 (U.S. CLS. 100, 101 AND 107).

PRINCIPAL REGISTER

FIRST USE 4-1-2011; IN COMMERCE 12-1-2011.

THE MARK CONSISTS OF STANDARD CHARACTERS WITHOUT CLAIM TO ANY PARTICULAR FONT, STYLE, SIZE, OR COLOR.

NO CLAIM IS MADE TO THE EXCLUSIVE RIGHT TO USE "GIRLS", APART FROM THE MARK AS SHOWN.

SN 85-304,746, FILED 4-26-2011.

JEFF DEFORD, EXAMINING ATTORNEY



David J. Kypos

Director of the United States Patent and Trademark Office

United States of America

United States Patent and Trademark Office

It's good to have options.

Reg. No. 4,176,808

INSPIRED JEWELRY, INC. (IOWA CORPORATION)

Registered July 17, 2012

P.O. BOX 162
CEDAR RAPIDS, IA 52406

Int. Cl.: 14

FOR: BRACELETS; BRONZE JEWELRY; CHARMS; CHARMS FOR COLLAR JEWELRY AND BRACELET; COSTUME JEWELRY; JEWELRY; JEWELRY AND IMITATION JEWELRY; JEWELRY FINDINGS; JEWELRY, NAMELY, AMULETS; JEWELRY, NAMELY, CROSSES; JEWELRY, NAMELY, MAGNETIC NECKLACES; JEWELRY, NAMELY, MAGNETIC PENDANTS; WOMEN'S JEWELRY, IN CLASS 14 (U.S. CLS. 2, 27, 28 AND 50).

TRADEMARK

PRINCIPAL REGISTER

FIRST USE 4-1-2012; IN COMMERCE 4-1-2012.

THE MARK CONSISTS OF STANDARD CHARACTERS WITHOUT CLAIM TO ANY PARTICULAR FONT, STYLE, SIZE, OR COLOR.

SN 85-305,111, FILED 4-26-2011.

JUSTINE D. PARKER, EXAMINING ATTORNEY



David J. Kyffers

Director of the United States Patent and Trademark Office

United States of America

United States Patent and Trademark Office

SPRINGARD

Reg. No. 4,176,809

KASSARJIAN, VASKEN (UNITED STATES INDIVIDUAL)
19 TOULON

Registered July 17, 2012

NEWPORT BEACH, CA 92660

Int. Cl.: 19

FOR: NON-METALLIC BUILDING MATERIALS, NAMELY, A NON-METALLIC COVER FOR AN EXPOSED END OF A CONCRETE REINFORCING BAR, IN CLASS 19 (U.S. CLS. 1, 12, 33 AND 50).

TRADEMARK

FIRST USE 2-1-2012; IN COMMERCE 2-1-2012.

PRINCIPAL REGISTER

THE MARK CONSISTS OF STANDARD CHARACTERS WITHOUT CLAIM TO ANY PARTICULAR FONT, STYLE, SIZE, OR COLOR.

SN 85-305,326, FILED 4-26-2011.

ROBERT C. CLARK JR., EXAMINING ATTORNEY



David J. Kyffers

Director of the United States Patent and Trademark Office

United States of America

United States Patent and Trademark Office

Garlic Girl

Reg. No. 4,176,810

Registered July 17, 2012

Int. Cl.: 31

TRADEMARK

PRINCIPAL REGISTER

HARMONI INTERNATIONAL SPICE, INC. (CALIFORNIA CORPORATION), DBA HARMONI GROUP, INC.,
2211 S. HACIENDA BLVD.
HACIENDA HEIGHTS, CA 91745

FOR: FRESH GARLIC, IN CLASS 31 (U.S. CLS. 1 AND 46).

FIRST USE 5-1-2011; IN COMMERCE 5-1-2011.

THE MARK CONSISTS OF STANDARD CHARACTERS WITHOUT CLAIM TO ANY PARTICULAR FONT, STYLE, SIZE, OR COLOR.

NO CLAIM IS MADE TO THE EXCLUSIVE RIGHT TO USE "GARLIC", APART FROM THE MARK AS SHOWN.

SN 85-305,414, FILED 4-26-2011.

GIANCARLO CASTRO, EXAMINING ATTORNEY



David J. Kybas

Director of the United States Patent and Trademark Office

United States of America

United States Patent and Trademark Office



Reg. No. 4,176,811

Registered July 17, 2012

Int. Cl.: 31

TRADEMARK

PRINCIPAL REGISTER

LAND O'LAKES PURINA FEED LLC (DELAWARE LIMITED LIABILITY COMPANY)
1080 COUNTY ROAD F WEST
SHOREVIEW, MN 55126

FOR: ANIMAL FEED, IN CLASS 31 (U.S. CLS. 1 AND 46).

FIRST USE 6-30-2011; IN COMMERCE 6-30-2011.

OWNER OF U.S. REG. NOS. 2,979,282 AND 3,074,718.

NO CLAIM IS MADE TO THE EXCLUSIVE RIGHT TO USE "FEEDS", APART FROM THE MARK AS SHOWN.

THE MARK CONSISTS OF A BANNER CONTAINING THE WORDS "CROSSROAD" WITH A DIAMOND SHAPE ON EACH SIDE OF THE WORD "FEEDS" LOCATED UNDER "CROSSROAD". AT THE TOP OF THE BANNER IS AN OVAL CONTAINING TWO SETS OF THREE INTERSECTING CURVED LINES.

SN 85-305,849, FILED 4-27-2011.

JASON BLAIR, EXAMINING ATTORNEY



David J. Kyffers

Director of the United States Patent and Trademark Office

United States of America

United States Patent and Trademark Office

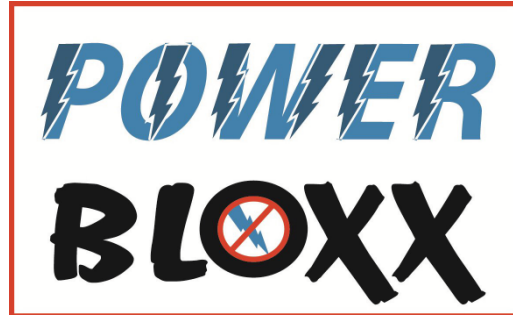

Reg. No. 4,176,812

Registered July 17, 2012

Int. Cl.: 9

TRADEMARK

PRINCIPAL REGISTER

DEAN T. ROY (UNITED STATES INDIVIDUAL)
82 FOX HOLLOW ROAD
ALEXANDRIA, NH 03222

FOR: PLASTIC BOX WITH A REGION FOR RECEIVING A PADLOCK FOR ENCLOSING AND LOCKING THE ENDS OF POWER CORDS SO THAT THE ENDS CANNOT BE PLUGGED IN TO A POWER SOCKET, IN CLASS 9 (U.S. CLS. 21, 23, 26, 36 AND 38).

FIRST USE 5-10-2011; IN COMMERCE 5-10-2011.

NO CLAIM IS MADE TO THE EXCLUSIVE RIGHT TO USE "POWER", APART FROM THE MARK AS SHOWN.

THE COLOR(S) BLUE, BLACK, RED AND WHITE IS/ARE CLAIMED AS A FEATURE OF THE MARK.

THE MARK CONSISTS OF THE STYLIZED WORD "POWER" APPEARING ABOVE THE STYLIZED WORD "BLOXX" WITH LIGHTNING BOLTS APPEARING IN THE LETTERS OF THE WORD "POWER" AND THE UNIVERSAL PROHIBITION SYMBOL SURROUNDING A LIGHTNING BOLT APPEARING IN THE LETTER "O" OF THE TERM "BLOXX" ALL OF WHICH IS SURROUNDED BY A SINGLE LINE RECTANGLE. THE COLOR BLACK APPEARS IN THE WORDING "BLOXX". THE COLOR RED APPEARS IN THE DEPICTION OF THE UNIVERSAL PROHIBITION SYMBOL AS WELL AS THE DEPICTION OF THE SINGLE LINE RECTANGLE. THE COLOR BLUE APPEARS IN THE WORDING "POWER" AS WELL AS IN THE DEPICTION OF THE LIGHTNING BOLTS FORMING THE LETTERS IN THE WORD "POWER" AND THE LIGHTNING BOLT SURROUNDED BY THE PROHIBITION SYMBOL. THE COLOR WHITE APPEARS IN THE BORDER OF THE LIGHTNING BOLTS FORMING THE LETTERS IN THE WORD "POWER" AS WELL AS IN THE BACKGROUND OF THE RECTANGLE SURROUNDING THE WORDING.

SN 85-305,967, FILED 4-27-2011.

MICHAEL TANNER, EXAMINING ATTORNEY



David J. Kyffers

Director of the United States Patent and Trademark Office

United States of America

United States Patent and Trademark Office

CYS Investments

Reg. No. 4,176,813

CYS INVESTMENTS, INC. (MARYLAND CORPORATION)
890 WINTER STREET, SUITE 200
WALTHAM, MA 02451

Registered July 17, 2012

Int. Cl.: 36

FOR: FUND INVESTMENT CONSULTATION; FUNDS INVESTMENT; INVESTMENT ADVICE; INVESTMENT MANAGEMENT, IN CLASS 36 (U.S. CLS. 100, 101 AND 102).

SERVICE MARK

FIRST USE 9-1-2011; IN COMMERCE 9-1-2011.

PRINCIPAL REGISTER

THE MARK CONSISTS OF STANDARD CHARACTERS WITHOUT CLAIM TO ANY PARTICULAR FONT, STYLE, SIZE, OR COLOR.

NO CLAIM IS MADE TO THE EXCLUSIVE RIGHT TO USE "INVESTMENTS", APART FROM THE MARK AS SHOWN.

SN 85-306,674, FILED 4-27-2011.

COLLEEN KEARNEY, EXAMINING ATTORNEY



David J. Kybas

Director of the United States Patent and Trademark Office

United States of America

United States Patent and Trademark Office

LifeStyle

Reg. No. 4,176,814

Registered July 17, 2012

Int. Cl.: 9

TRADEMARK

PRINCIPAL REGISTER

HIMS INTERNATIONAL CORPORATION (REPUBLIC OF KOREA CORPORATION)
1F, KT SATELLITE CENTER 139-9
GAJEONG-DONG
YUSEONG-GU DAEJEON, REPUBLIC OF KOREA 305-350

FOR: ELECTRONIC MAGNIFIERS DESIGNED TO HELP PEOPLE WITH LOW VISION BY
MAGNIFYING TEXTS, IMAGES AND OBJECTS, IN CLASS 9 (U.S. CLS. 21, 23, 26, 36 AND
38).

FIRST USE 5-24-2011; IN COMMERCE 6-27-2011.

THE MARK CONSISTS OF STANDARD CHARACTERS WITHOUT CLAIM TO ANY PAR-
TICULAR FONT, STYLE, SIZE, OR COLOR.

SN 85-306,863, FILED 4-28-2011.

DOMINICK J. SALEMI, EXAMINING ATTORNEY



David J. Kybas

Director of the United States Patent and Trademark Office

United States of America

United States Patent and Trademark Office

FREAKSHOW BOOKS

Reg. No. 4,176,815

SCOTCH WICHMANN (UNITED STATES INDIVIDUAL)
7336 SANTA MONICA BLVD., #242
WEST HOLLYWOOD, CA 90046

Registered July 17, 2012

Int. Cl.: 16

FOR: COMIC BOOKS; GRAPHIC NOVELS, IN CLASS 16 (U.S. CLS. 2, 5, 22, 23, 29, 37, 38 AND 50).

TRADEMARK

FIRST USE 1-16-2012; IN COMMERCE 1-16-2012.

PRINCIPAL REGISTER

THE MARK CONSISTS OF STANDARD CHARACTERS WITHOUT CLAIM TO ANY PARTICULAR FONT, STYLE, SIZE, OR COLOR.

OWNER OF U.S. REG. NO. 3,998,523.

NO CLAIM IS MADE TO THE EXCLUSIVE RIGHT TO USE "BOOKS", APART FROM THE MARK AS SHOWN.

SN 85-307,873, FILED 4-28-2011.

KAREN BRACEY, EXAMINING ATTORNEY



David J. Kyffers

Director of the United States Patent and Trademark Office

United States of America

United States Patent and Trademark Office

MDT

Reg. No. 4,176,816

Registered July 17, 2012

Int. Cl.: 14

TRADEMARK

PRINCIPAL REGISTER

88 RODEO HOLDINGS INC. (NEVADA CORPORATION)
100 NORTH WILKES-BARRE BOULEVARD
WILKES-BARRE, PA 18702

FOR: JEWELRY; TIMEPIECES; WATCHES, IN CLASS 14 (U.S. CLS. 2, 27, 28 AND 50).

FIRST USE 9-10-2008; IN COMMERCE 1-20-2009.

THE MARK CONSISTS OF STANDARD CHARACTERS WITHOUT CLAIM TO ANY PARTICULAR FONT, STYLE, SIZE, OR COLOR.

SN 85-308,015, FILED 4-29-2011.

KATHRYN COWARD, EXAMINING ATTORNEY



David J. Kybas

Director of the United States Patent and Trademark Office

United States of America

United States Patent and Trademark Office

LOVESWEPT

Reg. No. 4,176,817

Registered July 17, 2012

Int. Cl.: 9

TRADEMARK

PRINCIPAL REGISTER

RANDOM HOUSE, INC. (NEW YORK CORPORATION)
1745 BROADWAY
ATTN: LEGAL DEPT.
NEW YORK, NY 10019

FOR: DOWNLOADABLE ELECTRONIC PUBLICATIONS IN THE NATURE OF ELECTRONIC BOOKS IN THE FIELD OF ROMANCE FICTION, IN CLASS 9 (U.S. CLS. 21, 23, 26, 36 AND 38).

FIRST USE 8-8-2011; IN COMMERCE 8-8-2011.

THE MARK CONSISTS OF STANDARD CHARACTERS WITHOUT CLAIM TO ANY PARTICULAR FONT, STYLE, SIZE, OR COLOR.

SN 85-308,478, FILED 4-29-2011.

BRENDAN MCCAULEY, EXAMINING ATTORNEY



David J. Kybas

Director of the United States Patent and Trademark Office

United States of America

United States Patent and Trademark Office

CHEWZIE DOG

Reg. No. 4,176,818

Registered July 17, 2012

Int. Cl.: 28

TRADEMARK

PRINCIPAL REGISTER

PREMIER PET PRODUCTS, LLC (VIRGINIA LIMITED LIABILITY COMPANY)
14201 SOMMERVILLE COURT
MIDLOTHIAN, VA 23113

FOR: PET TOYS, IN CLASS 28 (U.S. CLS. 22, 23, 38 AND 50).

FIRST USE 2-0-2012; IN COMMERCE 2-0-2012.

THE MARK CONSISTS OF STANDARD CHARACTERS WITHOUT CLAIM TO ANY PARTICULAR FONT, STYLE, SIZE, OR COLOR.

NO CLAIM IS MADE TO THE EXCLUSIVE RIGHT TO USE "DOG", APART FROM THE MARK AS SHOWN.

SN 85-308,850, FILED 4-29-2011.

BRENDAN MCCAULEY, EXAMINING ATTORNEY



David J. Kyffers

Director of the United States Patent and Trademark Office

United States of America

United States Patent and Trademark Office

EYE RISE

Reg. No. 4,176,819

BRACCI, STEPHEN P. (UNITED STATES INDIVIDUAL), DBA VERVE,
216 EAST 50TH STREET
NEW YORK, NY 10022

Registered July 17, 2012

Int. Cl.: 44

FOR: MEDICAL SPA SERVICES, NAMELY, MINIMALLY AND NON-INVASIVE PROCEDURES FOR AESTHETIC EYE AREA ENHANCEMENT, IN CLASS 44 (U.S. CLS. 100 AND 101).

SERVICE MARK

FIRST USE 7-15-2011; IN COMMERCE 7-15-2011.

PRINCIPAL REGISTER

THE MARK CONSISTS OF STANDARD CHARACTERS WITHOUT CLAIM TO ANY PARTICULAR FONT, STYLE, SIZE, OR COLOR.

NO CLAIM IS MADE TO THE EXCLUSIVE RIGHT TO USE "EYE", APART FROM THE MARK AS SHOWN.

SN 85-308,860, FILED 4-29-2011.

MIDGE BUTLER, EXAMINING ATTORNEY



David J. Kybas

Director of the United States Patent and Trademark Office

United States of America

United States Patent and Trademark Office

BUNDALATES

Reg. No. 4,176,820

SILVIA GIAMANCO (UNITED STATES INDIVIDUAL)

Registered July 17, 2012

4311 ALDER STREET
SAN DIEGO, CA 92116

Int. Cl.: 41

FOR: PERSONAL TRAINING PROVIDED IN CONNECTION WITH WEIGHT LOSS AND EXERCISE PROGRAMS; PERSONAL TRAINING SERVICES, NAMELY, STRENGTH AND CONDITIONING TRAINING, IN CLASS 41 (U.S. CLS. 100, 101 AND 107).

SERVICE MARK

FIRST USE 11-0-2010; IN COMMERCE 5-4-2011.

PRINCIPAL REGISTER

THE MARK CONSISTS OF STANDARD CHARACTERS WITHOUT CLAIM TO ANY PARTICULAR FONT, STYLE, SIZE, OR COLOR.

SN 85-308,988, FILED 4-29-2011.

JESSICA A. POWERS, EXAMINING ATTORNEY



David J. Kyros

Director of the United States Patent and Trademark Office

United States of America

United States Patent and Trademark Office



Reg. No. 4,176,821

Registered July 17, 2012

Int. Cl.: 30

TRADEMARK

PRINCIPAL REGISTER

CHENG, FENG-WEN (TAIWAN INDIVIDUAL)
NO. 71, ZHONGSHAN RD.
LUGANG TOWNSHIP
CHANGHUA COUNTY 505, TAIWAN R.O.C.

FOR: BEAN JAM BUNS; BUNS; CAKES; CHINESE STEAMED DUMPLINGS (SHUMAI, COOKED); CHINESE STUFFED DUMPLINGS (GYOZA, COOKED); DOUGH-ENROBED FOODS CONSISTING OF A DOUGH-BASED WRAPPER WITH FILLINGS CONSISTING PRIMARILY OF MEATS, POULTRY, FISH, FRUITS AND VEGETABLES AND CHEESE; JAPANESE STYLE STEAMED CAKES (MUSHI-GASHI); RICE DUMPLINGS DRESSED WITH SWEET BEAN JAM (ANKORO); RICE-BASED SNACK FOODS; STEAMED BUNS STUFFED WITH MINCED MEAT (NIKU-MANJU); SWEET POUNDED RICE CAKES (MOCHI-GASHI); VEGAN CAKES, IN CLASS 30 (U.S. CL. 46).

FIRST USE 1-15-2012; IN COMMERCE 1-15-2012.

THE MARK CONSISTS OF A GRAPHIC USING BRUSHSTROKE TECHNIQUE CONSISTING OF A BROAD U-SHAPED STROKE WITH AN M-LIKE STROKE ABOVE IT AND THREE SHORT STROKES BELOW THE M THAT, IN TOTALITY, COULD BE INTERPRETED AS A GRAPHIC RENDITION OF AN ANIMAL'S FACE (POSSIBLY A CAT) INCLUDING EYES, NOSE AND EARS; WITH TWO CHINESE CHARACTERS AND THE WORDS "A ZEN" BENEATH THE CHARACTERS, ALL PLACED TO THE RIGHT OF THE GRAPHIC.

THE NON-LATIN CHARACTERS IN THE MARK TRANSLITERATE TO "A ZHEN" AND THIS HAS NO MEANING IN A FOREIGN LANGUAGE.

THE ENGLISH TRANSLATION OF "A ZEN" IN THE MARK IS AN INITIAL PARTICLE "(A)" AND TO RAISE "(ZEN)". THE WORDING "A ZEN" HAS NO MEANING IN A FOREIGN LANGUAGE.

SN 85-309,596, FILED 5-2-2011.

CURTIS FRENCH, EXAMINING ATTORNEY



David J. Kyros

Director of the United States Patent and Trademark Office

United States of America

United States Patent and Trademark Office

PLANTS OF STEEL

Reg. No. 4,176,822

COSTA FARMS, LLC (FLORIDA LIMITED LIABILITY COMPANY)
22290 SW 162ND AVENUE
GOULDS, FL 33170

Registered July 17, 2012

Int. Cl.: 31

FOR: LIVE FLOWERS AND LIVING PLANTS, IN CLASS 31 (U.S. CLS. 1 AND 46).

TRADEMARK

FIRST USE 1-1-2012; IN COMMERCE 1-1-2012.

PRINCIPAL REGISTER

THE MARK CONSISTS OF STANDARD CHARACTERS WITHOUT CLAIM TO ANY PARTICULAR FONT, STYLE, SIZE, OR COLOR.

NO CLAIM IS MADE TO THE EXCLUSIVE RIGHT TO USE "PLANTS", APART FROM THE MARK AS SHOWN.

SN 85-310,111, FILED 5-2-2011.

INGA ERVIN, EXAMINING ATTORNEY



David J. Kybas

Director of the United States Patent and Trademark Office

United States of America

United States Patent and Trademark Office

The L.A.B. Brewing Company

Reg. No. 4,176,823

Registered July 17, 2012

Int. Cl.: 43

SERVICE MARK

PRINCIPAL REGISTER

RRMB CORPORATION (CALIFORNIA CORPORATION)
203 A
28348 ROADSIDE DRIVE
AGOURA HILLS, CA 91302

FOR: RESTAURANT AND BAR SERVICES, INCLUDING RESTAURANT CARRYOUT SERVICES, IN CLASS 43 (U.S. CLS. 100 AND 101).

FIRST USE 11-1-2011; IN COMMERCE 11-1-2011.

THE MARK CONSISTS OF STANDARD CHARACTERS WITHOUT CLAIM TO ANY PARTICULAR FONT, STYLE, SIZE, OR COLOR.

NO CLAIM IS MADE TO THE EXCLUSIVE RIGHT TO USE "BREWING COMPANY", APART FROM THE MARK AS SHOWN.

SN 85-310,728, FILED 5-3-2011.

NAAKWAMA ANKRAH, EXAMINING ATTORNEY



David J. Kyffers

Director of the United States Patent and Trademark Office

United States of America

United States Patent and Trademark Office

LOVE YOUR PRODUCE MANAGER

Reg. No. 4,176,824

FRIEDA'S, INC. (CALIFORNIA CORPORATION)
4465 CORPORATE CENTER DRIVE
LOS ALAMITOS, CA 90720

Registered July 17, 2012

Int. Cls.: 31 and 35

FOR: FRESH FRUITS AND VEGETABLES, IN CLASS 31 (U.S. CLS. 1 AND 46).

TRADEMARK

FIRST USE 4-8-2012; IN COMMERCE 4-8-2012.

SERVICE MARK

FOR: PROMOTING CONSUMER INTEREST IN AND AWARENESS OF FRESH PRODUCE AND PRODUCE SECTIONS OF RETAIL GROCERY STORES, IN CLASS 35 (U.S. CLS. 100, 101 AND 102).

PRINCIPAL REGISTER

FIRST USE 4-8-2012; IN COMMERCE 4-8-2012.

THE MARK CONSISTS OF STANDARD CHARACTERS WITHOUT CLAIM TO ANY PARTICULAR FONT, STYLE, SIZE, OR COLOR.

SN 85-311,063, FILED 5-3-2011.

STEVEN R. FINE, EXAMINING ATTORNEY



David J. Kybas

Director of the United States Patent and Trademark Office

United States of America

United States Patent and Trademark Office

Di Flame

Reg. No. 4,176,825

LGP GEM LTD. (NEW YORK CORPORATION)
10 WEST 46TH STREET, SUITE 4A
NEW YORK, NY 10036

Registered July 17, 2012

Int. Cl.: 14

FOR: JEWELRY; CUBIC ZIRCONIA STONES; SYNTHETIC DIAMONDS, IN CLASS 14 (U.S. CLS. 2, 27, 28 AND 50).

TRADEMARK

FIRST USE 5-19-2011; IN COMMERCE 5-19-2011.

PRINCIPAL REGISTER

THE MARK CONSISTS OF THE LETTERS "DI" TO THE LEFT OF A DIAMOND SLANTED TO THE LEFT WITH THREE VERTICAL LINES ATOP OF IT REPRESENTING THE LETTER "A", ALL TO THE LEFT OF THE WORD "FLAME".

SN 85-311,312, FILED 5-3-2011.

JORDAN BAKER, EXAMINING ATTORNEY



David J. Kyffers

Director of the United States Patent and Trademark Office

United States of America

United States Patent and Trademark Office



Reg. No. 4,176,826

HARMS, BRIAN (UNITED STATES INDIVIDUAL)
9232 W. 140TH STREET
ORLAND PARK, IL 60462

Registered July 17, 2012

Int. Cl.: 25

FOR: BASEBALL CAPS; HOODED SWEATSHIRTS; SWEATSHIRTS; T-SHIRTS, IN CLASS 25 (U.S. CLS. 22 AND 39).

TRADEMARK

FIRST USE 3-11-2011; IN COMMERCE 3-24-2011.

PRINCIPAL REGISTER

NO CLAIM IS MADE TO THE EXCLUSIVE RIGHT TO USE "IRISH", APART FROM THE MARK AS SHOWN.

THE MARK CONSISTS OF A CIRCLE WITH A SHAMROCK AT IT'S CENTER. THE SHAMROCK HAS A HEART AT IT'S CENTER. WITHIN THE CIRCLE THERE ARE TWO SMALLER SHAMROCKS TO THE LEFT AND RIGHT OF THE CENTER SHAMROCK. ARCHING ABOVE THE CENTER SHAMROCK ARE THE STYLIZED TEXT "JUST IRISH". ARCHING BELOW THE CENTER SHAMROCK IS THE STYLIZED TEXT "ENOUGH".

SN 85-311,470, FILED 5-3-2011.

STEVEN JACKSON, EXAMINING ATTORNEY



David J. Kybas

Director of the United States Patent and Trademark Office

United States of America

United States Patent and Trademark Office

FULL METAL JOUSTING

Reg. No. 4,176,827

A&E TELEVISION NETWORKS, LLC (DELAWARE LIMITED LIABILITY COMPANY)
235 EAST 45TH STREET
NEW YORK, NY 10017

Registered July 17, 2012

Int. Cls.: 9 and 41

FOR: MULTIMEDIA GOODS, NAMELY, PRE-RECORDED DIGITAL VIDEO DISCS AND DVDS FEATURING SPORT COMPETITIONS, SPORTSMANSHIP, AND WEAPONRY; DIGITAL MEDIA, NAMELY, DOWNLOADABLE AUDIO AND VIDEO FILES FEATURING SPORT COMPETITIONS, SPORTSMANSHIP, AND WEAPONRY; DOWNLOADABLE WEBCASTS FEATURING SPORT COMPETITIONS, SPORTSMANSHIP, AND WEAPONRY; DOWNLOADABLE GRAPHICS FOR WIRELESS DEVICES; DOWNLOADABLE ON-LINE DISCUSSION BOARDS AND WEBCASTS FEATURING SPORT COMPETITIONS, SPORTSMANSHIP, AND WEAPONRY, IN CLASS 9 (U.S. CLS. 21, 23, 26, 36 AND 38).

TRADEMARK

SERVICE MARK

PRINCIPAL REGISTER

FIRST USE 2-12-2012; IN COMMERCE 2-12-2012.

FOR: ENTERTAINMENT SERVICES IN THE NATURE OF AN ONGOING REALITY-BASED, COMPETITION-ORIENTED MULTI-MEDIA PROGRAM SERIES THAT FOCUSES ON SPORT COMPETITIONS, SPORTSMANSHIP, AND WEAPONRY, DISTRIBUTED VIA VARIOUS PLATFORMS ACROSS MULTIPLE FORMS OF TRANSMISSION MEDIA; ENTERTAINMENT SERVICES, NAMELY, PROVIDING INFORMATION VIA THE INTERNET ON THE SPORT COMPETITIONS, SPORTSMANSHIP, AND WEAPONRY IN COMPETITION, IN CLASS 41 (U.S. CLS. 100, 101 AND 107).

FIRST USE 2-12-2012; IN COMMERCE 2-12-2012.

THE MARK CONSISTS OF STANDARD CHARACTERS WITHOUT CLAIM TO ANY PARTICULAR FONT, STYLE, SIZE, OR COLOR.

NO CLAIM IS MADE TO THE EXCLUSIVE RIGHT TO USE "JOUSTING", APART FROM THE MARK AS SHOWN.

SN 85-311,731, FILED 5-4-2011.

BRENDAN REGAN, EXAMINING ATTORNEY



David J. Kyros

Director of the United States Patent and Trademark Office

United States of America

United States Patent and Trademark Office

Miss Me Not Blanket

Reg. No. 4,176,828

LEASK, JUDY (UNITED STATES INDIVIDUAL)
137 SUNNYDALE AVE
SAN CARLOS, CA 94070

Registered July 17, 2012

Int. Cl.: 24

FOR: CHILDREN'S BLANKETS, IN CLASS 24 (U.S. CLS. 42 AND 50).

TRADEMARK

FIRST USE 1-27-2012; IN COMMERCE 3-25-2012.

PRINCIPAL REGISTER

THE MARK CONSISTS OF STANDARD CHARACTERS WITHOUT CLAIM TO ANY PARTICULAR FONT, STYLE, SIZE, OR COLOR.

NO CLAIM IS MADE TO THE EXCLUSIVE RIGHT TO USE "BLANKET", APART FROM THE MARK AS SHOWN.

SN 85-311,874, FILED 5-4-2011.

JOHN LINCOSKI, EXAMINING ATTORNEY



David J. Kyffers

Director of the United States Patent and Trademark Office

United States of America

United States Patent and Trademark Office

FLEXFORCE LIGHTNING

Reg. No. 4,176,829

Registered July 17, 2012

Int. Cl.: 28

TRADEMARK

PRINCIPAL REGISTER

MATTEL, INC. (DELAWARE CORPORATION)
M1-1518
333 CONTINENTAL BOULEVARD
EL SEGUNDO, CA 90245

FOR: TOY ACTION FIGURES AND ACCESSORIES THEREFOR, IN CLASS 28 (U.S. CLS. 22, 23, 38 AND 50).

FIRST USE 4-12-2012; IN COMMERCE 4-12-2012.

THE MARK CONSISTS OF STANDARD CHARACTERS WITHOUT CLAIM TO ANY PARTICULAR FONT, STYLE, SIZE, OR COLOR.

OWNER OF U.S. REG. NOS. 2,530,609, 3,791,316, AND OTHERS.

SN 85-311,983, FILED 5-4-2011.

LINDA LAVACHE, EXAMINING ATTORNEY



David J. Kybas

Director of the United States Patent and Trademark Office

United States of America

United States Patent and Trademark Office

MEMPHIS "DADDY O" LONGLEGS

Reg. No. 4,176,830

Registered July 17, 2012

Int. Cl.: 28

TRADEMARK

PRINCIPAL REGISTER

MATTEL, INC. (DELAWARE CORPORATION)
M1-1518
333 CONTINENTAL BOULEVARD
EL SEGUNDO, CA 90245

FOR: TOY FIGURES AND ACCESSORIES THEREFOR, IN CLASS 28 (U.S. CLS. 22, 23, 38 AND 50).

FIRST USE 4-11-2012; IN COMMERCE 4-11-2012.

THE MARK CONSISTS OF STANDARD CHARACTERS WITHOUT CLAIM TO ANY PARTICULAR FONT, STYLE, SIZE, OR COLOR.

THE NAME "MEMPHIS "DADDY O" LONGLEGS" IN THE MARK IS FICTITIOUS.

SN 85-311,986, FILED 5-4-2011.

LINDA LAVACHE, EXAMINING ATTORNEY



David J. Kyffers

Director of the United States Patent and Trademark Office

United States of America

United States Patent and Trademark Office

ZIPLOC PERFECT PORTIONS

Reg. No. 4,176,831

S. C. JOHNSON & SON, INC. (WISCONSIN CORPORATION)

Registered July 17, 2012

1525 HOWE STREET
RACINE, WI 53403

Int. Cl.: 16

FOR: PLASTIC BAGS FOR HOUSEHOLD USE, IN CLASS 16 (U.S. CLS. 2, 5, 22, 23, 29, 37, 38 AND 50).

TRADEMARK

FIRST USE 1-23-2012; IN COMMERCE 1-23-2012.

PRINCIPAL REGISTER

THE MARK CONSISTS OF STANDARD CHARACTERS WITHOUT CLAIM TO ANY PARTICULAR FONT, STYLE, SIZE, OR COLOR.

OWNER OF U.S. REG. NOS. 886,112, 2,853,908, AND OTHERS.

SN 85-312,020, FILED 5-4-2011.

BRENDAN REGAN, EXAMINING ATTORNEY



David J. Kyffers

Director of the United States Patent and Trademark Office

United States of America

United States Patent and Trademark Office

SIMPLE TRUTH ORGANIC

Reg. No. 4,176,832

THE KROGER CO. OF MICHIGAN (MICHIGAN CORPORATION)
40399 GRAND RIVER AVENUE
NOVI, MI 48375

Registered July 17, 2012

Int. Cl.: 29

FOR: ORGANIC EGGS; ORGANIC MILK, IN CLASS 29 (U.S. CL. 46).

TRADEMARK

FIRST USE 9-0-2011; IN COMMERCE 9-0-2011.

PRINCIPAL REGISTER

THE MARK CONSISTS OF STANDARD CHARACTERS WITHOUT CLAIM TO ANY PARTICULAR FONT, STYLE, SIZE, OR COLOR.

NO CLAIM IS MADE TO THE EXCLUSIVE RIGHT TO USE "ORGANIC", APART FROM THE MARK AS SHOWN.

SN 85-312,167, FILED 5-4-2011.

BARBARA BROWN, EXAMINING ATTORNEY



David J. Kyffers

Director of the United States Patent and Trademark Office

United States of America

United States Patent and Trademark Office

Safetyweave

Reg. No. 4,176,833

Registered July 17, 2012

**Int. Cls.: 10, 16, 24, and
25**

AFS APPAREL LLC (CALIFORNIA LIMITED LIABILITY COMPANY)
41185 RAINTREE CT
41185 RAINTREE COURT
MURRIETA, CA 92562

FOR: MEDICAL WEARING APPAREL, NAMELY, SCRUB PANTS, IN CLASS 10 (U.S. CLS. 26, 39 AND 44).

TRADEMARK

FIRST USE 1-30-2012; IN COMMERCE 4-4-2012.

PRINCIPAL REGISTER

FOR: GROCERY BAGS, IN CLASS 16 (U.S. CLS. 2, 5, 22, 23, 29, 37, 38 AND 50).

FIRST USE 1-30-2012; IN COMMERCE 4-4-2012.

FOR: BED SHEETS, IN CLASS 24 (U.S. CLS. 42 AND 50).

FIRST USE 1-30-2012; IN COMMERCE 4-4-2012.

FOR: ATHLETIC APPAREL, NAMELY, SHIRTS, PANTS, JACKETS, FOOTWEAR, HATS AND CAPS, ATHLETIC UNIFORMS, IN CLASS 25 (U.S. CLS. 22 AND 39).

FIRST USE 1-30-2012; IN COMMERCE 4-4-2012.

THE MARK CONSISTS OF STANDARD CHARACTERS WITHOUT CLAIM TO ANY PARTICULAR FONT, STYLE, SIZE, OR COLOR.

SN 85-312,176, FILED 5-4-2011.

LEIGH LOWRY, EXAMINING ATTORNEY



David J. Kyffers

Director of the United States Patent and Trademark Office

United States of America

United States Patent and Trademark Office

WISTEN

Reg. No. 4,176,834

Registered July 17, 2012

Int. Cl.: 11

TRADEMARK

PRINCIPAL REGISTER

PROGRESS LIGHTING PROPERTIES, INC. (MICHIGAN CORPORATION)
SUITE 328
300 DELAWARE AVENUE
WILMINGTON, DE 19801

FOR: LIGHTING FIXTURES, IN CLASS 11 (U.S. CLS. 13, 21, 23, 31 AND 34).

FIRST USE 3-30-2012; IN COMMERCE 3-30-2012.

THE MARK CONSISTS OF STANDARD CHARACTERS WITHOUT CLAIM TO ANY PARTICULAR FONT, STYLE, SIZE, OR COLOR.

SN 85-312,262, FILED 5-4-2011.

JUDITH HELFMAN, EXAMINING ATTORNEY



David J. Kyffers

Director of the United States Patent and Trademark Office

United States of America

United States Patent and Trademark Office

LACEUP

Reg. No. 4,176,835

Registered July 17, 2012

Int. Cl.: 20

TRADEMARK

PRINCIPAL REGISTER

LAROCQUE, ROBERT R. (CANADA INDIVIDUAL)
56 WOLF DRIVE, REDWOOD MEADOWS
ALBERTA, CANADA T3Z-1A3

FOR: FURNITURE, NAMELY, LOW SEATS AND STOOLS TO REST THE FEET OF A SEATED PERSON IN THE NATURE OF FOOT RESTS, FOOT STOOLS, AND STOOLS, IN CLASS 20 (U.S. CLS. 2, 13, 22, 25, 32 AND 50).

FIRST USE 9-30-2010; IN COMMERCE 9-30-2010.

THE MARK CONSISTS OF STANDARD CHARACTERS WITHOUT CLAIM TO ANY PARTICULAR FONT, STYLE, SIZE, OR COLOR.

SN 85-313,338, FILED 5-5-2011.

RONALD DELGIZZI, EXAMINING ATTORNEY



David J. Kyfos

Director of the United States Patent and Trademark Office

United States of America

United States Patent and Trademark Office

WE MAKE YOUR NETWORK...WORK

Reg. No. 4,176,836

Registered July 17, 2012

Int. Cls.: 9 and 35

TRADEMARK

SERVICE MARK

PRINCIPAL REGISTER

CABLEXPRESS CORPORATION (NEW YORK CORPORATION), DBA CXTEC,
P.O. BOX 4799
SYRACUSE, NY 122214799

FOR: NEW AND REFURBISHED COMPUTER CONNECTIVITY HARDWARE, NAMELY, ETHERNET, FIBER OPTIC, COAXIAL, UNSHIELDED TWISTED PAIR (UTP), SHIELDED TWISTED PAIR (STP) AND POWER CABLES AND CABLE ASSEMBLIES; NEW AND REFURBISHED COMPUTER CONNECTIVITY WIRING HARDWARE; NEW AND REFURBISHED MAINFRAME DATA CENTER HARDWARE; COMPUTER NETWORK HARDWARE, NAMELY, SERVERS, LAN ADAPTORS AND SWITCH BOXES; POWER SUPPLYING HARDWARE, NAMELY, ELECTRICAL POWER DISTRIBUTION UNITS (PDU), TRANSCEIVERS, WIRELESS COMPUTER NETWORK BRIDGES, ROUTERS, HUBS, ADAPTOR CARDS, MEMORY HARDWARE AND MODEMS; COMPUTER COMMUNICATION HARDWARE, NAMELY, ETHERNET SWITCHES, STORAGE AREA NETWORK (SAN) SWITCHES, COMPUTER NETWORK SWITCHES AND ISCSI COMPUTER NETWORK SWITCHES, IN CLASS 9 (U.S. CLS. 21, 23, 26, 36 AND 38).

FIRST USE 7-31-2011; IN COMMERCE 7-31-2011.

FOR: BUSINESS EVALUATION OF CUSTOMERS' CURRENT AND FUTURE NEEDS FOR NEW OR REFURBISHED TECHNOLOGY HARDWARE; BUSINESS CONSULTATION IN THE FIELD OF COMPUTER HARDWARE EXPENSE MANAGEMENT; RETAIL DISTRIBUTORSHIPS FEATURING TECHNOLOGY HARDWARE, NAMELY, CABLES, MAINFRAME DATA CENTERS, COMPUTER PRODUCTS, CONNECTORS, WIRING SYSTEMS, STORAGE PRODUCTS, NETWORK, VOICE, AND COMMUNICATION EQUIPMENT, IN CLASS 35 (U.S. CLS. 100, 101 AND 102).

FIRST USE 6-17-2010; IN COMMERCE 6-17-2010.

THE MARK CONSISTS OF STANDARD CHARACTERS WITHOUT CLAIM TO ANY PARTICULAR FONT, STYLE, SIZE, OR COLOR.

SN 85-313,415, FILED 5-5-2011.

JOHN GARTNER, EXAMINING ATTORNEY



David J. Kyffers

Director of the United States Patent and Trademark Office

United States of America

United States Patent and Trademark Office

ARMAGUARD

Reg. No. 4,176,837

LIQUIDMETAL COATINGS, LLC (DELAWARE LIMITED LIABILITY COMPANY)
30452 ESPERANZA

Registered July 17, 2012

RANCHO SANTA MARGARITA, CA 92688

Int. Cl.: 2

FOR: CERAMIC COATINGS, IN CLASS 2 (U.S. CLS. 6, 11 AND 16).

TRADEMARK

FIRST USE 4-30-2011; IN COMMERCE 4-30-2011.

PRINCIPAL REGISTER

THE MARK CONSISTS OF STANDARD CHARACTERS WITHOUT CLAIM TO ANY PARTICULAR FONT, STYLE, SIZE, OR COLOR.

SN 85-313,740, FILED 5-5-2011.

ALAIN LAPTER, EXAMINING ATTORNEY



David J. Kyffers

Director of the United States Patent and Trademark Office

United States of America

United States Patent and Trademark Office



Reg. No. 4,176,838

ABLENET, INC. (MINNESOTA CORPORATION)
2808 FAIRVIEW AVENUE N.
ROSEVILLE, MN 55113

Registered July 17, 2012

Int. Cl.: 9

FOR: PORTABLE AMPLIFICATION SYSTEM CONSISTING OF A VOICE AMPLIFIER AND HEADSETS, IN CLASS 9 (U.S. CLS. 21, 23, 26, 36 AND 38).

TRADEMARK

FIRST USE 10-31-2011; IN COMMERCE 10-31-2011.

PRINCIPAL REGISTER

OWNER OF U.S. REG. NOS. 1,468,059, 2,775,212, AND 3,857,369.

NO CLAIM IS MADE TO THE EXCLUSIVE RIGHT TO USE "AUDIBLE", APART FROM THE MARK AS SHOWN.

THE MARK CONSISTS OF THE STYLIZED TERM "AUDABLE" WITH THREE CONCENTRIC LINES EMANATING FROM THE TOP AND BOTTOM OF THE INITIAL LETTER "A" WITH THE PHRASE "BY ABLENET" UNDERNEATH.

SN 85-314,177, FILED 5-6-2011.

TRACY WHITTAKER-BROWN, EXAMINING ATTORNEY



David J. Kyffers

Director of the United States Patent and Trademark Office

United States of America

United States Patent and Trademark Office

Retail Union

Reg. No. 4,176,839

RETAILUNION, INC. (DELAWARE CORPORATION)
6116 N. CENTRAL EXPRESSWAY, SUITE 1201
DALLAS, TX 75206

Registered July 17, 2012

Int. Cls.: 36 and 42

FOR: PROVIDING REAL ESTATE LISTINGS AND REAL ESTATE INFORMATION VIA THE INTERNET, IN CLASS 36 (U.S. CLS. 100, 101 AND 102).

SERVICE MARK

FIRST USE 11-1-2011; IN COMMERCE 2-14-2012.

PRINCIPAL REGISTER

FOR: COMPUTER SERVICES, NAMELY, CREATING AN ON-LINE COMMUNITY FOR REGISTERED USERS TO PUBLISH AVAILABLE REAL ESTATE, PUBLISH TENANT REQUIREMENTS, ADVERTISE TO OTHER REGISTERED USERS, CONNECT TO PUBLISHED REAL ESTATE AND PUBLISH SERVICES PROVIDED THAT RELATE TO THE PUBLISHED REAL ESTATE, PARTICIPATE IN DISCUSSIONS, GET FEEDBACK FROM THEIR PEERS, FORM VIRTUAL COMMUNITIES, AND ENGAGE IN SOCIAL NETWORKING FEATURING REAL ESTATE, IN CLASS 42 (U.S. CLS. 100 AND 101).

FIRST USE 11-1-2011; IN COMMERCE 2-14-2012.

THE MARK CONSISTS OF STANDARD CHARACTERS WITHOUT CLAIM TO ANY PARTICULAR FONT, STYLE, SIZE, OR COLOR.

NO CLAIM IS MADE TO THE EXCLUSIVE RIGHT TO USE "RETAIL", APART FROM THE MARK AS SHOWN.

SN 85-314,198, FILED 5-6-2011.

JOHN WILKE, EXAMINING ATTORNEY



David J. Kyffers

Director of the United States Patent and Trademark Office

United States of America

United States Patent and Trademark Office



Reg. No. 4,176,840

Registered July 17, 2012

Int. Cl.: 36

SERVICE MARK

PRINCIPAL REGISTER

INDIA CAPITAL MANAGEMENT LIMITED (MAURITIUS CORPORATION)
IFS COURT, 28 CYBERCITY
EBENE, MAURITIUS

FOR: INVESTMENT MANAGEMENT AND ADVISORY SERVICES FEATURING INVESTMENTS IN COMPANIES AND ENTERPRISES ORGANIZED OR BASED IN INDIA , IN CLASS 36 (U.S. CLS. 100, 101 AND 102).

FIRST USE 5-4-2011; IN COMMERCE 5-4-2011.

THE MARK CONSISTS OF STYLIZED GEOMETRIC FLORAL (LOTUS) DESIGN IN BLUE, GREEN AND YELLOW.

THE COLOR(S) BLUE, GREEN AND YELLOW IS/ARE CLAIMED AS A FEATURE OF THE MARK.

SN 85-314,250, FILED 5-6-2011.

MARLENE BELL, EXAMINING ATTORNEY



David J. Kyffers

Director of the United States Patent and Trademark Office

United States of America

United States Patent and Trademark Office

Emily C

Reg. No. 4,176,841

Registered July 17, 2012

Int. Cl.: 14

TRADEMARK

PRINCIPAL REGISTER

EMILY C LLC (CALIFORNIA LIMITED LIABILITY COMPANY)
ATTN: EMILY CRITTENDEN
5042 WILSHIRE BLVD #18409
LOS ANGELES, CA 90036

FOR: JEWELRY, IN CLASS 14 (U.S. CLS. 2, 27, 28 AND 50).

FIRST USE 11-14-2011; IN COMMERCE 12-9-2011.

THE MARK CONSISTS OF STANDARD CHARACTERS WITHOUT CLAIM TO ANY PARTICULAR FONT, STYLE, SIZE, OR COLOR.

THE NAME(S), PORTRAIT(S), AND/OR SIGNATURE(S) SHOWN IN THE MARK IDENTIFIES "EMILY" GRAVES CRITTENDEN, WHOSE CONSENT(S) TO REGISTER IS MADE OF RECORD.

SN 85-314,368, FILED 5-6-2011.

TRACY WHITTAKER-BROWN, EXAMINING ATTORNEY



David J. Kybas

Director of the United States Patent and Trademark Office

United States of America

United States Patent and Trademark Office

InterlineMRO

More Products. Reliable Solutions. One Partner.

Reg. No. 4,176,842

Registered July 17, 2012

Int. Cl.: 35

SERVICE MARK

PRINCIPAL REGISTER

INTERLINE BRANDS, INC. (NEW JERSEY CORPORATION)
18TH FLOOR
701 SAN MARCO BOULEVARD
JACKSONVILLE, FL 32207

FOR: DISTRIBUTORSHIP SERVICES FEATURING MAINTENANCE, REPAIR AND OPERATIONS PRODUCTS, NAMELY, PLUMBING, HVAC, LIGHTING, ELECTRICAL, HARDWARE, POOL, SAFETY AND SECURITY, AND LAWN AND GARDEN PRODUCTS, JANITORIAL AND CLEANING SUPPLIES, APPLIANCES, OFFICE SUPPLIES, TOOLS AND FIXTURES; ONLINE RETAIL AND WHOLESALE STORE SERVICES FEATURING MAINTENANCE, REPAIR AND OPERATIONS PRODUCTS, NAMELY, PLUMBING, HVAC, LIGHTING, ELECTRICAL, HARDWARE, POOL, SAFETY AND SECURITY, AND LAWN AND GARDEN PRODUCTS, JANITORIAL AND CLEANING SUPPLIES, APPLIANCES, OFFICE SUPPLIES, TOOLS AND FIXTURES, IN CLASS 35 (U.S. CLS. 100, 101 AND 102).

FIRST USE 4-5-2012; IN COMMERCE 4-5-2012.

OWNER OF U.S. REG. NOS. 2,759,591 AND 3,448,685.

THE MARK CONSISTS OF THE WORD "INTERLINEMRO" WITH THE WORDS "MORE PRODUCTS. RELIABLE SOLUTIONS. ONE PARTNER." APPEARING BELOW THE WORD "INTERLINEMRO", AND WITH THE "M" IN "MORE" AND THE "R" IN "RELIABLE" AND THE "O" IN "ONE" APPEARING IN BOLD.

SN 85-314,448, FILED 5-6-2011.

Laurie Kaufman, Examining Attorney



David J. Kyffers

Director of the United States Patent and Trademark Office

United States of America

United States Patent and Trademark Office

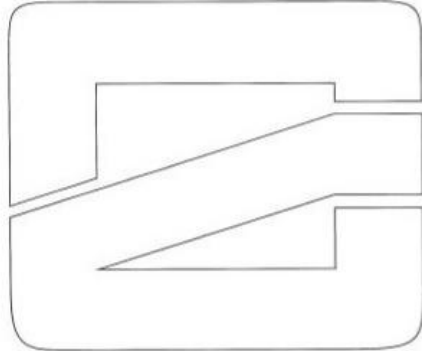

Reg. No. 4,176,843

Registered July 17, 2012

Int. Cl.: 25

TRADEMARK

PRINCIPAL REGISTER

OBTAIN DESIGN, LLC (MICHIGAN LIMITED LIABILITY COMPANY)
6637 THORNE ROAD
HORTON, MI 49246

FOR: WEARABLE GARMENTS AND CLOTHING, NAMELY, SHIRTS, PANTS, HEADBANDS, BELTS, DRESSES, SKIRTS, SWEATSHIRTS, SWEAT PANTS, TURTLENECK SHIRTS, T-SHIRTS, COATS, JACKETS, PULLOVERS, JEANS, SHORTS, SOCKS, SWIMWEAR, WET SUITS, PAJAMAS, TANK TOPS, SWEATERS, HATS, CAPS, VISORS, SWEAT BANDS, CAMISOLES, SCARVES, JUMPSUITS, SKI JACKETS AND SKI SLACKS; FOOTWEAR, IN CLASS 25 (U.S. CLS. 22 AND 39).

FIRST USE 8-22-2011; IN COMMERCE 1-27-2012.

THE MARK CONSISTS OF A HIGHLY STYLIZED LETTER "O" IN A SQUARE SHAPE WITH A DIAGONAL LINE REACHING FROM THE LOWER LEFT CORNER TO JUST BELOW THE UPPER RIGHT CORNER.

SN 85-314,489, FILED 5-6-2011.

JILL C. ALT, EXAMINING ATTORNEY



David J. Kybas

Director of the United States Patent and Trademark Office

United States of America

United States Patent and Trademark Office

ARMOR ACTIVE

Reg. No. 4,176,844

IPADENCLOSURES, LLC (UTAH LIMITED LIABILITY COMPANY)
1479 N. AUGUST DR.

Registered July 17, 2012

SARATOGA SPRINGS, UT 84043

Int. Cl.: 9

FOR: CASINGS AND KIOSKS FOR TABLET COMPUTERS, TOUCHSCREEN MONITORS, AND PORTABLE ELECTRONIC DEVICES FOR PURPOSES OF PROTECTING AND LIMITING A USER'S ABILITY TO INTERACT WITH THE PORTABLE ELECTRONIC DEVICE; CASINGS AND KIOSKS FOR TABLET COMPUTERS, TOUCHSCREEN MONITORS, AND PORTABLE ELECTRONIC DEVICES FOR PURPOSES OF SECURING THE ELECTRONIC DEVICES TO A FIXED LOCATION; INTERACTIVE COMPUTER KIOSKS COMPRISING COMPUTERS, COMPUTER HARDWARE, COMPUTER PERIPHERALS, AND COMPUTER OPERATING SOFTWARE, IN CLASS 9 (U.S. CLS. 21, 23, 26, 36 AND 38).

TRADEMARK

PRINCIPAL REGISTER

FIRST USE 12-31-2011; IN COMMERCE 12-31-2011.

THE MARK CONSISTS OF STANDARD CHARACTERS WITHOUT CLAIM TO ANY PARTICULAR FONT, STYLE, SIZE, OR COLOR.

SN 85-314,919, FILED 5-6-2011.

JULIE GUTTADAURO, EXAMINING ATTORNEY



David J. Kyros

Director of the United States Patent and Trademark Office

United States of America

United States Patent and Trademark Office

Eastpoint Pediatric Dental Associates

Reg. No. 4,176,845

BRILL, DMD, WARREN A. (UNITED STATES INDIVIDUAL)
1001 NORTH POINT BOULEVARD
BALTIMORE, MD 21224

Registered July 17, 2012

Int. Cl.: 44

FOR: MEDICAL SERVICES, NAMELY, PEDIATRIC DENTISTRY, IN CLASS 44 (U.S. CLS. 100 AND 101).

SERVICE MARK

FIRST USE 4-25-2012; IN COMMERCE 4-25-2012.

PRINCIPAL REGISTER

THE MARK CONSISTS OF STANDARD CHARACTERS WITHOUT CLAIM TO ANY PARTICULAR FONT, STYLE, SIZE, OR COLOR.

NO CLAIM IS MADE TO THE EXCLUSIVE RIGHT TO USE "PEDIATRIC DENTAL ASSOCIATES", APART FROM THE MARK AS SHOWN.

SN 85-315,872, FILED 5-9-2011.

DOMINICK J. SALEMI, EXAMINING ATTORNEY



David J. Kybas

Director of the United States Patent and Trademark Office

United States of America

United States Patent and Trademark Office

THINK BEFORE YOU BITE

Reg. No. 4,176,846

FROZEN NP LLC (COLORADO LIMITED LIABILITY COMPANY)
PO BOX 172863
DENVER, CO 80217

Registered July 17, 2012

Int. Cl.: 30

FOR: FROZEN PIZZA PRODUCTS, IN CLASS 30 (U.S. CL. 46).

TRADEMARK

FIRST USE 10-20-2011; IN COMMERCE 10-20-2011.

PRINCIPAL REGISTER

THE MARK CONSISTS OF STANDARD CHARACTERS WITHOUT CLAIM TO ANY PARTICULAR FONT, STYLE, SIZE, OR COLOR.

SN 85-316,094, FILED 5-9-2011.

CHRISTINE MARTIN, EXAMINING ATTORNEY



David J. Kybas

Director of the United States Patent and Trademark Office

United States of America

United States Patent and Trademark Office

1-800-DOOR-MEN

Reg. No. 4,176,847

1-800-DOOR-MEN LLC. (NEW HAMPSHIRE LIMITED LIABILITY COMPANY)
14 LINCOLN DR

Registered July 17, 2012

NOTTINGHAM, NH 03290

Int. Cl.: 37

FOR: INSTALLATION, MAINTENANCE AND REPAIR OF DOORS, IN CLASS 37 (U.S. CLS. 100, 103 AND 106).

SERVICE MARK

FIRST USE 9-20-2010; IN COMMERCE 7-15-2011.

PRINCIPAL REGISTER

THE MARK CONSISTS OF STANDARD CHARACTERS WITHOUT CLAIM TO ANY PARTICULAR FONT, STYLE, SIZE, OR COLOR.

SN 85-317,498, FILED 5-10-2011.

BARBARA RUTLAND, EXAMINING ATTORNEY



David J. Kyffers

Director of the United States Patent and Trademark Office

United States of America

United States Patent and Trademark Office

ALIEN PIRATES

Reg. No. 4,176,848

MICHAEL ZALETEL (UNITED STATES INDIVIDUAL)
378 E. CLIFTON COURT
GILBERT, AZ 85295

Registered July 17, 2012

Int. Cl.: 9

FOR: COMPUTER GAME SOFTWARE, IN CLASS 9 (U.S. CLS. 21, 23, 26, 36 AND 38).

TRADEMARK

FIRST USE 10-0-2011; IN COMMERCE 10-0-2011.

PRINCIPAL REGISTER

THE MARK CONSISTS OF STANDARD CHARACTERS WITHOUT CLAIM TO ANY PARTICULAR FONT, STYLE, SIZE, OR COLOR.

SN 85-317,686, FILED 5-11-2011.

NELSON SNYDER, EXAMINING ATTORNEY



David J. Kyfos

Director of the United States Patent and Trademark Office

United States of America

United States Patent and Trademark Office

RUNTECHNOLOGY

Reg. No. 4,176,849

CHALKTALK SPORTS, INC. (CONNECTICUT CORPORATION)
25 PERRY AVENUE
NORWALK, CT 06850

Registered July 17, 2012

Int. Cl.: 14

FOR: IDENTIFICATION BRACELETS; ANKLE BRACELETS; BRACELETS; EARRINGS; CHARMS FOR COLLAR JEWELRY, PERSONAL JEWELRY AND BRACELETS; DRESS, SPORT AND JEWELRY WATCHES; KEY CHAINS AS JEWELRY; JEWELRY; JEWELRY, NAMELY, DOG TAGS FOR WEAR BY HUMANS FOR DECORATIVE PURPOSES; NECKLACES, IN CLASS 14 (U.S. CLS. 2, 27, 28 AND 50).

TRADEMARK

PRINCIPAL REGISTER

FIRST USE 8-5-2011; IN COMMERCE 8-5-2011.

THE MARK CONSISTS OF STANDARD CHARACTERS WITHOUT CLAIM TO ANY PARTICULAR FONT, STYLE, SIZE, OR COLOR.

SN 85-317,932, FILED 5-11-2011.

STEVEN JACKSON, EXAMINING ATTORNEY



David J. Kyffers

Director of the United States Patent and Trademark Office

United States of America
United States Patent and Trademark Office

EVERCAST

Reg. No. 4,176,850

AVID ANGLERS, LLC (MISSOURI LIMITED LIABILITY COMPANY)
425 WOODSMILL ROAD, SUITE 170
ST. LOUIS, MO 63017

Registered July 17, 2012

Int. Cl.: 28

FOR: FISHING REELS; FISHING RODS, IN CLASS 28 (U.S. CLS. 22, 23, 38 AND 50).

TRADEMARK

FIRST USE 8-0-2011; IN COMMERCE 8-0-2011.

PRINCIPAL REGISTER

THE MARK CONSISTS OF STANDARD CHARACTERS WITHOUT CLAIM TO ANY PARTICULAR FONT, STYLE, SIZE, OR COLOR.

SN 85-318,363, FILED 5-11-2011.

BARNEY CHARLON, EXAMINING ATTORNEY



David J. Kyffers

Director of the United States Patent and Trademark Office

United States of America
United States Patent and Trademark Office

**EVERCAST**

Reg. No. 4,176,851

AVID ANGLERS, LLC (MISSOURI LIMITED LIABILITY COMPANY)
425 WOODSMILL ROAD, SUITE 170
ST. LOUIS, MO 63017

Registered July 17, 2012

Int. Cl.: 28

FOR: FISHING REELS; FISHING RODS, IN CLASS 28 (U.S. CLS. 22, 23, 38 AND 50).

TRADEMARK

FIRST USE 8-0-2011; IN COMMERCE 8-0-2011.

PRINCIPAL REGISTER

THE MARK CONSISTS OF AN ARCUATE EMBELLISHMENT ABOVE THE WORDING "EVERCAST".

SN 85-318,384, FILED 5-11-2011.

BARNEY CHARLON, EXAMINING ATTORNEY



David J. Kyffers

Director of the United States Patent and Trademark Office

United States of America

United States Patent and Trademark Office

TOUCHSECURE OPENACCESS READER

Reg. No. 4,176,852

Registered July 17, 2012

Int. Cl.: 9

TRADEMARK

PRINCIPAL REGISTER

IDONDEMAND, INC. (DELAWARE CORPORATION)
6800 KOLL CENTER PARKWAY, SUITE 180
PLEASANTON, CA 94566

FOR: CONTACTLESS COMMUNICATION SYSTEMS, NAMELY, PORTABLE INTEGRATED CIRCUIT CARDS, SMARTCARDS, AND HOST ELECTRONIC CARD READER/WRITERS TO COMMUNICATE INFORMATION BETWEEN THE CARDS AND THE HOST READER/WRITERS IN A CONTACTLESS MANNER, FOR SECURITY, IDENTIFICATION, PHYSICAL STATE AND FINANCIAL APPLICATIONS CONTROL, PHYSICAL ACCESS CONTROL TO SECURED AREAS, PERSONNEL TIME AND ATTENDANCE ACCESS AND CONTROL, IDENTITY CREDENTIALING, COMPUTER LOG-ON AND NETWORK ACCESS, DIGITAL CASH TRANSACTIONS IDENTITY CONTROL AND ACCESS, ALL USED IN CONNECTION WITH PORTABLE SECURE DEVICES, BUILDING ACCESS SYSTEMS TO SECURE AREAS, TIME AND ATTENDANCE MONITORING AND CONTROL SYSTEMS, COMPUTER LOG-ON ACCESS CONTROLS, INTERNET IDENTIFICATION, AND ECOMMERCE IDENTIFICATION AND AUTHENTICATION, IN CLASS 9 (U.S. CLS. 21, 23, 26, 36 AND 38).

FIRST USE 4-0-2011; IN COMMERCE 5-0-2011.

THE MARK CONSISTS OF STANDARD CHARACTERS WITHOUT CLAIM TO ANY PARTICULAR FONT, STYLE, SIZE, OR COLOR.

NO CLAIM IS MADE TO THE EXCLUSIVE RIGHT TO USE "READER", APART FROM THE MARK AS SHOWN.

SN 85-318,800, FILED 5-12-2011.

LESLEY LAMOTHE, EXAMINING ATTORNEY



David J. Kyffers

Director of the United States Patent and Trademark Office

United States of America

United States Patent and Trademark Office

QuoteNation

Reg. No. 4,176,853

ANDERSON, WAYNE (UNITED STATES INDIVIDUAL)
1644 MASTERS COURT
NAPERVILLE, IL 60563

Registered July 17, 2012

Int. Cl.: 9

FOR: COMPUTER APPLICATION SOFTWARE FOR MOBILE PHONES, PC TABLETS, PORTABLE MEDIA PLAYERS, AND HANDHELD COMPUTERS, NAMELY, SOFTWARE FOR THE ORGANIZATION, BOOKMARKING, SHARING, TRANSMISSION, PURCHASING AND RENTAL OF VIDEO, AUDIO, AND TEXT CONTENT IN THE FIELDS OF PERSONAL ENTERTAINMENT, EMAIL MARKETING AND SOCIAL MEDIA, IN CLASS 9 (U.S. CLS. 21, 23, 26, 36 AND 38).

TRADEMARK

PRINCIPAL REGISTER

FIRST USE 1-18-2012; IN COMMERCE 1-18-2012.

THE MARK CONSISTS OF STANDARD CHARACTERS WITHOUT CLAIM TO ANY PARTICULAR FONT, STYLE, SIZE, OR COLOR.

SN 85-319,043, FILED 5-12-2011.

AMY KERTGATE, EXAMINING ATTORNEY



David J. Kyffers

Director of the United States Patent and Trademark Office

United States of America
United States Patent and Trademark Office

TERRARIA

Reg. No. 4,176,854

Registered July 17, 2012

Int. Cls.: 9 and 41

TRADEMARK

SERVICE MARK

PRINCIPAL REGISTER

TEH GAMEZ, INC. (INDIANA CORPORATION)
605 W. UTICA STREET
SELLERSBURG, IN 47172

FOR: INTERACTIVE VIDEO GAME PROGRAMS; VIDEO AND COMPUTER GAME PROGRAMS; COMPUTER GAME SOFTWARE; INTERACTIVE MULTIMEDIA COMPUTER GAME PROGRAM; DOWNLOADABLE COMPUTER GAME PROGRAMS, IN CLASS 9 (U.S. CLS. 21, 23, 26, 36 AND 38).

FIRST USE 5-16-2011; IN COMMERCE 5-16-2011.

FOR: ENTERTAINMENT SERVICES, NAMELY, PROVIDING ONLINE VIDEO GAMES, IN CLASS 41 (U.S. CLS. 100, 101 AND 107).

FIRST USE 5-16-2011; IN COMMERCE 5-16-2011.

THE MARK CONSISTS OF STANDARD CHARACTERS WITHOUT CLAIM TO ANY PARTICULAR FONT, STYLE, SIZE, OR COLOR.

SN 85-319,658, FILED 5-12-2011.

SANI KHOURI, EXAMINING ATTORNEY



David J. Kyffers

Director of the United States Patent and Trademark Office

United States of America
United States Patent and Trademark Office

L'auberge

Reg. No. 4,176,855

Registered July 17, 2012

Int. Cl.: 44

SERVICE MARK

PRINCIPAL REGISTER

PINNACLE ENTERTAINMENT, INC. (DELAWARE CORPORATION)
8918 SPANISH RIDGE AVENUE
LAS VEGAS, NV 89148

FOR: BARBER SHOP SERVICES; BEAUTY SALON SERVICES; COSMETICIAN SERVICES;
DAY SPA SERVICES, NAMELY, NAIL CARE, MANICURES, PEDICURES AND NAIL EN-
HANCEMENTS; HEALTH SPA SERVICES FOR HEALTH AND WELLNESS OF THE BODY
AND SPIRIT, NAMELY, PROVIDING MASSAGE, FACIAL AND BODY TREATMENT SER-
VICES, COSMETIC BODY CARE SERVICES; TANNING SALONS, IN CLASS 44 (U.S. CLS.
100 AND 101).

FIRST USE 5-25-2005; IN COMMERCE 5-25-2005.

OWNER OF U.S. REG. NOS. 3,204,276, 3,436,520, AND OTHERS.

THE MARK CONSISTS OF THE WORD "L'AUBERGE" IN STYLIZED FORM.

THE ENGLISH TRANSLATION OF "L'AUBERGE" IN THE MARK IS "THE INN".

SN 85-319,834, FILED 5-12-2011.

PATRICIA EVANKO, EXAMINING ATTORNEY



David J. Kyros

Director of the United States Patent and Trademark Office

United States of America

United States Patent and Trademark Office

L'AUBERGE

Reg. No. 4,176,856

Registered July 17, 2012

Int. Cl.: 44

SERVICE MARK

PRINCIPAL REGISTER

PINNACLE ENTERTAINMENT, INC. (DELAWARE CORPORATION)
8918 SPANISH RIDGE AVENUE
LAS VEGAS, NV 89148

FOR: BARBER SHOP SERVICES; BEAUTY SALON SERVICES; COSMETICIAN SERVICES; DAY SPA SERVICES, NAMELY, NAIL CARE, MANICURES, PEDICURES AND NAIL ENHANCEMENTS; HEALTH SPA SERVICES FOR HEALTH AND WELLNESS OF THE BODY AND SPIRIT, NAMELY, PROVIDING MASSAGE, FACIAL AND BODY TREATMENT SERVICES, COSMETIC BODY CARE SERVICES; TANNING SALONS, IN CLASS 44 (U.S. CLS. 100 AND 101).

FIRST USE 5-25-2005; IN COMMERCE 5-25-2005.

THE MARK CONSISTS OF STANDARD CHARACTERS WITHOUT CLAIM TO ANY PARTICULAR FONT, STYLE, SIZE, OR COLOR.

OWNER OF U.S. REG. NOS. 3,204,276, 3,436,520, AND OTHERS.

THE ENGLISH TRANSLATION OF "L'AUBERGE" IN THE MARK IS "THE INN".

SN 85-319,837, FILED 5-12-2011.

PATRICIA EVANKO, EXAMINING ATTORNEY



David J. Kyffers

Director of the United States Patent and Trademark Office

United States of America
United States Patent and Trademark Office

L'auberge

Reg. No. 4,176,857

PINNACLE ENTERTAINMENT, INC. (DELAWARE CORPORATION)
8918 SPANISH RIDGE AVENUE
LAS VEGAS, NV 89148

Registered July 17, 2012

Int. Cl.: 41

FOR: ENTERTAINMENT SERVICES, NAMELY, LIVE PERFORMANCES FEATURING MUSICIANS AND SINGERS, DANCERS, MAGICIANS, ACTORS, ACROBATS, COMEDIANS AND PRERECORDED MUSIC AND VIDEO; NIGHT CLUBS; AMUSEMENT ARCADES; HEALTH CLUB SERVICES, NAMELY, PROVIDING EQUIPMENT IN THE FIELD OF PHYSICAL EXERCISE; ENTERTAINMENT SERVICES, NAMELY, ARRANGING FOR TICKET RESERVATIONS FOR SHOWS AND OTHER ENTERTAINMENT EVENTS; CONDUCTING AND PROVIDING FACILITIES FOR SPECIAL EVENTS FEATURING CASINO AND GAMING CONTESTS AND TOURNAMENTS; PROVIDING FACILITIES FOR RECREATION ACTIVITIES; ARRANGING AND CONDUCTING ATHLETIC COMPETITIONS; SPECIAL EVENT PLANNING FOR SOCIAL ENTERTAINMENT PURPOSES; PROVIDING SWIMMING POOLS, IN CLASS 41 (U.S. CLS. 100, 101 AND 107).

SERVICE MARK

PRINCIPAL REGISTER

FIRST USE 5-25-2005; IN COMMERCE 5-25-2005.

OWNER OF U.S. REG. NOS. 3,011,912, 3,436,520, AND OTHERS.

THE MARK CONSISTS OF THE WORD "L'AUBERGE" IN STYLIZED FORM.

THE ENGLISH TRANSLATION OF "L'AUBERGE" IN THE MARK IS "THE INN".

SN 85-319,840, FILED 5-12-2011.

PATRICIA EVANKO, EXAMINING ATTORNEY



David J. Kyros

Director of the United States Patent and Trademark Office

United States of America

United States Patent and Trademark Office

L'AUBERGE

Reg. No. 4,176,858

Registered July 17, 2012

Int. Cl.: 41

SERVICE MARK

PRINCIPAL REGISTER

PINNACLE ENTERTAINMENT, INC. (DELAWARE CORPORATION)
8918 SPANISH RIDGE AVENUE
LAS VEGAS, NV 89148

FOR: ENTERTAINMENT SERVICES, NAMELY, LIVE PERFORMANCES FEATURING MUSICIANS AND SINGERS, DANCERS, MAGICIANS, ACTORS, ACROBATS, COMEDIANS AND PRERECORDED MUSIC AND VIDEO; NIGHT CLUBS; AMUSEMENT ARCADES; HEALTH CLUB SERVICES, NAMELY, PROVIDING EQUIPMENT IN THE FIELD OF PHYSICAL EXERCISE; ENTERTAINMENT SERVICES, NAMELY, ARRANGING FOR TICKET RESERVATIONS FOR SHOWS AND OTHER ENTERTAINMENT EVENTS; CONDUCTING AND PROVIDING FACILITIES FOR SPECIAL EVENTS FEATURING CASINO AND GAMING CONTESTS AND TOURNAMENTS; PROVIDING FACILITIES FOR RECREATION ACTIVITIES; ARRANGING AND CONDUCTING ATHLETIC COMPETITIONS; SPECIAL EVENT PLANNING FOR SOCIAL ENTERTAINMENT PURPOSES; PROVIDING SWIMMING POOLS, IN CLASS 41 (U.S. CLS. 100, 101 AND 107).

FIRST USE 5-25-2005; IN COMMERCE 5-25-2005.

THE MARK CONSISTS OF STANDARD CHARACTERS WITHOUT CLAIM TO ANY PARTICULAR FONT, STYLE, SIZE, OR COLOR.

OWNER OF U.S. REG. NOS. 3,011,912, 3,436,520, AND OTHERS.

THE ENGLISH TRANSLATION OF "L'AUBERGE" IN THE MARK IS "THE INN".

SN 85-319,844, FILED 5-12-2011.

PATRICIA EVANKO, EXAMINING ATTORNEY



David J. Kypos

Director of the United States Patent and Trademark Office

United States of America

United States Patent and Trademark Office

RAMJAM

Reg. No. 4,176,859

ANDERSON, LARRY (CANADA INDIVIDUAL)
1112-95 STREET

Registered July 17, 2012

EDMONTON ALBERTA, CANADA T6X0A7

Int. Cl.: 41

FOR: EDUCATION SERVICES, NAMELY, CONDUCTING SEMINARS, WORKSHOPS, AND COACHING IN THE FIELD OF SELF-HELP AND PERSONAL DEVELOPMENT AND PROVIDING PRINTED MATERIALS THEREWITH, IN CLASS 41 (U.S. CLS. 100, 101 AND 107).

SERVICE MARK

PRINCIPAL REGISTER

FIRST USE 6-1-2011; IN COMMERCE 6-1-2011.

THE MARK CONSISTS OF STANDARD CHARACTERS WITHOUT CLAIM TO ANY PARTICULAR FONT, STYLE, SIZE, OR COLOR.

SN 85-319,902, FILED 5-13-2011.

RAUL CORDOVA, EXAMINING ATTORNEY



David J. Kyfos

Director of the United States Patent and Trademark Office

United States of America

United States Patent and Trademark Office



Reg. No. 4,176,860

Registered July 17, 2012

Int. Cl.: 29

SF INVESTMENTS, INC. (DELAWARE CORPORATION)
BAYNARD BUILDING SUITE 103
3411 SILVERSIDE ROAD
WILMINGTON, DE 19810

FOR: MEAT, BACON, IN CLASS 29 (U.S. CL. 46).

TRADEMARK

FIRST USE 8-31-2011; IN COMMERCE 8-31-2011.

PRINCIPAL REGISTER

NO CLAIM IS MADE TO THE EXCLUSIVE RIGHT TO USE "POUCH PACK" , APART FROM THE MARK AS SHOWN.

SEC. 2(F) AS TO "SMITHFIELD".

THE MARK CONSISTS OF THE WORDS ". ALL THE TASTE . . . NONE OF THE WASTE ." IN A CIRCLE WITH THE WORD "SMITHFIELD" ABOVE THE WORDS "POUCH PACK" IN A RECTANGLE WITHIN THE CIRCLE.

SN 85-320,217, FILED 5-13-2011.

KAREN BRACEY, EXAMINING ATTORNEY



David J. Kyffers

Director of the United States Patent and Trademark Office

United States of America

United States Patent and Trademark Office

OAK STREET
FUNDING 

Reg. No. 4,176,861

Registered July 17, 2012

Int. Cl.: 36

SERVICE MARK

PRINCIPAL REGISTER

OAK STREET FUNDING LLC (INDIANA LIMITED LIABILITY COMPANY)
SUITE 600
11350 NORTH MERIDIAN STREET
CARMEL, IN 46032

FOR: FINANCIAL SERVICES, NAMELY, MONEY LENDING, IN CLASS 36 (U.S. CLS. 100, 101 AND 102).

FIRST USE 6-9-2011; IN COMMERCE 6-9-2011.

OWNER OF U.S. REG. NOS. 2,929,595 AND 3,041,510.

NO CLAIM IS MADE TO THE EXCLUSIVE RIGHT TO USE "FUNDING", APART FROM THE MARK AS SHOWN.

THE MARK CONSISTS OF A THREE DIMENSIONAL DEPICTION OF THE EXTERIOR OF A BUILDING STRUCTURE COMPOSED OF HORIZONTAL AND DIAGONAL BARS WITH THE WORDS "OAK STREET FUNDING" POSITIONED TO ITS LEFT.

SN 85-320,461, FILED 5-13-2011.

KIMBERLY FRYE, EXAMINING ATTORNEY



David J. Kyros

Director of the United States Patent and Trademark Office

United States of America

United States Patent and Trademark Office

DAILY ADVANTAGE

Reg. No. 4,176,862

HEALTHY DIRECTIONS, LLC (DELAWARE LIMITED LIABILITY COMPANY)
7811 MONTROSE ROAD
POTOMAC, MD 20854

Registered July 17, 2012

Int. Cl.: 5

FOR: NUTRITIONAL SUPPLEMENTS, IN CLASS 5 (U.S. CLS. 6, 18, 44, 46, 51 AND 52).

FIRST USE 3-0-2006; IN COMMERCE 3-0-2006.

TRADEMARK

THE MARK CONSISTS OF STANDARD CHARACTERS WITHOUT CLAIM TO ANY PARTICULAR FONT, STYLE, SIZE, OR COLOR.

PRINCIPAL REGISTER

OWNER OF U.S. REG. NO. 2,317,016.

NO CLAIM IS MADE TO THE EXCLUSIVE RIGHT TO USE "DAILY", APART FROM THE MARK AS SHOWN.

SN 85-320,474, FILED 5-13-2011.

LOURDES AYALA, EXAMINING ATTORNEY



David J. Kyffers

Director of the United States Patent and Trademark Office

United States of America

United States Patent and Trademark Office



Reg. No. 4,176,863

J.Y. RAYS, INC. (CALIFORNIA CORPORATION)
2023 CHICO AVENUE
SOUTH EL MONTE, CA 91733

Registered July 17, 2012

Int. Cl.: 25

FOR: BOARD SHORTS, SWIM TRUNKS, RASH GUARDS, SWIMWEAR, IN CLASS 25 (U.S. CLS. 22 AND 39).

TRADEMARK

FIRST USE 10-0-2011; IN COMMERCE 10-0-2011.

PRINCIPAL REGISTER

SN 85-320,628, FILED 5-13-2011.

EDWARD NELSON, EXAMINING ATTORNEY



David J. Kybas

Director of the United States Patent and Trademark Office

United States of America

United States Patent and Trademark Office

NEURONASIUM

Reg. No. 4,176,864

ACTION BASED LEARNING LAB LLC (TEXAS LIMITED LIABILITY COMPANY)
232 ZACHARY WALK

Registered July 17, 2012

MURPHY, TX 750943790

Int. Cl.: 41

FOR: EDUCATIONAL SERVICES, NAMELY, CONDUCTING PROGRAMS IN THE FIELD OF PHYSICAL EXERCISE AND ACADEMIC ACHIEVEMENT BASED ON THE NEUROSCIENCE LINKING MOVEMENT AND EXERCISE TO LEARNING, IN CLASS 41 (U.S. CLS. 100, 101 AND 107).

SERVICE MARK

PRINCIPAL REGISTER

FIRST USE 8-1-2010; IN COMMERCE 8-1-2010.

THE MARK CONSISTS OF STANDARD CHARACTERS WITHOUT CLAIM TO ANY PARTICULAR FONT, STYLE, SIZE, OR COLOR.

SN 85-320,725, FILED 5-13-2011.

IRA J. GOODSaid, EXAMINING ATTORNEY



David J. Kyffers

Director of the United States Patent and Trademark Office

United States of America

United States Patent and Trademark Office

OFF LIMITS

Reg. No. 4,176,865

Registered July 17, 2012

Int. Cl.: 41

SERVICE MARK

PRINCIPAL REGISTER

THE TRAVEL CHANNEL, L.L.C. (DELAWARE LIMITED LIABILITY COMPANY)
5425 WISCONSIN AVE. SUITE 500
CHEVY CHASE, MD 20815

FOR: ENTERTAINMENT SERVICES IN THE NATURE OF A CONTINUING NON-FICTION PROGRAM ABOUT TRAVELLING THE WORLD AND EXPLORATION, ACCESSIBLE BY RADIO, TELEVISION, CABLE, FIBER OPTIC NETWORKS, WIRELESS NETWORKS, SATELLITE, AUDIO VIDEO, AND COMPUTER NETWORKS, IN CLASS 41 (U.S. CLS. 100, 101 AND 107).

FIRST USE 5-16-2011; IN COMMERCE 5-16-2011.

THE MARK CONSISTS OF STANDARD CHARACTERS WITHOUT CLAIM TO ANY PARTICULAR FONT, STYLE, SIZE, OR COLOR.

SN 85-320,766, FILED 5-13-2011.

DAVID I, EXAMINING ATTORNEY



David J. Kyffers

Director of the United States Patent and Trademark Office

United States of America

United States Patent and Trademark Office

IQB

Reg. No. 4,176,866

PARATOOLS, INC. (OREGON CORPORATION)
1600 MILLRACE DRIVE
EUGENE, OR 97403

Registered July 17, 2012

Int. Cl.: 9

FOR: COMPUTER SOFTWARE DEVELOPMENT TOOLS, NAMELY, SOFTWARE DEVELOPMENT TOOLS UTILIZING SEARCHABLE DATABASES OF SYMBOL INFORMATION, IN CLASS 9 (U.S. CLS. 21, 23, 26, 36 AND 38).

TRADEMARK

FIRST USE 1-9-2012; IN COMMERCE 4-2-2012.

PRINCIPAL REGISTER

THE MARK CONSISTS OF STANDARD CHARACTERS WITHOUT CLAIM TO ANY PARTICULAR FONT, STYLE, SIZE, OR COLOR.

SN 85-320,800, FILED 5-13-2011.

CHARLOTTE CORWIN, EXAMINING ATTORNEY



David J. Kybas

Director of the United States Patent and Trademark Office

United States of America

United States Patent and Trademark Office



Reg. No. 4,176,867

Registered July 17, 2012

Int. Cl.: 41

SERVICE MARK

PRINCIPAL REGISTER

ACTION BASED LEARNING LAB LLC (TEXAS LIMITED LIABILITY COMPANY)
232 ZACHARY WALK
MURPHY, TX 750943790

FOR: EDUCATIONAL SERVICES, NAMELY, CONDUCTING PROGRAMS IN THE FIELD OF PHYSICAL EXERCISE AND ACADEMIC ACHIEVEMENT BASED ON THE NEUROSCIENCE LINKING MOVEMENT AND EXERCISE TO LEARNING, IN CLASS 41 (U.S. CLS. 100, 101 AND 107).

FIRST USE 8-1-2010; IN COMMERCE 8-1-2010.

THE GRAY IN THE MARK IS FOR SHADING PURPOSES ONLY, AND DOES NOT REPRESENT COLOR.

THE MARK CONSISTS OF A STYLIZED BRAIN DESIGN FROM WHICH ELECTRICITY CHARGES EMANATE AND THE TERM "NEURONASIUM" APPEARS INSIDE.

SN 85-320,857, FILED 5-13-2011.

IRA J. GOODSaid, EXAMINING ATTORNEY



David J. Kyffers

Director of the United States Patent and Trademark Office

United States of America
United States Patent and Trademark Office

SHE

Reg. No. 4,176,868

Registered July 17, 2012

Int. Cl.: 44

SERVICE MARK

PRINCIPAL REGISTER

DRS. GOODMAN & PARTRIDGE OB/GYN, PLLC (ARIZONA LIMITED LIABILITY COMPANY)
1900 WEST CHANDLER ROAD #15-391
CHANDLER, AZ 85224

FOR: OBSTETRIC AND GYNECOLOGY SERVICES, IN CLASS 44 (U.S. CLS. 100 AND 101).

FIRST USE 4-20-2012; IN COMMERCE 4-20-2012.

THE MARK CONSISTS OF STANDARD CHARACTERS WITHOUT CLAIM TO ANY PARTICULAR FONT, STYLE, SIZE, OR COLOR.

SN 85-320,891, FILED 5-13-2011.

NAAKWAMA ANKRAH, EXAMINING ATTORNEY



David J. Kyffers

Director of the United States Patent and Trademark Office

United States of America

United States Patent and Trademark Office

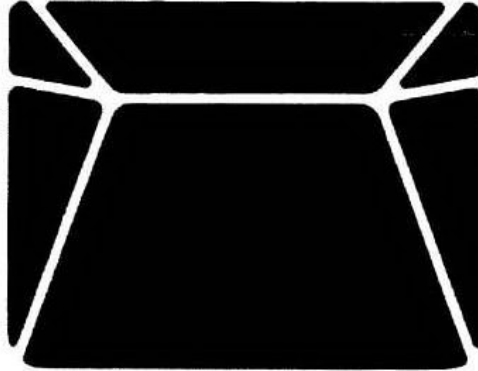

Reg. No. 4,176,869

Registered July 17, 2012

Int. Cl.: 9

TRADEMARK

PRINCIPAL REGISTER

HON HAI PRECISION INDUSTRY CO., LTD. (TAIWAN CORPORATION)
NO.2, TZU YU STREET, TU-CHENG CITY
TAIPEI HSIEN, TAIWAN

FOR: CASES FOR MOBILE PHONES; COMPUTER CARRYING CASES ESPECIALLY ADAPTED FOR HOLDING LAPTOPS AND NOTEBOOK COMPUTERS; BAGS FOR CAMERAS AND PHOTOGRAPHIC EQUIPMENT; AND CARRYING CASES FOR PERSONAL DIGITAL ASSISTANTS, IN CLASS 9 (U.S. CLS. 21, 23, 26, 36 AND 38).

FIRST USE 9-30-2011; IN COMMERCE 1-23-2012.

THE MARK CONSISTS OF FOUR DIFFERENT TRIANGLES ON THE RIGHT AND LEFT AND TWO QUADRILATERALS IN THE CENTER.

SN 85-321,060, FILED 5-14-2011.

TINA L. SNAPP, EXAMINING ATTORNEY



David J. Kyffers

Director of the United States Patent and Trademark Office

United States of America

United States Patent and Trademark Office

BLACK BEAN ENERGY FOOD RESTAURANT

Reg. No. 4,176,870

GROSSMAN, FRAN L. (UNITED STATES INDIVIDUAL)
2275 PORTSIDE WAY
CHARLESTON, SC 29407

Registered July 17, 2012

Int. Cl.: 43

FOR: RESTAURANTS, IN CLASS 43 (U.S. CLS. 100 AND 101).

SERVICE MARK

FIRST USE 4-0-2012; IN COMMERCE 4-0-2012.

PRINCIPAL REGISTER

THE MARK CONSISTS OF STANDARD CHARACTERS WITHOUT CLAIM TO ANY PARTICULAR FONT, STYLE, SIZE, OR COLOR.

NO CLAIM IS MADE TO THE EXCLUSIVE RIGHT TO USE "FOOD" AND "RESTAURANT", APART FROM THE MARK AS SHOWN.

SN 85-321,112, FILED 5-14-2011.

KAREN BRACEY, EXAMINING ATTORNEY



David J. Kyffers

Director of the United States Patent and Trademark Office

United States of America

United States Patent and Trademark Office



Reg. No. 4,176,871

Registered July 17, 2012

Int. Cl.: 19

TRADEMARK

PRINCIPAL REGISTER

IQ WINDOWS LLC (DELAWARE LIMITED LIABILITY COMPANY)
9254 UNITY STREET NW
COON RAPIDS, MN 55433

FOR: VINYL WINDOWS AND DOORS, IN CLASS 19 (U.S. CLS. 1, 12, 33 AND 50).

FIRST USE 11-15-2011; IN COMMERCE 11-15-2011.

NO CLAIM IS MADE TO THE EXCLUSIVE RIGHT TO USE "WINDOWS", APART FROM THE MARK AS SHOWN.

THE COLOR(S) GREEN AND BLUE IS/ARE CLAIMED AS A FEATURE OF THE MARK.

THE MARK CONSISTS OF THE STYLIZED LETTERS "IQ" WITH THE WORD "WINDOWS" DIRECTLY UNDERNEATH IN THE COLOR BLUE ALONG WITH FOUR SMALL INDIVIDUAL GREEN BOXES IN THE SHAPE OF A SQUARE ABOVE AND SERVING AS THE DOT IN THE LETTER "I".

SN 85-321,412, FILED 5-16-2011.

SUSAN STIGLITZ, EXAMINING ATTORNEY



David J. Kyffers

Director of the United States Patent and Trademark Office

United States of America

United States Patent and Trademark Office

 AquaLift

Reg. No. 4,176,872

Registered July 17, 2012

Int. Cl.: 11

TRADEMARK

PRINCIPAL REGISTER

WHIRLPOOL PROPERTIES, INC. (MICHIGAN CORPORATION)
SUITE 101
500 RENAISSANCE DRIVE
ST. JOSEPH, MI 49085

FOR: OVEN CLEANING SYSTEM COMPRISED OF THE OVEN WALL COATING, TIMER AND THERMOSTAT, SOLD AS AN INTEGRAL PART OF OVENS, IN CLASS 11 (U.S. CLS. 13, 21, 23, 31 AND 34).

FIRST USE 12-19-2011; IN COMMERCE 12-19-2011.

THE MARK CONSISTS OF THE WORD "AQUALIFT" TO THE RIGHT OF A WATER DROP DESIGN WITH A SMALL DIAMOND ON THE UPPER RIGHT EDGE.

SN 85-321,475, FILED 5-16-2011.

SUE LAWRENCE, EXAMINING ATTORNEY



David J. Kybas

Director of the United States Patent and Trademark Office

United States of America

United States Patent and Trademark Office

HYPER_{FX}

Reg. No. 4,176,873

Registered July 17, 2012

Int. Cl.: 5

TRADEMARK

PRINCIPAL REGISTER

GLANBIA NUTRITIONALS (IRELAND) LIMITED (IRELAND CORPORATION)
GLANBIA HOUSE
KILKENNY, IRELAND

FOR: DIETARY SUPPLEMENTS, IN CLASS 5 (U.S. CLS. 6, 18, 44, 46, 51 AND 52).

FIRST USE 10-13-2011; IN COMMERCE 10-13-2011.

THE MARK CONSISTS OF THE WORD "HYPERFX" WITH THE "FX" PORTION APPEARING
IN SUBSCRIPT.

SN 85-321,726, FILED 5-16-2011.

BARBARA RUTLAND, EXAMINING ATTORNEY



David J. Kybas

Director of the United States Patent and Trademark Office

United States of America

United States Patent and Trademark Office

AUDAMAXX

Reg. No. 4,176,874

MOJO BRANDS, LLC (NEVADA LIMITED LIABILITY COMPANY)
2657 WINDMILL PARKWAY #582
HENDERSON, NV 89074

Registered July 17, 2012

Int. Cl.: 5

FOR: DIETARY AND NUTRITIONAL SUPPLEMENTS, IN CLASS 5 (U.S. CLS. 6, 18, 44, 46, 51 AND 52).

TRADEMARK

FIRST USE 10-0-2011; IN COMMERCE 10-0-2011.

PRINCIPAL REGISTER

THE MARK CONSISTS OF STANDARD CHARACTERS WITHOUT CLAIM TO ANY PARTICULAR FONT, STYLE, SIZE, OR COLOR.

SN 85-322,022, FILED 5-16-2011.

MIDGE BUTLER, EXAMINING ATTORNEY



David J. Kyffers

Director of the United States Patent and Trademark Office

United States of America

United States Patent and Trademark Office

PORK'S 4 PILLARS OF SUSTAINABILITY

Reg. No. 4,176,875

Registered July 17, 2012

Int. Cls.: 35 and 41

SERVICE MARK

PRINCIPAL REGISTER

NATIONAL PORK BOARD (UNITED STATES BOARD ESTABLISHED UNDER FEDERAL STATUTE)
1776 N.W. 114TH STREET
CLIVE, IA 50325

FOR: PROMOTING THE INTERESTS OF PORK PRODUCERS COMMITTED TO PORK PRODUCTION AND ENVIRONMENTAL STEWARDSHIP, IN CLASS 35 (U.S. CLS. 100, 101 AND 102).

FIRST USE 5-18-2011; IN COMMERCE 5-18-2011.

FOR: EDUCATIONAL SERVICES, NAMELY, CONDUCTING CLASSES, SEMINARS, CONFERENCES AND WORKSHOPS IN THE FIELD OF PORK PRODUCTION AND ENVIRONMENTAL STEWARDSHIP AND DISTRIBUTION OF COURSE MATERIAL IN CONNECTION THEREWITH, IN CLASS 41 (U.S. CLS. 100, 101 AND 107).

FIRST USE 5-0-2011; IN COMMERCE 5-0-2011.

THE MARK CONSISTS OF STANDARD CHARACTERS WITHOUT CLAIM TO ANY PARTICULAR FONT, STYLE, SIZE, OR COLOR.

NO CLAIM IS MADE TO THE EXCLUSIVE RIGHT TO USE "PORK'S", APART FROM THE MARK AS SHOWN.

SN 85-322,503, FILED 5-17-2011.

RENEE MCCRAY, EXAMINING ATTORNEY



David J. Kyffers

Director of the United States Patent and Trademark Office

United States of America

United States Patent and Trademark Office

Y-KNOT

Reg. No. 4,176,876

LINVATEC CORPORATION (FLORIDA CORPORATION)
11311 CONCEPT BOULEVARD
LARGO, FL 33773

Registered July 17, 2012

Int. Cl.: 10

FOR: SURGICAL DEVICES, NAMELY, SUTURE ANCHORS FOR USE IN ARTHROSCOPIC SURGICAL PROCEDURES AND INSTRUMENTS FOR USE THEREWITH, IN CLASS 10 (U.S. CLS. 26, 39 AND 44).

TRADEMARK

FIRST USE 10-13-2011; IN COMMERCE 10-13-2011.

PRINCIPAL REGISTER

THE MARK CONSISTS OF STANDARD CHARACTERS WITHOUT CLAIM TO ANY PARTICULAR FONT, STYLE, SIZE, OR COLOR.

SN 85-322,734, FILED 5-17-2011.

ANNE MADDEN, EXAMINING ATTORNEY



David J. Kybas

Director of the United States Patent and Trademark Office

United States of America

United States Patent and Trademark Office

ONSTAR REMOTELINK

Reg. No. 4,176,877

Registered July 17, 2012

Int. Cl.: 9

TRADEMARK

PRINCIPAL REGISTER

ONSTAR LLC (DELAWARE LIMITED LIABILITY COMPANY)
400 RENAISSANCE CENTER
DETROIT, MI 482654000

FOR: SOFTWARE FOR SMARTPHONES THAT PROVIDES USERS THE ABILITY TO REMOTELY CONTROL FEATURES OF THEIR MOTOR VEHICLE, NAMELY, LOCKING AND UNLOCKING VEHICLE DOORS AND STARTING AND TURNING OFF THE VEHICLE; SOFTWARE FOR SMARTPHONES THAT PROVIDES USERS THE ABILITY TO REMOTELY CHECK STATUSES OF MOTOR VEHICLE OPERATING SYSTEMS, NAMELY, ENGINE OIL LIFE, FUEL LEVEL, TIRE PRESSURE AND BATTERY CHARGE; SOFTWARE FOR SMARTPHONES THAT PROVIDES USERS THE ABILITY TO CONNECT TO AN ONSTAR TELECOMMUNICATIONS SERVICE ADVISOR AT A CALL CENTER, IN CLASS 9 (U.S. CLS. 21, 23, 26, 36 AND 38).

FIRST USE 7-15-2011; IN COMMERCE 7-15-2011.

THE MARK CONSISTS OF STANDARD CHARACTERS WITHOUT CLAIM TO ANY PARTICULAR FONT, STYLE, SIZE, OR COLOR.

OWNER OF U.S. REG. NOS. 2,088,310, 4,080,214, AND OTHERS.

NO CLAIM IS MADE TO THE EXCLUSIVE RIGHT TO USE "REMOTELINK", APART FROM THE MARK AS SHOWN.

SN 85-323,504, FILED 5-18-2011.

DAVID YONTEF, EXAMINING ATTORNEY



David J. Kyffers

Director of the United States Patent and Trademark Office

United States of America

United States Patent and Trademark Office

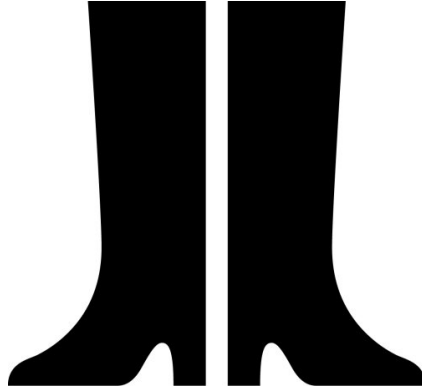

Reg. No. 4,176,878

MOLLY DUGAN HENNESSY (UNITED STATES INDIVIDUAL)
3040 PIEDMONT RD. NE
ATLANTA, GA 30305

Registered July 17, 2012

Int. Cl.: 26

FOR: PANTS BANDS AND PANTS CLIPS FOR SECURING PANT LEGS TO WEARERS' LEGS, IN CLASS 26 (U.S. CLS. 37, 39, 40, 42 AND 50).

TRADEMARK

FIRST USE 9-5-2011; IN COMMERCE 9-5-2011.

PRINCIPAL REGISTER

THE MARK CONSISTS OF A PAIR OF BOOTS.

SN 85-323,598, FILED 5-18-2011.

KAREN K. BUSH, EXAMINING ATTORNEY



David J. Kyffers

Director of the United States Patent and Trademark Office

United States of America

United States Patent and Trademark Office

FEEL GREAT

Reg. No. 4,176,879

BAREFOOTERS CORP. (CANADA CORPORATION)
439 WOBURN AVENUE

Registered July 17, 2012

TORONTO, ONTARIO, CANADA M5M1L6

Int. Cl.: 25

FOR: SLIP-RESISTANT BOOTS, SANDALS AND SHOES; T-SHIRTS, HATS, IN CLASS 25
(U.S. CLS. 22 AND 39).

TRADEMARK

FIRST USE 7-14-2011; IN COMMERCE 7-14-2011.

PRINCIPAL REGISTER

THE MARK CONSISTS OF STANDARD CHARACTERS WITHOUT CLAIM TO ANY PARTICULAR FONT, STYLE, SIZE, OR COLOR.

SN 85-324,371, FILED 5-18-2011.

FONG HSU, EXAMINING ATTORNEY



David J. Kybas

Director of the United States Patent and Trademark Office

United States of America

United States Patent and Trademark Office

TROY SOLDIER

Reg. No. 4,176,880

Registered July 17, 2012

Int. Cl.: 28

TRADEMARK

PRINCIPAL REGISTER

MATTEL, INC. (DELAWARE CORPORATION)
M1-1518
333 CONTINENTAL BOULEVARD
EL SEGUNDO, CA 90245

FOR: TOY VEHICLES, IN CLASS 28 (U.S. CLS. 22, 23, 38 AND 50).

FIRST USE 9-1-2011; IN COMMERCE 9-1-2011.

THE MARK CONSISTS OF STANDARD CHARACTERS WITHOUT CLAIM TO ANY PARTICULAR FONT, STYLE, SIZE, OR COLOR.

SN 85-324,643, FILED 5-19-2011.

LINDA LAVACHE, EXAMINING ATTORNEY



David J. Kyffers

Director of the United States Patent and Trademark Office

United States of America

United States Patent and Trademark Office

ARMITUDES

Reg. No. 4,176,881

Registered July 17, 2012

Int. Cl.: 25

TRADEMARK

PRINCIPAL REGISTER

MICHAELE ELLIOT (UNITED STATES INDIVIDUAL)
C/O ONOFRIO LAW
15 N. MILL STREET - SUITE 225
NYACK, NY 10960

FOR: CLOTHING SLEEVE; CLOTHING SLEEVE WITH DETACHABLE CUFFS; CLOTHING SLEEVE WITH PERMANENT CUFFS; CLOTHING SLEEVE WITH INTERCHANGEABLE CUFFS; DECORATIVE CLOTHING SLEEVES, IN CLASS 25 (U.S. CLS. 22 AND 39).

FIRST USE 6-1-2011; IN COMMERCE 9-1-2011.

THE MARK CONSISTS OF STANDARD CHARACTERS WITHOUT CLAIM TO ANY PARTICULAR FONT, STYLE, SIZE, OR COLOR.

SN 85-325,247, FILED 5-19-2011.

TEJBIR SINGH, EXAMINING ATTORNEY



David J. Kybas

Director of the United States Patent and Trademark Office

United States of America

United States Patent and Trademark Office

XPRESS FIRST AID

Reg. No. 4,176,882

ACME UNITED CORPORATION (CONNECTICUT CORPORATION)
60 ROUND HILL RD
FAIRFIELD, CT 06824

Registered July 17, 2012

Int. Cl.: 5

FOR: FIRST AID KITS; ANTISEPTICS; ANTIBIOTIC OINTMENTS; ADHESIVE BANDAGES;
HAND SANITIZERS, IN CLASS 5 (U.S. CLS. 6, 18, 44, 46, 51 AND 52).

TRADEMARK

FIRST USE 3-0-2012; IN COMMERCE 3-0-2012.

PRINCIPAL REGISTER

THE MARK CONSISTS OF STANDARD CHARACTERS WITHOUT CLAIM TO ANY PARTICULAR FONT, STYLE, SIZE, OR COLOR.

NO CLAIM IS MADE TO THE EXCLUSIVE RIGHT TO USE "FIRST AID", APART FROM THE MARK AS SHOWN.

SN 85-325,251, FILED 5-19-2011.

MARK SPARACINO, EXAMINING ATTORNEY



David J. Kyffers

Director of the United States Patent and Trademark Office

United States of America

United States Patent and Trademark Office



Reg. No. 4,176,883

SIX POINTS ENTERPRISES, LLC (DELAWARE LIMITED LIABILITY COMPANY)
401 EAST LAS OLAS BOULEVARD
FT. LAUDERDALE, FL 33301

Registered July 17, 2012

Int. Cls.: 36, 41, and 45

FOR: INSURANCE SUBROGATION SERVICES; MANAGEMENT OF INSURANCE SUBROGATION CLAIMS, NAMELY, ASSESSING SUBROGATION INSURANCE CLAIMS, SUBROGATION INSURANCE CLAIM ADMINISTRATION, SUBROGATION INSURANCE CLAIMS PROCESSING, IN CLASS 36 (U.S. CLS. 100, 101 AND 102).

SERVICE MARK

PRINCIPAL REGISTER

FIRST USE 4-5-2011; IN COMMERCE 4-5-2011.

FOR: EDUCATIONAL AND TRAINING SERVICES, NAMELY, CLASSES, SEMINARS, AND WORKSHOPS IN THE FIELDS OF ASSET RECOVERY, AND INSURANCE INVESTIGATIONS, IN CLASS 41 (U.S. CLS. 100, 101 AND 107).

FIRST USE 4-5-2011; IN COMMERCE 4-5-2011.

FOR: INVESTIGATION SERVICES RELATED TO INSURANCE CLAIMS, IN CLASS 45 (U.S. CLS. 100 AND 101).

FIRST USE 4-5-2011; IN COMMERCE 4-5-2011.

NO CLAIM IS MADE TO THE EXCLUSIVE RIGHT TO USE "SERVICES GROUP", APART FROM THE MARK AS SHOWN.

THE MARK CONSISTS OF THE WORDING "SHIELD PROTECT DEFEND" ABOVE "CONTEGO SERVICES GROUP" ALL IN A SHIELD DESIGN.

THE WORD "CONTEGO" IS DERIVED FROM LATIN AND HAVING A MEANING OF "TO SHIELD" AND "TO PROTECT".

SN 85-325,675, FILED 5-20-2011.

DAVID I, EXAMINING ATTORNEY



David J. Kyffers

Director of the United States Patent and Trademark Office

United States of America

United States Patent and Trademark Office

VERSIWICK

Reg. No. 4,176,884

SAGE MANUFACTURING CORPORATION (WASHINGTON CORPORATION)
8500 NORTHEAST DAY ROAD
BAINBRIDGE ISLAND, WA 98110

Registered July 17, 2012

Int. Cl.: 25

FOR: CLOTHING, NAMELY, JACKETS, SHIRTS, SHORTS, PANTS, SKIRTS, AND BLOUSES,
IN CLASS 25 (U.S. CLS. 22 AND 39).

TRADEMARK

FIRST USE 2-1-2012; IN COMMERCE 2-1-2012.

PRINCIPAL REGISTER

THE MARK CONSISTS OF STANDARD CHARACTERS WITHOUT CLAIM TO ANY PARTICULAR FONT, STYLE, SIZE, OR COLOR.

SN 85-326,320, FILED 5-20-2011.

ANDREW LEASER, EXAMINING ATTORNEY



David J. Kybas

Director of the United States Patent and Trademark Office

United States of America

United States Patent and Trademark Office

VERSISHIELD

Reg. No. 4,176,885

SAGE MANUFACTURING CORPORATION (WASHINGTON CORPORATION)
8500 NORTHEAST DAY ROAD
BAINBRIDGE ISLAND, WA 98110

Registered July 17, 2012

Int. Cl.: 25

FOR: CLOTHING, NAMELY, JACKETS AND GLOVES, IN CLASS 25 (U.S. CLS. 22 AND 39).

TRADEMARK

FIRST USE 2-1-2012; IN COMMERCE 2-1-2012.

PRINCIPAL REGISTER

THE MARK CONSISTS OF STANDARD CHARACTERS WITHOUT CLAIM TO ANY PARTICULAR FONT, STYLE, SIZE, OR COLOR.

SN 85-326,332, FILED 5-20-2011.

ANDREW LEASER, EXAMINING ATTORNEY



David J. Kybas

Director of the United States Patent and Trademark Office

United States of America

United States Patent and Trademark Office

VERSIDRI

Reg. No. 4,176,886

Registered July 17, 2012

Int. Cl.: 25

TRADEMARK

PRINCIPAL REGISTER

SAGE MANUFACTURING CORPORATION (WASHINGTON CORPORATION)
8500 NORTHEAST DAY ROAD
BAINBRIDGE ISLAND, WA 98110

FOR: CLOTHING, NAMELY, JACKETS, IN CLASS 25 (U.S. CLS. 22 AND 39).

FIRST USE 2-1-2012; IN COMMERCE 2-1-2012.

THE MARK CONSISTS OF STANDARD CHARACTERS WITHOUT CLAIM TO ANY PARTICULAR FONT, STYLE, SIZE, OR COLOR.

SN 85-326,342, FILED 5-20-2011.

ANDREW LEASER, EXAMINING ATTORNEY



David J. Kyffers

Director of the United States Patent and Trademark Office

United States of America
United States Patent and Trademark Office

VERISISUN

Reg. No. 4,176,887

SAGE MANUFACTURING CORPORATION (WASHINGTON CORPORATION)
8500 NORTHEAST DAY ROAD
BAINBRIDGE ISLAND, WA 98110

Registered July 17, 2012

Int. Cl.: 25

FOR: CLOTHING, NAMELY, JACKETS, SHIRTS, SHORTS, PANTS, SKIRTS, AND BLOUSES,
IN CLASS 25 (U.S. CLS. 22 AND 39).

TRADEMARK

FIRST USE 2-1-2012; IN COMMERCE 2-1-2012.

PRINCIPAL REGISTER

THE MARK CONSISTS OF STANDARD CHARACTERS WITHOUT CLAIM TO ANY PAR-
TICULAR FONT, STYLE, SIZE, OR COLOR.

SN 85-326,353, FILED 5-20-2011.

ANDREW LEASER, EXAMINING ATTORNEY



David J. Kyffers

Director of the United States Patent and Trademark Office

United States of America

United States Patent and Trademark Office

Simply Status

Reg. No. 4,176,888

Registered July 17, 2012

Int. Cl.: 9

TRADEMARK

PRINCIPAL REGISTER

MILLER SOLUTIONS, INC. (MARYLAND CORPORATION)
3663 SOLANO AVE. APT 135
NAPA, CA 94558

FOR: COMPUTER APPLICATION SOFTWARE FOR SCHEDULE MANAGEMENT; COMPUTER SOFTWARE FOR MONITORING AND REPORTING PROJECT ACTIVITY; DOWNLOADABLE SOFTWARE FOR MONITORING AND REPORTING PROJECT ACTIVITY; COMPUTER SOFTWARE FOR PROJECT MANAGEMENT; COMPUTER SOFTWARE FOR REAL-TIME MONITORING AND REPORTING PROJECT MEMBER TASKS; DOWNLOADABLE SOFTWARE FOR ENABLING THE MONITORING, TRACKING, AND REPORTING OF THE ACTIVITIES OF EMPLOYEES, STAFF, CONTRACTORS, CLIENTS, AND OTHERS, IN CLASS 9 (U.S. CLS. 21, 23, 26, 36 AND 38).

FIRST USE 2-0-2012; IN COMMERCE 2-0-2012.

THE MARK CONSISTS OF STANDARD CHARACTERS WITHOUT CLAIM TO ANY PARTICULAR FONT, STYLE, SIZE, OR COLOR.

SN 85-326,452, FILED 5-20-2011.

MICHAEL SOUDERS, EXAMINING ATTORNEY



David J. Kyffers

Director of the United States Patent and Trademark Office

United States of America

United States Patent and Trademark Office

Doctor Print

Reg. No. 4,176,889

Registered July 17, 2012

Int. Cl.: 42

SERVICE MARK

PRINCIPAL REGISTER

COHEN, MITCHELL (UNITED STATES INDIVIDUAL)
40 OSER AVENUE
SUITE 2
HAUPPAUGE, NY 117883885

FOR: PRINT MANAGEMENT SERVICES, NAMELY, REMOTE MONITORING OF PRINTERS FOR OTHERS, IN CLASS 42 (U.S. CLS. 100 AND 101).

FIRST USE 5-1-2011; IN COMMERCE 7-1-2011.

THE MARK CONSISTS OF STANDARD CHARACTERS WITHOUT CLAIM TO ANY PARTICULAR FONT, STYLE, SIZE, OR COLOR.

NO CLAIM IS MADE TO THE EXCLUSIVE RIGHT TO USE "PRINT", APART FROM THE MARK AS SHOWN.

SN 85-326,802, FILED 5-21-2011.

JULIE VEPPUMTHARA, EXAMINING ATTORNEY



David J. Kyffers

Director of the United States Patent and Trademark Office

United States of America

United States Patent and Trademark Office

ECOTOP

Reg. No. 4,176,890

ECOTOP, LLC (RHODE ISLAND LIMITED LIABILITY COMPANY)
2 WINSTON COURT
WARWICK, RI 02886

Registered July 17, 2012

Int. Cl.: 21

FOR: REUSABLE SELF-SEALING LIDS FOR HOUSEHOLD USE FOR CUPS AND MUGS,
IN CLASS 21 (U.S. CLS. 2, 13, 23, 29, 30, 33, 40 AND 50).

TRADEMARK

FIRST USE 1-9-2012; IN COMMERCE 4-17-2012.

PRINCIPAL REGISTER

THE MARK CONSISTS OF STANDARD CHARACTERS WITHOUT CLAIM TO ANY PAR-
TICULAR FONT, STYLE, SIZE, OR COLOR.

SN 85-328,132, FILED 5-23-2011.

LINDA E. BLOHM, EXAMINING ATTORNEY



David J. Kybas

Director of the United States Patent and Trademark Office

United States of America

United States Patent and Trademark Office

engineous

Reg. No. 4,176,891

Registered July 17, 2012

Int. Cl.: 1

TRADEMARK

PRINCIPAL REGISTER

SMILOVITS, ISAAC (UNITED STATES INDIVIDUAL), DBA ECO-SAFE SOLUTIONS, LLC.,
1516 N.E. 17 AVENUE
FORT LAUDERDALE, FL 33304

FOR: CHEMICAL ADDITIVES FOR ENHANCING THE PERFORMANCE OF LUBRICATING OILS, GREASES AND INTERNAL COMBUSTION ENGINE FUELS; CHEMICAL ADDITIVES FOR USE WITH INTERNAL COMBUSTION ENGINE FUELS; CHEMICAL ENGINE TREATMENTS AND ADDITIVES FOR ENGINE OILS, GASOLINE AND DIESEL FUELS, TRANSMISSION FLUIDS AND COOLING SYSTEMS, IN CLASS 1 (U.S. CLS. 1, 5, 6, 10, 26 AND 46).

FIRST USE 6-10-1999; IN COMMERCE 6-10-1999.

THE MARK CONSISTS OF STANDARD CHARACTERS WITHOUT CLAIM TO ANY PARTICULAR FONT, STYLE, SIZE, OR COLOR.

SN 85-328,479, FILED 5-24-2011.

MEGHAN REINHART, EXAMINING ATTORNEY



David J. Kypos

Director of the United States Patent and Trademark Office

United States of America

United States Patent and Trademark Office

NATURE'S SQUEEZE

Reg. No. 4,176,892

Registered July 17, 2012

Int. Cl.: 32

TRADEMARK

PRINCIPAL REGISTER

U&ME BEVERAGE COMPANY (CANADA CORPORATION)
UNIT A
450 EXPORT BLVD
MISSISSAUGA, ONTARIO, CANADA L5S2A4

FOR: FRUIT DRINKS AND JUICES, IN CLASS 32 (U.S. CLS. 45, 46 AND 48).

FIRST USE 12-6-2011; IN COMMERCE 12-6-2011.

THE MARK CONSISTS OF STANDARD CHARACTERS WITHOUT CLAIM TO ANY PARTICULAR FONT, STYLE, SIZE, OR COLOR.

SN 85-328,930, FILED 5-24-2011.

JOHN GARTNER, EXAMINING ATTORNEY



David J. Kyffers

Director of the United States Patent and Trademark Office

United States of America

United States Patent and Trademark Office

casefox

Reg. No. 4,176,893

MADNAWAT, RAJEEV (UNITED STATES INDIVIDUAL)
1431 ARIZONA AVE
MILPITAS, CA 95035

Registered July 17, 2012

Int. Cl.: 42

FOR: SOFTWARE AS A SERVICE (SAAS) SERVICES FEATURING SOFTWARE FOR DATA MANAGEMENT OF CUSTOMER INFORMATION, IN CLASS 42 (U.S. CLS. 100 AND 101).

SERVICE MARK

FIRST USE 12-25-2010; IN COMMERCE 11-10-2011.

PRINCIPAL REGISTER

THE MARK CONSISTS OF STANDARD CHARACTERS WITHOUT CLAIM TO ANY PARTICULAR FONT, STYLE, SIZE, OR COLOR.

SN 85-329,294, FILED 5-24-2011.

KATHRYN COWARD, EXAMINING ATTORNEY



David J. Kybas

Director of the United States Patent and Trademark Office

United States of America

United States Patent and Trademark Office

ACE ALL-BOND TE

Reg. No. 4,176,894

BISCO, INC. (ILLINOIS CORPORATION)
1100 W. IRVING PARK ROAD
SCHAUMBURG, IL 601933569

Registered July 17, 2012

Int. Cl.: 5

FOR: DENTAL MATERIAL FOR DENTAL RESTORATIONS, NAMELY, DENTAL ADHESIVES, IN CLASS 5 (U.S. CLS. 6, 18, 44, 46, 51 AND 52).

TRADEMARK

FIRST USE 5-0-2011; IN COMMERCE 5-0-2011.

PRINCIPAL REGISTER

THE MARK CONSISTS OF STANDARD CHARACTERS WITHOUT CLAIM TO ANY PARTICULAR FONT, STYLE, SIZE, OR COLOR.

OWNER OF U.S. REG. NOS. 1,651,166, 3,628,909, AND OTHERS.

NO CLAIM IS MADE TO THE EXCLUSIVE RIGHT TO USE "TE", APART FROM THE MARK AS SHOWN.

SN 85-329,566, FILED 5-25-2011.

TINA L. SNAPP, EXAMINING ATTORNEY



David J. Kybas

Director of the United States Patent and Trademark Office

United States of America

United States Patent and Trademark Office

ATHERION

Reg. No. 4,176,895

MODINE MANUFACTURING COMPANY (WISCONSIN CORPORATION)
1500 DEKOVEN AVENUE
RACINE, WI 53403

Registered July 17, 2012

Int. Cl.: 11

FOR: ROOFTOP VENTILATION UNITS USED TO FILTER, HEAT, COOL, OR DEHUMIDIFY AIR FOR COMMERCIAL OR INDUSTRIAL USE, IN CLASS 11 (U.S. CLS. 13, 21, 23, 31 AND 34).

TRADEMARK

FIRST USE 6-0-2011; IN COMMERCE 9-0-2011.

PRINCIPAL REGISTER

THE MARK CONSISTS OF STANDARD CHARACTERS WITHOUT CLAIM TO ANY PARTICULAR FONT, STYLE, SIZE, OR COLOR.

THE WORD(S) "ATHERION" HAS NO MEANING IN A FOREIGN LANGUAGE.

SN 85-329,935, FILED 5-25-2011.

ZHALEH DELANEY, EXAMINING ATTORNEY



David J. Kyffers

Director of the United States Patent and Trademark Office

United States of America

United States Patent and Trademark Office

KG:2

Reg. No. 4,176,896

SUN MOUNTAIN SPORTS, INC. (MONTANA CORPORATION)
301 N. FIRST STREET
MISSOULA, MT 59802

Registered July 17, 2012

Int. Cl.: 28

FOR: GOLF BAGS; GOLF CLUB BAGS, IN CLASS 28 (U.S. CLS. 22, 23, 38 AND 50).

TRADEMARK

FIRST USE 9-30-2011; IN COMMERCE 9-30-2011.

PRINCIPAL REGISTER

THE MARK CONSISTS OF STANDARD CHARACTERS WITHOUT CLAIM TO ANY PARTICULAR FONT, STYLE, SIZE, OR COLOR.

SN 85-330,088, FILED 5-25-2011.

C. DIONNE CLYBURN, EXAMINING ATTORNEY



David J. Kyffers

Director of the United States Patent and Trademark Office

United States of America

United States Patent and Trademark Office

SNAKE N DA BRUSH

Reg. No. 4,176,897

PODUNK IDEAS, LLC (KENTUCKY LIMITED LIABILITY COMPANY)
130 JESSE STREET
BENTON, KY 42025

Registered July 17, 2012

Int. Cl.: 28

FOR: FISHING TACKLE, SNAGLESS FLEXIBLE FISHING WEIGHTS, IN CLASS 28 (U.S. CLS. 22, 23, 38 AND 50).

TRADEMARK

FIRST USE 9-14-2011; IN COMMERCE 9-14-2011.

PRINCIPAL REGISTER

THE MARK CONSISTS OF STANDARD CHARACTERS WITHOUT CLAIM TO ANY PARTICULAR FONT, STYLE, SIZE, OR COLOR.

SN 85-330,090, FILED 5-25-2011.

C. DIONNE CLYBURN, EXAMINING ATTORNEY



David J. Kyffers

Director of the United States Patent and Trademark Office

United States of America

United States Patent and Trademark Office



BatteryProgBrain

Reg. No. 4,176,898

LEVINAS, YESHAIAHOU AHARON (UNITED STATES INDIVIDUAL)
28 OSPREY ROAD
KEY LARGO, FL 33037

Registered July 17, 2012

Int. Cl.: 9

FOR: AUTOMATIC BATTERY POWER CONTROLLER, IN CLASS 9 (U.S. CLS. 21, 23, 26, 36 AND 38).

TRADEMARK

FIRST USE 6-15-2011; IN COMMERCE 6-15-2011.

PRINCIPAL REGISTER

THE MARK CONSISTS OF A STYLIZED BATTERY WITHIN WHICH ARE THE LETTERS B P B. INSIDE THE TOP PORTION OF THE FIRST B IS THE "+" SYMBOL. INSIDE THE TOP PORTION OF THE SECOND B IS THE "-" SYMBOL. UNDERNEATH THE STYLIZED BATTERY APPEARS THE LITERAL ELEMENT, "BATTERYPROGBRAIN".

SN 85-330,144, FILED 5-25-2011.

WILLIAM ROSSMAN, EXAMINING ATTORNEY



David J. Kyffers

Director of the United States Patent and Trademark Office

United States of America

United States Patent and Trademark Office



Reg. No. 4,176,899

Registered July 17, 2012

Int. Cl.: 30

TRADEMARK

PRINCIPAL REGISTER

JUST LOVE COFFEE ROASTERS (TENNESSEE LIMITED LIABILITY COMPANY)
129 MTCS DR.
MURFREESBORO, TN 37129

FOR: COFFEE, IN CLASS 30 (U.S. CL. 46).

FIRST USE 11-10-2011; IN COMMERCE 11-10-2011.

OWNER OF U.S. REG. NO. 3,896,190.

NO CLAIM IS MADE TO THE EXCLUSIVE RIGHT TO USE "COFFEE ROASTERS", APART FROM THE MARK AS SHOWN.

THE MARK CONSISTS OF TWO COFFEE BEANS CROSSED IN THE SHAPE OF A HEART WHICH IS LOCATED IN THE MIDDLE OF THE WORDS, "JUST" AND "LOVE". THE WORDS "COFFEE ROASTERS" ARE WRITTEN BELOW THE DESIGN AND THE WORDS "JUST LOVE".

SN 85-330,553, FILED 5-26-2011.

STEVEN JACKSON, EXAMINING ATTORNEY



David J. Kybas

Director of the United States Patent and Trademark Office

United States of America

United States Patent and Trademark Office

News Whip

Reg. No. 4,176,900

NEWSWHIP MEDIA, LTD. (IRELAND LIMITED LIABILITY COMPANY), TA NEWSWHIP,
LUCCA, CASTLETROY
LIMERICK, IRELAND

Registered July 17, 2012

Int. Cl.: 41

FOR: PROVIDING AN INTERNET NEWS PORTAL FEATURING LINKS TO NEWS STORIES
AND ARTICLES IN THE FIELD OF CURRENT EVENTS, IN CLASS 41 (U.S. CLS. 100, 101
AND 107).

SERVICE MARK

FIRST USE 8-1-2010; IN COMMERCE 11-23-2010.

PRINCIPAL REGISTER

THE MARK CONSISTS OF STANDARD CHARACTERS WITHOUT CLAIM TO ANY PAR-
TICULAR FONT, STYLE, SIZE, OR COLOR.

SN 85-330,593, FILED 5-26-2011.

JANICE KIM, EXAMINING ATTORNEY



David J. Kyffers

Director of the United States Patent and Trademark Office

United States of America

United States Patent and Trademark Office

Lost Cause Productions

Reg. No. 4,176,901

COMBS, KEVAN (UNITED STATES INDIVIDUAL)

Registered July 17, 2012

1064 SUSAN WAY
NOVATO, CA 94947

Int. Cl.: 41

FOR: ENTERTAINMENT, NAMELY, PRODUCTION OF MOVIES AND SHOWS THROUGH FILM, INTERNET AND TELEVISION, IN CLASS 41 (U.S. CLS. 100, 101 AND 107).

SERVICE MARK

FIRST USE 5-16-2011; IN COMMERCE 6-1-2011.

PRINCIPAL REGISTER

THE MARK CONSISTS OF STANDARD CHARACTERS WITHOUT CLAIM TO ANY PARTICULAR FONT, STYLE, SIZE, OR COLOR.

NO CLAIM IS MADE TO THE EXCLUSIVE RIGHT TO USE "PRODUCTIONS", APART FROM THE MARK AS SHOWN.

SN 85-330,934, FILED 5-26-2011.

KAPIL BHANOT, EXAMINING ATTORNEY



David J. Kybas

Director of the United States Patent and Trademark Office

United States of America

United States Patent and Trademark Office

MUCHNESS

Reg. No. 4,176,902

FINDING MY MUCHNESS, L.L.C. (NEW JERSEY LIMITED LIABILITY COMPANY)
37 HERRICK AVENUE
TEANECK, NJ 07666

Registered July 17, 2012

Int. Cls.: 14 and 45

FOR: JEWELRY, IN CLASS 14 (U.S. CLS. 2, 27, 28 AND 50).

TRADEMARK

FIRST USE 4-0-2011; IN COMMERCE 4-0-2011.

SERVICE MARK

FOR: PROVIDING ON-LINE INFORMATION IN THE FIELD OF SPIRITUALITY, SELF-HELP,
AND PERSONAL EMPOWERMENT SUBJECT MATTERS, IN CLASS 45 (U.S. CLS. 100 AND
101).

PRINCIPAL REGISTER

FIRST USE 4-0-2011; IN COMMERCE 4-0-2011.

THE MARK CONSISTS OF STANDARD CHARACTERS WITHOUT CLAIM TO ANY PAR-
TICULAR FONT, STYLE, SIZE, OR COLOR.

SN 85-331,981, FILED 5-27-2011.

JOHN HWANG, EXAMINING ATTORNEY



David J. Kybas

Director of the United States Patent and Trademark Office

United States of America

United States Patent and Trademark Office

LONGTAIL VIDEO

Reg. No. 4,176,903

Registered July 17, 2012

Int. Cl.: 42

SERVICE MARK

PRINCIPAL REGISTER

LONGTAIL AD SOLUTIONS, INC. (DELAWARE CORPORATION)
5TH FLOOR
134 5TH AVENUE
NEW YORK, NY 10011

FOR: PROVIDING ON-LINE NON-DOWNLOADABLE COMPUTER SOFTWARE FOR INTERNET PUBLISHERS AND DEVELOPERS THAT FACILITATES THE PLAYING, VIEWING AND STREAMING OF AUDIO AND VIDEO FILES, IN CLASS 42 (U.S. CLS. 100 AND 101).

FIRST USE 2-0-2010; IN COMMERCE 2-0-2010.

THE MARK CONSISTS OF STANDARD CHARACTERS WITHOUT CLAIM TO ANY PARTICULAR FONT, STYLE, SIZE, OR COLOR.

NO CLAIM IS MADE TO THE EXCLUSIVE RIGHT TO USE "VIDEO", APART FROM THE MARK AS SHOWN.

SN 85-332,291, FILED 5-27-2011.

ROSELLE HERRERA, EXAMINING ATTORNEY



David J. Kybas

Director of the United States Patent and Trademark Office

United States of America

United States Patent and Trademark Office

VERY SEXY SEDUCTION

Reg. No. 4,176,904

Registered July 17, 2012

Int. Cl.: 25

TRADEMARK

PRINCIPAL REGISTER

VICTORIA'S SECRET STORES BRAND MANAGEMENT, INC. (DELAWARE CORPORATION)
INTELLECTUAL PROPERTY MANAGER
FOUR LIMITED PARKWAY
REYNOLDSBURG, OH 43068

FOR: BRAS; LINGERIE; PANTIES, IN CLASS 25 (U.S. CLS. 22 AND 39).

FIRST USE 10-9-2011; IN COMMERCE 10-9-2011.

THE MARK CONSISTS OF STANDARD CHARACTERS WITHOUT CLAIM TO ANY PARTICULAR FONT, STYLE, SIZE, OR COLOR.

OWNER OF U.S. REG. NOS. 2,725,765, 2,946,353, AND OTHERS.

SN 85-332,385, FILED 5-27-2011.

GENE MACIOL, EXAMINING ATTORNEY



David J. Kyffers

Director of the United States Patent and Trademark Office

United States of America

United States Patent and Trademark Office



Reg. No. 4,176,905

Registered July 17, 2012

Int. Cl.: 25

TRADEMARK

PRINCIPAL REGISTER

PERFORMA DESIGNS LLC (DELAWARE LIMITED LIABILITY COMPANY)
4414 EAST SAWMILL ROAD
PARK CITY, UT 84098

FOR: BLAZERS; BLOUSES; BOTTOMS; CAPS; CLOTHING, NAMELY, BASE LAYERS;
COATS; DRESS SHIRTS; DRESSES; FOOTWEAR; HATS; HEADWEAR; HOSIERY; JACKETS;
PANTS; POLO SHIRTS; SANDALS; SCARVES; SHIRTS; SHOES; SHORTS; SKIRTS; SOCKS;
SPORT COATS; SWEATERS; SWEATSHIRTS; T-SHIRTS; TOPS; TROUSERS; UNDERWEAR;
VESTS; YOGA PANTS; YOGA SHIRTS, IN CLASS 25 (U.S. CLS. 22 AND 39).

FIRST USE 9-0-2009; IN COMMERCE 11-0-2009.

THE MARK CONSISTS OF A STYLIZED GAZELLE DISPOSED ABOVE THE WORDING
"PERFORMA".

SN 85-332,453, FILED 5-27-2011.

WENDY JUN, EXAMINING ATTORNEY



David J. Kyffers

Director of the United States Patent and Trademark Office

United States of America

United States Patent and Trademark Office

I SLEEP WITH MY BEST FRIEND

Reg. No. 4,176,906

CANDEE, KEITH H. (UNITED STATES INDIVIDUAL)

Registered July 17, 2012

P.O. BOX 890700
TEMECULA, CA 92589

Int. Cl.: 25

FOR: BUTTON DOWN SHIRTS; CAMP SHIRTS; HATS; HEADGEAR, NAMELY, HATS, CAPS, VISORS, BEANIES, WOOLLY HATS AND DO RAGS; HOODED PULLOVERS; HOODED SWEAT SHIRTS; JACKETS; LONG-SLEEVED SHIRTS; POLO SHIRTS; RUGBY SHIRTS; SHIRTS; SHORT-SLEEVED OR LONG-SLEEVED T-SHIRTS; SPORTS CAPS AND HATS; SWEAT JACKETS; SWEAT SHIRTS; T-SHIRTS; TANK TOPS; UNDERWEAR, IN CLASS 25 (U.S. CLS. 22 AND 39).

TRADEMARK

PRINCIPAL REGISTER

FIRST USE 3-30-2012; IN COMMERCE 3-30-2012.

THE MARK CONSISTS OF STANDARD CHARACTERS WITHOUT CLAIM TO ANY PARTICULAR FONT, STYLE, SIZE, OR COLOR.

SN 85-332,768, FILED 5-27-2011.

LAURA KOVALSKY, EXAMINING ATTORNEY



David J. Kybas

Director of the United States Patent and Trademark Office

United States of America

United States Patent and Trademark Office

Under the Bed Friend

Reg. No. 4,176,907

Registered July 17, 2012

Int. Cl.: 28

TRADEMARK

PRINCIPAL REGISTER

DMN CONSULTING LLC (CONNECTICUT LIMITED LIABILITY COMPANY)
29 SOUTH LAKE DRIVE
STAMFORD, CT 06903

FOR: STUFFED AND PLUSH TOYS, IN CLASS 28 (U.S. CLS. 22, 23, 38 AND 50).

FIRST USE 1-1-2011; IN COMMERCE 12-1-2011.

THE MARK CONSISTS OF STANDARD CHARACTERS WITHOUT CLAIM TO ANY PARTICULAR FONT, STYLE, SIZE, OR COLOR.

SN 85-333,548, FILED 5-31-2011.

JOHN KELLY, EXAMINING ATTORNEY



David J. Kybas

Director of the United States Patent and Trademark Office

United States of America

United States Patent and Trademark Office

LIMITS

Reg. No. 4,176,908

Registered July 17, 2012

Int. Cl.: 9

TRADEMARK

PRINCIPAL REGISTER

OBJECT RESERVOIR, INC. (DELAWARE CORPORATION)
11767 KATY FREEWAY SUITE 700
HOUSTON, TX 77079

FOR: COMPUTER SOFTWARE FOR ANALYSIS OF NATURAL RESOURCE RESERVES
AND PLANNING FOR RECOVERY OF NATURAL RESOURCE RESERVES, IN CLASS 9
(U.S. CLS. 21, 23, 26, 36 AND 38).

FIRST USE 11-29-2010; IN COMMERCE 11-29-2010.

THE MARK CONSISTS OF STANDARD CHARACTERS WITHOUT CLAIM TO ANY PAR-
TICULAR FONT, STYLE, SIZE, OR COLOR.

SN 85-334,049, FILED 5-31-2011.

JENNIFER VASQUEZ, EXAMINING ATTORNEY



David J. Kyffers

Director of the United States Patent and Trademark Office

United States of America

United States Patent and Trademark Office

ORKA

Reg. No. 4,176,909

OBJECT RESERVOIR, INC. (DELAWARE CORPORATION)
11767 KATY FREEWAY SUITE 700
HOUSTON, TX 77079

Registered July 17, 2012

Int. Cl.: 9

FOR: COMPUTER SOFTWARE FOR WORKFLOW MANAGEMENT, DATA ORGANIZATION AND DATA PROVENANCE, IN CLASS 9 (U.S. CLS. 21, 23, 26, 36 AND 38).

TRADEMARK

FIRST USE 11-29-2010; IN COMMERCE 11-29-2010.

PRINCIPAL REGISTER

THE MARK CONSISTS OF STANDARD CHARACTERS WITHOUT CLAIM TO ANY PARTICULAR FONT, STYLE, SIZE, OR COLOR.

SN 85-334,097, FILED 5-31-2011.

JENNIFER VASQUEZ, EXAMINING ATTORNEY



David J. Kybas

Director of the United States Patent and Trademark Office

United States of America

United States Patent and Trademark Office

Body Brazil

Reg. No. 4,176,910

PRECISION PERFORMANCE MARKETING, INC. (FLORIDA CORPORATION)
4230 S. MACDILL AVE., SUITE E
TAMPA, FL 33611

Registered July 17, 2012

Int. Cl.: 35

FOR: ON-LINE RETAIL STORE SERVICES FEATURING BRAZILIAN STYLE PANTS, CAPRIS, SHORTS, TOPS, DRESSES, JACKETS, SWIM WEAR, TENNIS WEAR, HAND BAGS, DUFFEL BAGS, BELTS, JEWELRY, HATS AND HEADBANDS, IN CLASS 35 (U.S. CLS. 100, 101 AND 102).

SERVICE MARK

PRINCIPAL REGISTER

FIRST USE 6-2-2011; IN COMMERCE 6-2-2011.

THE MARK CONSISTS OF STANDARD CHARACTERS WITHOUT CLAIM TO ANY PARTICULAR FONT, STYLE, SIZE, OR COLOR.

NO CLAIM IS MADE TO THE EXCLUSIVE RIGHT TO USE "BRAZIL", APART FROM THE MARK AS SHOWN.

SN 85-335,246, FILED 6-1-2011.

BERYL GARDNER, EXAMINING ATTORNEY



David J. Kyffers

Director of the United States Patent and Trademark Office

United States of America

United States Patent and Trademark Office

SUPERSTRADA

Reg. No. 4,176,911

OYOUNG, GLENN K. (UNITED STATES INDIVIDUAL)

Registered July 17, 2012

PO BOX 661476
ARCADIA, CA 91006

Int. Cl.: 25

FOR: ATHLETIC APPAREL, NAMELY, SHIRTS, PANTS, JACKETS, FOOTWEAR, HATS AND CAPS, ATHLETIC UNIFORMS; COLLARED SHIRTS; HEAVY JACKETS; HOODED SWEAT SHIRTS; JACKETS; KNIT SHIRTS; LONG JACKETS; LONG-SLEEVED SHIRTS; MEN'S AND WOMEN'S JACKETS, COATS, TROUSERS, VESTS; MOISTURE-WICKING SPORTS SHIRTS; OPEN-NECKED SHIRTS; PIQUE SHIRTS; POLO KNIT TOPS; POLO SHIRTS; SHELL JACKETS; SHIRTS; SHORT-SLEEVED OR LONG-SLEEVED T-SHIRTS; SHORT-SLEEVED SHIRTS; SPORT SHIRTS; SWEAT SHIRTS; T-SHIRTS; TRACK JACKETS; WIND RESISTANT JACKETS; WIND SHIRTS; WOVEN TOPS, IN CLASS 25 (U.S. CLS. 22 AND 39).

TRADEMARK

PRINCIPAL REGISTER

FIRST USE 3-5-2012; IN COMMERCE 3-5-2012.

THE MARK CONSISTS OF STANDARD CHARACTERS WITHOUT CLAIM TO ANY PARTICULAR FONT, STYLE, SIZE, OR COLOR.

THE ENGLISH TRANSLATION OF "SUPERSTRADA" IN THE MARK IS HIGHWAY OR FREEWAY.

SN 85-335,831, FILED 6-1-2011.

SUNG IN, EXAMINING ATTORNEY



David J. Kypos

Director of the United States Patent and Trademark Office

United States of America

United States Patent and Trademark Office

SCRIBBO

Reg. No. 4,176,912

Registered July 17, 2012

Int. Cl.: 28

TRADEMARK

PRINCIPAL REGISTER

WINNING MOVES INC. (MASSACHUSETTS CORPORATION)
75 SYLVAN STREET SUITE C-104
DANVERS, MA 01923

FOR: BOARD GAMES; PARLOR GAMES, IN CLASS 28 (U.S. CLS. 22, 23, 38 AND 50).

FIRST USE 10-1-2011; IN COMMERCE 12-15-2011.

THE MARK CONSISTS OF STANDARD CHARACTERS WITHOUT CLAIM TO ANY PARTICULAR FONT, STYLE, SIZE, OR COLOR.

SN 85-335,937, FILED 6-2-2011.

DAVID C. REIHNER, EXAMINING ATTORNEY



David J. Kyffers

Director of the United States Patent and Trademark Office

United States of America

United States Patent and Trademark Office

TOTALFLEX

Reg. No. 4,176,913

Registered July 17, 2012

Int. Cl.: 19

TRADEMARK

PRINCIPAL REGISTER

H.B. FULLER CONSTRUCTION PRODUCTS INC. (MINNESOTA CORPORATION)
WLB-LAW-TRADEMARKS
1200 WILLOW LAKE BOULEVARD
SAINT PAUL, MN 551105101

FOR: MORTAR FOR THE APPLICATION OF TILES FOR WALLS AND FLOORS, IN CLASS 19 (U.S. CLS. 1, 12, 33 AND 50).

FIRST USE 6-29-2011; IN COMMERCE 10-3-2011.

THE MARK CONSISTS OF STANDARD CHARACTERS WITHOUT CLAIM TO ANY PARTICULAR FONT, STYLE, SIZE, OR COLOR.

OWNER OF U.S. REG. NOS. 1,559,845, 2,574,373, AND OTHERS.

SN 85-336,355, FILED 6-2-2011.

MIDGE BUTLER, EXAMINING ATTORNEY



David J. Kyffers

Director of the United States Patent and Trademark Office

United States of America

United States Patent and Trademark Office

EL MAIZ DE NUESTRA TIERRA

Reg. No. 4,176,914

Registered July 17, 2012

Int. Cl.: 30

TRADEMARK

PRINCIPAL REGISTER

GRUMA CORPORATION (NEVADA CORPORATION)
SUITE 200
1159 COTTONWOOD LANE
IRVING, TX 75038

FOR: CORN MASA FLOUR, IN CLASS 30 (U.S. CL. 46).

FIRST USE 6-0-2011; IN COMMERCE 6-0-2011.

THE MARK CONSISTS OF STANDARD CHARACTERS WITHOUT CLAIM TO ANY PARTICULAR FONT, STYLE, SIZE, OR COLOR.

NO CLAIM IS MADE TO THE EXCLUSIVE RIGHT TO USE "MAIZ", APART FROM THE MARK AS SHOWN.

THE ENGLISH TRANSLATION OF "EL MAIZ DE NUESTRA TIERRA" IN THE MARK IS "THE CORN OF OUR LAND" OR "THE CORN OF OUR COUNTRY".

SN 85-336,414, FILED 6-2-2011.

PAUL E. FAHRENKOPF, EXAMINING ATTORNEY



David J. Kyros

Director of the United States Patent and Trademark Office

United States of America

United States Patent and Trademark Office

KICK THE CAN AND POCKET THE PACKET

Reg. No. 4,176,915

CAN'T STOP IT, LLC (MINNESOTA LIMITED LIABILITY COMPANY)
1689 STINSON BLVD.

Registered July 17, 2012

NEW BRIGHTON, MN 55112

Int. Cl.: 5

FOR: DIETARY SUPPLEMENTS, IN CLASS 5 (U.S. CLS. 6, 18, 44, 46, 51 AND 52).

TRADEMARK

FIRST USE 4-29-2011; IN COMMERCE 4-29-2011.

PRINCIPAL REGISTER

THE MARK CONSISTS OF STANDARD CHARACTERS WITHOUT CLAIM TO ANY PARTICULAR FONT, STYLE, SIZE, OR COLOR.

SN 85-336,818, FILED 6-2-2011.

SANJEEV VOHRA, EXAMINING ATTORNEY



David J. Kybas

Director of the United States Patent and Trademark Office

United States of America

United States Patent and Trademark Office

PROPOWER PLUS

Reg. No. 4,176,916

Registered July 17, 2012

Int. Cl.: 7

TRADEMARK

PRINCIPAL REGISTER

ORECK HOLDINGS, LLC (DELAWARE LIMITED LIABILITY COMPANY)
SUITE 300
565 MARRIOTT DRIVE
NASHVILLE, TN 37214

FOR: VACUUM CLEANERS, IN CLASS 7 (U.S. CLS. 13, 19, 21, 23, 31, 34 AND 35).

FIRST USE 8-4-2011; IN COMMERCE 8-4-2011.

THE MARK CONSISTS OF STANDARD CHARACTERS WITHOUT CLAIM TO ANY PARTICULAR FONT, STYLE, SIZE, OR COLOR.

SN 85-337,312, FILED 6-3-2011.

MARILYN IZZI, EXAMINING ATTORNEY



David J. Kyffers

Director of the United States Patent and Trademark Office

United States of America
United States Patent and Trademark Office

ANY WAY

Reg. No. 4,176,917

Registered July 17, 2012

Int. Cl.: 9

TRADEMARK

PRINCIPAL REGISTER

WMS GAMING INC. (DELAWARE CORPORATION)
800 SOUTH NORTHPOINT BOULEVARD
WAUKEGAN, IL 60085

FOR: COMPONENTS FOR GAMING MACHINES THAT GENERATE OR DISPLAY WAGER OUTCOMES, NAMELY, CONTROLLERS, DISPLAYS, BUTTON PANELS, BOLSTERS, ELECTRICAL WIRING, AND COMPUTER HARDWARE AND SOFTWARE ASSOCIATED THEREWITH; GAMING MACHINES, NAMELY, DEVICES WHICH ACCEPT A WAGER; GAMING SOFTWARE THAT GENERATES OR DISPLAYS WAGER OUTCOMES OF GAMING MACHINES, IN CLASS 9 (U.S. CLS. 21, 23, 26, 36 AND 38).

FIRST USE 11-16-2010; IN COMMERCE 11-16-2010.

THE MARK CONSISTS OF STANDARD CHARACTERS WITHOUT CLAIM TO ANY PARTICULAR FONT, STYLE, SIZE, OR COLOR.

OWNER OF U.S. REG. NO. 3,929,703.

SN 85-337,539, FILED 6-3-2011.

RONALD MCMORROW, EXAMINING ATTORNEY



David J. Kyffers

Director of the United States Patent and Trademark Office

United States of America

United States Patent and Trademark Office

KEEP IT SIMPLE DOC

Reg. No. 4,176,918

Registered July 17, 2012

Int. Cl.: 44

SERVICE MARK

PRINCIPAL REGISTER

SIMPLE CARE NORTH AMERICA, INC. (WYOMING CORPORATION)
70 MAIN STREET
LYNNFIELD, MA 01940

FOR: VETERINARY SERVICES, IN CLASS 44 (U.S. CLS. 100 AND 101).

FIRST USE 9-24-2011; IN COMMERCE 9-24-2011.

THE MARK CONSISTS OF STANDARD CHARACTERS WITHOUT CLAIM TO ANY PARTICULAR FONT, STYLE, SIZE, OR COLOR.

NO CLAIM IS MADE TO THE EXCLUSIVE RIGHT TO USE "DOC", APART FROM THE MARK AS SHOWN.

SN 85-338,296, FILED 6-5-2011.

SHAILA SETTLES, EXAMINING ATTORNEY



David J. Kyffers

Director of the United States Patent and Trademark Office

United States of America

United States Patent and Trademark Office

WYNGUEST

Reg. No. 4,176,919

WYNDHAM TM CORP. (DELAWARE CORPORATION)
10750 WEST CHARLESTON BLVD., SUITE 130
LAS VEGAS, NV 89135

Registered July 17, 2012

Int. Cls.: 9 and 42

FOR: HOTEL PROPERTY MANAGEMENT AND HOTEL RESERVATION MANAGEMENT SOFTWARE, IN CLASS 9 (U.S. CLS. 21, 23, 26, 36 AND 38).

TRADEMARK

FIRST USE 8-0-2011; IN COMMERCE 8-0-2011.

SERVICE MARK

FOR: PROVIDING TEMPORARY USE OF ON-LINE NON-DOWNLOADABLE HOTEL PROPERTY MANAGEMENT AND HOTEL RESERVATION MANAGEMENT SOFTWARE, IN CLASS 42 (U.S. CLS. 100 AND 101).

PRINCIPAL REGISTER

FIRST USE 8-0-2011; IN COMMERCE 8-0-2011.

THE MARK CONSISTS OF STANDARD CHARACTERS WITHOUT CLAIM TO ANY PARTICULAR FONT, STYLE, SIZE, OR COLOR.

SN 85-339,537, FILED 6-7-2011.

WON TEAK OH, EXAMINING ATTORNEY



David J. Kyfos

Director of the United States Patent and Trademark Office

United States of America

United States Patent and Trademark Office

SUGAR KISSED

Reg. No. 4,176,920

SENO JEWELRY, LLC (NEW YORK LIMITED LIABILITY COMPANY)
259 WEST 30TH STREET, 10TH FLOOR
NEW YORK, NY 10001

Registered July 17, 2012

Int. Cl.: 14

FOR: JEWELRY, IN CLASS 14 (U.S. CLS. 2, 27, 28 AND 50).

TRADEMARK

FIRST USE 2-1-2011; IN COMMERCE 2-1-2011.

PRINCIPAL REGISTER

THE MARK CONSISTS OF STANDARD CHARACTERS WITHOUT CLAIM TO ANY PARTICULAR FONT, STYLE, SIZE, OR COLOR.

SN 85-339,697, FILED 6-7-2011.

MARLENE BELL, EXAMINING ATTORNEY



David J. Kyffers

Director of the United States Patent and Trademark Office

United States of America

United States Patent and Trademark Office

Mz Moni

Reg. No. 4,176,921

ROBERTS, MONICA JOICE (UNITED STATES INDIVIDUAL)
6301 PAR FOUR WAY
LITHONIA, GA 30038

Registered July 17, 2012

Int. Cl.: 41

FOR: ENTERTAINMENT SERVICES, NAMELY, LIVE MUSICAL PERFORMANCES BY A RAP ARTIST; SONG WRITING SERVICES FOR OTHERS, IN CLASS 41 (U.S. CLS. 100, 101 AND 107).

SERVICE MARK

FIRST USE 1-1-2010; IN COMMERCE 4-1-2012.

PRINCIPAL REGISTER

THE MARK CONSISTS OF STANDARD CHARACTERS WITHOUT CLAIM TO ANY PARTICULAR FONT, STYLE, SIZE, OR COLOR.

"MZ MONI" IDENTIFIES THE STAGE NAME OF MONICA JOICE ROBERTS, A LIVING INDIVIDUAL WHOSE CONSENT IS OF RECORD.

SN 85-339,846, FILED 6-7-2011.

RUSS HERMAN, EXAMINING ATTORNEY



David J. Kyffers

Director of the United States Patent and Trademark Office

United States of America
United States Patent and Trademark Office

BIER HAUS

Reg. No. 4,176,922

Registered July 17, 2012

Int. Cl.: 9

TRADEMARK

PRINCIPAL REGISTER

WMS GAMING INC. (DELAWARE CORPORATION)
800 SOUTH NORTHPOINT BOULEVARD
WAUKEGAN, IL 60085

FOR: COMPONENTS FOR GAMING MACHINES THAT GENERATE OR DISPLAY WAGER OUTCOMES, NAMELY, CONTROLLERS, DISPLAYS, BUTTON PANELS, BOLSTERS, ELECTRICAL WIRING, AND COMPUTER HARDWARE AND SOFTWARE ASSOCIATED THEREWITH; GAMING MACHINES, NAMELY, DEVICES WHICH ACCEPT A WAGER; GAMING SOFTWARE THAT GENERATES OR DISPLAYS WAGER OUTCOMES OF GAMING MACHINES, IN CLASS 9 (U.S. CLS. 21, 23, 26, 36 AND 38).

FIRST USE 10-4-2011; IN COMMERCE 10-4-2011.

THE MARK CONSISTS OF STANDARD CHARACTERS WITHOUT CLAIM TO ANY PARTICULAR FONT, STYLE, SIZE, OR COLOR.

THE ENGLISH TRANSLATION OF "BIER HAUS" IN THE MARK IS "BEER HOUSE".

SN 85-339,931, FILED 6-7-2011.

RONALD MCMORROW, EXAMINING ATTORNEY



David J. Kyffers

Director of the United States Patent and Trademark Office

United States of America

United States Patent and Trademark Office



Reg. No. 4,176,923

WELL HATCHED (NEW YORK CORPORATION)
9 HORIZON ROAD
NEW YORK, NY 11020

Registered July 17, 2012

Int. Cl.: 41

FOR: PROVIDING A WEBSITE FEATURING INFORMATION RELATING TO EDUCATIONAL OPPORTUNITIES IN APPLYING TO SCHOOLS AND EDUCATIONAL INSTITUTIONS, IN CLASS 41 (U.S. CLS. 100, 101 AND 107).

SERVICE MARK

FIRST USE 6-16-2010; IN COMMERCE 10-25-2011.

PRINCIPAL REGISTER

THE MARK CONSISTS OF AN EGG WITH A STAR IN IT. TO THE RIGHT THERE IS THE STYLIZED TEXT "WELL HATCHED".

SN 85-340,051, FILED 6-7-2011.

JOSETTE BEVERLY, EXAMINING ATTORNEY



David J. Kyffers

Director of the United States Patent and Trademark Office

United States of America

United States Patent and Trademark Office



Reg. No. 4,176,924

Registered July 17, 2012

Int. Cl.: 25

TRADEMARK

PRINCIPAL REGISTER

PIERRE, ROGER (UNITED STATES INDIVIDUAL), DBA PIERRE LEROCK
INTERNATIONAL,
765 AMSTERDAM AVENUE. #7D
NEW YORK, NY 10025

FOR: T-SHIRTS, SWEAT SHIRTS, TANK TOPS, HOODED SWEAT SHIRTS, JACKETS,
HATS, CAPS, AND HEAD BANDS, IN CLASS 25 (U.S. CLS. 22 AND 39).

FIRST USE 11-30-2010; IN COMMERCE 2-12-2012.

OWNER OF U.S. REG. NO. 3,955,534.

THE NAME "PIERRE LEROCK" IDENTIFIES THE NICKNAME OF A LIVING INDIVIDUAL
"ROGER PIERRE" WHOSE CONSENT TO REGISTER IS OF RECORD.

THE MARK CONSISTS OF THE HEAD OF A LION WITH ITS MOUTH OPEN, BORDERED
BY CURVED OR SWIRLING LINES AT THE BOTTOM. UNDERNEATH THE LION ARE
TWO SKULLS FACING ONE ANOTHER WITH WINGS EXTENDING OUT THE BACK OF
THEM. BELOW THE SKULLS IS A CURVED OR SWIRLING LINE, UNDER WHICH IS THE
WORDING "BEASTIN' TO THE MAX SURVIVAL OF THE STRONGEST". BENEATH THE
WORDING IS A CIRCLE INSIDE OF WHICH ARE TWO PICK AXES, CROSSED, AND A
STYLIZED "PL" SUPERIMPOSED OVER THE PICK AXES. ABOVE THE CIRCLE IS THE
CURVED WORDING "PIERRE" AND BELOW THE CIRCLE IS THE CURVED WORDING
"LEROCK". BENEATH THE CIRCLE DESIGN IS THE WORDING "INFINITE SOLIDITY".

SN 85-340,085, FILED S.R. 6-7-2011; AM. P.R. 10-6-2011.

EMILY CARLSEN, EXAMINING ATTORNEY



David J. Kyjars

Director of the United States Patent and Trademark Office

United States of America

United States Patent and Trademark Office

JAMMY JAMS

Reg. No. 4,176,925

JAMMY JAMS, LLC (MARYLAND LIMITED LIABILITY COMPANY)
610 MONTGOMERY STREET
LAUREL, MD 20707

Registered July 17, 2012

Int. Cl.: 9

FOR: DOWNLOADABLE MP3 FILES AND MP3 RECORDINGS FEATURING MUSIC; PRE-RECORDED CDS FEATURING MUSIC, IN CLASS 9 (U.S. CLS. 21, 23, 26, 36 AND 38).

TRADEMARK

FIRST USE 0-0-2011; IN COMMERCE 0-0-2011.

PRINCIPAL REGISTER

THE MARK CONSISTS OF STANDARD CHARACTERS WITHOUT CLAIM TO ANY PARTICULAR FONT, STYLE, SIZE, OR COLOR.

SN 85-340,108, FILED 6-7-2011.

ELLEN B. AWRICH, EXAMINING ATTORNEY



David J. Kyffers

Director of the United States Patent and Trademark Office

United States of America
United States Patent and Trademark Office

PAWTRACK

Reg. No. 4,176,926

Registered July 17, 2012

Int. Cl.: 9

TRADEMARK

PRINCIPAL REGISTER

PAWTRACK GLOBAL SERVICES LIMITED (UNITED KINGDOM LIMITED COMPANY
(LTD.))
OVERSTEPS HOUSE
KINGSWEAR
DEVON, UNITED KINGDOM TQ60DY

FOR: ELECTRONIC DEVICES FOR ANIMAL LOCATING AND TRACKING PROGRAMMED
TO USE GLOBAL POSITIONING SYSTEMS (GPS) AND CELLULAR COMMUNICATIONS,
IN CLASS 9 (U.S. CLS. 21, 23, 26, 36 AND 38).

FIRST USE 3-0-2012; IN COMMERCE 3-0-2012.

THE MARK CONSISTS OF STANDARD CHARACTERS WITHOUT CLAIM TO ANY PAR-
TICULAR FONT, STYLE, SIZE, OR COLOR.

SN 85-340,155, FILED 6-7-2011.

ALLISON HOLTZ, EXAMINING ATTORNEY



David J. Kyffers

Director of the United States Patent and Trademark Office

United States of America

United States Patent and Trademark Office

MNEMOSYNE

Reg. No. 4,176,927

POWER BRAIN INC. (ILLINOIS CORPORATION)

Registered July 17, 2012

425 HUEHL RD., BLDG 4B
NORTHBROOK, IL 60062

Int. Cl.: 5

FOR: DIETARY AND NUTRITIONAL SUPPLEMENTS; DIETARY SUPPLEMENTS FOR PROMOTING BRAIN ALERTNESS AND HEALTH; NUTRITIONAL SUPPLEMENTS; NUTRITIONAL SUPPLEMENTS FOR PROMOTING BRAIN ALERTNESS AND HEALTH, IN CLASS 5 (U.S. CLS. 6, 18, 44, 46, 51 AND 52).

TRADEMARK

PRINCIPAL REGISTER

FIRST USE 2-1-2012; IN COMMERCE 2-1-2012.

THE MARK CONSISTS OF STANDARD CHARACTERS WITHOUT CLAIM TO ANY PARTICULAR FONT, STYLE, SIZE, OR COLOR.

SN 85-340,540, FILED 6-7-2011.

ELIZABETH KAJUBI, EXAMINING ATTORNEY



David J. Kybas

Director of the United States Patent and Trademark Office

United States of America

United States Patent and Trademark Office



Reg. No. 4,176,928

Registered July 17, 2012

Int. Cl.: 43

SERVICE MARK

PRINCIPAL REGISTER

LITTLE ARTIST PRESCHOOL INC (FLORIDA CORPORATION), DBA TINY BLOCKS
PRESCHOOL,
5925 LYONS RD
COCONUT CREEK, FL 33073

FOR: PRESCHOOLER AND INFANT CARE AT DAYCARE CENTERS, IN CLASS 43 (U.S. CLS. 100 AND 101).

FIRST USE 1-1-2011; IN COMMERCE 8-22-2011.

NO CLAIM IS MADE TO THE EXCLUSIVE RIGHT TO USE "PRESCHOOL", APART FROM THE MARK AS SHOWN.

THE COLOR(S) RED, YELLOW, BLUE, PINK, PURPLE, ORANGE, GREEN, BLACK, WHITE AND GRAY IS/ARE CLAIMED AS A FEATURE OF THE MARK.

THE MARK CONSISTS OF THE WORDING "TINY BLOCKS PRESCHOOL" AND DESIGN ELEMENTS COMPRISING FIVE STACKED TOY BLOCKS. THE FORWARD FACING SURFACES OF THE FIVE STACKED BLOCKS EACH CONTAIN A LETTER IN THE WORDING "TINY BLOCKS", WITH THE FIRST BLOCK CONTAINING "TI", THE SECOND BLOCK CONTAINING "NY", THE THIRD BLOCK CONTAINING "BL", THE FOURTH BLOCK CONTAINING "OC" AND THE FINAL BLOCK CONTAINING "KS". THE TERMS "TINY" AND "PRESCHOOL" ARE BLACK, AND THE TERM "BLOCKS" IS BLACK WITH A WHITE SHADOW. THE BLOCKS ARE THE COLORS RED, YELLOW, BLUE, PINK, PURPLE, ORANGE, GREEN, AND GRAY, AND ALL SQUARE SURFACES OF THE BLOCKS HAVE THIN BLACK OUTLINES. THE MARK BACKGROUND IS WHITE.

SN 85-340,677, FILED 6-8-2011.

NELSON SNYDER, EXAMINING ATTORNEY



David J. Kypos

Director of the United States Patent and Trademark Office

United States of America

United States Patent and Trademark Office

NG NUTRA

Reg. No. 4,176,929

J Z ENTERPRISES, L.L.C. (SOUTH DAKOTA LIMITED LIABILITY COMPANY)
5109 S. LOUISE AVE.

Registered July 17, 2012

SIOUX FALLS, SD 57108

Int. Cl.: 5

FOR: DIETARY AND NUTRITIONAL SUPPLEMENTS OTHER THAN CEREAL-BASED OR
IN BAR FORM, IN CLASS 5 (U.S. CLS. 6, 18, 44, 46, 51 AND 52).

TRADEMARK

FIRST USE 10-0-2011; IN COMMERCE 10-0-2011.

PRINCIPAL REGISTER

THE MARK CONSISTS OF STANDARD CHARACTERS WITHOUT CLAIM TO ANY PAR-
TICULAR FONT, STYLE, SIZE, OR COLOR.

SN 85-341,989, FILED 6-9-2011.

WILLIAM BRECKENFELD, EXAMINING ATTORNEY



David J. Kyffers

Director of the United States Patent and Trademark Office

United States of America

United States Patent and Trademark Office

CBM-R

Reg. No. 4,176,930

GENERAL ELECTRIC COMPANY (NEW YORK CORPORATION)
1 RIVER ROAD
SCHENECTADY, NY 068280001

Registered July 17, 2012

Int. Cl.: 37

FOR: GAS TURBINE MAINTENANCE SERVICES AND GAS TURBINE REPAIR SERVICES,
IN CLASS 37 (U.S. CLS. 100, 103 AND 106).

SERVICE MARK

FIRST USE 1-26-2010; IN COMMERCE 1-26-2010.

PRINCIPAL REGISTER

THE MARK CONSISTS OF STANDARD CHARACTERS WITHOUT CLAIM TO ANY PARTICULAR FONT, STYLE, SIZE, OR COLOR.

SN 85-342,411, FILED 6-9-2011.

REBECCA SMITH, EXAMINING ATTORNEY



David J. Kybas

Director of the United States Patent and Trademark Office

United States of America

United States Patent and Trademark Office

CITY OF HEROES FREEDOM

Reg. No. 4,176,931

Registered July 17, 2012

Int. Cl.: 9

TRADEMARK

PRINCIPAL REGISTER

NCSOFT CORPORATION (REPUBLIC OF KOREA CORPORATION)
157-33 SAMSUNG-DONG, GANGNAM-GU
OKSAN BUILDING
SEOUL, REPUBLIC OF KOREA 135-090

FOR: COMPUTER GAME SOFTWARE; INTERACTIVE MULTIMEDIA COMPUTER GAME PROGRAMS; DOWNLOADABLE ELECTRONIC PUBLICATIONS IN THE NATURE OF NEWSLETTERS AND MAGAZINES FEATURING ROLE-PLAYING, IN CLASS 9 (U.S. CLS. 21, 23, 26, 36 AND 38).

FIRST USE 9-0-2011; IN COMMERCE 9-0-2011.

THE MARK CONSISTS OF STANDARD CHARACTERS WITHOUT CLAIM TO ANY PARTICULAR FONT, STYLE, SIZE, OR COLOR.

OWNER OF U.S. REG. NOS. 2,897,722, 3,890,776, AND 3,894,626.

SN 85-342,961, FILED 6-10-2011.

ODESSA BIBBINS, EXAMINING ATTORNEY



David J. Kyros

Director of the United States Patent and Trademark Office

United States of America

United States Patent and Trademark Office

Kitch-N-Witch

Reg. No. 4,176,932

Registered July 17, 2012

Int. Cls.: 3 and 21

TRADEMARK

PRINCIPAL REGISTER

E-SITE CENTRAL, INC. (INDIANA CORPORATION)
665 WIRTZ ROAD
CROWN POINT, IN 46307

FOR: AROMATIC POTPOURRIS; CLEANING AGENTS AND PREPARATIONS; CLEANING AGENTS FOR CLEANING SURFACES; CLEANING AND POLISHING PAPER; CLEANING AND POLISHING PREPARATIONS; CLEANING AND WASHING PREPARATIONS; CLEANING PREPARATIONS; CLEANING PREPARATIONS FOR CLEANING SURFACES; CLEANING PREPARATIONS FOR CLEANSING DRAINS; CLEANING PREPARATIONS FOR HOUSEHOLD PURPOSES; CLEANING PREPARATIONS FOR USE WITH MIXING CONTAINERS; CLEANING, POLISHING AND SCOURING PREPARATIONS; CLEANING, SCOURING AND POLISHING PREPARATIONS AND SUBSTANCES; CLEANING, WASHING AND POLISHING PREPARATIONS; DEGREASING PREPARATIONS FOR HOUSEHOLD PURPOSES; DETERGENT SOAP; DETERGENTS FOR HOUSEHOLD USE; DISH DETERGENTS; DISINFECTANT SOAPS; DISINFECTING PERFUMED SOAPS; ESSENTIAL OILS AS PERFUME FOR LAUNDRY PURPOSES; ESSENTIAL OILS FOR AROMATHERAPY USE; ESSENTIAL OILS FOR HOUSEHOLD USE; ESSENTIAL OILS FOR USE IN THE MANUFACTURE OF SCENTED PRODUCTS; GENERAL PURPOSE CLEANING, POLISHING, AND ABRASIVE LIQUIDS AND POWDERS; GENERAL PURPOSE SCOURING POWDER; GLASS CLEANERS; GLASS CLEANING PREPARATIONS; GRANULATED SOAPS; HAND CLEANING PREPARATIONS; LAUNDRY DETERGENT; LAUNDRY DETERGENTS; LAUNDRY SOAP; OVEN CLEANERS; PERFUMED SOAP; PERFUMED SOAPS; POLISHING PREPARATIONS; POLISHING WAX; POTPOURRI; POWDER CLEANERS FOR METALS, CERAMICS AND CARPETS; ROOM FRAGRANCES; ROOM FRAGRANCING PREPARATIONS; SACHETS; SCENTED LINEN WATER; SCENTED ROOM SPRAYS; SOAPS AND DETERGENTS; TOILET SOAP; TOILET SOAPS; WASHING PREPARATIONS AND LAUNDRY BLEACH, IN CLASS 3 (U.S. CLS. 1, 4, 6, 50, 51 AND 52).

FIRST USE 3-1-2012; IN COMMERCE 3-1-2012.

FOR: AEROSOL DISPENSERS NOT FOR MEDICAL USE; BOTTLES, SOLD EMPTY; BUCKETS; CANISTER SETS; CONTAINERS FOR HOUSEHOLD OR KITCHEN USE; CONTAINERS FOR HOUSEHOLD USE; CRUETS; DISPENSERS FOR CLEANING AND DISINFECTING SOLUTIONS; DISPENSERS FOR LIQUID SOAP; EMPTY SPRAY BOTTLES; FLASKS; FUNNELS; GLASS JARS; GLASS STORAGE JARS; HOUSEHOLD UTENSILS, NAMELY, CLEANING SOLUTION AND CLEANING POWDER MEASURES AND MIXERS; JUGS; MANUALLY ACTUATED PUMP DISPENSERS FOR ATTACHMENT TO CONTAINERS



David J. Kybas

Director of the United States Patent and Trademark Office

Reg. No. 4,176,932 FOR USE IN DISPENSING LIQUIDS; MIXING BOWLS; MUGS; NON-METAL AEROSOL CANS SOLD EMPTY; NON-MODULAR CONTAINERS FOR USE IN TRANSPORTATION AND STORAGE FOR HOUSEHOLD USE; PERFUME ATOMIZERS, SOLD EMPTY; PERFUME SPRAYERS; PERSONAL DISPENSERS FOR MEASURING AND MIXING CLEANING SOLUTIONS AND CLEANING POWDERS. FOR DOMESTIC USE; PLASTIC SPRAY NOZZLES; PLASTIC STORAGE CONTAINERS FOR DOMESTIC USE; PLASTIC STORAGE CONTAINERS FOR HOUSEHOLD OR DOMESTIC USE; PLASTIC STORAGE CONTAINERS FOR HOUSEHOLD USE; POURING SPOUTS FOR HOUSEHOLD USE; SCOOPS; SHALLOW BOWLS; SOAP CONTAINERS; SOAP DISPENSERS; SOAP HOLDERS; SOAP HOLDERS AND BOXES; SQUEEZE BOTTLE SOLD EMPTY; VACUUM BOTTLES, IN CLASS 21 (U.S. CLS. 2, 13, 23, 29, 30, 33, 40 AND 50).

FIRST USE 3-1-2012; IN COMMERCE 3-1-2012.

THE MARK CONSISTS OF STANDARD CHARACTERS WITHOUT CLAIM TO ANY PARTICULAR FONT, STYLE, SIZE, OR COLOR.

SN 85-344,456, FILED 6-13-2011.

RONALD AIKENS, EXAMINING ATTORNEY

United States of America

United States Patent and Trademark Office



Reg. No. 4,176,933

Registered July 17, 2012

Int. Cls.: 30 and 35

TRADEMARK

SERVICE MARK

PRINCIPAL REGISTER

POPSATIONS POPCORN COMPANY (MARYLAND CORPORATION)
6419 MURRAY HILL ROAD
BALTIMORE, MD 21212

FOR: GOURMET POPCORN, IN CLASS 30 (U.S. CL. 46).

FIRST USE 4-1-2012; IN COMMERCE 4-1-2012.

FOR: RETAIL STORE SERVICES, ONLINE RETAIL STORE SERVICES AND MAIL ORDER SERVICES FEATURING GOURMET POPCORN, IN CLASS 35 (U.S. CLS. 100, 101 AND 102).

FIRST USE 4-1-2012; IN COMMERCE 4-1-2012.

NO CLAIM IS MADE TO THE EXCLUSIVE RIGHT TO USE "OBX POPCORN", APART FROM THE MARK AS SHOWN.

THE COLOR(S) YELLOW, BLACK AND WHITE IS/ARE CLAIMED AS A FEATURE OF THE MARK.

THE MARK CONSISTS OF THE WORDS "OBX POPCORN" IN CAPITAL BLACK LETTERS, WITH A YELLOW FULLY-POPPED POPCORN KERNEL IN PLACE OF THE LETTER "O" IN "OBX", ON A WHITE BACKGROUND WITH A BLACK OVAL LINE FORMING A BORDER AROUND THE IMAGE.

SN 85-344,624, FILED 6-13-2011.

LEIGH LOWRY, EXAMINING ATTORNEY



David J. Kybas

Director of the United States Patent and Trademark Office

United States of America

United States Patent and Trademark Office



Reg. No. 4,176,934

BALANCED TECH CORP. (NEW YORK CORPORATION)
37 W. 37TH STREET
NEW YORK, NY 10018

Registered July 17, 2012

Int. Cl.: 25

FOR: CLOTHING, NAMELY, T-SHIRTS, SHIRTS, SWEATERS, SHORTS, UNDERWEAR, SLEEPWEAR, SWIMWEAR, BRAS, AND SOCKS, IN CLASS 25 (U.S. CLS. 22 AND 39).

TRADEMARK

FIRST USE 4-13-2012; IN COMMERCE 4-13-2012.

PRINCIPAL REGISTER

THE MARK CONSISTS OF A TRIANGLE DESIGN WITH THE WORDS "BALANCED TECH" APPEARING BELOW THE TRIANGLE DESIGN.

SN 85-345,322, FILED 6-14-2011.

ESTHER BELENKER, EXAMINING ATTORNEY



David J. Kyffers

Director of the United States Patent and Trademark Office

United States of America

United States Patent and Trademark Office

PEPPER PLANET

Reg. No. 4,176,935

Registered July 17, 2012

Int. Cl.: 30

TRADEMARK

PRINCIPAL REGISTER

WOLFER FOODS INC. (ILLINOIS CORPORATION)
2218 WEST IOWA STREET #2
CHICAGO, IL 60622

FOR: HOT SAUCE, IN CLASS 30 (U.S. CL. 46).

FIRST USE 4-17-2012; IN COMMERCE 5-3-2012.

THE MARK CONSISTS OF STANDARD CHARACTERS WITHOUT CLAIM TO ANY PARTICULAR FONT, STYLE, SIZE, OR COLOR.

NO CLAIM IS MADE TO THE EXCLUSIVE RIGHT TO USE "PEPPER", APART FROM THE MARK AS SHOWN.

SN 85-345,477, FILED 6-14-2011.

VERNA BETH RIRIE, EXAMINING ATTORNEY



David J. Kyffers

Director of the United States Patent and Trademark Office

United States of America

United States Patent and Trademark Office



Reg. No. 4,176,936

MATTHEWS, COREY P (UNITED STATES INDIVIDUAL)
7550 LYON STREET
SUTTER, CA 95982 AND

Registered July 17, 2012

Int. Cl.: 42

MOSIMAN, JOSHUA T (UNITED STATES INDIVIDUAL)
5660 LONE PINE ROAD
SEBASTOPOL, CA 95472

SERVICE MARK

PRINCIPAL REGISTER

FOR: CREATING AN ON-LINE COMMUNITY FOR RECREATIONAL ATHLETES FOR THE PURPOSE OF CONNECTING PLAYERS, TEAMS AND LEAGUES AND ORGANIZING GAME AND SPORTS ACTIVITIES, IN CLASS 42 (U.S. CLS. 100 AND 101).

FIRST USE 4-1-2011; IN COMMERCE 8-1-2011.

THE MARK CONSISTS OF THE BLACK AND WHITE WORDING "SUPER SKETCH" IN STYLIZED FONT, THE BLACK AND WHITE LETTER "S" IN STYLIZED FONT, A BLACK AND WHITE STAR, AND A RED SQUARE BACKGROUND SURROUNDED BY A PARTIAL BLACK OUTLINE.

THE COLOR(S) BLACK, RED, AND WHITE IS/ARE CLAIMED AS A FEATURE OF THE MARK.

SN 85-345,795, FILED 6-14-2011.

JOHN KELLY, EXAMINING ATTORNEY



David J. Kybas

Director of the United States Patent and Trademark Office

United States of America

United States Patent and Trademark Office

SWING ASSIST

Reg. No. 4,176,937

Registered July 17, 2012

Int. Cl.: 10

TRADEMARK

PRINCIPAL REGISTER

ONGOING CARE SOLUTIONS, INC. (FLORIDA CORPORATION)
6545 44TH STREET N., UNIT 4007
PINELLAS PARK, FL 33781

FOR: ORTHOPEDIC BRACES, IN CLASS 10 (U.S. CLS. 26, 39 AND 44).

FIRST USE 2-1-2012; IN COMMERCE 3-1-2012.

THE MARK CONSISTS OF STANDARD CHARACTERS WITHOUT CLAIM TO ANY PARTICULAR FONT, STYLE, SIZE, OR COLOR.

NO CLAIM IS MADE TO THE EXCLUSIVE RIGHT TO USE "SWING", APART FROM THE MARK AS SHOWN.

SN 85-345,871, FILED 6-14-2011.

ANNE E. GUSTASON, EXAMINING ATTORNEY



David J. Kyffers

Director of the United States Patent and Trademark Office

United States of America

United States Patent and Trademark Office

BEKNOWN

Reg. No. 4,176,938

MONSTER WORLDWIDE, INC. (DELAWARE CORPORATION)
622 THIRD AVENUE
NEW YORK, NY 10017

Registered July 17, 2012

Int. Cl.: 45

FOR: ON-LINE SOCIAL NETWORKING SERVICES, IN CLASS 45 (U.S. CLS. 100 AND 101).

SERVICE MARK

FIRST USE 6-0-2011; IN COMMERCE 6-0-2011.

PRINCIPAL REGISTER

THE MARK CONSISTS OF STANDARD CHARACTERS WITHOUT CLAIM TO ANY PARTICULAR FONT, STYLE, SIZE, OR COLOR.

SN 85-346,698, FILED 6-15-2011.

HEATHER BIDDULPH, EXAMINING ATTORNEY



David J. Kyffers

Director of the United States Patent and Trademark Office

United States of America

United States Patent and Trademark Office

Whiteout

Reg. No. 4,176,939

IP HOLDINGS LLC (WASHINGTON LIMITED LIABILITY COMPANY)
5408 NE 88TH ST. #A-101
VANCOUVER, WA 98665

Registered July 17, 2012

Int. Cl.: 11

FOR: HORTICULTURE GROW LIGHT REFLECTOR USED FOR GROWING PLANTS, IN CLASS 11 (U.S. CLS. 13, 21, 23, 31 AND 34).

TRADEMARK

FIRST USE 4-10-2012; IN COMMERCE 4-10-2012.

PRINCIPAL REGISTER

THE MARK CONSISTS OF STANDARD CHARACTERS WITHOUT CLAIM TO ANY PARTICULAR FONT, STYLE, SIZE, OR COLOR.

SN 85-346,764, FILED 6-15-2011.

ELIZABETH KAJUBI, EXAMINING ATTORNEY



David J. Kyffers

Director of the United States Patent and Trademark Office

United States of America

United States Patent and Trademark Office

SMOKIN' SAUSAGE

Reg. No. 4,176,940

Registered July 17, 2012

Int. Cl.: 30

TRADEMARK

PRINCIPAL REGISTER

CHECKERS DRIVE-IN RESTAURANTS, INC. (DELAWARE CORPORATION)
4300 WEST CYPRESS STREET, SUITE 600
TAMPA, FL 33607

FOR: SAUSAGE SANDWICHES, IN CLASS 30 (U.S. CL. 46).

FIRST USE 9-0-2011; IN COMMERCE 9-0-2011.

THE MARK CONSISTS OF STANDARD CHARACTERS WITHOUT CLAIM TO ANY PARTICULAR FONT, STYLE, SIZE, OR COLOR.

NO CLAIM IS MADE TO THE EXCLUSIVE RIGHT TO USE "SAUSAGE", APART FROM THE MARK AS SHOWN.

SN 85-346,864, FILED 6-15-2011.

TRACY CROSS, EXAMINING ATTORNEY



David J. Kyffers

Director of the United States Patent and Trademark Office

United States of America

United States Patent and Trademark Office



Reg. No. 4,176,941

Registered July 17, 2012

Int. Cl.: 44

SERVICE MARK

PRINCIPAL REGISTER

DCI DONOR SERVICES, INC. (TENNESSEE CORPORATION)
SUITE 300
1600 HAYES STREET
NASHVILLE, TN 37203

FOR: PROVIDING INFORMATION IN THE FIELD OF ORGAN AND TISSUE DONATION;
MEDICAL SERVICES IN THE FIELD OF ORGAN DONATION, NAMELY, OBTAINING
CONSENT, CONDUCTING DONOR SCREENING AND PROVIDING DONOR MEDICAL
DATA, IN CLASS 44 (U.S. CLS. 100 AND 101).

FIRST USE 12-12-2011; IN COMMERCE 12-12-2011.

THE MARK CONSISTS OF OUTLINE FIGURES OF MEN AND WOMEN HOLDING HANDS
CONNECTED IN A CIRCULAR PATTERN.

SN 85-347,781, FILED 6-16-2011.

JENNIFER VASQUEZ, EXAMINING ATTORNEY



David J. Kyffers

Director of the United States Patent and Trademark Office

United States of America

United States Patent and Trademark Office



Reg. No. 4,176,942

Registered July 17, 2012

Int. Cl.: 37

SERVICE MARK

PRINCIPAL REGISTER

WIERS FLEET PARTNERS, INC. (INDIANA CORPORATION)
2111 JIM NEU DRIVE
PLYMOUTH, IN 46563

FOR: VEHICLE MAINTENANCE CONSULTATION AND REPAIR, IN CLASS 37 (U.S. CLS. 100, 103 AND 106).

FIRST USE 12-1-2011; IN COMMERCE 12-1-2011.

NO CLAIM IS MADE TO THE EXCLUSIVE RIGHT TO USE "FLEET PARTNERS", APART FROM THE MARK AS SHOWN.

THE MARK CONSISTS OF A TRIANGULAR SHAPE CONTAINING THE WORD "FLEET" OVER THE WORD "WIERS" WITH "WIERS" CONTAINING A DECORATIVE "E" OVER A SECOND FILLED TRIANGULAR SHAPE CONTAINING THE WORD "PARTNERS" ALL ENCOMPASSED INSIDE A DIAMOND LIKE SHAPE.

SN 85-348,057, FILED 6-16-2011.

JORDAN BAKER, EXAMINING ATTORNEY



David J. Kybas

Director of the United States Patent and Trademark Office

United States of America

United States Patent and Trademark Office

TRANSFARRING

Reg. No. 4,176,943

KONAMI DIGITAL ENTERTAINMENT CO., LTD. (JAPAN CORPORATION)

Registered July 17, 2012

9-7-2, AKASAKA, MINATO-KU
TOKYO, JAPAN

Int. Cl.: 9

FOR: VIDEO GAME SOFTWARE; VIDEO GAME PROGRAMS; COMPUTER GAME SOFTWARE; COMPUTER GAME PROGRAMS; ELECTRONIC GAME PROGRAMS, IN CLASS 9 (U.S. CLS. 21, 23, 26, 36 AND 38).

TRADEMARK

FIRST USE 11-8-2011; IN COMMERCE 11-8-2011.

PRINCIPAL REGISTER

THE MARK CONSISTS OF STANDARD CHARACTERS WITHOUT CLAIM TO ANY PARTICULAR FONT, STYLE, SIZE, OR COLOR.

SN 85-348,605, FILED 6-16-2011.

KATHERINE STOIDES, EXAMINING ATTORNEY



David J. Kybas

Director of the United States Patent and Trademark Office

United States of America

United States Patent and Trademark Office

Nature Band

Reg. No. 4,176,944

Registered July 17, 2012

Int. Cl.: 14

TRADEMARK

PRINCIPAL REGISTER

DIGIDATA SYSTEMS LLC (NEW YORK LIMITED LIABILITY COMPANY), DBA
WWW.QRLIVING.COM,
128 LAFAYETTE ST. #302
NEW YORK, NY 10013

FOR: RUBBER OR SILICON WRISTBANDS IN THE NATURE OF A BRACELET, IN CLASS
14 (U.S. CLS. 2, 27, 28 AND 50).

FIRST USE 12-11-2011; IN COMMERCE 12-17-2011.

THE MARK CONSISTS OF STANDARD CHARACTERS WITHOUT CLAIM TO ANY PAR-
TICULAR FONT, STYLE, SIZE, OR COLOR.

NO CLAIM IS MADE TO THE EXCLUSIVE RIGHT TO USE "BAND", APART FROM THE
MARK AS SHOWN.

SN 85-348,932, FILED 6-17-2011.

HEATHER BIDDULPH, EXAMINING ATTORNEY



David J. Kyros

Director of the United States Patent and Trademark Office

United States of America

United States Patent and Trademark Office

Club W

Reg. No. 4,176,945

CLUB W, INC. (DELAWARE CORPORATION)
1425 MARKET ST. #205
DENVER, CO 80202

Registered July 17, 2012

Int. Cls.: 35, 39, and 43

FOR: ON-LINE RETAIL STORE SERVICES FEATURING WINE, IN CLASS 35 (U.S. CLS. 100, 101 AND 102).

SERVICE MARK

FIRST USE 8-8-2011; IN COMMERCE 8-8-2011.

PRINCIPAL REGISTER

FOR: WINE CLUB SERVICES FEATURING PERIODIC SHIPMENTS OF WINE TO MEMBERS, IN CLASS 39 (U.S. CLS. 100 AND 105).

FIRST USE 8-8-2011; IN COMMERCE 8-8-2011.

FOR: PROVIDING A WEB SITE WHERE USERS CAN POST RATINGS, REVIEWS AND RECOMMENDATIONS ON WINES FOR WINE APPRECIATION PURPOSES, IN CLASS 43 (U.S. CLS. 100 AND 101).

FIRST USE 3-26-2012; IN COMMERCE 3-26-2012.

THE MARK CONSISTS OF STANDARD CHARACTERS WITHOUT CLAIM TO ANY PARTICULAR FONT, STYLE, SIZE, OR COLOR.

NO CLAIM IS MADE TO THE EXCLUSIVE RIGHT TO USE "CLUB", APART FROM THE MARK AS SHOWN.

SN 85-349,102, FILED 6-17-2011.

HOWARD B. LEVINE, EXAMINING ATTORNEY



David J. Kyros

Director of the United States Patent and Trademark Office

United States of America

United States Patent and Trademark Office

Eruption Effervescent Energy

Reg. No. 4,176,946

CAN'T STOP IT, LLC (MINNESOTA LIMITED LIABILITY COMPANY)
1689 STINSON BLVD.

Registered July 17, 2012

NEW BRIGHTON, MN 55112

Int. Cl.: 35

FOR: PROMOTIONAL SPONSORSHIP OF CONCERTS, MIXED MARTIAL ARTS EVENTS, SPORTING EVENTS, AND EXTREME SPORTS EVENTS, IN CLASS 35 (U.S. CLS. 100, 101 AND 102).

SERVICE MARK

FIRST USE 6-8-2011; IN COMMERCE 6-8-2011.

PRINCIPAL REGISTER

THE MARK CONSISTS OF STANDARD CHARACTERS WITHOUT CLAIM TO ANY PARTICULAR FONT, STYLE, SIZE, OR COLOR.

SN 85-349,109, FILED 6-17-2011.

SANJEEV VOHRA, EXAMINING ATTORNEY



David J. Kyffers

Director of the United States Patent and Trademark Office

United States of America

United States Patent and Trademark Office

THE CLEAREST REFLECTION OF YOU

Reg. No. 4,176,947

ACNE BRANDS, LLC (WYOMING LIMITED LIABILITY COMPANY)
2510 WARREN AVENUE
CHEYENNE, WY 82001

Registered July 17, 2012

Int. Cl.: 5

FOR: MEDICATIONS AND PREPARATIONS FOR THE TREATMENT AND PREVENTION OF ACNE BLEMISHES AND OUTBREAKS, IN CLASS 5 (U.S. CLS. 6, 18, 44, 46, 51 AND 52).

TRADEMARK

FIRST USE 8-23-2011; IN COMMERCE 8-23-2011.

PRINCIPAL REGISTER

THE MARK CONSISTS OF STANDARD CHARACTERS WITHOUT CLAIM TO ANY PARTICULAR FONT, STYLE, SIZE, OR COLOR.

SN 85-349,194, FILED 6-17-2011.

KATINA MISTER, EXAMINING ATTORNEY



David J. Kyffers

Director of the United States Patent and Trademark Office

United States of America

United States Patent and Trademark Office

GIGGLE GROWER

Reg. No. 4,176,948

FIFI DELISH LLC (ILLINOIS LIMITED LIABILITY COMPANY)
209 W MADISON
DIVERNON, IL 62530

Registered July 17, 2012

Int. Cl.: 42

FOR: PROVIDING A WEBSITE FEATURING A WELLNESS TOOL, SPECIFICALLY, NON-DOWNLOADABLE DATABASE SOFTWARE FOR CAREGIVERS AND CHILDREN TO TRACK PROGRESS TOWARDS HEALTHY HABITS REGARDING NUTRITION, EXERCISE, HYGIENE, AND MANNERS, IN CLASS 42 (U.S. CLS. 100 AND 101).

SERVICE MARK

PRINCIPAL REGISTER

FIRST USE 12-24-2011; IN COMMERCE 12-24-2011.

THE MARK CONSISTS OF STANDARD CHARACTERS WITHOUT CLAIM TO ANY PARTICULAR FONT, STYLE, SIZE, OR COLOR.

SN 85-350,056, FILED 6-20-2011.

RONALD AIKENS, EXAMINING ATTORNEY



David J. Kybas

Director of the United States Patent and Trademark Office

United States of America

United States Patent and Trademark Office

ZONEWAVE

Reg. No. 4,176,949

Registered July 17, 2012

Int. Cl.: 9

TRADEMARK

PRINCIPAL REGISTER

HSU WU, WILLIAM (BRAZIL INDIVIDUAL)
6960 NW 50TH STREET
MIAMI, FL 33166

FOR: AMPLIFIER FOR WIRELESS COMMUNICATIONS; ANTENNAS FOR WIRELESS COMMUNICATIONS APPARATUS; APPARATUS FOR WIRELESS TRANSMISSION OF ACOUSTIC INFORMATION; BROADBAND WIRELESS EQUIPMENT, NAMELY, TELECOMMUNICATIONS BASE STATION EQUIPMENT FOR CELLULAR AND FIXED NETWORKING AND COMMUNICATIONS APPLICATIONS; COMPUTER EQUIPMENT, NAMELY, WIRELESS CARDS; COMPUTER HARDWARE FOR WIRELESS CONTENT DELIVERY; COMPUTER HARDWARE, NAMELY, WIRELESS ACCESS POINT (WAP) DEVICES; COMPUTER HARDWARE, NAMELY, WIRELESS NETWORK EXTENDERS; COMPUTER HARDWARE, NAMELY, WIRELESS NETWORK REPEATERS; COMPUTER SOFTWARE FOR WIRELESS CONTENT DELIVERY; CONTINGENCY RESPONSE COMMUNICATION SYSTEM DESIGNED TO PROVIDE RADIO INTEROPERABILITY, STREAMING VIDEO, WIRELESS INTERNET, AND VOIP PHONE; DEVICES FOR WIRELESS RADIO TRANSMISSION; INDUSTRIAL WIRELESS POINT-TO-MULTIPOINT RADIO; INTEGRATED CIRCUITS AND INTEGRATED CIRCUIT CORES FOR USE IN WIRELESS COMMUNICATIONS AND WIRELESS COMMUNICATION EQUIPMENT AND APPARATI AND DIGITAL SIGNAL PROCESSORS (DSP), IN CLASS 9 (U.S. CLS. 21, 23, 26, 36 AND 38).

FIRST USE 2-1-2012; IN COMMERCE 2-1-2012.

THE MARK CONSISTS OF STANDARD CHARACTERS WITHOUT CLAIM TO ANY PARTICULAR FONT, STYLE, SIZE, OR COLOR.

SN 85-350,167, FILED 6-20-2011.

ALLISON SCHRODY, EXAMINING ATTORNEY



David J. Kyros

Director of the United States Patent and Trademark Office

United States of America
United States Patent and Trademark Office

FOCUS
PEST MANAGEMENT

Reg. No. 4,176,950

KAUFFMANN, JOHN (UNITED STATES INDIVIDUAL)
424 WOOD BRANCH STREET
WOODSTOCK, GA 30188

Registered July 17, 2012

Int. Cl.: 37

FOR: PEST CONTROL, IN CLASS 37 (U.S. CLS. 100, 103 AND 106).

SERVICE MARK

FIRST USE 5-23-2011; IN COMMERCE 5-23-2011.

PRINCIPAL REGISTER

NO CLAIM IS MADE TO THE EXCLUSIVE RIGHT TO USE "PEST MANAGEMENT", APART FROM THE MARK AS SHOWN.

THE MARK CONSISTS OF THE STYLIZED TEXT "FOCUS PEST MANAGEMENT" WITH THE LETTER "O" AS A TARGET AND A HORIZONTAL LINE RUNNING THROUGH THE LETTERS "CUS" IN "FOCUS".

SN 85-351,056, FILED 6-20-2011.

APRIL HESIK, EXAMINING ATTORNEY



David J. Kyffers

Director of the United States Patent and Trademark Office

United States of America

United States Patent and Trademark Office

Leedmees

Reg. No. 4,176,951

KONAMI DIGITAL ENTERTAINMENT CO., LTD. (JAPAN CORPORATION)
9-7-2, AKASAKA, MINATO-KU
TOKYO, JAPAN

Registered July 17, 2012

Int. Cl.: 9

FOR: VIDEO GAME SOFTWARE; VIDEO GAME PROGRAMS; COMPUTER GAME SOFTWARE; COMPUTER GAME PROGRAMS, IN CLASS 9 (U.S. CLS. 21, 23, 26, 36 AND 38).

TRADEMARK

FIRST USE 9-7-2011; IN COMMERCE 9-7-2011.

PRINCIPAL REGISTER

THE MARK CONSISTS OF STANDARD CHARACTERS WITHOUT CLAIM TO ANY PARTICULAR FONT, STYLE, SIZE, OR COLOR.

SN 85-351,121, FILED 6-20-2011.

KATHERINE STOIDES, EXAMINING ATTORNEY



David J. Kybas

Director of the United States Patent and Trademark Office

United States of America

United States Patent and Trademark Office

AMORA

Reg. No. 4,176,952

KENOSIA INC. (DELAWARE CORPORATION)
51-53 KENOSIA AVENUE
DANBURY, CT 06810

Registered July 17, 2012

Int. Cl.: 30

FOR: GROUND AND WHOLE BEAN ROASTED COFFEE; TEA, IN CLASS 30 (U.S. CL. 46).

TRADEMARK

FIRST USE 10-19-2011; IN COMMERCE 10-19-2011.

PRINCIPAL REGISTER

THE MARK CONSISTS OF STANDARD CHARACTERS WITHOUT CLAIM TO ANY PARTICULAR FONT, STYLE, SIZE, OR COLOR.

THE WORD(S) "AMORA" HAS NO MEANING IN A FOREIGN LANGUAGE.

SN 85-351,196, FILED 6-21-2011.

BARBARA BROWN, EXAMINING ATTORNEY



David J. Kybas

Director of the United States Patent and Trademark Office

United States of America

United States Patent and Trademark Office

PROPELLER

Reg. No. 4,176,953

AQUASTAR POOL PRODUCTS, INC. (CALIFORNIA CORPORATION)

Registered July 17, 2012

1666 GARNET AVE #224
SAN DIEGO, CA 92109

Int. Cl.: 11

FOR: SWIMMING POOL DRAIN COVERS, IN CLASS 11 (U.S. CLS. 13, 21, 23, 31 AND 34).

TRADEMARK

FIRST USE 9-30-2011; IN COMMERCE 9-30-2011.

PRINCIPAL REGISTER

THE MARK CONSISTS OF STANDARD CHARACTERS WITHOUT CLAIM TO ANY PARTICULAR FONT, STYLE, SIZE, OR COLOR.

SN 85-352,756, FILED 6-22-2011.

MICHELLE DUBOIS, EXAMINING ATTORNEY



David J. Kyffers

Director of the United States Patent and Trademark Office

United States of America

United States Patent and Trademark Office

IP FOR A NEW AGE

Reg. No. 4,176,954

Registered July 17, 2012

Int. Cls.: 41 and 45

KNOBBE, MARTENS, OLSON & BEAR, LLP (CALIFORNIA LIMITED LIABILITY PARTNERSHIP)
2040 MAIN STREET
14TH FLOOR
IRVINE, CA 92614

SERVICE MARK

PRINCIPAL REGISTER

FOR: EDUCATION SERVICES, NAMELY, CONDUCTING EDUCATIONAL SEMINARS AND WORKSHOPS IN THE FIELD OF INTELLECTUAL PROPERTY; AND EDUCATIONAL SERVICES, NAMELY, PROVIDING EDUCATIONAL SPEAKERS IN THE FIELD OF INTELLECTUAL PROPERTY; TRAINING SERVICES IN THE FIELD OF INTELLECTUAL PROPERTY; AND DISTRIBUTING COURSE MATERIALS AND EDUCATION MATERIALS IN CONNECTION THEREWITH, IN CLASS 41 (U.S. CLS. 100, 101 AND 107).

FIRST USE 2-29-2012; IN COMMERCE 2-29-2012.

FOR: PROVIDING INFORMATION IN THE FIELD OF INTELLECTUAL PROPERTY; PROVIDING INTELLECTUAL PROPERTY SERVICES, IN CLASS 45 (U.S. CLS. 100 AND 101).

FIRST USE 2-29-2012; IN COMMERCE 2-29-2012.

THE MARK CONSISTS OF STANDARD CHARACTERS WITHOUT CLAIM TO ANY PARTICULAR FONT, STYLE, SIZE, OR COLOR.

NO CLAIM IS MADE TO THE EXCLUSIVE RIGHT TO USE "IP", APART FROM THE MARK AS SHOWN.

SN 85-352,910, FILED 6-22-2011.

GENE MACIOL, EXAMINING ATTORNEY



David J. Kybas

Director of the United States Patent and Trademark Office

United States of America

United States Patent and Trademark Office

Eruption Effervescent Energy

Reg. No. 4,176,955

CAN'T STOP IT, LLC (MINNESOTA LIMITED LIABILITY COMPANY)
1689 STINSON BLVD.

Registered July 17, 2012

NEW BRIGHTON, MN 55112

Int. Cl.: 14

FOR: JEWELRY, NAMELY, RINGS, AND BRACELETS, IN CLASS 14 (U.S. CLS. 2, 27, 28 AND 50).

TRADEMARK

FIRST USE 5-9-2011; IN COMMERCE 5-9-2011.

PRINCIPAL REGISTER

THE MARK CONSISTS OF STANDARD CHARACTERS WITHOUT CLAIM TO ANY PARTICULAR FONT, STYLE, SIZE, OR COLOR.

SN 85-353,725, FILED 6-23-2011.

SANJEEV VOHRA, EXAMINING ATTORNEY



David J. Kybas

Director of the United States Patent and Trademark Office

United States of America

United States Patent and Trademark Office



Reg. No. 4,176,956

FUNDAGEEK LLC (CALIFORNIA LIMITED LIABILITY COMPANY)

Registered July 17, 2012

56925 YUCCA TRAIL #254
YUCCA VALLEY, CA 92884

Int. Cl.: 42

FOR: HOSTING AN ONLINE WEBSITE FEATURING MULTIPLE PARTIES USING SOCIAL NETWORKS TO POOL MONEY AND OTHER RESOURCES TOGETHER VIA THE INTERNET TO SUPPORT PROJECT DEVELOPMENT EFFORTS INITIATED BY PROJECT OWNERS, IN CLASS 42 (U.S. CLS. 100 AND 101).

SERVICE MARK

PRINCIPAL REGISTER

FIRST USE 11-4-2011; IN COMMERCE 11-4-2011.

THE MARK CONSISTS OF BLACK EYEGLASSES WITH BLUE PUPILS THEREIN AND TO THE SIDE THE WORDS, "FUNDAGEEK", IN BLUE. THE COLOR WHITE IS FOR BACKGROUND PURPOSES.

THE COLOR(S) BLUE AND BLACK IS/ARE CLAIMED AS A FEATURE OF THE MARK.

SN 85-357,502, FILED 6-27-2011.

JESSICA A. POWERS, EXAMINING ATTORNEY



David J. Kyffers

Director of the United States Patent and Trademark Office

United States of America

United States Patent and Trademark Office



Reg. No. 4,176,957

Registered July 17, 2012

Int. Cl.: 41

SERVICE MARK

PRINCIPAL REGISTER

CABLE NEWS NETWORK, INC. (DELAWARE CORPORATION)
ONE CNN CENTER, 10N
C/O TURNER BROADCASTING SYSTEM, INC.
ATLANTA, GA 30303

FOR: ENTERTAINMENT SERVICES, NAMELY, A MULTIMEDIA PROGRAM SERIES FEATURING SPORTS AND NEWS DISTRIBUTED VIA VARIOUS PLATFORMS ACROSS MULTIPLE FORMS OF TRANSMISSION MEDIA, IN CLASS 41 (U.S. CLS. 100, 101 AND 107).

FIRST USE 3-30-2012; IN COMMERCE 3-30-2012.

NO CLAIM IS MADE TO THE EXCLUSIVE RIGHT TO USE "THE TOURNAMENT UPDATE", APART FROM THE MARK AS SHOWN.

THE MARK CONSISTS OF THE WORD "THE" INSIDE A HALF OF BASKETBALL WITH THE WORDS "TOURNAMENT UPDATE" BELOW THE HALF BASKETBALL DESIGN.

SN 85-357,951, FILED 6-28-2011.

SHANNON TWOHIG, EXAMINING ATTORNEY



David J. Kyffers

Director of the United States Patent and Trademark Office

United States of America

United States Patent and Trademark Office

GROW YOUR GIGGLE

Reg. No. 4,176,958

FIFI DELISH (ILLINOIS LIMITED LIABILITY COMPANY)

Registered July 17, 2012

209 W MADISON
DIVERNON, IL 62530

Int. Cl.: 44

FOR: PROVIDING A WEBSITE FEATURING INFORMATION AND ADVICE IN THE FIELD OF CHILDREN'S WELLNESS, HEALTH, AND NUTRITION, IN CLASS 44 (U.S. CLS. 100 AND 101).

SERVICE MARK

FIRST USE 12-24-2011; IN COMMERCE 12-24-2011.

PRINCIPAL REGISTER

THE MARK CONSISTS OF STANDARD CHARACTERS WITHOUT CLAIM TO ANY PARTICULAR FONT, STYLE, SIZE, OR COLOR.

SN 85-358,963, FILED 6-29-2011.

AMY KELLY, EXAMINING ATTORNEY



David J. Kyffers

Director of the United States Patent and Trademark Office

United States of America
United States Patent and Trademark Office

NANO-ID

Reg. No. 4,176,959

PARTICLE MEASURING SYSTEMS, INC. (COLORADO CORPORATION)
5475 AIRPORT BOULEVARD
BOULDER, CO 80301

Registered July 17, 2012

Int. Cl.: 9

FOR: AIR QUALITY PARTICLE ANALYZERS FOR SENSING AND CHARACTERIZING PARTICLES INCLUDING PARTICLE COUNTERS, PARTICLE MASS ANALYZERS, PARTICLE SPECTROMETERS, PARTICLE MOBILITY CLASSIFIERS AND PARTICLE SIZE CLASSIFIERS, IN CLASS 9 (U.S. CLS. 21, 23, 26, 36 AND 38).

TRADEMARK

PRINCIPAL REGISTER

FIRST USE 8-18-2010; IN COMMERCE 10-14-2011.

THE MARK CONSISTS OF STANDARD CHARACTERS WITHOUT CLAIM TO ANY PARTICULAR FONT, STYLE, SIZE, OR COLOR.

OWNER OF U.S. REG. NO. 3,835,902.

SN 85-360,549, FILED 6-30-2011.

EMILY CARLSEN, EXAMINING ATTORNEY



David J. Kybas

Director of the United States Patent and Trademark Office

United States of America

United States Patent and Trademark Office

ABS PLUS

Reg. No. 4,176,960

Registered July 17, 2012

Int. Cl.: 17

TRADEMARK

PRINCIPAL REGISTER

CHARLOTTE PIPE AND FOUNDRY COMPANY (NORTH CAROLINA CORPORATION)
POST OFFICE BOX 35430
2109 RANDOLPH ROAD
CHARLOTTE, NC 282355430

FOR: PLASTIC PLUMBING PIPES, IN CLASS 17 (U.S. CLS. 1, 5, 12, 13, 35 AND 50).

FIRST USE 4-24-2012; IN COMMERCE 4-24-2012.

THE MARK CONSISTS OF STANDARD CHARACTERS WITHOUT CLAIM TO ANY PARTICULAR FONT, STYLE, SIZE, OR COLOR.

NO CLAIM IS MADE TO THE EXCLUSIVE RIGHT TO USE "ABS", APART FROM THE MARK AS SHOWN.

SN 85-360,604, FILED 6-30-2011.

ALAIN LAPTER, EXAMINING ATTORNEY



David J. Kyffers

Director of the United States Patent and Trademark Office

United States of America

United States Patent and Trademark Office

THRIFT STUDIO

Reg. No. 4,176,961

DWELL WITH DIGNITY FOUNDATION, INC. (TEXAS NON-PROFIT CORPORATION)
1920 ABRAMS PARKWAY, #325
DALLAS, TX 75214

Registered July 17, 2012

Int. Cls.: 35 and 36

FOR: RETAIL STORE SERVICES FEATURING A WIDE VARIETY OF CONSUMER GOODS OF OTHERS, IN CLASS 35 (U.S. CLS. 100, 101 AND 102).

SERVICE MARK

FIRST USE 9-30-2011; IN COMMERCE 9-30-2011.

PRINCIPAL REGISTER

FOR: CHARITABLE FUNDRAISING SERVICES, IN CLASS 36 (U.S. CLS. 100, 101 AND 102).

FIRST USE 9-30-2011; IN COMMERCE 9-30-2011.

THE MARK CONSISTS OF STANDARD CHARACTERS WITHOUT CLAIM TO ANY PARTICULAR FONT, STYLE, SIZE, OR COLOR.

NO CLAIM IS MADE TO THE EXCLUSIVE RIGHT TO USE "THRIFT" IN INTERNATIONAL CLASS 35, APART FROM THE MARK AS SHOWN.

SN 85-360,822, FILED 6-30-2011.

BARBARA GAYNOR, EXAMINING ATTORNEY



David J. Kybas

Director of the United States Patent and Trademark Office

United States of America

United States Patent and Trademark Office

Time Dog

Reg. No. 4,176,962

Registered July 17, 2012

Int. Cl.: 45

SERVICE MARK

PRINCIPAL REGISTER

ITELL VENTURES, INC. (FLORIDA CORPORATION), DBA TIME DOG,
SUITE 906
412 EAST MADISON STREET
TAMPA, FL 33602

FOR: PERSONAL CONCIERGE SERVICES FOR OTHERS COMPRISING MAKING REQUESTED PERSONAL ARRANGEMENTS, RESERVATIONS AND PROVIDING CUSTOMER SPECIFIC INFORMATION TO MEET INDIVIDUAL NEEDS THROUGH ON-LINE GENERAL INFORMATION SEARCHES, PRODUCT SEARCHES AND GEOGRAPHIC LOCATION-BASED SEARCHES, ALL RENDERED IN A VIRTUAL CAPACITY, PERFORMED REMOTELY, IN CLASS 45 (U.S. CLS. 100 AND 101).

FIRST USE 2-25-2012; IN COMMERCE 2-25-2012.

THE MARK CONSISTS OF STANDARD CHARACTERS WITHOUT CLAIM TO ANY PARTICULAR FONT, STYLE, SIZE, OR COLOR.

SN 85-360,852, FILED 6-30-2011.

KATHLEEN LORENZO, EXAMINING ATTORNEY



David J. Kyffers

Director of the United States Patent and Trademark Office

United States of America

United States Patent and Trademark Office

ARTIST SERIES

Reg. No. 4,176,963

WAHL CLIPPER CORPORATION (ILLINOIS CORPORATION)
2900 NORTH LOCUST STREET
STERLING, IL 610810578

Registered July 17, 2012

Int. Cl.: 8

FOR: ELECTRIC AND BATTERY-POWERED HAIR CLIPPERS; ELECTRIC AND BATTERY-POWERED HAIR TRIMMERS, IN CLASS 8 (U.S. CLS. 23, 28 AND 44).

TRADEMARK

FIRST USE 9-0-2011; IN COMMERCE 9-0-2011.

PRINCIPAL REGISTER

THE MARK CONSISTS OF STANDARD CHARACTERS WITHOUT CLAIM TO ANY PARTICULAR FONT, STYLE, SIZE, OR COLOR.

NO CLAIM IS MADE TO THE EXCLUSIVE RIGHT TO USE "SERIES", APART FROM THE MARK AS SHOWN.

SN 85-361,794, FILED 7-1-2011.

TAMARA FRAZIER, EXAMINING ATTORNEY



David J. Kyffers

Director of the United States Patent and Trademark Office

United States of America

United States Patent and Trademark Office

Try Me Mardi Gras

Reg. No. 4,176,964

HARRINGTON, EVERETT (UNITED STATES INDIVIDUAL)
16414 OAK ROCK ST.
SAN ANTONIO, TX 78247

Registered July 17, 2012

Int. Cl.: 30

FOR: SPICES, IN CLASS 30 (U.S. CL. 46).

TRADEMARK

FIRST USE 2-3-2003; IN COMMERCE 2-3-2003.

PRINCIPAL REGISTER

THE MARK CONSISTS OF STANDARD CHARACTERS WITHOUT CLAIM TO ANY PARTICULAR FONT, STYLE, SIZE, OR COLOR.

SN 85-362,918, FILED 7-5-2011.

FRANK LATTUCA, EXAMINING ATTORNEY



David J. Kyffers

Director of the United States Patent and Trademark Office

United States of America

United States Patent and Trademark Office

Spotster

Reg. No. 4,176,965

Registered July 17, 2012

Int. Cls.: 41 and 45

SERVICE MARK

PRINCIPAL REGISTER

SPOTSTER INC. (DELAWARE CORPORATION)
93 SECOND AVENUE, APT 3
NEW YORK, NY 10003

FOR: PROVIDING AN INTERACTIVE WEBSITE FEATURING INFORMATION ABOUT ENTERTAINMENT, EDUCATION AND RECREATION, IN CLASS 41 (U.S. CLS. 100, 101 AND 107).

FIRST USE 7-20-2011; IN COMMERCE 7-20-2011.

FOR: ONLINE SOCIAL NETWORKING SERVICES PROVIDED THROUGH AN INTERACTIVE COMMUNITY WEBSITE, IN CLASS 45 (U.S. CLS. 100 AND 101).

FIRST USE 7-20-2011; IN COMMERCE 7-20-2011.

THE MARK CONSISTS OF STANDARD CHARACTERS WITHOUT CLAIM TO ANY PARTICULAR FONT, STYLE, SIZE, OR COLOR.

SN 85-362,994, FILED 7-5-2011.

IRA J. GOODSaid, EXAMINING ATTORNEY



David J. Kyffers

Director of the United States Patent and Trademark Office

United States of America

United States Patent and Trademark Office

PHANTOM

Reg. No. 4,176,966

Registered July 17, 2012

Int. Cl.: 16

TRADEMARK

PRINCIPAL REGISTER

MEGA BRANDS INTERNATIONAL, LUXEMBOURG, ZUG BRANCH (LUXEMBOURG CORPORATION)
POSTSTRASSE 6
ZUG, SWITZERLAND CH-6300

FOR: WRITING INSTRUMENTS; DRAWING INSTRUMENTS; BALL POINT PENS, GEL INK PENS, MECHANICAL PENCILS, PENCILS, ERASERS, IN CLASS 16 (U.S. CLS. 2, 5, 22, 23, 29, 37, 38 AND 50).

FIRST USE 3-0-2012; IN COMMERCE 3-0-2012.

THE MARK CONSISTS OF STANDARD CHARACTERS WITHOUT CLAIM TO ANY PARTICULAR FONT, STYLE, SIZE, OR COLOR.

SN 85-363,236, FILED 7-5-2011.

JENNIFER VASQUEZ, EXAMINING ATTORNEY



David J. Kybas

Director of the United States Patent and Trademark Office

United States of America

United States Patent and Trademark Office

Litter Getter

Reg. No. 4,176,967

RHEA CATTLE COMPANY (NEBRASKA CORPORATION)

Registered July 17, 2012

5935 MCCALL LANE
ARLINGTON, NE 68002

Int. Cl.: 28

FOR: CAT LITTER ADDITIVE, NAMELY, ALL-NATURAL ANIMAL ATTRACTANT SCENTS FOR ATTRACTING CATS TO THE LITTER BOX, IN CLASS 28 (U.S. CLS. 22, 23, 38 AND 50).

TRADEMARK

FIRST USE 9-1-2011; IN COMMERCE 9-1-2011.

PRINCIPAL REGISTER

THE MARK CONSISTS OF STANDARD CHARACTERS WITHOUT CLAIM TO ANY PARTICULAR FONT, STYLE, SIZE, OR COLOR.

NO CLAIM IS MADE TO THE EXCLUSIVE RIGHT TO USE "LITTER", APART FROM THE MARK AS SHOWN.

SN 85-363,879, FILED 7-6-2011.

ESTHER BELENKER, EXAMINING ATTORNEY



David J. Kybas

Director of the United States Patent and Trademark Office

United States of America

United States Patent and Trademark Office

WEB OUT

Reg. No. 4,176,968

NISUS CORPORATION (TENNESSEE CORPORATION)
100 NISUS DRIVE
ROCKFORD, TN 37853

Registered July 17, 2012

Int. Cl.: 1

FOR: LIQUID CHEMICAL PREPARATIONS FOR APPLICATION TO SURFACES FOR TREATING THE SURFACES TO DETER SPIDERS FROM FORMING WEBS ON THE TREATED SURFACES, IN CLASS 1 (U.S. CLS. 1, 5, 6, 10, 26 AND 46).

TRADEMARK

FIRST USE 1-1-2012; IN COMMERCE 1-1-2012.

PRINCIPAL REGISTER

THE MARK CONSISTS OF STANDARD CHARACTERS WITHOUT CLAIM TO ANY PARTICULAR FONT, STYLE, SIZE, OR COLOR.

NO CLAIM IS MADE TO THE EXCLUSIVE RIGHT TO USE "WEB", APART FROM THE MARK AS SHOWN.

SN 85-364,548, FILED 7-6-2011.

MICHELLE DUBOIS, EXAMINING ATTORNEY



David J. Kyffers

Director of the United States Patent and Trademark Office

United States of America

United States Patent and Trademark Office



Reg. No. 4,176,969

ZHEJIANG LEO CO., LTD (CHINA CORPORATION)
NO.1 LEO ROAD, BINHAI TOWN
WENLING, ZHEJIANG, CHINA

Registered July 17, 2012

Int. Cl.: 7

FOR: AQUARIUM PUMPS; DYNAMOS; MOTORS OTHER THAN FOR LAND VEHICLES;
PUMPS AS PARTS OF MACHINES, MOTORS AND ENGINES; PUMPS FOR MACHINES;
STARTERS FOR MOTORS AND ENGINES; VACUUM PUMPS; WATER PUMPS FOR LAND
VEHICLES, IN CLASS 7 (U.S. CLS. 13, 19, 21, 23, 31, 34 AND 35).

TRADEMARK

PRINCIPAL REGISTER

FIRST USE 11-15-2011; IN COMMERCE 11-15-2011.

SN 85-364,874, FILED 7-7-2011.

LEIGH LOWRY, EXAMINING ATTORNEY



David J. Kyffers

Director of the United States Patent and Trademark Office

United States of America

United States Patent and Trademark Office

HOLY DRIVER

Reg. No. 4,176,970

Registered July 17, 2012

Int. Cl.: 15

TRADEMARK

PRINCIPAL REGISTER

ETI SOUND SYSTEMS, INC. (CALIFORNIA CORPORATION)
3383 E. GAGE AVENUE
HUNTINGTON PARK, CA 90255

FOR: GUITAR PEDALS, IN CLASS 15 (U.S. CLS. 2, 21 AND 36).

FIRST USE 4-17-2012; IN COMMERCE 4-17-2012.

THE MARK CONSISTS OF STANDARD CHARACTERS WITHOUT CLAIM TO ANY PARTICULAR FONT, STYLE, SIZE, OR COLOR.

SN 85-365,423, FILED 7-7-2011.

EMILY CHUO, EXAMINING ATTORNEY



David J. Kyffers

Director of the United States Patent and Trademark Office

United States of America

United States Patent and Trademark Office

DON'T FORGET TO TAKE THEM
OFF

Reg. No. 4,176,971

AETREX WORLDWIDE, INC. (NEW JERSEY CORPORATION)
414 ALFRED AVENUE
TEANECK, NJ 07666

Registered July 17, 2012

Int. Cl.: 25

FOR: FOOTWEAR, IN CLASS 25 (U.S. CLS. 22 AND 39).

TRADEMARK

FIRST USE 1-1-2012; IN COMMERCE 1-1-2012.

PRINCIPAL REGISTER

THE MARK CONSISTS OF STANDARD CHARACTERS WITHOUT CLAIM TO ANY PARTICULAR FONT, STYLE, SIZE, OR COLOR.

SN 85-365,425, FILED 7-7-2011.

EMILY CHUO, EXAMINING ATTORNEY



David J. Kyffers

Director of the United States Patent and Trademark Office

United States of America

United States Patent and Trademark Office

PORFI BALOA Y SUS ADOLESCENTES

Reg. No. 4,176,972

BALOA DIAZ, VICTOR PORFIRIO (VENEZUELA INDIVIDUAL)
244 5TH AVENUE, SUITE 1756
NEW YORK, NY 10001

Registered July 17, 2012

Int. Cl.: 41

FOR: ENTERTAINMENT SERVICES IN THE NATURE OF LIVE MUSICAL PERFORMANCES;
LIVE PERFORMANCES BY A MUSICAL GROUP; ORCHESTRA SERVICES , IN CLASS 41
(U.S. CLS. 100, 101 AND 107).

SERVICE MARK

FIRST USE 4-14-2012; IN COMMERCE 4-14-2012.

PRINCIPAL REGISTER

THE MARK CONSISTS OF STANDARD CHARACTERS WITHOUT CLAIM TO ANY PARTICULAR FONT, STYLE, SIZE, OR COLOR.

THE NAME VICTOR PORFIRIO "BALOA" DIAZ IDENTIFIES A LIVING INDIVIDUAL WHOSE CONSENT IS OF RECORD.

THE ENGLISH TRANSLATION OF "Y SUS ADOLESCENTES" IN THE MARK IS "AND HIS TEENAGERS".

SN 85-365,528, FILED 7-7-2011.

TARAH HARDY, EXAMINING ATTORNEY



David J. Kyros

Director of the United States Patent and Trademark Office

United States of America

United States Patent and Trademark Office

Board Stiff

Reg. No. 4,176,973

DAVIS, RUSSELL A (UNITED STATES INDIVIDUAL)
801 PAFKO ST

Registered July 17, 2012

MYRTLE BEACH, SC 29588

Int. Cl.: 25

FOR: A-SHIRTS; APPAREL FOR DANCERS, NAMELY, TEE SHIRTS, SWEATSHIRTS, PANTS, LEGGINGS, SHORTS AND JACKETS; ATHLETIC APPAREL, NAMELY, SHIRTS, PANTS, JACKETS, FOOTWEAR, HATS AND CAPS, ATHLETIC UNIFORMS; BODY SHIRTS; BUTTON DOWN SHIRTS, IN CLASS 25 (U.S. CLS. 22 AND 39).

TRADEMARK

PRINCIPAL REGISTER

FIRST USE 12-1-2011; IN COMMERCE 12-1-2011.

THE MARK CONSISTS OF STANDARD CHARACTERS WITHOUT CLAIM TO ANY PARTICULAR FONT, STYLE, SIZE, OR COLOR.

SN 85-365,564, FILED 7-7-2011.

KAREN SEVERSON, EXAMINING ATTORNEY



David J. Kyffers

Director of the United States Patent and Trademark Office

United States of America

United States Patent and Trademark Office

ACXIOM RECOGNITION MANAGER

Reg. No. 4,176,974

Registered July 17, 2012

Int. Cl.: 35

SERVICE MARK

PRINCIPAL REGISTER

ACXIOM CORPORATION (DELAWARE CORPORATION)
601 EAST THIRD ST.
LITTLE ROCK, AR 72201

FOR: BUSINESS INFORMATION SERVICES, NAMELY, DATA STANDARDIZATION, CORRECTION, AND SUPPLEMENTATION, NAMELY, COMPILATION AND SYSTEMIZATION OF INFORMATION, NAMELY, INFORMATION IN THE NATURE OF THE CUSTOMER DATA OF OTHERS ACROSS MULTIPLE BUSINESS CHANNELS AND DISPARATE DATA SOURCES, IN DATABANKS AND INTO COMPUTER DATABASES TO PROVIDE RELEVANT CUSTOMER DATA FOR INTERACTION WITH RETAIL AND BUSINESS CUSTOMERS, IN CLASS 35 (U.S. CLS. 100, 101 AND 102).

FIRST USE 8-12-2011; IN COMMERCE 8-12-2011.

THE MARK CONSISTS OF STANDARD CHARACTERS WITHOUT CLAIM TO ANY PARTICULAR FONT, STYLE, SIZE, OR COLOR.

OWNER OF U.S. REG. NOS. 3,131,496, 3,472,367, AND OTHERS.

NO CLAIM IS MADE TO THE EXCLUSIVE RIGHT TO USE "RECOGNITION MANAGER", APART FROM THE MARK AS SHOWN.

SN 85-365,618, FILED 7-7-2011.

SETH A. RAPPAPORT, EXAMINING ATTORNEY



David J. Kybas

Director of the United States Patent and Trademark Office

United States of America

United States Patent and Trademark Office

FUNNY SIDE UP

Reg. No. 4,176,975

Registered July 17, 2012

Int. Cl.: 28

TRADEMARK

PRINCIPAL REGISTER

MATTEL, INC. (DELAWARE CORPORATION)
M1-1518
333 CONTINENTAL BOULEVARD
EL SEGUNDO, CA 90245

FOR: TOY VEHICLES AND ACCESSORIES THEREFOR, IN CLASS 28 (U.S. CLS. 22, 23, 38 AND 50).

FIRST USE 4-3-2012; IN COMMERCE 4-3-2012.

THE MARK CONSISTS OF STANDARD CHARACTERS WITHOUT CLAIM TO ANY PARTICULAR FONT, STYLE, SIZE, OR COLOR.

SN 85-365,647, FILED 7-7-2011.

STEPHANIE ALI, EXAMINING ATTORNEY



David J. Kyffers

Director of the United States Patent and Trademark Office

United States of America

United States Patent and Trademark Office

PayrollCentric

Reg. No. 4,176,976

Registered July 17, 2012

Int. Cl.: 35

SERVICE MARK

PRINCIPAL REGISTER

NETPAY SERVICES INC (CALIFORNIA CORPORATION)
STE 432
5250 W. CENTURY BLVD
LOS ANGELES, CA 90045

FOR: ADMINISTRATION OF BUSINESS PAYROLL FOR OTHERS; PAYROLL PREPARATION; PAYROLL PROCESSING SERVICES, IN CLASS 35 (U.S. CLS. 100, 101 AND 102).

FIRST USE 2-1-2012; IN COMMERCE 2-1-2012.

THE MARK CONSISTS OF STANDARD CHARACTERS WITHOUT CLAIM TO ANY PARTICULAR FONT, STYLE, SIZE, OR COLOR.

SN 85-365,842, FILED 7-7-2011.

BRENDAN MCCAULEY, EXAMINING ATTORNEY



David J. Kybas

Director of the United States Patent and Trademark Office

United States of America

United States Patent and Trademark Office

RxLINK

Reg. No. 4,176,977

Registered July 17, 2012

Int. Cls.: 9 and 42

TRADEMARK

SERVICE MARK

PRINCIPAL REGISTER

UNIVERSITY HEALTHSYSTEM CONSORTIUM (ILLINOIS NON-PROFIT CORPORATION)
155 NORTH WACKER DRIVE
CHICAGO, IL 60606

FOR: COMPUTER APPLICATION SOFTWARE FOR MOBILE PHONES, PORTABLE MEDIA PLAYERS, PORTABLE AND HANDHELD COMPUTERS, PORTABLE AND HANDHELD DIGITAL ELECTRONIC DEVICES, CONSUMER ELECTRONIC DEVICES, PERSONAL DIGITAL ASSISTANTS, NAMELY, SOFTWARE FOR COST PRICE ANALYSIS, SUPPLY CHAIN ANALYSIS, TRADE SPEND BUSINESS MANAGEMENT, COMPILATION OF BUSINESS PRICE AND STATISTICAL INFORMATION, COST MANAGEMENT SERVICES, COST ANALYSES, COST ASSESSMENT SERVICES, COST CONTAINMENT, SHORTAGE REPORTS, PRODUCT RECALL REPORTS, ALL IN THE FIELD OF PHARMACEUTICALS, IN CLASS 9 (U.S. CLS. 21, 23, 26, 36 AND 38).

FIRST USE 2-0-2012; IN COMMERCE 2-0-2012.

FOR: PROVIDING ON-LINE NON-DOWNLOADABLE SOFTWARE FOR COST PRICE ANALYSIS, SUPPLY CHAIN ANALYSIS, TRADE SPEND BUSINESS MANAGEMENT, COMPILATION OF BUSINESS PRICE AND STATISTICAL INFORMATION, COST MANAGEMENT SERVICES, COST ANALYSES, COST ASSESSMENT SERVICES, COST CONTAINMENT, SHORTAGE REPORTS, PRODUCT RECALL REPORTS, ALL IN THE FIELD OF PHARMACEUTICALS, IN CLASS 42 (U.S. CLS. 100 AND 101).

FIRST USE 11-0-2011; IN COMMERCE 11-0-2011.

THE MARK CONSISTS OF STANDARD CHARACTERS WITHOUT CLAIM TO ANY PARTICULAR FONT, STYLE, SIZE, OR COLOR.

OWNER OF U.S. REG. NO. 3,688,515.

SN 85-366,328, FILED 7-8-2011.

CAROLYN CATALDO, EXAMINING ATTORNEY



David J. Kyffers

Director of the United States Patent and Trademark Office

United States of America

United States Patent and Trademark Office

HighGlide

Reg. No. 4,176,978

TRICO PRODUCTS CORPORATION (NEW YORK CORPORATION)
3255 WEST HAMLIN ROAD
ROCHESTER HILLS, MI 48309

Registered July 17, 2012

Int. Cl.: 12

FOR: RUBBER ELEMENT SOLD AS A COMPONENT OF WINDSHIELD WIPER BLADES FOR VEHICLES FEATURING A COATING FOR ENHANCING PERFORMANCE CHARACTERISTICS OF THE BLADES , IN CLASS 12 (U.S. CLS. 19, 21, 23, 31, 35 AND 44).

TRADEMARK

FIRST USE 10-31-2011; IN COMMERCE 10-31-2011.

PRINCIPAL REGISTER

THE MARK CONSISTS OF STANDARD CHARACTERS WITHOUT CLAIM TO ANY PARTICULAR FONT, STYLE, SIZE, OR COLOR.

SN 85-366,348, FILED 7-8-2011.

HAI-LY LAM, EXAMINING ATTORNEY



David J. Kyffers

Director of the United States Patent and Trademark Office

United States of America

United States Patent and Trademark Office

HEARTS+CRAFTS
Grief Counseling

Reg. No. 4,176,979

Registered July 17, 2012

Int. Cl.: 45

SERVICE MARK

PRINCIPAL REGISTER

HEARTS & CRAFTS COUNSELING, LLC (NEW JERSEY LIMITED LIABILITY COMPANY),
DBA HEARTS & CRAFTS GRIEF COUNSELING,
60 EAST MAIN ST.
RAMSEY, NJ 07446

FOR: GRIEF COUNSELING, IN CLASS 45 (U.S. CLS. 100 AND 101).

FIRST USE 7-20-2011; IN COMMERCE 2-14-2012.

NO CLAIM IS MADE TO THE EXCLUSIVE RIGHT TO USE "GRIEF COUNSELING", APART FROM THE MARK AS SHOWN.

THE MARK CONSISTS OF THE STYLIZED WORD "HEARTS" TO THE RIGHT OF A STYLIZED HEART CONTAINING A STYLIZED PLUS MARK TO THE LEFT OF THE STYLIZED "CRAFTS" ABOVE A STYLIZED LINE CONTAINING THE STYLIZED WORD "GRIEF COUNSELING" UNDER "CRAFTS".

SN 85-366,831, FILED 7-8-2011.

ELI HELLMAN, EXAMINING ATTORNEY



David J. Kyros

Director of the United States Patent and Trademark Office

United States of America

United States Patent and Trademark Office

NERVITAN

Reg. No. 4,176,980

Registered July 17, 2012

Int. Cl.: 5

TRADEMARK

PRINCIPAL REGISTER

COMERCIALIZADORA MD, S.A. DE C.V. (MEXICO CORPORATION)
INDUSTRIA HULERA #97
FRACCIONAMIENTO INDUSTRIAL ZAPOPAN NORTE
ZAPOPAN, JALISCO, MEXICO C.P.45130

FOR: DIETARY AND NUTRITIONAL SUPPLEMENTS; FOOD SUPPLEMENTS, IN CLASS
5 (U.S. CLS. 6, 18, 44, 46, 51 AND 52).

FIRST USE 4-8-2012; IN COMMERCE 4-8-2012.

THE MARK CONSISTS OF STANDARD CHARACTERS WITHOUT CLAIM TO ANY PAR-
TICULAR FONT, STYLE, SIZE, OR COLOR.

SN 85-366,873, FILED 7-8-2011.

AMY KERTGATE, EXAMINING ATTORNEY



David J. Kyffers

Director of the United States Patent and Trademark Office

United States of America

United States Patent and Trademark Office

ADVENTURE GIRLZ

Reg. No. 4,176,981

Registered July 17, 2012

Int. Cl.: 28

TRADEMARK

PRINCIPAL REGISTER

PARADISE KIDS, LLC (CONNECTICUT LIMITED LIABILITY COMPANY)
28 ROCK RIDGE AVENUE
GREENWICK, CT 06831

FOR: DOLL ACCESSORIES; DOLL CASES; DOLL CLOTHING; DOLL FURNITURE; DOLLS;
DOLLS AND ACCESSORIES THEREFOR; DOLLS AND DOLLS' CLOTHING; DOLLS AND
PLAYSETS THEREFOR; DOLLS' CLOTHES; DOLLS' FEEDING BOTTLES; PLUSH DOLLS;
RAG DOLLS; STUFFED DOLLS AND ANIMALS; DOLL VEHICLES; DOLL HOUSES, IN
CLASS 28 (U.S. CLS. 22, 23, 38 AND 50).

FIRST USE 10-1-2011; IN COMMERCE 10-1-2011.

THE MARK CONSISTS OF STANDARD CHARACTERS WITHOUT CLAIM TO ANY PAR-
TICULAR FONT, STYLE, SIZE, OR COLOR.

NO CLAIM IS MADE TO THE EXCLUSIVE RIGHT TO USE "GIRLS", APART FROM THE
MARK AS SHOWN.

SN 85-367,155, FILED 7-8-2011.

WILLIAM VERHOSEK, EXAMINING ATTORNEY



David J. Kyfos

Director of the United States Patent and Trademark Office

United States of America

United States Patent and Trademark Office

MoMeet

Reg. No. 4,176,982

Registered July 17, 2012

Int. Cls.: 9 and 38

TRADEMARK

SERVICE MARK

PRINCIPAL REGISTER

SOFTFOUNDRY INTERNATIONAL PTE LTD (SINGAPORE CORPORATION)
JONI@SOFTFOUNDRY.COM
63, KAKI BUKIT PLACE #07-01,
SINGAPORE, SINGAPORE 416234

FOR: COMPUTER SOFTWARE FOR CONTROLLING AND MANAGING ACCESS SERVER APPLICATIONS; COMPUTER SOFTWARE, NAMELY, SOFTWARE DEVELOPMENT TOOLS FOR THE CREATION OF MOBILE INTERNET APPLICATIONS AND CLIENT INTERFACES; SOFTWARE FOR COMMUNICATIONS AND CONFERENCING SERVICES, NAMELY, SOFTWARE FOR USE IN PROVIDING ACCESS TO TELEPHONE, VIDEO, DATA AND INTERNET CONFERENCES; SOFTWARE FOR PROCESSING, TRANSMITTING, RECEIVING, RECORDING, REPRODUCING, AND MANAGING SOUND, IMAGES, AND DATA IN ONLINE AND MOBILE MEETINGS AND CONFERENCES; COMMUNICATIONS SOFTWARE FOR USE IN CONNECTING USERS OF COMPUTER NETWORKS, WIRELESS ELECTRONIC COMMUNICATIONS DEVICES, COMMUNICATIONS NETWORKS, INFORMATION SERVICES NETWORKS, DATA NETWORKS, LOCAL COMPUTER NETWORKS, GLOBAL COMPUTER NETWORKS, AND THE INTERNET; SOFTWARE FOR USE IN PROCESSING, TRANSMITTING, RECEIVING, RECORDING, REPRODUCING, AND MANAGING VOICE, MESSAGES, DATA, DOCUMENTS, SIGNALS, IMAGES, VIDEO, DIGITAL MEDIA CONTENT, AND AUDIO, VISUAL, AND AUDIOVISUAL MATERIALS VIA COMPUTERS, ELECTRONIC DEVICES, COMMUNICATIONS NETWORKS, INFORMATION SERVICES NETWORKS, DATA NETWORKS, LOCAL COMPUTER NETWORKS, GLOBAL COMPUTER NETWORKS, AND THE INTERNET; SOFTWARE PLATFORMS FOR SCHEDULING, HOSTING, JOINING, MANAGING, AND STREAMING AUDIO CONFERENCES, NETWORK CONFERENCES, TELECONFERENCES, TELEPHONE CONFERENCES, VIDEO CONFERENCES, VIDEO TELECONFERENCES, DATA CONFERENCE, VOICE OVER INTERNET PROTOCOL (VOIP) CONFERENCES, WEB CONFERENCES, AND INSTANT MESSAGING VIA THE INTERNET, IN CLASS 9 (U.S. CLS. 21, 23, 26, 36 AND 38).

FIRST USE 12-20-2011; IN COMMERCE 12-20-2011.

FOR: AUDIO AND VIDEO TELECONFERENCING WITH APPLICATION PROGRAMS SHARING; COMMUNICATIONS AND CONFERENCING SERVICES, NAMELY, PROVIDING TELEPHONE, VIDEO AND INTERNET COMMUNICATIONS SERVICES AND EQUIPMENT FOR TELEPHONE, VIDEO AND INTERNET CONFERENCING; COMMUNICATION SERVICES, NAMELY, TRANSMITTING AND STREAMING VOICE, MESSAGES, DATA, DOCUMENTS, SIGNALS, IMAGES, VIDEO, DIGITAL MEDIA CONTENT, AND AUDIO, VISUAL,



David J. Kyjars

Director of the United States Patent and Trademark Office

Reg. No. 4,176,982 AND AUDIOVISUAL MATERIALS VIA COMPUTERS, ELECTRONIC DEVICES, MOBILE PHONE, TABLET PC, COMMUNICATIONS NETWORKS, INFORMATION SERVICES NETWORKS, DATA NETWORKS, LOCAL COMPUTER NETWORKS, GLOBAL COMPUTER NETWORKS, AND THE INTERNET; PROVIDING ACCESS AND CONNECTIONS TO MULTINATIONAL TELECOMMUNICATION NETWORKS; INSTANT MESSAGING SERVICES; INTERACTIVE DELIVERY OF VIDEO OVER DIGITAL NETWORKS; PROVIDING ACCESS AND CONNECTIONS TO COMMUNICATIONS VIA TELECOMMUNICATION NETWORKS; PROVIDING ACCESS AND CONNECTIONS TO LOCAL COMPUTER NETWORKS, GLOBAL COMPUTER NETWORKS, AND THE INTERNET , IN CLASS 38 (U.S. CLS. 100, 101 AND 104).

FIRST USE 12-20-2011; IN COMMERCE 12-20-2011.

THE MARK CONSISTS OF STANDARD CHARACTERS WITHOUT CLAIM TO ANY PARTICULAR FONT, STYLE, SIZE, OR COLOR.

SN 85-367,240, FILED 7-9-2011.

MARC LEIPZIG, EXAMINING ATTORNEY

United States of America

United States Patent and Trademark Office

TAKE ROOT



Reg. No. 4,176,983

Registered July 17, 2012

Int. Cls.: 16 and 25

TRADEMARK

PRINCIPAL REGISTER

DUHN, DEBORAH L (UNITED STATES INDIVIDUAL), DBA DUHN & ASSOCIATES,
94608 TURNBOW LANE
JUNCTION CITY, OR 97448

FOR: MAGAZINES IN THE FIELD OF FOOD, IN CLASS 16 (U.S. CLS. 2, 5, 22, 23, 29, 37, 38 AND 50).

FIRST USE 10-8-2011; IN COMMERCE 10-8-2011.

FOR: ATHLETIC APPAREL, NAMELY, SHIRTS, PANTS, JACKETS, FOOTWEAR, HATS AND CAPS, ATHLETIC UNIFORMS, IN CLASS 25 (U.S. CLS. 22 AND 39).

FIRST USE 11-3-2011; IN COMMERCE 11-3-2011.

NO CLAIM IS MADE TO THE EXCLUSIVE RIGHT TO USE "ROOT", APART FROM THE MARK AS SHOWN.

THE MARK CONSISTS OF THE WORDING "TAKE ROOT" IN TRAJAN PRO WITH A ROOT DESIGN BELOW THE T.

SN 85-367,487, FILED 7-10-2011.

SHAILA SETTLES, EXAMINING ATTORNEY



David J. Kyffers

Director of the United States Patent and Trademark Office

United States of America

United States Patent and Trademark Office

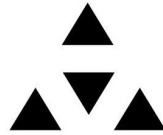

Reg. No. 4,176,984

BALANCED TECH CORP. (NEW YORK CORPORATION)
37 W. 37TH STREET
NEW YORK, NY 10018

Registered July 17, 2012

Int. Cl.: 25

FOR: CLOTHING, NAMELY, T-SHIRTS, SHIRTS, SWEATERS, SHORTS, UNDERWEAR, SLEEPWEAR, SWIMWEAR, BRAS, AND SOCKS, IN CLASS 25 (U.S. CLS. 22 AND 39).

TRADEMARK

FIRST USE 4-13-2012; IN COMMERCE 4-13-2012.

PRINCIPAL REGISTER

THE MARK CONSISTS OF A TRIANGLE DESIGN.

SN 85-367,570, FILED 7-11-2011.

ESTHER BELENKER, EXAMINING ATTORNEY



David J. Kyffers

Director of the United States Patent and Trademark Office

United States of America

United States Patent and Trademark Office

CabinComfortPlus

Reg. No. 4,176,985

HAWKER BEECHCRAFT CORPORATION (KANSAS CORPORATION)
10511 EAST CENTRAL
WICHITA, KS 67206

Registered July 17, 2012

Int. Cl.: 11

FOR: CLIMATE CONTROL SYSTEMS FOR FIXED-WING AIRCRAFT CONSISTING
PRIMARILY OF THERMOSTATS, AIR CONDITIONING, HEATING AND VENTILATION
CONTROL DEVICES, IN CLASS 11 (U.S. CLS. 13, 21, 23, 31 AND 34).

TRADEMARK

FIRST USE 0-0-2011; IN COMMERCE 0-0-2011.

PRINCIPAL REGISTER

THE MARK CONSISTS OF STANDARD CHARACTERS WITHOUT CLAIM TO ANY PAR-
TICULAR FONT, STYLE, SIZE, OR COLOR.

SN 85-367,591, FILED 7-11-2011.

CAROLYN CATALDO, EXAMINING ATTORNEY



David J. Kyffers

Director of the United States Patent and Trademark Office

United States of America
United States Patent and Trademark Office

BIKI

Reg. No. 4,176,986

Registered July 17, 2012

Int. Cl.: 9

TRADEMARK

PRINCIPAL REGISTER

A PERSONAL DIETITIAN COMPANY (CALIFORNIA SOLE PROPRIETORSHIP), AKA
PERSONALDIETS,
1640 BARRETT DRIVE
PLACERVILLE, CA 95667

FOR: COMPUTER APPLICATION SOFTWARE FOR MOBILE PHONES, PORTABLE MEDIA PLAYERS, HANDHELD COMPUTERS, NAMELY, SOFTWARE FOR DIET PLANS THAT PROVIDE USERS SEMI-CUSTOM DIETS BASED ON HEALTH OR WELLNESS NEEDS, NAMELY, SPECIFIC NUTRITION DATA, NUTRITION GUIDELINES, GROCERY LISTS, AS WELL AS PERSONALIZED DIET RECOMMENDATIONS AND DIET TOOLS, IN CLASS 9 (U.S. CLS. 21, 23, 26, 36 AND 38).

FIRST USE 5-10-2012; IN COMMERCE 5-10-2012.

THE MARK CONSISTS OF STANDARD CHARACTERS WITHOUT CLAIM TO ANY PARTICULAR FONT, STYLE, SIZE, OR COLOR.

SN 85-367,961, FILED 7-11-2011.

EDWARD NELSON, EXAMINING ATTORNEY



David J. Kyffers

Director of the United States Patent and Trademark Office

United States of America

United States Patent and Trademark Office

MASECA PREMIUM 30

Reg. No. 4,176,987

Registered July 17, 2012

Int. Cl.: 30

TRADEMARK

PRINCIPAL REGISTER

INVESTIGACION DE TECNOLOGIA AVANZADA, S. A. DE C.V. (MEXICO SOCIEDAD ANONIMA (SA DE CV)))
OTE. COLONIA LA PURISIMA
GUADALUPE RUIZ CORTINES NO. 2002
N.L. MEXICO, MEXICO 67100

FOR: FLOUR, IN CLASS 30 (U.S. CL. 46).

FIRST USE 3-0-2011; IN COMMERCE 3-0-2011.

THE MARK CONSISTS OF STANDARD CHARACTERS WITHOUT CLAIM TO ANY PARTICULAR FONT, STYLE, SIZE, OR COLOR.

OWNER OF U.S. REG. NOS. 833,021, 3,279,243, AND OTHERS.

NO CLAIM IS MADE TO THE EXCLUSIVE RIGHT TO USE "PREMIUM", APART FROM THE MARK AS SHOWN.

THE WORD(S) "MASECA" HAS NO MEANING IN A FOREIGN LANGUAGE.

SN 85-368,355, FILED 7-11-2011.

JAMES A. RAUEN, EXAMINING ATTORNEY



David J. Kyffers

Director of the United States Patent and Trademark Office

United States of America

United States Patent and Trademark Office



Reg. No. 4,176,988

Registered July 17, 2012

Int. Cl.: 30

TRADEMARK

PRINCIPAL REGISTER

INVESTIGACION DE TECNOLOGIA AVANZADA, S. A. DE C.V. (MEXICO SOCIEDAD ANONIMA (SA DE CV)))
OTE. COLONIA LA PURISIMA GUADALUPE
RUIZ CORTINES NO. 2002
N.L. MEXICO, MEXICO 67100

FOR: FLOUR, IN CLASS 30 (U.S. CL. 46).

FIRST USE 3-0-2011; IN COMMERCE 3-0-2011.

OWNER OF U.S. REG. NOS. 833,021, 3,279,243, AND OTHERS.

NO CLAIM IS MADE TO THE EXCLUSIVE RIGHT TO USE "PREMIUM", APART FROM THE MARK AS SHOWN.

THE MARK CONSISTS OF THE LETTERS "MA" ABOVE THE LETTERS "SE" WHICH ARE ABOVE THE LETTERS "CA", ALL IN STYLIZED FORM, WITH THE WORD "PREMIUM" IN STYLIZED LETTERS BELOW THEM, AND THE NUMBER "30" BELOW THE WORD "PREMIUM".

THE WORD(S) "MASECA" HAS NO MEANING IN A FOREIGN LANGUAGE.

SN 85-368,379, FILED 7-11-2011.

JAMES A. RAUEN, EXAMINING ATTORNEY



David J. Kybas

Director of the United States Patent and Trademark Office

United States of America

United States Patent and Trademark Office

MASECA TAQUERA

Reg. No. 4,176,989

Registered July 17, 2012

Int. Cl.: 30

TRADEMARK

PRINCIPAL REGISTER

INVESTIGACION DE TECNOLOGIA AVANZADA, S. A. DE C.V. (MEXICO SOCIEDAD ANONIMA (SA DE CV))
OTE. COLONIA LA PURISIMA
GUADALUPE RUIZ CORTINES NO. 2002
N.L. MEXICO, MEXICO 67100

FOR: FLOUR, IN CLASS 30 (U.S. CL. 46).

FIRST USE 12-0-2011; IN COMMERCE 12-0-2011.

THE MARK CONSISTS OF STANDARD CHARACTERS WITHOUT CLAIM TO ANY PARTICULAR FONT, STYLE, SIZE, OR COLOR.

OWNER OF U.S. REG. NOS. 833,021, 3,279,243, AND OTHERS.

NO CLAIM IS MADE TO THE EXCLUSIVE RIGHT TO USE "TAQUERA", APART FROM THE MARK AS SHOWN.

THE ENGLISH TRANSLATION OF "TAQUERA" IN THE MARK IS "OF TACOS".

THE WORDING "MASECA" HAS NO MEANING IN A FOREIGN LANGUAGE.

SN 85-368,401, FILED 7-11-2011.

JAMES A. RAUEN, EXAMINING ATTORNEY



David J. Kybas

Director of the United States Patent and Trademark Office

United States of America

United States Patent and Trademark Office



Reg. No. 4,176,990

Registered July 17, 2012

Int. Cl.: 30

TRADEMARK

PRINCIPAL REGISTER

INVESTIGACION DE TECNOLOGIA AVANZADA, S. A. DE C.V. (MEXICO SOCIEDAD ANONIMA (SA DE CV))
OTE. COLONIA LA PURISIMA
GUADALUPE RUIZ CORTINES NO. 2002
N.L. MEXICO, MEXICO 67100

FOR: FLOUR, IN CLASS 30 (U.S. CL. 46).

FIRST USE 12-0-2011; IN COMMERCE 12-0-2011.

OWNER OF U.S. REG. NOS. 833,021, 3,279,243, AND OTHERS.

NO CLAIM IS MADE TO THE EXCLUSIVE RIGHT TO USE "TAQUERA", APART FROM THE MARK AS SHOWN.

THE MARK CONSISTS OF THE LETTERS "MA" ABOVE THE LETTERS "SE" WHICH ARE ABOVE THE LETTERS "CA", ALL IN STYLIZED FORM, WITH THE WORD "TAQUERA" IN STYLIZED LETTERS BELOW THE LETTERS.

THE ENGLISH TRANSLATION OF "TAQUERA" IN THE MARK IS "OF TACOS". THE WORD(S) "MASECA" HAS NO MEANING IN A FOREIGN LANGUAGE.

SN 85-368,416, FILED 7-11-2011.

JAMES A. RAUEN, EXAMINING ATTORNEY



David J. Kybas

Director of the United States Patent and Trademark Office

United States of America

United States Patent and Trademark Office

Net Source Data Management application

Reg. No. 4,176,991

Registered July 17, 2012

Int. Cl.: 9

TRADEMARK

PRINCIPAL REGISTER

NET SOURCE, INC. (COLORADO CORPORATION)
SUITE 100
8020 SHAFFER PARKWAY
LITTLETON, CO 80127

FOR: COMPUTER APPLICATION SOFTWARE FOR COMPUTERS, NAMELY, SOFTWARE FOR AUTOMATING DATA MANAGEMENT OF LOGICAL VOLUMES AND PHYSICAL TAPE MEDIA , IN CLASS 9 (U.S. CLS. 21, 23, 26, 36 AND 38).

FIRST USE 6-1-2011; IN COMMERCE 9-1-2011.

THE MARK CONSISTS OF STANDARD CHARACTERS WITHOUT CLAIM TO ANY PARTICULAR FONT, STYLE, SIZE, OR COLOR.

NO CLAIM IS MADE TO THE EXCLUSIVE RIGHT TO USE "DATA MANAGEMENT APPLICATION", APART FROM THE MARK AS SHOWN.

SN 85-369,000, FILED 7-12-2011.

DANNEAN HETZEL, EXAMINING ATTORNEY



David J. Kyffers

Director of the United States Patent and Trademark Office

United States of America

United States Patent and Trademark Office

SIMPLICITY HOME PROTECTION

Reg. No. 4,176,992

ENTERPRISE FINANCIAL GROUP, INC. (TEXAS CORPORATION)
122 W. CARPENTER FREEWAY, 6TH FLOOR
IRVING, TX 75039

Registered July 17, 2012

Int. Cls.: 35 and 36

FOR: HOME WARRANTY SERVICES, NAMELY, ARRANGING FOR REPAIRS AND REPLACEMENT OF MAJOR HOME SYSTEMS, APPLIANCES AND PARTS THEREOF PROVIDED BY OTHERS PURSUANT TO SERVICE AGREEMENTS, IN CLASS 35 (U.S. CLS. 100, 101 AND 102).

SERVICE MARK

PRINCIPAL REGISTER

FIRST USE 8-8-2011; IN COMMERCE 8-8-2011.

FOR: PROVIDING HOME WARRANTY ADMINISTRATION, IN CLASS 36 (U.S. CLS. 100, 101 AND 102).

FIRST USE 8-8-2011; IN COMMERCE 8-8-2011.

THE MARK CONSISTS OF STANDARD CHARACTERS WITHOUT CLAIM TO ANY PARTICULAR FONT, STYLE, SIZE, OR COLOR.

NO CLAIM IS MADE TO THE EXCLUSIVE RIGHT TO USE "HOME PROTECTION", APART FROM THE MARK AS SHOWN.

SN 85-369,309, FILED 7-12-2011.

JANICE KIM, EXAMINING ATTORNEY



David J. Kybas

Director of the United States Patent and Trademark Office

United States of America

United States Patent and Trademark Office

DURABLE! SCRUBBABLE!

Reg. No. 4,176,993

Registered July 17, 2012

Int. Cl.: 16

TRADEMARK

PRINCIPAL REGISTER

THE PROCTER & GAMBLE COMPANY (OHIO CORPORATION)
ONE PROCTER & GAMBLE PLAZA
CINCINNATI, OH 45202

FOR: PAPER TOWELS, IN CLASS 16 (U.S. CLS. 2, 5, 22, 23, 29, 37, 38 AND 50).

FIRST USE 2-29-2012; IN COMMERCE 2-29-2012.

THE MARK CONSISTS OF STANDARD CHARACTERS WITHOUT CLAIM TO ANY PARTICULAR FONT, STYLE, SIZE, OR COLOR.

NO CLAIM IS MADE TO THE EXCLUSIVE RIGHT TO USE "DURABLE", APART FROM THE MARK AS SHOWN.

SN 85-369,313, FILED 7-12-2011.

ALYSSA STEEL, EXAMINING ATTORNEY



David J. Kybas

Director of the United States Patent and Trademark Office

United States of America

United States Patent and Trademark Office

SIMPLICITY FURNITURE PROTECTION

Reg. No. 4,176,994

ENTERPRISE FINANCIAL GROUP, INC. (TEXAS CORPORATION)
122 W. CARPENTER FREEWAY, 6TH FLOOR
IRVING, TX 75039

Registered July 17, 2012

Int. Cl.: 35

FOR: HOME WARRANTY SERVICES, NAMELY, ARRANGING FOR REPAIRS AND REPLACEMENT OF FURNITURE AND FURNISHINGS AND PARTS THEREOF PROVIDED BY OTHERS PURSUANT TO SERVICE AGREEMENTS, IN CLASS 35 (U.S. CLS. 100, 101 AND 102).

SERVICE MARK

PRINCIPAL REGISTER

FIRST USE 8-8-2011; IN COMMERCE 8-8-2011.

THE MARK CONSISTS OF STANDARD CHARACTERS WITHOUT CLAIM TO ANY PARTICULAR FONT, STYLE, SIZE, OR COLOR.

NO CLAIM IS MADE TO THE EXCLUSIVE RIGHT TO USE "FURNITURE", APART FROM THE MARK AS SHOWN.

SN 85-369,324, FILED 7-12-2011.

JANICE KIM, EXAMINING ATTORNEY



David J. Kyffers

Director of the United States Patent and Trademark Office

United States of America

United States Patent and Trademark Office

De Nulce

Reg. No. 4,176,995

Registered July 17, 2012

Int. Cl.: 25

TRADEMARK

PRINCIPAL REGISTER

NOGUEIRA, LEONARDO DA SILVA (BRAZIL INDIVIDUAL)
PRAÇA RODRIGUES DE ABREU 1-8
BAURU, SAO PAULO, BRAZIL

FOR: FOOTWEAR, IN CLASS 25 (U.S. CLS. 22 AND 39).

FIRST USE 1-1-2012; IN COMMERCE 1-1-2012.

THE MARK CONSISTS OF STANDARD CHARACTERS WITHOUT CLAIM TO ANY PARTICULAR FONT, STYLE, SIZE, OR COLOR.

THE WORDING "DE NULCE" HAS NO MEANING IN A FOREIGN LANGUAGE.

SN 85-369,858, FILED 7-13-2011.

JOHN WILKE, EXAMINING ATTORNEY



David J. Kyffers

Director of the United States Patent and Trademark Office

United States of America

United States Patent and Trademark Office

AN EXTRAORDINARY COMMITMENT TO SCIENCE, HEALTH AND HOPE

Reg. No. 4,176,996

Registered July 17, 2012

Int. Cl.: 44

SERVICE MARK

PRINCIPAL REGISTER

DCI DONOR SERVICES, INC. (TENNESSEE CORPORATION)
SUITE 300
1600 HAYES STREET
NASHVILLE, TN 37203

FOR: PROVIDING INFORMATION IN THE FIELD OF ORGAN AND TISSUE DONATION;
MEDICAL SERVICES IN THE FIELD OF ORGAN DONATION, NAMELY, OBTAINING
CONSENT, CONDUCTING DONOR SCREENING AND PROVIDING DONOR MEDICAL
DATA, IN CLASS 44 (U.S. CLS. 100 AND 101).

FIRST USE 12-12-2011; IN COMMERCE 12-12-2011.

THE MARK CONSISTS OF STANDARD CHARACTERS WITHOUT CLAIM TO ANY PAR-
TICULAR FONT, STYLE, SIZE, OR COLOR.

SN 85-370,121, FILED 7-13-2011.

JENNIFER VASQUEZ, EXAMINING ATTORNEY



David J. Kyjars

Director of the United States Patent and Trademark Office

United States of America

United States Patent and Trademark Office



StraightWear

BY MACADAMIA

Reg. No. 4,176,997

DETOUR CORPORATION (NEVADA CORPORATION)
9333 OSO AVE.
CHATSWORTH, CA 91311

Registered July 17, 2012

Int. Cl.: 3

FOR: HAIR CARE PREPARATIONS, NAMELY, HAIR STRAIGHTENER AND SEALER, IN CLASS 3 (U.S. CLS. 1, 4, 6, 50, 51 AND 52).

TRADEMARK

FIRST USE 1-28-2012; IN COMMERCE 1-28-2012.

PRINCIPAL REGISTER

OWNER OF U.S. REG. NOS. 3,948,362 AND 3,958,416.

NO CLAIM IS MADE TO THE EXCLUSIVE RIGHT TO USE "MACADAMIA", APART FROM THE MARK AS SHOWN.

THE MARK CONSISTS OF THE WORD "STRAIGHTWEAR", UNDERNEATH THE "H" AND EXTENDING TO THE "R" ARE THE WORDS "BY MACADAMIA", AND FURTHER, THE MARK CONTAINS AN OIL DROP ABOVE THE "H" AND "T".

SN 85-370,522, FILED 7-13-2011.

JEFFREY LOOK, EXAMINING ATTORNEY



David J. Kyffers

Director of the United States Patent and Trademark Office

United States of America

United States Patent and Trademark Office

Before Tomorrow Comes

Reg. No. 4,176,998

DEMCHUK, BOB (UNITED STATES INDIVIDUAL)

Registered July 17, 2012

P.O. BOX 658
PATTERSON, NY 12563

Int. Cl.: 16

FOR: SERIES OF PHOTOGRAPHIC BOOKS FOCUSING ON THE INHABITANTS AND ANIMALS OF AFRICA, TOGETHER, IN CLASS 16 (U.S. CLS. 2, 5, 22, 23, 29, 37, 38 AND 50).

TRADEMARK

FIRST USE 4-20-2012; IN COMMERCE 4-20-2012.

PRINCIPAL REGISTER

THE MARK CONSISTS OF STANDARD CHARACTERS WITHOUT CLAIM TO ANY PARTICULAR FONT, STYLE, SIZE, OR COLOR.

SN 85-370,712, FILED 7-13-2011.

YAT SYE, LEE, EXAMINING ATTORNEY



David J. Kybas

Director of the United States Patent and Trademark Office

United States of America

United States Patent and Trademark Office

POSHY COUTURE

Reg. No. 4,176,999

MARINA ESKENAZI (FRANCE INDIVIDUAL)
1989 NE 119TH ROAD
NORTH MIAMI, FL 33181

Registered July 17, 2012

Int. Cl.: 18

FOR: DOG COLLARS; DOG LEASHES, IN CLASS 18 (U.S. CLS. 1, 2, 3, 22 AND 41).

TRADEMARK

FIRST USE 4-10-2012; IN COMMERCE 4-10-2012.

PRINCIPAL REGISTER

THE MARK CONSISTS OF STANDARD CHARACTERS WITHOUT CLAIM TO ANY PARTICULAR FONT, STYLE, SIZE, OR COLOR.

NO CLAIM IS MADE TO THE EXCLUSIVE RIGHT TO USE "COUTURE", APART FROM THE MARK AS SHOWN.

SN 85-371,037, FILED 7-14-2011.

CHARISMA HAMPTON, EXAMINING ATTORNEY



David J. Kyffers

Director of the United States Patent and Trademark Office

United States of America

United States Patent and Trademark Office



Reg. No. 4,177,000

Registered July 17, 2012

Int. Cl.: 36

SERVICE MARK

PRINCIPAL REGISTER

385 OCEAN BLVD LLC (NEW JERSEY LIMITED LIABILITY COMPANY), DBA SEA VERGE APARTMENTS,
PO BOX 1340
RIDGEWOOD, NJ 074511340

FOR: APARTMENT AND OFFICE RENTALS; APARTMENT HOUSE MANAGEMENT; APARTMENT LOCATING SERVICES FOR OTHERS; CLASSIFIED REAL ESTATE LISTINGS OF APARTMENT RENTALS AND HOUSING RENTALS; LEASING OF APARTMENTS; MANAGEMENT OF APARTMENTS; REAL ESTATE LISTING SERVICES FOR HOUSING RENTALS AND APARTMENT RENTALS; REAL ESTATE SERVICES, NAMELY, PROPERTY MANAGEMENT SERVICES FOR CONDOMINIUM ASSOCIATIONS, HOMEOWNER ASSOCIATIONS AND APARTMENT BUILDINGS; REAL ESTATE SERVICES, NAMELY, RENTAL OF SHORT-TERM FURNISHED APARTMENTS; RENTAL OF APARTMENTS; RENTAL OF APARTMENTS AND OFFICES; RENTAL OF APARTMENTS IN AN APARTMENT COMMUNITY; RENTING OF APARTMENTS, IN CLASS 36 (U.S. CLS. 100, 101 AND 102).

FIRST USE 2-1-2009; IN COMMERCE 2-1-2009.

NO CLAIM IS MADE TO THE EXCLUSIVE RIGHT TO USE "SEA" AND "OCEANFRONT APARTMENTS", APART FROM THE MARK AS SHOWN.

THE COLOR(S) BROWN, YELLOW, BEIGE, BLACK AND WHITE IS/ARE CLAIMED AS A FEATURE OF THE MARK.

THE MARK CONSISTS OF A STYLIZED FISH WITH A BROWN SNOUT, YELLOW EYES, AND YELLOW, BROWN, AND BEIGE VERTICAL STRIPES, ON A BLACK BACKGROUND CIRCLE. BELOW THE FISH THE STYLIZED WORDING "SEA VERGE" APPEARS IN YELLOW WITH BEIGE WAVY LINES CROSSING THE LETTERS "E", "A", AND "E", RESPECTIVELY. BELOW THIS, THE WORDING "OCEANFRONT APARTMENTS" APPEARS IN WHITE BLOCK LETTERING ON A BLACK RECTANGULAR BACKGROUND.

SN 85-371,392, FILED 7-14-2011.

JEAN IM, EXAMINING ATTORNEY



David J. Kyffers

Director of the United States Patent and Trademark Office

United States of America

United States Patent and Trademark Office



TOTAL
REWARDS

Reg. No. 4,177,001

Registered July 17, 2012

Int. Cls.: 35, 41, and 43

SERVICE MARK

PRINCIPAL REGISTER

CAESARS LICENSE COMPANY, LLC (NEVADA LIMITED LIABILITY COMPANY)
ONE CAESARS PALACE DRIVE
LAS VEGAS, NV 89109

FOR: ADMINISTRATION OF AN INCENTIVE AWARD PROGRAM ENABLING PARTICIPANTS TO OBTAIN DISCOUNTS AND COMPLIMENTARY AWARDS ON GOODS AND SERVICES THROUGH MEMBERSHIP; PROVIDING INCENTIVE AWARD PROGRAMS FOR CUSTOMERS THROUGH THE ISSUANCE AND PROCESSING OF POINTS FOR FREQUENT USE OF PARTICIPATING BUSINESSES; ADVERTISING AND PROMOTION OF THE SALES AND GOODS OF OTHERS CONSISTING OF THE ACCUMULATION AND DISTRIBUTION OF POINTS FOR PURCHASES FROM PARTICIPATING MERCHANTS AND SERVICE ESTABLISHMENTS, WHICH CAN BE REDEEMED FOR GOODS AND SERVICES, IN CLASS 35 (U.S. CLS. 100, 101 AND 102).

FIRST USE 3-1-2012; IN COMMERCE 3-1-2012.

FOR: PROVIDING CASINO SERVICES FEATURING A CASINO PLAYERS REWARDS PROGRAM, PROVIDING CASINO SERVICES FEATURING STORED VALUE MEMBERSHIP CARDS FOR REDEEMING CASH, DISCOUNTS, AND OTHER BENEFITS, IN CLASS 41 (U.S. CLS. 100, 101 AND 107).

FIRST USE 3-1-2012; IN COMMERCE 3-1-2012.

FOR: HOTEL AND RESTAURANT SERVICES, NAMELY, PROVIDING A FREQUENT GUEST REWARD PROGRAM WITH ADDED FEATURES WHICH ALLOW PARTICIPANTS TO EARN FREE OR DISCOUNTED LODGING, MEALS, AND OTHER TRAVEL-RELATED BENEFITS, IN CLASS 43 (U.S. CLS. 100 AND 101).

FIRST USE 3-1-2012; IN COMMERCE 3-1-2012.

OWNER OF U.S. REG. NOS. 2,209,160, 2,830,063, AND OTHERS.

NO CLAIM IS MADE TO THE EXCLUSIVE RIGHT TO USE "REWARDS", APART FROM THE MARK AS SHOWN.



David J. Kyffers

Director of the United States Patent and Trademark Office

Reg. No. 4,177,001 THE MARK CONSISTS OF THE LETTERS "TR" INTEGRATED IN A CIRCLE WITH CURVED LINES AND CURLICUES OF VARYING SIZES AND DIRECTION CENTERED ABOVE THE STACKED WORDS "TOTAL REWARDS".

SN 85-372,252, FILED 7-15-2011.

DAVID I, EXAMINING ATTORNEY

United States of America

United States Patent and Trademark Office



TOTAL
REWARDS

Reg. No. 4,177,002

Registered July 17, 2012

Int. Cls.: 35, 41, and 43

SERVICE MARK

PRINCIPAL REGISTER

CAESARS LICENSE COMPANY, LLC (NEVADA LIMITED LIABILITY COMPANY)
LAW DEPT
ONE CAESARS PALACE DRIVE
LAS VEGAS, NV 89109

FOR: ADMINISTRATION OF AN INCENTIVE AWARD PROGRAM ENABLING PARTICIPANTS TO OBTAIN DISCOUNTS AND COMPLIMENTARY AWARDS ON GOODS AND SERVICES THROUGH MEMBERSHIP; PROVIDING INCENTIVE AWARD PROGRAMS FOR CUSTOMERS THROUGH THE ISSUANCE AND PROCESSING OF POINTS FOR FREQUENT USE OF PARTICIPATING BUSINESSES; ADVERTISING AND PROMOTION OF THE SALES AND GOODS OF OTHERS CONSISTING OF THE ACCUMULATION AND DISTRIBUTION OF POINTS FOR PURCHASES FROM PARTICIPATING MERCHANTS AND SERVICE ESTABLISHMENTS, WHICH CAN BE REDEEMED FOR GOODS AND SERVICES, IN CLASS 35 (U.S. CLS. 100, 101 AND 102).

FIRST USE 3-1-2012; IN COMMERCE 3-1-2012.

FOR: PROVIDING CASINO SERVICES FEATURING A CASINO PLAYERS REWARDS PROGRAM, PROVIDING CASINO SERVICES FEATURING STORED VALUE MEMBERSHIP CARDS FOR REDEEMING CASH, DISCOUNTS, AND OTHER BENEFITS, IN CLASS 41 (U.S. CLS. 100, 101 AND 107).

FIRST USE 3-1-2012; IN COMMERCE 3-1-2012.

FOR: HOTEL AND RESTAURANT SERVICES, NAMELY, PROVIDING A FREQUENT GUEST REWARD PROGRAM WITH ADDED FEATURES WHICH ALLOW PARTICIPANTS TO EARN FREE OR DISCOUNTED LODGING, MEALS, AND OTHER TRAVEL-RELATED BENEFITS, IN CLASS 43 (U.S. CLS. 100 AND 101).

FIRST USE 3-1-2012; IN COMMERCE 3-1-2012.

OWNER OF U.S. REG. NOS. 2,209,160, 2,830,063, AND OTHERS.

THE COLOR(S) ORANGE, RED AND BLACK IS/ARE CLAIMED AS A FEATURE OF THE MARK.



David J. Kyffers

Director of the United States Patent and Trademark Office

Reg. No. 4,177,002 NO CLAIM IS MADE TO THE EXCLUSIVE RIGHT TO USE "REWARDS", APART FROM THE MARK AS SHOWN.

THE MARK CONSISTS OF THE LETTERS "TR" INTEGRATED IN A CIRCLE WITH CURVED LINES AND CURLICUES OF VARYING SIZES AND DIRECTION CENTERED ABOVE THE STACKED WORDS "TOTAL REWARDS". THE "TR" AND THE MAJORITY OF THE CIRCLE ARE ORANGE WITH A RED SHADOWING AT THE BOTTOM LEFT OF CIRCLE. THE WORDS "TOTAL REWARDS" IN BLACK.

SN 85-372,313, FILED 7-15-2011.

DAVID I, EXAMINING ATTORNEY

United States of America

United States Patent and Trademark Office

SOUTHERN ART

Reg. No. 4,177,003

Registered July 17, 2012

Int. Cl.: 43

SERVICE MARK

PRINCIPAL REGISTER

ART SMITH LLC (ILLINOIS LIMITED LIABILITY COMPANY)
675 THIRD AVENUE, SUITE 2900
C/O EISENBERG TANCHUM & LEVY
NEW YORK, NY 10017

FOR: RESTAURANT AND BAR SERVICES, IN CLASS 43 (U.S. CLS. 100 AND 101).

FIRST USE 10-31-2011; IN COMMERCE 10-31-2011.

THE MARK CONSISTS OF STANDARD CHARACTERS WITHOUT CLAIM TO ANY PARTICULAR FONT, STYLE, SIZE, OR COLOR.

NO CLAIM IS MADE TO THE EXCLUSIVE RIGHT TO USE "SOUTHERN", APART FROM THE MARK AS SHOWN.

SN 85-372,452, FILED 7-15-2011.

JESSICA FATHY, EXAMINING ATTORNEY



David J. Kyffers

Director of the United States Patent and Trademark Office

United States of America

United States Patent and Trademark Office

BLOSSOM AMOUR

Reg. No. 4,177,004

ROBBINS BROS. JEWELRY, INC. (DELAWARE CORPORATION)
1300 WEST OPTICAL DRIVE, SUITE 200
AZUSA, CA 91702

Registered July 17, 2012

Int. Cl.: 14

FOR: FINE JEWELRY FEATURING PRECIOUS STONES, NAMELY, RUBIES, WHITE SAPPHIRES, BLUE SAPPHIRES AND COLORED PRECIOUS GEMSTONES, IN CLASS 14 (U.S. CLS. 2, 27, 28 AND 50).

TRADEMARK

FIRST USE 9-0-2011; IN COMMERCE 9-0-2011.

PRINCIPAL REGISTER

THE MARK CONSISTS OF STANDARD CHARACTERS WITHOUT CLAIM TO ANY PARTICULAR FONT, STYLE, SIZE, OR COLOR.

SN 85-373,813, FILED 7-18-2011.

WON TEAK OH, EXAMINING ATTORNEY



David J. Kyffers

Director of the United States Patent and Trademark Office

United States of America

United States Patent and Trademark Office



Reg. No. 4,177,005

Registered July 17, 2012

Int. Cl.: 9

TRADEMARK

PRINCIPAL REGISTER

WORDEN ENTERPRISES, INC. (PANAMA CORPORATION)
1612 NW 84TH AVE
MIAMI, FL 33126

FOR: CELLULAR TELEPHONES; CELLULAR TELEPHONE ACCESSORIES, NAMELY, HEADSETS, EAR BUDS, BATTERIES, BATTERY CHARGERS, IN CLASS 9 (U.S. CLS. 21, 23, 26, 36 AND 38).

FIRST USE 1-15-2012; IN COMMERCE 1-15-2012.

THE MARK CONSISTS OF THE LETTERS "NIU" IN STYLIZED WRITING.

THE WORD "NIU" HAS NO KNOWN MEANING TO THE APPLICANT IN A FOREIGN LANGUAGE.

SN 85-373,904, FILED 7-18-2011.

TRACY FLETCHER, EXAMINING ATTORNEY



David J. Kyffers

Director of the United States Patent and Trademark Office

United States of America

United States Patent and Trademark Office

VALERIE STEVENS

Reg. No. 4,177,006

SPECIALTY RETAILERS, INC. (TEXAS CORPORATION)

Registered July 17, 2012

10201 MAIN STREET
HOUSTON, TX 77025

Int. Cl.: 25

FOR: WOMEN'S CLOTHING, NAMELY, BLOUSES, KNIT TOPS, JACKETS, PANTS, CAPRI PANTS, DRESSES, SWEATERS, SKIRTS, IN CLASS 25 (U.S. CLS. 22 AND 39).

TRADEMARK

FIRST USE 1-9-2012; IN COMMERCE 1-9-2012.

PRINCIPAL REGISTER

THE MARK CONSISTS OF STANDARD CHARACTERS WITHOUT CLAIM TO ANY PARTICULAR FONT, STYLE, SIZE, OR COLOR.

THE NAME(S), PORTRAIT(S), AND/OR SIGNATURE(S) SHOWN IN THE MARK DOES NOT IDENTIFY A PARTICULAR LIVING INDIVIDUAL.

SN 85-374,698, FILED 7-19-2011.

RONALD MCMORROW, EXAMINING ATTORNEY



David J. Kybas

Director of the United States Patent and Trademark Office

United States of America

United States Patent and Trademark Office

Powered By Savings

Reg. No. 4,177,007

PROFESSIONAL GROUP PLANS (NEW YORK CORPORATION)
225 WIRELESS BLVD. #200
HAUPPAUGE, NY 11788

Registered July 17, 2012

Int. Cl.: 35

FOR: CONSULTING SERVICES IN THE FIELD OF ENERGY USAGE MANAGEMENT AND ENERGY EFFICIENCY, IN CLASS 35 (U.S. CLS. 100, 101 AND 102).

SERVICE MARK

FIRST USE 11-1-2011; IN COMMERCE 11-15-2011.

PRINCIPAL REGISTER

THE MARK CONSISTS OF STANDARD CHARACTERS WITHOUT CLAIM TO ANY PARTICULAR FONT, STYLE, SIZE, OR COLOR.

SN 85-374,769, FILED 7-19-2011.

STEPHANIE ALI, EXAMINING ATTORNEY



David J. Kybas

Director of the United States Patent and Trademark Office

United States of America

United States Patent and Trademark Office

MICHAELCAP

Reg. No. 4,177,008

DAVID MICHAEL & CO., INC. (PENNSYLVANIA CORPORATION)
10801 DECATUR ROAD
PHILADELPHIA, PA 19154

Registered July 17, 2012

Int. Cl.: 30

FOR: NON-NUTRITIONAL FOOD ADDITIVES IN THE NATURE OF MICROENCAPSULATED FLAVORINGS USED FOR FOOD AND BEVERAGES, IN CLASS 30 (U.S. CL. 46).

TRADEMARK

FIRST USE 1-29-2004; IN COMMERCE 1-29-2004.

PRINCIPAL REGISTER

THE MARK CONSISTS OF STANDARD CHARACTERS WITHOUT CLAIM TO ANY PARTICULAR FONT, STYLE, SIZE, OR COLOR.

OWNER OF U.S. REG. NO. 3,043,587.

SN 85-375,702, FILED 7-20-2011.

JOHN DALIER, EXAMINING ATTORNEY



David J. Kyffers

Director of the United States Patent and Trademark Office

United States of America

United States Patent and Trademark Office

CLARA CLARK

Reg. No. 4,177,009

LINEN CHOICE CORP. (NEW YORK CORPORATION)

Registered July 17, 2012

1449 36 ST
BROOKLYN, NY 11218

Int. Cl.: 24

FOR: BED BLANKETS; BLANKET THROWS; COMFORTERS; DUVET COVERS; HOUSEHOLD LINEN; LINEN; MATTRESS COVERS; MATTRESS PADS; SHEET SETS; TOWELS, IN CLASS 24 (U.S. CLS. 42 AND 50).

TRADEMARK

FIRST USE 11-30-2011; IN COMMERCE 11-30-2011.

PRINCIPAL REGISTER

THE MARK CONSISTS OF STANDARD CHARACTERS WITHOUT CLAIM TO ANY PARTICULAR FONT, STYLE, SIZE, OR COLOR.

THE NAME(S), PORTRAIT(S), AND/OR SIGNATURE(S) SHOWN IN THE MARK DOES NOT IDENTIFY A PARTICULAR LIVING INDIVIDUAL.

SN 85-376,507, FILED 7-20-2011.

VERNA BETH RIRIE, EXAMINING ATTORNEY



David J. Kyffers

Director of the United States Patent and Trademark Office

United States of America

United States Patent and Trademark Office



Reg. No. 4,177,010

Registered July 17, 2012

Int. Cl.: 25

TRADEMARK

PRINCIPAL REGISTER

J.J. EDWARDS & ASSOCIATES, INC. (TEXAS CORPORATION)
627 FLAGHOIST LANE
HOUSTON, TX 77079

FOR: BASEBALL CAPS AND HATS; FISHING SHIRTS; HOODED SWEAT SHIRTS; SHORT-SLEEVED OR LONG-SLEEVED T-SHIRTS; SPORTS CAPS AND HATS; SWEAT SHIRTS; T-SHIRTS, IN CLASS 25 (U.S. CLS. 22 AND 39).

FIRST USE 11-22-2010; IN COMMERCE 7-21-2011.

THE MARK CONSISTS OF A GRAPHIC DESIGN OF A FISH THAT FACES LEFT AND INCORPORATES THE LETTERS "BE" INSIDE THE BODY OF THE FISH. THE TAIL FORMS THE LETTER "A" LAYING SIDEWAYS. THE WORD "BEAFISH" IS POSITIONED TO THE RIGHT OF THE LOWER FIN OF THE FISH AND EXTENDS TO UNDER THE TAIL OF THE FISH.

SN 85-376,729, FILED 7-20-2011.

ELISSA GARBER KON, EXAMINING ATTORNEY



David J. Kyjars

Director of the United States Patent and Trademark Office

United States of America

United States Patent and Trademark Office

WILDHORSE

Reg. No. 4,177,011

PREMIER MANUFACTURING, INC. (MISSOURI CORPORATION)
17998 CHESTERFIELD AIRPORT ROAD
CHESTERFIELD, MO 63005

Registered July 17, 2012

Int. Cl.: 34

FOR: CIGARETTE TUBES, IN CLASS 34 (U.S. CLS. 2, 8, 9 AND 17).

TRADEMARK

FIRST USE 11-18-2011; IN COMMERCE 11-18-2011.

PRINCIPAL REGISTER

THE MARK CONSISTS OF STANDARD CHARACTERS WITHOUT CLAIM TO ANY PARTICULAR FONT, STYLE, SIZE, OR COLOR.

OWNER OF U.S. REG. NOS. 3,496,055 AND 3,971,853.

SN 85-377,555, FILED 7-21-2011.

JENNIFER VASQUEZ, EXAMINING ATTORNEY



David J. Kyffers

Director of the United States Patent and Trademark Office

United States of America

United States Patent and Trademark Office

ULTRA FINISH

Reg. No. 4,177,012

Registered July 17, 2012

Int. Cl.: 16

TRADEMARK

PRINCIPAL REGISTER

THE SHERWIN-WILLIAMS COMPANY (OHIO CORPORATION)
101 W. PROSPECT AVENUE
CLEVELAND, OH 441151075

FOR: PAINT APPLICATORS, IN CLASS 16 (U.S. CLS. 2, 5, 22, 23, 29, 37, 38 AND 50).

FIRST USE 2-3-2012; IN COMMERCE 2-3-2012.

THE MARK CONSISTS OF STANDARD CHARACTERS WITHOUT CLAIM TO ANY PARTICULAR FONT, STYLE, SIZE, OR COLOR.

NO CLAIM IS MADE TO THE EXCLUSIVE RIGHT TO USE "FINISH", APART FROM THE MARK AS SHOWN.

SN 85-377,757, FILED 7-21-2011.

H. M. FISHER, EXAMINING ATTORNEY



David J. Kyffers

Director of the United States Patent and Trademark Office

United States of America

United States Patent and Trademark Office

JUMPERMATIC

Reg. No. 4,177,013

PDI COMMUNICATIONS, INC. (DELAWARE CORPORATION)
6353 WEST ROGERS CIRCLE
BOCA RATON, FL 33487

Registered July 17, 2012

Int. Cl.: 9

FOR: CABLES FOR ELECTRICAL SIGNAL TRANSMISSION, IN CLASS 9 (U.S. CLS. 21, 23, 26, 36 AND 38).

TRADEMARK

FIRST USE 11-18-2011; IN COMMERCE 11-18-2011.

PRINCIPAL REGISTER

THE MARK CONSISTS OF STANDARD CHARACTERS WITHOUT CLAIM TO ANY PARTICULAR FONT, STYLE, SIZE, OR COLOR.

SN 85-377,820, FILED 7-21-2011.

DARRYL SPRUILL, EXAMINING ATTORNEY



David J. Kybas

Director of the United States Patent and Trademark Office

United States of America
United States Patent and Trademark Office



Reg. No. 4,177,014

Registered July 17, 2012

Int. Cl.: 11

TRADEMARK

PRINCIPAL REGISTER

HAVEN TECHNOLOGY SOLUTIONS L.L.C. (TEXAS LIMITED LIABILITY COMPANY)
SUITE D
32003 NICHOLS SAWMILL ROAD
MAGNOLIA, TX 77355

FOR: FILTRATION AND SEPARATION EQUIPMENT, NAMELY, GAS AND LIQUID SEPARATION SYSTEMS COMPRISED OF LINE SEPARATORS, VERTICAL GAS SEPARATORS AND HORIZONTAL GAS SEPARATORS, IN CLASS 11 (U.S. CLS. 13, 21, 23, 31 AND 34).

FIRST USE 5-1-2012; IN COMMERCE 5-1-2012.

NO CLAIM IS MADE TO THE EXCLUSIVE RIGHT TO USE "KICK", APART FROM THE MARK AS SHOWN.

THE MARK CONSISTS OF A OFFSHORE DRILLING RIG WITH THE STYLIZED TEXT "KICK BUSTER".

SN 85-378,191, FILED 7-22-2011.

ROBERT C. CLARK JR., EXAMINING ATTORNEY



David J. Kyffers

Director of the United States Patent and Trademark Office

United States of America

United States Patent and Trademark Office



Reg. No. 4,177,015

DEERPOINT GROUP, INC. (ILLINOIS CORPORATION)
4339 N. SELLAND AVE.
FRESNO, CA 93722

Registered July 17, 2012

Int. Cl.: 40

FOR: AGRICULTURAL CHEMICAL WATER TREATMENT, IN CLASS 40 (U.S. CLS. 100, 103 AND 106).

SERVICE MARK

FIRST USE 11-30-2008; IN COMMERCE 11-30-2008.

PRINCIPAL REGISTER

OWNER OF U.S. REG. NOS. 3,544,636 AND 3,647,031.

THE COLOR(S) BLUE, WHITE AND GREEN IS/ARE CLAIMED AS A FEATURE OF THE MARK.

NO CLAIM IS MADE TO THE EXCLUSIVE RIGHT TO USE "GROUP, INC.", APART FROM THE MARK AS SHOWN.

THE MARK CONSISTS OF A CIRCULAR DESIGN HAVING AN BLUE OUTER BORDER SEPARATED FROM CENTER BY A WHITE NARROWER RING, BLUE WATER DROP PLUS GREEN LEAF IN CENTER WHOSE STEM EXTENDS OUT TO OUTER BORDER, WITH THE WORDS "DEERPOINT GROUP, INC." DISPLAYED IN WHITE IN THE OUTER BORDER AND THE ACRONYM "DPG" SUPERIMPOSED IN WHITE ON THE CENTER DESIGN.

SN 85-378,269, FILED 7-22-2011.

EMILY CARLSEN, EXAMINING ATTORNEY



David J. Kybas

Director of the United States Patent and Trademark Office

United States of America

United States Patent and Trademark Office

IF YOU'RE CLEAN AND YOU
KNOW IT CLAP YOUR HANDS

Reg. No. 4,177,016

BURT'S BEES, INC. (DELAWARE CORPORATION)
210 W. PETTIGREW STREET
DURHAM, NC 27701

Registered July 17, 2012

Int. Cl.: 3

FOR: HAND SOAPS, IN CLASS 3 (U.S. CLS. 1, 4, 6, 50, 51 AND 52).

TRADEMARK

FIRST USE 12-8-2011; IN COMMERCE 12-8-2011.

PRINCIPAL REGISTER

THE MARK CONSISTS OF STANDARD CHARACTERS WITHOUT CLAIM TO ANY PARTICULAR FONT, STYLE, SIZE, OR COLOR.

SN 85-378,408, FILED 7-22-2011.

TEJBIR SINGH, EXAMINING ATTORNEY



David J. Kybas

Director of the United States Patent and Trademark Office

United States of America

United States Patent and Trademark Office

RUN LIGHT RUN SUPPORTED

Reg. No. 4,177,017

SUPERFEET WORLDWIDE, INC. (WASHINGTON CORPORATION)
1820 SCOUT PLACE
FERNDALE, WA 98248

Registered July 17, 2012

Int. Cl.: 25

FOR: SHOE INSERTS FOR PRIMARILY NON-ORTHOTIC PURPOSES, IN CLASS 25 (U.S. CLS. 22 AND 39).

TRADEMARK

FIRST USE 7-0-2011; IN COMMERCE 7-0-2011.

PRINCIPAL REGISTER

THE MARK CONSISTS OF STANDARD CHARACTERS WITHOUT CLAIM TO ANY PARTICULAR FONT, STYLE, SIZE, OR COLOR.

SN 85-378,478, FILED 7-22-2011.

CHARLOTTE CORWIN, EXAMINING ATTORNEY



David J. Kyffers

Director of the United States Patent and Trademark Office

United States of America

United States Patent and Trademark Office

EXCELCORD

Reg. No. 4,177,018

PROCORE SPORTS, LLC (FLORIDA LIMITED LIABILITY COMPANY)
6732 SCHOONER BAY CIR
SARASOTA, FL 34231

Registered July 17, 2012

Int. Cl.: 28

FOR: EXERCISE EQUIPMENT, NAMELY, RESISTANCE TRAINING EQUIPMENT BEING A SHOE MOUNTED HARNESS WITH CLIPS FOR ATTACHING AN ELASTIC RESISTANCE BAND, IN CLASS 28 (U.S. CLS. 22, 23, 38 AND 50).

TRADEMARK

FIRST USE 1-15-2012; IN COMMERCE 2-1-2012.

PRINCIPAL REGISTER

THE MARK CONSISTS OF STANDARD CHARACTERS WITHOUT CLAIM TO ANY PARTICULAR FONT, STYLE, SIZE, OR COLOR.

SN 85-379,579, FILED 7-25-2011.

JAMES GRIFFIN, EXAMINING ATTORNEY



David J. Kyffers

Director of the United States Patent and Trademark Office

United States of America

United States Patent and Trademark Office

CHRISTY METALS

Reg. No. 4,177,019

CHRISTY METALS (ILLINOIS CORPORATION)

Registered July 17, 2012

2810 OLD WILLOW ROAD
NORTHBROOK, IL 60033

Int. Cl.: 6

FOR: COMMON METALS AND THEIR ALLOYS INCLUDING STAINLESS STEEL, BRASS, COPPER, ALUMINUM, NICKEL, TIN, PHOSPHOR BRONZE, ZINC; SHEET METAL; ZINC STRIP ALLOYS; ALUMINUM ALLOYS; BRASS ALLOYS; COPPER ALLOYS; NICKEL ALLOYS; BERYLLIUM COPPER; CUPRO NICKELS, IN CLASS 6 (U.S. CLS. 2, 12, 13, 14, 23, 25 AND 50).

TRADEMARK

PRINCIPAL REGISTER

FIRST USE 12-15-1965; IN COMMERCE 12-15-1965.

THE MARK CONSISTS OF STANDARD CHARACTERS WITHOUT CLAIM TO ANY PARTICULAR FONT, STYLE, SIZE, OR COLOR.

NO CLAIM IS MADE TO THE EXCLUSIVE RIGHT TO USE "METALS", APART FROM THE MARK AS SHOWN.

SN 85-380,112, FILED 7-25-2011.

ERIN FALK, EXAMINING ATTORNEY



David J. Kybas

Director of the United States Patent and Trademark Office

United States of America

United States Patent and Trademark Office

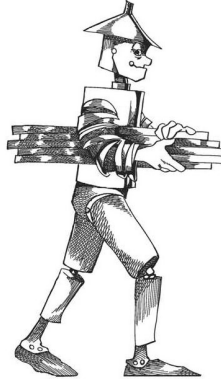

Reg. No. 4,177,020

Registered July 17, 2012

Int. Cl.: 6

TRADEMARK

PRINCIPAL REGISTER

CHRISTY METALS (ILLINOIS CORPORATION)
2810 OLD WILLOW ROAD
NORTHBROOK, IL 60033

FOR: COMMON METALS AND THEIR ALLOYS INCLUDING STAINLESS STEEL, BRASS, COPPER, ALUMINUM, NICKEL, TIN, PHOSPHOR BRONZE, ZINC; SHEET METAL; ZINC STRIP ALLOYS; ALUMINUM ALLOYS; BRASS ALLOYS; COPPER ALLOYS; NICKEL ALLOYS; BERYLLIUM COPPER; CUPRO NICKELS, IN CLASS 6 (U.S. CLS. 2, 12, 13, 14, 23, 25 AND 50).

FIRST USE 12-15-1965; IN COMMERCE 12-15-1965.

THE COLOR GRAY REPRESENTS SHADING AND IS NOT A PART OF THE MARK. THE STIPPLING SHOWN IN THE MARK IS A FEATURE OF THE MARK.

THE MARK CONSISTS OF AN IMAGE OF MAN SHOWN AS TIN MAN CARRYING RODS IN RIGHT HAND AS SHOWN IN THE MARK.

SN 85-380,144, FILED 7-25-2011.

ERIN FALK, EXAMINING ATTORNEY



David J. Kyros

Director of the United States Patent and Trademark Office

United States of America

United States Patent and Trademark Office

IT'S LIKE AN INVIGORATING
TOWEL SNAP. WITHOUT THE
STING.

Reg. No. 4,177,021

BURT'S BEES, INC. (DELAWARE CORPORATION)
210 W. PETTIGREW STREET
DURHAM, NC 27701

Registered July 17, 2012

Int. Cl.: 3

FOR: BODY WASH, IN CLASS 3 (U.S. CLS. 1, 4, 6, 50, 51 AND 52).

TRADEMARK

FIRST USE 11-16-2011; IN COMMERCE 11-16-2011.

PRINCIPAL REGISTER

THE MARK CONSISTS OF STANDARD CHARACTERS WITHOUT CLAIM TO ANY PARTICULAR FONT, STYLE, SIZE, OR COLOR.

SN 85-380,352, FILED 7-25-2011.

TEJBIR SINGH, EXAMINING ATTORNEY



David J. Kybas

Director of the United States Patent and Trademark Office

United States of America

United States Patent and Trademark Office

NPD-3000

Reg. No. 4,177,022

Registered July 17, 2012

Int. Cl.: 1

TRADEMARK

PRINCIPAL REGISTER

FTS INTERNATIONAL SERVICES, LLC (TEXAS LIMITED LIABILITY COMPANY)
STE 3000
777 MAIN ST.
FORT WORTH, TX 76102

FOR: CHEMICAL ADDITIVES FOR USE IN THE RECOVERY OF FLUIDS FROM UNDERGROUND FORMATIONS, IN CLASS 1 (U.S. CLS. 1, 5, 6, 10, 26 AND 46).

FIRST USE 3-21-2012; IN COMMERCE 3-21-2012.

THE MARK CONSISTS OF STANDARD CHARACTERS WITHOUT CLAIM TO ANY PARTICULAR FONT, STYLE, SIZE, OR COLOR.

SN 85-380,651, FILED 7-26-2011.

MATTHEW EINSTEIN, EXAMINING ATTORNEY



David J. Kybas

Director of the United States Patent and Trademark Office

United States of America

United States Patent and Trademark Office

D-RUST

Reg. No. 4,177,023

WEICHEM, INC. (LOUISIANA CORPORATION)
5734 SUSITNA DRIVE
HARAHAN, LA 70123

Registered July 17, 2012

Int. Cl.: 2

FOR: PRIMER AND NEUTRALIZER DESIGNED PRIMARILY TO PREVENT RUST, PRIME RUSTED METAL FOR PAINTING, AND FOR DECORATIVE PURPOSES WHERE RUST IS WANTED, AND WHICH MAY ALSO BE USED TO REMOVE RUST SCALE AND BUILDUP, IN CLASS 2 (U.S. CLS. 6, 11 AND 16).

TRADEMARK

PRINCIPAL REGISTER

FIRST USE 1-31-2012; IN COMMERCE 1-31-2012.

THE MARK CONSISTS OF STANDARD CHARACTERS WITHOUT CLAIM TO ANY PARTICULAR FONT, STYLE, SIZE, OR COLOR.

SN 85-380,700, FILED 7-26-2011.

REBECCA POVARCHUK, EXAMINING ATTORNEY



David J. Kyffers

Director of the United States Patent and Trademark Office

United States of America

United States Patent and Trademark Office

FIERCE FASHION

Reg. No. 4,177,024

D.M. MERCHANDISING, INC. (ILLINOIS CORPORATION)
835 N. CHURCH COURT
ELMHURST, IL 60126

Registered July 17, 2012

Int. Cl.: 14

FOR: BANGLE BRACELETS, IN CLASS 14 (U.S. CLS. 2, 27, 28 AND 50).

TRADEMARK

FIRST USE 1-1-2012; IN COMMERCE 1-1-2012.

PRINCIPAL REGISTER

THE MARK CONSISTS OF STANDARD CHARACTERS WITHOUT CLAIM TO ANY PARTICULAR FONT, STYLE, SIZE, OR COLOR.

NO CLAIM IS MADE TO THE EXCLUSIVE RIGHT TO USE "FASHION", APART FROM THE MARK AS SHOWN.

SN 85-380,758, FILED 7-26-2011.

JILL C. ALT, EXAMINING ATTORNEY



David J. Kyffers

Director of the United States Patent and Trademark Office

United States of America

United States Patent and Trademark Office

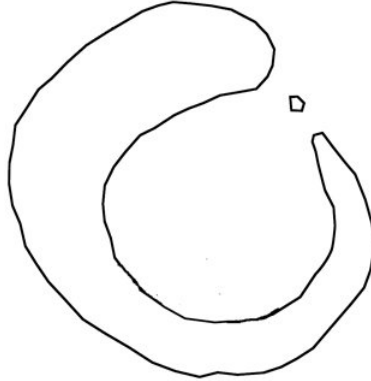

Reg. No. 4,177,025

Registered July 17, 2012

Int. Cl.: 25

TRADEMARK

PRINCIPAL REGISTER

LIQUID SOL, LLC (FLORIDA LIMITED LIABILITY COMPANY)
46 SAILFISH LANE
ST. AUGUSTINE, FL 32080

FOR: SHIRTS, IN CLASS 25 (U.S. CLS. 22 AND 39).

FIRST USE 9-25-2011; IN COMMERCE 1-2-2012.

THE MARK CONSISTS OF A HIGHLY STYLIZED LETTER "O" IN THE FORM OF AN INCOMPLETE CIRCLE WITH AN OPENING IN THE UPPER RIGHT PORTION AND A SMALL IRREGULARLY SHAPED FIGURE THEREIN

SN 85-382,889, FILED 7-27-2011.

HEATHER THOMPSON, EXAMINING ATTORNEY



David J. Kyffers

Director of the United States Patent and Trademark Office

United States of America

United States Patent and Trademark Office



TRUFFLE
HUNTER
FINE ITALIAN TRUFFLES

Reg. No. 4,177,026

Registered July 17, 2012

Int. Cl.: 29

TRADEMARK

PRINCIPAL REGISTER

THE ITALIAN TRUFFLE SHOP LTD (UNITED KINGDOM CORPORATION), TA
TRUFFLEHUNTER,
UNIT 1, SANDPOOL FARM, OAKSEY ROAD
POOLE KEYNES, UNITED KINGDOM

FOR: INFUSED OILS FOR COOKING ITALIAN-STYLED TRUFFLE, IN CLASS 29 (U.S. CL.
46).

FIRST USE 4-10-2012; IN COMMERCE 4-10-2012.

NO CLAIM IS MADE TO THE EXCLUSIVE RIGHT TO USE "TRUFFLE" AND "FINE
ITALIAN TRUFFLES", APART FROM THE MARK AS SHOWN.

THE MARK CONSISTS OF SILHOUETTE OF A MAN AND DOG, WITH THE MAN ON THE
LEFT BENDING TOWARDS DOG. THE WORD "TRUFFLE" IS IMMEDIATELY BELOW
THE MAN AND THE DOG AND THE WORD "HUNTER" IS BELOW THE WORD "TRUFFLE".
BELOW THE WORD "HUNTER" IS THE WORDING "FINE ITALIAN TRUFFLES".

SN 85-383,047, FILED 7-28-2011.

DAVID MURRAY, EXAMINING ATTORNEY



David J. Kyffers

Director of the United States Patent and Trademark Office

United States of America

United States Patent and Trademark Office



Reg. No. 4,177,027

UNION SAVINGS BANK (CONNECTICUT CHARTERED BANK)
225 MAIN STREET
DANBURY, CT 06810

Registered July 17, 2012

Int. Cl.: 36

FOR: BANKING; FINANCIAL SERVICES, NAMELY, MONEY LENDING; BROKERAGE, NAMELY, FINANCIAL INVESTMENT BROKERAGE, IN CLASS 36 (U.S. CLS. 100, 101 AND 102).

SERVICE MARK

FIRST USE 1-1-2010; IN COMMERCE 1-1-2010.

PRINCIPAL REGISTER

THE MARK CONSISTS OF A CIRCULAR SHAPE, COMPRISED OF TWO OUTER LINES AND A DESIGN RESEMBLING THE HANDS OF A CLOCK SHOWING TIME AS 9:00.

SN 85-383,437, FILED 7-28-2011.

CHARLOTTE CORWIN, EXAMINING ATTORNEY



David J. Kyffers

Director of the United States Patent and Trademark Office

United States of America

United States Patent and Trademark Office

PIZZICARE

Reg. No. 4,177,028

CRESCENT ORANGE, LLC (LOUISIANA LIMITED LIABILITY COMPANY)
5500 PRYTANIA ST.

Registered July 17, 2012

NEW ORLEANS, LA 70118

Int. Cl.: 43

FOR: RESTAURANT SERVICES, IN CLASS 43 (U.S. CLS. 100 AND 101).

SERVICE MARK

FIRST USE 9-7-2011; IN COMMERCE 9-7-2011.

PRINCIPAL REGISTER

THE MARK CONSISTS OF STANDARD CHARACTERS WITHOUT CLAIM TO ANY PARTICULAR FONT, STYLE, SIZE, OR COLOR.

SN 85-383,471, FILED 7-28-2011.

JAMES A. RAUEN, EXAMINING ATTORNEY



David J. Kyfos

Director of the United States Patent and Trademark Office

United States of America

United States Patent and Trademark Office

gloDNA

Reg. No. 4,177,029

Registered July 17, 2012

Int. Cl.: 42

SERVICE MARK

PRINCIPAL REGISTER

GLOSTREAM, INC. (MICHIGAN CORPORATION)
SUITE 200
1050 WILSHIRE DRIVE
TROY, MI 48084

FOR: CONSULTATION SERVICES IN THE FIELD OF THE DESIGN AND IMPLEMENTATION OF SOFTWARE AND HARDWARE SYSTEMS FOR ELECTRONIC MEDICAL RECORDS AND FOR MEDICAL PRACTICE MANAGEMENT , IN CLASS 42 (U.S. CLS. 100 AND 101).

FIRST USE 6-30-2009; IN COMMERCE 8-31-2009.

THE MARK CONSISTS OF STANDARD CHARACTERS WITHOUT CLAIM TO ANY PARTICULAR FONT, STYLE, SIZE, OR COLOR.

SN 85-383,521, FILED 7-28-2011.

ESTHER BELENKER, EXAMINING ATTORNEY



David J. Kyjars

Director of the United States Patent and Trademark Office

United States of America

United States Patent and Trademark Office

BECAUSE LITIGATION QUALITY
PATENTS GENERATE MORE
REVENUE FASTER

Reg. No. 4,177,030

Registered July 17, 2012

Int. Cl.: 45

SERVICE MARK

PRINCIPAL REGISTER

THOMPSON PATENT LAW OFFICES PC (MINNESOTA CORPORATION)
SUITE 104
4205 LANCASTER LANE NORTH
PLYMOUTH, MN 55441

FOR: LEGAL SERVICES, IN CLASS 45 (U.S. CLS. 100 AND 101).

FIRST USE 9-1-2011; IN COMMERCE 9-1-2011.

THE MARK CONSISTS OF STANDARD CHARACTERS WITHOUT CLAIM TO ANY PARTICULAR FONT, STYLE, SIZE, OR COLOR.

SN 85-383,738, FILED 7-28-2011.

CHERYL CLAYTON, EXAMINING ATTORNEY



David J. Kyjars

Director of the United States Patent and Trademark Office

United States of America

United States Patent and Trademark Office



Reg. No. 4,177,031

Registered July 17, 2012

Int. Cl.: 35

SERVICE MARK

PRINCIPAL REGISTER

BLUE C ADVERTISING (CALIFORNIA CORPORATION)
3183-C AIRWAY AVE.
COSTA MESA, CA 92626

FOR: ADVERTISING AGENCIES, IN CLASS 35 (U.S. CLS. 100, 101 AND 102).

FIRST USE 1-1-2012; IN COMMERCE 1-1-2012.

THE MARK CONSISTS OF A CIRCLE SURROUNDING A STYLIZED LETTER "C" AND A STAR. THE STAR SITS TO THE RIGHT OF THE "C".

SN 85-383,988, FILED 7-28-2011.

COLLEEN DOMBROW, EXAMINING ATTORNEY



David J. Kyffers

Director of the United States Patent and Trademark Office

United States of America

United States Patent and Trademark Office

PORTA-GRAZER

Reg. No. 4,177,032

THARP, WALTER (UNITED STATES INDIVIDUAL)
P.O. BOX 305
GALT, CA 95632

Registered July 17, 2012

Int. Cl.: 21

FOR: PORTABLE ANIMAL FEEDERS THAT ARE NON-MECHANIZED OR NON-ELECTRONIC, IN CLASS 21 (U.S. CLS. 2, 13, 23, 29, 30, 33, 40 AND 50).

TRADEMARK

FIRST USE 10-18-2009; IN COMMERCE 2-1-2010.

PRINCIPAL REGISTER

THE MARK CONSISTS OF STANDARD CHARACTERS WITHOUT CLAIM TO ANY PARTICULAR FONT, STYLE, SIZE, OR COLOR.

SN 85-384,114, FILED 7-28-2011.

ANTHONY RINKER, EXAMINING ATTORNEY



David J. Kybas

Director of the United States Patent and Trademark Office

United States of America

United States Patent and Trademark Office

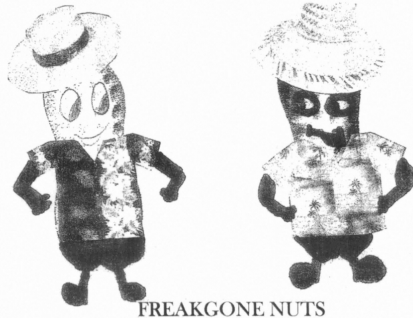

Reg. No. 4,177,033

Registered July 17, 2012

Int. Cl.: 25

TRADEMARK

PRINCIPAL REGISTER

TONDO, JOSEPH (UNITED STATES INDIVIDUAL)
1109 BALTIMORE RD.
SHIPPENSBURG, PA 17257 AND

BECK, NICKI M. (UNITED STATES INDIVIDUAL)
1109 BALTIMORE RD.
SHIPPENSBURG, PA 17257

FOR: SHIRTS; SHORTS; T-SHIRTS, IN CLASS 25 (U.S. CLS. 22 AND 39).

FIRST USE 1-13-2012; IN COMMERCE 1-13-2012.

THE STIPPLING IS FOR SHADING PURPOSES ONLY.

THE MARK CONSISTS OF 2 PEANUT SHELLS WITH EYES, ARMS, AND BOOTS IN HAWAIIAN SHIRTS, AND THE TEXT "FREAKGONE NUTS" BELOW THEM.

SN 85-384,755, FILED 7-29-2011.

AHSEN KHAN, EXAMINING ATTORNEY



David J. Kybas

Director of the United States Patent and Trademark Office

United States of America

United States Patent and Trademark Office

America Needs Inflation

Reg. No. 4,177,034

RUBBER MANUFACTURERS ASSOCIATION (DELAWARE CORPORATION)
1400 K STREET, N.W., SUITE 900
WASHINGTON, DC 20005

Registered July 17, 2012

Int. Cl.: 35

FOR: PROMOTING PUBLIC AWARENESS OF THE NEED FOR PROPER TIRE CARE AND SAFETY, IN CLASS 35 (U.S. CLS. 100, 101 AND 102).

SERVICE MARK

FIRST USE 1-4-2012; IN COMMERCE 1-4-2012.

PRINCIPAL REGISTER

THE MARK CONSISTS OF STANDARD CHARACTERS WITHOUT CLAIM TO ANY PARTICULAR FONT, STYLE, SIZE, OR COLOR.

SN 85-384,784, FILED 7-29-2011.

KAPIL BHANOT, EXAMINING ATTORNEY



David J. Kyffers

Director of the United States Patent and Trademark Office

United States of America

United States Patent and Trademark Office

MODIOLEGAL

Reg. No. 4,177,035

Registered July 17, 2012

Int. Cl.: 42

SERVICE MARK

PRINCIPAL REGISTER

KEVIN C. MITCHELL, INC. (CALIFORNIA CORPORATION)
429 IRIS AVENUE
CORONA DEL MAR, CA 92625

FOR: CONVERSION OF DATA AND DOCUMENTS FROM PHYSICAL TO ELECTRONIC MEDIA, IN THE NATURE OF CONVERTING THIRD PARTY CONTENT RELATED TO NEWS AND INFORMATION IN THE FIELD OF BUSINESS, LAW AND CURRENT EVENTS FROM A PHYSICAL FORMAT TO AN AUDIO FORMAT AND DISTRIBUTION OF THE CONVERTED AUDIO VERSIONS TO OTHERS VIA MOBILE COMMUNICATIONS NETWORKS, IN CLASS 42 (U.S. CLS. 100 AND 101).

FIRST USE 7-15-2011; IN COMMERCE 8-15-2011.

THE MARK CONSISTS OF STANDARD CHARACTERS WITHOUT CLAIM TO ANY PARTICULAR FONT, STYLE, SIZE, OR COLOR.

SN 85-384,917, FILED 7-29-2011.

ALAIN LAPTER, EXAMINING ATTORNEY



David J. Kyffers

Director of the United States Patent and Trademark Office

United States of America

United States Patent and Trademark Office

WH

Reg. No. 4,177,036

Registered July 17, 2012

Int. Cl.: 34

TRADEMARK

PRINCIPAL REGISTER

PREMIER MANUFACTURING, INC. (MISSOURI CORPORATION)
17998 CHESTERFIELD AIRPORT ROAD
CHESTERFIELD, MO 63005

FOR: CIGARETTE TUBES, IN CLASS 34 (U.S. CLS. 2, 8, 9 AND 17).

FIRST USE 11-18-2011; IN COMMERCE 11-18-2011.

OWNER OF U.S. REG. NO. 3,979,655.

THE MARK CONSISTS OF THE LETTERS "W" AND "H" WHICH BOTH APPEAR IN CAPITAL LETTERS. THE LETTER "W" APPEARS SLIGHTLY ABOVE AND TO THE LEFT OF THE LETTER "H".

SN 85-385,990, FILED 8-1-2011.

JENNIFER VASQUEZ, EXAMINING ATTORNEY



David J. Kybas

Director of the United States Patent and Trademark Office

United States of America

United States Patent and Trademark Office

THE BLUE AZUL COLLECTION

Reg. No. 4,177,037

THE BLUEAZUL COLLECTION, LLC (CALIFORNIA LIMITED LIABILITY COMPANY)
P.O. BOX 6278
SAN DIEGO, CA 92166

Registered July 17, 2012

Int. Cl.: 25

FOR: HATS; HEADBANDS, IN CLASS 25 (U.S. CLS. 22 AND 39).

TRADEMARK

FIRST USE 11-13-2011; IN COMMERCE 11-13-2011.

PRINCIPAL REGISTER

THE MARK CONSISTS OF STANDARD CHARACTERS WITHOUT CLAIM TO ANY PARTICULAR FONT, STYLE, SIZE, OR COLOR.

NO CLAIM IS MADE TO THE EXCLUSIVE RIGHT TO USE "COLLECTION", APART FROM THE MARK AS SHOWN.

THE ENGLISH TRANSLATION OF THE WORD "AZUL" IN THE MARK IS "BLUE".

SN 85-386,173, FILED 8-1-2011.

DORITT L. CARROLL, EXAMINING ATTORNEY



David J. Kyffers

Director of the United States Patent and Trademark Office

United States of America

United States Patent and Trademark Office

THE BLUE AZUL COLLECTION

Reg. No. 4,177,038

THE BLUEAZUL COLLECTION, LLC (CALIFORNIA LIMITED LIABILITY COMPANY)
P.O. BOX 6278
SAN DIEGO, CA 92166

Registered July 17, 2012

Int. Cl.: 18

FOR: HANDBAGS; PURSES, IN CLASS 18 (U.S. CLS. 1, 2, 3, 22 AND 41).

TRADEMARK

FIRST USE 11-13-2011; IN COMMERCE 11-13-2011.

PRINCIPAL REGISTER

THE MARK CONSISTS OF STANDARD CHARACTERS WITHOUT CLAIM TO ANY PARTICULAR FONT, STYLE, SIZE, OR COLOR.

NO CLAIM IS MADE TO THE EXCLUSIVE RIGHT TO USE "COLLECTION", APART FROM THE MARK AS SHOWN.

THE ENGLISH TRANSLATION OF THE WORD "AZUL" IN THE MARK IS "BLUE".

SN 85-386,180, FILED 8-1-2011.

DORITT L. CARROLL, EXAMINING ATTORNEY



David J. Kyffers

Director of the United States Patent and Trademark Office

United States of America

United States Patent and Trademark Office

FIND OUT HOW GOOD YOU
REALLY ARE.

Reg. No. 4,177,039

Registered July 17, 2012

Int. Cls.: 25 and 41

TRADEMARK

SERVICE MARK

PRINCIPAL REGISTER

LONG ISLAND UNIVERSITY (NEW YORK NEW YORK STATE NON-FOR-PROFIT
EDUCATION CORPORATION)
700 NORTHERN BOULEVARD
BROOKVILLE, NY 115481327

FOR: BASEBALL CAPS AND HATS; BOXER BRIEFS; HATS; HOODED SWEATSHIRTS;
JACKETS; JERSEYS; POLO SHIRTS; SHORTS; SOCKS; SWEAT PANTS; SWEAT SHIRTS;
T-SHIRTS; TANK TOPS, IN CLASS 25 (U.S. CLS. 22 AND 39).

FIRST USE 2-1-2012; IN COMMERCE 2-1-2012.

FOR: EDUCATION SERVICES IN THE NATURE OF COURSES AT THE UNIVERSITY
LEVEL, IN CLASS 41 (U.S. CLS. 100, 101 AND 107).

FIRST USE 12-26-2011; IN COMMERCE 12-26-2011.

THE MARK CONSISTS OF STANDARD CHARACTERS WITHOUT CLAIM TO ANY PAR-
TICULAR FONT, STYLE, SIZE, OR COLOR.

SN 85-386,255, FILED 8-1-2011.

WON TEAK OH, EXAMINING ATTORNEY



David J. Kybas

Director of the United States Patent and Trademark Office

United States of America

United States Patent and Trademark Office



Reg. No. 4,177,040

Registered July 17, 2012

Int. Cls.: 41 and 43

SERVICE MARK

PRINCIPAL REGISTER

GOSECROSS CELLARS (CALIFORNIA CORPORATION), DBA TOPFLIGHT,
1119 STATE LANE
YOUNTVILLE, CA 94599

FOR: ENTERTAINMENT SERVICES, NAMELY, WINE TASTINGS, IN CLASS 41 (U.S. CLS. 100, 101 AND 107).

FIRST USE 9-22-2011; IN COMMERCE 9-22-2011.

FOR: WINE BARS, IN CLASS 43 (U.S. CLS. 100 AND 101).

FIRST USE 9-22-2011; IN COMMERCE 9-22-2011.

THE MARK CONSISTS OF A YING-YANG SYMBOL IN WHICH THE LEFT SIDE IS FILLED WITH GOLDEN BEER TOPPED BY WHITE FOAM, AND THE RIGHT SIDE IS FILLED WITH RED WINE.

THE COLOR(S) GOLD, WHITE, AND RED IS/ARE CLAIMED AS A FEATURE OF THE MARK.

SN 85-387,475, FILED 8-2-2011.

ELI HELLMAN, EXAMINING ATTORNEY



David J. Kybas

Director of the United States Patent and Trademark Office

United States of America

United States Patent and Trademark Office

MAKE THE RIGHT CHOICE NATION

Reg. No. 4,177,041

ERLANGER, STEVEN (UNITED STATES INDIVIDUAL)
1095 AMETHYST DR. S.W.
VERO BEACH, FL 32968

Registered July 17, 2012

Int. Cl.: 25

FOR: CLOTHING, NAMELY, T-SHIRTS, HATS, IN CLASS 25 (U.S. CLS. 22 AND 39).

TRADEMARK

FIRST USE 1-20-2012; IN COMMERCE 1-20-2012.

PRINCIPAL REGISTER

THE MARK CONSISTS OF STANDARD CHARACTERS WITHOUT CLAIM TO ANY PARTICULAR FONT, STYLE, SIZE, OR COLOR.

SN 85-387,788, FILED 8-3-2011.

MICHAEL WEBSTER, EXAMINING ATTORNEY



David J. Kyffers

Director of the United States Patent and Trademark Office

United States of America

United States Patent and Trademark Office

ALWAYS INCREDIBLY THIN

Reg. No. 4,177,042

THE PROCTER & GAMBLE COMPANY (OHIO CORPORATION)
ONE PROCTER & GAMBLE PLAZA
CINCINNATI, OH 45202

Registered July 17, 2012

Int. Cl.: 5

FOR: CATAMENIAL PRODUCTS, NAMELY, MAXI PADS, MINI PADS AND PANTILINERS,
IN CLASS 5 (U.S. CLS. 6, 18, 44, 46, 51 AND 52).

TRADEMARK

FIRST USE 2-29-2012; IN COMMERCE 2-29-2012.

PRINCIPAL REGISTER

THE MARK CONSISTS OF STANDARD CHARACTERS WITHOUT CLAIM TO ANY PAR-
TICULAR FONT, STYLE, SIZE, OR COLOR.

OWNER OF U.S. REG. NOS. 1,601,853 AND 2,470,616.

NO CLAIM IS MADE TO THE EXCLUSIVE RIGHT TO USE "THIN", APART FROM THE
MARK AS SHOWN.

SN 85-388,508, FILED 8-3-2011.

SUSAN RICHARDS, EXAMINING ATTORNEY



David J. Kybas

Director of the United States Patent and Trademark Office

United States of America

United States Patent and Trademark Office

ENERPRO

Reg. No. 4,177,043

ENERPRO INC. (CANADA CORPORATION)

Registered July 17, 2012

1090 FOUNTAIN STREET NORTH
CAMBRIDGE, ONTARIO, CANADA N3A1A3

Int. Cl.: 11

FOR: HEATING BOILERS; ECONOMISERS, NAMELY, DEVICES FOR WARMING FEED WATER IN HEATING BOILERS, IN CLASS 11 (U.S. CLS. 13, 21, 23, 31 AND 34).

TRADEMARK

FIRST USE 1-1-2010; IN COMMERCE 1-1-2010.

PRINCIPAL REGISTER

THE MARK CONSISTS OF STANDARD CHARACTERS WITHOUT CLAIM TO ANY PARTICULAR FONT, STYLE, SIZE, OR COLOR.

SN 85-389,097, FILED 8-4-2011.

MARTHA FROMM, EXAMINING ATTORNEY



David J. Kyfos

Director of the United States Patent and Trademark Office

United States of America

United States Patent and Trademark Office

WHEYFER

Reg. No. 4,177,044

AMERICAN FITNESS WHOLESALERS, INC. (MASSACHUSETTS CORPORATION)
243 STAFFORD STREET
WORCESTER, MA 01603

Registered July 17, 2012

Int. Cls.: 29 and 30

FOR: WHEY PROTEIN-BASED, NUTRIENT DENSE SNACK BARS, IN CLASS 29 (U.S. CL. 46).

TRADEMARK

FIRST USE 3-28-2012; IN COMMERCE 3-28-2012.

PRINCIPAL REGISTER

FOR: COOKIES AND CRACKERS CONTAINING WHEY PROTEIN, IN CLASS 30 (U.S. CL. 46).

FIRST USE 3-28-2012; IN COMMERCE 3-28-2012.

THE MARK CONSISTS OF STANDARD CHARACTERS WITHOUT CLAIM TO ANY PARTICULAR FONT, STYLE, SIZE, OR COLOR.

SN 85-389,104, FILED 8-4-2011.

KAREN BRACEY, EXAMINING ATTORNEY



David J. Kyros

Director of the United States Patent and Trademark Office

United States of America

United States Patent and Trademark Office

4 POWER LEADERSHIP

Reg. No. 4,177,045

SHYTI, DANIEL A. (UNITED STATES INDIVIDUAL)
20600 AVALON COURT
POTOMAC FALLS, VA 20165

Registered July 17, 2012

Int. Cl.: 41

FOR: BUSINESS TRAINING; EDUCATIONAL SERVICES, NAMELY, CONDUCTING SEMINARS IN THE FIELD OF LEADERSHIP AND DISTRIBUTION OF TRAINING MATERIAL IN CONNECTION THEREWITH, IN CLASS 41 (U.S. CLS. 100, 101 AND 107).

SERVICE MARK

FIRST USE 11-15-2011; IN COMMERCE 11-15-2011.

PRINCIPAL REGISTER

THE MARK CONSISTS OF STANDARD CHARACTERS WITHOUT CLAIM TO ANY PARTICULAR FONT, STYLE, SIZE, OR COLOR.

NO CLAIM IS MADE TO THE EXCLUSIVE RIGHT TO USE "LEADERSHIP", APART FROM THE MARK AS SHOWN.

SN 85-389,154, FILED 8-4-2011.

HOWARD B. LEVINE, EXAMINING ATTORNEY



David J. Kyffers

Director of the United States Patent and Trademark Office

United States of America

United States Patent and Trademark Office



Reg. No. 4,177,046

Registered July 17, 2012

Int. Cl.: 31

TRADEMARK

PRINCIPAL REGISTER

SUNOPTA GRAINS AND FOODS, INC. (MINNESOTA CORPORATION)
3824 SW 93RD STREET
HOPE, MN 56046

FOR: AGRICULTURAL SEEDS, IN CLASS 31 (U.S. CLS. 1 AND 46).

FIRST USE 3-31-2011; IN COMMERCE 3-31-2011.

OWNER OF U.S. REG. NO. 3,970,028.

THE COLOR(S) ORANGE, BLACK AND GREEN IS/ARE CLAIMED AS A FEATURE OF THE MARK.

THE MARK CONSISTS OF AN ORANGE LEAF SHAPE IN THE INSIDE CURVE OF A BLACK LETTER "D" AND A GREEN LEAF FLOWING FROM THE BOTTOM OF THE INSIDE OF THE "D" TO THE OUTSIDE OF THE "D". THE COLOR WHITE REPRESENTS BACKGROUND, OUTLINING, SHADING, AND OR TRANSPARENT AREAS AND ARE NOT PART OF THE MARK.

SN 85-389,272, FILED 8-4-2011.

GEORGE LORENZO, EXAMINING ATTORNEY



David J. Kyffers

Director of the United States Patent and Trademark Office

United States of America

United States Patent and Trademark Office

Princess Power the Penny Pinching Princess

Reg. No. 4,177,047

RUIZ, NEDALEE (UNITED STATES INDIVIDUAL)
23341 DEL LAGO DRIVE
LAGUNA HILLS, CA 92653

Registered July 17, 2012

Int. Cl.: 9

FOR: DIGITAL MATERIALS, NAMELY, CDS AND DVDS FEATURING THE SUBJECT OF RESPONSIBLE FINANCIAL LIVING, PERSONAL RELATIONSHIPS, AND LIFESTYLE TIPS, IN CLASS 9 (U.S. CLS. 21, 23, 26, 36 AND 38).

TRADEMARK

FIRST USE 6-9-2011; IN COMMERCE 6-9-2011.

PRINCIPAL REGISTER

THE MARK CONSISTS OF STANDARD CHARACTERS WITHOUT CLAIM TO ANY PARTICULAR FONT, STYLE, SIZE, OR COLOR.

SN 85-389,294, FILED 8-4-2011.

RUDY R. SINGLETON, EXAMINING ATTORNEY



David J. Kyffers

Director of the United States Patent and Trademark Office

United States of America

United States Patent and Trademark Office

HAWAIIAN PARADISE

Reg. No. 4,177,048

Registered July 17, 2012

Int. Cl.: 9

MIAMI TRIBE OF OKLAHOMA BUSINESS DEVELOPMENT AUTHORITY, A TRIBAL
ENTERPRISE OF THE MIAMI TRIBE OF OKLAHOMA (UNITED STATES
FEDERALLY-RECOGNIZED INDIAN TRIBE)
3410 P STREET NW
MIAMI, OK 74355

TRADEMARK

FOR: GAMING MACHINES, NAMELY, BINGO-RELATED GAMES AND SLOT MACHINES
, IN CLASS 9 (U.S. CLS. 21, 23, 26, 36 AND 38).

PRINCIPAL REGISTER

FIRST USE 4-26-2012; IN COMMERCE 4-26-2012.

THE MARK CONSISTS OF STANDARD CHARACTERS WITHOUT CLAIM TO ANY PAR-
TICULAR FONT, STYLE, SIZE, OR COLOR.

SN 85-390,123, FILED 8-4-2011.

KATHY DE JONGE, EXAMINING ATTORNEY



David J. Kyffers

Director of the United States Patent and Trademark Office

United States of America

United States Patent and Trademark Office



Reg. No. 4,177,049

LEARNING RESOURCES, INC. (ILLINOIS CORPORATION)
380 NORTH FAIRWAY DRIVE
VERNON HILLS, IL 60061

Registered July 17, 2012

Int. Cl.: 9

FOR: HARDWARE AND SOFTWARE FOR TURNING A FLAT SURFACE INTO AN INTERACTIVE WHITEBOARD, IN CLASS 9 (U.S. CLS. 21, 23, 26, 36 AND 38).

TRADEMARK

FIRST USE 3-21-2012; IN COMMERCE 3-21-2012.

PRINCIPAL REGISTER

THE MARK CONSISTS OF THE TERM "NOW!" OVER THE TERM "BOARD", WITH THE TERM "BOARD" ENCLOSED IN A RECTANGLE WITH A LINE EXTENDING FROM THE RECTANGLE OUT AND OVER THE TERM "NOW!".

SN 85-390,781, FILED 8-5-2011.

RONALD AIKENS, EXAMINING ATTORNEY



David J. Kyffers

Director of the United States Patent and Trademark Office

United States of America

United States Patent and Trademark Office

I WORK I VOTE I'M PI\$SED

Reg. No. 4,177,050

INGENIUM BUSINESS SOLUTIONS, INC. (FLORIDA CORPORATION)
2124 NE 123RD ST. STE 218
NORTH MIAMI, FL 33181

Registered July 17, 2012

Int. Cl.: 25

FOR: CLOTHING, NAMELY, FOOTWEAR, HEADWEAR, HATS, TOPS, BOTTOMS, SHIRTS, PANTS, AND BELTS, IN CLASS 25 (U.S. CLS. 22 AND 39).

TRADEMARK

FIRST USE 3-30-2012; IN COMMERCE 3-30-2012.

PRINCIPAL REGISTER

THE MARK CONSISTS OF STANDARD CHARACTERS WITHOUT CLAIM TO ANY PARTICULAR FONT, STYLE, SIZE, OR COLOR.

SN 85-391,125, FILED 8-5-2011.

MICHAEL WEBSTER, EXAMINING ATTORNEY



David J. Kyffers

Director of the United States Patent and Trademark Office

United States of America

United States Patent and Trademark Office

griefteach



Reg. No. 4,177,051

AMARI, CHERYL (UNITED STATES INDIVIDUAL), DBA GRIEFTEACH,
140 MITCHELL G. DRIVE
TEWKSBURY, MA 01876

Registered July 17, 2012

Int. Cl.: 41

FOR: EDUCATION SERVICES, NAMELY, PROVIDING CLASSES, WORKSHOPS, LECTURES, SEMINARS, TRAINING SESSIONS AND CONSULTATIONS PROVIDED LIVE, THROUGH WEBINARS, BLOG ENTRIES, AND TELEPHONE CONSULTATIONS IN THE FIELD OF LOSS AND BEREAVEMENT, IN CLASS 41 (U.S. CLS. 100, 101 AND 107).

SERVICE MARK

PRINCIPAL REGISTER

FIRST USE 9-17-2011; IN COMMERCE 1-5-2012.

THE MARK CONSISTS OF "GRIEFTEACH" IN STYLIZED FORM WITH PURPLE, VIOLET, SLATEBLUE, BLUE, AND CYAN COLORED CIRCLES SPACED BENEATH THE LITERAL ELEMENTS OF THE MARK.

THE COLOR(S) PURPLE, VIOLET, SLATEBLUE, BLUE, AND CYAN IS/ARE CLAIMED AS A FEATURE OF THE MARK.

SN 85-392,366, FILED 8-8-2011.

ALEXANDER L. POWERS, EXAMINING ATTORNEY



David J. Kyros

Director of the United States Patent and Trademark Office

United States of America

United States Patent and Trademark Office

VOW TO WOW

Reg. No. 4,177,052

SAMUELS JEWELERS, INC. (DELAWARE CORPORATION)
2914 MONTOPOLIS DRIVE, SUITE 200
AUSTIN, TX 78741

Registered July 17, 2012

Int. Cl.: 14

FOR: CUT DIAMONDS; DIAMOND JEWELRY; DIAMONDS; JEWELRY, IN CLASS 14 (U.S. CLS. 2, 27, 28 AND 50).

TRADEMARK

FIRST USE 11-30-2010; IN COMMERCE 11-30-2010.

PRINCIPAL REGISTER

THE MARK CONSISTS OF STANDARD CHARACTERS WITHOUT CLAIM TO ANY PARTICULAR FONT, STYLE, SIZE, OR COLOR.

SN 85-392,546, FILED 8-8-2011.

ODESSA BIBBINS, EXAMINING ATTORNEY



David J. Kyffers

Director of the United States Patent and Trademark Office

United States of America

United States Patent and Trademark Office

TIME OPTICS

Reg. No. 4,177,053

Registered July 17, 2012

Int. Cl.: 14

TRADEMARK

PRINCIPAL REGISTER

TIMELESS SOURCES LLC (NEW YORK LIMITED LIABILITY COMPANY)
330 EAST 75TH STREET, SUITE 32C
NEW YORK, NY 10021

FOR: WATCHES, IN CLASS 14 (U.S. CLS. 2, 27, 28 AND 50).

FIRST USE 12-0-2011; IN COMMERCE 12-0-2011.

THE MARK CONSISTS OF STANDARD CHARACTERS WITHOUT CLAIM TO ANY PARTICULAR FONT, STYLE, SIZE, OR COLOR.

NO CLAIM IS MADE TO THE EXCLUSIVE RIGHT TO USE "TIME", APART FROM THE MARK AS SHOWN.

SN 85-392,902, FILED 8-9-2011.

MICHAEL WEBSTER, EXAMINING ATTORNEY



David J. Kyffers

Director of the United States Patent and Trademark Office

United States of America

United States Patent and Trademark Office



Reg. No. 4,177,054

Registered July 17, 2012

Int. Cl.: 14

TRADEMARK

PRINCIPAL REGISTER

SYMBIOTIQUE LLC (DELAWARE LIMITED LIABILITY COMPANY)
52 WEBSTER AVE #26
NEW ROCHELLE, NY 10801

FOR: JEWELRY, IN CLASS 14 (U.S. CLS. 2, 27, 28 AND 50).

FIRST USE 8-15-2011; IN COMMERCE 8-15-2011.

THE MARK CONSISTS OF A STYLIZED LETTER "S" IN A CIRCLE.

SN 85-393,161, FILED 8-9-2011.

RUSS HERMAN, EXAMINING ATTORNEY



David J. Kyffers

Director of the United States Patent and Trademark Office

United States of America

United States Patent and Trademark Office

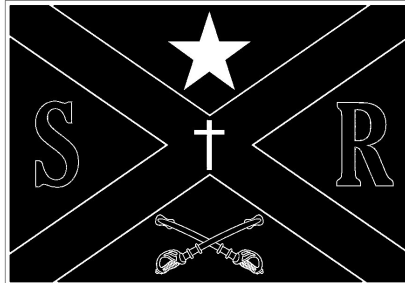

Southern Republic

Reg. No. 4,177,055

CARROLL, KEVIN (UNITED STATES INDIVIDUAL)
13199 SAMOSET CT
WELLINGTON, FL 33414

Registered July 17, 2012

Int. Cl.: 25

FOR: DRESS SHIRTS, IN CLASS 25 (U.S. CLS. 22 AND 39).

TRADEMARK

FIRST USE 8-1-2011; IN COMMERCE 1-1-2012.

PRINCIPAL REGISTER

SN 85-393,776, FILED 8-9-2011.

KATHERINE CHANG, EXAMINING ATTORNEY



David J. Kyffers

Director of the United States Patent and Trademark Office

United States of America

United States Patent and Trademark Office

redpunch

Reg. No. 4,177,056

Registered July 17, 2012

Int. Cl.: 42

SERVICE MARK

PRINCIPAL REGISTER

REDPUNCH SOFTWARE LLC (ILLINOIS LIMITED LIABILITY COMPANY)
SUITE 270
40 SHUMAN BLVD
NAPERVILLE, IL 60563

FOR: COMPUTER SOFTWARE DEVELOPMENT, IN CLASS 42 (U.S. CLS. 100 AND 101).

FIRST USE 5-10-2012; IN COMMERCE 5-10-2012.

THE MARK CONSISTS OF STANDARD CHARACTERS WITHOUT CLAIM TO ANY PARTICULAR FONT, STYLE, SIZE, OR COLOR.

SN 85-393,792, FILED 8-9-2011.

KATHERINE CONNOLLY, EXAMINING ATTORNEY



David J. Kybas

Director of the United States Patent and Trademark Office

United States of America

United States Patent and Trademark Office

SAFE-T-ZONE

Reg. No. 4,177,057

ALABAMA POWER COMPANY (ALABAMA CORPORATION)
600 NORTH 18TH STREET
BIRMINGHAM, AL 35203

Registered July 17, 2012

Int. Cl.: 41

FOR: EDUCATIONAL SERVICES, NAMELY, PROVIDING A PROGRAM REGARDING THE DANGERS OF WORKING NEAR ELECTRICAL LINES AND HOW TO RESPOND TO ELECTRICAL EMERGENCIES, IN CLASS 41 (U.S. CLS. 100, 101 AND 107).

SERVICE MARK

FIRST USE 4-1-2011; IN COMMERCE 4-1-2011.

PRINCIPAL REGISTER

THE MARK CONSISTS OF STANDARD CHARACTERS WITHOUT CLAIM TO ANY PARTICULAR FONT, STYLE, SIZE, OR COLOR.

SN 85-393,953, FILED 8-10-2011.

NICHOLAS COLEMAN, EXAMINING ATTORNEY



David J. Kyffers

Director of the United States Patent and Trademark Office

United States of America

United States Patent and Trademark Office

WE'RE BETTER TOGETHER

Reg. No. 4,177,058

MY COMMUNITY LIFE, LLC (TEXAS LIMITED LIABILITY COMPANY)
3403 PALMER DR.

Registered July 17, 2012

AMARILLO, TX 79109

Int. Cl.: 42

FOR: COMPUTER SERVICES, NAMELY, CREATING AN ON-LINE COMMUNITY FOR REGISTERED USERS TO PARTICIPATE IN DISCUSSIONS, GET FEEDBACK FROM THEIR PEERS, FORM VIRTUAL COMMUNITIES, AND ENGAGE IN SOCIAL NETWORKING FEATURING SOCIAL MEDIA, IN CLASS 42 (U.S. CLS. 100 AND 101).

SERVICE MARK

PRINCIPAL REGISTER

FIRST USE 5-2-2011; IN COMMERCE 12-1-2011.

THE MARK CONSISTS OF STANDARD CHARACTERS WITHOUT CLAIM TO ANY PARTICULAR FONT, STYLE, SIZE, OR COLOR.

SN 85-394,389, FILED 8-10-2011.

ELI HELLMAN, EXAMINING ATTORNEY



David J. Kyffers

Director of the United States Patent and Trademark Office

United States of America

United States Patent and Trademark Office



Reg. No. 4,177,059

FASTRAC MARKETS, LLC (NEW YORK LIMITED LIABILITY COMPANY)
6500 NEW VENTURE GEAR ROAD
EAST SYRACUSE, NY 13057

Registered July 17, 2012

Int. Cl.: 9

FOR: MAGNETIC CODED CARDS FOR IDENTIFYING CASH PAYING CUSTOMERS, AND THAT PERMITS THE CARD HOLDER WITH ACCESS TO ACTIVATE FUEL PUMP WITHOUT HAVING TO PREPAY FOR THE FUEL, IN CLASS 9 (U.S. CLS. 21, 23, 26, 36 AND 38).

TRADEMARK

FIRST USE 11-9-2011; IN COMMERCE 11-9-2011.

PRINCIPAL REGISTER

OWNER OF U.S. REG. NO. 3,937,552.

NO CLAIM IS MADE TO THE EXCLUSIVE RIGHT TO USE "HONOR CARD", APART FROM THE MARK AS SHOWN.

THE MARK CONSISTS OF THE WORD "FASTRAC" WITH A SWIRL LOGO ABOVE "FASTRAC" AND THE WORDS "HONOR CARD" IN A LARGER, SHADOWED FONT POSITIONED BELOW THE WORD "FASTRAC".

SN 85-394,792, FILED 8-10-2011.

JESSICA FATHY, EXAMINING ATTORNEY



David J. Kyros

Director of the United States Patent and Trademark Office

United States of America

United States Patent and Trademark Office

Prayermaker

Reg. No. 4,177,060

Registered July 17, 2012

Int. Cl.: 9

TRADEMARK

PRINCIPAL REGISTER

TRUMIST, LLC (TENNESSEE LIMITED LIABILITY COMPANY)
8220 ALAMO ROAD
BRENTWOOD, TN 37027

FOR: DOWNLOADABLE SOFTWARE IN THE NATURE OF A MOBILE APPLICATION FOR RETRIEVING AND COMPILING DIGITAL CONTENT, NAMELY, FOR THE SELECTION OF PRE-POPULATED SPIRITUAL CONTENT, SELECTION OF A FAITH OR SPIRITUAL STYLE FOR THE CONTENT, AND FOR THE DESIGN OF PERSONALIZED TEXT WITH A SPECIFIC INTENTION; DOWNLOADABLE SOFTWARE IN THE NATURE OF A MOBILE APPLICATION FOR ENABLING USERS TO PARTICIPATE IN ON-LINE CHAT ROOMS AND ELECTRONIC BULLETIN BOARDS FOR TRANSMISSION OF MESSAGES AND SHARING OF INFORMATION AMONG USERS IN THE FIELD OF SPIRITUAL CONTENT, FOR PROVIDING ACCESS TO SOCIAL MEDIA SITES ON THE INTERNET AND FOR TRANSMITTING AND RECEIVING E-MAIL COMMUNICATIONS , IN CLASS 9 (U.S. CLS. 21, 23, 26, 36 AND 38).

FIRST USE 6-1-2011; IN COMMERCE 3-19-2012.

THE MARK CONSISTS OF STANDARD CHARACTERS WITHOUT CLAIM TO ANY PARTICULAR FONT, STYLE, SIZE, OR COLOR.

SN 85-395,638, FILED 8-11-2011.

HAI-LY LAM, EXAMINING ATTORNEY



David J. Kyffers

Director of the United States Patent and Trademark Office

United States of America

United States Patent and Trademark Office

MAKE IT RAIN

Reg. No. 4,177,061

VICTOR, K.C. (UNITED STATES INDIVIDUAL)
12121 WILSHIRE BOULEVARD, SUITE 800
LOS ANGELES, CA 90025

Registered July 17, 2012

Int. Cl.: 35

FOR: INDIVIDUALLY TAILORED BUSINESS CONSULTING SERVICES FOR LAWYERS
RELATING TO CLIENT DEVELOPMENT, IN CLASS 35 (U.S. CLS. 100, 101 AND 102).

SERVICE MARK

FIRST USE 2-13-2012; IN COMMERCE 2-13-2012.

PRINCIPAL REGISTER

THE MARK CONSISTS OF STANDARD CHARACTERS WITHOUT CLAIM TO ANY PAR-
TICULAR FONT, STYLE, SIZE, OR COLOR.

SN 85-395,912, FILED 8-11-2011.

SUNG IN, EXAMINING ATTORNEY



David J. Kyffers

Director of the United States Patent and Trademark Office

United States of America

United States Patent and Trademark Office

SAMARITAN coffee 

Reg. No. 4,177,062

IDEASWELL, INC (CALIFORNIA CORPORATION)
21702 SANTA POLA
MISSION VIEJO, CA 92692

Registered July 17, 2012

Int. Cl.: 30

FOR: COFFEE, IN CLASS 30 (U.S. CL. 46).

TRADEMARK

FIRST USE 12-22-2011; IN COMMERCE 2-19-2012.

PRINCIPAL REGISTER

NO CLAIM IS MADE TO THE EXCLUSIVE RIGHT TO USE "COFFEE", APART FROM THE MARK AS SHOWN.

THE MARK CONSISTS OF THE STYLIZED TEXT "SAMARITAN COFFEE" WITH A LEAF ON THE RIGHT.

SN 85-395,952, FILED 8-11-2011.

REGINA DRUMMOND, EXAMINING ATTORNEY



David J. Kybas

Director of the United States Patent and Trademark Office

United States of America

United States Patent and Trademark Office



Reg. No. 4,177,063

Registered July 17, 2012

Int. Cl.: 29

TRADEMARK

PRINCIPAL REGISTER

SAPUTO CHEESE USA INC. (DELAWARE CORPORATION)
SUITE 250
25 TRI-STATE INTERNATIONAL OFFICE CENTER
LINCOLNSHIRE, IL 600694453

FOR: CHEESE, IN CLASS 29 (U.S. CL. 46).

FIRST USE 2-0-2012; IN COMMERCE 2-0-2012.

OWNER OF U.S. REG. NOS. 2,629,574, 2,647,622, AND 2,883,263.

THE MARK CONSISTS OF THE WORD "FRIGO" ON TOP OF A DIAMOND SHAPE WITH A STARBURST, A SHIELD IN THE UPPER CENTER AND A CROWN ABOVE THE LETTER "I".

SN 85-396,667, FILED 8-12-2011.

DARRYL SPRUILL, EXAMINING ATTORNEY



David J. Kybas

Director of the United States Patent and Trademark Office

United States of America

United States Patent and Trademark Office

GOLD CANYON GOURMET ANGUS. TASTE THE GOLD STANDARD

Reg. No. 4,177,064

Registered July 17, 2012

Int. Cl.: 29

SHAMROCK FOODS COMPANY (ARIZONA CORPORATION)
SUITE 300
3900 EAST CAMELBACK ROAD
PHOENIX, AZ 85018

FOR: MEAT, NAMELY, ANGUS BEEF, IN CLASS 29 (U.S. CL. 46).

TRADEMARK

FIRST USE 9-3-2011; IN COMMERCE 9-3-2011.

PRINCIPAL REGISTER

THE MARK CONSISTS OF STANDARD CHARACTERS WITHOUT CLAIM TO ANY PARTICULAR FONT, STYLE, SIZE, OR COLOR.

OWNER OF U.S. REG. NO. 3,914,013.

NO CLAIM IS MADE TO THE EXCLUSIVE RIGHT TO USE "GOURMET ANGUS", APART FROM THE MARK AS SHOWN.

SN 85-397,125, FILED 8-12-2011.

KHANH LE, EXAMINING ATTORNEY



David J. Kybas

Director of the United States Patent and Trademark Office

United States of America

United States Patent and Trademark Office

TABLETMALL

Reg. No. 4,177,065

WIRELESS EMPORIUM, INC. (CALIFORNIA CORPORATION)

Registered July 17, 2012

1410 N. BATAVIA
ORANGE, CA 92867

Int. Cl.: 35

FOR: ONLINE RETAIL STORE SERVICES FOR NOTEBOOK COMPUTER AND TABLET COMPUTER ACCESSORIES, NAMELY, COMPUTER CASES, COMPUTER STANDS, SCREEN PROTECTOR FILMS, COMPUTER CABLES, BATTERY CHARGERS, FACEPLATES AND POUCHES, IN CLASS 35 (U.S. CLS. 100, 101 AND 102).

SERVICE MARK

PRINCIPAL REGISTER

FIRST USE 1-21-2011; IN COMMERCE 9-1-2011.

THE MARK CONSISTS OF STANDARD CHARACTERS WITHOUT CLAIM TO ANY PARTICULAR FONT, STYLE, SIZE, OR COLOR.

SN 85-399,097, FILED 8-16-2011.

ALLISON HOLTZ, EXAMINING ATTORNEY



David J. Kybas

Director of the United States Patent and Trademark Office

United States of America

United States Patent and Trademark Office



Reg. No. 4,177,066

Registered July 17, 2012

Int. Cl.: 29

TRADEMARK

PRINCIPAL REGISTER

H. J. HEINZ COMPANY (PENNSYLVANIA CORPORATION)
P.O. BOX 57
PITTSBURGH, PA 15230

FOR: PROCESSED POTATOES; FROZEN PREPARED POTATOES; PROCESSED VEGETABLES, IN CLASS 29 (U.S. CL. 46).

FIRST USE 8-30-2011; IN COMMERCE 8-30-2011.

OWNER OF U.S. REG. NOS. 739,456, 3,417,895, AND 3,444,981.

THE COLOR(S) RED, BROWN, YELLOW AND WHITE IS/ARE CLAIMED AS A FEATURE OF THE MARK.

NO CLAIM IS MADE TO THE EXCLUSIVE RIGHT TO USE "SINCE 1952", APART FROM THE MARK AS SHOWN.

THE MARK CONSISTS OF A YELLOW, WHITE AND RED SUNBURST PATTERN CENTERED ACROSS A RED BACKGROUND. THE UPPER SECTION OF THE MARK ABOVE THE YELLOW SUNBURST PATTERN CONSISTS OF THE MARK "ORE IDA" IN YELLOW PLACED ON AN IMAGE OF TWO LEAVES UNDER THE WORDS "SINCE 1952" IN YELLOW AND A FAINT YELLOW LINE. THE LEFT SIDE OF THE IMAGE OF THE TWO LEAVES IS A BROWN LEAF AND THE RIGHT SIDE OF THE IMAGE IS A RED LEAF. THE ENTIRE IMAGE OF THE TWO LEAVES IS OUTLINED IN A WHITE AND YELLOW BORDER. THE LOWER SECTION OF THE MARK CONSISTS OF A YELLOW AND WHITE BANNER THAT FADES FROM YELLOW ON BOTH THE LEFT AND RIGHT SIDES TOWARDS A WHITE CENTER. DASHED LINES SHOWN IN THE DRAWING ARE INTENDED TO ILLUSTRATE AN ENVIRONMENT IN WHICH THE MARK IS USED, AND ARE NOT CLAIMED AS PART OF THE MARK. APPLICANT MAKES NO CLAIM TO THE SHAPE DEFINED BY THE DASHED LINES.

SN 85-399,697, FILED 8-16-2011.

HEATHER THOMPSON, EXAMINING ATTORNEY

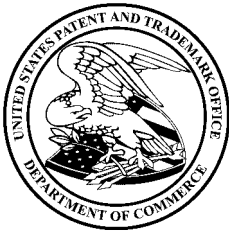

David J. Kyffers

Director of the United States Patent and Trademark Office

United States of America

United States Patent and Trademark Office

PURE₄

Reg. No. 4,177,067

BOMGAARS SUPPLY, INC. (IOWA CORPORATION)
1805 ZENITH DRIVE
SIOUX CITY, IA 51103

Registered July 17, 2012

Int. Cl.: 4

FOR: AUTOMOTIVE GREASES; LUBRICATING OILS FOR MOTOR VEHICLE ENGINES;
GREASES FOR AGRICULTURAL MACHINES; LUBRICATING OILS FOR AGRICULTURAL
MOTOR VEHICLE ENGINES, IN CLASS 4 (U.S. CLS. 1, 6 AND 15).

TRADEMARK

FIRST USE 8-29-2011; IN COMMERCE 8-29-2011.

PRINCIPAL REGISTER

THE MARK CONSISTS OF THE WORD "PURE" IN GRAY STYLIZED FONT OUTLINED IN
BLACK WITH A NUMBER "4" APPEARING IN GRAY WITH BLACK OUTLINING AS A
SUBSCRIPT TO THE RIGHT OF THE WORD "PURE".

THE COLOR(S) GRAY AND BLACK IS/ARE CLAIMED AS A FEATURE OF THE MARK.

SN 85-399,923, FILED 8-17-2011.

EMILY CHUO, EXAMINING ATTORNEY



David J. Kybas

Director of the United States Patent and Trademark Office

United States of America

United States Patent and Trademark Office

UNREAL
HAWAII

Reg. No. 4,177,068

Registered July 17, 2012

Int. Cl.: 41

SERVICE MARK

PRINCIPAL REGISTER

CHATSUTHIPHAN, DAVID (UNITED STATES INDIVIDUAL)
APT. 2103
1848 KAHAKAI DR.
HONOLULU, HI 96814

FOR: PROVIDING A WEBSITE FEATURING BLOGS IN THE FIELD OF OUTDOOR ACTIVITIES IN HAWAII, IN CLASS 41 (U.S. CLS. 100, 101 AND 107).

FIRST USE 6-30-2010; IN COMMERCE 6-30-2010.

NO CLAIM IS MADE TO THE EXCLUSIVE RIGHT TO USE "HAWAII", APART FROM THE MARK AS SHOWN.

THE MARK CONSISTS OF THE TWO WORDS "UNREAL" AND "HAWAII" SET IN UPPER CASE IN STYLIZED FONT. THE WORD "UNREAL" IS STACKED ON TOP OF THE WORD "HAWAII", AND OFFSET SLIGHTLY TO THE LEFT.

SN 85-399,973, FILED 8-17-2011.

KIMBERLY FRYE, EXAMINING ATTORNEY



David J. Kybas

Director of the United States Patent and Trademark Office

United States of America

United States Patent and Trademark Office

LEDGER

Reg. No. 4,177,069

TENKOZ, INC. (GEORGIA CORPORATION)
1725 WINDWARD CONCOURSE, SUITE 410
ALPHARETTA, GA 300051784

Registered July 17, 2012

Int. Cl.: 5

FOR: PESTICIDES AND PREPARATIONS FOR DESTROYING VERMIN, NAMELY, HERBICIDES, INSECTICIDES, FUNGICIDES AND MITICIDES FOR AGRICULTURE, HORTICULTURE, FORESTRY, TURF AND ORNAMENTAL, COMMERCIAL, INDUSTRIAL AND DOMESTIC USE, IN CLASS 5 (U.S. CLS. 6, 18, 44, 46, 51 AND 52).

TRADEMARK

PRINCIPAL REGISTER

FIRST USE 4-12-2012; IN COMMERCE 4-12-2012.

THE MARK CONSISTS OF STANDARD CHARACTERS WITHOUT CLAIM TO ANY PARTICULAR FONT, STYLE, SIZE, OR COLOR.

SN 85-400,119, FILED 8-17-2011.

NORA BUCHANAN WILL, EXAMINING ATTORNEY



David J. Kyjars

Director of the United States Patent and Trademark Office

United States of America

United States Patent and Trademark Office

SOLENCIA

Reg. No. 4,177,070

Registered July 17, 2012

Int. Cl.: 35

SERVICE MARK

PRINCIPAL REGISTER

SOLENCIA, INC. (NEVADA CORPORATION)
1785 EAST SAHARA AVENUE, SUITE 490-905
LAS VEGAS, NV 89104

FOR: PROVIDING INFORMATION AND NEWS IN THE FIELD OF BUSINESS; PROVIDING INFORMATION AND NEWS IN THE FIELD OF BUSINESS, NAMELY, INFORMATION AND NEWS ON CURRENT EVENTS AND ON ECONOMIC, LEGISLATIVE, AND REGULATORY DEVELOPMENTS AS IT RELATES TO AND CAN IMPACT BUSINESSES, IN CLASS 35 (U.S. CLS. 100, 101 AND 102).

FIRST USE 12-24-2011; IN COMMERCE 12-24-2011.

THE MARK CONSISTS OF STANDARD CHARACTERS WITHOUT CLAIM TO ANY PARTICULAR FONT, STYLE, SIZE, OR COLOR.

THE WORDING "SOLENCIA" HAS NO MEANING IN A FOREIGN LANGUAGE.

SN 85-401,061, FILED 8-18-2011.

WANDA KAY PRICE, EXAMINING ATTORNEY



David J. Kybas

Director of the United States Patent and Trademark Office

United States of America

United States Patent and Trademark Office



Reg. No. 4,177,071

PRODUCTION YAK (CALIFORNIA PARTNERSHIP)
4837 TILDEN AVE.

Registered July 17, 2012

SHERMAN OAKS, CA 91423

Int. Cl.: 42

FOR: COMPUTER SERVICES, NAMELY, CREATING AN ON-LINE COMMUNITY FOR REGISTERED USERS TO PARTICIPATE IN DISCUSSIONS, GET FEEDBACK FROM THEIR PEERS, FORM VIRTUAL COMMUNITIES, AND ENGAGE IN SOCIAL NETWORKING SERVICES IN THE FIELD OF THE ENTERTAINMENT INDUSTRY; PROVIDING A WEBSITE FEATURING RESOURCES, NAMELY, A WEBSITE FEATURING PRIMARILY NON-DOWNLOADABLE SOFTWARE FOR ENGAGING IN SOCIAL NETWORKING, PARTICIPATING IN DISCUSSIONS, PROVIDING A BUSINESS DATABASE, AND RECOMMENDATION FORUMS RELATED TO THE ENTERTAINMENT INDUSTRY AND ALSO FEATURING NON-DOWNLOADABLE PUBLICATIONS IN THE NATURE OF ARTICLES, POSTS, AND VIDEOS IN THE FIELD OF THE ENTERTAINMENT INDUSTRY; PROVIDING AN ONLINE NETWORK SERVICE THAT ENABLES USERS TO SHARE DATA IN THE FIELD OF THE ENTERTAINMENT INDUSTRY, IN CLASS 42 (U.S. CLS. 100 AND 101).

SERVICE MARK

PRINCIPAL REGISTER

FIRST USE 6-1-2011; IN COMMERCE 11-30-2011.

NO CLAIM IS MADE TO THE EXCLUSIVE RIGHT TO USE "PRODUCTION", APART FROM THE MARK AS SHOWN.

THE COLOR(S) GREEN, YELLOW, BROWN, BLACK, PINK, AND WHITE IS/ARE CLAIMED AS A FEATURE OF THE MARK.

THE MARK CONSISTS OF "PRODUCTION YAK" WRITTEN IN BLACK LETTERING PRECEDED BY A HEAD OF A YAK WITH BROWN FUR, PINK MOUTH AND EARS, WHITE NOSE, BLACK EYEBROWS AND OUTLINING, AND YELLOW HORNS PROJECTING OUTSIDE OF A GREEN CIRCLE.

SN 85-402,167, FILED 8-19-2011.

LEIGH CAROLINE CASE, EXAMINING ATTORNEY



David J. Kyffers

Director of the United States Patent and Trademark Office

United States of America

United States Patent and Trademark Office

Splendid Fare

Reg. No. 4,177,072

Registered July 17, 2012

Int. Cl.: 35

SERVICE MARK

PRINCIPAL REGISTER

SPLENDID FARE HEALTHCARE FOODSERVICE, LLC (LOUISIANA LIMITED LIABILITY COMPANY)
2179 OLVEY DRIVE
MANDEVILLE, LA 70448

FOR: BUSINESS AND MANAGEMENT CONSULTING FOR HEALTHCARE PROVIDERS AND RELATED BUSINESSES, IN CLASS 35 (U.S. CLS. 100, 101 AND 102).

FIRST USE 4-23-2012; IN COMMERCE 4-29-2010.

THE MARK CONSISTS OF STANDARD CHARACTERS WITHOUT CLAIM TO ANY PARTICULAR FONT, STYLE, SIZE, OR COLOR.

SN 85-402,292, FILED 8-19-2011.

KRISTINA MORRIS, EXAMINING ATTORNEY



David J. Kyffers

Director of the United States Patent and Trademark Office

United States of America

United States Patent and Trademark Office

KEMPTEN

Reg. No. 4,177,073

NOVALIS HOLDINGS LIMITED (HONG KONG CORPORATION)
338 HENNESSY RD., UNIT F, 10/F CNT TOWER
WAN CHAI, HONG KONG

Registered July 17, 2012

Int. Cl.: 27

FOR: VINYL FLOOR COVERING, IN CLASS 27 (U.S. CLS. 19, 20, 37, 42 AND 50).

TRADEMARK

FIRST USE 8-8-2011; IN COMMERCE 11-7-2011.

PRINCIPAL REGISTER

THE MARK CONSISTS OF STANDARD CHARACTERS WITHOUT CLAIM TO ANY PARTICULAR FONT, STYLE, SIZE, OR COLOR.

SN 85-402,370, FILED 8-19-2011.

JENNIFER DIXON, EXAMINING ATTORNEY



David J. Kyffers

Director of the United States Patent and Trademark Office

United States of America

United States Patent and Trademark Office



Reg. No. 4,177,074

Registered July 17, 2012

Int. Cl.: 36

SERVICE MARK

PRINCIPAL REGISTER

JAMES REALTY GROUP (ARIZONA LIMITED LIABILITY COMPANY)
922 N GILBERT RD
103
MESA, AZ 85203

FOR: REAL ESTATE MANAGEMENT SERVICES; REAL ESTATE SERVICE, NAMELY, RENTAL PROPERTY MANAGEMENT, IN CLASS 36 (U.S. CLS. 100, 101 AND 102).

FIRST USE 8-1-2011; IN COMMERCE 8-1-2011.

NO CLAIM IS MADE TO THE EXCLUSIVE RIGHT TO USE "REALTY GROUP", APART FROM THE MARK AS SHOWN.

THE MARK CONSISTS OF A SQUARE WITH ROUND CORNERS AND A ROOF SIGN OVER THE STYLIZED TEXT "JAMES REALTY GROUP".

SN 85-403,473, FILED 8-22-2011.

JAY FLOWERS, EXAMINING ATTORNEY



David J. Kybas

Director of the United States Patent and Trademark Office

United States of America

United States Patent and Trademark Office

Muay Thai Addict

Reg. No. 4,177,075

MUAY THAI ADDICT, INC. (FLORIDA CORPORATION)
245 POE DRIVE

Registered July 17, 2012

PALM SPRINGS, FL 33461

Int. Cls.: 9, 25, and 28

FOR: SPORTS EQUIPMENT FOR BOXING AND MARTIAL ARTS, NAMELY, PROTECTIVE HEADGEAR, IN CLASS 9 (U.S. CLS. 21, 23, 26, 36 AND 38).

TRADEMARK

FIRST USE 5-1-2011; IN COMMERCE 7-15-2011.

PRINCIPAL REGISTER

FOR: (BASED ON USE IN COMMERCE) ATHLETIC APPAREL, NAMELY, SHIRTS, PANTS, JACKETS, FOOTWEAR, HATS AND CAPS, ATHLETIC UNIFORMS; BOXING SHORTS; HOODED SWEAT SHIRTS; SHIRTS AND SHORT-SLEEVED SHIRTS; SHORT-SLEEVED OR LONG-SLEEVED T-SHIRTS; SHORT-SLEEVED SHIRTS; SPORT SHIRTS; SPORTS SHIRTS; SPORTS SHIRTS WITH SHORT SLEEVES; SWEAT SHIRTS; T-SHIRTS; T-SHIRTS FOR MEN, WOMEN AND CHILDREN; TEE SHIRTS (BASED ON INTENT TO USE) LONG-SLEEVED SHIRTS; MARTIAL ARTS UNIFORMS; MOISTURE-WICKING SPORTS SHIRTS, IN CLASS 25 (U.S. CLS. 22 AND 39).

FIRST USE 5-1-2011; IN COMMERCE 7-15-2011.

FOR: BOXING BAG SWIVEL MECHANISMS; BOXING BAGS; BOXING GLOVES; BOXING SWIVELS; MARTIAL ARTS TRAINING EQUIPMENT; PUNCHING BALLS; SPORTS EQUIPMENT FOR BOXING AND MARTIAL ARTS, NAMELY, BOXING GLOVES, BOXING BAGS, PUNCHING MITTS, BELLY PROTECTORS, GROIN PROTECTORS AND SHIN GUARDS; SPORTS EQUIPMENT FOR BOXING AND MARTIAL ARTS, NAMELY, BOXING GLOVES, MIXED MARTIAL ARTS GLOVES, PUNCHING MITTS, AND SHIN GUARDS; SPORTS EQUIPMENT FOR BOXING, MARTIAL ARTS, AND THE LIKE, NAMELY, AN APPARATUS TO SUPPORT A MOVING HEAVY BAG; TRAINING APPARATUS FOR BOXING, MARTIAL ARTS, AND SIMILAR SPORTS, IN CLASS 28 (U.S. CLS. 22, 23, 38 AND 50).

FIRST USE 5-1-2011; IN COMMERCE 7-15-2011.

THE MARK CONSISTS OF STANDARD CHARACTERS WITHOUT CLAIM TO ANY PARTICULAR FONT, STYLE, SIZE, OR COLOR.



David J. Kybas

Director of the United States Patent and Trademark Office

Reg. No. 4,177,075 NO CLAIM IS MADE TO THE EXCLUSIVE RIGHT TO USE "MUAY THAI", APART FROM THE MARK AS SHOWN.

SN 85-403,481, FILED 8-22-2011.

KHANH LE, EXAMINING ATTORNEY

United States of America

United States Patent and Trademark Office

THE MOBILE OUTFITTERS

Reg. No. 4,177,076

LIPPERT COMPONENTS, INC. (DELAWARE CORPORATION)
2703 COLLEGE AVENUE
GOSHEN, IN 46528

Registered July 17, 2012

Int. Cl.: 35

FOR: DISTRIBUTORSHIP SERVICES IN THE FIELD OF RECREATIONAL VEHICLE PARTS AND ACCESSORIES, IN CLASS 35 (U.S. CLS. 100, 101 AND 102).

SERVICE MARK

FIRST USE 2-21-2012; IN COMMERCE 2-21-2012.

PRINCIPAL REGISTER

THE MARK CONSISTS OF STANDARD CHARACTERS WITHOUT CLAIM TO ANY PARTICULAR FONT, STYLE, SIZE, OR COLOR.

NO CLAIM IS MADE TO THE EXCLUSIVE RIGHT TO USE "OUTFITTERS", APART FROM THE MARK AS SHOWN.

SN 85-404,944, FILED 8-23-2011.

IRA J. GOODSaid, EXAMINING ATTORNEY



David J. Kyffers

Director of the United States Patent and Trademark Office

United States of America

United States Patent and Trademark Office

POND HOPPER

Reg. No. 4,177,077

ODELL BREWING COMPANY (COLORADO CORPORATION)
800 E. LINCOLN
FORT COLLINS, CO 80524

Registered July 17, 2012

Int. Cl.: 32

FOR: ALE; BEER, IN CLASS 32 (U.S. CLS. 45, 46 AND 48).

TRADEMARK

FIRST USE 5-11-2012; IN COMMERCE 5-11-2012.

PRINCIPAL REGISTER

THE MARK CONSISTS OF STANDARD CHARACTERS WITHOUT CLAIM TO ANY PARTICULAR FONT, STYLE, SIZE, OR COLOR.

SN 85-405,184, FILED 8-23-2011.

JASON BLAIR, EXAMINING ATTORNEY



David J. Kyffers

Director of the United States Patent and Trademark Office

United States of America

United States Patent and Trademark Office

America's Pet Parents' First Choice

Reg. No. 4,177,078

KOTLARENKO, ALEXANDER (UNITED STATES INDIVIDUAL)
1401 RISING GLEN RD
LOS ANGELES, CA 90069

Registered July 17, 2012

Int. Cl.: 35

FOR: ONLINE ORDERING SERVICES USING A GLOBAL COMPUTER NETWORK, TELEPHONE ORDERING SERVICES AND MAIL ORDER SERVICES FEATURING PET SUPPLIES, PET NUTRITIONAL PRODUCTS, AND VETERINARY PHARMACEUTICALS FOR PETS, IN CLASS 35 (U.S. CLS. 100, 101 AND 102).

SERVICE MARK

PRINCIPAL REGISTER

FIRST USE 3-15-2012; IN COMMERCE 3-15-2012.

THE MARK CONSISTS OF STANDARD CHARACTERS WITHOUT CLAIM TO ANY PARTICULAR FONT, STYLE, SIZE, OR COLOR.

NO CLAIM IS MADE TO THE EXCLUSIVE RIGHT TO USE "AMERICA'S PET PARENTS", APART FROM THE MARK AS SHOWN.

SN 85-405,314, FILED 8-23-2011.

JOHN WILKE, EXAMINING ATTORNEY



David J. Kyros

Director of the United States Patent and Trademark Office

United States of America

United States Patent and Trademark Office

solutionreach

Reg. No. 4,177,079

Registered July 17, 2012

Int. Cl.: 42

SERVICE MARK

PRINCIPAL REGISTER

COMMUNITECT, INC. (DELAWARE CORPORATION)
3098 EXECUTIVE PARKWAY, SUITE #300
LEHI, UT 84043

FOR: SOFTWARE AS A SERVICE (SAAS) SERVICES FEATURING SOFTWARE FOR USE BY BUSINESS AND THEIR CUSTOMERS, PATRONS AND PATIENTS IN ELECTRONICALLY COMMUNICATING AND INTERACTING VIA THE INTERNET, PHONE, EMAIL, TEXT MESSAGES, AND SOCIAL MEDIA, FOR CREATING, CAPTURING, SHARING AND DISTRIBUTING AUDIO AND VIDEO, FOR CONDUCTING, COLLECTING AND DISSEMINATING ONLINE SURVEYS AND REVIEWS, FOR PROVIDING, ACCESSING AND MONITORING BUSINESS INFORMATION, HEALTHCARE INFORMATION, AND PERSONAL INFORMATION, DOCUMENTS, FORMS AND IMAGES, FOR CREATING, MONITORING AND EDITING APPOINTMENTS, FOR CREATING AND EDITING APPOINTMENTS AND APPOINTMENT REMINDERS, FOR PAYING BILLS, FOR CREATING AND DELIVERING E-NEWSLETTERS, FOR SENDING BIRTHDAY COMMUNICATIONS, AND FOR IDENTIFYING GEOGRAPHICAL LOCATION OF CUSTOMERS, PATRONS AND PATIENTS; COMPUTER SERVICES, NAMELY, SEARCH ENGINE OPTIMIZATION, IN CLASS 42 (U.S. CLS. 100 AND 101).

FIRST USE 9-1-2011; IN COMMERCE 9-1-2011.

THE MARK CONSISTS OF THE WORDING "SOLUTIONREACH" WITH TWO SEMI-CIRCLES ABOVE THE LETTER "I" DEPICTING TRANSMISSION WAVES.

SN 85-405,873, FILED 8-24-2011.

KATHERINE E. HALMEN, EXAMINING ATTORNEY



David J. Kyjars

Director of the United States Patent and Trademark Office

United States of America

United States Patent and Trademark Office

SOLUTIONREACH

Reg. No. 4,177,080

Registered July 17, 2012

Int. Cl.: 42

SERVICE MARK

PRINCIPAL REGISTER

COMMUNITECT, INC. (DELAWARE CORPORATION)
3098 EXECUTIVE PARKWAY, SUITE #300
LEHI, UT 84043

FOR: SOFTWARE AS A SERVICE (SAAS) SERVICES FEATURING SOFTWARE FOR USE BY BUSINESS AND THEIR CUSTOMERS, PATRONS AND PATIENTS IN ELECTRONICALLY COMMUNICATING AND INTERACTING VIA THE INTERNET, PHONE, EMAIL, TEXT MESSAGES, AND SOCIAL MEDIA, FOR CREATING, CAPTURING, SHARING AND DISTRIBUTING AUDIO AND VIDEO, FOR CONDUCTING, COLLECTING AND DISSEMINATING ONLINE SURVEYS AND REVIEWS, FOR PROVIDING, ACCESSING AND MONITORING BUSINESS INFORMATION, HEALTHCARE INFORMATION, AND PERSONAL INFORMATION, DOCUMENTS, FORMS AND IMAGES, FOR CREATING, MONITORING AND EDITING APPOINTMENTS, FOR CREATING AND EDITING APPOINTMENTS AND APPOINTMENT REMINDERS, FOR PAYING BILLS, FOR CREATING AND DELIVERING E-NEWSLETTERS, FOR SENDING BIRTHDAY COMMUNICATIONS, AND FOR IDENTIFYING GEOGRAPHICAL LOCATION OF CUSTOMERS, PATRONS AND PATIENTS; COMPUTER SERVICES, NAMELY, SEARCH ENGINE OPTIMIZATION, IN CLASS 42 (U.S. CLS. 100 AND 101).

FIRST USE 9-1-2011; IN COMMERCE 9-1-2011.

THE MARK CONSISTS OF STANDARD CHARACTERS WITHOUT CLAIM TO ANY PARTICULAR FONT, STYLE, SIZE, OR COLOR.

SN 85-405,974, FILED 8-24-2011.

KATHERINE E. HALMEN, EXAMINING ATTORNEY



David J. Kyjars

Director of the United States Patent and Trademark Office

United States of America

United States Patent and Trademark Office



Reg. No. 4,177,081

Registered July 17, 2012

Int. Cl.: 9

TRADEMARK

PRINCIPAL REGISTER

MEGATECH INC (ALABAMA CORPORATION)
4815 BRADFORD DR.
HUNTSVILLE, AL 35805

FOR: COMPUTER SOFTWARE APPLICATION FOR CREATING AND STORING INVENTORY,
IN CLASS 9 (U.S. CLS. 21, 23, 26, 36 AND 38).

FIRST USE 1-1-2006; IN COMMERCE 1-1-2006.

THE MARK CONSISTS OF THE IMAGE OF TRIANGULAR ROOF OF A HOUSE IN WHITE COLOR HAVING WINDOWS IN BLUE COLOR WHICH IS OVERLAPPING THE IMAGE OF GLOBE IN SHADES OF WHITE AND BLUE COLOR AND BOTH OF THIS IMAGES ARE OVERLAPPING A RECTANGLE IN YELLOW COLOR WHICH IS PLACED IN RECTANGLE OF WHITE COLOR AND ALL OF THESE IMAGES ARE BORDERED IN BLACK COLOR AS SHOWN IN THE MARK.

THE COLOR(S) BLUE, BLACK, WHITE AND YELLOW IS/ARE CLAIMED AS A FEATURE OF THE MARK.

SN 85-406,697, FILED 8-25-2011.

WILLIAM BRECKENFELD, EXAMINING ATTORNEY



David J. Kyros

Director of the United States Patent and Trademark Office

United States of America

United States Patent and Trademark Office

BREAKTHROUGH FOR BRAIN TUMORS

Reg. No. 4,177,082

AMERICAN BRAIN TUMOR ASSOCIATION (ILLINOIS NON-PROFIT CORPORATION)
8550 W. BRYN MAWR AVENUE, SUITE 550
CHICAGO, IL 606313225

Registered July 17, 2012

Int. Cl.: 36

FOR: CHARITABLE FUNDRAISING SERVICES, NAMELY, ORGANIZING AND CONDUCTING RUNNING AND WALKING EVENTS TO RAISE FUNDS IN THE FIELD OF BRAIN TUMOR RESEARCH, IN CLASS 36 (U.S. CLS. 100, 101 AND 102).

SERVICE MARK

FIRST USE 11-16-2011; IN COMMERCE 11-16-2011.

PRINCIPAL REGISTER

THE MARK CONSISTS OF STANDARD CHARACTERS WITHOUT CLAIM TO ANY PARTICULAR FONT, STYLE, SIZE, OR COLOR.

NO CLAIM IS MADE TO THE EXCLUSIVE RIGHT TO USE "BRAIN TUMORS", APART FROM THE MARK AS SHOWN.

SN 85-407,305, FILED 8-25-2011.

DAYNA BROWNE, EXAMINING ATTORNEY



David J. Kyffers

Director of the United States Patent and Trademark Office

United States of America

United States Patent and Trademark Office

IL PITTORE

Reg. No. 4,177,083

Registered July 17, 2012

Int. Cl.: 43

SERVICE MARK

PRINCIPAL REGISTER

STARR RESTAURANT ORGANIZATION, LP (PENNSYLVANIA LIMITED PARTNERSHIP)
134 MARKET STREET
PHILADELPHIA, PA 19106

FOR: RESTAURANT AND BAR SERVICES, IN CLASS 43 (U.S. CLS. 100 AND 101).

FIRST USE 10-0-2011; IN COMMERCE 10-0-2011.

THE MARK CONSISTS OF STANDARD CHARACTERS WITHOUT CLAIM TO ANY PARTICULAR FONT, STYLE, SIZE, OR COLOR.

THE ENGLISH TRANSLATION OF THE WORDS "IL PITTORE" IN THE MARK IS "PAINTER".

SN 85-407,974, FILED 8-26-2011.

MICHAEL SOUDERS, EXAMINING ATTORNEY



David J. Kyffers

Director of the United States Patent and Trademark Office

United States of America

United States Patent and Trademark Office

SLOPPY JOELOPY

Reg. No. 4,177,084

Registered July 17, 2012

Int. Cl.: 43

LEVY PREMIUM FOODSERVICE LIMITED PARTNERSHIP (ILLINOIS LIMITED PARTNERSHIP)

SUITE 400
980 NORTH MICHIGAN AVENUE
CHICAGO, IL 60611

SERVICE MARK

FOR: PROVIDING OF FOOD AND DRINK VIA A MOBILE TRUCK, IN CLASS 43 (U.S. CLS. 100 AND 101).

PRINCIPAL REGISTER

FIRST USE 10-22-2011; IN COMMERCE 11-2-2011.

THE MARK CONSISTS OF STANDARD CHARACTERS WITHOUT CLAIM TO ANY PARTICULAR FONT, STYLE, SIZE, OR COLOR.

SN 85-408,181, FILED 8-26-2011.

TINA MAI, EXAMINING ATTORNEY



David J. Kyffers

Director of the United States Patent and Trademark Office

United States of America

United States Patent and Trademark Office

BREASTDECIDE

Reg. No. 4,177,085

ORCA MD LLC (UTAH LIMITED LIABILITY COMPANY)
6300 SAGEWOOD DRIVE, SUITE H-115
PARK CITY, UT 84098

Registered July 17, 2012

Int. Cl.: 9

FOR: DOWNLOADABLE SOFTWARE FOR PROVIDING HEALTH INFORMATION, IN CLASS 9 (U.S. CLS. 21, 23, 26, 36 AND 38).

TRADEMARK

FIRST USE 7-1-2011; IN COMMERCE 7-1-2011.

PRINCIPAL REGISTER

THE MARK CONSISTS OF STANDARD CHARACTERS WITHOUT CLAIM TO ANY PARTICULAR FONT, STYLE, SIZE, OR COLOR.

OWNER OF U.S. REG. NOS. 3,965,514, 4,003,915, AND 4,003,916.

SN 85-408,250, FILED 8-26-2011.

ESTHER BELENKER, EXAMINING ATTORNEY



David J. Kyffers

Director of the United States Patent and Trademark Office

United States of America

United States Patent and Trademark Office

EYEDECIDE

Reg. No. 4,177,086

ORCA MD LLC (UTAH LIMITED LIABILITY COMPANY)
6300 SAGEWOOD DRIVE, SUITE H-115
PARK CITY, UT 84098

Registered July 17, 2012

Int. Cl.: 9

FOR: DOWNLOADABLE SOFTWARE FOR PROVIDING HEALTH INFORMATION, IN CLASS 9 (U.S. CLS. 21, 23, 26, 36 AND 38).

TRADEMARK

FIRST USE 8-1-2011; IN COMMERCE 8-1-2011.

PRINCIPAL REGISTER

THE MARK CONSISTS OF STANDARD CHARACTERS WITHOUT CLAIM TO ANY PARTICULAR FONT, STYLE, SIZE, OR COLOR.

OWNER OF U.S. REG. NOS. 3,965,514, 4,003,915, AND 4,003,916.

SN 85-408,261, FILED 8-26-2011.

ESTHER BELENKER, EXAMINING ATTORNEY



David J. Kybas

Director of the United States Patent and Trademark Office

United States of America

United States Patent and Trademark Office

TOPSEAT

Reg. No. 4,177,087

TOPSEAT INTERNATIONAL, INC. (TEXAS CORPORATION)
6913 K AVENUE, SUITE 311
PLANO, TX 75074

Registered July 17, 2012

Int. Cl.: 11

FOR: TOILETS, TOILET SEATS, IN CLASS 11 (U.S. CLS. 13, 21, 23, 31 AND 34).

TRADEMARK

FIRST USE 2-21-2011; IN COMMERCE 9-1-2011.

PRINCIPAL REGISTER

THE MARK CONSISTS OF STANDARD CHARACTERS WITHOUT CLAIM TO ANY PARTICULAR FONT, STYLE, SIZE, OR COLOR.

SN 85-408,278, FILED 8-26-2011.

MICHAEL WEBSTER, EXAMINING ATTORNEY



David J. Kyffers

Director of the United States Patent and Trademark Office

United States of America

United States Patent and Trademark Office

VERVE

Reg. No. 4,177,088

Registered July 17, 2012

Int. Cl.: 3

TRADEMARK

PRINCIPAL REGISTER

WHOLE FOODS MARKET IP, L.P. (DELAWARE LIMITED PARTNERSHIP)
550 BOWIE STREET, 6TH FLOOR
AUSTIN, TX 78703

FOR: BAR SOAP, IN CLASS 3 (U.S. CLS. 1, 4, 6, 50, 51 AND 52).

FIRST USE 4-7-2012; IN COMMERCE 4-7-2012.

THE MARK CONSISTS OF STANDARD CHARACTERS WITHOUT CLAIM TO ANY PARTICULAR FONT, STYLE, SIZE, OR COLOR.

SN 85-408,585, FILED 8-26-2011.

SUSAN RICHARDS, EXAMINING ATTORNEY



David J. Kyffers

Director of the United States Patent and Trademark Office

United States of America

United States Patent and Trademark Office

Neat 3B Facesaver

Reg. No. 4,177,089

Registered July 17, 2012

Int. Cl.: 3

TRADEMARK

PRINCIPAL REGISTER

NEAT FEAT PRODUCTS LIMITED (NEW ZEALAND LIMITED LIABILITY COMPANY)
UNIT 13, 101-111 DIANA DRIVE, GLENFIELD
NORTH SHORE, AUCKLAND, NEW ZEALAND

FOR: ANTIPERSPIRANTS, IN CLASS 3 (U.S. CLS. 1, 4, 6, 50, 51 AND 52).

FIRST USE 11-30-2009; IN COMMERCE 2-15-2012.

THE MARK CONSISTS OF STANDARD CHARACTERS WITHOUT CLAIM TO ANY PARTICULAR FONT, STYLE, SIZE, OR COLOR.

OWNER OF U.S. REG. NO. 3,352,259.

SN 85-409,196, FILED 8-28-2011.

ZHALEH DELANEY, EXAMINING ATTORNEY



David J. Kyffers

Director of the United States Patent and Trademark Office

United States of America

United States Patent and Trademark Office

Clearlyderm
Center for Dermatology

Reg. No. 4,177,090

CLEARLY DERM LLC (FLORIDA LIMITED LIABILITY COMPANY)
7050-30 PALMETTO PARK ROAD
BOCA RATON, FL 33433

Registered July 17, 2012

Int. Cl.: 44

FOR: MEDICAL SERVICES, NAMELY, DERMATOLOGICAL SERVICES, IN CLASS 44 (U.S. CLS. 100 AND 101).

SERVICE MARK

FIRST USE 9-1-2011; IN COMMERCE 4-1-2012.

PRINCIPAL REGISTER

NO CLAIM IS MADE TO THE EXCLUSIVE RIGHT TO USE "CENTER FOR DERMATOLOGY", APART FROM THE MARK AS SHOWN.

THE MARK CONSISTS OF THE STYLIZED WORDING "CLEARLYDERM" ABOVE THE STYLIZED WORDING "CENTER FOR DERMATOLOGY" WITH A STYLIZED LEAF ABOVE THE LETTER "Y" IN "CLEARLYDERM".

SN 85-409,538, FILED 8-29-2011.

KELLEY WELLS, EXAMINING ATTORNEY



David J. Kyffers

Director of the United States Patent and Trademark Office

United States of America

United States Patent and Trademark Office

WHORL

Reg. No. 4,177,091

WESLEY W. WHITMYER, JR. (UNITED STATES INDIVIDUAL)
986 BEDFORD STREET
STAMFORD, CT 069055619

Registered July 17, 2012

Int. Cl.: 42

FOR: DESIGNING, DEVELOPING, HOSTING, AND PROVIDING PERSONALIZED WEBSITES FEATURING TECHNOLOGY THAT ENABLES USERS TO PUBLISH PUBLIC AND PERSONAL INFORMATION FROM A VARIETY OF SOURCES AND RESTRICT ACCESS TO VARIOUS TYPES OF INFORMATION TO DIFFERENT CATEGORIES OF SITE VISITORS, IN CLASS 42 (U.S. CLS. 100 AND 101).

SERVICE MARK

PRINCIPAL REGISTER

FIRST USE 5-4-2012; IN COMMERCE 5-4-2012.

THE MARK CONSISTS OF STANDARD CHARACTERS WITHOUT CLAIM TO ANY PARTICULAR FONT, STYLE, SIZE, OR COLOR.

SN 85-410,260, FILED 8-30-2011.

JENNIFER VASQUEZ, EXAMINING ATTORNEY



David J. Kybas

Director of the United States Patent and Trademark Office

United States of America

United States Patent and Trademark Office

Kally Tea Keep It Loose

Reg. No. 4,177,092

KALLY TEA, LLC (CALIFORNIA LIMITED LIABILITY COMPANY)
42780 MINTO WAY
HEMET, CA 92544

Registered July 17, 2012

Int. Cl.: 35

FOR: ON-LINE RETAIL STORE SERVICES FEATURING TEA, TEA INFUSER, AND MUGS,
IN CLASS 35 (U.S. CLS. 100, 101 AND 102).

SERVICE MARK

FIRST USE 9-23-2011; IN COMMERCE 12-22-2011.

PRINCIPAL REGISTER

THE MARK CONSISTS OF STANDARD CHARACTERS WITHOUT CLAIM TO ANY PARTICULAR FONT, STYLE, SIZE, OR COLOR.

NO CLAIM IS MADE TO THE EXCLUSIVE RIGHT TO USE "TEA", APART FROM THE MARK AS SHOWN.

SN 85-410,331, FILED 8-30-2011.

KELLY BOULTON, EXAMINING ATTORNEY



David J. Kyffers

Director of the United States Patent and Trademark Office

United States of America

United States Patent and Trademark Office

BEAUTY MEETS SAFETY

Reg. No. 4,177,093

Registered July 17, 2012

Int. Cl.: 3

TRADEMARK

PRINCIPAL REGISTER

BEAUTY SYNERGY LLC (FLORIDA LIMITED LIABILITY COMPANY)
382 NE 191ST STREET
MIAMI, FL 33179

FOR: HAIR BALSAM; HAIR CARE PREPARATIONS; HAIR CONDITIONERS; HAIR DYE;
HAIR EMOLLIENTS; HAIR GELS; HAIR NOURISHERS; HAIR RELAXERS; HAIR SHAMPOO;
HAIR SHAMPOOS AND CONDITIONERS; HAIR SPRAY; HAIR STRAIGHTENING PREPAR-
ATIONS; HAIR STYLING GEL; HAIR STYLING SPRAY; HAIR TONIC; NON-MEDICATED
HAIR SERUMS, IN CLASS 3 (U.S. CLS. 1, 4, 6, 50, 51 AND 52).

FIRST USE 1-1-2010; IN COMMERCE 9-1-2011.

THE MARK CONSISTS OF STANDARD CHARACTERS WITHOUT CLAIM TO ANY PAR-
TICULAR FONT, STYLE, SIZE, OR COLOR.

SN 85-410,344, FILED 8-30-2011.

LAURIE MAYES, EXAMINING ATTORNEY



David J. Kyffers

Director of the United States Patent and Trademark Office

United States of America

United States Patent and Trademark Office

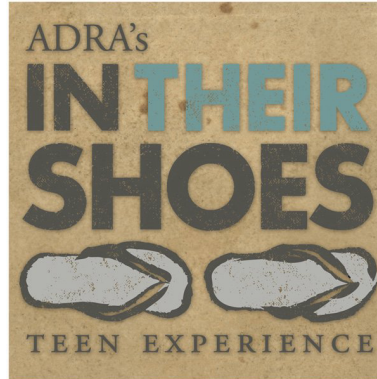

Reg. No. 4,177,094

Registered July 17, 2012

Int. Cl.: 41

SERVICE MARK

PRINCIPAL REGISTER

ADVENTIST DEVELOPMENT AND RELIEF AGENCY (D.C. CORPORATION), AKA ADRA,
12501 OLD COLUMBIA PIKE
SILVER SPRING, MD 20904

FOR: EDUCATIONAL SERVICES, NAMELY, CONDUCTING WORKSHOPS IN THE FIELD OF WORLD POVERTY AS IT RELATES TO WATER, FOOD, EDUCATION, AND HUMAN RIGHTS AND DISTRIBUTION OF EDUCATIONAL MATERIALS IN CONNECTION THEREWITH, IN CLASS 41 (U.S. CLS. 100, 101 AND 107).

FIRST USE 4-30-2011; IN COMMERCE 4-30-2011.

OWNER OF U.S. REG. NO. 2,065,031.

THE COLOR(S) TAN, BLACK, BLUE AND GRAY IS/ARE CLAIMED AS A FEATURE OF THE MARK.

NO CLAIM IS MADE TO THE EXCLUSIVE RIGHT TO USE "TEEN EXPERIENCE", APART FROM THE MARK AS SHOWN.

THE MARK CONSISTS OF A RECTANGLE THAT CONTAINS THE WORDS "ADRA'S IN THEIR SHOES" ABOVE TWO SANDALS AND THE WORDS "TEEN EXPERIENCE" BELOW THE SANDALS. THE WORDS "ADRA'S", "IN", AND "SHOES" APPEAR IN BLACK WITH TAN SPECKLES. THE WORD "THEIR" APPEARS IN BLUE WITH TAN SPECKLES. THE WORDS "TEEN EXPERIENCE" APPEAR IN BLACK. THE SANDALS APPEAR IN GRAY, TAN AND BLACK. THE RECTANGLE IS TAN AND IS SPECKLED TO RESEMBLE SAND.

SN 85-410,372, FILED 8-30-2011.

MEGHAN REINHART, EXAMINING ATTORNEY



David J. Kyffers

Director of the United States Patent and Trademark Office

United States of America

United States Patent and Trademark Office

TRUE BLUEBERRY DUET

Reg. No. 4,177,095

Registered July 17, 2012

Int. Cl.: 30

TRADEMARK

PRINCIPAL REGISTER

MOM BRANDS COMPANY (MINNESOTA CORPORATION)
2700 IDS CENTER, 80 S. 8TH STREET
MINNEAPOLIS, MN 55402

FOR: BREAKFAST CEREAL, IN CLASS 30 (U.S. CL. 46).

FIRST USE 12-26-2011; IN COMMERCE 12-26-2011.

THE MARK CONSISTS OF STANDARD CHARACTERS WITHOUT CLAIM TO ANY PARTICULAR FONT, STYLE, SIZE, OR COLOR.

OWNER OF U.S. REG. NOS. 3,269,145 AND 3,753,433.

NO CLAIM IS MADE TO THE EXCLUSIVE RIGHT TO USE "BLUEBERRY", APART FROM THE MARK AS SHOWN.

SN 85-410,478, FILED 8-30-2011.

JENNY PARK, EXAMINING ATTORNEY



David J. Kyffers

Director of the United States Patent and Trademark Office

United States of America

United States Patent and Trademark Office

CHOCOLATEY CHERRY JUBILATION

Reg. No. 4,177,096

Registered July 17, 2012

Int. Cl.: 30

TRADEMARK

PRINCIPAL REGISTER

MOM BRANDS COMPANY (MINNESOTA CORPORATION)
2700 IDS CENTER, 80 S. 8TH STREET
MINNEAPOLIS, MN 55402

FOR: BREAKFAST CEREAL, IN CLASS 30 (U.S. CL. 46).

FIRST USE 12-26-2011; IN COMMERCE 12-26-2011.

THE MARK CONSISTS OF STANDARD CHARACTERS WITHOUT CLAIM TO ANY PARTICULAR FONT, STYLE, SIZE, OR COLOR.

NO CLAIM IS MADE TO THE EXCLUSIVE RIGHT TO USE "CHOCOLATEY CHERRY", APART FROM THE MARK AS SHOWN.

SN 85-410,481, FILED 8-30-2011.

JENNY PARK, EXAMINING ATTORNEY



David J. Kyffers

Director of the United States Patent and Trademark Office

United States of America

United States Patent and Trademark Office



Reg. No. 4,177,097

Registered July 17, 2012

Int. Cl.: 35

SERVICE MARK

PRINCIPAL REGISTER

TRINITAS LLC (TEXAS LIMITED LIABILITY COMPANY)
620 CONGRESS AVENUE
STE 320
AUSTIN, TX 78701

FOR: MARKETING SERVICES, NAMELY, RETAIL STORE SERVICES IN THE FIELD OF OFFICE PHONES OF OTHERS, OFFICE PHONE HEADSETS OF OTHERS, AND WIRELESS ACCESSORIES OF OTHERS FOR CELLULAR DEVICES; RETAIL STORE SERVICES FEATURING OFFICE PHONES OF OTHERS, OFFICE PHONE HEADSETS OF OTHERS, AND WIRELESS ACCESSORIES OF OTHERS FOR CELLULAR DEVICES; RETAIL STORE SERVICES FEATURING OFFICE PHONES OF OTHERS, OFFICE PHONE HEADSETS OF OTHERS, AND WIRELESS ACCESSORIES OF OTHERS FOR CELLULAR DEVICES ACCESSIBLE ON-LINE AND BY TELEPHONE, FACSIMILE AND MAIL ORDER, IN CLASS 35 (U.S. CLS. 100, 101 AND 102).

FIRST USE 1-0-2012; IN COMMERCE 1-0-2012.

THE MARK CONSISTS OF TWO INTERLINKED STYLIZED CHAIN LINKS APPEARING WITHIN A SHADED, BORDERED CIRCLE REPRESENTING A CAMEO-STYLE SETTING.

SN 85-410,508, FILED 8-30-2011.

AMY KERTGATE, EXAMINING ATTORNEY



David J. Kybas

Director of the United States Patent and Trademark Office

United States of America

United States Patent and Trademark Office

PHYTEL ATMOSPHERE

Reg. No. 4,177,098

Registered July 17, 2012

Int. Cl.: 42

SERVICE MARK

PRINCIPAL REGISTER

PHYTEL, INC. (TEXAS CORPORATION)
SUITE 600
11511 LUNA ROAD
DALLAS, TX 75234

FOR: PROVIDING ONLINE DOWNLOADABLE COMPUTER SOFTWARE FOR AUTOMATING CARE MANAGEMENT, CARE INTERVENTIONS AND PATIENT ENGAGEMENT IN THE FIELD OF HEALTH AND DISEASE MANAGEMENT, IN CLASS 42 (U.S. CLS. 100 AND 101).

FIRST USE 9-19-2011; IN COMMERCE 9-19-2011.

THE MARK CONSISTS OF STANDARD CHARACTERS WITHOUT CLAIM TO ANY PARTICULAR FONT, STYLE, SIZE, OR COLOR.

OWNER OF U.S. REG. NOS. 2,241,255, 3,483,962, AND 3,589,829.

SN 85-411,098, FILED 8-30-2011.

MATTHEW MCDOWELL, EXAMINING ATTORNEY



David J. Kyros

Director of the United States Patent and Trademark Office

United States of America

United States Patent and Trademark Office

Practical Reviews presents Critiques in

Reg. No. 4,177,099

Registered July 17, 2012

Int. Cl.: 16

TRADEMARK

PRINCIPAL REGISTER

OAKSTONE PUBLISHING, LLC (DELAWARE LIMITED LIABILITY COMPANY), DBA
PERSONAL BEST,
100 CORPORATE PARKWAY, SUITE 600
BIRMINGHAM, AL 35242

FOR: PUBLICATIONS, NAMELY, TRANSCRIPTS OF MEDICAL AND DENTAL JOURNALS
EVALUATIONS AND ANALYSIS, IN CLASS 16 (U.S. CLS. 2, 5, 22, 23, 29, 37, 38 AND 50).

FIRST USE 7-31-2011; IN COMMERCE 7-31-2011.

NO CLAIM IS MADE TO THE EXCLUSIVE RIGHT TO USE "PRACTICAL REVIEWS" AND
"CRITIQUES", APART FROM THE MARK AS SHOWN.

THE MARK CONSISTS OF WORDS, "PRACTICAL REVIEWS", ABOVE THE WORD,
"PRESENTS", CENTERED WITH DRAWN LINES ON BOTH SIDES OF THE WORD,
"PRESENTS"; WITH WORD, "CRITIQUES", BELOW AND THREE LINES UNDERNEATH
THE LETTER, "Q", IN THE WORD, "CRITIQUES", TO THE END OF THE DESIGN; WITH A
DOT BEFORE THE LINE ON EACH OF THE THREE LINES; AND A LINE TO THE LEFT
OF THE BOTTOM LINE WITH THE WORD, "IN", AT THE INSIDE END OF THE LEFT-SIDE
LINE.

SN 85-411,565, FILED 8-31-2011.

JILL PRATER, EXAMINING ATTORNEY



David J. Kyffers

Director of the United States Patent and Trademark Office

United States of America

United States Patent and Trademark Office



Reg. No. 4,177,100

BT MANAGEMENT GROUP LLC (MICHIGAN LIMITED LIABILITY COMPANY)
187 S. GLENHURST DRIVE
BIRMINGHAM, MI 48009

Registered July 17, 2012

Int. Cl.: 43

FOR: RESTAURANT, BAR AND CATERING SERVICES, IN CLASS 43 (U.S. CLS. 100 AND 101).

SERVICE MARK

FIRST USE 3-1-2012; IN COMMERCE 3-1-2012.

PRINCIPAL REGISTER

NO CLAIM IS MADE TO THE EXCLUSIVE RIGHT TO USE "BAR", APART FROM THE MARK AS SHOWN.

THE MARK CONSISTS OF THE WORD "BAR" AND THE NUMBER "30", WITH A HORIZONTAL LINE BETWEEN THE TWO.

SN 85-411,631, FILED 8-31-2011.

YAT SYE, LEE, EXAMINING ATTORNEY



David J. Kybas

Director of the United States Patent and Trademark Office

United States of America

United States Patent and Trademark Office

KING BEAM

Reg. No. 4,177,101

Registered July 17, 2012

Int. Cl.: 19

BOISE CASCADE WOOD PRODUCTS, L.L.C. (DELAWARE LIMITED LIABILITY COMPANY)
PO BOX 50
1111 W JEFFERSON STREET, SUITE 300
BOISE, ID 837280001

FOR: LAMINATED WOOD BEAMS, IN CLASS 19 (U.S. CLS. 1, 12, 33 AND 50).

TRADEMARK

FIRST USE 5-15-2011; IN COMMERCE 5-15-2011.

PRINCIPAL REGISTER

THE MARK CONSISTS OF STANDARD CHARACTERS WITHOUT CLAIM TO ANY PARTICULAR FONT, STYLE, SIZE, OR COLOR.

NO CLAIM IS MADE TO THE EXCLUSIVE RIGHT TO USE "BEAM", APART FROM THE MARK AS SHOWN.

SN 85-412,302, FILED 8-31-2011.

JULIE WATSON, EXAMINING ATTORNEY



David J. Kybas

Director of the United States Patent and Trademark Office

United States of America

United States Patent and Trademark Office



Reg. No. 4,177,102

Registered July 17, 2012

Int. Cls.: 36 and 37

SERVICE MARK

PRINCIPAL REGISTER

801 NEW JERSEY, L.L.C. (DELAWARE LIMITED LIABILITY COMPANY)
4445 WILLARD AVENUE, SUITE 400
CHEVY CHASE, MD 20815

FOR: LEASING OF REAL ESTATE; REAL ESTATE CONSULTANCY; REAL ESTATE INVESTMENT SERVICES; REAL ESTATE MANAGEMENT SERVICES, IN CLASS 36 (U.S. CLS. 100, 101 AND 102).

FIRST USE 4-19-2012; IN COMMERCE 4-19-2012.

FOR: REAL ESTATE DEVELOPMENT, IN CLASS 37 (U.S. CLS. 100, 103 AND 106).

FIRST USE 4-19-2012; IN COMMERCE 4-19-2012.

THE MARK CONSISTS OF THE LETTER "H" WITH AN UPSIDE DOWN "7" ON THE TOP AND A RIGHT SIDE UP "7" AT THE BOTTOM.

SN 85-412,994, FILED 9-1-2011.

THOMAS MANOR, EXAMINING ATTORNEY



David J. Kypos

Director of the United States Patent and Trademark Office

United States of America

United States Patent and Trademark Office

PACE YOUR PUTT

Reg. No. 4,177,103

MORTIER EMMANUELLE (FRANCE INDIVIDUAL)

Registered July 17, 2012

CHEMIN GUILLENIA
ARCANGUES, FRANCE 64200

Int. Cl.: 27

FOR: CARPET BACKING; CARPET PADDING; CARPET TILES; CARPET TILES FOR COVERING FLOORS; CARPET TILES MADE OF TEXTILES; CARPET UNDERLAY; CARPET UNDERLAYS; CARPET UNDERLAYS, NAMELY, RUG GRIPPERS; CARPET UNDERLINING; CARPETING; CARPETS; CARPETS AND RUGS; CARPETS, RUGS, MATS AND MATTING, LINOLEUM FOR COVERING EXISTING FLOORS; PRIMARY CARPET BACKING; UNDERLAY FOR CARPETS, IN CLASS 27 (U.S. CLS. 19, 20, 37, 42 AND 50).

TRADEMARK

PRINCIPAL REGISTER

FIRST USE 1-25-2012; IN COMMERCE 1-25-2012.

THE MARK CONSISTS OF STANDARD CHARACTERS WITHOUT CLAIM TO ANY PARTICULAR FONT, STYLE, SIZE, OR COLOR.

SN 85-413,121, FILED 9-1-2011.

JANICE KIM, EXAMINING ATTORNEY



David J. Kybas

Director of the United States Patent and Trademark Office

United States of America

United States Patent and Trademark Office

ROCKHOUND

Reg. No. 4,177,104

Registered July 17, 2012

Int. Cl.: 33

TRADEMARK

PRINCIPAL REGISTER

THE BARTELL DRUG COMPANY (WASHINGTON CORPORATION)
4727 DENVER AVENUE SOUTH
SEATTLE, WA 98134

FOR: WINE, IN CLASS 33 (U.S. CLS. 47 AND 49).

FIRST USE 12-12-2011; IN COMMERCE 12-12-2011.

THE MARK CONSISTS OF STANDARD CHARACTERS WITHOUT CLAIM TO ANY PARTICULAR FONT, STYLE, SIZE, OR COLOR.

SN 85-413,217, FILED 9-1-2011.

C. DIONNE CLYBURN, EXAMINING ATTORNEY



David J. Kyffers

Director of the United States Patent and Trademark Office

United States of America

United States Patent and Trademark Office



Reg. No. 4,177,105

Registered July 17, 2012

Int. Cl.: 33

TRADEMARK

PRINCIPAL REGISTER

DIAGEO NORTH AMERICA, INC. (CONNECTICUT CORPORATION)
801 MAIN AVENUE
NORWALK, CT 06851

FOR: ALCOHOLIC BEVERAGES EXCEPT BEERS, IN CLASS 33 (U.S. CLS. 47 AND 49).

FIRST USE 11-30-2011, THE MARK WAS FIRST USED ANYWHERE IN A DIFFERENT FORM OTHER THAN THAT SOUGHT TO BE REGISTERED AT LEAST AS EARLY AS 04/15/1982.; IN COMMERCE 11-30-2011, THE MARK WAS FIRST USED IN COMMERCE IN A DIFFERENT FORM OTHER THAN THAT SOUGHT TO BE REGISTERED AT LEAST AS EARLY AS 04/15/1982..

OWNER OF U.S. REG. NOS. 1,285,506, 3,159,947, AND OTHERS.

THE MARK CONSISTS OF A PIRATE HOLDING A SWORD IN RIGHT HAND WITH LEFT LET RAISED AND ONE FOOT ON A BARREL.

SN 85-413,303, FILED 9-1-2011.

CHERYL CLAYTON, EXAMINING ATTORNEY



David J. Kyffers

Director of the United States Patent and Trademark Office

United States of America

United States Patent and Trademark Office

TEETHNOW

Reg. No. 4,177,106

Registered July 17, 2012

Int. Cl.: 35

SERVICE MARK

PRINCIPAL REGISTER

TEETH NOW LLC (NEVADA LIMITED LIABILITY COMPANY)
STE D#377
3651 LINDELL ROAD
LAS VEGAS, NV 89103

FOR: ADVERTISEMENT AND PUBLICITY SERVICES BY TELEVISION, RADIO, MAIL; ADVERTISEMENT FOR OTHERS ON THE INTERNET; ADVERTISEMENT VIA MOBILE PHONE NETWORKS; ADVERTISING AND BUSINESS SERVICES, NAMELY, SECURING AIRTIME ON ALL FORMS OF MEDIA COMMUNICATIONS STATIONS, SYSTEMS, NETWORKS, AND SERVICES FOR THE PURPOSE OF PROMOTING THE GOODS AND SERVICES OF OTHERS; ADVERTISING AND COMMERCIAL INFORMATION SERVICES, VIA THE INTERNET; ADVERTISING AND DIRECTORY SERVICES, NAMELY, PROMOTING THE SERVICES OF OTHERS BY PROVIDING A WEB PAGE FEATURING LINKS TO THE WEBSITES OF OTHERS; ADVERTISING AND MARKETING; ADVERTISING AND MARKETING CONSULTANCY; ADVERTISING AND MARKETING SERVICES PROVIDED BY MEANS OF INDIRECT METHODS OF MARKETING COMMUNICATIONS, NAMELY, SOCIAL MEDIA, SEARCH ENGINE MARKETING, INQUIRY MARKETING, INTERNET MARKETING, MOBILE MARKETING, BLOGGING AND OTHER FORMS OF PASSIVE, SHARABLE OR VIRAL COMMUNICATIONS CHANNELS; ADVERTISING AND MARKETING SERVICES, NAMELY, PROMOTING THE GOODS AND SERVICES OF OTHERS; ADVERTISING AND PROMOTION SERVICES AND RELATED CONSULTING; ADVERTISING AND PROMOTIONAL SERVICES; ADVERTISING AND PUBLICITY SERVICES; ADVERTISING IN PERIODICALS, BROCHURES AND NEWSPAPERS; ADVERTISING IN THE POPULAR AND PROFESSIONAL PRESS; ADVERTISING ON THE INTERNET FOR OTHERS; ADVERTISING SERVICES; ADVERTISING THROUGH ALL PUBLIC COMMUNICATION MEANS; ADVERTISING, MARKETING AND PROMOTION SERVICES; ADVERTISING, PROMOTION AND MARKETING SERVICES IN THE NATURE OF E-MAIL BLAST CAMPAIGNS FOR OTHERS; ADVICE IN THE FIELD OF BUSINESS MANAGEMENT AND MARKETING; BUSINESS MANAGEMENT AND CONSULTING SERVICES FOR THE HEALTH CARE INDUSTRY, NAMELY, CUSTOMER SERVICE, ACCOUNTING SERVICES, AND WEB-BASED ADVERTISING AND MARKETING SERVICES; BUSINESS MARKETING AND DIRECT MAIL CONSULTING SERVICES; BUSINESS MARKETING CONSULTING SERVICES; BUSINESS MARKETING SERVICES; CONSULTING SERVICES IN THE FIELD OF INTERNET MARKETING; COOPERATIVE ADVERTISING AND MARKETING; COOPERATIVE ADVERTISING AND MARKETING SERVICES BY WAY OF SOLICITATION, CUSTOMER SERVICE AND PROVIDING MARKETING INFORMATION VIA WEB SITES ON A GLOBAL COMPUTER NETWORK; DEVELOPMENT OF MARKETING STRATEGIES AND CONCEPTS;



David J. Kyjars

Director of the United States Patent and Trademark Office

Reg. No. 4,177,106 DIRECT MAIL ADVERTISING SERVICES; DIRECT MARKETING; DIRECT MARKETING ADVERTISING FOR OTHERS; DIRECT MARKETING CONSULTING SERVICES; DISSEMINATION OF ADVERTISEMENTS; INTERNET ADVERTISING SERVICES; MARKETING CONSULTING; MARKETING SERVICES, NAMELY, PROMOTING OR ADVERTISING THE GOODS AND SERVICES OF OTHERS; MARKETING SERVICES, NAMELY, PROVIDING ON-LINE NON-DOWNLOADABLE VIDEOS TO PROMOTE DOCTORS AND MEDICAL PRACTICES; MARKETING, ADVERTISING, AND PROMOTING THE RETAIL GOODS AND SERVICES OF OTHERS THROUGH WIRELESS ELECTRONIC DEVICES; MARKETING, PROMOTIONAL AND ADVERTISING SERVICES PROVIDED BY MOBILE TELEPHONE CONNECTIONS; NEWSPAPER ADVERTISING; ON-LINE ADVERTISING AND MARKETING SERVICES; ON-LINE ADVERTISING ON COMPUTER COMMUNICATION NETWORKS; ON-LINE ADVERTISING ON COMPUTER NETWORKS; ONLINE ADVERTISING AND PROMOTIONAL SERVICES; ONLINE ADVERTISING VIA A COMPUTER COMMUNICATIONS NETWORK; PRODUCTION OF ADVERTISING MATERIALS; PRODUCTION OF ADVERTISING MATTER AND COMMERCIALS; PROMOTING THE GOODS AND SERVICES OF OTHERS BY MEANS OF DISTRIBUTING ADVERTISING ON THE INTERNET; PROMOTION AND MARKETING SERVICES AND RELATED CONSULTING; PROMOTIONAL SERVICES, NAMELY, DISTRIBUTION OF ADVERTISING FLYERS, COUPONS, CATALOGS AND PROMOTIONAL ITEMS OF OTHERS; PROVIDING A SEARCHABLE ON-LINE ADVERTISING WEBSITE AND GUIDE FEATURING THE GOODS AND SERVICES OF OTHER VENDORS VIA THE INTERNET; PROVIDING A SEARCHABLE ONLINE ADVERTISING WEBSITE AND INFORMATIONAL GUIDE FEATURING THE GOODS AND SERVICES OF OTHER VENDORS VIA THE INTERNET IN THE FIELD OF HEALTH CARE; PROVIDING BUSINESS MARKETING INFORMATION; PROVIDING SPACE AT A WEB SITE FOR THE ADVERTISEMENT OF THE GOODS AND SERVICES OF OTHERS; PROVISION OF SPACE ON WEBSITES FOR ADVERTISING GOODS AND SERVICES, IN CLASS 35 (U.S. CLS. 100, 101 AND 102).

FIRST USE 11-1-2011; IN COMMERCE 11-1-2011.

THE MARK CONSISTS OF STANDARD CHARACTERS WITHOUT CLAIM TO ANY PARTICULAR FONT, STYLE, SIZE, OR COLOR.

SN 85-413,704, FILED 9-2-2011.

ANNE E. GUSTASON, EXAMINING ATTORNEY

United States of America

United States Patent and Trademark Office



Reg. No. 4,177,107

AUBC LTD (CYPRUS CORPORATION)
2708 COMMERCE WAY, STE 300
PHILADELPHIA, PA 19154

Registered July 17, 2012

Int. Cl.: 36

FOR: AUTOMOBILE LEASE FINANCING; BANKING AND FINANCING SERVICES, IN CLASS 36 (U.S. CLS. 100, 101 AND 102).

SERVICE MARK

FIRST USE 1-1-2009; IN COMMERCE 1-1-2011.

PRINCIPAL REGISTER

THE MARK CONSISTS OF A DESIGN OF AN AUTOMOBILE WITH A HORIZONTAL LINE COMING OFF THE TOP OF THE TOP RIGHT OF THE AUTOMOBILE AND ANOTHER HORIZONTAL LINE COMING OFF THE BOTTOM RIGHT OF THE AUTOMOBILE; IN BETWEEN THE LINES APPEARS THE TERM "CUCLA"; THE ENTIRE MARK IS RENDERED IN THE COLOR BLUE AT THE TOP, BLENDING INTO THE COLOR TURQUOISE FOR THE REST OF THE MARK.

THE COLOR(S) BLUE AND TURQUOISE IS/ARE CLAIMED AS A FEATURE OF THE MARK.

SN 85-413,776, FILED 9-2-2011.

JOHN GARTNER, EXAMINING ATTORNEY



David J. Kybas

Director of the United States Patent and Trademark Office

United States of America

United States Patent and Trademark Office

Tell Them

Reg. No. 4,177,108

Registered July 17, 2012

Int. Cl.: 35

SERVICE MARK

PRINCIPAL REGISTER

ADOPT ANYTHING INC. (NEVADA CORPORATION)
555 PLEASANTVILLE ROAD N106
BRIARCLIFF MANOR, NY 10510

FOR: AD SERVING, NAMELY, PLACING ADVERTISEMENTS ON WEBSITES FOR OTHERS USING SPECIALIZED COMPUTER SOFTWARE; ADVERTISEMENT AND PUBLICITY SERVICES BY TELEVISION, RADIO, MAIL; ADVERTISEMENT FOR OTHERS ON THE INTERNET; ADVERTISEMENT HOARDING RENTAL; ADVERTISEMENT VIA MOBILE PHONE NETWORKS; ADVERTISING AGENCIES; ADVERTISING AGENCIES SPECIALIZING IN PRODUCTS AND SERVICES; ADVERTISING AGENCIES, NAMELY, PROMOTING THE GOODS AND SERVICES OF OTHERS; ADVERTISING AGENCIES, NAMELY, PROMOTING THE SERVICES OF MERCHANTS THROUGH THE DISTRIBUTION OF PRINTED AND AUDIO PROMOTIONAL MATERIALS AND BY RENDERING SALES PROMOTION ADVICE; ADVERTISING AGENCY SPECIALIZING IN THE DESIGN AND EXECUTION OF WORD OF MOUTH, VIRAL, BUZZ AND EXPERIENTIAL MARKETING PROGRAMS; ADVERTISING AND BUSINESS MANAGEMENT CONSULTANCY; ADVERTISING AND BUSINESS SERVICES, NAMELY, SECURING AIRTIME ON ALL FORMS OF MEDIA COMMUNICATIONS STATIONS, SYSTEMS, NETWORKS, AND SERVICES FOR THE PURPOSE OF PROMOTING THE GOODS AND SERVICES OF OTHERS; ADVERTISING AND COMMERCIAL INFORMATION SERVICES, VIA THE INTERNET; ADVERTISING AND DIRECTORY SERVICES, NAMELY, PROMOTING THE SERVICES OF OTHERS BY PROVIDING A WEB PAGE FEATURING LINKS TO THE WEBSITES OF OTHERS; ADVERTISING AND MARKETING; ADVERTISING AND MARKETING CONSULTANCY; ADVERTISING AND MARKETING SERVICES PROVIDED BY MEANS OF INDIRECT METHODS OF MARKETING COMMUNICATIONS, NAMELY, SOCIAL MEDIA, SEARCH ENGINE MARKETING, INQUIRY MARKETING, INTERNET MARKETING, MOBILE MARKETING, BLOGGING AND OTHER FORMS OF PASSIVE, SHARABLE OR VIRAL COMMUNICATIONS CHANNELS; ADVERTISING AND MARKETING SERVICES, NAMELY, PROMOTING THE GOODS AND SERVICES OF OTHERS; ADVERTISING AND PROMOTING THE GOODS AND SERVICES OF A VISUAL ARTIST; ADVERTISING AND PROMOTION SERVICES AND RELATED CONSULTING; ADVERTISING AND PROMOTIONAL SERVICES; ADVERTISING AND PUBLICITY SERVICES; ADVERTISING AND PUBLICITY SERVICES, NAMELY, PROMOTING THE GOODS, SERVICES, BRAND IDENTITY AND COMMERCIAL INFORMATION AND NEWS OF THIRD PARTIES THROUGH PRINT, AUDIO, VIDEO, DIGITAL AND ON-LINE MEDIUM; ADVERTISING BY TRANSMISSION OF ON-LINE PUBLICITY FOR THIRD PARTIES THROUGH ELECTRONIC COMMUNICATIONS NETWORKS; ADVERTISING CONSULTATION; ADVERTISING COPYWRITING; ADVERTISING FLYER DISTRIBUTION; ADVERT-



David J. Kybas

Director of the United States Patent and Trademark Office

Reg. No. 4,177,108 ISING IN PERIODICALS, BROCHURES AND NEWSPAPERS; ADVERTISING IN THE POPULAR AND PROFESSIONAL PRESS; ADVERTISING OF COMMERCIAL OR RESIDENTIAL REAL ESTATE; ADVERTISING OF THE PUBLISHED TEXTS OF OTHERS; ADVERTISING ON THE INTERNET FOR OTHERS; ADVERTISING RELATING TO PHARMACEUTICAL PRODUCTS AND IN-VIVO IMAGING PRODUCTS; ADVERTISING SERVICES; ADVERTISING SERVICES FOR PROMOTING THE BROKERAGE OF STOCKS AND OTHER SECURITIES; ADVERTISING SERVICES OF A RADIO AND TELEVISION ADVERTISING AGENCY; ADVERTISING SERVICES, NAMELY, COST-PER-ACTION ON-LINE ADVERTISING; ADVERTISING SERVICES, NAMELY, CREATING CORPORATE AND BRAND IDENTITY FOR OTHERS; ADVERTISING SERVICES, NAMELY, CREATING CORPORATE LOGOS FOR OTHERS; ADVERTISING SERVICES, NAMELY, CREATING PROMOTIONAL MURALS ADVERTISING THE GOODS AND SERVICES OF OTHERS; ADVERTISING SERVICES, NAMELY, PRODUCTION OF SPECIAL EFFECTS INCLUDING MODEL-MAKING SERVICES, COMPUTER-GENERATED IMAGERY AND COMPUTER-GENERATED GRAPHICS FOR THE PRODUCTION OF COMMERCIALS; ADVERTISING SERVICES, NAMELY, PROMOTING AND MARKETING THE GOODS AND SERVICES OF OTHERS IN THE FIELD OF RETAILING AND SERVICES VIA PRINT AND ELECTRONIC MEDIA; ADVERTISING SERVICES, NAMELY, PROMOTING AND MARKETING THE GOODS AND SERVICES OF OTHERS THROUGH ALL PUBLIC COMMUNICATION MEANS; ADVERTISING SERVICES, NAMELY, PROMOTING CAR DEALERSHIPS OF OTHERS; ADVERTISING SERVICES, NAMELY, PROMOTING PROPERTIES FOR SALE BY OWNER VIA THE INTERNET; ADVERTISING SERVICES, NAMELY, PROMOTING THE BOOKS OF OTHERS IN THE FIELD OF LAW BY MEANS OF NEWS AND REVIEWS REGARDING SAME; ADVERTISING SERVICES, NAMELY, PROMOTING THE BRANDS, GOODS AND SERVICES OF OTHERS; ADVERTISING SERVICES, NAMELY, PROMOTING THE FOOD AND WINE OF OTHERS; ADVERTISING SERVICES, NAMELY, PROMOTING THE GIFT CARDS OF OTHERS; ADVERTISING SERVICES, NAMELY, PROMOTING THE POWER SPORTS DEALERSHIPS OF OTHERS; ADVERTISING SERVICES, NAMELY, PROMOTING THE SANDWICHES OF OTHERS; ADVERTISING SERVICES, NAMELY, PROVIDING ADVERTISING SPACE IN A PERIODICAL; ADVERTISING SERVICES, NAMELY, PROVIDING INFORMATION AS TO THE AVAILABILITY OF PRODUCTS AND SERVICES FOR RENT OR PURCHASE; ADVERTISING TEXT PUBLICATION SERVICES; ADVERTISING THROUGH ALL PUBLIC COMMUNICATION MEANS; ADVERTISING, INCLUDING PROMOTION OF PRODUCTS AND SERVICES OF THIRD PARTIES THROUGH SPONSORING ARRANGEMENTS AND LICENCE AGREEMENTS RELATING TO INTERNATIONAL SPORTS' EVENTS; ADVERTISING, MARKETING AND PROMOTING THE GOODS AND SERVICES OF OTHERS USING KIOSKS; ADVERTISING, MARKETING AND PROMOTION SERVICES; ADVERTISING, MARKETING AND PROMOTION SERVICES IN THE FIELD OF RETAILING AND WHOLESALING; ADVERTISING, MARKETING AND PROMOTION SERVICES, NAMELY, PROMOTING THE GOODS AND SERVICES OF OTHERS BY PROVIDING CUSTOMIZED EXHIBITS; ADVERTISING, MARKETING AND PROMOTIONAL SERVICES FOR THE DONATION OF HUMAN BLOOD THAT EXACTLY MATCHES THE BLOOD TYPE OF INDIVIDUALS NEEDING TRANSFUSIONS; ADVERTISING, MARKETING AND PROMOTIONAL SERVICES RELATED TO ALL INDUSTRIES FOR THE PURPOSE OF FACILITATING NETWORKING AND SOCIALIZING OPPORTUNITIES FOR BUSINESS PURPOSES; ADVERTISING, PROMOTION AND MARKETING SERVICES BASED ON CONSUMER CREDIT REPORTS AND SCORES OF OTHERS; ADVERTISING, PROMOTION AND MARKETING SERVICES IN THE NATURE OF E-MAIL BLAST CAMPAIGNS FOR OTHERS; AGENCIES FOR ADVERTISING TIME AND SPACE; ANALYSIS OF ADVERTISING RESPONSE; ARRANGING AND CONDUCTING OF FAIRS AND EXHIBITIONS FOR BUSINESS AND ADVERTISING PURPOSES; ARRANGING AND CONDUCTING SPECIAL EVENTS FOR COMMERCIAL, PROMOTIONAL OR ADVERTISING PURPOSES; BANNER ADVERTISING; BUSINESS MANAGEMENT AND CONSULTING SERVICES FOR THE HEALTH CARE INDUSTRY, NAMELY, CUSTOMER SERVICE, ACCOUNTING SERVICES, AND WEB-BASED ADVERTISING AND MARKETING SERVICES; BUSINESS SERVICES, NAMELY, TRACKING AND MONITORING OF CALLS FOR OTHERS IN RESPONSE TO ADVERTISING ADS; CINEMA ADVERTISING; CLASSIFIED ADVERTISING SERVICES; COMPILATION OF ADVERTISEMENTS FOR USE AS WEB PAGES ON THE INTERNET; COMPILATION, PRODUCTION AND DISSEMINATION OF

Reg. No. 4,177,108 ADVERTISING MATTER; CONDUCTING, ARRANGING AND ORGANIZING TRADE SHOWS AND TRADE FAIRS FOR COMMERCIAL AND ADVERTISING PURPOSES; CONSUMER LOYALTY SERVICES FOR COMMERCIAL, PROMOTIONAL, AND/OR ADVERTISING PURPOSES, NAMELY, ADMINISTRATION OF FREQUENT FLYER PROGRAM THAT ALLOWS MEMBERS TO REDEEM MILES FOR POINTS OR AWARDS OFFERED BY OTHER LOYALTY PROGRAMS; COOPERATIVE ADVERTISING AND MARKETING; COOPERATIVE ADVERTISING AND MARKETING SERVICES BY WAY OF SOLICITATION, CUSTOMER SERVICE AND PROVIDING MARKETING INFORMATION VIA WEB SITES ON A GLOBAL COMPUTER NETWORK; COOPERATIVE ADVERTISING AND MARKETING SERVICES, NAMELY, OFFERING DISCOUNTS TO CLIENTS THROUGH THE JOINT PARTICIPATION OF MEMBER BEAUTY SALONS; CREATING AND UPDATING ADVERTISING MATERIAL; PROMOTIONAL AND/OR ADVERTISING PURPOSES; DESIGN OF ADVERTISING BROCHURES FOR OTHERS; DESIGN OF ADVERTISING FLYERS FOR OTHERS; DESIGN OF ADVERTISING MATERIALS FOR OTHERS; DESIGN OF INTERNET ADVERTISING; DEVELOPING ADVERTISING CAMPAIGNS FOR OTHERS GEARED TOWARD ENVIRONMENTAL ISSUES; DEVELOPMENT, OPERATION AND ADMINISTRATION OF DIGITAL SIGNAGE SYSTEMS AND DIGITAL ADVERTISING SYSTEMS FOR OTHERS, NAMELY, PROVIDING ADVERTISING SPACE BY ELECTRONIC MEANS AND GLOBAL COMPUTER INFORMATION NETWORKS; DIRECT MAIL ADVERTISING SERVICES; DIRECT MARKETING ADVERTISING FOR OTHERS; DISPLAYING ADVERTISEMENTS FOR OTHERS; DISSEMINATION OF ADVERTISEMENTS; DISSEMINATION OF ADVERTISEMENTS AND OF ADVERTISING MATERIAL; DISSEMINATION OF ADVERTISING FOR OTHERS VIA PUBLIC AND PRIVATE WIRELESS NETWORKS FOR DISPLAY ON MOBILE DEVICES; DISSEMINATION OF ADVERTISING FOR OTHERS VIA THE INTERNET; DISSEMINATION OF ADVERTISING MATERIAL; DISSEMINATION OF ADVERTISING MATTER; DISSEMINATION OF ADVERTISING, SCHEDULING AND MANAGING OF TRAINING COURSES AND PROGRAMS FOR OTHERS VIA A GLOBAL COMPUTER NETWORK; DISTRIBUTION AND DISSEMINATION OF ADVERTISING MATERIALS; DISTRIBUTION OF ADVERTISEMENTS AND COMMERCIAL ANNOUNCEMENTS; DISTRIBUTION OF ADVERTISING MAIL AND OF ADVERTISING SUPPLEMENTS ATTACHED TO REGULAR EDITIONS; DISTRIBUTION OF ADVERTISING MATERIALS; DISTRIBUTION OF PRODUCTS FOR ADVERTISING PURPOSES; ELECTRONIC BILLBOARD ADVERTISING; ELECTRONIC COMMERCE SERVICES, NAMELY, PROVIDING INFORMATION ABOUT PRODUCTS VIA TELECOMMUNICATION NETWORKS FOR ADVERTISING AND SALES PURPOSES; ENTERTAINMENT MARKETING SERVICES, NAMELY, MARKETING, PROMOTION AND ADVERTISING FOR RECORDING AND PERFORMING ARTISTS; EVENT PLANNING AND MANAGEMENT FOR MARKETING, BRANDING, PROMOTING OR ADVERTISING THE GOODS AND SERVICES OF OTHERS; INTERNET ADVERTISING SERVICES; ISSUING AND UPDATING OF ADVERTISING TEXTS; LAYOUT SERVICES FOR ADVERTISING PURPOSES; MAGAZINE ADVERTISING; MANAGEMENT OF ADVERTISING THROUGH A COMMAND AND CONTROL CENTER FOR BOTH MOVIE THEATRE ON-SCREEN ADVERTISING AND OVER THE INTERNET; MARKETING AND ADVERTISING SERVICES FOR AUTOMOBILE DEALERSHIPS; MARKETING SERVICES, NAMELY, PROMOTING OR ADVERTISING THE GOODS AND SERVICES OF OTHERS; MARKETING, ADVERTISING, AND PROMOTING THE RETAIL GOODS AND SERVICES OF OTHERS THROUGH WIRELESS ELECTRONIC DEVICES; MARKETING, PROMOTIONAL AND ADVERTISING SERVICES PROVIDED BY MOBILE TELEPHONE CONNECTIONS; MEDIA BUYING ADVICE, NAMELY, ADVISING THE CLIENT HOW MUCH MEDIA TIME, AND AT WHAT TIMES THE CLIENT SHOULD BE PURCHASING ADVERTISING; MEDIA PLANNING, NAMELY, ADVISING THE CLIENT ON THE CORRECT TIMES AND STATIONS TO ADVERTISE BASED ON MEDIA ANALYSIS OF THE MARKET FOR THAT MEDIA; MEDIA PRODUCTION LOCATION SCOUTING SERVICES FOR ADVERTISING PURPOSES; MEDIATION OF ADVERTISING; MODELING FOR ADVERTISING OR SALES PROMOTION; MODELING SERVICES FOR ADVERTISING OR SALES PROMOTION; MUSIC SELECTION SERVICES FOR USE IN ADVERTISING; NEWSPAPER ADVERTISING; ON-LINE ADVERTISING AND MARKETING SERVICES; ON-LINE ADVERTISING ON COMPUTER COMMUNICATION NETWORKS; ON-LINE ADVERTISING ON COMPUTER NETWORKS; ON-LINE

Reg. No. 4,177,108 ADVERTISING SERVICES FOR OTHERS; ONLINE ADVERTISEMENTS; ONLINE ADVERTISING AND PROMOTIONAL SERVICES; ONLINE ADVERTISING VIA A COMPUTER COMMUNICATIONS NETWORK; ORGANISATION OF EXHIBITIONS AND EVENTS FOR COMMERCIAL OR ADVERTISING PURPOSES; ORGANIZATION OF EVENTS, EXHIBITIONS, FAIRS AND SHOWS FOR COMMERCIAL, PROMOTIONAL AND ADVERTISING PURPOSES; ORGANIZATION OF FAIRS AND EXHIBITIONS FOR COMMERCIAL AND ADVERTISING PURPOSES; ORGANIZATION OF FAIRS FOR COMMERCIAL AND ADVERTISING PURPOSES; ORGANIZING EXHIBITIONS FOR COMMERCIAL OR ADVERTISING PURPOSES; OUT-OF-HOME ADVERTISING SERVICES, NAMELY, RENTAL OF ADVERTISING SPACE, AND PREPARING AND PLACING ADVERTISEMENTS FOR OTHERS; OUTDOOR ADVERTISING; PAY PER CLICK (PPC) ADVERTISING MANAGEMENT SERVICES; PLACING ADVERTISEMENTS FOR OTHERS; PLANNING AND CONDUCTING OF TRADE FAIRS, EXHIBITIONS AND PRESENTATIONS FOR ECONOMIC OR ADVERTISING PURPOSES; PREPARATION AND REALIZATION OF MEDIA AND ADVERTISING PLANS AND CONCEPTS; PREPARATION OF CUSTOM ADVERTISEMENTS FOR OTHERS; PREPARATION OF CUSTOM OR NON-CUSTOM ADVERTISING FOR BUSINESSES FOR DISSEMINATION VIA THE WEB, CD OR DVD FOR OPTIONAL UPLOAD OR DOWNLOAD TO A COMPUTER; PREPARING ADVERTISEMENTS FOR OTHERS; PREPARING AND PLACING ADVERTISEMENTS FOR OTHERS; PREPARING AND PLACING OF ADVERTISEMENTS; PREPARING AUDIOVISUAL PRESENTATIONS FOR USE IN ADVERTISING; PREPARING SPEECHES AND ORAL PRESENTATIONS FOR OTHERS FOR USE IN ADVERTISING; PROCESSING TELEPHONE INQUIRIES REGARDING ADVERTISED GOODS AND SERVICES; PRODUCTION OF ADVERTISING MATERIALS; PRODUCTION OF ADVERTISING MATTER AND COMMERCIALS; PRODUCTION OF FILM AND TELEVISION ADVERTISING; PROMOTING AND MARKETING THE GOODS AND SERVICES OF OTHERS BY DISTRIBUTING ADVERTISING MATERIAL, COUPONS AND DISCOUNT OFFERS VIA TEXT MESSAGES; PROMOTING THE GOODS AND SERVICES OF OTHERS BY MEANS OF DISTRIBUTING ADVERTISING ON THE INTERNET; PROMOTING THE GOODS AND SERVICES OF OTHERS BY PREPARING AND PLACING ADVERTISEMENTS IN AN ELECTRONIC MAGAZINE ACCESSED THROUGH A GLOBAL COMPUTER NETWORK; PROMOTING, ADVERTISING AND MARKETING OF THE BRANDS, PRODUCTS, SERVICES AND ONLINE WEBSITES OF INDIVIDUALS, BUSINESSES AND NONPROFIT ORGANIZATIONS; PROMOTING, ADVERTISING AND MARKETING ON-LINE WEB SITES OF OTHERS; PROMOTING, ADVERTISING AND MARKETING THE ON-LINE DATABASES AND ELECTRONIC PUBLICATIONS OF OTHERS; PROMOTING, MARKETING AND ADVERTISING THE BRANDS AND GOODS OF OTHERS RELATED TO ALL INDUSTRIES, THROUGH ALL PUBLIC AND PRIVATE COMMUNICATION MEANS, NAMELY, PROMOTING THE BRANDS AND GOODS OF OTHERS MADE IN THE UNITED STATES; PROMOTIONAL SERVICES, NAMELY, DISTRIBUTION OF ADVERTISING FLYERS, COUPONS, CATALOGS AND PROMOTIONAL ITEMS OF OTHERS; PROVIDING A SEARCHABLE ON-LINE ADVERTISING WEBSITE AND GUIDE FEATURING THE GOODS AND SERVICES OF OTHER VENDORS VIA THE INTERNET; PROVIDING A SEARCHABLE ONLINE ADVERTISING GUIDE FEATURING THE GOODS AND SERVICES OF ONLINE VENDORS; PROVIDING A WEB SITE AT WHICH FITNESS PROFESSIONALS AND FACILITIES CAN POST PROMOTIONAL PROFILES AND RESPOND TO ADVERTISEMENTS FOR THEIR SERVICES; PROVIDING A WEB SITE WHERE USERS CAN POST ITEMS FOR SALE THROUGH ON-LINE CLASSIFIED ADVERTISEMENTS; PROVIDING A WEB SITE WHICH FEATURES ADVERTISEMENTS FOR THE GOODS AND SERVICES OF OTHERS ON A GLOBAL COMPUTER NETWORK; PROVIDING ADVERTISING SERVICES USING 3D AND ANIMATION DESIGNS; PROVIDING ADVERTISING SPACE IN PERIODICALS, NEWSPAPERS AND MAGAZINES; PROVIDING ADVERTISING SPACE ON BILLBOARDS AND IN KIOSKS; PROVIDING ADVERTISING SPACE ON FREE-STANDING VISUAL ADVERTISING SYSTEMS FEATURING THE GOODS AND SERVICES OF OTHERS; PROVIDING ADVERTISING, MARKETING AND PROMOTIONAL SERVICES FOR THE PHARMACEUTICAL AND MEDICAL INDUSTRY; PROVIDING ADVERTISING, MARKETING AND PROMOTIONAL SERVICES FOR THE PHARMACEUTICAL AND MEDICAL PRODUCTS OF OTHERS; PROVIDING ADVERTISING, MARKETING AND PROMOTIONAL SERVICES, NAMELY, DEVELOPMENT OF ADVERTISING CAMPAIGNS PROVIDED THROUGH CABLE TELEVI-

Reg. No. 4,177,108 SION BROADCAST, WEB CASTS, RADIO BROADCASTS, NEWSPAPERS, MAGAZINES, ONLINE BANNERS, OUTDOOR BILLBOARDS, WILD POSTINGS, BUS AND SUBWAY ADS; PROVIDING AN INTERNET WEBSITE PORTAL FEATURING PROMOTION AND ADVERTISING FOR HOME SERVICE PROVIDERS AND PRODUCT MANUFACTURERS; PROVIDING AN ONLINE DIRECTORY INFORMATION SERVICE FEATURING INFORMATION REGARDING VEHICLES IN THE NATURE OF CLASSIFIED ADVERTISEMENTS; PROVIDING AND RENTAL OF ADVERTISING SPACE ON THE INTERNET; PROVIDING ON-LINE BUSINESS INFORMATION OF OTHERS, NAMELY, ADVERTISEMENTS OR SOLICITATIONS; PROVIDING SPACE AT A WEB SITE FOR THE ADVERTISEMENT OF THE GOODS AND SERVICES OF OTHERS; PROVIDING TELEVISION ADVERTISING FOR OTHERS; PROVISION OF ADVERTISING SPACE BY ELECTRONIC MEANS AND GLOBAL INFORMATION NETWORKS; PROVISION OF SPACE ON WEBSITES FOR ADVERTISING GOODS AND SERVICES; PUBLIC RELATIONS, ADVERTISING AND MARKETING SERVICES FOR THE TOURISM AND CONVENTION INDUSTRY, NAMELY, ORGANIZING AND HOSTING SITE INSPECTIONS AND FAMILIARIZATION TOURS FOR WHOLESALERS, TOUR OPERATORS, TRAVEL AGENTS, MEETING AND INCENTIVE TRAVEL PLANNERS AND TRAVEL MEDIA; PUBLISHING OF ADVERTISING TEXTS; RADIO ADVERTISING; REAL ESTATE ADVERTISING SERVICES; RECRUITMENT ADVERTISEMENT SERVICES, NAMELY, POSTING OF CLINICAL TRIAL NOTICES FOR THE PURPOSE OF RECRUITING PATIENTS FOR PARTICIPATION IN CLINICAL TRIALS FOR THE TESTING OF DRUGS; RENTAL OF ADVERTISEMENT SPACE AND ADVERTISING MATERIAL; RENTAL OF ADVERTISING SPACE; RENTAL OF ADVERTISING SPACE ON WEB SITES; RENTAL OF SIGNS FOR ADVERTISING PURPOSES; SPECIAL EVENT PLANNING FOR COMMERCIAL, PROMOTIONAL OR ADVERTISING PURPOSES; STREET DISSEMINATION OF ADVERTISING MATERIALS; TELEVISION ADVERTISING; TELEVISION ADVERTISING AGENCIES; VENDOR-ON-PREMISE SERVICES, NAMELY, THE ADMINISTRATION OF THE EMPLOYMENT PROCESS ON-SITE, INCLUDING RESUME REVIEW AND CHECKING, EMPLOYMENT APPLICATION ACQUISITION, ADVERTISING FOR RECRUITMENT, CONDUCT OF INTERVIEWS, AND REFERENCE CHECKING, IN CLASS 35 (U.S. CLS. 100, 101 AND 102).

FIRST USE 12-4-2011; IN COMMERCE 4-24-2012.

THE MARK CONSISTS OF STANDARD CHARACTERS WITHOUT CLAIM TO ANY PARTICULAR FONT, STYLE, SIZE, OR COLOR.

SN 85-413,952, FILED 9-2-2011.

REBECCA POVARCHUK, EXAMINING ATTORNEY

United States of America

United States Patent and Trademark Office

MYTOXYGEN

Reg. No. 4,177,109

LONZA WALKERSVILLE, INC. (DELAWARE CORPORATION)
8830 BIGGS FORD ROAD
WALKERSVILLE, MD 217930127

Registered July 17, 2012

Int. Cl.: 1

FOR: TESTING KIT CONSISTING OF REAGENTS TO MONITOR DRUG INDUCED MITOCHONDRIAL DYSFUNCTION, FOR RESEARCH USE, IN CLASS 1 (U.S. CLS. 1, 5, 6, 10, 26 AND 46).

TRADEMARK

FIRST USE 11-14-2011; IN COMMERCE 11-14-2011.

PRINCIPAL REGISTER

THE MARK CONSISTS OF STANDARD CHARACTERS WITHOUT CLAIM TO ANY PARTICULAR FONT, STYLE, SIZE, OR COLOR.

SN 85-414,332, FILED 9-2-2011.

JOHN WILKE, EXAMINING ATTORNEY



David J. Kyffers

Director of the United States Patent and Trademark Office

United States of America
United States Patent and Trademark Office

KILL BILL

Reg. No. 4,177,110

2023 LLC (D.C. LIMITED LIABILITY COMPANY)
2023 MASSACHUSETTS AVENUE, N.W.
WASHINGTON, DC 20036

Registered July 17, 2012

Int. Cl.: 34

FOR: CIGARS, IN CLASS 34 (U.S. CLS. 2, 8, 9 AND 17).

TRADEMARK

FIRST USE 11-0-2011; IN COMMERCE 11-0-2011.

PRINCIPAL REGISTER

THE MARK CONSISTS OF STANDARD CHARACTERS WITHOUT CLAIM TO ANY PARTICULAR FONT, STYLE, SIZE, OR COLOR.

THE NAME "BILL" SHOWN IN THE MARK DOES NOT IDENTIFY A LIVING INDIVIDUAL.

SN 85-415,346, FILED 9-6-2011.

ANDREW RHIM, EXAMINING ATTORNEY



David J. Kyffers

Director of the United States Patent and Trademark Office

United States of America

United States Patent and Trademark Office



Reg. No. 4,177,111

Registered July 17, 2012

Int. Cl.: 29

TRADEMARK

PRINCIPAL REGISTER

OZARK MOUNTAIN POULTRY, INC. (ARKANSAS CORPORATION)
750 W. EASY ST.
ROGERS, AR 72756

FOR: POULTRY, IN CLASS 29 (U.S. CL. 46).

FIRST USE 3-30-2012; IN COMMERCE 3-30-2012.

NO CLAIM IS MADE TO THE EXCLUSIVE RIGHT TO USE THE DESIGN OF THE QUICK RESPONSE CODE, APART FROM THE MARK AS SHOWN.

THE COLOR(S) BLACK, WHITE AND YELLOW/GREEN IS/ARE CLAIMED AS A FEATURE OF THE MARK.

THE MARK CONSISTS OF A BLACK AND WHITE QUICK RESPONSE CODE DESIGN CONSISTING OF A WHITE BACKGROUND WITH BLACK MARKS AND A YELLOW/GREEN CHICKEN SILHOUETTE IN THE MIDDLE OF THE CODE.

SN 85-415,431, FILED 9-6-2011.

COLLEEN KEARNEY, EXAMINING ATTORNEY



David J. Kyffers

Director of the United States Patent and Trademark Office

United States of America

United States Patent and Trademark Office

AIRCREDITS

Reg. No. 4,177,112

QUINLAN, DAVID (UNITED STATES INDIVIDUAL)
735 ORCHARD COURT
ATLANTA, GA 30328

Registered July 17, 2012

Int. Cl.: 9

FOR: COMPUTER APPLICATION SOFTWARE FOR MOBILE DIGITAL ELECTRONIC DEVICES, NAMELY, SOFTWARE FOR USE IN TRACKING BANKING, CREDIT CARD, LOYALTY PROGRAM, AND REWARD PROGRAM INFORMATION, IN CLASS 9 (U.S. CLS. 21, 23, 26, 36 AND 38).

TRADEMARK

PRINCIPAL REGISTER

FIRST USE 11-15-2011; IN COMMERCE 11-15-2011.

THE MARK CONSISTS OF STANDARD CHARACTERS WITHOUT CLAIM TO ANY PARTICULAR FONT, STYLE, SIZE, OR COLOR.

SN 85-415,992, FILED 9-6-2011.

BERNICE MIDDLETON, EXAMINING ATTORNEY



David J. Kyffers

Director of the United States Patent and Trademark Office

United States of America

United States Patent and Trademark Office

CARE

Reg. No. 4,177,113

Registered July 17, 2012

Int. Cl.: 20

TRADEMARK

PRINCIPAL REGISTER

CARE CASKETS INTERNATIONAL, LLC (MICHIGAN LIMITED LIABILITY COMPANY)
4336 LAKING LANE
LUNA PIER, MI 48157

FOR: CASKETS, IN CLASS 20 (U.S. CLS. 2, 13, 22, 25, 32 AND 50).

FIRST USE 1-1-2011; IN COMMERCE 1-1-2011.

THE MARK CONSISTS OF STANDARD CHARACTERS WITHOUT CLAIM TO ANY PARTICULAR FONT, STYLE, SIZE, OR COLOR.

SN 85-416,241, FILED 9-7-2011.

ELI HELLMAN, EXAMINING ATTORNEY



David J. Kybas

Director of the United States Patent and Trademark Office

United States of America

United States Patent and Trademark Office

Good Karma Radio

Reg. No. 4,177,114

REESE, RON D (UNITED STATES INDIVIDUAL)
8221 GREEN TREE CT
REYNOLDSBURG, OH 43068

Registered July 17, 2012

Int. Cl.: 38

FOR: INTERNET RADIO BROADCASTING SERVICES, IN CLASS 38 (U.S. CLS. 100, 101 AND 104).

SERVICE MARK

FIRST USE 9-14-2011; IN COMMERCE 10-1-2011.

PRINCIPAL REGISTER

THE MARK CONSISTS OF STANDARD CHARACTERS WITHOUT CLAIM TO ANY PARTICULAR FONT, STYLE, SIZE, OR COLOR.

NO CLAIM IS MADE TO THE EXCLUSIVE RIGHT TO USE "RADIO", APART FROM THE MARK AS SHOWN.

SN 85-416,521, FILED 9-7-2011.

AMY ALFIERI, EXAMINING ATTORNEY



David J. Kyffers

Director of the United States Patent and Trademark Office

United States of America

United States Patent and Trademark Office

SHOP HERE. GIVE THERE.

Reg. No. 4,177,115

LES AMIS, LLC (TEXAS LIMITED LIABILITY COMPANY)
100 HIGHLAND PARK VILLAGE, SUITE 202
DALLAS, TX 75205

Registered July 17, 2012

Int. Cl.: 35

FOR: ON-LINE WHOLESALE AND RETAIL STORE SERVICES FEATURING JEWELRY AND FASHION ACCESSORIES; RETAIL STORE SERVICES FEATURING JEWELRY AND FASHION ACCESSORIES , IN CLASS 35 (U.S. CLS. 100, 101 AND 102).

SERVICE MARK

FIRST USE 2-10-2012; IN COMMERCE 2-10-2012.

PRINCIPAL REGISTER

THE MARK CONSISTS OF STANDARD CHARACTERS WITHOUT CLAIM TO ANY PARTICULAR FONT, STYLE, SIZE, OR COLOR.

SN 85-416,569, FILED 9-7-2011.

REGINA DRUMMOND, EXAMINING ATTORNEY



David J. Kyffers

Director of the United States Patent and Trademark Office

United States of America
United States Patent and Trademark Office

FitRight

Reg. No. 4,177,116

MEDLINE INDUSTRIES, INC. (ILLINOIS CORPORATION)
ONE MEDLINE PLACE
MUNDELEIN, IL 60060

Registered July 17, 2012

Int. Cl.: 5

FOR: INCONTINENCE GARMENTS, IN CLASS 5 (U.S. CLS. 6, 18, 44, 46, 51 AND 52).

TRADEMARK

FIRST USE 11-7-2011; IN COMMERCE 11-7-2011.

PRINCIPAL REGISTER

THE MARK CONSISTS OF WORDS "FIT RIGHT" IN STYLIZED FONT AND FLOWER DESIGN ABOVE THE LETTER "I" IN THE WORD "RIGHT". THE COLOR GRAY IS FOR SHADING PURPOSES ONLY.

SN 85-418,396, FILED 9-9-2011.

ALICIA COLLINS, EXAMINING ATTORNEY



David J. Kybas

Director of the United States Patent and Trademark Office

United States of America

United States Patent and Trademark Office

WHORLR

Reg. No. 4,177,117

Registered July 17, 2012

Int. Cl.: 42

SERVICE MARK

PRINCIPAL REGISTER

WHITMYER, JR., WESLEY W. (UNITED STATES INDIVIDUAL)
986 BEDFORD STREET
STAMFORD, CT 069055619

FOR: DESIGNING, DEVELOPING, HOSTING, AND PROVIDING PERSONALIZED WEBSITES FEATURING TECHNOLOGY THAT ENABLES USERS TO PUBLISH PUBLIC AND PERSONAL INFORMATION FROM A VARIETY OF SOURCES AND RESTRICT ACCESS TO VARIOUS TYPES OF INFORMATION TO DIFFERENT CATEGORIES OF SITE VISITORS, IN CLASS 42 (U.S. CLS. 100 AND 101).

FIRST USE 5-4-2012; IN COMMERCE 5-4-2012.

THE MARK CONSISTS OF STANDARD CHARACTERS WITHOUT CLAIM TO ANY PARTICULAR FONT, STYLE, SIZE, OR COLOR.

SN 85-418,879, FILED 9-9-2011.

JENNIFER VASQUEZ, EXAMINING ATTORNEY



David J. Kybas

Director of the United States Patent and Trademark Office

United States of America

United States Patent and Trademark Office

Highland Estates

Reg. No. 4,177,118

Registered July 17, 2012

Int. Cl.: 30

TRADEMARK

PRINCIPAL REGISTER

HIGHLAND SUGARWORKS, INC. (VERMONT CORPORATION)
P.O. BOX 58
WILSON INDUSTRIAL PARK
WEBSTERVILLE, VT 05678

FOR: MAPLE SYRUP, IN CLASS 30 (U.S. CL. 46).

FIRST USE 10-21-2011; IN COMMERCE 10-21-2011.

THE MARK CONSISTS OF STANDARD CHARACTERS WITHOUT CLAIM TO ANY PARTICULAR FONT, STYLE, SIZE, OR COLOR.

OWNER OF U.S. REG. NOS. 2,540,266, 2,540,267, AND 4,011,854.

SN 85-420,036, FILED 9-12-2011.

SUNG IN, EXAMINING ATTORNEY



David J. Kyffers

Director of the United States Patent and Trademark Office

United States of America
United States Patent and Trademark Office

Trash Dash

Reg. No. 4,177,119

RPS PRODUCTS, INC. (ILLINOIS CORPORATION)
281 KEYES AVE.
HAMPSHIRE, IL 60140

Registered July 17, 2012

Int. Cl.: 5

FOR: ODOR NEUTRALIZING PREPARATIONS FOR USE ON TRASH WASTE CONTAINERS,
IN CLASS 5 (U.S. CLS. 6, 18, 44, 46, 51 AND 52).

TRADEMARK

FIRST USE 7-6-2011; IN COMMERCE 1-27-2012.

PRINCIPAL REGISTER

THE MARK CONSISTS OF STANDARD CHARACTERS WITHOUT CLAIM TO ANY PAR-
TICULAR FONT, STYLE, SIZE, OR COLOR.

NO CLAIM IS MADE TO THE EXCLUSIVE RIGHT TO USE "TRASH", APART FROM THE
MARK AS SHOWN.

SN 85-420,143, FILED 9-12-2011.

ROBIN MITTLER, EXAMINING ATTORNEY



David J. Kyfos

Director of the United States Patent and Trademark Office

United States of America

United States Patent and Trademark Office

THE FIX

Reg. No. 4,177,120

WHIP-IT INVENTIONS, LLC (FLORIDA LIMITED LIABILITY COMPANY)
5946 COMMERCE ROAD
MILTON, FL 32583

Registered July 17, 2012

Int. Cls.: 1 and 3

FOR: CHEMICAL PREPARATIONS, NAMELY, DEGREASING AND CLEANING SOLVENTS,
IN CLASS 1 (U.S. CLS. 1, 5, 6, 10, 26 AND 46).

TRADEMARK

FIRST USE 10-1-2011; IN COMMERCE 10-1-2011.

PRINCIPAL REGISTER

FOR: ALL-PURPOSE CLEANERS; AUTOMOBILE AND CAR WAX PREPARATIONS;
AUTOMOBILE CARPET AND UPHOLSTERY CLEANING PREPARATIONS; AUTOMOBILE
CLEANERS; AUTOMOBILE TIRE CLEANING AND POLISHING PREPARATIONS; BIO-
TECHNOLOGICAL CHEMICAL AND SPRAY CLEANERS FOR INDUSTRIAL AND
HOUSEHOLD APPLICATIONS SUCH AS STAIN REMOVAL, ODOR ELIMINATION, AND
BIOREMEDIATION OF MANY TYPES OF ORGANIC AND HYDROCARBON-BASED MA-
TERIALS; CARPET CLEANERS; CARPET CLEANERS WITH DEODORIZER; GLASS
CLEANERS; OVEN CLEANERS; UPHOLSTERY CLEANERS; WHITEWALL CLEANERS,
IN CLASS 3 (U.S. CLS. 1, 4, 6, 50, 51 AND 52).

FIRST USE 10-1-2011; IN COMMERCE 10-1-2011.

THE MARK CONSISTS OF STANDARD CHARACTERS WITHOUT CLAIM TO ANY PAR-
TICULAR FONT, STYLE, SIZE, OR COLOR.

SN 85-420,331, FILED 9-12-2011.

WON TEAK OH, EXAMINING ATTORNEY



David J. Kyfos

Director of the United States Patent and Trademark Office

United States of America

United States Patent and Trademark Office

MOTHER LODGE

Reg. No. 4,177,121

Registered July 17, 2012

Int. Cl.: 33

TRADEMARK

PRINCIPAL REGISTER

MOTHER LODGE WINES, LLC (NORTH CAROLINA LIMITED LIABILITY COMPANY)
8226 VILLAGE HARBOR DRIVE
CORNELIUS, NC 28031

FOR: WINES, IN CLASS 33 (U.S. CLS. 47 AND 49).

FIRST USE 3-15-2012; IN COMMERCE 3-15-2012.

THE MARK CONSISTS OF STANDARD CHARACTERS WITHOUT CLAIM TO ANY PARTICULAR FONT, STYLE, SIZE, OR COLOR.

SN 85-421,575, FILED 9-13-2011.

JAMES A. RAUEN, EXAMINING ATTORNEY



David J. Kyffers

Director of the United States Patent and Trademark Office

United States of America

United States Patent and Trademark Office

CAPPY BLAST

Reg. No. 4,177,122

Registered July 17, 2012

Int. Cl.: 30

TRADEMARK

PRINCIPAL REGISTER

BR IP HOLDER LLC (DELAWARE LIMITED LIABILITY COMPANY)
130 ROYALL ST.
CANTON, MA 02021

FOR: COFFEE-BASED BEVERAGES, IN CLASS 30 (U.S. CL. 46).

FIRST USE 4-2-2012; IN COMMERCE 4-2-2012.

THE MARK CONSISTS OF STANDARD CHARACTERS WITHOUT CLAIM TO ANY PARTICULAR FONT, STYLE, SIZE, OR COLOR.

OWNER OF U.S. REG. NO. 2,774,702.

SN 85-423,786, FILED 9-15-2011.

STEPHANIE ALI, EXAMINING ATTORNEY



David J. Kyffers

Director of the United States Patent and Trademark Office

United States of America

United States Patent and Trademark Office

Where Social Meets Study

Reg. No. 4,177,123

PERSONALWEB TECHNOLOGIES, LLC (TEXAS LIMITED LIABILITY COMPANY)
112 E. LINE ST., SUITE 204
TYLER, TX 75702

Registered July 17, 2012

Int. Cl.: 45

FOR: ONLINE SOCIAL NETWORKING SERVICES PROVIDED THROUGH A COMMUNITY WEBSITE, IN CLASS 45 (U.S. CLS. 100 AND 101).

SERVICE MARK

FIRST USE 5-7-2012; IN COMMERCE 5-7-2012.

PRINCIPAL REGISTER

THE MARK CONSISTS OF STANDARD CHARACTERS WITHOUT CLAIM TO ANY PARTICULAR FONT, STYLE, SIZE, OR COLOR.

SN 85-424,624, FILED 9-16-2011.

FRANK LATTUCA, EXAMINING ATTORNEY



David J. Kyffers

Director of the United States Patent and Trademark Office

United States of America

United States Patent and Trademark Office

iottie

Reg. No. 4,177,124

Registered July 17, 2012

Int. Cl.: 9

TRADEMARK

PRINCIPAL REGISTER

IOTTIE INC. (NEW YORK CORPORATION)
SUITE 1610
38 W 32ND STREET
NEW YORK, NY 10001

FOR: CARRYING CASES FOR CELL PHONES; CARRYING CASES, HOLDERS, PROTECTIVE CASES AND STANDS FEATURING POWER SUPPLY CONNECTORS, ADAPTORS, SPEAKERS AND BATTERY CHARGING DEVICES, SPECIALLY ADAPTED FOR USE WITH HANDHELD DIGITAL ELECTRONIC DEVICES; PROTECTIVE COVERS AND CASES FOR CELL PHONES, LAPTOPS AND PORTABLE MEDIA PLAYERS, IN CLASS 9 (U.S. CLS. 21, 23, 26, 36 AND 38).

FIRST USE 4-20-2010; IN COMMERCE 10-15-2011.

THE MARK CONSISTS OF THE LETTERS "I", "T", "T", "I", AND "E" IN BLACK AND THE LETTER "O" IN GREEN WITH BLACK OUTLINE.

THE COLOR(S) GREEN AND BLACK IS/ARE CLAIMED AS A FEATURE OF THE MARK.

SN 85-425,057, FILED 9-16-2011.

ERIN FALK, EXAMINING ATTORNEY



David J. Kyffers

Director of the United States Patent and Trademark Office

United States of America

United States Patent and Trademark Office

CARETRICITY

Reg. No. 4,177,125

SHOPDOC LLC (FLORIDA LIMITED LIABILITY COMPANY)

Registered July 17, 2012

18181 NE 31ST CT 2404
AVENTURA, FL 33160

Int. Cl.: 35

FOR: PROMOTING THE GOODS AND SERVICES OF OTHERS BY PROVIDING A WEBSITE FEATURING A SEARCH FUNCTION FOR CONSUMERS TO LOCATE HEALTH CARE PROVIDERS BY LOCATION AND SPECIALTY; PROVIDING A WEBSITE THAT ENABLES PATIENTS TO COMMUNICATE WITH HEALTHCARE PROVIDERS FOR APPOINTMENT SCHEDULING AND FOR PROVIDING INFORMATION ABOUT HEALTHCARE PRICING, AND OUT OF POCKET PRICING INFORMATION; PROVIDING A WEBSITE FEATURING INDUSTRY INFORMATION ABOUT HEALTHCARE PROVIDERS AND HEALTHCARE COSTS, IN CLASS 35 (U.S. CLS. 100, 101 AND 102).

SERVICE MARK

PRINCIPAL REGISTER

FIRST USE 5-10-2012; IN COMMERCE 5-10-2012.

THE MARK CONSISTS OF STANDARD CHARACTERS WITHOUT CLAIM TO ANY PARTICULAR FONT, STYLE, SIZE, OR COLOR.

SN 85-425,239, FILED 9-16-2011.

JORDAN BAKER, EXAMINING ATTORNEY



David J. Kyffers

Director of the United States Patent and Trademark Office

United States of America

United States Patent and Trademark Office

Bad Kitty Films

Reg. No. 4,177,126

BAD KITTY FILMS L.L.C (FLORIDA LIMITED LIABILITY COMPANY)
4544 CANNA DRIVE
ORLANDO, FL 32839

Registered July 17, 2012

Int. Cl.: 41

FOR: FILM PRODUCTION, IN CLASS 41 (U.S. CLS. 100, 101 AND 107).

SERVICE MARK

FIRST USE 5-15-2011; IN COMMERCE 3-10-2012.

PRINCIPAL REGISTER

THE MARK CONSISTS OF STANDARD CHARACTERS WITHOUT CLAIM TO ANY PARTICULAR FONT, STYLE, SIZE, OR COLOR.

NO CLAIM IS MADE TO THE EXCLUSIVE RIGHT TO USE "FILMS", APART FROM THE MARK AS SHOWN.

SN 85-426,231, FILED 9-19-2011.

MARILYN IZZI, EXAMINING ATTORNEY



David J. Kyffers

Director of the United States Patent and Trademark Office

United States of America

United States Patent and Trademark Office



Reg. No. 4,177,127

Registered July 17, 2012

Int. Cl.: 35

SERVICE MARK

PRINCIPAL REGISTER

REVOLUTION FOODS, INC. (DELAWARE CORPORATION)
8383 CAPWELL DRIVE
OAKLAND, CA 94621

FOR: VENDING MACHINE SERVICES FEATURING FOOD AND BEVERAGES, IN CLASS 35 (U.S. CLS. 100, 101 AND 102).

FIRST USE 10-11-2011; IN COMMERCE 10-11-2011.

OWNER OF U.S. REG. NOS. 3,709,908, 3,989,108, AND OTHERS.

NO CLAIM IS MADE TO THE EXCLUSIVE RIGHT TO USE "FOODS", APART FROM THE MARK AS SHOWN.

THE MARK CONSISTS OF A HUMAN FIGURE LOOKING UP TO AN APPLE, WITH THE WORD "REVOLUTION FOODS" WITHIN THE APPLE AND A STAR ON THE LETTER "I".

SN 85-426,248, FILED 9-19-2011.

SALLY SHIH, EXAMINING ATTORNEY



David J. Kyros

Director of the United States Patent and Trademark Office

United States of America

United States Patent and Trademark Office

REAL FOOD FOR ALL

Reg. No. 4,177,128

Registered July 17, 2012

Int. Cl.: 43

SERVICE MARK

PRINCIPAL REGISTER

REVOLUTION FOODS, INC. (DELAWARE CORPORATION)
8383 CAPWELL DRIVE
OAKLAND, CA 94621

FOR: CATERING FOR SCHOOLS, IN CLASS 43 (U.S. CLS. 100 AND 101).

FIRST USE 8-0-2011; IN COMMERCE 8-0-2011.

THE MARK CONSISTS OF STANDARD CHARACTERS WITHOUT CLAIM TO ANY PARTICULAR FONT, STYLE, SIZE, OR COLOR.

NO CLAIM IS MADE TO THE EXCLUSIVE RIGHT TO USE "FOOD", APART FROM THE MARK AS SHOWN.

SN 85-426,282, FILED 9-19-2011.

SALLY SHIH, EXAMINING ATTORNEY



David J. Kyffers

Director of the United States Patent and Trademark Office

United States of America

United States Patent and Trademark Office

actifilter

Reg. No. 4,177,129

Registered July 17, 2012

Int. Cl.: 11

TRADEMARK

PRINCIPAL REGISTER

APIQE INC (DELAWARE CORPORATION), DBA APIQE,
1605 LOCKNESS PLACE
TORRANCE, CA 90501

FOR: FILTERING UNITS FOR WATER FILTERING; FILTERS FOR DRINKING WATER;
WATER FILTRATION AND PURIFICATION UNITS AND REPLACEMENT CARTRIDGES
AND FILTERS THEREFOR, IN CLASS 11 (U.S. CLS. 13, 21, 23, 31 AND 34).

FIRST USE 9-1-2011; IN COMMERCE 9-1-2011.

THE MARK CONSISTS OF STANDARD CHARACTERS WITHOUT CLAIM TO ANY PAR-
TICULAR FONT, STYLE, SIZE, OR COLOR.

SN 85-427,569, FILED 9-20-2011.

ALEX KEAM, EXAMINING ATTORNEY



David J. Kybas

Director of the United States Patent and Trademark Office

United States of America

United States Patent and Trademark Office

sniff 'n' discover

Reg. No. 4,177,130

SPALINK, KARIN J (UNITED STATES INDIVIDUAL)
3503 STONEGATE DRIVE
DURHAM, NC 27705

Registered July 17, 2012

Int. Cl.: 21

FOR: FEEDING VESSELS FOR PETS, IN CLASS 21 (U.S. CLS. 2, 13, 23, 29, 30, 33, 40 AND 50).

TRADEMARK

FIRST USE 12-1-2011; IN COMMERCE 12-1-2011.

PRINCIPAL REGISTER

THE MARK CONSISTS OF STANDARD CHARACTERS WITHOUT CLAIM TO ANY PARTICULAR FONT, STYLE, SIZE, OR COLOR.

SN 85-427,590, FILED 9-20-2011.

JOHN HWANG, EXAMINING ATTORNEY



David J. Kybas

Director of the United States Patent and Trademark Office

United States of America

United States Patent and Trademark Office

Love Sets

Reg. No. 4,177,131

WEISS, DANNA (UNITED STATES INDIVIDUAL)
561 10TH AVE. #31E
NEW YORK, NY 10036

Registered July 17, 2012

Int. Cl.: 14

FOR: BODY JEWELRY; BRACELETS; BROACHES; JEWELRY CHAINS; PINS BEING JEWELRY, IN CLASS 14 (U.S. CLS. 2, 27, 28 AND 50).

TRADEMARK

FIRST USE 4-1-2012; IN COMMERCE 4-1-2012.

PRINCIPAL REGISTER

THE MARK CONSISTS OF STANDARD CHARACTERS WITHOUT CLAIM TO ANY PARTICULAR FONT, STYLE, SIZE, OR COLOR.

NO CLAIM IS MADE TO THE EXCLUSIVE RIGHT TO USE "SETS", APART FROM THE MARK AS SHOWN.

SN 85-428,560, FILED 9-21-2011.

EMILY CHUO, EXAMINING ATTORNEY



David J. Kybas

Director of the United States Patent and Trademark Office

United States of America

United States Patent and Trademark Office

Metaphysical Couture

Reg. No. 4,177,132

WEISS, DANNA (UNITED STATES INDIVIDUAL)

Registered July 17, 2012

561 10TH AVE. #31E
NEW YORK, NY 10036

Int. Cl.: 14

FOR: BODY JEWELRY; BRACELETS; BROACHES; JEWELRY CHAINS; PINS BEING JEWELRY, IN CLASS 14 (U.S. CLS. 2, 27, 28 AND 50).

TRADEMARK

FIRST USE 4-1-2012; IN COMMERCE 4-1-2012.

PRINCIPAL REGISTER

THE MARK CONSISTS OF STANDARD CHARACTERS WITHOUT CLAIM TO ANY PARTICULAR FONT, STYLE, SIZE, OR COLOR.

NO CLAIM IS MADE TO THE EXCLUSIVE RIGHT TO USE "COUTURE", APART FROM THE MARK AS SHOWN.

SN 85-428,571, FILED 9-21-2011.

EMILY CHUO, EXAMINING ATTORNEY



David J. Kybas

Director of the United States Patent and Trademark Office

United States of America

United States Patent and Trademark Office

3RAZZLE

Reg. No. 4,177,133

DIMENSIONAL OPTICS, INC. (CALIFORNIA CORPORATION)
3590 SACRAMENTO DRIVE
SAN LUIS OBISPO, CA 93401

Registered July 17, 2012

Int. Cl.: 9

FOR: EYEWEAR, NAMELY, STEREOSCOPIC GLASSES, AND CASES THEREFOR, IN CLASS 9 (U.S. CLS. 21, 23, 26, 36 AND 38).

TRADEMARK

FIRST USE 11-7-2011; IN COMMERCE 11-7-2011.

PRINCIPAL REGISTER

THE MARK CONSISTS OF STANDARD CHARACTERS WITHOUT CLAIM TO ANY PARTICULAR FONT, STYLE, SIZE, OR COLOR.

SN 85-429,522, FILED 9-22-2011.

HENRY S. ZAK, EXAMINING ATTORNEY



David J. Kyffers

Director of the United States Patent and Trademark Office

United States of America

United States Patent and Trademark Office

3DAZZLE

Reg. No. 4,177,134

DIMENSIONAL OPTICS, INC. (CALIFORNIA CORPORATION)
3590 SACRAMENTO DRIVE
SAN LUIS OBISPO, CA 93401

Registered July 17, 2012

Int. Cl.: 9

FOR: EYEWEAR, NAMELY, STEREOSCOPIC GLASSES, AND CASES THEREFOR, IN CLASS 9 (U.S. CLS. 21, 23, 26, 36 AND 38).

TRADEMARK

FIRST USE 11-7-2011; IN COMMERCE 11-7-2011.

PRINCIPAL REGISTER

THE MARK CONSISTS OF STANDARD CHARACTERS WITHOUT CLAIM TO ANY PARTICULAR FONT, STYLE, SIZE, OR COLOR.

SN 85-429,576, FILED 9-22-2011.

HENRY S. ZAK, EXAMINING ATTORNEY



David J. Kyffers

Director of the United States Patent and Trademark Office

United States of America

United States Patent and Trademark Office

Unforgettable

Reg. No. 4,177,135

SOUTH BEACH CANDLE COMPANY (FLORIDA CORPORATION)
2260 WEST 80 STREET BAY #3
HIALEAH, FL 33016

Registered July 17, 2012

Int. Cl.: 4

FOR: CANDLES; PERFUMED CANDLES; SCENTED CANDLES; SCENTED WAX FOR USE
IN CANDLE WARMERS, IN CLASS 4 (U.S. CLS. 1, 6 AND 15).

TRADEMARK

FIRST USE 11-15-2011; IN COMMERCE 11-15-2011.

PRINCIPAL REGISTER

THE MARK CONSISTS OF STANDARD CHARACTERS WITHOUT CLAIM TO ANY PAR-
TICULAR FONT, STYLE, SIZE, OR COLOR.

SN 85-429,968, FILED 9-22-2011.

KATHRYN COWARD, EXAMINING ATTORNEY



David J. Kyffers

Director of the United States Patent and Trademark Office

United States of America

United States Patent and Trademark Office

Scrumptious

Reg. No. 4,177,136

SOUTH BEACH CANDLE COMPANY (FLORIDA CORPORATION)
2260 WEST 80 STREET BAY #3
HIALEAH, FL 33016

Registered July 17, 2012

Int. Cl.: 4

FOR: CANDLES; SCENTED WAX FOR USE IN CANDLE WARMERS, IN CLASS 4 (U.S. CLS. 1, 6 AND 15).

TRADEMARK

FIRST USE 11-15-2011; IN COMMERCE 11-15-2011.

PRINCIPAL REGISTER

THE MARK CONSISTS OF STANDARD CHARACTERS WITHOUT CLAIM TO ANY PARTICULAR FONT, STYLE, SIZE, OR COLOR.

SN 85-429,980, FILED 9-22-2011.

KATHRYN COWARD, EXAMINING ATTORNEY



David J. Kybas

Director of the United States Patent and Trademark Office

United States of America
United States Patent and Trademark Office

PYROFEST

Reg. No. 4,177,137

STEPHEN J. VITALE (UNITED STATES INDIVIDUAL)
299 WILSON ROAD
NEW CASTLE, PA 16101

Registered July 17, 2012

Int. Cl.: 41

FOR: ENTERTAINMENT SERVICES, NAMELY, PLANNING AND CONDUCTING A SERIES OF FIREWORK FESTIVALS, IN CLASS 41 (U.S. CLS. 100, 101 AND 107).

SERVICE MARK

FIRST USE 4-1-2012; IN COMMERCE 4-1-2012.

PRINCIPAL REGISTER

THE MARK CONSISTS OF STANDARD CHARACTERS WITHOUT CLAIM TO ANY PARTICULAR FONT, STYLE, SIZE, OR COLOR.

SN 85-430,379, FILED 9-23-2011.

MARK SHINER, EXAMINING ATTORNEY



David J. Kyffers

Director of the United States Patent and Trademark Office

United States of America

United States Patent and Trademark Office



Reg. No. 4,177,138

Registered July 17, 2012

Int. Cl.: 35

SERVICE MARK

PRINCIPAL REGISTER

AMERICAN ACADEMY OF DERMATOLOGY (MINNESOTA NON-PROFIT CORPORATION)
930 EAST WOODFIELD ROAD
SCHAUMBURG, IL 60173

FOR: PROMOTING PUBLIC AWARENESS OF SKIN CANCER DETECTION AND TREATMENT; PROMOTING PUBLIC AWARENESS OF THE NEED FOR GOOD DERMATOLOGICAL HEALTH, IN CLASS 35 (U.S. CLS. 100, 101 AND 102).

FIRST USE 5-1-2012; IN COMMERCE 5-1-2012.

OWNER OF U.S. REG. NOS. 1,237,768, 1,298,108, AND OTHERS.

SEC. 2(F) AS TO "AMERICAN ACADEMY OF DERMATOLOGY".

NO CLAIM IS MADE TO THE EXCLUSIVE RIGHT TO USE "SKIN CANCER", APART FROM THE MARK AS SHOWN.

THE MARK CONSISTS OF A SOLID CIRCLE CONTAINING THE WORD "SPOT" IN LARGE FONT ABOVE THE WORDS "SKIN CANCER" IN SMALLER FONT. THE TOP HALF OF THE CIRCLE IS SURROUNDED BY THE WORDS "AMERICAN ACADEMY OF DERMATOLOGY" AND THE BOTTOM HALF IS SURROUNDED BY THE WORDS "PREVENT DETECT LIVE" WITH A DOT BEFORE AND AFTER EACH WORD.

SN 85-430,502, FILED 9-23-2011.

ELLEN B. AWRICH, EXAMINING ATTORNEY



David J. Kyjars

Director of the United States Patent and Trademark Office

United States of America

United States Patent and Trademark Office

FASTTRANSACT

Reg. No. 4,177,139

Registered July 17, 2012

Int. Cl.: 36

SERVICE MARK

PRINCIPAL REGISTER

FRONTSTREAM PAYMENTS, INC. (DELAWARE CORPORATION)
SUITE 158
100 WINNERS CIRCLE
BRENTWOOD, TN 37027

FOR: PAYMENT PROCESSING SERVICES FOR MERCHANTS; CHECK PROCESSING SERVICES; CREDIT CARD TRANSACTION PROCESSING SERVICES; AND PRE-PAID PURCHASE CARD SERVICES, NAMELY, PROCESSING ELECTRONIC PAYMENTS MADE THROUGH PREPAID CARDS, IN CLASS 36 (U.S. CLS. 100, 101 AND 102).

FIRST USE 3-15-2012; IN COMMERCE 3-15-2012.

THE MARK CONSISTS OF STANDARD CHARACTERS WITHOUT CLAIM TO ANY PARTICULAR FONT, STYLE, SIZE, OR COLOR.

OWNER OF U.S. REG. NO. 3,068,027.

SN 85-430,832, FILED 9-23-2011.

JULIE WATSON, EXAMINING ATTORNEY



David J. Kyffers

Director of the United States Patent and Trademark Office

United States of America

United States Patent and Trademark Office

WICK IT CLEAN

Reg. No. 4,177,140

KEN WILSON (UNITED STATES INDIVIDUAL)
3639 MIDWAY DR., STE. B242
SAN DIEGO, CA 92110

Registered July 17, 2012

Int. Cl.: 21

FOR: FOAM APPLICATOR STICK FOR CLEANING EYEWEAR, GOGGLES, COMPUTER SCREENS, TABLET COMPUTERS, CELL PHONES AND OTHER LCD SCREENS, IN CLASS 21 (U.S. CLS. 2, 13, 23, 29, 30, 33, 40 AND 50).

TRADEMARK

FIRST USE 4-30-2012; IN COMMERCE 4-30-2012.

PRINCIPAL REGISTER

THE MARK CONSISTS OF STANDARD CHARACTERS WITHOUT CLAIM TO ANY PARTICULAR FONT, STYLE, SIZE, OR COLOR.

NO CLAIM IS MADE TO THE EXCLUSIVE RIGHT TO USE "CLEAN", APART FROM THE MARK AS SHOWN.

SN 85-430,926, FILED 9-23-2011.

ALICE BENMAMAN, EXAMINING ATTORNEY



David J. Kyffers

Director of the United States Patent and Trademark Office

United States of America

United States Patent and Trademark Office

Be Line

Reg. No. 4,177,141

SOUTH BEACH CANDLE COMPANY (FLORIDA CORPORATION)
2260 WEST 80 STREET BAY #3
HIALEAH, FL 33016

Registered July 17, 2012

Int. Cl.: 4

FOR: CANDLES; SCENTED WAX FOR USE IN CANDLE WARMERS, IN CLASS 4 (U.S. CLS. 1, 6 AND 15).

TRADEMARK

FIRST USE 11-15-2011; IN COMMERCE 11-15-2011.

PRINCIPAL REGISTER

THE MARK CONSISTS OF STANDARD CHARACTERS WITHOUT CLAIM TO ANY PARTICULAR FONT, STYLE, SIZE, OR COLOR.

SN 85-431,089, FILED 9-23-2011.

KATHRYN COWARD, EXAMINING ATTORNEY



David J. Kybas

Director of the United States Patent and Trademark Office

United States of America

United States Patent and Trademark Office

Perfect Personal Speeches

Reg. No. 4,177,142

PERFECT PERSONAL STATEMENT (TEXAS LIMITED LIABILITY COMPANY)
11424 CAMINITO GARCIA
SAN DIEGO, CA 92131

Registered July 17, 2012

Int. Cl.: 41

FOR: CUSTOM WRITING SERVICES, IN CLASS 41 (U.S. CLS. 100, 101 AND 107).

SERVICE MARK

FIRST USE 1-1-2012; IN COMMERCE 1-1-2012.

PRINCIPAL REGISTER

THE MARK CONSISTS OF STANDARD CHARACTERS WITHOUT CLAIM TO ANY PARTICULAR FONT, STYLE, SIZE, OR COLOR.

OWNER OF U.S. REG. NO. 3,644,749.

NO CLAIM IS MADE TO THE EXCLUSIVE RIGHT TO USE "PERSONAL SPEECHES", APART FROM THE MARK AS SHOWN.

SN 85-431,343, FILED 9-25-2011.

JANICE L. MCMORROW, EXAMINING ATTORNEY



David J. Kyffers

Director of the United States Patent and Trademark Office

United States of America
United States Patent and Trademark Office

FRESHICA

Reg. No. 4,177,143

MONTGOMERY WARD, INC. (WISCONSIN CORPORATION)
1112 7TH AVENUE
MONROE, WI 535668016

Registered July 17, 2012

Int. Cls.: 18 and 25

FOR: HANDBAGS, IN CLASS 18 (U.S. CLS. 1, 2, 3, 22 AND 41).

TRADEMARK

FIRST USE 1-9-2012; IN COMMERCE 1-9-2012.

PRINCIPAL REGISTER

FOR: FOOTWEAR, IN CLASS 25 (U.S. CLS. 22 AND 39).

FIRST USE 1-9-2012; IN COMMERCE 1-9-2012.

THE MARK CONSISTS OF STANDARD CHARACTERS WITHOUT CLAIM TO ANY PARTICULAR FONT, STYLE, SIZE, OR COLOR.

SN 85-431,923, FILED 9-26-2011.

JENNIFER VASQUEZ, EXAMINING ATTORNEY



David J. Kyros

Director of the United States Patent and Trademark Office

United States of America

United States Patent and Trademark Office

FUEL THE FRENZY

Reg. No. 4,177,144

Registered July 17, 2012

Int. Cl.: 32

TRADEMARK

PRINCIPAL REGISTER

PEPSICO, INC. (NORTH CAROLINA CORPORATION), DBA PEPSICO, INC.,
700 ANDERSON HILL ROAD
PURCHASE, NY 10577

FOR: SOFT DRINKS, IN CLASS 32 (U.S. CLS. 45, 46 AND 48).

FIRST USE 1-30-2012; IN COMMERCE 1-30-2012.

THE MARK CONSISTS OF STANDARD CHARACTERS WITHOUT CLAIM TO ANY PARTICULAR FONT, STYLE, SIZE, OR COLOR.

SN 85-434,232, FILED 9-28-2011.

MARK SPARACINO, EXAMINING ATTORNEY



David J. Kybas

Director of the United States Patent and Trademark Office

United States of America

United States Patent and Trademark Office

QUBE

Reg. No. 4,177,145

Registered July 17, 2012

Int. Cl.: 12

TRADEMARK

PRINCIPAL REGISTER

AEROVIRONMENT, INC. (DELAWARE CORPORATION)
181 W. HUNTINGTON DRIVE
SUITE 202
MONROVIA, CA 91016

FOR: UNMANNED AERIAL VEHICLES (UAVS), IN CLASS 12 (U.S. CLS. 19, 21, 23, 31, 35 AND 44).

FIRST USE 10-21-2011; IN COMMERCE 10-21-2011.

THE MARK CONSISTS OF STANDARD CHARACTERS WITHOUT CLAIM TO ANY PARTICULAR FONT, STYLE, SIZE, OR COLOR.

SN 85-434,238, FILED 9-28-2011.

KATHERINE CHANG, EXAMINING ATTORNEY



David J. Kyffers

Director of the United States Patent and Trademark Office

United States of America

United States Patent and Trademark Office

REDCINE-X PRO

Reg. No. 4,177,146

Registered July 17, 2012

Int. Cl.: 9

TRADEMARK

PRINCIPAL REGISTER

RED.COM, INC. (WASHINGTON CORPORATION)
34 PARKER
IRVINE, CA 92618

FOR: DIGITAL CINEMA CAMERA SYSTEMS AND ACCESSORIES COMPRISED OF CAMERAS, CAMERA LENSES, FLASH MEMORY CARDS, ELECTRONIC MEMORIES, VIDEO MONITORS AND FLAT PANEL DISPLAY SCREENS, ALL FOR USE IN THE CREATION, STORAGE, DELIVERY, MANIPULATION, RECORDING, PLAYBACK OR VIEWING OF VIDEO, MUSIC, GRAPHICS, PHOTOS, AUDIO, TEXT, AND MULTIMEDIA DATA; AUDIO AND VISUAL EDUCATIONAL AND TEACHING APPARATUS AND INSTRUMENTS, NAMELY, COMPUTER HARDWARE AND COMPUTER SOFTWARE PROGRAMS FOR THE INTEGRATION OF TEXT, AUDIO, GRAPHICS, STILL IMAGE AND MOVING PICTURES INTO AN INTERACTIVE DELIVERY FOR MULTIMEDIA APPLICATIONS, COMPUTER WHITE BOARDS, VIDEO PROJECTORS AND VIDEO DISPLAY MONITORS, IN CLASS 9 (U.S. CLS. 21, 23, 26, 36 AND 38).

FIRST USE 8-31-2011; IN COMMERCE 8-31-2011.

THE MARK CONSISTS OF STANDARD CHARACTERS WITHOUT CLAIM TO ANY PARTICULAR FONT, STYLE, SIZE, OR COLOR.

OWNER OF U.S. REG. NOS. 3,628,966, 3,719,995, AND 3,923,788.

NO CLAIM IS MADE TO THE EXCLUSIVE RIGHT TO USE "PRO", APART FROM THE MARK AS SHOWN.

SN 85-434,601, FILED 9-28-2011.

SETH A. RAPPAPORT, EXAMINING ATTORNEY



David J. Kyros

Director of the United States Patent and Trademark Office

United States of America

United States Patent and Trademark Office

SUCCESSFULLY STAGNANT

Reg. No. 4,177,147

AFFELDT, ERIC (UNITED STATES INDIVIDUAL)
3030 LBJ FREEWAY, SUITE 600
DALLAS, TX 75234

Registered July 17, 2012

Int. Cl.: 41

FOR: ARRANGING AND CONDUCTING BUSINESS SEMINARS AND PRESENTATIONS
IN THE FIELD OF BUSINESS RELATIONSHIPS AND BUSINESS SERVICES, IN CLASS 41
(U.S. CLS. 100, 101 AND 107).

SERVICE MARK

FIRST USE 11-15-2011; IN COMMERCE 5-5-2012.

PRINCIPAL REGISTER

THE MARK CONSISTS OF STANDARD CHARACTERS WITHOUT CLAIM TO ANY PAR-
TICULAR FONT, STYLE, SIZE, OR COLOR.

SN 85-434,649, FILED 9-28-2011.

JOHN WILKE, EXAMINING ATTORNEY



David J. Kyffers

Director of the United States Patent and Trademark Office

United States of America

United States Patent and Trademark Office

Friends Forever

Reg. No. 4,177,148

SOUTH BEACH CANDLE COMPANY (FLORIDA CORPORATION)
2260 WEST 80 STREET BAY #3
HIALEAH, FL 33016

Registered July 17, 2012

Int. Cl.: 4

FOR: CANDLES; PERFUMED CANDLES; SCENTED CANDLES; SCENTED WAX FOR USE
IN CANDLE WARMERS, IN CLASS 4 (U.S. CLS. 1, 6 AND 15).

TRADEMARK

FIRST USE 11-1-2011; IN COMMERCE 11-1-2011.

PRINCIPAL REGISTER

THE MARK CONSISTS OF STANDARD CHARACTERS WITHOUT CLAIM TO ANY PAR-
TICULAR FONT, STYLE, SIZE, OR COLOR.

SN 85-435,680, FILED 9-29-2011.

MARK T. MULLEN, EXAMINING ATTORNEY



David J. Kyffers

Director of the United States Patent and Trademark Office

United States of America

United States Patent and Trademark Office



Reg. No. 4,177,149

Registered July 17, 2012

Int. Cl.: 44

SERVICE MARK

PRINCIPAL REGISTER

PASCUA YAQUI TRIBE (UNITED STATES FEDERALLY-RECOGNIZED INDIAN TRIBE)
7474 S. CAMINO DE OESTE
TUCSON, AZ 85746

FOR: HEALTH SPA SERVICES, NAMELY, PROVIDING FACIAL AND BODY TREATMENT SERVICES, COSMETIC BODY CARE SERVICES, MANICURES AND PEDICURES, MASSAGE SERVICES AND HAIR CARE SERVICES, IN CLASS 44 (U.S. CLS. 100 AND 101).

FIRST USE 11-11-2011; IN COMMERCE 11-11-2011.

THE MARK CONSISTS OF A RED DOMED BUILDING WITH BROWN, GOLD AND YELLOW ACCENTS IN FRONT OF BROWN AND GOLD MOUNTAINS AND A YELLOW SUN.

THE COLOR(S) BROWN, GOLD, YELLOW, AND RED IS/ARE CLAIMED AS A FEATURE OF THE MARK.

SN 85-436,628, FILED 9-30-2011.

KATHLEEN M. VANSTON, EXAMINING ATTORNEY



David J. Kyffers

Director of the United States Patent and Trademark Office

United States of America

United States Patent and Trademark Office



Reg. No. 4,177,150

Registered July 17, 2012

Int. Cl.: 43

SERVICE MARK

PRINCIPAL REGISTER

PASCUA YAQUI TRIBE (UNITED STATES FEDERALLY-RECOGNIZED INDIAN TRIBE)
7474 S. CAMINO DE OESTE
TUCSON, AZ 85746

FOR: HOTEL SERVICES; PROVIDING BANQUET AND SOCIAL FUNCTION FACILITIES FOR SPECIAL OCCASIONS; CATERING; RESTAURANT AND BAR SERVICES , IN CLASS 43 (U.S. CLS. 100 AND 101).

FIRST USE 11-11-2011; IN COMMERCE 11-11-2011.

THE MARK CONSISTS OF A RED DOMED BUILDING WITH BROWN, GOLD AND YELLOW ACCENTS IN FRONT OF BROWN AND GOLD MOUNTAINS AND A YELLOW SUN.

THE COLOR(S) BROWN, GOLD, YELLOW, AND RED IS/ARE CLAIMED AS A FEATURE OF THE MARK.

SN 85-436,642, FILED 9-30-2011.

KATHLEEN M. VANSTON, EXAMINING ATTORNEY



David J. Kyros

Director of the United States Patent and Trademark Office

United States of America
United States Patent and Trademark Office

DEODORALL

Reg. No. 4,177,151

BIOLARGO, INC. (DELAWARE CORPORATION)
16333 PHOEBE AVENUE
LA MIRADA, CA 90638

Registered July 17, 2012

Int. Cls.: 3 and 5

FOR: STAIN REMOVERS, IN CLASS 3 (U.S. CLS. 1, 4, 6, 50, 51 AND 52).

TRADEMARK

FIRST USE 1-27-2012; IN COMMERCE 1-27-2012.

PRINCIPAL REGISTER

FOR: AIR DEODORIZER , IN CLASS 5 (U.S. CLS. 6, 18, 44, 46, 51 AND 52).

FIRST USE 1-27-2012; IN COMMERCE 1-27-2012.

THE MARK CONSISTS OF STANDARD CHARACTERS WITHOUT CLAIM TO ANY PARTICULAR FONT, STYLE, SIZE, OR COLOR.

SN 85-436,936, FILED 9-30-2011.

SANJEEV VOHRA, EXAMINING ATTORNEY



David J. Kybas

Director of the United States Patent and Trademark Office

United States of America

United States Patent and Trademark Office

QEYSTONE

Reg. No. 4,177,152

Registered July 17, 2012

Int. Cl.: 42

SERVICE MARK

PRINCIPAL REGISTER

MINITAB INC. (PENNSYLVANIA CORPORATION)
QUALITY PLAZA
1829 PINE HALL ROAD
STATE COLLEGE, PA 16801

FOR: CLOUD COMPUTING FEATURING SOFTWARE FOR USE IN PROJECT AND PORTFOLIO MANAGEMENT, DASHBOARDING, QUALITY IMPROVEMENT, PROCESS IMPROVEMENT, STATISTICS, DATA ANALYSIS AND BUSINESS INTELLIGENCE, IN CLASS 42 (U.S. CLS. 100 AND 101).

FIRST USE 2-15-2012; IN COMMERCE 2-15-2012.

THE MARK CONSISTS OF STANDARD CHARACTERS WITHOUT CLAIM TO ANY PARTICULAR FONT, STYLE, SIZE, OR COLOR.

SN 85-443,048, FILED 10-10-2011.

JACQUELINE A. LAVINE, EXAMINING ATTORNEY



David J. Kyffers

Director of the United States Patent and Trademark Office

United States of America

United States Patent and Trademark Office

DERODUCTION

Reg. No. 4,177,153

EBI, LLC (INDIANA LIMITED LIABILITY COMPANY)
100 INTERPACE PARKWAY
PARSIPPANY, NJ 07054

Registered July 17, 2012

Int. Cl.: 10

FOR: SURGICAL INSTRUMENTS FOR USE IN SPINAL SURGERY, IN CLASS 10 (U.S. CLS. 26, 39 AND 44).

TRADEMARK

FIRST USE 4-6-2012; IN COMMERCE 4-6-2012.

PRINCIPAL REGISTER

THE MARK CONSISTS OF STANDARD CHARACTERS WITHOUT CLAIM TO ANY PARTICULAR FONT, STYLE, SIZE, OR COLOR.

SN 85-445,668, FILED 10-12-2011.

KAREN BRACEY, EXAMINING ATTORNEY



David J. Kyffers

Director of the United States Patent and Trademark Office

United States of America

United States Patent and Trademark Office



Reg. No. 4,177,154

Registered July 17, 2012

Int. Cl.: 9

TRADEMARK

PRINCIPAL REGISTER

MGI COMPANIES, INC. (MINNESOTA CORPORATION)
16752 CREEKSIDE LANE
MINNETONKA, MN 55345

FOR: MAGNETS, IN CLASS 9 (U.S. CLS. 21, 23, 26, 36 AND 38).

FIRST USE 10-14-2011; IN COMMERCE 10-14-2011.

THE MARK CONSISTS OF SMILEY FACE WITH GRADUATION CAP HAVING OUTLINES OF GEOGRAPHIC TERRITORIES AND A TASSEL.

SN 85-447,120, FILED 10-13-2011.

THOMAS MANOR, EXAMINING ATTORNEY



David J. Kyffers

Director of the United States Patent and Trademark Office

United States of America

United States Patent and Trademark Office

CAPTAIN'S CONQUEST

Reg. No. 4,177,155

DIAGEO NORTH AMERICA, INC. (CONNECTICUT CORPORATION)
801 MAIN AVENUE
NORWALK, CT 06851

Registered July 17, 2012

Int. Cl.: 9

FOR: DOWNLOADABLE COMPUTER GAME SOFTWARE VIA A GLOBAL COMPUTER NETWORK AND WIRELESS DEVICES, IN CLASS 9 (U.S. CLS. 21, 23, 26, 36 AND 38).

TRADEMARK

FIRST USE 3-22-2012; IN COMMERCE 3-22-2012.

PRINCIPAL REGISTER

THE MARK CONSISTS OF STANDARD CHARACTERS WITHOUT CLAIM TO ANY PARTICULAR FONT, STYLE, SIZE, OR COLOR.

SN 85-451,664, FILED 10-20-2011.

CHERYL CLAYTON, EXAMINING ATTORNEY



David J. Kyffers

Director of the United States Patent and Trademark Office

United States of America

United States Patent and Trademark Office

RESIST

Reg. No. 4,177,156

Registered July 17, 2012

Int. Cl.: 5

TRADEMARK

PRINCIPAL REGISTER

TENKOZ, INC. (GEORGIA CORPORATION)
1725 WINDWARD CONCOURSE, SUITE 410
ALPHARETTA, GA 300051784

FOR: PESTICIDES; HERBICIDES; INSECTICIDES; FUNGICIDES AND MITICIDES FOR
COMMERCIAL, PROFESSIONAL, HORTICULTURAL, DOMESTIC AND AGRICULTURAL
USE, IN CLASS 5 (U.S. CLS. 6, 18, 44, 46, 51 AND 52).

FIRST USE 3-20-2012; IN COMMERCE 3-20-2012.

THE MARK CONSISTS OF STANDARD CHARACTERS WITHOUT CLAIM TO ANY PAR-
TICULAR FONT, STYLE, SIZE, OR COLOR.

SN 85-451,815, FILED 10-20-2011.

NORA BUCHANAN WILL, EXAMINING ATTORNEY



David J. Kyffers

Director of the United States Patent and Trademark Office

United States of America

United States Patent and Trademark Office

BE SMART. TAKE ACTION.
OWN YOUR FUTURE

Reg. No. 4,177,157

OM FINANCIAL LIFE INSURANCE COMPANY (MARYLAND CORPORATION)
1001 FLEET STREET
BALTIMORE, MD 21202

Registered July 17, 2012

Int. Cl.: 36

FOR: INSURANCE SERVICES, NAMELY, UNDERWRITING, ISSUING AND ADMINISTRATION OF LIFE INSURANCE; UNDERWRITING, ISSUANCE AND ADMINISTRATION OF ANNUITIES, IN CLASS 36 (U.S. CLS. 100, 101 AND 102).

SERVICE MARK

FIRST USE 2-10-2012; IN COMMERCE 2-10-2012.

PRINCIPAL REGISTER

THE MARK CONSISTS OF STANDARD CHARACTERS WITHOUT CLAIM TO ANY PARTICULAR FONT, STYLE, SIZE, OR COLOR.

SN 85-456,033, FILED 10-25-2011.

JOHN GARTNER, EXAMINING ATTORNEY



David J. Kybas

Director of the United States Patent and Trademark Office

United States of America

United States Patent and Trademark Office

BEAT IT

Reg. No. 4,177,158

YZY INC (FLORIDA CORPORATION)
6300 NW 72ND AVENUE
MIAMI, FL 33166

Registered July 17, 2012

Int. Cl.: 3

FOR: OILS FOR PERFUMES AND SCENTS; PERFUMES AND TOILET WATERS; PERFUMES, AFTERSHAVES AND COLOGNES; PERFUMES, EAU DE COLOGNES AND AFTERSHAVES, IN CLASS 3 (U.S. CLS. 1, 4, 6, 50, 51 AND 52).

TRADEMARK

FIRST USE 1-22-2012; IN COMMERCE 1-22-2012.

PRINCIPAL REGISTER

THE MARK CONSISTS OF STANDARD CHARACTERS WITHOUT CLAIM TO ANY PARTICULAR FONT, STYLE, SIZE, OR COLOR.

SN 85-461,456, FILED 11-1-2011.

JANET LEE, EXAMINING ATTORNEY



David J. Kyffers

Director of the United States Patent and Trademark Office

United States of America

United States Patent and Trademark Office

Webertise

Reg. No. 4,177,159

Registered July 17, 2012

Int. Cl.: 35

SERVICE MARK

PRINCIPAL REGISTER

ADOPT ANYTHING INC. (NEVADA CORPORATION)
555 PLEASANTVILLE ROAD N106
BRIARCLIFF MANOR, NY 10510

FOR: AD SERVING, NAMELY, PLACING ADVERTISEMENTS ON WEBSITES FOR OTHERS USING SPECIALIZED COMPUTER SOFTWARE; ADVERTISEMENT AND PUBLICITY SERVICES BY TELEVISION, RADIO, MAIL; ADVERTISEMENT FOR OTHERS ON THE INTERNET; ADVERTISEMENT HOARDING RENTAL; ADVERTISEMENT VIA MOBILE PHONE NETWORKS; ADVERTISING AGENCIES; ADVERTISING AGENCIES SPECIALIZING IN ECOMMERCE; ADVERTISING AGENCIES, NAMELY, PROMOTING THE GOODS AND SERVICES OF OTHERS; ADVERTISING AGENCIES, NAMELY, PROMOTING THE SERVICES OF ECOMMERCE THROUGH THE DISTRIBUTION OF PRINTED AND AUDIO PROMOTIONAL MATERIALS AND BY RENDERING SALES PROMOTION ADVICE; ADVERTISING AGENCY SPECIALIZING IN THE DESIGN AND EXECUTION OF WORD OF MOUTH, VIRAL, BUZZ AND EXPERIENTIAL MARKETING PROGRAMS; ADVERTISING AND BUSINESS MANAGEMENT CONSULTANCY; ADVERTISING AND BUSINESS SERVICES, NAMELY, SECURING AIRTIME ON ALL FORMS OF MEDIA COMMUNICATIONS STATIONS, SYSTEMS, NETWORKS, AND SERVICES FOR THE PURPOSE OF PROMOTING THE GOODS AND SERVICES OF OTHERS; ADVERTISING AND COMMERCIAL INFORMATION SERVICES, VIA THE INTERNET; ADVERTISING AND DIRECTORY SERVICES, NAMELY, PROMOTING THE SERVICES OF OTHERS BY PROVIDING A WEB PAGE FEATURING LINKS TO THE WEBSITES OF OTHERS; ADVERTISING AND MARKETING; ADVERTISING AND MARKETING CONSULTANCY; ADVERTISING AND MARKETING SERVICES PROVIDED BY MEANS OF INDIRECT METHODS OF MARKETING COMMUNICATIONS, NAMELY, SOCIAL MEDIA, SEARCH ENGINE MARKETING, INQUIRY MARKETING, INTERNET MARKETING, MOBILE MARKETING, BLOGGING AND OTHER FORMS OF PASSIVE, SHARABLE OR VIRAL COMMUNICATIONS CHANNELS; ADVERTISING AND MARKETING SERVICES, NAMELY, PROMOTING THE GOODS AND SERVICES OF OTHERS; ADVERTISING AND PROMOTING THE GOODS AND SERVICES OF A VISUAL ARTIST; ADVERTISING AND PROMOTION SERVICES AND RELATED CONSULTING; ADVERTISING AND PROMOTIONAL SERVICES; ADVERTISING AND PUBLICITY SERVICES; ADVERTISING AND PUBLICITY SERVICES, NAMELY, PROMOTING THE GOODS, SERVICES, BRAND IDENTITY AND COMMERCIAL INFORMATION AND NEWS OF THIRD PARTIES THROUGH PRINT, AUDIO, VIDEO, DIGITAL AND ON-LINE MEDIUM; ADVERTISING BY TRANSMISSION OF ON-LINE PUBLICITY FOR THIRD PARTIES THROUGH ELECTRONIC COMMUNICATIONS NETWORKS; ADVERTISING CONSULTATION; ADVERTISING COPYWRITING; ADVERTISING FLYER DISTRIBUTION FOR



David J. Kybas

Director of the United States Patent and Trademark Office

Reg. No. 4,177,159 OTHERS; ADVERTISING IN PERIODICALS, BROCHURES AND NEWSPAPERS; ADVERTISING IN THE POPULAR AND PROFESSIONAL PRESS; ADVERTISING OF COMMERCIAL OR RESIDENTIAL REAL ESTATE; ADVERTISING OF THE PUBLISHED TEXTS OF OTHERS; ADVERTISING ON THE INTERNET FOR OTHERS; ADVERTISING RELATING TO PHARMACEUTICAL PRODUCTS AND IN-VIVO IMAGING PRODUCTS; ADVERTISING SERVICES; ADVERTISING SERVICES FOR PROMOTING THE BROKERAGE OF STOCKS AND OTHER SECURITIES; ADVERTISING SERVICES OF A RADIO AND TELEVISION ADVERTISING AGENCY; ADVERTISING SERVICES, NAMELY, COST-PER-ACTION ON-LINE ADVERTISING; ADVERTISING SERVICES, NAMELY, CREATING CORPORATE AND BRAND IDENTITY FOR OTHERS; ADVERTISING SERVICES, NAMELY, CREATING CORPORATE LOGOS FOR OTHERS; ADVERTISING SERVICES, NAMELY, CREATING PROMOTIONAL MURALS ADVERTISING THE GOODS AND SERVICES OF OTHERS; ADVERTISING SERVICES, NAMELY, PRODUCTION OF SPECIAL EFFECTS INCLUDING MODEL-MAKING SERVICES, COMPUTER-GENERATED IMAGERY AND COMPUTER-GENERATED GRAPHICS FOR THE PRODUCTION OF COMMERCIALS; ADVERTISING SERVICES, NAMELY, PROMOTING AND MARKETING THE GOODS AND SERVICES OF OTHERS IN THE FIELD OF ECOMMERCE VIA PRINT AND ELECTRONIC MEDIA; ADVERTISING SERVICES, NAMELY, PROMOTING AND MARKETING THE GOODS AND SERVICES OF OTHERS THROUGH ALL PUBLIC COMMUNICATION MEANS; ADVERTISING SERVICES, NAMELY, PROMOTING CAR DEALERSHIPS OF OTHERS; ADVERTISING SERVICES, NAMELY, PROMOTING PROPERTIES FOR SALE BY OWNER VIA THE INTERNET; ADVERTISING SERVICES, NAMELY, PROMOTING THE BOOKS OF OTHERS IN THE FIELD OF LAW BY MEANS OF NEWS AND REVIEWS REGARDING SAME; ADVERTISING SERVICES, NAMELY, PROMOTING THE BRANDS, GOODS AND SERVICES OF OTHERS; ADVERTISING SERVICES, NAMELY, PROMOTING THE FOOD AND WINE OF OTHERS; ADVERTISING SERVICES, NAMELY, PROMOTING THE GIFT CARDS OF OTHERS; ADVERTISING SERVICES, NAMELY, PROMOTING THE POWER SPORTS DEALERSHIPS OF OTHERS; ADVERTISING SERVICES, NAMELY, PROMOTING THE SANDWICHES OF OTHERS; ADVERTISING SERVICES, NAMELY, PROVIDING ADVERTISING SPACE IN A PERIODICAL; ADVERTISING SERVICES, NAMELY, PROVIDING INFORMATION AS TO THE AVAILABILITY OF ECOMMERCE FOR RENT OR PURCHASE; ADVERTISING TEXT PUBLICATION SERVICES; ADVERTISING THROUGH ALL PUBLIC COMMUNICATION MEANS; ADVERTISING, INCLUDING PROMOTION OF PRODUCTS AND SERVICES OF THIRD PARTIES THROUGH SPONSORING ARRANGEMENTS AND LICENSE AGREEMENTS RELATING TO INTERNATIONAL SPORTS' EVENTS; ADVERTISING, MARKETING AND PROMOTING THE GOODS AND SERVICES OF OTHERS USING KIOSKS; ADVERTISING, MARKETING AND PROMOTION SERVICES; ADVERTISING, MARKETING AND PROMOTION SERVICES IN THE FIELD OF ECOMMERCE; ADVERTISING, MARKETING AND PROMOTION SERVICES, NAMELY, PROMOTING THE GOODS AND SERVICES OF OTHERS BY PROVIDING CUSTOMIZED EXHIBITS; ADVERTISING, MARKETING AND PROMOTIONAL SERVICES FOR THE DONATION OF HUMAN BLOOD THAT EXACTLY MATCHES THE BLOOD TYPE OF INDIVIDUALS NEEDING TRANSFUSIONS; ADVERTISING, MARKETING AND PROMOTIONAL SERVICES RELATED TO ALL INDUSTRIES FOR THE PURPOSE OF FACILITATING NETWORKING AND SOCIALIZING OPPORTUNITIES FOR BUSINESS PURPOSES; ADVERTISING, MARKETING, AND PROMOTING THE GOODS AND SERVICES OF OTHERS VIA ECOMMERCE; ADVERTISING, PROMOTION AND MARKETING SERVICES BASED ON CONSUMER CREDIT REPORTS AND SCORES OF OTHERS; ADVERTISING, PROMOTION AND MARKETING SERVICES IN THE NATURE OF E-MAIL BLAST CAMPAIGNS FOR OTHERS; ADVERTISING, PROMOTION, AND MARKETING SERVICES IN THE NATURE OF ECOMMERCE FOR BUSINESSES; AGENCIES FOR ADVERTISING TIME AND SPACE; ANALYSIS OF ADVERTISING RESPONSE; ARRANGING AND CONDUCTING OF FAIRS AND EXHIBITIONS FOR BUSINESS AND ADVERTISING PURPOSES; ARRANGING AND CONDUCTING SPECIAL EVENTS FOR COMMERCIAL, PROMOTIONAL OR ADVERTISING PURPOSES; BANNER ADVERTISING; BUSINESS MANAGEMENT AND CONSULTING SERVICES FOR THE HEALTH CARE INDUSTRY, NAMELY, CUSTOMER SERVICE, ACCOUNTING SERVICES, AND WEB-BASED ADVERTISING AND MARKETING SERVICES; BUSINESS SERVICES, NAMELY, TRACKING AND MONITORING OF CALLS FOR OTHERS IN RESPONSE TO

Reg. No. 4,177,159 ADVERTISING ADS; CINEMA ADVERTISING; CLASSIFIED ADVERTISING SERVICES; COMPILATION OF ADVERTISEMENTS FOR USE AS WEB PAGES ON THE INTERNET; COMPILATION, PRODUCTION AND DISSEMINATION OF ADVERTISING MATTER; CONDUCTING, ARRANGING AND ORGANIZING TRADE SHOWS AND TRADE FAIRS FOR COMMERCIAL AND ADVERTISING PURPOSES; CONSUMER LOYALTY SERVICES FOR COMMERCIAL, PROMOTIONAL, AND/OR ADVERTISING PURPOSES, NAMELY, ADMINISTRATION OF FREQUENT FLYER PROGRAM THAT ALLOWS MEMBERS TO REDEEM MILES FOR POINTS OR AWARDS OFFERED BY OTHER LOYALTY PROGRAMS; COOPERATIVE ADVERTISING AND MARKETING; COOPERATIVE ADVERTISING AND MARKETING SERVICES BY WAY OF SOLICITATION, CUSTOMER SERVICE AND PROVIDING MARKETING INFORMATION VIA WEB SITES ON A GLOBAL COMPUTER NETWORK; COOPERATIVE ADVERTISING AND MARKETING SERVICES, NAMELY, OFFERING DISCOUNTS TO CLIENTS THROUGH THE JOINT PARTICIPATION OF MEMBER BEAUTY SALONS; CREATING AND UPDATING ADVERTISING MATERIAL; CUSTOMER LOYALTY SERVICES AND CUSTOMER CLUB SERVICES, FOR COMMERCIAL, PROMOTIONAL AND/OR ADVERTISING PURPOSES; DESIGN OF ADVERTISING BROCHURES FOR OTHERS; DESIGN OF ADVERTISING FLYERS FOR OTHERS; DESIGN OF ADVERTISING MATERIALS FOR OTHERS; DESIGN OF INTERNET ADVERTISING; DEVELOPING ADVERTISING CAMPAIGNS FOR OTHERS GEARED TOWARD ENVIRONMENTAL ISSUES; DEVELOPMENT, OPERATION AND ADMINISTRATION OF DIGITAL SIGNAGE SYSTEMS AND DIGITAL ADVERTISING SYSTEMS FOR OTHERS, NAMELY, PROVIDING ADVERTISING SPACE BY ELECTRONIC MEANS AND GLOBAL COMPUTER INFORMATION NETWORKS; DIRECT MAIL ADVERTISING SERVICES; DIRECT MARKETING ADVERTISING FOR OTHERS; DISPLAYING ADVERTISEMENTS FOR OTHERS; DISSEMINATION OF ADVERTISEMENTS; DISSEMINATION OF ADVERTISEMENTS AND OF ADVERTISING MATERIAL; DISSEMINATION OF ADVERTISING FOR OTHERS VIA PUBLIC AND PRIVATE WIRELESS NETWORKS FOR DISPLAY ON MOBILE DEVICES; DISSEMINATION OF ADVERTISING FOR OTHERS VIA THE INTERNET; DISSEMINATION OF ADVERTISING MATERIAL; DISSEMINATION OF ADVERTISING MATTER; DISSEMINATION OF ADVERTISING, SCHEDULING AND MANAGING OF TRAINING COURSES AND PROGRAMS FOR OTHERS VIA A GLOBAL COMPUTER NETWORK; DISTRIBUTION AND DISSEMINATION OF ADVERTISING MATERIALS; DISTRIBUTION OF ADVERTISEMENTS AND COMMERCIAL ANNOUNCEMENTS; DISTRIBUTION OF ADVERTISING MAIL AND OF ADVERTISING SUPPLEMENTS ATTACHED TO REGULAR EDITIONS; DISTRIBUTION OF ADVERTISING MATERIALS; DISTRIBUTION OF PRODUCTS FOR ADVERTISING PURPOSES; ELECTRONIC BILLBOARD ADVERTISING; ELECTRONIC COMMERCE SERVICES, NAMELY, PROVIDING INFORMATION ABOUT PRODUCTS VIA TELECOMMUNICATION NETWORKS FOR ADVERTISING AND SALES PURPOSES; ENTERTAINMENT MARKETING SERVICES, NAMELY, MARKETING, PROMOTION AND ADVERTISING FOR RECORDING AND PERFORMING ARTISTS; EVENT PLANNING AND MANAGEMENT FOR MARKETING, BRANDING, PROMOTING OR ADVERTISING THE GOODS AND SERVICES OF OTHERS; INTERNATIONAL BUSINESS CONSULTING SERVICES RELATING TO ECOMMERCE; INTERNET ADVERTISING SERVICES; ISSUING AND UPDATING OF ADVERTISING TEXTS; LAYOUT SERVICES FOR ADVERTISING PURPOSES; MAGAZINE ADVERTISING; MANAGEMENT OF ADVERTISING THROUGH A COMMAND AND CONTROL CENTER FOR BOTH MOVIE THEATRE ON-SCREEN ADVERTISING AND OVER THE INTERNET; MARKETING AND ADVERTISING SERVICES FOR AUTOMOBILE DEALERSHIPS; MARKETING SERVICES, NAMELY, PROMOTING OR ADVERTISING THE GOODS AND SERVICES OF OTHERS; MARKETING, ADVERTISING, AND PROMOTING THE RETAIL GOODS AND SERVICES OF OTHERS THROUGH WIRELESS ELECTRONIC DEVICES; MARKETING, PROMOTIONAL AND ADVERTISING SERVICES PROVIDED BY MOBILE TELEPHONE CONNECTIONS; MEDIA BUYING ADVICE, NAMELY, ADVISING THE CLIENT HOW MUCH MEDIA TIME, AND AT WHAT TIMES THE CLIENT SHOULD BE PURCHASING ADVERTISING; MEDIA PLANNING, NAMELY, ADVISING THE CLIENT ON THE CORRECT TIMES AND STATIONS TO ADVERTISE BASED ON MEDIA ANALYSIS OF THE MARKET FOR THAT MEDIA; MEDIA PRODUCTION LOCATION SCOUTING SERVICES FOR ADVERTISING PURPOSES; MEDIATION OF ADVERTISING; MODELING FOR ADVERTISING OR SALES PROMOTION; MODELING SERVICES FOR ADVERTISING OR SALES PROMOTION.

Reg. No. 4,177,159 TION; MUSIC SELECTION SERVICES FOR USE IN ADVERTISING; NEWSPAPER ADVERTISING; ON-LINE ADVERTISING AND MARKETING SERVICES; ON-LINE ADVERTISING ON COMPUTER COMMUNICATION NETWORKS; ON-LINE ADVERTISING ON COMPUTER NETWORKS; ON-LINE ADVERTISING SERVICES FOR OTHERS; ONLINE ADVERTISEMENTS; ONLINE ADVERTISING AND PROMOTIONAL SERVICES; ONLINE ADVERTISING VIA A COMPUTER COMMUNICATIONS NETWORK; ORGANIZATION OF EXHIBITIONS AND EVENTS FOR COMMERCIAL OR ADVERTISING PURPOSES; ORGANIZATION OF EVENTS, EXHIBITIONS, FAIRS AND SHOWS FOR COMMERCIAL, PROMOTIONAL AND ADVERTISING PURPOSES; ORGANIZATION OF FAIRS AND EXHIBITIONS FOR COMMERCIAL AND ADVERTISING PURPOSES; ORGANIZATION OF FAIRS FOR COMMERCIAL AND ADVERTISING PURPOSES; ORGANIZING BUSINESS EXPOSITIONS FOR ECOMMERCE; ORGANIZING EXHIBITIONS FOR COMMERCIAL OR ADVERTISING PURPOSES; ORGANIZING EXHIBITIONS FOR ECOMMERCE; OUT-OF-HOME ADVERTISING SERVICES, NAMELY, RENTAL OF ADVERTISING SPACE, AND PREPARING AND PLACING ADVERTISEMENTS FOR OTHERS; OUTDOOR ADVERTISING; PAY PER CLICK (PPC) ADVERTISING MANAGEMENT SERVICES; PLACING ADVERTISEMENTS FOR OTHERS; PLANNING AND CONDUCTING OF TRADE FAIRS, EXHIBITIONS AND PRESENTATIONS FOR ECONOMIC OR ADVERTISING PURPOSES; PREPARATION AND REALIZATION OF MEDIA AND ADVERTISING PLANS AND CONCEPTS; PREPARATION OF CUSTOM ADVERTISEMENTS FOR OTHERS; PREPARATION OF CUSTOM OR NON-CUSTOM ADVERTISING FOR BUSINESSES FOR DISSEMINATION VIA THE WEB, CD OR DVD FOR OPTIONAL UPLOAD OR DOWNLOAD TO A COMPUTER; PREPARING ADVERTISEMENTS FOR OTHERS; PREPARING AND PLACING ADVERTISEMENTS FOR OTHERS; PREPARING AND PLACING OF ADVERTISEMENTS; PREPARING AUDIOVISUAL DISPLAYS IN THE FIELD OF ECOMMERCE; PREPARING AUDIOVISUAL PRESENTATIONS FOR USE IN ADVERTISING; PREPARING SPEECHES AND ORAL PRESENTATIONS FOR OTHERS FOR USE IN ADVERTISING; PROCESSING TELEPHONE INQUIRIES REGARDING ADVERTISED GOODS AND SERVICES; PRODUCTION OF ADVERTISING MATERIALS; PRODUCTION OF ADVERTISING MATTER AND COMMERCIALS; PRODUCTION OF FILM AND TELEVISION ADVERTISING; PROMOTING AND MARKETING THE GOODS AND SERVICES OF OTHERS BY DISTRIBUTING ADVERTISING MATERIAL, COUPONS AND DISCOUNT OFFERS VIA TEXT MESSAGES; PROMOTING AND SHOWCASING THE GOODS OF OTHERS IN THE FIELD OF ECOMMERCE BY MEANS OF AN ON-LINE SHOPPING SITE WITH LINKS TO THE RETAIL ADVERTISEMENTS OF OTHERS; PROMOTING THE GOODS AND SERVICES OF OTHERS BY MEANS OF DISTRIBUTING ADVERTISING ON THE INTERNET; PROMOTING THE GOODS AND SERVICES OF OTHERS BY PREPARING AND PLACING ADVERTISEMENTS IN AN ELECTRONIC MAGAZINE ACCESSED THROUGH A GLOBAL COMPUTER NETWORK; PROMOTING, ADVERTISING AND MARKETING OF THE BRANDS, PRODUCTS, SERVICES AND ONLINE WEBSITES OF INDIVIDUALS, BUSINESSES AND NONPROFIT ORGANIZATIONS; PROMOTING, ADVERTISING AND MARKETING ON-LINE WEB SITES OF OTHERS; PROMOTING, ADVERTISING AND MARKETING THE ON-LINE DATABASES AND ELECTRONIC PUBLICATIONS OF OTHERS; PROMOTING, MARKETING AND ADVERTISING THE BRANDS AND GOODS OF OTHERS RELATED TO ALL INDUSTRIES, THROUGH ALL PUBLIC AND PRIVATE COMMUNICATION MEANS, NAMELY, PROMOTING THE BRANDS AND GOODS OF OTHERS MADE IN THE UNITED STATES; PROMOTIONAL SERVICES, NAMELY, DISTRIBUTION OF ADVERTISING FLYERS, COUPONS, CATALOGS AND PROMOTIONAL ITEMS OF OTHERS; PROVIDING A SEARCHABLE ON-LINE ADVERTISING WEBSITE AND GUIDE FEATURING THE GOODS AND SERVICES OF OTHER VENDORS VIA THE INTERNET; PROVIDING A SEARCHABLE ONLINE ADVERTISING GUIDE FEATURING THE GOODS AND SERVICES OF ONLINE VENDORS; PROVIDING A SEARCHABLE ONLINE ADVERTISING WEBSITE AND INFORMATIONAL GUIDE FEATURING THE GOODS AND SERVICES OF OTHER VENDORS VIA THE INTERNET IN THE FIELD OF ECOMMERCE; PROVIDING A WEB SITE AT WHICH FITNESS PROFESSIONALS AND FACILITIES CAN POST PROMOTIONAL PROFILES AND RESPOND TO ADVERTISEMENTS FOR THEIR SERVICES; PROVIDING A WEB SITE WHERE USERS CAN POST ITEMS FOR SALE THROUGH ON-LINE CLASSIFIED ADVERTISEMENTS; PROVIDING A WEB SITE WHICH FEATURES ADVERTISEMENTS FOR THE GOODS AND SERVICES OF OTHERS ON A GLOBAL COMPUTER

Reg. No. 4,177,159 NETWORK; PROVIDING ADVERTISING SERVICES USING 3D AND ANIMATION DESIGNS; PROVIDING ADVERTISING SPACE IN PERIODICALS, NEWSPAPERS AND MAGAZINES; PROVIDING ADVERTISING SPACE ON BILLBOARDS AND IN KIOSKS; PROVIDING ADVERTISING SPACE ON FREE-STANDING VISUAL ADVERTISING SYSTEMS FEATURING THE GOODS AND SERVICES OF OTHERS; PROVIDING ADVERTISING, MARKETING AND PROMOTIONAL SERVICES FOR THE PHARMACEUTICAL AND MEDICAL INDUSTRY; PROVIDING ADVERTISING, MARKETING AND PROMOTIONAL SERVICES FOR THE PHARMACEUTICAL AND MEDICAL PRODUCTS OF OTHERS; PROVIDING ADVERTISING, MARKETING AND PROMOTIONAL SERVICES, NAMELY, DEVELOPMENT OF ADVERTISING CAMPAIGNS FOR ECOMMERCE; PROVIDING ADVERTISING, MARKETING AND PROMOTIONAL SERVICES, NAMELY, DEVELOPMENT OF ADVERTISING CAMPAIGNS PROVIDED THROUGH CABLE TELEVISION BROADCAST, WEB CASTS, RADIO BROADCASTS, NEWSPAPERS, MAGAZINES, ONLINE BANNERS, OUTDOOR BILLBOARDS, WILD POSTINGS, BUS AND SUBWAY ADS; PROVIDING AN IN-PERSON BUSINESS FORUM IN THE FIELD OF ECOMMERCE; PROVIDING AN INTERNET WEBSITE PORTAL FEATURING PROMOTION AND ADVERTISING FOR HOME SERVICE PROVIDERS AND PRODUCT MANUFACTURERS; PROVIDING AN ONLINE DIRECTORY INFORMATION SERVICE FEATURING INFORMATION REGARDING VEHICLES IN THE NATURE OF CLASSIFIED ADVERTISEMENTS; PROVIDING AND RENTAL OF ADVERTISING SPACE ON THE INTERNET; PROVIDING ON-LINE BUSINESS INFORMATION OF OTHERS, NAMELY, ADVERTISEMENTS OR SOLICITATIONS; PROVIDING SPACE AT A WEB SITE FOR THE ADVERTISEMENT OF THE GOODS AND SERVICES OF OTHERS; PROVIDING TELEVISION ADVERTISING FOR OTHERS; PROVISION OF ADVERTISING SPACE BY ELECTRONIC MEANS AND GLOBAL INFORMATION NETWORKS; PROVISION OF SPACE ON WEBSITES FOR ADVERTISING GOODS AND SERVICES; PUBLIC RELATIONS, ADVERTISING AND MARKETING SERVICES FOR THE TOURISM AND CONVENTION INDUSTRY, NAMELY, ORGANIZING AND HOSTING SITE INSPECTIONS AND FAMILIARIZATION TOURS FOR WHOLESALERS, TOUR OPERATORS, TRAVEL AGENTS, MEETING AND INCENTIVE TRAVEL PLANNERS AND TRAVEL MEDIA; PUBLISHING OF ADVERTISING TEXTS; RADIO ADVERTISING; REAL ESTATE ADVERTISING SERVICES; RECRUITMENT ADVERTISEMENT SERVICES, NAMELY, POSTING OF CLINICAL TRIAL NOTICES FOR THE PURPOSE OF RECRUITING PATIENTS FOR PARTICIPATION IN CLINICAL TRIALS FOR THE TESTING OF DRUGS; RENTAL OF ADVERTISEMENT SPACE AND ADVERTISING MATERIAL; RENTAL OF ADVERTISING SPACE; RENTAL OF ADVERTISING SPACE ON WEB SITES; RENTAL OF SIGNS FOR ADVERTISING PURPOSES; SPECIAL EVENT PLANNING FOR COMMERCIAL, PROMOTIONAL OR ADVERTISING PURPOSES; SPECIALTY MERCHANDISING SERVICES, NAMELY, PROMOTING THE GOODS AND SERVICES OF OTHERS THROUGH THE DISTRIBUTION OF CUSTOMIZED ADVERTISING MATERIALS, NAMELY, PENS; STREET DISSEMINATION OF ADVERTISING MATERIALS; TELEVISION ADVERTISING; TELEVISION ADVERTISING AGENCIES; VENDOR-ON-PREMISE SERVICES, NAMELY, THE ADMINISTRATION OF THE EMPLOYMENT PROCESS ON-SITE, INCLUDING RESUME REVIEW AND CHECKING, EMPLOYMENT APPLICATION ACQUISITION, ADVERTISING FOR RECRUITMENT, CONDUCT OF INTERVIEWS, AND REFERENCE CHECKING, IN CLASS 35 (U.S. CLS. 100, 101 AND 102).

FIRST USE 12-4-2011; IN COMMERCE 4-20-2012.

THE MARK CONSISTS OF STANDARD CHARACTERS WITHOUT CLAIM TO ANY PARTICULAR FONT, STYLE, SIZE, OR COLOR.

SN 85-466,713, FILED 11-8-2011.

REBECCA POVARCHUK, EXAMINING ATTORNEY

United States of America

United States Patent and Trademark Office

INHERITANCE LIFE PLUS

Reg. No. 4,177,160

AMERICAN INTERNATIONAL GROUP, INC. (DELAWARE CORPORATION)
180 MAIDEN LANE
NEW YORK, NY 10038

Registered July 17, 2012

Int. Cl.: 36

FOR: LIFE INSURANCE UNDERWRITING, IN CLASS 36 (U.S. CLS. 100, 101 AND 102).

SERVICE MARK

FIRST USE 1-16-2012; IN COMMERCE 1-16-2012.

PRINCIPAL REGISTER

THE MARK CONSISTS OF STANDARD CHARACTERS WITHOUT CLAIM TO ANY PARTICULAR FONT, STYLE, SIZE, OR COLOR.

OWNER OF U.S. REG. NOS. 3,351,898 AND 3,687,409.

NO CLAIM IS MADE TO THE EXCLUSIVE RIGHT TO USE "LIFE", APART FROM THE MARK AS SHOWN.

SN 85-473,024, FILED 11-15-2011.

ANDREA HACK, EXAMINING ATTORNEY



David J. Kyffers

Director of the United States Patent and Trademark Office

United States of America

United States Patent and Trademark Office

H2FLO

Reg. No. 4,177,161

Registered July 17, 2012

Int. Cl.: 11

TRADEMARK

PRINCIPAL REGISTER

THE TORO COMPANY (DELAWARE CORPORATION)
8111 LYNDALE AVENUE SOUTH
BLOOMINGTON, MN 55420

FOR: IRRIGATION SPRINKLERS, IN CLASS 11 (U.S. CLS. 13, 21, 23, 31 AND 34).

FIRST USE 2-14-2012; IN COMMERCE 2-14-2012.

THE MARK CONSISTS OF STANDARD CHARACTERS WITHOUT CLAIM TO ANY PARTICULAR FONT, STYLE, SIZE, OR COLOR.

SN 85-473,683, FILED 11-16-2011.

AMY C. KEAN, EXAMINING ATTORNEY



David J. Kybas

Director of the United States Patent and Trademark Office

United States of America
United States Patent and Trademark Office

TRI-FLARE

Reg. No. 4,177,162

Registered July 17, 2012

Int. Cl.: 9

TRADEMARK

PRINCIPAL REGISTER

ACCESSORY 3, INC. (WISCONSIN CORPORATION)
1380 BARRINGTON WOODS DRIVE
BROOKFIELD, WI 53045

FOR: LIGHT EMITTING DIODE (LED) DISPLAYS, NAMELY, ROAD FLARES AND LUMINOUS BEACONS FOR SAFETY OR WARNING PURPOSES, IN CLASS 9 (U.S. CLS. 21, 23, 26, 36 AND 38).

FIRST USE 11-0-2011; IN COMMERCE 11-0-2011.

THE MARK CONSISTS OF STANDARD CHARACTERS WITHOUT CLAIM TO ANY PARTICULAR FONT, STYLE, SIZE, OR COLOR.

SN 85-479,748, FILED 11-23-2011.

ELIZABETH KAJUBI, EXAMINING ATTORNEY



David J. Kyffers

Director of the United States Patent and Trademark Office

United States of America

United States Patent and Trademark Office

Move over potato chips,
healthy snacking is here.

Reg. No. 4,177,163

KAIA FOODS, INC (CALIFORNIA CORPORATION)
2921 ADELIN STREET
OAKLAND, CA 94608

Registered July 17, 2012

Int. Cl.: 29

FOR: VEGETABLE-BASED SNACK FOODS, IN CLASS 29 (U.S. CL. 46).

TRADEMARK

FIRST USE 12-2-2011; IN COMMERCE 3-8-2012.

PRINCIPAL REGISTER

THE MARK CONSISTS OF STANDARD CHARACTERS WITHOUT CLAIM TO ANY PARTICULAR FONT, STYLE, SIZE, OR COLOR.

SN 85-486,367, FILED 12-2-2011.

MIDGE BUTLER, EXAMINING ATTORNEY



David J. Kyffers

Director of the United States Patent and Trademark Office

United States of America

United States Patent and Trademark Office

ULTRASOAK

Reg. No. 4,177,164

ALOK INTERNATIONAL INC. (TEXAS CORPORATION)
123 OAK LAWN AVENUE
DALLAS, TX 75207

Registered July 17, 2012

Int. Cl.: 24

FOR: FABRIC FINISH OR SURFACE TREATMENT COMPOSITION SOLD AS A COMPONENT OF FINISHED TREATED OR COATED TEXTILES AND FABRICS TO ENHANCE ABSORBENCY; TOWELS TREATED WITH A FABRIC FINISH OR SURFACE TREATMENT TO ENHANCE ABSORBENCY; TOWELS, IN CLASS 24 (U.S. CLS. 42 AND 50).

TRADEMARK

PRINCIPAL REGISTER

FIRST USE 3-15-2012; IN COMMERCE 3-15-2012.

THE MARK CONSISTS OF STANDARD CHARACTERS WITHOUT CLAIM TO ANY PARTICULAR FONT, STYLE, SIZE, OR COLOR.

SN 85-488,346, FILED 12-6-2011.

NICHOLAS ALTREE, EXAMINING ATTORNEY



David J. Kybas

Director of the United States Patent and Trademark Office

United States of America

United States Patent and Trademark Office

ARGENTA

Reg. No. 4,177,165

MACDERMID ACUMEN, INC. (DELAWARE CORPORATION)
245 FREIGHT STREET
WATERBURY, CT 06702

Registered July 17, 2012

Int. Cl.: 1

FOR: INDUSTRIAL CHEMICALS FOR USE IN PLATING, CLEANING, AND ETCHING METAL AND PLASTIC SURFACES, IN CLASS 1 (U.S. CLS. 1, 5, 6, 10, 26 AND 46).

TRADEMARK

FIRST USE 1-0-2012; IN COMMERCE 1-0-2012.

PRINCIPAL REGISTER

THE MARK CONSISTS OF STANDARD CHARACTERS WITHOUT CLAIM TO ANY PARTICULAR FONT, STYLE, SIZE, OR COLOR.

SN 85-490,496, FILED 12-8-2011.

JACQUELINE A. LAVINE, EXAMINING ATTORNEY



David J. Kyffers

Director of the United States Patent and Trademark Office

United States of America

United States Patent and Trademark Office

Learn, Reach, Engage

Reg. No. 4,177,166

Registered July 17, 2012

Int. Cl.: 35

SERVICE MARK

PRINCIPAL REGISTER

EXPONENTIAL INTERACTIVE, INC. (CALIFORNIA CORPORATION)
2200 POWELL STREET, SUITE 600
EMERYVILLE, CA 94608

FOR: ADVERTISING AND PROMOTIONAL SERVICES FOR THE PURCHASE, SALE, DISSEMINATION, TARGETING AND ANALYSIS OF ADVERTISING, PROVIDED FOR OTHERS VIA ELECTRONIC INFORMATION NETWORKS; LEAD GENERATION, ADVERTISING CREATIVE, WEBSITE IN-TEXT LINKS IN THE NATURE OF PROMOTING THE GOODS AND SERVICES OF OTHERS BY PROVIDING HYPERTEXT LINKS TO THE WEB SITES OF OTHERS, AND VIDEO ADVERTISING SERVICES PROVIDED FOR OTHERS; ONLINE ADVERTISING EXCHANGE SERVICES, IN CLASS 35 (U.S. CLS. 100, 101 AND 102).

FIRST USE 2-16-2012; IN COMMERCE 2-16-2012.

THE MARK CONSISTS OF STANDARD CHARACTERS WITHOUT CLAIM TO ANY PARTICULAR FONT, STYLE, SIZE, OR COLOR.

SN 85-496,106, FILED 12-15-2011.

TASNEEM HUSSAIN, EXAMINING ATTORNEY



David J. Kyros

Director of the United States Patent and Trademark Office

United States of America

United States Patent and Trademark Office

ALOIC

Reg. No. 4,177,167

EPICUREX LLC (FLORIDA LIMITED LIABILITY COMPANY)
2055 NE 151ST STREET
NORTH MIAMI BEACH, FL 33162

Registered July 17, 2012

Int. Cl.: 32

FOR: ALOE JUICE BEVERAGES; ALOE VERA DRINKS; ALOE VERA JUICES, IN CLASS 32 (U.S. CLS. 45, 46 AND 48).

TRADEMARK

FIRST USE 2-14-2012; IN COMMERCE 2-14-2012.

PRINCIPAL REGISTER

THE MARK CONSISTS OF STANDARD CHARACTERS WITHOUT CLAIM TO ANY PARTICULAR FONT, STYLE, SIZE, OR COLOR.

SN 85-498,008, FILED 12-16-2011.

MICHAEL KEATING, EXAMINING ATTORNEY



David J. Kybas

Director of the United States Patent and Trademark Office

United States of America

United States Patent and Trademark Office

REIMBURSE ME

Reg. No. 4,177,168

HEWITT ASSOCIATES LLC (ILLINOIS LIMITED LIABILITY COMPANY)
100 HALF DAY ROAD
LINCOLNSHIRE, IL 60069

Registered July 17, 2012

Int. Cl.: 9

FOR: COMPUTER APPLICATION SOFTWARE FOR MOBILE PHONES AND DEVICES, NAMELY, SOFTWARE FOR ALLOWING USERS TO VIEW BENEFIT ACCOUNT INFORMATION AND TO SUBMIT REQUESTS FOR PAYMENT, IN CLASS 9 (U.S. CLS. 21, 23, 26, 36 AND 38).

TRADEMARK

PRINCIPAL REGISTER

FIRST USE 12-31-2011; IN COMMERCE 12-31-2011.

THE MARK CONSISTS OF STANDARD CHARACTERS WITHOUT CLAIM TO ANY PARTICULAR FONT, STYLE, SIZE, OR COLOR.

SN 85-498,425, FILED 12-19-2011.

NAAKWAMA ANKRAH, EXAMINING ATTORNEY



David J. Kyffers

Director of the United States Patent and Trademark Office

United States of America
United States Patent and Trademark Office



Reg. No. 4,177,169

FRESH EXPRESS INCORPORATED (DELAWARE CORPORATION)
PO BOX 80599
SALINAS, CA 93912

Registered July 17, 2012

Int. Cl.: 29

FOR: PRE-CUT PACKAGED VEGETABLES; PACKAGED GARDEN SALADS, PACKAGED VEGETABLE SALADS AND PACKAGED LETTUCE SALADS, IN CLASS 29 (U.S. CL. 46).

TRADEMARK

FIRST USE 7-29-2011; IN COMMERCE 7-29-2011.

PRINCIPAL REGISTER

NO CLAIM IS MADE TO THE EXCLUSIVE RIGHT TO USE "FRESH", APART FROM THE MARK AS SHOWN.

THE MARK CONSISTS OF THE WORD "FRESH" STACKED ON TOP OF THE WORD "RINSE", WITH TWO STYLIZED LEAVES TO THE RIGHT OF THE WORDS, AND ONE DASH CURVED UPWARD AND ONE DASH CURVED DOWNWARD BELOW THE WORD "RINSE".

SN 85-975,676, FILED 11-3-2010.

JERI J. FICKES, EXAMINING ATTORNEY



David J. Kybas

Director of the United States Patent and Trademark Office

United States of America

United States Patent and Trademark Office

403(B). WHY ME?

Reg. No. 4,177,170

Registered July 17, 2012

Int. Cls.: 9 and 36

TRADEMARK

SERVICE MARK

PRINCIPAL REGISTER

OMNI FINANCIAL GROUP, INC. (NEW YORK CORPORATION), DBA THE OMNI GROUP,
WATERTOWER OFFICE PARK, BUILDING F
1099 JAY STREET
ROCHESTER, NY 146111153

FOR: PRE-RECORDED DVDS FOR EDUCATIONAL PURPOSES IN THE FIELD OF EMPLOYER-SPONSORED RETIREMENT PLANS; AND DOWNLOADABLE WEBINARS FOR EDUCATIONAL PURPOSES IN THE FIELD OF EMPLOYER-SPONSORED RETIREMENT PLANS, IN CLASS 9 (U.S. CLS. 21, 23, 26, 36 AND 38).

FIRST USE 5-27-2011; IN COMMERCE 5-27-2011.

FOR: ADMINISTRATION OF EMPLOYER-SPONSORED RETIREMENT PLANS, IN CLASS 36 (U.S. CLS. 100, 101 AND 102).

FIRST USE 5-27-2011; IN COMMERCE 5-27-2011.

THE MARK CONSISTS OF STANDARD CHARACTERS WITHOUT CLAIM TO ANY PARTICULAR FONT, STYLE, SIZE, OR COLOR.

NO CLAIM IS MADE TO THE EXCLUSIVE RIGHT TO USE "403(B)", APART FROM THE MARK AS SHOWN.

SN 85-975,748, FILED 10-18-2010.

TASNEEM HUSSAIN, EXAMINING ATTORNEY



David J. Kyros

Director of the United States Patent and Trademark Office

United States of America

United States Patent and Trademark Office

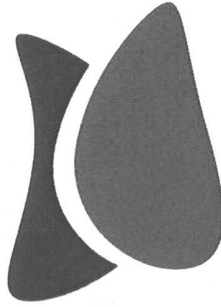

Reg. No. 4,177,171

Registered July 17, 2012

Int. Cl.: 5

TRADEMARK

PRINCIPAL REGISTER

BASF SE (FED REP GERMANY SOCIETAS EUROPÆ (SE))
CARL-BOSCH-STRASSE 38
LUDWIGSHAFEN AM RHEIN, FED REP GERMANY

FOR: FUNGICIDES, PESTICIDES, IN CLASS 5 (U.S. CLS. 6, 18, 44, 46, 51 AND 52).

FIRST USE 10-0-2010; IN COMMERCE 10-0-2010.

THE MARK CONSISTS OF LEAVES THAT LOOK LIKE BUTTERFLY WINGS.

SN 85-976,417, FILED 9-10-2010.

JESSICA FATHY, EXAMINING ATTORNEY



David J. Kybas

Director of the United States Patent and Trademark Office

United States of America

United States Patent and Trademark Office

DAVID MEISTER

Reg. No. 4,177,172

Registered July 17, 2012

Int. Cl.: 18

TRADEMARK

PRINCIPAL REGISTER

DAVID MEISTER INC. (CALIFORNIA CORPORATION)
9132 CORDELL DRIVE
LOS ANGELES, CA 90069

FOR: HANDBAGS, IN CLASS 18 (U.S. CLS. 1, 2, 3, 22 AND 41).

FIRST USE 2-6-2012; IN COMMERCE 2-6-2012.

THE MARK CONSISTS OF STANDARD CHARACTERS WITHOUT CLAIM TO ANY PARTICULAR FONT, STYLE, SIZE, OR COLOR.

OWNER OF U.S. REG. NO. 2,999,891.

THE NAME "DAVID MEISTER" IDENTIFIES A LIVING INDIVIDUAL WHOSE CONSENT IS OF RECORD.

SN 85-976,423, FILED 6-28-2010.

ANDREW LEASER, EXAMINING ATTORNEY



David J. Kyffers

Director of the United States Patent and Trademark Office

United States of America

United States Patent and Trademark Office

CHLOE ROSE

Reg. No. 4,177,173

LESTER'S GIRLS' SHOP, INC. (NEW YORK CORPORATION)
2411 CONEY ISLAND AVENUE
BROOKLYN, NY 11223

Registered July 17, 2012

Int. Cl.: 25

FOR: WOMEN'S AND JUNIOR'S APPAREL, NAMELY, SHIRTS, T-SHIRTS, TOPS, BLOUSES,
AND TANK TOPS, IN CLASS 25 (U.S. CLS. 22 AND 39).

TRADEMARK

FIRST USE 5-0-2011; IN COMMERCE 5-0-2011.

PRINCIPAL REGISTER

THE MARK CONSISTS OF STANDARD CHARACTERS WITHOUT CLAIM TO ANY PARTICULAR FONT, STYLE, SIZE, OR COLOR.

THE NAME(S), PORTRAIT(S), AND/OR SIGNATURE(S) SHOWN IN THE MARK DOES NOT IDENTIFY A PARTICULAR LIVING INDIVIDUAL.

SN 85-976,507, FILED 12-23-2010.

RONALD DELGIZZI, EXAMINING ATTORNEY



David J. Kybas

Director of the United States Patent and Trademark Office

United States of America

United States Patent and Trademark Office

THE TWILIGHT SAGA

Reg. No. 4,177,174

Registered July 17, 2012

Int. Cl.: 9

TRADEMARK

PRINCIPAL REGISTER

SUMMIT ENTERTAINMENT, LLC (DELAWARE LIMITED LIABILITY COMPANY)
1630 STEWART STREET, SUITE 120
SANTA MONICA, CA 90404

FOR: DOWNLOADABLE FILES IN THE FIELD OF ENTERTAINMENT, NAMELY, GRAPHICS, IMAGES, ELECTRONIC GAMES, AND MUSIC, VIA A GLOBAL COMPUTER NETWORK AND WIRELESS DEVICES; DOWNLOADABLE ELECTRONIC PUBLICATIONS IN THE NATURE OF SONG BOOKS, TABLATURE, AND SHEET MUSIC; MAGNETS; MAGNET SHEETS; MAGNETICALLY ENCODED DEBIT CARDS; MOTION PICTURE FILMS IN THE FIELDS OF DRAMA AND ROMANCE; MOUSEPADS; MUSICAL SOUND RECORDINGS; COMPUTER STORAGE DEVICES, NAMELY, BLANK FLASH DRIVES; DIGITAL MEDIA, NAMELY, PRE-RECORDED DVDS, DOWNLOADABLE AUDIO AND VIDEO RECORDINGS, AND CDS FEATURING AND PROMOTING MOTION PICTURES AND DOCUMENTARIES; COVERS FOR MOBILE PHONES; FITTED PLASTIC FILMS KNOWN AS SKINS FOR COVERING AND PROTECTING ELECTRONIC APPARATUS, NAMELY, MOBILE PHONES, PORTABLE MUSIC PLAYERS, COMPUTERS, COMPUTER ACCESSORIES AND PERIPHERALS, PDAS, GAMING DEVICES, CAMERAS, CAMCORDERS, AND E-BOOK READERS; CASES FOR MOBILE PHONES; CASES FOR PDAS; AND COMPUTER GAMES, NAMELY, COMPUTER GAME DISCS, IN CLASS 9 (U.S. CLS. 21, 23, 26, 36 AND 38).

FIRST USE 9-0-2009; IN COMMERCE 9-0-2009.

THE MARK CONSISTS OF STANDARD CHARACTERS WITHOUT CLAIM TO ANY PARTICULAR FONT, STYLE, SIZE, OR COLOR.

OWNER OF U.S. REG. NOS. 3,756,560, 3,884,386, AND OTHERS.

SN 85-976,571, FILED 3-29-2011.

KATHERINE E. HALMEN, EXAMINING ATTORNEY



David J. Kyros

Director of the United States Patent and Trademark Office

United States of America

United States Patent and Trademark Office

THE TWILIGHT SAGA

Reg. No. 4,177,175

Registered July 17, 2012

Int. Cl.: 16

TRADEMARK

PRINCIPAL REGISTER

SUMMIT ENTERTAINMENT, LLC (DELAWARE LIMITED LIABILITY COMPANY)
1630 STEWART STREET, SUITE 120
SANTA MONICA, CA 90404

FOR: ADHESIVE TAPE FOR STATIONERY OR HOUSEHOLD PURPOSES, BOOKMARKS, CALENDARS, DECALS, CARDBOARD DOOR HANGERS, GIFT CARDS, INVITATION CARDS, MOUNTED PHOTOGRAPHS AS LIFE-SIZE CARDBOARD CUTOUTS, GREETING CARDS, PAPER NAPKINS, PENS, PENCILS, PEN AND PENCIL CASES, POSTERS, BOOKS IN THE FIELD OF ENTERTAINMENT, STICKERS, SHEET MUSIC, PRINTED MUSIC BOOKS, TRADING CARDS, GIFT WRAPPING PAPER, LITHOGRAPHS, PAPER BAGS, PAPER PARTY DECORATIONS, PAPER PARTY FAVORS, STATIONERY, TEMPORARY TATTOOS, BINDERS, AND NOTEBOOKS; AND KITS CONTAINING PARTY SUPPLIES, NAMELY, PAPER NAPKINS, PAPER RIBBONS OR STREAMERS, PAPER PLATES, BALLOONS, CANDLES, PLASTIC TABLE COVERS, PLASTIC FORKS, PLASTIC KNIVES, PLASTIC SPOONS, AND CUPS; AND KITS CONTAINING ACTIVITY SUPPLIES, NAMELY, STICKER BOOKS AND WRITING INSTRUMENTS, IN CLASS 16 (U.S. CLS. 2, 5, 22, 23, 29, 37, 38 AND 50).

FIRST USE 10-1-2009; IN COMMERCE 10-1-2009.

THE MARK CONSISTS OF STANDARD CHARACTERS WITHOUT CLAIM TO ANY PARTICULAR FONT, STYLE, SIZE, OR COLOR.

OWNER OF U.S. REG. NOS. 3,756,560, 3,884,386, AND OTHERS.

SN 85-976,572, FILED 3-29-2011.

KATHERINE E. HALMEN, EXAMINING ATTORNEY



David J. Kyjars

Director of the United States Patent and Trademark Office

United States of America

United States Patent and Trademark Office

CELEBRITY SWEAT

Reg. No. 4,177,176

Registered July 17, 2012

Int. Cls.: 25 and 28

TRADEMARK

PRINCIPAL REGISTER

LISA ABBI ENTERPRISES, INC. (ILLINOIS CORPORATION)
9136 DR. KORCZAK TERRACE
SKOKIE, IL 60076

FOR: HEAD SWEATBANDS; HEADBANDS AGAINST SWEATING; SWEAT BANDS; T-SHIRTS, IN CLASS 25 (U.S. CLS. 22 AND 39).

FIRST USE 1-1-2012; IN COMMERCE 1-1-2012.

FOR: BOBBLE HEAD DOLLS; BOBBLEHEAD DOLLS; CHILDREN'S MULTIPLE ACTIVITY TOYS; COLLECTABLE TOY FIGURES; DISC TOSS TOYS; FLYING DISCS; FLYING SAUCERS; PLUSH TOYS; POSITIONABLE TOY FIGURES, IN CLASS 28 (U.S. CLS. 22, 23, 38 AND 50).

FIRST USE 1-1-2012; IN COMMERCE 1-1-2012.

THE MARK CONSISTS OF STANDARD CHARACTERS WITHOUT CLAIM TO ANY PARTICULAR FONT, STYLE, SIZE, OR COLOR.

OWNER OF U.S. REG. NO. 3,926,993.

NO CLAIM IS MADE TO THE EXCLUSIVE RIGHT TO USE "SWEAT" , APART FROM THE MARK AS SHOWN.

SN 85-976,667, FILED 4-4-2011.

DAVID TAYLOR, EXAMINING ATTORNEY



David J. Kypos

Director of the United States Patent and Trademark Office

United States of America

United States Patent and Trademark Office

WITH YOU FROM BIRTH

Reg. No. 4,177,177

LABORATORIOS ANDROMACO S.A. (CHILE SOCIEDAD ANONIMA (SA))
AVENIDA QUILIN 5273, PENALOLEN
SANTIAGO, CHILE

Registered July 17, 2012

Int. Cl.: 5

FOR: MEDICATED OINTMENTS, NAMELY, DIAPER RASH OINTMENTS, IN CLASS 5 (U.S. CLS. 6, 18, 44, 46, 51 AND 52).

TRADEMARK

FIRST USE 5-19-2011; IN COMMERCE 5-19-2011.

PRINCIPAL REGISTER

THE MARK CONSISTS OF STANDARD CHARACTERS WITHOUT CLAIM TO ANY PARTICULAR FONT, STYLE, SIZE, OR COLOR.

SN 85-976,709, FILED 5-4-2011.

PAUL E. FAHRENKOPF, EXAMINING ATTORNEY



David J. Kyffers

Director of the United States Patent and Trademark Office

United States of America

United States Patent and Trademark Office

WELCOME YOUR LITTLE ONE WITH A CUDDLE

Reg. No. 4,177,178

DISNEY ENTERPRISES, INC. (DELAWARE CORPORATION)
500 SOUTH BUENA VISTA STREET
BURBANK, CA 91521

Registered July 17, 2012

Int. Cl.: 25

FOR: CLOTHING, NAMELY, INFANTWEAR; HEADWEAR, IN CLASS 25 (U.S. CLS. 22 AND 39).

TRADEMARK

FIRST USE 6-1-2011; IN COMMERCE 6-1-2011.

PRINCIPAL REGISTER

THE MARK CONSISTS OF STANDARD CHARACTERS WITHOUT CLAIM TO ANY PARTICULAR FONT, STYLE, SIZE, OR COLOR.

SN 85-976,765, FILED 11-11-2010.

WILLIAM P. SHANAHAN, EXAMINING ATTORNEY



David J. Kybas

Director of the United States Patent and Trademark Office

United States of America

United States Patent and Trademark Office



Reg. No. 4,177,179

Registered July 17, 2012

Int. Cl.: 25

TRADEMARK

PRINCIPAL REGISTER

RETAIL ROYALTY COMPANY (NEVADA CORPORATION)
101 CONVENTION CENTER DRIVE
LAS VEGAS, NV 89109

FOR: CLOTHING, NAMELY, TOPS, IN CLASS 25 (U.S. CLS. 22 AND 39).

FIRST USE 7-0-2011; IN COMMERCE 7-0-2011.

OWNER OF U.S. REG. NOS. 2,601,845, 3,908,122, AND OTHERS.

THE MARK CONSISTS OF THE STYLIZED NUMBER "77" WITHIN A PAIR OF LIGHTNING BOLTS.

SN 85-976,767, FILED 3-29-2011.

FONG HSU, EXAMINING ATTORNEY



David J. Kyffers

Director of the United States Patent and Trademark Office

United States of America

United States Patent and Trademark Office



Reg. No. 4,177,180

Registered July 17, 2012

Int. Cls.: 9 and 18

TRADEMARK

PRINCIPAL REGISTER

RAY ENTERPRISES OF CHESAPEAKE WALK, INC. (MARYLAND CORPORATION)
SUITE 440
1819 BAY RIDGE AVENUE
ANNAPOLIS, MD 21403

FOR: EYEWEAR; SUNGLASSES; EYEGLASSES; SUNGLASS CASES; EYEGLASS CASES; SUNGLASS AND EYEGLASS CHAINS; SUNGLASS FRAMES; EYEGLASS FRAMES; EYEWEAR ACCESSORIES, NAMELY, STRAPS, NECK CORDS AND HEAD STRAPS WHICH RESTRAIN EYEWEAR FROM MOVEMENT ON A WEARER, IN CLASS 9 (U.S. CLS. 21, 23, 26, 36 AND 38).

FIRST USE 12-11-2011; IN COMMERCE 12-11-2011.

FOR: ACCESSORIES, NAMELY, PURSES, HANDBAGS; BACKPACKS; BOOK BAGS; TRAVEL BAGS; WALLETS; LEATHER KEY CHAINS; BRIEFCASES; BRIEFCASE TYPE PORTFOLIOS; DOCUMENT CASES; OVERNIGHT CASES; ALL PURPOSE SPORTS BAGS; CREDIT CARD CASES; JEWELRY ROLLS FOR TRAVEL USED TO ORGANIZE AND PROTECT JEWELRY NOT OF PRECIOUS METALS, IN CLASS 18 (U.S. CLS. 1, 2, 3, 22 AND 41).

FIRST USE 12-11-2011; IN COMMERCE 12-11-2011.

OWNER OF U.S. REG. NOS. 3,043,120, 3,210,507, AND OTHERS.

SEC. 2(F) AS TO "HOBO".

THE 2(F) IN PART CLAIM IS RESTRICTED TO CLASS(ES) 018

NO CLAIM IS MADE TO THE EXCLUSIVE RIGHT TO USE "HOBO" AS TO PURSES AND HANDBAGS, AND "THE ORIGINAL", APART FROM THE MARK AS SHOWN.

THE MARK CONSISTS OF THE WORDING "HOBO" AND "THE ORIGINAL" WITH A SILHOUETTE IN PARTIAL PROFILE OF A MAN CARRYING A KNAPSACK ON A STICK OVER HIS SHOULDER.

SN 85-976,772, FILED 9-8-2010.



David J. Kybas

Director of the United States Patent and Trademark Office

Reg. No. 4,177,180 HEATHER BIDDULPH, EXAMINING ATTORNEY

United States of America

United States Patent and Trademark Office

ARM & HAMMER

Reg. No. 4,177,181

CHURCH & DWIGHT CO., INC. (DELAWARE CORPORATION)
469 NORTH HARRISON STREET
PRINCETON, NJ 085435297

Registered July 17, 2012

Int. Cls.: 8, 16, and 21

FOR: HAND OPERATED TOOL FOR PICKING UP, RETRIEVING AND DISCARDING DOG WASTE, IN CLASS 8 (U.S. CLS. 23, 28 AND 44).

TRADEMARK

FIRST USE 4-23-2012; IN COMMERCE 4-23-2012.

PRINCIPAL REGISTER

FOR: PLASTIC DISPOSABLE BAGS FOR DISPOSING OF PET WASTE, IN CLASS 16 (U.S. CLS. 2, 5, 22, 23, 29, 37, 38 AND 50).

FIRST USE 4-23-2012; IN COMMERCE 4-23-2012.

FOR: SCOOPERS, NAMELY, SCOOPS FOR THE DISPOSAL OF PET WASTE; PERSONAL PORTABLE DISPENSERS NOT MADE OF METAL FOR PET WASTE, IN CLASS 21 (U.S. CLS. 2, 13, 23, 29, 30, 33, 40 AND 50).

FIRST USE 4-23-2012; IN COMMERCE 4-23-2012.

THE MARK CONSISTS OF STANDARD CHARACTERS WITHOUT CLAIM TO ANY PARTICULAR FONT, STYLE, SIZE, OR COLOR.

OWNER OF U.S. REG. NOS. 1,461,631, 1,970,953, AND OTHERS.

SN 85-976,778, FILED 5-31-2011.

ANGELA DUONG, EXAMINING ATTORNEY



David J. Kyros

Director of the United States Patent and Trademark Office

United States of America

United States Patent and Trademark Office

Franklin Chef

Reg. No. 4,177,182

Registered July 17, 2012

Int. Cl.: 11

TRADEMARK

PRINCIPAL REGISTER

FRANKLIN CHEF, LLC (FLORIDA CORPORATION)
11231 NW 20TH STREET
UNIT 140-167
MIAMI, FL 33172

FOR: KITCHEN APPLIANCES, NAMELY, ELECTRIC COFFEE MAKERS, MICROWAVE OVENS, ELECTRIC PRESSURE COOKERS, ELECTRIC RICE COOKERS, ELECTRIC FOOD STEAMERS, ELECTRIC TOASTER OVENS, ELECTRIC SLOW COOKERS, COFFEE ROASTING OVENS, COMBINATION MICROWAVE/CONVENTION OVEN, IN CLASS 11 (U.S. CLS. 13, 21, 23, 31 AND 34).

FIRST USE 1-5-2012; IN COMMERCE 1-5-2012.

NO CLAIM IS MADE TO THE EXCLUSIVE RIGHT TO USE "CHEF", APART FROM THE MARK AS SHOWN.

THE MARK CONSISTS OF THE LETTERS "FRANKLIN CHEF" IN STYLIZED FORM.

SN 85-976,814, FILED 1-11-2011.

LEIGH CAROLINE CASE, EXAMINING ATTORNEY



David J. Kyffers

Director of the United States Patent and Trademark Office

United States of America

United States Patent and Trademark Office



Reg. No. 4,177,183

Registered July 17, 2012

Int. Cls.: 21, 25, and 36

CHEGG, INC. (DELAWARE CORPORATION)
SUITE 1400
2350 MISSION COLLEGE BLVD.
SANTA CLARA, CA 95054

FOR: MUGS, IN CLASS 21 (U.S. CLS. 2, 13, 23, 29, 30, 33, 40 AND 50).

TRADEMARK

FIRST USE 10-0-2011; IN COMMERCE 10-0-2011.

SERVICE MARK

FOR: T-SHIRTS, IN CLASS 25 (U.S. CLS. 22 AND 39).

PRINCIPAL REGISTER

FIRST USE 1-0-2012; IN COMMERCE 1-0-2012.

FOR: PHILANTHROPIC SERVICES, NAMELY, FINANCIAL ENDOWMENT OF STUDENT ORGANIZATIONS, NOT-FOR-PROFIT COMMUNITY ORGANIZATIONS, GRASS-ROOTS ORGANIZATIONS, ENVIRONMENTAL AND GREEN INITIATIVES AND ORGANIZATIONS, AND EDUCATIONAL SERVICES INITIATIVES AND ORGANIZATIONS, IN CLASS 36 (U.S. CLS. 100, 101 AND 102).

FIRST USE 11-0-2011; IN COMMERCE 11-0-2011.

OWNER OF U.S. REG. NOS. 3,191,844, 3,974,413, AND OTHERS.

THE COLOR(S) ORANGE AND GREEN IS/ARE CLAIMED AS A FEATURE OF THE MARK.

THE MARK CONSISTS OF THE CAPITALIZED WORD "CHEGG" IN ORANGE LETTERS, OVER THE WORDS "FOR GOOD" IN LOWERCASE GREEN LETTERS, WITH TWO LEAVES SPROUTING FROM THE TOP OF THE LETTER "D" IN "GOOD".

SN 85-976,819, FILED 9-22-2011.

SANJEEV VOHRA, EXAMINING ATTORNEY



David J. Kyros

Director of the United States Patent and Trademark Office

United States of America

United States Patent and Trademark Office

JEWELMINT

Reg. No. 4,177,184

Registered July 17, 2012

Int. Cl.: 35

SERVICE MARK

PRINCIPAL REGISTER

BEACHMINT, INC. (DELAWARE CORPORATION)
101 SOUTH ROSSMORE AVENUE
LOS ANGELES, CA 90004

FOR: MARKETING AND CONSULTING SERVICES IN THE FIELD OF PROMOTING THE GOODS, SERVICES, AND BRANDS OF OTHERS IN THE FIELD OF JEWELRY AND FASHION ACCESSORIES THROUGH ALL PUBLIC COMMUNICATION MEANS, PARTICULARLY SPECIALIZING IN THE USE OF MOBILE, SOCIAL, AND PRINT MEDIA TO DRIVE CONSUMER INTEREST, ENGAGEMENT, AND ACTION, IN CLASS 35 (U.S. CLS. 100, 101 AND 102).

FIRST USE 9-1-2010; IN COMMERCE 9-1-2010.

THE MARK CONSISTS OF STANDARD CHARACTERS WITHOUT CLAIM TO ANY PARTICULAR FONT, STYLE, SIZE, OR COLOR.

SN 85-976,820, FILED 8-27-2010.

JOSETTE BEVERLY, EXAMINING ATTORNEY



David J. Kyffers

Director of the United States Patent and Trademark Office

United States of America

United States Patent and Trademark Office

BEACHMINT

Reg. No. 4,177,185

Registered July 17, 2012

Int. Cl.: 35

SERVICE MARK

PRINCIPAL REGISTER

BEACHMINT, INC. (DELAWARE CORPORATION)
101 SOUTH ROSSMORE AVENUE
LOS ANGELES, CA 90004

FOR: PROVIDING AND OPERATING ONLINE MARKETPLACES FOR SELLERS OF GOODS AND/OR SERVICES; MARKETING AND CONSULTING SERVICES IN THE FIELD OF PROMOTING THE GOODS, SERVICES, AND BRANDS OF OTHERS THROUGH ALL PUBLIC COMMUNICATION MEANS, PARTICULARLY SPECIALIZING IN THE USE OF MOBILE, SOCIAL, AND PRINT MEDIA TO DRIVE CONSUMER INTEREST, ENGAGEMENT, AND ACTION, IN CLASS 35 (U.S. CLS. 100, 101 AND 102).

FIRST USE 9-1-2010; IN COMMERCE 9-1-2010.

THE MARK CONSISTS OF STANDARD CHARACTERS WITHOUT CLAIM TO ANY PARTICULAR FONT, STYLE, SIZE, OR COLOR.

SN 85-976,821, FILED 8-27-2010.

JOSETTE BEVERLY, EXAMINING ATTORNEY



David J. Kyffers

Director of the United States Patent and Trademark Office

United States of America

United States Patent and Trademark Office

SEARCH. BOOK. RELAX.

Reg. No. 4,177,186

Registered July 17, 2012

Int. Cls.: 35 and 43

SERVICE MARK

PRINCIPAL REGISTER

HOTEL JV SERVICES, LLC (DELAWARE LIMITED LIABILITY COMPANY)
3811 TURTLE CREEK BLVD.
STE. 1450
DALLAS, TX 75219

FOR: PROMOTING THE GOODS AND SERVICES OF OTHERS BY PROVIDING HYPERLINKS TO WEBSITES OF TRAVEL SERVICE PROVIDERS, HOTELS AND PROVIDERS OF TEMPORARY ACCOMMODATIONS, IN CLASS 35 (U.S. CLS. 100, 101 AND 102).

FIRST USE 1-11-2012; IN COMMERCE 1-11-2012.

FOR: PROVIDING A WEBSITE FEATURING INFORMATION IN THE FIELD OF HOTELS AND TEMPORARY ACCOMMODATIONS; RESERVATIONS AND BOOKINGS FOR HOTELS AND TEMPORARY ACCOMMODATIONS, IN CLASS 43 (U.S. CLS. 100 AND 101).

FIRST USE 1-11-2012; IN COMMERCE 1-11-2012.

THE MARK CONSISTS OF STANDARD CHARACTERS WITHOUT CLAIM TO ANY PARTICULAR FONT, STYLE, SIZE, OR COLOR.

SN 85-976,831, FILED 10-6-2011.

JAMES GRIFFIN, EXAMINING ATTORNEY



David J. Kybas

Director of the United States Patent and Trademark Office

United States of America

United States Patent and Trademark Office

IMPORTANT MUSICALS

Reg. No. 4,177,187

Registered July 17, 2012

Int. Cl.: 41

SERVICE MARK

PRINCIPAL REGISTER

IMPORTANT MUSICALS, LLC (CALIFORNIA LIMITED LIABILITY COMPANY)
3RD FL. N.
2000 AVENUE OF THE STARS
LOS ANGELES, CA 90067

FOR: ENTERTAINMENT SERVICES, NAMELY, PRODUCTION OF LIVE STAGE MUSICALS AND PLAYS, TELEVISION SHOWS, MOTION PICTURES, TELEVISION SKITS, SHORT FILMS, AND TELEVISION MOVIES, AND THE DISTRIBUTION FOR OTHERS OF TELEVISION SHOWS, MOTION PICTURES, TELEVISION SKITS, SHORT FILMS, AND TELEVISION MOVIES FOR THEATRICAL RELEASE, TELEVISION BROADCAST, MULTI-MEDIA PLATFORMS, CELLULAR PHONES, WIRELESS DEVICES, AND FOR BROADCAST ON THE INTERNET, IN CLASS 41 (U.S. CLS. 100, 101 AND 107).

FIRST USE 12-1-2011; IN COMMERCE 2-1-2012.

THE MARK CONSISTS OF STANDARD CHARACTERS WITHOUT CLAIM TO ANY PARTICULAR FONT, STYLE, SIZE, OR COLOR.

NO CLAIM IS MADE TO THE EXCLUSIVE RIGHT TO USE "MUSICALS", APART FROM THE MARK AS SHOWN.

SN 85-976,833, FILED 2-1-2011.

JOHN DWYER, EXAMINING ATTORNEY



David J. Kybas

Director of the United States Patent and Trademark Office

United States of America

United States Patent and Trademark Office



Reg. No. 4,177,188

Registered July 17, 2012

Int. Cl.: 19

TRADEMARK

PRINCIPAL REGISTER

EASTMAN CHEMICAL COMPANY (DELAWARE CORPORATION)
200 SOUTH WILCOX DRIVE
KINGSPORT, TN 37660

FOR: LUMBER, IN CLASS 19 (U.S. CLS. 1, 12, 33 AND 50).

FIRST USE 2-6-2012; IN COMMERCE 3-15-2012.

NO CLAIM IS MADE TO THE EXCLUSIVE RIGHT TO USE "WOOD" , APART FROM THE MARK AS SHOWN.

THE MARK CONSISTS OF A STYLIZED LETTER "P" AND THE WORDING "PERENNIAL WOOD".

SN 85-976,841, FILED 2-21-2011.

MARGERIE A. TIERNEY, EXAMINING ATTORNEY



David J. Kybas

Director of the United States Patent and Trademark Office

United States of America

United States Patent and Trademark Office

WORK FOR HOPE

Reg. No. 4,177,189

Registered July 17, 2012

Int. Cl.: 25

TRADEMARK

PRINCIPAL REGISTER

WEST CHESTER HOLDINGS, INC. (OHIO CORPORATION)
100 CORRIDOR PARK DRIVE
MONROE, OH 45050

FOR: GLOVES, WRIST BANDS, IN CLASS 25 (U.S. CLS. 22 AND 39).

FIRST USE 6-27-2011; IN COMMERCE 6-27-2011.

THE MARK CONSISTS OF STANDARD CHARACTERS WITHOUT CLAIM TO ANY PARTICULAR FONT, STYLE, SIZE, OR COLOR.

SN 85-976,861, FILED 4-12-2011.

CHRISTINE COOPER, EXAMINING ATTORNEY



David J. Kybas

Director of the United States Patent and Trademark Office

United States of America

United States Patent and Trademark Office



LAKEHOUSE

Reg. No. 4,177,190

Registered July 17, 2012

Int. Cls.: 3 and 4

TRADEMARK

PRINCIPAL REGISTER

LAKE AUSTIN SPA INVESTORS, LTD. (TEXAS LIMITED PARTNERSHIP)
1705 SOUTH QUINLAN ROAD
AUSTIN, TX 78732

FOR: PERSONAL AND BODY CARE PRODUCTS, NAMELY, BODY LOTION, SHOWER GEL, BATH GEL, SKIN CREAM, SHAMPOO, CONDITIONER, LIP BALM, BAR SOAP, BODY POLISH, BODY SCRUB, NON-MEDICATED FOOT CREAM; BATH OILS AND BATH SALTS; BUBBLE BATH; SUNSCREEN LOTION, IN CLASS 3 (U.S. CLS. 1, 4, 6, 50, 51 AND 52).

FIRST USE 1-0-2011; IN COMMERCE 1-0-2011.

FOR: SCENTED CANDLES, IN CLASS 4 (U.S. CLS. 1, 6 AND 15).

FIRST USE 1-0-2011; IN COMMERCE 1-0-2011.

OWNER OF U.S. REG. NO. 2,988,178.

THE MARK CONSISTS OF THE STYLIZED WORDING "LAKEHOUSE" WITH A DESIGN OF A FLOWER AND ITS REFLECTION APPEARING ABOVE THE WORDING.

SN 85-976,923, FILED 4-9-2010.

KATHERINE CONNOLLY, EXAMINING ATTORNEY



David J. Kybas

Director of the United States Patent and Trademark Office

United States of America

United States Patent and Trademark Office

BEATS PRO

Reg. No. 4,177,191

BEATS ELECTRONICS, LLC (DELAWARE LIMITED LIABILITY COMPANY)
1601 CLOVERFIELD BLVD, SUITE 5000N
SANTA MONICA, CA 90404

Registered July 17, 2012

Int. Cl.: 9

FOR: HEADPHONES; PERSONAL HEADPHONES FOR USE WITH SOUND TRANSMITTING SYSTEMS, IN CLASS 9 (U.S. CLS. 21, 23, 26, 36 AND 38).

TRADEMARK

FIRST USE 10-14-2010; IN COMMERCE 10-14-2010.

PRINCIPAL REGISTER

THE MARK CONSISTS OF STANDARD CHARACTERS WITHOUT CLAIM TO ANY PARTICULAR FONT, STYLE, SIZE, OR COLOR.

OWNER OF U.S. REG. NOS. 3,532,627, 3,862,142, AND OTHERS.

SN 85-976,944, FILED 6-8-2010.

LAURIE MAYES, EXAMINING ATTORNEY



David J. Kyffers

Director of the United States Patent and Trademark Office

United States of America

United States Patent and Trademark Office

SERVEWISE

Reg. No. 4,177,192

FOH, INC. (FLORIDA CORPORATION)
9315 PARK DRIVE

Registered July 17, 2012

MIAMI SHORES, FL 33138

Int. Cl.: 21

FOR: DINNERWARE; DISHES, PLATES, PLATES FOR HORS D'OEUVRES, PLATTERS, BOWLS, SERVING DISHES, SERVING BOWLS, SERVING FORKS, SERVING SPOONS, SERVING TONGS, SERVING TRAYS, SERVINGWARE FOR SERVING FOOD, SERVERS BEING DINNERWARE, SERVING PLATTERS, SAMPLERS BEING DINNERWARE; BIODEGRADABLE DINNERWARE; BIODEGRADABLE BUFFETWARE, NAMELY, DISHES, PLATES, PLATES FOR HORS D'OEUVRES, PLATTERS, BOWLS, SERVING DISHES, SERVING BOWLS, SERVING FORKS, SERVING SPOONS, SERVING TONGS, SERVING TRAYS, SERVINGWARE FOR SERVING FOOD, SERVERS BEING DINNERWARE, SERVING PLATTERS, SAMPLERS BEING DINNERWARE; BEVERAGeware; BIODEGRADABLE BEVERAGeware, IN CLASS 21 (U.S. CLS. 2, 13, 23, 29, 30, 33, 40 AND 50).

TRADEMARK

PRINCIPAL REGISTER

FIRST USE 1-0-2012; IN COMMERCE 3-0-2012.

THE MARK CONSISTS OF STANDARD CHARACTERS WITHOUT CLAIM TO ANY PARTICULAR FONT, STYLE, SIZE, OR COLOR.

SN 85-976,948, FILED 11-3-2010.

JACLYN KIDWELL WALKER, EXAMINING ATTORNEY



David J. Kybas

Director of the United States Patent and Trademark Office

United States of America

United States Patent and Trademark Office

REDI-Sensor

Reg. No. 4,177,193

Registered July 17, 2012

Int. Cl.: 9

TRADEMARK

PRINCIPAL REGISTER

CONTINENTAL AUTOMOTIVE GMBH (FED REP GERMANY CORPORATION)
VAHRENWALDER STRABE 9
HANNOVER, FED REP GERMANY 30165

FOR: PRESSURE SENSORS; VEHICLE TIRE PRESSURE SENSORS; TIRE PRESSURE MEASURING, SIGNALING AND CHECKING APPARATUS AND INSTRUMENTS FOR VEHICLES, NAMELY, ELECTRONIC TIRE PRESSURE MONITORS; BAROMETERS; PRESSURE INDICATOR PLUGS FOR VALVES; AUTOMATIC INDICATORS OF LOW PRESSURE IN VEHICLE TIRES; PRESSURE GAUGES; TRANSMITTERS OF ELECTRONIC SIGNALS; TRANSMITTERS OF ELECTRONIC SIGNALS FOR VEHICLE TIRE PRESSURE MEASURING DEVICES, IN CLASS 9 (U.S. CLS. 21, 23, 26, 36 AND 38).

FIRST USE 1-25-2011; IN COMMERCE 1-25-2011.

OWNER OF U.S. REG. NO. 3,963,257.

THE COLOR(S) BLUE, BLACK IS/ARE CLAIMED AS A FEATURE OF THE MARK.

THE MARK CONSISTS OF THE TERM "REDI-SENSOR" IN STYLIZED LETTERS, WITH THE LETTER "E" IN "REDI" IN BLUE, AND THE REMAINING LETTERS IN BLACK.

SN 85-976,981, FILED 4-6-2011.

ANDREW LEASER, EXAMINING ATTORNEY



David J. Kyffers

Director of the United States Patent and Trademark Office

United States of America

United States Patent and Trademark Office

BUCKET DESCALER

Reg. No. 4,177,194

CROSSFORD INTERNATIONAL, LLC (CONNECTICUT LIMITED LIABILITY COMPANY)
420 WEST AVENUE
STAMFORD, CT 06902

Registered July 17, 2012

Int. Cl.: 7

FOR: MACHINE USING CHEMICAL SOLUTION TO REMOVE SCALE FROM HEAT EXCHANGE EQUIPMENT, IN CLASS 7 (U.S. CLS. 13, 19, 21, 23, 31, 34 AND 35).

TRADEMARK

FIRST USE 12-1-2010; IN COMMERCE 12-1-2010.

SUPPLEMENTAL REGISTER

THE MARK CONSISTS OF STANDARD CHARACTERS WITHOUT CLAIM TO ANY PARTICULAR FONT, STYLE, SIZE, OR COLOR.

NO CLAIM IS MADE TO THE EXCLUSIVE RIGHT TO USE "DESCALER", APART FROM THE MARK AS SHOWN.

SER. NO. 76-706,405, FILED P.R. 2-14-2011; AM. S.R. 6-8-2012.

SAMUEL E. SHARPER JR., EXAMINING ATTORNEY



David J. Kyffers

Director of the United States Patent and Trademark Office

United States of America

United States Patent and Trademark Office



Reg. No. 4,177,195

I SUPPORT VETS (TEXAS NON-PROFIT CORPORATION)
1620 E. RIVERSIDE DRIVE, #5079
AUSTIN, TX 78741

Registered July 17, 2012

Int. Cl.: 36

FOR: CHARITABLE FUNDRAISING, NAMELY, RAISING MONEY FOR PROGRAMS THAT PROVIDE DIRECT SUPPORT TO VETERANS AND THEIR FAMILIES, IN CLASS 36 (U.S. CLS. 100, 101 AND 102).

SERVICE MARK

FIRST USE 5-23-2011; IN COMMERCE 5-23-2011.

SUPPLEMENTAL REGISTER

THE MARK CONSISTS OF A DOG TAG WITH A HOLE ON THE LEFT SIDE AND THE WORDS "I SUPPORT VETS" IS WRITTEN IN THE TAG.

SER. NO. 76-707,940, FILED P.R. 6-10-2011; AM. S.R. 3-30-2012.

MAYUR VAGHANI, EXAMINING ATTORNEY



David J. Kyros

Director of the United States Patent and Trademark Office

United States of America

United States Patent and Trademark Office

I SUPPORT VETS

Reg. No. 4,177,196

Registered July 17, 2012

Int. Cl.: 36

SERVICE MARK

SUPPLEMENTAL REGISTER

I SUPPORT VETS (TEXAS NON PROFIT CORPORATION)
1620 E. RIVERSIDE DRIVE, #5079
AUSTIN, TX 78741

FOR: CHARITABLE FUNDRAISING, NAMELY, RAISING MONEY FOR PROGRAMS THAT PROVIDE DIRECT SUPPORT TO VETERANS AND THEIR FAMILIES, IN CLASS 36 (U.S. CLS. 100, 101 AND 102).

FIRST USE 5-23-2011; IN COMMERCE 5-23-2011.

THE MARK CONSISTS OF STANDARD CHARACTERS WITHOUT CLAIM TO ANY PARTICULAR FONT, STYLE, SIZE, OR COLOR.

SER. NO. 76-707,941, FILED P.R. 6-10-2011; AM. S.R. 3-30-2010.

MAYUR VAGHANI, EXAMINING ATTORNEY



David J. Kybas

Director of the United States Patent and Trademark Office

United States of America

United States Patent and Trademark Office

LOGOS DIRECT

Reg. No. 4,177,197

Registered July 17, 2012

Int. Cl.: 35

SERVICE MARK

SUPPLEMENTAL REGISTER

LOGOS DIRECT, LLC (NORTH CAROLINA CORPORATION)
4039 MASONBORO LOOP ROAD, SUITE 1G
WILMINGTON, NC 28409

FOR: ON LINE RETAIL STORE SERVICES FEATURING THE SALE OF VARIOUS PROMOTIONAL ITEMS, NAMELY, CLOTHING, HEADWEAR, WRITING INSTRUMENTS, SPORTS AND OUTDOOR CAMPING EQUIPMENT, BOOK BAGS, NOTEBOOKS, TOOLS, DRINKWARE, NAMELY, TUMBLERS AND DRINKING GLASSES, FIRST AID KITS, LUGGAGE, AND HOUSEWARES, IN CLASS 35 (U.S. CLS. 100, 101 AND 102).

FIRST USE 9-1-2007; IN COMMERCE 9-1-2007.

THE MARK CONSISTS OF STANDARD CHARACTERS WITHOUT CLAIM TO ANY PARTICULAR FONT, STYLE, SIZE, OR COLOR.

NO CLAIM IS MADE TO THE EXCLUSIVE RIGHT TO USE "DIRECT", APART FROM THE MARK AS SHOWN.

SER. NO. 76-708,052, FILED P.R. 6-20-2011; AM. S.R. 6-6-2012.

ANTHONY RINKER, EXAMINING ATTORNEY



David J. Kybas

Director of the United States Patent and Trademark Office

United States of America

United States Patent and Trademark Office

DINNER PARTY DIARY

Reg. No. 4,177,198

Registered July 17, 2012

Int. Cl.: 16

GOOD AND GREEN COLLABORATIVE, LLC (PENNSYLVANIA LIMITED LIABILITY COMPANY)
408 DORNISHWOOD PLACE
ATTN: KEN GREENSPAN
CHALFONT, PA 18914

TRADEMARK

SUPPLEMENTAL REGISTER

FOR: PERSONALIZED WRITING JOURNAL; PRINTED MATERIALS, NAMELY, JOURNALS FEATURING DINING AND ENTERTAINMENT; PRINTED PLANS; STATIONERY-TYPE PORTFOLIOS; AND BOOKS IN THE FIELD OF CULINARY ARTS, DINING, ENTERTAINING, HOSTING AND CUSTOMIZING PARTY PLANNING, HOSTING AND EXECUTION, IN CLASS 16 (U.S. CLS. 2, 5, 22, 23, 29, 37, 38 AND 50).

FIRST USE 11-2-2011; IN COMMERCE 11-2-2011.

THE MARK CONSISTS OF STANDARD CHARACTERS WITHOUT CLAIM TO ANY PARTICULAR FONT, STYLE, SIZE, OR COLOR.

NO CLAIM IS MADE TO THE EXCLUSIVE RIGHT TO USE "DIARY", APART FROM THE MARK AS SHOWN.

SER. NO. 76-710,413, FILED 1-31-2012.

AHSEN KHAN, EXAMINING ATTORNEY



David J. Kyffers

Director of the United States Patent and Trademark Office

United States of America

United States Patent and Trademark Office

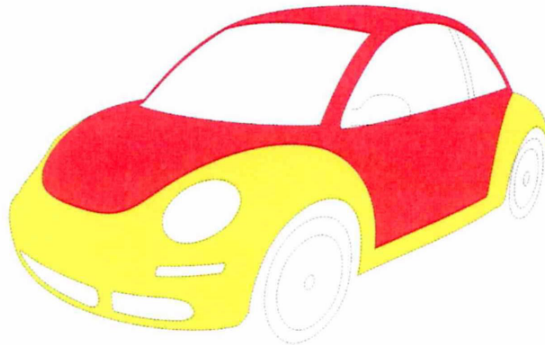

Reg. No. 4,177,199

Registered July 17, 2012

Int. Cl.: 36

SERVICE MARK

SUPPLEMENTAL REGISTER

ARMCO INSURANCE AGENCY, INC. (TEXAS CORPORATION)
3030 N STEMMONS FREEWAY
DALLAS, TX 75247 AND

INSUREMAX INSURANCE AGENCY, INC. (TEXAS CORPORATION)
3030 N STEMMONS FREEWAY
DALLAS, TX 75247 AND

WELSON HOLDINGS, INC. (TEXAS CORPORATION)
DALLAS, TX 75247

FOR: INSURANCE AGENCY SERVICES IN THE FIELD OF COMMERCIAL, HOME AND AUTO INSURANCE, IN CLASS 36 (U.S. CLS. 100, 101 AND 102).

FIRST USE 4-1-2006; IN COMMERCE 4-1-2006.

THE MARK CONSISTS OF THE COLOR COMBINATION OF RED AND YELLOW APPLIED TO THE EXTERIOR SURFACE OF AN AUTOMOBILE WHEREIN HEREIN THE COLOR RED IS APPLIED TO THE CENTER AND TOP OF THE AUTOMOBILE AND THE COLOR YELLOW IS APPLIED TO THE FRONT, BACK AND BOTTOM OF THE AUTOMOBILE. BROKEN-LINE OUTLINING IS USED TO SHOW THE POSITION OR PLACEMENT OF THE MARK ON THE AUTOMOBILE. THE OUTLINING AND SHAPE OF THE AUTOMOBILE ARE NOT CLAIMED AS PART OF THE MARK

THE COLOR(S) RED AND YELLOW IS/ARE CLAIMED AS A FEATURE OF THE MARK.

SER. NO. 76-710,998, FILED P.R. 3-23-2012; AM. S.R. 5-23-2012.

MARK RADEMACHER, EXAMINING ATTORNEY



David J. Kybas

Director of the United States Patent and Trademark Office

United States of America

United States Patent and Trademark Office

Coach Approach for Organizers

Reg. No. 4,177,200

DENSLOW BROWN, LLC (MISSOURI LIMITED LIABILITY COMPANY)
HC 73 BOX 172

Registered July 17, 2012

DRURY, MO 65638

Int. Cl.: 41

FOR: EDUCATIONAL SERVICES, NAMELY, PROVIDING TELECLASSES, TRAINING, AND PRESENTATIONS IN THE FIELDS OF COACHING AND PROFESSIONAL ORGANIZING, AND DISTRIBUTION OF TRAINING MATERIAL IN CONNECTION THEREWITH; EDUCATIONAL SERVICES, NAMELY, MENTORING IN THE FIELD OF COACHING AND PROFESSIONAL ORGANIZING; PROVIDING ON-LINE INFORMATION IN THE FIELD OF COACHING, IN CLASS 41 (U.S. CLS. 100, 101 AND 107).

SERVICE MARK

SUPPLEMENTAL REGISTER

FIRST USE 3-1-2006; IN COMMERCE 5-1-2006.

THE MARK CONSISTS OF STANDARD CHARACTERS WITHOUT CLAIM TO ANY PARTICULAR FONT, STYLE, SIZE, OR COLOR.

SER. NO. 77-520,811, FILED P.R. 7-12-2008; AM. S.R. 11-3-2009.

SARA BENJAMIN, EXAMINING ATTORNEY



David J. Kyffers

Director of the United States Patent and Trademark Office

United States of America

United States Patent and Trademark Office

BEIJING BEEF

Reg. No. 4,177,201

PANDA RESTAURANT GROUP, INC. (CALIFORNIA CORPORATION)
1683 WALNUT GROVE AVENUE
ROSEMEAD, CA 91770

Registered July 17, 2012

Int. Cl.: 29

FOR: PREPARED CHINESE FOOD, NAMELY, ENTREES CONSISTING PRIMARILY OF MEAT AND VEGETABLES, IN CLASS 29 (U.S. CL. 46).

TRADEMARK

FIRST USE 3-20-2008; IN COMMERCE 3-20-2008.

SUPPLEMENTAL REGISTER

THE MARK CONSISTS OF STANDARD CHARACTERS WITHOUT CLAIM TO ANY PARTICULAR FONT, STYLE, SIZE, OR COLOR.

NO CLAIM IS MADE TO THE EXCLUSIVE RIGHT TO USE "BEEF", APART FROM THE MARK AS SHOWN.

SER. NO. 77-757,688, FILED P.R. 6-11-2009; AM. S.R. 5-24-2012.

WILLIAM BRECKENFELD, EXAMINING ATTORNEY



David J. Kyffers

Director of the United States Patent and Trademark Office

United States of America

United States Patent and Trademark Office

TASTELESSTEEZ

Reg. No. 4,177,202

CUTTLEBACK JR., RODNEY (UNITED STATES INDIVIDUAL)
2608 RUSTIC RIDGE LOOP APT 102
LUTZ, FL 33559

Registered July 17, 2012

Int. Cl.: 25

FOR: SHIRTS; T-SHIRTS; TOPS, IN CLASS 25 (U.S. CLS. 22 AND 39).

TRADEMARK

FIRST USE 4-23-2012; IN COMMERCE 4-23-2012.

SUPPLEMENTAL REGISTER

THE MARK CONSISTS OF STANDARD CHARACTERS WITHOUT CLAIM TO ANY PARTICULAR FONT, STYLE, SIZE, OR COLOR.

SER. NO. 77-823,335, FILED P.R. 9-9-2009; AM. S.R. 5-23-2012.

BRIAN CALLAGHAN, EXAMINING ATTORNEY



David J. Kybas

Director of the United States Patent and Trademark Office

United States of America

United States Patent and Trademark Office

LOS ANGELES CAPITAL'S DYNAMIC ALPHA STOCK SELECTION MODEL

Reg. No. 4,177,203

Registered July 17, 2012

Int. Cl.: 36

SERVICE MARK

SUPPLEMENTAL REGISTER

LOS ANGELES CAPITAL MANAGEMENT AND EQUITY RESEARCH, INC. (CALIFORNIA CORPORATION)
11150 SANTA MONICA BLVD., SUITE 200
LOS ANGELES, CA 90025

FOR: FINANCIAL INVESTMENT CONSULTATION ABOUT STOCK SELECTION THAT RANKS STOCKS BY IDENTIFYING AND EVALUATING CONDITIONS IN THE MARKET, SAID SERVICES ARE NOT RELATED TO MUTUAL FUNDS OR MUTUAL FUND SERVICES, IN CLASS 36 (U.S. CLS. 100, 101 AND 102).

FIRST USE 10-26-2010; IN COMMERCE 10-26-2010.

THE MARK CONSISTS OF STANDARD CHARACTERS WITHOUT CLAIM TO ANY PARTICULAR FONT, STYLE, SIZE, OR COLOR.

SER. NO. 77-829,036, FILED P.R. 9-17-2009; AM. S.R. 5-23-2012.

JEAN IM, EXAMINING ATTORNEY



David J. Kyffers

Director of the United States Patent and Trademark Office

United States of America

United States Patent and Trademark Office

GOT SWAG ?

Reg. No. 4,177,204

Registered July 17, 2012

Int. Cl.: 25

TRADEMARK

SUPPLEMENTAL REGISTER

ONE UP ENTERTAINMENT (NEW JERSEY LIMITED LIABILITY COMPANY), AKA ONE UP ENTERTAINMENT,
5 WATERVIEW DR
LAKEWOOD, NJ 08701

FOR: SHIRTS, PANTS, HATS, UNDERWEAR, IN CLASS 25 (U.S. CLS. 22 AND 39).

FIRST USE 4-28-2012; IN COMMERCE 4-28-2012.

THE MARK CONSISTS OF STANDARD CHARACTERS WITHOUT CLAIM TO ANY PARTICULAR FONT, STYLE, SIZE, OR COLOR.

SER. NO. 77-884,144, FILED P.R. 12-2-2009; AM. S.R. 6-4-2012.

SALLY SHIH, EXAMINING ATTORNEY



David J. Kyffers

Director of the United States Patent and Trademark Office

United States of America

United States Patent and Trademark Office

EUPHORADISE

Reg. No. 4,177,205

ASTURI, PAUL D (UNITED STATES INDIVIDUAL)
1900 MARMADUKE ST.
PITTSBURGH, PA 15212

Registered July 17, 2012

Int. Cl.: 25

FOR: ATHLETIC APPAREL, NAMELY, SHIRTS, PANTS, JACKETS, FOOTWEAR, HATS AND CAPS, ATHLETIC UNIFORMS; T-SHIRTS, IN CLASS 25 (U.S. CLS. 22 AND 39).

TRADEMARK

FIRST USE 10-10-1998; IN COMMERCE 2-17-2010.

SUPPLEMENTAL REGISTER

THE MARK CONSISTS OF STANDARD CHARACTERS WITHOUT CLAIM TO ANY PARTICULAR FONT, STYLE, SIZE, OR COLOR.

SER. NO. 77-888,271, FILED P.R. 12-8-2009; AM. S.R. 12-26-2010.

KATHERINE CHANG, EXAMINING ATTORNEY



David J. Kyffers

Director of the United States Patent and Trademark Office

United States of America

United States Patent and Trademark Office

ANTIFOULING

Reg. No. 4,177,206

Registered July 17, 2012

Int. Cl.: 10

TRADEMARK

SUPPLEMENTAL REGISTER

BOSTON SCOTT CORPORATION (MASSACHUSETTS CORPORATION)
1 E. MELVIN STREET
WAKEFIELD, MA 01880

FOR: MEDICAL STENTS, AND CATHETERS COMPOSED OF HYDROGEL; MEDICAL STENTS, AND CATHETERS COMPOSED OF HYDROPHILIC MATERIALS, IN CLASS 10 (U.S. CLS. 26, 39 AND 44).

FIRST USE 5-28-2010; IN COMMERCE 5-28-2010.

THE MARK CONSISTS OF STANDARD CHARACTERS WITHOUT CLAIM TO ANY PARTICULAR FONT, STYLE, SIZE, OR COLOR.

SER. NO. 77-911,282, FILED P.R. 1-13-2010; AM. S.R. 4-26-2011.

DEIRDRE ROBERTSON, EXAMINING ATTORNEY



David J. Kybas

Director of the United States Patent and Trademark Office

United States of America

United States Patent and Trademark Office

WELLNESS WEEK

Reg. No. 4,177,207

SPAFINDER WELLNESS, INC. (MARYLAND CORPORATION)
257 PARK AVENUE SOUTH

Registered July 17, 2012

NEW YORK, NY 10010

Int. Cl.: 35

FOR: PROMOTING THE GOODS AND SERVICES OF HEALTH SPAS, MEDICAL SPAS, DAY SPAS, BEAUTY SALONS, RESORTS, AND HOTELS, NAMELY, ORGANIZING PROMOTIONAL BUSINESS TO BUSINESS AND CONSUMER EVENTS FEATURING DISCOUNTS AND SPECIAL OFFERS; PROMOTING THE GOODS AND SERVICES OF HEALTH SPAS, MEDICAL SPAS, DAY SPAS, BEAUTY SALONS, RESORTS, AND HOTELS, NAMELY, PROVIDING A WEB SITE FEATURING INFORMATION ON DISCOUNTS AND SPECIAL OFFERS; ARRANGING AND CONDUCTING MARKETING PROMOTIONAL EVENTS FOR OTHERS, IN CLASS 35 (U.S. CLS. 100, 101 AND 102).

SERVICE MARK

SUPPLEMENTAL REGISTER

FIRST USE 7-7-2010; IN COMMERCE 7-7-2010.

THE MARK CONSISTS OF STANDARD CHARACTERS WITHOUT CLAIM TO ANY PARTICULAR FONT, STYLE, SIZE, OR COLOR.

SER. NO. 85-020,483, FILED 4-22-2010.

DARRYL SPRUILL, EXAMINING ATTORNEY



David J. Kybas

Director of the United States Patent and Trademark Office

United States of America

United States Patent and Trademark Office

MYAMMEE

Reg. No. 4,177,208

ANGELA "MYAMMEE" PITTS (UNITED STATES INDIVIDUAL)
PO BOX 723006
ATLANTA, GA 31139

Registered July 17, 2012

Int. Cl.: 41

FOR: ENTERTAINMENT, NAMELY, PRODUCTION OF TELEVISION SHOWS AND MOVIES,
IN CLASS 41 (U.S. CLS. 100, 101 AND 107).

SERVICE MARK

FIRST USE 2-1-2009; IN COMMERCE 2-1-2009.

SUPPLEMENTAL REGISTER

THE MARK CONSISTS OF STANDARD CHARACTERS WITHOUT CLAIM TO ANY PARTICULAR FONT, STYLE, SIZE, OR COLOR.

THE NAME(S), PORTRAIT(S), AND/OR SIGNATURE(S) SHOWN IN THE MARK IDENTIFIES ANGELA PITTS, WHOSE CONSENT(S) TO REGISTER IS MADE OF RECORD.

SER. NO. 85-115,783, FILED P.R. 8-25-2010; AM. S.R. 4-30-2012.

GRETCHEN ULRICH, EXAMINING ATTORNEY



David J. Kyros

Director of the United States Patent and Trademark Office

United States of America

United States Patent and Trademark Office

JERSEY SWAGGER

Reg. No. 4,177,209

WALLOVER, JOSEPH (UNITED STATES INDIVIDUAL)
1 HAZELHURST AVE.
EWING, NJ 08638

Registered July 17, 2012

Int. Cl.: 25

FOR: BANDANAS; BASEBALL CAPS; BOXER SHORTS; CAP VISORS; CAPS WITH VISORS; HOODED SWEAT SHIRTS; KNITTED CAPS; LADIES' UNDERWEAR; MEN'S UNDERWEAR; POLO SHIRTS; SHORT-SLEEVED OR LONG-SLEEVED T-SHIRTS; SPORTS PANTS; SWEAT PANTS; SWEATSHIRTS, IN CLASS 25 (U.S. CLS. 22 AND 39).

TRADEMARK

SUPPLEMENTAL REGISTER FIRST USE 11-25-2009; IN COMMERCE 11-25-2009.

THE MARK CONSISTS OF STANDARD CHARACTERS WITHOUT CLAIM TO ANY PARTICULAR FONT, STYLE, SIZE, OR COLOR.

NO CLAIM IS MADE TO THE EXCLUSIVE RIGHT TO USE "JERSEY", APART FROM THE MARK AS SHOWN.

SER. NO. 85-117,192, FILED P.R. 8-27-2010; AM. S.R. 6-4-2012.

CIMMERIAN COLEMAN, EXAMINING ATTORNEY



David J. Kyffers

Director of the United States Patent and Trademark Office

United States of America

United States Patent and Trademark Office

DEFLECTION PAD

Reg. No. 4,177,210

Registered July 17, 2012

Int. Cl.: 7

TRADEMARK

SUPPLEMENTAL REGISTER

WAUKESHA BEARINGS CORPORATION (WISCONSIN CORPORATION)
W231 N2811 ROUNDY CIRCLE
SUITE 200
E. PEWAUKEE, WI 53072

FOR: MACHINE PARTS, NAMELY, FLUID FILM BEARINGS, IN CLASS 7 (U.S. CLS. 13, 19, 21, 23, 31, 34 AND 35).

FIRST USE 3-0-1993; IN COMMERCE 3-0-1993.

THE MARK CONSISTS OF STANDARD CHARACTERS WITHOUT CLAIM TO ANY PARTICULAR FONT, STYLE, SIZE, OR COLOR.

NO CLAIM IS MADE TO THE EXCLUSIVE RIGHT TO USE "PAD", APART FROM THE MARK AS SHOWN.

SER. NO. 85-135,715, FILED P.R. 9-22-2010; AM. S.R. 5-4-2012.

MARILYN IZZI, EXAMINING ATTORNEY



David J. Kyffers

Director of the United States Patent and Trademark Office

United States of America

United States Patent and Trademark Office

THE MASH BILL

Reg. No. 4,177,211

Registered July 17, 2012

Int. Cl.: 16

TRADEMARK

SUPPLEMENTAL REGISTER

KENTUCKY BOURBON DISTILLERS, LTD. (KENTUCKY CORPORATION)
P.O. BOX 785
1869 LORETTO ROAD
BARDSTOWN, KY 40004

FOR: GENERAL FEATURE MAGAZINES, IN CLASS 16 (U.S. CLS. 2, 5, 22, 23, 29, 37, 38 AND 50).

FIRST USE 12-10-2007; IN COMMERCE 12-10-2007.

THE MARK CONSISTS OF STANDARD CHARACTERS WITHOUT CLAIM TO ANY PARTICULAR FONT, STYLE, SIZE, OR COLOR.

SER. NO. 85-148,600, FILED P.R. 10-8-2010; AM. S.R. 4-27-2012.

CHRISTINA SOBRAL, EXAMINING ATTORNEY



David J. Kyffers

Director of the United States Patent and Trademark Office

United States of America

United States Patent and Trademark Office

PUBLIC VENTURE PROXY

Reg. No. 4,177,212

KNIGHTSBRIDGE ADVISERS, LLC (DELAWARE LIMITED LIABILITY COMPANY)
122 SW FRANK PHILLIPS BOULEVARD
BARTLESVILLE, OK 74003

Registered July 17, 2012

Int. Cl.: 36

FOR: FUNDS INVESTMENT, NAMELY, AN INVESTMENT FUND THAT TRACKS INITIALLY VENTURE-BACKED, NOW PUBLIC, COMPANIES FROM INITIAL PUBLIC OFFERINGS TO A SELECTED LATER STAGE USING PROCESS MODEL, IN CLASS 36 (U.S. CLS. 100, 101 AND 102).

SERVICE MARK

SUPPLEMENTAL REGISTER FIRST USE 2-16-2012; IN COMMERCE 2-16-2012.

THE MARK CONSISTS OF STANDARD CHARACTERS WITHOUT CLAIM TO ANY PARTICULAR FONT, STYLE, SIZE, OR COLOR.

NO CLAIM IS MADE TO THE EXCLUSIVE RIGHT TO USE "PUBLIC VENTURE", APART FROM THE MARK AS SHOWN.

SER. NO. 85-161,351, FILED P.R. 10-26-2010; AM. S.R. 12-15-2011.

GIANCARLO CASTRO, EXAMINING ATTORNEY



David J. Kyffers

Director of the United States Patent and Trademark Office

United States of America

United States Patent and Trademark Office

LIBERAL EDUCATION AND EFFECTIVE PRACTICE

Reg. No. 4,177,213

Registered July 17, 2012

Int. Cls.: 41 and 42

SERVICE MARK

SUPPLEMENTAL REGISTER

TRUSTEES OF CLARK UNIVERSITY (MASSACHUSETTS NON-PROFIT CORPORATION)
950 MAIN STREET
WORCESTER, MA 01610

FOR: EDUCATIONAL SERVICES, NAMELY, PROVIDING INSTRUCTION AND TRAINING AT THE SECONDARY, COLLEGE, GRADUATE, POST-GRADUATE AND CONTINUING PROFESSIONAL EDUCATION LEVELS FEATURING EXPERIENTIAL EDUCATIONAL PROJECTS IN THE FIELDS OF BUSINESS MANAGEMENT, THE SCIENCES, SOCIAL SCIENCES, THE ARTS, THE HUMANITIES, GEOGRAPHY, SUSTAINABILITY AND INTERNATIONAL AND COMMUNITY DEVELOPMENT; EDUCATIONAL SERVICES, NAMELY, PROVIDING INTERNSHIPS AND EXCHANGE PROGRAMS FEATURING EXPERIENTIAL EDUCATIONAL PROJECTS IN THE FIELDS OF BUSINESS MANAGEMENT, THE SCIENCES, SOCIAL SCIENCES, THE ARTS, THE HUMANITIES, GEOGRAPHY, SUSTAINABILITY AND INTERNATIONAL AND COMMUNITY DEVELOPMENT; EDUCATIONAL SERVICES, NAMELY, CONDUCTING DISTANCE LEARNING INSTRUCTION AT THE SECONDARY, COLLEGE, GRADUATE, POST-GRADUATE AND CONTINUING PROFESSIONAL EDUCATION LEVELS; PROVIDING A WEBSITE FEATURING DISTANCE LEARNING INSTRUCTION AT THE SECONDARY, COLLEGE, GRADUATE, POST-GRADUATE AND CONTINUING PROFESSIONAL EDUCATION LEVELS; ARRANGING AND CONDUCTING EDUCATIONAL CONFERENCES; ARRANGING AND CONDUCTING EDUCATIONAL SEMINARS FEATURING EXPERIENTIAL EDUCATIONAL PROJECTS IN THE FIELDS OF BUSINESS MANAGEMENT, THE SCIENCES, SOCIAL SCIENCES, THE ARTS, THE HUMANITIES, GEOGRAPHY, SUSTAINABILITY AND INTERNATIONAL AND COMMUNITY DEVELOPMENT; CONDUCTING EDUCATIONAL WORKSHOPS IN THE FIELD OF COMMUNITY SERVICE; PROVIDING A WEB SITE FEATURING INFORMATION AND LINKS TO OTHER WEB SITES REGARDING ACADEMIC ADMISSIONS, ACADEMIC AND RESEARCH PROGRAMS, UNIVERSITY ATHLETIC PROGRAMS AND EVENTS, UNIVERSITY ADMINISTRATIVE SERVICES RELATING TO ADMISSIONS, LIBRARIES AND REGISTRAR SERVICES, UNIVERSITY ALUMNI ACTIVITIES AND ORGANIZATIONS, UNIVERSITY EDUCATIONAL COUNSELING SERVICES, STUDENT ACTIVITIES AND ORGANIZATIONS, AND UNIVERSITY PUBLICATIONS, IN CLASS 41 (U.S. CLS. 100, 101 AND 107).



David J. Kyffers

Director of the United States Patent and Trademark Office

FIRST USE 11-11-2008; IN COMMERCE 11-11-2008.

FOR: RESEARCH FOR EXPERIENTIAL EDUCATIONAL PROJECTS IN THE FIELDS OF BUSINESS MANAGEMENT, THE SCIENCES, THE SOCIAL SCIENCES, THE ARTS, THE

Reg. No. 4,177,213 HUMANITIES, GEOGRAPHY, SUSTAINABILITY, AND INTERNATIONAL AND COMMUNITY DEVELOPMENT, IN CLASS 42 (U.S. CLS. 100 AND 101).

FIRST USE 11-11-2008; IN COMMERCE 11-11-2008.

THE MARK CONSISTS OF STANDARD CHARACTERS WITHOUT CLAIM TO ANY PARTICULAR FONT, STYLE, SIZE, OR COLOR.

NO CLAIM IS MADE TO THE EXCLUSIVE RIGHT TO USE "EDUCATION", APART FROM THE MARK AS SHOWN.

SER. NO. 85-166,945, FILED P.R. 11-2-2010; AM. S.R. 9-6-2011.

WENDY GOODMAN, EXAMINING ATTORNEY

United States of America

United States Patent and Trademark Office

Pentucket Bank

Reg. No. 4,177,214

Registered July 17, 2012

Int. Cl.: 36

SERVICE MARK

SUPPLEMENTAL REGISTER

PENTUCKET BANK (MASSACHUSETTS CORPORATION)
ONE MERRIMACK STREET
HAVERHILL, MA 01830

FOR: BANKING SERVICES, IN CLASS 36 (U.S. CLS. 100, 101 AND 102).

FIRST USE 3-1-1891; IN COMMERCE 3-1-1891.

THE MARK CONSISTS OF STANDARD CHARACTERS WITHOUT CLAIM TO ANY PARTICULAR FONT, STYLE, SIZE, OR COLOR.

OWNER OF U.S. REG. NO. 3,808,427.

NO CLAIM IS MADE TO THE EXCLUSIVE RIGHT TO USE "BANK", APART FROM THE MARK AS SHOWN.

SER. NO. 85-196,621, FILED P.R. 12-13-2010; AM. S.R. 3-29-2011.

CHRISTOPHER BUONGIORNO, EXAMINING ATTORNEY



David J. Kybas

Director of the United States Patent and Trademark Office

United States of America

United States Patent and Trademark Office

GREEN FACTORY SERIES

Reg. No. 4,177,215

Registered July 17, 2012

Int. Cl.: 7

TRADEMARK

SUPPLEMENTAL REGISTER

ENVIRONMENTAL CONTROL SYSTEMS, INC. (RHODE ISLAND CORPORATION), DBA
AQUAS GROUP,
830 WATERMAN AVENUE
EAST PROVIDENCE, RI 02914

FOR: PRESSURE WASHING MACHINES; REVERSE OSMOSIS PUMPS; ELECTRICAL WATER PUMPS FOR INDUSTRIAL USE; ELECTRICAL WATER PUMPS FOR MARINA USE; ELECTRICAL WATER PUMPS FOR VESSEL USE; SUCTION PUMPS; MACHINES FOR CLEANING SURFACES USING HIGH PRESSURE WATER; MACHINES FOR CLEANING MARINAS USING HIGH PRESSURE WATER; BILGE PUMPS FOR INDUSTRIAL AND MUNICIPAL MARINA USE; MACHINES FOR CLEANING VESSELS USING HIGH PRESSURE WATER, IN CLASS 7 (U.S. CLS. 13, 19, 21, 23, 31, 34 AND 35).

FIRST USE 5-13-2010; IN COMMERCE 5-13-2010.

THE MARK CONSISTS OF STANDARD CHARACTERS WITHOUT CLAIM TO ANY PARTICULAR FONT, STYLE, SIZE, OR COLOR.

NO CLAIM IS MADE TO THE EXCLUSIVE RIGHT TO USE "SERIES", APART FROM THE MARK AS SHOWN.

SER. NO. 85-198,016, FILED P.R. 12-15-2010; AM. S.R. 4-23-2012.

ALICE BENMAMAN, EXAMINING ATTORNEY



David J. Kyffers

Director of the United States Patent and Trademark Office

United States of America

United States Patent and Trademark Office

WORK PERSONALITY INDEX

Reg. No. 4,177,216

PSYCHOMETRICS CANADA LTD. (CANADA LIMITED LIABILITY COMPANY)
7125 - 77 AVENUE

Registered July 17, 2012

EDMONTON, ALBERTA, CANADA T6B0B5

Int. Cl.: 16

FOR: PRINTED PAMPHLETS, BOOKLETS, RESOURCE GUIDES AND TESTING MATERIALS, NAMELY, SCORING TEMPLATES, SELF-SCORABLE FORMS, REPORT FORMS AND EXPLANATORY PRINTED MATERIALS PROVIDING DIRECTIONS WITH RESPECT TO USE OF THE TESTING AND SCORABLE MATERIALS IN THE FIELD OF PSYCHOLOGICAL TESTING AND SCORING; PRINTED BOOKLETS AND SCORING ANSWER SHEETS USED IN CONNECTION WITH PRINTED AND ONLINE PSYCHOLOGICAL TESTING, IN CLASS 16 (U.S. CLS. 2, 5, 22, 23, 29, 37, 38 AND 50).

TRADEMARK

SUPPLEMENTAL REGISTER

THE MARK CONSISTS OF STANDARD CHARACTERS WITHOUT CLAIM TO ANY PARTICULAR FONT, STYLE, SIZE, OR COLOR.

PRIORITY CLAIMED UNDER SEC. 44(D) ON CANADA APPLICATION NO. 1503289, FILED 11-10-2010, REG. NO. TMA807632, DATED 9-27-2011, EXPIRES 9-27-2026.

SER. NO. 85-198,570, FILED P.R. 12-15-2010; AM. S.R. 5-29-2012.

JORDAN BAKER, EXAMINING ATTORNEY



David J. Kyffers

Director of the United States Patent and Trademark Office

United States of America

United States Patent and Trademark Office

INTERNATIONAL CLOTHIERS

Reg. No. 4,177,217

INTERNATIONAL CLOTHIERS INC. (CANADA CORPORATION)
111 ORFUS ROAD

Registered July 17, 2012

DOWNSVIEW, ONTARIO, CANADA M6A1M4

Int. Cl.: 35

FOR: RETAIL CLOTHING STORE SERVICES, IN CLASS 35 (U.S. CLS. 100, 101 AND 102).

SERVICE MARK

THE MARK CONSISTS OF STANDARD CHARACTERS WITHOUT CLAIM TO ANY PARTICULAR FONT, STYLE, SIZE, OR COLOR.

SUPPLEMENTAL REGISTER

OWNER OF CANADA REG. NO. TMA643,024, DATED 6-27-2005, EXPIRES 6-27-2020.

NO CLAIM IS MADE TO THE EXCLUSIVE RIGHT TO USE "CLOTHIERS", APART FROM THE MARK AS SHOWN.

SER. NO. 85-206,040, FILED P.R. 12-27-2010; AM. S.R. 4-23-2012.

ANNE FARRELL, EXAMINING ATTORNEY



David J. Kyffers

Director of the United States Patent and Trademark Office

United States of America

United States Patent and Trademark Office

RATIONAL DEISM

Reg. No. 4,177,218

Registered July 17, 2012

Int. Cl.: 9

TRADEMARK

SUPPLEMENTAL REGISTER

ZEGARELLI, GREGG (UNITED STATES INDIVIDUAL)
C/O TEV LAW GROUP
PO BOX 113345
PITTSBURGH, PA 15241

FOR: ELECTRONIC BOOKS AND NEWSLETTERS IN THE FIELD OF FIELD OF WISDOM, PHILOSOPHY RECORDED ON COMPUTER MEDIA AND DOWNLOADABLE FROM THE INTERNET; DOWNLOADABLE BOOKS AND NEWSLETTERS IN THE FIELD OF FIELD OF WISDOM, PHILOSOPHY, EDUCATION AND RELIGION, AND PERSONAL DEVELOPMENT; DOWNLOADABLE ELECTRONIC PUBLICATIONS IN THE NATURE OF NEWSLETTERS, ARTICLES AND ELECTRONIC BOOKS IN THE FIELD OF FIELD OF WISDOM, PHILOSOPHY, EDUCATION AND RELIGION, PERSONAL GROWTH, IN CLASS 9 (U.S. CLS. 21, 23, 26, 36 AND 38).

FIRST USE 4-15-2012; IN COMMERCE 4-15-2012.

THE MARK CONSISTS OF STANDARD CHARACTERS WITHOUT CLAIM TO ANY PARTICULAR FONT, STYLE, SIZE, OR COLOR.

SER. NO. 85-208,888, FILED P.R. 1-2-2011; AM. S.R. 4-15-2012.

MATTHEW EINSTEIN, EXAMINING ATTORNEY



David J. Kyffers

Director of the United States Patent and Trademark Office

United States of America

United States Patent and Trademark Office

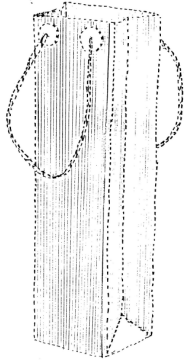

Reg. No. 4,177,219

9025-4798 QUEBEC INC. (CANADA CORPORATION)
5510, RUE MAURICE-CULLEN
LAVAL, CANADA

Registered July 17, 2012

Int. Cl.: 16

FOR: SEMI-RIGID CORRUGATED CARDBOARD BAGS, IN CLASS 16 (U.S. CLS. 2, 5, 22, 23, 29, 37, 38 AND 50).

TRADEMARK

FIRST USE 10-31-1995; IN COMMERCE 8-31-1996.

SUPPLEMENTAL REGISTER

THE MARK CONSISTS OF A CONFIGURATION OF A VERTICAL SEMI-RIGID CORRUGATED CARDBOARD BAG IN WHICH THE BAG INCLUDES FOUR CORRUGATED SIDES. THE OUTLINE OF THE BAG, HANDLE AND GROMMETS SHOWN IN BROKEN LINES ARE FOR POSITION PURPOSE ONLY AND ARE NOT PART OF THE MARK.

SER. NO. 85-212,273, FILED P.R. 1-6-2011; AM. S.R. 10-6-2011.

MARIA-VICTORIA SUAREZ, EXAMINING ATTORNEY



David J. Kybas

Director of the United States Patent and Trademark Office

United States of America

United States Patent and Trademark Office

Cake Saver

Reg. No. 4,177,220

ROCHELLE ZEIGLER (UNITED STATES INDIVIDUAL)
7711 MCDANIELS ROAD, APARTMENT 72A
NORTH FORT MYERS, FL 33917 AND

Registered July 17, 2012

Int. Cl.: 21

KLINE ZEIGLER (UNITED STATES INDIVIDUAL)
7711 MCDANIELS ROAD, APARTMENT 72A
NORTH FORT MYERS, FL 33917

TRADEMARK

FOR: CAKE DOMES , IN CLASS 21 (U.S. CLS. 2, 13, 23, 29, 30, 33, 40 AND 50).

SUPPLEMENTAL REGISTER

FIRST USE 8-1-2011; IN COMMERCE 8-1-2011.

THE MARK CONSISTS OF STANDARD CHARACTERS WITHOUT CLAIM TO ANY PARTICULAR FONT, STYLE, SIZE, OR COLOR.

SER. NO. 85-212,625, FILED P.R. 1-7-2011; AM. S.R. 9-30-2011.

DAVID TAYLOR, EXAMINING ATTORNEY



David J. Kyffers

Director of the United States Patent and Trademark Office

United States of America

United States Patent and Trademark Office

Filigree Cakes

Reg. No. 4,177,221

SUNNY LEE (UNITED STATES INDIVIDUAL)
18 WOODFERN
IRVINE, CA 92614

Registered July 17, 2012

Int. Cl.: 40

FOR: CUSTOM CAKE DECORATING SERVICES, IN CLASS 40 (U.S. CLS. 100, 103 AND 106).

SERVICE MARK

FIRST USE 5-4-2009; IN COMMERCE 5-4-2009.

SUPPLEMENTAL REGISTER

THE MARK CONSISTS OF STANDARD CHARACTERS WITHOUT CLAIM TO ANY PARTICULAR FONT, STYLE, SIZE, OR COLOR.

NO CLAIM IS MADE TO THE EXCLUSIVE RIGHT TO USE "CAKES", APART FROM THE MARK AS SHOWN.

SER. NO. 85-212,835, FILED P.R. 1-7-2011; AM. S.R. 4-20-2012.

KYLE PEETE, EXAMINING ATTORNEY



David J. Kyffers

Director of the United States Patent and Trademark Office

United States of America
United States Patent and Trademark Office

POYNTIR

Reg. No. 4,177,222

PRANALYTICA, INC. (CALIFORNIA CORPORATION)
1101 COLORADO AVENUE
SANTA MONICA, CA 90401

Registered July 17, 2012

Int. Cl.: 9

FOR: ELECTRICAL APPARATUS, NAMELY, HAND-HELD OFFICE LASER POINTERS USED FOR TARGET INFRARED ILLUMINATION AND TARGET DESIGNATION; LASER POINTING DEVICES FOR USE WITH FIREARMS WHICH PROVIDE TARGET INFRARED ILLUMINATION AND TARGET DESIGNATION; TACTICAL LASER SIGHTS FOR USE WITH FIREARMS WHICH PROVIDE TARGET INFRARED ILLUMINATION AND TARGET DESIGNATION, IN CLASS 9 (U.S. CLS. 21, 23, 26, 36 AND 38).

TRADEMARK

SUPPLEMENTAL REGISTER

FIRST USE 5-1-2007; IN COMMERCE 5-1-2007.

THE MARK CONSISTS OF STANDARD CHARACTERS WITHOUT CLAIM TO ANY PARTICULAR FONT, STYLE, SIZE, OR COLOR.

SER. NO. 85-220,289, FILED P.R. 1-18-2011; AM. S.R. 5-3-2012.

JEFFREY LOOK, EXAMINING ATTORNEY



David J. Kypos

Director of the United States Patent and Trademark Office

United States of America

United States Patent and Trademark Office

PANEL ON THE WEB

Reg. No. 4,177,223

PROMISE CONSULTING INC. (NEW YORK CORPORATION)
149 EAST 36TH STREET
NEW YORK, NY 10016

Registered July 17, 2012

Int. Cl.: 35

FOR: BUSINESS MARKETING SERVICES; CONDUCTING ONLINE PUBLIC OPINION
POLLS FOR USE IN BUSINESS MARKETING, IN CLASS 35 (U.S. CLS. 100, 101 AND 102).

SERVICE MARK

FIRST USE 8-0-2000; IN COMMERCE 10-0-2008.

SUPPLEMENTAL REGISTER

THE MARK CONSISTS OF STANDARD CHARACTERS WITHOUT CLAIM TO ANY PAR-
TICULAR FONT, STYLE, SIZE, OR COLOR.

SER. NO. 85-221,934, FILED P.R. 1-20-2011; AM. S.R. 4-30-2012.

EVELYN BRADLEY, EXAMINING ATTORNEY



David J. Kybas

Director of the United States Patent and Trademark Office

United States of America

United States Patent and Trademark Office

Press 2 Smell

Reg. No. 4,177,224

Registered July 17, 2012

Int. Cl.: 16

TRADEMARK

SUPPLEMENTAL REGISTER

MO'S NOSE, LLC (CALIFORNIA LIMITED LIABILITY COMPANY)
617 OCEAN AVENUE, UNIT A
SANTA MONICA, CA 90402

FOR: ALBUMS FOR STICKERS; ANNOUNCEMENT CARDS; BIRTHDAY BOOKS; BLANK JOURNAL BOOKS; BLANK NOTE CARDS; BOOK COVERS; CALENDARS; CHILDREN'S ACTIVITY BOOKS; CHILDREN'S BOOKS; CHILDREN'S INTERACTIVE EDUCATIONAL BOOKS; CHRISTMAS CARDS; COLORING BOOKS; CORRESPONDENCE CARDS; FLASH CARDS; GIFT CARDS; GREETING CARDS; HOLIDAY CARDS; INVITATION CARDS; NOTE BOOKS; NOTE CARDS; OCCASION CARDS; PAPER NAPKINS; PENCIL ORNAMENTS; POST CARDS; POSTERS; SERIES OF FICTION BOOKS; STATIONERY; STICKERS; STORY BOOKS; TABLE CLOTHS OF PAPER; TRADING CARDS, IN CLASS 16 (U.S. CLS. 2, 5, 22, 23, 29, 37, 38 AND 50).

FIRST USE 6-1-2008; IN COMMERCE 6-1-2008.

THE MARK CONSISTS OF STANDARD CHARACTERS WITHOUT CLAIM TO ANY PARTICULAR FONT, STYLE, SIZE, OR COLOR.

SER. NO. 85-223,346, FILED P.R. 1-21-2011; AM. S.R. 5-21-2012.

MATTHEW PAPPAS, EXAMINING ATTORNEY



David J. Kypas

Director of the United States Patent and Trademark Office

United States of America

United States Patent and Trademark Office

RadioMixes

Reg. No. 4,177,225

JAMTRAXX MEDIA INC. (ILLINOIS CORPORATION)
14 REBA COURT

Registered July 17, 2012

MORTON GROVE, IL 60053

Int. Cl.: 41

FOR: RADIO PROGRAMMING; SCHEDULING OF PROGRAMS, NAMELY, PROGRAMMING ON A GLOBAL COMPUTER NETWORK, IN CLASS 41 (U.S. CLS. 100, 101 AND 107).

SERVICE MARK

FIRST USE 4-27-2002; IN COMMERCE 4-27-2002.

SUPPLEMENTAL REGISTER

THE MARK CONSISTS OF STANDARD CHARACTERS WITHOUT CLAIM TO ANY PARTICULAR FONT, STYLE, SIZE, OR COLOR.

SER. NO. 85-223,909, FILED P.R. 1-23-2011; AM. S.R. 5-17-2012.

JIM RINGLE, EXAMINING ATTORNEY



David J. Kyffers

Director of the United States Patent and Trademark Office

United States of America

United States Patent and Trademark Office

GREAT KING ST

Reg. No. 4,177,226

Registered July 17, 2012

Int. Cl.: 33

TRADEMARK

SUPPLEMENTAL REGISTER

COMPASS BOX DELICIOUS WHISKY LTD. (SCOTLAND CORPORATION)
9 POWER ROAD
CHISWICK STUDIOS
LONDON, UNITED KINGDOM W45PY

FOR: ALCOHOLIC BEVERAGES, NAMELY, SCOTCH WHISKY, IN CLASS 33 (U.S. CLS. 47 AND 49).

FIRST USE 9-30-2011; IN COMMERCE 9-30-2011.

THE MARK CONSISTS OF STANDARD CHARACTERS WITHOUT CLAIM TO ANY PARTICULAR FONT, STYLE, SIZE, OR COLOR.

SER. NO. 85-224,304, FILED P.R. 1-24-2011; AM. S.R. 5-22-2012.

EDWARD FENNESSY, EXAMINING ATTORNEY



David J. Kyffers

Director of the United States Patent and Trademark Office

United States of America

United States Patent and Trademark Office

Remember: Knowledge is
Power, Deception is
Temporary!

Reg. No. 4,177,227

TSG THE SIERRA GROUP, INC. (TEXAS CORPORATION)
PO BOX 180791
ARLINGTON, TX 76096

Registered July 17, 2012

Int. Cls.: 16, 21, and 25

FOR: BUMPER STICKERS, IN CLASS 16 (U.S. CLS. 2, 5, 22, 23, 29, 37, 38 AND 50).

FIRST USE 1-19-2011; IN COMMERCE 1-19-2011.

TRADEMARK

FOR: COFFEE MUGS, IN CLASS 21 (U.S. CLS. 2, 13, 23, 29, 30, 33, 40 AND 50).

SUPPLEMENTAL REGISTER

FIRST USE 1-19-2011; IN COMMERCE 1-19-2011.

FOR: T-SHIRTS, IN CLASS 25 (U.S. CLS. 22 AND 39).

FIRST USE 1-19-2011; IN COMMERCE 1-19-2011.

THE MARK CONSISTS OF STANDARD CHARACTERS WITHOUT CLAIM TO ANY PARTICULAR FONT, STYLE, SIZE, OR COLOR.

SER. NO. 85-225,693, FILED P.R. 1-25-2011; AM. S.R. 5-29-2012.

GIANCARLO CASTRO, EXAMINING ATTORNEY



David J. Kybas

Director of the United States Patent and Trademark Office

United States of America

United States Patent and Trademark Office

GREEN GARAGE ASSOCIATES

Reg. No. 4,177,228

Registered July 17, 2012

Int. Cl.: 35

SERVICE MARK

SUPPLEMENTAL REGISTER

GREEN GARAGE ASSOCIATES, LLC (CONNECTICUT LIMITED LIABILITY COMPANY)
750 MAIN STREET
HARTFORD, CT 06103

FOR: BUSINESS CONSULTING AND ADVISORY SERVICES IN THE FIELD OF ENVIRONMENTALLY RESPONSIBLE PARKING FACILITIES AND SERVICES, IN CLASS 35 (U.S. CLS. 100, 101 AND 102).

FIRST USE 9-1-2010; IN COMMERCE 9-1-2010.

THE MARK CONSISTS OF STANDARD CHARACTERS WITHOUT CLAIM TO ANY PARTICULAR FONT, STYLE, SIZE, OR COLOR.

NO CLAIM IS MADE TO THE EXCLUSIVE RIGHT TO USE "ASSOCIATES", APART FROM THE MARK AS SHOWN.

SER. NO. 85-226,709, FILED P.R. 1-26-2011; AM. S.R. 5-16-2012.

MARTHA FROMM, EXAMINING ATTORNEY



David J. Kyffers

Director of the United States Patent and Trademark Office

United States of America

United States Patent and Trademark Office

MUSIC & ENTERTAINMENT SUPERSTORE

Reg. No. 4,177,229

Registered July 17, 2012

Int. Cl.: 35

SERVICE MARK

SUPPLEMENTAL REGISTER

GFM LICENSING GROUP LLC (CONNECTICUT LIMITED LIABILITY COMPANY)
90 KNOTHE ROAD
WESTBROOK, CT 06498

FOR: ON-LINE RETAIL STORE SERVICES AND MAIL ORDER CATALOG SERVICES FEATURING MEN'S, WOMEN'S AND CHILDREN'S APPAREL, POSTERS, STUFFED ANIMALS, BACKPACKS, DOLLS, JEWELRY, WATCHES, GLASSES, SUNGLASSES, SHOES, T-SHIRTS, CANDLES, LAMPS, STROBE LIGHTS, FLUORESCENT LIGHTS, TAPESTRIES, BLANKETS, INCENSE BURNERS, CLOCKS, FIGURINES, INCENSE AND OILS, DECALS, AND SMOKING ACCESSORIES, IN CLASS 35 (U.S. CLS. 100, 101 AND 102).

FIRST USE 1-1-1998; IN COMMERCE 1-1-1998.

THE MARK CONSISTS OF STANDARD CHARACTERS WITHOUT CLAIM TO ANY PARTICULAR FONT, STYLE, SIZE, OR COLOR.

OWNER OF U.S. REG. NO. 2,553,358.

NO CLAIM IS MADE TO THE EXCLUSIVE RIGHT TO USE "SUPERSTORE", APART FROM THE MARK AS SHOWN.

SER. NO. 85-229,808, FILED P.R. 1-31-2011; AM. S.R. 5-8-2012.

BENJAMIN OKEKE, EXAMINING ATTORNEY



David J. Kyffers

Director of the United States Patent and Trademark Office

United States of America

United States Patent and Trademark Office

Dermatology Center of Excellence

Reg. No. 4,177,230

GRAU, RENEE H. (UNITED STATES INDIVIDUAL)
2504 STRATTON DRIVE
EDMOND, OK 73013

Registered July 17, 2012

Int. Cl.: 44

FOR: HEALTHCARE SERVICES IN THE FIELD OF DERMATOLOGY, IN CLASS 44 (U.S. CLS. 100 AND 101).

SERVICE MARK

FIRST USE 12-1-2010; IN COMMERCE 4-17-2012.

SUPPLEMENTAL REGISTER

THE MARK CONSISTS OF STANDARD CHARACTERS WITHOUT CLAIM TO ANY PARTICULAR FONT, STYLE, SIZE, OR COLOR.

NO CLAIM IS MADE TO THE EXCLUSIVE RIGHT TO USE "DERMATOLOGY CENTER", APART FROM THE MARK AS SHOWN.

SER. NO. 85-230,457, FILED P.R. 1-31-2011; AM. S.R. 5-9-2012.

TASNEEM HUSSAIN, EXAMINING ATTORNEY



David J. Kyjars

Director of the United States Patent and Trademark Office

United States of America

United States Patent and Trademark Office

ROOM PLANNER

Reg. No. 4,177,231

CHIEF ARCHITECT, INC. (IDAHO CORPORATION)
6500 N. MINERAL DR., #105
COEUR D' ALENE, ID 83815

Registered July 17, 2012

Int. Cl.: 9

FOR: COMPUTER SOFTWARE, NAMELY, SOFTWARE FOR THE PLACEMENT AND MANIPULATION OF ARCHITECTURAL AND ENGINEERING STRUCTURAL ELEMENTS RELATIVE TO ONE ANOTHER AND TO OTHER STRUCTURES, IN CLASS 9 (U.S. CLS. 21, 23, 26, 36 AND 38).

TRADEMARK

SUPPLEMENTAL REGISTER FIRST USE 5-21-2012; IN COMMERCE 5-21-2012.

THE MARK CONSISTS OF STANDARD CHARACTERS WITHOUT CLAIM TO ANY PARTICULAR FONT, STYLE, SIZE, OR COLOR.

SER. NO. 85-233,825, FILED P.R. 2-3-2011; AM. S.R. 5-24-2012.

JIM RINGLE, EXAMINING ATTORNEY



David J. Kyffers

Director of the United States Patent and Trademark Office

United States of America

United States Patent and Trademark Office

TROOPS TO ENERGY JOBS

Reg. No. 4,177,232

Registered July 17, 2012

Int. Cls.: 35 and 41

SERVICE MARK

SUPPLEMENTAL REGISTER

EDISON ELECTRIC INSTITUTE (VIRGINIA NON-PROFIT CORPORATION)
701 PENNSYLVANIA AVENUE, N.W.
WASHINGTON, DC 200042696

FOR: PROVIDING EMPLOYMENT INFORMATION; PROVIDING EMPLOYMENT COUNSELING INFORMATION ON HOW TO SUCCESSFULLY TRANSITION JOBS; TESTING AND EVALUATION TO DETERMINE EMPLOYMENT SKILLS; EMPLOYMENT PLACEMENT SERVICES; CAREER COUNSELING; CONDUCTING PRE-EMPLOYMENT TESTING FOR DETERMINING EMPLOYMENT SKILLS AND INTERESTS; PROVIDING A WEBSITE FEATURING EMPLOYMENT AND CAREERS INFORMATION IN THE ENERGY, ELECTRICITY AND UTILITY INDUSTRIES; BUSINESS SERVICES, NAMELY, EMPLOYABILITY SKILLS ASSESSMENTS TO DETERMINE JOB COMPETENCY IN THE ENERGY, ELECTRICITY AND UTILITY INDUSTRIES, IN CLASS 35 (U.S. CLS. 100, 101 AND 102).

FIRST USE 3-14-2011; IN COMMERCE 7-11-2011.

FOR: EDUCATIONAL SERVICES, NAMELY, DEVELOPING CURRICULUM FOR OTHERS IN THE ENERGY, ELECTRICITY AND UTILITY INDUSTRIES; EDUCATIONAL ASSESSMENTS RELATED TO THE ENERGY, ELECTRICITY AND UTILITY INDUSTRIES; CONDUCTING EDUCATIONAL TESTING; DEVELOPING TRAINING SYSTEMS, CAREER COACHING AND LEARNING METHODOLOGIES FOR OTHERS; PROVIDING EDUCATIONAL MENTORING SERVICES AND PROGRAMS FOR OTHERS IN THE ENERGY, ELECTRICITY AND UTILITY INDUSTRIES; EDUCATIONAL COUNSELING SERVICES, NAMELY, DEVELOPING EDUCATION AND TRAINING PLANS AND PROGRAMS DESIGNED TO PREPARE THE STUDENT FOR TARGETED JOBS, IN CLASS 41 (U.S. CLS. 100, 101 AND 107).

FIRST USE 3-14-2011; IN COMMERCE 7-11-2011.

THE MARK CONSISTS OF STANDARD CHARACTERS WITHOUT CLAIM TO ANY PARTICULAR FONT, STYLE, SIZE, OR COLOR.

SER. NO. 85-238,578, FILED P.R. 2-10-2011; AM. S.R. 5-21-2012.

KAREN SEVERSON, EXAMINING ATTORNEY



David J. Kyffers

Director of the United States Patent and Trademark Office

United States of America

United States Patent and Trademark Office

SOFT TREAD

Reg. No. 4,177,233

BALEGA INTERNATIONAL LLC (NORTH CAROLINA LIMITED LIABILITY COMPANY)
406 20TH STREET SE
HICKORY, NC 28602

Registered July 17, 2012

Int. Cl.: 25

FOR: SOCKS, NAMELY, RUNNING SOCKS FOR MEN, WOMEN AND CHILDREN, IN CLASS 25 (U.S. CLS. 22 AND 39).

TRADEMARK

FIRST USE 8-1-2011; IN COMMERCE 8-1-2011.

SUPPLEMENTAL REGISTER

THE MARK CONSISTS OF STANDARD CHARACTERS WITHOUT CLAIM TO ANY PARTICULAR FONT, STYLE, SIZE, OR COLOR.

SER. NO. 85-245,865, FILED P.R. 2-18-2011; AM. S.R. 11-22-2011.

MARK T. MULLEN, EXAMINING ATTORNEY



David J. Kyfos

Director of the United States Patent and Trademark Office

United States of America

United States Patent and Trademark Office

Susquehanna Brewing Co.

Reg. No. 4,177,234

SUSQUEHANNA BREWING CO., LLC (PENNSYLVANIA LIMITED LIABILITY COMPANY)
635 S. MAIN STREET
PITTSTON, PA 18640

Registered July 17, 2012

Int. Cl.: 32

FOR: BEER, IN CLASS 32 (U.S. CLS. 45, 46 AND 48).

FIRST USE 5-1-2012; IN COMMERCE 5-1-2012.

TRADEMARK

THE MARK CONSISTS OF STANDARD CHARACTERS WITHOUT CLAIM TO ANY PARTICULAR FONT, STYLE, SIZE, OR COLOR.

SUPPLEMENTAL REGISTER

NO CLAIM IS MADE TO THE EXCLUSIVE RIGHT TO USE "BREWING CO.", APART FROM THE MARK AS SHOWN.

SER. NO. 85-250,373, FILED P.R. 2-24-2011; AM. S.R. 5-1-2012.

TASNEEM HUSSAIN, EXAMINING ATTORNEY



David J. Kyffers

Director of the United States Patent and Trademark Office

United States of America

United States Patent and Trademark Office

SBX IP

Reg. No. 4,177,235

Registered July 17, 2012

Int. Cl.: 9

TRADEMARK

SUPPLEMENTAL REGISTER

VERTICAL COMMUNICATIONS, INC. (DELAWARE CORPORATION)
ONE MEMORIAL DRIVE
CAMBRIDGE, MA 02142

FOR: TELEPHONY SYSTEM COMPRISING DIGITAL TELEPHONES, CELLULAR TELEPHONES, KEY SYSTEM UNIT, A VOICEMAIL CARD AND VOLP CARD, AND INCORPORATING VOICE OVER IP (VOIP) AND SUPPORTING TRADITIONAL ENDPOINTS, IP ENDPOINTS AND SIP TRUNKING, IN CLASS 9 (U.S. CLS. 21, 23, 26, 36 AND 38).

FIRST USE 10-22-2007, THE MARK WAS FIRST USED ANYWHERE IN A DIFFERENT FORM OTHER THAN THAT SOUGHT TO BE REGISTERED AT LEAST AS EARLY AS 10/22/2007; IN COMMERCE 10-22-2007, THE MARK WAS FIRST USED IN COMMERCE IN A DIFFERENT FORM OTHER THAN THAT SOUGHT TO BE REGISTERED AT LEAST AS EARLY AS 10/22/2007.

THE MARK CONSISTS OF STANDARD CHARACTERS WITHOUT CLAIM TO ANY PARTICULAR FONT, STYLE, SIZE, OR COLOR.

OWNER OF U.S. REG. NO. 3,530,498.

NO CLAIM IS MADE TO THE EXCLUSIVE RIGHT TO USE "IP", APART FROM THE MARK AS SHOWN.

SER. NO. 85-262,193, FILED P.R. 3-9-2011; AM. S.R. 6-5-2012.

SAIMA MAKHDOOM, EXAMINING ATTORNEY



David J. Kyjars

Director of the United States Patent and Trademark Office

United States of America

United States Patent and Trademark Office

EXPERTLY CRAFTED.
INDIVIDUALLY INSCRIBED. THE
WORLD'S MOST CAREFULLY
SELECTED DIAMONDS.

Reg. No. 4,177,236

DE BEERS CENTENARY AG (SWITZERLAND AKTIENGESELLSCHAFT)
ALPENSTRASSE 5

Registered July 17, 2012

6000 LUZERN 6, SWITZERLAND

Int. Cls.: 14 and 35

FOR: JEWELLERY AND IMITATION JEWELLERY FEATURING DIAMONDS; PRECIOUS AND SEMI-PRECIOUS STONES, NAMELY, DIAMONDS; HOROLOGICAL AND CHRONOMETRIC INSTRUMENTS FEATURING DIAMONDS, IN CLASS 14 (U.S. CLS. 2, 27, 28 AND 50).

TRADEMARK

SERVICE MARK

FIRST USE 12-31-2011; IN COMMERCE 12-31-2011.

SUPPLEMENTAL REGISTER

FOR: RETAIL AND WHOLESALE STORE SERVICES, ADVERTISING AND MARKETING SERVICES, ALL IN THE FIELD OF JEWELLERY AND IMITATION JEWELLERY FEATURING DIAMONDS, PRECIOUS AND SEMI-PRECIOUS STONES, NAMELY, DIAMONDS, HOROLOGICAL AND CHRONOMETRIC INSTRUMENTS FEATURING DIAMONDS, IN CLASS 35 (U.S. CLS. 100, 101 AND 102).

FIRST USE 12-31-2011; IN COMMERCE 12-31-2011.

THE MARK CONSISTS OF STANDARD CHARACTERS WITHOUT CLAIM TO ANY PARTICULAR FONT, STYLE, SIZE, OR COLOR.

NO CLAIM IS MADE TO THE EXCLUSIVE RIGHT TO USE "DIAMONDS", APART FROM THE MARK AS SHOWN.

SER. NO. 85-269,464, FILED P.R. 3-17-2011; AM. S.R. 4-6-2012.

ALLISON HOLTZ, EXAMINING ATTORNEY



David J. Kybas

Director of the United States Patent and Trademark Office

United States of America

United States Patent and Trademark Office

THE WORLD'S MOST CAREFULLY SELECTED DIAMONDS.

Reg. No. 4,177,237

DE BEERS CENTENARY AG (SWITZERLAND AKTIENGESELLSCHAFT)
ALPENSTRASSE 5

Registered July 17, 2012

6000 LUZERN 6, SWITZERLAND

Int. Cls.: 14 and 35

FOR: JEWELLERY AND IMITATION JEWELLERY FEATURING DIAMONDS; PRECIOUS AND SEMI-PRECIOUS STONES, NAMELY, DIAMONDS; HOROLOGICAL AND CHRONOMETRIC INSTRUMENTS FEATURING DIAMONDS, IN CLASS 14 (U.S. CLS. 2, 27, 28 AND 50).

TRADEMARK

SERVICE MARK

FIRST USE 12-31-2011; IN COMMERCE 12-31-2011.

SUPPLEMENTAL REGISTER

FOR: RETAIL AND WHOLESALE STORE SERVICES, ADVERTISING AND MARKETING SERVICES, ALL IN THE FIELD OF JEWELLERY AND IMITATION JEWELLERY FEATURING DIAMONDS; PRECIOUS AND SEMI-PRECIOUS STONES, NAMELY, DIAMONDS, HOROLOGICAL AND CHRONOMETRIC INSTRUMENTS FEATURING DIAMONDS, IN CLASS 35 (U.S. CLS. 100, 101 AND 102).

FIRST USE 12-31-2011; IN COMMERCE 12-31-2011.

THE MARK CONSISTS OF STANDARD CHARACTERS WITHOUT CLAIM TO ANY PARTICULAR FONT, STYLE, SIZE, OR COLOR.

NO CLAIM IS MADE TO THE EXCLUSIVE RIGHT TO USE "DIAMONDS", APART FROM THE MARK AS SHOWN.

SER. NO. 85-269,474, FILED P.R. 3-17-2011; AM. S.R. 4-9-2012.

ALLISON HOLTZ, EXAMINING ATTORNEY



David J. Kybas

Director of the United States Patent and Trademark Office

United States of America

United States Patent and Trademark Office

SEASONAL SOUTHERN CALIFORNIA COMFORT FOOD

Reg. No. 4,177,238

LEMONADE RESTAURANT GROUP, LLC (OREGON LIMITED LIABILITY COMPANY)
3515 W. WASHINGTON BLVD.

Registered July 17, 2012

LOS ANGELES, CA 90018

Int. Cl.: 43

FOR: CATERING; RESTAURANT SERVICES; SELF-SERVICE RESTAURANTS, IN CLASS
43 (U.S. CLS. 100 AND 101).

SERVICE MARK

FIRST USE 5-15-2012; IN COMMERCE 5-15-2012.

SUPPLEMENTAL REGISTER

THE MARK CONSISTS OF STANDARD CHARACTERS WITHOUT CLAIM TO ANY PAR-
TICULAR FONT, STYLE, SIZE, OR COLOR.

SER. NO. 85-270,801, FILED P.R. 3-18-2011; AM. S.R. 5-16-2012.

KRISTIN CARLSON, EXAMINING ATTORNEY



David J. Kybas

Director of the United States Patent and Trademark Office

United States of America

United States Patent and Trademark Office

THE FOOD GROUP

Reg. No. 4,177,239

Registered July 17, 2012

Int. Cl.: 35

SERVICE MARK

SUPPLEMENTAL REGISTER

WPP PROPERTIES (DELAWARE PARTNERSHIP)
4TH FLOOR
100 PARK AVENUE
NEW YORK, NY 10017

FOR: PROVIDING MARKETING COMMUNICATIONS SERVICES IN THE FOOD AND BEVERAGE INDUSTRY, NAMELY, PROVIDING CUSTOMIZED COMMUNICATIONS PROGRAMS TO OBTAIN CONSUMER INSIGHTS AND DEVELOP BRANDING STRATEGIES; BUSINESS MARKETING CONSULTING SERVICES TO THE FOOD AND BEVERAGE INDUSTRY; ADVERTISING AGENCY SERVICES IN THE FOOD AND BEVERAGE INDUSTRY, IN CLASS 35 (U.S. CLS. 100, 101 AND 102).

FIRST USE 7-18-1988; IN COMMERCE 7-18-1988.

THE MARK CONSISTS OF STANDARD CHARACTERS WITHOUT CLAIM TO ANY PARTICULAR FONT, STYLE, SIZE, OR COLOR.

NO CLAIM IS MADE TO THE EXCLUSIVE RIGHT TO USE "GROUP", APART FROM THE MARK AS SHOWN.

SER. NO. 85-273,184, FILED P.R. 3-22-2011; AM. S.R. 5-4-2012.

ALAIN LAPTER, EXAMINING ATTORNEY



David J. Kybas

Director of the United States Patent and Trademark Office

United States of America

United States Patent and Trademark Office

PROGRAMMABLEFLOW

Reg. No. 4,177,240

Registered July 17, 2012

Int. Cl.: 9

TRADEMARK

SUPPLEMENTAL REGISTER

NIPPON DENKI KABUSHIKI KAISHA (JAPAN CORPORATION), DBA NEC CORPORATION,
7-1, SHIBA 5-CHOME, MINATO-KU
TOKYO, JAPAN

FOR: COMPUTER NETWORK SWITCHES; COMPUTER SOFTWARE FOR CONTROLLING
COMPUTER NETWORK SWITCHES; COMPUTERS; COMPUTER SERVERS; COMPUTER
NETWORK SERVERS, IN CLASS 9 (U.S. CLS. 21, 23, 26, 36 AND 38).

FIRST USE 5-8-2011; IN COMMERCE 5-8-2011.

THE MARK CONSISTS OF STANDARD CHARACTERS WITHOUT CLAIM TO ANY PAR-
TICULAR FONT, STYLE, SIZE, OR COLOR.

SER. NO. 85-274,694, FILED P.R. 3-23-2011; AM. S.R. 5-16-2012.

BARBARA GAYNOR, EXAMINING ATTORNEY



David J. Kyros

Director of the United States Patent and Trademark Office

United States of America
United States Patent and Trademark Office

DOWNNS
CLUBHOUSE & LOUNGE

Reg. No. 4,177,241

MTR GAMING GROUP, INC. (DELAWARE CORPORATION)
ROUTE 2
CHESTER, WV 26034

Registered July 17, 2012

Int. Cl.: 43

FOR: BAR AND RESTAURANT SERVICES, IN CLASS 43 (U.S. CLS. 100 AND 101).

SERVICE MARK

FIRST USE 1-5-2011; IN COMMERCE 1-5-2011.

SUPPLEMENTAL REGISTER

NO CLAIM IS MADE TO THE EXCLUSIVE RIGHT TO USE "CLUBHOUSE & LOUNGE",
APART FROM THE MARK AS SHOWN.

SER. NO. 85-281,179, FILED P.R. 3-30-2011; AM. S.R. 1-26-2012.

TAMARA FRAZIER, EXAMINING ATTORNEY



David J. Kybas

Director of the United States Patent and Trademark Office

United States of America

United States Patent and Trademark Office

TOUCH AND TEST

Reg. No. 4,177,242

Registered July 17, 2012

Int. Cl.: 9

TRADEMARK

SUPPLEMENTAL REGISTER

AFL TELECOMMUNICATIONS, LLC (DELAWARE LIMITED LIABILITY COMPANY)
170 RIDGEVIEW CIRCLE
DUNCAN, SC 29334

FOR: TEST EQUIPMENT OPERATING SYSTEM SOFTWARE, NAMELY, USER INTERFACE SOFTWARE FOR CONTROLLING AND OPTIMIZING OPTICAL TIME DOMAIN REFLECTOMETER (OTDR), OPTICAL LIGHT SOURCE (OLS), OPTICAL POWER METER (OPM) AND DIGITAL FIBER SCOPE (DFS) INSPECTION INTERFACES; ELECTRONIC USER INTERFACE SOFTWARE FOR TEST EQUIPMENT OPERATION; COMPUTER SOFTWARE FOR STORING, CONTROLLING, AND MANAGING TEST INFORMATION BY INTERCONNECTING AND INTERFACING WITH FIBER OPTIC NETWORKS AND OUR RESULTS MANAGEMENT SYSTEMS, IN CLASS 9 (U.S. CLS. 21, 23, 26, 36 AND 38).

FIRST USE 1-0-2008; IN COMMERCE 1-0-2008.

THE MARK CONSISTS OF STANDARD CHARACTERS WITHOUT CLAIM TO ANY PARTICULAR FONT, STYLE, SIZE, OR COLOR.

SER. NO. 85-281,403, FILED P.R. 3-30-2011; AM. S.R. 1-19-2012.

ANDREA HACK, EXAMINING ATTORNEY



David J. Kyffers

Director of the United States Patent and Trademark Office

United States of America

United States Patent and Trademark Office

Nassau Buyers

Nassau Gold Buyers

Reg. No. 4,177,243

SMITHTOWN GOLD & DIAMONDS (NEW YORK CORPORATION), DBA NASSAU BUYERS,
10 WEST CHERRY STREET
HICKSVILLE, NY 11801

Registered July 17, 2012

Int. Cl.: 36

FOR: PROVIDING MONETARY EXCHANGE SERVICES, NAMELY, EXCHANGING GOLD
OF OTHERS FOR CASH, IN CLASS 36 (U.S. CLS. 100, 101 AND 102).

SERVICE MARK

FIRST USE 1-0-2007; IN COMMERCE 1-0-2007.

SUPPLEMENTAL REGISTER

THE MARK CONSISTS OF STANDARD CHARACTERS WITHOUT CLAIM TO ANY PAR-
TICULAR FONT, STYLE, SIZE, OR COLOR.

NO CLAIM IS MADE TO THE EXCLUSIVE RIGHT TO USE "BUYERS" AND "GOLD BUY-
ERS", APART FROM THE MARK AS SHOWN.

SER. NO. 85-288,917, FILED P.R. 4-7-2011; AM. S.R. 3-22-2012.

LINDA ESTRADA, EXAMINING ATTORNEY



David J. Kybas

Director of the United States Patent and Trademark Office

United States of America

United States Patent and Trademark Office

HARDWARESCIENCE

Reg. No. 4,177,244

HIZINC LLC (HAWAII LIMITED LIABILITY COMPANY)
333 KILAUEA AVE.
HILO, HI 96720

Registered July 17, 2012

Int. Cl.: 16

FOR: CHILDREN'S ACTIVITY BOOKS; EDUCATIONAL KITS SOLD AS A UNIT IN THE FIELD OF SCIENCE CONSISTING PRIMARILY OF PRINTED TEXT-BASED ACTIVITY BOOKS, WORKBOOKS, AND ALSO INCLUDING DVDS; PACKAGED KITS COMPRISING PRINTED INSTRUCTIONAL, EDUCATIONAL, AND TEACHING MATERIALS FOR EDUCATIONAL ACTIVITIES IN THE FIELD OF SCIENCE, IN CLASS 16 (U.S. CLS. 2, 5, 22, 23, 29, 37, 38 AND 50).

TRADEMARK

SUPPLEMENTAL REGISTER

FIRST USE 10-28-2010; IN COMMERCE 3-20-2011.

THE MARK CONSISTS OF STANDARD CHARACTERS WITHOUT CLAIM TO ANY PARTICULAR FONT, STYLE, SIZE, OR COLOR.

SER. NO. 85-293,522, FILED P.R. 4-12-2011; AM. S.R. 6-6-2012.

JAMES GRIFFIN, EXAMINING ATTORNEY



David J. Kyffers

Director of the United States Patent and Trademark Office

United States of America

United States Patent and Trademark Office

ASSOCIATION OF CLINICAL ELBOW AND SHOULDER SURGEONS

Reg. No. 4,177,245

Registered July 17, 2012

Int. Cls.: 41 and 44

SERVICE MARK

SUPPLEMENTAL REGISTER

ASSOCIATION OF CLINICAL ELBOW AND SHOULDER SURGEONS, INCORPORATED
(MARYLAND CORPORATION)
1568 COMANCHE ROAD
ARNOLD, MT 21012

FOR: PROVIDING AN EDUCATIONAL WEBSITE FOR ORTHOPEDIC SURGEONS AND PATIENTS IN THE FIELD OF ORTHOPEDIC MEDICINE; ARRANGING AND CONDUCTING CONFERENCES IN THE FIELD OF ORTHOPEDIC MEDICINE, IN CLASS 41 (U.S. CLS. 100, 101 AND 107).

FIRST USE 2-2-2012; IN COMMERCE 2-2-2012.

FOR: PROVIDING A WEBSITE FEATURING INFORMATION FOR ORTHOPEDIC SURGEONS AND PATIENTS IN THE FIELD OF ORTHOPEDIC MEDICINE; PROVIDING A WEBSITE FOR THE SHARING OF CLINICAL CASES ONLINE AMONG ORTHOPEDIC SURGEONS, IN CLASS 44 (U.S. CLS. 100 AND 101).

FIRST USE 2-2-2012; IN COMMERCE 2-2-2012.

THE MARK CONSISTS OF STANDARD CHARACTERS WITHOUT CLAIM TO ANY PARTICULAR FONT, STYLE, SIZE, OR COLOR.

SER. NO. 85-298,895, FILED P.R. 4-19-2011; AM. S.R. 2-3-2012.

ANNE FARRELL, EXAMINING ATTORNEY



David J. Kyjars

Director of the United States Patent and Trademark Office

United States of America

United States Patent and Trademark Office

ENERGY & ENDURANCE

Reg. No. 4,177,246

Registered July 17, 2012

Int. Cl.: 5

TRADEMARK

SUPPLEMENTAL REGISTER

BEACHBODY, LLC (CALIFORNIA LIMITED LIABILITY COMPANY)
THIRD FLOOR
3301 EXPOSITION BLVD.
SANTA MONICA, CA 90404

FOR: NUTRITIONAL AND DIETARY SUPPLEMENTS; MEAL REPLACEMENT SHAKES;
MEAL REPLACEMENT BARS, IN CLASS 5 (U.S. CLS. 6, 18, 44, 46, 51 AND 52).

FIRST USE 1-10-2012; IN COMMERCE 1-10-2012.

THE MARK CONSISTS OF STANDARD CHARACTERS WITHOUT CLAIM TO ANY PARTICULAR FONT, STYLE, SIZE, OR COLOR.

SER. NO. 85-309,915, FILED P.R. 5-2-2011; AM. S.R. 5-15-2012.

RONALD MCMORROW, EXAMINING ATTORNEY



David J. Kyffers

Director of the United States Patent and Trademark Office

United States of America

United States Patent and Trademark Office

PASTA HALL OF FAME

Reg. No. 4,177,247

DEFRANCISCI MACHINE COMPANY, LLC (FLORIDA LIMITED LIABILITY COMPANY)
7610 CORAL DRIVE

Registered July 17, 2012

WEST MELBOURNE, FL 329041102

Int. Cl.: 41

FOR: MUSEUM SERVICES FEATURING ACHIEVEMENTS IN THE CULINARY INNOVATIONS INDUSTRY; ENTERTAINMENT SERVICES, NAMELY, AN AWARD PROGRAM IN THE NATURE OF PRESENTING AWARDS FOR RECOGNITION OF THE ACHIEVEMENTS OF CULINARY INNOVATIONS, IN CLASS 41 (U.S. CLS. 100, 101 AND 107).

SERVICE MARK

SUPPLEMENTAL REGISTER FIRST USE 12-23-2011; IN COMMERCE 12-23-2011.

THE MARK CONSISTS OF STANDARD CHARACTERS WITHOUT CLAIM TO ANY PARTICULAR FONT, STYLE, SIZE, OR COLOR.

NO CLAIM IS MADE TO THE EXCLUSIVE RIGHT TO USE "HALL OF FAME", APART FROM THE MARK AS SHOWN.

SER. NO. 85-309,960, FILED P.R. 5-2-2011; AM. S.R. 5-23-2012.

SUE LAWRENCE, EXAMINING ATTORNEY



David J. Kybas

Director of the United States Patent and Trademark Office

United States of America

United States Patent and Trademark Office

PINK RIBBON RED RIBBON

Reg. No. 4,177,248

Registered July 17, 2012

Int. Cl.: 35

THE SUSAN G. KOMEN BREAST CANCER FOUNDATION, INC. (TEXAS NON-PROFIT CORPORATION)

SUITE 250
5005 LBJ FREEWAY
DALLAS, TX 75244

SERVICE MARK

FOR: PROMOTING PUBLIC AWARENESS OF THE IMPORTANCE OF THE PREVENTION AND THE EARLY DETECTION OF BREAST CANCER AND HIV/AIDS, IN CLASS 35 (U.S. CLS. 100, 101 AND 102).

SUPPLEMENTAL REGISTER

FIRST USE 1-0-2012; IN COMMERCE 1-0-2012.

THE MARK CONSISTS OF STANDARD CHARACTERS WITHOUT CLAIM TO ANY PARTICULAR FONT, STYLE, SIZE, OR COLOR.

SER. NO. 85-311,061, FILED P.R. 5-3-2011; AM. S.R. 5-3-2012.

STEVEN R. FINE, EXAMINING ATTORNEY



David J. Kyffers

Director of the United States Patent and Trademark Office

United States of America

United States Patent and Trademark Office



Reg. No. 4,177,249

THE JOLLY ROGERS MOTORCYCLE CLUB (WASHINGTON CORPORATION)
10220 37TH AV SW
SEATTLE, WA 98146

Registered July 17, 2012

Int. Cl.: 26

FOR: CLOTH PATCHES FOR CLOTHING; EMBROIDERED PATCHES FOR CLOTHING;
ORNAMENTAL CLOTH PATCHES, IN CLASS 26 (U.S. CLS. 37, 39, 40, 42 AND 50).

TRADEMARK

FIRST USE 1-1-1948; IN COMMERCE 1-1-1948.

SUPPLEMENTAL REGISTER

NO CLAIM IS MADE TO THE EXCLUSIVE RIGHT TO USE "SEATTLE WASH", APART
FROM THE MARK AS SHOWN.

THE STIPPLING IS FOR SHADING PURPOSES ONLY.

THE MARK CONSISTS OF THE WORDING "JOLLY ROGERS MC SEATTLE WASH" IN
STYLIZED FONT WITH THE HEAD OF A PIRATE WEARING A BANDANA, GOGGLES,
AND EARRING, WITH A DAGGER IN BETWEEN HIS TEETH.

SER. NO. 85-315,550, FILED P.R. 5-9-2011; AM. S.R. 5-29-2012.

ADA HAN, EXAMINING ATTORNEY



David J. Kybas

Director of the United States Patent and Trademark Office

United States of America

United States Patent and Trademark Office

HOLLYWOOD BLACK CARD

Reg. No. 4,177,250

Registered July 17, 2012

Int. Cl.: 35

SERVICE MARK

SUPPLEMENTAL REGISTER

CALLAHAN, MARS (UNITED STATES INDIVIDUAL)
1880 CENTURY PARK EAST
SUITE 618
LOS ANGELES, CA 90067

FOR: ADMINISTRATION OF A MEMBERSHIP PROGRAM FOR ENABLING PARTICIPANTS TO OBTAIN EXCLUSIVE OFFERS AND DISCOUNTS ON GOODS, SERVICES, AND EVENTS THROUGH USE OF A MEMBERSHIP CARD; CUSTOMER LOYALTY SERVICES AND CUSTOMER CLUB SERVICES FOR COMMERCIAL, PROMOTIONAL AND/OR ADVERTISING PURPOSES; PROMOTING THE GOODS, SERVICES AND EVENTS OF OTHERS BY MEANS OF THE ISSUANCE OF EXCLUSIVE MEMBERSHIP CARDS; PROVIDING CONSUMER INFORMATION SERVICES AND MAKING REFERRALS IN THE FIELD OF ENTERTAINMENT CONCERNING PRODUCTS, SERVICES, EVENTS, PRODUCTIONS, ACTIVITIES, ATTRACTIONS AND CAREERS, IN CLASS 35 (U.S. CLS. 100, 101 AND 102).

FIRST USE 11-1-2011; IN COMMERCE 12-1-2011.

THE MARK CONSISTS OF STANDARD CHARACTERS WITHOUT CLAIM TO ANY PARTICULAR FONT, STYLE, SIZE, OR COLOR.

NO CLAIM IS MADE TO THE EXCLUSIVE RIGHT TO USE "CARD", APART FROM THE MARK AS SHOWN.

SER. NO. 85-315,897, FILED P.R. 5-9-2011; AM. S.R. 5-23-2012.

ELIZABETH HUGHITT, EXAMINING ATTORNEY



David J. Kyros

Director of the United States Patent and Trademark Office

United States of America

United States Patent and Trademark Office

Rim to Rim Club

Reg. No. 4,177,251

DELLOSO, MICHELLE (UNITED STATES INDIVIDUAL)

Registered July 17, 2012

P.O. BOX 213
SANTA CLARA, UT 84765

Int. Cl.: 38

FOR: PROVIDING AN ONLINE FORUM FOR EXCHANGING AND TRANSMISSION OF INFORMATION AND EXPERIENCES ABOUT HIKING, IN CLASS 38 (U.S. CLS. 100, 101 AND 104).

SERVICE MARK

FIRST USE 10-1-2010; IN COMMERCE 1-1-2011.

SUPPLEMENTAL REGISTER

THE MARK CONSISTS OF STANDARD CHARACTERS WITHOUT CLAIM TO ANY PARTICULAR FONT, STYLE, SIZE, OR COLOR.

OWNER OF U.S. REG. NO. 3,956,195.

NO CLAIM IS MADE TO THE EXCLUSIVE RIGHT TO USE "CLUB", APART FROM THE MARK AS SHOWN.

SER. NO. 85-320,941, FILED P.R. 5-13-2011; AM. S.R. 6-1-2012.

KHANH LE, EXAMINING ATTORNEY



David J. Kyffers

Director of the United States Patent and Trademark Office

United States of America

United States Patent and Trademark Office

ENERGY AND ENDURANCE FORMULA

Reg. No. 4,177,252

Registered July 17, 2012

Int. Cl.: 5

TRADEMARK

SUPPLEMENTAL REGISTER

BEACHBODY, LLC (CALIFORNIA LIMITED LIABILITY COMPANY)
THIRD FLOOR
3301 EXPOSITION BLVD.
SANTA MONICA, CA 90404

FOR: MEAL REPLACEMENT AND DIETARY SUPPLEMENT DRINKS, POWDERED NUTRITIONAL SUPPLEMENT DRINKS; NUTRITIONAL AND DIETARY SUPPLEMENTS; MEAL REPLACEMENT SHAKES; MEAL REPLACEMENT BARS, IN CLASS 5 (U.S. CLS. 6, 18, 44, 46, 51 AND 52).

FIRST USE 1-10-2012; IN COMMERCE 1-10-2012.

THE MARK CONSISTS OF STANDARD CHARACTERS WITHOUT CLAIM TO ANY PARTICULAR FONT, STYLE, SIZE, OR COLOR.

SER. NO. 85-327,275, FILED P.R. 5-23-2011; AM. S.R. 5-15-2012.

RONALD MCMORROW, EXAMINING ATTORNEY



David J. Kyffers

Director of the United States Patent and Trademark Office

United States of America

United States Patent and Trademark Office

CUSTER

Reg. No. 4,177,253

THE FONT BUREAU INC. (MASSACHUSETTS CORPORATION)
50 MELCHER STREET, SUITE 2
BOSTON, MA 02210

Registered July 17, 2012

Int. Cl.: 9

FOR: PRINTING FONTS THAT CAN BE DOWNLOADED PROVIDED BY MEANS OF ELECTRONIC TRANSMISSION; TYPEFACE FONTS RECORDED ON MAGNETIC MEDIA , IN CLASS 9 (U.S. CLS. 21, 23, 26, 36 AND 38).

TRADEMARK

FIRST USE 5-20-2011; IN COMMERCE 5-20-2011.

SUPPLEMENTAL REGISTER

THE MARK CONSISTS OF STANDARD CHARACTERS WITHOUT CLAIM TO ANY PARTICULAR FONT, STYLE, SIZE, OR COLOR.

SER. NO. 85-331,215, FILED P.R. 5-26-2011; AM. S.R. 5-14-2012.

ANNE MADDEN, EXAMINING ATTORNEY



David J. Kyffers

Director of the United States Patent and Trademark Office

United States of America

United States Patent and Trademark Office

POCKET HOOKAH

Reg. No. 4,177,254

Registered July 17, 2012

Int. Cl.: 34

TMS INTERNATIONAL CORP (CALIFORNIA CORPORATION)
19528 VENTURA BLVD.
#140
TARZANA, CA 91607

FOR: HOOKAHS, IN CLASS 34 (U.S. CLS. 2, 8, 9 AND 17).

TRADEMARK

FIRST USE 2-16-2012; IN COMMERCE 2-16-2012.

SUPPLEMENTAL REGISTER

THE MARK CONSISTS OF STANDARD CHARACTERS WITHOUT CLAIM TO ANY PARTICULAR FONT, STYLE, SIZE, OR COLOR.

NO CLAIM IS MADE TO THE EXCLUSIVE RIGHT TO USE "HOOKAH", APART FROM THE MARK AS SHOWN.

SER. NO. 85-331,770, FILED P.R. 5-26-2011; AM. S.R. 5-23-2012.

DORITT L. CARROLL, EXAMINING ATTORNEY



David J. Kyros

Director of the United States Patent and Trademark Office

United States of America

United States Patent and Trademark Office

LUXE HOTELS

Reg. No. 4,177,255

LUXE HOSPITALITY COMPANY (DELAWARE LIMITED LIABILITY COMPANY)
11461 SUNSET BOULEVARD
LOS ANGELES, CA 90049

Registered July 17, 2012

Int. Cl.: 44

FOR: HEALTH SPA SERVICES FOR HEALTH AND WELLNESS OF THE BODY AND SPIRIT, NAMELY, PROVIDING MASSAGE, FACIAL AND BODY TREATMENT SERVICES, COSMETIC BODY CARE SERVICES, IN CLASS 44 (U.S. CLS. 100 AND 101).

SERVICE MARK

FIRST USE 2-15-2011; IN COMMERCE 2-15-2011.

SUPPLEMENTAL REGISTER

THE MARK CONSISTS OF STANDARD CHARACTERS WITHOUT CLAIM TO ANY PARTICULAR FONT, STYLE, SIZE, OR COLOR.

OWNER OF U.S. REG. NO. 3,548,611.

NO CLAIM IS MADE TO THE EXCLUSIVE RIGHT TO USE "HOTELS", APART FROM THE MARK AS SHOWN.

SER. NO. 85-334,841, FILED P.R. 6-1-2011; AM. S.R. 1-31-2012.

NORA BUCHANAN WILL, EXAMINING ATTORNEY



David J. Kyffers

Director of the United States Patent and Trademark Office

United States of America

United States Patent and Trademark Office

Anti-Sway

Reg. No. 4,177,256

PIER GENIUS (IOWA CORPORATION)
346 HOWARD AVENUE
WODEN, IA 50484

Registered July 17, 2012

Int. Cl.: 6

FOR: FLOATING METAL DOCK FRAMES, IN CLASS 6 (U.S. CLS. 2, 12, 13, 14, 23, 25 AND 50).

TRADEMARK

FIRST USE 1-20-2004; IN COMMERCE 1-1-2006.

SUPPLEMENTAL REGISTER

THE MARK CONSISTS OF STANDARD CHARACTERS WITHOUT CLAIM TO ANY PARTICULAR FONT, STYLE, SIZE, OR COLOR.

SER. NO. 85-334,937, FILED P.R. 6-1-2011; AM. S.R. 5-22-2012.

MARCIE MILONE, EXAMINING ATTORNEY



David J. Kybas

Director of the United States Patent and Trademark Office

United States of America

United States Patent and Trademark Office

BAD BEAT BACCARAT

Reg. No. 4,177,257

CANADIAN (21) STOOK LTD. (CANADA CORPORATION)
4950 - 47 AVENUE

Registered July 17, 2012

RED DEER, ALBERTA, CANADA T4N6P8

Int. Cls.: 9, 28, and 41

FOR: SOFTWARE FOR PROVIDING GAMES OF CHANCE ON A COMPUTERIZED GAMING PLATFORM THAT ENABLE ELECTRONIC WAGERING; ELECTRONIC GAMING DEVICES, NAMELY, GAMING MACHINES AND COMPUTERIZED VIDEO TABLE GAMES FOR GAMING PURPOSES, IN CLASS 9 (U.S. CLS. 21, 23, 26, 36 AND 38).

TRADEMARK

SERVICE MARK

FOR: CASINO CARD GAMES AND GAMING TABLES, IN CLASS 28 (U.S. CLS. 22, 23, 38 AND 50).

SUPPLEMENTAL REGISTER

FOR: ENTERTAINMENT SERVICES, NAMELY, PROVIDING A GAME OF CHANCE PLAYED WITH PLAYING CARDS IN A CASINO AND/OR GAMING ENVIRONMENT; ENTERTAINMENT SERVICES, NAMELY, CASINO GAMING IN THE NATURE OF CASINO CARD GAME SIDE BETS, IN CLASS 41 (U.S. CLS. 100, 101 AND 107).

THE MARK CONSISTS OF STANDARD CHARACTERS WITHOUT CLAIM TO ANY PARTICULAR FONT, STYLE, SIZE, OR COLOR.

PRIORITY CLAIMED UNDER SEC. 44(D) ON CANADA APPLICATION NO. 1530195, FILED 6-2-2011, REG. NO. TMA824,925, DATED 5-28-2012, EXPIRES 5-28-2027.

NO CLAIM IS MADE TO THE EXCLUSIVE RIGHT TO USE "BACCARAT", APART FROM THE MARK AS SHOWN.

SER. NO. 85-337,180, FILED P.R. 6-3-2011; AM. S.R. 3-13-2012.

MAYUR VAGHANI, EXAMINING ATTORNEY



David J. Kyros

Director of the United States Patent and Trademark Office

United States of America

United States Patent and Trademark Office

A Course in Miracles Original Edition

Reg. No. 4,177,258

Registered July 17, 2012

Int. Cls.: 9 and 16

TRADEMARK

SUPPLEMENTAL REGISTER

COURSE IN MIRACLES SOCIETY (NEBRASKA CORPORATION)
SUITE 200
7602 PACIFIC STREET
OMAHA, NE 68114

FOR: ELECTRONIC PUBLICATIONS, NAMELY, ELECTRONIC BOOKS FEATURING SPIRITUAL DEVELOPMENT AND EDUCATION RECORDED ON COMPUTER MEDIA, IN CLASS 9 (U.S. CLS. 21, 23, 26, 36 AND 38).

FIRST USE 10-8-2007; IN COMMERCE 10-8-2007.

FOR: RELIGIOUS BOOKS, IN CLASS 16 (U.S. CLS. 2, 5, 22, 23, 29, 37, 38 AND 50).

FIRST USE 12-5-2006; IN COMMERCE 12-5-2006.

THE MARK CONSISTS OF STANDARD CHARACTERS WITHOUT CLAIM TO ANY PARTICULAR FONT, STYLE, SIZE, OR COLOR.

NO CLAIM IS MADE TO THE EXCLUSIVE RIGHT TO USE "A COURSE IN MIRACLES" OR "EDITION", APART FROM THE MARK AS SHOWN.

SER. NO. 85-344,885, FILED 6-13-2011.

MATTHEW MCDOWELL, EXAMINING ATTORNEY



David J. Kyros

Director of the United States Patent and Trademark Office

United States of America

United States Patent and Trademark Office

POOLGEAR.COM

Reg. No. 4,177,259

SUN WHOLESALE SUPPLY, INC. (FLORIDA CORPORATION)
14480 62ND STREET N.
CLEARWATER, FL 33760

Registered July 17, 2012

Int. Cl.: 35

FOR: ONLINE RETAIL DISTRIBUTORSHIP OF SWIMMING POOL AND SPA SUPPLIES,
IN CLASS 35 (U.S. CLS. 100, 101 AND 102).

SERVICE MARK

FIRST USE 10-25-2009; IN COMMERCE 10-25-2009.

SUPPLEMENTAL REGISTER

THE MARK CONSISTS OF STANDARD CHARACTERS WITHOUT CLAIM TO ANY PARTICULAR FONT, STYLE, SIZE, OR COLOR.

OWNER OF U.S. REG. NO. 2,368,180.

SER. NO. 85-345,295, FILED P.R. 6-14-2011; AM. S.R. 4-30-2012.

SOPHIA S. KIM, EXAMINING ATTORNEY



David J. Kyffers

Director of the United States Patent and Trademark Office

United States of America

United States Patent and Trademark Office

THE WORLD'S MOST FAMOUS CUBAN RESTAURANT

Reg. No. 4,177,260

Registered July 17, 2012

Int. Cl.: 43

VALLS HOLDINGS, INC. (FLORIDA CORPORATION)
PENTHOUSE
3663 S.W. 8TH STREET
MIAMI, FL 33135

FOR: RESTAURANT SERVICES, IN CLASS 43 (U.S. CLS. 100 AND 101).

SERVICE MARK

FIRST USE 6-6-2011; IN COMMERCE 6-6-2011.

SUPPLEMENTAL REGISTER

THE MARK CONSISTS OF STANDARD CHARACTERS WITHOUT CLAIM TO ANY PARTICULAR FONT, STYLE, SIZE, OR COLOR.

NO CLAIM IS MADE TO THE EXCLUSIVE RIGHT TO USE "CUBAN RESTAURANT", APART FROM THE MARK AS SHOWN.

SER. NO. 85-345,887, FILED P.R. 6-14-2011; AM. S.R. 3-23-2012.

CAROLYN CATALDO, EXAMINING ATTORNEY



David J. Kybas

Director of the United States Patent and Trademark Office

United States of America

United States Patent and Trademark Office

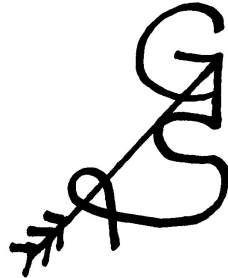

Reg. No. 4,177,261

WRIGHT, GARRY (UNITED STATES INDIVIDUAL)
394 SKYLINE DRIVE
STATEN ISLAND, NY 10304

Registered July 17, 2012

Int. Cl.: 25

FOR: HATS; JACKETS; PANTS; SHIRTS; SOCKS, IN CLASS 25 (U.S. CLS. 22 AND 39).

TRADEMARK

FIRST USE 3-5-2012; IN COMMERCE 3-5-2012.

SUPPLEMENTAL REGISTER

THE MARK CONSISTS OF THE TEXT "GASA" CONNECTED VERTICALLY WITHIN A STYLIZED ARROW DESIGN.

SER. NO. 85-350,263, FILED P.R. 6-20-2011; AM. S.R. 4-24-2012.

REBECCA POVARCHUK, EXAMINING ATTORNEY



David J. Kyffers

Director of the United States Patent and Trademark Office

United States of America

United States Patent and Trademark Office

POSITIVE INTELLIGENCE

Reg. No. 4,177,262

SHIRZAD CHAMINE (UNITED STATES INDIVIDUAL)
2862 SACRAMENTO STREET
SAN FRANCISCO, CA 94115

Registered July 17, 2012

Int. Cls.: 35 and 41

FOR: PROVIDING LIVE AND ONLINE BUSINESS INFORMATION, AND LIVE AND ONLINE PERSONALITY AND PSYCHOLOGICAL ASSESSMENTS, ALL FOR THE BUSINESS PURPOSES OF PROFESSIONAL DEVELOPMENT, LEADERSHIP DEVELOPMENT, AND ORGANIZATIONAL DEVELOPMENT, IN CLASS 35 (U.S. CLS. 100, 101 AND 102).

SERVICE MARK

SUPPLEMENTAL REGISTER FIRST USE 7-11-2011; IN COMMERCE 7-11-2011.

FOR: EDUCATION AND INFORMATION SERVICES, NAMELY, PROVIDING LIVE AND ONLINE TRAINING IN THE FIELDS OF APPLIED NEUROSCIENCE, PSYCHOLOGY, ORGANIZATIONAL DEVELOPMENT, LEADERSHIP DEVELOPMENT, AND PERSONAL AND PROFESSIONAL DEVELOPMENT, IN CLASS 41 (U.S. CLS. 100, 101 AND 107).

FIRST USE 7-11-2011; IN COMMERCE 7-11-2011.

THE MARK CONSISTS OF STANDARD CHARACTERS WITHOUT CLAIM TO ANY PARTICULAR FONT, STYLE, SIZE, OR COLOR.

SER. NO. 85-352,368, FILED P.R. 6-21-2011; AM. S.R. 3-26-2012.

LIEF MARTIN, EXAMINING ATTORNEY



David J. Kybas

Director of the United States Patent and Trademark Office

United States of America

United States Patent and Trademark Office

Naples Botanical Garden

Reg. No. 4,177,263

Registered July 17, 2012

Int. Cl.: 41

SERVICE MARK

SUPPLEMENTAL REGISTER

NAPLES BOTANICAL GARDEN, INC. (FLORIDA CORPORATION), DBA NAPLES
BOTANICAL GARDEN, INC.,
4820 BAYSHORE DRIVE
NAPLES, FL 34112

FOR: BOTANICAL GARDENS; EDUCATIONAL SERVICES, NAMELY, CONDUCTING CLASSES, SEMINARS, CONFERENCES, WORKSHOPS, RETREATS, CAMPS AND FIELD TRIPS IN THE FIELD OF BOTANY AND HORTICULTURAL AND DISTRIBUTION OF TRAINING MATERIAL IN CONNECTION THEREWITH; GARDENS FOR PUBLIC ADMISSION; GUIDED TOURS OF GARDENS AND NATURAL HABITATS, IN CLASS 41 (U.S. CLS. 100, 101 AND 107).

FIRST USE 10-1-2009; IN COMMERCE 10-1-2009.

THE MARK CONSISTS OF STANDARD CHARACTERS WITHOUT CLAIM TO ANY PARTICULAR FONT, STYLE, SIZE, OR COLOR.

NO CLAIM IS MADE TO THE EXCLUSIVE RIGHT TO USE "BOTANICAL GARDEN", APART FROM THE MARK AS SHOWN.

SER. NO. 85-352,726, FILED P.R. 6-22-2011; AM. S.R. 5-24-2012.

ANDREW LEASER, EXAMINING ATTORNEY



David J. Kyffers

Director of the United States Patent and Trademark Office

United States of America

United States Patent and Trademark Office

PADDOCK PATCH

Reg. No. 4,177,264

WILLIAM J. TOMLINSON (UNITED STATES INDIVIDUAL)
1161 BROADHEAD SCHOOL ROAD
GREENVILLE, VA 24440

Registered July 17, 2012

Int. Cl.: 22

FOR: KITS COMPRISING ELASTIC WEBBING AND CLASP MECHANISM FOR RESTORING OR REPLACING DAMAGED PORTIONS OF FENCES AND OTHER ENCLOSURES; ELASTIC WEBBING FOR RESTORING OR REPLACING DAMAGED PORTIONS OF FENCES AND OTHER ENCLOSURES, IN CLASS 22 (U.S. CLS. 1, 2, 7, 19, 22, 42 AND 50).

TRADEMARK

SUPPLEMENTAL REGISTER FIRST USE 10-1-2011; IN COMMERCE 10-1-2011.

THE MARK CONSISTS OF STANDARD CHARACTERS WITHOUT CLAIM TO ANY PARTICULAR FONT, STYLE, SIZE, OR COLOR.

SER. NO. 85-355,002, FILED P.R. 6-24-2011; AM. S.R. 11-15-2011.

ESTHER A. BORSUK, EXAMINING ATTORNEY



David J. Kybas

Director of the United States Patent and Trademark Office

United States of America

United States Patent and Trademark Office

JET FIGHTERS

Reg. No. 4,177,265

ADDMIRED, INC. (DELAWARE CORPORATION)
555 HAMILTON AVENUE
PALO ALTO, CA 94301

Registered July 17, 2012

Int. Cls.: 9, 41, and 42

FOR: DOWNLOADABLE VIDEO GAME SOFTWARE FOR USE ON WIRELESS DEVICES; COMPUTER GAME SOFTWARE DOWNLOADABLE FROM A GLOBAL COMPUTER NETWORK, IN CLASS 9 (U.S. CLS. 21, 23, 26, 36 AND 38).

TRADEMARK

FIRST USE 7-20-2009; IN COMMERCE 7-20-2009.

SERVICE MARK

SUPPLEMENTAL REGISTER

FOR: ENTERTAINMENT SERVICES, NAMELY, PROVIDING TEMPORARY USE OF NON-DOWNLOADABLE VIDEO GAMES; ENTERTAINMENT SERVICES, NAMELY, PROVIDING ONLINE, NON-DOWNLOADABLE VIRTUAL MISSIONS, WEAPONS, HEROES, LEGIONS, TROOPS, GIFTS, AND PRIZES, FOR USE IN VIRTUAL ENVIRONMENTS CREATED FOR ENTERTAINMENT PURPOSES; PROVIDING AN INTERNET WEBSITE PORTAL IN THE FIELD OF COMPUTER GAMES AND GAMING; ENTERTAINMENT SERVICES, NAMELY, PROVIDING VIRTUAL ENVIRONMENTS IN WHICH USERS CAN INTERACT THROUGH SOCIAL GAMES FOR RECREATIONAL, LEISURE, OR ENTERTAINMENT PURPOSES, IN CLASS 41 (U.S. CLS. 100, 101 AND 107).

FIRST USE 7-20-2009; IN COMMERCE 7-20-2009.



FOR: COMPUTER SERVICES, NAMELY, CREATING AN ONLINE COMMUNITY FOR REGISTERED USERS TO PARTICIPATE IN COMPETITIONS, SHOWCASE THEIR SKILLS, GET FEEDBACK FROM THEIR PEERS, FORM VIRTUAL COMMUNITIES, ENGAGE IN SOCIAL NETWORKING, AND IMPROVE THEIR TALENT; PROVIDING A WEBSITE FEATURING NON-DOWNLOADABLE SOFTWARE TOOLS FOR USE IN TRACKING PERFORMANCE OF COMPUTER GAMES, IN CLASS 42 (U.S. CLS. 100 AND 101).

FIRST USE 7-20-2009; IN COMMERCE 7-20-2009.

THE MARK CONSISTS OF STANDARD CHARACTERS WITHOUT CLAIM TO ANY PARTICULAR FONT, STYLE, SIZE, OR COLOR.

David J. Kyros

SER. NO. 85-361,131, FILED P.R. 6-30-2011; AM. S.R. 4-25-2012.

Director of the United States Patent and Trademark Office

VERNA BETH RIRIE, EXAMINING ATTORNEY

United States of America

United States Patent and Trademark Office

BASSENHANCINGCHAMBER

Reg. No. 4,177,266

Registered July 17, 2012

Int. Cl.: 9

TRADEMARK

SUPPLEMENTAL REGISTER

BENSUSSEN DEUTSCH & ASSOCIATES, INC. (WASHINGTON CORPORATION)
15525 WOODINVILLE-REDMOND ROAD NORTHEAST
WOODINVILLE, WA 98072

FOR: AUDIO SPEAKERS; EARPHONE ACCESSORIES, NAMELY, EARPHONE CUSHIONS, EARPHONE PADS, CORD MANAGEMENT SYSTEMS, EARPHONE CASES, AND EARPHONE EXTENSION CORDS; EARPHONES; HEADPHONES; HEARING PROTECTION HEADSETS, NOT FOR MEDICAL USE; PROTECTIVE EAR COVERINGS, IN CLASS 9 (U.S. CLS. 21, 23, 26, 36 AND 38).

FIRST USE 0-0-2011; IN COMMERCE 0-0-2011.

THE MARK CONSISTS OF STANDARD CHARACTERS WITHOUT CLAIM TO ANY PARTICULAR FONT, STYLE, SIZE, OR COLOR.

SER. NO. 85-361,956, FILED P.R. 7-1-2011; AM. S.R. 5-1-2012.

DAVID ELTON, EXAMINING ATTORNEY



David J. Kyffers

Director of the United States Patent and Trademark Office

United States of America

United States Patent and Trademark Office

ADMINISTRATIVE DEPOSIT

Reg. No. 4,177,267

Registered July 17, 2012

Int. Cl.: 36

SERVICE MARK

SUPPLEMENTAL REGISTER

STONECASTLE CASH MANAGEMENT LLC (DELAWARE LIMITED LIABILITY COMPANY)
120 WEST 45TH STREET
14TH FLOOR
NEW YORK, NY 10036

FOR: FINANCIAL SERVICES, NAMELY, ASSISTING FINANCIAL INSTITUTIONS WITH THE MANAGEMENT OF CUSTOMER FUNDS AND FACILITATING THE TRANSFER OF FUNDS BETWEEN FUND SOURCES AND DEPOSIT ACCOUNTS, MANAGEMENT OF DEPOSIT ACCOUNTS AND FACILITATING THE TRANSFER OF FUNDS BETWEEN FUND SOURCES AND DEPOSIT ACCOUNTS, ELECTRONIC FUND TRANSFER AND TRANSACTION SERVICES; INVESTMENT FUND TRANSFER AND TRANSACTION SERVICES; BANKING SERVICES IN THE NATURE OF ALLOCATION OF FUNDS TO AND PLACEMENT OF FUNDS IN DEPOSIT ACCOUNTS; FINANCIAL TRANSACTION SERVICES, NAMELY, CUSTODIAL AND SUB-CUSTODIAL SERVICES IN THE NATURE OF FINANCIAL TRUST OPERATIONS AND SETTLEMENT SERVICES IN THE NATURE OF SETTLEMENT OF ACCOUNT TRANSACTIONS; FDIC CLAIM PROCESSING SERVICES, NAMELY, FILING AND PROCESSING TO RESOLUTION CLAIMS FILED WITH THE FDIC FOR RECOVERY OF FUNDS DEPOSITED WITH FAILED BANKS, IN CLASS 36 (U.S. CLS. 100, 101 AND 102).

FIRST USE 4-30-2012; IN COMMERCE 4-30-2012.

THE MARK CONSISTS OF STANDARD CHARACTERS WITHOUT CLAIM TO ANY PARTICULAR FONT, STYLE, SIZE, OR COLOR.

SER. NO. 85-363,235, FILED P.R. 7-5-2011; AM. S.R. 4-30-2012.

ELIZABETH KAJUBI, EXAMINING ATTORNEY



David J. Kyffers

Director of the United States Patent and Trademark Office

United States of America

United States Patent and Trademark Office

Big Board

Reg. No. 4,177,268

SASSI AMERICA, INC. (ILLINOIS CORPORATION), DBA SASSI AMERICA, INC.,
1380 ABBOTT CT.

Registered July 17, 2012

BUFFALO GROVE, IL 60089

Int. Cl.: 3

FOR: NAIL CARE PREPARATIONS, NAMELY, EMERY BOARDS, EMERY BLOCKS; NAIL
BUFFING PREPARATIONS, NAMELY, SPONGE BUFFERS, MIRACLE SHINERS; NAIL
BUFFING PREPARATIONS, IN CLASS 3 (U.S. CLS. 1, 4, 6, 50, 51 AND 52).

TRADEMARK

FIRST USE 7-19-2010; IN COMMERCE 7-19-2010.

SUPPLEMENTAL REGISTER

NO CLAIM IS MADE TO THE EXCLUSIVE RIGHT TO USE "BOARD", APART FROM THE
MARK AS SHOWN.

THE MARK CONSISTS OF THE STYLIZED WORDING "BIG BOARD".

SER. NO. 85-364,254, FILED P.R. 7-6-2011; AM. S.R. 6-1-2012.

ALAIN LAPTEK, EXAMINING ATTORNEY



David J. Kyffers

Director of the United States Patent and Trademark Office

United States of America

United States Patent and Trademark Office

304

Reg. No. 4,177,269

NEYERS VINEYARDS, LLC (CALIFORNIA LIMITED LIABILITY COMPANY)
2153 SAGE CANYON ROAD
SAINT HELENA, CA 94574

Registered July 17, 2012

Int. Cl.: 33

FOR: WINE, IN CLASS 33 (U.S. CLS. 47 AND 49).

FIRST USE 3-17-2011; IN COMMERCE 3-23-2011.

TRADEMARK

THE MARK CONSISTS OF STANDARD CHARACTERS WITHOUT CLAIM TO ANY PARTICULAR FONT, STYLE, SIZE, OR COLOR.

SUPPLEMENTAL REGISTER

SER. NO. 85-364,904, FILED P.R. 7-7-2011; AM. S.R. 5-23-2012.

SANDRA BUJA, EXAMINING ATTORNEY



David J. Kyjars

Director of the United States Patent and Trademark Office

United States of America

United States Patent and Trademark Office

COLD N' HOT

Reg. No. 4,177,270

GOLDBERG, ELLIOTT (UNITED STATES INDIVIDUAL)
45 FRANKLIN ROAD
SCARSDALE, NY 10583

Registered July 17, 2012

Int. Cl.: 10

FOR: THERAPEUTIC HOT AND COLD THERAPY PACKS, IN CLASS 10 (U.S. CLS. 26, 39 AND 44).

TRADEMARK

FIRST USE 11-1-2010; IN COMMERCE 11-1-2010.

SUPPLEMENTAL REGISTER

THE MARK CONSISTS OF STANDARD CHARACTERS WITHOUT CLAIM TO ANY PARTICULAR FONT, STYLE, SIZE, OR COLOR.

SER. NO. 85-365,164, FILED P.R. 7-7-2011; AM. S.R. 6-1-2012.

ROBERT C. CLARK JR., EXAMINING ATTORNEY



David J. Kybas

Director of the United States Patent and Trademark Office

United States of America

United States Patent and Trademark Office

OKIE NOODLING INVITATIONAL CHAMPIONSHIP

Reg. No. 4,177,271

BRADLEY BEESLEY (UNITED STATES INDIVIDUAL)
1710 SINGLETON AVE
AUSTIN, TX 78702

Registered July 17, 2012

Int. Cl.: 41

FOR: ENTERTAINMENT IN THE NATURE OF HAND FISHING TOURNAMENTS; ORGANIZATION OF SPORT FISHING COMPETITIONS, IN CLASS 41 (U.S. CLS. 100, 101 AND 107).

SERVICE MARK

FIRST USE 6-10-2011; IN COMMERCE 6-24-2011.

SUPPLEMENTAL REGISTER

THE MARK CONSISTS OF STANDARD CHARACTERS WITHOUT CLAIM TO ANY PARTICULAR FONT, STYLE, SIZE, OR COLOR.

NO CLAIM IS MADE TO THE EXCLUSIVE RIGHT TO USE ""NOODLING INVITATIONAL CHAMPIONSHIP", APART FROM THE MARK AS SHOWN.

SER. NO. 85-367,115, FILED P.R. 7-8-2011; AM. S.R. 4-4-2012.

MATTHEW MCDOWELL, EXAMINING ATTORNEY



David J. Kyfos

Director of the United States Patent and Trademark Office

United States of America

United States Patent and Trademark Office

MENSLIFESTYLES

Reg. No. 4,177,272

ZETTWOCH, MATTHEW (UNITED STATES INDIVIDUAL)
27 HARTWELL DRIVE
MOUNT SINAI, NY 11766

Registered July 17, 2012

Int. Cl.: 41

FOR: ON-LINE ELECTRONIC MAGAZINES FOCUSING ON MEN'S FASHIONS, HEALTH, ENTERTAINMENT, AND RELATED LIFESTYLES, IN CLASS 41 (U.S. CLS. 100, 101 AND 107).

SERVICE MARK

FIRST USE 7-0-2011; IN COMMERCE 7-0-2011.

SUPPLEMENTAL REGISTER

THE MARK CONSISTS OF STANDARD CHARACTERS WITHOUT CLAIM TO ANY PARTICULAR FONT, STYLE, SIZE, OR COLOR.

SER. NO. 85-368,074, FILED P.R. 7-11-2011; AM. S.R. 4-27-2012.

JESSICA A. POWERS, EXAMINING ATTORNEY



David J. Kyffers

Director of the United States Patent and Trademark Office

United States of America

United States Patent and Trademark Office

WORLD MARKETS

Reg. No. 4,177,273

Registered July 17, 2012

Int. Cl.: 36

SERVICE MARK

SUPPLEMENTAL REGISTER

EVERBANK (FLORIDA FEDERAL SAVINGS INSTITUTION)
501 RIVERSIDE AVENUE, 12TH FLOOR
KAREN KOSTER BURR
JACKSONVILLE, FL 32202

FOR: BANKING SERVICES; FINANCIAL INVESTMENT IN THE FIELD OF CERTIFICATES OF DEPOSIT, MONEY MARKET FUNDS, METALS AND FOREIGN CURRENCIES; PROVIDING INFORMATION AND RESEARCH IN THE FIELD OF FINANCE AND FINANCIAL INVESTMENTS, IN CLASS 36 (U.S. CLS. 100, 101 AND 102).

FIRST USE 6-2-2000; IN COMMERCE 6-2-2000.

THE MARK CONSISTS OF STANDARD CHARACTERS WITHOUT CLAIM TO ANY PARTICULAR FONT, STYLE, SIZE, OR COLOR.

SER. NO. 85-368,262, FILED P.R. 7-11-2011; AM. S.R. 5-9-2012.

JENNIFER VASQUEZ, EXAMINING ATTORNEY



David J. Kybas

Director of the United States Patent and Trademark Office

United States of America

United States Patent and Trademark Office

AUDIENCE DISCOVERY

Reg. No. 4,177,274

CONNEXITY, LLC (CALIFORNIA LIMITED LIABILITY COMPANY)
505 POLI STREET, SUITE 310
VENTURA, CA 93001

Registered July 17, 2012

Int. Cl.: 35

FOR: AD SERVING, NAMELY, PLACING ADVERTISEMENTS ON WEBSITES FOR OTHERS USING SPECIALIZED COMPUTER SOFTWARE, IN CLASS 35 (U.S. CLS. 100, 101 AND 102).

SERVICE MARK

FIRST USE 7-14-2011; IN COMMERCE 7-14-2011.

SUPPLEMENTAL REGISTER

THE MARK CONSISTS OF STANDARD CHARACTERS WITHOUT CLAIM TO ANY PARTICULAR FONT, STYLE, SIZE, OR COLOR.

SER. NO. 85-371,707, FILED 7-14-2011.

LAURIE KAUFMAN, EXAMINING ATTORNEY



David J. Kyffers

Director of the United States Patent and Trademark Office

United States of America

United States Patent and Trademark Office

PENSION CASH FLOW GUARANTEE

Reg. No. 4,177,275

METROPOLITAN LIFE INSURANCE COMPANY (NEW YORK CORPORATION)
1095 AVENUE OF THE AMERICAS
NEW YORK, NY 10036

Registered July 17, 2012

Int. Cl.: 36

FOR: UNDERWRITING, ISSUANCE AND ADMINISTRATION OF ANNUITIES, IN CLASS 36 (U.S. CLS. 100, 101 AND 102).

SERVICE MARK

FIRST USE 6-1-2010; IN COMMERCE 6-1-2010.

SUPPLEMENTAL REGISTER

THE MARK CONSISTS OF STANDARD CHARACTERS WITHOUT CLAIM TO ANY PARTICULAR FONT, STYLE, SIZE, OR COLOR.

SER. NO. 85-375,130, FILED P.R. 7-19-2011; AM. S.R. 5-4-2012.

KRISTINA MORRIS, EXAMINING ATTORNEY



David J. Kybas

Director of the United States Patent and Trademark Office

United States of America

United States Patent and Trademark Office

HYBRID GI

Reg. No. 4,177,276

HYBRID GI LLP (NEW JERSEY LIMITED LIABILITY PARTNERSHIP)
597 SALEM RD
UNION, NJ 07083

Registered July 17, 2012

Int. Cl.: 25

FOR: CLOTHING, NAMELY, UNIFORMS FOR JIU JITSU; KIMONOS FOR JIU JITSU; SHORTS AND T-SHIRTS, IN CLASS 25 (U.S. CLS. 22 AND 39).

TRADEMARK

FIRST USE 9-1-2009; IN COMMERCE 9-1-2009.

SUPPLEMENTAL REGISTER

THE MARK CONSISTS OF STANDARD CHARACTERS WITHOUT CLAIM TO ANY PARTICULAR FONT, STYLE, SIZE, OR COLOR.

SER. NO. 85-376,734, FILED P.R. 7-20-2011; AM. S.R. 5-12-2012.

B. PARADEWELAI, EXAMINING ATTORNEY



David J. Kyffers

Director of the United States Patent and Trademark Office

United States of America

United States Patent and Trademark Office

BIG GAME FISHING

Reg. No. 4,177,277

ERA HOLDINGS, LLC (OKLAHOMA LIMITED LIABILITY COMPANY)
4 NE 10TH ST. SUITE 272

Registered July 17, 2012

OKLAHOMA CITY, OK 731041402

Int. Cl.: 9

FOR: COMPUTER GAME SOFTWARE, IN CLASS 9 (U.S. CLS. 21, 23, 26, 36 AND 38).

TRADEMARK

FIRST USE 2-8-2012; IN COMMERCE 2-8-2012.

SUPPLEMENTAL REGISTER

THE MARK CONSISTS OF STANDARD CHARACTERS WITHOUT CLAIM TO ANY PARTICULAR FONT, STYLE, SIZE, OR COLOR.

SER. NO. 85-380,180, FILED P.R. 7-25-2011; AM. S.R. 5-15-2012.

ROBERT C. CLARK JR., EXAMINING ATTORNEY



David J. Kyffers

Director of the United States Patent and Trademark Office

United States of America

United States Patent and Trademark Office

TRANSACTION EXPERT

Reg. No. 4,177,278

MATT KELLY (UNITED STATES INDIVIDUAL)
2724 MEADOW CREEK COURT
PARK CITY, UT 84060

Registered July 17, 2012

Int. Cl.: 36

FOR: COMMERCIAL AND RESIDENTIAL REAL ESTATE AGENCY SERVICES, IN CLASS 36 (U.S. CLS. 100, 101 AND 102).

SERVICE MARK

FIRST USE 8-1-2011; IN COMMERCE 8-1-2011.

SUPPLEMENTAL REGISTER

THE MARK CONSISTS OF STANDARD CHARACTERS WITHOUT CLAIM TO ANY PARTICULAR FONT, STYLE, SIZE, OR COLOR.

SER. NO. 85-384,537, FILED P.R. 7-29-2011; AM. S.R. 5-15-2012.

SANI KHOURI, EXAMINING ATTORNEY



David J. Kybas

Director of the United States Patent and Trademark Office

United States of America

United States Patent and Trademark Office

EMERALD CITY ATHLETIC CLUB

Reg. No. 4,177,279

SCHOBER, NEIL (UNITED STATES INDIVIDUAL)
4210 184TH AVENUE SE
ISSAQUAH, WA 980279776

Registered July 17, 2012

Int. Cl.: 41

FOR: HEALTH CLUB SERVICES, NAMELY, PROVIDING INSTRUCTION AND EQUIPMENT
IN THE FIELD OF PHYSICAL EXERCISE, IN CLASS 41 (U.S. CLS. 100, 101 AND 107).

SERVICE MARK

FIRST USE 3-31-2010; IN COMMERCE 3-31-2010.

SUPPLEMENTAL REGISTER

THE MARK CONSISTS OF STANDARD CHARACTERS WITHOUT CLAIM TO ANY PAR-
TICULAR FONT, STYLE, SIZE, OR COLOR.

NO CLAIM IS MADE TO THE EXCLUSIVE RIGHT TO USE "ATHLETIC CLUB", APART
FROM THE MARK AS SHOWN.

SER. NO. 85-384,968, FILED P.R. 7-29-2011; AM. S.R. 5-22-2012.

AMY HELLA, EXAMINING ATTORNEY



David J. Kyffers

Director of the United States Patent and Trademark Office

United States of America

United States Patent and Trademark Office

Waiter Wallet

Reg. No. 4,177,280

Registered July 17, 2012

Int. Cl.: 16

TRADEMARK

SUPPLEMENTAL REGISTER

SCHNEIDER, JONATHAN NEIL (UNITED STATES INDIVIDUAL), DBA WAITER WALLET,
P.O. BOX 491733
200 SOUTH BARRINGTON AVENUE
LOS ANGELES, CA 90049

FOR: PERSONAL ORGANIZERS, IN CLASS 16 (U.S. CLS. 2, 5, 22, 23, 29, 37, 38 AND 50).

FIRST USE 10-31-2009; IN COMMERCE 10-31-2009.

THE MARK CONSISTS OF STANDARD CHARACTERS WITHOUT CLAIM TO ANY PARTICULAR FONT, STYLE, SIZE, OR COLOR.

SER. NO. 85-385,013, FILED P.R. 7-29-2011; AM. S.R. 5-21-2012.

SAMUEL E. SHARPER JR., EXAMINING ATTORNEY



David J. Kybas

Director of the United States Patent and Trademark Office

United States of America

United States Patent and Trademark Office

WEIGHT EVENTS

Reg. No. 4,177,281

GI TRACK, LLC (INDIANA LIMITED LIABILITY COMPANY)

Registered July 17, 2012

PO BOX 55245
INDIANAPOLIS, IN 46205

Int. Cls.: 35 and 44

FOR: PROVIDING AN INTERNET-BASED DATABASE OF PATIENT MEDICAL INFORMATION DESIGNED TO FACILITATE PATIENT-AUTHORIZED, HIPAA-COMPLIANT SHARING AND MAINTENANCE OF PATIENT MEDICAL INFORMATION AMONGST A PATIENT'S DOCTORS SUCH THAT THIS INFORMATION CAN BE DIRECTLY INSERTED INTO THE DOCTOR'S MEDICAL REPORTS AS A MEANS OF INCREASING MEDICAL RECORD GENERATION EFFICIENCY AND ACCURACY FOR THE PURPOSES UPDATING THE PATIENT'S ELECTRONIC MEDICAL RECORD, IN CLASS 35 (U.S. CLS. 100, 101 AND 102).

SERVICE MARK

SUPPLEMENTAL REGISTER

FIRST USE 5-5-2011; IN COMMERCE 5-5-2011.

FOR: PROVIDING AN INTERNET WEBSITE FOR MEDICAL PROFESSIONALS AND MEDICAL PATIENTS FEATURING PATIENT MEDICAL INFORMATION FROM REMOTE LOCATIONS VIA ELECTRONIC PATIENT MONITORING DEVICES THAT FEED INFORMATION TO THE WEB SITE THAT CAN BE ACCESSED IN REAL TIME BY MEDICAL PROFESSIONALS FOR PURPOSES OF MONITORING AND DIAGNOSING MEDICAL CONDITIONS AND EVALUATING THE PATIENT'S ADHERENCE TO PRESCRIBED MEDICAL ADVICE, IN CLASS 44 (U.S. CLS. 100 AND 101).

FIRST USE 5-5-2011; IN COMMERCE 5-5-2011.

THE MARK CONSISTS OF STANDARD CHARACTERS WITHOUT CLAIM TO ANY PARTICULAR FONT, STYLE, SIZE, OR COLOR.

SER. NO. 85-385,529, FILED 7-31-2011.

Alice Benmaman, Examining Attorney



David J. Kyros

Director of the United States Patent and Trademark Office

United States of America

United States Patent and Trademark Office

BM EVENTS

Reg. No. 4,177,282

Registered July 17, 2012

Int. Cls.: 35 and 44

SERVICE MARK

SUPPLEMENTAL REGISTER

GI TRACK, LLC (INDIANA LIMITED LIABILITY COMPANY)
PO BOX 55245
INDIANAPOLIS, IN 46205

FOR: PROVIDING AN INTERNET-BASED DATABASE OF PATIENT MEDICAL INFORMATION DESIGNED TO FACILITATE PATIENT-AUTHORIZED, HIPAA-COMPLIANT SHARING AND MAINTENANCE OF PATIENT MEDICAL INFORMATION AMONGST A PATIENT'S DOCTORS SUCH THAT THIS INFORMATION CAN BE DIRECTLY INSERTED INTO THE DOCTOR'S MEDICAL REPORTS AS A MEANS OF INCREASING MEDICAL RECORD GENERATION EFFICIENCY AND ACCURACY FOR THE PURPOSES UPDATING THE PATIENT'S ELECTRONIC MEDICAL RECORD, IN CLASS 35 (U.S. CLS. 100, 101 AND 102).

FIRST USE 5-5-2011; IN COMMERCE 5-5-2011.

FOR: PROVIDING AN INTERNET WEBSITE FOR MEDICAL PROFESSIONALS AND MEDICAL PATIENTS FEATURING PATIENT MEDICAL INFORMATION FROM REMOTE LOCATIONS VIA ELECTRONIC PATIENT MONITORING DEVICES THAT FEED INFORMATION TO THE WEB SITE THAT CAN BE ACCESSED IN REAL TIME BY MEDICAL PROFESSIONALS FOR PURPOSES OF MONITORING AND DIAGNOSING MEDICAL CONDITIONS AND EVALUATING THE PATIENT'S ADHERENCE TO PRESCRIBED MEDICAL ADVICE, IN CLASS 44 (U.S. CLS. 100 AND 101).

FIRST USE 5-5-2011; IN COMMERCE 5-5-2011.

THE MARK CONSISTS OF STANDARD CHARACTERS WITHOUT CLAIM TO ANY PARTICULAR FONT, STYLE, SIZE, OR COLOR.

SER. NO. 85-385,530, FILED 7-31-2011.

ALICE BENMAMAN, EXAMINING ATTORNEY



David J. Kypos

Director of the United States Patent and Trademark Office

United States of America

United States Patent and Trademark Office

FOOD EVENTS

Reg. No. 4,177,283

Registered July 17, 2012

Int. Cls.: 35 and 44

SERVICE MARK

SUPPLEMENTAL REGISTER

GI TRACK, LLC (INDIANA LIMITED LIABILITY COMPANY)
PO BOX 55245
INDIANAPOLIS, IN 46205

FOR: PROVIDING AN INTERNET-BASED DATABASE OF PATIENT MEDICAL INFORMATION DESIGNED TO FACILITATE PATIENT-AUTHORIZED, HIPAA-COMPLIANT SHARING AND MAINTENANCE OF PATIENT MEDICAL INFORMATION AMONGST A PATIENT'S DOCTORS SUCH THAT THIS INFORMATION CAN BE DIRECTLY INSERTED INTO THE DOCTOR'S MEDICAL REPORTS AS A MEANS OF INCREASING MEDICAL RECORD GENERATION EFFICIENCY AND ACCURACY FOR THE PURPOSES UPDATING THE PATIENT'S ELECTRONIC MEDICAL RECORD, IN CLASS 35 (U.S. CLS. 100, 101 AND 102).

FIRST USE 5-5-2011; IN COMMERCE 5-5-2011.

FOR: PROVIDING AN INTERNET WEBSITE FOR MEDICAL PROFESSIONALS AND MEDICAL PATIENTS FEATURING PATIENT MEDICAL INFORMATION FROM REMOTE LOCATIONS VIA ELECTRONIC PATIENT MONITORING DEVICES THAT FEED INFORMATION TO THE WEB SITE THAT CAN BE ACCESSED IN REAL TIME BY MEDICAL PROFESSIONALS FOR PURPOSES OF MONITORING AND DIAGNOSING MEDICAL CONDITIONS AND EVALUATING THE PATIENT'S ADHERENCE TO PRESCRIBED MEDICAL ADVICE, IN CLASS 44 (U.S. CLS. 100 AND 101).

FIRST USE 5-5-2011; IN COMMERCE 5-5-2011.

THE MARK CONSISTS OF STANDARD CHARACTERS WITHOUT CLAIM TO ANY PARTICULAR FONT, STYLE, SIZE, OR COLOR.

SER. NO. 85-385,531, FILED 7-31-2011.

ALICE BENMAMAN, EXAMINING ATTORNEY



David J. Kypos

Director of the United States Patent and Trademark Office

United States of America

United States Patent and Trademark Office

HEALTH EVENTS

Reg. No. 4,177,284

Registered July 17, 2012

Int. Cls.: 35 and 44

SERVICE MARK

SUPPLEMENTAL REGISTER

GI TRACK, LLC (INDIANA LIMITED LIABILITY COMPANY)
PO BOX 55245
INDIANAPOLIS, IN 46205

FOR: PROVIDING AN INTERNET-BASED DATABASE OF PATIENT MEDICAL INFORMATION DESIGNED TO FACILITATE PATIENT-AUTHORIZED, HIPAA-COMPLIANT SHARING AND MAINTENANCE OF PATIENT MEDICAL INFORMATION AMONGST A PATIENT'S DOCTORS SUCH THAT THIS INFORMATION CAN BE DIRECTLY INSERTED INTO THE DOCTOR'S MEDICAL REPORTS AS A MEANS OF INCREASING MEDICAL RECORD GENERATION EFFICIENCY AND ACCURACY FOR THE PURPOSES UPDATING THE PATIENT'S ELECTRONIC MEDICAL RECORD, IN CLASS 35 (U.S. CLS. 100, 101 AND 102).

FIRST USE 5-5-2011; IN COMMERCE 5-5-2011.

FOR: PROVIDING AN INTERNET WEBSITE FOR MEDICAL PROFESSIONALS AND MEDICAL PATIENTS FEATURING PATIENT MEDICAL INFORMATION FROM REMOTE LOCATIONS VIA ELECTRONIC PATIENT MONITORING DEVICES THAT FEED INFORMATION TO THE WEB SITE THAT CAN BE ACCESSED IN REAL TIME BY MEDICAL PROFESSIONALS FOR PURPOSES OF MONITORING AND DIAGNOSING MEDICAL CONDITIONS AND EVALUATING THE PATIENT'S ADHERENCE TO PRESCRIBED MEDICAL ADVICE, IN CLASS 44 (U.S. CLS. 100 AND 101).

FIRST USE 5-5-2011; IN COMMERCE 5-5-2011.

THE MARK CONSISTS OF STANDARD CHARACTERS WITHOUT CLAIM TO ANY PARTICULAR FONT, STYLE, SIZE, OR COLOR.

SER. NO. 85-385,532, FILED 7-31-2011.

Alice Benmaman, Examining Attorney



David J. Kyros

Director of the United States Patent and Trademark Office

United States of America

United States Patent and Trademark Office

MEDICATION EVENTS

Reg. No. 4,177,285

Registered July 17, 2012

Int. Cls.: 35 and 44

SERVICE MARK

SUPPLEMENTAL REGISTER

GI TRACK, LLC (INDIANA LIMITED LIABILITY COMPANY)
PO BOX 55245
INDIANAPOLIS, IN 46205

FOR: PROVIDING AN INTERNET-BASED DATABASE OF PATIENT MEDICAL INFORMATION DESIGNED TO FACILITATE PATIENT-AUTHORIZED, HIPAA-COMPLIANT SHARING AND MAINTENANCE OF PATIENT MEDICAL INFORMATION AMONGST A PATIENT'S DOCTORS SUCH THAT THIS INFORMATION CAN BE DIRECTLY INSERTED INTO THE DOCTOR'S MEDICAL REPORTS AS A MEANS OF INCREASING MEDICAL RECORD GENERATION EFFICIENCY AND ACCURACY FOR THE PURPOSES UPDATING THE PATIENT'S ELECTRONIC MEDICAL RECORD, IN CLASS 35 (U.S. CLS. 100, 101 AND 102).

FIRST USE 5-5-2011; IN COMMERCE 5-5-2011.

FOR: PROVIDING AN INTERNET WEBSITE FOR MEDICAL PROFESSIONALS AND MEDICAL PATIENTS FEATURING PATIENT MEDICAL INFORMATION FROM REMOTE LOCATIONS VIA ELECTRONIC PATIENT MONITORING DEVICES THAT FEED INFORMATION TO THE WEB SITE THAT CAN BE ACCESSED IN REAL TIME BY MEDICAL PROFESSIONALS FOR PURPOSES OF MONITORING AND DIAGNOSING MEDICAL CONDITIONS AND EVALUATING THE PATIENT'S ADHERENCE TO PRESCRIBED MEDICAL ADVICE, IN CLASS 44 (U.S. CLS. 100 AND 101).

FIRST USE 5-5-2011; IN COMMERCE 5-5-2011.

THE MARK CONSISTS OF STANDARD CHARACTERS WITHOUT CLAIM TO ANY PARTICULAR FONT, STYLE, SIZE, OR COLOR.

SER. NO. 85-385,533, FILED 7-31-2011.

Alice Benmaman, Examining Attorney



David J. Kyros

Director of the United States Patent and Trademark Office

United States of America

United States Patent and Trademark Office

REMEDY+RECOVERY

Reg. No. 4,177,286

CARDINAL LABORATORIES, INC. (CALIFORNIA CORPORATION)

Registered July 17, 2012

710 S. AYON AVENUE
AZUSA, CA 91702

Int. Cl.: 5

FOR: DOG AND CAT SANITARY PREPARATIONS IN THE NATURE OF BACTERIOSTATS AND ANTI-INFECTIVE PRODUCTS FOR VETERINARY USE; WOUND DRESSING; ALL PURPOSE DISINFECTANTS; PHARMACEUTICAL PREPARATIONS FOR WOUNDS, IN CLASS 5 (U.S. CLS. 6, 18, 44, 46, 51 AND 52).

TRADEMARK

SUPPLEMENTAL REGISTER FIRST USE 2-12-2010; IN COMMERCE 2-12-2010.

THE MARK CONSISTS OF STANDARD CHARACTERS WITHOUT CLAIM TO ANY PARTICULAR FONT, STYLE, SIZE, OR COLOR.

SER. NO. 85-385,989, FILED P.R. 8-1-2011; AM. S.R. 5-21-2012.

KAREN BRACEY, EXAMINING ATTORNEY



David J. Kyffers

Director of the United States Patent and Trademark Office

United States of America

United States Patent and Trademark Office

GOLFCITRUSCLEAN

Reg. No. 4,177,287

HARPER III, GEORGE L. (UNITED STATES INDIVIDUAL)
165 BRENTWOOD AVENUE
TONKA BAY, MN 55331

Registered July 17, 2012

Int. Cl.: 3

FOR: GOLF CLUB AND GOLF BALL CLEANING SOLUTION, IN CLASS 3 (U.S. CLS. 1, 4, 6, 50, 51 AND 52).

TRADEMARK

FIRST USE 7-1-2011; IN COMMERCE 7-1-2011.

SUPPLEMENTAL REGISTER

THE MARK CONSISTS OF STANDARD CHARACTERS WITHOUT CLAIM TO ANY PARTICULAR FONT, STYLE, SIZE, OR COLOR.

SER. NO. 85-386,000, FILED P.R. 8-1-2011; AM. S.R. 5-22-2012.

ANDREA HACK, EXAMINING ATTORNEY



David J. Kybas

Director of the United States Patent and Trademark Office

United States of America

United States Patent and Trademark Office

VERIFIED CARBON UNIT

Reg. No. 4,177,288

Registered July 17, 2012

Int. Cl.: 45

CERTIFICATION MARK

SERVICES

SUPPLEMENTAL REGISTER

VERIFIED CARBON STANDARD ASSOCIATION (D.C. NON-PROFIT CORPORATION)
SUITE 803
1730 RHODE ISLAND AVENUE, NW
WASHINGTON, DC 20036

FOR: AGRICULTURAL OPERATIONS SERVICES, TIMBER AND FORESTRY SERVICES, WASTE MANAGEMENT SERVICES, ENERGY PRODUCTION SERVICES, ENERGY DISTRIBUTION SERVICES, TRANSPORTATION SERVICES, MINING OPERATIONS SERVICES, INDUSTRIAL MANUFACTURING SERVICES, IN CLASS B (U.S. CL. B).

FIRST USE 0-0-2006; IN COMMERCE 0-0-2006.

THE MARK CONSISTS OF STANDARD CHARACTERS WITHOUT CLAIM TO ANY PARTICULAR FONT, STYLE, SIZE, OR COLOR.

THE CERTIFICATION MARK, AS USED BY PERSONS AUTHORIZED BY THE CERTIFIER, CERTIFIES THAT THE SERVICES PROVIDED HAVE BEEN PERFORMED IN A MANNER THAT ONE METRIC TON OF CARBON DIOXIDE EQUIVALENT HAS BEEN REDUCED OR REMOVED FROM THE ATMOSPHERE, AS INDEPENDENTLY VALIDATED AND VERIFIED IN ACCORDANCE WITH THE RULES, PROCEDURES AND REQUIREMENTS ESTABLISHED BY THE CERTIFIER.

SER. NO. 85-386,336, FILED P.R. 8-1-2011; AM. S.R. 5-22-2012.

JIM RINGLE, EXAMINING ATTORNEY



David J. Kybas

Director of the United States Patent and Trademark Office

United States of America

United States Patent and Trademark Office

Anglican Mission in the Americas

Reg. No. 4,177,289

THE ANGLICAN MISSION IN AMERICA (ILLINOIS NON-PROFIT CORPORATION)
297 WILLBROOK BLVD.

Registered July 17, 2012

PAWLEYS ISLAND, SC 29585

Int. Cl.: 45

FOR: RELIGIOUS MINISTERIAL SERVICES, NAMELY, EVANGELISM, MISSIONARY SERVICES, AND PROVIDING RELIGIOUS AND MINISTERIAL INFORMATION CONCERNING MISSIONARIES, MISSIONS, AND MISSIONARY PROJECTS, IN CLASS 45 (U.S. CLS. 100 AND 101).

SERVICE MARK

SUPPLEMENTAL REGISTER FIRST USE 1-0-2007; IN COMMERCE 1-0-2007.

THE MARK CONSISTS OF STANDARD CHARACTERS WITHOUT CLAIM TO ANY PARTICULAR FONT, STYLE, SIZE, OR COLOR.

SER. NO. 85-386,898, FILED P.R. 8-2-2011; AM. S.R. 5-25-2012.

JAMES LOVELACE, EXAMINING ATTORNEY



David J. Kyfos

Director of the United States Patent and Trademark Office

United States of America

United States Patent and Trademark Office

Anglican Mission in America

Reg. No. 4,177,290

THE ANGLICAN MISSION IN AMERICA (ILLINOIS NON-PROFIT CORPORATION)
297 WILLBROOK BLVD.

Registered July 17, 2012

PAWLEYS ISLAND, SC 29585

Int. Cl.: 45

FOR: RELIGIOUS MINISTERIAL SERVICES, NAMELY, EVANGELISM, MISSIONARY SERVICES, AND PROVIDING RELIGIOUS AND MINISTERIAL INFORMATION CONCERNING MISSIONARIES, MISSIONS, AND MISSIONARY PROJECTS, IN CLASS 45 (U.S. CLS. 100 AND 101).

SERVICE MARK

SUPPLEMENTAL REGISTER FIRST USE 7-0-2000; IN COMMERCE 7-0-2000.

THE MARK CONSISTS OF STANDARD CHARACTERS WITHOUT CLAIM TO ANY PARTICULAR FONT, STYLE, SIZE, OR COLOR.

SER. NO. 85-386,930, FILED P.R. 8-2-2011; AM. S.R. 5-25-2012.

JAMES LOVELACE, EXAMINING ATTORNEY



David J. Kyffers

Director of the United States Patent and Trademark Office

United States of America

United States Patent and Trademark Office

Anglican Mission

Reg. No. 4,177,291

THE ANGLICAN MISSION IN AMERICA (ILLINOIS NON-PROFIT CORPORATION)
297 WILLBROOK BLVD.

Registered July 17, 2012

PAWLEYS ISLAND, SC 29585

Int. Cl.: 45

FOR: RELIGIOUS MINISTERIAL SERVICES, NAMELY, EVANGELISM, MISSIONARY SERVICES, AND PROVIDING RELIGIOUS AND MINISTERIAL INFORMATION CONCERNING MISSIONARIES, MISSIONS, AND MISSIONARY PROJECTS, IN CLASS 45 (U.S. CLS. 100 AND 101).

SERVICE MARK

SUPPLEMENTAL REGISTER FIRST USE 7-0-2000; IN COMMERCE 7-0-2000.

THE MARK CONSISTS OF STANDARD CHARACTERS WITHOUT CLAIM TO ANY PARTICULAR FONT, STYLE, SIZE, OR COLOR.

SER. NO. 85-387,005, FILED P.R. 8-2-2011; AM. S.R. 5-25-2012.

JAMES LOVELACE, EXAMINING ATTORNEY



David J. Kyffers

Director of the United States Patent and Trademark Office

United States of America

United States Patent and Trademark Office

SWEET COUNTRY CORN MUFFINS

Reg. No. 4,177,292

UNCLE WALLY'S LLC (NEW YORK CORPORATION)
41 NATCON DRIVE
SHIRLEY, NY 11967

Registered July 17, 2012

Int. Cl.: 30

FOR: MUFFINS, IN CLASS 30 (U.S. CL. 46).

TRADEMARK

FIRST USE 0-0-2011; IN COMMERCE 0-0-2011.

SUPPLEMENTAL REGISTER

THE MARK CONSISTS OF STANDARD CHARACTERS WITHOUT CLAIM TO ANY PARTICULAR FONT, STYLE, SIZE, OR COLOR.

NO CLAIM IS MADE TO THE EXCLUSIVE RIGHT TO USE "CORN MUFFINS", APART FROM THE MARK AS SHOWN.

SER. NO. 85-387,352, FILED P.R. 8-2-2011; AM. S.R. 5-3-2012.

BRIAN CALLAGHAN, EXAMINING ATTORNEY



David J. Kyffers

Director of the United States Patent and Trademark Office

United States of America

United States Patent and Trademark Office

FAST INSTALL

Reg. No. 4,177,293

FEULING OIL PUMP CORPORATION (CALIFORNIA CORPORATION)
17215 ROPER STREET
MOJAVE, CA 93501

Registered July 17, 2012

Int. Cl.: 7

FOR: VEHICLE ENGINE PARTS, NAMELY, PUSH RODS, IN CLASS 7 (U.S. CLS. 13, 19, 21, 23, 31, 34 AND 35).

TRADEMARK

FIRST USE 4-21-2010; IN COMMERCE 4-21-2010.

SUPPLEMENTAL REGISTER

THE MARK CONSISTS OF STANDARD CHARACTERS WITHOUT CLAIM TO ANY PARTICULAR FONT, STYLE, SIZE, OR COLOR.

SER. NO. 85-390,767, FILED P.R. 8-5-2011; AM. S.R. 5-21-2012.

SANDRA BUJA, EXAMINING ATTORNEY



David J. Kyffers

Director of the United States Patent and Trademark Office

United States of America

United States Patent and Trademark Office

INSTITUTE FOR MOLECULAR NEUROSCIENCE

Reg. No. 4,177,294

ERNEST GALLO CLINIC AND RESEARCH CENTER (CALIFORNIA CORPORATION)
5858 HORTON STREET, SUITE 200
EMERYVILLE, CA 94608

Registered July 17, 2012

Int. Cl.: 42

FOR: BIOMEDICAL RESEARCH SERVICES, IN CLASS 42 (U.S. CLS. 100 AND 101).

SERVICE MARK

FIRST USE 4-23-2012; IN COMMERCE 5-3-2012.

SUPPLEMENTAL REGISTER

THE MARK CONSISTS OF STANDARD CHARACTERS WITHOUT CLAIM TO ANY PARTICULAR FONT, STYLE, SIZE, OR COLOR.

NO CLAIM IS MADE TO THE EXCLUSIVE RIGHT TO USE "INSTITUTE", APART FROM THE MARK AS SHOWN.

SER. NO. 85-391,554, FILED P.R. 8-6-2011; AM. S.R. 5-22-2012.

ANDREW LEASER, EXAMINING ATTORNEY



David J. Kyjars

Director of the United States Patent and Trademark Office

United States of America

United States Patent and Trademark Office

Kiso Method

Reg. No. 4,177,295

CAIN, CRAIG (UNITED STATES INDIVIDUAL)
54 WAIANUENUE AVENUE
HILO, HI 96720

Registered July 17, 2012

Int. Cl.: 16

FOR: BOOKS IN THE FIELD OF PHYSICAL HEALING TECHNIQUES; MANUALS IN THE FIELD OF PHYSICAL HEALING TECHNIQUES, IN CLASS 16 (U.S. CLS. 2, 5, 22, 23, 29, 37, 38 AND 50).

TRADEMARK

FIRST USE 1-1-2007; IN COMMERCE 1-1-2007.

SUPPLEMENTAL REGISTER

THE MARK CONSISTS OF STANDARD CHARACTERS WITHOUT CLAIM TO ANY PARTICULAR FONT, STYLE, SIZE, OR COLOR.

NO CLAIM IS MADE TO THE EXCLUSIVE RIGHT TO USE "METHOD", APART FROM THE MARK AS SHOWN.

THE WORDING "KISO" HAS NO MEANING IN A FOREIGN LANGUAGE.

SER. NO. 85-394,614, FILED P.R. 8-10-2011; AM. S.R. 5-21-2012.

JOHN DALIER, EXAMINING ATTORNEY



David J. Kyffers

Director of the United States Patent and Trademark Office

United States of America

United States Patent and Trademark Office

HIGH-HIMALAYAN BLACK

Shilajit

Reg. No. 4,177,296

Registered July 17, 2012

Int. Cl.: 5

TRADEMARK

SUPPLEMENTAL REGISTER

THE TRUSTEE OF THE PROGRESSIVE TECHNOLOGIES TRUST (NEVADA TRUST)
#109-163
8370 WEST CHEYENNE AVENUE
LAS VEGAS, NV 89129

FOR: DIETARY AND NUTRITIONAL SUPPLEMENTS; MINERAL NUTRITIONAL SUPPLEMENTS; NUTRACEUTICALS FOR USE AS A DIETARY SUPPLEMENT; NUTRITIONAL SUPPLEMENTS; ALL OF THE FOREGOING CONTAINING BLACK SHILAJIT, IN CLASS 5 (U.S. CLS. 6, 18, 44, 46, 51 AND 52).

FIRST USE 2-1-2010; IN COMMERCE 5-1-2011.

NO CLAIM IS MADE TO THE EXCLUSIVE RIGHT TO USE "BLACK SHILAJIT", APART FROM THE MARK AS SHOWN.

THE COLOR(S) RED AND BLACK IS/ARE CLAIMED AS A FEATURE OF THE MARK.

THE MARK CONSISTS OF THE WORDS "HIGH-HIMALAYAN BLACK SHILAJIT" AS SHOWN WITH THE FIRST THREE WORDS STACKED ATOP "SHILAJIT" IN THE SUGGESTIVE TYPEFACE, THE WORDS "HIGH-HIMALAYAN BLACK" APPEAR IN BLACK AND THE WORD "SHILAJIT" APPEARS IN RED AND OUTLINED IN BLACK.

SER. NO. 85-394,894, FILED P.R. 8-10-2011; AM. S.R. 11-15-2011.

CHRISTINA SOBRAL, EXAMINING ATTORNEY



David J. Kyros

Director of the United States Patent and Trademark Office

United States of America

United States Patent and Trademark Office

BOOK WEDGE

Reg. No. 4,177,297

CYPRESS CREEK MARKETING (TEXAS LIMITED PARTNERSHIP)
400 LEDGEROCK ROAD
WIMBERLEY, TX 78676

Registered July 17, 2012

Int. Cl.: 20

FOR: BOOK STANDS, IN CLASS 20 (U.S. CLS. 2, 13, 22, 25, 32 AND 50).

TRADEMARK

FIRST USE 2-9-2012; IN COMMERCE 2-9-2012.

SUPPLEMENTAL REGISTER

THE MARK CONSISTS OF STANDARD CHARACTERS WITHOUT CLAIM TO ANY PARTICULAR FONT, STYLE, SIZE, OR COLOR.

SER. NO. 85-396,554, FILED P.R. 8-12-2011; AM. S.R. 5-18-2012.

LINDSEY RUBIN, EXAMINING ATTORNEY



David J. Kybas

Director of the United States Patent and Trademark Office

United States of America

United States Patent and Trademark Office

Functional Movement Systems

Reg. No. 4,177,298

Registered July 17, 2012

Int. Cls.: 9 and 28

TRADEMARK

SUPPLEMENTAL REGISTER

FUNCTIONAL MOVEMENT SYSTEMS, INC. (VIRGINIA CORPORATION)
47 DEPOT STREET
CHATHAM, VA 24531

FOR: MEASURING STICKS, NAMELY, APPARATUS COMPRISING GRADUATED RULERS TO MEASURE AN INDIVIDUAL'S MOVEMENT DURING PHYSICAL FITNESS EXERCISES; BALANCE MEASURING DEVICE COMPRISING GRADUATED RULERS TO MEASURE AN INDIVIDUAL'S BALANCE AND AGILITY DURING PHYSICAL FITNESS EXERCISES, IN CLASS 9 (U.S. CLS. 21, 23, 26, 36 AND 38).

FIRST USE 6-0-2009; IN COMMERCE 6-0-2009.

FOR: MANUALLY-OPERATED EXERCISE EQUIPMENT; PHYSICAL FITNESS EQUIPMENT, NAMELY, HURDLES, IN CLASS 28 (U.S. CLS. 22, 23, 38 AND 50).

FIRST USE 6-0-2009; IN COMMERCE 6-0-2009.

THE MARK CONSISTS OF STANDARD CHARACTERS WITHOUT CLAIM TO ANY PARTICULAR FONT, STYLE, SIZE, OR COLOR.

NO CLAIM IS MADE TO THE EXCLUSIVE RIGHT TO USE "SYSTEMS", APART FROM THE MARK AS SHOWN.

SER. NO. 85-400,354, FILED P.R. 8-17-2011; AM. S.R. 5-17-2012.

ADA HAN, EXAMINING ATTORNEY



David J. Kyffers

Director of the United States Patent and Trademark Office

United States of America

United States Patent and Trademark Office

Linesheet Maker

Reg. No. 4,177,299

FRIED, MATTHEW (UNITED STATES INDIVIDUAL)
167 ELDRIDGE STREET, #3C
NEW YORK, NY 10002

Registered July 17, 2012

Int. Cl.: 42

FOR: PROVIDING TEMPORARY USE OF A WEB-BASED SOFTWARE APPLICATION FOR DATABASE MANAGEMENT, IN CLASS 42 (U.S. CLS. 100 AND 101).

SERVICE MARK

FIRST USE 6-8-2011; IN COMMERCE 6-8-2011.

SUPPLEMENTAL REGISTER

THE MARK CONSISTS OF STANDARD CHARACTERS WITHOUT CLAIM TO ANY PARTICULAR FONT, STYLE, SIZE, OR COLOR.

SER. NO. 85-402,812, FILED P.R. 8-19-2011; AM. S.R. 5-21-2012.

ALEX KEAM, EXAMINING ATTORNEY



David J. Kybas

Director of the United States Patent and Trademark Office

United States of America

United States Patent and Trademark Office

SLIDELOCK

Reg. No. 4,177,300

JPJ INVESTMENT HOLDING CORP. (NEVADA CORPORATION)
18051 ARENTH AVENUE
CITY OF INDUSTRY, CA 91748

Registered July 17, 2012

Int. Cl.: 8

FOR: HAND TOOLS, NAMELY, KNIVES AND UTILITY KNIVES, IN CLASS 8 (U.S. CLS. 23, 28 AND 44).

TRADEMARK

FIRST USE 4-11-2012; IN COMMERCE 4-11-2012.

SUPPLEMENTAL REGISTER

THE MARK CONSISTS OF STANDARD CHARACTERS WITHOUT CLAIM TO ANY PARTICULAR FONT, STYLE, SIZE, OR COLOR.

SER. NO. 85-403,977, FILED P.R. 8-22-2011; AM. S.R. 4-30-2012.

FLORENTINA BLANDU, EXAMINING ATTORNEY



David J. Kybas

Director of the United States Patent and Trademark Office

United States of America

United States Patent and Trademark Office

sundaskool clothing co.

Reg. No. 4,177,301

NORMAN, TRAVIS (UNITED STATES INDIVIDUAL)
2908 WALLSEND DRIVE
WATERFORD, MI 48329

Registered July 17, 2012

Int. Cl.: 25

FOR: CLOTHING, NAMELY, T-SHIRTS, HEADWEAR, SCARVES, JEANS, SWEATERS, TRACK SUITS, JOGGING SUITS, SWEATSHIRTS, COATS, JACKETS, HEADBANDS, TIES, SHAWLS, GLOVES, UNDERWEAR, SOCKS, BRAS, SHIRTS, SHORTS, SWIMWEAR, PANTS, ARM WARMERS, HAND WARMERS, SHOES, BELTS, SUSPENDERS, SKIRTS, SKORTS, DRESSES, SKIWEAR, TANK TOPS, AND JERSEYS, IN CLASS 25 (U.S. CLS. 22 AND 39).

TRADEMARK

SUPPLEMENTAL REGISTER

FIRST USE 8-3-2011; IN COMMERCE 8-3-2011.

THE MARK CONSISTS OF STANDARD CHARACTERS WITHOUT CLAIM TO ANY PARTICULAR FONT, STYLE, SIZE, OR COLOR.

NO CLAIM IS MADE TO THE EXCLUSIVE RIGHT TO USE "CLOTHING CO.", APART FROM THE MARK AS SHOWN.

SER. NO. 85-404,650, FILED P.R. 8-23-2011; AM. S.R. 5-24-2012.

HEATHER THOMPSON, EXAMINING ATTORNEY



David J. Kyros

Director of the United States Patent and Trademark Office

United States of America

United States Patent and Trademark Office

FLYING STANDBY

Reg. No. 4,177,302

JOSH SPEAR LLC (CONNECTICUT LIMITED LIABILITY COMPANY)
87 CATHOLE ROAD
BANTAM, CT 06750

Registered July 17, 2012

Int. Cl.: 41

FOR: ON-LINE JOURNALS, NAMELY, BLOGS, FEATURING TRAVEL; PROVIDING ON-LINE NEWSLETTERS IN THE FIELD OF TRAVEL AND TRAVEL-RELATED GOODS AND SERVICES, IN CLASS 41 (U.S. CLS. 100, 101 AND 107).

SERVICE MARK

FIRST USE 2-1-2012; IN COMMERCE 2-1-2012.

SUPPLEMENTAL REGISTER

THE MARK CONSISTS OF STANDARD CHARACTERS WITHOUT CLAIM TO ANY PARTICULAR FONT, STYLE, SIZE, OR COLOR.

SER. NO. 85-404,907, FILED P.R. 8-23-2011; AM. S.R. 5-31-2012.

WILLIAM P. SHANAHAN, EXAMINING ATTORNEY



David J. Kyros

Director of the United States Patent and Trademark Office

United States of America

United States Patent and Trademark Office

VALACH MOTORS

Reg. No. 4,177,303

VOGELSANG AEROSCALE (NORTH CAROLINA LIMITED LIABILITY COMPANY)
372 LEGACY FALLS DRIVE NORTH
CHAPEL HILL, NC 27517

Registered July 17, 2012

Int. Cl.: 28

FOR: TOY MODEL MINIATURE ENGINES, IN CLASS 28 (U.S. CLS. 22, 23, 38 AND 50).

FIRST USE 7-5-2009; IN COMMERCE 7-5-2009.

TRADEMARK

THE MARK CONSISTS OF STANDARD CHARACTERS WITHOUT CLAIM TO ANY PARTICULAR FONT, STYLE, SIZE, OR COLOR.

SUPPLEMENTAL REGISTER

NO CLAIM IS MADE TO THE EXCLUSIVE RIGHT TO USE "MOTORS", APART FROM THE MARK AS SHOWN.

SER. NO. 85-407,725, FILED P.R. 8-25-2011; AM. S.R. 5-29-2012.

HAI-LY LAM, EXAMINING ATTORNEY



David J. Kyffers

Director of the United States Patent and Trademark Office

United States of America

United States Patent and Trademark Office

Orinoco 1613

Reg. No. 4,177,304

BERRYHILL, WENDELL WADE (UNITED STATES INDIVIDUAL)
2530 FOUNDERS BRIDGE ROAD
MIDLOTHIAN, VA 23113

Registered July 17, 2012

Int. Cl.: 34

FOR: CIGARS, IN CLASS 34 (U.S. CLS. 2, 8, 9 AND 17).

TRADEMARK

FIRST USE 5-1-2012; IN COMMERCE 5-1-2012.

SUPPLEMENTAL REGISTER

THE MARK CONSISTS OF STANDARD CHARACTERS WITHOUT CLAIM TO ANY PARTICULAR FONT, STYLE, SIZE, OR COLOR.

NO CLAIM IS MADE TO THE EXCLUSIVE RIGHT TO USE "ORINOCO", APART FROM THE MARK AS SHOWN.

SER. NO. 85-409,844, FILED P.R. 8-29-2011; AM. S.R. 5-16-2012.

ANTHONY RINKER, EXAMINING ATTORNEY



David J. Kybas

Director of the United States Patent and Trademark Office

United States of America

United States Patent and Trademark Office

APPLICATION TRANSPARENCY PLATFORM

Reg. No. 4,177,305

SOPHISTICATED BUSINESS SYSTEMS, INC. (TEXAS CORPORATION), DBA ATERAS,
660 LBJ FREEWAY, SUITE 210
DALLAS, TX 75240

Registered July 17, 2012

Int. Cls.: 9 and 42

FOR: COMPUTER SOFTWARE FOR MIGRATION AND MODERNIZATION OF EXISTING
ELECTRONIC DATA AND APPLICATIONS , IN CLASS 9 (U.S. CLS. 21, 23, 26, 36 AND 38).

TRADEMARK

FIRST USE 7-29-2011; IN COMMERCE 7-29-2011.

SERVICE MARK

FOR: COMPUTER SERVICES, NAMELY, PROVIDING MIGRATION AND MODERNIZATION
OF EXISTING ELECTRONIC DATA AND APPLICATIONS, IN CLASS 42 (U.S. CLS. 100
AND 101).

SUPPLEMENTAL REGISTER

FIRST USE 7-29-2011; IN COMMERCE 7-29-2011.

THE MARK CONSISTS OF STANDARD CHARACTERS WITHOUT CLAIM TO ANY PAR-
TICULAR FONT, STYLE, SIZE, OR COLOR.

SER. NO. 85-410,850, FILED P.R. 8-30-2011; AM. S.R. 5-7-2012.

LEIGH CAROLINE CASE, EXAMINING ATTORNEY



David J. Kypos

Director of the United States Patent and Trademark Office

United States of America

United States Patent and Trademark Office

AUTOSTEAM

Reg. No. 4,177,306

SUSSMAN-AUTOMATIC CORPORATION (NEW YORK CORPORATION)
43-20 34TH STREET

Registered July 17, 2012

LONG ISLAND CITY, NY 11101

Int. Cl.: 11

FOR: STEAM BATHS FOR RESIDENTIAL AND COMMERCIAL USE, IN CLASS 11 (U.S. CLS. 13, 21, 23, 31 AND 34).

TRADEMARK

FIRST USE 9-23-2011; IN COMMERCE 9-23-2011.

SUPPLEMENTAL REGISTER

THE MARK CONSISTS OF STANDARD CHARACTERS WITHOUT CLAIM TO ANY PARTICULAR FONT, STYLE, SIZE, OR COLOR.

SER. NO. 85-412,058, FILED P.R. 8-31-2011; AM. S.R. 5-22-2012.

CORY BOONE, EXAMINING ATTORNEY



David J. Kyffers

Director of the United States Patent and Trademark Office

United States of America

United States Patent and Trademark Office

White Trash Royalty

Reg. No. 4,177,307

SKEFFINGTON, STEVE (UNITED STATES INDIVIDUAL)
19386 HIGH RIDGE WAY
TRABUCO CANYON, CA 92679 AND

Registered July 17, 2012

Int. Cl.: 25

SKEFFINGTON, NICK (UNITED STATES INDIVIDUAL)
19386 HIGH RIDGE WAY
TRABUCO CANYON, CA 92679 AND

TRADEMARK

SUPPLEMENTAL REGISTER

SKEFFINGTON, SAVANNAH (UNITED STATES INDIVIDUAL)
19386 HIGH RIDGE WAY
TRABUCO CANYON, CA 92679

FOR: PANTIES; SHIRTS; SHORTS, IN CLASS 25 (U.S. CLS. 22 AND 39).

FIRST USE 12-31-2000; IN COMMERCE 12-31-2000.

THE MARK CONSISTS OF STANDARD CHARACTERS WITHOUT CLAIM TO ANY PARTICULAR FONT, STYLE, SIZE, OR COLOR.

SER. NO. 85-413,482, FILED P.R. 9-1-2011; AM. S.R. 5-18-2012.

LEIGH LOWRY, EXAMINING ATTORNEY



David J. Kyffers

Director of the United States Patent and Trademark Office

United States of America

United States Patent and Trademark Office

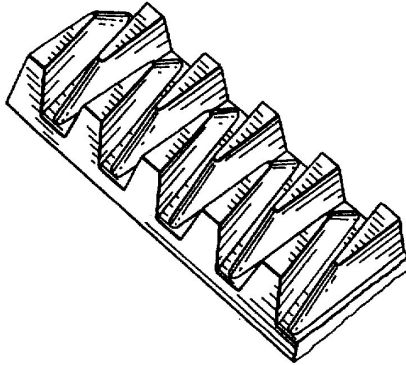

Reg. No. 4,177,308

Registered July 17, 2012

Int. Cl.: 30

TRADEMARK

SUPPLEMENTAL REGISTER

FEDERATION OF MIGROS COOPERATIVES (SWITZERLAND CORPORATION)
LIMMATSTRASSE 152
ZURICH, SWITZERLAND CH-8031

FOR: CHOCOLATE, IN CLASS 30 (U.S. CL. 46).

OWNER OF SWITZERLAND REG. NO. P-457471, DATED 12-23-1998, EXPIRES 6-26-2018.

THE MARK CONSISTS OF A THREE-DIMENSIONAL CONFIGURATION OF A CHOCOLATE BAR COMPRISING A RECTANGULAR BASE WITH RAISED CONTIGUOUS TRIANGULAR SEGMENTS, EACH SEGMENT FACING IN A DIRECTION OPPOSITE FROM ITS ADJACENT SEGMENTS. THE LINING IN THE DRAWING IS FOR SHADING PURPOSES ONLY.

SER. NO. 85-416,750, FILED P.R. 9-7-2011; AM. S.R. 4-23-2012.

TARA PATE, EXAMINING ATTORNEY



David J. Kybas

Director of the United States Patent and Trademark Office

United States of America

United States Patent and Trademark Office

WORKKIT

Reg. No. 4,177,309

CHICO'S BRANDS INVESTMENTS, INC. (FLORIDA CORPORATION)
11215 METRO PARKWAY
FORT MYERS, FL 33966

Registered July 17, 2012

Int. Cl.: 25

FOR: WOMEN'S APPAREL, NAMELY, TOPS, SHIRTS, BLOUSES, CARDIGANS, SWEATERS, JACKETS, SHELL JACKETS, CAMISOLES, BOTTOMS, PANTS, TROUSERS, SKIRTS, DRESSES, COATS, TRENCH COATS, PEACOATS, SUITS, SHOES, IN CLASS 25 (U.S. CLS. 22 AND 39).

TRADEMARK

SUPPLEMENTAL REGISTER FIRST USE 3-0-2011; IN COMMERCE 3-0-2011.

THE MARK CONSISTS OF STANDARD CHARACTERS WITHOUT CLAIM TO ANY PARTICULAR FONT, STYLE, SIZE, OR COLOR.

SER. NO. 85-419,932, FILED P.R. 9-12-2011; AM. S.R. 5-22-2012.

ANTHONY RINKER, EXAMINING ATTORNEY



David J. Kyffers

Director of the United States Patent and Trademark Office

United States of America

United States Patent and Trademark Office

"THE ITALIAN FETA"

Reg. No. 4,177,310

BELGIOIOSO CHEESE, INC. (DELAWARE CORPORATION)
4200 MAIN STREET
GREEN BAY, WI 54311

Registered July 17, 2012

Int. Cl.: 29

FOR: CHEESE, IN CLASS 29 (U.S. CL. 46).

TRADEMARK

FIRST USE 1-31-2011; IN COMMERCE 1-31-2011.

SUPPLEMENTAL REGISTER

THE MARK CONSISTS OF STANDARD CHARACTERS WITHOUT CLAIM TO ANY PARTICULAR FONT, STYLE, SIZE, OR COLOR.

NO CLAIM IS MADE TO THE EXCLUSIVE RIGHT TO USE "FETA", APART FROM THE MARK AS SHOWN.

SER. NO. 85-426,153, FILED P.R. 9-19-2011; AM. S.R. 4-25-2012.

KRISTIN CARLSON, EXAMINING ATTORNEY



David J. Kybas

Director of the United States Patent and Trademark Office

United States of America

United States Patent and Trademark Office

FLASH VIRTUALIZATION

Reg. No. 4,177,311

Registered July 17, 2012

Int. Cl.: 9

TRADEMARK

SUPPLEMENTAL REGISTER

SANDISK ENTERPRISE IP LLC (TEXAS LIMITED LIABILITY COMPANY)
C/O SANDISK CORPORATION
601 MCCARTHY BLVD.
MILPITAS, CA 95035

FOR: FLASH-MEMORY RELATED COMPUTER SOFTWARE FOR USE IN ACCELERATING THE PERFORMANCE AND INCREASING THE SCALABILITY OF COMPUTING PLATFORMS, IN CLASS 9 (U.S. CLS. 21, 23, 26, 36 AND 38).

FIRST USE 7-0-2011; IN COMMERCE 7-0-2011.

THE MARK CONSISTS OF STANDARD CHARACTERS WITHOUT CLAIM TO ANY PARTICULAR FONT, STYLE, SIZE, OR COLOR.

SER. NO. 85-427,023, FILED P.R. 9-20-2011; AM. S.R. 5-17-2012.

WENDY GOODMAN, EXAMINING ATTORNEY



David J. Kyffers

Director of the United States Patent and Trademark Office

United States of America

United States Patent and Trademark Office

SPORTS BUSINESS AWARDS

Reg. No. 4,177,312

AMERICAN CITY BUSINESS JOURNALS, INC. (DELAWARE CORPORATION)
120 WEST MOREHEAD STREET
CHARLOTTE, NC 28202

Registered July 17, 2012

Int. Cl.: 41

FOR: ENTERTAINMENT AND EDUCATIONAL SERVICES NAMELY, ORGANIZING, PRODUCING AND CONDUCTING LECTURES, EXHIBITIONS, SEMINARS, CONFERENCES AND MEETINGS IN THE FIELD OF SPORTS, IN CLASS 41 (U.S. CLS. 100, 101 AND 107).

SERVICE MARK

FIRST USE 10-1-2007; IN COMMERCE 10-1-2007.

SUPPLEMENTAL REGISTER

THE MARK CONSISTS OF STANDARD CHARACTERS WITHOUT CLAIM TO ANY PARTICULAR FONT, STYLE, SIZE, OR COLOR.

NO CLAIM IS MADE TO THE EXCLUSIVE RIGHT TO USE "AWARDS", APART FROM THE MARK AS SHOWN.

SER. NO. 85-434,941, FILED 9-29-2011.

LINDA ORNDORFF, EXAMINING ATTORNEY



David J. Kyjars

Director of the United States Patent and Trademark Office

United States of America

United States Patent and Trademark Office

TRADEMARK ATTORNEY

Reg. No. 4,177,313

MANDOUR & ASSOCIATES, APC (CALIFORNIA CORPORATION)
16870 WEST BERNARDO DRIVE, SUITE 400
SAN DIEGO, CA 92127

Registered July 17, 2012

Int. Cl.: 45

FOR: NEWS REPORTING AND EXPERT LEGAL COMMENTARY SERVICES IN THE FIELD OF LEGAL NEWS, IN CLASS 45 (U.S. CLS. 100 AND 101).

SERVICE MARK

FIRST USE 9-30-2011; IN COMMERCE 9-30-2011.

SUPPLEMENTAL REGISTER

THE MARK CONSISTS OF STANDARD CHARACTERS WITHOUT CLAIM TO ANY PARTICULAR FONT, STYLE, SIZE, OR COLOR.

SER. NO. 85-436,826, FILED P.R. 9-30-2011; AM. S.R. 4-30-2012.

BERYL GARDNER, EXAMINING ATTORNEY



David J. Kyffers

Director of the United States Patent and Trademark Office

United States of America

United States Patent and Trademark Office

WOOD ESSENCE

Reg. No. 4,177,314

SMITH MOUNTAIN INDUSTRIES, INC. (DELAWARE CORPORATION)
1000 DILLARD DRIVE
FOREST, VA 24551

Registered July 17, 2012

Int. Cl.: 4

FOR: CANDLES, IN CLASS 4 (U.S. CLS. 1, 6 AND 15).

TRADEMARK

FIRST USE 12-28-2011; IN COMMERCE 12-28-2011.

SUPPLEMENTAL REGISTER

THE MARK CONSISTS OF STANDARD CHARACTERS WITHOUT CLAIM TO ANY PARTICULAR FONT, STYLE, SIZE, OR COLOR.

SER. NO. 85-438,708, FILED P.R. 10-4-2011; AM. S.R. 5-11-2012.

DOMINICK J. SALEMI, EXAMINING ATTORNEY



David J. Kyffers

Director of the United States Patent and Trademark Office

United States of America

United States Patent and Trademark Office

CONTENT HUB

Reg. No. 4,177,315

ENTROPYSOFT SAS (FRANCE SOCIÉTÉ PAR ACTIONS SIMPLIFIÉE (SAS))
10, RUE D'UZÈS
75002 PARIS, FRANCE

Registered July 17, 2012

Int. Cl.: 9

FOR: COMPUTER SOFTWARE FOR INTEGRATING AND MANAGING UNSTRUCTURED DATA, IN CLASS 9 (U.S. CLS. 21, 23, 26, 36 AND 38).

TRADEMARK

FIRST USE 8-0-2009; IN COMMERCE 8-0-2010.

SUPPLEMENTAL REGISTER

THE MARK CONSISTS OF STANDARD CHARACTERS WITHOUT CLAIM TO ANY PARTICULAR FONT, STYLE, SIZE, OR COLOR.

SER. NO. 85-452,922, FILED P.R. 10-21-2011; AM. S.R. 3-28-2012.

ANTHONY RINKER, EXAMINING ATTORNEY



David J. Kybas

Director of the United States Patent and Trademark Office

United States of America

United States Patent and Trademark Office

HD AIR

Reg. No. 4,177,316

MAKE-UP DESIGNORY (CALIFORNIA CORPORATION)
25311 AVENUE STANFORD
VALENCIA, CA 91355

Registered July 17, 2012

Int. Cl.: 3

FOR: LIQUID COSMETICS AND MAKE-UP, NAMELY, FOUNDATIONS, CONCEALERS, HIGHLIGHTS, SHADOWS, CHEEK COLORS, LIPSTICK, EYE COLORS, EYE LINER, AND BLUSH, IN CLASS 3 (U.S. CLS. 1, 4, 6, 50, 51 AND 52).

TRADEMARK

FIRST USE 10-19-2011; IN COMMERCE 10-19-2011.

SUPPLEMENTAL REGISTER

THE MARK CONSISTS OF STANDARD CHARACTERS WITHOUT CLAIM TO ANY PARTICULAR FONT, STYLE, SIZE, OR COLOR.

SER. NO. 85-460,072, FILED P.R. 10-31-2011; AM. S.R. 5-16-2012.

TINA BROWN, EXAMINING ATTORNEY



David J. Kyffers

Director of the United States Patent and Trademark Office

United States of America

United States Patent and Trademark Office

AMERICAN BOARD OF PATIENT SAFETY

Reg. No. 4,177,317

Registered July 17, 2012

Int. Cl.: 42

SERVICE MARK

SUPPLEMENTAL REGISTER

AMERICAN ASSOCIATION OF PHYSICIAN SPECIALISTS, INC. (FLORIDA CORPORATION)
SUITE 400
5550 WEST EXECUTIVE DRIVE
TAMPA, FL 33609

FOR: ACCREDITATION SERVICES, NAMELY, DEVELOPING AND ADMINISTERING
STANDARDS AND PROCEDURES FOR CERTIFYING PROFESSIONALS IN THE FIELD OF
MEDICAL PATIENT SAFETY, IN CLASS 42 (U.S. CLS. 100 AND 101).

FIRST USE 3-24-2012; IN COMMERCE 3-24-2012.

THE MARK CONSISTS OF STANDARD CHARACTERS WITHOUT CLAIM TO ANY PAR-
TICULAR FONT, STYLE, SIZE, OR COLOR.

NO CLAIM IS MADE TO THE EXCLUSIVE RIGHT TO USE "BOARD OF PATIENT SAFETY",
APART FROM THE MARK AS SHOWN.

SER. NO. 85-462,437, FILED P.R. 11-2-2011; AM. S.R. 5-14-2012.

SIMON TENG, EXAMINING ATTORNEY



David J. Kyffers

Director of the United States Patent and Trademark Office

United States of America

United States Patent and Trademark Office

Simpli Fi

Reg. No. 4,177,318

TRINITY HEALTHCARE STAFFING GROUP (SOUTH CAROLINA CORPORATION)
1834 SALLY HILL FARMS BLVD.
FLORENCE, SC 29501

Registered July 17, 2012

Int. Cl.: 35

FOR: VENDOR MANAGEMENT SERVICES FOR HEALTHCARE FACILITIES, IN CLASS
35 (U.S. CLS. 100, 101 AND 102).

SERVICE MARK

FIRST USE 6-15-2011; IN COMMERCE 6-15-2011.

SUPPLEMENTAL REGISTER

THE MARK CONSISTS OF STANDARD CHARACTERS WITHOUT CLAIM TO ANY PARTICULAR FONT, STYLE, SIZE, OR COLOR.

SER. NO. 85-464,580, FILED P.R. 11-4-2011; AM. S.R. 4-20-2012.

PRISCILLA MILTON, EXAMINING ATTORNEY



David J. Kybas

Director of the United States Patent and Trademark Office

United States of America

United States Patent and Trademark Office

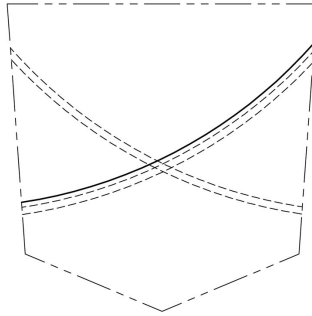

Reg. No. 4,177,319

Registered July 17, 2012

Int. Cl.: 25

TRADEMARK

SUPPLEMENTAL REGISTER

NYDJ APPAREL, LLC (NEW YORK LIMITED LIABILITY COMPANY)
5401 SOUTH SOTO STREET
VERNON, CA 90058

FOR: JEANS, PANTS, SHORTS, IN CLASS 25 (U.S. CLS. 22 AND 39).

FIRST USE 7-1-2009; IN COMMERCE 7-1-2009.

THE MARK CONSISTS OF A STITCHING DESIGN ON THE POCKET OF A GARMENT IN THE SHAPE OF TWO CURVED BROKEN LINES AND ONE SOLID LINE FROM THE TOP RIGHT TO THE BOTTOM LEFT OF THE POCKET AND TWO CURVED BROKEN LINES FROM THE TOP LEFT TO THE BOTTOM RIGHT OF THE POCKET. THE STRAIGHT BROKEN LINES IN THE SHAPE OF A POCKET IN THE DRAWING ARE USED TO INDICATE THE POSITION OF THE MARK ON THE GOODS AND ARE NOT A FEATURE OF THE MARK.

SER. NO. 85-477,336, FILED P.R. 11-20-2011; AM. S.R. 4-27-2012.

TINA MAI, EXAMINING ATTORNEY



David J. Kybas

Director of the United States Patent and Trademark Office

United States of America

United States Patent and Trademark Office

My Budget Box

Reg. No. 4,177,320

NOLAN, STEPHEN C. (UNITED STATES INDIVIDUAL)
7405 PIONEERS BLVD.

Registered July 17, 2012

LINCOLN, NE 68506

Int. Cl.: 16

FOR: FAMILY CASH PLANNING SYSTEM COMPRISED OF FIRE RETARDANT METAL BOX, MONEY POUCHES, GENERAL LEDGER BOOK, CALCULATOR AND INSTRUCTIONAL MANUAL ON HOW TO SET UP A HOME BUDGET, ALL SOLD AS A UNIT, IN CLASS 16 (U.S. CLS. 2, 5, 22, 23, 29, 37, 38 AND 50).

TRADEMARK

SUPPLEMENTAL REGISTER

FIRST USE 9-1-2008; IN COMMERCE 1-15-2009.

THE MARK CONSISTS OF STANDARD CHARACTERS WITHOUT CLAIM TO ANY PARTICULAR FONT, STYLE, SIZE, OR COLOR.

NO CLAIM IS MADE TO THE EXCLUSIVE RIGHT TO USE "BOX", APART FROM THE MARK AS SHOWN.

SER. NO. 85-477,839, FILED P.R. 11-21-2011; AM. S.R. 5-18-2012.

SAIMA MAKHDOOM, EXAMINING ATTORNEY



David J. Kyffers

Director of the United States Patent and Trademark Office

United States of America

United States Patent and Trademark Office

GA Study

Reg. No. 4,177,321

CHEN, GANG (UNITED STATES INDIVIDUAL)
4881 FLAGSTAR CIRCLE
IRVINE, CA 92604

Registered July 17, 2012

Int. Cl.: 16

FOR: EDUCATIONAL BOOKS IN THE FIELD OF ENVIRONMENTALLY FRIENDLY ARCHITECTURE, STANDARDIZED TEST PREPARATION RELATING TO ENVIRONMENTALLY FRIENDLY ARCHITECTURE, AND ENVIRONMENTAL ISSUES; EDUCATIONAL KITS SOLD AS A UNIT IN THE FIELD OF ENVIRONMENTALLY FRIENDLY ARCHITECTURE, STANDARDIZED TEST PREPARATION RELATING TO ENVIRONMENTALLY FRIENDLY ARCHITECTURE, AND ENVIRONMENTAL ISSUES CONSISTING PRIMARILY OF EDUCATIONAL BOOKS, IN CLASS 16 (U.S. CLS. 2, 5, 22, 23, 29, 37, 38 AND 50).

TRADEMARK

SUPPLEMENTAL REGISTER

FIRST USE 12-5-2011; IN COMMERCE 12-5-2011.

THE MARK CONSISTS OF STANDARD CHARACTERS WITHOUT CLAIM TO ANY PARTICULAR FONT, STYLE, SIZE, OR COLOR.

SER. NO. 85-487,741, FILED P.R. 12-6-2011; AM. S.R. 6-4-2012.

JIM RINGLE, EXAMINING ATTORNEY



David J. Kyros

Director of the United States Patent and Trademark Office

United States of America

United States Patent and Trademark Office

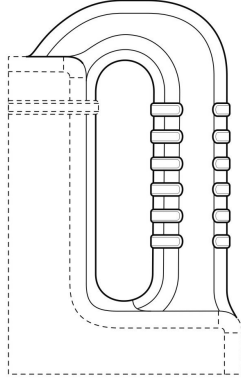

Reg. No. 4,177,322

Registered July 17, 2012

Int. Cl.: 3

TRADEMARK

SUPPLEMENTAL REGISTER

JELMAR, LLC (ILLINOIS LIMITED LIABILITY COMPANY)
5550 W. TOUHY AVE.
SKOKIE, IL 60077

FOR: CLEANING PREPARATIONS, NAMELY, ALL-PURPOSE CLEANING PREPARATIONS; SURFACE CLEANING PREPARATIONS, NAMELY, MULTI-SURFACE CLEANING PREPARATIONS FOR USE ON SURFACES MADE OF TILE, GLASS, CERAMIC, PORCELAIN, CEMENT, STUCCO, CHROME, GROUT, CAULK, FIBERGLASS, TILE, METAL SURFACES; GREASE AND TAR REMOVING PREPARATION FOR USE ON CONCRETE, TERRAZZO, GRANITE, STONE FLOORS, ASPHALT, AND BARBECUE GRILLS, IN CLASS 3 (U.S. CLS. 1, 4, 6, 50, 51 AND 52).

FIRST USE 4-0-2007; IN COMMERCE 4-0-2007.

THE MARK CONSISTS OF A THREE-DIMENSIONAL CONFIGURATION OF AN ARCUATE HANDLE HAVING HORIZONTALLY RIBBED COLUMN RIDGES ON EITHER SIDE OF THE GRIPPING PORTION OF THE HANDLE.

SER. NO. 85-488,243, FILED P.R. 12-6-2011; AM. S.R. 5-4-2012.

KELLY BOULTON, EXAMINING ATTORNEY



David J. Kyffers

Director of the United States Patent and Trademark Office

United States of America

United States Patent and Trademark Office

Best In The City

Reg. No. 4,177,323

LEWIS, AMERICK D (UNITED STATES INDIVIDUAL)
118-10 194 ST

Registered July 17, 2012

SAINT ALBANS, NY 11412 AND

Int. Cl.: 41

SOSIN, NICHOLAS J (UNITED STATES INDIVIDUAL)
41 HORSESHOE LN
LAKEVILLE, CT 06039

SERVICE MARK

SUPPLEMENTAL REGISTER

FOR: ENTERTAINMENT SERVICES, NAMELY, A MULTIMEDIA PROGRAM SERIES FEATURING COMEDY, ACTION AND ADVENTURE DISTRIBUTED VIA VARIOUS PLATFORMS ACROSS MULTIPLE FORMS OF TRANSMISSION MEDIA; ENTERTAINMENT SERVICES, NAMELY, PROVIDING ON-GOING WEBISODES FEATURING THE BEST LOCATIONS IN NEW YORK CITY VIA A GLOBAL COMPUTER NETWORK; ENTERTAINMENT SERVICES, NAMELY, THE PROVISION OF CONTINUING SEGMENTS FEATURING REVIEWS DELIVERED BY THE INTERNET; ENTERTAINMENT, NAMELY, A CONTINUING REVIEW SHOW BROADCAST OVER TELEVISION, SATELLITE, AUDIO, AND VIDEO MEDIA; ENTERTAINMENT, NAMELY, A CONTINUING REVIEW SHOW BROADCAST OVER INTERNET, IN CLASS 41 (U.S. CLS. 100, 101 AND 107).

FIRST USE 8-7-2011; IN COMMERCE 8-7-2011.

THE MARK CONSISTS OF STANDARD CHARACTERS WITHOUT CLAIM TO ANY PARTICULAR FONT, STYLE, SIZE, OR COLOR.

SER. NO. 85-488,447, FILED P.R. 12-6-2011; AM. S.R. 5-21-2012.

CHARLOTTE CORWIN, EXAMINING ATTORNEY



David J. Kyjars

Director of the United States Patent and Trademark Office

United States of America

United States Patent and Trademark Office

SALCHI-RICA

Reg. No. 4,177,324

GARZA CHORIZA, LLC (INDIANA LIMITED LIABILITY COMPANY)
1001 SPRINGVIEW COURT
VALPARAISO, IN 46383

Registered July 17, 2012

Int. Cl.: 29

FOR: MEXICAN STYLE GRILLING SAUSAGE, IN CLASS 29 (U.S. CL. 46).

FIRST USE 6-10-2011; IN COMMERCE 6-10-2011.

TRADEMARK

THE MARK CONSISTS OF STANDARD CHARACTERS WITHOUT CLAIM TO ANY PARTICULAR FONT, STYLE, SIZE, OR COLOR.

SUPPLEMENTAL REGISTER

THE ENGLISH TRANSLATION OF "SALCHI RICA" IN THE MARK IS "DELICIOUS, FLAVORFUL SAUSAGE".

SER. NO. 85-489,076, FILED P.R. 12-7-2011; AM. S.R. 4-30-2012.

BERYL GARDNER, EXAMINING ATTORNEY



David J. Kyffers

Director of the United States Patent and Trademark Office

United States of America

United States Patent and Trademark Office

UNDERGRADUATE INTERFRATERNITY INSTITUTE

Reg. No. 4,177,325

NORTH-AMERICAN INTERFRATERNITY CONFERENCE, INC. (INDIANA CORPORATION)
3901 W. 86TH ST., STE 390
INDIANAPOLIS, IN 46268

Registered July 17, 2012

Int. Cl.: 41

FOR: EDUCATIONAL SERVICES, NAMELY, CONDUCTING SEMINARS, CLASSES, WEBINARS AND WORKSHOPS IN THE FIELD OF LEADERSHIP FOR FRATERNITY AND SORORITY MEMBERS, IN CLASS 41 (U.S. CLS. 100, 101 AND 107).

SERVICE MARK

FIRST USE 12-31-1990; IN COMMERCE 12-31-1990.

SUPPLEMENTAL REGISTER

THE MARK CONSISTS OF STANDARD CHARACTERS WITHOUT CLAIM TO ANY PARTICULAR FONT, STYLE, SIZE, OR COLOR.

OWNER OF U.S. REG. NO. 860,304.

NO CLAIM IS MADE TO THE EXCLUSIVE RIGHT TO USE "INSTITUTE", APART FROM THE MARK AS SHOWN.

SER. NO. 85-491,796, FILED P.R. 12-9-2011; AM. S.R. 5-22-2012.

JEFF DEFORD, EXAMINING ATTORNEY



David J. Kyffers

Director of the United States Patent and Trademark Office

United States of America

United States Patent and Trademark Office

ESEATS

Reg. No. 4,177,326

SPORTWAVE, INC. (ARIZONA CORPORATION)
13951 NORTH SCOTTSDALE ROAD, SUITE 133
SCOTTSDALE, AZ 85254

Registered July 17, 2012

Int. Cl.: 41

FOR: ON-LINE ADMISSION TICKET AGENCY SERVICES FOR ENTERTAINMENT, EDUCATIONAL, SPORTING AND CULTURAL EVENTS; TICKET RESERVATION AND BOOKING SERVICES FOR ENTERTAINMENT, SPORTING AND CULTURAL EVENTS, IN CLASS 41 (U.S. CLS. 100, 101 AND 107).

SERVICE MARK

SUPPLEMENTAL REGISTER FIRST USE 8-6-2001; IN COMMERCE 8-6-2001.

THE MARK CONSISTS OF STANDARD CHARACTERS WITHOUT CLAIM TO ANY PARTICULAR FONT, STYLE, SIZE, OR COLOR.

SER. NO. 85-491,847, FILED P.R. 12-9-2011; AM. S.R. 5-17-2012.

JASON TURNER, EXAMINING ATTORNEY



David J. Kyffers

Director of the United States Patent and Trademark Office

United States of America

United States Patent and Trademark Office

IFC ACADEMY

Reg. No. 4,177,327

NORTH-AMERICAN INTERFRATERNITY CONFERENCE, INC. (INDIANA CORPORATION)
3901 W. 86TH ST., STE 390
INDIANAPOLIS, IN 46268

Registered July 17, 2012

Int. Cl.: 41

FOR: EDUCATIONAL SERVICES, NAMELY, CONDUCTING SEMINARS, CLASSES, WEBINARS AND WORKSHOPS IN THE FIELD OF FRATERNITY AND SORORITY DEVELOPMENT, PROBLEM SOLVING, LEADERSHIP DEVELOPMENT, VALUES-BASED DECISION MAKING, EFFECTIVE COMMUNICATION, AND COMMUNITY DEVELOPMENT, IN CLASS 41 (U.S. CLS. 100, 101 AND 107).

SERVICE MARK

SUPPLEMENTAL REGISTER

FIRST USE 12-31-2006; IN COMMERCE 12-31-2006.

THE MARK CONSISTS OF STANDARD CHARACTERS WITHOUT CLAIM TO ANY PARTICULAR FONT, STYLE, SIZE, OR COLOR.

OWNER OF U.S. REG. NO. 860,304.

NO CLAIM IS MADE TO THE EXCLUSIVE RIGHT TO USE "ACADEMY", APART FROM THE MARK AS SHOWN.

SER. NO. 85-492,813, FILED P.R. 12-12-2011; AM. S.R. 5-22-2012.

JEFF DEFORD, EXAMINING ATTORNEY



David J. Kyffers

Director of the United States Patent and Trademark Office

United States of America
United States Patent and Trademark Office

BARTERR

Reg. No. 4,177,328

Registered July 17, 2012

Int. Cl.: 35

SERVICE MARK

SUPPLEMENTAL REGISTER

BARTERR, INC. (FLORIDA CORPORATION)
SUITE 103
2425 E. COMMERCIAL BLVD.
FORT LAUDERDALE, FL 33308

FOR: BARTER EXCHANGE SERVICES, NAMELY, PROVIDING COMMERCIAL BARTER AND TRADE EXCHANGE OF PRODUCTS AND SERVICES VIA A GLOBAL COMPUTER INFORMATION NETWORK , IN CLASS 35 (U.S. CLS. 100, 101 AND 102).

FIRST USE 9-11-2010; IN COMMERCE 9-11-2010.

THE MARK CONSISTS OF STANDARD CHARACTERS WITHOUT CLAIM TO ANY PARTICULAR FONT, STYLE, SIZE, OR COLOR.

SER. NO. 85-493,052, FILED P.R. 12-12-2011; AM. S.R. 5-23-2012.

SUSAN STIGLITZ, EXAMINING ATTORNEY



David J. Kyffers

Director of the United States Patent and Trademark Office

United States of America

United States Patent and Trademark Office

BRAIN FITNESS

Reg. No. 4,177,329

MDR FITNESS CORP (FLORIDA CORPORATION)
14101 NW 4 STREET
SUNRISE, FL 33325

Registered July 17, 2012

Int. Cl.: 5

FOR: DIETARY AND NUTRITIONAL SUPPLEMENTS, IN CLASS 5 (U.S. CLS. 6, 18, 44, 46, 51 AND 52).

TRADEMARK

FIRST USE 11-1-2011; IN COMMERCE 11-1-2011.

SUPPLEMENTAL REGISTER

THE MARK CONSISTS OF STANDARD CHARACTERS WITHOUT CLAIM TO ANY PARTICULAR FONT, STYLE, SIZE, OR COLOR.

SER. NO. 85-496,161, FILED P.R. 12-15-2011; AM. S.R. 5-1-2012.

ANNE FARRELL, EXAMINING ATTORNEY



David J. Kybas

Director of the United States Patent and Trademark Office

United States of America

United States Patent and Trademark Office

Dog Training for Women

Reg. No. 4,177,330

GRAY, CAMILLA (UNITED STATES INDIVIDUAL)
P.O. BOX 751378

Registered July 17, 2012

PETALUMA, CA 94975

Int. Cl.: 41

FOR: TRAINING SERVICES IN THE FIELD OF TEACHING DOG OWNERS HOW TO TRAIN AND CONTROL THEIR DOG, IN CLASS 41 (U.S. CLS. 100, 101 AND 107).

SERVICE MARK

FIRST USE 2-0-2011; IN COMMERCE 2-0-2011.

SUPPLEMENTAL REGISTER

THE MARK CONSISTS OF STANDARD CHARACTERS WITHOUT CLAIM TO ANY PARTICULAR FONT, STYLE, SIZE, OR COLOR.

SER. NO. 85-496,757, FILED P.R. 12-15-2011; AM. S.R. 5-17-2012.

DEBORAH LOBO, EXAMINING ATTORNEY



David J. Kyffers

Director of the United States Patent and Trademark Office

United States of America

United States Patent and Trademark Office

YOUTH ROCK AWARDS

Reg. No. 4,177,331

GEORGE, JONATHAN (UNITED STATES INDIVIDUAL)
14130 FRIAR ST.

Registered July 17, 2012

VAN NUYS, CA 91401

Int. Cl.: 41

FOR: PROVIDING RECOGNITION AND INCENTIVES BY THE WAY OF AWARDS TO DEMONSTRATE EXCELLENCE IN THE FIELD OF ENTERTAINMENT; ENTERTAINMENT, NAMELY, A CONTINUING ENTERTAINMENT AWARD SHOW BROADCAST OVER TELEVISION, SATELLITE, CABLE, INTERNET, AUDIO, AND VIDEO MEDIA; ENTERTAINMENT, NAMELY, PRODUCTION OF AN ENTERTAINMENT AWARD SHOW, IN CLASS 41 (U.S. CLS. 100, 101 AND 107).

SERVICE MARK

SUPPLEMENTAL REGISTER

FIRST USE 10-1-2011; IN COMMERCE 12-7-2011.

THE MARK CONSISTS OF STANDARD CHARACTERS WITHOUT CLAIM TO ANY PARTICULAR FONT, STYLE, SIZE, OR COLOR.

NO CLAIM IS MADE TO THE EXCLUSIVE RIGHT TO USE "AWARDS", APART FROM THE MARK AS SHOWN.

SER. NO. 85-499,402, FILED P.R. 12-20-2011; AM. S.R. 5-1-2012.

ROBERT C. CLARK JR., EXAMINING ATTORNEY



David J. Kyros

Director of the United States Patent and Trademark Office

United States of America

United States Patent and Trademark Office

Alz Vitamins

Reg. No. 4,177,332

Registered July 17, 2012

Int. Cl.: 5

TRADEMARK

SUPPLEMENTAL REGISTER

ALZ VITAMINS, LLC (GEORGIA LIMITED LIABILITY COMPANY)
SUITE 425
11675 RAINWATER DRIVE
ALPHARETTA, GA 30004

FOR: MULTIVITAMINS FOR AIDING IN ALZHEIMER'S AND DEMENTIA, IN CLASS 5
(U.S. CLS. 6, 18, 44, 46, 51 AND 52).

FIRST USE 7-10-2010; IN COMMERCE 1-19-2011.

THE MARK CONSISTS OF STANDARD CHARACTERS WITHOUT CLAIM TO ANY PARTICULAR FONT, STYLE, SIZE, OR COLOR.

NO CLAIM IS MADE TO THE EXCLUSIVE RIGHT TO USE "VITAMINS", APART FROM THE MARK AS SHOWN.

SER. NO. 85-500,341, FILED P.R. 12-20-2011; AM. S.R. 4-30-2012.

DAWN HAN, EXAMINING ATTORNEY



David J. Kyjars

Director of the United States Patent and Trademark Office

United States of America

United States Patent and Trademark Office

Warehouse Winery

Reg. No. 4,177,333

Registered July 17, 2012

Int. Cl.: 33

TRADEMARK

SUPPLEMENTAL REGISTER

SMITH, WILLIAM F. (MINNESOTA LIMITED LIABILITY COMPANY), DBA WAREHOUSE WINERY, LLC.,
6415 CAMBRIDGE STREET
MINNEAPOLIS, MN 55426

FOR: GRAPE WINE; RED WINE; RED WINES; ROSE WINE; TABLE WINES; WHITE WINE; WINE; WINES, IN CLASS 33 (U.S. CLS. 47 AND 49).

FIRST USE 10-1-2008; IN COMMERCE 10-1-2008.

THE MARK CONSISTS OF STANDARD CHARACTERS WITHOUT CLAIM TO ANY PARTICULAR FONT, STYLE, SIZE, OR COLOR.

NO CLAIM IS MADE TO THE EXCLUSIVE RIGHT TO USE "WINERY", APART FROM THE MARK AS SHOWN.

SER. NO. 85-500,962, FILED P.R. 12-21-2011; AM. S.R. 4-4-2012.

MAYUR VAGHANI, EXAMINING ATTORNEY



David J. Kybas

Director of the United States Patent and Trademark Office

United States of America

United States Patent and Trademark Office

Lifestyle Integrated Advertising

Reg. No. 4,177,334

Registered July 17, 2012

Int. Cl.: 35

SERVICE MARK

SUPPLEMENTAL REGISTER

HEPPNER MARKETING, LLC (PENNSYLVANIA LIMITED LIABILITY COMPANY)
39 FOX POINTE DRIVE
PITTSBURGH, PA 15238

FOR: ADVERTISING AGENCIES SPECIALIZING IN PROMOTIONAL PRODUCTS AND APPAREL THAT SEAMLESSLY INTEGRATE INTO THE LIFESTYLE OF A SPECIFIC CUSTOMER BASE; ADVERTISING SERVICES, NAMELY, PROMOTING THE BRANDS, GOODS AND SERVICES OF OTHERS; ADVERTISING, PROMOTION, AND MARKETING SERVICES IN THE NATURE OF PROMOTING A LOGO OR BRAND, EVENT OR SERVICE THROUGH PROMOTIONAL PRODUCTS THAT INTEGRATE INTO CUSTOMER'S LIFESTYLE FOR BUSINESSES; PROMOTING THE GOODS AND SERVICES OF OTHERS BY CUSTOMIZING USEFUL AND APPROPRIATE EVERY DAY PRODUCTS WITH YOUR BRAND OR LOGO GEARED TO YOUR CUSTOMER BASE, IN CLASS 35 (U.S. CLS. 100, 101 AND 102).

FIRST USE 12-1-2011; IN COMMERCE 12-1-2011.

THE MARK CONSISTS OF STANDARD CHARACTERS WITHOUT CLAIM TO ANY PARTICULAR FONT, STYLE, SIZE, OR COLOR.

NO CLAIM IS MADE TO THE EXCLUSIVE RIGHT TO USE "ADVERTISING", APART FROM THE MARK AS SHOWN.

SER. NO. 85-502,884, FILED P.R. 12-23-2011; AM. S.R. 4-30-2012.

INGA ERVIN, EXAMINING ATTORNEY



David J. Kybas

Director of the United States Patent and Trademark Office

United States of America

United States Patent and Trademark Office

THRESHOLD TRAINING SYSTEM

Reg. No. 4,177,335

SALLY EDWARDS (CALIFORNIA SOLE PROPRIETORSHIP), DBA HEART ZONES USA,
2636 FULTON AVE., SUITE 100
SACRAMENTO, CA 95821

Registered July 17, 2012

Int. Cl.: 16

FOR: PUBLICATIONS, NAMELY, WORKBOOKS IN THE FIELDS OF PHYSICAL EXERCISE UTILIZING A HEART RATE MONITOR, NAMELY, WEIGHT MANAGEMENT, GENERAL FITNESS, EMOTIONAL WELL-BEING AND ATHLETIC PERFORMANCE, IN CLASS 16 (U.S. CLS. 2, 5, 22, 23, 29, 37, 38 AND 50).

TRADEMARK

SUPPLEMENTAL REGISTER FIRST USE 1-1-2006; IN COMMERCE 1-1-2006.

THE MARK CONSISTS OF STANDARD CHARACTERS WITHOUT CLAIM TO ANY PARTICULAR FONT, STYLE, SIZE, OR COLOR.

NO CLAIM IS MADE TO THE EXCLUSIVE RIGHT TO USE "TRAINING SYSTEM", APART FROM THE MARK AS SHOWN.

SER. NO. 85-506,508, FILED P.R. 12-30-2011; AM. S.R. 4-20-2012.

FONG HSU, EXAMINING ATTORNEY



David J. Kyffers

Director of the United States Patent and Trademark Office

United States of America

United States Patent and Trademark Office

IVF Network

Reg. No. 4,177,336

IVF NETWORK, LLC (NEVADA LIMITED LIABILITY COMPANY)
1300 TUMBERRY ST
LAS VEGAS, NV 89117

Registered July 17, 2012

Int. Cl.: 44

FOR: HUMAN FERTILITY TREATMENT SERVICES, IN CLASS 44 (U.S. CLS. 100 AND 101).

SERVICE MARK

FIRST USE 8-1-2011; IN COMMERCE 11-1-2011.

SUPPLEMENTAL REGISTER

THE MARK CONSISTS OF STANDARD CHARACTERS WITHOUT CLAIM TO ANY PARTICULAR FONT, STYLE, SIZE, OR COLOR.

NO CLAIM IS MADE TO THE EXCLUSIVE RIGHT TO USE "IVF", APART FROM THE MARK AS SHOWN.

SER. NO. 85-507,713, FILED 1-3-2012.

LESLEY LAMOTHE, EXAMINING ATTORNEY



David J. Kyffers

Director of the United States Patent and Trademark Office

United States of America

United States Patent and Trademark Office

AgStock Images

Reg. No. 4,177,337

Registered July 17, 2012

Int. Cl.: 45

SERVICE MARK

SUPPLEMENTAL REGISTER

AGSTOCK IMAGES, INC. (CALIFORNIA CORPORATION), FORMERLY AGSTOCK USA, INC.,
25315 ARRIBA DEL MUNDO DRIVE
CARMEL, CA 93923

FOR: LICENSING OF IMAGE REPRODUCTION RIGHTS, IN CLASS 45 (U.S. CLS. 100 AND 101).

FIRST USE 1-1-2011; IN COMMERCE 1-1-2011.

THE MARK CONSISTS OF STANDARD CHARACTERS WITHOUT CLAIM TO ANY PARTICULAR FONT, STYLE, SIZE, OR COLOR.

NO CLAIM IS MADE TO THE EXCLUSIVE RIGHT TO USE "IMAGES", APART FROM THE MARK AS SHOWN.

SER. NO. 85-509,283, FILED P.R. 1-5-2012; AM. S.R. 5-21-2012.

BARBARA A. GOLD, EXAMINING ATTORNEY



David J. Kyffers

Director of the United States Patent and Trademark Office

United States of America

United States Patent and Trademark Office

VIN ALERT

Reg. No. 4,177,338

Registered July 17, 2012

Int. Cl.: 35

SERVICE MARK

SUPPLEMENTAL REGISTER

CARFAX, INC. (PENNSYLVANIA CORPORATION)
SUITE 600
5860 TRINITY PARKWAY
CENTREVILLE, VA 20120

FOR: PROVIDING REPORTS IN THE FIELD OF VEHICLE HISTORY, NAMELY, UPDATES TO TITLE, ACCIDENT, DAMAGE, ODOMETER AND SERVICE HISTORIES OF MOTOR VEHICLES, FOR BUSINESS AND CONSUMER PURPOSES, IN CLASS 35 (U.S. CLS. 100, 101 AND 102).

FIRST USE 11-3-2011; IN COMMERCE 11-3-2011.

THE MARK CONSISTS OF STANDARD CHARACTERS WITHOUT CLAIM TO ANY PARTICULAR FONT, STYLE, SIZE, OR COLOR.

OWNER OF U.S. REG. NOS. 1,589,438, 3,861,113, AND OTHERS.

SER. NO. 85-514,125, FILED P.R. 1-11-2012; AM. S.R. 5-23-2012.

JANET LEE, EXAMINING ATTORNEY



David J. Kyffers

Director of the United States Patent and Trademark Office

United States of America

United States Patent and Trademark Office

THE VACCINE CENTER AND TRAVEL MEDICINE CLINIC

Reg. No. 4,177,339

THE VACCINE CENTER LLC (NEVADA LIMITED LIABILITY COMPANY)
300 S. 4TH STREET
LAS VEGAS, NV 89101

Registered July 17, 2012

Int. Cl.: 44

FOR: MEDICAL CLINICS, IN CLASS 44 (U.S. CLS. 100 AND 101).

SERVICE MARK

FIRST USE 11-1-2010; IN COMMERCE 11-1-2010.

SUPPLEMENTAL REGISTER

THE MARK CONSISTS OF STANDARD CHARACTERS WITHOUT CLAIM TO ANY PARTICULAR FONT, STYLE, SIZE, OR COLOR.

OWNER OF U.S. REG. NO. 4,113,283.

SER. NO. 85-515,056, FILED P.R. 1-12-2012; AM. S.R. 5-20-2012.

CHRIS WELLS, EXAMINING ATTORNEY



David J. Kyffers

Director of the United States Patent and Trademark Office

United States of America

United States Patent and Trademark Office

GREEN WATT

Reg. No. 4,177,340

LI, QINGSONG (CHINA INDIVIDUAL)
5328 SPICEWOOD LANE
FRISCO, TX 75034

Registered July 17, 2012

Int. Cl.: 11

FOR: LED (LIGHT EMITTING DIODE) LIGHTING FIXTURES; LED (LIGHT EMITTING DIODES) LIGHTING FIXTURES FOR USE IN DISPLAY, COMMERCIAL, INDUSTRIAL, RESIDENTIAL, AND ARCHITECTURAL ACCENT LIGHTING APPLICATIONS; LED AND HID LIGHT FIXTURES; LED LANDSCAPE LIGHTS; LED LIGHT APPARATUS THAT CLIPS ON TO A HANDBAG, USED TO ILLUMINATE A HANDBAG; LED LIGHT ASSEMBLIES FOR STREET LIGHTS, SIGNS, COMMERCIAL LIGHTING, AUTOMOBILES, BUILDINGS, AND OTHER ARCHITECTURAL USES; LED LIGHT BULBS; LED LIGHT ENGINES; LED LIGHT MACHINES; LED LIGHTING FIXTURES FOR INDOOR AND OUTDOOR LIGHTING APPLICATIONS; LED LIGHTING SYSTEMS, NAMELY, LED MODULES, POWER SUPPLIES, AND WIRING; LED LIGHTS FOR LIGHTING PURPOSES INCORPORATED INTO KEY CHAINS, SMALL TOYS OR OTHER SIMILAR PERSONAL ITEMS; LED LIGHTS FOR STRINGS, FLOWERS, BRANCHES AND OTHER ORNAMENTAL DECORATIONS; LED LUMINAIRES; LED UNDERWATER LIGHTS; LIGHT EMITTING DIODE (LED) PLANT GROW LIGHT; LUMINAIRES, USING LIGHT EMITTING DIODES (LEDS) AS A LIGHT SOURCE, FOR STREET OR ROADWAY LIGHTING; TOOLS, COMPONENTS AND SUPPLIES FOR USE IN MAKING SIGNS, NAMELY, FLUORESCENT, HID, LED AND INCANDESCENT BULBS, LAMPS AND FIXTURES, IN CLASS 11 (U.S. CLS. 13, 21, 23, 31 AND 34).

TRADEMARK

SUPPLEMENTAL REGISTER

FIRST USE 2-8-2012; IN COMMERCE 2-8-2012.

THE MARK CONSISTS OF THE WORD "GREEN" IN CAPITAL LETTERS, FOLLOWED BY THE WORD "WATT" IN CAPITAL LETTERS. THE LETTER "A" IN THE WORD, "WATT", IS STYLIZED AND UNDERLINED.

SER. NO. 85-515,171, FILED P.R. 1-12-2012; AM. S.R. 5-3-2012.

DORITT L. CARROLL, EXAMINING ATTORNEY



David J. Kypos

Director of the United States Patent and Trademark Office

United States of America

United States Patent and Trademark Office

Fruit & No-Nut Bar

Reg. No. 4,177,341

THE GOOD BEAN, LLC (CALIFORNIA LIMITED LIABILITY COMPANY)
2301 ASHBY AVENUE
BERKELEY, CA 94705

Registered July 17, 2012

Int. Cls.: 29 and 30

FOR: FRUIT AND SOY BASED SNACK FOOD; FRUIT-BASED SNACK FOOD; SOY-BASED SNACK FOODS; VEGETABLE-BASED SNACK FOODS, IN CLASS 29 (U.S. CL. 46).

TRADEMARK

FIRST USE 10-18-2011; IN COMMERCE 10-18-2011.

SUPPLEMENTAL REGISTER

FOR: CEREAL BASED SNACK FOOD; CEREAL-BASED SNACK FOODS; CHOCOLATES AND CHOCOLATE BASED READY TO EAT CANDIES AND SNACKS; GRAIN-BASED SNACK FOODS; GRANOLA SNACKS; GRANOLA-BASED SNACK BARS; RICE-BASED SNACK FOODS, IN CLASS 30 (U.S. CL. 46).

FIRST USE 10-18-2011; IN COMMERCE 10-18-2011.

THE MARK CONSISTS OF STANDARD CHARACTERS WITHOUT CLAIM TO ANY PARTICULAR FONT, STYLE, SIZE, OR COLOR.

NO CLAIM IS MADE TO THE EXCLUSIVE RIGHT TO USE "BAR" , APART FROM THE MARK AS SHOWN.

SER. NO. 85-516,820, FILED P.R. 1-14-2012; AM. S.R. 5-22-2012.

SAMUEL E. SHARPER JR., EXAMINING ATTORNEY



David J. Kybas

Director of the United States Patent and Trademark Office

United States of America

United States Patent and Trademark Office



Reg. No. 4,177,342

Registered July 17, 2012

Int. Cl.: 25

TRADEMARK

SUPPLEMENTAL REGISTER

RETROSPETTIVA, INC (US VIRGIN ISLANDS CORPORATION), DBA VITTONÉ,
RETROSPETTIVA, INC
4117 BROADWAY
NEW YORK, NY 10033

FOR: BLAZERS; BUTTON DOWN SHIRTS; COLLARED SHIRTS; DENIMS; DRESS PANTS;
DRESS SHIRTS; DRESS SUITS; JEANS; LEATHER SHOES; MEN'S DRESS SOCKS; PANTS;
PIQUE SHIRTS; POLO SHIRTS; SHIRTS; SHIRTS AND SHORT-SLEEVED SHIRTS; SHIRTS
FOR SUITS; SHOES; TEE SHIRTS; TIES, IN CLASS 25 (U.S. CLS. 22 AND 39).

FIRST USE 10-10-2009; IN COMMERCE 10-20-2010.

THE STIPPLING IS FOR SHADING PURPOSES ONLY.

THE COLOR(S) VITTONÉ IN BLACK COLOR WITH A RED BACKGROUND IS/ARE
CLAIMED AS A FEATURE OF THE MARK.

THE MARK CONSISTS OF "VITTONÉ" WRITTE IN BLACK UNDERLINED AND RED
BACKGROUND.

SER. NO. 85-517,531, FILED P.R. 1-16-2012; AM. S.R. 5-3-2012.

JAY FLOWERS, EXAMINING ATTORNEY



David J. Kyffers

Director of the United States Patent and Trademark Office

United States of America

United States Patent and Trademark Office

Express Audition

Reg. No. 4,177,343

Registered July 17, 2012

Int. Cl.: 9

TRADEMARK

SUPPLEMENTAL REGISTER

800 SOFTWARE SYSTEMS CORPORATION (NORTH CAROLINA CORPORATION)
SUITE 8-S
2451 BRICKELL AVE.
MIAMI, FL 33129

FOR: COMPUTER APPLICATION SOFTWARE FOR MOBILE PHONES, NAMELY, SOFTWARE FOR USE IN UPLOADING AND SHARING AUDITION AND TALENT VIDEOS , IN CLASS 9 (U.S. CLS. 21, 23, 26, 36 AND 38).

FIRST USE 1-28-2010; IN COMMERCE 1-28-2010.

THE MARK CONSISTS OF STANDARD CHARACTERS WITHOUT CLAIM TO ANY PARTICULAR FONT, STYLE, SIZE, OR COLOR.

SER. NO. 85-518,467, FILED P.R. 1-17-2012; AM. S.R. 5-16-2012.

DORITT L. CARROLL, EXAMINING ATTORNEY



David J. Kyffers

Director of the United States Patent and Trademark Office

United States of America

United States Patent and Trademark Office

Brooklyn Forest

Reg. No. 4,177,344

HOLDER, JOYLYNN T (UNITED STATES INDIVIDUAL)
31 MONROE STREET
BROOKLYN, NY 11238

Registered July 17, 2012

Int. Cl.: 41

FOR: EDUCATIONAL AND ENTERTAINMENT SERVICES FOR CHILDREN, NAMELY, PROVIDING INTERACTIVE PLAY AREAS, INSTRUCTIONAL CLASSES IN THE FIELD OF OUTDOOR EDUCATION AND SOCIAL GATHERINGS FOR CHILDREN, IN CLASS 41 (U.S. CLS. 100, 101 AND 107).

SERVICE MARK

SUPPLEMENTAL REGISTER FIRST USE 11-6-2011; IN COMMERCE 11-10-2011.

THE MARK CONSISTS OF STANDARD CHARACTERS WITHOUT CLAIM TO ANY PARTICULAR FONT, STYLE, SIZE, OR COLOR.

SER. NO. 85-518,722, FILED P.R. 1-18-2012; AM. S.R. 4-26-2012.

AMEEN IMAM, EXAMINING ATTORNEY



David J. Kyffers

Director of the United States Patent and Trademark Office

United States of America

United States Patent and Trademark Office

REALCPM

Reg. No. 4,177,345

MRC INTERNATIONAL (SWEDEN CORPORATION)
KUNGSGATAN 44

Registered July 17, 2012

STOCKHOLM, SWEDEN 11135

Int. Cl.: 35

FOR: BUSINESS ASSISTANCE, ADVISORY AND CONSULTING SERVICES IN THE FIELD OF MARKET RESEARCH VIA ONLINE SURVEYS USING WEBCAMS; MARKETING SERVICES, NAMELY, CONSUMER MARKETING RESEARCH, IN CLASS 35 (U.S. CLS. 100, 101 AND 102).

SERVICE MARK

SUPPLEMENTAL REGISTER FIRST USE 1-17-2012; IN COMMERCE 1-17-2012.

THE MARK CONSISTS OF STANDARD CHARACTERS WITHOUT CLAIM TO ANY PARTICULAR FONT, STYLE, SIZE, OR COLOR.

SER. NO. 85-519,244, FILED P.R. 1-18-2012; AM. S.R. 5-24-2012.

NICHOLAS COLEMAN, EXAMINING ATTORNEY



David J. Kyffers

Director of the United States Patent and Trademark Office

United States of America

United States Patent and Trademark Office

Advanced 9-1-1

Reg. No. 4,177,346

WEST CORPORATION (DELAWARE CORPORATION)
11808 MIRACLE HILLS DRIVE
OMAHA, NE 68154

Registered July 17, 2012

Int. Cl.: 38

FOR: INTERNET TELEPHONY SERVICES; TELECOMMUNICATION SERVICES FOR PUBLIC SAFETY EMERGENCY COMMUNICATIONS, NAMELY, LOCAL AND LONG DISTANCE TRANSMISSION, ROUTING, MANAGEMENT AND REPORTING OF VOICE, DATA, GRAPHICS, IMAGES, MESSAGES BY MEANS OF TELEPHONE, CABLE, INTERNET, SATELLITE AND GLOBAL COMMUNICATION NETWORKS, IN CLASS 38 (U.S. CLS. 100, 101 AND 104).

SERVICE MARK

SUPPLEMENTAL REGISTER

FIRST USE 5-0-2008; IN COMMERCE 5-0-2008.

THE MARK CONSISTS OF STANDARD CHARACTERS WITHOUT CLAIM TO ANY PARTICULAR FONT, STYLE, SIZE, OR COLOR.

OWNER OF U.S. REG. NO. 4,086,372.

NO CLAIM IS MADE TO THE EXCLUSIVE RIGHT TO USE "9-1-1", APART FROM THE MARK AS SHOWN.

SER. NO. 85-523,808, FILED P.R. 1-24-2012; AM. S.R. 5-21-2012.

RICHARD WHITE, EXAMINING ATTORNEY



David J. Kyjars

Director of the United States Patent and Trademark Office

United States of America

United States Patent and Trademark Office

Nonprofit & Corporate Partnership Seminar

Reg. No. 4,177,347

THE BURCHARD GROUP LLC (OREGON LIMITED LIABILITY COMPANY)
PO BOX 5368
PORTLAND, OR 97228

Registered July 17, 2012

**Int. Cls.: 9, 16, 35, and
41**

FOR: AUDIO DISCS FEATURING STRATEGIC PARTNERING, MARKETING, BUSINESS, BRAND POSITIONING, LEADERSHIP, AND TECHNOLOGY INSTRUCTION; DOWNLOADABLE VIDEO RECORDINGS FEATURING STRATEGIC PARTNERING, MARKETING, BUSINESS, BRAND POSITIONING, LEADERSHIP, AND TECHNOLOGY INSTRUCTION; ELECTRONIC PUBLICATIONS, NAMELY, ARTICLES AND BOOKS FEATURING STRATEGIC PARTNERING, MARKETING, BUSINESS, BRAND POSITIONING, LEADERSHIP, AND TECHNOLOGY INSTRUCTION RECORDED ON COMPUTER MEDIA; VIDEO DISCS FEATURING STRATEGIC PARTNERING, MARKETING, BUSINESS, BRAND POSITIONING, LEADERSHIP, AND TECHNOLOGY INSTRUCTION, IN CLASS 9 (U.S. CLS. 21, 23, 26, 36 AND 38).

TRADEMARK

SERVICE MARK

SUPPLEMENTAL REGISTER

FIRST USE 9-1-2009; IN COMMERCE 9-1-2009.

FOR: A SERIES OF BOOKS, WRITTEN ARTICLES, HANDOUTS AND WORKSHEETS IN THE FIELD OF BUSINESS, NAMELY STRATEGIC PARTNERING, BRAND POSITIONING, MARKETING, BUSINESS GROWTH, HOW-TO-ADVICE, LEADERSHIP, AND TECHNOLOGY; BOOKS IN THE FIELD OF BUSINESS, NAMELY, STRATEGIC PARTNERING, BRAND POSITIONING, MARKETING, BUSINESS GROWTH, LEADERSHIP, AND TECHNOLOGY, IN CLASS 16 (U.S. CLS. 2, 5, 22, 23, 29, 37, 38 AND 50).

FIRST USE 9-1-2007; IN COMMERCE 9-1-2007.

FOR: ADVICE IN THE FIELD OF BUSINESS MANAGEMENT AND MARKETING; BUSINESS ADVISORY SERVICES, CONSULTANCY AND INFORMATION; PROVIDING A WEB SITE FEATURING BUSINESS INFORMATION IN THE FORM OF AUDIO AND VIDEO INTERVIEWS, TRANSCRIPTS AND OTHER EDUCATIONAL MATERIALS, IN CLASS 35 (U.S. CLS. 100, 101 AND 102).

FIRST USE 9-1-2009; IN COMMERCE 9-1-2009.

FOR: EDUCATIONAL SERVICES, NAMELY, CONDUCTING SEMINARS, LECTURES, AND WORKSHOPS IN THE FIELD OF STRATEGIC PARTNERING, MARKETING, BUSINESS, BRAND POSITIONING, LEADERSHIP, AND TECHNOLOGY AND DISTRIBUTION OF



David J. Kyffers

Director of the United States Patent and Trademark Office

Reg. No. 4,177,347 COURSE MATERIAL IN CONNECTION THEREWITH, IN CLASS 41 (U.S. CLS. 100, 101 AND 107).

FIRST USE 9-7-2007; IN COMMERCE 9-7-2007.

THE MARK CONSISTS OF STANDARD CHARACTERS WITHOUT CLAIM TO ANY PARTICULAR FONT, STYLE, SIZE, OR COLOR.

NO CLAIM IS MADE TO THE EXCLUSIVE RIGHT TO USE "SEMINAR", APART FROM THE MARK AS SHOWN.

SER. NO. 85-523,944, FILED P.R. 1-24-2012; AM. S.R. 5-24-2012.

KATHERINE E. HALMEN, EXAMINING ATTORNEY

United States of America

United States Patent and Trademark Office

Experts Industry Association

Reg. No. 4,177,348

Registered July 17, 2012

Int. Cls.: 9, 35, and 41

TRADEMARK

SERVICE MARK

SUPPLEMENTAL REGISTER

THE BURCHARD GROUP LLC (OREGON LIMITED LIABILITY COMPANY)
PO BOX 5368
PORTLAND, OR 97228

FOR: AUDIO DISCS FEATURING BRAND POSITIONING, MARKETING, BUSINESS, LEADERSHIP, AND TECHNOLOGY INSTRUCTION; DOWNLOADABLE VIDEO RECORDINGS FEATURING BRAND POSITIONING, MARKETING, BUSINESS, LEADERSHIP, AND TECHNOLOGY INSTRUCTION; ELECTRONIC PUBLICATIONS, NAMELY, ARTICLES AND BOOKS FEATURING BRAND POSITIONING, MARKETING, BUSINESS, LEADERSHIP, AND TECHNOLOGY INSTRUCTION RECORDED ON COMPUTER MEDIA; VIDEO DISCS FEATURING BRAND POSITIONING, MARKETING, BUSINESS, LEADERSHIP, AND TECHNOLOGY INSTRUCTION, IN CLASS 9 (U.S. CLS. 21, 23, 26, 36 AND 38).

FIRST USE 1-1-2011; IN COMMERCE 9-1-2011.

FOR: ADVICE IN THE FIELD OF BUSINESS MANAGEMENT AND MARKETING; ASSOCIATION SERVICES, NAMELY, PROMOTING THE INTERESTS OF LEADERSHIP, BEST PRACTICE AND COMMUNITY FOR THE ADVICE AND HOW-TO INDUSTRY; BUSINESS ADVISORY SERVICES, CONSULTANCY AND INFORMATION; PROVIDING A WEB SITE FEATURING BUSINESS INFORMATION IN THE FORM OF AUDIO AND VIDEO INTERVIEWS, TRANSCRIPTS AND OTHER EDUCATIONAL MATERIALS, IN CLASS 35 (U.S. CLS. 100, 101 AND 102).

FIRST USE 1-1-2011; IN COMMERCE 9-1-2011.

FOR: EDUCATIONAL SERVICES, NAMELY, CONDUCTING SEMINARS, LECTURES, AND WORKSHOPS IN THE FIELD OF BRAND POSITIONING, MARKETING, BUSINESS, LEADERSHIP, AND TECHNOLOGY, AND DISTRIBUTION OF COURSE MATERIAL IN CONNECTION THEREWITH, IN CLASS 41 (U.S. CLS. 100, 101 AND 107).

FIRST USE 1-1-2011; IN COMMERCE 9-1-2011.

THE MARK CONSISTS OF STANDARD CHARACTERS WITHOUT CLAIM TO ANY PARTICULAR FONT, STYLE, SIZE, OR COLOR.

NO CLAIM IS MADE TO THE EXCLUSIVE RIGHT TO USE "ASSOCIATION", APART FROM THE MARK AS SHOWN.



David J. Kyffers

Director of the United States Patent and Trademark Office

Reg. No. 4,177,348 SER. NO. 85-524,027, FILED P.R. 1-24-2012; AM. S.R. 5-24-2012.

KATHERINE E. HALMEN, EXAMINING ATTORNEY

United States of America

United States Patent and Trademark Office

PREMIER RIA NETWORK

Reg. No. 4,177,349

Registered July 17, 2012

Int. Cl.: 36

SERVICE MARK

SUPPLEMENTAL REGISTER

PPS ADVISORS, INC. (NEW YORK CORPORATION)
SUITE 100E
4250 VETERANS MEMORIAL HIGHWAY
HOLBROOK, NY 11741

FOR: INVESTMENT ADVISORY SERVICES, IN CLASS 36 (U.S. CLS. 100, 101 AND 102).

FIRST USE 1-25-2012; IN COMMERCE 1-25-2012.

THE MARK CONSISTS OF STANDARD CHARACTERS WITHOUT CLAIM TO ANY PARTICULAR FONT, STYLE, SIZE, OR COLOR.

SER. NO. 85-524,169, FILED P.R. 1-24-2012; AM. S.R. 5-23-2012.

MATTHEW EINSTEIN, EXAMINING ATTORNEY



David J. Kybas

Director of the United States Patent and Trademark Office

United States of America

United States Patent and Trademark Office



Reg. No. 4,177,350

MICHAEL E. ZALETEL (UNITED STATES INDIVIDUAL)
378 E. CLIFTON COURT
GILBERT, AZ 85296

Registered July 17, 2012

Int. Cl.: 9

FOR: COMPUTER APPLICATION SOFTWARE FOR MOBILE PHONES, NAMELY, SOFTWARE FOR FLASHLIGHT, IN CLASS 9 (U.S. CLS. 21, 23, 26, 36 AND 38).

TRADEMARK

FIRST USE 6-25-2010; IN COMMERCE 6-25-2010.

SUPPLEMENTAL REGISTER

THE MARK CONSISTS OF A BLACK RECTANGLE OF SMOOTH TEXTURE THAT IS SITUATED IN AN OTHERWISE ROUGHER TEXTURED AREA. IN THE CENTER OF THE BLACK RECTANGLE, THERE IS A RED OVAL IMMEDIATELY BELOW THE WORD "ON" IN RED AND HIGHER ABOVE THE WORD "OFF" IN BLUE. THERE ARE ALSO THREE GREY LINES IN PARALLEL BELOW THE WORD OFF.

THE COLOR(S) BLACK, RED, BLUE, AND GRAY IS/ARE CLAIMED AS A FEATURE OF THE MARK.

SER. NO. 85-524,588, FILED 1-25-2012.

FONG HSU, EXAMINING ATTORNEY



David J. Kybas

Director of the United States Patent and Trademark Office

United States of America

United States Patent and Trademark Office

Statewide Electric Company

Reg. No. 4,177,351

Registered July 17, 2012

Int. Cl.: 37

SERVICE MARK

SUPPLEMENTAL REGISTER

STATEWIDE TRAFFIC SIGNAL COMPANY (TEXAS CORPORATION), DBA STATEWIDE ELECTRIC COMPANY,
1509 WEST 34TH STREET
HOUSTON, TX 77018

FOR: ELECTRICAL CONTRACTOR SERVICES, IN CLASS 37 (U.S. CLS. 100, 103 AND 106).

FIRST USE 10-2-2003; IN COMMERCE 10-2-2003.

THE MARK CONSISTS OF STANDARD CHARACTERS WITHOUT CLAIM TO ANY PARTICULAR FONT, STYLE, SIZE, OR COLOR.

NO CLAIM IS MADE TO THE EXCLUSIVE RIGHT TO USE "ELECTRIC COMPANY", APART FROM THE MARK AS SHOWN.

SER. NO. 85-525,711, FILED P.R. 1-26-2012; AM. S.R. 5-16-2012.

DAVID ELTON, EXAMINING ATTORNEY



David J. Kyffers

Director of the United States Patent and Trademark Office

United States of America

United States Patent and Trademark Office

PHOTOVOLTAIC MANUFACTURING CONSORTIUM

Reg. No. 4,177,352

Registered July 17, 2012

Int. Cls.: 35 and 42

SERVICE MARK

SUPPLEMENTAL REGISTER

SEMATECH, INC. (DELAWARE CORPORATION)
257 FULLER ROAD
SUITE 2200
ALBANY, NY 12203

FOR: PROMOTING COLLABORATION WITHIN RESEARCH COMMUNITIES TO DEVELOP, COMMERCIALIZE AND ACHIEVE IMPROVED MANUFACTURING PROCESSES IN THE FIELD OF SOLAR PHOTOVOLTAIC SYSTEMS, AND PROVIDING RELATED INFORMATION ABOUT OPPORTUNITIES TO PARTICIPATE IN SUCH RESEARCH; ASSOCIATION SERVICES, NAMELY, PROMOTING THE INTERESTS IN THE SOLAR PHOTOVOLTAIC INDUSTRY BY ORGANIZING GROUPS AND PARTNERSHIPS FOR THE PURPOSE OF COMMERCIALIZING AND CONDUCTING RESEARCH AND DEVELOPMENT OF MANUFACTURING TECHNIQUES FOR THE SOLAR PHOTOVOLTAIC INDUSTRY, IN CLASS 35 (U.S. CLS. 100, 101 AND 102).

FIRST USE 1-27-2011; IN COMMERCE 1-27-2011.

FOR: SCIENTIFIC AND PRODUCT RESEARCH SERVICES IN THE FIELD OF SOLAR PHOTOVOLTAIC SYSTEMS; CONDUCTING SCIENTIFIC AND PRODUCT RESEARCH GROUPS IN THE FIELD OF SOLAR PHOTOVOLTAIC SYSTEMS, IN CLASS 42 (U.S. CLS. 100 AND 101).

FIRST USE 1-27-2011; IN COMMERCE 1-27-2011.

THE MARK CONSISTS OF STANDARD CHARACTERS WITHOUT CLAIM TO ANY PARTICULAR FONT, STYLE, SIZE, OR COLOR.

SER. NO. 85-526,893, FILED 1-27-2012.

JEFFERY COWARD, EXAMINING ATTORNEY



David J. Kyros

Director of the United States Patent and Trademark Office

United States of America

United States Patent and Trademark Office



Reg. No. 4,177,353

BLESOFF, MARC S. (UNITED STATES INDIVIDUAL)
318 S. HUMPHREY AVE
OAK PARK, IL 60302

Registered July 17, 2012

Int. Cl.: 45

FOR: MEDIATION, IN CLASS 45 (U.S. CLS. 100 AND 101).

SERVICE MARK

FIRST USE 11-1-2011; IN COMMERCE 12-1-2011.

SUPPLEMENTAL REGISTER

NO CLAIM IS MADE TO THE EXCLUSIVE RIGHT TO USE "MEDIATION", APART FROM THE MARK AS SHOWN.

THE COLOR(S) GREEN, LIGHT BLUE AND WHITE IS/ARE CLAIMED AS A FEATURE OF THE MARK.

THE MARK CONSISTS OF THE WORDING "MEDIATION CAPE COD" IN THE COLOR LIGHT BLUE, ALONG WITH A DEPICTION OF A CAPE COD, MARTHA'S VINEYARD AND NANTUCKET IN THE COLOR GREEN, WITH A LIGHT BLUE SHADOW BEHIND THE DEPICTIONS OF CAPE COD, MARTHA'S VINEYARD, AND NANTUCKET, ALL ON A WHITE BACKGROUND.

SER. NO. 85-527,898, FILED P.R. 1-28-2012; AM. S.R. 5-14-2012.

MICHAEL GAAFAR, EXAMINING ATTORNEY



David J. Kybas

Director of the United States Patent and Trademark Office

United States of America

United States Patent and Trademark Office

TaxBlog

Reg. No. 4,177,354

TAXBLOG LLC (CALIFORNIA LIMITED LIABILITY COMPANY), AKA TAXBLOG,
12405 RUETTE ALLIANTE
SAN DIEGO, CA 92130

Registered July 17, 2012

Int. Cl.: 41

FOR: ON-LINE JOURNALS, NAMELY, BLOGS FEATURING TAX CONTENT, IN CLASS 41
(U.S. CLS. 100, 101 AND 107).

SERVICE MARK

FIRST USE 7-5-2008; IN COMMERCE 7-5-2008.

SUPPLEMENTAL REGISTER

THE MARK CONSISTS OF STANDARD CHARACTERS WITHOUT CLAIM TO ANY PARTICULAR FONT, STYLE, SIZE, OR COLOR.

SER. NO. 85-528,425, FILED P.R. 1-30-2012; AM. S.R. 5-15-2012.

B. PARADEWELAI, EXAMINING ATTORNEY



David J. Kyffers

Director of the United States Patent and Trademark Office

United States of America

United States Patent and Trademark Office

SocialNightlife

Reg. No. 4,177,355

SOCIALNIGHTLIFE LLC (CALIFORNIA LIMITED LIABILITY COMPANY)
1233 STANLEY AVE

Registered July 17, 2012

2
GLENDALE, CA 91206

Int. Cl.: 45

FOR: ON-LINE SOCIAL NETWORKING SERVICES, IN CLASS 45 (U.S. CLS. 100 AND 101).

SERVICE MARK

FIRST USE 12-1-2011; IN COMMERCE 12-1-2011.

SUPPLEMENTAL REGISTER

THE MARK CONSISTS OF STANDARD CHARACTERS WITHOUT CLAIM TO ANY PARTICULAR FONT, STYLE, SIZE, OR COLOR.

SER. NO. 85-533,932, FILED P.R. 2-3-2012; AM. S.R. 5-21-2012.

RONALD DELGIZZI, EXAMINING ATTORNEY



David J. Kyffers

Director of the United States Patent and Trademark Office

United States of America

United States Patent and Trademark Office

TRANSFER PRICING ANALYTICS

Reg. No. 4,177,356

EDGARSTAT, LLC (MARYLAND LIMITED LIABILITY COMPANY)
5404 BLACKISTONE ROAD
BETHESDA, MD 20816

Registered July 17, 2012

Int. Cl.: 42

FOR: COMPUTER SERVICES, NAMELY, PROVIDING AN ON-LINE COMPUTER DATABASE AND ANALYTICS FEATURING GLOBAL LISTED COMPANY INCOME STATEMENTS, BALANCE SHEETS, AND FINANCIAL RATIOS APPLICABLE TO INTERCOMPANY TRANSFER PRICING ANALYSIS AND TAX COMPLIANCE DOCUMENTATION, IN CLASS 42 (U.S. CLS. 100 AND 101).

SERVICE MARK

SUPPLEMENTAL REGISTER

FIRST USE 2-4-2003; IN COMMERCE 2-4-2003.

THE MARK CONSISTS OF STANDARD CHARACTERS WITHOUT CLAIM TO ANY PARTICULAR FONT, STYLE, SIZE, OR COLOR.

SER. NO. 85-534,730, FILED P.R. 2-6-2012; AM. S.R. 5-17-2012.

JOHN WILKE, EXAMINING ATTORNEY



David J. Kybas

Director of the United States Patent and Trademark Office

United States of America

United States Patent and Trademark Office

For The Tennessee Walking Horse

Reg. No. 4,177,357

Registered July 17, 2012

Int. Cl.: 41

SERVICE MARK

SUPPLEMENTAL REGISTER

OHNSTAD, ANDREA (UNITED STATES INDIVIDUAL)
2122 WEST VIRGIL DRIVE
QUEEN CREEK, AZ 85142

FOR: ON-LINE JOURNALS, NAMELY, BLOGS FEATURING EDUCATIONAL INFORMATION ABOUT THE HORSE BREED TENNESSEE WALKING HORSE INCLUDING INFORMATION ON ENDING THE ILLEGAL PRACTICE OF SORING AND REHABILITATING TENNESSEE WALKING HORSES THAT HAVE BEEN SORED, IN CLASS 41 (U.S. CLS. 100, 101 AND 107).

FIRST USE 5-0-2009; IN COMMERCE 5-0-2009.

THE MARK CONSISTS OF STANDARD CHARACTERS WITHOUT CLAIM TO ANY PARTICULAR FONT, STYLE, SIZE, OR COLOR.

SER. NO. 85-535,226, FILED P.R. 2-6-2012; AM. S.R. 5-19-2012.

LINDA POWELL, EXAMINING ATTORNEY



David J. Kyffers

Director of the United States Patent and Trademark Office

United States of America

United States Patent and Trademark Office

Brides Run

Reg. No. 4,177,358

FLOW ENTERPRISES INTERNATIONAL, INC. (ILLINOIS CORPORATION)
PO BOX 87526
CHICAGO, IL 60680

Registered July 17, 2012

Int. Cl.: 41

FOR: ARRANGING AND CONDUCTING LIVE, INTERACTIVE, TREASURE HUNT GAMING ADVENTURES; ORGANIZING, ARRANGING, AND CONDUCTING PHYSICAL FITNESS EVENTS; PROVIDING INFORMATION IN THE FIELD OF WEDDING PARTY PLANNING, IN CLASS 41 (U.S. CLS. 100, 101 AND 107).

SERVICE MARK

SUPPLEMENTAL REGISTER FIRST USE 11-3-2008; IN COMMERCE 11-3-2008.

THE MARK CONSISTS OF STANDARD CHARACTERS WITHOUT CLAIM TO ANY PARTICULAR FONT, STYLE, SIZE, OR COLOR.

NO CLAIM IS MADE TO THE EXCLUSIVE RIGHT TO USE "RUN", APART FROM THE MARK AS SHOWN.

SER. NO. 85-535,371, FILED P.R. 2-6-2012; AM. S.R. 5-22-2012.

MIDGE BUTLER, EXAMINING ATTORNEY



David J. Kyffers

Director of the United States Patent and Trademark Office

United States of America

United States Patent and Trademark Office

National Donor Day

Reg. No. 4,177,359

MARCH MARKETNG, INC. (CALIFORNIA CORPORATION)
19144 WESTON PLACE
TARZANA, CA 91356

Registered July 17, 2012

Int. Cl.: 35

FOR: PROMOTING PUBLIC AWARENESS OF THE NEED FOR HUMAN ORGAN, TISSUE, EYE, BLOOD AND BLOOD PRODUCTS DONATION, IN CLASS 35 (U.S. CLS. 100, 101 AND 102).

SERVICE MARK

FIRST USE 0-0-1998; IN COMMERCE 0-0-1998.

SUPPLEMENTAL REGISTER

THE MARK CONSISTS OF STANDARD CHARACTERS WITHOUT CLAIM TO ANY PARTICULAR FONT, STYLE, SIZE, OR COLOR.

SER. NO. 85-535,427, FILED P.R. 2-6-2012; AM. S.R. 5-23-2012.

ODESSA BIBBINS, EXAMINING ATTORNEY



David J. Kyffers

Director of the United States Patent and Trademark Office

United States of America

United States Patent and Trademark Office

Fibromyalgia & Chronic Pain LIFE

Reg. No. 4,177,360

Registered July 17, 2012

Int. Cl.: 16

CENTER FOR UNDERSTANDING, RESEARCH & EDUCATION OF FIBROMYALGIA (UTAH CORPORATION), DBA NATIONAL FIBROMYALGIA & CHRONIC PAIN ASSOCIATION,
JAN FAVERO CHAMBERS
31 FEDERAL AVENUE
LOGAN, UT 84321

TRADEMARK

FOR: MAGAZINES IN THE FIELD OF FIBROMYALGIA AND CHRONIC PAIN, IN CLASS 16 (U.S. CLS. 2, 5, 22, 23, 29, 37, 38 AND 50).

SUPPLEMENTAL REGISTER

FIRST USE 6-11-2011; IN COMMERCE 6-11-2011.

THE MARK CONSISTS OF STANDARD CHARACTERS WITHOUT CLAIM TO ANY PARTICULAR FONT, STYLE, SIZE, OR COLOR.

SER. NO. 85-535,441, FILED P.R. 2-6-2012; AM. S.R. 5-21-2012.

KAREN K. BUSH, EXAMINING ATTORNEY



David J. Kyffers

Director of the United States Patent and Trademark Office

United States of America

United States Patent and Trademark Office

DRY DATE SALAMI

Reg. No. 4,177,361

CHARLITO, LLC (NORTH CAROLINA LIMITED LIABILITY COMPANY)
622 GLASCOCK STREET
RALEIGH, NC 27604

Registered July 17, 2012

Int. Cl.: 29

FOR: NON-MEAT FRUIT SALAMI MADE IN SUBSTANTIAL PART OF DRIED DATES, IN CLASS 29 (U.S. CL. 46).

TRADEMARK

FIRST USE 9-1-2011; IN COMMERCE 9-1-2011.

SUPPLEMENTAL REGISTER

THE MARK CONSISTS OF STANDARD CHARACTERS WITHOUT CLAIM TO ANY PARTICULAR FONT, STYLE, SIZE, OR COLOR.

NO CLAIM IS MADE TO THE EXCLUSIVE RIGHT TO USE "SALAMI", APART FROM THE MARK AS SHOWN.

SER. NO. 85-535,752, FILED P.R. 2-7-2012; AM. S.R. 5-16-2012.

BRIAN PINO, EXAMINING ATTORNEY



David J. Kybas

Director of the United States Patent and Trademark Office

United States of America

United States Patent and Trademark Office

DRY FIG SALAMI

Reg. No. 4,177,362

CHARLITO, LLC (NORTH CAROLINA LIMITED LIABILITY COMPANY)
622 GLASCOCK STREET
RALEIGH, NC 27604

Registered July 17, 2012

Int. Cl.: 29

FOR: NON-MEAT FRUIT SALAMI MADE IN SUBSTANTIAL PART OF DRIED FIGS, IN CLASS 29 (U.S. CL. 46).

TRADEMARK

FIRST USE 9-1-2011; IN COMMERCE 9-1-2011.

SUPPLEMENTAL REGISTER

THE MARK CONSISTS OF STANDARD CHARACTERS WITHOUT CLAIM TO ANY PARTICULAR FONT, STYLE, SIZE, OR COLOR.

NO CLAIM IS MADE TO THE EXCLUSIVE RIGHT TO USE "SALAMI", APART FROM THE MARK AS SHOWN.

SER. NO. 85-535,762, FILED P.R. 2-7-2012; AM. S.R. 5-16-2012.

BRIAN PINO, EXAMINING ATTORNEY



David J. Kybas

Director of the United States Patent and Trademark Office

United States of America

United States Patent and Trademark Office

DRY PEAR SALAMI

Reg. No. 4,177,363

CHARLITO, LLC (NORTH CAROLINA LIMITED LIABILITY COMPANY)
622 GLASCOCK STREET
RALEIGH, NC 27604

Registered July 17, 2012

Int. Cl.: 29

FOR: NON-MEAT FRUIT SALAMI MADE IN SUBSTANTIAL PART OF DRIED PEARS, IN CLASS 29 (U.S. CL. 46).

TRADEMARK

FIRST USE 9-1-2011; IN COMMERCE 9-1-2011.

SUPPLEMENTAL REGISTER

THE MARK CONSISTS OF STANDARD CHARACTERS WITHOUT CLAIM TO ANY PARTICULAR FONT, STYLE, SIZE, OR COLOR.

NO CLAIM IS MADE TO THE EXCLUSIVE RIGHT TO USE "SALAMI", APART FROM THE MARK AS SHOWN.

SER. NO. 85-535,768, FILED P.R. 2-7-2012; AM. S.R. 5-16-2012.

BRIAN PINO, EXAMINING ATTORNEY



David J. Kybas

Director of the United States Patent and Trademark Office

United States of America

United States Patent and Trademark Office

POP TALK!

Reg. No. 4,177,364

STARLINE PUBLICATIONS, INC. (NEW YORK CORPORATION)
46 VIOLET AVENUE
POUGHKEEPSIE, NY 12601

Registered July 17, 2012

Int. Cl.: 16

FOR: MAGAZINES FEATURING CELEBRITIES AND ENTERTAINMENT, IN CLASS 16
(U.S. CLS. 2, 5, 22, 23, 29, 37, 38 AND 50).

TRADEMARK

FIRST USE 6-1-2011; IN COMMERCE 6-1-2011.

SUPPLEMENTAL REGISTER

THE MARK CONSISTS OF STANDARD CHARACTERS WITHOUT CLAIM TO ANY PARTICULAR FONT, STYLE, SIZE, OR COLOR.

SER. NO. 85-539,704, FILED P.R. 2-10-2012; AM. S.R. 5-18-2012.

KAPIL BHANOT, EXAMINING ATTORNEY



David J. Kyffers

Director of the United States Patent and Trademark Office

United States of America

United States Patent and Trademark Office

Ledge Pillow

Reg. No. 4,177,365

Registered July 17, 2012

Int. Cl.: 20

TRADEMARK

SUPPLEMENTAL REGISTER

LEDGE PILLOW LLC (FLORIDA LIMITED LIABILITY COMPANY)
SUITE 190
12230 FOREST HILL BLVD.
WELLINGTON, FL 33414

FOR: BED PILLOWS; BEDS, MATTRESSES, PILLOWS AND BOLSTERS; CUSHIONS; PILLOWS, IN CLASS 20 (U.S. CLS. 2, 13, 22, 25, 32 AND 50).

FIRST USE 10-1-2008; IN COMMERCE 10-1-2008.

THE MARK CONSISTS OF STANDARD CHARACTERS WITHOUT CLAIM TO ANY PARTICULAR FONT, STYLE, SIZE, OR COLOR.

NO CLAIM IS MADE TO THE EXCLUSIVE RIGHT TO USE "PILLOW", APART FROM THE MARK AS SHOWN.

SER. NO. 85-539,987, FILED P.R. 2-10-2012; AM. S.R. 5-22-2012.

NICHOLAS ALTREE, EXAMINING ATTORNEY



David J. Kyffers

Director of the United States Patent and Trademark Office

United States of America

United States Patent and Trademark Office

OnSiteDecals.com

Reg. No. 4,177,366

BURKE, STEVEN (UNITED STATES INDIVIDUAL)
P.O. BOX 702
FULSHEAR, TX 77441

Registered July 17, 2012

Int. Cls.: 37, 40, and 42

FOR: INSTALLATION SERVICES OF VINYL GRAPHICS ONTO EMERGENCY AND COMMERCIAL FLEET VEHICLES AND SINGLE VEHICLES, IN CLASS 37 (U.S. CLS. 100, 103 AND 106).

SERVICE MARK

FIRST USE 1-1-2009; IN COMMERCE 1-1-2009.

SUPPLEMENTAL REGISTER

FOR: MANUFACTURING SERVICES FOR OTHERS IN THE FIELD OF VINYL GRAPHICS, IN CLASS 40 (U.S. CLS. 100, 103 AND 106).

FIRST USE 1-1-2009; IN COMMERCE 1-1-2009.

FOR: DESIGN SERVICES, NAMELY, DESIGNING VINYL GRAPHICS ONTO EMERGENCY AND COMMERCIAL FLEET VEHICLES AND SINGLE VEHICLES, IN CLASS 42 (U.S. CLS. 100 AND 101).

FIRST USE 1-1-2009; IN COMMERCE 1-1-2009.

THE MARK CONSISTS OF STANDARD CHARACTERS WITHOUT CLAIM TO ANY PARTICULAR FONT, STYLE, SIZE, OR COLOR.

SER. NO. 85-541,481, FILED P.R. 2-13-2012; AM. S.R. 5-23-2012.

KATHY DE JONGE, EXAMINING ATTORNEY



David J. Kyros

Director of the United States Patent and Trademark Office

United States of America

United States Patent and Trademark Office

Intelligent Security Device

Reg. No. 4,177,367

Registered July 17, 2012

Int. Cl.: 9

TRADEMARK

SUPPLEMENTAL REGISTER

SHIELDCORE SYSTEMS INC. (CANADA CORPORATION)
#19
3871 NORTH FRASER WAY
BURNABY, CANADA V5J5G6

FOR: COMPUTER FIREWALL SOFTWARE AS A COMPONENT PART OF ROUTING DEVICES FOR CONTROLLING INCOMING AND OUTGOING INTERNET TRAFFIC, FOR MANAGING AND MONITORING INTERNAL NETWORK TRAFFIC, AND FOR IDENTIFYING AND CONTAINING POSSIBLE SECURITY THREATS, IN CLASS 9 (U.S. CLS. 21, 23, 26, 36 AND 38).

FIRST USE 4-1-2011; IN COMMERCE 4-1-2011.

THE MARK CONSISTS OF STANDARD CHARACTERS WITHOUT CLAIM TO ANY PARTICULAR FONT, STYLE, SIZE, OR COLOR.

NO CLAIM IS MADE TO THE EXCLUSIVE RIGHT TO USE "SECURITY DEVICE", APART FROM THE MARK AS SHOWN.

SER. NO. 85-543,579, FILED P.R. 2-15-2012; AM. S.R. 5-23-2012.

JACLYN KIDWELL WALKER, EXAMINING ATTORNEY



David J. Kyffers

Director of the United States Patent and Trademark Office

United States of America

United States Patent and Trademark Office

A Law Firm for Physicians

Reg. No. 4,177,368

LUBELL & ROSEN, LLC (FLORIDA LIMITED LIABILITY COMPANY)
200 S ANDREWS AVE, STE 900
FORT LAUDERDALE, FL 33301

Registered July 17, 2012

Int. Cl.: 45

FOR: LEGAL SERVICES, IN CLASS 45 (U.S. CLS. 100 AND 101).

SERVICE MARK

FIRST USE 1-1-2007; IN COMMERCE 1-1-2007.

SUPPLEMENTAL REGISTER

THE MARK CONSISTS OF STANDARD CHARACTERS WITHOUT CLAIM TO ANY PARTICULAR FONT, STYLE, SIZE, OR COLOR.

SER. NO. 85-544,012, FILED P.R. 2-15-2012; AM. S.R. 6-4-2012.

ROBIN CHOSID, EXAMINING ATTORNEY



David J. Kybas

Director of the United States Patent and Trademark Office

United States of America

United States Patent and Trademark Office

Las Vegas Escorts

Reg. No. 4,177,369

SPECTRUM ENTERTAINMENT INC. (NEVADA CORPORATION)
2601 S. HIGHLAND
LAS VEGAS, NV 89104

Registered July 17, 2012

Int. Cl.: 45

FOR: ESCORT SERVICES, IN CLASS 45 (U.S. CLS. 100 AND 101).

SERVICE MARK

FIRST USE 7-13-2003; IN COMMERCE 7-13-2003.

SUPPLEMENTAL REGISTER

THE MARK CONSISTS OF STANDARD CHARACTERS WITHOUT CLAIM TO ANY PARTICULAR FONT, STYLE, SIZE, OR COLOR.

NO CLAIM IS MADE TO THE EXCLUSIVE RIGHT TO USE "ESCORTS", APART FROM THE MARK AS SHOWN.

SER. NO. 85-547,065, FILED P.R. 2-20-2012; AM. S.R. 6-1-2012.

WENDY JUN, EXAMINING ATTORNEY



David J. Kybas

Director of the United States Patent and Trademark Office

United States of America

United States Patent and Trademark Office

Tour of Gymnastics Champions

Reg. No. 4,177,370

Registered July 17, 2012

Int. Cls.: 35 and 41

SERVICE MARK

SUPPLEMENTAL REGISTER

USA GYMNASTICS (TEXAS NON-PROFIT CORPORATION)
SUITE 700
132 EAST WASHINGTON STREET
INDIANAPOLIS, IN 46204

FOR: PROMOTING PUBLIC AWARENESS AND INTEREST IN THE SPORT OF GYMNASTICS, IN CLASS 35 (U.S. CLS. 100, 101 AND 102).

FIRST USE 1-1-2012; IN COMMERCE 1-1-2012.

FOR: EDUCATIONAL AND ENTERTAINMENT SERVICES, NAMELY, ORGANIZING AND CONDUCTING GYMNASTIC EXHIBITIONS AND EVENTS, IN CLASS 41 (U.S. CLS. 100, 101 AND 107).

FIRST USE 1-1-2012; IN COMMERCE 1-1-2012.

THE MARK CONSISTS OF STANDARD CHARACTERS WITHOUT CLAIM TO ANY PARTICULAR FONT, STYLE, SIZE, OR COLOR.

NO CLAIM IS MADE TO THE EXCLUSIVE RIGHT TO USE "GYMNASTICS", APART FROM THE MARK AS SHOWN.

SER. NO. 85-547,885, FILED P.R. 2-21-2012; AM. S.R. 6-12-2012.

GEORGE LORENZO, EXAMINING ATTORNEY



David J. Kybas

Director of the United States Patent and Trademark Office

United States of America

United States Patent and Trademark Office

America's Best Skiing

Reg. No. 4,177,371

Registered July 17, 2012

Int. Cl.: 35

SERVICE MARK

SUPPLEMENTAL REGISTER

COLORADO TOURISM OFFICE (COLORADO STATE AGENCY)
SUITE 2700
1625 BROADWAY
DENVER, CO 80202

FOR: MARKETING SERVICES, NAMELY, PROMOTING OR ADVERTISING THE GOODS AND SERVICES OF OTHERS; PROMOTING RECREATION AND TOURISM IN COLORADO, IN CLASS 35 (U.S. CLS. 100, 101 AND 102).

FIRST USE 11-1-2011; IN COMMERCE 11-1-2011.

THE MARK CONSISTS OF STANDARD CHARACTERS WITHOUT CLAIM TO ANY PARTICULAR FONT, STYLE, SIZE, OR COLOR.

NO CLAIM IS MADE TO THE EXCLUSIVE RIGHT TO USE "SKIING", APART FROM THE MARK AS SHOWN.

SER. NO. 85-550,508, FILED 2-23-2012.

KIMBERLY PERRY, EXAMINING ATTORNEY



David J. Kyffers

Director of the United States Patent and Trademark Office

United States of America

United States Patent and Trademark Office

WRAP & STRAP

Reg. No. 4,177,372

WASCO LLC (NEVADA LIMITED LIABILITY COMPANY)
8535 BENIDORM AVENUE
LAS VEGAS, NV 89178

Registered July 17, 2012

Int. Cl.: 24

FOR: PLASTIC TABLE COVERS; TABLE CLOTHS NOT OF PAPER; TEXTILE TABLE-CLOTHS, IN CLASS 24 (U.S. CLS. 42 AND 50).

TRADEMARK

FIRST USE 4-28-2011; IN COMMERCE 4-28-2011.

SUPPLEMENTAL REGISTER

THE MARK CONSISTS OF STANDARD CHARACTERS WITHOUT CLAIM TO ANY PARTICULAR FONT, STYLE, SIZE, OR COLOR.

SER. NO. 85-550,722, FILED P.R. 2-23-2012; AM. S.R. 6-8-2012.

RAUL CORDOVA, EXAMINING ATTORNEY



David J. Kyffers

Director of the United States Patent and Trademark Office

United States of America

United States Patent and Trademark Office

Sugar*Shine

Reg. No. 4,177,373

Registered July 17, 2012

Int. Cl.: 33

TRADEMARK

SUPPLEMENTAL REGISTER

LIMESTONE BRANCH DISTILLERS, INC. (KENTUCKY CORPORATION), DBA LIMESTONE
BRANCH DISTILLERY,
1280 VETERANS MEMORIAL HIGHWAY
LEBANON, KY 40033

FOR: ALCOHOLIC BEVERAGES, NAMELY, FLAVOR-INFUSED WHISKEY; WHISKEY;
WHISKEY, IN CLASS 33 (U.S. CLS. 47 AND 49).

FIRST USE 10-9-2011; IN COMMERCE 2-5-2012.

THE MARK CONSISTS OF STANDARD CHARACTERS WITHOUT CLAIM TO ANY PAR-
TICULAR FONT, STYLE, SIZE, OR COLOR.

SER. NO. 85-552,802, FILED 2-25-2012.

JAMES LOVELACE, EXAMINING ATTORNEY



David J. Kyffers

Director of the United States Patent and Trademark Office

United States of America

United States Patent and Trademark Office

Personnel Patrol

Reg. No. 4,177,374

Registered July 17, 2012

Int. Cl.: 35

SERVICE MARK

SUPPLEMENTAL REGISTER

V.T. EGG, INC. (MAINE CORPORATION), DBA VIRAL TECHNOLOGIES CORPORATION,
SUITE 501
75 MARKET STREET
PORTLAND, ME 04101

FOR: MEDIA MONITORING SERVICES, NAMELY, MONITORING PRINT MEDIA, TELEVISION, RADIO, AND OTHER MEDIA FOR CUSTOMER-SPECIFIED TOPICS, GATHERING RELEVANT CONTENT ON THOSE TOPICS, AND PROVIDING DOCUMENTATION AND ANALYSIS OF THAT MEDIA CONTENT TO OTHERS FOR BUSINESS PURPOSES; ONLINE MEDIA MONITORING SERVICES USING COMPUTER SOFTWARE TO AUTOMATICALLY MONITOR INTERNET WEBSITES AND ONLINE PUBLICATIONS FOR CUSTOMER-SPECIFIED TOPICS AND TO CAPTURE RELEVANT CONTENT ON THOSE TOPICS, AND PROVIDING DOCUMENTATION AND ANALYSIS OF THAT ONLINE CONTENT TO OTHERS FOR BUSINESS PURPOSES; ONLINE SERVICE FOR CONNECTING SOCIAL NETWORK USERS WITH RETAILERS FOR THE PURPOSE OF FACILITATING DISCOUNTED PURCHASES, IN CLASS 35 (U.S. CLS. 100, 101 AND 102).

FIRST USE 12-15-2011; IN COMMERCE 12-15-2011.

THE MARK CONSISTS OF STANDARD CHARACTERS WITHOUT CLAIM TO ANY PARTICULAR FONT, STYLE, SIZE, OR COLOR.

SER. NO. 85-554,428, FILED P.R. 2-28-2012; AM. S.R. 5-3-2012.

SHAUNIA CARLYLE, EXAMINING ATTORNEY



David J. Kyffers

Director of the United States Patent and Trademark Office

United States of America

United States Patent and Trademark Office

Product Patrol

Reg. No. 4,177,375

Registered July 17, 2012

Int. Cl.: 35

SERVICE MARK

SUPPLEMENTAL REGISTER

V.T. EGG, INC. (MAINE CORPORATION), DBA VIRAL TECHNOLOGIES CORPORATION,
SUITE 501
75 MARKET STREET
PORTLAND, ME 04101

FOR: MARKETING CONSULTING, NAMELY, SOCIAL MEDIA PRODUCT MONITORING,
IN CLASS 35 (U.S. CLS. 100, 101 AND 102).

FIRST USE 12-15-2011; IN COMMERCE 12-15-2011.

THE MARK CONSISTS OF STANDARD CHARACTERS WITHOUT CLAIM TO ANY PAR-
TICULAR FONT, STYLE, SIZE, OR COLOR.

SER. NO. 85-554,497, FILED P.R. 2-28-2012; AM. S.R. 5-3-2012.

SHAUNIA CARLYLE, EXAMINING ATTORNEY



David J. Kyffers

Director of the United States Patent and Trademark Office

United States of America

United States Patent and Trademark Office



Reg. No. 4,177,376

Registered July 17, 2012

Int. Cl.: 14

TRADEMARK

SUPPLEMENTAL REGISTER

TSI ACCESSORY GROUP, INC. (MISSOURI CORPORATION)
1031 EXECUTIVE PARKWAY DRIVE
ST. LOUIS, MO 63141

FOR: JEWELRY, IN CLASS 14 (U.S. CLS. 2, 27, 28 AND 50).

FIRST USE 11-0-2011; IN COMMERCE 11-0-2011.

THE MARK CONSISTS OF THE COLORS BLACK AND GOLD AS APPLIED TO THE EXTERIOR PACKAGING FOR THE GOODS. THE COLOR BLACK APPEARS DEPICTED ON THE ENTIRE BOTTOM SURFACE OF THE BOX AS WELL AS ON THE RIBBON ON THE TOP OF THE BOX. THE COLOR GOLD APPEARS DEPICTED ON THE ENTIRE TOP SURFACE OF THE BOX. THE DOTTED OUTLINE OF THE PACKAGING IS INTENDED TO SHOW THE POSITION OF THE MARK ON THE GOODS AND IS NOT PART OF THE MARK.

THE COLOR(S) GOLD AND BLACK IS/ARE CLAIMED AS A FEATURE OF THE MARK.

SER. NO. 85-555,002, FILED 2-28-2012.

MICHAEL TANNER, EXAMINING ATTORNEY



David J. Kyffers

Director of the United States Patent and Trademark Office

United States of America

United States Patent and Trademark Office

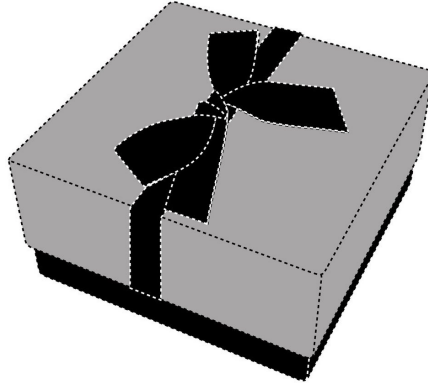

Reg. No. 4,177,377

Registered July 17, 2012

Int. Cl.: 14

TRADEMARK

SUPPLEMENTAL REGISTER

TSI ACCESSORY GROUP, INC. (MISSOURI CORPORATION)
1031 EXECUTIVE PARKWAY DRIVE
ST. LOUIS, MO 63141

FOR: JEWELRY, IN CLASS 14 (U.S. CLS. 2, 27, 28 AND 50).

FIRST USE 11-0-2011; IN COMMERCE 11-0-2011.

THE MARK CONSISTS OF THE COLORS BLACK AND SILVER AS APPLIED TO THE EXTERIOR PACKAGING FOR THE GOODS. THE COLOR BLACK APPEARS DEPICTED ON THE ENTIRE BOTTOM SURFACE OF THE BOX AS WELL AS ON THE RIBBON ON THE TOP OF THE BOX. THE COLOR SILVER APPEARS DEPICTED ON THE ENTIRE TOP SURFACE OF THE BOX. THE DOTTED OUTLINE OF THE PACKAGING IS INTENDED TO SHOW THE POSITION OF THE MARK ON THE GOODS AND IS NOT PART OF THE MARK.

THE COLOR(S) SILVER AND BLACK IS/ARE CLAIMED AS A FEATURE OF THE MARK.

SER. NO. 85-555,072, FILED 2-28-2012.

MICHAEL TANNER, EXAMINING ATTORNEY



David J. Kyffers

Director of the United States Patent and Trademark Office

United States of America

United States Patent and Trademark Office



Reg. No. 4,177,378

Registered July 17, 2012

Int. Cl.: 14

TRADEMARK

SUPPLEMENTAL REGISTER

TSI ACCESSORY GROUP, INC. (MISSOURI CORPORATION)
1031 EXECUTIVE PARKWAY DRIVE
ST. LOUIS, MO 63141

FOR: JEWELRY, IN CLASS 14 (U.S. CLS. 2, 27, 28 AND 50).

FIRST USE 11-0-2011; IN COMMERCE 11-0-2011.

THE MARK CONSISTS OF THE COLOR BLACK AS APPLIED TO THE EXTERIOR PACKAGING FOR THE GOODS. THE COLOR BLACK APPEARS DEPICTED ON THE ENTIRE SURFACE OF THE BOX AS WELL AS THE RIBBON ON THE TOP OF THE BOX. THE DOTTED OUTLINE OF THE PACKAGING IS INTENDED TO SHOW THE POSITION OF THE MARK ON THE GOODS AND IS NOT PART OF THE MARK.

THE COLOR(S) BLACK IS/ARE CLAIMED AS A FEATURE OF THE MARK.

SER. NO. 85-555,123, FILED 2-28-2012.

MICHAEL TANNER, EXAMINING ATTORNEY



David J. Kybas

Director of the United States Patent and Trademark Office

United States of America

United States Patent and Trademark Office

SANDIEGOTRADEMARKATTORNEY

Reg. No. 4,177,379

MANDOUR & ASSOCIATES, APC (CALIFORNIA CORPORATION)
16870 WEST BERNARDO DRIVE, SUITE 400
SAN DIEGO, CA 92127

Registered July 17, 2012

Int. Cl.: 45

FOR: NEWS REPORTING AND EXPERT LEGAL COMMENTARY SERVICES IN THE FIELD OF LEGAL NEWS, IN CLASS 45 (U.S. CLS. 100 AND 101).

SERVICE MARK

FIRST USE 10-1-2011; IN COMMERCE 10-1-2011.

SUPPLEMENTAL REGISTER

THE MARK CONSISTS OF STANDARD CHARACTERS WITHOUT CLAIM TO ANY PARTICULAR FONT, STYLE, SIZE, OR COLOR.

OWNER OF U.S. REG. NOS. 4,092,622, 4,092,623, AND 4,092,624.

SER. NO. 85-556,408, FILED 2-29-2012.

HEATHER THOMPSON, EXAMINING ATTORNEY



David J. Kybas

Director of the United States Patent and Trademark Office

United States of America

United States Patent and Trademark Office

ORANGECOUNTYPATENTATTORNEY

Reg. No. 4,177,380

MANDOUR & ASSOCIATES, APC (CALIFORNIA CORPORATION)
16870 WEST BERNARDO DRIVE, SUITE 400
SAN DIEGO, CA 92127

Registered July 17, 2012

Int. Cl.: 45

FOR: NEWS REPORTING AND EXPERT LEGAL COMMENTARY SERVICES IN THE FIELD OF LEGAL NEWS, IN CLASS 45 (U.S. CLS. 100 AND 101).

SERVICE MARK

FIRST USE 9-30-2011; IN COMMERCE 9-30-2011.

SUPPLEMENTAL REGISTER

THE MARK CONSISTS OF STANDARD CHARACTERS WITHOUT CLAIM TO ANY PARTICULAR FONT, STYLE, SIZE, OR COLOR.

OWNER OF U.S. REG. NOS. 4,092,622, 4,092,623, AND 4,092,624.

SER. NO. 85-556,413, FILED 2-29-2012.

HEATHER THOMPSON, EXAMINING ATTORNEY



David J. Kybas

Director of the United States Patent and Trademark Office

United States of America

United States Patent and Trademark Office

LOSANGELESTRADEMARKATTORNEY

Reg. No. 4,177,381

MANDOUR & ASSOCIATES, APC (CALIFORNIA CORPORATION)
16870 WEST BERNARDO DRIVE, SUITE 400
SAN DIEGO, CA 92127

Registered July 17, 2012

Int. Cl.: 45

FOR: NEWS REPORTING AND EXPERT LEGAL COMMENTARY SERVICES IN THE FIELD OF LEGAL NEWS, IN CLASS 45 (U.S. CLS. 100 AND 101).

SERVICE MARK

FIRST USE 9-30-2011; IN COMMERCE 9-30-2011.

SUPPLEMENTAL REGISTER

THE MARK CONSISTS OF STANDARD CHARACTERS WITHOUT CLAIM TO ANY PARTICULAR FONT, STYLE, SIZE, OR COLOR.

OWNER OF U.S. REG. NOS. 4,092,622, 4,092,623, AND 4,092,624.

SER. NO. 85-556,417, FILED 2-29-2012.

HEATHER THOMPSON, EXAMINING ATTORNEY



David J. Kybas

Director of the United States Patent and Trademark Office

United States of America

United States Patent and Trademark Office

CALIFORNIA PATENT ATTORNEY

Reg. No. 4,177,382

MANDOUR & ASSOCIATES, APC (CALIFORNIA CORPORATION)
16870 WEST BERNARDO DRIVE, SUITE 400
SAN DIEGO, CA 92127

Registered July 17, 2012

Int. Cl.: 45

FOR: NEWS REPORTING AND EXPERT LEGAL COMMENTARY SERVICES IN THE FIELD OF LEGAL NEWS, IN CLASS 45 (U.S. CLS. 100 AND 101).

SERVICE MARK

FIRST USE 10-1-2011; IN COMMERCE 10-1-2011.

SUPPLEMENTAL REGISTER

THE MARK CONSISTS OF STANDARD CHARACTERS WITHOUT CLAIM TO ANY PARTICULAR FONT, STYLE, SIZE, OR COLOR.

OWNER OF U.S. REG. NOS. 4,092,622, 4,092,623, AND 4,092,624.

SER. NO. 85-556,426, FILED 2-29-2012.

HEATHER THOMPSON, EXAMINING ATTORNEY



David J. Kyjars

Director of the United States Patent and Trademark Office

United States of America

United States Patent and Trademark Office

CALIFORNIA TRADEMARK ATTORNEY

Reg. No. 4,177,383

MANDOUR & ASSOCIATES, APC (CALIFORNIA CORPORATION)
16870 WEST BERNARDO DRIVE, SUITE 400
SAN DIEGO, CA 92127

Registered July 17, 2012

Int. Cl.: 45

FOR: NEWS REPORTING AND EXPERT LEGAL COMMENTARY SERVICES IN THE FIELD OF LEGAL NEWS, IN CLASS 45 (U.S. CLS. 100 AND 101).

SERVICE MARK

FIRST USE 10-14-2011; IN COMMERCE 10-14-2011.

SUPPLEMENTAL REGISTER

THE MARK CONSISTS OF STANDARD CHARACTERS WITHOUT CLAIM TO ANY PARTICULAR FONT, STYLE, SIZE, OR COLOR.

OWNER OF U.S. REG. NOS. 4,092,622, 4,092,623, AND 4,092,624.

SER. NO. 85-556,429, FILED 2-29-2012.

HEATHER THOMPSON, EXAMINING ATTORNEY



David J. Kyros

Director of the United States Patent and Trademark Office

United States of America

United States Patent and Trademark Office

Louie Swag

Reg. No. 4,177,384

Registered July 17, 2012

Int. Cl.: 25

TRADEMARK

SUPPLEMENTAL REGISTER

BURRIS, KEVIN EDWARD (UNITED STATES INDIVIDUAL), DBA LOUIE SWAG,
SUITE 4
1139 BARDSTOWN RD.
LOUISVILLE, KY 40204

FOR: HATS; HOODED SWEATSHIRTS; SWEATSHIRTS; T-SHIRTS, IN CLASS 25 (U.S. CLS.
22 AND 39).

FIRST USE 3-1-2011; IN COMMERCE 3-1-2011.

THE MARK CONSISTS OF STANDARD CHARACTERS WITHOUT CLAIM TO ANY PAR-
TICULAR FONT, STYLE, SIZE, OR COLOR.

SER. NO. 85-557,725, FILED 3-1-2012.

LINDA MICKLEBURGH, EXAMINING ATTORNEY



David J. Kyffers

Director of the United States Patent and Trademark Office

United States of America

United States Patent and Trademark Office



Reg. No. 4,177,385

Registered July 17, 2012

Int. Cl.: 25

TRADEMARK

SUPPLEMENTAL REGISTER

SPUNK J CO (MINNESOTA CORPORATION)
C/O WIESE LAW FIRM
3525 PLYMOUTH BOULEVARD (STUDIO 209)
PLYMOUTH, MN 55447

FOR: CLOTHING, NAMELY, SHIRTS, PANTS, SWEATERS, JACKETS, COATS, JOGGING OUTFITS, SOCKS, GLOVES, SHOES, SNEAKERS, HATS, VISORS, BANDANAS, BELTS AND SCARVES, IN CLASS 25 (U.S. CLS. 22 AND 39).

FIRST USE 6-15-2011; IN COMMERCE 6-15-2011.

THE MARK CONSISTS OF THE LETTER "I" FOLLOWED BY A DESIGN OF A CHERRY, FOLLOWED BY THE LETTERS "MPLS".

SER. NO. 85-558,129, FILED 3-1-2012.

TINA BROWN, EXAMINING ATTORNEY



David J. Kybas

Director of the United States Patent and Trademark Office

United States of America

United States Patent and Trademark Office

Gourmet Grown

Reg. No. 4,177,386

Registered July 17, 2012

Int. Cl.: 31

TRADEMARK

SUPPLEMENTAL REGISTER

PREMIER COLOR NURSERY, LLC (CALIFORNIA LIMITED LIABILITY COMPANY)
PO BOX 1660
1244 WINTERHAVEN ROAD
FALLBROOK, CA 92088

FOR: LIVE POTTED HERB PLANTS, LIVE POTTED ANNUAL FLOWERING PLANTS, LIVE POTTED VEGETABLE PLANTS LIVE POTTED PERENNIAL FLOWERING PLANTS , IN CLASS 31 (U.S. CLS. 1 AND 46).

FIRST USE 4-1-2004; IN COMMERCE 4-1-2004.

THE MARK CONSISTS OF STANDARD CHARACTERS WITHOUT CLAIM TO ANY PARTICULAR FONT, STYLE, SIZE, OR COLOR.

SER. NO. 85-559,254, FILED 3-2-2012.

SUE LAWRENCE, EXAMINING ATTORNEY



David J. Kyffers

Director of the United States Patent and Trademark Office

United States of America

United States Patent and Trademark Office

ONCOLOGY LIVE UROLOGISTS IN CANCER CARE

Reg. No. 4,177,387

Registered July 17, 2012

Int. Cl.: 16

TRADEMARK

SUPPLEMENTAL REGISTER

INTELLISPHERE, LLC (DELAWARE LIMITED LIABILITY COMPANY)
BUILDING 300
666 PLAINSBORO ROAD
PLAINSBORO, NJ 08536

FOR: PRINT PUBLICATIONS, NAMELY, JOURNALS, MAGAZINES, SUPPLEMENTS, AND ARTICLES IN THE FIELD OF UROLOGY AND ONCOLOGY, IN CLASS 16 (U.S. CLS. 2, 5, 22, 23, 29, 37, 38 AND 50).

FIRST USE 2-13-2012; IN COMMERCE 2-13-2012.

THE MARK CONSISTS OF STANDARD CHARACTERS WITHOUT CLAIM TO ANY PARTICULAR FONT, STYLE, SIZE, OR COLOR.

OWNER OF U.S. REG. NOS. 4,090,087 AND 4,092,933.

NO CLAIM IS MADE TO THE EXCLUSIVE RIGHT TO USE "ONCOLOGY" AND "UROLOGISTS IN CANCER CARE", APART FROM THE MARK AS SHOWN.

SER. NO. 85-560,346, FILED P.R. 3-5-2012; AM. S.R. 5-22-2012.

MATTHEW KLINE, EXAMINING ATTORNEY



David J. Kyffers

Director of the United States Patent and Trademark Office

United States of America

United States Patent and Trademark Office

Fruit Clusters

Reg. No. 4,177,388

Registered July 17, 2012

Int. Cl.: 29

BROTHERS INTERNATIONAL FOOD CORPORATION (DELAWARE CORPORATION),
DBA BROTHERS-ALL-NATURAL,
1175 LEXINGTON AVENUE
ROCHESTER, NY 14606

FOR: FRUIT-BASED SNACK FOOD, IN CLASS 29 (U.S. CL. 46).

TRADEMARK

FIRST USE 12-1-2011; IN COMMERCE 1-4-2012.

SUPPLEMENTAL REGISTER

THE MARK CONSISTS OF STANDARD CHARACTERS WITHOUT CLAIM TO ANY PARTICULAR FONT, STYLE, SIZE, OR COLOR.

SER. NO. 85-562,376, FILED P.R. 3-7-2012; AM. S.R. 5-5-2012.

BRIDGETT SMITH, EXAMINING ATTORNEY



David J. Kybas

Director of the United States Patent and Trademark Office

United States of America

United States Patent and Trademark Office

UT-FEM

Reg. No. 4,177,389

GLOBAL QUALITY HEALTH, INC. (DELAWARE CORPORATION)
1992 COMMERCE ST. #48

Registered July 17, 2012

YORKTOWN HEIGHTS, NY 10598

Int. Cl.: 5

FOR: DIETARY SUPPLEMENTS, IN CLASS 5 (U.S. CLS. 6, 18, 44, 46, 51 AND 52).

TRADEMARK

FIRST USE 3-8-2012; IN COMMERCE 3-8-2012.

SUPPLEMENTAL REGISTER

THE MARK CONSISTS OF STANDARD CHARACTERS WITHOUT CLAIM TO ANY PARTICULAR FONT, STYLE, SIZE, OR COLOR.

SER. NO. 85-574,634, FILED P.R. 3-20-2012; AM. S.R. 5-14-2012.

ALAIN LAPTER, EXAMINING ATTORNEY



David J. Kybas

Director of the United States Patent and Trademark Office

United States of America

United States Patent and Trademark Office

Shoot Many Robots

Reg. No. 4,177,390

Registered July 17, 2012

Int. Cl.: 9

TRADEMARK

SUPPLEMENTAL REGISTER

DEMIURGE GAME DEVELOPMENT, LLC (MASSACHUSETTS LIMITED LIABILITY COMPANY)
130 PROSPECT STREET FIRST FLOOR
CAMBRIDGE, MA 02139

FOR: COMPUTER GAME SOFTWARE FOR HOME VIDEO GAME CONSOLES; ELECTRONIC GAME PROGRAMS; GAME SOFTWARE; INTERACTIVE GAME PROGRAMS; VIDEO GAME SOFTWARE, IN CLASS 9 (U.S. CLS. 21, 23, 26, 36 AND 38).

FIRST USE 3-17-2012; IN COMMERCE 3-17-2012.

THE MARK CONSISTS OF STANDARD CHARACTERS WITHOUT CLAIM TO ANY PARTICULAR FONT, STYLE, SIZE, OR COLOR.

SER. NO. 85-976,771, FILED 9-20-2011.

ROBERT STRUCK, EXAMINING ATTORNEY



David J. Kybas

Director of the United States Patent and Trademark Office

United States of America

United States Patent and Trademark Office

SKYDIVE HAWAII

Reg. No. 4,177,391

SKYDIVING SCHOOL, INC. (HAWAII CORPORATION), DBA SKYDIVE HAWAII,
PO BOX 75520
HONOLULU, HI 96836

Registered July 17, 2012

Int. Cls.: 9, 12, and 18

FOR: BLANK RECORDABLE CD-RS AND DVD-RS; BLANK RECORDABLE DVDS; BLANK
USB FLASH DRIVES; COMPUTER STORAGE DEVICES, NAMELY, BLANK FLASH DRIVES,
IN CLASS 9 (U.S. CLS. 21, 23, 26, 36 AND 38).

TRADEMARK

FIRST USE 7-1-2007; IN COMMERCE 7-1-2007.

SUPPLEMENTAL REGISTER

FOR: PARACHUTES, IN CLASS 12 (U.S. CLS. 19, 21, 23, 31, 35 AND 44).

FIRST USE 1-1-2010; IN COMMERCE 1-1-2010.

FOR: ALL PURPOSE SPORT BAGS; ALL-PURPOSE ATHLETIC BAGS; ALL-PURPOSE
CARRYING BAGS; ATHLETIC BAGS; CARRY-ALL BAGS; SPORT BAGS; TRAVEL BAGS,
IN CLASS 18 (U.S. CLS. 1, 2, 3, 22 AND 41).

FIRST USE 7-1-2011; IN COMMERCE 7-1-2011.

NO CLAIM IS MADE TO THE EXCLUSIVE RIGHT TO USE "SKYDIVE" FOR CLASS 12
ONLY, APART FROM THE MARK AS SHOWN.



THE MARK CONSISTS OF A LOGOTYPE OF THE WORDS "SKYDIVE HAWAII", WHEREIN
THE INITIAL LETTERS "S", "K", AND "Y" HAVE PROGRESSIVELY DECREASE IN HEIGHT
AND THE REMAINING LETTERS "D", "I", "V", "E", "H", "A", "W", "A", "I", "I" HAVE UNIFORM
HEIGHT SMALLER THAN THE "Y" LETTER.

SER. NO. 85-976,807, FILED P.R. 7-18-2011; AM. S.R. 4-26-2012.

TEJBIR SINGH, EXAMINING ATTORNEY

David J. Kyffers

Director of the United States Patent and Trademark Office