

Chapter III

Bioventing

Contents

Overview	III-1
Initial Screening Of Bioventing Effectiveness	III-7
Detailed Evaluation Of Bioventing Effectiveness	III-7
Site Characteristics	III-9
Intrinsic Permeability	III-9
Soil Structure And Stratification	III-11
Microbial Presence	III-11
Soil Ph	III-13
Moisture Content	III-13
Soil Temperature	III-14
Nutrient Concentrations	III-14
Depth To Groundwater	III-15
Constituent Characteristics	III-15
Chemical Structure	III-15
Concentration And Toxicity	III-16
Vapor Pressure	III-18
Product Composition And Boiling Point	III-18
Henry's Law Constant	III-19
Pilot Scale Studies	III-20
Evaluation Of The Bioventing System Design	III-22
Rationale For The Design	III-22
Components Of A Bioventing System	III-25
Extraction Wells	III-25
Air Injection Wells	III-31
Manifold Piping	III-31
Vapor Pretreatment	III-32
Blower Selection	III-32
Instrumentation and Controls	III-32
Optional Bioventing Components	III-33
Evaluation Of Operation And Monitoring Plans	III-36
Start-Up Operations	III-36
Long-Term Operations	III-37
Remedial Progress Monitoring	III-37
References	III-40
Checklist: Can Bioventing Be Used At This Site?	III-41

List Of Exhibits

Number	Title	Page
III-1	Typical Bioventing System Using Vapor Extraction	III-2
III-2	Bioventing Summary	III-3
III-3	Bioventing Evaluation Process Flow Chart	III-4
III-4	Initial Screening For Bioventing Effectiveness	III-8
III-5	Key Parameters Used To Evaluate Site Characteristics And Constituent Characteristics	III-9
III-6	Oxygen Provided Per Day From A Single Well By A Vent System	III-10
III-7	Intrinsic Permeability And Bioventing Effectiveness	III-10
III-8	Heterotrophic Bacteria And Bioventing Effectiveness	III-12
III-9	Soil Ph And Bioventing Effectiveness	III-13
III-10	Depth To Groundwater And Bioventing Effectiveness	III-15
III-11	Chemical Structure And Biodegradability	III-16
III-12	Constituent Concentration And Bioventing Effectiveness	III-17
III-13	Cleanup Concentrations And Bioventing Effectiveness	III-18
III-14	Vapor Pressures Of Common Petroleum Constituents	III-19
III-15	Petroleum Product Boiling Ranges	III-19
III-16	Henry's Law Constant Of Common Petroleum Constituents	III-20
III-17	Schematic Of Bioventing System Using Vapor Extraction	III-26
III-18	Well Orientation And Site Conditions	III-27
III-19	Typical Bioventing Vertical Well Construction	III-29
III-20	Typical Horizontal Well	III-30
III-21	Performance Curves For Three Types Of Blowers	III-33
III-22	Monitoring Equipment	III-34
III-23	System Monitoring Recommendations	III-37
III-24	VOC/CO ₂ Concentration Reduction And Constituent Mass Removal And Degradation Behavior For Bioventing Systems	III-39

Chapter III

Bioventing

Overview

Bioventing is an in-situ remediation technology that uses indigenous microorganisms to biodegrade organic constituents adsorbed to soils in the unsaturated zone. Soils in the capillary fringe and the saturated zone are not affected. In bioventing, the activity of the indigenous bacteria is enhanced by inducing air (or oxygen) flow into the unsaturated zone (using extraction or injection wells) and, if necessary, by adding nutrients. A bioventing layout using extraction wells is shown in Exhibit III-1; air flow would be reversed if injection wells were used.

When extraction wells are used for bioventing, the process is similar to soil vapor extraction (SVE). However, while SVE removes constituents primarily through volatilization, bioventing systems promote biodegradation of constituents and minimize volatilization (generally by using lower air flow rates than for SVE). In practice, some degree of volatilization and biodegradation occurs when either SVE or bioventing is used. (See Chapter II for a discussion of SVE.)

All aerobically biodegradable constituents can be treated by bioventing. In particular, bioventing has proven to be very effective in remediating releases of petroleum products including gasoline, jet fuels, kerosene, and diesel fuel. Bioventing is most often used at sites with mid-weight petroleum products (i.e., diesel fuel and jet fuel), because lighter products (i.e., gasoline) tend to volatilize readily and can be removed more rapidly using SVE. Heavier products (e.g., lubricating oils) generally take longer to biodegrade than the lighter products. A summary of the advantages and disadvantages of bioventing is shown in Exhibit III-2.

This chapter will assist you in evaluating a corrective action plan (CAP) which proposes bioventing as a remedy for petroleum-contaminated soil. The evaluation process is summarized in a flow diagram shown on Exhibit III-3; this flow diagram serves as a roadmap for the decisions you will make during your evaluation. A checklist has also been provided at the end of this chapter for you to use as a tool to both evaluate the completeness of the CAP and focus attention on areas where additional information may be needed. The evaluation process can be divided into the four steps described below.

Exhibit III-1
 Typical Bioventing System Using Vapor Extraction

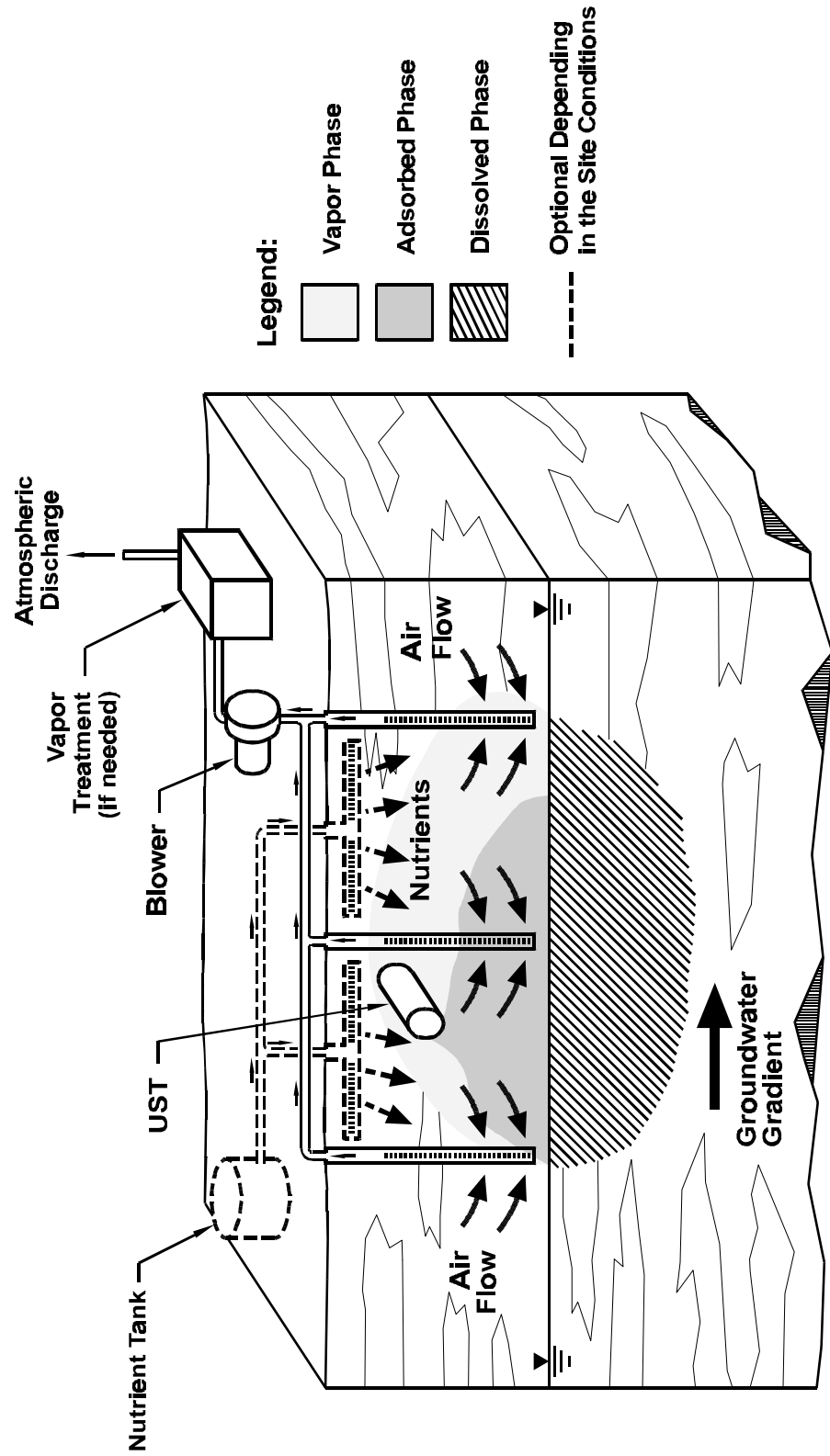
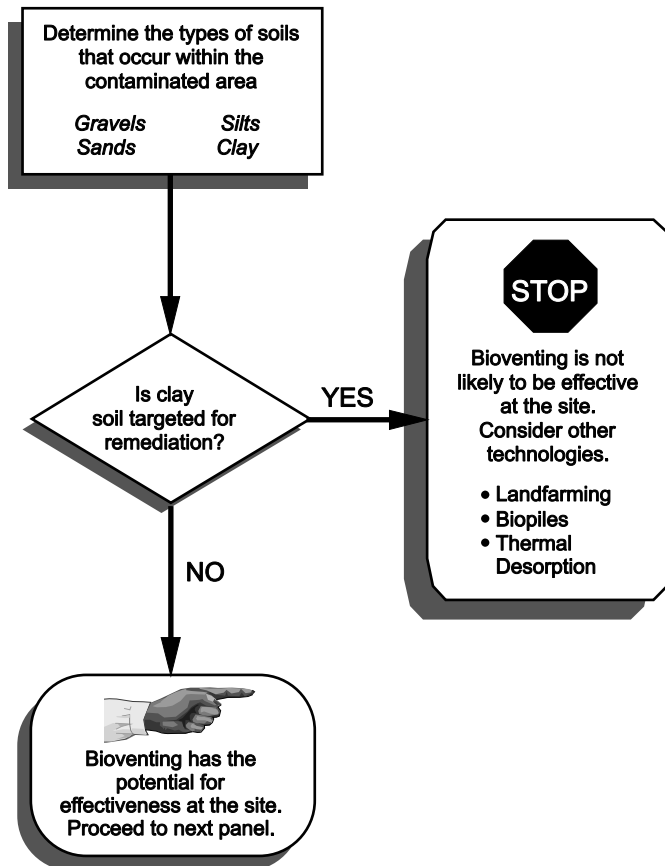
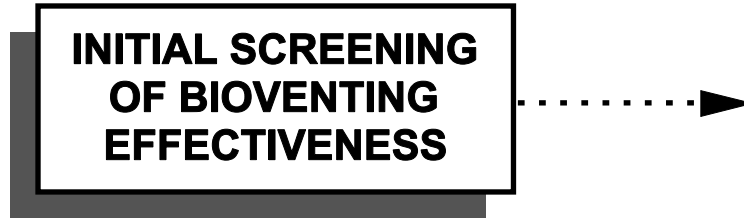

**Exhibit III-2
Bioventing Summary**

Advantages	Disadvantages
<ul style="list-style-type: none"> ○ Uses readily available equipment; easy to install. ○ Creates minimal disturbance to site operations. Can be used to address inaccessible areas (e.g., under buildings). ○ Requires short treatment times: usually 6 months to 2 years under optimal conditions. ○ Is cost competitive: \$45-140/ton of contaminated soil. ○ Easily combinable with other technologies (e.g., air sparging, groundwater extraction). ○ May not require costly offgas treatment. 	<ul style="list-style-type: none"> ○ High constituent concentrations may initially be toxic to microorganisms. ○ Not applicable for certain site conditions (e.g., low soil permeabilities, high clay content, insufficient delineation of subsurface conditions). ○ Cannot always achieve very low cleanup standards. ○ Permits generally required for nutrient injection wells (if used). (A few states also require permits for air injection.)

- **Step 1: An initial screening of bioventing effectiveness**, which will allow you to quickly gauge whether bioventing is likely to be effective, moderately effective, or ineffective.
- **Step 2: A detailed evaluation of bioventing effectiveness**, which provides further screening criteria to confirm whether bioventing is likely to be effective. To complete the detailed evaluation, you will need to identify specific soil properties and product constituent characteristics in the CAP, compare them to ranges where bioventing is effective, evaluate the results of pilot studies reported in the CAP, and conclude whether bioventing is likely to be effective.
- **Step 3: An evaluation of the bioventing system design**, which will allow you to determine if the rationale for the design has been appropriately defined based on pilot study data or other studies, whether the necessary design components have been specified, and whether the construction process flow designs are consistent with standard practice.

Exhibit III-3
Bioventing Evaluation Process Flow Chart



**Exhibit III-3
Bioventing Evaluation Process Flow Chart**

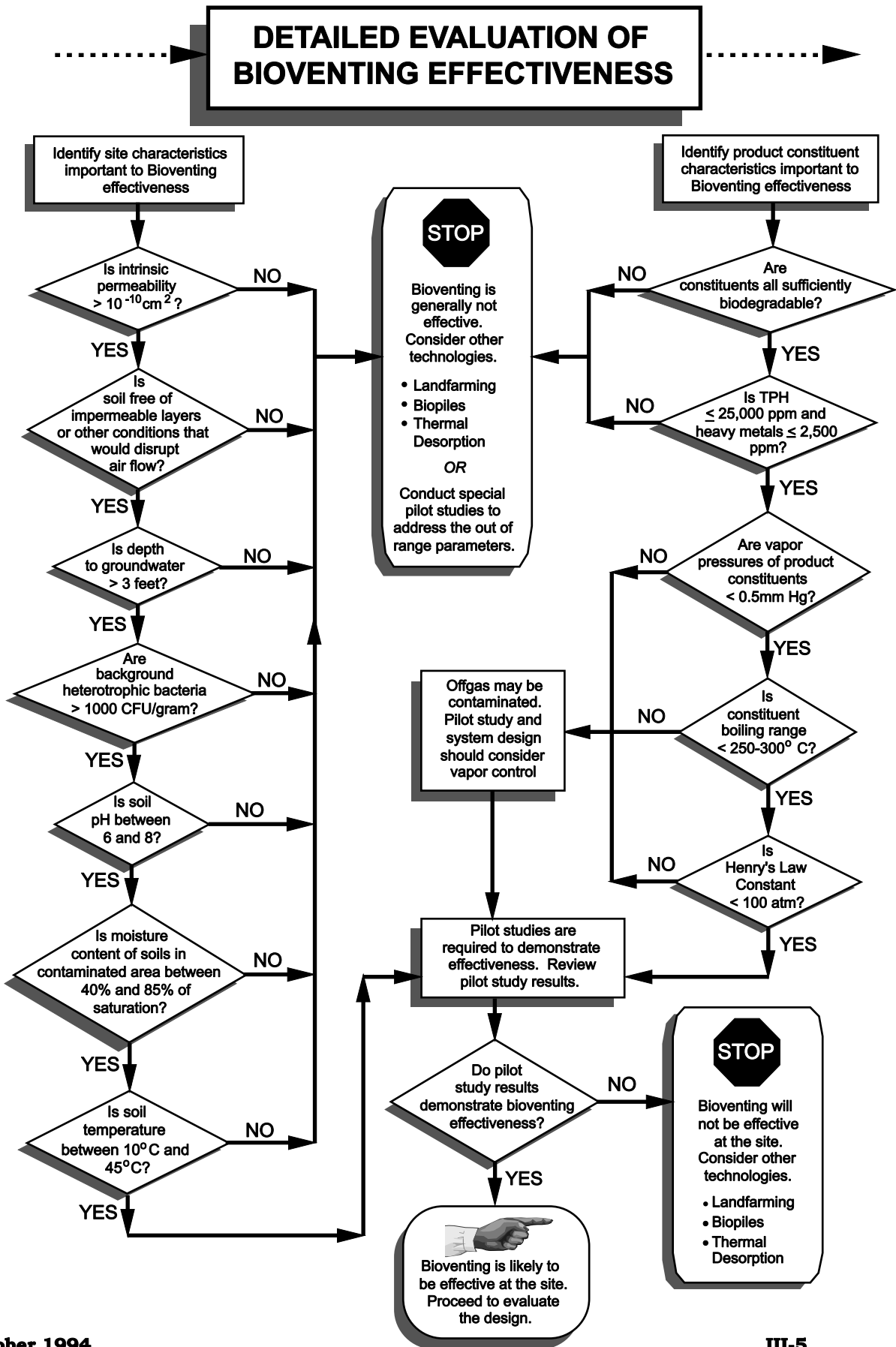

**Exhibit III-3
Bioventing Evaluation Process Flow Chart**

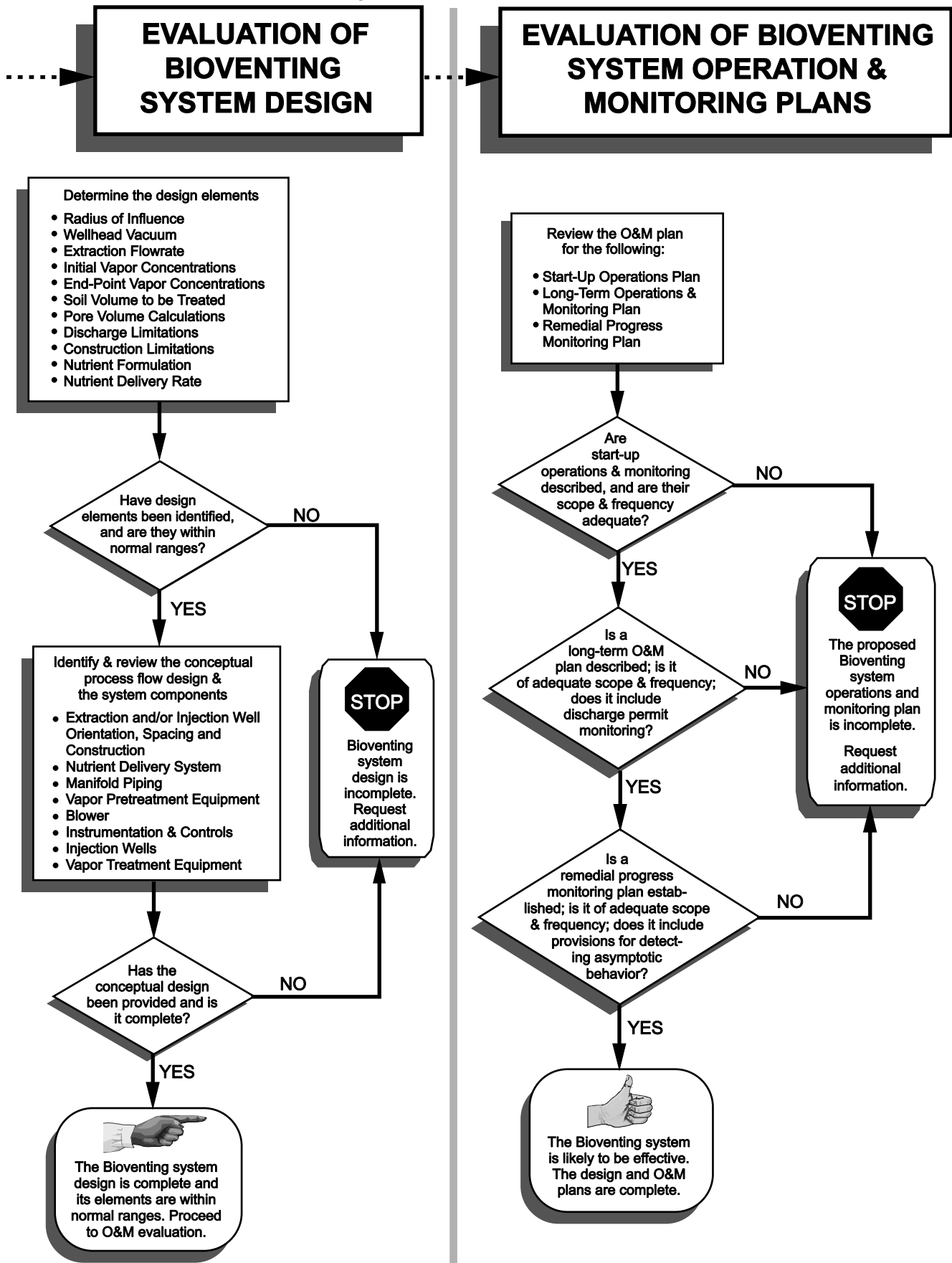

- **Step 4: An evaluation of the operation and monitoring plans**, which will allow you to determine whether start-up and long-term system operation monitoring is of sufficient scope and frequency and whether remedial progress monitoring plans are appropriate.

Initial Screening Of Bioventing Effectiveness

This section defines the key factors that should be used to decide whether bioventing has the potential to be effective at a particular site. These factors are:

- The *permeability* of the petroleum-contaminated soils. This will determine the rate at which oxygen can be supplied to the hydrocarbon-degrading microorganisms found in the subsurface.
- The *biodegradability* of the petroleum constituents. This will determine both the rate at which and the degree to which the constituents will be metabolized by microorganisms.

In general, the type of soil will determine its *permeability*. Fine-grained soils (e.g., clays and silts) have lower permeabilities than coarse-grained soils (e.g., sands and gravels). The *biodegradability* of a petroleum product constituent is a measure of its ability to be metabolized by hydrocarbon-degrading bacteria that produce carbon dioxide and water as byproducts of microbial respiration. Petroleum products are generally biodegradable regardless of their molecular weight, as long as indigenous microorganisms have an adequate supply of oxygen and nutrients. For heavier constituents (which are less volatile and less soluble than many lighter components), biodegradation will exceed volatilization as the primary removal mechanism, even though biodegradation is generally slower for heavier constituents than for lighter constituents.

Exhibit III-4 provides a screening tool you can use to make an initial assessment of the potential effectiveness of bioventing. To use this tool, first determine the type of soil present and the type of petroleum product released at the site. Information provided in the following section will allow a more thorough evaluation of effectiveness and will identify areas that could require special design considerations.

Detailed Evaluation Of Bioventing Effectiveness

Once you have completed the initial screening and determined that bioventing may be effective for the soil and petroleum product present, review the CAP further to reconfirm effectiveness.

**Exhibit III-4
Initial Screening For Bioventing Effectiveness**

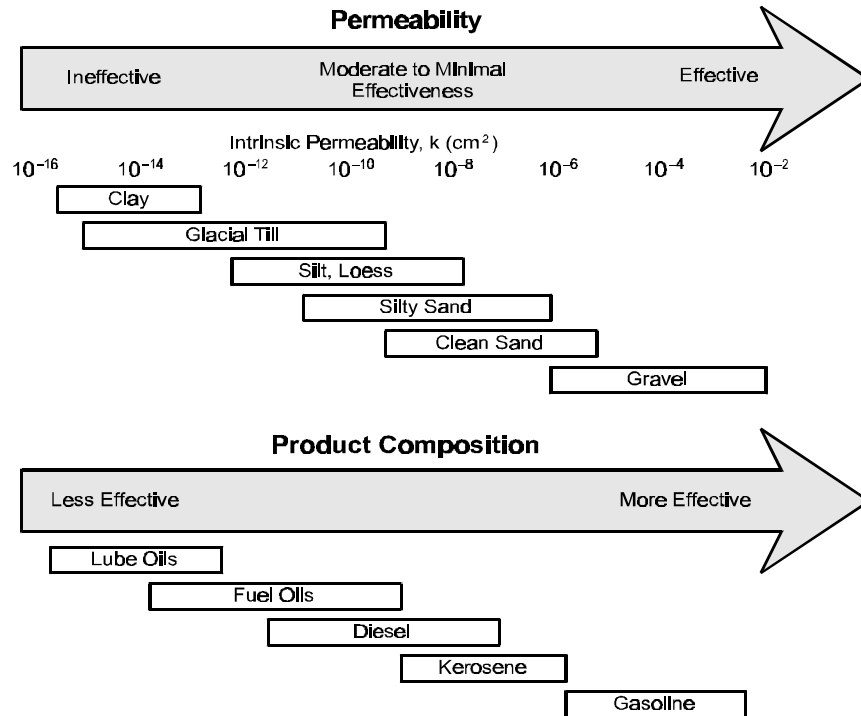

Note:
All petroleum products listed are amenable
for the bioventing remediation alternative.

While the initial screen focused on soil permeability and constituent biodegradability, the detailed evaluation should consider a broader range of site and constituent characteristics, which are listed in Exhibit III-5.

The remainder of this section describes each of these parameters, why each is important to bioventing, how they can be determined, and the range of each parameter considered appropriate for bioventing.

Exhibit III-5
Key Parameters Used To Evaluate Site Characteristics And
Constituent Characteristics

Site Characteristics	Constituent Characteristics
Intrinsic permeability	Chemical structure
Soil structure and stratification	Concentration and toxicity
Microbial presence	Vapor pressure
Soil pH	Product composition and boiling point
Moisture content	Henry's law constant
Soil temperature	
Nutrient concentrations	
Depth to groundwater	

Site Characteristics

Intrinsic Permeability

Intrinsic permeability is a measure of the ability of soils to transmit air and is the *single most important factor* in determining the effectiveness of bioventing because it determines how much oxygen can be delivered (via extraction or injection) to the subsurface bacteria. Hydrocarbon-degrading bacteria use oxygen to metabolize organic material to yield carbon dioxide and water, a process commonly referred to as aerobic respiration. To degrade large amounts of petroleum hydrocarbons, a substantial bacterial population is required which, in turn, requires oxygen for both the metabolic process and the growth of the bacterial mass itself. Approximately 3 to 3½ pounds of oxygen are needed to degrade one pound of petroleum product. Exhibit III-6 shows the relationship of oxygen provided per day from a single vent well for different induced flow rates.

Intrinsic permeability, which will determine the rate at which oxygen can be supplied to the subsurface, varies over 13 orders of magnitude (from 10^{-16} to 10^{-3} cm²) for the wide range of earth materials, although a more limited range applies for most soil types (10^{-13} to 10^{-5} cm²). Intrinsic permeability is best determined from field or laboratory tests, but can be estimated within one or two orders of magnitude from soil boring log data and laboratory tests. Procedures for these tests are described in EPA (1991a). Coarse-grained soils (e.g., sands) have higher intrinsic permeability than fine-grained soils (e.g., clays, silts). Note that the ability of a soil to transmit air, which is of prime importance to bioventing, is reduced by the presence of soil water, which can block the

Exhibit III-6 Oxygen Provided Per Day From A Single Well By A Vent System			
Air Flow Rate		Oxygen Provided	
SCFM	m ³ /min	lb/day	kg/day
1	2.83 · 10 ⁻²	23	10
5	1.42 · 10 ⁻¹	117	52
10	2.83 · 10 ⁻¹	233	106
20	5.66 · 10 ⁻¹	467	212
50	1.42 · 10 ⁰	1,170	529
100	2.83 · 10 ⁰	2,330	1,060

soil pores and reduce air flow. This is especially important in fine-grained soils, which tend to retain water. Use the values presented in Exhibit III-7 to determine if intrinsic permeability is within the effectiveness range for bioventing.

Exhibit III-7 Intrinsic Permeability And Bioventing Effectiveness	
Intrinsic Permeability (cm ²)	Bioventing Effectiveness
$k \geq 10^{-8}$	Effective.
$10^{-8} \geq k \geq 10^{-10}$	May be effective; needs further evaluation.
$k < 10^{-10}$	Not effective.

At sites where the soils in the saturated zone are similar to those within the unsaturated zone, hydraulic conductivity of the soils may be used to estimate the permeability of the soils. Hydraulic conductivity is a measure of the ability of soils to transmit water. Hydraulic conductivity can be determined from aquifer tests, including slug tests and pumping tests. You can convert hydraulic conductivity to intrinsic permeability using the following equation:

$$k = K (\mu / \rho g)$$

where: k = intrinsic permeability (cm²)
 K = hydraulic conductivity (cm/sec)
 μ = water viscosity (g/cm · sec)
 ρ = water density (g/cm³)
 g = acceleration due to gravity (cm/sec²)

At 20°C: $\mu/\rho g = 1.02 \cdot 10^{-5}$ cm/sec

To convert k from cm² to darcy, multiply by 10⁸

Soil Structure And Stratification

Soil structure and stratification are important to bioventing because they affect how and where soil vapors will flow within the soil matrix when extracted or injected. Structural characteristics such as microfracturing can result in higher permeabilities than expected for certain soils (e.g., clays). Increased flow will occur in the fractured but not in the unfractured media. Stratification of soils with different permeabilities can dramatically increase the lateral flow of soil vapors in more permeable strata while reducing the soil vapor flow through less permeable strata. This preferential flow behavior can lead to ineffective or extended remedial times for less-permeable strata or to the possible spreading of contamination if injection wells are used.

You can determine soil intergranular structure and stratification by reviewing soil boring logs for wells or borings and by examining geologic cross-sections. Verify that soil types have been identified, that visual observations of soil structure have been documented, and that boring logs are of sufficient detail to define any soil stratification.

The types of soils and their structures will determine their permeabilities. In general, fine-grained soils composed of clays or silts offer resistance to air flow. However, if the soils are highly fractured, they may have sufficient permeability to use bioventing. Stratified soils may require special consideration in design to ensure that less-permeable strata are adequately vented.

Fluctuations in the groundwater table should also be considered when reviewing the CAP. Significant seasonal or daily (e.g., tidal or precipitation-related) fluctuations may, at times, submerge some of the contaminated soil or a portion of the well screen, making it unavailable for air flow. These fluctuations are most important for horizontal wells, in which screens are placed parallel with the water table surface and a water table rise could occlude the entire length of screen.

Microbial Presence

Soil normally contains large numbers of diverse microorganisms including bacteria, algae, fungi, protozoa, and actinomycetes. In well-aerated soils, which are most appropriate for bioventing, these organisms are generally aerobic. Of these organisms, the bacteria are the most numerous and biochemically active group, particularly at low oxygen levels. Bacteria require a carbon source for cell growth and an energy source to sustain metabolic functions required for growth. Nutrients, including nitrogen and phosphorus, are also required for cell growth.

The metabolic process used by bacteria to produce energy requires a terminal electron acceptor (TEA) to enzymatically oxidize the carbon source to carbon dioxide.

Microbes are classified by the carbon and TEA sources they use to carry out metabolic processes. Bacteria that use organic compounds (such as petroleum constituents and other naturally occurring organics) as their source of carbon are called *heterotrophic*; those that use inorganic carbon compounds such as carbon dioxide are called *autotrophic*. Bacteria that use oxygen as their TEA are called *aerobic*; those that use a compound other than oxygen (e.g., nitrate or sulfate) are called *anaerobic*; and those that can utilize both oxygen and other compounds as TEAs are called *facultative*. For bioventing applications directed at petroleum products, bacteria that are both *aerobic* (or *facultative*) and *heterotrophic* are most important in the degradation process.

To evaluate the presence and population of naturally occurring bacteria that will contribute to degradation of petroleum constituents, laboratory analysis of soil samples from the site should be completed. These analyses, at a minimum, should include plate counts for total heterotrophic bacteria. Although heterotrophic bacteria are normally present in all soil environments, plate counts of less than 1000 colony-forming units (CFU)/gram of soil could indicate the presence of toxic concentrations of inorganic or organic compounds or depletion of oxygen or other essential nutrients. However, concentrations as low as 100 CFU per gram of soil can be increased by bioventing to acceptable levels. The total population of heterotrophic bacterial species that are capable of degrading the specific petroleum constituents present should also be measured. These conditions are summarized in Exhibit III-8.

Exhibit III-8	
Heterotrophic Bacteria And Bioventing Effectiveness	
Total Heterotrophic Bacteria (prior to bioventing)	Bioventing Effectiveness
> 1000 CFU/gram dry soil	Generally effective.
< 1000 CFU/gram dry soil	May be effective; needs further evaluation to determine if toxic conditions are present.

Soil pH

The optimum pH for bacterial growth is approximately 7; the acceptable range for soil pH in bioventing is between 6 and 8. Soils with pH values outside this range prior to bioventing will require pH adjustments prior to and during bioventing operations. Exhibit III-9 summarizes the effect of soil pH on bioventing effectiveness. Review the CAP to verify that soil pH measurements have been made. If the soil pH is less than 6 or greater than 8, make sure that pH adjustments are included in the bioventing design and operational plans.

Exhibit III-9	
Soil pH And Bioventing Effectiveness	
Soil pH (prior to bioventing)	Bioventing Effectiveness
$6 \leq \text{pH} \leq 8$	Generally effective.
$6 \geq \text{pH} \geq 8$	Soils will require amendments to correct pH to effective range.

Moisture Content

Bacteria require moist soil conditions for proper growth. Excessive soil moisture, however, reduces the availability of oxygen, which is also necessary for bacterial metabolic processes, by restricting the flow of air through soil pores. The ideal range for soil moisture is between 40 and 85 percent of the water-holding capacity of the soil. Generally, soils saturated with water prohibit air flow and oxygen delivery to bacteria, while dry soils lack the moisture necessary for bacterial growth.

Airflow is particularly important for soils within the capillary fringe, where a significant portion of the constituents often reside. Fine-grained soils create a thicker capillary fringe than coarse-grained soils. The thickness of the capillary fringe can usually be determined from soil boring logs (i.e., in the capillary fringe, soils are usually described as moist or wet). The capillary fringe usually extends from one to several feet above the elevation of the groundwater table. Moisture content of soils within the capillary fringe may be too high for effective bioventing. Depression of the water table by groundwater pumping may be necessary to biovent soils within the capillary fringe.

Stormwater infiltration can create excessively moist soils in areas that do not have surface covers, such as asphalt or concrete. This may be a persistent problem with fine-grained soils that have slow infiltration rates. Bioventing promotes dehydration of moist soils through increased air flow through the soil, but excessive dehydration hinders bioventing performance and extends operation time.

Soil Temperature

Bacterial growth rate is a function of temperature. Soil microbial activity has been shown to decrease significantly at temperatures below 10°C and essentially to cease at 5°C. Microbial activity of most bacteria important to petroleum hydrocarbon biodegradation also diminishes at temperatures greater than 45°C. Within the range of 10°C to 45°C, the rate of microbial activity typically doubles for every 10°C rise in temperature. In most areas of the U.S., subsurface soils have a fairly constant temperature of about 13°C throughout the year. However, subsurface soil temperatures in the extreme northern states may be lower, reducing the rate of biodegradation.

Nutrient Concentrations

Bacteria require inorganic nutrients such as ammonium and phosphate to support cell growth and sustain biodegradation processes. Nutrients may be available in sufficient quantities in the site soils but, more frequently, nutrients need to be added to soils to maintain bacterial populations. However, excessive amounts of certain nutrients (i.e., phosphate and sulfate) can repress metabolism.

A rough approximation of minimum nutrient requirements can be based on the stoichiometry of the overall biodegradation process:

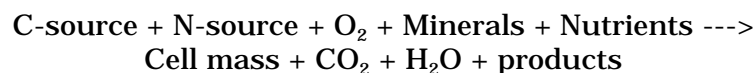

Different empirical formulas of bacterial cell mass have been proposed; the most widely accepted are $\text{C}_5\text{H}_7\text{O}_2\text{N}$ and $\text{C}_{60}\text{H}_{87}\text{O}_{32}\text{N}_{12}\text{P}$. Using the empirical formulas for cell biomass and other assumptions, the carbon:nitrogen:phosphorus ratios necessary to enhance biodegradation fall in the range of 100:10:1 to 100:1:0.5, depending on the constituents and bacteria involved in the biodegradation process.

Chemical analysis of soil samples from the site should be completed to determine the concentrations of nitrogen (expressed as ammonia) and phosphate that occur naturally in the soil. Using the stoichiometric ratios, the need for nutrient addition can be determined by using an

average concentration of the constituents (carbon source) in the soils to be treated.

Depth To Groundwater

Bioventing is not appropriate for sites with groundwater tables located less than 3 feet below the land surface. Special considerations must be taken for sites with a groundwater table located less than 10 feet below the land surface because groundwater upwelling can occur within bioventing wells under vacuum pressures, potentially occluding screens and reducing or eliminating vacuum-induced soil vapor flow. This potential problem is not encountered if injection wells are used instead of extraction wells to induce air flow. Use Exhibit III-10 to determine whether the water-table depth is of potential concern for use of bioventing.

Exhibit III-10	
Depth To Groundwater And Bioventing Effectiveness	
Depth To Groundwater	Bioventing Effectiveness
> 10 feet	Effective.
3 feet < depth < 10 feet	Need special controls (i.e., horizontal wells or groundwater pumping).
< 3 feet	Not effective.

Constituent Characteristics

Chemical Structure

The chemical structures of the constituents present in the soils proposed for treatment by bioventing are important for determining the rate at which biodegradation will occur. Although nearly all constituents in petroleum products typically found at UST sites are biodegradable, the more complex the molecular structure of the constituent, the more difficult and less rapid is biological treatment. Most low-molecular-weight (nine carbon atoms or less) aliphatic and monoaromatic constituents are more easily biodegraded than higher-molecular-weight aliphatic or polyaromatic organic constituents. Exhibit III-11 lists, in order of decreasing rate of potential biodegradability, some common constituents found at petroleum UST sites.

**Exhibit III-11
Chemical Structure And Biodegradability**

Biodegradability	Example Constituents	Products In Which Constituent Is Typically Found
More degradable	n-butane, l-pentane, n-octane Nonane	<input type="radio"/> Gasoline <input type="radio"/> Diesel fuel
■		
■		
■	Methyl butane, dimethylpentenes, methyloctanes	<input type="radio"/> Gasoline
■		
■	Benzene, toluene, ethylbenzene, xylenes Propylbenzenes	<input type="radio"/> Gasoline <input type="radio"/> Diesel, kerosene
■		
■	Decanes Dodecanes Tridecanes Tetradecanes	<input type="radio"/> Diesel <input type="radio"/> Kerosene <input type="radio"/> Heating fuels <input type="radio"/> Lubricating oils
■		
■	Naphthalenes Fluoranthenes Pyrenes Acenaphthenes	<input type="radio"/> Diesel <input type="radio"/> Kerosene <input type="radio"/> Heating oil <input type="radio"/> Lubricating oils
Less degradable		

Evaluation of the chemical structure of the constituents proposed for reduction by bioventing at the site will allow you to determine which constituents will be the most difficult to degrade. You should verify that remedial time estimates, biotreatability studies, field-pilot studies (if applicable), and bioventing operation and monitoring plans are based on the constituents that are the most difficult to degrade (or “rate limiting”) in the biodegradation process.

Concentration And Toxicity

The presence of very high concentrations of petroleum organics or heavy metals in site soils can be toxic or inhibit the growth and reproduction of bacteria responsible for biodegradation. In addition, very low concentrations of organic material will also result in diminished levels of bacterial activity.

In general, concentrations of petroleum hydrocarbons in excess of 25,000 ppm, or heavy metals in excess of 2,500 ppm, in soils are considered inhibitory and/or toxic to aerobic bacteria. Review the CAP to verify that the average concentrations of petroleum hydrocarbons and heavy metals in the soils to be treated are below these levels. Exhibit III-12 provides the general criteria for constituent concentration and bioventing effectiveness.

Exhibit III-12	
Constituent Concentration And Bioventing Effectiveness	
Constituent Concentration	Bioventing Effectiveness
Petroleum constituents \leq 25,000 ppm and Heavy metals \leq 2,500 ppm	Effective.
Petroleum constituents $>$ 25,000 ppm or Heavy metals $>$ 2,500 ppm	Ineffective; toxic or inhibitory conditions to bacterial growth exist. Long remediation times likely.

In addition to maximum concentrations, you should consider the cleanup concentrations proposed for the treated soils. Below a certain “threshold” constituent concentration, the bacteria cannot obtain sufficient carbon (from degradation of the constituents) to maintain adequate biological activity. The threshold level can be determined from laboratory studies and should be below the level required for cleanup. Although the threshold limit varies greatly depending on bacteria-specific and constituent-specific features, constituent concentrations below 0.1 ppm are generally not achievable by biological treatment alone. In addition, experience has shown that reductions in total petroleum hydrocarbon concentrations (TPH) greater than 95 percent can be very difficult to achieve because of the presence of “recalcitrant” or nondegradable petroleum species that are included in the TPH analysis. Identify the average starting concentrations and the cleanup concentrations in the CAP for individual constituents and TPH. If a cleanup level lower than 0.1 ppm is required for any individual constituent or a reduction in TPH greater than 95 percent is required to reach the cleanup level for TPH, either a pilot study should be required to demonstrate the ability of bioventing to achieve these reductions at the site or another technology should be considered. These conditions are summarized in Exhibit III-13.

Exhibit III-13
Cleanup Concentrations And Bioventing Effectiveness

Cleanup Requirement	Bioventing Effectiveness
Constituent concentration > 0.1 ppm and TPH reduction < 95%	Effective.
Constituent concentration ≤ 0.1 ppm or TPH reduction ≥ 95%	Potentially ineffective; pilot studies are required to demonstrate reductions.

Vapor Pressure

Vapor pressure is important in evaluating the extent to which constituents will be volatilized rather than biodegraded. The vapor pressure of a constituent is a measure of its tendency to evaporate. More precisely, it is the pressure that a vapor exerts when in equilibrium with its pure liquid or solid form. Constituents with higher vapor pressures are generally volatilized rather than undergoing biodegradation. Constituents with vapor pressures higher than 0.5 mm Hg will likely be volatilized by the induced air stream before they biodegrade. Constituents with vapor pressures lower than 0.5 mm Hg will not volatilize to a significant degree and can instead undergo *in situ* biodegradation by bacteria.

As previously discussed, petroleum products contain many different chemical constituents. Each constituent will be volatilized (rather than biodegraded) to different degrees by a bioventing system, depending on its vapor pressure. If concentrations of volatile constituents are significant, treatment of extracted vapors may be needed. Exhibit III-14 lists vapor pressures of select petroleum constituents.

Product Composition And Boiling Point

Boiling point is another measure of constituent volatility. Because of their complex constituent compositions, petroleum products are often classified by their boiling point ranges (rather than vapor pressures). In general, nearly all petroleum-derived organic compounds are capable of biological degradation, although constituents of higher molecular weights and higher boiling points require longer periods of time to be

Exhibit III-14
Vapor Pressures Of Common Petroleum Constituents

Constituent	Vapor Pressure (mm Hg at 20°C)
Methyl t-butyl ether	245
Benzene	76
Toluene	22
Ethylene dibromide	11
Ethylbenzene	7
Xylenes	6
Naphthalene	0.5
Tetraethyl lead	0.2

degraded. Products with boiling points of less than about 250°C to 300°C will volatilize to some extent and can be removed by a combination of volatilization and biodegradation in a bioventing system. The boiling point ranges for common petroleum products are shown in Exhibit III-15.

Exhibit III-15
Petroleum Product Boiling Ranges

Product	Boiling Range (°C)
Gasoline	40 to 205
Kerosene	175 to 325
Diesel fuel	200 to 338
Heating oil	> 275
Lubricating oils	Nonvolatile

Henry's Law Constant

Another method of gauging the volatility of a constituent is by noting its Henry's law constant. Henry's law constant is the partition coefficient that relates the concentration of a constituent dissolved in water to its partial pressure in the vapor under equilibrium conditions.

In other words, it describes the relative tendency for a dissolved constituent to exist in the vapor phase. Henry's law constants for several common constituents found in petroleum products are shown in Exhibit III-16. Constituents with Henry's law constants of greater than 100 atmospheres are generally considered volatile and are more likely to be volatilized rather than biodegraded.

Exhibit III-16 Henry's Law Constant Of Common Petroleum Constituents	
Constituent	Henry's Law Constant (atm)
Tetraethyl lead	4,700
Ethylbenzene	359
Xylenes	266
Benzene	230
Toluene	217
Naphthalene	72
Ethylene dibromide	34
Methy t-butyl ether	27

Pilot Scale Studies

After you have examined the data in the CAP to gauge the potential effectiveness of bioventing, you will be in a position to decide if bioventing is likely to be highly effective, somewhat effective, or ineffective for site conditions. In general, remedial approaches that rely on biological processes should be subject to field pilot studies to verify and quantify the potential effectiveness of the approach and provide data necessary to design the system. For bioventing, these studies may range in scope and complexity from a simple soil column test or microbial count to field respirometry tests and soil vapor extraction (or injection) pilot studies. The scope of pilot testing or laboratory studies should be commensurate with the size of the area to be remediated, the reduction in constituent concentration required, and the results of the initial effectiveness screening.

A list and description of commonly used laboratory and pilot-scale studies is provided below.

- *Soil Vapor Extraction and Injection Treatability Tests* are generally used to determine the radius of influence that an extraction well or injection well can exert in the surrounding soils, the optimum vapor

flow rate and pressure (or vacuum) that should be applied to the wells, and the concentration of petroleum constituents in the induced air stream. The test most often includes short-term vapor extraction or air injection from a single well while measuring the pressure effect in monitoring wells or probes spaced at increasing distances from the extraction well or the injection well. The test can assist in determining the spacing, number, and type of wells needed for the full-scale system. It is usually not economically attractive to perform this test for sites with areas smaller than 5,000 cubic yards of *in situ* contaminated soil or for sites with soil permeabilities greater than 10^{-8} cm².

- *Respirometry Studies* are generally used to determine the oxygen transport capacity of the site soils and to estimate the biodegradation rates under field conditions. The test includes short-term injection of an oxygen/inert gas mixture into a well that has been screened in the contaminated soil horizon. Carbon dioxide, inert gas (typically helium), and oxygen concentrations are measured in the injection well and surrounding wells periodically for about 1 to 5 days. The measurements are then compared to baseline concentrations of the gases prior to injection. Increases in carbon dioxide and decreases in oxygen concentrations are indications of biological metabolism of constituents; the inert gas concentration provides the baseline for these calculations. Temperature of the extracted vapor may also be monitored to serve as an additional indicator of biological activities. Field respirometry studies are usually only needed for sites with large areas of contamination, perhaps greater than 100,000 cubic yards of *in situ* soils requiring remediation; at sites where soil permeability is less than 10^{-8} cm²; or when reductions of more than 80 percent of the constituents that have vapor pressures less than 0.5 mm Hg are required.
- *Laboratory Microbial Screening* tests are used to determine the presence of a population of naturally-occurring bacteria that may be capable of degrading petroleum product constituents. Samples of soils from the site are analyzed in an offsite laboratory. Microbial plate counts determine the number of colony forming units (CFU) of heterotrophic bacteria and petroleum-degrading bacteria are present per unit mass of dry soil. These tests are relatively inexpensive.
- *Laboratory Biodegradation Studies* can be used to estimate the rate of oxygen delivery and to determine if the addition of inorganic nutrients is necessary. However, laboratory studies cannot duplicate field conditions, and field tests are more reliable. There are two kinds of laboratory studies: *slurry studies* and *column studies*. *Slurry studies*, which are more common and less costly, involve the preparation of

numerous “soil microcosms” consisting of small samples of site soils mixed into a slurry with site groundwater. The microcosms are divided into several groups which may include control groups that are “poisoned” to destroy any bacteria, non-nitrified test groups that have been provided oxygen but not nutrients, and nitrified test groups which are supplied both oxygen and nutrients. Microcosms from each group are analyzed periodically (usually weekly) for the test period duration (usually 4 to 12 weeks) for bacterial population counts and constituent concentrations. Results of slurry studies should be considered as representing optimal conditions because slurry microcosms do not consider the effects of limited oxygen delivery or soil heterogeneity. *Column studies* are set up in a similar way using columns of site soils and may provide more realistic expectations of bioventing performance.

Evaluation Of The Bioventing System Design

Once you have completed the detailed evaluation of bioventing effectiveness, you can evaluate the design of the system. The CAP should include a discussion of the design basis for the system and the conceptual design. Detailed engineering design documents might also be included, depending on state requirements. Further detail about information to look for in the discussion of the design is provided below.

Rationale For The Design

The rationale for the design includes the fundamental design decisions and requirements that form the foundation for the system design. For bioventing systems, the design should include the following information:

- *Design Radius of Influence* (ROI) is an estimate of the maximum distance from a vapor extraction well (or injection well) at which sufficient air flow can be induced to sustain acceptable degradation rates. Establishing the design ROI is not a trivial task because it depends on many factors including intrinsic permeability of the soil, soil chemistry, moisture content, and desired remediation time. The ROI should usually be determined through field pilot studies but can be estimated from air flow modeling or other empirical methods. Generally, the design ROI can range from 5 feet (for fine-grained soils) to 100 feet (for coarse-grained soils). For sites with stratified geology, radii of influence should be defined for each soil type. The ROI is important in determining the appropriate number and spacing of extraction or injection wells.

- *Wellhead Pressure* is the pressure (or vacuum) that is required at the top of the vent well to produce the desired induced air stream flow rate from the well. Although wellhead pressure (or vacuum) is usually determined through field pilot studies, it can be estimated and typically ranges from 3 to 100 inches of water vacuum for extraction and 10 to 50 psi for injection. Less permeable soils generally require higher vacuum or pressure to produce a reasonable radius of influence. It should be noted, however, that high vacuum pressures can cause upwelling of the water table and occlusion of the extraction well screens. For air injection, high pressure may push the contaminated vapor to previously uncontaminated soil and ground water.
- *Induced Vapor Flow Rate* is the volumetric flow rate of soil vapor that will be induced by each extraction or injection well and establishes the oxygen delivery rate to the *in situ* treatment area. The induced vapor flow rate, radius of influence, and wellhead pressure are all interdependent (i.e., a certain vapor flow rate requires a certain wellhead pressure and radius of influence). The induced vapor flow rate should be determined from pilot studies, but it may be calculated using mathematical or physical models (EPA, 1993). The flow rate will contribute to the operational time requirements of the bioventing system. Typical induced flow rates can range from 5 to 100 CFM per well.
- *Initial Constituent Vapor Concentrations* can be measured during pilot studies or estimated from soil gas samples or soil samples. They are used to estimate constituent mass extraction rate to determine whether treatment of extracted vapors will be required prior to atmospheric discharge or reinjection. Be advised that state regulations may not allow reinjection.
- *Required Final Constituent Concentrations* in soils or vapors are either defined by state regulations as "remedial action levels" or determined on a site-specific basis using transport modeling and risk assessment. They will determine what areas of the site require treatment and when bioventing operations can be terminated.
- *Required Remedial Cleanup Time* may also influence the design of the system. The designer may vary the well spacing to speed remediation to meet cleanup deadlines, if required.
- *Soil Volume To Be Treated* is determined by state action levels or a site-specific risk assessment using site characterization data for the soils.

- *Pore Volume Calculations* are used along with extraction flow rate to determine the pore volume exchange rate and, therefore, oxygen delivery rate. The exchange rate is calculated by dividing the soil pore space within the treatment zone by the design vapor extraction rate. The pore space within the treatment zone is calculated by multiplying the soil porosity by the volume of soil to be treated. Some literature suggests that one pore volume of soil vapor should be extracted at least weekly for effective remedial progress.

You can calculate the time required to exchange one pore volume of soil vapor using the following equation:

$$E = \frac{\epsilon V}{Q}$$

where: E = pore volume exchange time (hr)
 ϵ = soil porosity (m³ vapor/m³ soil)
 V = volume of soil to be treated (m³ soil)
 Q = total vapor extraction flowrate (m³ vapor/hr)

$$E = \frac{(\text{m}^3 \text{ vapor} / \text{m}^3 \text{ soil}) \cdot (\text{m}^3 \text{ soil})}{(\text{m}^3 \text{ vapor} / \text{hr})} = \text{hr}$$

- *Discharge Limitations And Monitoring Requirements* are usually established by state air quality regulations. Such requirements must be considered by designers of a bioventing system to ensure that monitoring ports are included in the system for sites where volatile constituents will be extracted. Discharge limitations imposed by state air quality regulations will determine whether offgas treatment is required.
- *Site Construction Limitations*, such as buildings, utilities, buried objects, and residences, must be identified and considered in the design process.
- *Nutrient Formulation and Delivery Rate*, which can be established through either field or laboratory pilot studies, determines if nutrients are required.

Components Of A Bioventing System

Once the design basis is defined, the design of the bioventing system can be developed. A typical bioventing system design will include the following components and information:

- Extraction well (or injection well) orientation, placement, and construction details
- Piping design
- Vapor pretreatment design (if necessary)
- Vapor treatment system selection (if necessary)
- Blower specification
- Instrumentation and control design
- Monitoring locations

Nutrient additions are sometimes included in bioventing designs. If nutrients are added, the design should specify the nutrient addition well orientation, placement, and construction details. Note that state regulations may either require permits for nutrient injection wells or prohibit them entirely. Exhibit III-17 is a conceptual schematic diagram for a bioventing system using vapor extraction.

The following subsections provide guidance for selecting the appropriate system configuration, standard system components, and additional system components to adequately address petroleum contaminated soils at a particular UST site.

Extraction Wells

Well Orientation. A bioventing system can use either vertical or horizontal extraction wells. Orientation of the wells should be based on site-specific needs and conditions. Exhibit III-18 lists site conditions and the corresponding appropriate well orientation.

Exhibit III-17
 Schematic of Bioventing System Using Vapor Extraction

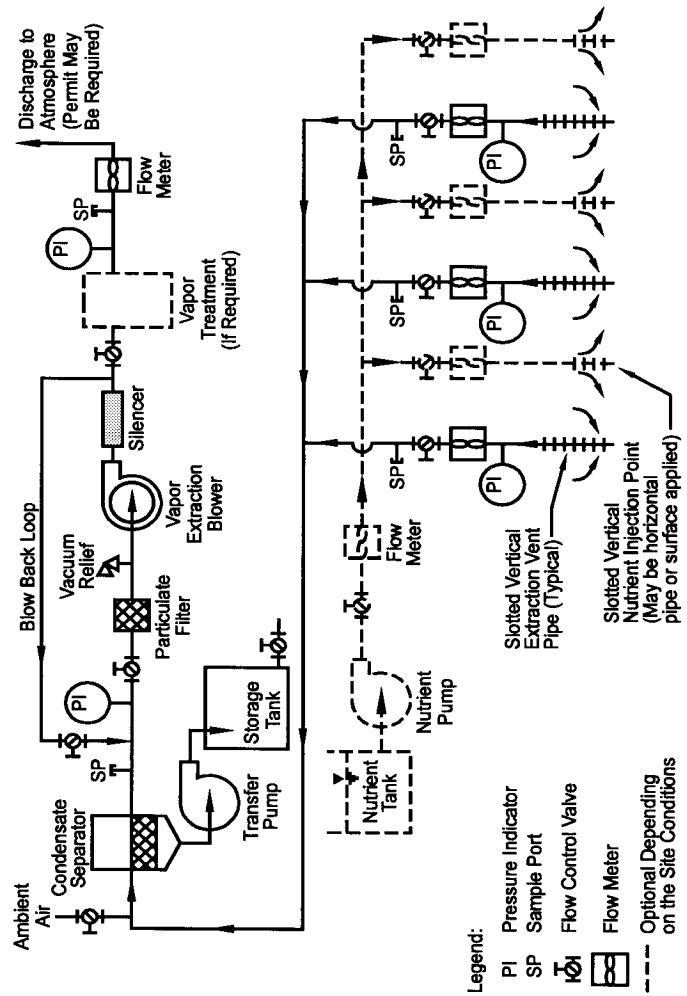

Exhibit III-18
Well Orientation And Site Conditions

Well Orientation	Site Conditions
Vertical extraction well	<ul style="list-style-type: none"> <input type="radio"/> Shallow to deep contamination (5 to 100+ feet). <input type="radio"/> Depth to groundwater > 10 feet.
Horizontal extraction well	<ul style="list-style-type: none"> <input type="radio"/> Shallow contamination (< 25 feet). More effective than vertical wells at depths < 10 feet. Construction difficult at depths > 25 feet. <input type="radio"/> Zone of contamination confined to a specific stratigraphic unit.

Well Placement and Number of Wells. You can determine the number and location of extraction wells by using several methods. In the first method, divide the area of the site requiring treatment by the area corresponding to the design ROI of a single well to obtain the total number of wells needed. Then space the wells evenly within the treatment area to provide areal coverage so that the areas of influence cover the entire area of contamination.

$$\text{Number of wells needed} = \frac{\text{Treatment area (m}^2\text{)}}{\text{Area for single extraction well (m}^2\text{ / well)}}$$

In the second method, determine the total extraction flow rate needed to exchange the soil pore volume within the treatment area in a reasonable amount of time (3 to 7 days). Determine the number of wells required by dividing the total extraction flow rate needed by the flow rate achievable with a single well.

$$\text{Number of wells needed} = \frac{\epsilon V / t_e}{q}$$

where: ϵ = soil porosity (m^3 vapor / m^3 soil)
 V = volume of soil in treatment area (m^3 soil)
 q = vapor extraction rate from single extraction well
(m^3 vapor/hr).
 t_e = time for exchange of pore volume(s), (hrs)

In the example below, a 7-day exchange time is used.

$$\text{Number of wells needed} = \frac{\left(\frac{\text{m}^3 \text{ vapor}}{\text{m}^3 \text{ soil}} \right) \cdot \left(\frac{\text{m}^3 \text{ soil}}{168 \text{ hrs}} \right)}{\frac{\text{m}^3 \text{ vapor}}{\text{hr}}}$$

Consider the following additional factors in evaluating proposed well spacing.

- In areas of high contaminant concentrations, closer well spacing is desired to increase oxygen flow and accelerate contaminant degradation rates.
- Wells may be spaced slightly farther apart if a surface seal is planned for installation or if one already exists. A surface seal increases the radius of influence by forcing air to be drawn from a greater distance by preventing short-circuiting from land surface. However, passive vent wells or air injection wells may be required to supplement the flow of air in the subsurface.
- In stratified or structured soils, well spacings may be irregular. Wells screened in zones of lower intrinsic permeability must be spaced closer together than wells screened in zones of higher intrinsic permeability.

Well Construction. Vertical Well Construction. Vertical extraction wells are similar in construction to monitoring wells and are installed using the same techniques. Extraction wells are usually constructed of polyvinyl chloride (PVC) casing and screen. Extraction well diameters typically range from 2 to 12 inches, depending on flow rates and depth; a 4-inch diameter is most common.

Exhibit III-19 depicts a typical vertical extraction well. Vertical extraction wells are constructed by placing the casing and screen in the center of a borehole. Filter pack material is placed in the annular space between the casing/screen and the walls of the borehole. The filter pack material extends 1-2 feet above the top of the well screen and is

Exhibit III-19
Typical Bioventing Vertical Well Construction

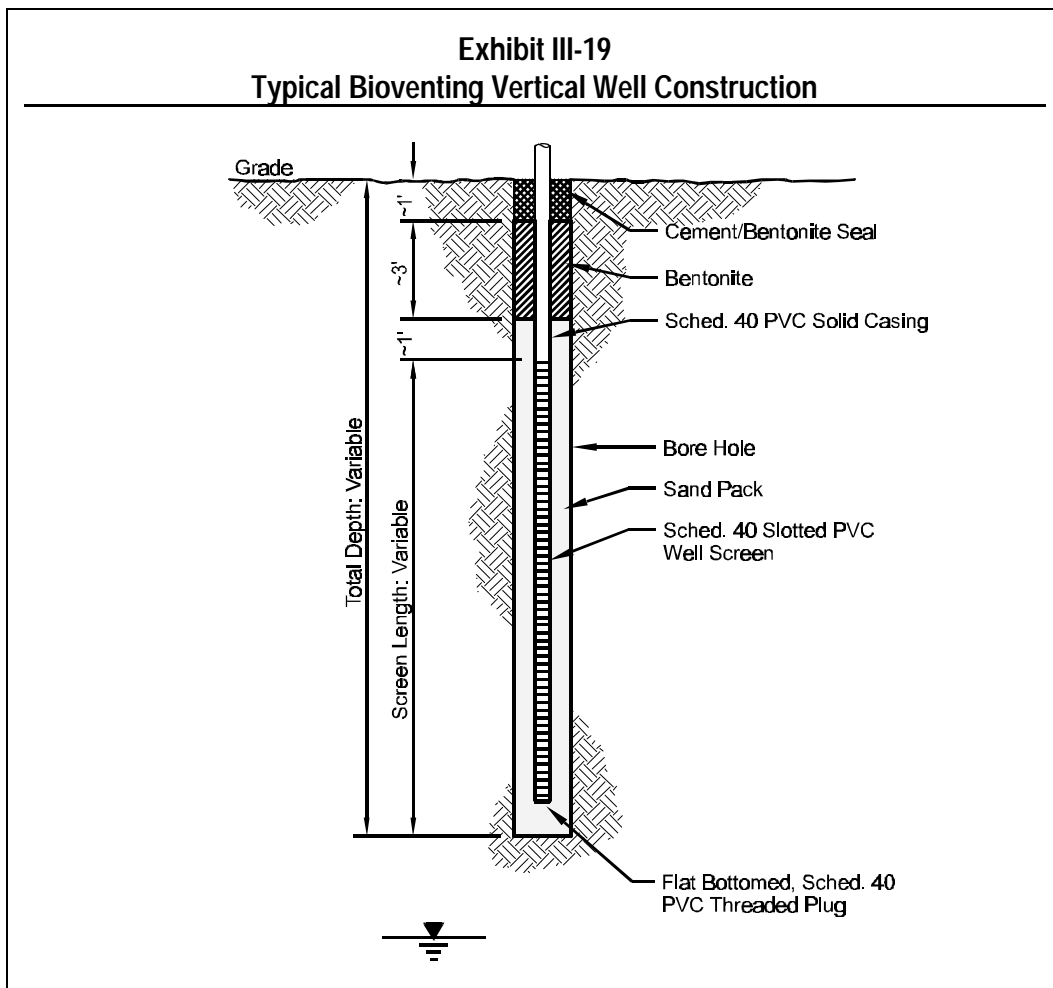

followed by a 1-2 foot thick bentonite seal. Cement-bentonite grout seals the remaining space up to the surface. Filter pack material and screen slot size must be consistent with the grain size of the surrounding soils.

The location and length of the well screen in vertical extraction or injection wells can vary and should be based on the depth to groundwater, the stratification of the soil, and the location and distribution of contaminants. In general, the length of the screen has little effect on the ROI of an extraction or injection well. However, because the ROI is affected by the intrinsic permeability of the soils in the screened interval (lower intrinsic permeability will result in a smaller ROI, other parameters being equal), the placement of the screen can affect the ROI.

- At a site with homogeneous soil conditions, ensure that the well is screened throughout the contaminated zone. The well screen may be placed as deep as the seasonal low water table. A deep well helps to ensure remediation of the greatest amount of soil during seasonal low groundwater conditions.
- At a site with stratified soils or lithology, the screened interval can be placed at a depth corresponding to a zone of lower permeability. This placement will help ensure that air passes through this zone rather than merely flow through adjacent zones of higher permeability.

Horizontal Well Construction. Horizontal extraction wells or trench systems are generally used in shallow groundwater conditions. Exhibit III-20 shows a typical shallow horizontal well construction detail. Horizontal extraction wells are constructed by placing slotted PVC piping near the bottom of an excavated trench. Gravel bedding surrounds the piping. A bentonite seal or impermeable liner prevents air leakage from the surface. When horizontal wells are used, the screen must be high enough above the groundwater table so that normal groundwater table fluctuations do not submerge the screen. Additionally, if vacuum extraction is used, pressures should be monitored to ensure that induced groundwater upwelling does not occlude the screen(s).

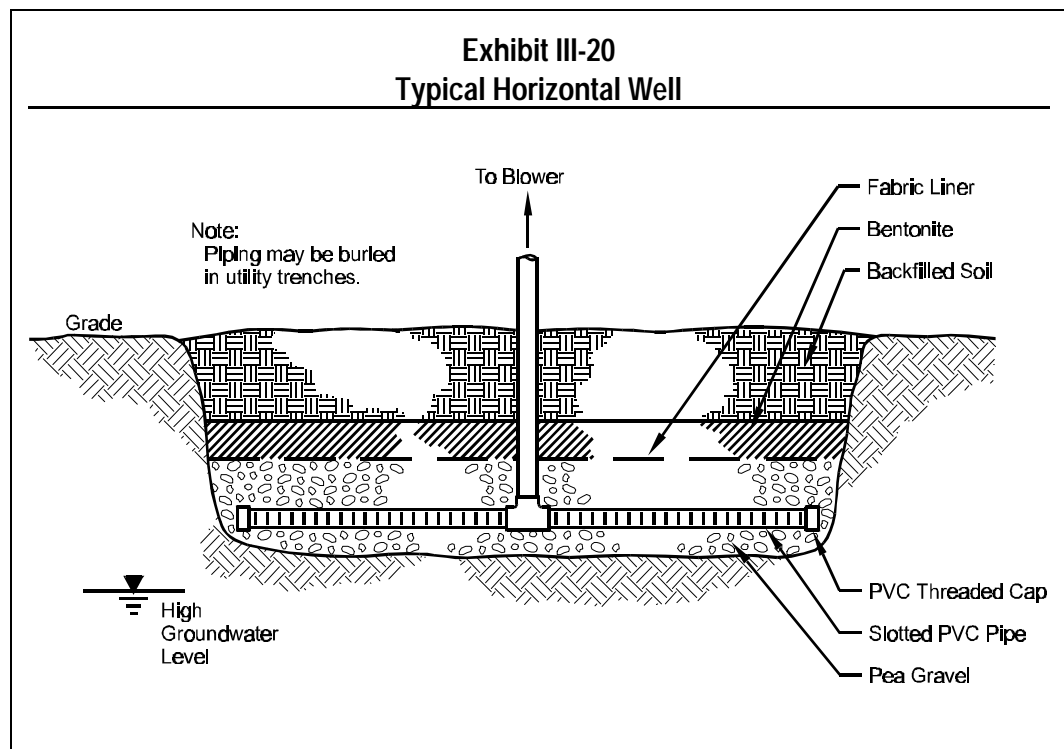

Air Injection Wells

Air injection wells are similar in construction to extraction wells, but air injection wells can be designed with a longer screened interval in order to ensure uniform air flow. Other design criteria for injection wells' orientation, well placement, and well construction are the same as that of extraction wells described above. Horizontal wells are also applicable for air injection. Active injection wells force compressed air into soils. Passive injection wells, or inlets, simply provide a pathway that helps extraction wells draw air from the atmosphere into the subsurface. Air injection wells should be placed to eliminate stagnation zones, but should not force contaminants to an area where they will not be recovered (i.e., off-site) or could cause adverse health or safety effects.

Air injection wells can be used alone or, more commonly, in conjunction with extraction wells. The injection well/extraction well combination is often used at sites that are covered with an impermeable cap (e.g., pavement or buildings) because the cap restricts direct air flow to the subsurface. They are used also to help prevent short-circuiting the air flow which may be restricted by preferential pathways in the subsurface. In addition, air injection can be used to eliminate potential stagnation zones (areas of no flow), which sometimes exist between extraction wells.

Air injection wells are seldom used by themselves primarily because the contaminated offgas can not be collected. Without the ability to collect the offgas, contaminated vapor may spread to previously uncontaminated areas. Also the offgas can not be used to evaluate the extent of subsurface biological activities. In most cases, air injections are limited to removing low or non-volatile petroleum products.

Manifold Piping

Manifold piping connects to the extraction or injection blower. Piping can either be placed above or below grade depending on site operations, ambient temperature, and local building codes. Below-grade piping is the more common and is installed in shallow utility trenches that lead from the wellhead vault to a central equipment location. The piping can either be manifolded in the equipment area or connected to a common pressure (or vacuum) main that supplies the wells in series, in which case flow control valves are sited at the wellhead. Piping to extraction well locations should be sloped toward the well so that condensate or entrained groundwater will flow back toward the well.

Vapor Pretreatment

Extracted vapor can contain condensate, entrained groundwater, and particulates that can damage blower parts and inhibit the effectiveness of downstream treatment systems. In order to minimize the potential for damage, vapors are usually passed through a moisture separator and a particulate filter prior to entering the blower. Check the CAP to verify that both a moisture separator and a particulate filter have been included in the design.

Blower Selection

The type and size of blower selected should be based on (1) the vacuum or pressure required to achieve design pressure at the wellheads (including upstream and downstream piping losses) and (2) the total flow rate. The flow rate requirement should be based on the sum of the flow rates from the contributing extraction or injection wells. In applications where explosions may occur, be sure the CAP specifies blowers with explosion-proof motors, starters, and electrical systems. Exhibit III-21 depicts the performance curves for the three basic types of blowers that can be used in a bioventing system.

- *Centrifugal* blowers (such as squirrel-cage fans) should be used for high-flow, low-pressure, or low-vacuum applications (less than 20 inches of water).
- *Regenerative and turbine* blowers should be used when a higher pressure or vacuum (up to 80 inches of water) is needed.
- *Rotary lobe* and other positive displacement blowers should be used when a very high pressure or vacuum (greater than 80 inches of water) is needed. Rotary lobe blowers are not generally applicable to bioventing systems.

Instrumentation and Controls

The parameters typically monitored in a bioventing system include:

- Pressure (or vacuum)
- Air/vapor flow rate
- Carbon dioxide and/or oxygen concentration in extracted vapor
- Contaminant mass extraction rates
- Temperature
- Nutrient delivery rate (if nutrients are added)

Exhibit III-21
Performance Curves For Three Types Of Blowers

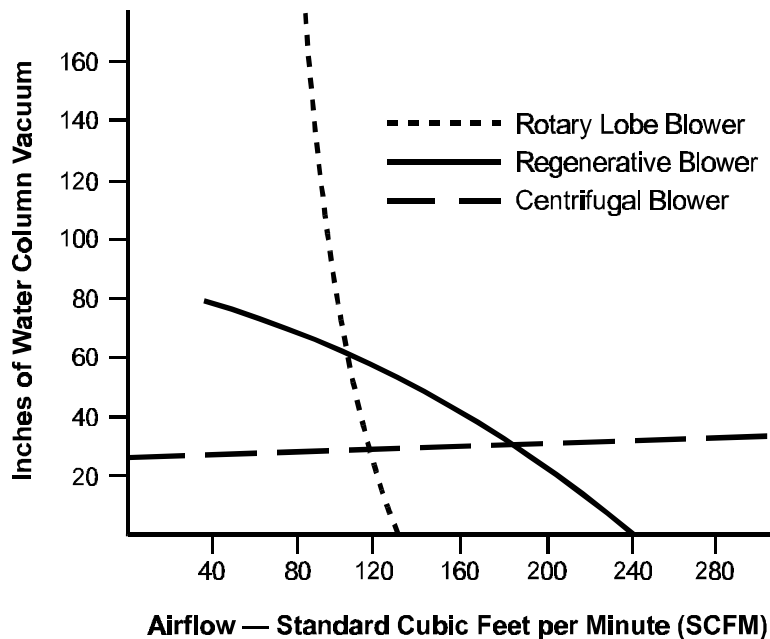

Notes:

Centrifugal blower type shown is a New York model 2004A at 3500 rpm. Regenerative blower type shown is a Rotron model DR707. Rotary lobe blower type shown is a M-D Pneumatics model 3204 at 3000 rpm.

From "Guidance for Design, Installation and Operation of Soil Venting Systems." Wisconsin Department of Natural Resources, Emergency and Remedial Response Section, PUBL-SW185-93, July 1993.

The monitoring equipment in a bioventing system enables you to observe the progress of remediation and to control each component of the system. Exhibit III-22 describes where each of these pieces of monitoring equipment is typically placed and the types of equipment that are available.

Optional Bioventing Components

Additional bioventing system components might be used when certain site conditions exist or when pilot studies dictate they are necessary. These components include:

- Nutrient delivery systems (if needed)
- Surface seals
- Groundwater depression pumps
- Vapor treatment systems.

**Exhibit III-22
Monitoring Equipment**

<u>Instrument</u>	<u>Location In System</u>	<u>Example Of Equipment</u>
Flow meter	<ul style="list-style-type: none"> ○ At each well head ○ Manifold to blower ○ Blower discharge ○ Nutrient manifold 	<ul style="list-style-type: none"> ○ Pitot tube ○ In-line rotameter ○ Orifice plate ○ Turbine wheel ○ Venturi or flow tube
Vacuum/Pressure gauge	<ul style="list-style-type: none"> ○ At each well head or manifold branch ○ Before and after filters before blower ○ Before and after vapor treatment 	<ul style="list-style-type: none"> ○ Manometer ○ Magnehelic gauge ○ Vacuum gauge
Sampling port	<ul style="list-style-type: none"> ○ At each well head or manifold branch ○ Manifold to blower ○ Blower discharge 	<ul style="list-style-type: none"> ○ Hose barb ○ Septa fitting
Flow control valves	<ul style="list-style-type: none"> ○ At each well head or manifold branch ○ Dilution or bleed valve at manifold to blower 	<ul style="list-style-type: none"> ○ Ball valve ○ Gate valve ○ Dilution/ambient air bleed valve
Vapor temperature sensor	<ul style="list-style-type: none"> ○ Manifold to blower ○ Blower discharge (prior to vapor treatment) 	<ul style="list-style-type: none"> ○ Bi-metal dial-type thermometer
Vapor sample collection equipment (used through a sampling port)	<ul style="list-style-type: none"> ○ At each well head or manifold branch ○ Manifold to blower ○ Blower discharge 	<ul style="list-style-type: none"> ○ Tedlar bags ○ Sorbent tubes ○ Sorbent canisters ○ Polypropylene tubing for direct GC injection
<u>Control Equipment</u>		
Flow control valves	<ul style="list-style-type: none"> ○ At each well head or manifold branch ○ Dilution or bleed valve at manifold to blower 	<ul style="list-style-type: none"> ○ Ball valve ○ Gate/globe valve ○ Butterfly valve

Each of these system components is discussed below.

Nutrient Delivery Systems. If the addition of nutrients is required to support biological growth, a nutrient delivery system will be needed. Nutrients are usually supplied to the subsurface through topical application or by injection through horizontal trenches or wells. Topical application is either by hand-spraying or through conventional irrigation systems (e.g., sprinklers). Horizontal wells are similar in design to those used for extraction, and typically consist of slotted or perforated PVC pipe installed in shallow (< 2 feet) trenches laid in a gravel bed. Nutrient solutions can be prepared from solid formulations used in agricultural applications of sodium tripolyphosphate and ammonium salts, and should be added monthly to quarterly. Nutrient delivery systems may also be used to add solutions to adjust pH as required.

Surface Seals. Surface seals might be included in a bioventing system design in order to prevent surface water infiltration that can reduce air flow rates, to reduce fugitive emissions, to prevent short-circuiting of air flow, or to increase the design ROI. These results are accomplished because surface seals force fresh air to travel a greater distance from the extraction or injection well. If a surface seal is used, the lower pressure gradients result in decreased flow velocities. This condition may require a higher vacuum or pressure to be applied to the extraction or injection well.

Surface seals or caps should be selected to match the site conditions and regular business activities at the site. Options include high density polyethylene (HDPE) liners (similar to landfill liners), clay or bentonite seals, or concrete or asphalt paving. Existing covers (e.g., pavement or concrete slabs) might not be applicable if they are constructed with a porous subgrade material.

Groundwater Pumps. Groundwater depression pumping might be necessary at a site with a shallow groundwater table or to expose contaminated soils in the capillary or saturated zone. Groundwater pumps reduce the upwelling of water into the extraction wells or lower the water table and allow a greater volume of soil to be remediated. Because groundwater depression is affected by pumping wells, these wells must be placed so that the surface of the groundwater is depressed in all areas where bioventing is to occur. Groundwater pumping, however, can create two additional waste streams requiring appropriate disposal:

- Groundwater contaminated with dissolved hydrocarbons; and
- Liquid hydrocarbons (i.e., free product), if present.

Vapor Treatment. Look for vapor treatment systems in the bioventing design if pilot study data indicate that extracted vapors will contain VOC concentrations in excess of established air quality limits. Commonly available treatment options are granular activated carbon (GAC), catalytic oxidation, or thermal oxidation for vapor treatment.

GAC is a popular choice for vapor treatment because it is readily available, simple to operate, and can be cost effective. Catalytic oxidation, however, is generally more economical than GAC when the contaminant mass loading is high. However, catalytic oxidation is not recommended when concentrations of chemical constituents are expected to be sustained at levels greater than 20 percent of their lower explosive limit (LEL). In these cases, a thermal oxidizer is typically employed because the vapor concentration is high enough for the constituents to burn. Biofilters, an emerging vapor-phase biological treatment technique, can be used for vapors with less than 10 percent LEL, appear to be cost effective, and may also be considered.

Evaluation Of Operation And Monitoring Plans

It is important to make sure that a system operation and monitoring plan has been developed for both the system start-up phase and for long-term operations. Operations and monitoring are necessary to ensure that system performance is optimized and contaminant mass extraction and degradation are tracked. Monitoring of remedial progress for bioventing systems is more difficult than for SVE systems in that mass removal cannot be directly measured in extracted vapors. Typically, both VOC concentrations (extracted mass) and carbon dioxide concentrations (a product of microbial respiration) must both be monitored.

Systems involving only injection wells will have an especially limited capability for performance monitoring because it is not possible to collect the offgas. The monitoring plan should include subsurface soil sampling to track constituent reduction and biodegradation conditions. Also, to ensure the injected air is not causing contamination of the atmosphere or previously uncontaminated soil or ground water, samples from each medium should be analyzed for potential constituents.

Start-Up Operations

The start-up phase should include 7 to 10 days of manifold valving adjustments. These adjustments should balance flow to optimize carbon dioxide production and oxygen uptake rate while, to the extent possible, minimizing volatilization by concentrating pressure (or vacuum) on the

wells that are in areas of higher contaminant concentrations. To accomplish this, flow measurements, pressure or vacuum readings, carbon dioxide concentrations, oxygen concentrations, and VOC concentrations should be recorded daily from each extraction well, from the manifold, and from the effluent stack. Nutrient delivery (if needed) should not be performed until after start-up operations are complete.

Long-Term Operations

Long-term monitoring should consist of flow-balancing, flow and pressure measurements, carbon dioxide measurements, oxygen measurements, and VOC concentration readings. Measurements should take place at weekly or biweekly intervals for the duration of the system operational period. Nutrient addition, if necessary, should occur on a periodic basis rather than continuously. Some literature suggests that nutrient solutions be injected in wells or trenches or applied to the surface at monthly or quarterly intervals. Exhibit III-23 provides a brief synopsis of system monitoring recommendations.

Exhibit III-23 System Monitoring Recommendations			
Phase	Frequency	What To Monitor	Where To Monitor
Start-up	At least daily	<ul style="list-style-type: none"> <input type="radio"/> Flow <input type="radio"/> Vacuum readings <input type="radio"/> VOCs <input type="radio"/> Carbon dioxide <input type="radio"/> Oxygen 	<ul style="list-style-type: none"> <input type="radio"/> Extraction vents <input type="radio"/> Manifold <input type="radio"/> Effluent stack
Remedial	Weekly to bi-weekly	<ul style="list-style-type: none"> <input type="radio"/> Flow <input type="radio"/> Vacuum <input type="radio"/> VOCs <input type="radio"/> Carbon dioxide <input type="radio"/> Oxygen 	<ul style="list-style-type: none"> <input type="radio"/> Extraction vents <input type="radio"/> Manifold <input type="radio"/> Effluent stack

Remedial Progress Monitoring

Monitoring the performance of the bioventing system in reducing contaminant concentrations in soils is necessary to determine if remedial progress is proceeding at a reasonable pace. A variety of methods can be used.

Since concentrations of petroleum constituents may be reduced due to both volatilization and biodegradation, both processes should be monitored in order to track the cumulative effect. The constituent mass

extraction component can be tracked and calculated using the VOC concentrations measured in the extraction manifold multiplied by the extraction flow rate. The constituent mass that is degraded is more difficult to quantify but can be monitored qualitatively by observing trends in carbon dioxide and oxygen concentrations in the extracted soil vapors.

Remedial progress of bioventing systems typically exhibits asymptotic behavior with respect to VOC, oxygen, and carbon dioxide concentrations in extracted vapors as shown in Exhibit III-24. When asymptotic behavior begins to occur, the operator should closely evaluate alternatives that may increase bioventing effectiveness (e.g., increasing extraction flow rate or nutrient addition frequency). Other, more aggressive steps to curb asymptotic behavior can include adding injection wells, additional extraction wells, or injecting concentrated solutions of bacteria.

If asymptotic behavior is persistent for periods greater than about 6 months, modification of the system design and operations (e.g., pulsing of injection or extraction air flow) may be appropriate. If asymptotic behavior continues, termination of operations may be appropriate.

Exhibit III-24
VOC/CO₂ Concentration Reduction And Constituent Mass Removal And
Degradation Behavior For Bioventing Systems

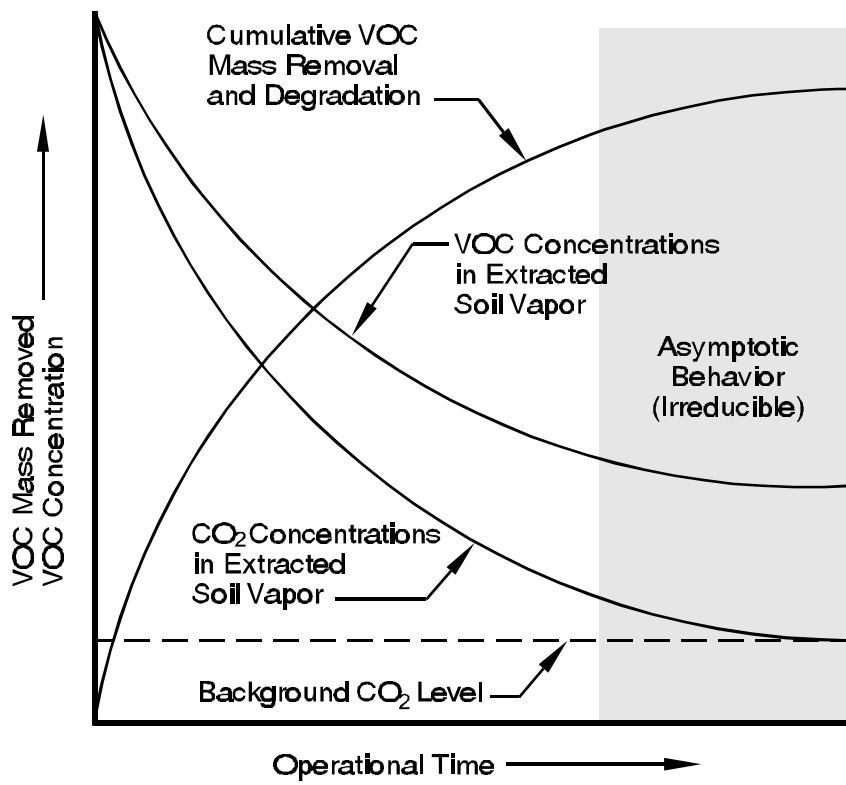

References

- Norris, R.D., Hincbee, R.E., Brown, R.A., McCarty, P.L., Semprini, L., Wilson, J.T., Kampbell, D.H., Reinhard, M., Bower, E.J., Borden, R.C., Vogel, T.M., Thomas, J.M., and C.H. Ward. *Handbook of Bioremediation*. Boca Raton, FL: CRC Press, 1994.
- U.S. Environmental Protection Agency (EPA). *Guide for Conducting Treatability Studies Under CERCLA: Aerobic Biodegradation Remedy Screening*. Washington, DC: Office of Emergency and Remedial Response. EPA/540/2-91/013A, 1991a.
- U.S. Environmental Protection Agency (EPA). *Soil Vapor Extraction Technology: Reference Handbook*. Cincinnati, OH: Office of Research and Development. EPA/540/2-91/003, 1991b.
- U.S. Environmental Protection Agency (EPA). *Guide for Conducting Treatability Studies Under CERCLA: Soil Vapor Extraction*. Washington, DC: Office of Emergency and Remedial Response. EPA/540/2-91/019A, 1991c.
- U.S. Environmental Protection Agency (EPA). *Decision-Support Software for Soil Vapor Extraction Technology Application: HyperVentilate*. Cincinnati, OH: Office of Research and Development. EPA/600/R-93/028, 1993.
- Wisconsin Department of Natural Resources (DNR). *Guidance for Design, Installation and Operation of Soil Venting Systems*. Madison, WI: Emergency and Remedial Response Section. PUBL-SW185-93, 1993.

Checklist: Can Bioventing Be Used At This Site?

This checklist can help you evaluate the completeness of the CAP and to identify areas that require closer scrutiny. As you go through the CAP, answer the following questions. If the answer to several questions is no, you should request additional information to determine if bioventing will accomplish cleanup goals at the site.

1. Site Characteristics

Yes No

- Is the soil intrinsic permeability greater than 10^{-10} cm²?
- Is the soil free of impermeable layers or other conditions that would disrupt air flow?
- Is the total heterotrophic bacteria count > 1,000 CFU/gram dry soil?
- Is soil pH between 6 and 8?
- Is the moisture content of soil in contaminated area between 40% to 85% of saturation?
- Is soil temperature between 10°C and 45°C during the proposed treatment season?
- Is the carbon:nitrogen:phosphorus ratio between 100:10:5 and 100:1:0.5?
- Is the depth to groundwater > 3 feet?¹

2. Constituent Characteristics

Yes No

- Are constituents all sufficiently biodegradable?
- Is the concentration of Total Petroleum Hydrocarbon ≤ 25,000 ppm and heavy metals ≤ 2,500 ppm?
- If there are constituents with vapor pressures greater than 0.5 mm Hg, boiling ranges above 300°C, or Henry's law constants greater than 100 atm/mole fraction, has the CAP addressed the potential environmental impact of the volatilized constituents?

¹ This parameter alone may not negate the use of bioventing. However, provisions for the construction of horizontal wells or trenches or for lowering the water table should be incorporated into the CAP.

3. Evaluation Of The Bioventing System Design

Yes No

- Will the induced air flow rates achieve cleanup in the time allotted for remediation in the CAP?
- Does the radius of influence (ROI) for the proposed extraction or injection wells fall in the range of 5 to 100 feet?
- Has the ROI been calculated for each soil type at the site?
- Is the type of well proposed (horizontal or vertical) appropriate for the site conditions present?
- Is the proposed well density appropriate, given the total area to be cleaned up and the radius of influence of each well?
- Do the proposed well screen intervals match soil conditions at the site?
- Are air injection wells proposed?
- Is the proposed air injection well design appropriate for this site?
- Is the selected blower appropriate for the desired vacuum conditions?

4. Optional Bioventing Components

Yes No

- If nutrient delivery systems will be needed, are designs for those systems provided?
- Are surface seals proposed?
- Are the proposed sealing materials appropriate for this site?
- Will groundwater depression be necessary?
- If groundwater depression is necessary, are the pumping wells correctly spaced?
- Is a vapor treatment system required?
- If a vapor treatment system is required, is the proposed system appropriate for the contaminant concentration at the site?

5. Operation And Monitoring Plans

Yes No

- Is monitoring of offgas vapors for VOC and carbon dioxide concentration proposed?
- Is subsurface soil sampling proposed for tracking constituent reduction and biodegradation conditions?
- Are manifold valving adjustments proposed for the start-up phase?
- Is nutrient addition (if necessary) proposed to be controlled on a periodic rather than continuous basis?